

2018

Bremshydraulik Hydraulic Components

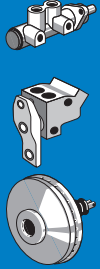

Bremshydraulik Hydraulic Components
Bremsen-Ersatzteilprogramm Brake Parts Program



2018

Bremsen-Ersatzteilprogramm

Brake Parts Program



Brakethrough Technology



Erstklassig First-class

Besser ist besser

Wenn es um Qualität geht, genügt uns ein „sehr gut“ noch lange nicht. Wir erfüllen hohe Ansprüche an das Qualitätsmanagement und die europäische Sicherheitsnorm ECE-R90 wird von ATE sogar übertroffen. Zudem führen wir zahlreiche zusätzliche Tests durch, unter anderem zu Verschleiß und Wärmeleistung.

Auch Nachhaltigkeit ist uns wichtig: Wir stellen die Mischungen für ATE Bremsbeläge auf kupferfreie Materialien um und setzen bei ATE Ceramic auf geringen Abrieb. Nutzen ausschließlich umweltfreundliches Material für die Beschichtung von Bremsscheiben. Und bereiten Produkte wie Bremsattel wieder auf.

Better is better

When it comes to quality, “very good” is simply not good enough for us. We meet high standards of quality management – and ATE even exceeds the European safety standard ECE-R90. We also perform many additional tests, including wear and thermal performance.

Sustainability is also important to us: we convert the compounds for ATE brake pads to copperfree materials and opt for low abrasion with ATE Ceramic. We only use environmentally friendly material for the coating of brake discs – and we remanufacture products like brake callipers.

Original? Mit Sicherheit

Qualität ist für uns nicht nur während der Produktentwicklung und vor der Auslieferung ein Thema. Nach dem Kauf können Sie jederzeit überprüfen, ob Sie ein Original ATE Produkt vor sich haben – über ein zweistufiges Sicherheitsetikett.

Die erste Stufe ist der tesa Priospot®. Hier wurden die Merkmale des tesa Holospot® – der nach wie vor höchste Sicherheit bietet – noch weiter entwickelt. Die fälschungssichere Holografie-Technik mit verschiedenen Prüf- und Sicherheitsmechanismen schützt sogar das Etikett selbst vor Nachahmern.

Die zweite Stufe ist ein DataMatrix-Code, kurz MAPP-Code. Dessen letzte vier Ziffern werden auch im Holospot® bzw. Priospot® dargestellt – für ein Höchstmaß an Sicherheit.

Der Code kann per Scanner oder durch manuelle Eingabe auf der ATE Website überprüft werden und zeigt sofort an, ob es sich bei dem Produkt um ein Originalteil handelt. In Verbindung mit entsprechender Software wie der ATE App ist auch die Abfrage per Smartphone möglich.



Mehrstufiges ATE Sicherheits-etikett mit DataMatrix-Code (Mitte) und Tesa Priospot® (oben rechts).

Multi-stage ATE security label with Data Matrix code (centre) and tesa Priospot® (top right).

Zur Online-Abfrage und zum App-Download:
www.ate.de/original

To online verification and app download:
www.ate-brakes.com/original



Wir engagieren uns bei MAPP –
Manufacturers against Product Piracy.

We are committed to MAPP –
Manufacturers against Product Piracy.

Einfach mehr Tests: ATE Bremsbeläge More tests: ATE brake pads

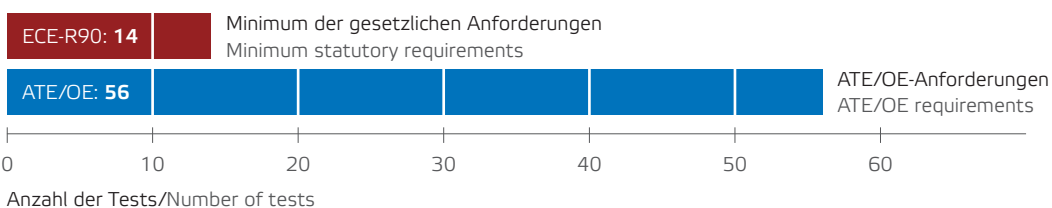

Bremsbeläge

Eine Klasse für sich

Brake pads

A class of their own

ATE Original Bremsbeläge

Andere Hersteller nutzen für Bremsbeläge zehn verschiedene Belagmischungen. Bei uns sind es mehr als 150 und unsere internen Tests sind weit strenger, als es die gesetzlichen Bestimmungen erfordern. So bieten wir für jeden Fahrzeugtyp den optimalen Bremsbelag – mit 98 Prozent Abdeckung in Europa, und das überwiegend mit Original-Erstausrüster-Mischungen. Dabei können sich die Autofahrer auf maximale Sicherheit ebenso verlassen wie auf maximalen Komfort. Es gibt eben nur ein Original.

ATE Original brake pads

Other manufacturers use ten different compounds for their brake pads. We use more than 150 – and our internal tests are far more stringent than required by the regulations. That's why we offer the optimum brake pad for every type of vehicle – with 98 per cent coverage in Europe, mainly with original equipment manufacturer compounds. So motorists can rely on maximum safety and maximum comfort. There is only one original.

ATE Ceramic Bremsbeläge

Wirklich eine saubere Sache. Durch die innovative Belagmischung entsteht bei ATE Ceramic Bremsbelägen nur sehr wenig Abrieb, der zudem kaum haftet. Deshalb setzt sich praktisch kein Bremsstaub ab und schöne Felgen behalten viel länger ihren Glanz. Ceramic Bremsbeläge sind so sicher wie ein konventioneller Belag, besonders langlebig und ideal in Kombination mit den beschichteten ATE Bremsscheiben. Und es gibt noch einen weiteren Vorteil: Sie lassen sich ganz einfach statt der üblichen Bremsbeläge einbauen.

ATE Ceramic brake pads

A clean solution. The innovative ATE Ceramic formula produces very few abraded particles, and they have hardly any adhesive characteristics. This means that hardly any brake dust settles and shiny wheel rims retain their lustre much longer. Ceramic brake pads are as safe as conventional pads, are particularly durable and ideal when used in combination with the coated ATE brake discs. Yet another advantage? They can be easily installed instead of the usual brake pads.

Auf unserer Website www.ate.de/originalbelag können Sie sich näher informieren.

Learn more on our website at www.ate-brakes.com/originalpad

Auf unserer Website www.ate.de/ceramic erfahren Sie mehr.

Learn more on our website at www.ate-brakes.com/ceramic



Bremsverhalten von Original ATE Bremsbelägen

Braking behaviour of ATE Original brake pads

Reibwert beim ersten Einbremsen der Beläge
Coefficient of friction at first application of the pads



Reibwert bei kaltem Bremssystem
Coefficient of friction with cold braking system



Reibwert beim Herunterbremsen aus hohen Geschwindigkeiten
Coefficient of friction when slowing from high speeds



Reibwert, wenn zum ersten Mal im Hochtemperaturbereich gebremst wird
Coefficient of friction when first used at high temperature



■ ATE Original Bremsbeläge / ATE Original brake pads
■ Standardbelag eines Wettbewerbers / Competitor's standard brake pads



Bremsscheiben Für jeden Anspruch die Richtige

Brake discs

The right one for every requirement

Die Details zur ATE Bremsscheiben finden Sie auf unserer Website
www.ate.de/produkte/scheibenbremsen/original-ate-bremsscheiben

You'll find more details about the ATE brake discs on our website at
www.ate.de/produkte/scheibenbremsen/original-ate-bremsscheiben





Alles für die optimale Bremsleistung

Es gibt so viele unterschiedliche Fahrzeugmodelle und Anforderungen – ATE hat für jeden Bedarf die richtigen Bremscheiben. Präzise gefertigt aus hervorragenden Erstausrüster-Materialien und in einer Qualität, die die ECE-R90-Norm schon heute im nahezu gesamten Portfolio übertrifft. Besser gehts nicht.

Original ATE Bremscheiben

In Original ATE Bremscheiben stecken durchdachte Technologie, hochwertige Materialien und unser ganzes Know-how. Sie entsprechen genau den Bremscheiben, die vom Hersteller verbaut wurden: Ob glatt, gelocht oder genietet, hochgekohlt, einteilig, gestiftet oder genietet, mit oder ohne Radlager – wir haben immer die passende Lösung für sicheres und komfortables Bremsen. Und auch den passenden Belag dazu. Eine gute Kombination sind zum Beispiel beschichtete Bremscheiben und die staubarmen ATE Ceramic Bremsbeläge oder natürlich unsere Original Bremsbeläge. Die Original ATE Bremscheiben sind mit 98 Prozent Abdeckung in Europa verfügbar und auch – wenn der Fahrzeughersteller es vorgibt – mit Befestigungsschrauben erhältlich.

Everything for optimal braking performance

There are so many different vehicle models and requirements – and ATE has the right brake disc for each one. Precisely manufactured from excellent OEM materials, the quality of which already surpasses the ECE-R90 standard throughout most of our portfolio. It just couldn't get any better.

Original ATE brake discs

ATE brake discs are packed full of sophisticated technology, high-quality materials and our entire expertise. They correspond exactly to the brake discs originally installed by the manufacturer. Whether smooth, perforated or grooved, high-carbon, one-piece, pinned or riveted and with or without wheel bearings – we always have the right solution for safe and comfortable braking. With the matching brake pad too. One good combination, for example – our coated brake discs and the low-dust ATE Ceramic brake pads, or our Original brake pads of course. Original ATE brake discs are available in 98 per cent of European countries and are also available with wheel bearings or – if prescribed by the vehicle manufacturer – with fixing screws.



ATE PowerDisc
ATE PowerDisc



Beschichtete Bremscheibe mit Befestigungsschrauben
Coated brake disc with fixing screws



Beschichtete zweiteilige Bremscheibe
Coated two-piece brake disc



Bremscheibe mit Radlager
Brake discs with wheel



Mehr als sicher More than safe

Bremsflüssigkeiten

ATE hat für jedes Fahrzeugmodell und jede Fahrweise die optimale Bremsflüssigkeit. Und alle lassen die gesetzlichen und technischen Standards weit hinter sich. Das Highlight für elektronische Bremssysteme: ATE SL.6. Die dünnflüssige Textur sorgt bei Niedrigtemperaturen für eine schnelle Reaktion von ABS oder ESP® – und so für höchste Sicherheit.

Brake fluids

ATE has the optimal brake fluid for every vehicle model and every driving style – and all our fluids leave the legal and technical standards far behind. Our highlight for electronic braking systems – the ATE SL.6. The low-viscosity texture ensures a quick response from ABS or ESP® at low temperatures, guaranteeing maximum safety.

Die Eigenschaften von ATE Bremsflüssigkeiten

The properties of ATE brake fluids

	Siedepunkt Boiling point	Nass-Siedepunkt Wet boiling point	Viskosität bei -40°C Viscosity at -40°C	Wechselintervall Replacement interval
ATE G DOT 3	min. 245°C	min. 150°C	max. 1.500 mm ² /s max. 1,500 mm ² /s	bis 1 Jahr up to 1 year
ATE SL DOT 4	min. 260°C	min. 165°C	max. 1.400 mm ² /s max. 1,400 mm ² /s	bis 1 Jahr up to 1 year
ATE SL.6 DOT 4 Ideal für/Ideal for ESP®, ABS, ASR	min. 265°C	min. 175°C	max. 700 mm ² /s	bis 2 Jahre up to 2 years
ATE TYP 200 DOT 4 New Racing Quality	min. 280°C	min. 198°C	max. 1.400 mm ² /s max. 1,400 mm ² /s	bis 3 Jahre up to 3 years
ATE SUPER DOT 4	min. 260°C	min. 180°C	max. 1.400 mm ² /s max. 1,400 mm ² /s	bis 2 Jahre up to 2 years

Typ Type	ATE Sachnummer ATE partnumber	EAN-Nr. 4006633 EAN-No. 4006633	Gebinde Container size	Paletteneinheit* Pallet unit*
G SAE Spezifikation J1703 FMVSS §571.116/DOT 3	705302 03.9901-5302.2/02	10199 8	1 l	D
	705303 03.9901-5303.2/02	10201 8	5 l	F
größere Gebinde auf Anfrage – Bigger container sizes on demand				
SL SAE Spezifikation J1704 FMVSS §571.116/DOT 4	705808 03.9901-5808.2/02	49000 9	1/4 l	A
	705801 03.9901-5801.2/02	49001 6	1/2 l	B
	705802 03.9901-5802.2/02	49002 3	1 l	D
	705803 03.9901-5803.2/02	49003 0	5 l	F
	705811 03.9901-5811.2/02	29907 7	20 l	R
	705820 03.9901-5820.2/01	10824 9	30 l	H
	705814 03.9901-5814.2/01	10366 4	50 l	P
	705805 03.9901-5805.2/01	49005 4	200 l	S
SL.6 SAE Spezifikation J1704 FMVSS §571.116/ DOT 4 ISO 4925. Klasse 6 – niedrigviskos	706408 03.9901-6408.2/02	22762 9	1/4 l	A
	706402 03.9901-6402.2/02	20746 1	1 l	D
	706403 03.9901-6403.2/02	20748 5	5 l	F
	706411 03.9901-6411.2/02	20750 8	20 l	R
	706420 03.9901-6420.2/02	23120 6	30 l	H
	706414 03.9901-6414.2/02	23005 6	50 l	P
	706405 03.9901-6405.2/02	23121 3	200 l	S
TYP 200 New racing quality SAE Spezifikation J1704 FMVSS §571.116/DOT 4	706202 03.9901-6202.2/02	10825 6	1 l	D
	706203 03.9901-6203.2/02	12166 8	5 l	F
	706220 03.9901-6220.2/01	12780 6	30 l	H
	706214 03.9901-6214.2/01	12779 0	50 l	P
	706205 03.9901-6205.2/01	12778 3	200 l	S
SUPER DOT 4 SAE Spezifikation J1704 FMVSS §571.116/DOT 4	706003 03.9901-6003.2/02	06249 7	5 l	F
	706020 03.9901-6020.2/01	14544 2	30 l	H
	706005 03.9901-6005.2/01	07769 9	200 l	S
ATE Bremszylinder-Paste ATE Brake Cylinder Paste	700009 03.9902-05XX.2/02	13536 8	180 g	L
	700010 03.9902-0503.2/01	13532 0	5 kg	K
	700011 03.9902-0504.2/01	13530 6	40 kg	P
ATE Prüfflüssigkeit ATE Testing Fluid	700002 03.9902-0116.2/02	10374 9	5 l	F
ATE plastilube™	700014 03.9902-1001.2/02	05176 7	35 ml	I
	700015 03.9902-1002.2/02	05184 2	75 ml	J
ATE Leerkanne ATE neutral empty container	740169 03.9302-1474.1/01	07782 8	25 l	S
Ausgiesser für 5-l-Kanne Spout for 5l container	760070 03.9314-5940.3/01	07786 6	1 St.	S
Kannen-Auslass-Hahn für 5-l- und 20-l-Kanne Tap for 5l and 20l tin	760153 03.9314-5960.3/02	30855 7	1 St.	S

***Paletteneinheit:**

A =	1.728 Kannen je Palette	(24 Kannen je Karton)
B =	1.200 Kannen je Palette	(20 Kannen je Karton)
D =	600 Kannen je Palette	(10 Kannen je Karton)
E =	360 Kannen je Palette	(10 Kannen je Karton)
F =	144 Kannen je Palette	(4 Kannen je Karton)
G =	50 Kannen je Palette	
H =	22 Kannen je Palette	
I =	5.040 Tuben je Palette	(24 Tuben je Karton)
J =	1.728 Tuben je Palette	(12 Tuben je Karton)
K =	60 Eimer je Palette	
L =	1.800 Tuben je Palette	(40 Tuben je Karton)
M =	18 Kannen je Palette	
N =	300 Kannen je Palette	(10 Kannen je Karton)
O =	64 Kannen je Palette	(4 Kannen je Karton)
P =	12 Kannen je Palette	
R =	36 Kannen je Palette	
S =	1 Stück	

***Pallet unit:**

A =	1.728 containers per pallet	(24 containers per box)
B =	1.200 containers per pallet	(20 containers per box)
D =	600 containers per pallet	(10 containers per box)
E =	360 containers per pallet	(10 containers per box)
F =	144 containers per pallet	(4 containers per box)
G =	50 containers per pallet	
H =	22 containers per pallet	
I =	5.040 tubes per pallet	(24 tubes per box)
J =	1.728 tubes per pallet	(12 tubes per box)
K =	60 buckets per pallet	
L =	1.800 tubes per pallet	(40 tubes per box)
M =	18 containers per pallet	
N =	300 containers per pallet	(10 tubes per box)
O =	64 containers per pallet	(4 containers per box)
P =	12 containers per pallet	
R =	36 containers per pallet	
S =	1 piece	

Mit sicherer Hand With a steady hand

Einen Überblick über alle Geräte und Werkzeuge bietet Ihnen unser Werkzeugkatalog unter www.ate-info.de

For an overview of all the equipment and tools, see our tool catalogue at www.ate-info.de



Test- und Prüfgeräte

Ob Sie Bremsflüssigkeit, Sensoren oder andere Komponenten testen: ATE Geräte und die passenden Werkzeuge sind exakt und zuverlässig – das macht die Bremsendiagnose einfacher.

Test and inspection equipment

Whether you're testing brake fluid, sensors or other components, ATE devices and their matching tools are accurate and reliable – and that makes brake diagnosis much easier.



Entlüftungsgeräte

Bremsen schnell und effektiv entlüften: Sie haben die Wahl unter verschiedenen Geräten für unterschiedliche Fahrzeugtypen und Bremssysteme – auch mit integrierter Absauganlage.

Brake bleeding units

Bleeding brakes quickly and effectively: choose from different units for different vehicle models and braking systems – integrated exhaust extraction systems are also available.

Professionelle Ausstattung

Werkzeuge und Geräte von ATE sind genau auf unsere Produkte und Services abgestimmt. Das erleichtert Ihnen die Arbeit und gibt Ihnen die Sicherheit, immer einen zuverlässigen Job zu machen. Und wenn es um Fahrzeugelektronik geht, sind VDO Ersatzteile und Services die ideale Ergänzung.

Professional equipment

ATE tools and devices are customised to exactly match our products and services. This makes your work easier and gives you the assurance that you're doing a dependable job. When it comes to vehicle electronics, VDO spare parts and services are also the perfect additions to your equipment.



Entsorgungsgeräte

Um gebrauchte Bremsflüssigkeit umwelt-schonend und kostengünstig zu entsorgen, muss sie zunächst sortenrein gesammelt werden. Kein Problem mit unseren Entsorgungssystemen.

Disposal devices

To dispose of used brake fluid in an environmentally friendly and cost-effective way, it must first be sorted into different types. That's no problem with our disposal systems.



Spezial-Werkzeuge

Bei ATE finden Sie alles, was Sie für den Einbau und die Wartung der verschiedenen Bremskomponenten brauchen – in Top-Qualität und genau auf die Anwendung abgestimmt.

Special tools

At ATE, you'll find everything you need for the installation and maintenance of different brake components – all in top quality and exactly tailored to suit their purpose.

Noch besser sein Be even better

Technische Trainings für ATE

Alles, was Sie zum Thema Bremsen-
wartung und -diagnose wissen
müssen, anschaulich und praxis-
orientiert vermittelt. Zum Beispiel:

- | Diagnose und Instandhaltung
moderner Bremsanlagen
- | Direktannahme: So nutzen Sie
Potenziale für Ihr Geschäft
- | ATE Classic Training zu Bremsen
für Old- und Youngtimer

Technische Trainings für VDO

In Fahrzeugen werden immer mehr
Elektronik- und Mechatronik-Teile ver-
baut – bleiben Sie auf dem Laufenden.
Einige Themen:

- | Elektrische Grundlagenpraxis
am Beispiel ATE/VDO
- | Reifendruckkontrollsysteme in
der Werkstatt-Praxis
- | Diesel: moderne Common-Rail-
Einspritzsysteme

Produkt- und Verkaufstrainings

Steigern Sie Ihren Geschäftserfolg
durch motivierte Mitarbeiter und
neue Angebote für Ihre Kunden.
Unter anderem mit diesen Trainings:

- | Produkttraining für aktuelle VDO
Mehrmarken-Tester
- | Gewährleistung als geschäftliche
Chance nutzen
- | Mitarbeiterführung und Entwicklung
für Kfz-Betriebe

Die Vorteile für ATE BremsenCenter

Sie nehmen an speziellen Informationsveranstaltungen und Trainings teil,
die eigens für ATE BremsenCenter konzipiert wurden. Regelmäßige fach-
spezifische Qualifikationen für Sie und Ihre Mitarbeiter sind kostenfrei.

The benefits for ATE BrakeCenters

You take part in special information events and training courses that have
been specially designed for ATE BrakeCenters. Regular training for you and
your employees is free of charge.



Unter www.morecontinental.com finden Sie eine Auswahl aus dem aktuellen Trainingsprogramm.

A selection from the current training programme is available at www.morecontinental.com



Technical ATE training courses

Everything you need to know about brake maintenance and diagnosis, presented clearly and with a practical emphasis. For example:

- | Diagnosis and maintenance of modern brake systems
- | Service reception bay: helping you to utilise all the potential opportunities for your business
- | ATE Classic training for vintage and classic car brakes

Technical VDO training courses

More and more electronic and mechatronic parts are being installed in today's vehicles – stay up to date! Some topics:

- | Basic electrical practice using ATE/VDO as an example
- | Tyre pressure monitoring systems used in workshop tasks
- | Diesel: modern common-rail injection systems

Product and sales training courses

Increase your business success through motivated employees and new offers for your customers – with these training courses (and more):

- | Product training for current VDO multibrand testers
- | Using a warranty as a business opportunity
- | Leadership and development for vehicle workshops



DE Inhaltsverzeichnis

Neue Artikel	15
Ersetzte Artikel	19
Fahrzeugregister	21
Fahrzeugverwendungen	27
Abbildungen Hauptbremszylinder	475
Universalteile	523
Technische Übersetzungen	585

EN Table of contents

New parts	15
Replaced parts	19
Index of vehicles	21
Applications of vehicles	27
Illustrations master cylinder	475
Universalparts	523
Technical translations	585

ES Índice

Nuevas referencias	15
Referencias de sustitución	19
Índice de vehículos	21
Aplicaciones	27
Ilustraciones cilindro freno	475
Piezas universales	523
Traducciones técnicas	585

FR Table des matières

Nouvelles références	15
Références remplacées	19
Liste des véhicules	21
Applications	27
Illustrations Maître-cylindres	475
Pièces universelles	523
Traductions techniques	585

IT Sommario

Codici nuovi	15
Codici sostitutivi	19
Indice autovetture	21
Applicazioni autoveicoli	27
Illustrazioni pompe Freno	475
Parti universali	523
Traduzioni tecniche	585





DE Neue Artikel

EN New parts

ES Nuevas referencias

FR Nouvelles références





IT Codici nuovi

2018



Neue Artikel

New parts - Nuevas referencias - Nouvelles références - Codici nuovi

					
03.0655-0002.2	370002 BMW	3 (E36)	24.2120-1760.3	011018 TOYOTA	COROLLA Stufenheck (_E12_)
03.0655-0002.2	370002 BMW	3 Cabriolet (E36)	24.2120-1760.3	011018 TOYOTA	COROLLA Verso (_E12_)
03.0655-0002.2	370002 BMW	3 Compact (E36)	24.2120-1760.3	011018 TOYOTA	COROLLA Verso (ZER_, ZZE12_, R1_)
03.0655-0002.2	370002 BMW	3 Touring (E36)	24.2120-1766.3	011000 TOYOTA	YARIS (_P1_)
03.0655-0003.2	370003 VOLVO	850 (LS)	24.2123-1771.3	010857 TOYOTA	AVENSIS (_T25_)
03.0655-0003.2	370003 VOLVO	850 Kombi (LW)	24.2123-1771.3	010857 TOYOTA	AVENSIS Kombi (_T25_)
03.0655-0101.2	370008 AUDI	A3 (8P1)	24.2123-1771.3	010857 TOYOTA	AVENSIS Stufenheck (_T25_)
03.0655-0101.2	370008 AUDI	A3 Sportback (8PA)	24.2123-1771.3	010857 TOYOTA	COROLLA Verso (ZER_, ZZE12_, R1_)
03.0655-0101.2	370008 AUDI	TT (8J3)	24.2125-1729.3	010752 ALFA ROMEO	166 (936_)
03.0655-0101.2	370008 AUDI	TT Roadster (8J9)	24.4120-1703.3	011015 SEAT	Mii (KF1)
03.0655-0101.2	370008 SEAT	ALTEA (5P1)	24.4120-1703.3	011015 SKODA	CITIGO
03.0655-0101.2	370008 SEAT	ALTEA XL (5P5, 5P8)	24.4120-1703.3	011015 VW	LOAD UP
03.0655-0101.2	370008 SEAT	LEON (1P1)	24.4120-1703.3	011015 VW	UP
03.0655-0101.2	370008 SEAT	TOLEDO III (5P2)	24.4122-1712.3	010899 FIAT	SEDICI (FY_)
03.0655-0101.2	370008 SKODA	OCTAVIA (1Z3)	24.4122-1712.3	010899 SUZUKI	SX4 (EY, GY)
03.0655-0101.2	370008 SKODA	OCTAVIA II Combi (1Z5)	24.4122-1712.3	010899 SUZUKI	SX4 Stufenheck (GY)
03.0655-0101.2	370008 VW	CC (358)	24.4122-1713.3	010900 FIAT	SEDICI (FY_)
03.0655-0101.2	370008 VW	GOLF V (1K1)	24.4122-1713.3	010900 SUZUKI	SX4 (EY, GY)
03.0655-0101.2	370008 VW	GOLF V Variant (1K5)	24.4122-1713.3	010900 SUZUKI	SX4 Stufenheck (GY)
03.0655-0101.2	370008 VW	GOLF PLUS (5M1, 521)	24.4122-1718.3	011019 OPEL	AGILA (B) (H08)
03.0655-0101.2	370008 VW	JETTA III (1K2)	24.4122-1718.3	011019 SUZUKI	SPLASH (EX)
03.0655-0101.2	370008 VW	SCIROCCO (137, 138)	24.4122-1718.3	011019 SUZUKI	SWIFT III (MZ, EZ)
03.0655-0101.2	370008 VW	TOURAN (1T1, 1T2)	24.4122-1718.3	011019 VAUXHALL	AGILA Mk II (B)
03.0655-0101.2	370008 VW	TOURAN (1T3)	24.4122-1719.3	011020 OPEL	AGILA (B) (H08)
03.2025-2521.3	010959 MERCEDES-BENZ	C-CLASS (W204)	24.4122-1719.3	011020 SUZUKI	SPLASH (EX)
03.2025-2521.3	010959 MERCEDES-BENZ	C-CLASS Coupe (C204)	24.4122-1719.3	011020 SUZUKI	SWIFT III (MZ, EZ)
03.2025-2521.3	010959 MERCEDES-BENZ	C-CLASS T-Model (S204)	24.4123-1718.3	011016 MERCEDES-BENZ	A-CLASS (W176)
03.2025-2521.3	010959 MERCEDES-BENZ	E-CLASS Cabriolet (A207)	24.4123-1718.3	011016 MERCEDES-BENZ	B-CLASS (W246, W242)
03.2025-2521.3	010959 MERCEDES-BENZ	E-CLASS Coupe (C207)	24.4123-1718.3	011016 MERCEDES-BENZ	CLA Coupe (C117)
03.2025-2521.3	010959 MERCEDES-BENZ	GLK-CLASS (X204)	24.4123-1718.3	011016 MERCEDES-BENZ	CLA Shooting Brake (X117)
03.2122-2171.3	010961 PEUGEOT	407 (6D_)	24.4123-1718.3	011016 MERCEDES-BENZ	GLA-CLASS (X156)
03.2122-2171.3	010961 PEUGEOT	407 SW (6E_)	24.4123-1719.3	011017 AUDI	A3 (8V1, 8VK)
03.2123-2751.3	011014 RENAULT	TWINGO II (CNO_)	24.4123-1719.3	011017 AUDI	A3 Cabriolet (8V7, 8VE)
03.2123-2751.3	011014 RENAULT	WIND (E4M_)	24.4123-1719.3	011017 AUDI	A3 Limousine (8VS, 8VM)
03.2123-3131.3	010977 CITROËN	C5 III (RD_)	24.4123-1719.3	011017 AUDI	A3 Sportback (8VA, 8VF)
03.2123-3131.3	010977 CITROËN	C5 III Break (TD_)	24.4123-1719.3	011017 AUDI	Q2 (GA)
03.2123-3131.3	010977 CITROËN	C6 (TD_)	24.4123-1719.3	011017 AUDI	TT (FV3)
03.2123-3131.3	010977 PEUGEOT	407 (6D_)	24.4123-1719.3	011017 AUDI	TT Roadster (FV9)
03.2123-3131.3	010977 PEUGEOT	407 Coupe (6C_)	24.4123-1719.3	011017 SEAT	ATECA (KH7)
03.2123-3131.3	010977 PEUGEOT	407 SW (6E_)	24.4123-1719.3	011017 SEAT	LEON (5F1)
03.2123-3131.3	010977 PEUGEOT	508	24.4123-1719.3	011017 SEAT	LEON SC (5F5)
03.2123-3131.3	010977 PEUGEOT	508 SW	24.4123-1719.3	011017 SEAT	LEON ST (5F8)
03.2125-0671.3	010965 CITROËN	JUMPY	24.4123-1719.3	011017 SKODA	KODIAQ (NS7)
03.2125-0671.3	010965 CITROËN	JUMPY Kasten	24.4123-1719.3	011017 SKODA	OCTAVIA III (5E3)
03.2125-0671.3	010965 CITROËN	JUMPY Pritsche/Fahrgestell	24.4123-1719.3	011017 SKODA	OCTAVIA III Combi (5E5)
03.2125-0671.3	010965 FIAT	SCUDO (270_, 272_)	24.4123-1719.3	011017 SKODA	SUPERB III (3V3)
03.2125-0671.3	010965 FIAT	SCUDO Kasten (270_, 272_)	24.4123-1719.3	011017 SKODA	SUPERB III Kombi (3V5)
03.2125-0671.3	010965 FIAT	SCUDO Pritsche/Fahrgestell (270_, 272_)	24.4123-1719.3	011017 VW	GOLF VII (5G1, BQ1, BE1, BE2)
03.2125-0671.3	010965 PEUGEOT	EXPERT Kasten (VF3A_, VF3U_, VF3X_)	24.4123-1719.3	011017 VW	GOLF VII Kombi (BA5, BV5)
03.2125-0671.3	010965 PEUGEOT	EXPERT Pritsche/Fahrgestell	24.4123-1719.3	011017 VW	GOLF ALLTRACK (BA5)
03.2125-0671.3	010965 PEUGEOT	EXPERT Tepee (VF3V_)	24.4123-1719.3	011017 VW	GOLF SPORTSVAN (AM1)
03.4156-0051.3	011011 JAGUAR	S-TYPE (CCX_)	24.4123-1719.3	011017 VW	PASSAT (3G2)
03.4156-0051.3	011011 JAGUAR	XJ (X350_)	24.4123-1719.3	011017 VW	PASSAT ALLTRACK (3G5)
03.4156-0051.3	011011 JAGUAR	XK Cabriolet (QQ6_)	24.4123-1719.3	011017 VW	PASSAT Variant (3G5)
03.4156-0051.3	011011 JAGUAR	XK Coupe (QQ6_)	24.4123-1719.3	011017 VW	TIGUAN (AD1)
03.4156-0076.3	011013 JAGUAR	XJ (X351_)	24.4123-1719.3	011017 VW	TOURAN (5T1)
24.2120-1758.3	011008 FORD	FIESTA III (GFJ)	24.4125-1702.3	010872 CITROËN	JUMPER Bus
24.2120-1758.3	011008 FORD	FIESTA Kasten (F3L, F5L)	24.4125-1702.3	010872 CITROËN	JUMPER Kasten
24.2120-1758.3	011008 FORD	FIESTA Kasten (FVD)			
24.2120-1760.3	011018 TOYOTA	COROLLA (_E12_)			
24.2120-1760.3	011018 TOYOTA	COROLLA Kombi (_E12_)			

Neue Artikel

New parts - Nuevas referencias - Nouvelles références - Codici nuovi



24.4125-1702.3	010872 CITROËN	JUMPER Pritsche/Fahrgestell
24.4125-1702.3	010872 FIAT	DUCATO Bus (250_, 290_)
24.4125-1702.3	010872 FIAT	DUCATO Kasten (250_, 290_)
24.4125-1702.3	010872 FIAT	DUCATO Pritsche/Fahrgestell (250_, 290_)
24.4125-1702.3	010872 PEUGEOT	BOXER Bus
24.4125-1702.3	010872 PEUGEOT	BOXER Kasten
24.4125-1702.3	010872 PEUGEOT	BOXER Pritsche/Fahrgestell
24.9145-0001.2	399005 AUDI	A3 (8P1)
24.9145-0001.2	399005 AUDI	A3 Sportback (8PA)
24.9145-0001.2	399005 SEAT	ALTEA (5P1)
24.9145-0001.2	399005 SEAT	LEON (1P1)
24.9145-0001.2	399005 SEAT	TOLEDO III (5P2)
24.9145-0001.2	399005 SKODA	OCTAVIA (1Z3)
24.9145-0001.2	399005 SKODA	OCTAVIA II Combi (1Z5)
24.9145-0001.2	399005 VW	CADDY III Kasten (2KA, 2KH, 2CA, 2CH)
24.9145-0001.2	399005 VW	CADDY III Kombi (2KB, 2KJ, 2CB, 2CJ)
24.9145-0001.2	399005 VW	EOS (1F7, 1F8)
24.9145-0001.2	399005 VW	GOLF V (1K1)
24.9145-0001.2	399005 VW	GOLF V Variant (1K5)
24.9145-0001.2	399005 VW	GOLF PLUS (5M1, 521)
24.9145-0001.2	399005 VW	JETTA III (1K2)
24.9145-0001.2	399005 VW	TOURAN (1T1, 1T2)
24.9145-0001.2	399005 VW	TOURAN (1T3)
24.9145-0003.2	399007 BMW	1 (E81)
24.9145-0003.2	399007 BMW	1 (E87)
24.9145-0003.2	399007 BMW	1 Cabriolet (E88)
24.9145-0003.2	399007 BMW	1 Coupe (E82)
24.9145-0003.2	399007 BMW	3 (E90)
24.9145-0003.2	399007 BMW	3 Cabriolet (E93)
24.9145-0003.2	399007 BMW	3 Coupe (E92)
24.9145-0003.2	399007 BMW	3 Touring (E91)
24.9145-0004.2	399008 FORD	C-MAX (DM2)
24.9145-0004.2	399008 FORD	FOCUS II (DA_)
24.9145-0004.2	399008 FORD	FOCUS II Cabriolet
24.9145-0004.2	399008 FORD	FOCUS II Kombi (DA_)
24.9145-0004.2	399008 FORD	FOCUS II Stufenheck (DA_)
24.9145-0004.2	399008 FORD	FOCUS C-MAX
24.9145-0004.2	399008 FORD	KUGA I
24.9145-0005.2	399009 VOLVO	C30
24.9145-0005.2	399009 VOLVO	C70 II Cabriolet
24.9145-0005.2	399009 VOLVO	S40 II (MS)
24.9145-0005.2	399009 VOLVO	V50 (MW)







- DE** Ersetzte Artikel
- EN** Replaced parts
- ES** Referencias de sustitución
- FR** Références remplacées
- IT** Codici sostitutivi

2018



Ersetzte Artikel

Replaced parts - Referencias de sustitución - Références remplacées - Codici sostitutivi

 Vorgänger Nr. Replaced No. Codice precedente Ancienne référence Número anterior	 Nachfolge Nr. Replacing No. Codice nuovo Nouvelle référence Número posterior	 Vorgänger Nr. Replaced No. Codice precedente Ancienne référence Número anterior	 Nachfolge Nr. Replacing No. Codice nuovo Nouvelle référence Número posterior
03.0655-0001.2 370001	03.0655-0005.2 370005		
03.2025-2301.3 010895	03.2025-2521.3 010959		
03.2122-2023.3 010798	03.2122-2171.3 010961		
03.2123-3123.3 010806	03.2123-3131.3 010977		
03.2125-0293.3 010817	03.2125-0671.3 010965		
03.7755-7703.4 300247	03.7755-3532.4 300290		
03.7860-5102.4 300218	03.7860-8002.4 300258		
03.7873-4002.4 300211	03.7873-4502.4 300284		
24.2120-1606.3 010582	24.2120-1758.3 011008		





- DE** Fahrzeugregister
- EN** Index of vehicles
- ES** Índice de vehículos
- FR** Liste des véhicules
- IT** Indice autovetture

2018



**ABARTH 28**

500 / 595 (312_)	28
500C / 595C (312_)	28

ALFA ROMEO 28

145 (930_)	28
146 (930_)	28
155 (167_)	28
156 (932_)	29
156 Sportwagon (932_)	29
159 (939_)	29
159 Sportwagon (939_)	29
166 (936_)	29
BRERA (939_)	30
GIULIETTA (940_)	30
GTV (916_)	30
MITO (955_)	30
SPIDER (916_)	31
SPIDER (939_)	31

AUDI 31

80 Avant (8C, B4)	31
A1 (8X1, 8XK)	32
A2 (8Z0)	32
A3 (8L1)	32
A3 (8P1)	33
A3 (8V1, 8VK)	35
A3 Cabriolet (8P7)	35
A3 Cabriolet (8V7, 8VE)	36
A3 Limousine (8VS, 8VM)	36
A3 Sportback (8PA)	36
A3 Sportback (8VA, 8VF)	38
A4 (8D2, B5)	39
A4 (8E2, B6)	40
A4 (8EC, B7)	40
A4 (8K2, B8)	41
A4 Allroad (8KH, B8)	42
A4 Avant (8D5, B5)	42
A4 Avant (8E5, B6)	43
A4 Avant (8ED, B7)	44
A4 Avant (8K5, B8)	45
A4 Cabriolet (8H7, B6, 8HE, B7)	45
A5 (8T3)	46
A5 Cabriolet (8F7)	46
A5 Sportback (8TA)	47
A6 (4A, C4)	47
A6 (4B2, C5)	48
A6 (4F2, C6)	49
A6 Allroad (4FH, C6)	50
A6 Avant (4A, C4)	50
A6 Avant (4B5, C5)	51
A6 Avant (4F5, C6)	52
A8 (4D2, 4D8)	53
A8 (4H_)	53
ALLROAD (4BH, C5)	53
CABRIOLET (8G7, B4)	53
COUPE (89, 8B)	54
Q2 (GA)	54
Q3 (8U)	55
Q5 (8R)	55
Q7 (4L)	56
TT (8J3)	56
TT (8N3)	57
TT (FV3)	57
TT Roadster (8J9)	57
TT Roadster (8N9)	58
TT Roadster (FV9)	58

AUTOBIANCHI 58

Y10	58
-----	----

BMW 58

1 (E81)	59
1 (E87)	59
1 Cabriolet (E88)	61
1 Coupe (E82)	61

**BMW 58**

3 (E36)	62
3 (E46)	63
3 (E90)	63
3 Cabriolet (E36)	65
3 Cabriolet (E46)	66
3 Cabriolet (E93)	66
3 Compact (E36)	67
3 Compact (E46)	67
3 Coupe (E36)	68
3 Coupe (E46)	68
3 Coupe (E92)	69
3 Touring (E36)	71
3 Touring (E46)	71
3 Touring (E91)	72
5 (E34)	74
5 (E39)	74
5 (E60)	74
5 (F10)	75
5 Gran Turismo (F07)	75
5 Touring (E34)	75
5 Touring (E39)	75
5 Touring (E61)	76
6 (E63)	76
6 Cabriolet (E64)	76
6 Cabriolet (F12)	76
6 Coupe (F13)	76
6 Gran Coupe (F06)	76
7 (E38)	77
7 (E65, E66, E67)	77
7 (F01, F02, F03, F04)	77
X1 (E84)	77
X3 (E83)	78
X5 (E53)	78
X5 (E70)	79
X5 (F15, F85)	79
X6 (E71, E72)	79
X6 (F16, F86)	79
Z3 Coupe (E36)	79
Z3 Roadster (E36)	80
Z4 Coupe (E86)	80
Z4 Roadster (E85)	80
Z4 Roadster (E89)	81
Z8 Roadster (E52)	81

CHEVROLET 81

ASTRA Schrägheck	81
ASTRA Stufenheck	81
CRUZE (J300)	81
CRUZE Schrägheck (J305)	82
CRUZE Station Wagon (J308)	82
MALIBU (V300)	82
MATIZ (M200, M250)	83
ORLANDO (J309)	83
SPARK	83
TIGRA	83
VECTRA	83

CHRYSLER 83

DELTA	84
-------	----

CITROËN 84

AX (ZA_)	84
BERLINGO (B9)	84
BERLINGO (MF)	84
BERLINGO Kasten (B9)	85
BERLINGO Kasten (M_)	86
BERLINGO Pritsche/Fahrgestell (B9)	86
C1 (PM_, PN_)	86
C15 (VD_)	92
C15 Kombi	92
C2 (JM_)	86
C2 ENTERPRISE	87
C3 I (FC_)	87
C3 II	88
C3 III (SX)	89
C3 Picasso	89
C3 Pluriel (HB_)	89

**CITROËN 84**

C4 CACTUS	89
C4 Grand Picasso I (UA_)	89
C4 Picasso I (UD_)	90
C5 III (RD_)	90
C5 III Break (TD_)	91
C6 (TD_)	91
C8 (EA_, EB_)	92
C-ELYSEE	92
DS3	92
DS3 Cabriolet	93
DS5	93
EVASION (22, U6)	93
JUMPER Bus	94
JUMPER Bus (230P)	94
JUMPER Bus (244, Z_)	96
JUMPER Kasten	96
JUMPER Kasten (230L)	96
JUMPER Kasten (244)	99
JUMPER Pritsche/Fahrgestell	99
JUMPER Pritsche/Fahrgestell (230)	99
JUMPER Pritsche/Fahrgestell (244)	100
JUMPY	101
JUMPY (U6U)	101
JUMPY Kasten	101
JUMPY Kasten (BS_, BT_, BY_, BZ_)	101
JUMPY Pritsche/Fahrgestell	101
JUMPY Pritsche/Fahrgestell (BU_, BV_, BW_, BX_)	101
SAXO (S0, S1)	102
XSARA (N1)	102
XSARA Break (N2)	103
XSARA Coupe (N0)	104
XSARA Kasten/Kombi	105
XSARA Kasten/Schrägheck	105
XSARA PICASSO (N68)	106
ZX (N2)	106
ZX Break (N2)	107

DACIA 107

DUSTER	107
DUSTER Kasten	107
LOGAN (LS_)	108
LOGAN EXPRESS (FS_)	108
LOGAN MCV (KS_)	108
LOGAN Pick-up (US_)	109
SANDERO	109

DAEWOO 110

MATIZ (KLYA)	110
MATIZ Kasten (KLA4)	110

DAIHATSU 110

CHARADE	110
CHARADE IV (G200, G202)	110
CHARADE IV Stufenheck (G203)	110

DS 110

DS 3 Cabriolet	111
DS5	110

FIAT 111

126 (126_)	111
500 (312_)	111
500 C (312_)	111
BARCETTA (183_)	111
BRAVA (182_)	111
BRAVO I (182_)	112
BRAVO II (198_)	112
CINQUECENTO (170_)	112
COUPE (175_)	112
CROMA (194_)	112
DOBLO Cargo (223_)	113
DOBLO Großraumlimousine (119_, 223_)	113
DUCATO Bus (230_)	113



**FIAT****111**

DUCATO Bus (244_)	115
DUCATO Bus (250_, 290_)	115
DUCATO Kasten (230_)	116
DUCATO Kasten (244_)	118
DUCATO Kasten (250_, 290_)	118
DUCATO Pritsche/Fahrgestell (230_)	118
DUCATO Pritsche/Fahrgestell (244_)	120
DUCATO Pritsche/Fahrgestell (250_, 290_)	120
ELBA (146_)	121
FIORINO Kasten (146_)	121
FIORINO Pick up (146_)	121
GRANDE PUNTO (199_)	121
IDEA (350_)	122
LINEA (323_)	123
MAREA (185_)	123
MAREA Weekend (185_)	123
PALIO (178BX)	123
PALIO Weekend (178_)	123
PANDA (141_)	124
PANDA (169_)	124
PANDA Van (141_)	124
PANDA Van (169_)	125
PREMIO	125
PUNTO (176_)	125
PUNTO (188_)	125
PUNTO (199_)	125
PUNTO Cabriolet (176_)	126
PUNTO EVO (199_)	127
PUNTO Van (176_)	127
PUNTO Van (188_)	127
PUNTO Van (199_)	127
SCUDO (270_, 272_)	128
SCUDO Combinato (220_)	128
SCUDO Kasten (220_)	128
SCUDO Kasten (270_, 272_)	128
SCUDO Pritsche/Fahrgestell (220_)	128
SCUDO Pritsche/Fahrgestell (270_, 272_)	128
SEDICI (FY_)	128
SEICENTO / 600 (187_)	129
SEICENTO / 600 Van (287_)	129
SIENA (178_)	129
STILO (192_)	129
STILO Multi Wagon (192_)	129
STRADA Pick-up (178_)	129
TEMPRA (159_)	129
TEMPRA S.W. (159_)	129
TIPO (160_)	130
ULYSSE (179_)	130
ULYSSE (220_)	130
UNO (146_)	130
UNO Kasten (146_)	131

FORD**131**

C-MAX (DM2)	131
C-MAX II (DXA/CB7, DXA/CEU)	131
C-MAX II Van	132
COUGAR (EC_)	132
COURIER Kasten (F3L, F5L)	132
COURIER Kasten (J5_, J3_)	132
ESCORT '95 Express (AVL)	132
ESCORT CLASSIC (AAL, ABL)	134
ESCORT CLASSIC Turnier (ANL)	134
ESCORT VI (GAL)	133
ESCORT VI Cabriolet (ALL)	133
ESCORT VII (GAL, AAL, ABL)	133
ESCORT VII Cabriolet (ALL)	133
ESCORT VII Kombi (GAL, ANL)	134
ESCORT VII Stufenheck (GAL, AFL)	134
ESCORT VI Kombi (GAL)	133
ESCORT VI Stufenheck (GAL)	133
FIESTA III (GFJ)	134
FIESTA IV (JA_, JB_)	135
FIESTA Kasten (FVD)	136
FIESTA Kasten (JV_)	136
FIESTA V (JH_, JD_)	135
FIESTA V Van	135
FOCUS (DAW, DBW)	136
FOCUS C-MAX	143
FOCUS II (DA_)	136

**FORD****131**

FOCUS II Cabriolet	138
FOCUS III	142
FOCUS III Kasten	142
FOCUS III Kasten/Schrägheck	142
FOCUS III Stufenheck	142
FOCUS III Turnier	143
FOCUS II Kombi (DA_)	138
FOCUS II Stufenheck (DA_)	141
FOCUS Kombi (DNW)	144
FOCUS Stufenheck (DFW)	144
FUSION (JU_)	144
GALAXY (WA6)	144
GALAXY (WGR)	145
GRAND C-MAX (DXA/CB7, DXA/CEU)	146
GRAND C-MAX Van	146
KUGA I	146
KUGA II (DM2)	147
KUGA II Van	147
MAVERICK (UDS, UNS)	147
MAVERICK VAN	147
MONDEO I (GBP)	147
MONDEO II (BAP)	149
MONDEO II Kombi (BNP)	149
MONDEO II Stufenheck (BFP)	149
MONDEO I Kombi (BNP)	148
MONDEO I Stufenheck (GBP)	148
MONDEO IV (BA7)	150
MONDEO IV Stufenheck (BA7)	150
MONDEO IV Turnier (BA7)	150
PUMA (EC_)	151
S-MAX (WA6)	151
TOURNEO CONNECT	151
TOURNEO CONNECT / GRAND	151
TOURNEO CONNECT Kombi	151
TRANSIT Bus (E_)	151
TRANSIT Bus (FD_, FB_, FS_, FZ_, FC_)	152
TRANSIT CONNECT (P65_, P70_, P80_)	152
TRANSIT CONNECT Kasten	152
TRANSIT CONNECT Kombi	152
TRANSIT Kasten (E_)	153
TRANSIT Kasten (FA_)	153
TRANSIT Pritsche/Fahrgestell (E_)	153
TRANSIT Pritsche/Fahrgestell (FM_, FN_)	154
TRANSIT TOURNEO	154

FSO**154**

126P	154
------	-----

HONDA**154**

ACCORD VII (CL, CN)	154
ACCORD VII Tourer (CM, CN)	154
CITY Stufenheck (GM2, GM3)	155
CIVIC V Coupe (EJ)	155
CIVIC VI Coupe (EJ, EM1)	155
CIVIC VI Hatchback (EJ, EK)	155
CIVIC VIII Hatchback (FN, FK)	155
CIVIC VIII Stufenheck (FD, FA)	155
CIVIC VI Stufenheck (EJ, EK)	155
CR-V I (RD)	155
JAZZ II (GD_, GE3, GE2)	155
JAZZ III (GE_, GG_, GP_)	155

HYUNDAI**156**

ATOS (MX)	156
ATOS PRIME (MX)	156
GETZ (TB)	156
MATRIX (FC)	156

JAGUAR**156**

S-TYPE (CCX_)	156
XF (CC9_)	157
XF SPORTBRAKE (CC9_)	157
XJ (X350_)	157
XJ (X351_)	157

**JAGUAR****156**

XK 8 Convertible (X100_, QDV_)	158
XK 8 Coupe (X100_, QEV_)	158
XK Cabriolet (QQ6_)	158
XK Coupe (QQ6_)	158

KIA**158**

SEPHIA (FA)	158
SEPHIA Stufenheck (FA)	158
SORENTO I (JC)	158
VENGA (YN)	158

LADA**158**

110 (2110)	158
111 (2111)	159
112 (2112)	159
1200-1600	159
NIVA (2121)	159
NOVA (2105)	159
NOVA Kombi (2104)	159
SAMARA (2108, 2109, 2115, 2113, 2114)	159
SAMARA FORMA Stufenheck (21099, 2115)	159

LANCIA**159**

DEDRA (835_)	159
DELTA II (836_)	160
DELTA III (844_)	160
MUSA (350_)	160
PHEDRA (179_)	160
Y (840_)	160
Y10 (156_)	161
YPSILON (843_)	161
ZETA (22_)	161

LAND ROVER**161**

DISCOVERY I (LJ_)	161
DISCOVERY IV (LA_)	161
FREELANDER (LN_)	162
FREELANDER 2 (LF_)	162
FREELANDER Soft Top (LN_)	162
RANGE ROVER II (LP_)	162
RANGE ROVER III (LM_)	162
RANGE ROVER SPORT (LS_)	162
RANGE ROVER SPORT (LW_)	162

MAZDA**162**

2 (DY)	162
6 Hatchback (GG)	163
6 Station Wagon (GY)	163
6 Stufenheck (GG)	163

MERCEDES-BENZ**163**

100 Bus (631)	163
100 Kasten (631)	163
A-KLASSE (W168)	163
A-KLASSE (W169)	164
A-KLASSE (W176)	164
B-KLASSE (W245)	164
B-KLASSE (W246, W242)	164
C-KLASSE (W202)	165
C-KLASSE (W203)	166
C-KLASSE (W204)	167
C-KLASSE Coupe (C204)	168
C-KLASSE Kombi (S202)	169
C-KLASSE Kombi (S203)	169
C-KLASSE Kombi (S204)	171
C-KLASSE Sportcoupe (CL203)	172
CLA Coupe (C117)	173
CLA Shooting Brake (X117)	173
CLC-KLASSE (CL203)	174
CLK (C208)	174
CLK (C209)	175
CLK Cabriolet (A208)	176
CLK Cabriolet (A209)	176

**MERCEDES-BENZ****163**

CLS (C218)	177
CLS (C219)	178
CLS Shooting Brake (X218)	178
E-KLASSE (W124)	178
E-KLASSE (W210)	179
E-KLASSE (W211)	180
E-KLASSE (W212)	180
E-KLASSE Cabriolet (A124)	182
E-KLASSE Cabriolet (A207)	182
E-KLASSE Coupe (C124)	183
E-KLASSE Coupe (C207)	183
E-KLASSE Kombi (S124)	184
E-KLASSE Kombi (S210)	184
E-KLASSE Kombi (S211)	185
E-KLASSE Kombi (S212)	186
G-KLASSE (W461)	187
G-KLASSE (W463)	188
G-KLASSE Geländewagen offen (W463)	189
GLA-KLASSE (X156)	189
GLK-KLASSE (X204)	190
GL-KLASSE (X164)	190
M-KLASSE (W163)	191
M-KLASSE (W164)	191
R-KLASSE (W251, V251)	192
S-KLASSE (W140)	193
S-KLASSE (W220)	193
S-KLASSE (W221)	194
S-KLASSE Coupe (C140)	196
S-KLASSE Coupe (C215)	196
S-KLASSE Coupe (C216)	196
SL (R129)	197
SL (R230)	197
SL (R231)	197
SLC (R172)	197
SLK (R170)	197
SLK (R171)	198
SLK (R172)	198
SPRINTER 2-t Bus (901, 902)	198
SPRINTER 2-t Kasten (901, 902)	198
SPRINTER 2-t Pritsche/Fahrgestell (901, 902)	199
SPRINTER 3,5-t Bus (906)	199
SPRINTER 3,5-t Kasten (906)	199
SPRINTER 3,5-t Pritsche/Fahrgestell (906)	200
SPRINTER 3-t Bus (903)	201
SPRINTER 3-t Bus (906)	201
SPRINTER 3-t Kasten (903)	201
SPRINTER 3-t Kasten (906)	202
SPRINTER 3-t Pritsche/Fahrgestell (903)	202
SPRINTER 3-t Pritsche/Fahrgestell (906)	202
SPRINTER 4,6-t Kasten (906)	203
SPRINTER 4,6-t Pritsche/Fahrgestell (906)	203
SPRINTER 4-t Bus (904)	203
SPRINTER 4-t Kasten (904)	203
SPRINTER 4-t Pritsche/Fahrgestell (904)	204
SPRINTER 5-t Bus	204
SPRINTER 5-t Kasten (906)	204
SPRINTER 5-t Pritsche/Fahrgestell (906)	205
SPRINTER CLASSIC 3,5-t Kasten (909)	205
SPRINTER CLASSIC 4,6-t Bus (909)	205
T1/TN Kasten/Kombi	205
T1/TN Pritsche/Fahrgestell	206
T1 Bus (601)	206
T1 Bus (602)	207
T1 Kasten (601, 611)	207
T1 Kasten (602)	208
T1 Pritsche/Fahrgestell (601)	208
T1 Pritsche/Fahrgestell (602)	209
VANEO (414)	209
VARIO Bus	209
VARIO Kasten/Kombi	209
VARIO Kipper	210
VARIO Pritsche/Fahrgestell	210
VARIO Triebkopf	211
VIANO (W639)	211
VITO / MIXTO Kasten (W639)	211
VITO Bus (638)	212
VITO Bus (W639)	212
VITO Kasten (638)	212
V-KLASSE (638/2)	212

**MINI****212**

MINI (R50, R53)	212
MINI (R56)	213
MINI Cabriolet (R52)	213
MINI Cabriolet (R57)	213
MINI CLUBMAN (R55)	213
MINI CLUBVAN (R55)	214
MINI COUNTRYMAN (R60)	214
MINI Coupe (R58)	214
MINI PACEMAN (R61)	214
MINI Roadster (R59)	215

MITSUBISHI**215**

CARISMA (DA_)	215
CARISMA Stufenheck (DA_)	215
COLT CZC Cabriolet (RG)	215
COLT PLUS VI (Z2_W)	215
COLT VI (Z3_A, Z2_A)	215

NISSAN**215**

ALMERA I (N15)	215
ALMERA I Hatchback (N15)	215
ALMERA II (N16)	216
ALMERA II Hatchback (N16)	216
INTERSTAR Bus (X70)	216
INTERSTAR Kasten (X70)	216
INTERSTAR Pritsche/Fahrgestell	216
KUBISTAR (X76)	217
KUBISTAR Kasten (X80)	217
MICRA C+C III (K12)	217
MICRA III (K12)	217
NOTE (E11, NE11)	217
NP300 NAVARA (D40)	218
NP300 PICKUP (D22)	218
PATHFINDER III (R51)	218
PRIMASTAR Bus (X83)	218
PRIMASTAR Kasten (X83)	218
PRIMASTAR Pritsche/Fahrgestell (X83)	218
PRIMERA (P12)	219
PRIMERA Hatchback (P12)	219
PRIMERA Traveller (WP12)	219
PULSAR I Stufenheck (N15)	219
TERRANO II (R20)	219
TERRANO II Van (R20)	219
X-TRAIL (T30)	219

OPEL**220**

AGILA (A) (H00)	220
AGILA (B) (H08)	220
ASTRA CLASSIC (L48)	220
ASTRA F (56_, 57_)	220
ASTRA F Cabriolet (53_B)	221
ASTRA F Caravan (51_, 52_)	221
ASTRA F CC (53_, 54_, 58_, 59_)	221
ASTRA F CLASSIC Caravan	222
ASTRA F CLASSIC CC	222
ASTRA F CLASSIC Stufenheck	222
ASTRA F Van (55_)	223
ASTRA G Cabriolet (F67)	223
ASTRA G Caravan (F35_)	223
ASTRA G CC (F48_, F08_)	224
ASTRA G Coupe (F07_)	224
ASTRA G Kasten (F70)	225
ASTRA G Stufenheck (F69_)	225
ASTRA H (L48)	226
ASTRA H Caravan (L35)	226
ASTRA H GTC (L08)	227
ASTRA H Kasten (L70)	227
ASTRA H Stufenheck (L69)	228
ASTRA H TwinTop (L67)	228
ASTRA J	229
ASTRA J GTC	229
ASTRA J Sports Tourer	230
ASTRA J Stufenheck	230
CALIBRA A (85_)	231
CAMPO (TF_)	231

**OPEL****220**

CASCADA (W13)	231
COMBO (71_)	231
COMBO Kasten/Kombi	231
COMBO Tour	232
CORSA B (73_, 78_, 79_)	232
CORSA B Kasten (73_)	232
CORSA B Kombi (F35)	233
CORSA C (F08, F68)	233
CORSA C Kasten (F08, W5L)	233
CORSA D	233
CORSA D Van	234
FRONTERA A (5_MWL4)	234
FRONTERA A Sport (5_SUD2)	234
INSIGNIA	234
INSIGNIA Caravan	235
INSIGNIA Stufenheck	236
MERIVA	236
MERIVA B	237
MOVANO Combi (J9)	237
MOVANO Kasten (F9)	237
MOVANO Kipper (H9)	237
MOVANO Pritsche/Fahrgestell (U9, E9)	237
OMEGA B (25_, 26_, 27_)	238
OMEGA B Caravan (21_, 22_, 23_)	238
SIGNUM	238
TIGRA (75_)	238
TIGRA TwinTop	238
VECTRA A (86_, 87_)	239
VECTRA A CC (88_, 89_)	239
VECTRA B (36_)	240
VECTRA B Caravan (31_)	240
VECTRA B CC (38_)	241
VECTRA C	242
VECTRA C Caravan	242
VECTRA C GTS	242
VIVARO Combi (J7)	242
VIVARO Kasten (F7)	243
VIVARO Pritsche/Fahrgestell (E7)	243
ZAFIRA A (F75_)	243
ZAFIRA B (A05)	244
ZAFIRA B Van	244
ZAFIRA TOURER C (P12)	244

PEUGEOT**245**

1007 (KM_)	270
106 I (1A, 1C)	245
106 II (1)	245
106 Van (1_)	246
107	246
2008	270
205 II (20A/C)	246
205 Kasten	247
206+ (T3E)	252
206 CC (2D)	247
206 Schrägheck (2A/C)	248
206 Stufenheck	250
206 SW (2E/K)	251
206 Van	252
207 (WA_, WC_)	253
207 CC (WD_)	253
207 Stufenheck	253
207 SW (WK_)	253
207 Van	253
208	254
208 Kasten	254
3008	270
301	254
306 (7B, N3, N5)	254
306 Break (7E, N3, N5)	257
306 Cabriolet (7D, N3, N5)	258
306 Kasten/Kombi (N_, 7_)	258
306 Kasten/Schrägheck	259
306 Schrägheck (7A, 7C, N3, N5)	260
405 II (4B)	263
405 II Break (4E)	263
406 (8B)	264
406 Break (8E/F)	265
406 Coupe (8C)	266
407 (6D_)	266



**PEUGEOT****245**

407 Coupe (6C_)	267
407 SW (6E_)	267
5008	271
505 (551A)	268
508	268
508 SW	268
605 (6B)	269
806 (221)	269
807 (E)	269
BOXER Bus	271
BOXER Bus (230P)	271
BOXER Bus (244, Z_)	275
BOXER Kasten	275
BOXER Kasten (230L)	275
BOXER Kasten (244)	277
BOXER Pritsche/Fahrgestell	277
BOXER Pritsche/Fahrgestell (244)	277
BOXER Pritsche/Fahrgestell (ZCT_)	278
EXPERT (224)	279
EXPERT Kasten (222)	280
EXPERT Kasten (VF3A_, VF3U_, VF3X_)	280
EXPERT Pritsche/Fahrgestell	280
EXPERT Pritsche/Fahrgestell (223)	280
EXPERT Tepee (VF3V_)	281
PARTNER Combispace (5F)	281
PARTNER Kasten	282
PARTNER Kasten (5)	283
PARTNER Pritsche/Fahrgestell	284
PARTNER Tepee	284

PORSCHE**284**

911 (996)	284
911 (997)	285
911 Cabriolet (996)	285
911 Cabriolet (997)	285
911 Targa (996)	285
928	285
968	285
968 Cabriolet	285
BOXSTER (986)	286
BOXSTER (987)	286
BOXSTER Spyder (987)	286
CAYENNE (9PA)	286
CAYMAN (987)	286

RENAULT**286**

19 II (B/C53_)	286
19 II Cabriolet (D53_, 853_)	287
19 II Chamade (L53_)	287
19 II Kasten (S53_)	288
21 Kasten (S48_)	288
21 Kombi (K48_)	288
AVANTIME (DE0_)	288
CLIO Grandtour (KR0/1_)	293
CLIO I (B/C57_, 5/357_)	288
CLIO II (BB0/1/2_, CB0/1/2_)	289
CLIO III (BR0/1, CR0/1)	291
CLIO III Kasten (SB_, SR_)	292
CLIO II Kasten (SB0/1/2_)	291
CLIO I Kasten (S57_)	289
DUSTER (HS_)	293
ESPACE II (J/S63_)	294
ESPACE III (JE0_)	294
ESPACE IV (JK0/1_)	294
EXPRESS Kasten/Kombi	295
EXPRESS Pick-up	295
GRAND SCÉNIC II (JM0/1_)	295
GRAND SCÉNIC III (JZ0/1_)	295
KANGOO (KC0/1_)	295
KANGOO Rapid (FC0/1_)	296
LAGUNA I (B56_, 556_)	296
LAGUNA I Grandtour (K56_)	297
LAGUNA II (BG0/1_)	297
LAGUNA II Grandtour (KG0/1_)	299
LOGAN EXPRESS (US_)	302
LOGAN I (LS_)	301
LOGAN I Kombi (KS_)	301
MASTER I Bus (T_)	302

**RENAULT****286**

MASTER II Bus (JD)	302
MASTER III Bus (JV)	303
MASTER III Kasten (FV)	303
MASTER III Pritsche/Fahrgestell (EV, HV, UV)	304
MASTER II Kasten (FD)	302
MASTER II Pritsche/Fahrgestell (ED/HD/UD)	303
MASTER I Kasten (T_)	302
MASTER I Pritsche/Fahrgestell (P_)	302
MEGANE CC (EZ0/1_)	313
MEGANE I (BA0/1_)	305
MEGANE I Cabriolet (EA0/1_)	307
MEGANE I Classic (LA0/1_)	307
MEGANE I Coach (DA0/1_)	309
MEGANE I Grandtour (KA0/1_)	310
MEGANE II (BM0/1_, CM0/1_)	311
MEGANE II Coupé-Cabriolet (EM0/1_)	311
MEGANE II Grandtour (KM0/1_)	311
MEGANE III Coupe (DZ0/1_)	312
MEGANE III Grandtour (KZ0/1_)	312
MEGANE III Schrägheck (BZ0_)	313
MEGANE II Stufenheck (LM0/1_)	312
MEGANE Scenic (JA0/1_)	313
MODUS / GRAND MODUS (F/JP0_)	314
RAPID	314
RAPID Kasten (F40_, G40_)	315
SAFRANE I (B54_)	315
SAFRANE II (B54_)	315
SANDERO/STEPWAY I (BS_)	315
SCÉNIC I (JA0/1_)	316
SCÉNIC II (JM0/1_)	316
SCÉNIC III (JZ0/1_)	317
SPORT SPIDER (EF0_)	317
SUPER 5 (B/C40_)	317
SUPER 5 Kasten (S40_)	317
THALIA I (LB0/1/2_)	317
THALIA II (LU1/2_)	318
TRAFIC Bus (TXW)	320
TRAFIC II Bus (JL)	318
TRAFIC II Kasten (FL)	319
TRAFIC II Pritsche/Fahrgestell (EL)	319
TRAFIC Kasten (TXX)	320
TRAFIC Pritsche/Fahrgestell (PXX)	320
TWINGO I (C06_)	320
TWINGO II (CN0_)	321
TWINGO I Kasten (S06_)	321
VEL SATIS (BJ0_)	321
WIND (E4M_)	322

SAAB**322**

9000	326
9000 Schrägheck	326
900 II	325
900 II Cabriolet	325
900 II Coupe	326
9-3 (YS3D)	322
9-3 (YS3F)	322
9-3 Cabriolet (YS3D)	323
9-3 Cabriolet (YS3F)	323
9-3 Kombi (YS3F)	323
9-3X	324
9-5 (YS3E)	324
9-5 (YS3G)	324
9-5 Kombi (YS3E)	325

SEAT**326**

ALHAMBRA (710, 711)	327
ALHAMBRA (7V8, 7V9)	326
ALTEA (5P1)	328
ALTEA XL (5P5, 5P8)	329
AROSA (6H)	330
ATECA (KH7)	330
CORDOBA (6K1, 6K2)	330
CORDOBA (6K2)	331
CORDOBA (6L2)	331
CORDOBA Vario (6K5)	332
EXEO (3R2)	333

**SEAT****326**

EXEO ST (3R5)	333
IBIZA II (6K1)	333
IBIZA III (6K1)	335
IBIZA IV (6L1)	335
IBIZA V (6J5, 6P1)	336
IBIZA V SPORTCOUPE (6J1, 6P5)	336
IBIZA V ST (6J8, 6P8)	336
INCA (6K9)	336
LEON (1M1)	337
LEON (1P1)	338
LEON (5F1)	340
LEON SC (5F5)	340
LEON ST (5F8)	341
MARBELLA (28)	341
Mii (KF1)	341
TOLEDO I (1L)	341
TOLEDO II (1M2)	342
TOLEDO III (5P2)	343

SKODA**344**

CITIGO	344
FABIA I (6Y2)	344
FABIA I Combi (6Y5)	345
FABIA II (542)	346
FABIA II Combi (545)	347
FABIA I Praktik (6Y5)	345
FABIA I Stufenheck (6Y3)	345
FELICIA I (6U1)	347
FELICIA II (6U1)	348
FELICIA II Kombi (6U5)	348
FELICIA I Kombi (6U5)	347
FELICIA I Pick-up (6UF, 6U7)	348
KODIAQ (NS7)	348
OCTAVIA (1Z3)	348
OCTAVIA I (1U2)	349
OCTAVIA I Combi (1U5)	351
OCTAVIA II Combi (1Z5)	352
OCTAVIA III (5E3)	353
OCTAVIA III Combi (5E5)	354
ROOMSTER (5J)	354
ROOMSTER Praktik (5J)	354
SUPERB I (3U4)	355
SUPERB II (3T4)	355
SUPERB III (3V3)	356
SUPERB III Kombi (3V5)	356
SUPERB II Kombi (3T5)	355
YETI (5L)	356

SMART**356**

CABRIO (450)	357
CITY-COUPE (450)	357
CROSSBLADE (450)	357
FORFOUR (454)	357
FORTWO Cabrio (450)	357
FORTWO Coupe (450)	357

SUBARU**357**

JUSTY III (G3X)	357
-----------------	-----

SUZUKI**357**

IGNIS II (MH)	357
JIMNY (FJ)	358
SPLASH (EX)	358
SWIFT III (MZ, EZ)	358
SX4 (EY, GY)	358
SX4 Stufenheck (GY)	358
WAGON R	358
WAGON R+ (MM)	359

TOYOTA**359**

AVENSIS (_T22_)	359
AVENSIS (_T25_)	359
AVENSIS Combi (_T25_)	359
AVENSIS Liftback (_T22_)	359

**TOYOTA 359**

AVENSIS Station Wagon (_T22_)	360
AVENSIS Stufenheck (_T25_)	360
AYGO (_B1_)	360
COROLLA (_E11_)	360
COROLLA (_E12_)	360
COROLLA Combi (_E12_)	361
COROLLA Compact (_E11_)	361
COROLLA Liftback (_E11_)	361
COROLLA Stufenheck (_E12_)	361
COROLLA Verso (_E12_)	361
COROLLA Verso (ZER_, ZZE12_, R1_)	361
COROLLA Wagon (_E11_)	362
RAV 4 II (_A2_)	362
YARIS (_P1_)	362
YARIS (_P9_)	362

VAUXHALL 363

AGILA Mk I (A)	363
AGILA Mk II (B)	363
ASTRA Mk III (F)	363
ASTRA Mk III (F) CC	364
ASTRA Mk III (F) Convertible	365
ASTRA Mk III (F) Estate	365
ASTRA Mk IV (G) CC	365
ASTRA Mk IV (G) Convertible	366
ASTRA Mk IV (G) Coupe (F67)	366
ASTRA Mk IV (G) Estate	366
ASTRA Mk IV (G) Sedan	367
ASTRA Mk V (H) CC	368
ASTRA Mk V (H) Estate	369
ASTRA Mk V (H) Sport Hatch	370
ASTRA Mk V (H) TwinTop	370
ASTRA Mk VI (J)	371
ASTRA Mk VI (J) Estate	371
ASTRA Mk VI (J) GTC	372
ASTRA Mk VI (J) Sedan	372
ASTRAVAN Mk III (F)	372
ASTRAVAN Mk IV (G)	373
ASTRAVAN Mk V (H)	373
BRAVA Pick-up	373
CALIBRA	373
CASCADA Convertible	374
CAVALIER Mk III (87)	374
CAVALIER Mk III CC	374
COMBO Mk I (B)	375
COMBO Mk II (C) Kasten/Kombi (F25)	375
COMBO TOUR Mk II (C) (F25)	376
CORSA Mk I (B)	376
CORSA Mk II (C) (W5L, F08)	377
CORSA Mk III (D) (L_8)	377
CORSAVAN Mk I (B)	377
CORSAVAN Mk II (C)	377
CORSAVAN Mk III (D)	378
FRONTERA Mk I (A)	378
FRONTERA Mk I (A) Sport	378
INSIGNIA Mk I (A)	378
INSIGNIA Mk I (A) Estate	379
INSIGNIA Mk I (A) Sedan	380
MERIVA Mk I (A)	380
MERIVA Mk II (B)	381
MOVANO Mk I (A) Chassis/Cab (ED, UD, HD)	381
MOVANO Mk I (A) Combi (JD)	382
MOVANO Mk I (A) Van (FD)	382
OMEGA (B)	382
OMEGA (B) Estate	382
SIGNUM	383
TIGRA Mk I (F07)	383
TIGRA TwinTop	383
VECTRA (B)	383
VECTRA (B) CC	384
VECTRA (B) Estate	385
VECTRA Mk II (C)	386
VECTRA Mk II (C) Estate	386
VECTRA Mk II (C) GTS	387
VIVARO Combi (J7)	387
VIVARO Kasten (F7)	387
VIVARO Pritsche/Fahrgestell (E7)	388
ZAFIRA Mk I (A) (F75)	388

**VAUXHALL 363**

ZAFIRA Mk II (B) (M75)	388
ZAFIRA Mk III (P12)	389

VOLVO 389

440 K (445)	389
460 L (464)	390
480 E	390
850 (LS)	390
850 Kombi (LW)	391
940 II (944)	392
940 II Kombi (945)	392
940 Kombi (945)	392
960 II (964)	393
960 II Kombi (965)	393
C30	393
C70 I Cabriolet	394
C70 I Coupe	394
C70 II Cabriolet	395
S40 I (VS)	395
S40 II (MS)	395
S60 I	396
S60 II	400
S70 (LS)	400
S80 I (TS, XY)	401
S80 II (AS)	402
S90	403
V40 Kombi (VW)	404
V50 (MW)	404
V60	405
V70 I (LV)	406
V70 II (SW)	407
V70 III (BW)	410
V90 Kombi	411
XC60	411
XC70 CROSS COUNTRY	413
XC70 II	412
XC90 I	413

VW 414

BORA (1J2)	414
BORA Kombi (1J6)	416
CADDY ALLTRACK Kasten (SAA)	420
CADDY ALLTRACK Kombi (SAB)	420
CADDY III Kasten (2KA, 2KH, 2CA, 2CH)	418
CADDY III Kombi (2KB, 2KJ, 2CB, 2CJ)	419
CADDY II Kasten (9K9A)	417
CADDY II Kombi (9K9B)	417
CADDY II Pick-up (9U7)	418
CADDY IV Kasten (SAA, SAH)	419
CADDY IV Kombi (SAB, SAJ)	420
CC (358)	420
CORRADO (53I)	421
CRAFTER 30-35 Bus (2E_)	421
CRAFTER 30-50 Kasten (2E_)	421
CRAFTER 30-50 Pritsche/Fahrgestell (2F_)	421
EOS (1F7, 1F8)	422
FOX (5Z1, 5Z3)	422
GOLF ALLTRACK (BA5)	436
GOLF III (1H1)	423
GOLF III Cabriolet (1E7)	425
GOLF III Van (1H1)	425
GOLF III Variant (1H5)	426
GOLF IV (1J1)	427
GOLF IV Cabriolet (1E7)	429
GOLF IV Van (1J1)	429
GOLF IV Variant (1J5)	430
GOLF PLUS (5M1, 521)	436
GOLF SPORTSVAN (AM1)	438
GOLF V (1K1)	431
GOLF VI (5K1)	433
GOLF VI Cabriolet (517)	434
GOLF VII (5G1, BQ1, BE1, BE2)	435
GOLF VII Kombi (BA5, BV5)	436
GOLF VI Variant (AJ5)	434
GOLF V Variant (1K5)	432
JETTA III (1K2)	438
JETTA IV (162, 163)	439
LOAD UP	439

**VW 414**

LT 28-35 I Bus (281-363)	439
LT 28-35 II Bus (2DB, 2DE, 2DK)	440
LT 28-35 I Kasten (281-363)	440
LT 28-35 I Pritsche/Fahrgestell (281-363)	440
LT 28-46 II Kasten (2DA, 2DD, 2DH)	440
LT 28-46 II Pritsche/Fahrgestell (2DC, 2DF, 2DG, 2DL, 2DM)	440
LT 40-55 I Kasten (291-512)	441
LT 40-55 I Pritsche/Fahrgestell (293-909)	441
LUPO (6X1, 6E1)	441
MULTIVAN T5 (7HM, 7HN, 7HF, 7EF, 7EM, 7EN)	441
NEW BEETLE (9C1, 1C1)	442
NEW BEETLE Cabriolet (1Y7)	444
PASSAT (362)	447
PASSAT (3A2, 35I)	444
PASSAT (3B2)	445
PASSAT (3B3)	446
PASSAT (3C2)	446
PASSAT (3G2)	447
PASSAT ALLTRACK (365)	448
PASSAT ALLTRACK (3G5)	448
PASSAT CC (357)	448
PASSAT Kombi (3B5)	449
PASSAT Variant (365)	453
PASSAT Variant (3A5, 35I)	449
PASSAT Variant (3B6)	451
PASSAT Variant (3C5)	452
PASSAT Variant (3G5)	453
POLO (6N1)	454
POLO (6N2)	455
POLO (9N_)	455
POLO CLASSIC (6V2)	456
POLO Kasten (6NF)	458
POLO Stufenheck (9A4)	458
POLO Variant (6V5)	459
SCIROCCO (137, 138)	459
SHARAN (7M8, 7M9, 7M6)	461
SHARAN (7N1, 7N2)	462
TIGUAN (5N_)	462
TIGUAN (AD1)	463
TOUAREG (7LA, 7L6, 7L7)	463
TOURAN (1T1, 1T2)	464
TOURAN (1T3)	465
TOURAN (5T1)	465
TRANSPORTER T4 Bus (70XB, 70XC, 7DB, 7DW, 7DK)	466
TRANSPORTER T4 Kasten (70XA)	467
TRANSPORTER T4 Pritsche/Fahrgestell (70XD)	469
TRANSPORTER T5 Bus (7HB, 7HJ, 7EB, 7EJ, 7EF, 7EG, 7HF, 7EC)	470
TRANSPORTER T5 Kasten (7HA, 7HH, 7EA, 7EH)	471
TRANSPORTER T5 Pritsche/Fahrgestell (7JD, 7JE, 7JL, 7JY, 7JZ)	472
UP	473
VENTO (1H2)	473





DE Fahrzeugverwendungen

EN Applications of vehicles













ES Aplicaciones













FR Applications













IT Applicazioni autoveicoli













2018

























	kW			 	! #		
ABARTH - 500 / 595 (312_) 01/08→							
 Hauptbremszylinder							
1.4 (312.AXY11, 312.AXY1A)	107	05/16→				24.4122-1714.3 010914	TRW Ø 22,2 ohne Bremsflüssigkeitsbehälter
1.4 (312.AXZ11)	121	05/16→					
1.4 (312.AYB11)	120	06/16→					
ABARTH - 500C / 595C (312_) 09/09→							
 Hauptbremszylinder							
1.4 (312.AXY1A)	107	05/16→				24.4122-1714.3 010914	TRW Ø 22,2 ohne Bremsflüssigkeitsbehälter
1.4 (312.AXZ1A)	121	05/16→					
ALFA ROMEO - 145 (930_) 07/94→01/01							
 Hauptbremszylinder							
1.4 i.e. (930.A3)	66	07/94→12/96		GG		24.2122-1716.3 010485	Ø 22,2
1.6 16V T.S. (930.A2C)	82	09/97→12/00					
1.6 i.e. (930.A2)	76	10/94→12/96					
1.7 i.e. 16V (930.A1)	95	10/94→12/96					
1.8 i.e. 16V (930.A1A)	106	03/98→01/01					
1.9 JTD (930.A4B)	77	02/99→01/01					
1.9 TD (930.A4)	66	10/94→02/99					
2.0 16V Quadrifoglio (930.A5)	114	03/98→01/01					
2.0 16V T.S. (930.A5)	110	10/95→01/01					
1.4 i.e. 16V T.S. (930.A3A)	76	12/96→01/01		01/97→; GG		24.2122-1716.3 010485	Ø 22,2
1.6 i.e. 16V T.S. (930.A2)	88	12/96→01/01					
1.8 i.e. 16V T.S. (930.A1A)	103	12/96→12/98					
ALFA ROMEO - 146 (930_) 12/94→01/01							
 Hauptbremszylinder							
1.4 i.e. (930.B3)	66	12/94→12/96		GG		24.2122-1716.3 010485	Ø 22,2
1.6 16V T.S. (930.B2C)	82	09/97→12/00					
1.6 i.e. (930.B2)	76	12/94→12/96					
1.7 i.e. 16V (930.B1)	95	12/94→12/96					
1.8 i.e. 16V T.S. (930.B1A)	106	03/98→01/01					
1.9 JTD (930.B4B)	77	02/99→01/01					
1.9 TD (930.B4A)	66	12/94→02/99					
2.0 16V Quadrifoglio (930.B5)	114	03/98→01/01					
2.0 16V T.S. (930.B5)	110	10/95→01/01					
1.4 i.e. 16V T.S. (930.B3A)	76	11/96→01/01		01/97→; GG		24.2122-1716.3 010485	Ø 22,2
1.6 i.e. 16V T.S. (930.B2B)	88	11/96→01/01					
1.8 i.e. 16V T.S. (930.B1A)	103	11/96→01/01					
ALFA ROMEO - 155 (167_) 01/92→12/97							
 Hauptbremszylinder							
1.6 16V T.S. (167.A6A)	88	05/96→12/97		GG		24.2122-1716.3 010485	Ø 22,2
1.7 T.S. (167.A4D, 167.A4H)	85	04/93→04/96					
1.7 T.S. (167.A4G)	83	04/93→04/96					
1.7 T.S. 16V (167.A4N)	103	05/96→12/97					
1.9 TD (167.A3B, 167.A3)	66	04/93→12/97					
2.0 T.S. 16V (167.A2G)	110	03/95→12/97					
2.5 TD (167.A1A, 167.A1G)	92	04/93→12/97					
2.5 V6 (167.A1C, 167.A1E)	120	10/92→12/97					
1.8 T.S. (167.A4C, 167.A)	77	02/92→12/97		05/92→; GG		24.2122-1716.3 010485	Ø 22,2
1.8 T.S. Sport (167.A4A, 167.A4C, 167.A4E)	93	01/92→12/96					
2.0 T.S. (167.A2A, 167.A2D)	104	02/92→02/95					
2.5 V6 (167.A1C, 167.A1)	121	02/92→09/96					
2.0 16V Turbo Q4 (167.A2B, 167.A2C, 167.A2E)	137	01/92→12/97		11/92→; GG		24.2122-1716.3 010485	Ø 22,2
2.0 16V Turbo Q4 (167.A2B, 167.A2C, 167.A2E)	140	01/92→12/97					







	kw			 	! #		
ALFA ROMEO - 156 (932_) 09/97→09/05							
 Hauptbremszylinder							
1.6 16V T.SPARK	82	09/97→09/05		10/97→ 07/05		24.2120-1735.3 010726	Ø 20,64
1.6 16V T.SPARK (932.A4, 932.A4100)	88	09/97→09/05					
1.8 16V T.SPARK (932.A3)	106	09/97→10/00		10/97→		24.2120-1735.3 010726	Ø 20,64
1.9 JTD (932B2)	77	09/97→10/00					
1.8 16V T.SPARK (932.A3100)	103	10/00→09/05		→ 07/05		24.2120-1735.3 010726	Ø 20,64
1.9 JTD	93	11/03→09/05					
1.9 JTD (932.A2B00, 932.A2C00)	85	05/01→09/05					
1.9 JTD (932.AXN00, 932.BXE00)	110	07/04→09/05					
1.9 JTD	100	11/02→11/04				24.2120-1735.3 010726	Ø 20,64
1.9 JTD (932.A2B00)	81	10/00→05/01					
ALFA ROMEO - 156 Sportwagon (932_) 01/00→05/06							
 Hauptbremszylinder							
1.6 16V T.SPARK	82	01/00→09/05		→ 07/05		24.2120-1735.3 010726	Ø 20,64
1.6 16V T.SPARK. (932A4)	88	05/00→05/06					
1.8 16V T.SPARK (932B31__)	103	10/00→05/06					
1.9 JTD	93	11/03→05/06					
1.9 JTD (932B2B, 932B2C)	85	05/01→05/06					
1.6 16V T.SPARK. (932.B4B00)	81	07/00→07/05				24.2120-1735.3 010726	Ø 20,64
1.8 16V T.SPARK (932A3)	106	05/00→10/00					
1.9 JTD	100	11/02→11/04					
1.9 JTD (932.B2B00)	81	10/00→05/01					
1.9 JTD (932B2)	77	05/00→10/00					
ALFA ROMEO - 159 (939_) 09/05→11/11							
 Hauptbremszylinder							
1.8 MPI	103	03/07→11/11		→ 06/08; für Fahrzeuge mit elektronischer Fahr- dynamikregelung		24.2125-1732.3 010827	TRW Ø 25,4
1.9 JTDM 16V	100	09/05→11/11					
1.9 JTDM 16V	110	09/05→11/11					
1.9 JTDM 8V	85	09/05→11/11		→ 06/08; für Fahrzeuge ohne elektronische Fahr- dynamikregelung		24.2125-1733.3 010830	TRW Ø 25,4
1.9 JTDM 8V	88	09/05→11/11					
1.9 JTS	118	09/05→11/11					
2.2 JTS	136	09/05→11/11					
2.4 JTDM	147	09/05→11/11		07/08→ 10/11		24.2125-1733.3 010830	TRW Ø 25,4
2.4 JTDM	154	05/07→11/11					
2.4 JTDM Q4	154	05/07→11/11					
3.2 JTS	191	02/08→11/11					
3.2 JTS Q4	191	12/05→11/11					
1.8 Tbi	147	05/09→11/11		→ 10/11		24.2125-1733.3 010830	TRW Ø 25,4
2.0 JTDM	100	06/10→11/11					
2.0 JTDM	120	05/09→11/11					
2.0 JTDM	125	05/09→11/11					
ALFA ROMEO - 159 Sportwagon (939_) 03/06→11/11							
 Hauptbremszylinder							
1.8 MPI	103	03/07→11/11		→ 06/08; für Fahrzeuge mit elektronischer Fahr- dynamikregelung		24.2125-1732.3 010827	TRW Ø 25,4
1.9 JTDM 16V	100	03/06→11/11					
1.9 JTDM 16V	110	03/06→11/11					
1.9 JTDM 8V	85	03/06→11/11		→ 06/08; für Fahrzeuge ohne elektronische Fahr- dynamikregelung		24.2125-1733.3 010830	TRW Ø 25,4
1.9 JTDM 8V	88	03/06→11/11					
1.9 JTS	118	03/06→11/11					
2.2 JTS	136	03/06→11/11					
2.4 JTDM	147	03/06→11/11		07/08→ 10/11		24.2125-1733.3 010830	TRW Ø 25,4
2.4 JTDM	154	05/07→11/11					
2.4 JTDM Q4	154	05/07→11/11					
3.2 JTS	191	02/08→11/11					
3.2 JTS Q4	191	03/06→11/11					
1.8 Tbi	147	05/09→11/11		→ 10/11		24.2125-1733.3 010830	TRW Ø 25,4
2.0 JTDM	100	06/10→11/11					
2.0 JTDM	120	05/09→11/11					
2.0 JTDM	125	05/09→11/11					
ALFA ROMEO - 166 (936_) 09/98→06/07							
 Hauptbremszylinder							
2.0 T.Spark (936A3A__)	114	09/98→10/00		10/98→; + ABS		24.2125-1723.3 010689	Ø 25,4
2.0 V6 (936A3__)	151	09/98→10/00					
2.4 JTD (936A2A__)	100	09/98→10/00					
2.5 V6 24V (936A2__)	140	09/98→12/06					







	kw			 	! #		
ALFA ROMEO - 166 (936_) 09/98→06/07							
 Hauptbremszylinder							
3.0 V6 24V (936A1_)	166	09/98→06/07		10/98→; für Fahrzeuge mit elektronischer Fahr- dynamikregelung		24.2125-1729.3 010752	Ø 25,4
2.0 T.Spark (936A3B_)	110	10/00→06/07		→ 10/00; + ABS		24.2125-1723.3 010689	Ø 25,4
				→ 10/00; für Fahrzeuge mit elektronischer Fahr- dynamikregelung		24.2125-1729.3 010752	Ø 25,4
2.4 JTD	110	04/02→06/07		+ ABS		24.2125-1723.3 010689	Ø 25,4
2.4 JTD	120	10/03→06/07					
2.4 JTD	129	10/03→06/07		für Fahrzeuge mit elektronischer Fahr- dynamikregelung		24.2125-1729.3 010752	Ø 25,4
2.4 JTD	132	07/06→06/07					
2.4 JTD	136	07/05→06/07					
2.4 JTD (936A2B_)	103	10/00→06/07					
2.5 V6 24V (936A21_)	138	10/00→06/07					
3.0 V6 24V (936A11_)	162	10/00→06/07					
3.2 V6 24V	176	10/03→06/07					
ALFA ROMEO - BRERA (939_) 01/06→06/10							
 Hauptbremszylinder							
1.8 TBi	147	05/09→06/10				24.2125-1732.3 010827	TRW Ø 25,4
2.0 JTDM	125	05/09→06/10					
2.2 JTS	136	01/06→06/10					
2.4 JTDM 20V	147	01/06→06/10					
2.4 JTDM 20V	154	05/07→06/10					
3.2 JTS	191	03/08→06/10					
3.2 JTS Q4	191	01/06→06/10					
2.0 JTDM	120	03/08→06/10		05/09→		24.2125-1732.3 010827	TRW Ø 25,4
ALFA ROMEO - GIULIETTA (940_) 04/10→							
 Hauptbremszylinder							
1.4 BiFuel	88	12/11→				03.2123-3571.3 010962	ATE Ø 23,81
1.4 TB	77	04/11→					
1.4 TB	85	04/10→					
1.4 TB	110	09/14→					
1.4 TB	120	04/10→					
1.4 TB (940FXA1A)	88	04/10→					
1.4 TB (940FXB1A)	125	04/10→					
1.6 JTDM (940.FYB1_)	88	02/15→					
1.6 JTDM (940.FYE1_)	85	09/15→					
1.6 JTDM (940FXD1A)	77	04/10→					
1.8 TBi	169	04/10→09/13					
1.8 TBi	177	09/13→					
1.8 TBi (940FXC1A)	173	04/10→					
2.0 JTDM	100	04/10→					
2.0 JTDM	120	04/10→					
2.0 JTDM	125	04/10→					
2.0 JTDM	129	11/13→					
2.0 JTDM (940.FXL1A)	103	04/10→					
2.0 JTDM (940.FYC1A, 940.FXQ1A)	110	08/13→					
ALFA ROMEO - GTV (916_) 09/94→10/05							
 Hauptbremszylinder							
1.8 16V (916C3)	106	05/98→10/05		GG		24.2122-1716.3 010485	Ø 22,2
2.0 JTS	121	04/03→10/05					
2.0 T.SPARK 16V (916.C2_, 916C2C00)	110	06/95→10/05					
2.0 T.SPARK 16V (916C2C)	114	05/98→08/00					
2.0 V6 Turbo (916.C2A)	148	06/95→09/98					
3.0 V6 24V (916.C1)	162	10/96→10/00					
3.0 V6 24V (916.C1B_)	160	10/00→10/05					
3.2 V6 24V	176	04/03→10/05					
ALFA ROMEO - MITO (955_) 09/08→							
 Hauptbremszylinder							
0.9	74	12/13→				24.4122-1709.3 010871	BOS Ø 22,2 ohne Bremsflüssigkeitsbehälter
0.9 TwinAir	63	07/11→					
0.9 TwinAir	77	04/13→					
1.4	51	05/11→					
1.4	58	09/08→					
1.4	70	09/08→					
1.4 MultiAir	77	08/10→					
1.4	57	03/11→		05/11→		24.4122-1709.3 010871	BOS Ø 22,2 ohne Bremsflüssigkeitsbehälter
						24.4122-1709.3 010871	BOS Ø 22,2 ohne Bremsflüssigkeitsbehälter













	kw			 	! #		
ALFA ROMEO - SPIDER (916_) 09/94→04/05							
 Hauptbremszylinder							
1.8 16V (916S3)	106	05/98→04/05		GG		24.2122-1716.3 010485	Ø 22,2
2.0 JTS	121	04/03→04/05					
2.0 T.SPARK 16V (916S2C00)	110	06/95→04/05					
2.0 V6 Turbo (916S2A)	148	05/98→04/05					
3.0 V6 (916S1)	141	06/95→04/05					
3.2 V6 24V	176	04/03→04/05					
2.0 T.SPARK 16V (916S2B)	114	05/98→08/00		GG		24.2122-1716.3 010485	Ø 22,2
3.0 V6 24V	162	01/99→10/03					
3.0 V6	141	04/95→04/98		05/95→; GG		24.2122-1716.3 010485	Ø 22,2
3.0 V6 (916S1B00)	160	09/94→04/05		10/00→; GG		24.2122-1716.3 010485	Ø 22,2
ALFA ROMEO - SPIDER (939_) 03/06→06/10							
 Hauptbremszylinder							
1.8 TBi	147	05/09→06/10				24.2125-1733.3 010830	TRW Ø 25,4
2.0 JTDM	120	04/09→06/10					
2.0 JTDM	125	05/09→06/10					
2.4 JTDM	147	04/07→06/10					
2.4 JTDM	154	03/08→06/10					
3.2 JTS	191	03/08→06/10					
2.2 JTS	136	03/06→06/10		04/06→ 09/06		24.2125-1732.3 010827	TRW Ø 25,4
3.2 JTS Q4	191	03/06→06/10		10/06→		24.2125-1733.3 010830	TRW Ø 25,4
AUDI - 80 Avant (8C, B4) 09/91→01/96							
 Bremskraftverstärker							
1.6 E	74	06/93→01/96		→ 8C-N-300000; für Linkslenker		03.7750-0302.4 300071	ATE Ø 9" pneumatisch
1.9 TDI	66	07/92→01/96					
2.0	66	07/92→01/96					
2.0 E	85	07/92→01/96					
2.0 E 16V	103	02/93→01/96					
2.3 E	98	07/92→01/96					
2.0 E 16V quattro	103	12/92→07/95		für Linkslenker		03.7750-0302.4 300071	ATE Ø 9" pneumatisch
2.0 quattro	79	11/93→01/96		→ 12/95; für Linkslenker		03.7750-0302.4 300071	ATE Ø 9" pneumatisch
RS2 quattro	232	03/94→05/95		→ 8C-S-000368; für Linkslenker		10.0124-3202.3 340011	ATE hydraulisch
S2 quattro	169	02/93→07/95		für Linkslenker		10.0124-3202.3 340011	ATE hydraulisch
 Hauptbremszylinder							
1.6 E	74	06/93→01/96		8C-P-000001→; → 12/95; für Linkslenker; - ABS		03.2123-0491.3 010167	Ø 23,81
1.9 TDI	66	07/92→01/96					
2.3 E	98	07/92→01/96		→ 12/95; + ABS		24.2123-1602.3 010384	TRW Ø 23,81
2.0	66	07/92→01/96		8C-P-000001→; → 12/95; für Linkslenker; - ABS		03.2123-0491.3 010167	Ø 23,81
2.0 E	85	07/92→01/96					
2.0 E 16V	103	02/93→01/96		→ 12/95; für Rechtslenker; + ABS		03.2123-0566.3 010169	Ø 23,81
				→ 12/95; + ABS		24.2123-1602.3 010384	TRW Ø 23,81
2.0 E 16V quattro	103	12/92→07/95		8C-P-000001→; für Linkslenker		03.2123-0491.3 010167	Ø 23,81
				für Rechtslenker		03.2123-0566.3 010169	Ø 23,81
2.0 quattro	79	11/93→01/96		8C-P-000001→; → 12/95; für Linkslenker		03.2123-0491.3 010167	Ø 23,81
				→ 12/95; für Rechtslenker		03.2123-0566.3 010169	Ø 23,81
2.6	110	07/92→01/96		→ 12/95; für Rechtslenker; + ABS		03.2123-0566.3 010169	Ø 23,81
				08/92→ 12/95; + ABS		24.2123-1602.3 010384	TRW Ø 23,81
2.6 quattro	110	07/92→07/95		08/92→; für Rechtslenker		03.2123-0566.3 010169	Ø 23,81
2.8	128	09/91→01/96		→ 12/95; für Rechtslenker; + ABS		03.2123-0566.3 010169	Ø 23,81
				→ 12/95; + ABS		24.2123-1602.3 010384	TRW Ø 23,81
2.8 quattro	128	08/92→07/95		für Rechtslenker		03.2123-0566.3 010169	Ø 23,81
RS2 quattro	232	03/94→05/95		→ 8C-S-000368; für Linkslenker		03.2125-3610.3 010214	Ø 25,4
				für Rechtslenker		03.2125-3610.3 010214	Ø 25,4
S2 quattro	169	02/93→07/95				03.2125-3610.3 010214	Ø 25,4
 Bremskraftregler							
1.6 E	74	06/93→01/96		→ 12/95		03.6584-0107.3 320110	ATE lastabhängig 8/4 4x
1.9 TDI	66	07/92→01/96					
2.0	66	07/92→01/96					
2.0 E	85	07/92→01/96					
2.0 E 16V	103	02/93→01/96					
2.3 E	98	07/92→01/96					
2.6	110	07/92→01/96					
2.8	128	09/91→01/96					







	kw					! #		
AUDI - A1 (8X1, 8XK) 05/10→								
 Hauptbremszylinder								
2.0 TFSI quattro	188	03/12→		10/12→; für Linkslenker		03.2125-5112.3	010966	ATE Ø 25,4
AUDI - A2 (8Z0) 02/00→08/05								
 Bremskraftverstärker								
1.2 TDI	45	03/01→08/05		8Z-2-013001→; für Linkslenker; → 07/05		03.7850-0102.4	300180	ATE Ø 9" pneumatisch
				→ 8Z-2-013000; für Linkslenker		03.7853-0202.4	300181	ATE Ø 9" pneumatisch
1.4	55	02/00→08/05		8Z-2-013001→; für Linkslenker; → 07/05		03.7850-0102.4	300180	ATE Ø 9" pneumatisch
1.4 TDI	55	02/00→08/05		06/00→; → 8Z-2-013000; für Linkslenker		03.7853-0202.4	300181	ATE Ø 9" pneumatisch
1.4 TDI	66	11/03→08/05		für Linkslenker; → 07/05		03.7850-0102.4	300180	ATE Ø 9" pneumatisch
1.6 FSI	81	05/02→08/05						
 Hauptbremszylinder								
1.2 TDI	45	03/01→08/05		→ 8Z-2-013000; für Linkslenker		03.2122-1663.3	010734	ATE Ø 22,2
				→ 8Z-3-019000; für Rechtslenker		03.2122-1663.3	010734	ATE Ø 22,2
				8Z-2-013001→ 8Z-3-019000; für Linkslenker		03.2122-1883.3	010735	ATE Ø 22,2
				8Z-3-019001→; für Linkslenker; → 07/05		03.2122-1888.3	010736	ATE Ø 22,2
				8Z-3-019001→; für Rechtslenker; → 07/05		03.2122-1888.3	010736	ATE Ø 22,2
1.4	55	02/00→08/05		06/00→; → 8Z-2-013000; für Linkslenker		03.2122-1663.3	010734	ATE Ø 22,2
1.4 TDI	55	02/00→08/05		06/00→; → 8Z-3-019000; für Rechtslenker		03.2122-1663.3	010734	ATE Ø 22,2
				8Z-2-013001→ 8Z-3-019000; für Linkslenker		03.2122-1883.3	010735	ATE Ø 22,2
				8Z-3-019001→; für Rechtslenker; → 07/05		03.2122-1888.3	010736	ATE Ø 22,2
				8Z-3-019001→; für Linkslenker; → 07/05		03.2122-1888.3	010736	ATE Ø 22,2
1.4 TDI	66	11/03→08/05		für Rechtslenker; → 07/05		03.2122-1888.3	010736	ATE Ø 22,2
				für Linkslenker; → 07/05		03.2122-1888.3	010736	ATE Ø 22,2
1.6 FSI	81	05/02→08/05		→ 8Z-3-019000; für Rechtslenker		03.2122-1663.3	010734	ATE Ø 22,2
				→ 8Z-3-019000; für Linkslenker		03.2122-1883.3	010735	ATE Ø 22,2
				8Z-3-019001→; für Linkslenker; → 07/05		03.2122-1888.3	010736	ATE Ø 22,2
				8Z-3-019001→; für Rechtslenker; → 07/05		03.2122-1888.3	010736	ATE Ø 22,2
AUDI - A3 (8L1) 09/96→06/03								
 Bremskraftverstärker								
1.6	74	09/96→05/03		09/00→; → 8L-2-037877; für Linkslenker; + ESP		03.7860-0602.4	300141	ATE Ø 10" pneumatisch
1.6	75	08/00→05/03						
1.8	92	09/96→05/03		→ 08/00; für Linkslenker; + ESP		03.7863-0402.4	300124	ATE Ø 10" pneumatisch
1.8 T	110	12/96→05/03						
1.8 T	132	12/98→05/03		8L-2-037878→; für Linkslenker; + ESP		03.7863-3502.4	300128	ATE Ø 10" pneumatisch
1.8 T quattro	132	10/98→05/03						
S3 quattro	154	03/99→04/02						
1.8 T quattro	110	12/96→05/03		09/00→; → 8L-2-037877; für Linkslenker; + ESP		03.7860-0602.4	300141	ATE Ø 10" pneumatisch
				08/98→ 08/00; für Linkslenker; + ESP		03.7863-0402.4	300124	ATE Ø 10" pneumatisch
				8L-2-037878→; für Linkslenker; + ESP		03.7863-3502.4	300128	ATE Ø 10" pneumatisch
1.9 TDI	66	09/96→07/01		09/00→ 06/01; für Linkslenker; + ESP		03.7860-0602.4	300141	ATE Ø 10" pneumatisch
1.9 TDI	81	08/97→07/01		→ 08/00; für Linkslenker; + ESP		03.7863-0402.4	300124	ATE Ø 10" pneumatisch
1.9 TDI	74	10/00→05/03		→ 8L-2-037877; für Linkslenker; + ESP		03.7860-0602.4	300141	ATE Ø 10" pneumatisch
S3 quattro	165	10/01→05/03		8L-2-037878→; für Linkslenker; + ESP		03.7863-3502.4	300128	ATE Ø 10" pneumatisch
1.9 TDI	96	08/00→05/03		09/00→; → 8L-2-037877; für Linkslenker; + ESP		03.7860-0602.4	300141	ATE Ø 10" pneumatisch
1.9 TDI quattro	96	08/00→05/03						
				8L-2-037878→; für Linkslenker; + ESP		03.7863-3502.4	300128	ATE Ø 10" pneumatisch
 Hauptbremszylinder								
1.6	74	09/96→05/03		→ 08/00; für Linkslenker; + ESP		03.2123-2024.3	010597	ATE Ø 23,81
1.6	75	08/00→05/03						
1.8	92	09/96→05/03		→ 08/00; für Rechtslenker; + ESP		03.2123-2064.3	010598	ATE Ø 23,81
1.8 T	110	12/96→05/03		09/00→; für Linkslenker; + ESP		03.2123-2715.3	010802	ATE Ø 23,81
1.8 T	132	12/98→05/03		09/00→; für Rechtslenker; + ESP		03.2123-2774.3	010803	ATE Ø 23,81
S3 quattro	154	03/99→04/02		für Linkslenker; - ESP		24.2123-1709.3	010503	Ø 23,81
1.8 T quattro	110	12/96→05/03		08/98→ 08/00; für Rechtslenker; + ESP		03.2123-2064.3	010598	ATE Ø 23,81
				09/00→; für Linkslenker; + ESP		03.2123-2715.3	010802	ATE Ø 23,81
				09/00→; für Rechtslenker; + ESP		03.2123-2774.3	010803	ATE Ø 23,81
				08/98→; - ESP; für Linkslenker		24.2123-1709.3	010503	Ø 23,81
↓								









	kw			 	! #		
AUDI - A3 (8L1) 09/96→06/03							
 Hauptbremszylinder							
1.8 T quattro	132	10/98→05/03		→ 08/00; für Rechtslenker; + ESP	03.2123-2064.3	010598	ATE Ø 23,81
				09/00→; für Linkslenker; + ESP	03.2123-2715.3	010802	ATE Ø 23,81
				09/00→; für Rechtslenker; + ESP	03.2123-2774.3	010803	ATE Ø 23,81
				für Linkslenker; - ESP	24.2123-1709.3	010503	Ø 23,81
1.9 TDI 1.9 TDI	66 81	09/96→07/01 08/97→07/01		→ 08/00; für Linkslenker; + ESP	03.2123-2024.3	010597	ATE Ø 23,81
				→ 08/00; für Rechtslenker; + ESP	03.2123-2064.3	010598	ATE Ø 23,81
				09/00→ 06/01; für Linkslenker; + ESP	03.2123-2715.3	010802	ATE Ø 23,81
				09/00→ 06/01; für Rechtslenker; + ESP	03.2123-2774.3	010803	ATE Ø 23,81
			→ 06/01; für Linkslenker; - ESP	24.2123-1709.3	010503	Ø 23,81	
1.9 TDI S3 quattro	74 165	10/00→05/03 10/01→05/03		für Linkslenker; + ESP	03.2123-2715.3	010802	ATE Ø 23,81
				für Rechtslenker; + ESP	03.2123-2774.3	010803	ATE Ø 23,81
				für Linkslenker; - ESP	24.2123-1709.3	010503	Ø 23,81
1.9 TDI 1.9 TDI quattro	96 96	08/00→05/03 08/00→05/03		09/00→; für Linkslenker; + ESP	03.2123-2715.3	010802	ATE Ø 23,81
				09/00→; für Rechtslenker; + ESP	03.2123-2774.3	010803	ATE Ø 23,81
				09/00→; für Linkslenker; - ESP	24.2123-1709.3	010503	Ø 23,81
AUDI - A3 (8P1) 05/03→08/12							
 Bremskraftverstärker							
1.2 TSI	77	04/10→08/12		für Linkslenker; +PR 1AC,1AT	03.7863-3232.4	300307	ATE Ø 10" pneumatisch
1.4 TFSI	92	09/07→08/12					
1.6	75	05/03→08/12		für Linkslenker; +PR 1AS	03.7863-9602.4	300206	ATE Ø 10" pneumatisch
1.6 E-Power	75	01/11→08/12					
1.6 FSI	85	08/03→09/07					
1.6 TDI	66	05/09→08/12					
1.6 TDI	77	05/09→08/12					
1.8 TFSI quattro	118	07/08→08/12					
2.0 FSI	110	05/03→06/08					
2.0 TDI	100	05/03→08/12					
2.0 TDI	103	06/05→06/08					
2.0 TDI	120	06/06→06/08					
2.0 TDI	125	03/06→08/12					
2.0 TDI 16V	103	05/03→08/12					
2.0 TDI 16V quattro	103	08/04→08/12					
2.0 TDI quattro	100	05/03→06/08					
2.0 TDI quattro	103	01/06→06/08					
2.0 TDI quattro	125	03/06→08/12					
2.0 TFSI	147	09/04→08/12					
2.0 TFSI quattro	147	09/04→08/12					
1.8 T	110	08/06→08/12		01/07→; +PR 1AC,1AT; für Linkslenker	03.7863-3232.4	300307	ATE Ø 10" pneumatisch
1.8 TFSI	118	11/06→08/12		01/07→; +PR 1AS; für Linkslenker	03.7863-9602.4	300206	ATE Ø 10" pneumatisch
1.9 TDI	77	05/03→05/10		06/03→; für Linkslenker; +PR 1AC,1AT	03.7863-3232.4	300307	ATE Ø 10" pneumatisch
				06/03→; für Linkslenker; +PR 1AS	03.7863-9602.4	300206	ATE Ø 10" pneumatisch
3.2 V6 quattro	184	07/03→05/09		für Linkslenker	03.7863-3332.4	300308	ATE Ø 10" pneumatisch
S3 quattro	195	11/06→08/12					
S3 quattro	188	02/07→08/12		07/08→; für Linkslenker	03.7863-3332.4	300308	ATE Ø 10" pneumatisch
 Hauptbremszylinder							
1.2 TSI	77	04/10→08/12		für Linkslenker; → 8P-6A094000; +PR 1ZE;1ZF;1ZP;1ZD / 1LJ;1ZM	03.2122-2129.3	010799	ATE Ø 22,2
				für Linkslenker; → 8P-6B009600; +PR 1ZE;1ZF;1ZP;1ZD / 1LJ;1ZM	03.2122-2129.3	010799	ATE Ø 22,2
				für Linkslenker; +PR 1ZE;1ZF;1ZP;1ZD / 1LJ;1ZM	03.2122-2129.3	010799	ATE Ø 22,2
				8P-6A094001→; für Linkslenker; +PR 1ZE;1ZF;1ZP;1ZD / 1LJ;1ZM	03.2122-2129.3	010799	ATE Ø 22,2
				8P-6A094001→; für Linkslenker; +PR 1LK;1ZK	03.2123-3449.3	010808	ATE Ø 23,81
				für Linkslenker; → 8P-6B009600; +PR 1LK	03.2123-3449.3	010808	ATE Ø 23,81
				für Linkslenker; +PR 1LK;1ZK	03.2123-3449.3	010808	ATE Ø 23,81
				für Linkslenker; → 8P-6A094000; +PR 1LK	03.2123-3449.3	010808	ATE Ø 23,81
1.4 TFSI	92	09/07→08/12		für Linkslenker; +PR 1ZE;1ZF;1ZP;1ZD / 1LJ;1ZM	03.2122-2129.3	010799	ATE Ø 22,2
1.8 TFSI quattro	118	07/08→08/12		für Linkslenker; +PR 1LK;1ZK	03.2123-3449.3	010808	ATE Ø 23,81
1.6	75	05/03→08/12		8P-6A094001→; für Linkslenker; +PR 1ZE;1ZF;1ZP;1ZD / 1LJ;1ZM	03.2122-2129.3	010799	ATE Ø 22,2
1.6 E-Power	75	01/11→08/12					
1.6 FSI	85	08/03→09/07					
1.6 TDI	66	05/09→08/12		für Linkslenker; → 8P-6B009600; +PR 1ZE;1ZF;1ZP;1ZD / 1LJ;1ZM	03.2122-2129.3	010799	ATE Ø 22,2
1.6 TDI	77	05/09→08/12					
2.0 FSI	110	05/03→06/08		8P-6B009601→; für Linkslenker; +PR 1ZE;1ZF;1ZP;1ZD / 1LJ;1ZM	03.2122-2129.3	010799	ATE Ø 22,2

	kw			 	! #		
AUDI - A3 (8P1) 05/03→08/12							
Hauptbremszylinder							
2.0 TDI	100	05/03→08/12		für Linkslenker; → 8P-6A094000;		03.2122-2129.3 010799	ATE Ø 22,2
2.0 TDI	103	06/05→06/08		+PR 1ZE;1ZF;1ZP;1ZD / 1LJ;1ZM			
2.0 TDI 16V	103	05/03→08/12		für Linkslenker; → 8P-6B009600;		03.2123-3449.3 010808	ATE Ø 23,81
2.0 TDI 16V quattro	103	08/04→08/12		+PR 1LK			
2.0 TDI quattro	100	05/03→06/08		8P-6A094001→; für Linkslenker;		03.2123-3449.3 010808	ATE Ø 23,81
2.0 TDI quattro	103	01/06→06/08		+PR 1LK;1ZK			
				8P-6B009601→; für Linkslenker;		03.2123-3449.3 010808	ATE Ø 23,81
				+PR 1LK;1ZK			
				für Linkslenker; → 8P-6A094000;		03.2123-3449.3 010808	ATE Ø 23,81
				+PR 1LK			
1.8 T	110	08/06→08/12		01/07→; für Linkslenker;		03.2122-2129.3 010799	ATE Ø 22,2
1.8 TFSI	118	11/06→08/12		+PR 1ZE;1ZF;1ZP;1ZD / 1LJ;1ZM			
				01/07→; für Linkslenker; +PR 1LK;1ZK		03.2123-3449.3 010808	ATE Ø 23,81
1.9 TDI	77	05/03→05/10		8P-6A094001→; für Linkslenker;		03.2122-2129.3 010799	ATE Ø 22,2
				+PR 1ZE;1ZF;1ZP;1ZD / 1LJ;1ZM			
				8P-6B009601→; für Linkslenker;		03.2122-2129.3 010799	ATE Ø 22,2
				+PR 1ZE;1ZF;1ZP;1ZD / 1LJ;1ZM			
				06/03→; für Linkslenker;		03.2122-2129.3 010799	ATE Ø 22,2
				→ 8P-6A094000;			
				+PR 1ZE;1ZF;1ZP;1ZD / 1LJ;1ZM			
				06/03→; für Linkslenker;		03.2122-2129.3 010799	ATE Ø 22,2
				→ 8P-6B009600;			
				+PR 1ZE;1ZF;1ZP;1ZD / 1LJ;1ZM			
				8P-6A094001→; für Linkslenker;		03.2123-3449.3 010808	ATE Ø 23,81
				+PR 1LK;1ZK			
				8P-6B009601→; für Linkslenker;		03.2123-3449.3 010808	ATE Ø 23,81
				+PR 1LK;1ZK			
				06/03→; für Linkslenker;		03.2123-3449.3 010808	ATE Ø 23,81
				→ 8P-6B009600; +PR 1LK			
				06/03→; für Linkslenker;		03.2123-3449.3 010808	ATE Ø 23,81
				→ 8P-6A094000; +PR 1LK			
2.0 TDI	120	06/06→06/08		8P-6A094001→; für Linkslenker;		03.2122-2129.3 010799	ATE Ø 22,2
				+PR 1ZE;1ZF;1ZP;1ZD / 1LJ;1ZM			
				für Linkslenker; → 8P-6B009600;		03.2122-2129.3 010799	ATE Ø 22,2
				+PR 1ZE;1ZF;1ZP;1ZD / 1LJ;1ZM			
				8P-6B009601→; für Linkslenker;		03.2122-2129.3 010799	ATE Ø 22,2
				+PR 1ZE;1ZF;1ZP;1ZD / 1LJ;1ZM			
				für Linkslenker; → 8P-6A094000;		03.2122-2129.3 010799	ATE Ø 22,2
				+PR 1ZE;1ZF;1ZP;1ZD / 1LJ;1ZM			
				8P-6A094001→; für Linkslenker;		03.2123-3449.3 010808	ATE Ø 23,81
				+PR 1LK;1ZK			
				für Linkslenker; → 8P-6B009600;		03.2123-3449.3 010808	ATE Ø 23,81
				+PR 1LK			
				für Linkslenker; → 8P-6A094000;		03.2123-3449.3 010808	ATE Ø 23,81
				+PR 1LK			
2.0 TDI	125	03/06→08/12		+PR 1ZE;1ZF;1ZP;1ZD / 1LJ;1ZM		03.2123-3449.3 010808	ATE Ø 23,81
2.0 TDI quattro	125	03/06→08/12		für Linkslenker; +PR 1LK;1ZK		03.2123-3449.3 010808	ATE Ø 23,81
2.0 TFSI	147	09/04→08/12		8P-6B009601→; für Linkslenker;		03.2122-2129.3 010799	ATE Ø 22,2
2.0 TFSI quattro	147	09/04→08/12		→ 8P-7-103000;			
				+PR 1ZE;1ZF;1ZP;1ZD / 1LJ;1ZM			
				für Linkslenker; → 8P-6A094000;		03.2122-2129.3 010799	ATE Ø 22,2
				+PR 1ZE;1ZF;1ZP;1ZD / 1LJ;1ZM			
				8P-6A094001→; für Linkslenker;		03.2122-2129.3 010799	ATE Ø 22,2
				→ 8P-7-103000;			
				+PR 1ZE;1ZF;1ZP;1ZD / 1LJ;1ZM			
				für Linkslenker; → 8P-6B009600;		03.2122-2129.3 010799	ATE Ø 22,2
				+PR 1ZE;1ZF;1ZP;1ZD / 1LJ;1ZM			
				8P-6B009601→; für Linkslenker;		03.2123-3449.3 010808	ATE Ø 23,81
				→ 8P-7-103000; +PR 1LK;1ZK			
				8P-6A094001→; für Linkslenker;		03.2123-3449.3 010808	ATE Ø 23,81
				→ 8P-7-103000; +PR 1LK;1ZK			
				für Linkslenker; → 8P-6B009600;		03.2123-3449.3 010808	ATE Ø 23,81
				+PR 1LK			
				für Linkslenker; → 8P-6A094000;		03.2123-3449.3 010808	ATE Ø 23,81
				+PR 1LK			
				8P-7-103001→;		03.2123-3449.3 010808	ATE Ø 23,81
				+PR 1ZE;1ZF;1ZP;1ZD / 1LJ;1ZM			
3.2 V6 quattro	184	07/03→05/09		für Linkslenker; - ESP		03.2122-2129.3 010799	ATE Ø 22,2
S3 quattro	195	11/06→08/12		für Linkslenker; + ESP		03.2123-3449.3 010808	ATE Ø 23,81
S3 quattro	188	02/07→08/12		07/08→; für Linkslenker; - ESP		03.2122-2129.3 010799	ATE Ø 22,2
				07/08→; für Linkslenker; + ESP		03.2123-3449.3 010808	ATE Ø 23,81
Hydraulikaggregat, Bremsanlage							
1.4 TFSI	92	09/07→08/12		→ 12/08; +PR 1AT,1AS		24.9145-0001.2 399005	
↓							

	kw			 	! #		
AUDI - A3 (8P1) 05/03→08/12							
Hydraulikaggregat, Bremsanlage							
1.6	75	05/03→08/12		→ 12/08; +PR 1AT,1AS		24.9145-0001.2	399005
1.8 TFSI quattro	118	07/08→08/12					
2.0 TDI	100	05/03→08/12					
2.0 TDI	125	03/06→08/12					
2.0 TDI 16V	103	05/03→08/12					
2.0 TDI 16V quattro	103	08/04→08/12					
2.0 TDI quattro	125	03/06→08/12					
2.0 TFSI	147	09/04→08/12					
2.0 TFSI quattro	147	09/04→08/12					
3.2 V6 quattro	184	07/03→05/09					
S3 quattro	195	11/06→08/12					
1.6 FSI	85	08/03→09/07		+PR 1AT,1AS		24.9145-0001.2	399005
2.0 FSI	110	05/03→06/08					
2.0 TDI	103	06/05→06/08					
2.0 TDI	120	06/06→06/08					
2.0 TDI quattro	100	05/03→06/08					
2.0 TDI quattro	103	01/06→06/08					
1.8 T	110	08/06→08/12		01/07→ 12/08; +PR 1AT,1AS		24.9145-0001.2	399005
1.8 TFSI	118	11/06→08/12					
1.9 TDI	77	05/03→05/10		06/03→ 12/08; +PR 1AT,1AS		24.9145-0001.2	399005
S3 quattro	188	02/07→08/12		07/08→ 12/08; +PR 1AT,1AS		24.9145-0001.2	399005
Drucksensor, Bremskraftverstärker							
1.2 TSI	77	04/10→08/12		für Linkslenker; +PR 1AS		03.0655-0101.2	370008 ATE
1.4 TFSI	92	09/07→08/12					
1.6	75	05/03→08/12					
1.6 E-Power	75	01/11→08/12					
1.6 FSI	85	08/03→09/07					
1.6 TDI	66	05/09→08/12					
1.6 TDI	77	05/09→08/12					
1.8 TFSI quattro	118	07/08→08/12					
2.0 FSI	110	05/03→06/08					
2.0 TDI	100	05/03→08/12					
2.0 TDI	103	06/05→06/08					
2.0 TDI	120	06/06→06/08					
2.0 TDI	125	03/06→08/12					
2.0 TDI 16V	103	05/03→08/12					
2.0 TDI 16V quattro	103	08/04→08/12					
2.0 TDI quattro	100	05/03→06/08					
2.0 TDI quattro	103	01/06→06/08					
2.0 TDI quattro	125	03/06→08/12					
2.0 TFSI	147	09/04→08/12					
2.0 TFSI quattro	147	09/04→08/12					
1.8 T	110	08/06→08/12		01/07→; +PR 1AS; für Linkslenker		03.0655-0101.2	370008 ATE
1.8 TFSI	118	11/06→08/12					
1.9 TDI	77	05/03→05/10		06/03→; für Linkslenker; +PR 1AS		03.0655-0101.2	370008 ATE
AUDI - A3 (8V1, 8VK) 04/12→							
Hauptbremszylinder							
1.0 TFSI	85	07/16→		für Linkslenker		03.4153-5403.3	010994 ATE Ø 23,81
1.2 TFSI	77	02/13→				24.4123-1719.3	011017 TRW Ø 23,81
1.2 TFSI	81	05/14→					ohne Bremsflüssigkeitsbehälter
1.4 TFSI	92	05/14→					
1.4 TFSI	103	03/13→					
1.4 TFSI	110	05/14→					
1.6 TDI	77	10/12→					
1.6 TDI	81	09/13→					
1.6 TDI	85	02/17→					
1.8 TFSI quattro	132	08/12→					
2.0 TDI	81	01/13→					
2.0 TDI	100	05/13→					
2.0 TDI	105	09/12→					
2.0 TDI	135	05/13→					
2.0 TDI quattro	110	10/12→					
2.0 TDI quattro	135	12/12→					
2.0 TFSI	140	05/16→					
2.0 TFSI quattro	140	05/16→					
1.4 TFSI	90	04/12→		08/12→; für Linkslenker		03.4153-5403.3	010994 ATE Ø 23,81
1.8 TFSI	132	04/12→				24.4123-1719.3	011017 TRW Ø 23,81
2.0 TDI	110	04/12→					ohne Bremsflüssigkeitsbehälter
AUDI - A3 Cabriolet (8P7) 04/08→05/13							
Bremskraftverstärker							
1.2 TFSI	77	03/10→05/13		für Linkslenker; +PR 1ZE,1ZF,1LJ,1ZA		03.7863-3232.4	300307 ATE Ø 10" pneumatisch
1.4 TFSI	92	02/11→05/13					
1.6	75	09/08→05/10					
1.6 TDI	77	05/09→05/13					
1.8 TFSI	118	04/08→05/13					
1.9 TDI	77	04/08→10/09					

	kw			 	! #		
AUDI - A3 Cabriolet (8P7) 04/08→05/13							
 Bremskraftverstärker							
2.0 TDI	100	04/08→05/13		für Linkslenker; +PR 1ZE,1ZF,1LJ,1ZA	03.7863-3232.4	300307	ATE Ø 10" pneumatisch
2.0 TDI	103	04/08→05/13					
2.0 TFSI	147	04/08→05/13		für Linkslenker; +PR 1ZE;1ZF;1LJ	03.7863-3332.4	300308	ATE Ø 10" pneumatisch
 Hauptbremszylinder							
1.2 TFSI	77	03/10→05/13		für Linkslenker; +PR 1ZE,1ZF,1LJ,1ZA	03.2122-2129.3	010799	ATE Ø 22,2
1.4 TFSI	92	02/11→05/13					
1.6	75	09/08→05/10					
1.6 TDI	77	05/09→05/13					
1.8 TFSI	118	04/08→05/13					
1.9 TDI	77	04/08→10/09					
2.0 TDI	100	04/08→05/13					
2.0 TDI	103	04/08→05/13					
2.0 TFSI	147	04/08→05/13		für Linkslenker; +PR 1ZE,1ZF,1LJ,1ZA	03.2123-3449.3	010808	ATE Ø 23,81
AUDI - A3 Cabriolet (8V7, 8VE) 10/13→							
 Hauptbremszylinder							
1.4 TFSI	85	02/16→		für Linkslenker	03.4153-5403.3	010994	ATE Ø 23,81
1.4 TFSI	92	02/14→					
1.4 TFSI	103	10/13→		für Linkslenker; +PR 1ZA,1ZD,1ZE,1ZF / 1ZP	24.4123-1719.3	011017	TRW Ø 23,81 ohne Bremsflüssigkeitsbehälter
1.4 TFSI	110	05/14→					
1.6 TDI	81	02/14→					
1.8 TFSI	125	05/14→					
1.8 TFSI	132	10/13→					
1.8 TFSI quattro	132	03/14→					
2.0 TDI	100	10/13→					
2.0 TDI	110	10/13→					
2.0 TDI	135	05/14→					
2.0 TDI quattro	110	03/14→					
2.0 TDI quattro	135	05/14→					
2.0 TFSI	140	05/16→					
2.0 TFSI quattro	140	05/16→					
2.0 TFSI quattro	162	05/14→					
S3 quattro	210	03/14→		04/14→; für Linkslenker	03.4153-5403.3	010994	ATE Ø 23,81
S3 quattro	213	07/16→		für Linkslenker	03.4153-5403.3	010994	ATE Ø 23,81
S3 quattro	221	04/14→					
S3 quattro	228	07/16→					
AUDI - A3 Limousine (8VS, 8VM) 05/13→							
 Hauptbremszylinder							
1.0 TFSI	85	07/16→		für Linkslenker	03.4153-5403.3	010994	ATE Ø 23,81
1.2 TFSI	77	10/13→					
1.2 TFSI	81	05/14→			24.4123-1719.3	011017	TRW Ø 23,81 ohne Bremsflüssigkeitsbehälter
1.4 TFSI	90	09/13→					
1.4 TFSI	92	09/13→					
1.4 TFSI	103	05/13→					
1.4 TFSI	110	05/14→					
1.6 TDI	77	09/13→					
1.6 TDI	81	05/14→					
1.6 TDI	85	03/17→					
1.6 TDI quattro	81	05/15→					
1.8 TFSI	125	11/13→					
1.8 TFSI	132	05/13→					
1.8 TFSI quattro	132	11/13→					
2.0 TDI	81	05/13→					
2.0 TDI	100	09/13→					
2.0 TDI	105	10/13→					
2.0 TDI	110	05/13→					
2.0 TDI	135	05/14→					
2.0 TDI quattro	110	10/13→					
2.0 TDI quattro	135	05/14→					
2.0 TFSI	140	05/16→					
2.0 TFSI quattro	140	05/16→					
AUDI - A3 Sportback (8PA) 09/04→03/13							
 Bremskraftverstärker							
1.2 TSI	77	04/10→03/13		für Linkslenker; +PR 1AC,1AT	03.7863-3232.4	300307	ATE Ø 10" pneumatisch
1.4 TFSI	92	09/07→03/13					
1.6	75	09/04→03/13		für Linkslenker; +PR 1AS	03.7863-9602.4	300206	ATE Ø 10" pneumatisch
1.6 E-Power	75	01/11→03/13					
1.6 FSI	85	09/04→09/07					
1.6 TDI	66	05/09→03/13					
1.6 TDI	77	05/09→03/13					
1.8 TFSI quattro	118	07/08→03/13					
1.9 TDI	77	09/04→05/10					
2.0 FSI	110	09/04→06/08					
2.0 TDI	100	09/04→03/13					
2.0 TDI	103	06/05→06/08					
↓							

	kw			 	! #		
AUDI - A3 Sportback (8PA) 09/04→03/13							
Bremskraftverstärker							
2.0 TDI	120	06/06→06/08		für Linkslenker; +PR 1AC,1AT	03.7863-3232.4	300307	ATE Ø 10" pneumatisch
2.0 TDI	125	03/06→03/13		für Linkslenker; +PR 1AS	03.7863-9602.4	300206	ATE Ø 10" pneumatisch
2.0 TDI 16V	103	09/04→03/13					
2.0 TDI 16V quattro	103	11/05→03/13					
2.0 TDI quattro	103	01/06→06/08					
2.0 TDI quattro	125	03/06→03/13					
2.0 TFSI	147	09/04→03/13					
2.0 TFSI quattro	147	09/04→03/13					
1.8 TFSI	118	11/06→03/13		01/07→; +PR 1AC,1AT; für Linkslenker	03.7863-3232.4	300307	ATE Ø 10" pneumatisch
				01/07→; +PR 1AS; für Linkslenker	03.7863-9602.4	300206	ATE Ø 10" pneumatisch
3.2 V6 quattro	184	09/04→05/09		für Linkslenker	03.7863-3332.4	300308	ATE Ø 10" pneumatisch
S3 quattro	188	07/08→03/13					
S3 quattro	195	06/08→03/13					
Hauptbremszylinder							
1.2 TSI	77	04/10→03/13		für Linkslenker; → 8P-6A094000; +PR 1ZE;1ZF;1ZP;1ZD / 1LJ;1ZM	03.2122-2129.3	010799	ATE Ø 22,2
				für Linkslenker; → 8P-6B009600; +PR 1ZE;1ZF;1ZP;1ZD / 1LJ;1ZM	03.2122-2129.3	010799	ATE Ø 22,2
				für Linkslenker; +PR 1ZE;1ZF;1ZP;1ZD / 1LJ;1ZM	03.2122-2129.3	010799	ATE Ø 22,2
				8P-6A094001→; für Linkslenker; +PR 1ZE;1ZF;1ZP;1ZD / 1LJ;1ZM	03.2122-2129.3	010799	ATE Ø 22,2
				8P-6A094001→; für Linkslenker; +PR 1LK;1ZK	03.2123-3449.3	010808	ATE Ø 23,81
				für Linkslenker; → 8P-6B009600; +PR 1LK	03.2123-3449.3	010808	ATE Ø 23,81
				für Linkslenker; +PR 1LK;1ZK	03.2123-3449.3	010808	ATE Ø 23,81
				für Linkslenker; → 8P-6A094000; +PR 1LK	03.2123-3449.3	010808	ATE Ø 23,81
1.4 TFSI	92	09/07→03/13		für Linkslenker; +PR 1ZE;1ZF;1ZP;1ZD / 1LJ;1ZM	03.2122-2129.3	010799	ATE Ø 22,2
1.8 TFSI quattro	118	07/08→03/13		für Linkslenker; +PR 1LK;1ZK	03.2123-3449.3	010808	ATE Ø 23,81
1.6	75	09/04→03/13		8P-6A094001→; für Linkslenker; +PR 1ZE;1ZF;1ZP;1ZD / 1LJ;1ZM	03.2122-2129.3	010799	ATE Ø 22,2
1.6 E-Power	75	01/11→03/13					
1.6 FSI	85	09/04→09/07		für Linkslenker; → 8P-6B009600; +PR 1ZE;1ZF;1ZP;1ZD / 1LJ;1ZM	03.2122-2129.3	010799	ATE Ø 22,2
1.6 TDI	66	05/09→03/13		8P-6B009601→; für Linkslenker; +PR 1ZE;1ZF;1ZP;1ZD / 1LJ;1ZM	03.2122-2129.3	010799	ATE Ø 22,2
1.6 TDI	77	05/09→03/13					
1.9 TDI	77	09/04→05/10		für Linkslenker; → 8P-6A094000; +PR 1ZE;1ZF;1ZP;1ZD / 1LJ;1ZM	03.2122-2129.3	010799	ATE Ø 22,2
2.0 FSI	110	09/04→06/08					
2.0 TDI	100	09/04→03/13		für Linkslenker; → 8P-6A094000; +PR 1ZE;1ZF;1ZP;1ZD / 1LJ;1ZM	03.2122-2129.3	010799	ATE Ø 22,2
2.0 TDI	103	06/05→06/08					
2.0 TDI 16V	103	09/04→03/13		für Linkslenker; → 8P-6B009600; +PR 1LK	03.2123-3449.3	010808	ATE Ø 23,81
2.0 TDI 16V quattro	103	11/05→03/13		8P-6A094001→; für Linkslenker; +PR 1LK;1ZK	03.2123-3449.3	010808	ATE Ø 23,81
2.0 TDI quattro	103	01/06→06/08		8P-6B009601→; für Linkslenker; +PR 1LK;1ZK	03.2123-3449.3	010808	ATE Ø 23,81
				für Linkslenker; → 8P-6A094000; +PR 1LK	03.2123-3449.3	010808	ATE Ø 23,81
1.8 TFSI	118	11/06→03/13		01/07→; für Linkslenker; +PR 1ZE;1ZF;1ZP;1ZD / 1LJ;1ZM	03.2122-2129.3	010799	ATE Ø 22,2
				01/07→; für Linkslenker; +PR 1LK;1ZK	03.2123-3449.3	010808	ATE Ø 23,81
2.0 TDI	120	06/06→06/08		8P-6A094001→; für Linkslenker; +PR 1ZE;1ZF;1ZP;1ZD / 1LJ;1ZM	03.2122-2129.3	010799	ATE Ø 22,2
				für Linkslenker; → 8P-6B009600; +PR 1ZE;1ZF;1ZP;1ZD / 1LJ;1ZM	03.2122-2129.3	010799	ATE Ø 22,2
				8P-6B009601→; für Linkslenker; +PR 1ZE;1ZF;1ZP;1ZD / 1LJ;1ZM	03.2122-2129.3	010799	ATE Ø 22,2
				für Linkslenker; → 8P-6A094000; +PR 1ZE;1ZF;1ZP;1ZD / 1LJ;1ZM	03.2122-2129.3	010799	ATE Ø 22,2
				8P-6A094001→; für Linkslenker; +PR 1LK;1ZK	03.2123-3449.3	010808	ATE Ø 23,81
				für Linkslenker; → 8P-6B009600; +PR 1LK	03.2123-3449.3	010808	ATE Ø 23,81
				für Linkslenker; → 8P-6A094000; +PR 1LK	03.2123-3449.3	010808	ATE Ø 23,81
2.0 TDI	125	03/06→03/13		+PR 1ZE;1ZF;1ZP;1ZD / 1LJ;1ZM	03.2123-3449.3	010808	ATE Ø 23,81
2.0 TDI quattro	125	03/06→03/13		für Linkslenker; +PR 1LK;1ZK	03.2123-3449.3	010808	ATE Ø 23,81
2.0 TFSI	147	09/04→03/13		8P-6B009601→; für Linkslenker; → 8P-7-103000; +PR 1ZE;1ZF;1ZP;1ZD / 1LJ;1ZM	03.2122-2129.3	010799	ATE Ø 22,2
2.0 TFSI quattro	147	09/04→03/13		für Linkslenker; → 8P-6A094000; +PR 1ZE;1ZF;1ZP;1ZD / 1LJ;1ZM	03.2122-2129.3	010799	ATE Ø 22,2
↓							

	kw			 	! #		
AUDI - A3 Sportback (8PA) 09/04→03/13							
 Hauptbremszylinder							
2.0 TFSI	147	09/04→03/13		8P-6A094001→; für Linkslenker; → 8P-7-103000; +PR 1ZE;1ZF;1ZP;1ZD / 1LJ;1ZM		03.2122-2129.3 010799	ATE Ø 22,2
2.0 TFSI quattro	147	09/04→03/13		für Linkslenker; → 8P-6B009600; +PR 1ZE;1ZF;1ZP;1ZD / 1LJ;1ZM		03.2122-2129.3 010799	ATE Ø 22,2
				8P-6B009601→; für Linkslenker; → 8P-7-103000; +PR 1LK;1ZK		03.2123-3449.3 010808	ATE Ø 23,81
				8P-6A094001→; für Linkslenker; → 8P-7-103000; +PR 1LK;1ZK		03.2123-3449.3 010808	ATE Ø 23,81
				für Linkslenker; → 8P-6B009600; +PR 1LK		03.2123-3449.3 010808	ATE Ø 23,81
				für Linkslenker; → 8P-6A094000; +PR 1LK		03.2123-3449.3 010808	ATE Ø 23,81
				8P-7-103001→; +PR 1ZE;1ZF;1ZP;1ZD / 1LJ;1ZM		03.2123-3449.3 010808	ATE Ø 23,81
3.2 V6 quattro	184	09/04→05/09		für Linkslenker; - ESP		03.2122-2129.3 010799	ATE Ø 22,2
S3 quattro	188	07/08→03/13		für Linkslenker; + ESP		03.2123-3449.3 010808	ATE Ø 23,81
S3 quattro	195	06/08→03/13					
RS3 quattro	250	01/11→12/12		04/11→; für Linkslenker		03.2125-5112.3 010966	ATE Ø 25,4
Hydraulikaggregat, Bremsanlage							
1.4 TFSI	92	09/07→03/13		→ 12/08; +PR 1AT,1AS		24.9145-0001.2 399005	
1.6	75	09/04→03/13					
1.8 TFSI quattro	118	07/08→03/13					
1.9 TDI	77	09/04→05/10					
2.0 TDI	100	09/04→03/13					
2.0 TDI	125	03/06→03/13					
2.0 TDI 16V	103	09/04→03/13					
2.0 TDI 16V quattro	103	11/05→03/13					
2.0 TDI quattro	125	03/06→03/13					
2.0 TFSI	147	09/04→03/13					
2.0 TFSI quattro	147	09/04→03/13					
3.2 V6 quattro	184	09/04→05/09					
S3 quattro	188	07/08→03/13					
S3 quattro	195	06/08→03/13					
1.6 FSI	85	09/04→09/07		+PR 1AT,1AS		24.9145-0001.2 399005	
2.0 FSI	110	09/04→06/08					
2.0 TDI	103	06/05→06/08					
2.0 TDI	120	06/06→06/08					
2.0 TDI quattro	103	01/06→06/08					
1.8 TFSI	118	11/06→03/13		01/07→ 12/08; +PR 1AT,1AS		24.9145-0001.2 399005	
Drucksensor, Bremskraftverstärker							
1.2 TSI	77	04/10→03/13		für Linkslenker; +PR 1AS		03.0655-0101.2 370008	ATE
1.4 TFSI	92	09/07→03/13					
1.6	75	09/04→03/13					
1.6 E-Power	75	01/11→03/13					
1.6 FSI	85	09/04→09/07					
1.6 TDI	66	05/09→03/13					
1.6 TDI	77	05/09→03/13					
1.8 TFSI quattro	118	07/08→03/13					
1.9 TDI	77	09/04→05/10					
2.0 FSI	110	09/04→06/08					
2.0 TDI	100	09/04→03/13					
2.0 TDI	103	06/05→06/08					
2.0 TDI	120	06/06→06/08					
2.0 TDI	125	03/06→03/13					
2.0 TDI 16V	103	09/04→03/13					
2.0 TDI 16V quattro	103	11/05→03/13					
2.0 TDI quattro	103	01/06→06/08					
2.0 TDI quattro	125	03/06→03/13					
2.0 TFSI	147	09/04→03/13					
2.0 TFSI quattro	147	09/04→03/13					
1.8 TFSI	118	11/06→03/13		01/07→; +PR 1AS; für Linkslenker		03.0655-0101.2 370008	ATE
AUDI - A3 Sportback (8VA, 8VF) 09/12→							
 Hauptbremszylinder							
1.0 TFSI	85	07/16→		für Linkslenker		03.4153-5403.3 010994	ATE Ø 23,81
1.2 TFSI	77	05/13→				24.4123-1719.3 011017	TRW Ø 23,81 ohne Bremsflüssigkeitsbehälter
1.2 TFSI	81	05/14→					
1.4 TFSI	90	09/12→					
1.4 TFSI	92	05/14→					
1.4 TFSI	103	03/13→					
1.4 TFSI	110	05/14→					
1.4 TFSI e-tron	110	05/14→					
1.6 TDI	77	10/12→					
1.6 TDI	81	09/13→					
1.6 TDI	85	02/17→					
1.6 TDI quattro	81	05/15→					

AUDI - A3 Sportback (8VA, 8VF) 09/12→

Hauptbremszylinder











1.8 TFSI	132	09/12→		für Linkslenker		03.4153-5403.3	010994	ATE Ø 23,81
1.8 TFSI quattro	132	05/13→				24.4123-1719.3	011017	TRW Ø 23,81
2.0 TDI	81	05/13→						ohne Bremsflüssigkeitsbehälter
2.0 TDI	100	05/13→						
2.0 TDI	105	03/13→						
2.0 TDI	110	09/12→						
2.0 TDI	135	05/13→						
2.0 TDI quattro	110	02/13→						
2.0 TDI quattro	135	05/13→						
2.0 TFSI	140	05/16→						
2.0 TFSI quattro	140	05/16→						
1.4 TFSI g-tron	81	11/13→		02/14→; für Linkslenker		03.4153-5403.3	010994	ATE Ø 23,81
						24.4123-1719.3	011017	TRW Ø 23,81
								ohne Bremsflüssigkeitsbehälter











AUDI - A4 (8D2, B5) 11/94→09/01











Hauptbremszylinder











1.6	74	11/94→10/00		→ 01/99		24.2123-1717.3	010521	Ø 23,81
1.8	85	04/95→11/00		02/99→; - ESP; für Linkslenker		24.2125-1712.3	010622	Ø 25,4
1.8	92	11/94→11/00						
1.8 T	132	12/97→11/00		02/99→; + ESP; für Linkslenker		24.2125-1713.3	010623	Ø 25,4
1.9 TDI	66	01/95→11/00						
2.4	120	08/97→11/00						
2.5 TDI	110	09/97→11/00						
2.6	110	01/95→11/00						
2.8	142	10/96→07/99						
2.8	142	10/96→11/00						
1.6	75	07/00→11/00		- ESP; für Linkslenker		24.2125-1712.3	010622	Ø 25,4
1.9 TDI	85	03/00→11/00						
1.9 TDI quattro	85	03/00→11/00		+ ESP; für Linkslenker		24.2125-1713.3	010623	Ø 25,4
2.8	140	09/99→10/00						
2.8 quattro	140	09/99→10/00						
1.8 quattro	85	07/95→11/00		→ 01/99; - ESP		24.2123-1717.3	010521	Ø 23,81
1.8 quattro	92	01/95→11/00		→ 01/99; + ESP		24.2123-1730.3	010620	Ø 23,81
1.8 T quattro	132	12/97→11/00						
1.9 TDI quattro	81	09/96→11/00		02/99→; - ESP; für Linkslenker		24.2125-1712.3	010622	Ø 25,4
2.4 quattro	120	08/97→11/00		02/99→; + ESP; für Linkslenker		24.2125-1713.3	010623	Ø 25,4
2.6 quattro	110	01/95→11/00						
1.8 T	110	01/95→11/00		05/95→ 01/99		24.2123-1717.3	010521	Ø 23,81
				02/99→; - ESP; für Linkslenker		24.2125-1712.3	010622	Ø 25,4
				02/99→; + ESP; für Linkslenker		24.2125-1713.3	010623	Ø 25,4
1.8 T quattro	110	01/95→11/00		02/95→ 01/99; - ESP		24.2123-1717.3	010521	Ø 23,81
				02/95→ 01/99; + ESP		24.2123-1730.3	010620	Ø 23,81
				02/99→; - ESP; für Linkslenker		24.2125-1712.3	010622	Ø 25,4
				02/99→; + ESP; für Linkslenker		24.2125-1713.3	010623	Ø 25,4
1.9 TDI	55	12/95→11/00		03/96→ 01/99		24.2123-1717.3	010521	Ø 23,81
				02/99→; - ESP; für Linkslenker		24.2125-1712.3	010622	Ø 25,4
				02/99→; + ESP; für Linkslenker		24.2125-1713.3	010623	Ø 25,4
1.9 TDI	81	10/95→11/00		02/96→ 01/99		24.2123-1717.3	010521	Ø 23,81
				02/99→; - ESP; für Linkslenker		24.2125-1712.3	010622	Ø 25,4
				02/99→; + ESP; für Linkslenker		24.2125-1713.3	010623	Ø 25,4
2.4	110	07/95→07/97				24.2123-1717.3	010521	Ø 23,81
2.6	102	01/96→07/97						
2.8	128	09/95→07/97						
2.4	121	03/97→11/00		→ 07/97		24.2123-1717.3	010521	Ø 23,81
				08/97→ 01/99		24.2123-1717.3	010521	Ø 23,81
				02/99→; - ESP; für Linkslenker		24.2125-1712.3	010622	Ø 25,4
				02/99→; + ESP; für Linkslenker		24.2125-1713.3	010623	Ø 25,4
2.4 quattro	121	03/97→11/00		08/97→ 01/99; - ESP		24.2123-1717.3	010521	Ø 23,81
				08/97→ 01/99; + ESP		24.2123-1730.3	010620	Ø 23,81
				02/99→; - ESP; für Linkslenker		24.2125-1712.3	010622	Ø 25,4
				02/99→; + ESP; für Linkslenker		24.2125-1713.3	010623	Ø 25,4
2.5 TDI quattro	110	09/97→11/00		11/97→ 01/99		24.2123-1717.3	010521	Ø 23,81
				11/97→ 01/99; + ESP		24.2123-1730.3	010620	Ø 23,81
				02/99→; - ESP; für Linkslenker		24.2125-1712.3	010622	Ø 25,4
				02/99→; + ESP; für Linkslenker		24.2125-1713.3	010623	Ø 25,4
2.8 quattro	128	01/95→07/97		→ 07/96; - ESP		24.2123-1717.3	010521	Ø 23,81
				→ 07/96; + ESP		24.2123-1730.3	010620	Ø 23,81
2.8 quattro	142	10/96→08/01		→ 01/99; - ESP		24.2123-1717.3	010521	Ø 23,81
				→ 01/99; + ESP		24.2123-1730.3	010620	Ø 23,81













	kw			 	! #		
AUDI - A4 (8D2, B5) 11/94→09/01							
 Hauptbremszylinder							
2.8 quattro	142	10/96→08/01		02/99→ 04/01; - ESP; für Linkslenker		24.2125-1712.3 010622	Ø 25,4
				02/99→ 04/01; + ESP; für Linkslenker		24.2125-1713.3 010623	Ø 25,4
S4 quattro	195	09/97→09/01		10/97→ 01/99; - ESP		24.2123-1717.3 010521	Ø 23,81
				10/97→ 01/99; + ESP		24.2123-1730.3 010620	Ø 23,81
				02/99→ 04/01; - ESP; für Linkslenker		24.2125-1712.3 010622	Ø 25,4
				02/99→ 04/01; + ESP; für Linkslenker		24.2125-1713.3 010623	Ø 25,4
AUDI - A4 (8E2, B6) 11/00→12/04							
 Bremskraftverstärker							
1.6	75	11/00→12/04		8E-3-235001→		03.7858-4502.4 300202	ATE Ø 9 / 8" pneumatisch
1.8 T	110	11/00→07/02					
1.8 T	120	07/02→12/04					
1.8 T	125	07/01→12/04					
1.8 T	140	11/02→12/04					
1.8 T quattro	110	11/00→07/02					
1.8 T quattro	120	07/02→12/04					
1.8 T quattro	125	07/01→12/04					
1.8 T quattro	140	11/02→12/04					
1.9 TDI	74	05/01→12/04					
1.9 TDI	96	11/00→12/04					
1.9 TDI quattro	96	11/01→12/04					
2.0	96	11/00→12/04					
2.0 FSI	110	07/02→12/04					
2.4	120	09/01→12/04					
2.4	125	09/01→12/04					
2.5 TDI	114	08/01→07/02					
2.5 TDI	120	07/02→12/04					
2.5 TDI quattro	132	11/00→12/04					
3.0	160	04/01→12/04					
3.0	162	11/00→12/04					
3.0 quattro	160	04/01→12/04					
3.0 quattro	162	11/00→12/04					
1.9 TDI	85	06/04→12/04				03.7858-4502.4 300202	ATE Ø 9 / 8" pneumatisch
 Hauptbremszylinder							
1.6	75	11/00→12/04		12/00→		03.2125-0373.3 010810	ATE Ø 25,4
1.8 T	110	11/00→07/02				24.2125-1720.3 010688	TRW Ø 25,4
1.8 T quattro	110	11/00→07/02					
1.9 TDI	96	11/00→12/04					
2.0	96	11/00→12/04					
2.5 TDI quattro	132	11/00→12/04					
3.0	162	11/00→12/04					
3.0 quattro	162	11/00→12/04					
1.8 T	120	07/02→12/04				03.2125-0373.3 010810	ATE Ø 25,4
1.8 T	125	07/01→12/04				24.2125-1720.3 010688	TRW Ø 25,4
1.8 T	140	11/02→12/04					
1.8 T quattro	120	07/02→12/04					
1.8 T quattro	125	07/01→12/04					
1.8 T quattro	140	11/02→12/04					
1.9 TDI	74	05/01→12/04					
1.9 TDI	85	06/04→12/04					
1.9 TDI quattro	96	11/01→12/04					
2.0 FSI	110	07/02→12/04					
2.4	120	09/01→12/04					
2.4	125	09/01→12/04					
2.5 TDI	114	08/01→07/02					
2.5 TDI	120	07/02→12/04					
3.0	160	04/01→12/04					
3.0 quattro	160	04/01→12/04					
S4 quattro	253	03/03→12/04				24.2126-1705.3 010999	TRW Ø 26,99
AUDI - A4 (8EC, B7) 11/04→06/08							
 Bremskraftverstärker							
1.6	75	11/04→06/08		8E-3-235001→		03.7858-4502.4 300202	ATE Ø 9 / 8" pneumatisch
1.8 T	120	11/04→06/08					
1.8 T quattro	120	11/04→06/08					
2.0	96	11/04→06/08					
2.5 TDI	120	11/04→05/06					
3.0	160	11/04→05/06					
3.0 quattro	160	11/04→07/06					
1.9 TDI	85	11/04→06/08				03.7858-4502.4 300202	ATE Ø 9 / 8" pneumatisch
2.0 TDI	120	06/06→06/08					
2.0 TDI	125	06/06→06/08					
2.0 TDI quattro	103	01/06→06/08					
2.0 TDI quattro	120	06/06→06/08					
2.0 TDI quattro	125	06/06→06/08					
2.0 TFSI	125	10/06→06/08					
↓							

	kw			 	! #				
AUDI - A4 (8EC, B7) 11/04→06/08									
 Bremskraftverstärker									
2.0 TFSI	147	11/04→06/08				03.7858-4502.4 300202	ATE Ø 9 / 8" pneumatisch		
2.0 TFSI	162	06/05→06/08							
2.7 TDI	120	11/05→06/08							
2.7 TDI	132	01/06→06/08							
3.0 TDI quattro	171	01/06→06/08							
3.2 FSI	188	01/05→06/08							
2.0 TDI	89	09/05→09/06		8E-5-400001→		03.7858-4502.4 300202	ATE Ø 9 / 8" pneumatisch		
2.0 TDI	100	11/04→06/08							
2.0 TDI	103	11/04→06/08							
2.0 TDI 16V	103	11/04→06/08							
2.0 TFSI quattro	147	11/04→06/08							
2.0 TFSI quattro	162	06/05→06/08							
3.0 TDI quattro	150	11/04→06/08							
3.2 FSI quattro	188	01/05→06/08							
2.0 TDI	93	11/05→11/06		06/06→				03.7858-4502.4 300202	ATE Ø 9 / 8" pneumatisch
 Hauptbremszylinder									
1.6	75	11/04→06/08				03.2125-0373.3 010810	ATE Ø 25,4		
1.8 T	120	11/04→06/08					24.2125-1720.3 010688	TRW Ø 25,4	
1.8 T quattro	120	11/04→06/08							
1.9 TDI	85	11/04→06/08							
2.0	96	11/04→06/08							
2.0 TDI	89	09/05→09/06							
2.0 TDI	100	11/04→06/08							
2.0 TDI	103	11/04→06/08							
2.0 TDI	120	06/06→06/08							
2.0 TDI	125	06/06→06/08							
2.0 TDI 16V	103	11/04→06/08							
2.0 TDI quattro	103	01/06→06/08							
2.0 TDI quattro	120	06/06→06/08							
2.0 TDI quattro	125	06/06→06/08							
2.0 TFSI	125	10/06→06/08							
2.0 TFSI	162	06/05→06/08							
2.0 TFSI quattro	147	11/04→06/08							
2.0 TFSI quattro	162	06/05→06/08							
2.5 TDI	120	11/04→05/06							
2.7 TDI	120	11/05→06/08							
2.7 TDI	132	01/06→06/08							
3.0	160	11/04→05/06							
3.0 quattro	160	11/04→07/06							
3.0 TDI quattro	150	11/04→06/08							
3.0 TDI quattro	171	01/06→06/08							
3.2 FSI	188	01/05→06/08							
3.2 FSI quattro	188	01/05→06/08							
2.0 TDI	93	11/05→11/06		06/06→		03.2125-0373.3 010810	ATE Ø 25,4		
						24.2125-1720.3 010688	TRW Ø 25,4		
2.0 TFSI	147	11/04→06/08		12/04→		03.2125-0373.3 010810	ATE Ø 25,4		
						24.2125-1720.3 010688	TRW Ø 25,4		
RS4 quattro	309	09/05→06/08		11/05→		24.2126-1705.3 010999	TRW Ø 26,99		
S4 quattro	253	11/04→06/08				24.2126-1705.3 010999	TRW Ø 26,99		
AUDI - A4 (8K2, B8) 11/07→12/15									
 Bremskraftverstärker									
1.8 TFSI	88	01/08→12/15				03.7858-4632.4 300273	ATE Ø 9 / 8" pneumatisch		
1.8 TFSI	118	11/07→03/12							
1.8 TFSI quattro	118	09/08→03/12							
2.0 TDI	88	06/08→12/15							
2.0 TDI	100	11/07→12/15							
2.0 TDI	105	11/07→12/15							
2.0 TDI	120	08/08→12/15							
2.0 TDI	125	01/08→03/12							
2.0 TDI 16V	103	07/08→							
2.0 TDI quattro	105	11/08→12/15							
2.0 TDI quattro	125	01/08→03/12							
2.0 TFSI	132	06/08→12/15							
2.0 TFSI	155	06/08→05/13							
2.0 TFSI flexible fuel	132	11/09→12/15							
2.0 TFSI flexible fuel quattro	132	11/09→12/15							
2.0 TFSI quattro	155	06/08→12/15							
2.7 TDI	120	11/07→03/12							
2.7 TDI	140	11/07→03/12							
3.0 TDI quattro	155	06/08→05/10							
3.0 TDI quattro	176	11/07→03/12							
3.2 FSI	195	09/08→03/12							
3.2 FSI quattro	195	11/07→03/12							
S4 quattro	245	11/08→12/15							
↓									

	kw			 	! #		
AUDI - A4 (8K2, B8) 11/07→12/15							
 Hauptbremszylinder							
1.8 TFSI	88	01/08→12/15				03.2125-0493.3 010940	ATE Ø 25,4
1.8 TFSI	118	11/07→03/12				24.2125-1739.3 010948	TRW Ø 25,4
1.8 TFSI quattro	118	09/08→03/12					
2.0 TDI	88	06/08→12/15					
2.0 TDI	100	11/07→12/15					
2.0 TDI	105	11/07→12/15					
2.0 TDI	120	08/08→12/15					
2.0 TDI	125	01/08→03/12					
2.0 TDI 16V	103	07/08→					
2.0 TDI quattro	105	11/08→12/15					
2.0 TDI quattro	125	01/08→03/12					
2.0 TFSI	132	06/08→12/15					
2.0 TFSI	155	06/08→05/13					
2.0 TFSI flexible fuel	132	11/09→12/15					
2.0 TFSI flexible fuel quattro	132	11/09→12/15					
2.0 TFSI quattro	155	06/08→12/15					
2.7 TDI	120	11/07→03/12					
2.7 TDI	140	11/07→03/12					
3.0 TDI quattro	155	06/08→05/10					
3.0 TDI quattro	176	11/07→03/12					
3.2 FSI	195	09/08→03/12					
3.2 FSI quattro	195	11/07→03/12					
S4 quattro	245	11/08→12/15					
AUDI - A4 Allroad (8KH, B8) 04/09→05/16							
 Bremskraftverstärker							
2.0 TDI quattro	100	09/09→05/16				03.7858-4632.4 300273	ATE Ø 9 / 8" pneumatisch
2.0 TDI quattro	105	09/09→05/16					
2.0 TDI quattro	120	04/09→05/16					
2.0 TDI quattro	125	04/09→05/16					
2.0 TFSI quattro	155	04/09→05/16					
3.0 TDI quattro	176	04/09→01/12					
2.0 TDI quattro	110	05/13→05/16		+PR GP0,GP1		03.7858-4632.4 300273	ATE Ø 9 / 8" pneumatisch
2.0 TDI quattro	140	09/13→05/16					
2.0 TFSI quattro	162	05/13→05/16					
2.0 TFSI quattro	165	05/13→05/16					
3.0 TDI quattro	180	01/12→05/16					
2.0 TDI quattro	130	11/11→05/16		01/12→; +PR GP0,GP1		03.7858-4632.4 300273	ATE Ø 9 / 8" pneumatisch
 Hauptbremszylinder							
2.0 TDI quattro	100	09/09→05/16				03.2125-0493.3 010940	ATE Ø 25,4
2.0 TDI quattro	105	09/09→05/16				24.2125-1739.3 010948	TRW Ø 25,4
2.0 TDI quattro	120	04/09→05/16					
2.0 TDI quattro	125	04/09→05/16					
2.0 TFSI quattro	155	04/09→05/16					
3.0 TDI quattro	176	04/09→01/12					
2.0 TDI quattro	110	05/13→05/16		+PR GP0,GP1		03.2125-0493.3 010940	ATE Ø 25,4
2.0 TDI quattro	140	09/13→05/16				24.2125-1739.3 010948	TRW Ø 25,4
2.0 TFSI quattro	162	05/13→05/16					
2.0 TFSI quattro	165	05/13→05/16					
3.0 TDI quattro	180	01/12→05/16					
2.0 TDI quattro	130	11/11→05/16		01/12→; +PR GP0,GP1		03.2125-0493.3 010940	ATE Ø 25,4
						24.2125-1739.3 010948	TRW Ø 25,4
AUDI - A4 Avant (8D5, B5) 11/94→09/01							
 Hauptbremszylinder							
1.6	74	11/94→09/01		→ 01/99		24.2123-1717.3 010521	Ø 23,81
1.8	85	07/95→09/01					
1.8	92	02/96→09/01		02/99→ 04/01; - ESP; für Linkslenker		24.2125-1712.3 010622	Ø 25,4
1.8 T	110	03/96→09/01		02/99→ 04/01; + ESP; für Linkslenker		24.2125-1713.3 010623	Ø 25,4
1.8 T	132	12/97→09/01					
1.9 DUO	66	03/98→09/01					
1.9 TDI	55	03/96→09/01					
1.9 TDI	66	02/96→09/01					
1.9 TDI	81	02/96→09/01					
2.4	120	08/97→09/01					
2.5 TDI	110	09/97→09/01					
2.6	110	02/96→09/01					
2.8	142	10/96→09/01					
1.6	75	07/00→09/01		→ 04/01; - ESP; für Linkslenker		24.2125-1712.3 010622	Ø 25,4
1.9 TDI	85	03/00→09/01					
1.9 TDI quattro	85	03/00→09/01		→ 04/01; + ESP; für Linkslenker		24.2125-1713.3 010623	Ø 25,4
1.8 quattro	85	07/95→09/01		→ 01/99; - ESP		24.2123-1717.3 010521	Ø 23,81
1.8 quattro	92	01/96→09/01		→ 01/99; + ESP		24.2123-1730.3 010620	Ø 23,81
1.8 T quattro	110	01/96→09/01					
1.8 T quattro	132	12/97→09/01		02/99→ 04/01; - ESP; für Linkslenker		24.2125-1712.3 010622	Ø 25,4
1.9 TDI quattro	81	09/96→09/01		02/99→ 04/01; + ESP; für Linkslenker		24.2125-1713.3 010623	Ø 25,4
2.4 quattro	120	08/97→09/01					
↓							

	kw			 	! #		
AUDI - A4 Avant (8D5, B5) 11/94→09/01							
 Hauptbremszylinder							
2.6 quattro	110	01/96→09/01		→ 01/99; - ESP		24.2123-1717.3 010521	Ø 23,81
2.8 quattro	142	10/96→09/01		→ 01/99; + ESP		24.2123-1730.3 010620	Ø 23,81
				02/99→ 04/01; - ESP; für Linkslenker		24.2125-1712.3 010622	Ø 25,4
				02/99→ 04/01; + ESP; für Linkslenker		24.2125-1713.3 010623	Ø 25,4
2.4	110	07/95→07/97				24.2123-1717.3 010521	Ø 23,81
2.8	128	03/96→09/96					
2.4	121	03/97→09/01		08/97→ 01/99		24.2123-1717.3 010521	Ø 23,81
				02/99→ 04/01; - ESP; für Linkslenker		24.2125-1712.3 010622	Ø 25,4
				02/99→ 04/01; + ESP; für Linkslenker		24.2125-1713.3 010623	Ø 25,4
2.4 quattro	121	03/97→09/01		08/97→ 01/99; - ESP		24.2123-1717.3 010521	Ø 23,81
				08/97→ 01/99; + ESP		24.2123-1730.3 010620	Ø 23,81
				02/99→ 04/01; - ESP; für Linkslenker		24.2125-1712.3 010622	Ø 25,4
				02/99→ 04/01; + ESP; für Linkslenker		24.2125-1713.3 010623	Ø 25,4
2.5 TDI quattro	110	09/97→09/01		11/97→ 01/99		24.2123-1717.3 010521	Ø 23,81
				11/97→ 01/99; + ESP		24.2123-1730.3 010620	Ø 23,81
				02/99→ 04/01; - ESP; für Linkslenker		24.2125-1712.3 010622	Ø 25,4
				02/99→ 04/01; + ESP; für Linkslenker		24.2125-1713.3 010623	Ø 25,4
2.8	140	03/99→09/00		- ESP; für Linkslenker		24.2125-1712.3 010622	Ø 25,4
2.8 quattro	140	03/99→09/00		+ ESP; für Linkslenker		24.2125-1713.3 010623	Ø 25,4
2.8 quattro	128	01/96→09/96		→ 07/96; - ESP		24.2123-1717.3 010521	Ø 23,81
				→ 07/96; + ESP		24.2123-1730.3 010620	Ø 23,81
2.8 quattro	280	10/00→09/01		→ 04/01; für Linkslenker		24.2125-1713.3 010623	Ø 25,4
RS4 quattro	280	05/00→09/01		06/00→ 04/01; für Linkslenker		24.2125-1713.3 010623	Ø 25,4
S4 quattro	195	09/97→09/01		10/97→ 01/99; - ESP		24.2123-1717.3 010521	Ø 23,81
				10/97→ 01/99; + ESP		24.2123-1730.3 010620	Ø 23,81
				02/99→ 04/01; - ESP; für Linkslenker		24.2125-1712.3 010622	Ø 25,4
				02/99→ 04/01; + ESP; für Linkslenker		24.2125-1713.3 010623	Ø 25,4
AUDI - A4 Avant (8E5, B6) 04/01→12/04							
 Bremskraftverstärker							
1.6	75	09/01→12/04		8E-3-235001→		03.7858-4502.4 300202	ATE Ø 9 / 8" pneumatisch
1.8 T	110	09/01→07/02					
1.8 T	120	07/02→12/04					
1.8 T	140	11/02→12/04					
1.8 T quattro	110	09/01→07/02					
1.8 T quattro	120	07/02→12/04					
1.8 T quattro	125	09/01→12/04					
1.8 T quattro	140	11/02→12/04					
1.9 TDI	74	11/01→12/04					
1.9 TDI	96	09/01→12/04					
1.9 TDI quattro	96	11/01→12/04					
2.0	96	09/01→12/04					
2.0 FSI	110	07/02→12/04					
2.4	120	09/01→12/04					
2.4	125	09/01→12/04					
2.5 TDI	114	09/01→07/02					
2.5 TDI	120	07/02→12/04					
2.5 TDI quattro	132	09/01→12/04					
3.0	160	04/01→12/04					
3.0	162	09/01→12/04					
3.0 quattro	160	04/01→12/04					
3.0 quattro	162	09/01→12/04					
1.9 TDI	85	06/04→12/04				03.7858-4502.4 300202	ATE Ø 9 / 8" pneumatisch
 Hauptbremszylinder							
1.6	75	09/01→12/04				03.2125-0373.3 010810	ATE Ø 25,4
1.8 T	110	09/01→07/02				24.2125-1720.3 010688	TRW Ø 25,4
1.8 T	120	07/02→12/04					
1.8 T	140	11/02→12/04					
1.8 T quattro	110	09/01→07/02					
1.8 T quattro	120	07/02→12/04					
1.8 T quattro	125	09/01→12/04					
1.8 T quattro	140	11/02→12/04					
1.9 TDI	74	11/01→12/04					
1.9 TDI	85	06/04→12/04					
1.9 TDI	96	09/01→12/04					
1.9 TDI quattro	96	11/01→12/04					
2.0	96	09/01→12/04					
2.0 FSI	110	07/02→12/04					
2.4	120	09/01→12/04					
2.4	125	09/01→12/04					
2.5 TDI	114	09/01→07/02					

	kW			 	! #		
AUDI - A4 Avant (8E5, B6) 04/01→12/04							
 Hauptbremszylinder							
2.5 TDI	120	07/02→12/04				03.2125-0373.3 010810	ATE Ø 25,4
2.5 TDI quattro	132	09/01→12/04				24.2125-1720.3 010688	TRW Ø 25,4
3.0	160	04/01→12/04					
3.0	162	09/01→12/04					
3.0 quattro	160	04/01→12/04					
3.0 quattro	162	09/01→12/04					
S4 quattro	253	03/03→12/04				24.2126-1705.3 010999	TRW Ø 26,99
AUDI - A4 Avant (8ED, B7) 11/04→06/08							
 Bremskraftverstärker							
1.6	75	11/04→06/08		8E-3-235001→		03.7858-4502.4 300202	ATE Ø 9 / 8" pneumatisch
1.8 T	120	11/04→06/08					
1.8 T quattro	120	11/04→06/08					
2.0	96	11/04→06/08					
2.5 TDI	120	11/04→05/06					
3.0	160	11/04→05/06					
3.0 quattro	160	11/04→07/06					
1.9 TDI	85	11/04→06/08				03.7858-4502.4 300202	ATE Ø 9 / 8" pneumatisch
2.0 TDI	120	06/06→06/08					
2.0 TDI	125	06/06→06/08					
2.0 TDI quattro	103	01/06→06/08					
2.0 TDI quattro	120	06/06→06/08					
2.0 TDI quattro	125	06/06→06/08					
2.0 TFSI	125	10/06→06/08					
2.0 TFSI	147	11/04→06/08					
2.0 TFSI	162	06/05→06/08					
2.7 TDi	120	11/05→03/08					
2.7 TDI	132	01/06→06/08					
3.0 TDI quattro	171	01/06→06/08					
3.2 FSI	188	01/05→06/08					
2.0 TDI	89	09/05→09/06		8E-5-400001→		03.7858-4502.4 300202	ATE Ø 9 / 8" pneumatisch
2.0 TDI	100	11/04→06/08					
2.0 TDI	103	11/04→06/08					
2.0 TDI 16V	103	11/04→06/08					
2.0 TFSI quattro	147	11/04→06/08					
2.0 TFSI quattro	162	06/05→06/08					
3.0 TDI quattro	150	11/04→06/08					
3.2 FSI quattro	188	01/05→06/08					
2.0 TDI	93	11/05→11/06		06/06→		03.7858-4502.4 300202	ATE Ø 9 / 8" pneumatisch
 Hauptbremszylinder							
1.6	75	11/04→06/08				03.2125-0373.3 010810	ATE Ø 25,4
1.8 T	120	11/04→06/08				24.2125-1720.3 010688	TRW Ø 25,4
1.8 T quattro	120	11/04→06/08					
1.9 TDI	85	11/04→06/08					
2.0	96	11/04→06/08					
2.0 TDI	89	09/05→09/06					
2.0 TDI	100	11/04→06/08					
2.0 TDI	103	11/04→06/08					
2.0 TDI	120	06/06→06/08					
2.0 TDI	125	06/06→06/08					
2.0 TDI 16V	103	11/04→06/08					
2.0 TDI quattro	103	01/06→06/08					
2.0 TDI quattro	120	06/06→06/08					
2.0 TDI quattro	125	06/06→06/08					
2.0 TFSI	125	10/06→06/08					
2.0 TFSI	162	06/05→06/08					
2.0 TFSI quattro	147	11/04→06/08					
2.0 TFSI quattro	162	06/05→06/08					
2.5 TDI	120	11/04→05/06					
2.7 TDi	120	11/05→03/08					
2.7 TDI	132	01/06→06/08					
3.0	160	11/04→05/06					
3.0 quattro	160	11/04→07/06					
3.0 TDI quattro	150	11/04→06/08					
3.0 TDI quattro	171	01/06→06/08					
3.2 FSI	188	01/05→06/08					
3.2 FSI quattro	188	01/05→06/08					
2.0 TDI	93	11/05→11/06		06/06→		03.2125-0373.3 010810	ATE Ø 25,4
						24.2125-1720.3 010688	TRW Ø 25,4
2.0 TFSI	147	11/04→06/08		12/04→		03.2125-0373.3 010810	ATE Ø 25,4
						24.2125-1720.3 010688	TRW Ø 25,4
RS4 quattro	309	09/05→06/08		11/05→		24.2126-1705.3 010999	TRW Ø 26,99
S4 quattro	253	11/04→06/08				24.2126-1705.3 010999	TRW Ø 26,99

AUDI - A4 Avant (8K5, B8) 11/07→12/15











Bremskraftverstärker							
1.8 TFSI	88	04/08→12/15				03.7858-4632.4	300273 ATE Ø 9 / 8" pneumatisch
1.8 TFSI quattro	118	09/08→03/12					
2.0 TDI	88	06/08→12/15					
2.0 TDI	100	04/08→12/15					
2.0 TDI	105	04/08→12/15					
2.0 TDI	120	08/08→12/15					
2.0 TDI	125	04/08→03/12					
2.0 TDI 16V	103	07/08→					
2.0 TDI quattro	105	04/08→12/15					
2.0 TDI quattro	125	08/08→03/12					
2.0 TFSI	132	06/08→12/15					
2.0 TFSI	155	06/08→05/13					
2.0 TFSI flexible fuel	132	11/09→12/15					
2.0 TFSI flexible fuel quattro	132	11/09→12/15					
2.0 TFSI quattro	155	06/08→12/15					
2.7 TDI	120	06/08→03/12					
3.0 TDI quattro	155	06/08→05/10					
3.0 TDI quattro	176	04/08→03/12					
3.2 FSI	195	09/08→03/12					
3.2 FSI quattro	195	04/08→03/12					
S4 quattro	245	11/08→12/15					
1.8 TFSI	118	11/07→03/12		04/08→		03.7858-4632.4	300273 ATE Ø 9 / 8" pneumatisch
2.7 TDI	140	04/08→03/12		06/08→		03.7858-4632.4	300273 ATE Ø 9 / 8" pneumatisch













Hauptbremszylinder							
1.8 TFSI	88	04/08→12/15				03.2125-0493.3	010940 ATE Ø 25,4
1.8 TFSI quattro	118	09/08→03/12				24.2125-1739.3	010948 TRW Ø 25,4
2.0 TDI	88	06/08→12/15					
2.0 TDI	100	04/08→12/15					
2.0 TDI	105	04/08→12/15					
2.0 TDI	120	08/08→12/15					
2.0 TDI	125	04/08→03/12					
2.0 TDI 16V	103	07/08→					
2.0 TDI quattro	105	04/08→12/15					
2.0 TDI quattro	125	08/08→03/12					
2.0 TFSI	132	06/08→12/15					
2.0 TFSI	155	06/08→05/13					
2.0 TFSI flexible fuel	132	11/09→12/15					
2.0 TFSI flexible fuel quattro	132	11/09→12/15					
2.0 TFSI quattro	155	06/08→12/15					
2.7 TDI	120	06/08→03/12					
3.0 TDI quattro	155	06/08→05/10					
3.0 TDI quattro	176	04/08→03/12					
3.2 FSI	195	09/08→03/12					
3.2 FSI quattro	195	04/08→03/12					
S4 quattro	245	11/08→12/15					
1.8 TFSI	118	11/07→03/12		04/08→		03.2125-0493.3	010940 ATE Ø 25,4
						24.2125-1739.3	010948 TRW Ø 25,4
2.7 TDI	140	04/08→03/12		06/08→		03.2125-0493.3	010940 ATE Ø 25,4
						24.2125-1739.3	010948 TRW Ø 25,4











AUDI - A4 Cabriolet (8H7, B6, 8HE, B7) 04/02→03/09











Bremskraftverstärker							
1.8 T	120	07/02→03/09		8H-3-017415→; → 11/08		03.7858-4502.4	300202 ATE Ø 9 / 8" pneumatisch
1.8 T	125	10/02→10/05		8H-3-017415→		03.7858-4502.4	300202 ATE Ø 9 / 8" pneumatisch
2.4	120	04/02→12/05					
2.4	125	04/02→12/05					
2.5 TDI	120	08/02→12/05					
3.0	162	04/02→12/05					
1.8 T quattro	120	05/03→03/09		→ 11/08		03.7858-4502.4	300202 ATE Ø 9 / 8" pneumatisch
2.0 TDI	100	01/06→03/09					
2.0 TDI	103	01/06→03/09					
2.0 TFSI 16V	147	01/06→03/09					
2.0 TFSI quattro	147	11/05→03/09					
2.7 TDI	132	06/06→03/09					
3.0 TDI quattro	150	01/06→03/09					
3.0 TDI quattro	171	01/06→03/09					
3.2 FSI	188	01/06→03/09					
3.2 FSI quattro	188	01/06→03/09					
2.0	96	09/04→12/05				03.7858-4502.4	300202 ATE Ø 9 / 8" pneumatisch
3.0 quattro	162	05/03→12/05					
3.0	160	04/02→12/05		8E-3-235001→		03.7858-4502.4	300202 ATE Ø 9 / 8" pneumatisch











Hauptbremszylinder							
1.8 T	120	07/02→03/09		8H-7-022001→; → 11/08		03.2125-0373.3	010810 ATE Ø 25,4
↓							











	kW					! #		
AUDI - A4 Cabriolet (8H7, B6, 8HE, B7) 04/02→03/09								
 Hauptbremszylinder								
1.8 T	120	07/02→03/09		8H-3-017415→ 8H-7-022000			03.2125-0373.3 010810	ATE Ø 25,4
				→ 11/08			24.2125-1720.3 010688	TRW Ø 25,4
1.8 T	125	10/02→10/05		8H-7-022001→			03.2125-0373.3 010810	ATE Ø 25,4
2.4	120	04/02→12/05						
2.4	125	04/02→12/05		8H-3-017415→ 8H-7-022000			03.2125-0373.3 010810	ATE Ø 25,4
2.5 TDI	120	08/02→12/05					24.2125-1720.3 010688	TRW Ø 25,4
3.0	162	04/02→12/05						
1.8 T quattro	120	05/03→03/09		→ 8H-7-022000			03.2125-0373.3 010810	ATE Ø 25,4
2.0 TDI	100	01/06→03/09						
2.0 TDI	103	01/06→03/09		8H-7-022001→; → 11/08			03.2125-0373.3 010810	ATE Ø 25,4
2.0 TFSI 16V	147	01/06→03/09		→ 11/08			24.2125-1720.3 010688	TRW Ø 25,4
2.0 TFSI quattro	147	11/05→03/09						
2.7 TDI	132	06/06→03/09						
3.0 TDI quattro	150	01/06→03/09						
3.0 TDI quattro	171	01/06→03/09						
3.2 FSI	188	01/06→03/09						
3.2 FSI quattro	188	01/06→03/09						
2.0	96	09/04→12/05		8H-7-022001→			03.2125-0373.3 010810	ATE Ø 25,4
3.0 quattro	162	05/03→12/05		→ 8H-7-022000			03.2125-0373.3 010810	ATE Ø 25,4
							24.2125-1720.3 010688	TRW Ø 25,4
3.0	160	04/02→12/05					03.2125-0373.3 010810	ATE Ø 25,4
							24.2125-1720.3 010688	TRW Ø 25,4
RS4 quattro	309	06/06→03/09		→ 11/08			24.2126-1705.3 010999	TRW Ø 26,99
S4 quattro	253	03/04→03/09						
AUDI - A5 (8T3) 06/07→01/17								
 Bremskraftverstärker								
1.8 TFSI	118	05/09→09/11					03.7858-4632.4 300273	ATE Ø 9 / 8" pneumatisch
1.8 TFSI	125	10/07→01/17						
2.0 TDI	125	08/08→03/12						
2.0 TDI	130	10/11→01/17						
2.0 TDI quattro	125	08/08→03/12						
2.0 TFSI	132	11/08→03/12						
2.0 TFSI	155	06/08→11/13						
2.0 TFSI quattro	155	06/08→01/17						
2.7 TDI	120	09/07→03/12						
2.7 TDI	140	06/07→03/12						
3.0 TDI	150	10/11→01/17						
3.0 TDI quattro	155	03/08→05/10						
3.0 TDI quattro	176	06/07→03/12						
3.0 TDI quattro	180	10/11→01/17						
3.2 FSI	195	06/07→03/12						
3.2 FSI quattro	195	06/07→03/12						
S5 quattro	245	10/11→01/17						
S5 quattro	260	06/07→03/12						
2.0 TDI	120	08/08→01/17		10/08→			03.7858-4632.4 300273	ATE Ø 9 / 8" pneumatisch
 Hauptbremszylinder								
1.8 TFSI	118	05/09→09/11					03.2125-0493.3 010940	ATE Ø 25,4
1.8 TFSI	125	10/07→01/17					24.2125-1739.3 010948	TRW Ø 25,4
2.0 TDI	125	08/08→03/12						
2.0 TDI	130	10/11→01/17						
2.0 TDI quattro	125	08/08→03/12						
2.0 TFSI	132	11/08→03/12						
2.0 TFSI	155	06/08→11/13						
2.0 TFSI quattro	155	06/08→01/17						
2.7 TDI	120	09/07→03/12						
2.7 TDI	140	06/07→03/12						
3.0 TDI	150	10/11→01/17						
3.0 TDI quattro	155	03/08→05/10						
3.0 TDI quattro	176	06/07→03/12						
3.0 TDI quattro	180	10/11→01/17						
3.2 FSI	195	06/07→03/12						
3.2 FSI quattro	195	06/07→03/12						
S5 quattro	245	10/11→01/17						
S5 quattro	260	06/07→03/12						
2.0 TDI	120	08/08→01/17		10/08→			03.2125-0493.3 010940	ATE Ø 25,4
							24.2125-1739.3 010948	TRW Ø 25,4
AUDI - A5 Cabriolet (8F7) 03/09→01/17								
 Bremskraftverstärker								
1.8 TFSI	118	09/09→03/12					03.7858-4632.4 300273	ATE Ø 9 / 8" pneumatisch
1.8 TFSI	125	10/11→03/16						
2.0 TDI	120	05/09→06/14						
2.0 TDI	125	05/09→03/12						
2.0 TDI	130	10/11→01/17						
↓								









	kW			 	! #				
AUDI - A5 Cabriolet (8F7) 03/09→01/17									
 Bremskraftverstärker									
2.0 TFSI	132	03/09→03/12				03.7858-4632.4 300273	ATE Ø 9 / 8" pneumatisch		
2.0 TFSI quattro	155	03/09→01/17							
2.7 TDI	120	05/09→03/12							
2.7 TDI	140	03/09→03/12							
3.0 TDI	150	10/11→01/17							
3.0 TDI quattro	176	03/09→03/12							
3.0 TDI quattro	180	10/11→01/17							
3.2 FSI	195	03/09→03/12							
3.2 FSI quattro	195	03/09→03/12							
S5 quattro	245	06/09→01/17							
2.0 TFSI	155	03/09→06/14		+PR 1LT		03.7858-4632.4 300273	ATE Ø 9 / 8" pneumatisch		
 Hauptbremszylinder									
1.8 TFSI	118	09/09→03/12				03.2125-0493.3 010940	ATE Ø 25,4		
1.8 TFSI	125	10/11→03/16							
2.0 TDI	120	05/09→06/14							
2.0 TDI	125	05/09→03/12							
2.0 TDI	130	10/11→01/17							
2.0 TFSI	132	03/09→03/12							
2.0 TFSI quattro	155	03/09→01/17							
2.7 TDI	120	05/09→03/12							
2.7 TDI	140	03/09→03/12							
3.0 TDI	150	10/11→01/17							
3.0 TDI quattro	176	03/09→03/12							
3.0 TDI quattro	180	10/11→01/17							
3.2 FSI	195	03/09→03/12							
3.2 FSI quattro	195	03/09→03/12							
S5 quattro	245	06/09→01/17							
2.0 TFSI	155	03/09→06/14		+PR 1LT				03.2125-0493.3 010940	ATE Ø 25,4
						24.2125-1739.3 010948	TRW Ø 25,4		
AUDI - A5 Sportback (8TA) 09/09→01/17									
 Bremskraftverstärker									
1.8 TFSI	118	11/09→09/11				03.7858-4632.4 300273	ATE Ø 9 / 8" pneumatisch		
1.8 TFSI	125	08/11→01/17							
2.0 TDI	100	09/09→01/17							
2.0 TDI	105	09/09→01/17							
2.0 TDI	120	09/09→01/17							
2.0 TDI	125	09/09→03/12							
2.0 TDI	130	10/11→01/17							
2.0 TDI quattro	125	09/09→03/12							
2.0 TFSI	132	09/09→06/14							
2.0 TFSI	155	09/09→11/13							
2.0 TFSI quattro	155	09/09→01/17							
2.7 TDI	120	09/09→01/17							
2.7 TDI	140	09/09→03/12							
3.0 TDI	150	10/11→01/17							
3.0 TDI quattro	176	09/09→03/12							
3.0 TDI quattro	180	10/11→01/17							
3.2 FSI quattro	195	09/09→03/12							
S5 quattro	245	01/10→01/17							
 Hauptbremszylinder									
1.8 TFSI	118	11/09→09/11						03.2125-0493.3 010940	ATE Ø 25,4
1.8 TFSI	125	08/11→01/17							
2.0 TDI	100	09/09→01/17							
2.0 TDI	105	09/09→01/17							
2.0 TDI	120	09/09→01/17							
2.0 TDI	125	09/09→03/12							
2.0 TDI	130	10/11→01/17							
2.0 TDI quattro	125	09/09→03/12							
2.0 TFSI	132	09/09→06/14							
2.0 TFSI	155	09/09→11/13							
2.0 TFSI quattro	155	09/09→01/17							
2.7 TDI	120	09/09→01/17							
2.7 TDI	140	09/09→03/12							
3.0 TDI	150	10/11→01/17							
3.0 TDI quattro	176	09/09→03/12							
3.0 TDI quattro	180	10/11→01/17							
3.2 FSI quattro	195	09/09→03/12							
S5 quattro	245	01/10→01/17							
AUDI - A6 (4A, C4) 06/94→10/97									
 Bremskraftverstärker									
S6 4.2 quattro	213	06/94→10/97		09/94→		10.0124-3202.3 340011	ATE hydraulisch		
S6 Plus quattro	240	04/96→10/97		06/96→					
S6 Turbo quattro	169	06/94→10/97							
↓									











	kw			 	! #		
AUDI - A6 (4A, C4) 06/94→10/97							
 Hauptbremszylinder							
1.8	92	12/95→10/97		+ ABS		24.2123-1731.3 010621	Ø 23,81
2.0	79	08/95→07/96					
2.8	120	08/95→07/96					
2.8	142	12/95→10/97					
1.8 quattro	92	12/95→10/97				24.2123-1731.3 010621	Ø 23,81
2.0 16V quattro	103	06/94→10/97					
2.5 TDI quattro	103	10/95→10/97					
2.6 quattro	110	06/94→10/97					
2.8 quattro	128	06/94→10/97					
2.8 quattro	142	12/95→10/97					
1.9 TDI	66	06/94→10/97		→ 06/95; - ABS		03.2123-0491.3 010167	Ø 23,81
2.0	74	06/94→10/97		→ 06/95; - EDS / + ABS		24.2123-1602.3 010384	TRW Ø 23,81
2.0	85	06/94→10/97					
2.0 16V	103	06/94→10/97		→ 06/95; + EDS / + ABS		24.2123-1731.3 010621	Ø 23,81
2.3	98	06/94→12/95		07/95→; + ABS		24.2123-1731.3 010621	Ø 23,81
2.5 TDI	84	01/95→10/97					
2.5 TDI	85	06/94→10/97					
2.5 TDI	103	08/94→10/97					
2.6	102	06/94→10/97					
2.6	110	06/94→10/97					
2.8	128	06/94→10/97					
2.3 quattro	98	06/94→12/95		08/94→		24.2123-1731.3 010621	Ø 23,81
 Bremskraftregler							
1.8	92	12/95→10/97		für Fahrzeuge ohne Niveauregulierung		03.6585-0108.3 320115	ATE lastabhängig 8/5 4x
1.9 TDI	66	06/94→10/97					
2.0	74	06/94→10/97					
2.0	79	08/95→07/96					
2.0	85	06/94→10/97					
2.0 16V	103	06/94→10/97					
2.3	98	06/94→12/95					
2.5 TDI	84	01/95→10/97					
2.5 TDI	85	06/94→10/97					
2.5 TDI	103	08/94→10/97					
2.6	102	06/94→10/97					
2.6	110	06/94→10/97					
2.8	120	08/95→07/96					
2.8	128	06/94→10/97					
2.8	142	12/95→10/97					
AUDI - A6 (4B2, C5) 01/97→01/05							
 Bremskraftverstärker							
1.8	85	05/97→01/05		4B-2-130001→		03.7858-4502.4 300202	ATE Ø 9 / 8" pneumatisch
1.8	92	07/97→01/05					
1.8 T	110	01/97→01/05					
1.8 T	132	12/97→01/05					
1.8 T quattro	110	02/97→01/05					
1.8 T quattro	132	12/97→01/05					
1.9 TDI	81	04/97→10/00					
1.9 TDI	85	07/00→01/05					
1.9 TDI	96	08/01→01/05					
2.0	96	08/01→01/05					
2.4	100	07/98→01/05					
2.4	115	02/97→01/05					
2.4	120	02/97→01/05					
2.4	121	02/97→01/05					
2.4	125	08/01→01/05					
2.4 quattro	115	08/98→07/99					
2.4 quattro	120	02/97→01/05					
2.4 quattro	121	02/97→01/05					
2.4 quattro	125	08/01→01/05					
2.5 TDI	110	07/97→01/05					
2.5 TDI	114	08/01→01/05					
2.5 TDI	120	07/02→01/05					
2.5 TDI	132	02/00→01/05					
2.5 TDI quattro	110	07/97→01/05					
2.5 TDI quattro	132	02/00→01/05					
2.7 quattro	187	05/01→07/04					
2.7 T	169	02/99→01/05					
2.7 T quattro	169	12/97→01/05					
2.7 T quattro	184	08/01→01/05					
2.8	132	10/97→05/00					
2.8	140	07/99→01/05					
2.8	142	02/97→01/05					
2.8 quattro	132	01/98→04/00					
2.8 quattro	140	07/99→05/01					
2.8 quattro	142	02/97→01/05					
3.0	160	06/01→01/05					
3.0	162	08/01→01/05					
3.0 quattro	160	06/01→07/04					
3.0 quattro	162	08/01→01/05					
↓							













	kW			 	! #		
AUDI - A6 (4B2, C5) 01/97→01/05							
 Bremskraftverstärker							
4.2 quattro S6 quattro	220 250	11/98→01/05 09/99→01/05		4B-2-130001→		03.7858-4502.4 300202	ATE Ø 9 / 8" pneumatisch
 Hauptbremszylinder							
1.8 1.8 1.8 T 1.8 T quattro 1.9 TDI 2.4 2.5 TDI 2.5 TDI quattro 2.5 TDI quattro 2.8	85 92 132 132 85 100 110 110 132 140	05/97→01/05 07/97→01/05 12/97→01/05 12/97→01/05 07/00→01/05 07/98→01/05 07/97→01/05 07/97→01/05 02/00→01/05 07/99→01/05		4B-2-130136→ → 4B-X-130000; + EDS → 4B-X-130000; + ESP 4B-X-130001→; → 05/01; für Linkslenker; + EDS 4B-X-130001→; → 05/01; für Linkslenker; + ESP 06/01→		03.2125-0373.3 010810 24.2123-1717.3 010521 24.2123-1730.3 010620 24.2125-1712.3 010622 24.2125-1713.3 010623 24.2125-1720.3 010688	ATE Ø 25,4 Ø 23,81 Ø 23,81 Ø 25,4 Ø 25,4 Ø 25,4 Ø 25,4 Ø 25,4 Ø 25,4
1.8 T 1.8 T quattro 2.4 2.4 2.4 2.4 quattro 2.4 quattro 2.8 2.8 quattro	110 110 115 120 121 120 121 142 142	01/97→01/05 02/97→01/05 02/97→01/05 02/97→01/05 02/97→01/05 02/97→01/05 02/97→01/05 02/97→01/05 02/97→01/05		4B-2-130136→ 04/97→; → 4B-X-130000; + EDS 04/97→; → 4B-X-130000; + ESP 4B-X-130001→; → 05/01; für Linkslenker; + EDS 4B-X-130001→; → 05/01; für Linkslenker; + ESP 06/01→		03.2125-0373.3 010810 24.2123-1717.3 010521 24.2123-1730.3 010620 24.2125-1712.3 010622 24.2125-1713.3 010623 24.2125-1720.3 010688	ATE Ø 25,4 Ø 23,81 Ø 23,81 Ø 25,4 Ø 25,4 Ø 25,4 Ø 25,4 Ø 25,4
1.9 TDI 2.4 quattro 2.8 2.8 quattro 2.8 quattro	81 115 132 132 140	04/97→10/00 08/98→07/99 10/97→05/00 01/98→04/00 07/99→05/01		4B-2-130136→ → 4B-X-130000; + EDS → 4B-X-130000; + ESP 4B-X-130001→; für Linkslenker; + EDS 4B-X-130001→; für Linkslenker; + ESP		03.2125-0373.3 010810 24.2123-1717.3 010521 24.2123-1730.3 010620 24.2125-1712.3 010622 24.2125-1713.3 010623	ATE Ø 25,4 Ø 23,81 Ø 23,81 Ø 25,4 Ø 25,4
1.9 TDI 2.4 2.4 quattro 2.5 TDI 2.7 T quattro	96 125 125 114 184	08/01→01/05 08/01→01/05 08/01→01/05 08/01→01/05 08/01→01/05		4B-2-130136→ → 4B-X-130000; + EDS → 4B-X-130000; + ESP → 4B-X-130000; + ESP		03.2125-0373.3 010810 24.2123-1717.3 010521 24.2123-1730.3 010620 24.2125-1720.3 010688	ATE Ø 25,4 Ø 23,81 Ø 23,81 Ø 23,81 Ø 25,4
2.0 2.5 TDI 3.0 3.0 3.0 quattro 3.0 quattro	96 120 160 162 160 162	08/01→01/05 07/02→01/05 06/01→01/05 08/01→01/05 06/01→07/04 08/01→01/05		4B-2-130136→		03.2125-0373.3 010810 24.2125-1720.3 010688	ATE Ø 25,4 Ø 25,4
2.5 TDI 2.7 T	132 169	02/00→01/05 02/99→01/05		4B-2-130136→ → 05/01; für Linkslenker; + EDS → 05/01; für Linkslenker; + ESP 06/01→		03.2125-0373.3 010810 24.2125-1712.3 010622 24.2125-1713.3 010623 24.2125-1720.3 010688	ATE Ø 25,4 Ø 25,4 Ø 25,4 Ø 25,4
2.7 quattro 2.7 T quattro	187 169	05/01→07/04 12/97→01/05		4B-2-130136→ → 4B-X-130000; + EDS → 4B-X-130000; + ESP → 05/01; für Linkslenker; + EDS 4B-X-130001→; → 05/01; für Linkslenker; + ESP 06/01→		03.2125-0373.3 010810 24.2123-1717.3 010521 24.2123-1730.3 010620 24.2125-1712.3 010622 24.2125-1713.3 010623 24.2125-1720.3 010688	ATE Ø 25,4 Ø 23,81 Ø 23,81 Ø 25,4 Ø 25,4 Ø 25,4
4.2 quattro	220	11/98→01/05		4B-2-130136→ → 05/01; + EDS → 05/01; + ESP 06/01→		03.2125-0373.3 010810 24.2125-1712.3 010622 24.2125-1713.3 010623 24.2125-1720.3 010688	ATE Ø 25,4 Ø 25,4 Ø 25,4 Ø 25,4
RS6 quattro	331	07/02→01/05				24.2126-1705.3 010999	TRW Ø 26,99
S6 quattro	250	09/99→01/05		4B-2-130136→ → 05/01 06/01→		03.2125-0373.3 010810 24.2125-1712.3 010622 24.2125-1713.3 010623 24.2125-1720.3 010688	ATE Ø 25,4 Ø 25,4 Ø 25,4 Ø 25,4
AUDI - A6 (4F2, C6) 05/04→03/11							
 Hauptbremszylinder							
2.0 TDI 2.0 TDI 2.0 TDI 2.0 TDI 2.0 TFSI 2.4 2.4 quattro 2.7 TDI 2.7 TDI ↓	89 103 120 125 125 130 130 120 132	09/05→06/06 07/04→10/08 04/09→03/11 11/08→03/11 06/05→03/11 05/04→10/08 01/05→10/08 11/04→03/11 11/04→10/08				24.2126-1705.3 010999	TRW Ø 26,99











	kW			 	! #		
AUDI - A6 (4F2, C6) 05/04→03/11							
 Hauptbremszylinder							
2.7 TDI	140	10/08→03/11				24.2126-1705.3 010999	TRW Ø 26,99
2.7 TDI quattro	120	06/05→03/11					
2.7 TDI quattro	132	11/04→10/08					
2.7 TDI quattro	140	10/08→03/11					
2.8 FSI	140	10/08→03/11					
2.8 FSI	154	11/06→10/08					
2.8 FSI	162	10/08→03/11					
2.8 FSI quattro	140	10/08→03/11					
2.8 FSI quattro	154	06/07→10/08					
2.8 FSI quattro	162	10/08→03/11					
3.0	160	08/04→05/06					
3.0 quattro	160	05/04→05/06					
3.0 TDI quattro	155	05/04→03/11					
3.0 TDI quattro	165	05/04→05/06					
3.0 TDI quattro	171	06/06→10/08					
3.0 TDI quattro	176	10/08→03/11					
3.0 TFSI quattro	213	10/08→03/11					
3.0 TFSI quattro	220	10/08→03/11					
3.2 FSI	188	05/04→05/09					
3.2 FSI	195	05/09→03/11					
3.2 FSI quattro	183	09/06→10/08					
3.2 FSI quattro	188	05/04→10/08					
4.2 FSI quattro	257	06/06→03/11					
4.2 quattro	246	05/04→05/06					
RS6 quattro	426	09/08→08/10					
S6 quattro	320	03/06→03/11					
2.0 TDI	100	07/04→03/11		06/05→		24.2126-1705.3 010999	TRW Ø 26,99
AUDI - A6 Allroad (4FH, C6) 05/06→08/11							
 Hauptbremszylinder							
2.7 TDI quattro	120	05/06→08/11		→ 05/11		24.2126-1705.3 010999	TRW Ø 26,99
2.7 TDI quattro	140	10/08→08/11					
3.0 TDI quattro	155	05/06→08/11					
3.0 TDI quattro	176	10/08→08/11					
3.0 TFSI quattro	213	10/08→08/11					
2.7 TDI quattro	132	05/06→10/08				24.2126-1705.3 010999	TRW Ø 26,99
3.0 TDI quattro	171	05/06→10/08					
3.2 FSI quattro	188	05/06→10/08					
4.2 FSI quattro	257	05/06→12/10					
AUDI - A6 Avant (4A, C4) 06/94→12/97							
 Bremskraftverstärker							
2.4	110	07/96→12/97		4B-2-130001→		03.7858-4502.4 300202	ATE Ø 9 / 8" pneumatisch
S6 4.2 quattro	213	06/94→12/97		09/94→		10.0124-3202.3 340011	ATE hydraulisch
S6 Plus quattro	240	04/96→12/97		06/96→		10.0124-3202.3 340011	ATE hydraulisch
S6 Turbo quattro	169	06/94→12/97				10.0124-3202.3 340011	ATE hydraulisch
 Hauptbremszylinder							
1.8	92	12/95→12/97		+ ABS		24.2123-1731.3 010621	Ø 23,81
2.0	79	08/95→07/96					
2.8	142	12/95→12/97					
1.8 quattro	92	12/95→12/97				24.2123-1731.3 010621	Ø 23,81
2.0 16V quattro	103	06/94→12/97					
2.5 TDI quattro	103	07/95→12/97					
2.6 quattro	110	06/94→12/97					
2.8 quattro	128	06/94→12/97					
2.8 quattro	142	12/95→12/97					
1.9 TDI	66	06/94→12/97		→ 06/95; - ABS		03.2123-0491.3 010167	Ø 23,81
2.0	74	06/94→12/97		→ 06/95; - EDS / + ABS		24.2123-1602.3 010384	TRW Ø 23,81
2.0	85	06/94→12/97					
2.0 16V	103	06/94→12/97		→ 06/95; + EDS / + ABS		24.2123-1731.3 010621	Ø 23,81
2.3	98	06/94→12/95					
2.5 TDI	84	01/95→12/97		07/95→; + ABS		24.2123-1731.3 010621	Ø 23,81
2.5 TDI	85	06/94→12/97					
2.5 TDI	103	08/94→12/97					
2.6	102	06/94→02/97					
2.6	110	06/94→12/97					
2.8	128	06/94→12/97					
2.3 quattro	98	06/94→12/95		08/94→		24.2123-1731.3 010621	Ø 23,81
2.4	110	07/96→12/97		4B-2-130136→		03.2125-0373.3 010810	ATE Ø 25,4
				04/97→; → 4B-X-130000; + EDS		24.2123-1717.3 010521	Ø 23,81
				04/97→; → 4B-X-130000; + ESP		24.2123-1730.3 010620	Ø 23,81
				4B-X-130001→; für Linkslenker; + EDS		24.2125-1712.3 010622	Ø 25,4
				4B-X-130001→; für Linkslenker; + ESP		24.2125-1713.3 010623	Ø 25,4
↓							













	kW			 	! #		
AUDI - A6 Avant (4A, C4) 06/94→12/97							
 Bremskraftregler							
1.8	92	12/95→12/97		für Fahrzeuge ohne Niveauregulierung	03.6585-0108.3	320115	ATE lastabhängig 8/5 4x
1.9 TDI	66	06/94→12/97					
2.0	74	06/94→12/97					
2.0	79	08/95→07/96					
2.0	85	06/94→12/97					
2.0 16V	103	06/94→12/97					
2.3	98	06/94→12/95					
2.5 TDI	84	01/95→12/97					
2.5 TDI	85	06/94→12/97					
2.5 TDI	103	08/94→12/97					
2.6	102	06/94→02/97					
2.6	110	06/94→12/97					
2.8	128	06/94→12/97					
2.8	142	12/95→12/97					
AUDI - A6 Avant (4B5, C5) 11/97→01/05							
 Bremskraftverstärker							
1.8	85	02/98→01/05		4B-2-130001→	03.7858-4502.4	300202	ATE Ø 9 / 8" pneumatisch
1.8	92	12/97→01/05					
1.8 T	110	12/97→01/05					
1.8 T	132	04/99→01/05					
1.8 T quattro	110	12/97→01/05					
1.8 T quattro	132	12/97→01/05					
1.9 TDI	81	02/98→04/01					
1.9 TDI	85	07/00→01/05					
1.9 TDI	96	08/01→01/05					
2.0	96	08/01→01/05					
2.4	100	07/98→01/05					
2.4	115	12/97→01/05					
2.4	120	12/97→01/05					
2.4	121	12/97→01/05					
2.4	125	08/01→01/05					
2.4 quattro	115	08/98→05/01					
2.4 quattro	120	12/97→01/05					
2.4 quattro	121	12/97→01/05					
2.4 quattro	125	08/01→01/05					
2.5 TDI	110	12/97→01/05					
2.5 TDI	114	08/01→01/05					
2.5 TDI	120	07/02→01/05					
2.5 TDI	132	02/00→01/05					
2.5 TDI quattro	110	12/97→01/05					
2.5 TDI quattro	132	02/00→01/05					
2.7 T	169	02/99→01/05					
2.7 T quattro	169	12/97→01/05					
2.7 T quattro	184	08/01→01/05					
2.8	132	12/97→05/00					
2.8	140	07/99→01/05					
2.8	142	12/97→01/05					
2.8 quattro	142	12/97→01/05					
3.0	160	06/01→01/05					
3.0	162	08/01→01/05					
3.0 quattro	160	06/01→01/05					
3.0 quattro	162	08/01→01/05					
4.2 quattro	220	11/98→01/05					
S6 quattro	250	09/99→01/05					
 Hauptbremszylinder							
1.8	85	02/98→01/05		4B-2-130136→	03.2125-0373.3	010810	ATE Ø 25,4
1.8	92	12/97→01/05		→ 4B-X-130000; + EDS	24.2123-1717.3	010521	Ø 23,81
1.8 T	110	12/97→01/05					
1.8 T	132	04/99→01/05		→ 4B-X-130000; + ESP	24.2123-1730.3	010620	Ø 23,81
1.8 T quattro	110	12/97→01/05		4B-X-130001→; → 05/01;			
1.8 T quattro	132	12/97→01/05		für Linkslenker; + EDS	24.2125-1712.3	010622	Ø 25,4
1.9 TDI	85	07/00→01/05					
2.4	100	07/98→01/05		4B-X-130001→; → 05/01;			
2.4	115	12/97→01/05		für Linkslenker; + ESP	24.2125-1713.3	010623	Ø 25,4
2.4	120	12/97→01/05		06/01→	24.2125-1720.3	010688	TRW Ø 25,4
2.4	121	12/97→01/05					
2.4 quattro	120	12/97→01/05					
2.4 quattro	121	12/97→01/05					
2.5 TDI	110	12/97→01/05					
2.5 TDI quattro	110	12/97→01/05					
2.5 TDI quattro	132	02/00→01/05					
2.8	140	07/99→01/05					
2.8	142	12/97→01/05					
2.8 quattro	142	12/97→01/05					
1.9 TDI	81	02/98→04/01		4B-2-130136→	03.2125-0373.3	010810	ATE Ø 25,4
2.4 quattro	115	08/98→05/01		→ 4B-X-130000; + EDS	24.2123-1717.3	010521	Ø 23,81
2.8	132	12/97→05/00		→ 4B-X-130000; + ESP	24.2123-1730.3	010620	Ø 23,81
				4B-X-130001→; für Linkslenker; + EDS	24.2125-1712.3	010622	Ø 25,4
↓							













	kW			 	! #		
AUDI - A6 Avant (4B5, C5) 11/97→01/05							
 Hauptbremszylinder							
1.9 TDI 2.4 quattro 2.8	81 115 132	02/98→04/01 08/98→05/01 12/97→05/00		4B-X-130001→; für Linkslenker; + ESP		24.2125-1713.3 010623	Ø 25,4
1.9 TDI 2.4 2.4 quattro 2.5 TDI 2.7 T quattro	96 125 125 114 184	08/01→01/05 08/01→01/05 08/01→01/05 08/01→01/05 08/01→01/05		4B-2-130136→ → 4B-X-130000; + EDS → 4B-X-130000; + ESP		03.2125-0373.3 010810 24.2123-1717.3 010521 24.2123-1730.3 010620 24.2125-1720.3 010688	ATE Ø 25,4 Ø 23,81 Ø 23,81 TRW Ø 25,4
2.0 2.5 TDI 3.0 3.0 3.0 quattro 3.0 quattro	96 120 160 162 160 162	08/01→01/05 07/02→01/05 06/01→01/05 08/01→01/05 06/01→01/05 08/01→01/05		4B-2-130136→		03.2125-0373.3 010810 24.2125-1720.3 010688	ATE Ø 25,4 TRW Ø 25,4
2.5 TDI 2.7 T	132 169	02/00→01/05 02/99→01/05		4B-2-130136→ → 05/01; für Linkslenker; + EDS → 05/01; für Linkslenker; + ESP 06/01→		03.2125-0373.3 010810 24.2125-1712.3 010622 24.2125-1713.3 010623 24.2125-1720.3 010688	ATE Ø 25,4 Ø 25,4 Ø 25,4 TRW Ø 25,4
2.7 T quattro	169	12/97→01/05		4B-2-130136→ → 4B-X-130000; + EDS → 4B-X-130000; + ESP → 05/01; für Linkslenker; + EDS 4B-X-130001→; → 05/01; für Linkslenker; + ESP 06/01→		03.2125-0373.3 010810 24.2123-1717.3 010521 24.2123-1730.3 010620 24.2125-1712.3 010622 24.2125-1713.3 010623 24.2125-1720.3 010688	ATE Ø 25,4 Ø 23,81 Ø 23,81 Ø 25,4 Ø 25,4 TRW Ø 25,4
4.2 quattro	220	11/98→01/05		4B-2-130136→ → 05/01; + EDS → 05/01; + ESP 06/01→		03.2125-0373.3 010810 24.2125-1712.3 010622 24.2125-1713.3 010623 24.2125-1720.3 010688	ATE Ø 25,4 Ø 25,4 Ø 25,4 TRW Ø 25,4
RS6 plus quattro RS6 quattro	353 331	04/04→01/05 07/02→01/05				24.2126-1705.3 010999	TRW Ø 26,99
S6 quattro	250	09/99→01/05		4B-2-130136→ → 05/01 06/01→		03.2125-0373.3 010810 24.2125-1712.3 010622 24.2125-1713.3 010623 24.2125-1720.3 010688	ATE Ø 25,4 Ø 25,4 Ø 25,4 TRW Ø 25,4
AUDI - A6 Avant (4F5, C6) 03/05→08/11							
 Hauptbremszylinder							
2.0 TDI 2.0 TDI 2.0 TDI 2.0 TDI 2.0 TFSI 2.4 2.4 quattro 2.7 TDI 2.7 TDI 2.7 TDI 2.7 TDI quattro 2.7 TDI quattro 2.7 TDI quattro 2.8 FSI 2.8 FSI 2.8 FSI 2.8 FSI quattro 2.8 FSI quattro 2.8 FSI quattro 3.0 3.0 quattro 3.0 TDi 3.0 TDI quattro 3.0 TDI quattro 3.0 TDI quattro 3.0 TDI quattro 3.0 TFSI quattro 3.0 TFSI quattro 3.2 FSI 3.2 FSI quattro 4.2 FSI quattro 4.2 quattro RS6 quattro S6 quattro	89 100 103 120 125 125 130 130 120 132 140 120 132 140 140 154 162 140 154 162 140 160 160 171 155 165 171 176 213 220 188 188 257 246 426 320	09/05→06/06 06/05→08/11 06/05→10/08 04/09→08/11 10/08→08/11 06/05→08/11 03/05→10/08 03/05→10/08 03/05→08/11 03/05→10/08 10/08→08/11 06/05→08/11 03/05→10/08 10/08→08/11 10/08→08/11 11/06→10/08 10/08→08/11 10/08→08/11 06/07→10/08 10/08→08/11 03/05→05/06 03/05→05/06 06/06→08/11 03/05→08/11 03/05→05/06 06/06→10/08 10/08→08/11 10/08→08/11 10/08→08/11 03/05→10/08 03/05→10/08 06/06→08/11 03/05→05/06 04/08→08/10 03/06→08/11				24.2126-1705.3 010999	TRW Ø 26,99













	kW			 	! #		
AUDI - A8 (4D2, 4D8) 03/94→12/02							
 Hauptbremszylinder							
2.5 TDI	110	01/97→04/00		06/97→; - ESP		24.2125-1712.3 010622	Ø 25,4
				06/97→; + ESP		24.2125-1713.3 010623	Ø 25,4
2.5 TDI	132	09/00→09/02		- ESP		24.2125-1712.3 010622	Ø 25,4
2.5 TDI quattro	110	07/97→04/00		+ ESP		24.2125-1713.3 010623	Ø 25,4
2.5 TDI quattro	132	09/00→09/02					
2.8	120	07/95→03/96					
2.8	142	04/96→09/02					
2.8 quattro	120	07/95→03/96					
2.8 quattro	142	04/96→09/02					
3.3 TDI quattro	165	06/00→09/02					
3.7	169	07/95→12/98					
3.7	191	11/98→09/02					
3.7 quattro	191	11/98→09/02					
4.2 quattro	175	02/99→04/00					
4.2 quattro	210	07/95→09/98					
4.2 quattro	224	09/96→12/99					
4.2 quattro	228	11/98→09/02					
6.0 W12 quattro	309	01/01→09/02					
S8 quattro	250	07/96→06/99					
S 8 quattro	265	06/99→09/02					
2.8	128	03/94→03/96		06/94→; - ESP		24.2125-1712.3 010622	Ø 25,4
2.8 quattro	128	03/94→03/96		06/94→; + ESP		24.2125-1713.3 010623	Ø 25,4
4.2 quattro	180	03/94→07/96					
4.2 quattro	220	03/94→11/98					
3.7 quattro	169	07/95→11/98		10/95→; - ESP		24.2125-1712.3 010622	Ø 25,4
				10/95→; + ESP		24.2125-1713.3 010623	Ø 25,4
AUDI - A8 (4H_) 11/09→							
 Hauptbremszylinder							
2.0 TFSI hybrid	155	02/12→		05/12→; nicht für gepanzerte Fahrzeuge		24.2125-1739.3 010948	TRW Ø 25,4
2.0 TFSI quattro	185	09/16→		nicht für gepanzerte Fahrzeuge		24.2125-1739.3 010948	TRW Ø 25,4
2.5 TFSI	150	07/12→					
3.0 TDI	150	09/11→					
3.0 TDI quattro	155	08/10→					
3.0 TDI quattro	176	11/12→					
3.0 TDI quattro	184	07/10→					
3.0 TDI quattro	190	10/13→					
3.0 TDI quattro	193	05/15→					
3.0 TFSI quattro	213	07/10→					
3.0 TFSI quattro	228	11/11→					
4.0 TFSI quattro	309	03/12→					
4.0 TFSI quattro	320	10/13→					
4.2 FSI quattro	273	11/09→					
4.2 TDI quattro	258	11/09→					
4.2 TDI quattro	283	10/13→					
6.3 W12 quattro	368	01/11→					
S8 plus quattro	445	11/15→					
S8 quattro	382	04/12→					
3.0 TFSI quattro	245	06/10→		07/10→; nicht für gepanzerte Fahrzeuge		24.2125-1739.3 010948	TRW Ø 25,4
AUDI - ALLROAD (4BH, C5) 05/00→08/05							
 Hauptbremszylinder							
2.5 TDI quattro	120	05/03→08/05		für Linkslenker; → 07/05		24.2125-1713.3 010623	Ø 25,4
2.5 TDI quattro	132	05/00→08/05					
2.7 quattro	187	09/00→08/05					
2.7 T quattro	184	05/00→08/05					
4.2 V8 quattro	220	07/02→08/05					
AUDI - CABRIOLET (8G7, B4) 05/91→08/00							
 Hauptbremszylinder							
1.9 TDI	66	06/95→08/00		07/95→; → 8G-V-010000; für Rechtslenker; - ABS		03.2122-9612.3 010159	Ø 22,2
				8G-P-000001→ 8G-V-010000; für Linkslenker; - ABS		03.2123-0491.3 010167	Ø 23,81
				07/95→; für Linkslenker; + ABS		24.2123-1602.3 010384	TRW Ø 23,81
2.0 16V	103	06/95→07/96		8G-P-000001→ 8G-V-010000; für Linkslenker; - ABS		03.2123-0491.3 010167	Ø 23,81
				für Linkslenker; + ABS		24.2123-1602.3 010384	TRW Ø 23,81
2.0 E	85	01/93→07/98		→ 8G-V-010000; für Rechtslenker; - ABS		03.2122-9612.3 010159	Ø 22,2
				8G-P-000001→ 8G-V-010000; für Linkslenker; - ABS		03.2123-0491.3 010167	Ø 23,81
2.6	102	05/95→08/00		→ 8G-V-010000; für Rechtslenker		03.2123-0566.3 010169	Ø 23,81
2.8	128	11/92→08/00		für Linkslenker		24.2123-1602.3 010384	TRW Ø 23,81
↓							











	kw			 	! #		
AUDI - CABRIOLET (8G7, B4) 05/91→08/00							
 Hauptbremszylinder							
2.6	110	06/93→08/00		01/94→; → 8G-V-010000; für Rechtslenker		03.2123-0566.3 010169	Ø 23,81
				01/94→; für Linkslenker		24.2123-1602.3 010384	TRW Ø 23,81
Verschlussschraube, Hauptbremszylinder							
1.9 TDI	66	06/95→08/00		8G-P-000001→ 8G-V-010000; für Linkslenker; - ABS		03.3517-0101.2 390322	
2.0 16V	103	06/95→07/96					
2.0 E	85	01/93→07/98					
 Bremskraftregler							
1.8	92	01/97→08/00		04/97→		03.6585-0108.3 320115	ATE lastabhängig 8/5 4x
1.9 TDI	66	06/95→08/00		07/95→		03.6585-0108.3 320115	ATE lastabhängig 8/5 4x
2.0 16V	103	06/95→07/96				03.6585-0108.3 320115	ATE lastabhängig 8/5 4x
2.0 E	85	01/93→07/98					
2.6	102	05/95→08/00					
2.6	110	06/93→08/00		01/94→		03.6585-0108.3 320115	ATE lastabhängig 8/5 4x
AUDI - COUPE (89, 8B) 10/88→12/96							
 Bremskraftverstärker							
2.0	85	05/89→12/96		→ 8B-N-500000; für Linkslenker		03.7750-0302.4 300071	ATE Ø 9" pneumatisch
2.0 16 V	103	08/92→12/96					
2.3	98	03/90→12/96					
2.3 20V quattro	123	05/90→12/96		für Linkslenker		10.0124-3202.3 340011	ATE hydraulisch
S2 quattro	169	10/92→12/96					
2.3 quattro	98	05/90→12/96		für Linkslenker		03.7750-0302.4 300071	ATE Ø 9" pneumatisch
 Hauptbremszylinder							
2.0	85	05/89→12/96		für Rechtslenker; - ABS		03.2122-9612.3 010159	Ø 22,2
				→ 07/92; für Linkslenker; - ABS		03.2122-9612.3 010159	Ø 22,2
				08/92→; für Linkslenker; - ABS		03.2123-0491.3 010167	Ø 23,81
				07/94→; für Rechtslenker		03.2123-0566.3 010169	Ø 23,81
				08/92→; für Linkslenker; + ABS		24.2123-1602.3 010384	TRW Ø 23,81
2.0 16 V	103	08/92→12/96		für Linkslenker; - ABS		03.2123-0491.3 010167	Ø 23,81
				07/94→; für Rechtslenker		03.2123-0566.3 010169	Ø 23,81
				für Linkslenker; + ABS		24.2123-1602.3 010384	TRW Ø 23,81
2.3	98	03/90→12/96		→ 07/92; für Linkslenker; - ABS		03.2122-9612.3 010159	Ø 22,2
				→ 07/94; für Rechtslenker; - ABS		03.2122-9612.3 010159	Ø 22,2
				08/92→; für Linkslenker; - ABS		03.2123-0491.3 010167	Ø 23,81
				08/92→; für Linkslenker; + ABS		24.2123-1602.3 010384	TRW Ø 23,81
2.3 20V quattro	123	05/90→12/96				03.2125-3210.3 010212	Ø 25,4
2.3 quattro	98	05/90→12/96		- ABS		03.2122-9612.3 010159	Ø 22,2
2.6	110	08/92→12/96		für Rechtslenker		03.2123-0566.3 010169	Ø 23,81
				→ 06/94; für Linkslenker		24.2123-1602.3 010384	TRW Ø 23,81
2.6 quattro	110	08/92→12/96		für Rechtslenker		03.2123-0566.3 010169	Ø 23,81
2.8 quattro	128	08/91→12/96					
2.8	128	09/91→12/96		für Linkslenker; - ABS		03.2123-0491.3 010167	Ø 23,81
				für Rechtslenker		03.2123-0566.3 010169	Ø 23,81
				→ 06/94; für Linkslenker; + ABS		24.2123-1602.3 010384	TRW Ø 23,81
S2 quattro	169	10/92→12/96				03.2125-3610.3 010214	Ø 25,4
Verschlussschraube, Hauptbremszylinder							
2.0	85	05/89→12/96		07/94→; für Rechtslenker		03.3517-0101.2 390322	
2.0 16 V	103	08/92→12/96					
2.6	110	08/92→12/96		für Rechtslenker		03.3517-0101.2 390322	
2.6 quattro	110	08/92→12/96					
2.8	128	09/91→12/96					
2.8 quattro	128	08/91→12/96					
 Bremskraftregler							
2.0	85	05/89→12/96				03.6585-0108.3 320115	ATE lastabhängig 8/5 4x
2.3	98	03/90→12/96					
2.6	110	08/92→12/96					
2.0 16 V	103	08/92→12/96		→ 07/94		03.6585-0108.3 320115	ATE lastabhängig 8/5 4x
AUDI - Q2 (GA) 06/16→							
 Hauptbremszylinder							
1.0 TFSI	85	09/16→		für Linkslenker		24.4123-1719.3 011017	TRW Ø 23,81
1.4 TFSI quattro	110	09/16→					ohne Bremsflüssigkeitsbehälter







	kW			 	! #		
AUDI - Q2 (GA) 06/16→							
 Hauptbremszylinder							
2.0 TDI	110	09/16→		für Linkslenker		24.4123-1719.3 011017	TRW Ø 23,81 ohne Bremsflüssigkeitsbehälter
2.0 TDI quattro	110	10/16→					
2.0 TFSI quattro	140	09/16→					
1.4 TFSI	110	06/16→		09/16→; für Linkslenker		24.4123-1719.3 011017	TRW Ø 23,81 ohne Bremsflüssigkeitsbehälter
1.6 TDI	85	06/16→					
2.0 TDI quattro	140	07/16→					
AUDI - Q3 (8U) 06/11→							
 Hauptbremszylinder							
1.4 TFSI	92	07/16→		für Linkslenker		03.2123-3549.3 010809	ATE Ø 23,81
1.4 TFSI	110	10/13→					
2.0 TDI	88	03/15→					
2.0 TDI	100	09/11→					
2.0 TDI	103	09/11→					
2.0 TDI	110	11/14→					
2.0 TDI	130	05/13→					
2.0 TDI	135	05/15→					
2.0 TDI quattro	103	01/12→					
2.0 TDI quattro	110	11/14→					
2.0 TDI quattro	120	06/11→					
2.0 TDI quattro	130	06/11→					
2.0 TDI quattro	135	11/14→					
2.0 TFSI	132	05/15→		für Linkslenker		03.4153-0186.3 010816	ATE Ø 23,81
2.0 TFSI quattro	125	06/11→					
2.0 TFSI quattro	132	11/14→					
2.0 TFSI quattro	155	06/11→					
2.0 TFSI quattro	162	11/14→					
RS 2.5 quattro	228	10/13→		für Linkslenker		03.2125-5112.3 010966	ATE Ø 25,4
RS performance 2.5 quattro	270	01/15→					
RS 2.5 quattro	250	05/13→		03/15→; für Linkslenker		03.2125-5112.3 010966	ATE Ø 25,4
AUDI - Q5 (8R) 11/08→							
 Bremskraftverstärker							
2.0 TDI	100	11/10→				03.7858-4432.4 300304	ATE Ø 9 / 8" pneumatisch
2.0 TDI	105	11/10→					
2.0 TDI	110	05/13→					
2.0 TDI	140	09/15→					
2.0 TDI quattro	100	08/09→					
2.0 TDI quattro	105	08/09→					
2.0 TDI quattro	110	05/13→					
2.0 TDI quattro	140	11/13→					
2.0 TFSI quattro	132	08/09→					
2.0 TFSI quattro	162	05/13→					
2.0 TFSI quattro	169	08/15→					
3.0 TDI quattro	190	11/13→					
SQ5 TDI quattro	230	12/12→					
SQ5 TDI quattro	240	04/15→					
SQ5 TDI quattro	250	11/15→					
SQ5 TFSI quattro	260	05/13→					
2.0 TDI quattro	120	11/08→		03/09→		03.7858-4432.4 300304	ATE Ø 9 / 8" pneumatisch
2.0 TDI quattro	125	11/08→		→ 02/09		03.7858-4432.4 300304	ATE Ø 9 / 8" pneumatisch
2.0 TFSI quattro	155	11/08→					
3.0 TDI quattro	155	11/08→					
3.0 TDI quattro	176	11/08→					
3.2 FSI quattro	199	11/08→					
2.0 TDI quattro	130	06/12→		09/12→		03.7858-4432.4 300304	ATE Ø 9 / 8" pneumatisch
2.0 TFSI quattro	165	06/12→					
3.0 TDI quattro	180	06/12→					
3.0 TDI quattro	184	06/12→					
3.0 TFSI quattro	200	06/12→					
2.0 TFSI hybrid quattro	155	06/11→				03.7858-4632.4 300273	ATE Ø 9 / 8" pneumatisch
 Hauptbremszylinder							
2.0 TDI	100	11/10→				03.2125-0493.3 010940	ATE Ø 25,4
2.0 TDI	105	11/10→					
2.0 TDI	110	05/13→					
2.0 TDI	140	09/15→					
2.0 TDI quattro	100	08/09→					
2.0 TDI quattro	105	08/09→					
2.0 TDI quattro	110	05/13→					
2.0 TDI quattro	140	11/13→					
2.0 TFSI quattro	132	08/09→					
2.0 TFSI quattro	162	05/13→					
3.0 TDI quattro	190	11/13→					
SQ5 TDI quattro	230	12/12→					
SQ5 TDI quattro	240	04/15→					
SQ5 TDI quattro	250	11/15→					
SQ5 TFSI quattro	260	05/13→					
↓							











	kw			 	! #		
AUDI - Q5 (8R) 11/08→							
 Hauptbremszylinder							
2.0 TDI quattro	120	11/08→		03/09→		03.2125-0493.3 010940	ATE Ø 25,4
2.0 TDI quattro	125	11/08→					
2.0 TFSI quattro	155	11/08→					
3.0 TDI quattro	155	11/08→					
3.0 TDI quattro	176	11/08→					
3.2 FSI quattro	199	11/08→					
2.0 TDI quattro	130	06/12→		09/12→		03.2125-0493.3 010940	ATE Ø 25,4
2.0 TFSI quattro	165	06/12→					
3.0 TDI quattro	180	06/12→					
3.0 TDI quattro	184	06/12→					
3.0 TFSI quattro	200	06/12→					
AUDI - Q7 (4L) 03/06→08/15							
 Bremskraftverstärker							
3.0 TDI quattro	150	05/10→08/15		für Linkslenker;		03.7868-4503.4 300245	ATE Ø 10 / 8" pneumatisch
3.0 TDI quattro	155	03/06→05/10		für Fahrzeuge ohne autom. Distanzregelung			
3.0 TDI quattro	165	06/09→05/12					
3.0 TDI quattro	171	03/06→05/08		für Linkslenker;		03.7868-4702.4 300253	ATE Ø 10 / 8" pneumatisch
3.0 TDI quattro	176	11/07→08/15		für Fahrzeuge mit autom. Distanzregelung			
3.0 TDI quattro	180	05/11→08/15					
3.0 TFSI quattro	200	05/10→08/15					
3.0 TFSI quattro	206	05/11→08/15					
3.0 TFSI quattro	245	05/10→08/15					
3.6 FSI quattro	206	08/06→05/10					
4.2 FSI quattro	257	03/06→05/10					
4.2 TDI quattro	240	03/07→06/09					
4.2 TDI quattro	250	05/09→08/15					
6.0 TDI quattro	368	09/08→05/14					
Pedalwegsensoren, Bremspedal							
3.0 TDI quattro	150	05/10→08/15		für Rechtslenker;		03.0655-0006.2 370006	ATE
3.0 TDI quattro	155	03/06→05/10		für Fahrzeuge mit autom. Distanzregelung			
3.0 TDI quattro	165	06/09→05/12					
3.0 TDI quattro	171	03/06→05/08		für Linkslenker;		03.0655-0006.2 370006	ATE
3.0 TDI quattro	176	11/07→08/15		für Fahrzeuge mit autom. Distanzregelung			
3.0 TDI quattro	180	05/11→08/15					
3.0 TFSI quattro	200	05/10→08/15					
3.0 TFSI quattro	206	05/11→08/15					
3.0 TFSI quattro	245	05/10→08/15					
3.6 FSI quattro	206	08/06→05/10					
4.2 FSI quattro	257	03/06→05/10					
4.2 TDI quattro	240	03/07→06/09					
4.2 TDI quattro	250	05/09→08/15					
6.0 TDI quattro	368	09/08→05/14					
 Hauptbremszylinder							
3.0 TDI quattro	150	05/10→08/15		für Linkslenker		03.2126-3063.3 010812	ATE Ø 26,99
3.0 TDI quattro	155	03/06→05/10					
3.0 TDI quattro	165	06/09→05/12					
3.0 TDI quattro	171	03/06→05/08					
3.0 TDI quattro	176	11/07→08/15					
3.0 TDI quattro	180	05/11→08/15					
3.0 TFSI quattro	200	05/10→08/15					
3.0 TFSI quattro	206	05/11→08/15					
3.0 TFSI quattro	245	05/10→08/15					
3.6 FSI quattro	206	08/06→05/10					
4.2 FSI quattro	257	03/06→05/10					
4.2 TDI quattro	240	03/07→06/09					
4.2 TDI quattro	250	05/09→08/15					
6.0 TDI quattro	368	09/08→05/14					
AUDI - TT (8J3) 08/06→06/14							
 Bremskraftverstärker							
1.8 TFSI	118	06/08→06/14		für Linkslenker		03.7860-4203.4 300243	ATE Ø 10" pneumatisch
2.0 TDI quattro	125	06/08→06/14					
2.0 TFSI	147	08/06→06/10					
2.0 TFSI	155	05/10→06/14					
2.0 TFSI quattro	147	06/08→06/10					
2.0 TFSI quattro	155	05/10→06/14					
2.0 TTS quattro	195	05/08→06/14					
2.0 TTS quattro	200	05/08→06/14		für Linkslenker		03.7870-0602.4 300310	ATE Ø 11" pneumatisch
2.5 RS quattro	250	07/09→06/14					
2.5 RS quattro	265	05/11→06/14		02/12→; für Linkslenker		03.7870-0602.4 300310	ATE Ø 11" pneumatisch
3.2 V6 quattro	184	08/06→06/10		für Linkslenker; +PR 1AT		03.7870-0602.4 300310	ATE Ø 11" pneumatisch
 Hauptbremszylinder							
1.8 TFSI	118	06/08→06/14		für Linkslenker		03.2123-3549.3 010809	ATE Ø 23,81
2.0 TDI quattro	125	06/08→06/14					











	kW			 	! #		
AUDI - TT (8J3) 08/06→06/14							
 Hauptbremszylinder							
2.0 TFSI	147	08/06→06/10		für Linkslenker		03.2123-3549.3 010809	ATE Ø 23,81
2.0 TFSI	155	05/10→06/14					
2.0 TFSI quattro	147	06/08→06/10					
2.0 TFSI quattro	155	05/10→06/14					
2.0 TTS quattro	195	05/08→06/14					
2.0 TTS quattro	200	05/08→06/14		für Linkslenker		03.2125-5112.3 010966	ATE Ø 25,4
2.5 RS quattro	250	07/09→06/14					
2.5 RS quattro	265	05/11→06/14					
3.2 V6 quattro	184	08/06→06/10					
Drucksensor, Bremskraftverstärker							
2.0 TTS quattro	200	05/08→06/14		für Rechtslenker; +PR 1AS		03.0655-0101.2 370008	ATE
2.5 RS quattro	250	07/09→06/14					
2.5 RS quattro	265	05/11→06/14					
3.2 V6 quattro	184	08/06→06/10		für Linkslenker; +PR 1AS		03.0655-0101.2 370008	ATE
AUDI - TT (8N3) 10/98→06/06							
 Bremskraftverstärker							
1.8 T	110	09/02→06/06		für Linkslenker		03.7860-0602.4 300141	ATE Ø 10" pneumatisch
1.8 T	120	09/05→06/06					
1.8 T	140	09/05→06/06					
1.8 T quattro	140	09/05→06/06					
1.8 T quattro	176	03/05→06/06					
3.2 VR6 quattro	184	07/03→06/06					
1.8 T	132	10/98→06/06		8N-2-014301→; für Linkslenker		03.7860-0602.4 300141	ATE Ø 10" pneumatisch
1.8 T quattro	132	10/98→06/06		→ 8N-2-014300; für Linkslenker; + ESP		03.7863-0402.4 300124	ATE Ø 10" pneumatisch
1.8 T quattro	165	10/98→06/06					
 Hauptbremszylinder							
1.8 T	110	09/02→06/06		für Linkslenker		03.2123-2654.3 010801	ATE Ø 23,81
1.8 T	120	09/05→06/06					
1.8 T	140	09/05→06/06					
1.8 T quattro	140	09/05→06/06					
1.8 T quattro	176	03/05→06/06					
3.2 VR6 quattro	184	07/03→06/06					
1.8 T	132	10/98→06/06		→ 8N-2-014300; für Linkslenker; + ESP		03.2123-2024.3 010597	ATE Ø 23,81
1.8 T quattro	132	10/98→06/06		→ 8N-2-014300; für Rechtslenker; + ESP		03.2123-2064.3 010598	ATE Ø 23,81
1.8 T quattro	165	10/98→06/06		09/02→; für Linkslenker		03.2123-2654.3 010801	ATE Ø 23,81
				8N-2-014301→; → 08/02; für Linkslenker		03.2123-2715.3 010802	ATE Ø 23,81
				8N-2-014301→; → 08/02; für Rechtslenker		03.2123-2774.3 010803	ATE Ø 23,81
				→ 8N-2-014300; für Linkslenker; - ESP		24.2123-1709.3 010503	Ø 23,81
AUDI - TT (FV3) 07/14→							
 Hauptbremszylinder							
1.8 TFSI	132	08/15→		für Linkslenker		24.4123-1719.3 011017	TRW Ø 23,81 ohne Bremsflüssigkeitsbehälter
2.0 TDI	135	07/14→					
2.0 TDI quattro	135	01/17→					
2.0 TFSI	169	07/14→					
2.0 TFSI quattro	162	04/15→					
2.0 TFSI quattro	169	07/14→					
AUDI - TT Roadster (8J9) 03/07→06/14							
 Bremskraftverstärker							
1.8 TFSI	118	06/08→06/14		für Linkslenker		03.7860-4203.4 300243	ATE Ø 10" pneumatisch
2.0 TDI quattro	125	06/08→06/14					
2.0 TFSI	147	03/07→06/10					
2.0 TFSI	155	05/10→06/14					
2.0 TFSI quattro	147	06/08→06/10					
2.0 TFSI quattro	155	05/10→06/14					
2.0 TTS quattro	195	05/08→06/14					
2.0 TTS quattro	200	05/08→06/14		für Linkslenker		03.7870-0602.4 300310	ATE Ø 11" pneumatisch
2.5 RS quattro	250	07/09→06/14					
2.5 RS quattro	265	03/12→06/14					
3.2 V6 quattro	184	03/07→06/10		für Linkslenker; +PR 1AT		03.7870-0602.4 300310	ATE Ø 11" pneumatisch
 Hauptbremszylinder							
1.8 TFSI	118	06/08→06/14		für Linkslenker		03.2123-3549.3 010809	ATE Ø 23,81
2.0 TDI quattro	125	06/08→06/14					
2.0 TFSI	147	03/07→06/10					
2.0 TFSI quattro	147	06/08→06/10					
2.0 TTS quattro	195	05/08→06/14					
2.0 TTS quattro	200	05/08→06/14		für Linkslenker		03.2125-5112.3 010966	ATE Ø 25,4
2.5 RS quattro	250	07/09→06/14					











	kW					! #		
AUDI - TT Roadster (8J9) 03/07→06/14								
 Hauptbremszylinder								
2.5 RS quattro	265	03/12→06/14		für Linkslenker		03.2125-5112.3	010966	ATE Ø 25,4
3.2 V6 quattro	184	03/07→06/10						
Drucksensor, Bremskraftverstärker								
2.0 TTS quattro	200	05/08→06/14		für Rechtslenker; +PR 1AS		03.0655-0101.2	370008	ATE
2.5 RS quattro	250	07/09→06/14						
2.5 RS quattro	265	03/12→06/14						
3.2 V6 quattro	184	03/07→06/10		für Linkslenker; +PR 1AS		03.0655-0101.2	370008	ATE
AUDI - TT Roadster (8N9) 10/99→06/06								
 Bremskraftverstärker								
1.8 T	110	01/01→06/06		8N-2-014301→; für Linkslenker		03.7860-0602.4	300141	ATE Ø 10" pneumatisch
1.8 T	132	10/99→06/06		→ 8N-2-014300; für Linkslenker; + ESP		03.7863-0402.4	300124	ATE Ø 10" pneumatisch
1.8 T quattro	132	02/00→06/06						
1.8 T quattro	165	10/99→06/06						
1.8 T	120	09/05→06/06		für Linkslenker		03.7860-0602.4	300141	ATE Ø 10" pneumatisch
1.8 T	140	09/05→06/06						
1.8 T quattro	140	09/05→06/06						
3.2 VR6 quattro	184	07/03→06/06						
 Hauptbremszylinder								
1.8 T	110	01/01→06/06		→ 8N-2-014300; für Linkslenker; + ESP		03.2123-2024.3	010597	ATE Ø 23,81
1.8 T	132	10/99→06/06						
1.8 T quattro	132	02/00→06/06		→ 8N-2-014300; für Rechtslenker; + ESP		03.2123-2064.3	010598	ATE Ø 23,81
1.8 T quattro	165	10/99→06/06						
				09/02→; für Linkslenker		03.2123-2654.3	010801	ATE Ø 23,81
				8N-2-014301→; → 08/02; für Linkslenker		03.2123-2715.3	010802	ATE Ø 23,81
				8N-2-014301→; → 08/02; für Rechtslenker		03.2123-2774.3	010803	ATE Ø 23,81
				→ 8N-2-014300; für Linkslenker; - ESP		24.2123-1709.3	010503	Ø 23,81
1.8 T	120	09/05→06/06		für Linkslenker		03.2123-2654.3	010801	ATE Ø 23,81
1.8 T	140	09/05→06/06						
1.8 T quattro	140	09/05→06/06						
3.2 VR6 quattro	184	07/03→06/06						
AUDI - TT Roadster (FV9) 11/14→								
 Hauptbremszylinder								
1.8 TFSI	132	08/15→		für Linkslenker		24.4123-1719.3	011017	TRW Ø 23,81 ohne Bremsflüssigkeitsbehälter
2.0 TDI	135	11/14→						
2.0 TDI quattro	135	01/17→						
2.0 TFSI	169	11/14→						
2.0 TFSI quattro	162	04/15→						
2.0 TFSI quattro	169	11/14→						
AUTOBIANCHI - Y10 03/85→10/95								
 Hauptbremszylinder								
1.0	33	03/85→10/95		06/85→ 12/89		24.2120-0801.3	010362	Ø 20,64
1.0	41	03/85→10/95		12/87→ 12/89		24.2120-0801.3	010362	Ø 20,64
1.0 4WD	37	12/86→10/95		→ 12/89		24.2120-0801.3	010362	Ø 20,64
1.0 Cat	33	10/87→10/95		12/87→ 12/89		24.2120-0801.3	010362	Ø 20,64
1.0 Turbo	63	03/85→10/95		06/85→ 12/89		24.2120-0801.3	010362	Ø 20,64
1.1	42	06/89→10/95		01/90→ 12/92		24.2120-0801.3	010362	Ø 20,64
				01/93→		24.2120-1733.3	010686	Ø 20,64
1.1 i.e. Cat	42	09/90→10/95		→ 12/92		24.2120-0801.3	010362	Ø 20,64
1.3 i.e. GT	54	06/89→10/95						
1.3 i.e. GT	57	06/89→10/95		01/93→		24.2120-1733.3	010686	Ø 20,64
 Bremskraftregler								
1.0	33	03/85→10/95		06/85→ 12/89		24.6513-0801.3	320117	lastabhängig 1/3 2x
1.0	41	03/85→10/95		12/87→ 12/89		24.6513-0801.3	320117	lastabhängig 1/3 2x
1.0 4WD	37	12/86→10/95		→ 12/89		24.6513-0801.3	320117	lastabhängig 1/3 2x
1.0 Cat	33	10/87→10/95		12/87→ 12/89		24.6513-0801.3	320117	lastabhängig 1/3 2x
1.0 Turbo	63	03/85→10/95		06/85→ 12/89		24.6513-0801.3	320117	lastabhängig 1/3 2x
1.1	42	06/89→10/95		01/90→		24.6513-0801.3	320117	lastabhängig 1/3 2x
1.1 i.e. Cat	42	09/90→10/95				24.6513-0801.3	320117	lastabhängig 1/3 2x
1.3 i.e. GT	54	06/89→10/95						
1.3 i.e. GT	57	06/89→10/95						









	kw			 	! #		
BMW - 1 (E81) 09/06→12/11							
 Bremskraftverstärker							
116 d	66	01/11→12/11		für Fahrzeuge ohne Start-Stopp-Funktion		03.7848-4003.4 300235	ATE Ø 8" pneumatisch
116 d	85	11/08→12/11		03/09→ 08/09		03.7848-4003.4 300235	ATE Ø 8" pneumatisch
				09/09→ 05/11; für Fahrzeuge ohne Start-Stopp-Funktion		03.7848-4003.4 300235	ATE Ø 8" pneumatisch
116 i	85	04/07→12/11		→ 08/07		03.7848-4003.4 300235	ATE Ø 8" pneumatisch
116 i	89	08/07→11/11		09/07→ 12/08		03.7848-4003.4 300235	ATE Ø 8" pneumatisch
116 i	90	03/07→11/11					
116 i	90	11/08→12/11		09/09→ 05/11; für Fahrzeuge ohne Start-Stopp-Funktion		03.7848-4003.4 300235	ATE Ø 8" pneumatisch
				01/09→ 08/09		03.7848-4003.4 300235	ATE Ø 8" pneumatisch
118 d	100	09/06→12/11		04/07→ 08/09		03.7848-4003.4 300235	ATE Ø 8" pneumatisch
118 d	105	09/06→12/11					
118 i	100	09/06→12/11		09/09→ 05/11; für Fahrzeuge ohne Start-Stopp-Funktion		03.7848-4003.4 300235	ATE Ø 8" pneumatisch
118 i	105	09/06→12/11					
120 i	120	09/06→12/11					
120 i	125	09/06→12/11					
120 d	120	09/06→12/11		→ 02/07		03.7848-4003.4 300235	ATE Ø 8" pneumatisch
120 d	130	09/06→12/11		03/07→ 08/09		03.7848-4003.4 300235	ATE Ø 8" pneumatisch
120 d	145	09/06→12/11		09/09→ 05/11; für Fahrzeuge ohne Start-Stopp-Funktion		03.7848-4003.4 300235	ATE Ø 8" pneumatisch
120 i	115	09/06→10/11		→ 03/07		03.7848-4003.4 300235	ATE Ø 8" pneumatisch
123 d	150	03/07→12/11		10/07→ 08/09		03.7848-5003.4 300236	ATE Ø 8" pneumatisch
				09/09→ 05/11; für Fahrzeuge ohne Start-Stopp-Funktion		03.7848-5003.4 300236	ATE Ø 8" pneumatisch
130 i	190	09/06→12/11		→ 05/11		03.7848-5003.4 300236	ATE Ø 8" pneumatisch
130 i	195	09/06→12/11					
 Hauptbremszylinder							
116 d	66	01/11→12/11		für Linkslenker		03.2023-2407.3 010796	ATE Ø1 23,81 Ø2 22,2
116 d	85	11/08→12/11		03/09→ 05/11; für Linkslenker		03.2023-2407.3 010796	ATE Ø1 23,81 Ø2 22,2
116 i	85	04/07→12/11		→ 08/07; für Linkslenker		03.2023-2407.3 010796	ATE Ø1 23,81 Ø2 22,2
116 i	89	08/07→11/11		09/07→ 12/08; für Linkslenker		03.2023-2407.3 010796	ATE Ø1 23,81 Ø2 22,2
116 i	90	03/07→11/11					
116 i	90	11/08→12/11		01/09→ 05/11; für Linkslenker		03.2023-2407.3 010796	ATE Ø1 23,81 Ø2 22,2
118 d	100	09/06→12/11		04/07→ 05/11; für Linkslenker		03.2023-2407.3 010796	ATE Ø1 23,81 Ø2 22,2
118 d	105	09/06→12/11					
118 i	100	09/06→12/11					
118 i	105	09/06→12/11					
120 i	120	09/06→12/11					
120 i	125	09/06→12/11					
120 d	120	09/06→12/11		→ 02/07; für Linkslenker		03.2023-2407.3 010796	ATE Ø1 23,81 Ø2 22,2
120 d	130	09/06→12/11		03/07→ 05/11; für Linkslenker		03.2023-2407.3 010796	ATE Ø1 23,81 Ø2 22,2
120 d	145	09/06→12/11					
120 i	115	09/06→10/11		→ 03/07; für Linkslenker		03.2023-2407.3 010796	ATE Ø1 23,81 Ø2 22,2
123 d	150	03/07→12/11		10/07→ 05/11; für Linkslenker		03.2025-1904.3 010797	ATE Ø1 25,4 Ø2 22,2
130 i	190	09/06→12/11		→ 05/11; für Linkslenker		03.2025-1904.3 010797	ATE Ø1 25,4 Ø2 22,2
130 i	195	09/06→12/11					
Hydraulikaggregat, Bremsanlage							
116 d	66	01/11→12/11				24.9145-0003.2 399007	
116 d	85	11/08→12/11		03/09→ 05/11		24.9145-0003.2 399007	
116 i	89	08/07→11/11		09/08→ 12/08		24.9145-0003.2 399007	
116 i	90	03/07→11/11					
116 i	90	11/08→12/11		01/09→ 05/11		24.9145-0003.2 399007	
118 d	100	09/06→12/11		09/08→ 05/11		24.9145-0003.2 399007	
118 d	105	09/06→12/11					
118 i	100	09/06→12/11					
118 i	105	09/06→12/11					
120 d	130	09/06→12/11					
120 d	145	09/06→12/11					
120 i	120	09/06→12/11					
120 i	125	09/06→12/11					
123 d	150	03/07→12/11		09/08→ 05/11; für Fahrzeuge ohne Aktivlenkung		24.9145-0003.2 399007	
BMW - 1 (E87) 02/03→01/13							
 Bremskraftverstärker							
116 d	66	01/11→12/11		für Fahrzeuge ohne Start-Stopp-Funktion		03.7848-4003.4 300235	ATE Ø 8" pneumatisch
116 d	85	12/08→09/12		03/09→ 08/09		03.7848-4003.4 300235	ATE Ø 8" pneumatisch
				09/09→ 05/11; für Fahrzeuge ohne Start-Stopp-Funktion		03.7848-4003.4 300235	ATE Ø 8" pneumatisch
↓							

	kw			 	! #		
BMW - 1 (E87) 02/03→01/13							
Bremskraftverstärker							
116 i	85	11/03→06/11		09/04→ 08/07		03.7848-4003.4 300235	ATE Ø 8" pneumatisch
116 i	89	03/07→06/11		09/07→ 12/08		03.7848-4003.4 300235	ATE Ø 8" pneumatisch
116 i	90	03/07→06/11					
116 i	90	01/09→06/11		→ 08/09		03.7848-4003.4 300235	ATE Ø 8" pneumatisch
				09/09→ 05/11; für Fahrzeuge ohne Start-Stopp-Funktion		03.7848-4003.4 300235	ATE Ø 8" pneumatisch
118 d	90	11/03→02/07		09/04→		03.7848-4003.4 300235	ATE Ø 8" pneumatisch
118 i	95	07/04→02/07					
120 d	110	03/03→02/07					
118 d	100	09/06→06/11		04/07→ 08/09		03.7848-4003.4 300235	ATE Ø 8" pneumatisch
118 d	105	09/06→06/11					
118 i	105	09/06→06/11		09/09→ 05/11; für Fahrzeuge ohne Start-Stopp-Funktion		03.7848-4003.4 300235	ATE Ø 8" pneumatisch
120 i	120	09/06→06/11					
120 i	125	09/06→06/11					
118 i	100	10/06→06/11		→ 03/07		03.7848-4003.4 300235	ATE Ø 8" pneumatisch
118 i	125	03/07→12/07		04/07→		03.7848-4003.4 300235	ATE Ø 8" pneumatisch
120 d	120	03/03→06/11		09/04→ 02/07		03.7848-4003.4 300235	ATE Ø 8" pneumatisch
120 d	130	09/06→06/11		03/07→ 08/09		03.7848-4003.4 300235	ATE Ø 8" pneumatisch
				09/09→ 05/11; für Fahrzeuge ohne Start-Stopp-Funktion		03.7848-4003.4 300235	ATE Ø 8" pneumatisch
120 i	110	11/03→06/11		09/04→ 03/07		03.7848-4003.4 300235	ATE Ø 8" pneumatisch
120 i	115	11/03→06/11					
123 d	150	03/07→09/12		10/07→ 08/09		03.7848-5003.4 300236	ATE Ø 8" pneumatisch
				09/09→ 05/11; für Fahrzeuge ohne Start-Stopp-Funktion		03.7848-5003.4 300236	ATE Ø 8" pneumatisch
130 i	190	03/05→09/12		→ 05/11		03.7848-5003.4 300236	ATE Ø 8" pneumatisch
130 i	195	03/05→09/12		09/05→ 05/11		03.7848-5003.4 300236	ATE Ø 8" pneumatisch
Hauptbremszylinder							
116 d	66	01/11→12/11		für Linkslenker		03.2023-2407.3 010796	ATE Ø1 23,81 Ø2 22,2
116 d	85	12/08→09/12		03/09→ 05/11; für Linkslenker		03.2023-2407.3 010796	ATE Ø1 23,81 Ø2 22,2
116 i	85	11/03→06/11		09/04→ 08/07; für Linkslenker		03.2023-2407.3 010796	ATE Ø1 23,81 Ø2 22,2
116 i	89	03/07→06/11		09/07→ 12/08; für Linkslenker		03.2023-2407.3 010796	ATE Ø1 23,81 Ø2 22,2
116 i	90	03/07→06/11					
116 i	90	01/09→06/11		→ 05/11; für Linkslenker		03.2023-2407.3 010796	ATE Ø1 23,81 Ø2 22,2
118 d	90	11/03→02/07		09/04→; für Linkslenker		03.2023-2407.3 010796	ATE Ø1 23,81 Ø2 22,2
118 i	95	07/04→02/07					
120 d	110	03/03→02/07					
118 d	100	09/06→06/11		04/07→ 05/11; für Linkslenker		03.2023-2407.3 010796	ATE Ø1 23,81 Ø2 22,2
118 d	105	09/06→06/11					
118 i	105	09/06→06/11					
120 i	120	09/06→06/11					
120 i	125	09/06→06/11					
118 i	100	10/06→06/11		→ 03/07; für Linkslenker		03.2023-2407.3 010796	ATE Ø1 23,81 Ø2 22,2
118 i	125	03/07→12/07		04/07→; für Linkslenker		03.2023-2407.3 010796	ATE Ø1 23,81 Ø2 22,2
120 d	120	03/03→06/11		09/04→ 02/07; für Linkslenker		03.2023-2407.3 010796	ATE Ø1 23,81 Ø2 22,2
120 d	130	09/06→06/11		03/07→ 05/11; für Linkslenker		03.2023-2407.3 010796	ATE Ø1 23,81 Ø2 22,2
120 i	110	11/03→06/11		09/04→ 03/07; für Linkslenker		03.2023-2407.3 010796	ATE Ø1 23,81 Ø2 22,2
120 i	115	11/03→06/11					
123 d	150	03/07→09/12		10/07→ 05/11; für Linkslenker		03.2025-1904.3 010797	ATE Ø1 25,4 Ø2 22,2
130 i	190	03/05→09/12		→ 05/11; für Linkslenker		03.2025-1904.3 010797	ATE Ø1 25,4 Ø2 22,2
130 i	195	03/05→09/12		09/05→ 05/11; für Linkslenker		03.2025-1904.3 010797	ATE Ø1 25,4 Ø2 22,2
Hydraulikaggregat, Bremsanlage							
116 d	66	01/11→12/11				24.9145-0003.2 399007	
116 d	85	12/08→09/12		03/09→ 05/11		24.9145-0003.2 399007	
116 i	89	03/07→06/11		09/08→ 12/08		24.9145-0003.2 399007	
116 i	90	03/07→06/11					
116 i	90	01/09→06/11		→ 05/11		24.9145-0003.2 399007	
118 d	100	09/06→06/11		09/08→ 05/11		24.9145-0003.2 399007	
118 d	105	09/06→06/11					
118 i	100	10/06→06/11					
118 i	105	09/06→06/11					
120 d	130	09/06→06/11					
120 i	120	09/06→06/11					
120 i	125	09/06→06/11					
123 d	150	03/07→09/12		09/08→ 05/11; für Fahrzeuge ohne Aktivlenkung		24.9145-0003.2 399007	











	kw			 	! #		
BMW - 1 Cabriolet (E88) 03/08→12/13							
 Bremskraftverstärker							
118 d	100	09/08→12/13		→ 10/13; für Fahrzeuge ohne Start-Stopp-Funktion	03.7848-4003.4	300235	ATE Ø 8" pneumatisch
118 d	105	09/08→12/13					
118 i	100	09/08→12/13					
118 i	105	03/08→12/13					
120 d	120	03/08→12/13					
120 d	130	03/08→12/13					
120 d	145	03/08→12/13					
120 i	115	03/08→12/13					
120 i	120	03/08→12/13					
120 i	125	03/08→12/13					
128 i	171	03/08→12/13					
123 d	150	09/08→12/13		→ 10/13; für Fahrzeuge ohne Start-Stopp-Funktion	03.7848-5003.4	300236	ATE Ø 8" pneumatisch
125 i	160	03/08→12/13		→ 10/13	03.7848-4003.4	300235	ATE Ø 8" pneumatisch
135 i	225	03/08→12/13		→ 10/13	03.7845-0103.4	300268	ATE Ø 8" pneumatisch
135 i	240	03/08→12/13					
 Hauptbremszylinder							
118 d	100	09/08→12/13		→ 10/13; für Linkslenker	03.2023-2407.3	010796	ATE Ø1 23,81 Ø2 22,2
118 d	105	09/08→12/13					
118 i	100	09/08→12/13					
118 i	105	03/08→12/13					
120 d	120	03/08→12/13					
120 d	130	03/08→12/13					
120 d	145	03/08→12/13					
120 i	115	03/08→12/13					
120 i	120	03/08→12/13					
120 i	125	03/08→12/13					
125 i	160	03/08→12/13					
128 i	171	03/08→12/13					
123 d	150	09/08→12/13		→ 10/13; für Linkslenker	03.2025-1904.3	010797	ATE Ø1 25,4 Ø2 22,2
135 i	225	03/08→12/13					
135 i	240	03/08→12/13					
Hydraulikaggregat, Bremsanlage							
118 d	100	09/08→12/13		→ 10/13	24.9145-0003.2	399007	
118 d	105	09/08→12/13					
118 i	100	09/08→12/13					
118 i	105	03/08→12/13		09/08→ 10/13	24.9145-0003.2	399007	
120 d	120	03/08→12/13		09/08→ 10/13; für Fahrzeuge ohne Aktivlenkung	24.9145-0003.2	399007	
120 d	130	03/08→12/13					
120 d	145	03/08→12/13					
120 i	115	03/08→12/13					
120 i	120	03/08→12/13					
120 i	125	03/08→12/13					
123 d	150	09/08→12/13		→ 10/13; für Fahrzeuge ohne Aktivlenkung	24.9145-0003.2	399007	
BMW - 1 Coupe (E82) 10/06→10/13							
 Bremskraftverstärker							
118 d	100	09/09→10/13		für Fahrzeuge ohne Start-Stopp-Funktion	03.7848-4003.4	300235	ATE Ø 8" pneumatisch
118 d	105	09/09→10/13					
120 d	120	10/07→10/13					
120 d	130	10/07→10/13					
120 i	115	09/09→10/13					
120 d	145	10/06→10/13		10/07→; für Fahrzeuge ohne Start-Stopp-Funktion	03.7848-4003.4	300235	ATE Ø 8" pneumatisch
120 i	125	10/07→10/13		09/09→; für Fahrzeuge ohne Start-Stopp-Funktion	03.7848-4003.4	300235	ATE Ø 8" pneumatisch
123 d	150	10/07→10/13		→ 08/09	03.7848-4003.4	300235	ATE Ø 8" pneumatisch
125 i	160	10/07→10/13		03/08→	03.7848-4003.4	300235	ATE Ø 8" pneumatisch
135 i	225	10/07→10/13			03.7845-0103.4	300268	ATE Ø 8" pneumatisch
135 i	240	10/07→10/13					
 Hauptbremszylinder							
118 d	100	09/09→10/13		für Linkslenker	03.2023-2407.3	010796	ATE Ø1 23,81 Ø2 22,2
118 d	105	09/09→10/13					
120 d	120	10/07→10/13					
120 d	130	10/07→10/13					
120 i	115	09/09→10/13					
120 d	145	10/06→10/13		10/07→; für Linkslenker	03.2023-2407.3	010796	ATE Ø1 23,81 Ø2 22,2
120 i	125	10/07→10/13		09/09→; für Linkslenker	03.2023-2407.3	010796	ATE Ø1 23,81 Ø2 22,2
123 d	150	10/07→10/13		für Linkslenker	03.2025-1904.3	010797	ATE Ø1 25,4 Ø2 22,2
135 i	225	10/07→10/13					
135 i	240	10/07→10/13					
↓							













	kw			 	! #		
BMW - 1 Coupe (E82) 10/06→10/13							
 Hauptbremszylinder							
125 i	160	10/07→10/13		03/08→; für Linkslenker		03.2023-2407.3 010796	ATE Ø1 23,81 Ø2 22,2
Hydraulikaggregat, Bremsanlage							
118 d	100	09/09→10/13				24.9145-0003.2 399007	
118 d	105	09/09→10/13					
120 d	120	10/07→10/13		09/08→;		24.9145-0003.2 399007	
120 d	130	10/07→10/13		für Fahrzeuge ohne Aktivlenkung			
120 d	145	10/06→10/13					
123 d	150	10/07→10/13					
120 i	115	09/09→10/13		für Fahrzeuge ohne Aktivlenkung		24.9145-0003.2 399007	
120 i	125	10/07→10/13		09/09→;		24.9145-0003.2 399007	
				für Fahrzeuge ohne Aktivlenkung			
BMW - 3 (E36) 09/90→02/98							
 Bremskraftverstärker							
316 i	75	07/93→02/98		09/94→; + ABS		03.7760-3102.4 300139	ATE Ø 10" pneumatisch
318 i	85	10/93→02/98		→ 08/94; + ABS		10.6360-1903.4 300093	ATE Ø 10" pneumatisch
318 is	103	03/93→02/98					
318 is	103	09/95→02/98		+ ABS		03.7760-3102.4 300139	ATE Ø 10" pneumatisch
318 tds	66	01/95→02/98					
320 i	110	09/90→02/98		09/94→; - ASC		03.7760-3102.4 300139	ATE Ø 10" pneumatisch
325 td	85	09/91→02/98		09/96→; + ASC		03.7760-3102.4 300139	ATE Ø 10" pneumatisch
325 tds	105	05/93→02/98		→ 08/96; + ASC		10.6360-1903.4 300093	ATE Ø 10" pneumatisch
				→ 08/94; - ASC		10.6360-1903.4 300093	ATE Ø 10" pneumatisch
323 i 2.5	125	03/95→02/98		- ASC		03.7760-3102.4 300139	ATE Ø 10" pneumatisch
328 i	142	01/95→02/98		09/96→; + ASC		03.7760-3102.4 300139	ATE Ø 10" pneumatisch
				→ 08/96; + ASC		10.6360-1903.4 300093	ATE Ø 10" pneumatisch
325 i	141	09/90→09/95		09/94→; - ASC		03.7760-3102.4 300139	ATE Ø 10" pneumatisch
				→ 08/94; - ASC		10.6360-1903.4 300093	ATE Ø 10" pneumatisch
				+ ASC		10.6360-1903.4 300093	ATE Ø 10" pneumatisch
M3 3.0	210	08/94→09/95				10.6360-1903.4 300093	ATE Ø 10" pneumatisch
Pedalwegsensor, Bremspedal							
316 i	75	07/93→02/98		→ 08/94; + ABS		03.0655-0002.2 370002	ATE
318 i	85	10/93→02/98					
318 is	103	03/93→02/98					
320 i	110	09/90→02/98		→ 08/94; - ASC		03.0655-0002.2 370002	ATE
325 td	85	09/91→02/98		→ 08/96; + ASC		03.0655-0002.2 370002	ATE
325 tds	105	05/93→02/98					
323 i 2.5	125	03/95→02/98		→ 08/96; + ASC		03.0655-0002.2 370002	ATE
328 i	142	01/95→02/98					
325 i	141	09/90→09/95		→ 08/94; - ASC		03.0655-0002.2 370002	ATE
				+ ASC		03.0655-0002.2 370002	ATE
M3 3.0	210	08/94→09/95				03.0655-0002.2 370002	ATE
 Hauptbremszylinder							
316 i	75	07/93→02/98		09/94→; + ABS		03.2023-0987.3 010473	Ø1 23,81 Ø2 20,64
318 i	85	10/93→02/98		→ 08/94; + ABS		10.6123-0239.3 010335	ATE Ø 23,81
318 is	103	03/93→02/98					
318 is	103	09/95→02/98		+ ABS		03.2023-0987.3 010473	Ø1 23,81 Ø2 20,64
318 tds	66	01/95→02/98					
320 i	110	09/90→02/98		09/96→; + ASC		03.2023-0987.3 010473	Ø1 23,81 Ø2 20,64
325 td	85	09/91→02/98		09/94→; - ASC		03.2023-0987.3 010473	Ø1 23,81 Ø2 20,64
				→ 08/94; - ASC		10.6123-0239.3 010335	ATE Ø 23,81
				→ 08/96; + ASC		10.6123-0239.3 010335	ATE Ø 23,81
				- ABS		24.2023-1601.3 010341	TRW Ø 23,81
323 i 2.5	125	03/95→02/98		- ASC		03.2023-0987.3 010473	Ø1 23,81 Ø2 20,64
328 i	142	01/95→02/98		09/96→; + ASC		03.2023-0987.3 010473	Ø1 23,81 Ø2 20,64
				→ 08/96; + ASC		10.6123-0239.3 010335	ATE Ø 23,81
325 i	141	09/90→09/95		09/94→; - ASC		03.2023-0987.3 010473	Ø1 23,81 Ø2 20,64
				→ 08/94; - ASC		10.6123-0239.3 010335	ATE Ø 23,81
				+ ASC		10.6123-0239.3 010335	ATE Ø 23,81
325 tds	105	05/93→02/98		09/94→; - ASC		03.2023-0987.3 010473	Ø1 23,81 Ø2 20,64
				09/96→; + ASC		03.2023-0987.3 010473	Ø1 23,81 Ø2 20,64
				→ 08/96; + ASC		10.6123-0239.3 010335	ATE Ø 23,81
				→ 08/94; - ASC		10.6123-0239.3 010335	ATE Ø 23,81











	kw			 	! #				
BMW - 3 (E46) 02/98→04/05									
 Bremskraftverstärker									
316 i	77	04/00→02/05				03.7860-0702.4 300123	ATE Ø 10" pneumatisch		
316 i	85	06/02→02/05							
316 i	85	02/02→02/05							
316 i	77	09/98→02/05							
318 d	85	09/01→03/03							
318 d	85	03/03→02/05							
318 i	87	02/98→09/01							
318 i	100	09/01→02/05							
318 i	105	09/01→02/05							
320 d	100	04/98→09/01							
320 d	110	09/01→02/05							
320 i	110	03/98→09/00							
320 i	120	09/00→02/05							
320 i	125	09/00→02/05							
323 i	120	03/98→09/00							
323 i	125	03/98→09/00							
325 i	141	09/00→02/05							
325 xi	141	09/00→02/05							
328 i	142	02/98→06/00							
330 d	135	10/99→02/05							
330 d	150	03/03→02/05							
330 i	170	06/00→02/05							
330 xi	170	06/00→02/05							
320 d	95	02/98→04/05		→ 02/05				03.7860-0702.4 300123	ATE Ø 10" pneumatisch
330 i	168	01/01→04/05							
330 xd	135	01/00→02/03		06/00→		03.7860-0702.4 300123	ATE Ø 10" pneumatisch		
330 xd	150	09/02→12/04		03/03→		03.7860-0702.4 300123	ATE Ø 10" pneumatisch		
 Hauptbremszylinder									
316 i	77	04/00→02/05		→ 08/01; - DSC		03.2022-2624.3 010588	Ø1 22,2 Ø2 20,64		
316 i	77	09/98→02/05		→ 08/00; + DSC		03.2022-2829.3 010589	ATE Ø1 22,2 Ø2 20,64		
				02/01→; + DSC		03.2023-2256.3 010870	ATE Ø1 23,81 Ø2 22,2		
				09/01→; - DSC		03.2023-2344.3 010647	ATE Ø1 23,81 Ø2 22,2		
316 i	85	06/02→02/05		+ DSC		03.2023-2256.3 010870	ATE Ø1 23,81 Ø2 22,2		
316 i	85	02/02→02/05		- DSC		03.2023-2344.3 010647	ATE Ø1 23,81 Ø2 22,2		
318 d	85	09/01→03/03							
318 d	85	03/03→02/05							
318 i	100	09/01→02/05							
318 i	105	09/01→02/05							
320 d	110	09/01→02/05							
318 i	87	02/98→09/01		- DSC		03.2022-2624.3 010588	Ø1 22,2 Ø2 20,64		
320 i	110	03/98→09/00		→ 08/00; + DSC		03.2022-2829.3 010589	ATE Ø1 22,2 Ø2 20,64		
320 d	95	02/98→04/05		→ 02/05; - DSC		03.2022-2624.3 010588	Ø1 22,2 Ø2 20,64		
				→ 08/00; + DSC		03.2022-2829.3 010589	ATE Ø1 22,2 Ø2 20,64		
				02/01→ 02/05; + DSC		03.2023-2256.3 010870	ATE Ø1 23,81 Ø2 22,2		
320 d	100	04/98→09/01		- DSC		03.2022-2624.3 010588	Ø1 22,2 Ø2 20,64		
				→ 08/00; + DSC		03.2022-2829.3 010589	ATE Ø1 22,2 Ø2 20,64		
				02/01→; + DSC		03.2023-2256.3 010870	ATE Ø1 23,81 Ø2 22,2		
320 i	120	09/00→02/05		→ 08/01; - DSC		03.2022-2624.3 010588	Ø1 22,2 Ø2 20,64		
320 i	125	09/00→02/05		02/01→; + DSC		03.2023-2256.3 010870	ATE Ø1 23,81 Ø2 22,2		
325 i	141	09/00→02/05		09/01→; - DSC		03.2023-2344.3 010647	ATE Ø1 23,81 Ø2 22,2		
323 i	120	03/98→09/00		- DSC		03.2022-2624.3 010588	Ø1 22,2 Ø2 20,64		
323 i	125	03/98→09/00		+ DSC		03.2022-2829.3 010589	ATE Ø1 22,2 Ø2 20,64		
328 i	142	02/98→06/00							
330 d	135	10/99→02/05		→ 08/00; + DSC		03.2023-2204.3 010644	ATE Ø1 23,81 Ø2 22,2		
330 i	170	06/00→02/05		02/01→; + DSC		03.2023-2256.3 010870	ATE Ø1 23,81 Ø2 22,2		
				→ 08/01; - DSC		03.2023-2304.3 010646	ATE Ø1 23,81 Ø2 22,2		
				09/01→; - DSC		03.2023-2344.3 010647	ATE Ø1 23,81 Ø2 22,2		
330 d	150	03/03→02/05		+ DSC		03.2023-2256.3 010870	ATE Ø1 23,81 Ø2 22,2		
330 i	168	01/01→04/05		02/01→ 02/05; + DSC		03.2023-2256.3 010870	ATE Ø1 23,81 Ø2 22,2		
				→ 08/01; - DSC		03.2023-2304.3 010646	ATE Ø1 23,81 Ø2 22,2		
				09/01→ 02/05; - DSC		03.2023-2344.3 010647	ATE Ø1 23,81 Ø2 22,2		
BMW - 3 (E90) 02/04→12/11									
 Bremskraftverstärker									
316 d	85	07/09→12/11		für Fahrzeuge ohne Start-Stopp-Funktion		03.7848-4003.4 300235	ATE Ø 8" pneumatisch		
316 i	85	03/05→10/11		→ 08/07;		03.7848-4003.4 300235	ATE Ø 8" pneumatisch		
320 i	115	09/06→12/11		für Fahrzeuge ohne Start-Stopp-Funktion					
316 i	90	02/07→10/11		09/07→;		03.7848-4003.4 300235	ATE Ø 8" pneumatisch		
318 d	100	02/07→03/10		für Fahrzeuge ohne Start-Stopp-Funktion					
318 d	105	02/07→10/11							
↓									













	kw			 	! #		
BMW - 3 (E90) 02/04→12/11							
 Bremskraftverstärker							
318 i	100	03/07→10/11		09/07→; für Fahrzeuge ohne Start-Stopp-Funktion		03.7848-4003.4 300235	ATE Ø 8" pneumatisch
318 i	105	02/07→10/11					
320 i	120	03/07→12/11					
320 i	125	03/07→12/11					
318 d	90	01/05→08/07		09/05→; für Fahrzeuge ohne Start-Stopp-Funktion		03.7848-4003.4 300235	ATE Ø 8" pneumatisch
318 i	95	08/04→08/07					
320 d	110	09/05→12/11		für Fahrzeuge ohne Start-Stopp-Funktion		03.7845-0103.4 300268	ATE Ø 8" pneumatisch
320 d	130	09/07→12/11					
320 d	135	01/10→12/11					
320 d xDrive	120	07/08→12/11					
320 d xDrive	130	09/08→12/11					
320 d xDrive	135	01/10→12/11					
320 xd	130	09/07→12/11					
335 d	210	09/06→12/11					
335 i xDrive	225	05/08→10/11					
335 i xDrive	240	05/08→10/11					
320 d	120	02/04→12/11		12/04→		03.7848-5003.4 300236	ATE Ø 8" pneumatisch
320 i	110	06/04→03/07		12/04→; für Fahrzeuge ohne Start-Stopp-Funktion		03.7848-4003.4 300235	ATE Ø 8" pneumatisch
320 si	127	09/05→08/06		06/06→		03.7848-5003.4 300236	ATE Ø 8" pneumatisch
325 d	145	09/06→12/11				03.7848-5003.4 300236	ATE Ø 8" pneumatisch
325 d	150	01/10→12/11					
325 i	155	01/06→12/11					
325 i	160	01/05→12/11					
325 i	155	03/07→12/11					
325 i	160	03/07→12/11					
330 i	190	01/05→08/07					
330 i xDrive	200	09/08→12/11					
330 xd	170	09/05→12/11					
330 xi	190	01/05→08/07					
330 xi	200	09/07→12/11					
325 i xDrive	160	06/08→10/11		Motorcode: N53		03.7848-5003.4 300236	ATE Ø 8" pneumatisch
325 xi	160	03/05→10/11		→ 08/07; Motorcode: N52N; für Fahrzeuge ohne Start-Stopp-Funktion		03.7845-0103.4 300268	ATE Ø 8" pneumatisch
325 xi	160	03/07→06/08					
				→ 08/07; Motorcode: N52		03.7848-5003.4 300236	ATE Ø 8" pneumatisch
				09/07→; Motorcode: N53		03.7848-5003.4 300236	ATE Ø 8" pneumatisch
330 d	155	09/04→12/11		09/05→		03.7848-5003.4 300236	ATE Ø 8" pneumatisch
330 d	170	09/04→08/08					
330 d	180	02/08→12/11		09/08→ 08/09; für Fahrzeuge ohne Start-Stopp-Funktion		03.7845-0103.4 300268	ATE Ø 8" pneumatisch
				09/09→		03.7848-5003.4 300236	ATE Ø 8" pneumatisch
330 d xDrive	180	01/09→12/11		→ 08/09; für Fahrzeuge ohne Start-Stopp-Funktion		03.7845-0103.4 300268	ATE Ø 8" pneumatisch
330 i	200	09/07→12/11					
				09/09→		03.7848-5003.4 300236	ATE Ø 8" pneumatisch
335 i	220	03/06→12/11		09/06→; für Fahrzeuge ohne Start-Stopp-Funktion		03.7845-0103.4 300268	ATE Ø 8" pneumatisch
335 i	224	03/06→12/11					
335 i	225	03/06→12/11					
335 i	240	03/06→12/11					
335 xi	224	09/06→06/08		03/07→; für Fahrzeuge ohne Start-Stopp-Funktion		03.7845-0103.4 300268	ATE Ø 8" pneumatisch
335 xi	225	09/06→06/08					
335 xi	240	09/06→06/08					
 Hauptbremszylinder							
316 d	85	07/09→12/11		für Linkslenker		03.2023-2407.3 010796	ATE Ø1 23,81 Ø2 22,2
316 i	85	03/05→10/11		→ 08/07; für Linkslenker		03.2023-2407.3 010796	ATE Ø1 23,81 Ø2 22,2
320 i	115	09/06→12/11					
316 i	90	02/07→10/11		09/07→; für Linkslenker		03.2023-2407.3 010796	ATE Ø1 23,81 Ø2 22,2
318 d	100	02/07→03/10					
318 d	105	02/07→10/11					
318 i	100	03/07→10/11					
318 i	105	02/07→10/11					
320 i	120	03/07→12/11					
320 i	125	03/07→12/11					
318 d	90	01/05→08/07		09/05→; für Linkslenker		03.2023-2407.3 010796	ATE Ø1 23,81 Ø2 22,2
318 i	95	08/04→08/07					
320 d	110	09/05→12/11		für Linkslenker		03.2025-1904.3 010797	ATE Ø1 25,4 Ø2 22,2
320 d	130	09/07→12/11					
320 d	135	01/10→12/11					
325 i	155	01/06→12/11					
325 i	160	01/05→12/11					
325 i	155	03/07→12/11					
325 i	160	03/07→12/11					
330 i	190	01/05→08/07					
330 i	200	09/07→12/11					
320 d	120	02/04→12/11		12/04→; für Linkslenker		03.2025-1904.3 010797	ATE Ø1 25,4 Ø2 22,2
320 d xDrive	120	07/08→12/11					
320 d xDrive	130	09/08→12/11					
↓							









	kw			 	! #		
BMW - 3 (E90) 02/04→12/11							
 Hauptbremszylinder							
320 d xDrive	135	01/10→12/11				03.2025-1904.3 010797	ATE Ø1 25,4 Ø2 22,2
320 xd	130	09/07→12/11					
325 d	145	09/06→12/11					
325 d	150	01/10→12/11					
325 i xDrive	160	06/08→10/11					
325 xi	160	03/05→10/11					
325 xi	160	03/07→06/08					
330 d xDrive	180	01/09→12/11					
330 i xDrive	200	09/08→12/11					
330 xd	170	09/05→12/11					
330 xi	190	01/05→08/07					
330 xi	200	09/07→12/11					
335 d	210	09/06→12/11					
335 i xDrive	225	05/08→10/11					
335 i xDrive	240	05/08→10/11					
320 i	110	06/04→03/07		12/04→; für Linkslenker		03.2023-2407.3 010796	ATE Ø1 23,81 Ø2 22,2
320 si	127	09/05→08/06		06/06→; für Linkslenker		03.2025-1904.3 010797	ATE Ø1 25,4 Ø2 22,2
330 d	155	09/04→12/11		09/05→		03.2025-1904.3 010797	ATE Ø1 25,4 Ø2 22,2
330 d	170	09/04→08/08					
330 d	180	02/08→12/11		09/08→; für Linkslenker		03.2025-1904.3 010797	ATE Ø1 25,4 Ø2 22,2
335 i	220	03/06→12/11		09/06→; für Linkslenker		03.2025-1904.3 010797	ATE Ø1 25,4 Ø2 22,2
335 i	224	03/06→12/11					
335 i	225	03/06→12/11					
335 i	240	03/06→12/11					
335 xi	224	09/06→06/08		03/07→		03.2025-1904.3 010797	ATE Ø1 25,4 Ø2 22,2
335 xi	225	09/06→06/08					
335 xi	240	09/06→06/08					
Hydraulikaggregat, Bremsanlage							
316 d	85	07/09→12/11				24.9145-0003.2 399007	
316 i	90	02/07→10/11		09/08→		24.9145-0003.2 399007	
318 d	100	02/07→03/10					
318 d	105	02/07→10/11					
318 i	100	03/07→10/11					
318 i	105	02/07→10/11					
320 d	110	09/05→12/11		09/08→;		24.9145-0003.2 399007	
320 d	120	02/04→12/11		für Fahrzeuge ohne Aktivlenkung			
320 d	130	09/07→12/11					
320 i	120	03/07→12/11					
320 i	125	03/07→12/11					
320 d	135	01/10→12/11		für Fahrzeuge ohne Aktivlenkung		24.9145-0003.2 399007	
BMW - 3 Cabriolet (E36) 03/93→04/99							
 Bremskraftverstärker							
318 i	85	01/94→04/99		09/94→; - ASC		03.7760-3102.4 300139	ATE Ø 10" pneumatisch
320 i	110	12/93→04/99		09/96→; + ASC		03.7760-3102.4 300139	ATE Ø 10" pneumatisch
				→ 08/96; + ASC		10.6360-1903.4 300093	ATE Ø 10" pneumatisch
				→ 08/94; - ASC		10.6360-1903.4 300093	ATE Ø 10" pneumatisch
323 i	125	06/95→04/99		- ASC		03.7760-3102.4 300139	ATE Ø 10" pneumatisch
328 i	142	03/95→04/99		09/96→; + ASC		03.7760-3102.4 300139	ATE Ø 10" pneumatisch
				→ 08/96; + ASC		10.6360-1903.4 300093	ATE Ø 10" pneumatisch
325 i	141	03/93→03/95		09/94→; - ASC		03.7760-3102.4 300139	ATE Ø 10" pneumatisch
				→ 08/94; - ASC		10.6360-1903.4 300093	ATE Ø 10" pneumatisch
				+ ASC		10.6360-1903.4 300093	ATE Ø 10" pneumatisch
M3 3.0	210	01/94→10/95				10.6360-1903.4 300093	ATE Ø 10" pneumatisch
Pedalwegsensor, Bremspedal							
318 i	85	01/94→04/99		→ 08/94; - ASC		03.0655-0002.2 370002	ATE
320 i	110	12/93→04/99		→ 08/96; + ASC		03.0655-0002.2 370002	ATE
323 i	125	06/95→04/99		→ 08/96; + ASC		03.0655-0002.2 370002	ATE
328 i	142	03/95→04/99					
325 i	141	03/93→03/95		→ 08/94; - ASC		03.0655-0002.2 370002	ATE
				+ ASC		03.0655-0002.2 370002	ATE
M3 3.0	210	01/94→10/95				03.0655-0002.2 370002	ATE
 Hauptbremszylinder							
318 i	85	01/94→04/99		09/94→; + ASC		03.2023-0987.3 010473	Ø1 23,81 Ø2 20,64
320 i	110	12/93→04/99		- ASC		03.2023-0987.3 010473	Ø1 23,81 Ø2 20,64
325 i	141	03/93→03/95		→ 08/94; + ASC		10.6123-0239.3 010335	ATE Ø 23,81
323 i	125	06/95→04/99		- ASC		03.2023-0987.3 010473	Ø1 23,81 Ø2 20,64
328 i	142	03/95→04/99		09/96→; + ASC		03.2023-0987.3 010473	Ø1 23,81 Ø2 20,64







	kw			 	! #		
BMW - 3 Cabriolet (E36) 03/93→04/99							
 Hauptbremszylinder							
323 i 328 i	125 142	06/95→04/99 03/95→04/99		→ 08/96; + ASC		10.6123-0239.3 010335	ATE Ø 23,81
BMW - 3 Cabriolet (E46) 04/00→12/07							
 Bremskraftverstärker							
318 Ci 318 Ci 318 Ci 320 Cd 320 Ci 320 Ci 325 Ci 330 Cd 330 Ci	100 105 110 110 120 125 141 150 170	12/00→08/06 09/01→12/07 02/05→12/07 02/05→12/07 01/06→12/07 09/00→12/07 09/00→12/07 08/05→12/07 06/00→12/07		09/01→ → 09/06		03.7860-0702.4 300123 03.7860-0702.4 300123	ATE Ø 10" pneumatisch ATE Ø 10" pneumatisch
323 Ci 323 Ci	120 125	04/00→09/00 04/00→09/00				03.7860-0702.4 300123	ATE Ø 10" pneumatisch
 Hauptbremszylinder							
318 Ci	100	12/00→08/06		09/01→; + DSC 09/01→; - DSC		03.2023-2256.3 010870 03.2023-2344.3 010647	ATE Ø1 23,81 Ø2 22,2 ATE Ø1 23,81 Ø2 22,2
318 Ci 320 Ci	105 120	09/01→12/07 01/06→12/07		→ 09/06; + DSC → 09/06; - DSC		03.2023-2256.3 010870 03.2023-2344.3 010647	ATE Ø1 23,81 Ø2 22,2 ATE Ø1 23,81 Ø2 22,2
318 Ci 320 Cd 330 Cd	110 110 150	02/05→12/07 02/05→12/07 08/05→12/07		→ 09/06		03.2023-2256.3 010870	ATE Ø1 23,81 Ø2 22,2
320 Ci 325 Ci	125 141	09/00→12/07 09/00→12/07		→ 08/01; - DSC → 09/06; + DSC		03.2022-2624.3 010588 03.2023-2256.3 010870	Ø1 22,2 Ø2 20,64 ATE Ø1 23,81 Ø2 22,2
				09/01→ 09/06; - DSC		03.2023-2344.3 010647	ATE Ø1 23,81 Ø2 22,2
323 Ci 323 Ci	120 125	04/00→09/00 04/00→09/00		- DSC + DSC		03.2022-2624.3 010588 03.2022-2829.3 010589	Ø1 22,2 Ø2 20,64 ATE Ø1 22,2 Ø2 20,64
330 Ci	170	06/00→12/07		→ 08/00; + DSC 09/00→ 09/06; + DSC → 08/01; - DSC 09/01→ 09/06; - DSC		03.2023-2204.3 010644 03.2023-2256.3 010870 03.2023-2304.3 010646 03.2023-2344.3 010647	ATE Ø1 23,81 Ø2 22,2 ATE Ø1 23,81 Ø2 22,2 ATE Ø1 23,81 Ø2 22,2 ATE Ø1 23,81 Ø2 22,2
BMW - 3 Cabriolet (E93) 05/06→12/13							
 Bremskraftverstärker							
318 i	105	03/10→12/13		→ 11/13; für Fahrzeuge ohne Start-Stopp-Funktion		03.7848-4003.4 300235	ATE Ø 8" pneumatisch
320 d	120	01/08→12/13		→ 11/13; für Fahrzeuge ohne Start-Stopp-Funktion		03.7845-0103.4 300268	ATE Ø 8" pneumatisch
320 d 320 d	130 145	09/07→02/10 09/07→02/10		03/08→; für Fahrzeuge ohne Start-Stopp-Funktion		03.7845-0103.4 300268	ATE Ø 8" pneumatisch
320 d 320 d	135 147	03/10→10/13 03/10→10/13		für Fahrzeuge ohne Start-Stopp-Funktion		03.7845-0103.4 300268	ATE Ø 8" pneumatisch
320 i 320 i 320 i 320 i	110 115 120 125	01/07→08/13 01/07→08/13 09/06→10/13 09/06→10/13		03/07→ 03/08; Motorcode: N43 04/08→; für Fahrzeuge ohne Start-Stopp-Funktion 03/07→ 03/08; Motorcode: N46N		03.7845-0103.4 300268 03.7848-4003.4 300235 03.7848-5003.4 300236	ATE Ø 8" pneumatisch ATE Ø 8" pneumatisch ATE Ø 8" pneumatisch
323 i 323 i	130 140	03/07→09/11 03/07→09/11				03.7845-0103.4 300268	ATE Ø 8" pneumatisch
325 d 325 d	145 155	03/07→12/10 03/07→12/10		09/07→		03.7848-5003.4 300236	ATE Ø 8" pneumatisch
325 d	150	09/09→09/13		03/10→		03.7848-5003.4 300236	ATE Ø 8" pneumatisch
325 i	155	10/06→12/13		03/07→; Motorcode: N52N; → 11/13 03/07→; Motorcode: N53; → 11/13		03.7845-0103.4 300268 03.7848-5003.4 300236	ATE Ø 8" pneumatisch ATE Ø 8" pneumatisch
325 i	160	03/07→12/13		Motorcode: N52N; → 11/13 Motorcode: N53; → 11/13		03.7845-0103.4 300268 03.7848-5003.4 300236	ATE Ø 8" pneumatisch ATE Ø 8" pneumatisch
330 d 330 d	170 180	03/07→12/13 01/09→12/13		→ 08/09 09/09→ 11/13		03.7845-0103.4 300268 03.7848-5003.4 300236	ATE Ø 8" pneumatisch ATE Ø 8" pneumatisch
330 i 330 i	190 200	03/07→12/13 03/07→12/13		→ 08/09; Motorcode: N53 Motorcode: N52N; → 11/13 09/09→; Motorcode: N53; → 11/13		03.7845-0103.4 300268 03.7848-5003.4 300236 03.7848-5003.4 300236	ATE Ø 8" pneumatisch ATE Ø 8" pneumatisch ATE Ø 8" pneumatisch
335 i 335 i	225 240	05/06→10/13 05/06→10/13		03/07→		03.7845-0103.4 300268	ATE Ø 8" pneumatisch
 Hauptbremszylinder							
318 i	105	03/10→12/13		→ 11/13		03.2023-2407.3 010796	ATE Ø1 23,81 Ø2 22,2
↓							













	kw			 	! #		
BMW - 3 Cabriolet (E93) 05/06→12/13							
 Hauptbremszylinder							
320 d	120	01/08→12/13		für Linkslenker; → 11/13		03.2025-1904.3 010797	ATE Ø1 25,4 Ø2 22,2
325 i	160	03/07→12/13					
330 d	170	03/07→12/13					
330 d	180	01/09→12/13					
330 i	190	03/07→12/13					
330 i	200	03/07→12/13					
320 d	130	09/07→02/10		03/08→; für Linkslenker		03.2025-1904.3 010797	ATE Ø1 25,4 Ø2 22,2
320 d	145	09/07→02/10					
320 d	135	03/10→10/13		für Linkslenker		03.2025-1904.3 010797	ATE Ø1 25,4 Ø2 22,2
320 d	147	03/10→10/13					
320 i	110	01/07→08/13		06/08→; für Linkslenker		03.2023-2407.3 010796	ATE Ø1 23,81 Ø2 22,2
320 i	115	01/07→08/13					
320 i	120	09/06→10/13		03/07→; für Linkslenker; → 05/08		03.2025-1904.3 010797	ATE Ø1 25,4 Ø2 22,2
320 i	125	09/06→10/13					
325 d	145	03/07→12/10		09/07→; für Linkslenker		03.2025-1904.3 010797	ATE Ø1 25,4 Ø2 22,2
325 d	155	03/07→12/10					
325 d	150	09/09→09/13		03/10→; für Linkslenker		03.2025-1904.3 010797	ATE Ø1 25,4 Ø2 22,2
325 i	155	10/06→12/13		03/07→; für Linkslenker; → 11/13		03.2025-1904.3 010797	ATE Ø1 25,4 Ø2 22,2
335 i	225	05/06→10/13		03/07→; für Linkslenker		03.2025-1904.3 010797	ATE Ø1 25,4 Ø2 22,2
335 i	240	05/06→10/13					
Hydraulikaggregat, Bremsanlage							
318 i	105	03/10→12/13		→ 11/13		24.9145-0003.2 399007	
320 d	120	01/08→12/13		09/08→ 11/13; für Fahrzeuge ohne Aktivlenkung		24.9145-0003.2 399007	
320 d	130	09/07→02/10		09/08→;		24.9145-0003.2 399007	
320 d	145	09/07→02/10		für Fahrzeuge ohne Aktivlenkung			
320 i	110	01/07→08/13					
320 i	115	01/07→08/13					
320 i	120	09/06→10/13					
320 i	125	09/06→10/13					
320 d	135	03/10→10/13		für Fahrzeuge ohne Aktivlenkung		24.9145-0003.2 399007	
320 d	147	03/10→10/13					
BMW - 3 Compact (E36) 03/94→08/00							
 Bremskraftverstärker							
316 g	75	03/94→08/00				03.7760-3102.4 300139	ATE Ø 10" pneumatisch
316 i	77	12/98→08/00					
318 tds	66	01/95→08/00					
323 ti	120	01/99→08/00					
323 ti	125	08/97→08/00					
316 i	75	03/94→08/00		09/96→; + ABS		03.7760-3102.4 300139	ATE Ø 10" pneumatisch
				→ 08/96; + ABS		10.6360-1903.4 300093	ATE Ø 10" pneumatisch
318 ti	103	11/94→08/95		- ASC		03.7760-3102.4 300139	ATE Ø 10" pneumatisch
				+ ASC		10.6360-1903.4 300093	ATE Ø 10" pneumatisch
318 ti	103	07/95→08/00		- ASC		03.7760-3102.4 300139	ATE Ø 10" pneumatisch
				09/96→; + ASC		03.7760-3102.4 300139	ATE Ø 10" pneumatisch
				→ 08/96; + ASC		10.6360-1903.4 300093	ATE Ø 10" pneumatisch
Pedalwegsensor, Bremspedal							
316 i	75	03/94→08/00		→ 08/96; + ABS		03.0655-0002.2 370002	ATE
318 ti	103	11/94→08/95		+ ASC		03.0655-0002.2 370002	ATE
318 ti	103	07/95→08/00		→ 08/96; + ASC		03.0655-0002.2 370002	ATE
 Hauptbremszylinder							
316 g	75	03/94→08/00				03.2023-0987.3 010473	Ø1 23,81 Ø2 20,64
316 i	77	12/98→08/00					
318 tds	66	01/95→08/00					
318 ti	103	11/94→08/95					
318 ti	103	07/95→08/00					
323 ti	120	01/99→08/00					
323 ti	125	08/97→08/00					
316 i	75	03/94→08/00		09/94→; + ABS		03.2023-0987.3 010473	Ø1 23,81 Ø2 20,64
				→ 08/94; + ABS		10.6123-0239.3 010335	ATE Ø 23,81
				- ABS		24.2023-1601.3 010341	TRW Ø 23,81
BMW - 3 Compact (E46) 03/01→02/05							
 Bremskraftverstärker							
316 ti	77	06/02→02/05				03.7860-0702.4 300123	ATE Ø 10" pneumatisch
316 ti	85	06/02→02/05					
316 ti	85	06/01→02/05					
318 td	85	03/03→02/05					
320 td	110	09/01→02/05					









	kw			 	! #		
BMW - 3 Compact (E46) 03/01→02/05							
 Bremskraftverstärker							
325 ti	141	06/01→02/05				03.7860-0702.4 300123	ATE Ø 10" pneumatisch
318 ti	100	03/01→12/04		09/01→		03.7860-0702.4 300123	ATE Ø 10" pneumatisch
318 ti	105	03/01→12/04					
 Hauptbremszylinder							
316 ti	77	06/02→02/05		+ DSC		03.2023-2256.3 010870	ATE Ø1 23,81 Ø2 22,2
316 ti	85	06/02→02/05		- DSC		03.2023-2344.3 010647	ATE Ø1 23,81 Ø2 22,2
320 td	110	09/01→02/05					
316 ti	85	06/01→02/05		→ 08/01; - DSC		03.2022-2624.3 010588	Ø1 22,2 Ø2 20,64
325 ti	141	06/01→02/05		09/01→; + DSC		03.2023-2256.3 010870	ATE Ø1 23,81 Ø2 22,2
				09/01→; - DSC		03.2023-2344.3 010647	ATE Ø1 23,81 Ø2 22,2
318 td	85	03/03→02/05		+ DSC		03.2023-2256.3 010870	ATE Ø1 23,81 Ø2 22,2
318 ti	100	03/01→12/04		09/01→; + DSC		03.2023-2256.3 010870	ATE Ø1 23,81 Ø2 22,2
318 ti	105	03/01→12/04		09/01→; - DSC		03.2023-2344.3 010647	ATE Ø1 23,81 Ø2 22,2
BMW - 3 Coupe (E36) 03/92→04/99							
 Bremskraftverstärker							
316 i	75	09/93→04/99		09/94→; - ASC		03.7760-3102.4 300139	ATE Ø 10" pneumatisch
320 i	110	03/92→04/99		09/96→; + ASC		03.7760-3102.4 300139	ATE Ø 10" pneumatisch
				→ 08/96; + ASC		10.6360-1903.4 300093	ATE Ø 10" pneumatisch
				→ 08/94; - ASC		10.6360-1903.4 300093	ATE Ø 10" pneumatisch
318 is	103	03/92→10/95		09/94→; - ASC		03.7760-3102.4 300139	ATE Ø 10" pneumatisch
				→ 08/94; - ASC		10.6360-1903.4 300093	ATE Ø 10" pneumatisch
				+ ASC		10.6360-1903.4 300093	ATE Ø 10" pneumatisch
318 is	103	09/95→04/99		09/96→; + ASC		03.7760-3102.4 300139	ATE Ø 10" pneumatisch
				→ 08/96; + ASC		10.6360-1903.4 300093	ATE Ø 10" pneumatisch
323 i	125	03/95→04/99		- ASC		03.7760-3102.4 300139	ATE Ø 10" pneumatisch
328 i	142	01/95→04/99		09/96→; + ASC		03.7760-3102.4 300139	ATE Ø 10" pneumatisch
				→ 08/96; + ASC		10.6360-1903.4 300093	ATE Ø 10" pneumatisch
325 i	141	03/92→04/99		09/94→; - ASC		03.7760-3102.4 300139	ATE Ø 10" pneumatisch
				06/96→; + ASC		03.7760-3102.4 300139	ATE Ø 10" pneumatisch
				→ 08/94; - ASC		10.6360-1903.4 300093	ATE Ø 10" pneumatisch
				→ 08/96; + ASC		10.6360-1903.4 300093	ATE Ø 10" pneumatisch
M3 3.0	210	10/92→01/95				10.6360-1903.4 300093	ATE Ø 10" pneumatisch
M3 3.0	217	01/95→10/95					
 Hauptbremszylinder							
316 i	75	09/93→04/99		09/94→; - ASC		03.2023-0987.3 010473	Ø1 23,81 Ø2 20,64
320 i	110	03/92→04/99		09/96→; + ASC		03.2023-0987.3 010473	Ø1 23,81 Ø2 20,64
				→ 08/96; + ASC		10.6123-0239.3 010335	ATE Ø 23,81
				→ 08/94; - ASC		10.6123-0239.3 010335	ATE Ø 23,81
318 is	103	03/92→10/95		09/94→; - ASC		03.2023-0987.3 010473	Ø1 23,81 Ø2 20,64
				→ 08/94; - ASC		10.6123-0239.3 010335	ATE Ø 23,81
				+ ASC		10.6123-0239.3 010335	ATE Ø 23,81
318 is	103	09/95→04/99		09/96→; + ASC		03.2023-0987.3 010473	Ø1 23,81 Ø2 20,64
				→ 08/96; + ASC		10.6123-0239.3 010335	ATE Ø 23,81
323 i	125	03/95→04/99		- ASC		03.2023-0987.3 010473	Ø1 23,81 Ø2 20,64
328 i	142	01/95→04/99		09/96→; + ASC		03.2023-0987.3 010473	Ø1 23,81 Ø2 20,64
				→ 08/96; + ASC		10.6123-0239.3 010335	ATE Ø 23,81
325 i	141	03/92→04/99		09/94→; - ASC		03.2023-0987.3 010473	Ø1 23,81 Ø2 20,64
				06/96→; + ASC		03.2023-0987.3 010473	Ø1 23,81 Ø2 20,64
				→ 08/94; - ASC		10.6123-0239.3 010335	ATE Ø 23,81
				→ 08/96; + ASC		10.6123-0239.3 010335	ATE Ø 23,81
BMW - 3 Coupe (E46) 02/99→07/06							
 Bremskraftverstärker							
316 Ci	77	04/00→07/06				03.7860-0702.4 300123	ATE Ø 10" pneumatisch
316 Ci	85	06/02→07/06					
318 Ci	85	11/99→09/01					
318 Ci	87	11/99→09/01					
318 Ci	110	03/05→07/06					
320 Cd	110	11/03→07/06					
323 Ci	120	04/99→09/00					
323 Ci	125	04/99→09/00					
325 Ci	141	09/00→07/06					



















	kw			 	! #		
BMW - 3 Coupe (E46) 02/99→07/06							
Bremskraftverstärker							
328 Ci	142	04/99→06/00				03.7860-0702.4 300123	ATE Ø 10" pneumatisch
330 Cd	150	03/03→07/06					
330 Ci	170	06/00→07/06					
330 xi	170	06/00→07/06					
318 Ci	100	12/00→05/06		09/01→		03.7860-0702.4 300123	ATE Ø 10" pneumatisch
318 Ci	105	12/00→05/06					
320 Ci	110	02/99→08/01		08/99→ 09/00		03.7860-0702.4 300123	ATE Ø 10" pneumatisch
320 Ci	120	01/00→05/06		09/00→		03.7860-0702.4 300123	ATE Ø 10" pneumatisch
320 Ci	125	01/00→05/06					
Hauptbremszylinder							
316 Ci	77	04/00→07/06		→ 08/01; - DSC		03.2022-2624.3 010588	Ø1 22,2 Ø2 20,64
				→ 08/00; + DSC		03.2022-2829.3 010589	ATE Ø1 22,2 Ø2 20,64
				02/01→; + DSC		03.2023-2256.3 010870	ATE Ø1 23,81 Ø2 22,2
				09/01→; - DSC		03.2023-2344.3 010647	ATE Ø1 23,81 Ø2 22,2
316 Ci	85	06/02→07/06		+ DSC		03.2023-2256.3 010870	ATE Ø1 23,81 Ø2 22,2
				- DSC		03.2023-2344.3 010647	ATE Ø1 23,81 Ø2 22,2
318 Ci	85	11/99→09/01		- DSC		03.2022-2624.3 010588	Ø1 22,2 Ø2 20,64
318 Ci	87	11/99→09/01		→ 08/00; + DSC		03.2022-2829.3 010589	ATE Ø1 22,2 Ø2 20,64
				02/01→; + DSC		03.2023-2256.3 010870	ATE Ø1 23,81 Ø2 22,2
318 Ci	100	12/00→05/06		09/01→; + DSC		03.2023-2256.3 010870	ATE Ø1 23,81 Ø2 22,2
318 Ci	105	12/00→05/06		09/01→; - DSC		03.2023-2344.3 010647	ATE Ø1 23,81 Ø2 22,2
318 Ci	110	03/05→07/06				03.2023-2256.3 010870	ATE Ø1 23,81 Ø2 22,2
320 Cd	110	11/03→07/06					
330 Cd	150	03/03→07/06					
320 Ci	110	02/99→08/01		08/99→ 09/00; - DSC		03.2022-2624.3 010588	Ø1 22,2 Ø2 20,64
				08/99→ 09/00; + DSC		03.2022-2829.3 010589	ATE Ø1 22,2 Ø2 20,64
320 Ci	120	01/00→05/06		09/00→ 08/01; - DSC		03.2022-2624.3 010588	Ø1 22,2 Ø2 20,64
320 Ci	125	01/00→05/06		09/00→; + DSC		03.2023-2256.3 010870	ATE Ø1 23,81 Ø2 22,2
				09/01→; - DSC		03.2023-2344.3 010647	ATE Ø1 23,81 Ø2 22,2
323 Ci	120	04/99→09/00		- DSC		03.2022-2624.3 010588	Ø1 22,2 Ø2 20,64
323 Ci	125	04/99→09/00		+ DSC		03.2022-2829.3 010589	ATE Ø1 22,2 Ø2 20,64
328 Ci	142	04/99→06/00					
325 Ci	141	09/00→07/06		→ 08/01; - DSC		03.2022-2624.3 010588	Ø1 22,2 Ø2 20,64
				+ DSC		03.2023-2256.3 010870	ATE Ø1 23,81 Ø2 22,2
				09/01→; - DSC		03.2023-2344.3 010647	ATE Ø1 23,81 Ø2 22,2
330 Ci	170	06/00→07/06		→ 08/00; + DSC		03.2023-2204.3 010644	ATE Ø1 23,81 Ø2 22,2
330 xi	170	06/00→07/06		09/00→; + DSC		03.2023-2256.3 010870	ATE Ø1 23,81 Ø2 22,2
				→ 08/01; - DSC		03.2023-2304.3 010646	ATE Ø1 23,81 Ø2 22,2
				09/01→; - DSC		03.2023-2344.3 010647	ATE Ø1 23,81 Ø2 22,2
BMW - 3 Coupe (E92) 01/05→12/13							
Bremskraftverstärker							
316 i	90	09/07→12/13		09/09→ 06/13;		03.7848-4003.4 300235	ATE Ø 8" pneumatisch
320 i	115	06/07→12/13		für Fahrzeuge ohne Start-Stopp-Funktion			
320 i	125	03/07→12/13		→ 08/09		03.7848-4003.4 300235	ATE Ø 8" pneumatisch
318 i	105	03/10→12/13		→ 06/13;		03.7848-4003.4 300235	ATE Ø 8" pneumatisch
				für Fahrzeuge ohne Start-Stopp-Funktion			
320 d	120	03/07→06/13		09/09→;		03.7845-0103.4 300268	ATE Ø 8" pneumatisch
				für Fahrzeuge ohne Start-Stopp-Funktion			
				→ 08/09		03.7848-5003.4 300236	ATE Ø 8" pneumatisch
320 d	130	09/06→02/10		09/09→;		03.7845-0103.4 300268	ATE Ø 8" pneumatisch
320 d	145	09/06→02/10		für Fahrzeuge ohne Start-Stopp-Funktion			
				03/07→ 08/09		03.7848-5003.4 300236	ATE Ø 8" pneumatisch
320 d	135	03/10→06/13		für Fahrzeuge ohne Start-Stopp-Funktion		03.7845-0103.4 300268	ATE Ø 8" pneumatisch
320 d	147	03/10→06/13					
320 d xDrive	120	03/10→06/13					
320 d xDrive	130	09/09→02/10					
320 d xDrive	135	03/10→06/13					
320 d xDrive	145	09/09→02/10					
320 d xDrive	147	03/10→06/13					
320 i	110	11/06→06/07		03/07→		03.7848-4003.4 300235	ATE Ø 8" pneumatisch
320 i	120	01/07→12/13		03/07→ 08/09		03.7848-4003.4 300235	ATE Ø 8" pneumatisch
				09/09→ 06/13;		03.7848-4003.4 300235	ATE Ø 8" pneumatisch
				für Fahrzeuge ohne Start-Stopp-Funktion			
320 xd	120	03/08→02/10		09/09→;		03.7845-0103.4 300268	ATE Ø 8" pneumatisch
320 xd	130	03/08→02/10		für Fahrzeuge ohne Start-Stopp-Funktion			
320 xd	145	03/08→02/10		→ 08/09		03.7845-0103.4 300268	ATE Ø 8" pneumatisch
↓							













	kW			 	! #		
BMW - 3 Coupe (E92) 01/05→12/13							
Bremskraftverstärker							
323 i	140	04/06→02/12		09/07→ 09/06→ 08/07		03.7845-0103.4 300268 03.7848-5003.4 300236	ATE Ø 8" pneumatisch ATE Ø 8" pneumatisch
325 d	145	03/07→12/13		→ 06/13		03.7848-5003.4 300236	ATE Ø 8" pneumatisch
325 d	150	04/10→12/13					
325 i xDrive	160	09/08→12/13					
325 xi	160	09/06→12/13					
325 xi	160	09/07→12/13					
325 d	155	01/07→12/09		03/07→		03.7848-5003.4 300236	ATE Ø 8" pneumatisch
325 i	155	05/05→06/13		09/06→		03.7848-5003.4 300236	ATE Ø 8" pneumatisch
325 i	160	05/05→06/13					
325 i	155	01/05→06/13					
325 i	160	01/05→06/13					
325 i xDrive	150	03/06→12/13		09/06→ 06/13		03.7848-5003.4 300236	ATE Ø 8" pneumatisch
328 i	172	06/07→12/13					
328 i xDrive	172	09/09→06/13				03.7848-5003.4 300236	ATE Ø 8" pneumatisch
330 d	170	09/06→12/13		→ 08/09		03.7845-0103.4 300268	ATE Ø 8" pneumatisch
330 d	180	01/09→12/13					
330 d xDrive	180	01/09→12/13		09/09→ 06/13		03.7848-5003.4 300236	ATE Ø 8" pneumatisch
330 i	190	09/06→12/13					
330 i	200	03/07→12/13					
330 i xDrive	200	09/08→12/13					
330 xd	170	09/06→12/13					
330 xd	180	01/09→12/13					
330 xi	190	09/06→12/13					
330 xi	200	09/06→12/13					
330 i	200	09/06→02/10		→ 08/09		03.7845-0103.4 300268	ATE Ø 8" pneumatisch
				09/09→		03.7848-5003.4 300236	ATE Ø 8" pneumatisch
335 d	210	09/06→12/13		→ 06/13		03.7845-0103.4 300268	ATE Ø 8" pneumatisch
335 i xDrive	225	11/08→12/13					
335 i	225	11/05→06/13		09/06→		03.7845-0103.4 300268	ATE Ø 8" pneumatisch
335 i	240	11/05→06/13					
335 i xDrive	240	11/08→06/13				03.7845-0103.4 300268	ATE Ø 8" pneumatisch
335 xi	225	03/07→02/10		09/07→		03.7845-0103.4 300268	ATE Ø 8" pneumatisch
335 xi	240	03/07→02/10					
Hauptbremszylinder							
316 i	90	09/07→12/13		für Linkslenker; → 06/13		03.2023-2407.3 010796	ATE Ø1 23,81 Ø2 22,2
318 i	105	03/10→12/13					
320 d	120	03/07→06/13		für Linkslenker		03.2025-1904.3 010797	ATE Ø1 25,4 Ø2 22,2
320 d	135	03/10→06/13					
320 d	147	03/10→06/13					
330 i	200	09/06→02/10					
320 d	130	09/06→02/10		03/07→; für Linkslenker		03.2025-1904.3 010797	ATE Ø1 25,4 Ø2 22,2
320 d	145	09/06→02/10					
320 i	110	11/06→06/07					
325 d	155	01/07→12/09					
320 d xDrive	120	03/10→06/13				03.2025-1904.3 010797	ATE Ø1 25,4 Ø2 22,2
320 d xDrive	130	09/09→02/10					
320 d xDrive	135	03/10→06/13					
320 d xDrive	145	09/09→02/10					
320 d xDrive	147	03/10→06/13					
320 xd	120	03/08→02/10					
320 xd	130	03/08→02/10					
320 xd	145	03/08→02/10					
328 i xDrive	172	09/09→06/13					
335 i xDrive	240	11/08→06/13					
320 i	115	06/07→12/13		09/07→ 06/13; für Linkslenker		03.2023-2407.3 010796	ATE Ø1 23,81 Ø2 22,2
320 i	125	03/07→12/13		→ 08/07; für Linkslenker		03.2025-1904.3 010797	ATE Ø1 25,4 Ø2 22,2
320 i	120	01/07→12/13		09/07→ 06/13; für Linkslenker		03.2023-2407.3 010796	ATE Ø1 23,81 Ø2 22,2
				03/07→ 08/07; für Linkslenker		03.2025-1904.3 010797	ATE Ø1 25,4 Ø2 22,2
325 d	145	03/07→12/13		→ 06/13; für Linkslenker		03.2025-1904.3 010797	ATE Ø1 25,4 Ø2 22,2
325 d	150	04/10→12/13					
330 d	170	09/06→12/13					
330 d	180	01/09→12/13					
330 i	190	09/06→12/13					
330 i	200	03/07→12/13					
335 d	210	09/06→12/13					
325 i	155	05/05→06/13		09/06→; für Linkslenker		03.2025-1904.3 010797	ATE Ø1 25,4 Ø2 22,2
325 i	160	05/05→06/13					
325 i	155	01/05→06/13					
325 i	160	01/05→06/13					
335 i	225	11/05→06/13					
335 i	240	11/05→06/13					
325 i xDrive	150	03/06→12/13		09/06→ 06/13		03.2025-1904.3 010797	ATE Ø1 25,4 Ø2 22,2
325 i xDrive	160	09/08→12/13		→ 06/13		03.2025-1904.3 010797	ATE Ø1 25,4 Ø2 22,2
325 xi	160	09/06→12/13					
325 xi	160	09/07→12/13					













	kW			 	! #		
BMW - 3 Coupe (E92) 01/05→12/13							
 Hauptbremszylinder							
328 i	172	06/07→12/13		→ 06/13		03.2025-1904.3 010797	ATE Ø1 25,4 Ø2 22,2
330 d xDrive	180	01/09→12/13					
330 i xDrive	200	09/08→12/13					
330 xd	170	09/06→12/13					
330 xd	180	01/09→12/13					
330 xi	190	09/06→12/13					
330 xi	200	09/06→12/13					
335 i xDrive	225	11/08→12/13					
335 xi	225	03/07→02/10		09/07→		03.2025-1904.3 010797	ATE Ø1 25,4 Ø2 22,2
335 xi	240	03/07→02/10					
Hydraulikaggregat, Bremsanlage							
316 i	90	09/07→12/13		09/08→ 06/13		24.9145-0003.2 399007	
318 i	105	03/10→12/13		→ 06/13		24.9145-0003.2 399007	
320 d	120	03/07→06/13		09/08→;		24.9145-0003.2 399007	
320 d	130	09/06→02/10		für Fahrzeuge ohne Aktivlenkung			
320 d	145	09/06→02/10					
320 d	135	03/10→06/13		für Fahrzeuge ohne Aktivlenkung		24.9145-0003.2 399007	
320 d	147	03/10→06/13					
320 i	115	06/07→12/13		09/08→ 06/13;		24.9145-0003.2 399007	
320 i	120	01/07→12/13		für Fahrzeuge ohne Aktivlenkung			
320 i	125	03/07→12/13					
BMW - 3 Touring (E36) 01/95→10/99							
 Bremskraftverstärker							
316 i	75	01/96→10/99				03.7760-3102.4 300139	ATE Ø 10" pneumatisch
318 i	85	07/95→10/99					
318 tds	66	01/95→10/99					
325 tds	105	01/95→10/99					
320 i	110	01/95→10/99		- ASC		03.7760-3102.4 300139	ATE Ø 10" pneumatisch
323 i	125	09/95→10/99		09/96→; + ASC		03.7760-3102.4 300139	ATE Ø 10" pneumatisch
328 i	142	01/95→10/99		→ 08/96; + ASC		10.6360-1903.4 300093	ATE Ø 10" pneumatisch
Pedalwegsensoren, Bremspedal							
320 i	110	01/95→10/99		→ 08/96		03.0655-0002.2 370002	ATE
323 i	125	09/95→10/99					
328 i	142	01/95→10/99					
 Hauptbremszylinder							
316 i	75	01/96→10/99				03.2023-0987.3 010473	Ø1 23,81 Ø2 20,64
318 i	85	07/95→10/99					
318 tds	66	01/95→10/99					
325 tds	105	01/95→10/99					
320 i	110	01/95→10/99		10/96→; - ASC		03.2023-0987.3 010473	Ø1 23,81 Ø2 20,64
323 i	125	09/95→10/99		09/96→; + ASC		03.2023-0987.3 010473	Ø1 23,81 Ø2 20,64
328 i	142	01/95→10/99		→ 08/96; + ASC		10.6123-0239.3 010335	ATE Ø 23,81
BMW - 3 Touring (E46) 10/99→05/05							
 Bremskraftverstärker							
316 i	85	06/02→02/05				03.7860-0702.4 300123	ATE Ø 10" pneumatisch
316 i	85	03/02→02/05					
318 d	85	10/02→03/03					
318 d	85	03/03→02/05					
318 i	85	10/99→09/01					
318 i	87	10/99→09/01					
318 i	105	09/01→02/05					
320 d	100	03/00→09/01					
320 d	110	09/01→02/05					
320 i	110	10/99→09/00					
320 i	120	09/00→02/05					
320 i	125	09/00→02/05					
325 i	141	09/00→02/05					
325 xi	141	09/00→02/05					
328 i	142	10/99→06/00					
330 d	135	10/99→02/05					
330 d	150	03/03→02/05					
330 i	170	06/00→02/05					
330 xi	170	06/00→02/05					
330 xd	135	01/00→03/03		06/00→		03.7860-0702.4 300123	ATE Ø 10" pneumatisch
330 xd	150	08/02→05/05		03/03→ 02/05		03.7860-0702.4 300123	ATE Ø 10" pneumatisch
 Hauptbremszylinder							
316 i	85	06/02→02/05		+ DSC		03.2023-2256.3 010870	ATE Ø1 23,81 Ø2 22,2
316 i	85	03/02→02/05					
318 d	85	10/02→03/03		- DSC		03.2023-2344.3 010647	ATE Ø1 23,81 Ø2 22,2
↓							











	kw			 	! #		
BMW - 3 Touring (E46) 10/99→05/05							
 Hauptbremszylinder							
318 d	85	03/03→02/05		+ DSC		03.2023-2256.3 010870	ATE Ø1 23,81 Ø2 22,2
318 i	105	09/01→02/05		- DSC		03.2023-2344.3 010647	ATE Ø1 23,81 Ø2 22,2
320 d	110	09/01→02/05					
318 i	85	10/99→09/01		- DSC		03.2022-2624.3 010588	Ø1 22,2 Ø2 20,64
318 i	87	10/99→09/01		→ 08/00; + DSC		03.2022-2829.3 010589	ATE Ø1 22,2 Ø2 20,64
320 d	100	03/00→09/01					
320 i	110	10/99→09/00					
320 i	120	09/00→02/05		→ 08/01; - DSC		03.2022-2624.3 010588	Ø1 22,2 Ø2 20,64
320 i	125	09/00→02/05		+ DSC		03.2023-2256.3 010870	ATE Ø1 23,81 Ø2 22,2
				09/01→; - DSC		03.2023-2344.3 010647	ATE Ø1 23,81 Ø2 22,2
325 i	141	09/00→02/05		→ 08/01; - DSC		03.2022-2624.3 010588	Ø1 22,2 Ø2 20,64
				02/01→; + DSC		03.2023-2256.3 010870	ATE Ø1 23,81 Ø2 22,2
				09/01→; - DSC		03.2023-2344.3 010647	ATE Ø1 23,81 Ø2 22,2
328 i	142	10/99→06/00		- DSC		03.2022-2624.3 010588	Ø1 22,2 Ø2 20,64
				+ DSC		03.2022-2829.3 010589	ATE Ø1 22,2 Ø2 20,64
330 d	135	10/99→02/05		→ 08/00; + DSC		03.2023-2204.3 010644	ATE Ø1 23,81 Ø2 22,2
				09/00→; + DSC		03.2023-2256.3 010870	ATE Ø1 23,81 Ø2 22,2
				→ 08/01; - DSC		03.2023-2304.3 010646	ATE Ø1 23,81 Ø2 22,2
				09/01→; - DSC		03.2023-2344.3 010647	ATE Ø1 23,81 Ø2 22,2
330 d	150	03/03→02/05		+ DSC		03.2023-2256.3 010870	ATE Ø1 23,81 Ø2 22,2
330 i	170	06/00→02/05		→ 08/01; + DSC		03.2023-2204.3 010644	ATE Ø1 23,81 Ø2 22,2
				09/01→; + DSC		03.2023-2256.3 010870	ATE Ø1 23,81 Ø2 22,2
				→ 08/01; - DSC		03.2023-2304.3 010646	ATE Ø1 23,81 Ø2 22,2
				09/01→; - DSC		03.2023-2344.3 010647	ATE Ø1 23,81 Ø2 22,2
BMW - 3 Touring (E91) 12/04→06/12							
 Bremskraftverstärker							
316 d	85	09/09→06/12		→ 05/12; für Fahrzeuge ohne Start-Stopp-Funktion		03.7848-4003.4 300235	ATE Ø 8" pneumatisch
316 i	90	05/08→05/12		für Fahrzeuge ohne Start-Stopp-Funktion		03.7848-4003.4 300235	ATE Ø 8" pneumatisch
318 d	90	09/05→06/12		→ 08/07		03.7848-5003.4 300236	ATE Ø 8" pneumatisch
318 d	100	07/07→06/12		09/07→ 05/12		03.7845-0103.4 300268	ATE Ø 8" pneumatisch
318 d	105	09/07→06/12		→ 05/12		03.7845-0103.4 300268	ATE Ø 8" pneumatisch
320 d xDrive	120	07/09→06/12					
330 i	200	09/07→06/12					
335 d	210	09/06→06/12					
318 i	95	01/06→08/07		03/07→; Motorcode: N46N		03.7845-0103.4 300268	ATE Ø 8" pneumatisch
				Motorcode: N46		03.7848-5003.4 300236	ATE Ø 8" pneumatisch
318 i	100	09/07→03/12				03.7845-0103.4 300268	ATE Ø 8" pneumatisch
320 d	135	03/10→05/12					
320 d	147	03/10→05/12					
320 d xDrive	130	02/08→02/10					
320 d xDrive	135	03/10→05/12					
320 d xDrive	145	02/08→02/10					
320 d xDrive	147	03/10→05/12					
323 i	140	09/06→07/08					
335 i xDrive	225	05/08→05/12					
335 i xDrive	240	05/08→05/12					
318 i	105	05/07→05/12		09/07→		03.7845-0103.4 300268	ATE Ø 8" pneumatisch
320 d	130	02/07→02/10					
320 d	145	02/07→02/10					
320 i	120	02/07→05/12					
320 i	125	02/07→05/12					
320 d	110	12/04→08/07		06/05→		03.7848-5003.4 300236	ATE Ø 8" pneumatisch
320 d	120	12/04→08/07					
325 i	155	12/04→12/10					
325 i	160	12/04→12/10					
330 d	155	12/04→05/12					
330 d	170	12/04→08/08					
320 i	110	09/05→06/12		→ 08/07; Motorcode: N46N		03.7845-0103.4 300268	ATE Ø 8" pneumatisch
				→ 08/07; Motorcode: N46		03.7848-5003.4 300236	ATE Ø 8" pneumatisch
323 i	130	04/06→06/07		09/06→		03.7845-0103.4 300268	ATE Ø 8" pneumatisch
335 i	225	03/06→05/12					
335 i	240	03/06→05/12					
325 d	145	09/06→06/12		→ 05/12		03.7848-5003.4 300236	ATE Ø 8" pneumatisch
325 d	150	02/10→06/12					
325 i	160	09/07→06/12					
325 i xDrive	160	09/07→06/12					
325 xi	160	09/07→06/12					
330 d xDrive	180	01/09→06/12					
330 i xDrive	200	09/07→06/12					
330 xd	170	09/05→06/12					











	kW			 	! #		
BMW - 3 Touring (E91) 12/04→06/12							
Bremskraftverstärker							
330 xi	200	09/07→06/12		→ 05/12		03.7848-5003.4 300236	ATE Ø 8" pneumatisch
325 i	155	09/07→06/12		01/12→ 05/12		03.7848-5003.4 300236	ATE Ø 8" pneumatisch
325 xi	160	09/05→08/11				03.7848-5003.4 300236	ATE Ø 8" pneumatisch
330 i	190	09/05→08/07					
330 xi	190	09/05→08/07					
330 d	180	02/08→05/12		09/08→		03.7845-0103.4 300268	ATE Ø 8" pneumatisch
335 xi	225	09/06→08/08		03/07→		03.7845-0103.4 300268	ATE Ø 8" pneumatisch
335 xi	240	09/06→08/08					
Hauptbremszylinder							
316 d	85	09/09→06/12		für Linkslenker; → 05/12		03.2023-2407.3 010796	ATE Ø1 23,81 Ø2 22,2
316 i	90	05/08→05/12				03.2023-2407.3 010796	ATE Ø1 23,81 Ø2 22,2
318 d	90	09/05→06/12		→ 08/07; für Linkslenker		03.2025-1904.3 010797	ATE Ø1 25,4 Ø2 22,2
320 i	110	09/05→06/12					
318 d	100	07/07→06/12		09/07→ 05/12		03.2025-1904.3 010797	ATE Ø1 25,4 Ø2 22,2
318 d	105	09/07→06/12		→ 05/12		03.2025-1904.3 010797	ATE Ø1 25,4 Ø2 22,2
320 d xDrive	120	07/09→06/12					
325 d	145	09/06→06/12					
325 d	150	02/10→06/12					
325 i xDrive	160	09/07→06/12					
325 xi	160	09/07→06/12					
330 d xDrive	180	01/09→06/12					
330 i xDrive	200	09/07→06/12					
330 xd	170	09/05→06/12					
330 xi	200	09/07→06/12					
318 i	95	01/06→08/07		für Linkslenker		03.2025-1904.3 010797	ATE Ø1 25,4 Ø2 22,2
320 d	135	03/10→05/12					
320 d	147	03/10→05/12					
330 i	190	09/05→08/07					
318 i	100	09/07→03/12				03.2025-1904.3 010797	ATE Ø1 25,4 Ø2 22,2
320 d xDrive	130	02/08→02/10					
320 d xDrive	135	03/10→05/12					
320 d xDrive	145	02/08→02/10					
320 d xDrive	147	03/10→05/12					
325 xi	160	09/05→08/11					
330 xi	190	09/05→08/07					
335 i xDrive	225	05/08→05/12					
335 i xDrive	240	05/08→05/12					
318 i	105	05/07→05/12		09/07→		03.2025-1904.3 010797	ATE Ø1 25,4 Ø2 22,2
320 d	110	12/04→08/07		06/05→; für Linkslenker		03.2025-1904.3 010797	ATE Ø1 25,4 Ø2 22,2
320 d	120	12/04→08/07					
325 i	155	12/04→12/10					
325 i	160	12/04→12/10					
320 d	130	02/07→02/10		09/07→; für Linkslenker		03.2025-1904.3 010797	ATE Ø1 25,4 Ø2 22,2
320 d	145	02/07→02/10					
320 i	120	02/07→05/12					
320 i	125	02/07→05/12					
325 i	155	09/07→06/12		01/12→; für Linkslenker; → 05/12		03.2025-1904.3 010797	ATE Ø1 25,4 Ø2 22,2
325 i	160	09/07→06/12		→ 05/12; für Linkslenker		03.2025-1904.3 010797	ATE Ø1 25,4 Ø2 22,2
330 i	200	09/07→06/12					
335 d	210	09/06→06/12					
330 d	155	12/04→05/12		06/05→		03.2025-1904.3 010797	ATE Ø1 25,4 Ø2 22,2
330 d	170	12/04→08/08					
330 d	180	02/08→05/12		09/08→; für Linkslenker		03.2025-1904.3 010797	ATE Ø1 25,4 Ø2 22,2
335 i	225	03/06→05/12		09/06→; für Linkslenker		03.2025-1904.3 010797	ATE Ø1 25,4 Ø2 22,2
335 i	240	03/06→05/12					
335 xi	225	09/06→08/08		03/07→		03.2025-1904.3 010797	ATE Ø1 25,4 Ø2 22,2
335 xi	240	09/06→08/08					
Hydraulikaggregat, Bremsanlage							
316 d	85	09/09→06/12		→ 05/12		24.9145-0003.2 399007	
316 i	90	05/08→05/12		09/08→		24.9145-0003.2 399007	
318 i	100	09/07→03/12					
318 i	105	05/07→05/12					
318 d	100	07/07→06/12		09/08→ 05/12		24.9145-0003.2 399007	
318 d	105	09/07→06/12					
320 d	130	02/07→02/10		09/08→;		24.9145-0003.2 399007	
320 d	145	02/07→02/10		für Fahrzeuge ohne Aktivlenkung			
320 i	120	02/07→05/12					
320 i	125	02/07→05/12					
320 d	135	03/10→05/12		für Fahrzeuge ohne Aktivlenkung		24.9145-0003.2 399007	
320 d	147	03/10→05/12					













	kw			 	! #		
BMW - 5 (E34) 12/87→11/95							
 Hauptbremszylinder							
518 i	83	08/89→09/95		09/91→		03.2025-1211.3 010475	ATE Ø1 25,4 Ø2 20,64
518 i	85	08/89→09/95					
520 i 24V	110	09/89→09/95		→ 08/91		03.2125-3011.3 010211	Ø 25,4
525 i 24V	141	09/89→09/95					
524 td	85	03/88→09/95		→ 08/91		03.2125-3011.3 010211	Ø 25,4
525 tds	105	09/91→09/95				03.2025-1211.3 010475	ATE Ø1 25,4 Ø2 20,64
530 i V8	160	09/92→09/95		→ 08/93; für Linkslenker		24.2125-1716.3 010663	Ø 25,4
540 i V8	210	09/92→09/95					
535 i	155	01/88→09/95				03.2125-3011.3 010211	Ø 25,4
M5	250	03/92→09/95					
BMW - 5 (E39) 11/95→06/03							
 Hauptbremszylinder							
520 d	100	02/00→06/03		04/00→		24.2025-1705.3 010624	TRW Ø1 25,4 Ø2 20,64
520 i	100	04/99→06/03		+ DSC		24.2025-1704.3 010619	Ø 25,4
520 i	120	09/00→06/03					
520 i	125	09/00→06/03		- DSC		24.2025-1705.3 010624	TRW Ø1 25,4 Ø2 20,64
530 d	142	09/00→06/03					
520 i	110	01/96→09/00		03/96→; + DSC		24.2025-1704.3 010619	Ø 25,4
				09/97→; - DSC		24.2025-1705.3 010624	TRW Ø1 25,4 Ø2 20,64
				03/96→ 08/97; - DSC		24.2120-1721.3 010553	Ø 20,64
523 i	125	11/95→09/00		12/95→; + DSC		24.2025-1704.3 010619	Ø 25,4
528 i	142	11/95→09/00		09/97→; - DSC		24.2025-1705.3 010624	TRW Ø1 25,4 Ø2 20,64
				12/95→ 08/97; - DSC		24.2120-1721.3 010553	Ø 20,64
525 d	120	02/00→06/03		04/00→; + DSC		24.2025-1704.3 010619	Ø 25,4
				04/00→; - DSC		24.2025-1705.3 010624	TRW Ø1 25,4 Ø2 20,64
525 i	141	09/00→06/03		10/00→; + DSC		24.2025-1704.3 010619	Ø 25,4
530 i	170	09/00→06/03		10/00→; - DSC		24.2025-1705.3 010624	TRW Ø1 25,4 Ø2 20,64
525 td	85	01/97→06/03		09/97→ 09/00		24.2025-1705.3 010624	TRW Ø1 25,4 Ø2 20,64
				→ 08/97		24.2120-1721.3 010553	Ø 20,64
525 tds	105	01/96→06/03		09/97→ 09/00		24.2025-1705.3 010624	TRW Ø1 25,4 Ø2 20,64
				02/96→ 08/97		24.2120-1721.3 010553	Ø 20,64
530 d	135	08/98→09/00		09/98→; + DSC		24.2025-1704.3 010619	Ø 25,4
				09/98→; - DSC		24.2025-1705.3 010624	TRW Ø1 25,4 Ø2 20,64
535 i	173	04/96→03/99		09/97→		24.2025-1704.3 010619	Ø 25,4
540 i	210	04/96→06/03		05/96→ 08/97		24.2120-1721.3 010553	Ø 20,64
535 i	180	04/99→06/03				24.2025-1704.3 010619	Ø 25,4
M5	294	10/98→06/03					
BMW - 5 (E60) 12/01→03/10							
 Hauptbremszylinder							
520 d	110	02/05→02/08		07/05→		24.2026-1702.3 010850	TRW Ø 26,99 Ø2 22,2
520 d	120	02/05→02/08					
530 i	190	09/04→02/07					
530 xd	170	02/05→02/07					
530 xi	190	09/04→02/07					
520 d	130	04/06→12/09		09/07→		24.2026-1702.3 010850	TRW Ø 26,99 Ø2 22,2
520 i	125	07/03→03/10		→ 03/05		24.2025-1710.3 010833	TRW Ø 25,4
523 i	130	07/05→03/10		→ 03/07		24.2026-1702.3 010850	TRW Ø 26,99 Ø2 22,2
525 d	120	12/04→03/10					
525 d	130	06/04→03/10					
535 d	200	09/04→03/10					
523 i	140	01/07→03/10		03/07→ 02/10		24.2026-1702.3 010850	TRW Ø 26,99 Ø2 22,2
525 d	145	01/07→03/10					
535 d	210	01/07→03/10					
525 d xDrive	145	09/07→12/09				24.2026-1702.3 010850	TRW Ø 26,99 Ø2 22,2
530 d	170	02/05→02/07					
530 d xDrive	173	09/07→12/09					
530 i	200	01/07→12/09					
530 i xDrive	200	09/07→12/09					
535 i	225	04/06→12/09					
540 i	225	09/05→02/10					
525 i	141	09/03→03/10		→ 06/05		24.2025-1710.3 010833	TRW Ø 25,4
525 i	155	07/05→03/10		→ 02/10		24.2026-1702.3 010850	TRW Ø 26,99 Ø2 22,2
525 i	160	07/05→03/10					
525 i	155	01/07→03/10					
525 i	160	01/07→03/10					
525 i xDrive	160	09/08→03/10					
525 xi	160	07/05→03/10					
525 xi	160	01/07→03/10					
540 i	225	07/05→03/10					
↓							















	kW			 	! #		
BMW - 5 (E60) 12/01→03/10							
 Hauptbremszylinder							
550 i M5	270 373	07/05→03/10 09/04→03/10		→ 02/10		24.2026-1702.3 010850	TRW Ø 26,99 Ø2 22,2
525 xd 530 d 530 xd 530 xi	145 173 173 200	11/06→08/07 09/06→12/09 09/06→08/07 11/05→08/07		03/07→		24.2026-1702.3 010850	TRW Ø 26,99 Ø2 22,2
530 d 530 d 530 i	155 160 170	02/02→12/09 02/02→09/05 12/01→02/05		07/03→ 08/05 07/03→		24.2026-1702.3 010850 24.2025-1710.3 010833	TRW Ø 26,99 Ø2 22,2 TRW Ø 25,4
530 i	187	03/05→03/10		07/05→ 03/07		24.2026-1702.3 010850	TRW Ø 26,99 Ø2 22,2
530 i	200	09/06→12/09		01/07→		24.2026-1702.3 010850	TRW Ø 26,99 Ø2 22,2
545 i	245	09/03→03/10		→ 08/05		24.2026-1702.3 010850	TRW Ø 26,99 Ø2 22,2
BMW - 5 (F10) 01/09→10/16							
 Hauptbremszylinder							
M5	412	10/10→10/16		09/11→		24.4126-1703.3 010991	TRW Ø 26,99
M5 Competition	423	02/13→10/16		01/14→		24.4126-1703.3 010991	TRW Ø 26,99
M5 Edition 30	441	07/14→10/16				24.4126-1703.3 010991	TRW Ø 26,99
BMW - 5 Gran Turismo (F07) 01/09→							
 Hauptbremszylinder							
520 d 530 d 530 d xDrive 550 i	100 190 190 298	10/12→ 10/11→ 11/11→ 10/09→05/12				24.2026-1702.3 010850	TRW Ø 26,99 Ø2 22,2
520 d 520 d 528 i	120 135 180	04/11→ 04/11→ 01/13→		10/11→ 08/13→		24.2026-1702.3 010850 24.2026-1702.3 010850	TRW Ø 26,99 Ø2 22,2 TRW Ø 26,99 Ø2 22,2
530 d	155	03/10→06/12		07/10→		24.2026-1702.3 010850	TRW Ø 26,99 Ø2 22,2
530 d 535 i 550 i	180 225 300	01/09→06/12 01/09→ 01/09→05/12		10/09→		24.2026-1702.3 010850	TRW Ø 26,99 Ø2 22,2
530 d xDrive 535 d xDrive 535 d xDrive 535 i xDrive 550 i xDrive	180 220 225 225 300	01/10→06/12 05/09→06/12 05/09→06/12 01/10→ 04/09→06/12		09/10→		24.2026-1702.3 010850	TRW Ø 26,99 Ø2 22,2
535 d 535 d	220 225	05/09→06/12 05/09→06/12		03/10→		24.2026-1702.3 010850	TRW Ø 26,99 Ø2 22,2
535 d 535 d xDrive	230 230	01/12→ 01/12→		02/12→		24.2026-1702.3 010850	TRW Ø 26,99 Ø2 22,2
550 i 550 i xDrive	330 330	01/12→07/16 04/11→		05/12→		24.2026-1702.3 010850	TRW Ø 26,99 Ø2 22,2
BMW - 5 Touring (E34) 11/91→01/97							
 Hauptbremszylinder							
530 i V8	160	09/92→01/97		→ 08/93; für Linklenker		24.2125-1716.3 010663	Ø 25,4
M5	250	09/94→01/97		→ 11/96		03.2125-3011.3 010211	Ø 25,4
BMW - 5 Touring (E39) 01/97→05/04							
 Hauptbremszylinder							
520 d	100	02/00→09/03		04/00→ 07/03		24.2025-1705.3 010624	TRW Ø1 25,4 Ø2 20,64
520 i 520 i 520 i 530 d	100 120 125 142	04/99→05/04 09/00→05/04 09/00→05/04 09/00→05/04		→ 07/03; + DSC → 07/03; - DSC		24.2025-1704.3 010619 24.2025-1705.3 010624	Ø 25,4 TRW Ø1 25,4 Ø2 20,64
520 i 523 i 523 i 528 i	110 120 125 142	01/97→09/00 01/97→09/00 01/97→09/00 01/97→09/00		05/97→; + DSC 09/97→; - DSC 05/97→ 08/97; - DSC		24.2025-1704.3 010619 24.2025-1705.3 010624 24.2120-1721.3 010553	Ø 25,4 TRW Ø1 25,4 Ø2 20,64 Ø 20,64
525 d	120	02/00→05/04		04/00→ 07/03; + DSC 04/00→ 07/03; - DSC		24.2025-1704.3 010619 24.2025-1705.3 010624	Ø 25,4 TRW Ø1 25,4 Ø2 20,64
525 i 530 i	141 170	09/00→05/04 09/00→05/04		10/00→ 07/03; + DSC 10/00→ 07/03; - DSC		24.2025-1704.3 010619 24.2025-1705.3 010624	Ø 25,4 TRW Ø1 25,4 Ø2 20,64
525 tds	105	03/97→05/04		06/98→ 09/00		24.2025-1705.3 010624	TRW Ø1 25,4 Ø2 20,64
530 d	135	08/98→09/00		09/98→; + DSC 09/98→; - DSC		24.2025-1704.3 010619 24.2025-1705.3 010624	Ø 25,4 TRW Ø1 25,4 Ø2 20,64
540 i	210	01/97→05/04		09/97→ 07/03 05/97→ 08/97		24.2025-1704.3 010619 24.2120-1721.3 010553	Ø 25,4 Ø 20,64















	kw			 	! #		
BMW - 5 Touring (E61) 06/04→12/10							
 Hauptbremszylinder							
520 d	110	04/05→02/08		09/05→		24.2026-1702.3 010850	TRW Ø 26,99 Ø2 22,2
520 d	120	04/05→02/08		07/05→		24.2026-1702.3 010850	TRW Ø 26,99 Ø2 22,2
520 d	130	03/07→05/10		09/07→		24.2026-1702.3 010850	TRW Ø 26,99 Ø2 22,2
520 i	120	07/07→08/10		→ 05/10		24.2026-1702.3 010850	TRW Ø 26,99 Ø2 22,2
520 i	125	09/07→12/10					
525 d	120	12/04→12/10					
525 d xDrive	145	09/08→12/10					
525 i xDrive	160	09/08→12/10					
525 xi	160	07/05→12/10					
525 xi	160	01/07→12/10					
530 d	155	11/05→12/10					
530 d	160	06/04→12/10					
530 d	170	07/05→12/10					
530 d xDrive	173	09/08→12/10					
530 i xDrive	200	09/08→12/10					
550 i	270	07/05→12/10					
M5	373	02/07→12/10					
523 i	130	07/05→12/10		→ 03/07		24.2025-1710.3 010833	TRW Ø 25,4
530 i	190	07/05→12/10					
523 i	140	01/07→12/10		03/07→ 05/10		24.2026-1702.3 010850	TRW Ø 26,99 Ø2 22,2
525 d	145	01/07→12/10					
525 xd	145	01/07→12/10					
530 d	173	01/07→12/10					
530 i	200	01/07→12/10					
530 xd	173	01/07→12/10					
530 xi	200	01/07→12/10					
535 d	210	01/07→12/10					
525 d	130	06/04→12/10		→ 03/07		24.2026-1702.3 010850	TRW Ø 26,99 Ø2 22,2
530 xd	170	07/05→12/10					
530 xi	190	07/05→12/10					
535 d	200	09/04→12/10					
525 i	141	06/04→12/10		→ 03/05		24.2025-1710.3 010833	TRW Ø 25,4
525 i	155	07/05→12/10		→ 03/07		24.2025-1710.3 010833	TRW Ø 25,4
525 i	160	07/05→12/10					
525 i	155	01/07→12/10		03/07→ 05/10		24.2026-1702.3 010850	TRW Ø 26,99 Ø2 22,2
525 i	160	01/07→12/10					
545 i	245	06/04→12/10		→ 08/05		24.2026-1702.3 010850	TRW Ø 26,99 Ø2 22,2
BMW - 6 (E63) 01/04→12/10							
 Hauptbremszylinder							
630 i	190	09/04→07/10		→ 08/07		24.2026-1702.3 010850	TRW Ø 26,99 Ø2 22,2
630 i	200	07/07→07/10		09/07→		24.2026-1702.3 010850	TRW Ø 26,99 Ø2 22,2
635 d	210	07/07→07/10					
645 Ci	245	01/04→08/05				24.2026-1702.3 010850	TRW Ø 26,99 Ø2 22,2
650 i	270	07/05→07/10					
M	373	09/05→07/10					
BMW - 6 Cabriolet (E64) 04/04→12/10							
 Hauptbremszylinder							
630 i	190	09/04→07/10		→ 08/07		24.2026-1702.3 010850	TRW Ø 26,99 Ø2 22,2
630 i	200	07/07→07/10		09/07→		24.2026-1702.3 010850	TRW Ø 26,99 Ø2 22,2
635 d	210	07/07→07/10					
645 Ci	245	04/04→08/05				24.2026-1702.3 010850	TRW Ø 26,99 Ø2 22,2
650 i	270	07/05→07/10					
M	373	07/06→07/10					
BMW - 6 Cabriolet (F12) 03/11→							
 Hauptbremszylinder							
M6	412	01/12→		06/12→		24.4126-1703.3 010991	TRW Ø 26,99
M6	423	02/14→				24.4126-1703.3 010991	TRW Ø 26,99
M6	441	07/15→					
BMW - 6 Coupe (F13) 11/10→							
 Hauptbremszylinder							
M6	412	01/12→		06/12→		24.4126-1703.3 010991	TRW Ø 26,99
M6	423	02/14→				24.4126-1703.3 010991	TRW Ø 26,99
M6	441	07/15→					
BMW - 6 Gran Coupe (F06) 09/11→							
 Hauptbremszylinder							
M6	412	12/12→				24.4126-1703.3 010991	TRW Ø 26,99
M6	423	02/14→					
M6	441	07/15→					















	kw			 	! #		
BMW - 7 (E38) 10/94→11/01							
 Hauptbremszylinder							
725 tds	105	04/96→11/01		09/98→		24.2025-1704.3 010619	Ø 25,4
				09/97→ 08/98		24.2025-1705.3 010624	TRW Ø1 25,4 Ø2 20,64
				05/96→ 08/97		24.2120-1721.3 010553	Ø 20,64
728 i, iL	142	08/95→11/01		09/98→		24.2025-1704.3 010619	Ø 25,4
				09/97→ 08/98		24.2025-1705.3 010624	TRW Ø1 25,4 Ø2 20,64
				01/96→ 08/97		24.2120-1721.3 010553	Ø 20,64
				→ 08/97		24.2120-1721.3 010553	Ø 20,64
728i X	142	11/95→09/01		09/98→		24.2025-1704.3 010619	Ø 25,4
730 i, iL	155	10/94→11/01		09/97→ 08/98		24.2025-1705.3 010624	TRW Ø1 25,4 Ø2 20,64
730 i, iL	160	10/94→11/01					
735 i, iL	173	01/96→12/98		→ 08/97		24.2120-1721.3 010553	Ø 20,64
740 i, iL	210	10/94→11/01					
740 i, iL	210	01/96→11/01					
750 i, iL	240	12/94→11/01					
730 d	135	08/98→04/00		09/98→; + DSC		24.2025-1704.3 010619	Ø 25,4
				09/98→; - DSC		24.2025-1705.3 010624	TRW Ø1 25,4 Ø2 20,64
730 d	142	04/00→11/01		+ DSC		24.2025-1704.3 010619	Ø 25,4
740 d	180	05/99→11/01		- DSC		24.2025-1705.3 010624	TRW Ø1 25,4 Ø2 20,64
735 i, iL	175	09/98→07/01				24.2025-1704.3 010619	Ø 25,4
BMW - 7 (E65, E66, E67) 11/01→12/09							
 Hauptbremszylinder							
730 d	150	10/02→07/08				24.2026-1701.3 010746	Ø 26,99 Ø2 20,64
730 d	155	10/02→07/08					
730 d	160	10/02→07/08					
735 i, Li	200	11/01→02/05					
740 d	190	10/02→02/05					
740 i, Li	225	07/05→07/08					
745 d	220	03/05→08/05					
745 d	242	07/05→07/08					
745 i, Li	245	11/01→07/08					
750 i, Li	270	07/05→07/08					
730 i, Li	170	03/03→07/08				24.2026-1701.3 010746	Ø 26,99 Ø2 20,64
						24.2026-1705.3 010992	TRW Ø 26,99 Ø2 20,64
730 i, Li	190	03/05→07/08		07/05→		24.2026-1701.3 010746	Ø 26,99 Ø2 20,64
730 Ld	170	07/05→12/09		→ 08/08		24.2026-1701.3 010746	Ø 26,99 Ø2 20,64
760 i, Li	327	01/03→07/08		03/03→		24.2026-1701.3 010746	Ø 26,99 Ø2 20,64
760 i, Li	326	11/01→12/09		03/03→ 08/08		24.2026-1701.3 010746	Ø 26,99 Ø2 20,64
BMW - 7 (F01, F02, F03, F04) 02/08→12/15							
 Hauptbremszylinder							
730 d	155	02/08→05/15		09/08→		24.2026-1702.3 010850	TRW Ø 26,99 Ø2 22,2
730 d	180	02/08→07/12					
730 i, Li	190	06/08→12/15					
730 d	190	07/12→05/15				24.2026-1702.3 010850	TRW Ø 26,99 Ø2 22,2
740 d	225	09/09→12/15					
740 d	230	07/12→12/15					
740 d xDrive	230	07/12→12/15					
740 i	240	10/08→12/15					
740 i, Li	235	07/12→12/15					
740 i, Li xDrive	235	07/12→12/15					
750 d xDrive	280	07/12→12/15					
750 i	300	10/08→12/15					
750 i	330	10/12→12/15					
750 i xDrive	300	09/09→12/15					
750 i xDrive	330	10/12→12/15					
760 i	400	09/09→12/15					
730 d xDrive	155	11/11→05/15		06/12→		24.2026-1702.3 010850	TRW Ø 26,99 Ø2 22,2
730 d xDrive	190	11/11→05/15					
740 d xDrive	225	09/09→12/15		09/10→		24.2026-1702.3 010850	TRW Ø 26,99 Ø2 22,2
BMW - X1 (E84) 03/09→06/15							
 Bremskraftverstärker							
sDrive 16 d	85	04/12→06/15		07/12→; für Fahrzeuge ohne Start-Stopp-Funktion		03.7845-0103.4 300268	ATE Ø 8" pneumatisch
sDrive 16 i	105	03/13→06/15		Automatikgetriebe		03.7845-0103.4 300268	ATE Ø 8" pneumatisch
sDrive 18 d	100	03/09→06/15		10/09→; für Fahrzeuge ohne Start-Stopp-Funktion		03.7845-0103.4 300268	ATE Ø 8" pneumatisch
xDrive 18 d	100	03/09→06/15					
sDrive 18 d	105	10/09→06/15		für Fahrzeuge ohne Start-Stopp-Funktion		03.7845-0103.4 300268	ATE Ø 8" pneumatisch
sDrive 20 d	120	03/10→06/15					
sDrive 20 d	130	10/09→06/15					
↓							















	kW			 	! #		
BMW - X1 (E84) 03/09→06/15							
 Bremskraftverstärker							
sDrive 20 d	135	07/12→06/15		für Fahrzeuge ohne Start-Stopp-Funktion		03.7845-0103.4 300268	ATE Ø 8" pneumatisch
sDrive 20 i	135	09/11→06/15					
xDrive 18 d	105	10/09→06/15					
xDrive 20 d	120	03/10→06/15					
xDrive 20 d	130	10/09→06/15					
xDrive 20 d	135	07/12→06/15					
xDrive 20 i	135	09/11→06/15					
xDrive 28 i	180	04/11→06/15					
xDrive 28 i	190	10/09→06/15					
xDrive 28 i Flex	180	04/11→06/15					
sDrive 18 i	100	03/09→06/15		03/10→;		03.7845-0103.4 300268	ATE Ø 8" pneumatisch
sDrive 18 i	110	01/10→06/15		für Fahrzeuge ohne Start-Stopp-Funktion			
xDrive 25 i	160	01/10→06/15					
xDrive 23 d	150	10/09→06/15		für Fahrzeuge ohne Start-Stopp-Funktion		03.7848-5003.4 300236	ATE Ø 8" pneumatisch
xDrive 25 d	160	10/09→06/15		07/12→; Automatikgetriebe		03.7845-0103.4 300268	ATE Ø 8" pneumatisch
 Hauptbremszylinder							
sDrive 16 d	85	04/12→06/15		07/12→; für Linkslenker		03.2025-1904.3 010797	ATE Ø1 25,4 Ø2 22,2
xDrive 25 d	160	10/09→06/15					
sDrive 16 i	105	03/13→06/15				03.2025-1904.3 010797	ATE Ø1 25,4 Ø2 22,2
sDrive 18 d	100	03/09→06/15		10/09→; für Linkslenker		03.2025-1904.3 010797	ATE Ø1 25,4 Ø2 22,2
xDrive 18 d	100	03/09→06/15					
sDrive 18 d	105	10/09→06/15		für Linkslenker		03.2025-1904.3 010797	ATE Ø1 25,4 Ø2 22,2
sDrive 20 d	120	03/10→06/15					
sDrive 20 d	130	10/09→06/15					
sDrive 20 d	135	07/12→06/15					
sDrive 20 i	135	09/11→06/15					
xDrive 18 d	105	10/09→06/15					
xDrive 20 d	120	03/10→06/15					
xDrive 20 d	130	10/09→06/15					
xDrive 20 d	135	07/12→06/15					
xDrive 20 i	135	09/11→06/15					
xDrive 23 d	150	10/09→06/15					
xDrive 28 i	180	04/11→06/15					
xDrive 28 i	190	10/09→06/15					
xDrive 28 i Flex	180	04/11→06/15					
sDrive 18 i	100	03/09→06/15		03/10→; für Linkslenker		03.2025-1904.3 010797	ATE Ø1 25,4 Ø2 22,2
sDrive 18 i	110	01/10→06/15					
xDrive 25 i	160	01/10→06/15					
BMW - X3 (E83) 01/03→12/11							
 Hauptbremszylinder							
2.0 d	110	11/03→08/07		08/04→		24.2025-1710.3 010833	TRW Ø 25,4
2.0 i	110	07/05→08/08				24.2025-1710.3 010833	TRW Ø 25,4
2.5 si	160	09/06→08/08					
3.0 d	155	10/04→07/06					
3.0 d	160	10/04→07/06					
3.0 i xDrive	170	01/04→08/06					
3.0 sd	210	09/06→08/08					
3.0 si	200	09/06→08/08					
2.5 i	141	01/04→08/06		03/04→		24.2025-1710.3 010833	TRW Ø 25,4
2.5 si xDrive	155	07/06→12/08		09/08→		24.2025-1710.3 010833	TRW Ø 25,4
xDrive 20 d	120	09/07→08/10					
xDrive 20 d	130	09/07→08/10					
xDrive 30 d	155	03/06→08/10					
xDrive 30 d	160	03/06→08/10					
3.0 d	150	01/03→08/05		10/03→		24.2025-1710.3 010833	TRW Ø 25,4
xDrive 18 d	100	04/09→12/11		→ 08/10		24.2025-1710.3 010833	TRW Ø 25,4
xDrive 18 d	105	09/08→12/11					
xDrive 20 i	110	09/08→08/11					
xDrive 25 i	160	09/08→12/11					
xDrive 30 i	200	09/08→12/11					
xDrive 35 d	210	09/08→08/11					
BMW - X5 (E53) 05/00→02/07							
 Hauptbremszylinder							
3.0 d	135	05/01→12/03		→ 08/01		24.2025-1704.3 010619	Ø 25,4
				09/01→ 09/03		24.2025-1707.3 010691	Ø 25,4
3.0 d	155	09/03→12/06		10/03→		24.2025-1707.3 010691	Ø 25,4
3.0 d	160	12/03→12/06				24.2025-1707.3 010691	Ø 25,4
4.4 i	235	12/03→09/06					
4.8 is	265	04/04→09/06					
3.0 i	163	05/00→12/06		→ 08/01		24.2025-1704.3 010619	Ø 25,4
3.0 i	170	05/00→12/06					
4.4 i	210	05/00→12/03		09/01→		24.2025-1707.3 010691	Ø 25,4
4.6 is	255	02/02→12/03		→ 09/03		24.2025-1707.3 010691	Ø 25,4











	kW			 	! #				
BMW - X5 (E70) 02/06→06/13									
 Hauptbremszylinder									
3.0 d	155	02/07→09/08				24.2026-1703.3 010910	TRW Ø 26,99 Ø2 22,2		
3.0 d	173	02/07→09/08							
4.8 i xDrive	261	02/07→09/08							
M	408	09/09→06/13							
xDrive 30 d	155	09/08→06/13							
xDrive 30 d	173	09/08→06/13							
xDrive 30 d	180	09/10→06/13							
xDrive 30 i	171	09/08→12/10							
xDrive 30 i	200	09/08→03/10							
xDrive 35 d	210	09/08→06/13							
xDrive 35 i	225	09/10→06/13							
xDrive 35 i	235	02/12→06/13							
xDrive 40 d	225	09/10→06/13							
xDrive 40 i	225	01/12→06/13							
xDrive 48 i	261	09/08→06/13							
xDrive 50 i	300	06/10→06/13							
3.0 sd	210	09/07→02/09		→ 09/08		24.2026-1703.3 010910	TRW Ø 26,99 Ø2 22,2		
3.0 si	200	02/06→09/08		01/07→		24.2026-1703.3 010910	TRW Ø 26,99 Ø2 22,2		
M 50 d	280	08/11→06/13		06/12→		24.2026-1703.3 010910	TRW Ø 26,99 Ø2 22,2		
BMW - X5 (F15, F85) 06/12→									
 Hauptbremszylinder									
M	423	12/14→				24.2026-1703.3 010910	TRW Ø 26,99 Ø2 22,2		
sDrive 25 d	155	11/13→							
sDrive 25 d	160	11/13→							
sDrive 25 d	170	07/15→							
xDrive 25 d	155	11/13→							
xDrive 25 d	160	11/13→							
xDrive 25 d	170	07/15→							
xDrive 25 d	160	06/15→							
xDrive 30 d	183	04/15→							
xDrive 30 d	204	11/13→							
xDrive 35 i	225	11/13→							
xDrive 35 i	240	11/13→							
xDrive 40 d	230	12/13→							
M 50 d	280	07/13→		08/13→				24.2026-1703.3 010910	TRW Ø 26,99 Ø2 22,2
xDrive 30 d	190	07/13→							
xDrive 30 d	210	07/13→							
xDrive 50 i	330	07/13→							
BMW - X6 (E71, E72) 06/07→06/14									
 Hauptbremszylinder									
M	408	07/08→06/14		09/09→		24.2026-1703.3 010910	TRW Ø 26,99 Ø2 22,2		
M 50 d	280	08/11→06/14		06/12→					
xDrive 30 d	155	07/09→06/14							
xDrive 35 i	235	07/09→06/14							
xDrive 30 d	173	09/07→03/10		09/08→					
xDrive 35 d	210	06/07→03/10							
xDrive 35 i	225	06/07→03/10							
xDrive 35 i	240	06/07→03/10							
xDrive 50 i	300	10/07→06/14							
xDrive 50 i	330	10/07→06/14							
xDrive 30 d	180	04/09→06/14		09/10→					
xDrive 40 d	225	07/09→06/14		10/10→					
								24.2026-1703.3 010910	TRW Ø 26,99 Ø2 22,2
								24.2026-1703.3 010910	TRW Ø 26,99 Ø2 22,2
BMW - X6 (F16, F86) 08/14→									
 Hauptbremszylinder									
M	423	12/14→				24.2026-1703.3 010910	TRW Ø 26,99 Ø2 22,2		
M 50 d	280	08/14→							
xDrive 30 d	155	08/14→							
xDrive 30 d	183	12/15→							
xDrive 30 d	190	08/14→							
xDrive 30 d	204	02/15→							
xDrive 35 i	225	12/14→							
xDrive 35 i	240	02/15→							
xDrive 40 d	230	12/14→							
xDrive 50 i	330	08/14→							
BMW - Z3 Coupe (E36) 04/97→06/03									
 Bremskraftverstärker									
2.8 i	142	07/97→06/00				03.7760-3102.4 300139	ATE Ø 10" pneumatisch		
3.0 i	170	06/00→06/03		→ 12/02					
↓						03.7760-3102.4 300139	ATE Ø 10" pneumatisch		

	kw			 	! #		
BMW - Z3 Coupe (E36) 04/97→06/03							
 Hauptbremszylinder							
2.8 i	142	07/97→06/00		- DSC	03.2023-0987.3	010473	Ø1 23,81 Ø2 20,64
				+ DSC	03.2023-1904.3	010724	ATE Ø1 23,81 Ø2 20,64
3.0 i	170	06/00→06/03		→ 12/02; - DSC	03.2023-0987.3	010473	Ø1 23,81 Ø2 20,64
				→ 08/00; + DSC	03.2023-1904.3	010724	ATE Ø1 23,81 Ø2 20,64
				09/00→ 12/02; + DSC	03.2023-1949.3	010725	ATE Ø1 23,81 Ø2 20,64
BMW - Z3 Roadster (E36) 10/95→01/03							
 Bremskraftverstärker							
1.8 i	85	10/95→10/98			03.7760-3102.4	300139	ATE Ø 10" pneumatisch
1.9 i	103	10/95→03/99					
1.9 i	85	01/99→01/03		→ 12/02	03.7760-3102.4	300139	ATE Ø 10" pneumatisch
1.9 i	87	07/98→01/03					
3.0 i	170	06/00→01/03					
2.0 i	110	04/99→01/03		→ 08/00	03.7760-3102.4	300139	ATE Ø 10" pneumatisch
2.2 i	120	08/00→01/03		10/00→ 12/02	03.7760-3102.4	300139	ATE Ø 10" pneumatisch
2.2 i	125	08/00→01/03					
2.8 i	142	04/97→06/00		05/97→	03.7760-3102.4	300139	ATE Ø 10" pneumatisch
2.8 i	143	01/96→07/00		05/97→ 06/00	03.7760-3102.4	300139	ATE Ø 10" pneumatisch
 Hauptbremszylinder							
1.8 i	85	10/95→10/98			03.2023-0987.3	010473	Ø1 23,81 Ø2 20,64
1.9 i	103	10/95→03/99					
1.9 i	85	01/99→01/03		→ 12/02	03.2023-0987.3	010473	Ø1 23,81 Ø2 20,64
1.9 i	87	07/98→01/03		09/00→ 12/02; + DSC	03.2023-1949.3	010725	ATE Ø1 23,81 Ø2 20,64
2.0 i	110	04/99→01/03		→ 08/00; - DSC	03.2023-0987.3	010473	Ø1 23,81 Ø2 20,64
				→ 08/00; + DSC	03.2023-1904.3	010724	ATE Ø1 23,81 Ø2 20,64
2.2 i	120	08/00→01/03		10/00→ 12/02; - DSC	03.2023-0987.3	010473	Ø1 23,81 Ø2 20,64
2.2 i	125	08/00→01/03		10/00→ 12/02; + DSC	03.2023-1949.3	010725	ATE Ø1 23,81 Ø2 20,64
2.8 i	142	04/97→06/00		05/97→; - DSC	03.2023-0987.3	010473	Ø1 23,81 Ø2 20,64
				05/97→; + DSC	03.2023-1904.3	010724	ATE Ø1 23,81 Ø2 20,64
2.8 i	143	01/96→07/00		05/97→ 06/00; - DSC	03.2023-0987.3	010473	Ø1 23,81 Ø2 20,64
				05/97→ 06/00; + DSC	03.2023-1904.3	010724	ATE Ø1 23,81 Ø2 20,64
3.0 i	170	06/00→01/03		→ 12/02; - DSC	03.2023-0987.3	010473	Ø1 23,81 Ø2 20,64
				→ 08/00; + DSC	03.2023-1904.3	010724	ATE Ø1 23,81 Ø2 20,64
				09/00→ 12/02; + DSC	03.2023-1949.3	010725	ATE Ø1 23,81 Ø2 20,64
BMW - Z4 Coupe (E86) 03/06→01/09							
 Bremskraftverstärker							
3.0 si	195	03/06→01/09		→ 09/08; für Rechtslenker	03.7860-0702.4	300123	ATE Ø 10" pneumatisch
				→ 09/08; für Linkslenker	03.7860-1302.4	300222	ATE Ø 10" pneumatisch
 Hauptbremszylinder							
3.0 si	195	03/06→01/09		→ 09/08	03.2023-2256.3	010870	ATE Ø1 23,81 Ø2 22,2
BMW - Z4 Roadster (E85) 02/03→12/09							
 Bremskraftverstärker							
2.0 i	110	03/05→02/09		04/05→ 12/08; für Rechtslenker	03.7860-0702.4	300123	ATE Ø 10" pneumatisch
				04/05→ 12/08; für Linkslenker	03.7860-1302.4	300222	ATE Ø 10" pneumatisch
2.2 i	125	10/03→10/05		für Rechtslenker	03.7860-0702.4	300123	ATE Ø 10" pneumatisch
2.5 i	141	02/03→12/05					
3.0 i	170	02/03→10/05		für Linkslenker	03.7860-1302.4	300222	ATE Ø 10" pneumatisch
3.0 si	195	01/06→12/08					
2.5 i	130	09/05→02/09		01/06→ 12/08; für Rechtslenker	03.7860-0702.4	300123	ATE Ø 10" pneumatisch
2.5 si	155	09/05→02/09					
2.5 si	160	09/05→02/09		01/06→ 12/08; für Linkslenker	03.7860-1302.4	300222	ATE Ø 10" pneumatisch
 Hauptbremszylinder							
2.0 i	110	03/05→02/09		04/05→ 12/08	03.2023-2249.3	010869	ATE Ø1 23,81 Ø2 22,2
2.2 i	125	10/03→10/05			03.2023-2249.3	010869	ATE Ø1 23,81 Ø2 22,2
2.5 i	141	02/03→12/05					
3.0 i	170	02/03→10/05					
2.5 i	130	09/05→02/09		01/06→ 12/08	03.2023-2256.3	010870	ATE Ø1 23,81 Ø2 22,2
2.5 si	155	09/05→02/09					
2.5 si	160	09/05→02/09					
3.0 si	195	01/06→12/08			03.2023-2256.3	010870	ATE Ø1 23,81 Ø2 22,2

	kw			 	! #		
BMW - Z4 Roadster (E89) 05/09→							
 Hauptbremszylinder							
sDrive 18 i	115	04/13→				03.2025-5826.3 010960	ATE Ø1 25,4 Ø2 22,2
sDrive 20 i	120	09/11→					
sDrive 20 i	135	09/11→					
sDrive 23 i	150	05/09→					
sDrive 28 i	180	09/11→					
sDrive 30 i	190	05/09→					
sDrive 35 i	225	05/09→					
sDrive 35 is	250	09/10→					
BMW - Z8 Roadster (E52) 06/00→06/03							
 Hauptbremszylinder							
4.9	294	06/00→06/03				24.2026-1705.3 010992	TRW Ø 26,99 Ø2 20,64
CHEVROLET - ASTRA Schrägheck 09/98→12/11							
 Hauptbremszylinder							
2.0 DTi	74	08/02→12/11		→ 07/05; Brems-/Fahr dyn. Artikelbezug: nicht für ESP		24.2123-1734.3 010640	TRW Ø 23,81
				→ 07/05; Brems-/Fahr dyn. Artikelbezug: für ESP		24.2123-1739.3 010661	Ø 23,81
 Bremskraftregler							
2.0 DTi	74	08/02→12/11		→ 07/05		03.6583-0085.3 320238	ATE lastabhängig 8/3 4x
CHEVROLET - ASTRA Stufenheck 01/99→12/11							
 Hauptbremszylinder							
2.0 DTi GLS	74	08/02→12/11		→ 07/05; Brems-/Fahr dyn. Artikelbezug: nicht für ESP		24.2123-1734.3 010640	TRW Ø 23,81
				→ 07/05; Brems-/Fahr dyn. Artikelbezug: für ESP		24.2123-1739.3 010661	Ø 23,81
 Bremskraftregler							
2.0 DTi GLS	74	08/02→12/11		→ 07/05		03.6583-0085.3 320238	ATE lastabhängig 8/3 4x
CHEVROLET - CRUZE (J300) 05/09→							
 Bremskraftverstärker							
1.4	74	07/13→		für Linkslenker		03.7858-0732.4 300272	ATE Ø 9 / 8" pneumatisch
1.4	103	09/10→					
1.6	80	05/09→					
1.6	83	05/09→					
1.6	86	12/12→					
1.6	89	12/12→					
1.6	91	05/09→					
1.6 T	135	12/12→					
1.7 D	96	01/12→					
1.7 TD	81	11/13→					
1.8	103	11/09→12/13					
1.8	104	05/09→					
1.8	108	12/12→					
1.8 Flex	106	01/11→					
1.8 LPG	104	06/11→					
2.0 CDI	90	05/09→					
2.0 CDI	92	05/09→					
2.0 CDI	110	05/09→					
2.0 CDI	120	08/10→					
 Hauptbremszylinder							
1.4	74	07/13→		für Linkslenker; + ESP		03.2125-0421.3 010934	ATE Ø 25,4
1.4	103	09/10→					
1.6	80	05/09→					
1.6	83	05/09→					
1.6	86	12/12→					
1.6	89	12/12→					
1.6	91	05/09→					
1.6 T	135	12/12→					
1.7 D	96	01/12→					
1.7 TD	81	11/13→					
1.8	103	11/09→12/13					
1.8	104	05/09→					
1.8	108	12/12→					
1.8 Flex	106	01/11→					
1.8 LPG	104	06/11→					
2.0 CDI	90	05/09→					
2.0 CDI	92	05/09→					
↓							

	kw			 	! #		
CHEVROLET - CRUZE (J300) 05/09→							
 Hauptbremszylinder							
2.0 CDI	110	05/09→		für Linkslenker; + ESP		03.2125-0421.3 010934	ATE Ø 25,4
2.0 CDI	120	08/10→					
CHEVROLET - CRUZE Schrägheck (J305) 12/10→							
 Bremskraftverstärker							
1.4	74	07/13→		für Linkslenker		03.7858-0732.4 300272	ATE Ø 9 / 8" pneumatisch
1.6	80	01/12→					
1.6	86	12/12→					
1.6	89	12/12→					
1.6	91	06/11→					
1.6 T	135	12/12→					
1.7 D	96	01/12→					
1.7 TD	81	08/13→					
1.8	103	10/11→					
1.8	104	06/11→					
1.8	108	12/12→					
1.8 LPG	104	06/11→					
2.0 CDI	120	06/11→					
1.4	103	06/12→		08/12→; für Linkslenker		03.7858-0732.4 300272	ATE Ø 9 / 8" pneumatisch
 Hauptbremszylinder							
1.4	74	07/13→		für Linkslenker; + ESP		03.2125-0421.3 010934	ATE Ø 25,4
1.6	80	01/12→					
1.6	86	12/12→					
1.6	89	12/12→					
1.6	91	06/11→					
1.6 T	135	12/12→					
1.7 D	96	01/12→					
1.7 TD	81	08/13→					
1.8	103	10/11→					
1.8	104	06/11→					
1.8	108	12/12→					
1.8 LPG	104	06/11→					
2.0 CDI	120	06/11→					
1.4	103	06/12→		08/12→; für Linkslenker; + ESP		03.2125-0421.3 010934	ATE Ø 25,4
CHEVROLET - CRUZE Station Wagon (J308) 08/12→							
 Bremskraftverstärker							
1.4	74	07/13→		für Linkslenker		03.7858-0732.4 300272	ATE Ø 9 / 8" pneumatisch
1.4	103	08/12→					
1.6	86	12/12→					
1.6	89	12/12→					
1.6	91	08/12→					
1.6 T	135	12/12→					
1.7 TD	81	11/13→					
1.7 TD	96	08/12→					
1.8	104	08/12→					
1.8	108	12/12→					
2.0 TD	120	08/12→					
 Hauptbremszylinder							
1.4	74	07/13→		für Linkslenker; + ESP		03.2125-0421.3 010934	ATE Ø 25,4
1.4	103	08/12→					
1.6	86	12/12→					
1.6	89	12/12→					
1.6	91	08/12→					
1.6 T	135	12/12→					
1.7 TD	81	11/13→					
1.7 TD	96	08/12→					
1.8	104	08/12→					
1.8	108	12/12→					
2.0 TD	120	08/12→					
CHEVROLET - MALIBU (V300) 01/12→							
 Bremskraftverstärker							
2.0	104	02/12→				03.7858-0732.4 300272	ATE Ø 9 / 8" pneumatisch
2.0	108	12/12→					
2.0 D	118	04/12→					
2.0 LPG	101	02/12→					
2.4	123	01/12→					
2.4	125	01/12→					
2.4	137	01/12→					
 Hauptbremszylinder							
2.0	104	02/12→				03.2125-0421.3 010934	ATE Ø 25,4
2.0	108	12/12→					
2.0 D	118	04/12→					
↓							

	kw					! #		
CHEVROLET - MALIBU (V300) 01/12→								
 Hauptbremszylinder								
2.0 LPG 2.4 2.4 2.4	101 123 125 137	02/12→ 01/12→ 01/12→ 01/12→					03.2125-0421.3 010934	ATE Ø 25,4
CHEVROLET - MATIZ (M200, M250) 03/05→								
 Hauptbremszylinder								
0.8 0.8 LPG 1.0 1.0 1.0 1.0 LPG 1.0 LPG	38 38 47 48 49 44 49	03/05→ 03/05→ 03/05→ 01/07→ 03/05→ 01/07→ 03/05→		645872→; → 12/10; + ABS → 645871; + ABS → 645871; - ABS 645872→; → 12/10; - ABS			24.2120-1755.3 010974 24.2120-1755.3 010974 24.2120-1765.3 011003 24.2120-1765.3 011003	Ø 20,64 ohne Bremsflüssigkeitsbehälter Ø 20,64 ohne Bremsflüssigkeitsbehälter Ø 20,64 ohne Bremsflüssigkeitsbehälter Ø 20,64 ohne Bremsflüssigkeitsbehälter
CHEVROLET - ORLANDO (J309) 12/10→								
 Bremskraftverstärker								
1.8 1.8 LPG 2.0 D 2.0 D 2.0 LPG	104 104 96 120 103	02/11→ 06/11→ 02/11→ 02/11→ 02/12→					03.7858-0732.4 300272	ATE Ø 9 / 8" pneumatisch
 Hauptbremszylinder								
1.8 1.8 LPG 2.0 D 2.0 D 2.0 LPG	104 104 96 120 103	02/11→ 06/11→ 02/11→ 02/11→ 02/12→		+ ESP			03.2125-0421.3 010934	ATE Ø 25,4
CHEVROLET - SPARK 05/05→								
 Hauptbremszylinder								
0.8 1.0 LPG 1.0 SX 1.0 SX 1.0 SX	37 46 44 46 49	05/05→ 05/05→ 06/09→ 05/05→ 05/05→		→ 645871; für Linkslenker; Schaltgetriebe; + ABS 645872→; → 02/10; für Linkslenker; Schaltgetriebe; + ABS → 645871; für Linkslenker; Schaltgetriebe; - ABS 645872→; → 02/10; für Linkslenker; Schaltgetriebe; - ABS → 645871; für Linkslenker; + ABS 645872→; → 02/10; für Linkslenker; + ABS 645872→; → 02/10; für Linkslenker; - ABS → 645871; für Linkslenker; - ABS			24.2120-1755.3 010974 24.2120-1755.3 010974 24.2120-1765.3 011003 24.2120-1765.3 011003 24.2120-1755.3 010974 24.2120-1755.3 010974 24.2120-1765.3 011003 24.2120-1765.3 011003	Ø 20,64 ohne Bremsflüssigkeitsbehälter Ø 20,64 ohne Bremsflüssigkeitsbehälter Ø 20,64 ohne Bremsflüssigkeitsbehälter Ø 20,64 ohne Bremsflüssigkeitsbehälter Ø 20,64 ohne Bremsflüssigkeitsbehälter Ø 20,64 ohne Bremsflüssigkeitsbehälter Ø 20,64 ohne Bremsflüssigkeitsbehälter Ø 20,64 ohne Bremsflüssigkeitsbehälter Ø 20,64 ohne Bremsflüssigkeitsbehälter
CHEVROLET - TIGRA 08/97→09/01								
 Hauptbremszylinder								
1.6	73	09/98→12/99		- ABS + ABS			24.2120-0702.3 010361 24.2120-1714.3 010455	Ø 20,64 Ø 20,64
 Bremskraftregler								
1.6	73	09/98→12/99					03.6585-0018.3 320114	ATE lastabhängig 8/5 4x
CHEVROLET - VECTRA 03/96→11/06								
 Hauptbremszylinder								
2.0 2.2 2.2	81 91 102	03/96→12/05 05/98→07/04 05/98→12/05		→ 07/98; für Rechtslenker 08/98→; für Rechtslenker → W7154258; für Linkslenker W1285447→ W7999999; für Linkslenker			03.2123-1722.3 010471 03.2125-7502.3 010616 24.2122-1724.3 010561 24.2123-1777.3 010943 03.2125-7502.3 010616	Ø 23,81 ATE Ø 25,4 Ø 22,2 Ø 23,81 ATE Ø 25,4

	kw			 	! #		
CHRYSLER - DELTA 08/11→							
 Hauptbremszylinder							
1.4	88	08/11→				24.4123-1710.3 010866	BOS Ø 23,81 ohne Bremsflüssigkeitsbehälter
1.4 16V	103	08/11→					
1.6 D Multijet	88	08/11→					
2.0 D Multijet	121	08/11→					
CITROËN - AX (ZA-) 07/86→12/98							
 Hauptbremszylinder							
1.4 GTi	66	08/91→12/96		- ABS		03.2120-2031.3 010106	ATE Ø 20,64
1.4 GTi	69	06/91→12/96					
10	33	07/86→12/98		Orga 03826→		03.2120-2031.3 010106	ATE Ø 20,64
10	37	02/87→12/98		07/92→		03.2120-2031.3 010106	ATE Ø 20,64
11	44	09/86→12/97		10/89→		03.2120-2031.3 010106	ATE Ø 20,64
14	55	04/87→04/97		03/89→ 12/96		03.2120-2031.3 010106	ATE Ø 20,64
14 D	37	08/91→12/97				03.2119-3389.3 010057	ATE Ø 19,05
15 D	40	08/94→12/97					
15 D	43	08/94→12/97					
Electric	25	04/93→10/96				03.2120-2031.3 010106	ATE Ø 20,64
Electric	28	11/96→04/97					
CITROËN - BERLINGO (B9) 04/08→							
 Hauptbremszylinder							
1.2 PureTech 110	81	02/16→		+ ESP		24.4123-1714.3 010979	TRW Ø 23,81
1.6	66	04/08→					
1.6	80	04/08→					
1.6 BlueHDi 100	73	12/14→					
1.6 BlueHDi 120	88	12/14→					
1.6 HDi 110	80	04/08→					
1.6 HDi 110	82	07/10→					
1.6 HDi 115	84	07/10→					
1.6 HDi 115 4x4	84	02/12→					
1.6 HDi 75 16V	55	04/08→					
1.6 HDi 90	66	04/08→					
1.6 HDi 90	68	07/10→					
1.6 HDi 90 4x4	66	02/12→					
1.6 VTi 120	88	11/09→					
1.6 VTi 95	72	07/10→					
1.6 HDi 75 / BlueHDi 75	55	04/08→		04/15→; + ESP		24.4123-1714.3 010979	TRW Ø 23,81
CITROËN - BERLINGO (MF) 07/96→12/11							
 Hauptbremszylinder							
1.1 i (MFHDZ, MFHFX)	44	07/96→05/08		Orga 08610→; → 03/08; - ABS		03.2123-2781.3 010631	ATE Ø 23,81
1.4 i (MFKFX, MFKFW)	55	07/96→10/08				24.2123-1714.3 010587	BDX Ø 23,81
				→Orga 08609; - ABS		24.2123-1710.3 010504	Ø 23,81
				→Orga 08609; für Linkslenker; + ABS		24.2123-1713.3 010505	Ø 23,81
				Orga 08610→; → 03/08; - ESP		24.2123-1715.3 010520	BDX Ø 23,81
1.4	53	11/02→10/05		- ABS		03.2123-2781.3 010631	ATE Ø 23,81
1.4 bivalent	53	11/02→10/05				24.2123-1714.3 010587	BDX Ø 23,81
2.0 HDi 4x4 (MFRHY)	66	11/02→10/05					
2.0 HDi 90 (MFRHY)	66	12/99→10/05		- ESP		24.2123-1715.3 010520	BDX Ø 23,81
electrique	16	01/00→10/02					
1.4 bivalent	48	11/02→12/11		→ 03/08; - ABS		03.2123-2781.3 010631	ATE Ø 23,81
1.4 i bivalent (MFKFW)	55	04/03→10/08				24.2123-1714.3 010587	BDX Ø 23,81
1.6 16V (MFNFU)	80	10/00→12/11					
1.6 16V (MFNFU)	81	11/02→10/08		→ 03/08; - ESP		24.2123-1715.3 010520	BDX Ø 23,81
1.6 HDi 110	80	08/05→12/11					
1.6 HDi 75 (MF9HW)	55	07/05→12/11					
1.6 HDi 90 (MF9HX)	66	07/05→05/08					
1.8 D (MFA9A)	43	07/98→10/02		Orga 08610→; - ABS		03.2123-2781.3 010631	ATE Ø 23,81
1.8 i (MFLFX)	66	05/97→10/02				24.2123-1714.3 010587	BDX Ø 23,81
1.9 D (MFDJY)	50	07/96→12/03					
1.9 D (MFWJZ)	51	07/98→10/05		→Orga 08609; - ABS		24.2123-1710.3 010504	Ø 23,81
1.9 D 4WD (MFWJZ)	51	07/98→10/05		→Orga 08609; für Linkslenker; + ABS		24.2123-1713.3 010505	Ø 23,81
				Orga 08610→; - ESP		24.2123-1715.3 010520	BDX Ø 23,81
1.8 i 4WD (MFLFX)	66	04/97→10/01		Orga 08610→; - ABS		03.2123-2781.3 010631	ATE Ø 23,81
						24.2123-1714.3 010587	BDX Ø 23,81
				05/97→; →Orga 08609; - ABS		24.2123-1710.3 010504	Ø 23,81
				05/97→; →Orga 08609; für Linkslenker; + ABS		24.2123-1713.3 010505	Ø 23,81
				Orga 08610→; - ESP		24.2123-1715.3 010520	BDX Ø 23,81
1.9 D (MFDJY)	51	07/96→10/99		Orga 08610→; - ABS		03.2123-2781.3 010631	ATE Ø 23,81
						24.2123-1714.3 010587	BDX Ø 23,81
				07/98→; →Orga 08609; - ABS		24.2123-1710.3 010504	Ø 23,81
↓							

CITROËN - BERLINGO (MF) 07/96→12/11

Hauptbremszylinder

1.9 D (MFDJY)	51	07/96→10/99	07/98→; →Orga 08609; für Linkslenker; + ABS	24.2123-1713.3	010505	Ø 23,81
			Orga 08610→; - ESP	24.2123-1715.3	010520	BDX Ø 23,81
Electric	28	01/98→12/05	11/02→; - ABS	03.2123-2781.3	010631	ATE Ø 23,81
			11/02→; - ESP	24.2123-1714.3	010587	BDX Ø 23,81
			11/02→; - ESP	24.2123-1715.3	010520	BDX Ø 23,81













Bremskraftregler











1.1 i (MFHDZ, MFHFX)	44	07/96→05/08	→ 03/08; - Mehrfunktionsdach; für Fahrzeuge ohne verstärktes Fahrwerk	03.6582-0010.3	320145	ATE lastabhängig 8/1,5 4x
1.4 bivalent	48	11/02→12/11				
1.4 i (MFKFX, MFKFW)	55	07/96→10/08	→ 03/08; - ABS;	03.6582-0011.3	320232	ATE lastabhängig 8/1,5 4x
1.4 i bivalent (MFKFW)	55	04/03→10/08	für Fahrzeuge mit verstärktem Fahrwerk			
1.6 16V (MFNFU)	80	10/00→12/11	→ 03/08; + ABS;	03.6582-0012.3	320233	ATE lastabhängig 8/1,5 4x
1.6 16V (MFNFU)	81	11/02→10/08	für Fahrzeuge mit verstärktem Fahrwerk			
1.6 HDi 110	80	08/05→12/11	→ 03/08; + Mehrfunktionsdach;	03.6582-0015.3	320227	ATE lastabhängig 8/1,5 4x
1.6 HDi 75 (MF9HW)	55	07/05→12/11	für Fahrzeuge ohne verstärktes Fahrwerk			
1.6 HDi 90 (MF9HX)	66	07/05→05/08				
1.4	53	11/02→10/05	- Mehrfunktionsdach;	03.6582-0010.3	320145	ATE lastabhängig 8/1,5 4x
1.4 bivalent	53	11/02→10/05	für Fahrzeuge ohne verstärktes Fahrwerk			
1.8 D (MFA9A)	43	07/98→10/02	- ABS;	03.6582-0011.3	320232	ATE lastabhängig 8/1,5 4x
1.8 i (MFLFX)	66	05/97→10/02	für Fahrzeuge mit verstärktem Fahrwerk			
1.9 D (MFDJY)	50	07/96→12/03	+ ABS;	03.6582-0012.3	320233	ATE lastabhängig 8/1,5 4x
1.9 D (MFWJZ)	51	07/98→10/05	für Fahrzeuge mit verstärktem Fahrwerk			
1.9 D 4WD (MFWJZ)	51	07/98→10/05	+ Mehrfunktionsdach;	03.6582-0015.3	320227	ATE lastabhängig 8/1,5 4x
2.0 HDi 4x4 (MFRHY)	66	11/02→10/05	für Fahrzeuge ohne verstärktes Fahrwerk			
2.0 HDi 90 (MFRHY)	66	12/99→10/05				
1.8 i 4WD (MFLFX)	66	04/97→10/01	05/97→; - Mehrfunktionsdach;	03.6582-0010.3	320145	ATE lastabhängig 8/1,5 4x
			für Fahrzeuge ohne verstärktes Fahrwerk			
			05/97→; - ABS;	03.6582-0011.3	320232	ATE lastabhängig 8/1,5 4x
			für Fahrzeuge mit verstärktem Fahrwerk			
1.9 D (MFDJY)	51	07/96→10/99	05/97→; + ABS;	03.6582-0012.3	320233	ATE lastabhängig 8/1,5 4x
			für Fahrzeuge mit verstärktem Fahrwerk			
			05/97→; + Mehrfunktionsdach;	03.6582-0015.3	320227	ATE lastabhängig 8/1,5 4x
			für Fahrzeuge ohne verstärktes Fahrwerk			
1.9 D (MFDJY)	51	07/96→10/99	07/98→; - Mehrfunktionsdach;	03.6582-0010.3	320145	ATE lastabhängig 8/1,5 4x
			für Fahrzeuge ohne verstärktes Fahrwerk			
			07/98→; - ABS;	03.6582-0011.3	320232	ATE lastabhängig 8/1,5 4x
			für Fahrzeuge mit verstärktem Fahrwerk			
Electric	28	01/98→12/05	07/98→; + ABS;	03.6582-0012.3	320233	ATE lastabhängig 8/1,5 4x
			für Fahrzeuge mit verstärktem Fahrwerk			
			07/98→; + Mehrfunktionsdach;	03.6582-0015.3	320227	ATE lastabhängig 8/1,5 4x
			für Fahrzeuge ohne verstärktes Fahrwerk			
electricue	16	01/00→10/02	01/00→; - Mehrfunktionsdach;	03.6582-0010.3	320145	ATE lastabhängig 8/1,5 4x
			für Fahrzeuge ohne verstärktes Fahrwerk			
			11/02→;	03.6582-0011.3	320232	ATE lastabhängig 8/1,5 4x
			für Fahrzeuge mit verstärktem Fahrwerk			
			11/02→; + Mehrfunktionsdach;	03.6582-0015.3	320227	ATE lastabhängig 8/1,5 4x
			für Fahrzeuge ohne verstärktes Fahrwerk			
			- Mehrfunktionsdach;	03.6582-0010.3	320145	ATE lastabhängig 8/1,5 4x
			für Fahrzeuge ohne verstärktes Fahrwerk			
			für Fahrzeuge mit verstärktem Fahrwerk	03.6582-0011.3	320232	ATE lastabhängig 8/1,5 4x
			+ Mehrfunktionsdach;	03.6582-0015.3	320227	ATE lastabhängig 8/1,5 4x
			für Fahrzeuge ohne verstärktes Fahrwerk			









CITROËN - BERLINGO Kasten (B9) 04/08→













Hauptbremszylinder













1.6	66	04/08→	+ ESP	24.4123-1714.3	010979	TRW Ø 23,81
1.6	80	04/08→				
1.6 BlueHDi 100	73	12/14→				
1.6 BlueHDi 100 4x4	73	12/14→				
1.6 BlueHDi 120	88	12/14→				
1.6 HDi 110	80	04/08→				
1.6 HDi 110	82	07/10→				
1.6 HDi 115	84	07/10→				
1.6 HDi 115 4x4	84	02/12→				
1.6 HDi 75	55	04/08→				
1.6 HDi 75 4x4	55	02/12→				
1.6 HDi 90	66	07/10→				
1.6 HDi 90	68	07/10→				
1.6 HDi 90 16V	66	04/08→				
1.6 HDi 90 4x4	66	02/12→				
1.6 VTi 120	88	11/09→				
1.6 VTi 95	72	07/10→				
Electric	49	03/14→				
1.6 HDi / BlueHDi 75	55	07/10→	04/15→; + ESP	24.4123-1714.3	010979	TRW Ø 23,81
Electric	35	01/13→	02/13→; + ESP	24.4123-1714.3	010979	TRW Ø 23,81
Electric	42	09/11→				













	kw			 	! #		
CITROËN - BERLINGO Kasten (M_) 07/96→12/11							
 Hauptbremszylinder							
1.1 i (MAHDZ, MBHDZ, MBHFX)	44	07/96→03/08		Orga 08610→; - ABS	03.2123-2781.3 010631	ATE Ø 23,81	
1.8 D (MBA9A, MCA9A)	43	07/96→10/02			24.2123-1714.3 010587	BDX Ø 23,81	
1.9 D (MBDJY)	51	07/96→12/03		→Orga 08609; - ABS	24.2123-1710.3 010504	Ø 23,81	
1.9 D 70 4WD (MBWJZ, MCWJZ)	51	07/98→03/06		→Orga 08609; + ABS; für Linkslenker	24.2123-1713.3 010505	Ø 23,81	
2.0 HDI 90 4WD (MBRHY, MCRHY)	66	11/00→10/05		Orga 08610→; + ABS	24.2123-1715.3 010520	BDX Ø 23,81	
1.4 bivalent	48	11/02→12/11		→ 03/08; - ABS	03.2123-2781.3 010631	ATE Ø 23,81	
1.6 HDI 75 (MB9HW)	55	07/05→12/11			24.2123-1714.3 010587	BDX Ø 23,81	
				→ 03/08; + ABS	24.2123-1715.3 010520	BDX Ø 23,81	
1.4 CNG	48	11/02→03/08		- ABS	03.2123-2781.3 010631	ATE Ø 23,81	
1.4 i bivalent (MBKFW)	55	04/03→10/05			24.2123-1714.3 010587	BDX Ø 23,81	
1.6 16V	81	08/05→12/07			24.2123-1715.3 010520	BDX Ø 23,81	
1.6 16V (MBNFU)	80	10/00→03/08		+ ABS	24.2123-1715.3 010520	BDX Ø 23,81	
1.4 i (MBKFX, MBKFW)	55	07/96→12/11		Orga 08610→; → 03/08; - ABS	03.2123-2781.3 010631	ATE Ø 23,81	
1.9 D 70 (MBWJZ, MCWJZ)	51	04/99→12/11			24.2123-1714.3 010587	BDX Ø 23,81	
2.0 HDI 90 (MBRHY, MCRHY)	66	12/99→12/11		→Orga 08609; - ABS	24.2123-1710.3 010504	Ø 23,81	
				→Orga 08609; + ABS; für Linkslenker	24.2123-1713.3 010505	Ø 23,81	
				Orga 08610→; → 03/08; + ABS	24.2123-1715.3 010520	BDX Ø 23,81	
 Bremskraftregler							
1.1 i (MAHDZ, MBHDZ, MBHFX)	44	07/96→03/08		Nutzlast [kg]: 500 / 600; für Fahrzeuge ohne verstärktes Fahrwerk	03.6582-0009.3 320143	ATE lastabhängig 8/1,5 4x	
1.4 CNG	48	11/02→03/08			03.6582-0012.3 320233	ATE lastabhängig 8/1,5 4x	
1.4 i bivalent (MBKFW)	55	04/03→10/05		Nutzlast [kg]: 500 / 600; für Fahrzeuge mit verstärktem Fahrwerk	03.6582-0009.3 320143	ATE lastabhängig 8/1,5 4x	
1.4 bivalent	48	11/02→12/11		→ 03/08; Nutzlast [kg]: 500 / 600; für Fahrzeuge ohne verstärktes Fahrwerk	03.6582-0009.3 320143	ATE lastabhängig 8/1,5 4x	
1.4 i (MBKFX, MBKFW)	55	07/96→12/11		→ 03/08; Nutzlast [kg]: 500 / 600; für Fahrzeuge mit verstärktem Fahrwerk	03.6582-0012.3 320233	ATE lastabhängig 8/1,5 4x	
1.6 16V	81	08/05→12/07		Nutzlast [kg]: 600; für Fahrzeuge ohne verstärktes Fahrwerk	03.6582-0009.3 320143	ATE lastabhängig 8/1,5 4x	
1.6 16V (MBNFU)	80	10/00→03/08			03.6582-0012.3 320233	ATE lastabhängig 8/1,5 4x	
1.8 D (MBA9A, MCA9A)	43	07/96→10/02		Nutzlast [kg]: 600; für Fahrzeuge mit verstärktem Fahrwerk	03.6582-0012.3 320233	ATE lastabhängig 8/1,5 4x	
1.9 D (MBDJY)	51	07/96→12/03			03.6582-0015.3 320227	ATE lastabhängig 8/1,5 4x	
1.9 D 70 4WD (MBWJZ, MCWJZ)	51	07/98→03/06		Nutzlast [kg]: 800	03.6582-0015.3 320227	ATE lastabhängig 8/1,5 4x	
2.0 HDI 90 4WD (MBRHY, MCRHY)	66	11/00→10/05					
1.6 HDI 75 (MB9HW)	55	07/05→12/11		→ 03/08; Nutzlast [kg]: 600; für Fahrzeuge ohne verstärktes Fahrwerk	03.6582-0009.3 320143	ATE lastabhängig 8/1,5 4x	
1.9 D 70 (MBWJZ, MCWJZ)	51	04/99→12/11			03.6582-0012.3 320233	ATE lastabhängig 8/1,5 4x	
2.0 HDI 90 (MBRHY, MCRHY)	66	12/99→12/11		→ 03/08; Nutzlast [kg]: 600; für Fahrzeuge mit verstärktem Fahrwerk	03.6582-0015.3 320227	ATE lastabhängig 8/1,5 4x	
				→ 03/08; Nutzlast [kg]: 800	03.6582-0015.3 320227	ATE lastabhängig 8/1,5 4x	
CITROËN - BERLINGO Pritsche/Fahrgestell (B9) 04/08→							
 Hauptbremszylinder							
1.6 BlueHDI 100	73	12/14→		+ ESP	24.4123-1714.3 010979	TRW Ø 23,81	
1.6 HDi 90	66	04/08→					
1.6 HDi 92	68	07/10→					
CITROËN - C1 (PM_, PN_) 06/05→09/14							
 Hauptbremszylinder							
1.0	50	06/05→09/14		für Linkslenker; → 04/14; - ESP	24.4120-1701.3 010846	BOS Ø 20,64	
1.4 HDi	40	06/05→09/14		→ 12/08; für Linkslenker; - ESP	24.4120-1701.3 010846	BOS Ø 20,64	
CITROËN - C2 (JM_) 09/03→							
 Hauptbremszylinder							
1.1	44	09/03→		→ 12/09; - ABS	24.2120-1741.3 010775	Ø 20,64	
				Orga 10815→ Orga 11192; für Linkslenker; - ESP	24.2122-1764.3 010851	BOS Ø 22,2	
				→Orga 10800; - ESP	24.2122-1766.3 010840	TRW Ø 22,2	
				→Orga 10800; + ESP	24.2122-1767.3 010841	TRW Ø 22,2 ohne Drucksensor	
				→ 12/09; Orga 10801→; + ESP	24.4122-1703.3 010843	TRW Ø 22,2	
				Orga 10801→ Orga 11192; für Rechtslenker; - ESP	24.4122-1704.3 010847	TRW Ø 22,2	
				Orga 10808→ Orga 10810; für Linkslenker; - ESP	24.4122-1704.3 010847	TRW Ø 22,2	
				Orga 10801→ Orga 10807; für Linkslenker; - ESP	24.4122-1708.3 010865	BOS Ø 22,2 ohne Bremsflüssigkeitsbehälter	
				Orga 11193→; → 12/09; für Linkslenker; - ESP	24.4122-1708.3 010865	BOS Ø 22,2 ohne Bremsflüssigkeitsbehälter	

















	kw			 	! #		
CITROËN - C2 (JM_) 09/03→							
 Hauptbremszylinder							
1.1	44	09/03→		Orga 10811→ Orga 10814; für Linkslenker; - ESP		24.4122-1708.3 010865	BOS Ø 22,2 ohne Bremsflüssigkeitsbehälter
1.4	54	09/03→		→ 12/09; - ABS		24.2120-1741.3 010775	Ø 20,64
1.4	55	10/06→		Orga 10815→ Orga 11192; für Linkslenker; - ESP		24.2122-1764.3 010851	BOS Ø 22,2
1.4 HDi	50	09/03→		→Orga 10800; - ESP		24.2122-1766.3 010840	TRW Ø 22,2
				→Orga 10800; + ESP		24.2122-1767.3 010841	TRW Ø 22,2 ohne Drucksensor
				→ 12/09; Orga 10801→; + ESP		24.4122-1703.3 010843	TRW Ø 22,2
				Orga 10808→ Orga 10810; für Linkslenker; - ESP		24.4122-1704.3 010847	TRW Ø 22,2
				Orga 10801→; → 12/09; für Rechtslenker; - ESP		24.4122-1704.3 010847	TRW Ø 22,2
				Orga 10801→ Orga 10807; für Linkslenker; - ESP		24.4122-1708.3 010865	BOS Ø 22,2 ohne Bremsflüssigkeitsbehälter
				Orga 10811→ Orga 10814; für Linkslenker; - ESP		24.4122-1708.3 010865	BOS Ø 22,2 ohne Bremsflüssigkeitsbehälter
				Orga 11193→; → 12/09; für Linkslenker; - ESP		24.4122-1708.3 010865	BOS Ø 22,2 ohne Bremsflüssigkeitsbehälter
1.4 16V	65	06/06→		→ 12/09; - ABS		24.2120-1741.3 010775	Ø 20,64
				Orga 10815→ Orga 11192; für Linkslenker; - ESP		24.2122-1764.3 010851	BOS Ø 22,2
				→ 12/09; Orga 10801→; + ESP		24.4122-1703.3 010843	TRW Ø 22,2
				Orga 10808→ Orga 10810; für Linkslenker; - ESP		24.4122-1704.3 010847	TRW Ø 22,2
				Orga 10801→; → 12/09; für Rechtslenker; - ESP		24.4122-1704.3 010847	TRW Ø 22,2
				Orga 10801→ Orga 10807; für Linkslenker; - ESP		24.4122-1708.3 010865	BOS Ø 22,2 ohne Bremsflüssigkeitsbehälter
				Orga 11193→; → 12/09; für Linkslenker; - ESP		24.4122-1708.3 010865	BOS Ø 22,2 ohne Bremsflüssigkeitsbehälter
				Orga 10811→ Orga 10814; für Linkslenker; - ESP		24.4122-1708.3 010865	BOS Ø 22,2 ohne Bremsflüssigkeitsbehälter
1.6	80	09/03→		→ 12/09; - ABS		24.2120-1741.3 010775	Ø 20,64
				→Orga 10800; - ESP		24.2122-1766.3 010840	TRW Ø 22,2
				→Orga 10800; + ESP		24.2122-1767.3 010841	TRW Ø 22,2 ohne Drucksensor
				→ 12/09; Orga 10801→; + ESP		24.4122-1703.3 010843	TRW Ø 22,2
				Orga 10801→; → 12/09; für Linkslenker; - ESP		24.4122-1704.3 010847	TRW Ø 22,2
1.6 HDi	80	09/05→		→ 12/09; Orga 10801→; + ESP		24.4122-1703.3 010843	TRW Ø 22,2
1.6 VTS	90	01/05→		→Orga 10800; - ESP		24.2122-1766.3 010840	TRW Ø 22,2
				→Orga 10800; + ESP		24.2122-1767.3 010841	TRW Ø 22,2 ohne Drucksensor
				→ 12/09; Orga 10801→; + ESP		24.4122-1703.3 010843	TRW Ø 22,2
CITROËN - C2 ENTERPRISE 04/09→							
 Hauptbremszylinder							
1.4 HDi	50	04/09→		→ 12/09; - ABS		24.2120-1741.3 010775	Ø 20,64
				Orga 10815→ Orga 11192; für Linkslenker; - ESP		24.2122-1764.3 010851	BOS Ø 22,2
				→Orga 10800; - ESP		24.2122-1766.3 010840	TRW Ø 22,2
				→Orga 10800; + ESP		24.2122-1767.3 010841	TRW Ø 22,2 ohne Drucksensor
				Orga 10801→; → 12/09; + ESP		24.4122-1703.3 010843	TRW Ø 22,2
				Orga 10808→ Orga 10810; für Linkslenker; - ESP		24.4122-1704.3 010847	TRW Ø 22,2
				Orga 10801→; → 12/09; für Rechtslenker; - ESP		24.4122-1704.3 010847	TRW Ø 22,2
				Orga 10801→ Orga 10807; für Linkslenker; - ESP		24.4122-1708.3 010865	BOS Ø 22,2 ohne Bremsflüssigkeitsbehälter
				Orga 10811→ Orga 10814; für Linkslenker; - ESP		24.4122-1708.3 010865	BOS Ø 22,2 ohne Bremsflüssigkeitsbehälter
				Orga 11193→; → 12/09; für Linkslenker; - ESP		24.4122-1708.3 010865	BOS Ø 22,2 ohne Bremsflüssigkeitsbehälter
CITROËN - C3 I (FC_) 02/02→							
 Hauptbremszylinder							
1.1 i	44	02/02→		→ 08/09; - ABS		24.2120-1741.3 010775	Ø 20,64
1.4 HDi	50	02/02→					
1.4 HDi	52	07/03→02/11		Orga 10815→; → 08/09; für Linkslenker; - ESP		24.2122-1764.3 010851	BOS Ø 22,2
1.4 HDi	55	05/05→					
↓							













	kw			 	! #		
CITROËN - C3 I (FC_) 02/02→							
 Hauptbremszylinder							
1.4 i	54	02/02→		→Orga 10800; für Linkslenker; - ESP	24.2122-1764.3	010851	BOS Ø 22,2
				→Orga 10800; - ESP	24.2122-1766.3	010840	TRW Ø 22,2
				→Orga 10800; + ESP	24.2122-1767.3	010841	TRW Ø 22,2 ohne Drucksensor
				Orga 10801→; → 08/09; + ESP	24.4122-1703.3	010843	TRW Ø 22,2
				→ 08/09; für Rechtslenker; - ESP	24.4122-1704.3	010847	TRW Ø 22,2
				Orga 10808→ Orga 10814; für Linkslenker; - ESP	24.4122-1704.3	010847	TRW Ø 22,2
				Orga 10801→ Orga 10807; für Linkslenker; - ESP	24.4122-1708.3	010865	BOS Ø 22,2 ohne Bremsflüssigkeitsbehälter
1.4 16V 1.6 16V	65 80	12/03→ 02/02→		→ 08/09; - ABS	24.2120-1741.3	010775	Ø 20,64
				→Orga 10800; für Linkslenker; - ESP	24.2122-1764.3	010851	BOS Ø 22,2
				→Orga 10800; - ESP	24.2122-1766.3	010840	TRW Ø 22,2
				→Orga 10800; + ESP	24.2122-1767.3	010841	TRW Ø 22,2 ohne Drucksensor
				Orga 10801→; → 08/09; + ESP	24.4122-1703.3	010843	TRW Ø 22,2
				→ 08/09; - ESP	24.4122-1704.3	010847	TRW Ø 22,2
1.4 16V HDi	66	02/02→		→ 08/09; - ABS	24.2120-1741.3	010775	Ø 20,64
				→Orga 10800; für Linkslenker; - ESP	24.2122-1764.3	010851	BOS Ø 22,2
				Orga 10815→; → 08/09; für Linkslenker; - ESP	24.2122-1764.3	010851	BOS Ø 22,2
				→Orga 10800; - ESP	24.2122-1766.3	010840	TRW Ø 22,2
				→Orga 10800; + ESP	24.2122-1767.3	010841	TRW Ø 22,2 ohne Drucksensor
				Orga 10801→; → 08/09; + ESP	24.4122-1703.3	010843	TRW Ø 22,2
				→ 08/09; - ESP	24.4122-1704.3	010847	TRW Ø 22,2
				Orga 10801→ Orga 10807; für Linkslenker; - ESP	24.4122-1708.3	010865	BOS Ø 22,2 ohne Bremsflüssigkeitsbehälter
1.4 i Bivalent	54	02/02→		09/05→ 08/09; - ABS	24.2120-1741.3	010775	Ø 20,64
				09/05→; →Orga 10800; für Linkslenker; - ESP	24.2122-1764.3	010851	BOS Ø 22,2
				09/05→; →Orga 10800; - ESP	24.2122-1766.3	010840	TRW Ø 22,2
				09/05→; →Orga 10800; + ESP	24.2122-1767.3	010841	TRW Ø 22,2 ohne Drucksensor
				Orga 10801→; → 08/09; + ESP	24.4122-1703.3	010843	TRW Ø 22,2
				09/05→ 08/09; für Linkslenker; - ESP	24.4122-1704.3	010847	TRW Ø 22,2
				Orga 10801→ Orga 10807; für Linkslenker; - ESP	24.4122-1708.3	010865	BOS Ø 22,2 ohne Bremsflüssigkeitsbehälter
1.6 16V	81	05/03→09/05		- ABS	24.2120-1741.3	010775	Ø 20,64
				→Orga 10800; für Linkslenker; - ESP	24.2122-1764.3	010851	BOS Ø 22,2
				→Orga 10800; - ESP	24.2122-1766.3	010840	TRW Ø 22,2
				→Orga 10800; + ESP	24.2122-1767.3	010841	TRW Ø 22,2 ohne Drucksensor
				Orga 10801→; + ESP	24.4122-1703.3	010843	TRW Ø 22,2
				- ESP	24.4122-1704.3	010847	TRW Ø 22,2
1.6 16V HDi	66	10/05→		→Orga 10800; für Linkslenker; - ESP	24.2122-1764.3	010851	BOS Ø 22,2
				→Orga 10800; - ESP	24.2122-1766.3	010840	TRW Ø 22,2
				→Orga 10800; + ESP	24.2122-1767.3	010841	TRW Ø 22,2 ohne Drucksensor
				Orga 10801→; → 08/09; + ESP	24.4122-1703.3	010843	TRW Ø 22,2
				→ 08/09; - ESP	24.4122-1704.3	010847	TRW Ø 22,2
1.6 16V HDi	80	09/05→		→Orga 10800; für Linkslenker; - ESP	24.2122-1764.3	010851	BOS Ø 22,2
				→Orga 10800; - ESP	24.2122-1766.3	010840	TRW Ø 22,2
				→Orga 10800; + ESP	24.2122-1767.3	010841	TRW Ø 22,2 ohne Drucksensor
				Orga 10801→; → 08/09; + ESP	24.4122-1703.3	010843	TRW Ø 22,2
				→ 08/09; - ESP	24.4122-1704.3	010847	TRW Ø 22,2
				Orga 10801→ Orga 10807; für Linkslenker; - ESP	24.4122-1708.3	010865	BOS Ø 22,2 ohne Bremsflüssigkeitsbehälter
CITROËN - C3 II 11/09→							
 Hauptbremszylinder							
1.1	44	11/09→		Orga 13153→; + DSC	24.4122-1703.3	010843	TRW Ø 22,2
1.1 BiFuel	44	11/10→			24.4122-1704.3	010847	TRW Ø 22,2
1.4	54	11/09→		Orga 13153→; - DSC			
1.4 HDi 70	50	11/09→					
1.4 LPG	54	07/10→					
1.6 HDi 90	66	11/09→					
1.2 VTi 68	50	07/16→		Trommelbremse	24.4122-1703.3	010843	TRW Ø 22,2
				Scheibenbremse	24.4123-1704.3	010828	TRW Ø 23,81
1.4 VTi	72	11/09→		Orga 13153→; + DSC	24.4123-1704.3	010828	TRW Ø 23,81
↓							











	kW					! #		
CITROËN - C3 II 11/09→								
 Hauptbremszylinder								
1.4 VTi 95	70	11/09→		Orga 13153→; - DSC			24.4123-1705.3 010832	TRW Ø 23,81
1.6 HDi 110	82	11/09→						
1.6 HDi 115	84	09/12→						
1.6 VTi 120	88	11/09→						
1.6 BlueHDi 100	73	07/14→		+ DSC			24.4122-1703.3 010843	TRW Ø 22,2
1.6 BlueHDi 75	55	04/15→		- DSC			24.4122-1704.3 010847	TRW Ø 22,2
1.6 HDi	68	11/09→		Orga 13153→; Trommelbremse; + DSC			24.4122-1703.3 010843	TRW Ø 22,2
				Orga 13153→; Trommelbremse; - DSC			24.4122-1704.3 010847	TRW Ø 22,2
				Orga 13153→; Scheibenbremse; + DSC			24.4123-1704.3 010828	TRW Ø 23,81
				Orga 13153→; Scheibenbremse; - DSC			24.4123-1705.3 010832	TRW Ø 23,81
CITROËN - C3 III (SX) 07/16→								
 Hauptbremszylinder								
1.2 THP 110	81	07/16→		Trommelbremse			24.4122-1703.3 010843	TRW Ø 22,2
1.2 VTi 82	60	07/16→						
1.6 BlueHDi 100	73	07/16→		Scheibenbremse			24.4123-1704.3 010828	TRW Ø 23,81
1.6 BlueHDi 75	55	07/16→						
CITROËN - C3 Picasso 02/09→								
 Hauptbremszylinder								
1.2 THP 110	81	01/15→		+ ESP			24.4123-1704.3 010828	TRW Ø 23,81
1.4 VTi 95	70	02/09→						
1.4 VTi 95 LPG	70	01/12→		- ESP			24.4123-1705.3 010832	TRW Ø 23,81
1.6 BlueHDi 100	73	01/15→						
1.6 HDi	66	02/09→						
1.6 HDi	80	02/09→						
1.6 HDi 110	82	05/10→						
1.6 HDi 115	84	01/13→						
1.6 HDi 90	68	07/10→						
1.6 VTi 120	88	02/09→						
1.6 VTRi	84	10/16→						
CITROËN - C3 Pluriel (HB_) 05/03→								
 Hauptbremszylinder								
1.4	54	05/03→		→ 07/10; - ABS			24.2120-1741.3 010775	Ø 20,64
1.4	55	07/03→						
1.4 HDi	50	04/04→		→Orga 10800; - ESP			24.2122-1764.3 010851	BOS Ø 22,2
							24.2122-1766.3 010840	TRW Ø 22,2
				→Orga 10800; + ESP			24.2122-1767.3 010841	TRW Ø 22,2 ohne Drucksensor
				Orga 10801→; → 07/10; + ESP			24.4122-1703.3 010843	TRW Ø 22,2
				Orga 10801→; → 07/10; - ESP			24.4122-1704.3 010847	TRW Ø 22,2
1.4 Hybrid	54	05/05→		→ 07/10; - ABS			24.2120-1741.3 010775	Ø 20,64
1.6	80	05/03→						
				→Orga 10800; - ESP			24.2122-1764.3 010851	BOS Ø 22,2
							24.2122-1766.3 010840	TRW Ø 22,2
							24.2122-1767.3 010841	TRW Ø 22,2 ohne Drucksensor
				Orga 10801→; → 07/10; + ESP			24.4122-1703.3 010843	TRW Ø 22,2
				Orga 10801→; → 07/10; - ESP			24.4122-1704.3 010847	TRW Ø 22,2
CITROËN - C4 CACTUS 09/14→								
 Hauptbremszylinder								
1.2 THP 110	81	09/14→		für Fahrzeuge mit Trommelbremse an der Hinterachse			24.4122-1703.3 010843	TRW Ø 22,2
1.2 VTi 75	55	09/14→						
1.2 VTi 82	60	09/14→						
1.6 BlueHDi 100	73	09/14→		für Fahrzeuge mit Scheibenbremse an der Hinterachse			24.4123-1704.3 010828	TRW Ø 23,81
1.6 HDi 90	68	09/14→						
CITROËN - C4 Grand Picasso I (UA_) 10/06→								
 Bremskraftverstärker								
1.6 16V	103	07/08→		→ 07/13;			03.7860-5702.4 300279	ATE Ø 10" pneumatisch
1.6 16V	110	10/08→		für Fahrzeuge ohne Start-Stopp-Funktion				
1.6 HDi 110	82	09/10→						
1.6 VTi 120	88	07/08→						
2.0 HDi 150	110	07/09→						
1.6 HDi	80	10/06→		→Orga 11437			03.7860-4103.4 300242	ATE Ø 10" pneumatisch
2.0 HDi 138	100	10/06→						
				Orga 11438→; → 07/13;			03.7860-5702.4 300279	ATE Ø 10" pneumatisch
				für Fahrzeuge ohne Start-Stopp-Funktion				
1.6 THP 155	115	09/10→		11/10→ 07/13;			03.7860-5702.4 300279	ATE Ø 10" pneumatisch
2.0 HDi 165	120	09/10→		für Fahrzeuge ohne Start-Stopp-Funktion				
1.8 i 16V	92	10/06→		→ 07/13			03.7870-1002.4 300282	ATE Ø 11" pneumatisch
2.0 i 16V	103	10/06→						
2.0 i 16V	105	01/10→						









	kw			 	! #		
CITROËN - C4 Grand Picasso I (UA_) 10/06→							
 Hauptbremszylinder							
1.6 16V	103	07/08→		→ 07/13		03.4153-0173.3 010815	ATE Ø 23,81
1.6 16V	110	10/08→					
1.6 HDi	80	10/06→					
1.6 HDi 110	82	09/10→					
1.6 VTi 120	88	07/08→					
1.8 i 16V	92	10/06→					
2.0 HDi 138	100	10/06→					
2.0 HDi 150	110	07/09→					
2.0 i 16V	103	10/06→					
2.0 i 16V	105	01/10→					
1.6 THP 155	115	09/10→		11/10→ 07/13		03.4153-0173.3 010815	ATE Ø 23,81
2.0 HDi 165	120	09/10→					
CITROËN - C4 Picasso I (UD_) 10/06→08/13							
 Bremskraftverstärker							
1.6 16V	110	07/08→08/13		→ 07/13;		03.7860-5702.4 300279	ATE Ø 10" pneumatisch
1.6 THP 140	103	07/08→08/13		für Fahrzeuge ohne Start-Stopp-Funktion			
1.6 VTi 120	88	07/08→08/13					
2.0 HDi 150	110	07/09→08/13					
1.6 HDi	80	02/07→08/13		→Orga 11437		03.7860-4103.4 300242	ATE Ø 10" pneumatisch
				Orga 11438→; → 07/13;		03.7860-5702.4 300279	ATE Ø 10" pneumatisch
				für Fahrzeuge ohne Start-Stopp-Funktion			
1.6 HDi 110	82	09/10→08/13		11/10→ 07/13;		03.7860-5702.4 300279	ATE Ø 10" pneumatisch
1.6 THP 155	115	09/10→08/13		für Fahrzeuge ohne Start-Stopp-Funktion			
2.0 HDi 165	120	09/10→08/13					
1.8 Bifuel	92	01/09→10/12				03.7870-1002.4 300282	ATE Ø 11" pneumatisch
1.8 i 16V	92	02/07→12/11					
2.0 i 16V	105	05/08→05/13					
2.0 HDi 138	100	10/06→08/13		02/07→; →Orga 11437		03.7860-4103.4 300242	ATE Ø 10" pneumatisch
				Orga 11438→; → 07/13;		03.7860-5702.4 300279	ATE Ø 10" pneumatisch
				für Fahrzeuge ohne Start-Stopp-Funktion			
2.0 i 16V	103	02/07→08/13		→ 07/13		03.7870-1002.4 300282	ATE Ø 11" pneumatisch
 Hauptbremszylinder							
1.6 16V	110	07/08→08/13		→ 07/13		03.4153-0173.3 010815	ATE Ø 23,81
1.6 HDi	80	02/07→08/13					
1.6 THP 140	103	07/08→08/13					
1.6 VTi 120	88	07/08→08/13					
2.0 HDi 150	110	07/09→08/13					
2.0 i 16V	103	02/07→08/13					
1.6 HDi 110	82	09/10→08/13		11/10→ 07/13		03.4153-0173.3 010815	ATE Ø 23,81
1.6 THP 155	115	09/10→08/13					
2.0 HDi 165	120	09/10→08/13					
1.8 Bifuel	92	01/09→10/12				03.4153-0173.3 010815	ATE Ø 23,81
1.8 i 16V	92	02/07→12/11					
2.0 i 16V	105	05/08→05/13					
2.0 HDi 138	100	10/06→08/13		02/07→ 07/13		03.4153-0173.3 010815	ATE Ø 23,81
CITROËN - C5 III (RD_) 02/08→							
 Bremskraftverstärker							
1.6 HDi 110	80	02/08→		für Linkslenker		03.7860-7802.4 300280	ATE Ø 10" pneumatisch
1.6 THP 150	110	07/10→					
1.6 THP 155	115	04/09→					
1.6 VTi 120	88	07/10→					
1.8 16V	92	02/08→					
2.0 16V	103	02/08→					
2.0 16V BioFlex	103	02/08→					
2.0 HDi	100	02/08→					
2.0 HDi 140	103	04/09→					
2.0 HDi 165	120	04/09→					
2.2 HDi	125	02/08→					
2.2 HDi 200	150	07/10→					
2.7 HDi	150	02/08→					
3.0	152	02/08→					
3.0 HDi 240	177	04/09→					
3.0 V6	155	02/08→					
1.6 HDi 110	82	07/10→		für Linkslenker;		03.7860-7802.4 300280	ATE Ø 10" pneumatisch
1.6 HDi 115	84	01/12→		für Fahrzeuge ohne Start-Stopp-Funktion			
2.0 HDi 180	133	03/15→					
 Hauptbremszylinder							
1.6 HDi 110	80	02/08→		Orga 12348→		03.2123-3131.3 010977	ATE Ø 23,81
1.6 HDi 110	82	07/10→					
1.6 THP 150	110	07/10→					
1.6 THP 155	115	04/09→					
1.6 VTi 120	88	07/10→					
1.8 16V	92	02/08→					
↓							













	kw			 	! #		
CITROËN - C5 III (RD_) 02/08→							
 Hauptbremszylinder							
2.0 16V	103	02/08→		Orga 12348→		03.2123-3131.3 010977	ATE Ø 23,81
2.0 16V BioFlex	103	02/08→					
2.0 HDi	100	02/08→					
2.0 HDi 140	103	04/09→					
2.0 HDi 165	120	04/09→					
2.2 HDi	125	02/08→					
2.2 HDi 200	150	07/10→					
2.7 HDi	150	02/08→					
3.0	152	02/08→					
3.0 HDi 240	177	04/09→					
3.0 V6	155	02/08→					
1.6 HDi 115	84	01/12→				03.2123-3131.3 010977	ATE Ø 23,81
2.0 HDi 180	133	03/15→					
2.0 HDi 150 / BlueHDi 150	110	04/09→		05/15→		03.2123-3131.3 010977	ATE Ø 23,81
CITROËN - C5 III Break (TD_) 02/08→							
 Bremskraftverstärker							
1.6 HDi 110	80	02/08→		für Linkslenker		03.7860-7802.4 300280	ATE Ø 10" pneumatisch
1.6 THP 150	110	04/09→					
1.6 THP 155	115	04/09→					
1.6 VTI 120	88	07/10→					
1.8 16V	92	02/08→					
2.0 16V	103	02/08→					
2.0 16V BioFlex	103	02/08→					
2.0 HDi	100	02/08→					
2.0 HDi 140	103	04/09→					
2.0 HDi 150 / BlueHDi 150	110	04/09→					
2.0 HDi 165	120	04/09→					
2.2 HDi	125	02/08→					
2.2 HDi 165	120	02/08→					
2.2 HDi 200	150	07/10→					
2.7 HDi	150	02/08→					
3.0	152	02/08→					
3.0 HDi 240	177	04/09→					
3.0 V6	155	02/08→					
1.6 HDi 110	82	07/10→		für Linkslenker;		03.7860-7802.4 300280	ATE Ø 10" pneumatisch
1.6 HDi 115	84	01/12→		für Fahrzeuge ohne Start-Stopp-Funktion			
2.0 HDi 180	133	03/15→					
 Hauptbremszylinder							
1.6 HDi 110	80	02/08→		01/12→		03.2123-3131.3 010977	ATE Ø 23,81
1.6 HDi 110	82	07/10→		Orga 12348→		03.2123-3131.3 010977	ATE Ø 23,81
1.6 HDi 115	84	01/12→					
1.6 THP 150	110	04/09→					
1.6 THP 155	115	04/09→					
1.6 VTI 120	88	07/10→					
1.8 16V	92	02/08→					
2.0 16V	103	02/08→					
2.0 16V BioFlex	103	02/08→					
2.0 HDi	100	02/08→					
2.0 HDi 140	103	04/09→					
2.0 HDi 150 / BlueHDi 150	110	04/09→					
2.0 HDi 165	120	04/09→					
2.2 HDi	125	02/08→					
2.2 HDi 165	120	02/08→					
2.2 HDi 200	150	07/10→					
2.7 HDi	150	02/08→					
3.0	152	02/08→					
3.0 HDi 240	177	04/09→					
3.0 V6	155	02/08→					
2.0 HDi 180	133	03/15→				03.2123-3131.3 010977	ATE Ø 23,81
CITROËN - C6 (TD_) 09/05→							
 Bremskraftverstärker							
2.2 HDi	120	06/06→		für Linkslenker; →Orga 11192		03.7860-3402.4 300217	ATE Ø 10" pneumatisch
2.2 HDi	125	06/06→		Orga 12047→; für Linkslenker; → 12/12		03.7860-8002.4 300258	ATE Ø 10" pneumatisch
2.7 HDi	150	09/05→		→Orga 11073; für Linkslenker		03.7860-3402.4 300217	ATE Ø 10" pneumatisch
3.0 HDi	177	04/09→		07/09→; für Linkslenker; → 12/12		03.7860-8002.4 300258	ATE Ø 10" pneumatisch
3.0 V6	155	09/05→		für Linkslenker; →Orga 11192		03.7860-3402.4 300217	ATE Ø 10" pneumatisch
 Hauptbremszylinder							
2.2 HDi	120	06/06→		Orga 12348→; → 12/12		03.2123-3131.3 010977	ATE Ø 23,81
2.2 HDi	125	06/06→					
2.7 HDi	150	09/05→					
↓							









	kw					! #		
CITROËN - C6 (TD_) 09/05→								
 Hauptbremszylinder								
3.0 HDi 3.0 V6	177 155	04/09→ 09/05→		Orga 12348→; → 12/12			03.2123-3131.3 010977	ATE Ø 23,81
CITROËN - C8 (EA_, EB_) 07/02→								
 Bremskraftverstärker								
2.0 16V 2.0 16V 2.0 HDi 135	103 104 100	09/05→ 09/05→ 03/06→		→Orga 10919; für Linkslenker Orga 10920→; für Linkslenker; → 07/14			03.7860-2002.4 300216 03.7860-4302.4 300231	ATE Ø 10" pneumatisch ATE Ø 10" pneumatisch
2.0 HDi 2.0 HDi 2.0 HDi 2.2 HDi 2.0 HDi	79 80 81 94 88	07/02→ 07/02→ 07/02→ 07/02→ 07/06→		Orga 10528→; für Linkslenker; → 07/14 02/07→; für Linkslenker; → 07/14			03.7860-2002.4 300216 03.7860-4302.4 300231	ATE Ø 10" pneumatisch ATE Ø 10" pneumatisch
2.0 HDi 165	120	03/06→		für Linkslenker; → 07/14			03.7870-1602.4 300311	ATE Ø 11" pneumatisch
 Hauptbremszylinder								
2.0 16V 2.0 16V 2.0 HDi 135	103 104 100	09/05→ 09/05→ 03/06→		→ 07/14			03.2122-2163.3 010800	ATE Ø 22,2
2.0 HDi 2.0 HDi 2.0 HDi 2.2 HDi 2.0 HDi	79 80 81 94 88	07/02→ 07/02→ 07/02→ 07/02→ 07/06→		Orga 10528→; → 07/14 02/07→ → 07/14			03.2122-2163.3 010800 03.2122-2163.3 010800	ATE Ø 22,2 ATE Ø 22,2
2.0 HDi 165 2.2 HDi 2.2 HDi	120 120 125	03/06→ 06/07→ 06/06→		→ 07/14			03.2123-3421.3 010933	ATE Ø 23,81
CITROËN - C15 (VD_) 10/84→10/06								
 Hauptbremszylinder								
1.0 1.0 E	33 37	10/84→12/97 11/92→07/96		→Orga 04195; für Linkslenker →Orga 04195; für Rechtslenker			24.2117-1501.3 010398 24.2119-1705.3 010460	Ø 17,46 Ø 19,05
1.4 1.4 E 1.4 E 1.4 i	49 40 44 55	07/87→12/96 07/87→12/96 05/87→12/96 05/91→12/96		→Orga 04195; für Rechtslenker			24.2119-1705.3 010460	Ø 19,05
 Bremskraftregler								
1.0 1.0 E 1.1 1.1 1.1 i 1.4 1.4 E 1.4 E 1.4 i 1.8 D 1.9 D 1.9 D	33 37 35 40 44 49 40 44 55 44 44 51	10/84→12/97 11/92→07/96 10/84→12/96 11/88→07/96 07/88→12/96 07/87→12/96 07/87→12/96 05/87→12/96 05/91→12/96 07/86→12/00 12/00→12/05 10/00→10/02					24.6512-1507.3 320023	lastabhängig 3x
CITROËN - C15 Kombi 04/87→08/00								
 Hauptbremszylinder								
1.4	55	05/91→07/96		→Orga 04195; für Rechtslenker			24.2119-1705.3 010460	Ø 19,05
 Bremskraftregler								
1.1 1.4 1.8 D	44 55 44	08/88→07/96 05/91→07/96 04/87→08/00					24.6512-1507.3 320023	lastabhängig 3x
CITROËN - C-ELYSEE 11/12→								
 Hauptbremszylinder								
1.6 HDi 92	68	11/12→		+ ESP			24.4122-1703.3 010843	TRW Ø 22,2
CITROËN - DS3 11/09→07/15								
 Hauptbremszylinder								
1.4 HDi 70 1.6 HDi 110 1.6 HDi 90 1.6 Racing 1.6 Racing 1.6 THP 150 1.6 THP 155 ↓	50 82 68 147 152 110 115	04/10→07/15 11/09→07/15 11/09→07/15 02/11→07/15 02/11→07/15 01/10→07/15 04/10→07/15		Orga 12999→ Orga 13341			24.4123-1704.3 010828	TRW Ø 23,81









	kw			 	! #		
CITROËN - DS3 11/09→07/15							
 Hauptbremszylinder							
1.6 VTi 120	88	04/10→07/15		Orga 12999→ Orga 13341		24.4123-1704.3 010828	TRW Ø 23,81
1.4 VTi 95	70	04/10→07/15		Orga 12999→ Orga 13341		24.4122-1703.3 010843	TRW Ø 22,2
1.4 VTi 95 LPG	70	08/12→07/15					
1.4 VTi 98	72	11/09→07/15					
1.6 HDi 115	84	08/12→07/15		→Orga 13341		24.4123-1704.3 010828	TRW Ø 23,81
CITROËN - DS3 Cabriolet 01/13→07/15							
 Hauptbremszylinder							
1.2 THP 110	81	10/14→07/15				24.4123-1704.3 010828	TRW Ø 23,81
1.6 BlueHDi 100	73	07/14→07/15					
1.6 BlueHDi 115	85	10/13→07/15					
1.6 BlueHDi 120	88	07/14→07/15					
1.6 Racing	152	03/14→07/15					
1.6 THP 165	121	10/14→07/15					
1.6 HDi 90	69	01/13→07/15		03/13→		24.4123-1704.3 010828	TRW Ø 23,81
1.6 THP 150	110	01/13→07/15					
1.6 THP 155	115	01/13→07/15					
1.6 VTi 120	88	01/13→07/15					
CITROËN - DS5 11/11→07/15							
 Bremskraftverstärker							
1.6 BlueHDi 120	88	07/14→07/15		für Fahrzeuge ohne Start-Stopp-Funktion		03.7860-3732.4 300306	ATE Ø 10" pneumatisch
1.6 HDi	85	11/13→07/15					
1.6 HDi 110	82	11/11→07/15					
1.6 THP 150	110	11/11→07/15					
1.6 THP 155	115	11/11→07/15					
1.6 THP 165	121	01/12→07/15					
1.6 THP 165 Hybrid	121	06/12→07/15					
1.6 THP 200	147	11/11→07/15					
1.6 THP 210	155	11/14→07/15					
2.0 BlueHDi 150	110	07/14→07/15					
2.0 BlueHDi 180	133	08/13→07/15					
2.0 HDi 135	100	11/11→07/15					
2.0 HDi 150 Hybrid	110	11/11→07/15					
2.0 HDi 165	120	11/11→07/15					
1.6 HDi 115	84	06/12→07/15		08/12→; für Fahrzeuge ohne Start-Stopp-Funktion		03.7860-3732.4 300306	ATE Ø 10" pneumatisch
 Hauptbremszylinder							
1.6 BlueHDi 120	88	07/14→07/15		Nabendurchmesser [mm]: 82		03.4153-0173.3 010815	ATE Ø 23,81
1.6 HDi	85	11/13→07/15					
1.6 HDi 110	82	11/11→07/15					
1.6 THP 150	110	11/11→07/15					
1.6 THP 155	115	11/11→07/15					
1.6 THP 165	121	01/12→07/15					
1.6 THP 165 Hybrid	121	06/12→07/15					
1.6 THP 200	147	11/11→07/15					
1.6 THP 210	155	11/14→07/15					
2.0 BlueHDi 150	110	07/14→07/15					
2.0 BlueHDi 180	133	08/13→07/15					
2.0 HDi 135	100	11/11→07/15					
2.0 HDi 150 Hybrid	110	11/11→07/15					
2.0 HDi 165	120	11/11→07/15					
2.0 HDi 165 Hybrid4 4x4	120	12/11→07/15					
2.0 HDi 200 Hybrid4	147	12/11→07/15					
1.6 HDi 115	84	06/12→07/15		08/12→; Nabendurchmesser [mm]: 82		03.4153-0173.3 010815	ATE Ø 23,81
CITROËN - EVASION (22, U6) 06/94→07/02							
 Hauptbremszylinder							
1.8	73	05/97→07/02		→Orga 08206; - ABS		24.2122-1703.3 010422	Ø 22,2
1.8	76	02/96→12/96		→Orga 08206; + ABS		24.2122-1708.3 010437	Ø 22,2
				Orga 08207→; - ABS		24.2122-1741.3 010695	Ø 22,2
				Orga 08207→; + ABS		24.2122-1742.3 010696	Ø 22,2
1.9 TD	66	11/94→07/02		02/95→; →Orga 08206; - ABS		24.2123-1707.3 010492	Ø 23,81
				Orga 08207→; + ABS		24.2123-1733.3 010657	BOS Ø 23,81
				Orga 08207→; - ABS		24.2123-1738.3 010658	Ø 23,81
1.9 TD	68	10/95→12/98		- ABS		24.2123-1707.3 010492	Ø 23,81
2.0	89	06/94→07/02		→Orga 08206; - ABS		24.2123-1707.3 010492	Ø 23,81
2.0 16V	100	05/00→07/02		Orga 08207→; + ABS		24.2123-1733.3 010657	BOS Ø 23,81
2.0 Turbo C.T.	108	06/94→07/02		Orga 08207→; - ABS		24.2123-1738.3 010658	Ø 23,81
2.1 TD	80	05/96→07/02		Orga 08207→; - ABS		24.2123-1738.3 010658	Ø 23,81
2.0 16V	97	05/98→04/00		12/98→; →Orga 08206; - ABS		24.2123-1707.3 010492	Ø 23,81
				Orga 08207→; + ABS		24.2123-1733.3 010657	BOS Ø 23,81
↓							













	kw			 	! #		
CITROËN - EVASION (22, U6) 06/94→07/02							
 Hauptbremszylinder							
2.0 16V	97	05/98→04/00		Orga 08207→; - ABS		24.2123-1738.3 010658	Ø 23,81
2.0 HDI	80	08/99→07/02		+ ABS		24.2123-1733.3 010657	BOS Ø 23,81
2.0 HDI 16V	80	09/99→07/02		- ABS		24.2123-1738.3 010658	Ø 23,81
CITROËN - JUMPER Bus 04/06→							
 Hauptbremszylinder							
2.2 HDi 100	74	04/06→		Nutzlast ab [kg] 1.600 Nutzlast bis [kg] 2.000; Nutzlast 16Q/20Q; + ESP		24.4125-1701.3 010867	BOS Ø 25,4 ohne Bremsflüssigkeitsbehälter
2.2 HDi 110	81	07/11→					
2.2 HDi 120	88	04/06→					
2.2 HDi 130	96	07/11→		Nutzlast ab [kg] 1.200 Nutzlast bis [kg] 1.400; Nutzlast 12Q/14Q; - ESP		24.4125-1702.3 010872	BOS Ø 25,4 ohne Bremsflüssigkeitsbehälter
2.2 HDi 150	110	07/11→					
3.0 HDi 155	115	07/10→		Nutzlast ab [kg] 1.200 Nutzlast bis [kg] 1.400; Nutzlast 12Q/14Q; + ESP		24.4126-1701.3 010868	BOS Ø 26,99 ohne Bremsflüssigkeitsbehälter
3.0 HDi 160	116	09/06→					
3.0 HDi 180	130	07/11→					
CITROËN - JUMPER Bus (230P) 02/94→04/02							
 Hauptbremszylinder							
1.9 D	51	01/99→04/02		→ S 15064995; Nutzlast [kg]: 1.000; + ABS		24.2122-1714.3 010480	Ø 22,2
				→ S 15064995; Nutzlast [kg]: 1.000; für Linkslenker; - ABS		24.2122-1715.3 010481	Ø 22,2
				S 15064996→ S 16206233; Nutzlast [kg]: 1.000; + ABS		24.2125-1702.3 010482	Ø 25,4
				S 15064996→ S 16205754; Nutzlast [kg]: 1.000; für Linkslenker; - ABS		24.2125-1703.3 010483	Ø 25,4
				S 16205755→; → 03/02; Nutzlast [kg]: 1.000; - ABS		24.2125-1725.3 010717	Ø 25,4
				S 16206234→; → 03/02; Nutzlast [kg]: 1.000; + ABS		24.2125-1726.3 010718	Ø 25,4
1.9 TD	66	08/94→04/02		→ S 15064995; Nutzlast ab [kg] 1.000 Nutzlast bis [kg] 1.400; + ABS		24.2122-1714.3 010480	Ø 22,2
1.9 TD	68	02/94→04/02					
1.9 TD 4x4	68	08/96→04/02		→ S 15064995; Nutzlast ab [kg] 1.000 Nutzlast bis [kg] 1.400; für Linkslenker; - ABS		24.2122-1715.3 010481	Ø 22,2
				S 15064996→ S 16206233; Nutzlast ab [kg] 1.000 Nutzlast bis [kg] 1.400; + ABS		24.2125-1702.3 010482	Ø 25,4
				S 15064996→ S 16205754; Nutzlast ab [kg] 1.000 Nutzlast bis [kg] 1.400; für Linkslenker; - ABS		24.2125-1703.3 010483	Ø 25,4
				S 16205755→; → 03/02; Nutzlast ab [kg] 1.000 Nutzlast bis [kg] 1.400; - ABS		24.2125-1725.3 010717	Ø 25,4
				S 16206234→; → 03/02; Nutzlast ab [kg] 1.000 Nutzlast bis [kg] 1.400; + ABS		24.2125-1726.3 010718	Ø 25,4
2.0	80	02/94→04/02		→ S 15064995; Nutzlast ab [kg] 1.000 Nutzlast bis [kg] 1.400; + ABS		24.2122-1714.3 010480	Ø 22,2
				→ S 15064995; Nutzlast [kg]: 1.000; für Linkslenker; - ABS		24.2122-1715.3 010481	Ø 22,2
				→ S 16194399; Nutzlast [kg]: 1.800; + ABS		24.2125-1702.3 010482	Ø 25,4
				S 15064996→ S 16206233; Nutzlast ab [kg] 1.000 Nutzlast bis [kg] 1.400; + ABS		24.2125-1702.3 010482	Ø 25,4
				→ S 16205754; Nutzlast [kg]: 1.800; für Linkslenker; - ABS		24.2125-1703.3 010483	Ø 25,4
				S 15064996→ S 16205754; Nutzlast ab [kg] 1.000 Nutzlast bis [kg] 1.400; für Linkslenker; - ABS		24.2125-1703.3 010483	Ø 25,4
				S 16205755→; → 03/02; Nutzlast ab [kg] 1.000 Nutzlast bis [kg] 1.400; - ABS		24.2125-1725.3 010717	Ø 25,4
				S 16205353→; → 03/02; Nutzlast [kg]: 1.800; - ABS		24.2125-1725.3 010717	Ø 25,4
				S 16206234→; → 03/02; Nutzlast ab [kg] 1.000 Nutzlast bis [kg] 1.400; + ABS		24.2125-1726.3 010718	Ø 25,4
				S 16194400→; → 03/02; Nutzlast [kg]: 1.800; + ABS		24.2125-1726.3 010718	Ø 25,4
2.0 4x4	80	08/96→04/02		→ S 15064995; Nutzlast ab [kg] 1.000 Nutzlast bis [kg] 1.400; + ABS		24.2122-1714.3 010480	Ø 22,2
				S 15064996→ S 16206233; Nutzlast ab [kg] 1.000 Nutzlast bis [kg] 1.400; + ABS		24.2125-1702.3 010482	Ø 25,4
				S 15064996→ S 16205754; Nutzlast ab [kg] 1.000 Nutzlast bis [kg] 1.400; für Linkslenker; - ABS		24.2125-1703.3 010483	Ø 25,4
				S 16205755→; → 03/02; Nutzlast ab [kg] 1.000 Nutzlast bis [kg] 1.400; - ABS		24.2125-1725.3 010717	Ø 25,4











	kw			 	! #		
CITROËN - JUMPER Bus (230P) 02/94→04/02							
 Hauptbremszylinder							
2.0 4x4	80	08/96→04/02		S 16206234→; → 03/02; Nutzlast ab [kg] 1.000 Nutzlast bis [kg] 1.400; + ABS		24.2125-1726.3 010718	Ø 25,4
2.5 D 2.5 TD	63 76	08/94→04/02 08/94→04/02		→ S 15064995; Nutzlast [kg]: 1.400; + ABS		24.2122-1714.3 010480	Ø 22,2
				→ S 15064995; Nutzlast [kg]: 1.400; für Linkslenker; - ABS		24.2122-1715.3 010481	Ø 22,2
				S 15064996→ S 16206233; Nutzlast [kg]: 1.400; + ABS		24.2125-1702.3 010482	Ø 25,4
				→ S 16194399; Nutzlast [kg]: 1.800; + ABS		24.2125-1702.3 010482	Ø 25,4
				→ S 16205754; Nutzlast [kg]: 1.800; für Linkslenker; - ABS		24.2125-1703.3 010483	Ø 25,4
				S 15064996→ S 16205754; Nutzlast [kg]: 1.400; für Linkslenker; - ABS		24.2125-1703.3 010483	Ø 25,4
				S 16205353→; → 03/02; Nutzlast [kg]: 1.800; - ABS		24.2125-1725.3 010717	Ø 25,4
				S 16205755→; → 03/02; Nutzlast [kg]: 1.400; - ABS		24.2125-1725.3 010717	Ø 25,4
				S 16194400→; → 03/02; Nutzlast [kg]: 1.800; + ABS		24.2125-1726.3 010718	Ø 25,4
2.5 TDi	79	12/96→11/00		→ S 16194399; Nutzlast [kg]: 1.800; + ABS		24.2125-1702.3 010482	Ø 25,4
				S 15064996→ S 16206233; Nutzlast [kg]: 1.400; + ABS		24.2125-1702.3 010482	Ø 25,4
				→ S 16205754; Nutzlast ab [kg] 1.400 Nutzlast bis [kg] 1.800; für Linkslenker; - ABS		24.2125-1703.3 010483	Ø 25,4
				S 16205353→; Nutzlast [kg]: 1.800; - ABS		24.2125-1725.3 010717	Ø 25,4
				S 16205755→; Nutzlast [kg]: 1.400; - ABS		24.2125-1725.3 010717	Ø 25,4
				S 16194400→; Nutzlast [kg]: 1.800; + ABS		24.2125-1726.3 010718	Ø 25,4
				S 16206234→; Nutzlast [kg]: 1.400; + ABS		24.2125-1726.3 010718	Ø 25,4
2.5 TDi 4x4 2.8 HDi 4x4	79 94	12/96→11/00 09/00→04/02		→ S 16205754; Nutzlast ab [kg] 1.400 Nutzlast bis [kg] 1.800; für Linkslenker; - ABS		24.2125-1703.3 010483	Ø 25,4
2.8 D	64	01/99→02/02		→ S 15064995; Nutzlast [kg]: 1.400; + ABS		24.2122-1714.3 010480	Ø 22,2
				→ S 15064995; Nutzlast [kg]: 1.400; für Linkslenker; - ABS		24.2122-1715.3 010481	Ø 22,2
				S 15064996→ S 16206253; Nutzlast [kg]: 1.400; + ABS		24.2125-1702.3 010482	Ø 25,4
				→ S 16194399; Nutzlast [kg]: 1.800		24.2125-1702.3 010482	Ø 25,4
				→ S 16205352; Nutzlast [kg]: 1.800; für Linkslenker; - ABS		24.2125-1703.3 010483	Ø 25,4
				S 15064996→ S 16205754; Nutzlast [kg]: 1.400; für Linkslenker; - ABS		24.2125-1703.3 010483	Ø 25,4
				S 16205755→; Nutzlast [kg]: 1.400; - ABS		24.2125-1725.3 010717	Ø 25,4
				S 16205353→; Nutzlast [kg]: 1.800; - ABS		24.2125-1725.3 010717	Ø 25,4
				S 16206254→; Nutzlast [kg]: 1.400; + ABS		24.2125-1726.3 010718	Ø 25,4
2.8 HDi	94	09/00→04/02		→ S 16206233; Nutzlast [kg]: 1.400; + ABS		24.2125-1702.3 010482	Ø 25,4
				→ S 16194399; Nutzlast [kg]: 1.800; + ABS		24.2125-1702.3 010482	Ø 25,4
				→ S 16205754; Nutzlast ab [kg] 1.400 Nutzlast bis [kg] 1.800; für Linkslenker; - ABS		24.2125-1703.3 010483	Ø 25,4
				S 16205755→; → 03/02; Nutzlast [kg]: 1.400; - ABS		24.2125-1725.3 010717	Ø 25,4
				S 16205353→; → 03/02; Nutzlast [kg]: 1.800; - ABS		24.2125-1725.3 010717	Ø 25,4
				S 16194400→; → 03/02; Nutzlast [kg]: 1.800; + ABS		24.2125-1726.3 010718	Ø 25,4
↓							















	kw			 	! #		
CITROËN - JUMPER Bus (230P) 02/94→04/02							
 Hauptbremszylinder							
2.8 HDi	94	09/00→04/02		S 16206234→; → 03/02; Nutzlast [kg]: 1.400; + ABS		24.2125-1726.3 010718	Ø 25,4
 Bremskraftregler							
1.9 D	51	01/99→04/02		→ S 16206244; Nutzlast [kg]: 1.000; - ABS		24.6512-1701.3 320153	lastabhängig 2x
1.9 TD	66	08/94→04/02		→ S 16206244; Nutzlast ab [kg] 1.000		24.6512-1701.3 320153	lastabhängig 2x
1.9 TD	68	02/94→04/02		Nutzlast bis [kg] 1.400; - ABS			
1.9 TD 4x4	68	08/96→04/02					
2.0	80	02/94→04/02		→ S 16206244; Nutzlast ab [kg] 1.000		24.6512-1701.3 320153	lastabhängig 2x
2.0 4x4	80	08/96→04/02		Nutzlast bis [kg] 1.800; - ABS			
2.5 D	63	08/94→04/02		→ S 16206244; Nutzlast ab [kg] 1.400		24.6512-1701.3 320153	lastabhängig 2x
2.5 D 4x4	63	08/96→04/02		Nutzlast bis [kg] 1.800; - ABS			
2.5 TD	76	08/94→04/02					
2.5 TD 4x4	76	08/96→04/02					
2.8 D	64	01/99→02/02					
2.8 HDi	94	09/00→04/02					
2.8 HDi 4x4	94	09/00→04/02					
2.5 TDi	79	12/96→11/00		Nutzlast ab [kg] 1.400 Nutzlast bis [kg]		24.6512-1701.3 320153	lastabhängig 2x
2.5 TDi 4x4	79	12/96→11/00		1.800; - ABS			
CITROËN - JUMPER Bus (244, Z_) 04/02→							
 Hauptbremszylinder							
2.0	81	04/02→		→ 03/06; Nutzlast ab [kg] 1.000 Nutzlast		24.2125-1725.3 010717	Ø 25,4
2.0 HDi	62	04/02→		bis [kg] 1.800; - ABS			
2.2 HDi	74	04/02→		→ 03/06; Nutzlast ab [kg] 1.000 Nutzlast		24.2125-1726.3 010718	Ø 25,4
2.8 HDi	94	04/02→		bis [kg] 1.800; + ABS			
2.0 bivalent	81	02/03→		→ S 15064995; Nutzlast [kg]: 1.000; für Linkslenker; - ABS		24.2122-1715.3 010481	Ø 22,2
2.8 HDi Allrad	94	04/02→		→ 03/06; - ABS		24.2125-1725.3 010717	Ø 25,4
				→ 03/06; + ABS		24.2125-1726.3 010718	Ø 25,4
 Bremskraftregler							
2.8 HDi Allrad	94	04/02→		→ 03/06; Nutzlast ab [kg] 1.000 Nutzlast		24.6512-1701.3 320153	lastabhängig 2x
				bis [kg] 1.800; - ABS			
CITROËN - JUMPER Kasten 04/06→							
 Hauptbremszylinder							
2.2 HDi 100	74	04/06→		Nutzlast ab [kg] 1.600 Nutzlast bis [kg]		24.4125-1701.3 010867	BOS Ø 25,4
2.2 HDi 110	81	07/11→		2.000; Nutzlast 16Q/20Q; + ESP			ohne Bremsflüssigkeitsbehälter
2.2 HDi 120	88	04/06→		Nutzlast ab [kg] 1.200 Nutzlast bis [kg]		24.4125-1702.3 010872	BOS Ø 25,4
2.2 HDi 130	96	07/11→		1.400; Nutzlast 12Q/14Q; - ESP			ohne Bremsflüssigkeitsbehälter
2.2 HDi 150	110	07/11→					
3.0 HDi 145	107	07/10→		Nutzlast ab [kg] 1.200 Nutzlast bis [kg]		24.4126-1701.3 010868	BOS Ø 26,99
3.0 HDi 155	115	07/10→		1.400; Nutzlast 12Q/14Q; + ESP			ohne Bremsflüssigkeitsbehälter
3.0 HDi 160	116	09/06→					
3.0 HDi 180	130	07/11→					
CITROËN - JUMPER Kasten (230L) 02/94→04/02							
 Hauptbremszylinder							
1.9 D	50	07/99→04/02		→ S 15064995; Nutzlast [kg]: 1.000;		24.2122-1714.3 010480	Ø 22,2
1.9 D	51	02/94→04/02		+ ABS			
				→ S 15064995; Nutzlast [kg]: 1.000;		24.2122-1715.3 010481	Ø 22,2
				für Linkslenker; - ABS			
				S 15064996→ S 16206233;		24.2125-1702.3 010482	Ø 25,4
				Nutzlast [kg]: 1.000; + ABS			
				S 15064996→ S 16205754;		24.2125-1703.3 010483	Ø 25,4
				Nutzlast [kg]: 1.000; für Linkslenker;			
				- ABS			
				S 16205755→; → 03/02;		24.2125-1725.3 010717	Ø 25,4
				Nutzlast [kg]: 1.000; - ABS			
				S 16206234→; → 03/02;		24.2125-1726.3 010718	Ø 25,4
				Nutzlast [kg]: 1.000; + ABS			
1.9 TD	66	03/94→04/02		→ S 15064995; Nutzlast ab [kg] 1.000		24.2122-1714.3 010480	Ø 22,2
1.9 TD	68	03/94→04/02		Nutzlast bis [kg] 1.400; + ABS			
				→ S 15064995; Nutzlast ab [kg] 1.000		24.2122-1715.3 010481	Ø 22,2
				Nutzlast bis [kg] 1.400; für Linkslenker;			
				- ABS			
				S 15064996→ S 16206233; Nutzlast ab		24.2125-1702.3 010482	Ø 25,4
				[kg] 1.000 Nutzlast bis [kg] 1.400; + ABS			
				S 15064996→ S 16205754; Nutzlast ab		24.2125-1703.3 010483	Ø 25,4
				[kg] 1.000 Nutzlast bis [kg] 1.400;			
				für Linkslenker; - ABS			
↓							













	kw			 	! #		
CITROËN - JUMPER Kasten (230L) 02/94→04/02							
 Hauptbremszylinder							
1.9 TD	66	03/94→04/02		S 16205755→; → 03/02; Nutzlast ab [kg] 1.000 Nutzlast bis [kg] 1.400; - ABS	24.2125-1725.3	010717	Ø 25,4
1.9 TD	68	03/94→04/02		S 16206234→; → 03/02; Nutzlast ab [kg] 1.000 Nutzlast bis [kg] 1.400; + ABS	24.2125-1726.3	010718	Ø 25,4
2.0	80	03/94→04/02		→ S 15064995; Nutzlast ab [kg] 1.000 Nutzlast bis [kg] 1.400; + ABS	24.2122-1714.3	010480	Ø 22,2
				→ S 15064995; Nutzlast ab [kg] 1.000 Nutzlast bis [kg] 1.400; für Linkslenker; - ABS	24.2122-1715.3	010481	Ø 22,2
				S 15064996→ S 16206233; Nutzlast ab [kg] 1.000 Nutzlast bis [kg] 1.400; + ABS	24.2125-1702.3	010482	Ø 25,4
				→ S 16194399; Nutzlast [kg]: 1.800; + ABS	24.2125-1702.3	010482	Ø 25,4
				S 15064996→ S 16205754; Nutzlast ab [kg] 1.000 Nutzlast bis [kg] 1.400; für Linkslenker; - ABS	24.2125-1703.3	010483	Ø 25,4
				→ S 16205754; Nutzlast [kg]: 1.800; für Linkslenker; - ABS	24.2125-1703.3	010483	Ø 25,4
				S 16205353→; → 03/02; Nutzlast [kg]: 1.800; - ABS	24.2125-1725.3	010717	Ø 25,4
				S 16205755→; → 03/02; Nutzlast ab [kg] 1.000 Nutzlast bis [kg] 1.400; - ABS	24.2125-1725.3	010717	Ø 25,4
				S 16194400→; → 03/02; Nutzlast [kg]: 1.800; + ABS	24.2125-1726.3	010718	Ø 25,4
		S 16206234→; → 03/02; Nutzlast ab [kg] 1.000 Nutzlast bis [kg] 1.400; + ABS	24.2125-1726.3	010718	Ø 25,4		
2.0 4x4	80	10/96→01/02		→ S 15064995; Nutzlast ab [kg] 1.000 Nutzlast bis [kg] 1.400; + ABS	24.2122-1714.3	010480	Ø 22,2
				→ S 15064995; Nutzlast ab [kg] 1.000 Nutzlast bis [kg] 1.400; für Linkslenker; - ABS	24.2122-1715.3	010481	Ø 22,2
				→ S 16194399; Nutzlast [kg]: 1.800; + ABS	24.2125-1702.3	010482	Ø 25,4
				S 15064996→ S 16206233; Nutzlast ab [kg] 1.000 Nutzlast bis [kg] 1.400; + ABS	24.2125-1702.3	010482	Ø 25,4
				→ S 16205754; Nutzlast [kg]: 1.800; für Linkslenker; - ABS	24.2125-1703.3	010483	Ø 25,4
				S 15064996→ S 16205754; Nutzlast ab [kg] 1.000 Nutzlast bis [kg] 1.400; für Linkslenker; - ABS	24.2125-1703.3	010483	Ø 25,4
				S 16205755→; Nutzlast ab [kg] 1.000 Nutzlast bis [kg] 1.400; - ABS	24.2125-1725.3	010717	Ø 25,4
				S 16205353→; Nutzlast [kg]: 1.800; - ABS	24.2125-1725.3	010717	Ø 25,4
				S 16194400→; Nutzlast [kg]: 1.800; + ABS	24.2125-1726.3	010718	Ø 25,4
		S 16206234→; Nutzlast ab [kg] 1.000 Nutzlast bis [kg] 1.400; + ABS	24.2125-1726.3	010718	Ø 25,4		
2.0 HDI	62	11/01→04/02		→ 03/02; Nutzlast ab [kg] 1.000 Nutzlast bis [kg] 1.800; - ABS	24.2125-1725.3	010717	Ø 25,4
				→ 03/02; Nutzlast ab [kg] 1.000 Nutzlast bis [kg] 1.800; + ABS	24.2125-1726.3	010718	Ø 25,4
2.5 D 2.5 D 4x4 2.5 TD	63	03/94→04/02		→ S 15064995; Nutzlast [kg]: 1.400; + ABS	24.2122-1714.3	010480	Ø 22,2
	63	03/00→04/02					
	76	03/94→04/02		→ S 15064995; Nutzlast [kg]: 1.400; für Linkslenker; - ABS	24.2122-1715.3	010481	Ø 22,2
			S 15064996→ S 16206233; Nutzlast [kg]: 1.400; + ABS	24.2125-1702.3	010482	Ø 25,4	
			→ S 16194399; Nutzlast [kg]: 1.800; + ABS	24.2125-1702.3	010482	Ø 25,4	
			→ S 16205754; Nutzlast [kg]: 1.800; für Linkslenker; - ABS	24.2125-1703.3	010483	Ø 25,4	
			S 15064996→ S 16205754; Nutzlast [kg]: 1.400; für Linkslenker; - ABS	24.2125-1703.3	010483	Ø 25,4	
			S 16205353→; → 03/02; Nutzlast [kg]: 1.800; - ABS	24.2125-1725.3	010717	Ø 25,4	
			S 16205755→; → 03/02; Nutzlast [kg]: 1.400; - ABS	24.2125-1725.3	010717	Ø 25,4	
		S 16194400→; → 03/02; Nutzlast [kg]: 1.800; + ABS	24.2125-1726.3	010718	Ø 25,4		
		S 16206234→; → 03/02; Nutzlast [kg]: 1.400; + ABS	24.2125-1726.3	010718	Ø 25,4		
2.5 DT 4x4	76	10/96→08/97		→ S 15064995; Nutzlast [kg]: 1.400; + ABS	24.2122-1714.3	010480	Ø 22,2
↓							

	kw			 	! #		
CITROËN - JUMPER Kasten (230L) 02/94→04/02							
 Hauptbremszylinder							
2.5 DT 4x4	76	10/96→08/97	→ S 15064995; Nutzlast [kg]: 1.400; für Linkslenker; - ABS	24.2122-1715.3	010481	Ø 22,2	
			S 15064996→ S 16206233; Nutzlast [kg]: 1.400; + ABS	24.2125-1702.3	010482	Ø 25,4	
			S 15064996→ S 16205754; Nutzlast [kg]: 1.400; für Linkslenker; - ABS	24.2125-1703.3	010483	Ø 25,4	
			S 16205755→; Nutzlast [kg]: 1.400; - ABS	24.2125-1725.3	010717	Ø 25,4	
			S 16206234→; Nutzlast [kg]: 1.400; + ABS	24.2125-1726.3	010718	Ø 25,4	
2.5 TDi 2.5 TDi 4x4	79 79	12/96→11/00 03/00→11/00	→ S 16194399; Nutzlast [kg]: 1.800; + ABS	24.2125-1702.3	010482	Ø 25,4	
			S 15064996→ S 16206233; Nutzlast [kg]: 1.400; + ABS	24.2125-1702.3	010482	Ø 25,4	
			→ S 16205754; Nutzlast ab [kg] 1.400 Nutzlast bis [kg] 1.800; für Linkslenker; - ABS	24.2125-1703.3	010483	Ø 25,4	
			S 16205353→; Nutzlast [kg]: 1.800; - ABS	24.2125-1725.3	010717	Ø 25,4	
			S 16205755→; Nutzlast [kg]: 1.400; - ABS	24.2125-1725.3	010717	Ø 25,4	
			S 16194400→; Nutzlast [kg]: 1.800; + ABS	24.2125-1726.3	010718	Ø 25,4	
			S 16206234→; Nutzlast [kg]: 1.400; + ABS	24.2125-1726.3	010718	Ø 25,4	
2.8 D	64	01/99→02/02	→ S 15064995; Nutzlast [kg]: 1.400; + ABS	24.2122-1714.3	010480	Ø 22,2	
			→ S 15064995; Nutzlast [kg]: 1.400; für Linkslenker; - ABS	24.2122-1715.3	010481	Ø 22,2	
			→ S 16194399; Nutzlast [kg]: 1.800; + ABS	24.2125-1702.3	010482	Ø 25,4	
			S 15064996→ S 16206253; Nutzlast [kg]: 1.400; + ABS	24.2125-1702.3	010482	Ø 25,4	
			→ S 16205352; Nutzlast [kg]: 1.800; für Linkslenker; - ABS	24.2125-1703.3	010483	Ø 25,4	
			S 15064996→ S 16205754; Nutzlast [kg]: 1.400; für Linkslenker; - ABS	24.2125-1703.3	010483	Ø 25,4	
			S 16205755→; Nutzlast [kg]: 1.400; - ABS	24.2125-1725.3	010717	Ø 25,4	
			S 16205353→; Nutzlast [kg]: 1.800; - ABS	24.2125-1725.3	010717	Ø 25,4	
			S 16206254→; Nutzlast [kg]: 1.400; + ABS	24.2125-1726.3	010718	Ø 25,4	
			S 16194400→; Nutzlast [kg]: 1.800; + ABS	24.2125-1726.3	010718	Ø 25,4	
2.8 HDi 2.8 HDi 4x4	94 94	09/00→04/02 09/00→04/02	S 15064996→ S 16206233; Nutzlast [kg]: 1.400; + ABS	24.2125-1702.3	010482	Ø 25,4	
			→ S 16194399; Nutzlast [kg]: 1.800; + ABS	24.2125-1702.3	010482	Ø 25,4	
			→ S 16205754; Nutzlast ab [kg] 1.400 Nutzlast bis [kg] 1.800; für Linkslenker; - ABS	24.2125-1703.3	010483	Ø 25,4	
			S 16205755→; → 03/02; Nutzlast [kg]: 1.400; - ABS	24.2125-1725.3	010717	Ø 25,4	
			S 16205353→; → 03/02; Nutzlast [kg]: 1.800; - ABS	24.2125-1725.3	010717	Ø 25,4	
			S 16194400→; → 03/02; Nutzlast [kg]: 1.800; + ABS	24.2125-1726.3	010718	Ø 25,4	
			S 16206234→; → 03/02; Nutzlast [kg]: 1.400; + ABS	24.2125-1726.3	010718	Ø 25,4	
 Bremskraftregler							
1.9 D	50	07/99→04/02	→ S 16206244; Nutzlast [kg]: 1.000; - ABS	24.6512-1701.3	320153	lastabhängig 2x	
1.9 D	51	02/94→04/02					
1.9 TD	66	03/94→04/02	→ S 16206244; Nutzlast ab [kg] 1.000 Nutzlast bis [kg] 1.400; - ABS	24.6512-1701.3	320153	lastabhängig 2x	
1.9 TD	68	03/94→04/02					
2.0	80	03/94→04/02	→ S 16206244; Nutzlast ab [kg] 1.000 Nutzlast bis [kg] 1.800; - ABS	24.6512-1701.3	320153	lastabhängig 2x	
2.0 4x4	80	10/96→01/02					
2.5 D	63	03/94→04/02	→ S 16206244; Nutzlast ab [kg] 1.400 Nutzlast bis [kg] 1.800; - ABS	24.6512-1701.3	320153	lastabhängig 2x	
2.5 D 4x4	63	03/00→04/02					
2.5 TD	76	03/94→04/02					
2.5 TDi	79	12/96→11/00					
2.5 TDi 4x4	79	03/00→11/00					
2.8 D	64	01/99→02/02					
↓							

	kw					! #		
CITROËN - JUMPER Kasten (230L) 02/94→04/02								
 Bremskraftregler								
2.8 HDi 2.8 HDi 4x4	94 94	09/00→04/02 09/00→04/02		→ S 16206244; Nutzlast ab [kg] 1.400 Nutzlast bis [kg] 1.800; - ABS		24.6512-1701.3	320153	lastabhängig 2x
CITROËN - JUMPER Kasten (244) 04/02→								
 Hauptbremszylinder								
2.0 2.0 bivalent 2.0 HDi 2.2 HDi 2.8 HDi 2.8 HDi	81 81 62 74 94 107	04/02→ 02/03→ 04/02→ 04/02→ 04/02→ 05/04→		→ 03/06; Nutzlast ab [kg] 1.000 Nutzlast bis [kg] 1.800; - ABS → 03/06; Nutzlast ab [kg] 1.000 Nutzlast bis [kg] 1.800; + ABS		24.2125-1725.3 24.2125-1726.3	010717 010718	Ø 25,4 Ø 25,4
2.8 HDi 4x4	94	04/02→		→ 03/06; - ABS → 03/06; + ABS		24.2125-1725.3 24.2125-1726.3	010717 010718	Ø 25,4 Ø 25,4
 Bremskraftregler								
2.8 HDi 4x4	94	04/02→		→ 03/06; Nutzlast ab [kg] 1.000 Nutzlast bis [kg] 1.800; - ABS		24.6512-1701.3	320153	lastabhängig 2x
CITROËN - JUMPER Pritsche/Fahrgestell 04/06→								
 Hauptbremszylinder								
2.2 HDi 100 2.2 HDi 110 2.2 HDi 120 2.2 HDi 130 2.2 HDi 150 3.0 HDi 145 3.0 HDi 160 3.0 HDi 180	74 81 88 96 110 107 116 130	04/06→ 07/11→ 04/06→ 07/11→ 07/11→ 07/10→ 09/06→ 07/11→		Nutzlast ab [kg] 1.600 Nutzlast bis [kg] 2.000; Nutzlast 16Q/20Q; + ESP Nutzlast ab [kg] 1.200 Nutzlast bis [kg] 1.400; Nutzlast 12Q/14Q; - ESP Nutzlast ab [kg] 1.200 Nutzlast bis [kg] 1.400; Nutzlast 12Q/14Q; + ESP		24.4125-1701.3 24.4125-1702.3 24.4126-1701.3	010867 010872 010868	BOS Ø 25,4 ohne Bremsflüssigkeitsbehälter BOS Ø 25,4 ohne Bremsflüssigkeitsbehälter BOS Ø 26,99 ohne Bremsflüssigkeitsbehälter
CITROËN - JUMPER Pritsche/Fahrgestell (230) 03/94→04/02								
 Hauptbremszylinder								
1.9 TD 1.9 TD	66 68	03/94→04/02 03/94→04/02		→ S 15064995; Nutzlast ab [kg] 1.000 Nutzlast bis [kg] 1.400; + ABS → S 15064995; Nutzlast ab [kg] 1.000 Nutzlast bis [kg] 1.400; - ABS; für Linkslenker S 15064996→ S 16206233; Nutzlast ab [kg] 1.000 Nutzlast bis [kg] 1.400; + ABS S 15064996→ S 16205754; Nutzlast ab [kg] 1.000 Nutzlast bis [kg] 1.400; - ABS; für Linkslenker S 16205755→; → 03/02; Nutzlast ab [kg] 1.000 Nutzlast bis [kg] 1.400; - ABS S 16206234→; → 03/02; Nutzlast ab [kg] 1.000 Nutzlast bis [kg] 1.400; + ABS		24.2122-1714.3 24.2122-1715.3 24.2125-1702.3 24.2125-1703.3 24.2125-1725.3 24.2125-1726.3	010480 010481 010482 010483 010717 010718	Ø 22,2 Ø 22,2 Ø 25,4 Ø 25,4 Ø 25,4 Ø 25,4
2.0	80	03/94→04/02		→ S 15064995; Nutzlast ab [kg] 1.000 Nutzlast bis [kg] 1.400; + ABS → S 15064995; Nutzlast ab [kg] 1.000 Nutzlast bis [kg] 1.400; - ABS; für Linkslenker S 15064996→ S 16206233; Nutzlast ab [kg] 1.000 Nutzlast bis [kg] 1.400; + ABS → S 16194399; Nutzlast [kg]: 1.800; + ABS S 15064996→ S 16205754; Nutzlast ab [kg] 1.000 Nutzlast bis [kg] 1.400; - ABS; für Linkslenker → S 16205754; Nutzlast [kg]: 1.800; - ABS; für Linkslenker S 16205353→; → 03/02; Nutzlast [kg]: 1.800; - ABS S 16205755→; → 03/02; Nutzlast ab [kg] 1.000 Nutzlast bis [kg] 1.400; - ABS S 16194400→; → 03/02; Nutzlast [kg]: 1.800; + ABS S 16206234→; → 03/02; Nutzlast ab [kg] 1.000 Nutzlast bis [kg] 1.400; + ABS		24.2122-1714.3 24.2122-1715.3 24.2125-1702.3 24.2125-1702.3 24.2125-1703.3 24.2125-1703.3 24.2125-1725.3 24.2125-1725.3 24.2125-1726.3 24.2125-1726.3	010480 010481 010482 010482 010483 010483 010717 010717 010718 010718	Ø 22,2 Ø 22,2 Ø 25,4 Ø 25,4 Ø 25,4 Ø 25,4 Ø 25,4 Ø 25,4 Ø 25,4 Ø 25,4
2.5 D 2.5 D 4x4 2.5 TD	63 63 76	03/94→04/02 03/00→04/02 03/94→04/02		→ S 15064995; Nutzlast [kg]: 1.400; + ABS → S 15064995; Nutzlast [kg]: 1.400; für Linkslenker; - ABS S 15064996→ S 16206233; Nutzlast [kg]: 1.400; + ABS		24.2122-1714.3 24.2122-1715.3 24.2125-1702.3	010480 010481 010482	Ø 22,2 Ø 22,2 Ø 25,4
↓								

	kw			 	! #		
CITROËN - JUMPER Pritsche/Fahrgestell (230) 03/94 → 04/02							
 Hauptbremszylinder							
2.5 D	63	03/94 → 04/02		→ S 16194399; Nutzlast [kg]: 1.800; + ABS	24.2125-1702.3	010482	Ø 25,4
2.5 D 4x4	63	03/00 → 04/02					
2.5 TD	76	03/94 → 04/02		→ S 16205754; Nutzlast [kg]: 1.800; - ABS; für Linkslenker	24.2125-1703.3	010483	Ø 25,4
				S 15064996 → S 16205754; Nutzlast [kg]: 1.400; für Linkslenker; - ABS	24.2125-1703.3	010483	Ø 25,4
				S 16205353 →; → 03/02; Nutzlast [kg]: 1.800; - ABS	24.2125-1725.3	010717	Ø 25,4
				S 16205755 →; → 03/02; Nutzlast [kg]: 1.400; - ABS	24.2125-1725.3	010717	Ø 25,4
				S 16194400 →; → 03/02; Nutzlast [kg]: 1.800; + ABS	24.2125-1726.3	010718	Ø 25,4
				S 16206234 →; → 03/02; Nutzlast [kg]: 1.400; + ABS	24.2125-1726.3	010718	Ø 25,4
2.5 TDi	79	12/96 → 04/02		→ S 16206233; Nutzlast [kg]: 1.400; + ABS	24.2125-1702.3	010482	Ø 25,4
2.5 TDi 4x4	79	03/00 → 04/02					
2.8 HDi	94	09/00 → 04/02		→ S 16194399; Nutzlast [kg]: 1.800; + ABS	24.2125-1702.3	010482	Ø 25,4
				→ S 16205754; Nutzlast ab [kg] 1.400 Nutzlast bis [kg] 1.800; - ABS; für Linkslenker	24.2125-1703.3	010483	Ø 25,4
				S 16205755 →; → 03/02; Nutzlast [kg]: 1.400; - ABS	24.2125-1725.3	010717	Ø 25,4
				S 16205353 →; → 03/02; Nutzlast [kg]: 1.800; - ABS	24.2125-1725.3	010717	Ø 25,4
				S 16194400 →; → 03/02; Nutzlast [kg]: 1.800; + ABS	24.2125-1726.3	010718	Ø 25,4
				S 16206234 →; → 03/02; Nutzlast [kg]: 1.400; + ABS	24.2125-1726.3	010718	Ø 25,4
2.8 D	64	01/99 → 02/02		→ S 15064995; Nutzlast [kg]: 1.400; + ABS	24.2122-1714.3	010480	Ø 22,2
				→ S 15064995; Nutzlast [kg]: 1.400; für Linkslenker; - ABS	24.2122-1715.3	010481	Ø 22,2
				→ S 16194399; Nutzlast [kg]: 1.800; + ABS	24.2125-1702.3	010482	Ø 25,4
				S 15064996 → S 16206253; Nutzlast [kg]: 1.400; + ABS	24.2125-1702.3	010482	Ø 25,4
				→ S 16205352; Nutzlast [kg]: 1.800; für Linkslenker; - ABS	24.2125-1703.3	010483	Ø 25,4
				S 15064996 → S 16205754; Nutzlast [kg]: 1.400; für Linkslenker; - ABS	24.2125-1703.3	010483	Ø 25,4
				S 16205755 →; Nutzlast [kg]: 1.400; - ABS	24.2125-1725.3	010717	Ø 25,4
				S 16205353 →; Nutzlast [kg]: 1.800; - ABS	24.2125-1725.3	010717	Ø 25,4
				S 16206254 →; Nutzlast [kg]: 1.400; + ABS	24.2125-1726.3	010718	Ø 25,4
				S 16194400 →; Nutzlast [kg]: 1.800; + ABS	24.2125-1726.3	010718	Ø 25,4
 Bremskraftregler							
1.9 TD	66	03/94 → 04/02		→ S 16206244; Nutzlast ab [kg] 1.000 Nutzlast bis [kg] 1.400; - ABS	24.6512-1701.3	320153	lastabhängig 2x
1.9 TD	68	03/94 → 04/02					
2.0	80	03/94 → 04/02		→ S 16206244; Nutzlast ab [kg] 1.000 Nutzlast bis [kg] 1.800; - ABS	24.6512-1701.3	320153	lastabhängig 2x
2.5 D	63	03/94 → 04/02		→ S 16206244; Nutzlast ab [kg] 1.400 Nutzlast bis [kg] 1.800; - ABS	24.6512-1701.3	320153	lastabhängig 2x
2.5 D 4x4	63	03/00 → 04/02					
2.5 TD	76	03/94 → 04/02					
2.5 TDi	79	12/96 → 04/02					
2.5 TDi 4x4	79	03/00 → 04/02					
2.8 D	64	01/99 → 02/02					
2.8 HDi	94	09/00 → 04/02					
CITROËN - JUMPER Pritsche/Fahrgestell (244) 02/02 →							
 Hauptbremszylinder							
2.0 HDi	62	04/02 →		→ 03/06; Nutzlast ab [kg] 1.000 Nutzlast bis [kg] 1.800; - ABS	24.2125-1725.3	010717	Ø 25,4
2.2 HDi	74	04/02 →					
2.8 HDi	94	04/02 →		→ 03/06; Nutzlast ab [kg] 1.000 Nutzlast bis [kg] 1.800; + ABS	24.2125-1726.3	010718	Ø 25,4
2.8 HDi	107	05/04 →					
2.2 HDi	74	02/02 → 06/06		04/02 → 03/06; Nutzlast ab [kg] 1.000 Nutzlast bis [kg] 1.800; - ABS	24.2125-1725.3	010717	Ø 25,4
				04/02 → 03/06; Nutzlast ab [kg] 1.000 Nutzlast bis [kg] 1.800; + ABS	24.2125-1726.3	010718	Ø 25,4
↓							

	kw				! #		
CITROËN - JUMPER Pritsche/Fahrgestell (244) 02/02→							
 Hauptbremszylinder							
2.8 HDi 4x4	94	02/02→06/06		04/02→ 03/06; - ABS		24.2125-1725.3 010717	Ø 25,4
				04/02→ 03/06; + ABS		24.2125-1726.3 010718	Ø 25,4
 Bremskraftregler							
2.8 HDi 4x4	94	02/02→06/06		04/02→ 03/06; Nutzlast ab [kg] 1.000 Nutzlast bis [kg] 1.800; - ABS		24.6512-1701.3 320153	lastabhängig 2x
CITROËN - JUMPY 01/07→							
 Hauptbremszylinder							
1.6 HDi 90 16V	66	01/07→		für Linkslenker; - ESP		03.2125-0298.3 010818	ATE Ø 25,4
1.6 HDi 90 8V	66	01/07→		für Linkslenker; + ESP		03.2125-0671.3 010965	ATE Ø 25,4
2.0 HDi 120	88	01/07→					
2.0 HDi 125	94	07/11→					
2.0 HDi 140	100	01/07→					
2.0 HDi 165	120	07/10→					
2.0 HDi 95	72	07/11→					
2.0 i	103	01/07→					
CITROËN - JUMPY (U6U) 06/94→12/06							
 Hauptbremszylinder							
1.6	58	10/95→08/00		→Orga 08206; - ABS; Nutzlast [kg]: 800		24.2122-1703.3 010422	Ø 22,2
1.6	59	10/95→08/00		→Orga 08206; + ABS; Nutzlast [kg]: 800		24.2122-1708.3 010437	Ø 22,2
1.9 D	51	10/95→08/98		Orga 08207→; - ABS; Nutzlast [kg]: 800		24.2122-1741.3 010695	Ø 22,2
1.9 D 70	51	04/98→11/03		Orga 08207→; + ABS; Nutzlast [kg]: 800		24.2122-1742.3 010696	Ø 22,2
1.9 TD	66	10/95→08/00		→Orga 08206; - ABS; Nutzlast [kg]: 900		24.2123-1707.3 010492	Ø 23,81
1.9 TD	68	04/96→11/03		Orga 08207→; + ABS; Nutzlast [kg]: 900		24.2123-1733.3 010657	BOS Ø 23,81
				Orga 08207→; - ABS; Nutzlast [kg]: 900		24.2123-1738.3 010658	Ø 23,81
2.0	100	04/00→12/06		+ ABS		24.2123-1733.3 010657	BOS Ø 23,81
2.0 HDi 110	80	03/00→10/06		- ABS		24.2123-1738.3 010658	Ø 23,81
2.0 HDi 95	69	10/99→10/06					
2.0 i 16V	102	03/00→10/06					
CITROËN - JUMPY Kasten 01/07→							
 Hauptbremszylinder							
1.6 HDi 90 16V	66	01/07→		für Linkslenker; - ESP		03.2125-0298.3 010818	ATE Ø 25,4
1.6 HDi 90 8V	66	01/07→		für Linkslenker; + ESP		03.2125-0671.3 010965	ATE Ø 25,4
2.0 HDi 120	88	01/07→					
2.0 HDi 120 4x4	88	01/10→					
2.0 HDi 125	94	07/11→					
2.0 HDi 125 4x4	94	07/11→					
2.0 HDi 140	100	01/07→					
2.0 HDi 165	120	07/10→					
2.0 HDi 95	72	07/11→					
2.0 i	103	01/07→					
CITROËN - JUMPY Kasten (BS_, BT_, BY_, BZ_) 06/94→10/06							
 Hauptbremszylinder							
1.6 i	58	10/95→08/00		→Orga 08206; - ABS; Nutzlast [kg]: 800		24.2122-1703.3 010422	Ø 22,2
1.9 D 70	51	04/98→10/06		→Orga 08206; + ABS; Nutzlast [kg]: 800		24.2122-1708.3 010437	Ø 22,2
1.9 DT	65	10/95→08/00		Orga 08207→; - ABS; Nutzlast [kg]: 800		24.2122-1741.3 010695	Ø 22,2
1.9 TD	66	10/95→08/00		Orga 08207→; + ABS; Nutzlast [kg]: 800		24.2122-1742.3 010696	Ø 22,2
				→Orga 08206; - ABS; Nutzlast [kg]: 900		24.2123-1707.3 010492	Ø 23,81
				Orga 08207→; + ABS; Nutzlast [kg]: 900		24.2123-1733.3 010657	BOS Ø 23,81
				Orga 08207→; - ABS; Nutzlast [kg]: 900		24.2123-1738.3 010658	Ø 23,81
2.0	100	04/00→10/06		+ ABS		24.2123-1733.3 010657	BOS Ø 23,81
2.0 HDi 110	80	01/02→10/06		- ABS		24.2123-1738.3 010658	Ø 23,81
2.0 HDi 95	69	10/99→10/06					
2.0 i 16V	102	03/00→10/06					
CITROËN - JUMPY Pritsche/Fahrgestell 07/11→							
 Hauptbremszylinder							
2.0 HDi 125	94	07/11→		für Linkslenker; - ESP		03.2125-0298.3 010818	ATE Ø 25,4
				für Linkslenker; + ESP		03.2125-0671.3 010965	ATE Ø 25,4
CITROËN - JUMPY Pritsche/Fahrgestell (BU_, BV_, BW_, BX_) 10/99→10/06							
 Hauptbremszylinder							
1.9 TD	68	10/99→10/06		- ABS; Nutzlast [kg]: 800		24.2122-1741.3 010695	Ø 22,2
				+ ABS; Nutzlast [kg]: 800		24.2122-1742.3 010696	Ø 22,2
↓							

	kW					! #		
CITROËN - JUMPY Pritsche/Fahrgestell (BU_, BV_, BW_, BX_) 10/99→10/06								
 Hauptbremszylinder								
1.9 TD	68	10/99→10/06		+ ABS; Nutzlast [kg]: 900		24.2123-1733.3	010657	BOS Ø 23,81
				- ABS; Nutzlast [kg]: 900		24.2123-1738.3	010658	Ø 23,81
2.0	100	12/03→10/06		+ ABS		24.2123-1733.3	010657	BOS Ø 23,81
2.0 HDi 110	80	12/03→10/06		- ABS		24.2123-1738.3	010658	Ø 23,81
2.0 HDi 110 16V	80	12/03→10/06						
2.0 HDi 95	69	10/99→10/06						
CITROËN - SAXO (S0, S1) 02/96→04/04								
 Bremskraftverstärker								
1.0 X	33	05/96→11/98		für Linkslenker; - ABS		03.7740-3302.4	300107	ATE Ø 8" pneumatisch
1.0 X	37	05/98→06/03						
1.1 BiFuel	44	07/00→06/03						
1.1 X,SX	40	05/96→09/03						
1.1 X,SX	44	05/96→09/03						
1.5 D	43	07/01→04/04						
1.6	66	02/96→06/03						
1.6	74	02/01→04/04						
1.6	88	02/96→04/04						
1.6 VTL,VTR	65	05/96→06/03						
1.6 VTS	72	09/00→09/03						
Electric	20	11/96→06/03						
1.6 VTS	87	06/96→09/03		07/96→; für Linkslenker; - ABS		03.7740-3302.4	300107	ATE Ø 8" pneumatisch
 Hauptbremszylinder								
1.0 X	33	05/96→11/98		- ABS; Felge Lochzahl: 3		03.2120-4166.3	010452	ATE Ø 20,64
1.0 X	37	05/98→06/03				24.2120-1722.3	010544	Ø 20,64
1.1 BiFuel	44	07/00→06/03						
1.1 X,SX	40	05/96→09/03		- ABS; Felge Lochzahl: 4		24.2119-1708.3	010543	BDX Ø 19,05
1.1 X,SX	44	05/96→09/03		+ ABS		24.2120-1728.3	010626	Ø 20,64
1.4 VTS	55	05/96→06/03		- ABS		03.2120-4166.3	010452	ATE Ø 20,64
1.5 D	40	09/96→09/03				24.2120-1722.3	010544	Ø 20,64
1.5 D	42	09/96→06/01						
1.5 D	43	07/01→04/04				24.2119-1708.3	010543	BDX Ø 19,05
1.6	66	02/96→06/03		+ ABS		24.2120-1728.3	010626	Ø 20,64
1.6 VTL,VTR	65	05/96→06/03						
1.6	74	02/01→04/04		- ABS		03.2120-4166.3	010452	ATE Ø 20,64
1.6	88	02/96→04/04				24.2120-1722.3	010544	Ø 20,64
1.6 VTS	72	09/00→09/03						
Electric	20	11/96→06/03				24.2119-1708.3	010543	BDX Ø 19,05
1.6 VTS	87	06/96→09/03		07/96→; - ABS		03.2120-4166.3	010452	ATE Ø 20,64
						24.2120-1722.3	010544	Ø 20,64
				07/96→		24.2119-1708.3	010543	BDX Ø 19,05
CITROËN - XSARA (N1) 04/97→04/05								
 Bremskraftverstärker								
1.4 HDi	50	01/03→03/05		für Linkslenker; + ABS		03.7853-0902.4	300150	ATE Ø 9" pneumatisch
1.4 i	55	04/97→03/05		→ 08/00		03.7750-9302.4	300116	ATE Ø 9" pneumatisch
1.9 D	51	07/98→03/05						
2.0 HDi 90	66	02/99→03/05		Orga 09002→; für Linkslenker; + ABS		03.7853-0902.4	300150	ATE Ø 9" pneumatisch
1.4 LPG	55	05/98→08/00						
				Orga 09002→; für Linkslenker; + ABS		03.7750-9302.4	300116	ATE Ø 9" pneumatisch
						03.7853-0902.4	300150	ATE Ø 9" pneumatisch
1.5 D	42	04/97→09/00		→ 08/00		03.7750-9302.4	300116	ATE Ø 9" pneumatisch
1.6 i	65	04/97→09/00						
1.8 D	43	04/97→09/00						
1.8 i	66	04/97→09/00						
1.8 i Aut.	74	04/97→09/00						
1.9 D	50	04/97→09/00						
1.9 SD	55	01/98→09/00						
1.9 TD	66	04/97→09/00						
1.6 16V	80	09/00→03/05		Orga 09002→; für Linkslenker; + ABS		03.7853-0902.4	300150	ATE Ø 9" pneumatisch
2.0 16V	100	09/00→03/05						
2.0 HDi 109	80	05/01→03/05						
1.9 D	52	04/00→04/05		→ 08/00		03.7750-9302.4	300116	ATE Ø 9" pneumatisch
				Orga 09002→; → 03/05; für Linkslenker; + ABS		03.7853-0902.4	300150	ATE Ø 9" pneumatisch
 Hauptbremszylinder								
1.4 HDi	50	01/03→03/05		- ESP		03.2123-2721.3	010632	ATE Ø 23,81
				+ ESP		03.2123-2761.3	010886	ATE Ø 23,81
				- ABS		03.2123-2781.3	010631	ATE Ø 23,81
1.4 i	55	04/97→03/05		→ 08/00; + ABS		03.2122-1351.3	010528	Ø 22,2
1.9 D	51	07/98→03/05				24.2122-1733.3	010668	Ø 22,2
2.0 HDi 90	66	02/99→03/05						
				→ 08/00; - ABS		03.2122-1356.3	010529	Ø 22,2

CITROËN - XSARA (N1) 04/97→04/05

Hauptbremszylinder

1.4 i	55	04/97→03/05	→ 08/00; - ABS	24.2122-1743.3	010712	Ø 22,2
1.9 D	51	07/98→03/05	Orga 09002→; - ESP	03.2123-2721.3	010632	ATE Ø 23,81
2.0 HDi 90	66	02/99→03/05	Orga 09065→; + ESP	03.2123-2761.3	010886	ATE Ø 23,81
			Orga 09002→; - ABS	03.2123-2781.3	010631	ATE Ø 23,81
			09/00→; →Orga 09001; - ABS	24.2123-1714.3	010587	BDX Ø 23,81
			09/00→; →Orga 09001; + ABS	24.2123-1715.3	010520	BDX Ø 23,81
1.4 LPG	55	05/98→08/00	+ ABS	03.2122-1351.3	010528	Ø 22,2
			- ABS	24.2122-1733.3	010668	Ø 22,2
			Orga 09002→; - ESP	03.2123-2721.3	010632	ATE Ø 23,81
			Orga 09065→; + ESP	03.2123-2761.3	010886	ATE Ø 23,81
			Orga 09002→; - ABS	03.2123-2781.3	010631	ATE Ø 23,81
1.5 D	42	04/97→09/00	→ 08/00; + ABS	03.2122-1351.3	010528	Ø 22,2
1.6 i	65	04/97→09/00		24.2122-1733.3	010668	Ø 22,2
1.8 D	43	04/97→09/00				
1.8 i	66	04/97→09/00	→ 08/00; - ABS	03.2122-1356.3	010529	Ø 22,2
1.8 i Aut.	74	04/97→09/00		24.2122-1743.3	010712	Ø 22,2
1.9 D	50	04/97→09/00				
1.9 SD	55	01/98→09/00				
1.9 TD	66	04/97→09/00				
1.6 16V	80	09/00→03/05	Orga 09002→; - ESP	03.2123-2721.3	010632	ATE Ø 23,81
2.0 HDi 109	80	05/01→03/05	Orga 09065→; + ESP	03.2123-2761.3	010886	ATE Ø 23,81
			Orga 09002→; - ABS	03.2123-2781.3	010631	ATE Ø 23,81
			→Orga 09001; - ABS	24.2123-1714.3	010587	BDX Ø 23,81
			→Orga 09001; + ABS	24.2123-1715.3	010520	BDX Ø 23,81
1.8 BiFuel	82	07/97→08/00	- ABS	24.2123-1714.3	010587	BDX Ø 23,81
			+ ABS	24.2123-1715.3	010520	BDX Ø 23,81
1.8 i 16V	81	04/97→09/00	→ 08/00; - ABS	24.2123-1714.3	010587	BDX Ø 23,81
2.0 16V	97	07/98→09/00	→ 08/00; + ABS	24.2123-1715.3	010520	BDX Ø 23,81
2.0 16V	120	04/97→09/00				
1.9 D	52	04/00→04/05	→ 08/00; + ABS	03.2122-1351.3	010528	Ø 22,2
			→ 08/00; - ABS	24.2122-1733.3	010668	Ø 22,2
			→ 08/00; - ABS	03.2122-1356.3	010529	Ø 22,2
			→ 08/00; - ABS	24.2122-1743.3	010712	Ø 22,2
			Orga 09002→; → 03/05; - ESP	03.2123-2721.3	010632	ATE Ø 23,81
			Orga 09065→; → 03/05; + ESP	03.2123-2761.3	010886	ATE Ø 23,81
			Orga 09002→; → 03/05; - ABS	03.2123-2781.3	010631	ATE Ø 23,81
			09/00→; →Orga 09001; - ABS	24.2123-1714.3	010587	BDX Ø 23,81
			09/00→; →Orga 09001; + ABS	24.2123-1715.3	010520	BDX Ø 23,81
2.0 16V	100	09/00→03/05	Orga 09002→; - ESP	03.2123-2721.3	010632	ATE Ø 23,81
			Orga 09065→; + ESP	03.2123-2761.3	010886	ATE Ø 23,81
			Orga 09002→; - ABS	03.2123-2781.3	010631	ATE Ø 23,81











CITROËN - XSARA Break (N2) 10/97→03/10

Bremskraftverstärker













1.4 HDi	50	01/03→08/05	für Linkslenker; + ABS	03.7853-0902.4	300150	ATE Ø 9" pneumatisch
1.4 i	55	10/97→08/05	→ 08/00; - ABS	03.7750-9302.4	300116	ATE Ø 9" pneumatisch
1.9 D	51	07/98→08/05				
2.0 HDi 90	66	02/99→08/05	Orga 09002→; für Linkslenker; + ABS	03.7853-0902.4	300150	ATE Ø 9" pneumatisch
1.5 D	42	10/97→09/00	→ 08/00; - ABS	03.7750-9302.4	300116	ATE Ø 9" pneumatisch
1.6 i	65	10/97→09/00				
1.8 D	43	10/97→09/00				
1.9 D	50	10/97→09/00				
1.9 D	55	01/98→09/00				
1.9 TD	66	10/97→09/00				
1.6 16V	80	09/00→08/05	Orga 09002→; für Linkslenker; + ABS	03.7853-0902.4	300150	ATE Ø 9" pneumatisch
2.0 16V	100	09/00→08/05				
2.0 HDi 109	80	05/01→08/05				













Hauptbremszylinder











1.4 HDi	50	01/03→08/05	- ESP	03.2123-2721.3	010632	ATE Ø 23,81
			+ ESP	03.2123-2761.3	010886	ATE Ø 23,81
			- ABS	03.2123-2781.3	010631	ATE Ø 23,81
1.4 i	55	10/97→08/05	→ 08/00; - ABS	03.2122-1356.3	010529	Ø 22,2
↓			Orga 09002→; - ESP	03.2123-2721.3	010632	ATE Ø 23,81













	kw			 	! #		
CITROËN - XSARA Break (N2) 10/97→03/10							
 Hauptbremszylinder							
1.4 i	55	10/97→08/05		Orga 09065→; + ESP	03.2123-2761.3	010886	ATE Ø 23,81
				Orga 09002→; - ABS	03.2123-2781.3	010631	ATE Ø 23,81
				→Orga 09001; - ABS	24.2123-1714.3	010587	BDX Ø 23,81
				→Orga 09001; + ABS	24.2123-1715.3	010520	BDX Ø 23,81
1.5 D	42	10/97→09/00		→ 08/00; - ABS	03.2122-1356.3	010529	Ø 22,2
1.6 i	65	10/97→09/00			24.2123-1714.3	010587	BDX Ø 23,81
1.8 D	43	10/97→09/00					
1.9 D	50	10/97→09/00		→ 08/00; + ABS	24.2123-1715.3	010520	BDX Ø 23,81
1.6 16V	80	09/00→08/05		Orga 09002→; - ESP	03.2123-2721.3	010632	ATE Ø 23,81
2.0 16V	100	09/00→08/05		Orga 09065→; + ESP	03.2123-2761.3	010886	ATE Ø 23,81
2.0 HDi 109	80	05/01→08/05					
2.0 HDi 90	66	02/99→08/05		Orga 09002→; - ABS	03.2123-2781.3	010631	ATE Ø 23,81
				→Orga 09001; - ABS	24.2123-1714.3	010587	BDX Ø 23,81
				→Orga 09001; + ABS	24.2123-1715.3	010520	BDX Ø 23,81
1.8 i	66	10/97→09/00		→ 08/00; - ABS	24.2123-1714.3	010587	BDX Ø 23,81
1.8 i 16V	81	10/97→09/00					
1.8 i Aut.	74	10/97→09/00		→ 08/00; + ABS	24.2123-1715.3	010520	BDX Ø 23,81
1.9 D	55	01/98→09/00					
1.9 TD	66	10/97→09/00					
2.0 16V	97	07/98→09/00					
1.8 LPG	81	05/98→08/00		- ABS	24.2123-1714.3	010587	BDX Ø 23,81
				+ ABS	24.2123-1715.3	010520	BDX Ø 23,81
1.9 D	51	07/98→08/05		Orga 09002→; - ESP	03.2123-2721.3	010632	ATE Ø 23,81
				Orga 09065→; + ESP	03.2123-2761.3	010886	ATE Ø 23,81
				Orga 09002→; - ABS	03.2123-2781.3	010631	ATE Ø 23,81
CITROËN - XSARA Coupe (N0) 01/98→04/05							
 Bremskraftverstärker							
1.4 HDi	50	01/03→03/05		für Linkslenker; + ABS	03.7853-0902.4	300150	ATE Ø 9" pneumatisch
1.4 i	55	03/98→03/05		→ 08/00	03.7750-9302.4	300116	ATE Ø 9" pneumatisch
1.9 D	51	02/99→03/05					
2.0 HDi 90	66	02/99→03/05		Orga 09002→; für Linkslenker; + ABS	03.7853-0902.4	300150	ATE Ø 9" pneumatisch
1.6 16V	80	09/00→03/05		Orga 09002→; für Linkslenker; + ABS	03.7853-0902.4	300150	ATE Ø 9" pneumatisch
2.0	97	08/98→08/00					
2.0 16V	100	09/00→03/05					
2.0 HDi 109	80	05/01→03/05					
2.0 i 16V	120	02/98→03/05					
1.6 i	65	02/98→09/00		→ 08/00	03.7750-9302.4	300116	ATE Ø 9" pneumatisch
1.8 i	66	02/98→09/00					
1.8 i	74	02/98→09/00					
1.8 i 16V	81	02/98→09/00					
1.9 D	50	02/98→09/00					
1.9 TD	66	02/98→09/00					
1.8 LPG	82	01/98→08/00		02/98→	03.7750-9302.4	300116	ATE Ø 9" pneumatisch
1.9 D	55	02/98→05/99			03.7750-9302.4	300116	ATE Ø 9" pneumatisch
 Hauptbremszylinder							
1.4 HDi	50	01/03→03/05		+ ABS	03.2123-2721.3	010632	ATE Ø 23,81
				+ ESP	03.2123-2761.3	010886	ATE Ø 23,81
				- ABS	03.2123-2781.3	010631	ATE Ø 23,81
1.4 i	55	03/98→03/05		→ 08/00; + ABS	03.2122-1351.3	010528	Ø 22,2
1.9 D	51	02/99→03/05			24.2122-1733.3	010668	Ø 22,2
2.0 HDi 90	66	02/99→03/05					
				→ 08/00; - ABS	03.2122-1356.3	010529	Ø 22,2
					24.2122-1743.3	010712	Ø 22,2
				Orga 09002→; + ABS	03.2123-2721.3	010632	ATE Ø 23,81
				Orga 09065→; + ESP	03.2123-2761.3	010886	ATE Ø 23,81
				Orga 09002→; - ABS	03.2123-2781.3	010631	ATE Ø 23,81
				09/00→; →Orga 09001; - ABS	24.2123-1714.3	010587	BDX Ø 23,81
				09/00→; →Orga 09001; + ABS	24.2123-1715.3	010520	BDX Ø 23,81
1.6 16V	80	09/00→03/05		Orga 09002→; + ABS	03.2123-2721.3	010632	ATE Ø 23,81
2.0	97	08/98→08/00					
2.0 16V	100	09/00→03/05		Orga 09065→; + ESP	03.2123-2761.3	010886	ATE Ø 23,81
2.0 HDi 109	80	05/01→03/05		Orga 09002→; - ABS	03.2123-2781.3	010631	ATE Ø 23,81
2.0 i 16V	120	02/98→03/05		→Orga 09001; - ABS	24.2123-1714.3	010587	BDX Ø 23,81
				→Orga 09001; + ABS	24.2123-1715.3	010520	BDX Ø 23,81
1.6 i	65	02/98→09/00		→ 08/00; + ABS	03.2122-1351.3	010528	Ø 22,2
1.8 i	66	02/98→09/00			24.2122-1733.3	010668	Ø 22,2
1.8 i	74	02/98→09/00					
1.9 D	50	02/98→09/00		→ 08/00; - ABS	03.2122-1356.3	010529	Ø 22,2
1.9 TD	66	02/98→09/00			24.2122-1743.3	010712	Ø 22,2
↓							































	kw			 	! #		
CITROËN - XSARA Coupe (N0) 01/98→04/05							
 Hauptbremszylinder							
1.8 i 16V	81	02/98→09/00		→ 08/00; - ABS		24.2123-1714.3 010587	BDX Ø 23,81
				→ 08/00; + ABS		24.2123-1715.3 010520	BDX Ø 23,81
1.8 LPG	82	01/98→08/00		02/98→; - ABS		24.2123-1714.3 010587	BDX Ø 23,81
				02/98→; + ABS		24.2123-1715.3 010520	BDX Ø 23,81
1.9 D	55	02/98→05/99		+ ABS		03.2122-1351.3 010528	Ø 22,2
				- ABS		24.2122-1733.3 010668	Ø 22,2
						03.2122-1356.3 010529	Ø 22,2
						24.2122-1743.3 010712	Ø 22,2
CITROËN - XSARA Kasten/Kombi 05/98→08/05							
 Bremskraftverstärker							
1.4	55	09/00→03/05		Orga 09002→; für Linkslenker; + ABS		03.7853-0902.4 300150	ATE Ø 9" pneumatisch
2.0 HDi	66	09/00→03/05					
1.8 D	43	05/98→05/99		- ABS		03.7750-9302.4 300116	ATE Ø 9" pneumatisch
1.9 D	51	06/99→08/05		→ 08/00; - ABS		03.7750-9302.4 300116	ATE Ø 9" pneumatisch
				Orga 09002→; für Linkslenker; + ABS		03.7853-0902.4 300150	ATE Ø 9" pneumatisch
 Hauptbremszylinder							
1.4	55	09/00→03/05		Orga 09002→; - ESP		03.2123-2721.3 010632	ATE Ø 23,81
2.0 HDi	66	09/00→03/05		Orga 09065→; + ESP		03.2123-2761.3 010886	ATE Ø 23,81
				Orga 09002→; - ABS		03.2123-2781.3 010631	ATE Ø 23,81
				→Orga 09001; - ABS		24.2123-1714.3 010587	BDX Ø 23,81
				→Orga 09001; + ABS		24.2123-1715.3 010520	BDX Ø 23,81
1.8 D	43	05/98→05/99		- ABS		03.2122-1356.3 010529	Ø 22,2
				+ ABS		24.2123-1715.3 010520	BDX Ø 23,81
1.9 D	51	06/99→08/05		Orga 09002→; - ESP		03.2123-2721.3 010632	ATE Ø 23,81
				Orga 09065→; + ESP		03.2123-2761.3 010886	ATE Ø 23,81
				Orga 09002→; - ABS		03.2123-2781.3 010631	ATE Ø 23,81
CITROËN - XSARA Kasten/Schrägheck 05/98→03/05							
 Bremskraftverstärker							
1.4	55	05/98→10/04		→ 08/00		03.7750-9302.4 300116	ATE Ø 9" pneumatisch
1.9 D	51	06/99→03/05		Orga 09002→; für Linkslenker; + ABS		03.7853-0902.4 300150	ATE Ø 9" pneumatisch
1.4 LPG	55	06/99→08/00				03.7750-9302.4 300116	ATE Ø 9" pneumatisch
				Orga 09002→; für Linkslenker; + ABS		03.7853-0902.4 300150	ATE Ø 9" pneumatisch
1.8 D	43	05/98→05/99				03.7750-9302.4 300116	ATE Ø 9" pneumatisch
1.9 D	65	05/98→08/00					
2.0 HDi	66	09/00→03/05		Orga 09002→; für Linkslenker; + ABS		03.7853-0902.4 300150	ATE Ø 9" pneumatisch
 Hauptbremszylinder							
1.4	55	05/98→10/04		→ 08/00; + ABS		03.2122-1351.3 010528	Ø 22,2
1.9 D	51	06/99→03/05				24.2122-1733.3 010668	Ø 22,2
				→ 08/00; - ABS		03.2122-1356.3 010529	Ø 22,2
						24.2122-1743.3 010712	Ø 22,2
				Orga 09002→; - ESP		03.2123-2721.3 010632	ATE Ø 23,81
				Orga 09065→; + ESP		03.2123-2761.3 010886	ATE Ø 23,81
				Orga 09002→; - ABS		03.2123-2781.3 010631	ATE Ø 23,81
				09/00→; →Orga 09001; - ABS		24.2123-1714.3 010587	BDX Ø 23,81
				09/00→; →Orga 09001; + ABS		24.2123-1715.3 010520	BDX Ø 23,81
1.4 LPG	55	06/99→08/00		+ ABS		03.2122-1351.3 010528	Ø 22,2
				- ABS		24.2122-1733.3 010668	Ø 22,2
						03.2122-1356.3 010529	Ø 22,2
						24.2122-1743.3 010712	Ø 22,2
				Orga 09002→; - ESP		03.2123-2721.3 010632	ATE Ø 23,81
				Orga 09065→; + ESP		03.2123-2761.3 010886	ATE Ø 23,81
				Orga 09002→; - ABS		03.2123-2781.3 010631	ATE Ø 23,81
1.8 D	43	05/98→05/99		+ ABS		03.2122-1351.3 010528	Ø 22,2
1.9 D	65	05/98→08/00				24.2122-1733.3 010668	Ø 22,2
				- ABS		03.2122-1356.3 010529	Ø 22,2
						24.2122-1743.3 010712	Ø 22,2
2.0 HDi	66	09/00→03/05		Orga 09002→; - ESP		03.2123-2721.3 010632	ATE Ø 23,81
↓							















	kw					! #		
CITROËN - XSARA Kasten/Schrägheck 05/98→03/05								
 Hauptbremszylinder								
2.0 HDi	66	09/00→03/05		Orga 09065→; + ESP		03.2123-2761.3	010886	ATE Ø 23,81
				Orga 09002→; - ABS		03.2123-2781.3	010631	ATE Ø 23,81
				→Orga 09001; - ABS		24.2123-1714.3	010587	BDX Ø 23,81
				→Orga 09001; + ABS		24.2123-1715.3	010520	BDX Ø 23,81
CITROËN - XSARA PICASSO (N68) 12/99→								
 Hauptbremszylinder								
1.6	65	12/99→		Orga 0882078→; → 03/10; für Linkslenker; - ABS		03.2123-2781.3	010631	ATE Ø 23,81
2.0 HDi	66	12/99→						
2.0 HDi	80	12/99→		06/00→ 03/10; - ABS		24.2123-1714.3	010587	BDX Ø 23,81
1.6	67	06/02→		Orga 08820→; → 03/10; für Linkslenker; - ABS		03.2123-2781.3	010631	ATE Ø 23,81
				→ 03/10; - ABS		24.2123-1714.3	010587	BDX Ø 23,81
1.6	70	12/99→		Orga 0882078→; → 03/10; für Linkslenker; - ABS		03.2123-2781.3	010631	ATE Ø 23,81
				09/00→ 03/10; - ABS		24.2123-1714.3	010587	BDX Ø 23,81
1.6 16V	80	09/05→		→ 03/10; für Linkslenker; - ABS		03.2123-2781.3	010631	ATE Ø 23,81
1.6 HDi	66	09/05→						
1.6 HDi	80	05/04→		→ 03/10; - ABS		24.2123-1714.3	010587	BDX Ø 23,81
2.0 16V	100	01/03→						
1.6 16V	81	06/05→09/06		09/05→; für Linkslenker; - ABS		03.2123-2781.3	010631	ATE Ø 23,81
				09/05→; - ABS		24.2123-1714.3	010587	BDX Ø 23,81
1.6 Chrono	74	04/01→10/04		Orga 0882078→; für Linkslenker; - ABS		03.2123-2781.3	010631	ATE Ø 23,81
				- ABS		24.2123-1714.3	010587	BDX Ø 23,81
1.8 16V	85	02/00→		Orga 0882078→; → 03/10; für Linkslenker; - ABS		03.2123-2781.3	010631	ATE Ø 23,81
				→ 03/10; - ABS		24.2123-1714.3	010587	BDX Ø 23,81
2.0 16V	101	12/99→11/11		01/03→ 03/10; für Linkslenker; - ABS		03.2123-2781.3	010631	ATE Ø 23,81
				01/03→ 03/10; - ABS		24.2123-1714.3	010587	BDX Ø 23,81
 Bremskraftregler								
1.6	65	12/99→		06/00→ 03/10; - ABS		03.6582-0015.3	320227	ATE lastabhängig 8/1,5 4x
2.0 HDi	66	12/99→						
2.0 HDi	80	12/99→						
1.6	67	06/02→		→ 03/10; - ABS		03.6582-0015.3	320227	ATE lastabhängig 8/1,5 4x
1.6 16V	80	09/05→						
1.6 HDi	66	09/05→						
1.6 HDi	80	05/04→						
1.8 16V	85	02/00→						
2.0 16V	100	01/03→						
1.6	70	12/99→		09/00→ 03/10; - ABS		03.6582-0015.3	320227	ATE lastabhängig 8/1,5 4x
1.6 16V	81	06/05→09/06		09/05→; - ABS		03.6582-0015.3	320227	ATE lastabhängig 8/1,5 4x
1.6 Chrono	74	04/01→10/04		- ABS		03.6582-0015.3	320227	ATE lastabhängig 8/1,5 4x
2.0 16V	101	12/99→11/11		01/03→ 03/10; - ABS		03.6582-0015.3	320227	ATE lastabhängig 8/1,5 4x
CITROËN - ZX (N2) 03/91→07/99								
 Bremskraftverstärker								
1.1	44	03/91→06/97		- ABS		03.7740-4002.4	300108	ATE Ø 8" pneumatisch
1.4	55	03/91→06/97						
1.4 i	55	03/91→06/97						
1.6 i	65	03/91→06/97						
1.8 D	44	06/93→06/97						
1.8 i	74	07/92→06/97						
1.9	93	03/91→06/97						
1.9 D	47	03/91→06/97						
1.9 i	88	03/91→06/97						
1.9 TD	66	07/92→06/97						
2.0 i	89	07/92→06/97						
1.4 D	37	07/94→10/97		→ 06/97; - ABS		03.7740-4002.4	300108	ATE Ø 8" pneumatisch
1.6	66	07/94→10/97						
1.8	76	07/94→10/97						
1.9 DT	65	07/94→10/97						
2.0	90	07/94→10/97						
1.9 D	50	07/93→06/97		06/94→; - ABS		03.7740-4002.4	300108	ATE Ø 8" pneumatisch
 Hauptbremszylinder								
1.1	44	03/91→06/97		→Orga 07125; - ABS		03.2120-2031.3	010106	ATE Ø 20,64
1.4	55	03/91→06/97				24.2120-1722.3	010544	Ø 20,64
1.4 i	55	03/91→06/97						
1.6 i	65	03/91→06/97		Orga 07126→; - ABS		03.2120-4221.3	010605	ATE Ø 20,64
1.8 D	44	06/93→06/97		Orga 07070→; + ABS; für Linkslenker		03.2122-1331.3	010607	ATE Ø 22,2
↓								













	kw			 	! #		
CITROËN - ZX (N2) 03/91→07/99							
 Hauptbremszylinder							
1.8 i	74	07/92→06/97		→Orga 07069; + ABS		24.2122-1704.3 010423	Ø 22,2
1.8 i 16V	81	01/96→06/97					
1.9	93	03/91→06/97					
1.9 D	47	03/91→06/97					
1.9 i	88	03/91→06/97					
1.9 TD	66	07/92→06/97					
2.0 i	89	07/92→06/97					
1.4 D	37	07/94→10/97		→Orga 07125; - ABS		03.2120-2031.3 010106	ATE Ø 20,64
1.6	66	07/94→10/97				24.2120-1722.3 010544	Ø 20,64
1.8	76	07/94→10/97					
1.8	82	04/96→10/97		Orga 07126→; → 06/97; - ABS		03.2120-4221.3 010605	ATE Ø 20,64
1.9 DT	65	07/94→10/97		Orga 07070→; → 06/97; + ABS; für Linkslenker		03.2122-1331.3 010607	ATE Ø 22,2
2.0	90	07/94→10/97					
				→Orga 07069; + ABS		24.2122-1704.3 010423	Ø 22,2
1.9 D	50	07/93→06/97		06/94→; →Orga 07125; - ABS		03.2120-2031.3 010106	ATE Ø 20,64
						24.2120-1722.3 010544	Ø 20,64
				Orga 07126→; - ABS		03.2120-4221.3 010605	ATE Ø 20,64
				Orga 07070→; + ABS; für Linkslenker		03.2122-1331.3 010607	ATE Ø 22,2
				06/94→; →Orga 07069; + ABS		24.2122-1704.3 010423	Ø 22,2
CITROËN - ZX Break (N2) 10/93→07/99							
 Hauptbremszylinder							
1.4 i	55	10/93→10/97		Orga 07070→; + ABS; für Linkslenker		03.2122-1331.3 010607	ATE Ø 22,2
1.6 i	65	10/93→10/97					
1.8 D	44	10/93→10/97		Orga 07070→; - ABS; für Linkslenker		03.2122-1331.3 010607	ATE Ø 22,2
1.8 i	74	10/93→10/97		→Orga 07069; + ABS		24.2122-1704.3 010423	Ø 22,2
1.9 D	47	10/93→10/97					
1.9 D	50	06/94→10/97					
1.9 TD	66	10/93→10/97					
1.5 D	42	06/96→02/98		Orga 07070→; + ABS; für Linkslenker		03.2122-1331.3 010607	ATE Ø 22,2
				→Orga 07069; + ABS		24.2122-1704.3 010423	Ø 22,2
1.8 i 16V	81	01/96→02/98		Orga 07070→; + ABS; für Linkslenker		03.2122-1331.3 010607	ATE Ø 22,2
				- ABS; für Linkslenker		03.2122-1331.3 010607	ATE Ø 22,2
				→Orga 07069; + ABS		24.2122-1704.3 010423	Ø 22,2
DACIA - DUSTER 04/10→							
 Bremskraftverstärker							
1.5 dCi	63	04/10→		→ 10/13; + ABS		03.7853-4602.4 300302	ATE Ø 9" pneumatisch
1.5 dCi	66	10/10→					
1.5 dCi	79	06/10→					
1.5 dCi 4x4	66	10/10→					
1.5 dCi 4x4	79	06/10→					
1.5 dCi 4x4	81	10/10→					
1.6 16V	77	04/10→					
1.6 16V 4x4	77	06/10→					
1.6 16V LPG	77	04/11→					
1.5 dCi 4x4	80	08/13→		+ ABS		03.7853-4602.4 300302	ATE Ø 9" pneumatisch
1.6 16V Hi-Flex	77	08/10→		04/11→ 10/13; + ABS		03.7853-4602.4 300302	ATE Ø 9" pneumatisch
 Hauptbremszylinder							
1.5 dCi	63	04/10→		+ ABS / - ESP; → 10/13		03.2122-2031.3 010938	ATE Ø 22,2
1.5 dCi	66	10/10→					
1.5 dCi	79	06/10→		+ ABS / + ESP; → 10/13		03.2122-2261.3 010964	ATE Ø 22,2
1.5 dCi 4x4	66	10/10→					
1.5 dCi 4x4	79	06/10→					
1.5 dCi 4x4	81	10/10→					
1.6 16V	77	04/10→					
1.6 16V 4x4	77	06/10→					
1.6 16V LPG	77	04/11→					
1.5 dCi 4x4	80	08/13→		+ ABS / - ESP		03.2122-2031.3 010938	ATE Ø 22,2
				+ ABS / + ESP		03.2122-2261.3 010964	ATE Ø 22,2
1.6 16V Hi-Flex	77	08/10→		04/11→; + ABS / - ESP; → 10/13		03.2122-2031.3 010938	ATE Ø 22,2
DACIA - DUSTER Kasten 04/11→							
 Bremskraftverstärker							
1.5 dCi	66	04/11→		→ 10/13; + ABS		03.7853-4602.4 300302	ATE Ø 9" pneumatisch
1.5 dCi 4x4	66	04/11→					
1.6 16V 4x4	77	04/11→					
1.6 16V Hi-Flex	77	04/11→					
1.5 dCi 4x4	80	04/13→		08/13→; + ABS		03.7853-4602.4 300302	ATE Ø 9" pneumatisch
↓							

	kw			 	! #		
DACIA - DUSTER Kasten 04/11→							
 Hauptbremszylinder							
1.5 dCi	66	04/11→		+ ABS / - ESP; → 10/13		03.2122-2031.3 010938	ATE Ø 22,2
1.5 dCi 4x4	66	04/11→		+ ABS / + ESP; → 10/13		03.2122-2261.3 010964	ATE Ø 22,2
1.6 16V 4x4	77	04/11→					
1.5 dCi 4x4	80	04/13→		08/13→; + ABS / - ESP		03.2122-2031.3 010938	ATE Ø 22,2
				08/13→; + ABS / + ESP		03.2122-2261.3 010964	ATE Ø 22,2
1.6 16V Hi-Flex	77	04/11→		+ ABS / - ESP; → 10/13		03.2122-2031.3 010938	ATE Ø 22,2
DACIA - LOGAN (LS_) 09/04→							
 Bremskraftverstärker							
1.2 16V	55	02/06→		→ 04/13; + ABS		03.7853-4102.4 300271	ATE Ø 9" pneumatisch
1.2 16V LPG	55	02/06→		→ 04/13		03.7853-4602.4 300302	ATE Ø 9" pneumatisch
1.5 dCi (LS04)	55	05/10→					
1.5 dCi (LS04)	65	05/10→					
1.6 Bifuel	62	05/10→					
1.6 MPI 85	62	05/10→					
1.5 dCi (LS0W)	63	09/07→		→ 04/13; + ABS		03.7750-8532.4 300264	ATE Ø 9" pneumatisch
1.6 (LSOB, LSOD, LSOF, LSOH)	64	09/04→					
1.6 16V Flexifuel	77	07/10→		01/11→ 04/13; + ABS		03.7853-4102.4 300271	ATE Ø 9" pneumatisch
				01/11→ 04/13		03.7853-4602.4 300302	ATE Ø 9" pneumatisch
 Hauptbremszylinder							
1.2 16V	55	02/06→		+ ABS; → 04/13		03.2120-4611.3 010937	ATE Ø 20,64
1.2 16V LPG	55	02/06→		- ABS; → 04/13		24.2120-1762.3 011002	Ø 20,64 ohne Bremsflüssigkeitsbehälter
1.5 dCi (LS04)	55	05/10→					
1.5 dCi (LS04)	65	05/10→					
1.5 dCi (LS0W)	63	09/07→					
1.6 Bifuel	62	05/10→					
1.6 MPI 85	62	05/10→					
1.4 (LSOA, LSOC, LSOE, LSOG)	55	09/04→		+ ABS; → 04/13		24.2120-1754.3 010949	Ø 20,64
1.4 MPI LPG (LS0C)	55	02/06→		- ABS; → 04/13		24.2120-1762.3 011002	Ø 20,64 ohne Bremsflüssigkeitsbehälter
1.5 dCi (LS0J, LS0Y)	48	09/05→					
1.5 dCi (LS0K)	50	01/06→					
1.6 (LSOB, LSOD, LSOF, LSOH)	64	09/04→					
1.6 16V (LS0M)	77	02/06→					
1.6 16V Flexifuel	77	07/10→		01/11→; + ABS; → 04/13		03.2120-4611.3 010937	ATE Ø 20,64
				01/11→; - ABS; → 04/13		24.2120-1762.3 011002	Ø 20,64 ohne Bremsflüssigkeitsbehälter
DACIA - LOGAN EXPRESS (FS_) 03/09→							
 Bremskraftverstärker							
1.4	55	03/09→		→ 06/13		03.7750-8532.4 300264	ATE Ø 9" pneumatisch
1.5 dCi	55	05/10→		+ ABS; → 06/13		03.7750-8532.4 300264	ATE Ø 9" pneumatisch
1.5 dCi	65	05/10→					
1.5 dCi (FS0K)	50	03/09→					
1.5 dCi (FS0W)	63	03/09→					
1.6 MPI 85	62	05/10→					
 Hauptbremszylinder							
1.4	55	03/09→		+ ABS; → 06/13		03.2122-2031.3 010938	ATE Ø 22,2
				- ABS; → 06/13		24.2120-1762.3 011002	Ø 20,64 ohne Bremsflüssigkeitsbehälter
1.5 dCi	55	05/10→		+ ABS; → 06/13		03.2122-2031.3 010938	ATE Ø 22,2
1.5 dCi	65	05/10→					
1.5 dCi (FS0K)	50	03/09→					
1.5 dCi (FS0W)	63	03/09→					
1.6 MPI 85	62	05/10→					
DACIA - LOGAN MCV (KS_) 02/07→							
 Bremskraftverstärker							
1.4	55	02/07→		→ 04/13; + ABS		03.7750-8532.4 300264	ATE Ø 9" pneumatisch
1.5 dCi (KS04)	55	05/10→					
1.5 dCi (KS04)	65	05/10→					
1.5 dCi (KS0K)	50	02/07→					
1.5 dCi (KS0W)	63	09/07→					
1.6	64	02/07→					
1.6 16V	77	02/07→					
1.6 16V Hi-Flex	77	11/09→					
1.6 Bifuel	62	05/10→					
1.6 Bifuel	64	11/08→					
1.6 MPI 85	62	05/10→					
↓							

	kw			 	! #		
DACIA - LOGAN MCV (KS_) 02/07→							
 Hauptbremszylinder							
1.4 1.5 dCi (KS0K)	55 50	02/07→		- ABS; → 04/13		24.2120-1762.3 011002	Ø 20,64 ohne Bremsflüssigkeitsbehälter
1.6 1.6 16V	64 77	02/07→					
1.5 dCi (KS04)	55	05/10→		+ ABS; → 04/13		03.2122-2031.3 010938	ATE Ø 22,2
1.5 dCi (KS04)	65	05/10→		- ABS; → 04/13		24.2120-1762.3 011002	Ø 20,64 ohne Bremsflüssigkeitsbehälter
1.5 dCi (KS0W)	63	09/07→					
1.6 16V Hi-Flex	77	11/09→					
1.6 Bifuel	62	05/10→		+ ABS; → 04/13		24.2120-1754.3 010949	Ø 20,64
1.6 Bifuel	64	11/08→		- ABS; → 04/13		24.2120-1762.3 011002	Ø 20,64 ohne Bremsflüssigkeitsbehälter
1.6 MPI 85	62	05/10→					
DACIA - LOGAN Pick-up (US_) 03/08→							
 Bremskraftverstärker							
1.4 1.5 dCi	55 55	01/09→		→ 06/13		03.7750-8532.4 300264	ATE Ø 9" pneumatisch
1.5 dCi	65	05/10→					
1.5 dCi (US0W)	63	03/08→					
1.6	64	03/08→					
1.6 Bifuel	62	05/10→					
1.6 MPI 85	62	05/10→					
1.5 dCi (US00, US0J, US0Y)	48	04/08→12/12		+ ABS		03.7750-8532.4 300264	ATE Ø 9" pneumatisch
1.6 16V (US1Y)	77	01/10→08/13					
1.5 dCi (US0K)	50	03/08→		→ 06/13; + ABS		03.7750-8532.4 300264	ATE Ø 9" pneumatisch
 Hauptbremszylinder							
1.4	55	01/09→		+ ABS; → 06/13		03.2122-2031.3 010938	ATE Ø 22,2
				- ABS; → 06/13		24.2120-1762.3 011002	Ø 20,64 ohne Bremsflüssigkeitsbehälter
1.5 dCi	55	05/10→		+ ABS; → 06/13		03.2122-2031.3 010938	ATE Ø 22,2
1.5 dCi	65	05/10→					
1.5 dCi (US0K)	50	03/08→					
1.5 dCi (US0W)	63	03/08→					
1.6	64	03/08→					
1.6 Bifuel	62	05/10→					
1.6 MPI 85	62	05/10→					
1.5 dCi (US00, US0J, US0Y)	48	04/08→12/12		+ ABS		03.2122-2031.3 010938	ATE Ø 22,2
1.6 16V (US1Y)	77	01/10→08/13					
DACIA - SANDERO 06/08→							
 Bremskraftverstärker							
1.2 16V	55	11/08→		→ 02/13; + ABS		03.7853-4102.4 300271	ATE Ø 9" pneumatisch
1.2 16V LPG	55	11/08→				03.7853-4602.4 300302	ATE Ø 9" pneumatisch
1.4	55	06/08→					
1.4 MPI LPG	53	01/09→					
1.5 dCi	48	11/08→					
1.5 dCi	50	11/08→					
1.5 dCi	55	05/10→					
1.5 dCi	65	05/10→					
1.6	64	06/08→					
1.6 16V	77	07/11→					
1.6 16V Bifuel	77	01/11→					
1.6 MPI 85	62	05/10→					
1.5 dCi	63	11/08→		→ 02/13		03.7750-8532.4 300264	ATE Ø 9" pneumatisch
1.6 Hi-Flex (BS1H)	64	06/08→12/12		+ ABS		03.7853-4102.4 300271	ATE Ø 9" pneumatisch
1.6 LPG	62	05/10→10/12				03.7853-4602.4 300302	ATE Ø 9" pneumatisch
1.6 LPG (BS03)	60	01/11→12/12		→ 10/12; + ABS		03.7853-4102.4 300271	ATE Ø 9" pneumatisch
						03.7853-4602.4 300302	ATE Ø 9" pneumatisch
 Hauptbremszylinder							
1.2 16V	55	11/08→		→ 02/13; + ABS		03.2120-4611.3 010937	ATE Ø 20,64
1.2 16V LPG	55	11/08→		→ 02/13; - ABS		24.2120-1762.3 011002	Ø 20,64 ohne Bremsflüssigkeitsbehälter
1.4	55	06/08→					
1.4 MPI LPG	53	01/09→					
1.5 dCi	48	11/08→					
1.5 dCi	50	11/08→					
1.5 dCi	55	05/10→					
1.5 dCi	65	05/10→					
1.6	64	06/08→					
1.6 16V	77	07/11→					
1.6 16V Bifuel	77	01/11→					
1.6 MPI 85	62	05/10→					
1.5 dCi	63	11/08→		→ 02/13; + ABS		03.2122-2031.3 010938	ATE Ø 22,2
↓							

	kw			 	! #		
DACIA - SANDERO 06/08 →							
 Hauptbremszylinder							
1.6 Hi-Flex (BS1H)	64	06/08 → 12/12		+ ABS		03.2120-4611.3 010937	ATE Ø 20,64
1.6 LPG	62	05/10 → 10/12		- ABS		24.2120-1762.3 011002	Ø 20,64 ohne Bremsflüssigkeitsbehälter
1.6 LPG (BS03)	60	01/11 → 12/12		→ 10/12; + ABS		03.2120-4611.3 010937	ATE Ø 20,64
				→ 10/12; - ABS		24.2120-1762.3 011002	Ø 20,64 ohne Bremsflüssigkeitsbehälter
DAEWOO - MATIZ (KLYA) 09/98 →							
 Hauptbremszylinder							
0.8	38	09/98 →		→ 02/05; für Linkslenker; + ABS		24.2120-1755.3 010974	Ø 20,64 ohne Bremsflüssigkeitsbehälter
1.0	47	01/03 →		→ 02/05; für Linkslenker; - ABS		24.2120-1765.3 011003	Ø 20,64 ohne Bremsflüssigkeitsbehälter
1.0	46	04/03 → 12/04		für Linkslenker; + ABS		24.2120-1755.3 010974	Ø 20,64 ohne Bremsflüssigkeitsbehälter
				für Linkslenker; - ABS		24.2120-1765.3 011003	Ø 20,64 ohne Bremsflüssigkeitsbehälter
DAEWOO - MATIZ Kasten (KLA4) 08/98 → 08/02							
 Hauptbremszylinder							
0.8	38	08/98 → 08/02		für Linkslenker; + ABS		24.2120-1755.3 010974	Ø 20,64 ohne Bremsflüssigkeitsbehälter
				für Linkslenker; - ABS		24.2120-1765.3 011003	Ø 20,64 ohne Bremsflüssigkeitsbehälter
DAIHATSU - CHARADE 05/11 →							
 Bremskraftverstärker							
1.33 16V	73	05/11 →		→ 01/13; für Linkslenker; + ESP		03.7750-7132.4 300255	ATE Ø 9" pneumatisch
				→ 01/13; für Linkslenker; - ESP		03.7853-3203.4 300241	ATE Ø 9" pneumatisch
 Hauptbremszylinder							
1.33 16V	73	05/11 →		→ 01/13; für Linkslenker; - ESP		03.4152-0153.3 011006	ATE Ø 22,2 ohne Bremsflüssigkeitsbehälter
				→ 01/13; für Linkslenker; + ESP		03.4152-0158.3 011007	ATE Ø 22,2 ohne Bremsflüssigkeitsbehälter
DAIHATSU - CHARADE IV (G200, G202) 01/93 → 09/00							
 Hauptbremszylinder							
1.3	44	09/96 → 11/99		- ABS		24.2119-1710.3 010880	TRW Ø 19,05 mit Bremsflüssigkeitsbehälter
1.3 16V	55	05/96 → 11/99					
1.3 i 16V	62	01/93 → 09/00					
1.5 i 16V	66	01/97 → 11/99					
1.6 GTi	77	03/93 → 11/99		→ 03/96; - ABS		24.2119-1710.3 010880	TRW Ø 19,05 mit Bremsflüssigkeitsbehälter
DAIHATSU - CHARADE IV Stufenheck (G203) 03/93 → 01/01							
 Hauptbremszylinder							
1.5 16V	55	10/94 → 01/01		→ 11/99; - ABS		24.2119-1710.3 010880	TRW Ø 19,05 mit Bremsflüssigkeitsbehälter
1.5 i 16V	66	06/94 → 11/99		08/94 →; - ABS		24.2119-1710.3 010880	TRW Ø 19,05 mit Bremsflüssigkeitsbehälter
DS - DS5 04/15 →							
 Bremskraftverstärker							
1.6 BlueHDi 120	88	07/15 →		für Fahrzeuge ohne Start-Stopp-Funktion		03.7860-3732.4 300306	ATE Ø 10" pneumatisch
1.6 THP 165	121	07/15 →					
1.6 THP 210	155	04/15 →					
2.0 BlueHDi 150	110	04/15 →					
2.0 BlueHDi 180	133	04/15 →					
 Hauptbremszylinder							
1.6 BlueHDi 120	88	07/15 →		Nabendurchmesser [mm]: 82		03.4153-0173.3 010815	ATE Ø 23,81
1.6 THP 165	121	07/15 →					
1.6 THP 210	155	04/15 →					
2.0 BlueHDi 150	110	04/15 →					
2.0 BlueHDi 180	133	04/15 →					
2.0 HDi 165 Hybrid4 4x4	120	04/15 →					

	kw			 	! #		
DS - DS 3 Cabriolet 07/15→							
 Hauptbremszylinder							
1.2 THP 110	81	07/15→				24.4123-1704.3 010828	TRW Ø 23,81
1.2 THP 130	96	09/15→					
1.6 BlueHDi 100	73	07/15→					
1.6 BlueHDi 120	88	07/15→					
1.6 THP 165	121	07/15→					
1.6 THP 208	153	09/15→					
FIAT - 126 (126_) 09/72→09/00							
 Hauptbremszylinder							
650	18	07/81→09/00		→ 08/87		24.2119-0815.3 010347	Ø 19,05
700	19	09/87→06/96		→ 07/90		24.2119-0815.3 010347	Ø 19,05
FIAT - 500 (312_) 10/07→							
 Hauptbremszylinder							
0.9	44	12/13→				24.4122-1714.3 010914	TRW Ø 22,2 ohne Bremsflüssigkeitsbehälter
0.9	48	09/12→					
0.9	59	12/13→					
0.9	63	07/10→					
1.3 D Multijet	57	06/16→					
1.4	74	10/07→					
1.4 (312.AXD1A)	99	08/08→					
1.4 (312.AXF11, 312.AXF1A, 312.AXD1A)	118	08/08→					
1.4 (312.AXF11)	132	08/08→					
1.4 (312.AXF1A)	103	05/10→					
1.4 (312.AXT1A)	139	08/08→					
0.9	77	10/13→		12/13→		24.4122-1714.3 010914	TRW Ø 22,2 ohne Bremsflüssigkeitsbehälter
1.2	51	10/07→				24.4120-1702.3 010913	TRW Ø 20,64 ohne Bremsflüssigkeitsbehälter
1.2 LPG	51	12/10→					
1.3 D Multijet	55	10/07→					
1.3 D Multijet	70	12/09→					
FIAT - 500 C (312_) 09/09→							
 Hauptbremszylinder							
0.9	44	12/13→				24.4122-1714.3 010914	TRW Ø 22,2 ohne Bremsflüssigkeitsbehälter
0.9	48	09/12→					
0.9	59	12/13→					
0.9	63	09/09→					
0.9	77	12/13→					
1.3 D Multijet	55	09/09→					
1.3 D Multijet	70	09/09→					
1.4	74	09/09→					
1.4	75	09/11→					
1.4 (312.AXD1A)	99	01/11→					
1.4 (312.AXF11)	132	09/09→					
1.4 (312.AXF1A, 312.AXD1A)	118	05/11→					
1.4 (312.AXF1A)	103	09/09→					
1.2	51	09/09→				24.4120-1702.3 010913	TRW Ø 20,64 ohne Bremsflüssigkeitsbehälter
FIAT - BARCHETTA (183_) 03/95→05/05							
 Hauptbremszylinder							
1.8 16V	96	04/95→05/05		→ 10/04; GG		24.2122-1716.3 010485	Ø 22,2
 Bremskraftregler							
1.8 16V	96	04/95→05/05		 + ABS; → 10/04		24.6513-1705.3 320237	lastabhängig 2x
FIAT - BRAVA (182_) 10/95→06/03							
 Hauptbremszylinder							
1.2 16V	64	12/98→12/02		→ 10/01; für Linkslenker; GG		24.2122-1716.3 010485	Ø 22,2
1.2 16V 80	60	12/98→12/02					
1.9 JTD	79	01/01→12/02					
1.2 16V 80	59	10/00→10/01		für Linkslenker; GG		24.2122-1716.3 010485	Ø 22,2
1.4 (182.BG)	55	10/95→10/01					
1.4 12 V (182.BA)	59	10/95→08/98					
1.6 16V (182.BB)	76	02/96→10/01					
1.6 16V (182.BH)	66	10/95→10/01					
1.6 16V (182.BU)	76	01/99→12/02					
1.8 GT 16V (182.BC)	83	10/95→10/01					
1.9 D	48	10/95→10/01					
1.9 JTD	74	09/00→10/01					
1.9 JTD 105	77	12/98→10/01					

	kw			 	! #		
FIAT - BRAVA (182_) 10/95→06/03							
 Hauptbremszylinder							
2.0	113	09/98→08/00		für Linkslenker; GG		24.2122-1716.3 010485	Ø 22,2
1.9 TD 100 S (182.BF)	74	03/96→10/01		06/96→; für Linkslenker; GG		24.2122-1716.3 010485	Ø 22,2
1.9 TD 75 S (182.BF)	55	03/96→10/01					
FIAT - BRAVO I (182_) 10/95→10/01							
 Hauptbremszylinder							
1.2 16V 80	59	10/00→10/01		für Linkslenker; GG		24.2122-1716.3 010485	Ø 22,2
1.2 16V 80	60	12/98→10/00					
1.2 16V 80	64	12/98→10/01					
1.4 (182.AA)	59	10/95→10/01					
1.4 (182.AG)	55	10/95→10/01					
1.6	76	09/00→10/01					
1.6 16V (182.AB)	76	03/96→10/01					
1.6 16V (182.AH)	66	10/95→10/01					
1.8 GT (182.AC)	83	10/95→10/01					
1.9 D	48	10/95→10/01					
1.9 JTD	74	09/00→10/01					
1.9 JTD 105	77	12/98→10/01					
2.0 HGT 20V (182.AD)	108	10/95→07/98					
2.0 HGT 20V (182.AQ)	113	07/98→10/01					
1.9 TD 100 S (182.AF)	74	03/96→10/01		06/96→; für Linkslenker; GG		24.2122-1716.3 010485	Ø 22,2
1.9 TD 75 S (182.AF)	55	03/96→10/01					
FIAT - BRAVO II (198_) 11/06→							
 Hauptbremszylinder							
1.4	66	04/07→		01/08→		24.4123-1710.3 010866	BOS Ø 23,81 ohne Bremsflüssigkeitsbehälter
1.4 T-Jet	88	09/07→					
1.4 T-Jet	110	09/07→					
1.9 D Multijet	66	04/07→12/08					
1.9 D Multijet	85	11/06→					
1.9 D Multijet	88	04/07→					
1.9 D Multijet	110	04/07→					
1.4 16V	103	03/08→		04/08→		24.4123-1710.3 010866	BOS Ø 23,81 ohne Bremsflüssigkeitsbehälter
1.4 LPG	66	12/08→12/14		11/09→		24.4123-1710.3 010866	BOS Ø 23,81 ohne Bremsflüssigkeitsbehälter
1.6 D Multijet	66	03/08→				24.4123-1710.3 010866	BOS Ø 23,81 ohne Bremsflüssigkeitsbehälter
1.6 D Multijet	85	11/08→					
1.6 D Multijet	88	03/08→					
2.0 D Multijet	120	09/08→					
2.0 D Multijet	121	09/08→					
1.6 D Multijet	77	09/07→		03/08→		24.4123-1710.3 010866	BOS Ø 23,81 ohne Bremsflüssigkeitsbehälter
FIAT - CINQUECENTO (170_) 07/91→07/99							
 Hauptbremszylinder							
0.7 (170AA)	23	12/91→01/96		02/92→		24.2119-0833.3 010418	Ø 19,05
0.7 i (170AD)	22	07/94→01/98				24.2119-0833.3 010418	Ø 19,05
0.9 i.e. S (170AF, 170CF)	29	07/91→07/99		02/92→ 05/98		24.2119-0833.3 010418	Ø 19,05
1.1 Sporting (170AH)	40	10/94→01/98		11/94→		24.2119-0833.3 010418	Ø 19,05
FIAT - COUPE (175_) 11/93→08/00							
 Hauptbremszylinder							
1.8 16V	96	03/96→08/00		07/96→; GG		24.2122-1716.3 010485	Ø 22,2
2.0 16V	102	11/93→08/96		12/93→ 06/96; GG		24.2122-1716.3 010485	Ø 22,2
2.0 16V Turbo	140	11/93→08/96					
FIAT - CROMA (194_) 06/05→							
 Hauptbremszylinder							
1.8 16V	103	12/05→		01/06→; für Linkslenker; → 11/10; für Fahrzeuge mit elektronischer Fahr- dynamikregelung		24.2125-1732.3 010827	TRW Ø 25,4
				01/06→; für Linkslenker; → 11/10; für Fahrzeuge ohne elektronische Fahr- dynamikregelung		24.2125-1733.3 010830	TRW Ø 25,4
1.9 D Multijet	85	06/05→		für Linkslenker; → 11/10;		24.2125-1732.3 010827	TRW Ø 25,4
1.9 D Multijet	88	06/05→		für Fahrzeuge mit elektronischer Fahr- dynamikregelung			
1.9 D Multijet	100	12/05→					
1.9 D Multijet	110	06/05→					
2.2 16V	108	06/05→		für Linkslenker; → 11/10;		24.2125-1733.3 010830	TRW Ø 25,4
2.4 D Multijet	147	06/05→		für Fahrzeuge ohne elektronische Fahr- dynamikregelung			

FIAT - DOBLO Cargo (223_) 11/00→

Hauptbremszylinder

1.2 (223ZXA1A)	48	03/01→		→ 09/05; + ABS	20.5522-1128.3	010747	ATE Ø 22,2
1.3 JTD 16V	51	05/04→12/06		→ 09/05; - ABS	24.2122-1750.3	010740	Ø 22,2
1.6 16V (223ZXD1A)	76	10/01→					
1.6 Natural Power	76	09/02→					
1.9 D (223ZXB1A)	46	03/01→					
1.3 D Multijet	55	10/05→01/10		+ ABS	24.4123-1710.3	010866	BOS Ø 23,81 ohne Bremsflüssigkeitsbehälter
1.3 JTD 16V Multijet	62	08/06→		→ 01/10; + ABS	24.4123-1710.3	010866	BOS Ø 23,81 ohne Bremsflüssigkeitsbehälter
1.9 JTD Multijet	88	12/06→					
1.9 JTD	77	07/03→		→ 09/05; + ABS	20.5522-1128.3	010747	ATE Ø 22,2
1.9 JTD (223ZXE1A)	74	10/01→		→ 09/05; - ABS	24.2122-1750.3	010740	Ø 22,2
				10/05→ 01/10; + ABS	24.4123-1710.3	010866	BOS Ø 23,81 ohne Bremsflüssigkeitsbehälter

Bremskraftregler

1.2 (223ZXA1A)	48	03/01→		→ 01/10; nicht für gepanzerte Fahrzeuge	03.6582-0014.3	320198	ATE lastabhängig 8/1,5 4x
1.6 16V (223ZXD1A)	76	10/01→					
1.6 Natural Power	76	09/02→					
1.9 D (223ZXB1A)	46	03/01→					
1.9 JTD	77	07/03→					
1.9 JTD (223ZXE1A)	74	10/01→					
1.3 JTD 16V	51	05/04→12/06		nicht für gepanzerte Fahrzeuge	03.6582-0014.3	320198	ATE lastabhängig 8/1,5 4x

FIAT - DOBLO Großraumlimousine (119_, 223_) 03/01→

Hauptbremszylinder

1.2 (223AXA1A)	48	03/01→		→ 09/05; + ABS	20.5522-1128.3	010747	ATE Ø 22,2
1.6 16V (223AXD1A)	76	10/01→		→ 09/05; - ABS	24.2122-1750.3	010740	Ø 22,2
1.9 D (223AXB1A)	46	03/01→					
1.3 D Multijet	62	10/05→		→ 01/10; + ABS	24.4123-1710.3	010866	BOS Ø 23,81 ohne Bremsflüssigkeitsbehälter
1.9 D Multijet	88	10/05→					
1.3 JTD	55	05/05→		10/05→ 01/10; + ABS	24.4123-1710.3	010866	BOS Ø 23,81 ohne Bremsflüssigkeitsbehälter
1.3 JTD 16V	51	12/04→05/05		+ ABS	20.5522-1128.3	010747	ATE Ø 22,2
				- ABS	24.2122-1750.3	010740	Ø 22,2
1.6 Natural Power	76	09/02→		→ 09/05; + ABS	20.5522-1128.3	010747	ATE Ø 22,2
				→ 09/05; - ABS	24.2122-1750.3	010740	Ø 22,2
				→ 01/10; + ABS	24.4123-1710.3	010866	BOS Ø 23,81 ohne Bremsflüssigkeitsbehälter
1.9 JTD	77	07/03→		→ 09/05; + ABS	20.5522-1128.3	010747	ATE Ø 22,2
1.9 JTD (223AXE1A)	74	10/01→		→ 09/05; - ABS	24.2122-1750.3	010740	Ø 22,2
				10/05→ 01/10; + ABS	24.4123-1710.3	010866	BOS Ø 23,81 ohne Bremsflüssigkeitsbehälter

Bremskraftregler









1.3 JTD 16V	51	12/04→05/05		nicht für gepanzerte Fahrzeuge	03.6582-0014.3	320198	ATE lastabhängig 8/1,5 4x
-------------	----	-------------	--	--------------------------------	----------------	--------	---------------------------











FIAT - DUCATO Bus (230_) 03/94→04/02









Hauptbremszylinder









1.9 D	50	04/98→04/02		→ 10/01; Nutzlast [kg]: 1.000; + ABS	24.2125-1702.3	010482	Ø 25,4
1.9 D Combinato	51	06/95→04/02		→ 10/01; Nutzlast [kg]: 1.000; - ABS	24.2125-1703.3	010483	Ø 25,4
1.9 TD	66	04/98→04/02		11/01→ 03/02; Nutzlast [kg]: 1.000; - ABS	24.2125-1725.3	010717	Ø 25,4
				11/01→ 03/02; Nutzlast [kg]: 1.000; + ABS	24.2125-1726.3	010718	Ø 25,4
1.9 D	59	05/98→11/01		→ 10/01; Nutzlast [kg]: 1.000; + ABS	24.2125-1702.3	010482	Ø 25,4
				→ 10/01; Nutzlast [kg]: 1.000; - ABS	24.2125-1703.3	010483	Ø 25,4
				11/01→; Nutzlast [kg]: 1.000; - ABS	24.2125-1725.3	010717	Ø 25,4
				11/01→; Nutzlast [kg]: 1.000; + ABS	24.2125-1726.3	010718	Ø 25,4
1.9 TD Combinato	59	08/94→04/02		→ 10/94; Nutzlast [kg]: 1.000; + ABS	24.2122-1714.3	010480	Ø 22,2
1.9 TD Panorama/Combinato	60	03/94→04/02		→ 10/94; Nutzlast [kg]: 1.000; - ABS	24.2122-1715.3	010481	Ø 22,2
				11/94→ 10/01; Nutzlast [kg]: 1.000; + ABS	24.2125-1702.3	010482	Ø 25,4
				11/94→ 10/01; Nutzlast [kg]: 1.000; - ABS	24.2125-1703.3	010483	Ø 25,4
				11/01→ 03/02; Nutzlast [kg]: 1.000; - ABS	24.2125-1725.3	010717	Ø 25,4
				11/01→ 03/02; Nutzlast [kg]: 1.000; + ABS	24.2125-1726.3	010718	Ø 25,4



















	kw			 	! #		
FIAT - DUCATO Bus (230_) 03/94→04/02							
 Hauptbremszylinder							
2.0 4x4	80	11/94→11/01	→ 10/01; Nutzlast ab [kg] 1.000 Nutzlast bis [kg] 1.400; + ABS	24.2125-1702.3	010482	Ø 25,4	
			→ 10/01; Nutzlast [kg]: 1.800; + ABS	24.2125-1702.3	010482	Ø 25,4	
			→ 10/01; Nutzlast ab [kg] 1.000 Nutzlast bis [kg] 1.400; - ABS	24.2125-1703.3	010483	Ø 25,4	
			→ 10/01; Nutzlast [kg]: 1.800; - ABS	24.2125-1703.3	010483	Ø 25,4	
			11/01→; Nutzlast [kg]: 1.800; - ABS	24.2125-1725.3	010717	Ø 25,4	
			11/01→; Nutzlast ab [kg] 1.000 Nutzlast bis [kg] 1.400; - ABS	24.2125-1725.3	010717	Ø 25,4	
			11/01→; Nutzlast ab [kg] 1.000 Nutzlast bis [kg] 1.400; + ABS	24.2125-1726.3	010718	Ø 25,4	
			11/01→; Nutzlast [kg]: 1.800; + ABS	24.2125-1726.3	010718	Ø 25,4	
2.0 JTD	62	10/01→04/02	→ 03/02; Nutzlast [kg]: 1.800; - ABS	24.2125-1725.3	010717	Ø 25,4	
			→ 03/02; Nutzlast [kg]: 1.400; - ABS	24.2125-1725.3	010717	Ø 25,4	
			→ 03/02; Nutzlast [kg]: 1.800; + ABS	24.2125-1726.3	010718	Ø 25,4	
			→ 03/02; Nutzlast [kg]: 1.400; + ABS	24.2125-1726.3	010718	Ø 25,4	
2.0 Panorama/Combinato	80	03/94→04/02	→ 10/94; Nutzlast ab [kg] 1.000 Nutzlast bis [kg] 1.400; + ABS	24.2122-1714.3	010480	Ø 22,2	
			→ 10/94; Nutzlast ab [kg] 1.000 Nutzlast bis [kg] 1.400; - ABS	24.2122-1715.3	010481	Ø 22,2	
			11/94→ 10/01; Nutzlast ab [kg] 1.000 Nutzlast bis [kg] 1.400; + ABS	24.2125-1702.3	010482	Ø 25,4	
			→ 10/01; Nutzlast [kg]: 1.800; + ABS	24.2125-1702.3	010482	Ø 25,4	
			→ 10/01; Nutzlast [kg]: 1.800; - ABS	24.2125-1703.3	010483	Ø 25,4	
			11/94→ 10/01; Nutzlast ab [kg] 1.000 Nutzlast bis [kg] 1.400; - ABS	24.2125-1703.3	010483	Ø 25,4	
			11/01→ 03/02; Nutzlast ab [kg] 1.000 Nutzlast bis [kg] 1.400; - ABS	24.2125-1725.3	010717	Ø 25,4	
			11/01→ 03/02; Nutzlast [kg]: 1.800; - ABS	24.2125-1725.3	010717	Ø 25,4	
			11/01→ 03/02; Nutzlast [kg]: 1.800; + ABS	24.2125-1726.3	010718	Ø 25,4	
			11/01→ 03/02; Nutzlast ab [kg] 1.000 Nutzlast bis [kg] 1.400; + ABS	24.2125-1726.3	010718	Ø 25,4	
2.5 D Combinato 2.5 TD 2.5 TDI Panorama/ Combinato 2.5 TDI Panorama/ Combinato	62	08/94→04/02	→ 10/94; Nutzlast [kg]: 1.400; + ABS	24.2122-1714.3	010480	Ø 22,2	
	70	03/94→04/02	→ 10/94; Nutzlast [kg]: 1.400; - ABS	24.2122-1715.3	010481	Ø 22,2	
	80	07/94→04/02	11/94→ 10/01; Nutzlast [kg]: 1.400; + ABS	24.2125-1702.3	010482	Ø 25,4	
	85	03/94→04/02	→ 10/01; Nutzlast [kg]: 1.800; + ABS	24.2125-1702.3	010482	Ø 25,4	
			11/94→ 10/01; Nutzlast [kg]: 1.400; - ABS	24.2125-1703.3	010483	Ø 25,4	
			→ 10/01; Nutzlast [kg]: 1.800; - ABS	24.2125-1703.3	010483	Ø 25,4	
			11/01→ 03/02; Nutzlast [kg]: 1.400; - ABS	24.2125-1725.3	010717	Ø 25,4	
			11/01→ 03/02; Nutzlast [kg]: 1.800; - ABS	24.2125-1725.3	010717	Ø 25,4	
			11/01→ 03/02; Nutzlast [kg]: 1.800; + ABS	24.2125-1726.3	010718	Ø 25,4	
			11/01→ 03/02; Nutzlast [kg]: 1.400; + ABS	24.2125-1726.3	010718	Ø 25,4	
2.5 TD	85	06/94→09/01	→ 10/94; Nutzlast [kg]: 1.400; + ABS	24.2122-1714.3	010480	Ø 22,2	
			→ 10/94; Nutzlast [kg]: 1.400; - ABS	24.2122-1715.3	010481	Ø 22,2	
			Nutzlast [kg]: 1.800; + ABS	24.2125-1702.3	010482	Ø 25,4	
			11/94→; Nutzlast [kg]: 1.400; + ABS	24.2125-1702.3	010482	Ø 25,4	
			11/94→; Nutzlast [kg]: 1.400; - ABS	24.2125-1703.3	010483	Ø 25,4	
			Nutzlast [kg]: 1.800; - ABS	24.2125-1703.3	010483	Ø 25,4	
2.5 TD 4x4	80	11/94→04/98	Nutzlast [kg]: 1.800; + ABS	24.2125-1702.3	010482	Ø 25,4	
			Nutzlast [kg]: 1.400; + ABS	24.2125-1702.3	010482	Ø 25,4	
			Nutzlast [kg]: 1.400; - ABS	24.2125-1703.3	010483	Ø 25,4	
			Nutzlast [kg]: 1.800; - ABS	24.2125-1703.3	010483	Ø 25,4	
2.5 TDI 4x4	85	04/97→04/02	→ 10/01; Nutzlast [kg]: 1.400; + ABS	24.2125-1702.3	010482	Ø 25,4	
			→ 10/01; Nutzlast [kg]: 1.400; - ABS	24.2125-1703.3	010483	Ø 25,4	
			11/01→ 03/02; Nutzlast [kg]: 1.400; - ABS	24.2125-1725.3	010717	Ø 25,4	
			11/01→ 03/02; Nutzlast [kg]: 1.400; + ABS	24.2125-1726.3	010718	Ø 25,4	
2.8 D 2.8 JTD 2.8 JTD 4x4 ↓	64	02/98→04/02	→ 10/01; Nutzlast [kg]: 1.400; + ABS	24.2125-1702.3	010482	Ø 25,4	
	94	11/00→04/02	→ 10/01; Nutzlast [kg]: 1.800; + ABS	24.2125-1702.3	010482	Ø 25,4	
	94	11/00→04/02	→ 10/01; Nutzlast [kg]: 1.800; + ABS	24.2125-1702.3	010482	Ø 25,4	











	kw			 	! #		
FIAT - DUCATO Bus (230_) 03/94→04/02							
 Hauptbremszylinder							
2.8 TDI	90	10/97→04/02		→ 10/01; Nutzlast [kg]: 1.400; - ABS		24.2125-1703.3 010483	Ø 25,4
2.8 TDI 4x4	90	07/99→04/02		→ 10/01; Nutzlast [kg]: 1.800; - ABS		24.2125-1703.3 010483	Ø 25,4
				11/01→ 03/02; Nutzlast [kg]: 1.800; - ABS		24.2125-1725.3 010717	Ø 25,4
				11/01→ 03/02; Nutzlast [kg]: 1.400; - ABS		24.2125-1725.3 010717	Ø 25,4
				11/01→ 03/02; Nutzlast [kg]: 1.400; + ABS		24.2125-1726.3 010718	Ø 25,4
				11/01→ 03/02; Nutzlast [kg]: 1.800; + ABS		24.2125-1726.3 010718	Ø 25,4
 Bremskraftregler							
1.9 D	50	04/98→04/02		→ 10/01; Nutzlast [kg]: 1.000; - ABS		24.6512-1701.3 320153	lastabhängig 2x
1.9 D	59	05/98→11/01					
1.9 D Combinato	51	06/95→04/02					
1.9 TD	66	04/98→04/02					
1.9 TD Combinato	59	08/94→04/02					
1.9 TD Panorama/Combinato	60	03/94→04/02					
2.0 4x4	80	11/94→11/01		→ 10/01; Nutzlast ab [kg] 1.000 Nutzlast bis [kg] 1.800; - ABS		24.6512-1701.3 320153	lastabhängig 2x
2.0 Panorama/Combinato	80	03/94→04/02					
2.5 D Combinato	62	08/94→04/02		→ 10/01; Nutzlast ab [kg] 1.400 Nutzlast bis [kg] 1.800; - ABS		24.6512-1701.3 320153	lastabhängig 2x
2.5 TD	70	03/94→04/02					
2.5 TDI 4x4	85	04/97→04/02					
2.5 TDI Panorama/Combinato	80	07/94→04/02					
2.5 TDI Panorama/Combinato	85	03/94→04/02					
2.8 D	64	02/98→04/02					
2.8 JTD	94	11/00→04/02					
2.8 JTD 4x4	94	11/00→04/02					
2.8 TDI	90	10/97→04/02					
2.8 TDI 4x4	90	07/99→04/02					
2.5 TD	85	06/94→09/01		Nutzlast ab [kg] 1.400 Nutzlast bis [kg] 1.800; - ABS		24.6512-1701.3 320153	lastabhängig 2x
2.5 TD 4x4	80	11/94→04/98					
FIAT - DUCATO Bus (244_) 04/02→							
 Hauptbremszylinder							
2.0	81	04/02→		→ 07/06; Nutzlast ab [kg] 1.100 Nutzlast bis [kg] 1.800; - ABS		24.2125-1725.3 010717	Ø 25,4
2.0 Bipower	81	11/02→					
2.0 JTD	62	04/02→		→ 07/06; Nutzlast ab [kg] 1.100 Nutzlast bis [kg] 1.800; + ABS		24.2125-1726.3 010718	Ø 25,4
2.3 JTD	81	04/02→					
2.8 JTD	94	04/02→					
2.8 JTD 4x4	94	07/02→					
2.0 4x4	81	05/02→07/06		Nutzlast ab [kg] 1.100 Nutzlast bis [kg] 1.800; - ABS		24.2125-1725.3 010717	Ø 25,4
2.8 JTD	107	04/04→07/06					
2.8 TD	90	11/03→07/06		Nutzlast ab [kg] 1.100 Nutzlast bis [kg] 1.800; + ABS		24.2125-1726.3 010718	Ø 25,4
2.8 TD 4x4	90	11/03→07/06					
FIAT - DUCATO Bus (250_, 290_) 07/06→							
 Hauptbremszylinder							
100 Multijet 2,2 D	74	07/06→		Nutzlast ab [kg] 1.100 Nutzlast bis [kg] 1.500; für Fahrzeuge mit elektronischer Fahrdynamikregelung		24.4125-1701.3 010867	BOS Ø 25,4 ohne Bremsflüssigkeitsbehälter
110 Multijet 2,3 D	83	10/11→					
115 Multijet 2,0 D	85	06/11→					
120 Multijet 2,3 D	88	07/06→		Nutzlast ab [kg] 1.100 Nutzlast bis [kg] 1.500; für Fahrzeuge ohne elektronische Fahrdynamikregelung		24.4125-1702.3 010872	BOS Ø 25,4 ohne Bremsflüssigkeitsbehälter
130 Multijet 2,3 D	93	01/10→					
130 Multijet 2,3 D	96	01/11→					
140 Natural Power	100	04/09→					
160 Multijet 3,0 D	115	10/06→					
160 Multijet 3,0 D	116	07/06→		Nutzlast ab [kg] 1.700 Nutzlast bis [kg] 2.000; light/heavy; für Fahrzeuge mit elektronischer Fahrdynamikregelung		24.4126-1701.3 010868	BOS Ø 26,99 ohne Bremsflüssigkeitsbehälter
180 Multijet 3,0 D	130	06/11→					
150 Multijet 2,3 D	109	06/11→		Nutzlast ab [kg] 1.700 Nutzlast bis [kg] 2.000; light/heavy; für Fahrzeuge mit elektronischer Fahrdynamikregelung		24.4126-1701.3 010868	BOS Ø 26,99 ohne Bremsflüssigkeitsbehälter
150 Multijet 3,0 D	107	04/10→		06/11→; Nutzlast ab [kg] 1.100 Nutzlast bis [kg] 1.500; für Fahrzeuge mit elektronischer Fahrdynamikregelung		24.4125-1701.3 010867	BOS Ø 25,4 ohne Bremsflüssigkeitsbehälter
				Nutzlast ab [kg] 1.100 Nutzlast bis [kg] 1.500; für Fahrzeuge mit elektronischer Fahrdynamikregelung		24.4125-1701.3 010867	BOS Ø 25,4 ohne Bremsflüssigkeitsbehälter
↓							













	kw			 	! #		
FIAT - DUCATO Bus (250_, 290_) 07/06→							
 Hauptbremszylinder							
150 Multijet 3,0 D	107	04/10→		Nutzlast ab [kg] 1.100 Nutzlast bis [kg] 1.500; für Fahrzeuge ohne elektronische Fahrdynamikregelung	24.4125-1702.3	010872	BOS Ø 25,4 ohne Bremsflüssigkeitsbehälter
				06/11→; Nutzlast ab [kg] 1.100 Nutzlast bis [kg] 1.500; für Fahrzeuge ohne elektronische Fahrdynamikregelung	24.4125-1702.3	010872	BOS Ø 25,4 ohne Bremsflüssigkeitsbehälter
				Nutzlast ab [kg] 1.700 Nutzlast bis [kg] 2.000; light/heavy; für Fahrzeuge mit elektronischer Fahrdynamikregelung	24.4126-1701.3	010868	BOS Ø 26,99 ohne Bremsflüssigkeitsbehälter
FIAT - DUCATO Kasten (230_) 03/94→04/02							
 Hauptbremszylinder							
1.9 D 1.9 TD	50 66	04/98→04/02 04/98→04/02		→ 10/01; Nutzlast [kg]: 1.000; + ABS	24.2125-1702.3	010482	Ø 25,4
				→ 10/01; Nutzlast [kg]: 1.000; - ABS	24.2125-1703.3	010483	Ø 25,4
				11/01→ 03/02; Nutzlast [kg]: 1.000; - ABS	24.2125-1725.3	010717	Ø 25,4
				11/01→ 03/02; Nutzlast [kg]: 1.000; + ABS	24.2125-1726.3	010718	Ø 25,4
1.9 D 1.9 TD 1.9 TD CAT	51 60 59	03/94→04/02 03/94→04/02 08/94→04/02		→ 10/94; Nutzlast [kg]: 1.000; + ABS	24.2122-1714.3	010480	Ø 22,2
				→ 10/94; Nutzlast [kg]: 1.000; - ABS	24.2122-1715.3	010481	Ø 22,2
				11/94→ 10/01; Nutzlast [kg]: 1.000; + ABS	24.2125-1702.3	010482	Ø 25,4
				11/94→ 10/01; Nutzlast [kg]: 1.000; - ABS	24.2125-1703.3	010483	Ø 25,4
			11/01→ 03/02; Nutzlast [kg]: 1.000; - ABS	24.2125-1725.3	010717	Ø 25,4	
			11/01→ 03/02; Nutzlast [kg]: 1.000; + ABS	24.2125-1726.3	010718	Ø 25,4	
1.9 TD	59	05/98→11/01		→ 10/01; Nutzlast [kg]: 1.000; + ABS	24.2125-1702.3	010482	Ø 25,4
				→ 10/01; Nutzlast [kg]: 1.000; - ABS	24.2125-1703.3	010483	Ø 25,4
				11/01→; Nutzlast [kg]: 1.000; - ABS	24.2125-1725.3	010717	Ø 25,4
				11/01→; Nutzlast [kg]: 1.000; + ABS	24.2125-1726.3	010718	Ø 25,4
2.0	80	03/94→04/02		→ 10/94; Nutzlast ab [kg] 1.000 Nutzlast bis [kg] 1.400; + ABS	24.2122-1714.3	010480	Ø 22,2
				→ 10/94; Nutzlast ab [kg] 1.000 Nutzlast bis [kg] 1.400; - ABS	24.2122-1715.3	010481	Ø 22,2
				11/94→ 10/01; Nutzlast ab [kg] 1.000 Nutzlast bis [kg] 1.400; + ABS	24.2125-1702.3	010482	Ø 25,4
				→ 10/01; Nutzlast [kg]: 1.800; + ABS	24.2125-1702.3	010482	Ø 25,4
				→ 10/01; Nutzlast [kg]: 1.800; - ABS	24.2125-1703.3	010483	Ø 25,4
				11/94→ 10/01; Nutzlast ab [kg] 1.000 Nutzlast bis [kg] 1.400; - ABS	24.2125-1703.3	010483	Ø 25,4
				11/01→ 03/02; Nutzlast ab [kg] 1.000 Nutzlast bis [kg] 1.400; - ABS	24.2125-1725.3	010717	Ø 25,4
				11/01→ 03/02; Nutzlast [kg]: 1.800; - ABS	24.2125-1725.3	010717	Ø 25,4
				11/01→ 03/02; Nutzlast [kg]: 1.800; + ABS	24.2125-1726.3	010718	Ø 25,4
				11/01→ 03/02; Nutzlast ab [kg] 1.000 Nutzlast bis [kg] 1.400; + ABS	24.2125-1726.3	010718	Ø 25,4
2.0 4x4	80	11/94→04/02		→ 10/01; Nutzlast ab [kg] 1.000 Nutzlast bis [kg] 1.400; + ABS	24.2125-1702.3	010482	Ø 25,4
				→ 10/01; Nutzlast [kg]: 1.800; + ABS	24.2125-1702.3	010482	Ø 25,4
				→ 10/01; Nutzlast ab [kg] 1.000 Nutzlast bis [kg] 1.400; - ABS	24.2125-1703.3	010483	Ø 25,4
				→ 10/01; Nutzlast [kg]: 1.800; - ABS	24.2125-1703.3	010483	Ø 25,4
				11/01→ 03/02; Nutzlast ab [kg] 1.000 Nutzlast bis [kg] 1.400; - ABS	24.2125-1725.3	010717	Ø 25,4
				11/01→ 03/02; Nutzlast [kg]: 1.800; - ABS	24.2125-1725.3	010717	Ø 25,4
				11/01→ 03/02; Nutzlast [kg]: 1.800; + ABS	24.2125-1726.3	010718	Ø 25,4
2.0 JTD	62	10/01→04/02		→ 03/02; Nutzlast [kg]: 1.800; - ABS	24.2125-1725.3	010717	Ø 25,4
				→ 03/02; Nutzlast [kg]: 1.400; - ABS	24.2125-1725.3	010717	Ø 25,4
				→ 03/02; Nutzlast [kg]: 1.800; + ABS	24.2125-1726.3	010718	Ø 25,4
				→ 03/02; Nutzlast [kg]: 1.400; + ABS	24.2125-1726.3	010718	Ø 25,4
↓							

	kw			 	! #		
FIAT - DUCATO Kasten (230_) 03/94→04/02							
 Hauptbremszylinder							
2.5 D	62	03/94→04/02		→ 10/94; Nutzlast [kg]: 1.400; + ABS		24.2122-1714.3 010480	Ø 22,2
2.5 D 4x4	62	03/94→04/02		→ 10/94; Nutzlast [kg]: 1.400; - ABS		24.2122-1715.3 010481	Ø 22,2
2.5 TDI	80	03/94→04/02		11/94→ 10/01; Nutzlast [kg]: 1.400; + ABS		24.2125-1702.3 010482	Ø 25,4
2.5 TDI	85	03/94→04/02		→ 10/01; Nutzlast [kg]: 1.800; + ABS		24.2125-1702.3 010482	Ø 25,4
				11/94→ 10/01; Nutzlast [kg]: 1.400; - ABS		24.2125-1703.3 010483	Ø 25,4
				→ 10/01; Nutzlast [kg]: 1.800; - ABS		24.2125-1703.3 010483	Ø 25,4
				11/01→ 03/02; Nutzlast [kg]: 1.400; - ABS		24.2125-1725.3 010717	Ø 25,4
				11/01→ 03/02; Nutzlast [kg]: 1.800; - ABS		24.2125-1725.3 010717	Ø 25,4
				11/01→ 03/02; Nutzlast [kg]: 1.800; + ABS		24.2125-1726.3 010718	Ø 25,4
				11/01→ 03/02; Nutzlast [kg]: 1.400; + ABS		24.2125-1726.3 010718	Ø 25,4
2.5 TD	80	06/94→08/98		→ 10/94; Nutzlast [kg]: 1.400; + ABS		24.2122-1714.3 010480	Ø 22,2
				→ 10/94; Nutzlast [kg]: 1.400; - ABS		24.2122-1715.3 010481	Ø 22,2
				Nutzlast [kg]: 1.800; + ABS		24.2125-1702.3 010482	Ø 25,4
				11/94→; Nutzlast [kg]: 1.400; + ABS		24.2125-1702.3 010482	Ø 25,4
				11/94→; Nutzlast [kg]: 1.400; - ABS		24.2125-1703.3 010483	Ø 25,4
				Nutzlast [kg]: 1.800; - ABS		24.2125-1703.3 010483	Ø 25,4
2.5 TD 4x4	80	11/94→04/98		Nutzlast [kg]: 1.800; + ABS		24.2125-1702.3 010482	Ø 25,4
2.5 TD 4x4	85	11/94→04/98		Nutzlast [kg]: 1.400; + ABS		24.2125-1702.3 010482	Ø 25,4
				Nutzlast [kg]: 1.400; - ABS		24.2125-1703.3 010483	Ø 25,4
				Nutzlast [kg]: 1.800; - ABS		24.2125-1703.3 010483	Ø 25,4
2.5 TDI 4x4	85	05/98→04/02		→ 10/01; Nutzlast [kg]: 1.400; + ABS		24.2125-1702.3 010482	Ø 25,4
2.8 D	64	05/98→04/02		→ 10/01; Nutzlast [kg]: 1.800; + ABS		24.2125-1702.3 010482	Ø 25,4
2.8 D 4x4	64	08/98→04/02		→ 10/01; Nutzlast [kg]: 1.400; - ABS		24.2125-1703.3 010483	Ø 25,4
2.8 JTD	94	11/00→04/02		→ 10/01; Nutzlast [kg]: 1.400; - ABS		24.2125-1703.3 010483	Ø 25,4
2.8 JTD 4x4	94	11/00→04/02		→ 10/01; Nutzlast [kg]: 1.800; - ABS		24.2125-1703.3 010483	Ø 25,4
2.8 TDI	90	10/97→04/02		11/01→ 03/02; Nutzlast [kg]: 1.800; - ABS		24.2125-1725.3 010717	Ø 25,4
2.8 TDI 4x4	90	06/99→04/02		11/01→ 03/02; Nutzlast [kg]: 1.400; - ABS		24.2125-1725.3 010717	Ø 25,4
				11/01→ 03/02; Nutzlast [kg]: 1.400; + ABS		24.2125-1726.3 010718	Ø 25,4
				11/01→ 03/02; Nutzlast [kg]: 1.800; + ABS		24.2125-1726.3 010718	Ø 25,4
2.8 TD 4x4	90	05/98→09/01		Nutzlast ab [kg] 1.400 Nutzlast bis [kg] 1.800; + ABS		24.2125-1702.3 010482	Ø 25,4
				Nutzlast ab [kg] 1.400 Nutzlast bis [kg] 1.800; - ABS		24.2125-1703.3 010483	Ø 25,4
 Bremskraftregler							
1.9 D	50	04/98→04/02		→ 10/01; Nutzlast [kg]: 1.000; - ABS		24.6512-1701.3 320153	lastabhängig 2x
1.9 D	51	03/94→04/02					
1.9 TD	59	05/98→11/01					
1.9 TD	60	03/94→04/02					
1.9 TD	66	04/98→04/02					
1.9 TD CAT	59	08/94→04/02					
2.0	80	03/94→04/02		→ 10/01; Nutzlast ab [kg] 1.000 Nutzlast bis [kg] 1.800; - ABS		24.6512-1701.3 320153	lastabhängig 2x
2.0 4x4	80	11/94→04/02					
2.5 D	62	03/94→04/02		→ 10/01; Nutzlast ab [kg] 1.400 Nutzlast bis [kg] 1.800; - ABS		24.6512-1701.3 320153	lastabhängig 2x
2.5 D 4x4	62	03/94→04/02					
2.5 TDI	80	03/94→04/02					
2.5 TDI	85	03/94→04/02					
2.5 TDI 4x4	85	05/98→04/02					
2.8 D	64	05/98→04/02					
2.8 D 4x4	64	08/98→04/02					
2.8 JTD	94	11/00→04/02					
2.8 JTD 4x4	94	11/00→04/02					
2.8 TDI	90	10/97→04/02					
2.8 TDI 4x4	90	06/99→04/02					
2.5 TD	80	06/94→08/98		Nutzlast ab [kg] 1.400 Nutzlast bis [kg] 1.800; - ABS		24.6512-1701.3 320153	lastabhängig 2x
2.5 TD 4x4	80	11/94→04/98					
2.5 TD 4x4	85	11/94→04/98					
2.8 TD 4x4	90	05/98→09/01					

	kw			 	! #		
FIAT - DUCATO Kasten (244_) 04/02→							
 Hauptbremszylinder							
2.0	81	04/02→		→ 07/06; Nutzlast ab [kg] 1.100 Nutzlast bis [kg] 1.800; - ABS		24.2125-1725.3 010717	Ø 25,4
2.0 Bipower	81	11/02→					
2.0 JTD	62	04/02→		→ 07/06; Nutzlast ab [kg] 1.100 Nutzlast bis [kg] 1.800; + ABS		24.2125-1726.3 010718	Ø 25,4
2.3 JTD	81	04/02→					
2.8 JTD	94	04/02→					
2.8 JTD 4x4	94	07/02→					
2.8 JTD Power	107	05/04→					
2.8 TD	90	04/02→07/06		Nutzlast ab [kg] 1.100 Nutzlast bis [kg] 1.800; - ABS		24.2125-1725.3 010717	Ø 25,4
				Nutzlast ab [kg] 1.100 Nutzlast bis [kg] 1.800; + ABS		24.2125-1726.3 010718	Ø 25,4
FIAT - DUCATO Kasten (250_, 290_) 07/06→							
 Hauptbremszylinder							
100 Multijet 2,2 D	74	07/06→		Nutzlast ab [kg] 1.100 Nutzlast bis [kg] 1.500; für Fahrzeuge mit elektronischer Fahrdynamikregelung		24.4125-1701.3 010867	BOS Ø 25,4 ohne Bremsflüssigkeitsbehälter
110 Multijet 2,3 D	83	10/11→					
115 Multijet 2,0 D	85	06/11→					
120 Multijet 2,3 D	88	07/06→					
120 Multijet 2,3 D 4x4	88	03/10→					
130 Multijet 2,3 D	96	01/11→					
140 Natural Power	100	04/09→					
160 Multijet 3,0 D	115	07/06→12/11					
160 Multijet 3,0 D	116	07/06→					
180 Multijet 3,0 D	130	06/11→		Nutzlast ab [kg] 1.700 Nutzlast bis [kg] 2.000; light/heavy; für Fahrzeuge mit elektronischer Fahrdynamikregelung		24.4126-1701.3 010868	BOS Ø 26,99 ohne Bremsflüssigkeitsbehälter
130 Multijet 2,3 D	93	08/06→		01/07→; Nutzlast ab [kg] 1.100 Nutzlast bis [kg] 1.500; für Fahrzeuge mit elektronischer Fahrdynamikregelung		24.4125-1701.3 010867	BOS Ø 25,4 ohne Bremsflüssigkeitsbehälter
				01/07→; Nutzlast ab [kg] 1.100 Nutzlast bis [kg] 1.500; für Fahrzeuge ohne elektronische Fahrdynamikregelung		24.4125-1702.3 010872	BOS Ø 25,4 ohne Bremsflüssigkeitsbehälter
				01/07→; Nutzlast ab [kg] 1.700 Nutzlast bis [kg] 2.000; light/heavy; für Fahrzeuge mit elektronischer Fahrdynamikregelung		24.4126-1701.3 010868	BOS Ø 26,99 ohne Bremsflüssigkeitsbehälter
150 Multijet 2,3 D	109	06/11→		Nutzlast ab [kg] 1.700 Nutzlast bis [kg] 2.000; light/heavy; für Fahrzeuge mit elektronischer Fahrdynamikregelung		24.4126-1701.3 010868	BOS Ø 26,99 ohne Bremsflüssigkeitsbehälter
150 Multijet 3,0 D	107	04/10→		06/11→; Nutzlast ab [kg] 1.100 Nutzlast bis [kg] 1.500; für Fahrzeuge mit elektronischer Fahrdynamikregelung		24.4125-1701.3 010867	BOS Ø 25,4 ohne Bremsflüssigkeitsbehälter
				Nutzlast ab [kg] 1.100 Nutzlast bis [kg] 1.500; für Fahrzeuge mit elektronischer Fahrdynamikregelung		24.4125-1701.3 010867	BOS Ø 25,4 ohne Bremsflüssigkeitsbehälter
				Nutzlast ab [kg] 1.100 Nutzlast bis [kg] 1.500; für Fahrzeuge ohne elektronische Fahrdynamikregelung		24.4125-1702.3 010872	BOS Ø 25,4 ohne Bremsflüssigkeitsbehälter
				06/11→; Nutzlast ab [kg] 1.100 Nutzlast bis [kg] 1.500; für Fahrzeuge ohne elektronische Fahrdynamikregelung		24.4125-1702.3 010872	BOS Ø 25,4 ohne Bremsflüssigkeitsbehälter
				Nutzlast ab [kg] 1.700 Nutzlast bis [kg] 2.000; light/heavy; für Fahrzeuge mit elektronischer Fahrdynamikregelung		24.4126-1701.3 010868	BOS Ø 26,99 ohne Bremsflüssigkeitsbehälter
FIAT - DUCATO Pritsche/Fahrgestell (230_) 03/94→04/02							
 Hauptbremszylinder							
1.9 D	50	04/98→04/02		→ 10/01; Nutzlast [kg]: 1.000; + ABS		24.2125-1702.3 010482	Ø 25,4
1.9 TD	66	04/98→04/02		→ 10/01; Nutzlast [kg]: 1.000; - ABS		24.2125-1703.3 010483	Ø 25,4
				11/01→ 03/02; Nutzlast [kg]: 1.000; - ABS		24.2125-1725.3 010717	Ø 25,4
				11/01→ 03/02; Nutzlast [kg]: 1.000; + ABS		24.2125-1726.3 010718	Ø 25,4
1.9 D	51	03/94→04/02		→ 10/94; Nutzlast [kg]: 1.000; + ABS		24.2122-1714.3 010480	Ø 22,2
1.9 TD	60	03/94→04/02		→ 10/94; Nutzlast [kg]: 1.000; - ABS		24.2122-1715.3 010481	Ø 22,2
1.9 TD CAT	59	08/94→04/02		11/94→ 10/01; Nutzlast [kg]: 1.000; + ABS		24.2125-1702.3 010482	Ø 25,4
↓							

	kw			 	! #		
FIAT - DUCATO Pritsche/Fahrgestell (230_) 03/94→04/02							
Hauptbremszylinder							
1.9 D	51	03/94→04/02		11/94→ 10/01; Nutzlast [kg]: 1.000;		24.2125-1703.3 010483	Ø 25,4
1.9 TD	60	03/94→04/02		- ABS			
1.9 TD CAT	59	08/94→04/02		11/01→ 03/02; Nutzlast [kg]: 1.000;		24.2125-1725.3 010717	Ø 25,4
				- ABS			
				11/01→ 03/02; Nutzlast [kg]: 1.000;		24.2125-1726.3 010718	Ø 25,4
				+ ABS			
1.9 TD	59	05/98→11/01		→ 10/01; Nutzlast [kg]: 1.000; + ABS		24.2125-1702.3 010482	Ø 25,4
				→ 10/01; Nutzlast [kg]: 1.000; - ABS		24.2125-1703.3 010483	Ø 25,4
				11/01→; Nutzlast [kg]: 1.000; - ABS		24.2125-1725.3 010717	Ø 25,4
				11/01→; Nutzlast [kg]: 1.000; + ABS		24.2125-1726.3 010718	Ø 25,4
2.0	80	03/94→04/02		→ 10/94; Nutzlast ab [kg] 1.000 Nutzlast		24.2122-1714.3 010480	Ø 22,2
				bis [kg] 1.400; + ABS			
				→ 10/94; Nutzlast ab [kg] 1.000 Nutzlast		24.2122-1715.3 010481	Ø 22,2
				bis [kg] 1.400; - ABS			
				11/94→ 10/01; Nutzlast ab [kg] 1.000		24.2125-1702.3 010482	Ø 25,4
				Nutzlast bis [kg] 1.400; + ABS			
				→ 10/01; Nutzlast [kg]: 1.800; + ABS		24.2125-1702.3 010482	Ø 25,4
				→ 10/01; Nutzlast [kg]: 1.800; - ABS		24.2125-1703.3 010483	Ø 25,4
				11/94→ 10/01; Nutzlast ab [kg] 1.000		24.2125-1703.3 010483	Ø 25,4
				Nutzlast bis [kg] 1.400; - ABS			
				11/01→ 03/02; Nutzlast ab [kg] 1.000		24.2125-1725.3 010717	Ø 25,4
				Nutzlast bis [kg] 1.400; - ABS			
				11/01→ 03/02; Nutzlast [kg]: 1.800;		24.2125-1725.3 010717	Ø 25,4
				- ABS			
				11/01→ 03/02; Nutzlast [kg]: 1.800;		24.2125-1726.3 010718	Ø 25,4
				+ ABS			
				11/01→ 03/02; Nutzlast ab [kg] 1.000		24.2125-1726.3 010718	Ø 25,4
				Nutzlast bis [kg] 1.400; + ABS			
2.0 JTD	62	07/01→04/02		10/01→ 03/02; Nutzlast [kg]: 1.800;		24.2125-1725.3 010717	Ø 25,4
				- ABS			
				10/01→ 03/02; Nutzlast [kg]: 1.400;		24.2125-1725.3 010717	Ø 25,4
				- ABS			
				10/01→ 03/02; Nutzlast [kg]: 1.400;		24.2125-1726.3 010718	Ø 25,4
				+ ABS			
				10/01→ 03/02; Nutzlast [kg]: 1.800;		24.2125-1726.3 010718	Ø 25,4
				+ ABS			
2.5 D	62	03/94→04/02		→ 10/94; Nutzlast [kg]: 1.400; + ABS		24.2122-1714.3 010480	Ø 22,2
2.5 D 4x4	62	03/94→04/02		→ 10/94; Nutzlast [kg]: 1.400; - ABS		24.2122-1715.3 010481	Ø 22,2
2.5 TDI	80	03/94→04/02		11/94→ 10/01; Nutzlast [kg]: 1.400;		24.2125-1702.3 010482	Ø 25,4
2.5 TDI	85	03/94→04/02		+ ABS			
				→ 10/01; Nutzlast [kg]: 1.800; + ABS		24.2125-1702.3 010482	Ø 25,4
				11/94→ 10/01; Nutzlast [kg]: 1.400;		24.2125-1703.3 010483	Ø 25,4
				- ABS			
				→ 10/01; Nutzlast [kg]: 1.800; - ABS		24.2125-1703.3 010483	Ø 25,4
				11/01→ 03/02; Nutzlast [kg]: 1.400;		24.2125-1725.3 010717	Ø 25,4
				- ABS			
				11/01→ 03/02; Nutzlast [kg]: 1.800;		24.2125-1725.3 010717	Ø 25,4
				- ABS			
				11/01→ 03/02; Nutzlast [kg]: 1.800;		24.2125-1726.3 010718	Ø 25,4
				+ ABS			
				11/01→ 03/02; Nutzlast [kg]: 1.400;		24.2125-1726.3 010718	Ø 25,4
				+ ABS			
2.5 TD	80	06/94→08/98		→ 10/94; Nutzlast [kg]: 1.400; + ABS		24.2122-1714.3 010480	Ø 22,2
2.5 TD	85	06/94→04/98		→ 10/94; Nutzlast [kg]: 1.400; - ABS		24.2122-1715.3 010481	Ø 22,2
				Nutzlast [kg]: 1.800; + ABS		24.2125-1702.3 010482	Ø 25,4
				11/94→; Nutzlast [kg]: 1.400; + ABS		24.2125-1702.3 010482	Ø 25,4
				11/94→; Nutzlast [kg]: 1.400; - ABS		24.2125-1703.3 010483	Ø 25,4
				Nutzlast [kg]: 1.800; - ABS		24.2125-1703.3 010483	Ø 25,4
2.5 TD 4x4	85	11/94→04/98		Nutzlast [kg]: 1.800; + ABS		24.2125-1702.3 010482	Ø 25,4
				Nutzlast [kg]: 1.400; + ABS		24.2125-1702.3 010482	Ø 25,4
				Nutzlast [kg]: 1.400; - ABS		24.2125-1703.3 010483	Ø 25,4
				Nutzlast [kg]: 1.800; - ABS		24.2125-1703.3 010483	Ø 25,4
2.5 TDI 4x4	85	06/98→04/02		→ 10/01; Nutzlast [kg]: 1.400; + ABS		24.2125-1702.3 010482	Ø 25,4
2.8 D	64	02/98→04/02		→ 10/01; Nutzlast [kg]: 1.800; + ABS		24.2125-1702.3 010482	Ø 25,4
2.8 JTD	94	11/00→04/02		→ 10/01; Nutzlast [kg]: 1.400; - ABS		24.2125-1703.3 010483	Ø 25,4
2.8 JTD	94	03/01→04/02		→ 10/01; Nutzlast [kg]: 1.400; - ABS		24.2125-1703.3 010483	Ø 25,4
2.8 JTD 4x4	94	10/01→04/02		→ 10/01; Nutzlast [kg]: 1.800; - ABS		24.2125-1703.3 010483	Ø 25,4
2.8 TDI	90	12/98→04/02		11/01→ 03/02; Nutzlast [kg]: 1.800;		24.2125-1725.3 010717	Ø 25,4
				- ABS			
↓							

	kw				! #		
FIAT - DUCATO Pritsche/Fahrgestell (230_) 03/94→04/02							
 Hauptbremszylinder							
2.5 TDI 4x4	85	06/98→04/02		11/01→ 03/02; Nutzlast [kg]: 1.400; - ABS		24.2125-1725.3 010717	Ø 25,4
2.8 D	64	02/98→04/02					
2.8 JTD	94	11/00→04/02		11/01→ 03/02; Nutzlast [kg]: 1.400; + ABS		24.2125-1726.3 010718	Ø 25,4
2.8 JTD	94	03/01→04/02					
2.8 JTD 4x4	94	10/01→04/02		11/01→ 03/02; Nutzlast [kg]: 1.800; + ABS		24.2125-1726.3 010718	Ø 25,4
2.8 TDI	90	12/98→04/02					
2.8 iDTD 4x4	90	05/98→09/01		Nutzlast ab [kg] 1.400 Nutzlast bis [kg] 1.800; + ABS		24.2125-1702.3 010482	Ø 25,4
				Nutzlast ab [kg] 1.400 Nutzlast bis [kg] 1.800; - ABS		24.2125-1703.3 010483	Ø 25,4
2.8 TD 4x4	64	05/98→11/01		→ 09/01; Nutzlast ab [kg] 1.400 Nutzlast bis [kg] 1.800; + ABS		24.2125-1702.3 010482	Ø 25,4
				→ 09/01; Nutzlast ab [kg] 1.400 Nutzlast bis [kg] 1.800; - ABS		24.2125-1703.3 010483	Ø 25,4
 Bremskraftregler							
1.9 D	50	04/98→04/02		→ 10/01; Nutzlast [kg]: 1.000; - ABS		24.6512-1701.3 320153	lastabhängig 2x
1.9 D	51	03/94→04/02					
1.9 TD	59	05/98→11/01					
1.9 TD	60	03/94→04/02					
1.9 TD	66	04/98→04/02					
1.9 TD CAT	59	08/94→04/02					
2.0	80	03/94→04/02		→ 10/01; Nutzlast ab [kg] 1.000 Nutzlast bis [kg] 1.800; - ABS		24.6512-1701.3 320153	lastabhängig 2x
2.5 D	62	03/94→04/02		→ 10/01; Nutzlast ab [kg] 1.400 Nutzlast bis [kg] 1.800; - ABS		24.6512-1701.3 320153	lastabhängig 2x
2.5 D 4x4	62	03/94→04/02					
2.5 TDI	80	03/94→04/02					
2.5 TDI	85	03/94→04/02					
2.5 TDI 4x4	85	06/98→04/02					
2.8 D	64	02/98→04/02					
2.8 JTD	94	11/00→04/02					
2.8 JTD	94	03/01→04/02					
2.8 JTD 4x4	94	10/01→04/02					
2.8 TDI	90	12/98→04/02					
2.5 TD	80	06/94→08/98		Nutzlast ab [kg] 1.400 Nutzlast bis [kg] 1.800; - ABS		24.6512-1701.3 320153	lastabhängig 2x
2.5 TD	85	06/94→04/98					
2.5 TD 4x4	85	11/94→04/98					
2.8 iDTD 4x4	90	05/98→09/01					
2.8 TD 4x4	64	05/98→11/01		→ 09/01; Nutzlast ab [kg] 1.400 Nutzlast bis [kg] 1.800; - ABS		24.6512-1701.3 320153	lastabhängig 2x
FIAT - DUCATO Pritsche/Fahrgestell (244_) 04/02→							
 Hauptbremszylinder							
2.0	81	04/02→07/06		Nutzlast ab [kg] 1.100 Nutzlast bis [kg] 1.800; - ABS		24.2125-1725.3 010717	Ø 25,4
2.0 JTD	62	04/02→07/06					
2.3 JTD	81	04/02→07/06		Nutzlast ab [kg] 1.100 Nutzlast bis [kg] 1.800; + ABS		24.2125-1726.3 010718	Ø 25,4
2.8 JTD	90	11/03→07/06					
2.8 JTD	94	04/02→07/06					
2.8 JTD 4x4	94	10/02→07/06					
2.8 JTD Power	107	05/04→07/06					
FIAT - DUCATO Pritsche/Fahrgestell (250_, 290_) 07/06→							
 Hauptbremszylinder							
100 Multijet 2,2 D	74	07/06→		Nutzlast ab [kg] 1.100 Nutzlast bis [kg] 1.500; für Fahrzeuge mit elektronischer Fahrdynamikregelung		24.4125-1701.3 010867	BOS Ø 25,4 ohne Bremsflüssigkeitsbehälter
110 Multijet 2,3 D	83	10/11→					
115 Multijet 2,0 D	85	06/11→					
120 Multijet 2,3 D	88	07/06→					
120 Multijet 2,3 D 4x4	88	03/10→		Nutzlast ab [kg] 1.100 Nutzlast bis [kg] 1.500; für Fahrzeuge ohne elektronische Fahrdynamikregelung		24.4125-1702.3 010872	BOS Ø 25,4 ohne Bremsflüssigkeitsbehälter
140 Natural Power	100	04/09→					
160 Multijet 3,0 D	115	07/06→12/11					
160 Multijet 3,0 D	116	07/06→					
180 Multijet 3,0 D	130	06/11→		Nutzlast ab [kg] 1.700 Nutzlast bis [kg] 2.000; light/heavy; für Fahrzeuge mit elektronischer Fahrdynamikregelung		24.4126-1701.3 010868	BOS Ø 26,99 ohne Bremsflüssigkeitsbehälter
130 Multijet 2,3 D	93	08/06→		01/07→; Nutzlast ab [kg] 1.100 Nutzlast bis [kg] 1.500; für Fahrzeuge mit elektronischer Fahrdynamikregelung		24.4125-1701.3 010867	BOS Ø 25,4 ohne Bremsflüssigkeitsbehälter
130 Multijet 2,3 D	96	10/06→					
				01/07→; Nutzlast ab [kg] 1.100 Nutzlast bis [kg] 1.500; für Fahrzeuge ohne elektronische Fahrdynamikregelung		24.4125-1702.3 010872	BOS Ø 25,4 ohne Bremsflüssigkeitsbehälter
				01/07→; Nutzlast ab [kg] 1.700 Nutzlast bis [kg] 2.000; light/heavy; für Fahrzeuge mit elektronischer Fahrdynamikregelung		24.4126-1701.3 010868	BOS Ø 26,99 ohne Bremsflüssigkeitsbehälter
↓							

	kw					! #		
FIAT - DUCATO Pritsche/Fahrgestell (250_, 290_) 07/06→								
 Hauptbremszylinder								
150 Multijet 2,3 D	109	06/11→			Nutzlast ab [kg] 1.700 Nutzlast bis [kg] 2.000; light/heavy; für Fahrzeuge mit elektronischer Fahrdynamikregelung		24.4126-1701.3 010868	BOS Ø 26,99 ohne Bremsflüssigkeitsbehälter
150 Multijet 3,0 D	107	04/10→			06/11→; Nutzlast ab [kg] 1.100 Nutzlast bis [kg] 1.500; für Fahrzeuge mit elektronischer Fahrdynamikregelung		24.4125-1701.3 010867	BOS Ø 25,4 ohne Bremsflüssigkeitsbehälter
					Nutzlast ab [kg] 1.100 Nutzlast bis [kg] 1.500; für Fahrzeuge mit elektronischer Fahrdynamikregelung		24.4125-1701.3 010867	BOS Ø 25,4 ohne Bremsflüssigkeitsbehälter
					Nutzlast ab [kg] 1.100 Nutzlast bis [kg] 1.500; für Fahrzeuge ohne elektronische Fahrdynamikregelung		24.4125-1702.3 010872	BOS Ø 25,4 ohne Bremsflüssigkeitsbehälter
					06/11→; Nutzlast ab [kg] 1.100 Nutzlast bis [kg] 1.500; für Fahrzeuge ohne elektronische Fahrdynamikregelung		24.4125-1702.3 010872	BOS Ø 25,4 ohne Bremsflüssigkeitsbehälter
					Nutzlast ab [kg] 1.700 Nutzlast bis [kg] 2.000; light/heavy; für Fahrzeuge mit elektronischer Fahrdynamikregelung		24.4126-1701.3 010868	BOS Ø 26,99 ohne Bremsflüssigkeitsbehälter
FIAT - ELBA (146_) 10/85→10/97								
 Bremskraftregler								
1.4	49	10/93→02/95					24.6513-0801.3 320117	lastabhängig 1/3 2x
1.5	49	01/92→12/96						
1.5	55	01/92→12/96						
1.6	69	01/94→12/96						
FIAT - FIORINO Kasten (146_) 01/88→								
 Hauptbremszylinder								
1.3	43	05/88→09/98			09/93→; + ABS		20.5522-1093.3 010731	ATE Ø 22,2
1.4	52	11/92→10/96						
1.7 TD	46	11/96→05/00			+ ABS		20.5522-1093.3 010731	ATE Ø 22,2
60 1.7 D	42	05/88→10/96			09/93→; + ABS		20.5522-1093.3 010731	ATE Ø 22,2
60 1.7 D	44	05/88→05/00			09/88→ 08/93		24.2120-0802.3 010363	ATE Ø 20,64
65 1.7 TD	46	01/97→05/01			→ 03/01; + ABS		20.5522-1093.3 010731	ATE Ø 22,2
70 i.e. 1.4	49	05/94→05/01						
75 i.e. 1.6	55	10/93→05/01						
 Bremskraftregler								
60 1.7 D	42	05/88→10/96			09/88→; → 8220596		24.6513-0801.3 320117	lastabhängig 1/3 2x
60 1.7 D	44	05/88→05/00						
65 1.7 TD	46	01/97→05/01			→ 8220596		24.6513-0801.3 320117	lastabhängig 1/3 2x
FIAT - FIORINO Pick up (146_) 01/88→05/01								
 Hauptbremszylinder								
1.4	49	05/94→05/01			→ 03/01; + ABS		20.5522-1093.3 010731	ATE Ø 22,2
1.6	55	01/94→05/01						
1.7 TD	46	01/97→05/01						
1.4	52	10/93→10/96			+ ABS		20.5522-1093.3 010731	ATE Ø 22,2
1.7 D	42	10/93→10/99						
1.7 D	44	05/88→10/99			09/93→; + ABS		20.5522-1093.3 010731	ATE Ø 22,2
FIAT - GRANDE PUNTO (199_) 10/05→								
 Hauptbremszylinder								
1.2	48	10/05→			09/10→ 01/11		24.4122-1709.3 010871	BOS Ø 22,2 ohne Bremsflüssigkeitsbehälter
1.2	50	09/06→						
1.3 D Multijet	51	07/08→						
1.3 D Multijet	62	04/10→			→ 08/10; für Fahrzeuge mit elektronischer Fahrdynamikregelung		24.4122-1709.3 010871	BOS Ø 22,2 ohne Bremsflüssigkeitsbehälter
1.3 D Multijet	66	10/05→						
1.4 16V	66	09/06→						
1.4 16V	70	10/05→						
1.4 16V	112	09/07→07/12						
1.4 LPG	57	12/08→						
1.4 Natural Power	57	07/08→						
1.4 T-Jet	88	09/07→						
1.6 D Multijet	88	07/08→						
1.9 D Multijet	88	10/05→						
1.2	51	09/10→			→ 01/11		24.4122-1709.3 010871	BOS Ø 22,2 ohne Bremsflüssigkeitsbehälter
↓								

FIAT - GRANDE PUNTO (199_) 10/05→













Hauptbremszylinder













1.2 LPG	51	07/08→		09/10→ 01/11	24.4122-1709.3	010871	BOS Ø 22,2 ohne Bremsflüssigkeitsbehälter
1.3 D Multijet	55	10/05→		04/08→ 08/10; für Fahrzeuge mit elektronischer Fahr- dynamikregelung	24.4122-1709.3	010871	BOS Ø 22,2 ohne Bremsflüssigkeitsbehälter
				09/10→ 01/11	24.4122-1709.3	010871	BOS Ø 22,2 ohne Bremsflüssigkeitsbehälter
1.3 D Multijet	56	06/09→		09/10→ 01/11	24.4122-1709.3	010871	BOS Ø 22,2 ohne Bremsflüssigkeitsbehälter
				→ 08/10; für Fahrzeuge mit elektronischer Fahr- dynamikregelung	24.4122-1709.3	010871	BOS Ø 22,2 ohne Bremsflüssigkeitsbehälter
				10/09→; für Linkslenker	24.4122-1709.3	010871	BOS Ø 22,2 ohne Bremsflüssigkeitsbehälter
1.4 1.4	55 57	06/06→ 10/05→		→ 08/10; für Fahrzeuge mit elektronischer Fahr- dynamikregelung	24.4122-1709.3	010871	BOS Ø 22,2 ohne Bremsflüssigkeitsbehälter
1.9 D Multijet	85	06/06→12/09		für Fahrzeuge mit elektronischer Fahr- dynamikregelung	24.4122-1709.3	010871	BOS Ø 22,2 ohne Bremsflüssigkeitsbehälter
1.9 D Multijet	96	10/05→		09/10→ 01/11	24.4122-1709.3	010871	BOS Ø 22,2 ohne Bremsflüssigkeitsbehälter
				02/06→ 08/10; für Fahrzeuge mit elektronischer Fahr- dynamikregelung	24.4122-1709.3	010871	BOS Ø 22,2 ohne Bremsflüssigkeitsbehälter



















FIAT - IDEA (350_) 12/03→











Hauptbremszylinder

















1.2 16V 1.9 JTD	59 74	01/04→ 01/04→		→ 11/06; für Fahrzeuge ohne elektronische Fahr- dynamikregelung	24.2123-1763.3	010842	Ø 23,81
				→ 11/06; für Fahrzeuge mit elektronischer Fahr- dynamikregelung	24.2123-1769.3	010863	BOS Ø 23,81
				→ 02/08	24.4123-1708.3	010859	BOS Ø 23,81
1.3 D Multijet 1.4 16V	51 70	01/04→ 01/04→		→ 11/06; für Fahrzeuge ohne elektronische Fahr- dynamikregelung	24.2123-1763.3	010842	Ø 23,81
				→ 11/06; für Fahrzeuge mit elektronischer Fahr- dynamikregelung	24.2123-1769.3	010863	BOS Ø 23,81
				12/06→ 02/08	24.4123-1708.3	010859	BOS Ø 23,81
1.3 D Multijet	66	10/05→		11/05→ 11/06; für Fahrzeuge ohne elektronische Fahr- dynamikregelung	24.2123-1763.3	010842	Ø 23,81
				11/05→ 11/06; für Fahrzeuge mit elektronischer Fahr- dynamikregelung	24.2123-1769.3	010863	BOS Ø 23,81
				12/06→ 02/08	24.4123-1708.3	010859	BOS Ø 23,81
1.3 D Multijet 1.4 LPG 1.6 D Multijet	70 57 88	05/08→12/12 03/09→ 05/08→		→ 09/10	24.4123-1708.3	010859	BOS Ø 23,81
1.4	57	10/05→		11/05→ 11/06; für Fahrzeuge ohne elektronische Fahr- dynamikregelung	24.2123-1763.3	010842	Ø 23,81
				11/05→ 11/06; für Fahrzeuge mit elektronischer Fahr- dynamikregelung	24.2123-1769.3	010863	BOS Ø 23,81
				11/05→ 02/08	24.4123-1708.3	010859	BOS Ø 23,81
1.4	66	12/03→		01/04→ 11/06; für Fahrzeuge ohne elektronische Fahr- dynamikregelung	24.2123-1763.3	010842	Ø 23,81
				01/04→ 11/06; für Fahrzeuge mit elektronischer Fahr- dynamikregelung	24.2123-1769.3	010863	BOS Ø 23,81
				12/06→ 02/08	24.4123-1708.3	010859	BOS Ø 23,81
1.6 D Multijet	85	11/08→12/10		10/10→	24.4123-1708.3	010859	BOS Ø 23,81
				→ 09/10	24.4123-1708.3	010859	BOS Ø 23,81
1.8	81	01/08→07/10			24.4123-1708.3	010859	BOS Ø 23,81















	kw			 	! #		
FIAT - LINEA (323_) 06/07→							
 Hauptbremszylinder							
1.3 D Multijet 1.4	66 57	06/07→ 06/07→		07/07→ 05/11; für Fahrzeuge mit elektronischer Fahr- namikregelung		24.4122-1709.3 010871	BOS Ø 22,2 ohne Bremsflüssigkeitsbehälter
1.3 D Multijet 1.4 1.4 T-Jet 1.4 T-Jet 1.4 T-Jet 1.6 1.6 D Multijet 1.9 16V 1.9 16V 1.9 16V	70 66 84 88 112 80 77 93 94 97	09/09→ 12/08→ 09/07→ 09/07→ 10/08→ 07/08→ 06/09→ 06/09→ 07/08→ 09/10→		→ 05/11; für Fahrzeuge mit elektronischer Fahr- namikregelung		24.4122-1709.3 010871	BOS Ø 22,2 ohne Bremsflüssigkeitsbehälter
FIAT - MAREA (185_) 09/96→12/07							
 Hauptbremszylinder							
1.2 16V	60	10/98→05/02		04/99→; für Linkslenker; GG		24.2122-1716.3 010485	Ø 22,2
1.4 80 12V 1.6 1.6 1.6 100 16V 1.6 100 16V Bipower 1.6 16V 1.6 SX 1.8 115 16V 1.9 JTD 105 1.9 JTD 110 1.9 TD 100 1.9 TD 75 2.0 150 20V 2.0 150 20V 2.0 155 20V 2.4 JTD 130 2.4 TD 125	59 68 76 76 76 75 72 83 77 81 74 55 108 110 113 96 91	09/96→05/02 03/99→08/00 09/00→08/02 09/96→05/02 04/99→05/02 04/97→02/99 09/00→08/02 09/96→05/02 04/99→01/01 01/01→05/02 09/96→05/02 09/96→05/02 09/96→04/99 01/01→05/02 04/99→01/01 04/99→05/02 09/96→04/99		für Linkslenker; GG		24.2122-1716.3 010485	Ø 22,2
1.9 JTD	79	01/01→12/07		→ 12/02; für Linkslenker; GG		24.2122-1716.3 010485	Ø 22,2
FIAT - MAREA Weekend (185_) 09/96→12/07							
 Hauptbremszylinder							
1.2 16V	60	10/98→05/02		04/99→; für Linkslenker; GG		24.2122-1716.3 010485	Ø 22,2
1.4 80 12V 1.6 1.6 1.6 100 16V 1.8 115 16V 1.9 JTD 105 1.9 JTD 110 1.9 TD 100 1.9 TD 75 2.0 150 20V 2.0 150 20V 2.4 JTD 130 2.4 TD 125	59 76 76 83 77 81 74 55 108 110 96 91	09/96→05/02 09/00→08/02 09/96→05/02 09/96→05/02 04/99→05/02 01/01→05/02 09/96→05/02 09/96→05/02 09/96→04/99 01/01→05/02 04/99→05/02 09/96→04/99		für Linkslenker; GG		24.2122-1716.3 010485	Ø 22,2
1.9 JTD 2.0 155 20V	79 113	01/01→12/07 04/99→02/03		→ 12/02; für Linkslenker; GG		24.2122-1716.3 010485	Ø 22,2
FIAT - PALIO (178BX) 04/96→							
 Hauptbremszylinder							
1.1 1.2	40 50	07/97→10/03 06/99→10/00		+ ABS		20.5522-1093.3 010731	ATE Ø 22,2
1.2 1.7 D	44 42	07/97→08/02 04/96→09/02		10/97→; + ABS		20.5522-1093.3 010731	ATE Ø 22,2
1.2 1.2 1.5 1.7 TD 1.7 TD	54 59 62 51 53	06/98→ 09/01→ 06/04→ 10/02→01/12 09/01→		→ 12/06; + ABS		20.5522-1093.3 010731	ATE Ø 22,2
FIAT - PALIO Weekend (178_) 04/96→							
 Hauptbremszylinder							
1.2 1.4	50 51	06/99→10/02 07/97→08/01		+ ABS		20.5522-1093.3 010731	ATE Ø 22,2
1.2 1.2 (178DYA1A) 1.5 1.6 1.6 16V (178DYC1A06) 1.9 D (178DYD1A07) 1.9 JTD	59 44 62 78 76 46 59	09/01→ 02/01→ 02/02→ 02/01→ 02/01→ 03/01→ 09/01→		→ 12/06; + ABS		20.5522-1093.3 010731	ATE Ø 22,2
↓							

















	kW			 	! #		
FIAT - PALIO Weekend (178_) 04/96→							
 Hauptbremszylinder							
1.2 (178DX.G1A)	54	04/96→02/01		10/97→; + ABS		20.5522-1093.3 010731	ATE Ø 22,2
1.2 Flex	44	07/97→08/02					
1.2 LPG	44	07/97→08/02					
1.6 16V (178DX.D1A)	74	04/96→02/01					
1.7 TD (178DX.H1A)	51	04/96→03/01					
FIAT - PANDA (141_) 03/80→07/04							
 Hauptbremszylinder							
1000 i.e. Cat	33	10/87→08/98		für Linkslenker		24.2119-0826.3 010349	Ø 19,05
				→ 12/92; für Linkslenker		24.2119-0826.3 010349	Ø 19,05
1100 900	37 29	05/91→12/99 04/92→12/96		für Linkslenker		24.2119-0826.3 010349	Ø 19,05
1100	40	02/95→09/03		→ 12/02; für Linkslenker		24.2119-0826.3 010349	Ø 19,05
1100 4x4 1100 Trekking 4x4	40 37	02/95→07/04 10/91→07/04		→ 12/02; für Linkslenker		24.2120-0801.3 010362	Ø 20,64
650	22	01/82→07/04		→ 12/85; 6223908→; für Linkslenker		24.2119-0826.3 010349	Ø 19,05
				6166304→ 6223907; für Linkslenker		24.2119-0827.3 010350	Ø 19,05
750	25	01/86→10/03		→ 12/97; für Linkslenker		24.2119-0826.3 010349	Ø 19,05
 Bremskraftregler							
1100 4x4 1100 Trekking 4x4	40 37	02/95→07/04 10/91→07/04		→ 12/02		24.6046-0801.3 320116	4/6 2x
650	22	01/82→07/04		6166304→ 6261411		24.6046-0801.3 320116	4/6 2x
FIAT - PANDA (169_) 09/03→							
 Hauptbremszylinder							
1.1	40	09/03→		→ 06/13; - ABS		24.2120-1744.3 010820	Ø 20,64
1.2	44	09/03→		→ 06/13;		24.2120-1746.3 010835	BOS Ø 20,64
1.2	51	03/10→		für Fahrzeuge mit elektronischer Fahr- dynamikregelung			
1.2 LPG	44	04/09→					
1.2 LPG	51	11/10→					
1.3 D Multijet	51	09/03→		→ 06/13; + ABS		24.2120-1747.3 010836	BOS Ø 20,64
1.3 D Multijet	55	06/06→					
1.4 Natural Power	51	01/10→					
1.4 Natural Power	57	09/10→					
1.2 4x4	44	10/04→		→ 06/13; + Diff		24.2120-1745.3 010834	Ø 20,64
				→ 06/13; - Diff		24.4120-1702.3 010913	TRW Ø 20,64 ohne Bremsflüssigkeitsbehälter
1.2 4x4	51	11/09→		10/10→ 06/13; + Diff		24.2120-1745.3 010834	Ø 20,64
				10/10→ 06/13; - Diff		24.4120-1702.3 010913	TRW Ø 20,64 ohne Bremsflüssigkeitsbehälter
1.2 Natural Power	44	01/07→11/09		- ABS		24.2120-1744.3 010820	Ø 20,64
				für Fahrzeuge mit elektronischer Fahr- dynamikregelung		24.2120-1746.3 010835	BOS Ø 20,64
				+ ABS		24.2120-1747.3 010836	BOS Ø 20,64
1.3 D Multijet 4x4	51	10/04→		04/06→ 08/11; - ABS		24.2120-1744.3 010820	Ø 20,64
				04/06→ 08/11; für Fahrzeuge mit elektronischer Fahr- dynamikregelung		24.2120-1746.3 010835	BOS Ø 20,64
				04/06→ 08/11; + ABS		24.2120-1747.3 010836	BOS Ø 20,64
				→ 06/13		24.4122-1714.3 010914	TRW Ø 22,2 ohne Bremsflüssigkeitsbehälter
				04/06→ 08/11		24.4122-1714.3 010914	TRW Ø 22,2 ohne Bremsflüssigkeitsbehälter
1.3 D Multijet 4x4	55	09/10→		→ 06/13		24.4122-1714.3 010914	TRW Ø 22,2 ohne Bremsflüssigkeitsbehälter
1.4	74	10/06→		11/06→ 06/13; für Fahrzeuge ohne elektronische Fahr- dynamikregelung		24.2122-1762.3 010837	Ø 22,2
				11/06→ 06/13; für Fahrzeuge mit elektronischer Fahr- dynamikregelung		24.2122-1768.3 010853	Ø 22,2
FIAT - PANDA Van (141_) 01/86→02/04							
 Hauptbremszylinder							
1.1	40	09/00→02/04		→ 12/02; für Linkslenker		24.2119-0826.3 010349	Ø 19,05
1000 i.e	33	08/92→02/04					
1.1 4x4	40	09/00→02/04		→ 12/02; für Linkslenker		24.2120-0801.3 010362	Ø 20,64
 Bremskraftregler							
1.1 4x4	40	09/00→02/04		→ 12/02		24.6046-0801.3 320116	4/6 2x













	kw			 	! #		
FIAT - PANDA Van (169_) 03/04→							
 Hauptbremszylinder							
1.1	40	09/04→		→ 06/13; - ABS		24.2120-1744.3 010820	Ø 20,64
1.2	44	09/04→		→ 06/13;		24.2120-1746.3 010835	BOS Ø 20,64
1.2	51	09/10→		für Fahrzeuge mit elektronischer Fahr- dynamikregelung			
1.2 LPG	44	04/09→					
1.3 D Multijet	51	03/04→		→ 06/13; + ABS		24.2120-1747.3 010836	BOS Ø 20,64
1.4 Natural Power	57	10/09→					
1.2 4x4	44	09/04→		10/04→ 06/13; + Diff		24.2120-1745.3 010834	Ø 20,64
				10/04→ 06/13; - Diff		24.4120-1702.3 010913	TRW Ø 20,64 ohne Bremsflüssigkeitsbehälter
1.2 4x4	51	09/10→		10/10→ 06/13; + Diff		24.2120-1745.3 010834	Ø 20,64
				10/10→ 06/13; - Diff		24.4120-1702.3 010913	TRW Ø 20,64 ohne Bremsflüssigkeitsbehälter
1.2 LPG	51	09/10→		11/10→ 06/13; - ABS		24.2120-1744.3 010820	Ø 20,64
				11/10→ 06/13; für Fahrzeuge mit elektronischer Fahr- dynamikregelung		24.2120-1746.3 010835	BOS Ø 20,64
				11/10→ 06/13; + ABS		24.2120-1747.3 010836	BOS Ø 20,64
1.2 Natural Power	44	01/07→11/09		- ABS		24.2120-1744.3 010820	Ø 20,64
				für Fahrzeuge mit elektronischer Fahr- dynamikregelung		24.2120-1746.3 010835	BOS Ø 20,64
				+ ABS		24.2120-1747.3 010836	BOS Ø 20,64
1.3 D Multijet	55	01/06→		06/06→ 06/13; - ABS		24.2120-1744.3 010820	Ø 20,64
				06/06→ 06/13; für Fahrzeuge mit elektronischer Fahr- dynamikregelung		24.2120-1746.3 010835	BOS Ø 20,64
				06/06→ 06/13; + ABS		24.2120-1747.3 010836	BOS Ø 20,64
1.3 D Multijet 4x4	51	10/04→12/06				24.4122-1714.3 010914	TRW Ø 22,2 ohne Bremsflüssigkeitsbehälter
1.3 D Multijet 4x4	55	01/06→		→ 06/13		24.4122-1714.3 010914	TRW Ø 22,2 ohne Bremsflüssigkeitsbehälter
FIAT - PREMIO 03/85→12/96							
 Bremskraftregler							
1.5 i.e.	55	06/92→12/96				24.6513-0801.3 320117	lastabhängig 1/3 2x
1.6 i.e.	60	08/93→12/96		01/94→		24.6513-0801.3 320117	lastabhängig 1/3 2x
FIAT - PUNTO (176_) 09/93→09/99							
 Hauptbremszylinder							
1.2 16V	63	04/97→09/99		06/97→		24.2120-1710.3 010468	Ø 20,64
1.4 GT Turbo	96	09/96→09/99		06/97→		24.2120-1710.3 010468	Ø 20,64
				→ 05/97; GG		24.2122-1716.3 010485	Ø 22,2
1.4 GT Turbo	98	01/94→09/96		GG		24.2122-1716.3 010485	Ø 22,2
1.6	65	01/94→04/97		03/94→		24.2120-1710.3 010468	Ø 20,64
1.7 D	42	04/94→09/97		01/95→ 05/97		24.2120-1710.3 010468	Ø 20,64
1.7 TD	46	09/96→09/99				24.2120-1710.3 010468	Ø 20,64
1.7 TD	51	01/94→09/99					
1.7 TD	52	01/94→09/99					
60 1.2	43	01/94→09/99					
55 1.1	40	09/93→09/99		11/93→		24.2120-1710.3 010468	Ø 20,64
60 1.2	44	09/93→09/99					
75 1.2	54	10/93→09/99					
 Bremskraftregler							
1.2 16V	63	04/97→09/99		 06/97→; - ABS		24.6513-1705.3 320237	lastabhängig 2x
1.4 GT Turbo	96	09/96→09/99					
55 1.1	40	09/93→09/99		 06/97→		24.6513-1705.3 320237	lastabhängig 2x
60 1.2	44	09/93→09/99		 11/93→ 05/97; - ABS		24.6513-1705.3 320237	lastabhängig 2x
60 1.2	43	01/94→09/99		 06/97→		24.6513-1705.3 320237	lastabhängig 2x
				 → 05/97; - ABS		24.6513-1705.3 320237	lastabhängig 2x
75 1.2	54	10/93→09/99		 11/93→ 05/97; - ABS		24.6513-1705.3 320237	lastabhängig 2x
FIAT - PUNTO (188_) 09/99→07/12							
 Hauptbremszylinder							
1.2 16V 80 (188.233, .235, .253, .255, .333, .353, .639...)	59	09/99→12/06		07/03→ 11/05; - ABS		24.2120-1742.3 010776	Ø 20,64
				10/99→ 06/03		24.2120-1742.3 010776	Ø 20,64
1.2 60 (188.030, .050, .130, .150, .230, .250)	44	09/99→12/10		07/03→ 11/05; + ABS		24.2120-1743.3 010777	Ø 20,64
↓							













	kw			 	! #		
FIAT - PUNTO (188_) 09/99→07/12							
 Hauptbremszylinder							
1.2 Bifuel	44	08/07→03/12		10/09→; für Linkslenker		24.4122-1709.3 010871	BOS Ø 22,2 ohne Bremsflüssigkeitsbehälter
1.2 Natural Power	44	09/03→03/12		→ 11/05; - ABS		24.2120-1742.3 010776	Ø 20,64
				→ 11/05; + ABS		24.2120-1743.3 010777	Ø 20,64
1.3 JTD 16V	51	06/03→03/12		07/03→ 11/05; - ABS		24.2122-1760.3 010821	Ø 22,2
				07/03→ 11/05; + ABS		24.2122-1763.3 010838	Ø 22,2
				07/03→ 11/05; für Fahrzeuge mit elektronischer Fahr- dynamikregelung		24.2122-1768.3 010853	Ø 22,2
1.4	70	09/03→03/12		→ 11/05; - ABS		24.2122-1760.3 010821	Ø 22,2
1.4	71	11/05→03/12		→ 11/05; + ABS		24.2122-1763.3 010838	Ø 22,2
				→ 11/05; für Fahrzeuge mit elektronischer Fahr- dynamikregelung		24.2122-1768.3 010853	Ø 22,2
1.8 130 HGT (188.738, . 718)	96	09/99→03/12		10/99→ 06/03		24.2120-1742.3 010776	Ø 20,64
				07/03→ 11/05; für Fahrzeuge mit elektronischer Fahr- dynamikregelung		24.2122-1768.3 010853	Ø 22,2
1.9 DS 60 (188.031, . 051, .231, .251)	44	09/99→03/12		10/99→ 06/03		24.2120-1742.3 010776	Ø 20,64
1.9 JTD 80 (188.237, . 257, .337, .357)	59	09/99→03/12					
1.9 JTD	63	10/01→03/12		→ 06/03		24.2120-1742.3 010776	Ø 20,64
				07/03→ 11/05; - ABS		24.2122-1760.3 010821	Ø 22,2
				07/03→ 11/05; + ABS		24.2122-1763.3 010838	Ø 22,2
				07/03→ 11/05; für Fahrzeuge mit elektronischer Fahr- dynamikregelung		24.2122-1768.3 010853	Ø 22,2
1.9 JTD	74	06/03→03/12		07/03→ 11/05; für Fahrzeuge mit elektronischer Fahr- dynamikregelung		24.2122-1768.3 010853	Ø 22,2
 Bremskraftregler							
1.2 16V 80 (188.233, . 235, .253, .255, .333, . 353, .639...)	59	09/99→12/06		10/99→ 06/03; - ABS		03.0101-0032.2 320231	ATE Satz 3/25 2x
1.2 60 (188.030, .050, . 130, .150, .230, .250)	44	09/99→12/10					
1.8 130 HGT (188.738, . 718)	96	09/99→03/12					
1.9 DS 60 (188.031, . 051, .231, .251)	44	09/99→03/12					
1.9 JTD 80 (188.237, . 257, .337, .357)	59	09/99→03/12					
1.9 JTD	63	10/01→03/12		→ 06/03; - ABS		03.0101-0032.2 320231	ATE Satz 3/25 2x
FIAT - PUNTO (199_) 03/12→							
 Hauptbremszylinder							
0.9	74	12/13→		für Linkslenker		24.4122-1709.3 010871	BOS Ø 22,2 ohne Bremsflüssigkeitsbehälter
0.9	77	07/13→					
0.9 Bifuel	63	03/12→					
0.9 Twinair Turbo	63	03/12→					
1.2	49	02/14→					
1.2	51	03/12→					
1.3 D Multijet	55	03/12→					
1.3 D Multijet	59	12/13→					
1.3 D Multijet	62	03/12→					
1.3 D Multijet	66	05/16→					
1.3 D Multijet	70	03/12→					
1.4	55	03/12→					
1.4	57	03/12→					
1.4 Bifuel	57	03/12→					
1.4 Multi Air	77	03/12→					
1.4 Natural Power	57	03/12→					
1.4 Turbo Multi Air	99	03/12→					
FIAT - PUNTO Cabriolet (176_) 04/94→06/00							
 Hauptbremszylinder							
60 1.2	43	04/94→06/00				24.2120-1710.3 010468	Ø 20,64
60 1.2	44	05/95→06/00					
90 1.6	65	04/94→04/97					
85 16V 1.2	63	04/97→06/00		06/97→		24.2120-1710.3 010468	Ø 20,64
↓							















	kw					! #		
FIAT - PUNTO Cabriolet (176_) 04/94→06/00								
 Bremskraftregler								
60 1.2	43	04/94→06/00			→ 05/95; - ABS		24.6513-1705.3 320237	lastabhängig 2x
60 1.2	44	05/95→06/00						
FIAT - PUNTO EVO (199_) 07/08→								
 Hauptbremszylinder								
1.2	48	10/09→02/12			für Linkslenker		24.4122-1709.3 010871	BOS Ø 22,2 ohne Bremsflüssigkeitsbehälter
1.2	51	10/09→02/12						
1.3 D Multijet	51	07/08→02/12						
1.3 D Multijet	55	10/09→02/12						
1.3 D Multijet	56	10/09→02/12						
1.3 D Multijet	62	10/09→02/12						
1.3 D Multijet	66	10/09→02/12						
1.3 D Multijet	68	10/14→						
1.3 D Multijet	70	10/09→02/12						
1.4	57	10/09→02/12						
1.4 16V	77	10/09→02/12						
1.4 16V	99	10/09→02/12						
1.4 LPG	57	06/09→02/12						
1.4 Natural Power	57	10/09→02/12						
1.6 D Multijet	88	10/09→02/12						
1.4	55	07/09→02/12			10/09→; für Linkslenker		24.4122-1709.3 010871	BOS Ø 22,2 ohne Bremsflüssigkeitsbehälter
FIAT - PUNTO Van (176_) 04/96→02/00								
 Hauptbremszylinder								
1.1	40	04/96→02/00			→ 09/99		24.2120-1710.3 010468	Ø 20,64
1.7 TD	52	04/96→02/00						
1.7 D	42	04/96→02/00			→ 05/97		24.2120-1710.3 010468	Ø 20,64
1.7 TD	46	09/96→09/99					24.2120-1710.3 010468	Ø 20,64
 Bremskraftregler								
1.1	40	04/96→02/00			→ 05/97; - ABS		24.6513-1705.3 320237	lastabhängig 2x
					06/97→ 09/99		24.6513-1705.3 320237	lastabhängig 2x
FIAT - PUNTO Van (188_) 02/00→10/09								
 Hauptbremszylinder								
1.2 60	44	02/00→10/09			→ 06/03		24.2120-1742.3 010776	Ø 20,64
1.9 D 60	44	02/00→10/09						
1.9 JTD	63	02/00→10/09						
1.3 D Multijet	55	02/05→10/09			→ 11/05; - ABS		24.2122-1760.3 010821	Ø 22,2
					→ 11/05; + ABS		24.2122-1763.3 010838	Ø 22,2
					→ 11/05; für Fahrzeuge mit elektronischer Fahr- dynamikregelung		24.2122-1768.3 010853	Ø 22,2
1.3 JTD	51	06/03→10/05			07/03→; - ABS		24.2122-1760.3 010821	Ø 22,2
					07/03→; + ABS		24.2122-1763.3 010838	Ø 22,2
					07/03→; für Fahrzeuge mit elektronischer Fahr- dynamikregelung		24.2122-1768.3 010853	Ø 22,2
 Bremskraftregler								
1.2 60	44	02/00→10/09			→ 06/03; - ABS		03.0101-0032.2 320231	ATE Satz 3/25 2x
1.9 D 60	44	02/00→10/09						
1.9 JTD	63	02/00→10/09						
FIAT - PUNTO Van (199_) 02/06→								
 Hauptbremszylinder								
0.9 Twinair Turbo	63	03/12→			für Linkslenker		24.4122-1709.3 010871	BOS Ø 22,2 ohne Bremsflüssigkeitsbehälter
1.3 D Multijet	62	03/12→						
1.3 D Multijet	66	01/10→02/12						
1.3 D Multijet	55	04/08→			09/10→ 01/11		24.4122-1709.3 010871	BOS Ø 22,2 ohne Bremsflüssigkeitsbehälter
					→ 08/10; für Fahrzeuge mit elektronischer Fahr- dynamikregelung		24.4122-1709.3 010871	BOS Ø 22,2 ohne Bremsflüssigkeitsbehälter
1.3 D Multijet	70	03/09→			10/09→; für Linkslenker		24.4122-1709.3 010871	BOS Ø 22,2 ohne Bremsflüssigkeitsbehälter
1.4 (199BxB1A)	57	02/06→06/13						
1.4 Natural Power	57	03/09→						
1.4 LPG (199AXB1A)	57	03/09→			06/09→; für Linkslenker		24.4122-1709.3 010871	BOS Ø 22,2 ohne Bremsflüssigkeitsbehälter













	kw			 	! #		
FIAT - SCUDO (270_, 272_) 01/07→							
 Hauptbremszylinder							
1.6 D Multijet	66	01/07→		für Linkslenker; - ESP	03.2125-0298.3	010818	ATE Ø 25,4
1.6 D Multijet	66	02/11→		für Linkslenker; + ESP	03.2125-0671.3	010965	ATE Ø 25,4
2.0 D Multijet	88	01/07→					
2.0 D Multijet	94	04/11→					
2.0 D Multijet	100	01/07→					
2.0 D Multijet	120	07/10→					
2.0 D Multijet 4x4	94	04/11→					
2.0 D Multijet 4x4	88	01/07→		04/11→; für Linkslenker; - ESP	03.2125-0298.3	010818	ATE Ø 25,4
				04/11→; für Linkslenker; + ESP	03.2125-0671.3	010965	ATE Ø 25,4
FIAT - SCUDO Combinato (220_) 02/96→12/06							
 Hauptbremszylinder							
1.6	58	02/96→12/06		- ABS	24.2122-1703.3	010422	Ø 22,2
1.9 D	51	02/96→04/98		+ ABS	24.2122-1708.3	010437	Ø 22,2
1.9 D	51	04/98→12/06					
1.9 TD	68	02/96→12/06					
1.9 TD Eco	66	02/96→12/06					
2.0 16V	100	06/00→12/06					
2.0 JTD	69	01/04→12/06					
2.0 JTD	80	12/99→12/06					
2.0 JTD 16V	80	05/99→12/06		12/99→; - ABS	24.2122-1703.3	010422	Ø 22,2
				12/99→; + ABS	24.2122-1708.3	010437	Ø 22,2
FIAT - SCUDO Kasten (220_) 02/96→12/06							
 Hauptbremszylinder							
1.6	58	02/96→12/06		- ABS	24.2122-1703.3	010422	Ø 22,2
1.9 D	51	02/96→12/06		+ ABS	24.2122-1708.3	010437	Ø 22,2
1.9 D	51	04/98→12/06					
1.9 TD	66	02/96→12/06					
1.9 TD	68	02/98→12/06					
2.0 JTD	80	12/02→12/06					
2.0	100	05/00→12/06		06/00→; - ABS	24.2122-1703.3	010422	Ø 22,2
				06/00→; + ABS	24.2122-1708.3	010437	Ø 22,2
2.0 JTD	69	10/99→12/06		12/99→; - ABS	24.2122-1703.3	010422	Ø 22,2
2.0 JTD 16V	80	05/99→12/06		12/99→; + ABS	24.2122-1708.3	010437	Ø 22,2
FIAT - SCUDO Kasten (270_, 272_) 01/07→							
 Hauptbremszylinder							
1.6 D Multijet	66	01/07→		für Linkslenker; - ESP	03.2125-0298.3	010818	ATE Ø 25,4
1.6 D Multijet	66	02/11→		für Linkslenker; + ESP	03.2125-0671.3	010965	ATE Ø 25,4
2.0 D Multijet	88	01/07→					
2.0 D Multijet	94	05/11→					
2.0 D Multijet	100	01/07→					
2.0 D Multijet	120	07/10→					
2.0 D Multijet 4x4	88	01/07→		04/11→; für Linkslenker; - ESP	03.2125-0298.3	010818	ATE Ø 25,4
				04/11→; für Linkslenker; + ESP	03.2125-0671.3	010965	ATE Ø 25,4
FIAT - SCUDO Pritsche/Fahrgestell (220_) 09/96→12/06							
 Hauptbremszylinder							
1.6	58	09/96→12/06		- ABS	24.2122-1703.3	010422	Ø 22,2
1.9 D	51	04/98→12/06		+ ABS	24.2122-1708.3	010437	Ø 22,2
1.9 TD	68	09/96→12/06					
2.0 JTD	80	12/02→12/06					
2.0 JTD	69	10/99→12/06		12/99→; - ABS	24.2122-1703.3	010422	Ø 22,2
2.0 JTD 16V	80	05/99→12/06		12/99→; + ABS	24.2122-1708.3	010437	Ø 22,2
FIAT - SCUDO Pritsche/Fahrgestell (270_, 272_) 01/07→							
 Hauptbremszylinder							
1.6 D Multijet	66	01/07→		für Linkslenker; - ESP	03.2125-0298.3	010818	ATE Ø 25,4
2.0 D Multijet	88	01/07→		für Linkslenker; + ESP	03.2125-0671.3	010965	ATE Ø 25,4
2.0 D Multijet	94	05/11→					
2.0 D Multijet	100	01/07→					
2.0 D Multijet	120	07/10→					
FIAT - SEDICI (FY_) 06/06→10/14							
 Hauptbremszylinder							
1.6 16V	79	06/06→10/14		für Fahrzeuge ohne elektronische Fahrdynamikregelung	24.4122-1712.3	010899	BOS Ø 22,2 ohne Bremsflüssigkeitsbehälter
1.6 16V	88	06/06→10/14					
1.6 16V 4x4	79	06/06→10/14		für Fahrzeuge mit elektronischer Fahrdynamikregelung	24.4122-1713.3	010900	BOS Ø 22,2 ohne Bremsflüssigkeitsbehälter
1.6 16V 4x4	88	06/06→10/14					
1.9 D Multijet	88	06/06→10/14					
↓							













	kw			 	! #		
FIAT - SEDICI (FY_) 06/06→10/14							
 Hauptbremszylinder							
1.9 D Multijet 4x4	88	06/06→10/14		für Fahrzeuge ohne elektronische Fahr- dynamikregelung		24.4122-1712.3 010899	BOS Ø 22,2 ohne Bremsflüssigkeitsbehälter
2.0 D Multijet	99	06/06→10/14					
2.0 D Multijet 4x4	99	06/06→10/14		für Fahrzeuge mit elektronischer Fahr- dynamikregelung		24.4122-1713.3 010900	BOS Ø 22,2 ohne Bremsflüssigkeitsbehälter
FIAT - SEICENTO / 600 (187_) 01/98→01/10							
 Hauptbremszylinder							
0.9 (187AXA, 187AXA1A)	29	01/98→01/10		04/98→ 03/08		24.2119-0833.3 010418	Ø 19,05
1.1 (187AXB, 187AXB1A)	40	01/98→01/10					
Elektra (187AEA1A, 187BEA1A)	30	01/99→01/05		03/00→		24.2119-0833.3 010418	Ø 19,05
Elettrica	22	03/00→04/04				24.2119-0833.3 010418	Ø 19,05
FIAT - SEICENTO / 600 Van (287_) 01/98→01/10							
 Hauptbremszylinder							
0.9 (187AXA)	29	01/98→01/10		04/98→ 03/08		24.2119-0833.3 010418	Ø 19,05
1.1 (187CXB/C)	40	01/98→01/10					
FIAT - SIENA (178_) 04/96→12/12							
 Hauptbremszylinder							
1.2	59	09/01→12/09		→ 12/06; + ABS		20.5522-1093.3 010731	ATE Ø 22,2
FIAT - STILO (192_) 10/01→11/10							
 Hauptbremszylinder							
1.6	100	04/05→11/06				24.2123-1769.3 010863	BOS Ø 23,81
1.9 D Multijet	110	09/05→11/06					
1.9 JTD	100	04/04→11/06					
1.9 JTD	103	01/04→11/06					
2.4 20V	123	01/04→11/06					
2.4 20V (192_XD1A)	125	10/01→11/06					
FIAT - STILO Multi Wagon (192_) 01/03→08/08							
 Hauptbremszylinder							
1.9 D Multijet (192DXT1B)	110	09/05→08/08		→ 03/08		24.2123-1769.3 010863	BOS Ø 23,81
1.9 JTD	100	04/04→08/08					
1.9 JTD	103	01/04→08/08					
2.4 20V	123	01/04→08/08					
FIAT - STRADA Pick-up (178_) 02/98→							
 Hauptbremszylinder							
1.2	44	04/03→		→ 12/11; + ABS		20.5522-1093.3 010731	ATE Ø 22,2
1.2 Trekking	60	11/05→					
1.3 D Multijet	62	05/06→					
1.9 D	46	12/00→					
1.9 JTD	59	04/03→					
1.2	54	06/99→12/06		+ ABS		20.5522-1093.3 010731	ATE Ø 22,2
1.7 TD	51	06/99→12/06					
FIAT - TEMPRA (159_) 03/90→12/98							
 Hauptbremszylinder							
1.4 i.e. (159.AC, 159.AX)	51	04/90→08/96		→ 04/93; für Linkslenker; - ABS		24.2120-1710.3 010468	Ø 20,64
1.4 i.e. (159.AC)	57	03/91→08/96					
1.6 (159.AD)	63	03/90→08/96					
1.6 i.e. (159.AS, 159.AT)	55	06/92→08/96					
1.8 i.e. (159.AN)	77	03/92→08/96					
1.8 i.e. (159.AN)	81	03/90→08/96					
1.9 TD (159.AQ)	59	07/92→08/96					
1.9 TD (159.CU, 159.AU, 159.AI, 159.BI)	66	05/90→08/96					
2.0 i.e. (159.AP)	83	10/90→08/96					
FIAT - TEMPRA S.W. (159_) 03/90→08/97							
 Hauptbremszylinder							
1.4 i.e. (159.AC, 159.AX)	51	10/92→08/96		→ 04/93; für Linkslenker; - ABS		24.2120-1710.3 010468	Ø 20,64
1.4 i.e. (159.AC)	57	03/91→08/96					
1.6 i.e. (159.AE)	57	10/90→08/96					
1.6 i.e. (159.AS, 159.AT)	55	10/92→08/96					
1.8 i.e. (159.AN)	81	03/90→08/96					
1.9 D (159.AG)	48	07/91→08/96					
↓							













	kw			 	! #		
FIAT - TEMPRA S.W. (159_) 03/90→08/97							
 Hauptbremszylinder							
1.9 TD (159.AI, 159.BI, 159.CU, 159.AU) 2.0 i.e. (159.AP)	66 83	07/91→02/95 01/91→03/95		→ 04/93; für Linkslenker; - ABS		24.2120-1710.3 010468	Ø 20,64
FIAT - TIPO (160_) 07/87→10/97							
 Hauptbremszylinder							
1.4 i.e. 1.4 i.e. (160.AP, 160.AD, 160.EA) 1.6 i.e. (160.A1, 160.EC, 160.EB) 1.6 SX DGT 1.7 D (160.AG) 1.9 D 1.9 TD (160.EL, 160.GL, 160.AQ, 160.EI, 160.AR) 2.0 16V (160.AV) 2.0 i.e. 16V Sport (160.EF)	57 51 55 66 45 48 66 107 102	05/89→04/95 05/89→04/95 10/92→04/95 05/89→10/95 01/88→10/95 07/91→08/95 09/90→04/95 07/91→04/95 03/93→04/95		→ 04/93; für Linkslenker; - ABS		24.2120-1710.3 010468	Ø 20,64
2.0 i.e. (160.AT, 160.AJ)	83	03/90→04/95		09/90→ 04/93; für Linkslenker; - ABS		24.2120-1710.3 010468	Ø 20,64
FIAT - ULYSSE (179_) 08/02→06/11							
 Hauptbremszylinder							
2.0 2.0 D Multijet 2.0 D Multijet 2.2 D Multijet 2.2 JTD	100 88 100 125 120	08/02→06/11 05/06→06/11 05/06→06/11 03/08→06/11 03/08→06/11		→ 01/11		03.2122-2163.3 010800	ATE Ø 22,2
2.0 JTD 2.0 JTD 2.2 JTD	79 80 94	05/03→08/06 08/02→08/06 08/02→08/06				03.2122-2163.3 010800	ATE Ø 22,2
FIAT - ULYSSE (220_) 06/94→08/02							
 Hauptbremszylinder							
1.8 (220.BB5) 1.9 TD (220AH5) 2.0 (220.AC5)	73 66 89	05/97→08/02 02/95→08/02 06/94→08/02		→ 04/99; - ABS 05/99→ 07/02; + ABS 05/99→ 07/02; - ABS		24.2123-1707.3 010492 24.2123-1733.3 010657 24.2123-1738.3 010658	Ø 23,81 BOS Ø 23,81 Ø 23,81
1.9 TD	68	05/97→12/99		→ 04/99; - ABS 05/99→; + ABS 05/99→; - ABS		24.2123-1707.3 010492 24.2123-1733.3 010657 24.2123-1738.3 010658	Ø 23,81 BOS Ø 23,81 Ø 23,81
2.0 16V 2.1 TD	97 80	05/98→09/00 03/96→10/99		05/99→		24.2123-1733.3 010657	BOS Ø 23,81
2.0 16V 2.0 JTD 2.0 JTD 16V	100 80 80	09/00→08/02 10/99→08/02 05/99→08/02		→ 07/02		24.2123-1733.3 010657	BOS Ø 23,81
2.0 Turbo (220.AD5)	108	06/94→08/02		05/99→ 07/02		24.2123-1733.3 010657	BOS Ø 23,81
FIAT - UNO (146_) 01/83→06/06							
 Hauptbremszylinder							
1.0 1.5 75 iE 1.6 R 1.7 D	42 56 66 43	05/93→06/01 01/94→10/95 12/92→12/95 11/94→08/00		→ 06/95		24.2120-0801.3 010362	Ø 20,64
1.1 1.5 SPI 70 i.e. 1.4	41 49 51	04/86→06/06 03/87→01/96 09/89→07/96		10/89→ 06/95		24.2120-0801.3 010362	Ø 20,64
45 i.e. 1.0	33	04/84→10/95		→ 12/85 10/89→ 06/95 01/86→ 09/89		24.2119-0826.3 010349 24.2120-0801.3 010362 24.2120-0801.3 010362	Ø 19,05 Ø 20,64 Ø 20,64
 Bremskraftregler							
1.0 1.4 Turbo i.e. 1.5 75 iE 1.7 D	42 87 56 43	05/93→06/01 12/89→12/96 01/94→10/95 11/94→08/00		→ 06/95		24.6513-0801.3 320117	lastabhängig 1/3 2x
1.1 1.5 SPI 70 i.e. 1.4	41 49 51	04/86→06/06 03/87→01/96 09/89→07/96		10/89→ 06/95		24.6513-0801.3 320117	lastabhängig 1/3 2x
45 i.e. 1.0	33	04/84→10/95		10/89→ 06/95 → 09/89		24.6513-0801.3 320117 24.6513-0801.3 320117	lastabhängig 1/3 2x lastabhängig 1/3 2x















	kw			 	! #		
FIAT - UNO Kasten (146_) 02/88→07/96							
 Hauptbremszylinder							
45 0.9	33	02/88→07/96		10/89→ 06/95		24.2120-0801.3 010362	Ø 20,64
 Bremskraftregler							
45 0.9	33	02/88→07/96		10/89→ 06/95		24.6513-0801.3 320117	lastabhängig 1/3 2x
FORD - C-MAX (DM2) 02/07→09/10							
 Bremskraftverstärker							
1.6	74	02/07→09/10		03/07→ 04/07		03.7863-0332.4 300203	ATE Ø 10" pneumatisch
1.6 TDCi	66	02/07→09/10		05/07→;	für Fahrzeuge mit Bremsassistent	03.7863-3932.4 300288	ATE Ø 10" pneumatisch
1.6 TDCi	74	02/07→09/10					
1.6 TDCi	80	02/07→09/10					
1.8	90	02/07→09/10					
1.8	92	02/07→09/10					
1.8 Flexifuel	92	02/07→09/10					
1.8 TDCi	85	02/07→09/10					
2.0	107	02/07→09/10					
2.0 TDCi	98	02/07→09/10					
2.0 TDCi	100	02/07→09/10					
1.6	85	04/07→09/10		→ 04/07		03.7863-0332.4 300203	ATE Ø 10" pneumatisch
				05/07→;	für Fahrzeuge mit Bremsassistent	03.7863-3932.4 300288	ATE Ø 10" pneumatisch
2.0 CNG	107	04/09→09/10			für Fahrzeuge mit Bremsassistent	03.7863-3932.4 300288	ATE Ø 10" pneumatisch
2.0 LPG	107	06/08→09/10					
2.0 TDCi	81	02/08→09/10					
 Hauptbremszylinder							
1.6	74	02/07→09/10		03/07→ 05/07		03.2123-3103.3 010781	ATE Ø 23,81
1.6 TDCi	66	02/07→09/10		06/07→ 10/08		03.2125-0483.3 010783	ATE Ø 25,4 ohne Bremsflüssigkeitsbehälter
1.6 TDCi	74	02/07→09/10			11/08→	03.2125-0661.3 010917	ATE Ø 25,4
1.6 TDCi	80	02/07→09/10					
1.8	90	02/07→09/10					
1.8	92	02/07→09/10					
1.8 Flexifuel	92	02/07→09/10					
1.8 TDCi	85	02/07→09/10					
2.0	107	02/07→09/10					
2.0 TDCi	98	02/07→09/10					
2.0 TDCi	100	02/07→09/10					
1.6	85	04/07→09/10		→ 05/07		03.2123-3103.3 010781	ATE Ø 23,81
				06/07→ 10/08		03.2125-0483.3 010783	ATE Ø 25,4 ohne Bremsflüssigkeitsbehälter
				11/08→		03.2125-0661.3 010917	ATE Ø 25,4
2.0 CNG	107	04/09→09/10				03.2125-0661.3 010917	ATE Ø 25,4
2.0 LPG	107	06/08→09/10		→ 10/08		03.2125-0483.3 010783	ATE Ø 25,4 ohne Bremsflüssigkeitsbehälter
2.0 TDCi	81	02/08→09/10				03.2125-0661.3 010917	ATE Ø 25,4
				11/08→		03.2125-0661.3 010917	ATE Ø 25,4
Hydraulikaggregat, Bremsanlage							
1.6	74	02/07→09/10		03/07→		24.9145-0004.2 399008	
1.6 TDCi	66	02/07→09/10					
1.6 TDCi	74	02/07→09/10					
1.6 TDCi	80	02/07→09/10					
1.8	90	02/07→09/10					
1.8	92	02/07→09/10					
1.8 Flexifuel	92	02/07→09/10					
1.8 TDCi	85	02/07→09/10					
2.0	107	02/07→09/10					
2.0 TDCi	98	02/07→09/10					
2.0 TDCi	100	02/07→09/10					
1.6	85	04/07→09/10				24.9145-0004.2 399008	
2.0 CNG	107	04/09→09/10					
2.0 LPG	107	06/08→09/10					
2.0 TDCi	81	02/08→09/10					
FORD - C-MAX II (DXA/CB7, DXA/CEU) 12/10→							
 Hauptbremszylinder							
1.0 EcoBoost	74	10/12→				03.4155-5451.3 010995	ATE Ø 25,4
1.0 EcoBoost	92	10/12→					
1.5 EcoBoost	110	03/15→					
1.5 EcoBoost	134	03/15→					
1.6 CNG	86	01/13→					
1.6 EcoBoost	110	12/10→					
1.6 EcoBoost	134	12/10→					
1.6 Flexifuel	88	02/11→					
1.6 LPG	86	02/12→					
1.6 LPG	88	02/12→					
1.6 TDCi	70	12/10→					
↓							









	kw					! #		
FORD - C-MAX II (DXA/CB7, DXA/CEU) 12/10→								
 Hauptbremszylinder								
1.6 TDCi	85	12/10→					03.4155-5451.3 010995	ATE Ø 25,4
1.6 Ti	63	12/10→						
1.6 Ti	77	12/10→						
1.6 Ti	88	02/12→						
1.6 Ti	92	12/10→						
2.0 TDCi	85	02/11→						
2.0 TDCi	100	02/11→						
2.0 TDCi	103	02/11→						
2.0 TDCi	110	03/15→						
2.0 TDCi	120	12/10→						
2.0 TDCi	125	03/15→						
FORD - C-MAX II Van 12/10→								
 Hauptbremszylinder								
1.0 EcoBoost	74	10/12→					03.4155-5451.3 010995	ATE Ø 25,4
1.0 EcoBoost	92	10/12→						
1.5 EcoBoost	110	03/15→						
1.5 EcoBoost	134	03/15→						
1.6 EcoBoost	110	12/10→						
1.6 TDCi	70	12/10→						
1.6 TDCi	85	12/10→						
2.0 TDCi	85	02/11→						
2.0 TDCi	103	02/11→						
2.0 TDCi	110	03/15→						
2.0 TDCi	120	12/10→						
2.0 TDCi	125	03/15→						
FORD - COUGAR (EC_) 08/98→12/01								
 Hauptbremszylinder								
2.0 16V	96	08/98→12/01		09/98→			24.2125-1709.3 010499	Ø 25,4
2.5 V6 24V	125	08/98→12/01						
2.5 ST 200	151	01/00→12/01					24.2125-1709.3 010499	Ø 25,4
2.5 V6 24V	125	06/00→12/01						
FORD - COURIER Kasten (F3L, F5L) 07/91→02/96								
 Hauptbremszylinder								
1.3	44	09/91→02/96		→ 01/94; - SCS			24.2120-1604.3 010370	Ø 20,64
1.8 D	44	09/91→02/96		02/94→; - SCS			24.2120-1758.3 011008	TRW Ø 20,64 ohne Bremsflüssigkeitsbehälter
				+ SCS			24.2122-1603.3 010381	Ø 22,2
FORD - COURIER Kasten (J5_, J3_) 02/96→								
 Bremskraftverstärker								
1.3	44	02/96→08/03		02/00→ 03/02; für Linkslenker; - ABS			03.7750-2332.4 300113	ATE Ø 9" pneumatisch
1.8 D	44	02/96→04/02						
1.8 DI	55	09/00→08/03		→ 03/02; für Linkslenker; - ABS			03.7750-2332.4 300113	ATE Ø 9" pneumatisch
 Hauptbremszylinder								
1.3	44	02/96→08/03		02/00→ 03/02; + ABS			03.2122-1564.3 010594	ATE Ø 22,2
1.8 D	44	02/96→04/02		02/00→ 03/02; - ABS			03.2122-1588.3 010733	ATE Ø 22,2 mit Druckregler
				→ 01/00; - ABS			24.2123-1737.3 010654	Ø 23,81
1.4 i	66	04/96→10/99		- ABS			24.2123-1735.3 010652	Ø 23,81
1.8 DI	55	09/00→08/03		→ 03/02; + ABS			03.2123-2243.3 010748	ATE Ø 23,81
				→ 03/02; - ABS			24.2122-1775.3 010981	Ø 22,2 ohne Bremsflüssigkeitsbehälter
FORD - ESCORT '95 Express (AVL) 01/95→06/01								
 Hauptbremszylinder								
1.4	54	01/95→08/00		08/95→ 02/99; + ABS			03.2123-1581.3 010487	Ø 23,81
1.8 D	44	01/95→08/00		02/95→ 02/99; - ABS			24.2123-1732.3 010625	Ø 23,81 ohne Bremsflüssigkeitsbehälter
1.8 TD	66	01/95→08/00		08/95→ 07/00; + ABS			03.2123-1581.3 010487	Ø 23,81
				02/95→ 02/99; - ABS			24.2123-1732.3 010625	Ø 23,81 ohne Bremsflüssigkeitsbehälter
1.8 Turbo D	51	12/95→06/01		→ 07/00; + ABS			03.2123-1581.3 010487	Ø 23,81
				→ 02/99; + ABS			03.2123-1581.3 010487	Ø 23,81
				→ 02/99; - ABS			24.2123-1732.3 010625	Ø 23,81 ohne Bremsflüssigkeitsbehälter











	kw			 	! #		
FORD - ESCORT VI (GAL) 09/92→09/96							
 Hauptbremszylinder							
1.3	44	09/92→01/95		- ABS		24.2123-1606.3 010386	Ø 23,81
1.4	52	09/92→01/95					
1.4	55	01/94→01/95					
1.6 i 16V	65	01/94→01/95					
1.6 i 16V	66	09/92→01/95					
1.8 D	44	09/92→01/95					
1.8 TD	66	02/93→01/95					
RS 2000	110	09/92→01/95					
RS 2000 4x4	110	08/93→01/95					
RS Cosworth 4x4	162	09/92→01/95					
FORD - ESCORT VI Cabriolet (ALL) 12/92→01/95							
 Hauptbremszylinder							
1.4 i	55	07/93→01/95		- ABS		24.2123-1606.3 010386	Ø 23,81
1.6 16V XR3i	66	12/92→01/95					
1.6 i 16V	65	02/94→01/95					
FORD - ESCORT VI Kombi (GAL) 09/92→01/95							
 Hauptbremszylinder							
1.3	44	09/92→01/95		- ABS		24.2123-1606.3 010386	Ø 23,81
1.4	52	09/92→01/95					
1.4	55	01/94→01/95					
1.6 i 16V	65	01/94→01/95					
1.6 i 16V	66	09/92→01/95					
1.8 D	44	09/92→01/95					
1.8 TD	66	02/93→01/95					
FORD - ESCORT VI Stufenheck (GAL) 08/93→01/95							
 Hauptbremszylinder							
1.3	44	08/93→01/95		- ABS		24.2123-1606.3 010386	Ø 23,81
1.4	55	08/93→01/95					
1.6 i 16V	65	01/94→01/95					
1.6 i 16V	66	08/93→01/95					
1.8 D	44	08/93→01/95					
1.8 TD	66	08/93→01/95					
FORD - ESCORT VII (GAL, AAL, ABL) 01/95→10/02							
 Hauptbremszylinder							
1.3	44	01/95→10/98		08/95→; + ABS		03.2123-1581.3 010487	Ø 23,81
1.4	55	01/95→10/98		02/95→; - ABS		24.2123-1732.3 010625	Ø 23,81 ohne Bremsflüssigkeitsbehälter
1.6 16V	66	01/95→10/98					
1.6 16V 4x4	66	01/95→10/98					
1.6 i 16V	65	01/95→08/95					
1.8 16V	77	01/95→08/95					
1.8 16V	85	01/95→10/98					
1.8 TD	66	01/95→10/98					
1.4	54	01/95→12/99		08/95→ 02/99; + ABS		03.2123-1581.3 010487	Ø 23,81
				02/95→ 02/99; - ABS		24.2123-1732.3 010625	Ø 23,81 ohne Bremsflüssigkeitsbehälter
1.8 D	44	01/95→12/96		08/95→; + ABS		03.2123-1581.3 010487	Ø 23,81
				→ 01/95; - ABS		24.2123-1606.3 010386	Ø 23,81
				02/95→; - ABS		24.2123-1732.3 010625	Ø 23,81 ohne Bremsflüssigkeitsbehälter
1.8 Turbo D	51	12/95→10/98		+ ABS		03.2123-1581.3 010487	Ø 23,81
				- ABS		24.2123-1732.3 010625	Ø 23,81 ohne Bremsflüssigkeitsbehälter
FORD - ESCORT VII Cabriolet (ALL) 02/95→08/00							
 Hauptbremszylinder							
1.4	55	02/95→08/98		08/95→; + ABS		03.2123-1581.3 010487	Ø 23,81
1.6 16V XR3i	65	02/95→12/96		- ABS		24.2123-1732.3 010625	Ø 23,81 ohne Bremsflüssigkeitsbehälter
1.6 16V XR3i	66	02/95→09/99		08/95→; + ABS		03.2123-1581.3 010487	Ø 23,81
				→ 02/99; - ABS		24.2123-1732.3 010625	Ø 23,81 ohne Bremsflüssigkeitsbehälter
1.8 16V XR3i	77	02/95→08/98		- ABS		24.2123-1732.3 010625	Ø 23,81 ohne Bremsflüssigkeitsbehälter
1.8 16V XR3i	85	10/95→08/98		+ ABS		03.2123-1581.3 010487	Ø 23,81
1.8 TD	66	09/95→08/98		- ABS		24.2123-1732.3 010625	Ø 23,81 ohne Bremsflüssigkeitsbehälter
1.8 Turbo D	51	10/96→08/99		+ ABS		03.2123-1581.3 010487	Ø 23,81
↓							







	kw					! #		
FORD - ESCORT VII Cabriolet (ALL) 02/95→08/00								
 Hauptbremszylinder								
1.8 Turbo D	51	10/96→08/99			→ 02/99; - ABS		24.2123-1732.3 010625	Ø 23,81 ohne Bremsflüssigkeitsbehälter
FORD - ESCORT VII Kombi (GAL, ANL) 01/95→10/02								
 Hauptbremszylinder								
1.3	44	01/95→01/99			08/95→; + ABS		03.2123-1581.3 010487	Ø 23,81
1.4	55	01/95→02/99						
1.6 16V	66	01/95→02/99			02/95→; - ABS		24.2123-1732.3 010625	Ø 23,81 ohne Bremsflüssigkeitsbehälter
1.6 i 16V	65	01/95→08/95						
1.8 16V	77	01/95→08/95						
1.8 16V	85	01/95→02/99						
1.8 D	44	01/95→02/99						
1.8 TD	66	01/95→02/99						
1.8 Turbo D	51	12/95→02/99			+ ABS		03.2123-1581.3 010487	Ø 23,81
					- ABS		24.2123-1732.3 010625	Ø 23,81 ohne Bremsflüssigkeitsbehälter
FORD - ESCORT VII Stufenheck (GAL, AFL) 01/95→08/02								
 Hauptbremszylinder								
1.3	44	01/95→02/99			08/95→; + ABS		03.2123-1581.3 010487	Ø 23,81
1.4	55	01/95→02/99						
1.6 i 16V	65	01/95→08/95			02/95→; - ABS		24.2123-1732.3 010625	Ø 23,81 ohne Bremsflüssigkeitsbehälter
1.6 i 16V	66	01/95→02/99						
1.8 16V	77	01/95→08/95						
1.8 16V	85	01/95→02/99						
1.8 TD	66	01/95→02/99						
1.8 D	44	01/95→12/96			08/95→; + ABS		03.2123-1581.3 010487	Ø 23,81
					→ 01/95; - ABS		24.2123-1606.3 010386	Ø 23,81
					02/95→; - ABS		24.2123-1732.3 010625	Ø 23,81 ohne Bremsflüssigkeitsbehälter
1.8 Turbo D	51	12/95→02/99			+ ABS		03.2123-1581.3 010487	Ø 23,81
					- ABS		24.2123-1732.3 010625	Ø 23,81 ohne Bremsflüssigkeitsbehälter
FORD - ESCORT CLASSIC (AAL, ABL) 10/98→07/00								
 Hauptbremszylinder								
1.6 16V	66	10/98→07/00			+ ABS		03.2123-1581.3 010487	Ø 23,81
1.8 TD	66	10/98→07/00			→ 02/99; - ABS		24.2123-1732.3 010625	Ø 23,81 ohne Bremsflüssigkeitsbehälter
FORD - ESCORT CLASSIC Turnier (ANL) 02/99→07/00								
 Hauptbremszylinder								
1.6 16V	66	02/99→07/00			+ ABS		03.2123-1581.3 010487	Ø 23,81
1.8 TD	66	02/99→07/00			→ 02/99; - ABS		24.2123-1732.3 010625	Ø 23,81 ohne Bremsflüssigkeitsbehälter
FORD - FIESTA III (GFJ) 01/89→01/97								
 Hauptbremszylinder								
1.0	33	03/89→12/95			+ SCS		24.2122-1603.3 010381	Ø 22,2
1.6 i 16V	65	01/94→12/95						
1.8 16V	77	02/92→12/95						
1.8 XR2i 16V	96	02/92→12/95						
1.1	37	03/89→12/95			05/91→ 01/94; - SCS		24.2120-1604.3 010370	Ø 20,64
1.1	40	03/89→12/95			05/89→ 04/91; - SCS		24.2120-1739.3 010762	TRW Ø 20,64 ohne Bremsflüssigkeitsbehälter
1.8 D	44	03/89→12/95						
					02/94→; - SCS		24.2120-1758.3 011008	TRW Ø 20,64 ohne Bremsflüssigkeitsbehälter
					05/89→; + SCS		24.2122-1603.3 010381	Ø 22,2
1.3	44	03/89→12/95			05/91→ 01/94; - SCS		24.2120-1604.3 010370	Ø 20,64
1.4	52	03/89→12/95			→ 04/91; - SCS		24.2120-1739.3 010762	TRW Ø 20,64 ohne Bremsflüssigkeitsbehälter
1.4	54	03/89→12/95						
1.4 Cat	54	03/89→12/95			02/94→; - SCS		24.2120-1758.3 011008	TRW Ø 20,64 ohne Bremsflüssigkeitsbehälter
					+ SCS		24.2122-1603.3 010381	Ø 22,2
1.3 Cat	44	05/91→01/97			→ 01/94; - SCS		24.2120-1604.3 010370	Ø 20,64
1.4	55	11/92→12/96			02/94→ 11/96; - SCS		24.2120-1758.3 011008	TRW Ø 20,64 ohne Bremsflüssigkeitsbehälter
					→ 11/96; + SCS		24.2122-1603.3 010381	Ø 22,2
↓								

	kw			 	! #		
FORD - FIESTA III (GFJ) 01/89→01/97							
 Hauptbremszylinder							
1.8 TD	55	03/93→12/95		→ 01/94; - SCS		24.2120-1604.3 010370	Ø 20,64
				02/94→; - SCS		24.2120-1758.3 011008	TRW Ø 20,64 ohne Bremsflüssigkeitsbehälter
				+ SCS		24.2122-1603.3 010381	Ø 22,2
FORD - FIESTA IV (JA_, JB_) 08/95→09/02							
 Bremskraftverstärker							
1.0 i	48	09/99→01/02		02/00→; für Linkslenker; - ABS		03.7750-2332.4 300113	ATE Ø 9" pneumatisch
1.25 i 16V	55	08/95→01/02					
1.3 i	37	08/95→01/02					
1.3 i	44	08/95→01/02					
1.4 i 16V	66	04/96→01/02					
1.8 D	44	08/95→04/00					
1.6	65	02/00→01/02		für Linkslenker; - ABS		03.7750-2332.4 300113	ATE Ø 9" pneumatisch
1.6 16V Sport	76	02/00→01/02					
1.8 DI	55	04/00→01/02					
 Hauptbremszylinder							
1.0 i	38	02/97→09/99		- ABS		24.2122-1775.3 010981	Ø 22,2 ohne Bremsflüssigkeitsbehälter
1.3	42	04/96→08/99					
1.3 i	44	04/96→08/99					
1.0 i	48	09/99→01/02		02/00→; - ABS		03.2122-1588.3 010733	ATE Ø 22,2 mit Druckregler
				02/00→; + ABS		03.2123-2243.3 010748	ATE Ø 23,81
				→ 01/00; - ABS		24.2122-1775.3 010981	Ø 22,2 ohne Bremsflüssigkeitsbehälter
1.25 i 16V	55	08/95→01/02		02/00→; - ABS		03.2122-1588.3 010733	ATE Ø 22,2 mit Druckregler
				02/00→; + ABS		03.2123-2243.3 010748	ATE Ø 23,81
				01/96→ 01/00; Schaltgetriebe; - ABS		24.2122-1775.3 010981	Ø 22,2 ohne Bremsflüssigkeitsbehälter
				01/96→ 01/00; Vollautomatik; - ABS		24.2123-1735.3 010652	Ø 23,81
1.3 i	37	08/95→01/02		02/00→; + ABS		03.2123-2243.3 010748	ATE Ø 23,81
1.3 i	44	08/95→01/02					
1.8 D	44	08/95→04/00		01/96→; - ABS		24.2122-1775.3 010981	Ø 22,2 ohne Bremsflüssigkeitsbehälter
1.4 i 16V	66	04/96→01/02		02/00→; + ABS		03.2123-2243.3 010748	ATE Ø 23,81
				- ABS		24.2123-1735.3 010652	Ø 23,81
1.6	65	02/00→01/02		+ ABS		03.2123-2243.3 010748	ATE Ø 23,81
1.6 16V Sport	76	02/00→01/02		- ABS		24.2123-1735.3 010652	Ø 23,81
1.8 DI	55	04/00→01/02		+ ABS		03.2123-2243.3 010748	ATE Ø 23,81
				- ABS		24.2122-1775.3 010981	Ø 22,2 ohne Bremsflüssigkeitsbehälter
FORD - FIESTA V (JH_, JD_) 11/01→03/10							
 Bremskraftverstärker							
1.25 16V	51	03/03→06/08		für Fahrzeuge ohne Bremsassistent		03.7750-8732.4 300199	ATE Ø 9" pneumatisch
1.25 16V	55	05/02→06/08		für Fahrzeuge mit Bremsassistent		03.7853-2102.4 300201	ATE Ø 9" pneumatisch
1.6 TDCi	66	11/04→06/08					
1.3	44	11/01→06/08		04/02→;		03.7750-8732.4 300199	ATE Ø 9" pneumatisch
1.3	51	11/01→06/08		für Fahrzeuge ohne Bremsassistent			
1.4 16V	59	11/01→06/08					
1.4 TDCi	50	11/01→06/08		04/02→;		03.7853-2102.4 300201	ATE Ø 9" pneumatisch
1.6 16V	74	11/01→06/08		für Fahrzeuge mit Bremsassistent			
 Hauptbremszylinder							
1.25 16V	51	03/03→06/08		für Linkslenker; - ABS		03.4153-0015.3 011005	ATE Ø 23,81 ohne Bremsflüssigkeitsbehälter
1.25 16V	55	05/02→06/08					
1.6 TDCi	66	11/04→06/08		für Linkslenker; + ABS		03.4153-5287.4 010953	ATE Ø 23,81 mit Bremsflüssigkeitsbehälter
1.3	44	11/01→06/08		04/02→; für Linkslenker; - ABS		03.4153-0015.3 011005	ATE Ø 23,81 ohne Bremsflüssigkeitsbehälter
1.3	51	11/01→06/08					
1.4 16V	59	11/01→06/08					
1.4 TDCi	50	11/01→06/08		04/02→; für Linkslenker; + ABS		03.4153-5287.4 010953	ATE Ø 23,81 mit Bremsflüssigkeitsbehälter
1.6 16V	74	11/01→06/08					
FORD - FIESTA V Van 10/03→12/10							
 Bremskraftverstärker							
1.3	51	10/03→07/05		für Fahrzeuge ohne Bremsassistent		03.7750-8732.4 300199	ATE Ø 9" pneumatisch
				für Fahrzeuge mit Bremsassistent		03.7853-2102.4 300201	ATE Ø 9" pneumatisch
1.4 TDCi	50	10/03→12/10		→ 08/08;		03.7750-8732.4 300199	ATE Ø 9" pneumatisch
1.6 TDCi	66	04/07→09/09		für Fahrzeuge ohne Bremsassistent			
↓							







	kw			 	! #		
FORD - FIESTA V Van 10/03→12/10							
 Bremskraftverstärker							
1.4 TDCi 1.6 TDCi	50 66	10/03→12/10 04/07→09/09		→ 08/08; für Fahrzeuge mit Bremsassistent		03.7853-2102.4 300201	ATE Ø 9" pneumatisch
 Hauptbremszylinder							
1.3	51	10/03→07/05		für Linkslenker; - ABS		03.4153-0015.3 011005	ATE Ø 23,81 ohne Bremsflüssigkeitsbehälter
				für Linkslenker; + ABS		03.4153-5287.4 010953	ATE Ø 23,81 mit Bremsflüssigkeitsbehälter
1.4 TDCi 1.6 TDCi	50 66	10/03→12/10 04/07→09/09		→ 08/08; für Linkslenker; - ABS		03.4153-0015.3 011005	ATE Ø 23,81 ohne Bremsflüssigkeitsbehälter
				→ 08/08; für Linkslenker; + ABS		03.4153-5287.4 010953	ATE Ø 23,81 mit Bremsflüssigkeitsbehälter
FORD - FIESTA Kasten (FVD) 03/83→12/95							
 Hauptbremszylinder							
1.8 D (FVJ)	43	03/89→12/95		09/91→ 01/94; - SCS		24.2120-1604.3 010370	Ø 20,64
				02/94→; - SCS		24.2120-1758.3 011008	TRW Ø 20,64 ohne Bremsflüssigkeitsbehälter
				09/91→; + SCS		24.2122-1603.3 010381	Ø 22,2
FORD - FIESTA Kasten (JV_) 05/98→08/03							
 Bremskraftverstärker							
D 1.8	44	05/98→04/02		02/00→ 03/02; für Linkslenker; - ABS		03.7750-2332.4 300113	ATE Ø 9" pneumatisch
 Hauptbremszylinder							
D 1.8	44	05/98→04/02		02/00→ 03/02; + ABS		03.2122-1564.3 010594	ATE Ø 22,2
				02/00→ 03/02; - ABS		03.2122-1588.3 010733	ATE Ø 22,2 mit Druckregler
				→ 01/00; - ABS		24.2123-1737.3 010654	Ø 23,81
TD 1.8	55	03/00→08/03		→ 03/02; + ABS		03.2122-1564.3 010594	ATE Ø 22,2
				→ 03/02; - ABS		03.2122-1588.3 010733	ATE Ø 22,2 mit Druckregler
FORD - FOCUS (DAW, DBW) 10/98→12/07							
 Hauptbremszylinder							
1.4 16V 1.6 16V 1.8 16V	55 74 85	10/98→11/04 10/98→11/04 10/98→11/04		11/01→ 09/04; + ESP		03.4123-0153.3 010659	ATE Ø 23,81
1.8 DI / TDDi 1.8 TDCi 1.8 Turbo DI / TDDi 2.0 16V	55 85 66 96	08/99→11/04 03/01→11/04 10/98→11/04 10/98→11/04		→ 09/04; + ABS		24.4123-1713.3 010905	BOS Ø 23,81 ohne Bremsflüssigkeitsbehälter
1.6 16V Flexifuel 1.8 TDCi	75 74	01/02→11/04 08/02→11/04		→ 09/04; + ESP		03.4123-0153.3 010659	ATE Ø 23,81
				→ 09/04; + ABS		24.4123-1713.3 010905	BOS Ø 23,81 ohne Bremsflüssigkeitsbehälter
FORD - FOCUS II (DA_) 07/04→09/12							
 Bremskraftverstärker							
1.4 1.6 1.6 TDCi 1.6 TDCi 1.6 Ti 2.0 2.0 TDCi	59 74 74 80 85 107 100	07/04→09/12 07/04→09/12 07/04→09/12 07/04→09/12 07/04→09/12 07/04→09/12 07/04→09/12		05/07→ 02/11; + ABS / für Fahrzeuge ohne Bremsassistent		03.7760-2232.4 300266	ATE Ø 10" pneumatisch
				10/04→ 02/11; - ABS / für Fahrzeuge ohne Bremsassistent		03.7760-2332.4 300267	ATE Ø 10" pneumatisch
				10/04→ 04/07; + ABS / für Fahrzeuge ohne Bremsassistent		03.7760-8103.4 300240	ATE Ø 10" pneumatisch
				10/04→ 04/07; + ABS / für Fahrzeuge mit Bremsassistent		03.7863-0332.4 300203	ATE Ø 10" pneumatisch
				05/07→ 02/11; + ABS / für Fahrzeuge mit Bremsassistent		03.7863-3932.4 300288	ATE Ø 10" pneumatisch
1.6 LPG 2.0 2.0 CNG 2.0 LPG 2.0 TDCi	85 105 107 107 81	10/09→07/11 04/10→09/12 04/09→07/11 06/08→07/11 02/08→07/11		→ 02/11; + ABS / für Fahrzeuge ohne Bremsassistent		03.7760-2232.4 300266	ATE Ø 10" pneumatisch
				→ 02/11; - ABS / für Fahrzeuge ohne Bremsassistent		03.7760-2332.4 300267	ATE Ø 10" pneumatisch
				→ 02/11; + ABS / für Fahrzeuge mit Bremsassistent		03.7863-3932.4 300288	ATE Ø 10" pneumatisch
↓							







	kw			 	! #			
FORD - FOCUS II (DA_) 07/04→09/12								
 Bremskraftverstärker								
1.6 TDCi 1.8 1.8 Flexifuel 1.8 TDCi	66 92 92 85	01/05→09/12 03/06→09/12 01/06→09/12 01/05→09/12		05/07→ 02/11; + ABS / für Fahrzeuge ohne Bremsassistent → 02/11; - ABS / für Fahrzeuge ohne Bremsassistent → 04/07; + ABS / für Fahrzeuge ohne Bremsassistent → 04/07; + ABS / für Fahrzeuge mit Bremsassistent 05/07→ 02/11; + ABS / für Fahrzeuge mit Bremsassistent		03.7760-2232.4 03.7760-2332.4 03.7760-8103.4 03.7863-0332.4 03.7863-3932.4	300266 300267 300240 300203 300288	ATE Ø 10" pneumatisch ATE Ø 10" pneumatisch ATE Ø 10" pneumatisch ATE Ø 10" pneumatisch ATE Ø 10" pneumatisch
2.0	104	06/05→09/08		05/07→; + ABS / für Fahrzeuge ohne Bremsassistent - ABS / für Fahrzeuge ohne Bremsassistent → 04/07; + ABS / für Fahrzeuge ohne Bremsassistent → 04/07; + ABS / für Fahrzeuge mit Bremsassistent 05/07→; + ABS / für Fahrzeuge mit Bremsassistent		03.7760-2232.4 03.7760-2332.4 03.7760-8103.4 03.7863-0332.4 03.7863-3932.4	300266 300267 300240 300203 300288	ATE Ø 10" pneumatisch ATE Ø 10" pneumatisch ATE Ø 10" pneumatisch ATE Ø 10" pneumatisch ATE Ø 10" pneumatisch
2.0 TDCi	98	07/04→01/08		05/07→; + ABS / für Fahrzeuge ohne Bremsassistent 10/04→; - ABS / für Fahrzeuge ohne Bremsassistent 10/04→ 04/07; + ABS / für Fahrzeuge ohne Bremsassistent 10/04→ 04/07; + ABS / für Fahrzeuge mit Bremsassistent 05/07→; + ABS / für Fahrzeuge mit Bremsassistent		03.7760-2232.4 03.7760-2332.4 03.7760-8103.4 03.7863-0332.4 03.7863-3932.4	300266 300267 300240 300203 300288	ATE Ø 10" pneumatisch ATE Ø 10" pneumatisch ATE Ø 10" pneumatisch ATE Ø 10" pneumatisch ATE Ø 10" pneumatisch
2.5 RS 2.5 RS 500	224 257	01/09→07/11 05/10→07/11		für Linkslenker; → 02/11		03.7755-3532.4	300290	ATE Ø 9 / 8" pneumatisch
 Hauptbremszylinder								
1.4 1.6 1.6 TDCi 1.6 TDCi 1.6 Ti 2.0 2.0 TDCi	59 74 74 80 85 107 100	07/04→09/12 07/04→09/12 07/04→09/12 07/04→09/12 07/04→09/12 07/04→09/12 07/04→09/12		10/04→ 02/11; - ABS 10/04→ 04/07; + ABS 05/07→ 10/08; + ABS 11/08→ 02/11; + ABS		03.2123-3041.3 03.2123-3103.3 03.2125-0483.3 03.2125-0661.3	010887 010781 010783 010917	ATE Ø 23,81 ohne Bremsflüssigkeitsbehälter / mit Druckregler ATE Ø 23,81 ATE Ø 25,4 ohne Bremsflüssigkeitsbehälter ATE Ø 25,4
1.6 LPG 2.0 2.0 CNG	85 105 107	10/09→07/11 04/10→09/12 04/09→07/11		→ 02/11; - ABS → 02/11; + ABS		03.2123-3041.3 03.2125-0661.3	010887 010917	ATE Ø 23,81 ohne Bremsflüssigkeitsbehälter / mit Druckregler ATE Ø 25,4
1.6 TDCi 1.8 1.8 Flexifuel 1.8 TDCi 2.5 ST	66 92 92 85 166	01/05→09/12 03/06→09/12 01/06→09/12 01/05→09/12 10/05→09/12		→ 02/11; - ABS → 04/07; + ABS 05/07→ 10/08; + ABS 11/08→ 02/11; + ABS		03.2123-3041.3 03.2123-3103.3 03.2125-0483.3 03.2125-0661.3	010887 010781 010783 010917	ATE Ø 23,81 ohne Bremsflüssigkeitsbehälter / mit Druckregler ATE Ø 23,81 ATE Ø 25,4 ohne Bremsflüssigkeitsbehälter ATE Ø 25,4
2.0	104	06/05→09/08		- ABS → 04/07; + ABS 05/07→; + ABS		03.2123-3041.3 03.2123-3103.3 03.2125-0483.3	010887 010781 010783	ATE Ø 23,81 ohne Bremsflüssigkeitsbehälter / mit Druckregler ATE Ø 23,81 ATE Ø 25,4 ohne Bremsflüssigkeitsbehälter
↓								











	kw			 	! #		
FORD - FOCUS II (DA_) 07/04→09/12							
 Hauptbremszylinder							
2.0 LPG 2.0 TDCi	107 81	06/08→07/11 02/08→07/11		→ 02/11; - ABS		03.2123-3041.3 010887	ATE Ø 23,81 ohne Bremsflüssigkeitsbehälter / mit Druckregler
				→ 10/08; + ABS		03.2125-0483.3 010783	ATE Ø 25,4 ohne Bremsflüssigkeitsbehälter
				11/08→ 02/11; + ABS		03.2125-0661.3 010917	ATE Ø 25,4
2.0 TDCi	98	07/04→01/08		10/04→; - ABS		03.2123-3041.3 010887	ATE Ø 23,81 ohne Bremsflüssigkeitsbehälter / mit Druckregler
				10/04→ 04/07; + ABS		03.2123-3103.3 010781	ATE Ø 23,81
				05/07→; + ABS		03.2125-0483.3 010783	ATE Ø 25,4 ohne Bremsflüssigkeitsbehälter
2.5 RS 2.5 RS 500	224 257	01/09→07/11 05/10→07/11		für Linkslenker; → 02/11		03.2125-0651.3 010935	ATE Ø 25,4
Hydraulikaggregat, Bremsanlage							
1.4 1.6 1.6 TDCi 1.6 TDCi 1.6 Ti 2.0 2.0 TDCi	59 74 74 80 85 107 100	07/04→09/12 07/04→09/12 07/04→09/12 07/04→09/12 07/04→09/12 07/04→09/12 07/04→09/12		10/04→ 02/11		24.9145-0004.2 399008	
1.6 LPG 1.6 TDCi 1.8 1.8 Flexifuel 1.8 TDCi 2.0 2.0 CNG 2.0 LPG 2.0 TDCi 2.5 ST 2.0	85 66 92 92 85 105 107 107 81 166 104	10/09→07/11 01/05→09/12 03/06→09/12 01/06→09/12 01/05→09/12 04/10→09/12 04/09→07/11 06/08→07/11 02/08→07/11 10/05→09/12 06/05→09/08		→ 02/11		24.9145-0004.2 399008	
2.0 TDCi	98	07/04→01/08		10/04→		24.9145-0004.2 399008	
FORD - FOCUS II Cabriolet 10/06→09/10							
 Bremskraftverstärker							
1.6 2.0 2.0 TDCi	74 107 100	10/06→09/10 10/06→09/10 10/06→09/10		05/07→; + ABS / für Fahrzeuge ohne Bremsassis- tent		03.7760-2232.4 300266	ATE Ø 10" pneumatisch
				- ABS / für Fahrzeuge ohne Bremsassis- tent		03.7760-2332.4 300267	ATE Ø 10" pneumatisch
				→ 04/07; + ABS / für Fahrzeuge ohne Bremsassis- tent		03.7760-8103.4 300240	ATE Ø 10" pneumatisch
				→ 04/07; + ABS / für Fahrzeuge mit Bremsassis- tent		03.7863-0332.4 300203	ATE Ø 10" pneumatisch
				05/07→; + ABS / für Fahrzeuge mit Bremsassis- tent		03.7863-3932.4 300288	ATE Ø 10" pneumatisch
 Hauptbremszylinder							
1.6 2.0 2.0 TDCi	74 107 100	10/06→09/10 10/06→09/10 10/06→09/10		- ABS		03.2123-3041.3 010887	ATE Ø 23,81 ohne Bremsflüssigkeitsbehälter / mit Druckregler
				→ 04/07; + ABS		03.2123-3103.3 010781	ATE Ø 23,81
				05/07→ 10/08; + ABS		03.2125-0483.3 010783	ATE Ø 25,4 ohne Bremsflüssigkeitsbehälter
				11/08→; + ABS		03.2125-0661.3 010917	ATE Ø 25,4
Hydraulikaggregat, Bremsanlage							
1.6 2.0 2.0 TDCi	74 107 100	10/06→09/10 10/06→09/10 10/06→09/10				24.9145-0004.2 399008	
FORD - FOCUS II Kombi (DA_) 07/04→09/12							
 Bremskraftverstärker							
1.4 1.6 1.6 TDCi 1.6 TDCi 1.6 Ti ↓	59 74 74 80 85	07/04→09/12 07/04→07/11 07/04→09/12 07/04→09/12 07/04→09/12		05/07→ 02/11; + ABS / für Fahrzeuge ohne Bremsassis- tent		03.7760-2232.4 300266	ATE Ø 10" pneumatisch











	kw			 	! #		
FORD - FOCUS II Kombi (DA_) 07/04→09/12							
Bremskraftverstärker							
2.0 2.0 TDCi	107 100	07/04→09/12 07/04→09/12	10/04→ 02/11; - ABS / für Fahrzeuge ohne Bremsassistent	03.7760-2332.4	300267	ATE Ø 10" pneumatisch	
			10/04→ 04/07; + ABS / für Fahrzeuge ohne Bremsassistent	03.7760-8103.4	300240	ATE Ø 10" pneumatisch	
			10/04→ 04/07; + ABS / für Fahrzeuge mit Bremsassistent	03.7863-0332.4	300203	ATE Ø 10" pneumatisch	
			05/07→ 02/11; + ABS / für Fahrzeuge mit Bremsassistent	03.7863-3932.4	300288	ATE Ø 10" pneumatisch	
1.6 LPG 1.6 TDCi 2.0 LPG 2.0 TDCi	85 81 107 81	10/09→09/12 12/07→09/12 06/08→07/11 02/08→07/11	→ 02/11; + ABS / für Fahrzeuge ohne Bremsassistent	03.7760-2232.4	300266	ATE Ø 10" pneumatisch	
			→ 02/11; - ABS / für Fahrzeuge ohne Bremsassistent	03.7760-2332.4	300267	ATE Ø 10" pneumatisch	
			→ 02/11; + ABS / für Fahrzeuge mit Bremsassistent	03.7863-3932.4	300288	ATE Ø 10" pneumatisch	
1.6 TDCi 1.8 TDCi	66 85	07/04→09/12 07/04→09/12	05/07→ 02/11; + ABS / für Fahrzeuge ohne Bremsassistent	03.7760-2232.4	300266	ATE Ø 10" pneumatisch	
			01/05→ 02/11; - ABS / für Fahrzeuge ohne Bremsassistent	03.7760-2332.4	300267	ATE Ø 10" pneumatisch	
			01/05→ 04/07; + ABS / für Fahrzeuge ohne Bremsassistent	03.7760-8103.4	300240	ATE Ø 10" pneumatisch	
			01/05→ 04/07; + ABS / für Fahrzeuge mit Bremsassistent	03.7863-0332.4	300203	ATE Ø 10" pneumatisch	
			05/07→ 02/11; + ABS / für Fahrzeuge mit Bremsassistent	03.7863-3932.4	300288	ATE Ø 10" pneumatisch	
1.8 1.8 Flexifuel	92 92	03/06→09/12 01/06→09/12	05/07→ 02/11; + ABS / für Fahrzeuge ohne Bremsassistent	03.7760-2232.4	300266	ATE Ø 10" pneumatisch	
			→ 02/11; - ABS / für Fahrzeuge ohne Bremsassistent	03.7760-2332.4	300267	ATE Ø 10" pneumatisch	
			→ 04/07; + ABS / für Fahrzeuge ohne Bremsassistent	03.7760-8103.4	300240	ATE Ø 10" pneumatisch	
			→ 04/07; + ABS / für Fahrzeuge mit Bremsassistent	03.7863-0332.4	300203	ATE Ø 10" pneumatisch	
			05/07→ 02/11; + ABS / für Fahrzeuge mit Bremsassistent	03.7863-3932.4	300288	ATE Ø 10" pneumatisch	
1.8 Flexifuel	97	12/05→01/08	05/07→; + ABS / für Fahrzeuge ohne Bremsassistent	03.7760-2232.4	300266	ATE Ø 10" pneumatisch	
			01/06→; - ABS / für Fahrzeuge ohne Bremsassistent	03.7760-2332.4	300267	ATE Ø 10" pneumatisch	
			01/06→ 04/07; + ABS / für Fahrzeuge ohne Bremsassistent	03.7760-8103.4	300240	ATE Ø 10" pneumatisch	
			01/06→ 04/07; + ABS / für Fahrzeuge mit Bremsassistent	03.7863-0332.4	300203	ATE Ø 10" pneumatisch	
			05/07→; + ABS / für Fahrzeuge mit Bremsassistent	03.7863-3932.4	300288	ATE Ø 10" pneumatisch	
2.0 TDCi	98	07/04→01/08	05/07→; + ABS / für Fahrzeuge ohne Bremsassistent	03.7760-2232.4	300266	ATE Ø 10" pneumatisch	
			10/04→; - ABS / für Fahrzeuge ohne Bremsassistent	03.7760-2332.4	300267	ATE Ø 10" pneumatisch	
			10/04→ 04/07; + ABS / für Fahrzeuge ohne Bremsassistent	03.7760-8103.4	300240	ATE Ø 10" pneumatisch	
			10/04→ 04/07; + ABS / für Fahrzeuge mit Bremsassistent	03.7863-0332.4	300203	ATE Ø 10" pneumatisch	

























	kW			 	! #		
FORD - FOCUS II Kombi (DA_) 07/04→09/12							
Bremskraftverstärker							
2.0 TDCi	98	07/04→01/08		05/07→; + ABS / für Fahrzeuge mit Bremsassistent		03.7863-3932.4 300288	ATE Ø 10" pneumatisch
Hauptbremszylinder							
1.4 1.6 1.6 TDCi 1.6 TDCi 1.6 Ti 2.0 2.0 TDCi	59 74 74 80 85 107 100	07/04→09/12 07/04→07/11 07/04→09/12 07/04→09/12 07/04→09/12 07/04→09/12 07/04→09/12		10/04→ 02/11; - ABS		03.2123-3041.3 010887	ATE Ø 23,81 ohne Bremsflüssigkeitsbehälter / mit Druckregler
				10/04→ 04/07; + ABS		03.2123-3103.3 010781	ATE Ø 23,81
				05/07→ 10/08; + ABS		03.2125-0483.3 010783	ATE Ø 25,4 ohne Bremsflüssigkeitsbehälter
				11/08→ 02/11; + ABS		03.2125-0661.3 010917	ATE Ø 25,4
1.6 LPG	85	10/09→09/12		→ 02/11; - ABS		03.2123-3041.3 010887	ATE Ø 23,81 ohne Bremsflüssigkeitsbehälter / mit Druckregler
				→ 02/11; + ABS		03.2125-0661.3 010917	ATE Ø 25,4
1.6 TDCi 1.8 TDCi	66 85	07/04→09/12 07/04→09/12		01/05→ 02/11; - ABS		03.2123-3041.3 010887	ATE Ø 23,81 ohne Bremsflüssigkeitsbehälter / mit Druckregler
				01/05→ 04/07; + ABS		03.2123-3103.3 010781	ATE Ø 23,81
				05/07→ 10/08; + ABS		03.2125-0483.3 010783	ATE Ø 25,4 ohne Bremsflüssigkeitsbehälter
				11/08→ 02/11; + ABS		03.2125-0661.3 010917	ATE Ø 25,4
1.6 TDCi 2.0 LPG 2.0 TDCi	81 107 81	12/07→09/12 06/08→07/11 02/08→07/11		→ 02/11; - ABS		03.2123-3041.3 010887	ATE Ø 23,81 ohne Bremsflüssigkeitsbehälter / mit Druckregler
				→ 10/08; + ABS		03.2125-0483.3 010783	ATE Ø 25,4 ohne Bremsflüssigkeitsbehälter
				11/08→ 02/11; + ABS		03.2125-0661.3 010917	ATE Ø 25,4
1.8 1.8 Flexifuel	92 92	03/06→09/12 01/06→09/12		→ 02/11; - ABS		03.2123-3041.3 010887	ATE Ø 23,81 ohne Bremsflüssigkeitsbehälter / mit Druckregler
				→ 04/07; + ABS		03.2123-3103.3 010781	ATE Ø 23,81
				05/07→ 10/08; + ABS		03.2125-0483.3 010783	ATE Ø 25,4 ohne Bremsflüssigkeitsbehälter
				11/08→ 02/11; + ABS		03.2125-0661.3 010917	ATE Ø 25,4
1.8 Flexifuel	97	12/05→01/08		01/06→; - ABS		03.2123-3041.3 010887	ATE Ø 23,81 ohne Bremsflüssigkeitsbehälter / mit Druckregler
				01/06→ 04/07; + ABS		03.2123-3103.3 010781	ATE Ø 23,81
				05/07→; + ABS		03.2125-0483.3 010783	ATE Ø 25,4 ohne Bremsflüssigkeitsbehälter
2.0 TDCi	98	07/04→01/08		10/04→; - ABS		03.2123-3041.3 010887	ATE Ø 23,81 ohne Bremsflüssigkeitsbehälter / mit Druckregler
				10/04→ 04/07; + ABS		03.2123-3103.3 010781	ATE Ø 23,81
				05/07→; + ABS		03.2125-0483.3 010783	ATE Ø 25,4 ohne Bremsflüssigkeitsbehälter
Hydraulikaggregat, Bremsanlage							
1.4 1.6 1.6 TDCi 1.6 TDCi 1.6 Ti 2.0 2.0 TDCi	59 74 74 80 85 107 100	07/04→09/12 07/04→07/11 07/04→09/12 07/04→09/12 07/04→09/12 07/04→09/12 07/04→09/12		10/04→ 02/11		24.9145-0004.2 399008	
1.6 LPG 1.6 TDCi 1.8 1.8 Flexifuel 2.0 LPG 2.0 TDCi	85 81 92 92 107 81	10/09→09/12 12/07→09/12 03/06→09/12 01/06→09/12 06/08→07/11 02/08→07/11		→ 02/11		24.9145-0004.2 399008	
1.6 TDCi 1.8 TDCi	66 85	07/04→09/12 07/04→09/12		01/05→ 02/11		24.9145-0004.2 399008	
1.8 Flexifuel	97	12/05→01/08		01/06→		24.9145-0004.2 399008	
2.0 TDCi	98	07/04→01/08		10/04→		24.9145-0004.2 399008	













	kw			 	! #		
FORD - FOCUS II Stufenheck (DA_) 04/05→							
Bremskraftverstärker							
1.4	59	04/05→09/12		05/07→ 02/11; + ABS / für Fahrzeuge ohne Bremsassistent	03.7760-2232.4	300266	ATE Ø 10" pneumatisch
1.6	74	04/05→09/12					
1.6 TDCi	66	04/05→09/12					
1.6 TDCi	74	04/05→09/12		→ 02/11;	03.7760-2332.4	300267	ATE Ø 10" pneumatisch
1.6 TDCi	80	04/05→09/12		- ABS / für Fahrzeuge ohne Bremsassistent			
1.6 Ti	85	04/05→09/12					
1.8	92	03/06→09/12					
1.8 Flexifuel	92	06/06→07/11		→ 04/07;	03.7760-8103.4	300240	ATE Ø 10" pneumatisch
1.8 TDCi	85	04/05→09/12		+ ABS / für Fahrzeuge ohne Bremsassistent			
2.0	107	04/05→07/11					
2.0 TDCi	100	04/05→09/12		→ 04/07;	03.7863-0332.4	300203	ATE Ø 10" pneumatisch
				+ ABS / für Fahrzeuge mit Bremsassistent			
				05/07→ 02/11; + ABS / für Fahrzeuge mit Bremsassistent	03.7863-3932.4	300288	ATE Ø 10" pneumatisch
1.8 Flexifuel	96	12/05→01/08		05/07→;	03.7760-2232.4	300266	ATE Ø 10" pneumatisch
				+ ABS / für Fahrzeuge ohne Bremsassistent			
				01/06→;	03.7760-2332.4	300267	ATE Ø 10" pneumatisch
				- ABS / für Fahrzeuge ohne Bremsassistent			
				01/06→ 04/07;	03.7760-8103.4	300240	ATE Ø 10" pneumatisch
				+ ABS / für Fahrzeuge ohne Bremsassistent			
				01/06→ 04/07;	03.7863-0332.4	300203	ATE Ø 10" pneumatisch
				+ ABS / für Fahrzeuge mit Bremsassistent			
				05/07→;	03.7863-3932.4	300288	ATE Ø 10" pneumatisch
				+ ABS / für Fahrzeuge mit Bremsassistent			
2.0	104	02/08→		→ 02/11;	03.7760-2232.4	300266	ATE Ø 10" pneumatisch
2.0 TDCi	81	02/08→07/11		+ ABS / für Fahrzeuge ohne Bremsassistent			
				→ 02/11;	03.7760-2332.4	300267	ATE Ø 10" pneumatisch
				- ABS / für Fahrzeuge ohne Bremsassistent			
				→ 02/11;	03.7863-3932.4	300288	ATE Ø 10" pneumatisch
				+ ABS / für Fahrzeuge mit Bremsassistent			
Hauptbremszylinder							
1.4	59	04/05→09/12		→ 02/11; - ABS	03.2123-3041.3	010887	ATE Ø 23,81 ohne Bremsflüssigkeitsbehälter / mit Druckregler
1.6	74	04/05→09/12					
1.6 TDCi	66	04/05→09/12					
1.6 TDCi	74	04/05→09/12		→ 04/07; + ABS	03.2123-3103.3	010781	ATE Ø 23,81
1.6 TDCi	80	04/05→09/12					
1.6 Ti	85	04/05→09/12		05/07→ 10/08; + ABS	03.2125-0483.3	010783	ATE Ø 25,4 ohne Bremsflüssigkeitsbehälter
1.8	92	03/06→09/12					
1.8 Flexifuel	92	06/06→07/11		11/08→ 02/11; + ABS	03.2125-0661.3	010917	ATE Ø 25,4
1.8 TDCi	85	04/05→09/12					
2.0	107	04/05→07/11					
2.0 TDCi	100	04/05→09/12					
1.8 Flexifuel	96	12/05→01/08		01/06→; - ABS	03.2123-3041.3	010887	ATE Ø 23,81 ohne Bremsflüssigkeitsbehälter / mit Druckregler
				01/06→ 04/07; + ABS	03.2123-3103.3	010781	ATE Ø 23,81
				05/07→; + ABS	03.2125-0483.3	010783	ATE Ø 25,4 ohne Bremsflüssigkeitsbehälter
2.0	104	02/08→		→ 02/11; - ABS	03.2123-3041.3	010887	ATE Ø 23,81 ohne Bremsflüssigkeitsbehälter / mit Druckregler
2.0 TDCi	81	02/08→07/11					
				→ 10/08; + ABS	03.2125-0483.3	010783	ATE Ø 25,4 ohne Bremsflüssigkeitsbehälter
				11/08→ 02/11; + ABS	03.2125-0661.3	010917	ATE Ø 25,4
Hydraulikaggregat, Bremsanlage							
1.4	59	04/05→09/12		→ 02/11	24.9145-0004.2	399008	
1.6	74	04/05→09/12					
1.6 TDCi	66	04/05→09/12					
1.6 TDCi	74	04/05→09/12					
1.6 TDCi	80	04/05→09/12					
1.6 Ti	85	04/05→09/12					
1.8	92	03/06→09/12					
1.8 Flexifuel	92	06/06→07/11					
1.8 TDCi	85	04/05→09/12					
2.0	104	02/08→					
2.0	107	04/05→07/11					
↓							

	kW			 	! #		
FORD - FOCUS II Stufenheck (DA_) 04/05→							
Hydraulikaggregat, Bremsanlage							
2.0 TDCi	81	02/08→07/11		→ 02/11		24.9145-0004.2	399008
2.0 TDCi	100	04/05→09/12					
1.8 Flexifuel	96	12/05→01/08		01/06→		24.9145-0004.2	399008
FORD - FOCUS III 07/10→							
 Hauptbremszylinder							
1.0 EcoBoost	74	02/12→				03.4155-5451.3	010995 ATE Ø 25,4
1.0 EcoBoost	92	02/12→					
1.5 EcoBoost	110	09/14→					
1.5 EcoBoost	134	09/14→					
1.5 TDCi	70	09/14→					
1.5 TDCi	88	09/14→					
1.5 TDCi ECONetic	77	09/14→					
1.6 Flexifuel	110	07/13→					
1.6 LPG	86	02/12→					
1.6 LPG	88	02/12→					
1.6 TDCi ECONetic	77	05/12→					
1.6 Ti	63	08/11→					
1.6 Ti	88	02/12→					
2.0 ST	184	07/12→					
2.0 TDCi	110	11/14→					
2.0 TDCi ST	136	11/14→					
1.6 EcoBoost	110	07/10→		03/11→		03.4155-5451.3	010995 ATE Ø 25,4
1.6 EcoBoost	134	07/10→					
1.6 Flexifuel	88	07/10→					
1.6 TDCi	70	07/10→					
1.6 TDCi	85	07/10→					
1.6 Ti	77	07/10→					
1.6 Ti	92	07/10→					
2.0 TDCi	85	07/10→					
2.0 TDCi	100	07/10→					
2.0 TDCi	103	07/10→					
2.0 TDCi	120	07/10→					
2.0 Ti-GDi	125	08/11→				03.4155-5456.3	010996 ATE Ø 25,4
2.3 RS AWD	257	07/15→					
FORD - FOCUS III Kasten 02/12→							
 Hauptbremszylinder							
1.0 EcoBoost	74	02/12→				03.4155-5451.3	010995 ATE Ø 25,4
1.0 EcoBoost	92	02/12→					
1.5 EcoBoost	110	09/14→					
1.5 EcoBoost	134	09/14→					
1.5 TDCi	70	09/14→					
1.5 TDCi	88	09/14→					
1.5 TDCi ECONetic	77	09/14→					
2.0 TDCi	110	11/14→					
FORD - FOCUS III Kasten/Schrägheck 01/11→							
 Hauptbremszylinder							
1.0 EcoBoost	74	02/12→				03.4155-5451.3	010995 ATE Ø 25,4
1.0 EcoBoost	92	02/12→					
1.5 EcoBoost	110	09/14→					
1.5 EcoBoost	134	09/14→					
1.5 TDCi	70	09/14→					
1.5 TDCi	88	09/14→					
1.5 TDCi ECONetic	77	09/14→					
1.6 EcoBoost	110	11/11→06/14					
1.6 EcoBoost	134	11/11→06/14					
1.6 TDCi	85	02/12→					
2.0 TDCi	110	11/14→					
1.6 Ti	77	01/11→		03/11→		03.4155-5451.3	010995 ATE Ø 25,4
2.0 TDCi	85	01/11→06/14					
2.0 TDCi	103	01/11→06/14					
FORD - FOCUS III Stufenheck 07/10→							
 Hauptbremszylinder							
1.0 EcoBoost	74	02/12→				03.4155-5451.3	010995 ATE Ø 25,4
1.0 EcoBoost	92	02/12→					
1.5 EcoBoost	110	11/14→					
1.5 EcoBoost	134	11/14→					
1.5 TDCi	70	11/14→					
1.5 TDCi	88	11/14→					
1.5 TDCi ECONetic	77	11/14→					
1.6 Flexifuel	110	07/13→					
1.6 TDCi	77	05/12→					
1.6 Ti	63	08/11→					
2.0 TDCi	110	11/14→					
1.6 EcoBoost	110	07/10→		03/11→		03.4155-5451.3	010995 ATE Ø 25,4







	kw			 	! #		
FORD - FOCUS III Stufenheck 07/10→							
 Hauptbremszylinder							
1.6 EcoBoost	134	07/10→		03/11→		03.4155-5451.3 010995	ATE Ø 25,4
1.6 Flexifuel	88	07/10→					
1.6 TDCi	70	07/10→					
1.6 TDCi	85	07/10→					
1.6 Ti	77	07/10→					
1.6 Ti	92	07/10→					
2.0 TDCi	85	07/10→					
2.0 TDCi	100	07/10→					
2.0 TDCi	103	07/10→					
2.0 TDCi	120	07/10→					
2.0 GDi	125	08/11→				03.4155-5456.3 010996	ATE Ø 25,4
FORD - FOCUS III Turnier 07/10→							
 Hauptbremszylinder							
1.0 EcoBoost	74	02/12→				03.4155-5451.3 010995	ATE Ø 25,4
1.0 EcoBoost	92	02/12→					
1.5 EcoBoost	110	09/14→					
1.5 EcoBoost	134	09/14→					
1.5 TDCi	70	09/14→					
1.5 TDCi	88	09/14→					
1.5 TDCi ECONetic	77	09/14→					
1.6 Flexifuel	110	07/13→					
1.6 LPG	86	02/12→					
1.6 LPG	88	02/12→					
1.6 TDCi ECONetic	77	05/12→					
1.6 Ti	63	08/11→					
1.6 Ti	88	02/12→					
2.0 ST	184	07/12→					
2.0 TDCi	110	11/14→					
2.0 TDCi ST	136	11/14→					
1.6 EcoBoost	110	07/10→		03/11→		03.4155-5451.3 010995	ATE Ø 25,4
1.6 EcoBoost	134	07/10→					
1.6 Flexifuel	88	07/10→					
1.6 TDCi	70	07/10→					
1.6 TDCi	85	07/10→					
1.6 Ti	77	07/10→					
1.6 Ti	92	07/10→					
2.0 TDCi	85	07/10→					
2.0 TDCi	100	07/10→					
2.0 TDCi	103	07/10→					
2.0 TDCi	120	07/10→					
2.0 Ti-GDi	125	07/10→		08/11→		03.4155-5456.3 010996	ATE Ø 25,4
FORD - FOCUS C-MAX 10/03→03/07							
 Bremskraftverstärker							
1.6	74	10/03→03/07		09/06→;		03.7760-2232.4 300266	ATE Ø 10" pneumatisch
1.6 TDCi	66	02/05→03/07		für Fahrzeuge ohne Bremsassistent			
1.6 TDCi	80	10/03→03/07		→ 08/06;		03.7760-8103.4 300240	ATE Ø 10" pneumatisch
1.6 Ti	85	08/04→03/07		für Fahrzeuge ohne Bremsassistent			
1.8	88	10/03→03/07		→ 08/06;		03.7863-0332.4 300203	ATE Ø 10" pneumatisch
1.8	90	09/05→03/07		für Fahrzeuge mit Bremsassistent			
1.8	92	04/04→03/07					
1.8 Flexifuel	92	01/06→03/07		09/06→;		03.7863-3932.4 300288	ATE Ø 10" pneumatisch
1.8 TDCi	85	01/05→03/07		für Fahrzeuge mit Bremsassistent			
2.0 TDCi	98	10/03→03/07					
2.0 TDCi	100	10/03→03/07					
2.0	107	03/04→03/07		09/06→;		03.7760-2232.4 300266	ATE Ø 10" pneumatisch
				für Fahrzeuge ohne Bremsassistent			
				04/04→ 08/06;		03.7760-8103.4 300240	ATE Ø 10" pneumatisch
				für Fahrzeuge ohne Bremsassistent			
				04/04→ 08/06;		03.7863-0332.4 300203	ATE Ø 10" pneumatisch
				für Fahrzeuge mit Bremsassistent			
				09/06→;		03.7863-3932.4 300288	ATE Ø 10" pneumatisch
				für Fahrzeuge mit Bremsassistent			
 Hauptbremszylinder							
1.6	74	10/03→03/07				03.2123-3103.3 010781	ATE Ø 23,81
1.6 TDCi	66	02/05→03/07				03.2125-0483.3 010783	ATE Ø 25,4
1.6 TDCi	80	10/03→03/07					ohne Bremsflüssigkeitsbehälter
1.6 Ti	85	08/04→03/07					
1.8	88	10/03→03/07					
1.8	90	09/05→03/07					
1.8	92	04/04→03/07					
1.8 Flexifuel	92	01/06→03/07					
1.8 TDCi	85	01/05→03/07					
2.0 TDCi	98	10/03→03/07					
2.0 TDCi	100	10/03→03/07					
2.0	107	03/04→03/07		04/04→		03.2123-3103.3 010781	ATE Ø 23,81
↓							













	kw			 	! #		
FORD - FOCUS C-MAX 10/03→03/07							
 Hauptbremszylinder							
2.0	107	03/04→03/07		04/04→		03.2125-0483.3 010783	ATE Ø 25,4 ohne Bremsflüssigkeitsbehälter
Hydraulikaggregat, Bremsanlage							
1.6	74	10/03→03/07				24.9145-0004.2 399008	
1.6 TDCi	66	02/05→03/07					
1.6 TDCi	80	10/03→03/07					
1.6 Ti	85	08/04→03/07					
1.8	88	10/03→03/07					
1.8	90	09/05→03/07					
1.8	92	04/04→03/07					
1.8 Flexifuel	92	01/06→03/07					
1.8 TDCi	85	01/05→03/07					
2.0 TDCi	98	10/03→03/07					
2.0 TDCi	100	10/03→03/07					
2.0	107	03/04→03/07		04/04→		24.9145-0004.2 399008	
FORD - FOCUS Kombi (DNW) 02/99→12/07							
 Hauptbremszylinder							
1.4 16V	55	02/99→11/04		11/01→ 09/04; + ESP		03.4123-0153.3 010659	ATE Ø 23,81
1.6 16V	74	02/99→11/04		→ 09/04; + ABS		24.4123-1713.3 010905	BOS Ø 23,81 ohne Bremsflüssigkeitsbehälter
1.8 16V	85	02/99→11/04					
1.8 DI / TDDi	55	08/99→11/04					
1.8 TDCi	85	03/01→11/04					
1.8 Turbo DI / TDDi	66	02/99→11/04					
2.0 16V	96	02/99→11/04					
1.6 16V Flexifuel	75	01/02→11/04		→ 09/04; + ESP		03.4123-0153.3 010659	ATE Ø 23,81
1.8 TDCi	74	08/02→11/04		→ 09/04; + ABS		24.4123-1713.3 010905	BOS Ø 23,81 ohne Bremsflüssigkeitsbehälter
1.8 BiFuel	82	02/03→01/05		+ ESP		03.4123-0153.3 010659	ATE Ø 23,81
				+ ABS		24.4123-1713.3 010905	BOS Ø 23,81 ohne Bremsflüssigkeitsbehälter
FORD - FOCUS Stufenheck (DFW) 02/99→12/07							
 Hauptbremszylinder							
1.4 16V	55	02/99→11/04		11/01→ 09/04; + ESP		03.4123-0153.3 010659	ATE Ø 23,81
1.6 16V	74	02/99→11/04		→ 09/04; + ABS		24.4123-1713.3 010905	BOS Ø 23,81 ohne Bremsflüssigkeitsbehälter
1.8 16V	85	02/99→11/04					
1.8 TDCi	85	03/01→11/04					
1.8 Turbo DI / TDDi	55	08/01→03/05					
1.8 Turbo DI / TDDi	66	02/99→11/04					
2.0 16V	96	02/99→11/04					
1.8 TDCi	74	08/02→11/04		→ 09/04; + ESP		03.4123-0153.3 010659	ATE Ø 23,81
				→ 09/04; + ABS		24.4123-1713.3 010905	BOS Ø 23,81 ohne Bremsflüssigkeitsbehälter
FORD - FUSION (JU_) 08/02→12/12							
 Bremskraftverstärker							
1.25	55	08/04→12/12		→ 09/12;		03.7750-8732.4 300199	ATE Ø 9" pneumatisch
1.4	59	08/02→12/12		für Fahrzeuge ohne Bremsassistent			
1.4 LPG	59	01/10→12/12		→ 09/12;		03.7853-2102.4 300201	ATE Ø 9" pneumatisch
1.4 TDCi	50	08/02→12/12		für Fahrzeuge mit Bremsassistent			
1.6 TDCi	66	11/04→12/12					
1.6	74	08/02→11/08		für Fahrzeuge ohne Bremsassistent		03.7750-8732.4 300199	ATE Ø 9" pneumatisch
				für Fahrzeuge mit Bremsassistent		03.7853-2102.4 300201	ATE Ø 9" pneumatisch
 Hauptbremszylinder							
1.25	55	08/04→12/12		→ 09/12; für Linkslenker; - ABS		03.4153-0015.3 011005	ATE Ø 23,81 ohne Bremsflüssigkeitsbehälter
1.4	59	08/02→12/12					
1.4 LPG	59	01/10→12/12		→ 09/12; für Linkslenker		03.4153-5287.4 010953	ATE Ø 23,81 mit Bremsflüssigkeitsbehälter
1.4 TDCi	50	08/02→12/12					
1.6 TDCi	66	11/04→12/12					
1.6	74	08/02→11/08		für Linkslenker; - ABS		03.4153-0015.3 011005	ATE Ø 23,81 ohne Bremsflüssigkeitsbehälter
				für Linkslenker		03.4153-5287.4 010953	ATE Ø 23,81 mit Bremsflüssigkeitsbehälter
FORD - GALAXY (WA6) 05/06→06/15							
 Bremskraftverstärker							
1.6 EcoBoost	118	11/10→06/15		02/11→		03.7755-1432.4 300300	ATE Ø 9 / 8" pneumatisch
1.6 TDCi	85	02/11→06/15				03.7755-1432.4 300300	ATE Ø 9 / 8" pneumatisch
1.8 TDCi	74	05/06→06/15					
1.8 TDCi	92	05/06→06/15					















	kw				! #		
FORD - GALAXY (WA6) 05/06→06/15							
 Bremskraftverstärker							
2.0	107	05/06→06/15				03.7755-1432.4 300300	ATE Ø 9 / 8" pneumatisch
2.0 EcoBoost	146	07/10→06/15					
2.0 EcoBoost	149	03/10→06/15					
2.0 Flexifuel	107	05/06→06/15					
2.0 TDCi	85	11/07→06/15					
2.0 TDCi	96	05/06→06/15					
2.0 TDCi	100	05/06→06/15					
2.0 TDCi	103	05/06→06/15					
2.0 TDCi	120	03/10→06/15					
2.2 TDCi	147	11/10→06/15					
2.3	118	09/07→06/15					
2.2 TDCi	129	03/08→12/12		04/08→		03.7755-1432.4 300300	ATE Ø 9 / 8" pneumatisch
FORD - GALAXY (WGR) 03/95→05/06							
 Bremskraftverstärker							
1.9 TDI	66	03/95→05/06		09/97→ 03/00; für Linkslenker; + ABS		03.7755-1902.4 300138	ATE Ø 9 / 8" pneumatisch
				04/00→ 04/06; für Rechtslenker; - ESP		03.7755-6302.4 300221	ATE Ø 9 / 8" pneumatisch
				04/00→ 10/02; für Linkslenker; - ESP		03.7755-6302.4 300221	ATE Ø 9 / 8" pneumatisch
				01/96→ 08/97; für Linkslenker		03.7760-3002.4 300120	ATE Ø 10" pneumatisch
				04/00→ 10/02; für Linkslenker; + ESP		03.7858-3302.4 300122	ATE Ø 9 / 8" pneumatisch
1.9 TDI	81	08/97→04/00		10/97→ 03/00; für Linkslenker; + ABS		03.7755-1902.4 300138	ATE Ø 9 / 8" pneumatisch
1.9 TDI	85	04/00→05/06		→ 04/06; für Rechtslenker; - ESP		03.7755-6302.4 300221	ATE Ø 9 / 8" pneumatisch
2.3 16V	103	09/01→05/06		→ 10/02; für Linkslenker; - ESP		03.7755-6302.4 300221	ATE Ø 9 / 8" pneumatisch
2.8 V6	150	04/00→05/06		→ 10/02; für Linkslenker; + ESP		03.7858-3302.4 300122	ATE Ø 9 / 8" pneumatisch
1.9 TDI	96	02/03→05/06		→ 04/06; für Rechtslenker; - ESP		03.7755-6302.4 300221	ATE Ø 9 / 8" pneumatisch
2.0 i	85	11/95→05/06		09/97→ 03/00; für Linkslenker; + ABS		03.7755-1902.4 300138	ATE Ø 9 / 8" pneumatisch
2.3 16V	107	01/97→05/06		04/00→ 04/06; für Rechtslenker; - ESP		03.7755-6302.4 300221	ATE Ø 9 / 8" pneumatisch
				04/00→ 10/02; für Linkslenker; - ESP		03.7755-6302.4 300221	ATE Ø 9 / 8" pneumatisch
				→ 08/97; für Linkslenker		03.7760-3002.4 300120	ATE Ø 10" pneumatisch
				04/00→ 10/02; für Linkslenker; + ESP		03.7858-3302.4 300122	ATE Ø 9 / 8" pneumatisch
2.3 4x4	107	09/96→04/00		09/97→ 03/00; für Linkslenker; + ABS		03.7755-1902.4 300138	ATE Ø 9 / 8" pneumatisch
				04/00→; für Linkslenker; - ESP		03.7755-6302.4 300221	ATE Ø 9 / 8" pneumatisch
				04/00→; für Rechtslenker; - ESP		03.7755-6302.4 300221	ATE Ø 9 / 8" pneumatisch
				01/97→ 08/97; für Linkslenker		03.7760-3002.4 300120	ATE Ø 10" pneumatisch
				04/00→; für Linkslenker; + ESP		03.7858-3302.4 300122	ATE Ø 9 / 8" pneumatisch
2.8 i V6	128	11/95→04/00		09/97→ 03/00; für Linkslenker; + ABS		03.7755-1902.4 300138	ATE Ø 9 / 8" pneumatisch
2.8 i V6 4x4	128	04/96→04/00		→ 08/97; für Linkslenker		03.7760-3002.4 300120	ATE Ø 10" pneumatisch
 Hauptbremszylinder							
1.9 TDI	66	03/95→05/06		01/96→ 08/97; + ABS		03.2123-1526.3 010477	Ø 23,81
				01/96→ 08/97; - ABS		03.2123-1548.3 010478	Ø 23,81
				04/00→ 10/02; - ESP		03.2125-0332.3 010952	Ø 25,4
				09/97→ 03/00; + ABS		03.2125-0332.3 010952	Ø 25,4
				11/02→ 04/06; - ESP		03.2125-0332.3 010952	Ø 25,4
				09/97→ 03/00; - ABS		03.2125-8404.3 010583	ATE Ø 25,4
				04/00→ 10/02; + ESP		03.2125-9604.3 010581	Ø 25,4
1.9 TDI	81	08/97→04/00		10/97→ 03/00; + ABS		03.2125-0332.3 010952	Ø 25,4
				10/97→ 03/00; - ABS		03.2125-8404.3 010583	ATE Ø 25,4
1.9 TDI	85	04/00→05/06		→ 10/02; - ESP		03.2125-0332.3 010952	Ø 25,4
2.3 16V	103	09/01→05/06		11/02→ 04/06; - ESP		03.2125-0332.3 010952	Ø 25,4
2.8 V6	150	04/00→05/06		→ 10/02; + ESP		03.2125-9604.3 010581	Ø 25,4
1.9 TDI	96	02/03→05/06		→ 04/06; - ESP		03.2125-0332.3 010952	Ø 25,4
1.9 TDI	110	05/05→05/06					
2.0 i	85	11/95→05/06		→ 08/97; + ABS		03.2123-1526.3 010477	Ø 23,81
2.3 16V	107	01/97→05/06		→ 08/97; - ABS		03.2123-1548.3 010478	Ø 23,81
				04/00→ 10/02; - ESP		03.2125-0332.3 010952	Ø 25,4
				09/97→ 03/00; + ABS		03.2125-0332.3 010952	Ø 25,4
				11/02→ 04/06; - ESP		03.2125-0332.3 010952	Ø 25,4
				09/97→ 03/00; - ABS		03.2125-8404.3 010583	ATE Ø 25,4
				04/00→ 10/02; + ESP		03.2125-9604.3 010581	Ø 25,4
2.3 4x4	107	09/96→04/00		01/97→ 08/97; + ABS		03.2123-1526.3 010477	Ø 23,81
				01/97→ 08/97; - ABS		03.2123-1548.3 010478	Ø 23,81
				04/00→; - ESP		03.2125-0332.3 010952	Ø 25,4
				09/97→ 03/00; + ABS		03.2125-0332.3 010952	Ø 25,4







	kw			 	! #		
FORD - GALAXY (WGR) 03/95→05/06							
 Hauptbremszylinder							
2.3 4x4	107	09/96→04/00		09/97→ 03/00; - ABS		03.2125-8404.3 010583	ATE Ø 25,4
				04/00→; + ESP		03.2125-9604.3 010581	Ø 25,4
2.8 i V6	128	11/95→04/00		→ 08/97; + ABS		03.2123-1526.3 010477	Ø 23,81
2.8 i V6 4x4	128	04/96→04/00		→ 08/97; - ABS		03.2123-1548.3 010478	Ø 23,81
				09/97→ 03/00; + ABS		03.2125-0332.3 010952	Ø 25,4
				09/97→ 03/00; - ABS		03.2125-8404.3 010583	ATE Ø 25,4
Verschlusschraube, Hauptbremszylinder							
1.9 TDI	66	03/95→05/06		01/96→ 08/97; - ABS		03.3517-5100.1 390326	
2.0 i	85	11/95→05/06		→ 08/97; - ABS		03.3517-5100.1 390326	
2.3 16V	107	01/97→05/06					
2.8 i V6	128	11/95→04/00					
2.8 i V6 4x4	128	04/96→04/00					
2.3 4x4	107	09/96→04/00		01/97→ 08/97; - ABS		03.3517-5100.1 390326	
FORD - GRAND C-MAX (DXA/CB7, DXA/CEU) 12/10→							
 Hauptbremszylinder							
1.0 EcoBoost	74	10/12→		für Linkslenker		03.4155-5456.3 010996	ATE Ø 25,4
1.0 EcoBoost	92	10/12→					
1.5 EcoBoost	110	03/15→					
1.5 EcoBoost	134	03/15→					
1.5 TDCi	70	03/15→					
1.5 TDCi	88	03/15→					
1.6 EcoBoost	110	12/10→					
1.6 EcoBoost	134	12/10→					
1.6 TDCi	70	12/10→					
1.6 TDCi	85	12/10→					
1.6 Ti	77	12/10→					
1.6 Ti	92	12/10→					
2.0 TDCi	85	02/11→		für Linkslenker		03.4155-5451.3 010995	ATE Ø 25,4
2.0 TDCi	103	02/11→				03.4155-5456.3 010996	ATE Ø 25,4
2.0 TDCi	120	12/10→					
2.0 TDCi	100	02/11→		für Linkslenker		03.4155-5451.3 010995	ATE Ø 25,4
2.0 TDCi	110	03/15→					
2.0 TDCi	125	03/15→					
FORD - GRAND C-MAX Van 12/10→							
 Hauptbremszylinder							
1.0 EcoBoost	74	10/12→		für Linkslenker		03.4155-5456.3 010996	ATE Ø 25,4
1.0 EcoBoost	92	10/12→					
1.5 EcoBoost	110	03/15→					
1.5 TDCi	88	03/15→					
1.6 EcoBoost	110	12/10→					
1.6 TDCi	70	12/10→					
1.6 TDCi	85	12/10→					
2.0 TDCi	103	12/10→		für Linkslenker		03.4155-5451.3 010995	ATE Ø 25,4
2.0 TDCi	120	12/10→				03.4155-5456.3 010996	ATE Ø 25,4
2.0 TDCi	85	02/11→					
2.0 TDCi	110	03/15→		für Linkslenker		03.4155-5451.3 010995	ATE Ø 25,4
2.0 TDCi	125	03/15→					
FORD - KUGA I 03/08→							
 Bremskraftverstärker							
2.0 TDCi	100	03/08→11/12		04/08→; für Linkslenker		03.7755-3532.4 300290	ATE Ø 9 / 8" pneumatisch
2.0 TDCi 4x4	100	03/08→11/12		04/08→; für Rechtslenker		03.7760-2232.4 300266	ATE Ø 10" pneumatisch
2.0 TDCi	103	03/10→11/12		für Linkslenker		03.7755-3532.4 300290	ATE Ø 9 / 8" pneumatisch
2.0 TDCi 4x4	103	03/10→11/12		für Rechtslenker		03.7760-2232.4 300266	ATE Ø 10" pneumatisch
2.0 TDCi 4x4	120	03/10→11/12					
2.5	147	03/09→11/12		für Linkslenker		03.7755-3532.4 300290	ATE Ø 9 / 8" pneumatisch
2.5 4x4	147	03/09→		→ 12/12; für Linkslenker		03.7755-3532.4 300290	ATE Ø 9 / 8" pneumatisch
 Hauptbremszylinder							
2.0 TDCi	100	03/08→11/12		04/08→; für Rechtslenker; → 10/08		03.2125-0483.3 010783	ATE Ø 25,4
2.0 TDCi 4x4	100	03/08→11/12					ohne Bremsflüssigkeitsbehälter
				11/08→; für Linkslenker		03.2125-0651.3 010935	ATE Ø 25,4
				11/08→; für Rechtslenker		03.2125-0661.3 010917	ATE Ø 25,4
2.0 TDCi	103	03/10→11/12		für Linkslenker		03.2125-0651.3 010935	ATE Ø 25,4
2.0 TDCi 4x4	103	03/10→11/12					
2.0 TDCi 4x4	120	03/10→11/12					
2.5	147	03/09→11/12					
2.5 4x4	147	03/09→		→ 12/12; für Linkslenker		03.2125-0651.3 010935	ATE Ø 25,4
↓							





























	kW			 	! #		
FORD - KUGA I 03/08→							
Hydraulikaggregat, Bremsanlage							
2.0 TDCi	100	03/08→11/12		04/08→		24.9145-0004.2	399008
2.0 TDCi 4x4	100	03/08→11/12					
2.0 TDCi	103	03/10→11/12				24.9145-0004.2	399008
2.0 TDCi 4x4	103	03/10→11/12					
2.0 TDCi 4x4	120	03/10→11/12					
2.5	147	03/09→11/12					
2.5 4x4	147	03/09→		→ 12/12		24.9145-0004.2	399008
FORD - KUGA II (DM2) 05/12→							
Hauptbremszylinder							
1.5 EcoBoost	88	01/16→				03.4155-5456.3	010996 ATE Ø 25,4
1.5 EcoBoost	110	09/14→					
1.5 EcoBoost 4x4	134	09/14→					
1.6 EcoBoost	110	03/13→					
1.6 EcoBoost 4x4	110	03/13→					
1.6 EcoBoost 4x4	134	03/13→					
2.0 TDCi	85	03/13→					
2.0 TDCi	88	09/14→					
2.0 TDCi	100	03/13→					
2.0 TDCi	103	03/13→					
2.0 TDCi	110	09/14→					
2.0 TDCi 4x4	100	03/13→					
2.0 TDCi 4x4	103	03/13→					
2.0 TDCi 4x4	110	09/14→					
2.0 TDCi 4x4	120	03/13→					
2.0 TDCi 4x4	132	09/14→					
2.5	110	01/14→					
FORD - KUGA II Van 05/12→							
Hauptbremszylinder							
1.5 EcoBoost	110	09/14→				03.4155-5456.3	010996 ATE Ø 25,4
1.5 EcoBoost 4x4	134	09/14→					
2.0 TDCi	110	09/14→					
2.0 TDCi 4x4	110	09/14→					
2.0 TDCi 4x4	132	09/14→					
FORD - MAVERICK (UDS, UNS) 02/93→04/98							
Hauptbremszylinder							
2.4 i	87	09/96→04/98		10/96→ 03/98		24.2125-1738.3	010931 TRW Ø 25,4
2.4 i (UDS)	85	09/96→04/98					
2.7 TD	92	09/96→04/98					
2.4 i	91	02/93→08/96				24.2123-1726.3	010557 Ø 23,81 ohne Bremsflüssigkeitsbehälter
2.7 TD	74	02/93→08/96					
FORD - MAVERICK VAN 06/96→04/98							
Hauptbremszylinder							
2.7 TD	74	06/96→04/98		10/96→ 03/98		24.2125-1738.3	010931 TRW Ø 25,4
2.7 TD	92	06/96→04/98					
FORD - MONDEO I (GBP) 02/93→08/96							
Hauptbremszylinder							
1.6 i 16V	65	07/94→08/96		01/96→; - ABS		24.2125-1706.3	010496 Ø 25,4
1.6 i 16V	66	02/93→08/96					
1.8 i 16V	82	07/94→08/96		→ 12/95; + ABS		24.2125-1707.3	010497 Ø 25,4
1.8 i 16V	85	02/93→08/96		01/96→; + ABS		24.2125-1708.3	010498 Ø 25,4
1.8 i 16V 4x4	85	02/93→08/96					
1.8 TD	65	06/93→08/96					
1.8 TD	66	10/95→08/96					
2.0 i 16V	97	12/94→08/96					
2.0 i 16V	100	02/93→08/96					
2.0 i 16V 4x4	97	12/94→08/96					
2.0 i 16V 4x4	100	04/93→08/96					
2.5 i 24V	125	07/94→08/96		08/94→ 12/95		24.2125-1707.3	010497 Ø 25,4
				01/96→		24.2125-1708.3	010498 Ø 25,4
Bremskraftregler							
1.6 i 16V	65	07/94→08/96		→ 12/95; - ABS		03.6043-1774.3	320031 ATE 3/30 2x
1.6 i 16V	66	02/93→08/96					
1.8 i 16V	82	07/94→08/96		→ 12/95; + ABS		03.6043-1776.3	320032 ATE 3/40 2x
1.8 i 16V	85	02/93→08/96		→ 12/95; - ABS		03.6043-1784.3	320034 ATE 3/30 2x
1.8 i 16V 4x4	85	02/93→08/96		→ 12/95; + ABS		03.6043-1786.3	320035 ATE 3/40 2x
2.0 i 16V	97	12/94→08/96					
2.0 i 16V	100	02/93→08/96		01/96→; - ABS	2	03.6043-1954.3	320226 ATE 3/30 2x
				01/96→; + ABS	2	03.6043-1956.3	320202 ATE 3/40 2x
1.8 TD	65	06/93→08/96		→ 12/95; - ABS		03.6043-1773.3	320030 ATE 3/25 2x
↓							













	kW					! #		
FORD - MONDEO I (GBP) 02/93→08/96								
 Bremskraftregler								
1.8 TD	66	10/95→08/96		→ 12/95; + ABS			03.6043-1776.3 320032	ATE 3/40 2x
				→ 12/95; - ABS			03.6043-1783.3 320033	ATE 3/25 2x
				→ 12/95; + ABS			03.6043-1786.3 320035	ATE 3/40 2x
				01/96→; + ABS	2	03.6043-1956.3 320202	ATE 3/40 2x	
2.5 i 24V	125	07/94→08/96		08/94→ 12/95			03.6043-1776.3 320032	ATE 3/40 2x
				08/94→ 12/95			03.6043-1786.3 320035	ATE 3/40 2x
				01/96→	2	03.6043-1956.3 320202	ATE 3/40 2x	
FORD - MONDEO I Kombi (BNP) 01/93→08/96								
 Hauptbremszylinder								
1.6 i 16V	65	07/94→08/96		01/96→; - ABS			24.2125-1706.3 010496	Ø 25,4
1.6 i 16V	66	04/93→08/96		→ 12/95; + ABS			24.2125-1707.3 010497	Ø 25,4
1.8 i 16V	82	07/94→08/96		→ 12/95; + ABS			24.2125-1707.3 010497	Ø 25,4
1.8 i 16V	85	04/93→08/96		01/96→; + ABS			24.2125-1708.3 010498	Ø 25,4
1.8 i 16V 4x4	85	04/93→08/96						
1.8 TD	65	06/93→08/96						
1.8 TD	66	11/95→08/96						
2.0 i 16V	97	01/93→08/96						
2.0 i 16V	100	04/93→08/96						
2.0 i 16V 4x4	97	12/94→08/96						
2.0 i 16V 4x4	100	04/93→08/96						
2.5 i 24V	125	07/94→08/96		08/94→ 12/95			24.2125-1707.3 010497	Ø 25,4
				01/96→	2	24.2125-1708.3 010498	Ø 25,4	
 Bremskraftregler								
1.6 i 16V	65	07/94→08/96		→ 12/95; - ABS			03.6043-1773.3 320030	ATE 3/25 2x
1.6 i 16V	66	04/93→08/96		→ 12/95; + ABS			03.6043-1776.3 320032	ATE 3/40 2x
1.8 i 16V	82	07/94→08/96		→ 12/95; + ABS			03.6043-1776.3 320032	ATE 3/40 2x
1.8 i 16V	85	04/93→08/96		→ 12/95; - ABS			03.6043-1783.3 320033	ATE 3/25 2x
1.8 i 16V 4x4	85	04/93→08/96		→ 12/95; + ABS			03.6043-1786.3 320035	ATE 3/40 2x
1.8 TD	65	06/93→08/96						
1.8 TD	66	11/95→08/96		01/96→; - ABS	2	03.6043-1953.3 320201	ATE 3/45 2x	
2.0 i 16V	97	01/93→08/96		01/96→; + ABS	2	03.6043-1956.3 320202	ATE 3/40 2x	
2.0 i 16V	100	04/93→08/96						
2.5 i 24V	125	07/94→08/96		08/94→ 12/95			03.6043-1776.3 320032	ATE 3/40 2x
				08/94→ 12/95			03.6043-1786.3 320035	ATE 3/40 2x
				01/96→	2	03.6043-1956.3 320202	ATE 3/40 2x	
FORD - MONDEO I Stufenheck (GBP) 02/93→08/96								
 Hauptbremszylinder								
1.6 i 16V	65	07/94→08/96		01/96→; - ABS			24.2125-1706.3 010496	Ø 25,4
1.6 i 16V	66	02/93→08/96		→ 12/95; + ABS			24.2125-1707.3 010497	Ø 25,4
1.8 4x4	85	02/93→08/96		→ 12/95; + ABS			24.2125-1707.3 010497	Ø 25,4
1.8 i 16V	82	01/94→08/96		01/96→; + ABS			24.2125-1708.3 010498	Ø 25,4
1.8 i 16V	85	02/93→08/96						
1.8 TD	65	06/93→08/96						
1.8 TD	66	10/95→08/96						
2.0 i 16V	100	02/93→08/96						
2.0 i 16V 4x4	97	12/94→08/96						
2.0 i 16V 4x4	100	02/93→08/96		01/96→; - ABS			24.2125-1706.3 010496	Ø 25,4
				04/93→ 12/95; + ABS			24.2125-1707.3 010497	Ø 25,4
				01/96→; + ABS			24.2125-1708.3 010498	Ø 25,4
2.5 i 24V	125	07/94→08/96		08/94→ 12/95			24.2125-1707.3 010497	Ø 25,4
				01/96→	2	24.2125-1708.3 010498	Ø 25,4	
 Bremskraftregler								
1.6 i 16V	65	07/94→08/96		→ 12/95; - ABS			03.6043-1774.3 320031	ATE 3/30 2x
1.6 i 16V	66	02/93→08/96		→ 12/95; + ABS			03.6043-1776.3 320032	ATE 3/40 2x
1.8 i 16V	82	01/94→08/96		→ 12/95; - ABS			03.6043-1784.3 320034	ATE 3/30 2x
1.8 i 16V	85	02/93→08/96		→ 12/95; + ABS			03.6043-1786.3 320035	ATE 3/40 2x
				01/96→; - ABS	2	03.6043-1954.3 320226	ATE 3/30 2x	
				01/96→; + ABS	2	03.6043-1956.3 320202	ATE 3/40 2x	
1.8 4x4	85	02/93→08/96		→ 12/95; + ABS			03.6043-1776.3 320032	ATE 3/40 2x
				→ 12/95; + ABS			03.6043-1786.3 320035	ATE 3/40 2x
2.0 i 16V	100	02/93→08/96		01/96→; + ABS	2	03.6043-1956.3 320202	ATE 3/40 2x	
1.8 TD	65	06/93→08/96		→ 12/95; - ABS			03.6043-1773.3 320030	ATE 3/25 2x
1.8 TD	66	10/95→08/96		→ 12/95; + ABS			03.6043-1776.3 320032	ATE 3/40 2x
				→ 12/95; - ABS			03.6043-1783.3 320033	ATE 3/25 2x
↓								













	kw					! #		
FORD - MONDEO I Stufenheck (GBP) 02/93→08/96								
 Bremskraftregler								
1.8 TD	65	06/93→08/96		→ 12/95; + ABS			03.6043-1786.3 320035	ATE 3/40 2x
1.8 TD	66	10/95→08/96		01/96→; + ABS	2	03.6043-1956.3 320202		ATE 3/40 2x
2.5 i 24V	125	07/94→08/96		08/94→ 12/95			03.6043-1776.3 320032	ATE 3/40 2x
				08/94→ 12/95			03.6043-1786.3 320035	ATE 3/40 2x
				01/96→	2	03.6043-1956.3 320202		ATE 3/40 2x
FORD - MONDEO II (BAP) 08/96→09/00								
 Hauptbremszylinder								
1.6 i	66	08/96→09/00		10/96→; - ABS			24.2125-1706.3 010496	Ø 25,4
1.8 i	85	08/96→09/00		10/96→; + ABS			24.2125-1709.3 010499	Ø 25,4
1.8 TD	66	08/96→09/00						
2.0 i	96	08/96→09/00						
2.5 24V	125	08/96→09/00						
1.6 i 16V	70	05/98→09/00		- ABS			24.2125-1706.3 010496	Ø 25,4
2.5 24V	125	06/00→09/00		+ ABS			24.2125-1709.3 010499	Ø 25,4
2.5 ST 200	151	05/99→09/00						
 Bremskraftregler								
1.6 i	66	08/96→09/00		10/96→; - ABS; Scheibenbremse			03.6043-1954.3 320226	ATE 3/30 2x
				10/96→; - ABS; Trommelbremse			03.6583-0165.3 320285	ATE lastabhängig 8/3 4x
1.6 i 16V	70	05/98→09/00		- ABS; Scheibenbremse			03.6043-1954.3 320226	ATE 3/30 2x
				- ABS; Trommelbremse			03.6583-0165.3 320285	ATE lastabhängig 8/3 4x
1.8 i	85	08/96→09/00		10/96→; - ABS; Scheibenbremse			03.6043-1954.3 320226	ATE 3/30 2x
2.0 i	96	08/96→09/00		10/96→; + ABS / + ASR	2	03.6043-1956.3 320202		ATE 3/40 2x
				10/96→; - ABS; Trommelbremse			03.6583-0165.3 320285	ATE lastabhängig 8/3 4x
1.8 TD	66	08/96→09/00		10/96→; - ABS; Scheibenbremse			03.6043-1954.3 320226	ATE 3/30 2x
				10/96→; + ABS	2	03.6043-1956.3 320202		ATE 3/40 2x
				10/96→; - ABS; Trommelbremse			03.6583-0165.3 320285	ATE lastabhängig 8/3 4x
2.5 24V	125	08/96→09/00		10/96→	2	03.6043-1956.3 320202		ATE 3/40 2x
2.5 24V	125	06/00→09/00			2	03.6043-1956.3 320202		ATE 3/40 2x
2.5 ST 200	151	05/99→09/00						
FORD - MONDEO II Kombi (BNP) 08/96→09/00								
 Hauptbremszylinder								
1.6 i	66	08/96→09/00		10/96→; - ABS			24.2125-1706.3 010496	Ø 25,4
1.8 i	85	08/96→09/00		10/96→; + ABS			24.2125-1709.3 010499	Ø 25,4
1.8 TD	66	08/96→09/00						
2.0 i	96	08/96→09/00						
2.5 24V	125	08/96→09/00						
1.6 i 16V	70	05/98→09/00		- ABS			24.2125-1706.3 010496	Ø 25,4
2.5 24V	125	10/99→09/00		+ ABS			24.2125-1709.3 010499	Ø 25,4
2.5 ST 200	151	05/99→09/00						
 Bremskraftregler								
1.6 i	66	08/96→09/00		10/96→; - ABS	2	03.6043-1953.3 320201		ATE 3/45 2x
1.6 i 16V	70	05/98→09/00		- ABS	2	03.6043-1953.3 320201		ATE 3/45 2x
1.8 i	85	08/96→09/00		10/96→; - ABS	2	03.6043-1953.3 320201		ATE 3/45 2x
2.0 i	96	08/96→09/00		10/96→; + ABS / + ASR	2	03.6043-1956.3 320202		ATE 3/40 2x
1.8 TD	66	08/96→09/00		10/96→; - ABS	2	03.6043-1953.3 320201		ATE 3/45 2x
				10/96→; + ABS	2	03.6043-1956.3 320202		ATE 3/40 2x
2.5 24V	125	08/96→09/00		10/96→	2	03.6043-1956.3 320202		ATE 3/40 2x
2.5 24V	125	10/99→09/00			2	03.6043-1956.3 320202		ATE 3/40 2x
2.5 ST 200	151	05/99→09/00						
FORD - MONDEO II Stufenheck (BFP) 08/96→09/00								
 Hauptbremszylinder								
1.6 i	66	08/96→09/00		10/96→; - ABS			24.2125-1706.3 010496	Ø 25,4
1.8 i	85	08/96→09/00		10/96→; + ABS			24.2125-1709.3 010499	Ø 25,4
1.8 TD	66	08/96→09/00						
2.0 i	96	08/96→09/00						
2.5 24V	125	08/96→09/00						
1.6 i 16V	70	05/98→09/00		- ABS			24.2125-1706.3 010496	Ø 25,4
2.5 24V	125	06/00→09/00		+ ABS			24.2125-1709.3 010499	Ø 25,4
2.5 ST 200	151	05/99→09/00						
 Bremskraftregler								
1.6 i	66	08/96→09/00		10/96→; - ABS; Scheibenbremse			03.6043-1954.3 320226	ATE 3/30 2x
				10/96→; - ABS; Trommelbremse			03.6583-0165.3 320285	ATE lastabhängig 8/3 4x
↓								

















	kW					! #		
FORD - MONDEO II Stufenheck (BFP) 08/96→09/00								
Bremskraftregler								
1.6 i 16V	70	05/98→09/00		- ABS; Scheibenbremse			03.6043-1954.3 320226	ATE 3/30 2x
				- ABS; Trommelbremse			03.6583-0165.3 320285	ATE lastabhängig 8/3 4x
1.8 i	85	08/96→09/00		10/96→; - ABS; Scheibenbremse			03.6043-1954.3 320226	ATE 3/30 2x
2.0 i	96	08/96→09/00		10/96→; + ABS / + ASR	2		03.6043-1956.3 320202	ATE 3/40 2x
				10/96→; - ABS; Trommelbremse			03.6583-0165.3 320285	ATE lastabhängig 8/3 4x
1.8 TD	66	08/96→09/00		10/96→; - ABS; Scheibenbremse			03.6043-1954.3 320226	ATE 3/30 2x
				10/96→; + ABS	2		03.6043-1956.3 320202	ATE 3/40 2x
				10/96→; - ABS; Trommelbremse			03.6583-0165.3 320285	ATE lastabhängig 8/3 4x
2.5 24V	125	08/96→09/00		10/96→	2		03.6043-1956.3 320202	ATE 3/40 2x
2.5 24V	125	06/00→09/00			2		03.6043-1956.3 320202	ATE 3/40 2x
2.5 ST 200	151	05/99→09/00						
FORD - MONDEO IV (BA7) 03/07→01/15								
Bremskraftverstärker								
1.6 EcoBoost	118	02/11→01/15		→ 09/14			03.7755-1432.4 300300	ATE Ø 9 / 8" pneumatisch
1.6 TDCi	85	02/11→01/15						
1.6 Ti	88	07/10→01/15						
1.8 TDCi	92	06/07→01/15						
2.0 EcoBoost	176	07/10→01/15						
2.0 Flexifuel	107	03/09→01/15						
2.0 LPG	107	07/09→01/15						
2.0 SCTi	149	03/10→01/15						
2.0 TDCi	85	11/07→01/15						
2.0 TDCi	100	03/07→01/15						
2.0 TDCi	120	03/10→01/15						
2.3	118	07/07→01/15						
1.6 Ti	81	03/07→01/15		04/07→ 09/14			03.7755-1432.4 300300	ATE Ø 9 / 8" pneumatisch
1.6 Ti	92	03/07→01/15						
1.8 TDCi	74	03/07→01/15						
2.0	107	03/07→01/15						
2.0 TDCi	96	03/07→01/15						
2.0 TDCi	103	03/07→01/15						
2.5	162	03/07→01/15						
2.2 TDCi	129	03/08→10/10		04/08→			03.7755-1432.4 300300	ATE Ø 9 / 8" pneumatisch
2.2 TDCi	147	07/10→01/15		11/10→ 09/14			03.7755-1432.4 300300	ATE Ø 9 / 8" pneumatisch
FORD - MONDEO IV Stufenheck (BA7) 03/07→01/15								
Bremskraftverstärker								
1.6 EcoBoost	118	11/10→01/15		02/11→ 09/14			03.7755-1432.4 300300	ATE Ø 9 / 8" pneumatisch
1.6 TDCi	85	12/10→01/15						
1.6 Ti	81	03/07→01/15		04/07→ 09/14			03.7755-1432.4 300300	ATE Ø 9 / 8" pneumatisch
1.6 Ti	92	03/07→01/15						
1.8 TDCi	74	03/07→01/15						
2.0	107	03/07→01/15						
2.0 TDCi	96	03/07→01/15						
2.0 TDCi	103	03/07→01/15						
2.5	162	03/07→01/15						
1.8 TDCi	92	06/07→01/15		→ 09/14			03.7755-1432.4 300300	ATE Ø 9 / 8" pneumatisch
2.0 Flexifuel	107	03/09→01/15						
2.0 LPG	107	07/09→01/15						
2.0 TDCi	85	11/07→01/15						
2.0 TDCi	120	03/10→01/15						
2.3	118	07/07→01/15						
2.2 TDCi	129	03/08→10/10		04/08→			03.7755-1432.4 300300	ATE Ø 9 / 8" pneumatisch
FORD - MONDEO IV Turnier (BA7) 03/07→01/15								
Bremskraftverstärker								
1.6 EcoBoost	118	02/11→01/15		→ 09/14			03.7755-1432.4 300300	ATE Ø 9 / 8" pneumatisch
1.6 TDCi	85	02/11→01/15						
1.6 Ti	88	07/10→01/15						
2.0 EcoBoost	176	07/10→01/15						
2.0 Flexifuel	107	03/09→01/15						
2.0 LPG	107	07/09→01/15						
2.0 SCTi	149	03/10→01/15						
2.0 TDCi	85	11/07→01/15						
2.0 TDCi	100	03/07→01/15						
2.0 TDCi	120	03/10→01/15						
2.3	118	07/07→01/15						
1.6 Ti	81	03/07→12/12		04/07→			03.7755-1432.4 300300	ATE Ø 9 / 8" pneumatisch
1.6 Ti	92	03/07→12/10						
1.8 TDCi	74	03/07→12/12						
2.0 TDCi	96	03/07→12/12						
2.5	162	03/07→12/12						
1.8 TDCi	92	06/07→12/12					03.7755-1432.4 300300	ATE Ø 9 / 8" pneumatisch
↓								











	kw			 	! #		
FORD - MONDEO IV Turnier (BA7) 03/07→01/15							
 Bremskraftverstärker							
2.0	107	03/07→01/15		04/07→ 09/14		03.7755-1432.4 300300	ATE Ø 9 / 8" pneumatisch
2.0 TDCi	103	03/07→01/15					
2.2 TDCi	129	03/08→10/10		04/08→		03.7755-1432.4 300300	ATE Ø 9 / 8" pneumatisch
2.2 TDCi	147	07/10→01/15		11/10→ 09/14		03.7755-1432.4 300300	ATE Ø 9 / 8" pneumatisch
FORD - PUMA (EC_) 03/97→06/02							
 Hauptbremszylinder							
1.4 16V	66	11/97→10/00		02/00→; + ABS		03.2123-2243.3 010748	ATE Ø 23,81
				02/98→ 01/00; - ABS		24.2123-1735.3 010652	Ø 23,81
1.6 16V	76	08/00→06/02		→ 12/01; + ABS		03.2123-2243.3 010748	ATE Ø 23,81
1.7 16V	92	03/97→06/02		02/00→ 12/01; + ABS		03.2123-2243.3 010748	ATE Ø 23,81
				01/98→ 01/00; - ABS		24.2123-1735.3 010652	Ø 23,81
FORD - S-MAX (WA6) 05/06→12/14							
 Bremskraftverstärker							
1.6 EcoBoost	118	02/11→12/14				03.7755-1432.4 300300	ATE Ø 9 / 8" pneumatisch
1.6 TDCi	85	02/11→12/14					
1.8 TDCi	74	01/07→12/10					
1.8 TDCi	92	05/06→12/14					
2.0	107	05/06→12/14					
2.0 EcoBoost	146	07/10→12/14					
2.0 EcoBoost	149	03/10→12/14					
2.0 EcoBoost	176	07/10→12/14					
2.0 Flexifuel	107	05/06→12/14					
2.0 TDCi	85	11/07→12/14					
2.0 TDCi	96	05/06→12/14					
2.0 TDCi	100	05/06→12/14					
2.0 TDCi	103	05/06→12/14					
2.0 TDCi	120	03/10→12/14					
2.2 TDCi	147	07/10→12/14					
2.3	118	07/07→12/14					
2.5 ST	162	05/06→12/14					
2.2 TDCi	129	03/08→12/12		04/08→		03.7755-1432.4 300300	ATE Ø 9 / 8" pneumatisch
FORD - TOURNEO CONNECT 06/02→12/13							
 Bremskraftregler							
1.8 16V	85	06/02→12/13		→ 08/13		03.6582-0118.3 320281	ATE lastabhängig 8/1,5 4x
1.8 TDCi	66	06/02→12/13					
1.8 TDCi	81	08/06→12/13					
1.8 TDCi /TDDi /DI	55	06/02→12/13					
FORD - TOURNEO CONNECT / GRAND TOURNEO CONNECT Kombi 09/13→							
 Hauptbremszylinder							
1.0 EcoBoost	74	11/13→		kurzer Radstand		03.4155-5451.3 010995	ATE Ø 25,4
1.6 EcoBoost	110	11/13→					
1.6 TDCi	55	09/13→		langer Radstand		03.4155-5456.3 010996	ATE Ø 25,4
1.6 TDCi	70	09/13→					
1.6 TDCi	85	09/13→					
FORD - TRANSIT Bus (E_) 06/94→07/00							
 Bremskraftverstärker							
2.0 (EBL, EBS, ECL, EDS, EDL, EGL, ESS, ESL, EUS)	84	09/95→03/00		→ 03/97; + ABS		10.6360-1302.4 300286	ATE Ø 10" pneumatisch
2.0 CNG	84	06/94→03/00					
2.5 DI (EBL, ECL, EDS, EDL)	56	07/94→03/00					
2.5 DI (EBL, EDS, ESL, ESS, EUS)	51	08/94→03/00					
2.5 TD (EB_, ED_, ES_)	55	08/94→06/00					
2.5 TD (EBL, EDL, EDS, EGL, ESL, ESS, EUS)	63	01/95→03/00					
2.5 TD (ECL, EDL, EDS, ESL, ESS, EUS)	74	07/94→03/00					
 Hauptbremszylinder							
2.0 (EBL, EBS, ECL, EDS, EDL, EGL, ESS, ESL, EUS)	84	09/95→03/00		→ 03/97; + ABS		10.6123-0154.3 010578	ATE Ø 23,81
				→ 03/97; - ABS		24.2123-1724.3 010566	BDX Ø 23,81
2.5 DI (EBL, ECL, EDS, EDL)	56	07/94→03/00		04/97→; + ABS		24.2123-1742.3 010671	Ø 23,81
2.5 DI (EBL, EDS, ESL, ESS, EUS)	51	08/94→03/00		04/97→; - ABS		24.2123-1749.3 010713	Ø 23,81
↓							













	kw			 	! #		
FORD - TRANSIT Bus (E_) 06/94→07/00							
 Hauptbremszylinder							
2.5 TD (EBL, EDL, EDS, EGL, ESL, ESS, EUS)	63	01/95→03/00		→ 03/97; + ABS		10.6123-0154.3 010578	ATE Ø 23,81
2.5 TD (ECL, EDL, EDS, ESL, ESS, EUS)	74	07/94→03/00		→ 03/97; - ABS		24.2123-1724.3 010566	BDX Ø 23,81
				04/97→; + ABS		24.2123-1742.3 010671	Ø 23,81
				04/97→; - ABS		24.2123-1749.3 010713	Ø 23,81
2.0 CNG	84	06/94→03/00		→ 03/97; + ABS		10.6123-0154.3 010578	ATE Ø 23,81
				07/94→ 03/97; + ABS		10.6123-0154.3 010578	ATE Ø 23,81
				→ 03/97; - ABS		24.2123-1724.3 010566	BDX Ø 23,81
				07/94→ 03/97; - ABS		24.2123-1724.3 010566	BDX Ø 23,81
				04/97→; + ABS		24.2123-1742.3 010671	Ø 23,81
				04/97→; - ABS		24.2123-1749.3 010713	Ø 23,81
2.5 DI (EBL, EDL, EDS, ESL, ESS)	85	08/97→03/00		+ ABS		24.2123-1742.3 010671	Ø 23,81
				- ABS		24.2123-1749.3 010713	Ø 23,81
2.5 TD (EB_, ED_, ES_)	55	08/94→06/00		→ 03/97; + ABS		10.6123-0154.3 010578	ATE Ø 23,81
				→ 03/97; - ABS		24.2123-1724.3 010566	BDX Ø 23,81
				04/97→ 03/00; + ABS		24.2123-1742.3 010671	Ø 23,81
				04/97→ 03/00; - ABS		24.2123-1749.3 010713	Ø 23,81
FORD - TRANSIT Bus (FD_, FB_, FS_, FZ_, FC_) 01/00→05/06							
 Hauptbremszylinder							
2.0 DI (F_E_, F_F_, F_G_)	55	08/00→05/06		→ 04/06; - ABS		24.2125-1721.3 010673	Ø 25,4 ohne Bremsflüssigkeitsbehälter
2.0 DI (F_E_, F_F_, F_G_)	63	08/00→05/06		→ 04/06; + ABS		24.2125-1722.3 010674	Ø 25,4 ohne Bremsflüssigkeitsbehälter
2.0 DI (F_E_, F_F_, F_G_)	74	08/00→05/06					
2.0 TDCi (F_F_, F_E_, F_G_)	92	08/02→05/06					
2.3 16V [RWD] (F_B_, F_C_, F_A_)	107	08/00→05/06					
2.4 DI (F_B_, F_C_, F_A_)	66	01/00→05/06					
2.4 DI [RWD] (F_B_, F_C_, F_A_)	88	01/00→05/06					
2.4 DI [RWD] (F_B_, F_C_)	55	01/00→05/06					
2.4 TDCi	101	03/04→05/06					
2.4 TDE	85	03/04→05/06					
2.4 TD	55	08/00→08/03		- ABS		24.2125-1721.3 010673	Ø 25,4 ohne Bremsflüssigkeitsbehälter
2.4 TDdi	66	10/01→03/06					
2.4 TDdi	88	08/00→08/03		+ ABS		24.2125-1722.3 010674	Ø 25,4 ohne Bremsflüssigkeitsbehälter
2.4 TDE (F_C_, F_B_, F_A_)	92	07/01→05/06		11/01→ 04/06; - ABS		24.2125-1721.3 010673	Ø 25,4 ohne Bremsflüssigkeitsbehälter
				11/01→ 04/06; + ABS		24.2125-1722.3 010674	Ø 25,4 ohne Bremsflüssigkeitsbehälter
FORD - TRANSIT CONNECT (P65_, P70_, P80_) 06/02→							
 Bremskraftregler							
1.8 16V	85	06/02→12/13		→ 08/13		03.6582-0118.3 320281	ATE lastabhängig 8/1,5 4x
1.8 16V LPG	85	06/02→12/13					
1.8 Di	55	06/02→12/13					
1.8 TDCi	66	06/02→12/13					
1.8 TDCi	81	08/06→12/13					
FORD - TRANSIT CONNECT Kasten 02/13→							
 Hauptbremszylinder							
1.0 EcoBoost	74	02/13→		09/13→; kurzer Radstand		03.4155-5451.3 010995	ATE Ø 25,4
1.6 TDCi	55	02/13→		09/13→; langer Radstand		03.4155-5456.3 010996	ATE Ø 25,4
1.6 TDCi	70	02/13→					
1.6 TDCi	85	02/13→					
1.6 EcoBoost	110	11/13→		kurzer Radstand		03.4155-5451.3 010995	ATE Ø 25,4
				langer Radstand		03.4155-5456.3 010996	ATE Ø 25,4
FORD - TRANSIT CONNECT Kombi 02/13→							
 Hauptbremszylinder							
1.6 EcoBoost	110	02/13→		09/13→; kurzer Radstand		03.4155-5451.3 010995	ATE Ø 25,4
1.6 TDCi	55	02/13→		09/13→; langer Radstand		03.4155-5456.3 010996	ATE Ø 25,4
1.6 TDCi	70	02/13→					
1.6 TDCi	85	02/13→					















	kw			 	! #		
FORD - TRANSIT Kasten (E_) 06/94→07/00							
 Bremskraftverstärker							
2.0 (EAL, EAS)	84	06/94→03/00		→ 03/97; + ABS		10.6360-1302.4 300286	ATE Ø 10" pneumatisch
2.5 DI (EAL, EAS)	51	06/94→03/00					
2.5 DI (EAL, EAS)	56	06/94→03/00					
2.5 TD (EAL, EAS)	63	06/94→03/00					
2.5 TDI (EAL, EAS)	74	06/94→03/00					
 Hauptbremszylinder							
2.0 (EAL, EAS)	84	06/94→03/00		→ 03/97; + ABS		10.6123-0154.3 010578	ATE Ø 23,81
2.5 DI (EAL, EAS)	51	06/94→03/00		→ 03/97; - ABS		24.2123-1724.3 010566	BDX Ø 23,81
2.5 DI (EAL, EAS)	56	06/94→03/00					
2.5 TD (EAL, EAS)	63	06/94→03/00		04/97→; + ABS		24.2123-1742.3 010671	Ø 23,81
2.5 TDI (EAL, EAS)	74	06/94→03/00		04/97→; - ABS		24.2123-1749.3 010713	Ø 23,81
2.5 DI (EAL, EAS)	85	05/99→03/00		+ ABS		24.2123-1742.3 010671	Ø 23,81
2.5 TD (EAS)	55	10/98→03/00		- ABS		24.2123-1749.3 010713	Ø 23,81
FORD - TRANSIT Kasten (FA_) 01/00→05/06							
 Hauptbremszylinder							
2.0 DI (FAE_, FAF_, FAG_)	55	08/00→05/06		→ 04/06; - ABS		24.2125-1721.3 010673	Ø 25,4 ohne Bremsflüssigkeitsbehälter
2.0 DI (FAE_, FAF_, FAG_)	63	08/00→05/06		→ 04/06; + ABS		24.2125-1722.3 010674	Ø 25,4 ohne Bremsflüssigkeitsbehälter
2.0 DI (FAE_, FAF_, FAG_)	74	08/00→05/06					
2.0 TDCi	92	08/02→05/06					
2.3 16V [RWD] (FAA_, FAB_, FAC_)	107	04/01→05/06					
2.4 DI (FAA_, FAB_, FAC_, FAD_)	66	01/00→05/06					
2.4 DI [RWD] (FAA_, FAB_, FAC_, FAD_)	55	01/00→05/06					
2.4 DI [RWD] (FAA_, FAB_, FAC_, FAD_)	88	01/00→05/06					
2.4 TDCi	101	03/04→05/06					
2.4 TDE	85	03/04→05/06					
2.3	105	03/01→03/06		04/01→; - ABS		24.2125-1721.3 010673	Ø 25,4 ohne Bremsflüssigkeitsbehälter
2.3	107	03/01→03/06		04/01→; + ABS		24.2125-1722.3 010674	Ø 25,4 ohne Bremsflüssigkeitsbehälter
2.4 TD Allrad	55	08/00→08/03		- ABS		24.2125-1721.3 010673	Ø 25,4 ohne Bremsflüssigkeitsbehälter
2.4 TDdi	88	08/00→08/03		+ ABS		24.2125-1722.3 010674	Ø 25,4 ohne Bremsflüssigkeitsbehälter
2.4 TDE	92	07/01→05/06		11/01→ 04/06; - ABS		24.2125-1721.3 010673	Ø 25,4 ohne Bremsflüssigkeitsbehälter
				11/01→ 04/06; + ABS		24.2125-1722.3 010674	Ø 25,4 ohne Bremsflüssigkeitsbehälter
FORD - TRANSIT Pritsche/Fahrgestell (E_) 08/94→07/00							
 Bremskraftverstärker							
2.0 (EME/L/S, ENE/L/S)	84	08/94→03/00		→ 03/97; + ABS		10.6360-1302.4 300286	ATE Ø 10" pneumatisch
2.5 DI (EME/L/S, ENE/L/S)	56	08/94→03/00					
2.5 DI (EML/S, ENL/S)	51	08/94→03/00					
2.5 TD (EME/L/S, ENE/L/S)	63	08/94→03/00					
2.5 TD (EME/L/S, ENE/L/S)	74	08/94→03/00					
 Hauptbremszylinder							
2.0 (EME/L/S, ENE/L/S)	84	08/94→03/00		→ 03/97; + ABS		10.6123-0154.3 010578	ATE Ø 23,81
2.5 DI (EME/L/S, ENE/L/S)	56	08/94→03/00		→ 03/97; - ABS		24.2123-1724.3 010566	BDX Ø 23,81
2.5 DI (EML/S, ENL/S)	51	08/94→03/00		04/97→; + ABS		24.2123-1742.3 010671	Ø 23,81
2.5 TD (EME/L/S, ENE/L/S)	63	08/94→03/00		04/97→; - ABS		24.2123-1749.3 010713	Ø 23,81
2.5 TD (EME/L/S, ENE/L/S)	74	08/94→03/00					
2.5 DI (EML, ENE/L)	85	05/99→03/00		+ ABS		24.2123-1742.3 010671	Ø 23,81
				- ABS		24.2123-1749.3 010713	Ø 23,81
2.5 TD (EME/L/S, ENE/L/S)	55	10/98→07/00		→ 03/00; + ABS		24.2123-1742.3 010671	Ø 23,81
				→ 03/00; - ABS		24.2123-1749.3 010713	Ø 23,81

















	kw			 	! #		
FORD - TRANSIT Pritsche/Fahrgestell (FM_-, FN_-) 01/00→05/06							
 Hauptbremszylinder							
2.0 DI (F_E-, F_F-)	55	08/00→05/06		→ 04/06; - ABS		24.2125-1721.3 010673	Ø 25,4 ohne Bremsflüssigkeitsbehälter
2.0 DI (F_E-, F_F-)	63	08/00→05/06					
2.0 DI (F_E-, F_F-)	74	08/00→05/06					
2.0 TDCi (F_E-, F_F-)	92	08/02→05/06		→ 04/06; + ABS		24.2125-1722.3 010674	Ø 25,4 ohne Bremsflüssigkeitsbehälter
2.3 16V (F_A-, F_B-, F_C-, F_D-)	107	04/01→05/06					
2.4 DI (F_A-, F_B-, F_C-, F_D-)	55	01/00→05/06					
2.4 DI (F_A-, F_B-, F_C-, F_D-)	66	01/00→05/06					
2.4 DI (F_A-, F_B-, F_C-, F_D-)	88	01/00→05/06					
2.4 TDCi	101	03/04→05/06					
2.4 TDE	85	03/04→05/06					
2.3	105	03/01→03/06		- ABS		24.2125-1721.3 010673	Ø 25,4 ohne Bremsflüssigkeitsbehälter
2.3 BiFuel	105	03/01→03/06					
2.4 TDdi	88	08/00→08/03		+ ABS		24.2125-1722.3 010674	Ø 25,4 ohne Bremsflüssigkeitsbehälter
2.4 TDE	92	07/01→05/06		11/01→ 04/06; - ABS		24.2125-1721.3 010673	Ø 25,4 ohne Bremsflüssigkeitsbehälter
				11/01→ 04/06; + ABS		24.2125-1722.3 010674	Ø 25,4 ohne Bremsflüssigkeitsbehälter
FORD - TRANSIT TOURNEO 08/94→12/00							
 Bremskraftverstärker							
2.0	84	11/94→12/00		09/95→ 03/97; + ABS		10.6360-1302.4 300286	ATE Ø 10" pneumatisch
2.5 DI	51	11/94→12/00		→ 03/97; + ABS		10.6360-1302.4 300286	ATE Ø 10" pneumatisch
2.5 DI	56	11/94→12/00					
2.5 TD	63	11/94→12/00		01/95→ 03/97; + ABS		10.6360-1302.4 300286	ATE Ø 10" pneumatisch
 Hauptbremszylinder							
2.0	84	11/94→12/00		09/95→ 03/97; + ABS		10.6123-0154.3 010578	ATE Ø 23,81
				09/95→ 03/97; - ABS		24.2123-1724.3 010566	BDX Ø 23,81
				04/97→ 03/00; + ABS		24.2123-1742.3 010671	Ø 23,81
				04/97→ 03/00; - ABS		24.2123-1749.3 010713	Ø 23,81
2.4 D	55	08/94→06/00		→ 03/97; + ABS		10.6123-0154.3 010578	ATE Ø 23,81
2.5 DI	51	11/94→12/00		→ 03/97; - ABS		24.2123-1724.3 010566	BDX Ø 23,81
2.5 DI	56	11/94→12/00					
				04/97→ 03/00; + ABS		24.2123-1742.3 010671	Ø 23,81
				04/97→ 03/00; - ABS		24.2123-1749.3 010713	Ø 23,81
2.5 TD	63	11/94→12/00		01/95→ 03/97; + ABS		10.6123-0154.3 010578	ATE Ø 23,81
				01/95→ 03/97; - ABS		24.2123-1724.3 010566	BDX Ø 23,81
				04/97→ 03/00; + ABS		24.2123-1742.3 010671	Ø 23,81
				04/97→ 03/00; - ABS		24.2123-1749.3 010713	Ø 23,81
2.5 TD	74	04/98→12/00		→ 03/00; + ABS		24.2123-1742.3 010671	Ø 23,81
				→ 03/00; - ABS		24.2123-1749.3 010713	Ø 23,81
FSO - 126P 07/72→09/00							
 Hauptbremszylinder							
650	18	07/81→09/00		→ 07/90		24.2119-0815.3 010347	Ø 19,05
HONDA - ACCORD VII (CL, CN) 01/03→09/12							
 Hauptbremszylinder							
2.0 (CL7)	114	02/03→05/08		01/06→; für Linkslenker		24.2120-1752.3 010928	ATE Ø 20,64 mit Bremsflüssigkeitsbehälter
2.4 (CL9)	140	02/03→05/08					
2.0 Allrad (CL8)	114	02/03→05/08		01/06→		24.2120-1752.3 010928	ATE Ø 20,64 mit Bremsflüssigkeitsbehälter
2.2 i-CTDi (CN1)	103	01/04→05/08					
2.4	113	09/06→05/08				24.2120-1752.3 010928	ATE Ø 20,64 mit Bremsflüssigkeitsbehälter
2.4 Vtec	122	04/06→07/08					
HONDA - ACCORD VII Tourer (CM, CN) 04/03→05/08							
 Hauptbremszylinder							
2.0 (CM1)	114	04/03→05/08		01/06→		24.2120-1752.3 010928	ATE Ø 20,64 mit Bremsflüssigkeitsbehälter
2.2 i-CTDi (CN2)	103	01/04→05/08					
2.4 (CM2)	140	04/03→05/08					
2.4 Vtec T	147	09/03→05/08					

















	kw			 	! #		
HONDA - CITY Stufenheck (GM2, GM3) 09/08→							
 Hauptbremszylinder							
1.4 i-V TEC	73	09/08→		→ 11/13		24.2122-1771.3 010901	TRW Ø 22,2 mit Bremsflüssigkeitsbehälter
HONDA - CIVIC V Coupe (EJ) 08/93→03/96							
 Hauptbremszylinder							
1.6 i (EJ6)	77	01/94→11/95		- ABS		24.2120-1751.3 010909	Ø 20,64
HONDA - CIVIC VI Coupe (EJ, EM1) 03/96→12/00							
 Hauptbremszylinder							
1.6 1.6 i	79 77	05/96→04/99 03/96→03/00		→ 12/98; - ABS		24.2120-1751.3 010909	Ø 20,64
HONDA - CIVIC VI Hatchback (EJ, EK) 10/95→02/01							
 Hauptbremszylinder							
1.4 i (EJ9) 1.4 i S (EJ9) 1.4 LPG	55 66 66	11/95→02/01 11/95→02/01 01/97→02/01		→ 01/01; - ABS; für Linkslenker		24.2120-1751.3 010909	Ø 20,64
HONDA - CIVIC VI Stufenheck (EJ, EK) 06/95→03/01							
 Hauptbremszylinder							
1.4 1.4 i (EJ9)	55 66	11/95→10/98 11/95→02/01		- ABS; für Linkslenker → 01/01; - ABS; für Linkslenker		24.2120-1751.3 010909	Ø 20,64 Ø 20,64
HONDA - CIVIC VIII Hatchback (FN, FK) 09/05→							
 Hauptbremszylinder							
1.4 (FK1, FN4) 1.6	73 84	10/08→ 09/05→		→ 12/12		24.2119-1709.3 010876	TRW Ø 19,05 mit Bremsflüssigkeitsbehälter
HONDA - CIVIC VIII Stufenheck (FD, FA) 09/05→							
 Hauptbremszylinder							
1.6 1.7	84 85	09/05→ 09/05→		01/06→ 12/12		24.2119-1709.3 010876	TRW Ø 19,05 mit Bremsflüssigkeitsbehälter
1.6 1.8	92 97	09/05→ 01/06→		→ 12/12		24.2119-1709.3 010876	TRW Ø 19,05 mit Bremsflüssigkeitsbehälter
1.8 (FD1)	103	09/05→02/12		für Linkslenker		24.2119-1709.3 010876	TRW Ø 19,05 mit Bremsflüssigkeitsbehälter
1.8 EXS Flex	103	11/06→		→ 12/12; für Linkslenker		24.2119-1709.3 010876	TRW Ø 19,05 mit Bremsflüssigkeitsbehälter
HONDA - CR-V I (RD) 10/95→02/02							
 Hauptbremszylinder							
2.0 (RD1)	98	04/99→02/02		→ 12/01; - ABS		24.2123-1774.3 010877	TRW Ø 23,81 mit Bremsflüssigkeitsbehälter
2.0 16V 4WD (RD1, RD3)	94	10/95→12/01		01/98→ 04/99; - ABS		24.2123-1774.3 010877	TRW Ø 23,81 mit Bremsflüssigkeitsbehälter
2.0 16V 4WD (RD1, RD3)	108	01/99→02/02		04/99→ 12/01; - ABS		24.2123-1774.3 010877	TRW Ø 23,81 mit Bremsflüssigkeitsbehälter
HONDA - JAZZ II (GD_, GE3, GE2) 06/01→12/08							
 Hauptbremszylinder							
1.2 i-DSi (GD5, GE2) 1.3 (GD1) 1.7	57 61 92	03/02→07/08 03/02→07/08 10/03→09/07		01/04→; - ESP		24.2122-1771.3 010901	TRW Ø 22,2 mit Bremsflüssigkeitsbehälter
1.3 iDSi	63	03/02→09/07		10/05→; - ESP		24.2122-1771.3 010901	TRW Ø 22,2 mit Bremsflüssigkeitsbehälter
1.4	59	12/06→10/08		- ESP		24.2122-1771.3 010901	TRW Ø 22,2 mit Bremsflüssigkeitsbehälter
1.5 1.5 FF	81 79	04/02→07/08 03/02→09/07		09/05→; - ESP		24.2122-1771.3 010901	TRW Ø 22,2 mit Bremsflüssigkeitsbehälter
HONDA - JAZZ III (GE_, GG_, GP_) 10/07→							
 Hauptbremszylinder							
1.2 1.3 i 1.5 Flexfuel 1.5 i-VTEC 1.5 i-VTEC	66 73 88 87 88	07/08→ 07/08→ 07/08→ 09/08→ 07/08→		→ 12/08; für Linkslenker; - ESP		24.2122-1771.3 010901	TRW Ø 22,2 mit Bremsflüssigkeitsbehälter
↓							

















	kW					! #		
HONDA - JAZZ III (GE_, GG_, GP_) 10/07→								
 Hauptbremszylinder								
1.5 Flex	85	10/07→			07/08→ 12/08; für Linkslenker; - ESP		24.2122-1771.3 010901	TRW Ø 22,2 mit Bremsflüssigkeitsbehälter
HYUNDAI - ATOS (MX) 01/97→								
 Hauptbremszylinder								
1.1	43	08/03→05/05			+ ABS		24.2120-1767.3 011004	Ø 20,64 ohne Bremsflüssigkeitsbehälter
1.1	45	06/03→12/10			→ 01/07; + ABS; für Linkslenker		24.2120-1767.3 011004	Ø 20,64 ohne Bremsflüssigkeitsbehälter
1.1	46	01/97→12/08			03/04→ 02/08; + ABS		24.2120-1767.3 011004	Ø 20,64 ohne Bremsflüssigkeitsbehälter
HYUNDAI - ATOS PRIME (MX) 08/99→								
 Hauptbremszylinder								
1.1	43	06/03→			→ 01/07; + ABS; für Linkslenker		24.2120-1767.3 011004	Ø 20,64 ohne Bremsflüssigkeitsbehälter
1.1	46	09/05→			→ 08/08; + ABS		24.2120-1767.3 011004	Ø 20,64 ohne Bremsflüssigkeitsbehälter
HYUNDAI - GETZ (TB) 08/02→12/10								
 Hauptbremszylinder								
1.1	46	09/02→09/05			→ 07/05; - ABS		24.2122-1761.3 010822	Ø 22,2
1.5 i	73	03/03→09/05						
1.6	77	09/02→09/05			→ 07/05; + ABS		24.2122-1765.3 010839	Ø 22,2
1.1	49	09/05→06/09			→ 02/09; - ESP		24.2122-1765.3 010839	Ø 22,2
1.4 i	71	08/05→12/10						
1.5 CRDi	65	08/05→06/09						
1.5 CRDi GLS	81	08/05→06/09						
1.3	61	09/04→06/09			→ 04/05; - ABS		24.2122-1761.3 010822	Ø 22,2
1.3	63	09/03→09/05			→ 04/05; + ABS		24.2122-1765.3 010839	Ø 22,2
1.3 i	60	09/02→03/04			- ABS		24.2122-1761.3 010822	Ø 22,2
					+ ABS		24.2122-1765.3 010839	Ø 22,2
1.5 CRDi	60	03/03→09/05			→ 04/05; - ESP		24.2122-1765.3 010839	Ø 22,2
1.5 CRDi GLS	75	07/04→08/05			→ 07/05; - ESP		24.2122-1765.3 010839	Ø 22,2
1.6	78	06/05→12/06			08/05→; - ESP		24.2122-1765.3 010839	Ø 22,2
HYUNDAI - MATRIX (FC) 06/01→08/10								
 Hauptbremszylinder								
1.5	75	06/01→08/10			→ 07/03; - ABS		24.2123-1762.3 010823	Ø 23,81
1.5 CRDi	60	10/01→08/10						
1.6	66	01/02→12/05						
1.6	76	06/01→08/10						
1.8	90	06/01→08/10			→ 07/03		24.2123-1762.3 010823	Ø 23,81
JAGUAR - S-TYPE (CCX_) 01/99→12/08								
Pedalwegsensor, Bremspedal								
2.5 V6	147	04/02→10/07			02/03→; für Rechtslenker		03.0655-0007.2 370007	ATE
4.2 V8	219	04/02→10/07			02/03→; für Linkslenker		03.0655-0007.2 370007	ATE
2.7 D	152	06/04→10/07			für Linkslenker		03.0655-0007.2 370007	ATE
					für Rechtslenker		03.0655-0007.2 370007	ATE
3.0 V6	175	01/99→10/07			05/03→; für Linkslenker		03.0655-0007.2 370007	ATE
					05/03→; für Rechtslenker		03.0655-0007.2 370007	ATE
4.2 Supercharged	298	11/01→12/08			08/03→; für Rechtslenker		03.0655-0007.2 370007	ATE
R 4,2 V8	291	04/02→10/07			08/03→; für Linkslenker		03.0655-0007.2 370007	ATE
 Hauptbremszylinder								
2.5 V6	147	04/02→10/07			M45255→ N52047; für Linkslenker; + ESP		03.4125-0032.3 010955	ATE Ø 25,4
2.7 D	152	06/04→10/07						
3.0 V6	175	01/99→10/07			N52048→; für Linkslenker; + ESP		03.4156-0051.3 011011	ATE Ø 26,99 ohne Bremsflüssigkeitsbehälter
4.0 V8	203	01/99→04/02						
4.0 V8	209	09/99→12/02						
4.2 Supercharged	298	11/01→12/08						
4.2 V8	219	04/02→10/07						
R 4,2 V8	291	04/02→10/07						

















	kw			 	! #				
JAGUAR - XF (CC9_) 03/08→04/15									
 Bremskraftverstärker									
2.0	177	06/12→04/15				03.7745-6502.4 300296	ATE Ø 8" pneumatisch		
2.2 D	120	04/11→04/15							
2.2 D	140	05/11→04/15							
2.2 D	147	03/12→04/15							
2.7 D	152	03/08→04/15							
3.0	250	03/12→04/15							
3.0 AWD	250	10/12→04/15							
3.0 D	155	03/09→04/15							
3.0 D	177	03/09→04/15							
3.0 D	202	03/09→04/15							
4.2	219	03/08→04/15							
4.2 Kompressor	306	03/08→04/15							
5.0	283	03/09→04/15							
 Hauptbremszylinder									
2.0	177	06/12→04/15		für Linkslenker		03.4156-0016.3 010970	ATE Ø 26,99		
2.2 D	120	04/11→04/15							
2.2 D	140	05/11→04/15							
2.2 D	147	03/12→04/15							
2.7 D	152	03/08→04/15							
3.0	175	03/08→04/15							
3.0	179	03/08→04/15							
3.0	250	03/12→04/15							
3.0 AWD	250	10/12→04/15							
3.0 D	155	03/09→04/15							
3.0 D	177	03/09→04/15							
3.0 D	202	03/09→04/15							
4.2	219	03/08→04/15							
4.2 Kompressor	306	03/08→04/15							
5.0	283	03/09→04/15							
5.0 Kompressor	346	01/09→04/15							
5.0 Kompressor	375	03/09→04/15							
5.0 XFR-S	405	10/12→04/15							
JAGUAR - XF SPORTBRAKE (CC9_) 09/12→04/14									
 Bremskraftverstärker									
2.2 D	120	09/12→04/14				03.7745-6502.4 300296	ATE Ø 8" pneumatisch		
2.2 D	147	09/12→04/14							
 Hauptbremszylinder									
2.2 D	120	09/12→04/14		für Linkslenker		03.4156-0016.3 010970	ATE Ø 26,99		
2.2 D	147	09/12→04/14							
3.0 D	177	09/12→04/14							
3.0 D	202	09/12→04/14							
5.0 XFR-S	405	02/13→04/14		02/14→; für Linkslenker		03.4156-0016.3 010970	ATE Ø 26,99		
JAGUAR - XJ (X350_) 05/03→03/09									
Pedalwegsensor, Bremspedal									
3.0	175	05/03→03/09		für Rechtslenker		03.0655-0007.2 370007	ATE		
3.0	179	04/04→01/07							
3.6	190	05/03→03/09		für Linkslenker		03.0655-0007.2 370007	ATE		
4.2	219	05/03→03/09		für Rechtslenker					
R 4.2	291	05/03→03/09		für Rechtslenker		03.0655-0007.2 370007	ATE		
 Hauptbremszylinder									
2,7 D	152	10/05→03/09		→ G49700; für Linkslenker		03.4125-0032.3 010955	ATE Ø 25,4		
				H17287→; für Linkslenker				03.4156-0051.3 011011	ATE Ø 26,99 ohne Bremsflüssigkeitsbehälter
				G49701→ H17286; für Linkslenker				03.4156-0051.3 011011	ATE Ø 26,99 ohne Bremsflüssigkeitsbehälter
3.0	175	05/03→03/09		für Linkslenker		03.4125-0032.3 010955	ATE Ø 25,4		
3.0	179	04/04→01/07							
3.6	190	05/03→03/09							
4.2	219	05/03→03/09							
R 4.2	291	05/03→03/09							
JAGUAR - XJ (X351_) 10/09→									
 Hauptbremszylinder									
2.0	177	05/12→		für Linkslenker		03.4156-0076.3 011013	ATE Ø 26,99		
3.0	175	01/11→							
3.0	250	03/12→							
3.0 AWD	250	10/12→							
3.0 D	202	10/09→12/15							
3.0 D	221	04/15→							
5.0 V8	346	10/09→							
5.0 V8	375	10/09→							
5.0 V8	405	06/13→							
5.0 V 8	283	10/09→							















	kw					! #		
JAGUAR - XK 8 Convertible (X100_, QDV_) 03/96→07/05								
Pedalwegsensord, Bremspedal								
4.2	219	08/02→07/05				03.0655-0007.2	370007	ATE
R 4.2	291	08/02→07/05						
JAGUAR - XK 8 Coupe (X100_, QEV_) 03/96→07/05								
Pedalwegsensord, Bremspedal								
4.2	219	08/02→07/05				03.0655-0007.2	370007	ATE
R 4.2	291	08/02→07/05						
JAGUAR - XK Cabriolet (QQ6_) 03/06→07/14								
 Hauptbremszylinder								
3.6	190	10/07→07/14		B13391→; für Linkslenker		03.4156-0051.3	011011	ATE Ø 26,99 ohne Bremsflüssigkeitsbehälter
4.2 XK8	219	03/06→07/14						
4.2 XKR	306	03/06→07/14		→ B13390; für Linkslenker		03.4156-0051.3	011011	ATE Ø 26,99 ohne Bremsflüssigkeitsbehälter
4.2 XKR	313	08/06→07/14						
5.0 V8	218	09/09→12/12						
5.0 V8	283	01/09→07/14						
5.0 XKR	375	01/09→07/14						
4.2	291	09/07→12/09		für Linkslenker		03.4156-0051.3	011011	ATE Ø 26,99 ohne Bremsflüssigkeitsbehälter
5.0 XKR-S	405	01/11→07/14		B13391→; für Linkslenker		03.4156-0051.3	011011	ATE Ø 26,99 ohne Bremsflüssigkeitsbehälter
JAGUAR - XK Coupe (QQ6_) 03/06→07/14								
 Hauptbremszylinder								
3.6	190	07/07→07/14		B13391→; für Linkslenker		03.4156-0051.3	011011	ATE Ø 26,99 ohne Bremsflüssigkeitsbehälter
4.2 XK8	219	03/06→07/14						
4.2 XKR	291	03/06→07/14		→ B13390; für Linkslenker		03.4156-0051.3	011011	ATE Ø 26,99 ohne Bremsflüssigkeitsbehälter
4.2 XKR	306	03/06→07/14						
4.2 XKR	313	08/06→07/14						
5.0 V8	218	09/09→12/12						
5.0 V8	283	01/09→07/14						
5.0 XKR	375	01/09→07/14						
5.0 XKR	390	09/10→07/14						
5.0 XKR-S	405	01/11→07/14		B13391→; für Linkslenker		03.4156-0051.3	011011	ATE Ø 26,99 ohne Bremsflüssigkeitsbehälter
KIA - SEPHIA (FA) 01/95→10/97								
 Bremskraftregler								
1.6 i	59	01/95→10/97		→ 03/95		03.0101-0014.2	320004	ATE Satz 3/25 2x
KIA - SEPHIA Stufenheck (FA) 01/92→09/01								
 Bremskraftregler								
1.6 i	59	09/93→10/97		10/93→ 03/95		03.0101-0014.2	320004	ATE Satz 3/25 2x
KIA - SORENTO I (JC) 08/02→								
 Hauptbremszylinder								
2.5 CRDi	103	08/02→		→ 11/06; + ABS		24.2126-1702.3	010950	Ø 26,99
3.5 V6 4WD	143	08/02→		→ 11/06; + ABS; Vollautomatik		24.2126-1702.3	010950	Ø 26,99
KIA - VENGA (YN) 02/10→								
 Hauptbremszylinder								
1.4 CRDi 75	55	02/10→		für Linkslenker; + ESP		24.4122-1715.3	010982	TRW Ø 22,2 ohne Bremsflüssigkeitsbehälter
1.4 CRDi 75	57	02/10→						
1.4 CRDi 90	66	02/10→						
1.4 CVVT	66	02/10→		für Linkslenker; - ESP		24.4122-1716.3	010983	TRW Ø 22,2 ohne Bremsflüssigkeitsbehälter
1.4 LPG	66	02/10→						
1.6 CRDi 115	85	02/10→						
1.6 CRDi 128	94	02/10→						
1.6 CVVT	92	02/10→						
LADA - 110 (2110) 01/95→12/12								
 Hauptbremszylinder								
1.5	52	01/95→12/05				24.2120-0803.3	010415	Ø 20,64
1.5	57	01/95→12/05						
1.5 16V	70	01/95→12/05						
1.6	66	01/00→04/07						
2.0 i	110	08/96→07/00						
Wankel	88	06/97→09/04						
1.6	60	01/00→12/12		→ 08/07		24.2120-0803.3	010415	Ø 20,64











	kw			 	! #		
LADA - 111 (2111) 01/95→							
 Hauptbremszylinder							
1.5	57	01/96→12/05				24.2120-0803.3 010415	Ø 20,64
1.5 16V	70	01/95→08/02					
1.6	60	09/04→12/13		01/05→12/08		24.2120-0803.3 010415	Ø 20,64
1.6	66	09/04→		03/06→12/08		24.2120-0803.3 010415	Ø 20,64
LADA - 112 (2112) 01/95→12/11							
 Hauptbremszylinder							
1.5	54	01/95→10/00				24.2120-0803.3 010415	Ø 20,64
1.5	57	01/95→09/04					
1.5 16V	70	01/95→09/00					
1.6	66	03/06→12/08					
1.6	60	01/05→12/11		→12/08		24.2120-0803.3 010415	Ø 20,64
LADA - 1200-1600 01/70→12/05							
 Hauptbremszylinder							
1600 N/L (VAZ2106, VAZ2103)	57	03/79→12/05		→06/85		24.2119-0831.3 010416	Ø 19,05
LADA - NIVA (2121) 12/76→							
 Hauptbremszylinder							
1600 4x4	54	01/87→03/95				24.2119-0832.3 010417	Ø 19,05
1700 i	59	06/96→12/06					
1700 i 4x4	60	10/00→12/10					
1900 Diesel	55	01/99→12/06					
1700 i 4x4	61	09/10→				24.2120-0803.3 010415	Ø 20,64
1900 Diesel	47	01/93→08/99		03/93→		24.2119-0832.3 010417	Ø 19,05
LADA - NOVA (2105) 05/81→04/12							
 Hauptbremszylinder							
1200 Junior/L (VAZ, WAS2105)	44	09/81→04/12		→12/96		24.2119-0832.3 010417	Ø 19,05
1300 Spezial/L (VAZ, WAS2105)	48	05/81→04/12					
1500 S (WAS21093)	52	06/89→04/12					
1500 Special (VAZ2105, WAS21053)	55	03/85→04/12					
1600 (WAS21074)	56	01/88→10/01					
1700 i Classic (VAZ2107)	62	06/96→04/12					
LADA - NOVA Kombi (2104) 09/81→04/12							
 Hauptbremszylinder							
1500	49	08/94→04/12		→12/96		24.2119-0832.3 010417	Ø 19,05
1700	62	08/94→04/12					
LADA - SAMARA (2108, 2109, 2115, 2113, 2114) 01/86→12/13							
 Hauptbremszylinder							
1.5	56	04/96→12/06		→12/99		24.2120-0803.3 010415	Ø 20,64
1500	52	02/95→12/06					
1100	43	02/96→08/99				24.2120-0803.3 010415	Ø 20,64
1300	45	09/91→08/99					
1300	46	06/87→12/96					
1300	50	02/96→12/96					
1500	50	09/91→12/96					
1500	53	09/87→12/96					
LADA - SAMARA FORMA Stufenheck (21099, 2115) 09/87→12/12							
 Hauptbremszylinder							
1100	39	07/91→08/99		→12/95		24.2120-0803.3 010415	Ø 20,64
1300	45	07/91→08/99					
1300	46	05/90→08/99					
1300	48	05/89→07/97					
1500	50	07/91→12/96					
1500	52	11/94→12/06					
1500	53	09/91→12/96					
LANCIA - DEDRA (835_) 01/89→07/99							
 Hauptbremszylinder							
1.6 i.e. (835AN)	55	04/93→07/99		→10/93; für Linkslenker; - ABS		24.2120-1710.3 010468	Ø 20,64
1.8 i.e. (835AT)	66	08/93→07/99					
1.8 i.e. (835BD, 835AD)	77	09/89→07/99		01/90→10/93; für Linkslenker; - ABS		24.2120-1710.3 010468	Ø 20,64
↓							

	kw			 	! #		
LANCIA - DEDRA (835_) 01/89→07/99							
 Hauptbremszylinder							
2.0 i.e. (835AL)	83	09/89→07/99		01/90→10/93; für Linkslenker; - ABS		24.2120-1710.3 010468	Ø 20,64
1.9 TDS (835EE, 835EF)	66	04/89→07/99		01/90→10/93; für Linkslenker; - ABS		24.2120-1710.3 010468	Ø 20,64
				01/90→10/93; - ABS		24.2120-1710.3 010468	Ø 20,64
2.0 i.e. Turbo (835AR)	119	04/91→07/99		05/91→10/93; GG		24.2122-1716.3 010485	Ø 22,2
LANCIA - DELTA II (836_) 06/93→09/99							
 Hauptbremszylinder							
1.4 i.e. (836AF, 836AH)	51	10/94→08/99		GG		24.2122-1716.3 010485	Ø 22,2
1.6 i.e. (836AP)	66	03/96→08/99					
1.6 i.e. 16V (836AO)	76	01/96→08/99					
1.8 i.e. (836AG, 836AL)	66	07/94→08/99					
1.8 i.e. 16V (836AQ)	83	03/96→08/99					
1.8 i.e. 16V GT (836AR)	96	03/96→08/99					
2.0 16V Turbo (836AS)	142	07/96→08/99					
1.6 i.e. (836AD)	55	06/93→08/99		→ 10/93		24.2119-0829.3 010351	Ø 19,05
				11/93→; GG		24.2122-1716.3 010485	Ø 22,2
1.8 i.e. (836AE)	76	06/93→08/99		11/93→; GG		24.2122-1716.3 010485	Ø 22,2
2.0 16V (836AA, 836CA)	102	06/93→08/99					
2.0 16V Turbo (836AB)	137	06/93→08/99					
LANCIA - DELTA III (844_) 08/08→08/14							
 Hauptbremszylinder							
1.4	88	09/08→08/14				24.4123-1710.3 010866	BOS Ø 23,81 ohne Bremsflüssigkeitsbehälter
1.4	110	09/08→08/14					
1.4 16V	103	07/10→08/14					
1.4 Bifuel	88	07/11→08/14					
1.6 D Multijet	77	04/11→08/14					
1.6 D Multijet	85	08/08→08/14					
1.6 D Multijet	88	09/08→08/14					
1.8	147	01/09→08/14					
1.9 D Multijet	140	01/09→08/14					
2.0 D Multijet	120	09/08→08/14					
2.0 D Multijet	121	09/08→08/14					
LANCIA - MUSA (350_) 10/04→09/12							
 Hauptbremszylinder							
1.3 D Multijet	51	10/04→09/12		→ 11/06;		24.2123-1763.3 010842	Ø 23,81
1.3 D Multijet	66	09/06→09/12		für Fahrzeuge ohne elektronische Fahr-			
1.4	57	09/05→09/12		dynamikregelung			
1.4	70	10/04→09/12		→ 11/06;		24.2123-1769.3 010863	BOS Ø 23,81
1.9 D Multijet	74	10/04→09/12		für Fahrzeuge mit elektronischer Fahr-			
				dynamikregelung			
				12/06→		24.4123-1708.3 010859	BOS Ø 23,81
1.3 D Multijet	70	03/09→09/12		08/09→		24.4123-1708.3 010859	BOS Ø 23,81
1.4	66	10/07→09/12				24.4123-1708.3 010859	BOS Ø 23,81
1.4 LPG	57	11/10→09/12					
1.6 D Multijet	85	07/08→09/12					
1.6 D Multijet	88	07/08→09/12					
LANCIA - PHEDRA (179_) 09/02→11/10							
 Hauptbremszylinder							
2.0 (179AXA11)	100	09/02→11/10		→ 09/10		03.2122-2163.3 010800	ATE Ø 22,2
2.0 D Multijet	100	07/06→11/10					
2.0 JTD	79	07/03→11/10					
2.0 JTD	88	06/06→11/10					
2.0 JTD (179AXB1A)	80	09/02→11/10					
2.2 D Multijet	125	03/08→11/10					
2.2 JTD	120	04/06→11/10					
2.2 JTD (179AXC1A)	94	09/02→11/10					
LANCIA - Y (840_) 11/95→09/03							
 Hauptbremszylinder							
1.1 (840AE)	40	11/95→09/03		05/97→12/98		24.2120-1710.3 010468	Ø 20,64
1.2 (840AA, 840AF1A)	44	03/96→09/03		→ 07/03		24.2120-1710.3 010468	Ø 20,64
1.2 16V (840AG1A)	59	10/00→09/03					
1.2 16V (840AD)	63	04/97→09/03		05/97→09/00		24.2120-1710.3 010468	Ø 20,64
1.4 12V (840AB)	59	10/96→09/03		→ 12/98		24.2120-1710.3 010468	Ø 20,64
1.4 12V (840AC)	55	03/96→09/03					
 Bremskraftregler							
1.1 (840AE)	40	11/95→09/03		 ; 05/97→12/98; - ABS		24.6513-1705.3 320237	lastabhängig 2x
1.2 (840AA, 840AF1A)	44	03/96→09/03		 ; → 07/03; - ABS		24.6513-1705.3 320237	lastabhängig 2x
↓							

	kW					! #		
LANCIA - Y (840_) 11/95→09/03								
 Bremskraftregler								
1.2 16V (840AG1A)	59	10/00→09/03			→ 07/03; - ABS		24.6513-1705.3 320237	lastabhängig 2x
1.2 16V (840AD)	63	04/97→09/03			05/97→ 09/00; - ABS		24.6513-1705.3 320237	lastabhängig 2x
1.4 12V (840AB)	59	10/96→09/03			→ 12/98; - ABS		24.6513-1705.3 320237	lastabhängig 2x
1.4 12V (840AC)	55	03/96→09/03						
LANCIA - Y10 (156_) 03/85→12/95								
 Hauptbremszylinder								
1.1 Fire (156AG)	40	01/95→12/95					24.2120-1733.3 010686	Ø 20,64
1.1 Fire Allrad (156AG)	40	01/95→12/95						
1.1 i.e. Fire (156AG)	37	07/89→09/95			01/90→ 12/92		24.2120-0801.3 010362	Ø 20,64
					01/93→		24.2120-1733.3 010686	Ø 20,64
1.1 i.e. Fire Allrad (156AG)	37	09/92→12/95			→ 12/92		24.2120-0801.3 010362	Ø 20,64
1.3 i.e. (156AF)	53	02/89→12/95			01/93→		24.2120-1733.3 010686	Ø 20,64
 Bremskraftregler								
1.1 Fire (156AG)	40	01/95→12/95					24.6513-0801.3 320117	lastabhängig 1/3 2x
1.1 Fire Allrad (156AG)	40	01/95→12/95						
1.1 i.e. Fire Allrad (156AG)	37	09/92→12/95						
1.3 i.e. (156AF)	53	02/89→12/95						
1.1 i.e. Fire (156AG)	37	07/89→09/95			01/90→		24.6513-0801.3 320117	lastabhängig 1/3 2x
LANCIA - YPSILON (843_) 10/03→12/11								
 Hauptbremszylinder								
1.2	44	10/03→12/11			→ 06/11		24.2120-1745.3 010834	Ø 20,64
1.2	51	08/10→12/11			→ 06/11;		24.2122-1762.3 010837	Ø 22,2
1.2	59	10/03→12/11			für Fahrzeuge ohne elektronische Fahr-			
1.3 JTD	51	10/03→12/11			dynamikregelung			
1.4	57	02/06→12/11			→ 06/11;		24.2122-1768.3 010853	Ø 22,2
1.4 16V	70	10/03→12/11			für Fahrzeuge mit elektronischer Fahr-			
1.4 LPG	57	11/10→12/11			dynamikregelung			
1.3 D Multijet	55	09/06→12/11			10/06→ 06/11;		24.2122-1762.3 010837	Ø 22,2
1.3 D Multijet	66	09/06→12/11			für Fahrzeuge ohne elektronische Fahr-			
					dynamikregelung		24.2122-1768.3 010853	Ø 22,2
					10/06→ 06/11;			
					für Fahrzeuge mit elektronischer Fahr-			
					dynamikregelung			
1.3 D Multijet	77	05/07→12/11			07/07→ 06/11;		24.2122-1762.3 010837	Ø 22,2
					für Fahrzeuge ohne elektronische Fahr-			
					dynamikregelung		24.2122-1768.3 010853	Ø 22,2
					07/07→ 06/11;			
					für Fahrzeuge mit elektronischer Fahr-			
					dynamikregelung			
LANCIA - ZETA (22_) 05/95→09/02								
 Hauptbremszylinder								
2.0 16V (220AL5)	97	05/98→07/00			05/99→		24.2123-1733.3 010657	BOS Ø 23,81
2.0 Turbo (220AD5, 220CD5)	108	05/95→09/02						
2.1 TD (220AJ5)	80	05/96→09/99						
2.0 16V (220AQ5)	100	07/00→09/02					24.2123-1733.3 010657	BOS Ø 23,81
2.0 JTD	80	04/00→09/02						
2.0 JTD 16V (220AN5)	80	09/99→09/02						
LAND ROVER - DISCOVERY I (LJ_) 06/89→10/98								
 Hauptbremszylinder								
2.0 16 V 4x4	99	06/89→10/98			01/94→; → LA061991; - ABS		24.2125-1710.3 010559	Ø 25,4
					09/93→; → LA061991; - ABS		24.2125-1710.3 010559	Ø 25,4
2.5 D 4x4	90	06/93→10/98			07/94→; → LA061991; - ABS		24.2125-1710.3 010559	Ø 25,4
2.5 TDI 4x4	83	10/89→10/98			→ LA061991; - ABS		24.2125-1710.3 010559	Ø 25,4
4.0 4x4	134	09/93→10/98			→ LA061991; - ABS		24.2125-1710.3 010559	Ø 25,4
					07/94→; → LA061991; - ABS		24.2125-1710.3 010559	Ø 25,4
LAND ROVER - DISCOVERY IV (LA_) 09/09→								
 Hauptbremszylinder								
2.7 TD 4x4	140	09/09→					24.2026-1704.3 010989	TRW Ø 26,99 Ø2 20,64
3.0 4x4	250	08/13→						
3.0 SDV6 4x4	188	11/09→						
3.0 TD 4x4	155	05/10→						
3.0 TD 4x4	180	09/09→						

	kw			 	! #		
LAND ROVER - DISCOVERY IV (LA_) 09/09→							
 Hauptbremszylinder							
3.0 TD 4x4	183	07/12→				24.2026-1704.3 010989	TRW Ø 26,99 Ø2 20,64
3.0 TD 4x4	200	09/09→					
4.0 4x4	160	09/09→					
5.0 V8 4x4	276	09/09→					
LAND ROVER - FREELANDER (LN_) 02/98→10/06							
 Hauptbremszylinder							
1.8 16V 4x4	86	11/00→10/06		02/01→		24.4125-1707.3 010986	TRW Ø 25,4
2.0 Td4 4x4	82	11/00→10/06					
2.5 V6 4x4	130	11/00→10/06					
2.0 Td4 4x4	80	03/01→10/06		11/01→		24.4125-1707.3 010986	TRW Ø 25,4
LAND ROVER - FREELANDER 2 (LF_) 10/06→10/14							
 Bremskraftverstärker							
2.0 Si4 4x4	177	10/11→10/14				03.7755-1232.4 300260	ATE Ø 9 / 8" pneumatisch
2.2 eD4	110	08/10→10/14					
2.2 SD4 4x4	140	08/10→10/14					
2.2 TD4 4x4	110	10/06→10/14					
2.2 TD4 4x4	112	01/07→10/14					
2.2 TD4 4x4	115	10/06→10/14					
2.2 TD4 4x4	118	10/06→10/14					
3.2 4x4	171	10/06→10/14					
LAND ROVER - FREELANDER Soft Top (LN_) 02/98→10/06							
 Hauptbremszylinder							
1.8 4x4	86	10/00→09/03		02/01→		24.4125-1707.3 010986	TRW Ø 25,4
2.0 TD4 4x4	82	10/00→10/06					
LAND ROVER - RANGE ROVER II (LP_) 07/94→03/02							
 Hauptbremszylinder							
2.5 D 4x4	83	08/94→03/02				24.2125-1710.3 010559	Ø 25,4
2.5 D 4x4	100	07/94→03/02					
3.9 4x4	140	07/94→03/02					
4.0 4x4	136	06/98→03/02					
4.6 4x4	160	06/98→03/02					
4.6 4x4	165	07/94→03/02					
4.6 4x4	168	09/95→03/02					
LAND ROVER - RANGE ROVER III (LM_) 03/02→08/12							
 Hauptbremszylinder							
3.0 D 4x4	130	03/02→08/12		→ 5A999999		24.2026-1705.3 010992	TRW Ø 26,99 Ø2 20,64
3.6 D 4x4	200	04/06→08/12					
4.2 4x4	291	05/05→08/12					
4.4 4x4	210	03/02→08/05					
4.4 4x4	220	08/04→08/12					
4.4 4x4	225	05/05→08/12					
LAND ROVER - RANGE ROVER SPORT (LS_) 02/05→03/13							
 Hauptbremszylinder							
3.0 D 4x4	155	05/10→03/13		für Linkslenker		24.2026-1704.3 010989	TRW Ø 26,99 Ø2 20,64
3.0 D 4x4	180	09/09→03/13					
3.0 D 4x4	183	08/12→03/13					
3.0 D 4x4	188	06/11→03/13					
5.0 4x4	276	07/09→03/13					
5.0 4x4	372	04/09→03/13					
5.0 4x4	375	09/09→03/13					
3.6 D 4x4	200	04/06→03/13		AA000001→; für Linkslenker		24.2026-1704.3 010989	TRW Ø 26,99 Ø2 20,64
LAND ROVER - RANGE ROVER SPORT (LW_) 04/13→							
 Hauptbremszylinder							
3.0 D 4x4	155	04/13→		→ 06/13; für Linkslenker		24.2026-1704.3 010989	TRW Ø 26,99 Ø2 20,64
3.0 D 4x4	183	04/13→					
3.0 D 4x4	190	04/13→					
3.0 D 4x4	215	04/13→					
5.0 4x4	375	04/13→					
MAZDA - 2 (DY) 02/03→06/07							
 Hauptbremszylinder							
1.2	55	02/03→06/07		- ABS		03.4153-0015.3 011005	ATE Ø 23,81 ohne Bremsflüssigkeitsbehälter
1.25	55	04/03→06/07					
1.3 L	67	04/03→06/07					
1.4	59	02/03→06/07		+ ABS		03.4153-5287.4 010953	ATE Ø 23,81 mit Bremsflüssigkeitsbehälter
1.4	59	04/03→06/07					
↓							

	kW			 	! #		
MAZDA - 2 (DY) 02/03→06/07							
 Hauptbremszylinder							
1.4 CD	50	04/03→06/07		- ABS		03.4153-0015.3 011005	ATE Ø 23,81 ohne Bremsflüssigkeitsbehälter
1.5	82	04/03→06/07					
1.6	74	02/03→06/07					
1.6	74	04/03→06/07		+ ABS		03.4153-5287.4 010953	ATE Ø 23,81 mit Bremsflüssigkeitsbehälter
MAZDA - 6 Hatchback (GG) 08/02→12/08							
 Hauptbremszylinder							
1.8	88	08/02→08/07		→ 07/07; + ESP; Schaltgetriebe		24.2120-1756.3 010975	Ø 20,64 ohne Bremsflüssigkeitsbehälter
2.0	104	08/02→08/07					
2.0	108	03/05→08/07					
2.0 DI	89	08/02→08/07					
2.0 DI	100	08/02→08/07					
2.0 DI	105	06/05→08/07					
2.3	122	08/02→08/07					
MAZDA - 6 Station Wagon (GY) 08/02→12/07							
 Hauptbremszylinder							
1.8	88	08/02→08/07		→ 07/07; + ESP; Schaltgetriebe		24.2120-1756.3 010975	Ø 20,64 ohne Bremsflüssigkeitsbehälter
2.0	104	08/02→08/07					
2.0	108	03/05→08/07					
2.0 DI	89	08/02→08/07					
2.0 DI	105	06/05→08/07					
2.3	122	08/02→08/07					
2.3 AWD	119	11/02→08/07					
2.0 DI	100	08/02→02/05		+ ESP; Schaltgetriebe		24.2120-1756.3 010975	Ø 20,64 ohne Bremsflüssigkeitsbehälter
MAZDA - 6 Stufenheck (GG) 06/02→12/08							
 Hauptbremszylinder							
1.8	88	08/02→08/07		→ 07/07; + ESP; Schaltgetriebe		24.2120-1756.3 010975	Ø 20,64 ohne Bremsflüssigkeitsbehälter
2.0	104	06/02→08/07					
2.0	108	03/05→08/07					
2.0 DI	89	08/02→08/07					
2.0 DI	100	06/02→08/07					
2.0 DI	105	06/05→08/07					
2.3	103	09/06→08/07					
2.3	122	06/02→08/07					
2.3 MPS Turbo	191	12/05→08/07					
2.3	118	07/03→02/05		+ ESP; Schaltgetriebe		24.2120-1756.3 010975	Ø 20,64 ohne Bremsflüssigkeitsbehälter
2.3	120	03/05→07/07					
MERCEDES-BENZ - 100 Bus (631) 02/88→04/96							
 Hauptbremszylinder							
2.0 D	45	09/93→04/96		021972→; → 02/96		24.2125-1719.3 010666	Ø 25,4
D (631.333, 631.343, 631.334, 631.344)	55	12/90→02/96		021972→		24.2125-1719.3 010666	Ø 25,4
MERCEDES-BENZ - 100 Kasten (631) 02/88→04/96							
 Hauptbremszylinder							
2.0 D	45	09/93→04/96		021972→; → 02/96		24.2125-1719.3 010666	Ø 25,4
D (631.332, 631.342)	55	12/90→02/96		021972→		24.2125-1719.3 010666	Ø 25,4
MERCEDES-BENZ - A-KLASSE (W168) 07/97→08/04							
 Hauptbremszylinder							
A 140 (168.031, 168.131)	60	07/97→08/04		09/97→		24.4122-1701.3 010533	TRW Ø 22,2
A 160 (168.033, 168.133)	75	07/97→08/04					
A 140 (168.031, 168.131)	60	01/01→08/04				24.4122-1701.3 010533	TRW Ø 22,2
A 160 CDI (168.006)	55	02/01→08/04					
A 170 CDI (168.009, 168.109)	70	02/01→08/04					
A 210 (168.035, 168.135)	103	03/02→08/04					
A 160 CDI (168.007)	44	07/98→02/01		08/98→ 01/01		24.4122-1701.3 010533	TRW Ø 22,2
A 170 CDI (168.008)	66	07/98→02/01		→ 01/01		24.4122-1701.3 010533	TRW Ø 22,2
A 190 (168.032, 168.132)	92	03/99→08/04		05/99→		24.4122-1701.3 010533	TRW Ø 22,2

	kW					! #		
MERCEDES-BENZ - A-KLASSE (W169) 09/04→06/12								
 Hauptbremszylinder								
A 150 (169.031, 169.331)	70	09/04→06/12		→ 05/12			24.2123-1776.3 010926	TRW Ø 23,81
A 160 (169.031, 169.331)	70	04/09→06/12						
A 160 CDI (169.006, 169.306)	60	09/04→06/12						
A 170 (169.032, 169.332)	85	09/04→06/12						
A 180 (169.032, 169.332)	85	04/09→06/12						
A 180 CDI (169.007, 169.307)	80	09/04→06/12						
A 200 (169.033, 169.333)	100	09/04→06/12						
A 200 CDI (169.008, 169.308)	103	09/04→06/12						
A 200 CDI (169.308)	100	09/04→06/12						
A 200 TURBO (169.034, 169.334)	142	09/05→06/12						
E-CELL (169.090)	50	12/10→06/12						
MERCEDES-BENZ - A-KLASSE (W176) 06/12→								
 Hauptbremszylinder								
A 160 (176.041)	75	07/15→		für Linkslenker			24.4123-1718.3 011016	TRW Ø 23,81 ohne Bremsflüssigkeitsbehälter
A 160 CDI / d (176.011)	66	06/13→						
A 180 (176.042)	90	06/12→						
A 180 CDI / d (176.012)	80	06/12→						
A 180 CDI (176.000)	80	06/12→						
A 200 (176.043)	115	06/12→						
A 200 CDI / d (176.008)	100	02/14→						
A 200 CDI / d 4-matic (176.002)	100	02/14→						
A 220 4-matic (176.047)	135	05/14→						
A 220 CDI (176.003)	120	01/14→						
A 220 CDI (176.003)	125	09/12→						
A 220 CDI 4-matic (176.005)	125	09/12→						
A 220 d (176.003)	130	07/15→						
A 220 d 4-matic (176.005)	130	07/15→						
A 250 (176.044)	155	06/12→06/15						
A 250 (176.050)	160	07/15→						
A 250 4-matic (176.051)	160	07/15→						
A 45 AMG 4-matic (176.052)	265	06/13→06/15						
AMG A 45 4-matic (176.052)	280	07/15→						
A 200 CDI (176.001)	100	06/12→		für Linkslenker; → 02/14			24.4123-1718.3 011016	TRW Ø 23,81 ohne Bremsflüssigkeitsbehälter
A 250 4-matic (176.046)	155	06/12→06/15		06/13→; für Linkslenker			24.4123-1718.3 011016	TRW Ø 23,81 ohne Bremsflüssigkeitsbehälter
MERCEDES-BENZ - B-KLASSE (W245) 03/05→11/11								
 Hauptbremszylinder								
B 150 (245.231)	70	03/05→11/11		→ 04/11			24.2123-1776.3 010926	TRW Ø 23,81
B 160 (245.231)	70	04/09→11/11						
B 170 (245.232)	85	03/05→11/11						
B 180 (245.232)	85	04/09→11/11						
B 180 CDI (245.207)	80	03/05→11/11						
B 200 (245.233)	100	03/05→11/11						
B 200 CDI (245.208)	100	03/05→11/11						
B 200 CDI (245.208)	103	03/05→11/11						
B 200 TURBO (245.234)	142	03/05→11/11						
B 170 NGT (245.233)	85	04/08→11/11		→ 04/09			24.2123-1776.3 010926	TRW Ø 23,81
B 180 NGT (245.233)	85	04/08→11/11		04/09→ 04/11			24.2123-1776.3 010926	TRW Ø 23,81
MERCEDES-BENZ - B-KLASSE (W246, W242) 10/11→								
 Hauptbremszylinder								
B 160 (246.241)	75	07/15→		für Linkslenker			24.4123-1718.3 011016	TRW Ø 23,81 ohne Bremsflüssigkeitsbehälter
B 160 CDI / d (246.211)	66	05/13→						
B 180 (246.242)	90	11/11→						
B 180 CDI / d (246.212)	80	02/13→						
B 180 CDI (246.200)	80	11/11→						
B 200 (246.243)	115	11/11→						
B 200 CDI / d (246.208)	100	08/14→						
B 200 CDI / d 4-matic (246.202)	100	08/14→						
B 200 CDI (246.201)	100	11/11→						
↓								

MERCEDES-BENZ - B-KLASSE (W246, W242) 10/11→

Hauptbremszylinder

B 200 Natural Gas Drive / B 200 c (242.848)	115	11/12→		für Linkslenker	24.4123-1718.3	011016	TRW Ø 23,81 ohne Bremsflüssigkeitsbehälter
B 220 4-matic (246.247)	135	05/13→					
B 220 CDI / d (246.203)	120	06/13→					
B 220 CDI / d (246.203)	130	09/14→					
B 220 CDI / d 4-matic (246.205)	130	09/14→					
B 250 4-matic (246.246)	155	08/14→					
B 220 CDI (246.203)	125	11/11→		12/12→; für Linkslenker	24.4123-1718.3	011016	TRW Ø 23,81 ohne Bremsflüssigkeitsbehälter
B 250 (246.244)	155	05/12→		09/12→; für Linkslenker	24.4123-1718.3	011016	TRW Ø 23,81 ohne Bremsflüssigkeitsbehälter

MERCEDES-BENZ - C-KLASSE (W202) 03/93→05/00









Bremskraftverstärker









C 180 (202.018)	89	11/94→05/00		A021677 / F011180→ A519673 / F619720	03.7760-2702.4	300090	ATE Ø 10" pneumatisch
C 180 (202.018)	90	03/93→05/00					
C 200 (202.020)	100	01/94→05/00		→ A519673 / F619720	03.7760-2702.4	300090	ATE Ø 10" pneumatisch
C 200 Kompressor (202.025)	132	10/95→05/00					
C 200 Kompressor (202.025)	141	11/96→05/00					
C 230 Kompressor (202.024)	142	10/95→05/00					
C 250 Turbo-D (202.128)	110	10/95→05/00					
C 200 D (202.120)	55	03/93→05/00		A072908 / F060570→ A519673 / F619720	03.7760-2702.4	300090	ATE Ø 10" pneumatisch
C 200 D (202.122)	65	10/96→05/00					
C 220 D (202.021)	55	07/96→05/00					
C 220 D (202.121)	70	08/93→05/00					
C 220 (202.022)	110	03/93→05/00		→ 08/96	03.7760-2702.4	300090	ATE Ø 10" pneumatisch
C 230 (202.023)	110	06/96→06/97		07/96→	03.7760-2702.4	300090	ATE Ø 10" pneumatisch
C 250 D (202.125)	83	05/93→05/00		→ 08/95; A072908 / F060570→	03.7760-2702.4	300090	ATE Ø 10" pneumatisch
C 280 (202.028)	142	05/93→05/00		06/93→ 05/97	03.7760-2702.4	300090	ATE Ø 10" pneumatisch
C 36 AMG (202.028)	206	05/94→05/00		→ 08/97	03.7760-2702.4	300090	ATE Ø 10" pneumatisch











Hauptbremszylinder

C 180 (202.018)	89	11/94→05/00		A021677→ A136773	03.2023-0825.3	010028	Ø1 23,81 Ø2 19,05
C 180 (202.018)	90	03/93→05/00		F011180→	03.2023-0825.3	010028	Ø1 23,81 Ø2 19,05
				→ A021676 / F011179	24.2022-1601.3	010340	Ø1 22,2 Ø2 17,46
				A136774→	24.2023-1701.3	010514	TRW Ø1 23,81 Ø2 19,05
C 200 (202.020)	100	01/94→05/00		→ A136773 / F110261	03.2023-0825.3	010028	Ø1 23,81 Ø2 19,05
				A136774 / F110262→	24.2023-1701.3	010514	TRW Ø1 23,81 Ø2 19,05
C 200 CDI (202.134)	75	03/98→05/00			24.2023-1702.3	010534	TRW Ø1 23,81 Ø2 19,05
C 220 CDI (202.133)	92	09/97→05/00					
C 200 D (202.120)	55	03/93→05/00		A072908 / F060570→	03.2023-0825.3	010028	Ø1 23,81 Ø2 19,05
C 200 D (202.122)	65	10/96→05/00		→ A072907 / F060569	24.2022-1601.3	010340	Ø1 22,2 Ø2 17,46
C 200 Kompressor (202.025)	132	10/95→05/00		→ A519673 / F619720	24.2023-1701.3	010514	TRW Ø1 23,81 Ø2 19,05
C 200 Kompressor (202.025)	141	11/96→05/00		A519674 / F619721→	24.2023-1702.3	010534	TRW Ø1 23,81 Ø2 19,05
C 230 Kompressor (202.024)	142	10/95→05/00					
C 250 Turbo-D (202.128)	110	10/95→05/00					
C 220 (202.022)	110	03/93→05/00		06/93→; → A136773 / F110261	03.2023-0825.3	010028	Ø1 23,81 Ø2 19,05
				→ 08/96; A136774 / F110262→	24.2023-1701.3	010514	TRW Ø1 23,81 Ø2 19,05
C 220 D (202.021)	55	07/96→05/00		A072908 / F060570→ A136773 / F110261	03.2023-0825.3	010028	Ø1 23,81 Ø2 19,05
C 220 D (202.121)	70	08/93→05/00		→ A072907 / F060569	24.2022-1601.3	010340	Ø1 22,2 Ø2 17,46
				A136774 / F110262→ A519673 / F619720	24.2023-1701.3	010514	TRW Ø1 23,81 Ø2 19,05
				A519674 / F619721→	24.2023-1702.3	010534	TRW Ø1 23,81 Ø2 19,05
C 230 (202.023)	110	06/96→06/97		07/96→	24.2023-1701.3	010514	TRW Ø1 23,81 Ø2 19,05
C 240 (202.026)	125	06/97→05/00		- ESP	24.2023-1702.3	010534	TRW Ø1 23,81 Ø2 19,05
				+ ESP	24.2023-1704.3	010635	TRW Ø 23,81
C 250 D (202.125)	83	05/93→05/00		A072908 / F060570→; → 08/95	03.2023-0825.3	010028	Ø1 23,81 Ø2 19,05
				06/93→; → A072907 / F060569	24.2022-1601.3	010340	Ø1 22,2 Ø2 17,46
C 280 (202.028)	142	05/93→05/00		06/93→; → A136773 / F110261	03.2023-0825.3	010028	Ø1 23,81 Ø2 19,05
				→ 05/97; A136774 / F110262→	24.2023-1701.3	010514	TRW Ø1 23,81 Ø2 19,05
				06/97→; - ESP	24.2023-1702.3	010534	TRW Ø1 23,81 Ø2 19,05
				06/97→; + ESP	24.2023-1704.3	010635	TRW Ø 23,81





















	kw				! #		
MERCEDES-BENZ - C-KLASSE (W202) 03/93→05/00							
 Hauptbremszylinder							
C 280 (202.029)	145	06/97→05/00		→ A136773 / F110261		03.2023-0825.3 010028	Ø1 23,81 Ø2 19,05
				- ESP		24.2023-1702.3 010534	TRW Ø1 23,81 Ø2 19,05
				+ ESP		24.2023-1704.3 010635	TRW Ø 23,81
C 36 AMG (202.028)	206	05/94→05/00		→ A136773 / F110261		03.2023-0825.3 010028	Ø1 23,81 Ø2 19,05
				→ 08/97; A136774 / F110262→		24.2023-1701.3 010514	TRW Ø1 23,81 Ø2 19,05
C 43 AMG (202.033)	225	08/97→05/00		09/97→		24.2023-1704.3 010635	TRW Ø 23,81
MERCEDES-BENZ - C-KLASSE (W203) 05/00→08/07							
 Bremskraftverstärker							
C 180 (203.035)	95	10/00→05/02		für Linkslenker		03.7848-2002.4 300166	ATE Ø 7 / 8" pneumatisch
C 180 Kompressor (203.046)	105	05/02→02/07					
C 200 CDI (203.004)	75	02/01→02/07					
C 200 CDI (203.004)	85	09/00→02/07					
C 200 CDI (203.007)	90	04/03→02/07					
C 200 CGI Kompressor (203.043)	125	07/03→02/07					
C 200 Kompressor (203.042)	120	05/02→02/07					
C 220 CDI (203.006)	100	05/00→02/07					
C 220 CDI (203.006)	105	05/00→02/07					
C 230 Kompressor (203.040)	141	02/04→02/07					
C 240 (203.061)	125	05/00→02/07					
C 240 4-matic (203.081)	125	07/02→02/07					
C 270 CDI (203.016)	120	12/00→02/07					
C 270 CDI (203.016)	125	12/00→02/07					
C 30 CDI AMG (203.018)	170	01/03→02/07					
C 320 (203.064)	160	05/00→02/07					
C 320 4-matic (203.084)	160	07/02→02/07					
C 55 AMG (203.076)	270	02/04→02/07					
C 200 Kompressor (203.045)	120	05/00→06/02		→ 05/02; für Linkslenker		03.7848-2002.4 300166	ATE Ø 7 / 8" pneumatisch
C 220 CDI (203.008)	110	02/03→02/07		02/04→; für Linkslenker		03.7848-2002.4 300166	ATE Ø 7 / 8" pneumatisch
C 230 (203.052)	150	01/05→02/07		06/05→; für Linkslenker		03.7848-2002.4 300166	ATE Ø 7 / 8" pneumatisch
C 280 (203.054)	170	01/05→02/07					
C 280 4-matic (203.092)	170	01/05→02/07					
C 350 (203.056)	200	01/05→02/07					
C 350 4-matic (203.087)	200	01/05→02/07					
C 320 CDI (203.020)	165	01/05→02/07		02/05→; für Linkslenker		03.7848-2002.4 300166	ATE Ø 7 / 8" pneumatisch
C 32 AMG Kompressor (203.065)	260	02/01→02/07		03/01→; für Linkslenker		03.7848-2002.4 300166	ATE Ø 7 / 8" pneumatisch
Pedalwegsensor, Bremspedal							
C 180 (203.035)	95	10/00→05/02		für Linkslenker		03.0655-0007.2 370007	ATE
C 180 Kompressor (203.046)	105	05/02→02/07		für Rechtslenker		03.0655-0007.2 370007	ATE
C 200 CDI (203.004)	75	02/01→02/07					
C 200 CDI (203.004)	85	09/00→02/07					
C 200 CDI (203.007)	90	04/03→02/07					
C 200 CGI Kompressor (203.043)	125	07/03→02/07					
C 200 Kompressor (203.042)	120	05/02→02/07					
C 220 CDI (203.006)	100	05/00→02/07					
C 220 CDI (203.006)	105	05/00→02/07					
C 230 Kompressor (203.040)	141	02/04→02/07					
C 240 (203.061)	125	05/00→02/07					
C 240 4-matic (203.081)	125	07/02→02/07					
C 270 CDI (203.016)	120	12/00→02/07					
C 270 CDI (203.016)	125	12/00→02/07					
C 30 CDI AMG (203.018)	170	01/03→02/07					
C 320 (203.064)	160	05/00→02/07					
C 320 4-matic (203.084)	160	07/02→02/07					
C 55 AMG (203.076)	270	02/04→02/07					
C 200 Kompressor (203.045)	120	05/00→06/02		→ 05/02; für Rechtslenker		03.0655-0007.2 370007	ATE
				→ 05/02; für Linkslenker		03.0655-0007.2 370007	ATE
C 220 CDI (203.008)	110	02/03→02/07		02/04→; für Linkslenker		03.0655-0007.2 370007	ATE
				02/04→; für Rechtslenker		03.0655-0007.2 370007	ATE
C 230 (203.052)	150	01/05→02/07		06/05→; für Rechtslenker		03.0655-0007.2 370007	ATE
C 280 (203.054)	170	01/05→02/07		06/05→; für Linkslenker		03.0655-0007.2 370007	ATE
C 350 (203.056)	200	01/05→02/07					
C 350 4-matic (203.087)	200	01/05→02/07					
↓							

	kW				! #					
MERCEDES-BENZ - C-KLASSE (W203) 05/00→08/07										
Pedalwegsensor, Bremspedal										
C 280 4-matic (203.092)	170	01/05→02/07		06/05→; für Linkslenker		03.0655-0007.2 370007	ATE			
C 320 CDI (203.020)	165	01/05→02/07		02/05→; für Rechtslenker		03.0655-0007.2 370007	ATE			
				02/05→; für Linkslenker		03.0655-0007.2 370007	ATE			
C 32 AMG Kompressor (203.065)	260	02/01→02/07		03/01→; für Rechtslenker		03.0655-0007.2 370007	ATE			
				03/01→; für Linkslenker		03.0655-0007.2 370007	ATE			
 Hauptbremszylinder										
C 180 (203.035)	95	10/00→05/02		für Linkslenker		03.2023-1741.3 010703	ATE Ø1 23,81 Ø2 20,64			
C 180 Kompressor (203.046)	105	05/02→02/07								
C 200 CDI (203.004)	75	02/01→02/07								
C 200 CDI (203.004)	85	09/00→02/07								
C 200 CDI (203.007)	90	04/03→02/07								
C 200 CGI Kompressor (203.043)	125	07/03→02/07								
C 200 Kompressor (203.042)	120	05/02→02/07								
C 220 CDI (203.006)	100	05/00→02/07								
C 220 CDI (203.006)	105	05/00→02/07								
C 230 Kompressor (203.040)	141	02/04→02/07								
C 240 (203.061)	125	05/00→02/07								
C 200 Kompressor (203.045)	120	05/00→06/02			→ 05/02; für Linkslenker				03.2023-1741.3 010703	ATE Ø1 23,81 Ø2 20,64
C 220 CDI (203.008)	110	02/03→02/07			02/04→; für Linkslenker				03.2023-1741.3 010703	ATE Ø1 23,81 Ø2 20,64
C 230 (203.052)	150	01/05→02/07			06/05→; für Linkslenker				03.2025-1741.3 010705	ATE Ø1 25,4 Ø2 20,64
C 280 (203.054)	170	01/05→02/07								
C 280 4-matic (203.092)	170	01/05→02/07								
C 350 (203.056)	200	01/05→02/07								
C 350 4-matic (203.087)	200	01/05→02/07								
C 240 4-matic (203.081)	125	07/02→02/07		für Linkslenker		03.2025-1741.3 010705	ATE Ø1 25,4 Ø2 20,64			
C 270 CDI (203.016)	120	12/00→02/07								
C 270 CDI (203.016)	125	12/00→02/07								
C 30 CDI AMG (203.018)	170	01/03→02/07								
C 320 (203.064)	160	05/00→02/07								
C 320 4-matic (203.084)	160	07/02→02/07								
C 55 AMG (203.076)	270	02/04→02/07								
C 320 CDI (203.020)	165	01/05→02/07			02/05→; für Linkslenker				03.2025-1741.3 010705	ATE Ø1 25,4 Ø2 20,64
C 32 AMG Kompressor (203.065)	260	02/01→02/07			03/01→; für Linkslenker				03.2025-1741.3 010705	ATE Ø1 25,4 Ø2 20,64
MERCEDES-BENZ - C-KLASSE (W204) 01/07→01/14										
 Bremskraftverstärker										
C 180 CDI (204.000)	88	01/11→01/14		für Linkslenker; für Fahrzeuge ohne Start-Stopp-Funktion		03.7745-6302.4 300261	ATE Ø 8" pneumatisch			
C 180 Kompressor (204.044, 204.045)	115	01/08→01/14								
C 200 (204.048)	137	05/11→01/14		für Linkslenker; für Fahrzeuge mit Start-Stopp-Funktion		03.7745-8902.4 300297	ATE Ø 8" pneumatisch			
C 200 CDI (204.001)	100	01/11→01/14								
C 220 CDI (204.002)	120	10/08→01/14								
C 220 CDI (204.002)	125	12/08→01/14								
C 220 CDI 4-matic (204.084)	125	02/13→01/14								
C 230 4-matic (204.085)	150	07/07→01/14								
C 250 CDI (204.003)	150	08/08→01/14								
C 250 CDI 4-matic (204.082)	150	01/11→01/14								
C 250 CGI (204.047)	150	07/09→01/14								
C 280 4-matic (204.081)	170	07/07→01/14								
C 300 (204.055)	185	02/11→01/14								
C 300 4-matic (204.080)	185	02/11→01/14								
C 300 CDI 4-matic (204.092)	170	01/11→01/14								
C 320 CDI 4-matic (204.089)	165	07/07→01/14								
C 350 (204.057)	225	01/11→01/14								
C 350 4-matic (204.087)	200	07/07→01/14								
C 350 4-matic (204.088)	225	01/11→01/14								
C 350 CDI (204.023)	195	06/11→01/14								
C 350 CDI (204.025)	170	10/09→01/14								
C 350 CDI 4-matic (204.089)	165	07/09→01/14								
C 350 CDI 4-matic (204.092)	170	10/09→01/14								
C 350 CGI (204.065)	215	09/08→01/14								
C 180 CGI (204.031)	115	01/08→01/14		04/09→; für Linkslenker; für Fahrzeuge ohne Start-Stopp-Funktion		03.7745-6302.4 300261	ATE Ø 8" pneumatisch			
C 180 CGI (204.049)	115	01/07→01/14								
C 200 CGI (204.048)	135	01/07→01/14								
↓										











	kW			 	! #					
MERCEDES-BENZ - C-KLASSE (W204) 01/07→01/14										
 Bremskraftverstärker										
C 300 4-matic (204.081)	170	07/07→01/14		04/09→; für Linkslenker; für Fahrzeuge mit Start-Stopp-Funktion		03.7745-8902.4 300297	ATE Ø 8" pneumatisch			
C 180 Kompressor (204.046)	115	01/07→01/14		03/07→; für Linkslenker; für Fahrzeuge ohne Start-Stopp-Funktion		03.7745-6302.4 300261	ATE Ø 8" pneumatisch			
C 200 CDI (204.007, 204.006)	100	01/07→12/10		03/07→; für Linkslenker; für Fahrzeuge mit Start-Stopp-Funktion		03.7745-8902.4 300297	ATE Ø 8" pneumatisch			
C 220 CDI (204.008)	120	01/07→11/08								
C 230 (204.052)	150	01/07→01/14								
C 200 Kompressor (204.041)	135	01/07→01/14								
C 220 CDI (204.008)	125	01/07→11/08		A 017628 / F 015295→; für Linkslenker; für Fahrzeuge ohne Start-Stopp-Funktion		03.7745-6302.4 300261	ATE Ø 8" pneumatisch			
C 280 (204.054)	170	01/07→01/14								
C 300 (204.054)	170	07/09→01/14								
C 320 CDI (204.022)	165	01/07→01/14								
C 350 (204.056)	200	01/07→01/14								
C 350 CDI (204.022)	165	07/09→01/14								
C 63 AMG	382	07/10→01/14								
C 63 AMG (204.077)	336	02/08→01/14								
C 63 AMG (204.077)	358	02/08→01/14								
C 63 AMG (204.077)	373	02/08→01/14								
 Hauptbremszylinder										
C 180 CDI (204.000)	88	01/11→01/14		für Linkslenker		03.2025-2521.3 010959	ATE Ø1 25,4 Ø2 22,2			
C 180 Kompressor (204.044, 204.045)	115	01/08→01/14								
C 200 (204.048)	137	05/11→01/14								
C 200 CDI (204.001)	100	01/11→01/14								
C 220 CDI (204.002)	120	10/08→01/14								
C 220 CDI (204.002)	125	12/08→01/14								
C 220 CDI 4-matic (204.084)	125	02/13→01/14								
C 230 4-matic (204.085)	150	07/07→01/14								
C 250 CDI 4-matic (204.082)	150	01/11→01/14								
C 250 CGI (204.047)	150	07/09→01/14								
C 280 4-matic (204.081)	170	07/07→01/14								
C 300 (204.054)	170	07/09→01/14								
C 300 (204.055)	185	02/11→01/14								
C 300 4-matic (204.080)	185	02/11→01/14								
C 300 CDI 4-matic (204.092)	170	01/11→01/14								
C 320 CDI 4-matic (204.089)	165	07/07→01/14								
C 350 (204.057)	225	01/11→01/14								
C 350 4-matic (204.087)	200	07/07→01/14								
C 350 4-matic (204.088)	225	01/11→01/14								
C 350 CDI (204.022)	165	07/09→01/14								
C 350 CDI (204.023)	195	06/11→01/14								
C 350 CDI (204.025)	170	10/09→01/14								
C 350 CDI 4-matic (204.089)	165	07/09→01/14								
C 350 CDI 4-matic (204.092)	170	10/09→01/14								
C 350 CGI (204.065)	215	09/08→01/14								
C 63 AMG	382	07/10→01/14								
C 63 AMG (204.077)	336	02/08→01/14								
C 63 AMG (204.077)	358	02/08→01/14								
C 63 AMG (204.077)	373	02/08→01/14								
C 180 CGI (204.031)	115	01/08→01/14			04/09→; für Linkslenker				03.2025-2521.3 010959	ATE Ø1 25,4 Ø2 22,2
C 180 CGI (204.049)	115	01/07→01/14			03/07→; für Linkslenker				03.2025-2521.3 010959	ATE Ø1 25,4 Ø2 22,2
C 200 CGI (204.048)	135	01/07→01/14								
C 300 4-matic (204.081)	170	07/07→01/14								
C 180 Kompressor (204.046)	115	01/07→01/14								
C 200 CDI (204.007, 204.006)	100	01/07→12/10		10/08→; für Linkslenker		03.2025-2521.3 010959	ATE Ø1 25,4 Ø2 22,2			
C 200 Kompressor (204.041)	135	01/07→01/14								
C 220 CDI (204.008)	120	01/07→11/08								
C 220 CDI (204.008)	125	01/07→11/08								
C 230 (204.052)	150	01/07→01/14								
C 280 (204.054)	170	01/07→01/14								
C 320 CDI (204.022)	165	01/07→01/14								
C 350 (204.056)	200	01/07→01/14								
C 250 CDI (204.003)	150	08/08→01/14								
MERCEDES-BENZ - C-KLASSE Coupe (C204) 01/11→										
 Bremskraftverstärker										
C 180 (204.331)	115	01/13→		für Linkslenker; für Fahrzeuge ohne Start-Stopp-Funktion		03.7745-6302.4 300261	ATE Ø 8" pneumatisch			
C 180 (204.349)	115	06/11→								
C 200 CGI (204.348)	135	06/11→								
↓										





















	kW					! #		
MERCEDES-BENZ - C-KLASSE Coupe (C204) 01/11→								
 Bremskraftverstärker								
C 220 CDI (204.302)	120	06/11→		für Linkslenker;		03.7745-8902.4	300297	ATE Ø 8" pneumatisch
C 220 CDI (204.302)	125	06/11→		für Fahrzeuge mit Start-Stopp-Funktion				
C 250 (204.347)	150	06/11→						
C 250 CDI (204.303)	150	06/11→						
C 350 (204.357)	225	06/11→						
C 350 4-matic	225	09/13→						
C 63 AMG (204.377)	336	06/11→						
C 63 AMG (204.377)	358	01/12→						
C 63 AMG (204.377)	373	11/12→						
C 63 AMG (204.377)	380	01/12→						
 Hauptbremszylinder								
C 180 (204.331)	115	01/13→		für Linkslenker		03.2025-2521.3	010959	ATE Ø1 25,4 Ø2 22,2
C 180 (204.349)	115	06/11→						
C 200 CGI (204.348)	135	06/11→						
C 220 CDI (204.302)	120	06/11→						
C 220 CDI (204.302)	125	06/11→						
C 250 (204.347)	150	06/11→						
C 250 CDI (204.303)	150	06/11→						
C 350 (204.357)	225	06/11→						
C 350 4-matic	225	09/13→						
C 63 AMG (204.377)	336	06/11→						
C 63 AMG (204.377)	358	01/12→						
C 63 AMG (204.377)	373	11/12→						
C 63 AMG (204.377)	380	01/12→						
MERCEDES-BENZ - C-KLASSE Kombi (S202) 06/96→03/01								
 Bremskraftverstärker								
C 180 T (202.078)	90	06/96→09/00		→ F619720		03.7760-2702.4	300090	ATE Ø 10" pneumatisch
C 180 T (202.081)	95	09/00→03/01						
C 200 T (202.080)	100	06/96→03/01						
C 200 T D (202.180)	65	10/96→03/01						
C 200 T Kompressor (202.082)	141	11/96→03/01						
C 200 T Kompressor (202.087)	120	09/00→03/01						
C 220 T D (202.182)	55	06/96→03/01						
C 220 T D (202.182)	70	06/96→09/98						
C 230 T (202.083)	110	06/96→06/98						
C 250 T Turbo-D (202.188)	110	06/96→03/01						
 Hauptbremszylinder								
C 180 T (202.078)	90	06/96→09/00		→ F619720		24.2023-1701.3	010514	TRW Ø1 23,81 Ø2 19,05
C 180 T (202.081)	95	09/00→03/01						
C 200 T (202.080)	100	06/96→03/01		F619721→		24.2023-1702.3	010534	TRW Ø1 23,81 Ø2 19,05
C 200 T D (202.180)	65	10/96→03/01						
C 200 T Kompressor (202.082)	141	11/96→03/01						
C 220 T D (202.182)	55	06/96→03/01						
C 220 T D (202.182)	70	06/96→09/98						
C 250 T Turbo-D (202.188)	110	06/96→03/01						
C 200 T CDI (202.194)	75	03/98→03/01				24.2023-1702.3	010534	TRW Ø1 23,81 Ø2 19,05
C 220 T CDI (202.193)	92	09/97→03/01						
C 230 T Kompressor (202.085)	142	06/97→09/00						
C 200 T Kompressor (202.087)	120	09/00→03/01		→ F619720		24.2023-1701.3	010514	TRW Ø1 23,81 Ø2 19,05
				F619621→		24.2023-1702.3	010534	TRW Ø1 23,81 Ø2 19,05
C 230 T (202.083)	110	06/96→06/98		→ F619720		24.2023-1701.3	010514	TRW Ø1 23,81 Ø2 19,05
				→ 06/97; F619721→		24.2023-1702.3	010534	TRW Ø1 23,81 Ø2 19,05
C 240 T (202.086)	125	06/97→09/00		- ESP		24.2023-1702.3	010534	TRW Ø1 23,81 Ø2 19,05
C 240 T (202.088)	125	09/00→03/01						
C 280 T (202.089)	145	06/97→03/01		+ ESP		24.2023-1704.3	010635	TRW Ø 23,81
C 43 AMG (202.093)	225	08/97→03/01		09/97→		24.2023-1704.3	010635	TRW Ø 23,81
MERCEDES-BENZ - C-KLASSE Kombi (S203) 03/01→08/07								
 Bremskraftverstärker								
C 180 (203.235)	95	03/01→05/02		für Linkslenker		03.7848-2002.4	300166	ATE Ø 7 / 8" pneumatisch
C 180 Kompressor (203.246)	105	05/02→08/07						
C 200 CDI (203.204, 203.207)	75	03/01→08/07						
C 200 CDI (203.204)	85	03/01→08/07						
C 200 CDI (203.207)	90	04/03→08/07						
C 200 CGI Kompressor (203.243)	125	07/03→08/07						
↓								











	kw			 	! #		
MERCEDES-BENZ - C-KLASSE Kombi (S203) 03/01→08/07							
Bremskraftverstärker							
C 200 Kompressor (203.242)	120	05/02→08/07		für Linkslenker		03.7848-2002.4 300166	ATE Ø 7 / 8" pneumatisch
C 220 CDI (203.206)	105	03/01→08/07					
C 220 CDI (203.208)	100	08/06→08/07					
C 220 CDI (203.208)	110	02/04→08/07					
C 230 Kompressor (203.240)	141	02/04→08/07					
C 240 (203.261)	125	03/01→08/07					
C 240 4-matic (203.281)	125	07/02→08/07					
C 270 CDI (203.216)	120	03/01→08/07					
C 270 CDI (203.216)	125	03/01→08/07					
C 30 CDI AMG (203.218)	170	01/03→08/07					
C 320 (203.264)	160	03/01→08/07					
C 320 4-matic (203.284)	160	07/02→08/07					
C 320 CDI (203.220)	165	06/05→08/07					
C 32 AMG Kompressor (203.265)	260	03/01→08/07					
C 55 AMG (203.276)	270	02/04→08/07					
C 200 Kompressor (203.245)	120	03/01→05/02		→ 04/02; für Linkslenker		03.7848-2002.4 300166	ATE Ø 7 / 8" pneumatisch
C 230 (203.252)	150	01/05→08/07		06/05→; für Linkslenker		03.7848-2002.4 300166	ATE Ø 7 / 8" pneumatisch
C 280 (203.254)	170	01/05→08/07					
C 280 4-matic (203.292)	170	01/05→08/07					
C 350 (203.256)	200	01/05→08/07					
C 350 4-matic (203.287)	200	01/05→08/07					
Pedalwegsensord, Bremspedal							
C 180 (203.235)	95	03/01→05/02		für Linkslenker		03.0655-0007.2 370007	ATE
C 180 Kompressor (203.246)	105	05/02→08/07		für Rechtslenker		03.0655-0007.2 370007	ATE
C 200 CDI (203.204, 203.207)	75	03/01→08/07					
C 200 CDI (203.204)	85	03/01→08/07					
C 200 CDI (203.207)	90	04/03→08/07					
C 200 CGI Kompressor (203.243)	125	07/03→08/07					
C 200 Kompressor (203.242)	120	05/02→08/07					
C 220 CDI (203.206)	105	03/01→08/07					
C 220 CDI (203.208)	100	08/06→08/07					
C 220 CDI (203.208)	110	02/04→08/07					
C 230 Kompressor (203.240)	141	02/04→08/07					
C 240 (203.261)	125	03/01→08/07					
C 240 4-matic (203.281)	125	07/02→08/07					
C 270 CDI (203.216)	120	03/01→08/07					
C 270 CDI (203.216)	125	03/01→08/07					
C 30 CDI AMG (203.218)	170	01/03→08/07					
C 320 (203.264)	160	03/01→08/07					
C 320 4-matic (203.284)	160	07/02→08/07					
C 320 CDI (203.220)	165	06/05→08/07					
C 32 AMG Kompressor (203.265)	260	03/01→08/07					
C 55 AMG (203.276)	270	02/04→08/07					
C 200 Kompressor (203.245)	120	03/01→05/02		→ 04/02; für Rechtslenker		03.0655-0007.2 370007	ATE
				→ 04/02; für Linkslenker		03.0655-0007.2 370007	ATE
C 230 (203.252)	150	01/05→08/07		06/05→; für Rechtslenker		03.0655-0007.2 370007	ATE
C 280 (203.254)	170	01/05→08/07					
C 350 (203.256)	200	01/05→08/07		06/05→; für Linkslenker		03.0655-0007.2 370007	ATE
C 350 4-matic (203.287)	200	01/05→08/07					
C 280 4-matic (203.292)	170	01/05→08/07		06/05→; für Linkslenker		03.0655-0007.2 370007	ATE
Hauptbremszylinder							
C 180 (203.235)	95	03/01→05/02		für Linkslenker		03.2023-1741.3 010703	ATE Ø1 23,81 Ø2 20,64
C 180 Kompressor (203.246)	105	05/02→08/07					
C 200 CDI (203.204, 203.207)	75	03/01→08/07					
C 200 CDI (203.204)	85	03/01→08/07					
C 200 CDI (203.207)	90	04/03→08/07					
C 200 CGI Kompressor (203.243)	125	07/03→08/07					
C 200 Kompressor (203.242)	120	05/02→08/07					
C 220 CDI (203.206)	105	03/01→08/07					
C 220 CDI (203.208)	100	08/06→08/07					
C 220 CDI (203.208)	110	02/04→08/07					
C 230 Kompressor (203.240)	141	02/04→08/07					
↓							













	kw			 	! #		
MERCEDES-BENZ - C-KLASSE Kombi (S203) 03/01→08/07							
 Hauptbremszylinder							
C 240 (203.261)	125	03/01→08/07		für Linkslenker		03.2023-1741.3 010703	ATE Ø1 23,81 Ø2 20,64
C 200 Kompressor (203.245)	120	03/01→05/02		→ 04/02; für Linkslenker		03.2023-1741.3 010703	ATE Ø1 23,81 Ø2 20,64
C 230 (203.252) C 280 (203.254) C 280 4-matic (203.292) C 350 (203.256) C 350 4-matic (203.287)	150 170 170 200 200	01/05→08/07 01/05→08/07 01/05→08/07 01/05→08/07 01/05→08/07		06/05→; für Linkslenker		03.2025-1741.3 010705	ATE Ø1 25,4 Ø2 20,64
C 240 4-matic (203.281) C 270 CDI (203.216) C 270 CDI (203.216) C 30 CDI AMG (203.218) C 320 (203.264) C 320 4-matic (203.284) C 320 CDI (203.220) C 32 AMG Kompressor (203.265) C 55 AMG (203.276)	125 120 125 170 160 160 165 260 270	07/02→08/07 03/01→08/07 03/01→08/07 01/03→08/07 03/01→08/07 07/02→08/07 06/05→08/07 03/01→08/07 02/04→08/07		für Linkslenker		03.2025-1741.3 010705	ATE Ø1 25,4 Ø2 20,64
MERCEDES-BENZ - C-KLASSE Kombi (S204) 08/07→08/14							
 Bremskraftverstärker							
C 180 (204.231) C 180 CDI (204.200) C 180 CGI (204.249) C 180 Kompressor (204.245) C 200 CDI (204.201) C 220 CDI (204.202) C 220 CDI (204.202) C 220 CDI 4-matic (204.284) C 250 CDI 4-matic (204.282) C 250 CGI (204.247) C 300 (204.254) C 350 CDI C 350 CDI (204.223) C 350 CDI (204.225) C 350 CDI 4-matic (204.292) C 350 CGI (204.257) C 63 AMG C 63 AMG C 63 AMG (204.277) C 63 AMG (204.277)	115 88 115 115 100 120 125 125 150 150 170 165 195 170 170 225 373 382 336 358	02/12→08/14 01/11→08/14 11/09→08/14 01/08→08/14 08/10→08/14 12/08→08/14 12/08→08/14 02/13→08/14 04/10→08/14 07/09→08/14 08/07→08/14 08/07→08/14 06/11→08/14 10/09→08/14 10/09→08/14 06/11→08/14 06/13→08/14 07/10→08/14 02/08→08/14 01/12→08/14		für Linkslenker; für Fahrzeuge ohne Start-Stopp-Funktion für Linkslenker; für Fahrzeuge mit Start-Stopp-Funktion		03.7745-6302.4 300261 03.7745-8902.4 300297	ATE Ø 8" pneumatisch ATE Ø 8" pneumatisch
C 180 Kompressor (204.246) C 200 CDI (204.207) C 200 Kompressor (204.241) C 220 CDI (204.208) C 230 (204.252) C 280 (204.254) C 320 CDI (204.222) C 320 CDI 4-matic (204.289) C 350 (204.256)	115 100 135 125 150 170 165 165 200	08/07→08/14 08/07→12/11 08/07→08/14 08/07→11/08 08/07→08/14 08/07→08/14 08/07→08/14 08/07→08/14 08/07→08/14		09/07→; für Linkslenker; für Fahrzeuge ohne Start-Stopp-Funktion 09/07→; für Linkslenker; für Fahrzeuge mit Start-Stopp-Funktion		03.7745-6302.4 300261 03.7745-8902.4 300297	ATE Ø 8" pneumatisch ATE Ø 8" pneumatisch
C 200 CGI (204.248) C 250 CDI (204.203)	135 150	08/07→08/14 01/09→08/14		04/09→; für Linkslenker; für Fahrzeuge ohne Start-Stopp-Funktion 04/09→; für Linkslenker; für Fahrzeuge mit Start-Stopp-Funktion		03.7745-6302.4 300261 03.7745-8902.4 300297	ATE Ø 8" pneumatisch ATE Ø 8" pneumatisch
C 220 CDI (204.208)	120	08/07→11/08		09/07→; für Linkslenker; für Fahrzeuge ohne Start-Stopp-Funktion für Linkslenker; für Fahrzeuge ohne Start-Stopp-Funktion für Linkslenker; für Fahrzeuge mit Start-Stopp-Funktion 09/07→; für Linkslenker; für Fahrzeuge mit Start-Stopp-Funktion		03.7745-6302.4 300261 03.7745-6302.4 300261 03.7745-8902.4 300297 03.7745-8902.4 300297	ATE Ø 8" pneumatisch ATE Ø 8" pneumatisch ATE Ø 8" pneumatisch ATE Ø 8" pneumatisch
 Hauptbremszylinder							
C 180 (204.231) C 180 CDI (204.200) C 180 CGI (204.249) C 180 Kompressor (204.245) C 200 CDI (204.201) C 220 CDI (204.202) C 220 CDI (204.202)	115 88 115 115 100 120 125	02/12→08/14 01/11→08/14 11/09→08/14 01/08→08/14 08/10→08/14 12/08→08/14 12/08→08/14		für Linkslenker		03.2025-2521.3 010959	ATE Ø1 25,4 Ø2 22,2











	kw			 	! #		
MERCEDES-BENZ - C-KLASSE Kombi (S204) 08/07→08/14							
 Hauptbremszylinder							
C 220 CDI 4-matic (204.284)	125	02/13→08/14		für Linkslenker		03.2025-2521.3 010959	ATE Ø1 25,4 Ø2 22,2
C 250 CDI 4-matic (204.282)	150	04/10→08/14					
C 250 CGI (204.247)	150	07/09→08/14					
C 300 (204.254)	170	08/07→08/14					
C 350 CDI	165	08/07→08/14					
C 350 CDI (204.223)	195	06/11→08/14					
C 350 CDI (204.225)	170	10/09→08/14					
C 350 CDI 4-matic (204.292)	170	10/09→08/14					
C 350 CGI (204.257)	225	06/11→08/14					
C 63 AMG	373	06/13→08/14					
C 63 AMG	382	07/10→08/14					
C 63 AMG (204.277)	336	02/08→08/14					
C 63 AMG (204.277)	358	01/12→08/14					
C 180 Kompressor (204.246)	115	08/07→08/14		09/07→; für Linkslenker		03.2025-2521.3 010959	ATE Ø1 25,4 Ø2 22,2
C 200 CDI (204.207)	100	08/07→12/11					
C 200 Kompressor (204.241)	135	08/07→08/14					
C 220 CDI (204.208)	125	08/07→11/08					
C 230 (204.252)	150	08/07→08/14					
C 280 (204.254)	170	08/07→08/14					
C 320 CDI (204.222)	165	08/07→08/14					
C 320 CDI 4-matic (204.289)	165	08/07→08/14					
C 350 (204.256)	200	08/07→08/14					
C 200 CGI (204.248)	135	08/07→08/14		04/09→; für Linkslenker		03.2025-2521.3 010959	ATE Ø1 25,4 Ø2 22,2
C 250 CDI (204.203)	150	01/09→08/14					
C 220 CDI (204.208)	120	08/07→11/08		für Linkslenker		03.2025-2521.3 010959	ATE Ø1 25,4 Ø2 22,2
				09/07→; für Linkslenker		03.2025-2521.3 010959	ATE Ø1 25,4 Ø2 22,2
MERCEDES-BENZ - C-KLASSE Sportcoupe (CL203) 03/01→06/11							
 Bremskraftverstärker							
C 160 Kompressor (203.730)	90	05/02→05/08		04/05→; für Linkslenker		03.7848-2002.4 300166	ATE Ø 7 / 8" pneumatisch
C 180 (203.735)	95	03/01→05/02		für Linkslenker		03.7848-2002.4 300166	ATE Ø 7 / 8" pneumatisch
C 180 Kompressor (203.746)	105	05/02→05/08					
C 200 Kompressor (203.742)	120	05/02→05/08					
C 200 Kompressor (203.745)	120	03/01→05/02					
C 220	120	05/02→05/08					
C 220 CDI	100	03/01→01/04					
C 220 CDI (203.706)	105	03/01→01/04					
C 220 CDI (203.708)	110	02/04→05/08					
C 230 Kompressor (203.740)	141	05/02→05/08					
C 230 Kompressor (203.747)	145	03/01→05/02					
C 30 CDI AMG (203.718)	170	09/02→05/08					
C 320 (203.764)	160	09/02→05/08					
C 200 CDI (203.707)	90	03/03→05/08		07/03→; für Linkslenker		03.7848-2002.4 300166	ATE Ø 7 / 8" pneumatisch
C 200 CGI Kompressor (203.743)	125	03/03→05/08					
C 230 (203.752)	150	01/05→05/08		06/05→; für Linkslenker		03.7848-2002.4 300166	ATE Ø 7 / 8" pneumatisch
C 350 (203.756)	200	01/05→05/08					
Pedalwegsensor, Bremspedal							
C 160 Kompressor (203.730)	90	05/02→05/08		04/05→; für Linkslenker		03.0655-0007.2 370007	ATE
				04/05→; für Rechtslenker		03.0655-0007.2 370007	ATE
C 180 (203.735)	95	03/01→05/02		für Linkslenker		03.0655-0007.2 370007	ATE
C 180 Kompressor (203.746)	105	05/02→05/08		für Rechtslenker		03.0655-0007.2 370007	ATE
C 200 Kompressor (203.742)	120	05/02→05/08					
C 200 Kompressor (203.745)	120	03/01→05/02					
C 220	120	05/02→05/08					
C 220 CDI	100	03/01→01/04					
C 220 CDI (203.706)	105	03/01→01/04					
C 220 CDI (203.708)	110	02/04→05/08					
C 230 Kompressor (203.740)	141	05/02→05/08					
C 230 Kompressor (203.747)	145	03/01→05/02					
↓							











	kW			 	! #		
MERCEDES-BENZ - C-KLASSE Sportcoupe (CL203) 03/01→06/11							
Pedalwegsensoren, Bremspedal							
C 30 CDI AMG (203.718)	170	09/02→05/08		für Linkslenker		03.0655-0007.2 370007	ATE
C 320 (203.764)	160	09/02→05/08		für Rechtslenker		03.0655-0007.2 370007	ATE
C 200 CDI (203.707)	90	03/03→05/08		07/03→; für Rechtslenker		03.0655-0007.2 370007	ATE
C 200 CGI Kompressor (203.743)	125	03/03→05/08		07/03→; für Linkslenker		03.0655-0007.2 370007	ATE
C 230 (203.752)	150	01/05→05/08		06/05→; für Rechtslenker		03.0655-0007.2 370007	ATE
C 350 (203.756)	200	01/05→05/08		06/05→; für Linkslenker		03.0655-0007.2 370007	ATE
 Hauptbremszylinder							
C 160 Kompressor (203.730)	90	05/02→05/08		04/05→; für Linkslenker		03.2023-1741.3 010703	ATE Ø1 23,81 Ø2 20,64
C 180 (203.735)	95	03/01→05/02		für Linkslenker		03.2023-1741.3 010703	ATE Ø1 23,81 Ø2 20,64
C 180 Kompressor (203.746)	105	05/02→05/08					
C 200 Kompressor (203.742)	120	05/02→05/08					
C 200 Kompressor (203.745)	120	03/01→05/02					
C 220	120	05/02→05/08					
C 220 CDI	100	03/01→01/04					
C 220 CDI (203.706)	105	03/01→01/04					
C 220 CDI (203.708)	110	02/04→05/08					
C 230 Kompressor (203.740)	141	05/02→05/08					
C 230 Kompressor (203.747)	145	03/01→05/02					
C 200 CDI (203.707)	90	03/03→05/08		07/03→; für Linkslenker		03.2023-1741.3 010703	ATE Ø1 23,81 Ø2 20,64
C 200 CGI Kompressor (203.743)	125	03/03→05/08					
C 230 (203.752)	150	01/05→05/08		06/05→; für Linkslenker		03.2025-1741.3 010705	ATE Ø1 25,4 Ø2 20,64
C 350 (203.756)	200	01/05→05/08					
C 30 CDI AMG (203.718)	170	09/02→05/08		für Linkslenker		03.2025-1741.3 010705	ATE Ø1 25,4 Ø2 20,64
C 320 (203.764)	160	09/02→05/08					
MERCEDES-BENZ - CLA Coupe (C117) 01/13→							
 Hauptbremszylinder							
AMG CLA 45 4-matic (117.352)	280	07/15→		für Linkslenker		24.4123-1718.3 011016	TRW Ø 23,81 ohne Bremsflüssigkeitsbehälter
CLA 180 (117.342)	90	01/13→					
CLA 180 CDI / d (117.312)	80	10/13→					
CLA 200 (117.343)	115	01/13→					
CLA 200 CDI / d (117.308)	100	07/14→					
CLA 200 CDI / d 4-matic (117.302)	100	07/14→					
CLA 200 CDI (117.301)	100	06/13→					
CLA 220 4-matic (117.347)	135	04/16→					
CLA 220 CDI / d (117.303)	120	01/13→					
CLA 220 CDI / d (117.303)	130	09/14→					
CLA 220 CDI / d 4-matic (117.305)	120	08/14→					
CLA 220 CDI / d 4-matic (117.305)	130	09/14→					
CLA 220 CDI (117.303)	125	01/13→					
CLA 220 CDI 4-matic (117.305)	125	07/14→					
CLA 250 (117.344)	155	01/13→					
CLA 250 (117.350)	160	07/15→					
CLA 250 4-matic (117.346)	155	07/13→					
CLA 250 4-matic (117.351)	160	07/15→					
CLA 45 AMG 4-matic (117.352)	265	07/13→06/15					
MERCEDES-BENZ - CLA Shooting Brake (X117) 01/15→							
 Hauptbremszylinder							
AMG CLA 45 4-matic (117.952)	280	07/15→		für Linkslenker		24.4123-1718.3 011016	TRW Ø 23,81 ohne Bremsflüssigkeitsbehälter
CLA 180 (117.942)	90	01/15→					
CLA 180 d (117.912)	80	07/15→					
CLA 200 (117.943)	115	01/15→					
↓							













	kW			 	! #		
MERCEDES-BENZ - CLA Shooting Brake (X117) 01/15→							
 Hauptbremszylinder							
CLA 200 CDI / d (117.908)	100	01/15→		für Linkslenker		24.4123-1718.3 011016	TRW Ø 23,81 ohne Bremsflüssigkeitsbehälter
CLA 200 CDI / d 4-matic (117.902)	100	01/15→					
CLA 220 4-matic (117.947)	135	04/16→					
CLA 220 CDI / d (117.903)	120	01/15→					
CLA 220 CDI / d (117.903)	130	01/15→					
CLA 220 CDI / d 4-matic (117.905)	120	09/15→					
CLA 220 CDI / d 4-matic (117.905)	130	01/15→					
CLA 250 (117.944)	155	01/15→					
CLA 250 4-matic (117.946)	155	01/15→					
CLA 250 4-matic (117.951)	160	07/15→					
CLA 45 AMG 4-matic (117.952)	265	01/15→06/15					
MERCEDES-BENZ - CLC-KLASSE (CL203) 05/08→06/11							
 Bremskraftverstärker							
CLC 160 (203.731)	95	02/09→06/11		→ 10/10; für Linkslenker		03.7848-2002.4 300166	ATE Ø 7 / 8" pneumatisch
CLC 180 Kompressor (203.746)	105	05/08→06/11					
CLC 200 CDI (203.707)	90	05/08→06/11					
CLC 200 Kompressor (203.741)	135	05/08→06/11					
CLC 220 CDI (203.708)	110	05/08→06/11					
CLC 230 (203.752)	150	05/08→06/11					
CLC 350 (203.756)	200	05/08→06/11					
Pedalwegsensoren, Bremspedal							
CLC 160 (203.731)	95	02/09→06/11		→ 10/10; für Rechtslenker		03.0655-0007.2 370007	ATE
CLC 180 Kompressor (203.746)	105	05/08→06/11		→ 10/10; für Linkslenker		03.0655-0007.2 370007	ATE
CLC 200 CDI (203.707)	90	05/08→06/11					
CLC 200 Kompressor (203.741)	135	05/08→06/11					
CLC 220 CDI (203.708)	110	05/08→06/11					
CLC 230 (203.752)	150	05/08→06/11					
CLC 350 (203.756)	200	05/08→06/11					
 Hauptbremszylinder							
CLC 160 (203.731)	95	02/09→06/11		→ 10/10; für Linkslenker		03.2023-1741.3 010703	ATE Ø1 23,81 Ø2 20,64
CLC 180 Kompressor (203.746)	105	05/08→06/11					
CLC 200 CDI (203.707)	90	05/08→06/11					
CLC 200 Kompressor (203.741)	135	05/08→06/11					
CLC 220 CDI (203.708)	110	05/08→06/11					
CLC 230 (203.752)	150	05/08→06/11		→ 10/10; für Linkslenker		03.2025-1741.3 010705	ATE Ø1 25,4 Ø2 20,64
CLC 350 (203.756)	200	05/08→06/11					
MERCEDES-BENZ - CLK (C208) 06/97→09/02							
 Bremskraftverstärker							
200 (208.335)	100	06/97→06/02		F 129679→		03.7863-0903.4 300244	ATE Ø 10" pneumatisch
200 Kompressor (208.345)	141	06/97→06/00					
230 Kompressor (208.347)	142	06/97→06/00					
200 Kompressor (208.344)	120	06/00→06/02				03.7863-0903.4 300244	ATE Ø 10" pneumatisch
230 Kompressor (208.348)	145	06/00→06/02					
Pedalwegsensoren, Bremspedal							
200 (208.335)	100	06/97→06/02		F 129679→		03.0655-0007.2 370007	ATE
200 Kompressor (208.345)	141	06/97→06/00					
230 Kompressor (208.347)	142	06/97→06/00					
200 Kompressor (208.344)	120	06/00→06/02				03.0655-0007.2 370007	ATE
230 Kompressor (208.348)	145	06/00→06/02					
↓							



	kw			 	! #		
MERCEDES-BENZ - CLK (C208) 06/97→09/02							
 Hauptbremszylinder							
200 (208.335)	100	06/97→06/02		F 129679→; für Linkslenker		03.2023-2004.3 010788	ATE Ø1 23,81 Ø2 19,05
200 Kompressor (208.345)	141	06/97→06/00		→ F 129678; - ESP		24.2023-1702.3 010534	TRW Ø1 23,81 Ø2 19,05
230 Kompressor (208.347)	142	06/97→06/00					
200 Kompressor (208.344)	120	06/00→06/02		für Linkslenker		03.2023-2004.3 010788	ATE Ø1 23,81 Ø2 19,05
230 Kompressor (208.348)	145	06/00→06/02					
320 (208.365)	160	06/97→06/02		→ F 129678; - ESP		24.2023-1702.3 010534	TRW Ø1 23,81 Ø2 19,05
				F 129679→		24.2023-1704.3 010635	TRW Ø 23,81
				→ F 129678; + ESP		24.2023-1704.3 010635	TRW Ø 23,81
430 (208.370)	205	07/98→06/02				24.2025-1709.3 010693	Ø 25,4
55 AMG (208.374)	255	08/99→06/02					
MERCEDES-BENZ - CLK (C209) 06/02→05/09							
 Bremskraftverstärker							
200 CGI (209.343)	125	07/03→05/09		→ 04/09; für Linkslenker		03.7848-2002.4 300166	ATE Ø 7 / 8" pneumatisch
200 Kompressor (209.341)	135	10/06→05/09					
200 Kompressor (209.342)	120	09/02→05/09					
240 (209.361)	120	06/02→05/09					
240 (209.361)	125	06/02→05/09					
270 CDI (209.316)	125	10/02→05/09					
320 (209.365)	160	06/02→05/09					
500 (209.372)	285	06/06→05/09					
500 (209.375)	225	06/02→05/09					
55 AMG (209.376)	270	09/02→05/09					
63 AMG (209.377)	354	04/06→05/09					
63 AMG (209.377)	373	05/07→05/09					
220 CDI (209.308)	100	01/05→05/09		05/05→ 04/09; für Linkslenker		03.7848-2002.4 300166	ATE Ø 7 / 8" pneumatisch
220 CDI (209.308)	110	01/05→05/09					
280 (209.354)	170	01/05→05/09					
320 CDI (209.320)	165	01/05→05/09					
350 (209.356)	200	01/05→05/09					
270 CDI (209.316)	120	02/03→06/05		für Linkslenker		03.7848-2002.4 300166	ATE Ø 7 / 8" pneumatisch
Pedalwegsensor, Bremspedal							
200 CGI (209.343)	125	07/03→05/09		→ 04/09; für Rechtslenker		03.0655-0007.2 370007	ATE
200 Kompressor (209.341)	135	10/06→05/09		→ 04/09; für Linkslenker		03.0655-0007.2 370007	ATE
200 Kompressor (209.342)	120	09/02→05/09					
240 (209.361)	120	06/02→05/09					
240 (209.361)	125	06/02→05/09					
270 CDI (209.316)	125	10/02→05/09					
320 (209.365)	160	06/02→05/09					
500 (209.372)	285	06/06→05/09					
500 (209.375)	225	06/02→05/09					
55 AMG (209.376)	270	09/02→05/09					
63 AMG (209.377)	354	04/06→05/09					
63 AMG (209.377)	373	05/07→05/09					
220 CDI (209.308)	100	01/05→05/09		05/05→ 04/09; für Rechtslenker		03.0655-0007.2 370007	ATE
220 CDI (209.308)	110	01/05→05/09		05/05→ 04/09; für Linkslenker		03.0655-0007.2 370007	ATE
280 (209.354)	170	01/05→05/09					
320 CDI (209.320)	165	01/05→05/09					
350 (209.356)	200	01/05→05/09					
270 CDI (209.316)	120	02/03→06/05		für Linkslenker		03.0655-0007.2 370007	ATE
				für Rechtslenker		03.0655-0007.2 370007	ATE
 Hauptbremszylinder							
200 CGI (209.343)	125	07/03→05/09		→ 04/09; für Linkslenker;		03.2023-1741.3 010703	ATE Ø1 23,81 Ø2 20,64
200 Kompressor (209.342)	120	09/02→05/09		für Fahrzeuge ohne Sportpaket / für Fahrzeuge ohne AMG-Sportpaket			
270 CDI (209.316)	125	10/02→05/09		→ 04/09; für Linkslenker;		03.2025-1741.3 010705	ATE Ø1 25,4 Ø2 20,64
				für Fahrzeuge mit Sportpaket / für Fahrzeuge mit AMG-Sportpaket			
200 Kompressor (209.341)	135	10/06→05/09		→ 04/09; für Linkslenker;		03.2023-1741.3 010703	ATE Ø1 23,81 Ø2 20,64
				für Fahrzeuge ohne AMG-Sportpaket / für Fahrzeuge ohne Sportpaket			
				→ 04/09; für Linkslenker;		03.2025-1741.3 010705	ATE Ø1 25,4 Ø2 20,64
				für Fahrzeuge mit Sportpaket / für Fahrzeuge mit AMG-Sportpaket			
220 CDI (209.308)	100	01/05→05/09		05/05→ 04/09; für Linkslenker		03.2025-1741.3 010705	ATE Ø1 25,4 Ø2 20,64
220 CDI (209.308)	110	01/05→05/09					
280 (209.354)	170	01/05→05/09					
320 CDI (209.320)	165	01/05→05/09					

	kw			 	! #		
MERCEDES-BENZ - CLK (C209) 06/02→05/09							
 Hauptbremszylinder							
350 (209.356)	200	01/05→05/09		05/05→ 04/09; für Linkslenker		03.2025-1741.3 010705	ATE Ø1 25,4 Ø2 20,64
240 (209.361)	120	06/02→05/09		→ 04/09; für Linkslenker		03.2025-1741.3 010705	ATE Ø1 25,4 Ø2 20,64
240 (209.361)	125	06/02→05/09					
320 (209.365)	160	06/02→05/09					
500 (209.372)	285	06/06→05/09					
500 (209.375)	225	06/02→05/09					
55 AMG (209.376)	270	09/02→05/09					
63 AMG (209.377)	354	04/06→05/09					
63 AMG (209.377)	373	05/07→05/09					
270 CDI (209.316)	120	02/03→06/05		für Linkslenker; für Fahrzeuge ohne Sportpaket / für Fahrzeuge ohne AMG-Sportpaket		03.2023-1741.3 010703	ATE Ø1 23,81 Ø2 20,64
				für Linkslenker; für Fahrzeuge mit Sportpaket / für Fahr- zeuge mit AMG-Sportpaket		03.2025-1741.3 010705	ATE Ø1 25,4 Ø2 20,64
MERCEDES-BENZ - CLK Cabriolet (A208) 03/98→03/02							
 Bremskraftverstärker							
200 (208.435)	100	03/98→03/02		T 028296→		03.7863-0903.4 300244	ATE Ø 10" pneumatisch
200 Kompressor (208.445)	141	03/98→06/00					
230 Kompressor (208.447)	142	03/98→06/00					
200 Kompressor (208.444)	120	06/00→03/02		T 028296→		03.7863-0903.4 300244	ATE Ø 10" pneumatisch
230 Kompressor (208.448)	145	06/00→03/02				03.7863-0903.4 300244	ATE Ø 10" pneumatisch
Pedalwegsensor, Bremspedal							
200 (208.435)	100	03/98→03/02		T 028296→		03.0655-0007.2 370007	ATE
200 Kompressor (208.445)	141	03/98→06/00					
230 Kompressor (208.447)	142	03/98→06/00					
200 Kompressor (208.444)	120	06/00→03/02		T 028296→		03.0655-0007.2 370007	ATE
230 Kompressor (208.448)	145	06/00→03/02				03.0655-0007.2 370007	ATE
 Hauptbremszylinder							
200 (208.435)	100	03/98→03/02		T 028296→; für Linkslenker		03.2023-2004.3 010788	ATE Ø1 23,81 Ø2 19,05
200 Kompressor (208.445)	141	03/98→06/00		06/98→; → T 028295; - ESP		24.2023-1702.3 010534	TRW Ø1 23,81 Ø2 19,05
230 Kompressor (208.447)	142	03/98→06/00					
200 Kompressor (208.444)	120	06/00→03/02		T 028296→; für Linkslenker		03.2023-2004.3 010788	ATE Ø1 23,81 Ø2 19,05
230 Kompressor (208.448)	145	06/00→03/02		für Linkslenker		03.2023-2004.3 010788	ATE Ø1 23,81 Ø2 19,05
				→ T 028295; - ESP		24.2023-1702.3 010534	TRW Ø1 23,81 Ø2 19,05
320 (208.465)	160	03/98→03/02		06/98→; → T 028295; - ESP		24.2023-1702.3 010534	TRW Ø1 23,81 Ø2 19,05
				06/98→; → T 028295; + ESP		24.2023-1704.3 010635	TRW Ø 23,81
				T 028296→		24.2023-1704.3 010635	TRW Ø 23,81
430 (208.470)	205	09/98→03/02		06/99→		24.2025-1709.3 010693	Ø 25,4
55 AMG (208.474)	255	01/00→03/02				24.2025-1709.3 010693	Ø 25,4
MERCEDES-BENZ - CLK Cabriolet (A209) 02/03→03/10							
 Bremskraftverstärker							
CLK 200 CGI (209.443)	125	07/03→03/10		→ 12/09; für Linkslenker		03.7848-2002.4 300166	ATE Ø 7 / 8" pneumatisch
CLK 200 Kompressor (209.441)	135	10/06→03/10					
CLK 500 (209.472)	285	06/06→03/10					
CLK 63 AMG (209.477)	354	04/06→03/10					
CLK 200 Kompressor (209.442)	120	02/03→03/10		05/03→ 12/09; für Linkslenker		03.7848-2002.4 300166	ATE Ø 7 / 8" pneumatisch
CLK 240 (209.461)	125	02/03→03/10					
CLK 320 (209.465)	160	02/03→03/10					
CLK 500 (209.475)	225	02/03→03/10					
CLK 55 AMG (209.476)	270	02/03→03/10					
CLK 280 (209.454)	170	01/05→03/10		05/05→ 12/09; für Linkslenker		03.7848-2002.4 300166	ATE Ø 7 / 8" pneumatisch
CLK 320 CDI (209.420)	165	03/05→03/10					
CLK 350 (209.456)	200	01/05→03/10					
Pedalwegsensor, Bremspedal							
CLK 200 CGI (209.443)	125	07/03→03/10		→ 12/09; für Linkslenker		03.0655-0007.2 370007	ATE
CLK 200 Kompressor (209.441)	135	10/06→03/10		→ 12/09; für Rechtslenker		03.0655-0007.2 370007	ATE
↓							

	kW			 	! #		
MERCEDES-BENZ - CLK Cabriolet (A209) 02/03→03/10							
Pedalwegsensor, Bremspedal							
CLK 500 (209.472)	285	06/06→03/10		→ 12/09; für Linkslenker		03.0655-0007.2 370007	ATE
CLK 63 AMG (209.477)	354	04/06→03/10		→ 12/09; für Rechtslenker		03.0655-0007.2 370007	ATE
CLK 200 Kompressor (209.442)	120	02/03→03/10		05/03→ 12/09; für Rechtslenker		03.0655-0007.2 370007	ATE
CLK 240 (209.461)	125	02/03→03/10		05/03→ 12/09; für Linkslenker		03.0655-0007.2 370007	ATE
CLK 320 (209.465)	160	02/03→03/10					
CLK 500 (209.475)	225	02/03→03/10					
CLK 55 AMG (209.476)	270	02/03→03/10					
CLK 280 (209.454)	170	01/05→03/10		05/05→ 12/09; für Rechtslenker		03.0655-0007.2 370007	ATE
CLK 320 CDI (209.420)	165	03/05→03/10		05/05→ 12/09; für Linkslenker		03.0655-0007.2 370007	ATE
CLK 350 (209.456)	200	01/05→03/10					
 Hauptbremszylinder							
CLK 200 CGI (209.443)	125	07/03→03/10		→ 12/09; für Linkslenker		03.2023-1741.3 010703	ATE Ø1 23,81 Ø2 20,64
CLK 200 Kompressor (209.441)	135	10/06→03/10		→ 12/09; für Linkslenker		03.2025-1741.3 010705	ATE Ø1 25,4 Ø2 20,64
CLK 500 (209.472)	285	06/06→03/10					
CLK 63 AMG (209.477)	354	04/06→03/10					
CLK 200 Kompressor (209.442)	120	02/03→03/10		05/03→ 12/09; für Linkslenker		03.2025-1741.3 010705	ATE Ø1 25,4 Ø2 20,64
CLK 240 (209.461)	125	02/03→03/10					
CLK 320 (209.465)	160	02/03→03/10					
CLK 500 (209.475)	225	02/03→03/10					
CLK 55 AMG (209.476)	270	02/03→03/10					
CLK 280 (209.454)	170	01/05→03/10		05/05→ 12/09; für Linkslenker		03.2025-1741.3 010705	ATE Ø1 25,4 Ø2 20,64
CLK 320 CDI (209.420)	165	03/05→03/10					
CLK 350 (209.456)	200	01/05→03/10					
MERCEDES-BENZ - CLS (C218) 01/11→							
 Bremskraftverstärker							
CLS 250 CDI / BlueTEC / d (218.303, 218.304)	150	04/11→		für Linkslenker		03.7755-8202.4 300301	ATE Ø 9 / 8" pneumatisch
CLS 350 (218.359)	225	01/11→					
CLS 350 CDI (218.323)	195	01/11→					
CLS 350 CDI 4-matic (218.393)	195	09/11→					
CLS 350 d 4-matic (218.394)	190	04/15→					
CLS 500 (218.373)	300	02/11→					
CLS 500 4-matic (218.391)	300	09/11→					
CLS 63 AMG (218.374)	410	01/11→					
CLS 63 AMG (218.374)	386	02/11→		03/11→; für Linkslenker		03.7755-8202.4 300301	ATE Ø 9 / 8" pneumatisch
 Hauptbremszylinder							
CLS 220 BlueTEC / d (218.301)	120	05/14→		für Linkslenker		03.2126-3196.3 010968	ATE Ø 26,99
CLS 220 BlueTEC / d (218.301)	125	05/14→					
CLS 220 BlueTEC (218.301)	130	05/14→					
CLS 250 BlueTEC / d 4-matic (218.397)	150	05/14→					
CLS 250 CDI / BlueTEC / d (218.303, 218.304)	150	04/11→					
CLS 350 (218.359)	225	01/11→					
CLS 350 BlueTEC / d (218.326)	190	06/14→					
CLS 350 CDI (218.323)	195	01/11→					
CLS 350 CDI 4-matic (218.393)	195	09/11→					
CLS 350 d 4-matic (218.394)	190	04/15→					
CLS 400 (218.361)	245	07/14→					
CLS 400 (218.365)	245	05/14→					
CLS 400 4-matic (218.367)	245	05/14→					
CLS 400 4-matic (218.368)	245	07/14→					
CLS 500 (218.373)	300	02/11→					
CLS 500 4-matic (218.391)	300	09/11→					
CLS 63 AMG (218.374)	410	01/11→					
CLS 63 AMG (218.375)	430	02/13→					
CLS 63 AMG 4-matic (218.376)	430	02/13→					
↓							

	kW			 	! #					
MERCEDES-BENZ - CLS (C218) 01/11→										
 Hauptbremszylinder										
CLS 63 AMG 4-matic (218.392)	410	05/13→		für Linkslenker		03.2126-3196.3 010968	ATE Ø 26,99			
CLS 350 BlueTEC (218.326)	185	11/12→		01/13→; für Linkslenker		03.2126-3196.3 010968	ATE Ø 26,99			
CLS 350 BlueTEC 4-matic (218.394)	185	11/12→								
CLS 63 AMG (218.374)	386	02/11→		03/11→; für Linkslenker		03.2126-3196.3 010968	ATE Ø 26,99			
MERCEDES-BENZ - CLS (C219) 10/04→02/11										
 Hauptbremszylinder										
CLS 280 (219.354)	170	07/08→12/10		→ 10/10; für Linkslenker		24.2125-1745.3 010998	TRW Ø 25,4			
CLS 300 (219.354)	170	04/09→12/10								
CLS 350 (219.356)	200	10/04→12/10								
CLS 350 (219.357)	215	04/06→12/10								
CLS 350 CDI	200	04/09→12/10								
CLS 350 CDI (219.322)	165	04/09→12/10								
CLS 350 CGI (219.357)	215	04/09→12/10								
CLS 500 (219.372)	285	04/06→12/10								
CLS 500 (219.375)	225	10/04→12/10								
CLS 55 AMG (219.376)	350	01/05→12/10								
CLS 63 AMG (219.377)	378	04/06→12/10								
CLS 320 CDI	155	01/05→12/10		05/05→ 10/10; für Linkslenker		24.2125-1745.3 010998	TRW Ø 25,4			
CLS 320 CDI (219.322)	165	01/05→12/10								
MERCEDES-BENZ - CLS Shooting Brake (X218) 10/12→										
 Bremskraftverstärker										
CLS 250 CDI / BlueTEC / d (218.903, 218.904)	150	10/12→		→ A 26541; für Linkslenker		03.7858-1932.4 300263	ATE Ø 9 / 8" pneumatisch			
CLS 350 (218.959)	225	10/12→								
CLS 350 CDI (218.923)	195	10/12→								
CLS 350 CDI 4-matic (218.993)	195	10/12→								
 Hauptbremszylinder										
CLS 220 BlueTEC / d (218.901)	120	05/14→		für Linkslenker		03.2126-3196.3 010968	ATE Ø 26,99			
CLS 220 BlueTEC / d (218.901)	125	05/14→								
CLS 220 BlueTEC (218.901)	130	05/14→								
CLS 250 BlueTEC / d 4-matic (218.997)	150	05/14→								
CLS 250 CDI / BlueTEC / d (218.903, 218.904)	150	10/12→								
CLS 350 (218.959)	225	10/12→								
CLS 350 BlueTEC / d (218.926)	190	05/14→								
CLS 350 BlueTEC 4-matic (218.994)	185	05/14→								
CLS 350 CDI (218.923)	195	10/12→								
CLS 350 CDI 4-matic (218.993)	195	10/12→								
CLS 350 d 4-matic (218.994)	190	04/15→								
CLS 400 (218.961)	245	07/14→								
CLS 400 (218.965)	245	05/14→								
CLS 400 4-matic (218.967)	245	05/14→								
CLS 400 4-matic (218.968)	245	07/14→								
CLS 500 (218.973)	300	10/12→								
CLS 500 4-matic (218.991)	300	10/12→								
CLS 63 AMG (218.974)	386	10/12→								
CLS 63 AMG (218.974)	410	05/13→								
CLS 63 AMG (218.975)	430	02/13→								
CLS 63 AMG 4-matic (218.976)	430	02/13→								
CLS 63 AMG 4-matic (218.992)	410	05/13→								
MERCEDES-BENZ - E-KLASSE (W124) 02/93→06/96										
 Bremskraftverstärker										
E 200 (124.019)	100	06/93→06/95							03.7760-2702.4 300090	ATE Ø 10" pneumatisch
E 200 D (124.120)	55	06/93→06/95								
E 220 (124.022)	110	06/93→06/95								
↓										

MERCEDES-BENZ - E-KLASSE (W124) 02/93→06/96

Bremskraftverstärker

E 250 D (124.126, 124.129)	83	07/93→06/95				03.7760-2702.4	300090	ATE Ø 10" pneumatisch
E 250 Turbo-D (124.128)	93	06/93→06/95						
E 280 (124.028)	145	06/93→06/95						
E 300 4-matic (124.230)	132	06/93→06/95						
E 300 D (124.131)	100	07/93→06/95						
E 300 Turbo-D (124.133)	108	06/93→06/95						
E 300 Turbo-D 4-matic (124.333)	108	06/93→06/95						
E 320 (124.032)	162	06/93→06/95						
E 36 AMG	200	07/94→01/95						

Hauptbremszylinder

E 200 (124.019)	100	06/93→06/95		→ C 164263		03.2023-0825.3	010028	Ø1 23,81 Ø2 19,05
E 200 D (124.120)	55	06/93→06/95						
E 220 (124.022)	110	06/93→06/95						
E 250 D (124.126, 124.129)	83	07/93→06/95						
E 250 Turbo-D (124.128)	93	06/93→06/95						
E 280 (124.028)	145	06/93→06/95						
E 280 (124.029)	142	06/93→06/95						
E 300 4-matic (124.230)	132	06/93→06/95						
E 300 D (124.131)	100	07/93→06/95						
E 300 Turbo-D (124.133)	108	06/93→06/95						
E 300 Turbo-D 4-matic (124.333)	108	06/93→06/95						
E 320 (124.032)	162	06/93→06/95		→ C 164263		03.2023-0825.3	010028	Ø1 23,81 Ø2 19,05
						03.2025-0211.3	010034	Ø1 25,4 Ø2 19,05
E 36 AMG	200	07/94→01/95				03.2023-0825.3	010028	Ø1 23,81 Ø2 19,05
E 420 (124.034)	205	06/93→06/95		→ C 164263		03.2025-0211.3	010034	Ø1 25,4 Ø2 19,05
E 500 (124.036)	235	06/93→06/95		→ B 927760		03.2025-0211.3	010034	Ø1 25,4 Ø2 19,05
E 60 AMG (124.036)	280	05/94→06/95						

MERCEDES-BENZ - E-KLASSE (W210) 06/95→08/03











Bremskraftverstärker

E 200 (210.035)	100	06/95→08/00		→ A394035		03.7760-4102.4	300091	ATE Ø 10" pneumatisch
E 220 D	55	05/96→03/02						
E 220 D (210.004)	70	06/95→07/99						
E 230 (210.037)	110	06/95→06/97						
E 290 Turbo-D (210.017)	95	03/96→07/99						
E 300 D (210.020)	100	06/95→06/97						
E 200 D (210.003)	65	01/96→03/02		10/96→; → A394035		03.7760-4102.4	300091	ATE Ø 10" pneumatisch
E 250 D (210.010)	83	06/95→07/99		→ A394035; für Rechtslenker		03.7760-4102.4	300091	ATE Ø 10" pneumatisch
				→ A394035		03.7760-4102.4	300091	ATE Ø 10" pneumatisch

Hauptbremszylinder

E 200 (210.035)	100	06/95→08/00		→ A394035		03.2023-1066.3	010032	Ø1 23,81 Ø2 19,05
E 290 Turbo-D (210.017)	95	03/96→07/99		A394036→		03.2023-1812.3	010570	Ø1 23,81 Ø2 19,05
E 300 D (210.020)	100	06/95→06/97						
E 200 CDI (210.007)	75	06/98→03/02		07/98→		03.2023-1812.3	010570	Ø1 23,81 Ø2 19,05
E 220 CDI (210.006)	92	06/98→07/99						
E 200 CDI (210.007)	85	07/99→03/02				03.2023-1812.3	010570	Ø1 23,81 Ø2 19,05
E 220 CDI (210.006)	100	07/99→03/02						
E 220 CDI (210.006)	105	07/99→03/02						
E 200 D (210.003)	65	01/96→03/02		10/96→; → A394035		03.2023-1066.3	010032	Ø1 23,81 Ø2 19,05
				A394036→		03.2023-1812.3	010570	Ø1 23,81 Ø2 19,05
E 200 Kompressor (210.045)	137	06/97→03/02		09/97→		24.2025-1703.3	010516	Ø1 25,4 Ø2 19,05
E 430 (210.070)	205	06/97→03/02						
E 55 AMG (210.074)	260	08/97→03/02						
E 200 Kompressor (210.048)	120	08/00→03/02				24.2025-1703.3	010516	Ø1 25,4 Ø2 19,05
E 270 CDI (210.016)	120	07/99→03/02						
E 270 CDI (210.016)	125	07/99→03/02						
E 280 (210.063)	150	12/96→03/02						
E 280 4-matic (210.081)	150	12/96→03/02						
E 300 Turbo-D (210.025)	130	12/96→07/99						
E 320 (210.065)	165	06/97→03/02						
E 320 4-matic (210.082)	165	06/97→03/02						
E 320 CDI (210.026)	145	07/99→03/02						
E 430 4-matic (210.083)	205	05/99→03/02						
E 55 AMG 4-matic (210.074)	260	03/01→03/02						
E 220 D	55	05/96→03/02		→ A394035		03.2023-1066.3	010032	Ø1 23,81 Ø2 19,05
E 220 D (210.004)	70	06/95→07/99		→ 06/98; A394036→		03.2023-1812.3	010570	Ø1 23,81 Ø2 19,05
E 230 (210.037)	110	06/95→06/97		→ A394035		03.2023-1066.3	010032	Ø1 23,81 Ø2 19,05



	kW			 	! #		
MERCEDES-BENZ - E-KLASSE (W210) 06/95→08/03							
 Hauptbremszylinder							
E 240 (210.061)	125	06/97→08/00		09/97→; - ESP		03.2023-1812.3 010570	Ø1 23,81 Ø2 19,05
				09/97→; + ESP		24.2025-1703.3 010516	Ø1 25,4 Ø2 19,05
E 240 (210.062)	125	08/00→03/02		- ESP		03.2023-1812.3 010570	Ø1 23,81 Ø2 19,05
				+ ESP		24.2025-1703.3 010516	Ø1 25,4 Ø2 19,05
E 250 D (210.010)	83	06/95→07/99		→ A394035; für Rechtslenker		03.2023-1066.3 010032	Ø1 23,81 Ø2 19,05
				→ A394035		03.2023-1066.3 010032	Ø1 23,81 Ø2 19,05
				A394036→		03.2023-1812.3 010570	Ø1 23,81 Ø2 19,05
				A394036→; für Rechtslenker		03.2023-1812.3 010570	Ø1 23,81 Ø2 19,05
E 250 Turbo-D (210.015)	110	06/97→07/99		09/97→		03.2023-1812.3 010570	Ø1 23,81 Ø2 19,05
E 280 (210.053)	142	01/96→06/97		→ 09/96		24.2025-1702.3 010515	Ø1 25,4 Ø2 19,05
E 320 (210.055)	162	06/95→06/97		10/96→		24.2025-1703.3 010516	Ø1 25,4 Ø2 19,05
E 420 (210.072)	205	01/96→06/97				24.2025-1702.3 010515	Ø1 25,4 Ø2 19,05
E 50 AMG (210.072)	255	02/96→08/97					
MERCEDES-BENZ - E-KLASSE (W211) 03/02→03/09							
 Hauptbremszylinder							
E 200 CDI (211.004)	75	07/02→12/08		für Linkslenker		24.2125-1745.3 010998	TRW Ø 25,4
E 200 CDI (211.004)	90	07/02→12/08					
E 200 CDI (211.007)	100	04/06→12/08					
E 200 Kompressor (211.041)	135	04/06→12/08					
E 200 Kompressor (211.042)	120	11/02→12/08					
E 200 NGT (211.041)	120	03/04→12/08					
E 220 CDI	120	03/03→12/08					
E 220 CDI (211.006)	100	03/02→12/08					
E 220 CDI (211.006)	110	03/02→12/08					
E 220 CDI (211.008)	125	04/06→12/08					
E 230 (211.052)	150	09/07→12/08					
E 240 (211.061)	130	03/02→12/08					
E 240 4-matic (211.080)	130	03/03→12/08					
E 270 CDI (211.016)	120	03/02→12/08					
E 270 CDI (211.016)	130	03/02→12/08					
E 280 4-matic (211.092)	170	01/06→12/08					
E 280 CDI (211.020)	140	03/05→12/08					
E 280 CDI (211.023)	130	05/04→12/08					
E 280 CDI 4-matic (211.084)	140	03/05→12/08					
E 300 BlueTEC (211.024)	155	09/07→12/08					
E 320 (211.065)	165	03/02→12/08					
E 320 4-matic (211.082)	165	03/03→12/08					
E 320 CDI (211.022)	165	03/05→12/08					
E 320 CDI (211.026)	150	11/02→12/08					
E 320 CDI 4-matic (211.089)	165	03/05→12/08					
E 350 (211.056)	200	03/05→12/08					
E 350 4-matic (211.087)	200	03/05→12/08					
E 350 CGI (211.057)	215	09/07→12/08					
E 420 CDI (211.029)	231	01/06→12/08					
E 500 (211.070)	225	03/02→12/08					
E 500 (211.072)	285	04/06→12/08					
E 500 4-matic (211.083)	225	10/03→12/08					
E 500 4-matic (211.090)	285	04/06→12/08					
E 55 AMG Kompressor (211.076)	350	10/02→12/08					
E 63 AMG (211.077, 211.177)	378	03/06→12/08					
E 280 (211.054)	170	03/05→12/08		05/05→; für Linkslenker		24.2125-1745.3 010998	TRW Ø 25,4
E 400 CDI (211.028)	191	02/03→12/08		03/03→; für Linkslenker		24.2125-1745.3 010998	TRW Ø 25,4
MERCEDES-BENZ - E-KLASSE (W212) 01/09→							
 Bremskraftverstärker							
E 200 (212.034)	135	01/13→		für Linkslenker		03.7755-8202.4 300301	ATE Ø 9 / 8" pneumatisch
E 200 CGI (212.048, 212.148)	135	08/09→					
E 200 NGT (212.035)	115	07/13→					
E 200 NGT (212.041)	120	03/11→					
E 220 BlueTEC (212.001)	130	05/14→					
E 220 BlueTEC 4-matic (212.011)	125	01/15→					
E 250 (212.036)	155	01/13→					
E 300 (212.055)	185	07/11→					
E 300 4-matic (212.080)	185	07/11→					
E 350 (212.059)	225	09/11→					
↓							













MERCEDES-BENZ - E-KLASSE (W212) 01/09→

Bremskraftverstärker













E 350 4-matic (212.088)	225	09/11→		für Linkslenker	03.7755-8202.4	300301	ATE Ø 9 / 8" pneumatisch
E 350 BlueTEC (212.026)	190	05/14→					
E 350 BlueTEC 4-matic (212.094)	190	05/14→					
E 350 CDI (212.023)	195	03/11→					
E 350 CDI 4-matic (212.089)	170	09/09→					
E 350 CDI 4-matic (212.093)	195	03/11→					
E 400 (212.061)	245	07/14→					
E 400 (212.065)	245	01/13→					
E 400 4-matic (212.067)	245	01/13→					
E 400 4-matic (212.099)	245	07/14→					
E 500 (212.073)	300	09/11→					
E 500 4-matic (212.091)	300	09/11→					
E 63 AMG (212.074)	386	02/11→					
E 63 AMG (212.074)	410	02/11→					
E 63 AMG (212.077)	386	12/09→					
E 63 AMG 4-matic (212.092)	410	02/11→					
E 200 CDI / BlueTEC (212.005, 212.006)	100	01/09→		03/09→; für Linkslenker	03.7755-8202.4	300301	ATE Ø 9 / 8" pneumatisch
E 220 CDI	120	01/09→					
E 220 CDI / BlueTEC (212.001, 212.002)	125	01/09→					
E 250 CDI / BlueTEC (212.003, 212.004)	150	01/09→					
E 250 CDI / BlueTEC 4-matic (212.082, 212.097)	150	01/09→					
E 250 CGI (212.047, 212.147)	150	01/09→					
E 300 (212.054)	170	01/09→					
E 350 (212.056)	200	01/09→					
E 350 4-matic (212.087)	200	01/09→08/11					
E 350 BlueTEC (212.024)	155	01/09→					
E 350 CDI (212.025)	170	01/09→					
E 350 CGI (212.057)	215	01/09→08/11					
E 500 (212.072)	285	01/09→					
E 500 4-matic (212.090)	285	01/09→					
E 300 CDI / BlueTEC (212.020, 212.021, 212.027)	170	03/11→		04/11→; für Linkslenker	03.7755-8202.4	300301	ATE Ø 9 / 8" pneumatisch
E 350 BlueTEC	185	11/12→		01/13→; für Linkslenker	03.7755-8202.4	300301	ATE Ø 9 / 8" pneumatisch
E 350 BlueTEC 4-matic (212.094)	185	11/12→					
E 63 AMG (212.075)	430	02/13→		04/13→; für Linkslenker	03.7755-8202.4	300301	ATE Ø 9 / 8" pneumatisch
E 63 AMG 4-matic (212.076)	430	02/13→					













Hauptbremszylinder









E 200 (212.034)	135	01/13→		für Linkslenker	03.2126-3196.3	010968	ATE Ø 26,99
E 200 CGI (212.048, 212.148)	135	08/09→			03.4156-5106.3	010997	ATE Ø 26,99
E 200 NGT (212.035)	115	07/13→					
E 200 NGT (212.041)	120	03/11→					
E 220 BlueTEC (212.001)	130	05/14→					
E 220 BlueTEC 4-matic (212.011)	125	01/15→					
E 250 (212.036)	155	01/13→					
E 250 CGI (212.047, 212.147)	150	01/09→					
E 300 (212.055)	185	07/11→					
E 300 4-matic (212.080)	185	07/11→					
E 350 (212.059)	225	09/11→					
E 350 4-matic (212.088)	225	09/11→					
E 350 BlueTEC (212.026)	190	05/14→					
E 350 BlueTEC 4-matic (212.094)	190	05/14→					
E 350 CDI (212.023)	195	03/11→					
E 350 CDI 4-matic (212.089)	170	09/09→					
E 350 CDI 4-matic (212.093)	195	03/11→					
E 400 (212.061)	245	07/14→					
E 400 (212.065)	245	01/13→					
E 400 4-matic (212.067)	245	01/13→					
E 400 4-matic (212.099)	245	07/14→					
E 500 (212.073)	300	09/11→					
E 500 4-matic (212.091)	300	09/11→					













	kW					! #		
MERCEDES-BENZ - E-KLASSE (W212) 01/09→								
 Hauptbremszylinder								
E 63 AMG (212.074)	386	02/11→			für Linkslenker		03.2126-3196.3 010968	ATE Ø 26,99
E 63 AMG (212.074)	410	02/11→					03.4156-5106.3 010997	ATE Ø 26,99
E 63 AMG (212.077)	386	12/09→						
E 63 AMG 4-matic (212.092)	410	02/11→						
E 200 CDI / BlueTEC (212.005, 212.006)	100	01/09→			03/09→; für Linkslenker		03.2126-3196.3 010968	ATE Ø 26,99
E 220 CDI	120	01/09→					03.4156-5106.3 010997	ATE Ø 26,99
E 220 CDI / BlueTEC (212.001, 212.002)	125	01/09→						
E 250 CDI / BlueTEC (212.003, 212.004)	150	01/09→						
E 250 CDI / BlueTEC 4-matic (212.082, 212.097)	150	01/09→						
E 300 (212.054)	170	01/09→						
E 350 (212.056)	200	01/09→						
E 350 4-matic (212.087)	200	01/09→08/11						
E 350 BlueTEC (212.024)	155	01/09→						
E 350 CDI (212.025)	170	01/09→						
E 350 CGI (212.057)	215	01/09→08/11						
E 500 (212.072)	285	01/09→						
E 500 4-matic (212.090)	285	01/09→						
E 300 CDI / BlueTEC (212.020, 212.021, 212.027)	170	03/11→			04/11→; für Linkslenker		03.2126-3196.3 010968	ATE Ø 26,99
							03.4156-5106.3 010997	ATE Ø 26,99
E 350 BlueTEC	185	11/12→			01/13→; für Linkslenker		03.2126-3196.3 010968	ATE Ø 26,99
E 350 BlueTEC 4-matic (212.094)	185	11/12→					03.4156-5106.3 010997	ATE Ø 26,99
E 63 AMG (212.075)	430	02/13→			04/13→; für Linkslenker		03.2126-3196.3 010968	ATE Ø 26,99
E 63 AMG 4-matic (212.076)	430	02/13→					03.4156-5106.3 010997	ATE Ø 26,99
MERCEDES-BENZ - E-KLASSE Cabriolet (A124) 05/93→03/98								
 Bremskraftverstärker								
E 200 (124.060)	100	06/93→03/98					03.7760-2702.4 300090	ATE Ø 10" pneumatisch
E 220 (124.062)	110	06/93→03/98						
E 320 (124.066)	162	06/93→03/98						
E 36 AMG (124.066)	200	05/94→03/98						
 Hauptbremszylinder								
E 200 (124.060)	100	06/93→03/98			→ C 164263		03.2023-0825.3 010028	Ø1 23,81 Ø2 19,05
E 220 (124.062)	110	06/93→03/98						
E 320 (124.066)	162	06/93→03/98						
E 36 AMG (124.066)	200	05/94→03/98						
MERCEDES-BENZ - E-KLASSE Cabriolet (A207) 01/10→								
 Bremskraftverstärker								
E 200 (207.434)	135	03/13→			für Linkslenker;		03.7745-6302.4 300261	ATE Ø 8" pneumatisch
E 220 BlueTEC (207.401)	130	05/14→			für Fahrzeuge ohne Start-Stopp-Funktion			
E 250 (207.436)	155	06/13→			für Linkslenker;		03.7745-8902.4 300297	ATE Ø 8" pneumatisch
E 300 (207.455)	185	04/11→			für Fahrzeuge mit Start-Stopp-Funktion			
E 320 (207.462)	200	07/14→						
E 350 (207.459)	225	04/11→						
E 350 BlueTEC/ d (207.426)	190	05/14→						
E 350 BlueTEC (207.426)	185	06/13→						
E 350 CDI	195	04/11→						
E 400 (207.461)	245	07/14→						
E 400 (207.465)	245	06/13→						
E 500 (207.473)	300	09/11→						
E 550	299	09/11→						
E 200 CGI (207.448)	135	01/10→			03/10→; für Linkslenker;		03.7745-6302.4 300261	ATE Ø 8" pneumatisch
E 220 CDI / BlueTEC / d (207.402, 207.401)	125	01/10→			für Fahrzeuge ohne Start-Stopp-Funktion			
E 220 CDI (207.402)	120	02/10→			03/10→; für Linkslenker;		03.7745-8902.4 300297	ATE Ø 8" pneumatisch
E 250 CDI / BlueTEC / d (207.403, 207.404)	150	01/10→			für Fahrzeuge mit Start-Stopp-Funktion			
E 250 CGI (207.447)	150	01/10→						
E 350 CDI (207.422)	170	01/10→						
E 350 CGI (207.457)	215	01/10→						
E 500 (207.472)	285	01/10→						
 Hauptbremszylinder								
E 200 (207.434)	135	03/13→			für Linkslenker		03.2025-2521.3 010959	ATE Ø1 25,4 Ø2 22,2
E 220 BlueTEC (207.401)	130	05/14→						
↓								











	kW					! #		
MERCEDES-BENZ - E-KLASSE Cabriolet (A207) 01/10→								
 Hauptbremszylinder								
E 250 (207.436)	155	06/13→		für Linkslenker		03.2025-2521.3	010959	ATE Ø1 25,4 Ø2 22,2
E 300 (207.455)	185	04/11→						
E 320 (207.462)	200	07/14→						
E 350 (207.459)	225	04/11→						
E 350 BlueTEC/ d (207.426)	190	05/14→						
E 350 BlueTEC (207.426)	185	06/13→						
E 350 CDI	195	04/11→						
E 400 (207.461)	245	07/14→						
E 400 (207.465)	245	06/13→						
E 500 (207.473)	300	09/11→						
E 550	299	09/11→						
E 200 CGI (207.448)	135	01/10→		03/10→; für Linkslenker		03.2025-2521.3	010959	ATE Ø1 25,4 Ø2 22,2
E 220 CDI / BlueTEC / d (207.402, 207.401)	125	01/10→						
E 220 CDI (207.402)	120	02/10→						
E 250 CDI / BlueTEC / d (207.403, 207.404)	150	01/10→						
E 250 CGI (207.447)	150	01/10→						
E 350 CDI (207.422)	170	01/10→						
E 350 CGI (207.457)	215	01/10→						
E 500 (207.472)	285	01/10→						
MERCEDES-BENZ - E-KLASSE Coupe (C124) 06/93→06/97								
 Bremskraftverstärker								
E 200 (124.040)	100	06/93→06/97				03.7760-2702.4	300090	ATE Ø 10" pneumatisch
E 220 (124.042)	110	06/93→06/97						
E 320 (124.052)	162	06/93→06/97						
E 36 AMG (124.052)	195	06/93→04/95						
E 36 AMG (124.052)	200	05/94→06/97						
 Hauptbremszylinder								
E 200 (124.040)	100	06/93→06/97		→ C 164263		03.2023-0825.3	010028	Ø1 23,81 Ø2 19,05
E 220 (124.042)	110	06/93→06/97						
E 320 (124.052)	162	06/93→06/97						
E 36 AMG (124.052)	195	06/93→04/95						
E 36 AMG (124.052)	200	05/94→06/97						
MERCEDES-BENZ - E-KLASSE Coupe (C207) 01/09→								
 Bremskraftverstärker								
E 200 (207.334)	135	06/13→		für Linkslenker;		03.7745-6302.4	300261	ATE Ø 8" pneumatisch
E 200 CGI (207.348)	135	01/10→		für Fahrzeuge ohne Start-Stopp-Funktion				
E 220 BlueTEC (207.301)	130	05/14→		für Linkslenker;		03.7745-8902.4	300297	ATE Ø 8" pneumatisch
E 220 CDI	120	07/14→		für Fahrzeuge mit Start-Stopp-Funktion				
E 220 CDI / d (207.302)	125	01/10→						
E 250 (207.336)	155	06/13→						
E 300 (207.355)	185	04/11→						
E 320 (207.362)	200	07/14→						
E 350 (207.356)	225	04/11→						
E 350 4-matic (207.388)	225	02/13→						
E 350 BlueTEC	185	03/13→						
E 350 BlueTEC / d (207.326)	190	05/14→						
E 350 CDI	195	04/11→						
E 400	245	06/13→						
E 400 (207.361)	245	07/14→						
E 500 (207.373)	300	09/11→						
E 250 CDI / BlueTEC / d (207.303)	150	01/09→		05/09→; für Linkslenker;		03.7745-6302.4	300261	ATE Ø 8" pneumatisch
E 250 CGI (207.347)	150	01/09→		für Fahrzeuge ohne Start-Stopp-Funktion				
E 350 CDI (207.322)	170	01/09→		05/09→; für Linkslenker;		03.7745-8902.4	300297	ATE Ø 8" pneumatisch
E 350 CGI (207.357)	215	01/09→		für Fahrzeuge mit Start-Stopp-Funktion				
E 500 (207.372)	285	01/09→						
 Hauptbremszylinder								
E 200 (207.334)	135	06/13→		für Linkslenker		03.2025-2521.3	010959	ATE Ø1 25,4 Ø2 22,2
E 200 CGI (207.348)	135	01/10→						
E 220 BlueTEC (207.301)	130	05/14→						
E 220 CDI	120	07/14→						
E 220 CDI / d (207.302)	125	01/10→						
E 250 (207.336)	155	06/13→						
E 300 (207.355)	185	04/11→						
E 320 (207.362)	200	07/14→						
E 350 (207.356)	225	04/11→						
E 350 4-matic (207.388)	225	02/13→						
E 350 BlueTEC	185	03/13→						
↓								











	kW					! #		
MERCEDES-BENZ - E-KLASSE Coupe (C207) 01/09→								
 Hauptbremszylinder								
E 350 BlueTEC / d (207.326)	190	05/14→			für Linkslenker		03.2025-2521.3 010959	ATE Ø1 25,4 Ø2 22,2
E 350 CDI	195	04/11→						
E 400	245	06/13→						
E 400 (207.361)	245	07/14→						
E 500 (207.373)	300	09/11→						
E 250 CDI / BlueTEC / d (207.303)	150	01/09→			05/09→; für Linkslenker		03.2025-2521.3 010959	ATE Ø1 25,4 Ø2 22,2
E 250 CGI (207.347)	150	01/09→						
E 350 CDI (207.322)	170	01/09→						
E 350 CGI (207.357)	215	01/09→						
E 500 (207.372)	285	01/09→						
MERCEDES-BENZ - E-KLASSE Kombi (S124) 06/93→06/96								
 Bremskraftverstärker								
E 200 T (124.079)	100	06/93→06/96					03.7760-2702.4 300090	ATE Ø 10" pneumatisch
E 220 T (124.082)	110	06/93→06/96						
E 250 TD (124.186)	83	06/93→06/96						
E 250 Turbo D	93	06/93→06/96						
E 280 T (124.088)	145	06/93→06/96						
E 280 T (124.088)	142	06/93→06/96						
E 300 T 4-matic (124.290)	132	06/93→06/96						
E 300 TD (124.191)	100	06/93→06/96						
E 300 TE-24 AMG (124.091)	162	06/93→06/96						
E 300 T Turbo-D (124.193)	108	06/93→06/96						
E 300 T Turbo-D 4-matic (124.393)	108	06/93→06/96						
E 320 T (124.092)	162	06/93→06/96						
E 36 T AMG (124.092)	200	05/94→06/96						
 Hauptbremszylinder								
E 200 T (124.079)	100	06/93→06/96			→ F 298225		03.2023-0825.3 010028	Ø1 23,81 Ø2 19,05
E 220 T (124.082)	110	06/93→06/96						
E 250 TD (124.186)	83	06/93→06/96						
E 250 Turbo D	93	06/93→06/96						
E 280 T (124.088)	145	06/93→06/96						
E 280 T (124.088)	142	06/93→06/96						
E 300 T 4-matic (124.290)	132	06/93→06/96						
E 300 T Turbo-D 4-matic (124.393)	108	06/93→06/96						
E 320 T (124.092)	162	06/93→06/96						
E 36 T AMG (124.092)	200	05/94→06/96						
E 300 TD (124.191)	100	06/93→06/96			→ C 164263		03.2023-0825.3 010028	Ø1 23,81 Ø2 19,05
E 300 T Turbo-D (124.193)	108	06/93→06/96						
E 300 TE-24 AMG (124.091)	162	06/93→06/96					03.2023-0825.3 010028	Ø1 23,81 Ø2 19,05
MERCEDES-BENZ - E-KLASSE Kombi (S210) 06/96→03/03								
 Bremskraftverstärker								
E 200 T (210.235)	100	06/96→08/00			→ A394035		03.7760-4102.4 300091	ATE Ø 10" pneumatisch
E 230 T (210.237)	110	06/96→06/97						
E 250 T D (210.210)	83	06/96→07/99			→ A394035; Radstand [mm]: 2.833		03.7760-4102.4 300091	ATE Ø 10" pneumatisch
					→ A394035; für Rechtslenker; Radstand [mm]: 2.833		03.7760-4102.4 300091	ATE Ø 10" pneumatisch
E 290 T Turbo-D (210.217)	95	06/96→07/99			→ A394035; Radstand [mm]: 2.833		03.7760-4102.4 300091	ATE Ø 10" pneumatisch
 Hauptbremszylinder								
E 200 T (210.235)	100	06/96→08/00			→ A394035		03.2023-1066.3 010032	Ø1 23,81 Ø2 19,05
E 230 T (210.237)	110	06/96→06/97			A394036→		03.2023-1812.3 010570	Ø1 23,81 Ø2 19,05
E 200 T Kompressor (210.245)	137	06/97→03/03			09/97→		24.2025-1703.3 010516	Ø1 25,4 Ø2 19,05
E 250 T Turbo-D (210.215)	110	06/97→07/99						
E 430 T (210.270)	205	06/97→03/03						
E 55 T AMG (210.274)	260	08/97→03/03						
E 200 T Kompressor (210.248)	120	08/00→03/03					24.2025-1703.3 010516	Ø1 25,4 Ø2 19,05
E 270 T CDI	120	02/00→03/03						
E 270 T CDI (210.216)	125	07/99→03/03						
E 280 T 4-matic (210.281)	150	12/96→03/03						
↓								













	kW			 	! #		
MERCEDES-BENZ - E-KLASSE Kombi (S210) 06/96→03/03							
 Hauptbremszylinder							
E 300 T Turbo-D (210.225)	130	12/96→07/99				24.2025-1703.3 010516	Ø1 25,4 Ø2 19,05
E 320 T (210.265)	165	12/96→03/03					
E 320 T CDI (210.226)	145	07/99→03/03					
E 430 T 4-matic (210.283)	205	05/99→03/03					
E 55 T AMG 4-matic (210.274)	260	03/01→03/03					
E 220 T CDI (210.206)	100	05/99→03/03		für Linkslenker; Radstand [mm]: 2.833		03.2023-1812.3 010570	Ø1 23,81 Ø2 19,05
E 220 T CDI (210.206)	105	07/99→03/03		für Linkslenker; Radstand [mm]: 3.570		24.2025-1703.3 010516	Ø1 25,4 Ø2 19,05
E 220 T CDI (210.206)	92	06/98→07/99		07/98→; für Linkslenker; Radstand [mm]: 2.833		03.2023-1812.3 010570	Ø1 23,81 Ø2 19,05
				07/98→; für Linkslenker; Radstand [mm]: 3.570		24.2025-1703.3 010516	Ø1 25,4 Ø2 19,05
E 240 T (210.261)	125	06/97→03/03		09/97→; - ESP		03.2023-1812.3 010570	Ø1 23,81 Ø2 19,05
				09/97→; + ESP		24.2025-1703.3 010516	Ø1 25,4 Ø2 19,05
E 240 T (210.262)	125	08/00→03/03		- ESP		03.2023-1812.3 010570	Ø1 23,81 Ø2 19,05
				+ ESP		24.2025-1703.3 010516	Ø1 25,4 Ø2 19,05
E 250 T D (210.210)	83	06/96→07/99		→ A394035; Radstand [mm]: 2.833		03.2023-1066.3 010032	Ø1 23,81 Ø2 19,05
				→ A394035; für Rechtslenker; Radstand [mm]: 2.833		03.2023-1066.3 010032	Ø1 23,81 Ø2 19,05
				→ A394035; Radstand [mm]: 3.570		24.2025-1702.3 010515	Ø1 25,4 Ø2 19,05
				A394036→; Radstand [mm]: 3.570		24.2025-1703.3 010516	Ø1 25,4 Ø2 19,05
				A394036→; für Rechtslenker; Radstand [mm]: 2.833		24.2025-1703.3 010516	Ø1 25,4 Ø2 19,05
				A394036→; Radstand [mm]: 2.833		24.2025-1703.3 010516	Ø1 25,4 Ø2 19,05
E 280 T (210.263)	150	12/96→03/03		Radstand [mm]: 3.570		24.2025-1703.3 010516	Ø1 25,4 Ø2 19,05
E 290 T Turbo-D (210.217)	95	06/96→07/99		→ A394035; Radstand [mm]: 2.833		03.2023-1066.3 010032	Ø1 23,81 Ø2 19,05
				→ A394035; Radstand [mm]: 3.570		24.2025-1702.3 010515	Ø1 25,4 Ø2 19,05
				A394036→		24.2025-1703.3 010516	Ø1 25,4 Ø2 19,05
E 320 T 4-matic (210.282)	165	12/96→03/03		06/97→		24.2025-1703.3 010516	Ø1 25,4 Ø2 19,05
E 420 T (210.272)	205	06/96→06/97				24.2025-1702.3 010515	Ø1 25,4 Ø2 19,05
MERCEDES-BENZ - E-KLASSE Kombi (S211) 03/03→07/09							
 Hauptbremszylinder							
350 CGI (211.257)	215	05/06→07/09		für Linkslenker		24.2125-1745.3 010998	TRW Ø 25,4
E 200 CDI (211.207)	100	04/06→07/09					
E 200 Kompressor (211.241)	135	04/06→07/09					
E 200 T Kompressor (211.242)	120	03/03→07/09					
E 220 CDI (211.206)	100	03/03→07/09					
E 220 T CDI	120	03/03→07/09					
E 220 T CDI (211.206)	110	03/03→07/09					
E 220 T CDI (211.208)	125	04/06→07/09					
E 230 T (211.252)	150	05/07→07/09					
E 240 T (211.261)	130	03/03→07/09					
E 240 T 4-matic (211.280)	130	07/03→07/09					
E 270 T CDI (211.216)	120	03/03→07/09					
E 270 T CDI (211.216)	130	03/03→07/09					
E 280 T CDI (211.220)	140	03/05→07/09					
E 280 T CDI (211.223)	130	05/04→07/09					
E 320 T (211.265)	165	03/03→07/09					
E 320 T 4-matic (211.282)	165	07/03→07/09					
E 320 T CDI (211.222)	165	03/05→07/09					
E 320 T CDI (211.226)	150	03/03→07/09					
E 350 T (211.256)	200	03/05→07/09					
E 350 T 4-matic (211.287)	200	03/05→07/09					
E 500 T (211.270)	225	10/03→07/09					
E 500 T (211.272)	285	04/06→07/09					
E 500 T 4-matic (211.283)	225	10/03→07/09					
E 500 T 4-matic (211.290)	285	04/06→07/09					
E 55 T AMG Kompressor (211.276)	350	07/03→07/09					
E 63 AMG (211.277)	378	03/06→07/09					
E 280 T (211.254)	170	03/05→07/09		05/05→; für Linkslenker		24.2125-1745.3 010998	TRW Ø 25,4
E 280 T 4-matic (211.292)	170	03/05→07/09					
↓							

	kW			 	! #		
MERCEDES-BENZ - E-KLASSE Kombi (S211) 03/03→07/09							
 Hauptbremszylinder							
E 280 T CDI 4-matic (211.284)	140	03/05→07/09		05/05→; für Linkslenker		24.2125-1745.3 010998	TRW Ø 25,4
E 320 T CDI 4-matic (211.289)	165	03/05→07/09					
MERCEDES-BENZ - E-KLASSE Kombi (S212) 08/09→							
 Bremskraftverstärker							
E 200 (212.234)	135	11/12→		03/13→; für Linkslenker		03.7755-8202.4 300301	ATE Ø 9 / 8" pneumatisch
E 250 (212.236)	155	11/12→					
E 200 CDI / BlueTEC (212.205, 212.206)	100	11/09→		für Linkslenker		03.7755-8202.4 300301	ATE Ø 9 / 8" pneumatisch
E 200 CGI (212.248)	135	11/09→					
E 220 BlueTEC	130	05/15→					
E 220 BlueTEC 4-matic (212.211)	125	12/14→					
E 220 CDI / BlueTEC (212.202, 212.201)	125	11/09→					
E 250 CDI / BlueTEC (212.203, 212.204)	150	11/09→					
E 250 CDI / BlueTEC 4-matic (212.282, 212.297)	150	07/10→					
E 250 CGI (212.247)	150	11/09→					
E 300 (212.254)	170	11/09→					
E 300 (212.255)	185	07/11→					
E 300 4-matic (212.280)	185	07/11→					
E 300 CDI / BlueTEC (212.227, 212.221)	170	11/09→					
E 350 (212.259)	225	09/11→					
E 350 4-matic (212.287)	200	11/09→					
E 350 4-matic (212.288, 212.287)	225	09/11→					
E 350 BlueTEC (212.224)	155	11/09→					
E 350 BlueTEC (212.226)	190	07/14→					
E 350 BlueTEC 4-matic (212.294)	190	07/14→					
E 350 CDI (212.223)	195	07/11→					
E 350 CDI (212.225)	170	11/09→					
E 350 CDI 4-matic (212.289)	170	11/09→					
E 350 CDI 4-matic (212.293)	195	07/11→					
E 350 CGI (212.257)	215	11/09→					
E 400	245	01/13→					
E 400 (212.261)	245	07/14→					
E 400 4-matic	245	01/13→					
E 400 4-matic (212.299)	245	07/14→					
E 500 (212.272)	285	11/09→					
E 500 (212.273)	300	09/11→					
E 500 4-matic (212.291)	300	09/11→					
E 63 AMG (212.274)	386	02/11→					
E 63 AMG (212.274)	410	02/11→					
E 63 AMG 4-matic (212.292)	410	02/11→					
E 220 CDI (212.202)	120	08/09→		11/09→; für Linkslenker		03.7755-8202.4 300301	ATE Ø 9 / 8" pneumatisch
E 350 (212.256)	200	08/09→					
E 63 AMG (212.277)	386	08/09→					
E 350 BlueTEC	185	11/12→		01/13→; für Linkslenker		03.7755-8202.4 300301	ATE Ø 9 / 8" pneumatisch
E 350 BlueTEC 4-matic	185	11/12→					
E 63 AMG (212.275)	430	02/13→		04/13→; für Linkslenker		03.7755-8202.4 300301	ATE Ø 9 / 8" pneumatisch
E 63 AMG 4-matic (212.276)	430	02/13→					
 Hauptbremszylinder							
E 200 (212.234)	135	11/12→		03/13→; für Linkslenker		03.2126-3196.3 010968	ATE Ø 26,99
E 250 (212.236)	155	11/12→				03.4156-5106.3 010997	ATE Ø 26,99
E 200 CDI / BlueTEC (212.205, 212.206)	100	11/09→		für Linkslenker		03.2126-3196.3 010968	ATE Ø 26,99
E 200 CGI (212.248)	135	11/09→				03.4156-5106.3 010997	ATE Ø 26,99
E 220 BlueTEC	130	05/15→					
E 220 BlueTEC 4-matic (212.211)	125	12/14→					
E 220 CDI / BlueTEC (212.202, 212.201)	125	11/09→					
E 250 CDI / BlueTEC (212.203, 212.204)	150	11/09→					
E 250 CDI / BlueTEC 4-matic (212.282, 212.297)	150	07/10→					
E 250 CGI (212.247)	150	11/09→					
E 300 (212.254)	170	11/09→					



	kw			 	! #		
MERCEDES-BENZ - E-KLASSE Kombi (S212) 08/09 →							
 Hauptbremszylinder							
E 300 (212.255)	185	07/11 →		für Linkslenker		03.2126-3196.3 010968	ATE Ø 26,99
E 300 4-matic (212.280)	185	07/11 →				03.4156-5106.3 010997	ATE Ø 26,99
E 300 CDI / BlueTEC (212.227, 212.221)	170	11/09 →					
E 350 (212.259)	225	09/11 →					
E 350 4-matic (212.287)	200	11/09 →					
E 350 4-matic (212.288, 212.287)	225	09/11 →					
E 350 BlueTEC (212.224)	155	11/09 →					
E 350 BlueTEC (212.226)	190	07/14 →					
E 350 BlueTEC 4-matic (212.294)	190	07/14 →					
E 350 CDI (212.223)	195	07/11 →					
E 350 CDI (212.225)	170	11/09 →					
E 350 CDI 4-matic (212.289)	170	11/09 →					
E 350 CDI 4-matic (212.293)	195	07/11 →					
E 350 CGI (212.257)	215	11/09 →					
E 400	245	01/13 →					
E 400 (212.261)	245	07/14 →					
E 400 4-matic	245	01/13 →					
E 400 4-matic (212.299)	245	07/14 →					
E 500 (212.272)	285	11/09 →					
E 500 (212.273)	300	09/11 →					
E 500 4-matic (212.291)	300	09/11 →					
E 63 AMG (212.274)	386	02/11 →					
E 63 AMG (212.274)	410	02/11 →					
E 63 AMG 4-matic (212.292)	410	02/11 →					
E 220 CDI (212.202)	120	08/09 →		11/09 →; für Linkslenker		03.2126-3196.3 010968	ATE Ø 26,99
E 350 (212.256)	200	08/09 →				03.4156-5106.3 010997	ATE Ø 26,99
E 63 AMG (212.277)	386	08/09 →					
E 350 BlueTEC	185	11/12 →		01/13 →; für Linkslenker		03.2126-3196.3 010968	ATE Ø 26,99
E 350 BlueTEC 4-matic	185	11/12 →				03.4156-5106.3 010997	ATE Ø 26,99
E 63 AMG (212.275)	430	02/13 →		04/13 →; für Linkslenker		03.2126-3196.3 010968	ATE Ø 26,99
E 63 AMG 4-matic (212.276)	430	02/13 →				03.4156-5106.3 010997	ATE Ø 26,99
MERCEDES-BENZ - G-KLASSE (W461) 09/89 →							
 Bremskraftverstärker							
230 GE (461.238, 461.239)	90	09/89 → 07/96		02/93 →; für Linkslenker		03.6855-1402.4 300057	ATE Ø 9" pneumatisch
				02/93 →; für Rechtslenker		03.6855-1902.4 300059	ATE Ø 9" pneumatisch
230 GE (461)	92	06/93 → 07/00		für Linkslenker		03.6855-1402.4 300057	ATE Ø 9" pneumatisch
290 GD/G 290 D (461.337, 461.338)	70	06/93 → 07/00		für Rechtslenker		03.6855-1902.4 300059	ATE Ø 9" pneumatisch
G 270 CDI	115	01/03 →					
G 290 TD (461.335, 461.336)	88	07/97 →					
G 280 CDI (461.304, 461.346, 461.370, 461.334, 461.339...)	135	04/09 →		für Linkslenker		03.6855-1402.4 300057	ATE Ø 9" pneumatisch
G 300 CDI	135	04/10 →					
 Hauptbremszylinder							
230 GE (461.238, 461.239)	90	09/89 → 07/96		02/93 →		03.2125-2102.3 010207	Ø 25,4
230 GE (461)	92	06/93 → 07/00				03.2125-2102.3 010207	Ø 25,4
290 GD/G 290 D (461.337, 461.338)	70	06/93 → 07/00					
G 290 TD (461.335, 461.336)	88	07/97 →					
G 270 CDI	115	01/03 →		für Rechtslenker		03.2125-2102.3 010207	Ø 25,4
 Bremskraftregler							
230 GE (461.238, 461.239)	90	09/89 → 07/96		02/93 →		03.6513-0340.3 320084	ATE lastabhängig 1/3 2x
230 GE (461)	92	06/93 → 07/00				03.6513-0340.3 320084	ATE lastabhängig 1/3 2x
290 GD/G 290 D (461.337, 461.338)	70	06/93 → 07/00					
G 290 TD (461.335, 461.336)	88	07/97 →					
G 270 CDI	115	01/03 →				03.6515-0305.3 320087	ATE lastabhängig 1/5 2x
G 280 CDI (461.304, 461.346, 461.370, 461.334, 461.339...)	135	04/09 →					

	kW			 	! #		
MERCEDES-BENZ - G-KLASSE (W463) 09/89→							
 Bremskraftverstärker							
300 GE (463.227, 463.228)	128	06/90→08/97		für Linkslenker		03.6855-1402.4 300057	ATE Ø 9" pneumatisch
350 Turbo GD (463.320, 463.321)	100	09/91→08/96		für Rechtslenker		03.6855-1902.4 300059	ATE Ø 9" pneumatisch
G 270 CDI (463.322, 463.323)	115	10/01→					
G 300 TD (463.330, 463.331)	130	08/96→07/00					
G 320 (463.230, 463.231)	155	09/94→12/97					
G 320 (463.232, 463.233, 463.244, 463.245)	158	07/97→					
G 36 AMG (463.230)	200	01/95→07/98					
G 400 CDI (463.332, 463.333)	184	12/00→					
G 500 (463.247, 463.248, 463.249, 463.240, 463.241)	218	04/98→					
G 55 AMG (463.243, 463.246)	260	04/99→					
G 55 AMG (463.270, 463.271)	350	06/04→					
G 55 AMG (463.270, 463.271)	368	08/06→					
G 55 AMG (463.270, 463.271)	373	08/08→					
 Hauptbremszylinder							
300 GE (463.227, 463.228)	128	06/90→08/97		für Linkslenker; - ABS		03.2125-2102.3 010207	Ø 25,4
350 Turbo GD (463.320, 463.321)	100	09/91→08/96					
G 270 CDI (463.322, 463.323)	115	10/01→					
G 300 TD (463.330, 463.331)	130	08/96→07/00					
G 320 (463.230, 463.231)	155	09/94→12/97					
G 320 (463.232, 463.233, 463.244, 463.245)	158	07/97→					
G 36 AMG (463.230)	200	01/95→07/98					
G 400 CDI (463.332, 463.333)	184	12/00→					
G 500 (463.247, 463.248, 463.249, 463.240, 463.241)	218	04/98→					
G 55 AMG (463.243, 463.246)	260	04/99→					
G 55 AMG (463.270, 463.271)	350	06/04→					
G 55 AMG (463.270, 463.271)	368	08/06→					
G 55 AMG (463.270, 463.271)	373	08/08→					
G 320 CDI (463.340, 463.341, 463.343)	165	09/06→				24.2125-1745.3 010998	TRW Ø 25,4
G 350 CDI	155	07/11→					
G 500 (463.202)	285	05/08→		→ 12/11		24.2125-1745.3 010998	TRW Ø 25,4
 Bremskraftregler							
300 GE (463.227, 463.228)	128	06/90→08/97				03.6513-0340.3 320084	ATE lastabhängig 1/3 2x
350 Turbo GD (463.320, 463.321)	100	09/91→08/96					
G 270 CDI (463.322, 463.323)	115	10/01→					
G 300 TD (463.330, 463.331)	130	08/96→07/00					
G 320 (463.230, 463.231)	155	09/94→12/97					
G 320 (463.232, 463.233, 463.244, 463.245)	158	07/97→					
G 36 AMG (463.230)	200	01/95→07/98					
G 400 CDI (463.332, 463.333)	184	12/00→					
G 500 (463.247, 463.248, 463.249, 463.240, 463.241)	218	04/98→					
↓							

	kW			 	! #		
MERCEDES-BENZ - G-KLASSE (W463) 09/89→							
 Bremskraftregler							
G 55 AMG (463.243, 463.246)	260	04/99→				03.6513-0340.3 320084	ATE lastabhängig 1/3 2x
G 55 AMG (463.270, 463.271)	350	06/04→					
G 55 AMG (463.270, 463.271)	368	08/06→					
G 55 AMG (463.270, 463.271)	373	08/08→					
MERCEDES-BENZ - G-KLASSE Geländewagen offen (W463) 09/89→							
 Bremskraftverstärker							
300 GD (463.307)	83	12/90→09/97		für Linkslenker		03.6855-1402.4 300057	ATE Ø 9" pneumatisch
300 GE (463.207)	125	09/89→09/97		für Rechtslenker		03.6855-1902.4 300059	ATE Ø 9" pneumatisch
320 GE (463.208)	155	09/94→11/97					
350 G Turbo-D (463.300)	100	09/91→09/97					
G 300 TD (463.308)	130	09/96→07/00					
G 320 (463.209)	158	11/97→					
G 400 CDI (463.309)	184	12/00→					
G 500	285	12/09→					
G 500 (463)	218	04/98→					
 Hauptbremszylinder							
300 GD (463.307)	83	12/90→09/97		für Linkslenker; - ABS		03.2125-2102.3 010207	Ø 25,4
300 GE (463.207)	125	09/89→09/97					
320 GE (463.208)	155	09/94→11/97					
350 G Turbo-D (463.300)	100	09/91→09/97					
G 300 TD (463.308)	130	09/96→07/00					
G 320 (463.209)	158	11/97→					
G 400 CDI (463.309)	184	12/00→					
G 500	285	12/09→					
G 500 (463)	218	04/98→					
G 320 CDI (463.303)	165	09/06→			24.2125-1745.3	010998	TRW Ø 25,4
G 350 CDI	155	07/11→					
 Bremskraftregler							
300 GD (463.307)	83	12/90→09/97				03.6513-0340.3 320084	ATE lastabhängig 1/3 2x
300 GE (463.207)	125	09/89→09/97					
320 GE (463.208)	155	09/94→11/97					
350 G Turbo-D (463.300)	100	09/91→09/97					
G 300 TD (463.308)	130	09/96→07/00					
G 320 (463.209)	158	11/97→					
G 400 CDI (463.309)	184	12/00→					
G 500	285	12/09→					
G 500 (463)	218	04/98→					
MERCEDES-BENZ - GLA-KLASSE (X156) 12/13→							
 Hauptbremszylinder							
AMG GLA 45 4-matic (156.952)	280	07/15→		für Linkslenker		24.4123-1718.3 011016	TRW Ø 23,81 ohne Bremsflüssigkeitsbehälter
GLA 180 (156.942)	90	02/15→					
GLA 180 CDI / d (156.912)	80	07/14→					
GLA 200 (156.943)	115	12/13→					
GLA 200 CDI / d (156.908)	100	12/13→					
GLA 200 CDI 4-matic (156.902)	100	12/13→					
GLA 220 CDI / d (156.903)	120	12/13→					
GLA 220 CDI / d 4-matic (156.905)	120	12/13→					
GLA 220 CDI (156.903)	125	12/13→					
GLA 220 CDI 4-matic (156.905)	125	12/13→					
GLA 220 d (156.903)	130	07/15→					
GLA 220 d 4-matic (156.905)	130	07/15→					
GLA 250 (156.944)	155	12/13→					
GLA 250 4-matic (156.946)	155	12/13→					
GLA 45 AMG 4-matic (156.952)	265	05/14→06/15					

MERCEDES-BENZ - GLK-KLASSE (X204) 06/08→

Bremskraftverstärker

200 (204.934)	135	08/13→06/15		für Linkslenker;			ATE Ø 8" pneumatisch
200 CDI (204.901)	100	12/13→06/15		für Fahrzeuge ohne Start-Stopp-Funktion			
200 CDI (204.901)	105	07/10→06/15					
250 (204.936)	155	08/13→06/15		für Linkslenker;			ATE Ø 8" pneumatisch
250 4-matic (204.937)	155	08/13→06/15		für Fahrzeuge mit Start-Stopp-Funktion			
250 CDI 4-matic (204.982, 204.904)	150	09/09→06/15					
300 4-matic	185	09/09→06/15					
300 4-matic (204.981)	170	07/09→04/11					
350 (204.956)	200	04/09→06/15					
350 CDI 4-matic (204.992)	165	07/09→01/10					
350 CDI 4-matic (204.992)	170	02/10→05/10					
350 CDI 4-matic (204.993)	195	07/12→06/15					
220 CDI (204.902)	120	12/08→06/15		04/09→; für Linkslenker;			ATE Ø 8" pneumatisch
220 CDI (204.902)	125	12/08→06/15		für Fahrzeuge ohne Start-Stopp-Funktion			
220 CDI 4-matic (204.984, 204.997)	125	12/08→06/15					
220 CDI 4-matic (204.984)	120	12/08→06/15		04/09→; für Linkslenker;			ATE Ø 8" pneumatisch
				für Fahrzeuge mit Start-Stopp-Funktion			
280 4-matic (204.981)	170	06/08→06/09		09/08→; für Linkslenker;			ATE Ø 8" pneumatisch
320 CDI 4-matic (204.983)	165	06/08→06/15		für Fahrzeuge ohne Start-Stopp-Funktion			
350 4-matic (204.987)	200	06/08→04/11					
350 4-matic (204.988)	225	06/08→06/15		09/08→; für Linkslenker;			ATE Ø 8" pneumatisch
				für Fahrzeuge mit Start-Stopp-Funktion			

Hauptbremszylinder

200 (204.934)	135	08/13→06/15		für Linkslenker			ATE Ø1 25,4 Ø2 22,2
200 CDI (204.901)	100	12/13→06/15					
200 CDI (204.901)	105	07/10→06/15					
250 (204.936)	155	08/13→06/15					
250 4-matic (204.937)	155	08/13→06/15					
250 CDI 4-matic (204.982, 204.904)	150	09/09→06/15					
300 4-matic	185	09/09→06/15					
300 4-matic (204.981)	170	07/09→04/11					
350 (204.956)	200	04/09→06/15					
350 CDI 4-matic (204.992)	165	07/09→01/10					
350 CDI 4-matic (204.992)	170	02/10→05/10					
350 CDI 4-matic (204.993)	195	07/12→06/15					
220 CDI (204.902)	120	12/08→06/15		04/09→; für Linkslenker			ATE Ø1 25,4 Ø2 22,2
220 CDI (204.902)	125	12/08→06/15					
220 CDI 4-matic (204.984, 204.997)	125	12/08→06/15					
220 CDI 4-matic (204.984)	120	12/08→06/15					
280 4-matic (204.981)	170	06/08→06/09		09/08→; für Linkslenker			ATE Ø1 25,4 Ø2 22,2
320 CDI 4-matic (204.983)	165	06/08→06/15					
350 4-matic (204.987)	200	06/08→04/11					
350 4-matic (204.988)	225	06/08→06/15					











MERCEDES-BENZ - GL-KLASSE (X164) 09/06→











Pedalwegsensord, Bremspedal

GL 320 CDI / 350 BlueTEC 4-matic (164.824, 164.825)	155	12/09→		→ 06/12			ATE
GL 350 CDI 4-matic (164.822)	165	05/09→					
GL 350 CDI 4-matic (164.823)	195	10/10→					
GL 450 4-matic (164.871)	250	09/06→					
GL 450 CDI 4-matic (164.828)	225	05/09→					
GL 500 4-matic (164.886)	285	09/06→					
GL 320 CDI 4-matic (164.822)	165	09/06→05/09					ATE
GL 420 CDI 4-matic (164.828)	225	09/06→05/09					











Hauptbremszylinder









GL 320 CDI / 350 BlueTEC 4-matic (164.824, 164.825)	155	12/09→		→ 06/12			ATE Ø 26,99 ohne Bremsflüssigkeitsbehälter
---	-----	--------	--	---------	--	--	--

	kW			 	! #		
MERCEDES-BENZ - GL-KLASSE (X164) 09/06→							
 Hauptbremszylinder							
GL 350 CDI 4-matic (164.822)	165	05/09→		→ 06/12		03.4156-0014.3 010930	ATE Ø 26,99 ohne Bremsflüssigkeitsbehälter
GL 350 CDI 4-matic (164.823)	195	10/10→					
GL 450 4-matic (164.871)	250	09/06→					
GL 450 CDI 4-matic (164.828)	225	05/09→					
GL 500 4-matic (164.886)	285	09/06→					
GL 320 CDI 4-matic (164.822)	165	09/06→05/09				03.4156-0014.3 010930	ATE Ø 26,99 ohne Bremsflüssigkeitsbehälter
GL 420 CDI 4-matic (164.828)	225	09/06→05/09					
MERCEDES-BENZ - M-KLASSE (W163) 02/98→06/05							
Pedalwegsensoren, Bremspedal							
ML 270 CDI (163.113)	120	12/99→06/05				03.0655-0007.2 370007	ATE
ML 350	173	02/03→06/05					
ML 400 CDI (163.128)	184	09/01→06/05					
ML 500 (163.175)	215	09/01→06/05					
ML 55 AMG (163.174)	255	02/00→06/05					
ML 320 (163.154)	160	02/98→08/02		03/98→; + ESP		03.0655-0007.2 370007	ATE
ML 350 (163.157)	180	08/02→06/05		09/02→		03.0655-0007.2 370007	ATE
ML 430 (163.172)	200	02/98→06/05		09/98→		03.0655-0007.2 370007	ATE
 Hauptbremszylinder							
ML 230 (163.136)	110	02/98→06/05		03/98→		03.2125-7310.3 010743	ATE Ø 25,4
ML 320 (163.154)	160	02/98→08/02					
ML 270 CDI (163.113)	120	12/99→06/05				03.2125-7310.3 010743	ATE Ø 25,4
ML 350	173	02/03→06/05					
ML 400 CDI (163.128)	184	09/01→06/05					
ML 500 (163.175)	215	09/01→06/05					
ML 55 AMG (163.174)	255	02/00→06/05					
ML 350 (163.157)	180	08/02→06/05		09/02→		03.2125-7310.3 010743	ATE Ø 25,4
ML 430 (163.172)	200	02/98→06/05		09/98→		03.2125-7310.3 010743	ATE Ø 25,4
MERCEDES-BENZ - M-KLASSE (W164) 07/05→12/11							
Pedalwegsensoren, Bremspedal							
ML 280 CDI 4-matic (164.120)	140	07/05→07/09				03.0655-0007.2 370007	ATE
ML 320 CDI 4-matic (164.122)	165	07/05→07/09					
ML 300 4-matic (164.182)	170	03/10→		→ 05/11		03.0655-0007.2 370007	ATE
ML 300 CDI 4-matic (164.120)	140	07/09→12/11					
ML 300 CDI 4-matic (164.121)	150	02/10→12/11					
ML 350 4-matic (164.186)	200	07/05→12/11					
ML 350 CDI 4-matic (164.122)	165	07/09→12/11					
ML 350 CDI 4-matic (164.125)	155	09/09→12/11					
ML 350 CDI 4-matic (164.125)	170	02/10→12/11					
ML 450 CDI 4-matic (164.128)	225	09/09→12/11					
ML 500 4-matic (164.172)	285	12/07→12/11					
ML 500 4-matic (164.175)	225	07/05→12/11					
ML 63 AMG 4-matic (164.177)	375	01/06→12/11					
ML 420 CDI 4-matic (164.128)	225	02/06→09/09		04/06→		03.0655-0007.2 370007	ATE
 Hauptbremszylinder							
ML 280 CDI 4-matic (164.120)	140	07/05→07/09				03.4156-0014.3 010930	ATE Ø 26,99 ohne Bremsflüssigkeitsbehälter
ML 320 CDI 4-matic (164.122)	165	07/05→07/09					
ML 300 4-matic (164.182)	170	03/10→		→ 05/11		03.4156-0014.3 010930	ATE Ø 26,99 ohne Bremsflüssigkeitsbehälter
ML 300 CDI 4-matic (164.120)	140	07/09→12/11					
↓							









	kW					! #		
MERCEDES-BENZ - M-KLASSE (W164) 07/05→12/11								
 Hauptbremszylinder								
ML 300 CDI 4-matic (164.121)	150	02/10→12/11			→ 05/11		03.4156-0014.3 010930	ATE Ø 26,99 ohne Bremsflüssigkeitsbehälter
ML 350 4-matic (164.186)	200	07/05→12/11						
ML 350 CDI 4-matic (164.122)	165	07/09→12/11						
ML 350 CDI 4-matic (164.125)	155	09/09→12/11						
ML 350 CDI 4-matic (164.125)	170	02/10→12/11						
ML 450 CDI 4-matic (164.128)	225	09/09→12/11						
ML 500 4-matic (164.172)	285	12/07→12/11						
ML 500 4-matic (164.175)	225	07/05→12/11						
ML 63 AMG 4-matic (164.177)	375	01/06→12/11						
ML 420 CDI 4-matic (164.128)	225	02/06→09/09			04/06→		03.4156-0014.3 010930	ATE Ø 26,99 ohne Bremsflüssigkeitsbehälter
MERCEDES-BENZ - R-KLASSE (W251, V251) 01/05→								
 Pedalwegsensord, Bremspedal								
R 280 (251.054, 251.154)	170	01/07→					03.0655-0007.2 370007	ATE
R 280 CDI (251.121, 251.026, 251.126)	140	05/06→						
R 280 CDI 4-matic (251.020)	140	05/06→						
R 300 (251.054, 251.154)	170	07/09→						
R 300 CDI (251.021, 251.121, 251.026, 251.126)	140	07/09→						
R 300 CDI 4-matic (251.020)	140	07/09→						
R 320 CDI 4-matic (251.022, 251.122)	165	01/06→						
R 320 CDI 4-matic (251.125)	155	01/06→						
R 350 (251.056, 251.156)	200	01/07→						
R 350 4-matic (251.065, 251.165)	200	01/06→						
R 350 CDI 4-matic (251.022, 251.122)	165	07/09→						
R 350 CDI 4-matic (251.023, 251.123)	195	08/10→						
R 350 CGI 4-matic (251.057, 251.157)	225	01/06→						
R 500 4-matic (251.072, 251.172)	285	01/07→						
R 500 4-matic (251.075, 251.175)	225	01/06→						
R 63 AMG 4-matic (251.077, 251.177)	375	02/06→						
R 350 CDI 4-matic (251.124, 251.125)	155	01/06→			05/09→		03.0655-0007.2 370007	ATE
 Hauptbremszylinder								
R 280 (251.054, 251.154)	170	01/07→					03.4156-0014.3 010930	ATE Ø 26,99 ohne Bremsflüssigkeitsbehälter
R 280 CDI (251.121, 251.026, 251.126)	140	05/06→						
R 280 CDI 4-matic (251.020)	140	05/06→						
R 300 (251.054, 251.154)	170	07/09→						
R 300 CDI (251.021, 251.121, 251.026, 251.126)	140	07/09→						
R 300 CDI 4-matic (251.020)	140	07/09→						
R 320 CDI 4-matic (251.022, 251.122)	165	01/06→						
R 320 CDI 4-matic (251.125)	155	01/06→						
R 350 (251.056, 251.156)	200	01/07→						
R 350 4-matic (251.065, 251.165)	200	01/06→						
↓								















	kw					! #			
MERCEDES-BENZ - R-KLASSE (W251, V251) 01/05→									
 Hauptbremszylinder									
R 350 CDI 4-matic (251.022, 251.122)	165	07/09→					03.4156-0014.3 010930	ATE Ø 26,99 ohne Bremsflüssigkeitsbehälter	
R 350 CDI 4-matic (251.023, 251.123)	195	08/10→							
R 350 CGI 4-matic (251.057, 251.157)	225	01/06→							
R 500 4-matic (251.072, 251.172)	285	01/07→							
R 500 4-matic (251.075, 251.175)	225	01/06→							
R 63 AMG 4-matic (251.077, 251.177)	375	02/06→							
R 350 CDI 4-matic (251.124, 251.125)	155	01/06→		05/09→			03.4156-0014.3 010930	ATE Ø 26,99 ohne Bremsflüssigkeitsbehälter	
MERCEDES-BENZ - S-KLASSE (W140) 02/91→10/98									
 Bremskraftverstärker									
300 SE, SEL/S320 (140.032, 140.033)	170	03/91→10/98		A 358833→; für Linkslenker			03.7858-0102.4 300262	ATE Ø 9 / 8" pneumatisch	
300 SE 2.8 (140.028)	145	01/93→10/98							
S 280 (140.028)	142	02/93→10/98							
S 300 Turbo-D (140.135)	130	05/96→10/98							
S 350 Turbo-D (140.134)	110	01/93→10/98		A 358833→; → 06/96; für Linkslenker			03.7858-0102.4 300262	ATE Ø 9 / 8" pneumatisch	
 Hauptbremszylinder									
300 SE, SEL/S320 (140.032, 140.033)	170	03/91→10/98		07/93→; → A212244			03.2025-0211.3 010034	Ø1 25,4 Ø2 19,05	
				04/91→ 06/93			03.2025-0211.3 010034	Ø1 25,4 Ø2 19,05	
				A212245→			24.2025-1702.3 010515	Ø1 25,4 Ø2 19,05	
300 SE 2.8 (140.028) S 280 (140.028)	145 142	01/93→10/98 02/93→10/98		07/93→; → A212244			03.2025-0211.3 010034	Ø1 25,4 Ø2 19,05	
				→ 06/93			03.2025-0211.3 010034	Ø1 25,4 Ø2 19,05	
				A212245→			24.2025-1702.3 010515	Ø1 25,4 Ø2 19,05	
400 SE, SEL/S420 (140.042, 140.043) 500 SE, SEL (140.050, 140.051)	210	02/91→10/98		→ 06/93; A110607→; für Linkslenker			03.2026-0462.3 010728	Ø1 26,99 Ø2 25,4	
				07/93→; → A358832; für Linkslenker			03.2026-0462.3 010728	Ø1 26,99 Ø2 25,4	
	240	02/91→10/98		07/93→; → A212244; für Rechtslenker				03.2026-0512.3 010038	Ø1 26,99 Ø2 25,4
				→ 06/93; A110607→; für Rechtslenker				03.2026-0512.3 010038	Ø1 26,99 Ø2 25,4
				A212245→ A358832; für Rechtslenker				03.2026-0562.3 010729	Ø1 26,99 Ø2 25,4
				A358833→; für Linkslenker				03.2026-0712.3 010730	Ø1 26,99 Ø2 25,4
S 300 Turbo-D (140.135)	130	05/96→10/98				24.2025-1702.3 010515	Ø1 25,4 Ø2 19,05		
S 350 Turbo-D (140.134)	110	01/93→10/98		03/93→ 06/93			03.2025-0211.3 010034	Ø1 25,4 Ø2 19,05	
				07/93→; → A212244			03.2025-0211.3 010034	Ø1 25,4 Ø2 19,05	
				→ 06/96; A212245→			24.2025-1702.3 010515	Ø1 25,4 Ø2 19,05	
S 420 (140.042) S 500 (140.050, 140.051)	205 235	01/93→10/98 01/93→10/98		07/93→; → A358832; für Linkslenker			03.2026-0462.3 010728	Ø1 26,99 Ø2 25,4	
				07/93→; → A212244; für Rechtslenker			03.2026-0512.3 010038	Ø1 26,99 Ø2 25,4	
S 600 (140.056, 140.057)	290	01/93→10/98		A212245→ A358832; für Rechtslenker			03.2026-0562.3 010729	Ø1 26,99 Ø2 25,4	
				A358833→; für Linkslenker			03.2026-0712.3 010730	Ø1 26,99 Ø2 25,4	
MERCEDES-BENZ - S-KLASSE (W220) 10/98→08/05									
 Hauptbremszylinder									
S 280 (220.063, 220.163)	150	10/98→08/05		11/98→			24.4025-1701.3 010719	Ø 25,4	
S 320 (220.065, 220.165)	165	10/98→08/05							
S 430 (220.070, 220.170)	205	10/98→08/05							
S 500 (220.075, 220.175, 220.875)	225	10/98→08/05							
S 320 CDI (220.025, 220.125)	150	09/02→08/05					24.4025-1701.3 010719	Ø 25,4	
S 320 CDI (220.026, 220.126)	145	08/99→09/02							
S 350 (220.067, 220.167)	180	09/02→08/05							
S 350 4-matic (220.087, 220.187)	180	06/03→08/05							
S 400 CDI (220.028, 220.128)	191	06/03→08/05							
S 430 4-matic (220.083, 220.183)	205	09/02→08/05							
S 500 4-matic (220.084, 220.184)	225	09/02→08/05							
S 55 AMG (220.073, 220.173)	265	04/99→08/05							
↓									













	kw			 	! #		
MERCEDES-BENZ - S-KLASSE (W220) 10/98→08/05							
 Hauptbremszylinder							
S 55 AMG Kompressor (220.074, 220.174)	368	06/02→08/05				24.4025-1701.3 010719	Ø 25,4
S 600 (220.176)	368	09/02→08/05					
S 600 (220.878, 220.178)	270	01/00→08/05					
S 63 AMG	326	09/01→08/05					
S 65 AMG (220.179)	450	03/04→08/05					
S 400 CDI (220.028, 220.128)	184	06/00→08/05		08/00→		24.4025-1701.3 010719	Ø 25,4
MERCEDES-BENZ - S-KLASSE (W221) 09/05→12/13							
 Bremskraftverstärker							
S 280 (221.054)	170	08/06→12/13		→ A 265574		03.7858-1932.4 300263	ATE Ø 9 / 8" pneumatisch
S 300 (221.054)	170	08/06→12/13					
S 320 CDI (221.022, 221.122)	173	12/05→06/09					
S 320 CDI 4-matic (221.080, 221.180)	173	10/06→12/13					
S 350 4-matic (221.087, 221.187)	200	02/08→12/13					
S 350 CDI	173	06/09→12/13					
S 420 CDI / S 450 CDI (221.028, 221.128)	235	10/06→12/13					
S 63 AMG (221.074, 221.174)	400	03/11→12/13					
S 63 AMG (221.074, 221.174)	420	02/12→12/13					
S 320 CDI	155	10/05→12/13		12/05→; → A 265574		03.7858-1932.4 300263	ATE Ø 9 / 8" pneumatisch
S 320 CDI 4-matic (221.080, 221.180)	155	10/05→12/13					
S 350 (221.056, 221.156)	200	10/05→12/13					
S 500 (221.071, 221.171)	285	10/05→12/13					
S 450 (221.070, 221.170)	250	12/05→12/13		04/06→; → A 265574		03.7858-1932.4 300263	ATE Ø 9 / 8" pneumatisch
S 450 4-matic (221.084, 221.184)	250	12/05→12/13					
S 500 4-matic (221.086, 221.186)	285	10/05→12/13					
S 63 AMG (221.077, 221.177)	386	10/06→12/13		01/07→; → A 265574		03.7858-1932.4 300263	ATE Ø 9 / 8" pneumatisch
Pedalwegsensoren, Bremspedal							
S 250 CDI (221.003, 221.103)	150	01/11→12/13		→ 05/13; + DISTRONIC Plus		03.0655-0007.2 370007	ATE
S 350 BlueTec (221.026, 221.126)	190	04/11→12/13					
S 350 BlueTEC 4-matic (221.083, 221.183)	190	04/11→12/13					
S 350 CGI (221.057, 221.157)	225	04/11→12/13					
S 350 CGI 4-matic (221.082, 221.182)	225	04/11→12/13					
S 500 CGI (221.073, 221.173)	320	04/11→12/13					
S 500 CGI 4-matic (221.094, 221.194)	320	03/11→12/13					
S 280 (221.054)	170	08/06→12/13		A 265575→; → 05/13; + DISTRONIC Plus		03.0655-0007.2 370007	ATE
S 300 (221.054)	170	08/06→12/13					
S 320 CDI 4-matic (221.080, 221.180)	173	10/06→12/13		→ A 265574		03.0655-0007.2 370007	ATE
S 350 4-matic (221.087, 221.187)	200	02/08→12/13					
S 350 CDI	173	06/09→12/13					
S 420 CDI / S 450 CDI (221.028, 221.128)	235	10/06→12/13					
S 320 CDI	155	10/05→12/13		A 265575→; → 05/13; + DISTRONIC Plus		03.0655-0007.2 370007	ATE
S 320 CDI 4-matic (221.080, 221.180)	155	10/05→12/13		12/05→; → A 265574		03.0655-0007.2 370007	ATE
S 350 (221.056, 221.156)	200	10/05→12/13					
S 500 (221.071, 221.171)	285	10/05→12/13					
S 320 CDI (221.022, 221.122)	173	12/05→06/09		A 265575→; + DISTRONIC Plus		03.0655-0007.2 370007	ATE
				→ A 265574		03.0655-0007.2 370007	ATE
S 400 Hybrid (221.095, 221.195)	205	01/09→12/13		06/09→ 05/13		03.0655-0007.2 370007	ATE
S 450 (221.070, 221.170)	250	12/05→12/13		A 265575→; → 05/13; + DISTRONIC Plus		03.0655-0007.2 370007	ATE
				04/06→; → A 265574		03.0655-0007.2 370007	ATE























	kw			 	! #		
MERCEDES-BENZ - S-KLASSE (W221) 09/05→12/13							
Pedalwegsensor, Bremspedal							
S 450 4-matic (221.084, 221.184)	250	12/05→12/13		A 265575→; → 05/13; + DISTRONIC Plus		03.0655-0007.2 370007	ATE
S 500 4-matic (221.086, 221.186)	285	10/05→12/13		04/06→; → A 265574		03.0655-0007.2 370007	ATE
S 600 (221.176)	380	12/05→12/13		A 060621→; für Fahrzeuge ohne Start-Stopp-Funktion; → 05/13		03.0655-0007.2 370007	ATE
				→ A 060620; für Fahrzeuge ohne Start-Stopp-Funktion		03.0655-0007.2 370007	ATE
				für Fahrzeuge ohne Start-Stopp-Funktion; → 05/13		03.0655-0007.2 370007	ATE
S 63 AMG (221.074, 221.174)	400	03/11→12/13		A 265575→; → 05/13; + DISTRONIC Plus		03.0655-0007.2 370007	ATE
S 63 AMG (221.074, 221.174)	420	02/12→12/13		→ A 265574		03.0655-0007.2 370007	ATE
				→ 05/13		03.0655-0007.2 370007	ATE
S 63 AMG (221.077, 221.177)	386	10/06→12/13		A 265575→; → 05/13; + DISTRONIC Plus		03.0655-0007.2 370007	ATE
				01/07→; → A 265574		03.0655-0007.2 370007	ATE
				01/07→ 05/13		03.0655-0007.2 370007	ATE
S 65 AMG (221.179)	450	12/05→12/13		04/06→; → A 060620		03.0655-0007.2 370007	ATE
				A 060621→; → 05/13		03.0655-0007.2 370007	ATE
				04/06→ 05/13		03.0655-0007.2 370007	ATE
S 65 AMG (221.179)	463	04/11→12/13		A 060621→; → 05/13		03.0655-0007.2 370007	ATE
				→ A 060620		03.0655-0007.2 370007	ATE
				→ 05/13		03.0655-0007.2 370007	ATE
 Hauptbremszylinder							
S 250 CDI (221.003, 221.103)	150	01/11→12/13		→ 05/13		03.4156-0073.3 010942	ATE Ø 26,99
S 350 BlueTec (221.026, 221.126)	190	04/11→12/13					
S 350 BlueTEC 4-matic (221.083, 221.183)	190	04/11→12/13					
S 350 CGI (221.057, 221.157)	225	04/11→12/13					
S 350 CGI 4-matic (221.082, 221.182)	225	04/11→12/13					
S 500 CGI (221.073, 221.173)	320	04/11→12/13					
S 500 CGI 4-matic (221.094, 221.194)	320	03/11→12/13					
S 280 (221.054)	170	08/06→12/13		→ A 293047;		03.4055-0013.3 010793	ATE Ø 25,4
S 300 (221.054)	170	08/06→12/13		nicht für gepanzerte Fahrzeuge			
S 320 CDI 4-matic (221.080, 221.180)	173	10/06→12/13		A 293048→; → 05/13;		03.4156-0073.3 010942	ATE Ø 26,99
S 350 4-matic (221.087, 221.187)	200	02/08→12/13		nicht für gepanzerte Fahrzeuge			
S 350 CDI	173	06/09→12/13					
S 420 CDI / S 450 CDI (221.028, 221.128)	235	10/06→12/13					
S 600 (221.176)	380	12/05→12/13					
S 63 AMG (221.074, 221.174)	400	03/11→12/13					
S 63 AMG (221.074, 221.174)	420	02/12→12/13					
S 65 AMG (221.179)	463	04/11→12/13					
S 320 CDI	155	10/05→12/13		12/05→; → A 293047;		03.4055-0013.3 010793	ATE Ø 25,4
S 320 CDI 4-matic (221.080, 221.180)	155	10/05→12/13		nicht für gepanzerte Fahrzeuge			
S 350 (221.056, 221.156)	200	10/05→12/13		A 293048→; → 05/13;		03.4156-0073.3 010942	ATE Ø 26,99
S 500 (221.071, 221.171)	285	10/05→12/13		nicht für gepanzerte Fahrzeuge			
S 320 CDI (221.022, 221.122)	173	12/05→06/09		→ A 293047;		03.4055-0013.3 010793	ATE Ø 25,4
				nicht für gepanzerte Fahrzeuge			
				A 293048→;		03.4156-0073.3 010942	ATE Ø 26,99
				nicht für gepanzerte Fahrzeuge			
S 400 Hybrid (221.095, 221.195)	205	01/09→12/13		06/09→ 05/13		03.4155-5141.3 010969	ATE Ø 25,4
S 450 (221.070, 221.170)	250	12/05→12/13		04/06→; → A 293047;		03.4055-0013.3 010793	ATE Ø 25,4
				nicht für gepanzerte Fahrzeuge			
S 450 4-matic (221.084, 221.184)	250	12/05→12/13		A 293048→; → 05/13;		03.4156-0073.3 010942	ATE Ø 26,99
S 500 4-matic (221.086, 221.186)	285	10/05→12/13		nicht für gepanzerte Fahrzeuge			
S 65 AMG (221.179)	450	12/05→12/13					
S 63 AMG (221.077, 221.177)	386	10/06→12/13		01/07→; → A 293047;		03.4055-0013.3 010793	ATE Ø 25,4
				nicht für gepanzerte Fahrzeuge			
↓							

	kw					! #		
MERCEDES-BENZ - S-KLASSE (W221) 09/05→12/13								
 Hauptbremszylinder								
S 63 AMG (221.077, 221.177)	386	10/06→12/13		A 293048→; → 05/13; nicht für gepanzerte Fahrzeuge			03.4156-0073.3 010942	ATE Ø 26,99
MERCEDES-BENZ - S-KLASSE Coupe (C140) 07/92→02/99								
 Hauptbremszylinder								
CL 500	225	09/96→12/97		für Linkslenker			03.2026-0462.3 010728	Ø1 26,99 Ø2 25,4
				für Rechtslenker			03.2026-0562.3 010729	Ø1 26,99 Ø2 25,4
SEC/CL 420 (140.063)	205	10/94→02/99		→ 05/96; für Linkslenker			03.2026-0462.3 010728	Ø1 26,99 Ø2 25,4
				06/96→; für Linkslenker			03.2026-0462.3 010728	Ø1 26,99 Ø2 25,4
				→ 05/96; für Rechtslenker			03.2026-0562.3 010729	Ø1 26,99 Ø2 25,4
				06/96→; für Rechtslenker			03.2026-0562.3 010729	Ø1 26,99 Ø2 25,4
SEC/CL 500 (140.070) SEC/CL 600 (140.076)	235 290	10/92→02/99 09/92→02/99		06/96→; für Linkslenker			03.2026-0462.3 010728	Ø1 26,99 Ø2 25,4
				→ 06/93; A110607→; für Linkslenker			03.2026-0462.3 010728	Ø1 26,99 Ø2 25,4
				07/93→; → A358832; für Linkslenker			03.2026-0462.3 010728	Ø1 26,99 Ø2 25,4
				→ 06/93; A110607→; für Rechtslenker			03.2026-0512.3 010038	Ø1 26,99 Ø2 25,4
				07/93→; → A212244; für Rechtslenker			03.2026-0512.3 010038	Ø1 26,99 Ø2 25,4
				06/96→; für Rechtslenker			03.2026-0562.3 010729	Ø1 26,99 Ø2 25,4
				A212245→ A358832; für Rechtslenker			03.2026-0562.3 010729	Ø1 26,99 Ø2 25,4
				A358833→; → 05/96; für Linkslenker			03.2026-0712.3 010730	Ø1 26,99 Ø2 25,4
MERCEDES-BENZ - S-KLASSE Coupe (C215) 03/99→08/06								
 Hauptbremszylinder								
CL 500 (215.375)	225	03/99→03/06					24.4025-1701.3 010719	Ø 25,4
CL 55 AMG (215.373)	265	10/99→03/06						
CL 55 AMG Kompressor (215.374)	368	06/02→03/06						
CL 600 (215.376)	368	09/02→03/06						
CL 600 (215.378)	270	03/99→03/06						
CL 65 AMG (215.379)	450	09/03→03/06						
MERCEDES-BENZ - S-KLASSE Coupe (C216) 05/06→12/13								
 Bremskraftverstärker								
CL 500 (216.371)	285	06/06→12/13		07/06→; → A 024306			03.7858-1932.4 300263	ATE Ø 9 / 8" pneumatisch
CL 600 (216.376)	380	05/06→12/13						
CL 500 (216.373)	320	02/11→12/13		→ A 024306			03.7858-1932.4 300263	ATE Ø 9 / 8" pneumatisch
CL 500 4-matic (216.394)	320	02/11→12/13						
CL 63 AMG (216.374)	400	02/11→12/13						
CL 63 AMG (216.374)	420	01/10→12/13						
CL 65 AMG (216.379)	463	02/11→12/13						
CL 500 4-matic (216.386)	285	02/08→12/13		03/08→; → A 024306			03.7858-1932.4 300263	ATE Ø 9 / 8" pneumatisch
CL 63 AMG (216.377)	386	10/06→12/13		01/07→; → A 024306			03.7858-1932.4 300263	ATE Ø 9 / 8" pneumatisch
CL 65 AMG (216.379)	450	10/06→12/10						
Pedalwegsensoren, Bremspedal								
CL 500 (216.371)	285	06/06→12/13		07/06→; → A 024306			03.0655-0007.2 370007	ATE
CL 600 (216.376)	380	05/06→12/13		A 024307→			03.0655-0007.2 370007	ATE
CL 500 (216.373)	320	02/11→12/13		A 024307→			03.0655-0007.2 370007	ATE
CL 500 4-matic (216.394)	320	02/11→12/13		→ A 024306			03.0655-0007.2 370007	ATE
CL 63 AMG (216.374)	400	02/11→12/13						
CL 63 AMG (216.374)	420	01/10→12/13						
CL 65 AMG (216.379)	463	02/11→12/13						
CL 500 4-matic (216.386)	285	02/08→12/13		A 024307→			03.0655-0007.2 370007	ATE
				03/08→; → A 024306			03.0655-0007.2 370007	ATE
CL 63 AMG (216.377)	386	10/06→12/13		01/07→; → A 024306			03.0655-0007.2 370007	ATE
CL 65 AMG (216.379)	450	10/06→12/10		A 024307→			03.0655-0007.2 370007	ATE
 Hauptbremszylinder								
CL 500 (216.371)	285	06/06→12/13		07/06→; → A 024016			03.4055-0013.3 010793	ATE Ø 25,4
CL 600 (216.376)	380	05/06→12/13		A 024017→			03.4156-0073.3 010942	ATE Ø 26,99
CL 500 (216.373)	320	02/11→12/13					03.4156-0073.3 010942	ATE Ø 26,99
CL 500 4-matic (216.394)	320	02/11→12/13						
CL 63 AMG (216.374)	400	02/11→12/13						
CL 63 AMG (216.374)	420	01/10→12/13						
CL 500 4-matic (216.386)	285	02/08→12/13		03/08→; → A 024016			03.4055-0013.3 010793	ATE Ø 25,4
				A 024017→			03.4156-0073.3 010942	ATE Ø 26,99
↓								



	kW					! #		
MERCEDES-BENZ - S-KLASSE Coupe (C216) 05/06→12/13								
 Hauptbremszylinder								
CL 63 AMG (216.377)	386	10/06→12/13		01/07→; → A 024016		03.4055-0013.3	010793	ATE Ø 25,4
CL 65 AMG (216.379)	450	10/06→12/10		A 024017→		03.4156-0073.3	010942	ATE Ø 26,99
CL 65 AMG (216.379)	463	02/11→12/13		→ A 024016		03.4055-0013.3	010793	ATE Ø 25,4
				A 024017→		03.4156-0073.3	010942	ATE Ø 26,99
MERCEDES-BENZ - SL (R129) 03/89→12/01								
 Hauptbremszylinder								
280 (129.058)	142	08/93→10/01		→ F102744; für Linkslenker		03.2025-0211.3	010034	Ø1 25,4 Ø2 19,05
320 (129.063)	170	09/93→10/01		F102745→ F148143; für Linkslenker		24.2025-1702.3	010515	Ø1 25,4 Ø2 19,05
500 (129.067)	235	09/92→10/01		08/93→; → F102744; - ESP; für Linkslenker		03.2025-0211.3	010034	Ø1 25,4 Ø2 19,05
				F102745→ F148143; - ESP; für Linkslenker		24.2025-1702.3	010515	Ø1 25,4 Ø2 19,05
60 AMG (129.067)	280	05/97→10/01		→ F102744; - ESP; für Linkslenker		03.2025-0211.3	010034	Ø1 25,4 Ø2 19,05
				F102745→ F148143; - ESP; für Linkslenker		24.2025-1702.3	010515	Ø1 25,4 Ø2 19,05
MERCEDES-BENZ - SL (R230) 10/01→01/12								
 Bremskraftverstärker								
65 AMG Black Series (230.479)	493	07/08→01/12		→ 11/11; für Linkslenker		03.7848-2002.4	300166	ATE Ø 7 / 8" pneumatisch
Pedalwegsensor, Bremspedal								
65 AMG Black Series (230.479)	493	07/08→01/12		→ 11/11; für Linkslenker		03.0655-0007.2	370007	ATE
MERCEDES-BENZ - SL (R231) 01/12→								
 Hauptbremszylinder								
350 (231.457)	225	02/12→		03/12→		03.2126-3196.3	010968	ATE Ø 26,99
500 (231.473)	320	01/12→						
63 AMG (231.474)	395	01/12→						
63 AMG (231.474)	415	01/12→						
400 (231.465)	245	04/14→				03.2126-3196.3	010968	ATE Ø 26,99
400 (231.466)	270	01/16→						
500 (231.473)	335	04/15→						
63 AMG (231.474)	430	04/14→						
65 AMG (231.479)	463	05/12→						
MERCEDES-BENZ - SLC (R172) 01/16→								
 Bremskraftverstärker								
180 (172.431)	115	01/16→		für Linkslenker;		03.7745-1632.4	300293	ATE Ø 8 / 7" pneumatisch
200 (172.434)	135	01/16→		für Fahrzeuge ohne Start-Stopp-Funktion				
250 d (172.404)	150	01/16→						
300 (172.438)	180	01/16→		für Linkslenker;		03.7745-1832.4	300294	ATE Ø 8 / 7" pneumatisch
AMG SLC 43 (172.466)	270	01/16→		für Fahrzeuge mit Start-Stopp-Funktion				
MERCEDES-BENZ - SLK (R170) 04/96→04/04								
Pedalwegsensor, Bremspedal								
200 Kompressor (170.444)	120	03/00→04/04		→ 03/04; für Linkslenker		03.0655-0007.2	370007	ATE
230 Kompressor (170.449)	145	03/00→04/04		→ 03/04; für Rechtslenker		03.0655-0007.2	370007	ATE
32 AMG Kompressor (170.466)	260	03/01→04/04						
320 (170.465)	160	03/00→04/04		04/00→ 03/04; für Linkslenker		03.0655-0007.2	370007	ATE
				04/00→ 03/04; für Rechtslenker		03.0655-0007.2	370007	ATE
 Hauptbremszylinder								
200 (170.435)	100	09/96→03/00		→ F025730		24.2023-1701.3	010514	TRW Ø1 23,81 Ø2 19,05
200 Kompressor (170.445)	141	10/96→03/00		F025731→		24.2023-1702.3	010534	TRW Ø1 23,81 Ø2 19,05
230 Kompressor (170.447)	142	09/96→03/00						
200 Kompressor (170.444)	120	03/00→04/04		→ 03/04; für Rechtslenker		03.2025-1741.3	010705	ATE Ø1 25,4 Ø2 20,64
230 Kompressor (170.449)	145	03/00→04/04						
32 AMG Kompressor (170.466)	260	03/01→04/04						
320 (170.465)	160	03/00→04/04		04/00→ 03/04; für Rechtslenker		03.2025-1741.3	010705	ATE Ø1 25,4 Ø2 20,64

	kw			 	! #		
MERCEDES-BENZ - SLK (R171) 03/04→02/11							
 Bremskraftverstärker							
200 Kompressor (171.442)	120	03/04→02/11		→ F 196638; für Linkslenker		03.7848-9402.4 300227	ATE Ø 7 / 8" pneumatisch
200 Kompressor (171.445)	135	01/08→02/11					
300 (171.454)	170	04/09→02/11					
350 (171.456)	200	06/04→02/11					
350 (171.458)	224	01/08→02/11					
55 AMG (171.473)	265	06/04→02/11					
55 AMG (171.473)	294	06/06→02/11					
280 (171.454)	170	01/05→02/11		04/05→; → F 196638; für Linkslenker		03.7848-9402.4 300227	ATE Ø 7 / 8" pneumatisch
Pedalwegsensor, Bremspedal							
200 Kompressor (171.442)	120	03/04→02/11		→ F 196638; für Linkslenker		03.0655-0007.2 370007	ATE
200 Kompressor (171.445)	135	01/08→02/11		F 196639→; → 01/11; für Rechtslenker		03.0655-0007.2 370007	ATE
				F 196639→; → 01/11; für Linkslenker		03.0655-0007.2 370007	ATE
300 (171.454)	170	04/09→02/11		→ F 196638; für Rechtslenker		03.0655-0007.2 370007	ATE
350 (171.456)	200	06/04→02/11					
350 (171.458)	224	01/08→02/11					
55 AMG (171.473)	265	06/04→02/11					
55 AMG (171.473)	294	06/06→02/11					
280 (171.454)	170	01/05→02/11		04/05→; → F 196638; für Rechtslenker		03.0655-0007.2 370007	ATE
				F 196639→; → 01/11; für Rechtslenker		03.0655-0007.2 370007	ATE
				F 196639→; → 01/11; für Linkslenker		03.0655-0007.2 370007	ATE
				04/05→; → F 196638; für Linkslenker		03.0655-0007.2 370007	ATE
 Hauptbremszylinder							
200 Kompressor (171.442)	120	03/04→02/11		→ 01/11; für Linkslenker		03.2025-1741.3 010705	ATE Ø1 25,4 Ø2 20,64
200 Kompressor (171.445)	135	01/08→02/11					
300 (171.454)	170	04/09→02/11					
350 (171.456)	200	06/04→02/11					
350 (171.458)	224	01/08→02/11					
55 AMG (171.473)	265	06/04→02/11					
55 AMG (171.473)	294	06/06→02/11					
280 (171.454)	170	01/05→02/11		04/05→ 01/11; für Linkslenker		03.2025-1741.3 010705	ATE Ø1 25,4 Ø2 20,64
MERCEDES-BENZ - SLK (R172) 02/11→							
 Bremskraftverstärker							
200 (172.434)	135	04/15→		für Linkslenker;		03.7745-1632.4 300293	ATE Ø 8 / 7" pneumatisch
200 (172.448)	135	02/11→		für Fahrzeuge ohne Start-Stopp-Funktion			
250 (172.447)	150	02/11→		für Linkslenker;		03.7745-1832.4 300294	ATE Ø 8 / 7" pneumatisch
250 CDI / d (172.403)	150	01/12→		für Fahrzeuge mit Start-Stopp-Funktion			
300 (172.438)	180	07/15→					
350 (172.457)	225	02/11→					
55 AMG (172.475)	310	01/12→					
MERCEDES-BENZ - SPRINTER 2-t Bus (901, 902) 01/95→05/06							
 Hauptbremszylinder							
208 CDI	60	04/00→05/06		→ A906425		24.2123-1711.3 010518	Ø 23,81
208 D	58	02/95→04/00		A906426→		24.2123-1754.3 010741	Ø 23,81
210 D	75	03/97→04/00					
211 CDI	80	04/00→05/06					
212 D	90	02/95→04/00					
213 CDI	95	04/00→05/06					
214 (902.071, 902.072, 902.671, 902.672)	105	02/95→05/06					
214 NGT	92	04/00→05/06					
216 CDI	115	04/00→05/06					
MERCEDES-BENZ - SPRINTER 2-t Kasten (901, 902) 01/95→05/06							
 Hauptbremszylinder							
208 CDI	60	04/00→05/06		→ A906425		24.2123-1711.3 010518	Ø 23,81
208 D	58	02/95→04/00		A906426→		24.2123-1754.3 010741	Ø 23,81
208 D	60	10/96→04/00					
210 D	75	01/97→04/00					
211 CDI	80	04/00→05/06					
212 D	90	02/95→04/00					
213 CDI	95	04/00→05/06					
214	105	02/95→05/06					
214 NGT	92	04/00→05/06					
216 CDI	115	04/00→05/06					

	kW			 	! #		
MERCEDES-BENZ - SPRINTER 2-t Pritsche/Fahrgestell (901, 902) 01/95→05/06							
 Hauptbremszylinder							
208 CDI	60	04/00→05/06		→ A906425		24.2123-1711.3 010518	Ø 23,81
208 D	60	09/96→04/00		A906426→		24.2123-1754.3 010741	Ø 23,81
210 D	75	01/97→04/00					
211 CDI	80	04/00→05/06					
212 D	90	02/95→04/00					
213 CDI	95	04/00→05/06					
214 (902.011, 902.012, 902.611, 902.612)	105	02/95→05/06					
214 NGT	92	04/00→05/06					
216 CDI	115	04/00→05/06					
208 D	58	01/95→04/00		02/95→; → A906425		24.2123-1711.3 010518	Ø 23,81
				A906426→		24.2123-1754.3 010741	Ø 23,81
MERCEDES-BENZ - SPRINTER 3,5-t Bus (906) 06/06→							
 Hauptbremszylinder							
310 CDI (906.731, 906.733, 906.735)	70	03/09→12/13		10/09→		24.2126-1704.3 010990	TRW Ø 26,99
311 CDI (906.731, 906.733, 906.735)	80	06/06→12/09					
311 CDI 4x4 (906.731, 906.733, 906.735)	80	02/08→12/09					
315 CDI (906.731, 906.733, 906.735)	110	06/06→12/09					
315 CDI 4x4 (906.731, 906.733, 906.735)	110	02/08→12/09					
316 (906.733, 906.735)	115	09/08→					
316 LGT	115	09/08→					
316 NGT (906.733, 906.735)	115	09/08→					
318 CDI (906.731, 906.733, 906.735)	135	02/08→12/09					
318 CDI 4x4 (906.731, 906.733, 906.735)	135	02/08→12/09					
319 CDI / BlueTEC (906.731, 906.733, 906.735)	140	03/09→					
319 CDI / BlueTEC 4x4 (906.731, 906.733, 906.735)	140	03/09→					
324 (906.733, 906.735)	190	06/06→12/13					
311 CDI (906.731, 906.733, 906.735)	84	05/16→				24.2126-1704.3 010990	TRW Ø 26,99
313 CDI (906.731, 906.733, 906.735)	95	08/11→05/16					
313 CDI 4x4 (906.731, 906.733, 906.735)	95	08/11→05/16					
314 CDI (906.731, 906.733, 906.735)	105	05/16→					
314 CDI 4x4 (906.731, 906.733, 906.735)	105	05/16→					
316 CDI (906.731, 906.733, 906.735)	120	08/11→					
316 CDI 4x4 (906.731, 906.733, 906.735)	120	08/11→					
MERCEDES-BENZ - SPRINTER 3,5-t Kasten (906) 06/06→							
 Hauptbremszylinder							
309 CDI (906.631, 906.633, 906.635, 906.637)	65	06/06→12/09		10/09→		24.2126-1704.3 010990	TRW Ø 26,99
310 CDI (906.631, 906.633, 906.635, 906.637)	70	03/09→					
311 CDI (906.631, 906.633, 906.635, 906.637)	80	06/06→12/09					
311 CDI 4x4 (906.631, 906.633, 906.635, 906.637)	80	02/08→12/09					
313 CDI (906.631, 906.633, 906.635, 906.637)	95	06/06→					
313 CDI (906.631, 906.633, 906.635, 906.637)	95	05/09→					
313 CDI 4x4 (906.631, 906.633, 906.635, 906.637)	95	05/09→					
↓							

MERCEDES-BENZ - SPRINTER 3,5-t Kasten (906) 06/06→











 **Hauptbremszylinder**











315 CDI (906.631, 906.633, 906.635, 906.637)	110	06/06→12/09		10/09→	24.2126-1704.3	010990	TRW Ø 26,99
315 CDI 4x4 (906.631, 906.633, 906.635, 906.637)	110	02/08→12/09					
316 (906.635, 906.633)	115	09/08→					
316 CDI (906.631, 906.633, 906.635, 906.637)	120	03/09→					
316 CDI 4x4 (906.631, 906.633, 906.635, 906.637)	120	03/09→					
316 LGT (906.633, 906.635)	115	09/08→					
316 NGT (906.633, 906.635)	115	09/08→					
318 CDI (906.631, 906.633, 906.635, 906.637)	135	06/06→12/09					
318 CDI 4x4 (906.631, 906.633, 906.635, 906.637)	135	02/08→12/09					
319 CDI / BlueTEC (906.631, 906.633, 906.635, 906.637)	140	03/09→					
319 CDI / BlueTEC 4x4 (906.631, 906.633, 906.635, 906.637)	140	03/09→					
324 (906.633, 906.635, 906.637)	190	06/06→12/13					
311 CDI (906.631, 906.633, 906.635, 906.637)	84	05/16→			24.2126-1704.3	010990	TRW Ø 26,99
314 CDI (906.631, 906.633, 906.635, 906.637)	105	05/16→					
314 CDI 4x4 (906.631, 906.633, 906.635, 906.637)	105	05/16→					













MERCEDES-BENZ - SPRINTER 3,5-t Pritsche/Fahrgestell (906) 06/06→











 **Hauptbremszylinder**













309 CDI (906.131, 906.133, 906.135, 906.231, 906.233...)	65	06/06→12/09		10/09→	24.2126-1704.3	010990	TRW Ø 26,99
310 CDI (906.131, 906.133, 906.135, 906.231, 906.233...)	70	03/09→05/16					
311 CDI (906.131, 906.133, 906.135, 906.231, 906.233...)	80	06/06→12/09					
311 CDI 4x4 (906.131, 906.133, 906.135, 906.231...)	80	02/08→12/09					
313 CDI (906.131, 906.133, 906.135, 906.231, 906.233...)	95	06/06→05/16					
313 CDI 4x4 (906.131, 906.133, 906.135, 906.231...)	95	06/06→05/16					
315 CDI (906.131, 906.133, 906.135, 906.231, 906.233...)	110	06/06→12/09					
315 CDI 4x4 (906.131, 906.133, 906.135, 906.231...)	110	02/08→12/09					
316 (906.133, 906.135, 906.233, 906.235)	115	09/08→					
316 CDI (906.131, 906.133, 906.135, 906.231, 906.233...)	120	03/09→					
316 CDI 4x4 (906.131, 906.133, 906.135, 906.231...)	120	03/09→					
316 LGT (906.133, 906.135, 906.233, 906.235)	115	09/08→					
316 NGT (906.133, 906.135, 906.233, 906.235)	115	09/08→					
↓							















	kW			 	! #		
MERCEDES-BENZ - SPRINTER 3,5-t Pritsche/Fahrgestell (906) 06/06→							
 Hauptbremszylinder							
318 CDI (906.131, 906.133, 906.135, 906.231, 906.233...)	135	06/06→12/09		10/09→		24.2126-1704.3 010990	TRW Ø 26,99
318 CDI 4x4 (906.131, 906.133, 906.135, 906.231...)	135	02/08→12/09					
319 CDI / BlueTEC (906.131, 906.133, 906.135, 906.231...)	140	03/09→					
324 (906.133, 906.135, 906.233, 906.235)	190	06/06→12/13					
311 CDI (906.131, 906.133, 906.135, 906.231, 906.233...)	84	05/16→				24.2126-1704.3 010990	TRW Ø 26,99
314 CDI (906.131, 906.133, 906.135, 906.231, 906.233...)	105	05/16→					
314 CDI 4x4 (906.131, 906.133, 906.135, 906.231...)	105	05/16→					
319 CDI / BlueTEC 4x4 (906.131, 906.133, 906.135...)	140	05/11→					
MERCEDES-BENZ - SPRINTER 3-t Bus (903) 01/95→05/06							
 Hauptbremszylinder							
308 CDI	60	04/00→05/06		→ A905511 / R400726		24.2123-1711.3 010518	Ø 23,81
308 D	58	02/95→04/00					
308 D (903.371, 903.372, 903.373)	60	03/97→04/00		A905512 / R400727→		24.2123-1754.3 010741	Ø 23,81
310 D (903.371, 903.372, 903.373)	75	01/97→12/99					
310 D 4x4	75	05/97→08/02					
311 CDI	80	04/00→05/06					
311 CDI 4x4	80	08/02→05/06					
312 D 2.9	90	02/95→04/00					
312 D 2.9 4x4	90	05/97→08/02					
313 CDI	95	04/00→05/06					
313 CDI 4x4	95	08/02→05/06					
314 (903.071, 903.072, 903.073, 903.671, 903.672, 903.673)	105	02/95→05/06					
314 4x4	105	08/02→05/06					
314 NGT	92	04/00→05/06					
316 CDI	115	04/00→05/06					
316 CDI 4x4	115	08/02→05/06					
MERCEDES-BENZ - SPRINTER 3-t Bus (906) 06/06→							
 Hauptbremszylinder							
210 CDI (906.711, 906.713)	70	03/09→12/13		10/09→		24.2126-1704.3 010990	TRW Ø 26,99
211 CDI (906.711, 906.713)	80	06/06→12/09					
213 CDI (906.711, 906.713)	95	06/06→05/16					
215 CDI (906.711, 906.713)	110	06/06→12/09					
216 (906.713)	115	09/08→					
216 CDI (906.711, 906.713)	120	06/06→					
224 (906.713)	190	06/06→12/13					
211 CDI (906.711, 906.713)	84	04/16→				24.2126-1704.3 010990	TRW Ø 26,99
214 CDI (906.711, 906.713)	105	04/16→					
MERCEDES-BENZ - SPRINTER 3-t Kasten (903) 01/95→05/06							
 Hauptbremszylinder							
308 CDI	60	04/00→05/06		→ A905511 / R400726		24.2123-1711.3 010518	Ø 23,81
308 D 2.3	58	02/95→04/00					
308 D 2.3	60	02/95→04/00		A905512 / R400727→		24.2123-1754.3 010741	Ø 23,81
310 D 2.9	75	02/95→04/00					
311 CDI	80	04/00→05/06					
311 CDI 4x4	80	08/02→05/06					
312 D 2.9	90	02/95→04/00					
312 D 2.9 4x4	90	05/97→08/02					
313 CDI	95	04/00→05/06					
313 CDI 4x4	95	08/02→05/06					
314	105	02/95→05/06					
314 4x4	105	08/02→05/06					
↓							















	kw			 	! #		
MERCEDES-BENZ - SPRINTER 3-t Kasten (903) 01/95→05/06							
 Hauptbremszylinder							
314 NGT (903.661)	92	04/00→05/06		→ A905511 / R400726		24.2123-1711.3 010518	Ø 23,81
316 CDI	115	04/00→05/06		A905512 / R400727→		24.2123-1754.3 010741	Ø 23,81
316 CDI 4x4	115	08/02→05/06					
MERCEDES-BENZ - SPRINTER 3-t Kasten (906) 06/06→							
 Hauptbremszylinder							
209 CDI (906.611, 906.613)	65	06/06→12/09		10/09→		24.2126-1704.3 010990	TRW Ø 26,99
210 CDI (906.611, 906.613)	70	03/09→					
211 CDI (906.611, 906.613)	80	06/06→12/09					
213 CDI (906.611, 906.613)	95	06/06→					
213 CDI (906.611, 906.613)	95	06/06→12/09					
215 CDI (906.611, 906.613)	110	06/06→12/09					
216 (906.613)	115	09/08→					
216 CDI (906.611, 906.613)	120	03/09→					
218 CDI (906.611, 906.613)	135	06/06→12/09					
219 CDI / BlueTEC (906.611, 906.613)	140	03/09→					
224 (906.613)	190	06/06→					
211 CDI (906.611, 906.613)	84	04/16→				24.2126-1704.3 010990	TRW Ø 26,99
214 CDI (906.611, 906.613)	105	04/16→					
MERCEDES-BENZ - SPRINTER 3-t Pritsche/Fahrgestell (903) 01/95→05/06							
 Hauptbremszylinder							
308 CDI	60	04/00→05/06		→ A905511 / R400726		24.2123-1711.3 010518	Ø 23,81
308 D 2.3	58	02/95→04/00		A905512 / R400727→		24.2123-1754.3 010741	Ø 23,81
308 D 2.3	60	11/96→04/00					
310 D 2.9	75	01/97→04/00					
311 CDI	80	04/00→05/06					
311 CDI 4x4	80	08/02→05/06					
312 D 2.9	90	02/95→04/00					
312 D 2.9 (903.411, 903.412, 903.413, 903.421, 903.422...)	85	12/98→09/01					
313 CDI	95	04/00→05/06					
313 CDI 4x4	95	08/02→05/06					
314 (903.011, 903.012, 903.013, 903.022, 903.611...)	105	02/95→05/06					
314 4x4	105	08/02→05/06					
314 NGT (903.611, 903.612)	92	04/00→05/06					
316 CDI	115	04/00→05/06					
316 CDI 4x4	115	08/02→05/06					
MERCEDES-BENZ - SPRINTER 3-t Pritsche/Fahrgestell (906) 06/06→							
 Hauptbremszylinder							
209 CDI (906.111, 906.113, 906.211, 906.213)	65	06/06→12/09		10/09→		24.2126-1704.3 010990	TRW Ø 26,99
210 CDI (906.111, 906.113, 906.211, 906.213)	70	03/09→05/16					
211 CDI (906.111, 906.113, 906.211, 906.213)	80	06/06→12/09					
213 CDI (906.111, 906.113, 906.211, 906.213)	95	06/06→12/09					
213 CDI (906.111, 906.113, 906.211, 906.213)	95	03/09→05/16					
215 CDI (906.111, 906.113, 906.211, 906.213)	110	06/06→12/09					
216 (906.113, 906.213)	115	09/08→05/16					
216 CDI (906.111, 906.113, 906.211, 906.213)	120	03/09→					
↓							















	kW					! #		
MERCEDES-BENZ - SPRINTER 3-t Pritsche/Fahrgestell (906) 06/06 →								
 Hauptbremszylinder								
218 CDI (906.111, 906.113, 906.211, 906.213)	135	06/06 → 12/09		10/09 →			24.2126-1704.3 010990	TRW Ø 26,99
219 CDI / BlueTEC (906.111, 906.113, 906.211, 906.213)	140	03/09 → 05/16						
224 (906.113, 906.213)	190	06/06 → 12/13						
211 CDI (906.111, 906.113, 906.211, 906.213)	84	04/16 →					24.2126-1704.3 010990	TRW Ø 26,99
214 CDI (906.111, 906.113, 906.211, 906.213)	105	04/16 →						
MERCEDES-BENZ - SPRINTER 4,6-t Kasten (906) 06/06 →								
 Hauptbremszylinder								
411 CDI (906.653, 906.655, 906.657)	80	06/09 → 12/09		10/09 →			24.2126-1704.3 010990	TRW Ø 26,99
413 CDI (906.653, 906.655, 906.657)	95	06/06 → 05/16						
415 CDI (906.653, 906.655, 906.657)	110	06/09 → 12/09						
416 CDI (906.653, 906.655, 906.657)	120	03/09 →						
418 CDI (906.653, 906.655, 906.657)	135	06/09 → 05/16						
419 CDI (906.653, 906.655, 906.657)	140	03/09 →						
424 (906.655, 906.657, 906.653)	190	06/06 → 12/13						
414 CDI	105	05/16 →					24.2126-1704.3 010990	TRW Ø 26,99
MERCEDES-BENZ - SPRINTER 4,6-t Pritsche/Fahrgestell (906) 06/06 →								
 Hauptbremszylinder								
411 CDI (906.153, 906.155, 906.253, 906.255)	80	06/09 → 12/09		10/09 →			24.2126-1704.3 010990	TRW Ø 26,99
413 CDI (906.153, 906.155, 906.253, 906.255)	95	06/06 → 05/16						
415 CDI (906.153, 906.155, 906.253, 906.255)	110	06/06 → 12/09						
416 CDI (906.153, 906.155, 906.253, 906.255)	120	03/09 →						
418 CDI (906.153, 906.155, 906.253, 906.255)	135	06/06 → 12/09						
419 CDI (906.153, 906.155, 906.253, 906.255)	140	03/09 →						
424 (906.153, 906.155, 906.253, 906.255)	190	06/06 → 12/13						
414 CDI	105	05/16 →					24.2126-1704.3 010990	TRW Ø 26,99
MERCEDES-BENZ - SPRINTER 4-t Bus (904) 02/96 → 05/06								
 Hauptbremszylinder								
408 CDI	60	04/00 → 05/06		→ A906425 / R400726			24.2125-1727.3 010723	Ø 25,4
411 CDI	80	04/00 → 05/06		A906426 / R400727 →			24.2125-1728.3 010751	Ø 25,4
413 CDI	95	04/00 → 05/06						
414	105	02/96 → 05/06						
416 CDI	115	04/00 → 05/06						
MERCEDES-BENZ - SPRINTER 4-t Kasten (904) 02/96 → 05/06								
 Hauptbremszylinder								
408 CDI	60	04/00 → 05/06		→ A906425 / R400726			24.2125-1727.3 010723	Ø 25,4
408 D	58	02/96 → 05/06		A906426 / R400727 →			24.2125-1728.3 010751	Ø 25,4
410 D 4x4	75	05/97 → 05/06						
411 CDI	80	04/00 → 05/06						
411 CDI 4x4	80	04/00 → 05/06						
412 D	85	02/96 → 05/06						
412 D	90	02/96 → 05/06						
412 D 4x4	85	05/97 → 05/06						
412 D 4x4	90	05/97 → 05/06						
413 CDI	95	04/00 → 05/06						
413 CDI 4x4	95	04/00 → 05/06						
↓								

	kW			 	! #		
MERCEDES-BENZ - SPRINTER 4-t Kasten (904) 02/96→05/06							
 Hauptbremszylinder							
414 (904.062, 904.063, 904.662, 904.663)	105	02/96→05/06		→ A906425 / R400726		24.2125-1727.3 010723	Ø 25,4
414 4x4 (904.062, 904.063, 904.662, 904.663)	105	05/97→05/06		A906426 / R400727→		24.2125-1728.3 010751	Ø 25,4
416 CDI	115	04/00→05/06					
416 CDI 4x4	115	04/00→05/06					
410 D	75	02/96→05/06		09/96→; → A906425 / R400726		24.2125-1727.3 010723	Ø 25,4
				A906426 / R400727→		24.2125-1728.3 010751	Ø 25,4
MERCEDES-BENZ - SPRINTER 4-t Pritsche/Fahrgestell (904) 02/96→05/06							
 Hauptbremszylinder							
408 CDI	60	04/00→05/06		→ A906425 / R400726		24.2125-1727.3 010723	Ø 25,4
408 D	58	02/96→05/06					
410 D 4x4	75	05/97→05/06		A906426 / R400727→		24.2125-1728.3 010751	Ø 25,4
411 CDI	80	04/00→05/06					
411 CDI 4x4	80	04/00→05/06					
412 D	85	02/96→05/06					
412 D	90	02/96→05/06					
412 D 4x4	85	05/97→05/06					
412 D 4x4	90	05/97→05/06					
413 CDI	95	04/00→05/06					
413 CDI 4x4	95	04/00→05/06					
414 (904.012, 904.013, 904.612, 904.613)	105	02/96→05/06					
414 4x4 (904.012, 904.013, 904.612, 904.613)	105	05/97→05/06					
416 CDI	115	04/00→05/06					
416 CDI 4x4	115	04/00→05/06					
410 D	75	02/96→05/06		09/96→; → A906425 / R400726		24.2125-1727.3 010723	Ø 25,4
				A906426 / R400727→		24.2125-1728.3 010751	Ø 25,4
MERCEDES-BENZ - SPRINTER 5-t Bus 06/06→							
 Hauptbremszylinder							
513 CDI (906.653, 906.655, 906.657)	95	06/06→		10/09→		24.2126-1704.3 010990	TRW Ø 26,99
516 CDI	120	03/09→					
519 CDI / BlueTEC	140	03/09→					
MERCEDES-BENZ - SPRINTER 5-t Kasten (906) 06/06→							
 Hauptbremszylinder							
509 CDI (906.653, 906.655, 906.657)	65	06/06→12/09		10/09→		24.2126-1704.3 010990	TRW Ø 26,99
510 CDI (906.653, 906.655, 906.657)	70	03/09→05/16					
511 CDI (906.653, 906.655, 906.657)	80	06/06→12/09					
511 CDI 4x4 (906.653, 906.655, 906.657)	80	06/06→12/09					
513 CDI (906.653, 906.655, 906.657)	95	06/06→					
513 CDI 4x4 (906.653, 906.655, 906.657)	95	06/06→					
515 CDI (906.653, 906.655, 906.657)	110	06/06→12/09					
515 CDI 4x4 (906.653, 906.655, 906.657)	110	06/06→12/09					
516 CDI (906.653, 906.655, 906.657)	120	03/09→					
516 CDI 4x4 (906.653, 906.655, 906.657)	120	06/06→					
518 CDI (906.653, 906.655, 906.657)	135	06/06→12/09					
518 CDI 4x4 (906.653, 906.655, 906.657)	135	06/06→12/09					
519 CDI / BlueTEC (906.653, 906.655, 906.657)	140	03/09→					
519 CDI / BlueTEC 4x4 (906.653, 906.655, 906.657)	140	03/09→					
524 (906.653, 906.655, 906.657)	190	06/06→12/13					
511 CDI (906.653, 906.655, 906.657)	84	05/16→				24.2126-1704.3 010990	TRW Ø 26,99
514 CDI (906.653, 906.655, 906.657)	105	05/16→					
↓							















	kW			 	! #		
MERCEDES-BENZ - SPRINTER 5-t Kasten (906) 06/06→							
 Hauptbremszylinder							
514 CDI 4x4 (906.653, 906.655, 906.657)	105	05/16→				24.2126-1704.3 010990	TRW Ø 26,99
MERCEDES-BENZ - SPRINTER 5-t Pritsche/Fahrgestell (906) 06/06→							
 Hauptbremszylinder							
509 CDI (906.153, 906.155, 906.253, 906.255)	65	06/06→12/09		10/09→		24.2126-1704.3 010990	TRW Ø 26,99
510 CDI (906.153, 906.155, 906.253, 906.255)	70	03/09→					
511 CDI (906.153, 906.155, 906.253, 906.255)	80	06/06→12/09					
511 CDI 4x4 (906.155, 906.253, 906.255)	80	06/06→12/09					
513 CDI (906.155, 906.253, 906.255)	95	06/06→05/16					
515 CDI (906.153, 906.155, 906.253, 906.255)	110	06/06→12/09					
515 CDI 4x4 (906.153, 906.155, 906.253, 906.255)	110	06/06→12/09					
516 (906.153, 906.155, 906.253, 906.255)	115	09/08→					
516 CDI (906.153, 906.155, 906.253, 906.255)	120	03/09→					
516 NGT (906.153, 906.155, 906.253, 906.255)	115	09/08→					
518 CDI (906.153, 906.155, 906.253, 906.255)	135	06/06→12/09					
518 CDI 4x4 (906.153, 906.155, 906.253, 906.255)	135	06/06→12/09					
519 CDI / BlueTEC (906.153, 906.155, 906.253, 906.255)	140	03/09→					
519 CDI / BlueTEC 4x4 (906.153, 906.155, 906.253, 906.255)	140	03/09→					
524 (906.153, 906.155, 906.253, 906.255)	190	06/06→12/13					
511 CDI (906.153, 906.155, 906.253, 906.255)	84	05/16→				24.2126-1704.3 010990	TRW Ø 26,99
513 CDI 4x4 (906.155, 906.253, 906.255)	95	05/11→05/16					
514 CDI (906.153, 906.155, 906.253, 906.255)	105	05/16→					
514 CDI 4x4 (906.153, 906.155, 906.253, 906.255)	105	05/16→					
516 CDI 4x4 (906.153, 906.155, 906.253, 906.255)	120	05/11→					
MERCEDES-BENZ - SPRINTER CLASSIC 3,5-t Kasten (909) 09/13→							
 Hauptbremszylinder							
311 CDI (909.632, 909.633)	80	09/13→				24.2126-1704.3 010990	TRW Ø 26,99
MERCEDES-BENZ - SPRINTER CLASSIC 4,6-t Bus (909) 09/13→							
 Hauptbremszylinder							
411 CDI (909.843)	80	09/13→				24.2126-1704.3 010990	TRW Ø 26,99
MERCEDES-BENZ - T1/TN Kasten/Kombi 07/81→06/95							
 Bremskraftverstärker							
408 D (611.367, 611.368)	58	11/88→06/95		598435→		03.6855-1402.4 300057	ATE Ø 9" pneumatisch
408 D (611.367, 611.368)	60	11/88→06/95					
410 (611.067, 611.068)	70	08/82→06/95					
410 (611.067, 611.068)	77	08/82→06/95					
↓							











	kW			 	! #		
MERCEDES-BENZ - T1/TN Kasten/Kombi 07/81→06/95							
 Bremskraftverstärker							
410 D (611.467, 611.468)	70	11/88→06/95		598435→		03.6855-1402.4 300057	ATE Ø 9" pneumatisch
410 D (611.467, 611.468)	72	11/88→06/95					
 Hauptbremszylinder							
408 D (611.367, 611.368)	58	11/88→06/95		598435→; - ABS		03.2126-0512.3 010217	Ø 26,99
408 D (611.367, 611.368)	60	11/88→06/95					
410 (611.067, 611.068)	70	08/82→06/95					
410 (611.067, 611.068)	77	08/82→06/95					
410 D (611.467, 611.468)	70	11/88→06/95					
410 D (611.467, 611.468)	72	11/88→06/95					
 Bremskraftregler							
408 D (611.367, 611.368)	58	11/88→06/95				03.6513-0340.3 320084	ATE lastabhängig 1/3 2x
408 D (611.367, 611.368)	60	11/88→06/95					
410 (611.067, 611.068)	70	08/82→06/95					
410 (611.067, 611.068)	77	08/82→06/95					
410 D (611.467, 611.468)	70	11/88→06/95					
410 D (611.467, 611.468)	72	11/88→06/95					
MERCEDES-BENZ - T1/TN Pritsche/Fahrgestell 07/81→06/95							
 Bremskraftverstärker							
408 D (611.317, 611.318)	58	11/88→06/95		598435→		03.6855-1402.4 300057	ATE Ø 9" pneumatisch
408 D (611.317, 611.318)	60	11/88→06/95					
410 (611.017, 611.018)	70	08/82→06/95					
410 (611.017, 611.018)	77	08/82→06/95					
410 D (611.417, 611.418)	70	11/88→06/95					
410 D (611.417, 611.418)	72	11/88→06/95					
 Hauptbremszylinder							
408 D (611.317, 611.318)	58	11/88→06/95		598435→; - ABS		03.2126-0512.3 010217	Ø 26,99
408 D (611.317, 611.318)	60	11/88→06/95					
410 (611.017, 611.018)	70	08/82→06/95					
410 (611.017, 611.018)	77	08/82→06/95					
410 D (611.417, 611.418)	70	11/88→06/95					
410 D (611.417, 611.418)	72	11/88→06/95					
 Bremskraftregler							
408 D (611.317, 611.318)	58	11/88→06/95				03.6513-0340.3 320084	ATE lastabhängig 1/3 2x
408 D (611.317, 611.318)	60	11/88→06/95					
410 (611.017, 611.018)	70	08/82→06/95					
410 (611.017, 611.018)	77	08/82→06/95					
410 D (611.417, 611.418)	70	11/88→06/95					
410 D (611.417, 611.418)	72	11/88→06/95					
MERCEDES-BENZ - T1 Bus (601) 05/77→02/96							
 Bremskraftverstärker							
208 D 2.3	60	10/88→02/96		→ 649390		03.6850-2602.4 300049	ATE Ø 9" pneumatisch
208 D 2.3 (601.371, 601.372, 601.376, 601.377)	58	10/88→02/96		→ 614796		03.6850-2602.4 300049	ATE Ø 9" pneumatisch
210 2.3	77	05/89→02/96		614797→		03.6855-1402.4 300057	ATE Ø 9" pneumatisch
210 D 2.8	70	11/88→02/96		649391→		03.6855-1402.4 300057	ATE Ø 9" pneumatisch
210 D 2.8	72	11/88→02/96					
 Hauptbremszylinder							
208 D 2.3	60	10/88→02/96		→ 649390 / P000000		03.2123-6002.3 010184	Ø 23,81
↓							











	kw			 	! #		
MERCEDES-BENZ - T1 Bus (601) 05/77→02/96							
 Hauptbremszylinder							
208 D 2.3 (601.371, 601.372, 601.376, 601.377)	58	10/88→02/96		→ 614796 / P000000		03.2123-6002.3 010184	Ø 23,81
				649391 / P000001→; - ABS		03.2125-1902.3 010206	Ø 25,4
210 2.3	77	05/89→02/96		614797 / P000001→; - ABS		03.2125-1902.3 010206	Ø 25,4
210 D 2.8	70	11/88→02/96					
210 D 2.8	72	11/88→02/96					
 Bremskraftregler							
208 D 2.3	60	10/88→02/96		→ 240106		03.6511-0030.3 320076	ATE lastabhängig 1/1 2x
208 D 2.3 (601.371, 601.372, 601.376, 601.377)	58	10/88→02/96		→ 649390		03.6511-0030.3 320076	ATE lastabhängig 1/1 2x
				500000→ 556499		03.6511-0030.3 320076	ATE lastabhängig 1/1 2x
				→ 249719		03.6511-0030.3 320076	ATE lastabhängig 1/1 2x
				→ 249588		03.6511-0030.3 320076	ATE lastabhängig 1/1 2x
				649391→		03.6515-0305.3 320087	ATE lastabhängig 1/5 2x
210 2.3	77	05/89→02/96		→ 240106		03.6511-0030.3 320076	ATE lastabhängig 1/1 2x
				→ 649390		03.6511-0030.3 320076	ATE lastabhängig 1/1 2x
				500000→ 556499		03.6511-0030.3 320076	ATE lastabhängig 1/1 2x
				→ 248950		03.6511-0030.3 320076	ATE lastabhängig 1/1 2x
				→ 249411		03.6511-0030.3 320076	ATE lastabhängig 1/1 2x
				649391→		03.6515-0305.3 320087	ATE lastabhängig 1/5 2x
210 D 2.8	70	11/88→02/96		→ 649390		03.6511-0030.3 320076	ATE lastabhängig 1/1 2x
210 D 2.8	72	11/88→02/96		649391→		03.6515-0305.3 320087	ATE lastabhängig 1/5 2x
				614797→		03.6515-0305.3 320087	ATE lastabhängig 1/5 2x
MERCEDES-BENZ - T1 Bus (602) 04/77→02/96							
 Bremskraftverstärker							
308 D 2.3	58	05/90→02/96		→ 649390		03.6850-2602.4 300049	ATE Ø 9" pneumatisch
308 D 2.3	60	06/89→02/96		→ 625656		03.6850-2602.4 300049	ATE Ø 9" pneumatisch
				625657→		03.6855-1402.4 300057	ATE Ø 9" pneumatisch
				649391→		03.6855-1402.4 300057	ATE Ø 9" pneumatisch
310 D 2.9	70	06/89→02/96		→ 649390		03.6850-2602.4 300049	ATE Ø 9" pneumatisch
310 D 2.9	72	06/90→02/96		649391→		03.6855-1402.4 300057	ATE Ø 9" pneumatisch
 Hauptbremszylinder							
308 D 2.3	58	05/90→02/96		→ 649390		03.2123-6002.3 010184	Ø 23,81
308 D 2.3	60	06/89→02/96		→ 625656		03.2123-6002.3 010184	Ø 23,81
				649391→; - ABS		03.2125-1902.3 010206	Ø 25,4
				625657→; - ABS		03.2125-1902.3 010206	Ø 25,4
310 D 2.9	70	06/89→02/96		→ 649390		03.2123-6002.3 010184	Ø 23,81
310 D 2.9	72	06/90→02/96		649391→; - ABS		03.2125-1902.3 010206	Ø 25,4
 Bremskraftregler							
308 D 2.3	58	05/90→02/96		→ 649390		03.6511-0030.3 320076	ATE lastabhängig 1/1 2x
308 D 2.3	60	06/89→02/96		→ 625656		03.6511-0030.3 320076	ATE lastabhängig 1/1 2x
				649391→		03.6513-0340.3 320084	ATE lastabhängig 1/3 2x
310 D 2.9	70	06/89→02/96		→ 649390		03.6511-0030.3 320076	ATE lastabhängig 1/1 2x
310 D 2.9	72	06/90→02/96		649391→		03.6513-0340.3 320084	ATE lastabhängig 1/3 2x
MERCEDES-BENZ - T1 Kasten (601, 611) 05/77→02/96							
 Bremskraftverstärker							
208 D 2.3	58	11/88→02/96		→ 649390		03.6850-2602.4 300049	ATE Ø 9" pneumatisch
208 D 2.3	60	10/88→02/96		→ 614796		03.6850-2602.4 300049	ATE Ø 9" pneumatisch
210 2.3	70	07/82→02/96					
210 2.3	77	05/89→02/96		614797→		03.6855-1402.4 300057	ATE Ø 9" pneumatisch
210 D 2.8	70	10/88→02/96		649391→		03.6855-1402.4 300057	ATE Ø 9" pneumatisch
210 D 2.8	72	10/88→02/96					
 Hauptbremszylinder							
208 D 2.3	58	11/88→02/96		→ 649390 / P000000		03.2123-6002.3 010184	Ø 23,81
208 D 2.3	60	10/88→02/96		→ 614796 / P000000		03.2123-6002.3 010184	Ø 23,81
210 2.3	70	07/82→02/96					
210 2.3	77	05/89→02/96		649391 / P000001→; - ABS		03.2125-1902.3 010206	Ø 25,4
210 D 2.8	70	10/88→02/96		614797 / P000001→; - ABS		03.2125-1902.3 010206	Ø 25,4
210 D 2.8	72	10/88→02/96					













	kw					! #		
MERCEDES-BENZ - T1 Kasten (601, 611) 05/77→02/96								
 Bremskraftregler								
208 D 2.3	58	11/88→02/96		→ 240106			03.6511-0030.3 320076	ATE lastabhängig 1/1 2x
208 D 2.3	60	10/88→02/96		→ 649390			03.6511-0030.3 320076	ATE lastabhängig 1/1 2x
				500000 → 556499			03.6511-0030.3 320076	ATE lastabhängig 1/1 2x
				→ 249719			03.6511-0030.3 320076	ATE lastabhängig 1/1 2x
				→ 249588			03.6511-0030.3 320076	ATE lastabhängig 1/1 2x
				649391→			03.6515-0305.3 320087	ATE lastabhängig 1/5 2x
210 2.3	70	07/82→02/96		→ 240106			03.6511-0030.3 320076	ATE lastabhängig 1/1 2x
210 2.3	77	05/89→02/96		→ 649390			03.6511-0030.3 320076	ATE lastabhängig 1/1 2x
				500000 → 556499			03.6511-0030.3 320076	ATE lastabhängig 1/1 2x
				→ 248950			03.6511-0030.3 320076	ATE lastabhängig 1/1 2x
				→ 249411			03.6511-0030.3 320076	ATE lastabhängig 1/1 2x
				649391→			03.6515-0305.3 320087	ATE lastabhängig 1/5 2x
210 D 2.8	70	10/88→02/96		→ 649390			03.6511-0030.3 320076	ATE lastabhängig 1/1 2x
210 D 2.8	72	10/88→02/96		649391→			03.6515-0305.3 320087	ATE lastabhängig 1/5 2x
				614797→			03.6515-0305.3 320087	ATE lastabhängig 1/5 2x
MERCEDES-BENZ - T1 Kasten (602) 10/82→02/96								
 Bremskraftverstärker								
308 D 2.3	58	11/88→02/96		→ 649390			03.6850-2602.4 300049	ATE Ø 9" pneumatisch
308 D 2.3	60	06/89→02/96		→ 625656			03.6850-2602.4 300049	ATE Ø 9" pneumatisch
310 2.3	70	06/89→02/96		625657→			03.6855-1402.4 300057	ATE Ø 9" pneumatisch
310 2.3	77	01/89→12/95		649391→			03.6855-1402.4 300057	ATE Ø 9" pneumatisch
310 D 2.9	70	06/89→02/96		→ 649390			03.6850-2602.4 300049	ATE Ø 9" pneumatisch
310 D 2.9	72	06/89→02/96		649391→			03.6855-1402.4 300057	ATE Ø 9" pneumatisch
 Hauptbremszylinder								
308 D 2.3	58	11/88→02/96		→ 649390			03.2123-6002.3 010184	Ø 23,81
308 D 2.3	60	06/89→02/96		→ 625656			03.2123-6002.3 010184	Ø 23,81
310 2.3	70	06/89→02/96		649391→; - ABS			03.2125-1902.3 010206	Ø 25,4
310 2.3	77	01/89→12/95		625657→; - ABS			03.2125-1902.3 010206	Ø 25,4
310 D 2.9	70	06/89→02/96		→ 649390			03.2123-6002.3 010184	Ø 23,81
310 D 2.9	72	06/89→02/96		649391→; - ABS			03.2125-1902.3 010206	Ø 25,4
 Bremskraftregler								
308 D 2.3	58	11/88→02/96		→ 649390			03.6511-0030.3 320076	ATE lastabhängig 1/1 2x
308 D 2.3	60	06/89→02/96		→ 625656			03.6511-0030.3 320076	ATE lastabhängig 1/1 2x
310 2.3	70	06/89→02/96		649391→			03.6513-0340.3 320084	ATE lastabhängig 1/3 2x
310 2.3	77	01/89→12/95		649391→			03.6513-0340.3 320084	ATE lastabhängig 1/3 2x
310 D 2.9	70	06/89→02/96		→ 649390			03.6511-0030.3 320076	ATE lastabhängig 1/1 2x
310 D 2.9	72	06/89→02/96		649391→			03.6513-0340.3 320084	ATE lastabhängig 1/3 2x
MERCEDES-BENZ - T1 Pritsche/Fahrgestell (601) 01/77→02/96								
 Bremskraftverstärker								
208 D 2.3	58	11/88→02/96		→ 649390			03.6850-2602.4 300049	ATE Ø 9" pneumatisch
208 D 2.3	60	06/89→02/96		→ 614796			03.6850-2602.4 300049	ATE Ø 9" pneumatisch
210 D 2.8	72	11/88→02/96		614797→			03.6855-1402.4 300057	ATE Ø 9" pneumatisch
210 D 2.9	70	11/88→02/96		649391→			03.6855-1402.4 300057	ATE Ø 9" pneumatisch
 Hauptbremszylinder								
208 D 2.3	58	11/88→02/96		→ 649390 / P000000			03.2123-6002.3 010184	Ø 23,81
208 D 2.3	60	06/89→02/96		→ 614796 / P000000			03.2123-6002.3 010184	Ø 23,81
210 D 2.8	72	11/88→02/96		649391 / P000001→; - ABS			03.2125-1902.3 010206	Ø 25,4
210 D 2.9	70	11/88→02/96		614797 / P000001→; - ABS			03.2125-1902.3 010206	Ø 25,4
 Bremskraftregler								
208 D 2.3	58	11/88→02/96		→ 240106			03.6511-0030.3 320076	ATE lastabhängig 1/1 2x
208 D 2.3	60	06/89→02/96		→ 649390			03.6511-0030.3 320076	ATE lastabhängig 1/1 2x
				500000 → 556499			03.6511-0030.3 320076	ATE lastabhängig 1/1 2x
				→ 249719			03.6511-0030.3 320076	ATE lastabhängig 1/1 2x
				→ 249588			03.6511-0030.3 320076	ATE lastabhängig 1/1 2x
				649391→			03.6515-0305.3 320087	ATE lastabhängig 1/5 2x
210 D 2.8	72	11/88→02/96		→ 649390			03.6511-0030.3 320076	ATE lastabhängig 1/1 2x
↓								

















	kw					! #		
MERCEDES-BENZ - T1 Pritsche/Fahrgestell (601) 01/77→02/96								
 Bremskraftregler								
210 D 2.9	70	11/88→02/96		649391→		03.6515-0305.3	320087	ATE lastabhängig 1/5 2x
				614797→		03.6515-0305.3	320087	ATE lastabhängig 1/5 2x
MERCEDES-BENZ - T1 Pritsche/Fahrgestell (602) 01/77→02/96								
 Bremskraftverstärker								
308 D 2.3	58	06/89→02/96		→ 649390		03.6850-2602.4	300049	ATE Ø 9" pneumatisch
308 D 2.3	60	06/89→02/96		→ 625656		03.6850-2602.4	300049	ATE Ø 9" pneumatisch
				625657→		03.6855-1402.4	300057	ATE Ø 9" pneumatisch
				649391→		03.6855-1402.4	300057	ATE Ø 9" pneumatisch
310 D 2.9	70	06/89→02/96		→ 649390		03.6850-2602.4	300049	ATE Ø 9" pneumatisch
310 D 2.9	72	06/89→02/96		649391→		03.6855-1402.4	300057	ATE Ø 9" pneumatisch
 Hauptbremszylinder								
308 D 2.3	58	06/89→02/96		→ 649390		03.2123-6002.3	010184	Ø 23,81
308 D 2.3	60	06/89→02/96		→ 625656		03.2123-6002.3	010184	Ø 23,81
				649391→; - ABS		03.2125-1902.3	010206	Ø 25,4
				625657→; - ABS		03.2125-1902.3	010206	Ø 25,4
310 D 2.9	70	06/89→02/96		→ 649390		03.2123-6002.3	010184	Ø 23,81
310 D 2.9	72	06/89→02/96		649391→; - ABS		03.2125-1902.3	010206	Ø 25,4
 Bremskraftregler								
308 D 2.3	58	06/89→02/96		→ 649390		03.6511-0030.3	320076	ATE lastabhängig 1/1 2x
308 D 2.3	60	06/89→02/96		→ 625656		03.6511-0030.3	320076	ATE lastabhängig 1/1 2x
				649391→		03.6513-0340.3	320084	ATE lastabhängig 1/3 2x
310 D 2.9	70	06/89→02/96		→ 649390		03.6511-0030.3	320076	ATE lastabhängig 1/1 2x
310 D 2.9	72	06/89→02/96		649391→		03.6513-0340.3	320084	ATE lastabhängig 1/3 2x
MERCEDES-BENZ - Vaneo (414) 02/02→07/05								
 Hauptbremszylinder								
1.6 (414.700)	60	02/02→07/05				24.4123-1703.3	010831	TRW Ø 23,81
1.6 (414.700)	75	02/02→07/05						
1.7 CDI (414.700)	55	02/02→07/05						
1.7 CDI (414.700)	67	02/02→07/05						
1.9 (414.700)	92	02/02→07/05						
MERCEDES-BENZ - Vario Bus 09/96→								
 Hauptbremszylinder								
O 810 (670.373, 670.374)	75	09/96→12/10				03.2128-1203.3	010922	ATE Ø 28,57
O 812 (670.373, 670.674)	90	09/96→12/10						
O 814 (670.373, 670.374)	100	09/96→12/10						
O 815 (670.373, 670.374)	112	09/96→12/10						
O 813 (670.373, 670.374)	95	01/06→		→ 12/13		03.2128-1203.3	010922	ATE Ø 28,57
O 816 D (670.373, 670.374)	115	01/06→						
O 818 D (670.373, 670.374)	130	09/06→						
MERCEDES-BENZ - Vario Kasten/Kombi 09/96→								
 Hauptbremszylinder								
512 D (667.351, 667.352, 667.353)	90	09/96→12/10				03.2128-1203.3	010922	ATE Ø 28,57
612 D (668.351, 668.352, 668.353)	90	09/96→12/10						
613 D, 614 D (668.351, 668.352, 668.353)	95	09/96→12/13						
613 D, 614 D (668.351, 668.352, 668.353)	100	09/96→12/11						
812 D (670.351, 670.352, 670.353)	90	09/96→12/10						
813 D, 814 D (670.351, 670.352, 670.353)	95	09/96→12/13						
813 D, 814 D (670.351, 670.352, 670.353)	100	09/96→12/13						
↓								













	kW					! #		
MERCEDES-BENZ - VARIO Kasten/Kombi 09/96→								
 Hauptbremszylinder								
813 DA, 814 DA 4x4 (669.599, 670.451, 670.452, 670.453)	95	09/96→12/13					03.2128-1203.3 010922	ATE Ø 28,57
815 D, 816 D (670.351, 670.352, 670.353)	112	09/96→12/10						
815 D, 816 D (670.351, 670.352, 670.353)	115	09/96→12/13						
815 DA, 816 DA 4x4 (669.599, 670.451, 670.452, 670.453)	112	09/96→12/10						
815 DA, 816 DA 4x4 (669.599, 670.451, 670.452, 670.453)	115	09/96→12/13						
615 D, 616 D (668.351, 668.352, 668.353)	112	09/98→		→ 12/13			03.2128-1203.3 010922	ATE Ø 28,57
615 D, 616 D (668.351, 668.352, 668.353)	115	09/98→						
618 D	130	09/06→						
813 DA, 814 DA 4x4 (669.599, 670.451, 670.452, 670.453)	100	09/96→						
818 D (670.351, 670.352, 670.353)	130	09/06→						
MERCEDES-BENZ - VARIO Kipper 09/96→								
 Hauptbremszylinder								
612 D (668.331, 668.332)	90	09/96→12/10					03.2128-1203.3 010922	ATE Ø 28,57
613 D, 614 D (668.331, 668.332)	95	09/96→12/13						
613 D, 614 D (668.331, 668.332)	100	09/96→11/12						
812 D (670.331, 670.332)	90	09/96→12/10						
813 D, 814 D (670.331, 670.332)	95	09/96→12/13						
813 D, 814 D (670.331, 670.332)	100	09/96→12/13						
813 DA, 814 DA 4x4 (670.431, 670.432)	95	09/96→12/13						
813 DA, 814 DA 4x4 (670.431, 670.432)	100	09/96→12/13						
815 D, 816 D (670.331, 670.332)	115	09/96→12/13						
815 DA, 816 DA 4x4 (670.431, 670.432)	112	09/96→12/10						
815 DA, 816 DA 4x4 (670.431, 670.432)	115	09/96→12/13						
615 D, 616 D (668.331, 668.332)	112	09/98→		→ 12/13			03.2128-1203.3 010922	ATE Ø 28,57
615 D, 616 D (668.331, 668.332)	115	09/98→						
618 D	130	09/06→						
815 D, 816 D (670.331, 670.332)	112	09/96→						
818 D (670.321, 670.322)	130	09/06→						
818 DA 4x4	130	09/06→						
MERCEDES-BENZ - VARIO Pritsche/Fahrgestell 09/96→								
 Hauptbremszylinder								
512 D (667.321, 667.322, 667.323)	90	09/96→12/10					03.2128-1203.3 010922	ATE Ø 28,57
612 D (668.321, 668.322, 668.323)	90	09/96→12/10						
613 D, 614 D (668.321, 668.322, 668.323)	100	09/96→12/11						
812 D (670.321, 670.322, 670.323, 670.324)	90	09/96→12/10						
813 D, 814 D (670.321, 670.322, 670.323, 670.324)	95	09/96→12/13						
813 D, 814 D (670.321, 670.322, 670.323, 670.324)	100	09/96→12/13						
813 DA, 814 DA 4x4 (670.421, 670.422, 670.423)	95	09/96→12/13						
↓								

	kW					! #		
MERCEDES-BENZ - VARIO Pritsche/Fahrgestell 09/96→								
 Hauptbremszylinder								
813 DA, 814 DA 4x4 (670.421, 670.422, 670.423)	100	09/96→12/13					03.2128-1203.3 010922	ATE Ø 28,57
815 D, 816 D (670.321, 670.322, 670.323, 670.324)	112	09/96→12/10						
815 D, 816 D (670.321, 670.322, 670.323, 670.324)	115	09/96→12/13						
815 DA, 816 DA 4x4 (670.421, 670.422, 670.423)	112	09/96→12/10						
815 DA, 816 DA 4x4 (670.421, 670.422, 670.423)	115	09/96→12/13						
613 D, 614 D (668.321, 668.322, 668.323)	95	09/96→		→ 12/13			03.2128-1203.3 010922	ATE Ø 28,57
615 D, 616 D (668.321, 668.322, 668.323)	112	09/98→						
615 D, 616 D (668.321, 668.322, 668.323)	115	09/98→						
618 D (668.321, 668.322, 668.323)	130	09/06→						
818 D (670.321, 670.322, 670.323, 670.324)	130	09/06→						
818 DA 4x4	130	09/06→						
MERCEDES-BENZ - VARIO Triebkopf 09/96→								
 Hauptbremszylinder								
613 D, 614 D (669.599, 669.899)	95	01/06→		→ 12/13			03.2128-1203.3 010922	ATE Ø 28,57
615 D, 616 D (669.599, 669.899)	115	01/06→						
618 D (669.599, 669.899)	130	09/06→						
814 DT (670.398)	100	09/96→						
816 DT (670.398)	112	09/96→						
810 DT (670.398)	75	09/96→12/10					03.2128-1203.3 010922	ATE Ø 28,57
812 DT	90	09/96→12/10						
MERCEDES-BENZ - VIANO (W639) 09/03→								
 Hauptbremszylinder								
3,0	140	09/03→		→ 02/14			24.2123-1772.3 010858	BOS Ø 23,81
3,2	160	09/03→						
3,5	190	09/07→						
3,7	170	06/04→						
CDI 2.0	80	09/03→						
CDI 2.0	85	08/05→						
CDI 2.0	100	07/10→						
CDI 2.0 4-matic	100	07/10→						
CDI 2.2	110	09/03→						
CDI 2.2	120	07/10→						
CDI 2.2 4-matic	120	07/10→						
CDI 3.0	150	03/06→						
CDI 3.0	165	07/10→						
CDI 2.0 4-matic	80	07/05→		07/10→ 02/14			24.2123-1772.3 010858	BOS Ø 23,81
CDI 2.2 4-matic	110	07/05→						
MERCEDES-BENZ - VITO / MIXTO Kasten (W639) 09/03→								
 Hauptbremszylinder								
109 CDI	65	09/03→		→ 3558104			24.2123-1772.3 010858	BOS Ø 23,81
109 CDI	70	08/06→						
110 CDI	70	09/10→		3558105→; → 02/14			24.2123-1778.3 010947	TRW Ø 23,81
111 CDI	80	09/03→						
111 CDI	85	09/07→						
111 CDI 4x4	80	09/07→						
113 CDI	100	09/10→						
113 CDI 4x4	100	09/10→						
115 CDI	110	09/03→						
116 CDI	120	09/10→						
116 CDI 4x4	120	09/10→						
119	140	09/03→						
122	160	09/03→						
122 CDI	165	09/10→						
126	190	09/07→						
115 CDI 4x4	110	07/06→		09/07→; → 3558104			24.2123-1772.3 010858	BOS Ø 23,81
120 CDI	150	07/06→		3558105→; → 02/14			24.2123-1778.3 010947	TRW Ø 23,81
↓								















	kW					! #		
MERCEDES-BENZ - VITO / MIXTO Kasten (W639) 09/03→								
 Hauptbremszylinder								
123	165	06/04→07/08		→ 3558104			24.2123-1772.3 010858	BOS Ø 23,81
123 (639.603)	170	06/04→07/08		3558105→			24.2123-1778.3 010947	TRW Ø 23,81
MERCEDES-BENZ - VITO Bus (638) 02/96→07/03								
 Hauptbremszylinder								
108 CDI 2.2 (638.194)	60	03/99→07/03		- ABS			24.2123-1712.3 010519	Ø 23,81
110 CDI 2.2 (638.194)	75	03/99→07/03		+ ABS			24.2123-1729.3 010567	Ø 23,81
112 CDI 2.2 (638.194)	90	03/99→07/03						
114 2.3 (638.134, 638.194)	105	12/96→07/03						
108 D 2.3 (638.164)	58	02/96→07/03		03/96→; - ABS			24.2123-1712.3 010519	Ø 23,81
110 TD 2.3 (638.174)	72	02/96→07/03						
113 2.0 (638.114, 638.194)	95	02/96→07/03		03/96→; + ABS			24.2123-1729.3 010567	Ø 23,81
MERCEDES-BENZ - VITO Bus (W639) 09/03→								
 Hauptbremszylinder								
109 CDI	65	09/03→		→ 3558104			24.2123-1772.3 010858	BOS Ø 23,81
109 CDI	70	09/06→						
109 CDI 4x4	70	09/07→		3558105→; → 02/14			24.2123-1778.3 010947	TRW Ø 23,81
110 CDI	70	09/10→						
111 CDI	80	09/03→						
111 CDI (639.701)	85	09/07→						
111 CDI 4x4	80	09/07→						
113 CDI	100	09/10→						
113 CDI 4x4	100	09/10→						
115 CDI	110	09/03→						
115 CDI 4x4	110	09/07→						
116 CDI	120	09/10→						
116 CDI 4x4	120	09/10→						
119	140	09/03→						
122	160	09/03→						
122 CDI	165	09/10→						
123	170	06/04→						
126	190	09/07→						
120 CDI	150	07/06→		09/07→; → 3558104			24.2123-1772.3 010858	BOS Ø 23,81
				3558105→; → 02/14			24.2123-1778.3 010947	TRW Ø 23,81
123	165	06/04→07/08		→ 3558104			24.2123-1772.3 010858	BOS Ø 23,81
				3558105→			24.2123-1778.3 010947	TRW Ø 23,81
MERCEDES-BENZ - VITO Kasten (638) 03/97→07/03								
 Hauptbremszylinder								
108 CDI 2.2 (638.094)	60	03/99→07/03		- ABS			24.2123-1712.3 010519	Ø 23,81
108 D 2.3 (638.064)	58	03/97→07/03		+ ABS			24.2123-1729.3 010567	Ø 23,81
110 CDI 2.2 (638.094)	75	03/99→07/03						
110 D 2.3 (638.074)	72	03/97→07/03						
112 CDI 2.2 (638.094)	90	03/99→07/03						
113 2.0 (638.014, 638.094)	95	03/97→07/03						
114 2.3 (638.034, 638.094)	105	03/97→07/03						
MERCEDES-BENZ - V-KLASSE (638/2) 02/96→07/03								
 Hauptbremszylinder								
V 200 (638.214, 638.294)	95	02/97→07/03		- ABS			24.2123-1712.3 010519	Ø 23,81
V 200 CDI (638.294)	75	03/99→07/03		+ ABS			24.2123-1729.3 010567	Ø 23,81
V 220 CDI (638.294)	90	03/99→07/03						
V 230 (638.234, 638.294)	105	10/96→07/03						
V 230 TD (638.274)	72	09/96→07/03						
V 280 (638.244, 638.294)	128	08/97→07/03		09/97→; - ABS			24.2123-1712.3 010519	Ø 23,81
				09/97→; + ABS			24.2123-1729.3 010567	Ø 23,81
MINI - MINI (R50, R53) 06/01→09/06								
 Bremskraftverstärker								
Cooper	85	06/01→09/06					03.7860-1402.4 300228	ATE Ø 10" pneumatisch
Cooper S	125	07/04→09/06						
One	55	04/03→09/06						
One	66	06/01→09/06						
One D	55	06/03→09/06						
One D	65	06/03→09/06						
S Works	149	11/03→06/05						
Works	155	11/03→09/06						
↓								



















	kW					! #		
MINI - MINI (R50, R53) 06/01→09/06								
 Bremskraftverstärker								
Cooper S	120	03/02→09/06		07/02→		03.7860-1402.4	300228	ATE Ø 10" pneumatisch
 Hauptbremszylinder								
Cooper	85	06/01→09/06		+ DSC		03.2122-1824.3	010892	ATE Ø 22,2
Cooper S	125	07/04→09/06		- DSC		03.2122-1853.3	010893	ATE Ø 22,2
One	55	04/03→09/06						
One	66	06/01→09/06						
One D	55	06/03→09/06						
One D	65	06/03→09/06						
S Works	149	11/03→06/05						
Works	155	11/03→09/06						
Cooper S	120	03/02→09/06		07/02→; + DSC		03.2122-1824.3	010892	ATE Ø 22,2
				07/02→; - DSC		03.2122-1853.3	010893	ATE Ø 22,2
MINI - MINI (R56) 11/05→11/13								
 Hauptbremszylinder								
Cooper	85	03/10→11/13				24.4123-1712.3	010897	TRW Ø 23,81
Cooper D	82	06/10→11/13						
Cooper D	82	02/11→11/13						
Cooper S	120	03/10→11/13						
Cooper S	135	03/10→11/13						
Cooper S	147	01/12→11/13						
Cooper SD	100	02/11→11/13						
Cooper SD	105	02/11→11/13						
One	55	03/09→03/10						
One	55	03/10→11/13						
One	72	03/10→11/13						
One D	66	07/10→11/13						
Cooper	88	10/06→02/12		11/06→		24.4123-1712.3	010897	TRW Ø 23,81
Cooper S	128	10/06→01/11						
Cooper	90	09/09→11/13		03/10→		24.4123-1712.3	010897	TRW Ø 23,81
One D	66	06/09→07/10						
Cooper D	80	11/06→09/10		04/07→		24.4123-1712.3	010897	TRW Ø 23,81
One	70	11/06→03/10						
John Cooper Works	141	11/06→12/11		03/08→		24.4123-1712.3	010897	TRW Ø 23,81
John Cooper Works	155	11/07→11/13						
MINI - MINI Cabriolet (R52) 07/04→11/07								
 Bremskraftverstärker								
Cooper	85	07/04→11/07				03.7860-1402.4	300228	ATE Ø 10" pneumatisch
Cooper S	120	07/04→11/07						
Cooper S	125	07/04→11/07						
John Cooper Works	155	07/04→11/07						
One	66	07/04→11/07						
 Hauptbremszylinder								
Cooper	85	07/04→11/07		+ DSC		03.2122-1824.3	010892	ATE Ø 22,2
Cooper S	120	07/04→11/07		- DSC		03.2122-1853.3	010893	ATE Ø 22,2
Cooper S	125	07/04→11/07						
John Cooper Works	155	07/04→11/07						
One	66	07/04→11/07						
MINI - MINI Cabriolet (R57) 10/07→06/15								
 Hauptbremszylinder								
Cooper	85	10/07→06/10		01/09→		24.4123-1712.3	010897	TRW Ø 23,81
Cooper S	128	11/07→07/10						
Cooper	88	10/07→06/15		01/09→ 06/14		24.4123-1712.3	010897	TRW Ø 23,81
Cooper S	120	10/07→06/15						
Cooper	90	09/09→06/15		03/10→ 06/14		24.4123-1712.3	010897	TRW Ø 23,81
Cooper S	135	06/09→06/15						
Cooper S	147	06/09→06/15						
One	72	09/09→06/15						
Cooper D	82	05/09→11/13		06/10→		24.4123-1712.3	010897	TRW Ø 23,81
Cooper D	82	02/11→05/15		→ 06/14		24.4123-1712.3	010897	TRW Ø 23,81
Cooper SD	105	06/09→05/15		02/11→ 06/14		24.4123-1712.3	010897	TRW Ø 23,81
John Cooper Works	155	08/08→05/15		03/09→ 06/14		24.4123-1712.3	010897	TRW Ø 23,81
MINI - MINI CLUBMAN (R55) 10/06→06/14								
 Hauptbremszylinder								
Cooper	85	03/10→06/14				24.4123-1712.3	010897	TRW Ø 23,81
Cooper	88	10/07→12/13						
Cooper	90	03/10→06/14						
Cooper D	80	10/07→02/10						
Cooper D	82	03/10→06/14						
↓								













	kw			 	! #		
MINI - MINI CLUBMAN (R55) 10/06→06/14							
 Hauptbremszylinder							
Cooper D	82	02/11→06/14				24.4123-1712.3 010897	TRW Ø 23,81
Cooper S	120	10/07→02/10					
Cooper S	128	10/07→02/10					
Cooper S	135	03/10→06/14					
Cooper S	147	03/10→06/14					
Cooper SD	100	02/11→06/14					
Cooper SD	105	02/11→06/14					
John Cooper Works One	141	10/08→02/10					
One	72	03/10→06/14					
One D	66	03/10→06/14					
John Cooper Works	155	11/07→06/14		03/08→		24.4123-1712.3 010897	TRW Ø 23,81
MINI - MINI CLUBVAN (R55) 12/12→06/14							
 Hauptbremszylinder							
Cooper	90	12/12→06/14				24.4123-1712.3 010897	TRW Ø 23,81
Cooper D	82	12/12→06/14					
One	72	12/12→06/14					
MINI - MINI COUNTRYMAN (R60) 01/10→10/16							
 Hauptbremszylinder							
Cooper	85	01/10→10/16		09/10→		24.4123-1712.3 010897	TRW Ø 23,81
Cooper	88	01/10→10/16					
Cooper	90	01/10→10/16					
Cooper D	82	01/10→10/16					
Cooper D ALL4	82	01/10→09/16					
Cooper D ALL4	82	07/10→09/16					
Cooper S	135	01/10→10/16					
Cooper S	140	01/10→10/16					
Cooper S ALL4	120	01/10→10/16					
Cooper S ALL4	135	01/10→10/16					
Cooper S ALL4	140	01/10→10/16					
One	72	01/10→09/16					
One D	66	01/10→10/16					
Cooper ALL4	90	11/12→09/16		11/14→			
Cooper ALL4	90	11/12→10/16					
Cooper S	147	01/10→10/16		02/12→			
Cooper SD	100	01/10→10/16		02/11→			
Cooper SD	105	01/10→10/16					
Cooper SD ALL4	100	01/10→09/16					
Cooper SD ALL4	105	01/10→09/16					
John Cooper Works ALL4	160	04/11→10/16		09/12→			
MINI - MINI Coupe (R58) 12/10→05/15							
 Hauptbremszylinder							
Cooper	85	12/10→04/15		10/11→		24.4123-1712.3 010897	TRW Ø 23,81
Cooper	90	12/10→04/15					
Cooper S	120	12/10→04/15					
Cooper S	135	12/10→04/15					
Cooper S	147	12/10→04/15					
Cooper SD	100	12/10→05/15					
Cooper SD	105	12/10→05/15					
John Cooper Works	155	12/10→05/15					
MINI - MINI PACEMAN (R61) 03/12→09/16							
 Hauptbremszylinder							
Cooper	88	04/12→09/16		11/12→		24.4123-1712.3 010897	TRW Ø 23,81
Cooper	90	04/12→09/16					
Cooper D	82	04/12→09/16					
Cooper D	82	07/12→09/16					
Cooper D ALL4	82	04/12→09/16					
Cooper D ALL4	82	03/12→09/16					
Cooper S	135	04/12→09/16					
Cooper S	140	04/12→09/16					
Cooper S ALL4	120	03/12→09/16					
Cooper S ALL4	135	03/12→09/16					
Cooper S ALL4	140	03/12→09/16					
Cooper SD	105	03/12→09/16					
Cooper SD ALL4	100	04/12→09/16					
Cooper SD ALL4	105	04/12→09/16					
John Cooper Works	160	09/12→09/16					
Cooper ALL4	90	11/12→09/16		07/14→			
Cooper ALL4	90	02/13→09/16					































	kw			 	! #		
MINI - MINI Roadster (R59) 01/11→04/15							
 Hauptbremszylinder							
Cooper	85	01/11→04/15		02/12→		24.4123-1712.3 010897	TRW Ø 23,81
Cooper	90	01/11→04/15					
Cooper S	120	01/11→04/15					
Cooper S	135	01/11→04/15					
Cooper S	147	01/11→04/15					
Cooper SD	100	01/11→04/15					
Cooper SD	105	01/11→04/15					
John Cooper Works	155	05/11→04/15					
MITSUBISHI - CARISMA (DA_) 07/95→06/06							
 Hauptbremszylinder							
1.6 (DA1A)	66	07/95→06/06		- ABS		24.2122-1718.3 010517	Ø 22,2
1.8 (DA2A)	85	07/95→07/97					
1.8 MSX - 16V (DA2A)	103	07/95→07/97					
MITSUBISHI - CARISMA Stufenheck (DA_) 09/96→06/06							
 Hauptbremszylinder							
1.6 (DA1A)	66	09/96→06/06		- ABS		24.2122-1718.3 010517	Ø 22,2
1.8 (DA2A)	85	09/96→09/97					
MITSUBISHI - COLT VI (Z3_A, Z2_A) 10/02→12/12							
 Hauptbremszylinder							
1.1	55	10/04→06/12		→ 09/08		24.2122-1770.3 010898	TRW Ø 22,2
1.1 LPG	55	10/04→06/12					
1.3	68	10/04→06/12		10/08→		24.4122-1717.3 010993	TRW Ø 22,2 ohne Bremsflüssigkeitsbehälter
1.3	70	06/04→06/12					
1.3 LPG	70	06/04→06/12					
1.5	80	06/04→06/12					
1.5 CZT	110	03/05→06/12					
1.5 (Z27)	72	09/04→02/06				24.2122-1770.3 010898	TRW Ø 22,2
1.5 DI-D	50	08/04→06/12					
1.5 DI-D	70	08/04→06/12					
1.5 Ralliart R	120	02/10→06/12				24.4122-1717.3 010993	TRW Ø 22,2 ohne Bremsflüssigkeitsbehälter
1.5 Ralliart R	132	02/10→06/12		für Linkslenker		24.4122-1717.3 010993	TRW Ø 22,2 ohne Bremsflüssigkeitsbehälter
1.5 Turbo (Z23)	113	09/06→06/12		05/07→ 09/08		24.2122-1770.3 010898	TRW Ø 22,2
				10/08→		24.4122-1717.3 010993	TRW Ø 22,2 ohne Bremsflüssigkeitsbehälter
MITSUBISHI - COLT CZC Cabriolet (RG) 05/06→07/09							
 Hauptbremszylinder							
1.5	80	05/06→07/09				24.2122-1770.3 010898	TRW Ø 22,2
1.5 Turbo	110	05/06→07/09					
MITSUBISHI - COLT PLUS VI (Z2_W) 08/04→							
 Hauptbremszylinder							
1.3	68	08/04→		10/04→ 09/08		24.2122-1770.3 010898	TRW Ø 22,2
				10/08→ 06/12		24.4122-1717.3 010993	TRW Ø 22,2 ohne Bremsflüssigkeitsbehälter
1.5	77	08/04→		→ 09/08		24.2122-1770.3 010898	TRW Ø 22,2
				10/08→ 06/12		24.4122-1717.3 010993	TRW Ø 22,2 ohne Bremsflüssigkeitsbehälter
NISSAN - ALMERA I (N15) 07/95→07/00							
 Hauptbremszylinder							
1.4	64	09/95→07/00		02/98→ 04/00; + ABS		24.2123-1761.3 010780	TRW Ø 23,81
1.4 GX,LX	55	09/95→07/00					mit Bremsflüssigkeitsbehälter
1.6	73	09/95→07/00		01/98→ 04/00; + ABS		24.2123-1761.3 010780	TRW Ø 23,81
1.6 SLX	66	09/95→07/00					mit Bremsflüssigkeitsbehälter
2.0 D	55	11/95→07/00					
1.6	75	07/95→03/00		01/98→; + ABS		24.2123-1761.3 010780	TRW Ø 23,81 mit Bremsflüssigkeitsbehälter
NISSAN - ALMERA I Hatchback (N15) 07/95→07/00							
 Hauptbremszylinder							
1.4	64	09/95→03/00		02/98→; + ABS		24.2123-1761.3 010780	TRW Ø 23,81
1.4 S,GX,LX	55	09/95→03/00					mit Bremsflüssigkeitsbehälter
1.6	73	09/95→03/00		01/98→; + ABS		24.2123-1761.3 010780	TRW Ø 23,81
1.6	75	07/95→03/00					mit Bremsflüssigkeitsbehälter
1.6 SR,SLX	66	09/95→03/00					











	kw					! #		
NISSAN - ALMERA I Hatchback (N15) 07/95→07/00								
 Hauptbremszylinder								
2.0 D	55	11/95→03/00		01/98→; + ABS		24.2123-1761.3	010780	TRW Ø 23,81 mit Bremsflüssigkeitsbehälter
1.6	86	09/95→07/00		01/98→ 04/00; + ABS		24.2123-1761.3	010780	TRW Ø 23,81 mit Bremsflüssigkeitsbehälter
2.0 GTi	105	07/96→03/00		01/98→		24.2123-1761.3	010780	TRW Ø 23,81 mit Bremsflüssigkeitsbehälter
NISSAN - ALMERA II (N16) 06/00→								
 Hauptbremszylinder								
1.5	66	07/00→		→ 03/01; + ASR / + ETS; für Linkslenker		24.2123-1761.3	010780	TRW Ø 23,81 mit Bremsflüssigkeitsbehälter
1.8	84	07/00→		→ 03/01; + ABS; für Linkslenker		24.2123-1761.3	010780	TRW Ø 23,81 mit Bremsflüssigkeitsbehälter
2.2 Di	81	07/00→		→ 03/01		24.2123-1761.3	010780	TRW Ø 23,81 mit Bremsflüssigkeitsbehälter
NISSAN - ALMERA II Hatchback (N16) 01/00→								
 Hauptbremszylinder								
1.5	66	03/00→		→ 03/01; + ASR / + ETS; für Linkslenker		24.2123-1761.3	010780	TRW Ø 23,81 mit Bremsflüssigkeitsbehälter
1.8	84	01/00→		03/00→ 03/01; + ABS; für Linkslenker		24.2123-1761.3	010780	TRW Ø 23,81 mit Bremsflüssigkeitsbehälter
2.2 Di	81	03/00→		→ 03/01		24.2123-1761.3	010780	TRW Ø 23,81 mit Bremsflüssigkeitsbehälter
NISSAN - INTERSTAR Bus (X70) 04/02→								
 Hauptbremszylinder								
dCi 100	73	11/03→		→ 06/10; - ABS		24.2025-1708.3	010692	Ø 25,4
dCi 100	74	04/06→		→ 06/10; + ABS		24.2123-1759.3	010768	BOS Ø 23,81
dCi 120	88	09/06→						
dCi 150	107	09/06→						
dCi 120	84	07/02→08/06		→ 12/02; + ABS		24.2025-1706.3	010676	Ø 25,4
				- ABS		24.2025-1708.3	010692	Ø 25,4
				01/03→; + ABS		24.2123-1759.3	010768	BOS Ø 23,81
dCi 140	100	11/03→		→ 08/06; - ABS		24.2025-1708.3	010692	Ø 25,4
				→ 08/06; + ABS		24.2123-1759.3	010768	BOS Ø 23,81
dCi 80	60	04/02→08/06		07/02→ 12/02; + ABS		24.2025-1706.3	010676	Ø 25,4
				07/02→; - ABS		24.2025-1708.3	010692	Ø 25,4
				01/03→; + ABS		24.2123-1759.3	010768	BOS Ø 23,81
dCi 90	66	07/02→		→ 12/02; + ABS		24.2025-1706.3	010676	Ø 25,4
				→ 08/06; - ABS		24.2025-1708.3	010692	Ø 25,4
				01/03→ 08/06; + ABS		24.2123-1759.3	010768	BOS Ø 23,81
NISSAN - INTERSTAR Kasten (X70) 04/02→								
 Hauptbremszylinder								
dCi 100	73	11/03→		→ 06/10; - ABS		24.2025-1708.3	010692	Ø 25,4
dCi 100	74	04/06→		→ 06/10; + ABS		24.2123-1759.3	010768	BOS Ø 23,81
dCi 120	88	09/06→						
dCi 150	107	09/06→						
dCi 120	84	07/02→		→ 12/02; + ABS		24.2025-1706.3	010676	Ø 25,4
dCi 90	66	07/02→		→ 08/06; - ABS		24.2025-1708.3	010692	Ø 25,4
				01/03→ 08/06; + ABS		24.2123-1759.3	010768	BOS Ø 23,81
dCi 140	100	11/03→		→ 08/06; - ABS		24.2025-1708.3	010692	Ø 25,4
				→ 08/06; + ABS		24.2123-1759.3	010768	BOS Ø 23,81
dCi 80	60	04/02→08/06		07/02→ 12/02; + ABS		24.2025-1706.3	010676	Ø 25,4
				07/02→; - ABS		24.2025-1708.3	010692	Ø 25,4
				01/03→; + ABS		24.2123-1759.3	010768	BOS Ø 23,81
NISSAN - INTERSTAR Pritsche/Fahrgestell 08/03→								
 Hauptbremszylinder								
dCi 100	73	02/04→		→ 06/10; - ABS		24.2025-1708.3	010692	Ø 25,4
				→ 06/10; + ABS		24.2123-1759.3	010768	BOS Ø 23,81
dCi 120	84	08/03→		→ 08/06; - ABS		24.2025-1708.3	010692	Ø 25,4
dCi 140	100	11/03→		→ 08/06; + ABS		24.2123-1759.3	010768	BOS Ø 23,81
dCi 120	88	08/06→		09/06→ 06/10; - ABS		24.2025-1708.3	010692	Ø 25,4
dCi 150	107	08/06→		09/06→ 06/10; + ABS		24.2123-1759.3	010768	BOS Ø 23,81













	kw			 	! #		
NISSAN - KUBISTAR (X76) 08/03→10/09							
 Hauptbremszylinder							
1.2	44	08/03→10/09		→ 08/05; - ABS		24.2122-1727.3 010586	BDX Ø 22,2
1.5 dCi	42	08/03→10/09					
1.5 dCi	48	08/03→10/09					
1.5 dCi	60	08/03→10/09					
1.2 16V	55	04/06→10/09		- ABS		24.2122-1727.3 010586	BDX Ø 22,2
1.5 dCi 70	50	04/06→10/09					
1.5 dCi 85	62	04/06→10/09					
1.6 16V	70	08/03→10/09					
1.4	55	08/03→10/09				24.2122-1727.3 010586	BDX Ø 22,2
1.5 dCi	45	08/05→10/09		09/05→; - ABS		24.2122-1727.3 010586	BDX Ø 22,2
NISSAN - KUBISTAR Kasten (X80) 08/03→							
 Hauptbremszylinder							
1.2	44	08/03→		→ 08/05; - ABS		24.2122-1727.3 010586	BDX Ø 22,2
1.5 dCi	48	08/03→					
1.5 dCi	60	08/03→					
1.2 16V	55	04/06→		→ 10/09; - ABS		24.2122-1727.3 010586	BDX Ø 22,2
1.5 dCi 70	50	04/06→03/10					
1.6 16V	70	08/03→					
1.5 dCi	45	08/05→		09/05→ 10/09; - ABS		24.2122-1727.3 010586	BDX Ø 22,2
NISSAN - MICRA III (K12) 03/02→06/10							
 Bremskraftverstärker							
1.0 16V	48	01/03→06/10		für Linkslenker		03.7863-3002.4 300223	ATE Ø 10" pneumatisch
1.2 16V	48	01/03→06/10					
1.2 16V	59	01/03→06/10					
1.2 LPG	59	06/05→06/10					
1.3	60	08/04→					
1.4 16V	65	01/03→06/10					
1.5 dCi	48	01/03→06/10					
1.5 dCi	50	06/05→06/10					
1.5 dCi	60	09/03→06/10					
1.5 dCi	63	06/05→06/10					
160 SR	81	05/05→06/10					
 Hauptbremszylinder							
1.0 16V	48	01/03→06/10		für Linkslenker; - ESP		03.2123-2863.3 010790	ATE Ø 23,81
1.2 16V	48	01/03→06/10		für Linkslenker; + ESP		03.2123-2923.3 010791	ATE Ø 23,81
1.2 16V	59	01/03→06/10					
1.2 LPG	59	06/05→06/10					
1.3	60	08/04→					
1.4 16V	65	01/03→06/10					
1.5 dCi	48	01/03→06/10					
1.5 dCi	50	06/05→06/10					
1.5 dCi	60	09/03→06/10					
1.5 dCi	63	06/05→06/10					
160 SR	81	05/05→06/10					
NISSAN - MICRA C+C III (K12) 08/05→							
 Bremskraftverstärker							
1.4 16V	65	08/05→		→ 12/10; für Linkslenker		03.7863-3002.4 300223	ATE Ø 10" pneumatisch
1.6 160 SR	81	08/05→					
 Hauptbremszylinder							
1.4 16V	65	08/05→		→ 12/10; - ESP		03.2123-2863.3 010790	ATE Ø 23,81
1.6 160 SR	81	08/05→		→ 12/10; + ESP		03.2123-2923.3 010791	ATE Ø 23,81
NISSAN - NOTE (E11, NE11) 01/05→06/12							
 Bremskraftverstärker							
1.4	65	03/06→06/12		für Linkslenker		03.7863-3002.4 300223	ATE Ø 10" pneumatisch
1.5 dCi	50	03/06→06/12					
1.5 dCi	63	03/06→06/12					
1.5 dCi	66	09/10→06/12					
1.5 dCi	76	07/08→06/12					
1.6	81	03/06→06/12					
 Hauptbremszylinder							
1.4	65	03/06→06/12		- ESP		03.2123-2863.3 010790	ATE Ø 23,81
1.5 dCi	50	03/06→06/12		+ ESP		03.2123-2923.3 010791	ATE Ø 23,81
1.5 dCi	63	03/06→06/12					
1.5 dCi	66	09/10→06/12					
1.5 dCi	76	07/08→06/12					
1.6	81	03/06→06/12					













	kw			 	! #		
NISSAN - NP300 NAVARA (D40) 10/04→							
 Hauptbremszylinder							
2.5 dCi	106	07/05→		→ 09/06		03.2125-0161.3 010920	ATE Ø 25,4
2.5 dCi	128	12/05→					
2.5 dCi 4WD	128	07/05→					
NISSAN - NP300 PICKUP (D22) 04/08→							
 Hauptbremszylinder							
2.5 dCi	98	04/08→				03.2125-0161.3 010920	ATE Ø 25,4
2.5 dCi 4x4	98	04/08→					
NISSAN - PATHFINDER III (R51) 01/05→							
 Bremskraftverstärker							
2.5 dCi	128	01/05→		10/06→; Vollautomatik		03.7858-7602.4 300277	ATE Ø 9 / 8" pneumatisch
2.5 dCi 4WD	128	03/05→					
2.5 dCi 4WD	126	10/06→		Vollautomatik		03.7858-7602.4 300277	ATE Ø 9 / 8" pneumatisch
4.0	198	01/05→		10/06→		03.7858-7602.4 300277	ATE Ø 9 / 8" pneumatisch
4.0 4WD	198	09/05→					
 Hauptbremszylinder							
2.5 dCi	128	01/05→		ohne Spezialausrust.		03.2125-0161.3 010920	ATE Ø 25,4
2.5 dCi 4WD	126	10/06→		mit Spezialausrust.		03.2125-0531.3 010945	ATE Ø 25,4
2.5 dCi 4WD	128	03/05→					
2.5 dCi 4WD	120	01/05→				03.2125-0531.3 010945	ATE Ø 25,4
4.0	198	01/05→					
4.0 4WD	198	09/05→					
2.5 dCi 4WD	140	08/10→				03.2125-0161.3 010920	ATE Ø 25,4
NISSAN - PRIMASTAR Bus (X83) 03/01→							
 Hauptbremszylinder							
2.0	88	03/01→		→ 01/03; - ABS		24.2120-1738.3 010759	TRW Ø 20,64
				02/03→; - ABS		24.2120-1740.3 010764	TRW Ø 20,64
				02/03→; + ABS		24.2125-1731.3 010826	TRW Ø 25,4
				02/03→; + ESP		24.2125-1734.3 010878	TRW Ø 25,4
dCi 100 dCi 80	74 60	03/01→ 03/01→		→ 01/03; - ABS		24.2120-1738.3 010759	TRW Ø 20,64
				02/03→ 08/06; - ABS		24.2120-1740.3 010764	TRW Ø 20,64
				02/03→ 08/06; + ABS		24.2125-1731.3 010826	TRW Ø 25,4
				04/06→; + ESP		24.2125-1734.3 010878	TRW Ø 25,4
dCi 115 dCi 120 dCi 150 dCi 90	84 84 107 66	09/08→ 09/06→ 09/06→ 09/06→		- ABS		24.2120-1740.3 010764	TRW Ø 20,64
				+ ABS		24.2125-1731.3 010826	TRW Ø 25,4
				+ ESP		24.2125-1734.3 010878	TRW Ø 25,4
dCi 140	99	07/03→		→ 08/06; - ABS		24.2120-1740.3 010764	TRW Ø 20,64
				→ 08/06; + ABS		24.2125-1731.3 010826	TRW Ø 25,4
				+ ESP		24.2125-1734.3 010878	TRW Ø 25,4
NISSAN - PRIMASTAR Kasten (X83) 09/02→							
 Hauptbremszylinder							
1.9 dCi 100 1.9 dCi 80	74 60	09/02→ 09/02→		→ 01/03; - ABS		24.2120-1738.3 010759	TRW Ø 20,64
				02/03→ 08/06; - ABS		24.2120-1740.3 010764	TRW Ø 20,64
				02/03→ 08/06; + ABS		24.2125-1731.3 010826	TRW Ø 25,4
				04/06→; + ESP		24.2125-1734.3 010878	TRW Ø 25,4
2.0 2.0 dCi 115 2.0 dCi 90 2.5 dCi 150	88 84 66 107	02/03→ 09/06→ 09/06→ 09/06→		- ABS		24.2120-1740.3 010764	TRW Ø 20,64
				+ ABS		24.2125-1731.3 010826	TRW Ø 25,4
				+ ESP		24.2125-1734.3 010878	TRW Ø 25,4
2.5 dCi 115	84	09/08→		- ABS		24.2120-1740.3 010764	TRW Ø 20,64
				+ ABS		24.2125-1731.3 010826	TRW Ø 25,4
2.5 dCi 140	99	07/03→		→ 08/06; - ABS		24.2120-1740.3 010764	TRW Ø 20,64
				→ 08/06; + ABS		24.2125-1731.3 010826	TRW Ø 25,4
				+ ESP		24.2125-1734.3 010878	TRW Ø 25,4
NISSAN - PRIMASTAR Pritsche/Fahrgestell (X83) 07/02→08/06							
 Hauptbremszylinder							
1.9 dCi 100 1.9 dCi 80	74 60	07/02→08/06 07/02→08/06		→ 01/03; - ABS		24.2120-1738.3 010759	TRW Ø 20,64
				02/03→; - ABS		24.2120-1740.3 010764	TRW Ø 20,64
				02/03→; + ABS		24.2125-1731.3 010826	TRW Ø 25,4
				04/06→; + ESP		24.2125-1734.3 010878	TRW Ø 25,4
↓							











	kw					! #		
NISSAN - PRIMASTAR Pritsche/Fahrgestell (X83) 07/02→08/06								
 Hauptbremszylinder								
2.5 dCi 140	99	07/02→08/06		- ABS		24.2120-1740.3	010764	TRW Ø 20,64
				+ ABS		24.2125-1731.3	010826	TRW Ø 25,4
				07/03→; + ESP		24.2125-1734.3	010878	TRW Ø 25,4
2.5 dCi 150	107	04/06→		09/06→; - ABS		24.2120-1740.3	010764	TRW Ø 20,64
				09/06→; + ABS		24.2125-1731.3	010826	TRW Ø 25,4
				09/06→; + ESP		24.2125-1734.3	010878	TRW Ø 25,4
NISSAN - PRIMERA (P12) 01/02→								
 Hauptbremszylinder								
1.6	78	03/02→		06/04→ 10/08		24.2122-1774.3	010987	Ø 22,2
1.8	85	03/02→						ohne Bremsflüssigkeitsbehälter
2.0	103	03/02→						
1.6	80	01/02→		06/04→ 04/06		24.2122-1774.3	010987	Ø 22,2
2.5	125	01/02→						ohne Bremsflüssigkeitsbehälter
1.9 dCi	85	08/02→		06/04→ 10/07		24.2122-1774.3	010987	Ø 22,2
1.9 dCi	88	04/03→						ohne Bremsflüssigkeitsbehälter
2.2 dCi	102	04/03→						
NISSAN - PRIMERA Hatchback (P12) 01/02→								
 Hauptbremszylinder								
1.6	78	07/02→		06/04→ 10/08		24.2122-1774.3	010987	Ø 22,2
1.8	85	07/02→						ohne Bremsflüssigkeitsbehälter
2.0	103	07/02→						
1.6	80	07/02→		06/04→ 04/06		24.2122-1774.3	010987	Ø 22,2
2.5	125	01/02→						ohne Bremsflüssigkeitsbehälter
1.9 dCi	85	08/02→		06/04→ 10/07		24.2122-1774.3	010987	Ø 22,2
1.9 dCi	88	04/03→						ohne Bremsflüssigkeitsbehälter
2.2 dCi	102	04/03→						
NISSAN - PRIMERA Traveller (WP12) 01/02→								
 Hauptbremszylinder								
1.6 Visia	80	01/02→		06/04→ 04/06		24.2122-1774.3	010987	Ø 22,2
2.5	125	01/02→						ohne Bremsflüssigkeitsbehälter
1.8	85	03/02→		06/04→ 10/08		24.2122-1774.3	010987	Ø 22,2
2.0	103	03/02→						ohne Bremsflüssigkeitsbehälter
1.9 dCi	85	08/02→		06/04→ 10/07		24.2122-1774.3	010987	Ø 22,2
1.9 dCi	88	04/03→						ohne Bremsflüssigkeitsbehälter
2.2 dCi	102	04/03→						
NISSAN - PULSAR I Stufenheck (N15) 07/95→07/00								
 Hauptbremszylinder								
1.6	86	09/95→07/00		01/98→ 04/00; + ABS		24.2123-1761.3	010780	TRW Ø 23,81 mit Bremsflüssigkeitsbehälter
NISSAN - TERRANO II (R20) 10/92→09/07								
 Hauptbremszylinder								
2.4 4WD	85	05/96→01/02		- ABS		24.2125-1738.3	010931	TRW Ø 25,4
2.4 4WD	87	05/96→09/07		→ 11/05; - ABS		24.2125-1738.3	010931	TRW Ø 25,4
2.7 TDi 4WD	92	05/96→09/07						
2.4 i 12V 4WD	91	02/93→12/97		→ 04/96; - ABS		24.2123-1726.3	010557	Ø 23,81 ohne Bremsflüssigkeitsbehälter
2.7 TD 4WD	74	02/93→01/02		→ 04/96; - ABS		24.2123-1726.3	010557	Ø 23,81 ohne Bremsflüssigkeitsbehälter
				05/96→; - ABS		24.2125-1738.3	010931	TRW Ø 25,4
3.0 Di 4WD	113	05/02→09/07		→ 04/06; - ABS		24.2125-1738.3	010931	TRW Ø 25,4
NISSAN - TERRANO II Van (R20) 06/98→09/07								
 Hauptbremszylinder								
2.7 TDi 4WD	92	06/98→09/07		→ 11/05; - ABS		24.2125-1738.3	010931	TRW Ø 25,4
3.0 Di 4WD	113	04/03→09/07		→ 04/06; - ABS		24.2125-1738.3	010931	TRW Ø 25,4
NISSAN - X-TRAIL (T30) 06/01→01/13								
 Hauptbremszylinder								
2.0	103	07/01→01/13		→ 08/03; Schaltgetriebe; - ESP		24.2125-1741.3	010988	Ø 25,4
2.0	110	09/01→01/13						ohne Bremsflüssigkeitsbehälter
2.0 4x4	103	07/01→01/13						
2.0 4x4	110	09/01→01/13						
2.0 4x4	206	06/01→01/13						
↓								













	kw			 	! #		
NISSAN - X-TRAIL (T30) 06/01→01/13							
 Hauptbremszylinder							
2.5 4x4 2.5 4x4	132 134	11/02→01/13 09/01→02/07		→ 08/03; Schaltgetriebe; - ESP		24.2125-1741.3 010988	Ø 25,4 ohne Bremsflüssigkeitsbehälter
2.2 DCi FWD	84	06/01→09/03		07/01→; Schaltgetriebe; - ESP		24.2125-1741.3 010988	Ø 25,4 ohne Bremsflüssigkeitsbehälter
2.2 Di 4x4	84	07/01→10/05		→ 09/03; Schaltgetriebe; - ESP		24.2125-1741.3 010988	Ø 25,4 ohne Bremsflüssigkeitsbehälter
2.5 4x4	121	09/02→01/13		01/03→ 08/03; Schaltgetriebe; - ESP		24.2125-1741.3 010988	Ø 25,4 ohne Bremsflüssigkeitsbehälter
2.5 FWD	131	06/01→12/07		11/02→ 08/03; Schaltgetriebe; - ESP		24.2125-1741.3 010988	Ø 25,4 ohne Bremsflüssigkeitsbehälter
OPEL - AGILA (A) (H00) 09/00→12/07							
 Hauptbremszylinder							
1.0 1.0 12V 1.2 16V 1.3 CDTI	44 43 55 51	08/03→12/07 09/00→12/07 09/00→12/07 08/03→12/07		+ ABS; → 07/07		24.2120-1730.3 010678	Ø 20,64
OPEL - AGILA (B) (H08) 04/08→							
 Hauptbremszylinder							
1.0 1.0 1.0 LPG 1.2 1.2 1.2 LPG 1.3 CDTI	48 50 48 63 69 63 55	04/08→ 07/11→ 01/10→ 04/08→ 11/10→ 04/08→ 04/08→		für Linkslenker; - ESP für Linkslenker; + ESP		24.4122-1718.3 011019 24.4122-1719.3 011020	BOS Ø 22,2 ohne Bremsflüssigkeitsbehälter Ø 22,2 ohne Bremsflüssigkeitsbehälter
OPEL - ASTRA CLASSIC (L48) 01/09→							
 Hauptbremszylinder							
1.3 CDTI 1.6	66 85	01/09→ 01/09→		→ 68999999; für Rechtslenker → 68999999; für Linkslenker; + ESP → 68999999; für Linkslenker; - ESP 72000001→; → 11/10; für Rechtslenker 72000001→; → 11/10; für Linkslenker; + ESP 72000001→; → 11/10; für Linkslenker; - ESP		24.2125-1736.3 010904 24.2125-1736.3 010904 24.2125-1737.3 010906 24.4125-1703.3 010907 24.4125-1703.3 010907 24.4125-1704.3 010908	TRW Ø 25,4 TRW Ø 25,4 TRW Ø 25,4 TRW Ø 25,4 TRW Ø 25,4 TRW Ø 25,4
OPEL - ASTRA F (56_, 57_) 09/91→09/98							
 Hauptbremszylinder							
1.4 i	44	09/91→09/98		10/91→; + ABS 10/91→; - ABS		03.2122-0282.3 010130 24.2120-0702.3 010361	ATE Ø 22,2 Ø 20,64
1.4 i 16V 1.7 D	66 44	02/96→09/98 07/92→09/98		- ABS; für Fahrzeuge mit verstärkter Bremse + ABS - ABS; nicht für Fahrzeuge mit verstärkter Bremse		03.2122-0264.3 010129 03.2122-0282.3 010130 24.2120-0702.3 010361	ATE Ø 22,2 ATE Ø 22,2 Ø 20,64
1.4 Si	60	03/92→09/98		- ABS; für Fahrzeuge mit verstärkter Bremse - ABS; nicht für Fahrzeuge mit verstärkter Bremse		03.2122-0264.3 010129 24.2120-0702.3 010361	ATE Ø 22,2 Ø 20,64
1.6 1.6 i 2.0 i 16V	55 55 100	09/95→09/98 03/92→09/98 02/95→09/98		+ ABS		03.2122-0282.3 010130	ATE Ø 22,2
1.6 i 1.7 TD 1.7 TDS 1.8 i	52 50 60 66	05/93→07/96 11/94→09/98 03/92→09/98 03/92→09/98		+ ABS - ABS		03.2122-0282.3 010130 24.2120-0702.3 010361	ATE Ø 22,2 Ø 20,64
1.6 i 16V 1.8 i 16V 1.8 i 16V 1.8 i 16V 2.0 i	74 82 85 85 85	08/94→09/98 09/95→09/96 11/94→09/98 09/95→08/97 03/92→09/98		- ABS + ABS		03.2122-0264.3 010129 03.2122-0282.3 010130	ATE Ø 22,2 ATE Ø 22,2
 Bremskraftregler							
1.4 i	44	09/91→09/98		10/91→		03.0101-0027.2 320022	ATE Satz 3/45 2x
1.4 i 16V 1.4 Si	66 60	02/96→09/98 03/92→09/98		Schaltgetriebe		03.0101-0027.2 320022	ATE Satz 3/45 2x
↓							

	kw			 	! #		
OPEL - ASTRA F (56_, 57_) 09/91→09/98							
 Bremskraftregler							
1.6	55	09/95→09/98		R2500001→ T2526383		03.0101-0025.2 320014	ATE Satz 3/35 2x
1.6 i	52	05/93→07/96		→ R2500000		03.0101-0027.2 320022	ATE Satz 3/45 2x
1.6 i	55	03/92→09/98		T2526384→		03.0101-0031.2 320211	ATE Satz 3/30 2x
1.6 i 16V	74	08/94→09/98				03.6583-0054.3 320146	ATE lastabhängig 8/3 4x
						03.6585-0018.3 320114	ATE lastabhängig 8/5 4x
1.7 D	44	07/92→09/98		→ 07/93		03.0101-0026.2 320230	ATE Satz 3/40 2x
				08/93→		03.0101-0031.2 320211	ATE Satz 3/30 2x
1.7 TD	50	11/94→09/98		für Fahrzeuge mit verstärkter Bremse		03.0101-0025.2 320014	ATE Satz 3/35 2x
				nicht für Fahrzeuge mit verstärkter Bremse		03.0101-0032.2 320231	ATE Satz 3/25 2x
1.7 TDS	60	03/92→09/98		08/93→; für Fahrzeuge mit verstärkter Bremse		03.0101-0025.2 320014	ATE Satz 3/35 2x
				→ 07/93		03.0101-0025.2 320014	ATE Satz 3/35 2x
				08/93→; nicht für Fahrzeuge mit verstärkter Bremse		03.0101-0032.2 320231	ATE Satz 3/25 2x
1.8 i	66	03/92→09/98		→ 07/93		03.0101-0027.2 320022	ATE Satz 3/45 2x
2.0 i	85	03/92→09/98		08/93→		03.6583-0054.3 320146	ATE lastabhängig 8/3 4x
2.0 i 16V	100	02/95→09/98				03.6583-0054.3 320146	ATE lastabhängig 8/3 4x
OPEL - ASTRA F Cabriolet (53_B) 03/93→03/01							
 Hauptbremszylinder							
1.4 i 16V	66	01/96→03/01		→ 09/98; - ABS; für Fahrzeuge mit verstärkter Bremse		03.2122-0264.3 010129	ATE Ø 22,2
1.4 Si	60	05/93→03/01		→ 09/98; + ABS		03.2122-0282.3 010130	ATE Ø 22,2
				→ 09/98; - ABS; nicht für Fahrzeuge mit verstärkter Bremse		24.2120-0702.3 010361	Ø 20,64
1.6 i	52	03/93→08/96		- ABS		24.2120-0702.3 010361	Ø 20,64
1.6 i	55	01/96→03/01		→ 09/98; + ABS		03.2122-0282.3 010130	ATE Ø 22,2
1.8 i 16V	85	11/94→03/01		→ 09/98; - ABS		03.2122-0264.3 010129	ATE Ø 22,2
				→ 09/98; + ABS		03.2122-0282.3 010130	ATE Ø 22,2
 Bremskraftregler							
1.6 i	52	03/93→08/96		R2500001→ T2526383		03.0101-0025.2 320014	ATE Satz 3/35 2x
1.6 i	55	01/96→03/01		→ R2500000		03.0101-0027.2 320022	ATE Satz 3/45 2x
				T2526384→		03.0101-0031.2 320211	ATE Satz 3/30 2x
OPEL - ASTRA F Caravan (51_, 52_) 09/91→01/98							
 Hauptbremszylinder							
1.4 i	44	09/91→01/98		10/91→; + ABS		03.2122-0282.3 010130	ATE Ø 22,2
1.8 i	66	09/91→01/98		10/91→; - ABS		24.2120-0702.3 010361	Ø 20,64
1.4 i 16V	66	02/96→01/98		- ABS;		03.2122-0264.3 010129	ATE Ø 22,2
1.4 Si	60	03/92→01/98		für Fahrzeuge mit verstärkter Bremse			
1.7 D	44	07/92→01/98		+ ABS		03.2122-0282.3 010130	ATE Ø 22,2
				- ABS; nicht für Fahrzeuge mit verstärkter Bremse		24.2120-0702.3 010361	Ø 20,64
1.6	55	09/95→01/98		+ ABS		03.2122-0282.3 010130	ATE Ø 22,2
1.6 i	52	05/93→07/96		+ ABS		03.2122-0282.3 010130	ATE Ø 22,2
1.7 TD	50	11/94→01/98		- ABS		24.2120-0702.3 010361	Ø 20,64
1.7 TDS	60	12/91→01/98					
1.6 i	55	09/91→01/98		10/91→; + ABS		03.2122-0282.3 010130	ATE Ø 22,2
1.6 i 16V	74	08/94→01/98		- ABS		03.2122-0264.3 010129	ATE Ø 22,2
1.8 i 16V	85	07/94→01/98		+ ABS		03.2122-0282.3 010130	ATE Ø 22,2
1.8 i 16V	92	06/93→01/98					
OPEL - ASTRA F CC (53_, 54_, 58_, 59_) 09/91→01/98							
 Hauptbremszylinder							
1.4 i	44	03/92→01/98		+ ABS		03.2122-0282.3 010130	ATE Ø 22,2
1.6 i	52	05/93→07/96		- ABS		24.2120-0702.3 010361	Ø 20,64
1.7 TD	50	11/94→01/98					
1.7 TDS	60	12/91→01/98					
1.4 i 16V	66	01/96→01/98		- ABS;		03.2122-0264.3 010129	ATE Ø 22,2
1.4 Si	60	03/92→01/98		für Fahrzeuge mit verstärkter Bremse			
1.7 D	44	07/92→01/98		+ ABS		03.2122-0282.3 010130	ATE Ø 22,2
↓							

	kW					! #		
OPEL - ASTRA F CC (53_, 54_, 58_, 59_) 09/91→01/98								
 Hauptbremszylinder								
1.4 i 16V 1.4 Si 1.7 D	66 60 44	01/96→01/98 03/92→01/98 07/92→01/98		- ABS; nicht für Fahrzeuge mit verstärkter Bremsen			24.2120-0702.3 010361	Ø 20,64
1.6 2.0 i 16V	55 100	09/95→01/98 02/95→01/98		+ ABS			03.2122-0282.3 010130	ATE Ø 22,2
1.6 i 2.0 GSI 16V	55 110	09/91→01/98 09/91→01/98		10/91→; + ABS			03.2122-0282.3 010130	ATE Ø 22,2
1.6 i 16V 1.8 i 16V	74 85	08/94→01/98 09/94→01/98		- ABS + ABS			03.2122-0264.3 010129 03.2122-0282.3 010130	ATE Ø 22,2 ATE Ø 22,2
1.8 i	66	09/91→01/98		10/91→; + ABS 10/91→; - ABS			03.2122-0282.3 010130 24.2120-0702.3 010361	ATE Ø 22,2 Ø 20,64
2.0 i	85	09/91→01/98		10/91→; - ABS 10/91→; + ABS			03.2122-0264.3 010129 03.2122-0282.3 010130	ATE Ø 22,2 ATE Ø 22,2
 Bremskraftregler								
1.4 i	44	03/92→01/98					03.0101-0027.2 320022	ATE Satz 3/45 2x
1.4 i 16V 1.4 Si	66 60	01/96→01/98 03/92→01/98		Schaltgetriebe			03.0101-0027.2 320022	ATE Satz 3/45 2x
1.6 1.6 i	55 52	09/95→01/98 05/93→07/96		R2500001→ T2526383 → R2500000 T2526384→			03.0101-0025.2 320014 03.0101-0027.2 320022 03.0101-0031.2 320211	ATE Satz 3/35 2x ATE Satz 3/45 2x ATE Satz 3/30 2x
1.6 i	55	09/91→01/98		R2500001→ T2526383 10/91→; → R2500000 T2526384→			03.0101-0025.2 320014 03.0101-0027.2 320022 03.0101-0031.2 320211	ATE Satz 3/35 2x ATE Satz 3/45 2x ATE Satz 3/30 2x
1.6 i 16V	74	08/94→01/98					03.6583-0054.3 320146 03.6585-0018.3 320114	ATE lastabhängig 8/3 4x ATE lastabhängig 8/5 4x
1.7 D	44	07/92→01/98		→ 07/93 08/93→			03.0101-0026.2 320230 03.0101-0031.2 320211	ATE Satz 3/40 2x ATE Satz 3/30 2x
1.7 TD	50	11/94→01/98		für Fahrzeuge mit verstärkter Bremse nicht für Fahrzeuge mit verstärkter Bremsen			03.0101-0025.2 320014 03.0101-0032.2 320231	ATE Satz 3/35 2x ATE Satz 3/25 2x
1.7 TDS	60	12/91→01/98		08/93→; für Fahrzeuge mit verstärkter Bremse → 07/93 08/93→; nicht für Fahrzeuge mit verstärkter Bremsen			03.0101-0025.2 320014 03.0101-0025.2 320014 03.0101-0032.2 320231	ATE Satz 3/35 2x ATE Satz 3/35 2x ATE Satz 3/25 2x
1.8 i 2.0 i	66 85	09/91→01/98 09/91→01/98		10/91→ 07/93 08/93→			03.0101-0027.2 320022 03.6583-0054.3 320146	ATE Satz 3/45 2x ATE lastabhängig 8/3 4x
2.0 GSI 16V 2.0 i 16V	110 100	09/91→01/98 02/95→01/98		08/92→			03.6583-0054.3 320146 03.6583-0054.3 320146	ATE lastabhängig 8/3 4x ATE lastabhängig 8/3 4x
OPEL - ASTRA F CLASSIC Caravan 01/98→01/05								
 Hauptbremszylinder								
1.4 i 1.6 i	44 55	01/98→01/05 01/98→01/05					24.2120-0702.3 010361	Ø 20,64
OPEL - ASTRA F CLASSIC CC 01/98→08/02								
 Hauptbremszylinder								
1.4 i 1.6 i	44 55	01/98→08/02 01/98→08/02		+ ABS - ABS			03.2122-0282.3 010130 24.2120-0702.3 010361	ATE Ø 22,2 Ø 20,64
1.6 i 16V	74	01/98→08/02		+ ABS			03.2122-0282.3 010130	ATE Ø 22,2
 Bremskraftregler								
1.4 i 1.6 i 1.6 i 16V	44 55 74	01/98→08/02 01/98→08/02 01/98→08/02					03.0101-0031.2 320211 03.6583-0054.3 320146	ATE Satz 3/30 2x ATE lastabhängig 8/3 4x
OPEL - ASTRA F CLASSIC Stufenheck 01/98→08/02								
 Hauptbremszylinder								
1.4 i 1.6 i	44 55	01/98→08/02 01/98→08/02		+ ABS - ABS			03.2122-0282.3 010130 24.2120-0702.3 010361	ATE Ø 22,2 Ø 20,64
1.6 i 16V ↓	74	01/98→08/02		+ ABS			03.2122-0282.3 010130	ATE Ø 22,2

	kw					! #		
OPEL - ASTRA F CLASSIC Stufenheck 01/98→08/02								
 Bremskraftregler								
1.4 i	44	01/98→08/02					03.0101-0031.2 320211	ATE Satz 3/30 2x
1.6 i	55	01/98→08/02						
1.6 i 16V	74	01/98→08/02					03.6583-0054.3 320146	ATE lastabhängig 8/3 4x
OPEL - ASTRA F Van (55_) 10/91→01/99								
 Hauptbremszylinder								
1.4 i	44	10/91→01/99		→ 09/98; + ABS			03.2122-0282.3 010130	ATE Ø 22,2
1.6 i	52	02/93→07/96		+ ABS			03.2122-0282.3 010130	ATE Ø 22,2
				- ABS			24.2120-0702.3 010361	Ø 20,64
1.6 i 16V	74	08/94→03/98		- ABS			03.2122-0264.3 010129	ATE Ø 22,2
				+ ABS			03.2122-0282.3 010130	ATE Ø 22,2
1.7 D	44	07/92→01/99		→ 09/98; - ABS; für Fahrzeuge mit verstärkter Bremse			03.2122-0264.3 010129	ATE Ø 22,2
				→ 09/98; + ABS			03.2122-0282.3 010130	ATE Ø 22,2
				→ 09/98; - ABS; nicht für Fahrzeuge mit verstärkter Bremse			24.2120-0702.3 010361	Ø 20,64
1.7 TD	50	08/94→01/99		→ 09/98; + ABS			03.2122-0282.3 010130	ATE Ø 22,2
				→ 09/98; - ABS			24.2120-0702.3 010361	Ø 20,64
OPEL - ASTRA G Cabriolet (F67) 03/01→10/05								
 Hauptbremszylinder								
1.6	76	01/03→10/05		- ESP			24.2123-1734.3 010640	TRW Ø 23,81
1.6 16V	74	03/01→10/05		+ ESP			24.2123-1739.3 010661	Ø 23,81
1.8 16V	92	03/01→10/05						
2.0 16V Turbo	147	11/02→10/05						
2.0 OPC	141	03/02→10/05						
2.2 16V	108	03/01→10/05						
2.2 DTI	92	09/02→10/05		- ESP			24.2123-1734.3 010640	TRW Ø 23,81
OPEL - ASTRA G Caravan (F35_) 02/98→12/09								
 Hauptbremszylinder								
1.2 16V	48	02/98→09/00		04/98→; - ESP; für Fahrzeuge mit Scheibenbremse an der Hinterachse			24.2123-1734.3 010640	TRW Ø 23,81
1.6	55	02/98→09/00						
1.6 16V	74	02/98→07/04						
				22000001→; - ESP; für Fahrzeuge mit Trommelbremse an der Hinterachse			24.2123-1734.3 010640	TRW Ø 23,81
				04/98→; + ESP			24.2123-1739.3 010661	Ø 23,81
1.2 16V	55	09/00→07/04		- ESP; für Fahrzeuge mit Scheibenbremse an der Hinterachse			24.2123-1734.3 010640	TRW Ø 23,81
1.4 16V	66	06/98→07/04						
1.6	62	09/00→07/04						
1.6	76	12/02→07/09						
1.7 DTI 16V	55	02/00→07/04		22000001→; - ESP; für Fahrzeuge mit Trommelbremse an der Hinterachse			24.2123-1734.3 010640	TRW Ø 23,81
				+ ESP			24.2123-1739.3 010661	Ø 23,81
1.4	66	10/04→12/09		09/07→; - ESP			24.2123-1734.3 010640	TRW Ø 23,81
				09/07→; + ESP			24.2123-1739.3 010661	Ø 23,81
1.6 CNG	71	03/03→07/04		- ESP			24.2123-1734.3 010640	TRW Ø 23,81
1.8 16V	92	09/00→07/04		+ ESP			24.2123-1739.3 010661	Ø 23,81
2.0 DTI 16V	74	08/99→07/04						
2.0 OPC	141	09/02→07/04						
2.0 OPC	147	11/02→07/04						
2.2 16V	108	03/01→07/04						
2.2 DTI	86	09/02→07/04						
2.2 DTI	92	09/02→07/04						
1.7 CDTI	59	04/03→07/09		- ESP			24.2123-1734.3 010640	TRW Ø 23,81
1.7 TD	50	02/98→08/00		04/98→; - ESP; für Fahrzeuge mit Scheibenbremse an der Hinterachse			24.2123-1734.3 010640	TRW Ø 23,81
				04/98→; + ESP			24.2123-1739.3 010661	Ø 23,81
1.8 16V	85	02/98→09/00		04/98→; - ESP			24.2123-1734.3 010640	TRW Ø 23,81
2.0 16V	100	02/98→07/04		04/98→; + ESP			24.2123-1739.3 010661	Ø 23,81
2.0 DI	60	02/98→07/04						
 Bremskraftregler								
1.2 16V	48	02/98→09/00		04/98→; - ABS			03.6583-0073.3 320234	ATE lastabhängig 8/3 4x
1.6	55	02/98→09/00						
1.6 16V	74	02/98→07/04						
1.7 TD	50	02/98→08/00						
1.8 16V	85	02/98→09/00						
↓								

	kw			 	! #		
OPEL - ASTRA G Caravan (F35_) 02/98→12/09							
 Bremskraftregler							
2.0 16V	100	02/98→07/04		04/98→; - ABS		03.6583-0073.3 320234	ATE lastabhängig 8/3 4x
1.2 16V	55	09/00→07/04		- ABS		03.6583-0073.3 320234	ATE lastabhängig 8/3 4x
1.4 16V	66	06/98→07/04					
1.6	62	09/00→07/04					
1.6	76	12/02→07/09					
1.6 CNG	71	03/03→07/04					
1.7 CDTI	59	04/03→07/09					
1.7 DTI 16V	55	02/00→07/04					
1.8 16V	92	09/00→07/04					
1.4	66	10/04→12/09		09/07→; - ABS		03.6583-0073.3 320234	ATE lastabhängig 8/3 4x
2.0 DI	60	02/98→07/04		04/98→; - ABS		03.6583-0074.3 320235	ATE lastabhängig 8/3 4x
2.0 DTI 16V	74	08/99→07/04		- ABS		03.6583-0074.3 320235	ATE lastabhängig 8/3 4x
OPEL - ASTRA G CC (F48_, F08_) 02/98→12/09							
 Hauptbremszylinder							
1.2 16V	48	02/98→09/00		04/98→; - ESP; für Fahrzeuge mit Scheibenbremse an der Hinterachse		24.2123-1734.3 010640	TRW Ø 23,81
1.4 16V	66	02/98→01/05					
1.6	55	02/98→09/00					
1.6 16V	74	02/98→01/05		22000001→; - ESP; für Fahrzeuge mit Trommelbremse an der Hinterachse		24.2123-1734.3 010640	TRW Ø 23,81
				04/98→; + ESP		24.2123-1739.3 010661	Ø 23,81
1.2 16V	55	09/00→01/05		- ESP; für Fahrzeuge mit Scheibenbremse an der Hinterachse		24.2123-1734.3 010640	TRW Ø 23,81
1.4	66	09/07→12/09					
1.6	62	09/00→01/05					
1.6	76	12/02→12/09					
1.7 DTI 16V	55	02/00→01/05		22000001→; - ESP; für Fahrzeuge mit Trommelbremse an der Hinterachse		24.2123-1734.3 010640	TRW Ø 23,81
				+ ESP		24.2123-1739.3 010661	Ø 23,81
1.7 CDTI	59	04/03→12/09		- ESP		24.2123-1734.3 010640	TRW Ø 23,81
1.7 TD	50	02/98→08/00		04/98→; - ESP; für Fahrzeuge mit Scheibenbremse an der Hinterachse		24.2123-1734.3 010640	TRW Ø 23,81
				04/98→; + ESP		24.2123-1739.3 010661	Ø 23,81
1.8 16V	85	02/98→09/00		04/98→; - ESP		24.2123-1734.3 010640	TRW Ø 23,81
2.0 16V	100	02/98→01/05					
2.0 DI	60	02/98→01/05		04/98→; + ESP		24.2123-1739.3 010661	Ø 23,81
1.8 16V	92	09/00→01/05		- ESP		24.2123-1734.3 010640	TRW Ø 23,81
2.0 16V OPC	118	11/99→09/02					
2.0 DTI 16V	74	08/99→01/05		+ ESP		24.2123-1739.3 010661	Ø 23,81
2.0 OPC	141	09/02→01/05					
2.0 OPC	147	11/02→01/05					
2.2 DTI	86	09/02→01/05					
2.2 DTI	92	09/02→01/05					
2.2 16V	108	06/00→01/05		09/00→; - ESP		24.2123-1734.3 010640	TRW Ø 23,81
				09/00→; + ESP		24.2123-1739.3 010661	Ø 23,81
 Bremskraftregler							
1.2 16V	48	02/98→09/00		04/98→; - ABS		03.6583-0073.3 320234	ATE lastabhängig 8/3 4x
1.2 16V	55	09/00→01/05		- ABS		03.6583-0073.3 320234	ATE lastabhängig 8/3 4x
1.4 16V	66	02/98→01/05		04/98→; - ABS		03.6583-0074.3 320235	ATE lastabhängig 8/3 4x
1.6	55	02/98→09/00					
1.6 16V	74	02/98→01/05					
1.7 TD	50	02/98→08/00					
1.8 16V	85	02/98→09/00					
2.0 16V	100	02/98→01/05					
2.0 DI	60	02/98→01/05					
1.6	62	09/00→01/05		- ABS		03.6583-0074.3 320235	ATE lastabhängig 8/3 4x
1.6	76	12/02→12/09					
1.7 CDTI	59	04/03→12/09					
1.7 DTI 16V	55	02/00→01/05					
1.8 16V	92	09/00→01/05					
2.0 DTI 16V	74	08/99→01/05					
OPEL - ASTRA G Coupe (F07_) 03/00→05/05							
 Hauptbremszylinder							
1.6 16V	74	03/00→05/05		- ESP; für Fahrzeuge mit Scheibenbremse an der Hinterachse		24.2123-1734.3 010640	TRW Ø 23,81
1.6 16V	76	03/00→05/05		22000001→; - ESP; für Fahrzeuge mit Trommelbremse an der Hinterachse		24.2123-1734.3 010640	TRW Ø 23,81
				+ ESP		24.2123-1739.3 010661	Ø 23,81
↓							

	kW			 	! #		
OPEL - ASTRA G Coupe (F07_) 03/00→05/05							
 Hauptbremszylinder							
1.8 16V	85	03/00→10/00		- ESP		24.2123-1734.3 010640	TRW Ø 23,81
1.8 16V	92	09/00→05/05		+ ESP		24.2123-1739.3 010661	Ø 23,81
2.0 16V Turbo	140	09/00→08/01					
2.0 16V Turbo	141	08/01→05/05					
2.0 16V Turbo	147	11/02→05/05					
2.2 16V	108	09/00→05/05					
2.2 DTI	92	09/02→05/05					
OPEL - ASTRA G Kasten (F70) 01/99→04/05							
 Hauptbremszylinder							
1.6	55	01/99→09/00		- ESP; für Fahrzeuge mit Scheibenbremse an der Hinterachse		24.2123-1734.3 010640	TRW Ø 23,81
1.6	62	09/00→04/05					
1.6	76	10/04→04/05					
1.7 DTI 16V	55	02/00→04/05		22000001→; - ESP; für Fahrzeuge mit Trommelbremse an der Hinterachse		24.2123-1734.3 010640	TRW Ø 23,81
				+ ESP		24.2123-1739.3 010661	Ø 23,81
1.7 TD	50	01/99→04/05		- ESP; für Fahrzeuge mit Scheibenbremse an der Hinterachse		24.2123-1734.3 010640	TRW Ø 23,81
				+ ESP		24.2123-1739.3 010661	Ø 23,81
2.0 DI	60	01/99→04/05		- ESP		24.2123-1734.3 010640	TRW Ø 23,81
				+ ESP		24.2123-1739.3 010661	Ø 23,81
 Bremskraftregler							
1.6	55	01/99→09/00		- ABS		03.6583-0073.3 320234	ATE lastabhängig 8/3 4x
1.6	62	09/00→04/05					
1.6	76	10/04→04/05					
1.7 TD	50	01/99→04/05					
2.0 DI	60	01/99→04/05		- ABS		03.6583-0074.3 320235	ATE lastabhängig 8/3 4x
OPEL - ASTRA G Stufenheck (F69_) 09/98→12/09							
 Hauptbremszylinder							
1.2 16V	48	09/98→09/00		- ESP; für Fahrzeuge mit Scheibenbremse an der Hinterachse		24.2123-1734.3 010640	TRW Ø 23,81
1.2 16V	55	09/00→01/05					
1.4 16V	66	09/98→01/05					
1.6	55	09/98→09/00		22000001→; - ESP; für Fahrzeuge mit Trommelbremse an der Hinterachse		24.2123-1734.3 010640	TRW Ø 23,81
1.6	62	09/00→01/05					
1.6	76	12/02→12/09					
1.6 16V	74	09/98→01/05		+ ESP		24.2123-1739.3 010661	Ø 23,81
1.7 DTI 16V	55	02/00→01/05					
1.4	66	09/07→12/09		- ESP		24.2123-1734.3 010640	TRW Ø 23,81
1.8 16V	85	09/98→09/00		+ ESP		24.2123-1739.3 010661	Ø 23,81
1.8 16V	92	06/00→01/05					
2.0 16V	100	09/98→01/05					
2.0 DI	60	09/98→01/05					
2.0 DTI 16V	74	08/99→01/05					
2.2 16V	108	03/01→01/05					
2.2 DTI	86	09/02→01/05					
2.2 DTI	92	09/02→01/05					
1.7 CDTI	59	04/03→12/09		- ESP		24.2123-1734.3 010640	TRW Ø 23,81
1.7 TD	50	09/98→08/00		- ESP; für Fahrzeuge mit Scheibenbremse an der Hinterachse		24.2123-1734.3 010640	TRW Ø 23,81
				+ ESP		24.2123-1739.3 010661	Ø 23,81
 Bremskraftregler							
1.2 16V	48	09/98→09/00		- ABS		03.6583-0073.3 320234	ATE lastabhängig 8/3 4x
1.2 16V	55	09/00→01/05					
1.4	66	09/07→12/09		- ABS		03.6583-0074.3 320235	ATE lastabhängig 8/3 4x
1.4 16V	66	09/98→01/05					
1.6	55	09/98→09/00					
1.6	62	09/00→01/05					
1.6	76	12/02→12/09					
1.6 16V	74	09/98→01/05					
1.7 CDTI	59	04/03→12/09					
1.7 DTI 16V	55	02/00→01/05					
1.7 TD	50	09/98→08/00					
1.8 16V	85	09/98→09/00					
1.8 16V	92	06/00→01/05					
2.0 16V	100	09/98→01/05					
2.0 DI	60	09/98→01/05					
2.0 DTI 16V	74	08/99→01/05					

OPEL - ASTRA H (L48) 01/04 → 05/14

 **Bremskraftverstärker**

1.9 CDTI	74	09/05 → 10/10	für Linkslenker	03.7863-7803.4	300237	ATE Ø 10" pneumatisch
1.9 CDTI	110	09/04 → 10/10				
1.9 CDTI	88	06/04 → 10/10	09/04 →; für Linkslenker	03.7863-7803.4	300237	ATE Ø 10" pneumatisch
1.9 CDTI 16V	88	04/04 → 10/10				

 **Hauptbremszylinder**

1.2	59	08/05 → 10/10	für Rechtslenker; → 68999999	24.2125-1736.3	010904	TRW Ø 25,4
1.3 CDTI	66	08/05 → 10/10	für Linkslenker; → 68999999; + ESP	24.2125-1736.3	010904	TRW Ø 25,4
1.4	55	04/04 → 10/04				
1.4	66	03/04 → 10/10	für Linkslenker; → 68999999; - ESP	24.2125-1737.3	010906	TRW Ø 25,4
1.4 LPG	66	08/09 → 10/10				
1.6	77	03/04 → 10/10	72000001 →; für Linkslenker; + ESP	24.4125-1703.3	010907	TRW Ø 25,4
1.6 Turbo	132	02/07 → 10/10	72000001 →; für Rechtslenker	24.4125-1703.3	010907	TRW Ø 25,4
1.7 CDTI	59	03/04 → 10/10	72000001 →; für Linkslenker; - ESP	24.4125-1704.3	010908	TRW Ø 25,4
1.7 CDTI	74	03/04 → 10/10				
1.8	92	01/04 → 10/10				
1.8	103	01/06 → 10/10				
2.0 Turbo	125	03/04 → 10/10				
2.0 Turbo	147	09/04 → 10/10				
2.0 Turbo	177	03/05 → 10/10				
1.6	85	12/06 → 05/14	01/07 →; → 68999999; für Rechtslenker	24.2125-1736.3	010904	TRW Ø 25,4
			01/07 →; → 68999999; für Linkslenker; + ESP	24.2125-1736.3	010904	TRW Ø 25,4
			01/07 →; → 68999999; für Linkslenker; - ESP	24.2125-1737.3	010906	TRW Ø 25,4
			72000001 →; → 11/10; für Linkslenker; + ESP	24.4125-1703.3	010907	TRW Ø 25,4
			72000001 →; → 11/10; für Rechtslenker	24.4125-1703.3	010907	TRW Ø 25,4
			72000001 →; → 11/10; für Linkslenker; - ESP	24.4125-1704.3	010908	TRW Ø 25,4
1.7 CDTI	81	02/07 → 05/14	04/07 →; → 68999999; für Rechtslenker	24.2125-1736.3	010904	TRW Ø 25,4
1.7 CDTI	92	02/07 → 05/14	04/07 →; → 68999999; für Linkslenker; + ESP	24.2125-1736.3	010904	TRW Ø 25,4
			04/07 →; → 68999999; für Linkslenker; - ESP	24.2125-1737.3	010906	TRW Ø 25,4
			72000001 →; → 11/10; für Rechtslenker	24.4125-1703.3	010907	TRW Ø 25,4
			72000001 →; → 11/10; für Linkslenker; + ESP	24.4125-1703.3	010907	TRW Ø 25,4
			72000001 →; → 11/10; für Linkslenker; - ESP	24.4125-1704.3	010908	TRW Ø 25,4
1.9 CDTI	74	09/05 → 10/10		03.4155-0156.3	010862	ATE Ø 25,4
1.9 CDTI	110	09/04 → 10/10				
1.9 CDTI	88	06/04 → 10/10	09/04 →	03.4155-0156.3	010862	ATE Ø 25,4
1.9 CDTI 16V	88	04/04 → 10/10				













OPEL - ASTRA H Caravan (L35) 08/04 → 05/14











 **Bremskraftverstärker**













1.9 CDTI	74	09/05 → 10/10	für Linkslenker	03.7863-7803.4	300237	ATE Ø 10" pneumatisch
1.9 CDTI	88	09/05 → 10/10				
1.9 CDTI	110	09/04 → 10/10				
1.9 CDTI 16V	88	08/04 → 10/10				













 **Hauptbremszylinder**















1.3 CDTI	66	08/05 → 10/10	72000001 →; für Linkslenker; + ESP	24.2125-1703.3	010483	Ø 25,4
1.4	55	08/04 → 10/10	72000001 →; für Linkslenker; - ESP	24.2125-1704.3	010446	TRW Ø 25,4
1.4	66	08/04 → 10/10				
1.4 LPG	66	08/09 → 10/10	für Rechtslenker; → 62999999	24.2125-1736.3	010904	TRW Ø 25,4
1.6	77	08/04 → 10/10	→ 68999999; für Linkslenker; + ESP	24.2125-1736.3	010904	TRW Ø 25,4
1.6 LPG	85	08/09 → 10/10				
1.6 Turbo	132	02/07 → 10/10	→ 68999999; für Linkslenker; - ESP	24.2125-1737.3	010906	TRW Ø 25,4
1.7 CDTI	59	08/04 → 10/10	72000001 →; für Rechtslenker	24.4125-1703.3	010907	TRW Ø 25,4
1.7 CDTI	74	08/04 → 10/10				
1.8	92	08/04 → 10/10				
1.8	103	08/05 → 10/10				
2.0 Turbo	125	08/04 → 10/10				
2.0 Turbo	147	09/04 → 10/10				
1.6	85	12/06 → 05/14	72000001 →; → 11/10; für Linkslenker; + ESP	24.2125-1703.3	010483	Ø 25,4
			72000001 →; → 11/10; für Linkslenker; - ESP	24.2125-1704.3	010446	TRW Ø 25,4
			01/07 →; → 68999999; für Linkslenker; + ESP	24.2125-1736.3	010904	TRW Ø 25,4
			01/07 →; → 62999999; für Rechtslenker	24.2125-1736.3	010904	TRW Ø 25,4
			01/07 →; → 68999999; für Linkslenker; - ESP	24.2125-1737.3	010906	TRW Ø 25,4
			72000001 →; → 11/10; für Rechtslenker	24.4125-1703.3	010907	TRW Ø 25,4













	kw			 	! #		
OPEL - ASTRA H Caravan (L35) 08/04→05/14							
 Hauptbremszylinder							
1.7 CDTi 1.7 CDTi	81 92	02/07→05/14 02/07→05/14		72000001→; → 11/10; für Linkslenker; + ESP		24.2125-1703.3 010483	Ø 25,4
				72000001→; → 11/10; für Linkslenker; - ESP		24.2125-1704.3 010446	TRW Ø 25,4
				04/07→; → 68999999; für Linkslenker; + ESP		24.2125-1736.3 010904	TRW Ø 25,4
				04/07→; → 62999999; für Rechtslenker		24.2125-1736.3 010904	TRW Ø 25,4
				04/07→; → 68999999; für Linkslenker; - ESP		24.2125-1737.3 010906	TRW Ø 25,4
				72000001→; → 11/10; für Rechtslenker		24.4125-1703.3 010907	TRW Ø 25,4
1.9 CDTi 1.9 CDTi 1.9 CDTi 1.9 CDTi 16V	74 88 110 88	09/05→10/10 09/05→10/10 09/04→10/10 08/04→10/10				03.4155-0156.3 010862	ATE Ø 25,4
OPEL - ASTRA H GTC (L08) 03/05→10/10							
 Bremskraftverstärker							
1.9 CDTi 1.9 CDTi 1.9 CDTi 1.9 CDTi 16V	110 74 88 88	03/05→10/10 01/06→10/10 09/05→10/10 03/05→10/10		für Linkslenker		03.7863-7803.4 300237	ATE Ø 10" pneumatisch
 Hauptbremszylinder							
1.2 1.4 1.4 1.6 1.6 Turbo 1.7 CDTi 1.7 CDTi 1.8 1.8 2.0 Turbo 2.0 Turbo 2.0 Turbo	59 55 66 77 132 74 59 92 103 125 147 177	08/05→10/10 03/05→10/10 03/05→10/10 03/05→10/10 02/07→10/10 03/05→10/10 03/05→10/10 03/05→10/10 01/06→10/10 03/05→10/10 03/05→10/10 08/05→10/10		für Rechtslenker; → 68999999 für Linkslenker; → 68999999; + ESP für Linkslenker; → 68999999; - ESP 72000001→; für Linkslenker; + ESP 72000001→; für Rechtslenker 72000001→; für Linkslenker; - ESP		24.2125-1736.3 010904 24.2125-1736.3 010904 24.2125-1737.3 010906 24.4125-1703.3 010907 24.4125-1703.3 010907 24.4125-1704.3 010908	TRW Ø 25,4 TRW Ø 25,4 TRW Ø 25,4 TRW Ø 25,4 TRW Ø 25,4 TRW Ø 25,4 TRW Ø 25,4
1.3 CDTi	66	04/05→10/10		08/05→; → 68999999; für Linkslenker; + ESP 08/05→; → 68999999; für Rechtslenker 08/05→; → 68999999; für Linkslenker; - ESP 72000001→; für Linkslenker; + ESP 72000001→; für Rechtslenker 72000001→; für Linkslenker; - ESP		24.2125-1736.3 010904 24.2125-1736.3 010904 24.2125-1737.3 010906 24.4125-1703.3 010907 24.4125-1703.3 010907 24.4125-1704.3 010908	TRW Ø 25,4 TRW Ø 25,4 TRW Ø 25,4 TRW Ø 25,4 TRW Ø 25,4 TRW Ø 25,4
1.6	85	12/06→10/10		01/07→; → 68999999; für Rechtslenker 01/07→; → 68999999; für Linkslenker; + ESP 01/07→; → 68999999; für Linkslenker; - ESP 72000001→; für Linkslenker; + ESP 72000001→; für Rechtslenker 72000001→; für Linkslenker; - ESP		24.2125-1736.3 010904 24.2125-1736.3 010904 24.2125-1737.3 010906 24.4125-1703.3 010907 24.4125-1703.3 010907 24.4125-1704.3 010908	TRW Ø 25,4 TRW Ø 25,4 TRW Ø 25,4 TRW Ø 25,4 TRW Ø 25,4 TRW Ø 25,4
1.7 CDTi 1.7 CDTi	81 92	02/07→10/10 02/07→10/10		04/07→; → 68999999; für Rechtslenker 04/07→; → 68999999; für Linkslenker; + ESP 04/07→; → 68999999; für Linkslenker; - ESP 72000001→; für Rechtslenker 72000001→; für Linkslenker; + ESP 72000001→; für Linkslenker; - ESP		24.2125-1736.3 010904 24.2125-1736.3 010904 24.2125-1737.3 010906 24.4125-1703.3 010907 24.4125-1703.3 010907 24.4125-1704.3 010908	TRW Ø 25,4 TRW Ø 25,4 TRW Ø 25,4 TRW Ø 25,4 TRW Ø 25,4 TRW Ø 25,4
1.9 CDTi 1.9 CDTi 1.9 CDTi 1.9 CDTi 16V	110 74 88 88	03/05→10/10 01/06→10/10 09/05→10/10 03/05→10/10				03.4155-0156.3 010862	ATE Ø 25,4
OPEL - ASTRA H Kasten (L70) 02/04→12/13							
 Bremskraftverstärker							
1.9 CDTi 1.9 CDTi 1.9 CDTi 16V	88 110 88	09/05→10/10 09/04→10/10 08/04→10/10		für Linkslenker		03.7863-7803.4 300237	ATE Ø 10" pneumatisch
 Hauptbremszylinder							
1.3 CDTi ↓	66	08/05→10/10		72000001→; für Linkslenker; + ESP		24.2125-1703.3 010483	Ø 25,4

	kw			 	! #		
OPEL - ASTRA H Kasten (L70) 02/04→12/13							
 Hauptbremszylinder							
1.3 CDTI	66	08/05→10/10		72000001→; für Linkslenker; - ESP		24.2125-1704.3 010446	TRW Ø 25,4
				→ 62999999; für Rechtslenker		24.2125-1736.3 010904	TRW Ø 25,4
				→ 68999999; für Linkslenker; + ESP		24.2125-1736.3 010904	TRW Ø 25,4
				→ 68999999; für Linkslenker; - ESP		24.2125-1737.3 010906	TRW Ø 25,4
				72000001→; für Rechtslenker		24.4125-1703.3 010907	TRW Ø 25,4
1.7 CDTI	74	03/04→10/10		72000001→; für Linkslenker; + ESP		24.2125-1703.3 010483	Ø 25,4
				72000001→; für Linkslenker; - ESP		24.2125-1704.3 010446	TRW Ø 25,4
				08/04→; → 68999999; für Linkslenker; + ESP		24.2125-1736.3 010904	TRW Ø 25,4
				08/04→; → 62999999; für Rechtslenker		24.2125-1736.3 010904	TRW Ø 25,4
				08/04→; → 68999999; für Linkslenker; - ESP		24.2125-1737.3 010906	TRW Ø 25,4
				72000001→; für Rechtslenker		24.4125-1703.3 010907	TRW Ø 25,4
1.7 CDTI	81	02/07→10/10		72000001→; für Linkslenker; + ESP		24.2125-1703.3 010483	Ø 25,4
1.7 CDTI	92	02/07→10/10		72000001→; für Linkslenker; - ESP		24.2125-1704.3 010446	TRW Ø 25,4
				04/07→; → 68999999; für Linkslenker; + ESP		24.2125-1736.3 010904	TRW Ø 25,4
				04/07→; → 62999999; für Rechtslenker		24.2125-1736.3 010904	TRW Ø 25,4
				04/07→; → 68999999; für Linkslenker; - ESP		24.2125-1737.3 010906	TRW Ø 25,4
				72000001→; für Rechtslenker		24.4125-1703.3 010907	TRW Ø 25,4
1.9 CDTI	88	09/05→10/10				03.4155-0156.3 010862	ATE Ø 25,4
1.9 CDTI	110	09/04→10/10					
1.9 CDTI 16V	88	08/04→10/10					
OPEL - ASTRA H Stufenheck (L69) 02/07→05/14							
 Hauptbremszylinder							
1.3 CDTi	66	02/07→10/10		→ 68999999; für Rechtslenker		24.2125-1736.3 010904	TRW Ø 25,4
1.7 CDTi	74	02/07→10/10		→ 68999999; für Linkslenker; + ESP		24.2125-1736.3 010904	TRW Ø 25,4
1.8	103	02/07→10/10		→ 68999999; für Linkslenker; - ESP		24.2125-1737.3 010906	TRW Ø 25,4
				72000001→; für Linkslenker; + ESP		24.4125-1703.3 010907	TRW Ø 25,4
				72000001→; für Rechtslenker		24.4125-1703.3 010907	TRW Ø 25,4
				72000001→; für Linkslenker; - ESP		24.4125-1704.3 010908	TRW Ø 25,4
1.6	85	02/07→05/14		→ 68999999; für Rechtslenker		24.2125-1736.3 010904	TRW Ø 25,4
				→ 68999999; für Linkslenker; + ESP		24.2125-1736.3 010904	TRW Ø 25,4
				→ 68999999; für Linkslenker; - ESP		24.2125-1737.3 010906	TRW Ø 25,4
				72000001→; → 11/10; für Rechtslenker		24.4125-1703.3 010907	TRW Ø 25,4
				72000001→; → 11/10; für Linkslenker; + ESP		24.4125-1703.3 010907	TRW Ø 25,4
				72000001→; → 11/10; für Linkslenker; - ESP		24.4125-1704.3 010908	TRW Ø 25,4
1.7 CDTi	81	02/07→05/14		04/07→; → 68999999; für Rechtslenker		24.2125-1736.3 010904	TRW Ø 25,4
1.7 CDTI	92	02/07→05/14		04/07→; → 68999999; für Linkslenker; + ESP		24.2125-1736.3 010904	TRW Ø 25,4
				04/07→; → 68999999; für Linkslenker; - ESP		24.2125-1737.3 010906	TRW Ø 25,4
				72000001→; → 11/10; für Rechtslenker		24.4125-1703.3 010907	TRW Ø 25,4
				72000001→; → 11/10; für Linkslenker; + ESP		24.4125-1703.3 010907	TRW Ø 25,4
				72000001→; → 11/10; für Linkslenker; - ESP		24.4125-1704.3 010908	TRW Ø 25,4
OPEL - ASTRA H TwinTop (L67) 09/05→10/10							
 Bremskraftverstärker							
1.9 CDTi	110	09/05→10/10		03/06→; für Linkslenker		03.7863-7803.4 300237	ATE Ø 10" pneumatisch
 Hauptbremszylinder							
1.6	77	09/05→10/10		03/06→; → 68999999; für Rechtslenker		24.2125-1736.3 010904	TRW Ø 25,4
1.8	92	09/05→10/10		03/06→; → 68999999; für Linkslenker; + ESP		24.2125-1736.3 010904	TRW Ø 25,4
1.8	103	09/05→10/10		03/06→; → 68999999; für Linkslenker; - ESP		24.2125-1737.3 010906	TRW Ø 25,4
2.0 Turbo	125	09/05→10/10		03/06→; → 68999999; für Linkslenker; - ESP		24.2125-1737.3 010906	TRW Ø 25,4
2.0 Turbo	147	09/05→10/10		03/06→; für Rechtslenker		24.4125-1703.3 010907	TRW Ø 25,4
				72000001→; für Linkslenker; + ESP		24.4125-1703.3 010907	TRW Ø 25,4
				72000001→; für Linkslenker; - ESP		24.4125-1704.3 010908	TRW Ø 25,4
1.6	85	12/06→10/10		→ 68999999; für Rechtslenker		24.2125-1736.3 010904	TRW Ø 25,4
↓							

















	kw					! #		
OPEL - ASTRA H TwinTop (L67) 09/05→10/10								
 Hauptbremszylinder								
1.6 Turbo	132	02/07→10/10		→ 68999999; für Linkslenker; + ESP	24.2125-1736.3	010904	TRW Ø 25,4	
				→ 68999999; für Linkslenker; - ESP	24.2125-1737.3	010906	TRW Ø 25,4	
				für Rechtslenker	24.4125-1703.3	010907	TRW Ø 25,4	
				72000001→; für Linkslenker; + ESP	24.4125-1703.3	010907	TRW Ø 25,4	
				72000001→; für Linkslenker; - ESP	24.4125-1704.3	010908	TRW Ø 25,4	
1.9 CDTi	110	09/05→10/10		03/06→; für Rechtslenker	03.4155-0156.3	010862	ATE Ø 25,4	
				03/06→; für Linkslenker; + ESP	03.4155-0156.3	010862	ATE Ø 25,4	
OPEL - ASTRA J 12/09→								
 Bremskraftverstärker								
1.3 CDTI	70	12/09→		für Linkslenker	03.7858-0732.4	300272	ATE Ø 9 / 8" pneumatisch	
1.4	64	12/09→						
1.4	74	12/09→						
1.4 LPG	103	01/12→						
1.4 Turbo	103	12/09→						
1.6	85	12/09→						
1.6 CDTi	81	02/14→						
1.6 CDTi	100	01/14→						
1.6 SIDI	125	12/12→						
1.6 Turbo	132	12/09→						
1.7 CDTI	74	10/10→						
1.7 CDTI	81	12/09→						
1.7 CDTI	92	12/09→						
1.7 CDTI	96	12/09→						
2.0 BiTurbo CDTI	143	12/12→						
2.0 CDTI	118	12/09→						
2.0 CDTI	121	06/11→						
1.4 Turbo	88	10/10→		11/10→; für Linkslenker	03.7858-0732.4	300272	ATE Ø 9 / 8" pneumatisch	
 Hauptbremszylinder								
1.3 CDTI	70	12/09→		für Linkslenker	03.2125-0421.3	010934	ATE Ø 25,4	
1.4	64	12/09→						
1.4	74	12/09→						
1.4 LPG	103	01/12→						
1.4 Turbo	103	12/09→						
1.6	85	12/09→						
1.6 CDTi	81	02/14→						
1.6 CDTi	100	01/14→						
1.6 SIDI	125	12/12→						
1.6 Turbo	132	12/09→						
1.7 CDTI	74	10/10→						
1.7 CDTI	81	12/09→						
1.7 CDTI	92	12/09→						
1.7 CDTI	96	12/09→						
2.0 BiTurbo CDTI	143	12/12→						
2.0 CDTI	118	12/09→						
2.0 CDTI	121	06/11→						
1.4 Turbo	88	10/10→		11/10→; für Linkslenker	03.2125-0421.3	010934	ATE Ø 25,4	
OPEL - ASTRA J GTC 10/11→								
 Bremskraftverstärker								
1.4	74	10/11→		für Linkslenker	03.7858-0732.4	300272	ATE Ø 9 / 8" pneumatisch	
1.4	88	10/11→						
1.4	103	10/11→						
1.6	132	10/11→						
1.6 CDTI	81	07/14→						
1.6 CDTI	100	07/14→						
1.6 SIDI	125	12/12→						
1.6 SIDI	147	07/13→						
1.7 CDTI	81	10/11→						
1.7 CDTI	96	10/11→						
1.8	103	10/11→						
2.0 CDTI	121	10/11→						
2.0 BiTurbo CDTI	143	10/12→		12/12→; für Linkslenker	03.7858-0732.4	300272	ATE Ø 9 / 8" pneumatisch	
 Hauptbremszylinder								
1.4	74	10/11→		für Linkslenker	03.2125-0421.3	010934	ATE Ø 25,4	
1.4	88	10/11→						
1.4	103	10/11→						
1.6	132	10/11→						
1.6 CDTI	81	07/14→						
1.6 CDTI	100	07/14→						
1.6 SIDI	125	12/12→						
1.6 SIDI	147	07/13→						
1.7 CDTI	81	10/11→						
1.7 CDTI	96	10/11→						
↓								













	kw			 	! #		
OPEL - ASTRA J GTC 10/11→							
 Hauptbremszylinder							
1.8	103	10/11→		für Linkslenker		03.2125-0421.3 010934	ATE Ø 25,4
2.0 CDTI	121	10/11→					
2.0 BiTurbo CDTI	143	10/12→		12/12→; für Linkslenker		03.2125-0421.3 010934	ATE Ø 25,4
OPEL - ASTRA J Sports Tourer 10/10→							
 Bremskraftverstärker							
1.3 CDTI	70	10/10→		11/10→; für Linkslenker		03.7858-0732.4 300272	ATE Ø 9 / 8" pneumatisch
1.4	64	10/10→10/15					
1.4	74	10/10→					
1.4 Turbo	88	10/10→					
1.4 Turbo	103	10/10→					
1.6	85	10/10→					
1.6 Turbo	132	10/10→					
1.7 CDTI	74	10/10→					
1.7 CDTI	81	10/10→					
1.7 CDTI	92	10/10→					
1.7 CDTI	96	10/10→					
2.0 CDTI	96	10/10→					
2.0 CDTI	118	10/10→					
1.4 LPG	103	01/12→		für Linkslenker		03.7858-0732.4 300272	ATE Ø 9 / 8" pneumatisch
1.6 CDTi	81	02/14→					
1.6 CDTi	100	01/14→					
1.6 LPG	84	10/12→					
1.6 SIDI	125	12/12→					
2.0 BiTurbo CDTI	143	12/12→					
2.0 CDTI	121	08/11→					
 Hauptbremszylinder							
1.3 CDTI	70	10/10→		11/10→; für Linkslenker		03.2125-0421.3 010934	ATE Ø 25,4
1.4	64	10/10→10/15					
1.4	74	10/10→					
1.4 Turbo	88	10/10→					
1.4 Turbo	103	10/10→					
1.6	85	10/10→					
1.6 Turbo	132	10/10→					
1.7 CDTI	74	10/10→					
1.7 CDTI	81	10/10→					
1.7 CDTI	92	10/10→					
1.7 CDTI	96	10/10→					
2.0 CDTI	96	10/10→					
2.0 CDTI	118	10/10→					
1.4 LPG	103	01/12→		für Linkslenker		03.2125-0421.3 010934	ATE Ø 25,4
1.6 CDTi	81	02/14→					
1.6 CDTi	100	01/14→					
1.6 LPG	84	10/12→					
1.6 SIDI	125	12/12→					
2.0 BiTurbo CDTI	143	12/12→					
2.0 CDTI	121	08/11→					
OPEL - ASTRA J Stufenheck 06/12→							
 Bremskraftverstärker							
1.3 CDTI	70	06/12→		für Linkslenker		03.7858-0732.4 300272	ATE Ø 9 / 8" pneumatisch
1.4	74	06/12→					
1.4 LPG	103	07/14→					
1.4 Turbo	88	06/12→					
1.4 Turbo	103	06/12→					
1.6	85	06/12→					
1.6 CDTi	81	04/14→					
1.6 CDTi	100	01/14→					
1.6 SIDI	125	12/12→					
1.6 Turbo	132	06/12→					
1.7 CDTI	81	06/12→					
1.7 CDTI	96	06/12→					
 Hauptbremszylinder							
1.3 CDTI	70	06/12→		für Linkslenker		03.2125-0421.3 010934	ATE Ø 25,4
1.4	74	06/12→					
1.4 LPG	103	07/14→					
1.4 Turbo	88	06/12→					
1.4 Turbo	103	06/12→					
1.6	85	06/12→					
1.6 CDTi	81	04/14→					
1.6 CDTi	100	01/14→					
1.6 SIDI	125	12/12→					
1.6 Turbo	132	06/12→					
1.7 CDTI	81	06/12→					
1.7 CDTI	96	06/12→					

	kw					! #		
OPEL - CALIBRA A (85_) 06/90→07/97								
 Hauptbremszylinder								
2.0 i	85	06/90→07/97					03.2122-0282.3 010130	ATE Ø 22,2
2.0 i 16V	100	02/94→07/97						
2.0 i 16V 4x4	100	02/94→07/97						
2.0 i 4x4	85	06/90→07/97						
2.0 i Turbo 4x4	150	03/92→07/97					03.2123-1121.3 010176	Ø 23,81
2.5 i V6	125	04/93→07/97		für Linkslenker			03.2123-1121.3 010176	Ø 23,81
 Bremskraftregler								
2.0 i	85	06/90→07/97		P1000001→			03.0101-0038.2 320245	Satz 2x
2.0 i 16V	100	02/94→07/97						
2.0 i 16V 4x4	100	02/94→07/97						
2.0 i 4x4	85	06/90→07/97						
2.5 i V6	125	04/93→07/97		T1000001→			03.0101-0038.2 320245	Satz 2x
OPEL - CAMPO (TF_) 08/87→06/02								
 Hauptbremszylinder								
2.2 D (TFR52)	39	08/91→09/96		01/92→ 09/92			03.2120-1981.3 010105	DEL Ø 20,64
2.2 D 4x4 (TFS52)	39	08/91→09/96		→ 09/92			03.2120-1981.3 010105	DEL Ø 20,64
2.5 TD (TFR54)	56	07/94→06/01		→ 08/96			03.2120-1981.3 010105	DEL Ø 20,64
2.5 TD 4x4 (TFS54)	56	07/94→06/01						
OPEL - CASCADA (W13) 03/13→								
 Bremskraftverstärker								
1.4	88	03/13→		für Linkslenker			03.7858-0732.4 300272	ATE Ø 9 / 8" pneumatisch
1.4 Turbo	103	03/13→						
1.6	147	11/13→						
1.6 SIDI	125	03/13→						
2.0 CDTI	121	03/13→						
2.0 CDTI	125	07/15→						
2.0 CDTI	143	03/13→						
 Hauptbremszylinder								
1.4	88	03/13→		für Linkslenker			03.2125-0421.3 010934	ATE Ø 25,4
1.4 Turbo	103	03/13→						
1.6	147	11/13→						
1.6 SIDI	125	03/13→						
2.0 CDTI	121	03/13→						
2.0 CDTI	125	07/15→						
2.0 CDTI	143	03/13→						
OPEL - COMBO (71_) 07/94→10/01								
 Hauptbremszylinder								
1.2	33	07/94→10/01		→ 09/00; für Linkslenker; - ABS			24.2120-0702.3 010361	Ø 20,64
1.4	44	07/94→10/01		→ 09/00; für Linkslenker; + ABS			24.2120-1714.3 010455	Ø 20,64
1.4	60	07/94→10/01						
1.7 D	44	07/94→10/01						
1.4 16V	66	08/99→10/01		10/01→; → 33999999			24.2122-1740.3 010711	DEL Ø 22,2
				43000001→; + ESP; Trommelbremse			24.2122-1757.3 010769	BOS Ø 22,2
				43000001→; - ESP; Scheibenbremse			24.2123-1767.3 010844	BOS Ø 23,81
				43000001→; + ESP; Scheibenbremse			24.2123-1768.3 010845	BOS Ø 23,81
 Bremskraftregler								
1.2	33	07/94→10/01					03.6585-0019.3 320239	ATE lastabhängig 8/5 4x
1.4	44	07/94→10/01						
1.4	60	07/94→10/01						
1.7 D	44	07/94→10/01						
1.4 16V	66	08/99→10/01		10/01→; - ABS			03.6583-0196.3 320246	ATE lastabhängig 8/3 4x
OPEL - COMBO Kasten/Kombi 10/01→								
 Hauptbremszylinder								
1.3 CDTI 16V	51	08/05→		→ 33999999			24.2122-1740.3 010711	DEL Ø 22,2
1.3 CDTI 16V	55	10/05→						
1.4 16V	66	08/05→		43000001→; → 10/11; + ESP; Trommelbremse			24.2122-1757.3 010769	BOS Ø 22,2
1.6	64	10/01→						
1.7 DI 16V	48	10/01→		43000001→; → 10/11; - ESP; Scheibenbremse			24.2123-1767.3 010844	BOS Ø 23,81
1.7 DTI 16V	55	10/01→						
				43000001→; → 10/11; + ESP; Scheibenbremse			24.2123-1768.3 010845	BOS Ø 23,81
1.6 CNG 16V	69	06/06→		→ 10/11; + ESP; Trommelbremse			24.2122-1757.3 010769	BOS Ø 22,2
1.6 CNG 16V	71	04/05→		→ 10/11; - ESP; Scheibenbremse			24.2123-1767.3 010844	BOS Ø 23,81
1.7 CDTI 16V	74	12/04→						
				→ 10/11; + ESP; Scheibenbremse			24.2123-1768.3 010845	BOS Ø 23,81
↓								

	kW			 	! #		
OPEL - COMBO Kasten/Kombi 10/01→							
 Bremskraftregler							
1.3 CDTI 16V	51	08/05→		→ 10/11; - ABS		03.6583-0196.3 320246	ATE lastabhängig 8/3 4x
1.3 CDTI 16V	55	10/05→					
1.4 16V	66	08/05→					
1.6	64	10/01→					
1.6 CNG 16V	69	06/06→					
1.6 CNG 16V	71	04/05→					
1.7 CDTI 16V	74	12/04→					
1.7 DI 16V	48	10/01→					
1.7 DTI 16V	55	10/01→					
OPEL - COMBO Tour 10/01→							
 Hauptbremszylinder							
1.3 CDTI 16V	51	10/04→		→ 33999999		24.2122-1740.3 010711	DEL Ø 22,2
1.3 CDTI 16V	55	10/05→					
1.4	66	10/04→		43000001→; → 10/11; + ESP; Trommelbremse		24.2122-1757.3 010769	BOS Ø 22,2
1.6	64	10/01→					
1.7 DI 16V	48	10/01→		43000001→; → 10/11; - ESP; Scheibenbremse		24.2123-1767.3 010844	BOS Ø 23,81
1.7 DTI 16V	55	10/01→		43000001→; → 10/11; + ESP; Scheibenbremse		24.2123-1768.3 010845	BOS Ø 23,81
1.6 CNG	69	06/06→		→ 10/11; + ESP; Trommelbremse		24.2122-1757.3 010769	BOS Ø 22,2
1.6 CNG	71	04/05→					
1.7 CDTI 16V	74	12/04→		→ 10/11; - ESP; Scheibenbremse		24.2123-1767.3 010844	BOS Ø 23,81
				→ 10/11; + ESP; Scheibenbremse		24.2123-1768.3 010845	BOS Ø 23,81
 Bremskraftregler							
1.3 CDTI 16V	51	10/04→		→ 10/11; - ABS		03.6583-0196.3 320246	ATE lastabhängig 8/3 4x
1.3 CDTI 16V	55	10/05→					
1.4	66	10/04→					
1.6	64	10/01→					
1.6 CNG	69	06/06→					
1.6 CNG	71	04/05→					
1.7 CDTI 16V	74	12/04→					
1.7 DI 16V	48	10/01→					
1.7 DTI 16V	55	10/01→					
OPEL - CORSA B (73_, 78_, 79_) 03/93→12/02							
 Hauptbremszylinder							
1.0 i 12V	40	11/96→09/00		für Linkslenker; - ABS		24.2120-0702.3 010361	Ø 20,64
1.2 i	33	03/93→09/00					
1.4 i	40	03/93→09/00		für Linkslenker; + ABS		24.2120-1714.3 010455	Ø 20,64
1.4 i	44	03/93→09/00					
1.4 i 16V	63	08/97→09/00					
1.4 i 16V	66	09/94→09/00					
1.4 i 16V	67	09/94→09/00					
1.4 Si	60	03/93→09/00					
1.5 D	37	03/93→09/00					
1.5 TD	49	03/93→09/00					
1.6 i 16V	74	08/97→09/00					
1.6 i 16V	78	09/94→09/00					
1.7 D	44	02/96→09/00					
1.2 i 16V	48	03/98→09/00		04/98→; für Linkslenker; - ABS		24.2120-0702.3 010361	Ø 20,64
				04/98→; für Linkslenker; + ABS		24.2120-1714.3 010455	Ø 20,64
1.6 GSI 16V	80	03/93→09/00		09/93→; für Linkslenker; - ABS		24.2120-0702.3 010361	Ø 20,64
				09/93→; für Linkslenker; + ABS		24.2120-1714.3 010455	Ø 20,64
 Bremskraftregler							
1.0 i 12V	40	11/96→09/00				03.0101-0031.2 320211	ATE Satz 3/30 2x
1.2 i	33	03/93→09/00					
1.2 i 16V	48	03/98→09/00		04/98→		03.6585-0018.3 320114	ATE lastabhängig 8/5 4x
1.4 i	40	03/93→09/00				03.6585-0018.3 320114	ATE lastabhängig 8/5 4x
1.4 i	44	03/93→09/00					
1.4 i 16V	63	08/97→09/00					
1.4 i 16V	66	09/94→09/00					
1.4 i 16V	67	09/94→09/00					
1.4 Si	60	03/93→09/00					
1.5 D	37	03/93→09/00					
1.5 TD	49	03/93→09/00					
1.6 i 16V	74	08/97→09/00					
1.6 i 16V	78	09/94→09/00					
1.7 D	44	02/96→09/00					
1.6 GSI 16V	80	03/93→09/00		09/93→		03.6585-0018.3 320114	ATE lastabhängig 8/5 4x
OPEL - CORSA B Kasten (73_) 08/99→09/00							
 Hauptbremszylinder							
1.4 i	44	08/99→09/00		für Linkslenker; - ABS		24.2120-0702.3 010361	Ø 20,64



	kw			 	! #		
OPEL - CORSA B Kasten (73_) 08/99→09/00							
 Hauptbremszylinder							
1.7 D	44	08/99→09/00		für Linkslenker; + ABS		24.2120-1714.3 010455	Ø 20,64
 Bremskraftregler							
1.4 i	44	08/99→09/00				03.6585-0018.3 320114	ATE lastabhängig 8/5 4x
1.7 D	44	08/99→09/00					
OPEL - CORSA B Kombi (F35) 01/99→12/02							
 Hauptbremszylinder							
1.4 i 16V	66	01/99→12/02		→ 09/00; für Linkslenker; - ABS		24.2120-0702.3 010361	Ø 20,64
1.7 D	44	01/99→12/02		→ 09/00; für Linkslenker; + ABS		24.2120-1714.3 010455	Ø 20,64
 Bremskraftregler							
1.4 i 16V	66	01/99→12/02		→ 09/00		03.6585-0018.3 320114	ATE lastabhängig 8/5 4x
1.7 D	44	01/99→12/02					
OPEL - CORSA C (F08, F68) 09/00→12/09							
 Hauptbremszylinder							
1.0	43	09/00→06/03		→ 36999999		24.2122-1740.3 010711	DEL Ø 22,2
				43000001→; + ESP		24.2122-1757.3 010769	BOS Ø 22,2
1.0	44	06/03→12/09		→ 36999999		24.2122-1740.3 010711	DEL Ø 22,2
1.2	55	09/00→12/09					
1.2 Twinport	59	07/04→12/09		43000001→; + ESP; → 09/06		24.2122-1757.3 010769	BOS Ø 22,2
1.3 CDTI	51	06/03→12/09					
1.7 CDTI	74	06/03→12/09					
1.7 DI	48	09/00→12/09					
1.7 DTI	55	09/00→12/09					
1.4	66	09/00→12/09		43000001→; → 09/06; - ESP		24.2123-1767.3 010844	BOS Ø 23,81
1.4 Twinport	66	06/03→12/09					
1.8	92	09/00→12/09		43000001→; → 09/06; + ESP		24.2123-1768.3 010845	BOS Ø 23,81
 Bremskraftregler							
1.0	43	09/00→06/03		- ABS; M10		03.6043-0964.3 320268	ATE 3/30 2x
				- ABS; M12		03.6043-0974.3 320244	ATE 3/30 2x
1.0	44	06/03→12/09		- ABS; → 09/06; M10		03.6043-0964.3 320268	ATE 3/30 2x
1.2	55	09/00→12/09					
1.2 Twinport	59	07/04→12/09		- ABS; → 09/06; M12		03.6043-0974.3 320244	ATE 3/30 2x
OPEL - CORSA C Kasten (F08, W5L) 09/00→							
 Hauptbremszylinder							
1.2	59	07/05→		→ 36999999		24.2122-1740.3 010711	DEL Ø 22,2
1.2 16V	55	09/00→					
1.3 CDTI 16V	51	08/05→		43000001→; + ESP; → 09/06		24.2122-1757.3 010769	BOS Ø 22,2
1.6	71	08/05→					
1.7 CDTi	74	08/03→					
1.7 DI 16V	48	09/00→					
1.7 DTI 16V	55	09/00→					
1.4	66	08/03→		43000001→; → 09/06; - ESP		24.2123-1767.3 010844	BOS Ø 23,81
				43000001→; → 09/06; + ESP		24.2123-1768.3 010845	BOS Ø 23,81
 Bremskraftregler							
1.2	59	07/05→		- ABS; → 09/06; M10		03.6043-0964.3 320268	ATE 3/30 2x
1.2 16V	55	09/00→		- ABS; → 09/06; M12		03.6043-0974.3 320244	ATE 3/30 2x
OPEL - CORSA D 07/06→							
 Hauptbremszylinder							
1.0	44	07/06→		10/06→; für Linkslenker; + ESP		24.4122-1705.3 010852	BOS Ø 22,2 ohne Bremsflüssigkeitsbehälter
1.2	59	07/06→					
1.3 CDTI	55	07/06→					
1.3 CDTI	66	07/06→		10/06→; für Linkslenker; - ESP		24.4122-1709.3 010871	BOS Ø 22,2 ohne Bremsflüssigkeitsbehälter
1.4 LPG	66	07/06→					
1.0	48	01/10→		für Linkslenker; + ESP		24.4122-1705.3 010852	BOS Ø 22,2 ohne Bremsflüssigkeitsbehälter
1.2	51	06/10→					
1.2	63	06/10→					
1.2 LPG	55	09/09→		für Linkslenker; - ESP		24.4122-1709.3 010871	BOS Ø 22,2 ohne Bremsflüssigkeitsbehälter
1.2 LPG	59	09/09→					
1.2 LPG	61	06/11→					
1.2 LPG	63	08/11→					
1.3 CDTI	70	06/10→					
1.4	64	09/09→					
1.4	74	06/10→					
1.4 LPG	64	09/09→					
↓							

	kw			 	! #		
OPEL - CORSA D 07/06→							
 Hauptbremszylinder							
1.4	66	07/06→		10/06→; + ESP		24.4122-1705.3 010852	BOS Ø 22,2 ohne Bremsflüssigkeitsbehälter
				10/06→; - ESP		24.4122-1709.3 010871	BOS Ø 22,2 ohne Bremsflüssigkeitsbehälter
OPEL - CORSA D Van 07/06→							
 Hauptbremszylinder							
1.0	44	07/06→		10/06→; für Linkslenker; + ESP		24.4122-1705.3 010852	BOS Ø 22,2 ohne Bremsflüssigkeitsbehälter
1.3 CDTI	55	07/06→					
1.3 CDTI	66	07/06→		10/06→; für Linkslenker; - ESP		24.4122-1709.3 010871	BOS Ø 22,2 ohne Bremsflüssigkeitsbehälter
1.0	48	01/10→		für Linkslenker; + ESP		24.4122-1705.3 010852	BOS Ø 22,2 ohne Bremsflüssigkeitsbehälter
1.2	51	06/10→					
1.2	59	07/09→		für Linkslenker; - ESP		24.4122-1709.3 010871	BOS Ø 22,2 ohne Bremsflüssigkeitsbehälter
1.2	63	06/10→					
1.3 CDTI	70	06/10→					
OPEL - FRONTERA A (5_MWL4) 03/92→10/98							
 Hauptbremszylinder							
2.2 i (54MWL4)	100	03/95→10/98		→ PV561117; für Rechtslenker		03.2120-1981.3 010105	DEL Ø 20,64
				→ PV561270; für Linkslenker		03.2120-1981.3 010105	DEL Ø 20,64
2.3 TD (5JMWL4)	74	03/92→10/98		→ PV561398; für Linkslenker		03.2120-1981.3 010105	DEL Ø 20,64
				→ PV563935; für Rechtslenker		03.2120-1981.3 010105	DEL Ø 20,64
2.4 i (53MWL4)	92	03/92→10/98		→ PV567152; für Rechtslenker		03.2120-1981.3 010105	DEL Ø 20,64
2.5 TDS	85	09/96→10/98					
2.8 TD (5BMW4)	83	03/95→10/98		→ PV560157; für Linkslenker		03.2120-1981.3 010105	DEL Ø 20,64
OPEL - FRONTERA A Sport (5_SUD2) 03/92→10/98							
 Hauptbremszylinder							
2.0 i (52SUD2, 55SUD2)	85	03/92→10/98		→ PV561117; für Rechtslenker		03.2120-1981.3 010105	DEL Ø 20,64
				→ PV561270; für Linkslenker		03.2120-1981.3 010105	DEL Ø 20,64
2.5 TDS	85	09/96→10/98		→ PV567152; für Rechtslenker		03.2120-1981.3 010105	DEL Ø 20,64
2.8 TD (53SUD2)	83	03/95→08/96		→ PV560157; für Linkslenker		03.2120-1981.3 010105	DEL Ø 20,64
OPEL - INSIGNIA 07/08→							
 Bremskraftverstärker							
1.4	103	04/11→		06/11→; für Linkslenker		03.7858-0732.4 300272	ATE Ø 9 / 8" pneumatisch
1.4 LPG	103	07/12→		für Linkslenker		03.7858-0732.4 300272	ATE Ø 9 / 8" pneumatisch
1.6	85	07/08→					
1.6 CDTi	88	07/15→					
1.6 CDTi	100	07/15→					
1.6 SIDI	125	03/13→					
1.8	103	07/08→					
2.0 Biturbo CDTI	140	07/08→					
2.0 Biturbo CDTI	143	01/12→					
2.0 Biturbo CDTI 4x4	140	05/09→					
2.0 Biturbo CDTI 4x4	143	01/12→					
2.0 CDTI	81	07/08→					
2.0 CDTI	96	07/08→					
2.0 CDTI	103	07/13→					
2.0 CDTI	118	07/08→					
2.0 CDTI	120	07/13→					
2.0 CDTI	125	11/14→					
2.0 CDTI 4x4	118	06/10→					
2.0 CDTI 4x4	120	07/13→					
2.0 CDTI 4x4	125	11/14→					
2.0 E85 Turbo	162	09/10→					
2.0 Turbo	162	07/08→					
2.0 Turbo	184	04/14→					
2.0 Turbo 4x4	162	07/08→					
2.0 Turbo 4x4	184	09/11→					
1.6 Turbo	132	07/08→		10/08→; für Linkslenker		03.7858-0732.4 300272	ATE Ø 9 / 8" pneumatisch
2.0 CDTI	88	03/12→		03/13→; für Linkslenker		03.7858-0732.4 300272	ATE Ø 9 / 8" pneumatisch
 Hauptbremszylinder							
1.4	103	04/11→		06/11→; für Linkslenker		03.2125-0421.3 010934	ATE Ø 25,4
1.4 LPG	103	07/12→		für Linkslenker		03.2125-0421.3 010934	ATE Ø 25,4
1.6	85	07/08→					
1.6 CDTi	88	07/15→					
1.6 CDTi	100	07/15→					
1.6 SIDI	125	03/13→					
1.8	103	07/08→					
↓							

OPEL - INSIGNIA 07/08 →

 **Hauptbremszylinder**

2.0 Biturbo CDTI	140	07/08 →		für Linkslenker		03.2125-0421.3	010934	ATE Ø 25,4
2.0 Biturbo CDTI	143	01/12 →						
2.0 Biturbo CDTI 4x4	140	05/09 →						
2.0 Biturbo CDTI 4x4	143	01/12 →						
2.0 CDTI	81	07/08 →						
2.0 CDTI	96	07/08 →						
2.0 CDTI	103	07/13 →						
2.0 CDTI	118	07/08 →						
2.0 CDTI	120	07/13 →						
2.0 CDTI	125	11/14 →						
2.0 CDTI 4x4	118	06/10 →						
2.0 CDTI 4x4	120	07/13 →						
2.0 CDTI 4x4	125	11/14 →						
2.0 E85 Turbo	162	09/10 →						
2.0 Turbo	162	07/08 →						
2.0 Turbo	184	04/14 →						
2.0 Turbo 4x4	162	07/08 →						
2.0 Turbo 4x4	184	09/11 →						
2.8 V6 Turbo 4x4	191	07/08 →						
2.8 V6 Turbo OPC 4x4	239	07/09 →						
1.6 Turbo	132	07/08 →		10/08 →; für Linkslenker		03.2125-0421.3	010934	ATE Ø 25,4
2.0 CDTI	88	03/12 →		03/13 →; für Linkslenker		03.2125-0421.3	010934	ATE Ø 25,4

OPEL - INSIGNIA Caravan 07/08 →











 **Bremskraftverstärker**













1.4	103	09/11 →		für Linkslenker		03.7858-0732.4	300272	ATE Ø 9 / 8" pneumatisch
1.4 LPG	103	07/12 →						
1.6	85	07/08 →						
1.6 CDTi	88	07/15 →						
1.6 CDTi	100	07/15 →						
1.6 SIDI	125	03/13 →						
1.6 Turbo	132	01/09 →						
1.8	103	07/08 →						
2.0 Biturbo CDTI	140	07/08 →						
2.0 Biturbo CDTI	143	01/12 →						
2.0 Biturbo CDTI 4x4	140	07/08 →						
2.0 Biturbo CDTI 4x4	143	01/12 →						
2.0 CDTI	81	07/08 →						
2.0 CDTI	96	07/08 →						
2.0 CDTI	103	07/13 →						
2.0 CDTI	118	07/08 →						
2.0 CDTI	120	07/13 →						
2.0 CDTI	125	11/14 →						
2.0 CDTI 4x4	118	06/10 →						
2.0 CDTI 4x4	120	07/13 →						
2.0 CDTI 4x4	125	11/14 →						
2.0 E85 Turbo	162	09/10 →						
2.0 Turbo	162	07/08 →						
2.0 Turbo	184	04/14 →						
2.0 Turbo 4x4	162	07/08 →						
2.0 Turbo 4x4	184	09/11 →						
2.0 CDTI	88	03/12 →		03/13 →; für Linkslenker		03.7858-0732.4	300272	ATE Ø 9 / 8" pneumatisch













 **Hauptbremszylinder**

1.4	103	09/11 →		für Linkslenker		03.2125-0421.3	010934	ATE Ø 25,4
1.4 LPG	103	07/12 →						
1.6	85	07/08 →						
1.6 CDTi	88	07/15 →						
1.6 CDTi	100	07/15 →						
1.6 SIDI	125	03/13 →						
1.6 Turbo	132	01/09 →						
1.8	103	07/08 →						
2.0 Biturbo CDTI	140	07/08 →						
2.0 Biturbo CDTI	143	01/12 →						
2.0 Biturbo CDTI 4x4	140	07/08 →						
2.0 Biturbo CDTI 4x4	143	01/12 →						
2.0 CDTI	81	07/08 →						
2.0 CDTI	96	07/08 →						
2.0 CDTI	103	07/13 →						
2.0 CDTI	118	07/08 →						
2.0 CDTI	120	07/13 →						
2.0 CDTI	125	11/14 →						
2.0 CDTI 4x4	118	06/10 →						
2.0 CDTI 4x4	120	07/13 →						
2.0 CDTI 4x4	125	11/14 →						
2.0 E85 Turbo	162	09/10 →						
2.0 Turbo	162	07/08 →						
2.0 Turbo	184	04/14 →						
2.0 Turbo 4x4	162	07/08 →						
2.0 Turbo 4x4	184	09/11 →						
2.8 V6 Turbo 4x4	191	10/08 →						



	kw			 	! #		
OPEL - INSIGNIA Caravan 07/08→							
 Hauptbremszylinder							
2.8 V6 Turbo OPC 4x4	239	07/09→		für Linkslenker		03.2125-0421.3 010934	ATE Ø 25,4
2.0 CDTI	88	03/12→		03/13→; für Linkslenker		03.2125-0421.3 010934	ATE Ø 25,4
OPEL - INSIGNIA Stufenheck 07/08→							
 Bremskraftverstärker							
1.4	103	04/11→		06/11→; für Linkslenker		03.7858-0732.4 300272	ATE Ø 9 / 8" pneumatisch
1.4 LPG	103	07/12→		für Linkslenker		03.7858-0732.4 300272	ATE Ø 9 / 8" pneumatisch
1.6	85	07/08→					
1.6 CDTi	88	07/15→					
1.6 CDTi	100	07/15→					
1.6 SIDI	125	03/13→					
1.6 Turbo	132	01/09→					
1.8	103	07/08→					
2.0 Biturbo CDTI	140	07/08→					
2.0 Biturbo CDTI	143	01/12→					
2.0 Biturbo CDTI 4x4	140	07/08→					
2.0 Biturbo CDTI 4x4	143	01/12→					
2.0 CDTI	81	07/08→					
2.0 CDTI	96	07/08→					
2.0 CDTI	103	07/13→					
2.0 CDTI	118	07/08→					
2.0 CDTI	120	07/13→					
2.0 CDTI	125	11/14→					
2.0 CDTI 4x4	118	06/10→					
2.0 CDTI 4x4	120	07/13→					
2.0 CDTI 4x4	125	11/14→					
2.0 Turbo	162	07/08→					
2.0 Turbo	184	04/14→					
2.0 Turbo 4x4	162	07/08→					
2.0 Turbo 4x4	184	09/11→					
2.0 Turbo E85	162	07/08→					
2.0 CDTI	88	03/12→		03/13→; für Linkslenker		03.7858-0732.4 300272	ATE Ø 9 / 8" pneumatisch
 Hauptbremszylinder							
1.4	103	04/11→		06/11→; für Linkslenker		03.2125-0421.3 010934	ATE Ø 25,4
1.4 LPG	103	07/12→		für Linkslenker		03.2125-0421.3 010934	ATE Ø 25,4
1.6	85	07/08→					
1.6 CDTi	88	07/15→					
1.6 CDTi	100	07/15→					
1.6 SIDI	125	03/13→					
1.6 Turbo	132	01/09→					
1.8	103	07/08→					
2.0 Biturbo CDTI	140	07/08→					
2.0 Biturbo CDTI	143	01/12→					
2.0 Biturbo CDTI 4x4	140	07/08→					
2.0 Biturbo CDTI 4x4	143	01/12→					
2.0 CDTI	81	07/08→					
2.0 CDTI	96	07/08→					
2.0 CDTI	103	07/13→					
2.0 CDTI	118	07/08→					
2.0 CDTI	120	07/13→					
2.0 CDTI	125	11/14→					
2.0 CDTI 4x4	118	06/10→					
2.0 CDTI 4x4	120	07/13→					
2.0 CDTI 4x4	125	11/14→					
2.0 Turbo	162	07/08→					
2.0 Turbo	184	04/14→					
2.0 Turbo 4x4	162	07/08→					
2.0 Turbo 4x4	184	09/11→					
2.0 Turbo E85	162	07/08→					
2.8 V6 Turbo 4x4	191	07/08→					
2.8 V6 Turbo OPC 4x4	239	07/09→					
2.0 CDTI	88	03/12→		03/13→; für Linkslenker		03.2125-0421.3 010934	ATE Ø 25,4
OPEL - MERIVA 05/03→05/10							
 Hauptbremszylinder							
1.3 CDTI	51	04/05→05/10		→ 44999999; - ESP		24.2123-1764.3 010824	TRW Ø 23,81
1.3 CDTI	55	09/03→05/10		74237192→; - ESP		24.4123-1716.3 010984	TRW Ø 23,81 ohne Bremsflüssigkeitsbehälter
1.4 16V Twinport	66	07/04→05/10					
1.4 16V Twinport LPG	66	07/04→05/10					
1.6	64	05/03→05/10		74237192→; + ESP		24.4123-1717.3 010985	TRW Ø 23,81 ohne Bremsflüssigkeitsbehälter
1.6	77	01/06→05/10					
1.6 16V	74	05/03→01/06					
1.6 Turbo	132	09/05→05/10					
1.7 CDTI	74	09/03→05/10					
1.7 CDTI	92	09/06→05/10					
1.7 DTI	55	09/03→05/10					
1.8	92	05/03→05/10					
↓							

	kw					! #		
OPEL - MERIVA 05/03→05/10								
 Bremskraftregler								
1.3 CDTI	51	04/05→05/10		- ABS			03.6583-0102.3 320280	ATE lastabhängig 8/3 4x
1.3 CDTI	55	09/03→05/10						
1.4 16V Twinport	66	07/04→05/10						
1.4 16V Twinport LPG	66	07/04→05/10						
1.6	64	05/03→05/10						
1.6	77	01/06→05/10						
1.6 16V	74	05/03→01/06						
1.7 CDTI	74	09/03→05/10						
1.7 CDTI	92	09/06→05/10						
1.7 DTI	55	09/03→05/10						
1.8	92	05/03→05/10						
OPEL - MERIVA B 06/10→								
 Hauptbremszylinder								
1.3 CDTI	55	06/10→		für Linkslenker; - ESP			24.4125-1705.3 010972	TRW Ø 25,4
1.3 CDTI	70	06/10→						
1.4	74	06/10→		für Linkslenker; + ESP			24.4125-1706.3 010973	TRW Ø 25,4
1.4	88	06/10→						
1.4	103	06/10→						
1.4 LPG	88	06/11→						
1.7 CDTI	74	06/10→						
1.7 CDTI	81	06/10→						
1.7 CDTI	96	06/10→						
1.6 CDTi	100	08/13→		für Linkslenker; - ESP			24.4125-1705.3 010972	TRW Ø 25,4
1.6 CDTI	81	03/14→						
1.6 CDTI	70	01/14→		03/14→; für Linkslenker; - ESP			24.4125-1705.3 010972	TRW Ø 25,4
OPEL - MOVANO Combi (J9) 07/98→								
 Hauptbremszylinder								
1.9 DTI	59	09/00→10/01		+ ABS			24.2025-1706.3 010676	Ø 25,4
2.5 D	59	07/98→09/00						
2.8 DTI	84	07/98→10/01		- ABS			24.2025-1708.3 010692	Ø 25,4
1.9 DTI	60	10/01→		→ 08/03; + ABS			24.2025-1706.3 010676	Ø 25,4
2.2 DTI	66	09/00→		→ 01/10; - ABS			24.2025-1708.3 010692	Ø 25,4
2.5 DTI	84	10/01→		09/03→; + ABS; → 08/06			24.2123-1759.3 010768	BOS Ø 23,81
3.0 DTi	100	10/03→		→ 01/10; - ABS			24.2025-1708.3 010692	Ø 25,4
				→ 08/06; + ABS			24.2123-1759.3 010768	BOS Ø 23,81
OPEL - MOVANO Kasten (F9) 01/99→								
 Hauptbremszylinder								
1.9 DTI	59	09/00→10/01		+ ABS			24.2025-1706.3 010676	Ø 25,4
2.5 D	59	01/99→09/00						
2.8 DTI	84	01/99→10/01		- ABS			24.2025-1708.3 010692	Ø 25,4
1.9 DTI	60	10/01→		→ 08/03; + ABS			24.2025-1706.3 010676	Ø 25,4
2.2 DTI	66	09/00→		→ 01/10; - ABS			24.2025-1708.3 010692	Ø 25,4
2.5 DTI	84	10/01→		09/03→; + ABS; → 08/06			24.2123-1759.3 010768	BOS Ø 23,81
2.5 DTi	73	10/03→		→ 01/10; - ABS			24.2025-1708.3 010692	Ø 25,4
3.0 DTI	100	10/03→		→ 08/06; + ABS			24.2123-1759.3 010768	BOS Ø 23,81
OPEL - MOVANO Kipper (H9) 01/99→								
 Hauptbremszylinder								
2.2 DTI	66	09/00→		→ 08/03; + ABS			24.2025-1706.3 010676	Ø 25,4
2.5 DTI	84	10/01→		→ 01/10; - ABS			24.2025-1708.3 010692	Ø 25,4
				09/03→; + ABS; → 08/06			24.2123-1759.3 010768	BOS Ø 23,81
2.5 D	59	01/99→09/00		+ ABS			24.2025-1706.3 010676	Ø 25,4
2.8 DTI	84	01/99→10/01		- ABS			24.2025-1708.3 010692	Ø 25,4
2.5 DTI	73	10/03→		→ 01/10; - ABS			24.2025-1708.3 010692	Ø 25,4
3.0 DTI	100	10/03→		→ 08/06; + ABS			24.2123-1759.3 010768	BOS Ø 23,81
OPEL - MOVANO Pritsche/Fahrgestell (U9, E9) 07/98→								
 Hauptbremszylinder								
2.2 DTI	66	09/00→		→ 08/03; + ABS			24.2025-1706.3 010676	Ø 25,4
2.5 DTI	84	10/01→		→ 01/10; - ABS			24.2025-1708.3 010692	Ø 25,4
				09/03→; + ABS; → 08/06			24.2123-1759.3 010768	BOS Ø 23,81
2.5 D	59	07/98→09/00		+ ABS			24.2025-1706.3 010676	Ø 25,4
2.8 DTI	84	07/98→10/01		- ABS			24.2025-1708.3 010692	Ø 25,4
2.5 DTi	73	10/03→		→ 01/10; - ABS			24.2025-1708.3 010692	Ø 25,4
3.0 DTI	100	10/03→		+ ABS; → 08/06			24.2123-1759.3 010768	BOS Ø 23,81

	kW					! #		
OPEL - OMEGA B (25_, 26_, 27_) 03/94→07/03								
 Hauptbremszylinder								
2.0	85	03/94→09/99		→ V1999999; für Linkslenker; nicht für Polizeifahrzeuge			24.2123-1740.3 010662	Ø 23,81
2.0	90	05/94→05/99						
2.0 16V	100	03/94→09/99		W1000001→; für Linkslenker; + ESP			24.2125-1740.3 010971	TRW Ø 25,4
2.0	85	03/94→12/00		→ V1999999; für Linkslenker; nicht für Polizeifahrzeuge			24.2123-1740.3 010662	Ø 23,81
				W1000001→; → 09/99; für Linkslenker; + ESP			24.2125-1740.3 010971	TRW Ø 25,4
2.0 DTI 16V	74	09/97→09/00		→ 08/00; für Linkslenker; + ESP			24.2125-1740.3 010971	TRW Ø 25,4
2.2 16V	106	09/99→07/03		10/99→; für Linkslenker; + ESP			24.2125-1740.3 010971	TRW Ø 25,4
2.2 DTI 16V	81	09/00→07/03		für Linkslenker; + ESP			24.2125-1740.3 010971	TRW Ø 25,4
2.2 DTI 16V	86	01/01→07/03						
2.2 DTI 16V	88	09/00→07/03						
2.5 DTI	110	09/01→07/03						
2.5 D	96	05/94→05/99		W1000001→; für Linkslenker; + ESP			24.2125-1740.3 010971	TRW Ø 25,4
2.5 TD	96	04/94→07/03						
2.5 V6	125	03/94→09/00		W1000001→; für Linkslenker; nicht für Sonderfahrzeuge; + ESP			24.2125-1740.3 010971	TRW Ø 25,4
2.6 V6	132	09/00→07/03		für Linkslenker;			24.2125-1740.3 010971	TRW Ø 25,4
3.2 V6	160	02/01→07/03		nicht für Sonderfahrzeuge; + ESP				
3.0 V6	155	04/94→02/01		W1000001→; → 01/01; für Linkslenker; nicht für Sonderfahrzeuge; + ESP			24.2125-1740.3 010971	TRW Ø 25,4
OPEL - OMEGA B Caravan (21_, 22_, 23_) 03/94→07/03								
 Hauptbremszylinder								
2.0	85	03/94→09/99		→ V1999999; für Linkslenker; nicht für Polizeifahrzeuge			24.2123-1740.3 010662	Ø 23,81
2.0	90	05/94→05/99						
2.0 16V	100	03/94→09/99		W1000001→; für Linkslenker; + ESP			24.2125-1740.3 010971	TRW Ø 25,4
2.0 DTI 16V	74	09/97→09/00		→ 08/00; für Linkslenker; + ESP			24.2125-1740.3 010971	TRW Ø 25,4
2.2 16V	106	09/99→07/03		10/99→; für Linkslenker; + ESP			24.2125-1740.3 010971	TRW Ø 25,4
2.2 DTI 16V	81	09/00→07/03		für Linkslenker; + ESP			24.2125-1740.3 010971	TRW Ø 25,4
2.2 DTI 16V	88	09/00→07/03						
2.5 DTI	110	09/01→07/03						
2.5 TD	96	04/94→07/01		W1000001→; für Linkslenker; + ESP			24.2125-1740.3 010971	TRW Ø 25,4
2.5 V6	125	03/94→09/00		W1000001→; für Linkslenker; nicht für Sonderfahrzeuge; + ESP			24.2125-1740.3 010971	TRW Ø 25,4
2.6 V6	132	09/00→07/03		für Linkslenker;			24.2125-1740.3 010971	TRW Ø 25,4
3.2 V6	160	02/01→07/03		nicht für Sonderfahrzeuge; + ESP				
3.0 V6	155	04/94→02/01		W1000001→; → 01/01; für Linkslenker; nicht für Sonderfahrzeuge; + ESP			24.2125-1740.3 010971	TRW Ø 25,4
OPEL - SIGNUM 05/03→								
 Hauptbremszylinder								
1.8	90	05/03→		für Linkslenker; → 05/08; + ESP			24.2125-1732.3 010827	TRW Ø 25,4
1.8	103	09/05→						
1.9 CDTI	74	08/05→						
1.9 CDTI	88	04/04→						
1.9 CDTI	110	04/04→						
2.0 DTI	74	05/03→						
2.0 Turbo	129	05/03→						
2.2 direct	114	05/03→						
2.2 DTI	92	05/03→						
2.2 DTI 16V	86	05/03→06/08						
3.0 V6 CDTI	130	05/03→						
3.0 V6 CDTI	135	09/05→						
3.2 V6	155	05/03→						
OPEL - TIGRA (75_) 07/94→12/00								
 Hauptbremszylinder								
1.4 16V	63	08/97→12/00		für Linkslenker; - ABS			24.2120-0702.3 010361	Ø 20,64
1.4 16V	66	07/94→12/00						
1.6 16V	74	08/97→08/98		für Linkslenker; + ABS			24.2120-1714.3 010455	Ø 20,64
1.6 16V	78	07/94→08/98						
 Bremskraftregler								
1.4 16V	63	08/97→12/00					03.6585-0018.3 320114	ATE lastabhängig 8/5 4x
1.4 16V	66	07/94→12/00						
1.6 16V	74	08/97→08/98						
1.6 16V	78	07/94→08/98						
OPEL - TIGRA TwinTop 06/04→								
 Hauptbremszylinder								
1.3 CDTI	51	06/04→		- ESP; → 08/09			24.2123-1767.3 010844	BOS Ø 23,81
1.4	66	06/04→						
1.8	92	06/04→		+ ESP; → 08/09			24.2123-1768.3 010845	BOS Ø 23,81

OPEL - VECTRA A (86_, 87_) 08/88→12/95

Hauptbremszylinder

1.6 i	52	09/93→11/95		→ 08/95; + ABS	03.2122-0282.3	010130	ATE Ø 22,2
1.6 i	55	09/88→11/95		P1000001→; → 08/95; - ABS	24.2120-0702.3	010361	Ø 20,64
1.6 i	55	09/93→11/95					
1.7 D	44	07/92→11/95		→ N5299999; - ABS	24.2120-0913.3	010392	DEL Ø 20,64
1.7 TD	60	03/90→11/95					
1.8 i Cat	66	03/90→11/95					
2.0 i 16V	100	06/94→11/95		→ N5299999; - ABS	03.2122-0264.3	010129	ATE Ø 22,2
2.0 i 16V 4x4	100	06/94→11/95		P1000001→; → 08/95; - ABS	03.2122-0264.3	010129	ATE Ø 22,2
2000/GT 16V Cat	110	02/90→11/95					
				→ NV1299999; - ABS	03.2122-0264.3	010129	ATE Ø 22,2
				P5000001→; → 08/95; - ABS	03.2122-0264.3	010129	ATE Ø 22,2
				→ N12999999; - ABS	03.2122-0264.3	010129	ATE Ø 22,2
				P7000001→; → 08/95; - ABS	03.2122-0264.3	010129	ATE Ø 22,2
				→ 08/95; + ABS	03.2122-0282.3	010130	ATE Ø 22,2
2.0 i Cat	85	09/88→11/95		P1000001→; → 08/95; - ABS	03.2122-0264.3	010129	ATE Ø 22,2
				→ NV1299999; - ABS	03.2122-0264.3	010129	ATE Ø 22,2
				P7000001→; → 08/95; + TCS	03.2122-0264.3	010129	ATE Ø 22,2
				→ N52999999; - ABS	03.2122-0264.3	010129	ATE Ø 22,2
				→ N12999999; - ABS	03.2122-0264.3	010129	ATE Ø 22,2
				P5000001→; → 08/95; - ABS	03.2122-0264.3	010129	ATE Ø 22,2
				→ 08/95; + ABS	03.2122-0282.3	010130	ATE Ø 22,2
2.0 i Turbo 4x4	150	06/94→11/95		→ 08/95	03.2123-1121.3	010176	Ø 23,81
2.5 V6	125	02/93→11/95		→ 08/95; für Linkslenker	03.2123-1121.3	010176	Ø 23,81

Bremskraftregler

1.6 i	52	09/93→11/95		P1000001→; → 08/95	03.0101-0027.2	320022	ATE Satz 3/45 2x
1.6 i	55	09/88→11/95					
1.6 i	55	09/93→11/95					
1.7 D	44	07/92→11/95					
1.7 TD	60	03/90→11/95					
1.8 i Cat	66	03/90→11/95					
2.5 V6	125	02/93→11/95		→ 08/95	03.0101-0025.2	320014	ATE Satz 3/35 2x

OPEL - VECTRA A CC (88_, 89_) 04/88→12/95

Hauptbremszylinder

1.6 i	52	09/93→11/95		→ 08/95; + ABS	03.2122-0282.3	010130	ATE Ø 22,2
1.6 i	55	09/93→11/95		P1000001→; → 08/95; - ABS	24.2120-0702.3	010361	Ø 20,64
1.6 i Cat	55	09/88→11/95					
1.7 D	44	07/92→11/95		→ N5299999; - ABS	24.2120-0913.3	010392	DEL Ø 20,64
1.7 TD	60	03/90→11/95					
1.8 i Cat	66	03/90→11/95					
2.0 i 16V	100	06/94→11/95		→ N52999999; - ABS	03.2122-0264.3	010129	ATE Ø 22,2
2.0 i 16V Cat	110	02/90→11/95		P1000001→; → 08/95; - ABS	03.2122-0264.3	010129	ATE Ø 22,2
				→ NV1299999; - ABS	03.2122-0264.3	010129	ATE Ø 22,2
				P5000001→; → 08/95; - ABS	03.2122-0264.3	010129	ATE Ø 22,2
				→ N12999999; - ABS	03.2122-0264.3	010129	ATE Ø 22,2
				P7000001→; → 08/95; - ABS	03.2122-0264.3	010129	ATE Ø 22,2
				→ 08/95; + ABS	03.2122-0282.3	010130	ATE Ø 22,2
2.0 i Cat	85	09/88→11/95		P1000001→; → 08/95; - ABS	03.2122-0264.3	010129	ATE Ø 22,2
2.0 i GT	95	09/88→11/95		→ NV1299999; - ABS	03.2122-0264.3	010129	ATE Ø 22,2
				P7000001→; → 08/95; + TCS	03.2122-0264.3	010129	ATE Ø 22,2
				→ N52999999; - ABS	03.2122-0264.3	010129	ATE Ø 22,2
				→ N12999999; - ABS	03.2122-0264.3	010129	ATE Ø 22,2
				P5000001→; → 08/95; - ABS	03.2122-0264.3	010129	ATE Ø 22,2
				→ 08/95; + ABS	03.2122-0282.3	010130	ATE Ø 22,2
2.5 V6	125	02/93→11/95		→ 08/95; für Linkslenker	03.2123-1121.3	010176	Ø 23,81

Bremskraftregler

1.6 i	52	09/93→11/95		P1000001→; → 08/95	03.0101-0027.2	320022	ATE Satz 3/45 2x
1.6 i	55	09/93→11/95					
1.6 i Cat	55	09/88→11/95					
1.7 D	44	07/92→11/95					
1.7 TD	60	03/90→11/95					
1.8 i Cat	66	03/90→11/95					
2.5 V6	125	02/93→11/95		→ 08/95	03.0101-0025.2	320014	ATE Satz 3/35 2x

OPEL - VECTRA B (36_) 09/95→04/02

Bremskraftverstärker

2.0 i	82	10/95→04/02	für Linkslenker; → W1285446	03.7745-3003.4	300157	ATE Ø 8 / 7" pneumatisch
2.0 i 16V	100	10/95→09/00				
2.5 i V6	125	10/95→09/00	für Linkslenker	03.7745-3003.4	300157	ATE Ø 8 / 7" pneumatisch
2.6 i V6	125	09/00→04/02				

Hauptbremszylinder

1.6 i	55	10/95→04/02	→ W5999999; für Rechtslenker	24.2122-1724.3	010561	Ø 22,2
1.6 i 16V	74	10/95→04/02				
1.8 i 16V	85	10/95→09/00	→ V5999999; für Linkslenker	24.2122-1724.3	010561	Ø 22,2
1.8 i 16V	92	09/00→04/02	→ V7999999; für Linkslenker	24.2122-1724.3	010561	Ø 22,2
2.0 DI 16V	60	11/96→04/02	→ W7999999; für Rechtslenker	24.2122-1724.3	010561	Ø 22,2
2.0 DTI 16V	74	06/97→04/02				
			→ V1999999; für Linkslenker	24.2122-1724.3	010561	Ø 22,2
			→ W1999999; für Rechtslenker	24.2122-1724.3	010561	Ø 22,2
			W1000001→ W1999999; für Linkslenker	24.2123-1777.3	010943	Ø 23,81
			W5000001→ W5999999; für Linkslenker	24.2123-1777.3	010943	Ø 23,81
			W7000001→ W7999999; für Linkslenker	24.2123-1777.3	010943	Ø 23,81
1.7 TD	60	10/95→12/98	→ 11/96	24.2122-1724.3	010561	Ø 22,2
2.0 i	82	10/95→04/02	→ W1285446; für Linkslenker	03.2123-1622.3	010470	Ø 23,81
2.0 i 16V	100	10/95→09/00				
			→ W7154258; für Linkslenker	03.2123-1622.3	010470	Ø 23,81
			→ W5276825; für Linkslenker	03.2123-1622.3	010470	Ø 23,81
			→ W7154258; für Rechtslenker	03.2123-1722.3	010471	Ø 23,81
			→ W1285446; für Rechtslenker	03.2123-1722.3	010471	Ø 23,81
			→ W5276825; für Rechtslenker	03.2123-1722.3	010471	Ø 23,81
			W5276826→; für Rechtslenker	03.2125-7502.3	010616	ATE Ø 25,4
			W7154259→; für Rechtslenker	03.2125-7502.3	010616	ATE Ø 25,4
			W1285447→; für Rechtslenker	03.2125-7502.3	010616	ATE Ø 25,4
2.2 i 16V	108	09/00→04/02	für Rechtslenker	03.2125-7502.3	010616	ATE Ø 25,4
2.5 i V6	125	10/95→09/00				
			→ W1285446; für Linkslenker	03.2123-1622.3	010470	Ø 23,81
			→ W7154258; für Linkslenker	03.2123-1622.3	010470	Ø 23,81
			→ W5276825; für Linkslenker	03.2123-1622.3	010470	Ø 23,81
			→ W1285446; für Rechtslenker	03.2123-1722.3	010471	Ø 23,81
			→ W7154258; für Rechtslenker	03.2123-1722.3	010471	Ø 23,81
			→ W5276825; für Rechtslenker	03.2123-1722.3	010471	Ø 23,81
			W1285447→; für Linkslenker	03.2125-7402.3	010541	ATE Ø 25,4
			W5276826→; für Linkslenker	03.2125-7402.3	010541	ATE Ø 25,4
			W7154259→; für Linkslenker	03.2125-7402.3	010541	ATE Ø 25,4
			W1285447→; für Rechtslenker	03.2125-7502.3	010616	ATE Ø 25,4
			W7154259→; für Rechtslenker	03.2125-7502.3	010616	ATE Ø 25,4
			W5276826→; für Rechtslenker	03.2125-7502.3	010616	ATE Ø 25,4
2.6 i V6	125	09/00→04/02				
			für Linkslenker	03.2125-7402.3	010541	ATE Ø 25,4
			für Rechtslenker	03.2125-7502.3	010616	ATE Ø 25,4

OPEL - VECTRA B Caravan (31_) 11/96→07/03











Bremskraftverstärker













2.0 i	82	11/96→02/02	für Linkslenker; → W1285446	03.7745-3003.4	300157	ATE Ø 8 / 7" pneumatisch
2.0 i 16V	100	11/96→09/00				
2.5 i V6	125	11/96→09/00	für Linkslenker	03.7745-3003.4	300157	ATE Ø 8 / 7" pneumatisch
2.6 i V6	125	09/00→07/03	→ 04/02; für Linkslenker	03.7745-3003.4	300157	ATE Ø 8 / 7" pneumatisch











Hauptbremszylinder













1.6 i	55	11/96→06/00	→ W5999999; für Rechtslenker	24.2122-1724.3	010561	Ø 22,2
1.6 i 16V	74	11/96→07/02				
1.8 i 16V	85	11/96→09/00	→ V5999999; für Linkslenker	24.2122-1724.3	010561	Ø 22,2
1.8 i 16V	92	09/00→07/03	→ V7999999; für Linkslenker	24.2122-1724.3	010561	Ø 22,2
2.0 DI 16V	60	11/96→06/00	→ W7999999; für Rechtslenker	24.2122-1724.3	010561	Ø 22,2
2.0 DTI 16V	74	06/97→07/03				
			→ V1999999; für Linkslenker	24.2122-1724.3	010561	Ø 22,2
			→ W1999999; für Rechtslenker	24.2122-1724.3	010561	Ø 22,2
			W1000001→ W1999999; für Linkslenker	24.2123-1777.3	010943	Ø 23,81
			W5000001→ W5999999; für Linkslenker	24.2123-1777.3	010943	Ø 23,81
			W7000001→ W7999999; für Linkslenker	24.2123-1777.3	010943	Ø 23,81
1.7 TD	60	11/96→12/97	→ 11/96	24.2122-1724.3	010561	Ø 22,2
2.0 i	82	11/96→02/02	→ W1285446; für Linkslenker	03.2123-1622.3	010470	Ø 23,81
2.0 i 16V	100	11/96→09/00				
			→ W7154258; für Linkslenker	03.2123-1622.3	010470	Ø 23,81
			→ W5276825; für Linkslenker	03.2123-1622.3	010470	Ø 23,81



























	kw			 	! #		
OPEL - VECTRA B Caravan (31_) 11/96→07/03							
 Hauptbremszylinder							
2.0 i 2.0 i 16V	82	11/96→02/02		→ W7154258; für Rechtslenker	03.2123-1722.3	010471	Ø 23,81
	100	11/96→09/00		→ W1285446; für Rechtslenker	03.2123-1722.3	010471	Ø 23,81
				→ W5276825; für Rechtslenker	03.2123-1722.3	010471	Ø 23,81
				W5276826→; für Rechtslenker	03.2125-7502.3	010616	ATE Ø 25,4
				W7154259→; für Rechtslenker	03.2125-7502.3	010616	ATE Ø 25,4
				W1285447→; für Rechtslenker	03.2125-7502.3	010616	ATE Ø 25,4
2.2 i 16V	108	09/00→07/03		→ 04/02; für Rechtslenker	03.2125-7502.3	010616	ATE Ø 25,4
2.5 i V6	125	11/96→09/00		→ W1285446; für Linkslenker	03.2123-1622.3	010470	Ø 23,81
				→ W7154258; für Linkslenker	03.2123-1622.3	010470	Ø 23,81
				→ W5276825; für Linkslenker	03.2123-1622.3	010470	Ø 23,81
				→ W1285446; für Rechtslenker	03.2123-1722.3	010471	Ø 23,81
				→ W7154258; für Rechtslenker	03.2123-1722.3	010471	Ø 23,81
				→ W5276825; für Rechtslenker	03.2123-1722.3	010471	Ø 23,81
				W1285447→; für Linkslenker	03.2125-7402.3	010541	ATE Ø 25,4
				W5276826→; für Linkslenker	03.2125-7402.3	010541	ATE Ø 25,4
				W7154259→; für Linkslenker	03.2125-7402.3	010541	ATE Ø 25,4
				W1285447→; für Rechtslenker	03.2125-7502.3	010616	ATE Ø 25,4
				W7154259→; für Rechtslenker	03.2125-7502.3	010616	ATE Ø 25,4
				W5276826→; für Rechtslenker	03.2125-7502.3	010616	ATE Ø 25,4
2.6 i V6	125	09/00→07/03		→ 04/02; für Linkslenker	03.2125-7402.3	010541	ATE Ø 25,4
				→ 04/02; für Rechtslenker	03.2125-7502.3	010616	ATE Ø 25,4
OPEL - VECTRA B CC (38_) 10/95→07/03							
 Bremskraftverstärker							
2.0 i 2.0 i 16V	82	10/95→02/02		für Linkslenker; → W1285446	03.7745-3003.4	300157	ATE Ø 8 / 7" pneumatisch
	100	10/95→09/00					
2.5	144	10/99→06/00		für Linkslenker	03.7745-3003.4	300157	ATE Ø 8 / 7" pneumatisch
2.5 i V6	125	10/95→09/00					
2.6 i V6	125	09/00→07/03		→ 04/02; für Linkslenker	03.7745-3003.4	300157	ATE Ø 8 / 7" pneumatisch
 Hauptbremszylinder							
1.6 i 1.6 i 16V 1.8 i 16V 1.8 i 16V 2.0 DI 16V 2.0 DTI 16V	55	10/95→07/03		→ W5999999; für Rechtslenker	24.2122-1724.3	010561	Ø 22,2
	74	10/95→07/02		→ V5999999; für Linkslenker	24.2122-1724.3	010561	Ø 22,2
	85	10/95→09/00		→ V7999999; für Linkslenker	24.2122-1724.3	010561	Ø 22,2
	92	09/00→07/03					
	60	11/96→06/00		→ W7999999; für Rechtslenker	24.2122-1724.3	010561	Ø 22,2
	74	06/97→07/03		→ V1999999; für Linkslenker	24.2122-1724.3	010561	Ø 22,2
				→ W1999999; für Rechtslenker	24.2122-1724.3	010561	Ø 22,2
				W1000001→ W1999999; für Linkslenker	24.2123-1777.3	010943	Ø 23,81
			W5000001→ W5999999; für Linkslenker	24.2123-1777.3	010943	Ø 23,81	
			W7000001→ W7999999; für Linkslenker	24.2123-1777.3	010943	Ø 23,81	
1.7 TD	60	10/95→12/98		→ 11/96	24.2122-1724.3	010561	Ø 22,2
2.0 i 2.0 i 16V	82	10/95→02/02		→ W1285446; für Linkslenker	03.2123-1622.3	010470	Ø 23,81
	100	10/95→09/00		→ W7154258; für Linkslenker	03.2123-1622.3	010470	Ø 23,81
				→ W5276825; für Linkslenker	03.2123-1622.3	010470	Ø 23,81
				→ W7154258; für Rechtslenker	03.2123-1722.3	010471	Ø 23,81
				→ W1285446; für Rechtslenker	03.2123-1722.3	010471	Ø 23,81
				→ W5276825; für Rechtslenker	03.2123-1722.3	010471	Ø 23,81
				W5276826→; für Rechtslenker	03.2125-7502.3	010616	ATE Ø 25,4
				W7154259→; für Rechtslenker	03.2125-7502.3	010616	ATE Ø 25,4
	W1285447→; für Rechtslenker	03.2125-7502.3	010616	ATE Ø 25,4			
2.2 i 16V	108	09/00→07/03		→ 04/02; für Rechtslenker	03.2125-7502.3	010616	ATE Ø 25,4
2.5 2.5 i V6	144	10/99→06/00		→ W1285446; für Linkslenker	03.2123-1622.3	010470	Ø 23,81
	125	10/95→09/00		→ W7154258; für Linkslenker	03.2123-1622.3	010470	Ø 23,81
				→ W5276825; für Linkslenker	03.2123-1622.3	010470	Ø 23,81
				→ W1285446; für Rechtslenker	03.2123-1722.3	010471	Ø 23,81
				→ W7154258; für Rechtslenker	03.2123-1722.3	010471	Ø 23,81
				→ W5276825; für Rechtslenker	03.2123-1722.3	010471	Ø 23,81
				W1285447→; für Linkslenker	03.2125-7402.3	010541	ATE Ø 25,4
				W5276826→; für Linkslenker	03.2125-7402.3	010541	ATE Ø 25,4
				W7154259→; für Linkslenker	03.2125-7402.3	010541	ATE Ø 25,4
				W1285447→; für Rechtslenker	03.2125-7502.3	010616	ATE Ø 25,4











	kw			 	! #		
OPEL - VECTRA B CC (38_) 10/95→07/03							
 Hauptbremszylinder							
2.5	144	10/99→06/00		W7154259→; für Rechtslenker		03.2125-7502.3 010616	ATE Ø 25,4
2.5 i V6	125	10/95→09/00		W5276826→; für Rechtslenker		03.2125-7502.3 010616	ATE Ø 25,4
2.6 i V6	125	09/00→07/03		→ 04/02; für Linkslenker		03.2125-7402.3 010541	ATE Ø 25,4
				→ 04/02; für Rechtslenker		03.2125-7502.3 010616	ATE Ø 25,4
OPEL - VECTRA C 04/02→							
 Hauptbremszylinder							
1.6	77	01/06→		für Linkslenker; + ESP; → 10/08		24.2125-1732.3 010827	TRW Ø 25,4
1.6 16V	74	06/04→					
1.8	81	04/02→					
1.8	103	01/06→					
1.8 16V	90	04/02→					
1.9 CDTI	74	10/05→					
1.9 CDTI	88	04/04→01/09					
1.9 CDTI	110	04/04→					
2.0 16V Turbo	129	03/03→					
2.0 DTI 16V	74	04/02→					
2.2 16V	108	04/02→					
2.2 direct	114	10/03→					
2.2 DTI 16V	92	04/02→					
3.0 CDTi	135	08/05→					
3.0 CDTI	130	06/03→					
3.2 V6	155	08/02→					
2.2 DTI 16V	86	04/02→12/04		für Linkslenker; + ESP		24.2125-1732.3 010827	TRW Ø 25,4
OPEL - VECTRA C Caravan 10/03→							
 Hauptbremszylinder							
1.6	77	01/06→		06/06→ 10/08; für Linkslenker; + ESP		24.2125-1732.3 010827	TRW Ø 25,4
1.6 16V	74	06/04→		für Linkslenker; + ESP; → 10/08		24.2125-1732.3 010827	TRW Ø 25,4
1.8	90	10/03→					
1.8	103	01/06→					
1.9 CDTI	74	10/05→					
1.9 CDTI	88	04/04→01/09					
1.9 CDTI	110	04/04→					
2.0 DTI	74	10/03→					
2.0 Turbo	129	10/03→					
2.2 direct	114	10/03→					
2.2 DTI	92	10/03→					
3.0 V6 CDTI	130	10/03→					
3.0 V6 CDTI	135	08/05→					
3.2 V6	155	10/03→					
2.2 DTI	86	10/03→06/08		für Linkslenker; + ESP		24.2125-1732.3 010827	TRW Ø 25,4
OPEL - VECTRA C GTS 08/02→							
 Hauptbremszylinder							
1.6	74	08/05→		für Linkslenker; + ESP; → 10/08		24.2125-1732.3 010827	TRW Ø 25,4
1.6	77	01/06→					
1.8	103	01/06→					
1.8 16V	90	08/02→					
1.9 CDTI	74	10/05→					
1.9 CDTI	88	04/04→01/09					
1.9 CDTI	110	04/04→					
2.0 16V Turbo	129	03/03→					
2.0 DTI 16V	74	08/02→					
2.2 16V	108	08/02→					
2.2 direct	114	10/03→					
2.2 DTI 16V	92	08/02→					
3.0 CDTi	135	08/05→					
3.0 CDTI	130	06/03→					
3.2 V6	155	08/02→					
1.8 16V	81	08/02→12/06		für Linkslenker; + ESP		24.2125-1732.3 010827	TRW Ø 25,4
2.2 DTI 16V	86	08/02→06/08					
OPEL - VIVARO Combi (J7) 08/01→							
 Hauptbremszylinder							
1.9 DI	60	08/01→		7V600001 / 7Y000001→; → 06/14; + ABS		24.2120-1748.3 010894	TRW Ø 20,64
1.9 DTI	74	08/01→		7V600001 / 7Y000001→; → 06/14; + ASR		24.2120-1753.3 010946	TRW Ø 20,64
				4V602168→ 6V699999; für Rechtslenker; - ASR		24.2125-1731.3 010826	TRW Ø 25,4
				für Linkslenker; → 6V699999; + ASR		24.2125-1734.3 010878	TRW Ø 25,4
2.0 16V	88	08/01→		7V600001 / 7Y000001→; → 06/14; + ABS		24.2120-1748.3 010894	TRW Ø 20,64
2.0 CDTI	66	08/06→					
2.0 CDTI	84	08/06→					
↓							











	kw			 	! #		
OPEL - VIVARO Combi (J7) 08/01→							
 Hauptbremszylinder							
2.0 ECOTEC	86	08/06→		7V600001 / 7Y000001→; → 06/14; + ASR		24.2120-1753.3 010946	TRW Ø 20,64
2.5 CDTI	84	08/06→		4V602168→ 6V699999; - ASR → 6V699999; + ASR		24.2125-1731.3 010826	TRW Ø 25,4
2.5 CDTI	107	08/06→					
2.5 DTI	99	05/03→					
OPEL - VIVARO Kasten (F7) 08/01→							
 Hauptbremszylinder							
1.9 DI	60	08/01→		7V600001 / 7Y000001→; → 06/14; + ABS		24.2120-1748.3 010894	TRW Ø 20,64
1.9 DTI	74	08/01→		7V600001 / 7Y000001→; → 06/14; + ASR		24.2120-1753.3 010946	TRW Ø 20,64
				4V602168→ 6V699999; für Rechtslenker; - ASR		24.2125-1731.3 010826	TRW Ø 25,4
				für Linkslenker; → 6V699999; + ASR		24.2125-1734.3 010878	TRW Ø 25,4
2.0 16V	88	08/01→		7V600001 / 7Y000001→; → 06/14; + ABS		24.2120-1748.3 010894	TRW Ø 20,64
2.0 CDTI	66	08/06→		7V600001 / 7Y000001→; → 06/14; + ASR		24.2120-1753.3 010946	TRW Ø 20,64
2.0 CDTI	84	08/06→					
2.0 ECOTEC	86	08/06→					
2.5 CDTI	84	08/06→		4V602168→ 6V699999; - ASR		24.2125-1731.3 010826	TRW Ø 25,4
2.5 CDTI	107	08/06→		→ 6V699999; + ASR		24.2125-1734.3 010878	TRW Ø 25,4
2.5 DTI	99	05/03→					
OPEL - VIVARO Pritsche/Fahrgestell (E7) 08/01→							
 Hauptbremszylinder							
1.9 Di	60	08/01→		7V600001 / 7Y000001→; → 06/14; + ABS		24.2120-1748.3 010894	TRW Ø 20,64
				7V600001 / 7Y000001→; → 06/14; + ASR		24.2120-1753.3 010946	TRW Ø 20,64
				4V602168→ 6V699999; für Rechtslenker; - ASR		24.2125-1731.3 010826	TRW Ø 25,4
				08/06→; → 6V699999; für Linkslenker; + ASR		24.2125-1734.3 010878	TRW Ø 25,4
1.9 DTI	74	08/06→		7V600001 / 7Y000001→; → 06/14; + ABS		24.2120-1748.3 010894	TRW Ø 20,64
				7V600001 / 7Y000001→; → 06/14; + ASR		24.2120-1753.3 010946	TRW Ø 20,64
				4V602168→ 6V699999; für Rechtslenker; - ASR		24.2125-1731.3 010826	TRW Ø 25,4
				für Linkslenker; → 6V699999; + ASR		24.2125-1734.3 010878	TRW Ø 25,4
2.0 16V	88	08/03→		7V600001 / 7Y000001→; → 06/14; + ABS		24.2120-1748.3 010894	TRW Ø 20,64
2.0 CDTI	84	08/06→		7V600001 / 7Y000001→; → 06/14; + ASR		24.2120-1753.3 010946	TRW Ø 20,64
2.0 ECOTEC	86	08/06→					
2.5 CDTI	84	08/06→					
2.5 CDTI	107	08/06→		4V602168→ 6V699999; - ASR		24.2125-1731.3 010826	TRW Ø 25,4
				→ 6V699999; + ASR		24.2125-1734.3 010878	TRW Ø 25,4
2.0 CDTI	66	01/06→		7V600001 / 7Y000001→; → 06/14; + ABS		24.2120-1748.3 010894	TRW Ø 20,64
2.5 DTI	99	08/03→		7V600001 / 7Y000001→; → 06/14; + ASR		24.2120-1753.3 010946	TRW Ø 20,64
				4V602168→ 6V699999; - ASR		24.2125-1731.3 010826	TRW Ø 25,4
				08/06→; → 6V699999; + ASR		24.2125-1734.3 010878	TRW Ø 25,4
OPEL - ZAFIRA A (F75_) 04/99→06/05							
 Hauptbremszylinder							
1.6	76	10/03→06/05		- ESP		24.2123-1734.3 010640	TRW Ø 23,81
1.6 16V	74	04/99→06/05		+ ESP		24.2123-1739.3 010661	Ø 23,81
1.6 CNG	71	09/01→06/05					
1.8 16V	85	04/99→09/00					
1.8 16V	92	09/00→06/05					
2.0 DTI 16V	74	09/00→06/05					
2.0 OPC	141	09/01→06/05					
2.0 OPC	147	11/02→06/05					
2.2 16V	108	09/00→06/05					
2.2 DTI 16V	86	01/02→06/05					
2.2 DTI 16V	92	01/02→06/05					
2.0 DI	63	07/99→06/00		06/00→; - ESP		24.2123-1734.3 010640	TRW Ø 23,81
				06/00→; + ESP		24.2123-1739.3 010661	Ø 23,81
2.0 DI 16V	60	07/99→06/05		10/99→; - ESP		24.2123-1734.3 010640	TRW Ø 23,81
				10/99→; + ESP		24.2123-1739.3 010661	Ø 23,81
↓							

	kw					! #		
OPEL - ZAFIRA A (F75_) 04/99→06/05								
 Bremskraftregler								
1.6	76	10/03→06/05		- ABS			03.6583-0085.3 320238	ATE lastabhängig 8/3 4x
1.6 16V	74	04/99→06/05						
1.6 CNG	71	09/01→06/05						
1.8 16V	85	04/99→09/00						
1.8 16V	92	09/00→06/05						
2.0 DTI 16V	74	09/00→06/05						
2.0 OPC	141	09/01→06/05						
2.0 OPC	147	11/02→06/05						
2.2 16V	108	09/00→06/05						
2.2 DTI 16V	86	01/02→06/05						
2.2 DTI 16V	92	01/02→06/05						
2.0 DI	63	07/99→06/00		06/00→; - ABS			03.6583-0085.3 320238	ATE lastabhängig 8/3 4x
2.0 DI 16V	60	07/99→06/05		10/99→; - ABS			03.6583-0085.3 320238	ATE lastabhängig 8/3 4x
OPEL - ZAFIRA B (A05) 07/05→								
 Bremskraftverstärker								
1.6	77	07/05→		für Linkslenker; + ESP			03.7863-7803.4 300237	ATE Ø 10" pneumatisch
1.6	85	01/08→						
1.6 CNG	69	01/06→						
1.6 CNG Turbo	110	02/09→						
1.7 CDTI	81	01/08→						
1.7 CDTI	92	01/08→						
1.8	88	06/13→						
1.8	103	07/05→						
1.9 CDTI	74	07/05→						
1.9 CDTI	88	07/05→						
1.9 CDTI	110	07/05→						
2.0	147	07/05→						
2.0	177	01/06→						
2.2	110	07/05→						
 Hauptbremszylinder								
1.6	77	07/05→		für Linkslenker; - ESP			03.4155-0153.3 010927	ATE Ø 25,4
1.6 CNG Turbo	110	02/09→		für Linkslenker; + ESP			03.4155-0156.3 010862	ATE Ø 25,4
1.8	103	07/05→						
2.0	147	07/05→		→ 6G999999; für Rechtslenker			24.2125-1736.3 010904	TRW Ø 25,4
2.0	177	01/06→		72000001→; für Rechtslenker			24.4125-1703.3 010907	TRW Ø 25,4
1.6	85	01/08→		für Linkslenker; - ESP			03.4155-0153.3 010927	ATE Ø 25,4
1.6 CNG	69	01/06→		für Linkslenker; + ESP			03.4155-0156.3 010862	ATE Ø 25,4
1.7 CDTI	81	01/08→		für Linkslenker; - ESP			03.4155-0153.3 010927	ATE Ø 25,4
1.7 CDTI	92	01/08→		für Linkslenker; + ESP			03.4155-0156.3 010862	ATE Ø 25,4
1.9 CDTI	74	07/05→						
1.9 CDTI	88	07/05→		für Rechtslenker			03.4155-0156.3 010862	ATE Ø 25,4
1.9 CDTI	110	07/05→						
2.2	110	07/05→						
1.8	88	06/13→		für Linkslenker; - ESP			03.4155-0153.3 010927	ATE Ø 25,4
				für Linkslenker; + ESP			03.4155-0156.3 010862	ATE Ø 25,4
				für Rechtslenker			24.4125-1703.3 010907	TRW Ø 25,4
OPEL - ZAFIRA B Van 07/05→								
 Bremskraftverstärker								
1.6 CNG Turbo	110	02/09→		für Linkslenker; + ESP			03.7863-7803.4 300237	ATE Ø 10" pneumatisch
1.7 CDTI	81	01/08→						
1.7 CDTI	92	01/08→						
1.8	103	07/05→						
 Hauptbremszylinder								
1.6 CNG Turbo	110	02/09→		für Linkslenker; - ESP			03.4155-0153.3 010927	ATE Ø 25,4
1.8	103	07/05→		für Linkslenker; + ESP			03.4155-0156.3 010862	ATE Ø 25,4
				→ 6G999999; für Rechtslenker			24.2125-1736.3 010904	TRW Ø 25,4
				72000001→; für Rechtslenker			24.4125-1703.3 010907	TRW Ø 25,4
1.7 CDTI	81	01/08→		für Linkslenker; - ESP			03.4155-0153.3 010927	ATE Ø 25,4
1.7 CDTI	92	01/08→		für Linkslenker; + ESP			03.4155-0156.3 010862	ATE Ø 25,4
				für Rechtslenker			03.4155-0156.3 010862	ATE Ø 25,4
OPEL - ZAFIRA TOURER C (P12) 10/11→								
 Bremskraftverstärker								
1.4	88	10/11→		11/11→; für Linkslenker			03.7858-0732.4 300272	ATE Ø 9 / 8" pneumatisch
1.4	103	10/11→						
1.4 LPG	103	10/11→						
1.6 CNG	110	10/11→						
1.8	85	10/11→						
1.8	103	10/11→						







	kw			 	! #		
OPEL - ZAFIRA TOURER C (P12) 10/11→							
 Bremskraftverstärker							
1.8 LPG 2.0 CDTi 2.0 CDTi 2.0 CDTi 2.0 CDTi	101 81 96 118 121	10/11→ 10/11→ 10/11→ 10/11→ 10/11→		11/11→; für Linkslenker		03.7858-0732.4 300272	ATE Ø 9 / 8" pneumatisch
1.6 CDTi 1.6 CDTi 1.6 SIDI 1.6 SIDI 2.0 BiTurbo CDTi 2.0 CDTi 1.6 CDTi	88 99 125 147 143 125 100	07/14→ 11/16→ 12/12→ 07/13→ 01/13→ 01/15→ 02/13→		für Linkslenker 03/13→; für Linkslenker		03.7858-0732.4 300272	ATE Ø 9 / 8" pneumatisch
 Hauptbremszylinder							
1.4 1.4 1.4 LPG 1.6 CNG 1.8 1.8 1.8 LPG 2.0 CDTi 2.0 CDTi 2.0 CDTi 2.0 CDTi	88 103 103 110 85 103 101 81 96 118 121	10/11→ 10/11→ 10/11→ 10/11→ 10/11→ 10/11→ 10/11→ 10/11→ 10/11→ 10/11→ 10/11→		11/11→; für Linkslenker		03.2125-0421.3 010934	ATE Ø 25,4
1.6 CDTi 1.6 CDTi 1.6 SIDI 1.6 SIDI 2.0 BiTurbo CDTi 2.0 CDTi 1.6 CDTi	88 99 125 147 143 125 100	07/14→ 11/16→ 12/12→ 07/13→ 01/13→ 01/15→ 02/13→		für Linkslenker 03/13→; für Linkslenker		03.2125-0421.3 010934	ATE Ø 25,4
PEUGEOT - 106 I (1A, 1C) 08/91→04/96							
 Hauptbremszylinder							
1.0 1.0 1.1	33 37 44	09/91→04/96 09/91→04/96 09/91→04/96		- ABS; Türenanzahl: 3 - ABS; Türenanzahl: 5		03.2119-3389.3 010057 03.2120-2031.3 010106	ATE Ø 19,05 ATE Ø 20,64
1.3 1.4 1.4 1.6	72 69 72 76	10/93→04/96 09/91→04/96 08/91→03/96 01/94→04/96		- ABS		03.2120-2031.3 010106	ATE Ø 20,64
1.4 1.4 1.4 D 1.5 D 1.5 D 1.6	51 55 37 40 43 65	08/91→03/96 09/91→04/96 09/92→04/96 06/94→04/96 06/94→04/96 06/93→04/96		- ABS		03.2119-3389.3 010057	ATE Ø 19,05
PEUGEOT - 106 II (1) 04/96→07/04							
 Bremskraftverstärker							
1.0 i 1.0 i 1.1 i 1.1 i 1.1 LPG	33 37 40 44 42	05/96→10/99 01/97→ 01/97→ 05/96→07/04 09/00→10/02		→Orga 08787; für Linkslenker; - ABS		03.7740-3302.4 300107	ATE Ø 8" pneumatisch
1.6 i 1.6 i 1.6 S16 Electric 1.6 S16	65 74 88 20 87	05/96→10/99 05/96→01/01 04/98→09/01 04/96→07/04 05/96→07/04		für Linkslenker; - ABS		03.7740-3302.4 300107	ATE Ø 8" pneumatisch
1.6 S16	87	05/96→07/04		→ 03/04; für Linkslenker; - ABS		03.7740-3302.4 300107	ATE Ø 8" pneumatisch
 Hauptbremszylinder							
1.0 i	33	05/96→10/99		→Orga 08787; - ABS		03.2120-4166.3 010452 24.2120-1722.3 010544	ATE Ø 20,64 Ø 20,64
				Orga 08788→; - ABS		24.2119-1708.3 010543	BDX Ø 19,05
				+ ABS		24.2120-1728.3 010626	Ø 20,64
1.0 i	37	01/97→		→Orga 08787; - ABS		03.2120-4166.3 010452 24.2120-1722.3 010544	ATE Ø 20,64 Ø 20,64
				Orga 08788→; → 03/04; - ABS		24.2119-1708.3 010543	BDX Ø 19,05
				→ 03/01; + ABS		24.2120-1728.3 010626	Ø 20,64
1.1 i 1.1 i	40 44	01/97→ 05/96→07/04		→Orga 08787; - ABS		03.2120-4166.3 010452 24.2120-1722.3 010544	ATE Ø 20,64 Ø 20,64
				Orga 08788→; → 03/04; - ABS		24.2119-1708.3 010543	BDX Ø 19,05
↓							











	kw			 	! #		
PEUGEOT - 106 II (1) 04/96→07/04							
 Hauptbremszylinder							
1.1 i	40	01/97→		→ 03/04; + ABS		24.2120-1728.3 010626	Ø 20,64
1.1 i	44	05/96→07/04					
1.1 LPG	42	09/00→10/02		+ ABS		24.2120-1728.3 010626	Ø 20,64
1.4 i	55	05/96→07/04		→ 03/04; - ABS		24.2119-1708.3 010543	BDX Ø 19,05
				→ 03/04; + ABS		24.2120-1728.3 010626	Ø 20,64
1.5 D	40	05/96→03/01		- ABS		24.2119-1708.3 010543	BDX Ø 19,05
				+ ABS		24.2120-1728.3 010626	Ø 20,64
1.5 D	42	04/98→		10/00→ 03/04; - ABS		24.2119-1708.3 010543	BDX Ø 19,05
				10/00→ 03/04; + ABS		24.2120-1728.3 010626	Ø 20,64
1.6 i	65	05/96→10/99		- ABS		03.2120-4166.3 010452	ATE Ø 20,64
1.6 i	74	05/96→01/01				24.2120-1722.3 010544	Ø 20,64
				+ ABS		24.2120-1728.3 010626	Ø 20,64
1.6 S16	87	05/96→07/04		→ 03/04; - ABS		03.2120-4166.3 010452	ATE Ø 20,64
						24.2120-1722.3 010544	Ø 20,64
1.6 S16	88	04/98→09/01		- ABS		03.2120-4166.3 010452	ATE Ø 20,64
						24.2120-1722.3 010544	Ø 20,64
Electric	20	04/96→07/04				03.2120-4166.3 010452	ATE Ø 20,64
						24.2120-1722.3 010544	Ø 20,64
PEUGEOT - 106 Van (1_) 08/91→03/01							
 Bremskraftverstärker							
1.0	33	09/91→03/01		05/96→; →Orga 08787; für Linkslenker; - ABS		03.7740-3302.4 300107	ATE Ø 8" pneumatisch
Electric	20	04/96→03/01		für Linkslenker; - ABS		03.7740-3302.4 300107	ATE Ø 8" pneumatisch
 Hauptbremszylinder							
1.0	33	09/91→03/01		05/96→; →Orga 08787; - ABS		03.2120-4166.3 010452	ATE Ø 20,64
				Orga 08788→; - ABS		24.2120-1722.3 010544	Ø 20,64
				05/96→; + ABS		24.2120-1728.3 010626	Ø 20,64
1.5 D	40	05/96→03/01		- ABS		24.2119-1708.3 010543	BDX Ø 19,05
1.5 D	42	10/00→03/01		+ ABS		24.2120-1728.3 010626	Ø 20,64
Electric	20	04/96→03/01				03.2120-4166.3 010452	ATE Ø 20,64
						24.2120-1722.3 010544	Ø 20,64
PEUGEOT - 107 06/05→							
 Hauptbremszylinder							
1.0	50	06/05→		für Linkslenker; → 05/14; - DSC		24.4120-1701.3 010846	BOS Ø 20,64
1.4 HDi	40	06/05→					
PEUGEOT - 205 II (20A/C) 01/87→09/98							
 Hauptbremszylinder							
1.0	33	10/87→09/98		09/90→		03.2119-3389.3 010057	ATE Ø 19,05
1.8 TD	57	01/90→09/98				03.2120-2031.3 010106	ATE Ø 20,64
1.0	37	08/92→05/97				03.2119-3389.3 010057	ATE Ø 19,05
						03.2120-2031.3 010106	ATE Ø 20,64
1.1	44	07/89→09/98		09/90→		03.2119-3389.3 010057	ATE Ø 19,05
1.6	53	10/87→09/98				03.2120-2031.3 010106	ATE Ø 20,64
1.6	55	10/87→09/98		→ 08/90		03.2119-3389.3 010057	ATE Ø 19,05
						03.2120-2031.3 010106	ATE Ø 20,64
1.4	55	07/88→09/98		09/90→		03.2119-3389.3 010057	ATE Ø 19,05
				→ 08/90		03.2120-2031.3 010106	ATE Ø 20,64
						03.2119-3389.3 010057	ATE Ø 19,05
						03.2120-2031.3 010106	ATE Ø 20,64
1.4	55	08/90→07/98		09/90→		03.2119-3389.3 010057	ATE Ø 19,05
						03.2120-2031.3 010106	ATE Ø 20,64
1.6 Aut.	58	10/87→09/98		→ 08/90; Automatikgetriebe		03.2119-3389.3 010057	ATE Ø 19,05
						03.2120-2031.3 010106	ATE Ø 20,64
				09/90→		03.2119-3389.3 010057	ATE Ø 19,05
						03.2120-2031.3 010106	ATE Ø 20,64
1.6 Aut.	65	05/90→09/98		09/90→; - ABS		03.2119-3389.3 010057	ATE Ø 19,05
						03.2120-2031.3 010106	ATE Ø 20,64
↓							

	kw			 	! #		
PEUGEOT - 205 II (20A/C) 01/87→09/98							
 Hauptbremszylinder							
1.6 Aut.	65	05/90→09/98		→ 08/90; Automatikgetriebe		03.2119-3389.3 010057 03.2120-2031.3 010106	ATE Ø 19,05 ATE Ø 20,64
1.7 Diesel	44	07/87→09/98		→ 08/90		03.2119-3389.3 010057	ATE Ø 19,05
				03/94→		03.2119-3389.3 010057 03.2120-2031.3 010106	ATE Ø 19,05 ATE Ø 20,64
1.8 XDT	58	08/90→05/97				03.2119-3389.3 010057 03.2120-2031.3 010106	ATE Ø 19,05 ATE Ø 20,64
1.9	77	08/92→05/97		→ 07/94; - ABS		03.2119-3389.3 010057 03.2120-2031.3 010106	ATE Ø 19,05 ATE Ø 20,64
1.9	89	08/90→05/97		09/90→ 10/94; - ABS		03.2119-3389.3 010057 03.2120-2031.3 010106	ATE Ø 19,05 ATE Ø 20,64
1.9 Diesel	47	10/87→09/98		09/90→		03.2119-3389.3 010057 03.2120-2031.3 010106	ATE Ø 19,05 ATE Ø 20,64
				09/88→ 08/90		03.2119-3389.3 010057	ATE Ø 19,05
1.9 GTI	94	10/87→09/98		→ 08/88; - ABS		03.2119-3389.3 010057 03.2120-2031.3 010106	ATE Ø 19,05 ATE Ø 20,64
				09/90→; - ABS		03.2119-3389.3 010057 03.2120-2031.3 010106	ATE Ø 19,05 ATE Ø 20,64
Verschlusschraube, Hauptbremszylinder							
1.0	33	10/87→09/98		09/90→		03.3517-5100.1 390326	
1.4	55	08/90→07/98					
1.8 TD	57	01/90→09/98					
1.9 Diesel	47	10/87→09/98					
1.0	37	08/92→05/97				03.3517-5100.1 390326	
1.8 XDT	58	08/90→05/97					
1.1	44	07/89→09/98		09/90→		03.3517-5100.1 390326	
1.4	55	07/88→09/98					
1.6	53	10/87→09/98		→ 08/90		03.3517-5100.1 390326	
1.6	55	10/87→09/98					
1.6 Aut.	58	10/87→09/98		→ 08/90; Automatikgetriebe		03.3517-5100.1 390326	
				09/90→		03.3517-5100.1 390326	
1.6 Aut.	65	05/90→09/98		→ 08/90; Automatikgetriebe		03.3517-5100.1 390326	
				09/90→; - ABS		03.3517-5100.1 390326	
1.7 Diesel	44	07/87→09/98		03/94→		03.3517-5100.1 390326	
1.9	77	08/92→05/97		→ 07/94; - ABS		03.3517-5100.1 390326	
1.9	89	08/90→05/97		09/90→ 10/94; - ABS		03.3517-5100.1 390326	
1.9 GTI	94	10/87→09/98		→ 08/88; - ABS		03.3517-5100.1 390326	
				09/90→; - ABS		03.3517-5100.1 390326	
 Bremskraftregler							
1.9	89	08/90→05/97		09/90→ 10/94; - ABS		24.6042-1701.3 320149	2/20 2x
1.9 GTI	94	10/87→09/98		09/90→; - ABS		24.6042-1701.3 320149	2/20 2x
				→ S 1831920; - ABS		24.6043-1701.3 320150	3/15 2x
				→ S 1811241; - ABS		24.6043-1701.3 320150	3/15 2x
PEUGEOT - 205 Kasten 03/94→05/97							
 Hauptbremszylinder							
1.7 Diesel	44	03/94→05/97				03.2119-3389.3 010057 03.2120-2031.3 010106	ATE Ø 19,05 ATE Ø 20,64
Verschlusschraube, Hauptbremszylinder							
1.7 Diesel	44	03/94→05/97				03.3517-5100.1 390326	
PEUGEOT - 206 CC (2D) 09/00→							
 Bremskraftverstärker							
1.6	81	09/01→12/08		→Orga 09456; + ABS; Schaltgetriebe		03.7750-1832.4 300111	ATE Ø 9" pneumatisch
1.6 16V	80	09/00→		→Orga 09820; - ABS; Schaltgetriebe		03.7750-1832.4 300111	ATE Ø 9" pneumatisch
				→Orga 09820; - ABS; Automatikgetriebe		03.7750-2232.4 300112	ATE Ø 9" pneumatisch
				→Orga 09456; + ABS; Automatikgetriebe		03.7750-2232.4 300112	ATE Ø 9" pneumatisch
				Orga 09821→; → 01/07; - ABS; Schaltgetriebe		03.7750-6232.4 300215	ATE Ø 9" pneumatisch
				Orga 09821→; → 01/07; - ABS; Vollautomatik		03.7750-6332.4 300226	ATE Ø 9" pneumatisch
↓							











	kw			 	! #		
PEUGEOT - 206 CC (2D) 09/00→							
 Bremskraftverstärker							
1.6 1.6 16V	81 80	09/01→12/08 09/00→		Orga 09457→ Orga 09740; + ABS; Schaltgetriebe	03.7853-1602.4	300167	ATE Ø 9" pneumatisch
				Orga 09741→; → 01/07; + ABS; Schaltgetriebe	03.7853-2602.4	300196	ATE Ø 9" pneumatisch
				Orga 09741→; → 01/07; Vollautomatik; + ABS	03.7853-2702.4	300269	ATE Ø 9" pneumatisch
1.6 HDi 110	80	04/05→		→ 01/07	03.7853-2602.4	300196	ATE Ø 9" pneumatisch
					03.7853-2702.4	300269	ATE Ø 9" pneumatisch
 Hauptbremszylinder							
1.6 1.6 16V	81 80	09/01→12/08 09/00→		→ 01/07; Schaltgetriebe; - ESP	03.2122-1351.3	010528	Ø 22,2
				→ 01/07; Schaltgetriebe; - ABS	03.2122-1356.3	010529	Ø 22,2
				→ 01/07; Schaltgetriebe; + ESP	03.2122-1942.3	010700	ATE Ø 22,2
				→ 01/07; Vollautomatik; - ABS	03.4122-0031.3	010611	ATE Ø 22,2
				→ 01/07; Vollautomatik; - ESP	03.4122-0041.3	010612	ATE Ø 22,2
				→ 01/07; Vollautomatik; + ESP	03.4122-0054.3	010813	ATE Ø 22,2
1.6 HDi 110	80	04/05→		→ 01/07; - ESP	03.2122-1351.3	010528	Ø 22,2
					03.4122-0041.3	010612	ATE Ø 22,2
				→ 01/07; + ESP	03.2122-1942.3	010700	ATE Ø 22,2
				03.4122-0054.3	010813	ATE Ø 22,2	
2.0 S16	100	09/00→		→ 01/07; - ESP	03.2122-1351.3	010528	Ø 22,2
				→ 01/07; + ESP	03.2122-1942.3	010700	ATE Ø 22,2
PEUGEOT - 206 Schrägheck (2A/C) 08/98→							
 Bremskraftverstärker							
1.1	40	08/98→07/00		09/98→; →Orga 09456; + ABS	03.7750-1832.4	300111	ATE Ø 9" pneumatisch
				Orga 09457→ Orga 09740; + ABS	03.7853-1602.4	300167	ATE Ø 9" pneumatisch
				Orga 09741→; + ABS	03.7853-2602.4	300196	ATE Ø 9" pneumatisch
1.1 i	44	09/98→		→Orga 09456; + ABS	03.7750-1832.4	300111	ATE Ø 9" pneumatisch
				Orga 09457→ Orga 09740; + ABS	03.7853-1602.4	300167	ATE Ø 9" pneumatisch
				Orga 09741→; → 02/09; + ABS	03.7853-2602.4	300196	ATE Ø 9" pneumatisch
1.4 16V	65	10/03→		→ 02/09; - ABS	03.7750-6232.4	300215	ATE Ø 9" pneumatisch
				→ 02/09	03.7853-2602.4	300196	ATE Ø 9" pneumatisch
1.4 CNG 1.4 LPG	55 55	05/06→09/07 05/06→09/07		- ABS; Vollautomatik	03.7750-6332.4	300226	ATE Ø 9" pneumatisch
				+ ABS; Schaltgetriebe	03.7853-2602.4	300196	ATE Ø 9" pneumatisch
				+ ABS; Vollautomatik	03.7853-2702.4	300269	ATE Ø 9" pneumatisch
1.4 HDi	51	09/02→02/07		→Orga 09820; - ABS	03.7750-0532.4	300110	ATE Ø 9" pneumatisch
				→Orga 09456; + ABS	03.7750-1832.4	300111	ATE Ø 9" pneumatisch
				Orga 09457→ Orga 09740; + ABS	03.7853-1602.4	300167	ATE Ø 9" pneumatisch
				Orga 09821→	03.7853-2602.4	300196	ATE Ø 9" pneumatisch
1.4 HDi eco 70	50	09/01→		→Orga 09820; - ABS	03.7750-0532.4	300110	ATE Ø 9" pneumatisch
				→Orga 09456; + ABS	03.7750-1832.4	300111	ATE Ø 9" pneumatisch
				Orga 09457→ Orga 09740; + ABS	03.7853-1602.4	300167	ATE Ø 9" pneumatisch
				Orga 09821→; → 02/09	03.7853-2602.4	300196	ATE Ø 9" pneumatisch
1.4 i	55	09/98→		→Orga 09820; Schaltgetriebe; - ABS	03.7750-0532.4	300110	ATE Ø 9" pneumatisch
				→Orga 09456; Schaltgetriebe; + ABS	03.7750-1832.4	300111	ATE Ø 9" pneumatisch
				→Orga 09820; Vollautomatik; - ABS	03.7750-2232.4	300112	ATE Ø 9" pneumatisch
				→Orga 09456; Vollautomatik; + ABS	03.7750-2232.4	300112	ATE Ø 9" pneumatisch
				Orga 09821→; → 02/09; Vollautomatik; - ABS	03.7750-6332.4	300226	ATE Ø 9" pneumatisch
				Orga 09457→ Orga 09740; Schaltgetriebe; + ABS	03.7853-1602.4	300167	ATE Ø 9" pneumatisch
				Orga 09741→; → 02/09; Schaltgetriebe	03.7853-2602.4	300196	ATE Ø 9" pneumatisch
	Orga 09741→; → 02/09; Vollautomatik	03.7853-2702.4	300269	ATE Ø 9" pneumatisch			
1.6 1.6 16V 1.6 16V	81 79 80	05/05→07/08 06/01→04/05 12/00→		→Orga 09820; - ABS / + ABS; Schaltgetriebe	03.7750-1832.4	300111	ATE Ø 9" pneumatisch
				→Orga 09456; Schaltgetriebe; + ABS	03.7750-1832.4	300111	ATE Ø 9" pneumatisch
				→Orga 09820; Vollautomatik; - ABS	03.7750-2232.4	300112	ATE Ø 9" pneumatisch
				→Orga 09456; Vollautomatik; + ABS	03.7750-2232.4	300112	ATE Ø 9" pneumatisch
				Orga 09821→ Orga 10996; - ABS; Schaltgetriebe	03.7750-6232.4	300215	ATE Ø 9" pneumatisch
				Orga 09821→ Orga 10996; Vollautomatik; - ABS	03.7750-6332.4	300226	ATE Ø 9" pneumatisch
↓							



























	kw			 	! #		
PEUGEOT - 206 Schrägheck (2A/C) 08/98→							
Bremskraftverstärker							
1.6 1.6 16V 1.6 16V	81 79 80	05/05→07/08 06/01→04/05 12/00→		Orga 09457→ Orga 09740; Schaltgetriebe; + ABS		03.7853-1602.4 300167	ATE Ø 9" pneumatisch
				Orga 09741→ Orga 10996; Schaltgetriebe		03.7853-2602.4 300196	ATE Ø 9" pneumatisch
				Orga 09741→ Orga 10996; Vollautomatik; + ABS		03.7853-2702.4 300269	ATE Ø 9" pneumatisch
1.6 8V	66	05/99→10/03		→ 12/00; Schaltgetriebe; - ABS		03.7750-0532.4 300110	ATE Ø 9" pneumatisch
				→ 12/00; Schaltgetriebe; + ABS		03.7750-1832.4 300111	ATE Ø 9" pneumatisch
				→ 12/00; Vollautomatik		03.7750-2232.4 300112	ATE Ø 9" pneumatisch
1.6 HDi 110	80	05/04→		→ 02/09		03.7853-2602.4 300196	ATE Ø 9" pneumatisch
				→ 02/09; + ABS		03.7853-2702.4 300269	ATE Ø 9" pneumatisch
1.6 i	65	09/98→12/00		Schaltgetriebe; - ABS		03.7750-0532.4 300110	ATE Ø 9" pneumatisch
				Schaltgetriebe; + ABS		03.7750-1832.4 300111	ATE Ø 9" pneumatisch
				Vollautomatik		03.7750-2232.4 300112	ATE Ø 9" pneumatisch
1.9 D	51	09/98→11/01				03.7750-0532.4 300110	ATE Ø 9" pneumatisch
						03.7750-2232.4 300112	ATE Ø 9" pneumatisch
				→Orga 09456; + ABS		03.7750-1832.4 300111	ATE Ø 9" pneumatisch
						03.7750-2232.4 300112	ATE Ø 9" pneumatisch
				Orga 09457→; + ABS		03.7853-1602.4 300167	ATE Ø 9" pneumatisch
2.0 HDI 90	66	12/99→		→Orga 09456		03.7750-1832.4 300111	ATE Ø 9" pneumatisch
						03.7750-2232.4 300112	ATE Ø 9" pneumatisch
				→Orga 09820		03.7750-1832.4 300111	ATE Ø 9" pneumatisch
						03.7750-2232.4 300112	ATE Ø 9" pneumatisch
				Orga 09821→; → 02/09		03.7750-6232.4 300215	ATE Ø 9" pneumatisch
						03.7750-6332.4 300226	ATE Ø 9" pneumatisch
				Orga 09457→ Orga 09820; + ABS		03.7853-1602.4 300167	ATE Ø 9" pneumatisch
				Orga 09821→; → 02/09; + ABS		03.7853-2602.4 300196	ATE Ø 9" pneumatisch
						03.7853-2702.4 300269	ATE Ø 9" pneumatisch
Hauptbremszylinder							
1.1	40	08/98→07/00		09/98→; - ABS		03.2120-4321.3 010525	ATE Ø 20,64
				09/98→; + ABS		03.2122-1351.3 010528	Ø 22,2
				09/98→		24.2120-1737.3 010757	Ø 20,64
1.1 i	44	09/98→		→ 02/09; - ABS		03.2120-4321.3 010525	ATE Ø 20,64
				→ 02/09; + ABS		03.2122-1351.3 010528	Ø 22,2
				→ 02/09		24.2120-1737.3 010757	Ø 20,64
1.4 16V	65	10/03→		→ 02/09; - ESP		03.2122-1351.3 010528	Ø 22,2
				→ 02/09; - ABS		03.2122-1356.3 010529	Ø 22,2
				→ 02/09; + ESP		03.2122-1942.3 010700	ATE Ø 22,2
1.4 CNG 1.4 LPG 1.6 i	55 55 65	05/06→09/07 05/06→09/07 09/98→12/00		Schaltgetriebe; - ABS		03.2120-4321.3 010525	ATE Ø 20,64
				Schaltgetriebe; + ABS		03.2122-1351.3 010528	Ø 22,2
				Vollautomatik; - ABS		03.4122-0031.3 010611	ATE Ø 22,2
				Vollautomatik; + ABS		03.4122-0041.3 010612	ATE Ø 22,2
				Schaltgetriebe		24.2120-1737.3 010757	Ø 20,64
1.4 HDi	51	09/02→02/07		- ABS		03.2120-4321.3 010525	ATE Ø 20,64
				- ESP		03.2122-1351.3 010528	Ø 22,2
				+ ESP		03.2122-1942.3 010700	ATE Ø 22,2
						24.2120-1737.3 010757	Ø 20,64
1.4 HDi eco 70	50	09/01→		→ 02/09; - ABS		03.2120-4321.3 010525	ATE Ø 20,64
				→ 02/09; - ESP		03.2122-1351.3 010528	Ø 22,2
				→ 02/09; + ESP		03.2122-1942.3 010700	ATE Ø 22,2
				→ 02/09		24.2120-1737.3 010757	Ø 20,64
1.4 i	55	09/98→		→ 02/09; Schaltgetriebe; - ABS		03.2120-4321.3 010525	ATE Ø 20,64
				→ 02/09; Schaltgetriebe; + ABS		03.2122-1351.3 010528	Ø 22,2
				→ 02/09; Vollautomatik; - ABS		03.4122-0031.3 010611	ATE Ø 22,2
				→ 02/09; Vollautomatik; + ABS		03.4122-0041.3 010612	ATE Ø 22,2
				→ 02/09; Schaltgetriebe		24.2120-1737.3 010757	Ø 20,64
1.6 1.6 16V	81 79	05/05→07/08 06/01→04/05		Schaltgetriebe; - ESP		03.2122-1351.3 010528	Ø 22,2
				Schaltgetriebe; + ABS		03.2122-1351.3 010528	Ø 22,2
				Schaltgetriebe; - ABS		03.2122-1356.3 010529	Ø 22,2
				Schaltgetriebe; + ESP		03.2122-1942.3 010700	ATE Ø 22,2
				Vollautomatik; - ABS		03.4122-0031.3 010611	ATE Ø 22,2











	kw			 	! #		
PEUGEOT - 206 Schrägheck (2A/C) 08/98→							
 Hauptbremszylinder							
1.6	81	05/05→07/08		Vollautomatik; - ESP		03.4122-0041.3 010612	ATE Ø 22,2
1.6 16V	79	06/01→04/05		Vollautomatik; + ESP		03.4122-0054.3 010813	ATE Ø 22,2
1.6 16V	80	12/00→		→ 02/09; Schaltgetriebe; - ESP		03.2122-1351.3 010528	Ø 22,2
				→ 02/09; Schaltgetriebe; + ABS		03.2122-1351.3 010528	Ø 22,2
				→ 02/09; Schaltgetriebe; - ABS		03.2122-1356.3 010529	Ø 22,2
				→ 02/09; Schaltgetriebe; + ESP		03.2122-1942.3 010700	ATE Ø 22,2
				→ 02/09; Vollautomatik; - ABS		03.4122-0031.3 010611	ATE Ø 22,2
				→ 02/09; Vollautomatik; - ESP		03.4122-0041.3 010612	ATE Ø 22,2
				→ 02/09; Vollautomatik; + ESP		03.4122-0054.3 010813	ATE Ø 22,2
1.6 8V	66	05/99→10/03		→ 12/00; Schaltgetriebe; - ABS		03.2120-4321.3 010525	ATE Ø 20,64
				→ 12/00; Schaltgetriebe; + ABS		03.2122-1351.3 010528	Ø 22,2
				→ 12/00; Vollautomatik; - ABS		03.4122-0031.3 010611	ATE Ø 22,2
				→ 12/00; Vollautomatik; + ABS		03.4122-0041.3 010612	ATE Ø 22,2
1.6 HDi 110	80	05/04→		→ 02/09; - ESP		03.2122-1351.3 010528	Ø 22,2
				→ 02/09; + ESP		03.2122-1942.3 010700	ATE Ø 22,2
						03.4122-0054.3 010813	ATE Ø 22,2
						03.4122-0041.3 010612	ATE Ø 22,2
1.9 D	51	09/98→11/01		- ABS		03.2120-4321.3 010525	ATE Ø 20,64
				+ ABS		03.2122-1351.3 010528	Ø 22,2
						03.4122-0041.3 010612	ATE Ø 22,2
						24.2120-1737.3 010757	Ø 20,64
2.0 HDI 90	66	12/99→		→ 02/09; - ESP		03.2122-1351.3 010528	Ø 22,2
				→ 02/09; - ABS		03.2122-1356.3 010529	Ø 22,2
				→ 02/09; + ESP		03.2122-1942.3 010700	ATE Ø 22,2
				→ 02/09; + ABS		03.4122-0054.3 010813	ATE Ø 22,2
2.0 RC	130	07/03→		→ 02/09		03.2122-1942.3 010700	ATE Ø 22,2
2.0 S16	99	04/99→10/00		- ESP		03.2122-1351.3 010528	Ø 22,2
				+ ESP		03.2122-1942.3 010700	ATE Ø 22,2
2.0 S16	100	06/99→		10/00→ 02/07; - ESP		03.2122-1351.3 010528	Ø 22,2
				10/00→ 02/07; + ESP		03.2122-1942.3 010700	ATE Ø 22,2
PEUGEOT - 206 Stufenheck 03/07→							
 Bremskraftverstärker							
1.4	55	03/07→		→ 02/09; - ABS; Vollautomatik		03.7750-6332.4 300226	ATE Ø 9" pneumatisch
				→ 02/09; + ABS; Schaltgetriebe		03.7853-2602.4 300196	ATE Ø 9" pneumatisch
				→ 02/09; + ABS; Vollautomatik		03.7853-2702.4 300269	ATE Ø 9" pneumatisch
1.4 HDi eco 70	50	09/08→		→ 02/09		03.7853-2602.4 300196	ATE Ø 9" pneumatisch
1.6 16V	80	03/07→		→Orga 09820; - ABS / + ABS; Schaltgetriebe		03.7750-1832.4 300111	ATE Ø 9" pneumatisch
				→Orga 09456; Schaltgetriebe; + ABS		03.7750-1832.4 300111	ATE Ø 9" pneumatisch
				→Orga 09820; Vollautomatik; - ABS		03.7750-2232.4 300112	ATE Ø 9" pneumatisch
				→Orga 09456; Vollautomatik; + ABS		03.7750-2232.4 300112	ATE Ø 9" pneumatisch
				Orga 09821→ Orga 10996; - ABS; Schaltgetriebe		03.7750-6232.4 300215	ATE Ø 9" pneumatisch
				Orga 09821→ Orga 10996; Vollautomatik; - ABS		03.7750-6332.4 300226	ATE Ø 9" pneumatisch
				Orga 09457→ Orga 09740; Schaltgetriebe; + ABS		03.7853-1602.4 300167	ATE Ø 9" pneumatisch
				Orga 09741→ Orga 10996; Schaltgetriebe		03.7853-2602.4 300196	ATE Ø 9" pneumatisch
				Orga 09741→ Orga 10996; Vollautomatik; + ABS		03.7853-2702.4 300269	ATE Ø 9" pneumatisch
 Hauptbremszylinder							
1.4	55	03/07→		→ 02/09; Schaltgetriebe; - ABS		03.2120-4321.3 010525	ATE Ø 20,64
				→ 02/09; Schaltgetriebe; + ABS		03.2122-1351.3 010528	Ø 22,2
				→ 02/09; Vollautomatik; - ABS		03.4122-0031.3 010611	ATE Ø 22,2
				→ 02/09; Vollautomatik; + ABS		03.4122-0041.3 010612	ATE Ø 22,2
↓							

















	kw			 	! #		
PEUGEOT - 206 Stufenheck 03/07→							
 Hauptbremszylinder							
1.4	55	03/07→		→ 02/09; Schaltgetriebe		24.2120-1737.3 010757	Ø 20,64
1.4 HDi eco 70	50	09/08→		→ 02/09; - ABS		03.2120-4321.3 010525	ATE Ø 20,64
				→ 02/09; + ABS		03.2122-1351.3 010528	Ø 22,2
				→ 02/09; - ESP		03.2122-1351.3 010528	Ø 22,2
				→ 02/09; + ESP		03.2122-1942.3 010700	ATE Ø 22,2
				→ 02/09		24.2120-1737.3 010757	Ø 20,64
1.6 16V	80	03/07→		→ 02/09; Schaltgetriebe; - ESP		03.2122-1351.3 010528	Ø 22,2
				→ 02/09; Schaltgetriebe; + ABS		03.2122-1351.3 010528	Ø 22,2
				→ 02/09; Schaltgetriebe; - ABS		03.2122-1356.3 010529	Ø 22,2
				→ 02/09; Schaltgetriebe; + ESP		03.2122-1942.3 010700	ATE Ø 22,2
				→ 02/09; Vollautomatik; - ABS		03.4122-0031.3 010611	ATE Ø 22,2
				→ 02/09; Vollautomatik; - ESP		03.4122-0041.3 010612	ATE Ø 22,2
				→ 02/09; Vollautomatik; + ESP		03.4122-0054.3 010813	ATE Ø 22,2
PEUGEOT - 206 SW (2E/K) 07/02→							
 Bremskraftverstärker							
1.1	44	07/02→		→ Orga 09456; + ABS		03.7750-1832.4 300111	ATE Ø 9" pneumatisch
				Orga 09457→ Orga 09740; + ABS		03.7853-1602.4 300167	ATE Ø 9" pneumatisch
				Orga 09741→; → 05/07; + ABS		03.7853-2602.4 300196	ATE Ø 9" pneumatisch
1.4	55	07/02→		→ Orga 09820; Schaltgetriebe; - ABS		03.7750-0532.4 300110	ATE Ø 9" pneumatisch
				→ Orga 09456; Schaltgetriebe; + ABS		03.7750-1832.4 300111	ATE Ø 9" pneumatisch
				→ Orga 09820; - ABS; Vollautomatik		03.7750-2232.4 300112	ATE Ø 9" pneumatisch
				→ Orga 09456; + ABS; Vollautomatik		03.7750-2232.4 300112	ATE Ø 9" pneumatisch
				Orga 09821→; → 05/07; - ABS; Automatikgetriebe		03.7750-6332.4 300226	ATE Ø 9" pneumatisch
				Orga 09457→ Orga 09740; Schaltgetriebe; + ABS		03.7853-1602.4 300167	ATE Ø 9" pneumatisch
				Orga 09741→; → 05/07; + ABS; Schaltgetriebe		03.7853-2602.4 300196	ATE Ø 9" pneumatisch
				Orga 09741→; → 05/07; + ABS; Automatikgetriebe		03.7853-2702.4 300269	ATE Ø 9" pneumatisch
1.4 16V	65	10/03→		→ 05/07; + ABS		03.7853-2602.4 300196	ATE Ø 9" pneumatisch
1.4 HDi	50	07/02→		→ Orga 09820; - ABS		03.7750-0532.4 300110	ATE Ø 9" pneumatisch
				→ Orga 09456; + ABS		03.7750-1832.4 300111	ATE Ø 9" pneumatisch
				Orga 09457→ Orga 09820; + ABS		03.7853-1602.4 300167	ATE Ø 9" pneumatisch
				Orga 09821→; → 05/07; + ABS		03.7853-2602.4 300196	ATE Ø 9" pneumatisch
1.6 1.6 16V	81 80	05/05→07/08 07/02→		→ Orga 09820; Schaltgetriebe; + ABS		03.7750-1832.4 300111	ATE Ø 9" pneumatisch
				→ Orga 09456; Schaltgetriebe; + ABS		03.7750-1832.4 300111	ATE Ø 9" pneumatisch
				→ Orga 09820; - ABS; Automatikgetriebe		03.7750-2232.4 300112	ATE Ø 9" pneumatisch
				→ Orga 09456; + ABS; Vollautomatik		03.7750-2232.4 300112	ATE Ø 9" pneumatisch
				Orga 09821→; → 05/07; Schaltgetriebe; - ABS		03.7750-6232.4 300215	ATE Ø 9" pneumatisch
				Orga 09821→; → 05/07; - ABS; Automatikgetriebe		03.7750-6332.4 300226	ATE Ø 9" pneumatisch
				Orga 09457→ Orga 09740; Schaltgetriebe; + ABS		03.7853-1602.4 300167	ATE Ø 9" pneumatisch
				Orga 09741→; → 05/07; + ABS; Schaltgetriebe		03.7853-2602.4 300196	ATE Ø 9" pneumatisch
				Orga 09741→; → 05/07; + ABS; Automatikgetriebe		03.7853-2702.4 300269	ATE Ø 9" pneumatisch
1.6 HDi 110	80	05/04→		→ 05/07; + ABS		03.7853-2602.4 300196	ATE Ø 9" pneumatisch
						03.7853-2702.4 300269	ATE Ø 9" pneumatisch
2.0 HDi	66	07/02→		→ Orga 09820; - ABS		03.7750-1832.4 300111	ATE Ø 9" pneumatisch
						03.7750-2232.4 300112	ATE Ø 9" pneumatisch
				→ Orga 09456; + ABS		03.7750-1832.4 300111	ATE Ø 9" pneumatisch
						03.7750-2232.4 300112	ATE Ø 9" pneumatisch
				Orga 09821→; → 05/07; - ABS		03.7750-6232.4 300215	ATE Ø 9" pneumatisch
						03.7750-6332.4 300226	ATE Ø 9" pneumatisch
	Orga 09457→ Orga 09820; + ABS		03.7853-1602.4 300167	ATE Ø 9" pneumatisch			
	Orga 09821→; → 05/07; + ABS		03.7853-2602.4 300196	ATE Ø 9" pneumatisch			
			03.7853-2702.4 300269	ATE Ø 9" pneumatisch			
 Hauptbremszylinder							
1.1 ↓	44	07/02→		→ 05/07; - ABS		03.2120-4321.3 010525	ATE Ø 20,64











	kW			 	! #		
PEUGEOT - 206 SW (2E/K) 07/02→							
 Hauptbremszylinder							
1.1	44	07/02→		→ 05/07; - ABS	24.2120-1737.3	010757	Ø 20,64
				→ 05/07; + ABS	03.2122-1351.3	010528	Ø 22,2
1.4	55	07/02→		→ 05/07; Schaltgetriebe; - ABS	03.2120-4321.3	010525	ATE Ø 20,64
				→ 05/07; Schaltgetriebe; + ABS	24.2120-1737.3	010757	Ø 20,64
				→ 05/07; Schaltgetriebe; + ABS	03.2122-1351.3	010528	Ø 22,2
				→ 05/07; Vollautomatik; - ABS	03.4122-0031.3	010611	ATE Ø 22,2
				→ 05/07; Vollautomatik; - ESP	03.4122-0041.3	010612	ATE Ø 22,2
				→ 05/07; Vollautomatik; + ESP	03.4122-0054.3	010813	ATE Ø 22,2
1.4 16V	65	10/03→		→ 05/07; - ESP	03.2122-1351.3	010528	Ø 22,2
				→ 05/07; - ABS	03.2122-1356.3	010529	Ø 22,2
				→ 05/07; + ESP	03.2122-1942.3	010700	ATE Ø 22,2
1.4 HDi	50	07/02→		→ 05/07; - ABS	03.2120-4321.3	010525	ATE Ø 20,64
				→ 05/07; - ESP	24.2120-1737.3	010757	Ø 20,64
				→ 05/07; - ESP	03.2122-1351.3	010528	Ø 22,2
				→ 05/07; + ESP	03.2122-1942.3	010700	ATE Ø 22,2
1.6	81	05/05→07/08		→ 05/07; Schaltgetriebe; - ESP	03.2122-1351.3	010528	Ø 22,2
1.6 16V	80	07/02→		→ 05/07; Schaltgetriebe; - ABS	03.2122-1356.3	010529	Ø 22,2
				→ 05/07; Schaltgetriebe; + ESP	03.2122-1942.3	010700	ATE Ø 22,2
				→ 05/07; Vollautomatik; - ABS	03.4122-0031.3	010611	ATE Ø 22,2
				→ 05/07; Vollautomatik; - ESP	03.4122-0041.3	010612	ATE Ø 22,2
				→ 05/07; Vollautomatik; + ESP	03.4122-0054.3	010813	ATE Ø 22,2
1.6 HDi 110	80	05/04→		→ 05/07; - ESP	03.2122-1351.3	010528	Ø 22,2
				→ 05/07; - ABS	03.4122-0041.3	010612	ATE Ø 22,2
				→ 05/07; + ESP	03.2122-1942.3	010700	ATE Ø 22,2
				→ 05/07; + ESP	03.4122-0054.3	010813	ATE Ø 22,2
2.0 16V	100	07/02→		→ 05/07; - ESP	03.2122-1351.3	010528	Ø 22,2
				→ 05/07; + ESP	03.2122-1942.3	010700	ATE Ø 22,2
2.0 HDi	66	07/02→		→ 05/07; - ESP	03.2122-1351.3	010528	Ø 22,2
				→ 05/07; - ABS	03.4122-0041.3	010612	ATE Ø 22,2
				→ 05/07; - ABS	03.2122-1356.3	010529	Ø 22,2
				→ 05/07; + ESP	03.4122-0031.3	010611	ATE Ø 22,2
				→ 05/07; + ESP	03.2122-1942.3	010700	ATE Ø 22,2
				→ 05/07; + ESP	03.4122-0054.3	010813	ATE Ø 22,2
PEUGEOT - 206 Van 04/99→03/09							
 Bremskraftverstärker							
1.4 HDi	50	09/01→03/09		→ Orga 09820; - ABS	03.7750-0532.4	300110	ATE Ø 9" pneumatisch
				→ Orga 09456; + ABS	03.7750-1832.4	300111	ATE Ø 9" pneumatisch
				Orga 09457→ Orga 09740; + ABS	03.7853-1602.4	300167	ATE Ø 9" pneumatisch
				Orga 09821→; → 02/09	03.7853-2602.4	300196	ATE Ø 9" pneumatisch
1.9 D	51	04/99→05/07			03.7750-0532.4	300110	ATE Ø 9" pneumatisch
					03.7750-2232.4	300112	ATE Ø 9" pneumatisch
				→ Orga 09456; + ABS	03.7750-1832.4	300111	ATE Ø 9" pneumatisch
					03.7750-2232.4	300112	ATE Ø 9" pneumatisch
				Orga 09457→; + ABS	03.7853-1602.4	300167	ATE Ø 9" pneumatisch
 Hauptbremszylinder							
1.4 HDi	50	09/01→03/09		→ 02/09; - ABS	03.2120-4321.3	010525	ATE Ø 20,64
				→ 02/09; - ESP	03.2122-1351.3	010528	Ø 22,2
				→ 02/09; + ESP	03.2122-1942.3	010700	ATE Ø 22,2
				→ 02/09	24.2120-1737.3	010757	Ø 20,64
1.9 D	51	04/99→05/07		- ABS	03.2120-4321.3	010525	ATE Ø 20,64
					03.4122-0031.3	010611	ATE Ø 22,2
				+ ABS	03.2122-1351.3	010528	Ø 22,2
					03.4122-0041.3	010612	ATE Ø 22,2
					24.2120-1737.3	010757	Ø 20,64
PEUGEOT - 206+ (T3E) 01/09→							
 Bremskraftverstärker							
1.1	44	01/09→		→ 05/13; + ABS	03.7853-2602.4	300196	ATE Ø 9" pneumatisch
1.4 HDi eco 70	50	01/09→					
↓							











	kw					! #		
PEUGEOT - 206+ (T3E) 01/09→								
 Bremskraftverstärker								
1.4 i	54	09/10→			→ 05/13; + ABS		03.7853-2602.4 300196	ATE Ø 9" pneumatisch
1.4 i	55	01/09→						
1.6 16V	80	07/10→			→ 05/13		03.7853-2702.4 300269	ATE Ø 9" pneumatisch
 Hauptbremszylinder								
1.1	44	01/09→			→ 05/13; - ABS		03.2120-4321.3 010525	ATE Ø 20,64
1.4 HDi eco 70	50	01/09→					24.2120-1737.3 010757	Ø 20,64
1.4 i	54	09/10→						
1.4 i	55	01/09→			→ 05/13; + ABS		03.2122-1351.3 010528	Ø 22,2
					→ 05/13; + ESP		03.2122-1942.3 010700	ATE Ø 22,2
1.6 16V	80	07/10→			→ 05/13		03.4122-0041.3 010612	ATE Ø 22,2
PEUGEOT - 207 (WA_, WC_) 02/06→								
 Hauptbremszylinder								
1.4	53	02/06→			→ 06/12; + ESP		24.4122-1703.3 010843	TRW Ø 22,2
1.4	54	12/07→						
1.4	55	08/08→			→ 06/12; - ESP		24.4122-1704.3 010847	TRW Ø 22,2
1.4 16V	65	02/06→						
1.4 16V	72	10/09→						
1.4 Bioflex	60	08/08→						
1.4 HDi	50	02/06→						
1.4 HDi	52	02/11→						
1.6	81	08/08→						
1.6 16V	80	02/06→						
1.6 HDi	66	02/06→						
1.4 16V	70	06/07→			08/07→ 06/12; + ESP		24.4122-1703.3 010843	TRW Ø 22,2
					08/07→ 06/12; - ESP		24.4122-1704.3 010847	TRW Ø 22,2
1.6	90	09/07→12/13			→ 06/12; + ESP		24.4123-1704.3 010828	TRW Ø 23,81
1.6 16V RC	128	02/07→						
1.6 16V Turbo	110	02/06→			→ 06/12; - ESP		24.4123-1705.3 010832	TRW Ø 23,81
1.6 16V VTi	88	02/07→						
1.6 HDi	68	11/09→						
1.6 HDi	80	02/06→						
1.6 HDi 110	82	08/09→						
1.6 16V Turbo	115	10/09→			01/10→ 06/12; + ESP		24.4123-1704.3 010828	TRW Ø 23,81
					01/10→ 06/12; - ESP		24.4123-1705.3 010832	TRW Ø 23,81
PEUGEOT - 207 CC (WD_) 02/07→								
 Hauptbremszylinder								
1.6	90	09/10→12/11			+ ESP		24.4123-1704.3 010828	TRW Ø 23,81
1.6 16V	88	02/07→						
1.6 16V Turbo	110	02/07→			- ESP		24.4123-1705.3 010832	TRW Ø 23,81
1.6 16V Turbo	115	10/09→						
1.6 HDi	80	02/07→						
1.6 HDi	82	08/09→						
PEUGEOT - 207 Stufenheck 12/07→								
 Hauptbremszylinder								
1.4	54	12/07→			→ 06/12; + ESP		24.4122-1703.3 010843	TRW Ø 22,2
					→ 06/12; - ESP		24.4122-1704.3 010847	TRW Ø 22,2
PEUGEOT - 207 SW (WK_) 02/07→								
 Hauptbremszylinder								
1.4	54	06/07→			→ 07/13; + ESP		24.4122-1703.3 010843	TRW Ø 22,2
1.4 16V	70	06/07→						
1.4 16V	72	11/09→			→ 07/13; - ESP		24.4122-1704.3 010847	TRW Ø 22,2
1.6 HDi	66	06/07→						
1.6 16V	88	06/07→			→ 07/13; + ESP		24.4123-1704.3 010828	TRW Ø 23,81
1.6 16V Turbo	110	02/07→						
1.6 HDi	68	11/09→			→ 07/13; - ESP		24.4123-1705.3 010832	TRW Ø 23,81
1.6 HDi	80	06/07→						
1.6 HDi	82	08/09→						
1.6 16V RC	128	02/07→			11/07→ 07/13; + ESP		24.4123-1704.3 010828	TRW Ø 23,81
					11/07→ 07/13; - ESP		24.4123-1705.3 010832	TRW Ø 23,81
PEUGEOT - 207 Van 04/07→								
 Hauptbremszylinder								
1.4	54	06/07→10/08			+ ESP		24.4122-1703.3 010843	TRW Ø 22,2
					- ESP		24.4122-1704.3 010847	TRW Ø 22,2
1.4 HDi	50	04/07→			→ 06/12; + ESP		24.4122-1703.3 010843	TRW Ø 22,2
1.6 HDi	66	04/07→						
1.6 HDi	68	11/09→			→ 06/12; - ESP		24.4122-1704.3 010847	TRW Ø 22,2

	kw					! #		
PEUGEOT - 208 03/12→								
 Hauptbremszylinder								
1.0	50	03/12→		Orga 13342→; Trommelbremse; + DSC		24.4122-1703.3	010843	TRW Ø 22,2
1.2	60	03/12→		Orga 13342→; Trommelbremse; - DSC		24.4122-1704.3	010847	TRW Ø 22,2
1.2 GPL	60	06/15→		Scheibenbremse; + DSC		24.4123-1704.3	010828	TRW Ø 23,81
1.2 THP	81	01/13→		Scheibenbremse; - DSC		24.4123-1705.3	010832	TRW Ø 23,81
1.4 GPL	70	10/13→		Trommelbremse; + DSC		24.4122-1703.3	010843	TRW Ø 22,2
1.4 HDi	50	03/12→		Trommelbremse; - DSC		24.4122-1704.3	010847	TRW Ø 22,2
1.4 VTi	70	03/12→		Scheibenbremse; + DSC		24.4123-1704.3	010828	TRW Ø 23,81
1.6	88	03/12→		Scheibenbremse; - DSC		24.4123-1705.3	010832	TRW Ø 23,81
1.6 BlueHDi 120	115	03/12→						
1.6 HDi	88	11/13→						
1.6 HDi	68	03/12→						
1.6 HDi	69	09/16→						
1.6 HDi	84	03/12→						
1.6 HDi	85	04/14→						
1.6 HDi / BlueHDi 75	55	01/13→						
1.6 BlueHDi 100	73	01/15→		Scheibenbremse; + DSC		24.4123-1704.3	010828	TRW Ø 23,81
1.6 THP 165	121	03/15→		Scheibenbremse; - DSC		24.4123-1705.3	010832	TRW Ø 23,81
1.6 GTi	147	08/12→		03/13→; + DSC		24.4123-1704.3	010828	TRW Ø 23,81
				03/13→; - DSC		24.4123-1705.3	010832	TRW Ø 23,81
1.6 GTi	153	10/14→		+ DSC		24.4123-1704.3	010828	TRW Ø 23,81
				- DSC		24.4123-1705.3	010832	TRW Ø 23,81
PEUGEOT - 208 Kasten 10/12→								
 Hauptbremszylinder								
1.4 HDi	50	10/12→		Trommelbremse; + DSC		24.4122-1703.3	010843	TRW Ø 22,2
1.6 BlueHDi 75	55	04/15→		Trommelbremse; - DSC		24.4122-1704.3	010847	TRW Ø 22,2
1.6 HDi	68	03/14→		Scheibenbremse; + DSC		24.4123-1704.3	010828	TRW Ø 23,81
				Scheibenbremse; - DSC		24.4123-1705.3	010832	TRW Ø 23,81
PEUGEOT - 301 11/12→								
 Hauptbremszylinder								
1.6 BlueHDi 100	73	04/14→		+ ESP		24.4122-1703.3	010843	TRW Ø 22,2
1.6 HDi 90	68	11/12→						
1.6 HDi 90	69	09/16→						
PEUGEOT - 306 (7B, N3, N5) 04/93→10/03								
 Bremskraftverstärker								
1.1	44	06/94→05/01		→ 04/97; + ABS; für Linkslenker		03.7750-9402.4	300117	ATE Ø 9" pneumatisch
1.4 SL	55	06/94→05/01		05/97→; - ABS		03.7750-9302.4	300116	ATE Ø 9" pneumatisch
				10/94→; →Orga 08575; + ABS; für Linkslenker		03.7750-9402.4	300117	ATE Ø 9" pneumatisch
1.6	72	10/00→05/01		- ABS		03.7750-9302.4	300116	ATE Ø 9" pneumatisch
1.6 SR	65	06/94→10/00		10/94→ 04/97; für Rechtslenker; + ABS		03.7750-2232.4	300112	ATE Ø 9" pneumatisch
				05/97→; - ABS; Türenanzahl: 4		03.7750-9302.4	300116	ATE Ø 9" pneumatisch
				10/94→; →Orga 08575; + ABS; für Linkslenker		03.7750-9402.4	300117	ATE Ø 9" pneumatisch
1.8	74	10/95→04/97		→Orga 08575; + ABS; für Linkslenker		03.7750-9402.4	300117	ATE Ø 9" pneumatisch
1.8 16V	81	03/97→05/01		05/97→; - ABS; für Linkslenker;		03.7750-9302.4	300116	ATE Ø 9" pneumatisch
1.8 ST	74	06/94→05/01		Türenanzahl: 4				
2.0 ST	89	07/94→05/01		→Orga 08575; + ABS; für Linkslenker		03.7750-9402.4	300117	ATE Ø 9" pneumatisch
1.8 16V	82	03/97→07/01		05/97→ 05/01; - ABS; für Linkslenker;		03.7750-9302.4	300116	ATE Ø 9" pneumatisch
				Türenanzahl: 4				
				→Orga 08575; + ABS; für Linkslenker		03.7750-9402.4	300117	ATE Ø 9" pneumatisch
1.9 D	51	09/98→05/01		- ABS; für Linkslenker		03.7750-9302.4	300116	ATE Ø 9" pneumatisch
2.0	99	05/97→06/00		→Orga 08575; + ABS; für Linkslenker		03.7750-9402.4	300117	ATE Ø 9" pneumatisch
2.0 HDi 90	66	06/99→05/01						
1.9 D	55	03/98→05/01		- ABS; für Linkslenker		03.7750-9302.4	300116	ATE Ø 9" pneumatisch
				+ ABS; für Linkslenker		03.7750-9402.4	300117	ATE Ø 9" pneumatisch
1.9 D	69	02/94→04/97		→Orga 08575; + ABS; für Linkslenker		03.7750-9402.4	300117	ATE Ø 9" pneumatisch
				10/94→; + ABS; für Linkslenker		03.7750-9402.4	300117	ATE Ø 9" pneumatisch
1.9 SLD	47	06/94→05/01		05/97→; - ABS; für Linkslenker		03.7750-9302.4	300116	ATE Ø 9" pneumatisch
1.9 SLD	50	06/94→05/01		10/94→; + ABS; für Linkslenker		03.7750-9402.4	300117	ATE Ø 9" pneumatisch
1.9 SRDT	66	06/94→05/01						
2.0	97	03/97→05/01		05/97→; - ABS; für Linkslenker		03.7750-9302.4	300116	ATE Ø 9" pneumatisch
				05/97→; - ABS; für Linkslenker;		03.7750-9302.4	300116	ATE Ø 9" pneumatisch
				Türenanzahl: 4				
				→Orga 08575; + ABS; für Linkslenker		03.7750-9402.4	300117	ATE Ø 9" pneumatisch
↓								

	kw			 	! #		
PEUGEOT - 306 (7B, N3, N5) 04/93→10/03							
Bremskraftverstärker							
2.0 S16	110	06/94→05/01		05/97→; - ABS; für Linkslenker		03.7750-9302.4 300116	ATE Ø 9" pneumatisch
				→Orga 08575; + ABS; für Linkslenker		03.7750-9402.4 300117	ATE Ø 9" pneumatisch
2.0 S16	112	06/94→05/01		05/97→; - ABS; für Linkslenker		03.7750-9302.4 300116	ATE Ø 9" pneumatisch
				07/94→; →Orga 08575; + ABS; für Linkslenker		03.7750-9402.4 300117	ATE Ø 9" pneumatisch
Hauptbremszylinder							
1.1	44	06/94→05/01		→ 04/97; - ABS; Türenanzahl: 5		03.2119-3391.3 010058	ATE Ø 19,05
						24.2119-1702.3 010435	BDX Ø 19,05
				→ 04/97; - ABS; Türenanzahl: 3		24.2120-1704.3 010429	BDX Ø 20,64
				→ 04/97; S 30209025→; + ABS		24.2122-1705.3 010434	Ø 22,2
1.4 SL	55	06/94→05/01		10/94→ 04/97; - ABS; nicht für Fahrschulwagen		03.2119-3391.3 010058	ATE Ø 19,05
						24.2119-1702.3 010435	BDX Ø 19,05
				05/97→; - ABS		03.2120-4321.3 010525	ATE Ø 20,64
						24.2120-1726.3 010564	BDX Ø 20,64
				05/97→; →Orga 08575; + ABS; für Linkslenker		03.2122-1351.3 010528	Ø 22,2
				10/94→ 04/97; - ABS; für Fahrschulwagen		24.2120-1704.3 010429	BDX Ø 20,64
				→ 04/97; S 30209025→; + ABS		24.2122-1705.3 010434	Ø 22,2
				Orga 08576→; + ABS; für Linkslenker		24.2123-1715.3 010520	BDX Ø 23,81
1.6	72	10/00→05/01		- ABS		03.2120-4321.3 010525	ATE Ø 20,64
						24.2120-1726.3 010564	BDX Ø 20,64
				+ ABS; für Linkslenker		24.2123-1715.3 010520	BDX Ø 23,81
1.6 SR	65	06/94→10/00		10/94→ 04/97; - ABS; für Linkslenker		03.2120-1897.3 010103	ATE Ø 20,64
						24.2120-1704.3 010429	BDX Ø 20,64
				05/97→; - ABS; Türenanzahl: 4		03.2120-4321.3 010525	ATE Ø 20,64
						24.2120-1726.3 010564	BDX Ø 20,64
				05/97→; →Orga 08575; + ABS; für Linkslenker		03.2122-1351.3 010528	Ø 22,2
				→ 04/97; S 30209025→; + ABS		24.2122-1705.3 010434	Ø 22,2
				Orga 08576→; + ABS; für Linkslenker		24.2123-1715.3 010520	BDX Ø 23,81
1.8	74	10/95→04/97		- ABS; für Linkslenker		03.2120-1897.3 010103	ATE Ø 20,64
						24.2120-1704.3 010429	BDX Ø 20,64
				- ABS; für Rechtslenker; Türenanzahl: 4		03.2120-4246.3 010614	ATE Ø 20,64
						24.2120-1722.3 010544	Ø 20,64
				- ABS; für Rechtslenker		03.2120-4246.3 010614	ATE Ø 20,64
						24.2120-1722.3 010544	Ø 20,64
				S 30209025→; + ABS		24.2122-1705.3 010434	Ø 22,2
				Orga 08576→; + ABS; für Linkslenker		24.2123-1715.3 010520	BDX Ø 23,81
1.8 16V	81	03/97→05/01		→ 04/97; - ABS; für Linkslenker; Türenanzahl: 4		03.2120-1897.3 010103	ATE Ø 20,64
						24.2120-1704.3 010429	BDX Ø 20,64
				05/97→; →Orga 08575; + ABS; für Linkslenker		03.2122-1351.3 010528	Ø 22,2
						03.2122-1356.3 010529	Ø 22,2
				05/97→; - ABS; für Linkslenker; Türenanzahl: 4		03.2122-1421.3 010615	ATE Ø 22,2
				05/97→; - ABS; für Rechtslenker; Türenanzahl: 4		03.2122-1421.3 010615	ATE Ø 22,2
				→ 04/97; + ABS		24.2122-1705.3 010434	Ø 22,2
				Orga 08576→; + ABS; für Linkslenker		24.2123-1715.3 010520	BDX Ø 23,81
1.8 16V	82	03/97→07/01		→ 04/97; - ABS; für Linkslenker; Türenanzahl: 4		03.2120-1897.3 010103	ATE Ø 20,64
						24.2120-1704.3 010429	BDX Ø 20,64
				05/97→; →Orga 08575; + ABS; für Linkslenker		03.2122-1351.3 010528	Ø 22,2
						03.2122-1356.3 010529	Ø 22,2
				05/97→ 05/01; - ABS; für Linkslenker; Türenanzahl: 4		03.2122-1356.3 010529	Ø 22,2
				05/97→ 05/01; - ABS; für Rechtslenker; Türenanzahl: 4		03.2122-1421.3 010615	ATE Ø 22,2
				→ 04/97; + ABS		24.2122-1705.3 010434	Ø 22,2
				Orga 08576→; → 05/01; + ABS; für Linkslenker		24.2123-1715.3 010520	BDX Ø 23,81
1.8 ST	74	06/94→05/01		10/94→ 04/97; - ABS; für Linkslenker		03.2120-1897.3 010103	ATE Ø 20,64
						24.2120-1704.3 010429	BDX Ø 20,64
				10/94→; - ABS; für Rechtslenker; Türenanzahl: 4		03.2120-4246.3 010614	ATE Ø 20,64
						24.2120-1722.3 010544	Ø 20,64

	kw			 	! #		
PEUGEOT - 306 (7B, N3, N5) 04/93→10/03							
Hauptbremszylinder							
1.8 ST	74	06/94→05/01		05/97→; - ABS; für Linkslenker; Türenanzahl: 4	03.2120-4321.3	010525	ATE Ø 20,64
				05/97→; →Orga 08575; + ABS; für Linkslenker	24.2120-1726.3	010564	BDX Ø 20,64
				→ 04/97; S 30209025→; + ABS	03.2122-1351.3	010528	Ø 22,2
				Orga 08576→; + ABS; für Linkslenker	24.2122-1705.3	010434	Ø 22,2
1.9 D	51	09/98→05/01		- ABS; für Linkslenker	03.2120-4321.3	010525	ATE Ø 20,64
				→Orga 08575; + ABS; für Linkslenker	24.2120-1726.3	010564	BDX Ø 20,64
				→Orga 08575; + ABS; für Linkslenker	03.2122-1351.3	010528	Ø 22,2
				→Orga 08575; + ABS; für Rechtslenker	03.2122-1461.3	010610	ATE Ø 22,2
				- ABS; für Rechtslenker	03.2122-1461.3	010610	ATE Ø 22,2
1.9 D	55	03/98→05/01		Orga 08576→; + ABS; für Linkslenker	24.2123-1715.3	010520	BDX Ø 23,81
				- ABS; für Rechtslenker	03.2120-4246.3	010614	ATE Ø 20,64
				- ABS; für Linkslenker	24.2120-1722.3	010544	Ø 20,64
				→Orga 08575; + ABS; für Linkslenker	03.2120-4321.3	010525	ATE Ø 20,64
1.9 D	69	02/94→04/97		24.2120-1726.3	010564	BDX Ø 20,64	
				10/94→; - ABS; für Linkslenker	03.2122-1351.3	010528	Ø 22,2
				für Rechtslenker; - ABS	03.2122-1421.3	010615	ATE Ø 22,2
				+ ABS	24.2123-1715.3	010520	BDX Ø 23,81
				10/94→; + ABS	24.2122-1705.3	010434	Ø 22,2
				Orga 08576→; + ABS; für Linkslenker	24.2122-1705.3	010434	Ø 22,2
1.9 SLD 1.9 SLD	47 50	06/94→05/01 06/94→05/01		10/94→ 04/97; - ABS; für Linkslenker	03.2120-1897.3	010103	ATE Ø 20,64
				24.2120-1704.3	010429	BDX Ø 20,64	
				10/94→; - ABS; für Rechtslenker	03.2120-4246.3	010614	ATE Ø 20,64
				24.2120-1722.3	010544	Ø 20,64	
				05/97→; - ABS; für Linkslenker	03.2120-4321.3	010525	ATE Ø 20,64
				24.2120-1726.3	010564	BDX Ø 20,64	
1.9 SRDT	66	06/94→05/01		05/97→; →Orga 08575; + ABS; für Linkslenker	03.2122-1351.3	010528	Ø 22,2
				05/97→; - ABS; für Linkslenker	03.2122-1356.3	010529	Ø 22,2
				05/97→; - ABS; für Rechtslenker	03.2122-1421.3	010615	ATE Ø 22,2
				10/94→ 04/97; + ABS	24.2122-1705.3	010434	Ø 22,2
				Orga 08576→; + ABS; für Linkslenker	24.2123-1715.3	010520	BDX Ø 23,81
				→ 04/97; - ABS; für Linkslenker; Türenanzahl: 4	03.2120-1897.3	010103	ATE Ø 20,64
2.0	97	03/97→05/01		24.2120-1704.3	010429	BDX Ø 20,64	
				→ 04/97; - ABS; für Linkslenker	03.2120-1897.3	010103	ATE Ø 20,64
				24.2120-1704.3	010429	BDX Ø 20,64	
				05/97→; →Orga 08575; + ABS; für Linkslenker	03.2122-1351.3	010528	Ø 22,2
				24.2122-1733.3	010668	Ø 22,2	
				05/97→; - ABS; für Linkslenker	03.2122-1356.3	010529	Ø 22,2
				05/97→; - ABS; für Linkslenker; Türenanzahl: 4	03.2122-1356.3	010529	Ø 22,2
				05/97→; - ABS; für Rechtslenker; Türenanzahl: 4	03.2122-1421.3	010615	ATE Ø 22,2
				für Rechtslenker; - ABS	03.2122-1421.3	010615	ATE Ø 22,2
				→ 04/97	24.2122-1705.3	010434	Ø 22,2
2.0	99	05/97→06/00		→ 04/97; + ABS	24.2122-1705.3	010434	Ø 22,2
				Orga 08576→; + ABS; für Linkslenker	24.2123-1715.3	010520	BDX Ø 23,81
				→Orga 08575; + ABS; für Linkslenker	03.2122-1351.3	010528	Ø 22,2
				24.2122-1733.3	010668	Ø 22,2	
		- ABS; für Linkslenker	03.2122-1356.3	010529	Ø 22,2		

	kw					! #		
PEUGEOT - 306 (7B, N3, N5) 04/93→10/03								
 Hauptbremszylinder								
2.0	99	05/97→06/00		für Rechtslenker; - ABS		03.2122-1421.3	010615	ATE Ø 22,2
				Orga 08576→; + ABS; für Linkslenker		24.2123-1715.3	010520	BDX Ø 23,81
2.0 HDI 90	66	06/99→05/01		- ABS; für Linkslenker		03.2122-1356.3	010529	Ø 22,2
				für Rechtslenker; - ABS		03.2122-1421.3	010615	ATE Ø 22,2
				+ ABS; für Linkslenker		24.2123-1715.3	010520	BDX Ø 23,81
2.0 S16	110	06/94→05/01		→ 04/97; - ABS; für Linkslenker		03.2120-1897.3	010103	ATE Ø 20,64
						24.2120-1704.3	010429	BDX Ø 20,64
				05/97→; →Orga 08575; + ABS; für Linkslenker		03.2122-1351.3	010528	Ø 22,2
				05/97→; - ABS; für Linkslenker		03.2122-1356.3	010529	Ø 22,2
				05/97→; - ABS; für Rechtslenker		03.2122-1421.3	010615	ATE Ø 22,2
				→ 04/97; + ABS		24.2122-1705.3	010434	Ø 22,2
				Orga 08576→; + ABS; für Linkslenker		24.2123-1715.3	010520	BDX Ø 23,81
2.0 S16	112	06/94→05/01		07/94→ 04/97; - ABS; für Linkslenker		03.2120-1897.3	010103	ATE Ø 20,64
						24.2120-1704.3	010429	BDX Ø 20,64
				05/97→; →Orga 08575; + ABS; für Linkslenker		03.2122-1351.3	010528	Ø 22,2
				05/97→; - ABS; für Linkslenker		03.2122-1356.3	010529	Ø 22,2
				05/97→; - ABS; für Rechtslenker		03.2122-1421.3	010615	ATE Ø 22,2
				07/94→ 04/97; + ABS		24.2122-1705.3	010434	Ø 22,2
				Orga 08576→; + ABS; für Linkslenker		24.2123-1715.3	010520	BDX Ø 23,81
2.0 ST	89	07/94→05/01		10/94→ 04/97; - ABS; für Linkslenker; Türenanzahl: 4		03.2120-1897.3	010103	ATE Ø 20,64
						24.2120-1704.3	010429	BDX Ø 20,64
				05/97→; →Orga 08575; + ABS; für Linkslenker		03.2122-1351.3	010528	Ø 22,2
				05/97→; - ABS; für Linkslenker; Türenanzahl: 4		03.2122-1356.3	010529	Ø 22,2
				05/97→; - ABS; für Rechtslenker; Türenanzahl: 4		03.2122-1421.3	010615	ATE Ø 22,2
				→ 04/97; + ABS		24.2122-1705.3	010434	Ø 22,2
				Orga 08576→; + ABS; für Linkslenker		24.2123-1715.3	010520	BDX Ø 23,81
 Bremskraftregler								
1.1	44	06/94→05/01		→ 04/97; + ABS		24.6042-1701.3	320149	2/20 2x
1.4 SL	55	06/94→05/01		10/94→ 04/97; + ABS;		24.6042-1701.3	320149	2/20 2x
1.9 SLD	47	06/94→05/01		für Fahrzeuge ohne verstärktes Fahrwerk				
1.9 SLD	50	06/94→05/01						
1.6 SR	65	06/94→10/00		10/94→ 04/97; + ABS;		24.6042-1701.3	320149	2/20 2x
1.8 ST	74	06/94→05/01		für Fahrzeuge ohne verstärktes Fahrwerk; Türenanzahl: 4				
1.8	74	10/95→04/97		+ ABS; für Fahrzeuge ohne verstärktes Fahrwerk; Türenanzahl: 4		24.6042-1701.3	320149	2/20 2x
1.8 16V	81	03/97→05/01		→ 04/97;		24.6042-1701.3	320149	2/20 2x
1.8 16V	82	03/97→07/01		für Fahrzeuge ohne verstärktes Fahrwerk; Türenanzahl: 4				
2.0	97	03/97→05/01		→ 04/97; Türenanzahl: 4		24.6042-1701.3	320149	2/20 2x
2.0 ST	89	07/94→05/01		10/94→ 04/97; für Fahrzeuge ohne verstärktes Fahrwerk; Türenanzahl: 4		24.6042-1701.3	320149	2/20 2x
PEUGEOT - 306 Break (7E, N3, N5) 06/94→04/02								
 Bremskraftverstärker								
1.4	55	03/97→04/02		→ 03/02; - ABS		03.7750-9302.4	300116	ATE Ø 9" pneumatisch
1.6	72	10/00→04/02						
1.6	65	03/97→10/00		- ABS		03.7750-9302.4	300116	ATE Ø 9" pneumatisch
1.9 D	50	03/97→04/02		→ 03/02; - ABS; für Linkslenker		03.7750-9302.4	300116	ATE Ø 9" pneumatisch
1.9 D	51	09/98→04/02						
1.9 D	55	03/98→04/02						
1.9 D	51	05/97→05/99		- ABS; für Linkslenker		03.7750-9302.4	300116	ATE Ø 9" pneumatisch
 Hauptbremszylinder								
1.4	55	03/97→04/02		→ 03/02; - ABS		03.2122-1356.3	010529	Ø 22,2
1.6	72	10/00→04/02		→ 03/02; + ABS; für Linkslenker		24.2123-1715.3	010520	BDX Ø 23,81
1.6	65	03/97→10/00		- ABS		03.2122-1356.3	010529	Ø 22,2
				+ ABS; für Linkslenker		24.2123-1715.3	010520	BDX Ø 23,81
1.8	74	03/97→04/02		→ 03/02; für Linkslenker; - ABS		24.2123-1714.3	010587	BDX Ø 23,81
1.8 16V	81	03/97→04/02						
↓								

	kw			 	! #		
PEUGEOT - 306 Break (7E, N3, N5) 06/94→04/02							
 Hauptbremszylinder							
2.0	97	03/97→04/02		→ 03/02; + ABS; für Linkslenker		24.2123-1715.3 010520	BDX Ø 23,81
2.0 16V	99	03/97→04/02					
2.0 HDI 90	66	06/99→04/02					
1.8 16V	82	03/97→07/01		für Linkslenker; - ABS		24.2123-1714.3 010587	BDX Ø 23,81
				+ ABS; für Linkslenker		24.2123-1715.3 010520	BDX Ø 23,81
1.9 D	50	03/97→04/02		→ 03/02; - ABS; für Linkslenker		03.2122-1356.3 010529	Ø 22,2
1.9 D	51	09/98→04/02		→ 03/02; - ABS; für Rechtslenker		03.2122-1421.3 010615	ATE Ø 22,2
1.9 D	55	03/98→04/02		→ 03/02; + ABS; für Linkslenker		24.2123-1715.3 010520	BDX Ø 23,81
1.9 D	51	05/97→05/99		- ABS; für Linkslenker		03.2122-1356.3 010529	Ø 22,2
				- ABS; für Rechtslenker		03.2122-1421.3 010615	ATE Ø 22,2
				+ ABS; für Linkslenker		24.2123-1715.3 010520	BDX Ø 23,81
1.9 Td	52	07/95→08/00		03/97→; - ABS; für Linkslenker		03.2122-1356.3 010529	Ø 22,2
						24.2123-1714.3 010587	BDX Ø 23,81
				03/97→; - ABS; für Rechtslenker		03.2122-1421.3 010615	ATE Ø 22,2
				03/97→; + ABS; für Linkslenker		24.2123-1715.3 010520	BDX Ø 23,81
1.9 TD	66	02/97→04/02		03/97→ 03/02; - ABS; für Linkslenker		03.2122-1356.3 010529	Ø 22,2
						24.2123-1714.3 010587	BDX Ø 23,81
				03/97→ 03/02; - ABS; für Rechtslenker		03.2122-1421.3 010615	ATE Ø 22,2
				03/97→ 03/02; + ABS; für Linkslenker		24.2123-1715.3 010520	BDX Ø 23,81
PEUGEOT - 306 Cabriolet (7D, N3, N5) 03/94→04/02							
 Bremskraftverstärker							
1.6	65	04/96→10/00		für Rechtslenker		03.7750-2232.4 300112	ATE Ø 9" pneumatisch
				→Orga 08575; für Linkslenker		03.7750-9402.4 300117	ATE Ø 9" pneumatisch
1.8	74	03/94→04/02		→Orga 08575; für Linkslenker		03.7750-9402.4 300117	ATE Ø 9" pneumatisch
1.8	74	05/97→04/99					
2.0	89	03/94→04/02					
2.0	90	02/95→11/97					
2.0 16V	97	03/97→04/02					
2.0 16V	99	03/97→04/02					
 Hauptbremszylinder							
1.6	65	04/96→10/00		→Orga 07737; - ABS		03.2120-4241.3 010524	ATE Ø 20,64
						24.2120-1722.3 010544	Ø 20,64
				→Orga 08575; + ABS; für Linkslenker		03.2122-1351.3 010528	Ø 22,2
				Orga 08576→; + ABS; für Linkslenker		24.2123-1715.3 010520	BDX Ø 23,81
1.6	72	10/00→04/02		+ ABS; für Linkslenker		24.2123-1715.3 010520	BDX Ø 23,81
1.8 16V	81	07/00→04/02					
1.8	74	03/94→04/02		→Orga 08575; + ABS; für Linkslenker		03.2122-1351.3 010528	Ø 22,2
				→ 10/00; - ABS		24.2120-1722.3 010544	Ø 20,64
				Orga 08576→; → 10/00; + ABS; für Linkslenker		24.2123-1715.3 010520	BDX Ø 23,81
1.8	74	05/97→04/99		→Orga 08575; + ABS; für Linkslenker		03.2122-1351.3 010528	Ø 22,2
				- ABS		24.2120-1722.3 010544	Ø 20,64
				Orga 08576→; + ABS; für Linkslenker		24.2123-1715.3 010520	BDX Ø 23,81
2.0	89	03/94→04/02		→ 04/97; + ABS; für Linkslenker		03.2122-1351.3 010528	Ø 22,2
2.0	90	02/95→11/97		→Orga 07744; - ABS		24.2122-1705.3 010434	Ø 22,2
2.0 16V	97	03/97→04/02		→Orga 08575; + ABS; für Linkslenker		03.2122-1351.3 010528	Ø 22,2
				→Orga 07744; - ABS		24.2122-1705.3 010434	Ø 22,2
				Orga 08576→; → 10/00; + ABS; für Linkslenker		24.2123-1715.3 010520	BDX Ø 23,81
2.0 16V	99	03/97→04/02		→Orga 08575; + ABS; für Linkslenker		03.2122-1351.3 010528	Ø 22,2
				→Orga 07744; - ABS		24.2122-1705.3 010434	Ø 22,2
				Orga 08576→; + ABS; für Linkslenker		24.2123-1715.3 010520	BDX Ø 23,81
PEUGEOT - 306 Kasten/Kombi (N_, 7_) 07/93→08/02							
 Bremskraftverstärker							
1.4	55	03/96→07/01		05/97→ 05/01; - ABS		03.7750-9302.4 300116	ATE Ø 9" pneumatisch
				→Orga 08575; + ABS; für Linkslenker		03.7750-9402.4 300117	ATE Ø 9" pneumatisch
1.9 D	51	02/99→08/02		→ 03/02; - ABS; für Linkslenker		03.7750-9302.4 300116	ATE Ø 9" pneumatisch
1.9 D	69	02/94→04/99		05/97→; - ABS; für Linkslenker		03.7750-9302.4 300116	ATE Ø 9" pneumatisch
				→Orga 08575; + ABS; für Linkslenker		03.7750-9402.4 300117	ATE Ø 9" pneumatisch
1.9 STD	51	02/94→05/99		09/98→; →Orga 08575; + ABS; für Linkslenker		03.7750-9402.4 300117	ATE Ø 9" pneumatisch
↓							



PEUGEOT - 306 Kasten/Kombi (N_, 7_) 07/93→08/02

Hauptbremszylinder

1.4	55	03/96→07/01	→ 04/97; - ABS; nicht für Fahrschulwagen; Türenanzahl: 5	03.2119-3391.3 010058	ATE Ø 19,05
				24.2119-1702.3 010435	BDX Ø 19,05
			05/97→ 05/01; - ABS	03.2120-4321.3 010525	ATE Ø 20,64
				24.2120-1726.3 010564	BDX Ø 20,64
			05/97→; →Orga 08575; + ABS; für Linkslenker	03.2122-1351.3 010528	Ø 22,2
				24.2122-1733.3 010668	Ø 22,2
1.9 D	51	02/99→08/02	→ 04/97; - ABS; für Fahrschulwagen; Türenanzahl: 3	24.2120-1704.3 010429	BDX Ø 20,64
			→ 04/97; S 30209025→; + ABS	24.2122-1705.3 010434	Ø 22,2
			Orga 08576→; → 05/01; + ABS; für Linkslenker	24.2123-1715.3 010520	BDX Ø 23,81
			→ 03/02; - ABS; für Linkslenker	03.2122-1356.3 010529	Ø 22,2
			→ 03/02; - ABS; für Rechtslenker	03.2122-1421.3 010615	ATE Ø 22,2
1.9 D	69	02/94→04/99	→ 03/02; + ABS; für Linkslenker	24.2123-1715.3 010520	BDX Ø 23,81
			→ 04/97; - ABS; für Linkslenker	03.2120-1897.3 010103	ATE Ø 20,64
				24.2120-1704.3 010429	BDX Ø 20,64
			05/97→; →Orga 08575; + ABS; für Linkslenker	03.2122-1351.3 010528	Ø 22,2
				24.2122-1733.3 010668	Ø 22,2
			05/97→; - ABS; für Linkslenker	03.2122-1356.3 010529	Ø 22,2
1.9 STD	51	02/94→05/99	für Rechtslenker; - ABS	03.2122-1421.3 010615	ATE Ø 22,2
			→ 04/97; + ABS	24.2122-1705.3 010434	Ø 22,2
			Orga 08576→; + ABS; für Linkslenker	24.2123-1715.3 010520	BDX Ø 23,81
			05/97→; →Orga 08575; + ABS; für Rechtslenker	03.2122-1461.3 010610	ATE Ø 22,2
			09/98→; - ABS; für Rechtslenker	03.2122-1461.3 010610	ATE Ø 22,2

Bremskraftregler

1.4	55	03/96→07/01	→ 04/97; + ABS	24.6042-1701.3 320149	2/20 2x
-----	----	-------------	----------------	-----------------------	---------











PEUGEOT - 306 Kasten/Schrägheck 04/93→08/01









Bremskraftverstärker

1.4	55	03/96→07/01	05/97→ 05/01; - ABS	03.7750-9302.4 300116	ATE Ø 9" pneumatisch
			→Orga 08575; + ABS; für Linkslenker	03.7750-9402.4 300117	ATE Ø 9" pneumatisch
1.8 D	44	04/93→05/99	05/97→; - ABS; für Linkslenker	03.7750-9302.4 300116	ATE Ø 9" pneumatisch
			+ ABS; für Linkslenker	03.7750-9402.4 300117	ATE Ø 9" pneumatisch
1.9 D	50	05/97→05/99	+ ABS; für Linkslenker	03.7750-9402.4 300117	ATE Ø 9" pneumatisch
1.9 D	51	02/99→08/01	→Orga 08575; + ABS; für Linkslenker	03.7750-9402.4 300117	ATE Ø 9" pneumatisch
1.9 D	69	02/94→04/99	05/97→; - ABS; für Linkslenker	03.7750-9302.4 300116	ATE Ø 9" pneumatisch
			→Orga 08575; + ABS; für Linkslenker	03.7750-9402.4 300117	ATE Ø 9" pneumatisch
1.9 STD	51	02/94→10/95	06/94→; + ABS; für Linkslenker	03.7750-9402.4 300117	ATE Ø 9" pneumatisch







Hauptbremszylinder

1.4	55	03/96→07/01	→ 04/97; - ABS; nicht für Fahrschulwagen; Türenanzahl: 5	03.2119-3391.3 010058	ATE Ø 19,05
				24.2119-1702.3 010435	BDX Ø 19,05
			05/97→ 05/01; - ABS	03.2120-4321.3 010525	ATE Ø 20,64
				24.2120-1726.3 010564	BDX Ø 20,64
			05/97→; →Orga 08575; + ABS; für Linkslenker	03.2122-1351.3 010528	Ø 22,2
				24.2122-1733.3 010668	Ø 22,2
1.8 D	44	04/93→05/99	→ 04/97; - ABS; für Fahrschulwagen; Türenanzahl: 3	24.2120-1704.3 010429	BDX Ø 20,64
			→ 04/97; S 30209025→; + ABS	24.2122-1705.3 010434	Ø 22,2
			Orga 08576→; → 05/01; + ABS; für Linkslenker	24.2123-1715.3 010520	BDX Ø 23,81
			→ 04/97; - ABS; für Linkslenker	03.2120-1897.3 010103	ATE Ø 20,64
				24.2120-1704.3 010429	BDX Ø 20,64
			- ABS; für Rechtslenker	03.2120-4246.3 010614	ATE Ø 20,64
↓			05/97→; - ABS; für Linkslenker	03.2120-4246.3 010614	ATE Ø 20,64
				24.2120-1722.3 010544	Ø 20,64
			05/97→; - ABS; für Linkslenker	03.2120-4321.3 010525	ATE Ø 20,64
				24.2120-1726.3 010564	BDX Ø 20,64
			05/97→; →Orga 08575; + ABS; für Linkslenker	03.2122-1351.3 010528	Ø 22,2
				24.2122-1733.3 010668	Ø 22,2
			→ 04/97; S 30209025→; + ABS	24.2122-1705.3 010434	Ø 22,2













	kw			 	! #		
PEUGEOT - 306 Kasten/Schrägheck 04/93→08/01							
 Hauptbremszylinder							
1.8 D	44	04/93→05/99		Orga 08576→; + ABS; für Linkslenker	24.2123-1715.3	010520	BDX Ø 23,81
1.9 D	50	05/97→05/99		- ABS; für Rechtslenker	03.2120-4246.3	010614	ATE Ø 20,64
					24.2120-1722.3	010544	Ø 20,64
1.9 D	51	02/99→08/01		→ 05/01; - ABS; für Rechtslenker	03.2122-1461.3	010610	ATE Ø 22,2
				→Orga 08575; + ABS; für Rechtslenker	03.2122-1461.3	010610	ATE Ø 22,2
1.9 D	69	02/94→04/99		→ 04/97; - ABS; für Linkslenker	03.2120-1897.3	010103	ATE Ø 20,64
					24.2120-1704.3	010429	BDX Ø 20,64
				05/97→; →Orga 08575; + ABS; für Linkslenker	03.2122-1351.3	010528	Ø 22,2
					24.2122-1733.3	010668	Ø 22,2
				05/97→; - ABS; für Linkslenker	03.2122-1356.3	010529	Ø 22,2
				für Rechtslenker; - ABS	03.2122-1421.3	010615	ATE Ø 22,2
				→ 04/97; + ABS	24.2122-1705.3	010434	Ø 22,2
				Orga 08576→; + ABS; für Linkslenker	24.2123-1715.3	010520	BDX Ø 23,81
1.9 STD	51	02/94→10/95		06/94→; - ABS; für Rechtslenker	03.2120-4246.3	010614	ATE Ø 20,64
					24.2120-1722.3	010544	Ø 20,64
 Bremskraftregler							
1.4	55	03/96→07/01		→ 04/97; + ABS	24.6042-1701.3	320149	2/20 2x
1.8 D	44	04/93→05/99					
1.9 STD	51	02/94→10/95		06/94→; + ABS	24.6042-1701.3	320149	2/20 2x
PEUGEOT - 306 Schrägheck (7A, 7C, N3, N5) 01/93→10/03							
 Bremskraftverstärker							
1.1	44	05/93→05/01		03/94→ 04/97; + ABS; für Linkslenker	03.7750-9402.4	300117	ATE Ø 9" pneumatisch
1.4	55	05/93→05/01		05/97→; - ABS	03.7750-9302.4	300116	ATE Ø 9" pneumatisch
				→Orga 08575; + ABS; für Linkslenker	03.7750-9402.4	300117	ATE Ø 9" pneumatisch
1.6	65	05/93→10/00		→ 04/97; + ABS; für Rechtslenker	03.7750-2232.4	300112	ATE Ø 9" pneumatisch
				05/97→; - ABS	03.7750-9302.4	300116	ATE Ø 9" pneumatisch
				→Orga 08575; + ABS; für Linkslenker	03.7750-9402.4	300117	ATE Ø 9" pneumatisch
1.6	72	10/00→05/01		- ABS	03.7750-9302.4	300116	ATE Ø 9" pneumatisch
1.8	74	05/93→05/01		05/97→; - ABS; für Linkslenker	03.7750-9302.4	300116	ATE Ø 9" pneumatisch
1.8 16V	81	03/97→05/01		→Orga 08575; + ABS; für Linkslenker	03.7750-9402.4	300117	ATE Ø 9" pneumatisch
1.9 Td	52	07/95→08/00					
2.0 16V	99	03/97→06/00					
2.0 S16	110	06/94→05/01					
1.8	74	05/97→04/99		- ABS; für Linkslenker	03.7750-9302.4	300116	ATE Ø 9" pneumatisch
				- ABS; für Linkslenker; Türenanzahl: 4	03.7750-9302.4	300116	ATE Ø 9" pneumatisch
				→Orga 08575; + ABS; für Linkslenker	03.7750-9402.4	300117	ATE Ø 9" pneumatisch
1.8 16V	82	03/97→10/03		05/97→ 05/01; - ABS; für Linkslenker	03.7750-9302.4	300116	ATE Ø 9" pneumatisch
				→Orga 08575; + ABS; für Linkslenker	03.7750-9402.4	300117	ATE Ø 9" pneumatisch
1.8 D	43	05/93→05/01		05/97→; - ABS; für Linkslenker	03.7750-9302.4	300116	ATE Ø 9" pneumatisch
1.8 D	44	04/93→05/99					
1.9 D	47	05/93→05/01		+ ABS; für Linkslenker	03.7750-9402.4	300117	ATE Ø 9" pneumatisch
1.9 D	50	06/94→05/01					
1.9 D	51	04/93→05/99		09/98→; →Orga 08575; + ABS; für Linkslenker	03.7750-9402.4	300117	ATE Ø 9" pneumatisch
1.9 D	51	09/98→05/01		- ABS; für Linkslenker	03.7750-9302.4	300116	ATE Ø 9" pneumatisch
2.0 HDI 90	66	06/99→05/01		→Orga 08575; + ABS; für Linkslenker	03.7750-9402.4	300117	ATE Ø 9" pneumatisch
1.9 D	52	01/99→08/03		→Orga 08575; + ABS; für Linkslenker	03.7750-9402.4	300117	ATE Ø 9" pneumatisch
1.9 D	55	03/98→05/01		- ABS; für Linkslenker	03.7750-9302.4	300116	ATE Ø 9" pneumatisch
				+ ABS; für Linkslenker	03.7750-9402.4	300117	ATE Ø 9" pneumatisch
1.9 D	69	04/93→04/97		10/93→; →Orga 08575; + ABS; für Linkslenker	03.7750-9402.4	300117	ATE Ø 9" pneumatisch
				10/94→; + ABS; für Linkslenker	03.7750-9402.4	300117	ATE Ø 9" pneumatisch
1.9 DT	66	05/93→05/01		05/97→; - ABS; für Linkslenker	03.7750-9302.4	300116	ATE Ø 9" pneumatisch
				10/93→; →Orga 08575; + ABS; für Linkslenker	03.7750-9402.4	300117	ATE Ø 9" pneumatisch
2.0 16V	97	03/97→05/01		05/97→; - ABS; für Linkslenker; Türenanzahl: 4	03.7750-9302.4	300116	ATE Ø 9" pneumatisch
				→Orga 08575; + ABS; für Linkslenker	03.7750-9402.4	300117	ATE Ø 9" pneumatisch
2.0 S16	112	05/93→05/01		05/97→; - ABS; für Linkslenker	03.7750-9302.4	300116	ATE Ø 9" pneumatisch
				07/94→; →Orga 08575; + ABS; für Linkslenker	03.7750-9402.4	300117	ATE Ø 9" pneumatisch
2.0 XSi	89	05/93→05/01		05/97→; - ABS; für Linkslenker	03.7750-9302.4	300116	ATE Ø 9" pneumatisch
				03/94→; →Orga 08575; + ABS; für Linkslenker	03.7750-9402.4	300117	ATE Ø 9" pneumatisch







	kw			 	! #		
PEUGEOT - 306 Schrägheck (7A, 7C, N3, N5) 01/93→10/03							
 Hauptbremszylinder							
1.1	44	05/93→05/01		03/94→04/97; - ABS; Türenanzahl: 5	03.2119-3391.3 010058	ATE Ø 19,05	
					24.2119-1702.3 010435	BDX Ø 19,05	
				03/94→04/97; - ABS; Türenanzahl: 3	24.2120-1704.3 010429	BDX Ø 20,64	
				→ 04/97; S 30209025→; + ABS	24.2122-1705.3 010434	Ø 22,2	
1.4	55	05/93→05/01		→ 04/97; - ABS; nicht für Fahrschulwagen; Türenanzahl: 5	03.2119-3391.3 010058	ATE Ø 19,05	
					24.2119-1702.3 010435	BDX Ø 19,05	
				05/97→; - ABS	03.2120-4321.3 010525	ATE Ø 20,64	
					24.2120-1726.3 010564	BDX Ø 20,64	
				05/97→; →Orga 08575; + ABS; für Linkslenker	03.2122-1351.3 010528	Ø 22,2	
					24.2122-1733.3 010668	Ø 22,2	
				→ 04/97; - ABS; für Fahrschulwagen; Türenanzahl: 3	24.2120-1704.3 010429	BDX Ø 20,64	
				→ 04/97; S 30209025→; + ABS	24.2122-1705.3 010434	Ø 22,2	
				Orga 08576→; + ABS; für Linkslenker	24.2123-1715.3 010520	BDX Ø 23,81	
1.6	65	05/93→10/00		→ 04/97; - ABS	03.2120-1897.3 010103	ATE Ø 20,64	
					24.2120-1704.3 010429	BDX Ø 20,64	
				05/97→; - ABS	03.2120-4321.3 010525	ATE Ø 20,64	
					24.2120-1726.3 010564	BDX Ø 20,64	
				05/97→; →Orga 08575; + ABS; für Linkslenker	03.2122-1351.3 010528	Ø 22,2	
					24.2122-1733.3 010668	Ø 22,2	
				→ 04/97; S 30209025→; + ABS	24.2122-1705.3 010434	Ø 22,2	
				Orga 08576→; + ABS; für Linkslenker	24.2123-1715.3 010520	BDX Ø 23,81	
1.6	72	10/00→05/01		- ABS	03.2120-4321.3 010525	ATE Ø 20,64	
					24.2120-1726.3 010564	BDX Ø 20,64	
				+ ABS; für Linkslenker	24.2123-1715.3 010520	BDX Ø 23,81	
1.8	74	05/93→05/01		→ 04/97; - ABS; für Linkslenker	03.2120-1897.3 010103	ATE Ø 20,64	
1.8 D	43	05/93→05/01			24.2120-1704.3 010429	BDX Ø 20,64	
1.8 D	44	04/93→05/99					
1.9 D	47	05/93→05/01		- ABS; für Rechtslenker	03.2120-4246.3 010614	ATE Ø 20,64	
1.9 D	50	06/94→05/01			24.2120-1722.3 010544	Ø 20,64	
				05/97→; - ABS; für Linkslenker	03.2120-4321.3 010525	ATE Ø 20,64	
					24.2120-1726.3 010564	BDX Ø 20,64	
				05/97→; →Orga 08575; + ABS; für Linkslenker	03.2122-1351.3 010528	Ø 22,2	
					24.2122-1733.3 010668	Ø 22,2	
				→ 04/97; S 30209025→; + ABS	24.2122-1705.3 010434	Ø 22,2	
				Orga 08576→; + ABS; für Linkslenker	24.2123-1715.3 010520	BDX Ø 23,81	
1.8	74	05/97→04/99		- ABS; für Rechtslenker	03.2120-4246.3 010614	ATE Ø 20,64	
					24.2120-1722.3 010544	Ø 20,64	
				- ABS; für Rechtslenker; Türenanzahl: 4	03.2120-4246.3 010614	ATE Ø 20,64	
					24.2120-1722.3 010544	Ø 20,64	
				- ABS; für Linkslenker; Türenanzahl: 4	03.2120-4321.3 010525	ATE Ø 20,64	
					24.2120-1726.3 010564	BDX Ø 20,64	
				- ABS; für Linkslenker	03.2120-4321.3 010525	ATE Ø 20,64	
					24.2120-1726.3 010564	BDX Ø 20,64	
				→Orga 08575; + ABS; für Linkslenker	03.2122-1351.3 010528	Ø 22,2	
					24.2122-1733.3 010668	Ø 22,2	
				Orga 08576→; + ABS; für Linkslenker	24.2123-1715.3 010520	BDX Ø 23,81	
1.8 16V	81	03/97→05/01		→ 04/97; - ABS; für Linkslenker	03.2120-1897.3 010103	ATE Ø 20,64	
1.9 Td	52	07/95→08/00			24.2120-1704.3 010429	BDX Ø 20,64	
2.0 16V	99	03/97→06/00					
2.0 S16	110	06/94→05/01		05/97→; →Orga 08575; + ABS; für Linkslenker	03.2122-1351.3 010528	Ø 22,2	
					24.2122-1733.3 010668	Ø 22,2	
				05/97→; - ABS; für Linkslenker	03.2122-1356.3 010529	Ø 22,2	
				- ABS; für Rechtslenker	03.2122-1421.3 010615	ATE Ø 22,2	
				→ 04/97; + ABS	24.2122-1705.3 010434	Ø 22,2	
				Orga 08576→; + ABS; für Linkslenker	24.2123-1715.3 010520	BDX Ø 23,81	
1.8 16V	82	03/97→10/03		→ 04/97; - ABS; für Linkslenker	03.2120-1897.3 010103	ATE Ø 20,64	
					24.2120-1704.3 010429	BDX Ø 20,64	
				05/97→; →Orga 08575; + ABS; für Linkslenker	03.2122-1351.3 010528	Ø 22,2	
					24.2122-1733.3 010668	Ø 22,2	
				05/97→ 05/01; - ABS; für Linkslenker	03.2122-1356.3 010529	Ø 22,2	
				→ 05/01; für Rechtslenker; - ABS	03.2122-1421.3 010615	ATE Ø 22,2	
				→ 04/97; + ABS	24.2122-1705.3 010434	Ø 22,2	























	kw			 	! #		
PEUGEOT - 306 Schrägheck (7A, 7C, N3, N5) 01/93→10/03							
Hauptbremszylinder							
1.8 16V	82	03/97→10/03		Orga 08576→; → 05/01; + ABS; für Linkslenker		24.2123-1715.3 010520	BDX Ø 23,81
1.9 D	51	04/93→05/99		05/97→; →Orga 08575; + ABS; für Rechtslenker		03.2122-1461.3 010610	ATE Ø 22,2
				09/98→; - ABS; für Rechtslenker		03.2122-1461.3 010610	ATE Ø 22,2
1.9 D	51	09/98→05/01		- ABS; für Linkslenker		03.2120-4321.3 010525	ATE Ø 20,64
				→Orga 08575; + ABS; für Linkslenker		24.2120-1726.3 010564	BDX Ø 20,64
				→Orga 08575; + ABS; für Linkslenker		03.2122-1351.3 010528	Ø 22,2
				→Orga 08575; + ABS; für Linkslenker		24.2122-1733.3 010668	Ø 22,2
				→Orga 08575; + ABS; für Rechtslenker		03.2122-1461.3 010610	ATE Ø 22,2
				- ABS; für Rechtslenker		03.2122-1461.3 010610	ATE Ø 22,2
1.9 D	52	01/99→08/03		Orga 08576→; + ABS; für Linkslenker		24.2123-1715.3 010520	BDX Ø 23,81
				→ 05/01; - ABS; für Rechtslenker		03.2122-1461.3 010610	ATE Ø 22,2
1.9 D	55	03/98→05/01		→Orga 08575; + ABS; für Rechtslenker		03.2122-1461.3 010610	ATE Ø 22,2
				- ABS; für Linkslenker		03.2120-4321.3 010525	ATE Ø 20,64
1.9 D	69	04/93→04/97		→Orga 08575; + ABS; für Linkslenker		24.2120-1726.3 010564	BDX Ø 20,64
				Orga 08576→; + ABS; für Linkslenker		03.2122-1351.3 010528	Ø 22,2
				→Orga 08575; + ABS; für Linkslenker		24.2122-1733.3 010668	Ø 22,2
				Orga 08576→; + ABS; für Linkslenker		24.2123-1715.3 010520	BDX Ø 23,81
1.9 DT	66	05/93→05/01		10/93→; - ABS; für Linkslenker		03.2120-1897.3 010103	ATE Ø 20,64
				10/93→; - ABS; für Linkslenker		24.2120-1704.3 010429	BDX Ø 20,64
				10/93→; für Rechtslenker; - ABS		03.2120-1897.3 010103	ATE Ø 20,64
				10/93→; + ABS		24.2120-1704.3 010429	BDX Ø 20,64
				10/94→; + ABS		03.2122-1421.3 010615	ATE Ø 22,2
				24.2122-1705.3 010434	Ø 22,2		
2.0 16V	97	03/97→05/01		Orga 08576→; + ABS; für Linkslenker		24.2122-1705.3 010434	Ø 22,2
				10/93→ 04/97; + ABS		24.2122-1705.3 010434	Ø 22,2
				Orga 08576→; + ABS; für Linkslenker		24.2123-1715.3 010520	BDX Ø 23,81
				10/93→ 04/97; - ABS; für Linkslenker		03.2120-1897.3 010103	ATE Ø 20,64
				05/97→; →Orga 08575; + ABS; für Linkslenker		24.2120-1704.3 010429	BDX Ø 20,64
				05/97→; - ABS; für Linkslenker		03.2122-1351.3 010528	Ø 22,2
2.0 HDI 90	66	06/99→05/01		05/97→; - ABS; für Linkslenker; Türenanzahl: 4		03.2122-1356.3 010529	Ø 22,2
				05/97→; - ABS; für Rechtslenker; Türenanzahl: 4		03.2122-1421.3 010615	ATE Ø 22,2
				→ 04/97		24.2122-1705.3 010434	Ø 22,2
				Orga 08576→; + ABS; für Linkslenker		24.2123-1715.3 010520	BDX Ø 23,81
				→Orga 08575; + ABS; für Linkslenker		03.2122-1351.3 010528	Ø 22,2
2.0 S16	112	05/93→05/01		→Orga 08575; + ABS; für Linkslenker		24.2122-1733.3 010668	Ø 22,2
				- ABS; für Linkslenker		03.2122-1356.3 010529	Ø 22,2
				- ABS; für Rechtslenker		03.2122-1421.3 010615	ATE Ø 22,2
				Orga 08576→; + ABS; für Linkslenker		24.2123-1715.3 010520	BDX Ø 23,81
				07/94→ 04/97; - ABS; für Linkslenker		03.2120-1897.3 010103	ATE Ø 20,64
				24.2120-1704.3 010429	BDX Ø 20,64		
2.0 S16	120	03/96→05/01		05/97→; →Orga 08575; + ABS; für Linkslenker		03.2122-1351.3 010528	Ø 22,2
				05/97→; - ABS; für Linkslenker		24.2122-1733.3 010668	Ø 22,2
				05/97→; - ABS; für Linkslenker		03.2122-1356.3 010529	Ø 22,2
				07/94→; für Rechtslenker		03.2122-1421.3 010615	ATE Ø 22,2
				07/94→ 04/97; + ABS		24.2122-1705.3 010434	Ø 22,2
				Orga 08576→; + ABS; für Linkslenker		24.2123-1715.3 010520	BDX Ø 23,81
2.0 XSi	89	05/93→05/01		- ABS		24.2123-1714.3 010587	BDX Ø 23,81
				+ ABS; für Linkslenker		24.2123-1715.3 010520	BDX Ø 23,81
↓				03/94→ 04/97; - ABS; für Linkslenker		03.2120-1897.3 010103	ATE Ø 20,64
						24.2120-1704.3 010429	BDX Ø 20,64





























	kw			 	! #		
PEUGEOT - 306 Schrägheck (7A, 7C, N3, N5) 01/93→10/03							
 Hauptbremszylinder							
2.0 XSi	89	05/93→05/01		05/97→; →Orga 08575; + ABS; für Linkslenker	03.2122-1351.3 010528	Ø 22,2	
					24.2122-1733.3 010668	Ø 22,2	
				05/97→; - ABS; für Linkslenker	03.2122-1356.3 010529	Ø 22,2	
				03/94→; für Rechtslenker; - ABS	03.2122-1421.3 010615	ATE Ø 22,2	
				03/94→ 04/97; + ABS	24.2122-1705.3 010434	Ø 22,2	
				Orga 08576→; + ABS; für Linkslenker	24.2123-1715.3 010520	BDX Ø 23,81	
 Bremskraftregler							
1.1	44	05/93→05/01		03/94→ 04/97; + ABS	24.6042-1701.3 320149	2/20 2x	
1.4	55	05/93→05/01		→ 04/97; + ABS	24.6042-1701.3 320149	2/20 2x	
1.6	65	05/93→10/00					
1.8 D	43	05/93→05/01					
1.8 D	44	04/93→05/99					
1.9 D	47	05/93→05/01					
1.9 D	50	06/94→05/01					
2.0 16V	97	03/97→05/01		→ 04/97; Türenanzahl: 4	24.6042-1701.3 320149	2/20 2x	
PEUGEOT - 405 II (4B) 01/92→11/99							
 Hauptbremszylinder							
1.4	55	08/92→10/95		09/92→; - ABS	24.2120-1701.3 010427	Ø 20,64	
1.6	65	08/92→10/95					
1.8	74	08/92→10/95		09/92→; + ABS	24.2122-1704.3 010423	Ø 22,2	
1.6	66	08/92→05/97		09/92→ 10/95; - ABS	24.2120-1701.3 010427	Ø 20,64	
				09/92→ 10/95; + ABS	24.2122-1704.3 010423	Ø 22,2	
1.9	90	01/92→11/97		09/92→ 12/93; + ABS	24.2122-1704.3 010423	Ø 22,2	
1.9 D	47	08/92→10/95		09/92→; + ABS	24.2122-1704.3 010423	Ø 22,2	
1.9 TD	66	08/92→10/95					
2.0	89	08/92→10/95					
2.0 MI-16	112	08/92→10/95					
2.0 X4	89	08/92→10/95					
1.9 D	50	06/94→10/95		+ ABS	24.2122-1704.3 010423	Ø 22,2	
2.0 16V	110	06/94→10/95					
1.9 TD	69	08/92→05/97		09/92→ 10/95; + ABS	24.2122-1704.3 010423	Ø 22,2	
 Bremskraftregler							
1.4	55	08/92→10/95		09/92→	03.6583-0037.3 320107	ATE lastabhängig 8/3 4x	
1.6	65	08/92→10/95					
1.8	74	08/92→10/95					
1.9 D	47	08/92→10/95					
1.9 TD	66	08/92→10/95					
2.0	89	08/92→10/95					
2.0 MI-16	112	08/92→10/95					
1.6	66	08/92→05/97		09/92→ 10/95	03.6583-0037.3 320107	ATE lastabhängig 8/3 4x	
1.9 TD	69	08/92→05/97					
1.9	90	01/92→11/97		09/92→ 12/93	03.6583-0037.3 320107	ATE lastabhängig 8/3 4x	
1.9 D	50	06/94→10/95			03.6583-0037.3 320107	ATE lastabhängig 8/3 4x	
2.0 16V	110	06/94→10/95					
PEUGEOT - 405 II Break (4E) 08/92→10/98							
 Hauptbremszylinder							
1.4	55	08/92→10/96		09/92→ 10/95; - ABS	24.2120-1701.3 010427	Ø 20,64	
1.6	65	08/92→10/96					
1.6	80	08/92→10/96		09/92→ 10/95; + ABS	24.2122-1704.3 010423	Ø 22,2	
1.8	74	08/92→10/96					
1.9 D	47	08/92→10/96		09/92→ 10/95; + ABS	24.2122-1704.3 010423	Ø 22,2	
1.9 D	52	08/92→10/98					
1.9 TD	66	08/92→10/96					
1.9 TD	69	08/92→10/96					
2.0	89	08/92→10/96					
2.0 4x4	89	08/92→10/96					
2.0 4x4	144	08/92→12/95					
1.9 D	50	06/94→10/96		→ 10/95; + ABS	24.2122-1704.3 010423	Ø 22,2	
 Bremskraftregler							
1.4	55	08/92→10/96		09/92→ 10/95	03.6583-0037.3 320107	ATE lastabhängig 8/3 4x	
1.6	65	08/92→10/96					
1.6	80	08/92→10/96					
1.8	74	08/92→10/96					
1.9 D	47	08/92→10/96					
1.9 D	52	08/92→10/98					
1.9 TD	66	08/92→10/96					
1.9 TD	69	08/92→10/96					
2.0	89	08/92→10/96					
↓							

	kw					! #		
PEUGEOT - 405 II Break (4E) 08/92→10/98								
Bremskraftregler								
2.0 4x4	144	08/92→12/95		09/92→10/95		03.6583-0037.3	320107	ATE lastabhängig 8/3 4x
1.9 D	50	06/94→10/96		→10/95		03.6583-0037.3	320107	ATE lastabhängig 8/3 4x
PEUGEOT - 406 (8B) 10/95→01/05								
Bremskraftverstärker								
1.6	65	11/95→05/04		Orga 08701→; →04/04; für Linkslenker		03.7863-2202.4	300127	ATE Ø 10" pneumatisch
1.8	74	10/96→03/99		Orga 08701→; für Linkslenker		03.7863-2202.4	300127	ATE Ø 10" pneumatisch
1.8 16V	81	11/95→10/00						
1.8 16V	85	10/00→05/04		→04/04; für Linkslenker		03.7863-2202.4	300127	ATE Ø 10" pneumatisch
1.8 Bifuel	81	04/99→05/03		Orga 08701→; →10/00; für Linkslenker		03.7863-2202.4	300127	ATE Ø 10" pneumatisch
2.0	104	11/96→03/99		Orga 08701→; - ESP; für Linkslenker		03.7863-2202.4	300127	ATE Ø 10" pneumatisch
2.0 HDI 110	80	06/98→08/01		Orga 08701→; + ESP; für Linkslenker		03.7863-2802.4	300188	ATE Ø 10" pneumatisch
2.0 16V	97	11/95→05/04		Orga 08701→; →04/04; - ESP; für Linkslenker		03.7863-2202.4	300127	ATE Ø 10" pneumatisch
2.0 16V	100	08/00→06/04						
2.0 HDI 90	66	02/99→05/04		Orga 08701→; →04/04; + ESP; für Linkslenker		03.7863-2802.4	300188	ATE Ø 10" pneumatisch
2.0 Turbo	108	04/96→05/04						
2.2	116	07/00→05/04						
2.2 HDi	98	03/00→05/04						
2.0 16V HPi	103	05/01→05/04		→04/04; - ESP; für Linkslenker		03.7863-2202.4	300127	ATE Ø 10" pneumatisch
2.0 HDi 110	79	08/01→05/04		→04/04; für Linkslenker; + ESP		03.7863-2802.4	300188	ATE Ø 10" pneumatisch
Hauptbremszylinder								
1.6	65	11/95→05/04		Orga 08701→; →04/04		03.2123-2581.3	010613	ATE Ø 23,81
1.8	66	05/97→05/04		→01/99; - ABS		24.2123-1710.3	010504	Ø 23,81
1.9 D	55	10/96→05/04		→01/99; + ABS		24.2123-1713.3	010505	Ø 23,81
1.9 TD	66	01/96→05/04						
1.9 TD	68	01/96→05/04		02/99→; →Orga 08700; + ABS		24.2123-1741.3	010681	Ø 23,81
3.0 24V	140	10/96→05/04		02/99→; →Orga 08700; - ABS		24.2123-1751.3	010698	Ø 23,81
1.8	74	10/96→03/99		Orga 08701→		03.2123-2581.3	010613	ATE Ø 23,81
1.8 16V	81	11/95→10/00		→01/99; - ABS		24.2123-1710.3	010504	Ø 23,81
3.0 24V	143	01/98→06/99		→01/99; + ABS		24.2123-1713.3	010505	Ø 23,81
				02/99→; →Orga 08700; + ABS		24.2123-1741.3	010681	Ø 23,81
				02/99→; →Orga 08700; - ABS		24.2123-1751.3	010698	Ø 23,81
1.8 16V	85	10/00→05/04		→04/04		03.2123-2561.3	010629	ATE Ø 23,81
				→04/04; - ESP		03.2123-2581.3	010613	ATE Ø 23,81
1.8 Bifuel	81	04/99→05/03		Orga 08701→; →10/00		03.2123-2581.3	010613	ATE Ø 23,81
				→Orga 08700; + ABS		24.2123-1741.3	010681	Ø 23,81
				→Orga 08700; - ABS		24.2123-1751.3	010698	Ø 23,81
1.9 TD	69	10/95→10/97		Orga 08701→		03.2123-2581.3	010613	ATE Ø 23,81
				01/96→; - ABS		24.2123-1710.3	010504	Ø 23,81
				01/96→; + ABS		24.2123-1713.3	010505	Ø 23,81
2.0	104	11/96→03/99		→01/99; - ABS		24.2123-1710.3	010504	Ø 23,81
2.0 Turbo	108	04/96→05/04		→01/99; + ABS		24.2123-1713.3	010505	Ø 23,81
2.1 TD 12V	80	01/96→05/04						
				02/99→; →Orga 08700; + ABS		24.2123-1741.3	010681	Ø 23,81
				02/99→; →Orga 08700; - ABS		24.2123-1751.3	010698	Ø 23,81
2.0 16V	97	11/95→05/04		Orga 08701→; →04/04; + ESP		03.2123-2561.3	010629	ATE Ø 23,81
				Orga 08701→; →04/04; - ESP		03.2123-2581.3	010613	ATE Ø 23,81
				→01/99; - ABS		24.2123-1710.3	010504	Ø 23,81
				→01/99; + ABS		24.2123-1713.3	010505	Ø 23,81
				02/99→; →Orga 08700; + ABS		24.2123-1741.3	010681	Ø 23,81
				02/99→; →Orga 08700; - ABS		24.2123-1751.3	010698	Ø 23,81
2.0 16V	99	01/99→08/00		02/99→; + ABS		24.2123-1741.3	010681	Ø 23,81
				02/99→; - ABS		24.2123-1751.3	010698	Ø 23,81
2.0 16V	100	08/00→06/04		Orga 08701→; →04/04; + ESP		03.2123-2561.3	010629	ATE Ø 23,81
2.0 HDI 90	66	02/99→05/04		Orga 08701→; →04/04; - ESP		03.2123-2581.3	010613	ATE Ø 23,81
2.2	116	07/00→05/04						
2.2 HDi	98	03/00→05/04		→Orga 08700; + ABS		24.2123-1741.3	010681	Ø 23,81
				→Orga 08700; - ABS		24.2123-1751.3	010698	Ø 23,81
2.0 16V HPi	103	05/01→05/04		→04/04; + ESP		03.2123-2561.3	010629	ATE Ø 23,81
2.0 HDi 110	79	08/01→05/04		→04/04; - ESP		03.2123-2581.3	010613	ATE Ø 23,81
2.0 HDi 110	80	06/98→08/01		Orga 08701→; + ESP		03.2123-2561.3	010629	ATE Ø 23,81
				Orga 08701→; - ESP		03.2123-2581.3	010613	ATE Ø 23,81
				02/99→; →Orga 08700; + ABS		24.2123-1741.3	010681	Ø 23,81
				02/99→; →Orga 08700; - ABS		24.2123-1751.3	010698	Ø 23,81
↓								













	kw			 	! #		
PEUGEOT - 406 (8B) 10/95→01/05							
 Hauptbremszylinder							
3.0 V6	152	03/00→05/04		Orga 08701→; → 04/04		03.2123-2581.3 010613	ATE Ø 23,81
				→Orga 08700; + ABS		24.2123-1741.3 010681	Ø 23,81
				→Orga 08700; - ABS		24.2123-1751.3 010698	Ø 23,81
3.0 V6	154	03/99→12/01		Orga 08701→		03.2123-2581.3 010613	ATE Ø 23,81
				03/00→; →Orga 08700; + ABS		24.2123-1741.3 010681	Ø 23,81
				03/00→; →Orga 08700; - ABS		24.2123-1751.3 010698	Ø 23,81
PEUGEOT - 406 Break (8E/F) 10/96→10/04							
 Bremskraftverstärker							
1.8	66	05/97→10/04		Orga 08701→; → 04/04; für Linkslenker		03.7863-2202.4 300127	ATE Ø 10" pneumatisch
1.9 D	55	10/96→10/04					
1.9 TD	66	10/96→10/04					
1.8 16V	81	10/96→10/00		Orga 08701→; für Linkslenker		03.7863-2202.4 300127	ATE Ø 10" pneumatisch
1.8 16V	85	10/00→10/04		→ 04/04; für Linkslenker		03.7863-2202.4 300127	ATE Ø 10" pneumatisch
2.0	104	11/96→03/99		Orga 08701→; - ESP; für Linkslenker		03.7863-2202.4 300127	ATE Ø 10" pneumatisch
2.0 16V	99	01/99→10/00		Orga 08701→; + ESP; für Linkslenker		03.7863-2802.4 300188	ATE Ø 10" pneumatisch
2.0 16V	97	10/96→10/04		Orga 08701→; → 04/04; - ESP; für Linkslenker		03.7863-2202.4 300127	ATE Ø 10" pneumatisch
2.0 HDI 90	66	02/99→10/04					
2.0 Turbo	108	10/96→10/04		Orga 08701→; → 04/04; + ESP; für Linkslenker		03.7863-2802.4 300188	ATE Ø 10" pneumatisch
2.2	116	07/00→10/04					
2.2 HDI	98	03/00→10/04					
2.0 16V	100	10/00→10/04		→ 04/04; - ESP; für Linkslenker		03.7863-2202.4 300127	ATE Ø 10" pneumatisch
2.0 HDi 110	79	08/01→10/04		→ 04/04; + ESP; für Linkslenker		03.7863-2802.4 300188	ATE Ø 10" pneumatisch
2.0 16V HPi	103	05/01→10/04		→ 04/04; + ESP; für Linkslenker		03.7863-2802.4 300188	ATE Ø 10" pneumatisch
2.0 HDI 110	80	02/99→04/04		Orga 08701→; → 08/01; - ESP; für Linkslenker		03.7863-2202.4 300127	ATE Ø 10" pneumatisch
				Orga 08701→; → 08/01; + ESP; für Linkslenker		03.7863-2802.4 300188	ATE Ø 10" pneumatisch
 Hauptbremszylinder							
1.8	66	05/97→10/04		Orga 08701→; → 04/04		03.2123-2581.3 010613	ATE Ø 23,81
1.9 D	55	10/96→10/04		→ 01/99; - ABS		24.2123-1710.3 010504	Ø 23,81
1.9 TD	66	10/96→10/04		→ 01/99; + ABS		24.2123-1713.3 010505	Ø 23,81
3.0 24V	140	10/96→10/04		02/99→; →Orga 08700; + ABS		24.2123-1741.3 010681	Ø 23,81
				02/99→; →Orga 08700; - ABS		24.2123-1751.3 010698	Ø 23,81
1.8 16V	81	10/96→10/00		Orga 08701→		03.2123-2581.3 010613	ATE Ø 23,81
				→ 01/99; - ABS		24.2123-1710.3 010504	Ø 23,81
				→ 01/99; + ABS		24.2123-1713.3 010505	Ø 23,81
				02/99→; →Orga 08700; + ABS		24.2123-1741.3 010681	Ø 23,81
				02/99→; →Orga 08700; - ABS		24.2123-1751.3 010698	Ø 23,81
1.8 16V	85	10/00→10/04		→ 04/04; + ESP		03.2123-2561.3 010629	ATE Ø 23,81
2.0 16V	100	10/00→10/04		→ 04/04; - ESP		03.2123-2581.3 010613	ATE Ø 23,81
2.0 16V HPi	103	05/01→10/04					
2.0 HDi 110	79	08/01→10/04					
2.0	104	11/96→03/99		Orga 08701→; + ESP		03.2123-2561.3 010629	ATE Ø 23,81
				Orga 08701→; - ESP		03.2123-2581.3 010613	ATE Ø 23,81
				→ 01/99; - ABS		24.2123-1710.3 010504	Ø 23,81
				→ 01/99; + ABS		24.2123-1713.3 010505	Ø 23,81
				02/99→; →Orga 08700; + ABS		24.2123-1741.3 010681	Ø 23,81
				02/99→; →Orga 08700; - ABS		24.2123-1751.3 010698	Ø 23,81
2.0 16V	97	10/96→10/04		Orga 08701→; → 04/04; + ESP		03.2123-2561.3 010629	ATE Ø 23,81
2.0 Turbo	108	10/96→10/04		Orga 08701→; → 04/04; - ESP		03.2123-2581.3 010613	ATE Ø 23,81
2.1 TD 12V	80	10/96→10/04		→ 01/99; - ABS		24.2123-1710.3 010504	Ø 23,81
				→ 01/99; + ABS		24.2123-1713.3 010505	Ø 23,81
				02/99→; →Orga 08700; + ABS		24.2123-1741.3 010681	Ø 23,81
				02/99→; →Orga 08700; - ABS		24.2123-1751.3 010698	Ø 23,81
2.0 16V	99	01/99→10/00		Orga 08701→; + ESP		03.2123-2561.3 010629	ATE Ø 23,81
				Orga 08701→; - ESP		03.2123-2581.3 010613	ATE Ø 23,81
				→Orga 08700; + ABS		24.2123-1741.3 010681	Ø 23,81
				→Orga 08700; - ABS		24.2123-1751.3 010698	Ø 23,81
2.0 HDI 110	80	02/99→04/04		Orga 08701→; → 08/01; + ESP		03.2123-2561.3 010629	ATE Ø 23,81
				Orga 08701→; → 08/01; - ESP		03.2123-2581.3 010613	ATE Ø 23,81
				→Orga 08700; + ABS		24.2123-1741.3 010681	Ø 23,81
				→Orga 08700; - ABS		24.2123-1751.3 010698	Ø 23,81
↓							











	kw					! #		
PEUGEOT - 406 Break (8E/F) 10/96→10/04								
 Hauptbremszylinder								
2.0 HDI 90	66	02/99→10/04		Orga 08701→; → 04/04; + ESP		03.2123-2561.3	010629	ATE Ø 23,81
2.2	116	07/00→10/04		Orga 08701→; → 04/04; - ESP		03.2123-2581.3	010613	ATE Ø 23,81
2.2 HDI	98	03/00→10/04		→Orga 08700; + ABS		24.2123-1741.3	010681	Ø 23,81
				→Orga 08700; - ABS		24.2123-1751.3	010698	Ø 23,81
3.0 V6	152	03/00→10/04		Orga 08701→; → 04/04		03.2123-2581.3	010613	ATE Ø 23,81
				→Orga 08700; + ABS		24.2123-1741.3	010681	Ø 23,81
				→Orga 08700; - ABS		24.2123-1751.3	010698	Ø 23,81
PEUGEOT - 406 Coupe (8C) 03/97→12/04								
 Bremskraftverstärker								
2.0 16V	97	03/97→12/04		Orga 08701→; - ESP; für Linkslenker		03.7863-2202.4	300127	ATE Ø 10" pneumatisch
2.0 16V	99	01/99→10/00		Orga 08701→; + ESP; für Linkslenker		03.7863-2802.4	300188	ATE Ø 10" pneumatisch
2.2 HDI	98	03/00→12/04						
2.0 16V	99	04/99→09/04		Orga 08701→; → 10/00; - ESP; für Linkslenker		03.7863-2202.4	300127	ATE Ø 10" pneumatisch
				Orga 08701→; → 10/00; + ESP; für Linkslenker		03.7863-2802.4	300188	ATE Ø 10" pneumatisch
2.0 16V	100	10/00→12/04		- ESP; für Linkslenker		03.7863-2202.4	300127	ATE Ø 10" pneumatisch
2.2	116	03/02→12/04		+ ESP; für Linkslenker		03.7863-2802.4	300188	ATE Ø 10" pneumatisch
 Hauptbremszylinder								
2.0 16V	97	03/97→12/04		Orga 08701→; + ESP		03.2123-2561.3	010629	ATE Ø 23,81
				Orga 08701→; - ESP		03.2123-2581.3	010613	ATE Ø 23,81
				→ 01/99; - ABS		24.2123-1710.3	010504	Ø 23,81
				→ 01/99; + ABS		24.2123-1713.3	010505	Ø 23,81
				02/99→; →Orga 08700; + ABS		24.2123-1741.3	010681	Ø 23,81
				02/99→; →Orga 08700; - ABS		24.2123-1751.3	010698	Ø 23,81
2.0 16V	99	01/99→10/00		Orga 08701→; + ESP		03.2123-2561.3	010629	ATE Ø 23,81
2.2 HDI	98	03/00→12/04		Orga 08701→; - ESP		03.2123-2581.3	010613	ATE Ø 23,81
				→Orga 08700; + ABS		24.2123-1741.3	010681	Ø 23,81
				→Orga 08700; - ABS		24.2123-1751.3	010698	Ø 23,81
2.0 16V	99	04/99→09/04		Orga 08701→; → 10/00; + ESP		03.2123-2561.3	010629	ATE Ø 23,81
				Orga 08701→; → 10/00; - ESP		03.2123-2581.3	010613	ATE Ø 23,81
				→Orga 08700; + ABS		24.2123-1741.3	010681	Ø 23,81
				→Orga 08700; - ABS		24.2123-1751.3	010698	Ø 23,81
2.0 16V	100	10/00→12/04		+ ESP		03.2123-2561.3	010629	ATE Ø 23,81
2.2	116	03/02→12/04		- ESP		03.2123-2581.3	010613	ATE Ø 23,81
3.0 24V	143	05/97→06/99		Orga 08701→		03.2123-2581.3	010613	ATE Ø 23,81
3.0 V6 24V	140	03/97→12/04		→ 01/99; - ABS		24.2123-1710.3	010504	Ø 23,81
				→ 01/99; + ABS		24.2123-1713.3	010505	Ø 23,81
				02/99→; →Orga 08700; + ABS		24.2123-1741.3	010681	Ø 23,81
				02/99→; →Orga 08700; - ABS		24.2123-1751.3	010698	Ø 23,81
3.0 V6	152	03/00→12/04		Orga 08701→		03.2123-2581.3	010613	ATE Ø 23,81
				→Orga 08700; + ABS		24.2123-1741.3	010681	Ø 23,81
				→Orga 08700; - ABS		24.2123-1751.3	010698	Ø 23,81
3.0 V6	154	03/99→06/01		Orga 08701→		03.2123-2581.3	010613	ATE Ø 23,81
				03/00→; →Orga 08700; + ABS		24.2123-1741.3	010681	Ø 23,81
				03/00→; →Orga 08700; - ABS		24.2123-1751.3	010698	Ø 23,81
PEUGEOT - 407 (6D_) 05/04→								
 Bremskraftverstärker								
1.6 HDi 110	80	05/04→		für Linkslenker; →Orga 11192		03.7860-3402.4	300217	ATE Ø 10" pneumatisch
1.8 16V	92	09/05→						
2.0 16V	103	09/05→		Orga 12047→; → 02/11; für Linkslenker		03.7860-8002.4	300258	ATE Ø 10" pneumatisch
2.0 Bioflex	103	09/07→						
2.0 HDi 135	100	05/04→						
2.2 HDi 170	125	05/06→						
3.0	155	05/04→						
1.8	85	05/04→		für Linkslenker; → 02/11		03.7860-3402.4	300217	ATE Ø 10" pneumatisch
2.0	100	05/04→						
2.0 16V	105	08/08→12/09		für Linkslenker; →Orga 11192		03.7860-3402.4	300217	ATE Ø 10" pneumatisch
				Orga 12047→; für Linkslenker		03.7860-8002.4	300258	ATE Ø 10" pneumatisch
2.0 HDi	103	08/08→		Orga 12047→; → 02/11; für Linkslenker		03.7860-8002.4	300258	ATE Ø 10" pneumatisch
2.2 HDi	120	06/08→						
2.0 HDi	110	02/10→		→ 02/11; für Linkslenker		03.7860-8002.4	300258	ATE Ø 10" pneumatisch

	kw			 	! #		
PEUGEOT - 407 (6D_) 05/04→							
 Bremskraftverstärker							
2.0 HDi	120	07/09→		→ 02/11; für Linkslenker	03.7860-8002.4	300258	ATE Ø 10" pneumatisch
2.2	116	05/04→		für Linkslenker; →Orga 11283	03.7860-3402.4	300217	ATE Ø 10" pneumatisch
2.2 16V	120	09/05→					
2.7 HDi	150	10/05→		→Orga 11073; für Linkslenker	03.7860-3402.4	300217	ATE Ø 10" pneumatisch
 Hauptbremszylinder							
1.6 HDi 110	80	05/04→		→ 02/11	03.2122-2171.3	010961	ATE Ø 22,2
1.8	85	05/04→					
1.8 16V	92	09/05→					
2.0	100	05/04→					
2.0 16V	103	09/05→					
2.0 Bioflex	103	09/07→					
2.0 16V	105	08/08→12/09			03.2122-2171.3	010961	ATE Ø 22,2
2.0 HDi	103	08/08→		Orga 12348→; → 02/11	03.2123-3131.3	010977	ATE Ø 23,81
2.0 HDi	110	02/10→					
2.0 HDi	120	07/09→					
2.2 HDi	120	06/08→					
2.2 HDi 170	125	05/06→					
3.0	155	05/04→					
2.0 HDi 135	100	05/04→		→Orga 11682	03.2122-2171.3	010961	ATE Ø 22,2
				Orga 12348→; → 02/11	03.2123-3131.3	010977	ATE Ø 23,81
PEUGEOT - 407 Coupe (6C_) 10/05→							
 Bremskraftverstärker							
2.0 HDi	100	10/05→		07/07→; →Orga 11192; für Linkslenker	03.7860-3402.4	300217	ATE Ø 10" pneumatisch
				Orga 12047→; → 12/11; für Linkslenker	03.7860-8002.4	300258	ATE Ø 10" pneumatisch
2.0 HDi	103	09/08→12/09		→Orga 11192; für Linkslenker	03.7860-3402.4	300217	ATE Ø 10" pneumatisch
				Orga 12047→; für Linkslenker	03.7860-8002.4	300258	ATE Ø 10" pneumatisch
2.0 HDi	110	02/10→		→ 12/11; für Linkslenker	03.7860-8002.4	300258	ATE Ø 10" pneumatisch
2.0 HDi	120	06/09→					
3.0 HDi	177	06/09→					
2.2 16V	120	10/05→		→Orga 11283; für Linkslenker	03.7860-3402.4	300217	ATE Ø 10" pneumatisch
2.7 HDi	150	10/05→		→Orga 11073; für Linkslenker	03.7860-3402.4	300217	ATE Ø 10" pneumatisch
3.0 V6	155	10/05→		→Orga 11192; für Linkslenker	03.7860-3402.4	300217	ATE Ø 10" pneumatisch
				Orga 12047→; → 12/11; für Linkslenker	03.7860-8002.4	300258	ATE Ø 10" pneumatisch
 Hauptbremszylinder							
2.0 HDi	100	10/05→		Orga 12348→; → 12/11	03.2123-3131.3	010977	ATE Ø 23,81
2.0 HDi	120	06/09→					
2.2 16V	120	10/05→					
3.0 HDi	177	06/09→					
3.0 V6	155	10/05→					
2.0 HDi	103	09/08→12/09		Orga 12348→	03.2123-3131.3	010977	ATE Ø 23,81
2.0 HDi	110	02/10→		→ 12/11	03.2123-3131.3	010977	ATE Ø 23,81
PEUGEOT - 407 SW (6E_) 05/04→							
 Bremskraftverstärker							
1.6 HDi 110	80	05/04→		für Linkslenker; →Orga 11192	03.7860-3402.4	300217	ATE Ø 10" pneumatisch
1.8 16V	92	09/05→					
2.0 16V	103	09/05→		Orga 12047→; → 02/11; für Linkslenker	03.7860-8002.4	300258	ATE Ø 10" pneumatisch
2.0 Bioflex	103	01/08→					
2.0 HDi	93	11/04→					
2.0 HDi 135	100	05/04→					
2.2 HDi 170	125	05/06→					
3.0	155	05/04→					
1.8	85	05/04→		für Linkslenker; → 02/11	03.7860-3402.4	300217	ATE Ø 10" pneumatisch
2.0	100	05/04→					
2.0 HDi	103	08/08→		Orga 12047→; → 02/11; für Linkslenker	03.7860-8002.4	300258	ATE Ø 10" pneumatisch
2.2 HDi	120	06/08→					
2.0 HDi	110	02/10→		→ 02/11; für Linkslenker	03.7860-8002.4	300258	ATE Ø 10" pneumatisch
2.0 HDi	120	07/09→					
2.2	116	05/04→		für Linkslenker; →Orga 11283	03.7860-3402.4	300217	ATE Ø 10" pneumatisch
2.2 16V	120	09/05→					
2.7 HDi	150	10/05→		→Orga 11073; für Linkslenker	03.7860-3402.4	300217	ATE Ø 10" pneumatisch
 Hauptbremszylinder							
1.6 HDi 110	80	05/04→		→ 02/11	03.2122-2171.3	010961	ATE Ø 22,2
1.8	85	05/04→					
1.8 16V	92	09/05→					
2.0	100	05/04→					
2.0 16V	103	09/05→					
2.0 Bioflex	103	01/08→					
↓							













	kw			 	! #		
PEUGEOT - 407 SW (6E_) 05/04 →							
 Hauptbremszylinder							
2.0 HDi	93	11/04 →		→ Orga 11682		03.2122-2171.3 010961	ATE Ø 22,2
2.0 HDi 135	100	05/04 →		Orga 12348 →; → 02/11		03.2123-3131.3 010977	ATE Ø 23,81
2.0 HDi	103	08/08 →		Orga 12348 →; → 02/11		03.2123-3131.3 010977	ATE Ø 23,81
2.0 HDi	110	02/10 →					
2.0 HDi	120	07/09 →					
2.2 HDi	120	06/08 →					
2.2 HDi 170	125	05/06 →					
3.0	155	05/04 →					
PEUGEOT - 505 (551A) 05/79 → 10/96							
 Hauptbremszylinder							
2.0	72	09/85 → 09/95		→ 10/86		03.2120-1122.3 010084	Ø 20,64
PEUGEOT - 508 11/10 →							
 Bremskraftverstärker							
1.6 HDi	82	11/10 →		für Linkslenker;		03.7860-7802.4 300280	ATE Ø 10" pneumatisch
1.6 HDi	84	02/12 →		für Fahrzeuge ohne Start-Stopp-Funktion; + DSC			
1.6 HDi	85	09/14 →					
1.6 THP	115	11/10 →		für Linkslenker; + DSC		03.7860-7802.4 300280	ATE Ø 10" pneumatisch
1.6 VTi	85	11/10 →					
1.6 VTi	88	11/10 →					
2.0 HDi	100	11/10 →					
2.0 HDi	103	11/10 →					
2.0 HDi	120	11/10 →					
2.0 HDi Hybrid4 AWC	120	11/10 →					
2.2 HDi	150	11/10 →					
 Hauptbremszylinder							
1.6	120	01/12 →		+ DSC		03.2123-3131.3 010977	ATE Ø 23,81
1.6	121	09/11 →					
1.6 BlueHDi 120	88	03/14 →		- DSC		03.2123-3641.3 010963	ATE Ø 23,81
1.6 HDi	82	11/10 →					
1.6 HDi	84	02/12 →					
1.6 HDi	85	09/14 →					
1.6 THP	110	11/10 →					
1.6 THP	115	11/10 →					
1.6 VTi	85	11/10 →					
1.6 VTi	88	11/10 →					
2.0 BlueHDi 150	110	04/14 →					
2.0 BlueHDi 180	133	04/14 →					
2.0 HDi	100	11/10 →					
2.0 HDi	103	11/10 →					
2.0 HDi	120	11/10 →					
2.0 HDi Hybrid4 AWC	120	11/10 →					
2.2 HDi	150	11/10 →					
2.0 HDi Hybrid4 AWC	147	11/10 →		06/12 →; + DSC		03.2123-3131.3 010977	ATE Ø 23,81
				06/12 →; - DSC		03.2123-3641.3 010963	ATE Ø 23,81
PEUGEOT - 508 SW 11/10 →							
 Bremskraftverstärker							
1.6 HDi	82	11/10 →		für Linkslenker;		03.7860-7802.4 300280	ATE Ø 10" pneumatisch
1.6 HDi	84	02/12 →		für Fahrzeuge ohne Start-Stopp-Funktion; + DSC			
1.6 HDi	85	09/14 →					
1.6 THP	115	11/10 →		für Linkslenker; + DSC		03.7860-7802.4 300280	ATE Ø 10" pneumatisch
1.6 VTi	85	11/10 →					
1.6 VTi	88	11/10 →					
2.0 HDi	100	11/10 →					
2.0 HDi	103	11/10 →					
2.0 HDi	120	11/10 →					
2.0 HDi RXH Hybrid4	120	11/10 →					
2.2 HDi	150	11/10 →					
 Hauptbremszylinder							
1.6	121	02/12 →		+ DSC		03.2123-3131.3 010977	ATE Ø 23,81
1.6 BlueHDi 120	88	03/14 →					
1.6 HDi	82	11/10 →		- DSC		03.2123-3641.3 010963	ATE Ø 23,81
1.6 HDi	84	02/12 →					
1.6 HDi	85	09/14 →					
1.6 THP	110	11/10 →					
1.6 THP	115	11/10 →					
1.6 VTi	85	11/10 →					
1.6 VTi	88	11/10 →					
2.0 BlueHDi 150	110	04/14 →					
2.0 BlueHDi 180	133	04/14 →					
2.0 HDi	100	11/10 →					
2.0 HDi	103	11/10 →					
↓							



















	kw			 	! #		
PEUGEOT - 508 SW 11/10→							
 Hauptbremszylinder							
2.0 HDi	120	11/10→		+ DSC		03.2123-3131.3 010977	ATE Ø 23,81
2.0 HDi 180 RXH	133	10/14→		- DSC		03.2123-3641.3 010963	ATE Ø 23,81
2.0 HDi RXH Hybrid4	120	11/10→					
2.2 HDi	150	11/10→					
PEUGEOT - 605 (6B) 06/89→09/99							
 Hauptbremszylinder							
2.0	79	02/90→09/99		04/90→; - ABS		24.2122-1703.3 010422	Ø 22,2
2.0	84	06/89→09/99		04/90→; + ABS		24.2122-1708.3 010437	Ø 22,2
2.0	89	06/89→09/99					
2.0 16V	97	07/94→09/99		09/94→; →Orga 07692; - ABS		24.2122-1703.3 010422	Ø 22,2
				09/94→; →Orga 07692; + ABS		24.2122-1708.3 010437	Ø 22,2
				Orga 07693→		24.2122-1708.3 010437	Ø 22,2
2.1 D	60	06/89→07/95		04/90→ 08/94; - ABS		24.2122-1703.3 010422	Ø 22,2
				04/90→ 08/94; + ABS		24.2122-1708.3 010437	Ø 22,2
2.1 TD 12V	80	08/94→09/99		- ABS		24.2122-1703.3 010422	Ø 22,2
				+ ABS		24.2122-1708.3 010437	Ø 22,2
2.1 Turbo Diesel	80	06/89→09/99		10/90→; - ABS		24.2122-1703.3 010422	Ø 22,2
				10/90→; + ABS		24.2122-1708.3 010437	Ø 22,2
3.0	123	10/89→09/99		04/90→ 08/94; - ABS		24.2122-1703.3 010422	Ø 22,2
 Bremskraftregler							
2.0	79	02/90→09/99		04/90→		03.6583-0031.3 320106	ATE lastabhängig 8/3 4x
2.0	84	06/89→09/99					
2.0	89	06/89→09/99					
3.0	123	10/89→09/99					
3.0 SV 24	147	08/89→09/99					
2.0 16V	97	07/94→09/99		09/94→		03.6583-0031.3 320106	ATE lastabhängig 8/3 4x
2.0 Turbo	108	07/91→09/99					
2.5 Turbo Diesel	95	07/94→09/99					
2.0 Turbo	104	07/92→09/99		12/92→ 08/94		03.6583-0031.3 320106	ATE lastabhängig 8/3 4x
2.1 D	60	06/89→07/95		04/90→ 08/94		03.6583-0031.3 320106	ATE lastabhängig 8/3 4x
2.1 TD 12V	80	08/94→09/99				03.6583-0031.3 320106	ATE lastabhängig 8/3 4x
3.0 V6	140	04/97→09/99					
2.1 Turbo Diesel	80	06/89→09/99		10/90→		03.6583-0031.3 320106	ATE lastabhängig 8/3 4x
PEUGEOT - 806 (221) 06/94→08/02							
 Hauptbremszylinder							
1.8	73	07/95→08/02		10/96→; →Orga 08206; - ABS		24.2122-1703.3 010422	Ø 22,2
				10/96→; →Orga 08206; + ABS		24.2122-1708.3 010437	Ø 22,2
				Orga 08207→; → 06/02; - ABS		24.2122-1741.3 010695	Ø 22,2
				Orga 08207→; → 06/02; + ABS		24.2122-1742.3 010696	Ø 22,2
1.9 TD	66	07/95→08/02		→Orga 08206; - ABS		24.2123-1707.3 010492	Ø 23,81
1.9 TD	68	05/97→08/02		Orga 08207→; → 06/02; + ABS		24.2123-1733.3 010657	BOS Ø 23,81
2.0 16V	100	09/00→08/02		Orga 08207→; → 06/02; - ABS		24.2123-1738.3 010658	Ø 23,81
2.0	89	06/94→08/02		08/94→; →Orga 08206; - ABS		24.2123-1707.3 010492	Ø 23,81
2.0 Turbo	108	06/94→08/02		Orga 08207→; → 06/02; + ABS		24.2123-1733.3 010657	BOS Ø 23,81
				Orga 08207→; → 06/02; - ABS		24.2123-1738.3 010658	Ø 23,81
2.0 16V	97	05/98→09/00		10/98→; →Orga 08206; - ABS		24.2123-1707.3 010492	Ø 23,81
				Orga 08207→; + ABS		24.2123-1733.3 010657	BOS Ø 23,81
				Orga 08207→; - ABS		24.2123-1738.3 010658	Ø 23,81
2.0 HDI	80	08/99→08/02		→ 06/02; + ABS		24.2123-1733.3 010657	BOS Ø 23,81
2.0 HDI 16V	80	08/99→08/02		→ 06/02; - ABS		24.2123-1738.3 010658	Ø 23,81
2.1 td 12V	80	06/96→08/99		→Orga 08206; - ABS		24.2123-1707.3 010492	Ø 23,81
				Orga 08207→; + ABS		24.2123-1733.3 010657	BOS Ø 23,81
				Orga 08207→; - ABS		24.2123-1738.3 010658	Ø 23,81
PEUGEOT - 807 (E) 06/02→							
 Bremskraftverstärker							
2.0	100	06/02→		Orga 10528→; für Linkslenker; → 06/14		03.7860-2002.4 300216	ATE Ø 10" pneumatisch
2.0 HDI	100	06/06→					
2.2	116	06/02→					
2.0 16V	103	09/05→		Orga 10528→ Orga 10919;		03.7860-2002.4 300216	ATE Ø 10" pneumatisch
2.0 HDi	79	06/02→		für Linkslenker			
2.0 HDi	88	02/06→		Orga 10920→; für Linkslenker; → 06/14		03.7860-4302.4 300231	ATE Ø 10" pneumatisch
2.2 HDi	94	06/02→					
2.2 HDi	100	04/04→					







	kw					! #		
PEUGEOT - 807 (E) 06/02→								
 Bremskraftverstärker								
2.0 HDi	80	04/04→05/06		Orga 10528→ Orga 10919; für Linkslenker		03.7860-2002.4	300216	ATE Ø 10" pneumatisch
				Orga 10920→; → 05/06; für Linkslenker		03.7860-4302.4	300231	ATE Ø 10" pneumatisch
2.0 HDi	120	06/09→		für Linkslenker; → 06/14		03.7870-1602.4	300311	ATE Ø 11" pneumatisch
 Hauptbremszylinder								
2.0	100	06/02→		Orga 10528→; → 06/14		03.2122-2163.3	010800	ATE Ø 22,2
2.0 HDi	79	06/02→						
2.0 HDi	88	02/06→						
2.2	116	06/02→						
2.2 HDi	94	06/02→						
2.2 HDi	100	04/04→						
2.0 16V	103	09/05→		→ 06/14		03.2122-2163.3	010800	ATE Ø 22,2
2.0 HDi	100	06/06→						
2.0 HDi	80	04/04→05/06		Orga 10528→; → 05/06		03.2122-2163.3	010800	ATE Ø 22,2
2.0 HDi	120	06/09→		→ 06/14		03.2123-3421.3	010933	ATE Ø 23,81
2.2 HDi	120	06/06→		10/07→ 06/14		03.2123-3421.3	010933	ATE Ø 23,81
2.2 HDi	125	06/06→						
PEUGEOT - 1007 (KM_) 04/05→								
 Hauptbremszylinder								
1.4	54	04/05→		→Orga 11009; - DSC		24.2122-1764.3	010851	BOS Ø 22,2
1.4 16V	65	10/05→				24.2122-1766.3	010840	TRW Ø 22,2
1.4 HDi	50	04/05→						
1.6 16V	80	04/05→		→Orga 11009; + DSC		24.2122-1767.3	010841	TRW Ø 22,2 ohne Drucksensor
				Orga 11010→; → 02/11; + DSC		24.4122-1703.3	010843	TRW Ø 22,2
				Orga 11010→; → 02/11; - DSC		24.4122-1704.3	010847	TRW Ø 22,2
1.6 HDi	80	06/07→		→ 02/11; + DSC		24.4122-1703.3	010843	TRW Ø 22,2
				→ 02/11; - DSC		24.4122-1704.3	010847	TRW Ø 22,2
PEUGEOT - 2008 03/13→								
 Hauptbremszylinder								
1.2 THP 110	81	01/15→				24.4123-1704.3	010828	TRW Ø 23,81
1.2 THP 130	96	01/15→						
1.4 HDi	50	06/13→						
1.6 BlueHDi 100	73	01/15→						
1.6 BlueHDi 120	88	07/14→						
1.6 BlueHDi 75	55	01/15→						
1.6 HDi	68	03/13→						
1.6 HDi	84	03/13→						
1.6 HDi	85	07/14→						
1.6 VTi	88	03/13→						
1.2 VTi	60	03/13→		Orga 13384→		24.4123-1704.3	010828	TRW Ø 23,81
PEUGEOT - 3008 06/09→								
 Bremskraftverstärker								
1.2	96	01/15→				03.7860-3732.4	300306	ATE Ø 10" pneumatisch
1.6 BlueHDi 120	88	05/14→						
1.6 HDi	80	06/09→						
1.6 HDi 115 / BlueHDi 115	85	02/13→						
1.6 THP	110	06/09→						
1.6 THP	115	06/09→						
1.6 VTi	88	06/09→						
2.0 HDi	100	09/11→						
2.0 HDi	120	06/09→						
2.0 HDi 150 / BlueHDi 150	110	06/09→						
1.6 HDi	82	08/10→		Orga 12621→; für Fahrzeuge ohne Start-Stopp-Funktion		03.7860-3732.4	300306	ATE Ø 10" pneumatisch
				→Orga 12620		03.7860-3732.4	300306	ATE Ø 10" pneumatisch
1.6 HDi	84	03/13→		für Fahrzeuge ohne Start-Stopp-Funktion		03.7860-3732.4	300306	ATE Ø 10" pneumatisch
 Hauptbremszylinder								
1.2	96	01/15→				03.4153-0173.3	010815	ATE Ø 23,81
1.6 BlueHDi 120	88	05/14→						
1.6 HDi	80	06/09→						
1.6 HDi	82	08/10→						
1.6 HDi	84	03/13→						
1.6 HDi 115 / BlueHDi 115	85	02/13→						
1.6 THP	110	06/09→						
1.6 THP	115	06/09→						
1.6 Turbo	121	05/14→						























	kw					! #		
PEUGEOT - 3008 06/09→								
 Hauptbremszylinder								
1.6 VTi	88	06/09→					03.4153-0173.3 010815	ATE Ø 23,81
2.0 HDi	100	09/11→						
2.0 HDi	120	06/09→						
2.0 HDi 150 / BlueHDi 150	110	06/09→						
2.0 HDi Hybrid4	120	02/11→						
2.0 HDi Hybrid4	147	11/11→						
PEUGEOT - 5008 06/09→								
 Bremskraftverstärker								
1.2	96	01/15→					03.7860-3732.4 300306	ATE Ø 10" pneumatisch
1.6 16V	88	09/09→						
1.6 16V	115	09/09→						
1.6 HDi	80	09/09→						
1.6 THP 150	110	02/12→						
1.6 THP 163	120	02/12→						
1.6 THP 165	121	02/12→						
2.0 HDi	120	09/09→						
2.0 HDi 136 / BlueHDi 136	100	02/12→						
1.6 BlueHDi 120	88	05/14→			für Fahrzeuge ohne Start-Stopp-Funktion		03.7860-3732.4 300306	ATE Ø 10" pneumatisch
1.6 HDi	84	03/13→						
1.6 HDi	82	08/10→			Orga 12656→; für Fahrzeuge ohne Start-Stopp-Funktion		03.7860-3732.4 300306	ATE Ø 10" pneumatisch
					→Orga 12655		03.7860-3732.4 300306	ATE Ø 10" pneumatisch
2.0 HDi 150 / BlueHDi 150	110	06/09→			09/09→		03.7860-3732.4 300306	ATE Ø 10" pneumatisch
 Hauptbremszylinder								
1.2	96	01/15→					03.4153-0173.3 010815	ATE Ø 23,81
1.6 16V	88	09/09→						
1.6 16V	115	09/09→						
1.6 HDi	80	09/09→						
1.6 HDi	82	08/10→						
1.6 HDi	84	03/13→						
2.0 HDi	120	09/09→						
2.0 HDi 136 / BlueHDi 136	100	02/12→						
2.0 HDi 150 / BlueHDi 150	110	06/09→			09/09→		03.4153-0173.3 010815	ATE Ø 23,81
PEUGEOT - BOXER Bus 04/06→								
 Hauptbremszylinder								
2.2 HDi 100	74	04/06→			Nutzlast ab [kg] 1.600 Nutzlast bis [kg] 2.000; Nutzlast 16Q/20Q; + DSC		24.4125-1701.3 010867	BOS Ø 25,4 ohne Bremsflüssigkeitsbehälter
2.2 HDi 110	81	03/11→						
2.2 HDi 120	88	04/06→						
2.2 HDi 130	96	03/11→			Nutzlast ab [kg] 1.200 Nutzlast bis [kg] 1.400; Nutzlast 12Q/14Q; - DSC		24.4125-1702.3 010872	BOS Ø 25,4 ohne Bremsflüssigkeitsbehälter
2.2 HDi 150	110	03/11→						
3.0 HDi 145	107	04/10→			Nutzlast ab [kg] 1.200 Nutzlast bis [kg] 1.400; Nutzlast 12Q/14Q; + DSC		24.4126-1701.3 010868	BOS Ø 26,99 ohne Bremsflüssigkeitsbehälter
3.0 HDi 160	116	04/06→						
3.0 HDi 175	130	03/11→						
PEUGEOT - BOXER Bus (230P) 03/94→04/02								
 Hauptbremszylinder								
1.9 D	51	03/94→04/02			→ S 15064995; Nutzlast [kg]: 1.000; + ABS		24.2122-1714.3 010480	Ø 22,2
					→ S 15064995; Nutzlast [kg]: 1.000; für Linkslenker; - ABS		24.2122-1715.3 010481	Ø 22,2
					S 15064996→ S 16206253; Nutzlast [kg]: 1.000; + ABS		24.2125-1702.3 010482	Ø 25,4
					S 15064996→ S 16205754; Nutzlast [kg]: 1.000; für Linkslenker; - ABS		24.2125-1703.3 010483	Ø 25,4
					S 16205755→; → 03/02; Nutzlast [kg]: 1.000; - ABS		24.2125-1725.3 010717	Ø 25,4
					S 16206254→; → 03/02; Nutzlast [kg]: 1.000; + ABS		24.2125-1726.3 010718	Ø 25,4
1.9 TD	66	08/94→04/02			→ S 15064995; Nutzlast ab [kg] 1.000		24.2122-1714.3 010480	Ø 22,2
1.9 TD	68	03/94→04/02			Nutzlast bis [kg] 1.400; + ABS			
1.9 TD 4x4	68	07/96→04/02			→ S 15064995; Nutzlast ab [kg] 1.000 Nutzlast bis [kg] 1.400; für Linkslenker; - ABS		24.2122-1715.3 010481	Ø 22,2
					S 15064996→ S 16206253; Nutzlast ab [kg] 1.000 Nutzlast bis [kg] 1.400; + ABS		24.2125-1702.3 010482	Ø 25,4
↓								













	kw			 	! #		
PEUGEOT - BOXER Bus (230P) 03/94→04/02							
 Hauptbremszylinder							
1.9 TD 1.9 TD 1.9 TD 4x4	66 68 68	08/94→04/02 03/94→04/02 07/96→04/02		S 15064996→ S 16205754; Nutzlast ab [kg] 1.000 Nutzlast bis [kg] 1.400; für Linkslenker; - ABS		24.2125-1703.3 010483	Ø 25,4
				S 16205755→; → 03/02; Nutzlast ab [kg] 1.000 Nutzlast bis [kg] 1.400; - ABS		24.2125-1725.3 010717	Ø 25,4
				S 16206254→; → 03/02; Nutzlast ab [kg] 1.000 Nutzlast bis [kg] 1.400; + ABS		24.2125-1726.3 010718	Ø 25,4
2.0 i 2.0 i 4x4	80 80	03/94→04/02 08/96→04/02		→ S 15064995; Nutzlast ab [kg] 1.000 Nutzlast bis [kg] 1.400; + ABS		24.2122-1714.3 010480	Ø 22,2
				→ S 15064995; Nutzlast ab [kg] 1.000 Nutzlast bis [kg] 1.400; für Linkslenker; - ABS		24.2122-1715.3 010481	Ø 22,2
				S 15064996→ S 16206253; Nutzlast ab [kg] 1.000 Nutzlast bis [kg] 1.400; + ABS		24.2125-1702.3 010482	Ø 25,4
				→ S 16194399; Nutzlast [kg]: 1.800; + ABS		24.2125-1702.3 010482	Ø 25,4
				→ S 16205352; Nutzlast [kg]: 1.800; für Linkslenker; - ABS		24.2125-1703.3 010483	Ø 25,4
				S 15064996→ S 16205754; Nutzlast ab [kg] 1.000 Nutzlast bis [kg] 1.400; für Linkslenker; - ABS		24.2125-1703.3 010483	Ø 25,4
				S 16205755→; → 03/02; Nutzlast ab [kg] 1.000 Nutzlast bis [kg] 1.400; - ABS		24.2125-1725.3 010717	Ø 25,4
				S 16205353→; → 03/02; Nutzlast [kg]: 1.800; - ABS		24.2125-1725.3 010717	Ø 25,4
				S 16206254→; → 03/02; Nutzlast ab [kg] 1.000 Nutzlast bis [kg] 1.400; + ABS		24.2125-1726.3 010718	Ø 25,4
				S 16194400→; → 03/02; Nutzlast [kg]: 1.800; + ABS		24.2125-1726.3 010718	Ø 25,4
2.5 D 2.5 D 4x4	63 63	08/94→04/02 07/96→04/02		→ S 15064995; Nutzlast [kg]: 1.400; + ABS		24.2122-1714.3 010480	Ø 22,2
				→ S 15064995; Nutzlast [kg]: 1.400; für Linkslenker; - ABS		24.2122-1715.3 010481	Ø 22,2
				S 15064996→ S 16206253; Nutzlast [kg]: 1.400; + ABS		24.2125-1702.3 010482	Ø 25,4
				→ S 16194399; Nutzlast [kg]: 1.800; + ABS		24.2125-1702.3 010482	Ø 25,4
				S 15064996→ S 16205754; Nutzlast [kg]: 1.400; für Linkslenker; + ABS		24.2125-1703.3 010483	Ø 25,4
				→ S 16205352; Nutzlast [kg]: 1.800; für Linkslenker; - ABS		24.2125-1703.3 010483	Ø 25,4
				S 16205755→; → 03/02; Nutzlast [kg]: 1.400; + ABS		24.2125-1725.3 010717	Ø 25,4
				S 16205353→; → 03/02; Nutzlast [kg]: 1.800; - ABS		24.2125-1725.3 010717	Ø 25,4
				S 16194400→; → 03/02; Nutzlast [kg]: 1.800; + ABS		24.2125-1726.3 010718	Ø 25,4
				S 16206254→; → 03/02; Nutzlast [kg]: 1.400; + ABS		24.2125-1726.3 010718	Ø 25,4
2.5 DT	62	10/97→11/01		→ S 15064995; Nutzlast [kg]: 1.400; + ABS		24.2122-1714.3 010480	Ø 22,2
				→ S 15064995; Nutzlast [kg]: 1.400; für Linkslenker; - ABS		24.2122-1715.3 010481	Ø 22,2
				S 15064996→ S 16206253; Nutzlast [kg]: 1.400; + ABS		24.2125-1702.3 010482	Ø 25,4
				→ S 16194399; Nutzlast [kg]: 1.800; + ABS		24.2125-1702.3 010482	Ø 25,4
				→ S 16205352; Nutzlast [kg]: 1.800; für Linkslenker; - ABS		24.2125-1703.3 010483	Ø 25,4
				S 15064996→ S 16205754; Nutzlast [kg]: 1.400; für Linkslenker; + ABS		24.2125-1703.3 010483	Ø 25,4
				S 16205755→; Nutzlast [kg]: 1.400; + ABS		24.2125-1725.3 010717	Ø 25,4
				S 16205353→; Nutzlast [kg]: 1.800; - ABS		24.2125-1725.3 010717	Ø 25,4
				S 16206254→; Nutzlast [kg]: 1.400; + ABS		24.2125-1726.3 010718	Ø 25,4
				S 16194400→; Nutzlast [kg]: 1.800; + ABS		24.2125-1726.3 010718	Ø 25,4
2.5 TD	76	07/94→04/02		08/94→; → S 15064995; Nutzlast [kg]: 1.400; + ABS		24.2122-1714.3 010480	Ø 22,2
				08/94→; → S 15064995; Nutzlast [kg]: 1.400; für Linkslenker; - ABS		24.2122-1715.3 010481	Ø 22,2











	kw			 	! #		
PEUGEOT - BOXER Bus (230P) 03/94→04/02							
 Hauptbremszylinder							
2.5 TD	76	07/94→04/02	S 15064996→ S 16206253; Nutzlast [kg]: 1.400; + ABS	24.2125-1702.3	010482	Ø 25,4	
			08/94→; → S 16194399; Nutzlast [kg]: 1.800; + ABS	24.2125-1702.3	010482	Ø 25,4	
			S 15064996→ S 16205754; Nutzlast [kg]: 1.400; für Linkslenker; - ABS	24.2125-1703.3	010483	Ø 25,4	
			08/94→; → S 16205352; Nutzlast [kg]: 1.800; für Linkslenker; - ABS	24.2125-1703.3	010483	Ø 25,4	
			S 16205353→; → 03/02; Nutzlast [kg]: 1.800; - ABS	24.2125-1725.3	010717	Ø 25,4	
			S 16205755→; → 03/02; Nutzlast [kg]: 1.400; - ABS	24.2125-1725.3	010717	Ø 25,4	
			S 16206254→; → 03/02; Nutzlast [kg]: 1.400; + ABS	24.2125-1726.3	010718	Ø 25,4	
			S 16194400→; → 03/02; Nutzlast [kg]: 1.800; + ABS	24.2125-1726.3	010718	Ø 25,4	
2.5 TD 4x4	76	07/96→04/02	→ S 15064995; Nutzlast [kg]: 1.400; + ABS	24.2122-1714.3	010480	Ø 22,2	
			→ S 15064995; Nutzlast [kg]: 1.400; für Linkslenker; - ABS	24.2122-1715.3	010481	Ø 22,2	
			→ S 16194399; Nutzlast [kg]: 1.800; + ABS	24.2125-1702.3	010482	Ø 25,4	
			S 15064996→ S 16206253; Nutzlast [kg]: 1.400; + ABS	24.2125-1702.3	010482	Ø 25,4	
			S 15064996→ S 16205754; Nutzlast [kg]: 1.400; für Linkslenker; - ABS	24.2125-1703.3	010483	Ø 25,4	
			→ S 16205352; Nutzlast [kg]: 1.800; für Linkslenker; - ABS	24.2125-1703.3	010483	Ø 25,4	
			S 16205353→; → 03/02; Nutzlast [kg]: 1.800; - ABS	24.2125-1725.3	010717	Ø 25,4	
			S 16205755→; → 03/02; Nutzlast [kg]: 1.400; - ABS	24.2125-1725.3	010717	Ø 25,4	
			S 16206254→; → 03/02; Nutzlast [kg]: 1.400; + ABS	24.2125-1726.3	010718	Ø 25,4	
S 16194400→; → 03/02; Nutzlast [kg]: 1.800; + ABS	24.2125-1726.3	010718	Ø 25,4				
2.5 TDI 2.5 TDI 4x4	79	01/97→04/02	→ S 16206253; Nutzlast [kg]: 1.400; + ABS	24.2125-1702.3	010482	Ø 25,4	
	79	01/97→04/02	→ S 16194399; Nutzlast [kg]: 1.800; + ABS	24.2125-1702.3	010482	Ø 25,4	
			S 15064996→ S 16205754; Nutzlast [kg]: 1.400; für Linkslenker; - ABS	24.2125-1703.3	010483	Ø 25,4	
			→ S 16205352; Nutzlast [kg]: 1.800; für Linkslenker; - ABS	24.2125-1703.3	010483	Ø 25,4	
			S 16205755→; → 03/02; Nutzlast [kg]: 1.400; - ABS	24.2125-1725.3	010717	Ø 25,4	
			S 16205353→; → 03/02; Nutzlast [kg]: 1.800; - ABS	24.2125-1725.3	010717	Ø 25,4	
			S 16206254→; → 03/02; Nutzlast [kg]: 1.400; + ABS	24.2125-1726.3	010718	Ø 25,4	
		S 16194400→; → 03/02; Nutzlast [kg]: 1.800; + ABS	24.2125-1726.3	010718	Ø 25,4		
2.8 D	64	01/99→02/02	→ S 15064995; Nutzlast [kg]: 1.400; + ABS	24.2122-1714.3	010480	Ø 22,2	
			→ S 15064995; Nutzlast [kg]: 1.400; für Linkslenker; - ABS	24.2122-1715.3	010481	Ø 22,2	
			S 15064995→ S 16206253; Nutzlast [kg]: 1.400; + ABS	24.2125-1702.3	010482	Ø 25,4	
			→ S 16194399; Nutzlast [kg]: 1.800; + ABS	24.2125-1702.3	010482	Ø 25,4	
			→ S 16205352; Nutzlast [kg]: 1.800; für Linkslenker; - ABS	24.2125-1703.3	010483	Ø 25,4	
			S 15064996→ S 16205754; Nutzlast [kg]: 1.400; für Linkslenker; - ABS	24.2125-1703.3	010483	Ø 25,4	
			S 16205755→; Nutzlast [kg]: 1.400; - ABS	24.2125-1725.3	010717	Ø 25,4	
			S 16205353→; Nutzlast [kg]: 1.800; - ABS	24.2125-1725.3	010717	Ø 25,4	
			S 16206254→; Nutzlast [kg]: 1.400; + ABS	24.2125-1726.3	010718	Ø 25,4	
↓							











	kw			 	! #		
PEUGEOT - BOXER Bus (230P) 03/94→04/02							
Hauptbremszylinder							
2.8 D	64	01/99→02/02		S 16194400→; Nutzlast [kg]: 1.800; + ABS		24.2125-1726.3 010718	Ø 25,4
2.8 HDI	94	11/00→04/02		→ S 16194399; Nutzlast [kg]: 1.800; + ABS		24.2125-1702.3 010482	Ø 25,4
				→ S 16206253; Nutzlast [kg]: 1.400; + ABS		24.2125-1702.3 010482	Ø 25,4
				→ S 16205754; Nutzlast [kg]: 1.400; für Linkslenker; - ABS		24.2125-1703.3 010483	Ø 25,4
				→ S 16205352; Nutzlast [kg]: 1.800; für Linkslenker; - ABS		24.2125-1703.3 010483	Ø 25,4
				S 16205755→; → 03/02; Nutzlast [kg]: 1.400; - ABS		24.2125-1725.3 010717	Ø 25,4
				S 16205353→; → 03/02; Nutzlast [kg]: 1.800; - ABS		24.2125-1725.3 010717	Ø 25,4
				S 16206254→; → 03/02; Nutzlast [kg]: 1.400; + ABS		24.2125-1726.3 010718	Ø 25,4
2.8 HDi 4x4	94	10/00→04/02		→ S 16194400→; → 03/02; Nutzlast [kg]: 1.800; + ABS		24.2125-1726.3 010718	Ø 25,4
				→ S 15064995; Nutzlast ab [kg] 1.000 Nutzlast bis [kg] 1.400; + ABS		24.2122-1714.3 010480	Ø 22,2
				→ S 15064995; Nutzlast ab [kg] 1.000 Nutzlast bis [kg] 1.400; für Linkslenker; - ABS		24.2122-1715.3 010481	Ø 22,2
				→ S 16194399; Nutzlast [kg]: 1.800; + ABS		24.2125-1702.3 010482	Ø 25,4
				S 15064995→ S 16206253; Nutzlast ab [kg] 1.000 Nutzlast bis [kg] 1.400; + ABS		24.2125-1702.3 010482	Ø 25,4
				→ S 16205352; Nutzlast [kg]: 1.800; für Linkslenker; - ABS		24.2125-1703.3 010483	Ø 25,4
				S 15064995→ S 16205754; Nutzlast ab [kg] 1.000 Nutzlast bis [kg] 1.400; für Linkslenker; - ABS		24.2125-1703.3 010483	Ø 25,4
				S 16205755→; → 03/02; Nutzlast ab [kg] 1.000 Nutzlast bis [kg] 1.400; - ABS		24.2125-1725.3 010717	Ø 25,4
				S 16205353→; → 03/02; Nutzlast [kg]: 1.800; - ABS		24.2125-1725.3 010717	Ø 25,4
				S 16206254→; → 03/02; Nutzlast ab [kg] 1.000 Nutzlast bis [kg] 1.400; + ABS		24.2125-1726.3 010718	Ø 25,4
2.8 HDi Allrad	93	10/00→11/01		S 16194400→; → 03/02; Nutzlast [kg]: 1.800; + ABS		24.2125-1726.3 010718	Ø 25,4
				→ S 15064995; Nutzlast ab [kg] 1.000 Nutzlast bis [kg] 1.400; + ABS		24.2122-1714.3 010480	Ø 22,2
				→ S 15064995; Nutzlast ab [kg] 1.000 Nutzlast bis [kg] 1.400; für Linkslenker; - ABS		24.2122-1715.3 010481	Ø 22,2
				→ S 16194399; Nutzlast [kg]: 1.800; + ABS		24.2125-1702.3 010482	Ø 25,4
				S 15064995→ S 16206253; Nutzlast ab [kg] 1.000 Nutzlast bis [kg] 1.400; + ABS		24.2125-1702.3 010482	Ø 25,4
				→ S 16205352; Nutzlast [kg]: 1.800; für Linkslenker; - ABS		24.2125-1703.3 010483	Ø 25,4
				S 15064995→ S 16205754; Nutzlast ab [kg] 1.000 Nutzlast bis [kg] 1.400; für Linkslenker; - ABS		24.2125-1703.3 010483	Ø 25,4
				S 16205755→; Nutzlast ab [kg] 1.000 Nutzlast bis [kg] 1.400; - ABS		24.2125-1725.3 010717	Ø 25,4
				S 16205353→; Nutzlast [kg]: 1.800; - ABS		24.2125-1725.3 010717	Ø 25,4
				S 16206254→; Nutzlast ab [kg] 1.000 Nutzlast bis [kg] 1.400; + ABS		24.2125-1726.3 010718	Ø 25,4
Bremskraftregler							
1.9 D	51	03/94→04/02		→ S 16206244; Nutzlast [kg]: 1.000; - ABS		24.6512-1701.3 320153	lastabhängig 2x
1.9 TD 1.9 TD 1.9 TD 4x4	66	08/94→04/02		→ S 16206244; Nutzlast ab [kg] 1.000 Nutzlast bis [kg] 1.400; - ABS		24.6512-1701.3 320153	lastabhängig 2x
	68	03/94→04/02					
	68	07/96→04/02					
2.0 i 2.0 i 4x4	80	03/94→04/02		→ S 16206244; Nutzlast ab [kg] 1.000 Nutzlast bis [kg] 1.800; - ABS		24.6512-1701.3 320153	lastabhängig 2x
	80	08/96→04/02					
2.5 TD	76	07/94→04/02		08/94→; → S 16206244; Nutzlast ab [kg] 1.400 Nutzlast bis [kg] 1.800; - ABS		24.6512-1701.3 320153	lastabhängig 2x
2.5 TD 4x4 2.5 TDI 2.5 TDI 4x4 ↓	76	07/96→04/02		→ S 16206244; Nutzlast ab [kg] 1.400 Nutzlast bis [kg] 1.800; - ABS		24.6512-1701.3 320153	lastabhängig 2x
	79	01/97→04/02					
	79	01/97→04/02					













	kw					! #		
PEUGEOT - BOXER Bus (230P) 03/94→04/02								
 Bremskraftregler								
2.8 D	64	01/99→02/02		→ S 16206244; Nutzlast ab [kg] 1.400		24.6512-1701.3	320153	lastabhängig 2x
2.8 HDi	94	11/00→04/02		Nutzlast bis [kg] 1.800; - ABS				
2.8 HDi	93	10/00→11/01		11/00→; → S 16206244; Nutzlast ab [kg] 1.400 Nutzlast bis [kg] 1.800; - ABS		24.6512-1701.3	320153	lastabhängig 2x
PEUGEOT - BOXER Bus (244, Z_) 12/01→								
 Hauptbremszylinder								
2.0	81	04/02→		→ 03/06; Nutzlast ab [kg] 1.000 Nutzlast bis [kg] 1.800; - ABS		24.2125-1725.3	010717	Ø 25,4
2.0 HDi	62	04/02→						
2.2 HDi	74	04/02→		→ 03/06; Nutzlast ab [kg] 1.000 Nutzlast bis [kg] 1.800; + ABS		24.2125-1726.3	010718	Ø 25,4
2.8 HDi	94	04/02→						
2.8 HDi	107	04/04→						
2.8 HDi 4x4	94	04/02→						
2.0 BiFuel	81	12/01→06/06		04/02→ 03/06; Nutzlast ab [kg] 1.000 Nutzlast bis [kg] 1.800; - ABS		24.2125-1725.3	010717	Ø 25,4
				04/02→ 03/06; Nutzlast ab [kg] 1.000 Nutzlast bis [kg] 1.800; + ABS		24.2125-1726.3	010718	Ø 25,4
 Bremskraftregler								
2.8 HDi 4x4	94	04/02→		→ 03/06; Nutzlast ab [kg] 1.000 Nutzlast bis [kg] 1.800; - ABS		24.6512-1701.3	320153	lastabhängig 2x
PEUGEOT - BOXER Kasten 04/06→								
 Hauptbremszylinder								
2.2 HDi 100	74	04/06→		Nutzlast ab [kg] 1.600 Nutzlast bis [kg] 2.000; Nutzlast 16Q/20Q; + DSC		24.4125-1701.3	010867	BOS Ø 25,4 ohne Bremsflüssigkeitsbehälter
2.2 HDi 110	81	03/11→						
2.2 HDi 120	88	04/06→		Nutzlast ab [kg] 1.200 Nutzlast bis [kg] 1.400; Nutzlast 12Q/14Q; - DSC		24.4125-1702.3	010872	BOS Ø 25,4 ohne Bremsflüssigkeitsbehälter
2.2 HDi 130	96	03/11→						
2.2 HDi 150	110	03/11→						
3.0 D	116	09/08→12/09		Nutzlast ab [kg] 1.200 Nutzlast bis [kg] 1.400; Nutzlast 12Q/14Q; + DSC		24.4126-1701.3	010868	BOS Ø 26,99 ohne Bremsflüssigkeitsbehälter
3.0 HDi	115	07/06→						
3.0 HDi 145	107	04/10→						
3.0 HDi 160	116	04/06→						
3.0 HDi 175	130	03/11→						
PEUGEOT - BOXER Kasten (230L) 03/94→06/03								
 Hauptbremszylinder								
1.9 D	50	07/99→04/02		→ S 16206253; Nutzlast [kg]: 1.000; + ABS		24.2125-1702.3	010482	Ø 25,4
				→ S 16205754; Nutzlast [kg]: 1.000; - ABS; für Linkslenker		24.2125-1703.3	010483	Ø 25,4
				S 16205755→; → 03/02; Nutzlast [kg]: 1.000; - ABS		24.2125-1725.3	010717	Ø 25,4
				S 16206254→; → 03/02; Nutzlast [kg]: 1.000; + ABS		24.2125-1726.3	010718	Ø 25,4
1.9 D	51	03/94→04/02		→ S 15064995; Nutzlast [kg]: 1.000; + ABS		24.2122-1714.3	010480	Ø 22,2
				→ S 15064995; Nutzlast [kg]: 1.000; - ABS; für Linkslenker		24.2122-1715.3	010481	Ø 22,2
				S 15064996→ S 16206253; Nutzlast [kg]: 1.000; + ABS		24.2125-1702.3	010482	Ø 25,4
				S 15064996→ S 16205754; Nutzlast [kg]: 1.000; - ABS; für Linkslenker		24.2125-1703.3	010483	Ø 25,4
				S 16205755→; → 03/02; Nutzlast [kg]: 1.000; - ABS		24.2125-1725.3	010717	Ø 25,4
				S 16206254→; → 03/02; Nutzlast [kg]: 1.000; + ABS		24.2125-1726.3	010718	Ø 25,4
1.9 TD	66	07/99→04/02		→ S 16206253; Nutzlast ab [kg] 1.000 Nutzlast bis [kg] 1.400; + ABS		24.2125-1702.3	010482	Ø 25,4
				→ S 16205754; Nutzlast ab [kg] 1.000 Nutzlast bis [kg] 1.400; - ABS; für Linkslenker		24.2125-1703.3	010483	Ø 25,4
				S 16205755→; → 03/02; Nutzlast ab [kg] 1.000 Nutzlast bis [kg] 1.400; - ABS		24.2125-1725.3	010717	Ø 25,4
				S 16206254→; → 03/02; Nutzlast ab [kg] 1.000 Nutzlast bis [kg] 1.400; + ABS		24.2125-1726.3	010718	Ø 25,4
1.9 TD	68	03/94→04/02		→ S 15064995; Nutzlast ab [kg] 1.000 Nutzlast bis [kg] 1.400; + ABS		24.2122-1714.3	010480	Ø 22,2
				→ S 15064995; Nutzlast ab [kg] 1.000 Nutzlast bis [kg] 1.400; - ABS; für Linkslenker		24.2122-1715.3	010481	Ø 22,2
				S 15064996→ S 16206253; Nutzlast ab [kg] 1.000 Nutzlast bis [kg] 1.400; + ABS		24.2125-1702.3	010482	Ø 25,4

	kw			 	! #		
PEUGEOT - BOXER Kasten (230L) 03/94→06/03							
 Hauptbremszylinder							
1.9 TD	68	03/94→04/02		S 15064996→ S 16205754; Nutzlast ab [kg] 1.000 Nutzlast bis [kg] 1.400; - ABS; für Linkslenker	24.2125-1703.3	010483	Ø 25,4
				S 16205755→; → 03/02; Nutzlast ab [kg] 1.000 Nutzlast bis [kg] 1.400; - ABS	24.2125-1725.3	010717	Ø 25,4
				S 16206254→; → 03/02; Nutzlast ab [kg] 1.000 Nutzlast bis [kg] 1.400; + ABS	24.2125-1726.3	010718	Ø 25,4
2.0 HDI	62	08/01→04/02		→ 03/02; Nutzlast ab [kg] 1.000 Nutzlast bis [kg] 1.800; - ABS	24.2125-1725.3	010717	Ø 25,4
				→ 03/02; Nutzlast ab [kg] 1.000 Nutzlast bis [kg] 1.800; + ABS	24.2125-1726.3	010718	Ø 25,4
2.0 i	80	06/94→04/02		→ S 15064995; Nutzlast ab [kg] 1.000 Nutzlast bis [kg] 1.400; + ABS	24.2122-1714.3	010480	Ø 22,2
				→ S 15064995; Nutzlast ab [kg] 1.000 Nutzlast bis [kg] 1.400; - ABS; für Linkslenker	24.2122-1715.3	010481	Ø 22,2
				S 15064996→ S 16206253; Nutzlast ab [kg] 1.000 Nutzlast bis [kg] 1.400; + ABS	24.2125-1702.3	010482	Ø 25,4
				→ S 16194399; Nutzlast [kg]: 1.800; + ABS	24.2125-1702.3	010482	Ø 25,4
				→ S 16205352; Nutzlast [kg]: 1.800; - ABS; für Linkslenker	24.2125-1703.3	010483	Ø 25,4
				S 15064996→ S 16205754; Nutzlast ab [kg] 1.000 Nutzlast bis [kg] 1.400; - ABS; für Linkslenker	24.2125-1703.3	010483	Ø 25,4
				S 16205755→; → 03/02; Nutzlast ab [kg] 1.000 Nutzlast bis [kg] 1.400; - ABS	24.2125-1725.3	010717	Ø 25,4
				S 16205353→; → 03/02; Nutzlast [kg]: 1.800; - ABS	24.2125-1725.3	010717	Ø 25,4
				S 16206254→; → 03/02; Nutzlast ab [kg] 1.000 Nutzlast bis [kg] 1.400; + ABS	24.2125-1726.3	010718	Ø 25,4
				S 16194400→; → 03/02; Nutzlast [kg]: 1.800; + ABS	24.2125-1726.3	010718	Ø 25,4
2.5 D 2.5 D 4x4 2.5 TD	63	03/94→04/02		→ S 15064995; Nutzlast [kg]: 1.400; + ABS	24.2122-1714.3	010480	Ø 22,2
	63	07/99→04/02		→ S 15064995; Nutzlast [kg]: 1.400; - ABS; für Linkslenker	24.2122-1715.3	010481	Ø 22,2
	76	03/94→04/02		→ S 15064995; Nutzlast [kg]: 1.400; - ABS; für Linkslenker	24.2122-1715.3	010481	Ø 22,2
				→ S 16194399; Nutzlast [kg]: 1.800; + ABS	24.2125-1702.3	010482	Ø 25,4
				S 15064996→ S 16206253; Nutzlast [kg]: 1.400; + ABS	24.2125-1702.3	010482	Ø 25,4
				S 15064996→ S 16205754; Nutzlast [kg]: 1.400; - ABS; für Linkslenker	24.2125-1703.3	010483	Ø 25,4
				→ S 16205352; Nutzlast [kg]: 1.800; - ABS; für Linkslenker	24.2125-1703.3	010483	Ø 25,4
				S 16205353→; → 03/02; Nutzlast [kg]: 1.800; - ABS	24.2125-1725.3	010717	Ø 25,4
				S 16205755→; → 03/02; Nutzlast [kg]: 1.400; - ABS	24.2125-1725.3	010717	Ø 25,4
				S 16206254→; → 03/02; Nutzlast [kg]: 1.400; + ABS	24.2125-1726.3	010718	Ø 25,4
	S 16194400→; → 03/02; Nutzlast [kg]: 1.800; + ABS	24.2125-1726.3	010718	Ø 25,4			
2.5 DT 2.8 D	62	10/97→11/01		→ S 15064995; Nutzlast [kg]: 1.400; + ABS	24.2122-1714.3	010480	Ø 22,2
	64	01/99→02/02		→ S 15064995; Nutzlast [kg]: 1.400; - ABS; für Linkslenker	24.2122-1715.3	010481	Ø 22,2
				→ S 16194399; Nutzlast [kg]: 1.800; + ABS	24.2125-1702.3	010482	Ø 25,4
				S 15064996→ S 16206253; Nutzlast [kg]: 1.400; + ABS	24.2125-1702.3	010482	Ø 25,4
				→ S 16205352; Nutzlast [kg]: 1.800; - ABS; für Linkslenker	24.2125-1703.3	010483	Ø 25,4
				S 15064996→ S 16205754; Nutzlast [kg]: 1.400; - ABS; für Linkslenker	24.2125-1703.3	010483	Ø 25,4
				S 16205755→; Nutzlast [kg]: 1.400; - ABS	24.2125-1725.3	010717	Ø 25,4
				S 16205353→; Nutzlast [kg]: 1.800; - ABS	24.2125-1725.3	010717	Ø 25,4
				S 16206254→; Nutzlast [kg]: 1.400; + ABS	24.2125-1726.3	010718	Ø 25,4
		S 16194400→; Nutzlast [kg]: 1.800; + ABS	24.2125-1726.3	010718	Ø 25,4		
↓							

	kw			 	! #		
PEUGEOT - BOXER Kasten (230L) 03/94→06/03							
 Hauptbremszylinder							
2.5 TDI	79	01/97→04/02		→ S 16194399; Nutzlast [kg]: 1.800; + ABS	24.2125-1702.3	010482	Ø 25,4
2.5 TDI 4x4	79	07/99→04/02					
2.8 HDI	94	11/00→04/02		→ S 16206253; Nutzlast [kg]: 1.400; + ABS	24.2125-1702.3	010482	Ø 25,4
				→ S 16205754; Nutzlast [kg]: 1.400; - ABS; für Linkslenker	24.2125-1703.3	010483	Ø 25,4
				→ S 16205352; Nutzlast [kg]: 1.800; - ABS; für Linkslenker	24.2125-1703.3	010483	Ø 25,4
				S 16205755→; → 03/02; Nutzlast [kg]: 1.400; - ABS	24.2125-1725.3	010717	Ø 25,4
				S 16205353→; → 03/02; Nutzlast [kg]: 1.800; - ABS	24.2125-1725.3	010717	Ø 25,4
				S 16206254→; → 03/02; Nutzlast [kg]: 1.400; + ABS	24.2125-1726.3	010718	Ø 25,4
				S 16194400→; → 03/02; Nutzlast [kg]: 1.800; + ABS	24.2125-1726.3	010718	Ø 25,4
 Bremskraftregler							
1.9 D	50	07/99→04/02		→ S 16206244; Nutzlast [kg]: 1.000; - ABS	24.6512-1701.3	320153	lastabhängig 2x
1.9 D	51	03/94→04/02					
1.9 TD	66	07/99→04/02		→ S 16206244; Nutzlast ab [kg] 1.000	24.6512-1701.3	320153	lastabhängig 2x
1.9 TD	68	03/94→04/02		Nutzlast bis [kg] 1.400; - ABS			
2.0 HDI	62	08/01→04/02		→ S 16206244; Nutzlast ab [kg] 1.000	24.6512-1701.3	320153	lastabhängig 2x
2.0 i	80	06/94→04/02		Nutzlast bis [kg] 1.800; - ABS			
2.5 D	63	03/94→04/02		→ S 16206244; Nutzlast ab [kg] 1.400	24.6512-1701.3	320153	lastabhängig 2x
2.5 D 4x4	63	07/99→04/02		Nutzlast bis [kg] 1.800; - ABS			
2.5 DT	62	10/97→11/01					
2.5 TD	76	03/94→04/02					
2.5 TDI	79	01/97→04/02					
2.5 TDI 4x4	79	07/99→04/02					
2.8 D	64	01/99→02/02					
2.8 HDI	94	11/00→04/02					
2.8 HDi	93	10/00→11/01		11/00→; → S 16206244; Nutzlast ab [kg] 1.400 Nutzlast bis [kg] 1.800; - ABS	24.6512-1701.3	320153	lastabhängig 2x
PEUGEOT - BOXER Kasten (244) 12/01→							
 Hauptbremszylinder							
2.0	81	04/02→		→ 03/06; Nutzlast ab [kg] 1.000 Nutzlast bis [kg] 1.800; - ABS	24.2125-1725.3	010717	Ø 25,4
2.0 HDi	62	04/02→					
2.2 HDi	74	04/02→					
2.8 HDi	93	09/05→09/09		→ 03/06; Nutzlast ab [kg] 1.000 Nutzlast bis [kg] 1.800; + ABS	24.2125-1726.3	010718	Ø 25,4
2.8 HDi	94	04/02→					
2.8 HDi	107	04/04→					
2.8 HDi 4x4	94	04/02→					
2.0 BiFuel	81	12/01→06/06		04/02→ 03/06; Nutzlast ab [kg] 1.000 Nutzlast bis [kg] 1.800; - ABS	24.2125-1725.3	010717	Ø 25,4
				04/02→ 03/06; Nutzlast ab [kg] 1.000 Nutzlast bis [kg] 1.800; + ABS	24.2125-1726.3	010718	Ø 25,4
 Bremskraftregler							
2.8 HDi 4x4	94	04/02→		→ 03/06; Nutzlast ab [kg] 1.000 Nutzlast bis [kg] 1.800; - ABS	24.6512-1701.3	320153	lastabhängig 2x
PEUGEOT - BOXER Pritsche/Fahrgestell 04/06→							
 Hauptbremszylinder							
2.2 HDi 100	74	04/06→		Nutzlast ab [kg] 1.600 Nutzlast bis [kg] 2.000; Nutzlast 16Q/20Q; + DSC	24.4125-1701.3	010867	BOS Ø 25,4 ohne Bremsflüssigkeitsbehälter
2.2 HDi 110	81	03/11→					
2.2 HDi 120	88	04/06→		Nutzlast ab [kg] 1.200 Nutzlast bis [kg] 1.400; Nutzlast 12Q/14Q; - DSC	24.4125-1702.3	010872	BOS Ø 25,4 ohne Bremsflüssigkeitsbehälter
2.2 HDi 130	96	03/11→					
2.2 HDi 150	110	03/11→					
3.0 HDi	115	02/07→		Nutzlast ab [kg] 1.200 Nutzlast bis [kg] 1.400; Nutzlast 12Q/14Q; + DSC	24.4126-1701.3	010868	BOS Ø 26,99 ohne Bremsflüssigkeitsbehälter
3.0 HDi 145	107	04/10→					
3.0 HDi 160	116	04/06→					
3.0 HDi 175	130	03/11→					
PEUGEOT - BOXER Pritsche/Fahrgestell (244) 12/01→							
 Hauptbremszylinder							
2.0 BiFuel	81	12/01→06/06		04/02→ 03/06; Nutzlast ab [kg] 1.000 Nutzlast bis [kg] 1.800; - ABS	24.2125-1725.3	010717	Ø 25,4
				04/02→ 03/06; Nutzlast ab [kg] 1.000 Nutzlast bis [kg] 1.800; + ABS	24.2125-1726.3	010718	Ø 25,4
2.0 HDi	62	04/02→		→ 03/06; Nutzlast ab [kg] 1.000 Nutzlast bis [kg] 1.800; - ABS	24.2125-1725.3	010717	Ø 25,4
2.2 HDi	74	04/02→					
2.8 HDi	94	04/02→					
2.8 HDi	107	04/04→					

	kw			 	! #		
PEUGEOT - BOXER Pritsche/Fahrgestell (244) 12/01→							
 Hauptbremszylinder							
2.8 HDi 4x4	94	04/02→		→ 03/06; Nutzlast ab [kg] 1.000 Nutzlast bis [kg] 1.800; + ABS		24.2125-1726.3 010718	Ø 25,4
 Bremskraftregler							
2.8 HDi 4x4	94	04/02→		→ 03/06; Nutzlast ab [kg] 1.000 Nutzlast bis [kg] 1.800; - ABS		24.6512-1701.3 320153	lastabhängig 2x
PEUGEOT - BOXER Pritsche/Fahrgestell (ZCT_) 03/94→04/02							
 Hauptbremszylinder							
1.9 D	51	03/94→04/02		→ S 15064995; Nutzlast ab [kg] 1.000 Nutzlast bis [kg] 1.400; + ABS		24.2122-1714.3 010480	Ø 22,2
				→ S 15064995; Nutzlast ab [kg] 1.000 Nutzlast bis [kg] 1.400; - ABS; für Linkslenker		24.2122-1715.3 010481	Ø 22,2
				S 15064996→ S 16206253; Nutzlast ab [kg] 1.000 Nutzlast bis [kg] 1.400; + ABS		24.2125-1702.3 010482	Ø 25,4
				S 15064996→ S 16205754; Nutzlast ab [kg] 1.000 Nutzlast bis [kg] 1.400; - ABS; für Linkslenker		24.2125-1703.3 010483	Ø 25,4
				S 16205755→; - ABS; Nutzlast ab [kg] 1.000 Nutzlast bis [kg] 1.400		24.2125-1725.3 010717	Ø 25,4
				S 16206254→; + ABS; Nutzlast ab [kg] 1.000 Nutzlast bis [kg] 1.400		24.2125-1726.3 010718	Ø 25,4
1.9 TD	66	06/94→04/02		12/98→; → S 16206253; Nutzlast ab [kg] 1.000 Nutzlast bis [kg] 1.400; + ABS		24.2125-1702.3 010482	Ø 25,4
				12/98→; → S 16205754; Nutzlast ab [kg] 1.000 Nutzlast bis [kg] 1.400; - ABS; für Linkslenker		24.2125-1703.3 010483	Ø 25,4
				S 16205755→; → 03/02; Nutzlast ab [kg] 1.000 Nutzlast bis [kg] 1.400; - ABS		24.2125-1725.3 010717	Ø 25,4
				S 16206254→; → 03/02; Nutzlast ab [kg] 1.000 Nutzlast bis [kg] 1.400; + ABS		24.2125-1726.3 010718	Ø 25,4
1.9 TD	68	07/94→04/02		07/96→; → S 16206253; Nutzlast ab [kg] 1.000 Nutzlast bis [kg] 1.400; + ABS		24.2125-1702.3 010482	Ø 25,4
				07/96→; → S 16205754; Nutzlast ab [kg] 1.000 Nutzlast bis [kg] 1.400; - ABS; für Linkslenker		24.2125-1703.3 010483	Ø 25,4
				S 16205755→; → 03/02; Nutzlast ab [kg] 1.000 Nutzlast bis [kg] 1.400; - ABS		24.2125-1725.3 010717	Ø 25,4
				S 16206254→; → 03/02; Nutzlast ab [kg] 1.000 Nutzlast bis [kg] 1.400; + ABS		24.2125-1726.3 010718	Ø 25,4
2.0 2.0 i	81 80	12/01→04/02 06/94→04/02		→ S 15064995; Nutzlast ab [kg] 1.000 Nutzlast bis [kg] 1.400; + ABS		24.2122-1714.3 010480	Ø 22,2
				→ S 15064995; Nutzlast ab [kg] 1.000 Nutzlast bis [kg] 1.400; - ABS; für Linkslenker		24.2122-1715.3 010481	Ø 22,2
				S 15064996→ S 16206253; Nutzlast ab [kg] 1.000 Nutzlast bis [kg] 1.400; + ABS		24.2125-1702.3 010482	Ø 25,4
				→ S 16194399; Nutzlast [kg]: 1.800; + ABS		24.2125-1702.3 010482	Ø 25,4
				→ S 16205352; Nutzlast [kg]: 1.800; für Linkslenker; - ABS		24.2125-1703.3 010483	Ø 25,4
				S 15064996→ S 16205754; Nutzlast ab [kg] 1.000 Nutzlast bis [kg] 1.400; - ABS; für Linkslenker		24.2125-1703.3 010483	Ø 25,4
				S 16205755→; → 03/02; Nutzlast ab [kg] 1.000 Nutzlast bis [kg] 1.400; - ABS		24.2125-1725.3 010717	Ø 25,4
				S 16205353→; → 03/02; Nutzlast [kg]: 1.800; - ABS		24.2125-1725.3 010717	Ø 25,4
				S 16206254→; → 03/02; Nutzlast ab [kg] 1.000 Nutzlast bis [kg] 1.400; + ABS		24.2125-1726.3 010718	Ø 25,4
				S 16194400→; → 03/02; Nutzlast [kg]: 1.800; + ABS		24.2125-1726.3 010718	Ø 25,4
2.5 D 2.5 D 4x4 2.5 TD	63 63 76	03/94→04/02 07/99→04/02 03/94→04/02		→ S 15064995; Nutzlast [kg]: 1.400; + ABS		24.2122-1714.3 010480	Ø 22,2
				→ S 15064995; Nutzlast [kg]: 1.400; für Linkslenker; - ABS		24.2122-1715.3 010481	Ø 22,2
				→ S 16194399; Nutzlast [kg]: 1.800; + ABS		24.2125-1702.3 010482	Ø 25,4
				S 15064996→ S 16206253; Nutzlast [kg]: 1.400; + ABS		24.2125-1702.3 010482	Ø 25,4
			S 15064996→ S 16205754; Nutzlast [kg]: 1.400; für Linkslenker; - ABS		24.2125-1703.3 010483	Ø 25,4	
↓							

	kw			 	! #		
PEUGEOT - BOXER Pritsche/Fahrgestell (ZCT_) 03/94→04/02							
 Hauptbremszylinder							
2.5 D	63	03/94→04/02		→ S 16205352; Nutzlast [kg]: 1.800; für Linkslenker; - ABS		24.2125-1703.3 010483	Ø 25,4
2.5 D 4x4	63	07/99→04/02					
2.5 TD	76	03/94→04/02		S 16205353→; → 03/02; Nutzlast [kg]: 1.800; - ABS		24.2125-1725.3 010717	Ø 25,4
				S 16205755→; → 03/02; Nutzlast [kg]: 1.400; - ABS		24.2125-1725.3 010717	Ø 25,4
				S 16206254→; → 03/02; Nutzlast [kg]: 1.400; + ABS		24.2125-1726.3 010718	Ø 25,4
				S 16194400→; → 03/02; Nutzlast [kg]: 1.800; + ABS		24.2125-1726.3 010718	Ø 25,4
2.5 TDI	79	01/97→04/02		→ S 16194399; Nutzlast [kg]: 1.800; + ABS		24.2125-1702.3 010482	Ø 25,4
2.5 TDI 4x4	79	07/99→04/02					
2.8 HDI	94	11/00→04/02		→ S 16206253; Nutzlast [kg]: 1.400; + ABS		24.2125-1702.3 010482	Ø 25,4
				→ S 16205754; Nutzlast [kg]: 1.400; - ABS; für Linkslenker		24.2125-1703.3 010483	Ø 25,4
				→ S 16205352; Nutzlast [kg]: 1.800; für Linkslenker; - ABS		24.2125-1703.3 010483	Ø 25,4
				S 16205755→; → 03/02; Nutzlast [kg]: 1.400; - ABS		24.2125-1725.3 010717	Ø 25,4
				S 16205353→; → 03/02; Nutzlast [kg]: 1.800; - ABS		24.2125-1725.3 010717	Ø 25,4
				S 16206254→; → 03/02; Nutzlast [kg]: 1.400; + ABS		24.2125-1726.3 010718	Ø 25,4
				S 16194400→; → 03/02; Nutzlast [kg]: 1.800; + ABS		24.2125-1726.3 010718	Ø 25,4
2.8 D	64	01/99→02/02		→ S 15064995; Nutzlast [kg]: 1.400; + ABS		24.2122-1714.3 010480	Ø 22,2
				→ S 15064995; Nutzlast [kg]: 1.400; für Linkslenker; - ABS		24.2122-1715.3 010481	Ø 22,2
				S 15064995→ S 16206253; Nutzlast [kg]: 1.400; + ABS		24.2125-1702.3 010482	Ø 25,4
				→ S 16194399; Nutzlast [kg]: 1.800; + ABS		24.2125-1702.3 010482	Ø 25,4
				→ S 16205352; Nutzlast [kg]: 1.800; für Linkslenker; - ABS		24.2125-1703.3 010483	Ø 25,4
				S 15064996→ S 16205754; Nutzlast [kg]: 1.400; für Linkslenker; - ABS		24.2125-1703.3 010483	Ø 25,4
				S 16205755→; Nutzlast [kg]: 1.400; - ABS		24.2125-1725.3 010717	Ø 25,4
				S 16205353→; Nutzlast [kg]: 1.800; - ABS		24.2125-1725.3 010717	Ø 25,4
				S 16206254→; Nutzlast [kg]: 1.400; + ABS		24.2125-1726.3 010718	Ø 25,4
				S 16194400→; Nutzlast [kg]: 1.800; + ABS		24.2125-1726.3 010718	Ø 25,4
 Bremskraftregler							
1.9 D	51	03/94→04/02		→ S 16206244; Nutzlast ab [kg] 1.000 Nutzlast bis [kg] 1.400; - ABS		24.6512-1701.3 320153	lastabhängig 2x
1.9 TD	66	06/94→04/02		12/98→; → S 16206244; Nutzlast ab [kg] 1.000 Nutzlast bis [kg] 1.400; - ABS		24.6512-1701.3 320153	lastabhängig 2x
1.9 TD	68	07/94→04/02		07/96→; → S 16206244; Nutzlast ab [kg] 1.000 Nutzlast bis [kg] 1.400; - ABS		24.6512-1701.3 320153	lastabhängig 2x
2.0	81	12/01→04/02		→ S 16206244; Nutzlast ab [kg] 1.000 Nutzlast bis [kg] 1.800; - ABS		24.6512-1701.3 320153	lastabhängig 2x
2.0 i	80	06/94→04/02					
2.5 D	63	03/94→04/02		→ S 16206244; Nutzlast ab [kg] 1.400 Nutzlast bis [kg] 1.800; - ABS		24.6512-1701.3 320153	lastabhängig 2x
2.5 D 4x4	63	07/99→04/02					
2.5 TD	76	03/94→04/02					
2.5 TDI	79	01/97→04/02					
2.5 TDI 4x4	79	07/99→04/02					
2.8 D	64	01/99→02/02					
2.8 HDI	94	11/00→04/02					
2.8 HDi	93	10/00→11/01		11/00→; → S 16206244; Nutzlast ab [kg] 1.400 Nutzlast bis [kg] 1.800; - ABS		24.6512-1701.3 320153	lastabhängig 2x
PEUGEOT - EXPERT (224) 10/95→12/06							
 Hauptbremszylinder							
1.6	58	02/96→09/00		→Orga 08206; - ABS; Nutzlast [kg]: 800		24.2122-1703.3 010422	Ø 22,2
1.8	74	10/96→09/00		→Orga 08206; + ABS; Nutzlast [kg]: 800		24.2122-1708.3 010437	Ø 22,2
1.9 D	51	02/96→12/98					
1.9 D	51	12/03→12/06		Orga 08207→; - ABS; Nutzlast [kg]: 800		24.2122-1741.3 010695	Ø 22,2
1.9 TD	66	02/96→09/00		Orga 08207→; + ABS; Nutzlast [kg]: 800		24.2122-1742.3 010696	Ø 22,2
				→Orga 08206; - ABS; Nutzlast [kg]: 900		24.2123-1707.3 010492	Ø 23,81
↓							

	kw			 	! #		
PEUGEOT - EXPERT (224) 10/95→12/06							
 Hauptbremszylinder							
1.6	58	02/96→09/00		Orga 08207→; + ABS; Nutzlast [kg]: 900		24.2123-1733.3 010657	BOS Ø 23,81
1.8	74	10/96→09/00		Orga 08207→; - ABS; Nutzlast [kg]: 900		24.2123-1738.3 010658	Ø 23,81
1.9 D	51	02/96→12/98					
1.9 D	51	12/03→12/06					
1.9 TD	66	02/96→09/00					
1.9 TD	68	02/96→05/98		04/96→; →Orga 08206; - ABS; Nutzlast [kg]: 800		24.2122-1703.3 010422	Ø 22,2
				04/96→; →Orga 08206; + ABS; Nutzlast [kg]: 800		24.2122-1708.3 010437	Ø 22,2
				Orga 08207→; - ABS; Nutzlast [kg]: 800		24.2122-1741.3 010695	Ø 22,2
				Orga 08207→; + ABS; Nutzlast [kg]: 800		24.2122-1742.3 010696	Ø 22,2
				04/96→; →Orga 08206; - ABS; Nutzlast [kg]: 900		24.2123-1707.3 010492	Ø 23,81
				Orga 08207→; + ABS; Nutzlast [kg]: 900		24.2123-1733.3 010657	BOS Ø 23,81
			Orga 08207→; - ABS; Nutzlast [kg]: 900		24.2123-1738.3 010658	Ø 23,81	
2.0	100	07/00→12/06		+ ABS		24.2123-1733.3 010657	BOS Ø 23,81
2.0 HDi	69	10/00→10/06		- ABS		24.2123-1738.3 010658	Ø 23,81
2.0 HDi	80	07/00→12/06					
2.0 HDi 16V	80	07/00→12/06					
PEUGEOT - EXPERT Kasten (222) 07/95→12/06							
 Hauptbremszylinder							
1.6	58	02/96→09/00		→Orga 08206; - ABS; Nutzlast [kg]: 800		24.2122-1703.3 010422	Ø 22,2
1.8	74	10/96→09/00		→Orga 08206; + ABS; Nutzlast [kg]: 800		24.2122-1708.3 010437	Ø 22,2
1.9 D	51	02/96→12/98					
1.9 D 70	51	12/98→12/06					
1.9 TD	66	02/96→09/00					
1.9 TD	68	02/96→05/98		Orga 08207→; + ABS; Nutzlast [kg]: 800		24.2122-1742.3 010696	Ø 22,2
				→Orga 08206; - ABS; Nutzlast [kg]: 900		24.2123-1707.3 010492	Ø 23,81
				Orga 08207→; + ABS; Nutzlast [kg]: 900		24.2123-1733.3 010657	BOS Ø 23,81
				Orga 08207→; - ABS; Nutzlast [kg]: 900		24.2123-1738.3 010658	Ø 23,81
				04/96→; →Orga 08206; - ABS; Nutzlast [kg]: 800		24.2122-1703.3 010422	Ø 22,2
				04/96→; →Orga 08206; + ABS; Nutzlast [kg]: 800		24.2122-1708.3 010437	Ø 22,2
			Orga 08207→; - ABS; Nutzlast [kg]: 800		24.2122-1741.3 010695	Ø 22,2	
			Orga 08207→; + ABS; Nutzlast [kg]: 800		24.2122-1742.3 010696	Ø 22,2	
			04/96→; →Orga 08206; - ABS; Nutzlast [kg]: 900		24.2123-1707.3 010492	Ø 23,81	
			Orga 08207→; + ABS; Nutzlast [kg]: 900		24.2123-1733.3 010657	BOS Ø 23,81	
			Orga 08207→; - ABS; Nutzlast [kg]: 900		24.2123-1738.3 010658	Ø 23,81	
2.0	100	09/02→12/06		+ ABS		24.2123-1733.3 010657	BOS Ø 23,81
2.0 HDi	69	07/00→12/06		- ABS		24.2123-1738.3 010658	Ø 23,81
2.0 HDi	80	07/00→12/06					
PEUGEOT - EXPERT Kasten (VF3A_, VF3U_, VF3X_) 01/07→							
 Hauptbremszylinder							
1.6 HDi 90 16V	66	01/07→		für Linkslenker; - ESP		03.2125-0298.3 010818	ATE Ø 25,4
1.6 HDi 90 8V	66	01/07→		für Linkslenker; + ESP		03.2125-0671.3 010965	ATE Ø 25,4
2.0 16V	103	01/07→					
2.0 HDi 100	72	03/11→					
2.0 HDi 120	88	01/07→					
2.0 HDi 120 4x4	88	01/10→					
2.0 HDi 130	94	03/11→					
2.0 HDi 130 4x4	94	01/12→					
2.0 HDi 140	100	01/07→					
2.0 HDi 165	120	09/09→					
PEUGEOT - EXPERT Pritsche/Fahrgestell 01/07→							
 Hauptbremszylinder							
1.6 HDi 90 16V	66	01/07→		für Linkslenker; - ESP		03.2125-0298.3 010818	ATE Ø 25,4
1.6 HDi 90 8V	66	01/07→		für Linkslenker; + ESP		03.2125-0671.3 010965	ATE Ø 25,4
2.0 HDi 120	88	01/07→					
2.0 HDi 130	94	03/11→					
2.0 HDi 140	100	01/07→					
2.0 HDi 165	120	09/09→					
PEUGEOT - EXPERT Pritsche/Fahrgestell (223) 12/95→12/06							
 Hauptbremszylinder							
1.6	58	02/96→09/00		→Orga 08206; - ABS; Nutzlast [kg]: 800		24.2122-1703.3 010422	Ø 22,2
1.9 D	51	02/96→12/98		→Orga 08206; + ABS; Nutzlast [kg]: 800		24.2122-1708.3 010437	Ø 22,2
1.9 D	51	06/98→09/01					
1.9 TD	66	02/96→09/00		Orga 08207→; - ABS; Nutzlast [kg]: 800		24.2122-1741.3 010695	Ø 22,2
↓							

PEUGEOT - EXPERT Pritsche/Fahrgestell (223) 12/95→12/06

Hauptbremszylinder

1.6	58	02/96→09/00		Orga 08207→; + ABS; Nutzlast [kg]: 800	24.2122-1742.3	010696	Ø 22,2
1.9 D	51	02/96→12/98		→Orga 08206; - ABS; Nutzlast [kg]: 900	24.2123-1707.3	010492	Ø 23,81
1.9 D	51	06/98→09/01					
1.9 TD	66	02/96→09/00		Orga 08207→; + ABS; Nutzlast [kg]: 900	24.2123-1733.3	010657	BOS Ø 23,81
				Orga 08207→; - ABS; Nutzlast [kg]: 900	24.2123-1738.3	010658	Ø 23,81
1.9 TD	68	02/96→05/98		04/96→; →Orga 08206; - ABS; Nutzlast [kg]: 800	24.2122-1703.3	010422	Ø 22,2
				04/96→; →Orga 08206; + ABS; Nutzlast [kg]: 800	24.2122-1708.3	010437	Ø 22,2
				Orga 08207→; - ABS; Nutzlast [kg]: 800	24.2122-1741.3	010695	Ø 22,2
				Orga 08207→; + ABS; Nutzlast [kg]: 800	24.2122-1742.3	010696	Ø 22,2
				04/96→; →Orga 08206; - ABS; Nutzlast [kg]: 900	24.2123-1707.3	010492	Ø 23,81
				Orga 08207→; + ABS; Nutzlast [kg]: 900	24.2123-1733.3	010657	BOS Ø 23,81
				Orga 08207→; - ABS; Nutzlast [kg]: 900	24.2123-1738.3	010658	Ø 23,81
2.0 HDi	69	10/00→10/06		- ABS; Nutzlast [kg]: 800	24.2122-1741.3	010695	Ø 22,2
2.0 HDi	80	10/00→10/06		+ ABS; Nutzlast [kg]: 800	24.2122-1742.3	010696	Ø 22,2
				+ ABS; Nutzlast [kg]: 900	24.2123-1733.3	010657	BOS Ø 23,81
				- ABS; Nutzlast [kg]: 900	24.2123-1738.3	010658	Ø 23,81

PEUGEOT - EXPERT Tepee (VF3V_) 01/07→

Hauptbremszylinder











1.6 HDi 90 16V	66	01/07→		für Linkslenker; - ESP	03.2125-0298.3	010818	ATE Ø 25,4
1.6 HDi 90 8V	66	01/07→		für Linkslenker; + ESP	03.2125-0671.3	010965	ATE Ø 25,4
2.0 16V	103	01/07→					
2.0 HDi 100	72	03/11→					
2.0 HDi 120	88	01/07→					
2.0 HDi 120 4x4	88	01/07→					
2.0 HDi 130	94	03/11→					
2.0 HDi 130 4x4	94	03/11→					
2.0 HDi 140	100	01/07→					
2.0 HDi 165	120	09/09→					









PEUGEOT - PARTNER Combispace (5F) 05/96→12/15













Hauptbremszylinder



















1.1	44	06/96→10/02		Orga 08610→; - ABS	03.2123-2781.3	010631	ATE Ø 23,81
1.9 D	50	06/96→12/02			24.2123-1714.3	010587	BDX Ø 23,81
				07/96→; →Orga 08609; - ABS	24.2123-1710.3	010504	Ø 23,81
				07/96→; →Orga 08609; + ABS; für Linkslenker	24.2123-1713.3	010505	Ø 23,81
				Orga 08610→; + ABS	24.2123-1715.3	010520	BDX Ø 23,81
1.4	55	06/96→12/15		Orga 08610→; → 03/08; - ABS	03.2123-2781.3	010631	ATE Ø 23,81
					24.2123-1714.3	010587	BDX Ø 23,81
				07/96→; →Orga 08609; - ABS	24.2123-1710.3	010504	Ø 23,81
				07/96→; →Orga 08609; + ABS; für Linkslenker	24.2123-1713.3	010505	Ø 23,81
				Orga 08610→; → 03/08; + ABS	24.2123-1715.3	010520	BDX Ø 23,81
1.6 16V	80	07/01→03/08		- ESP / - ABS	03.2123-2781.3	010631	ATE Ø 23,81
					24.2123-1714.3	010587	BDX Ø 23,81
2.0 HDi 4x4	66	04/04→08/05		- ESP / + ABS	24.2123-1715.3	010520	BDX Ø 23,81
1.6 Flexfuel	80	09/00→10/02		07/01→; - ESP / - ABS	03.2123-2781.3	010631	ATE Ø 23,81
					24.2123-1714.3	010587	BDX Ø 23,81
				07/01→; - ESP / + ABS	24.2123-1715.3	010520	BDX Ø 23,81
1.6 HDi 75	55	02/06→12/13		→ 03/08; - ABS	03.2123-2781.3	010631	ATE Ø 23,81
					24.2123-1714.3	010587	BDX Ø 23,81
				→ 03/08; + ABS	24.2123-1715.3	010520	BDX Ø 23,81
1.6 HDi 90	66	10/05→12/15		02/06→ 03/08; - ABS	03.2123-2781.3	010631	ATE Ø 23,81
					24.2123-1714.3	010587	BDX Ø 23,81
				02/06→ 03/08; + ABS	24.2123-1715.3	010520	BDX Ø 23,81
1.8	66	05/97→12/03		Orga 08610→; - ABS	03.2123-2781.3	010631	ATE Ø 23,81
					24.2123-1714.3	010587	BDX Ø 23,81
				→Orga 08609; - ABS	24.2123-1710.3	010504	Ø 23,81
				→Orga 08609; + ABS; für Linkslenker	24.2123-1713.3	010505	Ø 23,81
				Orga 08610→; + ABS	24.2123-1715.3	010520	BDX Ø 23,81
1.9 D	51	05/96→12/98		Orga 08610→; - ABS	03.2123-2781.3	010631	ATE Ø 23,81
					24.2123-1714.3	010587	BDX Ø 23,81



























	kw					! #		
PEUGEOT - PARTNER Combispace (5F) 05/96→12/15								
 Hauptbremszylinder								
1.9 D	51	05/96→12/98		12/98→; →Orga 08609; - ABS	24.2123-1710.3	010504	Ø 23,81	
				12/98→; →Orga 08609; + ABS; für Linkslenker	24.2123-1713.3	010505	Ø 23,81	
				Orga 08610→; + ABS	24.2123-1715.3	010520	BDX Ø 23,81	
1.9 D	51	12/98→07/08		Orga 08610→; → 03/08; - ABS	03.2123-2781.3	010631	ATE Ø 23,81	
				→Orga 08609; - ABS	24.2123-1714.3	010587	BDX Ø 23,81	
				→Orga 08609; + ABS; für Linkslenker	24.2123-1710.3	010504	Ø 23,81	
				Orga 08610→; → 03/08; + ABS	24.2123-1713.3	010505	Ø 23,81	
2.0 HDI	66	02/00→07/08		→ 03/08; - ESP / - ABS	24.2123-1715.3	010520	BDX Ø 23,81	
				→ 03/08; - ESP / + ABS	03.2123-2781.3	010631	ATE Ø 23,81	
Electric	28	01/98→12/01		→ 03/08; - ESP / + ABS	24.2123-1714.3	010587	BDX Ø 23,81	
				Orga 08610→; - ABS	24.2123-1710.3	010504	Ø 23,81	
				→Orga 08609; - ABS	24.2123-1713.3	010505	Ø 23,81	
				Orga 08610→; + ABS	24.2123-1715.3	010520	BDX Ø 23,81	
 Bremskraftregler								
1.1	44	06/96→10/02		07/96→; für Fahrzeuge ohne verstärktes Fahrwerk	03.6582-0010.3	320145	ATE lastabhängig 8/1,5 4x	
1.9 D	50	06/96→12/02		07/96→; für Fahrzeuge mit verstärktem Fahrwerk	03.6582-0011.3	320232	ATE lastabhängig 8/1,5 4x	
1.4	55	06/96→12/15		07/96→ 03/08; für Fahrzeuge ohne verstärktes Fahrwerk	03.6582-0010.3	320145	ATE lastabhängig 8/1,5 4x	
				07/96→ 03/08; für Fahrzeuge mit verstärktem Fahrwerk	03.6582-0011.3	320232	ATE lastabhängig 8/1,5 4x	
1.6 16V	80	07/01→03/08		für Fahrzeuge ohne verstärktes Fahrwerk	03.6582-0010.3	320145	ATE lastabhängig 8/1,5 4x	
1.8	66	05/97→12/03		für Fahrzeuge mit verstärktem Fahrwerk	03.6582-0011.3	320232	ATE lastabhängig 8/1,5 4x	
2.0 HDi 4x4	66	04/04→08/05						
1.6 Flexfuel	80	09/00→10/02		07/01→; für Fahrzeuge ohne verstärktes Fahrwerk	03.6582-0010.3	320145	ATE lastabhängig 8/1,5 4x	
				07/01→; für Fahrzeuge mit verstärktem Fahrwerk	03.6582-0011.3	320232	ATE lastabhängig 8/1,5 4x	
1.6 HDi 75	55	02/06→12/13		→ 03/08; für Fahrzeuge ohne verstärktes Fahrwerk	03.6582-0010.3	320145	ATE lastabhängig 8/1,5 4x	
1.9 D	51	12/98→07/08		→ 03/08; für Fahrzeuge mit verstärktem Fahrwerk	03.6582-0011.3	320232	ATE lastabhängig 8/1,5 4x	
2.0 HDI	66	02/00→07/08						
1.6 HDi 90	66	10/05→12/15		02/06→ 03/08; für Fahrzeuge ohne verstärktes Fahrwerk	03.6582-0010.3	320145	ATE lastabhängig 8/1,5 4x	
				02/06→ 03/08; für Fahrzeuge mit verstärktem Fahrwerk	03.6582-0011.3	320232	ATE lastabhängig 8/1,5 4x	
1.9 D	51	05/96→12/98		12/98→; für Fahrzeuge ohne verstärktes Fahrwerk	03.6582-0010.3	320145	ATE lastabhängig 8/1,5 4x	
				12/98→; für Fahrzeuge mit verstärktem Fahrwerk	03.6582-0011.3	320232	ATE lastabhängig 8/1,5 4x	
Electric	28	01/98→12/01			03.6582-0015.3	320227	ATE lastabhängig 8/1,5 4x	
PEUGEOT - PARTNER Kasten 04/08→								
 Hauptbremszylinder								
1.6	66	04/08→		+ ESP	24.4123-1714.3	010979	TRW Ø 23,81	
1.6	72	11/10→						
1.6	80	04/08→						
1.6	88	04/10→						
1.6 BlueHDi 100	73	04/15→						
1.6 BlueHDi 120	88	04/15→						
1.6 Flex	81	09/08→						
1.6 HDi	55	04/08→						
1.6 HDi	66	03/13→						
1.6 HDi	67	09/09→12/12						
1.6 HDi	80	04/08→						
1.6 HDi	82	08/10→						
1.6 HDi	84	03/13→						
1.6 HDi 16V	66	04/08→						
1.6 HDi 16V 4x4	66	04/12→						
1.6 HDi 90	68	04/10→						
Électrique	49	06/13→						
1.6 HDi / BlueHDi 75	55	01/14→		01/15→; + ESP	24.4123-1714.3	010979	TRW Ø 23,81	













	kw			 	! #		
PEUGEOT - PARTNER Kasten (5) 04/96→12/15							
 Hauptbremszylinder							
1.1 1.8 D 1.9 D	44 43 51	06/96→09/05 06/96→12/02 06/96→12/02		Orga 08610→; - ABS		03.2123-2781.3 010631 24.2123-1714.3 010587	ATE Ø 23,81 BDX Ø 23,81
				07/96→; →Orga 08609; - ABS		24.2123-1710.3 010504	Ø 23,81
				07/96→; →Orga 08609; + ABS; für Linkslenker		24.2123-1713.3 010505	Ø 23,81
				Orga 08610→; + ABS		24.2123-1715.3 010520	BDX Ø 23,81
1.4 1.4 BiFuel 1.8 1.9 D 1.9 D 4x4	54 55 66 50 51	11/02→10/06 04/03→10/06 03/97→08/00 05/96→12/98 04/04→11/07		Orga 08610→; - ABS		03.2123-2781.3 010631 24.2123-1714.3 010587	ATE Ø 23,81 BDX Ø 23,81
				→Orga 08609; - ABS		24.2123-1710.3 010504	Ø 23,81
				→Orga 08609; + ABS; für Linkslenker		24.2123-1713.3 010505	Ø 23,81
				Orga 08610→; + ABS		24.2123-1715.3 010520	BDX Ø 23,81
1.4 1.9 D	55 51	06/96→12/15 06/96→12/15		Orga 08610→; → 03/08; - ABS		03.2123-2781.3 010631 24.2123-1714.3 010587	ATE Ø 23,81 BDX Ø 23,81
				07/96→; →Orga 08609; - ABS		24.2123-1710.3 010504	Ø 23,81
				07/96→; →Orga 08609; + ABS; für Linkslenker		24.2123-1713.3 010505	Ø 23,81
				Orga 08610→; → 03/08; + ABS		24.2123-1715.3 010520	BDX Ø 23,81
1.6 HDi 75 1.6 HDi 90 2.0 HDi	55 66 66	02/06→07/08 02/06→12/15 04/00→07/08		→ 03/08; - ABS		03.2123-2781.3 010631 24.2123-1714.3 010587	ATE Ø 23,81 BDX Ø 23,81
				→ 03/08; + ABS		24.2123-1715.3 010520	BDX Ø 23,81
1.8 D	44	11/96→02/98		Orga 08610→; → 11/96; - ABS		03.2123-2781.3 010631 24.2123-1714.3 010587	ATE Ø 23,81 BDX Ø 23,81
				→Orga 08609; - ABS		24.2123-1710.3 010504	Ø 23,81
				→Orga 08609; + ABS; für Linkslenker		24.2123-1713.3 010505	Ø 23,81
				Orga 08610→; → 11/96; + ABS		24.2123-1715.3 010520	BDX Ø 23,81
2.0 HDi 4x4	66	04/04→08/05		- ABS		03.2123-2781.3 010631 24.2123-1714.3 010587	ATE Ø 23,81 BDX Ø 23,81
				+ ABS		24.2123-1715.3 010520	BDX Ø 23,81
Electric	25	04/96→12/02		01/98→; - ABS		03.2123-2781.3 010631 24.2123-1714.3 010587	ATE Ø 23,81 BDX Ø 23,81
				01/98→; + ABS		24.2123-1715.3 010520	BDX Ø 23,81
 Bremskraftregler							
1.1	44	06/96→09/05		07/96→; Nutzlast ab [kg] 500 Nutzlast bis [kg] 600; für Fahrzeuge ohne verstärktes Fahrwerk		03.6582-0009.3 320143	ATE lastabhängig 8/1,5 4x
				07/96→; Nutzlast ab [kg] 500 Nutzlast bis [kg] 600; für Fahrzeuge mit verstärktem Fahrwerk		03.6582-0012.3 320233	ATE lastabhängig 8/1,5 4x
1.4 1.4 BiFuel	54 55	11/02→10/06 04/03→10/06		Nutzlast ab [kg] 500 Nutzlast bis [kg] 600; für Fahrzeuge ohne verstärktes Fahrwerk		03.6582-0009.3 320143	ATE lastabhängig 8/1,5 4x
				Nutzlast ab [kg] 500 Nutzlast bis [kg] 600; für Fahrzeuge mit verstärktem Fahrwerk		03.6582-0012.3 320233	ATE lastabhängig 8/1,5 4x
1.4	55	06/96→12/15		07/96→ 03/08; Nutzlast ab [kg] 500 Nutzlast bis [kg] 600; für Fahrzeuge ohne verstärktes Fahrwerk		03.6582-0009.3 320143	ATE lastabhängig 8/1,5 4x
				07/96→ 03/08; Nutzlast ab [kg] 500 Nutzlast bis [kg] 600; für Fahrzeuge mit verstärktem Fahrwerk		03.6582-0012.3 320233	ATE lastabhängig 8/1,5 4x
1.6 HDi 75 1.6 HDi 90 2.0 HDi	55 66 66	02/06→07/08 02/06→12/15 04/00→07/08		→ 03/08; Nutzlast [kg]: 600; für Fahrzeuge ohne verstärktes Fahrwerk		03.6582-0009.3 320143	ATE lastabhängig 8/1,5 4x
				→ 03/08; Nutzlast [kg]: 600; für Fahrzeuge mit verstärktem Fahrwerk		03.6582-0012.3 320233	ATE lastabhängig 8/1,5 4x
				→ 03/08; Nutzlast [kg]: 800; für Fahrzeuge ohne verstärktes Fahrwerk		03.6582-0015.3 320227	ATE lastabhängig 8/1,5 4x
1.8	66	03/97→08/00		Nutzlast ab [kg] 500 Nutzlast bis [kg] 600; für Fahrzeuge ohne verstärktes Fahrwerk		03.6582-0009.3 320143	ATE lastabhängig 8/1,5 4x
				Nutzlast ab [kg] 500 Nutzlast bis [kg] 600; für Fahrzeuge mit verstärktem Fahrwerk		03.6582-0012.3 320233	ATE lastabhängig 8/1,5 4x
				Nutzlast [kg]: 800; für Fahrzeuge ohne verstärktes Fahrwerk		03.6582-0015.3 320227	ATE lastabhängig 8/1,5 4x
1.8 D 1.9 D	43 51	06/96→12/02 06/96→12/02		07/96→; Nutzlast [kg]: 600; für Fahrzeuge ohne verstärktes Fahrwerk		03.6582-0009.3 320143	ATE lastabhängig 8/1,5 4x
				07/96→; Nutzlast [kg]: 600; für Fahrzeuge mit verstärktem Fahrwerk		03.6582-0012.3 320233	ATE lastabhängig 8/1,5 4x
↓							











	kw			 	! #		
PEUGEOT - PARTNER Kasten (5) 04/96→12/15							
 Bremskraftregler							
1.8 D 1.9 D	43 51	06/96→12/02 06/96→12/02		07/96→; Nutzlast [kg]: 800; für Fahrzeuge ohne verstärktes Fahrwerk		03.6582-0015.3 320227	ATE lastabhängig 8/1,5 4x
1.8 D 1.9 D 1.9 D 4x4 2.0 HDi 4x4	44 50 51 66	11/96→02/98 05/96→12/98 04/04→11/07 04/04→08/05		Nutzlast [kg]: 600; für Fahrzeuge ohne verstärktes Fahrwerk		03.6582-0009.3 320143	ATE lastabhängig 8/1,5 4x
				Nutzlast [kg]: 600; für Fahrzeuge mit verstärktem Fahrwerk		03.6582-0012.3 320233	ATE lastabhängig 8/1,5 4x
				Nutzlast [kg]: 800; für Fahrzeuge ohne verstärktes Fahrwerk		03.6582-0015.3 320227	ATE lastabhängig 8/1,5 4x
1.9 D	51	06/96→12/15		07/96→ 03/08; Nutzlast [kg]: 600; für Fahrzeuge ohne verstärktes Fahrwerk		03.6582-0009.3 320143	ATE lastabhängig 8/1,5 4x
				07/96→ 03/08; Nutzlast [kg]: 600; für Fahrzeuge mit verstärktem Fahrwerk		03.6582-0012.3 320233	ATE lastabhängig 8/1,5 4x
				07/96→ 03/08; Nutzlast [kg]: 800; für Fahrzeuge ohne verstärktes Fahrwerk		03.6582-0015.3 320227	ATE lastabhängig 8/1,5 4x
Electric	25	04/96→12/02		01/98→; Nutzlast ab [kg] 500 Nutzlast bis [kg] 600; für Fahrzeuge ohne verstärktes Fahrwerk		03.6582-0009.3 320143	ATE lastabhängig 8/1,5 4x
				01/98→; Nutzlast ab [kg] 500 Nutzlast bis [kg] 600; für Fahrzeuge mit verstärktem Fahrwerk		03.6582-0012.3 320233	ATE lastabhängig 8/1,5 4x
				01/98→; Nutzlast [kg]: 800; für Fahrzeuge ohne verstärktes Fahrwerk		03.6582-0015.3 320227	ATE lastabhängig 8/1,5 4x
PEUGEOT - PARTNER Pritsche/Fahrgestell 01/99→07/08							
 Hauptbremszylinder							
1.9 D	51	01/99→07/08		Orga 08610→; → 03/08; - ABS		03.2123-2781.3 010631	ATE Ø 23,81
				→Orga 08609; - ABS		24.2123-1714.3 010587	BDX Ø 23,81
				→Orga 08609; + ABS; für Linkslenker		24.2123-1710.3 010504	Ø 23,81
				Orga 08610→; → 03/08; + ABS		24.2123-1715.3 010520	BDX Ø 23,81
2.0 HDi	66	11/02→07/08		→ 03/08; - ABS		03.2123-2781.3 010631	ATE Ø 23,81
				→ 03/08; + ABS		24.2123-1714.3 010587	BDX Ø 23,81
				→ 03/08; + ABS		24.2123-1715.3 010520	BDX Ø 23,81
 Bremskraftregler							
1.9 D 2.0 HDi	51 66	01/99→07/08 11/02→07/08		→ 03/08; Nutzlast [kg]: 600; für Fahrzeuge ohne verstärktes Fahrwerk		03.6582-0009.3 320143	ATE lastabhängig 8/1,5 4x
				→ 03/08; Nutzlast [kg]: 600; für Fahrzeuge mit verstärktem Fahrwerk		03.6582-0012.3 320233	ATE lastabhängig 8/1,5 4x
				→ 03/08; Nutzlast [kg]: 800; für Fahrzeuge ohne verstärktes Fahrwerk		03.6582-0015.3 320227	ATE lastabhängig 8/1,5 4x
PEUGEOT - PARTNER Pritsche/Fahrgestell 01/09→							
 Hauptbremszylinder							
1.6 HDi 1.6 HDi 1.6 HDi 16V	55 66 66	01/09→ 03/13→ 01/09→		+ ESP		24.4123-1714.3 010979	TRW Ø 23,81
PEUGEOT - PARTNER Tepee 04/08→							
 Hauptbremszylinder							
1.2 THP 1.6 1.6 1.6 1.6 1.6 BlueHDi 100 1.6 BlueHDi 100 4x4 1.6 BlueHDi 120 1.6 BlueHDi 75 1.6 Flex 1.6 HDi 1.6 HDi 1.6 HDi 1.6 HDi 1.6 HDi 1.6 HDi 16V 1.6 HDi 90 1.6	81 66 72 80 88 73 73 88 55 81 55 66 80 82 84 66 68 81	02/16→ 04/08→ 08/10→ 04/08→ 04/10→ 12/14→ 04/15→ 12/14→ 01/15→ 09/08→ 04/08→ 03/13→ 04/08→ 08/10→ 03/13→ 04/08→ 04/10→ 09/08→		+ ESP		24.4123-1714.3 010979	TRW Ø 23,81
				04/10→; + ESP		24.4123-1714.3 010979	TRW Ø 23,81
PORSCHE - 911 (996) 09/97→08/05							
 Hauptbremszylinder							
3.4 Carrera ↓	221	09/97→09/01				24.2123-1717.3 010521	Ø 23,81











	kw			 	! #		
PORSCHE - 911 (996) 09/97→08/05							
 Hauptbremszylinder							
3.6 Carrera	235	10/01→08/05				24.2123-1717.3 010521	Ø 23,81
3.6 Carrera S	254	02/03→08/05					
3.6 S	331	08/04→08/05					
3.4 Carrera	235	05/01→08/05		→ 09/01		24.2123-1717.3 010521	Ø 23,81
3.4 Carrera 4	221	09/97→09/01				24.2123-1730.3 010620	Ø 23,81
3.6 Carrera 4	235	10/01→08/05					
3.6 Carrera 4S	254	02/03→08/05					
3.4 Carrera 4	235	05/01→08/05		→ 09/01		24.2123-1730.3 010620	Ø 23,81
PORSCHE - 911 (997) 07/04→12/12							
 Hauptbremszylinder							
3.6 Carrera	235	08/04→07/05				24.2123-1766.3 010825	TRW Ø 23,81
3.6 Carrera	239	07/04→12/08					
3.6 Carrera	242	07/04→12/08					
PORSCHE - 911 Cabriolet (996) 02/98→08/05							
 Hauptbremszylinder							
3.4 Carrera	221	02/98→09/01				24.2123-1717.3 010521	Ø 23,81
3.6 Carrera	235	10/01→08/05					
3.6 Carrera S	254	06/02→08/05					
3.4 Carrera	235	05/01→08/05		→ 09/01		24.2123-1717.3 010521	Ø 23,81
3.4 Carrera 4	221	02/98→09/01				24.2123-1730.3 010620	Ø 23,81
3.6 Carrera 4	235	10/01→08/05					
3.6 Carrera 4S	254	06/02→08/05					
3.4 Carrera 4	235	05/01→08/05		→ 09/01		24.2123-1730.3 010620	Ø 23,81
PORSCHE - 911 Cabriolet (997) 04/05→12/12							
 Hauptbremszylinder							
3.6 Carrera	235	04/05→07/05				24.2123-1766.3 010825	TRW Ø 23,81
3.6 Carrera	239	04/05→12/08					
3.6 Carrera	242	04/05→12/08					
3.6 Carrera	254	06/08→12/11					
3.6 Carrera 4	239	04/05→12/08					
3.6 Carrera 4	242	04/05→12/08					
3.6 Carrera 4	254	06/08→12/12					
PORSCHE - 911 Targa (996) 12/01→08/05							
 Hauptbremszylinder							
3.6	235	12/01→08/05				24.2123-1717.3 010521	Ø 23,81
PORSCHE - 928 09/77→11/95							
 Bremskraftverstärker							
5.4 GTS	257	08/91→11/95				03.7760-0402.4 300087	ATE Ø 10" pneumatisch
 Hauptbremszylinder							
5.4 GTS	257	08/91→11/95		für Linkslenker		03.2023-0262.3 010020	Ø1 23,81 Ø2 20,64
PORSCHE - 968 06/91→11/95							
 Bremskraftverstärker							
3.0	176	06/91→11/95				03.7750-5702.4 300083	ATE Ø 9" pneumatisch
3.0 Turbo S	224	03/93→11/95					
 Hauptbremszylinder							
3.0	176	06/91→11/95				03.2023-0542.3 010024	Ø1 23,81 Ø2 20,64
3.0 Turbo S	224	03/93→11/95					
Verschlussschraube, Hauptbremszylinder							
3.0	176	06/91→11/95				03.3517-0101.2 390322	
3.0 Turbo S	224	03/93→11/95					
PORSCHE - 968 Cabriolet 06/91→11/95							
 Bremskraftverstärker							
3.0	176	06/91→11/95				03.7750-5702.4 300083	ATE Ø 9" pneumatisch
 Hauptbremszylinder							
3.0	176	06/91→11/95				03.2023-0542.3 010024	Ø1 23,81 Ø2 20,64
Verschlussschraube, Hauptbremszylinder							
3.0	176	06/91→11/95				03.3517-0101.2 390322	

	kw			 	! #		
PORSCHE - BOXSTER (986) 09/96→12/04							
 Hauptbremszylinder							
2.5	150	09/96→08/99		→ 07/99		24.2123-1717.3 010521	Ø 23,81
2.7	155	06/99→12/02		08/99→ 12/00		24.2123-1717.3 010521	Ø 23,81
				12/01→ 06/02		24.2123-1730.3 010620	Ø 23,81
2.7 S 3.2	162	08/99→07/02		→ 12/00		24.2123-1717.3 010521	Ø 23,81
	185	08/99→07/02		12/01→ 06/02		24.2123-1730.3 010620	Ø 23,81
2.7 S 3.2 S 3.2	168	07/02→12/04				24.2123-1730.3 010620	Ø 23,81
	191	07/02→12/04					
	196	01/04→12/04					
PORSCHE - BOXSTER (987) 11/04→12/11							
 Hauptbremszylinder							
2.7 S 3.2	176	11/04→12/06		→ 07/06;		24.2123-1766.3 010825	TRW Ø 23,81
	206	11/04→12/06		für Fahrzeuge ohne Keramikbremse			
2.7 S 3.4	180	07/06→12/09		für Fahrzeuge ohne Keramikbremse		24.2123-1766.3 010825	TRW Ø 23,81
	217	07/06→12/09					
2.9 S 3.4	188	06/09→12/11		→ 09/11;		24.2123-1766.3 010825	TRW Ø 23,81
	228	06/09→12/11		für Fahrzeuge ohne Keramikbremse			
S 3.4	223	08/08→12/09		06/09→;		24.2123-1766.3 010825	TRW Ø 23,81
				für Fahrzeuge ohne Keramikbremse			
PORSCHE - BOXSTER Spyder (987) 09/07→12/11							
 Hauptbremszylinder							
3.4 RS 60	223	09/07→12/08		08/08→;		24.2123-1766.3 010825	TRW Ø 23,81
				für Fahrzeuge ohne Keramikbremse			
PORSCHE - CAYENNE (9PA) 09/02→09/10							
 Bremskraftverstärker							
3.0 TDI	176	02/09→09/10		→ 04/10; für Linkslenker		03.7868-4102.4 300250	ATE Ø 10 / 8" pneumatisch
3.6	213	02/07→09/10					
S 4.8	283	02/07→09/10					
Turbo S 4.8	368	02/07→09/10		→ 04/10; für Linkslenker		03.7868-5302.4 300251	ATE Ø 10 / 8" pneumatisch
Pedalwegsensor, Bremspedal							
3.2	177	08/03→09/07		10/03→; für Linkslenker; → 12/06		03.0655-0006.2 370006	ATE
				10/03→; für Rechtslenker; → 12/06		03.0655-0006.2 370006	ATE
3.2 S 4.5 Turbo 4.5	184	10/03→09/07		für Rechtslenker; → 12/06		03.0655-0006.2 370006	ATE
	250	09/02→09/07					
	331	09/02→09/07		für Linkslenker; → 12/06		03.0655-0006.2 370006	ATE
 Hauptbremszylinder							
3.0 TDI	176	02/09→09/10		für Linkslenker; → 04/10		03.2126-3014.3 010811	ATE Ø 26,99
3.6	213	02/07→09/10					
GTS 4.8	298	10/07→09/10					
S 4.8	283	02/07→09/10					
Turbo S 4.8	368	02/07→09/10					
Turbo S 4.8	397	02/07→09/10					
Turbo S 4.8	404	08/08→09/10					
3.2	177	08/03→09/07		10/03→ 12/06; für Linkslenker		03.2126-3014.3 010811	ATE Ø 26,99
3.2 S 4.5 Turbo 4.5	184	10/03→09/07		→ 12/06; für Linkslenker		03.2126-3014.3 010811	ATE Ø 26,99
	250	09/02→09/07					
	331	09/02→09/07					
Turbo S 4.5	368	01/04→09/07		für Linkslenker		03.2126-3014.3 010811	ATE Ø 26,99
Turbo S 4.5	383	03/06→09/07					
PORSCHE - CAYMAN (987) 11/05→12/13							
 Hauptbremszylinder							
2.7 S 3.4	180	07/06→12/09		für Fahrzeuge ohne Keramikbremse		24.2123-1766.3 010825	TRW Ø 23,81
	217	11/05→12/09					
2.9 R 3.4 S 3.4 Sport S 3.4	195	02/09→12/12		→ 05/12;		24.2123-1766.3 010825	TRW Ø 23,81
	243	11/10→12/12		für Fahrzeuge ohne Keramikbremse			
	223	08/08→12/12					
	235	02/09→06/13					
RENAULT - 19 II (B/C53_) 01/91→06/01							
 Hauptbremszylinder							
1.2	40	04/92→12/95				03.2120-2031.3 010106	ATE Ø 20,64
1.4 (B/C532)	43	04/92→12/95					
1.4	59	01/92→12/95		→ 01/92; - ABS		03.2119-3389.3 010057	ATE Ø 19,05
				02/92→; für Fahrschulwagen		03.2119-3389.3 010057	ATE Ø 19,05
				→ 01/92		03.2119-3389.3 010057	ATE Ø 19,05
↓							













	kw			 	! #		
RENAULT - 19 II (B/C53_) 01/91→06/01							
 Hauptbremszylinder							
1.4	59	01/92→12/95			03.2119-3389.3	010057	ATE Ø 19,05
				02/92→; - ABS; für Fahrschulwagen	03.2119-3389.3	010057	ATE Ø 19,05
				02/92→	03.2120-2031.3	010106	ATE Ø 20,64
				05/92→	03.2120-2031.3	010106	ATE Ø 20,64
				02/92→; - ABS; nicht für Fahrschulwagen	03.2120-2031.3	010106	ATE Ø 20,64
				02/92→; nicht für Fahrschulwagen	03.2120-2031.3	010106	ATE Ø 20,64
				02/92→; - ABS	03.2120-2031.3	010106	ATE Ø 20,64
1.4 (B/C535)	55	01/92→12/95	09/94→; - ABS		03.2120-2031.3	010106	ATE Ø 20,64
			09/94→; Schaltgetriebe; + ABS		24.2120-1725.3	010579	BDX Ø 20,64
1.7 (B/C53B)	54	04/92→12/95		- ABS	03.2119-3389.3	010057	ATE Ø 19,05
				- ABS; für Fahrschulwagen	03.2119-3389.3	010057	ATE Ø 19,05
					03.2119-3389.3	010057	ATE Ø 19,05
				- ABS; nicht für Fahrschulwagen	03.2120-2031.3	010106	ATE Ø 20,64
				Schaltgetriebe; + ABS	24.2120-1725.3	010579	BDX Ø 20,64
1.7 (B/C53C)	66	04/92→12/95		- ABS; für Fahrschulwagen	03.2119-3389.3	010057	ATE Ø 19,05
				Schaltgetriebe; + ABS	24.2120-1725.3	010579	BDX Ø 20,64
1.8 (5/353A)	66	04/92→12/95		09/94→	03.2120-2031.3	010106	ATE Ø 20,64
				09/94→; - ABS	03.2120-2031.3	010106	ATE Ø 20,64
				09/94→; Schaltgetriebe; + ABS	24.2120-1725.3	010579	BDX Ø 20,64
1.8 (B/C53Y)	65	04/92→12/95		05/92→; - ABS	03.2120-2031.3	010106	ATE Ø 20,64
				05/92→; Schaltgetriebe; + ABS	24.2120-1725.3	010579	BDX Ø 20,64
1.8 16V (B/C53D)	99	04/92→12/95		- ABS	03.2120-2031.3	010106	ATE Ø 20,64
				+ ABS	24.2120-1725.3	010579	BDX Ø 20,64
				Schaltgetriebe; + ABS	24.2120-1725.3	010579	BDX Ø 20,64
1.9 D (B/C53J)	47	04/92→12/95		- ABS	03.2120-2031.3	010106	ATE Ø 20,64
				- ABS; nicht für Fahrschulwagen	03.2120-2031.3	010106	ATE Ø 20,64
				05/92→; - ABS	03.2120-2031.3	010106	ATE Ø 20,64
					03.2120-2031.3	010106	ATE Ø 20,64
				05/92→	03.2120-2031.3	010106	ATE Ø 20,64
			Schaltgetriebe; + ABS	24.2120-1725.3	010579	BDX Ø 20,64	
1.9 dT (B/C53T)	66	04/92→12/95		- ABS	03.2120-2031.3	010106	ATE Ø 20,64
				05/92→	03.2120-2031.3	010106	ATE Ø 20,64
					03.2120-2031.3	010106	ATE Ø 20,64
			10/95→; Schaltgetriebe; + ABS	24.2120-1725.3	010579	BDX Ø 20,64	
RENAULT - 19 II Cabriolet (D53_, 853_) 04/92→06/01							
 Hauptbremszylinder							
1.8 1.8 16V (D53D)	86	01/95→06/01		→ 03/95; - ABS	03.2120-2031.3	010106	ATE Ø 20,64
	99	04/92→06/96		→ 03/95; + ABS	24.2120-1725.3	010579	BDX Ø 20,64
1.8 (853A)	66	09/93→06/96		→ 12/94	03.2120-2031.3	010106	ATE Ø 20,64
				Schaltgetriebe; + ABS	24.2120-1725.3	010579	BDX Ø 20,64
1.8 (D53V, 853F, D53C)	79	07/94→06/96		- ABS	03.2120-2031.3	010106	ATE Ø 20,64
1.8 (D53Y)	65	04/92→06/96		→ 12/94	03.2120-2031.3	010106	ATE Ø 20,64
RENAULT - 19 II Chamade (L53_) 04/92→08/03							
 Hauptbremszylinder							
1.4 (532)	43	04/92→12/95		für Fahrschulwagen; - ABS	03.2119-3389.3	010057	ATE Ø 19,05
				für Linkslenker	03.2120-2031.3	010106	ATE Ø 20,64
				- ABS; nicht für Fahrschulwagen	03.2120-2031.3	010106	ATE Ø 20,64
				05/92→	03.2120-2031.3	010106	ATE Ø 20,64
				nicht für Fahrschulwagen	03.2120-2031.3	010106	ATE Ø 20,64
1.4 (L535)	55	11/93→12/95		für Fahrschulwagen; - ABS	03.2119-3389.3	010057	ATE Ø 19,05
				- ABS; nicht für Fahrschulwagen	03.2120-2031.3	010106	ATE Ø 20,64
				nicht für Fahrschulwagen	03.2120-2031.3	010106	ATE Ø 20,64
					03.2120-2031.3	010106	ATE Ø 20,64
				09/94→; - ABS	03.2120-2031.3	010106	ATE Ø 20,64
			09/94→; Schaltgetriebe; + ABS	24.2120-1725.3	010579	BDX Ø 20,64	
1.7	55	05/92→11/95		Schaltgetriebe; + ABS	24.2120-1725.3	010579	BDX Ø 20,64
↓							











	kw			 	! #		
RENAULT - 19 II Chamade (L53_) 04/92→08/03							
 Hauptbremszylinder							
1.7 (L533)	68	01/93→08/95		für Fahrschulwagen; - ABS		03.2119-3389.3 010057	ATE Ø 19,05
				Schaltgetriebe; + ABS		24.2120-1725.3 010579	BDX Ø 20,64
1.7 (L53B)	54	04/92→12/95		für Fahrschulwagen; - ABS		03.2119-3389.3 010057	ATE Ø 19,05
						03.2119-3389.3 010057	ATE Ø 19,05
				- ABS; nicht für Fahrschulwagen		03.2120-2031.3 010106	ATE Ø 20,64
				Schaltgetriebe; + ABS		24.2120-1725.3 010579	BDX Ø 20,64
1.7 (L53C)	66	04/92→12/95		für Fahrschulwagen; - ABS		03.2119-3389.3 010057	ATE Ø 19,05
				- ABS; nicht für Fahrschulwagen		03.2120-2031.3 010106	ATE Ø 20,64
				Schaltgetriebe; + ABS		24.2120-1725.3 010579	BDX Ø 20,64
1.8	79	05/92→11/95		- ABS		03.2120-2031.3 010106	ATE Ø 20,64
1.8 (L53V, L538)	79	05/94→12/95		Schaltgetriebe; + ABS		24.2120-1725.3 010579	BDX Ø 20,64
1.8 16V (L53D)	99	04/92→12/95					
1.8 (453A/F)	66	04/92→12/95		09/94→		03.2120-2031.3 010106	ATE Ø 20,64
				09/94→; - ABS		03.2120-2031.3 010106	ATE Ø 20,64
				09/94→; Schaltgetriebe; + ABS		24.2120-1725.3 010579	BDX Ø 20,64
1.8 (L53Y)	65	04/92→12/95		05/92→; - ABS		03.2120-2031.3 010106	ATE Ø 20,64
				05/92→; Schaltgetriebe; + ABS		24.2120-1725.3 010579	BDX Ø 20,64
1.9 D (L53J)	47	04/92→12/95		für Fahrschulwagen; - ABS		03.2119-3389.3 010057	ATE Ø 19,05
				05/92→; - ABS		03.2120-2031.3 010106	ATE Ø 20,64
				- ABS; nicht für Fahrschulwagen		03.2120-2031.3 010106	ATE Ø 20,64
				Schaltgetriebe; + ABS		24.2120-1725.3 010579	BDX Ø 20,64
1.9 dT (L53T)	66	04/92→12/95		für Fahrschulwagen; - ABS		03.2119-3389.3 010057	ATE Ø 19,05
				- ABS; nicht für Fahrschulwagen		03.2120-2031.3 010106	ATE Ø 20,64
				10/95→; Schaltgetriebe; + ABS		24.2120-1725.3 010579	BDX Ø 20,64
RENAULT - 19 II Kasten (S53_) 03/92→12/95							
 Hauptbremszylinder							
1.2	40	03/92→12/95				03.2120-2031.3 010106	ATE Ø 20,64
1.9 dT	68	03/92→12/95		- ABS; für Fahrschulwagen		03.2119-3389.3 010057	ATE Ø 19,05
				- ABS; nicht für Fahrschulwagen		03.2120-2031.3 010106	ATE Ø 20,64
						03.2120-2031.3 010106	ATE Ø 20,64
				10/95→; Schaltgetriebe; + ABS		24.2120-1725.3 010579	BDX Ø 20,64
RENAULT - 21 Kasten (S48_) 06/86→04/95							
 Hauptbremszylinder							
1.7	65	06/86→04/95		07/86→		03.2119-3389.3 010057	ATE Ø 19,05
RENAULT - 21 Kombi (K48_) 03/86→07/97							
 Hauptbremszylinder							
2.1 D (K480)	51	02/92→09/95		04/92→; - ABS		03.2122-9631.3 010160	ATE Ø 22,2
RENAULT - AVANTIME (DE0_) 09/01→05/03							
 Hauptbremszylinder							
2.0 16V Turbo (DE0U, DE0V)	120	11/01→05/03				03.2123-1486.3 010488	Ø 23,81
2.2 dCi (DE01)	110	05/02→05/03		- ASR		03.2123-1486.3 010488	Ø 23,81
3.0 V6 (DE04, DE0T)	152	09/01→05/03		+ ASR		03.2123-2621.3 010701	ATE Ø 23,81
RENAULT - CLIO I (B/C57_, 5/357_) 05/90→09/98							
 Hauptbremszylinder							
1.1	34	01/91→09/98				03.2120-2031.3 010106	ATE Ø 20,64
Electric	21	05/96→02/98					
Williams (B/C57M)	108	01/94→09/98					
1.2 (5/357Y, 5/357K)	40	01/96→09/98		- ABS; für Fahrschulwagen		03.2119-3389.3 010057	ATE Ø 19,05
1.2 (5/357Y, 5/357K)	43	01/96→09/98		- ABS; nicht für Fahrschulwagen		03.2120-2031.3 010106	ATE Ø 20,64
1.2 (B/C/S572)	44	05/90→03/96		+ ABS; für Linkslenker		24.2120-1725.3 010579	BDX Ø 20,64
1.9 D	40	01/97→09/98					
1.2 (B/C/S577)	40	01/96→12/96		- ABS; für Fahrschulwagen		03.2119-3389.3 010057	ATE Ø 19,05
				- ABS; nicht für Fahrschulwagen		03.2120-2031.3 010106	ATE Ø 20,64
				+ ASC; für Linkslenker		24.2120-1725.3 010579	BDX Ø 20,64
1.2 (B/C/S57A, B/C57S, 5/357F, 5/357J, 5/357L, 5/357R)	43	05/90→09/98		- ABS; für Fahrschulwagen		03.2119-3389.3 010057	ATE Ø 19,05
				10/94→; - ABS; für Fahrschulwagen		03.2119-3389.3 010057	ATE Ø 19,05
				- ABS; nicht für Fahrschulwagen		03.2120-2031.3 010106	ATE Ø 20,64
↓							

	kw			 	! #		
RENAULT - CLIO I (B/C57_, 5/357_) 05/90→09/98							
 Hauptbremszylinder							
1.2 (B/C/S57A, B/C57S, 5/357F, 5/357J, 5/357L, 5/357R)	43	05/90→09/98		10/94→; - ABS; nicht für Fahrschulwagen		03.2120-2031.3 010106	ATE Ø 20,64
				10/94→; + ABS; für Linkslenker		24.2120-1725.3 010579	BDX Ø 20,64
				+ ABS; für Linkslenker		24.2120-1725.3 010579	BDX Ø 20,64
1.2 (B/C57R)	40	01/91→06/96		→ 01/96; - ABS; für Fahrschulwagen		03.2119-3389.3 010057	ATE Ø 19,05
				→ 01/96; - ABS; nicht für Fahrschulwagen		03.2120-2031.3 010106	ATE Ø 20,64
				→ 01/96; + ABS; für Linkslenker		24.2120-1725.3 010579	BDX Ø 20,64
1.4	57	05/90→02/98		01/91→; für Rechtslenker		03.2120-2031.3 010106	ATE Ø 20,64
				01/91→; - ABS; nicht für Fahrschulwagen; für Linkslenker		03.2120-2031.3 010106	ATE Ø 20,64
				01/91→; + ABS; für Linkslenker		24.2120-1725.3 010579	BDX Ø 20,64
1.4	59	01/91→09/98		- ABS; für Rechtslenker		03.2119-3389.3 010057	ATE Ø 19,05
1.4 (B/C57T, B/C57Y)	58	01/91→09/98		- ABS; nicht für Fahrschulwagen; für Linkslenker		03.2120-2031.3 010106	ATE Ø 20,64
1.4 (B57J, C57J)	55	01/91→09/98		für Rechtslenker		03.2120-2031.3 010106	ATE Ø 20,64
				+ ABS; für Linkslenker		24.2120-1725.3 010579	BDX Ø 20,64
1.8	66	08/90→04/96		08/94→; - ABS; für Rechtslenker		03.2119-3389.3 010057	ATE Ø 19,05
				08/94→; - ABS; für Linkslenker		03.2120-2031.3 010106	ATE Ø 20,64
				08/94→; + ABS; für Linkslenker		24.2120-1725.3 010579	BDX Ø 20,64
1.8	70	01/91→09/98		- ABS; für Rechtslenker		03.2119-3389.3 010057	ATE Ø 19,05
1.8 (B/C578)	66	08/94→09/98		- ABS; für Linkslenker		03.2120-2031.3 010106	ATE Ø 20,64
1.8 (B/C57C, B/C57U)	65	01/91→09/98		+ ABS; für Linkslenker		24.2120-1725.3 010579	BDX Ø 20,64
1.8 Rsi (B/C579)	80	01/93→08/95					
1.8 Rsi (B/C57H)	79	08/95→09/98					
1.8 16V (C57D)	99	01/91→03/96		08/91→ 06/94; - ABS; für Rechtslenker		03.2119-3389.3 010057	ATE Ø 19,05
				08/91→ 06/94; - ABS; für Linkslenker		03.2120-2031.3 010106	ATE Ø 20,64
				08/91→ 06/94; + ABS; für Linkslenker		24.2120-1725.3 010579	BDX Ø 20,64
1.9 D	48	05/96→02/98		- ABS; nicht für Fahrschulwagen		03.2119-3389.3 010057	ATE Ø 19,05
1.9 D (B/C/S576, B/C/S57L)	47	01/91→09/98				03.2120-2031.3 010106	ATE Ø 20,64
				+ ABS; für Linkslenker		24.2120-1725.3 010579	BDX Ø 20,64
RENAULT - CLIO I Kasten (S57_) 01/91→09/98							
 Hauptbremszylinder							
1.1	34	01/91→09/98				03.2120-2031.3 010106	ATE Ø 20,64
1.2	40	01/91→09/98		- ABS; für Fahrschulwagen		03.2119-3389.3 010057	ATE Ø 19,05
1.2	40	06/94→02/98		- ABS; nicht für Fahrschulwagen		03.2120-2031.3 010106	ATE Ø 20,64
1.2	44	01/91→09/98					
1.9 D	48	01/91→09/98		für Linkslenker; + ABS		24.2120-1725.3 010579	BDX Ø 20,64
1.9 RND	40	04/96→02/98					
RENAULT - CLIO II (BB0/1/2_, CB0/1/2_) 09/98→							
 Bremskraftverstärker							
1.0	40	02/00→05/01		für Linkslenker; - ABS		03.7750-1332.4 300155	ATE Ø 9" pneumatisch
1.2 (BB0A, CB0A)	44	03/99→05/01					
1.2 LPG	43	09/98→06/09					
1.4 (B/CB0C)	55	09/98→05/05					
1.6	81	11/04→02/09					
1.6 (B/CB0D)	66	09/98→05/05					
1.6 16V	82	10/01→12/08					
1.6 Flex	81	05/00→12/06					
1.6 Hi-Flex (CB0H)	86	01/05→02/10					
1.9 D (B/CB0E)	47	09/98→05/05					
1.9 D (B/CB0J)	48	02/00→05/01					
1.2 (BB0A, BB0F, BB10, BB1K, BB28, BB2D, BB2H, CB0A...)	43	09/98→		für Linkslenker; → 12/12; - ABS		03.7750-1332.4 300155	ATE Ø 9" pneumatisch
1.5 dCi (B/CB3M)	47	06/05→					
1.6 16V (BB01, BB0H, BB0T, BB14, BB1D, BB1R, BB2KL...)	79	09/98→					
1.2 16V (BB05, BB0W, BB11, BB27, BB2T, BB2U, BB2V, CB05...)	55	06/01→		→ 10/03; für Linkslenker; - ABS		03.7750-1332.4 300155	ATE Ø 9" pneumatisch
				→ 10/03; + ESP		03.7853-0702.4 300195	ATE Ø 9" pneumatisch
				→ 10/03; - ESP		03.7853-1502.4 300200	ATE Ø 9" pneumatisch
1.4 16V (B/CB0L)	70	10/99→09/04		→ 07/00; für Linkslenker; - ABS		03.7750-1332.4 300155	ATE Ø 9" pneumatisch
				→ 07/00; + ESP		03.7853-0702.4 300195	ATE Ø 9" pneumatisch
				→ 07/00; - ESP		03.7853-1502.4 300200	ATE Ø 9" pneumatisch
1.4 16V (B/CB0P)	72	08/00→		für Linkslenker; → 12/12; - ABS		03.7750-1332.4 300155	ATE Ø 9" pneumatisch
1.5 dCi	74	01/04→					
1.5 dCi (B/C2J)	50	08/04→		→ 12/12; + ESP		03.7853-0702.4 300195	ATE Ø 9" pneumatisch
↓							













	kw			 	! #		
RENAULT - CLIO II (BB0/1/2_, CB0/1/2_) 09/98→							
 Bremskraftverstärker							
1.5 dCi (B/CB07)	48	06/01→		→ 12/12; - ESP		03.7853-1502.4 300200	ATE Ø 9" pneumatisch
1.5 dCi (B/CB08)	60	06/01→					
1.5 dCi (B/CB3N)	62	02/07→					
1.5 dCi	42	06/01→12/06		für Linkslenker; - ABS		03.7750-1332.4 300155	ATE Ø 9" pneumatisch
1.5 dCi (B/CB03)	59	06/01→10/03		+ ESP		03.7853-0702.4 300195	ATE Ø 9" pneumatisch
				- ESP		03.7853-1502.4 300200	ATE Ø 9" pneumatisch
1.9 dTi (B/CB0U)	59	12/99→05/05		02/00→; für Linkslenker; - ABS		03.7750-1332.4 300155	ATE Ø 9" pneumatisch
 Hauptbremszylinder							
1.0	40	02/00→05/01		für Linkslenker; - ABS		03.2120-4381.3 010526	ATE Ø 20,64
1.2 (BB0A, CB0A)	44	03/99→05/01		für Linkslenker; + ABS		03.2120-4461.3 010571	ATE Ø 20,64
1.2 LPG	43	09/98→06/09					
1.4 (B/CB0C)	55	09/98→05/05		für Linkslenker; + ESP		03.2120-4468.3 010789	ATE Ø 20,64
1.5 dCi	42	06/01→12/06					
1.5 dCi (B/CB03)	59	06/01→10/03					
1.6	81	11/04→02/09					
1.6 (B/CB0D)	66	09/98→05/05					
1.6 16V	82	10/01→12/08					
1.6 Flex	81	05/00→12/06					
1.6 Hi-Flex (CB0H)	86	01/05→02/10					
1.9 D (B/CB0E)	47	09/98→05/05					
1.9 D (B/CB0J)	48	02/00→05/01					
1.2 (BB0A, BB0F, BB10, BB1K, BB28, BB2D, BB2H, CB0A...)	43	09/98→		für Linkslenker; → 12/12; - ABS		03.2120-4381.3 010526	ATE Ø 20,64
				für Linkslenker; → 12/12; + ABS		03.2120-4461.3 010571	ATE Ø 20,64
1.4 16V (B/CB0P)	72	08/00→		für Linkslenker; → 12/12; + ESP		03.2120-4468.3 010789	ATE Ø 20,64
1.5 dCi	74	01/04→					
1.5 dCi (B/C2J)	50	08/04→					
1.5 dCi (B/CB07)	48	06/01→					
1.5 dCi (B/CB08)	60	06/01→					
1.5 dCi (B/CB3M)	47	06/05→					
1.5 dCi (B/CB3N)	62	02/07→					
1.6 16V (BB01, BB0H, BB0T, BB14, BB1D, BB1R, BB2KL...)	79	09/98→					
1.2 16V (BB05, BB0W, BB11, BB27, BB2T, BB2U, BB2V, CB05...)	55	06/01→		→ 10/03; für Linkslenker; - ABS		03.2120-4381.3 010526	ATE Ø 20,64
				→ 10/03; für Linkslenker; + ABS		03.2120-4461.3 010571	ATE Ø 20,64
				→ 10/03; für Linkslenker; + ESP		03.2120-4468.3 010789	ATE Ø 20,64
1.4 16V (B/CB0L)	70	10/99→09/04		→ 07/00; für Linkslenker; - ABS		03.2120-4381.3 010526	ATE Ø 20,64
				→ 07/00; für Linkslenker; + ABS		03.2120-4461.3 010571	ATE Ø 20,64
				→ 07/00; für Linkslenker; + ESP		03.2120-4468.3 010789	ATE Ø 20,64
1.9 dTi (B/CB0U)	59	12/99→05/05		02/00→; für Linkslenker; - ABS		03.2120-4381.3 010526	ATE Ø 20,64
				02/00→; für Linkslenker; + ABS		03.2120-4461.3 010571	ATE Ø 20,64
				02/00→; für Linkslenker; + ESP		03.2120-4468.3 010789	ATE Ø 20,64
2.0 16V Sport	132	01/04→		→ 12/12; für Linkslenker		03.2122-1926.3 010916	ATE Ø 22,2
2.0 16V Sport (CB0M)	124	02/00→					
 Bremskraftregler							
1.0	40	02/00→05/01		- ABS		24.6582-1721.3 320212	lastabhängig 4x
1.2 (BB0A, CB0A)	44	03/99→05/01					
1.2 LPG	43	09/98→06/09					
1.4 (B/CB0C)	55	09/98→05/05					
1.5 dCi	42	06/01→12/06					
1.5 dCi (B/CB03)	59	06/01→10/03					
1.6	81	11/04→02/09					
1.6 (B/CB0D)	66	09/98→05/05					
1.6 16V	82	10/01→12/08					
1.6 Flex	81	05/00→12/06					
1.6 Hi-Flex (CB0H)	86	01/05→02/10					
1.9 D (B/CB0E)	47	09/98→05/05					
1.9 D (B/CB0J)	48	02/00→05/01					
1.2 (BB0A, BB0F, BB10, BB1K, BB28, BB2D, BB2H, CB0A...)	43	09/98→		→ 12/12; - ABS		24.6582-1721.3 320212	lastabhängig 4x
1.2 16V	54	06/06→					
1.2 16V (BB05, BB0W, BB11, BB27, BB2T, BB2U, BB2V, CB05...)	55	06/01→					
1.4 16V (B/CB0P)	72	08/00→					
1.5 dCi	74	01/04→					
1.5 dCi (B/C2J)	50	08/04→					
1.5 dCi (B/CB07)	48	06/01→					
1.5 dCi (B/CB08)	60	06/01→					
1.5 dCi (B/CB3M)	47	06/05→					
1.5 dCi (B/CB3N)	62	02/07→					















	kw			 	! #		
RENAULT - CLIO II (BB0/1/2_, CB0/1/2_) 09/98→							
 Bremskraftregler							
1.6 16V (BB01, BB0H, BB0T, BB14, BB1D, BB1R, BB2KL...)	79	09/98→		→ 12/12; - ABS		24.6582-1721.3 320212	lastabhängig 4x
1.4 16V (B/CB0L)	70	10/99→09/04		→ 07/00; - ABS		24.6582-1721.3 320212	lastabhängig 4x
1.9 dTi (B/CB0U)	59	12/99→05/05		02/00→; - ABS		24.6582-1721.3 320212	lastabhängig 4x
RENAULT - CLIO II Kasten (SB0/1/2_) 09/98→							
 Bremskraftverstärker							
1.2 (SB0A, SB0F, SB10) 1.9 D (SB0J) 1.9 D (SB0R) 1.9 DTi (SB0U)	44 48 40 59	03/99→10/03 02/00→05/01 03/99→01/00 02/00→05/01		- ABS		03.7750-1332.4 300155	ATE Ø 9" pneumatisch
1.2 (SB0A, SB0F, SB1K, SB2D) 1.9 D (SB0E)	43 47	09/98→ 09/98→		→ 12/12; - ABS		03.7750-1332.4 300155	ATE Ø 9" pneumatisch
1.5 dCi 1.5 dCi 1.5 dCi (SB07)	50 60 48	04/04→ 11/03→ 06/01→		für Linkslenker; → 12/12; - ABS → 12/12; + ESP → 12/12; - ESP		03.7750-1332.4 300155 03.7853-0702.4 300195 03.7853-1502.4 300200	ATE Ø 9" pneumatisch ATE Ø 9" pneumatisch ATE Ø 9" pneumatisch
1.5 dCi	59	06/01→10/04		für Linkslenker; - ABS + ESP - ESP		03.7750-1332.4 300155 03.7853-0702.4 300195 03.7853-1502.4 300200	ATE Ø 9" pneumatisch ATE Ø 9" pneumatisch ATE Ø 9" pneumatisch
1.6 (SB0H)	79	11/03→		→ 04/05; + ESP → 04/05; - ESP		03.7853-0702.4 300195 03.7853-1502.4 300200	ATE Ø 9" pneumatisch ATE Ø 9" pneumatisch
 Hauptbremszylinder							
1.2 (SB0A, SB0F, SB10) 1.9 D (SB0J) 1.9 D (SB0R) 1.9 DTi (SB0U)	44 48 40 59	03/99→10/03 02/00→05/01 03/99→01/00 02/00→05/01		- ABS - ESP + ESP		03.2120-4381.3 010526 03.2120-4461.3 010571 03.2120-4468.3 010789	ATE Ø 20,64 ATE Ø 20,64 ATE Ø 20,64
1.2 (SB0A, SB0F, SB1K, SB2D) 1.9 D (SB0E)	43 47	09/98→ 09/98→		→ 12/12; - ABS → 12/12; - ESP → 12/12; + ESP		03.2120-4381.3 010526 03.2120-4461.3 010571 03.2120-4468.3 010789	ATE Ø 20,64 ATE Ø 20,64 ATE Ø 20,64
1.5 dCi 1.5 dCi 1.5 dCi (SB07)	50 60 48	04/04→ 11/03→ 06/01→		für Linkslenker; → 12/12; - ABS für Linkslenker; → 12/12; - ESP für Linkslenker; → 12/12; + ESP		03.2120-4381.3 010526 03.2120-4461.3 010571 03.2120-4468.3 010789	ATE Ø 20,64 ATE Ø 20,64 ATE Ø 20,64
1.5 dCi	59	06/01→10/04		für Linkslenker; - ABS für Linkslenker; - ESP für Linkslenker; + ESP		03.2120-4381.3 010526 03.2120-4461.3 010571 03.2120-4468.3 010789	ATE Ø 20,64 ATE Ø 20,64 ATE Ø 20,64
1.6 (SB0H)	79	11/03→		→ 04/05; - ABS → 04/05; - ESP → 04/05; + ESP		03.2120-4381.3 010526 03.2120-4461.3 010571 03.2120-4468.3 010789	ATE Ø 20,64 ATE Ø 20,64 ATE Ø 20,64
 Bremskraftregler							
1.2 (SB0A, SB0F, SB1K, SB2D) 1.5 dCi 1.5 dCi 1.5 dCi (SB07) 1.9 D (SB0E)	43 50 60 48 47	09/98→ 04/04→ 11/03→ 06/01→ 09/98→		→ 12/12; - ABS		24.6582-1721.3 320212	lastabhängig 4x
1.5 dCi 1.9 D (SB0J) 1.9 D (SB0R) 1.9 DTi (SB0U)	59 48 40 59	06/01→10/04 02/00→05/01 03/99→01/00 02/00→05/01		- ABS		24.6582-1721.3 320212	lastabhängig 4x
1.6 (SB0H)	79	11/03→		→ 04/05; - ABS		24.6582-1721.3 320212	lastabhängig 4x
RENAULT - CLIO III (BR0/1, CR0/1) 01/05→							
 Bremskraftverstärker							
1.2	43	05/05→06/09		06/06→ 11/07; für Linkslenker; + ABS		03.7863-4502.4 300230	ATE Ø 10" pneumatisch
1.2 (BR01, BR03, BR0E, CR0E) 1.2 16V 1.2 16V 1.2 16V (BR02, BR0J, BR11, CR02, CR0J, CR11) 1.2 16V (BR0P, CR0P) 1.2 16V (BR0R, BR1D, BR1L, CR0R) 1.4 16V 1.5 dCi (BR0H, CR0H) ↓	57 43 58 55 74 48 72 78	10/05→ 06/06→08/10 06/05→ 06/05→ 05/07→ 06/05→ 06/05→ 06/05→		→ 11/07; für Linkslenker; + ABS		03.7863-4502.4 300230	ATE Ø 10" pneumatisch













	kw			 	! #		
RENAULT - CLIO III (BR0/1, CR0/1) 01/05→							
 Bremskraftverstärker							
1.5 dCi (BR17, CR17)	63	06/05→		→ 11/07; für Linkslenker; + ABS		03.7863-4502.4 300230	ATE Ø 10" pneumatisch
1.5 dCi (BR1C, CR1C)	76	06/05→					
1.5 dCi (C/BR0G, C/BR1G)	50	06/05→					
1.6 16V (BR05, BR0B, BR0Y, BR15, BR1J, BR1M, BR1Y, CR0B...)	82	06/05→					
1.6 16V (BR09, BR0T, CR09, CR0T)	65	06/05→					
1.6 Hi-Flex	86	05/05→02/10					
2.0 16V (BR0C, BR0K, CR0C, CR0K)	102	09/06→					
1.5 dCi	48	05/05→		→ 10/06; für Linkslenker; + ABS		03.7863-4502.4 300230	ATE Ø 10" pneumatisch
2.0 16V Sport	145	02/06→		für Linkslenker; → 12/12		03.7860-3702.4 300305	ATE Ø 9" pneumatisch
2.0 16V Sport	148	09/08→					
 Hauptbremszylinder							
1.2	43	05/05→06/09		06/06→; - ABS		03.2123-2821.3 010944	ATE Ø 23,81
				12/07→; für Linkslenker; - ESP		03.2123-2863.3 010790	ATE Ø 23,81
				12/07→; für Linkslenker; + ESP		03.2123-2923.3 010791	ATE Ø 23,81
				06/06→ 11/07; für Linkslenker; - ESP		03.2123-3241.3 010882	ATE Ø 23,81
				06/06→ 11/07; für Linkslenker; + ESP		03.2123-3493.3 010792	ATE Ø 23,81
1.2 (BR01, BR03, BR0E, CR0E)	57	10/05→		→ 12/12; - ABS		03.2123-2821.3 010944	ATE Ø 23,81
1.2 16V	58	06/05→		12/07→; für Linkslenker; → 12/12; - ESP		03.2123-2863.3 010790	ATE Ø 23,81
1.2 16V (BR02, BR0J, BR11, CR02, CR0J, CR11)	55	06/05→		12/07→; für Linkslenker; → 12/12; + ESP		03.2123-2923.3 010791	ATE Ø 23,81
				→ 11/07; für Linkslenker; - ESP		03.2123-3241.3 010882	ATE Ø 23,81
1.2 16V (BR0P, CR0P)	74	05/07→		→ 11/07; für Linkslenker; + ESP		03.2123-3493.3 010792	ATE Ø 23,81
1.2 16V (BR0R, BR1D, BR1L, CR0R)	48	06/05→					
1.4 16V	72	06/05→					
1.5 dCi (BR0H, CR0H)	78	06/05→					
1.5 dCi (BR17, CR17)	63	06/05→					
1.5 dCi (BR1C, CR1C)	76	06/05→					
1.5 dCi (C/BR0G, C/BR1G)	50	06/05→					
1.6 16V (BR05, BR0B, BR0Y, BR15, BR1J, BR1M, BR1Y, CR0B...)	82	06/05→					
1.6 16V (BR09, BR0T, CR09, CR0T)	65	06/05→					
2.0 16V (BR0C, BR0K, CR0C, CR0K)	102	09/06→					
1.2 16V	43	06/06→08/10		- ABS		03.2123-2821.3 010944	ATE Ø 23,81
1.6 Hi-Flex	86	05/05→02/10		12/07→; für Linkslenker; - ESP		03.2123-2863.3 010790	ATE Ø 23,81
				12/07→; für Linkslenker; + ESP		03.2123-2923.3 010791	ATE Ø 23,81
				→ 11/07; für Linkslenker; - ESP		03.2123-3241.3 010882	ATE Ø 23,81
				→ 11/07; für Linkslenker; + ESP		03.2123-3493.3 010792	ATE Ø 23,81
1.2 16V	76	09/10→		→ 12/12; - ABS		03.2123-2821.3 010944	ATE Ø 23,81
1.2 16V Hi-Flex (BR1U, CR1U)	55	07/08→		für Linkslenker; → 12/12; - ESP		03.2123-2863.3 010790	ATE Ø 23,81
1.2 Ethanol	55	07/08→		für Linkslenker; → 12/12; + ESP		03.2123-2923.3 010791	ATE Ø 23,81
1.5 dCi	55	08/10→					
1.5 dCi	65	08/10→					
1.6 16V GT (BR10, CR10)	94	06/09→					
1.5 dCi	48	05/05→		→ 10/06; - ABS		03.2123-2821.3 010944	ATE Ø 23,81
				→ 10/06; für Linkslenker; - ESP		03.2123-3241.3 010882	ATE Ø 23,81
				→ 10/06; für Linkslenker; + ESP		03.2123-3493.3 010792	ATE Ø 23,81
1.5 dCi	60	11/07→		→ 12/12; - ABS		03.2123-2821.3 010944	ATE Ø 23,81
				12/07→; für Linkslenker; → 12/12; - ESP		03.2123-2863.3 010790	ATE Ø 23,81
				12/07→; für Linkslenker; → 12/12; + ESP		03.2123-2923.3 010791	ATE Ø 23,81
2.0 16V Sport	145	02/06→		→ 12/12; - ABS		03.2123-2821.3 010944	ATE Ø 23,81
2.0 16V Sport	148	09/08→		für Linkslenker; → 12/12		03.2123-3493.3 010792	ATE Ø 23,81
RENAULT - CLIO III Kasten (SB_, SR_) 06/05→							
 Bremskraftverstärker							
1.2 (SR0J)	55	11/05→12/14		→ 11/07; für Linkslenker; + ABS		03.7863-4502.4 300230	ATE Ø 10" pneumatisch
1.2 (SR0P)	74	11/07→12/11					
1.5 dCi	50	10/05→07/10					
1.5 dCi	63	06/05→07/10					
1.5 dCi	78	10/05→10/07		für Linkslenker; + ABS		03.7863-4502.4 300230	ATE Ø 10" pneumatisch
↓							













	kw			 	! #		
RENAULT - CLIO III Kasten (SB_, SR_) 06/05→							
 Hauptbremszylinder							
1.2 (SR0J)	55	11/05→12/14		→ 12/12; - ABS	03.2123-2821.3 010944	ATE Ø 23,81	
				12/07→; für Linkslenker; → 12/12; - ESP	03.2123-2863.3 010790	ATE Ø 23,81	
				12/07→; für Linkslenker; → 12/12; + ESP	03.2123-2923.3 010791	ATE Ø 23,81	
				→ 11/07; für Linkslenker; - ESP	03.2123-3241.3 010882	ATE Ø 23,81	
				→ 11/07; für Linkslenker; + ESP	03.2123-3493.3 010792	ATE Ø 23,81	
1.2 (SR0P)	74	11/07→12/11		- ABS	03.2123-2821.3 010944	ATE Ø 23,81	
1.5 dCi	50	10/05→07/10		12/07→; für Linkslenker; - ESP	03.2123-2863.3 010790	ATE Ø 23,81	
1.5 dCi	63	06/05→07/10		12/07→; für Linkslenker; + ESP	03.2123-2923.3 010791	ATE Ø 23,81	
				→ 11/07; für Linkslenker; - ESP	03.2123-3241.3 010882	ATE Ø 23,81	
				→ 11/07; für Linkslenker; + ESP	03.2123-3493.3 010792	ATE Ø 23,81	
1.5 dCi	78	10/05→10/07		- ABS	03.2123-2821.3 010944	ATE Ø 23,81	
				für Linkslenker; - ESP	03.2123-3241.3 010882	ATE Ø 23,81	
				für Linkslenker; + ESP	03.2123-3493.3 010792	ATE Ø 23,81	
1.5 dCi (SR1H)	65	08/10→12/14		→ 12/12; - ABS	03.2123-2821.3 010944	ATE Ø 23,81	
				für Linkslenker; → 12/12; - ESP	03.2123-2863.3 010790	ATE Ø 23,81	
				für Linkslenker; → 12/12; + ESP	03.2123-2923.3 010791	ATE Ø 23,81	
RENAULT - CLIO Grandtour (KR0/1_) 02/08→							
 Bremskraftverstärker							
1.2 16V	76	09/10→		für Linkslenker; → 12/12	03.7863-4502.4 300230	ATE Ø 10" pneumatisch	
1.2 16V (KR02, KR0J)	55	02/08→					
1.2 16V (KR0E)	58	02/08→					
1.2 16V (KR0P)	74	02/08→					
1.2 16V Hi-Flex (KR0S)	55	07/08→					
1.4 16V	72	02/10→					
1.5 dCi	48	02/10→					
1.5 dCi	55	08/10→					
1.5 dCi	65	08/10→					
1.5 dCi (KR0F)	63	02/08→					
1.5 dCi (KR0G)	50	02/08→					
1.5 dCi (KR0H)	78	02/08→					
1.5 dCi (KR1C, KR1N)	76	02/08→					
1.6 16V	80	02/08→					
1.6 16V (KR0B)	82	02/08→					
1.6 16V (KR10)	94	11/08→					
 Hauptbremszylinder							
1.2 16V	76	09/10→		→ 12/12; - ABS	03.2123-2821.3 010944	ATE Ø 23,81	
1.2 16V (KR02, KR0J)	55	02/08→		→ 12/12; - ESP	03.2123-3241.3 010882	ATE Ø 23,81	
1.2 16V (KR0E)	58	02/08→		→ 12/12; + ESP	03.2123-3493.3 010792	ATE Ø 23,81	
1.2 16V (KR0P)	74	02/08→					
1.2 16V Hi-Flex (KR0S)	55	07/08→					
1.5 dCi	48	02/10→					
1.5 dCi	55	08/10→					
1.5 dCi	65	08/10→					
1.5 dCi (KR0F)	63	02/08→					
1.5 dCi (KR0G)	50	02/08→					
1.5 dCi (KR0H)	78	02/08→					
1.5 dCi (KR1C, KR1N)	76	02/08→					
1.6 16V	80	02/08→					
1.6 16V (KR0B)	82	02/08→					
1.4 16V	72	02/10→		→ 12/12; - ESP	03.2123-3241.3 010882	ATE Ø 23,81	
				→ 12/12; + ESP	03.2123-3493.3 010792	ATE Ø 23,81	
1.6 16V (KR10)	94	11/08→		→ 12/12; - ESP	03.2123-2863.3 010790	ATE Ø 23,81	
				→ 12/12; + ESP	03.2123-2923.3 010791	ATE Ø 23,81	
RENAULT - DUSTER (HS_) 01/11→							
 Bremskraftverstärker							
1.5 dCi	66	06/11→		für Linkslenker; + ABS	03.7853-4602.4 300302	ATE Ø 9" pneumatisch	
1.5 dCi 4x4	66	06/11→					
1.6 16V	84	06/15→					
1.6 16V (HSAT)	75	02/12→					
1.6 16V 4x4	75	06/11→05/15					
1.6 16V 4x4	84	06/15→					
2.0	98	02/12→					
2.0 4x4	99	02/12→					
 Hauptbremszylinder							
1.5 dCi	66	06/11→		für Linkslenker; + ABS	03.2122-2031.3 010938	ATE Ø 22,2	
1.5 dCi 4x4	66	06/11→		für Linkslenker; + ESP	03.2122-2261.3 010964	ATE Ø 22,2	
1.6 16V	84	06/15→					
1.6 16V (HSAT)	75	02/12→					
↓							











	kw				! #		
RENAULT - DUSTER (HS_) 01/11→							
 Hauptbremszylinder							
1.6 16V 4x4	75	06/11→05/15		für Linkslenker; + ABS		03.2122-2031.3 010938	ATE Ø 22,2
1.6 16V 4x4	84	06/15→		für Linkslenker; + ESP		03.2122-2261.3 010964	ATE Ø 22,2
2.0	98	02/12→					
2.0 4x4	99	02/12→					
RENAULT - ESPACE II (J/S63_) 01/91→10/97							
 Bremskraftverstärker							
2.0 (J636)	76	01/91→10/96		für Linkslenker		03.6750-2902.4 300037	ATE Ø 9" pneumatisch
2.1 TD (J633, J634, J/S635, J/S63D)	65	01/91→10/96					
2.1 TD (J63E)	66	11/94→10/96					
2.2 (J/S637, J63G)	79	01/91→10/96				03.6750-2902.4 300037	ATE Ø 9" pneumatisch
2.2 4x4 (J/S637, J63G)	79	03/91→12/96					
 Hauptbremszylinder							
2.0 (J636)	76	01/91→10/96		- ABS; für Fahrzeuge ohne Niveauregulierung		03.2120-2682.3 010118	ATE Ø 20,64
				07/93→; + ABS; für Linkslenker		03.2122-0626.3 010539	ATE Ø 22,2
				- ABS		03.2122-9631.3 010160	ATE Ø 22,2
2.1 TD (J633, J634, J/S635, J/S63D)	65	01/91→10/96		für Fahrzeuge ohne Niveauregulierung		03.2120-2682.3 010118	ATE Ø 20,64
				07/93→; + ABS; für Linkslenker		03.2122-0626.3 010539	ATE Ø 22,2
				- ABS		03.2122-9631.3 010160	ATE Ø 22,2
2.1 TD (J63E)	66	11/94→10/96		+ ABS; für Linkslenker		03.2122-0626.3 010539	ATE Ø 22,2
				- ABS		03.2122-9631.3 010160	ATE Ø 22,2
2.2 (J/S637, J63G)	79	01/91→10/96		- ABS; für Fahrzeuge ohne Niveauregulierung		03.2120-2682.3 010118	ATE Ø 20,64
2.2 4x4 (J/S637, J63G)	79	03/91→12/96		07/93→; + ABS		03.2122-0626.3 010539	ATE Ø 22,2
				- ABS		03.2122-9631.3 010160	ATE Ø 22,2
2.8 V6 (J638, J63J)	110	01/91→10/96				24.2123-1701.3 010424	Ø 23,81
RENAULT - ESPACE III (JE0_) 11/96→10/02							
 Hauptbremszylinder							
1.9 dTi (JE0M)	72	02/99→10/02		+ ABS		03.2123-1486.3 010488	Ø 23,81
2.0	102	09/01→10/02		- ABS		03.2123-1546.3 010536	ATE Ø 23,81
2.0 (JE0A)	84	11/96→10/00					
2.0 16V (JE0N, JE0L, JE02)	103	10/98→10/02					
2.2 12V TD (JE0E, JE0H, JE0P)	83	11/96→10/00		+ ABS		03.2123-1486.3 010488	Ø 23,81
2.2 D	84	11/97→01/00		- ABS		03.2123-1741.3 010537	ATE Ø 23,81
3.0 (JE0D)	123	11/96→10/98					
3.0 V6 24V (JE0G, JE0R)	140	10/98→10/02					
2.2 dCi (JE0K)	95	10/00→10/02				03.2123-1486.3 010488	Ø 23,81
2.2 dCi (JE0S)	85	07/00→10/02				03.2123-1741.3 010537	ATE Ø 23,81
RENAULT - ESPACE IV (JK0/1_) 11/02→							
 Bremskraftverstärker							
1.9 dCi (JK0U, JK0G)	88	11/02→		für Linkslenker		03.7868-1602.4 300220	ATE Ø 10 / 8" pneumatisch
1.9 dCi (JK0U)	85	04/03→02/05					
2.0 (JK09)	100	11/02→					
2.0 (JK0A, JK1D, JK0N)	125	04/05→					
2.0 (JK0K)	98	11/02→02/05					
2.0 dCi (JK01, JK02, JK1J, JK1K)	110	01/06→					
2.0 dCi (JK02, JK03)	96	01/06→					
2.0 dCi (JK03, JK04)	127	01/06→					
2.0 Turbo (JK0A, JK0B, JK0N)	120	11/02→					
2.2 dCi (JK07)	102	02/06→					
2.2 dCi (JK0H)	110	11/02→					
3.0 dCi	120	09/05→					
3.0 dCi (JK0E, JK0Y)	133	01/06→					
3.0 dCi (JK0J, JK0V)	130	11/02→					
3.5 V6 (JK00, JK0F, JK0P, JK0S, JK0W)	177	11/02→					
 Hauptbremszylinder							
1.9 dCi (JK0U, JK0G)	88	11/02→		→ 12/04; + ESP		03.4125-0014.3 010794	ATE Ø 25,4
1.9 dCi (JK0U)	85	04/03→02/05		- ESP		03.4125-0021.3 010888	ATE Ø 25,4
2.0 (JK09)	100	11/02→					
2.0 (JK0K)	98	11/02→02/05		01/05→; + ESP		03.4155-0043.3 010795	ATE Ø 25,4
↓							









	kw			 	! #		
RENAULT - ESPACE IV (JK0/1_) 11/02→							
 Hauptbremszylinder							
2.0 Turbo (JK0A, JK0B, JK0N)	120	11/02→		→ 12/04; + ESP		03.4125-0014.3 010794	ATE Ø 25,4
2.2 dCi (JK0H)	110	11/02→		- ESP		03.4125-0021.3 010888	ATE Ø 25,4
3.0 dCi (JK0J, JK0V)	130	11/02→		01/05→; + ESP		03.4155-0043.3 010795	ATE Ø 25,4
3.5 V6 (JK00, JK0F, JK0P, JK0S, JK0W)	177	11/02→					
2.0 (JK0A, JK1D, JK0N)	125	04/05→		- ESP		03.4125-0021.3 010888	ATE Ø 25,4
2.0 dCi (JK01, JK02, JK1J, JK1K)	110	01/06→		+ ESP		03.4155-0043.3 010795	ATE Ø 25,4
2.0 dCi (JK02, JK03)	96	01/06→					
2.0 dCi (JK03, JK04)	127	01/06→					
2.2 dCi (JK07)	102	02/06→					
3.0 dCi	120	09/05→					
3.0 dCi (JK0E, JK0Y)	133	01/06→					
RENAULT - EXPRESS Kasten/Kombi 07/95→03/98							
 Hauptbremszylinder							
1.9 D	47	07/95→03/98				03.2120-2031.3 010106	ATE Ø 20,64
RENAULT - EXPRESS Pick-up 07/95→10/99							
 Hauptbremszylinder							
1.9 D	40	07/95→10/97		09/95→		03.2120-2031.3 010106	ATE Ø 20,64
1.9 D	47	07/95→10/99		→ 03/98		03.2120-2031.3 010106	ATE Ø 20,64
RENAULT - GRAND SCÉNIC II (JM0/1_) 04/04→							
 Hauptbremszylinder							
1.5 dCi	60	04/04→		→ 03/09		24.2123-1760.3 010779	TRW Ø 23,81
1.5 dCi (JM02, JM13)	74	04/04→					
1.6	77	06/06→					
1.6	83	04/04→					
1.9 dCi (JM0G, JM12, JM1G, JM2C)	88	04/04→					
1.9 dCi (JM14)	96	05/05→					
1.9 dCi (JM15)	81	05/05→					
2.0	99	04/04→					
2.0	120	04/04→					
2.0 dCi (JM1K)	110	09/05→					
1.5 dCi	76	06/06→11/08				24.2123-1760.3 010779	TRW Ø 23,81
1.6	82	06/06→11/08					
1.6 Flex	82	06/06→11/08					
1.9 dCi	85	05/05→01/09					
1.5 dCi (JM1E)	78	05/05→		06/06→ 03/09		24.2123-1760.3 010779	TRW Ø 23,81
RENAULT - GRAND SCÉNIC III (JZ0/1_) 02/09→							
 Hauptbremszylinder							
1.2 TCe	85	04/12→				24.4123-1715.3 010980	TRW Ø 23,81
1.4 16V (JZ0F)	96	02/09→					
1.5 dCi	63	04/09→					
1.5 dCi	70	11/10→					
1.5 dCi	78	02/09→					
1.5 dCi	81	04/09→					
1.6 16V (JZ0U)	81	02/09→					
1.6 16V Bifuel	79	04/12→					
1.6 16V Bifuel	81	02/09→					
1.6 dCi (JZ00, JZ12)	96	04/11→					
1.6 E85	81	02/09→					
1.9 dCi	96	02/09→					
2.0 16V (JZ0G)	103	02/09→					
2.0 dCi (JZ0L)	118	04/09→					
2.0 dCi (JZ0Y)	110	02/09→					
1.2 TCe (JZ16)	97	01/13→		03/13→		24.4123-1715.3 010980	TRW Ø 23,81
RENAULT - KANGOO (KC0/1_) 08/97→							
 Hauptbremszylinder							
1.2 (KC0A, KC0K, KC0F, KC01)	43	08/97→		03/98→ 12/07; - ABS		24.2122-1727.3 010586	BDX Ø 22,2
1.4 (KC0C, KC0H, KC0B, KC0M)	55	08/97→		03/98→ 12/07; + ABS; für Rechtslenker		24.2122-1744.3 010697	Ø 22,2
D 55 1.9 (KC0D)	40	08/97→					
D 65 1.9 (KC0E, KC02, KC0J, KC0N)	47	08/97→					
1.2 16V (KC05, KC06, KC03, KC0T, KC0W, KC1D)	55	06/01→		→ 12/07; - ABS		24.2122-1727.3 010586	BDX Ø 22,2
1.5 dCi	50	06/05→		→ 12/07; + ABS; für Rechtslenker		24.2122-1744.3 010697	Ø 22,2
↓							

	kw			 	! #		
RENAULT - KANGOO (KC0/1_) 08/97→							
 Hauptbremszylinder							
1.5 dCi (KC07)	48	12/01→		→ 12/07; - ABS		24.2122-1727.3 010586	BDX Ø 22,2
1.5 dCi (KC08, KC09)	60	07/02→		→ 12/07; + ABS; für Rechtslenker		24.2122-1744.3 010697	Ø 22,2
1.6 16V	70	06/01→					
1.6 16V 4x4 (KC0P, KC0S, KC0L)	70	10/01→					
1.9 dCi 4x4	62	10/03→					
1.9 dCi 4x4 (KC0V)	59	10/01→					
1.9 dTi (KC0U)	59	02/00→					
1.5 dCi	45	04/05→06/10		→ 12/07; - ABS		24.2122-1727.3 010586	BDX Ø 22,2
1.9 RXED	48	09/99→06/01		- ABS		24.2122-1727.3 010586	BDX Ø 22,2
				+ ABS; für Rechtslenker		24.2122-1744.3 010697	Ø 22,2
RENAULT - KANGOO Rapid (FC0/1_) 08/97→							
 Hauptbremszylinder							
1.0	40	07/03→		→ 12/07; - ABS		24.2122-1727.3 010586	BDX Ø 22,2
1.2 16V (FC05)	55	10/01→		→ 12/07; für Rechtslenker; + ABS		24.2122-1744.3 010697	Ø 22,2
1.5 dCi	45	10/05→					
1.5 dCi (FC07, FC1R)	48	12/01→					
1.5 dCi (FC08, FC09)	60	04/03→					
1.5 dCi (FC1E)	50	06/05→					
1.5 dCi (FC1G)	62	06/05→					
1.5 dCi (FC1R)	42	12/02→					
1.6 16V	70	10/01→					
1.6 16V 4x4 (FC0L, FC0P, FC0S)	70	10/01→					
1.6 16V bivalent	60	06/05→					
1.9 dCi (FC0V)	62	07/03→					
1.9 dCi 4x4 (FC0V)	59	10/01→					
1.9 dCi 4x4 (FC0V)	62	07/03→					
1.9 dTi (FC0U)	59	02/00→					
1.0	50	01/02→01/07		07/03→; - ABS		24.2122-1727.3 010586	BDX Ø 22,2
				07/03→; + ABS; für Rechtslenker		24.2122-1744.3 010697	Ø 22,2
1.2 (FC01, FC0A, FC0F)	43	08/97→		03/98→ 12/07; - ABS		24.2122-1727.3 010586	BDX Ø 22,2
			1.4 (FC0C, FC0B, FC0H, FC0M)	55	08/97→		03/98→ 12/07; + ABS; für Rechtslenker
D 55 1.9 (FC0D)	40	08/97→					
D 65 1.9 (FC0E, FC02, FC0J, FC0N)	47	08/97→					
1.2 (FC1A)	44	07/98→07/01		- ABS		24.2122-1727.3 010586	BDX Ø 22,2
				für Rechtslenker		24.2122-1744.3 010697	Ø 22,2
1.2 BiFuel	43	07/98→07/01		- ABS		24.2122-1727.3 010586	BDX Ø 22,2
1.9 D (FC0J)	48	09/99→06/03		für Rechtslenker; + ABS		24.2122-1744.3 010697	Ø 22,2
1.6	66	09/99→06/01		- ABS		24.2122-1727.3 010586	BDX Ø 22,2
RENAULT - LAGUNA I (B56_, 556_) 11/93→08/02							
 Hauptbremszylinder							
1.6 16V (B568, B561)	79	11/97→03/01		02/99→ 02/01		24.2123-1701.3 010424	Ø 23,81
1.8 16V (B563, B564)	88	04/98→03/01		→ 01/99		24.2123-1725.3 010549	Ø 23,81
1.9 dTi (B56J)	72	10/97→03/01					
3.0 24V (B56V)	140	03/97→03/01					
1.8	69	06/95→02/01		- ABS		03.2122-1001.3 010562	Ø 22,2
1.8	70	06/95→06/98		→ 01/97; + ABS		10.6123-0312.3 010457	ATE Ø 23,81
				02/97→; + ABS		24.2123-1725.3 010549	Ø 23,81
1.8 (B56A/B)	66	11/93→03/01		→ 02/01; - ABS		03.2122-1001.3 010562	Ø 22,2
1.8 (B56Z)	69	08/95→03/01		→ 01/97; + ABS		10.6123-0312.3 010457	ATE Ø 23,81
2.2 D (B56F/2)	61	11/93→03/01					
1.8 (B56S/T/0)	66	08/95→03/01		02/97→ 02/01; + ABS		24.2123-1725.3 010549	Ø 23,81
				02/99→ 02/01; + ABS		24.2123-1701.3 010424	Ø 23,81
				02/97→ 02/01; + ABS		24.2123-1725.3 010549	Ø 23,81
1.9 dCi (B56W)	79	09/99→03/01		→ 02/01		24.2123-1701.3 010424	Ø 23,81
2.0	80	03/99→03/01					
2.0 16V (556A/B)	103	09/99→03/01					
2.0	70	11/93→03/01		02/99→ 02/01; + ABS		24.2123-1701.3 010424	Ø 23,81
				02/97→ 01/99; + ABS		24.2123-1725.3 010549	Ø 23,81
				06/95→ 02/01; - ABS		24.2123-1725.3 010549	Ø 23,81
2.0	84	06/95→02/01		→ 01/97; + ABS		10.6123-0312.3 010457	ATE Ø 23,81
2.0 (B56C/H/N)	83	11/93→03/01		→ 02/01; - ABS		24.2123-1725.3 010549	Ø 23,81
				02/97→ 02/01; + ABS		24.2123-1725.3 010549	Ø 23,81
2.0 16V (B56D/M)	102	06/95→03/01		→ 02/01; + ABS		10.6123-0312.3 010457	ATE Ø 23,81
				02/99→ 02/01; + ABS		24.2123-1701.3 010424	Ø 23,81
				→ 02/01; - ABS		24.2123-1725.3 010549	Ø 23,81
↓							



	kw			 	! #		
RENAULT - LAGUNA I (B56_, 556_) 11/93→08/02							
 Hauptbremszylinder							
2.0 16V (B56D/M)	102	06/95→03/01		02/97→ 01/99; + ABS		24.2123-1725.3 010549	Ø 23,81
2.2 dT (B569)	83	03/96→03/01		→ 01/97; + ABS		10.6123-0312.3 010457	ATE Ø 23,81
				02/99→ 02/01; + ABS		24.2123-1701.3 010424	Ø 23,81
				→ 02/01; - ABS		24.2123-1725.3 010549	Ø 23,81
				02/97→ 01/99; + ABS		24.2123-1725.3 010549	Ø 23,81
3.0 (B56E/R, B565)	123	11/93→03/01		→ 01/97; + ABS		10.6123-0312.3 010457	ATE Ø 23,81
				02/97→ 02/01		24.2123-1725.3 010549	Ø 23,81
RENAULT - LAGUNA I Grandtour (K56_) 09/95→08/02							
 Hauptbremszylinder							
1.6 16V (K568)	79	11/97→03/01		02/99→ 02/01		24.2123-1701.3 010424	Ø 23,81
1.8 16V (K563, K564)	88	04/98→03/01		→ 01/99		24.2123-1725.3 010549	Ø 23,81
1.9 dTi (K56J)	72	10/97→03/01					
3.0 24V (K56V)	140	03/97→03/01					
1.8 (K56S/T/0)	66	09/95→03/01		→ 01/97; + ABS		10.6123-0312.3 010457	ATE Ø 23,81
				02/99→ 02/01; + ABS		24.2123-1701.3 010424	Ø 23,81
				→ 02/01; - ABS		24.2123-1725.3 010549	Ø 23,81
				02/97→ 01/99; + ABS		24.2123-1725.3 010549	Ø 23,81
1.8 (K56Z)	69	09/95→03/01		→ 01/97; + ABS		10.6123-0312.3 010457	ATE Ø 23,81
			2.2 D (K56F/2, S56F)	61	09/95→03/01		→ 02/01; - ABS
				02/97→ 02/01; + ABS		24.2123-1725.3 010549	Ø 23,81
1.9 dCi (K56W)	79	09/99→03/01		→ 02/01		24.2123-1701.3 010424	Ø 23,81
2.0	84	10/98→01/01		+ ABS		10.6123-0312.3 010457	ATE Ø 23,81
				- ABS		24.2123-1725.3 010549	Ø 23,81
2.0 (K56C/H)	83	09/95→03/01		→ 01/97; + ABS		10.6123-0312.3 010457	ATE Ø 23,81
				11/95→ 01/97; + ABS		10.6123-0312.3 010457	ATE Ø 23,81
				→ 02/01; + ABS		10.6123-0312.3 010457	ATE Ø 23,81
				02/99→ 02/01; + ABS		24.2123-1701.3 010424	Ø 23,81
				02/97→ 01/99; + ABS		24.2123-1725.3 010549	Ø 23,81
				→ 02/01; - ABS		24.2123-1725.3 010549	Ø 23,81
				11/95→ 02/01; - ABS		24.2123-1725.3 010549	Ø 23,81
				→ 02/01		24.2123-1725.3 010549	Ø 23,81
2.0 16V (K56D/M)	102	09/95→03/01		→ 02/01; + ABS		10.6123-0312.3 010457	ATE Ø 23,81
				→ 01/97; + ABS		10.6123-0312.3 010457	ATE Ø 23,81
				02/99→ 02/01; + ABS		24.2123-1701.3 010424	Ø 23,81
				09/99→ 02/01		24.2123-1701.3 010424	Ø 23,81
				→ 02/01; - ABS		24.2123-1725.3 010549	Ø 23,81
				02/97→ 01/99		24.2123-1725.3 010549	Ø 23,81
2.2 dT (K569)	83	03/96→03/01		→ 01/97; + ABS		10.6123-0312.3 010457	ATE Ø 23,81
				02/99→ 02/01; + ABS		24.2123-1701.3 010424	Ø 23,81
				→ 02/01; - ABS		24.2123-1725.3 010549	Ø 23,81
				02/97→ 01/99; + ABS		24.2123-1725.3 010549	Ø 23,81
3.0 (K56R, K565)	123	02/96→03/01		→ 02/01; + ABS		10.6123-0312.3 010457	ATE Ø 23,81
				03/96→ 01/97; + ABS		10.6123-0312.3 010457	ATE Ø 23,81
				02/97→ 02/01		24.2123-1725.3 010549	Ø 23,81
RENAULT - LAGUNA II (BG0/1_) 03/01→							
 Bremskraftverstärker							
1.6	76	03/01→05/05		06/01→; für Linkslenker		03.7873-1202.4 300197	ATE Ø 11" pneumatisch
1.6 LPG	76	03/01→05/05					
1.6 LPG	79	03/01→05/05					
1.6 16V (BG0A, BG0L)	79	03/01→		06/01→ 06/07; für Linkslenker		03.7873-1202.4 300197	ATE Ø 11" pneumatisch
1.8 16V (BG04, BG0B, BG0C, BG0V)	86	03/01→					
1.8 16V (BG06, BG0J, BG0M)	85	03/01→					
1.8 16V (BG0B, BG0C, BG0J, BG0M, BG0V)	89	03/01→					
1.8 16V (BG0B, BG0M)	88	03/01→					
1.9 dCi (BG08, BG0G)	88	03/01→					
2.0 16V IDE (BG0N)	103	04/01→					
3.0 V6 24V (BG01, BG02, BG0D, BG0Y)	152	03/01→					
↓							

	kW			 	! #		
RENAULT - LAGUNA II (BG0/1_) 03/01→							
Bremskraftverstärker							
1.6 16V (BG1G, BG1H)	82	02/05→		→ 06/07; für Linkslenker		03.7873-1202.4 300197	ATE Ø 11" pneumatisch
1.9 dCi	79	03/01→					
1.9 dCi	85	09/05→					
1.9 dCi	92	09/05→					
1.9 dCi (BG05)	68	03/04→					
1.9 dCi (BG0E)	77	06/01→					
1.9 dCi (BG0R)	74	10/01→					
1.9 dCi (BG1A, BG1V)	96	05/05→					
1.9 dCi (BG1A, BG1W)	81	01/05→					
2.0 16V	98	08/02→					
2.0 16V	125	01/05→					
2.0 16V	150	01/05→					
2.0 16V (BG00, BG0K, BG0P, BG0W)	99	08/02→					
2.0 16V Turbo (BG0S, BG0Z, BG1L, BG1M)	120	01/03→					
2.0 dCi (BG14, BG1S)	127	01/06→					
2.0 dCi (BG1T)	110	08/05→					
2.2 dCi	102	05/05→					
2.2 dCi (BG0F)	110	10/01→					
2.2 dCi (BG09)	85	04/04→10/05		für Linkslenker		03.7873-1202.4 300197	ATE Ø 11" pneumatisch
2.9 V6 24V	157	09/02→12/05					
Pedalwegsensord, Bremspedal							
1.6	76	03/01→05/05		für Rechtslenker		03.0655-0007.2 370007	ATE
1.6 LPG	76	03/01→05/05					
1.6 LPG	79	03/01→05/05		→ 05/01; für Linkslenker		03.0655-0007.2 370007	ATE
1.6 16V (BG0A, BG0L)	79	03/01→		→ 05/01; für Linkslenker		03.0655-0007.2 370007	ATE
1.8 16V (BG04, BG0B, BG0C, BG0V)	86	03/01→		→ 06/07; für Rechtslenker		03.0655-0007.2 370007	ATE
1.8 16V (BG06, BG0J, BG0M)	85	03/01→					
1.8 16V (BG0B, BG0C, BG0J, BG0M, BG0V)	89	03/01→					
1.8 16V (BG0B, BG0M)	88	03/01→					
1.9 dCi (BG08, BG0G)	88	03/01→					
2.0 16V IDE (BG0N)	103	04/01→					
3.0 V6 24V (BG01, BG02, BG0D, BG0Y)	152	03/01→					
1.6 16V (BG1G, BG1H)	82	02/05→		→ 06/07; für Rechtslenker		03.0655-0007.2 370007	ATE
1.9 dCi	79	03/01→					
1.9 dCi	85	09/05→					
1.9 dCi	92	09/05→					
1.9 dCi (BG05)	68	03/04→					
1.9 dCi (BG0E)	77	06/01→					
1.9 dCi (BG0R)	74	10/01→					
1.9 dCi (BG1A, BG1V)	96	05/05→					
1.9 dCi (BG1A, BG1W)	81	01/05→					
2.0 16V	98	08/02→					
2.0 16V	125	01/05→					
2.0 16V	150	01/05→					
2.0 16V (BG00, BG0K, BG0P, BG0W)	99	08/02→					
2.0 16V Turbo (BG0S, BG0Z, BG1L, BG1M)	120	01/03→					
2.0 dCi (BG14, BG1S)	127	01/06→					
2.0 dCi (BG1T)	110	08/05→					
2.2 dCi	102	05/05→					
2.2 dCi (BG0F)	110	10/01→					
2.2 dCi (BG09)	85	04/04→10/05		für Rechtslenker		03.0655-0007.2 370007	ATE
2.9 V6 24V	157	09/02→12/05					
2.9 V6 24V	155	03/01→08/07		für Linkslenker		03.0655-0007.2 370007	ATE
				für Rechtslenker		03.0655-0007.2 370007	ATE
Hauptbremszylinder							
1.6	76	03/01→05/05		→ 03/05		03.4123-0081.3 010585	ATE Ø 23,81
1.6 LPG	76	03/01→05/05					
1.6 LPG	79	03/01→05/05		04/05→		03.4153-0063.3 010773	ATE Ø 23,81
2.2 dCi (BG09)	85	04/04→10/05					
2.9 V6 24V	157	09/02→12/05					
1.6 16V (BG0A, BG0L)	79	03/01→		→ 03/05		03.4123-0081.3 010585	ATE Ø 23,81
1.8 16V (BG04, BG0B, BG0C, BG0V)	86	03/01→		04/05→ 06/07		03.4153-0063.3 010773	ATE Ø 23,81
1.8 16V (BG06, BG0J, BG0M)	85	03/01→					
1.8 16V (BG0B, BG0C, BG0J, BG0M, BG0V)	89	03/01→					
1.8 16V (BG0B, BG0M)	88	03/01→					
1.9 dCi	79	03/01→					
1.9 dCi (BG05)	68	03/04→					
1.9 dCi (BG08, BG0G)	88	03/01→					
↓							

RENAULT - LAGUNA II (BG0/1_) 03/01→

Hauptbremszylinder

1.9 dCi (BG0E)	77	06/01→		→ 03/05	03.4123-0081.3	010585	ATE Ø 23,81
1.9 dCi (BG0R)	74	10/01→			03.4153-0063.3	010773	ATE Ø 23,81
1.9 dCi (BG1A, BG1W)	81	01/05→		04/05→ 06/07			
2.0 16V	98	08/02→					
2.0 16V	125	01/05→					
2.0 16V	150	01/05→					
2.0 16V (BG00, BG0K, BG0P, BG0W)	99	08/02→					
2.0 16V IDE (BG0N)	103	04/01→					
2.2 dCi (BG0F)	110	10/01→					
3.0 V6 24V (BG01, BG02, BG0D, BG0Y)	152	03/01→					
1.6 16V (BG1G, BG1H)	82	02/05→		→ 06/07			
1.9 dCi	85	09/05→			03.4153-0063.3	010773	ATE Ø 23,81
1.9 dCi	92	09/05→					
1.9 dCi (BG1A, BG1V)	96	05/05→					
2.0 16V Turbo (BG0S, BG0Z, BG1L, BG1M)	120	01/03→					
2.0 dCi (BG14, BG1S)	127	01/06→					
2.0 dCi (BG1T)	110	08/05→					
2.2 dCi	102	05/05→					
2.9 V6 24V	155	03/01→08/07					







Verschlusschraube, Hauptbremszylinder











1.6	76	03/01→05/05		→ 03/05; - ESP	03.3517-0300.1	390323				
1.6 16V (BG0A, BG0L)	79	03/01→			03.3517-0300.1	390323				
1.6 LPG	76	03/01→05/05								
1.6 LPG	79	03/01→05/05								
1.8 16V (BG04, BG0B, BG0C, BG0V)	86	03/01→								
1.8 16V (BG06, BG0J, BG0M)	85	03/01→								
1.8 16V (BG0B, BG0C, BG0J, BG0M, BG0V)	89	03/01→								
1.8 16V (BG0B, BG0M)	88	03/01→								
1.9 dCi	79	03/01→								
1.9 dCi (BG05)	68	03/04→								
1.9 dCi (BG08, BG0G)	88	03/01→								
1.9 dCi (BG0E)	77	06/01→								
1.9 dCi (BG0R)	74	10/01→								
1.9 dCi (BG1A, BG1W)	81	01/05→								
2.0 16V	98	08/02→								
2.0 16V	125	01/05→								
2.0 16V	150	01/05→								
2.0 16V (BG00, BG0K, BG0P, BG0W)	99	08/02→								
2.0 16V IDE (BG0N)	103	04/01→								
2.2 dCi (BG09)	85	04/04→10/05								
2.2 dCi (BG0F)	110	10/01→								
2.9 V6 24V	157	09/02→12/05								
3.0 V6 24V (BG01, BG02, BG0D, BG0Y)	152	03/01→								
2.9 V6 24V	155	03/01→08/07		- ESP				03.3517-0300.1	390323	

















RENAULT - LAGUNA II Grandtour (KG0/1_) 03/01→













Bremskraftverstärker











1.6	76	03/01→10/05		06/01→; für Linkslenker	03.7873-1202.4	300197	ATE Ø 11" pneumatisch
1.6 16V	82	02/05→		→ 06/07; für Linkslenker	03.7873-1202.4	300197	ATE Ø 11" pneumatisch
1.6 Bifuel	79	06/05→12/07					
1.9 dCi	79	03/01→					
1.9 dCi	92	09/05→					
1.9 dCi (KG05)	68	03/04→					
1.9 dCi (KG0E, KG0R)	74	10/01→					
1.9 dCi (KG0E)	77	06/01→					
1.9 dCi (KG12)	85	08/05→09/07					
1.9 dCi (KG1A, KG1W)	81	01/05→					
1.9 dCi (KG1V)	96	05/05→					
2.0 16V	98	10/04→09/07					
2.0 16V	125	01/05→					
2.0 16V	150	01/05→					
2.0 16V (KG00, KG0K, KG0W)	99	08/02→					
2.0 16V Turbo (KG0S, KG0Z, KG1L, KG1M)	120	01/03→					
2.0 dCi (KG1S)	127	01/06→					
2.0 dCi (KG1T)	110	08/05→					
2.2 dCi	102	05/05→					
2.2 dCi (KG0F)	110	10/01→					
1.6 16V (KG0A, KG0L)	79	03/01→		06/01→ 06/07; für Linkslenker			
1.8 16V	86	03/01→			03.7873-1202.4	300197	ATE Ø 11" pneumatisch
1.8 16V	89	03/01→					









	kw					! #		
RENAULT - LAGUNA II Grandtour (KG0/1_) 03/01→								
Bremskraftverstärker								
1.8 16V (KG0B, KG0M)	88	03/01→		06/01→ 06/07; für Linkslenker		03.7873-1202.4	300197	ATE Ø 11" pneumatisch
1.8 16V (KG0J)	85	03/01→						
1.9 dCi (KG0G)	88	03/01→						
2.0 16V IDE (KG0N)	103	04/01→						
3.0 V6 24V (KG0D)	152	03/01→						
1.6 FlexFuel	76	06/01→10/03		für Linkslenker		03.7873-1202.4	300197	ATE Ø 11" pneumatisch
2.0 Flex	95	09/02→05/05						
2.0 Flex	97	09/02→05/05						
2.2 dCi (KG09)	85	04/04→10/05						
2.9 V6 24V	157	09/02→12/05						
1.9 dCi	66	08/03→09/07		03/04→ 06/07; für Linkslenker		03.7873-1202.4	300197	ATE Ø 11" pneumatisch
Pedalwegsensoren, Bremspedal								
1.6	76	03/01→10/05		für Rechtslenker		03.0655-0007.2	370007	ATE
				→ 05/01; für Linkslenker		03.0655-0007.2	370007	ATE
1.6 16V	82	02/05→		→ 06/07; für Rechtslenker		03.0655-0007.2	370007	ATE
1.6 Bifuel	79	06/05→12/07						
1.9 dCi	79	03/01→						
1.9 dCi	92	09/05→						
1.9 dCi (KG05)	68	03/04→						
1.9 dCi (KG0E, KG0R)	74	10/01→						
1.9 dCi (KG0E)	77	06/01→						
1.9 dCi (KG12)	85	08/05→09/07						
1.9 dCi (KG1A, KG1W)	81	01/05→						
1.9 dCi (KG1V)	96	05/05→						
2.0 16V	98	10/04→09/07						
2.0 16V	125	01/05→						
2.0 16V	150	01/05→						
2.0 16V (KG00, KG0K, KG0W)	99	08/02→						
2.0 16V Turbo (KG0S, KG0Z, KG1L, KG1M)	120	01/03→						
2.0 dCi (KG1S)	127	01/06→						
2.0 dCi (KG1T)	110	08/05→						
2.2 dCi	102	05/05→						
2.2 dCi (KG0F)	110	10/01→						
1.6 16V (KG0A, KG0L)	79	03/01→		→ 05/01; für Linkslenker		03.0655-0007.2	370007	ATE
1.8 16V	86	03/01→		→ 06/07; für Rechtslenker		03.0655-0007.2	370007	ATE
1.8 16V	89	03/01→						
1.8 16V (KG0B, KG0M)	88	03/01→						
1.8 16V (KG0J)	85	03/01→						
2.0 16V IDE (KG0N)	103	04/01→						
3.0 V6 24V (KG0D)	152	03/01→						
1.6 FlexFuel	76	06/01→10/03		für Rechtslenker		03.0655-0007.2	370007	ATE
2.0 Flex	95	09/02→05/05						
2.0 Flex	97	09/02→05/05						
2.2 dCi (KG09)	85	04/04→10/05						
2.9 V6 24V	157	09/02→12/05						
1.9 dCi	66	08/03→09/07		03/04→ 06/07; für Rechtslenker		03.0655-0007.2	370007	ATE
1.9 dCi (KG0G)	88	03/01→		06/01→ 06/07; für Rechtslenker		03.0655-0007.2	370007	ATE
				→ 05/01; für Linkslenker		03.0655-0007.2	370007	ATE
Hauptbremszylinder								
1.6	76	03/01→10/05		→ 03/05		03.4123-0081.3	010585	ATE Ø 23,81
2.0 Flex	95	09/02→05/05		04/05→		03.4153-0063.3	010773	ATE Ø 23,81
2.0 Flex	97	09/02→05/05						
2.2 dCi (KG09)	85	04/04→10/05						
2.9 V6 24V	157	09/02→12/05						
1.6 16V	82	02/05→		→ 03/05		03.4123-0081.3	010585	ATE Ø 23,81
1.6 16V (KG0A, KG0L)	79	03/01→		04/05→ 06/07		03.4153-0063.3	010773	ATE Ø 23,81
1.8 16V	86	03/01→						
1.8 16V	89	03/01→						
1.8 16V (KG0B, KG0M)	88	03/01→						
1.8 16V (KG0J)	85	03/01→						
1.9 dCi	79	03/01→						
1.9 dCi (KG05)	68	03/04→						
1.9 dCi (KG0E, KG0R)	74	10/01→						
1.9 dCi (KG0E)	77	06/01→						
1.9 dCi (KG0G)	88	03/01→						
2.0 16V	98	10/04→09/07						
2.0 16V (KG00, KG0K, KG0W)	99	08/02→						
2.0 16V IDE (KG0N)	103	04/01→						
2.2 dCi (KG0F)	110	10/01→						
3.0 V6 24V (KG0D)	152	03/01→						
1.6 Bifuel	79	06/05→12/07		→ 06/07		03.4153-0063.3	010773	ATE Ø 23,81
1.9 dCi	92	09/05→						
1.9 dCi (KG12)	85	08/05→09/07						
1.9 dCi (KG1V)	96	05/05→						
2.0 16V	125	01/05→						
↓								









	kw					! #		
RENAULT - LAGUNA II Grandtour (KG0/1_) 03/01→								
 Hauptbremszylinder								
2.0 16V	150	01/05→		→ 06/07			03.4153-0063.3 010773	ATE Ø 23,81
2.0 16V Turbo (KG0S, KG0Z, KG1L, KG1M)	120	01/03→						
2.0 dCi (KG1S)	127	01/06→						
2.0 dCi (KG1T)	110	08/05→						
2.2 dCi	102	05/05→						
1.6 FlexFuel	76	06/01→10/03					03.4123-0081.3 010585	ATE Ø 23,81
1.9 dCi	66	08/03→09/07		03/04→ 03/05			03.4123-0081.3 010585	ATE Ø 23,81
				04/05→ 06/07			03.4153-0063.3 010773	ATE Ø 23,81
1.9 dCi (KG1A, KG1W)	81	01/05→		→ 03/05			03.4123-0081.3 010585	ATE Ø 23,81
				→ 06/07			03.4153-0063.3 010773	ATE Ø 23,81
Verschlusschraube, Hauptbremszylinder								
1.6	76	03/01→10/05		→ 03/05; - ESP			03.3517-0300.1 390323	
1.6 16V	82	02/05→						
1.6 16V (KG0A, KG0L)	79	03/01→						
1.8 16V	86	03/01→						
1.8 16V	89	03/01→						
1.8 16V (KG0B, KG0M)	88	03/01→						
1.8 16V (KG0J)	85	03/01→						
1.9 dCi	79	03/01→						
1.9 dCi (KG05)	68	03/04→						
1.9 dCi (KG0E, KG0R)	74	10/01→						
1.9 dCi (KG0E)	77	06/01→						
1.9 dCi (KG0G)	88	03/01→						
1.9 dCi (KG1A, KG1W)	81	01/05→						
2.0 16V	98	10/04→09/07						
2.0 16V (KG00, KG0K, KG0W)	99	08/02→						
2.0 16V IDE (KG0N)	103	04/01→						
2.0 Flex	95	09/02→05/05						
2.0 Flex	97	09/02→05/05						
2.2 dCi (KG09)	85	04/04→10/05						
2.2 dCi (KG0F)	110	10/01→						
2.9 V6 24V	157	09/02→12/05						
3.0 V6 24V (KG0D)	152	03/01→						
1.6 FlexFuel	76	06/01→10/03		- ESP			03.3517-0300.1 390323	
1.9 dCi	66	08/03→09/07		03/04→ 03/05; - ESP			03.3517-0300.1 390323	
RENAULT - LOGAN I (LS_) 09/04→								
 Bremskraftverstärker								
1.4	55	09/04→		→ 10/09; + ABS			03.7750-8532.4 300264	ATE Ø 9" pneumatisch
1.5 dCi	50	04/07→						
1.5 dCi	63	02/08→		11/09→ 04/13; + ABS			03.7853-4102.4 300271	ATE Ø 9" pneumatisch
1.6	64	09/04→					03.7853-4602.4 300302	ATE Ø 9" pneumatisch
1.6	66	05/08→						
1.6	77	04/07→						
1.6 Flex	68	11/07→						
1.5 dCi	48	06/11→		→ 04/13; + ABS			03.7853-4102.4 300271	ATE Ø 9" pneumatisch
							03.7853-4602.4 300302	ATE Ø 9" pneumatisch
1.6	80	02/07→		04/07→ 10/09; + ABS			03.7750-8532.4 300264	ATE Ø 9" pneumatisch
				11/09→; + ABS			03.7853-4102.4 300271	ATE Ø 9" pneumatisch
							03.7853-4602.4 300302	ATE Ø 9" pneumatisch
 Hauptbremszylinder								
1.4	55	09/04→		+ ABS; → 04/13			24.2120-1754.3 010949	Ø 20,64
1.5 dCi	48	06/11→						
1.5 dCi	50	04/07→		- ABS; → 04/13			24.2120-1762.3 011002	Ø 20,64
1.5 dCi	63	02/08→						ohne Bremsflüssigkeitsbehälter
1.6	64	09/04→						
1.6	66	05/08→						
1.6	77	04/07→						
1.6 Flex	68	11/07→						
1.6	80	02/07→		04/07→; + ABS			24.2120-1754.3 010949	Ø 20,64
				04/07→; - ABS			24.2120-1762.3 011002	Ø 20,64
								ohne Bremsflüssigkeitsbehälter
RENAULT - LOGAN I Kombi (KS_) 04/07→								
 Bremskraftverstärker								
1.4	55	10/07→		→ 10/09; + ABS			03.7750-8532.4 300264	ATE Ø 9" pneumatisch
1.5 dCi	50	04/07→						
1.5 dCi	63	02/08→		11/09→ 04/13; + ABS			03.7853-4102.4 300271	ATE Ø 9" pneumatisch
1.6	64	04/07→					03.7853-4602.4 300302	ATE Ø 9" pneumatisch
1.6	77	04/07→						
↓								











	kw					! #		
RENAULT - LOGAN I Kombi (KS_) 04/07→								
 Bremskraftverstärker								
1.5 dCi	48	06/11→			→ 04/13; + ABS		03.7853-4102.4 300271	ATE Ø 9" pneumatisch
1.5 dCi	66	06/11→					03.7853-4602.4 300302	ATE Ø 9" pneumatisch
 Hauptbremszylinder								
1.4	55	10/07→			+ ABS; → 04/13		24.2120-1754.3 010949	Ø 20,64
1.5 dCi	48	06/11→						
1.5 dCi	50	04/07→			- ABS; → 04/13		24.2120-1762.3 011002	Ø 20,64
1.5 dCi	63	02/08→						ohne Bremsflüssigkeitsbehälter
1.5 dCi	66	06/11→						
1.6	64	04/07→						
1.6	77	04/07→						
RENAULT - LOGAN EXPRESS (US_) 04/07→								
 Bremskraftverstärker								
1.5 dCi	50	04/07→			→ 04/13; + ABS		03.7750-8532.4 300264	ATE Ø 9" pneumatisch
1.6	64	04/07→						
 Hauptbremszylinder								
1.5 dCi	50	04/07→			09/07→ 04/13; + ABS		03.2122-2031.3 010938	ATE Ø 22,2
1.6	64	04/07→						
RENAULT - MASTER I Bus (T_) 08/80→07/98								
 Hauptbremszylinder								
28-35 2,5 TD	72	08/89→07/98			→ 08/94		24.2125-1704.3 010446	TRW Ø 25,4
28-35 2.0	58	10/86→07/98					24.2125-1704.3 010446	TRW Ø 25,4
28-35 2.1 D	44	08/80→07/98						
28-35 2.5 D	55	08/89→07/98						
30 2,2	67	08/80→07/98						
35 2,5 TD	69	08/89→07/98						
RENAULT - MASTER I Kasten (T_) 07/80→07/98								
 Hauptbremszylinder								
28-35 2,5 D	55	08/89→07/98					24.2125-1704.3 010446	TRW Ø 25,4
28-35 2,5 TD	72	08/89→07/98						
28-35 2.0	58	10/86→07/98						
28-35 2.1 D	44	08/80→07/98						
30 2,2	67	08/80→07/98						
35 2,5 TD	69	08/89→07/98						
RENAULT - MASTER I Pritsche/Fahrgestell (P_) 07/80→07/98								
 Hauptbremszylinder								
28-35 2.0	58	10/86→07/98					24.2125-1704.3 010446	TRW Ø 25,4
28-35 2.5 D	52	09/80→07/98			08/89→		24.2125-1704.3 010446	TRW Ø 25,4
RENAULT - MASTER II Bus (JD) 03/98→								
 Hauptbremszylinder								
1.9 dCi 80	60	11/01→			→ 10/03; + ABS		24.2025-1706.3 010676	Ø 25,4
1.9 dTi	59	09/00→			11/03→ 08/06; - ABS		24.2025-1708.3 010692	Ø 25,4
2.2 dCi 90	66	09/00→						
2.5 dCi 120	84	10/01→			→ 10/03; - ABS		24.2025-1708.3 010692	Ø 25,4
					11/03→ 08/06; + ABS		24.2123-1759.3 010768	BOS Ø 23,81
2.5 D	59	07/98→01/01			+ ABS		24.2025-1706.3 010676	Ø 25,4
2.8 dTi	84	07/98→10/01			- ABS		24.2025-1708.3 010692	Ø 25,4
2.5 dCi	74	08/06→			- ABS; → 12/10		24.2025-1708.3 010692	Ø 25,4
2.5 dCi	88	08/06→						
2.5 dCi	107	08/06→						
2.5 dCi 100 (JDCV)	73	10/03→			→ 08/06; - ABS		24.2025-1708.3 010692	Ø 25,4
3.0 dCi 140 (JD0T)	100	10/03→			→ 08/06; + ABS		24.2123-1759.3 010768	BOS Ø 23,81
RENAULT - MASTER II Kasten (FD) 07/98→								
 Hauptbremszylinder								
1.9 dCi 80	60	11/01→			→ 10/03; + ABS		24.2025-1706.3 010676	Ø 25,4
1.9 dTi	59	09/00→			11/03→ 08/06; - ABS		24.2025-1708.3 010692	Ø 25,4
2.2 dCi 90	66	09/00→						
2.5 dCi 120	84	10/01→			→ 10/03; - ABS		24.2025-1708.3 010692	Ø 25,4
					11/03→ 08/06; + ABS		24.2123-1759.3 010768	BOS Ø 23,81
2.5 D	59	07/98→01/01			+ ABS		24.2025-1706.3 010676	Ø 25,4
2.8 dTi	84	07/98→10/01			- ABS		24.2025-1708.3 010692	Ø 25,4
2.5 dCi	74	08/06→			- ABS; → 12/10		24.2025-1708.3 010692	Ø 25,4
2.5 dCi	88	08/06→						
↓								







	kW					! #		
RENAULT - MASTER II Kasten (FD) 07/98→								
 Hauptbremszylinder								
2.5 dCi	107	08/06→			- ABS; → 12/10		24.2025-1708.3 010692	Ø 25,4
2.5 dCi 100 (FD0U, FD0V)	73	10/03→			→ 08/06; - ABS		24.2025-1708.3 010692	Ø 25,4
3.0 dCi 120	85	06/05→			→ 08/06; + ABS		24.2123-1759.3 010768	BOS Ø 23,81
3.0 dCi 140 (HD0S, FD0S, HD1S)	100	10/03→						
3.0 dCi 160	115	06/05→						
RENAULT - MASTER II Pritsche/Fahrgestell (ED/HD/UD) 07/98→								
 Hauptbremszylinder								
2.2 dCi 90	66	09/00→			→ 10/03; + ABS		24.2025-1706.3 010676	Ø 25,4
2.5 dCi 120	84	10/01→			11/03→ 08/06; - ABS		24.2025-1708.3 010692	Ø 25,4
					→ 10/03; - ABS		24.2025-1708.3 010692	Ø 25,4
					11/03→ 08/06; + ABS		24.2123-1759.3 010768	BOS Ø 23,81
2.5 D	59	07/98→01/01			+ ABS		24.2025-1706.3 010676	Ø 25,4
2.8 dTi	84	07/98→10/01			- ABS		24.2025-1708.3 010692	Ø 25,4
2.5 dCi	74	08/06→			- ABS; → 12/10		24.2025-1708.3 010692	Ø 25,4
2.5 dCi	88	08/06→						
2.5 dCi	107	08/06→						
2.5 dCi 100 (ED4V, ED8V)	73	10/03→			→ 08/06; - ABS		24.2025-1708.3 010692	Ø 25,4
3.0 dCi 120	85	06/05→			→ 08/06; + ABS		24.2123-1759.3 010768	BOS Ø 23,81
3.0 dCi 140 (ED0S, UD0S)	100	10/03→						
3.0 dCi 160	115	06/05→						
RENAULT - MASTER III Bus (JV) 02/11→								
 Bremskraftverstärker								
2.3 dCi 100 FWD (JV0A, JV0B)	74	02/11→					03.7868-5202.4 300309	ATE Ø 10 / 8" pneumatisch
2.3 dCi 110 FWD	81	09/14→						
2.3 dCi 125 FWD (JV0C, JV0D, JV0H)	92	02/11→						
2.3 dCi 135 FWD	100	07/14→						
2.3 dCi 145 FWD (JV0F, JV0H)	107	02/11→						
2.3 dCi 165 FWD	120	07/14→						
2.3 dCi 170 FWD	125	07/15→						
2.3 dCi 150 FWD	110	10/12→			01/13→		03.7868-5202.4 300309	ATE Ø 10 / 8" pneumatisch
 Hauptbremszylinder								
2.3 dCi 100 FWD (JV0A, JV0B)	74	02/11→					03.2126-3121.3 010967	ATE Ø 26,99
2.3 dCi 110 FWD	81	09/14→						
2.3 dCi 125 FWD (JV0C, JV0D, JV0H)	92	02/11→						
2.3 dCi 135 FWD	100	07/14→						
2.3 dCi 145 FWD (JV0F, JV0H)	107	02/11→						
2.3 dCi 165 FWD	120	07/14→						
2.3 dCi 170 FWD	125	07/15→						
2.3 dCi 150 FWD	110	10/12→			01/13→		03.2126-3121.3 010967	ATE Ø 26,99
RENAULT - MASTER III Kasten (FV) 02/10→								
 Bremskraftverstärker								
2.3 dCi 100 [RWD] (FV0B, FV0C, FV0D)	74	02/10→					03.7868-5202.4 300309	ATE Ø 10 / 8" pneumatisch
2.3 dCi 100 FWD (FV0A, FV0B, FV0G, FV0K)	74	02/10→						
2.3 dCi 110 FWD	81	09/14→						
2.3 dCi 125 [RWD] (FV0C, FV0D, FV0H, FV0J)	92	02/10→						
2.3 dCi 125 FWD (FV0C, FV0D)	92	02/10→						
2.3 dCi 130 [RWD]	96	03/12→						
2.3 dCi 130 FWD	96	06/16→						
2.3 dCi 135 [RWD]	100	07/14→						
2.3 dCi 135 FWD	100	07/14→						
2.3 dCi 145 [RWD] (FV0E, FV0F, FV0J)	107	02/10→						
2.3 dCi 145 FWD (FV0E, FV0F, FV0H, FV0J)	107	02/10→						
2.3 dCi 150 [RWD]	110	03/13→						
2.3 dCi 150 FWD	110	03/13→						
2.3 dCi 165 [RWD]	120	07/14→						
↓								









	kW			 	! #		
RENAULT - MASTER III Kasten (FV) 02/10→							
 Bremskraftverstärker							
2.3 dCi 165 FWD	120	07/14→				03.7868-5202.4 300309	ATE Ø 10 / 8" pneumatisch
2.3 dCi 170 FWD	125	07/15→					
 Hauptbremszylinder							
2.3 dCi 100 [RWD] (FV0B, FV0C, FV0D)	74	02/10→				03.2126-3121.3 010967	ATE Ø 26,99
2.3 dCi 100 FWD (FV0A, FV0B, FV0G, FV0K)	74	02/10→					
2.3 dCi 110 FWD	81	09/14→					
2.3 dCi 125 [RWD] (FV0C, FV0D, FV0H, FV0J)	92	02/10→					
2.3 dCi 125 FWD (FV0C, FV0D)	92	02/10→					
2.3 dCi 130 [RWD]	96	03/12→					
2.3 dCi 130 FWD	96	06/16→					
2.3 dCi 135 [RWD]	100	07/14→					
2.3 dCi 135 FWD	100	07/14→					
2.3 dCi 145 [RWD] (FV0E, FV0F, FV0J)	107	02/10→					
2.3 dCi 145 FWD (FV0E, FV0F, FV0H, FV0J)	107	02/10→					
2.3 dCi 150 [RWD]	110	03/13→					
2.3 dCi 150 FWD	110	03/13→					
2.3 dCi 165 [RWD]	120	07/14→					
2.3 dCi 165 FWD	120	07/14→					
2.3 dCi 170 FWD	125	07/15→					
RENAULT - MASTER III Pritsche/Fahrgestell (EV, HV, UV) 02/10→							
 Bremskraftverstärker							
2.3 dCi 100 [RWD] (UV0C, UV0D, HV0C, HV0D)	74	02/10→				03.7868-5202.4 300309	ATE Ø 10 / 8" pneumatisch
2.3 dCi 100 FWD (EV0A, EV0B, HV0A, HV0B, HV0G, UV0A...)	74	02/10→					
2.3 dCi 110 FWD	81	09/14→					
2.3 dCi 125 [RWD] (HV0C, HV0D, UV0C, UV0D, UV0H, UV0J)	92	02/10→					
2.3 dCi 125 FWD (EV0C, EV0D, EV0J, HV0C, HV0D, HV0H...)	92	02/10→					
2.3 dCi 130 [RWD]	96	07/16→					
2.3 dCi 130 FWD	96	03/12→					
2.3 dCi 135 [RWD]	100	07/14→					
2.3 dCi 135 FWD	100	07/14→					
2.3 dCi 145 [RWD] (UV0F, UV0E)	107	02/10→					
2.3 dCi 145 FWD (EV0E, EV0F, HV0E, HV0F, UV0E, UV0F)	107	02/10→					
2.3 dCi 150 [RWD]	110	03/13→					
2.3 dCi 150 FWD	110	03/13→					
2.3 dCi 165 [RWD]	120	07/14→					
2.3 dCi 165 FWD	120	07/14→					
2.3 dCi 170 FWD	125	06/16→					
 Hauptbremszylinder							
2.3 dCi 100 [RWD] (UV0C, UV0D, HV0C, HV0D)	74	02/10→				03.2126-3121.3 010967	ATE Ø 26,99
2.3 dCi 100 FWD (EV0A, EV0B, HV0A, HV0B, HV0G, UV0A...)	74	02/10→					
2.3 dCi 110 FWD	81	09/14→					
2.3 dCi 125 [RWD] (HV0C, HV0D, UV0C, UV0D, UV0H, UV0J)	92	02/10→					
2.3 dCi 125 FWD (EV0C, EV0D, EV0J, HV0C, HV0D, HV0H...)	92	02/10→					
2.3 dCi 130 [RWD]	96	07/16→					
2.3 dCi 130 FWD	96	03/12→					
2.3 dCi 135 [RWD]	100	07/14→					
2.3 dCi 135 FWD	100	07/14→					
2.3 dCi 145 [RWD] (UV0F, UV0E)	107	02/10→					
2.3 dCi 145 FWD (EV0E, EV0F, HV0E, HV0F, UV0E, UV0F)	107	02/10→					
↓							











	kw				! #		
RENAULT - MASTER III Pritsche/Fahrgestell (EV, HV, UV) 02/10→							
 Hauptbremszylinder							
2.3 dCi 150 [RWD]	110	03/13→				03.2126-3121.3 010967	ATE Ø 26,99
2.3 dCi 150 FWD	110	03/13→					
2.3 dCi 165 [RWD]	120	07/14→					
2.3 dCi 165 FWD	120	07/14→					
2.3 dCi 170 FWD	125	06/16→					
RENAULT - MEGANE I (BA0/1_) 08/95→12/04							
 Bremskraftverstärker							
1.4 16V (BA0D, BA1H, BA0W, BA10)	70	03/99→08/03		→ 12/02; + ABS; für Linkslenker		03.7760-5502.4 300151	ATE Ø 10" pneumatisch
				→ 12/02; - ABS		03.7863-2002.4 300126	ATE Ø 10" pneumatisch
1.4 e (BA0E, BA0V)	55	01/96→08/03		03/99→ 12/02; + ABS; für Linkslenker		03.7760-5502.4 300151	ATE Ø 10" pneumatisch
				03/99→ 12/02; - ABS		03.7760-5602.4 300121	ATE Ø 10" pneumatisch
1.6 16V	81	11/01→12/04		→ 12/02; + ABS; für Linkslenker;		03.7760-5102.4 300140	ATE Ø 10" pneumatisch
1.6 16V (BA11, BA04, BA0B, BA1J)	79	03/99→08/03		für Fahrzeuge ohne verstärktes Fahrwerk			
				→ 12/02; + ABS; für Linkslenker		03.7760-5502.4 300151	ATE Ø 10" pneumatisch
				→ 12/02; + ABS; für Linkslenker;		03.7760-5502.4 300151	ATE Ø 10" pneumatisch
				für Fahrzeuge mit verstärktem Fahrwerk			
				→ 12/02; - ABS		03.7760-5602.4 300121	ATE Ø 10" pneumatisch
				→ 12/02; - ABS;		03.7760-5602.4 300121	ATE Ø 10" pneumatisch
				für Fahrzeuge mit verstärktem Fahrwerk			
1.6 LPG	80	10/00→08/02		+ ABS; für Linkslenker;		03.7760-5102.4 300140	ATE Ø 10" pneumatisch
				für Fahrzeuge ohne verstärktes Fahrwerk			
				+ ABS; für Linkslenker		03.7760-5502.4 300151	ATE Ø 10" pneumatisch
						03.7863-2002.4 300126	ATE Ø 10" pneumatisch
				+ ABS; für Linkslenker;		03.7760-5502.4 300151	ATE Ø 10" pneumatisch
				für Fahrzeuge mit verstärktem Fahrwerk			
				- ABS		03.7760-5602.4 300121	ATE Ø 10" pneumatisch
				- ABS;		03.7760-5602.4 300121	ATE Ø 10" pneumatisch
				für Fahrzeuge mit verstärktem Fahrwerk			
1.8 16V (BA06, BA12, BA1A, BA1M, BA1R)	85	01/01→08/03		→ 12/02; für Linkslenker		03.7863-2002.4 300126	ATE Ø 10" pneumatisch
1.9 dCi (BA05, BA1F)	75	02/01→08/03		→ 12/02; + ABS; für Linkslenker		03.7760-5102.4 300140	ATE Ø 10" pneumatisch
						03.7863-2002.4 300126	ATE Ø 10" pneumatisch
				→ 12/02; - ABS		03.7760-5602.4 300121	ATE Ø 10" pneumatisch
1.9 D Eco (B/SA0U, BA0A)	47	01/96→08/03		06/98→ 12/02; + ABS; für Linkslenker		03.7760-5502.4 300151	ATE Ø 10" pneumatisch
				06/98→ 12/02; - ABS		03.7760-5602.4 300121	ATE Ø 10" pneumatisch
1.9 dTi (BA08, BA0N)	72	03/97→02/01		03/99→; für Linkslenker		03.7760-5102.4 300140	ATE Ø 10" pneumatisch
1.9 dTi (BA1U)	59	02/01→08/03		→ 12/02; + ABS; für Linkslenker		03.7863-2002.4 300126	ATE Ø 10" pneumatisch
 Hauptbremszylinder							
1.4 16V (BA0D, BA1H, BA0W, BA10)	70	03/99→08/03		→ 12/02; für Rechtslenker		03.2120-4441.3 010510	ATE Ø 20,64
				→ 12/02; + ABS; für Linkslenker		03.2122-1521.3 010494	Ø 22,2
				→ 12/02; - ABS		03.2122-1541.3 010511	Ø 22,2
1.4 e (BA0E, BA0V)	55	01/96→08/03		06/98→ 02/99; - ABS		03.2120-2031.3 010106	ATE Ø 20,64
				→ 12/02; - ABS		03.2120-2031.3 010106	ATE Ø 20,64
				06/98→ 02/99; + ABS		03.2120-4441.3 010510	ATE Ø 20,64
				03/99→ 12/02; + ABS		03.2122-1521.3 010494	Ø 22,2
				03/99→ 12/02; - ABS		03.2122-1541.3 010511	Ø 22,2
				→ 12/02; + ABS; für Linkslenker		24.2120-1723.3 010545	BDX Ø 20,64
				→ 12/02; + ABS; für Rechtslenker		24.2120-1725.3 010579	BDX Ø 20,64
1.4 Eco (BA0T)	52	01/96→03/99		- ABS		03.2120-2031.3 010106	ATE Ø 20,64
1.6 i (BA0L)	55	01/96→03/99		+ ABS		24.2120-1723.3 010545	BDX Ø 20,64
1.6 16V	81	11/01→12/04		→ 12/02; + ABS; für Linkslenker;		03.2122-1521.3 010494	Ø 22,2
1.6 16V (BA11, BA04, BA0B, BA1J)	79	03/99→08/03		für Fahrzeuge mit verstärktem Fahrwerk			
				→ 12/02; + ABS		03.2122-1521.3 010494	Ø 22,2
				→ 12/02; - ABS;		03.2122-1541.3 010511	Ø 22,2
				für Fahrzeuge mit verstärktem Fahrwerk			
				→ 12/02; - ABS		03.2122-1541.3 010511	Ø 22,2
				→ 12/02; + ABS; für Linkslenker		03.2123-2146.3 010572	Ø 23,81
				→ 12/02; + ABS; für Linkslenker;		03.2123-2146.3 010572	Ø 23,81
				für Fahrzeuge ohne verstärktes Fahrwerk			
1.6 e (BA0F, BA0S)	66	01/96→03/99		- ABS		03.2120-2031.3 010106	ATE Ø 20,64
				+ ABS; für Linkslenker		24.2120-1723.3 010545	BDX Ø 20,64
				+ ABS		24.2120-1723.3 010545	BDX Ø 20,64











	kw			 	! #		
RENAULT - MEGANE I (BA0/1_) 08/95→12/04							
 Hauptbremszylinder							
1.6 e (BA0F, BA0S)	66	01/96→03/99		+ ABS; für Rechtslenker		24.2120-1725.3 010579	BDX Ø 20,64
1.6 LPG	66	08/95→03/99		01/96→; - ABS		03.2120-2031.3 010106	ATE Ø 20,64
				01/96→; + ABS		24.2120-1723.3 010545	BDX Ø 20,64
				01/96→; + ABS; für Linkslenker		24.2120-1723.3 010545	BDX Ø 20,64
				01/96→; + ABS; für Rechtslenker		24.2120-1725.3 010579	BDX Ø 20,64
1.6 LPG	80	10/00→08/02		+ ABS		03.2122-1521.3 010494	Ø 22,2
				+ ABS; für Linkslenker; für Fahrzeuge mit verstärktem Fahrwerk		03.2122-1521.3 010494	Ø 22,2
				- ABS; für Fahrzeuge mit verstärktem Fahrwerk		03.2122-1541.3 010511	Ø 22,2
				- ABS		03.2122-1541.3 010511	Ø 22,2
				+ ABS; für Linkslenker		03.2123-2146.3 010572	Ø 23,81
				+ ABS; für Linkslenker; für Fahrzeuge ohne verstärktes Fahrwerk		03.2123-2146.3 010572	Ø 23,81
1.8 16V (BA06, BA12, BA1A, BA1M, BA1R)	85	01/01→08/03		→ 12/02; für Linkslenker		03.2123-2146.3 010572	Ø 23,81
1.9 D	69	04/96→02/01		09/96→; - ABS		03.2120-2031.3 010106	ATE Ø 20,64
				09/96→; + ABS		24.2120-1723.3 010545	BDX Ø 20,64
1.9 DCi	77	03/99→08/03		→ 12/02; + ABS; für Linkslenker		03.2123-2146.3 010572	Ø 23,81
1.9 dTi (BA1U)	59	02/01→08/03					
1.9 dCi (BA05, BA1F)	75	02/01→08/03		→ 12/02; - ABS		03.2122-1541.3 010511	Ø 22,2
				→ 12/02; + ABS; für Linkslenker		03.2123-2146.3 010572	Ø 23,81
1.9 D Eco (B/SA0U, BA0A)	47	01/96→08/03		→ 12/02; - ABS; für Fahrschulwagen		03.2119-3389.3 010057	ATE Ø 19,05
				→ 12/02; - ABS; für Linkslenker; nicht für Fahrschulwagen		03.2120-2031.3 010106	ATE Ø 20,64
				→ 12/02; - ABS; für Rechtslenker		03.2120-2031.3 010106	ATE Ø 20,64
				→ 12/02; - ABS		03.2120-2031.3 010106	ATE Ø 20,64
				06/98→ 12/02; für Rechtslenker		03.2120-4441.3 010510	ATE Ø 20,64
				→ 12/02; + ABS; für Linkslenker; nicht für Fahrschulwagen		03.2120-4441.3 010510	ATE Ø 20,64
						24.2120-1723.3 010545	BDX Ø 20,64
				→ 12/02; + ABS; für Linkslenker		03.2120-4441.3 010510	ATE Ø 20,64
						24.2120-1723.3 010545	BDX Ø 20,64
				06/98→ 12/02; für Linkslenker; + ABS		03.2122-1521.3 010494	Ø 22,2
				06/98→ 12/02; - ABS		03.2122-1541.3 010511	Ø 22,2
				→ 03/99; + ABS; für Rechtslenker		24.2120-1725.3 010579	BDX Ø 20,64
				→ 12/02; + ABS; für Rechtslenker		24.2120-1725.3 010579	BDX Ø 20,64
1.9 dT	76	08/98→10/99		- ABS		03.2120-2031.3 010106	ATE Ø 20,64
						03.2122-1541.3 010511	Ø 22,2
				+ ABS		03.2120-4441.3 010510	ATE Ø 20,64
						24.2120-1723.3 010545	BDX Ø 20,64
				+ ABS; für Linkslenker		03.2120-4441.3 010510	ATE Ø 20,64
						24.2120-1723.3 010545	BDX Ø 20,64
1.9 dT (B/SA0K, B/SA0Y)	66	01/96→08/03		03/99→; + ABS		03.2122-1521.3 010494	Ø 22,2
				+ ABS; für Rechtslenker		24.2120-1725.3 010579	BDX Ø 20,64
				→ 12/02; - ABS		03.2120-2031.3 010106	ATE Ø 20,64
						03.2122-1541.3 010511	Ø 22,2
				03/96→ 12/02; - ABS		03.2120-2031.3 010106	ATE Ø 20,64
				→ 12/02; + ABS		03.2120-4441.3 010510	ATE Ø 20,64
						24.2120-1723.3 010545	BDX Ø 20,64
1.9 dTi (BA08, BA0N)	72	03/97→02/01		→ 12/02; + ABS; für Linkslenker		03.2120-4441.3 010510	ATE Ø 20,64
						24.2120-1723.3 010545	BDX Ø 20,64
				03/99→ 12/02; + ABS		03.2122-1521.3 010494	Ø 22,2
				→ 12/02; + ABS; für Rechtslenker		24.2120-1725.3 010579	BDX Ø 20,64
				- ABS		03.2120-2031.3 010106	ATE Ø 20,64
						03.2122-1541.3 010511	Ø 22,2
				→ 02/99; + ABS		03.2120-4441.3 010510	ATE Ø 20,64
						24.2120-1723.3 010545	BDX Ø 20,64
				+ ABS; für Linkslenker		03.2120-4441.3 010510	ATE Ø 20,64
						24.2120-1723.3 010545	BDX Ø 20,64
				→ 02/99; + ABS; für Linkslenker		03.2120-4441.3 010510	ATE Ø 20,64
						24.2120-1723.3 010545	BDX Ø 20,64
				+ ABS		03.2122-1521.3 010494	Ø 22,2
				03/99→; + ABS; für Linkslenker		03.2123-2146.3 010572	Ø 23,81











	kw			 	! #		
RENAULT - MEGANE I (BA0/1_) 08/95→12/04							
 Hauptbremszylinder							
1.9 dTi (BA08, BA0N)	72	03/97→02/01		03/99→; + ABS	03.2123-2146.3	010572	Ø 23,81
				→ 02/99; + ABS; für Rechtslenker	24.2120-1725.3	010579	BDX Ø 20,64
				+ ABS; für Rechtslenker	24.2120-1725.3	010579	BDX Ø 20,64
1.9 TDI	69	09/96→08/03		→ 12/02; - ABS	03.2120-2031.3	010106	ATE Ø 20,64
				→ 12/02; + ABS	24.2120-1723.3	010545	BDX Ø 20,64
2.0 16V (BA0H)	108	07/96→08/03		→ 12/02	24.2123-1701.3	010424	Ø 23,81
2.0 i	80	03/99→08/03		→ 12/02	03.2120-2031.3	010106	ATE Ø 20,64
2.0 i (BA0G)	84	01/96→08/03		→ 12/02; - ABS	03.2120-2031.3	010106	ATE Ø 20,64
				→ 12/02; + ABS; für Linkslenker	03.2122-1541.3	010511	Ø 22,2
				→ 12/02; + ABS; für Linkslenker	03.2120-4441.3	010510	ATE Ø 20,64
				→ 12/02; + ABS; für Rechtslenker	24.2120-1723.3	010545	BDX Ø 20,64
				→ 12/02; + ABS	03.2122-1521.3	010494	Ø 22,2
				→ 12/02; + ABS; für Rechtslenker	24.2120-1725.3	010579	BDX Ø 20,64
RENAULT - MEGANE I Cabriolet (EA0/1_) 10/96→08/03							
 Bremskraftverstärker							
1.4 16V (EA0D, EA1H, EA0W, EA10)	70	03/99→08/03		+ ABS; für Linkslenker	03.7760-5502.4	300151	ATE Ø 10" pneumatisch
				- ABS	03.7760-5602.4	300121	ATE Ø 10" pneumatisch
				10/00→; + ABS; für Linkslenker	03.7863-2002.4	300126	ATE Ø 10" pneumatisch
1.6 16V (EA0B, EA04, EA11)	79	03/99→08/03		+ ABS; für Linkslenker	03.7760-5102.4	300140	ATE Ø 10" pneumatisch
				10/00→; - ABS	03.7760-5602.4	300121	ATE Ø 10" pneumatisch
				10/00→; + ABS; für Linkslenker	03.7863-2002.4	300126	ATE Ø 10" pneumatisch
2.0 16V	102	01/02→08/03		für Linkslenker	03.7760-5102.4	300140	ATE Ø 10" pneumatisch
2.0 16V IDE (EA03, EA0P, EA14)	103	11/99→08/03		für Linkslenker	03.7760-5102.4	300140	ATE Ø 10" pneumatisch
				10/00→; - ABS	03.7760-5602.4	300121	ATE Ø 10" pneumatisch
				10/00→; + ABS; für Linkslenker	03.7863-2002.4	300126	ATE Ø 10" pneumatisch
 Hauptbremszylinder							
1.4 16V (EA0D, EA1H, EA0W, EA10)	70	03/99→08/03		+ ABS; für Linkslenker	03.2122-1521.3	010494	Ø 22,2
				- ABS	03.2122-1541.3	010511	Ø 22,2
				10/00→; + ABS; für Linkslenker	03.2123-2146.3	010572	Ø 23,81
1.6 16V (EA0B, EA04, EA11)	79	03/99→08/03		10/00→; - ABS	03.2122-1541.3	010511	Ø 22,2
				+ ABS; für Linkslenker	03.2123-2146.3	010572	Ø 23,81
				10/00→; + ABS; für Linkslenker	03.2123-2146.3	010572	Ø 23,81
1.6 e (EA0F) 2.0 (EA0G) 2.0 i (EA0G)	66 84 80	10/96→03/99 04/97→08/03 03/99→08/03		- ABS; für Linkslenker	03.2120-2031.3	010106	ATE Ø 20,64
				+ ABS; für Linkslenker	03.2120-4441.3	010510	ATE Ø 20,64
				+ ABS; für Rechtslenker	24.2120-1723.3	010545	BDX Ø 20,64
2.0 16V	102	01/02→08/03		für Linkslenker	03.2123-2146.3	010572	Ø 23,81
2.0 16V (EA0H)	108	10/96→11/99			24.2123-1701.3	010424	Ø 23,81
2.0 16V IDE (EA03, EA0P, EA14)	103	11/99→08/03		10/00→; - ABS	03.2122-1541.3	010511	Ø 22,2
				für Linkslenker	03.2123-2146.3	010572	Ø 23,81
				10/00→; + ABS; für Linkslenker	03.2123-2146.3	010572	Ø 23,81
RENAULT - MEGANE I Classic (LA0/1_) 09/96→08/08							
 Bremskraftverstärker							
1.4 (LA0E, LA0V)	55	09/96→08/03		09/98→ 12/02; + ABS	03.7760-5502.4	300151	ATE Ø 10" pneumatisch
				04/98→ 12/02; + ABS	03.7760-5602.4	300121	ATE Ø 10" pneumatisch
1.4 16V (LA0D, LA1H, IA0W, LA10)	70	03/99→08/03		→ 12/02; + ABS; für Linkslenker	03.7760-5502.4	300151	ATE Ø 10" pneumatisch
				→ 12/02; - ABS	03.7863-2002.4	300126	ATE Ø 10" pneumatisch
1.6	64	02/00→09/00		+ ABS	03.7760-5502.4	300151	ATE Ø 10" pneumatisch
				- ABS	03.7760-5602.4	300121	ATE Ø 10" pneumatisch
1.6 16V	81	09/99→12/01		+ ABS; für Linkslenker; für Fahrzeuge ohne verstärktes Fahrwerk	03.7760-5102.4	300140	ATE Ø 10" pneumatisch
				+ ABS; für Linkslenker; für Fahrzeuge mit verstärktem Fahrwerk	03.7760-5502.4	300151	ATE Ø 10" pneumatisch
				+ ABS	03.7760-5502.4	300151	ATE Ø 10" pneumatisch
				- ABS; für Fahrzeuge mit verstärktem Fahrwerk	03.7760-5602.4	300121	ATE Ø 10" pneumatisch
				- ABS	03.7760-5602.4	300121	ATE Ø 10" pneumatisch
↓							













	kw			 	! #		
RENAULT - MEGANE I Classic (LA0/1) 09/96→08/08							
Bremskraftverstärker							
1.6 16V (La04, LA11, LA0B, LA1C, LA1J)	79	03/99→08/03	→ 12/02; + ABS; für Linkslenker; für Fahrzeuge ohne verstärktes Fahrwerk	03.7760-5102.4	300140	ATE Ø 10" pneumatisch	
			→ 12/02; + ABS; für Linkslenker; für Fahrzeuge mit verstärktem Fahrwerk	03.7760-5502.4	300151	ATE Ø 10" pneumatisch	
			09/99→ 12/02; + ABS	03.7760-5502.4	300151	ATE Ø 10" pneumatisch	
			09/99→ 12/02; - ABS	03.7760-5602.4	300121	ATE Ø 10" pneumatisch	
			→ 12/02; - ABS; für Fahrzeuge mit verstärktem Fahrwerk	03.7760-5602.4	300121	ATE Ø 10" pneumatisch	
1.6 e (LA0F, LA0S)	66	09/96→03/99	+ ABS; für Linkslenker	03.7760-5502.4	300151	ATE Ø 10" pneumatisch	
			- ABS; für Linkslenker; für Fahrzeuge mit verstärktem Fahrwerk	03.7760-5602.4	300121	ATE Ø 10" pneumatisch	
1.8 16V (LA06, LA12, LA1A, LA1M, LA1R)	85	01/01→08/03	→ 12/02; + ABS; für Linkslenker	03.7863-2002.4	300126	ATE Ø 10" pneumatisch	
1.9 D (LA0A, LA0U)	47	09/96→08/03	09/98→ 12/02; + ABS; für Linkslenker	03.7760-5502.4	300151	ATE Ø 10" pneumatisch	
			09/98→ 12/02; - ABS	03.7760-5602.4	300121	ATE Ø 10" pneumatisch	
1.9 dCi (LA05, LA1F)	75	02/01→08/03	→ 12/02; + ABS; für Linkslenker	03.7760-5102.4	300140	ATE Ø 10" pneumatisch	
				03.7863-2002.4	300126	ATE Ø 10" pneumatisch	
1.9 dTi (LA08, LA0N)	72	03/97→02/01	03/99→; für Linkslenker	03.7760-5102.4	300140	ATE Ø 10" pneumatisch	
			03/99→; + ABS; für Linkslenker	03.7760-5502.4	300151	ATE Ø 10" pneumatisch	
			- ABS	03.7760-5602.4	300121	ATE Ø 10" pneumatisch	
			+ ABS; für Linkslenker	03.7863-2002.4	300126	ATE Ø 10" pneumatisch	
1.9 TDI	69	09/96→08/03	→ 12/02; + ABS	03.7760-5502.4	300151	ATE Ø 10" pneumatisch	
			→ 12/02; - ABS	03.7760-5602.4	300121	ATE Ø 10" pneumatisch	
2.0 i (LA07, LA0G)	84	09/96→08/03	09/98→ 12/02; + ABS; für Linkslenker	03.7760-5502.4	300151	ATE Ø 10" pneumatisch	
			→ 12/02; - ABS; für Linkslenker	03.7760-5602.4	300121	ATE Ø 10" pneumatisch	
2.0 RT	103	03/01→08/03	→ 02/03; - ABS	03.7760-5602.4	300121	ATE Ø 10" pneumatisch	
			→ 02/03; + ABS; für Linkslenker	03.7863-2002.4	300126	ATE Ø 10" pneumatisch	
Hauptbremszylinder							
1.4 (LA0E, LA0V)	55	09/96→08/03	→ 12/02; - ABS	03.2120-2031.3	010106	ATE Ø 20,64	
			→ 03/99; + ABS	03.2120-4441.3	010510	ATE Ø 20,64	
			03/99→ 12/02; + ABS	03.2122-1521.3	010494	Ø 22,2	
			04/98→ 12/02; - ABS	03.2122-1541.3	010511	Ø 22,2	
			→ 12/02; + ABS	24.2120-1723.3	010545	BDX Ø 20,64	
			09/98→ 02/99; + ABS	24.2120-1723.3	010545	BDX Ø 20,64	
1.4 16V (LA0D, LA1H, IA0W, LA10)	70	03/99→08/03	→ 12/02; + ABS; für Rechtslenker	03.2120-4441.3	010510	ATE Ø 20,64	
			→ 12/02; + ABS; für Linkslenker	03.2122-1521.3	010494	Ø 22,2	
			→ 12/02; - ABS	03.2122-1541.3	010511	Ø 22,2	
1.6	64	02/00→09/00	+ ABS	03.2122-1521.3	010494	Ø 22,2	
			- ABS	03.2122-1541.3	010511	Ø 22,2	
1.6 16V	81	09/99→12/01	+ ABS; für Linkslenker; für Fahrzeuge mit verstärktem Fahrwerk	03.2122-1521.3	010494	Ø 22,2	
				03.2122-1521.3	010494	Ø 22,2	
			- ABS; für Fahrzeuge mit verstärktem Fahrwerk	03.2122-1541.3	010511	Ø 22,2	
			- ABS	03.2122-1541.3	010511	Ø 22,2	
			+ ABS; für Linkslenker; für Fahrzeuge ohne verstärktes Fahrwerk	03.2123-2146.3	010572	Ø 23,81	
1.6 16V (La04, LA11, LA0B, LA1C, LA1J)	79	03/99→08/03	09/99→ 12/02	03.2122-1521.3	010494	Ø 22,2	
			→ 12/02; + ABS; für Linkslenker; für Fahrzeuge mit verstärktem Fahrwerk	03.2122-1521.3	010494	Ø 22,2	
			09/99→ 12/02; - ABS	03.2122-1541.3	010511	Ø 22,2	
			→ 12/02; - ABS; für Fahrzeuge mit verstärktem Fahrwerk	03.2122-1541.3	010511	Ø 22,2	
			→ 12/02; + ABS; für Linkslenker; für Fahrzeuge ohne verstärktes Fahrwerk	03.2123-2146.3	010572	Ø 23,81	
1.6 e (LA0F, LA0S)	66	09/96→03/99	- ABS	03.2120-2031.3	010106	ATE Ø 20,64	
			+ ABS; für Linkslenker	03.2120-4441.3	010510	ATE Ø 20,64	
				24.2120-1723.3	010545	BDX Ø 20,64	
			+ ABS; für Rechtslenker	24.2120-1725.3	010579	BDX Ø 20,64	
1.6 i (LA0L)	55	09/96→03/99	- ABS	03.2120-2031.3	010106	ATE Ø 20,64	
			+ ABS	03.2120-4441.3	010510	ATE Ø 20,64	
				24.2120-1723.3	010545	BDX Ø 20,64	
1.8 16V (LA06, LA12, LA1A, LA1M, LA1R)	85	01/01→08/03	→ 12/02; + ABS; für Linkslenker	03.2123-2146.3	010572	Ø 23,81	
↓							

	kw					! #		
RENAULT - MEGANE I Classic (LA0/1_) 09/96→08/08								
 Hauptbremszylinder								
1.9 D (LA0A, LA0U)	47	09/96→08/03	→ 12/02; - ABS	03.2120-2031.3	010106	ATE Ø 20,64		
			→ 12/02; + ABS	03.2120-4441.3	010510	ATE Ø 20,64		
			24.2120-1723.3	010545	BDX Ø 20,64			
			→ 12/02; + ABS; für Linkslenker	03.2120-4441.3	010510	ATE Ø 20,64		
			24.2120-1723.3	010545	BDX Ø 20,64			
			09/98→ 12/02; + ABS; für Linkslenker	03.2122-1521.3	010494	Ø 22,2		
09/98→ 12/02; - ABS	03.2122-1541.3	010511	Ø 22,2					
1.9 dCi (LA05, LA1F)	75	02/01→08/03	→ 12/02; - ABS	03.2122-1541.3	010511	Ø 22,2		
			→ 12/02; + ABS; für Linkslenker	03.2123-2146.3	010572	Ø 23,81		
1.9 dT	76	08/98→10/99	- ABS	03.2120-2031.3	010106	ATE Ø 20,64		
			+ ABS; für Linkslenker	03.2120-4441.3	010510	ATE Ø 20,64		
			24.2120-1723.3	010545	BDX Ø 20,64			
			+ ABS	03.2120-4441.3	010510	ATE Ø 20,64		
24.2120-1723.3	010545	BDX Ø 20,64						
+ ABS; für Rechtslenker	24.2120-1725.3	010579	BDX Ø 20,64					
1.9 dT (LA0K, LA0Y)	66	09/96→08/03	→ 12/02; - ABS	03.2120-2031.3	010106	ATE Ø 20,64		
			→ 12/02; + ABS	03.2120-4441.3	010510	ATE Ø 20,64		
			24.2120-1723.3	010545	BDX Ø 20,64			
			→ 12/02; + ABS; für Linkslenker	03.2120-4441.3	010510	ATE Ø 20,64		
24.2120-1723.3	010545	BDX Ø 20,64						
→ 12/02; + ABS; für Rechtslenker	24.2120-1725.3	010579	BDX Ø 20,64					
1.9 dTi (LA08, LA0N)	72	03/97→02/01	- ABS	03.2120-2031.3	010106	ATE Ø 20,64		
			+ ABS; für Linkslenker	03.2120-4441.3	010510	ATE Ø 20,64		
			03.2123-2146.3	010572	Ø 23,81			
			24.2120-1723.3	010545	BDX Ø 20,64			
			08/99→; + ABS; für Linkslenker; für Fahrzeuge mit verstärktem Fahrwerk	03.2122-1521.3	010494	Ø 22,2		
			03/99→; - ABS; für Linkslenker	03.2122-1541.3	010511	Ø 22,2		
			+ ABS; für Linkslenker; für Fahrzeuge ohne verstärktes Fahrwerk	03.2123-2146.3	010572	Ø 23,81		
→ 02/99; + ABS; für Rechtslenker	24.2120-1725.3	010579	BDX Ø 20,64					
+ ABS; für Rechtslenker	24.2120-1725.3	010579	BDX Ø 20,64					
1.9 TDI	69	09/96→08/03	→ 12/02; + ABS	03.2122-1521.3	010494	Ø 22,2		
			→ 12/02; - ABS	03.2122-1541.3	010511	Ø 22,2		
2.0 i (LA07, LA0G)	84	09/96→08/03	→ 12/02; - ABS	03.2120-2031.3	010106	ATE Ø 20,64		
			→ 12/02	03.2120-2031.3	010106	ATE Ø 20,64		
			→ 12/02; + ABS; für Linkslenker	03.2120-4441.3	010510	ATE Ø 20,64		
			24.2120-1723.3	010545	BDX Ø 20,64			
			08/99→ 12/02; + ABS; für Linkslenker	03.2122-1521.3	010494	Ø 22,2		
			03/99→ 12/02; - ABS; für Linkslenker	03.2122-1541.3	010511	Ø 22,2		
→ 12/02; + ABS; für Rechtslenker	24.2120-1725.3	010579	BDX Ø 20,64					
2.0 RT	103	03/01→08/03	→ 02/03; - ABS	03.2122-1541.3	010511	Ø 22,2		
			→ 02/03; + ABS; für Linkslenker	03.2123-2146.3	010572	Ø 23,81		
2.0 RT	112	10/96→02/99		03.2120-2031.3	010106	ATE Ø 20,64		
			+ ABS; für Linkslenker	03.2120-4441.3	010510	ATE Ø 20,64		
RENAULT - MEGANE I Coach (DA0/1_) 03/96→08/03								
 Bremskraftverstärker								
1.4 16V (DA0D, DA1H, DA0W, DA10)	70	03/99→08/03	→ 02/03; + ABS; für Linkslenker	03.7760-5502.4	300151	ATE Ø 10" pneumatisch		
			→ 02/03; - ABS	03.7760-5602.4	300121	ATE Ø 10" pneumatisch		
			10/00→ 02/03; + ABS; für Linkslenker	03.7863-2002.4	300126	ATE Ø 10" pneumatisch		
1.6 16V (DA0B, DA04, DA11)	79	03/99→08/03	→ 02/03; + ABS; für Linkslenker	03.7760-5102.4	300140	ATE Ø 10" pneumatisch		
			10/00→ 02/03; - ABS	03.7760-5602.4	300121	ATE Ø 10" pneumatisch		
			10/00→ 02/03; + ABS; für Linkslenker	03.7863-2002.4	300126	ATE Ø 10" pneumatisch		
1.9 dCi (DA05, DA1F)	75	02/01→08/03	→ 02/03; + ABS; für Linkslenker	03.7760-5102.4	300140	ATE Ø 10" pneumatisch		
				03.7863-2002.4	300126	ATE Ø 10" pneumatisch		
1.9 dTi (DA0N)	72	03/97→02/01	03/99→; für Linkslenker	03.7760-5102.4	300140	ATE Ø 10" pneumatisch		
2.0 16V (DA0H)	108	03/96→11/99						
2.0 16V	102	01/02→08/03	→ 02/03; für Linkslenker	03.7760-5102.4	300140	ATE Ø 10" pneumatisch		
			→ 02/03; - ABS	03.7760-5602.4	300121	ATE Ø 10" pneumatisch		
			→ 02/03; + ABS; für Linkslenker	03.7863-2002.4	300126	ATE Ø 10" pneumatisch		
↓								

	kw					! #		
RENAULT - MEGANE I Coach (DA0/1_) 03/96→08/03								
 Bremskraftverstärker								
2.0 16V IDE (DA03, DA0P, DA14)	103	11/99→08/03		→ 02/03; für Linkslenker		03.7760-5102.4	300140	ATE Ø 10" pneumatisch
				10/00→ 02/03; - ABS		03.7760-5602.4	300121	ATE Ø 10" pneumatisch
				10/00→ 02/03; + ABS; für Linkslenker		03.7863-2002.4	300126	ATE Ø 10" pneumatisch
 Hauptbremszylinder								
1.4 16V (DA0D, DA1H, DA0W, DA10)	70	03/99→08/03		→ 02/03; für Rechtslenker		03.2120-4441.3	010510	ATE Ø 20,64
				→ 02/03; + ABS; für Linkslenker		03.2122-1521.3	010494	Ø 22,2
				→ 02/03; - ABS		03.2122-1541.3	010511	Ø 22,2
				10/00→ 02/03; + ABS; für Linkslenker		03.2123-2146.3	010572	Ø 23,81
1.6 16V (DA0B, DA04, DA11)	79	03/99→08/03		10/00→ 02/03; - ABS		03.2122-1541.3	010511	Ø 22,2
				10/00→ 02/03; + ABS; für Linkslenker		03.2123-2146.3	010572	Ø 23,81
				→ 02/03; + ABS; für Linkslenker		03.2123-2146.3	010572	Ø 23,81
1.6 e (DA0F)	66	03/96→03/99		- ABS; für Linkslenker		03.2120-2031.3	010106	ATE Ø 20,64
				+ ABS; für Linkslenker		03.2120-4441.3	010510	ATE Ø 20,64
				24.2120-1723.3	010545	BDX Ø 20,64		
			+ ABS; für Rechtslenker		03.2120-4441.3	010510	ATE Ø 20,64	
			24.2120-1725.3	010579	BDX Ø 20,64			
1.9 dCi (DA05, DA1F) 2.0 16V	75 102	02/01→08/03 01/02→08/03		→ 02/03; - ABS		03.2122-1541.3	010511	Ø 22,2
				→ 02/03; + ABS; für Linkslenker		03.2123-2146.3	010572	Ø 23,81
1.9 dTi (DA0N)	72	03/97→02/01		05/97→; - ABS		03.2120-2031.3	010106	ATE Ø 20,64
				05/97→ 02/99; + ABS		03.2120-4441.3	010510	ATE Ø 20,64
				24.2120-1723.3	010545	BDX Ø 20,64		
			03/99→; + ABS		03.2123-2146.3	010572	Ø 23,81	
2.0 16V (DA0H)	108	03/96→11/99		03/99→; für Linkslenker		03.2123-2146.3	010572	Ø 23,81
				→ 02/99		24.2123-1701.3	010424	Ø 23,81
2.0 16V IDE (DA03, DA0P, DA14)	103	11/99→08/03		10/00→ 02/03; - ABS		03.2122-1541.3	010511	Ø 22,2
				10/00→ 02/03; + ABS; für Linkslenker		03.2123-2146.3	010572	Ø 23,81
				→ 02/03; für Linkslenker		03.2123-2146.3	010572	Ø 23,81
2.0 i 2.0 i (DA0G)	80 84	03/99→08/03 03/96→08/03		→ 02/03; - ABS; für Linkslenker		03.2120-2031.3	010106	ATE Ø 20,64
				→ 02/03; + ABS; für Linkslenker		03.2120-4441.3	010510	ATE Ø 20,64
				24.2120-1723.3	010545	BDX Ø 20,64		
				→ 02/03; + ABS; für Rechtslenker		03.2120-4441.3	010510	ATE Ø 20,64
			24.2120-1725.3	010579	BDX Ø 20,64			
RENAULT - MEGANE I Grandtour (KA0/1_) 03/99→08/03								
 Bremskraftverstärker								
1.4 16V (KA0D, KA1H, KA0W, KA10)	70	03/99→08/03		+ ABS; Motorcode: KA0W; für Fahrzeuge mit verstärktem Fahrwerk		03.7760-5502.4	300151	ATE Ø 10" pneumatisch
				- ABS		03.7760-5602.4	300121	ATE Ø 10" pneumatisch
				+ ABS; für Linkslenker; Motorcode: KA0D		03.7863-2002.4	300126	ATE Ø 10" pneumatisch
1.4 e (KA0V) 1.6 e (KA0F) 1.9 D (KA0J, KA0R)	55 66 47	03/99→08/03 03/99→08/03 04/99→08/03		+ ABS; für Fahrzeuge mit verstärktem Fahrwerk		03.7760-5502.4	300151	ATE Ø 10" pneumatisch
				- ABS		03.7760-5602.4	300121	ATE Ø 10" pneumatisch
1.6 16V (KA0B, KA04, KA11)	79	03/99→08/03		+ ABS; für Linkslenker; Motorcode: KA04; für Fahrzeuge ohne verstärktes Fahrwerk		03.7760-5102.4	300140	ATE Ø 10" pneumatisch
				- ABS		03.7760-5602.4	300121	ATE Ø 10" pneumatisch
				+ ABS; für Linkslenker; Motorcode: KA0B		03.7863-2002.4	300126	ATE Ø 10" pneumatisch
1.6 Bifuel	80	03/99→09/00		- ABS		03.7760-5602.4	300121	ATE Ø 10" pneumatisch
1.8 16V (KA0S, KA12, KA1A, KA1M, KA1R)	85	01/01→08/03		+ ABS; für Linkslenker		03.7863-2002.4	300126	ATE Ø 10" pneumatisch
1.9 dCi (KA05, KA1F)	75	02/01→08/03		+ ABS; für Linkslenker; Motorcode: KA05; für Fahrzeuge ohne verstärktes Fahrwerk		03.7760-5102.4	300140	ATE Ø 10" pneumatisch
				+ ABS; für Linkslenker; Motorcode: KA1F		03.7863-2002.4	300126	ATE Ø 10" pneumatisch
1.9 dTi (KA0N)	72	03/99→02/01		+ ABS; für Linkslenker; Motorcode: KA0N; für Fahrzeuge ohne verstärktes Fahrwerk		03.7760-5102.4	300140	ATE Ø 10" pneumatisch
				- ABS; Motorcode: KA0N		03.7760-5602.4	300121	ATE Ø 10" pneumatisch
1.9 dTi (KA1U)	59	02/01→08/03		- ABS; Motorcode: KA1U		03.7760-5602.4	300121	ATE Ø 10" pneumatisch
				+ ABS; für Linkslenker; Motorcode: KA1U		03.7863-2002.4	300126	ATE Ø 10" pneumatisch
↓								

	kw			 	! #		
RENAULT - MEGANE I Grandtour (KA0/1_) 03/99→08/03							
 Hauptbremszylinder							
1.4 16V (KA0D, KA1H, KA0W, KA10)	70	03/99→08/03		+ ABS		03.2122-1521.3 010494	Ø 22,2
1.4 e (KA0V)	55	03/99→08/03		- ABS		03.2122-1541.3 010511	Ø 22,2
1.6 e (KA0F)	66	03/99→08/03					
1.9 D (KA0J, KA0R)	47	04/99→08/03					
1.6 16V (KA0B, KA04, KA11)	79	03/99→08/03		- ABS		03.2123-1551.3 010512	Ø 23,81
1.6 Bifuel	80	03/99→09/00		+ ABS		03.2123-2146.3 010572	Ø 23,81
1.9 dCi (KA05, KA1F)	75	02/01→08/03					
1.9 dTi (KA0N)	72	03/99→02/01					
1.8 16V (KA0S, KA12, KA1A, KA1M, KA1R)	85	01/01→08/03		+ ABS		03.2123-2146.3 010572	Ø 23,81
						03.2123-2621.3 010701	ATE Ø 23,81
1.9 dTi (KA1U)	59	02/01→08/03		- ABS		03.2123-2146.3 010572	Ø 23,81
				+ ABS		03.2123-2621.3 010701	ATE Ø 23,81
RENAULT - MEGANE II (BM0/1_, CM0/1_) 11/02→01/11							
 Hauptbremszylinder							
1.4 16V	60	10/03→02/08				24.2123-1760.3 010779	TRW Ø 23,81
1.4 16V (BM0B, CM0B)	72	11/02→02/08					
1.5 dCi	63	05/05→02/08					
1.5 dCi	76	01/07→02/08					
1.5 dCi	78	05/05→06/08					
1.5 dCi (BM0F, CM0F)	60	11/02→02/08					
1.6	77	06/05→02/08					
1.6 16V	82	01/06→06/08					
1.6 16V (BM0C, CM0C)	83	11/02→02/08					
1.6 Flex-Fuel	77	01/07→02/08					
1.9 dCi (BM0G, CM0G)	88	11/02→02/08					
2.0	102	06/06→12/10					
2.0	169	08/06→02/08					
2.0 16V (BM0U, CM0U)	99	11/02→02/08					
2.0 16V Turbo	120	05/04→02/08					
2.0 dCi	127	01/07→02/08					
2.0 dCi (BM1K, CM1K)	110	09/05→02/08					
1.6 Bifuel	77	06/05→02/08		01/07→		24.2123-1760.3 010779	TRW Ø 23,81
1.9 dCi	68	03/04→08/06		01/06→		24.2123-1760.3 010779	TRW Ø 23,81
1.9 dCi	81	05/05→02/08					
1.9 dCi	85	11/02→02/08					
1.9 dCi	96	05/05→12/09		→ 11/08		24.2123-1760.3 010779	TRW Ø 23,81
2.0 Renault Sport	165	05/04→10/09					
RENAULT - MEGANE II Coupé-Cabriolet (EM0/1_) 09/03→12/09							
 Hauptbremszylinder							
1.5 dCi (EM16)	76	01/07→06/09				24.2123-1760.3 010779	TRW Ø 23,81
1.5 dCi (EM1E)	78	03/06→06/08					
1.6	77	06/05→03/09					
1.6	83	09/03→03/09					
1.9 dCi	81	05/05→03/09					
1.9 dCi	88	09/03→03/09					
1.9 dCi	96	05/05→02/07					
2.0	102	09/03→02/07					
2.0 16V Turbo	120	05/04→03/09					
2.0 dCi	110	09/05→03/09					
1.6 16V	82	01/06→06/08		01/07→		24.2123-1760.3 010779	TRW Ø 23,81
1.9 dCi	85	09/03→03/09		01/06→		24.2123-1760.3 010779	TRW Ø 23,81
2.0	99	09/03→12/09		→ 03/07		24.2123-1760.3 010779	TRW Ø 23,81
RENAULT - MEGANE II Grandtour (KM0/1_) 08/03→08/12							
 Hauptbremszylinder							
1.4	72	08/03→07/09		09/03→ 12/08		24.2123-1760.3 010779	TRW Ø 23,81
1.6	83	08/03→07/09					
1.9 dCi	88	08/03→07/09					
2.0	99	08/03→07/09					
1.5 dCi	60	08/03→05/06		09/03→		24.2123-1760.3 010779	TRW Ø 23,81
1.5 dCi	63	05/05→07/09		→ 12/08		24.2123-1760.3 010779	TRW Ø 23,81
1.5 dCi (KM13)	76	01/07→07/09					
1.6 16V Hi-Flex	77	02/08→07/09					
1.9 dCi	81	05/05→07/09					
1.9 dCi	85	05/05→07/09					
2.0 dCi	110	09/05→07/09					
1.5 dCi	74	02/04→03/06				24.2123-1760.3 010779	TRW Ø 23,81
1.5 dCi (KM16, KM1E)	78	05/05→06/08					
1.6 16V	75	05/05→07/09					
1.6 16V	77	05/05→07/09					
1.6 LPG 16V	82	01/06→08/09					
1.9 dCi	66	04/04→12/05					

	kw					! #		
RENAULT - MEGANE II Grandtour (KM0/1_) 08/03→08/12								
 Hauptbremszylinder								
1.9 dCi 2.0	68 102	03/04→02/07 12/06→01/11					24.2123-1760.3 010779	TRW Ø 23,81
1.6 16V	81	05/06→10/11			→ 07/09		24.2123-1760.3 010779	TRW Ø 23,81
1.6 16V 1.6 Flex	82 81	01/06→08/09 12/06→08/12			01/07→ 12/08		24.2123-1760.3 010779	TRW Ø 23,81
1.9 dCi	96	05/05→07/09			→ 02/07		24.2123-1760.3 010779	TRW Ø 23,81
RENAULT - MEGANE II Stufenheck (LM0/1_) 09/03→								
 Hauptbremszylinder								
1.4	60	09/03→			→ 08/06		24.2123-1760.3 010779	TRW Ø 23,81
1.4 1.5 dCi 1.5 dCi 1.6 1.6 1.6 1.6 Hi-Flex 1.9 dCi 1.9 dCi (LM0G, LM1G, LM2C) 1.9 dCi (LM14, LM1D) 2.0 dCi	72 60 78 75 77 83 85 96 88 81 110	09/03→ 09/03→ 05/05→ 09/03→ 05/05→ 09/03→ 03/06→ 05/05→ 09/03→ 05/05→ 09/05→			→ 12/08		24.2123-1760.3 010779	TRW Ø 23,81
1.5 dCi 1.5 dCi 1.9 dCi 2.0	63 76 68 99	05/05→ 01/07→ 03/04→ 09/03→			für Fahrzeuge ohne Sportfahrwerk; → 12/08		24.2123-1760.3 010779	TRW Ø 23,81
1.9 dCi 2.0	68 99	03/04→ 09/03→			für Fahrzeuge mit Sportfahrwerk; → 12/08		24.2125-1742.3 010978	TRW Ø 25,4
1.5 dCi	74	02/04→			→ 03/06; für Fahrzeuge ohne Sportfahrwerk		24.2123-1760.3 010779	TRW Ø 23,81
					→ 03/06; für Fahrzeuge mit Sportfahrwerk		24.2125-1742.3 010978	TRW Ø 25,4
1.6 2.0	81 101	09/03→11/08 04/06→11/10					24.2123-1760.3 010779	TRW Ø 23,81
1.6 16V	82	01/06→			01/07→ 12/08		24.2123-1760.3 010779	TRW Ø 23,81
1.9 dCi	66	09/03→12/05			für Fahrzeuge ohne Sportfahrwerk		24.2123-1760.3 010779	TRW Ø 23,81
					für Fahrzeuge mit Sportfahrwerk		24.2125-1742.3 010978	TRW Ø 25,4
RENAULT - MEGANE III Coupe (DZ0/1_) 11/08→								
 Hauptbremszylinder								
1.2 TCe 1.2 TCe (DZ16) 1.4 TCe (DZ0F, DZ1V) 1.5 dCi 1.5 dCi (DZ09, DZ0D, DZ1F, DZ1G) 1.5 dCi (DZ0A) 1.5 dCi (DZ0B) 1.5 dCi (DZ0C, DZ1A) 1.6 16V (DZ0H) 1.6 16V (DZ0U, DZ1B, DZ1H) 1.6 16V Bifuel (DZ03, DZ1Y) 1.6 dCi (DZ00) 1.9 dCi (DZ0N, DZ0J, DZ1J, DZ1K) 2.0 CVT (DZ0G, DZ1E) 2.0 dCi 2.0 dCi (DZ0L) 2.0 dCi (DZ0Y) 2.0 TCe (DZ0K) 2.0 TCe (DZ1N)	85 97 96 70 81 63 78 66 74 81 81 96 96 103 120 118 110 132 184	03/12→ 01/13→ 04/09→ 07/14→ 02/09→ 11/08→ 02/09→ 11/08→ 11/08→ 11/08→ 11/08→ 04/11→ 11/08→ 05/09→ 07/12→ 04/09→ 04/09→ 11/08→ 05/09→					24.4123-1715.3 010980	TRW Ø 23,81
RENAULT - MEGANE III Grandtour (KZ0/1) 11/08→								
 Hauptbremszylinder								
1.2 TCe 1.2 TCe (KZ16) 1.4 TCe (KZ0F, KZ1V) 1.5 dCi 1.5 dCi (KZ09, KZ0D, KZ1G, KZ1M, KZ1W) 1.5 dCi (KZ0C, KZ1A) 1.6 16V (KZ0H) 1.6 16V (KZ0U, KZ1B, KZ1U) 1.6 16V Bifuel (KZ03) 1.6 dCi (KZ00, KZ12) ↓	85 97 96 70 81 66 74 81 81 96	03/12→ 01/13→ 05/09→ 11/13→ 02/09→ 05/09→ 05/09→ 05/09→ 11/08→ 04/11→					24.4123-1715.3 010980	TRW Ø 23,81

	kw			 	! #		
RENAULT - MEGANE III Grandtour (KZ0/1) 11/08→							
 Hauptbremszylinder							
1.9 dCi (KZ0J, KZ0N, KZ1S)	96	05/09→				24.4123-1715.3 010980	TRW Ø 23,81
2.0 CVT (KZ0G, KZ1P)	103	05/09→					
2.0 dCi	120	07/12→					
2.0 dCi (KZ0L)	118	04/09→					
2.0 dCi (KZ0Y)	110	10/10→					
2.0 TCe	140	09/12→					
2.0 TCe	162	09/12→					
1.5 dCi	63	03/09→		08/09→		24.4123-1715.3 010980	TRW Ø 23,81
1.5 dCi (KZ1M, KZ1W)	78	02/09→		05/09→		24.4123-1715.3 010980	TRW Ø 23,81
2.0 TCe (KZ0K, KZ1T)	132	11/08→					
RENAULT - MEGANE III Schrägheck (BZ0_) 11/08→							
 Hauptbremszylinder							
1.2 TCe	85	03/12→				24.4123-1715.3 010980	TRW Ø 23,81
1.2 TCe (BZ16)	97	01/13→					
1.4 TCe (BZ0F, BZ1V)	96	04/09→					
1.5 dCi	63	12/09→					
1.5 dCi	70	11/13→					
1.5 dCi	78	02/09→					
1.5 dCi (BZ09, BZ0D)	81	02/09→					
1.5 dCi (BZ0C)	66	11/08→					
1.6 16V	82	11/08→					
1.6 16V	85	10/15→					
1.6 16V (BZ0H)	74	11/08→					
1.6 16V (BZ1B, BZ1H)	81	11/08→					
1.6 16V Bifuel (BZ03)	81	11/08→					
1.6 dCi (BZ00, BZ12)	96	04/11→					
1.9 dCi (BZ0N, BZ0J)	96	11/08→					
2.0	105	01/11→					
2.0 CVT (BZ0G, BZ1P)	103	02/09→					
2.0 dCi	120	07/12→					
2.0 dCi (BZ0L)	118	04/09→					
2.0 dCi (BZ0Y)	110	10/10→					
2.0 TCe (BZ0K)	132	11/08→					
RENAULT - MEGANE CC (EZ0/1_) 06/10→							
 Hauptbremszylinder							
1.2 TCe (EZ16)	97	01/13→		04/13→		24.4123-1715.3 010980	TRW Ø 23,81
1.4 TCe (EZ0F, EZ1V)	96	06/10→				24.4123-1715.3 010980	TRW Ø 23,81
1.5 dCi (EZ09, EZ1G, EZ0D)	81	06/10→					
1.6 16V (EZ0U, EZ1U)	81	06/10→					
1.6 dCi (EZ00)	96	04/11→					
1.9 dCi (EZ0J, EZ1S)	96	06/10→					
2.0 CVT (EZ0G, EZ1E, EZ1P)	103	06/10→					
2.0 dCi (EZ0L)	118	06/10→					
2.0 TCe (EZ1T)	132	06/10→					
2.0 Turbo	195	10/11→					
RENAULT - MEGANE Scenic (JA0/1_) 10/96→12/01							
 Bremskraftverstärker							
1.4 i (JA0E)	55	01/97→09/99		10/98→		03.7760-5102.4 300140	ATE Ø 10" pneumatisch
1.6 i (JA0L)	55	01/97→09/99					
1.6 16V (JA0B, JA04, JA11)	79	04/98→10/99		10/98→ 09/99; für Linkslenker		03.7760-5102.4 300140	ATE Ø 10" pneumatisch
1.6 e (JA0F)	66	10/96→10/99					
2.0 RXE 4x4	84	05/97→10/99					
1.9 D (JA0J)	47	03/97→09/99		10/98→; für Linkslenker		03.7760-5102.4 300140	ATE Ø 10" pneumatisch
1.9 dTi (JA0N)	72	04/97→09/99		10/98→		03.7760-5102.4 300140	ATE Ø 10" pneumatisch
2.0 i (JA02, JA0G)	80	01/99→09/99		für Linkslenker		03.7760-5102.4 300140	ATE Ø 10" pneumatisch
2.0 i (JA0G)	84	01/97→09/99		10/98→; für Linkslenker		03.7760-5102.4 300140	ATE Ø 10" pneumatisch
 Hauptbremszylinder							
1.4 i (JA0E)	55	01/97→09/99		→ 09/98; - ABS		03.2120-2031.3 010106	ATE Ø 20,64
1.6 i (JA0L)	55	01/97→09/99		10/98→; - ABS		03.2123-1551.3 010512	Ø 23,81
				10/98→; + ABS		03.2123-2146.3 010572	Ø 23,81
				→ 09/98; + ABS		24.2120-1723.3 010545	BDX Ø 20,64
1.6 16V (JA0B, JA04, JA11)	79	04/98→10/99		10/98→ 09/99; - ABS; für Linkslenker		03.2123-1551.3 010512	Ø 23,81
2.0 RXE 4x4	84	05/97→10/99		10/98→ 09/99; + ABS; für Linkslenker		03.2123-2146.3 010572	Ø 23,81
1.6 e (JA0F)	66	10/96→10/99		11/96→ 09/98; - ABS; Schaltgetriebe		03.2120-2031.3 010106	ATE Ø 20,64
				10/98→ 09/99; - ABS; für Linkslenker		03.2123-1551.3 010512	Ø 23,81
↓							

RENAULT - MEGANE Scenic (JA0/1_) 10/96→12/01

Hauptbremszylinder

1.6 e (JA0F)	66	10/96→10/99	10/98→09/99; + ABS; für Linkslenker	03.2123-2146.3	010572	Ø 23,81
			11/96→09/98; + ABS; für Linkslenker; Schaltgetriebe	24.2120-1723.3	010545	BDX Ø 20,64
			11/96→09/98; + ABS; für Rechtslenker; Schaltgetriebe	24.2120-1725.3	010579	BDX Ø 20,64
1.9 D (JA0J) 1.9 dTi (JA0N)	47 72	03/97→09/99 04/97→09/99	10/98→; - ABS	03.2123-1551.3	010512	Ø 23,81
			10/98→; - ABS; für Linkslenker	03.2123-1551.3	010512	Ø 23,81
			10/98→; + ABS	03.2123-2146.3	010572	Ø 23,81
2.0 i (JA02, JA0G)	80	01/99→09/99	10/98→; + ABS; für Linkslenker	03.2123-2146.3	010572	Ø 23,81
			- ABS; für Linkslenker	03.2123-1551.3	010512	Ø 23,81
			+ ABS; für Linkslenker	03.2123-2146.3	010572	Ø 23,81
2.0 i (JA0G)	84	01/97→09/99	10/98→; - ABS; für Linkslenker	03.2123-1551.3	010512	Ø 23,81
			10/98→; + ABS; für Linkslenker	03.2123-2146.3	010572	Ø 23,81

RENAULT - MODUS / GRAND MODUS (F/JP0_) 09/04→

Bremskraftverstärker

1.2 (FP0C, FP0K, FP0P) 1.2 (JP0S) 1.2 16V (JP0W)	48 58 74	05/05→ 12/04→ 05/07→	für Linkslenker; → 06/13; + ABS	03.7863-4502.4	300230	ATE Ø 10" pneumatisch			
			1.2 (JP0C, JP0K, FP0C, FP0K, FP0P, JP0P, JP0T)	55	12/04→	für Linkslenker; → 06/13; + ABS	03.7863-4502.4	300230	ATE Ø 10" pneumatisch
			→ 01/05; für Linkslenker	03.7863-6002.4	300249	ATE Ø 10" pneumatisch			
1.4 (JP01, JP0J)	72	12/04→	02/05→; für Linkslenker; → 10/07; + ABS	03.7863-4502.4	300230	ATE Ø 10" pneumatisch			
			→ 01/05; für Linkslenker	03.7863-6002.4	300249	ATE Ø 10" pneumatisch			
1.5 dCi (FP0D, JP0D) 1.5 dCi (FP0F, JP0F) 1.5 dCi (FP0G, JP0G) 1.6 (JP03, JP0B, JP0U, JP0Y, JP1G) 1.6 (JP0L, JP0V)	60 63 50 82	09/04→ 12/04→ 12/04→ 12/04→	02/05→; für Linkslenker; → 06/13; + ABS	03.7863-4502.4	300230	ATE Ø 10" pneumatisch			
			→ 01/05; für Linkslenker	03.7863-6002.4	300249	ATE Ø 10" pneumatisch			
			1.5 dCi (FP0E, JP0E)	48	12/04→	02/05→; für Linkslenker; → 06/13; + ABS	03.7863-4502.4	300230	ATE Ø 10" pneumatisch
			1.5 dCi (JP02)	76	05/07→	→ 10/07; für Linkslenker; + ABS	03.7863-4502.4	300230	ATE Ø 10" pneumatisch













Hauptbremszylinder











1.2 1.2 (FP0C, FP0K, FP0P) 1.2 (JP0S) 1.5 dCi 75 1.5 dCi 90	76 48 58 55 65	04/11→ 05/05→ 12/04→ 10/10→ 10/10→	→ 06/13; für Linkslenker; - ESP	03.2123-3241.3	010882	ATE Ø 23,81
			→ 06/13; für Linkslenker; + ESP	03.2123-3493.3	010792	ATE Ø 23,81
			1.2 (JP0C, JP0K, FP0C, FP0K, FP0P, JP0P, JP0T)	55	12/04→	für Linkslenker; → 06/13; - ABS
1.4 (JP01, JP0J) 1.5 dCi (FP0F, JP0F) 1.5 dCi (FP0G, JP0G)	72 63 50	12/04→ 12/04→ 12/04→	für Linkslenker; → 01/05; + ABS / - ESP	03.2123-2863.3	010790	ATE Ø 23,81
			für Linkslenker; → 01/05; + ESP	03.2123-2923.3	010791	ATE Ø 23,81
			02/05→; für Linkslenker; → 06/13; - ESP	03.2123-3241.3	010882	ATE Ø 23,81
			02/05→; für Linkslenker; → 06/13; + ESP	03.2123-3493.3	010792	ATE Ø 23,81
1.2 16V (JP0W) 1.5 dCi (JP02)	74 76	05/07→ 05/07→	für Linkslenker; → 06/13; - ABS	03.2123-2821.3	010944	ATE Ø 23,81
			→ 06/13; für Linkslenker; - ESP	03.2123-3241.3	010882	ATE Ø 23,81
			→ 06/13; für Linkslenker; + ESP	03.2123-3493.3	010792	ATE Ø 23,81
1.2 16V Hi-Flex 1.5 dCi (FP0D, JP0D)	55 60	10/08→ 09/04→	für Linkslenker; → 06/13; - ABS	03.2123-2821.3	010944	ATE Ø 23,81
			09/05→; für Linkslenker; → 06/13; - ABS	03.2123-2821.3	010944	ATE Ø 23,81
			für Linkslenker; → 01/05; + ABS / - ESP	03.2123-2863.3	010790	ATE Ø 23,81
			für Linkslenker; → 01/05; + ESP	03.2123-2923.3	010791	ATE Ø 23,81
			02/05→; für Linkslenker; → 06/13; - ESP	03.2123-3241.3	010882	ATE Ø 23,81
1.5 dCi (FP0E, JP0E)	48	12/04→	02/05→; für Linkslenker; → 06/13; + ESP	03.2123-3493.3	010792	ATE Ø 23,81
			02/05→; für Linkslenker; → 06/13; - ESP	03.2123-3241.3	010882	ATE Ø 23,81
1.5 dCi (JP0G, JP0H)	78	05/05→	02/05→; für Linkslenker; → 06/13; + ESP	03.2123-3493.3	010792	ATE Ø 23,81
			05/07→; für Linkslenker; → 06/13; - ESP	03.2123-3241.3	010882	ATE Ø 23,81
1.6 (JP03, JP0B, JP0U, JP0Y, JP1G) 1.6 (JP0L, JP0V)	82 65	12/04→ 12/04→	05/07→; für Linkslenker; → 06/13; + ESP	03.2123-3493.3	010792	ATE Ø 23,81
			für Linkslenker; → 06/13; - ABS	03.2123-2821.3	010944	ATE Ø 23,81
			für Linkslenker; → 01/05; + ABS / - ESP	03.2123-2863.3	010790	ATE Ø 23,81
			für Linkslenker; → 01/05; + ESP	03.2123-2923.3	010791	ATE Ø 23,81
			→ 06/13; für Linkslenker; - ESP	03.2123-3241.3	010882	ATE Ø 23,81
			→ 06/13; für Linkslenker; + ESP	03.2123-3493.3	010792	ATE Ø 23,81















RENAULT - RAPID 09/94→03/98















Hauptbremszylinder











1.9 D	47	09/94→03/98	07/95→	03.2120-2031.3	010106	ATE Ø 20,64
-------	----	-------------	--------	----------------	--------	-------------















	kw			 	! #		
RENAULT - RAPID Kasten (F40_, G40_) 07/85→11/01							
 Hauptbremszylinder							
1.1	35	09/93→04/95				03.2119-3389.3 010057	ATE Ø 19,05
1.1 (F401)	33	07/85→04/95		09/91→		03.2119-3389.3 010057	ATE Ø 19,05
						03.2119-3389.3 010057	ATE Ø 19,05
1.2	48	05/95→11/98		für Linkslenker		03.2120-2031.3 010106	ATE Ø 20,64
1.4	59	05/95→08/97					
1.9 D (F40R)	40	09/94→03/98					
1.2 (F406, G40A)	40	09/91→03/98		10/92→; für Linkslenker		03.2120-2031.3 010106	ATE Ø 20,64
						03.2120-2031.3 010106	ATE Ø 20,64
1.4 (F40D)	58	01/94→03/98		für Linkslenker		03.2120-2031.3 010106	ATE Ø 20,64
				09/94→		03.2120-2031.3 010106	ATE Ø 20,64
						03.2120-2031.3 010106	ATE Ø 20,64
1.4 (F40U, F40V)	55	09/91→03/98		für Linkslenker		03.2120-2031.3 010106	ATE Ø 20,64
						03.2120-2031.3 010106	ATE Ø 20,64
1.4 Cat (F407)	43	08/88→03/98		→ 08/91		03.2119-3389.3 010057	ATE Ø 19,05
1.6 D (F404)	40	03/86→08/98		09/91→		03.2120-2031.3 010106	ATE Ø 20,64
1.6 D Electric	40	09/93→04/95				03.2120-2031.3 010106	ATE Ø 20,64
	21	01/94→11/98					
1.9 D (F40P, F40N, F40E)	47	09/91→03/98		09/92→		03.2119-3389.3 010057	ATE Ø 19,05
				09/95→		03.2120-2031.3 010106	ATE Ø 20,64
						03.2120-2031.3 010106	ATE Ø 20,64
 Bremskraftregler							
1.1 (F401)	33	07/85→04/95		→ 08/91		03.6583-0006.3 320100	ATE lastabhängig 8/3 4x
1.4 Cat (F407)	43	08/88→03/98					
1.6 D (F404)	40	03/86→08/98					
RENAULT - SAFRANE I (B54_) 04/92→10/97							
 Hauptbremszylinder							
2.0 (B540)	77	11/92→07/96		→ 01/95; für Linkslenker; - ABS		03.2122-0621.3 010131	ATE Ø 22,2
				→ 01/95; + ABS		24.2122-1707.3 010438	Ø 22,2
				→ 01/95; für Rechtslenker; - ABS		24.2122-1707.3 010438	Ø 22,2
				02/95→		24.2122-1707.3 010438	Ø 22,2
2.0 12V (B542, B54E)	97	04/92→07/96				24.2122-1707.3 010438	Ø 22,2
2.2 (B543)	101	04/92→07/96					
2.1 dT (B546)	65	11/93→07/96		→ 01/95; - ABS		03.2122-0621.3 010131	ATE Ø 22,2
				→ 01/95; + ABS		24.2122-1707.3 010438	Ø 22,2
				02/95→		24.2122-1707.3 010438	Ø 22,2
2.2 (B541)	79	04/92→07/96		→ 01/95; - ABS		03.2122-0621.3 010131	ATE Ø 22,2
				→ 01/95; + ABS		24.2122-1707.3 010438	Ø 22,2
2.5 dT (B548)	83	12/92→07/96		07/93→ 05/94; Schaltgetriebe		24.2122-1707.3 010438	Ø 22,2
				→ 06/93		24.2122-1707.3 010438	Ø 22,2
				06/94→		24.2123-1701.3 010424	Ø 23,81
				07/93→ 05/94; Automatikgetriebe		24.2123-1701.3 010424	Ø 23,81
3.0 Biturbo 4x4 (B545)	193	02/93→07/96					
3.0 V6 (B54B, B544)	123	12/92→07/96					
3.0 V6 4x4 (B54B, B544)	123	12/92→07/96					
RENAULT - SAFRANE II (B54_) 07/96→12/00							
 Hauptbremszylinder							
2.0 16V (B54L)	100	07/96→12/00		08/96→; für Rechtslenker		24.2122-1707.3 010438	Ø 22,2
				08/96→; für Linkslenker		24.2123-1701.3 010424	Ø 23,81
2.2 dT (B54G)	83	07/96→12/00		08/96→		24.2123-1701.3 010424	Ø 23,81
2.5 20V (B54F)	121	07/96→12/00					
2.9 24V (B54N)	140	03/99→12/00				24.2123-1701.3 010424	Ø 23,81
3.0 V6 (B54M)	123	07/96→12/00		→ 07/96		24.2123-1701.3 010424	Ø 23,81
				10/96→		24.2123-1701.3 010424	Ø 23,81
RENAULT - SANDERO/STEPWAY I (BS_) 11/07→							
 Bremskraftverstärker							
1.4	55	02/09→		+ ABS		03.7853-4102.4 300271	ATE Ø 9" pneumatisch
1.6	62	11/10→				03.7853-4602.4 300302	ATE Ø 9" pneumatisch
1.6	64	02/09→					
1.6	66	05/09→					
1.6	75	12/07→					
1.6	76	12/07→					
↓							













	kw					! #		
RENAULT - SANDERO/STEPWAY I (BS_) 11/07→								
 Hauptbremszylinder								
1.4	55	02/09→		+ ABS		03.2120-4611.3	010937	ATE Ø 20,64
1.6	62	11/10→		- ABS		24.2120-1762.3	011002	Ø 20,64 ohne Bremsflüssigkeitsbehälter
1.6	64	02/09→						
1.6	66	05/09→						
1.6	75	12/07→						
1.6	76	12/07→						
RENAULT - SCÉNIC I (JA0/1_) 09/99→09/03								
 Bremskraftverstärker								
1.4 16V (JA0D, JA1H, JA0W, JA10)	70	09/99→08/03		- ABS; → 06/03; für Linkslenker		03.7760-5102.4	300140	ATE Ø 10" pneumatisch
1.6	75	03/01→08/03		→ 06/03; + ABS; für Linkslenker		03.7863-2002.4	300126	ATE Ø 10" pneumatisch
1.6	79	09/99→09/03						
1.6	81	06/01→09/03						
1.6 16V	85	09/99→08/03						
1.6 BiFuel	75	03/01→08/03						
1.8 16V (JA12, JA1R, JA1M, JA1A)	85	01/01→08/03						
1.9 dCi (JA05, JA1F)	75	09/99→08/03						
1.9 dCi RX4	74	12/02→08/03						
1.9 dCi RX4	75	11/00→08/03						
2.0 16V	103	09/99→08/03						
2.0 16V RX4	102	06/00→08/03						
1.6 BiFuel (JA04)	79	09/99→04/01		- ABS; für Linkslenker		03.7760-5102.4	300140	ATE Ø 10" pneumatisch
1.8 4x4	85	07/00→04/01		+ ABS; für Linkslenker		03.7863-2002.4	300126	ATE Ø 10" pneumatisch
1.9 D	47	09/99→03/01		+ ABS; für Linkslenker		03.7863-2002.4	300126	ATE Ø 10" pneumatisch
1.9 dTi (JA0N)	72	09/99→08/03		- ABS; → 06/03; für Linkslenker		03.7760-5102.4	300140	ATE Ø 10" pneumatisch
2.0 16V (JA1B, JA1D)	102	07/00→08/03						
1.9 dTi (JA1U)	59	02/01→08/03		→ 06/03; + ABS; für Linkslenker		03.7863-2002.4	300126	ATE Ø 10" pneumatisch
 Hauptbremszylinder								
1.4 16V (JA0D, JA1H, JA0W, JA10)	70	09/99→08/03		→ 06/03; - ABS; für Linkslenker		03.2123-1551.3	010512	Ø 23,81
1.6	75	03/01→08/03		→ 06/03; + ABS / - ESP; für Linkslenker		03.2123-2146.3	010572	Ø 23,81
1.6	79	09/99→09/03		→ 06/03; + ABS / + ESP; für Linkslenker		03.2123-2621.3	010701	ATE Ø 23,81
1.6	81	06/01→09/03						
1.6 16V	85	09/99→08/03						
1.6 BiFuel	75	03/01→08/03						
1.8 16V (JA12, JA1R, JA1M, JA1A)	85	01/01→08/03						
1.9 dCi (JA05, JA1F)	75	09/99→08/03						
1.9 dCi RX4	74	12/02→08/03						
1.9 dCi RX4	75	11/00→08/03						
2.0 16V	103	09/99→08/03						
2.0 16V (JA1B, JA1D)	102	07/00→08/03						
2.0 16V RX4	102	06/00→08/03						
1.6 BiFuel (JA04)	79	09/99→04/01		für Linkslenker; - ABS		03.2123-1551.3	010512	Ø 23,81
1.8 4x4	85	07/00→04/01		+ ABS / - ESP; für Linkslenker		03.2123-2146.3	010572	Ø 23,81
				+ ABS / + ESP; für Linkslenker		03.2123-2621.3	010701	ATE Ø 23,81
1.9 D	47	09/99→03/01		+ ABS / - ESP; für Linkslenker		03.2123-2146.3	010572	Ø 23,81
				+ ABS / + ESP; für Linkslenker		03.2123-2621.3	010701	ATE Ø 23,81
1.9 dTi (JA0N)	72	09/99→08/03		→ 06/03; - ABS; für Linkslenker		03.2123-1551.3	010512	Ø 23,81
				→ 06/03; + ABS; für Linkslenker		03.2123-2146.3	010572	Ø 23,81
1.9 dTi (JA1U)	59	02/01→08/03		→ 06/03; + ABS / - ESP; für Linkslenker		03.2123-2146.3	010572	Ø 23,81
				→ 06/03; + ABS / + ESP; für Linkslenker		03.2123-2621.3	010701	ATE Ø 23,81
RENAULT - SCÉNIC II (JM0/1_) 06/03→								
 Hauptbremszylinder								
1.4 (JM0B, JM0H, JM1A)	72	06/03→		→ 03/09		24.2123-1760.3	010779	TRW Ø 23,81
1.5 dCi (JM02, JM13)	74	11/03→						
1.5 dCi (JM0F)	60	06/03→						
1.5 dCi (JM16)	76	01/07→						
1.5 dCi (JM1E)	78	05/05→						
1.5 dCi (JM1F)	63	05/05→						
1.6	77	06/06→						
1.6 (JM0C, JM0J, JM1B)	83	06/03→						
1.9 D	85	06/06→						
1.9 dCi	92	06/03→						
1.9 dCi (JM0G, JM12, JM1G, JM2C)	88	06/03→						
1.9 dCi (JM14)	96	05/05→						
1.9 dCi (JM15)	81	05/05→						
2.0	101	02/08→04/09						
2.0	103	06/03→07/10						
↓								













	kW					! #		
RENAULT - SCÉNIC II (JM0/1_) 06/03→								
 Hauptbremszylinder								
2.0 (JM05, JM0U, JM1N, JM1U, JM2V)	99	06/03→			→ 03/09		24.2123-1760.3 010779	TRW Ø 23,81
2.0 16V Turbo (JM0W)	120	05/04→						
2.0 dCi (JM1K)	110	09/05→						
1.6 16V (JM1R)	82	10/05→			01/07→ 03/09		24.2123-1760.3 010779	TRW Ø 23,81
1.6 BiFuel	83	08/03→05/06					24.2123-1760.3 010779	TRW Ø 23,81
1.6 Hi-Flex	81	03/05→07/10						
1.9 dCi 130	97	10/05→12/09						
RENAULT - SCÉNIC III (JZ0/1_) 02/09→								
 Hauptbremszylinder								
1.2 TCe	85	04/12→					24.4123-1715.3 010980	TRW Ø 23,81
1.5 dCi	63	04/09→						
1.5 dCi	81	04/09→						
1.5 dCi (JZ02, JZ0R)	70	11/10→						
1.6 16V Bifuel	79	04/12→						
1.6 dCi (JZ00, JZ12)	96	04/11→						
2.0 dCi (JZ0L)	118	04/09→						
1.2 TCe (JZ16)	97	01/13→			03/13→		24.4123-1715.3 010980	TRW Ø 23,81
1.4 16V (JZ0F, JZ1V)	96	02/09→			04/09→		24.4123-1715.3 010980	TRW Ø 23,81
1.5 dCi	78	02/09→						
1.6 16V (JZ0U, JZ1B)	81	02/09→						
1.9 dCi (JZ0J, JZ1J, JZ1K, JZ1S)	96	02/09→						
2.0 16V (JZ0G, JZ0P, JZ1E, JZ1P)	103	02/09→						
2.0 dCi (JZ0Y, JZ26)	110	02/09→						
1.6 16V Bifuel	81	02/09→			06/09→		24.4123-1715.3 010980	TRW Ø 23,81
1.6 E85 (JZ03, JZ1Y)	81	02/09→						
RENAULT - SPORT SPIDER (EF0_) 03/95→10/99								
 Hauptbremszylinder								
2.0	108	12/95→08/96					24.2123-1702.3 010431	Ø 23,81
2.0 16V	110	03/95→10/99						
RENAULT - SUPER 5 (B/C40_) 10/84→12/96								
 Hauptbremszylinder								
1.1 (B/C/401, B/C40H)	33	01/86→03/95			06/87→ 08/90		03.2119-3389.3 010057	ATE Ø 19,05
							03.2119-3389.3 010057	ATE Ø 19,05
1.4 Cat (B/C/407)	43	10/85→12/96					03.2119-3389.3 010057	ATE Ø 19,05
1.6 D (B/C/404)	40	08/85→12/96						
1.7 (B/C40K, B/C40G)	64	06/87→03/95						
1.7 (B/C408)	54	10/86→03/95			01/87→		03.2119-3389.3 010057	ATE Ø 19,05
 Bremskraftregler								
1.1 (B/C/401, B/C40H)	33	01/86→03/95					03.6583-0007.3 320101	ATE lastabhängig 8/3 4x
1.6 D (B/C/404)	40	08/85→12/96			01/86→ 05/87		03.6583-0007.3 320101	ATE lastabhängig 8/3 4x
					→ 05/87		03.6583-0007.3 320101	ATE lastabhängig 8/3 4x
					06/87→		03.6583-0007.3 320101	ATE lastabhängig 8/3 4x
1.7 (B/C408)	54	10/86→03/95			01/87→ 05/87		03.6583-0007.3 320101	ATE lastabhängig 8/3 4x
1.7 (B/C40K, B/C40G)	64	06/87→03/95			→ 08/90		03.6583-0007.3 320101	ATE lastabhängig 8/3 4x
RENAULT - SUPER 5 Kasten (S40_) 10/84→12/96								
 Hauptbremszylinder								
1.1 (S401)	34	10/84→12/96			01/85→ 03/95		03.2119-3389.3 010057	ATE Ø 19,05
1.2 (S40F, S407)	44	01/87→12/96			→ 08/90		03.2119-3389.3 010057	ATE Ø 19,05
1.6 D (S404)	40	10/84→12/96			01/85→		03.2119-3389.3 010057	ATE Ø 19,05
 Bremskraftregler								
1.6 D (S404)	40	10/84→12/96			01/85→ 05/87		03.6583-0007.3 320101	ATE lastabhängig 8/3 4x
RENAULT - THALIA I (LB0/1/2_) 02/98→								
 Bremskraftverstärker								
1.2 16V	55	04/02→					03.7750-1332.4 300155	ATE Ø 9" pneumatisch
1.4	55	08/00→						
1.4 16V	72	08/00→						
1.5 dCi	47	06/05→						
1.5 dCi	48	04/02→						
1.5 dCi	50	02/03→						
1.5 dCi	58	04/04→11/09						
↓								













	kw			 	! #		
RENAULT - THALIA I (LB0/1/2_) 02/98→							
 Bremskraftverstärker							
1.5 dCi	60	06/01→				03.7750-1332.4 300155	ATE Ø 9" pneumatisch
1.6 16V	79	04/02→					
1.9 D	48	02/98→05/01					
1.6	66	03/98→		04/02→		03.7750-1332.4 300155	ATE Ø 9" pneumatisch
 Hauptbremszylinder							
1.2 16V	55	04/02→		- ABS		03.2120-2031.3 010106	ATE Ø 20,64
1.4	55	08/00→					
1.4 16V	72	08/00→		+ ABS		03.2120-4461.3 010571	ATE Ø 20,64
1.5 dCi	47	06/05→					
1.5 dCi	48	04/02→					
1.5 dCi	50	02/03→					
1.5 dCi	58	04/04→11/09					
1.5 dCi	60	06/01→					
 Bremskraftregler							
1.2 16V	55	04/02→				24.6582-1721.3 320212	lastabhängig 4x
1.4	55	08/00→					
1.4 16V	72	08/00→					
1.5 dCi	47	06/05→					
1.5 dCi	48	04/02→					
1.5 dCi	50	02/03→					
1.5 dCi	58	04/04→11/09					
1.5 dCi	60	06/01→					
1.6 16V	79	04/02→					
1.9 D	48	02/98→05/01					
1.6	66	03/98→		04/02→		24.6582-1721.3 320212	lastabhängig 4x
RENAULT - THALIA II (LU1/2_) 09/08→							
 Bremskraftverstärker							
1.2 16V (LU2V)	55	09/08→		12/10→		03.7853-1502.4 300200	ATE Ø 9" pneumatisch
1.2 LPG	55	01/10→12/13					
1.4	55	09/08→06/14					
1.4	72	09/08→12/12					
1.5 dCi	47	09/08→					
1.5 dCi	48	01/09→					
1.5 dCi	62	09/08→					
1.5 dCi	66	01/09→					
1.6 16V	77	09/08→					
1.5 dCi	55	11/12→06/14				03.7853-1502.4 300200	ATE Ø 9" pneumatisch
 Hauptbremszylinder							
1.2 16V (LU2V)	55	09/08→		- ABS		03.2120-2031.3 010106	ATE Ø 20,64
1.2 LPG	55	01/10→12/13					
1.4	55	09/08→06/14					
1.4	72	09/08→12/12					
1.5 dCi	47	09/08→					
1.5 dCi	48	01/09→					
1.5 dCi	55	11/12→06/14					
1.5 dCi	62	09/08→					
1.5 dCi	66	01/09→					
1.6 16V	77	09/08→		+ ABS		03.2120-4461.3 010571	ATE Ø 20,64
 Bremskraftregler							
1.6 16V	77	09/08→				24.6582-1721.3 320212	lastabhängig 4x
RENAULT - TRAFIC II Bus (JL) 03/01→							
 Hauptbremszylinder							
1.9 dCi	59	04/01→07/03		für Linkslenker; - ESP		24.2120-1738.3 010759	TRW Ø 20,64
				für Rechtslenker; - ESP		24.2125-1731.3 010826	TRW Ø 25,4
				für Linkslenker; + ESP		24.2125-1734.3 010878	TRW Ø 25,4
1.9 dCi 100 (JL0C)	74	03/01→		→ 09/03; für Linkslenker; - ESP		24.2120-1738.3 010759	TRW Ø 20,64
				10/03→; für Linkslenker; → 08/14; - ESP		24.2120-1740.3 010764	TRW Ø 20,64
				10/03→; für Rechtslenker; → 08/14; - ESP		24.2125-1731.3 010826	TRW Ø 25,4
				10/03→; für Linkslenker; → 08/14		24.2125-1734.3 010878	TRW Ø 25,4
				→ 09/03; für Linkslenker; + ESP		24.2125-1734.3 010878	TRW Ø 25,4
1.9 dCi 80 (JL0B)	60	03/01→		→ 09/03; für Linkslenker; - ESP		24.2120-1738.3 010759	TRW Ø 20,64
				10/03→; für Linkslenker; → 08/14; - ESP		24.2120-1740.3 010764	TRW Ø 20,64
				für Rechtslenker; → 08/14; - ESP		24.2125-1731.3 010826	TRW Ø 25,4
				10/03→; für Linkslenker; → 08/14		24.2125-1734.3 010878	TRW Ø 25,4
				→ 09/03; für Linkslenker; + ESP		24.2125-1734.3 010878	TRW Ø 25,4
↓							













	kw			 	! #		
RENAULT - TRAFIC II Bus (JL) 03/01→							
 Hauptbremszylinder							
2.0 (JL0A)	88	03/01→		→ 08/14; - ESP		24.2125-1731.3 010826	TRW Ø 25,4
2.5 dCi 135 (JL0D)	99	05/03→					
2.0 16V	86	08/06→		für Linkslenker; → 08/14; - ESP		24.2120-1740.3 010764	TRW Ø 20,64
				für Rechtslenker; → 08/14; - ESP		24.2125-1731.3 010826	TRW Ø 25,4
				für Linkslenker; → 08/14		24.2125-1734.3 010878	TRW Ø 25,4
2.0 dCi 115 (JL0H)	84	08/06→		10/06→ 08/14; + ABS / - ESP		24.2120-1748.3 010894	TRW Ø 20,64
2.5 dCi 145 (JL0J)	107	08/06→		10/06→ 08/14; + ABS / + ESP		24.2120-1753.3 010946	TRW Ø 20,64
2.0 dCi 90 (JL0H)	66	08/06→		10/06→ 08/14; - ESP		24.2125-1731.3 010826	TRW Ø 25,4
2.5 dCi 115	84	02/08→		→ 08/14; + ABS / - ESP		24.2120-1748.3 010894	TRW Ø 20,64
				→ 08/14; + ABS / + ESP		24.2120-1753.3 010946	TRW Ø 20,64
2.5 DTi	99	03/03→07/03		- ESP		24.2125-1731.3 010826	TRW Ø 25,4
RENAULT - TRAFIC II Kasten (FL) 03/01→							
 Hauptbremszylinder							
1.9 dCi	59	04/01→07/03		für Linkslenker; - ESP		24.2120-1738.3 010759	TRW Ø 20,64
				für Rechtslenker; - ESP		24.2125-1731.3 010826	TRW Ø 25,4
				für Linkslenker; + ESP		24.2125-1734.3 010878	TRW Ø 25,4
1.9 dCi 1.9 dCi 80 (FL0B)	75 60	03/01→ 03/01→		→ 09/03; für Linkslenker; - ESP		24.2120-1738.3 010759	TRW Ø 20,64
				10/03→; für Linkslenker; → 08/14; - ESP		24.2120-1740.3 010764	TRW Ø 20,64
				für Rechtslenker; → 08/14; - ESP		24.2125-1731.3 010826	TRW Ø 25,4
				10/03→; für Linkslenker; → 08/14		24.2125-1734.3 010878	TRW Ø 25,4
1.9 dCi 100 (FL0C)	74	03/01→		→ 09/03; für Linkslenker; + ESP		24.2125-1734.3 010878	TRW Ø 25,4
				→ 09/03; für Linkslenker; - ESP		24.2120-1738.3 010759	TRW Ø 20,64
				10/03→; für Linkslenker; → 08/14; - ESP		24.2120-1740.3 010764	TRW Ø 20,64
				10/03→; für Rechtslenker; → 08/14; - ESP		24.2125-1731.3 010826	TRW Ø 25,4
2.0 (FL0A) 2.5 dCi 2.5 dCi 135 (FL0D)	88 84 99	03/01→ 08/07→ 05/03→		10/03→; für Linkslenker; → 08/14		24.2125-1734.3 010878	TRW Ø 25,4
				→ 09/03; für Linkslenker; + ESP		24.2125-1734.3 010878	TRW Ø 25,4
				→ 08/14; - ESP		24.2125-1731.3 010826	TRW Ø 25,4
2.0 16V	86	08/06→		für Linkslenker; → 08/14; - ESP		24.2120-1740.3 010764	TRW Ø 20,64
				für Rechtslenker; → 08/14; - ESP		24.2125-1731.3 010826	TRW Ø 25,4
				für Linkslenker; → 08/14		24.2125-1734.3 010878	TRW Ø 25,4
2.0 dCi 115 (FL01, FL0U)	84	08/06→		10/06→ 08/14; + ABS / - ESP		24.2120-1748.3 010894	TRW Ø 20,64
2.5 dCi 145 (FL0J)	107	08/06→		10/06→ 08/14; + ABS / + ESP		24.2120-1753.3 010946	TRW Ø 20,64
2.0 dCi 90 (FL0H)	66	08/06→		10/06→ 08/14; - ESP		24.2125-1731.3 010826	TRW Ø 25,4
2.5 DTi	99	03/03→07/03		- ESP		24.2125-1731.3 010826	TRW Ø 25,4
RENAULT - TRAFIC II Pritsche/Fahrgestell (EL) 03/01→							
 Hauptbremszylinder							
1.9 dCi	59	09/01→07/03		für Linkslenker; - ESP		24.2120-1738.3 010759	TRW Ø 20,64
				für Rechtslenker; - ESP		24.2125-1731.3 010826	TRW Ø 25,4
				für Linkslenker; + ESP		24.2125-1734.3 010878	TRW Ø 25,4
1.9 dCi 100 (EL0C)	74	03/01→		→ 09/03; für Linkslenker; - ESP		24.2120-1738.3 010759	TRW Ø 20,64
				10/03→; für Linkslenker; → 08/14; - ESP		24.2120-1740.3 010764	TRW Ø 20,64
				10/03→; für Rechtslenker; → 08/14; - ESP		24.2125-1731.3 010826	TRW Ø 25,4
				10/03→; für Linkslenker; → 08/14		24.2125-1734.3 010878	TRW Ø 25,4
1.9 dCi 80 (EL0B)	60	03/01→		→ 09/03; für Linkslenker; + ESP		24.2125-1734.3 010878	TRW Ø 25,4
				→ 09/03; für Linkslenker; - ESP		24.2120-1738.3 010759	TRW Ø 20,64
				10/03→; für Linkslenker; → 08/14; - ESP		24.2120-1740.3 010764	TRW Ø 20,64
				für Rechtslenker; → 08/14; - ESP		24.2125-1731.3 010826	TRW Ø 25,4
2.0 (EL0A) 2.5 dCi 2.0 16V	88 84 86	03/01→ 08/07→ 08/06→		10/03→; für Linkslenker; → 08/14		24.2125-1734.3 010878	TRW Ø 25,4
				→ 09/03; für Linkslenker; + ESP		24.2125-1734.3 010878	TRW Ø 25,4
				→ 08/14; - ESP		24.2125-1731.3 010826	TRW Ø 25,4
2.0 dCi 115 (EL0H) 2.5 dCi 145 (EL0J)	84 107	08/06→ 08/06→		für Linkslenker; → 08/14; - ESP		24.2120-1740.3 010764	TRW Ø 20,64
				für Rechtslenker; → 08/14; - ESP		24.2125-1731.3 010826	TRW Ø 25,4
				für Linkslenker; → 08/14		24.2125-1734.3 010878	TRW Ø 25,4
2.0 dCi 115 (EL0H) 2.5 dCi 145 (EL0J)	84 107	08/06→ 08/06→		10/06→ 08/14; + ABS / - ESP		24.2120-1748.3 010894	TRW Ø 20,64
				10/06→ 08/14; + ABS / + ESP		24.2120-1753.3 010946	TRW Ø 20,64
↓							













	kw			 	! #		
RENAULT - TRAFIC II Pritsche/Fahrgestell (EL) 03/01→							
 Hauptbremszylinder							
2.0 dCi 90 (ELOH)	66	08/06→		10/06→ 08/14; - ESP		24.2125-1731.3 010826	TRW Ø 25,4
2.5 dCi 135 (ELOD)	99	03/01→		05/03→ 08/14; - ESP		24.2125-1731.3 010826	TRW Ø 25,4
RENAULT - TRAFIC Bus (TXW) 03/89→03/01							
 Hauptbremszylinder							
2.1 D	47	06/94→10/97				03.2125-3801.3 010215	Ø 25,4
				+ ABS		03.2125-7002.3 010628	ATE Ø 25,4
2.2	74	06/94→10/97		- ABS; für Linkslenker		03.2125-3701.3 010627	ATE Ø 25,4
				- ABS; für Rechtslenker		03.2125-3801.3 010215	Ø 25,4
2.2 4x4	74	06/94→10/97				03.2125-3701.3 010627	ATE Ø 25,4
2.5 D	55	05/89→03/01				03.2125-3801.3 010215	Ø 25,4
				→ 10/97; + ABS		03.2125-7002.3 010628	ATE Ø 25,4
				11/97→; + ABS		24.2025-1706.3 010676	Ø 25,4
				11/97→; - ABS		24.2025-1708.3 010692	Ø 25,4
2.5 D 4x4	55	08/89→03/01				03.2125-3801.3 010215	Ø 25,4
				11/97→; + ABS		24.2025-1706.3 010676	Ø 25,4
				11/97→; - ABS		24.2025-1708.3 010692	Ø 25,4
 Bremskraftregler							
1.9 D	44	06/97→03/01				03.6512-0100.3 320077	ATE lastabhängig 1/2 2x
2.1 D	47	06/94→10/97					
2.2	74	06/94→10/97					
2.2 4x4	74	06/94→10/97					
2.5 D	55	05/89→03/01					
2.5 D 4x4	55	08/89→03/01					
RENAULT - TRAFIC Kasten (TXX) 03/89→12/01							
 Hauptbremszylinder							
2.1 D	47	06/94→10/97				03.2125-3801.3 010215	Ø 25,4
2.2	74	06/94→10/97		- ABS; für Linkslenker		03.2125-3701.3 010627	ATE Ø 25,4
				+ ABS		03.2125-3701.3 010627	ATE Ø 25,4
				- ABS; für Rechtslenker		03.2125-3801.3 010215	Ø 25,4
2.2 4x4	74	06/94→10/97		- ABS; für Linkslenker		03.2125-3701.3 010627	ATE Ø 25,4
				+ ABS		03.2125-3701.3 010627	ATE Ø 25,4
						03.2125-3701.3 010627	ATE Ø 25,4
				- ABS; für Rechtslenker		03.2125-3801.3 010215	Ø 25,4
2.5 D	55	05/89→03/01		→ 10/97		03.2125-3801.3 010215	Ø 25,4
2.5 D 4x4	55	05/89→03/01		11/97→; + ABS		24.2025-1706.3 010676	Ø 25,4
				11/97→; - ABS		24.2025-1708.3 010692	Ø 25,4
 Bremskraftregler							
1.9 D	44	06/97→03/01		→ 10/97		03.6512-0100.3 320077	ATE lastabhängig 1/2 2x
2.1 D	47	06/94→10/97				03.6512-0100.3 320077	ATE lastabhängig 1/2 2x
2.2	74	06/94→10/97					
2.2 4x4	74	06/94→10/97					
2.5 D	55	05/89→03/01					
2.5 D 4x4	55	05/89→03/01					
RENAULT - TRAFIC Pritsche/Fahrgestell (PXX) 03/89→03/01							
 Hauptbremszylinder							
2.0 [RWD]	59	05/89→10/97				03.2125-3801.3 010215	Ø 25,4
2.1 D	47	09/94→04/98		→ 10/97		03.2125-3801.3 010215	Ø 25,4
2.1 D [RWD]	47	06/94→10/97		→ 0005150		03.2120-1142.3 010085	Ø 20,64
						03.2125-3801.3 010215	Ø 25,4
 Bremskraftregler							
2.0 [RWD]	59	05/89→10/97				03.6512-0100.3 320077	ATE lastabhängig 1/2 2x
2.1 D [RWD]	47	06/94→10/97					
2.1 D	47	09/94→04/98		→ 10/97		03.6512-0100.3 320077	ATE lastabhängig 1/2 2x
RENAULT - TWINGO I (C06_) 03/93→10/12							
 Hauptbremszylinder							
1.2	44	09/98→08/00		- ABS		24.2120-1706.3 010262	Ø 20,64
1.2 (C063, C064)	40	03/93→10/96		+ ABS		24.2120-1723.3 010545	BDX Ø 20,64
1.2 (C066, C068)	43	05/96→06/07					
↓							











	kw				! #					
RENAULT - TWINGO I (C06_) 03/93→10/12										
 Hauptbremszylinder										
1.2 (C067)	40	05/96→03/07		- ABS		24.2120-1706.3 010262	Ø 20,64			
1.2 16V (C060)	44	08/04→06/07		+ ABS		24.2120-1723.3 010545	BDX Ø 20,64			
1.2 16V (C06C, C06D, C06K)	55	01/01→06/07								
1.2 LPG	44	10/03→06/07		08/04→; - ABS		24.2120-1706.3 010262	Ø 20,64			
				08/04→; + ABS		24.2120-1723.3 010545	BDX Ø 20,64			
RENAULT - TWINGO I Kasten (S06_) 03/93→08/04										
 Hauptbremszylinder										
1.2 (S063, S064)	40	03/93→05/96		→ 04/96; - ABS		24.2120-1706.3 010262	Ø 20,64			
				→ 04/96; + ABS		24.2120-1723.3 010545	BDX Ø 20,64			
1.2 (S066, S068)	43	05/96→08/04		- ABS		24.2120-1706.3 010262	Ø 20,64			
				+ ABS		24.2120-1723.3 010545	BDX Ø 20,64			
RENAULT - TWINGO II (CN0_) 03/07→										
 Bremskraftverstärker										
1.2 (CN0D)	43	03/07→		für Linkslenker; → 07/14; + ESP		03.7750-7332.4 300298	ATE Ø 9" pneumatisch			
1.2 16V	55	03/08→		für Linkslenker; → 07/14; - ESP		03.7853-3902.4 300270	ATE Ø 9" pneumatisch			
1.2 16V (CN04, CN0A, CN0B)	55	03/07→								
1.2 16V (CN0K, CN0V)	56	03/07→								
1.2 TCe 100 (CN0P)	75	02/11→								
1.2 Turbo (CN0C, CN0F)	74	03/07→								
1.5 dCi (CN0E)	47	03/07→								
1.5 dCi (CN0U)	62	04/08→								
1.5 dCi 75	55	10/10→								
1.5 dCi 90	63	10/10→								
1.6 RS (CN0N, CN0R, CN0S)	98	05/08→		für Linkslenker; → 07/14		03.7750-8832.4 300299	ATE Ø 9" pneumatisch			
 Hauptbremszylinder										
1.2 (CN0D)	43	03/07→		für Linkslenker; → 07/14; - ESP		03.2120-4581.3 010915	ATE Ø 20,64			
1.2 16V	55	03/08→		für Linkslenker; → 07/14; + ESP		03.2120-4641.3 010932	ATE Ø 20,64			
1.2 16V (CN04, CN0A, CN0B)	55	03/07→								
1.2 16V (CN0K, CN0V)	56	03/07→								
1.2 TCe 100 (CN0P)	75	02/11→								
1.2 Turbo (CN0C, CN0F)	74	03/07→								
1.5 dCi (CN0E)	47	03/07→								
1.5 dCi (CN0U)	62	04/08→								
1.5 dCi 75	55	10/10→								
1.5 dCi 90	63	10/10→								
1.6 RS (CN0N, CN0R, CN0S)	98	05/08→		für Linkslenker; → 07/14		03.2123-2751.3 011014	ATE Ø 23,81			
RENAULT - VEL SATIS (BJ0_) 06/02→										
 Bremskraftverstärker										
2.0 16 V Turbo	125	04/04→		→ 10/05; für Linkslenker; für Fahrzeuge ohne autom. Distanzregelung		03.7858-2802.4 300303	ATE Ø 9 / 8" pneumatisch			
2.0 16V Turbo (BJ0K)	120	06/02→								
2.0 Turbo	108	04/05→								
2.2 dCi (BJ0E, BJ0F, BJ0G, BJ0H)	102	09/04→								
2.2 dCi (BJ0E, BJ0F)	110	06/02→								
2.2 dCi (BJ0H)	85	04/04→								
2.2 dCi (BJ0M)	83	12/04→								
3.0 dCi (BJ0J, BJ0N)	130	06/02→								
3.5 (BJ01)	170	10/04→								
3.5 V6 (BJ0R, BJ0V, BJ0U)	177	06/02→								
Pedalwegsensoren, Bremspedal										
2.0 16 V Turbo	125	04/04→			→ 10/05; für Rechtslenker; für Fahrzeuge mit autom. Distanzregelung				03.0655-0005.2 370005	ATE
2.0 16V Turbo (BJ0K)	120	06/02→								
2.0 Turbo	108	04/05→			→ 10/05; für Linkslenker; für Fahrzeuge mit autom. Distanzregelung				03.0655-0005.2 370005	ATE
2.2 dCi (BJ0E, BJ0F, BJ0G, BJ0H)	102	09/04→								
2.2 dCi (BJ0E, BJ0F)	110	06/02→								
2.2 dCi (BJ0H)	85	04/04→								
2.2 dCi (BJ0M)	83	12/04→								
3.0 dCi (BJ0J, BJ0N)	130	06/02→								
3.5 (BJ01)	170	10/04→								
3.5 V6 (BJ0R, BJ0V, BJ0U)	177	06/02→								
 Hauptbremszylinder										
2.0 16 V Turbo	125	04/04→		→ 03/05			03.4125-0014.3 010794	ATE Ø 25,4		

	kw			 	! #		
RENAULT - VEL SATIS (BJ0_) 06/02→							
 Hauptbremszylinder							
2.0 16V Turbo (BJ0K)	120	06/02→		04/05→ 12/09		03.4155-0043.3 010795	ATE Ø 25,4
2.2 dCi (BJ0E, BJ0F, BJ0G, BJ0H)	102	09/04→					
2.2 dCi (BJ0E, BJ0F)	110	06/02→					
2.2 dCi (BJ0H)	85	04/04→					
2.2 dCi (BJ0M)	83	12/04→					
3.0 dCi (BJ0J, BJ0N)	130	06/02→					
3.5 V6 (BJ0R, BJ0V, BJ0U)	177	06/02→					
2.0 dCi (BJ03, BJ0B)	127	01/06→		→ 12/09		03.4155-0043.3 010795	ATE Ø 25,4
2.0 dCi (BJ03)	110	08/05→					
2.0 Turbo	108	04/05→					
3.0 dCi (BJ0S)	133	06/06→					
3.5 (BJ01)	170	10/04→		→ 03/05		03.4125-0014.3 010794	ATE Ø 25,4
				→ 12/09		03.4155-0043.3 010795	ATE Ø 25,4
RENAULT - WIND (E4M_) 07/10→							
 Bremskraftverstärker							
1.2 (E4MF)	74	07/10→		für Linkslenker; → 09/13		03.7750-8832.4 300299	ATE Ø 9" pneumatisch
1.2 TCe 100 (E4MA)	75	02/11→					
1.6 (E4MB, E4MC)	98	07/10→					
 Hauptbremszylinder							
1.2 (E4MF)	74	07/10→		für Linkslenker; → 09/13		03.2123-2751.3 011014	ATE Ø 23,81
1.2 TCe 100 (E4MA)	75	02/11→					
1.6 (E4MB, E4MC)	98	07/10→					
SAAB - 9-3 (YS3D) 02/98→08/03							
 Bremskraftverstärker							
2.0 i	96	02/98→09/02		01/01→; für Linkslenker		03.7750-2932.4 300175	ATE Ø 9" pneumatisch
2.0 SE Turbo	147	02/98→09/02					
2.0 Turbo	113	10/98→09/02					
2.0 Turbo	136	02/98→09/02					
2.0 Turbo	151	10/99→09/02					
2.2 TiD	92	11/00→09/02					
2.3 i	110	02/98→09/02					
2.0 Turbo	110	01/01→09/02		für Linkslenker		03.7750-2932.4 300175	ATE Ø 9" pneumatisch
 Hauptbremszylinder							
2.0 i	96	02/98→09/02		→ 12/00; für Linkslenker		03.2123-1121.3 010176	Ø 23,81
2.0 SE Turbo	147	02/98→09/02					
2.0 Turbo	113	10/98→09/02		01/01→		03.2123-1626.3 010727	ATE Ø 23,81
2.0 Turbo	136	02/98→09/02					
2.0 Turbo	151	10/99→09/02					
2.2 TiD	92	11/00→09/02					
2.3 i	110	02/98→09/02					
2.0 Turbo	110	01/01→09/02				03.2123-1626.3 010727	ATE Ø 23,81
2.2 TiD	85	02/98→11/00		für Linkslenker		03.2123-1121.3 010176	Ø 23,81
2.3	169	09/99→01/02				03.2125-7502.3 010616	ATE Ø 25,4
2.3 Turbo	165	10/98→09/02					
SAAB - 9-3 (YS3F) 09/02→02/15							
 Hauptbremszylinder							
1,8t	110	09/02→02/15		für Linkslenker; → 06/12		24.2125-1732.3 010827	TRW Ø 25,4
1,8t BioPower	110	01/07→02/15					
1,9 TiD	88	09/04→02/15					
1,9 TiD	110	09/04→02/15					
1,9 TTiD	96	12/07→02/15					
1,9 TTiD	118	12/07→02/15					
1,9 TTiD	132	12/07→02/15					
2,0 t	120	01/07→02/15					
2,0 t	129	09/02→02/15					
2,0 t	154	09/02→02/15					
2,0 t	162	01/11→02/15					
2,0 t	177	05/09→02/15					
2,0 t BioPower	129	01/07→02/15					
2,0 t BioPower	145	06/07→02/15					
2,0 t Bio Power	120	01/07→02/15					
2,0 t BioPower XWD	120	01/08→02/15					
2,0 t BioPower XWD	154	01/08→02/15					
2,0 t BioPower XWD	162	01/08→02/15					
2,0 Turbo Performance	185	04/04→02/15					
2,0 Turbo XWD	154	01/08→02/15					
2,0 t XWD	120	01/07→02/15					
2,0 t XWD	162	01/08→02/15					
2,0 t XWD	177	05/09→02/15					
↓							







	kw			 	! #		
SAAB - 9-3 (YS3F) 09/02→02/15							
 Hauptbremszylinder							
2.2 TiD	92	09/02→02/15		für Linkslenker; → 06/12		24.2125-1732.3 010827	TRW Ø 25,4
1.8 i	90	01/04→02/15		03/04→; für Linkslenker; → 06/12		24.2125-1732.3 010827	TRW Ø 25,4
2.8 Turbo V6	184	03/05→02/15		→ 12/05; für Linkslenker		24.2125-1732.3 010827	TRW Ø 25,4
SAAB - 9-3 Cabriolet (YS3D) 02/98→08/03							
 Bremskraftverstärker							
2.0 i	96	02/98→08/03		09/00→ 07/03; für Linkslenker		03.7750-2932.4 300175	ATE Ø 9" pneumatisch
2.0 Turbo	113	10/98→08/03					
2.0 Turbo	136	02/98→08/03					
2.0 Turbo	151	10/99→08/03					
2.3 i	110	02/98→08/03					
2.3 Turbo	165	10/99→08/03					
2.0 SE Turbo	147	02/98→08/03		01/01→ 07/03; für Linkslenker		03.7750-2932.4 300175	ATE Ø 9" pneumatisch
2.0 Turbo	110	01/01→08/03		→ 07/03; für Linkslenker		03.7750-2932.4 300175	ATE Ø 9" pneumatisch
2.3	169	09/99→01/02		09/00→; für Linkslenker		03.7750-2932.4 300175	ATE Ø 9" pneumatisch
 Hauptbremszylinder							
2.0 i	96	02/98→08/03		→ 08/00; für Linkslenker		03.2123-1121.3 010176	Ø 23,81
2.0 Turbo	113	10/98→08/03					
2.0 Turbo	136	02/98→08/03		09/00→ 07/03		03.2123-1626.3 010727	ATE Ø 23,81
2.0 Turbo	151	10/99→08/03					
2.3 i	110	02/98→08/03					
2.3 Turbo	165	10/99→08/03					
2.0 SE Turbo	147	02/98→08/03		→ 08/00; für Linkslenker		03.2123-1121.3 010176	Ø 23,81
				01/01→ 07/03		03.2123-1626.3 010727	ATE Ø 23,81
2.0 Turbo	110	01/01→08/03		→ 07/03		03.2123-1626.3 010727	ATE Ø 23,81
2.3	169	09/99→01/02		10/99→ 08/00; für Linkslenker		03.2123-1121.3 010176	Ø 23,81
				09/00→		03.2123-1626.3 010727	ATE Ø 23,81
SAAB - 9-3 Cabriolet (YS3F) 08/03→02/15							
 Hauptbremszylinder							
1.8t	110	08/03→02/15		→ 06/12; für Linkslenker		24.2125-1732.3 010827	TRW Ø 25,4
1.8t BioPower	110	01/07→02/15					
1.8 i	90	01/04→02/15					
1.9 TiD	88	09/04→02/15					
1.9 TiD	110	01/06→02/15					
1.9 TTiD	96	12/07→02/15					
1.9 TTiD	118	12/07→02/15					
1.9 TTiD	132	12/07→02/15					
2.0 t	120	01/11→02/15					
2.0 t	129	08/03→02/15					
2.0 t	154	08/03→02/15					
2.0 t	162	01/11→02/15					
2.0 t BioPower	120	01/11→02/15					
2.0 t BioPower	129	01/07→02/15					
2.0 t BioPower	162	01/11→02/15					
1.8t BioPower	129	01/07→02/15		07/07→ 06/12; für Linkslenker		24.2125-1732.3 010827	TRW Ø 25,4
2.0 t BioPower	147	06/07→02/15					
2.0	143	04/06→09/07		für Linkslenker		24.2125-1732.3 010827	TRW Ø 25,4
SAAB - 9-3 Kombi (YS3F) 03/05→02/15							
 Hauptbremszylinder							
1.8 i	90	03/05→02/15		→ 06/12; für Linkslenker		24.2125-1732.3 010827	TRW Ø 25,4
1.8t 2.0	110	03/05→02/15					
1.9 TiD	88	03/05→02/15					
1.9 TiD	110	03/05→02/15					
1.9 TTiD	96	12/07→02/15					
1.9 TTiD	118	12/07→02/15					
1.9 TTiD	132	12/07→02/15					
2.0 t	110	03/05→02/15					
2.0 t	120	01/07→02/15					
2.0 t	129	03/05→02/15					
2.0 t	147	02/09→02/15					
2.0 t	154	03/05→02/15					
2.0 t	162	01/11→02/15					
2.0 t	177	05/09→02/15					
2.0 t BioPower	110	01/07→02/15					
2.0 t BioPower	120	01/11→02/15					
2.0 t BioPower	129	01/07→02/15					
2.0 t BioPower	145	06/07→02/15					
2.0 t BioPower	162	01/11→02/15					
2.0 t Bio Power	147	02/09→02/15					
2.0 t BioPower XWD	120	01/11→02/15					
2.0 t BioPower XWD	162	01/11→02/15					
2.0 t Bio Power XWD	154	06/08→02/15					











	kW			 	! #		
SAAB - 9-3 Kombi (YS3F) 03/05→02/15							
 Hauptbremszylinder							
2.0 t XWD	120	01/07→02/15		→ 06/12; für Linkslenker		24.2125-1732.3 010827	TRW Ø 25,4
2.0 t XWD	162	01/11→02/15					
2.0 t XWD	177	05/09→02/15					
2.0 t XWD	154	06/08→02/15		07/08→ 06/12; für Linkslenker		24.2125-1732.3 010827	TRW Ø 25,4
SAAB - 9-3X 02/09→12/12							
 Hauptbremszylinder							
1.9 TTiD	132	02/09→12/12		03/09→ 06/12; für Linkslenker		24.2125-1732.3 010827	TRW Ø 25,4
2.0 t BioPower XWD	154	02/09→12/12					
2.0 t XWD	154	02/09→12/12					
2.0 t BioPower XWD	162	01/11→12/12		→ 06/12; für Linkslenker		24.2125-1732.3 010827	TRW Ø 25,4
SAAB - 9-5 (YS3E) 09/97→12/09							
 Bremskraftverstärker							
1.9 TiD	110	01/06→12/09		für Linkslenker		03.7745-3902.4 300129	ATE Ø 8 / 7" pneumatisch
2.0 t BioPower	110	01/05→12/09					
2.2 TiD	88	03/02→12/09					
2.3 t BioPower	136	01/07→12/09					
2.3 t BioPower	152	11/06→12/09					
2.3 Turbo	134	04/08→12/09					
2.3 Turbo	162	07/03→12/09					
2.3 Turbo	188	04/08→12/09					
2.3 Turbo	191	11/05→12/09					
2.0 t	110	09/97→12/09		→ 12/01; für Linkslenker		03.7745-3003.4 300157	ATE Ø 8 / 7" pneumatisch
2.0 t	136	07/00→12/09					
2.3 t	125	09/97→12/09		01/02→; für Linkslenker		03.7745-3902.4 300129	ATE Ø 8 / 7" pneumatisch
2.3 t	136	01/01→12/09					
2.3 Turbo	184	09/01→12/09					
3.0 TiD	130	07/01→12/09					
3.0 V6t	147	01/98→12/09					
2.0 t Biopower	132	09/05→12/09		06/06→; für Linkslenker		03.7745-3902.4 300129	ATE Ø 8 / 7" pneumatisch
2.0 Turbo SE	141	10/98→07/00		für Linkslenker		03.7745-3003.4 300157	ATE Ø 8 / 7" pneumatisch
2.3 Turbo	169	10/99→09/01					
2.3 Turbo	224	06/03→08/05		→ 03/04; für Linkslenker		03.7745-3902.4 300129	ATE Ø 8 / 7" pneumatisch
 Hauptbremszylinder							
1.9 TiD	110	01/06→12/09		für Linkslenker		03.2125-9911.3 010883	ATE Ø 25,4
2.3 t BioPower	136	01/07→12/09					
2.3 t BioPower	152	11/06→12/09					
2.3 Turbo	134	04/08→12/09					
2.3 Turbo	188	04/08→12/09					
2.0 t	110	09/97→12/09		→ 12/01; für Linkslenker		03.2125-7402.3 010541	ATE Ø 25,4
2.0 t	136	07/00→12/09		→ 12/01; für Rechtslenker		03.2125-7502.3 010616	ATE Ø 25,4
2.3 t	125	09/97→12/09					
2.3 t	136	01/01→12/09		01/02→ 12/05; für Linkslenker		03.2125-9901.3 010634	ATE Ø 25,4
2.3 Turbo	184	09/01→12/09		01/06→; für Linkslenker		03.2125-9911.3 010883	ATE Ø 25,4
3.0 TiD	130	07/01→12/09					
3.0 V6t	147	01/98→12/09					
2.0 t Biopower	132	09/05→12/09		06/06→; für Linkslenker		03.2125-9911.3 010883	ATE Ø 25,4
2.0 t BioPower	110	01/05→12/09		→ 12/05; für Linkslenker		03.2125-9901.3 010634	ATE Ø 25,4
2.2 TiD	88	03/02→12/09					
2.3 Turbo	162	07/03→12/09		01/06→; für Linkslenker		03.2125-9911.3 010883	ATE Ø 25,4
2.3 Turbo	191	11/05→12/09					
2.0 Turbo SE	141	10/98→07/00		für Linkslenker		03.2125-7402.3 010541	ATE Ø 25,4
2.3 Turbo	169	10/99→09/01		für Rechtslenker		03.2125-7502.3 010616	ATE Ø 25,4
2.3 Turbo	224	06/03→08/05		→ 03/04; für Linkslenker		03.2125-9901.3 010634	ATE Ø 25,4
SAAB - 9-5 (YS3G) 01/10→01/12							
 Bremskraftverstärker							
1.6 Turbo	132	05/10→01/12		für Linkslenker		03.7858-0732.4 300272	ATE Ø 9 / 8" pneumatisch
2.0 t BioPower	162	05/10→01/12					
2.0 t BioPower XWD	162	05/10→01/12					
2.0 TiD	118	05/10→01/12					
2.0 TTiD	140	05/10→01/12					
2.0 TTiD XWD	140	05/10→01/12					
2.0 Turbo	162	05/10→01/12					
2.0 Turbo XWD	162	05/10→01/12					
2.8 Turbo V6 XWD	221	05/10→01/12					
 Hauptbremszylinder							
1.6 Turbo	132	05/10→01/12		für Linkslenker		03.2125-0421.3 010934	ATE Ø 25,4
2.0 t BioPower	162	05/10→01/12					
2.0 t BioPower XWD	162	05/10→01/12					
2.0 TiD	118	05/10→01/12					
2.0 TTiD	140	05/10→01/12					
↓							







	kw			 	! #		
SAAB - 9-5 (YS3G) 01/10→01/12							
 Hauptbremszylinder							
2.0 TiD XWD	140	05/10→01/12		für Linkslenker		03.2125-0421.3 010934	ATE Ø 25,4
2.0 Turbo	162	05/10→01/12					
2.0 Turbo XWD	162	05/10→01/12					
2.8 Turbo V6 XWD	221	05/10→01/12					
SAAB - 9-5 Kombi (YS3E) 10/98→12/09							
 Bremskraftverstärker							
1.9 TiD	110	01/06→12/09		für Linkslenker		03.7745-3902.4 300129	ATE Ø 8 / 7" pneumatisch
1.9 TiD	129	01/07→12/09					
2.0 t BioPower	110	01/06→12/09					
2.2 TiD	88	03/02→12/09					
2.3 t BioPower	136	01/07→12/09					
2.3 t BioPower	152	11/06→12/09					
2.3 Turbo	162	07/03→12/09					
2.3 Turbo	188	04/08→12/09					
2.3 Turbo	191	01/06→12/09					
2.3 Turbo	224	06/03→08/05					
2.0 t	110	10/98→12/09		→ 12/01; für Linkslenker		03.7745-3003.4 300157	ATE Ø 8 / 7" pneumatisch
2.3 t	125	10/98→12/09					
2.3 t	136	01/01→12/09		01/02→; für Linkslenker		03.7745-3902.4 300129	ATE Ø 8 / 7" pneumatisch
3.0 TiD	130	07/01→12/09					
3.0 V6t	147	10/98→12/09					
2.0 t	136	07/00→07/01		für Linkslenker		03.7745-3003.4 300157	ATE Ø 8 / 7" pneumatisch
2.0 t	141	10/98→07/00					
2.3 Turbo	169	10/99→09/01					
2.0 t Biopower	132	09/05→12/09		06/06→; für Linkslenker		03.7745-3902.4 300129	ATE Ø 8 / 7" pneumatisch
2.3 t BioPower	154	11/06→12/09		01/07→; für Linkslenker		03.7745-3902.4 300129	ATE Ø 8 / 7" pneumatisch
2.3 Turbo	184	09/01→12/09		01/02→; für Linkslenker		03.7745-3902.4 300129	ATE Ø 8 / 7" pneumatisch
 Hauptbremszylinder							
1.9 TiD	110	01/06→12/09		für Linkslenker		03.2125-9911.3 010883	ATE Ø 25,4
1.9 TiD	129	01/07→12/09					
2.0 t BioPower	110	01/06→12/09					
2.3 t BioPower	136	01/07→12/09					
2.3 t BioPower	152	11/06→12/09					
2.3 Turbo	188	04/08→12/09					
2.3 Turbo	191	01/06→12/09					
2.0 t	110	10/98→12/09		→ 12/01; für Linkslenker		03.2125-7402.3 010541	ATE Ø 25,4
2.3 t	125	10/98→12/09		→ 12/01; für Rechtslenker		03.2125-7502.3 010616	ATE Ø 25,4
2.3 t	136	01/01→12/09					
3.0 TiD	130	07/01→12/09		01/02→ 12/05; für Linkslenker		03.2125-9901.3 010634	ATE Ø 25,4
3.0 V6t	147	10/98→12/09		01/06→; für Linkslenker		03.2125-9911.3 010883	ATE Ø 25,4
2.0 t	136	07/00→07/01		für Linkslenker		03.2125-7402.3 010541	ATE Ø 25,4
2.0 t	141	10/98→07/00					
2.3 Turbo	169	10/99→09/01		für Rechtslenker		03.2125-7502.3 010616	ATE Ø 25,4
2.0 t Biopower	132	09/05→12/09		06/06→; für Linkslenker		03.2125-9911.3 010883	ATE Ø 25,4
2.2 TiD	88	03/02→12/09		→ 12/05; für Linkslenker		03.2125-9901.3 010634	ATE Ø 25,4
2.3 Turbo	162	07/03→12/09		01/06→; für Linkslenker		03.2125-9911.3 010883	ATE Ø 25,4
2.3 t BioPower	154	11/06→12/09		01/07→; für Linkslenker		03.2125-9911.3 010883	ATE Ø 25,4
2.3 Turbo	184	09/01→12/09		01/02→ 12/05; für Linkslenker		03.2125-9901.3 010634	ATE Ø 25,4
				01/06→; für Linkslenker		03.2125-9911.3 010883	ATE Ø 25,4
2.3 Turbo	224	06/03→08/05		für Linkslenker		03.2125-9901.3 010634	ATE Ø 25,4
SAAB - 900 II 07/93→04/99							
 Hauptbremszylinder							
2.0 -16 Turbo	136	07/93→02/98		09/93→; → T2024503; für Rechtslenker		03.2123-1121.3 010176	Ø 23,81
2.3 -16	110	07/93→02/98		09/93→; → T7003723; für Rechtslenker		03.2123-1121.3 010176	Ø 23,81
				09/93→; für Linkslenker		03.2123-1121.3 010176	Ø 23,81
2.0 i	96	08/94→02/98		für Linkslenker		03.2123-1121.3 010176	Ø 23,81
				→ T7003723; für Rechtslenker		03.2123-1121.3 010176	Ø 23,81
				→ T2024503; für Rechtslenker		03.2123-1121.3 010176	Ø 23,81
2.5 -24 V6	125	07/93→02/98		09/93→; für Linkslenker		03.2123-1121.3 010176	Ø 23,81
SAAB - 900 II Cabriolet 09/93→04/99							
 Hauptbremszylinder							
2.0 -16 Turbo	136	12/93→02/98		für Linkslenker		03.2123-1121.3 010176	Ø 23,81
2.0 i	96	12/93→02/98		→ T7003723; für Rechtslenker		03.2123-1121.3 010176	Ø 23,81
2.3 -16	110	12/93→02/98		→ T2024503; für Rechtslenker		03.2123-1121.3 010176	Ø 23,81
2.5 -24 V6	125	12/93→02/98		für Linkslenker		03.2123-1121.3 010176	Ø 23,81













	kW			 	! #		
SAAB - 900 II Coupe 12/93→04/99							
 Hauptbremszylinder							
2.0 -16 Turbo	136	12/93→02/98		für Linkslenker		03.2123-1121.3 010176	Ø 23,81
2.0 i	96	08/94→02/98		→ T7003723; für Rechtslenker		03.2123-1121.3 010176	Ø 23,81
2.3 -16	110	12/93→02/98		→ T2024503; für Rechtslenker		03.2123-1121.3 010176	Ø 23,81
2.5 -24 V6	125	12/93→02/98		für Linkslenker		03.2123-1121.3 010176	Ø 23,81
SAAB - 9000 04/85→12/98							
 Hauptbremszylinder							
2.0 -16 CD	96	09/93→12/98		→ 05/98; - ASR		10.6123-0522.3 010633	ATE Ø 23,81
2.0 -16 CD	110	09/93→12/98					
2.3 -16 CDE	108	09/93→12/98					
2.3 -16 CDE Eco-Power	125	09/93→12/98					
2.0 -16 Turbo CD	108	09/92→12/98		09/93→ 05/98; - ASR		10.6123-0522.3 010633	ATE Ø 23,81
				→ 08/93; + ABS / - ASR		10.6123-0522.3 010633	ATE Ø 23,81
2.0 -16 Turbo CD	136	09/89→12/98		08/92→ 08/93; + ABS / - ASR		10.6123-0522.3 010633	ATE Ø 23,81
				09/93→ 05/98; - ASR		10.6123-0522.3 010633	ATE Ø 23,81
2.3 -16 CD	107	08/89→12/98		08/92→ 08/93; + ABS / - ASR		10.6123-0522.3 010633	ATE Ø 23,81
2.3 -16 CD Turbo	147	07/90→12/98		09/93→ 05/98; - ASR		10.6123-0522.3 010633	ATE Ø 23,81
3.0 -24 V6 CD/CDE	155	07/94→12/98		09/94→ 05/98; - ASR		10.6123-0522.3 010633	ATE Ø 23,81
SAAB - 9000 Schrägheck 09/84→12/98							
 Hauptbremszylinder							
2.0 -16 CS	94	01/89→12/98		08/92→ 08/93; + ABS / - ASR		10.6123-0522.3 010633	ATE Ø 23,81
2.3 -16 CS	107	09/89→12/98					
2.0 -16 CS	96	09/93→12/98		→ 05/98; - ASR		10.6123-0522.3 010633	ATE Ø 23,81
2.0 -16 ND Turbo	110	09/93→12/98					
2.3 -16 CSE	108	09/93→12/98					
2.3 -16 CSE Eco Power	125	09/93→12/98					
2.3 -16 Turbo CSE	147	09/93→12/98					
2.0 -16 Turbo CS	136	09/88→12/98		08/92→ 08/93; + ABS / - ASR		10.6123-0522.3 010633	ATE Ø 23,81
				09/93→ 05/98; - ASR		10.6123-0522.3 010633	ATE Ø 23,81
2.3 -16 Aero CS	162	02/93→12/98		09/93→ 05/98; - ASR		10.6123-0522.3 010633	ATE Ø 23,81
2.3 -16 Aero CS	165	02/93→12/98					
2.3 -16 Turbo	143	09/90→12/98					
3.0 -24 V6 CS/CSE	155	07/94→12/98		09/94→ 05/98; - ASR		10.6123-0522.3 010633	ATE Ø 23,81
SEAT - ALHAMBRA (7V8, 7V9) 04/96→03/10							
 Bremskraftverstärker							
1.8 T 20V	110	10/97→03/10		7M-W-507042→; → 05/00; für Linkslenker; + ABS		03.7755-1902.4 300138	ATE Ø 9 / 8" pneumatisch
				7M-3-515800→; für Linkslenker; - ESP		03.7755-6302.4 300221	ATE Ø 9 / 8" pneumatisch
				06/00→; für Rechtslenker; - ESP		03.7755-6302.4 300221	ATE Ø 9 / 8" pneumatisch
				06/00→; → 7M-3-515799; für Linkslenker; - ESP		03.7755-6302.4 300221	ATE Ø 9 / 8" pneumatisch
				05/98→; → 7M-W-507041; für Linkslenker; + ABS		03.7760-3002.4 300120	ATE Ø 10" pneumatisch
				05/98→ 05/00; für Rechtslenker; + ABS		03.7760-3002.4 300120	ATE Ø 10" pneumatisch
				06/00→; → 7M-3-515799; für Linkslenker; + ESP		03.7858-3302.4 300122	ATE Ø 9 / 8" pneumatisch
				7M-3-515800→; für Linkslenker; + ESP		03.7858-9502.4 300205	ATE Ø 9 / 8" pneumatisch
1.9 TDI	66	04/96→03/10		7M-W-507042→; → 05/00; für Linkslenker; + ABS		03.7755-1902.4 300138	ATE Ø 9 / 8" pneumatisch
2.0 i	85	04/96→03/10		7M-3-515800→; für Linkslenker; - ESP		03.7755-6302.4 300221	ATE Ø 9 / 8" pneumatisch
				06/00→; → 7M-3-515799; für Linkslenker; - ESP		03.7755-6302.4 300221	ATE Ø 9 / 8" pneumatisch
				06/00→; für Rechtslenker; - ESP		03.7755-6302.4 300221	ATE Ø 9 / 8" pneumatisch
				→ 7M-W-507041; für Linkslenker; + ABS		03.7760-3002.4 300120	ATE Ø 10" pneumatisch
				→ 05/00; für Rechtslenker; + ABS		03.7760-3002.4 300120	ATE Ø 10" pneumatisch
				06/00→; → 7M-3-515799; für Linkslenker; + ESP		03.7858-3302.4 300122	ATE Ø 9 / 8" pneumatisch
				7M-3-515800→; für Linkslenker; + ESP		03.7858-9502.4 300205	ATE Ø 9 / 8" pneumatisch
1.9 TDI	81	08/96→06/00		7M-W-507042→; → 05/00; für Linkslenker; + ABS		03.7755-1902.4 300138	ATE Ø 9 / 8" pneumatisch
				10/97→ 05/00; für Rechtslenker; + ABS		03.7760-3002.4 300120	ATE Ø 10" pneumatisch
				10/97→; → 7M-W-507041; für Linkslenker; + ABS		03.7760-3002.4 300120	ATE Ø 10" pneumatisch
1.9 TDI	85	06/00→03/10		für Rechtslenker; - ESP		03.7755-6302.4 300221	ATE Ø 9 / 8" pneumatisch
1.9 TDI	96	11/02→11/08		→ 7M-3-515799; für Linkslenker; - ESP		03.7755-6302.4 300221	ATE Ø 9 / 8" pneumatisch
2.8 V6	150	06/00→03/10					



























	kw			 	! #		
SEAT - ALHAMBRA (7V8, 7V9) 04/96→03/10							
Bremskraftverstärker							
1.9 TDI	85	06/00→03/10		7M-3-515800→; für Linkslenker; - ESP	03.7755-6302.4	300221	ATE Ø 9 / 8" pneumatisch
1.9 TDI	96	11/02→11/08		→ 7M-3-515799; für Linkslenker; + ESP	03.7858-3302.4	300122	ATE Ø 9 / 8" pneumatisch
2.8 V6	150	06/00→03/10		7M-3-515800→; für Linkslenker; + ESP	03.7858-9502.4	300205	ATE Ø 9 / 8" pneumatisch
1.9 TDI	110	05/05→05/07		für Linkslenker; - ESP	03.7755-6302.4	300221	ATE Ø 9 / 8" pneumatisch
2.0 TDI	103	11/05→03/10		für Rechtslenker; - ESP	03.7755-6302.4	300221	ATE Ø 9 / 8" pneumatisch
				für Linkslenker; + ESP	03.7858-9502.4	300205	ATE Ø 9 / 8" pneumatisch
1.9 TDI 4motion	85	06/00→03/10		7M-3-515800→; für Linkslenker; - ESP	03.7755-6302.4	300221	ATE Ø 9 / 8" pneumatisch
2.8 V6 4motion	150	06/00→03/10		02/01→; für Rechtslenker; - ESP	03.7755-6302.4	300221	ATE Ø 9 / 8" pneumatisch
				02/01→; → 7M-3-515799; für Linkslenker; - ESP	03.7755-6302.4	300221	ATE Ø 9 / 8" pneumatisch
				02/01→; → 7M-3-515799; für Linkslenker; + ESP	03.7858-3302.4	300122	ATE Ø 9 / 8" pneumatisch
				7M-3-515800→; für Linkslenker; + ESP	03.7858-9502.4	300205	ATE Ø 9 / 8" pneumatisch
Pedalwegsensor, Bremspedal							
1.8 T 20V	110	10/97→03/10		7M-3-515800→; für Linkslenker; + ESP	03.0655-0006.2	370006	ATE
1.9 TDI	66	04/96→03/10					
1.9 TDI	85	06/00→03/10					
1.9 TDI	96	11/02→11/08					
1.9 TDI 4motion	85	06/00→03/10					
2.0 i	85	04/96→03/10					
2.8 V6	150	06/00→03/10					
2.8 V6 4motion	150	06/00→03/10					
1.9 TDI	110	05/05→05/07		für Linkslenker; + ESP	03.0655-0006.2	370006	ATE
2.0 TDI	103	11/05→03/10					
Hauptbremszylinder							
1.8 T 20V	110	10/97→03/10		05/98→; → 7M-W-507041; + ABS	03.2123-1526.3	010477	Ø 23,81
				05/98→; → 7M-W-507041; - ABS	03.2123-1548.3	010478	Ø 23,81
				06/00→; → 7M-3-515799; - ESP	03.2125-0332.3	010952	Ø 25,4
				7M-W-507042→; → 05/00; + ABS	03.2125-0332.3	010952	Ø 25,4
				7M-3-515800→; - ESP	03.2125-0332.3	010952	Ø 25,4
				7M-W-507042→; → 05/00; - ABS	03.2125-8404.3	010583	ATE Ø 25,4
				06/00→; → 7M-3-515799; + ESP	03.2125-9604.3	010581	Ø 25,4
1.9 TDI	66	04/96→03/10		→ 7M-W-507041; + ABS	03.2123-1526.3	010477	Ø 23,81
2.0 i	85	04/96→03/10		→ 7M-W-507041; - ABS	03.2123-1548.3	010478	Ø 23,81
				06/00→; → 7M-3-515799; - ESP	03.2125-0332.3	010952	Ø 25,4
				7M-W-507042→; → 05/00; + ABS	03.2125-0332.3	010952	Ø 25,4
				7M-3-515800→; - ESP	03.2125-0332.3	010952	Ø 25,4
				7M-W-507042→; → 05/00; - ABS	03.2125-8404.3	010583	ATE Ø 25,4
				06/00→; → 7M-3-515799; + ESP	03.2125-9604.3	010581	Ø 25,4
1.9 TDI	81	08/96→06/00		10/97→; → 7M-W-507041; + ABS	03.2123-1526.3	010477	Ø 23,81
				10/97→; → 7M-W-507041; - ABS	03.2123-1548.3	010478	Ø 23,81
				7M-W-507042→; → 05/00; + ABS	03.2125-0332.3	010952	Ø 25,4
				7M-W-507042→; → 05/00; - ABS	03.2125-8404.3	010583	ATE Ø 25,4
1.9 TDI	85	06/00→03/10		→ 7M-3-515799; - ESP	03.2125-0332.3	010952	Ø 25,4
1.9 TDI	96	11/02→11/08		7M-3-515800→; - ESP	03.2125-0332.3	010952	Ø 25,4
2.8 V6	150	06/00→03/10		→ 7M-3-515799; + ESP	03.2125-9604.3	010581	Ø 25,4
1.9 TDI	110	05/05→05/07		- ESP	03.2125-0332.3	010952	Ø 25,4
2.0 TDI	103	11/05→03/10					
1.9 TDI 4motion	85	06/00→03/10		02/01→; → 7M-3-515799; - ESP	03.2125-0332.3	010952	Ø 25,4
2.8 V6 4motion	150	06/00→03/10		7M-3-515800→; - ESP	03.2125-0332.3	010952	Ø 25,4
				02/01→; → 7M-3-515799; + ESP	03.2125-9604.3	010581	Ø 25,4
Verschlusschraube, Hauptbremszylinder							
1.8 T 20V	110	10/97→03/10		05/98→; → 7M-W-507041; - ABS	03.3517-5100.1	390326	
1.9 TDI	66	04/96→03/10		→ 7M-W-507041; - ABS	03.3517-5100.1	390326	
2.0 i	85	04/96→03/10					
1.9 TDI	81	08/96→06/00		10/97→; → 7M-W-507041; - ABS	03.3517-5100.1	390326	
SEAT - ALHAMBRA (710, 711) 06/10→							
Bremskraftverstärker							
1.4 TSI	110	06/10→		09/10→; für Linkslenker	03.7873-4502.4	300284	ATE Ø 11" pneumatisch
2.0 TDI	100	06/10→05/11					
2.0 TDI	125	06/10→					
1.4 TSI	110	05/15→		für Linkslenker	03.7873-4502.4	300284	ATE Ø 11" pneumatisch
1.8 TSI	118	11/12→					















	kw			 	! #		
SEAT - ALHAMBRA (710, 711) 06/10→							
 Bremskraftverstärker							
2.0 TDI	85	05/11→		für Linkslenker		03.7873-4502.4 300284	ATE Ø 11" pneumatisch
2.0 TDI	103	06/10→					
2.0 TDI	130	11/12→					
2.0 TDI 4Drive	103	05/11→					
2.0 TSI	147	11/10→					
 Hauptbremszylinder							
1.4 TSI	110	06/10→		09/10→; für Linkslenker		03.4153-0186.3 010816	ATE Ø 23,81
2.0 TDI	100	06/10→05/11					
2.0 TDI	125	06/10→					
1.4 TSI	110	05/15→		für Linkslenker		03.4153-0186.3 010816	ATE Ø 23,81
1.8 TSI	118	11/12→					
2.0 TDI	85	05/11→					
2.0 TDI	103	06/10→					
2.0 TDI	110	05/15→					
2.0 TDI	130	11/12→					
2.0 TDI	135	05/15→					
2.0 TDI 4Drive	103	05/11→					
2.0 TDI 4Drive	110	05/15→					
2.0 TDI 4Drive	135	05/16→					
2.0 TSI	147	11/10→					
2.0 TSI	162	05/15→					
SEAT - ALTEA (5P1) 03/04→							
 Bremskraftverstärker							
1.2 TSI	77	04/10→		05/10→; für Linkslenker		03.7863-3232.4 300307	ATE Ø 10" pneumatisch
1.4 16V	63	05/06→				03.7863-3332.4 300308	ATE Ø 10" pneumatisch
1.4 TSI	92	11/07→					
1.6	75	03/04→		→ 04/10; +PR 1AC,1AT; für Linkslenker		03.7863-3232.4 300307	ATE Ø 10" pneumatisch
1.6 LPG	75	09/09→					
1.6 TDI	77	10/09→		→ 04/10; +PR 1AS; für Linkslenker		03.7863-9602.4 300206	ATE Ø 10" pneumatisch
1.8 TFSI	118	01/07→					
1.9 TDI	66	08/09→					
1.9 TDI	77	04/04→					
2.0 TDI	103	11/05→					
2.0 TDI	125	03/06→					
2.0 TDI 16V	103	03/04→					
1.6 TDI	66	11/10→		für Linkslenker		03.7863-3232.4 300307	ATE Ø 10" pneumatisch
						03.7863-3332.4 300308	ATE Ø 10" pneumatisch
2.0 FSI	110	05/04→03/09		+PR 1AC,1AT; für Linkslenker		03.7863-3232.4 300307	ATE Ø 10" pneumatisch
2.0 TDI	100	03/04→05/09					
2.0 TFSI	147	04/06→05/09		+PR 1AS; für Linkslenker		03.7863-9602.4 300206	ATE Ø 10" pneumatisch
 Hauptbremszylinder							
1.2 TSI	77	04/10→		05/10→; +PR 1AC,1AT,1AS; für Linkslenker		03.2122-2129.3 010799	ATE Ø 22,2
1.4 16V	63	05/06→					
1.4 TSI	92	11/07→		→ 04/10; für Linkslenker		03.2122-2129.3 010799	ATE Ø 22,2
1.6	75	03/04→					
1.6 LPG	75	09/09→					
1.6 TDI	77	10/09→		05/10→; +PR 1AC,1AT,1LJ; für Linkslenker		03.2123-3449.3 010808	ATE Ø 23,81
1.8 TFSI	118	01/07→					
1.9 TDI	66	08/09→					
1.9 TDI	77	04/04→					
2.0 TDI	103	11/05→					
2.0 TDI	125	03/06→					
2.0 TDI 16V	103	03/04→					
1.6 TDI	66	11/10→		für Linkslenker; +PR 1AC,1AT,1AS		03.2122-2129.3 010799	ATE Ø 22,2
				für Linkslenker; +PR 1AC,1AT,1LJ		03.2123-3449.3 010808	ATE Ø 23,81
2.0 FSI	110	05/04→03/09		für Linkslenker		03.2122-2129.3 010799	ATE Ø 22,2
2.0 TDI	100	03/04→05/09					
2.0 TFSI	147	04/06→05/09					
Hydraulikaggregat, Bremsanlage							
1.2 TSI	77	04/10→		+PR 1AT,1AS		24.9145-0001.2 399005	
1.4 16V	63	05/06→					
1.4 TSI	92	11/07→					
1.6	75	03/04→					
1.6 LPG	75	09/09→					
1.6 TDI	66	11/10→					
1.6 TDI	77	10/09→					
1.8 TFSI	118	01/07→					
1.9 TDI	66	08/09→					
1.9 TDI	77	04/04→					
2.0 FSI	110	05/04→03/09					
2.0 TDI	100	03/04→05/09					
2.0 TDI	103	11/05→					
2.0 TDI	125	03/06→					
2.0 TDI 16V	103	03/04→					
2.0 TFSI	147	04/06→05/09					











	kw			 	! #		
SEAT - ALTEA (5P1) 03/04 →							
Drucksensor, Bremskraftverstärker							
1.2 TSI	77	04/10 →		→ 04/10; +PR 1AS; für Linkslenker		03.0655-0101.2 370008	ATE
1.4 16V	63	05/06 →					
1.4 TSI	92	11/07 →					
1.6	75	03/04 →					
1.6 LPG	75	09/09 →					
1.6 TDI	77	10/09 →					
1.8 TFSI	118	01/07 →					
1.9 TDI	66	08/09 →					
1.9 TDI	77	04/04 →					
2.0 TDI	103	11/05 →					
2.0 TDI	125	03/06 →					
2.0 TDI 16V	103	03/04 →					
2.0 FSI	110	05/04 → 03/09		+PR 1AS; für Linkslenker		03.0655-0101.2 370008	ATE
2.0 TDI	100	03/04 → 05/09					
2.0 TFSI	147	04/06 → 05/09					
SEAT - ALTEA XL (5P5, 5P8) 10/06 →							
Bremskraftverstärker							
1.2 TSI	77	04/10 →		05/10 →; für Linkslenker		03.7863-3232.4 300307	ATE Ø 10" pneumatisch
1.4 TSI	92	11/07 →				03.7863-3332.4 300308	ATE Ø 10" pneumatisch
1.6	75	10/06 →					
1.6 LPG	75	09/09 →		+PR 1AC,1AT; → 04/10; für Linkslenker		03.7863-3232.4 300307	ATE Ø 10" pneumatisch
1.6 Multifuel	75	10/06 →					
1.6 TDI	77	10/09 →		+PR 1AS; → 04/10; für Linkslenker		03.7863-9602.4 300206	ATE Ø 10" pneumatisch
1.8 TFSI	118	01/07 →					
1.9 TDI	66	08/09 →					
1.9 TDI	77	10/06 →					
1.9 TDI 4x4	77	06/09 → 12/10					
2.0 TDI	103	10/06 →					
2.0 TDI	125	06/07 →					
2.0 TDI 16V	103	10/06 →					
2.0 TDI 4x4	103	06/07 →					
2.0 TDI 4x4	125	06/07 →					
2.0 TFSI 4x4	155	05/09 →					
1.4 16V	63	10/06 →		05/08 →; +PR 1AC,1AT; → 04/10; für Linkslenker		03.7863-3232.4 300307	ATE Ø 10" pneumatisch
				05/10 →; für Linkslenker		03.7863-3232.4 300307	ATE Ø 10" pneumatisch
						03.7863-3332.4 300308	ATE Ø 10" pneumatisch
				05/08 →; +PR 1AS; → 04/10; für Linkslenker		03.7863-9602.4 300206	ATE Ø 10" pneumatisch
1.6 TDI	66	11/10 →					
2.0 TDI 16V 4x4	103	10/10 →		für Linkslenker		03.7863-3232.4 300307	ATE Ø 10" pneumatisch
						03.7863-3332.4 300308	ATE Ø 10" pneumatisch
2.0 FSI	110	10/06 → 03/09		+PR 1AC,1AT; für Linkslenker		03.7863-3232.4 300307	ATE Ø 10" pneumatisch
2.0 TDI	100	11/06 → 03/09					
2.0 TFSI	147	10/06 → 05/09		+PR 1AS; für Linkslenker		03.7863-9602.4 300206	ATE Ø 10" pneumatisch
2.0 TFSI 4x4	147	06/07 → 05/09					
Hauptbremszylinder							
1.2 TSI	77	04/10 →		05/10 →; +PR 1AC,1AT,1AS; für Linkslenker		03.2122-2129.3 010799	ATE Ø 22,2
1.4 TSI	92	11/07 →					
1.6	75	10/06 →		→ 04/10; für Linkslenker		03.2122-2129.3 010799	ATE Ø 22,2
1.6 LPG	75	09/09 →					
1.6 Multifuel	75	10/06 →		05/10 →; +PR 1AC,1AT,1LJ; für Linkslenker		03.2123-3449.3 010808	ATE Ø 23,81
1.6 TDI	77	10/09 →					
1.8 TFSI	118	01/07 →					
1.9 TDI	66	08/09 →					
1.9 TDI	77	10/06 →					
2.0 TDI	103	10/06 →					
2.0 TDI	125	06/07 →					
2.0 TDI 16V	103	10/06 →					
2.0 TDI 4x4	103	06/07 →					
2.0 TDI 4x4	125	06/07 →					
2.0 TFSI 4x4	155	05/09 →					
1.4 16V	63	10/06 →		05/10 →; +PR 1AC,1AT,1AS; für Linkslenker		03.2122-2129.3 010799	ATE Ø 22,2
				05/08 → 04/10; für Linkslenker		03.2122-2129.3 010799	ATE Ø 22,2
				05/10 →; +PR 1AC,1AT,1LJ; für Linkslenker		03.2123-3449.3 010808	ATE Ø 23,81
1.6 TDI	66	11/10 →		für Linkslenker; +PR 1AC,1AT,1AS		03.2122-2129.3 010799	ATE Ø 22,2
2.0 TDI 16V 4x4	103	10/10 →		für Linkslenker; +PR 1AC,1AT,1LJ		03.2123-3449.3 010808	ATE Ø 23,81
1.9 TDI 4x4	77	06/09 → 12/10		05/10 →; +PR 1AC,1AT,1AS; für Linkslenker		03.2122-2129.3 010799	ATE Ø 22,2
				→ 04/10; für Linkslenker		03.2122-2129.3 010799	ATE Ø 22,2
2.0 FSI	110	10/06 → 03/09		für Linkslenker		03.2122-2129.3 010799	ATE Ø 22,2
2.0 TDI	100	11/06 → 03/09					
2.0 TFSI	147	10/06 → 05/09					
2.0 TFSI 4x4	147	06/07 → 05/09					













	kw			 	! #		
SEAT - ALTEA XL (5P5, 5P8) 10/06→							
Drucksensor, Bremskraftverstärker							
1.2 TSI	77	04/10→		+PR 1AS; → 04/10; für Linkslenker		03.0655-0101.2 370008	ATE
1.4 TSI	92	11/07→					
1.6	75	10/06→					
1.6 LPG	75	09/09→					
1.6 Multifuel	75	10/06→					
1.6 TDI	77	10/09→					
1.8 TFSI	118	01/07→					
1.9 TDI	66	08/09→					
1.9 TDI	77	10/06→					
1.9 TDI 4x4	77	06/09→12/10					
2.0 TDI	103	10/06→					
2.0 TDI	125	06/07→					
2.0 TDI 16V	103	10/06→					
2.0 TDI 4x4	103	06/07→					
2.0 TDI 4x4	125	06/07→					
2.0 TFSI 4x4	155	05/09→					
1.4 16V	63	10/06→		05/08→; +PR 1AS; → 04/10; für Linkslenker		03.0655-0101.2 370008	ATE
2.0 FSI	110	10/06→03/09		+PR 1AS; für Linkslenker		03.0655-0101.2 370008	ATE
2.0 TDI	100	11/06→03/09					
2.0 TFSI	147	10/06→05/09					
2.0 TFSI 4x4	147	06/07→05/09					
SEAT - AROSA (6H) 05/97→06/04							
 Hauptbremszylinder							
1.0	37	05/97→06/04		für Linkslenker; - ABS		03.2120-3943.3 010532	ATE Ø 20,64
1.0	37	10/98→01/01					
1.4	44	05/97→06/04		für Rechtslenker; + ABS		03.2122-1184.3 010592	ATE Ø 22,2
1.4 16V	74	01/00→06/04		für Linkslenker; + ABS		03.2122-1344.3 010593	ATE Ø 22,2
1.4 TDI	55	01/00→06/04					
1.7 SDI	44	08/97→06/04		11/97→; für Linkslenker; - ABS		03.2120-3943.3 010532	ATE Ø 20,64
				11/97→; für Rechtslenker; + ABS		03.2122-1184.3 010592	ATE Ø 22,2
				11/97→; für Linkslenker; + ABS		03.2122-1344.3 010593	ATE Ø 22,2
 Bremskraftregler							
1.0	37	05/97→06/04				03.6583-0184.3 320229	ATE lastabhängig 8/3 4x
1.0	37	10/98→01/01					
1.4	44	05/97→06/04					
1.4 16V	74	01/00→06/04					
1.4 TDI	55	01/00→06/04					
1.7 SDI	44	08/97→06/04		11/97→		03.6583-0184.3 320229	ATE lastabhängig 8/3 4x
SEAT - ATECA (KH7) 04/16→							
 Hauptbremszylinder							
1.0 TSI	85	05/16→		06/16→; für Linkslenker		24.4123-1719.3 011017	TRW Ø 23,81 ohne Bremsflüssigkeitsbehälter
1.6 TDI	85	04/16→					
2.0 TDI	110	04/16→					
2.0 TDI 4Drive	110	04/16→					
1.4 TSI	110	06/16→		für Linkslenker		24.4123-1719.3 011017	TRW Ø 23,81 ohne Bremsflüssigkeitsbehälter
1.4 TSI 4Drive	110	06/16→					
2.0 TDI	81	10/16→					
2.0 TDI	105	10/16→					
2.0 TDI 4Drive	140	06/16→					
SEAT - CORDOBA (6K1, 6K2) 02/93→10/99							
 Bremskraftverstärker							
1.0 i	37	09/96→06/99		06/99→; für Linkslenker; - ABS		03.7750-6302.4 300161	ATE Ø 9" pneumatisch
				06/99→; + ABS; für Linkslenker; +PR 1KB		10.6350-3902.4 300213	ATE Ø 9" pneumatisch
				06/99→; + ABS; für Linkslenker; +PR 1KK,1KM,1KQ		10.6350-4002.4 300285	ATE Ø 9" pneumatisch
1.8 i 16V	95	10/93→08/96		02/94→; für Linkslenker; - ABS		03.7740-1402.4 300133	ATE Ø 8" pneumatisch
2.0 i	85	02/93→06/99		11/93→ 05/99; für Linkslenker; - ABS		03.7740-1402.4 300133	ATE Ø 8" pneumatisch
 Hauptbremszylinder							
1.0 i	37	09/96→06/99		06/99→; für Linkslenker; - ABS		03.2122-1042.3 010137	Ø 22,2
				06/99→; für Linkslenker; + ABS		03.2123-1424.3 010637	ATE Ø 23,81
1.4	40	12/97→04/99		- ABS		03.2120-3943.3 010532	ATE Ø 20,64
1.9 D	47	01/96→08/96					
1.4 i	44	06/94→06/99		→ 05/99; - ABS		03.2120-3943.3 010532	ATE Ø 20,64
1.4 i 16V	74	09/96→06/99					
1.6 i	55	05/94→06/99					
1.6 i	74	07/96→10/99					
1.9 SDI	47	08/96→06/99					
↓							













	kw			 	! #		
SEAT - CORDOBA (6K1, 6K2) 02/93→10/99							
 Hauptbremszylinder							
1.6 i	55	02/93→06/99		11/93→ 05/99; - ABS		03.2120-3943.3 010532	ATE Ø 20,64
1.8 i	66	02/93→06/99					
1.8 i 16V	95	10/93→08/96		02/94→; - ABS		03.2122-1042.3 010137	Ø 22,2
				02/94→; für Linkslenker; + ABS		10.6123-0674.3 010639	ATE Ø 23,81
1.9 D	50	02/93→08/96		11/93→; - ABS		03.2120-3943.3 010532	ATE Ø 20,64
1.9 TD	55	02/93→08/96					
1.9 TDI	66	08/96→06/99		→ 05/99; - ABS		03.2122-1042.3 010137	Ø 22,2
1.9 TDI	81	03/97→06/99					
2.0 i	85	02/93→06/99		11/93→ 05/99; - ABS		03.2122-1042.3 010137	Ø 22,2
				11/93→ 05/99; für Linkslenker; + ABS		10.6123-0674.3 010639	ATE Ø 23,81
Verschlusschraube, Hauptbremszylinder							
1.4	40	12/97→04/99		- ABS		03.3517-0101.2 390322	
1.9 D	47	01/96→08/96					
1.4 i	44	06/94→06/99		→ 05/99; - ABS		03.3517-0101.2 390322	
1.4 i 16V	74	09/96→06/99					
1.6 i	55	05/94→06/99					
1.6 i	74	07/96→10/99					
1.9 SDI	47	08/96→06/99					
1.9 TDI	66	08/96→06/99					
1.9 TDI	81	03/97→06/99					
1.6 i	55	02/93→06/99		11/93→ 05/99; - ABS		03.3517-0101.2 390322	
1.8 i	66	02/93→06/99					
2.0 i	85	02/93→06/99					
1.8 i 16V	95	10/93→08/96		02/94→; - ABS		03.3517-0101.2 390322	
1.9 D	50	02/93→08/96		11/93→; - ABS		03.3517-0101.2 390322	
1.9 TD	55	02/93→08/96					
 Bremskraftregler							
1.4	40	12/97→04/99				03.0101-0025.2 320014	ATE Satz 3/35 2x
1.9 D	47	01/96→08/96				03.6584-0113.3 320111	ATE lastabhängig 8/4 4x
1.4 i	44	06/94→06/99		→ 05/99		03.0101-0025.2 320014	ATE Satz 3/35 2x
1.4 i 16V	74	09/96→06/99				03.6584-0113.3 320111	ATE lastabhängig 8/4 4x
1.6 i	55	05/94→06/99					
1.6 i	74	07/96→10/99					
1.9 SDI	47	08/96→06/99					
1.9 TDI	66	08/96→06/99					
1.9 TDI	81	03/97→06/99					
1.6 i	55	02/93→06/99		11/93→ 05/99		03.0101-0025.2 320014	ATE Satz 3/35 2x
1.8 i	66	02/93→06/99				03.6584-0113.3 320111	ATE lastabhängig 8/4 4x
2.0 i	85	02/93→06/99					
1.8 i 16V	95	10/93→08/96		02/94→		03.0101-0025.2 320014	ATE Satz 3/35 2x
						03.6584-0113.3 320111	ATE lastabhängig 8/4 4x
1.9 D	50	02/93→08/96		11/93→		03.0101-0025.2 320014	ATE Satz 3/35 2x
1.9 TD	55	02/93→08/96				03.6584-0113.3 320111	ATE lastabhängig 8/4 4x
SEAT - CORDOBA (6K2) 06/99→10/02							
 Bremskraftverstärker							
1.0	37	06/99→10/02		→ 09/02; für Linkslenker; - ABS		03.7750-6302.4 300161	ATE Ø 9" pneumatisch
1.4	44	06/99→10/02					
1.4 16V	55	05/00→10/02		→ 09/02; für Linkslenker; + ABS; +PR 1KB		10.6350-3902.4 300213	ATE Ø 9" pneumatisch
1.4 16V	74	02/00→10/02					
1.6	55	06/99→10/02		→ 09/02; für Linkslenker; + ABS; +PR 1KK,1KM,1KQ		10.6350-4002.4 300285	ATE Ø 9" pneumatisch
1.6	74	06/99→10/02					
1.8 T 20V Cupra	115	07/00→10/02					
1.9 SDI	50	06/99→10/02					
1.9 TDI	66	06/99→10/02					
1.9 TDI	81	06/99→10/02					
 Hauptbremszylinder							
1.0	37	06/99→10/02		→ 09/02; für Linkslenker; - ABS		03.2122-1042.3 010137	Ø 22,2
1.4	44	06/99→10/02					
1.4 16V	55	05/00→10/02		→ 09/02; für Linkslenker; + ABS		03.2123-1424.3 010637	ATE Ø 23,81
1.4 16V	74	02/00→10/02					
1.6	55	06/99→10/02					
1.6	74	06/99→10/02					
1.8 T 20V Cupra	115	07/00→10/02					
1.9 SDI	50	06/99→10/02					
1.9 TDI	66	06/99→10/02					
1.9 TDI	81	06/99→10/02					
SEAT - CORDOBA (6L2) 09/02→11/09							
 Bremskraftverstärker							
1.2	47	10/02→06/06		für Linkslenker		03.7750-6302.4 300161	ATE Ø 9" pneumatisch
↓							











	kW			 	! #		
SEAT - CORDOBA (6L2) 09/02→11/09							
 Bremskraftverstärker							
1.4 TDI	55	10/02→12/05		für Linkslenker		03.7750-6302.4 300161	ATE Ø 9" pneumatisch
1.2 12V	51	05/06→11/09		→ 06/09; für Linkslenker		03.7750-6302.4 300161	ATE Ø 9" pneumatisch
1.4 16V	63	05/06→11/09					
1.4 16V	74	10/02→11/09					
1.4 TDI	51	05/05→11/09					
1.4 TDI	59	06/05→11/09					
1.6	74	04/03→11/09					
1.6 16V	77	11/06→11/09					
1.9 TDI	96	10/02→11/09					
1.4 16V	55	09/02→12/07		10/02→; für Linkslenker		03.7750-6302.4 300161	ATE Ø 9" pneumatisch
1.9 SDI	47	09/02→11/09		10/02→ 06/09; für Linkslenker		03.7750-6302.4 300161	ATE Ø 9" pneumatisch
1.9 TDI	74	09/02→11/09					
2.0	85	09/02→11/09					
 Hauptbremszylinder							
1.2	47	10/02→06/06		+ ABS		24.2120-1734.3 010702	Ø 20,64
1.4 TDI	55	10/02→12/05		- ABS		24.2120-1736.3 010732	Ø 20,64
1.2 12V	51	05/06→11/09		→ 06/09; + ABS		24.2120-1734.3 010702	Ø 20,64
1.4 16V	63	05/06→11/09					
1.4 16V	74	10/02→11/09		→ 06/09; - ABS		24.2120-1736.3 010732	Ø 20,64
1.4 TDI	51	05/05→11/09					
1.4 TDI	59	06/05→11/09					
1.6	74	04/03→11/09					
1.6 16V	77	11/06→11/09					
1.9 TDI	96	10/02→11/09					
1.4 16V	55	09/02→12/07		10/02→; + ABS		24.2120-1734.3 010702	Ø 20,64
				10/02→; - ABS		24.2120-1736.3 010732	Ø 20,64
1.9 SDI	47	09/02→11/09		10/02→ 06/09; + ABS		24.2120-1734.3 010702	Ø 20,64
1.9 TDI	74	09/02→11/09		10/02→ 06/09; - ABS		24.2120-1736.3 010732	Ø 20,64
2.0	85	09/02→11/09					
 Bremskraftregler							
1.2	47	10/02→06/06		- ABS		03.6583-0216.3 320247	ATE lastabhängig 8/3 4x
1.4 TDI	55	10/02→12/05				03.6584-0120.3 320279	ATE lastabhängig 8/4 4x
1.2 12V	51	05/06→11/09		→ 06/09; - ABS		03.6583-0216.3 320247	ATE lastabhängig 8/3 4x
1.4 16V	63	05/06→11/09				03.6584-0120.3 320279	ATE lastabhängig 8/4 4x
1.4 16V	74	10/02→11/09					
1.4 TDI	51	05/05→11/09					
1.4 TDI	59	06/05→11/09					
1.6	74	04/03→11/09					
1.6 16V	77	11/06→11/09					
1.9 TDI	96	10/02→11/09					
1.4 16V	55	09/02→12/07		10/02→; - ABS		03.6583-0216.3 320247	ATE lastabhängig 8/3 4x
						03.6584-0120.3 320279	ATE lastabhängig 8/4 4x
1.9 SDI	47	09/02→11/09		10/02→ 06/09; - ABS		03.6583-0216.3 320247	ATE lastabhängig 8/3 4x
1.9 TDI	74	09/02→11/09				03.6584-0120.3 320279	ATE lastabhängig 8/4 4x
2.0	85	09/02→11/09					
SEAT - CORDOBA Vario (6K5) 08/96→06/99							
 Hauptbremszylinder							
1.4 i	44	09/96→06/99		→ 05/99; - ABS		03.2120-3943.3 010532	ATE Ø 20,64
1.6 i	55	09/96→06/99					
1.6 i	55	05/97→06/99					
1.6 i	74	09/96→06/99					
1.9 SDI	47	09/96→06/99					
1.9 TDI	66	08/96→06/99		→ 05/99; - ABS		03.2122-1042.3 010137	Ø 22,2
1.9 TDI	81	07/97→06/99					
Verschlusschraube, Hauptbremszylinder							
1.4 i	44	09/96→06/99		→ 05/99; - ABS		03.3517-0101.2 390322	
1.6 i	55	09/96→06/99					
1.6 i	55	05/97→06/99					
1.6 i	74	09/96→06/99					
1.9 SDI	47	09/96→06/99					
1.9 TDI	66	08/96→06/99					
1.9 TDI	81	07/97→06/99					
 Bremskraftregler							
1.4 i	44	09/96→06/99		→ 05/99		03.0101-0025.2 320014	ATE Satz 3/35 2x
1.6 i	55	09/96→06/99				03.6584-0113.3 320111	ATE lastabhängig 8/4 4x
1.6 i	55	05/97→06/99					
1.6 i	74	09/96→06/99					
1.9 SDI	47	09/96→06/99					
1.9 TDI	66	08/96→06/99					
1.9 TDI	81	07/97→06/99					











	kw			 	! #		
SEAT - CORDOBA Vario (6K5) 06/99→12/02							
 Bremskraftverstärker							
1.4	44	06/99→12/02		→ 09/02; für Linkslenker; - ABS	03.7750-6302.4	300161	ATE Ø 9" pneumatisch
1.4 16V	55	06/99→12/02		→ 09/02; für Linkslenker; + ABS;	10.6350-3902.4	300213	ATE Ø 9" pneumatisch
1.6	55	06/99→12/02		+PR 1KB			
1.6	74	06/99→12/02					
1.9 SDI	50	06/99→12/02		→ 09/02; für Linkslenker; + ABS;	10.6350-4002.4	300285	ATE Ø 9" pneumatisch
1.9 TDI	66	06/99→12/02		+PR 1KK,1KM,1KQ			
1.9 TDI	81	06/99→12/02					
 Hauptbremszylinder							
1.4	44	06/99→12/02		→ 09/02; für Linkslenker; - ABS	03.2122-1042.3	010137	Ø 22,2
1.4 16V	55	06/99→12/02		→ 09/02; für Linkslenker; + ABS	03.2123-1424.3	010637	ATE Ø 23,81
1.6	55	06/99→12/02					
1.6	74	06/99→12/02					
1.9 SDI	50	06/99→12/02					
1.9 TDI	66	06/99→12/02					
1.9 TDI	81	06/99→12/02					
SEAT - EXEO (3R2) 12/08→							
 Bremskraftverstärker							
1.6	75	03/09→09/10		04/09→	03.7858-4502.4	300202	ATE Ø 9 / 8" pneumatisch
1.8 T	110	12/08→05/10					
1.8 TSI	88	09/10→		→ 06/13	03.7858-4502.4	300202	ATE Ø 9 / 8" pneumatisch
1.8 TSI	118	05/10→					
2.0 TFSI	155	05/10→					
2.0 TDI	88	12/08→		04/09→ 06/13	03.7858-4502.4	300202	ATE Ø 9 / 8" pneumatisch
2.0 TDI	105	12/08→					
2.0 TDI	125	02/09→					
2.0 TFSI	147	03/09→					
 Hauptbremszylinder							
1.6	75	03/09→09/10		04/09→	03.2125-0373.3	010810	ATE Ø 25,4
1.8 T	110	12/08→05/10			24.2125-1720.3	010688	TRW Ø 25,4
1.8 TSI	88	09/10→		→ 06/13	03.2125-0373.3	010810	ATE Ø 25,4
1.8 TSI	118	05/10→			24.2125-1720.3	010688	TRW Ø 25,4
2.0 TFSI	155	05/10→					
2.0 TDI	88	12/08→		04/09→ 06/13	03.2125-0373.3	010810	ATE Ø 25,4
2.0 TDI	105	12/08→			24.2125-1720.3	010688	TRW Ø 25,4
2.0 TDI	125	02/09→					
2.0 TFSI	147	03/09→					
SEAT - EXEO ST (3R5) 05/09→							
 Bremskraftverstärker							
1.6	75	06/09→09/10			03.7858-4502.4	300202	ATE Ø 9 / 8" pneumatisch
1.8 T	110	06/09→05/10					
1.8 TSI	88	09/10→		→ 06/13	03.7858-4502.4	300202	ATE Ø 9 / 8" pneumatisch
1.8 TSI	118	05/10→					
2.0 TDI	88	07/09→					
2.0 TDI	105	05/09→					
2.0 TDI	125	05/09→					
2.0 TFSI	147	06/09→					
2.0 TFSI	155	05/10→					
 Hauptbremszylinder							
1.6	75	06/09→09/10			03.2125-0373.3	010810	ATE Ø 25,4
1.8 T	110	06/09→05/10			24.2125-1720.3	010688	TRW Ø 25,4
1.8 TSI	88	09/10→		→ 06/13	03.2125-0373.3	010810	ATE Ø 25,4
1.8 TSI	118	05/10→			24.2125-1720.3	010688	TRW Ø 25,4
2.0 TDI	88	07/09→					
2.0 TDI	105	05/09→					
2.0 TDI	125	05/09→					
2.0 TFSI	147	06/09→					
2.0 TFSI	155	05/10→					
SEAT - IBIZA II (6K1) 03/93→08/99							
 Bremskraftverstärker							
1.0	33	03/93→09/96		für Linkslenker; - ABS	03.7740-1402.4	300133	ATE Ø 8" pneumatisch
1.4	40	12/97→04/99		6K-TR069487→; für Linkslenker	10.6350-3902.4	300213	ATE Ø 9" pneumatisch
				6K-TR069487→; für Linkslenker; + ABS	10.6350-4002.4	300285	ATE Ø 9" pneumatisch
1.0 i	37	09/96→08/99		→ 07/99; für Linkslenker; - ABS	03.7740-1402.4	300133	ATE Ø 8" pneumatisch
1.3 i	40	03/93→08/99			10.6350-3902.4	300213	ATE Ø 9" pneumatisch
1.4 i	44	09/93→08/99		6K-TR069487→; → 07/99; für Linkslenker	10.6350-4002.4	300285	ATE Ø 9" pneumatisch
				6K-TR069487→; → 07/99; für Linkslenker; + ABS	10.6350-4002.4	300285	ATE Ø 9" pneumatisch
↓							

	kw			 	! #		
SEAT - IBIZA II (6K1) 03/93→08/99							
 Bremskraftverstärker							
1.4 i 16V	74	06/97→08/99		6K-TR069487→; → 07/99; für Linkslenker		10.6350-3902.4 300213	ATE Ø 9" pneumatisch
1.9 TDI	66	08/96→08/99					
1.9 TDI	81	02/97→08/99		6K-TR069487→; → 07/99; für Linkslenker; + ABS		10.6350-4002.4 300285	ATE Ø 9" pneumatisch
2.0 i 16V	110	08/96→08/99					
1.6 i	55	03/93→08/99		→ 07/99; für Linkslenker; - ABS		03.7740-1402.4 300133	ATE Ø 8" pneumatisch
1.6 i	74	04/96→08/99				03.7750-6302.4 300161	ATE Ø 9" pneumatisch
				6K-TR069487→; → 07/99; für Linkslenker		10.6350-3902.4 300213	ATE Ø 9" pneumatisch
				6K-TR069487→; → 07/99; für Linkslenker; + ABS		10.6350-4002.4 300285	ATE Ø 9" pneumatisch
1.6 i	55	09/94→06/99		für Linkslenker; - ABS		03.7740-1402.4 300133	ATE Ø 8" pneumatisch
						03.7750-6302.4 300161	ATE Ø 9" pneumatisch
				6K-TR069487→; für Linkslenker		10.6350-3902.4 300213	ATE Ø 9" pneumatisch
				6K-TR069487→; für Linkslenker; + ABS		10.6350-4002.4 300285	ATE Ø 9" pneumatisch
1.8 i	66	03/93→08/99		→ 07/99; für Linkslenker; - ABS		03.7750-6302.4 300161	ATE Ø 9" pneumatisch
1.9 SDI	47	08/96→08/99					
2.0 i	85	03/93→08/99		6K-TR069487→; → 07/99; für Linkslenker		10.6350-3902.4 300213	ATE Ø 9" pneumatisch
				6K-TR069487→; → 07/99; für Linkslenker; + ABS		10.6350-4002.4 300285	ATE Ø 9" pneumatisch
1.8 i 16V	95	11/93→08/96		02/94→; für Linkslenker; - ABS		03.7750-6302.4 300161	ATE Ø 9" pneumatisch
				6K-TR069487→; für Linkslenker		10.6350-3902.4 300213	ATE Ø 9" pneumatisch
				6K-TR069487→; für Linkslenker; + ABS		10.6350-4002.4 300285	ATE Ø 9" pneumatisch
1.9 D	47	04/93→08/96		für Linkslenker; - ABS		03.7750-6302.4 300161	ATE Ø 9" pneumatisch
1.9 D	50	10/94→08/96					
1.9 TD	55	03/93→08/96		6K-TR069487→; für Linkslenker		10.6350-3902.4 300213	ATE Ø 9" pneumatisch
				6K-TR069487→; für Linkslenker; + ABS		10.6350-4002.4 300285	ATE Ø 9" pneumatisch
 Hauptbremszylinder							
1.0	33	03/93→09/96		- ABS		03.2120-3943.3 010532	ATE Ø 20,64
1.4	40	12/97→04/99					
1.6 i	55	09/94→06/99					
1.9 D	47	04/93→08/96					
1.9 D	50	10/94→08/96					
1.9 TD	55	03/93→08/96					
1.0 i	37	09/96→08/99		→ 07/99; - ABS		03.2120-3943.3 010532	ATE Ø 20,64
1.3 i	40	03/93→08/99					
1.4 i	44	09/93→08/99					
1.6 i	55	03/93→08/99					
1.6 i	74	04/96→08/99					
1.8 i	66	03/93→08/99					
1.9 SDI	47	08/96→08/99					
1.8 i 16V	95	11/93→08/96		02/94→; - ABS		03.2122-1042.3 010137	Ø 22,2
				02/94→; für Linkslenker; + ABS		10.6123-0674.3 010639	ATE Ø 23,81
1.9 TDI	66	08/96→08/99		→ 07/99; - ABS		03.2122-1042.3 010137	Ø 22,2
1.9 TDI	81	02/97→08/99		03/97→ 07/99; - ABS		03.2122-1042.3 010137	Ø 22,2
2.0 i	85	03/93→08/99		→ 07/99; - ABS		03.2122-1042.3 010137	Ø 22,2
				→ 07/99; für Linkslenker; + ABS		10.6123-0674.3 010639	ATE Ø 23,81
Verschlusschraube, Hauptbremszylinder							
1.0	33	03/93→09/96		- ABS		03.3517-0101.2 390322	
1.4	40	12/97→04/99					
1.6 i	55	09/94→06/99					
1.9 D	47	04/93→08/96					
1.9 D	50	10/94→08/96					
1.9 TD	55	03/93→08/96					
1.0 i	37	09/96→08/99		→ 07/99; - ABS		03.3517-0101.2 390322	
1.3 i	40	03/93→08/99					
1.4 i	44	09/93→08/99					
1.6 i	55	03/93→08/99					
1.6 i	74	04/96→08/99					
1.8 i	66	03/93→08/99					
1.9 SDI	47	08/96→08/99					
1.9 TDI	66	08/96→08/99					
2.0 i	85	03/93→08/99					
1.8 i 16V	95	11/93→08/96		02/94→; - ABS		03.3517-0101.2 390322	
1.9 TDI	81	02/97→08/99		03/97→ 07/99; - ABS		03.3517-0101.2 390322	
 Bremskraftregler							
1.0	33	03/93→09/96				03.0101-0025.2 320014	ATE Satz 3/35 2x
1.4	40	12/97→04/99				03.6584-0113.3 320111	ATE lastabhängig 8/4 4x
1.6 i	55	09/94→06/99					
1.9 D	47	04/93→08/96					
1.9 D	50	10/94→08/96					
↓							







	kw			 	! #		
SEAT - IBIZA II (6K1) 03/93→08/99							
 Bremskraftregler							
1.9 TD	55	03/93→08/96				03.0101-0025.2 320014 03.6584-0113.3 320111	ATE Satz 3/35 2x ATE lastabhängig 8/4 4x
1.0 i	37	09/96→08/99		→ 07/99		03.0101-0025.2 320014 03.6584-0113.3 320111	ATE Satz 3/35 2x ATE lastabhängig 8/4 4x
1.3 i	40	03/93→08/99					
1.4 i	44	09/93→08/99					
1.6 i	55	03/93→08/99					
1.6 i	74	04/96→08/99					
1.8 i	66	03/93→08/99					
1.9 SDI	47	08/96→08/99					
1.9 TDI	66	08/96→08/99					
2.0 i	85	03/93→08/99					
1.8 i 16V	95	11/93→08/96		02/94→		03.0101-0025.2 320014 03.6584-0113.3 320111	ATE Satz 3/35 2x ATE lastabhängig 8/4 4x
1.9 TDI	81	02/97→08/99		03/97→ 07/99		03.0101-0025.2 320014 03.6584-0113.3 320111	ATE Satz 3/35 2x ATE lastabhängig 8/4 4x
SEAT - IBIZA III (6K1) 08/99→02/02							
 Bremskraftverstärker							
1.0	37	08/99→02/02		→ 01/02; für Linkslenker; - ABS		03.7750-6302.4 300161	ATE Ø 9" pneumatisch
1.0 16V	51	10/99→02/02		→ 01/02; für Linkslenker;		10.6350-3902.4 300213	ATE Ø 9" pneumatisch
1.4	44	08/99→02/02		+PR 0G1, 0G3, 1KB; Schaltgetriebe			
1.4 16V	55	05/00→02/02		→ 01/02; für Linkslenker; +PR 0G4;		10.6350-4002.4 300285	ATE Ø 9" pneumatisch
1.4 16V	74	08/99→02/02		Schaltgetriebe			
1.6	55	08/99→02/02		→ 01/02; für Linkslenker;		10.6350-4002.4 300285	ATE Ø 9" pneumatisch
1.6	74	08/99→02/02		+PR 1KM,1KK,1KQ,1ZK / 1KB;			
1.8 T 20V Cupra	115	07/00→02/02		Automatikgetriebe			
1.9 SDI	50	08/99→02/02					
1.9 TDI	66	08/99→02/02					
1.9 TDI	81	08/99→02/02					
 Hauptbremszylinder							
1.0	37	08/99→02/02		→ 01/02; für Linkslenker; - ABS		03.2122-1042.3 010137	Ø 22,2
1.0 16V	51	10/99→02/02		→ 01/02; für Linkslenker; + ABS		03.2123-1424.3 010637	ATE Ø 23,81
1.4	44	08/99→02/02					
1.4 16V	55	05/00→02/02					
1.4 16V	74	08/99→02/02					
1.6	55	08/99→02/02					
1.6	74	08/99→02/02					
1.8 T 20V Cupra	115	07/00→02/02					
1.9 SDI	50	08/99→02/02					
1.9 TDI	66	08/99→02/02					
1.9 TDI	81	08/99→02/02					
SEAT - IBIZA IV (6L1) 02/02→11/09							
 Hauptbremszylinder							
1.2	44	06/07→05/08		+ ABS		24.2120-1734.3 010702	Ø 20,64
1.2	47	02/02→06/06		- ABS		24.2120-1736.3 010732	Ø 20,64
1.2 12V	51	05/06→11/09					
1.4 16V	55	02/02→12/07					
1.4 16V	63	05/06→11/09					
1.4 16V	74	02/02→11/09					
1.4 TDI	51	05/05→11/09					
1.4 TDI	55	05/02→12/05					
1.4 TDI	59	06/05→11/09					
1.6	74	02/03→11/09					
1.6 16V	77	11/06→11/09					
1.8 T Cupra R	132	01/04→02/08					
1.8 T FR	110	12/03→05/08					
1.9 SDI	47	02/02→12/05					
1.9 TDI	74	02/02→11/09					
1.9 TDI	96	02/02→11/09					
1.9 TDI Cupra R	118	03/04→02/08					
2.0	85	04/02→11/09					
 Bremskraftregler							
1.2	44	06/07→05/08		- ABS		03.6583-0216.3 320247	ATE lastabhängig 8/3 4x
1.2	47	02/02→06/06				03.6584-0120.3 320279	ATE lastabhängig 8/4 4x
1.2 12V	51	05/06→11/09					
1.4 16V	55	02/02→12/07					
1.4 16V	63	05/06→11/09					
1.4 16V	74	02/02→11/09					
1.4 TDI	51	05/05→11/09					
1.4 TDI	55	05/02→12/05					
1.4 TDI	59	06/05→11/09					
1.6	74	02/03→11/09					
1.6 16V	77	11/06→11/09					
1.8 T Cupra R	132	01/04→02/08					
1.8 T FR	110	12/03→05/08					









	kW			 	! #		
SEAT - IBIZA IV (6L1) 02/02→11/09							
 Bremskraftregler							
1.9 SDI	47	02/02→12/05		- ABS		03.6583-0216.3 320247	ATE lastabhängig 8/3 4x
1.9 TDI	74	02/02→11/09				03.6584-0120.3 320279	ATE lastabhängig 8/4 4x
1.9 TDI	96	02/02→11/09					
1.9 TDI Cupra R	118	03/04→02/08					
2.0	85	04/02→11/09					
SEAT - IBIZA V (6J5, 6P1) 03/08→							
 Bremskraftregler							
1.0	55	05/15→		- ABS		03.6583-0216.3 320247	ATE lastabhängig 8/3 4x
1.0 TSI	70	05/15→				03.6584-0120.3 320279	ATE lastabhängig 8/4 4x
1.0 TSI	81	05/15→					
1.2	44	07/09→					
1.2 TDI	55	05/10→					
1.2 TSI	63	08/12→					
1.2 TSI	66	05/15→					
1.2 TSI	77	09/10→					
1.2 TSI	81	09/15→					
1.4 TDI	55	05/15→					
1.4 TDI	59	07/08→06/10					
1.4 TDI	66	05/15→					
1.4 TDI	77	05/15→					
1.6 LPG	60	05/11→					
1.9 TDI	66	07/08→06/10					
1.2	51	03/08→		07/08→; - ABS		03.6583-0216.3 320247	ATE lastabhängig 8/3 4x
1.4	63	03/08→				03.6584-0120.3 320279	ATE lastabhängig 8/4 4x
1.6	77	05/08→					
1.9 TDI	77	03/08→06/10					
SEAT - IBIZA V SPORTCOUPE (6J1, 6P5) 07/08→							
 Bremskraftregler							
1.0	55	05/15→		- ABS		03.6583-0216.3 320247	ATE lastabhängig 8/3 4x
1.0 TSI	70	05/15→				03.6584-0120.3 320279	ATE lastabhängig 8/4 4x
1.0 TSI	81	05/15→					
1.2	44	07/09→					
1.2	51	07/08→					
1.2 TDI	55	05/10→					
1.2 TSI	63	08/12→					
1.2 TSI	66	05/15→					
1.2 TSI	77	09/10→					
1.2 TSI	81	09/15→					
1.4	63	07/08→					
1.4 TDI	55	05/15→					
1.4 TDI	59	07/08→06/10					
1.4 TDI	66	05/15→					
1.4 TDI	77	05/15→					
1.6	77	07/08→					
1.6 LPG	60	05/11→					
1.9 TDI	66	07/08→06/10					
1.9 TDI	77	07/08→06/10					
SEAT - IBIZA V ST (6J8, 6P8) 03/10→							
 Bremskraftregler							
1.0	55	05/15→		- ABS		03.6583-0216.3 320247	ATE lastabhängig 8/3 4x
1.0 TSI	70	05/15→				03.6584-0120.3 320279	ATE lastabhängig 8/4 4x
1.0 TSI	81	05/15→					
1.2	44	05/10→					
1.2	51	05/10→					
1.2 TDI	55	04/10→					
1.2 TSI	63	09/12→					
1.2 TSI	66	05/15→					
1.2 TSI	77	09/10→					
1.2 TSI	81	09/15→					
1.4	63	03/10→					
1.4 TDI	55	05/15→					
1.4 TDI	66	05/15→					
1.4 TDI	77	05/15→					
SEAT - INCA (6K9) 11/95→06/03							
 Bremskraftverstärker							
1.4 16V	55	04/00→06/03		für Linkslenker; - ABS		03.7750-6302.4 300161	ATE Ø 9" pneumatisch
1.4 i	44	11/95→06/03					
1.6 i	55	11/95→05/98		für Linkslenker; + ABS		10.6350-4002.4 300285	ATE Ø 9" pneumatisch
1.6 i	55	06/97→09/00					
1.7 D	42	09/96→06/03					
1.9 D	47	11/95→06/03					
1.9 SDI	47	11/95→06/03					
1.9 TDI	66	09/96→06/03					
↓							



	kw					! #		
SEAT - INCA (6K9) 11/95→06/03								
 Hauptbremszylinder								
1.4 16V	55	04/00→06/03		- ABS		03.2122-1042.3	010137	Ø 22,2
				+ ABS		03.2123-1424.3	010637	ATE Ø 23,81
						03.2123-1484.3	010595	ATE Ø 23,81
1.4 i	44	11/95→06/03		→ 9K-X-006000; für Rechtslenker; - ABS		03.2122-1042.3	010137	Ø 22,2
1.6 i	55	11/95→05/98		für Linkslenker; - ABS		03.2122-1042.3	010137	Ø 22,2
1.6 i	55	06/97→09/00						
1.7 D	42	09/96→06/03		für Linkslenker; + ABS		03.2123-1424.3	010637	ATE Ø 23,81
1.9 D	47	11/95→06/03		für Rechtslenker; + ABS		03.2123-1484.3	010595	ATE Ø 23,81
1.9 SDI	47	11/95→06/03						
1.9 TDI	66	09/96→06/03						
Verschlusschraube, Hauptbremszylinder								
1.4 16V	55	04/00→06/03		- ABS		03.3517-0101.2	390322	
1.4 i	44	11/95→06/03		→ 9K-X-006000; für Rechtslenker; - ABS		03.3517-0101.2	390322	
1.6 i	55	11/95→05/98		für Linkslenker; - ABS		03.3517-0101.2	390322	
1.6 i	55	06/97→09/00						
1.7 D	42	09/96→06/03						
1.9 D	47	11/95→06/03						
1.9 SDI	47	11/95→06/03						
1.9 TDI	66	09/96→06/03						
SEAT - LEON (1M1) 11/99→06/06								
 Bremskraftverstärker								
1.4 16V	55	11/99→06/06		1M-1B018342→; → 07/05;		03.7860-0602.4	300141	ATE Ø 10" pneumatisch
1.6	74	11/99→06/06		für Linkslenker; + ESP				
1.6 16 V	77	09/00→06/06				03.7860-0602.4	300141	ATE Ø 10" pneumatisch
1.8 20V	92	11/99→06/06		1M-1R023639→; → 07/05;				
				für Linkslenker; + ESP				
1.8 20V T	132	11/99→06/06				03.7863-0402.4	300124	ATE Ø 10" pneumatisch
1.8 20V T 4	132	11/99→06/06		→ 1M-1B018341; für Linkslenker; + ESP				
1.8 T Cupra R	165	07/03→06/06		→ 1M-1R023638; für Linkslenker; + ESP		03.7863-0402.4	300124	ATE Ø 10" pneumatisch
1.9 SDI	50	11/99→06/06						
1.9 TDI	66	11/99→06/06						
1.9 TDI	81	11/99→06/06						
1.9 TDI	96	05/03→06/06						
1.9 TDI Syncro	110	05/02→06/06						
2.8 Cupra 4	150	02/01→06/06						
1.6	75	10/05→06/06		→ 1M-1R023638; für Linkslenker; + ESP		03.7863-0402.4	300124	ATE Ø 10" pneumatisch
1.9 TDI	74	10/05→06/06		→ 1M-1B018341; für Linkslenker; + ESP		03.7863-0402.4	300124	ATE Ø 10" pneumatisch
1.8 T Cupra R	154	02/02→06/06		1M-1R023639→; → 07/05;		03.7860-0602.4	300141	ATE Ø 10" pneumatisch
				für Linkslenker; + ESP				
				1M-1B018342→; → 07/05;		03.7860-0602.4	300141	ATE Ø 10" pneumatisch
				für Linkslenker; + ESP				
				05/02→; → 1M-1B018341; + ESP;		03.7863-0402.4	300124	ATE Ø 10" pneumatisch
				für Linkslenker				
				05/02→; → 1M-1R023638; + ESP;		03.7863-0402.4	300124	ATE Ø 10" pneumatisch
				für Linkslenker				
1.8 Turbo 4x4	154	05/02→05/03		1M-1R023639→; für Linkslenker; + ESP		03.7860-0602.4	300141	ATE Ø 10" pneumatisch
2.8	150	05/02→06/04		1M-1B018342→; für Linkslenker; + ESP		03.7860-0602.4	300141	ATE Ø 10" pneumatisch
				→ 1M-1B018341; für Linkslenker; + ESP		03.7863-0402.4	300124	ATE Ø 10" pneumatisch
				→ 1M-1R023638; für Linkslenker; + ESP		03.7863-0402.4	300124	ATE Ø 10" pneumatisch
1.9 TDI	110	09/00→06/06		1M-1B018342→; → 07/05;		03.7860-0602.4	300141	ATE Ø 10" pneumatisch
				für Linkslenker; + ESP				
				1M-1R023639→; → 07/05;		03.7860-0602.4	300141	ATE Ø 10" pneumatisch
				für Linkslenker; + ESP				
				02/01→; → 1M-1R023638;		03.7863-0402.4	300124	ATE Ø 10" pneumatisch
				für Linkslenker; + ESP				
				02/01→; → 1M-1B018341;		03.7863-0402.4	300124	ATE Ø 10" pneumatisch
				für Linkslenker; + ESP				
 Hauptbremszylinder								
1.4 16V	55	11/99→06/06		→ 08/00; für Linkslenker; + ESP		03.2123-2024.3	010597	ATE Ø 23,81
1.6	74	11/99→06/06		→ 08/00; für Rechtslenker; + ESP		03.2123-2064.3	010598	ATE Ø 23,81
1.8 20V	92	11/99→06/06						
1.8 20V T	132	11/99→06/06		09/00→ 07/05; für Linkslenker; + ESP		03.2123-2715.3	010802	ATE Ø 23,81
1.9 SDI	50	11/99→06/06		09/00→ 07/05; für Rechtslenker; + ESP		03.2123-2774.3	010803	ATE Ø 23,81
1.9 TDI	66	11/99→06/06		→ 07/05; für Linkslenker; - ESP		24.2123-1709.3	010503	Ø 23,81
1.6 16 V	77	09/00→06/06		→ 07/05; für Linkslenker; + ESP		03.2123-2715.3	010802	ATE Ø 23,81
1.8 T Cupra R	165	07/03→06/06		→ 07/05; + ESP; für Rechtslenker		03.2123-2774.3	010803	ATE Ø 23,81
1.9 TDI	96	05/03→06/06						
1.9 TDI Syncro	110	05/02→06/06		→ 07/05; für Linkslenker; - ESP		24.2123-1709.3	010503	Ø 23,81
2.8 Cupra 4	150	02/01→06/06						
1.8 20V T 4	132	11/99→06/06		→ 08/00; für Linkslenker; + ESP		03.2123-2024.3	010597	ATE Ø 23,81
				→ 08/00; für Rechtslenker; + ESP		03.2123-2064.3	010598	ATE Ø 23,81
↓								









	kw					! #		
SEAT - LEON (1M1) 11/99→06/06								
 Hauptbremszylinder								
1.8 20V T 4	132	11/99→06/06		→ 07/05; für Linkslenker; + ESP	03.2123-2715.3	010802	ATE Ø 23,81	
				→ 07/05; + ESP; für Rechtslenker	03.2123-2774.3	010803	ATE Ø 23,81	
				→ 07/05; für Linkslenker; - ESP	24.2123-1709.3	010503	Ø 23,81	
1.8 T Cupra R	154	02/02→06/06		05/02→ 07/05; für Linkslenker; + ESP	03.2123-2715.3	010802	ATE Ø 23,81	
				05/02→ 07/05; + ESP; für Rechtslenker	03.2123-2774.3	010803	ATE Ø 23,81	
				05/02→ 07/05; für Linkslenker; - ESP	24.2123-1709.3	010503	Ø 23,81	
1.8 Turbo 4x4 2.8	154	05/02→05/03		für Linkslenker; + ESP	03.2123-2715.3	010802	ATE Ø 23,81	
	150	05/02→06/04		für Rechtslenker; + ESP	03.2123-2774.3	010803	ATE Ø 23,81	
				für Linkslenker; - ESP	24.2123-1709.3	010503	Ø 23,81	
1.9 TDI	81	11/99→06/06		→ 08/00; für Linkslenker; + ESP	03.2123-2024.3	010597	ATE Ø 23,81	
				→ 08/00; für Rechtslenker; + ESP	03.2123-2064.3	010598	ATE Ø 23,81	
				→ 07/05; für Linkslenker; + ESP	03.2123-2715.3	010802	ATE Ø 23,81	
				09/00→ 07/05; für Rechtslenker; + ESP	03.2123-2774.3	010803	ATE Ø 23,81	
				→ 07/05; für Linkslenker; - ESP	24.2123-1709.3	010503	Ø 23,81	
1.9 TDI	110	09/00→06/06		02/01→ 07/05; + ESP; für Linkslenker	03.2123-2715.3	010802	ATE Ø 23,81	
				02/01→ 07/05; für Rechtslenker; + ESP	03.2123-2774.3	010803	ATE Ø 23,81	
				02/01→ 07/05; für Linkslenker; - ESP	24.2123-1709.3	010503	Ø 23,81	
 Bremskraftregler								
1.4 16V	55	11/99→06/06		→ 07/05	03.6583-0179.3	320228	ATE lastabhängig 8/3 4x	
1.6	74	11/99→06/06						
1.6 16 V	77	09/00→06/06						
1.8 20V	92	11/99→06/06						
1.8 20V T	132	11/99→06/06						
1.8 20V T 4	132	11/99→06/06						
1.8 T Cupra R	165	07/03→06/06						
1.9 SDI	50	11/99→06/06						
1.9 TDI	66	11/99→06/06						
1.9 TDI	81	11/99→06/06						
1.9 TDI	96	05/03→06/06						
1.9 TDI Syncro	110	05/02→06/06						
2.8 Cupra 4	150	02/01→06/06						
1.8 T Cupra R	154	02/02→06/06		05/02→ 07/05	03.6583-0179.3	320228	ATE lastabhängig 8/3 4x	
1.8 Turbo 4x4	154	05/02→05/03			03.6583-0179.3	320228	ATE lastabhängig 8/3 4x	
2.8	150	05/02→06/04						
1.9 TDI	110	09/00→06/06		02/01→ 07/05	03.6583-0179.3	320228	ATE lastabhängig 8/3 4x	
SEAT - LEON (1P1) 05/05→12/12								
 Bremskraftverstärker								
1.2 TSI	77	02/10→12/12		06/10→; für Linkslenker; → 10/12;	03.7863-3232.4	300307	ATE Ø 10" pneumatisch	
1.4 16V	63	06/06→12/12		+PR 1AC,1AT; für Kolben-Ø [mm]: 22,2				
1.4 TSI	92	11/07→12/12		→ 05/10; für Linkslenker; +PR 1AC,1AT;	03.7863-3232.4	300307	ATE Ø 10" pneumatisch	
1.6 LPG	75	12/09→12/12		für Kolben-Ø [mm]: 22,2				
1.6 TDI	77	02/10→12/12		→ 05/10; für Linkslenker; +PR 1AC,1AT;	03.7863-3332.4	300308	ATE Ø 10" pneumatisch	
1.8 TSI	118	06/07→12/12		für Kolben-Ø [mm]: 23,81				
2.0 Cupra R	195	09/09→12/12		06/10→; für Linkslenker; → 10/12;	03.7863-3332.4	300308	ATE Ø 10" pneumatisch	
2.0 TDI	125	05/06→12/12		+PR 1AC,1AT; für Kolben-Ø [mm]: 23,81				
2.0 TFSI	155	06/09→12/12		für Linkslenker; → 10/12; +PR 1AS;	03.7863-9602.4	300206	ATE Ø 10" pneumatisch	
				für Kolben-Ø [mm]: 22,2				
1.6 2.0 TDI 16V	75 103	07/05→12/12 07/05→12/12		06/10→; für Linkslenker; → 10/12;	03.7863-3232.4	300307	ATE Ø 10" pneumatisch	
				+PR 1AC,1AT; für Kolben-Ø [mm]: 22,2				
				08/05→ 05/10; +PR 1AC,1AT;	03.7863-3232.4	300307	ATE Ø 10" pneumatisch	
				für Linkslenker; für Kolben-Ø [mm]: 22,2				
				06/10→; für Linkslenker; → 10/12;	03.7863-3332.4	300308	ATE Ø 10" pneumatisch	
	+PR 1AC,1AT; für Kolben-Ø [mm]: 23,81							
				08/05→ 05/10; +PR 1AC,1AT;	03.7863-3332.4	300308	ATE Ø 10" pneumatisch	
				für Linkslenker; für Kolben-Ø [mm]: 23,81				
				08/05→; +PR 1AS; → 10/12;	03.7863-9602.4	300206	ATE Ø 10" pneumatisch	
				für Linkslenker; für Kolben-Ø [mm]: 22,2				
1.6 MultiFuel 1.6 TDI	75 66	11/10→12/12 11/10→12/12		für Linkslenker; → 10/12; +PR 1AC,1AT;	03.7863-3232.4	300307	ATE Ø 10" pneumatisch	
				für Kolben-Ø [mm]: 22,2				
				für Linkslenker; → 10/12; +PR 1AC,1AT;	03.7863-3332.4	300308	ATE Ø 10" pneumatisch	
				für Kolben-Ø [mm]: 23,81				
				für Linkslenker; → 10/12; +PR 1AS;	03.7863-9602.4	300206	ATE Ø 10" pneumatisch	
				für Kolben-Ø [mm]: 22,2				
1.9 TDI 2.0 TDI 2.0 TFSI	66 103 177	06/07→12/10 10/05→10/10 11/06→05/11		06/10→; +PR 1AC,1AT; für Linkslenker;	03.7863-3232.4	300307	ATE Ø 10" pneumatisch	
				für Kolben-Ø [mm]: 22,2				
				→ 05/10; für Linkslenker; +PR 1AC,1AT;	03.7863-3232.4	300307	ATE Ø 10" pneumatisch	
				für Kolben-Ø [mm]: 22,2				
				06/10→; +PR 1AC,1AT; für Linkslenker;	03.7863-3332.4	300308	ATE Ø 10" pneumatisch	
				für Kolben-Ø [mm]: 23,81				



	kw			 	! #		
SEAT - LEON (1P1) 05/05→12/12							
Bremskraftverstärker							
1.9 TDI 2.0 TDI 2.0 TFSI	66 103 177	06/07→12/10 10/05→10/10 11/06→05/11		→ 05/10; für Linkslenker; +PR 1AC,1AT; für Kolben-Ø [mm]: 23,81	03.7863-3332.4 300308		ATE Ø 10" pneumatisch
				+PR 1AS; für Linkslenker; für Kolben-Ø [mm]: 22,2	03.7863-9602.4 300206		ATE Ø 10" pneumatisch
1.9 TDI	77	07/05→12/10		06/10→; +PR 1AC,1AT; für Linkslenker; für Kolben-Ø [mm]: 22,2	03.7863-3232.4 300307		ATE Ø 10" pneumatisch
				08/05→ 05/10; +PR 1AC,1AT; für Linkslenker; für Kolben-Ø [mm]: 22,2	03.7863-3232.4 300307		ATE Ø 10" pneumatisch
				08/05→ 05/10; +PR 1AC,1AT; für Linkslenker; für Kolben-Ø [mm]: 23,81	03.7863-3332.4 300308		ATE Ø 10" pneumatisch
				06/10→; +PR 1AC,1AT; für Linkslenker; für Kolben-Ø [mm]: 23,81	03.7863-3332.4 300308		ATE Ø 10" pneumatisch
				08/05→; +PR 1AS; für Linkslenker; für Kolben-Ø [mm]: 22,2	03.7863-9602.4 300206		ATE Ø 10" pneumatisch
2.0 FSI 2.0 TDI 2.0 TFSI	110 100 147	07/05→05/10 07/05→05/10 05/05→03/09		08/05→; +PR 1AC,1AT; für Linkslenker; für Kolben-Ø [mm]: 22,2	03.7863-3232.4 300307		ATE Ø 10" pneumatisch
				08/05→; +PR 1AC,1AT; für Linkslenker; für Kolben-Ø [mm]: 23,81	03.7863-3332.4 300308		ATE Ø 10" pneumatisch
				08/05→; +PR 1AS; für Linkslenker; für Kolben-Ø [mm]: 22,2	03.7863-9602.4 300206		ATE Ø 10" pneumatisch
2.0 TFSI	136	09/05→05/06		+PR 1AC,1AT; für Linkslenker; für Kolben-Ø [mm]: 22,2	03.7863-3232.4 300307		ATE Ø 10" pneumatisch
				+PR 1AC,1AT; für Linkslenker; für Kolben-Ø [mm]: 23,81	03.7863-3332.4 300308		ATE Ø 10" pneumatisch
				+PR 1AS; für Linkslenker; für Kolben-Ø [mm]: 22,2	03.7863-9602.4 300206		ATE Ø 10" pneumatisch
Hauptbremszylinder							
1.2 TSI 1.4 16V 1.4 TSI 1.6 1.6 LPG 1.6 TDI 1.8 TSI 2.0 Cupra R 2.0 TDI 2.0 TDI 16V 2.0 TFSI	77 63 92 75 75 77 118 195 125 103 155	02/10→12/12 06/06→12/12 11/07→12/12 07/05→12/12 12/09→12/12 02/10→12/12 06/07→12/12 09/09→12/12 05/06→12/12 07/05→12/12 06/09→12/12		06/10→; für Linkslenker; → 10/12; +PR 1ZE,1ZF	03.2122-2129.3 010799		ATE Ø 22,2
				F1P-6-027023→; für Linkslenker; → 05/10; +PR 1AC,1AT,1AS	03.2122-2129.3 010799		ATE Ø 22,2
				06/10→; für Linkslenker; → 10/12; +PR 1LB,1ZA,1ZB	03.2123-3449.3 010808		ATE Ø 23,81
				F1P-6-027023→; für Linkslenker; → 05/10; +PR 1AC,1AT,1LJ,1ZA	03.2123-3449.3 010808		ATE Ø 23,81
1.6 MultiFuel 1.6 TDI	75 66	11/10→12/12 11/10→12/12		für Linkslenker; → 10/12; +PR 1ZE,1ZF	03.2122-2129.3 010799		ATE Ø 22,2
				für Linkslenker; → 10/12; +PR 1LB,1ZA,1ZB	03.2123-3449.3 010808		ATE Ø 23,81
1.9 TDI 1.9 TDI 2.0 TDI 2.0 TFSI	66 77 103 177	06/07→12/10 07/05→12/10 10/05→10/10 11/06→05/11		06/10→; +PR 1ZE,1ZF; für Linkslenker	03.2122-2129.3 010799		ATE Ø 22,2
				F1P-6-027023→; für Linkslenker; → 05/10; +PR 1AC,1AT,1AS	03.2122-2129.3 010799		ATE Ø 22,2
				06/10→; +PR 1LB,1ZA,1ZB; für Linkslenker	03.2123-3449.3 010808		ATE Ø 23,81
				F1P-6-027023→; für Linkslenker; → 05/10; +PR 1AC,1AT,1LJ,1ZA	03.2123-3449.3 010808		ATE Ø 23,81
2.0 FSI 2.0 TDI 2.0 TFSI 2.0 TFSI	110 100 136 147	07/05→05/10 07/05→05/10 09/05→05/06 05/05→03/09		F1P-6-027023→; für Linkslenker; +PR 1AC,1AT,1AS	03.2122-2129.3 010799		ATE Ø 22,2
				F1P-6-027023→; für Linkslenker; +PR 1AC,1AT,1LJ,1ZA	03.2123-3449.3 010808		ATE Ø 23,81
Hydraulikaggregat, Bremsanlage							
1.2 TSI 1.4 16V 1.4 TSI 1.6 LPG 1.6 MultiFuel 1.6 TDI 1.6 TDI 1.8 TSI 2.0 Cupra R 2.0 TDI 2.0 TFSI	77 63 92 75 75 66 77 118 195 125 155	02/10→12/12 06/06→12/12 11/07→12/12 12/09→12/12 11/10→12/12 11/10→12/12 02/10→12/12 06/07→12/12 09/09→12/12 05/06→12/12 06/09→12/12	➡	→ 10/12; +PR 1AT,1AS	24.9145-0001.2 399005		
1.6 2.0 TDI 16V	75 103	07/05→12/12 07/05→12/12	➡	08/05→ 10/12; +PR 1AT,1AS	24.9145-0001.2 399005		
1.9 TDI 2.0 TDI 2.0 TFSI 2.0 TFSI	66 103 136 177	06/07→12/10 10/05→10/10 09/05→05/06 11/06→05/11	➡	+PR 1AT,1AS	24.9145-0001.2 399005		
1.9 TDI 2.0 FSI 2.0 TDI 2.0 TFSI ↓	77 110 100 147	07/05→12/10 07/05→05/10 07/05→05/10 05/05→03/09	➡	08/05→; +PR 1AT,1AS	24.9145-0001.2 399005		

	kw			 	! #		
SEAT - LEON (1P1) 05/05→12/12							
Drucksensor, Bremskraftverstärker							
1.2 TSI	77	02/10→12/12		für Linkslenker; → 10/12; +PR 1AS		03.0655-0101.2 370008	ATE
1.4 16V	63	06/06→12/12		für Rechtslenker; → 10/12; +PR 1AS		03.0655-0101.2 370008	ATE
1.4 TSI	92	11/07→12/12					
1.6 LPG	75	12/09→12/12					
1.6 MultiFuel	75	11/10→12/12					
1.6 TDI	66	11/10→12/12					
1.6 TDI	77	02/10→12/12					
1.8 TSI	118	06/07→12/12					
2.0 Cupra R	195	09/09→12/12					
2.0 TDI	125	05/06→12/12					
2.0 TFSI	155	06/09→12/12					
1.6	75	07/05→12/12		08/05→; +PR 1AS; → 10/12; für Linkslenker		03.0655-0101.2 370008	ATE
2.0 TDI 16V	103	07/05→12/12		08/05→; +PR 1AS; → 10/12; für Rechtslenker		03.0655-0101.2 370008	ATE
1.9 TDI	66	06/07→12/10		+PR 1AS; für Linkslenker		03.0655-0101.2 370008	ATE
2.0 TDI	103	10/05→10/10		+PR 1AS; für Rechtslenker		03.0655-0101.2 370008	ATE
2.0 TFSI	136	09/05→05/06					
2.0 TFSI	177	11/06→05/11					
1.9 TDI	77	07/05→12/10		08/05→; +PR 1AS; für Linkslenker		03.0655-0101.2 370008	ATE
2.0 FSI	110	07/05→05/10		08/05→; +PR 1AS; für Rechtslenker		03.0655-0101.2 370008	ATE
2.0 TDI	100	07/05→05/10					
2.0 TFSI	147	05/05→03/09					
SEAT - LEON (5F1) 09/12→							
 Hauptbremszylinder							
1.0 TSI	85	05/15→		für Linkslenker		03.4153-5403.3 010994	ATE Ø 23,81
1.2 TSI	63	12/12→				24.4123-1719.3 011017	TRW Ø 23,81 ohne Bremsflüssigkeitsbehälter
1.2 TSI	77	01/13→					
1.2 TSI	81	04/14→					
1.4 TSI	90	11/12→		11/16→; für Linkslenker; +PR 1ZA,1ZE		24.4123-1719.3 011017	TRW Ø 23,81 ohne Bremsflüssigkeitsbehälter
1.4 TSI	92	05/14→					
1.4 TSI	103	09/12→					
1.4 TSI	110	05/14→					
1.6 TDI	66	11/12→					
1.6 TDI	77	11/12→					
1.6 TDI	81	09/13→					
1.8 TSI	132	02/13→					
2.0 Cupra	195	10/13→					
2.0 Cupra	206	10/13→					
2.0 Cupra	213	10/15→					
2.0 TDI	81	05/13→					
2.0 TDI	105	05/13→					
2.0 TDI	110	10/12→					
2.0 TDI	135	09/12→					
1.4 TGI	81	02/13→		10/13→; für Linkslenker		03.4153-5403.3 010994	ATE Ø 23,81
						24.4123-1719.3 011017	TRW Ø 23,81 ohne Bremsflüssigkeitsbehälter
				11/16→; für Linkslenker; +PR 1ZA,1ZE		24.4123-1719.3 011017	TRW Ø 23,81 ohne Bremsflüssigkeitsbehälter
1.6 TDI	85	11/16→		01/17→; für Linkslenker		03.4153-5403.3 010994	ATE Ø 23,81
						24.4123-1719.3 011017	TRW Ø 23,81 ohne Bremsflüssigkeitsbehälter
				01/17→; für Linkslenker; +PR 1ZA,1ZE		24.4123-1719.3 011017	TRW Ø 23,81 ohne Bremsflüssigkeitsbehälter
2.0 Cupra	221	01/17→		für Linkslenker; +PR 1ZA,1ZE		24.4123-1719.3 011017	TRW Ø 23,81 ohne Bremsflüssigkeitsbehälter
SEAT - LEON SC (5F5) 01/13→							
 Hauptbremszylinder							
1.0 TSI	85	05/15→		für Linkslenker		03.4153-5403.3 010994	ATE Ø 23,81
1.2 TSI	63	01/13→				24.4123-1719.3 011017	TRW Ø 23,81 ohne Bremsflüssigkeitsbehälter
1.2 TSI	77	02/13→					
1.2 TSI	81	05/14→					
1.4 TSI	90	02/13→		11/16→; für Linkslenker; +PR 1ZA,1ZE		24.4123-1719.3 011017	TRW Ø 23,81 ohne Bremsflüssigkeitsbehälter
1.4 TSI	92	05/14→					
1.4 TSI	103	02/13→					
1.4 TSI	110	05/14→					
1.6 TDI	66	02/13→					
1.6 TDI	77	02/13→					
1.6 TDI	81	09/13→					
1.8 TSI	132	02/13→					
2.0 Cupra	195	10/13→					
2.0 Cupra	206	10/13→					
2.0 Cupra	213	10/15→					
2.0 TDI	105	05/13→					
2.0 TDI	110	02/13→					
2.0 TDI	135	03/13→					
↓							

	kw			 	! #		
SEAT - LEON SC (5F5) 01/13→							
 Hauptbremszylinder							
1.6 TDI	85	11/16→		01/17→; für Linkslenker	03.4153-5403.3 010994 24.4123-1719.3 011017	ATE Ø 23,81 TRW Ø 23,81 ohne Bremsflüssigkeitsbehälter	
				01/17→; für Linkslenker; +PR 1ZA,1ZE	24.4123-1719.3 011017	TRW Ø 23,81 ohne Bremsflüssigkeitsbehälter	
2.0 Cupra	221	01/17→		für Linkslenker; +PR 1ZA,1ZE	24.4123-1719.3 011017	TRW Ø 23,81 ohne Bremsflüssigkeitsbehälter	
2.0 TDI	81	02/13→		05/13→; für Linkslenker	03.4153-5403.3 010994 24.4123-1719.3 011017	ATE Ø 23,81 TRW Ø 23,81 ohne Bremsflüssigkeitsbehälter	
				11/16→; für Linkslenker; +PR 1ZA,1ZE	24.4123-1719.3 011017	TRW Ø 23,81 ohne Bremsflüssigkeitsbehälter	
SEAT - LEON ST (5F8) 08/13→							
 Hauptbremszylinder							
1.0 TSI	85	05/15→		für Linkslenker	03.4153-5403.3 010994 24.4123-1719.3 011017	ATE Ø 23,81 TRW Ø 23,81 ohne Bremsflüssigkeitsbehälter	
1.2 TSI	63	11/13→					
1.2 TSI	77	08/13→					
1.2 TSI	81	05/14→					
1.4 TGI	81	10/13→		11/16→; für Linkslenker; +PR 1ZA,1ZE	24.4123-1719.3 011017	TRW Ø 23,81 ohne Bremsflüssigkeitsbehälter	
1.4 TSI	90	10/13→					
1.4 TSI	92	05/14→					
1.4 TSI	103	10/13→					
1.4 TSI	110	05/14→					
1.6 TDI	66	11/13→					
1.6 TDI	77	10/13→					
1.6 TDI	81	09/13→					
1.6 TDI 4Drive	77	04/14→					
1.6 TDI 4Drive	81	11/14→					
1.8 TSI	132	10/13→					
1.8 TSI 4Drive	132	11/14→					
2.0 Cupra	195	10/13→					
2.0 Cupra	206	10/13→					
2.0 Cupra	213	10/15→					
2.0 TDI	81	11/13→					
2.0 TDI	105	10/13→					
2.0 TDI	110	10/13→					
2.0 TDI	135	08/13→					
2.0 TDI 4Drive	110	04/14→					
2.0 TDI 4Drive	135	11/14→					
1.6 TDI	85	11/16→		01/17→; für Linkslenker	03.4153-5403.3 010994 24.4123-1719.3 011017	ATE Ø 23,81 TRW Ø 23,81 ohne Bremsflüssigkeitsbehälter	
				01/17→; für Linkslenker; +PR 1ZA,1ZE	24.4123-1719.3 011017	TRW Ø 23,81 ohne Bremsflüssigkeitsbehälter	
2.0 Cupra	221	11/16→		für Linkslenker; +PR 1ZA,1ZE	24.4123-1719.3 011017	TRW Ø 23,81 ohne Bremsflüssigkeitsbehälter	
2.0 Cupra 4Drive	221	11/16→					
SEAT - MARBELLA (28) 08/86→10/98							
 Hauptbremszylinder							
0.9	32	07/97→10/98			24.2119-0826.3 010349	Ø 19,05	
0.9 Cat	29	01/90→11/96					
0.9 Cat	30	11/96→10/98					
SEAT - Mii (KF1) 10/11→							
 Hauptbremszylinder							
1.0	44	10/11→		05/12→	24.4120-1703.3 011015	TRW Ø 20,64 ohne Bremsflüssigkeitsbehälter	
1.0	55	10/11→					
1.0 EcoFuel	50	11/12→			24.4120-1703.3 011015	TRW Ø 20,64 ohne Bremsflüssigkeitsbehälter	
SEAT - TOLEDO I (1L) 01/91→10/99							
 Hauptbremszylinder							
1.6 i	54	05/91→03/99		09/91→; → 1L-ZD101450	03.2120-2031.3 010106 03.2120-3943.3 010532 03.2122-1042.3 010137	ATE Ø 20,64 ATE Ø 20,64 Ø 22,2	
				1L-ZD101451→ 1L-ZD315000			
				→ 09/98; 1L-ZD315001→			
1.6 i	55	01/93→03/99		→ 1L-ZD101450	03.2120-2031.3 010106	ATE Ø 20,64	
1.6 i	74	11/96→03/99		1L-ZD101451→ 1L-ZD315000	03.2120-3943.3 010532 03.2122-1042.3 010137	ATE Ø 20,64 Ø 22,2	
				→ 09/98; 1L-ZD315001→			
1.8 16V	92	05/91→03/99		09/91→ 03/94; für Linkslenker	10.6123-0674.3 010639	ATE Ø 23,81	
1.8 16V	98	05/91→03/99					
↓							

	kw			 	! #		
SEAT - TOLEDO I (1L) 01/91→10/99							
 Hauptbremszylinder							
1.8 i	65	05/91→12/96		09/91→; → 1L-ZD315000; - ABS		03.2120-3943.3 010532	ATE Ø 20,64
				1L-ZD315001→; - ABS		03.2122-1042.3 010137	Ø 22,2
1.8 i	66	11/93→12/96		→ 1L-ZD315000; - ABS		03.2120-3943.3 010532	ATE Ø 20,64
				1L-ZD315001→; - ABS		03.2122-1042.3 010137	Ø 22,2
1.9 D	47	12/95→03/99		→ 1L-ZD315000		03.2120-3943.3 010532	ATE Ø 20,64
				→ 09/98; 1L-ZD315001→		03.2122-1042.3 010137	Ø 22,2
1.9 D	50	05/91→03/99		09/91→; → 1L-ZD315000		03.2120-3943.3 010532	ATE Ø 20,64
				→ 09/98; 1L-ZD315001→		03.2122-1042.3 010137	Ø 22,2
1.9 TD	55	05/91→03/99		09/91→; → 1L-ZD315000; - ABS		03.2120-3943.3 010532	ATE Ø 20,64
				→ 09/98; 1L-ZD315001→; - ABS		03.2122-1042.3 010137	Ø 22,2
1.9 TDI	66	08/95→03/99		→ 09/98; - ABS		03.2122-1042.3 010137	Ø 22,2
1.9 TDI	81	11/96→03/99		→ 09/98; für Linkslenker; + ABS		10.6123-0674.3 010639	ATE Ø 23,81
2.0 i	85	05/91→03/99		09/91→ 09/98; für Linkslenker		10.6123-0674.3 010639	ATE Ø 23,81
2.0 i 16V	110	11/93→03/99		03/94→ 09/98; für Linkslenker		10.6123-0674.3 010639	ATE Ø 23,81
Verschlusschraube, Hauptbremszylinder							
1.6 i	54	05/91→03/99		1L-ZD101451→ 1L-ZD315000		03.3517-0101.2 390322	
				→ 09/98; 1L-ZD315001→		03.3517-0101.2 390322	
				09/91→; → 1L-ZD101450		03.3517-0101.2 390322	
1.6 i	55	01/93→03/99		1L-ZD101451→ 1L-ZD315000		03.3517-0101.2 390322	
1.6 i	74	11/96→03/99		→ 09/98; 1L-ZD315001→		03.3517-0101.2 390322	
				→ 1L-ZD101450		03.3517-0101.2 390322	
1.8 i	65	05/91→12/96		09/91→; → 1L-ZD315000; - ABS		03.3517-0101.2 390322	
				1L-ZD315001→; - ABS		03.3517-0101.2 390322	
1.8 i	66	11/93→12/96		→ 1L-ZD315000; - ABS		03.3517-0101.2 390322	
				1L-ZD315001→; - ABS		03.3517-0101.2 390322	
1.9 D	47	12/95→03/99		→ 1L-ZD315000		03.3517-0101.2 390322	
				→ 09/98; 1L-ZD315001→		03.3517-0101.2 390322	
1.9 D	50	05/91→03/99		09/91→; → 1L-ZD315000		03.3517-0101.2 390322	
				→ 09/98; 1L-ZD315001→		03.3517-0101.2 390322	
1.9 TD	55	05/91→03/99		09/91→; → 1L-ZD315000; - ABS		03.3517-0101.2 390322	
				→ 09/98; 1L-ZD315001→; - ABS		03.3517-0101.2 390322	
1.9 TDI	66	08/95→03/99		→ 09/98; - ABS		03.3517-0101.2 390322	
1.9 TDI	81	11/96→03/99					
Bremskraftregler							
1.6 i	54	05/91→03/99		09/91→ 09/98		03.6584-0015.3 320109	ATE lastabhängig 8/4 4x
1.9 D	50	05/91→03/99					
1.9 TD	55	05/91→03/99					
2.0 i	85	05/91→03/99					
1.6 i	55	01/93→03/99		→ 09/98		03.6584-0015.3 320109	ATE lastabhängig 8/4 4x
1.6 i	74	11/96→03/99					
1.9 D	47	12/95→03/99					
1.9 TDI	66	08/95→03/99					
1.9 TDI	81	11/96→03/99					
1.8 16V	92	05/91→03/99		09/91→ 03/94		03.6584-0015.3 320109	ATE lastabhängig 8/4 4x
1.8 16V	98	05/91→03/99					
1.8 i	65	05/91→12/96		09/91→		03.6584-0015.3 320109	ATE lastabhängig 8/4 4x
1.8 i	66	11/93→12/96				03.6584-0015.3 320109	ATE lastabhängig 8/4 4x
2.0 i 16V	110	11/93→03/99		03/94→ 09/98		03.6584-0113.3 320111	ATE lastabhängig 8/4 4x
SEAT - TOLEDO II (1M2) 10/98→05/06							
 Bremskraftverstärker							
1.4 16V	55	01/00→05/02		1M-1R023639→; für Linkslenker; + ESP		03.7860-0602.4 300141	ATE Ø 10" pneumatisch
1.6	74	10/98→07/04					
1.8 20V	92	10/98→07/04		1M-1B018342→; für Linkslenker; + ESP		03.7860-0602.4 300141	ATE Ø 10" pneumatisch
1.9 TDI	66	03/99→07/04		→ 1M-1B018341; für Linkslenker; + ESP		03.7863-0402.4 300124	ATE Ø 10" pneumatisch
1.9 TDI	81	10/98→07/04					
1.9 TDI	110	10/00→07/04		→ 1M-1R023638; für Linkslenker; + ESP		03.7863-0402.4 300124	ATE Ø 10" pneumatisch
2.3 V5	110	10/98→11/00					
2.3 V5 20V	125	09/00→11/03					
2.8	150	10/00→07/01					
1.6	75	08/05→05/06		→ 1M-1R023638; für Linkslenker; + ESP		03.7863-0402.4 300124	ATE Ø 10" pneumatisch
				→ 1M-1B018341; für Linkslenker; + ESP		03.7863-0402.4 300124	ATE Ø 10" pneumatisch
1.6 16V	77	06/00→05/06		1M-1R023639→; → 09/04;		03.7860-0602.4 300141	ATE Ø 10" pneumatisch
1.9 TDI	96	05/03→05/06		für Linkslenker; + ESP			
↓							

SEAT - TOLEDO II (1M2) 10/98→05/06

 **Bremskraftverstärker**

1.6 16V 1.9 TDI	77 96	06/00→05/06 05/03→05/06	1M-1B018342→; → 09/04; für Linkslenker; + ESP	03.7860-0602.4	300141	ATE Ø 10" pneumatisch
			→ 1M-1B018341; für Linkslenker; + ESP	03.7863-0402.4	300124	ATE Ø 10" pneumatisch
			→ 1M-1R023638; für Linkslenker; + ESP	03.7863-0402.4	300124	ATE Ø 10" pneumatisch
1.8 20VT	132	09/00→07/04	1M-1R023639→; für Linkslenker; + ESP	03.7860-0602.4	300141	ATE Ø 10" pneumatisch
			1M-1B018342→; für Linkslenker; + ESP	03.7860-0602.4	300141	ATE Ø 10" pneumatisch
			05/01→; → 1M-1B018341; für Linkslenker; + ESP	03.7863-0402.4	300124	ATE Ø 10" pneumatisch
			05/01→; → 1M-1R023638; für Linkslenker; + ESP	03.7863-0402.4	300124	ATE Ø 10" pneumatisch

 **Hauptbremszylinder**

1.4 16V 1.6	55 74	01/00→05/02 10/98→07/04	→ 08/00; für Linkslenker; + ESP	03.2123-2024.3	010597	ATE Ø 23,81
			→ 08/00; für Rechtslenker; + ESP	03.2123-2064.3	010598	ATE Ø 23,81
1.8 20V	92	10/98→07/04				
1.9 TDI	66	03/99→07/04	09/00→; für Linkslenker; + ESP	03.2123-2715.3	010802	ATE Ø 23,81
1.9 TDI	81	10/98→07/04	09/00→; für Rechtslenker; + ESP	03.2123-2774.3	010803	ATE Ø 23,81
2.3 V5	110	10/98→11/00	für Linkslenker; - ESP	24.2123-1709.3	010503	Ø 23,81
1.6 16V	77	06/00→05/06	→ 08/00; für Linkslenker; + ESP	03.2123-2024.3	010597	ATE Ø 23,81
			→ 08/00; für Rechtslenker; + ESP	03.2123-2064.3	010598	ATE Ø 23,81
			09/00→ 09/04; für Linkslenker; + ESP	03.2123-2715.3	010802	ATE Ø 23,81
			09/00→ 09/04; für Rechtslenker; + ESP	03.2123-2774.3	010803	ATE Ø 23,81
			→ 09/04; für Linkslenker; - ESP	24.2123-1709.3	010503	Ø 23,81
1.8 20VT	132	09/00→07/04	05/01→; + ESP; für Linkslenker	03.2123-2715.3	010802	ATE Ø 23,81
			05/01→; für Rechtslenker; + ESP	03.2123-2774.3	010803	ATE Ø 23,81
1.9 TDI	96	05/03→05/06	→ 09/04; für Linkslenker; + ESP	03.2123-2715.3	010802	ATE Ø 23,81
			→ 09/04; + ESP; für Rechtslenker	03.2123-2774.3	010803	ATE Ø 23,81
			→ 09/04; für Linkslenker; - ESP	24.2123-1709.3	010503	Ø 23,81
1.9 TDI 2.3 V5 20V	110 125	10/00→07/04 09/00→11/03	für Linkslenker; + ESP	03.2123-2715.3	010802	ATE Ø 23,81
			für Rechtslenker; + ESP	03.2123-2774.3	010803	ATE Ø 23,81
			für Linkslenker; - ESP	24.2123-1709.3	010503	Ø 23,81
2.8	150	10/00→07/01	für Linkslenker; + ESP	03.2123-2715.3	010802	ATE Ø 23,81
			für Rechtslenker; + ESP	03.2123-2774.3	010803	ATE Ø 23,81

 **Bremskraftregler**

1.4 16V 1.6 1.8 20V 1.9 TDI 1.9 TDI 1.9 TDI 2.3 V5 2.3 V5 20V	55 74 92 66 81 110 110 125	01/00→05/02 10/98→07/04 10/98→07/04 03/99→07/04 10/98→07/04 10/00→07/04 10/98→11/00 09/00→11/03	- ABS	03.6583-0179.3	320228	ATE lastabhängig 8/3 4x			
			→ 09/04; - ABS				03.6583-0179.3	320228	ATE lastabhängig 8/3 4x











SEAT - TOLEDO III (5P2) 04/04→05/09













 **Bremskraftverstärker**











1.4 16V 1.4 TSI	63 92	05/06→05/09 11/07→05/09	→ 03/09; für Linkslenker; +PR 1AC,1AT	03.7863-3232.4	300307	ATE Ø 10" pneumatisch
			→ 03/09; für Linkslenker; +PR 1AS			
1.6	75	10/04→05/09				
1.8 TFSI	118	01/07→05/09				
1.9 TDI	77	10/04→05/09				
2.0 FSI	110	10/04→05/09				
2.0 TDI	103	11/05→05/09				
2.0 TDI	125	01/06→05/09				
2.0 TFSI	147	11/05→05/09				
2.0 TDI 2.0 TDI 16V	100 103	09/04→05/09 04/04→05/09	10/04→ 03/09; für Linkslenker; +PR 1AC,1AT	03.7863-3232.4	300307	ATE Ø 10" pneumatisch
			10/04→ 03/09; für Linkslenker; +PR 1AS			

 **Hauptbremszylinder**













1.4 16V	63	05/06→05/09	→ 03/09; für Linkslenker	03.2122-2129.3	010799	ATE Ø 22,2
1.4 TSI	92	11/07→05/09				
1.6	75	10/04→05/09				
1.8 TFSI	118	01/07→05/09				
1.9 TDI	77	10/04→05/09				
2.0 FSI	110	10/04→05/09				
2.0 TDI	103	11/05→05/09				
2.0 TDI	125	01/06→05/09				
2.0 TFSI	147	11/05→05/09				













	kw			 	! #		
SEAT - TOLEDO III (5P2) 04/04→05/09							
 Hauptbremszylinder							
2.0 TDI	100	09/04→05/09		10/04→ 03/09; für Linkslenker		03.2122-2129.3 010799	ATE Ø 22,2
2.0 TDI 16V	103	04/04→05/09					
Hydraulikaggregat, Bremsanlage							
1.4 16V	63	05/06→05/09	➔	→ 03/09; +PR 1AT,1AS		24.9145-0001.2 399005	
1.4 TSI	92	11/07→05/09					
1.6	75	10/04→05/09					
1.8 TFSI	118	01/07→05/09					
1.9 TDI	77	10/04→05/09					
2.0 FSI	110	10/04→05/09					
2.0 TDI	103	11/05→05/09					
2.0 TDI	125	01/06→05/09					
2.0 TFSI	147	11/05→05/09					
2.0 TDI	100	09/04→05/09	➔	10/04→ 03/09; +PR 1AT,1AS		24.9145-0001.2 399005	
2.0 TDI 16V	103	04/04→05/09					
Drucksensor, Bremskraftverstärker							
1.4 16V	63	05/06→05/09		→ 03/09; für Linkslenker; +PR 1AS		03.0655-0101.2 370008	ATE
1.4 TSI	92	11/07→05/09					
1.6	75	10/04→05/09					
1.8 TFSI	118	01/07→05/09					
1.9 TDI	77	10/04→05/09					
2.0 FSI	110	10/04→05/09					
2.0 TDI	103	11/05→05/09					
2.0 TDI	125	01/06→05/09					
2.0 TFSI	147	11/05→05/09					
2.0 TDI	100	09/04→05/09		10/04→ 03/09; für Linkslenker; +PR 1AS		03.0655-0101.2 370008	ATE
2.0 TDI 16V	103	04/04→05/09					
SKODA - CITIGO 10/11→							
 Hauptbremszylinder							
1.0	44	10/11→		05/12→		24.4120-1703.3 011015	TRW Ø 20,64 ohne Bremsflüssigkeitsbehälter
1.0	55	10/11→					
1.0 CNG	50	11/12→				24.4120-1703.3 011015	TRW Ø 20,64 ohne Bremsflüssigkeitsbehälter
SKODA - FABIA I (6Y2) 08/99→03/08							
 Hauptbremszylinder							
1.0	37	12/99→08/02		02/00→; + ABS		24.2120-1734.3 010702	Ø 20,64
1.4	50	08/99→05/03		02/00→; - ABS		24.2120-1736.3 010732	Ø 20,64
1.2	40	08/02→03/08		→ 12/07; + ABS		24.2120-1734.3 010702	Ø 20,64
1.2	47	01/03→03/08					
1.4 16V	55	12/99→03/08		→ 12/07; - ABS		24.2120-1736.3 010732	Ø 20,64
1.4 16V	74	12/99→03/08					
1.4 TDI	51	10/05→03/08					
1.4 TDI	55	04/03→03/08					
1.4 TDI	59	10/05→03/08					
1.9 SDI	47	12/99→03/08					
2.0	85	12/99→03/08					
1.4	44	08/00→08/02		+ ABS		24.2120-1734.3 010702	Ø 20,64
				- ABS		24.2120-1736.3 010732	Ø 20,64
1.9 TDI	74	01/00→03/08		02/00→ 12/07; + ABS		24.2120-1734.3 010702	Ø 20,64
				02/00→ 12/07; - ABS		24.2120-1736.3 010732	Ø 20,64
1.9 TDI RS	96	06/03→03/08		09/03→ 12/07; + ABS		24.2120-1734.3 010702	Ø 20,64
				09/03→ 12/07; - ABS		24.2120-1736.3 010732	Ø 20,64
 Bremskraftregler							
1.4	44	08/00→08/02		+PR 1AB, 1LM; - ABS		03.6043-1733.3 320284	ATE 3/25 2x
				+PR 1AL; - ABS; Schrägheck		03.6583-0216.3 320247	ATE lastabhängig 8/3 4x
				- ABS; Stufenheck / Kasten/Kombi		03.6584-0120.3 320279	ATE lastabhängig 8/4 4x
1.4	50	08/99→05/03		02/00→; +PR 1AB, 1LM; - ABS		03.6043-1733.3 320284	ATE 3/25 2x
				02/00→; +PR 1AL; - ABS; Schrägheck		03.6583-0216.3 320247	ATE lastabhängig 8/3 4x
				02/00→; - ABS; Stufenheck / Kasten/Kombi		03.6584-0120.3 320279	ATE lastabhängig 8/4 4x
1.4 16V	55	12/99→03/08		→ 12/07; +PR 1AB, 1LM; - ABS		03.6043-1733.3 320284	ATE 3/25 2x
1.4 16V	74	12/99→03/08					
1.4 TDI	51	10/05→03/08		→ 12/07; +PR 1AL; - ABS; Schrägheck		03.6583-0216.3 320247	ATE lastabhängig 8/3 4x
1.4 TDI	55	04/03→03/08		→ 12/07; - ABS; Stufenheck / Kasten/Kombi		03.6584-0120.3 320279	ATE lastabhängig 8/4 4x
1.4 TDI	59	10/05→03/08					
1.9 SDI	47	12/99→03/08					
2.0	85	12/99→03/08					
1.9 TDI	74	01/00→03/08		02/00→ 12/07; +PR 1AB, 1LM; - ABS		03.6043-1733.3 320284	ATE 3/25 2x
↓							

	kw			 	! #		
SKODA - FABIA I (6Y2) 08/99→03/08							
 Bremskraftregler							
1.9 TDI	74	01/00→03/08		02/00→ 12/07; +PR 1AL; - ABS; Schrägheck		03.6583-0216.3 320247	ATE lastabhängig 8/3 4x
				02/00→ 12/07; - ABS; Stufenheck / Kasten/Kombi		03.6584-0120.3 320279	ATE lastabhängig 8/4 4x
1.9 TDI RS	96	06/03→03/08		09/03→ 12/07; +PR 1AB, 1LM; - ABS		03.6043-1733.3 320284	ATE 3/25 2x
				09/03→ 12/07; +PR 1AL; - ABS; Schrägheck		03.6583-0216.3 320247	ATE lastabhängig 8/3 4x
				09/03→ 12/07; - ABS; Stufenheck / Kasten/Kombi		03.6584-0120.3 320279	ATE lastabhängig 8/4 4x
SKODA - FABIA I Combi (6Y5) 04/00→12/07							
 Hauptbremszylinder							
1.2	40	07/01→12/07		08/02→; + ABS		24.2120-1734.3 010702	Ø 20,64
				08/02→; - ABS		24.2120-1736.3 010732	Ø 20,64
1.2	47	01/03→12/07		+ ABS		24.2120-1734.3 010702	Ø 20,64
1.4	44	04/00→03/03		- ABS		24.2120-1736.3 010732	Ø 20,64
1.4	50	04/00→05/03					
1.4 16V	55	05/00→12/07					
1.4 16V	59	04/06→12/07					
1.4 16V	74	04/00→12/07					
1.4 TDI	51	10/05→12/07					
1.4 TDI	55	04/03→12/07					
1.4 TDI	59	10/05→12/07					
1.9 SDI	47	04/00→12/07					
1.9 TDI	74	04/00→12/07					
2.0	85	04/00→12/07					
 Bremskraftregler							
1.4	44	04/00→03/03		+PR 1AB, 1LM; - ABS		03.6043-1733.3 320284	ATE 3/25 2x
1.4	50	04/00→05/03		+PR 1AL; - ABS; Schrägheck		03.6583-0216.3 320247	ATE lastabhängig 8/3 4x
1.4 16V	55	05/00→12/07		- ABS; Stufenheck / Kasten/Kombi		03.6584-0120.3 320279	ATE lastabhängig 8/4 4x
1.4 16V	59	04/06→12/07					
1.4 16V	74	04/00→12/07					
1.4 TDI	51	10/05→12/07					
1.4 TDI	55	04/03→12/07					
1.4 TDI	59	10/05→12/07					
1.9 SDI	47	04/00→12/07					
1.9 TDI	74	04/00→12/07					
2.0	85	04/00→12/07					
SKODA - FABIA I Praktik (6Y5) 07/01→12/07							
 Hauptbremszylinder							
1.2	40	07/01→12/07		08/02→; + ABS		24.2120-1734.3 010702	Ø 20,64
				08/02→; - ABS		24.2120-1736.3 010732	Ø 20,64
1.2	47	01/03→12/07		+ ABS		24.2120-1734.3 010702	Ø 20,64
1.4	50	07/01→05/03		- ABS		24.2120-1736.3 010732	Ø 20,64
1.4 TDI	51	10/05→12/07					
1.9 SDI	47	07/01→12/07					
 Bremskraftregler							
1.4	50	07/01→05/03		+PR 1AB, 1LM; - ABS		03.6043-1733.3 320284	ATE 3/25 2x
1.4 TDI	51	10/05→12/07		+PR 1AL; - ABS; Schrägheck		03.6583-0216.3 320247	ATE lastabhängig 8/3 4x
1.9 SDI	47	07/01→12/07		- ABS; Stufenheck / Kasten/Kombi		03.6584-0120.3 320279	ATE lastabhängig 8/4 4x
SKODA - FABIA I Stufenheck (6Y3) 10/99→12/07							
 Hauptbremszylinder							
1.2	40	07/01→12/07		08/02→; + ABS		24.2120-1734.3 010702	Ø 20,64
				08/02→; - ABS		24.2120-1736.3 010732	Ø 20,64
1.2	47	01/03→12/07		+ ABS		24.2120-1734.3 010702	Ø 20,64
1.4	44	04/00→08/02		- ABS		24.2120-1736.3 010732	Ø 20,64
1.4	50	07/01→05/03					
1.4 16V	55	10/99→12/07					
1.4 16V	59	04/06→12/07					
1.4 16V	74	12/99→12/07					
1.4 TDI	51	10/05→12/07					
1.4 TDI	55	04/03→12/07					
1.4 TDI	59	10/05→12/07					
2.0	85	12/99→12/07					
1.9 SDI	47	11/99→12/07		12/99→; + ABS		24.2120-1734.3 010702	Ø 20,64
				12/99→; - ABS		24.2120-1736.3 010732	Ø 20,64
1.9 TDI	74	01/00→12/07		02/00→; + ABS		24.2120-1734.3 010702	Ø 20,64
				02/00→; - ABS		24.2120-1736.3 010732	Ø 20,64
↓							

	kw			 	! #		
SKODA - FABIA I Stufenheck (6Y3) 10/99→12/07							
 Bremskraftregler							
1.4	44	04/00→08/02		+PR 1AB, 1LM; - ABS	03.6043-1733.3	320284	ATE 3/25 2x
1.4	50	07/01→05/03		+PR 1AL; - ABS; Schrägheck	03.6583-0216.3	320247	ATE lastabhängig 8/3 4x
1.4 16V	55	10/99→12/07					
1.4 16V	59	04/06→12/07		- ABS; Stufenheck / Kasten/Kombi	03.6584-0120.3	320279	ATE lastabhängig 8/4 4x
1.4 16V	74	12/99→12/07					
1.4 TDI	51	10/05→12/07					
1.4 TDI	55	04/03→12/07					
1.4 TDI	59	10/05→12/07					
2.0	85	12/99→12/07					
1.9 SDI	47	11/99→12/07		12/99→; +PR 1AB, 1LM; - ABS	03.6043-1733.3	320284	ATE 3/25 2x
				12/99→; +PR 1AL; - ABS; Schrägheck	03.6583-0216.3	320247	ATE lastabhängig 8/3 4x
				12/99→; - ABS; Stufenheck / Kasten/Kombi	03.6584-0120.3	320279	ATE lastabhängig 8/4 4x
1.9 TDI	74	01/00→12/07		02/00→; +PR 1AB, 1LM; - ABS	03.6043-1733.3	320284	ATE 3/25 2x
				02/00→; +PR 1AL; - ABS; Schrägheck	03.6583-0216.3	320247	ATE lastabhängig 8/3 4x
				02/00→; - ABS; Stufenheck / Kasten/Kombi	03.6584-0120.3	320279	ATE lastabhängig 8/4 4x
SKODA - FABIA II (542) 12/06→12/14							
 Hauptbremszylinder							
1.2	44	12/06→12/14		03/07→ 06/14; +PR 1AC,1AR,1LB,1LM; für Linkslenker; + ABS	24.2119-1712.3	010912	Ø 19,05 ohne Bremsflüssigkeitsbehälter
1.2	51	01/07→12/14					
1.4	63	01/07→12/14		03/07→; +PR 1AC,1AR,1AT / 1LN,1LQ,1LR; → 06/14; für Linkslenker; + ABS	24.2120-1734.3	010702	Ø 20,64
				03/07→ 06/14; +PR 1AL,1LQ,1LN,1LR; für Linkslenker; - ABS	24.2120-1736.3	010732	Ø 20,64
1.2 12V	44	11/11→12/14		→ 06/14; +PR 1AC,1AR,1LB,1LM; für Linkslenker; + ABS	24.2119-1712.3	010912	Ø 19,05 ohne Bremsflüssigkeitsbehälter
1.2 TSI	63	03/10→12/14					
1.2 TSI	77	03/10→12/14		+PR 1AC,1AR,1AT / 1LN,1LQ,1LR; → 06/14; für Linkslenker; + ABS	24.2120-1734.3	010702	Ø 20,64
1.4 TSI RS	132	05/10→12/14					
1.6	77	04/07→12/14		→ 06/14; +PR 1AL,1LQ,1LN,1LR; für Linkslenker; - ABS	24.2120-1736.3	010732	Ø 20,64
1.6 TDI	55	04/10→12/14					
1.6 TDI	66	03/10→12/14					
1.6 TDI	77	03/10→12/14					
1.2 TDI	55	05/10→12/14		→ 06/14; +PR 1AC,1AR,1LB,1LM; für Linkslenker; + ABS	24.2119-1712.3	010912	Ø 19,05 ohne Bremsflüssigkeitsbehälter
				→ 06/14; +PR 1AC,1AR,1AT,1LN / 1LQ,1LR; für Linkslenker; + ABS	24.2120-1734.3	010702	Ø 20,64
				→ 06/14; +PR 1AL,1LQ,1LN,1LR; für Linkslenker; - ABS	24.2120-1736.3	010732	Ø 20,64
1.4 TDI	51	02/07→03/10		03/07→; +PR 1AC,1AR,1LB,1LM; für Linkslenker; + ABS	24.2119-1712.3	010912	Ø 19,05 ohne Bremsflüssigkeitsbehälter
1.4 TDI	59	01/07→03/10					
				03/07→; +PR 1AC,1AR,1AT / 1LN,1LQ,1LR; für Linkslenker; + ABS	24.2120-1734.3	010702	Ø 20,64
				03/07→; +PR 1AL,1LQ,1LN,1LR; für Linkslenker; - ABS	24.2120-1736.3	010732	Ø 20,64
1.9 TDI	77	04/07→03/10		+PR 1AC,1AR,1LB,1LM; für Linkslenker; + ABS	24.2119-1712.3	010912	Ø 19,05 ohne Bremsflüssigkeitsbehälter
				für Linkslenker; +PR 1AC,1AR,1AT / 1LN,1LQ,1LR; + ABS	24.2120-1734.3	010702	Ø 20,64
				+PR 1AL,1LQ,1LN,1LR; für Linkslenker; - ABS	24.2120-1736.3	010732	Ø 20,64
 Bremskraftregler							
1.2	44	12/06→12/14		03/07→ 06/14; - ABS	03.6583-0216.3	320247	ATE lastabhängig 8/3 4x
1.2	51	01/07→12/14					
1.4	63	01/07→12/14			03.6584-0120.3	320279	ATE lastabhängig 8/4 4x
1.2 12V	44	11/11→12/14		→ 06/14; - ABS	03.6583-0216.3	320247	ATE lastabhängig 8/3 4x
1.2 TDI	55	05/10→12/14					
1.2 TSI	63	03/10→12/14			03.6584-0120.3	320279	ATE lastabhängig 8/4 4x
1.2 TSI	77	03/10→12/14					
1.6	77	04/07→12/14					
1.6 TDI	55	04/10→12/14					
1.6 TDI	66	03/10→12/14					
1.6 TDI	77	03/10→12/14					
1.4 TDI	51	02/07→03/10		03/07→; - ABS	03.6583-0216.3	320247	ATE lastabhängig 8/3 4x
1.4 TDI	59	01/07→03/10			03.6584-0120.3	320279	ATE lastabhängig 8/4 4x
1.9 TDI	77	04/07→03/10		- ABS	03.6583-0216.3	320247	ATE lastabhängig 8/3 4x
					03.6584-0120.3	320279	ATE lastabhängig 8/4 4x



	kw			 	! #		
SKODA - FABIA II Combi (545) 10/07→12/14							
 Hauptbremszylinder							
1.2	44	10/07→11/14		→ 06/14; +PR 1AC,1AR,1LB,1LM; für Linkslenker; + ABS	24.2119-1712.3	010912	Ø 19,05 ohne Bremsflüssigkeitsbehälter
1.2	51	10/07→12/14					
1.2 12V	44	11/11→12/14					
1.2 TSI	63	03/10→12/14		+PR 1AC,1AR,1AT / 1LN,1LQ,1LR; → 06/14; für Linkslenker; + ABS	24.2120-1734.3	010702	Ø 20,64
1.2 TSI	77	03/10→12/14					
1.4	63	10/07→12/14		→ 06/14; +PR 1AL,1LQ,1LN,1LR; für Linkslenker; - ABS	24.2120-1736.3	010732	Ø 20,64
1.4 TSI RS	132	05/10→12/14					
1.6	77	10/07→12/14					
1.6 TDI	55	04/10→12/14					
1.6 TDI	66	03/10→12/14					
1.6 TDI	77	03/10→12/14					
1.2 TDI	55	05/10→12/14		→ 06/14; +PR 1AC,1AR,1LB,1LM; für Linkslenker; + ABS	24.2119-1712.3	010912	Ø 19,05 ohne Bremsflüssigkeitsbehälter
				→ 06/14; +PR 1AC,1AR,1AT,1LN / 1LQ,1LR; für Linkslenker; + ABS	24.2120-1734.3	010702	Ø 20,64
				→ 06/14; +PR 1AL,1LQ,1LN,1LR; für Linkslenker; - ABS	24.2120-1736.3	010732	Ø 20,64
1.4 TDI	51	10/07→03/10		+PR 1AC,1AR,1LB,1LM; für Linkslenker; + ABS	24.2119-1712.3	010912	Ø 19,05 ohne Bremsflüssigkeitsbehälter
1.4 TDI	59	10/07→03/10					
1.9 TDI	77	10/07→03/10		+PR 1AC,1AR,1AT / 1LN,1LQ,1LR; für Linkslenker; + ABS	24.2120-1734.3	010702	Ø 20,64
				+PR 1AL,1LQ,1LN,1LR; für Linkslenker; - ABS	24.2120-1736.3	010732	Ø 20,64
 Bremskraftregler							
1.2	44	10/07→11/14		→ 06/14; - ABS	03.6583-0216.3	320247	ATE lastabhängig 8/3 4x
1.2	51	10/07→12/14			03.6584-0120.3	320279	ATE lastabhängig 8/4 4x
1.2 12V	44	11/11→12/14					
1.2 TDI	55	05/10→12/14					
1.2 TSI	63	03/10→12/14					
1.2 TSI	77	03/10→12/14					
1.4	63	10/07→12/14					
1.6	77	10/07→12/14					
1.6 TDI	55	04/10→12/14					
1.6 TDI	66	03/10→12/14					
1.6 TDI	77	03/10→12/14					
1.4 TDI	51	10/07→03/10		- ABS	03.6583-0216.3	320247	ATE lastabhängig 8/3 4x
1.4 TDI	59	10/07→03/10			03.6584-0120.3	320279	ATE lastabhängig 8/4 4x
1.9 TDI	77	10/07→03/10					
SKODA - FELICIA I (6U1) 10/94→03/98							
 Hauptbremszylinder							
1.3	40	10/94→03/98		→ 02/98; + ABS	03.2123-1428.3	010476	Ø 23,81
1.3	43	10/94→03/98					
1.3	50	10/94→03/98		→ 02/98; - ABS	24.2122-1731.3	010656	Ø 22,2
1.6 LX	55	08/95→03/98					
1.9 D	47	10/95→03/98		10/96→ 02/98; + ABS	03.2123-1428.3	010476	Ø 23,81
				10/96→ 02/98; - ABS	24.2122-1731.3	010656	Ø 22,2
 Bremskraftregler							
1.3	40	10/94→03/98		→ 02/98	03.6584-0107.3	320110	ATE lastabhängig 8/4 4x
1.3	43	10/94→03/98					
1.3	50	10/94→03/98					
1.6 LX	55	08/95→03/98					
1.9 D	47	10/95→03/98		10/96→ 02/98	03.6583-0167.3	320140	ATE lastabhängig 8/3 4x
SKODA - FELICIA I Kombi (6U5) 07/95→03/98							
 Hauptbremszylinder							
1.3	43	08/95→03/98		→ 02/98; + ABS	03.2123-1428.3	010476	Ø 23,81
1.3 LX	40	08/95→03/98					
1.3 LXI	50	08/95→03/98		→ 02/98; - ABS	24.2122-1731.3	010656	Ø 22,2
1.6 GLX	55	08/95→03/98					
1.9 D	47	10/95→03/98		10/96→ 02/98; + ABS	03.2123-1428.3	010476	Ø 23,81
				10/96→ 02/98; - ABS	24.2122-1731.3	010656	Ø 22,2
 Bremskraftregler							
1.3	43	08/95→03/98		→ 02/98	03.6584-0107.3	320110	ATE lastabhängig 8/4 4x
1.3 LX	40	08/95→03/98					
1.3 LXI	50	08/95→03/98					
1.6 GLX	55	08/95→03/98					
1.9 D	47	10/95→03/98		10/96→ 02/98	03.6583-0167.3	320140	ATE lastabhängig 8/3 4x

	kw					! #		
SKODA - FELICIA I Pick-up (6UF, 6U7) 10/95→04/02								
 Hauptbremszylinder								
1.3	40	06/97→04/02		→ 12/00; - ABS / + ABS		03.2123-1428.3 010476	Ø 23,81	
				→ 12/00; - ABS		24.2122-1731.3 010656	Ø 22,2	
1.3	43	10/95→04/02		06/97→ 12/00; - ABS / + ABS		03.2123-1428.3 010476	Ø 23,81	
				06/97→ 12/00; - ABS		24.2122-1731.3 010656	Ø 22,2	
1.3	50	06/97→04/02		→ 12/00; + ABS		03.2123-1428.3 010476	Ø 23,81	
1.9 D	47	06/97→04/02		→ 12/00		24.2122-1731.3 010656	Ø 22,2	
1.6	55	06/97→04/02		→ 12/99; + ABS		03.2123-1428.3 010476	Ø 23,81	
				→ 12/99		24.2122-1731.3 010656	Ø 22,2	
 Bremskraftregler								
1.3	40	06/97→04/02		→ 12/00		03.6584-0107.3 320110	ATE lastabhängig 8/4 4x	
1.3	50	06/97→04/02						
1.3	43	10/95→04/02		06/97→ 12/00		03.6584-0107.3 320110	ATE lastabhängig 8/4 4x	
1.6	55	06/97→04/02		→ 12/99		03.6584-0107.3 320110	ATE lastabhängig 8/4 4x	
1.9 D	47	06/97→04/02		→ 12/00		03.6583-0167.3 320140	ATE lastabhängig 8/3 4x	
SKODA - FELICIA II (6U1) 01/98→06/01								
 Hauptbremszylinder								
1.3	40	01/98→06/01		03/98→		03.2123-1428.3 010476	Ø 23,81	
1.3	43	01/98→06/01						
1.3	50	01/98→06/01						
1.6	55	01/98→06/01						
1.9 D	47	01/98→06/01						
SKODA - FELICIA II Kombi (6U5) 01/98→06/01								
 Hauptbremszylinder								
1.3	50	01/98→06/01		03/98→		03.2123-1428.3 010476	Ø 23,81	
1.6	55	01/98→06/01						
1.9 D	47	01/98→06/01						
SKODA - KODIAQ (NS7) 10/16→								
 Hauptbremszylinder								
1.4 TSI	92	03/17→		für Linkslenker; +PR 1ZA		24.4123-1719.3 011017	TRW Ø 23,81 ohne Bremsflüssigkeitsbehälter	
1.4 TSI	110	03/17→						
1.4 TSI 4x4	110	03/17→						
2.0 TDI	110	03/17→						
2.0 TDI 4x4	110	03/17→						
2.0 TDI 4x4	140	03/17→						
2.0 TSI 4x4	132	03/17→						
SKODA - OCTAVIA (1Z3) 02/04→06/13								
 Bremskraftverstärker								
1.2 TSI	77	02/10→06/13		→ 01/13; für Linkslenker; +PR 1AC,1AT		03.7863-3232.4 300307	ATE Ø 10" pneumatisch	
1.4	59	06/04→04/13						
1.4 TSI	90	11/08→06/13		→ 01/13; für Linkslenker; +PR 1AS		03.7863-9602.4 300206	ATE Ø 10" pneumatisch	
1.6	75	06/04→06/13						
1.6 TDI	77	06/09→04/13						
1.8 TSI	112	03/09→06/13						
1.8 TSI	118	06/07→04/13						
2.0 RS	147	10/05→02/13						
2.0 TDI	81	03/10→06/13						
2.0 TDI RS	125	04/06→02/13						
1.4	55	05/04→05/06		06/04→; für Linkslenker; +PR 1AC,1AT		03.7863-3232.4 300307	ATE Ø 10" pneumatisch	
1.6 FSI	85	02/04→10/08		06/04→; für Linkslenker; +PR 1AS		03.7863-9602.4 300206	ATE Ø 10" pneumatisch	
2.0 TDI	100	02/04→05/10						
1.6 LPG	75	08/09→11/12		09/09→; für Linkslenker; +PR 1AC,1AT		03.7863-3232.4 300307	ATE Ø 10" pneumatisch	
				09/09→; für Linkslenker; +PR 1AS		03.7863-9602.4 300206	ATE Ø 10" pneumatisch	
1.6 MultiFuel	75	01/08→06/13		09/09→ 01/13; für Linkslenker; +PR 1AC,1AT		03.7863-3232.4 300307	ATE Ø 10" pneumatisch	
				09/09→ 01/13; für Linkslenker; +PR 1AS		03.7863-9602.4 300206	ATE Ø 10" pneumatisch	
1.8 T	110	09/05→12/08		06/07→; für Linkslenker; +PR 1AC,1AT		03.7863-3232.4 300307	ATE Ø 10" pneumatisch	
				06/07→; für Linkslenker; +PR 1AS		03.7863-9602.4 300206	ATE Ø 10" pneumatisch	
1.9 TDI	77	06/04→12/10		für Linkslenker; +PR 1AC,1AT		03.7863-3232.4 300307	ATE Ø 10" pneumatisch	
2.0 FSI	110	11/04→10/08		für Linkslenker; +PR 1AS		03.7863-9602.4 300206	ATE Ø 10" pneumatisch	
2.0 TDI	103	11/05→05/10						
2.0 TDI 16V	103	02/04→04/13		06/04→ 01/13; für Linkslenker; +PR 1AC,1AT		03.7863-3232.4 300307	ATE Ø 10" pneumatisch	
↓				06/04→ 01/13; für Linkslenker; +PR 1AS		03.7863-9602.4 300206	ATE Ø 10" pneumatisch	

SKODA - OCTAVIA (1Z3) 02/04→06/13

Hauptbremszylinder

1.2 TSI	77	02/10→06/13		→ 01/13; für Linkslenker		03.2122-2129.3	010799	ATE Ø 22,2
1.4	59	06/04→04/13						
1.4 TSI	90	11/08→06/13						
1.6	75	06/04→06/13						
1.6 TDI	77	06/09→04/13						
1.8 TSI	112	03/09→06/13						
1.8 TSI	118	06/07→04/13						
2.0 RS	147	10/05→02/13						
2.0 TDI	81	03/10→06/13						
2.0 TDI RS	125	04/06→02/13						
1.4	55	05/04→05/06		06/04→; für Linkslenker		03.2122-2129.3	010799	ATE Ø 22,2
1.6 FSI	85	02/04→10/08						
2.0 TDI	100	02/04→05/10						
1.6 LPG	75	08/09→11/12		09/09→; für Linkslenker		03.2122-2129.3	010799	ATE Ø 22,2
1.6 MultiFuel	75	01/08→06/13		09/09→ 01/13; für Linkslenker		03.2122-2129.3	010799	ATE Ø 22,2
1.8 T	110	09/05→12/08		06/07→; für Linkslenker		03.2122-2129.3	010799	ATE Ø 22,2
1.9 TDI	77	06/04→12/10		für Linkslenker		03.2122-2129.3	010799	ATE Ø 22,2
2.0 FSI	110	11/04→10/08						
2.0 TDI	103	11/05→05/10						
2.0 TDI 16V	103	02/04→04/13		06/04→ 01/13; für Linkslenker		03.2122-2129.3	010799	ATE Ø 22,2

Hydraulikaggregat, Bremsanlage

1.4	55	05/04→05/06		06/04→; +PR 1AT		24.9145-0001.2	399005	
1.6 FSI	85	02/04→10/08						
1.4	59	06/04→04/13		→ 12/08; +PR 1AT		24.9145-0001.2	399005	
1.4 TSI	90	11/08→06/13						
1.6	75	06/04→06/13						
1.8 TSI	118	06/07→04/13						
1.9 TDI	77	06/04→12/10						
2.0 RS	147	10/05→02/13						
2.0 TDI	103	11/05→05/10						
2.0 TDI RS	125	04/06→02/13						
1.8 T	110	09/05→12/08		06/07→; +PR 1AT		24.9145-0001.2	399005	
2.0 FSI	110	11/04→10/08		+PR 1AT		24.9145-0001.2	399005	
2.0 TDI	100	02/04→05/10		06/04→ 12/08; +PR 1AT		24.9145-0001.2	399005	
2.0 TDI 16V	103	02/04→04/13						

Drucksensor, Bremskraftverstärker











1.2 TSI	77	02/10→06/13		→ 01/13; für Linkslenker; +PR 1AS		03.0655-0101.2	370008	ATE
1.4	59	06/04→04/13						
1.4 TSI	90	11/08→06/13						
1.6	75	06/04→06/13						
1.6 TDI	77	06/09→04/13						
1.8 TSI	112	03/09→06/13						
1.8 TSI	118	06/07→04/13						
2.0 RS	147	10/05→02/13						
2.0 TDI	81	03/10→06/13						
2.0 TDI RS	125	04/06→02/13						
1.4	55	05/04→05/06		06/04→; für Linkslenker; +PR 1AS		03.0655-0101.2	370008	ATE
1.6 FSI	85	02/04→10/08						
2.0 TDI	100	02/04→05/10						
1.6 LPG	75	08/09→11/12		09/09→; für Linkslenker; +PR 1AS		03.0655-0101.2	370008	ATE
1.6 MultiFuel	75	01/08→06/13		09/09→ 01/13; für Linkslenker; +PR 1AS		03.0655-0101.2	370008	ATE
1.8 T	110	09/05→12/08		06/07→; für Linkslenker; +PR 1AS		03.0655-0101.2	370008	ATE
1.9 TDI	77	06/04→12/10		für Linkslenker; +PR 1AS		03.0655-0101.2	370008	ATE
2.0 FSI	110	11/04→10/08						
2.0 TDI	103	11/05→05/10						
2.0 TDI 16V	103	02/04→04/13		06/04→ 01/13; für Linkslenker; +PR 1AS		03.0655-0101.2	370008	ATE











SKODA - OCTAVIA I (1U2) 09/96→12/10











Bremskraftverstärker

1.4	44	04/99→03/01		→ 07/00; für Linkslenker; + ESP		03.7863-0402.4	300124	ATE Ø 10" pneumatisch
1.4 16V	55	09/00→12/10		05/01→ 06/10; +PR 1AC,1AH,1AJ,1AT;		03.7863-3502.4	300128	ATE Ø 10" pneumatisch
1.6	75	11/00→12/10		für Linkslenker				
1.6	55	09/96→09/04		10/96→ 07/00; für Linkslenker; + ESP		03.7863-0402.4	300124	ATE Ø 10" pneumatisch
1.9 TDI	66	09/96→03/10		05/01→; +PR 1AC,1AH,1AJ,1AT;		03.7863-3502.4	300128	ATE Ø 10" pneumatisch
				für Linkslenker				
1.6	74	02/97→12/07		→ 07/00; für Linkslenker; + ESP		03.7863-0402.4	300124	ATE Ø 10" pneumatisch
1.9 SDI	50	06/97→12/03						
1.9 TDI	81	08/97→01/06		05/01→; +PR 1AC,1AH,1AJ,1AT;		03.7863-3502.4	300128	ATE Ø 10" pneumatisch
2.0	85	04/99→05/07		für Linkslenker				
1.8	92	09/96→07/00		10/96→; für Linkslenker; + ESP		03.7863-0402.4	300124	ATE Ø 10" pneumatisch
1.8 T	110	08/97→12/10		03/98→ 07/00; für Linkslenker; + ESP		03.7863-0402.4	300124	ATE Ø 10" pneumatisch
				05/01→ 06/10; +PR 1AC,1AH,1AJ,1AT;		03.7863-3502.4	300128	ATE Ø 10" pneumatisch
				für Linkslenker				

↓

	kw			 	! #		
SKODA - OCTAVIA I (1U2) 09/96→12/10							
 Bremskraftverstärker							
1.8 T 4x4 RS 1.8 T	110 132	05/01→05/06 05/01→01/06		+PR 1AC,1AH,1AJ,1AT; für Linkslenker		03.7863-3502.4 300128	ATE Ø 10" pneumatisch
1.9 TDI	74	10/05→12/10		→ 06/10; +PR 1AC,1AH,1AJ,1AT; für Linkslenker		03.7863-3502.4 300128	ATE Ø 10" pneumatisch
1.9 TDI	96	09/02→09/04		01/03→; +PR 1AC,1AH,1AJ,1AT; für Linkslenker		03.7863-3502.4 300128	ATE Ø 10" pneumatisch
 Hauptbremszylinder							
1.4	44	04/99→03/01		→ 07/00; für Linkslenker; + ESP		03.2123-2024.3 010597	ATE Ø 23,81
1.6	74	02/97→12/07		→ 07/00; für Rechtslenker; + ESP		03.2123-2064.3 010598	ATE Ø 23,81
1.9 SDI	50	06/97→12/03					
1.9 TDI	81	08/97→01/06		08/00→; für Linkslenker; +PR 1AT		03.2123-2715.3 010802	ATE Ø 23,81
2.0	85	04/99→05/07		08/00→; für Rechtslenker; +PR 1AT		03.2123-2774.3 010803	ATE Ø 23,81
				08/00→; für Linkslenker; +PR 1AC,1AH,1AJ		03.2123-2973.3 010951	ATE Ø 23,81
				08/00→; für Linkslenker; +PR 1AM		24.2123-1709.3 010503	Ø 23,81
				→ 07/00; für Linkslenker; - ESP		24.2123-1709.3 010503	Ø 23,81
1.4 16V	55	09/00→12/10		→ 06/10; für Linkslenker; +PR 1AT		03.2123-2715.3 010802	ATE Ø 23,81
1.6	75	11/00→12/10		→ 06/10; für Rechtslenker; +PR 1AT		03.2123-2774.3 010803	ATE Ø 23,81
1.9 TDI	74	10/05→12/10					
				→ 06/10; für Linkslenker; +PR 1AC,1AH,1AJ		03.2123-2973.3 010951	ATE Ø 23,81
				→ 06/10; für Linkslenker; +PR 1AM		24.2123-1709.3 010503	Ø 23,81
1.6	55	09/96→09/04		10/96→ 07/00; für Linkslenker; + ESP		03.2123-2024.3 010597	ATE Ø 23,81
1.9 TDI	66	09/96→03/10		10/96→ 07/00; für Rechtslenker; + ESP		03.2123-2064.3 010598	ATE Ø 23,81
				08/00→; für Linkslenker; +PR 1AT		03.2123-2715.3 010802	ATE Ø 23,81
				08/00→; für Rechtslenker; +PR 1AT		03.2123-2774.3 010803	ATE Ø 23,81
				08/00→; für Linkslenker; +PR 1AC,1AH,1AJ		03.2123-2973.3 010951	ATE Ø 23,81
				08/00→; für Linkslenker; +PR 1AM		24.2123-1709.3 010503	Ø 23,81
				10/96→ 07/00; für Linkslenker; - ESP		24.2123-1709.3 010503	Ø 23,81
1.8	92	09/96→07/00		10/96→; für Linkslenker; + ESP		03.2123-2024.3 010597	ATE Ø 23,81
				10/96→; für Rechtslenker; + ESP		03.2123-2064.3 010598	ATE Ø 23,81
				10/96→; für Linkslenker; - ESP		24.2123-1709.3 010503	Ø 23,81
1.8 T	110	08/97→12/10		03/98→ 07/00; für Linkslenker; + ESP		03.2123-2024.3 010597	ATE Ø 23,81
				03/98→ 07/00; für Rechtslenker; + ESP		03.2123-2064.3 010598	ATE Ø 23,81
				08/00→ 06/10; für Linkslenker; +PR 1AT		03.2123-2715.3 010802	ATE Ø 23,81
				08/00→ 06/10; für Rechtslenker; +PR 1AT		03.2123-2774.3 010803	ATE Ø 23,81
				08/00→ 06/10; für Linkslenker; +PR 1AC,1AH,1AJ		03.2123-2973.3 010951	ATE Ø 23,81
				03/98→ 07/00; für Linkslenker; - ESP		24.2123-1709.3 010503	Ø 23,81
				08/00→ 06/10; für Linkslenker; +PR 1AM		24.2123-1709.3 010503	Ø 23,81
1.8 T 4x4 RS 1.8 T	110 132	05/01→05/06 05/01→01/06		für Linkslenker; +PR 1AT		03.2123-2715.3 010802	ATE Ø 23,81
				für Rechtslenker; +PR 1AT		03.2123-2774.3 010803	ATE Ø 23,81
				für Linkslenker; +PR 1AC,1AH,1AJ		03.2123-2973.3 010951	ATE Ø 23,81
				für Linkslenker; +PR 1AM		24.2123-1709.3 010503	Ø 23,81
1.9 TDI	96	09/02→09/04		01/03→; für Linkslenker; +PR 1AT		03.2123-2715.3 010802	ATE Ø 23,81
				01/03→; für Rechtslenker; +PR 1AT		03.2123-2774.3 010803	ATE Ø 23,81
				01/03→; für Linkslenker; +PR 1AC,1AH,1AJ		03.2123-2973.3 010951	ATE Ø 23,81
				01/03→; für Linkslenker; +PR 1AM		24.2123-1709.3 010503	Ø 23,81
 Bremskraftregler							
1.4	44	04/99→03/01		Scheibenbremse		03.6583-0179.3 320228	ATE lastabhängig 8/3 4x
1.6	74	02/97→12/07					
1.9 SDI	50	06/97→12/03		Trommelbremse		03.6584-0107.3 320110	ATE lastabhängig 8/4 4x
1.4 16V	55	09/00→12/10		→ 06/10; Scheibenbremse		03.6583-0179.3 320228	ATE lastabhängig 8/3 4x
1.6	75	11/00→12/10		→ 06/10; Trommelbremse		03.6584-0107.3 320110	ATE lastabhängig 8/4 4x
1.6	55	09/96→09/04		10/96→; Scheibenbremse		03.6583-0179.3 320228	ATE lastabhängig 8/3 4x
1.9 TDI	66	09/96→03/10		10/96→; Trommelbremse		03.6584-0107.3 320110	ATE lastabhängig 8/4 4x
1.8	92	09/96→07/00		10/96→; Scheibenbremse		03.6583-0179.3 320228	ATE lastabhängig 8/3 4x
1.8 T	110	08/97→12/10		03/98→ 06/10; Scheibenbremse		03.6583-0179.3 320228	ATE lastabhängig 8/3 4x
1.8 T 4x4 1.9 TDI 2.0 RS 1.8 T	110 81 85 132	05/01→05/06 08/97→01/06 04/99→05/07 05/01→01/06		Scheibenbremse		03.6583-0179.3 320228	ATE lastabhängig 8/3 4x
1.9 TDI	74	10/05→12/10		→ 06/10; Scheibenbremse		03.6583-0179.3 320228	ATE lastabhängig 8/3 4x
↓							

	kw					! #		
SKODA - OCTAVIA I (1U2) 09/96→12/10								
 Bremskraftregler								
1.9 TDI	96	09/02→09/04		01/03→;	Scheibenbremse		03.6583-0179.3 320228	ATE lastabhängig 8/3 4x
SKODA - OCTAVIA I Combi (1U5) 07/98→12/10								
 Bremskraftverstärker								
1.4 16V	55	08/00→12/10		05/01→ 06/10;	+PR 1AC,1AH,1AJ,1AT;		03.7863-3502.4 300128	ATE Ø 10" pneumatisch
1.6	75	09/00→12/10			für Linkslenker			
1.9 TDI	74	08/00→12/10						
1.6	55	07/98→09/04		→ 07/00;	für Linkslenker; + ESP		03.7863-0402.4 300124	ATE Ø 10" pneumatisch
1.6	74	07/98→12/07						
1.9 SDI	50	07/98→12/03		05/01→;	+PR 1AC,1AH,1AJ,1AT;		03.7863-3502.4 300128	ATE Ø 10" pneumatisch
1.9 TDI	66	07/98→03/10			für Linkslenker			
1.9 TDI	81	07/98→01/06						
1.9 TDI 4x4	66	11/99→02/06						
2.0	85	04/99→05/07						
1.8 20V	92	07/98→07/00			für Linkslenker; + ESP		03.7863-0402.4 300124	ATE Ø 10" pneumatisch
1.8 T	110	07/98→12/10		→ 07/00;	für Linkslenker; + ESP		03.7863-0402.4 300124	ATE Ø 10" pneumatisch
2.0 4x4	88	01/00→12/10		05/01→ 06/10;	+PR 1AC,1AH,1AJ,1AT;		03.7863-3502.4 300128	ATE Ø 10" pneumatisch
					für Linkslenker			
1.8 T 4x4	110	05/01→05/06			+PR 1AC,1AH,1AJ,1AT; für Linkslenker		03.7863-3502.4 300128	ATE Ø 10" pneumatisch
RS 1.8 T	132	08/02→01/06						
1.9 TDI	96	09/02→09/04		01/03→;	+PR 1AC,1AH,1AJ,1AT;		03.7863-3502.4 300128	ATE Ø 10" pneumatisch
					für Linkslenker			
1.9 TDI 4x4	74	09/00→01/06		05/01→;	+PR 1AC,1AH,1AJ,1AT;		03.7863-3502.4 300128	ATE Ø 10" pneumatisch
2.0 4x4	85	08/00→09/04			für Linkslenker			
 Hauptbremszylinder								
1.4 16V	55	08/00→12/10		→ 06/10;	für Linkslenker; +PR 1AT		03.2123-2715.3 010802	ATE Ø 23,81
1.6	75	09/00→12/10		→ 06/10;	für Rechtslenker; +PR 1AT		03.2123-2774.3 010803	ATE Ø 23,81
1.9 TDI	74	08/00→12/10		→ 06/10;	für Linkslenker;		03.2123-2973.3 010951	ATE Ø 23,81
					+PR 1AC,1AH,1AJ			
				→ 06/10;	für Linkslenker; +PR 1AM		24.2123-1709.3 010503	Ø 23,81
1.6	55	07/98→09/04		→ 07/00;	für Linkslenker; + ESP		03.2123-2024.3 010597	ATE Ø 23,81
1.6	74	07/98→12/07		→ 07/00;	für Rechtslenker; + ESP		03.2123-2064.3 010598	ATE Ø 23,81
1.9 SDI	50	07/98→12/03		08/00→;	für Linkslenker; +PR 1AT		03.2123-2715.3 010802	ATE Ø 23,81
1.9 TDI	66	07/98→03/10		08/00→;	für Rechtslenker; +PR 1AT		03.2123-2774.3 010803	ATE Ø 23,81
1.9 TDI	81	07/98→01/06		08/00→;	für Linkslenker;		03.2123-2973.3 010951	ATE Ø 23,81
1.9 TDI 4x4	66	11/99→02/06			+PR 1AC,1AH,1AJ			
2.0	85	04/99→05/07		08/00→;	für Linkslenker; +PR 1AM		24.2123-1709.3 010503	Ø 23,81
				→ 07/00;	für Linkslenker; - ESP		24.2123-1709.3 010503	Ø 23,81
1.8 20V	92	07/98→07/00			für Linkslenker; + ESP		03.2123-2024.3 010597	ATE Ø 23,81
					für Rechtslenker; + ESP		03.2123-2064.3 010598	ATE Ø 23,81
					für Linkslenker; - ESP		24.2123-1709.3 010503	Ø 23,81
1.8 T	110	07/98→12/10		→ 07/00;	für Linkslenker; + ESP		03.2123-2024.3 010597	ATE Ø 23,81
2.0 4x4	88	01/00→12/10		→ 07/00;	für Rechtslenker; + ESP		03.2123-2064.3 010598	ATE Ø 23,81
				08/00→ 06/10;	für Linkslenker; +PR 1AT		03.2123-2715.3 010802	ATE Ø 23,81
				08/00→ 06/10;	für Rechtslenker;		03.2123-2774.3 010803	ATE Ø 23,81
					+PR 1AT			
				08/00→ 06/10;	für Linkslenker;		03.2123-2973.3 010951	ATE Ø 23,81
					+PR 1AC,1AH,1AJ			
				→ 07/00;	für Linkslenker; - ESP		24.2123-1709.3 010503	Ø 23,81
				08/00→ 06/10;	für Linkslenker; +PR 1AM		24.2123-1709.3 010503	Ø 23,81
1.8 T 4x4	110	05/01→05/06			für Linkslenker; +PR 1AT		03.2123-2715.3 010802	ATE Ø 23,81
1.9 TDI 4x4	74	09/00→01/06			für Rechtslenker; +PR 1AT		03.2123-2774.3 010803	ATE Ø 23,81
RS 1.8 T	132	08/02→01/06			für Linkslenker; +PR 1AC,1AH,1AJ		03.2123-2973.3 010951	ATE Ø 23,81
					für Linkslenker; +PR 1AM		24.2123-1709.3 010503	Ø 23,81
1.9 TDI	96	09/02→09/04		01/03→;	für Linkslenker; +PR 1AT		03.2123-2715.3 010802	ATE Ø 23,81
				01/03→;	für Rechtslenker; +PR 1AT		03.2123-2774.3 010803	ATE Ø 23,81
				01/03→;	für Linkslenker;		03.2123-2973.3 010951	ATE Ø 23,81
					+PR 1AC,1AH,1AJ			
				01/03→;	für Linkslenker; +PR 1AM		24.2123-1709.3 010503	Ø 23,81
2.0 4x4	85	08/00→09/04		05/01→;	für Linkslenker; +PR 1AT		03.2123-2715.3 010802	ATE Ø 23,81
				05/01→;	für Rechtslenker; +PR 1AT		03.2123-2774.3 010803	ATE Ø 23,81
				05/01→;	für Linkslenker;		03.2123-2973.3 010951	ATE Ø 23,81
					+PR 1AC,1AH,1AJ			
				05/01→;	für Linkslenker; +PR 1AM		24.2123-1709.3 010503	Ø 23,81
↓								

	kw			 	! #		
SKODA - OCTAVIA I Combi (1U5) 07/98→12/10							
 Bremskraftregler							
1.4 16V	55	08/00→12/10		→ 06/10; Scheibenbremse		03.6583-0179.3 320228	ATE lastabhängig 8/3 4x
1.6	75	09/00→12/10		→ 06/10; Trommelbremse		03.6584-0107.3 320110	ATE lastabhängig 8/4 4x
1.6	55	07/98→09/04		Scheibenbremse		03.6583-0179.3 320228	ATE lastabhängig 8/3 4x
1.6	74	07/98→12/07					
1.9 SDI	50	07/98→12/03		Trommelbremse		03.6584-0107.3 320110	ATE lastabhängig 8/4 4x
1.9 TDI	66	07/98→03/10					
1.8 20V	92	07/98→07/00		Scheibenbremse		03.6583-0179.3 320228	ATE lastabhängig 8/3 4x
1.8 T 4x4	110	05/01→05/06					
1.9 TDI	81	07/98→01/06					
1.9 TDI 4x4	66	11/99→02/06					
1.9 TDI 4x4	74	09/00→01/06					
2.0	85	04/99→05/07					
RS 1.8 T	132	08/02→01/06					
1.8 T	110	07/98→12/10		→ 06/10; Scheibenbremse		03.6583-0179.3 320228	ATE lastabhängig 8/3 4x
1.9 TDI	74	08/00→12/10					
2.0 4x4	88	01/00→12/10					
1.9 TDI	96	09/02→09/04		01/03→; Scheibenbremse		03.6583-0179.3 320228	ATE lastabhängig 8/3 4x
2.0 4x4	85	08/00→09/04		05/01→; Scheibenbremse		03.6583-0179.3 320228	ATE lastabhängig 8/3 4x
SKODA - OCTAVIA II Combi (1Z5) 02/04→06/13							
 Bremskraftverstärker							
1.2 TSI	77	02/10→04/13		→ 01/13; für Linkslenker; +PR 1AC,1AT		03.7863-3232.4 300307	ATE Ø 10" pneumatisch
1.4	59	05/06→06/13					
1.4 TSI	90	11/08→06/13		→ 01/13; für Linkslenker; +PR 1AS		03.7863-9602.4 300206	ATE Ø 10" pneumatisch
1.6	75	09/04→06/13					
1.6 TDI	77	06/09→04/13					
1.6 TDI 4x4	77	06/09→02/13					
1.8 TSI	112	03/09→06/13					
1.8 TSI	118	06/07→04/13					
1.8 TSI 4x4	112	03/09→02/13					
1.8 TSI 4x4	118	11/08→02/13					
2.0 RS	147	10/05→02/13					
2.0 TDI	81	03/10→06/13					
2.0 TDI 16V 4x4	103	05/10→02/13					
2.0 TDI 4x4	81	05/11→02/13					
2.0 TDI RS	125	04/06→02/13					
1.4	55	05/04→05/06		06/04→; für Linkslenker; +PR 1AC,1AT		03.7863-3232.4 300307	ATE Ø 10" pneumatisch
1.6 FSI	85	02/04→10/08					
2.0 TDI 16V	100	02/04→05/10		06/04→; für Linkslenker; +PR 1AS		03.7863-9602.4 300206	ATE Ø 10" pneumatisch
1.6 LPG	75	08/09→11/12		09/09→; für Linkslenker; +PR 1AC,1AT		03.7863-3232.4 300307	ATE Ø 10" pneumatisch
				09/09→; für Linkslenker; +PR 1AS		03.7863-9602.4 300206	ATE Ø 10" pneumatisch
1.6 MultiFuel	75	01/08→06/13		09/09→ 01/13; für Linkslenker; +PR 1AC,1AT		03.7863-3232.4 300307	ATE Ø 10" pneumatisch
				09/09→ 01/13; für Linkslenker; +PR 1AS		03.7863-9602.4 300206	ATE Ø 10" pneumatisch
1.9 TDI	77	09/04→12/10		für Linkslenker; +PR 1AC,1AT		03.7863-3232.4 300307	ATE Ø 10" pneumatisch
1.9 TDI 4x4	77	11/04→12/10					
2.0 FSI	110	11/04→10/08		für Linkslenker; +PR 1AS		03.7863-9602.4 300206	ATE Ø 10" pneumatisch
2.0 FSI 4x4	110	11/04→10/08					
2.0 TDI	103	11/05→05/10					
2.0 TDI 4x4	103	07/06→05/10					
2.0 TDI 16V	103	02/04→05/13		06/04→ 01/13; für Linkslenker; +PR 1AC,1AT		03.7863-3232.4 300307	ATE Ø 10" pneumatisch
				06/04→ 01/13; für Linkslenker; +PR 1AS		03.7863-9602.4 300206	ATE Ø 10" pneumatisch
 Hauptbremszylinder							
1.2 TSI	77	02/10→04/13		→ 01/13; für Linkslenker		03.2122-2129.3 010799	ATE Ø 22,2
1.4	59	05/06→06/13					
1.4 TSI	90	11/08→06/13					
1.6	75	09/04→06/13					
1.6 TDI	77	06/09→04/13					
1.6 TDI 4x4	77	06/09→02/13					
1.8 TSI	112	03/09→06/13					
1.8 TSI	118	06/07→04/13					
1.8 TSI 4x4	112	03/09→02/13					
1.8 TSI 4x4	118	11/08→02/13					
2.0 RS	147	10/05→02/13					
2.0 TDI	81	03/10→06/13					
2.0 TDI 16V 4x4	103	05/10→02/13					
2.0 TDI 4x4	81	05/11→02/13					
2.0 TDI RS	125	04/06→02/13					
1.4	55	05/04→05/06		06/04→; für Linkslenker		03.2122-2129.3 010799	ATE Ø 22,2
1.6 FSI	85	02/04→10/08					
2.0 TDI 16V	100	02/04→05/10					
1.6 LPG	75	08/09→11/12		09/09→; für Linkslenker		03.2122-2129.3 010799	ATE Ø 22,2
1.6 MultiFuel	75	01/08→06/13		09/09→ 01/13; für Linkslenker		03.2122-2129.3 010799	ATE Ø 22,2
1.9 TDI	77	09/04→12/10		für Linkslenker		03.2122-2129.3 010799	ATE Ø 22,2
1.9 TDI 4x4	77	11/04→12/10					

SKODA - OCTAVIA II Combi (1Z5) 02/04→06/13

Hauptbremszylinder

2.0 FSI	110	11/04→10/08		für Linkslenker	03.2122-2129.3	010799	ATE Ø 22,2
2.0 FSI 4x4	110	11/04→10/08					
2.0 TDI	103	11/05→05/10					
2.0 TDI 4x4	103	07/06→05/10					
2.0 TDI 16V	103	02/04→05/13		06/04→ 01/13; für Linkslenker	03.2122-2129.3	010799	ATE Ø 22,2

Hydraulikaggregat, Bremsanlage

1.4	55	05/04→05/06		06/04→; +PR 1AT	24.9145-0001.2	399005	
1.6 FSI	85	02/04→10/08					
1.4	59	05/06→06/13		→ 12/08; +PR 1AT	24.9145-0001.2	399005	
1.4 TSI	90	11/08→06/13					
1.6	75	09/04→06/13					
1.8 TSI	118	06/07→04/13					
1.8 TSI 4x4	118	11/08→02/13					
1.9 TDI	77	09/04→12/10					
1.9 TDI 4x4	77	11/04→12/10					
2.0 RS	147	10/05→02/13					
2.0 TDI	103	11/05→05/10					
2.0 TDI 4x4	103	07/06→05/10					
2.0 TDI RS	125	04/06→02/13					
2.0 FSI	110	11/04→10/08		+PR 1AT	24.9145-0001.2	399005	
2.0 FSI 4x4	110	11/04→10/08					
2.0 TDI 16V	100	02/04→05/10		06/04→ 12/08; +PR 1AT	24.9145-0001.2	399005	
2.0 TDI 16V	103	02/04→05/13					

Drucksensor, Bremskraftverstärker













1.2 TSI	77	02/10→04/13		→ 01/13; für Linkslenker; +PR 1AS	03.0655-0101.2	370008	ATE
1.4	59	05/06→06/13					
1.4 TSI	90	11/08→06/13					
1.6	75	09/04→06/13					
1.6 TDI	77	06/09→04/13					
1.6 TDI 4x4	77	06/09→02/13					
1.8 TSI	112	03/09→06/13					
1.8 TSI	118	06/07→04/13					
1.8 TSI 4x4	112	03/09→02/13					
1.8 TSI 4x4	118	11/08→02/13					
2.0 RS	147	10/05→02/13					
2.0 TDI	81	03/10→06/13					
2.0 TDI 16V 4x4	103	05/10→02/13					
2.0 TDI 4x4	81	05/11→02/13					
2.0 TDI RS	125	04/06→02/13					
1.4	55	05/04→05/06		06/04→; für Linkslenker; +PR 1AS	03.0655-0101.2	370008	ATE
1.6 FSI	85	02/04→10/08					
2.0 TDI 16V	100	02/04→05/10					
1.6 LPG	75	08/09→11/12		09/09→; für Linkslenker; +PR 1AS	03.0655-0101.2	370008	ATE
1.6 MultiFuel	75	01/08→06/13		09/09→ 01/13; für Linkslenker; +PR 1AS	03.0655-0101.2	370008	ATE
1.9 TDI	77	09/04→12/10		für Linkslenker; +PR 1AS	03.0655-0101.2	370008	ATE
1.9 TDI 4x4	77	11/04→12/10					
2.0 FSI	110	11/04→10/08					
2.0 FSI 4x4	110	11/04→10/08					
2.0 TDI	103	11/05→05/10					
2.0 TDI 4x4	103	07/06→05/10					
2.0 TDI 16V	103	02/04→05/13		06/04→ 01/13; für Linkslenker; +PR 1AS	03.0655-0101.2	370008	ATE













SKODA - OCTAVIA III (5E3) 11/12→













Hauptbremszylinder















1.0 TSI	85	05/16→		+PR 1ZA,1ZB,1ZE,1ZF; für Linkslenker	03.4153-5403.3	010994	ATE Ø 23,81
1.2 TSI	81	05/15→			24.4123-1719.3	011017	TRW Ø 23,81 ohne Bremsflüssigkeitsbehälter
1.4 TSI	103	11/12→					
1.4 TSI G-TEC	81	11/13→					
1.6	81	01/14→					
1.6 TDI	81	05/13→					
1.6 TDI	85	02/17→					
1.6 TDI 4x4	77	09/14→					
1.6 TDI 4x4	81	05/15→					
1.8 TSI	132	11/12→					
1.8 TSI 4x4	132	09/14→					
2.0 TDI	105	11/12→					
2.0 TDI / TDI RS 4x4	135	09/14→					
2.0 TDI 4x4	110	09/14→					
2.0 TDI RS	135	05/13→					
2.0 TSI RS	162	05/13→					
2.0 TSI RS	169	05/15→					
2.0 TSI RS	180	02/17→					
1.2 TSI	63	11/12→		02/13→; für Linkslenker; +PR 1ZA,1ZB,1ZE,1ZF	03.4153-5403.3	010994	ATE Ø 23,81
1.2 TSI	77	11/12→			24.4123-1719.3	011017	TRW Ø 23,81 ohne Bremsflüssigkeitsbehälter
1.6 TDI	66	11/12→					
1.6 TDI	77	11/12→					
2.0 TDI	110	11/12→					















↓















	kw					! #		
SKODA - OCTAVIA III (5E3) 11/12→								
 Hauptbremszylinder								
1.4 TSI	110	08/14→		05/15→; für Linkslenker; +PR 1ZA,1ZB,1ZE,1ZF		03.4153-5403.3 24.4123-1719.3	010994 011017	ATE Ø 23,81 TRW Ø 23,81 ohne Bremsflüssigkeitsbehälter
SKODA - OCTAVIA III Combi (5E5) 11/12→								
 Hauptbremszylinder								
1.0 TSI	85	05/16→		+PR 1ZA,1ZB,1ZE,1ZF; für Linkslenker		03.4153-5403.3 24.4123-1719.3	010994 011017	ATE Ø 23,81 TRW Ø 23,81 ohne Bremsflüssigkeitsbehälter
1.2 TSI	81	05/15→						
1.4 TSI	103	11/12→						
1.4 TSI G-TEC	81	11/13→						
1.6	81	01/14→						
1.6 TDI	81	05/13→						
1.6 TDI	85	02/17→						
1.6 TDI 4x4	77	11/12→						
1.6 TDI 4x4	81	05/15→						
1.8 TSI	132	11/12→						
1.8 TSI 4x4	132	11/12→						
2.0 TDI	105	11/12→						
2.0 TDI / TDI RS 4x4	135	09/14→						
2.0 TDI 4x4	110	11/12→						
2.0 TDI RS	135	05/13→						
2.0 TSI RS	169	05/15→						
2.0 TSI RS	180	02/17→						
1.2 TSI	63	11/12→		02/13→; für Linkslenker; +PR 1ZA,1ZB,1ZE,1ZF		03.4153-5403.3 24.4123-1719.3	010994 011017	ATE Ø 23,81 TRW Ø 23,81 ohne Bremsflüssigkeitsbehälter
1.2 TSI	77	11/12→						
1.6 TDI	66	11/12→						
1.6 TDI	77	11/12→						
2.0 TDI	110	11/12→						
1.4 TSI	110	08/14→		05/15→; für Linkslenker; +PR 1ZA,1ZB,1ZE,1ZF		03.4153-5403.3 24.4123-1719.3	010994 011017	ATE Ø 23,81 TRW Ø 23,81 ohne Bremsflüssigkeitsbehälter
2.0 TSI RS	162	11/12→		05/13→; +PR 1ZA,1ZB,1ZE,1ZF; für Linkslenker		03.4153-5403.3 24.4123-1719.3	010994 011017	ATE Ø 23,81 TRW Ø 23,81 ohne Bremsflüssigkeitsbehälter
SKODA - ROOMSTER (5J) 03/06→05/15								
 Hauptbremszylinder								
1.2	47	05/06→01/07		07/06→; für Linkslenker; + ABS		24.2120-1734.3 24.2120-1736.3	010702 010732	Ø 20,64 Ø 20,64
				07/06→; für Linkslenker; - ABS				
1.2	51	01/07→05/15		→ 12/10; für Linkslenker; + ABS		24.2120-1734.3 24.2120-1736.3	010702 010732	Ø 20,64 Ø 20,64
1.2 TDI	55	03/10→05/15						
1.2 TSI	63	03/10→05/15		→ 12/10; für Linkslenker; - ABS		24.2120-1736.3 24.2120-1736.3	010732 010732	Ø 20,64 Ø 20,64
1.2 TSI	77	03/10→05/15						
1.4	63	09/06→05/15						
1.6	77	09/06→05/15						
1.6 TDI	66	03/10→05/15						
1.6 TDI	77	03/10→05/15						
1.4 TDI	51	07/06→03/10		für Linkslenker; + ABS		24.2120-1734.3 24.2120-1736.3	010702 010732	Ø 20,64 Ø 20,64
1.4 TDI	59	09/06→03/10		für Linkslenker; - ABS				
1.9 TDI	77	09/06→03/10						
 Bremskraftregler								
1.2	47	05/06→01/07		07/06→; - ABS		03.6584-0107.3 03.6584-0107.3	320110 320110	ATE lastabhängig 8/4 4x ATE lastabhängig 8/4 4x
1.2	51	01/07→05/15		→ 04/15; - ABS				
1.2 TDI	55	03/10→05/15						
1.2 TSI	63	03/10→05/15						
1.2 TSI	77	03/10→05/15						
1.4	63	09/06→05/15						
1.6	77	09/06→05/15						
1.6 TDI	66	03/10→05/15						
1.6 TDI	77	03/10→05/15						
1.4 TDI	51	07/06→03/10		- ABS		03.6584-0107.3 03.6584-0107.3	320110 320110	ATE lastabhängig 8/4 4x ATE lastabhängig 8/4 4x
1.4 TDI	59	09/06→03/10						
1.9 TDI	77	09/06→03/10						
SKODA - ROOMSTER Praktik (5J) 03/07→05/15								
 Hauptbremszylinder								
1.2	51	03/07→05/15		für Linkslenker; → 12/10; + ABS		24.2120-1734.3 24.2120-1736.3	010702 010732	Ø 20,64 Ø 20,64
1.2 TDI	55	03/10→05/15						
1.2 TSI	63	03/10→05/15		für Linkslenker; → 12/10; - ABS		24.2120-1736.3 24.2120-1736.3	010732 010732	Ø 20,64 Ø 20,64
1.4	63	03/07→05/15						
1.6 TDI	66	03/10→05/15						
1.4 TDI	51	03/07→03/10		für Linkslenker; + ABS		24.2120-1734.3 24.2120-1736.3	010702 010732	Ø 20,64 Ø 20,64
1.4 TDI	59	03/07→03/10		für Linkslenker; - ABS				
↓								













	kw			 	! #		
SKODA - ROOMSTER Praktik (5J) 03/07→05/15							
 Bremskraftregler							
1.2	51	03/07→05/15		→ 04/15; - ABS		03.6584-0107.3 320110	ATE lastabhängig 8/4 4x
1.2 TDI	55	03/10→05/15					
1.2 TSI	63	03/10→05/15					
1.4	63	03/07→05/15					
1.6 TDI	66	03/10→05/15					
1.4 TDI	51	03/07→03/10		- ABS		03.6584-0107.3 320110	ATE lastabhängig 8/4 4x
1.4 TDI	59	03/07→03/10					
SKODA - SUPERB I (3U4) 12/01→03/08							
 Hauptbremszylinder							
1.8 T	110	12/01→03/08		→ 02/08		03.2125-0373.3 010810	ATE Ø 25,4
2.0	85	12/01→03/08				24.2125-1720.3 010688	TRW Ø 25,4
1.9 TDI	74	08/02→10/05				03.2125-0373.3 010810	ATE Ø 25,4
1.9 TDI	77	10/05→05/07				24.2125-1720.3 010688	TRW Ø 25,4
2.5 TDI	114	12/01→08/03					
1.9 TDI	85	01/07→03/08		→ 12/07		03.2125-0373.3 010810	ATE Ø 25,4
1.9 TDI	96	12/01→03/08				24.2125-1720.3 010688	TRW Ø 25,4
2.0 TDI	103	10/05→03/08					
2.5 TDI	120	06/03→03/08					
2.8 V6	140	06/02→03/08					
2.8 V6	142	12/01→03/08					
SKODA - SUPERB II (3T4) 03/08→05/15							
 Bremskraftverstärker							
1.4 TSI	92	07/08→05/15		08/08→ 02/15; für Linkslenker		03.7863-3332.4 300308	ATE Ø 10" pneumatisch
1.8 TSI	118	03/08→05/15					
2.0 TDI	125	07/08→05/15					
1.6 TDI	77	09/10→05/15		→ 02/15; für Linkslenker		03.7863-3332.4 300308	ATE Ø 10" pneumatisch
1.8 TSI	112	03/09→05/15					
1.8 TSI 4x4	112	03/09→05/15					
1.8 TSI 4x4	118	11/08→05/15					
2.0 TDI 16V	103	01/09→05/15					
2.0 TDI 16V 4x4	103	11/10→05/15					
2.0 TSI	147	05/10→05/15					
3.6 FSI 4x4	191	11/08→05/15					
1.9 TDI	77	03/08→11/10		08/08→; für Linkslenker		03.7863-3332.4 300308	ATE Ø 10" pneumatisch
2.0 TDI	103	03/08→05/10					
2.0 TDI 4x4	125	09/08→05/15		10/08→ 02/15; für Linkslenker		03.7863-3332.4 300308	ATE Ø 10" pneumatisch
 Hauptbremszylinder							
1.4 TSI	92	07/08→05/15		08/08→ 02/15; für Linkslenker		03.2123-3449.3 010808	ATE Ø 23,81
1.8 TSI	118	03/08→05/15					
2.0 TDI	125	07/08→05/15					
1.6 TDI	77	09/10→05/15		→ 02/15; für Linkslenker		03.2123-3449.3 010808	ATE Ø 23,81
1.8 TSI	112	03/09→05/15					
1.8 TSI 4x4	112	03/09→05/15					
1.8 TSI 4x4	118	11/08→05/15					
2.0 TDI 16V	103	01/09→05/15					
2.0 TDI 16V 4x4	103	11/10→05/15					
2.0 TSI	147	05/10→05/15					
3.6 FSI 4x4	191	11/08→05/15					
1.9 TDI	77	03/08→11/10		08/08→; für Linkslenker		03.2123-3449.3 010808	ATE Ø 23,81
2.0 TDI	103	03/08→05/10					
2.0 TDI 4x4	125	09/08→05/15		10/08→ 02/15; für Linkslenker		03.2123-3449.3 010808	ATE Ø 23,81
SKODA - SUPERB II Kombi (3T5) 10/09→05/15							
 Bremskraftverstärker							
1.4 TSI	92	10/09→05/15		11/09→ 02/15; für Linkslenker		03.7863-3332.4 300308	ATE Ø 10" pneumatisch
1.8 TSI	112	10/09→05/15					
1.8 TSI	118	10/09→05/15					
1.8 TSI 4x4	112	10/09→05/15					
1.8 TSI 4x4	118	10/09→05/15					
2.0 TDI	125	10/09→05/15					
2.0 TDI 16V	103	10/09→05/15					
2.0 TDI 4x4	125	10/09→05/15					
3.6 V6 4x4	191	10/09→05/15					
1.6 TDI	77	09/10→05/15		→ 02/15; für Linkslenker		03.7863-3332.4 300308	ATE Ø 10" pneumatisch
2.0 TDI 16V 4x4	103	11/10→05/15					
2.0 TSI	147	05/10→05/15					
1.9 TDI	77	10/09→11/10		für Linkslenker		03.7863-3332.4 300308	ATE Ø 10" pneumatisch
2.0 TDI	103	10/09→03/10		11/09→; für Linkslenker		03.7863-3332.4 300308	ATE Ø 10" pneumatisch
 Hauptbremszylinder							
1.4 TSI	92	10/09→05/15		11/09→ 02/15; für Linkslenker		03.2123-3449.3 010808	ATE Ø 23,81
1.8 TSI	112	10/09→05/15					
↓							











	kw			 	! #		
SKODA - SUPERB II Kombi (3T5) 10/09→05/15							
 Hauptbremszylinder							
1.8 TSI	118	10/09→05/15		11/09→ 02/15; für Linkslenker		03.2123-3449.3 010808	ATE Ø 23,81
1.8 TSI 4x4	112	10/09→05/15					
1.8 TSI 4x4	118	10/09→05/15					
2.0 TDI	125	10/09→05/15					
2.0 TDI 16V	103	10/09→05/15					
2.0 TDI 4x4	125	10/09→05/15					
3.6 V6 4x4	191	10/09→05/15					
1.6 TDI	77	09/10→05/15		→ 02/15; für Linkslenker		03.2123-3449.3 010808	ATE Ø 23,81
2.0 TDI 16V 4x4	103	11/10→05/15					
2.0 TSI	147	05/10→05/15					
1.9 TDI	77	10/09→11/10		für Linkslenker		03.2123-3449.3 010808	ATE Ø 23,81
2.0 TDI	103	10/09→03/10		11/09→; für Linkslenker		03.2123-3449.3 010808	ATE Ø 23,81
SKODA - SUPERB III (3V3) 03/15→							
 Hauptbremszylinder							
1.4 TSI	92	03/15→		für Linkslenker		24.4123-1719.3 011017	TRW Ø 23,81 ohne Bremsflüssigkeitsbehälter
1.4 TSI	110	03/15→					
1.4 TSI 4x4	110	03/15→					
1.6 TDI	88	03/15→					
1.8 TSI	132	03/15→					
2.0 TDI	110	03/15→					
2.0 TDI	140	03/15→					
2.0 TDI 4x4	110	03/15→					
2.0 TDI 4x4	140	03/15→					
2.0 TSI	162	03/15→					
2.0 TSI 4x4	206	03/15→					
SKODA - SUPERB III Kombi (3V5) 03/15→							
 Hauptbremszylinder							
1.4 TSI	92	03/15→		für Linkslenker		24.4123-1719.3 011017	TRW Ø 23,81 ohne Bremsflüssigkeitsbehälter
1.4 TSI	110	03/15→					
1.4 TSI 4x4	110	03/15→					
1.6 TDI	88	03/15→					
1.8 TSI	132	03/15→					
2.0 TDI	110	03/15→					
2.0 TDI	140	03/15→					
2.0 TDI 4x4	110	03/15→					
2.0 TDI 4x4	140	03/15→					
2.0 TSI	162	03/15→					
2.0 TSI 4x4	206	03/15→					
SKODA - YETI (5L) 05/09→							
 Bremskraftverstärker							
1.2 TSI	77	09/09→		für Linkslenker; +PR 1AC,1AS,1AT,1ZE / 1ZF		03.7863-3232.4 300307	ATE Ø 10" pneumatisch
1.2 TSI	81	05/15→					
1.4 TSI	90	06/10→					
1.4 TSI	92	05/15→		+PR 1AT,1ZA,1ZE,1LK; für Linkslenker		03.7863-3332.4 300308	ATE Ø 10" pneumatisch
1.4 TSI 4x4	110	05/15→					
1.6	81	04/14→					
1.6 TDI	77	11/10→					
1.8 TSI 4x4	112	11/09→					
1.8 TSI 4x4	118	05/09→					
2.0 TDI	81	11/09→					
2.0 TDI	103	11/11→					
2.0 TDI	110	05/15→					
2.0 TDI 4x4	81	11/09→					
2.0 TDI 4x4	103	05/09→					
2.0 TDI 4x4	110	05/15→					
2.0 TDI 4x4	125	11/09→					
 Hauptbremszylinder							
1.2 TSI	77	09/09→		für Linkslenker; +PR 1ZE,1ZF		03.2122-2129.3 010799	ATE Ø 22,2
1.2 TSI	81	05/15→					
1.4 TSI	90	06/10→					
1.4 TSI	92	05/15→					
1.4 TSI 4x4	110	05/15→					
1.6	81	04/14→					
1.6 TDI	77	11/10→					
1.8 TSI 4x4	112	11/09→					
1.8 TSI 4x4	118	05/09→					
2.0 TDI	81	11/09→					
2.0 TDI	103	11/11→					
2.0 TDI	110	05/15→					
2.0 TDI 4x4	81	11/09→					
2.0 TDI 4x4	103	05/09→					
2.0 TDI 4x4	110	05/15→					
2.0 TDI 4x4	125	11/09→					













	kw			 	! #		
SMART - CABRIO (450) 03/00→01/04							
 Hauptbremszylinder							
0.6 (450.432)	52	06/02→01/04		01/03→; für Linkslenker		24.2119-1711.3 010911	Ø 19,05 ohne Bremsflüssigkeitsbehälter
0.6 (S1OLA1, 450.441, 450.442, 450.443)	40	03/00→01/04					
0.6 (S1OLD2, 450.452)	45	01/01→01/04		→ 12/02; für Linkslenker;		24.2119-1711.3 010911	Ø 19,05
0.8 CDI (S1OLC1, 450.401, 450.402, 450.403, 450.400)	30	03/01→01/04		zusätzlich benötigter Artikel (Artikel-Nummer): Q0014462V001000000			ohne Bremsflüssigkeitsbehälter
0.7 (450.433)	55	01/03→01/04		für Linkslenker		24.2119-1711.3 010911	Ø 19,05
0.7 (450.452, 450.432)	45	01/03→01/04					ohne Bremsflüssigkeitsbehälter
SMART - CITY-COUPE (450) 07/98→01/04							
 Hauptbremszylinder							
0.6 (450.330, 450.332)	52	06/02→01/04		01/03→; für Linkslenker		24.2119-1711.3 010911	Ø 19,05
0.6 (450.352, 450.353)	45	01/01→01/04					ohne Bremsflüssigkeitsbehälter
0.6 (S1CLA1, 450.341)	40	07/98→01/04		→ 12/02; für Linkslenker;		24.2119-1711.3 010911	Ø 19,05
0.6 (S1CLB1, 450.331, 450.336)	33	07/98→01/04		zusätzlich benötigter Artikel (Artikel-Nummer): Q0014462V001000000			ohne Bremsflüssigkeitsbehälter
0.8 CDI (S1CLC1, 450.300, 450.301, 450.302, 450.303...)	30	11/99→01/04					
0.7 (450.330)	37	01/03→01/04		für Linkslenker		24.2119-1711.3 010911	Ø 19,05
0.7 (450.333)	55	01/03→01/04					ohne Bremsflüssigkeitsbehälter
0.7 (450.352, 450.353)	45	01/03→01/04					
SMART - CROSSBLADE (450) 06/02→12/03							
 Hauptbremszylinder							
0.6 (450.418)	52	06/02→12/03		01/03→; für Linkslenker		24.2119-1711.3 010911	Ø 19,05
				→ 12/02; für Linkslenker;		24.2119-1711.3 010911	Ø 19,05
				zusätzlich benötigter Artikel (Artikel-Nummer): Q0014462V001000000			ohne Bremsflüssigkeitsbehälter
SMART - FORFOUR (454) 01/04→06/06							
 Hauptbremszylinder							
1.1 (454.030)	55	01/04→06/06		03/04→; für Linkslenker		24.2122-1770.3 010898	TRW Ø 22,2
1.3 (454.031)	70	01/04→06/06					
1.5 (454.032)	80	01/04→06/06					
1.1 (454.033)	47	02/05→06/06		für Linkslenker		24.2122-1770.3 010898	TRW Ø 22,2
1.5 BRABUS (454.034)	130	05/05→06/06					
1.5 CDI (454.000)	50	09/04→06/06					
1.5 CDI (454.001)	70	09/04→06/06					
1.5 (454.032)	90	01/04→06/06		11/04→; für Linkslenker		24.2122-1770.3 010898	TRW Ø 22,2
SMART - FORTWO Cabrio (450) 01/04→01/07							
 Hauptbremszylinder							
0.6 Brabus (450.433)	55	01/04→12/06		für Linkslenker		24.2119-1711.3 010911	Ø 19,05
0.7 (450.433)	55	01/04→01/07					ohne Bremsflüssigkeitsbehälter
0.7 (450.452)	45	01/04→01/07					
0.8 CDI (450.401, 450.402, 450.403, 450.400)	30	01/04→01/07					
SMART - FORTWO Coupe (450) 01/04→02/07							
 Hauptbremszylinder							
0.6 (450.332)	45	01/04→02/07		→ J182805; für Linkslenker		24.2119-1711.3 010911	Ø 19,05
0.7 (450.352, 450.332)	45	01/04→01/07					ohne Bremsflüssigkeitsbehälter
0.8 CDI (450.300, 450.301, 450.302, 450.303, 450.306)	30	01/04→01/07					
0.7 (450.330)	37	01/04→01/07		für Linkslenker		24.2119-1711.3 010911	Ø 19,05
0.7 (450.333)	55	01/04→01/07					ohne Bremsflüssigkeitsbehälter
0.7 (450.335)	40	01/04→01/07		→ J182808; für Linkslenker		24.2119-1711.3 010911	Ø 19,05
							ohne Bremsflüssigkeitsbehälter
SUBARU - JUSTY III (G3X) 09/03→							
 Hauptbremszylinder							
1.3 AWD	69	09/03→		→ 08/07		24.2120-1730.3 010678	Ø 20,64
1.5 AWD	73	09/03→					
SUZUKI - IGNIS II (MH) 09/03→							
 Hauptbremszylinder							
1.3 (RM413)	69	09/03→		→ 12/12; + ABS		24.2120-1730.3 010678	Ø 20,64
1.3 4x4 (RM413)	69	09/03→					
↓							











	kw			 	! #		
SUZUKI - IGNIS II (MH) 09/03→							
 Hauptbremszylinder							
1.3 DDiS (RM413D)	51	09/03→		→ 12/12; + ABS		24.2120-1730.3 010678	Ø 20,64
1.5 (RM415)	73	09/03→					
1.5 4x4 (RM415)	73	09/03→					
SUZUKI - JIMNY (FJ) 07/98→							
 Hauptbremszylinder							
1.3 (SN413)	63	08/04→		- ABS		24.2122-1776.3 011001	Ø 22,2
1.3 16V (SN413)	59	09/98→					ohne Bremsflüssigkeitsbehälter
1.3 16V (SN413)	60	02/01→					
1.3 16V 4WD (SN413)	59	09/98→					
1.3 16V 4WD (SN413)	60	02/01→					
1.3 16V 4x4 (SN413)	63	08/05→					
1.3 4WD (SN413)	62	05/14→					
1.3 4x4 (SN413)	63	09/98→08/00					
1.3 4x4 (SN413)	65	09/00→08/02					
1.5 DDiS 4WD (SN415D)	48	12/03→					
1.5 DDiS 4x4	63	08/05→					
SUZUKI - SPLASH (EX) 01/08→							
 Hauptbremszylinder							
1.0 (A5B 310)	48	01/08→		für Linkslenker; - ESP		24.4122-1718.3 011019	BOS Ø 22,2
1.0 (A5B 310)	50	06/11→					ohne Bremsflüssigkeitsbehälter
1.2 (A5B 412)	63	01/08→		für Linkslenker; + ESP		24.4122-1719.3 011020	Ø 22,2
1.2 VVT (A5B 412)	66	06/11→					ohne Bremsflüssigkeitsbehälter
1.2 VVT (A5B 412)	67	08/12→					
1.2 VVT (A5B 412)	69	09/10→					
1.3 CDTI (A5B 413D)	55	01/08→					
SUZUKI - SWIFT III (MZ, EZ) 02/05→							
 Hauptbremszylinder							
1.3 (RS 413)	68	02/05→		→ 09/10; für Linkslenker; - ESP		24.4122-1718.3 011019	BOS Ø 22,2
1.3 4x4 (RS 413)	66	01/06→					ohne Bremsflüssigkeitsbehälter
1.3 4x4 (RS 413)	68	02/05→		→ 09/10; für Linkslenker; + ESP		24.4122-1719.3 011020	Ø 22,2
1.3 DDiS (RS 413D)	55	08/05→					ohne Bremsflüssigkeitsbehälter
1.5 (RS 415)	75	02/05→					
1.5 4x4 (RS 415)	74	02/05→					
1.6 (RS 416)	92	05/06→					
1.3 DDiS (RS 413D)	51	08/05→		→ 09/07; für Linkslenker; - ESP		24.4122-1718.3 011019	BOS Ø 22,2
				→ 09/07; für Linkslenker; + ESP		24.4122-1719.3 011020	Ø 22,2
							ohne Bremsflüssigkeitsbehälter
SUZUKI - SX4 (EY, GY) 06/06→							
 Hauptbremszylinder							
1.5 (RW 415)	73	06/06→07/10		- ESP; Made in Ungarn		24.4122-1712.3 010899	BOS Ø 22,2
1.5 VVT (RW 415)	82	07/10→					ohne Bremsflüssigkeitsbehälter
1.5 VVTi	81	07/07→12/15		+ ESP; Made in Ungarn		24.4122-1713.3 010900	BOS Ø 22,2
1.6 (RW 416)	74	06/06→					ohne Bremsflüssigkeitsbehälter
1.6 VVT (RW 416)	79	06/06→					
1.6 VVT (RW 416)	88	07/09→					
1.6 VVT 4x4 (RW 416)	79	06/06→					
1.6 VVT 4x4 (RW 416)	82	07/09→					
1.6 VVT 4x4 (RW 416)	88	07/09→					
1.5 VVT 4x4 (RW 415)	82	07/10→		- ESP		24.4122-1712.3 010899	BOS Ø 22,2
1.6 DDiS (RW 416D)	66	04/07→					ohne Bremsflüssigkeitsbehälter
1.9 DDiS (RW 419D)	88	06/06→		+ ESP		24.4122-1713.3 010900	BOS Ø 22,2
1.9 DDiS 4x4 (RW 419D)	88	06/06→					ohne Bremsflüssigkeitsbehälter
2.0 DDiS (RW 420D)	99	07/09→					
2.0 DDiS 4x4 (RW 420D)	99	07/09→					
SUZUKI - SX4 Stufenheck (GY) 10/07→							
 Hauptbremszylinder							
1.6 (RW 416)	74	10/07→		- ESP; Made in Ungarn		24.4122-1712.3 010899	BOS Ø 22,2
1.6 (RW 416)	75	10/07→					ohne Bremsflüssigkeitsbehälter
1.6 (RW 416)	79	10/07→		+ ESP; Made in Ungarn		24.4122-1713.3 010900	BOS Ø 22,2
1.6 (RW 416)	88	10/07→					ohne Bremsflüssigkeitsbehälter
1.6 AWD (RW 416)	79	10/07→12/11					
SUZUKI - WAGON R 07/03→08/05							
 Hauptbremszylinder							
1.0	39	07/03→08/05				24.2120-1730.3 010678	Ø 20,64
1.0	44	06/04→08/05					
1.2	59	06/04→08/05					











	kw			 	! #		
SUZUKI - WAGON R+ (MM) 05/00→							
 Hauptbremszylinder							
1.0	51	08/00→07/03				24.2120-1730.3 010678	Ø 20,64
1.0 XT Plus	74	08/00→07/01					
1.3 (RB 413)	56	05/00→12/04		+ ABS		24.2120-1730.3 010678	Ø 20,64
1.3 (RB 413)	65	08/01→		→ 04/08; + ABS		24.2120-1730.3 010678	Ø 20,64
1.3 (RB 413)	69	09/03→					
1.3 4WD (RB 413)	69	09/03→					
1.3 DDiS (RB 413D)	51	09/03→					
1.3 4WD (RB 413)	56	10/01→		→ 12/04; + ABS		24.2120-1730.3 010678	Ø 20,64
TOYOTA - AVENSIS (T22_) 09/97→02/03							
 Bremskraftverstärker							
1.8 (AT221_)	81	09/97→10/00		→ 09/00; für Linkslenker		03.7745-4402.4 300295	ATE Ø 8 / 7" pneumatisch
1.8 VVT-i (ZZT221_)	95	10/00→02/03		für Linkslenker		03.7745-4402.4 300295	ATE Ø 8 / 7" pneumatisch
2.0 VVT-i (AZT220_)	110	10/00→02/03		08/01→; für Linkslenker		03.7745-4402.4 300295	ATE Ø 8 / 7" pneumatisch
 Hauptbremszylinder							
1.6 (AT220_)	74	09/97→10/00		→ 09/00		03.2123-2221.3 010861	ATE Ø 23,81
1.6 (AT220_)	81	09/97→10/00					
1.8 (AT221_)	81	09/97→10/00					
2.0 (ST220_)	94	09/97→10/00					
1.6 VVT-i (ZZT220_)	81	10/00→02/03				03.2123-2221.3 010861	ATE Ø 23,81
1.8 VVT-i (ZZT221_)	95	10/00→02/03					
2.0 D (CT220_)	61	10/97→05/98					
2.0 D-4D (CDT220_)	81	10/99→02/03					
2.0 TD (CT220_)	66	09/97→02/03					
2.0 VVT-i (AZT220_)	110	10/00→02/03					
TOYOTA - AVENSIS (T25_) 04/03→11/08							
 Hauptbremszylinder							
1.6 VVT-i (ZZT250_)	81	04/03→11/08		+ ESP		24.2123-1771.3 010857	BOS Ø 23,81 ohne Bremsflüssigkeitsbehälter
1.8 (ZZT251_)	95	04/03→11/08					
2.0 (AZT250_)	108	04/03→11/08					
2.0 D-4D (ADT250_)	93	03/06→11/08					
2.0 D-4D (CDT250_)	85	04/03→11/08					
2.0 VVTi (AZT250_)	114	04/03→11/08					
2.2 D-4D (ADT251_)	110	10/05→11/08					
2.2 D-CAT (ADT251_)	130	07/05→11/08					
2.2 TD	74	04/05→11/08					
2.4 (AZT251_)	120	10/03→11/08					
2.4 (AZT251_)	125	09/03→11/08					
TOYOTA - AVENSIS Combi (T25_) 04/03→11/08							
 Hauptbremszylinder							
1.6 VVT-i (ZZT250_)	81	04/03→11/08		+ ESP		24.2123-1771.3 010857	BOS Ø 23,81 ohne Bremsflüssigkeitsbehälter
1.8 (ZZT251_)	95	04/03→11/08					
2.0 (AZT250_)	108	04/03→11/08					
2.0 D-4D (ADT250_)	93	03/06→11/08					
2.0 D-4D (CDT250_)	85	04/03→11/08					
2.0 VVTi (AZT250_)	114	04/03→11/08					
2.2 D-4D (ADT251_)	110	10/05→11/08					
2.2 D-CAT (ADT251_)	130	07/05→11/08					
2.2 TD	74	04/05→11/08					
2.4 (AZT251_)	120	10/03→11/08					
2.4 (AZT251_)	125	09/03→11/08					
TOYOTA - AVENSIS Liftback (T22_) 09/97→02/03							
 Bremskraftverstärker							
1.8 (AT221_)	81	09/97→10/00		→ 09/00; für Linkslenker		03.7745-4402.4 300295	ATE Ø 8 / 7" pneumatisch
1.8 (ZZT221_)	95	10/00→02/03		für Linkslenker		03.7745-4402.4 300295	ATE Ø 8 / 7" pneumatisch
2.0 (AZT220_)	110	10/00→02/03		08/01→; für Linkslenker		03.7745-4402.4 300295	ATE Ø 8 / 7" pneumatisch
 Hauptbremszylinder							
1.6 (AT220_)	74	09/97→10/00		→ 09/00		03.2123-2221.3 010861	ATE Ø 23,81
1.6 (AT220_)	81	09/97→10/00					
1.8 (AT221_)	81	09/97→10/00					
2.0 (ST220_)	94	09/97→10/00					
1.6 (ZZT220_)	81	10/00→02/03				03.2123-2221.3 010861	ATE Ø 23,81
1.8 (ZZT221_)	95	10/00→02/03					
2.0 (AZT220_)	110	10/00→02/03					
2.0 D (CDT220_)	85	09/02→02/03					
2.0 D (CT220_)	61	10/97→05/98					
2.0 D-4D (CDT220_)	81	10/99→02/03					
2.0 TD (CT220_)	66	09/97→02/03					













	kw					! #		
TOYOTA - AVENSIS Station Wagon (_T22_) 09/97→02/03								
 Bremskraftverstärker								
1.8 (AT221_)	81	09/97→10/00		→ 09/00; für Linkslenker		03.7745-4402.4	300295	ATE Ø 8 / 7" pneumatisch
1.8 (ZZT221_)	95	10/00→02/03		für Linkslenker		03.7745-4402.4	300295	ATE Ø 8 / 7" pneumatisch
2.0 (AZT220_)	110	10/00→02/03		08/01→; für Linkslenker		03.7745-4402.4	300295	ATE Ø 8 / 7" pneumatisch
 Hauptbremszylinder								
1.6 (AT220_, ZZT220_)	81	09/97→10/00		→ 09/00		03.2123-2221.3	010861	ATE Ø 23,81
1.6 (AT220_)	74	09/97→10/00						
1.8 (AT221_)	81	09/97→10/00						
2.0 (ST220_)	94	09/97→10/00						
1.6 (ZZT250_)	81	10/00→02/03				03.2123-2221.3	010861	ATE Ø 23,81
1.8 (ZZT221_)	95	10/00→02/03						
2.0 (AZT220_)	110	10/00→02/03						
2.0 D (CDT220_)	85	09/02→02/03						
2.0 D (CT220_)	61	10/97→05/98						
2.0 D-4D (CDT220_)	81	10/99→02/03						
2.0 TD (CT220_)	66	09/97→02/03						
TOYOTA - AVENSIS Stufenheck (_T25_) 04/03→11/08								
 Hauptbremszylinder								
1.6 VVT-i (ZZT250_)	81	04/03→11/08		+ ESP		24.2123-1771.3	010857	BOS Ø 23,81 ohne Bremsflüssigkeitsbehälter
1.8 (ZZT251_)	95	04/03→11/08						
2.0 (AZT250_)	108	04/03→11/08						
2.0 D-4D (ADT250_)	93	03/06→11/08						
2.0 D-4D (CDT250_)	85	04/03→11/08						
2.0 VVTi (AZT250_)	114	04/03→11/08						
2.2 D-4D (ADT251_)	110	10/05→11/08						
2.2 D-CAT (ADT251_)	130	07/05→11/08						
2.2 TD	74	04/05→11/08						
2.4 (AZT251_)	120	10/03→11/08						
2.4 (AZT251_)	125	09/03→11/08						
TOYOTA - AYGO (_B1_) 02/05→								
 Hauptbremszylinder								
1.0 (KGB10_)	50	07/05→		- ESP; → 06/14; für Linkslenker		24.4120-1701.3	010846	BOS Ø 20,64
1.0 GPL (KGB10_)	50	07/05→						
1.4 HDi (WNB10_)	40	07/05→08/10		- ESP; für Linkslenker		24.4120-1701.3	010846	BOS Ø 20,64
TOYOTA - COROLLA (_E11_) 04/97→06/02								
 Hauptbremszylinder								
1.4 (EE111_)	63	04/97→02/00		05/97→ 09/99; für Linkslenker		03.2122-1691.3	010918	ATE Ø 22,2
1.4 16V (ZZE111_)	71	02/00→11/01		für Linkslenker; + ABS		03.2122-1691.3	010918	ATE Ø 22,2
1.6 16V (ZZE112_)	81	02/00→11/01				03.2122-1691.3	010918	ATE Ø 22,2
1.9 D (WZE110_)	51	02/00→11/01						
2.0 D-4D (CDE110_)	66	09/00→11/01						
1.8	85	08/98→06/02		→ 01/02		03.2122-1691.3	010918	ATE Ø 22,2
TOYOTA - COROLLA (_E12_) 01/01→02/07								
 Hauptbremszylinder								
1.4 D (NDE120_)	66	07/04→02/07		→ 10/06; - ESP		24.2120-1749.3	010903	TRW Ø 20,64
				→ 10/06; + ESP		24.2120-1760.3	011018	Ø 20,64 ohne Bremsflüssigkeitsbehälter
1.4 VVT-i (ZZE120_)	71	01/02→12/06		→ 05/04; - ESP		24.2120-1749.3	010903	TRW Ø 20,64
1.6 VVT-i (ZZE121_)	81	01/02→12/06		06/04→ 10/06; - ESP		24.2120-1749.3	010903	TRW Ø 20,64
2.0 D-4D (CDE120R_, CDE120L_)	85	05/03→02/07		06/04→ 10/06; + ESP		24.2120-1760.3	011018	Ø 20,64 ohne Bremsflüssigkeitsbehälter
				→ 05/04; + ESP		24.2120-1760.3	011018	Ø 20,64 ohne Bremsflüssigkeitsbehälter
1.8 4WD	100	12/01→02/07		→ 01/02		03.2122-1691.3	010918	ATE Ø 22,2
1.8 VVTi	100	06/04→02/07		→ 10/06; + ESP		24.2120-1760.3	011018	Ø 20,64 ohne Bremsflüssigkeitsbehälter
1.8 VVTL-i TS (ZZE123_)	160	10/05→12/06						
1.8 VVTL-i TS (ZZE123_)	165	02/05→02/07						
1.8 VVTL-i TS	141	01/02→02/07		→ 05/04; + ESP		24.2120-1760.3	011018	Ø 20,64 ohne Bremsflüssigkeitsbehälter
2.0 D-4D (CDE120_)	66	01/02→12/06		→ 05/04; - ESP		24.2120-1749.3	010903	TRW Ø 20,64
2.0 D-4D (CDE120R_, CDE120L_)	81	01/02→12/06		→ 05/04; + ESP		24.2120-1760.3	011018	Ø 20,64 ohne Bremsflüssigkeitsbehälter













	kw				! #		
TOYOTA - COROLLA Combi (_E12_) 03/01→02/07							
 Hauptbremszylinder							
1.4 D4-D (NDE120_)	66	07/04→02/07		→ 10/06; - ESP		24.2120-1749.3 010903	TRW Ø 20,64
				→ 10/06; + ESP		24.2120-1760.3 011018	Ø 20,64 ohne Bremsflüssigkeitsbehälter
1.4 VVT-i (ZZE120_)	71	01/02→02/07		→ 05/04; - ESP		24.2120-1749.3 010903	TRW Ø 20,64
1.6 VVT-i (ZZE121_)	81	01/02→02/07					
2.0 D-4D (CDE120_)	85	04/04→02/07		06/04→ 10/06; - ESP		24.2120-1749.3 010903	TRW Ø 20,64
				06/04→ 10/06; + ESP		24.2120-1760.3 011018	Ø 20,64 ohne Bremsflüssigkeitsbehälter
				→ 05/04; + ESP		24.2120-1760.3 011018	Ø 20,64 ohne Bremsflüssigkeitsbehälter
1.8	100	06/04→02/07		→ 10/06; + ESP		24.2120-1760.3 011018	Ø 20,64 ohne Bremsflüssigkeitsbehälter
1.8 4WD	100	12/01→02/07		→ 01/02		03.2122-1691.3 010918	ATE Ø 22,2
2.0 D-4D (CDE120_)	66	01/02→02/07		→ 05/04; - ESP		24.2120-1749.3 010903	TRW Ø 20,64
				→ 05/04; + ESP		24.2120-1760.3 011018	Ø 20,64 ohne Bremsflüssigkeitsbehälter
TOYOTA - COROLLA Compact (_E11_) 04/97→01/02							
 Hauptbremszylinder							
1.4 (EE111_)	63	04/97→02/00		05/97→ 09/99; für Linkslenker		03.2122-1691.3 010918	ATE Ø 22,2
1.4 (ZZE111_)	71	02/00→01/02		für Linkslenker; + ABS		03.2122-1691.3 010918	ATE Ø 22,2
1.6 (ZZE112_)	81	02/00→01/02				03.2122-1691.3 010918	ATE Ø 22,2
1.9 D (WZE110_)	51	02/00→01/02					
2.0 D-4D (CDE110_)	66	09/00→01/02					
TOYOTA - COROLLA Liftback (_E11_) 04/97→01/02							
 Hauptbremszylinder							
1.4 (EE111_)	63	04/97→02/00		05/97→ 09/99; für Linkslenker		03.2122-1691.3 010918	ATE Ø 22,2
1.4 (ZZE111_)	71	02/00→01/02		für Linkslenker; + ABS		03.2122-1691.3 010918	ATE Ø 22,2
1.6 (ZZE112_)	81	02/00→01/02				03.2122-1691.3 010918	ATE Ø 22,2
1.9 D (WZE110_)	51	02/00→01/02					
2.0 D-4D (CDE110_)	66	09/00→01/02					
TOYOTA - COROLLA Stufenheck (_E12_) 08/00→03/08							
 Hauptbremszylinder							
1.4 D-4D	55	07/04→07/07		→ 10/06; - ESP		24.2120-1749.3 010903	TRW Ø 20,64
1.4 D-4D (NDE120_)	66	07/04→07/07		→ 10/06; + ESP		24.2120-1760.3 011018	Ø 20,64 ohne Bremsflüssigkeitsbehälter
2.0 D-4D (CDE120_)	85	06/04→07/07					
1.4 VVT-i (ZZE120_)	71	08/02→07/07		→ 05/04; - ESP		24.2120-1749.3 010903	TRW Ø 20,64
1.6 VVT-i (ZZE121_)	81	08/02→07/07		06/04→ 10/06; - ESP		24.2120-1749.3 010903	TRW Ø 20,64
				06/04→ 10/06; + ESP		24.2120-1760.3 011018	Ø 20,64 ohne Bremsflüssigkeitsbehälter
				→ 05/04; + ESP		24.2120-1760.3 011018	Ø 20,64 ohne Bremsflüssigkeitsbehälter
1.8	100	11/01→07/07		06/04→ 10/06; + ESP		24.2120-1760.3 011018	Ø 20,64 ohne Bremsflüssigkeitsbehälter
2.0 D-4D (CDE120_)	66	08/02→07/07		05/03→ 05/04; - ESP		24.2120-1749.3 010903	TRW Ø 20,64
				→ 05/04; - ESP		24.2120-1749.3 010903	TRW Ø 20,64
				05/03→ 05/04; + ESP		24.2120-1760.3 011018	Ø 20,64 ohne Bremsflüssigkeitsbehälter
				→ 05/04; + ESP		24.2120-1760.3 011018	Ø 20,64 ohne Bremsflüssigkeitsbehälter
TOYOTA - COROLLA Verso (_E12_) 07/01→07/04							
 Hauptbremszylinder							
1.6 VVT-i (ZZE121_)	81	01/02→05/04				24.2120-1749.3 010903	TRW Ø 20,64
2.0 D-4D (CDE120_)	66	01/02→05/04					
2.0 D-4D (CDE120_)	85	09/01→07/04		06/04→; - ESP		24.2120-1749.3 010903	TRW Ø 20,64
				06/04→; + ESP		24.2120-1760.3 011018	Ø 20,64 ohne Bremsflüssigkeitsbehälter
TOYOTA - COROLLA Verso (ZER_, ZZE12_, R1_) 03/04→04/09							
 Hauptbremszylinder							
1.4 D-4D	66	03/04→03/09		06/04→ 10/06; - ESP		24.2120-1749.3 010903	TRW Ø 20,64
				06/04→ 10/06; + ESP		24.2120-1760.3 011018	Ø 20,64 ohne Bremsflüssigkeitsbehälter
↓							

	kw					! #		
TOYOTA - COROLLA Verso (ZER_, ZZE12_, R1_) 03/04→04/09								
 Hauptbremszylinder								
1.6 (ZNR10_) 1.8	81 92	04/04→03/09 03/04→03/09		09/05→; + ESP			24.2123-1771.3 010857	BOS Ø 23,81 ohne Bremsflüssigkeitsbehälter
1.8 (ZNR11_) 2.0 D-4D (CUR10_)	95 85	04/04→03/09 04/04→03/09		05/04→ 08/05; + ESP			24.2123-1771.3 010857	BOS Ø 23,81 ohne Bremsflüssigkeitsbehälter
2.2 D-4D (AUR10_) 2.2 D-4D (AUR10_)	100 130	10/05→03/09 10/05→03/09		+ ESP			24.2123-1771.3 010857	BOS Ø 23,81 ohne Bremsflüssigkeitsbehälter
TOYOTA - COROLLA Wagon (_E11_) 04/97→10/01								
 Hauptbremszylinder								
1.4 (EE111_) 1.4 16V (ZZE111_)	63 71	04/97→02/00 02/00→10/01		05/97→ 09/99; für Linkslenker für Linkslenker; + ABS			03.2122-1691.3 010918 03.2122-1691.3 010918	ATE Ø 22,2 ATE Ø 22,2
1.6 16V (ZZE112_) 1.8 1.9 D (WZE110_) 2.0 D-4D (CDE110_) 1.8 4WD (AE115_)	81 81 51 66 81	02/00→10/01 10/97→10/01 02/00→10/01 09/00→10/01 04/97→10/01					03.2122-1691.3 010918 03.2122-1691.3 010918 03.2122-1691.3 010918	ATE Ø 22,2 ATE Ø 22,2 ATE Ø 22,2
TOYOTA - RAV 4 II (_A2_) 06/00→11/05								
 Hauptbremszylinder								
1.8 (ZCA25_, ZCA26_) 2.0 4WD 2.0 4WD 2.0 D-4D 4WD (CLA20_, CLA21_) 2.0 D-4D 4WD (CLA20_, CLA21_)	92 110 110 85 85	08/00→11/05 06/00→11/05 06/00→11/05 05/01→11/05 05/01→11/05		02/01→ 07/03; Schaltgetriebe 02/01→ 07/03; Vollautomatik → 07/03; Vollautomatik → 07/03; Schaltgetriebe 09/01→ 07/03; Vollautomatik 09/01→ 07/03; Schaltgetriebe			24.2120-1757.3 010976 24.2120-1757.3 010976 24.2120-1757.3 010976 24.2120-1757.3 010976 24.2120-1757.3 010976	Ø 20,64 ohne Bremsflüssigkeitsbehälter Ø 20,64 ohne Bremsflüssigkeitsbehälter Ø 20,64 ohne Bremsflüssigkeitsbehälter Ø 20,64 ohne Bremsflüssigkeitsbehälter Ø 20,64 ohne Bremsflüssigkeitsbehälter
TOYOTA - YARIS (_P1_) 01/99→12/05								
 Hauptbremszylinder								
1.0 (SCP10_) 1.3 (SCP12_) 1.3 (SCP12_) 1.4 D-4D (NLP10_)	48 57 64 55	03/03→09/05 09/03→12/04 08/99→09/05 10/01→09/05		04/03→ 08/05; Made in Frankreich Made in Frankreich 04/02→ 08/05; Made in Frankreich 12/01→ 08/05; Made in Frankreich			24.2120-1766.3 011000 24.2120-1766.3 011000 24.2120-1766.3 011000 24.2120-1766.3 011000	Ø 20,64 ohne Bremsflüssigkeitsbehälter Ø 20,64 ohne Bremsflüssigkeitsbehälter Ø 20,64 ohne Bremsflüssigkeitsbehälter Ø 20,64 ohne Bremsflüssigkeitsbehälter
TOYOTA - YARIS (_P9_) 01/05→								
 Bremskraftverstärker								
1.0 GPL (KSP90_) 1.0 VVT-i (KSP90_) 1.0 VVT-i (KSP90_) 1.3 VVT-i (NSP90_) 1.3 VVT-i (NSP90_) 1.3 VVT-i (NCP90_, SCP90_) 1.3 VVT-i (SCP90_) 1.4 D-4D (NLP90_) 1.4 D-4D (NLP90_)	51 51 51 73 74 63 64 66 66	01/06→ 01/05→11/11 01/05→11/11 07/10→ 11/08→ 01/05→ 08/05→ 08/05→		→ 08/11; für Linkslenker; Made in Frankreich; + ESP → 08/11; für Linkslenker; Made in Frankreich; - ESP 01/06→ 08/11; für Linkslenker; Made in Frankreich; + ESP 01/06→ 08/11; für Linkslenker; Made in Frankreich; - ESP → 08/11; für Linkslenker; + ESP → 08/11; für Linkslenker; - ESP 03/09→ 08/11; für Linkslenker; + ESP 03/09→ 08/11; für Linkslenker; - ESP 01/06→ 08/11; für Linkslenker; + ESP 01/06→ 08/11; für Linkslenker; - ESP 01/06→ 08/11; für Linkslenker; + ESP 01/06→ 08/11; für Linkslenker			03.7750-7132.4 300255 03.7853-3203.4 300241 03.7750-7132.4 300255 03.7853-3203.4 300241 03.7750-7132.4 300255 03.7853-3203.4 300241 03.7750-7132.4 300255 03.7853-3203.4 300241 03.7750-7132.4 300255 03.7853-3203.4 300241 03.7750-7132.4 300255 03.7853-3402.4 300256	ATE Ø 9" pneumatisch ATE Ø 9" pneumatisch ATE Ø 9" pneumatisch ATE Ø 9" pneumatisch ATE Ø 9" pneumatisch ATE Ø 9" pneumatisch ATE Ø 9" pneumatisch ATE Ø 9" pneumatisch ATE Ø 9" pneumatisch ATE Ø 9" pneumatisch ATE Ø 9" pneumatisch ATE Ø 9" pneumatisch
 Hauptbremszylinder								
1.0 GPL (KSP90_) ↓	51	01/06→		→ 08/11; Made in Frankreich; - ESP			03.4152-0053.3 010884 03.4152-0153.3 011006	ATE Ø 22,2 ohne Bremsflüssigkeitsbehälter ATE Ø 22,2 ohne Bremsflüssigkeitsbehälter

	kw			 	! #		
TOYOTA - YARIS (_P9_) 01/05→							
 Hauptbremszylinder							
1.0 GPL (KSP90_)	51	01/06→		→ 08/11; Made in Frankreich; + ESP		03.4152-0058.3 010885 03.4152-0158.3 011007	ATE Ø 22,2 ohne Bremsflüssigkeitsbehälter ATE Ø 22,2 ohne Bremsflüssigkeitsbehälter
1.0 VVT-i (KSP90_)	51	01/05→11/11		01/06→ 08/11; Made in Frankreich; - ESP		03.4152-0053.3 010884 03.4152-0153.3 011006	ATE Ø 22,2 ohne Bremsflüssigkeitsbehälter ATE Ø 22,2 ohne Bremsflüssigkeitsbehälter
				01/06→ 08/11; Made in Frankreich; + ESP		03.4152-0058.3 010885 03.4152-0158.3 011007	ATE Ø 22,2 ohne Bremsflüssigkeitsbehälter ATE Ø 22,2 ohne Bremsflüssigkeitsbehälter
1.33 VVT-i (NSP90_)	73	07/10→		→ 08/11; - ESP		03.4152-0053.3 010884 03.4152-0153.3 011006	ATE Ø 22,2 ohne Bremsflüssigkeitsbehälter ATE Ø 22,2 ohne Bremsflüssigkeitsbehälter
				→ 08/11; + ESP		03.4152-0058.3 010885 03.4152-0158.3 011007	ATE Ø 22,2 ohne Bremsflüssigkeitsbehälter ATE Ø 22,2 ohne Bremsflüssigkeitsbehälter
1.33 VVT-i (NSP90_)	74	11/08→		03/09→ 08/11; - ESP		03.4152-0053.3 010884 03.4152-0153.3 011006	ATE Ø 22,2 ohne Bremsflüssigkeitsbehälter ATE Ø 22,2 ohne Bremsflüssigkeitsbehälter
				03/09→ 08/11; + ESP		03.4152-0058.3 010885 03.4152-0158.3 011007	ATE Ø 22,2 ohne Bremsflüssigkeitsbehälter ATE Ø 22,2 ohne Bremsflüssigkeitsbehälter
1.3 VVT-i (NCP90_, SCP90_) 1.3 VVT-i (SCP90_) 1.4 D-4D (NLP90_)	63	01/05→		01/06→ 08/11; - ESP		03.4152-0053.3 010884	ATE Ø 22,2 ohne Bremsflüssigkeitsbehälter
	64	08/05→				03.4152-0153.3 011006	ATE Ø 22,2 ohne Bremsflüssigkeitsbehälter
	66	08/05→			01/06→ 08/11; + ESP	03.4152-0058.3 010885 03.4152-0158.3 011007	ATE Ø 22,2 ohne Bremsflüssigkeitsbehälter ATE Ø 22,2 ohne Bremsflüssigkeitsbehälter
VAUXHALL - AGILA Mk I (A) 02/00→03/08							
 Hauptbremszylinder							
1.0 12V	43	09/00→08/05		+ ABS		24.2120-1730.3 010678	Ø 20,64
1.2 16V Twinport	59	07/04→11/06					
1.0 12V	44	02/00→11/06		09/00→; + ABS		24.2120-1730.3 010678	Ø 20,64
1.2 16V	55	09/00→03/08		+ ABS; → 07/07		24.2120-1730.3 010678	Ø 20,64
VAUXHALL - AGILA Mk II (B) 01/08→11/14							
 Hauptbremszylinder							
1.0 12V	48	01/08→11/14		für Linkslenker; - ESP		24.4122-1718.3 011019	BOS Ø 22,2 ohne Bremsflüssigkeitsbehälter
1.0 i	50	08/11→11/14					
1.2 i 16V	63	01/08→11/14					
1.2 i 16V	69	01/08→11/14		für Linkslenker; + ESP		24.4122-1719.3 011020	Ø 22,2 ohne Bremsflüssigkeitsbehälter
1.3 CDTI	55	01/08→11/14					
VAUXHALL - ASTRA Mk III (F) 09/91→09/98							
 Hauptbremszylinder							
1.4 i	44	04/92→09/98		+ ABS		03.2122-0282.3 010130	ATE Ø 22,2
1.4 i	60	04/92→09/98					
1.4 i 16V	66	02/96→09/98					
1.6 i	55	03/92→09/98					
2.0 i 16V	100	02/95→09/98					
1.6 i	52	08/94→07/96		+ ABS		03.2122-0282.3 010130	ATE Ø 22,2
1.7 TD	50	08/94→09/98					
1.7 TD	60	12/91→09/98		- ABS		24.2120-0702.3 010361	Ø 20,64
1.8 i	66	03/92→09/98					
1.6 i 16V	74	08/94→09/98		- ABS		03.2122-0264.3 010129	ATE Ø 22,2
1.8 i 16V	82	09/95→02/98					
1.8 i 16V	85	01/94→12/96		+ ABS		03.2122-0282.3 010130	ATE Ø 22,2
2.0 i	85	03/92→09/98					
1.7 D	44	07/92→09/98		- ABS; für Fahrzeuge mit verstärkter Bremse		03.2122-0264.3 010129	ATE Ø 22,2
				+ ABS		03.2122-0282.3 010130	ATE Ø 22,2
↓							

	kw					! #		
VAUXHALL - ASTRA Mk III (F) 09/91→09/98								
 Hauptbremszylinder								
1.7 D	44	07/92→09/98		- ABS; nicht für Fahrzeuge mit verstärkter Bremsen		24.2120-0702.3	010361	Ø 20,64
 Bremskraftregler								
1.6 i	52	08/94→07/96		R2500001→ T2526383		03.0101-0025.2	320014	ATE Satz 3/35 2x
1.6 i	55	03/92→09/98		→ R2500000		03.0101-0027.2	320022	ATE Satz 3/45 2x
				T2526384→		03.0101-0031.2	320211	ATE Satz 3/30 2x
1.6 i 16V	74	08/94→09/98				03.6583-0054.3	320146	ATE lastabhängig 8/3 4x
						03.6585-0018.3	320114	ATE lastabhängig 8/5 4x
1.7 D	44	07/92→09/98		→ 07/93		03.0101-0026.2	320230	ATE Satz 3/40 2x
				08/93→		03.0101-0031.2	320211	ATE Satz 3/30 2x
1.7 TD	50	08/94→09/98		für Fahrzeuge mit verstärkter Bremsen		03.0101-0025.2	320014	ATE Satz 3/35 2x
				nicht für Fahrzeuge mit verstärkter Bremsen		03.0101-0032.2	320231	ATE Satz 3/25 2x
1.7 TD	60	12/91→09/98		08/93→; für Fahrzeuge mit verstärkter Bremsen		03.0101-0025.2	320014	ATE Satz 3/35 2x
				→ 07/93		03.0101-0025.2	320014	ATE Satz 3/35 2x
				08/93→; nicht für Fahrzeuge mit verstärkter Bremsen		03.0101-0032.2	320231	ATE Satz 3/25 2x
1.8 i	66	03/92→09/98		→ 07/93		03.0101-0027.2	320022	ATE Satz 3/45 2x
2.0 i	85	03/92→09/98		08/93→		03.6583-0054.3	320146	ATE lastabhängig 8/3 4x
2.0 i 16V	100	02/95→09/98				03.6583-0054.3	320146	ATE lastabhängig 8/3 4x
VAUXHALL - ASTRA Mk III (F) CC 09/91→02/98								
 Hauptbremszylinder								
1.4 i	44	09/91→02/98		10/91→; + ABS		03.2122-0282.3	010130	ATE Ø 22,2
1.4 S	55	09/91→02/98		10/91→; - ABS		24.2120-0702.3	010361	Ø 20,64
1.8 i	66	09/91→02/98						
1.4 i	60	03/92→02/98		- ABS; für Fahrzeuge mit verstärkter Bremsen		03.2122-0264.3	010129	ATE Ø 22,2
1.7 D	42	12/91→02/98		+ ABS		03.2122-0282.3	010130	ATE Ø 22,2
				- ABS; nicht für Fahrzeuge mit verstärkter Bremsen		24.2120-0702.3	010361	Ø 20,64
1.4 i 16V	66	02/96→02/98		+ ABS		03.2122-0282.3	010130	ATE Ø 22,2
1.8 i 16V	85	09/94→02/98						
1.6 i	52	02/93→12/96		+ ABS		03.2122-0282.3	010130	ATE Ø 22,2
1.7 TD	50	08/94→02/98		- ABS		24.2120-0702.3	010361	Ø 20,64
1.7 TD	60	12/91→02/98						
1.6 i	55	09/91→02/98		10/91→; + ABS		03.2122-0282.3	010130	ATE Ø 22,2
2.0 i 16V	110	09/91→02/98						
1.6 i	74	03/92→02/98		- ABS		03.2122-0264.3	010129	ATE Ø 22,2
1.6 i 16V	74	01/94→02/98		+ ABS		03.2122-0282.3	010130	ATE Ø 22,2
1.8 i 16V	92	09/94→02/98						
2.0 i	85	09/91→02/98		10/91→; - ABS		03.2122-0264.3	010129	ATE Ø 22,2
				10/91→; + ABS		03.2122-0282.3	010130	ATE Ø 22,2
 Bremskraftregler								
1.4 i	44	09/91→02/98		10/91→		03.0101-0027.2	320022	ATE Satz 3/45 2x
1.4 S	55	09/91→02/98						
1.4 i	60	03/92→02/98		Schaltgetriebe		03.0101-0027.2	320022	ATE Satz 3/45 2x
1.6 i	52	02/93→12/96		R2500001→ T2526383		03.0101-0025.2	320014	ATE Satz 3/35 2x
				→ R2500000		03.0101-0027.2	320022	ATE Satz 3/45 2x
				T2526384→		03.0101-0031.2	320211	ATE Satz 3/30 2x
1.6 i	55	09/91→02/98		R2500001→ T2526383		03.0101-0025.2	320014	ATE Satz 3/35 2x
				10/91→; → R2500000		03.0101-0027.2	320022	ATE Satz 3/45 2x
				T2526384→		03.0101-0031.2	320211	ATE Satz 3/30 2x
1.6 i	74	03/92→02/98		→ 07/93		03.0101-0026.2	320230	ATE Satz 3/40 2x
				08/93→		03.6583-0054.3	320146	ATE lastabhängig 8/3 4x
1.6 i 16V	74	01/94→02/98				03.6583-0054.3	320146	ATE lastabhängig 8/3 4x
						03.6585-0018.3	320114	ATE lastabhängig 8/5 4x
1.7 D	42	12/91→02/98		→ 07/93		03.0101-0026.2	320230	ATE Satz 3/40 2x
				08/93→		03.0101-0031.2	320211	ATE Satz 3/30 2x
1.7 TD	60	12/91→02/98		08/93→; für Fahrzeuge mit verstärkter Bremsen		03.0101-0025.2	320014	ATE Satz 3/35 2x
				→ 07/93		03.0101-0025.2	320014	ATE Satz 3/35 2x

	kw			 	! #		
VAUXHALL - ASTRA Mk III (F) CC 09/91→02/98							
 Bremskraftregler							
1.7 TD	60	12/91→02/98		08/93→; nicht für Fahrzeuge mit verstärkter Bremsen		03.0101-0032.2 320231	ATE Satz 3/25 2x
1.8 i	66	09/91→02/98		10/91→ 07/93		03.0101-0027.2 320022	ATE Satz 3/45 2x
2.0 i	85	09/91→02/98		08/93→		03.6583-0054.3 320146	ATE lastabhängig 8/3 4x
1.8 i 16V	85	09/94→02/98				03.6583-0054.3 320146	ATE lastabhängig 8/3 4x
1.8 i 16V	92	09/94→02/98					
2.0 i 16V	110	09/91→02/98		08/92→		03.6583-0054.3 320146	ATE lastabhängig 8/3 4x
VAUXHALL - ASTRA Mk III (F) Convertible 03/93→03/01							
 Hauptbremszylinder							
1.4 i	60	05/93→03/01		→ 09/98; + ABS		03.2122-0282.3 010130	ATE Ø 22,2
1.4 i 16V	66	01/96→03/01					
1.6 i	55	01/96→03/01					
1.8 16V	85	11/94→03/01					
1.6	74	03/94→08/95		- ABS		03.2122-0264.3 010129	ATE Ø 22,2
1.8	92	09/94→08/96		+ ABS		03.2122-0282.3 010130	ATE Ø 22,2
1.6 i	52	03/93→08/96		+ ABS		03.2122-0282.3 010130	ATE Ø 22,2
				- ABS		24.2120-0702.3 010361	Ø 20,64
 Bremskraftregler							
1.6	74	03/94→08/95		R2500001→ T2526383		03.0101-0025.2 320014	ATE Satz 3/35 2x
1.6 i	52	03/93→08/96		→ R2500000		03.0101-0027.2 320022	ATE Satz 3/45 2x
1.6 i	55	01/96→03/01		T2526384→		03.0101-0031.2 320211	ATE Satz 3/30 2x
VAUXHALL - ASTRA Mk III (F) Estate 03/91→02/98							
 Hauptbremszylinder							
1.4 i	44	09/91→02/98		10/91→; + ABS		03.2122-0282.3 010130	ATE Ø 22,2
1.4 S	55	09/91→02/98		10/91→; - ABS		24.2120-0702.3 010361	Ø 20,64
1.8 i	66	09/91→02/98					
1.4 i	60	03/91→02/98		10/91→; - ABS; für Fahrzeuge mit verstärkter Bremsen		03.2122-0264.3 010129	ATE Ø 22,2
				10/91→; + ABS		03.2122-0282.3 010130	ATE Ø 22,2
				10/91→; - ABS; nicht für Fahrzeuge mit verstärkter Bremsen		24.2120-0702.3 010361	Ø 20,64
1.4 i 16V	66	02/96→01/98		+ ABS		03.2122-0282.3 010130	ATE Ø 22,2
1.8 i 16V	85	09/94→02/98					
1.8 i 16V	92	09/94→02/98					
1.6 i	52	07/94→02/98		+ ABS		03.2122-0282.3 010130	ATE Ø 22,2
1.7 TD	50	01/94→02/98		- ABS		24.2120-0702.3 010361	Ø 20,64
1.7 TD	60	12/91→02/98					
1.6 i	55	09/91→02/98		10/91→; + ABS		03.2122-0282.3 010130	ATE Ø 22,2
1.6 i 16V	74	01/94→02/98		- ABS		03.2122-0264.3 010129	ATE Ø 22,2
				+ ABS		03.2122-0282.3 010130	ATE Ø 22,2
1.7 D	42	12/91→02/98		- ABS; für Fahrzeuge mit verstärkter Bremsen		03.2122-0264.3 010129	ATE Ø 22,2
				+ ABS		03.2122-0282.3 010130	ATE Ø 22,2
				- ABS; nicht für Fahrzeuge mit verstärkter Bremsen		24.2120-0702.3 010361	Ø 20,64
2.0 i	85	09/91→02/98		10/91→; - ABS		03.2122-0264.3 010129	ATE Ø 22,2
				10/91→; + ABS		03.2122-0282.3 010130	ATE Ø 22,2
VAUXHALL - ASTRA Mk IV (G) CC 02/98→05/05							
 Hauptbremszylinder							
1.2 16V	48	02/98→09/00		04/98→; - ESP; für Fahrzeuge mit Scheibenbremse an der Hinterachse		24.2123-1734.3 010640	TRW Ø 23,81
1.4 16V	66	02/98→05/05					
1.6	55	02/98→09/00					
1.6 16V	74	02/98→05/05		22000001→; - ESP; für Fahrzeuge mit Trommelbremse an der Hinterachse		24.2123-1734.3 010640	TRW Ø 23,81
				04/98→; + ESP		24.2123-1739.3 010661	Ø 23,81
1.2 16V	55	09/00→05/05		- ESP; für Fahrzeuge mit Scheibenbremse an der Hinterachse		24.2123-1734.3 010640	TRW Ø 23,81
1.6	62	09/00→05/05					
1.6 Dualfuel	62	07/00→05/05					
1.6 Dualfuel	63	09/02→05/05		22000001→; - ESP; für Fahrzeuge mit Trommelbremse an der Hinterachse		24.2123-1734.3 010640	TRW Ø 23,81
1.7 DTI 16V	55	02/00→05/05		+ ESP		24.2123-1739.3 010661	Ø 23,81
↓							

	kw			 	! #		
VAUXHALL - ASTRA Mk IV (G) CC 02/98→05/05							
 Hauptbremszylinder							
1.6	76	12/02→05/05		- ESP		24.2123-1734.3 010640	TRW Ø 23,81
1.8 16V	92	09/00→05/05		+ ESP		24.2123-1739.3 010661	Ø 23,81
1.8 16V Dualfuel	87	09/02→05/05					
2.0	118	10/99→08/00					
2.0 DTI 16V	74	08/99→05/05					
2.0 SRI Turbo	141	11/01→05/05					
2.2 16V	108	03/01→05/05					
1.7 CDTI 16V	59	04/03→05/05		- ESP		24.2123-1734.3 010640	TRW Ø 23,81
1.7 TD	50	02/98→08/00		04/98→; - ESP; für Fahrzeuge mit Scheibenbremse an der Hinterachse		24.2123-1734.3 010640	TRW Ø 23,81
				04/98→; + ESP		24.2123-1739.3 010661	Ø 23,81
1.8 16V	85	02/98→09/00		04/98→; - ESP		24.2123-1734.3 010640	TRW Ø 23,81
2.0 16V	100	02/98→05/05		04/98→; + ESP		24.2123-1739.3 010661	Ø 23,81
2.0 DI	60	02/98→05/05					
 Bremskraftregler							
1.2 16V	48	02/98→09/00		04/98→; - ABS		03.6583-0073.3 320234	ATE lastabhängig 8/3 4x
1.2 16V	55	09/00→05/05		- ABS		03.6583-0073.3 320234	ATE lastabhängig 8/3 4x
1.4 16V	66	02/98→05/05		04/98→; - ABS		03.6583-0074.3 320235	ATE lastabhängig 8/3 4x
1.6	55	02/98→09/00					
1.6 16V	74	02/98→05/05					
1.7 TD	50	02/98→08/00					
1.8 16V	85	02/98→09/00					
2.0 16V	100	02/98→05/05					
2.0 DI	60	02/98→05/05					
1.6	62	09/00→05/05		- ABS		03.6583-0074.3 320235	ATE lastabhängig 8/3 4x
1.6 Dualfuel	63	09/02→05/05					
1.7 CDTI 16V	59	04/03→05/05					
1.7 DTI 16V	55	02/00→05/05					
1.8 16V	92	09/00→05/05					
1.8 16V Dualfuel	87	09/02→05/05					
2.0 DTI 16V	74	08/99→05/05					
VAUXHALL - ASTRA Mk IV (G) Convertible 03/01→10/05							
 Hauptbremszylinder							
1.6 16V	74	03/01→10/05		- ESP		24.2123-1734.3 010640	TRW Ø 23,81
1.6 16V	76	03/03→10/05		+ ESP		24.2123-1739.3 010661	Ø 23,81
1.8 16V	92	03/01→10/05					
2.0	147	09/02→10/05					
2.0 Turbo	141	03/02→10/05					
2.2 16V	108	03/01→10/05					
VAUXHALL - ASTRA Mk IV (G) Coupe (F67) 03/00→08/05							
 Hauptbremszylinder							
1.6 16V	76	03/00→08/05		- ESP; für Fahrzeuge mit Scheibenbremse an der Hinterachse		24.2123-1734.3 010640	TRW Ø 23,81
				22000001→; - ESP; für Fahrzeuge mit Trommelbremse an der Hinterachse		24.2123-1734.3 010640	TRW Ø 23,81
				+ ESP		24.2123-1739.3 010661	Ø 23,81
1.8 16V	85	03/00→08/05		- ESP		24.2123-1734.3 010640	TRW Ø 23,81
1.8 16V	92	09/00→08/05					
1.8 16V Dualfuel	87	09/02→08/05		+ ESP		24.2123-1739.3 010661	Ø 23,81
2.0	147	08/02→05/05					
2.0 16V Turbo	140	09/00→08/05					
2.2 16V	108	03/00→08/05		09/00→; - ESP		24.2123-1734.3 010640	TRW Ø 23,81
				09/00→; + ESP		24.2123-1739.3 010661	Ø 23,81
VAUXHALL - ASTRA Mk IV (G) Estate 02/98→05/05							
 Hauptbremszylinder							
1.2 16V	48	02/98→09/00		04/98→; - ESP; für Fahrzeuge mit Scheibenbremse an der Hinterachse		24.2123-1734.3 010640	TRW Ø 23,81
1.4 16V	66	02/98→05/05					
1.6	55	03/98→04/04					
1.6	62	03/98→04/04		22000001→; - ESP; für Fahrzeuge mit Trommelbremse an der Hinterachse		24.2123-1734.3 010640	TRW Ø 23,81
1.6 16V	74	03/98→04/04					
1.6 Dualfuel	63	03/98→04/04					
				04/98→; + ESP		24.2123-1739.3 010661	Ø 23,81
1.2 16V	55	09/00→05/05		- ESP; für Fahrzeuge mit Scheibenbremse an der Hinterachse		24.2123-1734.3 010640	TRW Ø 23,81
1.6	76	12/02→05/05					
1.6 Dualfuel	62	07/00→05/05					
1.7 DTI 16V	55	02/00→05/05					
↓							

VAUXHALL - ASTRA Mk IV (G) Estate 02/98→05/05

Hauptbremszylinder

1.2 16V	55	09/00→05/05		22000001→; - ESP;	24.2123-1734.3	010640	TRW Ø 23,81
1.6	76	12/02→05/05		für Fahrzeuge mit Trommelbremse an			
1.6 Dualfuel	62	07/00→05/05		der Hinterachse			
1.7 DTI 16V	55	02/00→05/05		+ ESP	24.2123-1739.3	010661	Ø 23,81
1.7 CDTI 16V	59	04/03→05/05		- ESP	24.2123-1734.3	010640	TRW Ø 23,81
1.7 TD	50	02/98→08/00		04/98→; - ESP;	24.2123-1734.3	010640	TRW Ø 23,81
				für Fahrzeuge mit Scheibenbremse an			
				der Hinterachse			
				04/98→; + ESP	24.2123-1739.3	010661	Ø 23,81
1.8 16V	85	02/98→08/00		04/98→; - ESP	24.2123-1734.3	010640	TRW Ø 23,81
2.0 16V	100	02/98→05/05		04/98→; + ESP	24.2123-1739.3	010661	Ø 23,81
2.0 DI	60	03/98→04/04					
1.8 16V	92	09/00→05/05		- ESP	24.2123-1734.3	010640	TRW Ø 23,81
1.8 16V Dualfuel	87	09/02→05/05		+ ESP	24.2123-1739.3	010661	Ø 23,81
2.2 16V	108	03/01→05/05					
2.0 DTI 16V	74	03/98→04/04		08/99→; - ESP	24.2123-1734.3	010640	TRW Ø 23,81
				08/99→; + ESP	24.2123-1739.3	010661	Ø 23,81

Bremskraftregler

1.2 16V	48	02/98→09/00		04/98→; - ABS	03.6583-0073.3	320234	ATE lastabhängig 8/3 4x
1.4 16V	66	02/98→05/05					
1.6	55	03/98→04/04					
1.6	62	03/98→04/04					
1.6 16V	74	03/98→04/04					
1.6 Dualfuel	63	03/98→04/04					
1.7 TD	50	02/98→08/00					
1.8 16V	85	02/98→08/00					
2.0 16V	100	02/98→05/05					
1.2 16V	55	09/00→05/05		- ABS	03.6583-0073.3	320234	ATE lastabhängig 8/3 4x
1.6	76	12/02→05/05					
1.7 CDTI 16V	59	04/03→05/05					
1.7 DTI 16V	55	02/00→05/05					
1.8 16V	92	09/00→05/05					
1.8 16V Dualfuel	87	09/02→05/05					
2.0 16V	118	10/99→05/05					
2.0 DI	60	03/98→04/04		04/98→; - ABS	03.6583-0074.3	320235	ATE lastabhängig 8/3 4x
2.0 DTI 16V	74	03/98→04/04		08/99→; - ABS	03.6583-0074.3	320235	ATE lastabhängig 8/3 4x







VAUXHALL - ASTRA Mk IV (G) Sedan 02/98→05/05











Hauptbremszylinder











1.2 16V	48	09/98→09/00		- ESP;	24.2123-1734.3	010640	TRW Ø 23,81
1.2 16V	55	09/00→05/05		für Fahrzeuge mit Scheibenbremse an			
1.4 16V	66	09/98→05/05		der Hinterachse			
1.6	55	09/98→09/00		22000001→; - ESP;	24.2123-1734.3	010640	TRW Ø 23,81
1.6	62	09/00→05/05		für Fahrzeuge mit Trommelbremse an			
1.6 16V	74	09/98→05/05		der Hinterachse			
1.6 Dualfuel	62	07/00→05/05		+ ESP	24.2123-1739.3	010661	Ø 23,81
1.6 Dualfuel	63	09/02→05/05					
1.7 DTI 16V	55	02/00→05/05					
1.7 CDTI 16V	59	04/03→05/05		- ESP	24.2123-1734.3	010640	TRW Ø 23,81
1.7 TD	50	09/98→08/00		- ESP;	24.2123-1734.3	010640	TRW Ø 23,81
				für Fahrzeuge mit Scheibenbremse an			
				der Hinterachse			
				+ ESP	24.2123-1739.3	010661	Ø 23,81
1.8 16V	85	02/98→07/04		04/98→; - ESP	24.2123-1734.3	010640	TRW Ø 23,81
1.8 16V	92	02/98→07/04		04/98→; + ESP	24.2123-1739.3	010661	Ø 23,81
1.8 16V Dualfuel	87	02/98→07/04					
2.0 DI	60	02/98→07/04					
2.0 16V	100	09/98→05/05		- ESP	24.2123-1734.3	010640	TRW Ø 23,81
2.0 16V	118	10/99→05/05		+ ESP	24.2123-1739.3	010661	Ø 23,81
2.2 16V	108	03/01→05/05					
2.2 DTI	92	09/02→05/05					
2.0 DTI 16V	74	02/98→07/04		08/99→; - ESP	24.2123-1734.3	010640	TRW Ø 23,81
				08/99→; + ESP	24.2123-1739.3	010661	Ø 23,81













Bremskraftregler













1.2 16V	48	09/98→09/00		- ABS	03.6583-0073.3	320234	ATE lastabhängig 8/3 4x
1.2 16V	55	09/00→05/05					
1.4 16V	66	09/98→05/05		- ABS	03.6583-0074.3	320235	ATE lastabhängig 8/3 4x
1.6	55	09/98→09/00					
1.6	62	09/00→05/05					
1.6 16V	74	09/98→05/05					
1.6 Dualfuel	63	09/02→05/05					
1.7 CDTI 16V	59	04/03→05/05					
1.7 DTI 16V	55	02/00→05/05					
↓							















	kw				! #				
VAUXHALL - ASTRA Mk IV (G) Sedan 02/98→05/05									
Bremskraftregler									
1.7 TD 2.0 16V	50 100	09/98→08/00 09/98→05/05		- ABS		03.6583-0074.3 320235	ATE lastabhängig 8/3 4x		
1.8 16V 1.8 16V 1.8 16V Dualfuel 2.0 DI	85 92 87 60	02/98→07/04 02/98→07/04 02/98→07/04 02/98→07/04		04/98→; - ABS		03.6583-0074.3 320235	ATE lastabhängig 8/3 4x		
2.0 DTI 16V	74	02/98→07/04		08/99→; - ABS		03.6583-0074.3 320235	ATE lastabhängig 8/3 4x		
VAUXHALL - ASTRA Mk V (H) CC 01/04→09/09									
Bremskraftverstärker									
1.9 CDTI 1.9 CDTI 1.9 CDTI 16V	88 110 88	01/04→05/09 01/04→05/09 01/04→05/09		09/04→; für Linkslenker		03.7863-7803.4 300237	ATE Ø 10" pneumatisch		
Hauptbremszylinder									
1.3 CDTI	66	01/04→05/09		08/05→; → 68999999; für Linkslenker; + ESP	24.2125-1736.3 010904	TRW Ø 25,4			
				08/05→; → 68999999; für Rechtslenker	24.2125-1736.3 010904	TRW Ø 25,4			
				08/05→; → 68999999; für Linkslenker; - ESP	24.2125-1737.3 010906	TRW Ø 25,4			
				72000001→; für Linkslenker; + ESP	24.4125-1703.3 010907	TRW Ø 25,4			
				72000001→; für Rechtslenker	24.4125-1703.3 010907	TRW Ø 25,4			
				72000001→; für Linkslenker; - ESP	24.4125-1704.3 010908	TRW Ø 25,4			
1.4 1.4 1.6 1.7 CDTI 1.7 CDTI 1.8 2.0 Turbo	55 66 77 59 74 92 125	04/04→12/05 01/04→05/09 01/04→05/09 01/04→05/09 01/04→05/09 01/04→05/09 01/04→05/09		für Rechtslenker; → 68999999	24.2125-1736.3 010904	TRW Ø 25,4			
				für Linkslenker; → 68999999; + ESP	24.2125-1736.3 010904	TRW Ø 25,4			
				für Linkslenker; → 68999999; - ESP	24.2125-1737.3 010906	TRW Ø 25,4			
				72000001→; für Linkslenker; + ESP	24.4125-1703.3 010907	TRW Ø 25,4			
				72000001→; für Rechtslenker	24.4125-1703.3 010907	TRW Ø 25,4			
				72000001→; für Linkslenker; - ESP	24.4125-1704.3 010908	TRW Ø 25,4			
1.6 1.6 Turbo	85 132	01/04→05/09 09/06→09/09		01/07→; → 68999999; für Rechtslenker	24.2125-1736.3 010904	TRW Ø 25,4			
				01/07→; → 68999999; für Linkslenker; + ESP	24.2125-1736.3 010904	TRW Ø 25,4			
				01/07→; → 68999999; für Linkslenker; - ESP	24.2125-1737.3 010906	TRW Ø 25,4			
				72000001→; für Linkslenker; + ESP	24.4125-1703.3 010907	TRW Ø 25,4			
				72000001→; für Rechtslenker	24.4125-1703.3 010907	TRW Ø 25,4			
				72000001→; für Linkslenker; - ESP	24.4125-1704.3 010908	TRW Ø 25,4			
1.7 CDTi	81	01/04→05/09		04/07→; → 68999999; für Rechtslenker	24.2125-1736.3 010904	TRW Ø 25,4			
				04/07→; → 68999999; für Linkslenker; + ESP	24.2125-1736.3 010904	TRW Ø 25,4			
				04/07→; → 68999999; für Linkslenker; - ESP	24.2125-1737.3 010906	TRW Ø 25,4			
				72000001→; für Rechtslenker	24.4125-1703.3 010907	TRW Ø 25,4			
				72000001→; für Linkslenker; + ESP	24.4125-1703.3 010907	TRW Ø 25,4			
				72000001→; für Linkslenker; - ESP	24.4125-1704.3 010908	TRW Ø 25,4			
1.8	103	01/04→05/09		01/06→; → 68999999; für Rechtslenker	24.2125-1736.3 010904	TRW Ø 25,4			
				01/06→; → 68999999; für Linkslenker; + ESP	24.2125-1736.3 010904	TRW Ø 25,4			
				01/06→; → 68999999; für Linkslenker; - ESP	24.2125-1737.3 010906	TRW Ø 25,4			
				72000001→; für Rechtslenker	24.4125-1703.3 010907	TRW Ø 25,4			
				72000001→; für Linkslenker; + ESP	24.4125-1703.3 010907	TRW Ø 25,4			
				72000001→; für Linkslenker; - ESP	24.4125-1704.3 010908	TRW Ø 25,4			
1.9 CDTI 1.9 CDTI 1.9 CDTI 16V	88 110 88	01/04→05/09 01/04→05/09 01/04→05/09		09/04→	03.4155-0156.3 010862	ATE Ø 25,4			
			2.0 Turbo	147	01/04→05/09		09/04→; für Linkslenker; → 68999999; + ESP	24.2125-1736.3 010904	TRW Ø 25,4
							09/04→; für Rechtslenker; → 68999999	24.2125-1736.3 010904	TRW Ø 25,4
	09/04→; für Linkslenker; → 68999999; - ESP	24.2125-1737.3 010906				TRW Ø 25,4			
	72000001→; für Rechtslenker	24.4125-1703.3 010907				TRW Ø 25,4			
	72000001→; für Linkslenker; + ESP	24.4125-1703.3 010907				TRW Ø 25,4			
	72000001→; für Linkslenker; - ESP	24.4125-1704.3 010908				TRW Ø 25,4			
2.0 Turbo	177	01/04→05/09		03/05→; → 68999999; für Linkslenker; + ESP	24.2125-1736.3 010904	TRW Ø 25,4			
				03/05→; → 68999999; für Rechtslenker	24.2125-1736.3 010904	TRW Ø 25,4			
↓									

	kw			 	! #		
VAUXHALL - ASTRA Mk V (H) CC 01/04→09/09							
 Hauptbremszylinder							
2.0 Turbo	177	01/04→05/09		03/05→; → 68999999; für Linkslenker; - ESP	24.2125-1737.3	010906	TRW Ø 25,4
				72000001→; für Linkslenker; + ESP	24.4125-1703.3	010907	TRW Ø 25,4
				72000001→; für Rechtslenker	24.4125-1703.3	010907	TRW Ø 25,4
				72000001→; für Linkslenker; - ESP	24.4125-1704.3	010908	TRW Ø 25,4
VAUXHALL - ASTRA Mk V (H) Estate 08/04→10/12							
 Bremskraftverstärker							
1.9 CDTi	74	08/04→03/09		09/05→; für Linkslenker	03.7863-7803.4	300237	ATE Ø 10" pneumatisch
1.9 CDTi	88	08/04→03/09		für Linkslenker	03.7863-7803.4	300237	ATE Ø 10" pneumatisch
1.9 CDTi	110	08/04→03/09		09/04→; für Linkslenker	03.7863-7803.4	300237	ATE Ø 10" pneumatisch
 Hauptbremszylinder							
1.3 CDTi	66	08/04→03/09		72000001→; für Linkslenker; + ESP	24.2125-1703.3	010483	Ø 25,4
				72000001→; für Linkslenker; - ESP	24.2125-1704.3	010446	TRW Ø 25,4
				08/05→; → 62999999; für Rechtslenker	24.2125-1736.3	010904	TRW Ø 25,4
				08/05→; → 68999999; für Linkslenker; + ESP	24.2125-1736.3	010904	TRW Ø 25,4
				08/05→; → 68999999; für Linkslenker; - ESP	24.2125-1737.3	010906	TRW Ø 25,4
				72000001→; für Rechtslenker	24.4125-1703.3	010907	TRW Ø 25,4
1.4	55	08/04→10/10		72000001→; für Linkslenker; + ESP	24.2125-1703.3	010483	Ø 25,4
1.4	66	08/04→03/09		72000001→; für Linkslenker; - ESP	24.2125-1704.3	010446	TRW Ø 25,4
1.6	77	08/04→03/09		→ 62999999; für Rechtslenker	24.2125-1736.3	010904	TRW Ø 25,4
1.7 CDTi	74	08/04→03/09		→ 68999999; für Linkslenker; + ESP	24.2125-1736.3	010904	TRW Ø 25,4
1.7 CDTi	59	08/04→05/09		→ 68999999; für Linkslenker; - ESP	24.2125-1737.3	010906	TRW Ø 25,4
1.8	92	10/04→03/09		→ 68999999; für Linkslenker; - ESP	24.2125-1737.3	010906	TRW Ø 25,4
1.8	103	12/05→10/10		72000001→; für Rechtslenker	24.4125-1703.3	010907	TRW Ø 25,4
2.0 Turbo	125	08/04→10/10		72000001→; für Rechtslenker	24.4125-1703.3	010907	TRW Ø 25,4
1.6	85	08/04→03/09		72000001→; für Linkslenker; + ESP	24.2125-1703.3	010483	Ø 25,4
				72000001→; für Linkslenker; - ESP	24.2125-1704.3	010446	TRW Ø 25,4
				01/07→; → 62999999; für Rechtslenker	24.2125-1736.3	010904	TRW Ø 25,4
				01/07→; → 68999999; für Linkslenker; + ESP	24.2125-1736.3	010904	TRW Ø 25,4
				01/07→; → 68999999; für Linkslenker; - ESP	24.2125-1737.3	010906	TRW Ø 25,4
				72000001→; für Rechtslenker	24.4125-1703.3	010907	TRW Ø 25,4
1.6	132	08/04→03/09		72000001→; für Linkslenker; + ESP	24.2125-1703.3	010483	Ø 25,4
				72000001→; für Linkslenker; - ESP	24.2125-1704.3	010446	TRW Ø 25,4
				01/07→; → 62999999; für Rechtslenker	24.2125-1736.3	010904	TRW Ø 25,4
				01/07→; → 68999999; für Linkslenker; + ESP	24.2125-1736.3	010904	TRW Ø 25,4
				01/07→; → 68999999; für Linkslenker; - ESP	24.2125-1737.3	010906	TRW Ø 25,4
				72000001→; für Rechtslenker	24.4125-1703.3	010907	TRW Ø 25,4
1.7 CDTi	81	08/04→10/12		72000001→; → 11/10; für Linkslenker; + ESP	24.2125-1703.3	010483	Ø 25,4
				72000001→; → 11/10; für Linkslenker; - ESP	24.2125-1704.3	010446	TRW Ø 25,4
				04/07→; → 68999999; für Linkslenker; + ESP	24.2125-1736.3	010904	TRW Ø 25,4
				04/07→; → 62999999; für Rechtslenker	24.2125-1736.3	010904	TRW Ø 25,4
				04/07→; → 68999999; für Linkslenker; - ESP	24.2125-1737.3	010906	TRW Ø 25,4
				72000001→; → 11/10; für Rechtslenker	24.4125-1703.3	010907	TRW Ø 25,4
1.7 CDTi	92	02/07→10/10		72000001→; für Linkslenker; + ESP	24.2125-1703.3	010483	Ø 25,4
				72000001→; für Linkslenker; - ESP	24.2125-1704.3	010446	TRW Ø 25,4
				04/07→; → 68999999; für Linkslenker; + ESP	24.2125-1736.3	010904	TRW Ø 25,4
				04/07→; → 62999999; für Rechtslenker	24.2125-1736.3	010904	TRW Ø 25,4
				04/07→; → 68999999; für Linkslenker; - ESP	24.2125-1737.3	010906	TRW Ø 25,4
				72000001→; für Rechtslenker	24.4125-1703.3	010907	TRW Ø 25,4
1.9 CDTi	74	08/04→03/09		09/05→	03.4155-0156.3	010862	ATE Ø 25,4
1.9 CDTi	88	08/04→03/09			03.4155-0156.3	010862	ATE Ø 25,4
1.9 CDTi	110	08/04→03/09		09/04→	03.4155-0156.3	010862	ATE Ø 25,4
2.0 Turbo	147	08/04→10/10		72000001→; für Linkslenker; + ESP	24.2125-1703.3	010483	Ø 25,4
				72000001→; für Linkslenker; - ESP	24.2125-1704.3	010446	TRW Ø 25,4
				09/04→; → 68999999; für Linkslenker; + ESP	24.2125-1736.3	010904	TRW Ø 25,4
				09/04→; → 62999999; für Rechtslenker	24.2125-1736.3	010904	TRW Ø 25,4
				09/04→; → 68999999; für Linkslenker; - ESP	24.2125-1737.3	010906	TRW Ø 25,4
				72000001→; für Rechtslenker	24.4125-1703.3	010907	TRW Ø 25,4

	kw				! #		
VAUXHALL - ASTRA Mk V (H) Sport Hatch 02/05→11/10							
 Bremskraftverstärker							
1.9 CDTi	74	08/05→11/10		09/05→; für Linkslenker		03.7863-7803.4 300237	ATE Ø 10" pneumatisch
1.9 CDTi	88	02/05→11/10		für Linkslenker		03.7863-7803.4 300237	ATE Ø 10" pneumatisch
1.9 CDTi	110	02/05→11/10					
 Hauptbremszylinder							
1.3 CDTi	66	04/05→11/10		08/05→; → 68999999; für Linkslenker; + ESP		24.2125-1736.3 010904	TRW Ø 25,4
				08/05→; → 68999999; für Rechtslenker		24.2125-1736.3 010904	TRW Ø 25,4
				08/05→; → 68999999; für Linkslenker; - ESP		24.2125-1737.3 010906	TRW Ø 25,4
				72000001→; für Linkslenker; + ESP		24.4125-1703.3 010907	TRW Ø 25,4
				72000001→; für Rechtslenker		24.4125-1703.3 010907	TRW Ø 25,4
				72000001→; für Linkslenker; - ESP		24.4125-1704.3 010908	TRW Ø 25,4
1.4	55	02/05→11/10		für Rechtslenker; → 68999999		24.2125-1736.3 010904	TRW Ø 25,4
1.4 i 16V	66	03/05→11/10		für Linkslenker; → 68999999; + ESP		24.2125-1736.3 010904	TRW Ø 25,4
1.6	77	02/05→11/10					
1.7 CDTi	74	02/05→11/10		für Linkslenker; → 68999999; - ESP		24.2125-1737.3 010906	TRW Ø 25,4
1.8	92	02/05→11/10		72000001→; für Linkslenker; + ESP		24.4125-1703.3 010907	TRW Ø 25,4
1.8 i 16V	103	03/07→11/10					
2.0 Turbo	125	02/05→11/10		72000001→; für Rechtslenker		24.4125-1703.3 010907	TRW Ø 25,4
2.0 VXR	176	02/09→11/10		72000001→; für Linkslenker; - ESP		24.4125-1704.3 010908	TRW Ø 25,4
1.6	132	10/06→11/10		01/07→; → 68999999; für Rechtslenker		24.2125-1736.3 010904	TRW Ø 25,4
1.6 i 16V	85	12/06→11/10		01/07→; → 68999999; für Linkslenker; + ESP		24.2125-1736.3 010904	TRW Ø 25,4
				01/07→; → 68999999; für Linkslenker; - ESP		24.2125-1737.3 010906	TRW Ø 25,4
				72000001→; für Linkslenker; + ESP		24.4125-1703.3 010907	TRW Ø 25,4
				72000001→; für Rechtslenker		24.4125-1703.3 010907	TRW Ø 25,4
				72000001→; für Linkslenker; - ESP		24.4125-1704.3 010908	TRW Ø 25,4
1.7 CDTi	81	02/07→11/10		04/07→; → 68999999; für Rechtslenker		24.2125-1736.3 010904	TRW Ø 25,4
				04/07→; → 68999999; für Linkslenker; + ESP		24.2125-1736.3 010904	TRW Ø 25,4
				04/07→; → 68999999; für Linkslenker; - ESP		24.2125-1737.3 010906	TRW Ø 25,4
				72000001→; für Rechtslenker		24.4125-1703.3 010907	TRW Ø 25,4
				72000001→; für Linkslenker; + ESP		24.4125-1703.3 010907	TRW Ø 25,4
				72000001→; für Linkslenker; - ESP		24.4125-1704.3 010908	TRW Ø 25,4
1.9 CDTi	74	08/05→11/10		09/05→		03.4155-0156.3 010862	ATE Ø 25,4
1.9 CDTi	88	02/05→11/10				03.4155-0156.3 010862	ATE Ø 25,4
1.9 CDTi	110	02/05→11/10					
VAUXHALL - ASTRA Mk V (H) TwinTop 09/05→11/10							
 Bremskraftverstärker							
1.9 CDTi	110	01/06→11/10		03/06→; für Linkslenker		03.7863-7803.4 300237	ATE Ø 10" pneumatisch
 Hauptbremszylinder							
1.6	77	09/05→11/10		03/06→; → 68999999; für Rechtslenker		24.2125-1736.3 010904	TRW Ø 25,4
2.0	125	02/06→11/10		03/06→; → 68999999; für Linkslenker; + ESP		24.2125-1736.3 010904	TRW Ø 25,4
2.0 Turbo	147	01/06→11/10		03/06→; → 68999999; für Linkslenker; - ESP		24.2125-1737.3 010906	TRW Ø 25,4
				03/06→; für Rechtslenker		24.4125-1703.3 010907	TRW Ø 25,4
				72000001→; für Linkslenker; + ESP		24.4125-1703.3 010907	TRW Ø 25,4
				72000001→; für Linkslenker; - ESP		24.4125-1704.3 010908	TRW Ø 25,4
1.6	132	10/06→11/10		02/07→; → 68999999; für Linkslenker; + ESP		24.2125-1736.3 010904	TRW Ø 25,4
				02/07→; → 68999999; für Rechtslenker		24.2125-1736.3 010904	TRW Ø 25,4
				02/07→; → 68999999; für Linkslenker; - ESP		24.2125-1737.3 010906	TRW Ø 25,4
				02/07→; für Rechtslenker		24.4125-1703.3 010907	TRW Ø 25,4
				72000001→; für Linkslenker; + ESP		24.4125-1703.3 010907	TRW Ø 25,4
				72000001→; für Linkslenker; - ESP		24.4125-1704.3 010908	TRW Ø 25,4
1.6 i 16V	85	10/06→11/10		12/06→; → 68999999; für Rechtslenker		24.2125-1736.3 010904	TRW Ø 25,4
				12/06→; → 68999999; für Linkslenker; + ESP		24.2125-1736.3 010904	TRW Ø 25,4
				12/06→; → 68999999; für Linkslenker; - ESP		24.2125-1737.3 010906	TRW Ø 25,4
				12/06→; für Rechtslenker		24.4125-1703.3 010907	TRW Ø 25,4
↓							

	kW			 	! #		
VAUXHALL - ASTRA Mk V (H) TwinTop 09/05→11/10							
 Hauptbremszylinder							
1.6 i 16V	85	10/06→11/10		72000001→; für Linkslenker; + ESP		24.4125-1703.3 010907	TRW Ø 25,4
				72000001→; für Linkslenker; - ESP		24.4125-1704.3 010908	TRW Ø 25,4
1.8	103	05/08→11/10		→ 68999999; für Rechtslenker		24.2125-1736.3 010904	TRW Ø 25,4
				→ 68999999; für Linkslenker; + ESP		24.2125-1736.3 010904	TRW Ø 25,4
				→ 68999999; für Linkslenker; - ESP		24.2125-1737.3 010906	TRW Ø 25,4
				für Rechtslenker		24.4125-1703.3 010907	TRW Ø 25,4
				72000001→; für Linkslenker; + ESP		24.4125-1703.3 010907	TRW Ø 25,4
				72000001→; für Linkslenker; - ESP		24.4125-1704.3 010908	TRW Ø 25,4
1.9 CDTi	110	01/06→11/10		03/06→; für Rechtslenker		03.4155-0156.3 010862	ATE Ø 25,4
				03/06→; für Linkslenker; + ESP		03.4155-0156.3 010862	ATE Ø 25,4
VAUXHALL - ASTRA Mk VI (J) 12/09→							
 Bremskraftverstärker							
1.3 CDTi	70	12/09→		für Linkslenker		03.7858-0732.4 300272	ATE Ø 9 / 8" pneumatisch
1.4	64	12/09→					
1.4	74	12/09→					
1.4 Turbo	88	08/11→					
1.4 Turbo	103	12/09→					
1.6	85	12/09→					
1.6 SIDI	125	12/12→					
1.6 Turbo	132	12/09→					
1.7 CDTi	81	12/09→					
1.7 CDTi	92	12/09→					
1.7 CDTi	96	06/11→					
2.0 BiTurbo CDTi	143	12/12→					
2.0 CDTi	118	12/09→					
2.0 CDTi	121	08/11→					
1.6 CDTi	81	11/13→		02/14→; für Linkslenker		03.7858-0732.4 300272	ATE Ø 9 / 8" pneumatisch
1.6 CDTi	100	11/13→		01/14→; für Linkslenker		03.7858-0732.4 300272	ATE Ø 9 / 8" pneumatisch
 Hauptbremszylinder							
1.3 CDTi	70	12/09→		für Linkslenker		03.2125-0421.3 010934	ATE Ø 25,4
1.4	64	12/09→					
1.4	74	12/09→					
1.4 Turbo	88	08/11→					
1.4 Turbo	103	12/09→					
1.6	85	12/09→					
1.6 SIDI	125	12/12→					
1.6 Turbo	132	12/09→					
1.7 CDTi	81	12/09→					
1.7 CDTi	92	12/09→					
1.7 CDTi	96	06/11→					
2.0 BiTurbo CDTi	143	12/12→					
2.0 CDTi	118	12/09→					
2.0 CDTi	121	08/11→					
1.6 CDTi	81	11/13→		02/14→; für Linkslenker		03.2125-0421.3 010934	ATE Ø 25,4
1.6 CDTi	100	11/13→		01/14→; für Linkslenker		03.2125-0421.3 010934	ATE Ø 25,4
VAUXHALL - ASTRA Mk VI (J) Estate 10/10→							
 Bremskraftverstärker							
1.3 CDTi	70	10/10→		11/10→; für Linkslenker		03.7858-0732.4 300272	ATE Ø 9 / 8" pneumatisch
1.4	64	10/10→					
1.4	74	10/10→					
1.4 Turbo	88	10/10→					
1.4 Turbo	103	10/10→					
1.6	85	10/10→					
1.6 Turbo	132	10/10→					
1.7 CDTi	81	10/10→					
1.7 CDTi	92	10/10→					
2.0 CDTi	118	10/10→					
1.6 CDTi	81	01/14→		02/14→; für Linkslenker		03.7858-0732.4 300272	ATE Ø 9 / 8" pneumatisch
1.6 CDTi	100	01/14→		für Linkslenker		03.7858-0732.4 300272	ATE Ø 9 / 8" pneumatisch
1.6 SIDI	125	12/12→					
1.7 CDTi	96	06/11→05/14					
2.0 BiTurbo CDTi	143	12/12→					
2.0 CDTi	121	08/11→					
 Hauptbremszylinder							
1.3 CDTi	70	10/10→		11/10→; für Linkslenker		03.2125-0421.3 010934	ATE Ø 25,4
1.4	64	10/10→					
1.4	74	10/10→					
1.4 Turbo	88	10/10→					
1.4 Turbo	103	10/10→					
1.6	85	10/10→					
↓							

	kw			 	! #		
VAUXHALL - ASTRA Mk VI (J) Estate 10/10→							
 Hauptbremszylinder							
1.6 Turbo	132	10/10→		11/10→; für Linkslenker		03.2125-0421.3 010934	ATE Ø 25,4
1.7 CDTi	81	10/10→					
1.7 CDTi	92	10/10→					
2.0 CDTi	118	10/10→					
1.6 CDTi	81	01/14→		02/14→; für Linkslenker		03.2125-0421.3 010934	ATE Ø 25,4
1.6 CDTi	100	01/14→		für Linkslenker		03.2125-0421.3 010934	ATE Ø 25,4
1.6 SIDI	125	12/12→					
1.7 CDTi	96	06/11→05/14					
2.0 BiTurbo CDTi	143	12/12→					
2.0 CDTi	121	08/11→					
VAUXHALL - ASTRA Mk VI (J) GTC 10/11→							
 Bremskraftverstärker							
1.4	74	10/11→		für Linkslenker		03.7858-0732.4 300272	ATE Ø 9 / 8" pneumatisch
1.4	88	10/11→					
1.4	103	10/11→					
1.6	132	10/11→					
1.6 CDTi	81	07/14→					
1.6 CDTi	100	07/14→					
1.6 SIDI	125	12/12→					
1.6 SIDI	147	09/13→					
1.7 CDTi	81	10/11→					
1.7 CDTi	96	10/11→					
2.0 BiTurbo CDTi	143	12/12→					
2.0 CDTi	121	10/11→					
 Hauptbremszylinder							
1.4	74	10/11→		für Linkslenker		03.2125-0421.3 010934	ATE Ø 25,4
1.4	88	10/11→					
1.4	103	10/11→					
1.6	132	10/11→					
1.6 CDTi	81	07/14→					
1.6 CDTi	100	07/14→					
1.6 SIDI	125	12/12→					
1.6 SIDI	147	09/13→					
1.7 CDTi	81	10/11→					
1.7 CDTi	96	10/11→					
2.0 BiTurbo CDTi	143	12/12→					
2.0 CDTi	121	10/11→					
VAUXHALL - ASTRA Mk VI (J) Sedan 06/12→							
 Bremskraftverstärker							
1.3 CDTi	70	06/12→		für Linkslenker		03.7858-0732.4 300272	ATE Ø 9 / 8" pneumatisch
1.4	74	06/12→					
1.4 Turbo	103	06/12→					
1.6	85	06/12→					
1.6 SIDI	125	12/12→					
1.6 Turbo	132	06/12→					
1.7 CDTi	81	06/12→					
1.7 CDTi	96	06/12→					
2.0 BiTurbo CDTi	143	12/12→					
 Hauptbremszylinder							
1.3 CDTi	70	06/12→		für Linkslenker		03.2125-0421.3 010934	ATE Ø 25,4
1.4	74	06/12→					
1.4 Turbo	103	06/12→					
1.6	85	06/12→					
1.6 SIDI	125	12/12→					
1.6 Turbo	132	06/12→					
1.7 CDTi	81	06/12→					
1.7 CDTi	96	06/12→					
2.0 BiTurbo CDTi	143	12/12→					
VAUXHALL - ASTRVAN Mk III (F) 01/91→08/98							
 Hauptbremszylinder							
1.6 i	52	02/94→10/96		- ABS		03.2122-0264.3 010129	ATE Ø 22,2
				+ ABS		03.2122-0282.3 010130	ATE Ø 22,2
1.6 i	55	01/91→08/98		10/91→; - ABS		03.2122-0264.3 010129	ATE Ø 22,2
				10/91→; + ABS		03.2122-0282.3 010130	ATE Ø 22,2
1.7 TD	50	01/94→08/98		+ ABS		03.2122-0282.3 010130	ATE Ø 22,2
				- ABS		24.2120-0702.3 010361	Ø 20,64

	kw			 	! #		
VAUXHALL - ASTRAVAN Mk IV (G) 08/98→08/06							
 Hauptbremszylinder							
1.6 i 1.6 i 1.7 DTI 16V	55 62 55	08/98→09/00 09/00→08/06 04/01→08/06		- ESP; für Fahrzeuge mit Scheibenbremse an der Hinterachse		24.2123-1734.3 010640	TRW Ø 23,81
				22000001→; - ESP; für Fahrzeuge mit Trommelbremse an der Hinterachse		24.2123-1734.3 010640	TRW Ø 23,81
				+ ESP		24.2123-1739.3 010661	Ø 23,81
1.7 CDTI	59	04/04→08/06		- ESP		24.2123-1734.3 010640	TRW Ø 23,81
1.7 TD	50	08/98→08/06		- ESP; für Fahrzeuge mit Scheibenbremse an der Hinterachse		24.2123-1734.3 010640	TRW Ø 23,81
				+ ESP		24.2123-1739.3 010661	Ø 23,81
2.0 DI 2.0 DTI	60 74	08/98→08/06 04/04→08/06		- ESP		24.2123-1734.3 010640	TRW Ø 23,81
				+ ESP		24.2123-1739.3 010661	Ø 23,81
 Bremskraftregler							
1.7 CDTI 1.7 TD	59 50	04/04→08/06 08/98→08/06		- ABS		03.6583-0073.3 320234	ATE lastabhängig 8/3 4x
2.0 DI 2.0 DTI	60 74	08/98→08/06 04/04→08/06		- ABS		03.6583-0074.3 320235	ATE lastabhängig 8/3 4x
VAUXHALL - ASTRAVAN Mk V (H) 03/05→							
 Bremskraftverstärker							
1.9 CDTi 1.9 CDTi	88 110	03/05→11/11 03/05→11/11		→ 11/10; für Linkslenker		03.7863-7803.4 300237	ATE Ø 10" pneumatisch
 Hauptbremszylinder							
1.3 CDTi 1.4 i 1.6 1.7 CDTI	66 66 76 74	08/05→ 03/05→ 03/05→ 03/05→11/11		72000001→; → 11/10; für Linkslenker; + ESP		24.2125-1703.3 010483	Ø 25,4
				72000001→; → 11/10; für Linkslenker; - ESP		24.2125-1704.3 010446	TRW Ø 25,4
				→ 62999999; für Rechtslenker		24.2125-1736.3 010904	TRW Ø 25,4
				→ 68999999; für Linkslenker; + ESP		24.2125-1736.3 010904	TRW Ø 25,4
				→ 68999999; für Linkslenker; - ESP		24.2125-1737.3 010906	TRW Ø 25,4
				72000001→; → 11/10; für Rechtslenker		24.4125-1703.3 010907	TRW Ø 25,4
1.7 CDTi	59	03/05→07/06		72000001→; für Linkslenker; + ESP		24.2125-1703.3 010483	Ø 25,4
				72000001→; für Linkslenker; - ESP		24.2125-1704.3 010446	TRW Ø 25,4
				→ 62999999; für Rechtslenker		24.2125-1736.3 010904	TRW Ø 25,4
				→ 68999999; für Linkslenker; + ESP		24.2125-1736.3 010904	TRW Ø 25,4
				→ 68999999; für Linkslenker; - ESP		24.2125-1737.3 010906	TRW Ø 25,4
				72000001→; für Rechtslenker		24.4125-1703.3 010907	TRW Ø 25,4
1.7 CDTi 1.7 CDTi	81 92	06/11→12/13 11/11→		→ 62999999; für Rechtslenker		24.2125-1736.3 010904	TRW Ø 25,4
				→ 68999999; für Linkslenker; + ESP		24.2125-1736.3 010904	TRW Ø 25,4
				→ 68999999; für Linkslenker; - ESP		24.2125-1737.3 010906	TRW Ø 25,4
1.9 CDTi 1.9 CDTi	88 110	03/05→11/11 03/05→11/11		→ 11/10		03.4155-0156.3 010862	ATE Ø 25,4
VAUXHALL - BRAVA Pick-up 12/88→12/02							
 Hauptbremszylinder							
2.2 D (TFR52)	39	12/88→09/96		01/92→ 09/92		03.2120-1981.3 010105	DEL Ø 20,64
2.2 D 4x4 (TFS52)	39	12/88→09/96		09/90→ 09/92		03.2120-1981.3 010105	DEL Ø 20,64
2.5 TD (TFR54) 2.5 TD 4x4 (TFS54)	56 56	07/94→12/02 07/94→12/02		→ 08/96		03.2120-1981.3 010105	DEL Ø 20,64
VAUXHALL - CALIBRA 06/90→07/97							
 Hauptbremszylinder							
2.0 i 2.0 i 16V 2.0 i 16V 4x4 2.0 i 4x4 2.0 i Turbo 4x4	85 100 100 85 150	06/90→07/97 06/90→07/97 02/94→07/97 06/90→07/97 03/92→07/97				03.2122-0282.3 010130	ATE Ø 22,2
2.5 i V6	125	04/93→07/97		für Linkslenker		03.2123-1121.3 010176	Ø 23,81
						03.2123-1121.3 010176	Ø 23,81
 Bremskraftregler							
2.0 i 2.0 i 16V 2.0 i 16V 4x4 2.0 i 4x4	85 100 100 85	06/90→07/97 06/90→07/97 02/94→07/97 06/90→07/97		P1000001→		03.0101-0038.2 320245	Satz 2x
2.5 i V6	125	04/93→07/97		T1000001→		03.0101-0038.2 320245	Satz 2x

VAUXHALL - CASCADA Convertible 02/13→

Bremskraftverstärker

1.4	88	02/13→		für Linkslenker	03.7858-0732.4	300272	ATE Ø 9 / 8" pneumatisch
1.4	103	02/13→					
1.6	125	02/13→					
1.6	147	11/13→					
2.0 CDTI	121	02/13→					
2.0 CDTI	125	07/15→					
2.0 CDTI	143	02/13→					

Hauptbremszylinder

1.4	88	02/13→		für Linkslenker	03.2125-0421.3	010934	ATE Ø 25,4
1.4	103	02/13→					
1.6	125	02/13→					
1.6	147	11/13→					
2.0 CDTI	121	02/13→					
2.0 CDTI	125	07/15→					
2.0 CDTI	143	02/13→					

VAUXHALL - CAVALIER Mk III (87) 08/88→11/95

Hauptbremszylinder

1.4 S	55	09/88→11/95		→ 08/95; + ABS	03.2122-0282.3	010130	ATE Ø 22,2
1.6 i	52	09/93→11/95		P1000001→; → 08/95; - ABS	24.2120-0702.3	010361	Ø 20,64
1.6 i	55	09/88→11/95					
1.7 D	44	07/92→11/95		→ N5299999; - ABS	24.2120-0913.3	010392	DEL Ø 20,64
1.7 TD	60	09/88→11/95					
1.8 i Cat	66	03/90→11/95					
1.8	66	09/88→08/95		+ ABS	03.2122-0282.3	010130	ATE Ø 22,2
				P1000001→; - ABS	24.2120-0702.3	010361	Ø 20,64
				→ N5299999; - ABS	24.2120-0913.3	010392	DEL Ø 20,64
2.0 i 16V	110	09/88→11/95		→ N5299999; - ABS	03.2122-0264.3	010129	ATE Ø 22,2
2.0 SRi 16V	100	09/93→11/95		P1000001→; → 08/95; - ABS	03.2122-0264.3	010129	ATE Ø 22,2
				→ NV1299999; - ABS	03.2122-0264.3	010129	ATE Ø 22,2
				P5000001→; → 08/95; - ABS	03.2122-0264.3	010129	ATE Ø 22,2
				→ N1299999; - ABS	03.2122-0264.3	010129	ATE Ø 22,2
				P7000001→; → 08/95; - ABS	03.2122-0264.3	010129	ATE Ø 22,2
				→ 08/95; + ABS	03.2122-0282.3	010130	ATE Ø 22,2
2.0 i Cat	85	09/90→11/95		P1000001→; → 08/95; - ABS	03.2122-0264.3	010129	ATE Ø 22,2
				→ NV1299999; - ABS	03.2122-0264.3	010129	ATE Ø 22,2
				P7000001→; → 08/95; + TCS	03.2122-0264.3	010129	ATE Ø 22,2
				→ N5299999; - ABS	03.2122-0264.3	010129	ATE Ø 22,2
				→ N1299999; - ABS	03.2122-0264.3	010129	ATE Ø 22,2
				P5000001→; → 08/95; - ABS	03.2122-0264.3	010129	ATE Ø 22,2
				→ 08/95; + ABS	03.2122-0282.3	010130	ATE Ø 22,2

Bremskraftregler













1.4 S	55	09/88→11/95		P1000001→; → 08/95	03.0101-0027.2	320022	ATE Satz 3/45 2x
1.6 i	52	09/93→11/95					
1.6 i	55	09/88→11/95					
1.7 D	44	07/92→11/95					
1.7 TD	60	09/88→11/95					
1.8 i Cat	66	03/90→11/95					
1.8	66	09/88→08/95		P1000001→	03.0101-0027.2	320022	ATE Satz 3/45 2x











VAUXHALL - CAVALIER Mk III CC 09/88→11/95















Hauptbremszylinder









1.4 S	55	09/88→11/95		→ 08/95; + ABS	03.2122-0282.3	010130	ATE Ø 22,2
1.6 i	52	09/93→11/95		P1000001→; → 08/95; - ABS	24.2120-0702.3	010361	Ø 20,64
1.6 i	55	09/88→11/95					
1.7 D	44	07/92→11/95		→ N5299999; - ABS	24.2120-0913.3	010392	DEL Ø 20,64
1.7 TD	60	09/88→11/95					
1.8 i Cat	66	03/90→11/95					
2.0 i 16V	100	09/93→11/95		→ N5299999; - ABS	03.2122-0264.3	010129	ATE Ø 22,2
2.0 i 16V	110	09/88→11/95		P1000001→; → 08/95; - ABS	03.2122-0264.3	010129	ATE Ø 22,2
				→ NV1299999; - ABS	03.2122-0264.3	010129	ATE Ø 22,2
				P5000001→; → 08/95; - ABS	03.2122-0264.3	010129	ATE Ø 22,2
				→ N1299999; - ABS	03.2122-0264.3	010129	ATE Ø 22,2
				P7000001→; → 08/95; - ABS	03.2122-0264.3	010129	ATE Ø 22,2
				→ 08/95; + ABS	03.2122-0282.3	010130	ATE Ø 22,2
2.0 i Cat	85	09/90→11/95		P1000001→; → 08/95; - ABS	03.2122-0264.3	010129	ATE Ø 22,2
				→ NV1299999; - ABS	03.2122-0264.3	010129	ATE Ø 22,2











↓











	kw			 	! #		
VAUXHALL - CAVALIER Mk III CC 09/88→11/95							
 Hauptbremszylinder							
2.0 i Cat	85	09/90→11/95		P7000001→; → 08/95; + TCS		03.2122-0264.3 010129	ATE Ø 22,2
				→ N5299999; - ABS		03.2122-0264.3 010129	ATE Ø 22,2
				→ N1299999; - ABS		03.2122-0264.3 010129	ATE Ø 22,2
				P5000001→; → 08/95; - ABS		03.2122-0264.3 010129	ATE Ø 22,2
				→ 08/95; + ABS		03.2122-0282.3 010130	ATE Ø 22,2
 Bremskraftregler							
1.4 S	55	09/88→11/95		P1000001→; → 08/95		03.0101-0027.2 320022	ATE Satz 3/45 2x
1.6 i	52	09/93→11/95					
1.6 i	55	09/88→11/95					
1.7 D	44	07/92→11/95					
1.7 TD	60	09/88→11/95					
1.8 i Cat	66	03/90→11/95					
VAUXHALL - COMBO Mk I (B) 07/94→10/01							
 Hauptbremszylinder							
1.2	33	07/94→10/01		→ 09/00; für Linkslenker; - ABS		24.2120-0702.3 010361	Ø 20,64
1.4	44	07/94→10/01		→ 09/00; für Linkslenker; + ABS		24.2120-1714.3 010455	Ø 20,64
1.4	60	07/94→10/01					
1.4 16V	66	08/99→10/01					
1.7 D	44	07/94→10/01					
 Bremskraftregler							
1.2	33	07/94→10/01				03.6585-0019.3 320239	ATE lastabhängig 8/5 4x
1.4	44	07/94→10/01					
1.4	60	07/94→10/01					
1.4 16V	66	08/99→10/01					
1.7 D	44	07/94→10/01					
VAUXHALL - COMBO Mk II (C) Kasten/Kombi (F25) 09/01→02/12							
 Hauptbremszylinder							
1.3 CDTI 16V	51	09/04→02/12		→ 33999999		24.2122-1740.3 010711	DEL Ø 22,2
1.3 CDTI 16V	55	10/05→11/11					
1.4 i 16V	66	01/04→11/11		43000001→; → 10/11; + ESP; Trommelbremse		24.2122-1757.3 010769	BOS Ø 22,2
1.6	64	10/01→11/11					
1.7 DTI 16V	55	10/01→11/11		43000001→; → 10/11; - ESP; Scheibenbremse		24.2123-1767.3 010844	BOS Ø 23,81
				43000001→; → 10/11; + ESP; Scheibenbremse		24.2123-1768.3 010845	BOS Ø 23,81
1.4 16V	66	10/01→05/07		→ 33999999		24.2122-1740.3 010711	DEL Ø 22,2
				43000001→; + ESP; Trommelbremse		24.2122-1757.3 010769	BOS Ø 22,2
				43000001→; - ESP; Scheibenbremse		24.2123-1767.3 010844	BOS Ø 23,81
				43000001→; + ESP; Scheibenbremse		24.2123-1768.3 010845	BOS Ø 23,81
1.6	62	09/01→10/04		10/01→; → 33999999		24.2122-1740.3 010711	DEL Ø 22,2
				43000001→; + ESP; Trommelbremse		24.2122-1757.3 010769	BOS Ø 22,2
				43000001→; - ESP; Scheibenbremse		24.2123-1767.3 010844	BOS Ø 23,81
				43000001→; + ESP; Scheibenbremse		24.2123-1768.3 010845	BOS Ø 23,81
1.6 CNG 16V	69	06/06→02/12		→ 10/11; + ESP; Trommelbremse		24.2122-1757.3 010769	BOS Ø 22,2
1.6 CNG 16V	71	04/05→02/12		→ 10/11; - ESP; Scheibenbremse		24.2123-1767.3 010844	BOS Ø 23,81
1.7 CDTI 16V	74	12/04→11/11		→ 10/11; + ESP; Scheibenbremse		24.2123-1768.3 010845	BOS Ø 23,81
1.7 DI 16V	48	09/01→11/11		10/01→; → 33999999		24.2122-1740.3 010711	DEL Ø 22,2
				43000001→; → 10/11; + ESP; Trommelbremse		24.2122-1757.3 010769	BOS Ø 22,2
				43000001→; → 10/11; - ESP; Scheibenbremse		24.2123-1767.3 010844	BOS Ø 23,81
				43000001→; → 10/11; + ESP; Scheibenbremse		24.2123-1768.3 010845	BOS Ø 23,81
 Bremskraftregler							
1.3 CDTI 16V	51	09/04→02/12		→ 10/11; - ABS		03.6583-0196.3 320246	ATE lastabhängig 8/3 4x
1.3 CDTI 16V	55	10/05→11/11					
1.4 i 16V	66	01/04→11/11					
1.6	64	10/01→11/11					
1.6 CNG 16V	69	06/06→02/12					
1.6 CNG 16V	71	04/05→02/12					
1.7 CDTI 16V	74	12/04→11/11					
1.7 DTI 16V	55	10/01→11/11					
1.4 16V	66	10/01→05/07		- ABS		03.6583-0196.3 320246	ATE lastabhängig 8/3 4x
1.6	62	09/01→10/04		10/01→; - ABS		03.6583-0196.3 320246	ATE lastabhängig 8/3 4x
1.7 DI 16V	48	09/01→11/11		10/01→ 10/11; - ABS		03.6583-0196.3 320246	ATE lastabhängig 8/3 4x











	kw					! #		
VAUXHALL - COMBO TOUR Mk II (C) (F25) 09/01→02/12								
 Hauptbremszylinder								
1.3 CDTI 16V	51	09/04→09/06		→ 33999999			24.2122-1740.3 010711	DEL Ø 22,2
1.4	66	10/04→09/10		43000001→; + ESP; Trommelbremse			24.2122-1757.3 010769	BOS Ø 22,2
1.6	64	10/01→06/04		43000001→; - ESP; Scheibenbremse			24.2123-1767.3 010844	BOS Ø 23,81
				43000001→; + ESP; Scheibenbremse			24.2123-1768.3 010845	BOS Ø 23,81
1.3 CDTI 16V	55	07/06→02/12		→ 33999999			24.2122-1740.3 010711	DEL Ø 22,2
1.7 DTI 16V	55	10/01→02/12		43000001→; → 10/11; + ESP; Trommelbremse			24.2122-1757.3 010769	BOS Ø 22,2
				43000001→; → 10/11; - ESP; Scheibenbremse			24.2123-1767.3 010844	BOS Ø 23,81
				43000001→; → 10/11; + ESP; Scheibenbremse			24.2123-1768.3 010845	BOS Ø 23,81
1.6 CNG	69	06/06→09/10		+ ESP; Trommelbremse			24.2122-1757.3 010769	BOS Ø 22,2
1.7 CDTI 16V	74	12/04→09/10		- ESP; Scheibenbremse			24.2123-1767.3 010844	BOS Ø 23,81
				+ ESP; Scheibenbremse			24.2123-1768.3 010845	BOS Ø 23,81
1.6 CNG	71	04/05→02/12		→ 10/11; + ESP; Trommelbremse			24.2122-1757.3 010769	BOS Ø 22,2
				→ 10/11; - ESP; Scheibenbremse			24.2123-1767.3 010844	BOS Ø 23,81
				→ 10/11; + ESP; Scheibenbremse			24.2123-1768.3 010845	BOS Ø 23,81
1.7 DI 16V	48	09/01→06/04		10/01→; → 33999999			24.2122-1740.3 010711	DEL Ø 22,2
				43000001→; + ESP; Trommelbremse			24.2122-1757.3 010769	BOS Ø 22,2
				43000001→; - ESP; Scheibenbremse			24.2123-1767.3 010844	BOS Ø 23,81
				43000001→; + ESP; Scheibenbremse			24.2123-1768.3 010845	BOS Ø 23,81
 Bremskraftregler								
1.3 CDTI 16V	51	09/04→09/06		- ABS			03.6583-0196.3 320246	ATE lastabhängig 8/3 4x
1.4	66	10/04→09/10						
1.6	64	10/01→06/04						
1.6 CNG	69	06/06→09/10						
1.7 CDTI 16V	74	12/04→09/10						
1.3 CDTI 16V	55	07/06→02/12		→ 10/11; - ABS			03.6583-0196.3 320246	ATE lastabhängig 8/3 4x
1.6 CNG	71	04/05→02/12						
1.7 DTI 16V	55	10/01→02/12						
1.7 DI 16V	48	09/01→06/04		10/01→; - ABS			03.6583-0196.3 320246	ATE lastabhängig 8/3 4x
VAUXHALL - CORSA Mk I (B) 12/92→09/00								
 Hauptbremszylinder								
1.0 i 12V	40	11/96→09/00		für Linkslenker; - ABS			24.2120-0702.3 010361	Ø 20,64
1.4 i	44	03/93→09/00						
1.4 i 16V	63	08/97→09/00		für Linkslenker; + ABS			24.2120-1714.3 010455	Ø 20,64
1.4 i 16V	66	09/94→09/00						
1.4 i S	60	03/93→09/00						
1.5 TD	49	03/93→10/96						
1.6 i 16V	74	08/97→09/00						
1.6 i 16V	78	09/94→09/00						
1.7 D	44	02/96→09/00						
1.2 i	33	03/93→09/00		04/98→; für Linkslenker; - ABS			24.2120-0702.3 010361	Ø 20,64
				für Linkslenker; - ABS			24.2120-0702.3 010361	Ø 20,64
				für Linkslenker; + ABS			24.2120-1714.3 010455	Ø 20,64
				04/98→; für Linkslenker; + ABS			24.2120-1714.3 010455	Ø 20,64
1.2 i 16V	48	03/98→09/00		04/98→; für Linkslenker; - ABS			24.2120-0702.3 010361	Ø 20,64
				04/98→; für Linkslenker; + ABS			24.2120-1714.3 010455	Ø 20,64
1.5 D	37	12/92→12/96		03/93→; für Linkslenker; - ABS			24.2120-0702.3 010361	Ø 20,64
				03/93→; für Linkslenker; + ABS			24.2120-1714.3 010455	Ø 20,64
1.6 GSI 16V	80	03/93→09/00		09/93→; für Linkslenker; - ABS			24.2120-0702.3 010361	Ø 20,64
				09/93→; für Linkslenker; + ABS			24.2120-1714.3 010455	Ø 20,64
 Bremskraftregler								
1.0 i 12V	40	11/96→09/00					03.0101-0031.2 320211	ATE Satz 3/30 2x
1.2 i	33	03/93→09/00					03.0101-0031.2 320211	ATE Satz 3/30 2x
				04/98→			03.6585-0018.3 320114	ATE lastabhängig 8/5 4x
1.2 i 16V	48	03/98→09/00		04/98→			03.6585-0018.3 320114	ATE lastabhängig 8/5 4x
1.4 i	44	03/93→09/00					03.6585-0018.3 320114	ATE lastabhängig 8/5 4x
1.4 i 16V	63	08/97→09/00						
1.4 i 16V	66	09/94→09/00						
1.4 i S	60	03/93→09/00						
1.5 TD	49	03/93→10/96						
1.6 i 16V	74	08/97→09/00						
1.6 i 16V	78	09/94→09/00						
1.7 D	44	02/96→09/00						
↓								





	kw					! #		
VAUXHALL - CORSA Mk I (B) 12/92→09/00								
 Bremskraftregler								
1.5 D	37	12/92→12/96		03/93→		03.6585-0018.3	320114	ATE lastabhängig 8/5 4x
1.6 GSI 16V	80	03/93→09/00		09/93→		03.6585-0018.3	320114	ATE lastabhängig 8/5 4x
VAUXHALL - CORSA Mk II (C) (W5L, F08) 08/00→10/06								
 Hauptbremszylinder								
1.0 12V	43	09/00→10/03		→ 36999999		24.2122-1740.3	010711	DEL Ø 22,2
1.3 CDTI 16V	55	09/05→09/06		43000001→; + ESP		24.2122-1757.3	010769	BOS Ø 22,2
1.0 12V	44	11/03→10/06		→ 36999999		24.2122-1740.3	010711	DEL Ø 22,2
1.2 16V	55	09/00→10/06		43000001→; + ESP; → 09/06		24.2122-1757.3	010769	BOS Ø 22,2
1.2 16V Dualfuel	55	08/01→10/06						
1.2 Twinport	59	07/04→10/06						
1.3 CDTI 16V	52	08/00→09/06		06/03→; → 36999999		24.2122-1740.3	010711	DEL Ø 22,2
1.7 CDTI 16V	74	08/00→09/06		43000001→; + ESP		24.2122-1757.3	010769	BOS Ø 22,2
1.4 16V	66	09/00→10/06		43000001→; → 09/06; - ESP		24.2123-1767.3	010844	BOS Ø 23,81
1.4 Twinport	66	06/03→10/06		43000001→; → 09/06; + ESP		24.2123-1768.3	010845	BOS Ø 23,81
1.6	62	08/00→10/04		09/01→; → 36999999		24.2122-1740.3	010711	DEL Ø 22,2
				43000001→; + ESP		24.2122-1757.3	010769	BOS Ø 22,2
1.7 DI 16V	48	08/00→09/06		09/00→; → 36999999		24.2122-1740.3	010711	DEL Ø 22,2
1.7 DTI 16V	55	08/00→09/06		43000001→; + ESP		24.2122-1757.3	010769	BOS Ø 22,2
1.8 16V	92	08/00→09/06		43000001→; - ESP		24.2123-1767.3	010844	BOS Ø 23,81
				43000001→; + ESP		24.2123-1768.3	010845	BOS Ø 23,81
 Bremskraftregler								
1.0 12V	43	09/00→10/03		- ABS; M10		03.6043-0964.3	320268	ATE 3/30 2x
				- ABS; M12		03.6043-0974.3	320244	ATE 3/30 2x
1.0 12V	44	11/03→10/06		- ABS; → 09/06; M10		03.6043-0964.3	320268	ATE 3/30 2x
1.2 16V	55	09/00→10/06		- ABS; → 09/06; M12		03.6043-0974.3	320244	ATE 3/30 2x
1.2 16V Dualfuel	55	08/01→10/06						
1.2 Twinport	59	07/04→10/06						
VAUXHALL - CORSA Mk III (D) (L_8) 07/06→08/14								
 Hauptbremszylinder								
1.0	44	11/06→08/14		für Linkslenker; + ESP		24.4122-1705.3	010852	BOS Ø 22,2
1.0 i 12V	48	06/10→08/14						ohne Bremsflüssigkeitsbehälter
1.2	51	06/10→08/14		für Linkslenker; - ESP		24.4122-1709.3	010871	BOS Ø 22,2
1.2	59	11/06→08/14						ohne Bremsflüssigkeitsbehälter
1.2 LPG	59	09/09→08/14						
1.2 LPG	61	06/11→08/14						
1.2 LPG	63	08/11→08/14						
1.3 CDTI	70	06/10→08/14						
1.4	64	09/09→08/14						
1.4	74	07/10→08/14						
1.4 LPG	64	09/09→08/14						
1.2 i 16V	63	11/06→08/14		06/10→; für Linkslenker; + ESP		24.4122-1705.3	010852	BOS Ø 22,2
				06/10→; für Linkslenker; - ESP		24.4122-1709.3	010871	BOS Ø 22,2
								ohne Bremsflüssigkeitsbehälter
1.3 CDTI	55	07/06→08/14		10/06→; für Linkslenker; + ESP		24.4122-1705.3	010852	BOS Ø 22,2
1.3 CDTI	66	07/06→08/14						ohne Bremsflüssigkeitsbehälter
1.4	66	07/06→08/14		10/06→; für Linkslenker; - ESP		24.4122-1709.3	010871	BOS Ø 22,2
1.4 LPG	66	07/06→08/14						ohne Bremsflüssigkeitsbehälter
VAUXHALL - CORSAVAN Mk I (B) 01/94→09/00								
 Hauptbremszylinder								
1.4 i	44	01/94→09/00		für Linkslenker; - ABS		24.2120-0702.3	010361	Ø 20,64
1.5 D	37	08/94→12/95		für Linkslenker; + ABS		24.2120-1714.3	010455	Ø 20,64
1.7 D	44	01/94→09/00						
 Bremskraftregler								
1.4 i	44	01/94→09/00				03.6585-0018.3	320114	ATE lastabhängig 8/5 4x
1.5 D	37	08/94→12/95						
1.7 D	44	01/94→09/00						
VAUXHALL - CORSAVAN Mk II (C) 09/00→06/06								
 Hauptbremszylinder								
1.2 16V	55	09/00→06/06		→ 36999999		24.2122-1740.3	010711	DEL Ø 22,2
1.2 16V Dualfuel	55	08/01→06/06		43000001→; + ESP		24.2122-1757.3	010769	BOS Ø 22,2
1.3 CDTI 16V	52	04/04→06/06						
1.7 DI 16V	48	09/00→06/06						
1.7 DTI 16V	55	09/00→06/06						















	kw					! #		
VAUXHALL - CORSAVAN Mk II (C) 09/00→06/06								
 Hauptbremszylinder								
1.4	66	11/03→06/06		43000001→; - ESP		24.2123-1767.3	010844	BOS Ø 23,81
				43000001→; + ESP		24.2123-1768.3	010845	BOS Ø 23,81
 Bremskraftregler								
1.2 16V	55	09/00→06/06		- ABS; M10		03.6043-0964.3	320268	ATE 3/30 2x
1.2 16V Dualfuel	55	08/01→06/06		- ABS; M12		03.6043-0974.3	320244	ATE 3/30 2x
VAUXHALL - CORSAVAN Mk III (D) 07/06→								
 Hauptbremszylinder								
1.2	51	01/10→		06/10→; für Linkslenker; + ESP		24.4122-1705.3	010852	BOS Ø 22,2 ohne Bremsflüssigkeitsbehälter
1.3 CDTI	70	07/06→		06/10→; für Linkslenker; - ESP		24.4122-1709.3	010871	BOS Ø 22,2 ohne Bremsflüssigkeitsbehälter
1.2	59	07/09→		für Linkslenker; + ESP		24.4122-1705.3	010852	BOS Ø 22,2 ohne Bremsflüssigkeitsbehälter
				für Linkslenker; - ESP		24.4122-1709.3	010871	BOS Ø 22,2 ohne Bremsflüssigkeitsbehälter
1.3 CDTI	55	07/06→		10/06→; für Linkslenker; + ESP		24.4122-1705.3	010852	BOS Ø 22,2 ohne Bremsflüssigkeitsbehälter
1.3 CDTI	66	07/06→		10/06→; für Linkslenker; - ESP		24.4122-1709.3	010871	BOS Ø 22,2 ohne Bremsflüssigkeitsbehälter
VAUXHALL - FRONTERA Mk I (A) 09/91→10/98								
 Hauptbremszylinder								
2.0	85	04/95→08/98		→ PV561117; für Rechtslenker		03.2120-1981.3	010105	DEL Ø 20,64
2.2 i	100	03/95→10/98		→ PV561270; für Linkslenker		03.2120-1981.3	010105	DEL Ø 20,64
2.3 TD	74	09/91→06/98		03/92→; → PV561398; für Linkslenker		03.2120-1981.3	010105	DEL Ø 20,64
				03/92→; → PV563935; für Rechtslenker		03.2120-1981.3	010105	DEL Ø 20,64
2.4 i	92	03/92→10/98		→ PV567152; für Rechtslenker		03.2120-1981.3	010105	DEL Ø 20,64
				→ PV560157; für Linkslenker		03.2120-1981.3	010105	DEL Ø 20,64
2.5 TDS	85	11/91→06/98		09/96→; → PV567152; für Rechtslenker		03.2120-1981.3	010105	DEL Ø 20,64
				09/96→; → PV560157; für Linkslenker		03.2120-1981.3	010105	DEL Ø 20,64
2.8 TD	83	01/95→12/96		03/95→; → PV560157; für Linkslenker		03.2120-1981.3	010105	DEL Ø 20,64
				03/95→; → PV567152; für Rechtslenker		03.2120-1981.3	010105	DEL Ø 20,64
VAUXHALL - FRONTERA Mk I (A) Sport 03/92→10/98								
 Hauptbremszylinder								
2.0 i	85	03/92→10/98		→ PV561117; für Rechtslenker		03.2120-1981.3	010105	DEL Ø 20,64
				→ PV561270; für Linkslenker		03.2120-1981.3	010105	DEL Ø 20,64
2.5 TDS	85	09/96→10/98		→ PV567152; für Rechtslenker		03.2120-1981.3	010105	DEL Ø 20,64
				→ PV560157; für Linkslenker		03.2120-1981.3	010105	DEL Ø 20,64
2.8 TD	83	01/95→12/96		03/95→; → PV560157; für Linkslenker		03.2120-1981.3	010105	DEL Ø 20,64
				03/95→; → PV567152; für Rechtslenker		03.2120-1981.3	010105	DEL Ø 20,64
VAUXHALL - INSIGNIA Mk I (A) 07/08→05/17								
 Bremskraftverstärker								
1.4	103	04/11→05/17		06/11→; für Linkslenker		03.7858-0732.4	300272	ATE Ø 9 / 8" pneumatisch
1.4 LPG	103	07/12→05/17		für Linkslenker		03.7858-0732.4	300272	ATE Ø 9 / 8" pneumatisch
1.6	85	07/08→05/17						
1.6 CDTI	100	07/15→05/17						
1.6 Turbo	125	07/13→05/17						
1.6 Turbo	132	01/09→05/17						
1.8	103	07/08→05/17						
2.0 Biturbo CDTI	143	03/12→05/17						
2.0 Biturbo CDTI 4x4	143	03/12→05/17						
2.0 CDTI	81	07/08→05/17						
2.0 CDTI	96	07/08→12/14						
2.0 CDTI	103	07/13→05/17						
2.0 CDTI	118	07/08→05/17						
2.0 CDTI	120	07/13→05/17						
2.0 CDTI	125	11/14→05/17						
2.0 CDTI	140	10/08→05/17						
2.0 CDTI 4x4	120	07/13→05/17						
2.0 CDTI 4x4	125	11/14→05/17						
2.0 CDTI 4x4	140	05/09→05/17						
2.0 Turbo	162	07/08→05/17						
2.0 Turbo	184	04/14→05/17						
2.0 Turbo 4x4	162	07/08→05/17						
↓								











	kw			 	! #		
VAUXHALL - INSIGNIA Mk I (A) 07/08→05/17							
 Bremskraftverstärker							
2.0 Turbo 4x4	184	09/11→05/17		für Linkslenker		03.7858-0732.4 300272	ATE Ø 9 / 8" pneumatisch
2.0 CDTI	88	03/12→03/16		03/13→; für Linkslenker		03.7858-0732.4 300272	ATE Ø 9 / 8" pneumatisch
2.0 CDTI 4x4	118	07/08→05/17		06/10→; für Linkslenker		03.7858-0732.4 300272	ATE Ø 9 / 8" pneumatisch
 Hauptbremszylinder							
1.4	103	04/11→05/17		06/11→; für Linkslenker		03.2125-0421.3 010934	ATE Ø 25,4
1.4 LPG	103	07/12→05/17		für Linkslenker		03.2125-0421.3 010934	ATE Ø 25,4
1.6	85	07/08→05/17					
1.6 CDTI	100	07/15→05/17					
1.6 Turbo	125	07/13→05/17					
1.6 Turbo	132	01/09→05/17					
1.8	103	07/08→05/17					
2.0 Biturbo CDTI	143	03/12→05/17					
2.0 Biturbo CDTI 4x4	143	03/12→05/17					
2.0 CDTI	81	07/08→05/17					
2.0 CDTI	96	07/08→12/14					
2.0 CDTI	103	07/13→05/17					
2.0 CDTI	118	07/08→05/17					
2.0 CDTI	120	07/13→05/17					
2.0 CDTI	125	11/14→05/17					
2.0 CDTI	140	10/08→05/17					
2.0 CDTI 4x4	120	07/13→05/17					
2.0 CDTI 4x4	125	11/14→05/17					
2.0 CDTI 4x4	140	05/09→05/17					
2.0 Turbo	162	07/08→05/17					
2.0 Turbo	184	04/14→05/17					
2.0 Turbo 4x4	162	07/08→05/17					
2.0 Turbo 4x4	184	09/11→05/17					
2.8 V6 Turbo 4x4	191	07/08→05/17					
2.8 VXR	239	07/09→05/17					
2.0 CDTI	88	03/12→03/16		03/13→; für Linkslenker		03.2125-0421.3 010934	ATE Ø 25,4
2.0 CDTI 4x4	118	07/08→05/17		06/10→; für Linkslenker		03.2125-0421.3 010934	ATE Ø 25,4
VAUXHALL - INSIGNIA Mk I (A) Estate 07/08→05/17							
 Bremskraftverstärker							
1.4	103	04/11→05/17		06/11→; für Linkslenker		03.7858-0732.4 300272	ATE Ø 9 / 8" pneumatisch
1.4 LPG	103	07/12→05/17		für Linkslenker		03.7858-0732.4 300272	ATE Ø 9 / 8" pneumatisch
1.6	85	07/08→05/17					
1.6 CDTI	100	07/15→05/17					
1.6 Turbo	125	07/13→05/17					
1.6 Turbo	132	01/09→05/17					
1.8	103	07/08→05/17					
2.0 Biturbo CDTI	143	03/12→05/17					
2.0 Biturbo CDTI 4x4	143	03/12→05/17					
2.0 CDTI	81	07/08→05/17					
2.0 CDTI	96	07/08→12/14					
2.0 CDTI	103	07/13→05/17					
2.0 CDTI	118	07/08→05/17					
2.0 CDTI	120	07/13→05/17					
2.0 CDTI	125	11/14→05/17					
2.0 CDTI	140	11/08→05/17					
2.0 CDTI 4x4	120	07/13→05/17					
2.0 CDTI 4x4	125	11/14→05/17					
2.0 CDTI 4x4	140	05/09→05/17					
2.0 Turbo	162	07/08→05/17					
2.0 Turbo	184	04/14→05/17					
2.0 Turbo 4x4	162	07/08→05/17					
2.0 Turbo 4x4	184	09/11→05/17					
2.0 CDTI	88	03/12→03/16		03/13→; für Linkslenker		03.7858-0732.4 300272	ATE Ø 9 / 8" pneumatisch
2.0 CDTI 4x4	118	07/08→05/17		06/10→; für Linkslenker		03.7858-0732.4 300272	ATE Ø 9 / 8" pneumatisch
 Hauptbremszylinder							
1.4	103	04/11→05/17		06/11→; für Linkslenker		03.2125-0421.3 010934	ATE Ø 25,4
1.4 LPG	103	07/12→05/17		für Linkslenker		03.2125-0421.3 010934	ATE Ø 25,4
1.6	85	07/08→05/17					
1.6 CDTI	100	07/15→05/17					
1.6 Turbo	125	07/13→05/17					
1.6 Turbo	132	01/09→05/17					
1.8	103	07/08→05/17					
2.0 Biturbo CDTI	143	03/12→05/17					
2.0 Biturbo CDTI 4x4	143	03/12→05/17					
2.0 CDTI	81	07/08→05/17					
2.0 CDTI	96	07/08→12/14					
2.0 CDTI	103	07/13→05/17					
2.0 CDTI	118	07/08→05/17					
2.0 CDTI	120	07/13→05/17					
2.0 CDTI	125	11/14→05/17					
↓							

	kW					! #		
VAUXHALL - INSIGNIA Mk I (A) Estate 07/08→05/17								
 Hauptbremszylinder								
2.0 CDTI	140	11/08→05/17		für Linkslenker			03.2125-0421.3 010934	ATE Ø 25,4
2.0 CDTI 4x4	120	07/13→05/17						
2.0 CDTI 4x4	125	11/14→05/17						
2.0 CDTI 4x4	140	05/09→05/17						
2.0 Turbo	162	07/08→05/17						
2.0 Turbo	184	04/14→05/17						
2.0 Turbo 4x4	162	07/08→05/17						
2.0 Turbo 4x4	184	09/11→05/17						
2.8 V6 Turbo	191	08/08→05/17						
2.8 VXR	239	07/09→05/17						
2.0 CDTI	88	03/12→03/16		03/13→; für Linkslenker			03.2125-0421.3 010934	ATE Ø 25,4
2.0 CDTI 4x4	118	07/08→05/17		06/10→; für Linkslenker			03.2125-0421.3 010934	ATE Ø 25,4
VAUXHALL - INSIGNIA Mk I (A) Sedan 07/08→05/17								
 Bremskraftverstärker								
1.4	103	04/11→05/17		06/11→; für Linkslenker			03.7858-0732.4 300272	ATE Ø 9 / 8" pneumatisch
1.4 LPG	103	07/12→05/17		für Linkslenker			03.7858-0732.4 300272	ATE Ø 9 / 8" pneumatisch
1.6	85	07/08→05/17						
1.6 Turbo	125	07/13→05/17						
1.6 Turbo	132	01/09→05/17						
1.8	103	07/08→05/17						
2.0 Biturbo CDTI	143	03/12→05/17						
2.0 Biturbo CDTI 4x4	143	03/12→05/17						
2.0 CDTI	81	07/08→05/17						
2.0 CDTI	96	07/08→12/14						
2.0 CDTI	103	07/13→05/17						
2.0 CDTI	118	07/08→05/17						
2.0 CDTI	120	07/13→05/17						
2.0 CDTI	125	11/14→05/17						
2.0 CDTI	140	11/08→05/17						
2.0 CDTI 4x4	120	07/13→05/17						
2.0 CDTI 4x4	125	11/14→05/17						
2.0 CDTI 4x4	140	05/09→05/17						
2.0 Turbo	162	07/08→05/17						
2.0 Turbo 4x4	162	07/08→05/17						
2.0 Turbo 4x4	184	09/11→05/17						
2.0 CDTI	88	03/12→12/14		03/13→; für Linkslenker			03.7858-0732.4 300272	ATE Ø 9 / 8" pneumatisch
2.0 CDTI 4x4	118	07/08→05/17		06/10→; für Linkslenker			03.7858-0732.4 300272	ATE Ø 9 / 8" pneumatisch
2.0 Turbo	184	09/11→05/17		04/14→; für Linkslenker			03.7858-0732.4 300272	ATE Ø 9 / 8" pneumatisch
 Hauptbremszylinder								
1.4	103	04/11→05/17		06/11→; für Linkslenker			03.2125-0421.3 010934	ATE Ø 25,4
1.4 LPG	103	07/12→05/17		für Linkslenker			03.2125-0421.3 010934	ATE Ø 25,4
1.6	85	07/08→05/17						
1.6 Turbo	125	07/13→05/17						
1.6 Turbo	132	01/09→05/17						
1.8	103	07/08→05/17						
2.0 Biturbo CDTI	143	03/12→05/17						
2.0 Biturbo CDTI 4x4	143	03/12→05/17						
2.0 CDTI	81	07/08→05/17						
2.0 CDTI	96	07/08→12/14						
2.0 CDTI	103	07/13→05/17						
2.0 CDTI	118	07/08→05/17						
2.0 CDTI	120	07/13→05/17						
2.0 CDTI	125	11/14→05/17						
2.0 CDTI	140	11/08→05/17						
2.0 CDTI 4x4	120	07/13→05/17						
2.0 CDTI 4x4	125	11/14→05/17						
2.0 CDTI 4x4	140	05/09→05/17						
2.0 Turbo	162	07/08→05/17						
2.0 Turbo 4x4	162	07/08→05/17						
2.0 Turbo 4x4	184	09/11→05/17						
2.8 V6 Turbo 4x4	191	07/08→05/17						
2.8 VXR	239	07/09→05/17						
2.0 CDTI	88	03/12→12/14		03/13→; für Linkslenker			03.2125-0421.3 010934	ATE Ø 25,4
2.0 CDTI 4x4	118	07/08→05/17		06/10→; für Linkslenker			03.2125-0421.3 010934	ATE Ø 25,4
2.0 Turbo	184	09/11→05/17		04/14→; für Linkslenker			03.2125-0421.3 010934	ATE Ø 25,4
VAUXHALL - MERIVA Mk I (A) 01/03→06/10								
 Hauptbremszylinder								
1.3 CDTI	51	04/05→06/10		→ 44999999; - ESP			24.2123-1764.3 010824	TRW Ø 23,81
1.6 Turbo	132	05/06→06/10						
1.7 CDTI	74	09/03→06/10		74237192→; → 05/10; - ESP			24.4123-1716.3 010984	TRW Ø 23,81 ohne Bremsflüssigkeitsbehälter
1.7 DTI	55	06/03→06/10						
1.8 i 16V	92	05/03→06/10		74237192→; → 05/10; + ESP			24.4123-1717.3 010985	TRW Ø 23,81 ohne Bremsflüssigkeitsbehälter
↓								

	kw			 	! #		
VAUXHALL - MERIVA Mk I (A) 01/03→06/10							
 Hauptbremszylinder							
1.3 CDTI	55	01/03→10/09		09/03→; → 44999999; - ESP		24.2123-1764.3 010824	TRW Ø 23,81
				74237192→; - ESP		24.4123-1716.3 010984	TRW Ø 23,81 ohne Bremsflüssigkeitsbehälter
				74237192→; + ESP		24.4123-1717.3 010985	TRW Ø 23,81 ohne Bremsflüssigkeitsbehälter
1.4 16V Twinport	66	01/03→06/10		07/04→; → 44999999; - ESP		24.2123-1764.3 010824	TRW Ø 23,81
				74237192→; → 05/10; - ESP		24.4123-1716.3 010984	TRW Ø 23,81 ohne Bremsflüssigkeitsbehälter
				74237192→; → 05/10; + ESP		24.4123-1717.3 010985	TRW Ø 23,81 ohne Bremsflüssigkeitsbehälter
1.6 i	64	01/03→06/10		05/03→; → 44999999; - ESP		24.2123-1764.3 010824	TRW Ø 23,81
				74237192→; → 05/10; - ESP		24.4123-1716.3 010984	TRW Ø 23,81 ohne Bremsflüssigkeitsbehälter
				74237192→; → 05/10; + ESP		24.4123-1717.3 010985	TRW Ø 23,81 ohne Bremsflüssigkeitsbehälter
1.6 i 16V	74	01/03→09/05		05/03→; → 44999999; - ESP		24.2123-1764.3 010824	TRW Ø 23,81
				74237192→; - ESP		24.4123-1716.3 010984	TRW Ø 23,81 ohne Bremsflüssigkeitsbehälter
				74237192→; + ESP		24.4123-1717.3 010985	TRW Ø 23,81 ohne Bremsflüssigkeitsbehälter
1.6 i 16V Twinport	77	05/03→06/10		01/06→; → 44999999; - ESP		24.2123-1764.3 010824	TRW Ø 23,81
				74237192→; → 05/10; - ESP		24.4123-1716.3 010984	TRW Ø 23,81 ohne Bremsflüssigkeitsbehälter
				74237192→; → 05/10; + ESP		24.4123-1717.3 010985	TRW Ø 23,81 ohne Bremsflüssigkeitsbehälter
1.7 CDTI	92	08/06→05/10		09/06→; → 44999999; - ESP		24.2123-1764.3 010824	TRW Ø 23,81
				74237192→; - ESP		24.4123-1716.3 010984	TRW Ø 23,81 ohne Bremsflüssigkeitsbehälter
				74237192→; + ESP		24.4123-1717.3 010985	TRW Ø 23,81 ohne Bremsflüssigkeitsbehälter
 Bremskraftregler							
1.3 CDTI	51	04/05→06/10		→ 05/10; - ABS		03.6583-0102.3 320280	ATE lastabhängig 8/3 4x
1.7 CDTI	74	09/03→06/10					
1.7 DTI	55	06/03→06/10					
1.8 i 16V	92	05/03→06/10					
1.3 CDTI	55	01/03→10/09		09/03→; - ABS		03.6583-0102.3 320280	ATE lastabhängig 8/3 4x
1.4 16V Twinport	66	01/03→06/10		07/04→ 05/10; - ABS		03.6583-0102.3 320280	ATE lastabhängig 8/3 4x
1.6 i	64	01/03→06/10		05/03→ 05/10; - ABS		03.6583-0102.3 320280	ATE lastabhängig 8/3 4x
1.6 i 16V	74	01/03→09/05		05/03→; - ABS		03.6583-0102.3 320280	ATE lastabhängig 8/3 4x
1.6 i 16V Twinport	77	05/03→06/10		01/06→ 05/10; - ABS		03.6583-0102.3 320280	ATE lastabhängig 8/3 4x
1.7 CDTI	92	08/06→05/10		09/06→; - ABS		03.6583-0102.3 320280	ATE lastabhängig 8/3 4x
VAUXHALL - MERIVA Mk II (B) 06/10→							
 Hauptbremszylinder							
1.3 CDTi	70	06/10→		für Linkslenker; - ESP		24.4125-1705.3 010972	TRW Ø 25,4
1.3 CDTI	55	06/10→		für Linkslenker; + ESP		24.4125-1706.3 010973	TRW Ø 25,4
1.4	74	06/10→					
1.4	88	06/10→					
1.4	103	06/10→					
1.4 LPG	88	06/11→					
1.7 CDTi	81	06/10→					
1.7 CDTi	96	06/10→					
1.7 CDTI	74	06/10→					
1.6 CDTi	81	07/14→		für Linkslenker; - ESP		24.4125-1705.3 010972	TRW Ø 25,4
1.6 CDTi	100	08/13→					
1.6 CDTI	70	01/14→		03/14→; für Linkslenker; - ESP		24.4125-1705.3 010972	TRW Ø 25,4
VAUXHALL - MOVANO Mk I (A) Chassis/Cab (ED, UD, HD) 10/98→05/10							
 Hauptbremszylinder							
2.2 DTI	66	09/00→05/10		→ 08/03; + ABS		24.2025-1706.3 010676	Ø 25,4
2.5 DTI	84	10/01→05/10		→ 01/10; - ABS		24.2025-1708.3 010692	Ø 25,4
				09/03→; + ABS; → 08/06		24.2123-1759.3 010768	BOS Ø 23,81
2.5 D	59	10/98→08/02		→ 09/00; + ABS		24.2025-1706.3 010676	Ø 25,4
				→ 09/00; - ABS		24.2025-1708.3 010692	Ø 25,4
2.8 DTI	84	10/98→10/01		+ ABS		24.2025-1706.3 010676	Ø 25,4
				- ABS		24.2025-1708.3 010692	Ø 25,4
3.0 DTi	100	10/03→05/10		→ 01/10; - ABS		24.2025-1708.3 010692	Ø 25,4
↓							

	kw					! #		
VAUXHALL - MOVANO Mk I (A) Chassis/Cab (ED, UD, HD) 10/98→05/10								
 Hauptbremszylinder								
3.0 DTi	100	10/03→05/10		→ 08/06; + ABS		24.2123-1759.3	010678	BOS Ø 23,81
VAUXHALL - MOVANO Mk I (A) Combi (JD) 10/98→05/10								
 Hauptbremszylinder								
1.9 DTI	59	09/00→10/01		+ ABS		24.2025-1706.3	010676	Ø 25,4
2.5 D	59	10/98→09/00		- ABS		24.2025-1708.3	010692	Ø 25,4
2.8 DTI	84	10/98→10/01						
1.9 DTI	60	10/01→05/10		→ 08/03; + ABS		24.2025-1706.3	010676	Ø 25,4
2.2 DTI	66	09/00→05/10		→ 01/10; - ABS		24.2025-1708.3	010692	Ø 25,4
				09/03→; + ABS; → 08/06		24.2123-1759.3	010768	BOS Ø 23,81
2.5 DTI	84	10/01→08/09		→ 08/03; + ABS		24.2025-1706.3	010676	Ø 25,4
				- ABS		24.2025-1708.3	010692	Ø 25,4
				09/03→; + ABS; → 08/06		24.2123-1759.3	010768	BOS Ø 23,81
3.0 DTi	100	10/03→05/10		→ 01/10; - ABS		24.2025-1708.3	010692	Ø 25,4
				→ 08/06; + ABS		24.2123-1759.3	010768	BOS Ø 23,81
VAUXHALL - MOVANO Mk I (A) Van (FD) 10/98→05/10								
 Hauptbremszylinder								
1.9 DTI	59	09/00→10/01		+ ABS		24.2025-1706.3	010676	Ø 25,4
2.5 D	59	10/98→09/00		- ABS		24.2025-1708.3	010692	Ø 25,4
2.8 TDI	84	10/98→10/01						
1.9 DTI	60	10/01→05/10		→ 08/03; + ABS		24.2025-1706.3	010676	Ø 25,4
2.2 DTI	66	09/00→05/10		→ 01/10; - ABS		24.2025-1708.3	010692	Ø 25,4
2.5 DTI	84	10/01→05/10		09/03→; + ABS; → 08/06		24.2123-1759.3	010768	BOS Ø 23,81
3.0 DTi	100	10/03→05/10		→ 01/10; - ABS		24.2025-1708.3	010692	Ø 25,4
				→ 08/06; + ABS		24.2123-1759.3	010768	BOS Ø 23,81
VAUXHALL - OMEGA (B) 12/93→07/03								
 Hauptbremszylinder								
2.0	85	03/94→09/99		→ V1999999; für Linkslenker; nicht für Polizeifahrzeuge		24.2123-1740.3	010662	Ø 23,81
2.0	85	09/95→09/96		W1000001→; für Linkslenker; + ESP		24.2125-1740.3	010971	TRW Ø 25,4
2.0 16V	100	03/94→07/01		→ V1999999; für Linkslenker; nicht für Polizeifahrzeuge		24.2123-1740.3	010662	Ø 23,81
				W1000001→; → 09/99; für Linkslenker; + ESP		24.2125-1740.3	010971	TRW Ø 25,4
2.0 DTI 16V	74	01/98→09/00		→ 08/00; für Linkslenker; + ESP		24.2125-1740.3	010971	TRW Ø 25,4
2.2 16V	106	01/94→06/03		10/99→; für Linkslenker; + ESP		24.2125-1740.3	010971	TRW Ø 25,4
2.2 DTI 16V	88	08/00→07/03		09/00→; für Linkslenker; + ESP		24.2125-1740.3	010971	TRW Ø 25,4
2.5 DTI 24V	110	09/01→07/03		für Linkslenker; + ESP		24.2125-1740.3	010971	TRW Ø 25,4
2.5 TD	96	04/94→07/01		W1000001→; für Linkslenker; + ESP		24.2125-1740.3	010971	TRW Ø 25,4
2.5 V6	125	03/94→09/00		W1000001→; für Linkslenker; nicht für Sonderfahrzeuge; + ESP		24.2125-1740.3	010971	TRW Ø 25,4
3.0 V6	155	04/94→07/00						
2.6 V6	132	08/00→07/03		09/00→; für Linkslenker; nicht für Sonderfahrzeuge; + ESP		24.2125-1740.3	010971	TRW Ø 25,4
3.2 V6	160	02/01→07/03		für Linkslenker; nicht für Sonderfahrzeuge; + ESP		24.2125-1740.3	010971	TRW Ø 25,4
VAUXHALL - OMEGA (B) Estate 12/93→06/03								
 Hauptbremszylinder								
2.0	85	03/94→09/99		→ V1999999; für Linkslenker; nicht für Polizeifahrzeuge		24.2123-1740.3	010662	Ø 23,81
				W1000001→; für Linkslenker; + ESP		24.2125-1740.3	010971	TRW Ø 25,4
2.0 16V	100	03/94→07/01		→ V1999999; für Linkslenker; nicht für Polizeifahrzeuge		24.2123-1740.3	010662	Ø 23,81
				W1000001→; → 09/99; für Linkslenker; + ESP		24.2125-1740.3	010971	TRW Ø 25,4
2.0 DTI 16V	74	01/98→09/00		→ 08/00; für Linkslenker; + ESP		24.2125-1740.3	010971	TRW Ø 25,4
2.2 16V	106	02/94→06/03		10/99→; für Linkslenker; + ESP		24.2125-1740.3	010971	TRW Ø 25,4
2.2 DTI 16V	88	08/00→06/03		09/00→; für Linkslenker; + ESP		24.2125-1740.3	010971	TRW Ø 25,4
2.5 DTI 24V	110	09/01→06/03		für Linkslenker; + ESP		24.2125-1740.3	010971	TRW Ø 25,4
2.5 TD	96	04/94→07/01		W1000001→; für Linkslenker; + ESP		24.2125-1740.3	010971	TRW Ø 25,4
2.5 V6	125	03/94→09/00		W1000001→; für Linkslenker; nicht für Sonderfahrzeuge; + ESP		24.2125-1740.3	010971	TRW Ø 25,4
3.0 V6	155	07/94→07/00						
2.6 V6	132	08/00→06/03		09/00→; für Linkslenker; nicht für Sonderfahrzeuge; + ESP		24.2125-1740.3	010971	TRW Ø 25,4
↓								

	kw					! #		
VAUXHALL - OMEGA (B) Estate 12/93→06/03								
 Hauptbremszylinder								
3.2 V6	160	02/01→06/03		für Linkslenker; nicht für Sonderfahrzeuge; + ESP		24.2125-1740.3	010971	TRW Ø 25,4
VAUXHALL - SIGNUM 03/03→10/08								
 Hauptbremszylinder								
1.8	90	06/03→07/05		für Linkslenker; + ESP		24.2125-1732.3	010827	TRW Ø 25,4
1.9 CDTi	88	04/04→03/08						
1.9 CDTi 16V	110	04/04→03/08						
1.9 Turbo	74	01/05→05/08						
2.0 DTi	74	05/03→05/08						
2.2 DTi	92	05/03→05/08						
2.2 i	114	05/03→05/08						
3.0 CDTi	130	05/03→05/08						
3.2 V6	155	05/03→05/08						
1.8	103	08/05→05/08		09/05→; für Linkslenker; + ESP		24.2125-1732.3	010827	TRW Ø 25,4
2.0 i Turbo	129	03/03→10/08		05/03→; für Linkslenker; → 05/08; + ESP		24.2125-1732.3	010827	TRW Ø 25,4
3.0 V6 CDTi	135	07/05→06/08		09/05→ 05/08; für Linkslenker; + ESP		24.2125-1732.3	010827	TRW Ø 25,4
VAUXHALL - TIGRA Mk I (F07) 07/94→12/00								
 Hauptbremszylinder								
1.4 16V	66	07/94→12/00		für Linkslenker; - ABS		24.2120-0702.3	010361	Ø 20,64
				für Linkslenker; + ABS		24.2120-1714.3	010455	Ø 20,64
1.6 16V	78	07/94→12/00		→ 08/98; für Linkslenker; - ABS		24.2120-0702.3	010361	Ø 20,64
				→ 08/98; für Linkslenker; + ABS		24.2120-1714.3	010455	Ø 20,64
 Bremskraftregler								
1.4 16V	66	07/94→12/00				03.6585-0018.3	320114	ATE lastabhängig 8/5 4x
1.6 16V	78	07/94→12/00		→ 08/98		03.6585-0018.3	320114	ATE lastabhängig 8/5 4x
VAUXHALL - TIGRA TwinTop 06/04→08/09								
 Hauptbremszylinder								
1.3 CDTi	51	06/04→08/09		- ESP		24.2123-1767.3	010844	BOS Ø 23,81
1.4	66	06/04→08/09		+ ESP		24.2123-1768.3	010845	BOS Ø 23,81
1.8	92	06/04→08/09						
VAUXHALL - VECTRA (B) 08/95→03/02								
 Bremskraftverstärker								
2.0 i 16V	100	10/95→01/01		für Linkslenker; → W1285446		03.7745-3003.4	300157	ATE Ø 8 / 7" pneumatisch
2.5 i GSi	143	03/98→07/00		für Linkslenker		03.7745-3003.4	300157	ATE Ø 8 / 7" pneumatisch
2.5 i V6	125	09/95→08/00						
2.6 i V6	125	09/00→03/02						
 Hauptbremszylinder								
1.6 i	55	08/95→10/01		09/95→; → W5999999; für Rechtslenker		24.2122-1724.3	010561	Ø 22,2
1.6 i 16V	74	08/95→10/01		09/95→; → V7999999; für Linkslenker		24.2122-1724.3	010561	Ø 22,2
				09/95→; → W1999999; für Rechtslenker		24.2122-1724.3	010561	Ø 22,2
				09/95→; → W7999999; für Rechtslenker		24.2122-1724.3	010561	Ø 22,2
				09/95→; → V1999999; für Linkslenker		24.2122-1724.3	010561	Ø 22,2
				09/95→; → V5999999; für Linkslenker		24.2122-1724.3	010561	Ø 22,2
				W1000001→ W1999999; für Linkslenker		24.2123-1777.3	010943	Ø 23,81
				W7000001→ W7999999; für Linkslenker		24.2123-1777.3	010943	Ø 23,81
				W5000001→ W5999999; für Linkslenker		24.2123-1777.3	010943	Ø 23,81
1.7 TD	60	10/95→11/96				24.2122-1724.3	010561	Ø 22,2
1.8 Dualfuel	92	09/00→03/02		→ W5999999; für Rechtslenker		24.2122-1724.3	010561	Ø 22,2
1.8 i 16V	85	10/95→09/00		→ V5999999; für Linkslenker		24.2122-1724.3	010561	Ø 22,2
1.8 i 16V	92	09/00→03/02		→ V7999999; für Linkslenker		24.2122-1724.3	010561	Ø 22,2
				→ W7999999; für Rechtslenker		24.2122-1724.3	010561	Ø 22,2
				→ V1999999; für Linkslenker		24.2122-1724.3	010561	Ø 22,2
				→ W1999999; für Rechtslenker		24.2122-1724.3	010561	Ø 22,2
				W1000001→ W1999999; für Linkslenker		24.2123-1777.3	010943	Ø 23,81
				W5000001→ W5999999; für Linkslenker		24.2123-1777.3	010943	Ø 23,81
				W7000001→ W7999999; für Linkslenker		24.2123-1777.3	010943	Ø 23,81
2.0 DI 16V	60	08/95→10/01		11/96→; → W5999999; für Rechtslenker		24.2122-1724.3	010561	Ø 22,2
				11/96→; → W1999999; für Rechtslenker		24.2122-1724.3	010561	Ø 22,2
				11/96→; → V7999999; für Linkslenker		24.2122-1724.3	010561	Ø 22,2
↓								

	kw			 	! #				
VAUXHALL - VECTRA (B) 08/95→03/02									
 Hauptbremszylinder									
2.0 DI 16V	60	08/95→10/01		11/96→; → V1999999; für Linkslenker	24.2122-1724.3	010561	Ø 22,2		
				11/96→; → W7999999; für Rechtslenker	24.2122-1724.3	010561	Ø 22,2		
				11/96→; → V5999999; für Linkslenker	24.2122-1724.3	010561	Ø 22,2		
				W1000001→ W1999999; für Linkslenker	24.2123-1777.3	010943	Ø 23,81		
				W7000001→ W7999999; für Linkslenker	24.2123-1777.3	010943	Ø 23,81		
				W5000001→ W5999999; für Linkslenker	24.2123-1777.3	010943	Ø 23,81		
2.0 DTI 16V	74	08/95→10/01		06/97→; → V5999999; für Linkslenker	24.2122-1724.3	010561	Ø 22,2		
				06/97→; → V1999999; für Linkslenker	24.2122-1724.3	010561	Ø 22,2		
				06/97→; → W5999999; für Rechtslenker	24.2122-1724.3	010561	Ø 22,2		
				06/97→; → W7999999; für Rechtslenker	24.2122-1724.3	010561	Ø 22,2		
				06/97→; → W1999999; für Rechtslenker	24.2122-1724.3	010561	Ø 22,2		
				06/97→; → V7999999; für Linkslenker	24.2122-1724.3	010561	Ø 22,2		
				W7000001→ W7999999; für Linkslenker	24.2123-1777.3	010943	Ø 23,81		
				W1000001→ W1999999; für Linkslenker	24.2123-1777.3	010943	Ø 23,81		
2.0 i 16V	100	10/95→01/01		→ W1285446; für Linkslenker	03.2123-1622.3	010470	Ø 23,81		
				→ W7154258; für Linkslenker	03.2123-1622.3	010470	Ø 23,81		
				→ W5276825; für Linkslenker	03.2123-1622.3	010470	Ø 23,81		
				→ W7154258; für Rechtslenker	03.2123-1722.3	010471	Ø 23,81		
				→ W1285446; für Rechtslenker	03.2123-1722.3	010471	Ø 23,81		
				→ W5276825; für Rechtslenker	03.2123-1722.3	010471	Ø 23,81		
				W5276826→; für Rechtslenker	03.2125-7502.3	010616	ATE Ø 25,4		
				W7154259→; für Rechtslenker	03.2125-7502.3	010616	ATE Ø 25,4		
2.2 i 16V	108	08/95→10/01		09/00→; für Rechtslenker	03.2125-7502.3	010616	ATE Ø 25,4		
				→ W1285446; für Linkslenker	03.2123-1622.3	010470	Ø 23,81		
2.5 i GSi 2.5 i V6	143	03/98→07/00		→ W7154258; für Linkslenker	03.2123-1622.3	010470	Ø 23,81		
				→ W5276825; für Linkslenker	03.2123-1622.3	010470	Ø 23,81		
				→ W1285446; für Rechtslenker	03.2123-1722.3	010471	Ø 23,81		
				→ W7154258; für Rechtslenker	03.2123-1722.3	010471	Ø 23,81		
				→ W5276825; für Rechtslenker	03.2123-1722.3	010471	Ø 23,81		
				W1285447→; für Linkslenker	03.2125-7402.3	010541	ATE Ø 25,4		
	125	09/95→08/00		W5276826→; für Linkslenker	03.2125-7402.3	010541	ATE Ø 25,4		
				W7154259→; für Linkslenker	03.2125-7402.3	010541	ATE Ø 25,4		
				W1285447→; für Rechtslenker	03.2125-7502.3	010616	ATE Ø 25,4		
				W7154259→; für Rechtslenker	03.2125-7502.3	010616	ATE Ø 25,4		
				W5276826→; für Rechtslenker	03.2125-7502.3	010616	ATE Ø 25,4		
2.6 i V6	125	09/00→03/02		für Linkslenker	03.2125-7402.3	010541	ATE Ø 25,4		
				für Rechtslenker	03.2125-7502.3	010616	ATE Ø 25,4		
VAUXHALL - VECTRA (B) CC 08/95→07/03									
 Bremskraftverstärker									
2.0 i 16V	100	10/95→01/01		für Linkslenker; → W1285446	03.7745-3003.4	300157	ATE Ø 8 / 7" pneumatisch		
2.5 i GSi 2.5 i V6	143	03/98→07/00		für Linkslenker	03.7745-3003.4	300157	ATE Ø 8 / 7" pneumatisch		
	125	09/95→08/00							
2.6 i V6	125	09/00→07/03		→ 04/02; für Linkslenker	03.7745-3003.4	300157	ATE Ø 8 / 7" pneumatisch		
 Hauptbremszylinder									
1.6 i 1.6 i 16V	55	08/95→10/01		09/95→; → W5999999; für Rechtslenker	24.2122-1724.3	010561	Ø 22,2		
			74	08/95→10/01		09/95→; → V7999999; für Linkslenker	24.2122-1724.3	010561	Ø 22,2
						09/95→; → W1999999; für Rechtslenker	24.2122-1724.3	010561	Ø 22,2
		09/95→; → W7999999; für Rechtslenker			24.2122-1724.3	010561	Ø 22,2		
		09/95→; → V1999999; für Linkslenker			24.2122-1724.3	010561	Ø 22,2		
		09/95→; → V5999999; für Linkslenker			24.2122-1724.3	010561	Ø 22,2		
		W1000001→ W1999999; für Linkslenker			24.2123-1777.3	010943	Ø 23,81		
		W7000001→ W7999999; für Linkslenker	24.2123-1777.3	010943	Ø 23,81				
		W5000001→ W5999999; für Linkslenker	24.2123-1777.3	010943	Ø 23,81				
1.7 TD	60	10/95→11/96			24.2122-1724.3	010561	Ø 22,2		
1.8 Dualfuel 1.8 i 16V 1.8 i 16V 2.0 DTi 16V	92	09/00→07/03		→ W5999999; für Rechtslenker	24.2122-1724.3	010561	Ø 22,2		
	85	10/95→09/00		→ V5999999; für Linkslenker	24.2122-1724.3	010561	Ø 22,2		
	92	09/00→07/03							
	74	06/97→10/01		→ V7999999; für Linkslenker	24.2122-1724.3	010561	Ø 22,2		
↓									

VAUXHALL - VECTRA (B) CC 08/95→07/03

Hauptbremszylinder

1.8 Dualfuel 1.8 i 16V 1.8 i 16V 2.0 DTi 16V	92	09/00→07/03	→ W7999999; für Rechtslenker	24.2122-1724.3 010561	Ø 22,2			
	85	10/95→09/00	→ V1999999; für Linkslenker	24.2122-1724.3 010561	Ø 22,2			
	92	09/00→07/03	→ W1999999; für Rechtslenker	24.2122-1724.3 010561	Ø 22,2			
	74	06/97→10/01	→ W1000001→ W1999999; für Linkslenker	24.2123-1777.3 010943	Ø 23,81			
			→ W5000001→ W5999999; für Linkslenker	24.2123-1777.3 010943	Ø 23,81			
			→ W7000001→ W7999999; für Linkslenker	24.2123-1777.3 010943	Ø 23,81			
2.0 Di 16V	60	08/95→10/01	11/96→; → W5999999; für Rechtslenker	24.2122-1724.3 010561	Ø 22,2			
			11/96→; → W1999999; für Rechtslenker	24.2122-1724.3 010561	Ø 22,2			
			11/96→; → V7999999; für Linkslenker	24.2122-1724.3 010561	Ø 22,2			
			11/96→; → V1999999; für Linkslenker	24.2122-1724.3 010561	Ø 22,2			
			11/96→; → W7999999; für Rechtslenker	24.2122-1724.3 010561	Ø 22,2			
			11/96→; → V5999999; für Linkslenker	24.2122-1724.3 010561	Ø 22,2			
			W1000001→ W1999999; für Linkslenker	24.2123-1777.3 010943	Ø 23,81			
			W7000001→ W7999999; für Linkslenker	24.2123-1777.3 010943	Ø 23,81			
			→ W5000001→ W5999999; für Linkslenker	24.2123-1777.3 010943	Ø 23,81			
2.0 i 16V	100	10/95→01/01	→ W1285446; für Linkslenker	03.2123-1622.3 010470	Ø 23,81			
			→ W7154258; für Linkslenker	03.2123-1622.3 010470	Ø 23,81			
			→ W5276825; für Linkslenker	03.2123-1622.3 010470	Ø 23,81			
			→ W7154258; für Rechtslenker	03.2123-1722.3 010471	Ø 23,81			
			→ W1285446; für Rechtslenker	03.2123-1722.3 010471	Ø 23,81			
			→ W5276825; für Rechtslenker	03.2123-1722.3 010471	Ø 23,81			
			W5276826→; für Rechtslenker	03.2125-7502.3 010616	ATE Ø 25,4			
			W7154259→; für Rechtslenker	03.2125-7502.3 010616	ATE Ø 25,4			
			W1285447→; für Rechtslenker	03.2125-7502.3 010616	ATE Ø 25,4			
						→ 04/02; für Rechtslenker	03.2125-7502.3 010616	ATE Ø 25,4
2.2 i 16V	108	09/00→07/03						
2.5 i GSi 2.5 i V6	143 125	03/98→07/00 09/95→08/00	→ W1285446; für Linkslenker	03.2123-1622.3 010470	Ø 23,81			
			→ W7154258; für Linkslenker	03.2123-1622.3 010470	Ø 23,81			
			→ W5276825; für Linkslenker	03.2123-1622.3 010470	Ø 23,81			
			→ W1285446; für Rechtslenker	03.2123-1722.3 010471	Ø 23,81			
			→ W7154258; für Rechtslenker	03.2123-1722.3 010471	Ø 23,81			
			→ W5276825; für Rechtslenker	03.2123-1722.3 010471	Ø 23,81			
			W1285447→; für Linkslenker	03.2125-7402.3 010541	ATE Ø 25,4			
			W5276826→; für Linkslenker	03.2125-7402.3 010541	ATE Ø 25,4			
			W7154259→; für Linkslenker	03.2125-7402.3 010541	ATE Ø 25,4			
			W1285447→; für Rechtslenker	03.2125-7502.3 010616	ATE Ø 25,4			
			W7154259→; für Rechtslenker	03.2125-7502.3 010616	ATE Ø 25,4			
			W5276826→; für Rechtslenker	03.2125-7502.3 010616	ATE Ø 25,4			
						→ 04/02; für Linkslenker	03.2125-7402.3 010541	ATE Ø 25,4
						→ 04/02; für Rechtslenker	03.2125-7502.3 010616	ATE Ø 25,4

VAUXHALL - VECTRA (B) Estate 08/95→03/02











Bremskraftverstärker

2.0 i 16V	100	10/95→01/01	für Linkslenker; → W1285446	03.7745-3003.4 300157	ATE Ø 8 / 7" pneumatisch
2.5 i GSi	143	05/98→09/99	für Linkslenker	03.7745-3003.4 300157	ATE Ø 8 / 7" pneumatisch
2.5 i V6	125	11/96→08/00			
2.6 i V6	125	09/00→03/02			











Hauptbremszylinder











1.8 Dualfuel 1.8 i 16V 1.8 i 16V	92 85 92	09/00→03/02 11/96→09/00 09/00→03/02	→ W5999999; für Rechtslenker	24.2122-1724.3 010561	Ø 22,2
			→ V5999999; für Linkslenker	24.2122-1724.3 010561	Ø 22,2
			→ V7999999; für Linkslenker	24.2122-1724.3 010561	Ø 22,2
			→ W7999999; für Rechtslenker	24.2122-1724.3 010561	Ø 22,2
			→ V1999999; für Linkslenker	24.2122-1724.3 010561	Ø 22,2
			→ W1999999; für Rechtslenker	24.2122-1724.3 010561	Ø 22,2
			W1000001→ W1999999; für Linkslenker	24.2123-1777.3 010943	Ø 23,81
			W5000001→ W5999999; für Linkslenker	24.2123-1777.3 010943	Ø 23,81
			W7000001→ W7999999; für Linkslenker	24.2123-1777.3 010943	Ø 23,81
			11/96→; → W1999999; für Rechtslenker	24.2122-1724.3 010561	Ø 22,2
			11/96→; → V7999999; für Linkslenker	24.2122-1724.3 010561	Ø 22,2
			11/96→; → V1999999; für Linkslenker	24.2122-1724.3 010561	Ø 22,2















	kw			 	! #						
VAUXHALL - VECTRA (B) Estate 08/95→03/02											
 Hauptbremszylinder											
2.0 DI 16V	60	08/95→10/01		11/96→; → W7999999; für Rechtslenker	24.2122-1724.3	010561	Ø 22,2				
				11/96→; → V5999999; für Linkslenker	24.2122-1724.3	010561	Ø 22,2				
				W1000001→ W1999999; für Linkslenker	24.2123-1777.3	010943	Ø 23,81				
				W7000001→ W7999999; für Linkslenker	24.2123-1777.3	010943	Ø 23,81				
				W5000001→ W5999999; für Linkslenker	24.2123-1777.3	010943	Ø 23,81				
2.0 DTI 16V	74	08/95→10/01		06/97→; → V5999999; für Linkslenker	24.2122-1724.3	010561	Ø 22,2				
				06/97→; → V1999999; für Linkslenker	24.2122-1724.3	010561	Ø 22,2				
				06/97→; → W5999999; für Rechtslenker	24.2122-1724.3	010561	Ø 22,2				
				06/97→; → W7999999; für Rechtslenker	24.2122-1724.3	010561	Ø 22,2				
				06/97→; → W1999999; für Rechtslenker	24.2122-1724.3	010561	Ø 22,2				
				06/97→; → V7999999; für Linkslenker	24.2122-1724.3	010561	Ø 22,2				
				W7000001→ W7999999; für Linkslenker	24.2123-1777.3	010943	Ø 23,81				
				W1000001→ W1999999; für Linkslenker	24.2123-1777.3	010943	Ø 23,81				
2.0 i 16V	100	10/95→01/01		→ W1285446; für Linkslenker	03.2123-1622.3	010470	Ø 23,81				
				→ W7154258; für Linkslenker	03.2123-1622.3	010470	Ø 23,81				
				→ W5276825; für Linkslenker	03.2123-1622.3	010470	Ø 23,81				
				→ W7154258; für Rechtslenker	03.2123-1722.3	010471	Ø 23,81				
				→ W1285446; für Rechtslenker	03.2123-1722.3	010471	Ø 23,81				
				→ W5276825; für Rechtslenker	03.2123-1722.3	010471	Ø 23,81				
				W5276826→; für Rechtslenker	03.2125-7502.3	010616	ATE Ø 25,4				
				W7154259→; für Rechtslenker	03.2125-7502.3	010616	ATE Ø 25,4				
2.2 i 16V	108	08/95→10/01		09/00→; für Rechtslenker	03.2125-7502.3	010616	ATE Ø 25,4				
				→ W1285446; für Linkslenker	03.2123-1622.3	010470	Ø 23,81				
2.5 i GSi 2.5 i V6	143 125	05/98→09/99 11/96→08/00		→ W7154258; für Linkslenker	03.2123-1622.3	010470	Ø 23,81				
				→ W5276825; für Linkslenker	03.2123-1622.3	010470	Ø 23,81				
				→ W1285446; für Rechtslenker	03.2123-1722.3	010471	Ø 23,81				
				→ W7154258; für Rechtslenker	03.2123-1722.3	010471	Ø 23,81				
				→ W5276825; für Rechtslenker	03.2123-1722.3	010471	Ø 23,81				
				W1285447→; für Linkslenker	03.2125-7402.3	010541	ATE Ø 25,4				
				W5276826→; für Linkslenker	03.2125-7402.3	010541	ATE Ø 25,4				
				W7154259→; für Linkslenker	03.2125-7402.3	010541	ATE Ø 25,4				
				W1285447→; für Rechtslenker	03.2125-7502.3	010616	ATE Ø 25,4				
				W7154259→; für Rechtslenker	03.2125-7502.3	010616	ATE Ø 25,4				
				W5276826→; für Rechtslenker	03.2125-7502.3	010616	ATE Ø 25,4				
			2.6 i V6	125	09/00→03/02		für Linkslenker	03.2125-7402.3	010541	ATE Ø 25,4	
	für Rechtslenker	03.2125-7502.3				010616	ATE Ø 25,4				
VAUXHALL - VECTRA Mk II (C) 01/00→10/08											
 Hauptbremszylinder											
1.8 1.8 16V 1.8 16V Dualfuel 1.9 CDTi 16V 2.0 DTI 16V 2.2 DTI 16V 3.0 CDTi 3.0 V6 CDTi 3.2 V6	103 90 90 110 74 92 135 130 155	01/06→07/08 04/02→07/08 04/02→07/08 04/04→08/08 04/02→10/08 04/02→10/08 08/05→07/08 06/03→08/05 06/03→07/08		für Linkslenker; + ESP	24.2125-1732.3	010827	TRW Ø 25,4				
				1.9 CDTi	88	04/02→09/08		04/04→; für Linkslenker; + ESP	24.2125-1732.3	010827	TRW Ø 25,4
				2.0 16V Turbo	129	01/00→10/08		03/03→; für Linkslenker; + ESP	24.2125-1732.3	010827	TRW Ø 25,4
				2.2 16V	108	01/02→10/08		04/02→; für Linkslenker; + ESP	24.2125-1732.3	010827	TRW Ø 25,4
				2.2 direct	114	01/02→10/08		10/03→; für Linkslenker; + ESP	24.2125-1732.3	010827	TRW Ø 25,4
			VAUXHALL - VECTRA Mk II (C) Estate 10/03→07/08								
			 Hauptbremszylinder								
			1.8 1.8 16V 1.9 CDTi 1.9 CDTi 16V 2.0 16V Turbo 2.0 DTI 16V 2.2 direct 2.2 DTI 16V ↓	103 90 88 110 129 74 114 92	01/06→07/08 10/03→08/05 04/04→07/08 04/04→07/08 10/03→07/08 10/03→07/08 10/03→07/08 10/03→07/08		für Linkslenker; + ESP	24.2125-1732.3	010827	TRW Ø 25,4	



























	kw					! #		
VAUXHALL - VECTRA Mk II (C) Estate 10/03→07/08								
 Hauptbremszylinder								
3.0 CDTi 3.0 V6 CDTI 3.2 V6	135 130 155	08/05→07/08 10/03→08/05 10/03→08/05		für Linkslenker; + ESP			24.2125-1732.3 010827	TRW Ø 25,4
VAUXHALL - VECTRA Mk II (C) GTS 08/02→07/08								
 Hauptbremszylinder								
1.8 1.8 16V 1.8 16V Dualfuel 1.9 CDTI 16V 2.0 16V Turbo 2.0 DTI 16V 2.2 16V 2.2 direct 2.2 DTI 16V 3.0 CDTi 3.0 V6 CDTI 3.2 V6	103 90 90 110 129 74 108 114 92 135 130 155	01/06→07/08 08/02→07/08 08/02→07/08 04/04→07/08 03/03→07/08 08/02→07/08 08/02→07/08 10/03→08/05 08/02→07/08 08/05→07/08 06/03→08/05 08/02→07/08		für Linkslenker; + ESP			24.2125-1732.3 010827	TRW Ø 25,4
1.9 CDTI	88	08/02→07/08		04/04→; für Linkslenker; + ESP			24.2125-1732.3 010827	TRW Ø 25,4
VAUXHALL - VIVARO Combi (J7) 08/01→07/14								
 Hauptbremszylinder								
1.9 DI 1.9 DTI	59 74	08/01→12/06 08/01→12/06		7V600001 / 7Y000001→; + ABS 7V600001 / 7Y000001→; + ASR 4V602168→ 6V699999; für Rechtslenker; - ASR für Linkslenker; → 6V699999; + ASR			24.2120-1748.3 010894 24.2120-1753.3 010946 24.2125-1731.3 010826 24.2125-1734.3 010878	TRW Ø 20,64 TRW Ø 20,64 TRW Ø 25,4 TRW Ø 25,4
2.0 16V	88	08/01→12/06		7V600001 / 7Y000001→; + ABS 7V600001 / 7Y000001→; + ASR 4V602168→ 6V699999; - ASR → 6V699999; + ASR			24.2120-1748.3 010894 24.2120-1753.3 010946 24.2125-1731.3 010826 24.2125-1734.3 010878	TRW Ø 20,64 TRW Ø 20,64 TRW Ø 25,4 TRW Ø 25,4
2.0 CDTI 2.5 CDTI	66 107	01/06→07/14 01/06→07/14		7V600001 / 7Y000001→; → 06/14; + ABS 7V600001 / 7Y000001→; → 06/14; + ASR 4V602168→ 6V699999; - ASR 08/06→; → 6V699999; + ASR			24.2120-1748.3 010894 24.2120-1753.3 010946 24.2125-1731.3 010826 24.2125-1734.3 010878	TRW Ø 20,64 TRW Ø 20,64 TRW Ø 25,4 TRW Ø 25,4
2.0 CDTI 2.0 ECOTEC 2.5 CDTI 2.5 DTI	84 86 84 99	08/06→07/14 08/06→07/14 08/06→07/14 07/03→07/14		7V600001 / 7Y000001→; → 06/14; + ABS 7V600001 / 7Y000001→; → 06/14; + ASR 4V602168→ 6V699999; - ASR → 6V699999; + ASR			24.2120-1748.3 010894 24.2120-1753.3 010946 24.2125-1731.3 010826 24.2125-1734.3 010878	TRW Ø 20,64 TRW Ø 20,64 TRW Ø 25,4 TRW Ø 25,4
VAUXHALL - VIVARO Kasten (F7) 08/01→07/14								
 Hauptbremszylinder								
1.9 DI 1.9 DTI	59 74	08/01→12/06 08/01→12/06		7V600001 / 7Y000001→; + ABS 7V600001 / 7Y000001→; + ASR 4V602168→ 6V699999; für Rechtslenker; - ASR für Linkslenker; → 6V699999; + ASR			24.2120-1748.3 010894 24.2120-1753.3 010946 24.2125-1731.3 010826 24.2125-1734.3 010878	TRW Ø 20,64 TRW Ø 20,64 TRW Ø 25,4 TRW Ø 25,4
2.0 16V 2.5 CDTI	88 84	08/01→12/06 08/06→08/08		7V600001 / 7Y000001→; + ABS 7V600001 / 7Y000001→; + ASR 4V602168→ 6V699999; - ASR → 6V699999; + ASR			24.2120-1748.3 010894 24.2120-1753.3 010946 24.2125-1731.3 010826 24.2125-1734.3 010878	TRW Ø 20,64 TRW Ø 20,64 TRW Ø 25,4 TRW Ø 25,4
2.0 CDTI	66	01/06→07/14		7V600001 / 7Y000001→; → 06/14; + ABS 7V600001 / 7Y000001→; → 06/14; + ASR 4V602168→ 6V699999; - ASR 08/06→; → 6V699999; + ASR			24.2120-1748.3 010894 24.2120-1753.3 010946 24.2125-1731.3 010826 24.2125-1734.3 010878	TRW Ø 20,64 TRW Ø 20,64 TRW Ø 25,4 TRW Ø 25,4
2.0 CDTI 2.0 ECOTEC 2.5 CDTI 2.5 DTI	84 86 107 99	08/06→07/14 08/06→07/14 08/06→07/14 07/03→07/14		7V600001 / 7Y000001→; → 06/14; + ABS 7V600001 / 7Y000001→; → 06/14; + ASR 4V602168→ 6V699999; - ASR → 6V699999; + ASR			24.2120-1748.3 010894 24.2120-1753.3 010946 24.2125-1731.3 010826 24.2125-1734.3 010878	TRW Ø 20,64 TRW Ø 20,64 TRW Ø 25,4 TRW Ø 25,4















	kw					! #		
VAUXHALL - VIVARO Pritsche/Fahrgestell (E7) 04/03→07/14								
 Hauptbremszylinder								
1.9 DI	59	04/03→07/14		7V600001 / 7Y000001→; → 06/14; + ABS		24.2120-1748.3	010894	TRW Ø 20,64
				7V600001 / 7Y000001→; → 06/14; + ASR		24.2120-1753.3	010946	TRW Ø 20,64
				4V602168→ 6V699999; für Rechtslenker; - ASR		24.2125-1731.3	010826	TRW Ø 25,4
				für Linkslenker; → 6V699999; + ASR		24.2125-1734.3	010878	TRW Ø 25,4
2.0 16V	88	04/03→07/14		7V600001 / 7Y000001→; → 06/14; + ABS		24.2120-1748.3	010894	TRW Ø 20,64
2.0 CDTI	84	08/06→07/14						
2.0 ECOTEC	86	08/06→07/14		7V600001 / 7Y000001→; → 06/14; + ASR		24.2120-1753.3	010946	TRW Ø 20,64
2.5 CDTI	84	08/06→07/14						
2.5 CDTI	107	08/06→07/14		4V602168→ 6V699999; - ASR		24.2125-1731.3	010826	TRW Ø 25,4
				→ 6V699999; + ASR		24.2125-1734.3	010878	TRW Ø 25,4
2.0 CDTI	66	01/06→07/14		7V600001 / 7Y000001→; → 06/14; + ABS		24.2120-1748.3	010894	TRW Ø 20,64
				7V600001 / 7Y000001→; → 06/14; + ASR		24.2120-1753.3	010946	TRW Ø 20,64
				4V602168→ 6V699999; - ASR		24.2125-1731.3	010826	TRW Ø 25,4
				08/06→; → 6V699999; + ASR		24.2125-1734.3	010878	TRW Ø 25,4
2.5 CDTI	99	04/03→07/06		7V600001 / 7Y000001→; + ABS		24.2120-1748.3	010894	TRW Ø 20,64
				7V600001 / 7Y000001→; + ASR		24.2120-1753.3	010946	TRW Ø 20,64
				4V602168→ 6V699999; - ASR		24.2125-1731.3	010826	TRW Ø 25,4
				05/03→; → 6V699999; + ASR		24.2125-1734.3	010878	TRW Ø 25,4
VAUXHALL - ZAFIRA Mk I (A) (F75) 11/98→08/05								
 Hauptbremszylinder								
1.6 16V	74	04/99→08/05		- ESP; → 06/05		24.2123-1734.3	010640	TRW Ø 23,81
1.8 16V	92	09/00→08/05						
1.8 Dualfuel	92	09/00→08/05		+ ESP; → 06/05		24.2123-1739.3	010661	Ø 23,81
2.0 DI 16V	60	10/99→08/05						
1.6 CNG	71	09/01→06/05		- ESP		24.2123-1734.3	010640	TRW Ø 23,81
1.8 16V	85	05/99→08/00						
2.0	147	06/02→06/05		+ ESP		24.2123-1739.3	010661	Ø 23,81
2.0 GSI Turbo	141	09/01→06/05						
1.6 Dualfuel	74	11/98→08/05		04/99→; - ESP; → 06/05		24.2123-1734.3	010640	TRW Ø 23,81
				04/99→; + ESP; → 06/05		24.2123-1739.3	010661	Ø 23,81
2.0 DTI 16V	74	04/99→08/05		06/00→; - ESP; → 06/05		24.2123-1734.3	010640	TRW Ø 23,81
				06/00→; + ESP; → 06/05		24.2123-1739.3	010661	Ø 23,81
2.2 16V	108	11/98→08/04		09/00→; - ESP		24.2123-1734.3	010640	TRW Ø 23,81
				09/00→; + ESP		24.2123-1739.3	010661	Ø 23,81
2.2 D	92	06/01→06/05		01/02→; - ESP		24.2123-1734.3	010640	TRW Ø 23,81
				01/02→; + ESP		24.2123-1739.3	010661	Ø 23,81
 Bremskraftregler								
1.6 16V	74	04/99→08/05		- ABS; → 06/05		03.6583-0085.3	320238	ATE lastabhängig 8/3 4x
1.8 16V	92	09/00→08/05						
1.8 Dualfuel	92	09/00→08/05						
2.0 DI 16V	60	10/99→08/05						
1.6 CNG	71	09/01→06/05		- ABS		03.6583-0085.3	320238	ATE lastabhängig 8/3 4x
1.8 16V	85	05/99→08/00						
2.0	147	06/02→06/05						
2.0 GSI Turbo	141	09/01→06/05						
1.6 Dualfuel	74	11/98→08/05		04/99→; - ABS; → 06/05		03.6583-0085.3	320238	ATE lastabhängig 8/3 4x
2.0 DTI 16V	74	04/99→08/05		06/00→; - ABS; → 06/05		03.6583-0085.3	320238	ATE lastabhängig 8/3 4x
2.2 16V	108	11/98→08/04		09/00→; - ABS		03.6583-0085.3	320238	ATE lastabhängig 8/3 4x
2.2 D	92	06/01→06/05		01/02→; - ABS		03.6583-0085.3	320238	ATE lastabhängig 8/3 4x
VAUXHALL - ZAFIRA Mk II (B) (M75) 04/05→11/14								
 Bremskraftverstärker								
1.6	77	07/05→11/14		für Linkslenker; + ESP		03.7863-7803.4	300237	ATE Ø 10" pneumatisch
1.6	85	12/07→11/14						
1.6 CNG Turbo	110	02/09→11/14						
1.7 CDTI	81	04/09→11/14						
1.7 CDTI	92	01/08→11/14						
1.9 CDTI	74	07/05→11/14						
1.9 CDTI	88	07/05→11/14						
1.9 CDTI	110	07/05→11/14						
2.0	147	07/05→11/14						
2.0	176	01/06→11/14						
2.2	110	07/05→11/14						
↓								



























	kw			 	! #		
VAUXHALL - ZAFIRA Mk II (B) (M75) 04/05→11/14							
 Bremskraftverstärker							
1.6 CNG	69	07/05→11/14		01/06→; für Linkslenker; + ESP	03.7863-7803.4	300237	ATE Ø 10" pneumatisch
1.8	88	04/13→11/14		06/13→; für Linkslenker; + ESP	03.7863-7803.4	300237	ATE Ø 10" pneumatisch
1.8	103	04/05→11/14		07/05→; für Linkslenker; + ESP	03.7863-7803.4	300237	ATE Ø 10" pneumatisch
 Hauptbremszylinder							
1.6	77	07/05→11/14		für Linkslenker; - ESP	03.4155-0153.3	010927	ATE Ø 25,4
1.6 CNG Turbo	110	02/09→11/14		für Linkslenker; + ESP	03.4155-0156.3	010862	ATE Ø 25,4
2.0	147	07/05→11/14		→ 6G999999; für Rechtslenker	24.2125-1736.3	010904	TRW Ø 25,4
2.0	176	01/06→11/14		72000001→; für Rechtslenker	24.4125-1703.3	010907	TRW Ø 25,4
1.6	85	12/07→11/14		für Linkslenker; - ESP	03.4155-0153.3	010927	ATE Ø 25,4
				für Linkslenker; + ESP	03.4155-0156.3	010862	ATE Ø 25,4
1.6 CNG	69	07/05→11/14		01/06→; für Linkslenker; - ESP	03.4155-0153.3	010927	ATE Ø 25,4
				01/06→; für Linkslenker; + ESP	03.4155-0156.3	010862	ATE Ø 25,4
1.7 CDTi	81	04/09→11/14		für Linkslenker; - ESP	03.4155-0153.3	010927	ATE Ø 25,4
1.7 CDTi	92	01/08→11/14		für Linkslenker; + ESP	03.4155-0156.3	010862	ATE Ø 25,4
1.9 CDTi	74	07/05→11/14		für Linkslenker; + ESP	03.4155-0156.3	010862	ATE Ø 25,4
1.9 CDTi	88	07/05→11/14		für Rechtslenker	03.4155-0156.3	010862	ATE Ø 25,4
1.9 CDTi	110	07/05→11/14					
2.2	110	07/05→11/14					
1.8	88	04/13→11/14		06/13→; für Linkslenker; - ESP	03.4155-0153.3	010927	ATE Ø 25,4
				06/13→; für Linkslenker; + ESP	03.4155-0156.3	010862	ATE Ø 25,4
				06/13→; für Rechtslenker	24.4125-1703.3	010907	TRW Ø 25,4
1.8	103	04/05→11/14		07/05→; für Linkslenker; - ESP	03.4155-0153.3	010927	ATE Ø 25,4
				07/05→; für Linkslenker; + ESP	03.4155-0156.3	010862	ATE Ø 25,4
				07/05→; → 6G999999; für Rechtslenker	24.2125-1736.3	010904	TRW Ø 25,4
				72000001→; für Rechtslenker	24.4125-1703.3	010907	TRW Ø 25,4
VAUXHALL - ZAFIRA Mk III (P12) 10/11→							
 Bremskraftverstärker							
1.4	88	10/11→		11/11→; für Linkslenker	03.7858-0732.4	300272	ATE Ø 9 / 8" pneumatisch
1.4	103	10/11→					
1.4 LPG	103	10/11→					
1.6 CNG	110	10/11→					
1.8	85	10/11→					
1.8	88	10/11→					
1.8	103	10/11→					
2.0 CDTi	81	10/11→					
2.0 CDTi	96	10/11→					
2.0 CDTi	118	10/11→					
2.0 CDTi	121	10/11→					
1.6 CDTi	99	10/16→		für Linkslenker	03.7858-0732.4	300272	ATE Ø 9 / 8" pneumatisch
1.6 CDTi	100	03/13→					
1.6 SIDI	147	07/13→					
1.6 Turbo	125	12/12→					
2.0 BiTurbo CDTi	143	01/13→					
2.0 CDTi	125	01/15→					
 Hauptbremszylinder							
1.4	88	10/11→		11/11→; für Linkslenker	03.2125-0421.3	010934	ATE Ø 25,4
1.4	103	10/11→					
1.4 LPG	103	10/11→					
1.6 CNG	110	10/11→					
1.8	85	10/11→					
1.8	88	10/11→					
1.8	103	10/11→					
2.0 CDTi	81	10/11→					
2.0 CDTi	96	10/11→					
2.0 CDTi	118	10/11→					
2.0 CDTi	121	10/11→					
1.6 CDTi	99	10/16→		für Linkslenker	03.2125-0421.3	010934	ATE Ø 25,4
1.6 CDTi	100	03/13→					
1.6 SIDI	147	07/13→					
1.6 Turbo	125	12/12→					
2.0 BiTurbo CDTi	143	01/13→					
2.0 CDTi	125	01/15→					
VOLVO - 440 K (445) 08/88→12/96							
 Hauptbremszylinder							
1.6	61	09/88→12/96		09/92→; + ABS; für Linkslenker	10.6120-0287.3	010334	ATE Ø 20,64
1.7	64	09/88→12/96					
1.7	75	08/89→12/96					
1.7	78	09/88→12/96					
1.7 Turbo	88	08/88→07/96					

	kW			 	! #		
VOLVO - 440 K (445) 08/88→12/96							
 Hauptbremszylinder							
1.7 Turbo 1.8 2.0	90 66 81	01/91→12/96 08/91→07/96 08/92→07/95		09/92→; + ABS; für Linkslenker		10.6120-0287.3 010334	ATE Ø 20,64
1.8 1.9 Turbo-Diesel 2.0	66 66 80	09/95→12/96 07/94→12/96 08/93→07/96		+ ABS; für Linkslenker		10.6120-0287.3 010334	ATE Ø 20,64
 Bremskraftregler							
1.6 1.7 1.7 1.7 1.7 Turbo 1.7 Turbo 1.8	61 64 75 78 88 90 66	09/88→12/96 09/88→12/96 08/89→12/96 09/88→12/96 08/88→07/96 01/91→12/96 08/91→07/96		→ 08/92; - ABS		03.0101-0014.2 320004	ATE Satz 3/25 2x
VOLVO - 460 L (464) 09/88→07/96							
 Hauptbremszylinder							
1.6 1.7 1.7 1.7 Turbo 1.7 Turbo 1.8 2.0	61 64 66 88 90 66 81	07/92→07/96 09/88→07/96 09/90→07/96 08/89→07/96 01/91→07/96 08/91→07/96 08/92→07/95		09/92→; + ABS; für Linkslenker		10.6120-0287.3 010334	ATE Ø 20,64
1.9 Turbo-Diesel 2.0	66 80	07/94→07/96 08/93→07/96		+ ABS; für Linkslenker		10.6120-0287.3 010334	ATE Ø 20,64
 Bremskraftregler							
1.6 1.7 1.7 1.7 Turbo 1.7 Turbo 1.8 2.0	61 64 66 88 90 66 81	07/92→07/96 09/88→07/96 09/90→07/96 08/89→07/96 01/91→07/96 08/91→07/96 08/92→07/95		→ 08/92; - ABS		03.0101-0014.2 320004	ATE Satz 3/25 2x
VOLVO - 480 E 04/86→07/96							
 Hauptbremszylinder							
1.7 1.7 Turbo 1.7 Turbo 2.0	75 88 90 81	08/89→07/96 08/87→07/96 01/91→07/96 08/92→09/95		09/92→; + ABS; für Linkslenker		10.6120-0287.3 010334	ATE Ø 20,64
 Bremskraftregler							
1.7 1.7 Turbo 1.7 Turbo	75 88 90	08/89→07/96 08/87→07/96 01/91→07/96		→ 08/92; - ABS		03.0101-0014.2 320004	ATE Satz 3/25 2x
VOLVO - 850 (LS) 06/91→10/97							
 Bremskraftverstärker							
2.0 2.0 2.0 Turbo 2.0 Turbo 2.3 T5 2.3 T5-R 2.3 Turbo R 2.4 2.4 2.5 TDI	93 105 132 155 166 184 177 106 125 103	08/94→12/96 06/91→12/96 09/93→10/96 08/93→12/96 08/93→07/96 08/95→12/96 06/95→10/96 08/94→12/96 08/91→12/96 08/95→12/96		09/95→; für Linkslenker		03.7760-3602.4 300176	ATE Ø 10" pneumatisch
2.3 T5 R 2.3 Turbo R	176 179	04/96→10/96 09/94→10/97		für Linkslenker 09/95→ 12/96; für Linkslenker		03.7760-3602.4 300176	ATE Ø 10" pneumatisch ATE Ø 10" pneumatisch
Pedalwegsensor, Bremspedal							
2.0 2.0 2.0 Turbo 2.0 Turbo 2.3 T5 2.3 T5-R 2.4 2.5 TDI	93 105 132 155 166 184 106 103	08/94→12/96 06/91→12/96 09/93→10/96 08/93→12/96 08/93→07/96 08/95→12/96 08/94→12/96 08/95→12/96		→ 08/95; für Linkslenker → 08/95; für Rechtslenker		03.0655-0003.2 370003	ATE ATE
2.3 Turbo R 2.3 Turbo R	177 179	06/95→10/96 09/94→10/97		08/95→ 08/95; für Rechtslenker 08/95→ 08/95; für Linkslenker		03.0655-0003.2 370003	ATE ATE
2.4 ↓	125	08/91→12/96		09/93→ 08/95; für Linkslenker		03.0655-0003.2 370003	ATE













	kw			 	! #		
VOLVO - 850 (LS) 06/91→10/97							
Pedalwegsensor, Bremspedal							
2.4	125	08/91→12/96		09/93→ 08/95; für Rechtslenker		03.0655-0003.2 370003	ATE
 Hauptbremszylinder							
2.0	93	08/94→12/96		09/95→; + ASR		03.2023-1044.3 010590	ATE Ø1 23,81 Ø2 20,64
2.0	105	06/91→12/96		09/95→; - ASR		03.2023-1084.3 010591	ATE Ø1 23,81 Ø2 20,64
2.0 Turbo	132	09/93→10/96		09/95→; - ASR		03.2023-1084.3 010591	ATE Ø1 23,81 Ø2 20,64
2.0 Turbo	155	08/93→12/96		→ 08/95; für Linkslenker		10.6123-0445.3 010957	ATE Ø 23,81 ohne Bremsflüssigkeitsbehälter
2.3 T5	166	08/93→07/96					
2.3 T5-R	184	08/95→12/96					
2.4	106	08/94→12/96					
2.4	125	08/91→12/96					
2.5 TDI	103	08/95→12/96					
2.3 T5 R	176	04/96→10/96		+ ASR		03.2023-1044.3 010590	ATE Ø1 23,81 Ø2 20,64
				- ASR		03.2023-1084.3 010591	ATE Ø1 23,81 Ø2 20,64
2.3 Turbo R	177	06/95→10/96		09/95→; + ASR		03.2023-1044.3 010590	ATE Ø1 23,81 Ø2 20,64
				09/95→; - ASR		03.2023-1084.3 010591	ATE Ø1 23,81 Ø2 20,64
				08/95→ 08/95; für Linkslenker		10.6123-0445.3 010957	ATE Ø 23,81 ohne Bremsflüssigkeitsbehälter
2.3 Turbo R	179	09/94→10/97		09/95→ 12/96; + ASR		03.2023-1044.3 010590	ATE Ø1 23,81 Ø2 20,64
				09/95→ 12/96; - ASR		03.2023-1084.3 010591	ATE Ø1 23,81 Ø2 20,64
				08/95→ 08/95; für Linkslenker		10.6123-0445.3 010957	ATE Ø 23,81 ohne Bremsflüssigkeitsbehälter
 Bremskraftregler							
2.0	93	08/94→12/96		→ 08/95		03.6055-0430.3 320065	ATE 5/25 4x
2.0	105	06/91→12/96					
2.0 Turbo	132	09/93→10/96					
2.0 Turbo	155	08/93→12/96					
2.3 T5	166	08/93→07/96					
2.3 T5-R	184	08/95→12/96					
2.4	106	08/94→12/96					
2.4	125	08/91→12/96					
2.5 TDI	103	08/95→12/96					
2.3 Turbo R	177	06/95→10/96		08/95→ 08/95		03.6055-0430.3 320065	ATE 5/25 4x
2.3 Turbo R	179	09/94→10/97					
VOLVO - 850 Kombi (LW) 04/92→10/97							
 Bremskraftverstärker							
2.0	93	08/94→12/96		09/95→; für Linkslenker		03.7760-3602.4 300176	ATE Ø 10" pneumatisch
2.0	105	02/93→12/96					
2.3 T5	166	02/93→12/96					
2.3 T5-R	184	08/95→12/96					
2.4	106	08/94→12/96					
2.5 TDI	103	08/95→12/96					
2.0 Turbo	132	09/93→10/97		09/95→ 12/95; für Linkslenker		03.7760-3602.4 300176	ATE Ø 10" pneumatisch
2.0 Turbo	155	02/93→12/96					
2.3 T5 R	176	04/96→10/96		für Linkslenker		03.7760-3602.4 300176	ATE Ø 10" pneumatisch
2.4	125	09/92→12/96					
2.4 AWD	142	04/96→12/96					
2.3 Turbo R	177	06/95→10/97		09/95→ 12/96; für Linkslenker		03.7760-3602.4 300176	ATE Ø 10" pneumatisch
Pedalwegsensor, Bremspedal							
2.0	93	08/94→12/96		→ 08/95; für Linkslenker		03.0655-0003.2 370003	ATE
2.0	105	02/93→12/96					
2.0 Turbo	132	09/93→10/97		→ 08/95; für Rechtslenker		03.0655-0003.2 370003	ATE
2.0 Turbo	155	02/93→12/96					
2.3 T5	166	02/93→12/96					
2.3 T5-R	184	08/95→12/96					
2.4	106	08/94→12/96					
2.5 TDI	103	08/95→12/96					
2.3 Turbo R	177	06/95→10/97		08/95→ 08/95; für Rechtslenker		03.0655-0003.2 370003	ATE
				08/95→ 08/95; für Linkslenker		03.0655-0003.2 370003	ATE
2.4	125	09/92→12/96		09/93→ 08/95; für Linkslenker		03.0655-0003.2 370003	ATE
				09/93→ 08/95; für Rechtslenker		03.0655-0003.2 370003	ATE
 Hauptbremszylinder							
2.0	93	08/94→12/96		09/95→; + ASR		03.2023-1044.3 010590	ATE Ø1 23,81 Ø2 20,64
2.0	105	02/93→12/96		09/95→; - ASR		03.2023-1084.3 010591	ATE Ø1 23,81 Ø2 20,64
2.0 Turbo	155	02/93→12/96		09/95→; - ASR		03.2023-1084.3 010591	ATE Ø1 23,81 Ø2 20,64
2.3 T5	166	02/93→12/96		→ 08/95		10.6123-0445.3 010957	ATE Ø 23,81 ohne Bremsflüssigkeitsbehälter
2.3 T5-R	184	08/95→12/96					
2.4	106	08/94→12/96					
2.5 TDI	103	08/95→12/96					
2.0 Turbo	132	09/93→10/97		09/95→ 12/96; + ASR		03.2023-1044.3 010590	ATE Ø1 23,81 Ø2 20,64
↓							











	kw					! #		
VOLVO - 850 Kombi (LW) 04/92→10/97								
 Hauptbremszylinder								
2.0 Turbo	132	09/93→10/97		09/95→ 12/96; - ASR			03.2023-1084.3 010591	ATE Ø1 23,81 Ø2 20,64
				→ 08/95			10.6123-0445.3 010957	ATE Ø 23,81 ohne Bremsflüssigkeitsbehälter
2.3 T5 R	176	04/96→10/96		+ ASR			03.2023-1044.3 010590	ATE Ø1 23,81 Ø2 20,64
2.4 AWD	142	04/96→12/96		- ASR			03.2023-1084.3 010591	ATE Ø1 23,81 Ø2 20,64
2.3 Turbo R	177	06/95→10/97		09/95→ 12/96; + ASR			03.2023-1044.3 010590	ATE Ø1 23,81 Ø2 20,64
				09/95→ 12/96; - ASR			03.2023-1084.3 010591	ATE Ø1 23,81 Ø2 20,64
				08/95→ 08/95			10.6123-0445.3 010957	ATE Ø 23,81 ohne Bremsflüssigkeitsbehälter
2.4	125	09/92→12/96		→ 08/95			10.6123-0445.3 010957	ATE Ø 23,81 ohne Bremsflüssigkeitsbehälter
 Bremskraftregler								
2.0	93	08/94→12/96		→ 08/95			03.6055-0431.3 320142	ATE 5/35 4x
2.0	105	02/93→12/96						
2.0 Turbo	132	09/93→10/97						
2.0 Turbo	155	02/93→12/96						
2.3 T5	166	02/93→12/96						
2.3 T5-R	184	08/95→12/96						
2.4	106	08/94→12/96						
2.4	125	09/92→12/96						
2.5 TDI	103	08/95→12/96						
2.3 Turbo R	177	06/95→10/97		08/95→ 08/95			03.6055-0431.3 320142	ATE 5/35 4x
VOLVO - 940 II (944) 08/94→12/98								
 Hauptbremszylinder								
2.0 Turbo	114	04/96→10/98					03.2023-0875.3 010890	ATE Ø1 23,81 Ø2 20,64 ohne Bremsflüssigkeitsbehälter
2.3	85	08/94→07/95						
2.3	96	08/94→10/98						
2.3 ti	99	01/95→10/98						
2.3 Turbo	121	08/94→10/98						
2.4 TD Interc.	90	08/94→10/98						
2.3 Turbo	126	01/95→12/98		→ 10/98			03.2023-0875.3 010890	ATE Ø1 23,81 Ø2 20,64 ohne Bremsflüssigkeitsbehälter
 Bremskraftregler								
2.0 Turbo	114	04/96→10/98					03.6055-0431.3 320142	ATE 5/35 4x
2.3	85	08/94→07/95					03.6055-0430.3 320065	ATE 5/25 4x
2.3	96	08/94→10/98						
2.3 ti	99	01/95→10/98						
2.3 Turbo	121	08/94→10/98						
2.4 TD Interc.	90	08/94→10/98						
2.3 Turbo	126	01/95→12/98		→ 10/98			03.6055-0430.3 320065	ATE 5/25 4x
VOLVO - 940 II Kombi (945) 08/94→10/98								
 Hauptbremszylinder								
2.0 Turbo	114	04/96→10/98					03.2023-0875.3 010890	ATE Ø1 23,81 Ø2 20,64 ohne Bremsflüssigkeitsbehälter
2.3	85	08/94→07/95						
2.3	96	08/94→10/98						
2.3 ti	99	01/95→10/98						
2.3 Turbo	121	08/94→10/98						
2.3 Turbo	126	08/95→10/98						
2.4 TD Interc.	90	08/94→10/98						
 Bremskraftregler								
2.0 Turbo	114	04/96→10/98					03.6055-0431.3 320142	ATE 5/35 4x
2.3	85	08/94→07/95						
2.3	96	08/94→10/98						
2.3 ti	99	01/95→10/98						
2.3 Turbo	121	08/94→10/98						
2.3 Turbo	126	08/95→10/98						
2.4 TD Interc.	90	08/94→10/98						
VOLVO - 940 Kombi (945) 08/90→10/95								
 Hauptbremszylinder								
2.0 Turbo	114	01/91→07/95		→ 12/91; + ABS			03.2023-0164.3 010014	Ø1 23,81 Ø2 19,05 mit Bremsflüssigkeitsbehälter
2.4 D	60	08/90→07/95		→ 12/91; - ABS			03.2023-0503.3 010022	Ø1 23,81 Ø2 16,84 mit Bremsflüssigkeitsbehälter
				01/92→			03.2023-0875.3 010890	ATE Ø1 23,81 Ø2 20,64 ohne Bremsflüssigkeitsbehälter
↓								







	kw			 	! #		
VOLVO - 940 Kombi (945) 08/90→10/95							
Verschlusschraube, Hauptbremszylinder							
2.0 Turbo 2.4 D	114 60	01/91→07/95 08/90→07/95		→ 12/91; - ABS		03.3517-5100.1 390326	
 Bremskraftregler							
2.0 Turbo 2.4 D	114 60	01/91→07/95 08/90→07/95				03.6055-0431.3 320142	ATE 5/35 4x
VOLVO - 960 II (964) 07/94→12/96							
 Hauptbremszylinder							
2.5 2.9	125 150	07/94→12/96 07/94→12/96		08/94→		03.2023-0875.3 010890	ATE Ø1 23,81 Ø2 20,64 ohne Bremsflüssigkeitsbehälter
 Bremskraftregler							
2.5 2.9	125 150	07/94→12/96 07/94→12/96		08/94→		03.6055-0430.3 320065	ATE 5/25 4x
VOLVO - 960 II Kombi (965) 07/94→12/96							
 Hauptbremszylinder							
2.5 2.9	125 150	08/94→12/96 09/94→12/96				03.2023-0875.3 010890	ATE Ø1 23,81 Ø2 20,64 ohne Bremsflüssigkeitsbehälter
 Bremskraftregler							
2.5 2.9	125 150	08/94→12/96 09/94→12/96				03.6055-0430.3 320065	ATE 5/25 4x
VOLVO - C30 10/06→12/13							
 Bremskraftverstärker							
1.6 1.6 D 1.8 2.0 2.0 D 2.0 FlexFuel 2.4 i D5 D5 Electric Electric T5 T5	74 80 92 107 100 107 125 120 132 82 89 162 169	10/06→12/12 10/06→12/12 10/06→12/12 10/06→12/12 10/06→12/12 01/10→12/12 10/06→12/12 10/06→12/12 10/06→12/12 12/10→12/12 12/10→12/12 10/06→12/12 03/07→12/12		für Linkslenker		03.7863-4832.4 300289	ATE Ø 10" pneumatisch
1.8 FlexFuel	92	01/07→12/12		04/07→; für Linkslenker		03.7863-4832.4 300289	ATE Ø 10" pneumatisch
Pedalwegsensoren, Bremspedal							
1.6 1.6 D 1.8 2.0 2.0 D 2.0 FlexFuel 2.4 i D5 D5 T5 T5	74 80 92 107 100 107 125 120 132 162 169	10/06→12/12 10/06→12/12 10/06→12/12 10/06→12/12 10/06→12/12 01/10→12/12 10/06→12/12 10/06→12/12 10/06→12/12 10/06→12/12 03/07→12/12		für Linkslenker		03.0655-0007.2 370007	ATE
				für Rechtslenker		03.0655-0007.2 370007	ATE
1.8 FlexFuel	92	01/07→12/12		04/07→; für Rechtslenker		03.0655-0007.2 370007	ATE
				04/07→; für Linkslenker		03.0655-0007.2 370007	ATE
Electric Electric	82 89	12/10→12/12 12/10→12/12		für Linkslenker		03.0655-0007.2 370007	ATE
 Hauptbremszylinder							
1.6 1.6 D 1.8 2.0 2.0 D 2.0 FlexFuel 2.4 i D5 D5 Electric Electric T5 T5	74 80 92 107 100 107 125 120 132 82 89 162 169	10/06→12/12 10/06→12/12 10/06→12/12 10/06→12/12 10/06→12/12 01/10→12/12 10/06→12/12 10/06→12/12 10/06→12/12 12/10→12/12 12/10→12/12 10/06→12/12 03/07→12/12		für Linkslenker		03.2123-3593.3 010919	ATE Ø 23,81
1.8 FlexFuel ↓	92	01/07→12/12		04/07→; für Linkslenker		03.2123-3593.3 010919	ATE Ø 23,81









	kW					! #		
VOLVO - C30 10/06→12/13								
Hydraulikaggregat, Bremsanlage								
1.6	74	10/06→12/12		für Linkslenker; Getriebetyp: M66; Schaltgetriebe; + DSTC		24.9145-0005.2	399009	
1.6 D	80	10/06→12/12						
1.6 D2	84	10/10→12/12		für Rechtslenker; Getriebetyp: B6; Schaltgetriebe; + DSTC		24.9145-0005.2	399009	
1.8	92	10/06→12/12						
2.0	107	10/06→12/12		für Rechtslenker; Getriebetyp: AW55-50/51SN; Automatikgetriebe; + DSTC		24.9145-0005.2	399009	
2.0 D	100	10/06→12/12						
2.0 FlexFuel	107	01/10→12/12						
2.4 i	125	10/06→12/12						
D5	120	10/06→12/12						
D5	132	10/06→12/12						
T5	162	10/06→12/12						
T5	169	03/07→12/12						
1.8 FlexFuel	92	01/07→12/12		04/07→; für Linkslenker; Getriebetyp: M66; Schaltgetriebe; + DSTC		24.9145-0005.2	399009	
				04/07→; für Rechtslenker; Getriebetyp: AW55-50/51SN; Automatikgetriebe; + DSTC		24.9145-0005.2	399009	
				04/07→; für Rechtslenker; Getriebetyp: B6; Schaltgetriebe; + DSTC		24.9145-0005.2	399009	
D3	110	10/10→12/12		für Rechtslenker; Getriebetyp: AW55-50/51SN; Automatikgetriebe; + DSTC		24.9145-0005.2	399009	
D4	130	10/10→12/12		→ 203925; für Rechtslenker; Getriebetyp: B6; Schaltgetriebe; + DSTC		24.9145-0005.2	399009	
Electric	82	12/10→12/12		+ DSTC		24.9145-0005.2	399009	
Electric	89	12/10→12/12						
VOLVO - C70 I Cabriolet 03/98→10/05								
 Bremskraftverstärker								
2.0	132	03/98→10/05		→ 12/98; für Linkslenker		03.7760-3602.4	300176	ATE Ø 10" pneumatisch
2.0 T	166	03/98→10/05						
2.3 T5	176	03/98→10/05						
2.4	125	06/98→10/05						
2.4 T	142	03/98→10/05						
Pedalwegsensoren, Bremspedal								
2.0	132	03/98→10/05		01/99→; für Rechtslenker		03.0655-0004.2	370004	ATE
2.0 T	166	03/98→10/05						
2.3 T5	176	03/98→10/05		01/99→; für Linkslenker		03.0655-0004.2	370004	ATE
2.4	125	06/98→10/05						
2.4 T	142	03/98→10/05						
2.0 T	120	03/00→10/05		für Linkslenker		03.0655-0004.2	370004	ATE
2.3 T5	180	07/02→10/05		für Rechtslenker		03.0655-0004.2	370004	ATE
2.4 T	147	07/02→10/05						
 Hauptbremszylinder								
2.0	132	03/98→10/05		→ 12/98; + ASR		03.2023-1044.3	010590	ATE Ø1 23,81 Ø2 20,64
2.0 T	166	03/98→10/05		→ 12/98; - ASR		03.2023-1084.3	010591	ATE Ø1 23,81 Ø2 20,64
2.3 T5	176	03/98→10/05						
2.4	125	06/98→10/05		01/99→		03.2123-2164.3	010599	ATE Ø 23,81
2.4 T	142	03/98→10/05						
2.0 T	120	03/00→10/05				03.2123-2164.3	010599	ATE Ø 23,81
2.3 T5	180	07/02→10/05						
2.4 T	147	07/02→10/05						
VOLVO - C70 I Coupe 03/97→09/02								
 Bremskraftverstärker								
2.0	132	03/97→09/02		→ 12/98; für Linkslenker		03.7760-3602.4	300176	ATE Ø 10" pneumatisch
2.0 T	166	03/97→09/02						
2.3 T-5	176	03/97→09/02						
2.4 T	142	03/97→09/02						
Pedalwegsensoren, Bremspedal								
2.0	132	03/97→09/02		01/99→; für Rechtslenker		03.0655-0004.2	370004	ATE
2.0 T	166	03/97→09/02						
2.3 T-5	176	03/97→09/02		01/99→; für Linkslenker		03.0655-0004.2	370004	ATE
2.4 T	142	03/97→09/02						
2.0 T	120	03/00→09/02		für Linkslenker		03.0655-0004.2	370004	ATE
2.4	121	03/99→09/02		für Rechtslenker		03.0655-0004.2	370004	ATE
2.4	125	05/99→09/02		11/99→; für Linkslenker		03.0655-0004.2	370004	ATE
				11/99→; für Rechtslenker		03.0655-0004.2	370004	ATE
 Hauptbremszylinder								
2.0	132	03/97→09/02		→ 12/98; für Linkslenker; + ASR		03.2023-1044.3	010590	ATE Ø1 23,81 Ø2 20,64
2.0 T	166	03/97→09/02		→ 12/98; für Linkslenker; - ASR		03.2023-1084.3	010591	ATE Ø1 23,81 Ø2 20,64
↓								









	kw			 	! #		
VOLVO - C70 I Coupe 03/97→09/02							
 Hauptbremszylinder							
2.3 T-5	176	03/97→09/02		01/99→		03.2123-2164.3 010599	ATE Ø 23,81
2.4 T	142	03/97→09/02					
2.0 T	120	03/00→09/02				03.2123-2164.3 010599	ATE Ø 23,81
2.4	121	03/99→09/02					
2.4	125	05/99→09/02		11/99→		03.2123-2164.3 010599	ATE Ø 23,81
VOLVO - C70 II Cabriolet 03/06→06/13							
 Bremskraftverstärker							
2.0 D	100	01/08→10/09		06/08→; für Linkslenker		03.7863-4832.4 300289	ATE Ø 10" pneumatisch
2.4	103	03/06→10/09		für Linkslenker		03.7863-4832.4 300289	ATE Ø 10" pneumatisch
2.4 D	120	03/07→06/13					
2.4 i	125	03/06→10/09					
D5	132	03/06→06/13					
T5	162	03/06→02/07					
T5	169	03/07→10/09					
Pedalwegsensoren, Bremspedal							
2.0 D	100	01/08→10/09		50576→; für Rechtslenker		03.0655-0007.2 370007	ATE
				06/08→; → 50575; für Rechtslenker		03.0655-0007.2 370007	ATE
				06/08→; für Linkslenker		03.0655-0007.2 370007	ATE
2.4	103	03/06→10/09		für Linkslenker		03.0655-0007.2 370007	ATE
2.4 D	120	03/07→06/13					
2.4 i	125	03/06→10/09		für Rechtslenker		03.0655-0007.2 370007	ATE
D5	132	03/06→06/13					
T5	162	03/06→02/07					
T5	169	03/07→10/09					
 Hauptbremszylinder							
2.0 D	100	01/08→10/09		06/08→; für Linkslenker		03.2123-3593.3 010919	ATE Ø 23,81
2.4	103	03/06→10/09		für Linkslenker		03.2123-3593.3 010919	ATE Ø 23,81
2.4 D	120	03/07→06/13					
2.4 i	125	03/06→10/09					
D5	132	03/06→06/13					
T5	162	03/06→02/07					
T5	169	03/07→10/09					
Hydraulikaggregat, Bremsanlage							
2.0 D	100	01/08→10/09		112004→; variant code: GZ01; + DSTC		24.9145-0005.2 399009	
				06/08→; → 112003; + DSTC		24.9145-0005.2 399009	
2.4	103	03/06→10/09		112004→; variant code: GZ01; + DSTC		24.9145-0005.2 399009	
2.4 D	120	03/07→06/13					
2.4 i	125	03/06→10/09		→ 112003; + DSTC		24.9145-0005.2 399009	
D5	132	03/06→06/13					
T5	162	03/06→02/07					
T5	169	03/07→10/09					
D3	110	10/10→06/13		→ 112003; + DSTC		24.9145-0005.2 399009	
D4	130	10/10→06/13					
VOLVO - S40 I (VS) 07/95→06/04							
 Hauptbremszylinder							
1.6	77	09/95→08/99		→ 08/97		24.2122-1718.3 010517	Ø 22,2
1.8	85	07/95→08/99					
1.9 T4	147	05/97→07/00		09/97→		24.2123-1746.3 010682	Ø 23,81
1.9 TD	66	07/95→08/99					
2.0	100	07/95→12/03					
2.0	103	07/95→08/99					
1.6	80	03/99→12/03				24.2123-1746.3 010682	Ø 23,81
1.8	90	03/99→12/03					
1.8 i	90	06/01→12/03					
1.8 i	92	03/98→12/03					
1.9 DI	70	03/99→07/00					
1.9 DI	75	07/00→12/03					
1.9 DI	85	07/00→12/03					
2.0 T	120	06/01→12/03					
2.0 T	121	07/00→06/01					
2.0 T4	147	07/00→12/03					
2.0 T	118	10/97→12/03		→ 07/00		24.2123-1746.3 010682	Ø 23,81
VOLVO - S40 II (MS) 01/04→12/12							
 Bremskraftverstärker							
1.6	74	01/05→12/12		→ 05/12; für Linkslenker		03.7863-4832.4 300289	ATE Ø 10" pneumatisch
1.6 D	81	01/05→12/12					
2.0	107	10/06→12/12					
2.0 F	107	10/09→12/12					
2.4 AWD	125	08/06→12/12					
↓							











	kW			 	! #		
VOLVO - S40 II (MS) 01/04→12/12							
 Bremskraftverstärker							
T5	169	03/07→12/12		→ 05/12; für Linkslenker		03.7863-4832.4 300289	ATE Ø 10" pneumatisch
1.8	92	04/04→12/10		für Linkslenker		03.7863-4832.4 300289	ATE Ø 10" pneumatisch
2.0 D	100	01/04→12/10					
2.0 D4	96	07/05→12/06					
2.4	103	01/04→12/10					
2.4	125	01/04→12/10					
2.4 D5	132	03/06→12/10					
T5	162	01/04→12/07					
T5 AWD	162	04/04→12/07					
T5 AWD	169	03/07→12/10					
1.8 FlexFuel	92	01/06→12/10		04/07→; für Linkslenker		03.7863-4832.4 300289	ATE Ø 10" pneumatisch
Pedalwegsensor, Bremspedal							
1.6	74	01/05→12/12		→ 05/12; für Rechtslenker		03.0655-0007.2 370007	ATE
1.6 D	81	01/05→12/12					
2.0	107	10/06→12/12		→ 05/12; für Linkslenker		03.0655-0007.2 370007	ATE
2.0 F	107	10/09→12/12					
2.4 AWD	125	08/06→12/12					
T5	169	03/07→12/12					
1.8	92	04/04→12/10		für Linkslenker		03.0655-0007.2 370007	ATE
2.0 D	100	01/04→12/10					
2.0 D4	96	07/05→12/06		für Rechtslenker		03.0655-0007.2 370007	ATE
2.4	103	01/04→12/10					
2.4	125	01/04→12/10					
2.4 D5	132	03/06→12/10					
T5	162	01/04→12/07					
T5 AWD	162	04/04→12/07					
T5 AWD	169	03/07→12/10					
1.8 FlexFuel	92	01/06→12/10		04/07→; für Rechtslenker		03.0655-0007.2 370007	ATE
				04/07→; für Linkslenker		03.0655-0007.2 370007	ATE
 Hauptbremszylinder							
1.6	74	01/05→12/12		→ 05/12; für Linkslenker		03.2123-3593.3 010919	ATE Ø 23,81
1.6 D	81	01/05→12/12					
2.0	107	10/06→12/12					
2.0 F	107	10/09→12/12					
2.4 AWD	125	08/06→12/12					
T5	169	03/07→12/12					
1.8	92	04/04→12/10		für Linkslenker		03.2123-3593.3 010919	ATE Ø 23,81
2.0 D	100	01/04→12/10					
2.0 D4	96	07/05→12/06					
2.4	103	01/04→12/10					
2.4	125	01/04→12/10					
2.4 D5	132	03/06→12/10					
T5	162	01/04→12/07					
T5 AWD	162	04/04→12/07					
T5 AWD	169	03/07→12/10					
1.8 FlexFuel	92	01/06→12/10		04/07→; für Linkslenker		03.2123-3593.3 010919	ATE Ø 23,81
Hydraulikaggregat, Bremsanlage							
1.6	74	01/05→12/12		→ 05/12; + DSTC		24.9145-0005.2 399009	
1.6 D	81	01/05→12/12					
2.0	107	10/06→12/12					
2.0 F	107	10/09→12/12					
2.4 AWD	125	08/06→12/12					
T5	169	03/07→12/12					
1.8	92	04/04→12/10		+ DSTC		24.9145-0005.2 399009	
2.0 D	100	01/04→12/10					
2.0 D4	96	07/05→12/06					
2.4	103	01/04→12/10					
2.4	125	01/04→12/10					
2.4 D5	132	03/06→12/10					
T5	162	01/04→12/07					
1.8 FlexFuel	92	01/06→12/10		04/07→; + DSTC		24.9145-0005.2 399009	
VOLVO - S60 I 07/00→04/10							
 Bremskraftverstärker							
2.0 T	132	07/00→04/10		09/01→ 12/01		03.7755-3402.4 300189	ATE Ø 9 / 8" pneumatisch
				01/02→ 01/09; - DSTC		03.7755-4702.4 300224	ATE Ø 9 / 8" pneumatisch
				01/02→ 01/09; + DSTC		03.7858-3532.4 300233	ATE Ø 9 / 8" pneumatisch
2.3 T5	195	07/00→09/02		→ 12/01		03.7755-3402.4 300189	ATE Ø 9 / 8" pneumatisch
				- DSTC		03.7755-4702.4 300224	ATE Ø 9 / 8" pneumatisch
				+ DSTC		03.7858-3532.4 300233	ATE Ø 9 / 8" pneumatisch
2.4	103	07/00→04/10		11/00→ 12/01		03.7755-3402.4 300189	ATE Ø 9 / 8" pneumatisch
2.4 T	147	07/00→04/10		01/02→ 01/09; - DSTC		03.7755-4702.4 300224	ATE Ø 9 / 8" pneumatisch
↓							

	kw			 	! #		
VOLVO - S60 I 07/00→04/10							
Bremskraftverstärker							
2.4 2.4 T	103 147	07/00→04/10 07/00→04/10		01/02→ 01/09; + DSTC		03.7858-3532.4 300233	ATE Ø 9 / 8" pneumatisch
2.4	125	11/00→04/10		→ 12/01		03.7755-3402.4 300189	ATE Ø 9 / 8" pneumatisch
				01/02→ 01/09; - DSTC		03.7755-4702.4 300224	ATE Ø 9 / 8" pneumatisch
				01/02→ 01/09; + DSTC		03.7858-3532.4 300233	ATE Ø 9 / 8" pneumatisch
2.4 2.4 D	132 90	01/05→10/06 05/05→12/06		- DSTC		03.7755-4702.4 300224	ATE Ø 9 / 8" pneumatisch
				+ DSTC		03.7858-3532.4 300233	ATE Ø 9 / 8" pneumatisch
2.4 AWD 2.5 T AWD	191 154	02/04→04/10 07/02→04/10		04/04→ 01/09; - DSTC		03.7755-4702.4 300224	ATE Ø 9 / 8" pneumatisch
				04/04→ 01/09; + DSTC		03.7858-3532.4 300233	ATE Ø 9 / 8" pneumatisch
2.4 Bifuel (CNG) 2.4 Bifuel (LPG)	103 103	07/01→04/10 07/01→04/10		06/02→ 01/09; - DSTC		03.7755-4702.4 300224	ATE Ø 9 / 8" pneumatisch
				06/02→ 01/09; + DSTC		03.7858-3532.4 300233	ATE Ø 9 / 8" pneumatisch
2.4 D 2.4 D5	93 136	03/05→04/10 03/05→04/10		09/05→ 01/09; - DSTC		03.7755-4702.4 300224	ATE Ø 9 / 8" pneumatisch
				09/05→ 01/09; + DSTC		03.7858-3532.4 300233	ATE Ø 9 / 8" pneumatisch
2.4 D	96	05/01→04/10		01/02→ 01/09; - DSTC		03.7755-4702.4 300224	ATE Ø 9 / 8" pneumatisch
				01/02→ 01/09; + DSTC		03.7858-3532.4 300233	ATE Ø 9 / 8" pneumatisch
2.4 D 2.4 T5	120 191	07/05→12/09 04/04→04/10		→ 01/09; - DSTC		03.7755-4702.4 300224	ATE Ø 9 / 8" pneumatisch
				→ 01/09; + DSTC		03.7858-3532.4 300233	ATE Ø 9 / 8" pneumatisch
2.4 D5	120	01/01→04/10		07/01→ 12/01		03.7755-3402.4 300189	ATE Ø 9 / 8" pneumatisch
				01/02→ 01/09; - DSTC		03.7755-4702.4 300224	ATE Ø 9 / 8" pneumatisch
				01/02→ 01/09; + DSTC		03.7858-3532.4 300233	ATE Ø 9 / 8" pneumatisch
2.4 T AWD	147	06/01→04/10		11/01→ 12/01		03.7755-3402.4 300189	ATE Ø 9 / 8" pneumatisch
				01/02→ 01/09; - DSTC		03.7755-4702.4 300224	ATE Ø 9 / 8" pneumatisch
				01/02→ 01/09; + DSTC		03.7858-3532.4 300233	ATE Ø 9 / 8" pneumatisch
2.5 T	154	01/03→04/10		02/04→ 01/09; - DSTC		03.7755-4702.4 300224	ATE Ø 9 / 8" pneumatisch
				02/04→ 01/09; + DSTC		03.7858-3532.4 300233	ATE Ø 9 / 8" pneumatisch
R 2,5 T AWD	221	01/03→04/10		03/03→ 01/09; - DSTC		03.7755-4702.4 300224	ATE Ø 9 / 8" pneumatisch
				03/03→ 01/09; + DSTC		03.7858-3532.4 300233	ATE Ø 9 / 8" pneumatisch
T5	184	07/00→04/10		08/00→ 12/01		03.7755-3402.4 300189	ATE Ø 9 / 8" pneumatisch
				01/02→ 04/04; - DSTC		03.7755-4702.4 300224	ATE Ø 9 / 8" pneumatisch
				01/02→ 04/04; + DSTC		03.7858-3532.4 300233	ATE Ø 9 / 8" pneumatisch
Pedalwegsensoren, Bremspedal							
2.0 T	132	07/00→04/10		09/01→ 12/01		03.0655-0004.2 370004	ATE
				01/05→ 01/09		03.0655-0005.2 370005	ATE
				01/02→ 01/09		03.0655-0005.2 370005	ATE
2.3 T5	195	07/00→09/02		→ 12/01		03.0655-0004.2 370004	ATE
						03.0655-0005.2 370005	ATE
2.4 2.4 T	103 147	07/00→04/10 07/00→04/10		11/00→ 12/01		03.0655-0004.2 370004	ATE
				01/05→ 01/09		03.0655-0005.2 370005	ATE
				01/02→ 01/09		03.0655-0005.2 370005	ATE
2.4	125	11/00→04/10		→ 12/01		03.0655-0004.2 370004	ATE
				01/05→ 01/09		03.0655-0005.2 370005	ATE
				01/02→ 01/09		03.0655-0005.2 370005	ATE
2.4 2.4 D	132 90	01/05→10/06 05/05→12/06				03.0655-0005.2 370005	ATE
2.4 AWD 2.5 T AWD	191 154	02/04→04/10 07/02→04/10		01/05→ 01/09		03.0655-0005.2 370005	ATE
				04/04→ 01/09		03.0655-0005.2 370005	ATE
2.4 Bifuel (CNG) 2.4 Bifuel (LPG)	103 103	07/01→04/10 07/01→04/10		01/05→ 01/09		03.0655-0005.2 370005	ATE
				06/02→ 01/09		03.0655-0005.2 370005	ATE
2.4 D 2.4 D5	93 136	03/05→04/10 03/05→04/10		09/05→ 01/09		03.0655-0005.2 370005	ATE
2.4 D	96	05/01→04/10		01/05→ 01/09		03.0655-0005.2 370005	ATE
				01/02→ 01/09		03.0655-0005.2 370005	ATE
2.4 D 2.4 D5	120 120	07/05→12/09 01/01→04/10		→ 01/09		03.0655-0005.2 370005	ATE
				07/01→ 12/01		03.0655-0004.2 370004	ATE
				01/05→ 01/09		03.0655-0005.2 370005	ATE
				01/02→ 01/09		03.0655-0005.2 370005	ATE
2.4 T5	191	04/04→04/10		01/05→ 01/09		03.0655-0005.2 370005	ATE
				→ 01/09		03.0655-0005.2 370005	ATE
2.4 T AWD	147	06/01→04/10		11/01→ 12/01		03.0655-0004.2 370004	ATE
				01/05→ 01/09		03.0655-0005.2 370005	ATE
				01/02→ 01/09		03.0655-0005.2 370005	ATE
↓							

	kw			 	! #		
VOLVO - S60 I 07/00→04/10							
Pedalwegsensoren, Bremspedal							
2.5 T	154	01/03→04/10		01/05→ 01/09		03.0655-0005.2 370005	ATE
				02/04→ 01/09		03.0655-0005.2 370005	ATE
R 2.5 T AWD	221	01/03→04/10		01/05→ 01/09		03.0655-0005.2 370005	ATE
				03/03→ 01/09		03.0655-0005.2 370005	ATE
T5	184	07/00→04/10		08/00→ 12/01		03.0655-0004.2 370004	ATE
				01/02→ 04/04		03.0655-0005.2 370005	ATE
 Hauptbremszylinder							
2.0 T	132	07/00→04/10		09/01→; → 8535; - DSTC		03.2125-7637.3 010707	ATE Ø 25,4
				09/01→; → 11551; für Rechtslenker; + DSTC		03.2125-7637.3 010707	ATE Ø 25,4
				8536→; → 01/09; für Rechtslenker; - DSTC		03.2125-7638.3 010738	ATE Ø 25,4
				11552→; → 01/09; für Rechtslenker; + DSTC		03.2125-7638.3 010738	ATE Ø 25,4
				09/01→; → 9499; für Linkslenker; + DSTC		03.2125-7708.3 010739	ATE Ø 25,4
				9500→; → 01/09; für Linkslenker; + DSTC		03.2125-7713.3 010819	ATE Ø 25,4
				8536→; → 01/09; für Linkslenker; - DSTC		03.2125-7743.3 010921	ATE Ø 25,4
2.3 T5	195	07/00→09/02		→ 11551; für Rechtslenker; + DSTC		03.2125-7637.3 010707	ATE Ø 25,4
				→ 8535; - DSTC		03.2125-7637.3 010707	ATE Ø 25,4
				11552→; für Rechtslenker; + DSTC		03.2125-7638.3 010738	ATE Ø 25,4
				8536→; für Rechtslenker; - DSTC		03.2125-7638.3 010738	ATE Ø 25,4
				→ 9499; für Linkslenker; + DSTC		03.2125-7708.3 010739	ATE Ø 25,4
				9500→; für Linkslenker; + DSTC		03.2125-7713.3 010819	ATE Ø 25,4
				8536→; für Linkslenker; - DSTC		03.2125-7743.3 010921	ATE Ø 25,4
2.4 2.4 T	103 147	07/00→04/10 07/00→04/10		11/00→; → 11551; für Rechtslenker; + DSTC		03.2125-7637.3 010707	ATE Ø 25,4
				11/00→; → 8535; - DSTC		03.2125-7637.3 010707	ATE Ø 25,4
				8536→; → 01/09; für Rechtslenker; - DSTC		03.2125-7638.3 010738	ATE Ø 25,4
				11552→; → 01/09; für Rechtslenker; + DSTC		03.2125-7638.3 010738	ATE Ø 25,4
				11/00→; → 9499; für Linkslenker; + DSTC		03.2125-7708.3 010739	ATE Ø 25,4
				9500→; → 01/09; für Linkslenker; + DSTC		03.2125-7713.3 010819	ATE Ø 25,4
				8536→; → 01/09; für Linkslenker; - DSTC		03.2125-7743.3 010921	ATE Ø 25,4
2.4 2.4 D	125 120	11/00→04/10 07/05→12/09		→ 8535; - DSTC		03.2125-7637.3 010707	ATE Ø 25,4
				→ 11551; für Rechtslenker; + DSTC		03.2125-7637.3 010707	ATE Ø 25,4
				8536→; → 01/09; für Rechtslenker; - DSTC		03.2125-7638.3 010738	ATE Ø 25,4
				11552→; → 01/09; für Rechtslenker; + DSTC		03.2125-7638.3 010738	ATE Ø 25,4
				→ 9499; für Linkslenker; + DSTC		03.2125-7708.3 010739	ATE Ø 25,4
				9500→; → 01/09; für Linkslenker; + DSTC		03.2125-7713.3 010819	ATE Ø 25,4
				8536→; → 01/09; für Linkslenker; - DSTC		03.2125-7743.3 010921	ATE Ø 25,4
2.4 2.4 D	132 90	01/05→10/06 05/05→12/06		für Linkslenker; + DSTC		03.2125-7713.3 010819	ATE Ø 25,4
				für Linkslenker; - DSTC		03.2125-7743.3 010921	ATE Ø 25,4
2.4 AWD 2.5 T AWD	191 154	02/04→04/10 07/02→04/10		04/04→; → 11551; für Rechtslenker; + DSTC		03.2125-7637.3 010707	ATE Ø 25,4
				11552→; → 01/09; für Rechtslenker; + DSTC		03.2125-7638.3 010738	ATE Ø 25,4
				04/04→ 01/09; für Rechtslenker; - DSTC		03.2125-7638.3 010738	ATE Ø 25,4
				04/04→; → 9499; für Linkslenker; + DSTC		03.2125-7708.3 010739	ATE Ø 25,4
				9500→; → 01/09; für Linkslenker; + DSTC		03.2125-7713.3 010819	ATE Ø 25,4
				04/04→ 01/09; für Linkslenker; - DSTC		03.2125-7743.3 010921	ATE Ø 25,4
2.4 Bifuel (CNG) 2.4 Bifuel (LPG)	103 103	07/01→04/10 07/01→04/10		06/02→; → 11551; für Rechtslenker; + DSTC		03.2125-7637.3 010707	ATE Ø 25,4
				11552→; → 01/09; für Rechtslenker; + DSTC		03.2125-7638.3 010738	ATE Ø 25,4
				06/02→ 01/09; für Rechtslenker; - DSTC		03.2125-7638.3 010738	ATE Ø 25,4
↓							

	kw			 	! #		
VOLVO - S60 I 07/00→04/10							
Hauptbremszylinder							
2.4 Bifuel (CNG) 2.4 Bifuel (LPG)	103 103	07/01→04/10 07/01→04/10		06/02→; → 9499; für Linkslenker; + DSTC		03.2125-7708.3 010739	ATE Ø 25,4
				9500→; → 01/09; für Linkslenker; + DSTC		03.2125-7713.3 010819	ATE Ø 25,4
				06/02→ 01/09; für Linkslenker; - DSTC		03.2125-7743.3 010921	ATE Ø 25,4
2.4 D 2.4 D5	93 136	03/05→04/10 03/05→04/10		09/05→ 01/09; für Rechtslenker; + DSTC		03.2125-7638.3 010738	ATE Ø 25,4
				09/05→; für Rechtslenker; → 01/09; - DSTC		03.2125-7638.3 010738	ATE Ø 25,4
				09/05→ 01/09; für Linkslenker; + DSTC		03.2125-7713.3 010819	ATE Ø 25,4
				09/05→ 01/09; für Linkslenker; - DSTC		03.2125-7743.3 010921	ATE Ø 25,4
2.4 D	96	05/01→04/10		12/01→; → 8535; - DSTC		03.2125-7637.3 010707	ATE Ø 25,4
				12/01→; → 11551; für Rechtslenker; + DSTC		03.2125-7637.3 010707	ATE Ø 25,4
				8536→; → 01/09; für Rechtslenker; - DSTC		03.2125-7638.3 010738	ATE Ø 25,4
				11552→; → 01/09; für Rechtslenker; + DSTC		03.2125-7638.3 010738	ATE Ø 25,4
				12/01→; → 9499; für Linkslenker; + DSTC		03.2125-7708.3 010739	ATE Ø 25,4
				9500→; → 01/09; für Linkslenker; + DSTC		03.2125-7713.3 010819	ATE Ø 25,4
				8536→; → 01/09; für Linkslenker; - DSTC		03.2125-7743.3 010921	ATE Ø 25,4
2.4 D5	120	01/01→04/10		07/01→; → 11551; für Rechtslenker; + DSTC		03.2125-7637.3 010707	ATE Ø 25,4
				07/01→; → 8535; - DSTC		03.2125-7637.3 010707	ATE Ø 25,4
				8536→; → 01/09; für Rechtslenker; - DSTC		03.2125-7638.3 010738	ATE Ø 25,4
				11552→; → 01/09; für Rechtslenker; + DSTC		03.2125-7638.3 010738	ATE Ø 25,4
				07/01→; → 9499; für Linkslenker; + DSTC		03.2125-7708.3 010739	ATE Ø 25,4
				9500→; → 01/09; für Linkslenker; + DSTC		03.2125-7713.3 010819	ATE Ø 25,4
				8536→; → 01/09; für Linkslenker; - DSTC		03.2125-7743.3 010921	ATE Ø 25,4
2.4 T5	191	04/04→04/10		→ 11551; für Rechtslenker; + DSTC		03.2125-7637.3 010707	ATE Ø 25,4
				→ 01/09; für Rechtslenker; - DSTC		03.2125-7638.3 010738	ATE Ø 25,4
				11552→; → 01/09; für Rechtslenker; + DSTC		03.2125-7638.3 010738	ATE Ø 25,4
				→ 9499; für Linkslenker; + DSTC		03.2125-7708.3 010739	ATE Ø 25,4
				9500→; → 01/09; für Linkslenker; + DSTC		03.2125-7713.3 010819	ATE Ø 25,4
				→ 01/09; für Linkslenker; - DSTC		03.2125-7743.3 010921	ATE Ø 25,4
2.4 T AWD	147	06/01→04/10		11/01→; → 11551; für Rechtslenker; + DSTC		03.2125-7637.3 010707	ATE Ø 25,4
				11/01→; → 8535; - DSTC		03.2125-7637.3 010707	ATE Ø 25,4
				8536→; → 01/09; für Rechtslenker; - DSTC		03.2125-7638.3 010738	ATE Ø 25,4
				11552→; → 01/09; für Rechtslenker; + DSTC		03.2125-7638.3 010738	ATE Ø 25,4
				11/01→; → 9499; für Linkslenker; + DSTC		03.2125-7708.3 010739	ATE Ø 25,4
				9500→; → 01/09; für Linkslenker; + DSTC		03.2125-7713.3 010819	ATE Ø 25,4
				8536→; → 01/09; für Linkslenker; - DSTC		03.2125-7743.3 010921	ATE Ø 25,4
2.5 T	154	01/03→04/10		02/04→; → 11551; für Rechtslenker; + DSTC		03.2125-7637.3 010707	ATE Ø 25,4
				11552→; → 01/09; für Rechtslenker; + DSTC		03.2125-7638.3 010738	ATE Ø 25,4
				02/04→ 01/09; für Rechtslenker; - DSTC		03.2125-7638.3 010738	ATE Ø 25,4
				02/04→; → 9499; für Linkslenker; + DSTC		03.2125-7708.3 010739	ATE Ø 25,4
				9500→; → 01/09; für Linkslenker; + DSTC		03.2125-7713.3 010819	ATE Ø 25,4
				02/04→ 01/09; für Linkslenker; - DSTC		03.2125-7743.3 010921	ATE Ø 25,4
R 2,5 T AWD	221	01/03→04/10		03/03→; → 11551; für Rechtslenker; + DSTC		03.2125-7637.3 010707	ATE Ø 25,4
				03/03→ 01/09; für Rechtslenker; - DSTC		03.2125-7638.3 010738	ATE Ø 25,4
				11552→; → 01/09; für Rechtslenker; + DSTC		03.2125-7638.3 010738	ATE Ø 25,4



	kw			 	! #		
VOLVO - S60 I 07/00→04/10							
 Hauptbremszylinder							
R 2,5 T AWD	221	01/03→04/10		03/03→; → 9499; für Linkslenker; + DSTC		03.2125-7708.3 010739	ATE Ø 25,4
				9500→; → 01/09; für Linkslenker; + DSTC		03.2125-7713.3 010819	ATE Ø 25,4
				03/03→ 01/09; für Linkslenker; - DSTC		03.2125-7743.3 010921	ATE Ø 25,4
T5	184	07/00→04/10		08/00→; → 8535; - DSTC		03.2125-7637.3 010707	ATE Ø 25,4
				08/00→; → 11551; für Rechtslenker; + DSTC		03.2125-7637.3 010707	ATE Ø 25,4
				11552→; → 04/04; für Rechtslenker; + DSTC		03.2125-7638.3 010738	ATE Ø 25,4
				8536→; → 04/04; für Rechtslenker; - DSTC		03.2125-7638.3 010738	ATE Ø 25,4
				08/00→; → 9499; für Linkslenker; + DSTC		03.2125-7708.3 010739	ATE Ø 25,4
				9500→; → 04/04; für Linkslenker; + DSTC		03.2125-7713.3 010819	ATE Ø 25,4
				8536→; → 04/04; für Linkslenker; - DSTC		03.2125-7743.3 010921	ATE Ø 25,4
VOLVO - S60 II 04/10→							
 Bremskraftverstärker							
2.0 D2	88	03/15→		für Fahrzeuge ohne Kollisionswarner		03.7755-9703.4 300239	ATE Ø 9 / 8" pneumatisch
2.0 D3	110	03/15→					
2.0 D4	140	03/15→					
2.0 D5	165	03/15→					
2.4 D4 AWD	140	03/15→					
2.5 T5	186	09/11→					
D4	133	09/13→12/15					
T5 AWD	187	08/15→					
2.0 T	132	05/12→12/15		12/13→; für Fahrzeuge ohne Kollisionswarner		03.7755-9703.4 300239	ATE Ø 9 / 8" pneumatisch
Pedalwegsensord, Bremspedal							
1.5 T2	90	10/15→		für Fahrzeuge mit Kollisionswarner		03.0655-0007.2 370007	ATE
1.5 T3	112	03/15→					
2.0 D2	88	03/15→					
2.0 D3	110	03/15→					
2.0 D4	140	03/15→					
2.0 D5	165	03/15→					
2.0 T	149	04/10→12/11					
2.0 T3	112	03/15→					
2.4 D4 AWD	140	03/15→					
2.5 T5	186	09/11→					
2.5 T5 AWD	186	09/12→					
D3	100	05/12→12/15					
D3	120	04/10→12/14					
D4	133	09/13→12/15					
D5	151	04/10→12/11					
D5	169	04/14→12/15					
D5 AWD	151	04/10→12/11					
D5 AWD	169	04/14→12/15					
DRIVE / D2	84	01/11→12/15					
T3	110	04/10→12/15					
T4	132	04/10→12/15					
T4F	132	04/11→12/15					
T5	177	04/10→12/14					
T5	180	09/13→					
T5	225	08/13→					
T5 AWD	180	07/14→					
T5 AWD	187	08/15→					
T6	225	09/13→					
T6 AWD	225	09/15→					
T6 AWD	224	04/10→12/15					
T6 AWD	242	04/14→12/15					
2.0 T	132	05/12→12/15		12/13→; für Fahrzeuge mit Kollisionswarner		03.0655-0007.2 370007	ATE
2.0 T4	140	03/15→		05/15→; für Fahrzeuge mit Kollisionswarner		03.0655-0007.2 370007	ATE
D4	120	04/10→12/14		05/12→; für Fahrzeuge mit Kollisionswarner		03.0655-0007.2 370007	ATE
D5	158	04/11→12/15		06/11→; für Fahrzeuge mit Kollisionswarner		03.0655-0007.2 370007	ATE
D5 AWD	158	04/11→12/15					
VOLVO - S70 (LS) 11/96→11/00							
 Bremskraftverstärker							
2.0	93	01/97→11/00		für Linkslenker		03.7760-3602.4 300176	ATE Ø 10" pneumatisch
2.0 ↓	105	01/97→11/00					

VOLVO - S70 (LS) 11/96→11/00

Bremskraftverstärker

2.0	120	01/97→11/00		für Linkslenker			ATE Ø 10" pneumatisch
2.0	132	01/97→11/00			03.7760-3602.4	300176	
2.0 Turbo	155	01/97→11/00					
2.0 Turbo	166	01/97→11/00					
2.3	195	04/99→09/00					
2.3 T-5	176	01/97→11/00					
2.3 Turbo	184	01/97→11/00					
2.4	103	08/99→11/00					
2.4	106	01/97→11/00					
2.4	121	06/98→11/00					
2.4	125	01/97→11/00					
2.4 AWD	103	04/99→09/00					
2.4 AWD	106	11/96→05/99					
2.4 AWD	121	10/98→05/99					
2.4 Bifuel	103	07/99→11/00					
2.4 Bifuel	106	10/98→11/00					
2.4 Blu-Fuel	103	07/97→09/00					
2.4 T5 AWD	142	11/96→04/99					
2.4 Turbo	142	01/97→11/00					
2.5 TDI	103	01/97→11/00					
2.5 TDi AWD	103	10/99→09/00					
2.3	177	11/96→11/00		01/97→; für Linkslenker	03.7760-3602.4	300176	ATE Ø 10" pneumatisch
2.4 AWD	125	04/99→09/00		→ 05/99; für Linkslenker	03.7760-3602.4	300176	ATE Ø 10" pneumatisch











Hauptbremszylinder











2.0	93	01/97→11/00		→ 12/98; + ASR			ATE Ø1 23,81 Ø2 20,64									
2.0	105	01/97→11/00		→ 12/98; - ASR	03.2023-1044.3	010590	ATE Ø1 23,81 Ø2 20,64									
2.0	120	01/97→11/00						03.2023-1084.3	010591	ATE Ø1 23,81 Ø2 20,64						
2.0	132	01/97→11/00		01/99→							03.2123-2164.3	010599	ATE Ø 23,81			
2.0 Turbo	155	01/97→11/00														
2.0 Turbo	166	01/97→11/00														
2.3 T-5	176	01/97→11/00														
2.3 Turbo	184	01/97→11/00														
2.4	106	01/97→11/00														
2.4	121	06/98→11/00														
2.4	125	01/97→11/00														
2.4 AWD	121	10/98→05/99														
2.4 Bifuel	106	10/98→11/00														
2.4 T5 AWD	142	11/96→04/99														
2.4 Turbo	142	01/97→11/00														
2.5 TDI	103	01/97→11/00														
2.3	177	11/96→11/00		01/97→ 12/98; + ASR										03.2023-1044.3	010590	ATE Ø1 23,81 Ø2 20,64
				01/97→ 12/98; - ASR										03.2023-1084.3	010591	ATE Ø1 23,81 Ø2 20,64
				01/99→										03.2123-2164.3	010599	ATE Ø 23,81
2.3	195	04/99→09/00												03.2123-2164.3	010599	ATE Ø 23,81
2.4	103	08/99→11/00														
2.4 AWD	103	04/99→09/00														
2.4 Bifuel	103	07/99→11/00														
2.4 Blu-Fuel	103	07/97→09/00														
2.5 TDi AWD	103	10/99→09/00														
2.4 AWD	106	11/96→05/99		→ 12/98; - ASR	03.2023-1044.3	010590	ATE Ø1 23,81 Ø2 20,64									
					03.2023-1084.3	010591	ATE Ø1 23,81 Ø2 20,64									
				01/99→	03.2123-2164.3	010599	ATE Ø 23,81									
2.4 AWD	125	04/99→09/00		→ 05/99	03.2123-2164.3	010599	ATE Ø 23,81									











VOLVO - S80 I (TS, XY) 05/98→02/08









Bremskraftverstärker









2.0	120	06/98→07/06		→ 12/01; - DSTC			ATE Ø 9 / 8" pneumatisch									
2.0 T	132	12/99→07/06		01/02→ 02/06; - DSTC	03.7755-3402.4	300189	ATE Ø 9 / 8" pneumatisch									
2.0 T	166	06/98→07/06						03.7755-4702.4	300224	ATE Ø 9 / 8" pneumatisch						
2.4	103	01/99→07/06		01/02→ 02/06; + DSTC							03.7858-3532.4	300233	ATE Ø 9 / 8" pneumatisch			
2.4	125	01/99→07/06														
2.4 Bifuel (CNG)	103	09/01→07/06														
2.4 Bifuel (LPG)	103	09/01→07/06														
2.4 D	96	10/01→07/06														
2.4 D5	120	08/01→07/06														
2.4 T	147	06/00→07/06														
2.5 TDI	103	01/99→07/06														
2.8 T6	200	05/98→07/06														
2.9	147	03/99→07/06														
2.9	150	05/98→07/06														
3.0	144	06/01→07/06														
3.0 T6	200	06/01→07/06														
2.4 T5 AWD	147	04/00→09/03		06/00→ 12/01; - DSTC										03.7755-3402.4	300189	ATE Ø 9 / 8" pneumatisch
				01/02→; - DSTC										03.7755-4702.4	300224	ATE Ø 9 / 8" pneumatisch
				01/02→; + DSTC										03.7858-3532.4	300233	ATE Ø 9 / 8" pneumatisch
2.5 T	154	03/03→07/06		07/03→ 02/06; - DSTC										03.7755-4702.4	300224	ATE Ø 9 / 8" pneumatisch

	kw			 	! #		
VOLVO - S80 I (TS, XY) 05/98→02/08							
 Bremskraftverstärker							
2.5 T	154	03/03→07/06		07/03→ 02/06; + DSTC		03.7858-3532.4 300233	ATE Ø 9 / 8" pneumatisch
2.5 T AWD	154	07/03→07/06		→ 02/06; - DSTC		03.7755-4702.4 300224	ATE Ø 9 / 8" pneumatisch
				→ 02/06; + DSTC		03.7858-3532.4 300233	ATE Ø 9 / 8" pneumatisch
Pedalwegsensoren, Bremspedal							
2.0	120	06/98→07/06		→ 12/01		03.0655-0004.2 370004	ATE
2.0 T	132	12/99→07/06					
2.0 T	166	06/98→07/06		01/02→ 02/06		03.0655-0005.2 370005	ATE
2.4	103	01/99→07/06					
2.4	125	01/99→07/06					
2.4 Bifuel (CNG)	103	09/01→07/06					
2.4 Bifuel (LPG)	103	09/01→07/06					
2.4 D	96	10/01→07/06					
2.4 D5	120	08/01→07/06					
2.4 T	147	06/00→07/06					
2.5 TDI	103	01/99→07/06					
2.8 T6	200	05/98→07/06					
2.9	147	03/99→07/06					
2.9	150	05/98→07/06					
3.0	144	06/01→07/06					
3.0 T6	200	06/01→07/06					
2.4 T5 AWD	147	04/00→09/03		06/00→ 12/01		03.0655-0004.2 370004	ATE
				01/02→		03.0655-0005.2 370005	ATE
2.5 T	154	03/03→07/06		07/03→ 02/06		03.0655-0005.2 370005	ATE
2.5 T AWD	154	07/03→07/06		→ 02/06		03.0655-0005.2 370005	ATE
 Hauptbremszylinder							
2.0	120	06/98→07/06		→ 174095; - DSTC		03.2125-7637.3 010707	ATE Ø 25,4
2.0 T	166	06/98→07/06		→ 02/06; 174096→; für Rechtslenker		03.2125-7638.3 010738	ATE Ø 25,4
2.4	103	01/99→07/06		→ 174095; + DSTC		03.2125-7708.3 010739	ATE Ø 25,4
2.4	125	01/99→07/06		→ 02/06; 174096→; für Linkslenker; + DSTC		03.2125-7713.3 010819	ATE Ø 25,4
2.5 TDI	103	01/99→07/06		→ 02/06; 174096→; für Linkslenker; - DSTC		03.2125-7743.3 010921	ATE Ø 25,4
2.8 T6	200	05/98→07/06					
2.9	147	03/99→07/06					
2.9	150	05/98→07/06					
2.0 T	132	12/99→07/06		→ 02/06; für Rechtslenker		03.2125-7638.3 010738	ATE Ø 25,4
2.4 Bifuel (CNG)	103	09/01→07/06		→ 02/06; für Linkslenker; + DSTC		03.2125-7713.3 010819	ATE Ø 25,4
2.4 Bifuel (LPG)	103	09/01→07/06		→ 02/06; für Linkslenker; - DSTC		03.2125-7743.3 010921	ATE Ø 25,4
2.4 D	96	10/01→07/06					
2.4 D5	120	08/01→07/06					
2.4 T	147	06/00→07/06					
2.5 T AWD	154	07/03→07/06					
3.0	144	06/01→07/06					
3.0 T6	200	06/01→07/06					
2.4 T5 AWD	147	04/00→09/03		06/00→; für Rechtslenker		03.2125-7638.3 010738	ATE Ø 25,4
				06/00→; für Linkslenker; + DSTC		03.2125-7713.3 010819	ATE Ø 25,4
				06/00→; für Linkslenker; - DSTC		03.2125-7743.3 010921	ATE Ø 25,4
2.5 T	154	03/03→07/06		07/03→ 02/06; für Rechtslenker		03.2125-7638.3 010738	ATE Ø 25,4
				07/03→ 02/06; für Linkslenker; + DSTC		03.2125-7713.3 010819	ATE Ø 25,4
				07/03→ 02/06; für Linkslenker; - DSTC		03.2125-7743.3 010921	ATE Ø 25,4
VOLVO - S80 II (AS) 03/06→							
 Bremskraftverstärker							
1.6 D DRiVe	80	01/10→		für Linkslenker;		03.7755-9703.4 300239	ATE Ø 9 / 8" pneumatisch
1.6 DRiVe	84	06/11→		für Fahrzeuge ohne Kollisionswarner			
D3 / D4	120	01/10→		für Linkslenker; → 151000; für Fahrzeuge mit Kollisionswarner		03.7858-5032.4 300275	ATE Ø 9 / 8" pneumatisch
2.0	107	01/08→		für Linkslenker;		03.7755-9703.4 300239	ATE Ø 9 / 8" pneumatisch
2.0 FlexFuel	107	01/08→		für Fahrzeuge ohne Kollisionswarner			
2.0 T	149	01/10→		für Linkslenker;		03.7858-4832.4 300274	ATE Ø 9 / 8" pneumatisch
2.0 TDi	100	02/08→		für Fahrzeuge mit Kollisionswarner			
2.4 D	120	03/06→					
2.4 D	129	01/10→					
2.5 T	147	03/06→					
2.5 T AWD	147	10/06→					
2.5 T FlexFuel	147	05/08→					
3.2	175	03/06→					
3.2	179	01/10→					
3.2 AWD	175	01/07→					
3.2 AWD	179	01/10→					
D5	136	03/06→					
D5	151	01/10→					
D5 AWD	136	01/07→					
D5 AWD	151	01/10→					
T6 AWD	210	01/07→					
↓							







	kw			 	! #		
VOLVO - S80 II (AS) 03/06→							
 Bremskraftverstärker							
2.0 Drive- E	180	12/14→		für Linkslenker; für Fahrzeuge ohne Kollisionswarner	03.7755-9703.4	300239	ATE Ø 9 / 8" pneumatisch
				für Linkslenker; für Fahrzeuge mit Kollisionswarner	03.7858-5032.4	300275	ATE Ø 9 / 8" pneumatisch
2.5 T	170	01/10→		für Fahrzeuge ohne Kollisionswarner	03.7755-9703.4	300239	ATE Ø 9 / 8" pneumatisch
2.5 T FlexFuel	170	01/10→		→ 151000;	03.7858-5032.4	300275	ATE Ø 9 / 8" pneumatisch
D3	100	05/12→		für Fahrzeuge mit Kollisionswarner			
D5	158	06/11→					
D5 AWD	158	06/11→					
T4	132	10/10→					
T4F	132	05/11→					
T6 AWD	224	10/10→					
2.5 T	183	09/12→		für Fahrzeuge ohne Kollisionswarner	03.7755-9703.4	300239	ATE Ø 9 / 8" pneumatisch
2.5 T	187	01/12→					
D4	133	09/13→					
T5	177	10/10→		für Linkslenker; für Fahrzeuge ohne Kollisionswarner	03.7755-9703.4	300239	ATE Ø 9 / 8" pneumatisch
T5	180	09/13→		für Rechtslenker; für Fahrzeuge mit Kollisionswarner	03.7858-4832.4	300274	ATE Ø 9 / 8" pneumatisch
				für Linkslenker; für Fahrzeuge mit Kollisionswarner	03.7858-5032.4	300275	ATE Ø 9 / 8" pneumatisch
Pedalwegsensord, Bremspedal							
1.6 D DRIVE	80	01/10→		für Linkslenker; → 151000	03.0655-0007.2	370007	ATE
1.6 DRIVe	84	06/11→		für Rechtslenker	03.0655-0007.2	370007	ATE
D3 / D4	120	01/10→		151001→; für Linkslenker; für Fahrzeuge mit Kollisionswarner	03.0655-0007.2	370007	ATE
2.0	107	01/08→		für Linkslenker; für Fahrzeuge mit Kollisionswarner	03.0655-0007.2	370007	ATE
2.0 FlexFuel	107	01/08→					
2.0 T	149	01/10→		für Rechtslenker	03.0655-0007.2	370007	ATE
2.0 TDi	100	02/08→					
2.4 D	120	03/06→					
2.4 D	129	01/10→					
2.5 T	147	03/06→					
2.5 T AWD	147	10/06→					
2.5 T FlexFuel	147	05/08→					
3.2	175	03/06→					
3.2	179	01/10→					
3.2 AWD	175	01/07→					
3.2 AWD	179	01/10→					
D5	136	03/06→					
D5	151	01/10→					
D5 AWD	136	01/07→					
D5 AWD	151	01/10→					
T6 AWD	210	01/07→					
2.0 Drive- E	180	12/14→		für Linkslenker; für Fahrzeuge mit Kollisionswarner	03.0655-0007.2	370007	ATE
2.5 T	170	01/10→		151001→;	03.0655-0007.2	370007	ATE
2.5 T FlexFuel	170	01/10→		für Fahrzeuge mit Kollisionswarner			
D3	100	05/12→		→ 151000	03.0655-0007.2	370007	ATE
D5	158	06/11→					
D5 AWD	158	06/11→					
T4	132	10/10→					
T4F	132	05/11→					
T6 AWD	224	10/10→					
2.5 T	183	09/12→		für Fahrzeuge mit Kollisionswarner	03.0655-0007.2	370007	ATE
2.5 T	187	01/12→					
D4	133	09/13→					
T5	177	10/10→		für Rechtslenker; für Fahrzeuge mit Kollisionswarner	03.0655-0007.2	370007	ATE
T5	180	09/13→		für Linkslenker; für Fahrzeuge mit Kollisionswarner	03.0655-0007.2	370007	ATE
VOLVO - S90 11/96→12/98							
 Hauptbremszylinder							
2.5	125	11/96→10/98			03.2023-0875.3	010890	ATE Ø1 23,81 Ø2 20,64 ohne Bremsflüssigkeitsbehälter
2.5	132	11/96→10/97					
2.9	132	01/97→05/98					
2.9	150	01/97→05/98					
 Bremskraftregler							
2.5	125	11/96→10/98			03.6055-0430.3	320065	ATE 5/25 4x
2.5	132	11/96→10/97					
2.9	132	01/97→05/98					
2.9	150	01/97→05/98					









	kW			 	! #		
VOLVO - V40 Kombi (VW) 07/95→06/04							
 Hauptbremszylinder							
1.6	77	12/95→08/99		→ 08/97		24.2122-1718.3 010517	Ø 22,2
1.8	85	07/95→08/99					
1.9 TD	66	07/95→08/99		09/97→		24.2123-1746.3 010682	Ø 23,81
2.0	100	07/95→06/04					
2.0	103	07/95→08/99					
1.6	80	03/99→06/04				24.2123-1746.3 010682	Ø 23,81
1.8	90	03/99→06/04					
1.8 i	90	06/01→06/04					
1.8 i	92	03/98→06/04					
1.9 DI	70	03/99→07/00					
1.9 DI	75	07/00→06/04					
1.9 DI	85	07/00→06/04					
2.0 T	118	10/97→07/00					
2.0 T	120	06/01→06/04					
1.9 T4	147	05/97→07/00		→ 08/97; + ABS		24.2122-1718.3 010517	Ø 22,2
				09/97→		24.2123-1746.3 010682	Ø 23,81
2.0 T	121	07/99→06/04		07/00→ 06/01		24.2123-1746.3 010682	Ø 23,81
2.0 T4	147	07/00→06/04		→ 04/04		24.2123-1746.3 010682	Ø 23,81
VOLVO - V50 (MW) 12/03→12/12							
 Bremskraftverstärker							
1.6	74	01/05→12/12		→ 05/12; für Linkslenker		03.7863-4832.4 300289	ATE Ø 10" pneumatisch
2.0	107	10/06→12/12					
2.0 FlexFuel	107	01/10→12/12					
T5	169	03/07→12/12					
1.6 D	81	01/05→12/11		für Linkslenker		03.7863-4832.4 300289	ATE Ø 10" pneumatisch
1.8	92	04/04→12/10					
2.0 D	100	04/04→12/10					
2.4	103	04/04→12/10					
2.4	125	04/04→12/10					
2.4 AWD	125	08/06→12/09					
2.4 D5	132	03/06→12/10					
2.4 Tdi	120	05/07→12/10					
T5	162	04/04→12/07					
T5 AWD	162	04/04→12/07					
T5 AWD	169	03/07→12/10					
1.8 FlexFuel	92	01/05→12/10		04/07→; für Linkslenker		03.7863-4832.4 300289	ATE Ø 10" pneumatisch
Pedalwegsensoren, Bremspedal							
1.6	74	01/05→12/12		→ 05/12; für Rechtslenker		03.0655-0007.2 370007	ATE
2.0	107	10/06→12/12					
2.0 FlexFuel	107	01/10→12/12		→ 05/12; für Linkslenker		03.0655-0007.2 370007	ATE
T5	169	03/07→12/12					
1.6 D	81	01/05→12/11		für Linkslenker		03.0655-0007.2 370007	ATE
1.8	92	04/04→12/10					
2.0 D	100	04/04→12/10		für Rechtslenker		03.0655-0007.2 370007	ATE
2.4	103	04/04→12/10					
2.4	125	04/04→12/10					
2.4 AWD	125	08/06→12/09					
2.4 D5	132	03/06→12/10					
2.4 Tdi	120	05/07→12/10					
T5	162	04/04→12/07					
T5 AWD	162	04/04→12/07					
T5 AWD	169	03/07→12/10					
1.8 FlexFuel	92	01/05→12/10		04/07→; für Rechtslenker		03.0655-0007.2 370007	ATE
				04/07→; für Linkslenker		03.0655-0007.2 370007	ATE
 Hauptbremszylinder							
1.6	74	01/05→12/12		→ 05/12; für Linkslenker		03.2123-3593.3 010919	ATE Ø 23,81
2.0	107	10/06→12/12					
2.0 FlexFuel	107	01/10→12/12					
T5	169	03/07→12/12					
1.6 D	81	01/05→12/11		für Linkslenker		03.2123-3593.3 010919	ATE Ø 23,81
1.8	92	04/04→12/10					
2.0 D	100	04/04→12/10					
2.4	103	04/04→12/10					
2.4	125	04/04→12/10					
2.4 AWD	125	08/06→12/09					
2.4 D5	132	03/06→12/10					
2.4 Tdi	120	05/07→12/10					
T5	162	04/04→12/07					
T5 AWD	162	04/04→12/07					
T5 AWD	169	03/07→12/10					
1.8 FlexFuel	92	01/05→12/10		04/07→; für Linkslenker		03.2123-3593.3 010919	ATE Ø 23,81
↓							

	kW			 	! #		
VOLVO - V50 (MW) 12/03→12/12							
Hydraulikaggregat, Bremsanlage							
1.6	74	01/05→12/12		→ 520022; für Linkslenker; + DSTC; nicht für Getriebetyp: MPS6		24.9145-0005.2	399009
1.6 D2	84	01/10→12/12					
2.0	107	10/06→12/12		520023→; → 05/12; für Linkslenker; + DSTC; nicht für Getriebetyp: MPS6		24.9145-0005.2	399009
2.0 FlexFuel	107	01/10→12/12					
D3	110	10/10→12/12					
D4	130	10/10→12/12		→ 05/12; + DSTC; Getriebetyp: MPS6		24.9145-0005.2	399009
T5	169	03/07→12/12					
1.6 D	81	01/05→12/11		→ 520022; für Linkslenker; + DSTC; nicht für Getriebetyp: MPS6		24.9145-0005.2	399009
1.8	92	04/04→12/10					
2.0 D	100	04/04→12/10		520023→; → 05/12; für Linkslenker; + DSTC; nicht für Getriebetyp: MPS6		24.9145-0005.2	399009
2.4	103	04/04→12/10					
2.4	125	04/04→12/10					
2.4 AWD	125	08/06→12/09		+ DSTC; Getriebetyp: MPS6		24.9145-0005.2	399009
2.4 D5	132	03/06→12/10					
2.4 Tdi	120	05/07→12/10					
T5	162	04/04→12/07					
T5 AWD	162	04/04→12/07					
T5 AWD	169	03/07→12/10					
1.8 FlexFuel	92	01/05→12/10		520023→; für Linkslenker; + DSTC; nicht für Getriebetyp: MPS6		24.9145-0005.2	399009
				04/07→; → 520022; für Linkslenker; + DSTC; nicht für Getriebetyp: MPS6		24.9145-0005.2	399009
				04/07→; + DSTC; Getriebetyp: MPS6		24.9145-0005.2	399009
VOLVO - V60 07/10→							
	Bremskraftverstärker						
2.0 D2	88	03/15→		für Fahrzeuge ohne Kollisionswarner		03.7755-9703.4	300239
2.0 D3	110	03/15→					
2.0 D4	140	03/15→					
D4	133	10/13→12/15					
D4 AWD	133	10/13→12/15					
D4 AWD	140	03/15→					
D5	165	03/15→					
D6 Hybrid AWD	162	03/15→					
T6 AWD	242	04/14→12/15					
3.0 T AWD	258	04/14→		05/14→; für Fahrzeuge ohne Kollisionswarner		03.7755-9703.4	300239
D4 AWD	120	05/12→		12/12→; für Fahrzeuge ohne Kollisionswarner		03.7755-9703.4	300239
T5	157	10/13→		04/14→; für Fahrzeuge ohne Kollisionswarner		03.7755-9703.4	300239
Pedalwegsensoren, Bremspedal							
1.5 T2	90	10/15→		01/16→; für Fahrzeuge mit Kollisionswarner		03.0655-0007.2	370007
1.6 DRiVe	84	02/11→12/15		06/11→; für Fahrzeuge mit Kollisionswarner		03.0655-0007.2	370007
2.4 D5	158	04/11→12/15					
2.4 D5 AWD	158	04/11→12/15					
2.0 D2	88	03/15→		für Fahrzeuge mit Kollisionswarner		03.0655-0007.2	370007
2.0 D3	110	03/15→					
2.0 D4	140	03/15→					
2.4 D5 Hybrid AWD	120	03/15→					
D4	133	10/13→12/15					
D4 AWD	133	10/13→12/15					
D4 AWD	140	03/15→					
D5	165	03/15→					
D5	169	04/14→12/15					
D5 AWD	169	04/14→12/15					
D6 Hybrid AWD	162	03/15→					
T3	112	03/15→					
T4F	132	04/11→12/15					
T5	176	08/12→					
T5	180	10/13→					
T6	225	10/13→					
T6 AWD	225	10/13→					
T6 AWD	242	04/14→12/15					
2.0 T	149	07/10→12/12		11/10→; für Fahrzeuge mit Kollisionswarner		03.0655-0007.2	370007
D3 / D4	120	07/10→12/14					
D5	151	07/10→12/11					
D5 AWD	151	07/10→12/11					
T3	110	09/10→12/15					
T4	132	09/10→12/15					
T5	177	09/10→12/14					
T6 AWD	224	07/10→12/15					
2.0 T4	140	03/15→		05/15→; für Fahrzeuge mit Kollisionswarner		03.0655-0007.2	370007
2.4 Hybrid D6 AWD	158	06/12→12/15		11/12→; für Fahrzeuge mit Kollisionswarner		03.0655-0007.2	370007
↓							







	kW			 	! #		
VOLVO - V60 07/10→							
Pedalwegsensoren, Bremspedal							
D3	100	05/12→12/15		10/12→; für Fahrzeuge mit Kollisionswarner		03.0655-0007.2 370007	ATE
D4 AWD	120	05/12→		12/12→; für Fahrzeuge mit Kollisionswarner		03.0655-0007.2 370007	ATE
T5	157	10/13→		04/14→; für Fahrzeuge mit Kollisionswarner		03.0655-0007.2 370007	ATE
VOLVO - V70 I (LV) 12/95→12/00							
 Bremskraftverstärker							
2.0	93	12/95→03/00		01/97→; für Linkslenker		03.7760-3602.4 300176	ATE Ø 10" pneumatisch
2.0	105	12/95→03/00					
2.0	132	11/96→03/00					
2.0 Turbo	155	12/95→03/00					
2.3 Turbo	184	12/95→03/00					
2.4	106	12/95→03/00					
2.5 TDi AWD	103	11/96→02/00					
2.0	120	01/97→12/00		→ 03/00; für Linkslenker		03.7760-3602.4 300176	ATE Ø 10" pneumatisch
2.3 T-5 AWD	176	01/97→12/00					
2.4 Bifuel	103	08/99→12/00					
2.4 Turbo AWD	195	03/99→12/00					
2.0 Turbo	166	11/96→12/00		01/97→ 03/00; für Linkslenker		03.7760-3602.4 300176	ATE Ø 10" pneumatisch
2.0 Turbo AWD	166	11/96→12/00					
2.3	177	11/96→11/00					
2.3 T-5	176	11/96→12/00					
2.4	125	12/95→05/00					
2.4 Turbo	142	04/96→12/00					
2.4 Turbo AWD	142	04/96→12/00					
2.5 TDI	103	12/95→12/00					
2.3 AWD	177	04/97→09/98		für Linkslenker		03.7760-3602.4 300176	ATE Ø 10" pneumatisch
2.3 T AWD	184	04/97→03/00					
2.4	121	06/98→12/99					
2.4	103	03/99→12/00		08/99→ 03/00; für Linkslenker		03.7760-3602.4 300176	ATE Ø 10" pneumatisch
2.4 AWD	121	06/98→12/99		10/98→ 05/99; für Linkslenker		03.7760-3602.4 300176	ATE Ø 10" pneumatisch
2.4 Bifuel	106	05/98→12/99		10/98→ 08/99; für Linkslenker		03.7760-3602.4 300176	ATE Ø 10" pneumatisch
 Hauptbremszylinder							
2.0	93	12/95→03/00		01/97→ 12/98; + ASR		03.2023-1044.3 010590	ATE Ø1 23,81 Ø2 20,64
2.0	105	12/95→03/00		01/97→ 12/98; - ASR		03.2023-1084.3 010591	ATE Ø1 23,81 Ø2 20,64
2.0	132	11/96→03/00					
2.0 Turbo	155	12/95→03/00		01/99→		03.2123-2164.3 010599	ATE Ø 23,81
2.3 Turbo	184	12/95→03/00					
2.4	106	12/95→03/00					
2.5 TDi AWD	103	11/96→02/00					
2.0	120	01/97→12/00		→ 12/98; + ASR		03.2023-1044.3 010590	ATE Ø1 23,81 Ø2 20,64
2.3 T-5 AWD	176	01/97→12/00		→ 12/98; - ASR		03.2023-1084.3 010591	ATE Ø1 23,81 Ø2 20,64
				01/99→ 03/00		03.2123-2164.3 010599	ATE Ø 23,81
2.0 Turbo	166	11/96→12/00		01/97→ 12/98; + ASR		03.2023-1044.3 010590	ATE Ø1 23,81 Ø2 20,64
2.0 Turbo AWD	166	11/96→12/00		01/97→ 12/98; - ASR		03.2023-1084.3 010591	ATE Ø1 23,81 Ø2 20,64
2.3	177	11/96→11/00					
2.3 T-5	176	11/96→12/00		01/99→ 03/00		03.2123-2164.3 010599	ATE Ø 23,81
2.4	125	12/95→05/00					
2.4 Turbo	142	04/96→12/00					
2.4 Turbo AWD	142	04/96→12/00					
2.5 TDI	103	12/95→12/00					
2.3 AWD	177	04/97→09/98		+ ASR		03.2023-1044.3 010590	ATE Ø1 23,81 Ø2 20,64
				- ASR		03.2023-1084.3 010591	ATE Ø1 23,81 Ø2 20,64
2.3 AWD	195	12/98→02/00		→ 12/98; + ASR		03.2023-1044.3 010590	ATE Ø1 23,81 Ø2 20,64
				01/99→ 05/99		03.2123-2164.3 010599	ATE Ø 23,81
2.3 T AWD	184	04/97→03/00		→ 12/98; + ASR		03.2023-1044.3 010590	ATE Ø1 23,81 Ø2 20,64
2.4	121	06/98→12/99		→ 12/98; - ASR		03.2023-1084.3 010591	ATE Ø1 23,81 Ø2 20,64
				01/99→		03.2123-2164.3 010599	ATE Ø 23,81
2.4	103	03/99→12/00		08/99→ 03/00		03.2123-2164.3 010599	ATE Ø 23,81
2.4 AWD	121	06/98→12/99		10/98→ 12/98; + ASR		03.2023-1044.3 010590	ATE Ø1 23,81 Ø2 20,64
				10/98→ 05/99; - ASR		03.2023-1084.3 010591	ATE Ø1 23,81 Ø2 20,64
				01/99→ 05/99		03.2123-2164.3 010599	ATE Ø 23,81
2.4 Bifuel	103	08/99→12/00		→ 03/00		03.2123-2164.3 010599	ATE Ø 23,81
2.4 Turbo AWD	195	03/99→12/00					
2.4 Bifuel	106	05/98→12/99		10/98→ 12/98; + ASR		03.2023-1044.3 010590	ATE Ø1 23,81 Ø2 20,64
				10/98→ 12/98; - ASR		03.2023-1084.3 010591	ATE Ø1 23,81 Ø2 20,64
				01/99→ 08/99		03.2123-2164.3 010599	ATE Ø 23,81











	kw			 	! #		
VOLVO - V70 II (SW) 11/99→12/08							
Bremskraftverstärker							
2.0 T	132	11/99→08/07		07/01→ 12/01; - DSTC		03.7755-3402.4 300189	ATE Ø 9 / 8" pneumatisch
				01/02→ 07/07; - DSTC		03.7755-4702.4 300224	ATE Ø 9 / 8" pneumatisch
				01/02→ 07/07; + DSTC		03.7858-3532.4 300233	ATE Ø 9 / 8" pneumatisch
2.3	195	10/00→09/04		→ 12/01; - DSTC		03.7755-3402.4 300189	ATE Ø 9 / 8" pneumatisch
				- DSTC		03.7755-4702.4 300224	ATE Ø 9 / 8" pneumatisch
				+ DSTC		03.7858-3532.4 300233	ATE Ø 9 / 8" pneumatisch
2.3 T5	184	11/99→12/04		03/00→ 12/01; - DSTC		03.7755-3402.4 300189	ATE Ø 9 / 8" pneumatisch
2.4 T	147	11/99→08/03		01/02→; - DSTC		03.7755-4702.4 300224	ATE Ø 9 / 8" pneumatisch
				01/02→; + DSTC		03.7858-3532.4 300233	ATE Ø 9 / 8" pneumatisch
2.4	103	03/00→08/07		→ 12/01; - DSTC		03.7755-3402.4 300189	ATE Ø 9 / 8" pneumatisch
2.4	125	03/00→08/07		01/02→ 07/07; - DSTC		03.7755-4702.4 300224	ATE Ø 9 / 8" pneumatisch
2.4 Bifuel (CNG)	103	09/01→08/07		01/02→ 07/07; + DSTC		03.7858-3532.4 300233	ATE Ø 9 / 8" pneumatisch
2.4 Bifuel (LPG)	103	09/01→08/07		→ 12/01; - DSTC		03.7755-3402.4 300189	ATE Ø 9 / 8" pneumatisch
2.4 AWD	121	03/00→09/03		01/02→; - DSTC		03.7755-4702.4 300224	ATE Ø 9 / 8" pneumatisch
2.4 T AWD	147	09/01→08/02		01/02→; + DSTC		03.7858-3532.4 300233	ATE Ø 9 / 8" pneumatisch
2.4 D	93	04/05→12/08		05/05→ 07/07; - DSTC		03.7755-4702.4 300224	ATE Ø 9 / 8" pneumatisch
				05/05→ 07/07; + DSTC		03.7858-3532.4 300233	ATE Ø 9 / 8" pneumatisch
2.4 D	96	07/01→08/07		12/01→ 12/01; - DSTC		03.7755-3402.4 300189	ATE Ø 9 / 8" pneumatisch
				01/02→ 07/07; - DSTC		03.7755-4702.4 300224	ATE Ø 9 / 8" pneumatisch
				01/02→ 07/07; + DSTC		03.7858-3532.4 300233	ATE Ø 9 / 8" pneumatisch
2.4 D5	120	01/01→12/08		08/01→ 12/01; - DSTC		03.7755-3402.4 300189	ATE Ø 9 / 8" pneumatisch
				01/02→ 07/07; - DSTC		03.7755-4702.4 300224	ATE Ø 9 / 8" pneumatisch
				01/02→ 07/07; + DSTC		03.7858-3532.4 300233	ATE Ø 9 / 8" pneumatisch
2.4 D5	136	04/05→12/08		12/05→ 07/07; - DSTC		03.7755-4702.4 300224	ATE Ø 9 / 8" pneumatisch
2.4 D5 AWD	136	07/05→12/08		12/05→ 07/07; + DSTC		03.7858-3532.4 300233	ATE Ø 9 / 8" pneumatisch
2.4 D5 AWD	120	07/02→08/07		03/03→ 07/07; - DSTC		03.7755-4702.4 300224	ATE Ø 9 / 8" pneumatisch
				03/03→ 07/07; + DSTC		03.7858-3532.4 300233	ATE Ø 9 / 8" pneumatisch
2.4 T5	191	04/04→08/07		→ 07/07; - DSTC		03.7755-4702.4 300224	ATE Ø 9 / 8" pneumatisch
R 2,5 T AWD	221	03/03→08/07		→ 07/07; + DSTC		03.7858-3532.4 300233	ATE Ø 9 / 8" pneumatisch
2.5 AWD	155	09/02→12/04		- DSTC		03.7755-4702.4 300224	ATE Ø 9 / 8" pneumatisch
2.5 R Sport	221	12/02→08/07		+ DSTC		03.7858-3532.4 300233	ATE Ø 9 / 8" pneumatisch
2.5 T	154	07/01→08/07		04/04→ 07/07; - DSTC		03.7755-4702.4 300224	ATE Ø 9 / 8" pneumatisch
				04/04→ 07/07; + DSTC		03.7858-3532.4 300233	ATE Ø 9 / 8" pneumatisch
2.5 T AWD	154	07/02→08/07		09/02→ 07/07; - DSTC		03.7755-4702.4 300224	ATE Ø 9 / 8" pneumatisch
				09/02→ 07/07; + DSTC		03.7858-3532.4 300233	ATE Ø 9 / 8" pneumatisch
2.5 TDI	103	11/99→08/07		03/00→ 12/01; - DSTC		03.7755-3402.4 300189	ATE Ø 9 / 8" pneumatisch
				01/02→ 07/07; - DSTC		03.7755-4702.4 300224	ATE Ø 9 / 8" pneumatisch
				01/02→ 07/07; + DSTC		03.7858-3532.4 300233	ATE Ø 9 / 8" pneumatisch
Pedalwegsensoren, Bremspedal							
2.0 T	132	11/99→08/07		07/01→ 12/01		03.0655-0004.2 370004	ATE
				01/05→ 07/07		03.0655-0005.2 370005	ATE
				01/02→ 07/07		03.0655-0005.2 370005	ATE
2.3	195	10/00→09/04		→ 12/01		03.0655-0004.2 370004	ATE
						03.0655-0005.2 370005	ATE
2.3 T5	184	11/99→12/04		03/00→ 12/01		03.0655-0004.2 370004	ATE
2.4 T	147	11/99→08/03		01/02→		03.0655-0005.2 370005	ATE
2.4	103	03/00→08/07		→ 12/01		03.0655-0004.2 370004	ATE
2.4	125	03/00→08/07		01/05→ 07/07		03.0655-0005.2 370005	ATE
2.4 Bifuel (CNG)	103	09/01→08/07		01/02→ 07/07		03.0655-0005.2 370005	ATE
2.4 Bifuel (LPG)	103	09/01→08/07		→ 12/01		03.0655-0004.2 370004	ATE
2.4 AWD	121	03/00→09/03		01/02→		03.0655-0005.2 370005	ATE
2.4 T AWD	147	09/01→08/02				03.0655-0005.2 370005	ATE
2.4 D	93	04/05→12/08		05/05→ 07/07		03.0655-0005.2 370005	ATE
2.4 D	96	07/01→08/07		12/01→ 12/01		03.0655-0004.2 370004	ATE
				01/05→ 07/07		03.0655-0005.2 370005	ATE
				01/02→ 07/07		03.0655-0005.2 370005	ATE
2.4 D5	120	01/01→12/08		08/01→ 12/01		03.0655-0004.2 370004	ATE
				01/05→ 07/07		03.0655-0005.2 370005	ATE
				01/02→ 07/07		03.0655-0005.2 370005	ATE
2.4 D5	136	04/05→12/08		12/05→ 07/07		03.0655-0005.2 370005	ATE
↓							











	kw			 	! #		
VOLVO - V70 II (SW) 11/99→12/08							
Pedalwegsensord, Bremspedal							
2.4 D5 AWD	136	07/05→12/08		12/05→ 07/07		03.0655-0005.2 370005	ATE
2.4 D5 AWD	120	07/02→08/07		01/05→ 07/07		03.0655-0005.2 370005	ATE
				03/03→ 07/07		03.0655-0005.2 370005	ATE
2.4 T5 R 2,5 T AWD	191 221	04/04→08/07 03/03→08/07		→ 07/07		03.0655-0005.2 370005	ATE
				01/05→ 07/07		03.0655-0005.2 370005	ATE
2.5 AWD	155	09/02→12/04				03.0655-0005.2 370005	ATE
2.5 R Sport	221	12/02→08/07					
2.5 T	154	07/01→08/07		01/05→ 07/07		03.0655-0005.2 370005	ATE
				04/04→ 07/07		03.0655-0005.2 370005	ATE
2.5 T AWD	154	07/02→08/07		01/05→ 07/07		03.0655-0005.2 370005	ATE
				09/02→ 07/07		03.0655-0005.2 370005	ATE
2.5 TDI	103	11/99→08/07		03/00→ 12/01		03.0655-0004.2 370004	ATE
				01/05→ 07/07		03.0655-0005.2 370005	ATE
				01/02→ 07/07		03.0655-0005.2 370005	ATE
 Hauptbremszylinder							
2.0 T	132	11/99→08/07		07/01→; → 67770; für Rechtslenker; + DSTC		03.2125-7637.3 010707	ATE Ø 25,4
				07/01→; → 68132; - DSTC		03.2125-7637.3 010707	ATE Ø 25,4
				68133→; → 07/07; für Rechtslenker; - DSTC		03.2125-7638.3 010738	ATE Ø 25,4
				67771→; → 07/07; für Rechtslenker; + DSTC		03.2125-7638.3 010738	ATE Ø 25,4
				07/01→; → 70377; für Linkslenker; + DSTC		03.2125-7708.3 010739	ATE Ø 25,4
				70378→; → 07/07; für Linkslenker; + DSTC		03.2125-7713.3 010819	ATE Ø 25,4
				68133→; → 07/07; für Linkslenker; - DSTC		03.2125-7743.3 010921	ATE Ø 25,4
2.3 2.4 2.4 T AWD	195 121 147	10/00→09/04 03/00→09/03 09/01→08/02		→ 67770; für Rechtslenker; + DSTC		03.2125-7637.3 010707	ATE Ø 25,4
				→ 68132; - DSTC		03.2125-7637.3 010707	ATE Ø 25,4
				67771→; für Rechtslenker; + DSTC		03.2125-7638.3 010738	ATE Ø 25,4
				68133→; für Rechtslenker; - DSTC		03.2125-7638.3 010738	ATE Ø 25,4
				→ 70377; für Linkslenker; + DSTC		03.2125-7708.3 010739	ATE Ø 25,4
				70378→; für Linkslenker; + DSTC		03.2125-7713.3 010819	ATE Ø 25,4
				68133→; für Linkslenker; - DSTC		03.2125-7743.3 010921	ATE Ø 25,4
2.3 T5 2.4 T	184 147	11/99→12/04 11/99→08/03		03/00→; → 68132; - DSTC		03.2125-7637.3 010707	ATE Ø 25,4
				03/00→; → 67770; für Rechtslenker; + DSTC		03.2125-7637.3 010707	ATE Ø 25,4
				68133→; für Rechtslenker; - DSTC		03.2125-7638.3 010738	ATE Ø 25,4
				67771→; für Rechtslenker; + DSTC		03.2125-7638.3 010738	ATE Ø 25,4
				03/00→; → 70377; für Linkslenker; + DSTC		03.2125-7708.3 010739	ATE Ø 25,4
				70378→; für Linkslenker; + DSTC		03.2125-7713.3 010819	ATE Ø 25,4
				68133→; für Linkslenker; - DSTC		03.2125-7743.3 010921	ATE Ø 25,4
2.4 2.4 2.4 Bifuel (CNG) 2.4 Bifuel (LPG)	103 125 103 103	03/00→08/07 03/00→08/07 09/01→08/07 09/01→08/07		→ 67770; für Rechtslenker; + DSTC		03.2125-7637.3 010707	ATE Ø 25,4
				→ 68132; - DSTC		03.2125-7637.3 010707	ATE Ø 25,4
				68133→; → 07/07; für Rechtslenker; - DSTC		03.2125-7638.3 010738	ATE Ø 25,4
				67771→; → 07/07; für Rechtslenker; + DSTC		03.2125-7638.3 010738	ATE Ø 25,4
				→ 70377; für Linkslenker; + DSTC		03.2125-7708.3 010739	ATE Ø 25,4
				70378→; → 07/07; für Linkslenker; + DSTC		03.2125-7713.3 010819	ATE Ø 25,4
				68133→; → 07/07; für Linkslenker; - DSTC		03.2125-7743.3 010921	ATE Ø 25,4
2.4 AWD	121	03/00→09/03		→ 68132; - DSTC		03.2125-7637.3 010707	ATE Ø 25,4
				→ 67770; für Rechtslenker; + DSTC		03.2125-7637.3 010707	ATE Ø 25,4
				68133→; für Rechtslenker; - DSTC		03.2125-7638.3 010738	ATE Ø 25,4
				für Rechtslenker; + DSTC		03.2125-7638.3 010738	ATE Ø 25,4
				→ 70377; für Linkslenker; + DSTC		03.2125-7708.3 010739	ATE Ø 25,4
				70378→; für Linkslenker; + DSTC		03.2125-7713.3 010819	ATE Ø 25,4
				68133→; für Linkslenker; - DSTC		03.2125-7743.3 010921	ATE Ø 25,4
2.4 D	93	04/05→12/08		05/05→ 07/07; für Rechtslenker; - DSTC		03.2125-7638.3 010738	ATE Ø 25,4
				05/05→ 07/07; für Rechtslenker; + DSTC		03.2125-7638.3 010738	ATE Ø 25,4
				05/05→ 07/07; für Linkslenker; + DSTC		03.2125-7713.3 010819	ATE Ø 25,4























	kw			 	! #		
VOLVO - V70 II (SW) 11/99→12/08							
Hauptbremszylinder							
2.4 D	93	04/05→12/08		05/05→07/07; für Linkslenker; - DSTC		03.2125-7743.3 010921	ATE Ø 25,4
2.4 D	96	07/01→08/07		12/01→; → 67770; für Rechtslenker; + DSTC		03.2125-7637.3 010707	ATE Ø 25,4
				12/01→; → 68132; - DSTC		03.2125-7637.3 010707	ATE Ø 25,4
				67771→; → 07/07; für Rechtslenker; + DSTC		03.2125-7638.3 010738	ATE Ø 25,4
				68133→; → 07/07; für Rechtslenker; - DSTC		03.2125-7638.3 010738	ATE Ø 25,4
				12/01→; → 70377; für Linkslenker; + DSTC		03.2125-7708.3 010739	ATE Ø 25,4
				70378→; → 07/07; für Linkslenker; + DSTC		03.2125-7713.3 010819	ATE Ø 25,4
				68133→; → 07/07; für Linkslenker; - DSTC		03.2125-7743.3 010921	ATE Ø 25,4
2.4 D5	120	01/01→12/08		08/01→; → 67770; für Rechtslenker; + DSTC		03.2125-7637.3 010707	ATE Ø 25,4
				08/01→; → 68132; - DSTC		03.2125-7637.3 010707	ATE Ø 25,4
				68133→; → 07/07; für Rechtslenker; - DSTC		03.2125-7638.3 010738	ATE Ø 25,4
				67771→; → 07/07; für Rechtslenker; + DSTC		03.2125-7638.3 010738	ATE Ø 25,4
				08/01→; → 70377; für Linkslenker; + DSTC		03.2125-7708.3 010739	ATE Ø 25,4
				70378→; → 07/07; für Linkslenker; + DSTC		03.2125-7713.3 010819	ATE Ø 25,4
				68133→; → 07/07; für Linkslenker; - DSTC		03.2125-7743.3 010921	ATE Ø 25,4
2.4 D5 2.4 D5 AWD	136 136	04/05→12/08 07/05→12/08		12/05→07/07; für Rechtslenker; - DSTC		03.2125-7638.3 010738	ATE Ø 25,4
				12/05→07/07; für Rechtslenker; + DSTC		03.2125-7638.3 010738	ATE Ø 25,4
				12/05→07/07; für Linkslenker; + DSTC		03.2125-7713.3 010819	ATE Ø 25,4
				12/05→07/07; für Linkslenker; - DSTC		03.2125-7743.3 010921	ATE Ø 25,4
2.4 D5 AWD	120	07/02→08/07		68133→; → 07/07; für Rechtslenker; - DSTC		03.2125-7638.3 010738	ATE Ø 25,4
				03/03→07/07; für Rechtslenker; + DSTC		03.2125-7638.3 010738	ATE Ø 25,4
				03/03→07/07; für Linkslenker; + DSTC		03.2125-7713.3 010819	ATE Ø 25,4
				03/03→07/07; für Linkslenker; - DSTC		03.2125-7743.3 010921	ATE Ø 25,4
2.4 T5	191	04/04→08/07		→ 07/07; für Rechtslenker; - DSTC		03.2125-7638.3 010738	ATE Ø 25,4
				→ 07/07; für Rechtslenker; + DSTC		03.2125-7638.3 010738	ATE Ø 25,4
				→ 07/07; für Linkslenker; + DSTC		03.2125-7713.3 010819	ATE Ø 25,4
				→ 07/07; für Linkslenker; - DSTC		03.2125-7743.3 010921	ATE Ø 25,4
2.5 AWD	155	09/02→12/04		für Rechtslenker; - DSTC		03.2125-7638.3 010738	ATE Ø 25,4
				für Rechtslenker; + DSTC		03.2125-7638.3 010738	ATE Ø 25,4
				für Linkslenker; + DSTC		03.2125-7713.3 010819	ATE Ø 25,4
				für Linkslenker; - DSTC		03.2125-7743.3 010921	ATE Ø 25,4
2.5 R Sport	221	12/02→08/07		für Rechtslenker; + DSTC		03.2125-7638.3 010738	ATE Ø 25,4
				für Linkslenker; + DSTC		03.2125-7713.3 010819	ATE Ø 25,4
2.5 T	154	07/01→08/07		04/04→07/07; für Rechtslenker; + DSTC		03.2125-7638.3 010738	ATE Ø 25,4
				04/04→07/07; für Rechtslenker; - DSTC		03.2125-7638.3 010738	ATE Ø 25,4
				04/04→07/07; für Linkslenker; + DSTC		03.2125-7713.3 010819	ATE Ø 25,4
				04/04→07/07; für Linkslenker; - DSTC		03.2125-7743.3 010921	ATE Ø 25,4
2.5 T AWD	154	07/02→08/07		09/02→07/07; für Rechtslenker; + DSTC		03.2125-7638.3 010738	ATE Ø 25,4
				09/02→07/07; für Rechtslenker; - DSTC		03.2125-7638.3 010738	ATE Ø 25,4
				09/02→07/07; für Linkslenker; + DSTC		03.2125-7713.3 010819	ATE Ø 25,4
				09/02→07/07; für Linkslenker; - DSTC		03.2125-7743.3 010921	ATE Ø 25,4
2.5 TDI	103	11/99→08/07		03/00→; → 68132; - DSTC		03.2125-7637.3 010707	ATE Ø 25,4
				03/00→; → 67770; für Rechtslenker; + DSTC		03.2125-7637.3 010707	ATE Ø 25,4
				68133→; → 07/07; für Rechtslenker; - DSTC		03.2125-7638.3 010738	ATE Ø 25,4
				67771→; → 07/07; für Rechtslenker; + DSTC		03.2125-7638.3 010738	ATE Ø 25,4
				03/00→; → 70377; für Linkslenker; + DSTC		03.2125-7708.3 010739	ATE Ø 25,4
				70378→; → 07/07; für Linkslenker; + DSTC		03.2125-7713.3 010819	ATE Ø 25,4
				68133→; → 07/07; für Linkslenker; - DSTC		03.2125-7743.3 010921	ATE Ø 25,4
R 2,5 T AWD ↓	221	03/03→08/07		→ 07/07; für Rechtslenker; + DSTC		03.2125-7638.3 010738	ATE Ø 25,4







	kw					! #		
VOLVO - V70 II (SW) 11/99→12/08								
 Hauptbremszylinder								
R 2,5 T AWD	221	03/03→08/07		→ 07/07; für Linkslenker; + DSTC		03.2125-7713.3	010819	ATE Ø 25,4
				→ 07/07; für Linkslenker; - DSTC		03.2125-7743.3	010921	ATE Ø 25,4
VOLVO - V70 III (BW) 04/07→								
 Bremskraftverstärker								
1.6 D	80	07/09→12/11		01/10→; für Linkslenker;		03.7755-9703.4	300239	ATE Ø 9 / 8" pneumatisch
2.0 T	149	09/09→12/11		für Fahrzeuge ohne Kollisionswarner				
				01/10→; für Rechtslenker;		03.7858-4832.4	300274	ATE Ø 9 / 8" pneumatisch
				für Fahrzeuge mit Kollisionswarner				
1.6 DRiVe / D2	84	04/11→12/15		für Linkslenker;		03.7755-9703.4	300239	ATE Ø 9 / 8" pneumatisch
2.0	107	10/07→12/11		für Fahrzeuge ohne Kollisionswarner				
2.0 D	100	10/07→12/15		für Rechtslenker;		03.7858-4832.4	300274	ATE Ø 9 / 8" pneumatisch
2.0 FlexiFuel	107	01/08→12/11		für Fahrzeuge mit Kollisionswarner				
T5	177	01/10→12/14						
1.6 T4F	132	01/11→12/15		→ 213000;		03.7755-9703.4	300239	ATE Ø 9 / 8" pneumatisch
2.0 BiFuel	157	03/13→12/15		für Fahrzeuge ohne Kollisionswarner				
2.5 T	147	08/07→12/09		→ 213000;		03.7858-5032.4	300275	ATE Ø 9 / 8" pneumatisch
2.5 T FlexiFuel	147	05/08→12/09		für Fahrzeuge mit Kollisionswarner				
3.2	175	08/07→12/10						
3.2	179	04/10→12/14						
3.2 AWD	179	04/10→12/15						
D3 / D4	120	03/10→12/15						
D5 AWD	151	12/09→12/11						
T4	132	10/10→12/15						
T6 AWD	210	08/07→12/10						
2.4 D	120	04/07→12/10		08/07→; → 213000;		03.7755-9703.4	300239	ATE Ø 9 / 8" pneumatisch
3.2 AWD	175	04/07→12/10		für Fahrzeuge ohne Kollisionswarner				
D5	136	04/07→12/09		08/07→; → 213000;		03.7858-5032.4	300275	ATE Ø 9 / 8" pneumatisch
				für Fahrzeuge mit Kollisionswarner				
2.4 D	129	04/09→12/10		10/09→; → 213000;		03.7755-9703.4	300239	ATE Ø 9 / 8" pneumatisch
2.5 T	170	04/09→12/12		für Fahrzeuge ohne Kollisionswarner				
2.5 T FlexiFuel	170	04/09→12/11		10/09→; → 213000;		03.7858-5032.4	300275	ATE Ø 9 / 8" pneumatisch
				für Fahrzeuge mit Kollisionswarner				
D3	100	10/07→12/15		05/12→; → 213000;		03.7755-9703.4	300239	ATE Ø 9 / 8" pneumatisch
				für Fahrzeuge ohne Kollisionswarner				
				05/12→; → 213000;		03.7858-5032.4	300275	ATE Ø 9 / 8" pneumatisch
				für Fahrzeuge mit Kollisionswarner				
D4	133	10/13→		für Fahrzeuge ohne Kollisionswarner		03.7755-9703.4	300239	ATE Ø 9 / 8" pneumatisch
D4 AWD	133	10/13→						
D5	151	10/08→12/11		12/09→; → 213000;		03.7755-9703.4	300239	ATE Ø 9 / 8" pneumatisch
				für Fahrzeuge ohne Kollisionswarner				
				12/09→; → 213000;		03.7858-5032.4	300275	ATE Ø 9 / 8" pneumatisch
				für Fahrzeuge mit Kollisionswarner				
D5	158	04/11→12/15		06/11→; → 213000;		03.7755-9703.4	300239	ATE Ø 9 / 8" pneumatisch
D5 AWD	158	04/11→12/15		für Fahrzeuge ohne Kollisionswarner				
				06/11→; → 213000;		03.7858-5032.4	300275	ATE Ø 9 / 8" pneumatisch
				für Fahrzeuge mit Kollisionswarner				
D5 AWD	136	04/07→12/09		10/07→; → 213000;		03.7755-9703.4	300239	ATE Ø 9 / 8" pneumatisch
				für Fahrzeuge ohne Kollisionswarner				
				10/07→; → 213000;		03.7858-5032.4	300275	ATE Ø 9 / 8" pneumatisch
				für Fahrzeuge mit Kollisionswarner				
T5	180	10/13→		für Fahrzeuge ohne Kollisionswarner		03.7755-9703.4	300239	ATE Ø 9 / 8" pneumatisch
				für Fahrzeuge mit Kollisionswarner		03.7858-5032.4	300275	ATE Ø 9 / 8" pneumatisch
T6 AWD	224	01/10→12/15		04/11→; → 213000;		03.7755-9703.4	300239	ATE Ø 9 / 8" pneumatisch
				für Fahrzeuge ohne Kollisionswarner				
				04/11→; → 213000;		03.7858-5032.4	300275	ATE Ø 9 / 8" pneumatisch
				für Fahrzeuge mit Kollisionswarner				
Pedalwegsensor, Bremspedal								
1.6 D	80	07/09→12/11		01/10→; für Rechtslenker;		03.0655-0007.2	370007	ATE
2.0 T	149	09/09→12/11		für Fahrzeuge mit Kollisionswarner				
				01/10→; für Linkslenker;		03.0655-0007.2	370007	ATE
				für Fahrzeuge mit Kollisionswarner				
1.6 DRiVe / D2	84	04/11→12/15		für Rechtslenker;		03.0655-0007.2	370007	ATE
2.0	107	10/07→12/11		für Fahrzeuge mit Kollisionswarner				
2.0 D	100	10/07→12/15		für Linkslenker;		03.0655-0007.2	370007	ATE
2.0 FlexiFuel	107	01/08→12/11		für Fahrzeuge mit Kollisionswarner				
T5	177	01/10→12/14						
1.6 T4F	132	01/11→12/15		→ 213000;		03.0655-0007.2	370007	ATE
2.5 T	147	08/07→12/09		für Fahrzeuge mit Kollisionswarner				
2.5 T FlexiFuel	147	05/08→12/09		213001→;		03.0655-0007.2	370007	ATE
3.2	175	08/07→12/10		für Fahrzeuge mit Kollisionswarner				
3.2	179	04/10→12/14						
3.2 AWD	179	04/10→12/15						
D3 / D4	120	03/10→12/15						
D5 AWD	151	12/09→12/11						
↓								









	kw			 	! #		
VOLVO - V70 III (BW) 04/07→							
Pedalwegsensoren, Bremspedal							
T4 T6 AWD	132 210	10/10→12/15 08/07→12/10		→ 213000; für Fahrzeuge mit Kollisionswarner		03.0655-0007.2 370007	ATE
				213001→; für Fahrzeuge mit Kollisionswarner		03.0655-0007.2 370007	ATE
2.0 BiFuel	157	03/13→12/15		→ 213000; für Fahrzeuge mit Kollisionswarner		03.0655-0007.2 370007	ATE
				für Fahrzeuge mit Kollisionswarner		03.0655-0007.2 370007	ATE
2.0 GDI	157	04/12→12/15		03/13→; für Fahrzeuge mit Kollisionswarner		03.0655-0007.2 370007	ATE
2.4 D 3.2 AWD D5	120 175 136	04/07→12/10 04/07→12/10 04/07→12/09		213001→; für Fahrzeuge mit Kollisionswarner		03.0655-0007.2 370007	ATE
				08/07→; → 213000; für Fahrzeuge mit Kollisionswarner		03.0655-0007.2 370007	ATE
2.4 D 2.5 T 2.5 T FlexiFuel	129 170 170	04/09→12/10 04/09→12/12 04/09→12/11		213001→; für Fahrzeuge mit Kollisionswarner		03.0655-0007.2 370007	ATE
				10/09→; → 213000; für Fahrzeuge mit Kollisionswarner		03.0655-0007.2 370007	ATE
D3	100	10/07→12/15		213001→; für Fahrzeuge mit Kollisionswarner		03.0655-0007.2 370007	ATE
				05/12→; → 213000; für Fahrzeuge mit Kollisionswarner		03.0655-0007.2 370007	ATE
D4 D4 AWD T5	133 133 180	10/13→ 10/13→ 10/13→		für Fahrzeuge mit Kollisionswarner		03.0655-0007.2 370007	ATE
D4 AWD	120	10/07→12/15		01/13→; für Fahrzeuge mit Kollisionswarner		03.0655-0007.2 370007	ATE
D5	151	10/08→12/11		213001→; für Fahrzeuge mit Kollisionswarner		03.0655-0007.2 370007	ATE
				12/09→; → 213000; für Fahrzeuge mit Kollisionswarner		03.0655-0007.2 370007	ATE
D5 D5 AWD	158 158	04/11→12/15 04/11→12/15		213001→; für Fahrzeuge mit Kollisionswarner		03.0655-0007.2 370007	ATE
				06/11→; → 213000; für Fahrzeuge mit Kollisionswarner		03.0655-0007.2 370007	ATE
D5 AWD	136	04/07→12/09		213001→; für Fahrzeuge mit Kollisionswarner		03.0655-0007.2 370007	ATE
				10/07→; → 213000; für Fahrzeuge mit Kollisionswarner		03.0655-0007.2 370007	ATE
T6 AWD	224	01/10→12/15		213001→; für Fahrzeuge mit Kollisionswarner		03.0655-0007.2 370007	ATE
				04/11→; → 213000; für Fahrzeuge mit Kollisionswarner		03.0655-0007.2 370007	ATE
VOLVO - V90 Kombi 11/96→12/98							
 Hauptbremszylinder							
2.5	125	11/96→10/98				03.2023-0875.3 010890	ATE Ø1 23,81 Ø2 20,64 ohne Bremsflüssigkeitsbehälter
2.5	132	11/96→10/97					
2.9	132	01/97→12/98					
2.9	150	01/97→12/98					
 Bremskraftregler							
2.5	125	11/96→10/98				03.6055-0430.3 320065	ATE 5/25 4x
2.5	132	11/96→10/97					
2.9	132	01/97→12/98					
2.9	150	01/97→12/98					
VOLVO - XC60 05/08→							
 Bremskraftverstärker							
2.4 D 2.4 D AWD 3.2 AWD D3 / D4 D5 D5 AWD	129 129 175 120 158 151	04/09→12/10 06/09→12/10 07/09→12/10 03/10→12/14 06/11→ 07/09→06/11		für Fahrzeuge ohne Kollisionswarner		03.7755-0132.4 300265	ATE Ø 9 / 8" pneumatisch
				für Fahrzeuge mit Kollisionswarner		03.7858-5132.4 300276	ATE Ø 9 / 8" pneumatisch
2.4 D / D3 / D4 AWD D5 AWD T6 AWD	120 136 210	05/08→ 05/08→12/09 05/08→12/10		09/08→; für Fahrzeuge ohne Kollisionswarner		03.7755-0132.4 300265	ATE Ø 9 / 8" pneumatisch
				09/08→; für Fahrzeuge mit Kollisionswarner		03.7858-5132.4 300276	ATE Ø 9 / 8" pneumatisch
3.2 AWD D5 AWD T6 AWD	179 169 224	03/10→12/15 04/14→12/15 03/10→12/15		→ 236999; für Fahrzeuge ohne Kollisionswarner		03.7755-0132.4 300265	ATE Ø 9 / 8" pneumatisch
				→ 236999; für Fahrzeuge mit Kollisionswarner		03.7858-5132.4 300276	ATE Ø 9 / 8" pneumatisch
D3 D4 D4	110 133 140	03/15→ 10/13→12/15 03/15→		für Fahrzeuge ohne Kollisionswarner		03.7755-0132.4 300265	ATE Ø 9 / 8" pneumatisch
↓							

	kw			 	! #		
VOLVO - XC60 05/08→							
 Bremskraftverstärker							
D4 AWD D4 AWD D5 AWD T6 AWD	133 140 162 242	10/13→12/15 03/15→ 03/15→ 04/14→12/15		237000→; für Fahrzeuge ohne Kollisionswarner → 236999; für Fahrzeuge ohne Kollisionswarner → 236999; für Fahrzeuge mit Kollisionswarner	03.7755-0132.4 03.7755-0132.4 03.7858-5132.4	300265 300265 300276	ATE Ø 9 / 8" pneumatisch ATE Ø 9 / 8" pneumatisch ATE Ø 9 / 8" pneumatisch
D5 AWD	158	04/11→12/15		06/11→; → 236999; für Fahrzeuge ohne Kollisionswarner 06/11→; → 236999; für Fahrzeuge mit Kollisionswarner	03.7755-0132.4 03.7858-5132.4	300265 300276	ATE Ø 9 / 8" pneumatisch ATE Ø 9 / 8" pneumatisch
T5 T5 AWD T6 T6 AWD	180 180 225 225	10/13→ 10/15→ 10/13→ 10/13→		für Fahrzeuge ohne Kollisionswarner	03.7755-9703.4	300239	ATE Ø 9 / 8" pneumatisch
Pedalwegsensor, Bremspedal							
2.0 T	149	12/09→12/12		03/10→; für Fahrzeuge mit Kollisionswarner	03.0655-0007.2	370007	ATE
2.4 D 2.4 D AWD 3.2 AWD D3 D3 / D4 D4 D4 D5 D5 AWD T5 T5 T5 AWD T5 AWD T6 T6 AWD	129 129 175 110 120 133 140 158 151 177 180 180 187 225 225	04/09→12/10 06/09→12/10 07/09→12/10 03/15→ 03/10→12/14 10/13→12/15 03/15→ 06/11→ 07/09→06/11 09/10→12/14 10/13→ 10/15→ 04/14→ 10/13→ 10/13→		für Fahrzeuge mit Kollisionswarner	03.0655-0007.2	370007	ATE
2.4 D / D3 / D4 AWD D5 AWD T6 AWD	120 136 210	05/08→ 05/08→12/09 05/08→12/10		09/08→; für Fahrzeuge mit Kollisionswarner	03.0655-0007.2	370007	ATE
3.2 AWD D4 AWD D4 AWD D5 AWD D5 AWD T6 AWD T6 AWD	179 133 140 162 169 224 242	03/10→12/15 10/13→12/15 03/15→ 03/15→ 04/14→12/15 03/10→12/15 04/14→12/15		→ 236999; für Fahrzeuge mit Kollisionswarner 237000→; für Fahrzeuge mit Kollisionswarner	03.0655-0007.2 03.0655-0007.2	370007 370007	ATE ATE
D5 AWD	158	04/11→12/15		06/11→; → 236999; für Fahrzeuge mit Kollisionswarner 237000→; für Fahrzeuge mit Kollisionswarner	03.0655-0007.2 03.0655-0007.2	370007 370007	ATE ATE
VOLVO - XC70 II 04/07→							
 Bremskraftverstärker							
2.4 D	129	06/09→12/10		01/10→; für Fahrzeuge ohne Kollisionswarner 01/10→; für Fahrzeuge mit Kollisionswarner	03.7755-0132.4 03.7755-9703.4 03.7858-5032.4 03.7858-5132.4	300265 300239 300275 300276	ATE Ø 9 / 8" pneumatisch ATE Ø 9 / 8" pneumatisch ATE Ø 9 / 8" pneumatisch ATE Ø 9 / 8" pneumatisch
2.4 D / D4 AWD 3.2 AWD 3.2 AWD D5 AWD T5 T6 AWD T6 AWD	120 175 179 162 180 210 224	08/07→ 08/07→ 08/07→ 03/15→ 10/13→ 01/08→ 01/10→		für Fahrzeuge ohne Kollisionswarner für Fahrzeuge mit Kollisionswarner	03.7755-0132.4 03.7755-9703.4 03.7858-5032.4 03.7858-5132.4	300265 300239 300275 300276	ATE Ø 9 / 8" pneumatisch ATE Ø 9 / 8" pneumatisch ATE Ø 9 / 8" pneumatisch ATE Ø 9 / 8" pneumatisch
D3	120	04/10→12/15		08/11→; für Fahrzeuge ohne Kollisionswarner 08/11→; für Fahrzeuge mit Kollisionswarner	03.7755-0132.4 03.7755-9703.4 03.7858-5032.4 03.7858-5132.4	300265 300239 300275 300276	ATE Ø 9 / 8" pneumatisch ATE Ø 9 / 8" pneumatisch ATE Ø 9 / 8" pneumatisch ATE Ø 9 / 8" pneumatisch
D4 D4 AWD T5 AWD	133 133 187	10/13→ 10/13→ 08/15→		für Fahrzeuge ohne Kollisionswarner	03.7755-9703.4	300239	ATE Ø 9 / 8" pneumatisch
D5 AWD	136	04/07→12/09		08/07→; für Fahrzeuge ohne Kollisionswarner 08/07→; für Fahrzeuge mit Kollisionswarner	03.7755-0132.4 03.7755-9703.4 03.7858-5032.4 03.7858-5132.4	300265 300239 300275 300276	ATE Ø 9 / 8" pneumatisch ATE Ø 9 / 8" pneumatisch ATE Ø 9 / 8" pneumatisch ATE Ø 9 / 8" pneumatisch
D5 AWD	151	04/09→12/11		12/09→; für Fahrzeuge ohne Kollisionswarner	03.7755-0132.4 03.7755-9703.4	300265 300239	ATE Ø 9 / 8" pneumatisch ATE Ø 9 / 8" pneumatisch
↓							











	kw			 	! #		
VOLVO - XC70 II 04/07→							
 Bremskraftverstärker							
D5 AWD	151	04/09→12/11		12/09→; für Fahrzeuge mit Kollisionswarner	03.7858-5032.4 300275 03.7858-5132.4 300276	ATE Ø 9 / 8" pneumatisch ATE Ø 9 / 8" pneumatisch	
D5 AWD	158	04/11→12/15		06/11→; für Fahrzeuge ohne Kollisionswarner	03.7755-0132.4 300265 03.7755-9703.4 300239	ATE Ø 9 / 8" pneumatisch ATE Ø 9 / 8" pneumatisch	
				06/11→; für Fahrzeuge mit Kollisionswarner	03.7858-5032.4 300275 03.7858-5132.4 300276	ATE Ø 9 / 8" pneumatisch ATE Ø 9 / 8" pneumatisch	
Pedalwegsensord, Bremspedal							
2.4 D	129	06/09→12/10		01/10→; für Fahrzeuge mit Kollisionswarner	03.0655-0007.2 370007	ATE	
2.4 D / D4 AWD	120	08/07→		für Fahrzeuge mit Kollisionswarner	03.0655-0007.2 370007	ATE	
3.2 AWD	175	08/07→					
3.2 AWD	179	08/07→					
D5 AWD	162	03/15→					
T5	180	10/13→					
T6 AWD	210	01/08→					
T6 AWD	224	01/10→					
D3	120	04/10→12/15		08/11→; für Fahrzeuge mit Kollisionswarner	03.0655-0007.2 370007	ATE	
D5 AWD	136	04/07→12/09		08/07→; für Fahrzeuge mit Kollisionswarner	03.0655-0007.2 370007	ATE	
D5 AWD	151	04/09→12/11		12/09→; für Fahrzeuge mit Kollisionswarner	03.0655-0007.2 370007	ATE	
D5 AWD	158	04/11→12/15		06/11→; für Fahrzeuge mit Kollisionswarner	03.0655-0007.2 370007	ATE	
VOLVO - XC70 CROSS COUNTRY 10/97→08/07							
 Bremskraftverstärker							
2.4 D5 AWD	136	12/05→08/07		→ 07/07; - DSTC	03.7755-4702.4 300224	ATE Ø 9 / 8" pneumatisch	
2.4 D5 XC AWD	120	09/02→08/07		→ 07/07; + DSTC	03.7858-3532.4 300233	ATE Ø 9 / 8" pneumatisch	
2.5 T XC AWD	154	09/02→08/07					
2.4 T XC AWD	142	11/97→09/02		→ 12/01; - DSTC	03.7755-3402.4 300189	ATE Ø 9 / 8" pneumatisch	
2.4 T XC AWD	147	03/00→09/02		01/02→; - DSTC	03.7755-4702.4 300224	ATE Ø 9 / 8" pneumatisch	
				+ DSTC	03.7858-3532.4 300233	ATE Ø 9 / 8" pneumatisch	
Pedalwegsensord, Bremspedal							
2.4 D5 AWD	136	12/05→08/07		→ 07/07	03.0655-0005.2 370005	ATE	
2.4 D5 XC AWD	120	09/02→08/07					
2.5 T XC AWD	154	09/02→08/07					
2.4 T XC AWD	142	11/97→09/02		→ 12/01	03.0655-0004.2 370004	ATE	
2.4 T XC AWD	147	03/00→09/02		01/02→	03.0655-0005.2 370005	ATE	
					03.0655-0005.2 370005	ATE	
 Hauptbremszylinder							
2.4 D5 AWD	136	12/05→08/07		→ 07/07; für Rechtslenker; - DSTC	03.2125-7637.3 010707	ATE Ø 25,4	
				→ 07/07; für Linkslenker; + DSTC	03.2125-7713.3 010819	ATE Ø 25,4	
				→ 07/07; für Linkslenker; - DSTC	03.2125-7743.3 010921	ATE Ø 25,4	
2.4 D5 XC AWD	120	09/02→08/07		→ 07/07; für Rechtslenker; - DSTC	03.2125-7637.3 010707	ATE Ø 25,4	
2.5 T XC AWD	154	09/02→08/07		→ 07/07; für Rechtslenker; + DSTC	03.2125-7638.3 010738	ATE Ø 25,4	
				→ 07/07; für Linkslenker; + DSTC	03.2125-7713.3 010819	ATE Ø 25,4	
				→ 07/07; für Linkslenker; - DSTC	03.2125-7743.3 010921	ATE Ø 25,4	
2.4 T XC AWD	142	11/97→09/02		→ 11000; für Linkslenker; - DSTC	03.2125-7637.3 010707	ATE Ø 25,4	
2.4 T XC AWD	147	03/00→09/02		→ 69018; für Rechtslenker; + DSTC	03.2125-7637.3 010707	ATE Ø 25,4	
				11001→; für Rechtslenker; - DSTC	03.2125-7637.3 010707	ATE Ø 25,4	
				69019→; für Rechtslenker; + DSTC	03.2125-7638.3 010738	ATE Ø 25,4	
				→ 11000; für Rechtslenker; - DSTC	03.2125-7638.3 010738	ATE Ø 25,4	
				→ 66913; für Linkslenker; + DSTC	03.2125-7708.3 010739	ATE Ø 25,4	
				66914→; für Linkslenker; + DSTC	03.2125-7713.3 010819	ATE Ø 25,4	
				11001→; für Linkslenker; - DSTC	03.2125-7743.3 010921	ATE Ø 25,4	
VOLVO - XC90 I 10/02→12/14							
 Bremskraftverstärker							
2.5 T	154	10/02→12/06		für Linkslenker;	03.7858-3032.4 300257	ATE Ø 9 / 8" pneumatisch	
2.5 T AWD	154	10/12→09/14		passend für Felgenreöße [Zoll]: 18			
D3 / D5	120	04/09→12/14		für Linkslenker	03.7858-3632.4 300234	ATE Ø 9 / 8" pneumatisch	
D5 AWD	120	10/02→12/06					
D5 AWD	120	10/07→12/10					
T6 AWD	200	10/02→12/06					
↓							

	kw			 	! #		
VOLVO - XC90 I 10/02→12/14							
Bremskraftverstärker							
V8 AWD	232	01/05→12/10		für Linkslenker; passend für Felgengröße [Zoll]: 18	03.7858-3032.4	300257	ATE Ø 9 / 8" pneumatisch
				für Linkslenker	03.7858-3632.4	300234	ATE Ø 9 / 8" pneumatisch
3.2 AWD	175	03/06→12/10		05/06→; für Linkslenker;	03.7858-3032.4	300257	ATE Ø 9 / 8" pneumatisch
D5 AWD	136	04/05→12/10		passend für Felgengröße [Zoll]: 18			
				05/06→; für Linkslenker	03.7858-3632.4	300234	ATE Ø 9 / 8" pneumatisch
3.2 AWD	179	04/10→12/12		für Linkslenker	03.7858-3632.4	300234	ATE Ø 9 / 8" pneumatisch
D5 AWD	147	01/11→12/14					
Pedalwegsensor, Bremspedal							
2.5 T	154	10/02→12/06		für Linkslenker	03.0655-0005.2	370005	ATE
2.5 T AWD	154	10/12→09/14		für Rechtslenker	03.0655-0005.2	370005	ATE
3.2 AWD	179	04/10→12/12					
D3 / D5	120	04/09→12/14					
D5 AWD	120	10/02→12/06					
D5 AWD	120	10/07→12/10					
D5 AWD	147	01/11→12/14					
T6 AWD	200	10/02→12/06					
V8 AWD	232	01/05→12/10					
3.2 AWD	175	03/06→12/10		05/06→; für Linkslenker	03.0655-0005.2	370005	ATE
D5 AWD	136	04/05→12/10		05/06→; für Rechtslenker	03.0655-0005.2	370005	ATE
Hauptbremszylinder							
2.5 T	154	10/02→12/06		für Rechtslenker	03.2125-7638.3	010738	ATE Ø 25,4
2.5 T AWD	154	10/12→09/14		für Linkslenker	03.2125-7713.3	010819	ATE Ø 25,4
D3 / D5	120	04/09→12/14					
D5 AWD	120	10/02→12/06					
D5 AWD	120	10/07→12/10					
D5 AWD	147	01/11→12/14					
3.2 AWD	175	03/06→12/10		05/06→; für Linkslenker	03.2125-7713.3	010819	ATE Ø 25,4
3.2 AWD	179	04/10→12/12		für Linkslenker	03.2125-7713.3	010819	ATE Ø 25,4
T6 AWD	200	10/02→12/06					
V8 AWD	232	01/05→12/10					
D5 AWD	136	04/05→12/10		05/06→; für Rechtslenker	03.2125-7638.3	010738	ATE Ø 25,4
				05/06→; für Linkslenker	03.2125-7713.3	010819	ATE Ø 25,4
VW - BORA (1J2) 10/98→09/05							
Bremskraftverstärker							
1.4 16V	55	03/00→05/05		09/00→; → 1J-2-373846; für Linkslenker;	03.7860-0602.4	300141	ATE Ø 10" pneumatisch
1.6	74	10/98→05/05		+ ESP			
1.6	75	08/00→05/05		→ 08/00; für Linkslenker; + ESP	03.7863-0402.4	300124	ATE Ø 10" pneumatisch
1.6 16V	77	05/00→05/05					
1.8	92	10/98→05/05		1J-2-373847→; für Linkslenker; + ESP;	03.7863-3502.4	300128	ATE Ø 10" pneumatisch
1.8 4motion	92	02/99→05/05		→ 12/04			
1.9 SDI	50	10/98→05/05					
2.0	85	10/98→05/05					
1.6	78	06/02→10/04		→ 1J-2-373846; für Linkslenker; + ESP	03.7860-0602.4	300141	ATE Ø 10" pneumatisch
				1J-2-373847→; für Linkslenker; + ESP	03.7863-3502.4	300128	ATE Ø 10" pneumatisch
1.6 FSI	81	01/02→05/05		→ 1J-2-373846; für Linkslenker; + ESP	03.7860-0602.4	300141	ATE Ø 10" pneumatisch
1.9 TDI	74	09/00→05/05					
1.9 TDI 4motion	74	09/00→05/05		1J-2-373847→; für Linkslenker; + ESP;	03.7863-3502.4	300128	ATE Ø 10" pneumatisch
2.0 4motion	85	04/00→05/05		→ 12/04			
2.3 V5	125	10/00→05/05					
2.3 V5 4motion	125	10/00→05/05					
1.8 T	110	05/00→05/05		09/00→; → 1J-2-373846; für Linkslenker;	03.7860-0602.4	300141	ATE Ø 10" pneumatisch
				+ ESP			
				1J-2-373847→; für Linkslenker; + ESP;	03.7863-3502.4	300128	ATE Ø 10" pneumatisch
				→ 12/04			
1.8 T	132	03/02→05/05		05/02→; für Linkslenker; + ESP; → 12/04	03.7863-3502.4	300128	ATE Ø 10" pneumatisch
1.9 TDI	66	10/98→05/05		09/00→ 06/01; für Linkslenker; + ESP	03.7860-0602.4	300141	ATE Ø 10" pneumatisch
				→ 08/00; für Linkslenker; + ESP	03.7863-0402.4	300124	ATE Ø 10" pneumatisch
1.9 TDI	81	10/98→06/01		09/00→; für Linkslenker; + ESP	03.7860-0602.4	300141	ATE Ø 10" pneumatisch
1.9 TDI 4motion	85	02/99→06/01		→ 08/00; für Linkslenker; + ESP	03.7863-0402.4	300124	ATE Ø 10" pneumatisch
1.9 TDI	85	12/98→01/02		09/00→ 06/01; für Linkslenker; + ESP	03.7860-0602.4	300141	ATE Ø 10" pneumatisch
1.9 TDI 4motion	66	11/98→04/02		02/99→ 08/00; für Linkslenker; + ESP	03.7863-0402.4	300124	ATE Ø 10" pneumatisch
1.9 TDI	96	11/00→05/05		04/01→; → 1J-2-373846; für Linkslenker;	03.7860-0602.4	300141	ATE Ø 10" pneumatisch
1.9 TDI 4motion	96	11/00→05/05		+ ESP			
				1J-2-373847→; für Linkslenker; + ESP;	03.7863-3502.4	300128	ATE Ø 10" pneumatisch
				→ 12/04			
1.9 TDI	110	05/00→05/05		10/00→; → 1J-2-373846; für Linkslenker;	03.7860-0602.4	300141	ATE Ø 10" pneumatisch
1.9 TDI 4motion	110	05/00→05/05		+ ESP			
				1J-2-373847→; für Linkslenker; + ESP;	03.7863-3502.4	300128	ATE Ø 10" pneumatisch
				→ 12/04			
↓							

























	kw			 	! #		
VW - BORA (1J2) 10/98→09/05							
Bremskraftverstärker							
2.3 V5	110	10/98→10/00		09/00→; → 1J-2-373846; für Linkslenker; + ESP	03.7860-0602.4	300141	ATE Ø 10" pneumatisch
				→ 08/00; für Linkslenker; + ESP	03.7863-0402.4	300124	ATE Ø 10" pneumatisch
				1J-2-373847→; für Linkslenker; + ESP	03.7863-3502.4	300128	ATE Ø 10" pneumatisch
2.3 V5 4motion	110	12/98→10/00		09/00→; → 1J-2-373846; für Linkslenker; + ESP	03.7860-0602.4	300141	ATE Ø 10" pneumatisch
				02/99→ 08/00; für Linkslenker; + ESP	03.7863-0402.4	300124	ATE Ø 10" pneumatisch
				1J-2-373847→; für Linkslenker; + ESP	03.7863-3502.4	300128	ATE Ø 10" pneumatisch
2.8 V6 4motion	150	03/99→05/05		09/00→; → 1J-2-373846; für Linkslenker; + ESP	03.7860-0602.4	300141	ATE Ø 10" pneumatisch
				05/99→ 08/00; für Linkslenker; + ESP	03.7863-0402.4	300124	ATE Ø 10" pneumatisch
				1J-2-373847→; für Linkslenker; + ESP; → 12/04	03.7863-3502.4	300128	ATE Ø 10" pneumatisch
Hauptbremszylinder							
1.4 16V	55	03/00→05/05		→ 08/00; für Linkslenker; + ESP	03.2123-2024.3	010597	ATE Ø 23,81
1.6	74	10/98→05/05		→ 08/00; für Rechtslenker; + ESP	03.2123-2064.3	010598	ATE Ø 23,81
1.6	75	08/00→05/05					
1.6 16V	77	05/00→05/05		09/00→; für Linkslenker; + ESP; → 12/04	03.2123-2715.3	010802	ATE Ø 23,81
1.8	92	10/98→05/05		09/00→; für Rechtslenker; + ESP; → 12/04	03.2123-2774.3	010803	ATE Ø 23,81
1.8 4motion	92	02/99→05/05					
1.9 SDI	50	10/98→05/05		für Linkslenker; - ESP; → 12/04	24.2123-1709.3	010503	Ø 23,81
2.0	85	10/98→05/05					
1.6	78	06/02→10/04		für Linkslenker; + ESP	03.2123-2715.3	010802	ATE Ø 23,81
				für Rechtslenker; + ESP	03.2123-2774.3	010803	ATE Ø 23,81
				für Linkslenker; - ESP	24.2123-1709.3	010503	Ø 23,81
1.6 FSI	81	01/02→05/05		für Linkslenker; + ESP; → 12/04	03.2123-2715.3	010802	ATE Ø 23,81
1.9 TDI	74	09/00→05/05		für Rechtslenker; + ESP; → 12/04	03.2123-2774.3	010803	ATE Ø 23,81
1.9 TDI 4motion	74	09/00→05/05					
2.0 4motion	85	04/00→05/05		für Linkslenker; - ESP; → 12/04	24.2123-1709.3	010503	Ø 23,81
2.3 V5	125	10/00→05/05					
2.3 V5 4motion	125	10/00→05/05					
1.8 T	110	05/00→05/05		09/00→; für Linkslenker; + ESP; → 12/04	03.2123-2715.3	010802	ATE Ø 23,81
				09/00→; für Rechtslenker; + ESP; → 12/04	03.2123-2774.3	010803	ATE Ø 23,81
				09/00→; für Linkslenker; - ESP; → 12/04	24.2123-1709.3	010503	Ø 23,81
1.8 T	132	03/02→05/05		05/02→; für Linkslenker; + ESP; → 12/04	03.2123-2715.3	010802	ATE Ø 23,81
				05/02→; für Rechtslenker; + ESP; → 12/04	03.2123-2774.3	010803	ATE Ø 23,81
				05/02→; für Linkslenker; - ESP; → 12/04	24.2123-1709.3	010503	Ø 23,81
1.9 TDI	66	10/98→05/05		→ 08/00; für Linkslenker; + ESP	03.2123-2024.3	010597	ATE Ø 23,81
				→ 08/00; für Rechtslenker; + ESP	03.2123-2064.3	010598	ATE Ø 23,81
				09/00→ 06/01; für Linkslenker; + ESP	03.2123-2715.3	010802	ATE Ø 23,81
				09/00→ 06/01; für Rechtslenker; + ESP	03.2123-2774.3	010803	ATE Ø 23,81
				→ 06/01; für Linkslenker; - ESP	24.2123-1709.3	010503	Ø 23,81
1.9 TDI	81	10/98→06/01		→ 08/00; für Linkslenker; + ESP	03.2123-2024.3	010597	ATE Ø 23,81
1.9 TDI 4motion	85	02/99→06/01		→ 08/00; für Rechtslenker; + ESP	03.2123-2064.3	010598	ATE Ø 23,81
2.3 V5	110	10/98→10/00		09/00→; für Linkslenker; + ESP	03.2123-2715.3	010802	ATE Ø 23,81
				09/00→; für Rechtslenker; + ESP	03.2123-2774.3	010803	ATE Ø 23,81
				für Linkslenker; - ESP	24.2123-1709.3	010503	Ø 23,81
1.9 TDI	85	12/98→01/02		02/99→ 08/00; für Linkslenker; + ESP	03.2123-2024.3	010597	ATE Ø 23,81
1.9 TDI 4motion	66	11/98→04/02		02/99→ 08/00; für Rechtslenker; + ESP	03.2123-2064.3	010598	ATE Ø 23,81
				09/00→ 06/01; für Linkslenker; + ESP	03.2123-2715.3	010802	ATE Ø 23,81
				09/00→ 06/01; für Rechtslenker; + ESP	03.2123-2774.3	010803	ATE Ø 23,81
				02/99→ 06/01; für Linkslenker; - ESP	24.2123-1709.3	010503	Ø 23,81
1.9 TDI	96	11/00→05/05		04/01→; für Linkslenker; + ESP; → 12/04	03.2123-2715.3	010802	ATE Ø 23,81
1.9 TDI 4motion	96	11/00→05/05		04/01→; für Rechtslenker; + ESP; → 12/04	03.2123-2774.3	010803	ATE Ø 23,81
				04/01→; für Linkslenker; - ESP; → 12/04	24.2123-1709.3	010503	Ø 23,81
1.9 TDI	110	05/00→05/05		10/00→; für Linkslenker; + ESP; → 12/04	03.2123-2715.3	010802	ATE Ø 23,81
1.9 TDI 4motion	110	05/00→05/05		10/00→; für Rechtslenker; + ESP; → 12/04	03.2123-2774.3	010803	ATE Ø 23,81
				10/00→; für Linkslenker; - ESP; → 12/04	24.2123-1709.3	010503	Ø 23,81
2.3 V5 4motion	110	12/98→10/00		02/99→ 08/00; für Linkslenker; + ESP	03.2123-2024.3	010597	ATE Ø 23,81
				02/99→ 08/00; für Rechtslenker; + ESP	03.2123-2064.3	010598	ATE Ø 23,81
				09/00→; für Linkslenker; + ESP	03.2123-2715.3	010802	ATE Ø 23,81
				09/00→; für Rechtslenker; + ESP	03.2123-2774.3	010803	ATE Ø 23,81

























	kW			 	! #		
VW - BORA (1J2) 10/98→09/05							
 Hauptbremszylinder							
2.3 V5 4motion	110	12/98→10/00		02/99→; für Linkslenker; - ESP		24.2123-1709.3 010503	Ø 23,81
2.8 V6 4motion	150	03/99→05/05		05/99→ 08/00; + ESP; für Linkslenker		03.2123-2024.3 010597	ATE Ø 23,81
				05/99→ 08/00; + ESP; für Rechtslenker		03.2123-2064.3 010598	ATE Ø 23,81
				09/00→; für Linkslenker; + ESP; → 12/04		03.2123-2715.3 010802	ATE Ø 23,81
				09/00→; für Rechtslenker; + ESP; → 12/04		03.2123-2774.3 010803	ATE Ø 23,81
				05/99→; für Linkslenker; - ESP; → 12/04		24.2123-1709.3 010503	Ø 23,81
VW - BORA Kombi (1J6) 05/99→05/05							
 Bremskraftverstärker							
1.4 16V	55	09/01→05/05		→ 1J-2-373846; für Linkslenker; + ESP		03.7860-0602.4 300141	ATE Ø 10" pneumatisch
1.6 FSI	81	01/02→05/05		1J-2-373847→; für Linkslenker; + ESP; → 12/04		03.7863-3502.4 300128	ATE Ø 10" pneumatisch
1.9 TDI	74	09/00→05/05					
1.9 TDI	110	05/01→05/05					
1.9 TDI 4motion	74	09/00→05/05					
1.9 TDI 4motion	110	05/01→05/05					
2.0 4motion	85	04/00→05/05					
2.3 V5	125	10/00→05/05					
2.3 V5 4motion	125	10/00→05/05					
1.6	74	05/99→05/05		09/00→; → 1J-2-373846; für Linkslenker; + ESP		03.7860-0602.4 300141	ATE Ø 10" pneumatisch
1.6	75	08/00→05/05					
1.6 16V	77	02/00→05/05		→ 08/00; für Linkslenker; + ESP		03.7863-0402.4 300124	ATE Ø 10" pneumatisch
1.8 4motion	92	05/99→05/05					
2.0	85	05/99→05/05		1J-2-373847→; für Linkslenker; + ESP; → 12/04		03.7863-3502.4 300128	ATE Ø 10" pneumatisch
2.8 V6 4motion	150	05/99→05/05					
1.8 T	110	05/00→05/05		09/00→; → 1J-2-373846; für Linkslenker; + ESP		03.7860-0602.4 300141	ATE Ø 10" pneumatisch
				1J-2-373847→; für Linkslenker; + ESP; → 12/04		03.7863-3502.4 300128	ATE Ø 10" pneumatisch
1.8 T	132	05/02→05/05		für Linkslenker; + ESP; → 12/04		03.7863-3502.4 300128	ATE Ø 10" pneumatisch
1.9 TDI	81	05/99→06/01		09/00→; für Linkslenker; + ESP		03.7860-0602.4 300141	ATE Ø 10" pneumatisch
1.9 TDI	85	05/99→06/01					
1.9 TDI 4motion	85	05/99→06/01		→ 08/00; für Linkslenker; + ESP		03.7863-0402.4 300124	ATE Ø 10" pneumatisch
1.9 TDI	96	11/00→05/05		04/01→; → 1J-2-373846; für Linkslenker; + ESP		03.7860-0602.4 300141	ATE Ø 10" pneumatisch
1.9 TDI 4motion	96	11/00→05/05					
				1J-2-373847→; für Linkslenker; + ESP; → 12/04		03.7863-3502.4 300128	ATE Ø 10" pneumatisch
2.0 4motion	88	12/99→05/03		04/00→; → 1J-2-373846; für Linkslenker; + ESP		03.7860-0602.4 300141	ATE Ø 10" pneumatisch
				1J-2-373847→; für Linkslenker; + ESP		03.7863-3502.4 300128	ATE Ø 10" pneumatisch
2.3 V5	110	05/99→10/00		09/00→; → 1J-2-373846; für Linkslenker; + ESP		03.7860-0602.4 300141	ATE Ø 10" pneumatisch
2.3 V5 4motion	110	05/99→10/00					
				→ 08/00; für Linkslenker; + ESP		03.7863-0402.4 300124	ATE Ø 10" pneumatisch
				1J-2-373847→; für Linkslenker; + ESP		03.7863-3502.4 300128	ATE Ø 10" pneumatisch
2.8 VR6	150	03/00→05/00		für Linkslenker; + ESP		03.7863-0402.4 300124	ATE Ø 10" pneumatisch
				1J-2-373847→; für Linkslenker; + ESP		03.7863-3502.4 300128	ATE Ø 10" pneumatisch
 Hauptbremszylinder							
1.4 16V	55	09/01→05/05		für Linkslenker; + ESP; → 12/04		03.2123-2715.3 010802	ATE Ø 23,81
1.6 FSI	81	01/02→05/05		für Rechtslenker; + ESP; → 12/04		03.2123-2774.3 010803	ATE Ø 23,81
1.8 T	132	05/02→05/05					
1.9 TDI	74	09/00→05/05		für Linkslenker; - ESP; → 12/04		24.2123-1709.3 010503	Ø 23,81
1.9 TDI	110	05/01→05/05					
1.9 TDI 4motion	74	09/00→05/05					
1.9 TDI 4motion	110	05/01→05/05					
2.0 4motion	85	04/00→05/05					
2.3 V5	125	10/00→05/05					
2.3 V5 4motion	125	10/00→05/05					
1.6	74	05/99→05/05		→ 08/00; für Linkslenker; + ESP		03.2123-2024.3 010597	ATE Ø 23,81
1.6	75	08/00→05/05					
1.6 16V	77	02/00→05/05		→ 08/00; für Rechtslenker; + ESP		03.2123-2064.3 010598	ATE Ø 23,81
1.8 4motion	92	05/99→05/05		09/00→; für Linkslenker; + ESP; → 12/04		03.2123-2715.3 010802	ATE Ø 23,81
2.0	85	05/99→05/05		09/00→; für Rechtslenker; + ESP; → 12/04		03.2123-2774.3 010803	ATE Ø 23,81
2.8 V6 4motion	150	05/99→05/05					
				für Linkslenker; - ESP; → 12/04		24.2123-1709.3 010503	Ø 23,81
1.8 T	110	05/00→05/05		09/00→; für Linkslenker; + ESP; → 12/04		03.2123-2715.3 010802	ATE Ø 23,81
				09/00→; für Rechtslenker; + ESP; → 12/04		03.2123-2774.3 010803	ATE Ø 23,81
				09/00→; für Linkslenker; - ESP; → 12/04		24.2123-1709.3 010503	Ø 23,81
1.9 TDI	81	05/99→06/01		→ 08/00; für Linkslenker; + ESP		03.2123-2024.3 010597	ATE Ø 23,81
1.9 TDI	85	05/99→06/01					
1.9 TDI 4motion	85	05/99→06/01		→ 08/00; für Rechtslenker; + ESP		03.2123-2064.3 010598	ATE Ø 23,81
2.3 V5	110	05/99→10/00		09/00→; für Linkslenker; + ESP		03.2123-2715.3 010802	ATE Ø 23,81
2.3 V5 4motion	110	05/99→10/00					





























	kw			 	! #		
VW - BORA Kombi (1J6) 05/99→05/05							
 Hauptbremszylinder							
1.9 TDI	81	05/99→06/01		09/00→; für Rechtslenker; + ESP		03.2123-2774.3 010803	ATE Ø 23,81
1.9 TDI	85	05/99→06/01		für Linkslenker; - ESP		24.2123-1709.3 010503	Ø 23,81
1.9 TDI 4motion	85	05/99→06/01					
2.3 V5	110	05/99→10/00					
2.3 V5 4motion	110	05/99→10/00					
1.9 TDI	96	11/00→05/05		04/01→; für Linkslenker; + ESP; → 12/04		03.2123-2715.3 010802	ATE Ø 23,81
1.9 TDI 4motion	96	11/00→05/05		04/01→; für Rechtslenker; + ESP; → 12/04		03.2123-2774.3 010803	ATE Ø 23,81
				04/01→; für Linkslenker; - ESP; → 12/04		24.2123-1709.3 010503	Ø 23,81
2.0 4motion	88	12/99→05/03		04/00→; für Linkslenker; + ESP		03.2123-2715.3 010802	ATE Ø 23,81
				04/00→; für Rechtslenker; + ESP		03.2123-2774.3 010803	ATE Ø 23,81
				04/00→; für Linkslenker; - ESP		24.2123-1709.3 010503	Ø 23,81
2.8 VR6	150	03/00→05/00		+ ESP; für Linkslenker		03.2123-2024.3 010597	ATE Ø 23,81
				+ ESP; für Rechtslenker		03.2123-2064.3 010598	ATE Ø 23,81
				für Linkslenker; - ESP		24.2123-1709.3 010503	Ø 23,81
VW - CADDY II Kasten (9K9A) 11/95→01/04							
 Bremskraftverstärker							
1.4	55	08/00→01/04		für Linkslenker; - ABS		03.7750-6302.4 300161	ATE Ø 9" pneumatisch
1.7 SDI	42	07/96→09/00		→ 9K-1-538270; für Linkslenker		10.6350-3902.4 300213	ATE Ø 9" pneumatisch
1.9 D	47	11/95→01/04					
1.9 SDI	47	11/95→01/04		9K-1-538271→; für Linkslenker		10.6350-4002.4 300285	ATE Ø 9" pneumatisch
1.9 TDI	66	09/96→01/04					
60 1.4	44	11/95→01/04					
75 1.6	55	11/95→05/97					
75 1.6	55	11/95→09/00					
 Hauptbremszylinder							
1.4	55	08/00→01/04		→ 9K-X-514000; für Rechtslenker; - ABS		03.2122-1042.3 010137	Ø 22,2
1.9 D	47	11/95→01/04		für Linkslenker; - ABS		03.2122-1042.3 010137	Ø 22,2
1.9 SDI	47	11/95→01/04					
1.9 TDI	66	09/96→01/04		für Linkslenker; + ABS		03.2123-1424.3 010637	ATE Ø 23,81
60 1.4	44	11/95→01/04		für Rechtslenker; + ABS		03.2123-1484.3 010595	ATE Ø 23,81
75 1.6	55	11/95→05/97					
75 1.6	55	11/95→09/00					
1.7 SDI	42	07/96→09/00		→ 9K-X-514000; für Rechtslenker; - ABS		03.2122-1042.3 010137	Ø 22,2
				für Linkslenker; - ABS		03.2122-1042.3 010137	Ø 22,2
				für Linkslenker; + ABS		03.2123-1424.3 010637	ATE Ø 23,81
Verschlusschraube, Hauptbremszylinder							
1.4	55	08/00→01/04		→ 9K-X-514000; für Rechtslenker; - ABS		03.3517-0101.2 390322	
1.7 SDI	42	07/96→09/00		für Linkslenker; - ABS		03.3517-0101.2 390322	
1.9 D	47	11/95→01/04					
1.9 SDI	47	11/95→01/04					
1.9 TDI	66	09/96→01/04					
60 1.4	44	11/95→01/04					
75 1.6	55	11/95→05/97					
75 1.6	55	11/95→09/00					
VW - CADDY II Kombi (9K9B) 11/95→01/04							
 Bremskraftverstärker							
1.4	44	11/95→01/04		für Linkslenker; - ABS		03.7750-6302.4 300161	ATE Ø 9" pneumatisch
1.4 16V	55	08/00→01/04		→ 9K-1-538270; für Linkslenker		10.6350-3902.4 300213	ATE Ø 9" pneumatisch
1.6	55	11/95→05/97					
1.6	55	06/97→09/00		9K-1-538271→; für Linkslenker		10.6350-4002.4 300285	ATE Ø 9" pneumatisch
1.7 SDI	42	07/96→09/00					
1.9 D	47	11/95→01/04					
1.9 SDI	47	11/95→01/04					
1.9 TDI	66	10/96→01/04					
 Hauptbremszylinder							
1.4	44	11/95→01/04		→ 9K-X-514000; für Rechtslenker; - ABS		03.2122-1042.3 010137	Ø 22,2
1.4 16V	55	08/00→01/04		für Linkslenker; - ABS		03.2122-1042.3 010137	Ø 22,2
1.6	55	11/95→05/97					
1.6	55	06/97→09/00		für Linkslenker; + ABS		03.2123-1424.3 010637	ATE Ø 23,81
1.9 D	47	11/95→01/04		für Rechtslenker; + ABS		03.2123-1484.3 010595	ATE Ø 23,81
1.9 SDI	47	11/95→01/04					
1.9 TDI	66	10/96→01/04					
1.7 SDI	42	07/96→09/00		→ 9K-X-514000; für Rechtslenker; - ABS		03.2122-1042.3 010137	Ø 22,2
				für Linkslenker; - ABS		03.2122-1042.3 010137	Ø 22,2
				für Linkslenker; + ABS		03.2123-1424.3 010637	ATE Ø 23,81
↓							









	kw			 	! #		
VW - CADDY II Kombi (9K9B) 11/95→01/04							
Verschlusschraube, Hauptbremszylinder							
1.4	44	11/95→01/04		→ 9K-X-514000; für Rechtslenker; - ABS		03.3517-0101.2	390322
1.4 16V	55	08/00→01/04		für Linkslenker; - ABS		03.3517-0101.2	390322
1.6	55	11/95→05/97					
1.6	55	06/97→09/00					
1.7 SDI	42	07/96→09/00					
1.9 D	47	11/95→01/04					
1.9 SDI	47	11/95→01/04					
1.9 TDI	66	10/96→01/04					
VW - CADDY II Pick-up (9U7) 06/96→12/00							
 Hauptbremszylinder							
1.6	55	06/96→12/00		10/97→; + ABS		03.2123-1428.3	010476 Ø 23,81
1.9 D	47	06/96→12/00		10/97→; - ABS		24.2122-1731.3	010656 Ø 22,2
 Bremskraftregler							
1.6	55	06/96→12/00		10/97→		03.6583-0167.3	320140 ATE lastabhängig 8/3 4x
1.9 D	47	06/96→12/00				03.6584-0107.3	320110 ATE lastabhängig 8/4 4x
VW - CADDY III Kasten (2KA, 2KH, 2CA, 2CH) 03/04→05/15							
 Bremskraftverstärker							
1.2 TSI	63	09/10→05/15		für Linkslenker		03.7873-4302.4	300312 ATE Ø 11" pneumatisch
1.2 TSI	77	09/10→05/15					
1.4	55	03/04→05/06					
1.4	59	05/06→08/10					
1.6	75	04/04→05/15					
1.6 BiFuel	75	05/11→05/15					
1.6 TDI	55	08/10→05/15					
1.6 TDI	75	08/10→05/15					
1.9 TDI	55	09/05→08/10					
1.9 TDI	77	04/04→08/10					
1.9 TDI 4motion	77	11/08→08/10					
2.0 EcoFuel	80	04/06→05/15					
2.0 SDI	51	03/04→08/10					
2.0 TDI	62	11/10→05/15					
2.0 TDI	103	09/07→08/10					
2.0 TDI	125	05/12→05/15					
2.0 TDI 16V	103	11/10→05/15					
2.0 TDI 16V 4motion	103	11/10→05/15					
2.0 TDI 4motion	62	12/10→05/15					
2.0 TDI	81	08/10→05/15			10/10→; für Linkslenker		
2.0 TDI 4motion	81	08/10→05/15					
 Hauptbremszylinder							
1.2 TSI	63	09/10→05/15		für Linkslenker		03.2122-2129.3	010799 ATE Ø 22,2
1.2 TSI	77	09/10→05/15					
1.4	55	03/04→05/06					
1.4	59	05/06→08/10					
1.6	75	04/04→05/15					
1.6 BiFuel	75	05/11→05/15					
1.6 TDI	55	08/10→05/15					
1.6 TDI	75	08/10→05/15					
1.9 TDI	55	09/05→08/10					
1.9 TDI	77	04/04→08/10					
1.9 TDI 4motion	77	11/08→08/10					
2.0 EcoFuel	80	04/06→05/15					
2.0 SDI	51	03/04→08/10					
2.0 TDI	62	11/10→05/15					
2.0 TDI	103	09/07→08/10					
2.0 TDI	125	05/12→05/15					
2.0 TDI 16V	103	11/10→05/15					
2.0 TDI 16V 4motion	103	11/10→05/15					
2.0 TDI 4motion	62	12/10→05/15					
2.0 TDI	81	08/10→05/15			10/10→; für Linkslenker		
2.0 TDI 4motion	81	08/10→05/15					
Hydraulikaggregat, Bremsanlage							
1.2 TSI	63	09/10→05/15		→ 12/10; +PR 1AT		24.9145-0001.2	399005
1.2 TSI	77	09/10→05/15					
1.6	75	04/04→05/15					
1.6 TDI	55	08/10→05/15					
1.6 TDI	75	08/10→05/15					
2.0 EcoFuel	80	04/06→05/15					
2.0 TDI	62	11/10→05/15					
2.0 TDI 16V	103	11/10→05/15					
2.0 TDI 16V 4motion	103	11/10→05/15					
2.0 TDI 4motion	62	12/10→05/15					
1.4	55	03/04→05/06		+PR 1AT		24.9145-0001.2	399005
1.4	59	05/06→08/10					
↓							









	kw			 	! #		
VW - CADDY III Kasten (2KA, 2KH, 2CA, 2CH) 03/04→05/15							
Hydraulikaggregat, Bremsanlage							
1.9 TDI	55	09/05→08/10		+PR 1AT		24.9145-0001.2	399005
1.9 TDI	77	04/04→08/10					
1.9 TDI 4motion	77	11/08→08/10					
2.0 SDI	51	03/04→08/10					
2.0 TDI	103	09/07→08/10					
2.0 TDI	81	08/10→05/15		10/10→ 12/10; +PR 1AT		24.9145-0001.2	399005
2.0 TDI 4motion	81	08/10→05/15					
VW - CADDY III Kombi (2KB, 2KJ, 2CB, 2CJ) 03/04→05/15							
 Bremskraftverstärker							
1.2 TSI	63	09/10→05/15		für Linkslenker		03.7873-4302.4	300312
1.2 TSI	77	09/10→05/15					
1.4	55	03/04→05/06					
1.4	59	05/06→08/10					
1.6	74	03/05→05/15					
1.6	75	04/04→05/15					
1.6 BiFuel	75	05/11→05/15					
1.6 TDI	55	08/10→05/15					
1.6 TDI	75	08/10→05/15					
1.9 TDI	55	09/05→08/10					
1.9 TDI	77	04/04→08/10					
1.9 TDI 4motion	77	05/08→08/10					
2.0 EcoFuel	80	04/06→05/15					
2.0 SDI	51	03/04→08/10					
2.0 TDI	103	09/07→08/10					
2.0 TDI	125	05/12→05/15					
2.0 TDI 16V	103	11/10→05/15					
2.0 TDI 16V 4motion	103	11/10→05/15					
2.0 TDI	81	08/10→05/15		10/10→; für Linkslenker		03.7873-4302.4	300312
2.0 TDI 4motion	81	08/10→05/15					
 Hauptbremszylinder							
1.2 TSI	63	09/10→05/15		für Linkslenker		03.2122-2129.3	010799
1.2 TSI	77	09/10→05/15					
1.4	55	03/04→05/06					
1.4	59	05/06→08/10					
1.6	74	03/05→05/15					
1.6	75	04/04→05/15					
1.6 BiFuel	75	05/11→05/15					
1.6 TDI	55	08/10→05/15					
1.6 TDI	75	08/10→05/15					
1.9 TDI	55	09/05→08/10					
1.9 TDI	77	04/04→08/10					
1.9 TDI 4motion	77	05/08→08/10					
2.0 EcoFuel	80	04/06→05/15					
2.0 SDI	51	03/04→08/10					
2.0 TDI	103	09/07→08/10					
2.0 TDI	125	05/12→05/15					
2.0 TDI 16V	103	11/10→05/15					
2.0 TDI 16V 4motion	103	11/10→05/15					
2.0 TDI	81	08/10→05/15		10/10→; für Linkslenker		03.2122-2129.3	010799
2.0 TDI 4motion	81	08/10→05/15					
Hydraulikaggregat, Bremsanlage							
1.2 TSI	63	09/10→05/15		→ 12/10; +PR 1AT		24.9145-0001.2	399005
1.2 TSI	77	09/10→05/15					
1.6	74	03/05→05/15					
1.6	75	04/04→05/15					
1.6 TDI	55	08/10→05/15					
1.6 TDI	75	08/10→05/15					
2.0 EcoFuel	80	04/06→05/15					
2.0 TDI 16V	103	11/10→05/15					
2.0 TDI 16V 4motion	103	11/10→05/15					
1.4	55	03/04→05/06		+PR 1AT		24.9145-0001.2	399005
1.4	59	05/06→08/10					
1.9 TDI	55	09/05→08/10					
1.9 TDI	77	04/04→08/10					
1.9 TDI 4motion	77	05/08→08/10					
2.0 SDI	51	03/04→08/10					
2.0 TDI	103	09/07→08/10					
2.0 TDI	81	08/10→05/15		10/10→ 12/10; +PR 1AT		24.9145-0001.2	399005
2.0 TDI 4motion	81	08/10→05/15					
VW - CADDY IV Kasten (SAA, SAH) 05/15→							
 Hauptbremszylinder							
1.0 TSI	75	11/15→		für Linkslenker		03.2123-3449.3	010808
1.2 TSI	62	06/15→					
1.4 TGI CNG	81	06/15→					
1.4 TSI	92	05/15→					
1.6	81	11/15→					
↓							

	kw			 	! #		
VW - CADDY IV Kasten (SAA, SAH) 05/15→							
 Hauptbremszylinder							
1.6 TDI	55	05/15→		für Linkslenker		03.2123-3449.3 010808	ATE Ø 23,81
1.6 TDI	75	05/15→					
2.0 TDI	55	05/15→					
2.0 TDI	75	05/15→					
2.0 TDI	81	09/15→					
2.0 TDI	103	05/15→					
2.0 TDI	110	05/15→					
2.0 TDI 4motion	55	11/15→					
2.0 TDI 4motion	81	05/15→					
2.0 TDI 4motion	90	05/15→					
2.0 TDI 4motion	103	05/15→					
2.0 TDI 4motion	110	11/15→					
VW - CADDY IV Kombi (SAB, SAJ) 05/15→							
 Hauptbremszylinder							
1.0 TSI	75	11/15→		für Linkslenker		03.2123-3449.3 010808	ATE Ø 23,81
1.2 TSI	62	06/15→					
1.4 TGI CNG	81	06/15→					
1.4 TSI	92	05/15→					
1.6	81	11/15→					
1.6 TDI	55	05/15→					
1.6 TDI	75	05/15→					
2.0 TDI	55	05/15→					
2.0 TDI	75	05/15→					
2.0 TDI	81	09/15→					
2.0 TDI	103	05/15→					
2.0 TDI	110	05/15→					
2.0 TDI 4motion	81	05/15→					
2.0 TDI 4motion	90	05/15→					
2.0 TDI 4motion	103	05/15→					
2.0 TDI 4motion	110	11/15→					
VW - CADDY ALLTRACK Kasten (SAA) 05/15→							
 Hauptbremszylinder							
1.0 TSI	75	11/15→		für Linkslenker		03.2123-3449.3 010808	ATE Ø 23,81
1.2 TSI	62	06/15→					
1.4 TGI CNG	81	06/15→					
1.4 TSI	92	05/15→					
2.0 TDI	55	05/15→					
2.0 TDI	75	05/15→					
2.0 TDI	110	05/15→					
2.0 TDI 4motion	90	05/15→					
2.0 TDI 4motion	110	11/15→					
VW - CADDY ALLTRACK Kombi (SAB) 05/15→							
 Hauptbremszylinder							
1.0 TSI	75	11/15→		für Linkslenker		03.2123-3449.3 010808	ATE Ø 23,81
1.2 TSI	62	06/15→					
1.4 TGI CNG	81	06/15→					
1.4 TSI	92	05/15→					
2.0 TDI	55	05/15→					
2.0 TDI	75	05/15→					
2.0 TDI	110	05/15→					
2.0 TDI 4motion	90	05/15→					
2.0 TDI 4motion	110	11/15→					
VW - CC (358) 11/11→12/16							
 Bremskraftverstärker							
1.4 TSI	110	05/15→12/16		+PR 1ZG; für Linkslenker		03.7873-4402.4 300292	ATE Ø 11" pneumatisch
1.4 TSI	118	11/11→12/16					
1.4 TSI MultiFuel	118	11/11→12/16		+PR 1LA,1LB,1ZM; für Linkslenker		03.7873-4502.4 300284	ATE Ø 11" pneumatisch
1.8 TSI	112	11/11→12/16					
1.8 TSI	118	11/11→12/16					
2.0 TDI	100	11/11→12/16					
2.0 TDI	103	11/11→12/16					
2.0 TDI	110	05/15→12/16					
2.0 TDI	125	11/11→12/16					
2.0 TDI	130	12/12→12/16					
2.0 TDI	135	05/15→12/16					
2.0 TDI 4motion	103	11/11→12/16					
2.0 TDI 4motion	125	11/11→01/13					
2.0 TDI 4motion	130	12/12→12/16					
2.0 TSI	155	11/11→12/16					
3.6 FSI 4motion	206	11/11→					
3.6 FSI 4motion	220	11/11→12/16					
 Hauptbremszylinder							
1.4 TSI	110	05/15→12/16		+PR 1ZG; für Linkslenker		03.4152-0116.3 010814	ATE Ø 22,2
↓							















	kw			 	! #		
VW - CC (358) 11/11→12/16							
 Hauptbremszylinder							
1.4 TSI	118	11/11→12/16		+PR 1LA,1LB,1ZM; für Linkslenker		03.4153-0186.3 010816	ATE Ø 23,81
1.4 TSI MultiFuel	118	11/11→12/16					
1.8 TSI	112	11/11→12/16					
1.8 TSI	118	11/11→12/16					
2.0 TDI	100	11/11→12/16					
2.0 TDI	103	11/11→12/16					
2.0 TDI	110	05/15→12/16					
2.0 TDI	125	11/11→12/16					
2.0 TDI	130	12/12→12/16					
2.0 TDI	135	05/15→12/16					
2.0 TDI 4motion	103	11/11→12/16					
2.0 TDI 4motion	125	11/11→01/13					
2.0 TDI 4motion	130	12/12→12/16					
2.0 TSI	155	11/11→12/16					
3.6 FSI 4motion	206	11/11→					
3.6 FSI 4motion	220	11/11→12/16					
Drucksensor, Bremskraftverstärker							
3.6 FSI 4motion	206	11/11→		+PR 1ZG; für Rechtslenker		03.0655-0101.2 370008	ATE
3.6 FSI 4motion	220	11/11→12/16					
VW - CORRADO (53I) 08/87→12/95							
 Bremskraftverstärker							
2.0 i	85	04/93→12/95		→ 07/95; für Linkslenker; - ABS		03.7750-4302.4 300076	ATE Ø 9" pneumatisch
2.0 i 16V	100	08/91→12/95					
2.9 VR6	140	08/91→12/95		→ 07/95; für Rechtslenker; - ABS		03.7750-4902.4 300079	ATE Ø 9" pneumatisch
 Hauptbremszylinder							
2.0 i	85	04/93→12/95		→ 07/95; - ABS		03.2122-1042.3 010137	Ø 22,2
2.0 i 16V	100	08/91→12/95					
2.9 VR6	140	08/91→12/95					
Verschlusschraube, Hauptbremszylinder							
2.0 i	85	04/93→12/95		→ 07/95; - ABS		03.3517-0101.2 390322	
2.0 i 16V	100	08/91→12/95					
2.9 VR6	140	08/91→12/95					
 Bremskraftregler							
2.0 i	85	04/93→12/95		→ 07/95		03.6584-0015.3 320109	ATE lastabhängig 8/4 4x
2.0 i 16V	100	08/91→12/95					
2.9 VR6	140	08/91→12/95		→ 07/95		03.6584-0113.3 320111	ATE lastabhängig 8/4 4x
VW - CRAFTER 30-35 Bus (2E_) 04/06→12/16							
 Hauptbremszylinder							
2.0 TDI	80	05/11→12/16		07/11→		24.2126-1704.3 010990	TRW Ø 26,99
2.0 TDI	100	05/11→12/16					
2.5 TDI	65	04/06→07/11					
2.5 TDI	80	04/06→05/13					
2.5 TDI	100	04/06→05/13					
2.5 TDI	120	04/06→07/11					
2.0 TDI	84	11/13→12/16				24.2126-1704.3 010990	TRW Ø 26,99
2.0 TDI	105	10/11→12/16					
2.0 TDI	120	07/11→12/16					
2.0 TDI 4motion	120	11/11→12/16					
VW - CRAFTER 30-50 Kasten (2E_) 04/06→12/16							
 Hauptbremszylinder							
2.0 TDI	80	05/11→12/16		07/11→		24.2126-1704.3 010990	TRW Ø 26,99
2.0 TDI	100	05/11→12/16					
2.5 TDI	65	04/06→07/11					
2.5 TDI	80	04/06→05/13					
2.5 TDI	100	04/06→05/13					
2.5 TDI	120	04/06→07/11					
2.0 TDI	84	11/13→12/16				24.2126-1704.3 010990	TRW Ø 26,99
2.0 TDI	103	11/15→12/16					
2.0 TDI	105	10/11→12/16					
2.0 TDI	120	07/11→12/16					
2.0 TDI 4motion	120	11/11→12/16					
VW - CRAFTER 30-50 Pritsche/Fahrgestell (2F_) 04/06→12/16							
 Hauptbremszylinder							
2.0 TDI	80	05/11→12/16		07/11→		24.2126-1704.3 010990	TRW Ø 26,99
2.0 TDI	100	05/11→12/16					
2.5 TDI	65	04/06→07/11					
2.5 TDI	80	04/06→05/13					
2.5 TDI	100	04/06→05/13					
↓							











	kw					! #		
VW - CRAFTER 30-50 Pritsche/Fahrgestell (2F_) 04/06→12/16								
 Hauptbremszylinder								
2.5 TDI	120	04/06→07/11		07/11→			24.2126-1704.3 010990	TRW Ø 26,99
2.0 TDI	84	11/13→12/16					24.2126-1704.3 010990	TRW Ø 26,99
2.0 TDI	103	11/15→12/16						
2.0 TDI	105	10/11→12/16						
2.0 TDI	120	07/11→12/16						
2.0 TDI 4motion	120	11/11→12/16						
VW - EOS (1F7, 1F8) 03/06→08/15								
 Bremskraftverstärker								
1.4 TSI	90	11/07→08/15		für Linkslenker			03.7863-3332.4 300308	ATE Ø 10" pneumatisch
1.4 TSI	118	05/08→08/15						
1.6 FSI	85	06/06→05/08						
2.0 TDI	100	11/10→08/15						
2.0 TDI	103	06/06→05/08						
2.0 TDI 16V	103	05/08→08/15						
2.0 FSI	110	03/06→05/08		05/06→; für Linkslenker; +PR 1ZD			03.7863-3232.4 300307	ATE Ø 10" pneumatisch
2.0 TFSI	147	03/06→08/15		05/06→; für Linkslenker; +PR 1ZA,1ZE,1LJ			03.7863-3332.4 300308	ATE Ø 10" pneumatisch
2.0 TSI	155	11/09→08/15		für Linkslenker; +PR 1ZD			03.7863-3232.4 300307	ATE Ø 10" pneumatisch
3.2 V6	184	06/06→05/09		für Linkslenker; +PR 1ZA,1ZE,1LJ			03.7863-3332.4 300308	ATE Ø 10" pneumatisch
3.6 V6	191	05/09→11/10		für Linkslenker; +PR 1ZD			03.7863-3232.4 300307	ATE Ø 10" pneumatisch
				+PR 1LK; für Linkslenker			03.7863-3332.4 300308	ATE Ø 10" pneumatisch
 Hauptbremszylinder								
1.4 TSI	90	11/07→08/15		für Linkslenker; +PR 1AT,1ZD			03.2122-2129.3 010799	ATE Ø 22,2
1.4 TSI	118	05/08→08/15						
1.6 FSI	85	06/06→05/08		für Linkslenker; +PR 1ZA,1ZE,1LJ,1LK			03.2123-3449.3 010808	ATE Ø 23,81
2.0 TDI	100	11/10→08/15						
2.0 TDI	103	06/06→05/08						
2.0 TDI 16V	103	05/08→08/15						
2.0 TSI	155	11/09→08/15						
3.2 V6	184	06/06→05/09						
3.6 V6	191	05/09→11/10						
2.0 FSI	110	03/06→05/08		05/06→; für Linkslenker; +PR 1AT,1ZD			03.2122-2129.3 010799	ATE Ø 22,2
2.0 TFSI	147	03/06→08/15		05/06→; für Linkslenker; +PR 1ZA,1ZE,1LJ,1LK			03.2123-3449.3 010808	ATE Ø 23,81
Hydraulikaggregat, Bremsanlage								
1.4 TSI	90	11/07→08/15		→ 12/08			24.9145-0001.2 399005	
1.4 TSI	118	05/08→08/15						
2.0 TDI 16V	103	05/08→08/15						
3.2 V6	184	06/06→05/09						
1.6 FSI	85	06/06→05/08					24.9145-0001.2 399005	
2.0 TDI	103	06/06→05/08						
2.0 FSI	110	03/06→05/08		05/06→			24.9145-0001.2 399005	
2.0 TFSI	147	03/06→08/15		05/06→ 12/08			24.9145-0001.2 399005	
VW - FOX (5Z1, 5Z3) 10/03→								
 Hauptbremszylinder								
1.0	53	10/03→		→ 08/11; +PR 1ZN; + ABS			24.2120-1734.3 010702	Ø 20,64
1.0	54	04/08→						
1.0 Total Flex	53	10/03→		→ 08/11; +PR 1ZF,1AC,1AT; + ABS			24.2120-1734.3 010702	Ø 20,64
1.0 Total Flex	54	05/05→						
1.6	74	10/03→						
1.6 Total Flex	74	10/03→						
1.9 D	47	12/07→						
1.2	40	04/05→		→ 08/11; +PR 1ZN; + ABS			24.2120-1734.3 010702	Ø 20,64
1.2	44	09/10→						
1.4	55	04/05→		→ 08/11; +PR 1ZF;1AC;1AT; + ABS			24.2120-1734.3 010702	Ø 20,64
1.4 TDI	51	04/05→						
 Bremskraftregler								
1.0	53	10/03→		→ 08/11; - ABS			03.6584-0120.3 320279	ATE lastabhängig 8/4 4x
1.0	54	04/08→						
1.0 Total Flex	53	10/03→						
1.0 Total Flex	54	05/05→						
1.2	40	04/05→						
1.2	44	09/10→						
1.4	55	04/05→						
1.4 TDI	51	04/05→						
1.6	74	10/03→						
1.6 Total Flex	74	10/03→						
1.9 D	47	12/07→						

	kw			 	! #		
VW - GOLF III (1H1) 08/91→07/98							
 Bremskraftverstärker							
1.4	40	11/91→08/97		für Linkslenker; - ABS	03.7750-5502.4	300081	ATE Ø 9" pneumatisch
1.6	55	09/92→08/97		→ 1H-S-088704; für Linkslenker; + ABS	10.6360-1003.4	300156	ATE Ø 10" pneumatisch
1.6	74	07/95→08/97					
1.8	55	11/91→08/97		1H-S-088705→; für Linkslenker; + ABS	10.6360-2002.4	300143	ATE Ø 10" pneumatisch
1.8	66	11/91→08/97					
1.8 Syncro (1HX1)	66	01/93→08/97					
1.9 TD,GTD	55	11/91→08/97					
2.0 GTI 16V	110	08/92→08/97					
2.8 VR6	128	01/92→08/97					
1.4	44	10/91→08/97		11/91→; für Linkslenker; - ABS	03.7750-5502.4	300081	ATE Ø 9" pneumatisch
				11/91→; → 1H-S-088704; für Linkslenker; + ABS	10.6360-1003.4	300156	ATE Ø 10" pneumatisch
				1H-S-088705→; für Linkslenker; + ABS	10.6360-2002.4	300143	ATE Ø 10" pneumatisch
1.9 D	48	11/91→08/97		für Linkslenker; - ABS	03.7750-5502.4	300081	ATE Ø 9" pneumatisch
				08/93→ 07/95; für Linkslenker; - ABS	03.7750-5502.4	300081	ATE Ø 9" pneumatisch
				→ 1H-S-088704; für Linkslenker; + ABS	10.6360-1003.4	300156	ATE Ø 10" pneumatisch
				08/93→; → 1H-S-088704; für Linkslenker; + ABS	10.6360-1003.4	300156	ATE Ø 10" pneumatisch
				1H-S-088705→; → 07/95; für Linkslenker; + ABS	10.6360-2002.4	300143	ATE Ø 10" pneumatisch
				1H-S-088705→; für Linkslenker; + ABS	10.6360-2002.4	300143	ATE Ø 10" pneumatisch
1.9 SDI	47	07/95→08/97		für Linkslenker; - ABS	03.7750-5502.4	300081	ATE Ø 9" pneumatisch
1.9 TDI	81	04/96→08/97					
1.9 TDI Syncro (1HX1)	66	08/95→08/97		für Linkslenker; + ABS	10.6360-2002.4	300143	ATE Ø 10" pneumatisch
2.0 Syncro (1HX1)	85	08/95→08/97					
1.9 TDI	66	09/93→08/97		10/93→; für Linkslenker; - ABS	03.7750-5502.4	300081	ATE Ø 9" pneumatisch
				10/93→; → 1H-S-088704; für Linkslenker; + ABS	10.6360-1003.4	300156	ATE Ø 10" pneumatisch
				1H-S-088705→; für Linkslenker; + ABS	10.6360-2002.4	300143	ATE Ø 10" pneumatisch
2.0	85	11/91→08/97		für Linkslenker; - ABS	03.7750-5502.4	300081	ATE Ø 9" pneumatisch
2.0 GL	79	08/95→09/97		→ 08/97; für Linkslenker; - ABS	03.7750-5502.4	300081	ATE Ø 9" pneumatisch
2.8 VR6	120	08/95→09/97		→ 1H-S-088704; für Linkslenker; + ABS	10.6360-1003.4	300156	ATE Ø 10" pneumatisch
				1H-S-088705→; → 08/97; für Linkslenker; + ABS	10.6360-2002.4	300143	ATE Ø 10" pneumatisch
2.9 VR6 Syncro (1HX1)	140	10/94→08/97		→ 1H-S-088704; für Linkslenker; + ABS	10.6360-1003.4	300156	ATE Ø 10" pneumatisch
				1H-S-088705→; für Linkslenker; + ABS	10.6360-2002.4	300143	ATE Ø 10" pneumatisch
 Hauptbremszylinder							
1.4	40	11/91→08/97		- ABS	03.2120-3943.3	010532	ATE Ø 20,64
1.6	55	09/92→08/97		1H-S-088705→; für Linkslenker; + ABS	03.2122-1144.3	010636	ATE Ø 22,2
1.9 TD,GTD	55	11/91→08/97		1H-S-088705→; für Rechtslenker; + ABS	03.2122-1184.3	010592	ATE Ø 22,2
1.4	44	10/91→08/97		11/91→; - ABS	03.2120-3943.3	010532	ATE Ø 20,64
				1H-S-088705→; für Linkslenker; + ABS	03.2122-1144.3	010636	ATE Ø 22,2
				1H-S-088705→; für Rechtslenker; + ABS	03.2122-1184.3	010592	ATE Ø 22,2
1.6	74	07/95→08/97		- ABS	03.2122-1042.3	010137	Ø 22,2
2.0 GTI 16V	110	08/92→08/97		1H-S-088705→; für Linkslenker; + ABS	03.2123-1424.3	010637	ATE Ø 23,81
				1H-S-088705→; für Rechtslenker; + ABS	03.2123-1484.3	010595	ATE Ø 23,81
				→ 1H-S-088704; für Linkslenker; + ABS	10.6123-0674.3	010639	ATE Ø 23,81
1.8	55	11/91→08/97		- ABS	03.2120-3943.3	010532	ATE Ø 20,64
1.8	66	11/91→08/97		- ABS	03.2122-1042.3	010137	Ø 22,2
				1H-S-088705→; für Linkslenker; + ABS	03.2122-1144.3	010636	ATE Ø 22,2
				1H-S-088705→; für Rechtslenker; + ABS	03.2122-1184.3	010592	ATE Ø 22,2
				1H-S-088705→; für Linkslenker; + ABS	03.2123-1424.3	010637	ATE Ø 23,81
				1H-S-088705→; für Rechtslenker; + ABS	03.2123-1484.3	010595	ATE Ø 23,81
				→ 1H-S-088704; für Linkslenker; + ABS	10.6123-0674.3	010639	ATE Ø 23,81
1.8 Syncro (1HX1)	66	01/93→08/97		- ABS	03.2122-1042.3	010137	Ø 22,2
				1H-S-088705→; für Linkslenker; + ABS	03.2123-1424.3	010637	ATE Ø 23,81
1.9 D	48	11/91→08/97		08/93→ 07/95; - ABS	03.2120-3943.3	010532	ATE Ø 20,64
				- ABS	03.2120-3943.3	010532	ATE Ø 20,64
				1H-S-088705→; → 07/95; für Linkslenker; + ABS	03.2122-1144.3	010636	ATE Ø 22,2
				1H-S-088705→; für Linkslenker; + ABS	03.2122-1144.3	010636	ATE Ø 22,2
				1H-S-088705→; für Rechtslenker; + ABS	03.2122-1184.3	010592	ATE Ø 22,2
1.9 SDI	47	07/95→08/97		- ABS	03.2120-3943.3	010532	ATE Ø 20,64
				+ ABS	03.2122-1144.3	010636	ATE Ø 22,2
				für Rechtslenker; + ABS	03.2122-1184.3	010592	ATE Ø 22,2
↓							







	kw			 	! #		
VW - GOLF III (1H1) 08/91→07/98							
 Hauptbremszylinder							
1.9 TDI	66	09/93→08/97		10/93→; - ABS		03.2122-1042.3 010137	Ø 22,2
				1H-S-088705→; für Linkslenker; + ABS		03.2123-1424.3 010637	ATE Ø 23,81
				1H-S-088705→; für Rechtslenker; + ABS		03.2123-1484.3 010595	ATE Ø 23,81
				10/93→; → 1H-S-088704; für Linkslenker; + ABS		10.6123-0674.3 010639	ATE Ø 23,81
1.9 TDI	81	04/96→08/97		- ABS		03.2122-1042.3 010137	Ø 22,2
				für Linkslenker; + ABS		03.2123-1424.3 010637	ATE Ø 23,81
				für Rechtslenker; + ABS		03.2123-1484.3 010595	ATE Ø 23,81
1.9 TDI Syncro (1HX1) 2.0 Syncro (1HX1)	66 85	08/95→08/97 08/95→08/97		- ABS		03.2122-1042.3 010137	Ø 22,2
				für Linkslenker; + ABS		03.2123-1424.3 010637	ATE Ø 23,81
2.0	85	11/91→08/97		- ABS		03.2122-1042.3 010137	Ø 22,2
2.0 GL	79	08/95→09/97		→ 08/97; - ABS		03.2122-1042.3 010137	Ø 22,2
				1H-S-088705→; → 08/97; für Linkslenker; + ABS		03.2123-1424.3 010637	ATE Ø 23,81
				1H-S-088705→; → 08/97; für Rechtslenker; + ABS		03.2123-1484.3 010595	ATE Ø 23,81
				→ 1H-S-088704; für Linkslenker; + ABS		10.6123-0674.3 010639	ATE Ø 23,81
2.8 VR6	120	08/95→09/97		1H-S-088705→; → 08/97; für Linkslenker; + ABS		03.2123-1424.3 010637	ATE Ø 23,81
				1H-S-088705→; → 08/97; für Rechtslenker; + ABS		03.2123-1484.3 010595	ATE Ø 23,81
				→ 1H-S-088704; für Linkslenker; + ABS		10.6123-0674.3 010639	ATE Ø 23,81
2.8 VR6	128	01/92→08/97		1H-S-088705→; für Linkslenker; + ABS		03.2123-1424.3 010637	ATE Ø 23,81
				1H-S-088705→; für Rechtslenker; + ABS		03.2123-1484.3 010595	ATE Ø 23,81
				→ 1H-S-088704; für Linkslenker; + ABS		10.6123-0674.3 010639	ATE Ø 23,81
2.9 VR6 Syncro (1HX1)	140	10/94→08/97		1H-S-088705→; für Linkslenker; + ABS		03.2123-1424.3 010637	ATE Ø 23,81
				→ 1H-S-088704; für Linkslenker; + ABS		10.6123-0674.3 010639	ATE Ø 23,81
Citystromer	20	11/94→08/97		+ ABS; für Linkslenker		03.2122-1144.3 010636	ATE Ø 22,2
Verschlusschraube, Hauptbremszylinder							
1.4	40	11/91→08/97		- ABS		03.3517-0101.2 390322	
1.6	55	09/92→08/97					
1.6	74	07/95→08/97					
1.8 Syncro (1HX1)	66	01/93→08/97					
1.9 SDI	47	07/95→08/97					
1.9 TD,GTD	55	11/91→08/97					
1.9 TDI	81	04/96→08/97					
1.9 TDI Syncro (1HX1)	66	08/95→08/97					
2.0	85	11/91→08/97					
2.0 GTI 16V	110	08/92→08/97					
2.0 Syncro (1HX1)	85	08/95→08/97					
1.4	44	10/91→08/97		11/91→; - ABS		03.3517-0101.2 390322	
1.8	55	11/91→08/97		- ABS		03.3517-0101.2 390322	
1.8	66	11/91→08/97		- ABS		03.3517-0101.2 390322	
1.9 D	48	11/91→08/97		08/93→ 07/95; - ABS		03.3517-0101.2 390322	
				- ABS		03.3517-0101.2 390322	
1.9 TDI	66	09/93→08/97		10/93→; - ABS		03.3517-0101.2 390322	
2.0 GL	79	08/95→09/97		→ 08/97; - ABS		03.3517-0101.2 390322	
 Bremskraftregler							
1.4	40	11/91→08/97		→ 1H-V-040000		03.0101-0025.2 320014	ATE Satz 3/35 2x
				1H-V-040001→		03.6584-0107.3 320110	ATE lastabhängig 8/4 4x
1.4	44	10/91→08/97		11/91→; → 1H-V-040000		03.0101-0025.2 320014	ATE Satz 3/35 2x
				1H-V-040001→		03.6584-0107.3 320110	ATE lastabhängig 8/4 4x
1.6	55	09/92→08/97				03.6584-0107.3 320110	ATE lastabhängig 8/4 4x
1.6	74	07/95→08/97				03.6584-0107.3 320110	ATE lastabhängig 8/4 4x
1.8	55	11/91→08/97				03.6584-0113.3 320111	ATE lastabhängig 8/4 4x
1.8	66	11/91→08/97				03.6584-0113.3 320111	ATE lastabhängig 8/4 4x
1.8 Syncro (1HX1)	66	01/93→08/97				03.6584-0015.3 320109	ATE lastabhängig 8/4 4x
1.9 TDI Syncro (1HX1)	66	08/95→08/97					
2.0 Syncro (1HX1)	85	08/95→08/97					
2.9 VR6 Syncro (1HX1)	140	10/94→08/97					
1.9 D	48	11/91→08/97		08/93→ 07/95		03.6584-0107.3 320110	ATE lastabhängig 8/4 4x
						03.6584-0107.3 320110	ATE lastabhängig 8/4 4x
1.9 SDI	47	07/95→08/97				03.6584-0107.3 320110	ATE lastabhängig 8/4 4x
1.9 TD,GTD	55	11/91→08/97					
1.9 TDI	66	09/93→08/97		10/93→		03.6584-0107.3 320110	ATE lastabhängig 8/4 4x
1.9 TDI	81	04/96→08/97				03.6584-0113.3 320111	ATE lastabhängig 8/4 4x
↓							























	kw					! #		
VW - GOLF III (1H1) 08/91→07/98								
 Bremskraftregler								
2.0	85	11/91→08/97					03.6584-0113.3 320111	ATE lastabhängig 8/4 4x
2.0 GTI 16V	110	08/92→08/97						
2.8 VR6	128	01/92→08/97						
2.0 GL	79	08/95→09/97		→ 08/97			03.6584-0113.3 320111	ATE lastabhängig 8/4 4x
2.8 VR6	120	08/95→09/97						
VW - GOLF III Cabriolet (1E7) 07/93→05/98								
 Bremskraftverstärker								
1.6	74	10/94→05/98		für Linkslenker; - ABS			03.7750-5502.4 300081	ATE Ø 9" pneumatisch
1.9 TDI	66	08/95→05/98		→ 1E-S-021846; für Linkslenker; + ABS			10.6360-1003.4 300156	ATE Ø 10" pneumatisch
				1E-S-021847→; für Linkslenker; + ABS			10.6360-2002.4 300143	ATE Ø 10" pneumatisch
1.8	55	07/93→05/98		09/93→; für Linkslenker; - ABS			03.7750-5502.4 300081	ATE Ø 9" pneumatisch
1.8	66	07/93→05/98		09/93→; → 1E-S-021846; für Linkslenker; + ABS			10.6360-1003.4 300156	ATE Ø 10" pneumatisch
2.0	85	07/93→05/98		1E-S-021847→; für Linkslenker; + ABS			10.6360-2002.4 300143	ATE Ø 10" pneumatisch
1.9 TDI	81	07/96→05/98		09/96→; für Linkslenker; - ABS			03.7750-5502.4 300081	ATE Ø 9" pneumatisch
				09/96→; für Linkslenker; + ABS			10.6360-2002.4 300143	ATE Ø 10" pneumatisch
 Hauptbremszylinder								
1.6	74	10/94→05/98		- ABS			03.2122-1042.3 010137	Ø 22,2
1.9 TDI	66	08/95→05/98		1E-S-021847→; für Linkslenker; + ABS			03.2123-1424.3 010637	ATE Ø 23,81
				1E-S-021847→; für Rechtslenker; + ABS			03.2123-1484.3 010595	ATE Ø 23,81
				→ 1E-S-021846; für Linkslenker; + ABS			10.6123-0674.3 010639	ATE Ø 23,81
1.8	55	07/93→05/98		09/93→; - ABS			03.2122-1042.3 010137	Ø 22,2
1.8	66	07/93→05/98		1E-S-021847→; für Linkslenker; + ABS			03.2123-1424.3 010637	ATE Ø 23,81
2.0	85	07/93→05/98		1E-S-021847→; für Rechtslenker; + ABS			03.2123-1484.3 010595	ATE Ø 23,81
				09/93→; → 1E-S-021846; für Linkslenker; + ABS			10.6123-0674.3 010639	ATE Ø 23,81
1.9 TDI	81	07/96→05/98		09/96→; - ABS			03.2122-1042.3 010137	Ø 22,2
				09/96→; für Linkslenker; + ABS			03.2123-1424.3 010637	ATE Ø 23,81
				09/96→; für Rechtslenker; + ABS			03.2123-1484.3 010595	ATE Ø 23,81
Verschlusschraube, Hauptbremszylinder								
1.6	74	10/94→05/98		- ABS			03.3517-0101.2 390322	
1.9 TDI	66	08/95→05/98						
1.8	55	07/93→05/98		09/93→; - ABS			03.3517-0101.2 390322	
1.8	66	07/93→05/98						
2.0	85	07/93→05/98						
1.9 TDI	81	07/96→05/98		09/96→; - ABS			03.3517-0101.2 390322	
 Bremskraftregler								
1.6	74	10/94→05/98					03.6584-0107.3 320110	ATE lastabhängig 8/4 4x
1.9 TDI	66	08/95→05/98						
1.8	55	07/93→05/98		09/93→			03.6584-0107.3 320110	ATE lastabhängig 8/4 4x
1.8	66	07/93→05/98						
2.0	85	07/93→05/98						
1.9 TDI	81	07/96→05/98		09/96→			03.6584-0113.3 320111	ATE lastabhängig 8/4 4x
VW - GOLF III Van (1H1) 08/91→12/97								
 Bremskraftverstärker								
1.8	66	08/91→12/97		11/91→ 08/97; für Linkslenker; - ABS			03.7750-5502.4 300081	ATE Ø 9" pneumatisch
				11/91→; → 1H-S-088704; für Linkslenker; + ABS			10.6360-1003.4 300156	ATE Ø 10" pneumatisch
				1H-S-088705→; → 08/97; für Linkslenker; + ABS			10.6360-2002.4 300143	ATE Ø 10" pneumatisch
 Hauptbremszylinder								
1.8	66	08/91→12/97		11/91→ 08/97; - ABS			03.2120-3943.3 010532	ATE Ø 20,64
				1H-S-088705→; → 08/97; für Linkslenker; + ABS			03.2122-1144.3 010636	ATE Ø 22,2
				1H-S-088705→; → 08/97; für Rechtslenker; + ABS			03.2122-1184.3 010592	ATE Ø 22,2
Verschlusschraube, Hauptbremszylinder								
1.8	66	08/91→12/97		11/91→ 08/97; - ABS			03.3517-0101.2 390322	
 Bremskraftregler								
1.8	66	08/91→12/97		11/91→ 08/97			03.6584-0107.3 320110	ATE lastabhängig 8/4 4x











	kw			 	! #		
VW - GOLF III Variant (1H5) 07/93→04/99							
 Bremskraftverstärker							
1.4	40	07/93→04/99		für Linkslenker; - ABS		03.7750-5502.4 300081	ATE Ø 9" pneumatisch
1.4	44	07/93→04/99		→ 1H-SW385334; für Linkslenker; + ABS		10.6360-1003.4 300156	ATE Ø 10" pneumatisch
1.6	74	07/94→04/99					
1.8	55	07/93→04/99		1H-SW385335→; für Linkslenker; + ABS		10.6360-2002.4 300143	ATE Ø 10" pneumatisch
1.8	66	07/93→04/99					
1.8 Syncro	66	10/94→04/99					
1.9 D	48	07/93→04/99					
1.9 TD	55	07/93→04/99					
1.9 TDI	66	03/94→04/99					
1.9 TDI Syncro	66	07/95→04/99					
2.0	79	08/95→04/96					
2.0	85	07/93→04/99					
2.0 Syncro	85	08/95→04/99					
1.9 SDI	47	07/95→04/99		für Linkslenker; - ABS		03.7750-5502.4 300081	ATE Ø 9" pneumatisch
1.9 TDI	81	04/96→04/99		für Linkslenker; + ABS		10.6360-2002.4 300143	ATE Ø 10" pneumatisch
2.9 VR6 Syncro	140	10/94→04/99		07/95→; → 1H-SW385334; für Linkslenker; + ABS		10.6360-1003.4 300156	ATE Ø 10" pneumatisch
				1H-SW385335→; für Linkslenker; + ABS		10.6360-2002.4 300143	ATE Ø 10" pneumatisch
 Hauptbremszylinder							
1.4	40	07/93→04/99		- ABS		03.2120-3943.3 010532	ATE Ø 20,64
1.4	44	07/93→04/99		1H-SW385335→; für Linkslenker; + ABS		03.2122-1144.3 010636	ATE Ø 22,2
				1H-SW385335→; für Rechtslenker; + ABS		03.2122-1184.3 010592	ATE Ø 22,2
1.6	74	07/94→04/99		- ABS		03.2122-1042.3 010137	Ø 22,2
1.8	55	07/93→04/99		1H-SW385335→; für Linkslenker; + ABS		03.2123-1424.3 010637	ATE Ø 23,81
1.8	66	07/93→04/99					
1.9 TDI	66	03/94→04/99		1H-SW385335→; für Rechtslenker; + ABS		03.2123-1484.3 010595	ATE Ø 23,81
2.0	79	08/95→04/96					
2.0	85	07/93→04/99		→ 1H-SW385334; für Linkslenker; + ABS		10.6123-0674.3 010639	ATE Ø 23,81
1.8 Syncro	66	10/94→04/99		- ABS		03.2122-1042.3 010137	Ø 22,2
1.9 TDI Syncro	66	07/95→04/99		1H-SW385335→; für Linkslenker; + ABS		03.2123-1424.3 010637	ATE Ø 23,81
2.0 Syncro	85	08/95→04/99					
1.9 D	48	07/93→04/99		- ABS		03.2122-1042.3 010137	Ø 22,2
1.9 TD	55	07/93→04/99		1H-SW385335→; für Linkslenker; + ABS		03.2122-1144.3 010636	ATE Ø 22,2
				1H-SW385335→; für Rechtslenker; + ABS		03.2122-1184.3 010592	ATE Ø 22,2
1.9 SDI	47	07/95→04/99		- ABS		03.2122-1042.3 010137	Ø 22,2
				für Linkslenker; + ABS		03.2122-1144.3 010636	ATE Ø 22,2
				für Rechtslenker; + ABS		03.2122-1184.3 010592	ATE Ø 22,2
1.9 TDI	81	04/96→04/99		- ABS		03.2122-1042.3 010137	Ø 22,2
				für Linkslenker; + ABS		03.2123-1424.3 010637	ATE Ø 23,81
				für Rechtslenker; + ABS		03.2123-1484.3 010595	ATE Ø 23,81
2.9 VR6 Syncro	140	10/94→04/99		1H-SW385335→; für Linkslenker; + ABS		03.2123-1424.3 010637	ATE Ø 23,81
				07/95→; → 1H-SW385334; für Linkslenker; + ABS		10.6123-0674.3 010639	ATE Ø 23,81
Verschlusschraube, Hauptbremszylinder							
1.4	40	07/93→04/99		- ABS	2	03.3517-0101.2 390322	
1.4	44	07/93→04/99					
1.6	74	07/94→04/99		- ABS		03.3517-0101.2 390322	
1.8	55	07/93→04/99					
1.8	66	07/93→04/99					
1.8 Syncro	66	10/94→04/99					
1.9 D	48	07/93→04/99					
1.9 SDI	47	07/95→04/99					
1.9 TD	55	07/93→04/99					
1.9 TDI	66	03/94→04/99					
1.9 TDI	81	04/96→04/99					
1.9 TDI Syncro	66	07/95→04/99					
2.0	79	08/95→04/96					
2.0	85	07/93→04/99					
2.0 Syncro	85	08/95→04/99					
 Bremskraftregler							
1.4	40	07/93→04/99				03.6584-0107.3 320110	ATE lastabhängig 8/4 4x
1.4	44	07/93→04/99					
1.6	74	07/94→04/99					
1.8	55	07/93→04/99					
1.8	66	07/93→04/99					
1.9 D	48	07/93→04/99					
1.9 SDI	47	07/95→04/99					
1.9 TD	55	07/93→04/99					
1.9 TDI	66	03/94→04/99					
1.9 TDI	81	04/96→04/99					
↓							













	kW				! #			
VW - GOLF III Variant (1H5) 07/93→04/99								
Bremskraftregler								
2.0	79	08/95→04/96				03.6584-0107.3	320110	ATE lastabhängig 8/4 4x
2.0	85	07/93→04/99						
1.8 Syncro	66	10/94→04/99				03.6584-0015.3	320109	ATE lastabhängig 8/4 4x
1.9 TDI Syncro	66	07/95→04/99						
2.0 Syncro	85	08/95→04/99						
2.9 VR6 Syncro	140	10/94→04/99		07/95→		03.6584-0015.3	320109	ATE lastabhängig 8/4 4x
VW - GOLF IV (1J1) 08/97→06/05								
Bremskraftverstärker								
1.4 16V	55	08/97→06/05		09/00→ 10/01; für Linkslenker; +PR 1AT		03.7860-0602.4	300141	ATE Ø 10" pneumatisch
1.6	74	08/97→05/04						
1.8	92	08/97→06/05		10/97→ 08/00; für Linkslenker; +PR 1AT		03.7863-0402.4	300124	ATE Ø 10" pneumatisch
1.8 T	110	08/97→06/05		11/01→ 10/03; für Linkslenker; +PR 1AT		03.7863-3502.4	300128	ATE Ø 10" pneumatisch
1.9 SDI	50	08/97→06/05						
1.9 TDI	81	08/97→05/04						
1.6	74	02/01→06/01		für Linkslenker; +PR 1AT		03.7860-0602.4	300141	ATE Ø 10" pneumatisch
1.6	75	08/00→06/05		09/00→ 10/01; für Linkslenker; +PR 1AT		03.7860-0602.4	300141	ATE Ø 10" pneumatisch
1.6 16V	77	02/00→06/05		→ 08/00; für Linkslenker; +PR 1AT		03.7863-0402.4	300124	ATE Ø 10" pneumatisch
				11/01→ 10/03; für Linkslenker; +PR 1AT		03.7863-3502.4	300128	ATE Ø 10" pneumatisch
1.6	78	08/03→06/05		→ 10/03; für Linkslenker; +PR 1AT		03.7863-3502.4	300128	ATE Ø 10" pneumatisch
1.6 FSI	81	01/02→06/05						
3.2 R32 4motion	177	09/02→06/05						
1.8 4motion	92	05/98→06/05		09/00→ 10/01; für Linkslenker; +PR 1AT		03.7860-0602.4	300141	ATE Ø 10" pneumatisch
				07/98→ 08/00; für Linkslenker; +PR 1AT		03.7863-0402.4	300124	ATE Ø 10" pneumatisch
				11/01→ 10/03; für Linkslenker; +PR 1AT		03.7863-3502.4	300128	ATE Ø 10" pneumatisch
1.8 T GTI	132	08/01→06/05		→ 10/01; für Linkslenker; +PR 1AT		03.7860-0602.4	300141	ATE Ø 10" pneumatisch
2.0 4motion	85	10/00→06/05		11/01→ 10/03; für Linkslenker; +PR 1AT		03.7863-3502.4	300128	ATE Ø 10" pneumatisch
1.9 TDI	66	10/97→05/04		09/00→ 06/01; für Linkslenker; +PR 1AT		03.7860-0602.4	300141	ATE Ø 10" pneumatisch
1.9 TDI 4motion	66	07/98→04/02		→ 08/00; für Linkslenker; +PR 1AT		03.7863-0402.4	300124	ATE Ø 10" pneumatisch
1.9 TDI	74	09/00→06/05		→ 10/01; für Linkslenker; +PR 1AT		03.7860-0602.4	300141	ATE Ø 10" pneumatisch
1.9 TDI 4motion	74	09/00→06/05		11/01→; für Linkslenker; +PR 1AT		03.7863-3502.4	300128	ATE Ø 10" pneumatisch
1.9 TDI	85	12/98→06/01		09/00→; für Linkslenker; +PR 1AT		03.7860-0602.4	300141	ATE Ø 10" pneumatisch
				05/99→ 08/00; für Linkslenker; +PR 1AT		03.7863-0402.4	300124	ATE Ø 10" pneumatisch
1.9 TDI	96	11/00→06/05		04/01→ 10/01; für Linkslenker; +PR 1AT		03.7860-0602.4	300141	ATE Ø 10" pneumatisch
1.9 TDI 4motion	96	11/00→06/05		11/01→ 10/03; für Linkslenker; +PR 1AT		03.7863-3502.4	300128	ATE Ø 10" pneumatisch
1.9 TDI	110	05/00→06/05		09/00→ 10/01; für Linkslenker; +PR 1AT		03.7860-0602.4	300141	ATE Ø 10" pneumatisch
1.9 TDI 4motion	110	02/00→06/05		11/01→ 10/03; für Linkslenker; +PR 1AT		03.7863-3502.4	300128	ATE Ø 10" pneumatisch
1.9 TDI 4motion	85	09/99→06/01		09/00→; für Linkslenker; +PR 1AT		03.7860-0602.4	300141	ATE Ø 10" pneumatisch
				11/99→ 08/00; für Linkslenker; +PR 1AT		03.7863-0402.4	300124	ATE Ø 10" pneumatisch
2.0	85	07/98→05/04		09/00→ 10/01; für Linkslenker; +PR 1AT		03.7860-0602.4	300141	ATE Ø 10" pneumatisch
				08/98→ 08/00; für Linkslenker; +PR 1AT		03.7863-0402.4	300124	ATE Ø 10" pneumatisch
				11/01→ 10/03; für Linkslenker; +PR 1AT		03.7863-3502.4	300128	ATE Ø 10" pneumatisch
2.3 V5	110	08/97→10/00		09/00→; für Linkslenker; +PR 1AT		03.7860-0602.4	300141	ATE Ø 10" pneumatisch
				10/97→ 08/00; für Linkslenker; +PR 1AT		03.7863-0402.4	300124	ATE Ø 10" pneumatisch
2.3 V5	125	10/00→06/05		→ 10/03; für Linkslenker; +PR 1AT		03.7860-0602.4	300141	ATE Ø 10" pneumatisch
2.3 V5 4motion	125	10/00→06/05		11/01→ 10/03; für Linkslenker; +PR 1AT		03.7863-3502.4	300128	ATE Ø 10" pneumatisch
2.3 V5 4motion	110	12/98→10/00		09/00→; für Linkslenker; +PR 1AT		03.7860-0602.4	300141	ATE Ø 10" pneumatisch
				→ 08/00; für Linkslenker; +PR 1AT		03.7863-0402.4	300124	ATE Ø 10" pneumatisch
2.8 V6 4motion	150	03/99→06/05		09/00→ 10/03; für Linkslenker; +PR 1AT		03.7860-0602.4	300141	ATE Ø 10" pneumatisch
				→ 08/00; für Linkslenker; +PR 1AT		03.7863-0402.4	300124	ATE Ø 10" pneumatisch
				11/01→ 10/03; für Linkslenker; +PR 1AT		03.7863-3502.4	300128	ATE Ø 10" pneumatisch
Hauptbremszylinder								
1.4 16V	55	08/97→06/05		10/97→ 08/00; für Linkslenker; +PR 1AT		03.2123-2024.3	010597	ATE Ø 23,81
1.6	74	08/97→05/04						
1.8	92	08/97→06/05		10/97→ 08/00; für Rechtslenker; +PR 1AT		03.2123-2064.3	010598	ATE Ø 23,81
1.8 T	110	08/97→06/05						
1.9 SDI	50	08/97→06/05		09/00→ 10/03; für Linkslenker; +PR 1AT		03.2123-2715.3	010802	ATE Ø 23,81
1.9 TDI	81	08/97→05/04		09/00→ 10/03; für Rechtslenker; +PR 1AT		03.2123-2774.3	010803	ATE Ø 23,81
				10/97→ 10/03; für Linkslenker; +PR 1AM,1AC,1AH,1AJ		24.2123-1709.3	010503	Ø 23,81
1.6	74	02/01→06/01		für Linkslenker; +PR 1AT		03.2123-2715.3	010802	ATE Ø 23,81
1.9 TDI	74	09/00→06/05		für Rechtslenker; +PR 1AT		03.2123-2774.3	010803	ATE Ø 23,81
1.9 TDI 4motion	74	09/00→06/05		für Linkslenker; +PR 1AM,1AC,1AH,1AJ		24.2123-1709.3	010503	Ø 23,81
1.6	75	08/00→06/05		→ 08/00; für Linkslenker; +PR 1AT		03.2123-2024.3	010597	ATE Ø 23,81
↓								









	kw			 	! #		
VW - GOLF IV (1J1) 08/97→06/05							
 Hauptbremszylinder							
1.6 16V 2.8 V6 4motion	77	02/00→06/05		→ 08/00; für Rechtslenker; +PR 1AT	03.2123-2064.3	010598	ATE Ø 23,81
	150	03/99→06/05		09/00→ 10/03; für Linkslenker; +PR 1AT	03.2123-2715.3	010802	ATE Ø 23,81
				09/00→ 10/03; für Rechtslenker; +PR 1AT	03.2123-2774.3	010803	ATE Ø 23,81
				→ 10/03; für Linkslenker; +PR 1AM,1AC,1AH,1AJ	24.2123-1709.3	010503	Ø 23,81
1.6 1.6 FSI 1.8 T GTI 2.0 4motion 2.3 V5 2.3 V5 4motion 3.2 R32 4motion	78	08/03→06/05		→ 10/03; für Linkslenker; +PR 1AT	03.2123-2715.3	010802	ATE Ø 23,81
	81	01/02→06/05		→ 10/03; für Rechtslenker; +PR 1AT	03.2123-2774.3	010803	ATE Ø 23,81
	132	08/01→06/05		→ 10/03; für Rechtslenker; +PR 1AT	03.2123-2774.3	010803	ATE Ø 23,81
	85	10/00→06/05		→ 10/03; für Linkslenker; +PR 1AM,1AC,1AH,1AJ	24.2123-1709.3	010503	Ø 23,81
	125	10/00→06/05		→ 10/03; für Linkslenker; +PR 1AM,1AC,1AH,1AJ	24.2123-1709.3	010503	Ø 23,81
	125	10/00→06/05		→ 10/03; für Linkslenker; +PR 1AM,1AC,1AH,1AJ	24.2123-1709.3	010503	Ø 23,81
1.8 4motion	92	05/98→06/05		07/98→ 08/00; für Linkslenker; +PR 1AT	03.2123-2024.3	010597	ATE Ø 23,81
				07/98→ 08/00; für Rechtslenker; +PR 1AT	03.2123-2064.3	010598	ATE Ø 23,81
				09/00→ 10/03; für Linkslenker; +PR 1AT	03.2123-2715.3	010802	ATE Ø 23,81
				09/00→ 10/03; für Rechtslenker; +PR 1AT	03.2123-2774.3	010803	ATE Ø 23,81
				07/98→ 10/03; für Linkslenker; +PR 1AM,1AC,1AH,1AJ	24.2123-1709.3	010503	Ø 23,81
1.9 TDI	66	10/97→05/04		→ 08/00; für Linkslenker; +PR 1AT	03.2123-2024.3	010597	ATE Ø 23,81
				→ 08/00; für Rechtslenker; +PR 1AT	03.2123-2064.3	010598	ATE Ø 23,81
				09/00→ 04/02; für Linkslenker; +PR 1AT	03.2123-2715.3	010802	ATE Ø 23,81
				09/00→ 06/01; für Rechtslenker; +PR 1AT	03.2123-2774.3	010803	ATE Ø 23,81
1.9 TDI	85	12/98→06/01		→ 06/01; für Linkslenker; +PR 1AM,1AC,1AH,1AJ	24.2123-1709.3	010503	Ø 23,81
				05/99→ 08/00; für Linkslenker; +PR 1AT	03.2123-2024.3	010597	ATE Ø 23,81
				05/99→ 08/00; für Rechtslenker; +PR 1AT	03.2123-2064.3	010598	ATE Ø 23,81
				09/00→; für Linkslenker; +PR 1AT	03.2123-2715.3	010802	ATE Ø 23,81
				09/00→; für Rechtslenker; +PR 1AT	03.2123-2774.3	010803	ATE Ø 23,81
1.9 TDI 1.9 TDI 4motion	96	11/00→06/05		04/01→ 10/03; für Linkslenker; +PR 1AT	03.2123-2715.3	010802	ATE Ø 23,81
	96	11/00→06/05		04/01→ 10/03; für Rechtslenker; +PR 1AT	03.2123-2774.3	010803	ATE Ø 23,81
				04/01→ 10/03; für Linkslenker; +PR 1AM,1AC,1AH,1AJ	24.2123-1709.3	010503	Ø 23,81
1.9 TDI 1.9 TDI 4motion	110	05/00→06/05		09/00→ 10/03; für Linkslenker; +PR 1AT	03.2123-2715.3	010802	ATE Ø 23,81
	110	02/00→06/05		09/00→ 10/03; für Rechtslenker; +PR 1AT	03.2123-2774.3	010803	ATE Ø 23,81
				09/00→ 10/03; für Linkslenker; +PR 1AM,1AC,1AH,1AJ	24.2123-1709.3	010503	Ø 23,81
1.9 TDI 4motion	66	07/98→04/02		→ 08/00; für Linkslenker; +PR 1AT	03.2123-2024.3	010597	ATE Ø 23,81
				→ 08/00; für Rechtslenker; +PR 1AT	03.2123-2064.3	010598	ATE Ø 23,81
				09/00→ 06/01; für Linkslenker; +PR 1AT	03.2123-2715.3	010802	ATE Ø 23,81
				09/00→ 06/01; für Rechtslenker; +PR 1AT	03.2123-2774.3	010803	ATE Ø 23,81
				→ 06/01; für Linkslenker; +PR 1AM,1AC,1AH,1AJ	24.2123-1709.3	010503	Ø 23,81
1.9 TDI 4motion	85	09/99→06/01		11/99→ 08/00; für Linkslenker; +PR 1AT	03.2123-2024.3	010597	ATE Ø 23,81
				11/99→ 08/00; für Rechtslenker; +PR 1AT	03.2123-2064.3	010598	ATE Ø 23,81
				09/00→; für Linkslenker; +PR 1AT	03.2123-2715.3	010802	ATE Ø 23,81
				09/00→; für Rechtslenker; +PR 1AT	03.2123-2774.3	010803	ATE Ø 23,81
2.0	85	07/98→05/04		11/99→; für Linkslenker; +PR 1AM,1AC,1AH,1AJ	24.2123-1709.3	010503	Ø 23,81
				08/98→ 08/00; für Linkslenker; +PR 1AT	03.2123-2024.3	010597	ATE Ø 23,81
				08/98→ 08/00; für Rechtslenker; +PR 1AT	03.2123-2064.3	010598	ATE Ø 23,81
				09/00→ 10/03; für Linkslenker; +PR 1AT	03.2123-2715.3	010802	ATE Ø 23,81
				09/00→ 10/03; für Rechtslenker; +PR 1AT	03.2123-2774.3	010803	ATE Ø 23,81
2.3 V5	110	08/97→10/00		08/98→ 10/03; für Linkslenker; +PR 1AM,1AC,1AH,1AJ	24.2123-1709.3	010503	Ø 23,81
				10/97→ 08/00; für Linkslenker; +PR 1AT	03.2123-2024.3	010597	ATE Ø 23,81
				10/97→ 08/00; für Rechtslenker; +PR 1AT	03.2123-2064.3	010598	ATE Ø 23,81











	kw					! #		
VW - GOLF IV (1J1) 08/97→06/05								
 Hauptbremszylinder								
2.3 V5	110	08/97→10/00		09/00→; für Linkslenker; +PR 1AT	03.2123-2715.3	010802	ATE Ø 23,81	
				09/00→; für Rechtslenker; +PR 1AT	03.2123-2774.3	010803	ATE Ø 23,81	
				10/97→; für Linkslenker; +PR 1AM,1AC,1AH,1AJ	24.2123-1709.3	010503	Ø 23,81	
2.3 V5 4motion	110	12/98→10/00		→ 08/00; für Linkslenker; +PR 1AT	03.2123-2024.3	010597	ATE Ø 23,81	
				→ 08/00; für Rechtslenker; +PR 1AT	03.2123-2064.3	010598	ATE Ø 23,81	
				09/00→; für Linkslenker; +PR 1AT	03.2123-2715.3	010802	ATE Ø 23,81	
				09/00→; für Rechtslenker; +PR 1AT	03.2123-2774.3	010803	ATE Ø 23,81	
				für Linkslenker; +PR 1AM,1AC,1AH,1AJ	24.2123-1709.3	010503	Ø 23,81	
VW - GOLF IV Cabriolet (1E7) 06/98→06/02								
 Bremskraftverstärker								
1.6	74	06/98→06/02		für Linkslenker; - ABS; → 02/02	03.7750-5502.4	300081	ATE Ø 9" pneumatisch	
1.8	55	06/98→06/02		→ 1E-S-021846; für Linkslenker; + ABS	10.6360-1003.4	300156	ATE Ø 10" pneumatisch	
1.8	66	06/98→06/02						
1.9 TDI	66	06/98→06/02		1E-S-021847→; für Linkslenker; + ABS; → 02/02	10.6360-2002.4	300143	ATE Ø 10" pneumatisch	
2.0	85	06/98→06/02						
1.9 TDI	81	06/98→06/02		für Linkslenker; - ABS; → 02/02	03.7750-5502.4	300081	ATE Ø 9" pneumatisch	
				für Linkslenker; + ABS; → 02/02	10.6360-2002.4	300143	ATE Ø 10" pneumatisch	
 Hauptbremszylinder								
1.6	74	06/98→06/02		- ABS; → 02/02	03.2122-1042.3	010137	Ø 22,2	
1.8	55	06/98→06/02						
1.8	66	06/98→06/02		1E-S-021847→; für Linkslenker; + ABS; → 02/02	03.2123-1424.3	010637	ATE Ø 23,81	
1.9 TDI	66	06/98→06/02						
2.0	85	06/98→06/02		1E-S-021847→; für Rechtslenker; + ABS; → 02/02	03.2123-1484.3	010595	ATE Ø 23,81	
				→ 1E-S-021846; für Linkslenker; + ABS	10.6123-0674.3	010639	ATE Ø 23,81	
1.9 TDI	81	06/98→06/02		- ABS; → 02/02	03.2122-1042.3	010137	Ø 22,2	
				für Linkslenker; + ABS; → 02/02	03.2123-1424.3	010637	ATE Ø 23,81	
				für Rechtslenker; + ABS; → 02/02	03.2123-1484.3	010595	ATE Ø 23,81	
Verschlusschraube, Hauptbremszylinder								
1.6	74	06/98→06/02		- ABS; → 02/02	03.3517-0101.2	390322		
1.8	55	06/98→06/02						
1.8	66	06/98→06/02						
1.9 TDI	66	06/98→06/02						
1.9 TDI	81	06/98→06/02						
2.0	85	06/98→06/02						
 Bremskraftregler								
1.6	74	06/98→06/02		→ 02/02	03.6584-0107.3	320110	ATE lastabhängig 8/4 4x	
1.8	55	06/98→06/02						
1.8	66	06/98→06/02						
1.9 TDI	66	06/98→06/02						
2.0	85	06/98→06/02						
1.9 TDI	81	06/98→06/02		→ 02/02	03.6584-0113.3	320111	ATE lastabhängig 8/4 4x	
VW - GOLF IV Van (1J1) 05/00→05/04								
 Bremskraftverstärker								
1.9 TDI	66	05/00→09/02		09/00→ 06/01; für Linkslenker; +PR 1AT	03.7860-0602.4	300141	ATE Ø 10" pneumatisch	
				→ 08/00; für Linkslenker; +PR 1AT	03.7863-0402.4	300124	ATE Ø 10" pneumatisch	
1.9 TDI	96	04/01→05/04		→ 10/01; für Linkslenker; +PR 1AT	03.7860-0602.4	300141	ATE Ø 10" pneumatisch	
				→ 06/01; für Linkslenker; +PR 1AT	03.7860-0602.4	300141	ATE Ø 10" pneumatisch	
				11/01→ 10/03; für Linkslenker; +PR 1AT	03.7863-3502.4	300128	ATE Ø 10" pneumatisch	
 Hauptbremszylinder								
1.9 TDI	66	05/00→09/02		→ 08/00; für Linkslenker; +PR 1AT	03.2123-2024.3	010597	ATE Ø 23,81	
				→ 08/00; für Rechtslenker; +PR 1AT	03.2123-2064.3	010598	ATE Ø 23,81	
				09/00→ 04/02; für Linkslenker; +PR 1AT	03.2123-2715.3	010802	ATE Ø 23,81	
				09/00→ 06/01; für Rechtslenker; +PR 1AT	03.2123-2774.3	010803	ATE Ø 23,81	
				→ 06/01; für Linkslenker; +PR 1AM,1AC,1AH,1AJ	24.2123-1709.3	010503	Ø 23,81	
1.9 TDI	96	04/01→05/04		→ 10/03; für Linkslenker; +PR 1AT	03.2123-2715.3	010802	ATE Ø 23,81	
				→ 04/02; für Linkslenker; +PR 1AT	03.2123-2715.3	010802	ATE Ø 23,81	
				→ 06/01; für Rechtslenker; +PR 1AT	03.2123-2774.3	010803	ATE Ø 23,81	
				→ 10/03; für Rechtslenker; +PR 1AT	03.2123-2774.3	010803	ATE Ø 23,81	
↓								











	kw			 	! #		
VW - GOLF IV Van (1J1) 05/00→05/04							
 Hauptbremszylinder							
1.9 TDI	96	04/01→05/04		→ 06/01; für Linkslenker; +PR 1AM,1AC,1AH,1AJ		24.2123-1709.3 010503	Ø 23,81
				→ 10/03; für Linkslenker; +PR 1AM,1AC,1AH,1AJ		24.2123-1709.3 010503	Ø 23,81
VW - GOLF IV Variant (1J5) 05/99→06/06							
 Bremskraftverstärker							
1.4 16V	55	05/99→06/06		09/00→; für Linkslenker; +PR 1AT; → 10/01		03.7860-0602.4 300141	ATE Ø 10" pneumatisch
1.6	74	05/99→04/02					
1.6	75	08/00→06/06		→ 08/00; für Linkslenker; +PR 1AT		03.7863-0402.4 300124	ATE Ø 10" pneumatisch
1.6 16V	77	02/00→06/06					
1.8 4motion	92	05/99→06/06		11/01→; für Linkslenker; +PR 1AT		03.7863-3502.4 300128	ATE Ø 10" pneumatisch
1.8 T	110	05/00→06/06					
1.9 SDI	50	05/99→06/06					
1.9 TDI	66	05/99→05/06					
1.9 TDI 4motion	66	05/99→04/02					
2.0	85	05/99→06/06					
2.3 V5	110	05/99→06/06					
2.3 V5 4motion	110	05/99→06/06					
2.8 V6 4motion	150	05/99→06/06					
1.6 FSI	81	01/02→06/06		für Linkslenker; +PR 1AT		03.7863-3502.4 300128	ATE Ø 10" pneumatisch
1.9 TDI 4motion	110	05/02→06/05					
2.0 Bi-Fuel	85	02/02→06/06					
1.9 TDI	74	09/00→06/06		für Linkslenker; +PR 1AT; → 10/01		03.7860-0602.4 300141	ATE Ø 10" pneumatisch
1.9 TDI	110	06/01→06/06					
1.9 TDI 4motion	74	09/00→06/06		11/01→; für Linkslenker; +PR 1AT		03.7863-3502.4 300128	ATE Ø 10" pneumatisch
2.0 4motion	85	10/00→06/06					
2.3 V5	125	10/00→06/06					
2.3 V5 4motion	125	10/00→06/06					
1.9 TDI	81	05/99→06/01		09/00→; für Linkslenker; +PR 1AT		03.7860-0602.4 300141	ATE Ø 10" pneumatisch
1.9 TDI	85	08/99→06/01		→ 08/00; für Linkslenker; +PR 1AT		03.7863-0402.4 300124	ATE Ø 10" pneumatisch
1.9 TDI	96	11/00→06/06		04/01→; für Linkslenker; +PR 1AT; → 10/01		03.7860-0602.4 300141	ATE Ø 10" pneumatisch
1.9 TDI 4motion	96	11/00→06/06		11/01→; für Linkslenker; +PR 1AT		03.7863-3502.4 300128	ATE Ø 10" pneumatisch
1.9 TDI 4motion	85	05/99→06/01		09/00→; für Linkslenker; +PR 1AT		03.7860-0602.4 300141	ATE Ø 10" pneumatisch
				11/99→ 08/00; für Linkslenker; +PR 1AT		03.7863-0402.4 300124	ATE Ø 10" pneumatisch
2.0 4motion	88	12/99→06/06		09/00→; für Linkslenker; +PR 1AT; → 10/01		03.7860-0602.4 300141	ATE Ø 10" pneumatisch
				04/00→ 08/00; für Linkslenker; +PR 1AT		03.7863-0402.4 300124	ATE Ø 10" pneumatisch
				11/01→; für Linkslenker; +PR 1AT		03.7863-3502.4 300128	ATE Ø 10" pneumatisch
 Hauptbremszylinder							
1.4 16V	55	05/99→06/06		→ 08/00; für Linkslenker; +PR 1AT		03.2123-2024.3 010597	ATE Ø 23,81
1.6	74	05/99→04/02					
1.6	75	08/00→06/06		→ 08/00; für Rechtslenker; +PR 1AT		03.2123-2064.3 010598	ATE Ø 23,81
1.6 16V	77	02/00→06/06		09/00→; für Linkslenker; +PR 1AT		03.2123-2715.3 010802	ATE Ø 23,81
1.8 4motion	92	05/99→06/06		09/00→; für Rechtslenker; +PR 1AT		03.2123-2774.3 010803	ATE Ø 23,81
1.8 T	110	05/00→06/06					
1.9 SDI	50	05/99→06/06		für Linkslenker; +PR 1AM,1AC,1AH,1AJ		24.2123-1709.3 010503	Ø 23,81
1.9 TDI	66	05/99→05/06					
1.9 TDI	81	05/99→06/01					
1.9 TDI	85	08/99→06/01					
1.9 TDI 4motion	66	05/99→04/02					
2.0	85	05/99→06/06					
2.3 V5	110	05/99→06/06					
2.3 V5 4motion	110	05/99→06/06					
2.8 V6 4motion	150	05/99→06/06					
1.6 FSI	81	01/02→06/06		für Linkslenker; +PR 1AT		03.2123-2715.3 010802	ATE Ø 23,81
1.9 TDI	74	09/00→06/06		für Rechtslenker; +PR 1AT		03.2123-2774.3 010803	ATE Ø 23,81
1.9 TDI	110	06/01→06/06					
1.9 TDI 4motion	74	09/00→06/06		für Linkslenker; +PR 1AM,1AC,1AH,1AJ		24.2123-1709.3 010503	Ø 23,81
1.9 TDI 4motion	110	05/02→06/05					
2.0 4motion	85	10/00→06/06					
2.0 Bi-Fuel	85	02/02→06/06					
2.3 V5	125	10/00→06/06					
2.3 V5 4motion	125	10/00→06/06					
1.9 TDI	96	11/00→06/06		04/01→; für Linkslenker; +PR 1AT		03.2123-2715.3 010802	ATE Ø 23,81
1.9 TDI 4motion	96	11/00→06/06		04/01→; für Rechtslenker; +PR 1AT		03.2123-2774.3 010803	ATE Ø 23,81
				04/01→; für Linkslenker; +PR 1AM,1AC,1AH,1AJ		24.2123-1709.3 010503	Ø 23,81
1.9 TDI 4motion	85	05/99→06/01		11/99→ 08/00; für Linkslenker; +PR 1AT		03.2123-2024.3 010597	ATE Ø 23,81
				11/99→ 08/00; für Rechtslenker; +PR 1AT		03.2123-2064.3 010598	ATE Ø 23,81
				09/00→; für Linkslenker; +PR 1AT		03.2123-2715.3 010802	ATE Ø 23,81
				09/00→; für Rechtslenker; +PR 1AT		03.2123-2774.3 010803	ATE Ø 23,81
↓							























	kW			 	! #		
VW - GOLF IV Variant (1J5) 05/99→06/06							
 Hauptbremszylinder							
1.9 TDI 4motion	85	05/99→06/01		11/99→; für Linkslenker; +PR 1AM,1AC,1AH,1AJ		24.2123-1709.3 010503	Ø 23,81
2.0 4motion	88	12/99→06/06		04/00→ 08/00; +PR 1AT; für Linkslenker		03.2123-2024.3 010597	ATE Ø 23,81
				04/00→ 08/00; +PR 1AT; für Rechtslenker		03.2123-2064.3 010598	ATE Ø 23,81
				09/00→; für Linkslenker; +PR 1AT		03.2123-2715.3 010802	ATE Ø 23,81
				09/00→; für Rechtslenker; +PR 1AT		03.2123-2774.3 010803	ATE Ø 23,81
				04/00→; für Linkslenker; +PR 1AM,1AC,1AH,1AJ		24.2123-1709.3 010503	Ø 23,81
VW - GOLF V (1K1) 10/03→02/09							
 Bremskraftverstärker							
1.4 16V	55	10/03→05/06		für Linkslenker; +PR 1AC,1AT		03.7863-3232.4 300307	ATE Ø 10" pneumatisch
1.4 FSI	66	10/03→07/06		für Linkslenker; +PR 1AS		03.7863-9602.4 300206	ATE Ø 10" pneumatisch
1.6 FSI	85	10/03→07/08		für Linkslenker; +PR 1AS / 1AS,1LJ		03.7863-9802.4 300281	ATE Ø 10" pneumatisch
1.4 16V	59	05/06→11/08		für Linkslenker; → 09/08; +PR 1AC,1AT		03.7863-3232.4 300307	ATE Ø 10" pneumatisch
1.4 TSI	90	05/07→11/08		für Linkslenker; → 09/08; +PR 1AS		03.7863-9602.4 300206	ATE Ø 10" pneumatisch
1.4 TSI	103	05/06→11/08		für Linkslenker; → 09/08; +PR 1AS		03.7863-9602.4 300206	ATE Ø 10" pneumatisch
1.4 TSI	125	11/05→11/08		für Linkslenker; → 09/08; +PR 1AS / 1AS,1LJ		03.7863-9802.4 300281	ATE Ø 10" pneumatisch
1.6	75	01/04→11/08					
1.6 MultiFuel	75	10/07→11/08					
1.9 TDI	66	05/04→11/08					
1.9 TDI	77	10/03→11/08					
1.9 TDI 4motion	77	08/04→11/08					
2.0 FSI	110	01/04→11/08					
2.0 FSI 4motion	110	08/04→11/08					
2.0 SDI	55	01/04→11/08					
2.0 TDI	100	10/03→11/08					
2.0 TDI	103	12/04→11/08					
2.0 TDI	125	11/05→11/08					
2.0 TDI 16V	103	10/03→11/08					
2.0 TDI 16V 4motion	103	08/04→11/08					
2.0 TDI 4motion	103	08/04→11/08					
1.8 GTI	132	08/06→11/08		für Linkslenker; → 09/08; +PR 1AC,1AT		03.7863-3332.4 300308	ATE Ø 10" pneumatisch
2.0 GTI	147	10/04→02/09					
2.0 GTI	169	09/06→12/08					
3.2 R32 4motion	184	11/05→11/08					
3.2	184	09/05→11/08		11/05→; für Linkslenker; → 09/08; +PR 1AC,1AT		03.7863-3332.4 300308	ATE Ø 10" pneumatisch
 Hauptbremszylinder							
1.4 16V	55	10/03→05/06		1K-6W078890→; für Linkslenker		03.2122-2129.3 010799	ATE Ø 22,2
1.4 FSI	66	10/03→07/06		für Linkslenker; → 1K-6W078889		03.2122-2129.3 010799	ATE Ø 22,2
1.6 FSI	85	10/03→07/08					
1.4 16V	59	05/06→11/08		1K-6W078890→; für Linkslenker; → 09/08		03.2122-2129.3 010799	ATE Ø 22,2
1.4 TSI	103	05/06→11/08					
1.4 TSI	125	11/05→11/08		für Linkslenker; → 1K-6W078889		03.2122-2129.3 010799	ATE Ø 22,2
1.6	75	01/04→11/08					
1.6 MultiFuel	75	10/07→11/08					
1.9 TDI	66	05/04→11/08					
1.9 TDI	77	10/03→11/08					
1.9 TDI 4motion	77	08/04→11/08					
2.0 FSI	110	01/04→11/08					
2.0 FSI 4motion	110	08/04→11/08					
2.0 SDI	55	01/04→11/08					
2.0 TDI	100	10/03→11/08					
2.0 TDI	103	12/04→11/08					
2.0 TDI	125	11/05→11/08					
2.0 TDI 16V	103	10/03→11/08					
2.0 TDI 16V 4motion	103	08/04→11/08					
2.0 TDI 4motion	103	08/04→11/08					
1.4 TSI	90	05/07→11/08		→ 09/08; für Linkslenker		03.2122-2129.3 010799	ATE Ø 22,2
2.0 GTI	147	10/04→02/09		1K-6W078890→; für Linkslenker; → 09/08		03.2123-3449.3 010808	ATE Ø 23,81
2.0 GTI	169	09/06→12/08					
3.2 R32 4motion	184	11/05→11/08		für Linkslenker; → 1K-6W078889		03.2123-3449.3 010808	ATE Ø 23,81
3.2	184	09/05→11/08		1K-6W078890→; für Linkslenker; → 09/08		03.2123-3449.3 010808	ATE Ø 23,81
				11/05→; für Linkslenker; → 1K-6W078889		03.2123-3449.3 010808	ATE Ø 23,81
Hydraulikaggregat, Bremsanlage							
1.4 16V	55	10/03→05/06		+PR 1AT,1AS		24.9145-0001.2 399005	
1.4 FSI	66	10/03→07/06					
1.6 FSI	85	10/03→07/08					
1.4 16V	59	05/06→11/08		→ 09/08; +PR 1AT,1AS		24.9145-0001.2 399005	
1.4 TSI	90	05/07→11/08					

	kw			 	! #		
VW - GOLF V (1K1) 10/03→02/09							
Hydraulikaggregat, Bremsanlage							
1.4 TSI	103	05/06→11/08		→ 09/08; +PR 1AT,1AS		24.9145-0001.2	399005
1.4 TSI	125	11/05→11/08					
1.6	75	01/04→11/08					
1.6 MultiFuel	75	10/07→11/08					
1.9 TDI	66	05/04→11/08					
1.9 TDI	77	10/03→11/08					
1.9 TDI 4motion	77	08/04→11/08					
2.0 FSI	110	01/04→11/08					
2.0 FSI 4motion	110	08/04→11/08					
2.0 GTI	147	10/04→02/09					
2.0 GTI	169	09/06→12/08					
2.0 SDI	55	01/04→11/08					
2.0 TDI	100	10/03→11/08					
2.0 TDI	103	12/04→11/08					
2.0 TDI	125	11/05→11/08					
2.0 TDI 16V	103	10/03→11/08					
2.0 TDI 16V 4motion	103	08/04→11/08					
2.0 TDI 4motion	103	08/04→11/08					
3.2 R32 4motion	184	11/05→11/08					
3.2	184	09/05→11/08		11/05→ 09/08; +PR 1AT,1AS		24.9145-0001.2	399005
Drucksensor, Bremskraftverstärker							
1.4 16V	55	10/03→05/06		für Linkslenker; +PR 1AS		03.0655-0101.2	370008 ATE
1.4 FSI	66	10/03→07/06					
1.6 FSI	85	10/03→07/08					
1.4 16V	59	05/06→11/08		für Linkslenker; → 09/08; +PR 1AS		03.0655-0101.2	370008 ATE
1.4 TSI	90	05/07→11/08					
1.4 TSI	103	05/06→11/08					
1.4 TSI	125	11/05→11/08					
1.6	75	01/04→11/08					
1.6 MultiFuel	75	10/07→11/08					
1.9 TDI	66	05/04→11/08					
1.9 TDI	77	10/03→11/08					
1.9 TDI 4motion	77	08/04→11/08					
2.0 FSI	110	01/04→11/08					
2.0 FSI 4motion	110	08/04→11/08					
2.0 SDI	55	01/04→11/08					
2.0 TDI	100	10/03→11/08					
2.0 TDI	103	12/04→11/08					
2.0 TDI	125	11/05→11/08					
2.0 TDI 16V	103	10/03→11/08					
2.0 TDI 16V 4motion	103	08/04→11/08					
2.0 TDI 4motion	103	08/04→11/08					
VW - GOLF V Variant (1K5) 06/07→07/09							
	Bremskraftverstärker						
1.4	59	06/07→07/09		→ 06/09; für Linkslenker; +PR 1AC,1AT		03.7863-3232.4	300307 ATE Ø 10" pneumatisch
1.4 TSI	103	06/07→07/09					
1.9 TDI	77	06/07→07/09					
1.9 TDI 4motion	77	01/08→07/09					
1.4 TSI	90	06/07→07/09		→ 06/09; für Linkslenker; +PR 1AC,1AT		03.7863-3232.4	300307 ATE Ø 10" pneumatisch
1.6	75	06/07→07/09					
1.6 MultiFuel	75	11/07→07/09		→ 06/09; für Linkslenker; +PR 1AS		03.7863-9602.4	300206 ATE Ø 10" pneumatisch
2.0 TDI	100	06/07→07/09					
2.0 TDI	103	06/07→07/09					
2.0 TDI 16V	103	06/07→07/09					
1.4 TSI	118	07/08→07/09		→ 06/09; für Linkslenker; +PR 1AC,1AT		03.7863-3332.4	300308 ATE Ø 10" pneumatisch
				→ 06/09; für Linkslenker; +PR 1AS		03.7863-9602.4	300206 ATE Ø 10" pneumatisch
1.4 TSI	125	06/07→07/09		→ 06/09; für Linkslenker; +PR 1AC,1AT		03.7863-3332.4	300308 ATE Ø 10" pneumatisch
				→ 06/09; für Linkslenker; +PR 1AS		03.7863-9802.4	300281 ATE Ø 10" pneumatisch
2.0	147	06/07→07/09		→ 06/09; für Linkslenker; +PR 1AC,1AT		03.7863-3332.4	300308 ATE Ø 10" pneumatisch
	Hauptbremszylinder						
1.4	59	06/07→07/09		→ 06/09; für Linkslenker		03.2122-2129.3	010799 ATE Ø 22,2
1.4 TSI	90	06/07→07/09		→ 06/09; für Linkslenker; +PR 1AS		03.2122-2129.3	010799 ATE Ø 22,2
1.4 TSI	103	06/07→07/09					
1.6	75	06/07→07/09					
1.6 MultiFuel	75	11/07→07/09					
1.4 TSI	118	07/08→07/09		→ 06/09; für Linkslenker		03.2122-2129.3	010799 ATE Ø 22,2
				→ 06/09; +PR 1LJ,1LL; für Linkslenker		03.2123-3449.3	010808 ATE Ø 23,81
1.4 TSI	125	06/07→07/09		→ 06/09; für Linkslenker; +PR 1AS		03.2122-2129.3	010799 ATE Ø 22,2
				→ 06/09; +PR 1LJ,1LL; für Linkslenker		03.2123-3449.3	010808 ATE Ø 23,81
1.9 TDI	77	06/07→07/09		→ 06/09; für Linkslenker; +PR 1AC,1AT		03.2122-2129.3	010799 ATE Ø 22,2
1.9 TDI 4motion	77	01/08→07/09					
2.0 TDI	100	06/07→07/09					
2.0 TDI	103	06/07→07/09					
2.0 TDI 16V	103	06/07→07/09					
↓							







	kw			 	! #		
VW - GOLF V Variant (1K5) 06/07→07/09							
 Hauptbremszylinder							
2.0	147	06/07→07/09		→ 06/09; für Linkslenker; +PR 1AC,1AT	03.2122-2129.3 010799	ATE Ø 22,2	
				→ 06/09; +PR 1LJ,1LL; für Linkslenker	03.2123-3449.3 010808	ATE Ø 23,81	
Hydraulikaggregat, Bremsanlage							
1.4	59	06/07→07/09		→ 06/09; +PR 1AT,1AS	24.9145-0001.2 399005		
1.4 TSI	90	06/07→07/09					
1.4 TSI	103	06/07→07/09					
1.4 TSI	118	07/08→07/09					
1.4 TSI	125	06/07→07/09					
1.6	75	06/07→07/09					
1.6 MultiFuel	75	11/07→07/09					
1.9 TDI	77	06/07→07/09					
1.9 TDI 4motion	77	01/08→07/09					
2.0	147	06/07→07/09					
2.0 TDI	100	06/07→07/09					
2.0 TDI	103	06/07→07/09					
2.0 TDI 16V	103	06/07→07/09					
Drucksensor, Bremskraftverstärker							
1.4 TSI	90	06/07→07/09		→ 06/09; für Linkslenker; +PR 1AS	03.0655-0101.2 370008	ATE	
1.4 TSI	118	07/08→07/09					
2.0 TDI	100	06/07→07/09					
2.0 TDI	103	06/07→07/09					
2.0 TDI 16V	103	06/07→07/09					
1.4 TSI	103	06/07→07/09		→ 06/09; für Rechtslenker; +PR 1AS	03.0655-0101.2 370008	ATE	
1.4 TSI	125	06/07→07/09					
1.6	75	06/07→07/09		→ 06/09; für Linkslenker; +PR 1AS	03.0655-0101.2 370008	ATE	
1.6 MultiFuel	75	11/07→07/09		→ 06/09; für Rechtslenker; +PR 1AS	03.0655-0101.2 370008	ATE	
VW - GOLF VI (5K1) 10/08→11/13							
 Bremskraftverstärker							
1.2 TSI	63	05/10→11/12		1K-9-400001→; → 11/10; +PR 1ZK; für Linkslenker	03.7860-8802.4 300291	ATE Ø 10" pneumatisch	
1.4	59	10/08→11/12					
1.4 TSI	90	10/08→11/12		+PR 1ZD,1ZF,1ZP,1LV; für Linkslenker	03.7863-3232.4 300307	ATE Ø 10" pneumatisch	
1.4 TSI	118	10/08→11/12					
1.6	75	10/08→11/12		→ 1K-9-200000; +PR 1LJ,1LL,1LM; für Linkslenker	03.7863-3332.4 300308	ATE Ø 10" pneumatisch	
1.6 BiFuel	75	03/09→11/12					
1.6 MultiFuel	75	10/08→11/12		1K-9-400001→; → 11/10; +PR 1ZA,1ZB,1ZE,1LJ; für Linkslenker	03.7863-3332.4 300308	ATE Ø 10" pneumatisch	
1.6 TDI	66	02/09→11/12					
1.6 TDI	77	02/09→11/12					
2.0 GTi	155	04/09→11/12					
2.0 R 4motion	188	11/09→11/13					
2.0 R 4motion	195	11/09→05/11					
2.0 R 4motion	199	11/09→11/12					
2.0 TDI	81	10/08→11/12					
2.0 TDI	100	10/08→11/12					
2.0 TDI	103	10/08→05/13					
2.0 TDI	125	04/09→11/12					
2.0 TDI 4motion	103	05/09→11/12					
1.2 TSI	77	11/08→11/12		1K-9-400001→; → 11/10; +PR 1ZK; für Linkslenker	03.7860-8802.4 300291	ATE Ø 10" pneumatisch	
				05/09→; für Linkslenker; +PR 1ZD,1ZF,1ZP,1LV	03.7863-3232.4 300307	ATE Ø 10" pneumatisch	
				1K-9-400001→; → 11/10; +PR 1ZA,1ZB,1ZE,1LJ; für Linkslenker	03.7863-3332.4 300308	ATE Ø 10" pneumatisch	
				05/09→; → 1K-9-200000; für Linkslenker; +PR 1LJ,1LL,1LM	03.7863-3332.4 300308	ATE Ø 10" pneumatisch	
1.8 TSI	118	06/09→01/11		1K-9-400001→; → 11/10; +PR 1ZK; für Linkslenker	03.7860-8802.4 300291	ATE Ø 10" pneumatisch	
				+PR 1ZD,1ZF,1ZP,1LV; für Linkslenker	03.7863-3232.4 300307	ATE Ø 10" pneumatisch	
				→ 1K-9-200000; für Linkslenker	03.7863-3332.4 300308	ATE Ø 10" pneumatisch	
				1K-9-400001→; → 11/10; +PR 1ZA,1ZB,1ZE,1LJ; für Linkslenker	03.7863-3332.4 300308	ATE Ø 10" pneumatisch	
2.0 GTi	173	05/11→11/12		+PR 1ZD,1ZF,1ZP,1LV; für Linkslenker	03.7863-3232.4 300307	ATE Ø 10" pneumatisch	
				→ 1K-9-200000; +PR 1LJ,1LL,1LM; für Linkslenker	03.7863-3332.4 300308	ATE Ø 10" pneumatisch	
 Hauptbremszylinder							
1.2 TSI	63	05/10→11/12		+PR 1ZD,1ZF,1ZP,1LV; für Linkslenker	03.2122-2129.3 010799	ATE Ø 22,2	
1.4	59	10/08→11/12					
1.4 TSI	90	10/08→11/12		+PR 1ZA,1ZB,1ZE,1LJ; für Linkslenker	03.2123-3449.3 010808	ATE Ø 23,81	
1.4 TSI	118	10/08→11/12					
1.6	75	10/08→11/12					
1.6 BiFuel	75	03/09→11/12					
1.6 MultiFuel	75	10/08→11/12					
1.6 TDI	66	02/09→11/12					
1.6 TDI	77	02/09→11/12					







	kw			 	! #		
VW - GOLF VI (5K1) 10/08→11/13							
 Hauptbremszylinder							
1.8 TSI	118	06/09→01/11		+PR 1ZD,1ZF,1ZP,1LV; für Linkslenker	03.2122-2129.3	010799	ATE Ø 22,2
2.0 GTI	155	04/09→11/12		+PR 1ZA,1ZB,1ZE,1LJ; für Linkslenker	03.2123-3449.3	010808	ATE Ø 23,81
2.0 GTI	173	05/11→11/12					
2.0 R 4motion	188	11/09→11/13					
2.0 R 4motion	195	11/09→05/11					
2.0 R 4motion	199	11/09→11/12					
2.0 TDI	81	10/08→11/12					
2.0 TDI	100	10/08→11/12					
2.0 TDI	103	10/08→05/13					
2.0 TDI	125	04/09→11/12					
2.0 TDI 4motion	103	05/09→11/12					
1.2 TSI	77	11/08→11/12		05/09→; für Linkslenker; +PR 1ZD,1ZF,1ZP,1LV	03.2122-2129.3	010799	ATE Ø 22,2
				05/09→; für Linkslenker; +PR 1ZA,1ZB,1ZE,1LJ	03.2123-3449.3	010808	ATE Ø 23,81
VW - GOLF VI Cabriolet (517) 03/11→							
 Bremskraftverstärker							
1.2 TSI	77	03/11→11/13		06/11→; für Linkslenker; +PR 1ZK	03.7860-8802.4	300291	ATE Ø 10" pneumatisch
1.4 TSI	118	03/11→		06/11→; für Linkslenker; +PR 1ZD,1ZP,1LV	03.7863-3232.4	300307	ATE Ø 10" pneumatisch
1.6 TDI	77	03/11→					
1.2 TSI 16V	77	11/13→		für Linkslenker; +PR 1ZK	03.7860-8802.4	300291	ATE Ø 10" pneumatisch
1.4 TSI	90	11/11→		für Linkslenker; +PR 1ZD,1ZP,1LV	03.7863-3232.4	300307	ATE Ø 10" pneumatisch
1.4 TSI	92	11/13→					
1.4 TSI	110	11/13→		für Linkslenker; +PR 1ZA,1ZB,1ZE	03.7863-3332.4	300308	ATE Ø 10" pneumatisch
2.0 GTI	155	11/11→					
2.0 R	195	01/13→					
2.0 TDI	81	11/13→					
2.0 TDI	103	11/11→					
2.0 TDI	110	11/13→					
2.0 TSI	162	11/13→					
 Hauptbremszylinder							
1.2 TSI	77	03/11→11/13		06/11→; für Linkslenker; +PR 1ZD,1ZP,1LV	03.2122-2129.3	010799	ATE Ø 22,2
1.4 TSI	118	03/11→		06/11→; für Linkslenker; +PR 1ZA,1ZB,1ZE,1ZK	03.2123-3449.3	010808	ATE Ø 23,81
1.6 TDI	77	03/11→					
1.2 TSI 16V	77	11/13→		für Linkslenker; +PR 1ZD,1ZP,1LV	03.2122-2129.3	010799	ATE Ø 22,2
1.4 TSI	90	11/11→		für Linkslenker; +PR 1ZA,1ZB,1ZE,1ZK	03.2123-3449.3	010808	ATE Ø 23,81
1.4 TSI	92	11/13→					
1.4 TSI	110	11/13→					
2.0 GTI	155	11/11→					
2.0 R	195	01/13→					
2.0 TDI	81	11/13→					
2.0 TDI	103	11/11→					
2.0 TDI	110	11/13→					
2.0 TSI	162	11/13→					
VW - GOLF VI Variant (AJ5) 07/09→07/13							
 Bremskraftverstärker							
1.2 TSI	63	07/10→07/13		für Linkslenker	03.7863-3232.4	300307	ATE Ø 10" pneumatisch
1.6 MultiFuel	75	07/10→07/13		12/09→; für Linkslenker	03.7863-3232.4	300307	ATE Ø 10" pneumatisch
2.0 TDI	81	01/10→07/13					
1.2 TSI	77	07/09→07/13					
1.4	59	07/09→07/13		12/09→; für Linkslenker	03.7863-3232.4	300307	ATE Ø 10" pneumatisch
2.0 TDI	100	07/09→07/13		für Linkslenker; → 11/09; +PR 1AC,1AT	03.7863-3232.4	300307	ATE Ø 10" pneumatisch
2.0 TDI	103	07/09→07/13					
1.4 TSI	90	07/09→07/13		für Linkslenker; → 11/09; +PR 1AC,1AT	03.7863-3232.4	300307	ATE Ø 10" pneumatisch
				12/09→; für Linkslenker; +PR 1ZP	03.7863-3232.4	300307	ATE Ø 10" pneumatisch
				+PR 1AS; → 11/09; für Linkslenker	03.7863-9602.4	300206	ATE Ø 10" pneumatisch
1.4 TSI	118	07/09→07/13		12/09→; für Linkslenker; +PR 1ZD,1ZP	03.7863-3232.4	300307	ATE Ø 10" pneumatisch
				+PR 1AC,1AT; → 11/09; für Linkslenker	03.7863-3332.4	300308	ATE Ø 10" pneumatisch
1.6	75	07/09→07/13		12/09→; für Linkslenker	03.7863-3232.4	300307	ATE Ø 10" pneumatisch
				für Linkslenker; → 11/09; +PR 1AC,1AT	03.7863-3232.4	300307	ATE Ø 10" pneumatisch
				+PR 1AS; → 11/09; für Linkslenker	03.7863-9602.4	300206	ATE Ø 10" pneumatisch
1.6 TDI	66	12/09→07/13		für Linkslenker; +PR 1ZP,1ZM	03.7863-3232.4	300307	ATE Ø 10" pneumatisch
1.6 TDI	77	07/09→07/13		für Linkslenker; → 11/09; +PR 1AC,1AT	03.7863-3232.4	300307	ATE Ø 10" pneumatisch
1.6 TDI 4motion	77	07/09→07/13		12/09→; für Linkslenker; +PR 1ZP,1ZM	03.7863-3232.4	300307	ATE Ø 10" pneumatisch
2.0 TSI	147	07/09→07/13		für Linkslenker; +PR 1ZD	03.7863-3232.4	300307	ATE Ø 10" pneumatisch
↓							

	kw					! #		
VW - GOLF VI Variant (AJ5) 07/09→07/13								
 Bremskraftverstärker								
2.0 TSI	147	07/09→07/13			+PR 1LJ,1ZA; für Linkslenker		03.7863-3332.4 300308	ATE Ø 10" pneumatisch
 Hauptbremszylinder								
1.2 TSI	63	07/10→07/13			für Linkslenker		03.2122-2129.3 010799	ATE Ø 22,2
1.6 MultiFuel	75	07/10→07/13						
2.0 TDI	81	01/10→07/13						
1.2 TSI	77	07/09→07/13			12/09→; für Linkslenker		03.2122-2129.3 010799	ATE Ø 22,2
					08/09→; +PR 1AC,1AT; → 11/09; für Linkslenker		03.2122-2129.3 010799	ATE Ø 22,2
1.4	59	07/09→07/13			12/09→; für Linkslenker		03.2122-2129.3 010799	ATE Ø 22,2
2.0 TDI	100	07/09→07/13			für Linkslenker; → 11/09; +PR 1AC,1AT		03.2122-2129.3 010799	ATE Ø 22,2
2.0 TDI	103	07/09→07/13						
1.4 TSI	90	07/09→07/13			für Linkslenker; → 11/09; +PR 1AC,1AT		03.2122-2129.3 010799	ATE Ø 22,2
					12/09→; für Linkslenker; +PR 1ZP		03.2122-2129.3 010799	ATE Ø 22,2
					+PR 1AS; → 11/09; für Linkslenker		03.2122-2129.3 010799	ATE Ø 22,2
1.4 TSI	118	07/09→07/13			für Linkslenker; → 11/09; +PR 1AC,1AT		03.2122-2129.3 010799	ATE Ø 22,2
					12/09→; für Linkslenker; +PR 1ZD,1ZP		03.2122-2129.3 010799	ATE Ø 22,2
					→ 11/09; +PR 1LJ,1LL		03.2123-3449.3 010808	ATE Ø 23,81
1.6	75	07/09→07/13			12/09→; für Linkslenker		03.2122-2129.3 010799	ATE Ø 22,2
					für Linkslenker; → 11/09; +PR 1AC,1AT		03.2122-2129.3 010799	ATE Ø 22,2
					+PR 1AS; → 11/09; für Linkslenker		03.2122-2129.3 010799	ATE Ø 22,2
1.6 TDI	66	12/09→07/13			für Linkslenker; +PR 1ZP,1ZM		03.2122-2129.3 010799	ATE Ø 22,2
1.6 TDI	77	07/09→07/13			für Linkslenker; → 11/09; +PR 1AC,1AT		03.2122-2129.3 010799	ATE Ø 22,2
1.6 TDI 4motion	77	07/09→07/13			12/09→; für Linkslenker; +PR 1ZP,1ZM		03.2122-2129.3 010799	ATE Ø 22,2
2.0 TSI	147	07/09→07/13			für Linkslenker; +PR 1ZD		03.2122-2129.3 010799	ATE Ø 22,2
					+PR 1LJ,1ZA		03.2123-3449.3 010808	ATE Ø 23,81
VW - GOLF VII (5G1, BQ1, BE1, BE2) 08/12→								
 Hauptbremszylinder								
1.0 TSI	63	01/17→			für Linkslenker;		03.4153-5403.3 010994	ATE Ø 23,81
1.0 TSI	81	11/16→			+PR 1ZA,1ZD,1ZE,1ZF / 1ZP		24.4123-1719.3 011017	TRW Ø 23,81 ohne Bremsflüssigkeitsbehälter
1.0 TSI	85	05/15→						
1.2 TSI	77	11/12→						
1.2 TSI	81	04/14→						
1.4 TSI	90	11/12→						
1.4 TSI	92	05/14→						
1.4 TSI	110	05/14→						
1.4 TSI MultiFuel	90	04/13→						
1.4 TSI MultiFuel	92	12/13→						
1.6	81	05/14→						
1.6 TDI	66	04/13→						
1.6 TDI	85	11/16→						
1.6 TDI 4motion	77	11/12→						
1.6 TDI 4motion	81	01/13→						
2.0 GTD	135	04/13→						
2.0 GTI	155	11/13→						
2.0 GTI	162	04/13→						
2.0 GTI	169	04/13→						
2.0 GTI	180	03/17→						
2.0 GTI Clubsport	195	02/16→						
2.0 GTI Clubsport S	228	09/16→						
2.0 R 360S 4motion	265	09/16→						
2.0 R 4motion	206	11/13→						
2.0 R 4motion	213	12/16→						
2.0 R 4motion	221	11/13→						
2.0 R 4motion	228	12/16→						
2.0 TDI	81	11/12→						
2.0 TDI	105	08/12→						
2.0 TDI	110	11/12→						
2.0 TDI 4motion	110	11/12→						
1.2 TSI	63	08/12→			11/12→; für Linkslenker;		03.4153-5403.3 010994	ATE Ø 23,81
1.4 TSI	103	08/12→			+PR 1ZA,1ZD,1ZE,1ZF / 1ZP		24.4123-1719.3 011017	TRW Ø 23,81 ohne Bremsflüssigkeitsbehälter
1.6 TDI	77	08/12→						
1.4 TGI CNG	81	06/13→			08/13→; für Linkslenker;		03.4153-5403.3 010994	ATE Ø 23,81
					+PR 1ZA,1ZD,1ZE,1ZF / 1ZP		24.4123-1719.3 011017	TRW Ø 23,81 ohne Bremsflüssigkeitsbehälter
1.6 TDI	81	01/13→			06/13→; für Linkslenker;		03.4153-5403.3 010994	ATE Ø 23,81
					+PR 1ZA,1ZD,1ZE,1ZF / 1ZP		24.4123-1719.3 011017	TRW Ø 23,81 ohne Bremsflüssigkeitsbehälter











	kw			 	! #			
VW - GOLF VII Kombi (BA5, BV5) 04/13→								
 Hauptbremszylinder								
1.0 TSI	63	01/17→		für Linkslenker;		03.4153-5403.3	010994	ATE Ø 23,81
1.0 TSI	81	11/16→		+PR 1ZA,1ZD,1ZE,1ZF / 1ZP		24.4123-1719.3	011017	TRW Ø 23,81 ohne Bremsflüssigkeitsbehälter
1.0 TSI	85	05/15→						
1.2 TSI	81	04/14→						
1.4 TGI CNG	81	09/13→						
1.4 TSI	92	05/14→						
1.4 TSI	110	05/14→						
1.4 TSI MultiFuel	90	04/13→						
1.4 TSI MultiFuel	92	05/14→						
1.6	81	05/14→						
1.6 TDI	85	11/16→						
2.0 GTD	135	01/15→						
2.0 R 360S 4motion	265	09/16→						
2.0 R 4motion	206	03/15→						
2.0 R 4motion	213	12/16→						
2.0 R 4motion	221	03/15→						
2.0 R 4motion	228	12/16→						
1.2 TSI	63	05/13→		07/13→; für Linkslenker;		03.4153-5403.3	010994	ATE Ø 23,81
1.2 TSI	77	05/13→		+PR 1ZA,1ZD,1ZE,1ZF / 1ZP		24.4123-1719.3	011017	TRW Ø 23,81 ohne Bremsflüssigkeitsbehälter
1.4 TSI	90	05/13→						
1.4 TSI	103	05/13→						
1.6 TDI	66	05/13→						
1.6 TDI	77	05/13→						
1.6 TDI	81	05/13→						
1.6 TDI 4motion	77	05/13→						
1.6 TDI 4motion	81	05/13→						
2.0 TDI	81	05/13→						
2.0 TDI	110	04/13→						
2.0 TDI 4motion	110	04/13→						
VW - GOLF ALLTRACK (BA5) 12/14→								
 Hauptbremszylinder								
1.6 TDI 4motion	81	12/14→		+PR 1ZA,1ZD,1ZE,1ZF / 1ZP;		24.4123-1719.3	011017	TRW Ø 23,81 ohne Bremsflüssigkeitsbehälter
1.8 TSI 4motion	132	12/14→		für Rechtslenker				
2.0 TDI 4motion	110	12/14→						
2.0 TDI 4motion	135	12/14→		+PR 1ZA,1ZD,1ZE,1ZF / 1ZP;		24.4123-1719.3	011017	TRW Ø 23,81 ohne Bremsflüssigkeitsbehälter
				für Linkslenker				
VW - GOLF PLUS (5M1, 521) 01/05→12/13								
 Bremskraftverstärker								
1.2 TSI	63	05/10→12/13		1K-9-900001→; → 11/10;		03.7860-8802.4	300291	ATE Ø 10" pneumatisch
1.2 TSI	77	11/09→12/13		für Linkslenker; +PR 1ZK				
1.6 BiFuel	75	05/09→12/13		1K-9-900001→; → 11/10;		03.7863-3232.4	300307	ATE Ø 10" pneumatisch
1.6 TDI	66	02/09→12/13		für Linkslenker; +PR 1ZD,1ZF,1ZP,1LV				
1.6 TDI	77	03/09→12/13						
2.0 TDI	81	01/09→12/13		12/10→; für Linkslenker; +PR 1ZF,1AC		03.7863-3232.4	300307	ATE Ø 10" pneumatisch
				12/10→; für Linkslenker;		03.7863-3332.4	300308	ATE Ø 10" pneumatisch
				+PR 1ZA,1ZE,1AS,1AT				
				1K-9-900001→; → 11/10;		03.7863-3332.4	300308	ATE Ø 10" pneumatisch
				für Linkslenker; +PR 1ZA,1ZB,1ZE				
1.4 16V	55	01/05→11/06		1K-9-900001→; für Linkslenker;		03.7860-8802.4	300291	ATE Ø 10" pneumatisch
1.4 FSI	66	07/05→11/06		+PR 1ZK				
1.4 TSI	103	05/06→06/08		1K-9-900001→; für Linkslenker;		03.7863-3232.4	300307	ATE Ø 10" pneumatisch
1.6 FSI	85	01/05→05/08		+PR 1ZD,1ZF,1ZP,1LV				
1.9 TDI	66	05/05→12/08		für Linkslenker; +PR 1AC,1AT;		03.7863-3232.4	300307	ATE Ø 10" pneumatisch
1.9 TDI	77	01/05→01/09		→ 1K-9-899999				
2.0 FSI	110	05/05→06/08		1K-9-900001→; für Linkslenker;		03.7863-3332.4	300308	ATE Ø 10" pneumatisch
2.0 TDI	96	05/05→05/07		+PR 1ZA,1ZB,1ZE				
				für Linkslenker; +PR 1AS;		03.7863-9602.4	300206	ATE Ø 10" pneumatisch
				→ 1K-9-899999				
1.4 16V	59	05/06→12/13		1K-9-900001→; → 11/10;		03.7860-8802.4	300291	ATE Ø 10" pneumatisch
1.4 TSI	90	06/07→12/13		für Linkslenker; +PR 1ZK				
1.4 TSI	118	06/08→12/13		12/10→; für Linkslenker; +PR 1ZF,1AC		03.7863-3232.4	300307	ATE Ø 10" pneumatisch
1.6	75	05/05→12/13						
1.6 MultiFuel	75	11/07→12/13		1K-9-900001→; → 11/10;		03.7863-3232.4	300307	ATE Ø 10" pneumatisch
2.0 TDI	100	05/05→12/13		für Linkslenker; +PR 1ZD,1ZF,1ZP,1LV				
2.0 TDI	103	12/05→05/11		für Linkslenker; +PR 1AC,1AT;		03.7863-3232.4	300307	ATE Ø 10" pneumatisch
2.0 TDI 16V	103	01/05→12/13		→ 1K-9-899999				
				12/10→; für Linkslenker;		03.7863-3332.4	300308	ATE Ø 10" pneumatisch
				+PR 1ZA,1ZE,1AS,1AT				
				1K-9-900001→; → 11/10;		03.7863-3332.4	300308	ATE Ø 10" pneumatisch
				für Linkslenker; +PR 1ZA,1ZB,1ZE				
				für Linkslenker; +PR 1AS;		03.7863-9602.4	300206	ATE Ø 10" pneumatisch
				→ 1K-9-899999				
1.4 TSI	125	05/06→06/08		1K-9-900001→; für Linkslenker;		03.7860-8802.4	300291	ATE Ø 10" pneumatisch
				+PR 1ZK				
				1K-9-900001→; für Linkslenker;		03.7863-3232.4	300307	ATE Ø 10" pneumatisch
				+PR 1ZD,1ZF,1ZP,1LV				
↓								

















	kw			 	! #		
VW - GOLF PLUS (5M1, 521) 01/05→12/13							
Bremskraftverstärker							
1.4 TSI	125	05/06→06/08		+PR 1AC,1AT; für Linkslenker; → 1K-6-565000		03.7863-3232.4 300307	ATE Ø 10" pneumatisch
				1K-9-900001→; für Linkslenker; +PR 1ZA,1ZB,1ZE		03.7863-3332.4 300308	ATE Ø 10" pneumatisch
				1K-6-565001→ 1K-9-899999; für Linkslenker; +PR 1AC,1AT		03.7863-3332.4 300308	ATE Ø 10" pneumatisch
				+PR 1AS; für Linkslenker; → 1K-6-565000		03.7863-9602.4 300206	ATE Ø 10" pneumatisch
				1K-6-565001→ 1K-9-899999; für Linkslenker; +PR 1AS		03.7863-9802.4 300281	ATE Ø 10" pneumatisch
Hauptbremszylinder							
1.2 TSI	63	05/10→12/13		1K-9-900001→; für Linkslenker; → 1K-C-500000; +PR 1ZF		03.2122-2129.3 010799	ATE Ø 22,2
1.2 TSI	77	11/09→12/13					
1.6 BiFuel	75	05/09→12/13		1K-C-500001→; für Linkslenker; +PR 1ZF,1AC		03.2122-2129.3 010799	ATE Ø 22,2
1.6 TDI	66	02/09→12/13					
1.6 TDI	77	03/09→12/13		1K-C-500001→; für Linkslenker; +PR 1ZA,1ZE,1AS,1AT		03.2123-3449.3 010808	ATE Ø 23,81
2.0 TDI	81	01/09→12/13					
				1K-9-900001→; für Linkslenker; → 1K-C-500000; +PR 1ZE,1LJ,1ZA		03.2123-3449.3 010808	ATE Ø 23,81
1.4 16V	55	01/05→11/06		1K-9-900001→; für Linkslenker; → 1K-C-500000; +PR 1ZF		03.2122-2129.3 010799	ATE Ø 22,2
1.4 16V	59	05/06→12/13					
1.4 FSI	66	07/05→11/06		1K-6-565001→; für Linkslenker; → 1K-8-500000; +PR 1AC,1AT,1AS		03.2122-2129.3 010799	ATE Ø 22,2
1.4 TSI	103	05/06→06/08					
1.4 TSI	125	05/06→06/08		für Linkslenker; → 1K-6-565000		03.2122-2129.3 010799	ATE Ø 22,2
1.6	75	05/05→12/13					
1.6 FSI	85	01/05→05/08		1K-8-500001→; für Linkslenker; → 1K-9-899999;		03.2122-2129.3 010799	ATE Ø 22,2
1.6 MultiFuel	75	11/07→12/13		+PR 1LK,1ZA,1ZC,1ZD / 1ZE,1ZF,1ZM, 1ZP			
1.9 TDI	66	05/05→12/08					
1.9 TDI	77	01/05→01/09					
2.0 FSI	110	05/05→06/08		1K-C-500001→; für Linkslenker; +PR 1ZF,1AC		03.2122-2129.3 010799	ATE Ø 22,2
2.0 TDI	96	05/05→05/07					
2.0 TDI	100	05/05→12/13		1K-6-565001→; für Linkslenker; → 1K-8-500000; +PR 1LJ		03.2123-3449.3 010808	ATE Ø 23,81
2.0 TDI	103	12/05→05/11					
2.0 TDI 16V	103	01/05→12/13		1K-8-500001→; für Linkslenker; → 1K-9-899999; +PR 1LJ		03.2123-3449.3 010808	ATE Ø 23,81
				1K-9-900001→; für Linkslenker; → 1K-C-500000; +PR 1ZE,1LJ,1ZA		03.2123-3449.3 010808	ATE Ø 23,81
				1K-C-500001→; für Linkslenker; +PR 1ZA,1ZE,1AS,1AT		03.2123-3449.3 010808	ATE Ø 23,81
1.4 TSI	90	06/07→12/13		1K-9-900001→; für Linkslenker; → 1K-C-500000; +PR 1ZF		03.2122-2129.3 010799	ATE Ø 22,2
				1K-6-565001→; für Linkslenker; → 1K-8-500000; +PR 1AC,1AT,1AS		03.2122-2129.3 010799	ATE Ø 22,2
				1K-8-500001→; für Linkslenker; → 1K-9-899999;		03.2122-2129.3 010799	ATE Ø 22,2
				+PR 1LK,1ZA,1ZC,1ZD / 1ZE,1ZF,1ZM, 1ZP			
				1K-C-500001→; für Linkslenker; +PR 1ZF,1AC		03.2122-2129.3 010799	ATE Ø 22,2
				1K-9-900001→; für Linkslenker; → 1K-C-500000; +PR 1ZE,1LJ,1ZA		03.2123-3449.3 010808	ATE Ø 23,81
				1K-8-500001→; für Linkslenker; → 1K-9-899999; +PR 1LJ		03.2123-3449.3 010808	ATE Ø 23,81
				1K-6-565001→; für Linkslenker; → 1K-8-500000; +PR 1LJ		03.2123-3449.3 010808	ATE Ø 23,81
				1K-C-500001→; für Linkslenker; +PR 1ZA,1ZE,1AS,1AT		03.2123-3449.3 010808	ATE Ø 23,81
1.4 TSI	118	06/08→12/13		1K-9-900001→; für Linkslenker; → 1K-C-500000; +PR 1ZF		03.2122-2129.3 010799	ATE Ø 22,2
				1K-C-500001→; für Linkslenker; +PR 1ZF,1AC		03.2122-2129.3 010799	ATE Ø 22,2
				1K-8-500001→; für Linkslenker; → 1K-9-899999;		03.2122-2129.3 010799	ATE Ø 22,2
				+PR 1LK,1ZA,1ZC,1ZD / 1ZE,1ZF,1ZM, 1ZP			
				1K-9-900001→; für Linkslenker; → 1K-C-500000; +PR 1ZE,1LJ,1ZA		03.2123-3449.3 010808	ATE Ø 23,81
				1K-8-500001→; für Linkslenker; → 1K-9-899999; +PR 1LJ		03.2123-3449.3 010808	ATE Ø 23,81
				1K-C-500001→; für Linkslenker; +PR 1ZA,1ZE,1AS,1AT		03.2123-3449.3 010808	ATE Ø 23,81
Hydraulikaggregat, Bremsanlage							
1.4 16V	55	01/05→11/06		+PR 1AT,1AS		24.9145-0001.2 399005	
1.4 FSI	66	07/05→11/06					
↓							













	kw			 	! #		
VW - GOLF PLUS (5M1, 521) 01/05→12/13							
Hydraulikaggregat, Bremsanlage							
1.4 TSI	103	05/06→06/08		+PR 1AT,1AS		24.9145-0001.2	399005
1.4 TSI	125	05/06→06/08					
1.6 FSI	85	01/05→05/08					
1.9 TDI	66	05/05→12/08					
2.0 FSI	110	05/05→06/08					
2.0 TDI	96	05/05→05/07					
1.4 16V	59	05/06→12/13		→ 12/08; +PR 1AT,1AS		24.9145-0001.2	399005
1.4 TSI	90	06/07→12/13					
1.4 TSI	118	06/08→12/13					
1.6	75	05/05→12/13					
1.6 MultiFuel	75	11/07→12/13					
1.9 TDI	77	01/05→01/09					
2.0 TDI	100	05/05→12/13					
2.0 TDI	103	12/05→05/11					
2.0 TDI 16V	103	01/05→12/13					
Drucksensor, Bremskraftverstärker							
1.4 16V	55	01/05→11/06		für Linkslenker; +PR 1AS; → 1K-9-899999		03.0655-0101.2	370008 ATE
1.4 16V	59	05/06→12/13					
1.4 FSI	66	07/05→11/06		1K-6-565001→; für Rechtslenker; → 1K-9-899999; +PR 1AS		03.0655-0101.2	370008 ATE
1.4 TSI	90	06/07→12/13					
1.4 TSI	103	05/06→06/08					
1.4 TSI	118	06/08→12/13					
1.6	75	05/05→12/13					
1.6 FSI	85	01/05→05/08					
1.6 MultiFuel	75	11/07→12/13					
1.9 TDI	66	05/05→12/08					
1.9 TDI	77	01/05→01/09					
2.0 FSI	110	05/05→06/08					
2.0 TDI	96	05/05→05/07					
2.0 TDI	100	05/05→12/13					
2.0 TDI	103	12/05→05/11					
2.0 TDI 16V	103	01/05→12/13					
1.4 TSI	125	05/06→06/08		+PR 1AS; für Linkslenker; → 1K-6-565000		03.0655-0101.2	370008 ATE
				1K-6-565001→ 1K-9-899999; für Rechtslenker; +PR 1AC,1AT,1AS		03.0655-0101.2	370008 ATE
VW - GOLF SPORTSVAN (AM1) 02/14→							
Hauptbremszylinder							
1.0 TSI	85	05/15→		für Linkslenker		24.4123-1719.3	011017 TRW Ø 23,81 ohne Bremsflüssigkeitsbehälter
1.2 TSI	63	05/14→					
1.2 TSI	81	04/14→					
1.4 TSI	92	04/14→					
1.4 TSI MultiFuel	92	04/14→					
1.6	81	05/14→					
1.6 TDI	66	02/14→					
1.6 TDI	85	11/16→					
2.0 TDI	81	05/14→					
1.4 TSI	110	02/14→		05/14→; für Linkslenker		24.4123-1719.3	011017 TRW Ø 23,81 ohne Bremsflüssigkeitsbehälter
1.6 TDI	81	02/14→					
2.0 TDI	110	02/14→					
VW - JETTA III (1K2) 08/05→10/10							
Bremskraftverstärker							
1.4 TSI	90	05/07→10/10		für Linkslenker; +PR 1AS		03.7863-9602.4	300206 ATE Ø 10" pneumatisch
1.4 TSI	103	07/06→10/10					
1.4 TSI	118	07/08→10/10		für Linkslenker; +PR 1AS,1LJ		03.7863-9802.4	300281 ATE Ø 10" pneumatisch
1.4 TSI	125	07/06→10/10					
1.6	75	10/05→10/10					
1.6 FSI	85	09/05→10/10					
1.6 MultiFuel	75	01/08→10/10					
1.6 TDI	66	12/09→10/10					
1.6 TDI	77	06/09→10/10					
1.9 TDI	77	08/05→10/10					
2.0 FSI	110	08/05→10/10					
2.0 TDI	100	09/05→10/10					
2.0 TDI	103	10/05→10/10					
2.0 TDI	125	10/06→10/10					
2.0 TDI 16V	103	08/05→10/10					
2.0 TFSI	125	03/08→10/10					
2.0 TFSI	147	10/05→10/10					
2.5	125	07/08→10/10					
2.5	110	01/06→10/10		07/08→; für Linkslenker; +PR 1AS		03.7863-9602.4	300206 ATE Ø 10" pneumatisch
				07/08→; für Linkslenker; +PR 1AS,1LJ		03.7863-9802.4	300281 ATE Ø 10" pneumatisch
Hauptbremszylinder							
1.4 TSI	90	05/07→10/10		für Linkslenker; +PR 1AS		03.2122-2129.3	010799 ATE Ø 22,2
1.4 TSI	103	07/06→10/10					
↓							













	kw			 	! #		
VW - JETTA III (1K2) 08/05→10/10							
 Hauptbremszylinder							
1.4 TSI	118	07/08→10/10		für Linkslenker; +PR 1AS		03.2122-2129.3 010799	ATE Ø 22,2
1.4 TSI	125	07/06→10/10					
1.6	75	10/05→10/10					
1.6 FSI	85	09/05→10/10					
1.6 MultiFuel	75	01/08→10/10					
1.6 TDI	66	12/09→10/10					
1.6 TDI	77	06/09→10/10					
1.9 TDI	77	08/05→10/10					
2.0 FSI	110	08/05→10/10					
2.0 TDI	100	09/05→10/10					
2.0 TDI	103	10/05→10/10					
2.0 TDI	125	10/06→10/10					
2.0 TDI 16V	103	08/05→10/10					
2.0 TFSI	125	03/08→10/10					
2.0 TFSI	147	10/05→10/10					
2.5	125	07/08→10/10					
2.5	110	01/06→10/10		07/08→; für Linkslenker; +PR 1AS		03.2122-2129.3 010799	ATE Ø 22,2
Hydraulikaggregat, Bremsanlage							
1.4 TSI	90	05/07→10/10		+PR 1AT,1AS		24.9145-0001.2 399005	
1.4 TSI	103	07/06→10/10					
1.4 TSI	118	07/08→10/10					
1.4 TSI	125	07/06→10/10					
1.6	75	10/05→10/10					
1.6 FSI	85	09/05→10/10					
1.6 MultiFuel	75	01/08→10/10					
1.6 TDI	66	12/09→10/10					
1.6 TDI	77	06/09→10/10					
1.9 TDI	77	08/05→10/10					
2.0 FSI	110	08/05→10/10					
2.0 TDI	100	09/05→10/10					
2.0 TDI	103	10/05→10/10					
2.0 TDI	125	10/06→10/10					
2.0 TDI 16V	103	08/05→10/10					
2.0 TFSI	125	03/08→10/10					
2.0 TFSI	147	10/05→10/10					
2.5	125	07/08→10/10					
2.5	110	01/06→10/10		07/08→; +PR 1AT,1AS		24.9145-0001.2 399005	
Drucksensor, Bremskraftverstärker							
1.4 TSI	90	05/07→10/10		für Linkslenker; +PR 1AS		03.0655-0101.2 370008	ATE
1.4 TSI	103	07/06→10/10					
1.4 TSI	118	07/08→10/10					
1.4 TSI	125	07/06→10/10					
1.6	75	10/05→10/10					
1.6 FSI	85	09/05→10/10					
1.6 MultiFuel	75	01/08→10/10					
1.6 TDI	66	12/09→10/10					
1.6 TDI	77	06/09→10/10					
1.9 TDI	77	08/05→10/10					
2.0 FSI	110	08/05→10/10					
2.0 TDI	100	09/05→10/10					
2.0 TDI	103	10/05→10/10					
2.0 TDI	125	10/06→10/10					
2.0 TDI 16V	103	08/05→10/10					
2.0 TFSI	125	03/08→10/10					
2.0 TFSI	147	10/05→10/10					
2.5	125	07/08→10/10					
2.5	110	01/06→10/10		07/08→; für Linkslenker; +PR 1AS		03.0655-0101.2 370008	ATE
VW - JETTA IV (162, 163) 04/10→							
 Bremskraftverstärker							
2.0 TSI	147	12/10→		04/11→; für Linkslenker; - ESP		03.7863-3332.4 300308	ATE Ø 10" pneumatisch
2.0 TSI	155	12/12→		für Linkslenker; - ESP		03.7863-3332.4 300308	ATE Ø 10" pneumatisch
VW - LOAD UP 12/14→							
 Hauptbremszylinder							
1.0	44	12/14→		für Linkslenker		24.4120-1703.3 011015	TRW Ø 20,64
1.0 EcoFuel	50	12/14→					ohne Bremsflüssigkeitsbehälter
VW - LT 28-35 I Bus (281-363) 04/75→06/96							
 Bremskraftverstärker							
2.4 D	51	08/89→06/96				03.6850-5402.4 300055	ATE Ø 9" pneumatisch
2.4 i	69	08/89→06/96					
2.4 TD	70	09/92→06/96					
↓							









	kw					! #		
VW - LT 28-35 I Bus (281-363) 04/75→06/96								
 Hauptbremszylinder								
2.4 D	51	08/89→06/96		- ABS			03.2123-5212.3 010183	Ø 23,81
2.4 i	69	08/89→06/96						
2.4 TD	70	09/92→06/96						
VW - LT 28-35 I Kasten (281-363) 04/75→06/96								
 Bremskraftverstärker								
2.4 D	51	07/90→05/96		nicht für Doppelbereifung			03.6850-5402.4 300055	ATE Ø 9" pneumatisch
2.4 i	69	03/94→06/96						
2.4 TD	70	06/92→05/96					03.6850-5402.4 300055	ATE Ø 9" pneumatisch
2.4 TD Syncro	70	08/92→04/96						
 Hauptbremszylinder								
2.4 D	51	07/90→05/96		- ABS			03.2123-5212.3 010183	Ø 23,81
2.4 i	69	03/94→06/96						
2.4 TD	70	06/92→05/96		nicht für Doppelbereifung; - ABS			03.2123-5212.3 010183	Ø 23,81
2.4 TD Syncro	70	08/92→04/96		mit Doppelbereifung; - ABS			03.2125-1712.3 010204	Ø 25,4
VW - LT 28-35 I Pritsche/Fahrgestell (281-363) 04/75→06/96								
 Bremskraftverstärker								
2.4 D	51	08/90→06/96		nicht für Doppelbereifung			03.6850-5402.4 300055	ATE Ø 9" pneumatisch
2.4 i	69	03/94→06/96						
2.4 TD	70	08/92→06/96					03.6850-5402.4 300055	ATE Ø 9" pneumatisch
2.4 TD Syncro	70	08/92→04/96						
 Hauptbremszylinder								
2.4 D	51	08/90→06/96		- ABS			03.2123-5212.3 010183	Ø 23,81
2.4 i	69	03/94→06/96						
2.4 TD	70	08/92→06/96		nicht für Doppelbereifung; - ABS			03.2123-5212.3 010183	Ø 23,81
2.4 TD Syncro	70	08/92→04/96		mit Doppelbereifung; - ABS			03.2125-1712.3 010204	Ø 25,4
VW - LT 28-35 II Bus (2DB, 2DE, 2DK) 04/96→07/06								
 Hauptbremszylinder								
2.3	105	05/96→07/06		→ 2D-2-011024; + ABS			24.2123-1711.3 010518	Ø 23,81
2.5 SDI	55	07/96→07/06		→ 2D-X-012290; + ABS			24.2123-1711.3 010518	Ø 23,81
2.5 TDI	75	05/96→08/99		→ 2D-2-011024; - ABS			24.2123-1728.3 010558	Ø 23,81
				2D-2-011025→			24.2123-1755.3 010750	Ø 23,81
				2D-X-012291→ 2D-2-011024; + ABS			24.2125-1727.3 010723	Ø 25,4
				2D-2-011025→; + ABS			24.2125-1735.3 010879	TRW Ø 25,4
2.5 TDI	61	05/01→07/06		→ 2D-2-011024; + ABS			24.2123-1711.3 010518	Ø 23,81
2.5 TDI	66	05/99→07/06		→ 2D-2-011024; - ABS			24.2123-1728.3 010558	Ø 23,81
2.5 TDI	70	05/01→07/06		2D-2-011025→			24.2123-1755.3 010750	Ø 23,81
2.5 TDI	80	05/99→07/06		2D-2-011025→			24.2123-1755.3 010750	Ø 23,81
2.8 TDI	96	01/99→01/02						
2.8 TDI	116	05/01→06/06						
VW - LT 28-46 II Kasten (2DA, 2DD, 2DH) 04/96→07/06								
 Hauptbremszylinder								
2.3	105	05/96→07/06		→ 2D-2-011024; + ABS			24.2123-1711.3 010518	Ø 23,81
2.5 SDI	55	09/96→07/06		→ 2D-X-012290; + ABS			24.2123-1711.3 010518	Ø 23,81
2.5 TDI	61	05/01→07/06		→ 2D-2-011024; - ABS			24.2123-1728.3 010558	Ø 23,81
2.5 TDI	66	05/99→07/06		2D-2-011025→			24.2123-1755.3 010750	Ø 23,81
2.5 TDI	70	05/01→07/06		2D-X-012291→ 2D-2-011024; + ABS			24.2125-1727.3 010723	Ø 25,4
2.5 TDI	75	05/96→08/99		2D-2-011025→; + ABS			24.2125-1735.3 010879	TRW Ø 25,4
2.5 TDI	80	05/99→07/06						
2.8 TDI	92	07/97→01/02						
2.8 TDI	96	01/99→07/06						
2.8 TDI	116	04/02→07/06						
VW - LT 28-46 II Pritsche/Fahrgestell (2DC, 2DF, 2DG, 2DL, 2DM) 04/96→07/06								
 Hauptbremszylinder								
2.3	105	06/96→07/06		→ 2D-2-011024; + ABS			24.2123-1711.3 010518	Ø 23,81
2.5 SDI	55	09/96→07/06		→ 2D-X-012290; + ABS			24.2123-1711.3 010518	Ø 23,81
2.5 TDI	61	05/01→07/06		→ 2D-2-011024; - ABS			24.2123-1728.3 010558	Ø 23,81
2.5 TDI	66	05/99→07/06		2D-2-011025→			24.2123-1755.3 010750	Ø 23,81
2.5 TDI	70	05/01→07/06		2D-X-012291→ 2D-2-011024; + ABS			24.2125-1727.3 010723	Ø 25,4
2.5 TDI	75	06/96→08/99		2D-2-011025→; + ABS			24.2125-1735.3 010879	TRW Ø 25,4
2.5 TDI	80	05/99→07/06						
2.8 TDI	92	07/97→01/02						
2.8 TDI	96	01/99→07/06						
2.8 TDI	116	04/02→07/06						













	kw					! #		
VW - LT 40-55 I Kasten (291-512) 04/75→06/96								
 Hauptbremszylinder								
2.4 D	51	07/90→05/96		- ABS		03.2125-1712.3	010204	Ø 25,4
2.4 i	69	01/93→06/96						
2.4 TD	70	06/92→05/96						
VW - LT 40-55 I Pritsche/Fahrgestell (293-909) 04/75→06/96								
 Hauptbremszylinder								
2.4 D	51	08/90→06/96		- ABS		03.2125-1712.3	010204	Ø 25,4
2.4 i	69	03/94→06/96						
2.4 TD	70	08/92→06/96						
VW - LUPO (6X1, 6E1) 09/98→07/05								
 Bremskraftverstärker								
1.4 16V	74	08/99→07/05		für Linkslenker; + ESP;		03.7853-0102.4	300252	ATE Ø 9" pneumatisch
1.4 FSI	77	02/01→07/05		+PR 1AT,1LX,1ZE				
1.6 GTI	92	09/00→07/05						
 Hauptbremszylinder								
1.0	37	09/98→07/05		- ABS		03.2120-3943.3	010532	ATE Ø 20,64
1.0	37	10/98→05/00		für Rechtslenker; + ABS		03.2122-1184.3	010592	ATE Ø 22,2
1.2 TDI 3L	45	07/99→07/05		für Linkslenker; + ABS / - ESP		03.2122-1344.3	010593	ATE Ø 22,2
1.4	44	10/00→07/05						
1.4 TDI	55	01/99→07/05		für Linkslenker; + ABS / + ESP		03.2122-1724.3	010648	ATE Ø 22,2
1.7 SDI	44	09/98→07/05						
1.4 16V	55	09/98→07/05		10/98→; - ABS		03.2120-3943.3	010532	ATE Ø 20,64
				10/98→; für Rechtslenker; + ABS		03.2122-1184.3	010592	ATE Ø 22,2
				10/98→; für Linkslenker; + ABS / - ESP		03.2122-1344.3	010593	ATE Ø 22,2
				10/98→; für Linkslenker; + ABS / + ESP		03.2122-1724.3	010648	ATE Ø 22,2
1.4 16V	74	08/99→07/05		für Rechtslenker; + ABS		03.2122-1184.3	010592	ATE Ø 22,2
1.4 FSI	77	02/01→07/05		für Linkslenker; + ABS / - ESP		03.2123-1824.3	010596	ATE Ø 23,81
1.6 GTI	92	09/00→07/05						
 Bremskraftregler								
1.0	37	09/98→07/05				03.6583-0184.3	320229	ATE lastabhängig 8/3 4x
1.0	37	10/98→05/00						
1.2 TDI 3L	45	07/99→07/05						
1.4	44	10/00→07/05						
1.4 TDI	55	01/99→07/05						
1.7 SDI	44	09/98→07/05						
1.4 16V	55	09/98→07/05		10/98→		03.6583-0184.3	320229	ATE lastabhängig 8/3 4x
VW - MULTIVAN T5 (7HM, 7HN, 7HF, 7EF, 7EM, 7EN) 04/03→08/15								
 Bremskraftverstärker								
1.9 TDI	62	01/06→11/09		+PR 1AJ,1AE,1AC,1AR;		03.7765-1002.4	300246	ATE Ø 10 / 9" pneumatisch
1.9 TDI	63	04/03→11/09		→ 7H-A-050000				
1.9 TDI	75	06/06→11/09		+PR 1AK; → 7H-A-050000		03.7868-3702.4	300208	ATE Ø 10 / 8" pneumatisch
1.9 TDI	77	04/03→11/09						
2.0	85	11/03→08/15						
2.0 BiTDI	132	09/09→08/15						
2.0 BiTDI 4motion	132	09/09→08/15						
2.0 TDI	62	09/09→08/15						
2.0 TDI	75	09/09→08/15						
2.0 TDI	103	09/09→08/15						
2.0 TDI 4motion	103	09/09→08/15						
2.5 TDI	96	04/03→11/09						
2.5 TDI	120	11/03→11/09						
2.5 TDI	128	04/03→11/09						
2.5 TDI 4motion	96	07/04→11/09						
2.5 TDI 4motion	128	07/04→11/09						
3.2 V6	170	02/04→06/04						
3.2 V6	173	02/04→11/09						
3.2 V6 4motion	173	07/04→11/09						
3.2 4motion	170	11/03→06/06		07/04→; +PR 1AJ,1AE,1AC,1AR;		03.7765-1002.4	300246	ATE Ø 10 / 9" pneumatisch
				→ 7H-A-050000				
				07/04→; +PR 1AK; → 7H-A-050000		03.7868-3702.4	300208	ATE Ø 10 / 8" pneumatisch
Pedalwegsensor, Bremspedal								
1.9 TDI	62	01/06→11/09		+PR 1AT; → 7H-A-050000		03.0655-0006.2	370006	ATE
1.9 TDI	63	04/03→11/09						
1.9 TDI	75	06/06→11/09						
1.9 TDI	77	04/03→11/09						
2.0	85	11/03→08/15						
2.0 BiTDI	132	09/09→08/15						
2.0 BiTDI 4motion	132	09/09→08/15						
2.0 TDI	62	09/09→08/15						
2.0 TDI	75	09/09→08/15						
2.0 TDI	103	09/09→08/15						











	kW					! #		
VW - MULTIVAN T5 (7HM, 7HN, 7HF, 7EF, 7EM, 7EN) 04/03→08/15								
Pedalwegsensor, Bremspedal								
2.0 TDI 4motion	103	09/09→08/15		+PR 1AT; → 7H-A-050000			03.0655-0006.2 370006	ATE
2.5 TDI	96	04/03→11/09						
2.5 TDI	120	11/03→11/09						
2.5 TDI	128	04/03→11/09						
2.5 TDI 4motion	96	07/04→11/09						
2.5 TDI 4motion	128	07/04→11/09						
3.2 V6	170	02/04→06/04						
3.2 V6	173	02/04→11/09						
3.2 V6 4motion	173	07/04→11/09						
3.2 4motion	170	11/03→06/06		07/04→; +PR 1AT; → 7H-A-050000			03.0655-0006.2 370006	ATE
 Hauptbremszylinder								
1.9 TDI	62	01/06→11/09		7H-6-000001→ 7H-6-200000; für Rechtslenker; +PR 1AT			03.2126-3014.3 010811	ATE Ø 26,99
1.9 TDI	63	04/03→11/09						
1.9 TDI	75	06/06→11/09		→ 7H-A-050000			03.2126-3014.3 010811	ATE Ø 26,99
1.9 TDI	77	04/03→11/09						
2.0	85	11/03→08/15		7H-A-200001→			03.2126-3144.3 010941	ATE Ø 26,99
3.2 V6	170	02/04→06/04						
3.2 V6	173	02/04→11/09						
2.0 BiTDI	132	09/09→08/15		→ 7H-A-050000			03.2126-3014.3 010811	ATE Ø 26,99
2.0 BiTDI 4motion	132	09/09→08/15						
2.0 TDI	62	09/09→08/15		7H-A-200001→			03.2126-3144.3 010941	ATE Ø 26,99
2.0 TDI	75	09/09→08/15						
2.0 TDI	100	05/10→08/15						
2.0 TDI	103	09/09→08/15						
2.0 TDI 4motion	100	05/10→08/15						
2.0 TDI 4motion	103	09/09→08/15						
2.5 TDI	96	04/03→11/09						
2.5 TDI	120	11/03→11/09						
2.5 TDI	128	04/03→11/09						
2.5 TDI 4motion	96	07/04→11/09						
2.5 TDI 4motion	128	07/04→11/09						
3.2 V6 4motion	173	07/04→11/09						
2.0 TDI	84	05/11→08/15					03.2126-3144.3 010941	ATE Ø 26,99
2.0 TSI	110	07/12→08/15						
2.0 TSI	150	05/11→08/15						
2.0 TSI 4motion	150	07/11→08/15						
3.2 4motion	170	11/03→06/06		07/04→; → 7H-A-050000			03.2126-3014.3 010811	ATE Ø 26,99
				7H-A-200001→			03.2126-3144.3 010941	ATE Ø 26,99
VW - NEW BEETLE (9C1, 1C1) 01/98→09/10								
 Bremskraftverstärker								
1.4	55	11/01→09/10		→ 9C-2-620000; für Linkslenker; + ESP			03.7860-0602.4 300141	ATE Ø 10" pneumatisch
				9C-2-620001→; für Linkslenker; + ESP; → 05/10			03.7863-3502.4 300128	ATE Ø 10" pneumatisch
1.6	74	10/99→09/00		9C-Y-613783→ 9C-2-620000; für Linkslenker; + ESP			03.7860-0602.4 300141	ATE Ø 10" pneumatisch
				11/99→; → 9C-Y-613782; für Linkslenker; + ESP			03.7863-0402.4 300124	ATE Ø 10" pneumatisch
				9C-2-620001→; für Linkslenker; + ESP			03.7863-3502.4 300128	ATE Ø 10" pneumatisch
1.6	75	06/00→09/10		9C-Y-613783→ 9C-2-620000; für Linkslenker; + ESP			03.7860-0602.4 300141	ATE Ø 10" pneumatisch
1.8 T	110	10/99→09/10						
1.9 TDI	74	02/01→09/10		→ 9C-Y-613782; für Linkslenker; + ESP			03.7863-0402.4 300124	ATE Ø 10" pneumatisch
2.0	85	01/98→09/10		9C-2-620001→; für Linkslenker; + ESP; → 05/10			03.7863-3502.4 300128	ATE Ø 10" pneumatisch
1.8 T	132	11/01→06/05		→ 9C-2-620000; für Linkslenker; + ESP			03.7860-0602.4 300141	ATE Ø 10" pneumatisch
				9C-2-620001→; für Linkslenker; + ESP			03.7863-3502.4 300128	ATE Ø 10" pneumatisch
1.9 TDI	66	01/98→06/04		9C-Y-613783→; → 02/01; für Linkslenker; + ESP			03.7860-0602.4 300141	ATE Ø 10" pneumatisch
				→ 9C-Y-613782; für Linkslenker; + ESP			03.7863-0402.4 300124	ATE Ø 10" pneumatisch
1.9 TDI	77	07/05→09/10		für Linkslenker; + ESP; → 05/10			03.7863-3502.4 300128	ATE Ø 10" pneumatisch
2.3 V5	125	10/00→09/10		9C-Y-613783→ 9C-2-620000; für Linkslenker; + ESP			03.7860-0602.4 300141	ATE Ø 10" pneumatisch
				→ 9C-Y-613782; für Linkslenker; + ESP			03.7863-0402.4 300124	ATE Ø 10" pneumatisch
				9C-2-620001→; für Linkslenker; + ESP; → 05/05			03.7863-3502.4 300128	ATE Ø 10" pneumatisch
RSI 3.2 4motion (1C9)	165	04/00→05/01		9C-Y-613783→ 9C-2-620000; für Linkslenker; + ESP			03.7860-0602.4 300141	ATE Ø 10" pneumatisch
				→ 9C-Y-613782; für Linkslenker; + ESP			03.7863-0402.4 300124	ATE Ø 10" pneumatisch
				9C-2-620001→; für Linkslenker; + ESP			03.7863-3502.4 300128	ATE Ø 10" pneumatisch
 Hauptbremszylinder								
1.4	55	11/01→09/10		für Linkslenker; + ESP; → 05/10			03.2123-2715.3 010802	ATE Ø 23,81
↓								













	kw			 	! #		
VW - NEW BEETLE (9C1, 1C1) 01/98—09/10							
 Hauptbremszylinder							
1.4	55	11/01→09/10		für Rechtslenker; + ESP; → 9C-7-557428		03.2123-2774.3 010803	ATE Ø 23,81
				9C-7-557429→; für Rechtslenker; + ESP; → 05/10		03.2123-2774.3 010803	ATE Ø 23,81
				für Linkslenker; - ESP; → 06/05		24.2123-1709.3 010503	Ø 23,81
1.6	74	10/99→09/00		11/99→; → 9C-Y-613782; für Linkslenker; + ESP		03.2123-2024.3 010597	ATE Ø 23,81
				11/99→; → 9C-Y-613782; für Rechtslenker; + ESP		03.2123-2064.3 010598	ATE Ø 23,81
				9C-Y-613783→; für Linkslenker; + ESP		03.2123-2715.3 010802	ATE Ø 23,81
				9C-7-557429→; für Rechtslenker; + ESP		03.2123-2774.3 010803	ATE Ø 23,81
				9C-Y-613783→; für Rechtslenker; + ESP; → 9C-7-557428		03.2123-2774.3 010803	ATE Ø 23,81
				11/99→; für Linkslenker; - ESP		24.2123-1709.3 010503	Ø 23,81
1.6 1.8 T 1.9 TDI 2.0	75 110 74 85	06/00→09/10 10/99→09/10 02/01→09/10 01/98→09/10		→ 9C-Y-613782; für Linkslenker; + ESP		03.2123-2024.3 010597	ATE Ø 23,81
				→ 9C-Y-613782; für Rechtslenker; + ESP		03.2123-2064.3 010598	ATE Ø 23,81
				9C-Y-613783→; für Linkslenker; + ESP; → 05/10		03.2123-2715.3 010802	ATE Ø 23,81
				9C-7-557429→; für Rechtslenker; + ESP; → 05/10		03.2123-2774.3 010803	ATE Ø 23,81
				9C-Y-613783→; für Rechtslenker; + ESP; → 9C-7-557428		03.2123-2774.3 010803	ATE Ø 23,81
				für Linkslenker; - ESP; → 06/05		24.2123-1709.3 010503	Ø 23,81
1.8 T	132	11/01→06/05		für Linkslenker; + ESP		03.2123-2715.3 010802	ATE Ø 23,81
				für Rechtslenker; + ESP		03.2123-2774.3 010803	ATE Ø 23,81
				für Linkslenker; - ESP		24.2123-1709.3 010503	Ø 23,81
1.9 TDI	66	01/98→06/04		→ 9C-Y-613782; für Linkslenker; + ESP		03.2123-2024.3 010597	ATE Ø 23,81
				→ 9C-Y-613782; für Rechtslenker; + ESP		03.2123-2064.3 010598	ATE Ø 23,81
				9C-Y-613783→; → 02/01; für Linkslenker; + ESP		03.2123-2715.3 010802	ATE Ø 23,81
				9C-Y-613783→; → 02/01; für Rechtslenker; + ESP		03.2123-2774.3 010803	ATE Ø 23,81
				→ 02/01; für Linkslenker; - ESP		24.2123-1709.3 010503	Ø 23,81
1.9 TDI	77	07/05→09/10		für Linkslenker; + ESP; → 05/10		03.2123-2715.3 010802	ATE Ø 23,81
				für Rechtslenker; + ESP; → 9C-7-557428		03.2123-2774.3 010803	ATE Ø 23,81
				9C-7-557429→; für Rechtslenker; + ESP; → 05/10		03.2123-2774.3 010803	ATE Ø 23,81
2.3 V5	125	10/00→09/10		→ 9C-Y-613782; für Linkslenker; + ESP		03.2123-2024.3 010597	ATE Ø 23,81
				→ 9C-Y-613782; für Rechtslenker; + ESP		03.2123-2064.3 010598	ATE Ø 23,81
				9C-Y-613783→; für Linkslenker; + ESP; → 12/05		03.2123-2715.3 010802	ATE Ø 23,81
				9C-Y-613783→; für Rechtslenker; + ESP; → 12/05		03.2123-2774.3 010803	ATE Ø 23,81
				für Linkslenker; - ESP; → 05/05		24.2123-1709.3 010503	Ø 23,81
RSI 3.2 4motion (1C9)	165	04/00→05/01		→ 9C-Y-613782; für Linkslenker; + ESP		03.2123-2024.3 010597	ATE Ø 23,81
				→ 9C-Y-613782; für Rechtslenker; + ESP		03.2123-2064.3 010598	ATE Ø 23,81
				9C-Y-613783→; für Linkslenker; + ESP		03.2123-2715.3 010802	ATE Ø 23,81
				9C-Y-613783→; für Rechtslenker; + ESP		03.2123-2774.3 010803	ATE Ø 23,81
				für Linkslenker; - ESP		24.2123-1709.3 010503	Ø 23,81
 Bremskraftregler							
1.4 1.6 1.8 T 1.9 TDI 2.0	55 75 110 74 85	11/01→09/10 06/00→09/10 10/99→09/10 02/01→09/10 01/98→09/10		- ABS; → 06/05		03.6583-0179.3 320228	ATE lastabhängig 8/3 4x
1.6	74	10/99→09/00		11/99→; - ABS		03.6583-0179.3 320228	ATE lastabhängig 8/3 4x
1.8 T RSI 3.2 4motion (1C9)	132 165	11/01→06/05 04/00→05/01		- ABS		03.6583-0179.3 320228	ATE lastabhängig 8/3 4x
1.9 TDI	66	01/98→06/04		→ 02/01; - ABS		03.6583-0179.3 320228	ATE lastabhängig 8/3 4x
2.3 V5	125	10/00→09/10		- ABS; → 05/05		03.6583-0179.3 320228	ATE lastabhängig 8/3 4x











	kw					! #		
VW - NEW BEETLE Cabriolet (1Y7) 09/02→10/10								
 Bremskraftverstärker								
1.4	55	01/03→09/10		für Linkslenker; + ESP; → 05/10		03.7863-3502.4	300128	ATE Ø 10" pneumatisch
1.6	75	01/03→09/10						
1.9 TDI	77	07/05→09/10						
1.8 T	110	01/03→09/10		12/03→; für Linkslenker; + ESP; → 05/10		03.7863-3502.4	300128	ATE Ø 10" pneumatisch
1.9 TDI	74	06/03→09/10		07/03→; für Linkslenker; + ESP; → 05/10		03.7863-3502.4	300128	ATE Ø 10" pneumatisch
2.0	85	09/02→10/10		01/03→; für Linkslenker; + ESP; → 05/10		03.7863-3502.4	300128	ATE Ø 10" pneumatisch
 Hauptbremszylinder								
1.4	55	01/03→09/10		für Linkslenker; + ESP; → 05/10		03.2123-2715.3	010802	ATE Ø 23,81
1.6	75	01/03→09/10		für Rechtslenker; + ESP; → 1Y-7-413420		03.2123-2774.3	010803	ATE Ø 23,81
				1Y-7-413421→; für Rechtslenker; + ESP; → 05/10		03.2123-2774.3	010803	ATE Ø 23,81
				für Linkslenker; - ESP; → 06/05		24.2123-1709.3	010503	Ø 23,81
1.8 T	110	01/03→09/10		12/03→; für Linkslenker; + ESP; → 05/10		03.2123-2715.3	010802	ATE Ø 23,81
				12/03→; für Rechtslenker; + ESP; → 1Y-7-413420		03.2123-2774.3	010803	ATE Ø 23,81
				1Y-7-413421→; für Rechtslenker; + ESP; → 05/10		03.2123-2774.3	010803	ATE Ø 23,81
				12/03→; für Linkslenker; - ESP; → 06/05		24.2123-1709.3	010503	Ø 23,81
1.9 TDI	74	06/03→09/10		07/03→; für Linkslenker; + ESP; → 05/10		03.2123-2715.3	010802	ATE Ø 23,81
				1Y-7-413421→; für Rechtslenker; + ESP; → 05/10		03.2123-2774.3	010803	ATE Ø 23,81
				07/03→; für Rechtslenker; + ESP; → 1Y-7-413420		03.2123-2774.3	010803	ATE Ø 23,81
				07/03→; für Linkslenker; - ESP; → 06/05		24.2123-1709.3	010503	Ø 23,81
1.9 TDI	77	07/05→09/10		für Linkslenker; + ESP; → 05/10		03.2123-2715.3	010802	ATE Ø 23,81
				für Rechtslenker; + ESP; → 1Y-7-413420		03.2123-2774.3	010803	ATE Ø 23,81
				1Y-7-413421→; für Rechtslenker; + ESP; → 05/10		03.2123-2774.3	010803	ATE Ø 23,81
2.0	85	09/02→10/10		01/03→; für Linkslenker; + ESP; → 05/10		03.2123-2715.3	010802	ATE Ø 23,81
				1Y-7-413421→; für Rechtslenker; + ESP; → 05/10		03.2123-2774.3	010803	ATE Ø 23,81
				01/03→; für Rechtslenker; + ESP; → 1Y-7-413420		03.2123-2774.3	010803	ATE Ø 23,81
				01/03→; für Linkslenker; - ESP; → 06/05		24.2123-1709.3	010503	Ø 23,81
VW - PASSAT (3A2, 35I) 02/88→12/97								
 Bremskraftverstärker								
1.6	74	10/94→08/96		für Linkslenker; - ABS		03.7750-4302.4	300076	ATE Ø 9" pneumatisch
1.9 TDI	66	10/93→08/96		→ 12/95; für Rechtslenker; - ABS		03.7750-4902.4	300079	ATE Ø 9" pneumatisch
2.0	79	03/95→08/96						
2.0 16V	110	01/94→08/96						
1.8	55	08/90→08/96		→ 10/93; für Linkslenker; - ABS		03.7750-4302.4	300076	ATE Ø 9" pneumatisch
1.9 TD	55	03/91→08/96		10/93→; für Linkslenker; - ABS		03.7750-4302.4	300076	ATE Ø 9" pneumatisch
2.8 VR6	128	06/91→08/96		10/93→ 12/95; für Rechtslenker; - ABS		03.7750-4902.4	300079	ATE Ø 9" pneumatisch
				→ 10/93; für Rechtslenker; - ABS		03.7750-4902.4	300079	ATE Ø 9" pneumatisch
1.8	66	02/88→08/96		10/93→; für Linkslenker; - ABS		03.7750-4302.4	300076	ATE Ø 9" pneumatisch
				04/88→ 10/93; für Linkslenker; - ABS		03.7750-4302.4	300076	ATE Ø 9" pneumatisch
				10/93→ 12/95; für Rechtslenker; - ABS		03.7750-4902.4	300079	ATE Ø 9" pneumatisch
				04/88→ 10/93; für Rechtslenker; - ABS		03.7750-4902.4	300079	ATE Ø 9" pneumatisch
1.9 TDI	81	03/96→08/96		für Linkslenker; - ABS		03.7750-4302.4	300076	ATE Ø 9" pneumatisch
2.0	85	02/90→08/96		10/93→; für Linkslenker; - ABS		03.7750-4302.4	300076	ATE Ø 9" pneumatisch
				03/90→ 10/93; für Linkslenker; - ABS		03.7750-4302.4	300076	ATE Ø 9" pneumatisch
				03/90→ 10/93; für Rechtslenker; - ABS		03.7750-4902.4	300079	ATE Ø 9" pneumatisch
				10/93→ 12/95; für Rechtslenker; - ABS		03.7750-4902.4	300079	ATE Ø 9" pneumatisch
 Hauptbremszylinder								
1.6	74	10/94→08/96		- ABS		03.2122-1042.3	010137	Ø 22,2
1.9 TDI	66	10/93→08/96		3A-T-000001→; für Linkslenker; + ABS		03.2123-1424.3	010637	ATE Ø 23,81
1.9 TDI	81	03/96→08/96						
2.0	79	03/95→08/96		3A-T-000001→; für Rechtslenker; + ABS		03.2123-1484.3	010595	ATE Ø 23,81
2.0 16V	110	01/94→08/96		→ 3A-S-300000; für Linkslenker; + ABS		10.6123-0674.3	010639	ATE Ø 23,81
1.8	55	08/90→08/96		→ 07/91; - ABS		03.2120-3943.3	010532	ATE Ø 20,64
1.9 TD	55	03/91→08/96		08/91→ 10/93; - ABS		03.2122-1042.3	010137	Ø 22,2
				10/93→; - ABS		03.2122-1042.3	010137	Ø 22,2
				3A-T-000001→; für Linkslenker; + ABS		03.2123-1424.3	010637	ATE Ø 23,81
↓								















	kw			 	! #					
VW - PASSAT (3A2, 35I) 02/88→12/97										
 Hauptbremszylinder										
1.8 1.9 TD	55 55	08/90→08/96 03/91→08/96		3A-T-000001→; für Rechtslenker; + ABS 10/93→; → 3A-S-300000; für Linkslenker; + ABS		03.2123-1484.3 010595 10.6123-0674.3 010639	ATE Ø 23,81 ATE Ø 23,81			
1.8	66	02/88→08/96		04/88→ 10/93; - ABS 10/93→; - ABS		03.2122-1042.3 010137 03.2122-1042.3 010137	Ø 22,2 Ø 22,2			
				3A-T-000001→; für Linkslenker; + ABS 3A-T-000001→; für Rechtslenker; + ABS		03.2123-1424.3 010637 03.2123-1484.3 010595	ATE Ø 23,81 ATE Ø 23,81			
				10/93→; → 3A-S-300000; für Linkslenker; + ABS		10.6123-0674.3 010639	ATE Ø 23,81			
				03/90→ 07/91; - ABS 08/91→ 10/93; - ABS 10/93→; - ABS		03.2120-3943.3 010532 03.2122-1042.3 010137 03.2122-1042.3 010137	ATE Ø 20,64 Ø 22,2 Ø 22,2			
2.0 Syncro	85	10/90→08/96		3A-T-000001→; für Linkslenker; + ABS 01/94→; → 3A-S-300000; für Linkslenker; + ABS		03.2123-1424.3 010637 10.6123-0674.3 010639	ATE Ø 23,81 ATE Ø 23,81			
				3A-T-000001→; für Rechtslenker; + ABS 10/93→; → 3A-S-300000; für Linkslenker; + ABS		03.2123-1484.3 010595 10.6123-0674.3 010639	ATE Ø 23,81 ATE Ø 23,81			
2.8 VR6	128	06/91→08/96		10/93→; - ABS 3A-T-000001→; für Linkslenker; + ABS 3A-T-000001→; für Rechtslenker; + ABS 10/93→; → 3A-S-300000; für Linkslenker; + ABS		03.2122-1042.3 010137 03.2123-1424.3 010637 03.2123-1484.3 010595 10.6123-0674.3 010639	Ø 22,2 ATE Ø 23,81 ATE Ø 23,81 ATE Ø 23,81			
			Verschlusschraube, Hauptbremszylinder							
			1.6 1.9 TDI 1.9 TDI 2.0 2.0 16V	74 66 81 79 110	10/94→08/96 10/93→08/96 03/96→08/96 03/95→08/96 01/94→08/96		- ABS		03.3517-0101.2 390322	
			1.8 1.9 TD	55 55	08/90→08/96 03/91→08/96		08/91→ 10/93; - ABS 10/93→; - ABS → 07/91; - ABS		03.3517-0101.2 390322 03.3517-0101.2 390322 03.3517-0101.2 390322	
1.8	66	02/88→08/96					04/88→ 10/93; - ABS 10/93→; - ABS		03.3517-0101.2 390322 03.3517-0101.2 390322	
			2.0	85	02/90→08/96		08/91→ 10/93; - ABS 10/93→; - ABS 03/90→ 07/91; - ABS 10/93→; - ABS		03.3517-0101.2 390322 03.3517-0101.2 390322 03.3517-0101.2 390322 03.3517-0101.2 390322	
2.8 VR6	128	06/91→08/96					10/93→; - ABS		03.3517-0101.2 390322	
 Bremskraftregler										
1.6 1.9 TDI 1.9 TDI 2.0 2.0 16V	74 66 81 79 110	10/94→08/96 10/93→08/96 03/96→08/96 03/95→08/96 01/94→08/96				03.6584-0015.3 320109	ATE lastabhängig 8/4 4x			
1.8 1.9 TD 2.8 VR6	55 55 128	08/90→08/96 03/91→08/96 06/91→08/96		10/93→ → 10/93		03.6584-0015.3 320109 03.6584-0015.3 320109	ATE lastabhängig 8/4 4x ATE lastabhängig 8/4 4x			
			1.8	66	02/88→08/96		10/93→ 04/88→ 10/93		03.6584-0015.3 320109 03.6584-0015.3 320109	ATE lastabhängig 8/4 4x ATE lastabhängig 8/4 4x
1.8 G60 Syncro	118	08/88→08/96					→ 10/93		03.6584-0015.3 320109	ATE lastabhängig 8/4 4x
2.0	85	02/90→08/96		10/93→ 03/90→ 10/93		03.6584-0015.3 320109 03.6584-0015.3 320109	ATE lastabhängig 8/4 4x ATE lastabhängig 8/4 4x			
			2.0 Syncro	85	10/90→08/96		01/94→ → 10/93		03.6584-0015.3 320109 03.6584-0015.3 320109	ATE lastabhängig 8/4 4x ATE lastabhängig 8/4 4x
VW - PASSAT (3B2) 08/96→12/01										
 Hauptbremszylinder										
1.6 1.8 1.8 T	74 112 110	10/96→11/00 01/00→12/01 10/96→11/00		→ 3B-X-800000; - ESP → 3B-X-800000; + ESP		24.2123-1717.3 010521 24.2123-1730.3 010620	Ø 23,81 Ø 23,81			
1.9 TDI 1.9 TDI 1.9 TDI 4motion 1.9 TDI Syncro/4motion 2.3 VR5	81 85 85 81 110	10/96→11/00 08/98→11/00 08/99→11/00 10/96→11/00 10/96→11/00		3B-Y-000001→ 3B-1-400000; für Linkslenker; - ESP 3B-Y-000001→ 3B-1-400000; für Linkslenker; + ESP 3B-2-000001→		24.2125-1712.3 010622 24.2125-1713.3 010623 24.2125-1720.3 010688	Ø 25,4 Ø 25,4 TRW Ø 25,4			











	kW			 	! #		
VW - PASSAT (3B2) 08/96→12/01							
 Hauptbremszylinder							
2.3 VR5 Syncro/4motion	110	10/97→11/00		→ 3B-X-800000; - ESP		24.2123-1717.3 010521	Ø 23,81
2.5 TDI Syncro/4motion	110	12/98→11/00		→ 3B-X-800000; + ESP		24.2123-1730.3 010620	Ø 23,81
2.8 Syncro	132	05/97→09/99					
2.8 V6	132	05/97→09/99		3B-Y-000001→ 3B-1-400000;		24.2125-1712.3 010622	Ø 25,4
2.8 V6	140	09/99→11/00		für Linkslenker; - ESP			
2.8 V6	142	08/96→11/00		3B-Y-000001→ 3B-1-400000;		24.2125-1713.3 010623	Ø 25,4
2.8 V6 4motion	140	09/99→11/00		für Linkslenker; + ESP			
2.8 V6 Syncro/4motion	142	10/96→11/00		3B-2-000001→		24.2125-1720.3 010688	TRW Ø 25,4
1.8	85	01/97→11/00		→ 3B-X-800000; - ESP		24.2123-1717.3 010521	Ø 23,81
1.8	92	10/96→11/00		→ 3B-X-800000; + ESP		24.2123-1730.3 010620	Ø 23,81
1.8 Syncro/4motion	92	10/96→11/00					
1.9 TDI	66	10/96→11/00		3B-Y-000001→; → 09/00;		24.2125-1712.3 010622	Ø 25,4
				für Linkslenker; - ESP			
				3B-Y-000001→; → 09/00;		24.2125-1713.3 010623	Ø 25,4
				für Linkslenker; + ESP			
1.9 TDI	74	02/00→11/00		10/00→; → 3B-1-400000;		24.2125-1712.3 010622	Ø 25,4
2.0	88	04/00→11/00		für Linkslenker; - ESP			
2.0 4motion	88	04/00→11/00		10/00→; → 3B-1-400000;		24.2125-1713.3 010623	Ø 25,4
				für Linkslenker; + ESP			
				3B-2-000001→		24.2125-1720.3 010688	TRW Ø 25,4
2.5 TDI	110	07/98→11/00		08/98→; → 3B-X-800000; - ESP		24.2123-1717.3 010521	Ø 23,81
				08/98→; → 3B-X-800000; + ESP		24.2123-1730.3 010620	Ø 23,81
				3B-Y-000001→ 3B-1-400000;		24.2125-1712.3 010622	Ø 25,4
				für Linkslenker; - ESP			
				3B-Y-000001→ 3B-1-400000;		24.2125-1713.3 010623	Ø 25,4
				für Linkslenker; + ESP			
				3B-2-000001→		24.2125-1720.3 010688	TRW Ø 25,4
VW - PASSAT (3B3) 11/00→05/05							
 Hauptbremszylinder							
1.6	75	11/00→05/05		05/02→		03.2125-0373.3 010810	ATE Ø 25,4
1.8 T	125	02/01→05/05					
1.8 T 20V	110	11/00→05/05		→ 3B-X-800000; - ESP		24.2123-1717.3 010521	Ø 23,81
2.3 V5	125	11/00→05/05		→ 3B-X-800000; + ESP		24.2123-1730.3 010620	Ø 23,81
2.3 V5 4motion	125	11/00→05/05		3B-Y-000001→ 3B-1-400000;		24.2125-1712.3 010622	Ø 25,4
2.5 TDI	110	11/00→05/05		für Linkslenker; - ESP			
2.5 TDI 4motion	110	11/00→05/05		3B-Y-000001→ 3B-1-400000;		24.2125-1713.3 010623	Ø 25,4
2.8 4motion	142	11/00→05/05		für Linkslenker; + ESP			
				3B-2-000001→		24.2125-1720.3 010688	TRW Ø 25,4
1.8 T 4motion	125	03/01→05/05		→ 3B-X-800000; - ESP		24.2123-1717.3 010521	Ø 23,81
				→ 3B-X-800000; + ESP		24.2123-1730.3 010620	Ø 23,81
1.9 TDI	74	11/00→05/05		05/02→		03.2125-0373.3 010810	ATE Ø 25,4
1.9 TDI	96	11/00→05/05		→ 3B-1-400000; für Linkslenker; - ESP		24.2125-1712.3 010622	Ø 25,4
1.9 TDI 4motion	96	11/00→05/05					
2.0	85	11/00→05/05		→ 3B-1-400000; für Linkslenker; + ESP		24.2125-1713.3 010623	Ø 25,4
2.0 4motion	85	11/00→05/05		3B-2-000001→		24.2125-1720.3 010688	TRW Ø 25,4
2.0	96	11/01→05/05		05/02→		03.2125-0373.3 010810	ATE Ø 25,4
						24.2125-1720.3 010688	TRW Ø 25,4
2.0 TDI	100	12/03→05/05				03.2125-0373.3 010810	ATE Ø 25,4
						24.2125-1720.3 010688	TRW Ø 25,4
2.5 TDI	120	05/03→05/05				03.2125-0373.3 010810	ATE Ø 25,4
2.5 TDI 4motion	132	01/03→05/05		→ 3B-X-800000; - ESP		24.2123-1717.3 010521	Ø 23,81
2.8	142	05/02→05/05		→ 3B-X-800000; + ESP		24.2123-1730.3 010620	Ø 23,81
				3B-Y-000001→ 3B-1-400000;		24.2125-1712.3 010622	Ø 25,4
				für Linkslenker; - ESP			
				3B-Y-000001→ 3B-1-400000;		24.2125-1713.3 010623	Ø 25,4
				für Linkslenker; + ESP			
				3B-2-000001→		24.2125-1720.3 010688	TRW Ø 25,4
4.0 W8 4motion	202	09/01→09/04		05/02→		03.2125-0373.3 010810	ATE Ø 25,4
						24.2125-1720.3 010688	TRW Ø 25,4
VW - PASSAT (3C2) 03/05→11/10							
 Bremskraftverstärker							
1.4 TSI	90	05/07→07/10		10/07→; + ESP; für Linkslenker		03.7873-3902.4 300254	ATE Ø 11" pneumatisch
1.8 TSI	118	05/07→07/10		10/07→; für Linkslenker; - ESP		03.7873-4402.4 300292	ATE Ø 11" pneumatisch
1.4 TSI EcoFuel	110	01/09→07/10		für Linkslenker; + ESP		03.7873-3902.4 300254	ATE Ø 11" pneumatisch
1.6	75	05/05→07/10					
1.6 FSI	85	03/05→06/08		für Linkslenker; - ESP		03.7873-4402.4 300292	ATE Ø 11" pneumatisch
1.6 TDI	77	08/09→07/10					
1.8 TSI	112	11/09→07/10					
1.9 TDI	77	03/05→11/08					











	kw			 	! #					
VW - PASSAT (3C2) 03/05→11/10										
 Bremskraftverstärker										
2.0 FSI	110	03/05→07/10		für Linkslenker; + ESP		03.7873-3902.4 300254	ATE Ø 11" pneumatisch			
2.0 FSI	125	08/07→07/10		für Linkslenker; - ESP		03.7873-4402.4 300292	ATE Ø 11" pneumatisch			
2.0 FSI	147	07/05→07/10								
2.0 FSI 4motion	110	09/05→07/10								
2.0 TDI	81	11/08→07/10								
2.0 TDI	88	11/05→05/07								
2.0 TDI	90	08/05→07/06								
2.0 TDI	103	03/05→05/09								
2.0 TDI	120	08/05→05/09								
2.0 TDI	125	08/05→07/10								
2.0 TDI 16V	103	03/05→07/10								
2.0 TDI 4motion	103	03/05→05/09								
2.0 TDI 4motion	125	05/09→07/10								
3.2 FSI 4motion	184	11/05→07/10								
2.0 BlueTDI	105	01/09→11/10		für Linkslenker; + ESP; → 07/10		03.7873-3902.4 300254	ATE Ø 11" pneumatisch			
2.0 TDI	100	03/05→11/10		für Linkslenker; - ESP; → 07/10		03.7873-4402.4 300292	ATE Ø 11" pneumatisch			
2.0 TDI 16V 4motion	103	03/05→08/10								
3.6 R36 4motion	220	04/07→07/10		für Linkslenker		03.7873-4502.4 300284	ATE Ø 11" pneumatisch			
 Hauptbremszylinder										
1.4 TSI	90	05/07→07/10		10/07→; +PR 1ZG; für Linkslenker		03.4152-0116.3 010814	ATE Ø 22,2			
1.8 TSI	118	05/07→07/10		für Linkslenker; +PR 1LJ;1LK;1LH;1LM		03.4153-0186.3 010816	ATE Ø 23,81			
1.4 TSI EcoFuel	110	01/09→07/10								
1.6	75	05/05→07/10								
1.6 FSI	85	03/05→06/08								
1.9 TDI	77	03/05→11/08								
2.0 FSI	110	03/05→07/10								
2.0 FSI	125	08/07→07/10								
2.0 FSI	147	07/05→07/10								
2.0 FSI 4motion	110	09/05→07/10								
2.0 TDI	81	11/08→07/10								
2.0 TDI	88	11/05→05/07								
2.0 TDI	90	08/05→07/06								
2.0 TDI	103	03/05→05/09								
2.0 TDI	120	08/05→05/09								
2.0 TDI	125	08/05→07/10								
2.0 TDI 4motion	103	03/05→05/09								
3.2 FSI 4motion	184	11/05→07/10								
1.6 TDI	77	08/09→07/10		für Linkslenker; +PR 1ZG		03.4152-0116.3 010814	ATE Ø 22,2			
1.8 TSI	112	11/09→07/10		+PR 1LJ,1LK,1LH,1LM; für Linkslenker		03.4153-0186.3 010816	ATE Ø 23,81			
2.0 TDI 16V	103	03/05→07/10								
2.0 TDI 4motion	125	05/09→07/10								
3.6 R36 4motion	220	04/07→07/10								
2.0 BlueTDI	105	01/09→11/10		für Linkslenker; +PR 1ZG; → 07/10		03.4152-0116.3 010814	ATE Ø 22,2			
2.0 TDI	100	03/05→11/10		für Linkslenker; +PR 1LJ;1LK;1LH;1LM; → 07/10		03.4153-0186.3 010816	ATE Ø 23,81			
2.0 TDI 16V 4motion	103	03/05→08/10								
VW - PASSAT (3G2) 08/14→										
 Hauptbremszylinder										
1.4 TSI	92	11/14→		für Linkslenker; +PR 1ZA,1ZD		24.4123-1719.3 011017	TRW Ø 23,81 ohne Bremsflüssigkeitsbehälter			
1.4 TSI	110	11/14→								
1.4 TSI 4motion	110	02/15→								
1.8 TSI	132	02/15→								
2.0 TDI	110	11/14→								
2.0 TDI	135	07/15→								
2.0 TDI	140	11/14→								
2.0 TDI 4motion	110	02/15→								
2.0 TDI 4motion	140	11/14→								
2.0 TSI 4motion	206	05/15→								
1.6 TDI	88	08/14→		11/14→; für Linkslenker; +PR 1ZA,1ZD		24.4123-1719.3 011017	TRW Ø 23,81 ohne Bremsflüssigkeitsbehälter			
2.0 TDI 4motion	176	08/14→								
2.0 TSI	162	02/15→		05/15→; für Linkslenker; +PR 1ZA,1ZD		24.4123-1719.3 011017	TRW Ø 23,81 ohne Bremsflüssigkeitsbehälter			
VW - PASSAT (362) 08/10→12/14										
 Bremskraftverstärker										
1.4 TSI	90	08/10→12/14		→ 10/14; +PR 1ZG; für Linkslenker		03.7873-4402.4 300292	ATE Ø 11" pneumatisch			
1.4 TSI	118	11/12→12/14		für Linkslenker		03.7873-4502.4 300284	ATE Ø 11" pneumatisch			
1.4 TSI EcoFuel	110	08/10→12/14								
1.4 TSI MultiFuel	118	11/10→12/14								
1.6 TDI	77	08/10→12/14								
1.8 TSI	112	02/11→12/14								
1.8 TSI	118	08/10→12/14								
2.0 TDI	100	08/10→12/14								
2.0 TDI	103	08/10→12/14								
2.0 TDI	125	08/10→12/14								
2.0 TDI	130	12/12→12/14								
↓										











	kw			 	! #		
VW - PASSAT (362) 08/10→12/14							
 Bremskraftverstärker							
2.0 TDI 4motion	103	08/10→12/14		→ 10/14; +PR 1ZG; für Linkslenker	03.7873-4402.4	300292	ATE Ø 11" pneumatisch
2.0 TDI 4motion	130	01/13→12/14		→ 10/14; +PR 1LA,1LB,1ZM; für Linkslenker	03.7873-4502.4	300284	ATE Ø 11" pneumatisch
2.0 TSI	155	11/10→12/14					
3.6 FSI 4motion	220	01/11→12/14					
2.0 TDI 4motion	125	08/10→01/13		+PR 1ZG; für Linkslenker	03.7873-4402.4	300292	ATE Ø 11" pneumatisch
				+PR 1LA,1LB,1ZM; für Linkslenker	03.7873-4502.4	300284	ATE Ø 11" pneumatisch
 Hauptbremszylinder							
1.4 TSI	90	08/10→12/14		→ 10/14; +PR 1ZG; für Linkslenker	03.4152-0116.3	010814	ATE Ø 22,2
1.4 TSI	118	11/12→12/14		→ 10/14; +PR 1LA,1LB,1ZM; für Linkslenker	03.4153-0186.3	010816	ATE Ø 23,81
1.4 TSI EcoFuel	110	08/10→12/14					
1.4 TSI MultiFuel	118	11/10→12/14					
1.6 TDI	77	08/10→12/14					
1.8 TSI	112	02/11→12/14					
1.8 TSI	118	08/10→12/14					
2.0 TDI	100	08/10→12/14					
2.0 TDI	103	08/10→12/14					
2.0 TDI	125	08/10→12/14					
2.0 TDI	130	12/12→12/14					
2.0 TDI 4motion	103	08/10→12/14					
2.0 TDI 4motion	130	01/13→12/14					
2.0 TSI	155	11/10→12/14					
3.6 FSI 4motion	220	01/11→12/14					
2.0 TDI 4motion	125	08/10→01/13		+PR 1ZG; für Linkslenker	03.4152-0116.3	010814	ATE Ø 22,2
				+PR 1LA,1LB,1ZM; für Linkslenker	03.4153-0186.3	010816	ATE Ø 23,81
VW - PASSAT ALLTRACK (3G5) 05/15→							
 Hauptbremszylinder							
1.4 TSI 4motion	110	05/15→		für Linkslenker; +PR 1ZA,1ZD	24.4123-1719.3	011017	TRW Ø 23,81 ohne Bremsflüssigkeitsbehälter
2.0 TDI 4motion	110	05/15→					
2.0 TDI 4motion	135	07/15→					
2.0 TDI 4motion	140	05/15→					
2.0 TDI 4motion	176	05/15→					
2.0 TSI 4motion	162	07/15→					
VW - PASSAT ALLTRACK (365) 01/12→12/14							
 Bremskraftverstärker							
1.8 TSI	112	01/12→12/14		+PR 1ZG; für Linkslenker	03.7873-4402.4	300292	ATE Ø 11" pneumatisch
1.8 TSI	118	01/12→12/14		+PR 1LA,1LB,1ZM; für Linkslenker	03.7873-4502.4	300284	ATE Ø 11" pneumatisch
2.0 TDI	103	01/12→12/14					
2.0 TDI 4motion	103	01/12→12/14					
2.0 TDI 4motion	125	01/12→12/14					
2.0 TDI 4motion	130	01/13→12/14					
2.0 TSI 4motion	155	01/12→12/14					
 Hauptbremszylinder							
1.8 TSI	112	01/12→12/14		+PR 1ZG; für Linkslenker	03.4152-0116.3	010814	ATE Ø 22,2
1.8 TSI	118	01/12→12/14		+PR 1LA,1LB,1ZM; für Linkslenker	03.4153-0186.3	010816	ATE Ø 23,81
2.0 TDI	103	01/12→12/14					
2.0 TDI 4motion	103	01/12→12/14					
2.0 TDI 4motion	125	01/12→12/14					
2.0 TDI 4motion	130	01/13→12/14					
2.0 TSI 4motion	155	01/12→12/14					
VW - PASSAT CC (357) 05/08→01/12							
 Bremskraftverstärker							
1.4 TSI MultiFuel	118	01/11→01/12		→ 09/11; für Linkslenker; +PR 1ZG	03.7873-4402.4	300292	ATE Ø 11" pneumatisch
2.0 TSI	155	11/10→01/12		→ 09/11; +PR 1LA,1LB,1ZM; für Linkslenker	03.7873-4502.4	300284	ATE Ø 11" pneumatisch
1.8 TSI	112	11/08→05/10		+PR 1AS,1ZG; für Linkslenker	03.7873-3902.4	300254	ATE Ø 11" pneumatisch
				für Linkslenker; +PR 1AT,1ZG	03.7873-4402.4	300292	ATE Ø 11" pneumatisch
				+PR 1AT,1LH,1LK,1ZM; für Linkslenker	03.7873-4502.4	300284	ATE Ø 11" pneumatisch
1.8 TSI	118	06/08→01/12		→ 10/10; +PR 1AS,1ZG; für Linkslenker	03.7873-3902.4	300254	ATE Ø 11" pneumatisch
2.0 TDI	103	06/08→01/12		→ 05/10; +PR 1AT,1ZG; für Linkslenker	03.7873-4402.4	300292	ATE Ø 11" pneumatisch
2.0 TDI	125	06/08→01/12					
2.0 TDI 4motion	103	08/09→01/12		06/10→ 09/11; für Linkslenker; +PR 1ZG	03.7873-4402.4	300292	ATE Ø 11" pneumatisch
2.0 TDI 4motion	125	11/09→01/12		11/10→ 09/11; für Linkslenker; +PR 1LA,1LB,1ZM	03.7873-4502.4	300284	ATE Ø 11" pneumatisch
2.0 TSI	147	06/08→01/12		→ 10/10; +PR 1AT,1LH,1LK,1ZM; für Linkslenker	03.7873-4502.4	300284	ATE Ø 11" pneumatisch
2.0 BlueTDI	105	05/09→11/10		→ 10/10; +PR 1AS,1ZG; für Linkslenker	03.7873-3902.4	300254	ATE Ø 11" pneumatisch
2.0 TDI	100	06/08→05/11		06/10→; +PR 1ZG; für Linkslenker	03.7873-4402.4	300292	ATE Ø 11" pneumatisch
2.0 TDI	120	05/08→05/11		→ 05/10; +PR 1AT,1ZG; für Linkslenker	03.7873-4402.4	300292	ATE Ø 11" pneumatisch
↓							























	kw			 	! #		
VW - PASSAT CC (357) 05/08→01/12							
 Bremskraftverstärker							
2.0 BlueTDI	105	05/09→11/10		11/10→; +PR 1LA,1LB,1ZM; für Linkslenker		03.7873-4502.4 300284	ATE Ø 11" pneumatisch
2.0 TDI	100	06/08→05/11					
2.0 TDI	120	05/08→05/11		→ 10/10; +PR 1AT,1LH,1LK,1ZM; für Linkslenker		03.7873-4502.4 300284	ATE Ø 11" pneumatisch
3.6 FSI 4motion	206	06/08→01/12		→ 10/10; +PR 1AS,1ZG; für Linkslenker		03.7873-3902.4 300254	ATE Ø 11" pneumatisch
				→ 10/10; +PR 1AT,1LH,1LK,1ZM; für Linkslenker		03.7873-4502.4 300284	ATE Ø 11" pneumatisch
				11/10→ 09/11; für Linkslenker; +PR 1LA,1LB,1ZM		03.7873-4502.4 300284	ATE Ø 11" pneumatisch
3.6 FSI 4motion	220	06/08→05/10		+PR 1AS,1ZG; für Linkslenker		03.7873-3902.4 300254	ATE Ø 11" pneumatisch
				+PR 1AT,1LH,1LK,1ZM; für Linkslenker		03.7873-4502.4 300284	ATE Ø 11" pneumatisch
 Hauptbremszylinder							
1.4 TSI MultiFuel	118	01/11→01/12		→ 09/11; +PR 1ZG; für Linkslenker		03.4152-0116.3 010814	ATE Ø 22,2
2.0 TDI 4motion	103	08/09→01/12					
2.0 TDI 4motion	125	11/09→01/12		→ 09/11; für Linkslenker; +PR 1LH,1LK,1ZM		03.4153-0186.3 010816	ATE Ø 23,81
1.8 TSI	112	11/08→05/10		+PR 1ZG; für Linkslenker		03.4152-0116.3 010814	ATE Ø 22,2
2.0 BlueTDI	105	05/09→11/10					
2.0 TDI	100	06/08→05/11		+PR 1LH;1LK; für Linkslenker		03.4153-0186.3 010816	ATE Ø 23,81
2.0 TDI	120	05/08→05/11					
3.6 FSI 4motion	220	06/08→05/10					
1.8 TSI	118	06/08→01/12		→ 09/11; +PR 1ZG; für Linkslenker		03.4152-0116.3 010814	ATE Ø 22,2
2.0 TDI	103	06/08→01/12					
2.0 TDI	125	06/08→01/12		→ 09/11; +PR 1LH;1LK; für Linkslenker		03.4153-0186.3 010816	ATE Ø 23,81
2.0 TSI	147	06/08→01/12					
2.0 TSI	155	11/10→01/12					
3.6 FSI 4motion	206	06/08→01/12					
VW - PASSAT Kombi (3B5) 05/97→12/01							
 Hauptbremszylinder							
1.6	74	06/97→11/00		→ 3B-X-800000; - ESP		24.2123-1717.3 010521	Ø 23,81
1.8	112	01/00→12/01					
1.8 T	110	06/97→11/00		→ 3B-X-800000; + ESP		24.2123-1730.3 010620	Ø 23,81
1.9 TDI	81	06/97→11/00		3B-Y-000001→ 3B-1-400000; für Linkslenker; - ESP		24.2125-1712.3 010622	Ø 25,4
1.9 TDI	85	08/98→11/00					
1.9 TDI 4motion	85	08/99→11/00		3B-Y-000001→ 3B-1-400000; für Linkslenker; + ESP		24.2125-1713.3 010623	Ø 25,4
1.9 TDI Syncro/4motion	81	06/97→11/00					
2.3 VR5	110	06/97→11/00		3B-2-000001→		24.2125-1720.3 010688	TRW Ø 25,4
2.3 VR5 Syncro/4motion	110	10/97→11/00					
2.5 TDI Syncro/4motion	110	12/98→11/00					
2.8 V6	132	09/97→09/99					
2.8 V6	140	09/99→11/00					
2.8 V6	142	06/97→11/00					
2.8 V6 4motion	140	09/99→11/00					
2.8 V6 Syncro/4motion	142	06/97→11/00					
1.8	85	06/97→11/00		→ 3B-X-800000; - ESP		24.2123-1717.3 010521	Ø 23,81
1.8	92	06/97→11/00		→ 3B-X-800000; + ESP		24.2123-1730.3 010620	Ø 23,81
1.8 Syncro/4motion	92	06/97→11/00					
1.9 TDI	66	06/97→11/00		3B-Y-000001→; → 09/00; für Linkslenker; - ESP		24.2125-1712.3 010622	Ø 25,4
				3B-Y-000001→; → 09/00; für Linkslenker; + ESP		24.2125-1713.3 010623	Ø 25,4
1.9 TDI	74	02/00→11/00		10/00→; → 3B-1-400000; für Linkslenker; - ESP		24.2125-1712.3 010622	Ø 25,4
2.0	88	04/00→11/00					
2.0 4motion	88	04/00→11/00		10/00→; → 3B-1-400000; für Linkslenker; + ESP		24.2125-1713.3 010623	Ø 25,4
				3B-2-000001→		24.2125-1720.3 010688	TRW Ø 25,4
2.5 TDI	110	07/98→11/00		08/98→; → 3B-X-800000; - ESP		24.2123-1717.3 010521	Ø 23,81
				08/98→; → 3B-X-800000; + ESP		24.2123-1730.3 010620	Ø 23,81
				3B-Y-000001→ 3B-1-400000; für Linkslenker; - ESP		24.2125-1712.3 010622	Ø 25,4
				3B-Y-000001→ 3B-1-400000; für Linkslenker; + ESP		24.2125-1713.3 010623	Ø 25,4
				3B-2-000001→		24.2125-1720.3 010688	TRW Ø 25,4
VW - PASSAT Variant (3A5, 35I) 02/88→06/97							
 Bremskraftverstärker							
1.6	74	07/94→12/95		10/94→; für Linkslenker; - ABS		03.7750-4302.4 300076	ATE Ø 9" pneumatisch
				10/94→; für Rechtslenker; - ABS		03.7750-4902.4 300079	ATE Ø 9" pneumatisch
1.8	55	08/90→05/97		→ 10/93; für Linkslenker; - ABS		03.7750-4302.4 300076	ATE Ø 9" pneumatisch
1.9 TD	55	03/91→05/97					
2.8 VR6	128	06/91→05/97		10/93→ 12/96; für Linkslenker; - ABS		03.7750-4302.4 300076	ATE Ø 9" pneumatisch
				→ 10/93; für Rechtslenker; - ABS		03.7750-4902.4 300079	ATE Ø 9" pneumatisch
				10/93→ 12/95; für Rechtslenker; - ABS		03.7750-4902.4 300079	ATE Ø 9" pneumatisch
↓							











	kw			 	! #		
VW - PASSAT Variant (3A5, 35I) 02/88→06/97							
 Bremskraftverstärker							
1.8	66	02/88→05/97		10/93→ 12/96; für Linkslenker; - ABS	03.7750-4302.4	300076	ATE Ø 9" pneumatisch
				04/88→ 10/93; für Linkslenker; - ABS	03.7750-4302.4	300076	ATE Ø 9" pneumatisch
				10/93→ 12/95; für Rechtslenker; - ABS	03.7750-4902.4	300079	ATE Ø 9" pneumatisch
				04/88→ 10/93; für Rechtslenker; - ABS	03.7750-4902.4	300079	ATE Ø 9" pneumatisch
1.9 TDI	66	10/93→05/97		→ 12/96; für Linkslenker; - ABS	03.7750-4302.4	300076	ATE Ø 9" pneumatisch
2.0 16V	110	01/94→05/97		→ 12/95; für Rechtslenker; - ABS	03.7750-4902.4	300079	ATE Ø 9" pneumatisch
1.9 TDI	81	03/96→05/97		→ 12/96; für Linkslenker; - ABS	03.7750-4302.4	300076	ATE Ø 9" pneumatisch
2.0	79	03/95→08/96		für Linkslenker; - ABS	03.7750-4302.4	300076	ATE Ø 9" pneumatisch
2.0	85	10/93→10/96		→ 12/95; für Rechtslenker; - ABS	03.7750-4902.4	300079	ATE Ø 9" pneumatisch
2.0	85	02/90→05/97		03/90→ 10/93; für Linkslenker; - ABS	03.7750-4302.4	300076	ATE Ø 9" pneumatisch
				10/93→ 12/96; für Linkslenker; - ABS	03.7750-4302.4	300076	ATE Ø 9" pneumatisch
				03/90→ 10/93; für Rechtslenker; - ABS	03.7750-4902.4	300079	ATE Ø 9" pneumatisch
				10/93→ 12/95; für Rechtslenker; - ABS	03.7750-4902.4	300079	ATE Ø 9" pneumatisch
 Hauptbremszylinder							
1.6	74	07/94→12/95		10/94→; - ABS	03.2122-1042.3	010137	Ø 22,2
				3A-T-000001→; für Linkslenker; + ABS	03.2123-1424.3	010637	ATE Ø 23,81
				3A-T-000001→; für Rechtslenker; + ABS	03.2123-1484.3	010595	ATE Ø 23,81
				10/94→; → 3A-S-300000; für Linkslenker; + ABS	10.6123-0674.3	010639	ATE Ø 23,81
1.8	55	08/90→05/97		→ 07/91; - ABS	03.2120-3943.3	010532	ATE Ø 20,64
1.9 TD	55	03/91→05/97		08/91→ 10/93; - ABS	03.2122-1042.3	010137	Ø 22,2
				10/93→ 12/96; - ABS	03.2122-1042.3	010137	Ø 22,2
				3A-T-000001→; → 12/96; für Linkslenker; + ABS	03.2123-1424.3	010637	ATE Ø 23,81
				3A-T-000001→; → 12/96; für Rechtslenker; + ABS	03.2123-1484.3	010595	ATE Ø 23,81
				10/93→; → 3A-S-300000; für Linkslenker; + ABS	10.6123-0674.3	010639	ATE Ø 23,81
1.8	66	02/88→05/97		04/88→ 10/93; - ABS	03.2122-1042.3	010137	Ø 22,2
				10/93→ 12/96; - ABS	03.2122-1042.3	010137	Ø 22,2
				3A-T-000001→; → 12/96; für Linkslenker; + ABS	03.2123-1424.3	010637	ATE Ø 23,81
				3A-T-000001→; → 12/96; für Rechtslenker; + ABS	03.2123-1484.3	010595	ATE Ø 23,81
				10/93→; → 3A-S-300000; für Linkslenker; + ABS	10.6123-0674.3	010639	ATE Ø 23,81
1.9 TDI	66	10/93→05/97		→ 12/96; - ABS	03.2122-1042.3	010137	Ø 22,2
1.9 TDI	81	03/96→05/97		3A-T-000001→; → 12/96; für Linkslenker; + ABS	03.2123-1424.3	010637	ATE Ø 23,81
2.0 16V	110	01/94→05/97		3A-T-000001→; → 12/96; für Rechtslenker; + ABS	03.2123-1484.3	010595	ATE Ø 23,81
				→ 3A-S-300000; für Linkslenker; + ABS	10.6123-0674.3	010639	ATE Ø 23,81
2.0	79	03/95→08/96		- ABS	03.2122-1042.3	010137	Ø 22,2
2.0	85	10/93→10/96		3A-T-000001→; für Linkslenker; + ABS	03.2123-1424.3	010637	ATE Ø 23,81
				3A-T-000001→; für Rechtslenker; + ABS	03.2123-1484.3	010595	ATE Ø 23,81
				→ 3A-S-300000; für Linkslenker; + ABS	10.6123-0674.3	010639	ATE Ø 23,81
2.0	85	02/90→05/97		03/90→ 07/91; - ABS	03.2120-3943.3	010532	ATE Ø 20,64
				08/91→ 10/93; - ABS	03.2122-1042.3	010137	Ø 22,2
				10/93→ 12/96; - ABS	03.2122-1042.3	010137	Ø 22,2
				3A-T-000001→; → 12/96; für Linkslenker; + ABS	03.2123-1424.3	010637	ATE Ø 23,81
				3A-T-000001→; → 12/96; für Rechtslenker; + ABS	03.2123-1484.3	010595	ATE Ø 23,81
				10/93→; → 3A-S-300000; für Linkslenker; + ABS	10.6123-0674.3	010639	ATE Ø 23,81
2.0 Syncro	85	10/90→05/97		3A-T-000001→; → 12/96; für Linkslenker; + ABS	03.2123-1424.3	010637	ATE Ø 23,81
				01/94→; → 3A-S-300000; für Linkslenker; + ABS	10.6123-0674.3	010639	ATE Ø 23,81
2.8 VR6	128	06/91→05/97		10/93→ 12/96; - ABS	03.2122-1042.3	010137	Ø 22,2
				3A-T-000001→; → 12/96; für Linkslenker; + ABS	03.2123-1424.3	010637	ATE Ø 23,81
				3A-T-000001→; → 12/96; für Rechtslenker; + ABS	03.2123-1484.3	010595	ATE Ø 23,81
				10/93→; → 3A-S-300000; für Linkslenker; + ABS	10.6123-0674.3	010639	ATE Ø 23,81
↓							













	kw			 	! #		
VW - PASSAT Variant (3A5, 35I) 02/88→06/97							
 Hauptbremszylinder							
2.9 VR6 Syncro	135	01/94→05/97		3A-T-000001→; → 12/96; für Linkslenker; + ABS		03.2123-1424.3 010637	ATE Ø 23,81
				10/94→; → 3A-S-300000; für Linkslenker; + ABS		10.6123-0674.3 010639	ATE Ø 23,81
Verschlusschraube, Hauptbremszylinder							
1.6	74	07/94→12/95		10/94→; - ABS		03.3517-0101.2 390322	
1.8	55	08/90→05/97		08/91→ 10/93; - ABS		03.3517-0101.2 390322	
1.9 TD	55	03/91→05/97		→ 07/91; - ABS		03.3517-0101.2 390322	
				10/93→ 12/96; - ABS		03.3517-0101.2 390322	
1.8	66	02/88→05/97		04/88→ 10/93; - ABS		03.3517-0101.2 390322	
				10/93→ 12/96; - ABS		03.3517-0101.2 390322	
1.9 TDI	66	10/93→05/97		→ 12/96; - ABS		03.3517-0101.2 390322	
1.9 TDI	81	03/96→05/97					
2.0 16V	110	01/94→05/97					
2.0	79	03/95→08/96		- ABS		03.3517-0101.2 390322	
2.0	85	10/93→10/96					
2.0	85	02/90→05/97		08/91→ 10/93; - ABS		03.3517-0101.2 390322	
				03/90→ 07/91; - ABS		03.3517-0101.2 390322	
				10/93→ 12/96; - ABS		03.3517-0101.2 390322	
2.8 VR6	128	06/91→05/97		10/93→ 12/96; - ABS		03.3517-0101.2 390322	
 Bremskraftregler							
1.6	74	07/94→12/95		10/94→		03.6584-0015.3 320109	ATE lastabhängig 8/4 4x
1.8	55	08/90→05/97		→ 10/93		03.6584-0015.3 320109	ATE lastabhängig 8/4 4x
1.9 TD	55	03/91→05/97		10/93→ 12/96		03.6584-0015.3 320109	ATE lastabhängig 8/4 4x
2.8 VR6	128	06/91→05/97					
1.8	66	02/88→05/97		04/88→ 10/93		03.6584-0015.3 320109	ATE lastabhängig 8/4 4x
				10/93→ 12/96		03.6584-0015.3 320109	ATE lastabhängig 8/4 4x
1.8 G60 Syncro	118	08/88→05/97		→ 10/93		03.6584-0015.3 320109	ATE lastabhängig 8/4 4x
1.9 TDI	66	10/93→05/97		→ 12/96		03.6584-0015.3 320109	ATE lastabhängig 8/4 4x
1.9 TDI	81	03/96→05/97					
2.0 16V	110	01/94→05/97					
2.0	79	03/95→08/96				03.6584-0015.3 320109	ATE lastabhängig 8/4 4x
2.0	85	10/93→10/96					
2.0	85	02/90→05/97		03/90→ 10/93		03.6584-0015.3 320109	ATE lastabhängig 8/4 4x
				10/93→ 12/96		03.6584-0015.3 320109	ATE lastabhängig 8/4 4x
2.0 Syncro	85	10/90→05/97		01/94→ 12/96		03.6584-0015.3 320109	ATE lastabhängig 8/4 4x
				→ 10/93		03.6584-0015.3 320109	ATE lastabhängig 8/4 4x
2.9 VR6 Syncro	135	01/94→05/97		10/94→ 12/96		03.6584-0015.3 320109	ATE lastabhängig 8/4 4x
VW - PASSAT Variant (3B6) 10/00→08/05							
 Hauptbremszylinder							
1.6	75	11/00→05/05		05/02→		03.2125-0373.3 010810	ATE Ø 25,4
1.8 T 20V	110	11/00→05/05		→ 3B-X-800000; - ESP		24.2123-1717.3 010521	Ø 23,81
2.3 VR5	125	11/00→05/05		→ 3B-X-800000; + ESP		24.2123-1730.3 010620	Ø 23,81
2.3 VR5 4motion	125	11/00→05/05					
2.5 TDI	110	11/00→05/05		3B-Y-000001→ 3B-1-400000; für Linkslenker; - ESP		24.2125-1712.3 010622	Ø 25,4
2.5 TDI 4motion	110	11/00→05/05					
2.8 4motion	142	11/00→05/05		3B-Y-000001→ 3B-1-400000; für Linkslenker; + ESP		24.2125-1713.3 010623	Ø 25,4
				3B-2-000001→		24.2125-1720.3 010688	TRW Ø 25,4
1.8 T	125	05/02→08/05		→ 06/05		03.2125-0373.3 010810	ATE Ø 25,4
				→ 3B-X-800000; - ESP		24.2123-1717.3 010521	Ø 23,81
				→ 3B-X-800000; + ESP		24.2123-1730.3 010620	Ø 23,81
				3B-Y-000001→ 3B-1-400000; für Linkslenker; - ESP		24.2125-1712.3 010622	Ø 25,4
				3B-Y-000001→ 3B-1-400000; für Linkslenker; + ESP		24.2125-1713.3 010623	Ø 25,4
				3B-2-000001→; → 06/05		24.2125-1720.3 010688	TRW Ø 25,4
1.9 TDI	74	11/00→05/05		05/02→		03.2125-0373.3 010810	ATE Ø 25,4
1.9 TDI	96	11/00→05/05		→ 3B-1-400000; für Linkslenker; - ESP		24.2125-1712.3 010622	Ø 25,4
1.9 TDI 4motion	96	11/00→05/05					
2.0	85	11/00→05/05		→ 3B-1-400000; für Linkslenker; + ESP		24.2125-1713.3 010623	Ø 25,4
2.0 4motion	85	11/00→05/05					
				3B-2-000001→		24.2125-1720.3 010688	TRW Ø 25,4
2.0	96	11/01→05/05		05/02→		03.2125-0373.3 010810	ATE Ø 25,4
						24.2125-1720.3 010688	TRW Ø 25,4
2.0 TDI	100	12/03→05/05				03.2125-0373.3 010810	ATE Ø 25,4
↓							











	kw			 	! #		
VW - PASSAT Variant (3B6) 10/00→08/05							
 Hauptbremszylinder							
2.0 TDI	100	12/03→05/05				24.2125-1720.3 010688	TRW Ø 25,4
2.5 TDI	120	05/03→05/05				03.2125-0373.3 010810	ATE Ø 25,4
2.5 TDI 4motion	132	01/03→05/05		→ 3B-X-800000; - ESP		24.2123-1717.3 010521	Ø 23,81
				→ 3B-X-800000; + ESP		24.2123-1730.3 010620	Ø 23,81
				3B-Y-000001→ 3B-1-400000; für Linkslenker; - ESP		24.2125-1712.3 010622	Ø 25,4
				3B-Y-000001→ 3B-1-400000; für Linkslenker; + ESP		24.2125-1713.3 010623	Ø 25,4
				3B-2-000001→		24.2125-1720.3 010688	TRW Ø 25,4
2.8	142	10/00→08/05		05/02→ 06/05		03.2125-0373.3 010810	ATE Ø 25,4
				→ 3B-X-800000; - ESP		24.2123-1717.3 010521	Ø 23,81
				→ 3B-X-800000; + ESP		24.2123-1730.3 010620	Ø 23,81
				3B-Y-000001→ 3B-1-400000; für Linkslenker; - ESP		24.2125-1712.3 010622	Ø 25,4
				3B-Y-000001→ 3B-1-400000; für Linkslenker; + ESP		24.2125-1713.3 010623	Ø 25,4
				3B-2-000001→; → 06/05		24.2125-1720.3 010688	TRW Ø 25,4
4.0 W8 4motion	202	09/01→09/04		05/02→		03.2125-0373.3 010810	ATE Ø 25,4
						24.2125-1720.3 010688	TRW Ø 25,4
VW - PASSAT Variant (3C5) 08/05→10/11							
 Bremskraftverstärker							
1.4 TSI	90	05/07→11/10		10/07→ 07/10; +PR 1LK; für Linkslenker		03.7873-4102.4 300212	ATE Ø 11" pneumatisch
				10/07→ 07/10; +PR 1LJ; für Linkslenker		03.7873-4502.4 300284	ATE Ø 11" pneumatisch
1.4 TSI EcoFuel	110	01/09→11/10		→ 07/10; +PR 1LK; für Linkslenker		03.7873-4102.4 300212	ATE Ø 11" pneumatisch
				→ 07/10; +PR 1LJ; für Linkslenker		03.7873-4502.4 300284	ATE Ø 11" pneumatisch
1.6	75	08/05→11/10		→ 07/10; +PR 1LK; für Linkslenker		03.7873-4102.4 300212	ATE Ø 11" pneumatisch
1.6 TDI	77	08/09→11/10		→ 07/10; +PR 1ZG; für Linkslenker		03.7873-4402.4 300292	ATE Ø 11" pneumatisch
1.8 TSI	112	11/09→11/10		→ 07/10; +PR 1ZG; für Linkslenker		03.7873-4402.4 300292	ATE Ø 11" pneumatisch
2.0 BlueTDI	105	01/09→11/10		→ 07/10; +PR 1LJ; für Linkslenker		03.7873-4502.4 300284	ATE Ø 11" pneumatisch
2.0 FSI	110	08/05→11/10					
2.0 FSI	125	08/07→11/10					
2.0 FSI	147	08/05→11/10					
2.0 FSI 4motion	110	09/05→11/10					
2.0 TDI	81	11/08→11/10					
2.0 TDI	100	08/05→11/10					
2.0 TDI	125	08/05→11/10					
2.0 TDI 16V	103	08/05→11/10					
2.0 TDI 4motion	125	05/09→11/10					
3.2 FSI 4motion	184	11/05→11/10					
1.6 FSI	85	08/05→06/08		+PR 1LK; für Linkslenker		03.7873-4102.4 300212	ATE Ø 11" pneumatisch
1.9 TDI	77	08/05→11/08		+PR 1ZG; für Linkslenker		03.7873-4402.4 300292	ATE Ø 11" pneumatisch
2.0 TDI	88	11/05→05/07		+PR 1LJ; für Linkslenker		03.7873-4502.4 300284	ATE Ø 11" pneumatisch
2.0 TDI	90	08/05→02/06					
2.0 TDI	103	08/05→05/09					
2.0 TDI	120	08/05→05/09					
1.8 TSI	118	05/07→10/11		10/07→ 07/10; +PR 1LK; für Linkslenker		03.7873-4102.4 300212	ATE Ø 11" pneumatisch
				10/07→ 07/10; +PR 1ZG; für Linkslenker		03.7873-4402.4 300292	ATE Ø 11" pneumatisch
				10/07→ 07/10; +PR 1LJ; für Linkslenker		03.7873-4502.4 300284	ATE Ø 11" pneumatisch
2.0 TDI 16V 4motion	103	08/05→11/10		09/05→ 07/10; +PR 1LK; für Linkslenker		03.7873-4102.4 300212	ATE Ø 11" pneumatisch
				09/05→ 07/10; +PR 1ZG; für Linkslenker		03.7873-4402.4 300292	ATE Ø 11" pneumatisch
				09/05→ 07/10; +PR 1LJ; für Linkslenker		03.7873-4502.4 300284	ATE Ø 11" pneumatisch
2.0 TDI 4motion	103	08/05→05/09		09/05→; +PR 1LK; für Linkslenker		03.7873-4102.4 300212	ATE Ø 11" pneumatisch
				09/05→; +PR 1ZG; für Linkslenker		03.7873-4402.4 300292	ATE Ø 11" pneumatisch
				09/05→; +PR 1LJ; für Linkslenker		03.7873-4502.4 300284	ATE Ø 11" pneumatisch
3.6 R36 4motion	220	04/07→11/10		→ 07/10; für Linkslenker		03.7873-4502.4 300284	ATE Ø 11" pneumatisch
 Hauptbremszylinder							
1.4 TSI	90	05/07→11/10		10/07→ 07/10; +PR 1ZG; für Linkslenker		03.4152-0116.3 010814	ATE Ø 22,2
1.8 TSI	118	05/07→10/11		10/07→ 07/10; für Linkslenker; +PR 1LJ;1LK;1LH;1LM		03.4153-0186.3 010816	ATE Ø 23,81
1.4 TSI EcoFuel	110	01/09→11/10		→ 07/10; +PR 1ZG; für Linkslenker		03.4152-0116.3 010814	ATE Ø 22,2
1.6	75	08/05→11/10		→ 07/10; +PR 1LJ;1LK;1LH;1LM; für Linkslenker		03.4153-0186.3 010816	ATE Ø 23,81
2.0 BlueTDI	105	01/09→11/10					
2.0 FSI	110	08/05→11/10					
2.0 FSI	125	08/07→11/10					
2.0 FSI	147	08/05→11/10					
2.0 FSI 4motion	110	09/05→11/10					
2.0 TDI	100	08/05→11/10					
2.0 TDI	125	08/05→11/10					
↓							











	kw			 	! #		
VW - PASSAT Variant (3C5) 08/05→10/11							
 Hauptbremszylinder							
3.2 FSI 4motion	184	11/05→11/10		→ 07/10; +PR 1ZG; für Linkslenker		03.4152-0116.3 010814	ATE Ø 22,2
				→ 07/10; +PR 1LJ;1LK;1LH;1LM; für Linkslenker		03.4153-0186.3 010816	ATE Ø 23,81
1.6 FSI	85	08/05→06/08		+PR 1ZG; für Linkslenker		03.4152-0116.3 010814	ATE Ø 22,2
1.9 TDI	77	08/05→11/08					
2.0 TDI	90	08/05→02/06		+PR 1LJ;1LK;1LH;1LM; für Linkslenker		03.4153-0186.3 010816	ATE Ø 23,81
2.0 TDI	103	08/05→05/09					
2.0 TDI	120	08/05→05/09					
1.6 TDI	77	08/09→11/10		→ 07/10; +PR 1ZG; für Linkslenker		03.4152-0116.3 010814	ATE Ø 22,2
1.8 TSI	112	11/09→11/10					
2.0 TDI	81	11/08→11/10		→ 07/10; für Linkslenker; +PR 1LJ,1LK,1LH,1LM		03.4153-0186.3 010816	ATE Ø 23,81
2.0 TDI 16V	103	08/05→11/10					
2.0 TDI 4motion	125	05/09→11/10					
3.6 R36 4motion	220	04/07→11/10					
2.0 TDI	88	11/05→05/07		+PR 1ZG; für Linkslenker		03.4152-0116.3 010814	ATE Ø 22,2
				für Linkslenker; +PR 1LJ,1LK,1LH,1LM		03.4153-0186.3 010816	ATE Ø 23,81
2.0 TDI 16V 4motion	103	08/05→11/10		09/05→ 07/10; +PR 1ZG; für Linkslenker		03.4152-0116.3 010814	ATE Ø 22,2
				09/05→ 07/10; +PR 1LJ;1LK;1LH;1LM; für Linkslenker		03.4153-0186.3 010816	ATE Ø 23,81
2.0 TDI 4motion	103	08/05→05/09		09/05→; +PR 1ZG; für Linkslenker		03.4152-0116.3 010814	ATE Ø 22,2
				09/05→; +PR 1LJ;1LK;1LH;1LM; für Linkslenker		03.4153-0186.3 010816	ATE Ø 23,81
VW - PASSAT Variant (3G5) 08/14→							
 Hauptbremszylinder							
1.4 TSI	92	11/14→		für Linkslenker; +PR 1ZA,1ZD		24.4123-1719.3 011017	TRW Ø 23,81 ohne Bremsflüssigkeitsbehälter
1.4 TSI	110	11/14→					
1.4 TSI 4motion	110	02/15→					
1.8 TSI	132	02/15→					
2.0 TDI	110	11/14→					
2.0 TDI	135	07/15→					
2.0 TDI	140	11/14→					
2.0 TDI 4motion	110	02/15→					
2.0 TDI 4motion	140	11/14→					
2.0 TSI 4motion	206	05/15→					
1.6 TDI	88	08/14→		11/14→; für Linkslenker; +PR 1ZA,1ZD		24.4123-1719.3 011017	TRW Ø 23,81 ohne Bremsflüssigkeitsbehälter
2.0 TDI 4motion	176	08/14→					
2.0 TSI	162	02/15→		05/15→; für Linkslenker; +PR 1ZA,1ZD		24.4123-1719.3 011017	TRW Ø 23,81 ohne Bremsflüssigkeitsbehälter
VW - PASSAT Variant (365) 08/10→12/14							
 Bremskraftverstärker							
1.4 TSI	90	08/10→12/14		→ 10/14; +PR 1ZG; für Linkslenker		03.7873-4402.4 300292	ATE Ø 11" pneumatisch
1.4 TSI	118	11/12→12/14					
1.4 TSI EcoFuel	110	08/10→12/14		→ 10/14; +PR 1LA,1LB,1ZM; für Linkslenker		03.7873-4502.4 300284	ATE Ø 11" pneumatisch
1.4 TSI MultiFuel	118	11/10→12/14					
1.6 TDI	77	08/10→12/14					
1.8 TSI	112	02/11→12/14					
1.8 TSI	118	08/10→12/14					
2.0 TDI	100	08/10→12/14					
2.0 TDI	103	08/10→12/14					
2.0 TDI	125	08/10→12/14					
2.0 TDI	130	12/12→12/14					
2.0 TDI 4motion	103	08/10→12/14					
2.0 TDI 4motion	130	01/13→12/14					
2.0 TSI	155	11/10→12/14					
3.6 FSI 4motion	220	01/11→12/14					
2.0 TDI 4motion	125	08/10→01/13		+PR 1ZG; für Linkslenker		03.7873-4402.4 300292	ATE Ø 11" pneumatisch
				+PR 1LA,1LB,1ZM; für Linkslenker		03.7873-4502.4 300284	ATE Ø 11" pneumatisch
 Hauptbremszylinder							
1.4 TSI	90	08/10→12/14		→ 10/14; +PR 1ZG; für Linkslenker		03.4152-0116.3 010814	ATE Ø 22,2
1.4 TSI	118	11/12→12/14					
1.4 TSI EcoFuel	110	08/10→12/14		→ 10/14; +PR 1LA,1LB,1ZM; für Linkslenker		03.4153-0186.3 010816	ATE Ø 23,81
1.4 TSI MultiFuel	118	11/10→12/14					
1.6 TDI	77	08/10→12/14					
1.8 TSI	112	02/11→12/14					
1.8 TSI	118	08/10→12/14					
2.0 TDI	100	08/10→12/14					
2.0 TDI	103	08/10→12/14					
2.0 TDI	125	08/10→12/14					
2.0 TDI	130	12/12→12/14					
2.0 TDI 4motion	103	08/10→12/14					
2.0 TDI 4motion	130	01/13→12/14					
2.0 TSI	155	11/10→12/14					
3.6 FSI 4motion	220	01/11→12/14					
↓							













	kw				! #						
VW - PASSAT Variant (365) 08/10→12/14											
 Hauptbremszylinder											
2.0 TDI 4motion	125	08/10→01/13		+PR 1ZG; für Linkslenker	03.4152-0116.3	010814	ATE Ø 22,2				
				+PR 1LA,1LB,1ZM; für Linkslenker	03.4153-0186.3	010816	ATE Ø 23,81				
VW - POLO (6N1) 10/94→10/99											
 Bremskraftverstärker											
1.7 SDI	42	04/97→10/99		05/97→; für Linkslenker; + ESP; +PR 1AT,1LX,1ZE,1ZJ / 1ZK	03.7853-0102.4	300252	ATE Ø 9" pneumatisch				
100 1.4 16V	74	04/96→10/99		→ 6N-T-300000; für Linkslenker; + ABS	03.7750-6002.4	300134	ATE Ø 9" pneumatisch				
45 1.0	33	10/94→09/96		für Linkslenker; + ESP; +PR 1AT,1LX,1ZE,1ZJ / 1ZK	03.7853-0102.4	300252	ATE Ø 9" pneumatisch				
55 1.3	40	10/94→07/95									
55 1.4	40	08/95→10/99									
60 1.4	44	07/95→10/99									
64 1.9 D	47	10/94→10/99									
64 1.9 SDI	47	07/96→10/99									
75 1.6 4motion	55	08/95→10/99									
120 1.6 16V GTI	88	09/98→10/99		für Linkslenker; + ESP; +PR 1AT,1LX,1ZE,1ZJ / 1ZK	03.7853-0102.4	300252	ATE Ø 9" pneumatisch				
50 1.0	37	09/96→10/99		→ 6N-T-300000; für Linkslenker; + ABS	03.7750-6002.4	300134	ATE Ø 9" pneumatisch				
60 1.7 SDI	44	08/97→10/99									
75 1.6	55	10/94→10/99									
				→ 09/99; für Linkslenker; + ESP; +PR 1AT,1LX,1ZE,1ZJ / 1ZK	03.7853-0102.4	300252	ATE Ø 9" pneumatisch				
 Hauptbremszylinder											
1.7 SDI	42	04/97→10/99		05/97→; für Linkslenker; - ABS	03.2120-3943.3	010532	ATE Ø 20,64				
				05/97→; + ABS	03.2122-1344.3	010593	ATE Ø 22,2				
100 1.4 16V	74	04/96→10/99		- ABS	03.2122-1184.3	010592	ATE Ø 22,2				
				→ 6N-T-300000; + ABS	03.2123-1484.3	010595	ATE Ø 23,81				
				6N-V-000001→; + ABS	03.2123-1824.3	010596	ATE Ø 23,81				
120 1.6 16V GTI	88	09/98→10/99		+ ABS	03.2123-1824.3	010596	ATE Ø 23,81				
45 1.0	33	10/94→09/96		für Linkslenker; - ABS	03.2120-3943.3	010532	ATE Ø 20,64				
55 1.3	40	10/94→07/95		→ 6N-T-250000; + ABS	03.2122-1184.3	010592	ATE Ø 22,2				
60 1.4	44	07/95→10/99		6N-V-000001→; + ABS	03.2122-1344.3	010593	ATE Ø 22,2				
64 1.9 D	47	10/94→10/99									
64 1.9 SDI	47	07/96→10/99									
75 1.6 4motion	55	08/95→10/99									
50 1.0	37	09/96→10/99						für Linkslenker; - ABS	03.2120-3943.3	010532	ATE Ø 20,64
60 1.7 SDI	44	08/97→10/99						+ ABS	03.2122-1344.3	010593	ATE Ø 22,2
55 1.4	40	08/95→10/99						für Linkslenker; - ABS	03.2120-3943.3	010532	ATE Ø 20,64
75 1.6	55	10/94→10/99		→ 09/99; für Linkslenker; - ABS	03.2120-3943.3	010532	ATE Ø 20,64				
				→ 6N-T-250000; + ABS	03.2122-1184.3	010592	ATE Ø 22,2				
				6N-V-000001→; → 09/99; + ABS	03.2122-1344.3	010593	ATE Ø 22,2				
Verschlusschraube, Hauptbremszylinder											
1.7 SDI	42	04/97→10/99		05/97→; für Linkslenker; - ABS	03.3517-0101.2	390322					
45 1.0	33	10/94→09/96		für Linkslenker; - ABS	03.3517-0101.2	390322					
50 1.0	37	09/96→10/99			03.3517-0101.2	390322					
55 1.3	40	10/94→07/95									
55 1.4	40	08/95→10/99									
60 1.4	44	07/95→10/99									
60 1.7 SDI	44	08/97→10/99									
64 1.9 D	47	10/94→10/99									
64 1.9 SDI	47	07/96→10/99									
75 1.6 4motion	55	08/95→10/99									
75 1.6	55	10/94→10/99						→ 09/99; für Linkslenker; - ABS	03.3517-0101.2	390322	
 Bremskraftregler											
1.7 SDI	42	04/97→10/99		05/97→	03.6583-0184.3	320229	ATE lastabhängig 8/3 4x				
100 1.4 16V	74	04/96→10/99			03.6583-0167.3	320140	ATE lastabhängig 8/3 4x				
					03.6583-0179.3	320228	ATE lastabhängig 8/3 4x				
					03.6583-0184.3	320229	ATE lastabhängig 8/3 4x				
					03.6583-0179.3	320228	ATE lastabhängig 8/3 4x				
120 1.6 16V GTI	88	09/98→10/99			03.6583-0184.3	320229	ATE lastabhängig 8/3 4x				
45 1.0	33	10/94→09/96									
50 1.0	37	09/96→10/99									
55 1.3	40	10/94→07/95									
55 1.4	40	08/95→10/99									
60 1.4	44	07/95→10/99									
60 1.7 SDI	44	08/97→10/99									
64 1.9 D	47	10/94→10/99									
64 1.9 SDI	47	07/96→10/99									
75 1.6 4motion	55	08/95→10/99									
75 1.6	55	10/94→10/99		→ 09/99	03.6583-0184.3	320229	ATE lastabhängig 8/3 4x				















	kw			 	! #		
VW - POLO (6N2) 10/99→10/01							
 Bremskraftverstärker							
1.0 1.4 16V 1.4 TDI 1.6 16V GTI 1.7 SDI	37 55 55 92 44	10/99→09/01 10/99→09/01 10/99→09/01 10/99→09/01 10/99→09/01		für Linkslenker; + ESP; +PR 1AT,1LX,1ZE,1ZJ / 1ZK		03.7853-0102.4 300252	ATE Ø 9" pneumatisch
1.4 1.4 16V 1.9 D 1.9 SDI	40 44 74 47 47	10/99→09/01 10/99→09/01 10/99→09/01 10/99→09/01 10/99→09/01		→ 6N-T-300000; für Linkslenker; + ABS für Linkslenker; + ESP; +PR 1AT,1LX,1ZE,1ZJ / 1ZK		03.7750-6002.4 300134 03.7853-0102.4 300252	ATE Ø 9" pneumatisch ATE Ø 9" pneumatisch
 Hauptbremszylinder							
1.0 1.7 SDI	37 44	10/99→09/01 10/99→09/01		für Linkslenker; - ABS + ABS		03.2120-3943.3 010532 03.2122-1344.3 010593	ATE Ø 20,64 ATE Ø 22,2
1.4 1.4 16V	40 55	10/99→09/01 10/99→09/01		für Linkslenker; - ABS		03.2120-3943.3 010532	ATE Ø 20,64
1.4 1.9 D 1.9 SDI	44 47 47	10/99→09/01 10/99→09/01 10/99→09/01		für Linkslenker; - ABS → 6N-T-250000; + ABS 6N-V-000001→; + ABS		03.2120-3943.3 010532 03.2122-1184.3 010592 03.2122-1344.3 010593	ATE Ø 20,64 ATE Ø 22,2 ATE Ø 22,2
1.4 16V	74	10/99→09/01		- ABS → 6N-T-300000; + ABS 6N-V-000001→; + ABS		03.2122-1184.3 010592 03.2123-1484.3 010595 03.2123-1824.3 010596	ATE Ø 22,2 ATE Ø 23,81 ATE Ø 23,81
1.4 TDI	55	10/99→09/01		+ ABS		03.2122-1184.3 010592 03.2123-1824.3 010596	ATE Ø 22,2 ATE Ø 23,81
1.6 16V GTI	92	10/99→09/01		+ ABS		03.2123-1824.3 010596	ATE Ø 23,81
Verschlusschraube, Hauptbremszylinder							
1.0 1.4 1.4 1.4 16V 1.7 SDI 1.9 D 1.9 SDI	37 40 44 55 44 47 47	10/99→09/01 10/99→09/01 10/99→09/01 10/99→09/01 10/99→09/01 10/99→09/01 10/99→09/01		für Linkslenker; - ABS		03.3517-0101.2 390322	
 Bremskraftregler							
1.0 1.4 1.4 1.7 SDI 1.9 D 1.9 SDI	37 40 44 44 47 47	10/99→09/01 10/99→09/01 10/99→09/01 10/99→09/01 10/99→09/01 10/99→09/01				03.6583-0184.3 320229	ATE lastabhängig 8/3 4x
1.4 16V 1.4 TDI	55 55	10/99→09/01 10/99→09/01		+ ABS - ABS		03.6583-0179.3 320228 03.6583-0184.3 320229	ATE lastabhängig 8/3 4x ATE lastabhängig 8/3 4x
1.4 16V	74	10/99→09/01				03.6583-0167.3 320140 03.6583-0179.3 320228 03.6583-0184.3 320229	ATE lastabhängig 8/3 4x ATE lastabhängig 8/3 4x ATE lastabhängig 8/3 4x
1.6 16V GTI	92	10/99→09/01				03.6583-0179.3 320228	ATE lastabhängig 8/3 4x
VW - POLO (9N_) 10/01→01/12							
 Hauptbremszylinder							
1.2	40	01/02→05/07		9N-5-500001→; + ABS - ABS; für Fahrzeuge mit Servolenkung; → 9N-5-180000 9N-5-500001→; - ABS		24.2119-1712.3 010912 24.2120-1734.3 010702 24.2120-1736.3 010732 24.2120-1736.3 010732	Ø 19,05 ohne Bremsflüssigkeitsbehälter Ø 20,64 Ø 20,64 Ø 20,64
1.2 1.2 12V 1.8 GTI	44 51 110	05/07→11/09 05/07→11/09 09/05→11/09		→ 05/09; + ABS → 05/09; - ABS		24.2119-1712.3 010912 24.2120-1734.3 010702 24.2120-1736.3 010732	Ø 19,05 ohne Bremsflüssigkeitsbehälter Ø 20,64 Ø 20,64
1.2 12V	47	10/01→07/07		11/01→; + ABS 11/01→; - ABS		24.2119-1712.3 010912 24.2120-1734.3 010702 24.2120-1736.3 010732	Ø 19,05 ohne Bremsflüssigkeitsbehälter Ø 20,64 Ø 20,64
1.4	61	08/02→11/09		9N-5-500001→; → 05/09; + ABS 05/06→; → 9N-5-180000; + ABS		24.2119-1712.3 010912 24.2120-1734.3 010702 24.2120-1734.3 010702	Ø 19,05 ohne Bremsflüssigkeitsbehälter Ø 20,64 Ø 20,64
↓							







	kw			 	! #		
VW - POLO (9N_) 10/01→01/12							
 Hauptbremszylinder							
1.4	61	08/02→11/09		05/06→; → 9N-5-180000; - ABS		24.2120-1736.3 010732	Ø 20,64
				9N-5-500001→; → 05/09; - ABS		24.2120-1736.3 010732	Ø 20,64
1.4 16V	55	10/01→05/08		9N-5-500001→; + ABS		24.2119-1712.3 010912	Ø 19,05 ohne Bremsflüssigkeitsbehälter
1.4 16V	74	10/01→05/08					
1.4 TDI	55	10/01→06/05				24.2120-1734.3 010702	Ø 20,64
				11/01→; + ABS; → 9N-5-180000		24.2120-1734.3 010702	Ø 20,64
				11/01→; - ABS; → 9N-5-180000		24.2120-1736.3 010732	Ø 20,64
				9N-5-500001→; - ABS		24.2120-1736.3 010732	Ø 20,64
1.4 16V	59	05/06→11/09		9N-5-500001→; → 05/09; + ABS		24.2119-1712.3 010912	Ø 19,05 ohne Bremsflüssigkeitsbehälter
1.4 TDI	51	04/05→11/09					
1.4 TDI	59	04/05→11/09				24.2120-1734.3 010702	Ø 20,64
1.6 16V	77	05/06→11/09		+ ABS; → 9N-5-180000		24.2120-1734.3 010702	Ø 20,64
1.9 TDI	96	11/03→11/09		- ABS; → 9N-5-180000		24.2120-1736.3 010732	Ø 20,64
2.0	85	10/04→01/12		9N-5-500001→; → 05/09; - ABS		24.2120-1736.3 010732	Ø 20,64
1.4 FSI	63	02/02→07/06		9N-5-500001→; + ABS		24.2119-1712.3 010912	Ø 19,05 ohne Bremsflüssigkeitsbehälter
				+ ABS; → 9N-5-180000		24.2120-1734.3 010702	Ø 20,64
				9N-5-500001→; - ABS		24.2120-1736.3 010732	Ø 20,64
				- ABS; → 9N-5-180000		24.2120-1736.3 010732	Ø 20,64
1.8 GTI Cup Edition	132	05/06→11/09		06/06→ 05/09; + ABS		24.2119-1712.3 010912	Ø 19,05 ohne Bremsflüssigkeitsbehälter
				06/06→ 05/09; - ABS		24.2120-1736.3 010732	Ø 20,64
1.9 SDI	47	10/01→11/09		9N-5-500001→; → 05/09; + ABS		24.2119-1712.3 010912	Ø 19,05 ohne Bremsflüssigkeitsbehälter
1.9 TDI	74	10/01→11/09				24.2120-1734.3 010702	Ø 20,64
				11/01→; + ABS; → 9N-5-180000		24.2120-1734.3 010702	Ø 20,64
				11/01→; - ABS; → 9N-5-180000		24.2120-1736.3 010732	Ø 20,64
				9N-5-500001→; → 05/09; - ABS		24.2120-1736.3 010732	Ø 20,64
 Bremskraftregler							
1.2	40	01/02→05/07		- ABS		03.6583-0216.3 320247	ATE lastabhängig 8/3 4x
1.4	61	08/02→11/09		05/06→ 05/09; - ABS		03.6584-0120.3 320279	ATE lastabhängig 8/4 4x
1.4 16V	55	10/01→05/08		11/01→; - ABS		03.6584-0120.3 320279	ATE lastabhängig 8/4 4x
1.4 16V	74	10/01→05/08					
1.4 TDI	55	10/01→06/05					
1.4 16V	59	05/06→11/09		→ 05/09; - ABS		03.6584-0120.3 320279	ATE lastabhängig 8/4 4x
1.4 TDI	51	04/05→11/09					
1.4 TDI	59	04/05→11/09					
1.6 16V	77	05/06→11/09					
1.9 TDI	96	11/03→11/09					
2.0	85	10/04→01/12					
1.4 FSI	63	02/02→07/06		- ABS		03.6584-0120.3 320279	ATE lastabhängig 8/4 4x
1.9 SDI	47	10/01→11/09		11/01→ 05/09; - ABS		03.6584-0120.3 320279	ATE lastabhängig 8/4 4x
1.9 TDI	74	10/01→11/09					
VW - POLO CLASSIC (6V2) 11/95→07/06							
 Bremskraftverstärker							
1.9 SDI	48	06/96→09/01		für Linkslenker; - ABS		03.7740-1402.4 300133	ATE Ø 8" pneumatisch
54 1.4	40	01/98→08/99		für Linkslenker; + ABS; +PR 1KB		10.6350-3902.4 300213	ATE Ø 9" pneumatisch
57 1.7 SDI	42	07/97→09/01					
60 1.4	44	12/95→09/01		für Linkslenker; + ABS;		10.6350-4002.4 300285	ATE Ø 9" pneumatisch
64 1.9 SDI	47	12/95→08/99		+PR 1KK,1KM,1KQ			
75 1.4 16V	55	10/99→09/01					
1.9 TDI	67	01/97→08/99		für Linkslenker; - ABS		03.7750-6302.4 300161	ATE Ø 9" pneumatisch
2.0	85	08/99→09/01		für Linkslenker; + ABS; +PR 1KB		10.6350-3902.4 300213	ATE Ø 9" pneumatisch
90 1.9 TDI	66	09/96→09/01		für Linkslenker; + ABS;		10.6350-4002.4 300285	ATE Ø 9" pneumatisch
				+PR 1KK,1KM,1KQ			
100 1.6	74	12/95→09/01		für Linkslenker; - ABS		03.7750-6302.4 300161	ATE Ø 9" pneumatisch
				05/96→; für Linkslenker; + ABS;		10.6350-3902.4 300213	ATE Ø 9" pneumatisch
				+PR 1KB			
				05/96→; für Linkslenker; + ABS;		10.6350-4002.4 300285	ATE Ø 9" pneumatisch
				+PR 1KK,1KM,1KQ			
110 1.9 TDI	81	06/98→01/02		für Linkslenker; - ABS; → 09/01		03.7750-6302.4 300161	ATE Ø 9" pneumatisch
				für Linkslenker; + ABS; → 09/01;		10.6350-3902.4 300213	ATE Ø 9" pneumatisch
				+PR 1KB			
↓							

	kw			 	! #		
VW - POLO CLASSIC (6V2) 11/95→07/06							
 Bremskraftverstärker							
110 1.9 TDI	81	06/98→01/02		für Linkslenker; + ABS; → 09/01; +PR 1KK,1KM,1KQ		10.6350-4002.4 300285	ATE Ø 9" pneumatisch
64 1,9 D	47	01/96→10/96		→ 6N-T-300000; für Linkslenker; + ABS		03.7750-6002.4 300134	ATE Ø 9" pneumatisch
				für Linkslenker; + ESP; +PR 1AT,1LX,1ZE,1ZJ / 1ZK		03.7853-0102.4 300252	ATE Ø 9" pneumatisch
68 1.9 SDI	50	08/99→01/02		für Linkslenker; - ABS; → 09/01		03.7740-1402.4 300133	ATE Ø 8" pneumatisch
				für Linkslenker; + ABS; → 09/01; +PR 1KB		10.6350-3902.4 300213	ATE Ø 9" pneumatisch
				für Linkslenker; + ABS; → 09/01; +PR 1KK,1KM,1KQ		10.6350-4002.4 300285	ATE Ø 9" pneumatisch
75 1.6 75 1.6	55	11/95→09/97		09/97→; für Linkslenker; - ABS		03.7740-1402.4 300133	ATE Ø 8" pneumatisch
	55	11/95→09/01		für Linkslenker; + ABS; +PR 1KB		10.6350-3902.4 300213	ATE Ø 9" pneumatisch
90 1.8	66	01/97→09/01		03/98→; für Linkslenker; - ABS		03.7750-6302.4 300161	ATE Ø 9" pneumatisch
				03/98→; für Linkslenker; + ABS; +PR 1KB		10.6350-3902.4 300213	ATE Ø 9" pneumatisch
				03/98→; für Linkslenker; + ABS; +PR 1KK,1KM,1KQ		10.6350-4002.4 300285	ATE Ø 9" pneumatisch
 Hauptbremszylinder							
1.9 SDI	48	06/96→09/01		für Linkslenker; - ABS		03.2120-3943.3 010532	ATE Ø 20,64
54 1.4	40	01/98→08/99		→ 6K-X-523000; für Rechtslenker; - ABS		03.2120-3943.3 010532	ATE Ø 20,64
60 1.4	44	12/95→09/01		→ 6K-X-523000; für Rechtslenker; - ABS		03.2122-1144.3 010636	ATE Ø 22,2
64 1.9 SDI	47	12/95→08/99		für Linkslenker; + ABS		03.2122-1184.3 010592	ATE Ø 22,2
75 1.4 16V	55	10/99→09/01		für Rechtslenker; + ABS		03.2122-1184.3 010592	ATE Ø 22,2
1.9 TDI	67	01/97→08/99		für Linkslenker; - ABS		03.2122-1042.3 010137	Ø 22,2
90 1.9 TDI	66	09/96→09/01		→ 6K-X-523000; für Rechtslenker; - ABS		03.2122-1042.3 010137	Ø 22,2
100 1.6	74	12/95→09/01		für Linkslenker; + ABS		03.2122-1144.3 010636	ATE Ø 22,2
				für Rechtslenker; + ABS		03.2122-1184.3 010592	ATE Ø 22,2
				für Linkslenker; - ABS		03.2122-1042.3 010137	Ø 22,2
110 1.9 TDI	81	06/98→01/02		→ 6K-X-523000; für Rechtslenker; - ABS		03.2122-1042.3 010137	Ø 22,2
				für Linkslenker; + ABS; → 09/01		03.2122-1144.3 010636	ATE Ø 22,2
				für Rechtslenker; + ABS; → 09/01		03.2122-1184.3 010592	ATE Ø 22,2
2.0	85	08/99→09/01		für Linkslenker; - ABS		03.2122-1042.3 010137	Ø 22,2
57 1.7 SDI	42	07/97→09/01		11/97→; → 6K-X-523000; für Rechtslenker; - ABS		03.2120-3943.3 010532	ATE Ø 20,64
64 1,9 D	47	01/96→10/96		für Linkslenker; - ABS		03.2120-3943.3 010532	ATE Ø 20,64
				→ 6N-T-250000; + ABS		03.2122-1184.3 010592	ATE Ø 22,2
				6N-V-000001→; + ABS		03.2122-1344.3 010593	ATE Ø 22,2
68 1.9 SDI	50	08/99→01/02		für Linkslenker; + ABS; → 09/01		03.2122-1144.3 010636	ATE Ø 22,2
				für Rechtslenker; + ABS; → 09/01		03.2122-1184.3 010592	ATE Ø 22,2
				für Linkslenker; - ABS; → 09/01		03.2120-3943.3 010532	ATE Ø 20,64
				→ 6K-X-523000; für Rechtslenker; - ABS		03.2120-3943.3 010532	ATE Ø 20,64
75 1.6 75 1.6	55	11/95→09/97 11/95→09/01		für Linkslenker; + ABS; → 09/01		03.2122-1144.3 010636	ATE Ø 22,2
				für Rechtslenker; + ABS; → 09/01		03.2122-1184.3 010592	ATE Ø 22,2
				6K-V-022629→ 6K-X-523000; für Rechtslenker; - ABS		03.2120-3943.3 010532	ATE Ø 20,64
				6K-V-022629→; für Linkslenker; - ABS		03.2120-3943.3 010532	ATE Ø 20,64
				→ 6K-V-022628; - ABS		03.2122-1042.3 010137	Ø 22,2
90 1.8	66	01/97→09/01		für Linkslenker; + ABS		03.2122-1144.3 010636	ATE Ø 22,2
				03/98→; für Linkslenker; + ABS		03.2122-1144.3 010636	ATE Ø 22,2
Verschlusschraube, Hauptbremszylinder							
64 1,9 D	47	01/96→10/96		für Linkslenker; - ABS		03.3517-0101.2 390322	
 Bremskraftregler							
1.9 SDI	48	06/96→09/01				03.6584-0113.3 320111	ATE lastabhängig 8/4 4x
2.0	85	08/99→09/01					
54 1.4	40	01/98→08/99					
↓							







	kw			 	! #		
VW - POLO CLASSIC (6V2) 11/95→07/06							
 Bremskraftregler							
57 1.7 SDI	42	07/97→09/01				03.6584-0113.3 320111	ATE lastabhängig 8/4 4x
60 1.4	44	12/95→09/01					
64 1.9 SDI	47	12/95→08/99					
75 1.4 16V	55	10/99→09/01					
75 1.6	55	11/95→09/97					
75 1.6	55	11/95→09/01					
1.9 TDI	67	01/97→08/99				03.6583-0179.3 320228	ATE lastabhängig 8/3 4x
90 1.9 TDI	66	09/96→09/01					
100 1.6	74	12/95→09/01		05/96→		03.6584-0113.3 320111	ATE lastabhängig 8/4 4x
110 1.9 TDI	81	06/98→01/02		→ 09/01		03.6583-0179.3 320228	ATE lastabhängig 8/3 4x
64 1.9 D	47	01/96→10/96				03.6583-0184.3 320229	ATE lastabhängig 8/3 4x
68 1.9 SDI	50	08/99→01/02		→ 09/01		03.6584-0113.3 320111	ATE lastabhängig 8/4 4x
90 1.8	66	01/97→09/01		03/98→		03.6584-0113.3 320111	ATE lastabhängig 8/4 4x
VW - POLO Kasten (6NF) 09/94→12/99							
 Bremskraftverstärker							
1.0	33	10/94→12/99		→ 6N-T-300000; für Linkslenker; + ABS		03.7750-6002.4 300134	ATE Ø 9" pneumatisch
				→ 09/96; für Linkslenker; + ESP; +PR 1AT,1LX,1ZE,1ZJ / 1ZK		03.7853-0102.4 300252	ATE Ø 9" pneumatisch
1.4	44	05/98→12/99		→ 6N-T-300000; für Linkslenker; + ABS		03.7750-6002.4 300134	ATE Ø 9" pneumatisch
1.9 D	47	10/94→12/99		für Linkslenker; + ESP; +PR 1AT,1LX,1ZE,1ZJ / 1ZK		03.7853-0102.4 300252	ATE Ø 9" pneumatisch
1.7 SDI	44	08/97→12/99		für Linkslenker; + ESP; +PR 1AT,1LX,1ZE,1ZJ / 1ZK		03.7853-0102.4 300252	ATE Ø 9" pneumatisch
1.9 SDI	47	07/96→12/99		03/97→; für Linkslenker; - ABS		03.7750-6302.4 300161	ATE Ø 9" pneumatisch
				03/97→; für Linkslenker; +PR 1KB; + ABS		10.6350-3902.4 300213	ATE Ø 9" pneumatisch
 Hauptbremszylinder							
1.0	33	10/94→12/99		→ 09/96; für Linkslenker; - ABS		03.2120-3943.3 010532	ATE Ø 20,64
				→ 6N-T-250000; + ABS		03.2122-1184.3 010592	ATE Ø 22,2
				6N-V-000001→; → 09/96; + ABS		03.2122-1344.3 010593	ATE Ø 22,2
1.4	44	05/98→12/99		für Linkslenker; - ABS		03.2120-3943.3 010532	ATE Ø 20,64
1.9 D	47	10/94→12/99		→ 6N-T-250000; + ABS		03.2122-1184.3 010592	ATE Ø 22,2
				6N-V-000001→; + ABS		03.2122-1344.3 010593	ATE Ø 22,2
1.7 SDI	44	08/97→12/99		für Linkslenker; - ABS		03.2120-3943.3 010532	ATE Ø 20,64
				+ ABS		03.2122-1344.3 010593	ATE Ø 22,2
1.9 SDI	47	07/96→12/99		03/97→; - ABS		03.2122-1042.3 010137	Ø 22,2
				03/97→; für Linkslenker; + ABS		03.2122-1144.3 010636	ATE Ø 22,2
				03/97→; für Rechtslenker; + ABS		03.2122-1184.3 010592	ATE Ø 22,2
Verschlusschraube, Hauptbremszylinder							
1.0	33	10/94→12/99		→ 09/96; für Linkslenker; - ABS		03.3517-0101.2 390322	
1.4	44	05/98→12/99		für Linkslenker; - ABS		03.3517-0101.2 390322	
1.7 SDI	44	08/97→12/99					
1.9 D	47	10/94→12/99					
 Bremskraftregler							
1.0	33	10/94→12/99		→ 09/96		03.6583-0184.3 320229	ATE lastabhängig 8/3 4x
1.4	44	05/98→12/99				03.6583-0184.3 320229	ATE lastabhängig 8/3 4x
1.7 SDI	44	08/97→12/99					
1.9 D	47	10/94→12/99					
1.9 SDI	47	07/96→12/99		03/97→		03.6584-0113.3 320111	ATE lastabhängig 8/4 4x
VW - POLO Stufenheck (9A4) 09/02→							
 Hauptbremszylinder							
1.4	55	07/03→		9N-5-500001→; → 05/09; + ABS		24.2119-1712.3 010912	Ø 19,05 ohne Bremsflüssigkeitsbehälter
1.4	74	11/03→					
1.4 TDI	55	07/03→				24.2120-1734.3 010702	Ø 20,64
1.9 SDI	47	09/02→		+ ABS; → 9N-5-180000		24.2120-1734.3 010702	Ø 20,64
1.9 TDi	74	09/02→		- ABS; → 9N-5-180000		24.2120-1736.3 010732	Ø 20,64
2.0	85	09/02→		9N-5-500001→; → 05/09; - ABS		24.2120-1736.3 010732	Ø 20,64
1.6	74	09/02→		9N-5-500001→; → 05/09; + ABS		24.2119-1712.3 010912	Ø 19,05 ohne Bremsflüssigkeitsbehälter
						24.2120-1734.3 010702	Ø 20,64
				05/06→; → 9N-5-180000; + ABS		24.2120-1734.3 010702	Ø 20,64
				05/06→; → 9N-5-180000; - ABS		24.2120-1736.3 010732	Ø 20,64

























	kw			 	! #		
VW - POLO Stufenheck (9A4) 09/02→							
 Hauptbremszylinder							
1.6	74	09/02→		9N-5-500001→; → 05/09; - ABS		24.2120-1736.3 010732	Ø 20,64
 Bremskraftregler							
1.4	55	07/03→		→ 05/09; - ABS		03.6584-0120.3 320279	ATE lastabhängig 8/4 4x
1.4	74	11/03→					
1.4 TDI	55	07/03→					
1.9 SDI	47	09/02→					
1.9 TDi	74	09/02→					
2.0	85	09/02→					
1.6	74	09/02→		05/06→ 05/09; - ABS		03.6584-0120.3 320279	ATE lastabhängig 8/4 4x
VW - POLO Variant (6V5) 04/97→09/01							
 Bremskraftverstärker							
1.4	40	12/98→09/01		für Linkslenker; - ABS		03.7740-1402.4 300133	ATE Ø 8" pneumatisch
1.4	44	05/97→09/01		für Linkslenker; +PR 1KB; + ABS		10.6350-3902.4 300213	ATE Ø 9" pneumatisch
1.4 16V	55	10/99→09/01					
1.6	55	05/97→09/01		für Linkslenker; - ABS		03.7750-6302.4 300161	ATE Ø 9" pneumatisch
1.6	74	05/97→09/01		für Linkslenker; + ABS		10.6350-3902.4 300213	ATE Ø 9" pneumatisch
1.7 SDI	42	08/97→09/01		für Linkslenker; - ABS		03.7750-6302.4 300161	ATE Ø 9" pneumatisch
1.8	66	05/97→09/01		für Linkslenker; +PR 1KB; + ABS		10.6350-3902.4 300213	ATE Ø 9" pneumatisch
1.9 SDI	47	06/97→09/01					
1.9 SDI	50	08/99→09/01					
1.9 TDI	66	05/97→09/01					
1.9 TDI	81	06/98→09/01					
 Hauptbremszylinder							
1.4	40	12/98→09/01		- ABS		03.2122-1042.3 010137	Ø 22,2
1.4	44	05/97→09/01		+ ABS; für Linkslenker		03.2122-1144.3 010636	ATE Ø 22,2
1.4 16V	55	10/99→09/01					
1.6	55	05/97→09/01		für Rechtslenker; + ABS		03.2122-1184.3 010592	ATE Ø 22,2
1.6	74	05/97→09/01					
1.7 SDI	42	08/97→09/01					
1.8	66	05/97→09/01					
1.9 SDI	47	06/97→09/01					
1.9 SDI	50	08/99→09/01					
1.9 TDI	66	05/97→09/01					
1.9 TDI	81	06/98→09/01					
 Bremskraftregler							
1.4	40	12/98→09/01				03.6584-0113.3 320111	ATE lastabhängig 8/4 4x
1.4	44	05/97→09/01					
1.4 16V	55	10/99→09/01					
1.6	55	05/97→09/01					
1.6	74	05/97→09/01					
1.9 SDI	47	06/97→09/01					
1.9 SDI	50	08/99→09/01					
1.8	66	05/97→09/01				03.6583-0179.3 320228	ATE lastabhängig 8/3 4x
1.9 TDI	66	05/97→09/01					
1.9 TDI	81	06/98→09/01					
VW - SCIROCCO (137, 138) 05/08→							
 Bremskraftverstärker							
1.4 TSI	90	08/08→		09/08→; für Linkslenker; +PR 1ZK		03.7860-8802.4 300291	ATE Ø 10" pneumatisch
				09/08→; für Linkslenker; +PR 1ZD,1ZP		03.7863-3232.4 300307	ATE Ø 10" pneumatisch
				09/08→; für Linkslenker; +PR 1ZA,1ZE,1LJ		03.7863-3332.4 300308	ATE Ø 10" pneumatisch
1.4 TSI	92	11/13→		für Linkslenker; +PR 1ZK		03.7860-8802.4 300291	ATE Ø 10" pneumatisch
1.4 TSI	110	07/15→		für Linkslenker; +PR 1ZD,1ZP		03.7863-3232.4 300307	ATE Ø 10" pneumatisch
2.0 R	188	11/09→					
2.0 R	195	11/09→		für Linkslenker; +PR 1ZA,1ZE,1LJ		03.7863-3332.4 300308	ATE Ø 10" pneumatisch
2.0 TDI	100	11/10→					
2.0 TDI	110	11/13→					
2.0 TDI	125	05/09→					
2.0 TDI	130	01/13→					
2.0 TDI	135	05/14→					
2.0 TSI	132	11/13→					
2.0 TSI	155	11/09→05/11					
2.0 TSI	162	11/13→					
1.4 TSI	118	05/08→		08/08→; +PR 1ZK; für Linkslenker		03.7860-8802.4 300291	ATE Ø 10" pneumatisch
2.0 TSI	147	05/08→11/09		08/08→; +PR 1ZD,1ZP; für Linkslenker		03.7863-3232.4 300307	ATE Ø 10" pneumatisch
				08/08→; +PR 1ZA,1ZE,1LJ; für Linkslenker		03.7863-3332.4 300308	ATE Ø 10" pneumatisch
2.0 R	206	05/14→		08/14→; für Linkslenker; +PR 1ZK		03.7860-8802.4 300291	ATE Ø 10" pneumatisch
				08/14→; für Linkslenker; +PR 1ZD,1ZP		03.7863-3232.4 300307	ATE Ø 10" pneumatisch
↓							











	kw			 	! #						
VW - SCIROCCO (137, 138) 05/08→											
Bremskraftverstärker											
2.0 R	206	05/14→		08/14→; für Linkslenker; +PR 1ZA,1ZE,1LJ	03.7863-3332.4	300308	ATE Ø 10" pneumatisch				
2.0 TDI	103	08/08→		10/08→; +PR 1ZK; für Linkslenker	03.7860-8802.4	300291	ATE Ø 10" pneumatisch				
				10/08→; +PR 1ZD,1ZP; für Linkslenker	03.7863-3232.4	300307	ATE Ø 10" pneumatisch				
				10/08→; +PR 1ZA,1ZE,1LJ; für Linkslenker	03.7863-3332.4	300308	ATE Ø 10" pneumatisch				
Hauptbremszylinder											
1.4 TSI	90	08/08→		09/08→; +PR 1ZD,1ZP; für Linkslenker	03.2122-2129.3	010799	ATE Ø 22,2				
				09/08→; +PR 1ZA,1ZE,1LJ,1ZK; für Linkslenker	03.2123-3449.3	010808	ATE Ø 23,81				
1.4 TSI	92	11/13→		für Linkslenker; +PR 1ZD,1ZP	03.2122-2129.3	010799	ATE Ø 22,2				
1.4 TSI	110	07/15→		für Linkslenker; +PR 1ZA,1ZE,1LJ,1ZK	03.2123-3449.3	010808	ATE Ø 23,81				
2.0 R	188	11/09→									
2.0 R	195	11/09→									
2.0 TDI	100	11/10→									
2.0 TDI	110	11/13→									
2.0 TDI	125	05/09→									
2.0 TDI	130	01/13→									
2.0 TDI	135	05/14→									
2.0 TSI	132	11/13→									
2.0 TSI	155	11/09→05/11									
2.0 TSI	162	11/13→									
1.4 TSI	118	05/08→						08/08→; +PR 1ZD,1ZP; für Linkslenker	03.2122-2129.3	010799	ATE Ø 22,2
2.0 TSI	147	05/08→11/09						08/08→; +PR 1ZA,1ZE,1LJ,1ZK; für Linkslenker	03.2123-3449.3	010808	ATE Ø 23,81
2.0 R	206	05/14→		08/14→; für Linkslenker; +PR 1ZD,1ZP	03.2122-2129.3	010799	ATE Ø 22,2				
				08/14→; für Linkslenker; +PR 1ZA,1ZE,1LJ,1ZK	03.2123-3449.3	010808	ATE Ø 23,81				
2.0 TDI	103	08/08→		10/08→; +PR 1ZD,1ZP; für Linkslenker	03.2122-2129.3	010799	ATE Ø 22,2				
				10/08→; +PR 1ZA,1ZE,1LJ,1ZK; für Linkslenker	03.2123-3449.3	010808	ATE Ø 23,81				
Drucksensor, Bremskraftverstärker											
1.4 TSI	90	08/08→		09/08→; für Rechtslenker; +PR 1ZA,1ZB,1ZE,1LJ	03.0655-0101.2	370008	ATE				
				09/08→; für Rechtslenker; +PR 1ZK	03.0655-0101.2	370008	ATE				
				09/08→; für Linkslenker; +PR 1ZK	03.0655-0101.2	370008	ATE				
				09/08→; für Rechtslenker; +PR 1ZD,1ZP	03.0655-0101.2	370008	ATE				
				09/08→; für Linkslenker; +PR 1ZA,1ZE,1LJ	03.0655-0101.2	370008	ATE				
1.4 TSI 1.4 TSI 2.0 R 2.0 R 2.0 TDI 2.0 TDI 2.0 TDI 2.0 TDI 2.0 TDI 2.0 TDI 2.0 TSI 2.0 TSI 2.0 TSI	92 110 188 195 100 110 125 130 135 132 155 162	11/13→ 07/15→ 11/09→ 11/09→ 11/10→ 11/13→ 05/09→ 01/13→ 05/14→ 11/13→ 11/09→05/11 11/13→		für Linkslenker; +PR 1ZK	03.0655-0101.2	370008	ATE				
				für Rechtslenker; +PR 1ZA,1ZB,1ZE,1LJ	03.0655-0101.2	370008	ATE				
				für Linkslenker; +PR 1ZA,1ZE,1LJ	03.0655-0101.2	370008	ATE				
				für Rechtslenker; +PR 1ZD,1ZP	03.0655-0101.2	370008	ATE				
				für Linkslenker; +PR 1ZD,1ZP	03.0655-0101.2	370008	ATE				
				für Rechtslenker; +PR 1ZK	03.0655-0101.2	370008	ATE				
			1.4 TSI 2.0 TSI	118 147	05/08→ 05/08→11/09		08/08→; +PR 1ZD,1ZP; für Linkslenker	03.0655-0101.2	370008	ATE	
							08/08→; +PR 1ZK; für Rechtslenker	03.0655-0101.2	370008	ATE	
							08/08→; +PR 1ZK; für Linkslenker	03.0655-0101.2	370008	ATE	
							08/08→; +PR 1ZD,1ZP; für Rechtslenker	03.0655-0101.2	370008	ATE	
							08/08→; +PR 1ZA,1ZB,1ZE,1LJ; für Rechtslenker	03.0655-0101.2	370008	ATE	
				08/08→; +PR 1ZA,1ZE,1LJ; für Linkslenker	03.0655-0101.2	370008	ATE				
			2.0 R	206	05/14→		08/14→; für Rechtslenker; +PR 1ZD,1ZP	03.0655-0101.2	370008	ATE	
	08/14→; für Rechtslenker; +PR 1ZA,1ZB,1ZE,1LJ	03.0655-0101.2				370008	ATE				
	08/14→; für Linkslenker; +PR 1ZD,1ZP	03.0655-0101.2				370008	ATE				
	08/14→; für Linkslenker; +PR 1ZA,1ZE,1LJ	03.0655-0101.2				370008	ATE				
	08/14→; für Rechtslenker; +PR 1ZK	03.0655-0101.2				370008	ATE				
	08/14→; für Linkslenker; +PR 1ZK	03.0655-0101.2	370008	ATE							
2.0 TDI	103	08/08→		10/08→; +PR 1ZA,1ZE,1LJ; für Linkslenker	03.0655-0101.2	370008	ATE				
↓											













	kw			 	! #		
VW - SCIROCCO (137, 138) 05/08→							
Drucksensor, Bremskraftverstärker							
2.0 TDI	103	08/08→		10/08→; +PR 1ZA,1ZB,1ZE,1LJ; für Rechtslenker	03.0655-0101.2	370008	ATE
				10/08→; +PR 1ZK; für Rechtslenker	03.0655-0101.2	370008	ATE
				10/08→; +PR 1ZD,1ZP; für Rechtslenker	03.0655-0101.2	370008	ATE
				10/08→; +PR 1ZD,1ZP; für Linkslenker	03.0655-0101.2	370008	ATE
				10/08→; +PR 1ZK; für Linkslenker	03.0655-0101.2	370008	ATE
VW - SHARAN (7M8, 7M9, 7M6) 05/95→03/10							
Bremskraftverstärker							
1.8 T 20V	110	09/97→03/10		7M-W-020919→; → 04/00; für Linkslenker	03.7755-1902.4	300138	ATE Ø 9 / 8" pneumatisch
1.9 TDI	66	09/95→03/10					
2.0	85	09/95→03/10		05/02→; - ESP; für Linkslenker	03.7755-6302.4	300221	ATE Ø 9 / 8" pneumatisch
				05/00→ 04/02; +PR 1AT	03.7755-6302.4	300221	ATE Ø 9 / 8" pneumatisch
				→ 7M-W-060000; für Linkslenker	03.7760-3002.4	300120	ATE Ø 10" pneumatisch
				→ 7M-W-020918; für Rechtslenker	03.7760-3002.4	300120	ATE Ø 10" pneumatisch
				05/00→; für Linkslenker; + ESP; → 7M-3-029999	03.7858-3302.4	300122	ATE Ø 9 / 8" pneumatisch
				7M-3-030000→; + ESP; für Linkslenker	03.7858-9502.4	300205	ATE Ø 9 / 8" pneumatisch
1.9 TDI	81	09/96→04/00		7M-W-020919→; für Linkslenker	03.7755-1902.4	300138	ATE Ø 9 / 8" pneumatisch
2.8 VR6	128	09/95→04/00		→ 7M-W-060000; für Linkslenker	03.7760-3002.4	300120	ATE Ø 10" pneumatisch
2.8 VR6 Syncro	128	11/96→04/00		→ 7M-W-020918; für Rechtslenker	03.7760-3002.4	300120	ATE Ø 10" pneumatisch
1.9 TDI	85	04/00→03/10		05/02→; - ESP; für Linkslenker	03.7755-6302.4	300221	ATE Ø 9 / 8" pneumatisch
1.9 TDI 4motion	85	04/00→03/10		05/00→ 04/02; +PR 1AT	03.7755-6302.4	300221	ATE Ø 9 / 8" pneumatisch
				05/00→; für Linkslenker; + ESP; → 7M-3-029999	03.7858-3302.4	300122	ATE Ø 9 / 8" pneumatisch
				7M-3-030000→; + ESP; für Linkslenker	03.7858-9502.4	300205	ATE Ø 9 / 8" pneumatisch
1.9 TDI	96	11/02→03/10		für Linkslenker; - ESP	03.7755-6302.4	300221	ATE Ø 9 / 8" pneumatisch
1.9 TDI	110	06/05→03/10					
2.0 TDI	100	11/05→03/10		für Linkslenker; + ESP	03.7858-9502.4	300205	ATE Ø 9 / 8" pneumatisch
2.0 TDI	103	11/05→03/10					
2.0 16V	110	09/95→02/00		7M-W-020919→; für Linkslenker	03.7755-1902.4	300138	ATE Ø 9 / 8" pneumatisch
				→ 7M-W-060000; für Linkslenker	03.7760-3002.4	300120	ATE Ø 10" pneumatisch
				→ 7M-W-020918; für Rechtslenker	03.7760-3002.4	300120	ATE Ø 10" pneumatisch
				7M-3-030000→; + ESP; für Linkslenker	03.7858-9502.4	300205	ATE Ø 9 / 8" pneumatisch
2.0 LPG	85	04/06→03/10		für Linkslenker; - ESP	03.7755-6302.4	300221	ATE Ø 9 / 8" pneumatisch
				→ 7M-W-060000; für Linkslenker	03.7760-3002.4	300120	ATE Ø 10" pneumatisch
				→ 7M-W-020918; für Rechtslenker	03.7760-3002.4	300120	ATE Ø 10" pneumatisch
				für Linkslenker; + ESP; → 7M-3-029999	03.7858-3302.4	300122	ATE Ø 9 / 8" pneumatisch
				7M-3-030000→; + ESP; für Linkslenker	03.7858-9502.4	300205	ATE Ø 9 / 8" pneumatisch
2.8 V6 24V	150	04/00→03/10		05/02→; - ESP; für Linkslenker	03.7755-6302.4	300221	ATE Ø 9 / 8" pneumatisch
2.8 V6 24V 4motion	150	04/00→03/10		→ 04/02; +PR 1AT	03.7755-6302.4	300221	ATE Ø 9 / 8" pneumatisch
				für Linkslenker; + ESP; → 7M-3-029999	03.7858-3302.4	300122	ATE Ø 9 / 8" pneumatisch
				7M-3-030000→; + ESP; für Linkslenker	03.7858-9502.4	300205	ATE Ø 9 / 8" pneumatisch
Pedalwegsensord, Bremspedal							
1.8 T 20V	110	09/97→03/10		7M-3-030364→; für Rechtslenker; + ESP	03.0655-0006.2	370006	ATE
1.9 TDI	66	09/95→03/10					
1.9 TDI	85	04/00→03/10		7M-3-030000→; + ESP; für Linkslenker	03.0655-0006.2	370006	ATE
1.9 TDI 4motion	85	04/00→03/10					
2.0	85	09/95→03/10					
2.0 16V	110	09/95→02/00					
2.0 LPG	85	04/06→03/10					
2.8 V6 24V	150	04/00→03/10					
2.8 V6 24V 4motion	150	04/00→03/10					
1.9 TDI	96	11/02→03/10		für Linkslenker; + ESP	03.0655-0006.2	370006	ATE
1.9 TDI	110	06/05→03/10					
2.0 TDI	100	11/05→03/10					
2.0 TDI	103	11/05→03/10					
Hauptbremszylinder							
1.8 T 20V	110	09/97→03/10		→ 7M-W-020918; + ABS	03.2123-1526.3	010477	Ø 23,81
				→ 7M-W-020918; - ABS	03.2123-1548.3	010478	Ø 23,81
				05/02→; - ESP; für Rechtslenker	03.2125-0332.3	010952	Ø 25,4
				7M-W-020919→; - ESP; → 04/02	03.2125-0332.3	010952	Ø 25,4
				7M-W-020919→; → 04/00; - ABS	03.2125-8404.3	010583	ATE Ø 25,4
				05/00→; + ESP; → 7M-3-029999	03.2125-9604.3	010581	Ø 25,4
1.9 TDI	66	09/95→03/10		→ 7M-W-020918; + ABS	03.2123-1526.3	010477	Ø 23,81
↓							











	kW			 	! #		
VW - SHARAN (7M8, 7M9, 7M6) 05/95→03/10							
 Hauptbremszylinder							
2.0	85	09/95→03/10		→ 7M-W-020918; - ABS		03.2123-1548.3 010478	Ø 23,81
				7M-W-020919→; - ESP; → 04/02		03.2125-0332.3 010952	Ø 25,4
				05/02→; - ESP; für Rechtslenker; → 05/05		03.2125-0332.3 010952	Ø 25,4
				7M-W-020919→; → 04/00; - ABS		03.2125-8404.3 010583	ATE Ø 25,4
				05/00→; + ESP; → 7M-3-029999		03.2125-9604.3 010581	Ø 25,4
1.9 TDI	81	09/96→04/00		→ 7M-W-020918; + ABS		03.2123-1526.3 010477	Ø 23,81
2.0 16V	110	09/95→02/00		→ 7M-W-020918; - ABS		03.2123-1548.3 010478	Ø 23,81
2.8 VR6	128	09/95→04/00		7M-W-020919→; - ESP		03.2125-0332.3 010952	Ø 25,4
2.8 VR6 Syncro	128	11/96→04/00		7M-W-020919→; - ABS		03.2125-8404.3 010583	ATE Ø 25,4
1.9 TDI	85	04/00→03/10		05/02→; - ESP; für Rechtslenker; → 05/05		03.2125-0332.3 010952	Ø 25,4
1.9 TDI 4motion	85	04/00→03/10		05/00→; + ESP; → 7M-3-029999		03.2125-9604.3 010581	Ø 25,4
1.9 TDI	96	11/02→03/10		- ESP; für Rechtslenker; → 05/05		03.2125-0332.3 010952	Ø 25,4
2.0 LPG	85	04/06→03/10		→ 7M-W-020918; + ABS		03.2123-1526.3 010477	Ø 23,81
				→ 7M-W-020918; - ABS		03.2123-1548.3 010478	Ø 23,81
				+ ESP; → 7M-3-029999		03.2125-9604.3 010581	Ø 25,4
2.8 V6 24V	150	04/00→03/10		+ ESP; → 7M-3-029999		03.2125-9604.3 010581	Ø 25,4
2.8 V6 24V 4motion	150	04/00→03/10					
Verschlusschraube, Hauptbremszylinder							
1.8 T 20V	110	09/97→03/10		→ 7M-W-020918		03.3517-5100.1 390326	
1.9 TDI	66	09/95→03/10					
1.9 TDI	81	09/96→04/00					
2.0	85	09/95→03/10					
2.0 16V	110	09/95→02/00					
2.0 LPG	85	04/06→03/10					
2.8 VR6	128	09/95→04/00					
2.8 VR6 Syncro	128	11/96→04/00					
VW - SHARAN (7N1, 7N2) 05/10→							
 Bremskraftverstärker							
1.4 TSI	110	05/10→		07/10→; für Linkslenker		03.7873-4502.4 300284	ATE Ø 11" pneumatisch
2.0 TDI	100	05/10→					
2.0 TDI	103	05/10→					
1.8 TSI	118	11/11→		05/12→; für Linkslenker		03.7873-4502.4 300284	ATE Ø 11" pneumatisch
2.0 TDI	85	05/11→		für Linkslenker		03.7873-4502.4 300284	ATE Ø 11" pneumatisch
2.0 TDI	125	08/10→					
2.0 TDI	130	01/13→					
2.0 TDI 4motion	103	05/11→					
2.0 TSI	147	12/10→					
 Hauptbremszylinder							
1.4 TSI	110	05/10→		07/10→; für Linkslenker		03.4153-0186.3 010816	ATE Ø 23,81
2.0 TDI	100	05/10→					
2.0 TDI	103	05/10→					
1.4 TSI	110	05/15→		für Linkslenker		03.4153-0186.3 010816	ATE Ø 23,81
2.0 TDI	85	05/11→					
2.0 TDI	110	05/15→					
2.0 TDI	125	08/10→					
2.0 TDI	130	01/13→					
2.0 TDI	135	05/15→					
2.0 TDI 4motion	103	05/11→					
2.0 TDI 4motion	110	05/15→					
2.0 TDI 4motion	135	05/16→					
2.0 TSI	147	12/10→					
2.0 TSI	162	05/15→					
1.8 TSI	118	11/11→		05/12→; für Linkslenker		03.4153-0186.3 010816	ATE Ø 23,81
VW - TIGUAN (5N_) 09/07→							
 Bremskraftverstärker							
1.4 TSI	90	08/10→		für Linkslenker		03.7873-4502.4 300284	ATE Ø 11" pneumatisch
1.4 TSI	92	05/15→					
1.4 TSI	110	05/08→					
1.4 TSI	110	05/15→					
1.4 TSI	118	05/11→					
1.4 TSI 4motion	110	09/07→					
1.4 TSI 4motion	118	05/11→					
2.0 TDI	81	05/10→					
2.0 TDI	103	03/08→					
2.0 TDI	110	05/15→					
2.0 TDI 4motion	100	11/07→					
2.0 TDI 4motion	110	05/15→					
↓							

	kw					! #		
VW - TIGUAN (5N_) 09/07→								
 Bremskraftverstärker								
2.0 TDI 4motion	120	02/08→08/09		für Linkslenker		03.7873-4502.4	300284	ATE Ø 11" pneumatisch
2.0 TDI 4motion	130	11/12→						
2.0 TDI 4motion	135	05/15→						
2.0 TSI 4motion	132	05/11→						
2.0 TSI 4motion	155	05/11→						
2.0 TDI 4motion	103	09/07→		11/07→; für Linkslenker		03.7873-4502.4	300284	ATE Ø 11" pneumatisch
2.0 TDI 4motion	125	09/07→		01/08→; für Linkslenker		03.7873-4502.4	300284	ATE Ø 11" pneumatisch
2.0 TFSI 4motion	125	09/07→		02/08→; für Linkslenker		03.7873-4502.4	300284	ATE Ø 11" pneumatisch
2.0 TFSI 4motion	147	09/07→						
 Hauptbremszylinder								
1.4 TSI	90	08/10→		für Linkslenker		03.4153-0186.3	010816	ATE Ø 23,81
1.4 TSI	92	05/15→						
1.4 TSI	110	05/08→						
1.4 TSI	110	05/15→						
1.4 TSI	118	05/11→						
1.4 TSI 4motion	110	09/07→						
1.4 TSI 4motion	118	05/11→						
2.0 TDI	81	05/10→						
2.0 TDI	103	03/08→						
2.0 TDI	110	05/15→						
2.0 TDI 4motion	100	11/07→						
2.0 TDI 4motion	110	05/15→						
2.0 TDI 4motion	120	02/08→08/09						
2.0 TDI 4motion	130	11/12→						
2.0 TDI 4motion	135	05/15→						
2.0 TSI 4motion	132	05/11→						
2.0 TSI 4motion	155	05/11→						
2.0 TDI 4motion	103	09/07→		11/07→; für Linkslenker		03.4153-0186.3	010816	ATE Ø 23,81
2.0 TDI 4motion	125	09/07→		01/08→; für Linkslenker		03.4153-0186.3	010816	ATE Ø 23,81
2.0 TFSI 4motion	125	09/07→		02/08→; für Linkslenker		03.4153-0186.3	010816	ATE Ø 23,81
2.0 TFSI 4motion	147	09/07→						
VW - TIGUAN (AD1) 01/16→								
 Hauptbremszylinder								
1.4 TSI	92	01/16→		für Linkslenker; +PR 1ZA,1ZD		24.4123-1719.3	011017	TRW Ø 23,81 ohne Bremsflüssigkeitsbehälter
1.4 TSI	110	05/16→						
1.4 TSI 4motion	110	05/16→						
1.6 TDI	85	05/16→						
2.0 TDI	81	08/16→						
2.0 TDI	85	05/16→						
2.0 TDI 4motion	105	06/16→						
2.0 TDI 4motion	130	08/16→						
2.0 TDI 4motion	140	04/16→						
2.0 TDI 4motion	176	05/16→						
2.0 TSI 4motion	162	06/16→						
2.0 TDI	110	01/16→		02/16→; für Linkslenker; +PR 1ZA,1ZD		24.4123-1719.3	011017	TRW Ø 23,81 ohne Bremsflüssigkeitsbehälter
2.0 TDI 4motion	110	01/16→						
2.0 TSI 4motion	132	01/16→						
VW - TOUAREG (7LA, 7L6, 7L7) 10/02→05/10								
 Bremskraftverstärker								
2.5 R5 TDI	120	08/03→05/10		12/06→; für Linkslenker; → 03/10; +PR 1LB,1LE,LF		03.7868-3702.4	300208	ATE Ø 10 / 8" pneumatisch
2.5 R5 TDI	128	01/03→05/10						
3.0 TDI	155	04/06→05/10		12/06→; für Linkslenker; → 03/10; +PR 1LA		03.7868-5302.4	300251	ATE Ø 10 / 8" pneumatisch
3.0 V6 TDI	165	11/04→05/10						
3.6 V6 FSI	206	10/05→05/10						
4.2 V8 FSI	257	06/06→05/10						
5.0 V10 TDI	230	10/02→05/10						
3.0 V6 TDI	176	11/07→05/10		→ 03/10; für Linkslenker; +PR 1LB,1LE,LF		03.7868-3702.4	300208	ATE Ø 10 / 8" pneumatisch
				→ 03/10; für Linkslenker; +PR 1LA		03.7868-5302.4	300251	ATE Ø 10 / 8" pneumatisch
5.0 R50 TDI	257	08/07→05/10		01/08→ 03/10; für Linkslenker; +PR 1LB,1LE,LF		03.7868-3702.4	300208	ATE Ø 10 / 8" pneumatisch
				01/08→ 03/10; für Linkslenker; +PR 1LA		03.7868-5302.4	300251	ATE Ø 10 / 8" pneumatisch
Pedalwegsensor, Bremspedal								
2.5 R5 TDI	120	08/03→05/10		für Rechtslenker; → 11/06		03.0655-0006.2	370006	ATE
2.5 R5 TDI	128	01/03→05/10						
3.0 TDI	155	04/06→05/10		für Linkslenker; → 11/06		03.0655-0006.2	370006	ATE
3.0 V6 TDI	165	11/04→05/10						
6.0 W12	331	08/04→05/10						
3.2 V6	162	10/02→11/06		11/02→; für Rechtslenker; → 12/05		03.0655-0006.2	370006	ATE
				11/02→; für Linkslenker; → 12/05		03.0655-0006.2	370006	ATE
3.2 V6	177	11/04→11/06		für Linkslenker; → 12/05		03.0655-0006.2	370006	ATE
↓								

	kw			 	! #		
VW - TOUAREG (7LA, 7L6, 7L7) 10/02→05/10							
Pedalwegsensor, Bremspedal							
3.2 V6	177	11/04→11/06		für Rechtslenker; → 12/05		03.0655-0006.2 370006	ATE
3.6 V6 FSI	206	10/05→05/10		01/06→ 11/06; für Rechtslenker		03.0655-0006.2 370006	ATE
				01/06→ 11/06; für Linkslenker		03.0655-0006.2 370006	ATE
4.2 V8	228	12/02→11/06		für Linkslenker		03.0655-0006.2 370006	ATE
				für Rechtslenker		03.0655-0006.2 370006	ATE
5.0 V10 TDI	230	10/02→05/10		11/02→; für Linkslenker; → 11/06		03.0655-0006.2 370006	ATE
				11/02→; für Rechtslenker; → 11/06		03.0655-0006.2 370006	ATE
 Hauptbremszylinder							
2.5 R5 TDI	120	08/03→05/10		für Linkslenker; → 03/10		03.2126-3014.3 010811	ATE Ø 26,99
2.5 R5 TDI	128	01/03→05/10					
3.0 TDI	155	04/06→05/10					
3.0 V6 TDI	165	11/04→05/10					
3.0 V6 TDI	176	11/07→05/10					
3.2 V6	162	10/02→11/06		11/02→; für Linkslenker; → 12/05		03.2126-3014.3 010811	ATE Ø 26,99
3.2 V6	177	11/04→11/06		für Linkslenker; → 12/05		03.2126-3014.3 010811	ATE Ø 26,99
3.6 V6 FSI	206	10/05→05/10		01/06→ 03/10; für Linkslenker		03.2126-3014.3 010811	ATE Ø 26,99
4.2 V8	228	12/02→11/06		für Linkslenker		03.2126-3014.3 010811	ATE Ø 26,99
4.2 V8 FSI	257	06/06→05/10		12/06→ 03/10; für Linkslenker		03.2126-3014.3 010811	ATE Ø 26,99
5.0 R50 TDI	257	08/07→05/10		01/08→ 03/10; für Linkslenker		03.2126-3014.3 010811	ATE Ø 26,99
5.0 V10 TDI	230	10/02→05/10		11/02→; für Linkslenker; → 03/10		03.2126-3014.3 010811	ATE Ø 26,99
6.0 W12	331	08/04→05/10		für Linkslenker; → 11/06		03.2126-3014.3 010811	ATE Ø 26,99
VW - TOURAN (1T1, 1T2) 02/03→05/10							
 Bremskraftverstärker							
1.4 FSI	125	11/06→05/10		für Linkslenker; +PR 1AS		03.7873-3702.4 300283	ATE Ø 11" pneumatisch
1.4 TSI EcoFuel	110	05/09→05/10					
1.6	75	07/03→05/10		für Linkslenker; +PR 1AT		03.7873-4302.4 300312	ATE Ø 11" pneumatisch
1.6 FSI	85	02/03→01/07					
1.9 TDI	66	11/04→05/10					
1.9 TDI	74	02/03→05/04					
1.9 TDI	77	08/03→05/10					
2.0 EcoFuel	80	02/06→05/09					
2.0 FSI	85	10/04→05/10					
2.0 FSI	110	10/03→01/07					
2.0 TDI	103	12/05→05/10					
2.0 TDI 16V	103	08/03→05/10					
1.4 TSI	103	02/06→05/10		09/06→; +PR 1AS; für Linkslenker		03.7873-3702.4 300283	ATE Ø 11" pneumatisch
				09/06→; +PR 1AT; für Linkslenker		03.7873-4302.4 300312	ATE Ø 11" pneumatisch
2.0 TDI	100	02/03→05/10		08/03→; für Linkslenker; +PR 1AS		03.7873-3702.4 300283	ATE Ø 11" pneumatisch
				08/03→; für Linkslenker; +PR 1AT		03.7873-4302.4 300312	ATE Ø 11" pneumatisch
2.0 TDI	125	12/05→05/10		02/06→; +PR 1AS; für Linkslenker		03.7873-3702.4 300283	ATE Ø 11" pneumatisch
				02/06→; +PR 1AT; für Linkslenker		03.7873-4302.4 300312	ATE Ø 11" pneumatisch
 Hauptbremszylinder							
1.4 FSI	125	11/06→05/10		für Linkslenker; +PR 1ZE,1ZP		03.2122-2129.3 010799	ATE Ø 22,2
1.6	75	07/03→05/10					
1.9 TDI	66	11/04→05/10					
1.9 TDI	74	02/03→05/04					
1.9 TDI	77	08/03→05/10					
2.0 EcoFuel	80	02/06→05/09					
2.0 FSI	85	10/04→05/10					
2.0 FSI	110	10/03→01/07					
2.0 TDI	103	12/05→05/10					
2.0 TDI 16V	103	08/03→05/10					
1.4 TSI	103	02/06→05/10		09/06→; +PR 1ZE,1ZP; für Linkslenker		03.2122-2129.3 010799	ATE Ø 22,2
1.4 TSI EcoFuel	110	05/09→05/10		für Linkslenker		03.2122-2129.3 010799	ATE Ø 22,2
1.6 FSI	85	02/03→01/07					
2.0 TDI	100	02/03→05/10		08/03→; für Linkslenker; +PR 1ZE,1ZP		03.2122-2129.3 010799	ATE Ø 22,2
2.0 TDI	125	12/05→05/10		02/06→; für Linkslenker; +PR 1ZE,1ZP		03.2122-2129.3 010799	ATE Ø 22,2
Hydraulikaggregat, Bremsanlage							
1.4 FSI	125	11/06→05/10		+PR 1AT,1AS		24.9145-0001.2 399005	
1.4 TSI EcoFuel	110	05/09→05/10					
1.6	75	07/03→05/10					
1.6 FSI	85	02/03→01/07					
1.9 TDI	66	11/04→05/10					
1.9 TDI	74	02/03→05/04					
1.9 TDI	77	08/03→05/10					
2.0 EcoFuel	80	02/06→05/09					
2.0 FSI	85	10/04→05/10					
2.0 FSI	110	10/03→01/07					



	kw			 	! #		
VW - TOURAN (1T1, 1T2) 02/03→05/10							
Hydraulikaggregat, Bremsanlage							
2.0 TDI	103	12/05→05/10		+PR 1AT,1AS		24.9145-0001.2	399005
2.0 TDI 16V	103	08/03→05/10					
1.4 TSI	103	02/06→05/10		09/06→; +PR 1AT,1AS		24.9145-0001.2	399005
2.0 TDI	100	02/03→05/10		08/03→; +PR 1AT,1AS		24.9145-0001.2	399005
2.0 TDI	125	12/05→05/10		02/06→; +PR 1AT,1AS		24.9145-0001.2	399005
Drucksensor, Bremskraftverstärker							
1.4 FSI	125	11/06→05/10		für Rechtslenker; +PR 1AS		03.0655-0101.2	370008 ATE
1.4 TSI EcoFuel	110	05/09→05/10					
1.6	75	07/03→05/10					
1.6 FSI	85	02/03→01/07					
1.9 TDI	66	11/04→05/10					
1.9 TDI	74	02/03→05/04					
1.9 TDI	77	08/03→05/10					
2.0 EcoFuel	80	02/06→05/09					
2.0 FSI	85	10/04→05/10					
2.0 FSI	110	10/03→01/07					
2.0 TDI	103	12/05→05/10					
2.0 TDI 16V	103	08/03→05/10					
1.4 TSI	103	02/06→05/10		09/06→; +PR 1AS; für Rechtslenker		03.0655-0101.2	370008 ATE
2.0 TDI	100	02/03→05/10		08/03→; für Rechtslenker; +PR 1AS		03.0655-0101.2	370008 ATE
2.0 TDI	125	12/05→05/10		02/06→; +PR 1AS; für Rechtslenker		03.0655-0101.2	370008 ATE
VW - TOURAN (1T3) 05/10→05/15							
 Bremskraftverstärker							
1.2 TSI	77	05/10→05/15		für Linkslenker; +PR 1AS		03.7873-3702.4	300283 ATE Ø 11" pneumatisch
1.4 TSI	103	05/10→05/15					
1.4 TSI	125	05/10→05/15		für Linkslenker; +PR 1AT		03.7873-4302.4	300312 ATE Ø 11" pneumatisch
1.4 TSI EcoFuel	110	05/10→05/15					
1.6 TDI	66	05/10→05/15					
1.6 TDI	77	05/10→05/15					
2.0 TDI	81	11/10→05/15					
2.0 TDI	103	05/10→05/15					
2.0 TDI	125	05/10→01/13					
2.0 TDI	130	01/13→05/15		für Linkslenker		03.7873-4302.4	300312 ATE Ø 11" pneumatisch
 Hauptbremszylinder							
1.2 TSI	77	05/10→05/15		für Linkslenker; +PR 1ZE,1ZP		03.2122-2129.3	010799 ATE Ø 22,2
1.4 TSI	103	05/10→05/15					
1.4 TSI	125	05/10→05/15					
1.6 TDI	66	05/10→05/15					
1.6 TDI	77	05/10→05/15					
2.0 TDI	81	11/10→05/15					
2.0 TDI	103	05/10→05/15					
2.0 TDI	125	05/10→01/13					
1.4 TSI EcoFuel	110	05/10→05/15		für Linkslenker		03.2122-2129.3	010799 ATE Ø 22,2
2.0 TDI	130	01/13→05/15					
Hydraulikaggregat, Bremsanlage							
1.2 TSI	77	05/10→05/15		→ 12/10; +PR 1AT,1AS		24.9145-0001.2	399005
1.4 TSI	103	05/10→05/15					
1.4 TSI	125	05/10→05/15					
1.4 TSI EcoFuel	110	05/10→05/15					
1.6 TDI	66	05/10→05/15					
1.6 TDI	77	05/10→05/15					
2.0 TDI	81	11/10→05/15					
2.0 TDI	103	05/10→05/15					
2.0 TDI	125	05/10→01/13					
Drucksensor, Bremskraftverstärker							
1.2 TSI	77	05/10→05/15		für Rechtslenker; +PR 1AS		03.0655-0101.2	370008 ATE
1.4 TSI	103	05/10→05/15					
1.4 TSI	125	05/10→05/15					
1.4 TSI EcoFuel	110	05/10→05/15					
1.6 TDI	66	05/10→05/15					
1.6 TDI	77	05/10→05/15					
2.0 TDI	81	11/10→05/15					
2.0 TDI	103	05/10→05/15					
2.0 TDI	125	05/10→01/13					
VW - TOURAN (5T1) 05/15→							
 Hauptbremszylinder							
1.2 TSI	81	05/15→		09/15→; für Linkslenker		24.4123-1719.3	011017 TRW Ø 23,81 ohne Bremsflüssigkeitsbehälter
1.4 TSI	110	05/15→					
1.6 TDI	81	05/15→05/16					
2.0 TDI	110	05/15→					
↓							

	kw			 	! #		
VW - TOURAN (5T1) 05/15 →							
 Hauptbremszylinder							
1.6 TDI 1.8 TSI 2.0 TDI 2.0 TDI	85 132 81 140	05/16 → 11/15 → 11/15 → 11/15 →		für Linkslenker		24.4123-1719.3 011017	TRW Ø 23,81 ohne Bremsflüssigkeitsbehälter
VW - TRANSPORTER T4 Bus (70XB, 70XC, 7DB, 7DW, 7DK) 09/90 → 04/03							
 Bremskraftverstärker							
1.9 D 1.9 D 2.4 D	44 45 57	09/90 → 12/95 09/90 → 12/95 09/90 → 04/98		07/95 →; für Rechtslenker; → 70-T-199000 → 70-S-127805		03.7750-7402.4 300084	ATE Ø 9" pneumatisch
				70-S-127806 →; → 06/95		03.7755-4202.4 300164	ATE Ø 9 / 8" pneumatisch
				70-T-200001 →		03.7755-4202.4 300164	ATE Ø 9 / 8" pneumatisch
				07/95 →; für Linkslenker; → 70-T-199000		03.7755-4202.4 300164	ATE Ø 9 / 8" pneumatisch
1.9 TD 2.0 2.5 2.5 Syncro	50 62 81 81	10/92 → 04/03 09/90 → 04/03 11/90 → 04/03 11/92 → 04/03		07/95 →; für Rechtslenker; → 70-T-199000 → 70-S-127805		03.7750-7402.4 300084	ATE Ø 9" pneumatisch
				70-S-127806 →; → 06/95		03.7755-4202.4 300164	ATE Ø 9 / 8" pneumatisch
				70-T-200001 →		03.7755-4202.4 300164	ATE Ø 9 / 8" pneumatisch
				07/95 →; für Linkslenker; → 70-T-199000		03.7755-4202.4 300164	ATE Ø 9 / 8" pneumatisch
				05/98 →		03.7755-4302.4 300165	ATE Ø 9 / 8" pneumatisch
2.4 D 2.5 2.5 Syncro	55 85 85	08/97 → 04/03 08/96 → 04/03 07/96 → 04/03		für Rechtslenker; → 70-T-199000 → 70-S-127805		03.7750-7402.4 300084	ATE Ø 9" pneumatisch
				70-T-200001 →		03.7755-4202.4 300164	ATE Ø 9 / 8" pneumatisch
				für Linkslenker; → 70-T-199000		03.7755-4202.4 300164	ATE Ø 9 / 8" pneumatisch
				05/98 →		03.7755-4302.4 300165	ATE Ø 9 / 8" pneumatisch
2.4 D Syncro	57	10/92 → 09/98		07/95 →; für Rechtslenker; → 70-T-199000		03.7750-7402.4 300084	ATE Ø 9" pneumatisch
				11/92 →; → 70-S-127805		03.7750-7402.4 300084	ATE Ø 9" pneumatisch
				70-T-200001 →		03.7755-4202.4 300164	ATE Ø 9 / 8" pneumatisch
				70-S-127806 →; → 06/95		03.7755-4202.4 300164	ATE Ø 9 / 8" pneumatisch
				07/95 →; für Linkslenker; → 70-T-199000		03.7755-4202.4 300164	ATE Ø 9 / 8" pneumatisch
				05/98 →		03.7755-4302.4 300165	ATE Ø 9 / 8" pneumatisch
2.5 TDI 2.5 TDI 2.8 VR6	65 111 150	05/98 → 04/03 05/98 → 04/03 04/00 → 04/03		für Rechtslenker; → 70-T-199000 für Linkslenker; → 70-T-199000 70-T-200001 →		03.7750-7402.4 300084 03.7755-4202.4 300164 03.7755-4202.4 300164	ATE Ø 9" pneumatisch ATE Ø 9 / 8" pneumatisch ATE Ø 9 / 8" pneumatisch
						03.7755-4302.4 300165	ATE Ø 9 / 8" pneumatisch
2.5 TDI 2.5 TDI Syncro 2.8 VR 6	75 75 103	09/95 → 04/03 01/96 → 04/03 11/95 → 04/00		für Rechtslenker; → 70-T-199000 für Linkslenker; → 70-T-199000 70-T-200001 →		03.7750-7402.4 300084 03.7755-4202.4 300164 03.7755-4202.4 300164	ATE Ø 9" pneumatisch ATE Ø 9 / 8" pneumatisch ATE Ø 9 / 8" pneumatisch
				05/98 →		03.7755-4302.4 300165	ATE Ø 9 / 8" pneumatisch
 Hauptbremszylinder							
1.9 D 1.9 D	44 45	09/90 → 12/95 09/90 → 12/95		→ 70-S-127805; für Linkslenker; + ABS → 70-S-127805; für Linkslenker; - ABS		03.2122-0646.3 010133 03.2122-1042.3 010137	Ø 22,2 Ø 22,2
				70-S-127806 →; + ABS		03.2123-1526.3 010477	Ø 23,81
				70-S-127806 →; für Linkslenker; - ABS		03.2123-1548.3 010478	Ø 23,81
				70-Y-027264 →; + ESP		03.2125-9704.3 010603	ATE Ø 25,4
1.9 TD 2.0 2.4 D	50 62 57	10/92 → 04/03 09/90 → 04/03 09/90 → 04/98		→ 70-S-127805; für Linkslenker; + ABS → 70-S-127805; für Linkslenker; - ABS		03.2122-0646.3 010133 03.2122-1042.3 010137	Ø 22,2 Ø 22,2
2.5 2.5 Syncro	81 81	11/90 → 04/03 11/92 → 04/03		70-S-127806 →; + ABS 70-S-127806 →; für Linkslenker; - ABS		03.2123-1526.3 010477 03.2123-1548.3 010478	Ø 23,81 Ø 23,81
				05/96 →; - ABS; +PR 1LU		03.2125-8111.3 010479	Ø 25,4
				05/96 →; - ESP		03.2125-9704.3 010603	ATE Ø 25,4
				70-Y-027264 →; + ESP		03.2125-9704.3 010603	ATE Ø 25,4
2.4 D 2.5 2.5 Syncro	55 85 85	08/97 → 04/03 08/96 → 04/03 07/96 → 04/03		→ 70-S-127805; für Linkslenker; + ABS → 70-S-127805; für Linkslenker; - ABS		03.2122-0646.3 010133 03.2122-1042.3 010137	Ø 22,2 Ø 22,2
				70-S-127806 →; + ABS		03.2123-1526.3 010477	Ø 23,81
				70-S-127806 →; für Linkslenker; - ABS		03.2123-1548.3 010478	Ø 23,81
				- ABS; +PR 1LU		03.2125-8111.3 010479	Ø 25,4
				- ESP		03.2125-9704.3 010603	ATE Ø 25,4
				70-Y-027264 →; + ESP		03.2125-9704.3 010603	ATE Ø 25,4
2.4 D Syncro	57	10/92 → 09/98		11/92 →; → 70-S-127805; für Linkslenker; + ABS		03.2122-0646.3 010133	Ø 22,2
↓							



VW - TRANSPORTER T4 Bus (70XB, 70XC, 7DB, 7DW, 7DK) 09/90→04/03

Hauptbremszylinder

2.4 D Syncro	57	10/92→09/98		11/92→; → 70-S-127805; für Linkslenker; - ABS	03.2122-1042.3	010137	Ø 22,2
				70-S-127806→; + ABS	03.2123-1526.3	010477	Ø 23,81
				70-S-127806→; für Linkslenker; - ABS	03.2123-1548.3	010478	Ø 23,81
				05/96→; - ABS; +PR 1LU	03.2125-8111.3	010479	Ø 25,4
				70-Y-027264→; + ESP	03.2125-9704.3	010603	ATE Ø 25,4
			05/96→; - ESP	03.2125-9704.3	010603	ATE Ø 25,4	
2.5 TDI 2.5 TDI 2.8 VR6	65 111 150	05/98→04/03 05/98→04/03 04/00→04/03		+ ABS	03.2123-1526.3	010477	Ø 23,81
				für Linkslenker; - ABS	03.2123-1548.3	010478	Ø 23,81
				- ABS; +PR 1LU	03.2125-8111.3	010479	Ø 25,4
				- ESP	03.2125-9704.3	010603	ATE Ø 25,4
				70-Y-027264→; + ESP	03.2125-9704.3	010603	ATE Ø 25,4
2.5 TDI	75	09/95→04/03		+ ABS	03.2123-1526.3	010477	Ø 23,81
				für Linkslenker; - ABS	03.2123-1548.3	010478	Ø 23,81
				05/96→; - ABS; +PR 1LU	03.2125-8111.3	010479	Ø 25,4
				05/96→; - ESP	03.2125-9704.3	010603	ATE Ø 25,4
				70-Y-027264→; + ESP	03.2125-9704.3	010603	ATE Ø 25,4
2.5 TDI Syncro	75	01/96→04/03		für Linkslenker; - ABS	03.2123-1548.3	010478	Ø 23,81
				05/96→; - ABS; +PR 1LU	03.2125-8111.3	010479	Ø 25,4
				70-Y-027264→; + ESP	03.2125-9704.3	010603	ATE Ø 25,4
				05/96→; - ESP	03.2125-9704.3	010603	ATE Ø 25,4
2.8 VR 6	103	11/95→04/00		+ ABS	03.2123-1526.3	010477	Ø 23,81
				für Linkslenker; - ABS	03.2123-1548.3	010478	Ø 23,81
				- ABS; +PR 1LU	03.2125-8111.3	010479	Ø 25,4
				05/96→; - ESP	03.2125-9704.3	010603	ATE Ø 25,4
				70-Y-027264→; + ESP	03.2125-9704.3	010603	ATE Ø 25,4







Verschlusschraube, Hauptbremszylinder

1.9 D	44	09/90→12/95		→ 70-S-127805; für Linkslenker; - ABS	03.3517-0101.2	390322	
1.9 D	45	09/90→12/95					
1.9 TD	50	10/92→04/03					
2.0	62	09/90→04/03					
2.4 D	55	08/97→04/03					
2.4 D	57	09/90→04/98					
2.5	81	11/90→04/03					
2.5	85	08/96→04/03					
2.5 Syncro	81	11/92→04/03					
2.5 Syncro	85	07/96→04/03					
2.4 D Syncro	57	10/92→09/98		11/92→; → 70-S-127805; für Linkslenker; - ABS	03.3517-0101.2	390322	









VW - TRANSPORTER T4 Kasten (70XA) 07/90→04/03







Bremskraftverstärker

1.9 D 1.9 D 2.4 D	44 45 57	09/90→12/95 07/90→12/95 07/90→04/98		07/95→; für Rechtslenker; → 70-T-199000	03.7750-7402.4	300084	ATE Ø 9" pneumatisch
				→ 70-S-127805	03.7750-7402.4	300084	ATE Ø 9" pneumatisch
				70-S-127806→; → 06/95	03.7755-4202.4	300164	ATE Ø 9 / 8" pneumatisch
				70-T-200001→	03.7755-4202.4	300164	ATE Ø 9 / 8" pneumatisch
				07/95→; für Linkslenker; → 70-T-199000	03.7755-4202.4	300164	ATE Ø 9 / 8" pneumatisch
1.9 TD 2.0 2.5	50 62 81	10/92→04/03 07/90→04/03 11/90→04/03		07/95→; für Rechtslenker; → 70-T-199000	03.7750-7402.4	300084	ATE Ø 9" pneumatisch
				→ 70-S-127805	03.7750-7402.4	300084	ATE Ø 9" pneumatisch
				70-S-127806→; → 06/95	03.7755-4202.4	300164	ATE Ø 9 / 8" pneumatisch
				70-T-200001→	03.7755-4202.4	300164	ATE Ø 9 / 8" pneumatisch
				07/95→; für Linkslenker; → 70-T-199000	03.7755-4202.4	300164	ATE Ø 9 / 8" pneumatisch
2.4 D 2.5 2.5 Syncro	55 85 85	08/97→04/03 08/96→04/03 08/96→04/03		für Rechtslenker; → 70-T-199000	03.7750-7402.4	300084	ATE Ø 9" pneumatisch
				→ 70-S-127805	03.7750-7402.4	300084	ATE Ø 9" pneumatisch
				70-T-200001→	03.7755-4202.4	300164	ATE Ø 9 / 8" pneumatisch
				für Linkslenker; → 70-T-199000	03.7755-4202.4	300164	ATE Ø 9 / 8" pneumatisch
				05/98→	03.7755-4302.4	300165	ATE Ø 9 / 8" pneumatisch
2.4 D Syncro 2.5 Syncro	57 81	10/92→09/98 10/92→04/03		07/95→; für Rechtslenker; → 70-T-199000	03.7750-7402.4	300084	ATE Ø 9" pneumatisch
				11/92→; → 70-S-127805	03.7750-7402.4	300084	ATE Ø 9" pneumatisch
				70-T-200001→	03.7755-4202.4	300164	ATE Ø 9 / 8" pneumatisch









	kw			 	! #		
VW - TRANSPORTER T4 Kasten (70XA) 07/90→04/03							
Bremskraftverstärker							
2.4 D Syncro 2.5 Syncro	57 81	10/92→09/98 10/92→04/03		70-S-127806→; → 06/95 07/95→; für Linkslenker; → 70-T-199000 05/98→	03.7755-4202.4 300164 03.7755-4202.4 300164 03.7755-4302.4 300165		ATE Ø 9 / 8" pneumatisch ATE Ø 9 / 8" pneumatisch ATE Ø 9 / 8" pneumatisch
2.5 TDI 2.5 TDI 2.8 VR6	65 111 150	12/98→04/03 09/00→04/03 06/00→04/03		für Rechtslenker; → 70-T-199000 für Linkslenker; → 70-T-199000 70-T-200001→	03.7750-7402.4 300084 03.7755-4202.4 300164 03.7755-4202.4 300164 03.7755-4302.4 300165		ATE Ø 9" pneumatisch ATE Ø 9 / 8" pneumatisch ATE Ø 9 / 8" pneumatisch ATE Ø 9 / 8" pneumatisch
2.5 TDI 2.5 TDI Syncro 2.8 VR6	75 75 103	09/95→04/03 09/95→04/03 05/96→05/00		für Rechtslenker; → 70-T-199000 für Linkslenker; → 70-T-199000 70-T-200001→ 05/98→	03.7750-7402.4 300084 03.7755-4202.4 300164 03.7755-4202.4 300164 03.7755-4302.4 300165		ATE Ø 9" pneumatisch ATE Ø 9 / 8" pneumatisch ATE Ø 9 / 8" pneumatisch ATE Ø 9 / 8" pneumatisch
Hauptbremszylinder							
1.9 D 1.9 D	44 45	09/90→12/95 07/90→12/95		→ 70-S-127805; für Linkslenker; + ABS → 70-S-127805; für Linkslenker; - ABS 70-S-127806→; + ABS 70-S-127806→; für Linkslenker; - ABS 70-Y-027264→; + ESP	03.2122-0646.3 010133 03.2122-1042.3 010137 03.2123-1526.3 010477 03.2123-1548.3 010478 03.2125-9704.3 010603		Ø 22,2 Ø 22,2 Ø 23,81 Ø 23,81 ATE Ø 25,4
1.9 TD 2.0 2.4 D 2.5	50 62 57 81	10/92→04/03 07/90→04/03 07/90→04/98 11/90→04/03		→ 70-S-127805; für Linkslenker; + ABS → 70-S-127805; für Linkslenker; - ABS 70-S-127806→; + ABS 70-S-127806→; für Linkslenker; - ABS 05/96→; - ABS; +PR 1LU 05/96→; - ESP 70-Y-027264→; + ESP	03.2122-0646.3 010133 03.2122-1042.3 010137 03.2123-1526.3 010477 03.2123-1548.3 010478 03.2125-8111.3 010479 03.2125-9704.3 010603 03.2125-9704.3 010603		Ø 22,2 Ø 22,2 Ø 23,81 Ø 23,81 Ø 25,4 ATE Ø 25,4 ATE Ø 25,4
2.4 D 2.5 2.5 Syncro	55 85 85	08/97→04/03 08/96→04/03 08/96→04/03		→ 70-S-127805; für Linkslenker; + ABS → 70-S-127805; für Linkslenker; - ABS 70-S-127806→; + ABS 70-S-127806→; für Linkslenker; - ABS - ABS; +PR 1LU - ESP 70-Y-027264→; + ESP	03.2122-0646.3 010133 03.2122-1042.3 010137 03.2123-1526.3 010477 03.2123-1548.3 010478 03.2125-8111.3 010479 03.2125-9704.3 010603 03.2125-9704.3 010603		Ø 22,2 Ø 22,2 Ø 23,81 Ø 23,81 Ø 25,4 ATE Ø 25,4 ATE Ø 25,4
2.4 D Syncro 2.5 Syncro	57 81	10/92→09/98 10/92→04/03		11/92→; → 70-S-127805; für Linkslenker; + ABS 11/92→; → 70-S-127805; für Linkslenker; - ABS 70-S-127806→; + ABS 70-S-127806→; für Linkslenker; - ABS 05/96→; - ABS; +PR 1LU 70-Y-027264→; + ESP 05/96→; - ESP	03.2122-0646.3 010133 03.2122-1042.3 010137 03.2123-1526.3 010477 03.2123-1548.3 010478 03.2125-8111.3 010479 03.2125-9704.3 010603 03.2125-9704.3 010603		Ø 22,2 Ø 22,2 Ø 23,81 Ø 23,81 Ø 25,4 ATE Ø 25,4 ATE Ø 25,4
2.5 TDI 2.5 TDI 2.8 VR6 2.8 VR6	65 111 103 150	12/98→04/03 09/00→04/03 05/96→05/00 06/00→04/03		+ ABS für Linkslenker; - ABS - ABS; +PR 1LU - ESP 70-Y-027264→; + ESP	03.2123-1526.3 010477 03.2123-1548.3 010478 03.2125-8111.3 010479 03.2125-9704.3 010603 03.2125-9704.3 010603		Ø 23,81 Ø 23,81 Ø 25,4 ATE Ø 25,4 ATE Ø 25,4
2.5 TDI	75	09/95→04/03		+ ABS für Linkslenker; - ABS 05/96→; - ABS; +PR 1LU 05/96→; - ESP 70-Y-027264→; + ESP	03.2123-1526.3 010477 03.2123-1548.3 010478 03.2125-8111.3 010479 03.2125-9704.3 010603 03.2125-9704.3 010603		Ø 23,81 Ø 23,81 Ø 25,4 ATE Ø 25,4 ATE Ø 25,4
2.5 TDI Syncro	75	09/95→04/03		für Linkslenker; - ABS 05/96→; - ABS; +PR 1LU 70-Y-027264→; + ESP 05/96→; - ESP	03.2123-1548.3 010478 03.2125-8111.3 010479 03.2125-9704.3 010603 03.2125-9704.3 010603		Ø 23,81 Ø 25,4 ATE Ø 25,4 ATE Ø 25,4
Verschlusschraube, Hauptbremszylinder							
1.9 D 1.9 D 1.9 TD 2.0 2.4 D 2.4 D ↓	44 45 50 62 55 57	09/90→12/95 07/90→12/95 10/92→04/03 07/90→04/03 08/97→04/03 07/90→04/98		→ 70-S-127805; für Linkslenker; - ABS	03.3517-0101.2 390322		













	kw			 	! #		
VW - TRANSPORTER T4 Kasten (70XA) 07/90→04/03							
Verschlusschraube, Hauptbremszylinder							
2.5	81	11/90→04/03		→ 70-S-127805; für Linkslenker; - ABS		03.3517-0101.2	390322
2.5	85	08/96→04/03					
2.5 Syncro	85	08/96→04/03					
2.4 D Syncro	57	10/92→09/98		11/92→; → 70-S-127805;		03.3517-0101.2	390322
2.5 Syncro	81	10/92→04/03		für Linkslenker; - ABS			
VW - TRANSPORTER T4 Pritsche/Fahrgestell (70XD) 07/90→04/03							
 Bremskraftverstärker							
1.9 D	44	09/90→12/95		07/95→; für Rechtslenker;		03.7750-7402.4	300084
1.9 D	45	07/90→12/95		→ 70-T-199000			ATE Ø 9" pneumatisch
2.4 D	57	09/90→04/98		→ 70-S-127805		03.7750-7402.4	300084
				70-S-127806→; → 06/95		03.7755-4202.4	300164
				70-T-200001→		03.7755-4202.4	300164
				07/95→; für Linkslenker; → 70-T-199000		03.7755-4202.4	300164
1.9 TD	50	10/92→04/03		07/95→; für Rechtslenker;		03.7750-7402.4	300084
2.0	62	07/90→04/03		→ 70-T-199000			ATE Ø 9" pneumatisch
2.5	81	11/90→04/03		→ 70-S-127805		03.7750-7402.4	300084
				70-S-127806→; → 06/95		03.7755-4202.4	300164
				70-T-200001→		03.7755-4202.4	300164
				07/95→; für Linkslenker; → 70-T-199000		03.7755-4202.4	300164
				05/98→		03.7755-4302.4	300165
2.4 D	55	08/97→04/03		für Rechtslenker; → 70-T-199000		03.7750-7402.4	300084
2.5	85	08/96→04/03		→ 70-S-127805		03.7750-7402.4	300084
2.5 Syncro	85	08/96→04/03		70-T-200001→		03.7755-4202.4	300164
				für Linkslenker; → 70-T-199000		03.7755-4202.4	300164
				05/98→		03.7755-4302.4	300165
2.4 D Syncro	57	10/92→09/98		07/95→; für Rechtslenker;		03.7750-7402.4	300084
2.5 Syncro	81	10/92→04/03		→ 70-T-199000			ATE Ø 9" pneumatisch
				11/92→; → 70-S-127805		03.7750-7402.4	300084
				70-T-200001→		03.7755-4202.4	300164
				70-S-127806→; → 06/95		03.7755-4202.4	300164
				07/95→; für Linkslenker; → 70-T-199000		03.7755-4202.4	300164
				05/98→		03.7755-4302.4	300165
2.5 TDI	65	05/98→04/03		für Rechtslenker; → 70-T-199000		03.7750-7402.4	300084
2.5 TDI Syncro	75	05/98→04/03		für Linkslenker; → 70-T-199000		03.7755-4202.4	300164
				70-T-200001→		03.7755-4202.4	300164
						03.7755-4302.4	300165
							ATE Ø 9" pneumatisch
2.5 TDI	75	09/95→04/03		für Rechtslenker; → 70-T-199000		03.7750-7402.4	300084
				für Linkslenker; → 70-T-199000		03.7755-4202.4	300164
				70-T-200001→		03.7755-4202.4	300164
				05/98→		03.7755-4302.4	300165
							ATE Ø 9" pneumatisch
 Hauptbremszylinder							
1.9 D	44	09/90→12/95		→ 70-S-127805; für Linkslenker; + ABS		03.2122-0646.3	010133
1.9 D	45	07/90→12/95		→ 70-S-127805; für Linkslenker; - ABS		03.2122-1042.3	010137
				70-S-127806→; + ABS		03.2123-1526.3	010477
				70-S-127806→; für Linkslenker; - ABS		03.2123-1548.3	010478
				70-Y-027264→; + ESP		03.2125-9704.3	010603
1.9 TD	50	10/92→04/03		→ 70-S-127805; für Linkslenker; + ABS		03.2122-0646.3	010133
2.0	62	07/90→04/03		→ 70-S-127805; für Linkslenker; - ABS		03.2122-1042.3	010137
2.4 D	57	09/90→04/98		70-S-127806→; + ABS		03.2123-1526.3	010477
2.5	81	11/90→04/03		70-S-127806→; für Linkslenker; - ABS		03.2123-1548.3	010478
				05/96→; - ABS; +PR 1LU		03.2125-8111.3	010479
				05/96→; - ESP		03.2125-9704.3	010603
				70-Y-027264→; + ESP		03.2125-9704.3	010603
2.4 D	55	08/97→04/03		→ 70-S-127805; für Linkslenker; + ABS		03.2122-0646.3	010133
2.5	85	08/96→04/03		→ 70-S-127805; für Linkslenker; - ABS		03.2122-1042.3	010137
2.5 Syncro	85	08/96→04/03		70-S-127806→; + ABS		03.2123-1526.3	010477
				70-S-127806→; für Linkslenker; - ABS		03.2123-1548.3	010478
				- ABS; +PR 1LU		03.2125-8111.3	010479
				- ESP		03.2125-9704.3	010603
				70-Y-027264→; + ESP		03.2125-9704.3	010603
							ATE Ø 22,2
							ATE Ø 23,81
							ATE Ø 25,4
							ATE Ø 22,2
							ATE Ø 23,81
							ATE Ø 25,4
							ATE Ø 22,2
							ATE Ø 23,81
							ATE Ø 25,4
							ATE Ø 22,2
							ATE Ø 23,81
							ATE Ø 25,4
							ATE Ø 22,2
							ATE Ø 23,81
							ATE Ø 25,4
							ATE Ø 22,2
							ATE Ø 23,81
							ATE Ø 25,4
							ATE Ø 22,2
							ATE Ø 23,81
							ATE Ø 25,4
							ATE Ø 22,2
							ATE Ø 23,81
							ATE Ø 25,4
							ATE Ø 22,2
							ATE Ø 23,81
							ATE Ø 25,4
							ATE Ø 22,2
							ATE Ø 23,81
							ATE Ø 25,4
							ATE Ø 22,2
							ATE Ø 23,81
							ATE Ø 25,4
							ATE Ø 22,2
							ATE Ø 23,81
							ATE Ø 25,4
							ATE Ø 22,2
							ATE Ø 23,81
							ATE Ø 25,4
							ATE Ø 22,2
							ATE Ø 23,81
							ATE Ø 25,4
							ATE Ø 22,2
							ATE Ø 23,81
							ATE Ø 25,4
							ATE Ø 22,2
							ATE Ø 23,81
							ATE Ø 25,4
							ATE Ø 22,2
							ATE Ø 23,81
							ATE Ø 25,4
							ATE Ø 22,2
							ATE Ø 23,81
							ATE Ø 25,4
							ATE Ø 22,2
							ATE Ø 23,81
							ATE Ø 25,4
							ATE Ø 22,2
							ATE Ø 23,81
							ATE Ø 25,4
							ATE Ø 22,2
							ATE Ø 23,81
							ATE Ø 25,4
							ATE Ø 22,2
							ATE Ø 23,81
							ATE Ø 25,4
							ATE Ø 22,2
							ATE Ø 23,81
							ATE Ø 25,4
							ATE Ø 22,2
							ATE Ø 23,81
							ATE Ø 25,4
							ATE Ø 22,2
							ATE Ø 23,81
							ATE Ø 25,4
							ATE Ø 22,2
							ATE Ø 23,81
							ATE Ø 25,4
							ATE Ø 22,2
							ATE Ø 23,81
							ATE Ø 25,4
							ATE Ø 22,2
							ATE Ø 23,81
							ATE Ø 25,4
							ATE Ø 22,2
							ATE Ø 23,81
							ATE Ø 25,4
							ATE Ø 22,2
							ATE Ø 23,81
							ATE Ø 25,4
							ATE Ø 22,2
							ATE Ø 23,81
							ATE Ø 25,4
							ATE Ø 22,2
							ATE Ø 23,81
							ATE Ø 25,4
							ATE Ø 22,2
							ATE Ø 23,81
							ATE Ø 25,4
							ATE Ø 22,2
							ATE Ø 23,81
							ATE Ø 25,4
							ATE Ø 22,2
							ATE Ø 23,81
							ATE Ø 25,4
							ATE Ø 22,2
							ATE Ø 23,81
							ATE Ø 25,4
							ATE Ø 22,2
							ATE Ø 23,81
							ATE Ø 25,4
							ATE Ø 22,2
							ATE Ø 23,81
							ATE Ø 25,4
							ATE Ø 22,2
							ATE Ø 23,81
							ATE Ø 25,4
							ATE Ø 22,2
		</					











	kw					! #			
VW - TRANSPORTER T4 Pritsche/Fahrgestell (70XD) 07/90→04/03									
Hauptbremszylinder									
2.4 D Syncro	57	10/92→09/98		11/92→; → 70-S-127805;			03.2122-0646.3	010133	Ø 22,2
2.5 Syncro	81	10/92→04/03		für Linkslenker; + ABS			03.2122-1042.3	010137	Ø 22,2
				11/92→; → 70-S-127805;			03.2123-1526.3	010477	Ø 23,81
				für Linkslenker; - ABS			03.2123-1548.3	010478	Ø 23,81
				70-S-127806→; + ABS			03.2125-8111.3	010479	Ø 25,4
				70-S-127806→; für Linkslenker; - ABS			03.2125-9704.3	010603	ATE Ø 25,4
				05/96→; - ABS; +PR 1LU			03.2125-9704.3	010603	ATE Ø 25,4
				70-Y-027264→; + ESP					
				05/96→; - ESP					
2.5 TDI	65	05/98→04/03		+ ABS			03.2123-1526.3	010477	Ø 23,81
				für Linkslenker; - ABS			03.2123-1548.3	010478	Ø 23,81
				- ABS; +PR 1LU			03.2125-8111.3	010479	Ø 25,4
				- ESP			03.2125-9704.3	010603	ATE Ø 25,4
				70-Y-027264→; + ESP			03.2125-9704.3	010603	ATE Ø 25,4
2.5 TDI	75	09/95→04/03		+ ABS			03.2123-1526.3	010477	Ø 23,81
				für Linkslenker; - ABS			03.2123-1548.3	010478	Ø 23,81
				05/96→; - ABS; +PR 1LU			03.2125-8111.3	010479	Ø 25,4
				05/96→; - ESP			03.2125-9704.3	010603	ATE Ø 25,4
				70-Y-027264→; + ESP			03.2125-9704.3	010603	ATE Ø 25,4
2.5 TDI Syncro	75	05/98→04/03		für Linkslenker; - ABS			03.2123-1548.3	010478	Ø 23,81
				- ABS; +PR 1LU			03.2125-8111.3	010479	Ø 25,4
				- ESP			03.2125-9704.3	010603	ATE Ø 25,4
				70-Y-027264→; + ESP			03.2125-9704.3	010603	ATE Ø 25,4
Verschlusschraube, Hauptbremszylinder									
1.9 D	44	09/90→12/95		→ 70-S-127805; für Linkslenker; - ABS			03.3517-0101.2	390322	
1.9 D	45	07/90→12/95							
1.9 TD	50	10/92→04/03							
2.0	62	07/90→04/03							
2.4 D	55	08/97→04/03							
2.4 D	57	09/90→04/98							
2.5	81	11/90→04/03							
2.5	85	08/96→04/03							
2.5 Syncro	85	08/96→04/03							
2.4 D Syncro	57	10/92→09/98		11/92→; → 70-S-127805;			03.3517-0101.2	390322	
2.5 Syncro	81	10/92→04/03		für Linkslenker; - ABS					
VW - TRANSPORTER T5 Bus (7HB, 7HJ, 7EB, 7EJ, 7EF, 7EG, 7HF, 7EC) 04/03→08/15									
Bremskraftverstärker									
1.9 TDI	62	01/06→11/09		+PR 1AJ,1AE,1AC,1AR;			03.7765-1002.4	300246	ATE Ø 10 / 9" pneumatisch
1.9 TDI	63	04/03→11/09		→ 7H-A-050000					
1.9 TDI	75	06/06→11/09							
1.9 TDI	77	04/03→11/09		+PR 1AK; → 7H-A-050000			03.7868-3702.4	300208	ATE Ø 10 / 8" pneumatisch
2.0	85	11/03→08/15							
2.0 BiTDI	132	09/09→08/15							
2.0 BiTDI 4motion	132	09/09→08/15							
2.0 TDI	62	09/09→08/15							
2.0 TDI	75	09/09→08/15							
2.0 TDI	103	09/09→08/15							
2.0 TDI 4motion	103	09/09→08/15							
2.5 TDi	120	11/03→11/09							
2.5 TDI	96	04/03→11/09							
2.5 TDI	128	04/03→11/09							
2.5 TDI 4motion	96	07/04→11/09							
2.5 TDI 4motion	128	07/04→11/09							
3.2 V6	170	02/04→06/04							
3.2 V6	173	02/04→11/09							
3.2 V6 4motion	173	11/03→11/09		07/04→; +PR 1AJ,1AE,1AC,1AR;			03.7765-1002.4	300246	ATE Ø 10 / 9" pneumatisch
				→ 7H-A-050000					
				07/04→; +PR 1AK; → 7H-A-050000			03.7868-3702.4	300208	ATE Ø 10 / 8" pneumatisch
Pedalwegsensor, Bremspedal									
1.9 TDI	62	01/06→11/09		+PR 1AT; → 7H-A-050000			03.0655-0006.2	370006	ATE
1.9 TDI	63	04/03→11/09							
1.9 TDI	75	06/06→11/09							
1.9 TDI	77	04/03→11/09							
2.0	85	11/03→08/15							
2.0 BiTDI	132	09/09→08/15							
2.0 BiTDI 4motion	132	09/09→08/15							
2.0 TDI	62	09/09→08/15							
2.0 TDI	75	09/09→08/15							
2.0 TDI	103	09/09→08/15							
2.0 TDI 4motion	103	09/09→08/15							
↓									











	kW			 	! #		
VW - TRANSPORTER T5 Bus (7HB, 7HJ, 7EB, 7EJ, 7EF, 7EG, 7HF, 7EC) 04/03→08/15							
Pedalwegsensord, Bremspedal							
2.5 TDi	120	11/03→11/09		+PR 1AT; → 7H-A-050000		03.0655-0006.2 370006	ATE
2.5 TDi	96	04/03→11/09					
2.5 TDi	128	04/03→11/09					
2.5 TDi 4motion	96	07/04→11/09					
2.5 TDi 4motion	128	07/04→11/09					
3.2 V6	170	02/04→06/04					
3.2 V6	173	02/04→11/09					
3.2 V6 4motion	173	11/03→11/09		07/04→; +PR 1AT; → 7H-A-050000		03.0655-0006.2 370006	ATE
 Hauptbremszylinder							
1.9 TDi	62	01/06→11/09		7H-6-000001→ 7H-6-200000;		03.2126-3014.3 010811	ATE Ø 26,99
1.9 TDi	63	04/03→11/09		für Rechtslenker; +PR 1AT			
1.9 TDi	75	06/06→11/09		→ 7H-A-050000		03.2126-3014.3 010811	ATE Ø 26,99
1.9 TDi	77	04/03→11/09					
2.0	85	11/03→08/15		7H-A-200001→		03.2126-3144.3 010941	ATE Ø 26,99
3.2 V6	170	02/04→06/04					
3.2 V6	173	02/04→11/09					
2.0 BiTDI	132	09/09→08/15		→ 7H-A-050000		03.2126-3014.3 010811	ATE Ø 26,99
2.0 BiTDI 4motion	132	09/09→08/15					
2.0 TDi	62	09/09→08/15		7H-A-200001→		03.2126-3144.3 010941	ATE Ø 26,99
2.0 TDi	75	09/09→08/15					
2.0 TDi	100	05/10→08/15					
2.0 TDi	103	09/09→08/15					
2.0 TDi 4motion	100	05/10→08/15					
2.0 TDi 4motion	103	09/09→08/15					
2.5 TDi	120	11/03→11/09					
2.5 TDi	96	04/03→11/09					
2.5 TDi	128	04/03→11/09					
2.5 TDi 4motion	96	07/04→11/09					
2.5 TDi 4motion	128	07/04→11/09					
2.0 TDi	84	05/11→08/15				03.2126-3144.3 010941	ATE Ø 26,99
2.0 TSi	110	07/12→08/15					
2.0 TSi	150	05/11→08/15					
2.0 TSi 4motion	150	07/11→08/15					
3.2 V6 4motion	173	11/03→11/09		07/04→; → 7H-A-050000		03.2126-3014.3 010811	ATE Ø 26,99
				7H-A-200001→		03.2126-3144.3 010941	ATE Ø 26,99
VW - TRANSPORTER T5 Kasten (7HA, 7HH, 7EA, 7EH) 04/03→08/15							
 Bremskraftverstärker							
1.9 TDi	62	01/06→11/09		+PR 1AJ,1AE,1AC,1AR;		03.7765-1002.4 300246	ATE Ø 10 / 9" pneumatisch
1.9 TDi	63	04/03→11/09		→ 7H-A-050000			
1.9 TDi	75	06/06→11/09					
1.9 TDi	77	04/03→11/09		+PR 1AK; → 7H-A-050000		03.7868-3702.4 300208	ATE Ø 10 / 8" pneumatisch
2.0	85	11/03→08/15					
2.0 BiFuel	85	05/11→08/15					
2.0 BiTDI	132	09/09→08/15					
2.0 BiTDI 4motion	132	09/09→08/15					
2.0 TDi	62	09/09→08/15					
2.0 TDi	75	09/09→08/15					
2.0 TDi	103	09/09→08/15					
2.0 TDi 4motion	103	09/09→08/15					
2.5 TDi	96	04/03→11/09					
2.5 TDi	128	04/03→11/09					
2.5 TDi 4motion	96	07/04→11/09					
2.5 TDi 4motion	128	07/04→11/09					
3.2 V6	170	04/03→06/04					
3.2 V6	173	02/04→11/09					
3.2 4motion	173	11/03→11/09		07/04→; +PR 1AJ,1AE,1AC,1AR;		03.7765-1002.4 300246	ATE Ø 10 / 9" pneumatisch
				→ 7H-A-050000			
				07/04→; +PR 1AK; → 7H-A-050000		03.7868-3702.4 300208	ATE Ø 10 / 8" pneumatisch
Pedalwegsensord, Bremspedal							
1.9 TDi	62	01/06→11/09		+PR 1AT; → 7H-A-050000		03.0655-0006.2 370006	ATE
1.9 TDi	63	04/03→11/09					
1.9 TDi	75	06/06→11/09					
1.9 TDi	77	04/03→11/09					
2.0	85	11/03→08/15					
2.0 BiFuel	85	05/11→08/15					
2.0 BiTDI	132	09/09→08/15					
2.0 BiTDI 4motion	132	09/09→08/15					
2.0 TDi	62	09/09→08/15					
2.0 TDi	75	09/09→08/15					
2.0 TDi	103	09/09→08/15					
2.0 TDi 4motion	103	09/09→08/15					
2.5 TDi	96	04/03→11/09					
2.5 TDi	128	04/03→11/09					
2.5 TDi 4motion	96	07/04→11/09					
2.5 TDi 4motion	128	07/04→11/09					
3.2 V6	170	04/03→06/04					
3.2 V6	173	02/04→11/09					

	kW					! #		
VW - TRANSPORTER T5 Kasten (7HA, 7HH, 7EA, 7EH) 04/03→08/15								
Pedalwegsensord, Bremspedal								
3.2 4motion	173	11/03→11/09		07/04→; +PR 1AT; → 7H-A-050000			03.0655-0006.2 370006	ATE
 Hauptbremszylinder								
1.9 TDI	62	01/06→11/09		7H-6-000001→ 7H-6-200000;			03.2126-3014.3 010811	ATE Ø 26,99
1.9 TDI	63	04/03→11/09		für Rechtslenker; +PR 1AT				
1.9 TDI	75	06/06→11/09		→ 7H-A-050000			03.2126-3014.3 010811	ATE Ø 26,99
1.9 TDI	77	04/03→11/09						
2.0	85	11/03→08/15		7H-A-200001→			03.2126-3144.3 010941	ATE Ø 26,99
2.0 BiFuel	85	05/11→08/15						
3.2 V6	170	04/03→06/04						
3.2 V6	173	02/04→11/09						
2.0 BiTDI	132	09/09→08/15		→ 7H-A-050000			03.2126-3014.3 010811	ATE Ø 26,99
2.0 BiTDI 4motion	132	09/09→08/15		7H-A-200001→			03.2126-3144.3 010941	ATE Ø 26,99
2.0 TDI	62	09/09→08/15						
2.0 TDI	75	09/09→08/15						
2.0 TDI	100	05/10→08/15						
2.0 TDI	103	09/09→08/15						
2.0 TDI 4motion	100	05/10→08/15						
2.0 TDI 4motion	103	09/09→08/15						
2.5 TDI	96	04/03→11/09						
2.5 TDI	128	04/03→11/09						
2.5 TDI 4motion	96	07/04→11/09						
2.5 TDI 4motion	128	07/04→11/09						
2.0 TDI	84	05/11→08/15					03.2126-3144.3 010941	ATE Ø 26,99
2.0 TSI	110	07/12→08/15						
2.0 TSI	150	05/11→08/15						
2.0 TSI 4motion	150	07/11→08/15						
3.2 4motion	173	11/03→11/09		07/04→; → 7H-A-050000			03.2126-3014.3 010811	ATE Ø 26,99
				7H-A-200001→			03.2126-3144.3 010941	ATE Ø 26,99
VW - TRANSPORTER T5 Pritsche/Fahrgestell (7JD, 7JE, 7JL, 7JY, 7JZ 04/03→08/15								
 Bremskraftverstärker								
1.9 TDI	62	01/06→11/09		→ 7J-A-010000; +PR 1AJ,1AE,1AC,1AR			03.7765-1002.4 300246	ATE Ø 10 / 9" pneumatisch
1.9 TDI	63	04/03→11/09						
1.9 TDI	75	06/06→11/09		→ 7J-A-010000; +PR 1AK			03.7868-3702.4 300208	ATE Ø 10 / 8" pneumatisch
1.9 TDI	77	04/03→11/09						
2.0	85	11/03→05/13						
2.0 BiTDI	132	09/09→08/15						
2.0 BiTDI 4motion	132	09/09→08/15						
2.0 TDI	62	09/09→08/15						
2.0 TDI	75	09/09→08/15						
2.0 TDI	103	09/09→08/15						
2.0 TDI 4motion	103	09/09→08/15						
2.5 TDI	96	04/03→11/09						
2.5 TDI	128	04/03→11/09						
2.5 TDI 4motion	96	07/04→11/09						
3.2 V6	170	02/04→11/09						
3.2 V6	173	08/03→05/06						
2.5 TDI 4motion	128	04/04→11/09		07/04→; → 7J-A-010000;			03.7765-1002.4 300246	ATE Ø 10 / 9" pneumatisch
				+PR 1AJ,1AE,1AC,1AR				
				07/04→; → 7J-A-010000; +PR 1AK			03.7868-3702.4 300208	ATE Ø 10 / 8" pneumatisch
3.2 4motion	170	11/03→11/09		07/04→; +PR 1AJ,1AE,1AC,1AR;			03.7765-1002.4 300246	ATE Ø 10 / 9" pneumatisch
				→ 7H-A-050000				
				07/04→; +PR 1AK; → 7H-A-050000			03.7868-3702.4 300208	ATE Ø 10 / 8" pneumatisch
Pedalwegsensord, Bremspedal								
1.9 TDI	62	01/06→11/09		→ 7J-A-010000; +PR 1AT			03.0655-0006.2 370006	ATE
1.9 TDI	63	04/03→11/09						
1.9 TDI	75	06/06→11/09						
1.9 TDI	77	04/03→11/09						
2.0	85	11/03→05/13						
2.0 BiTDI	132	09/09→08/15						
2.0 BiTDI 4motion	132	09/09→08/15						
2.0 TDI	62	09/09→08/15						
2.0 TDI	75	09/09→08/15						
2.0 TDI	103	09/09→08/15						
2.0 TDI 4motion	103	09/09→08/15						
2.5 TDI	96	04/03→11/09						
2.5 TDI	128	04/03→11/09						
2.5 TDI 4motion	96	07/04→11/09						
3.2 V6	170	02/04→11/09						
3.2 V6	173	08/03→05/06						
2.5 TDI 4motion	128	04/04→11/09		07/04→; → 7J-A-010000; +PR 1AT			03.0655-0006.2 370006	ATE
3.2 4motion	170	11/03→11/09		07/04→; +PR 1AT; → 7H-A-050000			03.0655-0006.2 370006	ATE
 Hauptbremszylinder								
1.9 TDI	62	01/06→11/09		→ 7J-A-010000			03.2126-3014.3 010811	ATE Ø 26,99
1.9 TDI	63	04/03→11/09						
↓								



	kw					! #		
VW - TRANSPORTER T5 Pritsche/Fahrgestell (7JD, 7JE, 7JL, 7JY, 7JZ 04/03→08/15)								
 Hauptbremszylinder								
1.9 TDI	75	06/06→11/09		7J-A-200001→			03.2126-3144.3 010941	ATE Ø 26,99
1.9 TDI	77	04/03→11/09						
2.0	85	11/03→05/13						
2.0 BiTDI	132	09/09→08/15						
2.0 BiTDI 4motion	132	09/09→08/15						
2.0 TDI	62	09/09→08/15						
2.0 TDI	75	09/09→08/15						
2.0 TDI	103	09/09→08/15						
2.0 TDI 4motion	103	09/09→08/15						
2.5 TDI	96	04/03→11/09						
2.5 TDI	128	04/03→11/09						
2.5 TDI 4motion	96	07/04→11/09						
3.2 V6	170	02/04→11/09						
3.2 V6	173	08/03→05/06						
2.0 TDI	84	05/11→08/15					03.2126-3144.3 010941	ATE Ø 26,99
2.0 TDI	100	05/10→08/15						
2.0 TDI 4motion	100	05/10→08/15						
2.0 TSI	110	07/12→08/15						
2.5 TDI 4motion	128	04/04→11/09		07/04→; → 7J-A-010000			03.2126-3014.3 010811	ATE Ø 26,99
				7J-A-200001→			03.2126-3144.3 010941	ATE Ø 26,99
3.2 4motion	170	11/03→11/09		07/04→; → 7H-A-050000			03.2126-3014.3 010811	ATE Ø 26,99
				7H-A-200001→			03.2126-3144.3 010941	ATE Ø 26,99
VW - UP 08/11→								
 Hauptbremszylinder								
1.0	44	08/11→		12/11→; für Linkslenker			24.4120-1703.3 011015	TRW Ø 20,64 ohne Bremsflüssigkeitsbehälter
1.0	55	08/11→						
1.0 EcoFuel	50	11/12→		für Linkslenker			24.4120-1703.3 011015	TRW Ø 20,64 ohne Bremsflüssigkeitsbehälter
1.0 TSI	66	05/16→						
VW - VENTO (1H2) 11/91→09/98								
 Bremskraftverstärker								
1.4	40	11/91→09/98		für Linkslenker; - ABS			03.7750-5502.4 300081	ATE Ø 9" pneumatisch
1.4	44	11/91→09/98						
1.6	55	09/92→09/98		→ 1H-S-385334; für Linkslenker; + ABS			10.6360-1003.4 300156	ATE Ø 10" pneumatisch
1.6	74	10/94→09/98		1H-S-385335→; für Linkslenker; + ABS			10.6360-2002.4 300143	ATE Ø 10" pneumatisch
1.9 D	48	11/91→09/98						
1.9 TD	55	11/91→09/98						
1.9 TDI	66	09/93→09/98						
2.0	85	11/91→09/98						
1.8	55	11/91→09/98		01/92→; für Linkslenker; - ABS			03.7750-5502.4 300081	ATE Ø 9" pneumatisch
1.8	66	11/91→09/98		01/92→; → 1H-S-385334; für Linkslenker; + ABS			10.6360-1003.4 300156	ATE Ø 10" pneumatisch
				1H-S-385335→; für Linkslenker; + ABS			10.6360-2002.4 300143	ATE Ø 10" pneumatisch
1.9 SDI	47	04/97→09/98		für Linkslenker; - ABS			03.7750-5502.4 300081	ATE Ø 9" pneumatisch
1.9 TDI	81	04/96→09/98		für Linkslenker; + ABS			10.6360-2002.4 300143	ATE Ø 10" pneumatisch
2.8 VR6	128	01/92→09/98		→ 1H-S-385334; für Linkslenker; + ABS			10.6360-1003.4 300156	ATE Ø 10" pneumatisch
				1H-S-385335→; für Linkslenker; + ABS			10.6360-2002.4 300143	ATE Ø 10" pneumatisch
 Hauptbremszylinder								
1.4	40	11/91→09/98		- ABS			03.2120-3943.3 010532	ATE Ø 20,64
1.4	44	11/91→09/98		1H-S-385335→; für Linkslenker; + ABS			03.2122-1144.3 010636	ATE Ø 22,2
1.9 D	48	11/91→09/98		1H-S-385335→; für Rechtslenker; + ABS			03.2122-1184.3 010592	ATE Ø 22,2
1.6	55	09/92→09/98		- ABS			03.2120-3943.3 010532	ATE Ø 20,64
				1H-S-430001→; Vollautomatik; - ABS			03.2122-1042.3 010137	Ø 22,2
				1H-S-385335→; für Linkslenker; + ABS			03.2122-1144.3 010636	ATE Ø 22,2
				1H-S-385335→; für Rechtslenker; + ABS			03.2122-1184.3 010592	ATE Ø 22,2
1.6	74	10/94→09/98		- ABS			03.2120-3943.3 010532	ATE Ø 20,64
							03.2122-1042.3 010137	Ø 22,2
				1H-S-385335→; für Linkslenker; + ABS			03.2123-1424.3 010637	ATE Ø 23,81
				1H-S-385335→; für Rechtslenker; + ABS			03.2123-1484.3 010595	ATE Ø 23,81
				→ 1H-S-385334; für Linkslenker; + ABS			10.6123-0674.3 010639	ATE Ø 23,81
1.8	55	11/91→09/98		01/92→; - ABS			03.2120-3943.3 010532	ATE Ø 20,64
				1H-S-385335→; für Linkslenker; + ABS			03.2122-1144.3 010636	ATE Ø 22,2
				1H-S-385335→; für Rechtslenker; + ABS			03.2122-1184.3 010592	ATE Ø 22,2
1.8	66	11/91→09/98		01/92→; - ABS			03.2120-3943.3 010532	ATE Ø 20,64
				01/92→; - ABS			03.2122-1042.3 010137	Ø 22,2
				1H-S-385335→; für Linkslenker; + ABS			03.2122-1144.3 010636	ATE Ø 22,2
↓								

	kw			 	! #		
VW - VENTO (1H2) 11/91→09/98							
 Hauptbremszylinder							
1.8	66	11/91→09/98		1H-S-385335→; für Rechtslenker; + ABS	03.2122-1184.3	010592	ATE Ø 22,2
				1H-S-385335→; für Linkslenker; + ABS	03.2123-1424.3	010637	ATE Ø 23,81
				1H-S-385335→; für Rechtslenker; + ABS	03.2123-1484.3	010595	ATE Ø 23,81
				01/92→; → 1H-S-385334; für Linkslenker; + ABS	10.6123-0674.3	010639	ATE Ø 23,81
1.9 SDI	47	04/97→09/98		- ABS	03.2120-3943.3	010532	ATE Ø 20,64
				für Linkslenker; + ABS	03.2122-1144.3	010636	ATE Ø 22,2
				für Rechtslenker; + ABS	03.2122-1184.3	010592	ATE Ø 22,2
1.9 TD	55	11/91→09/98		- ABS	03.2120-3943.3	010532	ATE Ø 20,64
				1H-S-430001→; - ABS	03.2122-1042.3	010137	Ø 22,2
				1H-S-385335→; für Linkslenker; + ABS	03.2122-1144.3	010636	ATE Ø 22,2
				1H-S-385335→; für Rechtslenker; + ABS	03.2122-1184.3	010592	ATE Ø 22,2
1.9 TDI 2.0	66 85	09/93→09/98 11/91→09/98		- ABS	03.2122-1042.3	010137	Ø 22,2
				1H-S-385335→; für Linkslenker; + ABS	03.2123-1424.3	010637	ATE Ø 23,81
				1H-S-385335→; für Rechtslenker; + ABS	03.2123-1484.3	010595	ATE Ø 23,81
				→ 1H-S-385334; für Linkslenker; + ABS	10.6123-0674.3	010639	ATE Ø 23,81
1.9 TDI	81	04/96→09/98		- ABS	03.2122-1042.3	010137	Ø 22,2
				für Linkslenker; + ABS	03.2123-1424.3	010637	ATE Ø 23,81
				für Rechtslenker; + ABS	03.2123-1484.3	010595	ATE Ø 23,81
2.8 VR6	128	01/92→09/98		1H-S-385335→; für Linkslenker; + ABS	03.2123-1424.3	010637	ATE Ø 23,81
				1H-S-385335→; für Rechtslenker; + ABS	03.2123-1484.3	010595	ATE Ø 23,81
				→ 1H-S-385334; für Linkslenker; + ABS	10.6123-0674.3	010639	ATE Ø 23,81
Verschlusschraube, Hauptbremszylinder							
1.4	40	11/91→09/98		- ABS	03.3517-0101.2	390322	
1.4	44	11/91→09/98					
1.6	74	10/94→09/98					
1.9 D	48	11/91→09/98					
1.9 SDI	47	04/97→09/98					
1.9 TDI	66	09/93→09/98					
1.9 TDI	81	04/96→09/98					
2.0	85	11/91→09/98					
1.6	55	09/92→09/98		- ABS	03.3517-0101.2	390322	
				1H-S-430001→; Vollautomatik; - ABS	03.3517-0101.2	390322	
1.8	55	11/91→09/98		01/92→; - ABS	03.3517-0101.2	390322	
1.8	66	11/91→09/98		01/92→; - ABS	03.3517-0101.2	390322	
				01/92→; - ABS	03.3517-0101.2	390322	
1.9 TD	55	11/91→09/98		1H-S-430001→; - ABS	03.3517-0101.2	390322	
				- ABS	03.3517-0101.2	390322	
 Bremskraftregler							
1.4	40	11/91→09/98			03.6584-0107.3	320110	ATE lastabhängig 8/4 4x
1.4	44	11/91→09/98					
1.6	55	09/92→09/98					
1.9 D	48	11/91→09/98					
1.9 SDI	47	04/97→09/98					
1.9 TD	55	11/91→09/98					
1.6	74	10/94→09/98			03.6584-0113.3	320111	ATE lastabhängig 8/4 4x
1.9 TDI	81	04/96→09/98					
2.0	85	11/91→09/98					
2.8 VR6	128	01/92→09/98					
1.8	55	11/91→09/98		01/92→	03.6584-0107.3	320110	ATE lastabhängig 8/4 4x
1.8	66	11/91→09/98		01/92→	03.6584-0107.3	320110	ATE lastabhängig 8/4 4x
				01/92→	03.6584-0113.3	320111	ATE lastabhängig 8/4 4x
1.9 TDI	66	09/93→09/98			03.6584-0107.3	320110	ATE lastabhängig 8/4 4x
					03.6584-0113.3	320111	ATE lastabhängig 8/4 4x



DE Abbildungen Hauptbremszylinder

EN Illustrations master cylinder

ES Ilustraciones cilindro freno

FR Illustrations Maître-cylindres

IT Illustrazioni pompe Freno

2018



Abbildungen Hauptbremszylinder

Illustrations master cylinder - Ilustraciones cilindro freno - Illustrations Maître-cylindres - Illustrazioni pompe Freno

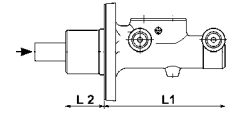

03.2022-2624.3	010588	L1 33,3	L2 113,2	03.2022-2829.3	010589	L1 36,9	L2 116,4
ø22,2/ 20,64 2x 1x M10x1 1x M12x1				ø22,2/ 20,64 M12x1 5x			



03.2023-0164.3	010014	L1 18,5	L2 159,5	03.2023-0262.3	010020	L1 17,6	L2 159
ø23,81/ 19,05 M10x1 3x				ø23,81/ 20,64 M10x1 2x			



03.2023-0503.3	010022	L1 16	L2 226,5	03.2023-0542.3	010024	L1 17,6	L2 159
ø23,81/ 16,84 M10x1 4x				ø23,81/ 20,64 M10x1 3x			



03.2023-0825.3	010028	L1 57,4	L2 109,6	03.2023-0875.3	010890	L1 16	L2 166
ø23,81/ 19,05 M10x1 3x				ø23,81/ 20,64 M10x1 4x			



Abbildungen Hauptbremszylinder

Illustrations master cylinder - Ilustraciones cilindro freno - Illustrations Maître-cylindres - Illustrazioni pompe Freno

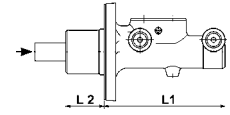

03.2023-0987.3 010473	L1 38,3	L2 131,5	03.2023-1044.3 010590	L1 41,7	L2 132,5
ø23,81/20,64 2x 1x M10x1 1x M12x1			ø23,81/20,64 3x 2x M10x1 1x M12x1		



03.2023-1066.3 010032	L1 49,8	L2 109	03.2023-1084.3 010591	L1 38,3	L2 132,5
ø23,81/19,05 2x 1x M10x1 1x M12x1			ø23,81/20,64 M10x1 3x		



03.2023-1741.3 010703	L1 12	L2 169,5	03.2023-1812.3 010570	L1 4	L2 147
ø23,81/20,64 M12x1 4x			ø23,81/19,05 3x 1x M10x1 2x M12x1		



03.2023-1904.3 010724	L1 36,9	L2 116,4	03.2023-1949.3 010725	L1 35,9	L2 116,4
ø23,81/20,64 M12x1 5x			ø23,81/20,64 M12x1 4x		

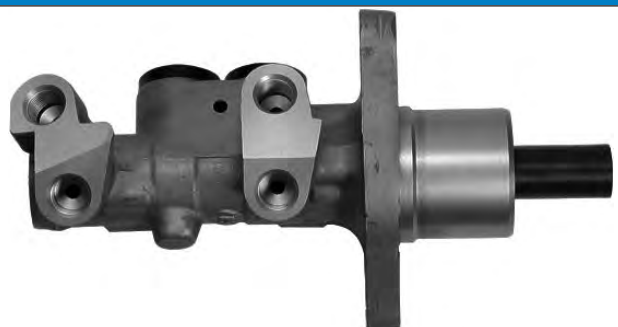
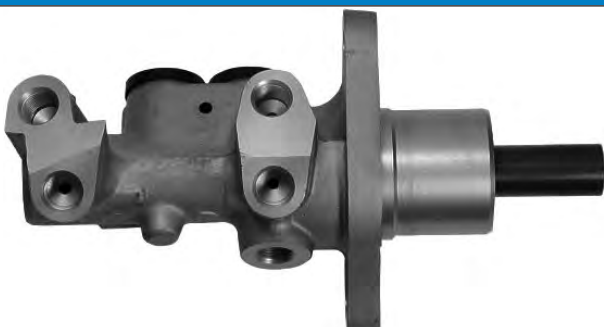

Abbildungen Hauptbremszylinder

Illustrations master cylinder - Ilustraciones cilindro freno - Illustrations Maître-cylindres - Illustrazioni pompe Freno

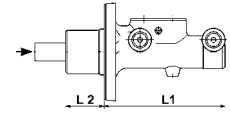

03.2023-2004.3 010788	L1 4	L2 147	03.2023-2204.3 010644	L1 36,9	L2 116,4
ø23,81/19,05 M12x1 4x			ø23,81/22,2 M12x1 5x		



03.2023-2249.3 010869	L1 35,9	L2 116,4	03.2023-2256.3 010870	L1 35,9	L2 116,4
ø23,81/22,2 M12x1 4x			ø23,81/22,2 M12x1 2x		



03.2023-2304.3 010646	L1 32,8	L2 113,2	03.2023-2344.3 010647	L1 32,8	L2 113,2
ø23,81/22,2 2x 1x M10x1 1x M12x1			ø23,81/22,2 2x 1x M10x1 1x M12x1		



03.2023-2407.3 010796	L1 59,2	L2 105,7	03.2025-0211.3 010034	L1 57,8	L2 108
ø23,81/22,2 M12x1 2x			ø25,4/19,05 M10x1 3x		

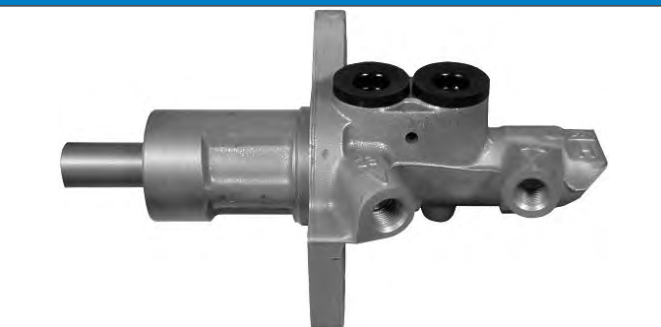

Abbildungen Hauptbremszylinder

Illustrations master cylinder - Ilustraciones cilindro freno - Illustrations Maître-cylindres - Illustrazioni pompe Freno

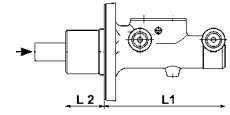

03.2025-1211.3 010475	L1 53,9	L2 118	03.2025-1741.3 010705	L1 12	L2 169,5
ø25,4/20,64 M10x1 2x			ø25,4/20,64 M12x1 4x		



03.2025-1904.3 010797	L1 59,2	L2 105,7	03.2026-0462.3 010728	L1 57,4	L2 115,9
ø25,4/22,2 M12x1 2x			ø26,99/25,4 M10x1 2x		



03.2026-0512.3 010038	L1 57,6	L2 115,9	03.2026-0562.3 010729	L1 57,4	L2 115,9
ø26,99/25,4 M10x1 2x			ø26,99/25,4 2x 1x M10x1 1x M12x1		



03.2026-0712.3 010730	L1 39,5	L2 119,8	03.2119-3389.3 010057	L1 40	L2 114,9
ø26,99/25,4 2x 1x M10x1 1x M12x1			ø19,05 M10x1 4x		



Abbildungen Hauptbremszylinder

Illustrations master cylinder - Ilustraciones cilindro freno - Illustrations Maître-cylindres - Illustrazioni pompe Freno

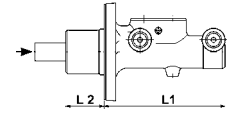

03.2119-3391.3	010058	L1 40	L2 114,9	03.2120-1122.3	010084	L1 10	L2 206,5
ø19,05 M10x1 2x				ø20,64 M10x1 3x			



03.2120-1142.3	010085	L1 18,8	L2 167	03.2120-1897.3	010103	L1 40	L2 114,9
ø20,64 M10x1 3x				ø20,64 M10x1 2x			



03.2120-1981.3	010105	L1 15,5	L2 198,5	03.2120-2031.3	010106	L1 32,4	L2 114,9
ø20,64 3x 2x M10x1 1x M12x1				ø20,64 M10x1 4x			



03.2120-2682.3	010118	L1 36	L2 114,9	03.2120-3943.3	010532	L1 35,4	L2 109,7
ø20,64 M10x1 4x				ø20,64 M10x1 4x			



Abbildungen Hauptbremszylinder

Illustrations master cylinder - Ilustraciones cilindro freno - Illustrations Maître-cylindres - Illustrazioni pompe Freno

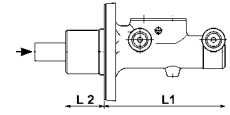

03.2120-4166.3	010452	L1 29,9	L2 115,9	03.2120-4221.3	010605	L1 29,9	L2 115,9
ø20,64 M10x1 4x				ø20,64 M10x1 2x			



03.2120-4241.3	010524	L1 29,9	L2 115,9	03.2120-4246.3	010614	L1 29,9	L2 115,9
ø20,64 M10x1 2x				ø20,64 M10x1 2x			



03.2120-4321.3	010525	L1 29,9	L2 115,9	03.2120-4381.3	010526	L1 29,9	L2 124,7
ø20,64 4x 2x M10x1 2x M12x1				ø20,64 4x 2x M10x1 2x M12x1			



03.2120-4441.3	010510	L1 31,5	L2 115,9	03.2120-4461.3	010571	L1 31,5	L2 124,7
ø20,64 M10x1 2x				ø20,64 2x 1x M10x1 1x M12x1			



Abbildungen Hauptbremszylinder

Illustrations master cylinder - Ilustraciones cilindro freno - Illustrations Maître-cylindres - Illustrazioni pompe Freno

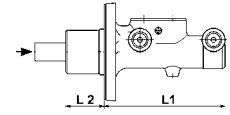

03.2120-4468.3	010789	L1	L2	03.2120-4581.3	010915	L1	L2
ø20,64	M12x1 2x	31,5	124,7	ø20,64	2x M10x1 M12x1	31,5	162,5



03.2122-0264.3	010129	L1	L2	03.2122-0282.3	010130	L1	L2
ø22,2	4x 2x M10x1 2x M12x1	33,1	118	ø22,2	2x 1x M10x1 1x M12x1	28,6	134,2



03.2122-0621.3	010131	L1	L2	03.2122-0626.3	010539	L1	L2
ø22,2	M10x1 4x	33,2	131,7	ø22,2	M10x1 2x	33,2	131,7



03.2122-0646.3	010133	L1	L2	03.2122-1001.3	010562	L1	L2
ø22,2	M10x1 2x	36	115,7	ø22,2	4x 2x M10x1 2x M12x1	27,9	131,7



Abbildungen Hauptbremszylinder

Illustrations master cylinder - Ilustraciones cilindro freno - Illustrations Maître-cylindres - Illustrazioni pompe Freno

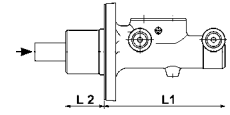

03.2122-1042.3	010137	L1 36	L2 109,7	03.2122-1144.3	010636	L1 36	L2 109,7
ø22,2 M10x1 4x				ø22,2 M10x1 2x			

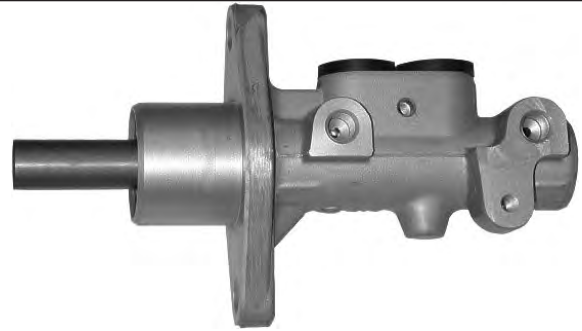

03.2122-1184.3	010592	L1 31,5	L2 119,6	03.2122-1331.3	010607	L1 31,5	L2 115,9
ø22,2 M12x1 2x				ø22,2 M10x1 2x			



03.2122-1344.3	010593	L1 31,5	L2 119,6	03.2122-1351.3	010528	L1 31,5	L2 115,9
ø22,2 M10x1 2x				ø22,2 2x 1x M10x1 1x M12x1			









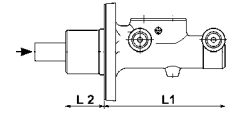

03.2122-1356.3	010529	L1 27,9	L2 115,9	03.2122-1421.3	010615	L1 31,5	L2 115,9
ø22,2 4x 2x M10x1 2x M12x1				ø22,2 M10x1 2x			



Abbildungen Hauptbremszylinder

Illustrations master cylinder - Ilustraciones cilindro freno - Illustrations Maître-cylindres - Illustrazioni pompe Freno



<p>03.2122-1461.3 010610 L1 L2 31,5 109,4 ø22,2 M10x1 2x</p>	<p>03.2122-1521.3 010494 L1 L2 31,5 119 ø22,2 M10x1 2x</p>
	
<p>03.2122-1541.3 010511 L1 L2 27,4 119 ø22,2 M10x1 4x</p>	<p>03.2122-1564.3 010594 L1 L2 26,5 124 ø22,2 M12x1 2x</p>
	
<p>03.2122-1588.3 010733 L1 L2 27,4 124 ø22,2 M10x1 4x</p>	<p>03.2122-1663.3 010734 L1 L2 4,1 143,3 ø22,2 M12x1 3x</p>
	
<p>03.2122-1691.3 010918 L1 L2 33,1 114,5 ø22,2 M12x10 2x</p>	<p>03.2122-1724.3 010648 L1 L2 4,1 139,6 ø22,2 4x 2x M10x1 2x M12x1</p>
	

Abbildungen Hauptbremszylinder

Illustrations master cylinder - Ilustraciones cilindro freno - Illustrations Maître-cylindres - Illustrazioni pompe Freno

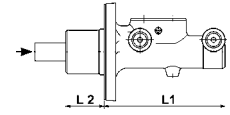

03.2122-1824.3 010892	L1 42,1	L2 109,3	03.2122-1853.3 010893	L1 40,9	L2 109,3
ø22,2 M12x1 3x			ø22,2 M12x1 2x		



03.2122-1883.3 010735	L1 6,4	L2 143,3	03.2122-1888.3 010736	L1 6,4	L2 143,3
ø22,2 M12x1 3x			ø22,2 M12x1 3x		



03.2122-1942.3 010700	L1 30,5	L2 117,7	03.2122-2129.3 010799	L1 36,1	L2 134,9
ø22,2 M12x1 3x			ø22,2 M12x1 2x		



03.2122-2163.3 010800	L1 39,8	L2 128,2	03.2122-9612.3 010159	L1 36	L2 103,7
ø22,2 M12x1 3x			ø22,2 M10x1 4x		

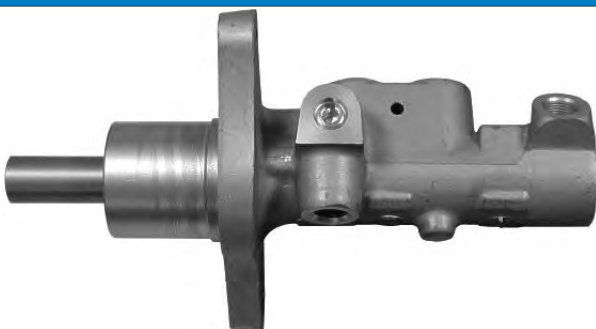

Abbildungen Hauptbremszylinder

Illustrations master cylinder - Ilustraciones cilindro freno - Illustrations Maître-cylindres - Illustrazioni pompe Freno

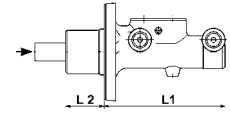

03.2122-9631.3	010160	L1 36	L2 103,7	03.2123-0491.3	010167	L1 36	L2 115,7
ø22,2 M10x1 4x				ø23,81 M10x1 4x			



03.2123-0566.3	010169	L1 36	L2 115,7	03.2123-1121.3	010176	L1 29,1	L2 118
ø23,81 M10x1 4x				ø23,81 2x 1x M10x1 1x M12x1			



03.2123-1424.3	010637	L1 34,4	L2 116,6	03.2123-1428.3	010476	L1 34,4	L2 116,6
ø23,81 M10x1 2x				ø23,81 M10x1 2x			

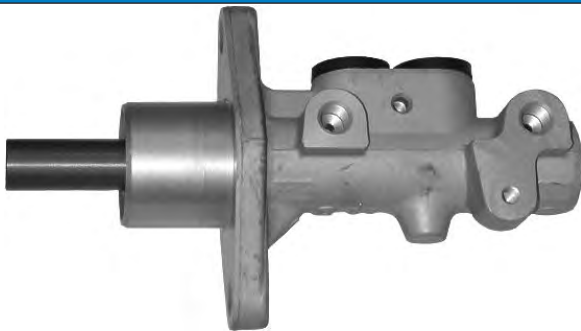







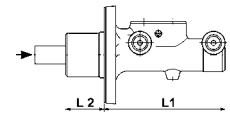

03.2123-1484.3	010595	L1 31,5	L2 119,6	03.2123-1486.3	010488	L1 31,5	L2 119,6
ø23,81 M12x1 2x				ø23,81 M12x1 2x			



Abbildungen Hauptbremszylinder

Illustrations master cylinder - Ilustraciones cilindro freno - Illustrations Maître-cylindres - Illustrazioni pompe Freno



<p>03.2123-1526.3 010477 L1 L2 31,5 119,6 ø23,81 M12x1 2x</p>	<p>03.2123-1546.3 010536 L1 L2 27,9 114,1 ø23,81 M10x1 4x</p>
	
<p>03.2123-1548.3 010478 L1 L2 27,9 114,1 ø23,81 M10x1 4x</p>	<p>03.2123-1551.3 010512 L1 L2 27,9 114,1 ø23,81 M10x1 4x</p>
	
<p>03.2123-1581.3 010487 L1 L2 33,1 125,8 ø23,81 M12x1 2x</p>	<p>03.2123-1622.3 010470 L1 L2 31,5 119,6 ø23,81 3x 1x M10x1 2x M12x1</p>
	
<p>03.2123-1626.3 010727 L1 L2 31,5 119,6 ø23,81 3x 1x M10x1 2x M12x1</p>	<p>03.2123-1722.3 010471 L1 L2 56 95,1 ø23,81 M12x1 2x</p>
	

Abbildungen Hauptbremszylinder

Illustrations master cylinder - Ilustraciones cilindro freno - Illustrations Maître-cylindres - Illustrazioni pompe Freno

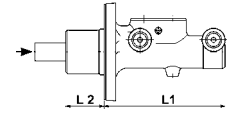

03.2123-1741.3	010537	L1	L2	03.2123-1824.3	010596	L1	L2
ø23,81	M10x1 4x	27,9	113,1	ø23,81	M10x1 2x	31,5	119,6



03.2123-2024.3	010597	L1	L2	03.2123-2064.3	010598	L1	L2
ø23,81	4x 2x M10x1 2x M12x1	4,1	137,8	ø23,81	M12x1 4x	12,5	128,9



03.2123-2146.3	010572	L1	L2	03.2123-2164.3	010599	L1	L2
ø23,81	M10x1 2x	31,5	119	ø23,81	M12x1 2x	40,3	130



03.2123-2221.3	010861	L1	L2	03.2123-2243.3	010748	L1	L2
ø23,81	M10x1 2x	13,2	1.437	ø23,81	M12x1 2x	26,5	124



Abbildungen Hauptbremszylinder

Illustrations master cylinder - Ilustraciones cilindro freno - Illustrations Maître-cylindres - Illustrazioni pompe Freno

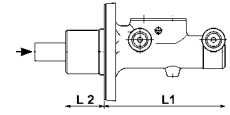

03.2123-2561.3	010629	L1 23,9	L2 133,8	03.2123-2581.3	010613	L1 31,5	L2 119,6
ø23,81 M12x1 3x				ø23,81 M12x1 2x			



03.2123-2621.3	010701	L1 30,5	L2 124,8	03.2123-2654.3	010801	L1 34,9	L2 121,4
ø23,81 M12x1 2x				ø23,81 M12x1 4x			



03.2123-2715.3	010802	L1 34,9	L2 121,4	03.2123-2721.3	010632	L1 31,5	L2 119,6
ø23,81 M12x1 3x				ø23,81 2x 1x M10x1 1x M12x1			



03.2123-2761.3	010886	L1 30,5	L2 123,7	03.2123-2774.3	010803	L1 26,6	L2 130,2
ø23,81 M12x1 2x				ø23,81 M12x1 4x			



Abbildungen Hauptbremszylinder

Illustrations master cylinder - Ilustraciones cilindro freno - Illustrations Maître-cylindres - Illustrazioni pompe Freno

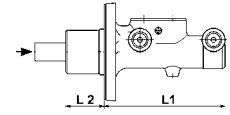

03.2123-2781.3	010631	L1 27,9	L2 119,6	03.2123-2863.3	010790	L1 29,2	L2 116
ø23,81 4x 2x M10x1 2x M12x1				ø23,81 M10x1 2x			



03.2123-2923.3	010791	L1 28,2	L2 119	03.2123-3041.3	010887	L1 41,5	L2 101,7
ø23,81 M12x1 2x				ø23,81 M10x1 4x			



03.2123-3103.3	010781	L1 37	L2 116,3	03.2123-3241.3	010882	L1 29,2	L2 116
ø23,81 M12x1 2x				ø23,81 M10x1 2x			



03.2123-3449.3	010808	L1 36,1	L2 134,9	03.2123-3493.3	010792	L1 28,2	L2 119
ø23,81 M12x1 2x				ø23,81 M12x1 2x			



Abbildungen Hauptbremszylinder

Illustrations master cylinder - Ilustraciones cilindro freno - Illustrations Maître-cylindres - Illustrazioni pompe Freno

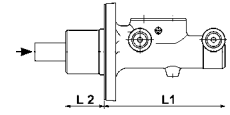

03.2123-3549.3	010809	L1	L2	03.2123-3593.3	010919	L1	L2
ø23,81	M12x1	2x	36,1	134,9	ø23,81	M12x1	2x
						37	116,3



03.2123-5212.3	010183	L1	L2	03.2123-6002.3	010184	L1	L2
ø23,81	M10x1	2x	18,5	166	ø23,81	M10x1	2x
						18,5	175



03.2125-0161.3	010920	L1	L2	03.2125-0298.3	010818	L1	L2
ø25,4	M10x1	2x	9	142	ø25,4	M10x1	2x
						35,2	133,8









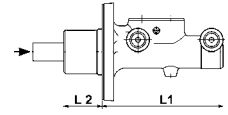

03.2125-0373.3	010810	L1	L2	03.2125-0483.3	010783	L1	L2
ø25,4	M12x1	2x	64,2	93,5	ø25,4	M12x1	2x
						37	117,5

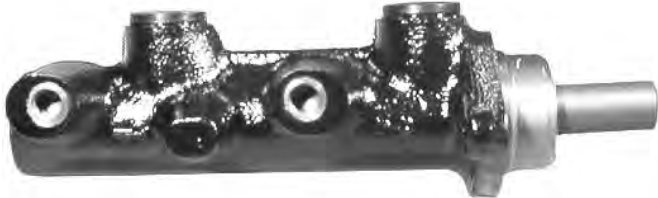

Abbildungen Hauptbremszylinder

Illustrations master cylinder - Ilustraciones cilindro freno - Illustrations Maître-cylindres - Illustrazioni pompe Freno



<p>03.2125-0661.3 010917 L1 L2 37 117,5 ø25,4 M14x1 2x</p>	<p>03.2125-1712.3 010204 L1 L2 18,5 166 ø25,4 M10x1 2x</p>
	
<p>03.2125-1902.3 010206 L1 L2 18,5 155 ø25,4 M10x1 2x</p>	<p>03.2125-2102.3 010207 L1 L2 18,5 158,5 ø25,4 M10x1 2x</p>
	
<p>03.2125-3011.3 010211 L1 L2 55,4 114,5 ø25,4 M10x1 2x</p>	<p>03.2125-3210.3 010212 L1 L2 36 116,2 ø25,4 M10x1 4x</p>
	
<p>03.2125-3610.3 010214 L1 L2 36 116,2 ø25,4 M10x1 2x</p>	<p>03.2125-3701.3 010627 L1 L2 18,5 166 ø25,4 M10x1 5x</p>
	

Abbildungen Hauptbremszylinder

Illustrations master cylinder - Ilustraciones cilindro freno - Illustrations Maître-cylindres - Illustrazioni pompe Freno

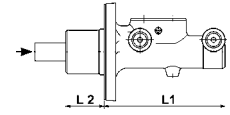

03.2125-3801.3	010215	L1 18,5	L2 166	03.2125-7002.3	010628	L1 10,2	L2 166
ø25,4 M10x1 5x				ø25,4 M10x1 2x			



03.2125-7310.3	010743	L1 11,6	L2 141	03.2125-7402.3	010541	L1 31,5	L2 120,8
ø25,4 M12x1 2x				ø25,4 3x 1x M10x1 2x M12x1			

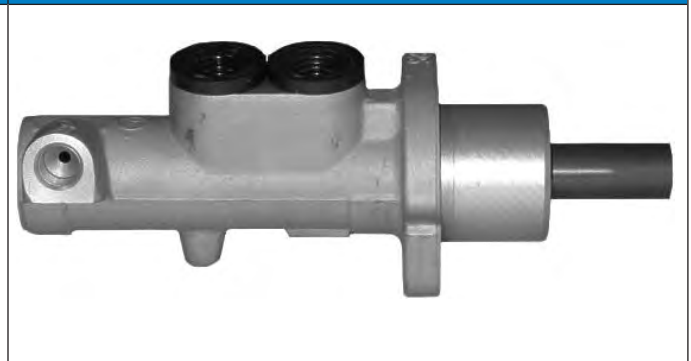

03.2125-7502.3	010616	L1 56	L2 96,3	03.2125-7637.3	010707	L1 11,6	L2 140,7
ø25,4 M12x1 2x				ø25,4 M12x1 2x			



03.2125-7638.3	010738	L1 11,6	L2 140,7	03.2125-7708.3	010739	L1 11,6	L2 140,7
ø25,4 M12x1 2x				ø25,4 M12x1 4x			



Abbildungen Hauptbremszylinder

Illustrations master cylinder - Ilustraciones cilindro freno - Illustrations Maître-cylindres - Illustrazioni pompe Freno

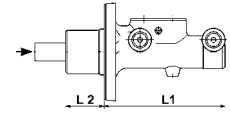

03.2125-7713.3 010819

L1 11,6
L2 140,7

ø25,4 M12x1 4x



03.2125-8111.3 010479

L1 31,5
L2 120,8

ø25,4 M10x1 4x



03.2125-8404.3 010583

L1 34,6
L2 108

ø25,4 M10x1 4x



03.2125-9604.3 010581

L1 14,6
L2 131,5

ø25,4 M10x1 5x



03.2125-9704.3 010603

L1 32,9
L2 125,5

ø25,4 M12x1 2x



03.2125-9901.3 010634

L1 44,7
L2 110,9

ø25,4 3x 1x M10x1 2x M12x1

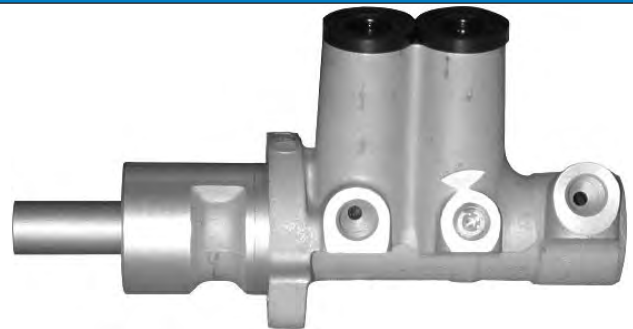

03.2125-9911.3 010883

L1 44,7
L2 112,4

ø25,4 M12x1 2x



03.2126-0512.3 010217

L1 18,5
L2 155

ø26,99 M10x1 2x



Abbildungen Hauptbremszylinder

Illustrations master cylinder - Ilustraciones cilindro freno - Illustrations Maître-cylindres - Illustrazioni pompe Freno

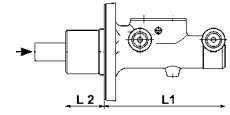

03.2126-3014.3	010811	L1	L2	03.2126-3063.3	010812	L1	L2
ø26,99	M12x1	2x	18,7	133,5	ø26,99	M12x1	2x
						23,3	128,9



03.4055-0013.3	010793	L1	L2	03.4122-0031.3	010611	L1	L2
ø25,4	M12x1	2x	20	106	ø22,2	M10x1	4x
						14	85,1

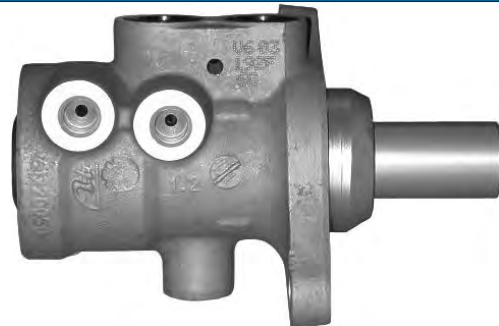

03.4122-0041.3	010612	L1	L2	03.4122-0054.3	010813	L1	L2
ø22,2	M10x1	2x	14	85,1	ø22,2	M12x1	2x
						13,7	87,9





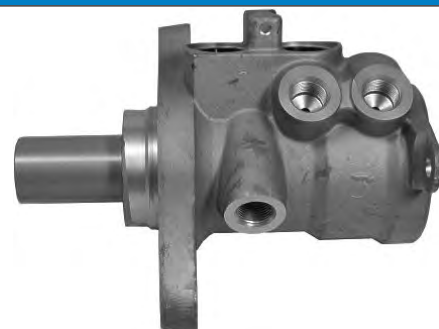



03.4123-0081.3	010585	L1	L2	03.4123-0153.3	010659	L1	L2
ø23,81	M12x1	3x	5,5	102,3	ø23,81	M12x1	3x
						12,8	90,3

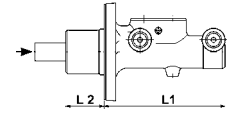

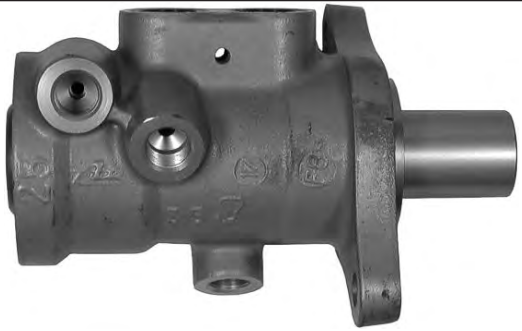
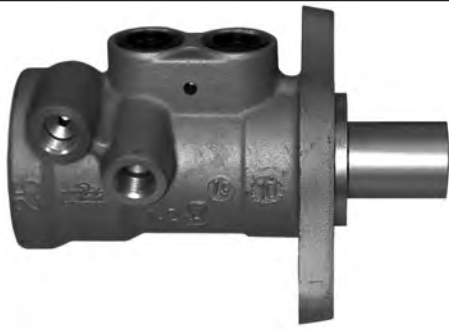
Abbildungen Hauptbremszylinder

Illustrations master cylinder - Ilustraciones cilindro freno - Illustrations Maître-cylindres - Illustrazioni pompe Freno

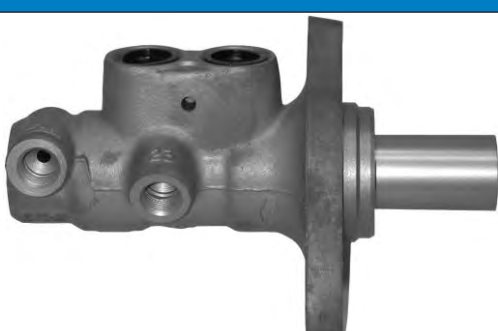







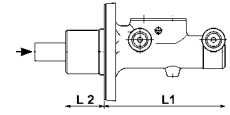

<p>03.4125-0014.3 010794 L1 L2 4,2 105 ø25,4 M12x1 3x</p>	<p>03.4125-0021.3 010888 L1 L2 4,2 105 ø25,4 M12x1 2x</p>
	
<p>03.4152-0053.3 010884 L1 L2 27,9 91 ø22,2 M10x1 2x</p>	<p>03.4152-0058.3 010885 L1 L2 27,9 91 ø22,2 M12x1 2x</p>
	
<p>03.4152-0116.3 010814 L1 L2 27,1 117 ø22,2 M12x1 2x</p>	<p>03.4153-0063.3 010773 L1 L2 9,9 105,1 ø23,81 M10x1 2x</p>
	
<p>03.4153-0173.3 010815 L1 L2 31,7 92,2 ø23,81 M12x1 2x</p>	<p>03.4153-0186.3 010816 L1 L2 27,1 117 ø23,81 M12x1 2x</p>
	

Abbildungen Hauptbremszylinder

Illustrations master cylinder - Ilustraciones cilindro freno - Illustrations Maître-cylindres - Illustrazioni pompe Freno









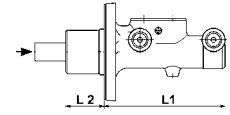

<p>03.4155-0043.3 010795 L1 L2 9,9 105 ø25,4 M12x1 2x</p>	<p>03.4155-0156.3 010862 L1 L2 24,2 90,7 ø25,4 M12x1 2x</p>
	
<p>10.6120-0287.3 010334 L1 L2 39,8 121,1 ø20,64 M10x1 2x</p>	<p>10.6123-0154.3 010578 L1 L2 12 174,6 ø23,81 2x 1x M10x1 1x M12x1</p>
	
<p>10.6123-0239.3 010335 L1 L2 43,3 132 ø23,81 M10x1 2x</p>	<p>10.6123-0312.3 010457 L1 L2 38 133,2 ø23,81 2x 1x M10x1 1x M12x1</p>
	
<p>10.6123-0522.3 010633 L1 L2 38 142 ø23,81 M10x1 2x</p>	<p>10.6123-0674.3 010639 L1 L2 41 127,9 ø23,81 M10x1 2x</p>
	

Abbildungen Hauptbremszylinder

Illustrations master cylinder - Ilustraciones cilindro freno - Illustrations Maître-cylindres - Illustrazioni pompe Freno



<p>20.5522-1093.3 010731 L1 L2 31,5 120 ø22,2 M10x1 2x</p>	<p>20.5522-1128.3 010747 L1 L2 31,5 120 ø22,2 M10x1 2x</p>
	
<p>24.2022-1601.3 010340 L1 L2 58 113 ø22,2/17,46 M10x1 3x</p>	<p>24.2023-1601.3 010341 L1 L2 50 120,5 ø23,81 M10x1 3x</p>
	
<p>24.2023-1701.3 010514 L1 L2 51,5 106 ø23,81/19,05 2x 1x M10x1 1x M12x1</p>	<p>24.2023-1702.3 010534 L1 L2 24 125 ø23,81/19,05 M12x1 3x</p>
	
<p>24.2023-1704.3 010635 L1 L2 14 135 ø23,81 M12x1 3x</p>	<p>24.2025-1702.3 010515 L1 L2 51,3 106,2 ø25,4/19,05 2x 1x M10x1 1x M12x1</p>
	

Abbildungen Hauptbremszylinder

Illustrations master cylinder - Ilustraciones cilindro freno - Illustrations Maître-cylindres - Illustrazioni pompe Freno

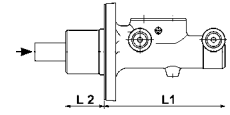

24.2025-1703.3 010516	L1 51,3	L2 106,2	24.2025-1704.3 010619	L1 51,3	L2 107,7
ø25,4/19,05 M12x1 2x			ø25,4 3x 1x M10x1 2x M12x1		



24.2025-1705.3 010624	L1 51,5	L2 108	24.2025-1706.3 010676	L1 33	L2 127
ø25,4/20,64 2x 1x M10x1 1x M12x1			ø25,4 2x 1x M10x1 1x M12x1		



24.2025-1707.3 010691	L1 51,7	L2 108,5	24.2025-1708.3 010692	L1 33	L2 127
ø25,4 M12x1 2x			ø25,4 5x 3x M10x1 2x M12x1		



24.2025-1709.3 010693	L1 51,3	L2 108	24.2025-1710.3 010833	L1 69,3	L2 90
ø25,4 M12x1 2x			ø25,4 M12x1 2x		



Abbildungen Hauptbremszylinder

Illustrations master cylinder - Ilustraciones cilindro freno - Illustrations Maître-cylindres - Illustrazioni pompe Freno

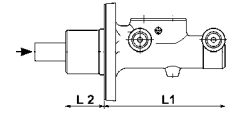

24.2026-1701.3	010746	L1 51,2	L2 107,3	24.2026-1702.3	010850	L1 69,2	L2 90,5
ø26,99/ 20,64 M12x1 3x				ø26,99/ 22,2 M12x1 2x			

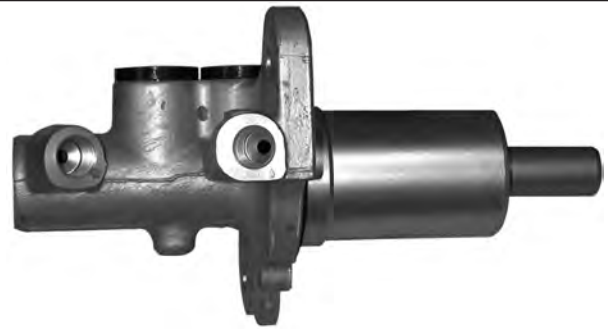

24.2026-1703.3	010910	L1 68,5	L2 90,5	24.2117-1501.3	010398	L1 8,5	L2 182,5
ø26,99/ 22,2 M12x1 2x				ø17,46 M10x1 2x			



24.2119-0815.3	010347	L1 12	L2 177,5	24.2119-0826.3	010349	L1 12	L2 178,4
ø19,05 M10x1,25 3x				ø19,05 M10x1 3x			









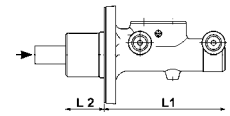

24.2119-0827.3	010350	L1 12	L2 178	24.2119-0829.3	010351	L1 9	L2 194,1
ø19,05 M10x1 3x				ø19,05 M10x1 3x			



Abbildungen Hauptbremszylinder

Illustrations master cylinder - Ilustraciones cilindro freno - Illustrations Maître-cylindres - Illustrazioni pompe Freno



<p>24.2119-0831.3 010416 L1 L2 9,5 190 ø19,05 M10x1,25 3x</p>	<p>24.2119-0832.3 010417 L1 L2 9,5 190 ø19,05 M10x1,25 3x</p>
	
<p>24.2119-0833.3 010418 L1 L2 10,5 190 ø19,05 M10x1 4x</p>	<p>24.2119-1702.3 010435 L1 L2 40 115,2 ø19,05 M10x1 4x</p>
	
<p>24.2119-1705.3 010460 L1 L2 8,5 192,5 ø19,05 M10x1 2x</p>	<p>24.2119-1708.3 010543 L1 L2 34,5 116,5 ø19,05 M10x1 4x</p>
	
<p>24.2119-1709.3 010876 L1 L2 18 164 ø19,05 M10x1 2x</p>	<p>24.2119-1710.3 010880 L1 L2 17 130 ø19,05 M10x1 2x</p>
	

Abbildungen Hauptbremszylinder

Illustrations master cylinder - Ilustraciones cilindro freno - Illustrations Maître-cylindres - Illustrazioni pompe Freno

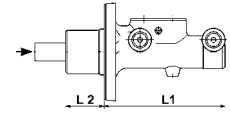

24.2119-1711.3	010911	L1	L2	24.2119-1712.3	010912	L1	L2
ø19,05	M12x1 2x	41	116,5	ø19,05	M12x1 2x	38,5	140



24.2120-0702.3	010361	L1	L2	24.2120-0801.3	010362	L1	L2
ø20,64	4x 2x M10x1 2x M12x1	16	130	ø20,64	M10x1 3x	9	190,2



24.2120-0802.3	010363	L1	L2	24.2120-0803.3	010415	L1	L2
ø20,64	M10x1 3x	39,1	120,4	ø20,64	M10x1,25 4x	9	178,5



24.2120-0913.3	010392	L1	L2	24.2120-1604.3	010370	L1	L2
ø20,64	4x 1x M10x1/1x M12x1 2x M15x1	16	130,5	ø20,64	2x 1x M10x1 1x M12x1	16,5	172,5



Abbildungen Hauptbremszylinder

Illustrations master cylinder - Ilustraciones cilindro freno - Illustrations Maître-cylindres - Illustrazioni pompe Freno

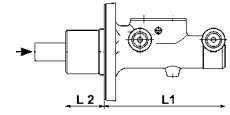

24.2120-1701.3	010427	L1 38	L2 114,2	24.2120-1704.3	010429	L1 40	L2 114,2
ø20,64 M10x1 2x				ø20,64 M10x1 4x			



24.2120-1706.3	010262	L1 40,1	L2 118	24.2120-1710.3	010468	L1 33,5	L2 130
ø20,64 M10x1 4x				ø20,64 M10x1 4x			



24.2120-1721.3	010553	L1 51,3	L2 143,8	24.2120-1722.3	010544	L1 34,5	L2 116,5
ø20,64 3x 2x M10x1 1x M12x1				ø20,64 M10x1 4x			



24.2120-1723.3	010545	L1 34,5	L2 118	24.2120-1725.3	010579	L1 34,5	L2 118
ø20,64 M10x1 2x				ø20,64 M10x1 2x			



Abbildungen Hauptbremszylinder

Illustrations master cylinder - Ilustraciones cilindro freno - Illustrations Maître-cylindres - Illustrazioni pompe Freno

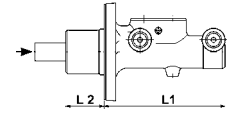

24.2120-1726.3	010564	L1	L2	24.2120-1728.3	010626	L1	L2
ø20,64	2x 1x M10x1 1x M12x1	33	120	ø20,64	M10x1 2x	34,5	116,2



24.2120-1730.3	010678	L1	L2	24.2120-1733.3	010686	L1	L2
ø20,64	M10x1 2x	34,5	116,2	ø20,64	M10x1 3x	33,5	128,5



24.2120-1734.3	010702	L1	L2	24.2120-1735.3	010726	L1	L2
ø20,64	M12x1 2x	38,5	139,5	ø20,64	M12x1 2x	33	130,5



24.2120-1736.3	010732	L1	L2	24.2120-1737.3	010757	L1	L2
ø20,64	M12x1 4x	28,1	138,2	ø20,64	4x 2x M10x1 2x M12x1	30	117



Abbildungen Hauptbremszylinder

Illustrations master cylinder - Ilustraciones cilindro freno - Illustrations Maître-cylindres - Illustrazioni pompe Freno

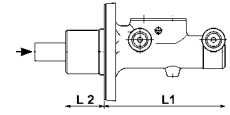

24.2120-1738.3 010759

L1
51 L2
139

ø20,64 4x 2x M10x1 2x M12x1



24.2120-1739.3 010762

L1
19 L2
171

ø20,64 4x 2x M10x1 2x M12x1



24.2120-1740.3 010764

L1
51 L2
139

ø20,64 M12x1 4x



24.2120-1741.3 010775

L1
24 L2
132

ø20,64 M12x1 4x



24.2120-1742.3 010776

L1
33 L2
125

ø20,64 M10x1 4x



24.2120-1743.3 010777

L1
33 L2
125

ø20,64 M10x1 2x



24.2120-1744.3 010820

L1
36,5 L2
132,5

ø20,64 M10x1 4x



24.2120-1745.3 010834

L1
30,5 L2
131

ø20,64 M10x1 2x



Abbildungen Hauptbremszylinder

Illustrations master cylinder - Ilustraciones cilindro freno - Illustrations Maître-cylindres - Illustrazioni pompe Freno

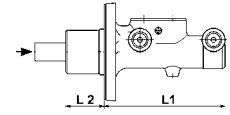

24.2120-1746.3 010835	L1 33	L2 130,5	24.2120-1747.3 010836	L1 36,5	L2 134
ø20,64 M12x1 2x			ø20,64 M10x1 2x		



24.2120-1748.3 010894	L1 25	L2 162	24.2120-1749.3 010903	L1	L2
ø20,64 M12x1 2x			ø20,64 M10x1 2x		



24.2120-1751.3 010909	L1 15,5	L2 153,5	24.2120-1752.3 010928	L1 26	L2 157
ø20,64 M10x1 2x			ø20,64 M10x1 2x		









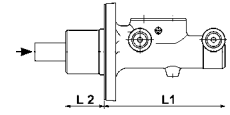

24.2120-1754.3 010949	L1 23,5	L2 107,5	24.2122-1603.3 010381	L1 16,5	L2 173,5
ø20,64 2x M10x1 M12x1			ø22,2 2x 1x M10x1 1x M12x1		

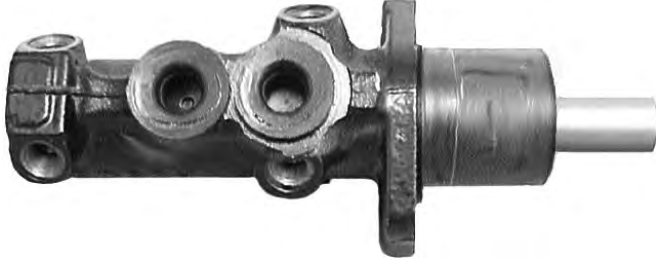

Abbildungen Hauptbremszylinder

Illustrations master cylinder - Ilustraciones cilindro freno - Illustrations Maître-cylindres - Illustrazioni pompe Freno









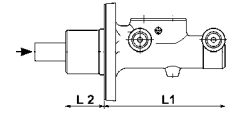

<p>24.2122-1703.3 010422 L1 L2 36,2 115,2 ø22,2 M10x1 4x</p>	<p>24.2122-1704.3 010423 L1 L2 39 115,5 ø22,2 M10x1 4x</p>
	
<p>24.2122-1705.3 010434 L1 L2 36,5 118 ø22,2 M10x1 4x</p>	<p>24.2122-1707.3 010438 L1 L2 36,5 128 ø22,2 M10x1 4x</p>
	
<p>24.2122-1708.3 010437 L1 L2 35 131,5 ø22,2 M10x1 2x</p>	<p>24.2122-1714.3 010480 L1 L2 19 168 ø22,2 M10x1 2x</p>
	
<p>24.2122-1715.3 010481 L1 L2 19 167 ø22,2 M10x1 5x</p>	<p>24.2122-1716.3 010485 L1 L2 36 132 ø22,2 M10x1 4x</p>
	

Abbildungen Hauptbremszylinder

Illustrations master cylinder - Ilustraciones cilindro freno - Illustrations Maître-cylindres - Illustrazioni pompe Freno









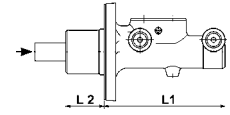

<p>24.2122-1718.3 010517 L1 L2 36,5 117 ø22,2 M10x1 2x</p>	<p>24.2122-1724.3 010561 L1 L2 23,5 122,5 ø22,2 2x 1x M10x1 1x M12x1</p>
	
<p>24.2122-1727.3 010586 L1 L2 34,5 115,5 ø22,2 4x 2x M10x1 2x M12x1</p>	<p>24.2122-1731.3 010656 L1 L2 36 150,2 ø22,2 M10x1 4x</p>
	
<p>24.2122-1733.3 010668 L1 L2 34,5 165 ø22,2 4x 2x M10x1 2x M12x1</p>	<p>24.2122-1740.3 010711 L1 L2 27,5 118,5 ø22,2 2x 1x M10x1 1x M12x1</p>
	
<p>24.2122-1741.3 010695 L1 L2 36 115 ø22,2 M10x1 4x</p>	<p>24.2122-1742.3 010696 L1 L2 35 131,5 ø22,2 M10x1 2x</p>
	

Abbildungen Hauptbremszylinder

Illustrations master cylinder - Ilustraciones cilindro freno - Illustrations Maître-cylindres - Illustrazioni pompe Freno









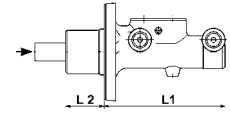

<p>24.2122-1743.3 010712 L1 L2 29 117 ø22,2 4x 2x M10x1 2x M12x1</p>	<p>24.2122-1744.3 010697 L1 L2 34,6 116 ø22,2 2x 1x M10x1 1x M12x1</p>
	
<p>24.2122-1750.3 010740 L1 L2 29,5 120,5 ø22,2 M10x1 4x</p>	<p>24.2122-1757.3 010769 L1 L2 31 132 ø22,2 M12x1 2x</p>
	
<p>24.2122-1760.3 010821 L1 L2 33 125 ø22,2 M10x1 4x</p>	<p>24.2122-1761.3 010822 L1 L2 16 154,3 ø22,2 M10x1 2x</p>
	
<p>24.2122-1762.3 010837 L1 L2 30 131 ø22,2 M10x1 2x</p>	<p>24.2122-1763.3 010838 L1 L2 33 125 ø22,2 M10x1 2x</p>
	

Abbildungen Hauptbremszylinder

Illustrations master cylinder - Ilustraciones cilindro freno - Illustrations Maître-cylindres - Illustrazioni pompe Freno









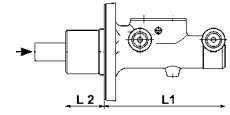

<p>24.2122-1764.3 010851 L1 L2 26,5 138 ø22,2 M12x1 2x</p>	<p>24.2122-1765.3 010839 L1 L2 16 154 ø22,2 M10x1 2x</p>
	
<p>24.2122-1766.3 010840 L1 L2 25 135 ø22,2 M12x1 2x</p>	<p>24.2122-1767.3 010841 L1 L2 25 135 ø22,2 M12x1 3x</p>
	
<p>24.2122-1768.3 010853 L1 L2 30 131 ø22,2 M12x1 2x</p>	<p>24.2122-1770.3 010898 L1 L2 45 114 ø22,2 M12x1 2x</p>
	
<p>24.2122-1771.3 010901 L1 L2 15,5 153,5 ø22,2 M10x1 2x</p>	<p>24.2123-1602.3 010384 L1 L2 32 126,5 ø23,81 M10x1 2x</p>
	

Abbildungen Hauptbremszylinder

Illustrations master cylinder - Ilustraciones cilindro freno - Illustrations Maître-cylindres - Illustrazioni pompe Freno



<p>24.2123-1606.3 010386 L1 L2 36 119 ø23,81 2x 1x M10x1 1x M12x1</p>	<p>24.2123-1701.3 010424 L1 L2 36,5 126,7 ø23,81 M10x1 4x</p>
	
<p>24.2123-1702.3 010431 L1 L2 10,5 200 ø23,81 4x 2x M10x1</p>	<p>24.2123-1707.3 010492 L1 L2 36 117,5 ø23,81 M10x1 4x</p>
	
<p>24.2123-1709.3 010503 L1 L2 32 122 ø23,81 M12x1 2x</p>	<p>24.2123-1710.3 010504 L1 L2 36 118 ø23,81 M10x1 4x</p>
	
<p>24.2123-1711.3 010518 L1 L2 35 165 ø23,81 M10x1 2x</p>	<p>24.2123-1712.3 010519 L1 L2 36 120 ø23,81 M10x1 4x</p>
	

Abbildungen Hauptbremszylinder

Illustrations master cylinder - Ilustraciones cilindro freno - Illustrations Maître-cylindres - Illustrazioni pompe Freno

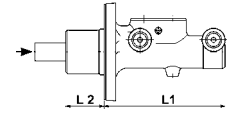

24.2123-1713.3 010505	L1 34,5	L2 127	24.2123-1714.3 010587	L1 33	L2 120,5
ø23,81 M12x1 2x			ø23,81 4x 2x M10x1 2x M12x1		



24.2123-1715.3 010520	L1 33	L2 120,5	24.2123-1717.3 010521	L1 39,5	L2 121,5
ø23,81 2x 1x M10x1 1x M12x1			ø23,81 M12x1 2x		



24.2123-1725.3 010549	L1 36,5	L2 126,5	24.2123-1726.3 010557	L1 36	L2 110
ø23,81 4x 2x M10x1 2x M12x1			ø23,81 M10x1 3x		



24.2123-1728.3 010558	L1 36	L2 128	24.2123-1729.3 010567	L1 35	L2 150,8
ø23,81 M10x1 2x			ø23,81 M10x1 2x		



Abbildungen Hauptbremszylinder

Illustrations master cylinder - Ilustraciones cilindro freno - Illustrations Maître-cylindres - Illustrazioni pompe Freno

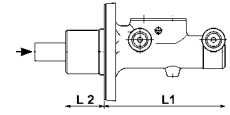

24.2123-1730.3 010620	L1 39,5	L2 120,5	24.2123-1731.3 010621	L1 32	L2 124,5
ø23,81 2x 1x M10x1 1x M12x1			ø23,81 M12x1 2x		



24.2123-1732.3 010625	L1 36	L2 105,5	24.2123-1733.3 010657	L1 36,5	L2 126,7
ø23,81 M10x1 4x			ø23,81 M10x1 2x		



24.2123-1734.3 010640	L1 39,5	L2 119,5	24.2123-1735.3 010652	L1 17	L2 174
ø23,81 2x 1x M10x1 1x M12x1			ø23,81 M10x1 2x		

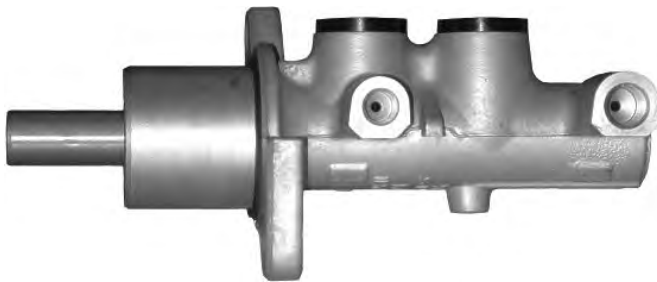

24.2123-1737.3 010654	L1 17	L2 174	24.2123-1738.3 010658	L1 36	L2 118,5
ø23,81 M10x1 4x			ø23,81 M10x1 4x		



Abbildungen Hauptbremszylinder

Illustrations master cylinder - Ilustraciones cilindro freno - Illustrations Maître-cylindres - Illustrazioni pompe Freno

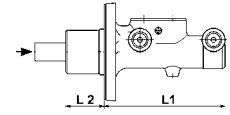

24.2123-1739.3	010661	L1 39,5	L2 121	24.2123-1740.3	010662	L1 51,5	L2 112
ø23,81 M12x1 2x				ø23,81 M12x1 2x			



24.2123-1741.3	010681	L1 33	L2 127	24.2123-1742.3	010671	L1 33	L2 121
ø23,81 M12x1 2x				ø23,81 M12x1 2x			



24.2123-1746.3	010682	L1 36,5	L2 116,5	24.2123-1749.3	010713	L1 33	L2 120
ø23,81 M10x1 2x				ø23,81 M10x1 2x			



24.2123-1751.3	010698	L1 36	L2 118	24.2123-1754.3	010741	L1 67	L2 111,5
ø23,81 M10x1 4x				ø23,81 M12x1 2x			



Abbildungen Hauptbremszylinder

Illustrations master cylinder - Ilustraciones cilindro freno - Illustrations Maître-cylindres - Illustrazioni pompe Freno

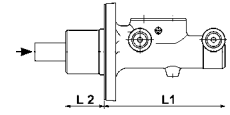

24.2123-1755.3 010750	L1 67	L2 110	24.2123-1759.3 010768	L1 39	L2 143,2
ø23,81 M10x1 2x			ø23,81 M12x1 2x		



24.2123-1760.3 010779	L1 25	L2 155	24.2123-1761.3 010780	L1 15	L2 152
ø23,81 M12x1 2x			ø23,81 M10x1 2x		



24.2123-1762.3 010823	L1 15	L2 161	24.2123-1763.3 010842	L1 32,5	L2 131
ø23,81 M10x1 2x			ø23,81 M10x1 2x		



24.2123-1764.3 010824	L1 29	L2 132	24.2123-1766.3 010825	L1 40	L2 121
ø23,81 2x 1x M10x1 1x M12x1			ø23,81 M12x1 2x		



Abbildungen Hauptbremszylinder

Illustrations master cylinder - Ilustraciones cilindro freno - Illustrations Maître-cylindres - Illustrazioni pompe Freno

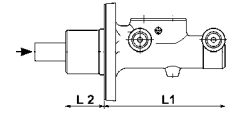

24.2123-1767.3 010844	L1 31	L2 131	24.2123-1768.3 010845	L1 31	L2 131
ø23,81 M10x1 2x			ø23,81 M12x1 2x		



24.2123-1769.3 010863	L1 32,5	L2 131	24.2123-1772.3 010858	L1 73	L2 122
ø23,81 M12x1 2x			ø23,81 M12x1 2x		



24.2123-1774.3 010877	L1 15,5	L2 153	24.2123-1776.3 010926	L1 40	L2 115
ø23,81 M10x1 2x			ø23,81 M12x1 2x		

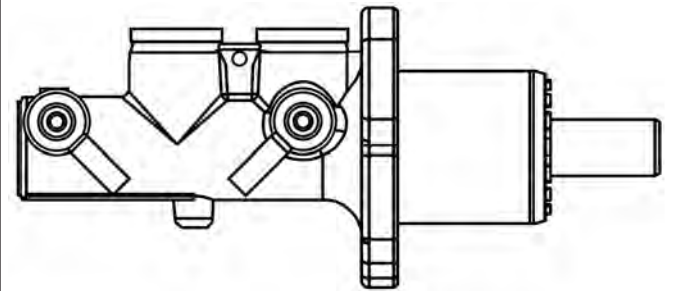







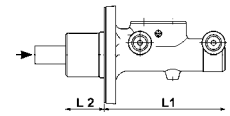

24.2123-1777.3 010943	L1 39,5	L2 120,5	24.2125-1702.3 010482	L1 19	L2 173,5
ø23,81 2x 1x M10x1 1x M12x1			ø25,4 M10x1 2x		



Abbildungen Hauptbremszylinder

Illustrations master cylinder - Ilustraciones cilindro freno - Illustrations
Maître-cylindres - Illustrazioni pompe Freno







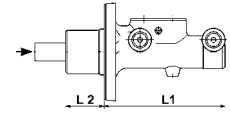

<p>24.2125-1703.3 010483 L1 L2 9 168 ø25,4 M10x1 5x</p>	<p>24.2125-1704.3 010446 L1 L2 15,5 189 ø25,4 2x 1x M10x1 1x M12x1</p>
	
<p>24.2125-1706.3 010496 L1 L2 43 99 ø25,4 4x 2x M10x1 2x M12x1</p>	<p>24.2125-1707.3 010497 L1 L2 42,5 110,5 ø25,4 M12x1 2x</p>
	
<p>24.2125-1708.3 010498 L1 L2 46,8 112 ø25,4 M12x1 2x</p>	<p>24.2125-1709.3 010499 L1 L2 38 125 ø25,4 M12x1 2x</p>
	
<p>24.2125-1710.3 010559 L1 L2 36,5 109 ø25,4 M10x1 4x</p>	<p>24.2125-1712.3 010622 L1 L2 49,5 111,5 ø25,4 M12x1 2x</p>
	

Abbildungen Hauptbremszylinder

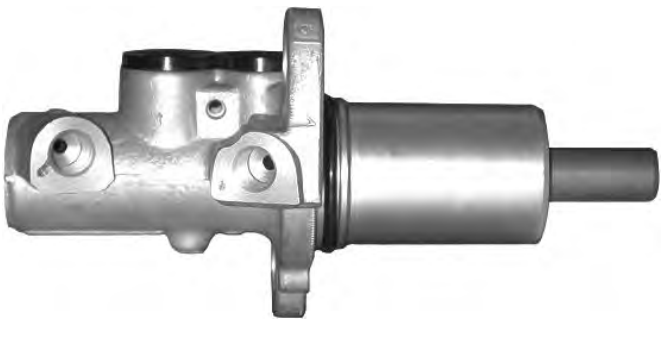
Illustrations master cylinder - Ilustraciones cilindro freno - Illustrations Maître-cylindres - Illustrazioni pompe Freno









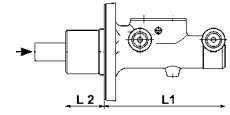

<p>24.2125-1713.3 010623 L1 L2 49 111 ø25,4 2x 1x M10x1 1x M12x1</p>	<p>24.2125-1716.3 010663 L1 L2 57 120 ø25,4 M12x1 2x</p>
	
<p>24.2125-1719.3 010666 L1 L2 38 110 ø25,4 2x 1x M10x1 1x M12x1</p>	<p>24.2125-1720.3 010688 L1 L2 69,5 92 ø25,4 M12x1 2x</p>
	
<p>24.2125-1723.3 010689 L1 L2 47,5 113,5 ø25,4 M10x1 2x</p>	<p>24.2125-1725.3 010717 L1 L2 33 147 ø25,4 M10x1 5x</p>
	
<p>24.2125-1726.3 010718 L1 L2 33 147 ø25,4 M10x1 2x</p>	<p>24.2125-1727.3 010723 L1 L2 35 165,3 ø25,4 M10x1 2x</p>
	

Abbildungen Hauptbremszylinder

Illustrations master cylinder - Ilustraciones cilindro freno - Illustrations Maître-cylindres - Illustrazioni pompe Freno



<p>24.2125-1728.3 010751 L1 L2 67 111,5 ø25,4 M12x1 2x</p>	<p>24.2125-1731.3 010826 L1 L2 47,5 113 ø25,4 M12x1 2x</p>
	
<p>24.2125-1732.3 010827 L1 L2 40 122 ø25,4 M12x1 2x</p>	<p>24.2125-1733.3 010830 L1 L2 40 122 ø25,4 2x 1x M10x1 1x M12x1</p>
	
<p>24.2125-1734.3 010878 L1 L2 47,5 115 ø25,4 M12x1 2x</p>	<p>24.2125-1735.3 010879 L1 L2 67 111,5 ø25,4 M10x1 2x</p>
	
<p>24.2125-1736.3 010904 L1 L2 31 129 ø25,4 M12x1 2x</p>	<p>24.2125-1737.3 010906 L1 L2 31 129 ø25,4 2x M10x1 M12x1</p>
	

Abbildungen Hauptbremszylinder

Illustrations master cylinder - Ilustraciones cilindro freno - Illustrations Maître-cylindres - Illustrazioni pompe Freno

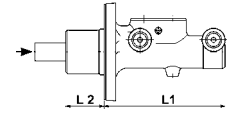

24.2125-1738.3	010931	L1 34	L2 114	24.4025-1701.3	010719	L1 51	L2 67,2
ø25,4 M10x1 3x				ø25,4 M12x1 2x			



24.4120-1701.3	010846	L1 32	L2 86,3	24.4120-1702.3	010913	L1 6	L2 119
ø20,64 M10x1 2x				ø20,64 M10x1 2x			

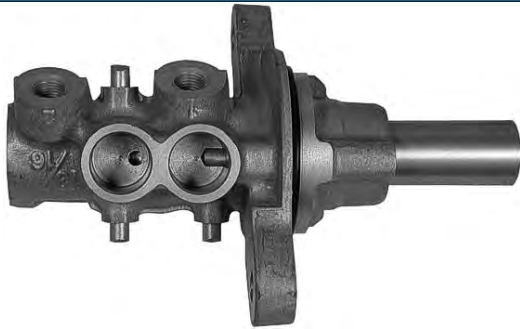

24.4122-1701.3	010533	L1 10,2	L2 109	24.4122-1703.3	010843	L1 32	L2 112
ø22,2 M12x1 2x				ø22,2 M12x1 2x			



24.4122-1704.3	010847	L1 6	L2 112	24.4122-1705.3	010852	L1 32	L2 80
ø22,2 M10x1 2x				ø22,2 M12x1 2x			



Abbildungen Hauptbremszylinder

Illustrations master cylinder - Ilustraciones cilindro freno - Illustrations Maître-cylindres - Illustrazioni pompe Freno

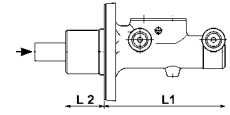

24.4122-1708.3	010865	L1 20	L2 95	24.4122-1709.3	010871	L1 32	L2 78
ø22,2 M10x1 2x				ø22,2 M10x1 2x			



24.4122-1714.3	010914	L1 6	L2 119	24.4123-1703.3	010831	L1 55	L2 53
ø22,2 M10x1 2x				ø23,81 M12x1 2x			



24.4123-1704.3	010828	L1 6	L2 112	24.4123-1705.3	010832	L1 6	L2 112
ø23,81 M12x1 2x				ø23,81 M10x1 2x			



24.4123-1708.3	010859	L1 32	L2 83,5	24.4123-1710.3	010866	L1 32	L2 86,2
ø23,81 2x M10x1 2x				ø23,81 M10x1 2x			

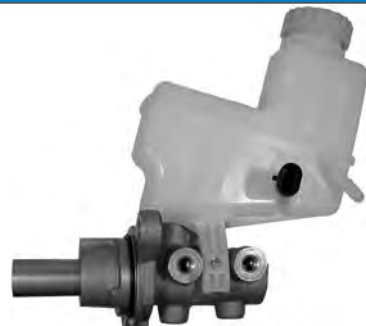

Abbildungen Hauptbremszylinder

Illustrations master cylinder - Ilustraciones cilindro freno - Illustrations Maître-cylindres - Illustrazioni pompe Freno

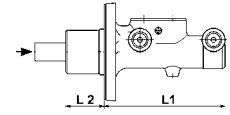

24.4123-1712.3 010897	L1 14	L2 95	24.4123-1713.3 010905	L1 31,7	L2 93,5
ø23,81 M12x1 2x			ø23,81 4x 2x M10x1 2x M12x1		



24.4125-1701.3 010867	L1 10,5	L2 126,5	24.4125-1703.3 010907	L1 18	L2 90,5
ø25,4 M12x1 2x			ø25,4 M12x1 2x		

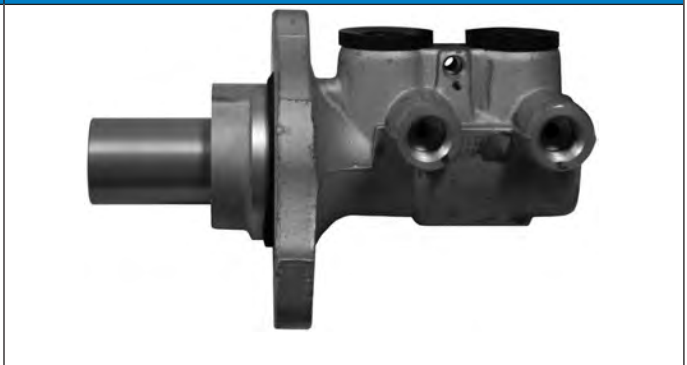
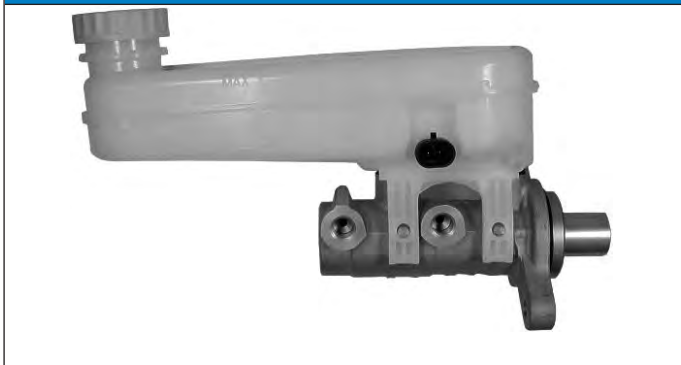

24.4125-1704.3 010908	L1 18	L2 90,5	24.4126-1701.3 010868	L1 10,5	L2 126,5
ø25,4 2x M10x1 M12x1			ø26,99 M12x1 2x		





- DE** Universalteile
- EN** Universalparts
- ES** Piezas universales
- FR** Pièces universelles
- IT** Parti universali

2018



Universalteile

Universalparts - Piezas universales - Pièces universelles - Parti universali

03.3304-0600.1 390081

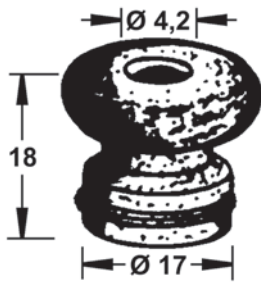

Stopfen, Bremsflüssigkeitsbehälter

Ø 17
Innendurchmesser [mm]: 4,2
x 18
FPM (Fluor-Kautschuk)/ACM (Polyacryl-Kautschuk)

03.3304-1000.1 390083

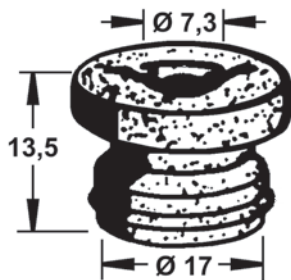

Stopfen, Bremsflüssigkeitsbehälter

Ø 17
Innendurchmesser [mm]: 7,3
x 13,5
FPM (Fluor-Kautschuk)/ACM (Polyacryl-Kautschuk)

03.3304-1100.1 390084

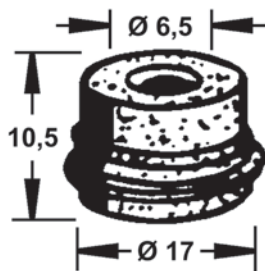

Stopfen, Bremsflüssigkeitsbehälter

Ø 17
Innendurchmesser [mm]: 6,5
x 10,5
FPM (Fluor-Kautschuk)/ACM (Polyacryl-Kautschuk)

03.3304-1102.1 390085

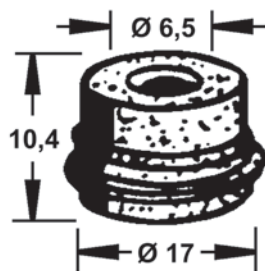

Stopfen, Bremsflüssigkeitsbehälter

Ø 17
Innendurchmesser [mm]: 6,5
x 10,4
EPDM (Ethylen-Propylen-Dien-Kautschuk)

03.3304-2208.1 390090

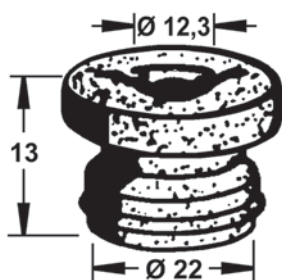

Stopfen, Bremsflüssigkeitsbehälter

Ø 22
Innendurchmesser [mm]: 12,3
x 13
EPDM (Ethylen-Propylen-Dien-Kautschuk)

Universalteile

Universalparts - Piezas universales - Pièces universelles - Parti universali

03.3390-0055.1 390149

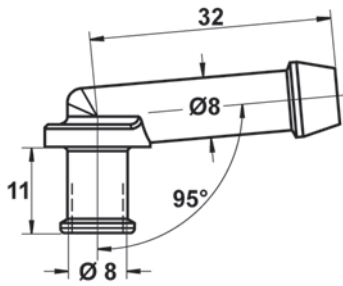

Anschlussstutzen, Schlauchleitung

Ø 8
x 11
L= 32

03.3390-0065.1 390150

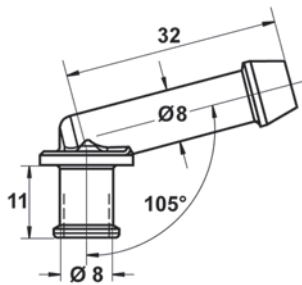

Anschlussstutzen, Schlauchleitung

Ø 8
x 11
L= 32

03.3390-0130.1 390153

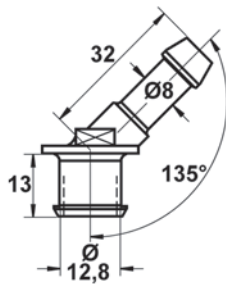

Anschlussstutzen, Schlauchleitung

12,8/8,0
x 13
L= 32

03.3390-0139.1 390154

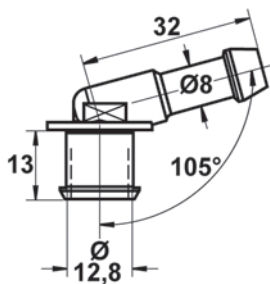

Anschlussstutzen, Schlauchleitung

12,8/8,0
x 13
L= 32

03.3510-0026.2 390266

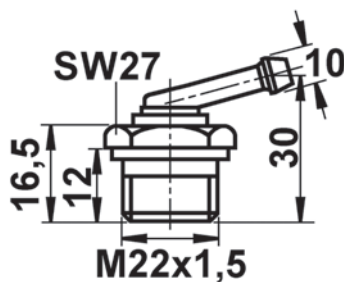

Adapter, Bremsleitung

Ø 10
M22x1,5
L= 12
x 16,5
Schlüsselweite: 27

Universalteile

Universalparts - Piezas universales - Pièces universelles - Parti universali

03.3510-0054.1 390269

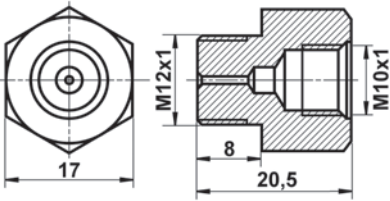

Adapter, Bremsleitung

Anschlussgewinde: M10x1
 Gewindeausführung: DIN 74235 Form FL
 M12x1
 L= 8
 L= 20,5
 Schlüsselweite: 17

03.3510-0100.1 390271

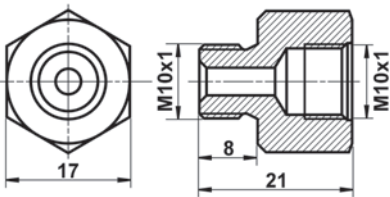

Adapter, Bremsleitung

Anschlussgewinde: M10x1
 Gewindeausführung: DIN 74235 Form FL
 M10x1
 L= 8
 L= 21
 Schlüsselweite: 17

03.3510-0200.1 390272

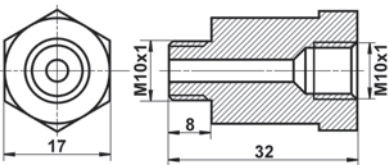

Adapter, Bremsleitung

Anschlussgewinde: M10x1
 Gewindeausführung: DIN 74235 Form FL
 M10x1
 L= 8
 L= 32
 Schlüsselweite: 17

03.3510-0300.1 390273

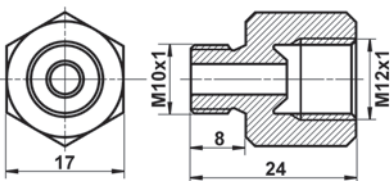

Adapter, Bremsleitung

Anschlussgewinde: M12x1
 Gewindeausführung: DIN 74235 Form EL
 M10x1
 L= 8
 L= 24
 Schlüsselweite: 17

03.3510-0800.1 390275

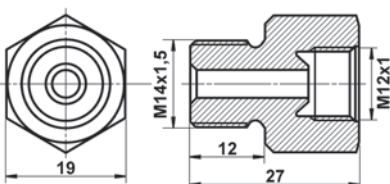

Adapter, Bremsleitung

Anschlussgewinde: M12x1
 Gewindeausführung: DIN 74235 Form EL
 M14x1,5
 L= 12
 L= 27
 Schlüsselweite: 19

Universalteile

Universalparts - Piezas universales - Pièces universelles - Parti universali

03.3510-4100.1 390279

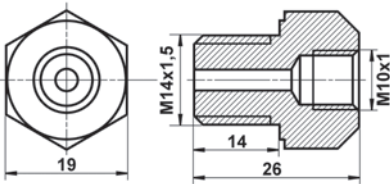

Adapter, Bremsleitung

Anschlussgewinde: M10x1
 Gewindeausführung: DIN 74235 Form FL
 M14x1,5
 L= 14
 L= 26
 Schlüsselweite: 19

03.3510-7900.1 390281

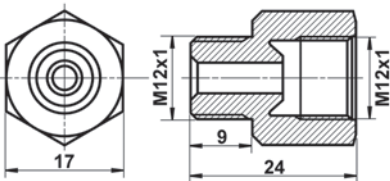

Adapter, Bremsleitung

Anschlussgewinde: M12x1
 Gewindeausführung: DIN 74235 Form EL
 M12x1
 L= 9
 L= 24
 Schlüsselweite: 17

03.3511-0800.1 390285

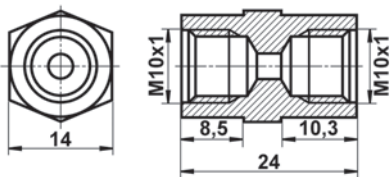

Adapter, Bremsleitung

Anschlussgewinde: M10x1
 Gewindeausführung: DIN 74235 Form FL
 L= 8,5
 L= 24
 Schlüsselweite: 14

03.3511-1000.1 390286

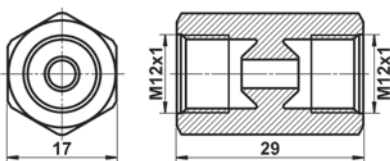

Adapter, Bremsleitung

Anschlussgewinde: M12x1
 Gewindeausführung: DIN 74235 Form EL
 L= 29
 Schlüsselweite: 17

03.3511-1100.1 390287

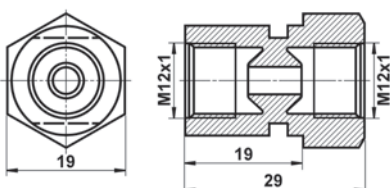

Adapter, Bremsleitung

Anschlussgewinde: M12x1
 Gewindeausführung: DIN 74235 Form EL
 L= 19
 L= 29
 Schlüsselweite: 19

Universalteile

Universalparts - Piezas universales - Pièces universelles - Parti universali

03.3511-3800.1 390291

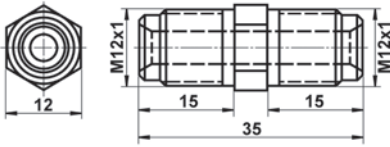

Adapter, Bremsleitung

Anschlussgewinde: M12x1
M12x1
L= 15
L= 35
Schlüsselweite: 12

03.3513-0200.1 390297

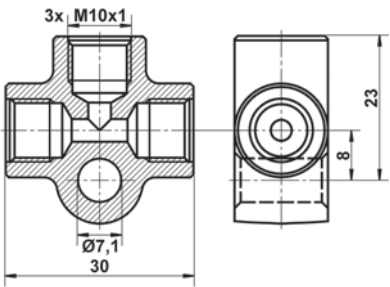

Verbindungs-/Verteilerstück, Rohrleitungen

T-Form (T-Stück)
3x
Anschlussgewinde: M10x1
Gewindeausführung: DIN 74235 Form FL
Flanschbefestigung
7,1
8,0/23,0
L= 30

03.3513-0300.1 390298

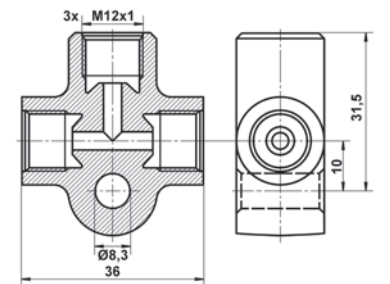

Verbindungs-/Verteilerstück, Rohrleitungen

T-Form (T-Stück)
3x
Anschlussgewinde: M12x1
Gewindeausführung: DIN 74235 Form EL
Flanschbefestigung
8,3
10,0/31,5
L= 36

03.3513-1000.1 390299

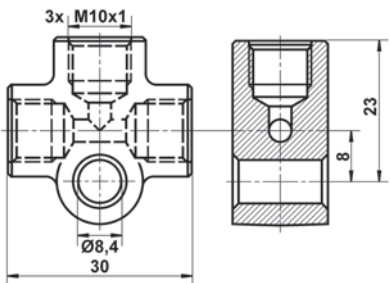

Verbindungs-/Verteilerstück, Rohrleitungen

T-Form (T-Stück)
3x
Anschlussgewinde: M10x1
Gewindeausführung: DIN 74235 Form FL
Flanschbefestigung
8,4
8,0/23,0
L= 30

Universalteile

Universalparts - Piezas universales - Pièces universelles - Parti universali

03.3513-2700.1 390300

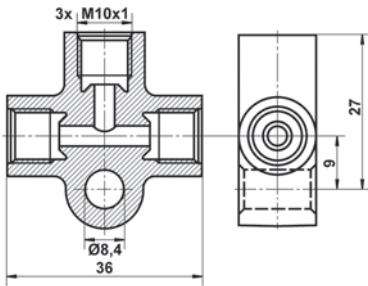

Verbindungs-/Verteilerstück, Rohrleitungen

T-Form (T-Stück)
3x
Anschlussgewinde: M10x1
Gewindeausführung: DIN 74235 Form EL
Flanschbefestigung
8,4
9,0/27,0
L= 36

03.3514-2600.1 390306

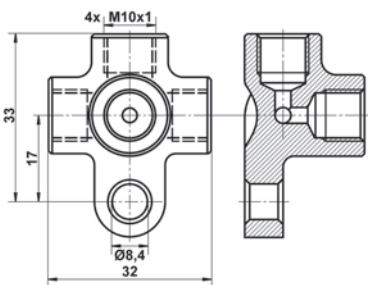

Verbindungs-/Verteilerstück, Rohrleitungen

T-Form (T-Stück)
4x
Anschlussgewinde: M10x1
Gewindeausführung: DIN 74235 Form FL
Flanschbefestigung
8,4
M10x1
17,0/33,0
L= 32

03.3514-2600.2 390307

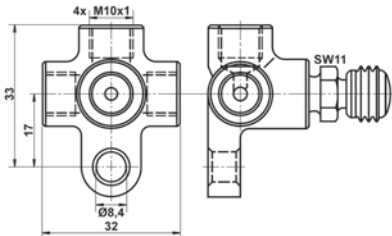

Verbindungs-/Verteilerstück, Rohrleitungen

T-Form (T-Stück)
4x
Anschlussgewinde: M10x1
Gewindeausführung: DIN 74235 Form FL
Flanschbefestigung
8,4
M10x1
17,0/33,0
L= 32
mit Entlüfterventil

03.3516-0602.1 390412

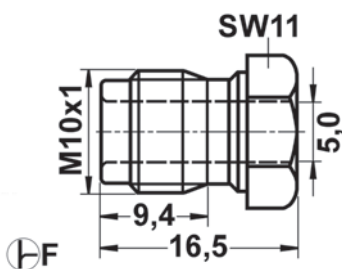

Überwurfschraube

M10x1
5
Gewindelänge [mm]: 9,4
L= 16,5
Schlüsselweite: 11
Bördelform: F

Universalteile

Universalparts - Piezas universales - Pièces universelles - Parti universali

03.3516-0800.1 390313

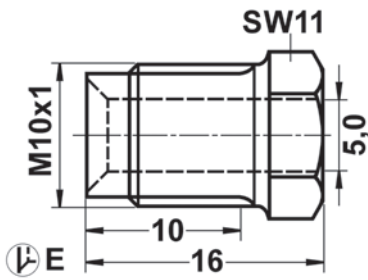

Überwurfschraube

M10x1
5
Gewindelänge [mm]: 10
L= 16
Schlüsselweite: 11
Bördelform: E

03.3516-2300.1 390317

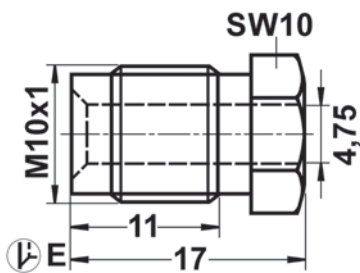

Überwurfschraube

M10x1
4,75
Gewindelänge [mm]: 11
L= 17
Schlüsselweite: 10
Bördelform: E

03.3516-3500.1 390318

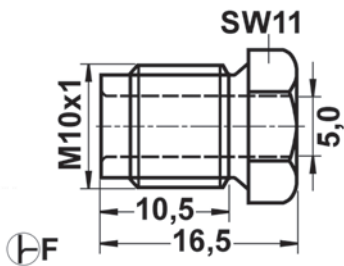

Überwurfschraube

M10x1
5
Gewindelänge [mm]: 10,5
L= 16,5
Schlüsselweite: 11
Bördelform: F

03.3517-0100.1 390321

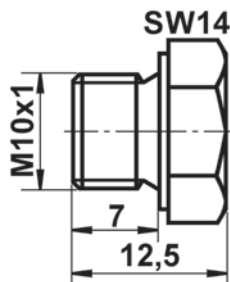

Verschlusschraube

M10x1
L= 7,5
L= 12,5
Schlüsselweite: 14

03.3518-0100.2 390329

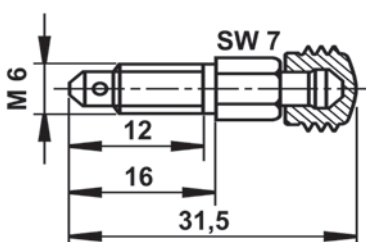

Entlüfterschraube/-ventil

M6
L= 16
L= 31,5
Schlüsselweite: 7

Universalteile

Universalparts - Piezas universales - Pièces universelles - Parti universali

03.3518-0102.2 390330

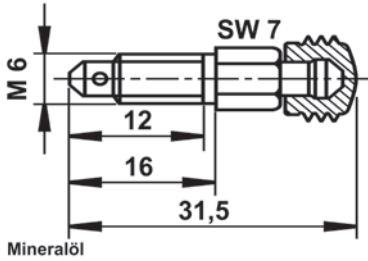

Entlüfterschraube/-ventil

M6
L= 16
L= 31,5
Schlüsselweite: 7
nur für Mineralöl

03.3518-0200.2 390332

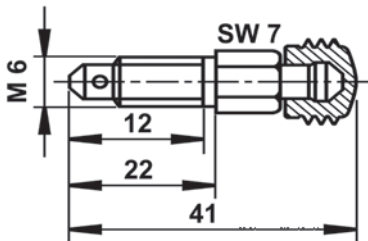

Entlüfterschraube/-ventil

M6
L= 22
L= 41
Schlüsselweite: 7

03.3518-0300.2 390333

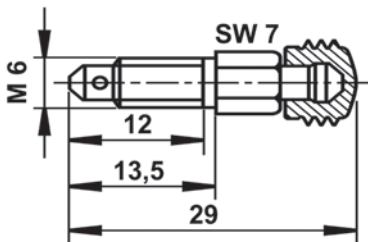

Entlüfterschraube/-ventil

M6
L= 13,5
L= 29
Schlüsselweite: 7

03.3518-0302.2 390334

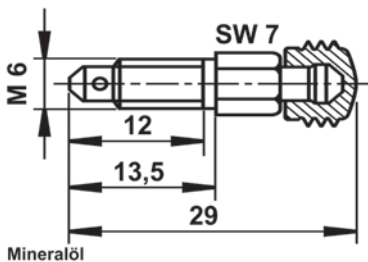

Entlüfterschraube/-ventil

M6
L= 13,5
L= 29
Schlüsselweite: 7
nur für Mineralöl

03.3518-0500.2 390337

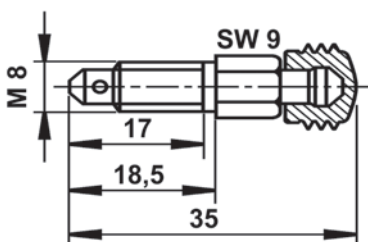

Entlüfterschraube/-ventil

M8
L= 18,5
L= 35
Schlüsselweite: 9

Universalteile

Universalparts - Piezas universales - Pièces universelles - Parti universali

03.3518-0502.2 390339

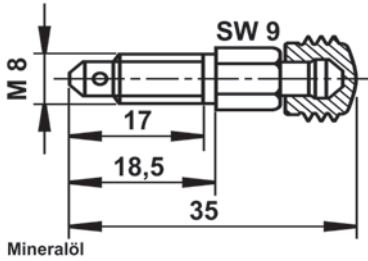

Entlüfterschraube/-ventil

M8
L= 18,5
L= 35
Schlüsselweite: 9
nur für Mineralöl

03.3518-0600.2 390340

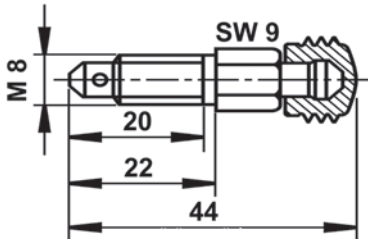

Entlüfterschraube/-ventil

M8
L= 22
L= 44
Schlüsselweite: 9

03.3518-0700.2 390342

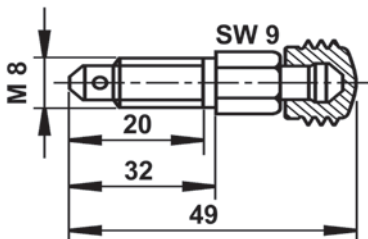

Entlüfterschraube/-ventil

M8
L= 32
L= 49
Schlüsselweite: 9

03.3518-0900.2 390345

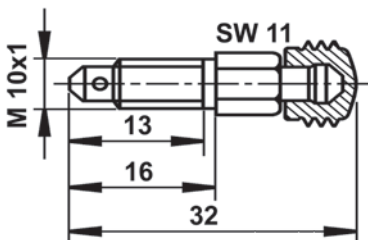

Entlüfterschraube/-ventil

M10x1
L= 16
L= 32
Schlüsselweite: 11

03.3518-0902.2 390346

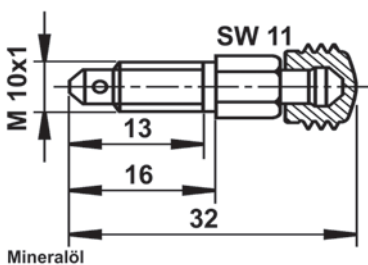

Entlüfterschraube/-ventil

M10x1
L= 16
L= 32
Schlüsselweite: 11
nur für Mineralöl

Universalteile

Universalparts - Piezas universales - Pièces universelles - Parti universali

03.3518-1300.2 390347

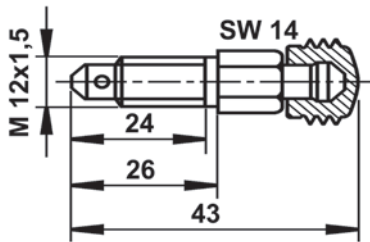

Entlüfterschraube/-ventil

M12x1,5

L= 26

L= 43

Schlüsselweite: 14

03.3518-1501.2 390349

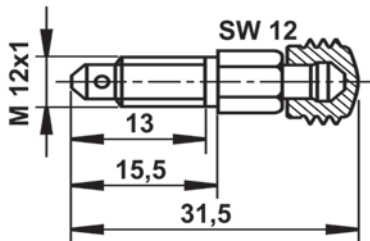

Entlüfterschraube/-ventil

M12x1

L= 15,5

L= 31,5

Schlüsselweite: 12

03.3518-1700.2 390352

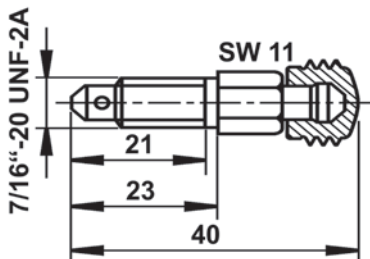

Entlüfterschraube/-ventil

7/16" -20 UNF-2A

L= 23

L= 40

Schlüsselweite: 11

03.3518-1900.2 390354

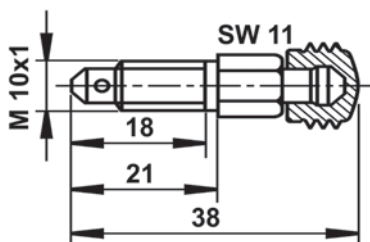

Entlüfterschraube/-ventil

M10x1

L= 21

L= 38

Schlüsselweite: 11

03.3518-4200.2 390357

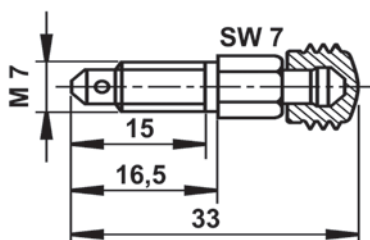

Entlüfterschraube/-ventil

M7

L= 16,5

L= 33

Schlüsselweite: 7

Universalteile

Universalparts - Piezas universales - Pièces universelles - Parti universali

03.3518-5200.2 390358

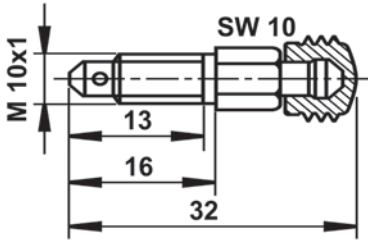

Entlüfterschraube/-ventil

M10x1

L= 16

L= 32

Schlüsselweite: 10

03.3518-5900.2 390363

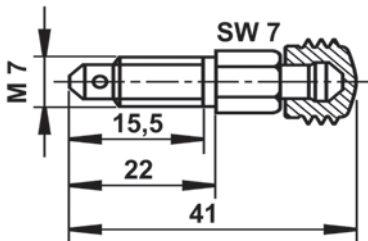

Entlüfterschraube/-ventil

M7

L= 22

L= 41

Schlüsselweite: 7

03.3518-6100.2 390364

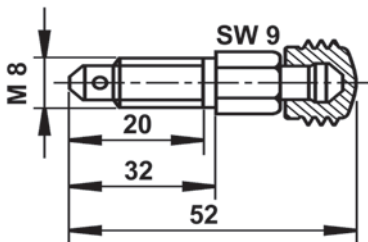

Entlüfterschraube/-ventil

M8

L= 32

L= 52

Schlüsselweite: 9

03.3518-6800.2 390369

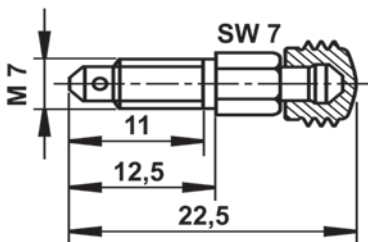

Entlüfterschraube/-ventil

M7

L= 12,5

L= 22,5

Schlüsselweite: 7

03.3518-6901.2 390370

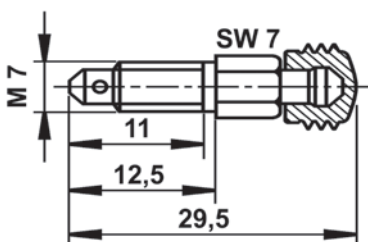

Entlüfterschraube/-ventil

M7

L= 12,5

L= 29,5

Schlüsselweite: 7

Universalteile

Universalparts - Piezas universales - Pièces universelles - Parti universali

03.3518-8000.2 390373

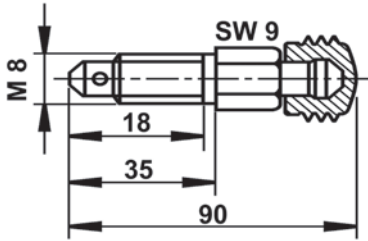

Entlüfterschraube/-ventil

M8
L= 35
L= 90
Schlüsselweite: 9

03.3520-0302.1 390381

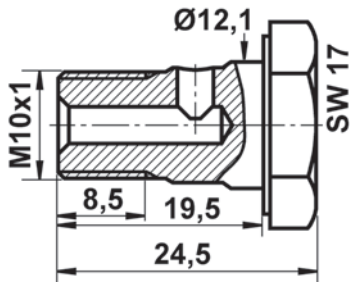

Hohlschraube

M10x1
Schlüsselweite: 17
L= 24,5
L1= 19,5
L2= 8,5

03.3520-0501.1 390382

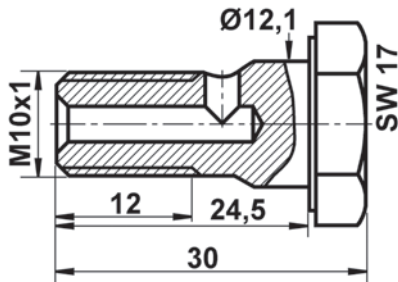

Hohlschraube

M10x1
Schlüsselweite: 17
L= 30
L1= 24,5
L2= 12

03.3520-0600.1 390383

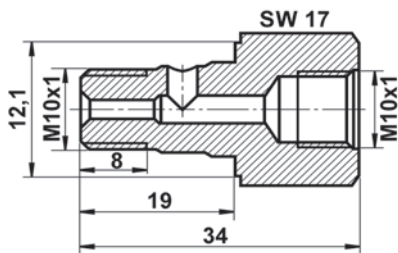

Hohlschraube

M10x1
Schlüsselweite: 17
L= 34
L1= 19
L2= 8

03.3520-1003.1 390418

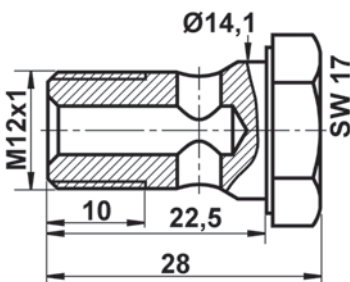

Hohlschraube

M12x1
Schlüsselweite: 17
L= 28
L1= 22,5
L2= 10

Universalteile

Universalparts - Piezas universales - Pièces universelles - Parti universali

03.3520-2900.1 390390

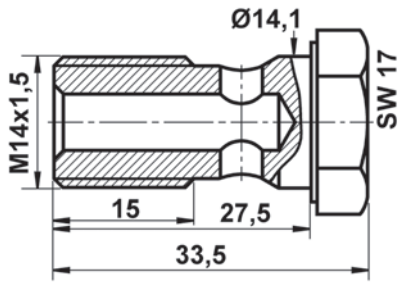

Hohlschraube

M14x1,5
Schlüsselweite: 17
L= 33,5
L1= 27,5
L2= 15

03.3521-0100.1 390392

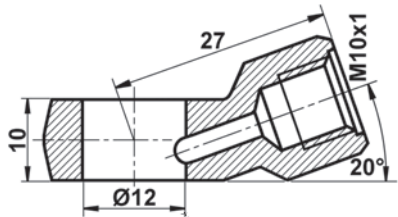

Ringstutzen, Rohrleitung

1x
Anschlussgewinde: M10x1
Gewindeausführung: DIN 74235 Form FL
12
L= 27
x 10

03.3521-0200.1 390393

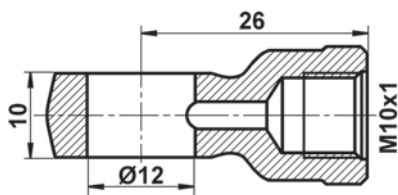

Ringstutzen, Rohrleitung

1x
Anschlussgewinde: M10x1
Gewindeausführung: DIN 74235 Form FL
12
L= 32
x 12

03.3521-0400.1 390394

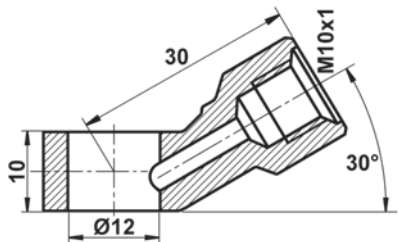

Ringstutzen, Rohrleitung

1x
Anschlussgewinde: M10x1
Gewindeausführung: DIN 74235 Form FL
12
L= 30
x 10

03.3521-0600.1 390395

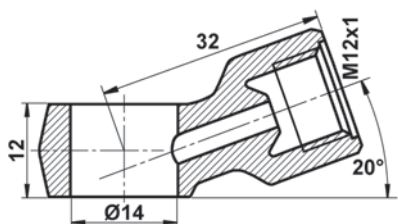

Ringstutzen, Rohrleitung

1x
Anschlussgewinde: M12x1
Gewindeausführung: DIN 74235 Form EL
14
L= 32
x 12

Universalteile

Universalparts - Piezas universales - Pièces universelles - Parti universali

03.3521-0800.1 390398

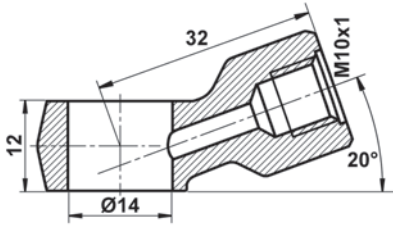

Ringstutzen, Rohrleitung

1x
Anschlussgewinde: M10x1
Gewindeausführung: DIN 74235 Form FL
14
L= 32
x 12

03.3522-0200.1 390402

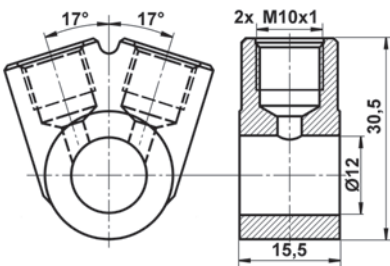

Ringstutzen, Rohrleitung

2x
Anschlussgewinde: M10x1
Gewindeausführung: DIN 74235 Form FL
12
L= 20,5
x 15,5

03.3522-0500.1 390403

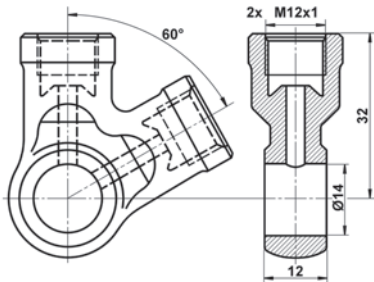

Ringstutzen, Rohrleitung

2x
Anschlussgewinde: M12x1
Gewindeausführung: DIN 74235 Form EL
14
L= 32
x 12

03.3522-1100.1 390404

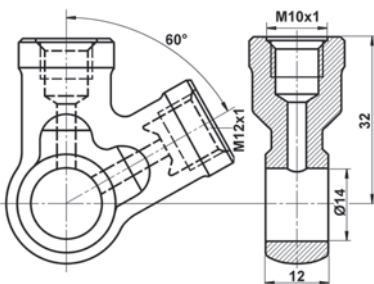

Ringstutzen, Rohrleitung

2x
Anschlussgewinde: M12x1
Gewindeausführung: DIN 74235 Form EL
14
L= 32
x 12

03.3524-0300.1 390407

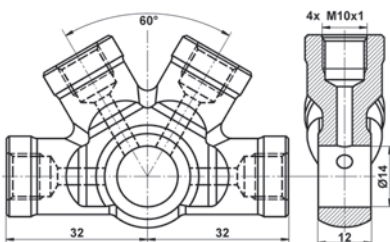

Ringstutzen, Rohrleitung

4x
Anschlussgewinde: M10x1
Gewindeausführung: DIN 74235 Form FL
14
L= 64
x 12

Universalteile

Universalparts - Piezas universales - Pièces universelles - Parti universali

03.3538-0005.1 390414

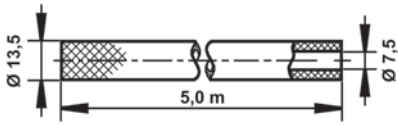

Schlauch

Innendurchmesser [mm]: 7,5
 Außendurchmesser [mm]: 13,5
 Kunststoff
 L= 5.000

03.3538-0020.1 390415

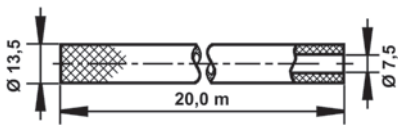

Schlauch

Innendurchmesser [mm]: 7,5
 Außendurchmesser [mm]: 13,5
 Kunststoff
 L= 20.000

03.3556-1065.2 390425

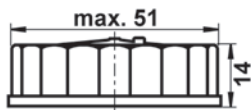

Verschluss, Bremsflüssigkeitsbehälter

→Ø 51
 x 14

03.3556-1094.2 390427

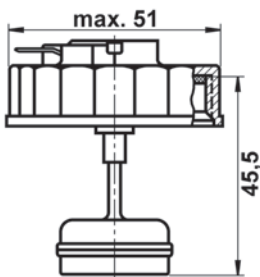

Verschluss, Bremsflüssigkeitsbehälter

→Ø 51
 L= 45,5

03.3556-1113.2 390428

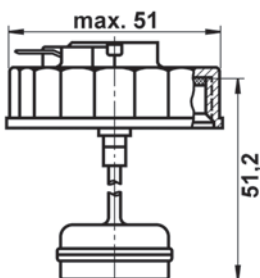

Verschluss, Bremsflüssigkeitsbehälter

→Ø 51
 L= 51,2

Universalteile

Universalparts - Piezas universales - Pièces universelles - Parti universali

03.3556-1115.2 390431

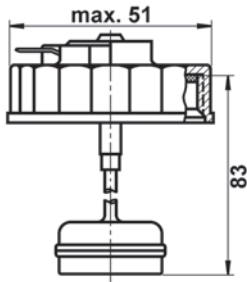

Verschluss, Bremsflüssigkeitsbehälter

→Ø 51

L= 83

03.3556-1124.2 390433

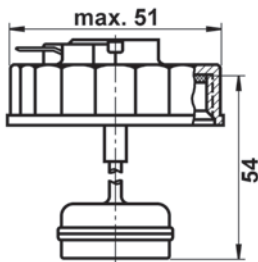

Verschluss, Bremsflüssigkeitsbehälter

→Ø 51

L= 54

03.3556-1147.2 390435

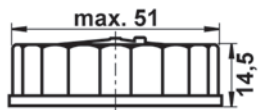

Verschluss, Bremsflüssigkeitsbehälter

→Ø 51

x 14,5

nur für Mineralöl

Mineralöl

03.3556-1164.2 390437

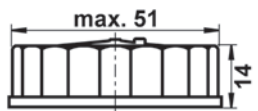

Verschluss, Bremsflüssigkeitsbehälter

→Ø 51

x 14

03.3556-1199.2 390440

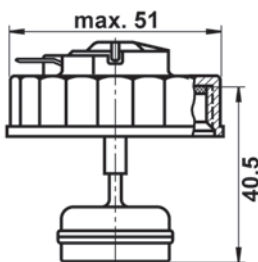

Verschluss, Bremsflüssigkeitsbehälter

→Ø 51

L= 40,5

Universalteile

Universalparts - Piezas universales - Pièces universelles - Parti universali

03.3590-0700.1 390456

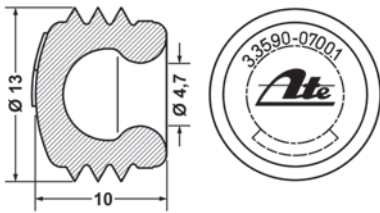

Verschluss-/Schutzkappe

Ø 13
Innendurchmesser [mm]: 4,7
x 10

03.3590-0701.1 390457

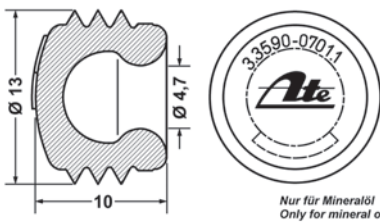

Verschluss-/Schutzkappe

Ø 13
Innendurchmesser [mm]: 4,7
x 10
nur für Mineralöl

03.5004-0101.1 990010

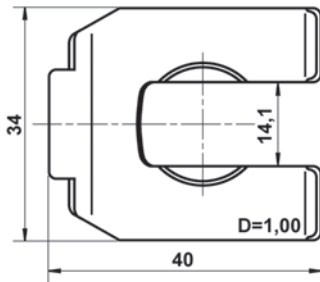

Halter, Bremsschlauch

x 14
1

03.6118-7305.2 990032

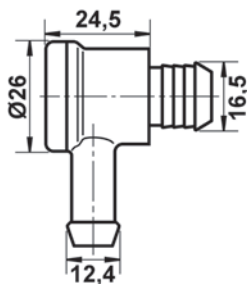

Ventil, Unterdruckleitung

Rückschlagventil
Ø1 12,4
Ø2 16,5

03.6118-7307.2 990033

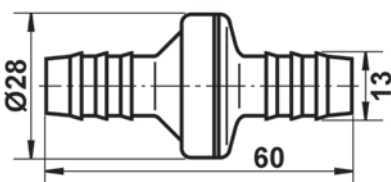

Ventil, Unterdruckleitung

Rückschlagventil
Ø 13

Universalteile

Universalparts - Piezas universales - Pièces universelles - Parti universali

03.7718-7202.1 390378

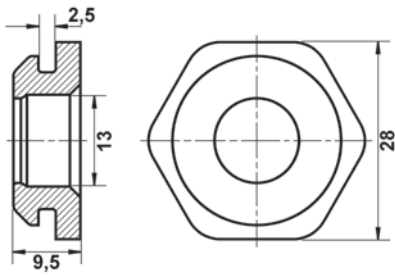

Dichtung, Unterdruck-Anschlussstutzen BKV

Außendurchmesser [mm]: 28

Innendurchmesser [mm]: 13

9,5

03.7718-7203.1 390360

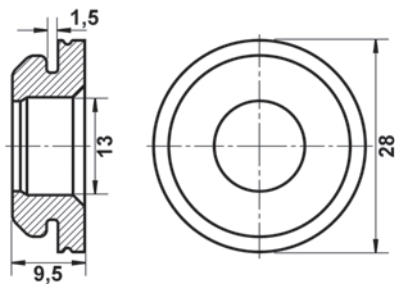

Dichtung, Unterdruck-Anschlussstutzen BKV

Außendurchmesser [mm]: 28

Innendurchmesser [mm]: 13

9,5

03.9305-0501.3 390481



Prüfanschluss, Rohrleitungen

Anschlussgewinde: M12x1

Gewindeausführung: DIN 74235 Form EL

2x

Anzahl der Bohrungen: 1

03.9305-0510.3 390483



Prüfanschluss, Rohrleitungen

Anschlussgewinde: M12x1

Gewindeausführung: DIN 74235 Form EL

3x

Anzahl der Bohrungen: 1

03.9305-0520.3 390485



Prüfanschluss, Rohrleitungen

Anschlussgewinde: M10x1

Gewindeausführung: DIN 74235 Form FL

2x

Anzahl der Bohrungen: 2

Universalteile

Universalparts - Piezas universales - Pièces universelles - Parti universali

03.9305-0530.3 390486



Prüfanschluss, Rohrleitungen

Anschlussgewinde: M12x1
 Gewindeausführung: DIN 74235 Form EL
 2x
 Anzahl der Bohrungen: 2

03.9305-0570.3 390488



Prüfanschluss, Rohrleitungen

Anschlussgewinde: M12x1
 Gewindeausführung: DIN 74235 Form EL
 3x
 Anzahl der Bohrungen: 1
 mit Entlüfterventil

03.9305-0590.3 390489



Prüfanschluss, Rohrleitungen

Anschlussgewinde: M10x1
 Gewindeausführung: DIN 74235 Form FL
 3x
 Anzahl der Bohrungen: 1

03.9305-0700.3 390491

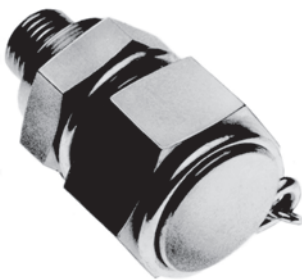

Prüfanschluss, Rohrleitungen

Anschlussgewinde: M10x1
 1x

13.8190-0296.1 390409

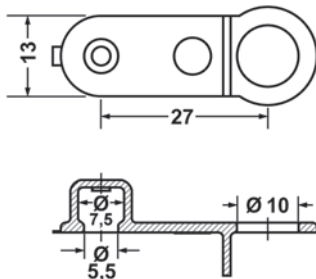

Verschluss-/Schutzkappe

Ø 5,5
 x 8,5

Universalteile

Universalparts - Piezas universales - Pièces universelles - Parti universali

24.3516-0020.1 390541

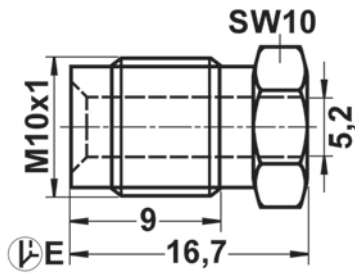

Überwurfschraube

M10x1

5,2

L= 16,7

Schlüsselweite: 10

Bördelform: E

24.3516-0030.1 390542

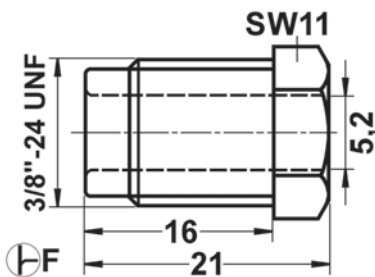

Überwurfschraube

3/8" -24UNF-2A

5,2

L= 21

Schlüsselweite: 11

Bördelform: F

24.3516-0040.1 390543

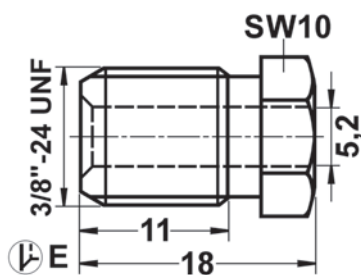

Überwurfschraube

3/8" -24UNF-2A

4,9

L= 11,8

L= 18

Schlüsselweite: 10

Bördelform: E

24.3516-0050.1 390544

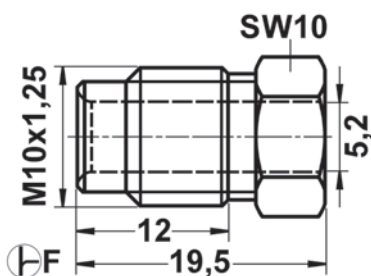

Überwurfschraube

M10x1,25

5,2

L= 13,5

L= 19,5

Schlüsselweite: 10

Bördelform: F

24.3516-0060.1 390545

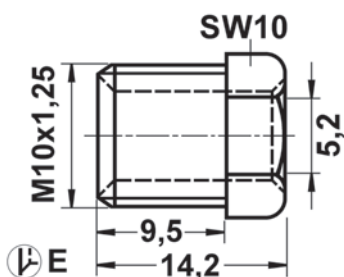

Überwurfschraube

M10x1,25

5,2

L= 8,5

L= 14

Schlüsselweite: 10

Bördelform: E

Universalteile

Universalparts - Piezas universales - Pièces universelles - Parti universali

24.3516-0070.1 390546

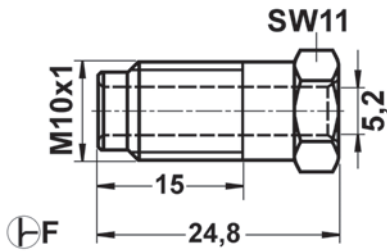

Überwurfschraube

M10x1

5

L= 13,2

L= 24,6

Schlüsselweite: 11

Bördelform: F

24.3516-0080.1 390547

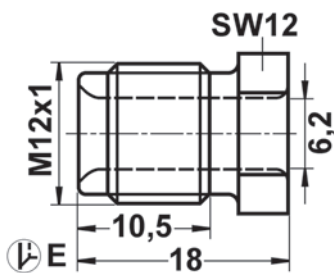

Überwurfschraube

M12x1

6,2

L= 10,5

L= 18

Schlüsselweite: 12

Bördelform: E

24.3516-0090.1 390548

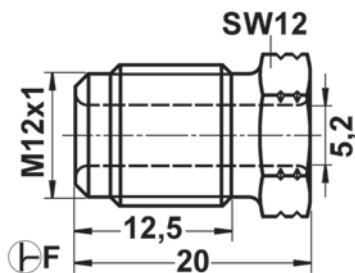

Überwurfschraube

M12x1

5,2

L= 12,5

L= 20

Schlüsselweite: 12

Bördelform: F

24.3516-0110.1 390549

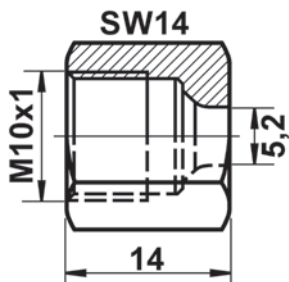

Überwurfmutter

M10x1

5,2

L= 14

Schlüsselweite: 14

Bördelform: E

24.3516-0111.1 390550

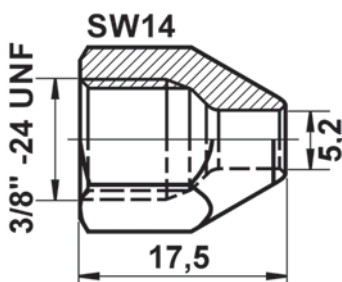

Überwurfmutter

3/8" -24UNF-2B

5,2

L= 17,5

Schlüsselweite: 14

Bördelform: E

Universalteile

Universalparts - Piezas universales - Pièces universelles - Parti universali

24.3516-0210.2 390553



Sortiment, Armaturen

24.3516-0220.2 390554



Sortiment, Entlüfterschrauben

24.3516-0230.2 390555



Sortiment, Befestigungselemente

24.3526-0600.3 340027

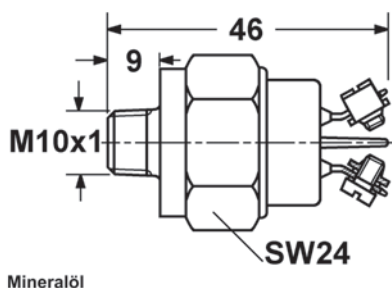

Schalter, Bremsleuchte

- elektrisch-hydraulisch
- nur für Mineralöl
- Pol-Anzahl: 2
- Steckerausführung: Schraubkontakt
- Schraubanschluss
- L= 46
- M10x1 konisch
- Gewindelänge [mm]: 9
- Schlüsselweite: 24

Universalteile

Universalparts - Piezas universales - Pièces universelles - Parti universali

24.3526-0610.3 340030

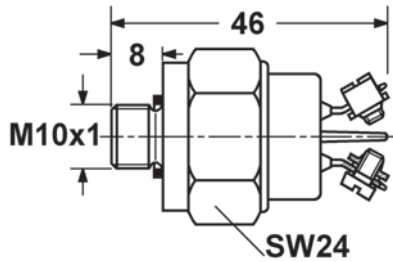

Mineralöl

Schalter, Bremsleuchte

elektrisch-hydraulisch
nur für Mineralöl
Pol-Anzahl: 2
Steckerausführung: Schraubkontakt
Schraubanschluss
L= 46
M10x1
Gewindelänge [mm]: 8
Schlüsselweite: 24

24.3526-2200.0 340039

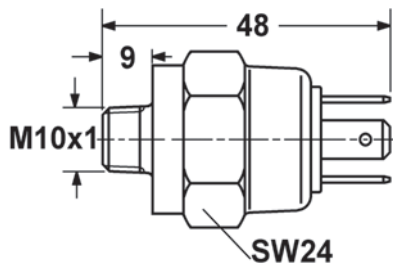

Mineralöl

Schalter, Bremsleuchte

elektrisch-hydraulisch
nur für Mineralöl
Pol-Anzahl: 3
Steckerausführung: Flachstecker
Schraubanschluss
M10x1 konisch
Gewindelänge [mm]: 9
L= 48
Schlüsselweite: 24

24.3590-0002.1 390567

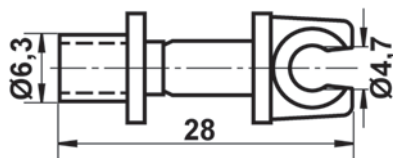

Halter, Bremsleitung

Ø 6,3
Durchmesser Aufnahme [mm]: 4,7
L= 28

24.5004-0001.1 390568

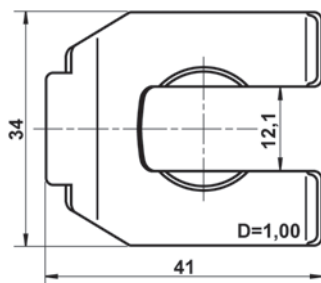

Halter, Bremsschlauch

x 12
1

Universalteile

Universalparts - Piezas universales - Pièces universelles - Parti universali

24.5004-0002.1 390569

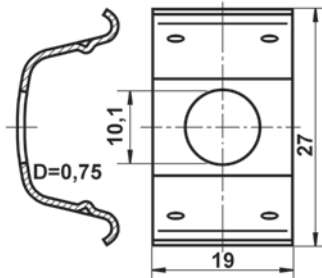

Halter, Bremsschlauch

x 10

0,7

24.5004-0003.1 390570

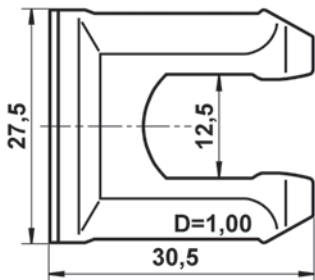

Halter, Bremsschlauch

x 11

1

24.7718-7301.2 990024

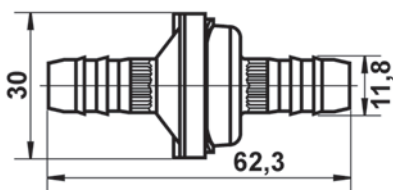

Ventil, Unterdruckleitung

Rückschlagventil

Ø 11,8

24.8134-0547.1 390571

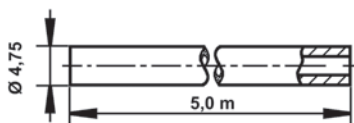

Bremsleitung

Ø 4,75

L= 5.000

DIN/ISO: 74234

24.8134-0560.1 390572

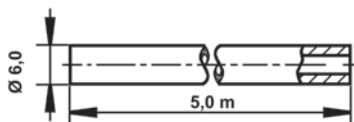

Bremsleitung

Ø 6

L= 5.000

DIN/ISO: 74234

Universalteile

Universalparts - Piezas universales - Pièces universelles - Parti universali

24.8134-0580.1 390573

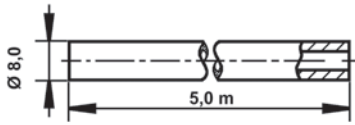

Bremsleitung

Ø 8

L= 5.000

DIN/ISO: 74234

24.8134-3147.1 390574

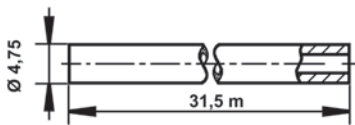

Bremsleitung

Ø 4,75

L= 31.500



- DE** Bremsgeräte komplett
- EN** Booster units complete
- ES** Servofreno completo
- FR** Servo-freins complets
- IT** Servofreni completi





2018



Bremsgeräte komplett

Booster units complete - Servofreno completo - Servo-freins
complets - Servofreni completi

• Die Nummer befindet sich auf dem im Fahrzeug eingebautem Aggregat.
the number is on the unit build in the car
El número está ubicado en la unidad instalada en el vehículo
Le numéro est situé sur l'unité installée dans le véhicule
Il numero si trova sull'unità installata nel veicolo







		i			i
03.6121-0501.4	03.3508-0264.3	310009 Ausgleichsbehälter	03.6132-6515.4	03.2120-1491.3	010089 Hauptbremszylinder
03.6122-0010.4	03.3508-8302.3	310046 Ausgleichsbehälter	03.6132-6706.4	03.2120-1491.3	010089 Hauptbremszylinder
03.6122-0017.4	03.3508-8302.3	310046 Ausgleichsbehälter	03.6142-0301.4	03.3508-8302.3	310046 Ausgleichsbehälter
03.6122-0018.4	03.3508-8302.3	310046 Ausgleichsbehälter	03.6142-0701.4	03.3508-8302.3	310046 Ausgleichsbehälter
03.6122-0601.4	03.3508-8302.3	310046 Ausgleichsbehälter	03.6142-1201.4	03.2123-2604.3	010178 Hauptbremszylinder
03.6122-1002.4	03.3508-8302.3	310046 Ausgleichsbehälter	03.6142-1202.4	03.2123-2604.3	010178 Hauptbremszylinder
03.6122-1006.4	03.3508-8302.3	310046 Ausgleichsbehälter	03.6142-1205.4	03.2123-2604.3	010178 Hauptbremszylinder
03.6122-1401.4	03.3508-8302.3	310046 Ausgleichsbehälter	03.6142-1701.4	03.2119-6207.3	010060 Hauptbremszylinder
03.6122-2001.4	03.2119-6207.3	010060 Hauptbremszylinder		03.3558-0676.3	310077 Ausgleichsbehälter
03.6122-2002.4	03.2119-6207.3	010060 Hauptbremszylinder	03.6142-1703.4	03.2120-4504.3	010123 Hauptbremszylinder
03.6122-2003.4	03.2119-6207.3	010060 Hauptbremszylinder		03.3558-0676.3	310077 Ausgleichsbehälter
03.6122-2102.4	03.3508-8302.3	310046 Ausgleichsbehälter	03.6142-1704.4	03.2120-4504.3	010123 Hauptbremszylinder
03.6122-2401.4	03.2119-0525.3	010046 Hauptbremszylinder		03.3558-0676.3	310077 Ausgleichsbehälter
03.6122-2402.4	03.2120-0148.3	010070 Hauptbremszylinder	03.6142-2402.4	03.2123-6207.3	010185 Hauptbremszylinder
03.6122-2407.4	03.2120-0148.3	010070 Hauptbremszylinder		03.3508-7504.3	310045 Ausgleichsbehälter
03.6127-0001.4	03.2123-6802.3	010186 Hauptbremszylinder	03.6142-2403.4	03.3508-7504.3	310045 Ausgleichsbehälter
03.6127-0301.4	03.2123-6802.3	010186 Hauptbremszylinder	03.6142-3001.4	03.2120-5503.3	010124 Hauptbremszylinder
03.6127-0801.4	03.2122-0142.3	010128 Hauptbremszylinder	03.6142-3301.4	03.2123-6207.3	010185 Hauptbremszylinder
	03.3558-0676.3	310077 Ausgleichsbehälter		03.3508-7504.3	310045 Ausgleichsbehälter
03.6127-0804.4	03.3558-0676.3	310077 Ausgleichsbehälter	03.6142-3302.4	03.3508-7504.3	310045 Ausgleichsbehälter
03.6132-0702.4	03.3508-8302.3	310046 Ausgleichsbehälter	03.6142-4401.4	03.2123-2604.3	010178 Hauptbremszylinder
03.6132-1103.4	03.2120-0148.3	010070 Hauptbremszylinder	03.6142-4601.4	03.2122-0142.3	010128 Hauptbremszylinder
03.6132-1401.4	03.3508-8302.3	310046 Ausgleichsbehälter		03.3558-0676.3	310077 Ausgleichsbehälter
03.6132-1501.4	03.2122-0142.3	010128 Hauptbremszylinder	03.6142-4602.4	03.2122-0142.3	010128 Hauptbremszylinder
	03.3558-0676.3	310077 Ausgleichsbehälter		03.3558-0676.3	310077 Ausgleichsbehälter
03.6132-1502.4	03.2122-0142.3	010128 Hauptbremszylinder	03.6142-4603.4	03.2122-0142.3	010128 Hauptbremszylinder
	03.3558-0676.3	310077 Ausgleichsbehälter		03.3558-0676.3	310077 Ausgleichsbehälter
03.6132-1701.4	03.2123-1003.3	010175 Hauptbremszylinder	03.6142-4604.4	03.2122-0142.3	010128 Hauptbremszylinder
03.6132-1901.4	03.2120-5503.3	010124 Hauptbremszylinder		03.3558-0676.3	310077 Ausgleichsbehälter
03.6132-2001.4	03.3508-8302.3	310046 Ausgleichsbehälter	03.6142-4605.4	03.2122-0142.3	010128 Hauptbremszylinder
03.6132-2701.4	03.3508-7504.3	310045 Ausgleichsbehälter		03.3558-0676.3	310077 Ausgleichsbehälter
03.6132-2901.4	03.2120-0148.3	010070 Hauptbremszylinder	03.6142-4701.4	03.2122-4902.3	010144 Hauptbremszylinder
03.6132-3401.4	03.3508-8302.3	310046 Ausgleichsbehälter	03.6142-4702.4	03.2122-4902.3	010144 Hauptbremszylinder
03.6132-3905.4	03.3508-7504.3	310045 Ausgleichsbehälter	03.6142-4704.4	03.2122-4902.3	010144 Hauptbremszylinder
03.6132-3907.4	03.3508-7504.3	310045 Ausgleichsbehälter	03.6142-4801.4	03.2123-6207.3	010185 Hauptbremszylinder
03.6132-3908.4	03.3508-7504.3	310045 Ausgleichsbehälter		03.3508-7504.3	310045 Ausgleichsbehälter
03.6132-4201.4	03.2120-0148.3	010070 Hauptbremszylinder	03.6142-4802.4	03.3508-7504.3	310045 Ausgleichsbehälter
03.6132-4202.4	03.2120-0148.3	010070 Hauptbremszylinder	03.6142-4803.4	03.3508-7504.3	310045 Ausgleichsbehälter
03.6132-4203.4	03.2120-0148.3	010070 Hauptbremszylinder	03.6142-5201.4	03.2123-6207.3	010185 Hauptbremszylinder
03.6132-4207.4	03.2120-0148.3	010070 Hauptbremszylinder		03.3508-7504.3	310045 Ausgleichsbehälter
03.6132-4401.4	03.2120-5503.3	010124 Hauptbremszylinder	03.6142-5202.4	03.3508-7504.3	310045 Ausgleichsbehälter
03.6132-4601.4	03.3508-7504.3	310045 Ausgleichsbehälter	03.6142-5203.4	03.3508-7504.3	310045 Ausgleichsbehälter
03.6132-4703.4	03.3508-8302.3	310046 Ausgleichsbehälter	03.6142-5205.4	03.2123-4911.3	010182 Hauptbremszylinder
03.6132-4704.4	03.3508-8302.3	310046 Ausgleichsbehälter	03.6142-5301.4	03.3508-8302.3	310046 Ausgleichsbehälter
03.6132-4901.4	03.3508-7504.3	310045 Ausgleichsbehälter	03.6142-5502.4	03.3508-7504.3	310045 Ausgleichsbehälter
03.6132-5201.4	03.3508-7504.3	310045 Ausgleichsbehälter	03.6142-6803.4	03.2122-4902.3	010144 Hauptbremszylinder
03.6132-5405.4	03.2120-0538.3	010077 Hauptbremszylinder	03.6142-7203.4	03.2120-1491.3	010089 Hauptbremszylinder
03.6132-5501.4	03.3508-7504.3	310045 Ausgleichsbehälter	03.6142-7204.4	03.2120-1491.3	010089 Hauptbremszylinder
03.6132-5502.4	03.3508-7504.3	310045 Ausgleichsbehälter	03.6142-7205.4	03.2120-1491.3	010089 Hauptbremszylinder
03.6132-5802.4	03.3508-7504.3	310045 Ausgleichsbehälter	03.6142-7301.4	03.2120-1491.3	010089 Hauptbremszylinder



Bremsgeräte komplett

Booster units complete - Servofreno completo - Servo-freins
complets - Servofreni completi





• Die Nummer befindet sich auf dem im Fahrzeug eingebautem Aggregat.
the number is on the unit build in the car
El número está ubicado en la unidad instalada en el vehículo
Le numéro est situé sur l'unité installée dans le véhicule
Il numero si trova sull'unità installata nel veicolo

					
03.6142-7302.4	03.2120-1491.3	010089 Hauptbremszylinder	03.6157-0304.4	03.2123-3402.3	010181 Hauptbremszylinder
03.6142-7303.4	03.2120-1491.3	010089 Hauptbremszylinder		03.3508-8753.3	310049 Ausgleichsbehälter
03.6147-0401.4	03.2125-1102.3	010202 Hauptbremszylinder		03.6855-1202.4	300056 Bremskraftverstärker
	03.3508-3600.3	310030 Ausgleichsbehälter	03.6157-0305.4	03.2123-1003.3	010175 Hauptbremszylinder
03.6147-0501.4	03.2125-1102.3	010202 Hauptbremszylinder		03.3508-8753.3	310049 Ausgleichsbehälter
03.6147-1101.4	03.2125-1302.3	010203 Hauptbremszylinder		03.6855-1202.4	300056 Bremskraftverstärker
03.6147-1102.4	03.2125-1302.3	010203 Hauptbremszylinder	03.6157-0306.4	03.2123-3402.3	010181 Hauptbremszylinder
03.6147-1103.4	03.2125-1302.3	010203 Hauptbremszylinder		03.3508-8753.3	310049 Ausgleichsbehälter
03.6147-1301.4	03.2123-6802.3	010186 Hauptbremszylinder		03.6855-1202.4	300056 Bremskraftverstärker
03.6147-1703.4	03.2125-1302.3	010203 Hauptbremszylinder	03.6157-0307.4	03.2023-0112.3	010013 Hauptbremszylinder
03.6147-2402.4	03.2123-8611.3	010195 Hauptbremszylinder		03.6855-1202.4	300056 Bremskraftverstärker
03.6152-0206.4	03.2123-3402.3	010181 Hauptbremszylinder	03.6157-0308.4	03.6855-1202.4	300056 Bremskraftverstärker
	03.3508-8753.3	310049 Ausgleichsbehälter		03.2023-0112.3	010013 Hauptbremszylinder
	03.6850-0202.4	300043 Bremskraftverstärker		03.6855-1202.4	300056 Bremskraftverstärker
03.6152-0209.4	03.6850-0202.4	300043 Bremskraftverstärker	03.6157-0309.4	03.2023-0112.3	010013 Hauptbremszylinder
03.6152-0210.4	03.6850-0202.4	300043 Bremskraftverstärker		03.6855-1202.4	300056 Bremskraftverstärker
03.6152-0401.4	03.2122-6202.3	010148 Hauptbremszylinder	03.6157-0310.4	03.6855-1202.4	300056 Bremskraftverstärker
03.6152-0601.4	03.3508-8302.3	310046 Ausgleichsbehälter	03.6197-1501.4	03.3508-8302.3	310046 Ausgleichsbehälter
03.6152-0701.4	03.2123-6802.3	010186 Hauptbremszylinder	03.6197-2101.4	03.3508-8302.3	310046 Ausgleichsbehälter
03.6152-0702.4	03.2122-6202.3	010148 Hauptbremszylinder	03.6197-2201.4	03.3508-8302.3	310046 Ausgleichsbehälter
03.6152-0703.4	03.2122-6202.3	010148 Hauptbremszylinder	03.6197-2202.4	03.3508-8302.3	310046 Ausgleichsbehälter
03.6152-0803.4	03.2123-6207.3	010185 Hauptbremszylinder	03.6197-2203.4	03.3508-8302.3	310046 Ausgleichsbehälter
	03.3508-7504.3	310045 Ausgleichsbehälter	03.6197-2204.4	03.3508-8302.3	310046 Ausgleichsbehälter
03.6152-1101.4	03.3508-8302.3	310046 Ausgleichsbehälter	03.6197-2801.4	03.3508-8302.3	310046 Ausgleichsbehälter
03.6152-1401.4	03.2123-6802.3	010186 Hauptbremszylinder	03.6197-3301.4	03.3508-8302.3	310046 Ausgleichsbehälter
03.6152-1502.4	03.2123-3302.3	010180 Hauptbremszylinder	03.6197-3302.4	03.3508-8302.3	310046 Ausgleichsbehälter
03.6152-1701.4	03.2123-6207.3	010185 Hauptbremszylinder	03.6732-0101.4	03.2120-2031.3	010106 Hauptbremszylinder
	03.3508-7504.3	310045 Ausgleichsbehälter	03.6732-0201.4	03.2120-2031.3	010106 Hauptbremszylinder
03.6152-1801.4	03.2122-0142.3	010128 Hauptbremszylinder	03.6732-0203.4	03.2120-2031.3	010106 Hauptbremszylinder
	03.3558-0676.3	310077 Ausgleichsbehälter	03.6732-0401.4	03.2120-2031.3	010106 Hauptbremszylinder
03.6152-2001.4	03.2123-6207.3	010185 Hauptbremszylinder	03.6732-0503.4	03.2120-2598.3	010116 Hauptbremszylinder
	03.3508-7504.3	310045 Ausgleichsbehälter	03.6732-0504.4	03.2120-2598.3	010116 Hauptbremszylinder
03.6152-2002.4	03.3508-7504.3	310045 Ausgleichsbehälter	03.6732-0601.4	03.2120-2031.3	010106 Hauptbremszylinder
03.6152-2003.4	03.2123-4911.3	010182 Hauptbremszylinder	03.6732-0901.4	03.2119-3389.3	010057 Hauptbremszylinder
03.6152-2101.4	03.3508-8302.3	310046 Ausgleichsbehälter	03.6732-1001.4	03.2119-3389.3	010057 Hauptbremszylinder
03.6157-0201.4	03.3508-8302.3	310046 Ausgleichsbehälter	03.6732-1101.4	03.2119-3389.3	010057 Hauptbremszylinder
03.6157-0301.4	03.2123-1003.3	010175 Hauptbremszylinder	03.6732-1103.4	03.2119-3389.3	010057 Hauptbremszylinder
	03.3508-8753.3	310049 Ausgleichsbehälter	03.6732-1201.4	03.2119-3389.3	010057 Hauptbremszylinder
	03.6855-1202.4	300056 Bremskraftverstärker	03.6732-3301.4	03.2119-3389.3	010057 Hauptbremszylinder
03.6157-0302.4	03.2123-1003.3	010175 Hauptbremszylinder	03.6732-3501.4	03.2119-3389.3	010057 Hauptbremszylinder
	03.3508-8753.3	310049 Ausgleichsbehälter	03.6742-0101.4	03.2120-2598.3	010116 Hauptbremszylinder
	03.6855-1202.4	300056 Bremskraftverstärker	03.6742-0102.4	03.2120-2598.3	010116 Hauptbremszylinder
03.6157-0303.4	03.2123-1003.3	010175 Hauptbremszylinder	03.6742-0103.4	03.2120-2598.3	010116 Hauptbremszylinder
	03.3508-8753.3	310049 Ausgleichsbehälter	03.6742-0104.4	03.2120-2598.3	010116 Hauptbremszylinder
	03.6855-1202.4	300056 Bremskraftverstärker	03.6742-0105.4	03.2120-2598.3	010116 Hauptbremszylinder
			03.6742-0106.4	03.2120-2598.3	010116 Hauptbremszylinder

Bremsgeräte komplett

Booster units complete - Servofreno completo - Servo-freins
complets - Servofreni completi

• Die Nummer befindet sich auf dem im Fahrzeug eingebautem Aggregat.
the number is on the unit build in the car
El número está ubicado en la unidad instalada en el vehículo
Le numéro est situé sur l'unité installée dans le véhicule
Il numero si trova sull'unità installata nel veicolo







		i			i
03.6742-0107.4	03.2120-2598.3	010116 Hauptbremszylinder	03.6752-0201.4	03.6750-0202.4	300033 Bremskraftverstärker
03.6742-0108.4	03.2120-2598.3	010116 Hauptbremszylinder			
03.6742-0109.4	03.2120-2598.3	010116 Hauptbremszylinder	03.6752-0302.4	03.2120-2031.3	010106 Hauptbremszylinder
03.6742-0110.4	03.2120-2598.3	010116 Hauptbremszylinder	03.6752-0305.4	03.2120-2331.3	010110 Hauptbremszylinder
03.6742-0111.4	03.2120-2598.3	010116 Hauptbremszylinder	03.6752-0306.4	03.2120-2031.3	010106 Hauptbremszylinder
03.6742-0112.4	03.2120-2598.3	010116 Hauptbremszylinder	03.6752-0502.4	03.2120-2598.3	010116 Hauptbremszylinder
03.6742-0113.4	03.2120-2598.3	010116 Hauptbremszylinder	03.6752-0505.4	03.2120-2597.3	010115 Hauptbremszylinder
03.6742-0114.4	03.2120-2598.3	010116 Hauptbremszylinder	03.6752-0506.4	03.2120-2597.3	010115 Hauptbremszylinder
03.6742-0115.4	03.2120-2598.3	010116 Hauptbremszylinder	03.6752-0507.4	03.2120-2597.3	010115 Hauptbremszylinder
03.6742-0116.4	03.2120-2598.3	010116 Hauptbremszylinder	03.6752-0508.4	03.2120-2597.3	010115 Hauptbremszylinder
03.6742-0117.4	03.2120-2598.3	010116 Hauptbremszylinder	03.6752-0801.4	03.2122-9812.3	010161 Hauptbremszylinder
03.6742-0118.4	03.2120-2598.3	010116 Hauptbremszylinder	03.6752-0902.4	03.2120-2331.3	010110 Hauptbremszylinder
03.6742-0119.4	03.2120-2597.3	010115 Hauptbremszylinder	03.6752-0903.4	03.7750-0302.4	300071 Bremskraftverstärker
03.6742-0120.4	03.2120-2597.3	010115 Hauptbremszylinder			
03.6742-0121.4	03.2120-2597.3	010115 Hauptbremszylinder	03.6752-1002.4	03.2120-2682.3	010118 Hauptbremszylinder
03.6742-0122.4	03.2120-2597.3	010115 Hauptbremszylinder	03.6752-1101.4	03.2120-2331.3	010110 Hauptbremszylinder
03.6742-0123.4	03.2120-2597.3	010115 Hauptbremszylinder	03.6752-1201.4	03.2120-2331.3	010110 Hauptbremszylinder
03.6742-0124.4	03.2120-2597.3	010115 Hauptbremszylinder	03.6752-1301.4	03.2126-0512.3	010217 Hauptbremszylinder
03.6742-0201.4	03.2123-4911.3	010182 Hauptbremszylinder	03.6752-1401.4	03.2120-2331.3	010110 Hauptbremszylinder
03.6742-0202.4	03.2120-0538.3	010077 Hauptbremszylinder	03.6752-1607.4	03.2120-2597.3	010115 Hauptbremszylinder
03.6742-0203.4	03.2120-2598.3	010116 Hauptbremszylinder	03.6752-1608.4	03.2120-2597.3	010115 Hauptbremszylinder
03.6742-0204.4	03.2120-2598.3	010116 Hauptbremszylinder	03.6752-1609.4	03.2120-2597.3	010115 Hauptbremszylinder
03.6742-0301.4	03.2120-2598.3	010116 Hauptbremszylinder	03.6752-1610.4	03.2120-2597.3	010115 Hauptbremszylinder
03.6742-0302.4	03.2120-2598.3	010116 Hauptbremszylinder	03.6752-1611.4	03.2120-2597.3	010115 Hauptbremszylinder
03.6742-0401.4	03.2120-2598.3	010116 Hauptbremszylinder	03.6752-1703.4	03.2120-2597.3	010115 Hauptbremszylinder
03.6742-0402.4	03.2120-2598.3	010116 Hauptbremszylinder	03.6752-1704.4	03.2120-2597.3	010115 Hauptbremszylinder
03.6742-0404.4	03.2120-2598.3	010116 Hauptbremszylinder	03.6752-1901.4	03.2120-2031.3	010106 Hauptbremszylinder
03.6742-0406.4	03.2120-2598.3	010116 Hauptbremszylinder	03.6752-2101.4	03.2120-2682.3	010118 Hauptbremszylinder
03.6742-0407.4	03.2120-2598.3	010116 Hauptbremszylinder	03.6752-2502.4	03.2122-9631.3	010160 Hauptbremszylinder
03.6742-0409.4	03.2120-2597.3	010115 Hauptbremszylinder	03.6752-2601.4	03.2122-9631.3	010160 Hauptbremszylinder
03.6742-0410.4	03.2120-2597.3	010115 Hauptbremszylinder	03.6752-2901.4	03.6750-2902.4	300037 Bremskraftverstärker
03.6742-0411.4	03.2120-2597.3	010115 Hauptbremszylinder			
03.6742-0412.4	03.2120-2597.3	010115 Hauptbremszylinder	03.6752-2902.4	03.2122-9631.3	010160 Hauptbremszylinder
03.6742-0413.4	03.2120-2597.3	010115 Hauptbremszylinder		03.6750-2902.4	300037 Bremskraftverstärker
03.6742-0414.4	03.2120-2597.3	010115 Hauptbremszylinder			
03.6742-0415.4	03.2120-2597.3	010115 Hauptbremszylinder	03.6752-2903.4	03.2120-2682.3	010118 Hauptbremszylinder
03.6742-0416.4	03.2120-2597.3	010115 Hauptbremszylinder		03.6750-2902.4	300037 Bremskraftverstärker
03.6742-0419.4	03.2120-2597.3	010115 Hauptbremszylinder	03.6752-3103.4	03.2120-2682.3	010118 Hauptbremszylinder
03.6742-0420.4	03.2120-2597.3	010115 Hauptbremszylinder	03.6752-3201.4	03.2120-2031.3	010106 Hauptbremszylinder
03.6742-0421.4	03.2120-2597.3	010115 Hauptbremszylinder	03.6752-3501.4	03.2120-2682.3	010118 Hauptbremszylinder
03.6742-0422.4	03.2120-2597.3	010115 Hauptbremszylinder	03.6752-3601.4	03.2120-2682.3	010118 Hauptbremszylinder
03.6742-0423.4	03.2120-2597.3	010115 Hauptbremszylinder	03.6752-3701.4	03.2122-0626.3	010539 Hauptbremszylinder
03.6742-0601.4	03.2122-0142.3	010128 Hauptbremszylinder	03.6752-3702.4	03.2122-9631.3	010160 Hauptbremszylinder
	03.3558-0676.3	310077 Ausgleichsbehälter	03.6757-1004.4	03.2023-0166.3	010015 Hauptbremszylinder
03.6742-0701.4	03.2119-3389.3	010057 Hauptbremszylinder		03.6855-1202.4	300056 Bremskraftverstärker
03.6742-1201.4	03.2119-3389.3	010057 Hauptbremszylinder			
03.6742-1501.4	03.2120-2031.3	010106 Hauptbremszylinder	03.6762-0101.4	03.2123-8311.3	010192 Hauptbremszylinder
03.6742-1701.4	03.2120-2031.3	010106 Hauptbremszylinder		03.7760-0902.4	300088 Bremskraftverstärker
03.6742-1801.4	03.2119-3391.3	010058 Hauptbremszylinder			
03.6752-0201.4	03.2120-2031.3	010106 Hauptbremszylinder	03.6762-0102.4	03.2122-6911.3	010153 Hauptbremszylinder



Bremsgeräte komplett

Booster units complete - Servofreno completo - Servo-freins
complets - Servofreni completi







• Die Nummer befindet sich auf dem im Fahrzeug eingebautem Aggregat.
the number is on the unit build in the car
El número está ubicado en la unidad instalada en el vehículo
Le numéro est situé sur l'unité installée dans le véhicule
Il numero si trova sull'unità installata nel veicolo

					
03.6762-0102.4	03.7760-0902.4	300088 Bremskraftverstärker	03.6832-0601.4	03.2120-0322.3	010074 Hauptbremszylinder
03.6762-0103.4	03.2122-6911.3	010153 Hauptbremszylinder	03.6832-1102.4	03.2120-0148.3	010070 Hauptbremszylinder
	03.7760-0902.4	300088 Bremskraftverstärker	03.6832-1301.4	03.2120-0151.3	010071 Hauptbremszylinder
03.6762-0104.4	03.7760-0902.4	300088 Bremskraftverstärker	03.6842-0301.4	03.2120-0622.3	010079 Hauptbremszylinder
			03.6842-0601.4	03.2120-0538.3	010077 Hauptbremszylinder
03.6762-0105.4	03.2020-0402.3	010001 Hauptbremszylinder	03.6842-0701.4	03.2120-0538.3	010077 Hauptbremszylinder
	03.7760-0902.4	300088 Bremskraftverstärker	03.6842-0702.4	03.2120-0538.3	010077 Hauptbremszylinder
03.6762-0106.4	03.2123-8311.3	010192 Hauptbremszylinder	03.6842-0703.4	03.2123-4911.3	010182 Hauptbremszylinder
	03.7760-0902.4	300088 Bremskraftverstärker	03.6842-0704.4	03.2120-0538.3	010077 Hauptbremszylinder
03.6762-0108.4	03.2123-8311.3	010192 Hauptbremszylinder	03.6842-1001.4	03.2123-0162.3	010162 Hauptbremszylinder
	03.7760-0902.4	300088 Bremskraftverstärker	03.6842-1003.4	03.2123-0162.3	010162 Hauptbremszylinder
03.6762-0110.4	03.2120-2082.3	010107 Hauptbremszylinder	03.6842-1401.4	03.2120-0151.3	010071 Hauptbremszylinder
	03.2120-1802.3	010099 Hauptbremszylinder	03.6842-1605.4	03.2120-2598.3	010116 Hauptbremszylinder
03.6762-0111.4	03.2020-0402.3	010001 Hauptbremszylinder	03.6842-1606.4	03.2120-2598.3	010116 Hauptbremszylinder
03.6762-0112.4	03.2120-1802.3	010099 Hauptbremszylinder	03.6842-1607.4	03.2120-2598.3	010116 Hauptbremszylinder
03.6762-0114.4	03.2020-0402.3	010001 Hauptbremszylinder	03.6842-1608.4	03.2120-2598.3	010116 Hauptbremszylinder
03.6762-0115.4	03.2120-2082.3	010107 Hauptbremszylinder	03.6842-1609.4	03.2120-2598.3	010116 Hauptbremszylinder
03.6762-0116.4	03.2123-8311.3	010192 Hauptbremszylinder	03.6842-1610.4	03.2120-2598.3	010116 Hauptbremszylinder
03.6762-0117.4	03.7760-0902.4	300088 Bremskraftverstärker	03.6842-1611.4	03.2120-2598.3	010116 Hauptbremszylinder
03.6762-0118.4	03.2123-8311.3	010192 Hauptbremszylinder	03.6842-1612.4	03.2120-2598.3	010116 Hauptbremszylinder
	03.7760-0902.4	300088 Bremskraftverstärker	03.6842-1613.4	03.2120-2598.3	010116 Hauptbremszylinder
03.6762-0312.4	03.7760-2702.4	300090 Bremskraftverstärker	03.6842-1614.4	03.2120-2598.3	010116 Hauptbremszylinder
03.6762-0401.4	03.2023-0825.3	010028 Hauptbremszylinder	03.6842-3401.4	03.2123-0162.3	010162 Hauptbremszylinder
	03.7760-2702.4	300090 Bremskraftverstärker	03.6852-0201.4	03.2123-1003.3	010175 Hauptbremszylinder
03.6762-0402.4	03.2023-0825.3	010028 Hauptbremszylinder		03.3508-8753.3	310049 Ausgleichsbehälter
	03.7760-2702.4	300090 Bremskraftverstärker		03.6850-0202.4	300043 Bremskraftverstärker
03.6762-0501.4	03.2022-0702.3	010007 Hauptbremszylinder	03.6852-0202.4	03.2123-3402.3	010181 Hauptbremszylinder
03.6762-0502.4	03.2022-0702.3	010007 Hauptbremszylinder		03.3508-8753.3	310049 Ausgleichsbehälter
03.6762-0503.4	03.2022-0702.3	010007 Hauptbremszylinder		03.6850-0202.4	300043 Bremskraftverstärker
03.6762-0504.4	03.2022-1402.3	010010 Hauptbremszylinder	03.6852-0203.4	03.2123-1003.3	010175 Hauptbremszylinder
03.6762-0505.4	03.2022-1402.3	010010 Hauptbremszylinder		03.3508-8753.3	310049 Ausgleichsbehälter
03.6762-0508.4	03.2022-1602.3	010011 Hauptbremszylinder		03.6850-0202.4	300043 Bremskraftverstärker
03.6762-0509.4	03.2022-1602.3	010011 Hauptbremszylinder	03.6852-0204.4	03.2023-0112.3	010013 Hauptbremszylinder
03.6762-0519.4	03.2022-1402.3	010010 Hauptbremszylinder		03.6850-0202.4	300043 Bremskraftverstärker
03.6762-0520.4	03.2022-1602.3	010011 Hauptbremszylinder	03.6852-0204.4	03.2023-0112.3	010013 Hauptbremszylinder
03.6762-0522.4	03.2022-0702.3	010007 Hauptbremszylinder		03.6850-0202.4	300043 Bremskraftverstärker
03.6762-0523.4	03.2022-1402.3	010010 Hauptbremszylinder	03.6852-0205.4	03.6850-0202.4	300043 Bremskraftverstärker
03.6762-0525.4	03.2022-1602.3	010011 Hauptbremszylinder	03.6852-0207.4	03.6850-0202.4	300043 Bremskraftverstärker
03.6762-0601.4	03.2020-0402.3	010001 Hauptbremszylinder	03.6852-0210.4	03.2023-0166.3	010015 Hauptbremszylinder
	03.7760-0902.4	300088 Bremskraftverstärker		03.6850-0202.4	300043 Bremskraftverstärker
03.6762-0602.4	03.2120-1802.3	010099 Hauptbremszylinder	03.6852-0211.4	03.2023-0166.3	010015 Hauptbremszylinder
	03.7760-0902.4	300088 Bremskraftverstärker		03.6850-0202.4	300043 Bremskraftverstärker
03.6832-0101.4	03.2120-3412.3	010121 Hauptbremszylinder	03.6852-0501.4	03.2123-2604.3	010178 Hauptbremszylinder
				03.6850-0502.4	300044 Bremskraftverstärker
			03.6852-0503.4	03.2123-2604.3	010178 Hauptbremszylinder

Bremsgeräte komplett

Booster units complete - Servofreno completo - Servo-freins
complets - Servofreni completi

• Die Nummer befindet sich auf dem im Fahrzeug eingebautem Aggregat.
the number is on the unit build in the car
El número está ubicado en la unidad instalada en el vehículo
Le numéro est situé sur l'unité installée dans le véhicule
Il numero si trova sull'unità installata nel veicolo





					
03.6852-0503.4	03.6850-0502.4	300044 Bremskraftverstärker	03.6852-4405.4	03.2122-8806.3	010157 Hauptbremszylinder
03.6852-1001.4	03.2123-5212.3	010183 Hauptbremszylinder	03.6852-4406.4	03.2122-8806.3	010157 Hauptbremszylinder
	03.6850-5402.4	300055 Bremskraftverstärker	03.6852-4407.4	03.2122-8806.3	010157 Hauptbremszylinder
03.6852-1002.4	03.2123-5212.3	010183 Hauptbremszylinder	03.6852-4408.4	03.2122-8806.3	010157 Hauptbremszylinder
	03.6850-5402.4	300055 Bremskraftverstärker	03.6852-4409.4	03.2122-8806.3	010157 Hauptbremszylinder
03.6852-1006.4	03.2123-0271.3	010164 Hauptbremszylinder	03.6852-4603.4	03.2123-7902.3	010191 Hauptbremszylinder
	03.6850-5402.4	300055 Bremskraftverstärker		03.7750-5702.4	300083 Bremskraftverstärker
03.6852-1007.4	03.2123-0271.3	010164 Hauptbremszylinder	03.6852-4604.4	03.2123-8902.3	010197 Hauptbremszylinder
	03.6850-5402.4	300055 Bremskraftverstärker		03.7750-5702.4	300083 Bremskraftverstärker
03.6852-1008.4	03.2123-0291.3	010165 Hauptbremszylinder	03.6852-4605.4	03.2023-0172.3	010016 Hauptbremszylinder
	03.6850-5402.4	300055 Bremskraftverstärker		03.7750-5702.4	300083 Bremskraftverstärker
03.6852-1009.4	03.2123-0291.3	010165 Hauptbremszylinder	03.6852-4606.4	03.2023-0172.3	010016 Hauptbremszylinder
	03.6850-5402.4	300055 Bremskraftverstärker		03.7750-5702.4	300083 Bremskraftverstärker
03.6852-1012.4	03.2123-0271.3	010164 Hauptbremszylinder	03.6852-4702.4	03.2123-7902.3	010191 Hauptbremszylinder
	03.6850-5402.4	300055 Bremskraftverstärker	03.6852-4703.4	03.2123-8902.3	010197 Hauptbremszylinder
03.6852-1013.4	03.2123-0271.3	010164 Hauptbremszylinder	03.6852-5002.4	03.2120-1491.3	010089 Hauptbremszylinder
	03.6850-5402.4	300055 Bremskraftverstärker	03.6852-5401.4	03.2123-5212.3	010183 Hauptbremszylinder
03.6852-1014.4	03.2123-0271.3	010164 Hauptbremszylinder		03.6850-5402.4	300055 Bremskraftverstärker
	03.6850-5402.4	300055 Bremskraftverstärker	03.6852-5402.4	03.2123-5212.3	010183 Hauptbremszylinder
03.6852-1015.4	03.6850-5402.4	300055 Bremskraftverstärker		03.6850-5402.4	300055 Bremskraftverstärker
03.6852-1301.4	03.2123-6802.3	010186 Hauptbremszylinder	03.6852-5403.4	03.2123-5212.3	010183 Hauptbremszylinder
03.6852-1302.4	03.2123-6802.3	010186 Hauptbremszylinder		03.6850-5402.4	300055 Bremskraftverstärker
03.6852-1303.4	03.2123-6802.3	010186 Hauptbremszylinder	03.6852-5404.4	03.2123-5212.3	010183 Hauptbremszylinder
03.6852-1304.4	03.2122-6202.3	010148 Hauptbremszylinder		03.6850-5402.4	300055 Bremskraftverstärker
03.6852-1601.4	03.6850-2602.4	300049 Bremskraftverstärker	03.6857-0101.4	03.6855-1202.4	300056 Bremskraftverstärker
03.6852-1701.4	03.2123-9002.3	010198 Hauptbremszylinder	03.6857-0102.4	03.2023-0112.3	010013 Hauptbremszylinder
03.6852-1702.4	03.2123-9002.3	010198 Hauptbremszylinder	03.6857-0104.4	03.2023-0112.3	010013 Hauptbremszylinder
03.6852-1902.4	03.2123-4911.3	010182 Hauptbremszylinder		03.6855-1202.4	300056 Bremskraftverstärker
03.6852-1903.4	03.2123-6207.3	010185 Hauptbremszylinder	03.6857-0105.4	03.2023-0166.3	010015 Hauptbremszylinder
03.6852-2001.4	03.6850-2602.4	300049 Bremskraftverstärker		03.6855-1202.4	300056 Bremskraftverstärker
03.6852-2101.4	03.2120-0562.3	010078 Hauptbremszylinder	03.6857-0108.4	03.2023-0166.3	010015 Hauptbremszylinder
03.6852-2201.4	03.2123-4911.3	010182 Hauptbremszylinder		03.6855-1202.4	300056 Bremskraftverstärker
03.6852-2202.4	03.2123-6207.3	010185 Hauptbremszylinder	03.6857-0303.4	03.2023-0166.3	010015 Hauptbremszylinder
03.6852-2205.4	03.2120-0538.3	010077 Hauptbremszylinder		03.6855-1202.4	300056 Bremskraftverstärker
03.6852-2307.4	03.2120-1491.3	010089 Hauptbremszylinder	03.6857-0304.4	03.2023-0166.3	010015 Hauptbremszylinder
03.6852-2401.4	03.2120-0622.3	010079 Hauptbremszylinder		03.6855-1202.4	300056 Bremskraftverstärker
03.6852-2402.4	03.2120-0622.3	010079 Hauptbremszylinder	03.6857-0501.4	03.2125-1712.3	010204 Hauptbremszylinder
03.6852-2405.4	03.2120-0622.3	010079 Hauptbremszylinder	03.6857-0502.4	03.2125-1712.3	010204 Hauptbremszylinder
03.6852-3801.4	03.2120-1142.3	010085 Hauptbremszylinder	03.6857-0503.4	03.2125-1712.3	010204 Hauptbremszylinder
03.6852-4403.4	03.2122-8806.3	010157 Hauptbremszylinder			
03.6852-4404.4	03.2122-8806.3	010157 Hauptbremszylinder			



Bremsgeräte komplett

Booster units complete - Servofreno completo - Servo-freins
complets - Servofreni completi





• Die Nummer befindet sich auf dem im Fahrzeug eingebautem Aggregat.
The number is on the unit build in the car
El número está ubicado en la unidad instalada en el vehículo
Le numéro est situé sur l'unité installée dans le véhicule
Il numero si trova sull'unità installata nel veicolo

		i			i
03.6857-0504.4	03.2125-1712.3	010204 Hauptbremszylinder	03.6857-1416.4	03.6855-1402.4	300057 Bremskraftverstärker
03.6857-1001.4	03.2023-0166.3	010015 Hauptbremszylinder	03.6857-1417.4	03.6855-1402.4	300057 Bremskraftverstärker
	03.6855-1202.4	300056 Bremskraftverstärker	03.6857-1420.4	03.6855-1402.4	300057 Bremskraftverstärker
03.6857-1002.4	03.2023-0166.3	010015 Hauptbremszylinder	03.6857-1421.4	03.6855-1402.4	300057 Bremskraftverstärker
	03.6855-1202.4	300056 Bremskraftverstärker	03.6857-1422.4	03.6855-1402.4	300057 Bremskraftverstärker
03.6857-1003.4	03.2023-0166.3	010015 Hauptbremszylinder	03.6857-1423.4	03.6855-1402.4	300057 Bremskraftverstärker
	03.6855-1202.4	300056 Bremskraftverstärker	03.6857-1424.4	03.6855-1402.4	300057 Bremskraftverstärker
03.6857-1106.4	03.2123-8512.3	010194 Hauptbremszylinder	03.6857-1425.4	03.6855-1402.4	300057 Bremskraftverstärker
03.6857-1201.4	03.2023-0166.3	010015 Hauptbremszylinder	03.6857-1426.4	03.6855-1402.4	300057 Bremskraftverstärker
	03.6855-1202.4	300056 Bremskraftverstärker	03.6857-1501.4	03.2125-1712.3	010204 Hauptbremszylinder
03.6857-1202.4	03.2023-0166.3	010015 Hauptbremszylinder	03.6857-1502.4	03.2125-1712.3	010204 Hauptbremszylinder
	03.6855-1202.4	300056 Bremskraftverstärker	03.6857-1503.4	03.2125-1712.3	010204 Hauptbremszylinder
03.6857-1203.4	03.2025-0111.3	010033 Hauptbremszylinder	03.6857-1504.4	03.2125-1712.3	010204 Hauptbremszylinder
	03.6855-1202.4	300056 Bremskraftverstärker	03.6857-1701.4	03.3558-0676.3	310077 Ausgleichsbehälter
03.6857-1204.4	03.2025-0111.3	010033 Hauptbremszylinder	03.6857-1801.4	03.2125-3801.3	010215 Hauptbremszylinder
	03.6855-1202.4	300056 Bremskraftverstärker	03.6857-1901.4	03.6855-1902.4	300059 Bremskraftverstärker
03.6857-1205.4	03.2025-0111.3	010033 Hauptbremszylinder	03.6857-1902.4	03.6855-1902.4	300059 Bremskraftverstärker
	03.6855-1202.4	300056 Bremskraftverstärker	03.6857-1905.4	03.6855-1902.4	300059 Bremskraftverstärker
03.6857-1401.4	03.2126-0512.3	010217 Hauptbremszylinder	03.6857-1906.4	03.2125-1902.3	010206 Hauptbremszylinder
	03.6855-1402.4	300057 Bremskraftverstärker	03.6857-1911.4	03.6855-1902.4	300059 Bremskraftverstärker
03.6857-1402.4	03.2125-1902.3	010206 Hauptbremszylinder	03.6857-1912.4	03.6855-1902.4	300059 Bremskraftverstärker
	03.6855-1402.4	300057 Bremskraftverstärker	03.6857-1913.4	03.2125-2102.3	010207 Hauptbremszylinder
03.6857-1403.4	03.2125-1902.3	010206 Hauptbremszylinder		03.6855-1902.4	300059 Bremskraftverstärker
	03.6855-1402.4	300057 Bremskraftverstärker	03.6857-2101.4	03.2130-0102.3	010221 Hauptbremszylinder
03.6857-1404.4	03.2125-2102.3	010207 Hauptbremszylinder		03.6855-2202.4	300061 Bremskraftverstärker
	03.6855-1402.4	300057 Bremskraftverstärker	03.6857-2103.4	03.6855-2202.4	300061 Bremskraftverstärker
03.6857-1405.4	03.6855-1402.4	300057 Bremskraftverstärker	03.6857-2201.4	03.2130-0102.3	010221 Hauptbremszylinder
03.6857-1406.4	03.6855-1402.4	300057 Bremskraftverstärker		03.6855-2202.4	300061 Bremskraftverstärker
03.6857-1407.4	03.6855-1402.4	300057 Bremskraftverstärker	03.6857-2202.4	03.6855-2202.4	300061 Bremskraftverstärker
03.6857-1408.4	03.6855-1402.4	300057 Bremskraftverstärker	03.6857-2203.4	03.6855-2202.4	300061 Bremskraftverstärker
03.6857-1409.4	03.6855-1402.4	300057 Bremskraftverstärker	03.6857-2204.4	03.6855-2202.4	300061 Bremskraftverstärker
03.6857-1410.4	03.6855-1402.4	300057 Bremskraftverstärker	03.6857-2205.4	03.2128-1203.3	010922 Hauptbremszylinder
03.6857-1411.4	03.6855-1402.4	300057 Bremskraftverstärker		03.6855-2202.4	300061 Bremskraftverstärker
03.6857-1413.4	03.6855-1402.4	300057 Bremskraftverstärker			

Bremsgeräte komplett

Booster units complete - Servofreno completo - Servo-freins
complets - Servofreni completi

• Die Nummer befindet sich auf dem im Fahrzeug eingebautem Aggregat.
the number is on the unit build in the car
El número está ubicado en la unidad instalada en el vehículo
Le numéro est situé sur l'unité installée dans le véhicule
Il numero si trova sull'unità installata nel veicolo







		i			i
03.6857-2301.4	03.2123-8512.3	010194 Hauptbremszylinder	03.6952-0601.4	03.7750-0302.4	300071 Bremskraftverstärker
03.6857-2401.4	03.2125-3801.3	010215 Hauptbremszylinder			
03.6857-2402.4	03.2125-3701.3	010627 Hauptbremszylinder	03.6952-0701.4	03.2122-9612.3	010159 Hauptbremszylinder
03.6862-0201.4	03.2023-0166.3	010015 Hauptbremszylinder		03.7750-0302.4	300071 Bremskraftverstärker
03.6862-0202.4	03.2023-0166.3	010015 Hauptbremszylinder			
03.6862-0203.4	03.2023-0166.3	010015 Hauptbremszylinder	03.7732-0201.4	03.2120-2031.3	010106 Hauptbremszylinder
03.6862-0204.4	03.2023-0166.3	010015 Hauptbremszylinder	03.7732-0401.4	03.2120-2031.3	010106 Hauptbremszylinder
03.6862-0301.4	03.2123-9002.3	010198 Hauptbremszylinder	03.7742-0801.4	03.2120-2031.3	010106 Hauptbremszylinder
03.6862-0501.4	03.2123-4911.3	010182 Hauptbremszylinder	03.7742-0901.4	03.2120-2031.3	010106 Hauptbremszylinder
03.6862-0502.4	03.2123-4911.3	010182 Hauptbremszylinder	03.7742-1402.4	03.7740-1402.4	300133 Bremskraftverstärker
03.6862-0505.4	03.2123-4911.3	010182 Hauptbremszylinder			
03.6862-0506.4	03.2123-6207.3	010185 Hauptbremszylinder	03.7742-1403.4	03.7740-1402.4	300133 Bremskraftverstärker
03.6862-0507.4	03.2123-4911.3	010182 Hauptbremszylinder			
03.6862-0508.4	03.2123-4911.3	010182 Hauptbremszylinder	03.7742-1404.4	03.2120-3943.3	010532 Hauptbremszylinder
03.6862-0801.4	03.2123-9002.3	010198 Hauptbremszylinder		03.7740-1402.4	300133 Bremskraftverstärker
	03.7760-0402.4	300087 Bremskraftverstärker	03.7742-1405.4	03.7740-1402.4	300133 Bremskraftverstärker
03.6862-0802.4	03.2023-0183.3	010017 Hauptbremszylinder	03.7742-2001.4	03.2120-2031.3	010106 Hauptbremszylinder
	03.7760-0402.4	300087 Bremskraftverstärker	03.7742-2101.4	03.2120-2031.3	010106 Hauptbremszylinder
03.6862-0803.4	03.7760-0402.4	300087 Bremskraftverstärker	03.7742-3301.4	03.2120-4166.3	010452 Hauptbremszylinder
				03.7740-3302.4	300107 Bremskraftverstärker
03.6862-0901.4	03.2122-6911.3	010153 Hauptbremszylinder	03.7742-3501.4	03.2120-4166.3	010452 Hauptbremszylinder
	03.7760-0902.4	300088 Bremskraftverstärker	03.7742-3601.4	03.2120-4166.3	010452 Hauptbremszylinder
03.6862-0902.4	03.2122-6911.3	010153 Hauptbremszylinder	03.7742-3701.4	03.2120-4166.3	010452 Hauptbremszylinder
	03.7760-0902.4	300088 Bremskraftverstärker	03.7742-3802.4	03.2122-1184.3	010592 Hauptbremszylinder
03.6862-0903.4	03.2123-8311.3	010192 Hauptbremszylinder	03.7742-3806.4	03.2122-1184.3	010592 Hauptbremszylinder
	03.7760-0902.4	300088 Bremskraftverstärker	03.7742-3808.4	03.2122-1184.3	010592 Hauptbremszylinder
03.6862-1101.4	03.2125-3801.3	010215 Hauptbremszylinder	03.7742-3901.4	03.2120-4241.3	010524 Hauptbremszylinder
03.6862-1105.4	03.2125-3801.3	010215 Hauptbremszylinder	03.7742-3902.4	03.2120-4246.3	010614 Hauptbremszylinder
03.6862-1201.4	03.2023-0262.3	010020 Hauptbremszylinder	03.7742-4001.4	03.2120-4221.3	010605 Hauptbremszylinder
03.6862-1303.4	03.2125-7002.3	010628 Hauptbremszylinder	03.7742-4401.4	03.2123-1484.3	010595 Hauptbremszylinder
03.6862.0904.4	03.7760-0902.4	300088 Bremskraftverstärker	03.7742-4402.4	03.2123-1484.3	010595 Hauptbremszylinder
03.6952-0202.4	03.2122-8012.3	010156 Hauptbremszylinder	03.7742-4601.4	03.2120-4321.3	010525 Hauptbremszylinder
03.6952-0301.4	03.2023-0172.3	010016 Hauptbremszylinder	03.7742-5401.4	03.2120-4321.3	010525 Hauptbremszylinder
	03.7750-5702.4	300083 Bremskraftverstärker	03.7747-1501.4	03.2123-1622.3	010470 Hauptbremszylinder
03.6952-0302.4	03.2023-0172.3	010016 Hauptbremszylinder		03.7745-3003.4	300157 Bremskraftverstärker
	03.7750-5702.4	300083 Bremskraftverstärker	03.7747-1502.4	03.2125-7402.3	010541 Hauptbremszylinder
03.6952-0401.4	03.2122-9612.3	010159 Hauptbremszylinder		03.7745-3003.4	300157 Bremskraftverstärker
	03.7750-0302.4	300071 Bremskraftverstärker	03.7747-1503.4	03.2125-7402.3	010541 Hauptbremszylinder
03.6952-0501.4	03.2122-9612.3	010159 Hauptbremszylinder		03.7745-3003.4	300157 Bremskraftverstärker
	03.7750-0302.4	300071 Bremskraftverstärker	03.7747-1602.4	03.2125-7502.3	010616 Hauptbremszylinder
03.6952-0601.4	03.2122-9612.3	010159 Hauptbremszylinder	03.7747-1603.4	03.2125-7502.3	010616 Hauptbremszylinder
			03.7747-1604.4	03.2125-7502.3	010616 Hauptbremszylinder
			03.7747-1631.4	03.7745-1632.4	300293 Bremskraftverstärker
			03.7747-1831.4	03.7745-1832.4	300294 Bremskraftverstärker



Bremsgeräte komplett

Booster units complete - Servofreno completo - Servo-freins
complets - Servofreni completi





• Die Nummer befindet sich auf dem im Fahrzeug eingebautem Aggregat.
the number is on the unit build in the car
El número está ubicado en la unidad instalada en el vehículo
Le numéro est situé sur l'unité installée dans le véhicule
Il numero si trova sull'unità installata nel veicolo

					
03.7747-3201.4	03.2123-2221.3	010861 Hauptbremszylinder	03.7752-0201.4	03.7750-0302.4	300071 Bremskraftverstärker
03.7747-3401.4	03.2123-2221.3	010861 Hauptbremszylinder			
03.7747-3601.4	03.2123-2774.3	010803 Hauptbremszylinder	03.7752-0204.4	03.2122-9612.3	010159 Hauptbremszylinder
03.7747-3602.4	03.2123-2774.3	010803 Hauptbremszylinder		03.7750-0302.4	300071 Bremskraftverstärker
03.7747-3605.4	03.2123-2774.3	010803 Hauptbremszylinder			
03.7747-3901.4	03.2125-9901.3	010634 Hauptbremszylinder	03.7752-0232.4	03.2122-1461.3	010610 Hauptbremszylinder
	03.7745-3902.4	300129 Bremskraftverstärker	03.7752-0241.4	03.4153-5287.4	010953 Hauptbremszylinder
03.7747-3902.4	03.2125-9901.3	010634 Hauptbremszylinder	03.7752-0302.4	03.2122-9612.3	010159 Hauptbremszylinder
03.7747-3903.4	03.2125-9911.3	010883 Hauptbremszylinder		03.7750-0302.4	300071 Bremskraftverstärker
	03.7745-3902.4	300129 Bremskraftverstärker	03.7752-0341.4	03.2120-4611.3	010937 Hauptbremszylinder
				03.2125-0493.3	010940 Hauptbremszylinder
				03.2126-3144.3	010941 Hauptbremszylinder
03.7747-4301.4	03.2123-2221.3	010861 Hauptbremszylinder	03.7752-0342.4	03.2122-2031.3	010938 Hauptbremszylinder
03.7747-4401.4	03.2123-2221.3	010861 Hauptbremszylinder	03.7752-0401.4	03.2023-0562.3	010025 Hauptbremszylinder
	03.7745-4402.4	300295 Bremskraftverstärker		03.7750-0302.4	300071 Bremskraftverstärker
03.7747-4402.4	03.7745-4402.4	300295 Bremskraftverstärker	03.7752-0402.4	03.2023-0542.3	010024 Hauptbremszylinder
				03.7750-0302.4	300071 Bremskraftverstärker
03.7747-4600.4	03.2125-9901.3	010634 Hauptbremszylinder	03.7752-0404.4	03.7750-5702.4	300083 Bremskraftverstärker
03.7747-5802.4	03.2025-2301.3	010895 Hauptbremszylinder	03.7752-0405.4	03.2023-0542.3	010024 Hauptbremszylinder
03.7747-6301.4	03.2025-2301.3	010895 Hauptbremszylinder		03.7750-5702.4	300083 Bremskraftverstärker
	03.7745-6302.4	300261 Bremskraftverstärker	03.7752-0442.4	03.2122-2031.3	010938 Hauptbremszylinder
03.7747-6302.4	03.7745-6302.4	300261 Bremskraftverstärker	03.7752-0443.4	03.2120-4611.3	010937 Hauptbremszylinder
				03.2125-0493.3	010940 Hauptbremszylinder
				03.2126-3144.3	010941 Hauptbremszylinder
03.7747-6501.4	03.7745-6502.4	300296 Bremskraftverstärker	03.7752-0501.4	03.2122-9612.3	010159 Hauptbremszylinder
03.7747-6502.4	03.7745-6502.4	300296 Bremskraftverstärker		03.7750-0302.4	300071 Bremskraftverstärker
03.7747-6503.4	03.7745-6502.4	300296 Bremskraftverstärker	03.7752-0532.4	03.2120-4321.3	010525 Hauptbremszylinder
03.7747-6504.4	03.7745-6502.4	300296 Bremskraftverstärker		03.7750-0532.4	300110 Bremskraftverstärker
03.7747-7101.4	03.2025-2301.3	010895 Hauptbremszylinder	03.7752-0541.4	03.2120-4611.3	010937 Hauptbremszylinder
03.7747-8501.4	03.4156-0073.3	010942 Hauptbremszylinder		03.2125-0493.3	010940 Hauptbremszylinder
03.7747-8901.4	03.2025-2301.3	010895 Hauptbremszylinder		03.2126-3144.3	010941 Hauptbremszylinder
	03.7745-8902.4	300297 Bremskraftverstärker	03.7752-0707.4	03.2122-0264.3	010129 Hauptbremszylinder
03.7747-8902.4	03.2025-2301.3	010895 Hauptbremszylinder	03.7752-0708.4	03.2122-0264.3	010129 Hauptbremszylinder
	03.7745-8902.4	300297 Bremskraftverstärker	03.7752-0709.4	03.2122-0264.3	010129 Hauptbremszylinder
03.7747-8903.4	03.7745-8902.4	300297 Bremskraftverstärker	03.7752-0710.4	03.2122-0282.3	010130 Hauptbremszylinder
03.7747-8904.4	03.7745-8902.4	300297 Bremskraftverstärker	03.7752-0713.4	03.2122-0264.3	010129 Hauptbremszylinder
			03.7752-0714.4	03.2122-0264.3	010129 Hauptbremszylinder
03.7750-2333.4	03.2122-1588.3	010733 Hauptbremszylinder	03.7752-0715.4	03.2122-0264.3	010129 Hauptbremszylinder
	03.7750-2332.4	300113 Bremskraftverstärker	03.7752-0716.4	03.2122-0264.3	010129 Hauptbremszylinder
03.7752-0101.4	03.2022-0602.3	010006 Hauptbremszylinder	03.7752-0717.4	03.2122-0264.3	010129 Hauptbremszylinder
03.7752-0102.4	03.2022-0602.3	010006 Hauptbremszylinder	03.7752-0718.4	03.2122-0264.3	010129 Hauptbremszylinder
03.7752-0104.4	03.2022-0602.3	010006 Hauptbremszylinder	03.7752-0722.4	03.2122-0264.3	010129 Hauptbremszylinder
03.7752-0132.4	03.2122-1421.3	010615 Hauptbremszylinder	03.7752-0723.4	03.2123-1121.3	010176 Hauptbremszylinder
03.7752-0201.4	03.2122-9612.3	010159 Hauptbremszylinder	03.7752-0808.4	03.2122-0264.3	010129 Hauptbremszylinder
			03.7752-0809.4	03.2122-0264.3	010129 Hauptbremszylinder

Bremsgeräte komplett

Booster units complete - Servofreno completo - Servo-freins
complets - Servofreni completi

• Die Nummer befindet sich auf dem im Fahrzeug eingebautem Aggregat.
The number is on the unit build in the car
El número está ubicado en la unidad instalada en el vehículo
Le numéro est situé sur l'unité installée dans le véhicule
Il numero si trova sull'unità installata nel veicolo

		i			i
03.7752-0810.4	03.2122-0282.3	010130 Hauptbremszylinder	03.7752-2142.4	03.2122-2031.3	010938 Hauptbremszylinder
03.7752-0813.4	03.2122-0264.3	010129 Hauptbremszylinder	03.7752-2231.4	03.4122-0031.3	010611 Hauptbremszylinder
03.7752-0814.4	03.2122-0264.3	010129 Hauptbremszylinder	03.7750-2232.4	300112 Bremskraftverstärker	
03.7752-0815.4	03.2122-0264.3	010129 Hauptbremszylinder	03.7752-2232.4	03.4122-0041.3	010612 Hauptbremszylinder
03.7752-0816.4	03.2122-0264.3	010129 Hauptbremszylinder	03.7750-2232.4	300112 Bremskraftverstärker	
03.7752-0819.4	03.2122-0264.3	010129 Hauptbremszylinder	03.7752-2331.4	03.2122-1564.3	010594 Hauptbremszylinder
03.7752-0820.4	03.2123-1121.3	010176 Hauptbremszylinder	03.7750-2332.4	300113 Bremskraftverstärker	
03.7752-0831.4	03.2122-1691.3	010918 Hauptbremszylinder	03.7752-2332.4	03.7750-2332.4	300113 Bremskraftverstärker
03.7752-0901.4	03.2122-1042.3	010137 Hauptbremszylinder	03.7752-2333.4	03.2122-1588.3	010733 Hauptbremszylinder
03.7750-4302.4	300076 Bremskraftverstärker		03.7750-2332.4	300113 Bremskraftverstärker	
03.7752-0902.4	03.2120-3943.3	010532 Hauptbremszylinder	03.7752-2334.4	03.2123-2243.3	010748 Hauptbremszylinder
03.7750-4302.4	300076 Bremskraftverstärker		03.7750-2332.4	300113 Bremskraftverstärker	
03.7752-1001.4	03.7750-7402.4	300084 Bremskraftverstärker	03.7752-2335.4	03.7750-2332.4	300113 Bremskraftverstärker
03.7752-1005.4	03.2122-0646.3	010133 Hauptbremszylinder	03.7752-2336.4	03.7750-2332.4	300113 Bremskraftverstärker
03.7750-7402.4	300084 Bremskraftverstärker		03.7752-2402.4	03.2122-0621.3	010131 Hauptbremszylinder
03.7752-1006.4	03.2122-0646.3	010133 Hauptbremszylinder	03.7752-2431.4	03.2122-1564.3	010594 Hauptbremszylinder
03.7750-7402.4	300084 Bremskraftverstärker		03.7752-2433.4	03.2122-1588.3	010733 Hauptbremszylinder
03.7752-1006.4	03.2122-0646.3	010133 Hauptbremszylinder	03.7752-2434.4	03.2123-2243.3	010748 Hauptbremszylinder
03.7750-7402.4	300084 Bremskraftverstärker		03.7752-2601.4	03.2120-3943.3	010532 Hauptbremszylinder
03.7752-1031.4	03.2123-1484.3	010595 Hauptbremszylinder	03.7752-2603.4	03.2120-3943.3	010532 Hauptbremszylinder
03.7752-1201.4	03.2122-1042.3	010137 Hauptbremszylinder	03.7752-2604.4	03.2120-3943.3	010532 Hauptbremszylinder
03.7750-4902.4	300079 Bremskraftverstärker		03.7752-2607.4	03.2120-3943.3	010532 Hauptbremszylinder
03.7752-1202.4	03.2120-3943.3	010532 Hauptbremszylinder	03.7752-2608.4	03.2120-3943.3	010532 Hauptbremszylinder
03.7750-4902.4	300079 Bremskraftverstärker		03.7750-5502.4	300081 Bremskraftverstärker	
03.7752-1204.4	03.2120-3943.3	010532 Hauptbremszylinder	03.7752-2631.4	03.2122-1691.3	010918 Hauptbremszylinder
03.7750-4902.4	300079 Bremskraftverstärker		03.7752-2632.4	03.2122-1691.3	010918 Hauptbremszylinder
03.7752-1331.4	03.7750-1332.4	300155 Bremskraftverstärker	03.7752-2701.4	03.2120-3943.3	010532 Hauptbremszylinder
03.7752-1332.4	03.2120-4461.3	010571 Hauptbremszylinder	03.7752-2731.4	03.2122-1691.3	010918 Hauptbremszylinder
03.7750-1332.4	300155 Bremskraftverstärker		03.7752-2732.4	03.2122-1691.3	010918 Hauptbremszylinder
03.7752-1831.4	03.2122-1356.3	010529 Hauptbremszylinder	03.7752-2801.4	03.2122-0264.3	010129 Hauptbremszylinder
03.7750-1832.4	300111 Bremskraftverstärker		03.7752-2931.4	03.2123-1626.3	010727 Hauptbremszylinder
03.7752-1832.4	03.2122-1351.3	010528 Hauptbremszylinder	03.7750-2932.4	300175 Bremskraftverstärker	
03.7750-1832.4	300111 Bremskraftverstärker		03.7752-3031.4	03.2123-1626.3	010727 Hauptbremszylinder
03.7752-1833.4	03.2122-1351.3	010528 Hauptbremszylinder	03.7752-3101.4	03.2120-3943.3	010532 Hauptbremszylinder
03.7750-1832.4	300111 Bremskraftverstärker		03.7752-3103.4	03.2120-3943.3	010532 Hauptbremszylinder
03.7752-1834.4	03.2122-1356.3	010529 Hauptbremszylinder	03.7752-3131.4	03.2122-1184.3	010592 Hauptbremszylinder
03.7750-1832.4	300111 Bremskraftverstärker		03.7752-3231.4	03.7750-8732.4	300199 Bremskraftverstärker
03.7752-2041.4	03.2120-4611.3	010937 Hauptbremszylinder	03.7752-3232.4	03.4153-5287.4	010953 Hauptbremszylinder
03.2125-0493.3	010940 Hauptbremszylinder		03.7750-8732.4	300199 Bremskraftverstärker	
03.2126-3144.3	010941 Hauptbremszylinder		03.7752-3233.4	03.7750-8732.4	300199 Bremskraftverstärker
03.7752-2042.4	03.2122-2031.3	010938 Hauptbremszylinder			



Bremsgeräte komplett

Booster units complete - Servofreno completo - Servo-freins
complets - Servofreni completi





• Die Nummer befindet sich auf dem im Fahrzeug eingebautem Aggregat.
the number is on the unit build in the car
El número está ubicado en la unidad instalada en el vehículo
Le numéro est situé sur l'unité installée dans le véhicule
Il numero si trova sull'unità installata nel veicolo

					
03.7752-3234.4	03.7750-8732.4	300199 Bremskraftverstärker	03.7752-5733.4	03.7750-8732.4	300199 Bremskraftverstärker
03.7752-3401.4	03.2122-0264.3	010129 Hauptbremszylinder	03.7752-5734.4	03.7750-8732.4	300199 Bremskraftverstärker
03.7752-3402.4	03.2122-0282.3	010130 Hauptbremszylinder	03.7752-5739.4	03.7750-8732.4	300199 Bremskraftverstärker
03.7752-3403.4	03.2123-1121.3	010176 Hauptbremszylinder	03.7752-5740.4	03.4153-5287.4	010953 Hauptbremszylinder
03.7752-3405.4	03.2122-0282.3	010130 Hauptbremszylinder	03.7750-8732.4		300199 Bremskraftverstärker
03.7752-3501.4	03.2122-0264.3	010129 Hauptbremszylinder	03.7752-5741.4	03.7750-8732.4	300199 Bremskraftverstärker
03.7752-3502.4	03.2122-0282.3	010130 Hauptbremszylinder	03.7752-5742.4	03.7750-8732.4	300199 Bremskraftverstärker
03.7752-3504.4	03.2123-1121.3	010176 Hauptbremszylinder	03.7752-6001.4	03.7750-6002.4	300134 Bremskraftverstärker
03.7752-3510.4	03.2122-0282.3	010130 Hauptbremszylinder	03.7752-6002.4	03.7750-6002.4	300134 Bremskraftverstärker
03.7752-3531.4	03.2123-2781.3	010631 Hauptbremszylinder	03.7752-6003.4	03.2122-1184.3	010592 Hauptbremszylinder
03.7752-3532.4	03.2123-2781.3	010631 Hauptbremszylinder	03.7750-6002.4		300134 Bremskraftverstärker
03.7752-3534.4	03.2123-2781.3	010631 Hauptbremszylinder	03.7752-6102.4	03.2122-1042.3	010137 Hauptbremszylinder
03.7752-3731.4	03.2122-1184.3	010592 Hauptbremszylinder	03.7752-6104.4	03.2122-1042.3	010137 Hauptbremszylinder
03.7752-3831.4	03.2123-1484.3	010595 Hauptbremszylinder	03.7752-6131.4	03.2120-4321.3	010525 Hauptbremszylinder
03.7752-4231.4	03.2123-2781.3	010631 Hauptbremszylinder	03.7752-6132.4	03.2120-4321.3	010525 Hauptbremszylinder
03.7752-4232.4	03.2123-2781.3	010631 Hauptbremszylinder	03.7752-6231.4	03.2122-1356.3	010529 Hauptbremszylinder
03.7752-4233.4	03.2123-2781.3	010631 Hauptbremszylinder	03.7750-6232.4		300215 Bremskraftverstärker
03.7752-4302.4	03.2122-1042.3	010137 Hauptbremszylinder	03.7752-6232.4	03.2122-1356.3	010529 Hauptbremszylinder
03.7750-4302.4		300076 Bremskraftverstärker	03.7750-6232.4		300215 Bremskraftverstärker
03.7752-4401.4	03.2123-1121.3	010176 Hauptbremszylinder	03.7752-6301.4	03.7750-6302.4	300161 Bremskraftverstärker
03.7752-4402.4	03.2123-1121.3	010176 Hauptbremszylinder	03.7752-6302.4	03.7750-6302.4	300161 Bremskraftverstärker
03.7752-4431.4	03.2122-1926.3	010916 Hauptbremszylinder	03.7752-6303.4	03.7750-6302.4	300161 Bremskraftverstärker
03.7752-4501.4	03.2123-1121.3	010176 Hauptbremszylinder	03.7752-6304.4	03.7750-6302.4	300161 Bremskraftverstärker
03.7752-4503.4	03.2123-1121.3	010176 Hauptbremszylinder	03.7752-6305.4	03.7750-6302.4	300161 Bremskraftverstärker
03.7752-4531.4	03.2123-2781.3	010631 Hauptbremszylinder	03.7752-6306.4	03.7750-6302.4	300161 Bremskraftverstärker
03.7752-4532.4	03.2123-2781.3	010631 Hauptbremszylinder	03.7752-6331.4	03.4122-0031.3	010611 Hauptbremszylinder
03.7752-4701.4	03.2120-2031.3	010106 Hauptbremszylinder	03.7750-6332.4		300226 Bremskraftverstärker
03.7752-4703.4	03.2120-4441.3	010510 Hauptbremszylinder	03.7752-6403.4	03.2122-1184.3	010592 Hauptbremszylinder
03.7752-4901.4	03.2122-1042.3	010137 Hauptbremszylinder	03.7752-6404.4	03.2123-1484.3	010595 Hauptbremszylinder
03.7750-4902.4		300079 Bremskraftverstärker	03.7752-6802.4	03.2123-1484.3	010595 Hauptbremszylinder
03.7752-5509.4	03.7750-5502.4	300081 Bremskraftverstärker	03.7752-6902.4	03.2123-1484.3	010595 Hauptbremszylinder
03.7752-5510.4	03.7750-5502.4	300081 Bremskraftverstärker	03.7752-6903.4	03.2123-1484.3	010595 Hauptbremszylinder
03.7752-5511.4	03.7750-5502.4	300081 Bremskraftverstärker	03.7752-7131.4	03.7750-7132.4	300255 Bremskraftverstärker
03.7752-5512.4	03.7750-5502.4	300081 Bremskraftverstärker	03.7752-7132.4	03.7750-7132.4	300255 Bremskraftverstärker
03.7752-5513.4	03.7750-5502.4	300081 Bremskraftverstärker			
03.7752-5514.4	03.7750-5502.4	300081 Bremskraftverstärker			
03.7752-5631.4	03.2123-2243.3	010748 Hauptbremszylinder			
03.7752-5731.4	03.7750-8732.4	300199 Bremskraftverstärker			
03.7752-5732.4	03.4153-5287.4	010953 Hauptbremszylinder			
03.7750-8732.4		300199 Bremskraftverstärker			

Bremsgeräte komplett

Booster units complete - Servofreno completo - Servo-freins
complets - Servofreni completi

• Die Nummer befindet sich auf dem im Fahrzeug eingebautem Aggregat.
the number is on the unit build in the car
El número está ubicado en la unidad instalada en el vehículo
Le numéro est situé sur l'unité installée dans le véhicule
Il numero si trova sull'unità installata nel veicolo







		i			i
03.7752-7332.4	03.2120-4641.3	010932 Hauptbremszylinder	03.7752-9001.4	03.2123-1581.3	010487 Hauptbremszylinder
	03.7750-7332.4	300298 Bremskraftverstärker	03.7752-9101.4	03.2123-1581.3	010487 Hauptbremszylinder
03.7752-7401.4	03.2122-1042.3	010137 Hauptbremszylinder	03.7752-9231.4	03.2120-4611.3	010937 Hauptbremszylinder
	03.7750-7402.4	300084 Bremskraftverstärker		03.2125-0493.3	010940 Hauptbremszylinder
03.7752-7431.4	03.4153-5287.4	010953 Hauptbremszylinder	03.7752-9233.4	03.2122-2031.3	010938 Hauptbremszylinder
03.7752-7435.4	03.4153-5287.4	010953 Hauptbremszylinder	03.7752-9301.4	03.2120-4321.3	010525 Hauptbremszylinder
03.7752-8105.4	03.2122-1331.3	010607 Hauptbremszylinder		03.7750-9302.4	300116 Bremskraftverstärker
03.7752-8108.4	03.2122-1331.3	010607 Hauptbremszylinder	03.7752-9302.4	03.2122-1356.3	010529 Hauptbremszylinder
03.7752-8432.4	03.2120-4611.3	010937 Hauptbremszylinder		03.7750-9302.4	300116 Bremskraftverstärker
	03.2125-0493.3	010940 Hauptbremszylinder	03.7752-9303.4	03.2120-4321.3	010525 Hauptbremszylinder
	03.2126-3144.3	010941 Hauptbremszylinder		03.7750-9302.4	300116 Bremskraftverstärker
03.7752-8437.4	03.2120-4611.3	010937 Hauptbremszylinder	03.7752-9304.4	03.2122-1356.3	010529 Hauptbremszylinder
	03.2125-0493.3	010940 Hauptbremszylinder		03.7750-9302.4	300116 Bremskraftverstärker
	03.2126-3144.3	010941 Hauptbremszylinder	03.7752-9305.4	03.2120-4321.3	010525 Hauptbremszylinder
03.7752-8533.4	03.7750-8532.4	300264 Bremskraftverstärker		03.7750-9302.4	300116 Bremskraftverstärker
03.7752-8534.4	03.2120-4611.3	010937 Hauptbremszylinder	03.7752-9306.4	03.2122-1356.3	010529 Hauptbremszylinder
	03.2125-0493.3	010940 Hauptbremszylinder		03.7750-9302.4	300116 Bremskraftverstärker
	03.2126-3144.3	010941 Hauptbremszylinder	03.7752-9307.4	03.2122-1351.3	010528 Hauptbremszylinder
	03.7750-8532.4	300264 Bremskraftverstärker		03.7750-9302.4	300116 Bremskraftverstärker
03.7752-8535.4	03.2122-2031.3	010938 Hauptbremszylinder	03.7752-9308.4	03.2122-1351.3	010528 Hauptbremszylinder
	03.7750-8532.4	300264 Bremskraftverstärker		03.7750-9302.4	300116 Bremskraftverstärker
03.7752-8536.4	03.2120-4611.3	010937 Hauptbremszylinder	03.7752-9309.4	03.7750-9302.4	300116 Bremskraftverstärker
	03.2125-0493.3	010940 Hauptbremszylinder	03.7752-9310.4	03.2122-1351.3	010528 Hauptbremszylinder
	03.2126-3144.3	010941 Hauptbremszylinder		03.7750-9302.4	300116 Bremskraftverstärker
	03.7750-8532.4	300264 Bremskraftverstärker	03.7752-9401.4	03.2122-1351.3	010528 Hauptbremszylinder
03.7752-8537.4	03.2122-2031.3	010938 Hauptbremszylinder		03.7750-9402.4	300117 Bremskraftverstärker
	03.7750-8532.4	300264 Bremskraftverstärker	03.7752-9402.4	03.2122-1351.3	010528 Hauptbremszylinder
03.7752-8631.4	03.2120-4611.3	010937 Hauptbremszylinder		03.7750-9402.4	300117 Bremskraftverstärker
	03.2125-0493.3	010940 Hauptbremszylinder	03.7752-9403.4	03.2122-1351.3	010528 Hauptbremszylinder
	03.2126-3144.3	010941 Hauptbremszylinder		03.7750-9402.4	300117 Bremskraftverstärker
03.7752-8632.4	03.2125-0493.3	010940 Hauptbremszylinder	03.7752-9532.4	03.2122-2031.3	010938 Hauptbremszylinder
	03.2126-3144.3	010941 Hauptbremszylinder	03.7752-9702.4	03.2123-2221.3	010861 Hauptbremszylinder
03.7752-8633.4	03.2122-2031.3	010938 Hauptbremszylinder	03.7752-9703.4	03.2123-2221.3	010861 Hauptbremszylinder
03.7752-8731.4	03.7750-8732.4	300199 Bremskraftverstärker	03.7752-9704.4	03.2123-2221.3	010861 Hauptbremszylinder
03.7752-8732.4	03.7750-8732.4	300199 Bremskraftverstärker	03.7752-9705.4	03.2123-2221.3	010861 Hauptbremszylinder
03.7752-8733.4	03.4153-5287.4	010953 Hauptbremszylinder	03.7752-9706.4	03.2123-2221.3	010861 Hauptbremszylinder
	03.7750-8732.4	300199 Bremskraftverstärker	03.7752-9802.4	03.2123-2221.3	010861 Hauptbremszylinder
03.7752-8734.4	03.7750-8732.4	300199 Bremskraftverstärker	03.7752-9803.4	03.2123-2221.3	010861 Hauptbremszylinder
03.7752-8735.4	03.7750-8732.4	300199 Bremskraftverstärker	03.7752-9804.4	03.2123-2221.3	010861 Hauptbremszylinder
03.7752-8831.4	03.7750-8832.4	300299 Bremskraftverstärker			



Bremsgeräte komplett

Booster units complete - Servofreno completo - Servo-freins
complets - Servofreni completi



• Die Nummer befindet sich auf dem im Fahrzeug eingebautem Aggregat.
the number is on the unit build in the car
El número está ubicado en la unidad instalada en el vehículo
Le numéro est situé sur l'unité installée dans le véhicule
Il numero si trova sull'unità installata nel veicolo

					
03.7752-9805.4	03.2123-2221.3	010861 Hauptbremszylinder	03.7757-1206.4	03.7755-3402.4	300189 Bremskraftverstärker
03.7752-9806.4	03.2123-2221.3	010861 Hauptbremszylinder	03.7757-1207.4	03.2125-7637.3	010707 Hauptbremszylinder
03.7757-0101.4	03.2023-0230.3	010019 Hauptbremszylinder	03.7755-3402.4	300189 Bremskraftverstärker	
03.7757-0102.4	03.2023-0825.3	010028 Hauptbremszylinder	03.7757-1208.4	03.2125-7743.3	010921 Hauptbremszylinder
03.7757-0131.4	03.7755-0132.4	300265 Bremskraftverstärker	03.7755-3402.4	300189 Bremskraftverstärker	
03.7757-0201.4	03.2025-0211.3	010034 Hauptbremszylinder	03.7757-1209.4	03.2125-7638.3	010738 Hauptbremszylinder
03.7757-0203.4	03.7750-0302.4	300071 Bremskraftverstärker	03.7755-3402.4	300189 Bremskraftverstärker	
03.7757-0204.4	03.7750-0302.4	300071 Bremskraftverstärker	03.7757-1210.4	03.2125-7743.3	010921 Hauptbremszylinder
03.7757-0231.4	03.4156-0073.3	010942 Hauptbremszylinder	03.7755-3402.4	300189 Bremskraftverstärker	
03.7757-0314.4	03.2023-0642.3	010026 Hauptbremszylinder	03.7757-1231.4	03.7755-1232.4	300260 Bremskraftverstärker
03.7757-0319.4	03.2023-0642.3	010026 Hauptbremszylinder	03.7757-1431.4	03.7755-1432.4	300300 Bremskraftverstärker
03.7757-0321.4	03.2023-0642.3	010026 Hauptbremszylinder	03.7757-1501.4	03.2125-8404.3	010583 Hauptbremszylinder
03.7757-0324.4	03.2023-0642.3	010026 Hauptbremszylinder	03.7755-1902.4	300138 Bremskraftverstärker	
03.7757-0631.4	03.2125-0651.3	010935 Hauptbremszylinder	03.7757-1601.4	03.2125-8404.3	010583 Hauptbremszylinder
03.7757-0632.4	03.2125-0651.3	010935 Hauptbremszylinder	03.7757-1902.4	03.2125-0332.3	010952 Hauptbremszylinder
03.7757-0633.4	03.2125-0651.3	010935 Hauptbremszylinder	03.7755-1902.4	300138 Bremskraftverstärker	
03.7757-0801.4	03.2123-1526.3	010477 Hauptbremszylinder	03.7757-1903.4	03.2125-0332.3	010952 Hauptbremszylinder
	03.7755-4202.4	300164 Bremskraftverstärker	03.7755-1902.4	300138 Bremskraftverstärker	
03.7757-0802.4	03.2123-1526.3	010477 Hauptbremszylinder	03.7757-2002.4	03.2125-0332.3	010952 Hauptbremszylinder
	03.7755-4202.4	300164 Bremskraftverstärker	03.7757-2004.4	03.2125-0332.3	010952 Hauptbremszylinder
03.7757-0803.4	03.7755-4202.4	300164 Bremskraftverstärker	03.7757-2201.4	03.7755-4302.4	300165 Bremskraftverstärker
03.7757-0804.4	03.7755-4202.4	300164 Bremskraftverstärker	03.7757-2202.4	03.7755-4302.4	300165 Bremskraftverstärker
03.7757-0805.4	03.2125-8111.3	010479 Hauptbremszylinder	03.7757-2203.4	03.7755-4302.4	300165 Bremskraftverstärker
	03.7755-4202.4	300164 Bremskraftverstärker	03.7757-2501.4	03.2123-1486.3	010488 Hauptbremszylinder
03.7757-0806.4	03.2125-8111.3	010479 Hauptbremszylinder	03.7757-2503.4	03.2123-2621.3	010701 Hauptbremszylinder
	03.7755-4202.4	300164 Bremskraftverstärker	03.7757-2601.4	03.2123-1486.3	010488 Hauptbremszylinder
03.7757-0901.4	03.2123-1486.3	010488 Hauptbremszylinder	03.7757-2603.4	03.2123-2621.3	010701 Hauptbremszylinder
03.7757-0902.4	03.2123-1741.3	010537 Hauptbremszylinder	03.7757-2801.4	03.2125-0332.3	010952 Hauptbremszylinder
03.7757-1001.4	03.2123-1486.3	010488 Hauptbremszylinder	03.7755-6302.4	300221 Bremskraftverstärker	
03.7757-1002.4	03.2123-1741.3	010537 Hauptbremszylinder	03.7757-2802.4	03.2125-0332.3	010952 Hauptbremszylinder
03.7757-1031.4	03.2125-0651.3	010935 Hauptbremszylinder	03.7755-6302.4	300221 Bremskraftverstärker	
03.7757-1032.4	03.2125-0651.3	010935 Hauptbremszylinder	03.7757-2803.4	03.2125-0332.3	010952 Hauptbremszylinder
03.7757-1033.4	03.2125-0651.3	010935 Hauptbremszylinder	03.7755-6302.4	300221 Bremskraftverstärker	
03.7757-1034.4	03.2125-0651.3	010935 Hauptbremszylinder	03.7757-2804.4	03.2125-0332.3	010952 Hauptbremszylinder
03.7757-1201.4	03.7755-3402.4	300189 Bremskraftverstärker	03.7755-6302.4	300221 Bremskraftverstärker	
03.7757-1202.4	03.7755-3402.4	300189 Bremskraftverstärker	03.7757-2805.4	03.2125-0332.3	010952 Hauptbremszylinder
03.7757-1203.4	03.7755-3402.4	300189 Bremskraftverstärker			
03.7757-1204.4	03.7755-3402.4	300189 Bremskraftverstärker			
03.7757-1205.4	03.7755-3402.4	300189 Bremskraftverstärker			

Bremsgeräte komplett

Booster units complete - Servofreno completo - Servo-freins
complets - Servofreni completi

• Die Nummer befindet sich auf dem im Fahrzeug eingebautem Aggregat.
the number is on the unit build in the car
El número está ubicado en la unidad instalada en el vehículo
Le numéro est situé sur l'unité installée dans le véhicule
Il numero si trova sull'unità installata nel veicolo

		i			i
03.7757-2805.4	03.7755-6302.4	300221 Bremskraftverstärker	03.7757-3801.4	03.2125-7638.3	010738 Hauptbremszylinder
03.7757-2806.4	03.2125-0332.3	010952 Hauptbremszylinder	03.7757-4501.4	03.2125-7743.3	010921 Hauptbremszylinder
	03.7755-6302.4	300221 Bremskraftverstärker	03.7757-4601.4	03.2125-7638.3	010738 Hauptbremszylinder
03.7757-2807.4	03.2125-0332.3	010952 Hauptbremszylinder	03.7757-4701.4	03.2125-7743.3	010921 Hauptbremszylinder
	03.7755-6302.4	300221 Bremskraftverstärker		03.7755-4702.4	300224 Bremskraftverstärker
03.7757-2808.4	03.2125-0332.3	010952 Hauptbremszylinder	03.7757-4702.4	03.2125-7637.3	010707 Hauptbremszylinder
	03.7755-6302.4	300221 Bremskraftverstärker		03.2125-7638.3	010738 Hauptbremszylinder
03.7757-2811.4	03.2125-0332.3	010952 Hauptbremszylinder		03.7755-4702.4	300224 Bremskraftverstärker
	03.7755-6302.4	300221 Bremskraftverstärker	03.7757-4703.4	03.2125-7743.3	010921 Hauptbremszylinder
03.7757-2812.4	03.2125-0332.3	010952 Hauptbremszylinder		03.7755-4702.4	300224 Bremskraftverstärker
	03.7755-6302.4	300221 Bremskraftverstärker	03.7757-4704.4	03.2125-7638.3	010738 Hauptbremszylinder
03.7757-2931.4	03.2125-0651.3	010935 Hauptbremszylinder		03.7755-4702.4	300224 Bremskraftverstärker
03.7757-3201.4	03.2123-1526.3	010477 Hauptbremszylinder	03.7757-4705.4	03.2125-7743.3	010921 Hauptbremszylinder
	03.7755-4202.4	300164 Bremskraftverstärker		03.7755-4702.4	300224 Bremskraftverstärker
03.7757-3202.4	03.2123-1526.3	010477 Hauptbremszylinder	03.7757-4706.4	03.2125-7638.3	010738 Hauptbremszylinder
	03.7755-4202.4	300164 Bremskraftverstärker		03.7755-4702.4	300224 Bremskraftverstärker
03.7757-3203.4	03.7755-4202.4	300164 Bremskraftverstärker	03.7757-4707.4	03.2125-7743.3	010921 Hauptbremszylinder
03.7757-3204.4	03.7755-4202.4	300164 Bremskraftverstärker		03.7755-4702.4	300224 Bremskraftverstärker
03.7757-3205.4	03.2125-8111.3	010479 Hauptbremszylinder	03.7757-4708.4	03.2125-7638.3	010738 Hauptbremszylinder
	03.7755-4202.4	300164 Bremskraftverstärker		03.7755-4702.4	300224 Bremskraftverstärker
03.7757-3206.4	03.2125-8111.3	010479 Hauptbremszylinder	03.7757-4807.4	03.2125-0161.3	010920 Hauptbremszylinder
	03.7755-4202.4	300164 Bremskraftverstärker	03.7757-4808.4	03.2125-0531.3	010945 Hauptbremszylinder
03.7757-3301.4	03.7755-4302.4	300165 Bremskraftverstärker	03.7757-4813.4	03.2125-0161.3	010920 Hauptbremszylinder
03.7757-3302.4	03.7755-4302.4	300165 Bremskraftverstärker	03.7757-5001.4	03.2125-7743.3	010921 Hauptbremszylinder
03.7757-3303.4	03.2125-9704.3	010603 Hauptbremszylinder	03.7757-5002.4	03.2125-7638.3	010738 Hauptbremszylinder
	03.7755-4302.4	300165 Bremskraftverstärker	03.7757-5301.4	03.7755-1432.4	300300 Bremskraftverstärker
03.7757-3401.4	03.2125-7743.3	010921 Hauptbremszylinder	03.7757-5501.4	03.7755-9703.4	300239 Bremskraftverstärker
	03.7755-3402.4	300189 Bremskraftverstärker	03.7757-5502.4	03.7755-9703.4	300239 Bremskraftverstärker
03.7757-3402.4	03.2125-7638.3	010738 Hauptbremszylinder	03.7757-6101.4	03.7755-1232.4	300260 Bremskraftverstärker
	03.7755-3402.4	300189 Bremskraftverstärker	03.7757-6102.4	03.7755-1232.4	300260 Bremskraftverstärker
03.7757-3501.4	03.2123-2621.3	010701 Hauptbremszylinder	03.7757-6201.4	03.7755-1432.4	300300 Bremskraftverstärker
03.7757-3531.4	03.2125-0651.3	010935 Hauptbremszylinder	03.7757-6202.4	03.7755-1432.4	300300 Bremskraftverstärker
03.7757-3601.4	03.2123-2621.3	010701 Hauptbremszylinder	03.7757-6301.4	03.7755-6302.4	300221 Bremskraftverstärker
03.7757-3701.4	03.2125-7743.3	010921 Hauptbremszylinder	03.7757-6302.4	03.7755-6302.4	300221 Bremskraftverstärker
	03.7755-4702.4	300224 Bremskraftverstärker	03.7757-6303.4	03.2125-0332.3	010952 Hauptbremszylinder
03.7757-3702.4	03.2125-7638.3	010738 Hauptbremszylinder		03.7755-6302.4	300221 Bremskraftverstärker



Bremsgeräte komplett

Booster units complete - Servofreno completo - Servo-freins
complets - Servofreni completi







• Die Nummer befindet sich auf dem im Fahrzeug eingebautem Aggregat.
the number is on the unit build in the car
El número está ubicado en la unidad instalada en el vehículo
Le numéro est situé sur l'unité installée dans le véhicule
Il numero si trova sull'unità installata nel veicolo

					
03.7757-6401.4	03.7755-1432.4	300300 Bremskraftverstärker	03.7762-0112.4	03.2120-1802.3	010099 Hauptbremszylinder
03.7757-6402.4	03.7755-1432.4	300300 Bremskraftverstärker		03.7760-0902.4	300088 Bremskraftverstärker
03.7757-6404.4	03.7755-1432.4	300300 Bremskraftverstärker	03.7762-0114.4	03.2020-0402.3	010001 Hauptbremszylinder
03.7757-6405.4	03.7755-1432.4	300300 Bremskraftverstärker		03.7760-0902.4	300088 Bremskraftverstärker
03.7757-7301.4	03.2025-2301.3	010895 Hauptbremszylinder	03.7762-0115.4	03.2120-2082.3	010107 Hauptbremszylinder
03.7757-7501.4	03.7755-7703.4	300247 Bremskraftverstärker		03.7760-0902.4	300088 Bremskraftverstärker
03.7757-7601.4	03.7755-0132.4	300265 Bremskraftverstärker	03.7762-0116.4	03.2123-8311.3	010192 Hauptbremszylinder
03.7757-7701.4	03.2125-0651.3	010935 Hauptbremszylinder		03.7760-0902.4	300088 Bremskraftverstärker
	03.7755-7703.4	300247 Bremskraftverstärker	03.7762-0117.4	03.2123-8311.3	010192 Hauptbremszylinder
03.7757-7702.4	03.2125-0651.3	010935 Hauptbremszylinder		03.7760-0902.4	300088 Bremskraftverstärker
	03.7755-7703.4	300247 Bremskraftverstärker	03.7762-0118.4	03.2120-2082.3	010107 Hauptbremszylinder
03.7757-7702.4	03.2125-0651.3	010935 Hauptbremszylinder		03.7760-0902.4	300088 Bremskraftverstärker
	03.7755-7703.4	300247 Bremskraftverstärker	03.7762-0119.4	03.2120-2082.3	010107 Hauptbremszylinder
03.7757-8201.4	03.2126-3196.3	010968 Hauptbremszylinder		03.7760-0902.4	300088 Bremskraftverstärker
	03.7755-8202.4	300301 Bremskraftverstärker	03.7762-0120.4	03.2120-2082.3	010107 Hauptbremszylinder
03.7757-8801.4	03.4156-0073.3	010942 Hauptbremszylinder		03.7760-0902.4	300088 Bremskraftverstärker
03.7757-9001.4	03.2126-3196.3	010968 Hauptbremszylinder	03.7762-0121.4	03.2120-1802.3	010099 Hauptbremszylinder
03.7757-9002.4	03.2126-3196.3	010968 Hauptbremszylinder		03.7760-0902.4	300088 Bremskraftverstärker
03.7757-9301.4	03.7755-1232.4	300260 Bremskraftverstärker	03.7762-0122.4	03.2120-1802.3	010099 Hauptbremszylinder
03.7757-9401.4	03.7755-1432.4	300300 Bremskraftverstärker		03.7760-0902.4	300088 Bremskraftverstärker
03.7757-9402.4	03.7755-1432.4	300300 Bremskraftverstärker	03.7762-0123.4	03.2020-0402.3	010001 Hauptbremszylinder
03.7757-9501.4	03.7755-1432.4	300300 Bremskraftverstärker		03.7760-0902.4	300088 Bremskraftverstärker
03.7757-9601.4	03.7755-1432.4	300300 Bremskraftverstärker	03.7762-0124.4	03.7760-0902.4	300088 Bremskraftverstärker
03.7757-9701.4	03.7755-9703.4	300239 Bremskraftverstärker	03.7762-0201.4	03.2020-0402.3	010001 Hauptbremszylinder
03.7762-0101.4	03.2123-8311.3	010192 Hauptbremszylinder		03.7760-0902.4	300088 Bremskraftverstärker
	03.7760-0902.4	300088 Bremskraftverstärker	03.7762-0202.4	03.2120-1802.3	010099 Hauptbremszylinder
03.7762-0102.4	03.2122-6911.3	010153 Hauptbremszylinder		03.7760-0902.4	300088 Bremskraftverstärker
	03.7760-0902.4	300088 Bremskraftverstärker	03.7762-0204.4	03.2120-2082.3	010107 Hauptbremszylinder
03.7762-0103.4	03.2122-6911.3	010153 Hauptbremszylinder		03.7760-0902.4	300088 Bremskraftverstärker
	03.7760-0902.4	300088 Bremskraftverstärker	03.7762-0301.4	03.2023-0825.3	010028 Hauptbremszylinder
03.7762-0104.4	03.7760-0902.4	300088 Bremskraftverstärker		03.7760-2702.4	300090 Bremskraftverstärker
03.7762-0108.4	03.2120-2082.3	010107 Hauptbremszylinder	03.7762-0302.4	03.2023-0825.3	010028 Hauptbremszylinder
	03.7760-0902.4	300088 Bremskraftverstärker		03.7760-2702.4	300090 Bremskraftverstärker
03.7762-0110.4	03.2120-1802.3	010099 Hauptbremszylinder	03.7762-0312.4	03.2023-0825.3	010028 Hauptbremszylinder
	03.7760-0902.4	300088 Bremskraftverstärker		03.7760-2702.4	300090 Bremskraftverstärker
			03.7762-0313.4	03.2023-0825.3	010028 Hauptbremszylinder

Bremsgeräte komplett

Booster units complete - Servofreno completo - Servo-freins
complets - Servofreni completi







• Die Nummer befindet sich auf dem im Fahrzeug eingebautem Aggregat.
The number is on the unit build in the car
El número está ubicado en la unidad instalada en el vehículo
Le numéro est situé sur l'unité installée dans le véhicule
Il numero si trova sull'unità installata nel veicolo

					
03.7762-0313.4	03.7760-2702.4	300090 Bremskraftverstärker	03.7762-0902.4	03.2022-1201.3	010009 Hauptbremszylinder
03.7762-0401.4	03.2023-0262.3	010020 Hauptbremszylinder	03.7760-0902.4	03.7760-0902.4	300088 Bremskraftverstärker
03.7762-0402.4	03.7760-0402.4	300087 Bremskraftverstärker	03.7762-1001.4	03.2125-3011.3	010211 Hauptbremszylinder
03.7762-0501.4	03.2120-1802.3	010099 Hauptbremszylinder	03.7762-1002.4	03.2125-3011.3	010211 Hauptbremszylinder
03.7762-0502.4	03.2120-2082.3	010107 Hauptbremszylinder	03.7762-1032.4	03.2123-3041.3	010887 Hauptbremszylinder
03.7762-0503.4	03.7760-0902.4	300088 Bremskraftverstärker	03.7760-2332.4	03.7760-2332.4	300267 Bremskraftverstärker
03.7762-0504.4	03.2120-1802.3	010099 Hauptbremszylinder	03.7762-1203.4	03.2125-3011.3	010211 Hauptbremszylinder
03.7762-0505.4	03.2120-2082.3	010107 Hauptbremszylinder	03.7762-1204.4	03.2125-3011.3	010211 Hauptbremszylinder
03.7762-0506.4	03.7760-0902.4	300088 Bremskraftverstärker	03.7762-1801.4	03.2125-3011.3	010211 Hauptbremszylinder
03.7762-0631.4	03.2125-0483.3	010783 Hauptbremszylinder	03.7762-1802.4	03.2125-3011.3	010211 Hauptbremszylinder
03.7762-0632.4	03.2125-0483.3	010783 Hauptbremszylinder	03.7762-1901.4	03.2125-3011.3	010211 Hauptbremszylinder
03.7762-0631.4	03.7760-2232.4	300266 Bremskraftverstärker	03.7762-1902.4	03.2125-3011.3	010211 Hauptbremszylinder
03.7762-0632.4	03.2125-0483.3	010783 Hauptbremszylinder	03.7762-2001.4	03.2125-3011.3	010211 Hauptbremszylinder
03.7762-0632.4	03.7760-2232.4	300266 Bremskraftverstärker	03.7762-2002.4	03.2125-3011.3	010211 Hauptbremszylinder
03.7762-0701.4	03.2022-1201.3	010009 Hauptbremszylinder	03.7762-2031.4	03.2125-0483.3	010783 Hauptbremszylinder
03.7762-0702.4	03.2022-1201.3	010009 Hauptbremszylinder	03.7762-2032.4	03.2125-0483.3	010783 Hauptbremszylinder
03.7762-0703.4	03.2022-1201.3	010009 Hauptbremszylinder	03.7762-2033.4	03.2125-0661.3	010917 Hauptbremszylinder
03.7762-0704.4	03.2022-1201.3	010009 Hauptbremszylinder	03.7762-2034.4	03.2125-0661.3	010917 Hauptbremszylinder
03.7762-0705.4	03.2022-1201.3	010009 Hauptbremszylinder	03.7762-2231.4	03.2125-0661.3	010917 Hauptbremszylinder
03.7762-0731.4	03.2123-2821.3	010944 Hauptbremszylinder	03.7762-2232.4	03.2125-0661.3	010917 Hauptbremszylinder
03.7762-0801.4	03.2022-1201.3	010009 Hauptbremszylinder	03.7762-2233.4	03.2125-0661.3	010917 Hauptbremszylinder
03.7762-0802.4	03.2022-1201.3	010009 Hauptbremszylinder	03.7762-2331.4	03.2123-3041.3	010887 Hauptbremszylinder
03.7762-0901.4	03.2022-1201.3	010009 Hauptbremszylinder	03.7760-2332.4	03.7760-2332.4	300267 Bremskraftverstärker
	03.7760-0902.4	300088 Bremskraftverstärker	03.7762-2332.4	03.7760-2332.4	300267 Bremskraftverstärker
	03.7760-0902.4	300088 Bremskraftverstärker	03.7762-2333.4	03.2123-3041.3	010887 Hauptbremszylinder
	03.7760-0902.4	300088 Bremskraftverstärker	03.7760-2332.4	03.7760-2332.4	300267 Bremskraftverstärker
	03.7760-0902.4	300088 Bremskraftverstärker	03.7762-2334.4	03.7760-2332.4	300267 Bremskraftverstärker
	03.7760-0902.4	300088 Bremskraftverstärker	03.7762-2402.4	03.2023-0987.3	010473 Hauptbremszylinder
	03.7760-0902.4	300088 Bremskraftverstärker	03.7762-2701.4	03.2023-0825.3	010028 Hauptbremszylinder
	03.7760-0902.4	300088 Bremskraftverstärker	03.7760-2702.4	03.7760-2702.4	300090 Bremskraftverstärker
	03.7760-0902.4	300088 Bremskraftverstärker	03.7762-3102.4	03.2023-0987.3	010473 Hauptbremszylinder
	03.7760-0902.4	300088 Bremskraftverstärker	03.7760-3102.4	03.7760-3102.4	300139 Bremskraftverstärker
	03.7760-0902.4	300088 Bremskraftverstärker	03.7762-3103.4	03.2023-0987.3	010473 Hauptbremszylinder
	03.7760-0902.4	300088 Bremskraftverstärker	03.7760-3102.4	03.7760-3102.4	300139 Bremskraftverstärker
	03.7760-0902.4	300088 Bremskraftverstärker	03.7762-3109.4	03.2023-0987.3	010473 Hauptbremszylinder
	03.7760-0902.4	300088 Bremskraftverstärker	03.7760-3102.4	03.7760-3102.4	300139 Bremskraftverstärker
	03.7760-0902.4	300088 Bremskraftverstärker	03.7762-3110.4	03.2023-1904.3	010724 Hauptbremszylinder
	03.7760-0902.4	300088 Bremskraftverstärker	03.7760-3102.4	03.7760-3102.4	300139 Bremskraftverstärker
	03.7760-0902.4	300088 Bremskraftverstärker	03.7762-3111.4	03.2023-1904.3	010724 Hauptbremszylinder
	03.7760-0902.4	300088 Bremskraftverstärker	03.7760-3102.4	03.7760-3102.4	300139 Bremskraftverstärker

Bremsgeräte komplett

Booster units complete - Servofreno completo - Servo-freins
complets - Servofreni completi





• Die Nummer befindet sich auf dem im Fahrzeug eingebautem Aggregat.
the number is on the unit build in the car
El número está ubicado en la unidad instalada en el vehículo
Le numéro est situé sur l'unité installée dans le véhicule
Il numero si trova sull'unità installata nel veicolo

					
03.7762-3120.4	03.2023-1949.3	010725 Hauptbremszylinder	03.7762-6301.4	03.2123-2164.3	010599 Hauptbremszylinder
	03.7760-3102.4	300139 Bremskraftverstärker	03.7762-6901.4	03.2123-2821.3	010944 Hauptbremszylinder
03.7762-3121.4	03.2023-1949.3	010725 Hauptbremszylinder	03.7762-7110.4	03.2123-3041.3	010887 Hauptbremszylinder
	03.7760-3102.4	300139 Bremskraftverstärker		03.7760-2332.4	300267 Bremskraftverstärker
03.7762-3606.4	03.2023-1084.3	010591 Hauptbremszylinder	03.7762-7111.4	03.2123-3041.3	010887 Hauptbremszylinder
	03.7760-3602.4	300176 Bremskraftverstärker		03.7760-2332.4	300267 Bremskraftverstärker
03.7762-3607.4	03.7760-3602.4	300176 Bremskraftverstärker	03.7762-7114.4	03.2123-3041.3	010887 Hauptbremszylinder
03.7762-3706.4	03.2023-1084.3	010591 Hauptbremszylinder		03.7760-2332.4	300267 Bremskraftverstärker
03.7762-4101.4	03.2023-1066.3	010032 Hauptbremszylinder	03.7762-7631.4	03.2123-2821.3	010944 Hauptbremszylinder
	03.7760-4102.4	300091 Bremskraftverstärker	03.7762-8101.4	03.2123-3103.3	010781 Hauptbremszylinder
03.7762-4102.4	03.2023-1066.3	010032 Hauptbremszylinder		03.7760-8103.4	300240 Bremskraftverstärker
	03.7760-4102.4	300091 Bremskraftverstärker	03.7762-8102.4	03.2123-3103.3	010781 Hauptbremszylinder
03.7762-4203.4	03.2123-1486.3	010488 Hauptbremszylinder		03.7760-8103.4	300240 Bremskraftverstärker
03.7762-4204.4	03.2123-1546.3	010536 Hauptbremszylinder	03.7762-8104.4	03.2123-3103.3	010781 Hauptbremszylinder
03.7762-4301.4	03.2123-1486.3	010488 Hauptbremszylinder		03.7760-8103.4	300240 Bremskraftverstärker
03.7762-4302.4	03.2123-1546.3	010536 Hauptbremszylinder	03.7762-8105.4	03.2123-3103.3	010781 Hauptbremszylinder
03.7762-4803.4	03.2123-2164.3	010599 Hauptbremszylinder		03.7760-8103.4	300240 Bremskraftverstärker
03.7762-4903.4	03.2123-2164.3	010599 Hauptbremszylinder	03.7762-9101.4	03.2123-3103.3	010781 Hauptbremszylinder
03.7762-5003.4	03.2123-2164.3	010599 Hauptbremszylinder		03.2125-0483.3	010783 Hauptbremszylinder
03.7762-5101.4	03.2123-2146.3	010572 Hauptbremszylinder		03.7760-2232.4	300266 Bremskraftverstärker
	03.7760-5102.4	300140 Bremskraftverstärker	03.7762-9602.4	03.2125-0483.3	010783 Hauptbremszylinder
03.7762-5102.4	03.2123-1551.3	010512 Hauptbremszylinder		03.7760-2232.4	300266 Bremskraftverstärker
	03.7760-5102.4	300140 Bremskraftverstärker	03.7762-9801.4	03.2123-3041.3	010887 Hauptbremszylinder
03.7762-5103.4	03.7760-5102.4	300140 Bremskraftverstärker		03.7760-2332.4	300267 Bremskraftverstärker
03.7762-5104.4	03.7760-5102.4	300140 Bremskraftverstärker	03.7767-0101.4	03.2026-0462.3	010728 Hauptbremszylinder
03.7762-5202.4	03.2120-4441.3	010510 Hauptbremszylinder		03.2026-0462.3	010728 Hauptbremszylinder
03.7762-5301.4	03.2122-1351.3	010528 Hauptbremszylinder	03.7767-0102.4	03.2026-0512.3	010038 Hauptbremszylinder
03.7762-5401.4	03.2123-2146.3	010572 Hauptbremszylinder		03.2026-0512.3	010038 Hauptbremszylinder
	03.7760-5102.4	300140 Bremskraftverstärker	03.7767-0103.4	03.2026-0512.3	010038 Hauptbremszylinder
03.7762-5501.4	03.2122-1521.3	010494 Hauptbremszylinder		03.2026-0462.3	010728 Hauptbremszylinder
	03.7760-5502.4	300151 Bremskraftverstärker	03.7767-0104.4	03.2026-0562.3	010729 Hauptbremszylinder
03.7762-5503.4	03.2122-1541.3	010511 Hauptbremszylinder		03.2026-0462.3	010728 Hauptbremszylinder
	03.7760-5502.4	300151 Bremskraftverstärker	03.7767-0105.4	03.2026-0562.3	010729 Hauptbremszylinder
03.7762-5602.4	03.2123-1551.3	010512 Hauptbremszylinder		03.2026-0562.3	010729 Hauptbremszylinder
	03.7760-5602.4	300121 Bremskraftverstärker	03.7767-0106.4	03.2126-3014.3	010811 Hauptbremszylinder
03.7762-5603.4	03.2122-1541.3	010511 Hauptbremszylinder		03.7765-1002.4	300246 Bremskraftverstärker
	03.7760-5602.4	300121 Bremskraftverstärker	03.7767-0107.4	03.2126-3014.3	010811 Hauptbremszylinder
03.7762-6201.4	03.2123-2164.3	010599 Hauptbremszylinder		03.7765-1002.4	300246 Bremskraftverstärker
			03.7767-1001.4	03.2126-3144.3	010941 Hauptbremszylinder
				03.2126-3144.3	010941 Hauptbremszylinder
			03.7767-1302.4	03.2126-3144.3	010941 Hauptbremszylinder
				03.2126-3144.3	010941 Hauptbremszylinder
			03.7767-1303.4	03.2025-1904.3	010797 Hauptbremszylinder
			03.7767-1401.4		
			03.7847-0101.4		

Bremsgeräte komplett

Booster units complete - Servofreno completo - Servo-freins
complets - Servofreni completi

• Die Nummer befindet sich auf dem im Fahrzeug eingebautem Aggregat.
the number is on the unit build in the car
El número está ubicado en la unidad instalada en el vehículo
Le numéro est situé sur l'unité installée dans le véhicule
Il numero si trova sull'unità installata nel veicolo







		i			i
03.7847-0101.4	03.7845-0103.4	300268 Bremskraftverstärker	03.7849-9401.4	03.7848-9402.4	300227 Bremskraftverstärker
03.7847-0102.4	03.7845-0103.4	300268 Bremskraftverstärker	03.7852-0102.4	03.2122-1883.3	010735 Hauptbremszylinder
03.7847-0103.4	03.2025-1904.3	010797 Hauptbremszylinder		03.7850-0102.4	300180 Bremskraftverstärker
	03.7845-0103.4	300268 Bremskraftverstärker	03.7852-0103.4	03.2122-1888.3	010736 Hauptbremszylinder
03.7847-0104.4	03.7845-0103.4	300268 Bremskraftverstärker		03.7850-0102.4	300180 Bremskraftverstärker
03.7847-0501.4	03.2025-1904.3	010797 Hauptbremszylinder	03.7854-0101.4	03.7853-0102.4	300252 Bremskraftverstärker
03.7847-0601.4	03.2025-1904.3	010797 Hauptbremszylinder	03.7854-0102.4	03.7853-0102.4	300252 Bremskraftverstärker
03.7849-0101.4	03.2123-2064.3	010598 Hauptbremszylinder	03.7854-0201.4	03.7853-0202.4	300181 Bremskraftverstärker
03.7849-0201.4	03.7848-2002.4	300166 Bremskraftverstärker	03.7854-0202.4	03.7853-0202.4	300181 Bremskraftverstärker
03.7849-0202.4	03.2025-1741.3	010705 Hauptbremszylinder		03.7853-0702.4	300195 Bremskraftverstärker
	03.7848-2002.4	300166 Bremskraftverstärker	03.7854-0701.4	03.7853-0702.4	300195 Bremskraftverstärker
03.7849-0203.4	03.7848-2002.4	300166 Bremskraftverstärker	03.7854-0702.4	03.7853-0702.4	300195 Bremskraftverstärker
03.7849-0204.4	03.7848-2002.4	300166 Bremskraftverstärker	03.7854-0901.4	03.7853-0902.4	300150 Bremskraftverstärker
03.7849-0901.4	03.2025-1741.3	010705 Hauptbremszylinder	03.7854-0902.4	03.7853-0902.4	300150 Bremskraftverstärker
03.7849-0902.4	03.2025-1741.3	010705 Hauptbremszylinder	03.7854-0903.4	03.7853-0902.4	300150 Bremskraftverstärker
03.7849-1201.4	03.2123-2064.3	010598 Hauptbremszylinder	03.7854-0904.4	03.7853-0902.4	300150 Bremskraftverstärker
03.7849-2001.4	03.7848-2002.4	300166 Bremskraftverstärker	03.7854-0905.4	03.7853-0902.4	300150 Bremskraftverstärker
03.7849-2002.4	03.7848-2002.4	300166 Bremskraftverstärker	03.7854-0906.4	03.7853-0902.4	300150 Bremskraftverstärker
03.7849-3001.4	03.7848-9402.4	300227 Bremskraftverstärker	03.7854-0907.4	03.7853-0902.4	300150 Bremskraftverstärker
03.7849-3301.4	03.4125-0032.3	010955 Hauptbremszylinder	03.7854-0908.4	03.7853-0902.4	300150 Bremskraftverstärker
03.7849-4001.4	03.2023-2407.3	010796 Hauptbremszylinder	03.7854-1501.4	03.2120-4461.3	010571 Hauptbremszylinder
	03.7848-4003.4	300235 Bremskraftverstärker		03.7853-1502.4	300200 Bremskraftverstärker
03.7849-4002.4	03.7848-4003.4	300235 Bremskraftverstärker	03.7854-1502.4	03.7853-1502.4	300200 Bremskraftverstärker
03.7849-4005.4	03.2023-2407.3	010796 Hauptbremszylinder	03.7854-1601.4	03.2122-1351.3	010528 Hauptbremszylinder
	03.7848-4003.4	300235 Bremskraftverstärker		03.7853-1602.4	300167 Bremskraftverstärker
03.7849-4006.4	03.7848-4003.4	300235 Bremskraftverstärker	03.7854-1602.4	03.2122-1942.3	010700 Hauptbremszylinder
03.7849-5001.4	03.2025-1904.3	010797 Hauptbremszylinder	03.7854-1603.4	03.2122-1351.3	010528 Hauptbremszylinder
	03.7848-5003.4	300236 Bremskraftverstärker	03.7854-1604.4	03.2122-1942.3	010700 Hauptbremszylinder
03.7849-5002.4	03.7848-5003.4	300236 Bremskraftverstärker	03.7854-1701.4	03.4122-0041.3	010612 Hauptbremszylinder
03.7849-5005.4	03.2025-1904.3	010797 Hauptbremszylinder	03.7854-1703.4	03.4122-0041.3	010612 Hauptbremszylinder
	03.7848-5003.4	300236 Bremskraftverstärker	03.7854-2101.4	03.7853-2102.4	300201 Bremskraftverstärker
03.7849-5006.4	03.7848-5003.4	300236 Bremskraftverstärker	03.7854-2102.4	03.7853-2102.4	300201 Bremskraftverstärker
03.7849-6201.4	03.7848-9402.4	300227 Bremskraftverstärker	03.7854-2103.4	03.7853-2102.4	300201 Bremskraftverstärker



Bremsgeräte komplett

Booster units complete - Servofreno completo - Servo-freins
complets - Servofreni completi

• Die Nummer befindet sich auf dem im Fahrzeug eingebautem Aggregat.
the number is on the unit build in the car
El número está ubicado en la unidad instalada en el vehículo
Le numéro est situé sur l'unité installée dans le véhicule
Il numero si trova sull'unità installata nel veicolo

					
03.7854-2104.4	03.7853-2102.4	300201 Bremskraftverstärker	03.7854-4108.4	03.7853-4102.4	300271 Bremskraftverstärker
03.7854-2105.4	03.7853-2102.4	300201 Bremskraftverstärker	03.7854-4501.4	03.2125-0493.3	010940 Hauptbremszylinder
03.7854-2106.4	03.7853-2102.4	300201 Bremskraftverstärker		03.2126-3144.3	010941 Hauptbremszylinder
03.7854-2107.4	03.7853-2102.4	300201 Bremskraftverstärker	03.7854-4502.4	03.2122-2031.3	010938 Hauptbremszylinder
03.7854-2108.4	03.7853-2102.4	300201 Bremskraftverstärker	03.7854-4601.4	03.2125-0493.3	010940 Hauptbremszylinder
03.7854-2109.4	03.7853-2102.4	300201 Bremskraftverstärker		03.2126-3144.3	010941 Hauptbremszylinder
03.7854-2110.4	03.7853-2102.4	300201 Bremskraftverstärker		03.7853-4602.4	300302 Bremskraftverstärker
03.7854-2111.4	03.7853-2102.4	300201 Bremskraftverstärker	03.7854-4602.4	03.2122-2031.3	010938 Hauptbremszylinder
03.7854-2112.4	03.7853-2102.4	300201 Bremskraftverstärker		03.7853-4602.4	300302 Bremskraftverstärker
03.7854-2113.4	03.7853-2102.4	300201 Bremskraftverstärker	03.7854-4603.4	03.7853-4602.4	300302 Bremskraftverstärker
03.7854-2114.4	03.7853-2102.4	300201 Bremskraftverstärker	03.7854-4701.4	03.2125-0493.3	010940 Hauptbremszylinder
03.7854-2115.4	03.7853-2102.4	300201 Bremskraftverstärker		03.2126-3144.3	010941 Hauptbremszylinder
03.7854-2116.4	03.7853-2102.4	300201 Bremskraftverstärker	03.7854-4702.4	03.2122-2031.3	010938 Hauptbremszylinder
03.7854-2601.4	03.7853-2602.4	300196 Bremskraftverstärker	03.7854-5401.4	03.2125-0493.3	010940 Hauptbremszylinder
03.7854-2602.4	03.7853-2602.4	300196 Bremskraftverstärker		03.2126-3144.3	010941 Hauptbremszylinder
03.7854-2701.4	03.7853-2702.4	300269 Bremskraftverstärker	03.7854-5402.4	03.2122-2031.3	010938 Hauptbremszylinder
03.7854-2702.4	03.7853-2702.4	300269 Bremskraftverstärker	03.7854-5404.4	03.2122-2031.3	010938 Hauptbremszylinder
03.7854-3901.4	03.7853-3902.4	300270 Bremskraftverstärker	03.7854-5406.4	03.2125-0493.3	010940 Hauptbremszylinder
03.7854-4101.4	03.2120-4611.3	010937 Hauptbremszylinder		03.2126-3144.3	010941 Hauptbremszylinder
	03.2125-0493.3	010940 Hauptbremszylinder	03.7854-5501.4	03.2125-0493.3	010940 Hauptbremszylinder
	03.2126-3144.3	010941 Hauptbremszylinder		03.2126-3144.3	010941 Hauptbremszylinder
	03.7853-4102.4	300271 Bremskraftverstärker	03.7854-5502.4	03.2122-2031.3	010938 Hauptbremszylinder
03.7854-4103.4	03.2122-2031.3	010938 Hauptbremszylinder	03.7854-6001.4	03.2122-2031.3	010938 Hauptbremszylinder
	03.7853-4102.4	300271 Bremskraftverstärker	03.7859-0101.4	03.7858-0102.4	300262 Bremskraftverstärker
03.7854-4105.4	03.2120-4611.3	010937 Hauptbremszylinder	03.7859-0103.4	03.7858-0102.4	300262 Bremskraftverstärker
	03.2125-0493.3	010940 Hauptbremszylinder	03.7859-0731.4	03.7858-0732.4	300272 Bremskraftverstärker
	03.2126-3144.3	010941 Hauptbremszylinder	03.7859-0732.4	03.7858-0732.4	300272 Bremskraftverstärker
	03.7853-4102.4	300271 Bremskraftverstärker	03.7859-1231.4	03.2125-0493.3	010940 Hauptbremszylinder
03.7854-4106.4	03.2120-4611.3	010937 Hauptbremszylinder	03.7859-1931.4	03.7858-1932.4	300263 Bremskraftverstärker
	03.2125-0493.3	010940 Hauptbremszylinder	03.7859-2801.4	03.7858-2802.4	300303 Bremskraftverstärker
	03.2126-3144.3	010941 Hauptbremszylinder	03.7859-2802.4	03.7858-2802.4	300303 Bremskraftverstärker
	03.7853-4102.4	300271 Bremskraftverstärker	03.7859-3301.4	03.2125-9604.3	010581 Hauptbremszylinder
				03.7858-3302.4	300122 Bremskraftverstärker
			03.7859-3302.4	03.2125-9604.3	010581 Hauptbremszylinder
				03.7858-3302.4	300122 Bremskraftverstärker
			03.7859-4001.4	03.7858-3532.4	300233 Bremskraftverstärker
			03.7859-4002.4	03.7858-3532.4	300233 Bremskraftverstärker

Bremsgeräte komplett

Booster units complete - Servofreno completo - Servo-freins
complets - Servofreni completi

• Die Nummer befindet sich auf dem im Fahrzeug eingebautem Aggregat.
the number is on the unit build in the car
El número está ubicado en la unidad instalada en el vehículo
Le numéro est situé sur l'unité installée dans le véhicule
Il numero si trova sull'unità installata nel veicolo





		i			i
03.7859-4431.4	03.7858-4432.4	300304 Bremskraftverstärker	03.7862-3902.4	03.7860-8802.4	300291 Bremskraftverstärker
03.7859-4502.4	03.7858-4502.4	300202 Bremskraftverstärker	03.7862-3903.4	03.7860-8802.4	300291 Bremskraftverstärker
03.7859-4631.4	03.2125-0493.3	010940 Hauptbremszylinder	03.7862-4301.4	03.7860-4302.4	300231 Bremskraftverstärker
	03.7858-4632.4	300273 Bremskraftverstärker	03.7862-4701.4	03.2123-3421.3	010933 Hauptbremszylinder
03.7859-4632.4	03.7858-4632.4	300273 Bremskraftverstärker	03.7862-4801.4	03.2123-3421.3	010933 Hauptbremszylinder
03.7859-4831.4	03.7858-4832.4	300274 Bremskraftverstärker	03.7862-5301.4	03.2123-3421.3	010933 Hauptbremszylinder
03.7859-5031.4	03.7858-5032.4	300275 Bremskraftverstärker	03.7862-5701.4	03.7860-5702.4	300279 Bremskraftverstärker
03.7859-5131.4	03.7858-5132.4	300276 Bremskraftverstärker	03.7862-5801.4	03.7860-3732.4	300306 Bremskraftverstärker
03.7859-5232.4	03.2125-0421.3	010934 Hauptbremszylinder	03.7862-7801.4	03.7860-7802.4	300280 Bremskraftverstärker
03.7859-5233.4	03.2125-0421.3	010934 Hauptbremszylinder	03.7862-8601.4	03.2123-3421.3	010933 Hauptbremszylinder
03.7859-5234.4	03.2125-0421.3	010934 Hauptbremszylinder	03.7864-0331.4	03.7863-0332.4	300203 Bremskraftverstärker
03.7859-5331.4	03.2125-0421.3	010934 Hauptbremszylinder	03.7864-0332.4	03.7863-0332.4	300203 Bremskraftverstärker
03.7859-6001.4	03.7858-3532.4	300233 Bremskraftverstärker	03.7864-0401.4	03.7863-0402.4	300124 Bremskraftverstärker
03.7859-6002.4	03.7858-3532.4	300233 Bremskraftverstärker	03.7864-0402.4	03.7863-0402.4	300124 Bremskraftverstärker
03.7859-6102.4	03.7858-3632.4	300234 Bremskraftverstärker	03.7864-0730.4	03.7863-3932.4	300288 Bremskraftverstärker
03.7859-7601.4	03.7858-7602.4	300277 Bremskraftverstärker	03.7864-0731.4	03.7863-3932.4	300288 Bremskraftverstärker
03.7862-0101.4	03.2022-2624.3	010588 Hauptbremszylinder	03.7864-0831.4	03.7863-4832.4	300289 Bremskraftverstärker
	03.7860-0702.4	300123 Bremskraftverstärker	03.7864-0901.4	03.7863-0903.4	300244 Bremskraftverstärker
03.7862-0601.4	03.7860-0602.4	300141 Bremskraftverstärker	03.7864-0902.4	03.7863-0903.4	300244 Bremskraftverstärker
03.7862-0602.4	03.7860-0602.4	300141 Bremskraftverstärker	03.7864-1101.4	03.7863-0903.4	300244 Bremskraftverstärker
03.7862-0603.4	03.7860-0602.4	300141 Bremskraftverstärker	03.7864-1102.4	03.7863-0903.4	300244 Bremskraftverstärker
03.7862-0604.4	03.7860-0602.4	300141 Bremskraftverstärker	03.7864-2001.4	03.2123-2146.3	010572 Hauptbremszylinder
03.7862-0605.4	03.7860-0602.4	300141 Bremskraftverstärker		03.7863-2002.4	300126 Bremskraftverstärker
03.7862-0606.4	03.7860-0602.4	300141 Bremskraftverstärker	03.7864-2003.4	03.2123-2621.3	010701 Hauptbremszylinder
03.7862-1403.4	03.7860-1402.4	300228 Bremskraftverstärker		03.7863-2002.4	300126 Bremskraftverstärker
03.7862-1405.4	03.7860-1402.4	300228 Bremskraftverstärker	03.7864-2101.4	03.2122-1521.3	010494 Hauptbremszylinder
03.7862-1406.4	03.7860-1402.4	300228 Bremskraftverstärker		03.7863-2002.4	300126 Bremskraftverstärker
03.7862-2801.4	03.2123-3421.3	010933 Hauptbremszylinder	03.7864-2201.4	03.2123-2581.3	010613 Hauptbremszylinder
03.7862-3301.4	03.2123-3421.3	010933 Hauptbremszylinder		03.7863-2202.4	300127 Bremskraftverstärker
03.7862-3701.4	03.7860-3702.4	300305 Bremskraftverstärker	03.7864-2301.4	03.2123-2581.3	010613 Hauptbremszylinder
03.7862-3901.4	03.7860-8802.4	300291 Bremskraftverstärker	03.7864-2801.4	03.2123-2561.3	010629 Hauptbremszylinder
				03.7863-2802.4	300188 Bremskraftverstärker



Bremsgeräte komplett

Booster units complete - Servofreno completo - Servo-freins
complets - Servofreni completi



• Die Nummer befindet sich auf dem im Fahrzeug eingebautem Aggregat.
the number is on the unit build in the car
El número está ubicado en la unidad instalada en el vehículo
Le numéro est situé sur l'unité installée dans le véhicule
Il numero si trova sull'unità installata nel veicolo

		i			i
03.7864-3001.4	03.7863-3002.4	300223 Bremskraftverstärker	03.7864-9801.4	03.7863-9802.4	300281 Bremskraftverstärker
03.7864-3236.4	03.7863-3232.4	300307 Bremskraftverstärker	03.7869-4101.4	03.7868-4102.4	300250 Bremskraftverstärker
03.7864-3237.4	03.7863-3232.4	300307 Bremskraftverstärker	03.7869-4701.4	03.7868-4702.4	300253 Bremskraftverstärker
03.7864-3331.4	03.7863-3332.4	300308 Bremskraftverstärker	03.7869-4702.4	03.7868-4702.4	300253 Bremskraftverstärker
03.7864-3332.4	03.7863-3332.4	300308 Bremskraftverstärker	03.7869-4703.4	03.7868-4702.4	300253 Bremskraftverstärker
03.7864-3503.4	03.2123-2715.3	010802 Hauptbremszylinder	03.7869-5201.4	03.7868-5202.4	300309 Bremskraftverstärker
	03.7863-3502.4	300128 Bremskraftverstärker	03.7869-5301.4	03.7868-5302.4	300251 Bremskraftverstärker
03.7864-3504.4	03.2123-2715.3	010802 Hauptbremszylinder	03.7872-0607.4	03.7870-0602.4	300310 Bremskraftverstärker
	03.7863-3502.4	300128 Bremskraftverstärker	03.7872-0608.4	03.7870-0602.4	300310 Bremskraftverstärker
03.7864-3601.4	03.2122-2129.3	010799 Hauptbremszylinder	03.7872-1101.4	03.2123-3421.3	010933 Hauptbremszylinder
	03.7873-4302.4	300312 Bremskraftverstärker	03.7872-1201.4	03.2123-3421.3	010933 Hauptbremszylinder
03.7864-3602.4	03.2122-2129.3	010799 Hauptbremszylinder	03.7872-1601.4	03.2123-3421.3	010933 Hauptbremszylinder
	03.7873-4302.4	300312 Bremskraftverstärker		03.7870-1602.4	300311 Bremskraftverstärker
03.7864-4401.4	03.2122-1351.3	010528 Hauptbremszylinder	03.7874-1201.4	03.7873-1202.4	300197 Bremskraftverstärker
03.7864-4402.4	03.2122-1942.3	010700 Hauptbremszylinder	03.7874-1202.4	03.7873-1202.4	300197 Bremskraftverstärker
03.7864-4501.4	03.7863-4502.4	300230 Bremskraftverstärker	03.7874-1205.4	03.4153-0063.3	010773 Hauptbremszylinder
03.7864-4502.4	03.2123-3493.3	010792 Hauptbremszylinder		03.7873-1202.4	300197 Bremskraftverstärker
	03.7863-4502.4	300230 Bremskraftverstärker	03.7874-1305.4	03.4153-0063.3	010773 Hauptbremszylinder
03.7864-5001.4	03.2122-1351.3	010528 Hauptbremszylinder	03.7874-1801.4	03.2122-2129.3	010799 Hauptbremszylinder
03.7864-5002.4	03.2122-1942.3	010700 Hauptbremszylinder	03.7874-2601.4	03.4153-0063.3	010773 Hauptbremszylinder
03.7864-5003.4	03.2122-1351.3	010528 Hauptbremszylinder	03.7874-2701.4	03.4153-0063.3	010773 Hauptbremszylinder
03.7864-5004.4	03.2122-1942.3	010700 Hauptbremszylinder	03.7874-3001.4	03.2122-2129.3	010799 Hauptbremszylinder
03.7864-5301.4	03.2122-2129.3	010799 Hauptbremszylinder	03.7874-3701.4	03.7873-3702.4	300283 Bremskraftverstärker
03.7864-5302.4	03.2122-2129.3	010799 Hauptbremszylinder	03.7874-3702.4	03.7873-3702.4	300283 Bremskraftverstärker
03.7864-6001.4	03.7863-6002.4	300249 Bremskraftverstärker	03.7874-3901.4	03.7873-3902.4	300254 Bremskraftverstärker
03.7864-6002.4	03.7863-6002.4	300249 Bremskraftverstärker	03.7874-3902.4	03.7873-3902.4	300254 Bremskraftverstärker
03.7864-6302.4	03.2122-2129.3	010799 Hauptbremszylinder	03.7874-4304.4	03.7873-4302.4	300312 Bremskraftverstärker
03.7864-7801.4	03.7863-7803.4	300237 Bremskraftverstärker	03.7874-4305.4	03.7873-4302.4	300312 Bremskraftverstärker
03.7864-7802.4	03.7863-7803.4	300237 Bremskraftverstärker	03.7874-4501.4	03.7873-4502.4	300284 Bremskraftverstärker
03.7864-7803.4	03.4155-0153.3	010927 Hauptbremszylinder	03.7874-4502.4	03.7873-4502.4	300284 Bremskraftverstärker
	03.7863-7803.4	300237 Bremskraftverstärker	03.7874-4503.4	03.7873-4502.4	300284 Bremskraftverstärker
03.7864-7804.4	03.7863-7803.4	300237 Bremskraftverstärker	03.7874-4504.4	03.7873-4502.4	300284 Bremskraftverstärker
03.7864-8501.4	03.7863-3932.4	300288 Bremskraftverstärker			
03.7864-8502.4	03.7863-3932.4	300288 Bremskraftverstärker			

Bremsgeräte komplett

Booster units complete - Servofreno completo - Servo-freins
complets - Servofreni completi

- Die Nummer befindet sich auf dem im Fahrzeug eingebautem Aggregat.
the number is on the unit build in the car
El número está ubicado en la unidad instalada en el vehículo
Le numéro est situé sur l'unité installée dans le véhicule
Il numero si trova sull'unità installata nel veicolo

			
03.7874-4505.4	03.7873-4502.4	300284	Bremskraftverstärker
03.7874-4506.4	03.7873-4502.4	300284	Bremskraftverstärker
10.6350-2002.4	10.6123-0522.3	010633	Hauptbremszylinder
10.6352-2901.4	10.6350-3902.4	300213	Bremskraftverstärker
10.6352-2902.4	10.6350-3902.4	300213	Bremskraftverstärker
10.6352-4001.4	03.2122-1421.3	010615	Hauptbremszylinder
	10.6350-4002.4	300285	Bremskraftverstärker
10.6353-2901.4	10.6350-3902.4	300213	Bremskraftverstärker
10.6353-2902.4	10.6350-3902.4	300213	Bremskraftverstärker
10.6353-4001.4	03.2122-1421.3	010615	Hauptbremszylinder
	10.6350-4002.4	300285	Bremskraftverstärker
10.6362-0403.4	10.6360-1903.4	300093	Bremskraftverstärker
10.6362-0501.4	10.6360-1003.4	300156	Bremskraftverstärker
10.6362-0502.4	10.6360-1003.4	300156	Bremskraftverstärker
10.6362-0503.4	10.6360-1003.4	300156	Bremskraftverstärker
10.6362-0504.4	10.6360-1003.4	300156	Bremskraftverstärker
10.6362-1001.4	10.6360-1003.4	300156	Bremskraftverstärker
10.6362-1002.4	10.6360-1003.4	300156	Bremskraftverstärker
10.6362-1003.4	10.6360-1003.4	300156	Bremskraftverstärker
10.6362-1004.4	10.6360-1003.4	300156	Bremskraftverstärker
10.6362-1301.4	10.6360-1302.4	300286	Bremskraftverstärker
10.6362-1302.4	10.6360-1302.4	300286	Bremskraftverstärker
10.6362-1905.4	10.6360-1903.4	300093	Bremskraftverstärker
10.6362-2001.4	10.6360-2002.4	300143	Bremskraftverstärker
10.6362-2002.4	10.6360-2002.4	300143	Bremskraftverstärker









- DE** Reparatursätze
- EN** Repair kits
- ES** Juegos de reparación
- FR** Nécessaires de réparation
- IT** Corredi riparazione

2018



Reparatursätze





Repair kits - Juegos de reparación - Nécessaires de réparation - Corredi riparazione

									
03.3138-2001.3	010310	03.0370-1038.2	051038	Reparatursatz, Hauptbremszylinder	11.3451-8501.2	220389	11.8116-0172.1	390500	Feder, Bremsattel
		03.0370-9998.2	059998	Reparatursatz, Hauptbremszylinder	11.3451-8502.2	220390	11.0101-5409.2	260035	Führungshülzensatz, Bremssattel
							11.0441-4502.2	250143	Dichtungssatz, Bremssattel
11.3331-0037.2	220395	11.0441-3305.2	250006	Dichtungssatz, Bremssattel			11.8116-0172.1	390500	Feder, Bremsattel
11.3331-0038.2	220396	11.0441-3305.2	250006	Dichtungssatz, Bremssattel	11.3481-8512.2	220338	11.0441-4805.2	250020	Dichtungssatz, Bremssattel
11.3331-0039.2	220387	11.0441-3305.2	250006	Dichtungssatz, Bremssattel	11.3481-8513.2	220335	11.0230-0687.1	260106	Halter, Bremsattel
11.3331-0040.2	220388	11.0441-3305.2	250006	Dichtungssatz, Bremssattel			11.0441-4805.2	250020	Dichtungssatz, Bremssattel
11.3331-8501.2	220004	11.0441-3302.2	250004	Dichtungssatz, Bremssattel			11.8116-0264.1	390594	Feder, Bremsattel
		11.8116-0015.1	390492	Feder, Bremsattel	11.3481-8514.2	220336	11.0230-0687.1	260106	Halter, Bremsattel
11.3331-8502.2	220005	11.0441-3302.2	250004	Dichtungssatz, Bremssattel			11.0441-4805.2	250020	Dichtungssatz, Bremssattel
		11.8116-0015.1	390492	Feder, Bremsattel			11.8116-0264.1	390594	Feder, Bremsattel
11.3361-8504.2	220017	11.0441-3602.2	250008	Dichtungssatz, Bremssattel	11.3481-8515.2	220365	11.8116-0264.1	390594	Feder, Bremsattel
		11.8116-0066.1	390577	Feder, Bremsattel	11.3481-8516.2	220366	11.8116-0264.1	390594	Feder, Bremsattel
11.3361-8505.2	220024	11.0441-3602.2	250008	Dichtungssatz, Bremssattel	11.3481-9833.2	220561	11.0441-4811.2	250024	Dichtungssatz, Bremssattel
		11.8116-0185.1	390592	Feder, Bremsattel			11.8116-0129.1	390591	Feder, Bremsattel
11.3361-9975.2	220281	11.0441-3602.2	250008	Dichtungssatz, Bremssattel	11.3481-9834.2	220562	11.0441-4811.2	250024	Dichtungssatz, Bremssattel
		11.8116-0073.1	390498	Feder, Bremsattel			11.8116-0129.1	390591	Feder, Bremsattel
11.3361-9976.2	220282	11.0441-3602.2	250008	Dichtungssatz, Bremssattel	11.3521-8501.2	220391	11.0101-5409.2	260035	Führungshülzensatz, Bremssattel
		11.8116-0073.1	390498	Feder, Bremsattel			11.0441-5203.2	250144	Dichtungssatz, Bremssattel
11.3381-8501.2	220018	11.0441-3802.2	250009	Dichtungssatz, Bremssattel			11.8116-0191.1	390522	Feder, Bremsattel
		11.8116-0066.1	390577	Feder, Bremsattel	11.3521-8502.2	220392	11.0101-5409.2	260035	Führungshülzensatz, Bremssattel
11.3381-8504.2	220021	11.0441-3803.2	250010	Dichtungssatz, Bremssattel			11.0441-5203.2	250144	Dichtungssatz, Bremssattel
		11.8116-0066.1	390577	Feder, Bremsattel			11.8116-0191.1	390522	Feder, Bremsattel
11.3401-0055.2	220519	11.8116-0143.1	390513	Feder, Bremsattel	11.3541-8514.2	220106	11.8170-0729.1	260107	Halter, Bremsattel
11.3401-0056.2	220520	11.8116-0143.1	390513	Feder, Bremsattel	11.3541-8521.2	220113	11.0101-5409.2	260035	Führungshülzensatz, Bremssattel
11.3401-8503.2	220030	11.0441-4002.2	250011	Dichtungssatz, Bremssattel			11.0441-5405.2	250030	Dichtungssatz, Bremssattel
		11.8116-0066.1	390577	Feder, Bremsattel	11.3541-8529.2	220341	11.0441-5402.2	250028	Dichtungssatz, Bremssattel
11.3401-8504.2	220031	11.0441-4002.2	250011	Dichtungssatz, Bremssattel			11.8116-0264.1	390594	Feder, Bremsattel
		11.8116-0066.1	390577	Feder, Bremsattel	11.3541-8530.2	220342	11.0441-5402.2	250028	Dichtungssatz, Bremssattel
11.3451-8501.2	220389	11.0101-5409.2	260035	Führungshülzensatz, Bremssattel			11.8116-0264.1	390594	Feder, Bremsattel
		11.0441-4502.2	250143	Dichtungssatz, Bremssattel	11.3571-8508.2	220128	11.0101-5409.2	260035	Führungshülzensatz, Bremssattel









Reparatursätze

Repair kits - Juegos de reparación - Nécessaires de réparation - Corredi riparazione

		i			i				
11.3571-8508.2	220128	11.8116-0143.1	390513	Feder, Bremsattel	11.9381-9957.2	220661	11.8116-0143.1	390513	Feder, Bremsattel
		11.8170-0306.1	260102	Halter, Bremsattel	11.9381-9958.2	220662	11.0101-5407.2	260011	Führungshülzensatz, Bremssattel
11.3571-8509.2	220313	11.0441-5703.2	250145	Dichtungssatz, Bremssattel			11.8116-0143.1	390513	Feder, Bremsattel
		11.8116-0253.1	390512	Feder, Bremsattel	11.9381-9959.2	220433	11.0441-3803.2	250010	Dichtungssatz, Bremssattel
11.3571-8510.2	220314	11.0441-5703.2	250145	Dichtungssatz, Bremssattel			11.8116-0066.1	390577	Feder, Bremsattel
		11.8116-0253.1	390512	Feder, Bremsattel	11.9381-9960.2	220434	11.0441-3803.2	250010	Dichtungssatz, Bremssattel
11.3571-8512.2	220316	11.0441-5703.2	250145	Dichtungssatz, Bremssattel			11.8116-0066.1	390577	Feder, Bremsattel
		11.8116-0253.1	390512	Feder, Bremsattel	11.9381-9961.2	220435	11.0441-3803.2	250010	Dichtungssatz, Bremssattel
		11.8170-0401.1	260103	Halter, Bremsattel			11.8116-0066.1	390577	Feder, Bremsattel
11.3571-8517.2	220321	11.0101-5409.2	260035	Führungshülzensatz, Bremssattel	11.9381-9962.2	220436	11.0441-3803.2	250010	Dichtungssatz, Bremssattel
		11.8116-0143.1	390513	Feder, Bremsattel			11.8116-0066.1	390577	Feder, Bremsattel
11.3571-8518.2	220322	11.0101-5409.2	260035	Führungshülzensatz, Bremssattel	11.9387-7001.2	220397	11.8116-0340.1	390595	Feder, Bremsattel
		11.8116-0143.1	390513	Feder, Bremsattel	11.9387-7002.2	220398	11.8116-0340.1	390595	Feder, Bremsattel
11.3601-8501.2	220145	11.8116-0083.1	390501	Feder, Bremsattel	11.9387-7003.2	220567	11.8116-0340.1	390595	Feder, Bremsattel
11.3601-8505.2	220149	11.8116-0083.1	390501	Feder, Bremsattel			11.8170-0633.1	260117	Halter, Bremsattel
11.3601-8513.2	220393	11.0101-5704.2	260095	Führungshülzensatz, Bremssattel	11.9387-7004.2	220568	11.8116-0340.1	390595	Feder, Bremsattel
		11.8116-0200.1	390505	Feder, Bremsattel			11.8170-0633.1	260117	Halter, Bremsattel
		11.8170-0510.1	260111	Halter, Bremsattel	11.9387-7005.2	220569	11.8116-0340.1	390595	Feder, Bremsattel
11.3601-8515.2	220323	11.0441-6003.2	250037	Dichtungssatz, Bremssattel	11.9387-7006.2	220570	11.8116-0340.1	390595	Feder, Bremsattel
		11.8116-0083.1	390501	Feder, Bremsattel	11.9387-7015.2	220627	11.0230-0698.2	260091	Halter, Bremsattel
11.3601-8516.2	220324	11.0441-6003.2	250037	Dichtungssatz, Bremssattel			11.8116-0340.1	390595	Feder, Bremsattel
		11.8116-0083.1	390501	Feder, Bremsattel	11.9387-7016.2	220628	11.0230-0698.2	260091	Halter, Bremsattel
11.9347-7001.2	220473	11.8170-0584.1	260105	Halter, Bremsattel			11.8116-0340.1	390595	Feder, Bremsattel
11.9347-7002.2	220474	11.8170-0584.1	260105	Halter, Bremsattel	11.9401-9959.2	220833	11.0101-5402.2	260009	Führungshülzensatz, Bremssattel
11.9347-7003.2	220565	11.8170-0584.1	260105	Halter, Bremsattel			11.0441-4002.2	250011	Dichtungssatz, Bremssattel
11.9347-7004.2	220566	11.8170-0584.1	260105	Halter, Bremsattel			11.8171-0008.1	990049	Führungsbolzen, Bremssattel
11.9347-7005.2	220643	11.8116-0340.1	390595	Feder, Bremsattel	11.9401-9960.2	220834	11.0101-5402.2	260009	Führungshülzensatz, Bremssattel
11.9347-7006.2	220644	11.8116-0340.1	390595	Feder, Bremsattel			11.0441-4002.2	250011	Dichtungssatz, Bremssattel
11.9367-7001.2	220733	11.8116-0340.1	390595	Feder, Bremsattel			11.8171-0008.1	990049	Führungsbolzen, Bremssattel
11.9367-7002.2	220734	11.8116-0340.1	390595	Feder, Bremsattel	11.9406-9993.2	220413	11.0441-4004.2	250012	Dichtungssatz, Bremssattel
11.9381-9957.2	220661	11.0101-5407.2	260011	Führungshülzensatz, Bremssattel			11.8116-0168.1	390499	Feder, Bremsattel







Reparatursätze

Repair kits - Juegos de reparación - Nécessaires de réparation - Corredi riparazione

									
11.9406-9994.2	220414	11.0441-4004.2	250012	Dichtungssatz, Bremssattel	11.9426-9992.2	220642	11.8116-0323.1	390459	Feder, Bremssattel
		11.8116-0168.1	390499	Feder, Bremssattel	11.9426-9993.2	220443	11.0101-5402.2	260009	Führungshülzensatz, Bremssattel
11.9406-9995.2	220415	11.0441-4004.2	250012	Dichtungssatz, Bremssattel			11.0441-4203.2	250013	Dichtungssatz, Bremssattel
		11.8116-0168.1	390499	Feder, Bremssattel			11.8116-0168.1	390499	Feder, Bremssattel
11.9406-9996.2	220416	11.0441-4004.2	250012	Dichtungssatz, Bremssattel	11.9441-9949.2	220803	11.0101-5409.2	260035	Führungshülzensatz, Bremssattel
		11.8116-0168.1	390499	Feder, Bremssattel			11.8116-0310.1	390611	Feder, Bremssattel
11.9407-7001.2	220573	11.8116-0340.1	390595	Feder, Bremssattel	11.9441-9950.2	220804	11.0101-5409.2	260035	Führungshülzensatz, Bremssattel
		11.8170-0633.1	260117	Halter, Bremssattel			11.8116-0310.1	390611	Feder, Bremssattel
11.9407-7002.2	220574	11.8116-0340.1	390595	Feder, Bremssattel	11.9441-9955.2	220805	11.8116-0133.1	390511	Feder, Bremssattel
		11.8170-0633.1	260117	Halter, Bremssattel			11.8171-0096.1	250155	Führungsbolzen, Bremssattel
11.9407-7005.2	220637	11.8116-0340.1	390595	Feder, Bremssattel	11.9441-9956.2	220806	11.8116-0133.1	390511	Feder, Bremssattel
		11.8170-0633.1	260117	Halter, Bremssattel			11.8171-0096.1	250155	Führungsbolzen, Bremssattel
11.9407-7006.2	220638	11.8116-0340.1	390595	Feder, Bremssattel	11.9441-9967.2	220807	11.0101-5409.2	260035	Führungshülzensatz, Bremssattel
		11.8170-0633.1	260117	Halter, Bremssattel			11.8116-0310.1	390611	Feder, Bremssattel
11.9421-9911.2	220825	11.8116-0066.1	390577	Feder, Bremssattel	11.9441-9968.2	220808	11.0101-5409.2	260035	Führungshülzensatz, Bremssattel
11.9421-9912.2	220826	11.8116-0066.1	390577	Feder, Bremssattel			11.8116-0310.1	390611	Feder, Bremssattel
11.9421-9963.2	220465	11.0101-5402.2	260009	Führungshülzensatz, Bremssattel	11.9441-9971.2	220839	11.0101-7003.2	260124	Führungshülzensatz, Bremssattel
		11.8116-0296.1	390445	Feder, Bremssattel	11.9441-9972.2	220840	11.0101-7003.2	260124	Führungshülzensatz, Bremssattel
11.9421-9979.2	220497	11.8116-0236.1	390507	Feder, Bremssattel	11.9461-9981.2	220899	11.8116-0296.1	390445	Feder, Bremssattel
11.9421-9980.2	220498	11.8116-0236.1	390507	Feder, Bremssattel	11.9461-9982.2	220900	11.8116-0296.1	390445	Feder, Bremssattel
11.9426-9957.2	220895	11.0441-4203.2	250013	Dichtungssatz, Bremssattel	11.9481-9811.2	220445	11.8116-0274.1	390516	Feder, Bremssattel
		11.8116-0330.1	390472	Feder, Bremssattel	11.9481-9812.2	220446	11.8116-0274.1	390516	Feder, Bremssattel
11.9426-9958.2	220896	11.0441-4203.2	250013	Dichtungssatz, Bremssattel	11.9481-9871.2	220681	11.0101-5407.2	260011	Führungshülzensatz, Bremssattel
		11.8116-0330.1	390472	Feder, Bremssattel			11.0441-4811.2	250024	Dichtungssatz, Bremssattel
11.9426-9959.2	220801	11.0101-5407.2	260011	Führungshülzensatz, Bremssattel			11.8116-0129.1	390591	Feder, Bremssattel
		11.8116-0323.1	390459	Feder, Bremssattel	11.9481-9872.2	220682	11.0101-5407.2	260011	Führungshülzensatz, Bremssattel
11.9426-9960.2	220802	11.0101-5407.2	260011	Führungshülzensatz, Bremssattel			11.0441-4811.2	250024	Dichtungssatz, Bremssattel
		11.8116-0323.1	390459	Feder, Bremssattel			11.8116-0129.1	390591	Feder, Bremssattel
11.9426-9991.2	220641	11.0441-4203.2	250013	Dichtungssatz, Bremssattel	11.9541-9549.2	220575	11.0101-5409.2	260035	Führungshülzensatz, Bremssattel
		11.8116-0323.1	390459	Feder, Bremssattel			11.0441-5409.2	250031	Dichtungssatz, Bremssattel
11.9426-9992.2	220642	11.0441-4203.2	250013	Dichtungssatz, Bremssattel			11.8171-0069.1	250152	Führungsbolzen, Bremssattel







Reparatursätze

Repair kits - Juegos de reparación - Nécessaires de réparation - Corredi riparazione

									
11.9541-9550.2	220576	11.0101-5409.2	260035	Führungshülse- satz, Bremssattel	11.9541-9951.2	220844	11.8170-0002.1	260110	Halter, Brems- sattel
		11.0441-5409.2	250031	Dichtungssatz, Bremssattel	11.9571-9757.2	220857	11.8116-0301.1	390610	Feder, Brems- sattel
		11.8171-0069.1	250152	Führungsbolzen, Bremssattel	11.9571-9758.2	220858	11.8116-0301.1	390610	Feder, Brems- sattel
11.9541-9553.2	220563	11.0101-5409.2	260035	Führungshülse- satz, Bremssattel	11.9571-9765.2	220663	11.0101-5704.2	260095	Führungshülse- satz, Bremssattel
		11.8116-0351.1	390538	Feder, Brems- sattel			11.8116-0351.1	390538	Feder, Brems- sattel
11.9541-9554.2	220564	11.0101-5409.2	260035	Führungshülse- satz, Bremssattel	11.9571-9766.2	220664	11.0101-5704.2	260095	Führungshülse- satz, Bremssattel
		11.8116-0351.1	390538	Feder, Brems- sattel			11.8116-0351.1	390538	Feder, Brems- sattel
11.9541-9569.2	220725	11.8116-0264.1	390594	Feder, Brems- sattel	11.9571-9779.2	220657	11.8116-0356.1	390586	Feder, Brems- sattel
11.9541-9570.2	220726	11.8116-0264.1	390594	Feder, Brems- sattel	11.9571-9780.2	220658	11.8116-0356.1	390586	Feder, Brems- sattel
11.9541-9588.2	220420	11.0101-5402.2	260009	Führungshülse- satz, Bremssattel	11.9571-9781.2	220659	11.8116-0295.2	390524	Feder, Brems- sattel
		11.0441-5402.2	250028	Dichtungssatz, Bremssattel			11.8116-0356.1	390586	Feder, Brems- sattel
		11.8116-0109.1	390495	Feder, Brems- sattel	11.9571-9785.2	220595	11.0101-5407.2	260011	Führungshülse- satz, Bremssattel
		11.8116-0206.1	390593	Feder, Brems- sattel			11.8116-0356.1	390586	Feder, Brems- sattel
		11.8170-0729.1	260107	Halter, Brems- sattel	11.9571-9786.2	220596	11.0101-5407.2	260011	Führungshülse- satz, Bremssattel
		11.8170-0730.1	260108	Halter, Brems- sattel			11.8116-0356.1	390586	Feder, Brems- sattel
11.9541-9595.2	220501	11.0101-5409.2	260035	Führungshülse- satz, Bremssattel	11.9571-9811.2	220485	11.0101-5706.2	260097	Führungshülse- satz, Bremssattel
		11.0230-0451.1	260130	Halter, Brems- sattel			11.0441-5704.2	250034	Dichtungssatz, Bremssattel
		11.0441-5409.2	250031	Dichtungssatz, Bremssattel			11.8116-0326.1	390471	Feder, Brems- sattel
		11.8116-0143.1	390513	Feder, Brems- sattel			11.8171-0067.1	250153	Führungsbolzen, Bremssattel
11.9541-9596.2	220502	11.0101-5409.2	260035	Führungshülse- satz, Bremssattel	11.9571-9812.2	220486	11.0101-5706.2	260097	Führungshülse- satz, Bremssattel
		11.0230-0451.1	260130	Halter, Brems- sattel			11.0441-5704.2	250034	Dichtungssatz, Bremssattel
		11.0441-5409.2	250031	Dichtungssatz, Bremssattel			11.8116-0326.1	390471	Feder, Brems- sattel
		11.8116-0143.1	390513	Feder, Brems- sattel			11.8171-0067.1	250153	Führungsbolzen, Bremssattel
11.9541-9668.2	220422	11.0101-5402.2	260009	Führungshülse- satz, Bremssattel	11.9571-9819.2	220469	11.0101-5705.2	260096	Führungshülse- satz, Bremssattel
		11.0230-0444.1	260104	Halter, Brems- sattel			11.0441-5704.2	250034	Dichtungssatz, Bremssattel
		11.0441-5402.2	250028	Dichtungssatz, Bremssattel			11.8116-0326.1	390471	Feder, Brems- sattel
		11.8116-0109.1	390495	Feder, Brems- sattel			11.8171-0067.1	250153	Führungsbolzen, Bremssattel
		11.8116-0206.1	390593	Feder, Brems- sattel	11.9571-9820.2	220470	11.0101-5705.2	260096	Führungshülse- satz, Bremssattel
11.9541-9806.2	220504	11.0101-5407.2	260011	Führungshülse- satz, Bremssattel			11.0441-5704.2	250034	Dichtungssatz, Bremssattel
		11.8116-0073.1	390498	Feder, Brems- sattel			11.8116-0326.1	390471	Feder, Brems- sattel
11.9541-9950.2	220843	11.8170-0002.1	260110	Halter, Brems- sattel			11.8171-0067.1	250153	Führungsbolzen, Bremssattel







Reparatursätze

Repair kits - Juegos de reparación - Nécessaires de réparation - Corredi riparazione

									
11.9571-9824.2	220472	11.0441-5704.2	250034	Dichtungssatz, Bremssattel	11.9601-9721.2	220875	11.8116-0367.1	390600	Feder, Bremssattel
		11.8116-0292.1	390521	Feder, Bremssattel	11.9601-9722.2	220876	11.8116-0367.1	390600	Feder, Bremssattel
11.9571-9835.2	220427	11.0101-5409.2	260035	Führungshülensatz, Bremssattel	11.9601-9731.2	220853	11.0441-6008.2	250038	Dichtungssatz, Bremssattel
		11.0230-0451.1	260130	Halter, Bremssattel	11.9601-9732.2	220854	11.0441-6008.2	250038	Dichtungssatz, Bremssattel
		11.0441-5704.2	250034	Dichtungssatz, Bremssattel	11.9601-9787.2	220585	11.0441-6008.2	250038	Dichtungssatz, Bremssattel
		11.8116-0143.1	390513	Feder, Bremssattel			11.8116-0301.1	390610	Feder, Bremssattel
		11.8116-0347.2	390535	Feder, Bremssattel	11.9601-9788.2	220586	11.0441-6008.2	250038	Dichtungssatz, Bremssattel
11.9571-9836.2	220428	11.0101-5409.2	260035	Führungshülensatz, Bremssattel			11.8116-0301.1	390610	Feder, Bremssattel
		11.0230-0451.1	260130	Halter, Bremssattel	11.9601-9883.2	220917	11.0441-6008.2	250038	Dichtungssatz, Bremssattel
		11.0441-5704.2	250034	Dichtungssatz, Bremssattel	11.9601-9884.2	220918	11.0441-6008.2	250038	Dichtungssatz, Bremssattel
		11.8116-0143.1	390513	Feder, Bremssattel	11.9606-9945.2	220727	11.0101-5704.2	260095	Führungshülensatz, Bremssattel
		11.8116-0347.2	390535	Feder, Bremssattel			11.8116-0388.2	390588	Feder, Bremssattel
11.9571-9841.2	220401	11.8116-0301.1	390610	Feder, Bremssattel	11.9606-9946.2	220728	11.0101-5704.2	260095	Führungshülensatz, Bremssattel
11.9571-9842.2	220402	11.8116-0301.1	390610	Feder, Bremssattel			11.8116-0388.2	390588	Feder, Bremssattel
11.9571-9864.2	220514	11.0101-5407.2	260011	Führungshülensatz, Bremssattel	11.9606-9953.2	220587	11.0101-5409.2	260035	Führungshülensatz, Bremssattel
		11.8116-0366.2	390587	Feder, Bremssattel			11.0441-6008.2	250038	Dichtungssatz, Bremssattel
11.9571-9972.2	220606	11.0441-5702.2	250033	Dichtungssatz, Bremssattel			11.8116-0347.2	390535	Feder, Bremssattel
		11.8116-0073.1	390498	Feder, Bremssattel			11.8116-0410.2	390589	Feder, Bremssattel
11.9576-9975.2	220649	11.0101-5407.2	260011	Führungshülensatz, Bremssattel	11.9606-9954.2	220588	11.0101-5409.2	260035	Führungshülensatz, Bremssattel
		11.8116-0345.2	390596	Feder, Bremssattel			11.0441-6008.2	250038	Dichtungssatz, Bremssattel
		11.8116-0410.2	390589	Feder, Bremssattel			11.8116-0347.2	390535	Feder, Bremssattel
11.9576-9976.2	220650	11.0101-5407.2	260011	Führungshülensatz, Bremssattel			11.8116-0410.2	390589	Feder, Bremssattel
		11.8116-0345.2	390596	Feder, Bremssattel	11.9606-9957.2	220815	11.0101-5409.2	260035	Führungshülensatz, Bremssattel
		11.8116-0410.2	390589	Feder, Bremssattel			11.0441-6008.2	250038	Dichtungssatz, Bremssattel
11.9576-9995.2	220651	11.0101-5409.2	260035	Führungshülensatz, Bremssattel			11.8116-0410.2	390589	Feder, Bremssattel
11.9576-9996.2	220652	11.0101-5409.2	260035	Führungshülensatz, Bremssattel	11.9606-9958.2	220816	11.0101-5409.2	260035	Führungshülensatz, Bremssattel
		11.8116-0410.2	390589	Feder, Bremssattel			11.0441-6008.2	250038	Dichtungssatz, Bremssattel
11.9601-9711.2	220873	11.0441-6008.2	250038	Dichtungssatz, Bremssattel			11.8116-0410.2	390589	Feder, Bremssattel
11.9601-9712.2	220874	11.0441-6008.2	250038	Dichtungssatz, Bremssattel	11.9606-9959.2	220729	11.0101-6006.2	260098	Führungshülensatz, Bremssattel
11.9601-9717.2	220901	11.0441-6008.2	250038	Dichtungssatz, Bremssattel			11.8116-0366.2	390587	Feder, Bremssattel
11.9601-9718.2	220902	11.0441-6008.2	250038	Dichtungssatz, Bremssattel			11.8171-0067.1	250153	Führungsbolzen, Bremssattel





Reparatursätze

Repair kits - Juegos de reparación - Nécessaires de réparation - Corredi riparazione

									
11.9606-9960.2	220730	11.0101-6006.2	260098	Führungshülse- satz, Bremssattel	11.9606-9979.2	220907	11.8116-0315.2	390447	Feder, Brems- sattel
		11.8116-0366.2	390587	Feder, Brems- sattel			11.8171-0067.1	250153	Führungsbolzen, Bremssattel
		11.8171-0067.1	250153	Führungsbolzen, Bremssattel	11.9606-9980.2	220908	11.0101-6006.2	260098	Führungshülse- satz, Bremssattel
11.9606-9961.2	220655	11.0101-5409.2	260035	Führungshülse- satz, Bremssattel			11.0441-6008.2	250038	Dichtungssatz, Bremssattel
		11.0441-6008.2	250038	Dichtungssatz, Bremssattel			11.8116-0315.2	390447	Feder, Brems- sattel
		11.8116-0410.2	390589	Feder, Brems- sattel			11.8171-0067.1	250153	Führungsbolzen, Bremssattel
11.9606-9962.2	220656	11.0101-5409.2	260035	Führungshülse- satz, Bremssattel	13.2351-0013.2	210010	13.0441-3506.2	250052	Dichtungssatz, Bremssattel
		11.0441-6008.2	250038	Dichtungssatz, Bremssattel	13.2351-0014.2	210011	13.0441-3506.2	250052	Dichtungssatz, Bremssattel
		11.8116-0410.2	390589	Feder, Brems- sattel	13.2351-0025.2	210210	13.0441-3506.2	250052	Dichtungssatz, Bremssattel
11.9606-9965.2	220817	11.0101-5409.2	260035	Führungshülse- satz, Bremssattel	13.2351-0026.2	210211	13.0441-3506.2	250052	Dichtungssatz, Bremssattel
		11.0101-5704.2	260095	Führungshülse- satz, Bremssattel	13.2351-0051.2	210180	13.0441-3507.2	250053	Dichtungssatz, Bremssattel
		11.0441-6008.2	250038	Dichtungssatz, Bremssattel	13.2351-0052.2	210181	13.0441-3507.2	250053	Dichtungssatz, Bremssattel
		11.8116-0299.1	390446	Feder, Brems- sattel	13.2351-8019.2	210139	13.0441-3507.2	250053	Dichtungssatz, Bremssattel
		11.8116-0327.1	390599	Feder, Brems- sattel	13.2351-8020.2	210140	13.0441-3507.2	250053	Dichtungssatz, Bremssattel
11.9606-9966.2	220818	11.0101-5409.2	260035	Führungshülse- satz, Bremssattel	13.2353-8003.2	210016	13.0441-3504.2	250050	Dichtungssatz, Bremssattel
		11.0101-5704.2	260095	Führungshülse- satz, Bremssattel	13.2353-8004.2	210017	13.0441-3504.2	250050	Dichtungssatz, Bremssattel
		11.0441-6008.2	250038	Dichtungssatz, Bremssattel	13.2361-8001.2	210214	13.0441-3606.2	250147	Dichtungssatz, Bremssattel
		11.8116-0299.1	390446	Feder, Brems- sattel	13.2361-8003.2	210220	13.0441-3609.2	250057	Dichtungssatz, Bremssattel
		11.8116-0327.1	390599	Feder, Brems- sattel	13.2361-8004.2	210221	13.0441-3609.2	250057	Dichtungssatz, Bremssattel
11.9606-9967.2	220905	11.0101-5402.2	260009	Führungshülse- satz, Bremssattel	13.2361-8005.2	210237	13.0441-3609.2	250057	Dichtungssatz, Bremssattel
		11.0441-6008.2	250038	Dichtungssatz, Bremssattel	13.2361-8006.2	210238	13.0441-3609.2	250057	Dichtungssatz, Bremssattel
		11.8116-0339.2	390528	Feder, Brems- sattel	13.2381-8027.2	210033	13.0441-3811.2	250067	Dichtungssatz, Bremssattel
11.9606-9968.2	220906	11.0101-5402.2	260009	Führungshülse- satz, Bremssattel	13.2381-8028.2	210034	13.0441-3811.2	250067	Dichtungssatz, Bremssattel
		11.0441-6008.2	250038	Dichtungssatz, Bremssattel	13.2381-8029.2	210035	13.0441-3811.2	250067	Dichtungssatz, Bremssattel
		11.8116-0339.2	390528	Feder, Brems- sattel	13.2381-8030.2	210036	13.0441-3811.2	250067	Dichtungssatz, Bremssattel
11.9606-9971.2	220589	11.0441-6008.2	250038	Dichtungssatz, Bremssattel	13.2381-9996.2	210039	13.0441-3801.2	250058	Dichtungssatz, Bremssattel
		11.8116-0345.2	390596	Feder, Brems- sattel	13.2381-9997.2	210040	13.0441-3801.2	250058	Dichtungssatz, Bremssattel
11.9606-9972.2	220590	11.0441-6008.2	250038	Dichtungssatz, Bremssattel	13.2401-0028.2	210046	13.0441-4014.2	250079	Dichtungssatz, Bremssattel
		11.8116-0345.2	390596	Feder, Brems- sattel	13.2401-0039.2	210153	13.0441-4022.2	250149	Dichtungssatz, Bremssattel
11.9606-9979.2	220907	11.0101-6006.2	260098	Führungshülse- satz, Bremssattel	13.2401-0040.2	210154	13.0441-4022.2	250149	Dichtungssatz, Bremssattel
		11.0441-6008.2	250038	Dichtungssatz, Bremssattel	13.2401-8007.2	210047	13.0441-4002.2	250074	Dichtungssatz, Bremssattel







Reparatursätze

Repair kits - Juegos de reparación - Nécessaires de réparation - Corredi riparazione

		i			i				
13.2401-8007.2	210047	13.0441-4008.2	250076	Dichtungssatz, Bremssattel	13.2601-7016.2	210231	13.0441-6012.2	250133	Dichtungssatz, Bremssattel
13.2401-8008.2	210048	13.0441-4002.2	250074	Dichtungssatz, Bremssattel	13.2601-8027.2	210159	13.0441-6001.2	250126	Dichtungssatz, Bremssattel
		13.0441-4008.2	250076	Dichtungssatz, Bremssattel	13.2601-8028.2	210160	13.0441-6001.2	250126	Dichtungssatz, Bremssattel
13.2401-8013.2	210051	13.0441-4020.2	250084	Dichtungssatz, Bremssattel	13.2601-8033.2	210165	13.0441-6003.2	250128	Dichtungssatz, Bremssattel
13.2401-8014.2	210052	13.0441-4020.2	250084	Dichtungssatz, Bremssattel	13.2601-8034.2	210166	13.0441-6003.2	250128	Dichtungssatz, Bremssattel
13.2421-0025.2	210145	13.0441-4206.2	250087	Dichtungssatz, Bremssattel	13.2601-8035.2	210167	13.0441-6012.2	250133	Dichtungssatz, Bremssattel
13.2421-0026.2	210146	13.0441-4206.2	250087	Dichtungssatz, Bremssattel	13.2601-8036.2	210168	13.0441-6012.2	250133	Dichtungssatz, Bremssattel
13.2421-0043.2	210193	13.0441-4216.2	250093	Dichtungssatz, Bremssattel	13.2601-8037.2	210169	13.0441-6012.2	250133	Dichtungssatz, Bremssattel
13.2421-0044.2	210194	13.0441-4216.2	250093	Dichtungssatz, Bremssattel	13.2601-8038.2	210170	13.0441-6012.2	250133	Dichtungssatz, Bremssattel
13.2421-8006.2	210054	13.0441-4205.2	250086	Dichtungssatz, Bremssattel	13.2601-9996.2	210176	13.0441-6001.2	250126	Dichtungssatz, Bremssattel
13.2421-8025.2	210061	13.0441-4216.2	250093	Dichtungssatz, Bremssattel	13.2601-9997.2	210177	13.0441-6001.2	250126	Dichtungssatz, Bremssattel
13.2421-8026.2	210062	13.0441-4216.2	250093	Dichtungssatz, Bremssattel	13.4341-8001.2	210151	13.0441-3401.2	250044	Dichtungssatz, Bremssattel
13.2423-8009.2	210063	13.0441-4206.2	250087	Dichtungssatz, Bremssattel	13.4341-8002.2	210152	13.0441-3401.2	250044	Dichtungssatz, Bremssattel
13.2423-8010.2	210064	13.0441-4206.2	250087	Dichtungssatz, Bremssattel	13.4401-8021.2	210189	13.0441-4018.2	250083	Dichtungssatz, Bremssattel
13.2481-0075.2	210081	13.0441-4819.2	250104	Dichtungssatz, Bremssattel	13.4401-8022.2	210190	13.0441-4018.2	250083	Dichtungssatz, Bremssattel
13.2481-0076.2	210082	13.0441-4819.2	250104	Dichtungssatz, Bremssattel	13.4421-8010.2	210229	13.0441-4214.2	250091	Dichtungssatz, Bremssattel
13.2481-8011.2	210092	13.0441-4825.2	250107	Dichtungssatz, Bremssattel	13.4571-8005.3	210205	13.0441-5721.2	250123	Dichtungssatz, Bremssattel
13.2481-8012.2	210093	13.0441-4825.2	250107	Dichtungssatz, Bremssattel	13.9361-0023.2	210241	13.0441-3609.2	250057	Dichtungssatz, Bremssattel
13.2481-8067.2	210098	13.0441-4819.2	250104	Dichtungssatz, Bremssattel	13.9361-0024.2	210242	13.0441-3609.2	250057	Dichtungssatz, Bremssattel
13.2481-8068.2	210099	13.0441-4819.2	250104	Dichtungssatz, Bremssattel	13.9361-0035.2	210253	13.0441-3609.2	250057	Dichtungssatz, Bremssattel
13.2481-9998.2	210102	13.0441-4815.2	250102	Dichtungssatz, Bremssattel	13.9361-0036.2	210254	13.0441-3609.2	250057	Dichtungssatz, Bremssattel
13.2481-9999.2	210103	13.0441-4815.2	250102	Dichtungssatz, Bremssattel	13.9544-0021.2	210257	13.0441-5417.2	250118	Dichtungssatz, Bremssattel
13.2541-8001.2	210110	13.0441-5416.2	250117	Dichtungssatz, Bremssattel			13.0471-5405.2	250136	Reparatursatz, Bremssattel
13.2541-8002.2	210111	13.0441-5416.2	250117	Dichtungssatz, Bremssattel			13.0471-5407.2	250137	Reparatursatz, Bremssattel
13.2571-8013.2	210123	13.0441-5718.2	250120	Dichtungssatz, Bremssattel	13.9544-0022.2	210258	13.0441-5417.2	250118	Dichtungssatz, Bremssattel
13.2571-8014.2	210124	13.0441-5718.2	250120	Dichtungssatz, Bremssattel			13.0471-5405.2	250136	Reparatursatz, Bremssattel
13.2571-8023.2	210127	13.0441-5724.2	250125	Dichtungssatz, Bremssattel			13.0471-5407.2	250137	Reparatursatz, Bremssattel
13.2571-8024.2	210128	13.0441-5724.2	250125	Dichtungssatz, Bremssattel	24.3331-0037.5	240547	11.0441-3305.2	250006	Dichtungssatz, Bremssattel
13.2571-9998.2	210133	13.0441-5718.2	250120	Dichtungssatz, Bremssattel	24.3331-0038.5	240548	11.0441-3305.2	250006	Dichtungssatz, Bremssattel
13.2571-9999.2	210134	13.0441-5718.2	250120	Dichtungssatz, Bremssattel	24.3331-8501.5	240509	11.0101-5402.2	260009	Führungshülse-satz, Bremssattel
13.2601-7015.2	210230	13.0441-6012.2	250133	Dichtungssatz, Bremssattel			11.0441-3302.2	250004	Dichtungssatz, Bremssattel







Reparatursätze

Repair kits - Juegos de reparación - Nécessaires de réparation - Corredi riparazione

									
24.3331-8501.5	240509	11.8116-0015.1	390492	Feder, Brems-sattel	24.3401-1706.5	240424	11.0441-4002.2	250011	Dichtungssatz, Brems-sattel
24.3331-8502.5	240510	11.0101-5402.2	260009	Führungshülse-n-satz, Brems-sattel	24.3401-8503.5	240521	11.0101-5402.2	260009	Führungshülse-n-satz, Brems-sattel
		11.0441-3302.2	250004	Dichtungssatz, Brems-sattel			11.0441-4002.2	250011	Dichtungssatz, Brems-sattel
		11.8116-0015.1	390492	Feder, Brems-sattel	24.3401-8504.5	240522	11.0101-5402.2	260009	Führungshülse-n-satz, Brems-sattel
24.3361-8503.5	240513	11.0101-5402.2	260009	Führungshülse-n-satz, Brems-sattel			11.0441-4002.2	250011	Dichtungssatz, Brems-sattel
		11.0441-3602.2	250008	Dichtungssatz, Brems-sattel	24.3401-9977.5	240523	11.0101-5402.2	260009	Führungshülse-n-satz, Brems-sattel
24.3361-8504.5	240514	11.0101-5402.2	260009	Führungshülse-n-satz, Brems-sattel			11.0441-4003.2	250001	Dichtungssatz, Brems-sattel
		11.0441-3602.2	250008	Dichtungssatz, Brems-sattel			11.8116-0094.1	390504	Feder, Brems-sattel
24.3361-9975.5	240541	11.0101-5407.2	260011	Führungshülse-n-satz, Brems-sattel			11.8171-0008.1	990049	Führungsbolzen, Brems-sattel
		11.0441-3602.2	250008	Dichtungssatz, Brems-sattel	24.3401-9978.5	240524	11.0101-5402.2	260009	Führungshülse-n-satz, Brems-sattel
		11.8116-0073.1	390498	Feder, Brems-sattel			11.0441-4003.2	250001	Dichtungssatz, Brems-sattel
		11.8171-0008.1	990049	Führungsbolzen, Brems-sattel			11.8116-0094.1	390504	Feder, Brems-sattel
24.3361-9976.5	240542	11.0101-5407.2	260011	Führungshülse-n-satz, Brems-sattel			11.8171-0008.1	990049	Führungsbolzen, Brems-sattel
		11.0441-3602.2	250008	Dichtungssatz, Brems-sattel	24.3421-1705.5	240353	11.0101-5402.2	260009	Führungshülse-n-satz, Brems-sattel
		11.8116-0073.1	390498	Feder, Brems-sattel			11.8116-0296.1	390445	Feder, Brems-sattel
		11.8171-0008.1	990049	Führungsbolzen, Brems-sattel	24.3421-1706.5	240354	11.0101-5402.2	260009	Führungshülse-n-satz, Brems-sattel
24.3364-1605.5	240011	11.0101-5403.2	260010	Führungshülse-n-satz, Brems-sattel			11.8116-0296.1	390445	Feder, Brems-sattel
24.3364-1606.5	240012	11.0101-5403.2	260010	Führungshülse-n-satz, Brems-sattel	24.3421-9979.5	240475	11.0101-5407.2	260011	Führungshülse-n-satz, Brems-sattel
24.3381-8503.5	240515	11.0101-5402.2	260009	Führungshülse-n-satz, Brems-sattel			11.8116-0236.1	390507	Feder, Brems-sattel
		11.0441-3803.2	250010	Dichtungssatz, Brems-sattel			11.8171-0008.1	990049	Führungsbolzen, Brems-sattel
24.3381-8504.5	240516	11.0101-5402.2	260009	Führungshülse-n-satz, Brems-sattel	24.3421-9980.5	240476	11.0101-5407.2	260011	Führungshülse-n-satz, Brems-sattel
		11.0441-3803.2	250010	Dichtungssatz, Brems-sattel			11.8116-0236.1	390507	Feder, Brems-sattel
24.3401-1703.5	240351	11.0101-5402.2	260009	Führungshülse-n-satz, Brems-sattel			11.8171-0008.1	990049	Führungsbolzen, Brems-sattel
		11.0441-4002.2	250011	Dichtungssatz, Brems-sattel	24.3434-1701.5	240357	11.0101-5403.2	260010	Führungshülse-n-satz, Brems-sattel
		11.8116-0066.1	390577	Feder, Brems-sattel	24.3434-1702.5	240358	11.0101-5403.2	260010	Führungshülse-n-satz, Brems-sattel
24.3401-1704.5	240352	11.0101-5402.2	260009	Führungshülse-n-satz, Brems-sattel	24.3481-1733.5	240213	11.0441-4811.2	250024	Dichtungssatz, Brems-sattel
		11.0441-4002.2	250011	Dichtungssatz, Brems-sattel			11.8116-0129.1	390591	Feder, Brems-sattel
		11.8116-0066.1	390577	Feder, Brems-sattel	24.3481-1734.5	240214	11.0441-4811.2	250024	Dichtungssatz, Brems-sattel
24.3401-1705.5	240423	11.0101-5402.2	260009	Führungshülse-n-satz, Brems-sattel			11.8116-0129.1	390591	Feder, Brems-sattel
		11.0441-4002.2	250011	Dichtungssatz, Brems-sattel	24.3481-1735.5	240283	11.0441-4808.2	250022	Dichtungssatz, Brems-sattel
24.3401-1706.5	240424	11.0101-5402.2	260009	Führungshülse-n-satz, Brems-sattel			24.0102-4801.2	260085	Führungshülse-n-satz, Brems-sattel







Reparatursätze

Repair kits - Juegos de reparación - Nécessaires de réparation - Corredi riparazione

									
24.3481-1736.5	240284	11.0441-4808.2	250022	Dichtungssatz, Bremssattel	24.3521-7001.5	240481	11.0101-5407.2	260011	Führungshülseinsatz, Bremssattel
		24.0102-4801.2	260085	Führungshülseinsatz, Bremssattel			11.8171-0008.1	990049	Führungsbolzen, Bremssattel
24.3481-1745.5	240277	11.0101-4803.2	260008	Führungshülseinsatz, Bremssattel	24.3521-7002.5	240482	11.0101-5407.2	260011	Führungshülseinsatz, Bremssattel
		11.0441-4808.2	250022	Dichtungssatz, Bremssattel			11.8171-0008.1	990049	Führungsbolzen, Bremssattel
		24.0102-4803.2	260086	Führungshülseinsatz, Bremssattel	24.3541-1609.5	240039	11.0101-5403.2	260010	Führungshülseinsatz, Bremssattel
24.3481-1746.5	240278	11.0101-4803.2	260008	Führungshülseinsatz, Bremssattel			11.0101-5409.2	260035	Führungshülseinsatz, Bremssattel
		11.0441-4808.2	250022	Dichtungssatz, Bremssattel	24.3541-1610.5	240040	11.0101-5403.2	260010	Führungshülseinsatz, Bremssattel
		24.0102-4803.2	260086	Führungshülseinsatz, Bremssattel			11.0101-5409.2	260035	Führungshülseinsatz, Bremssattel
24.3481-1749.5	240281	11.0441-4808.2	250022	Dichtungssatz, Bremssattel	24.3541-1701.5	240005	11.0441-5402.2	250028	Dichtungssatz, Bremssattel
		24.0102-4801.2	260085	Führungshülseinsatz, Bremssattel	24.3541-1719.5	240057	11.0101-5403.2	260010	Führungshülseinsatz, Bremssattel
24.3481-1750.5	240282	11.0101-4801.2	260006	Führungshülseinsatz, Bremssattel			11.0101-5409.2	260035	Führungshülseinsatz, Bremssattel
		11.0441-4808.2	250022	Dichtungssatz, Bremssattel	24.3541-1720.5	240058	11.0101-5403.2	260010	Führungshülseinsatz, Bremssattel
		24.0102-4801.2	260085	Führungshülseinsatz, Bremssattel			11.0101-5409.2	260035	Führungshülseinsatz, Bremssattel
24.3481-8515.5	240477	11.0101-5407.2	260011	Führungshülseinsatz, Bremssattel	24.3541-1725.5	240003	11.0441-5404.2	250029	Dichtungssatz, Bremssattel
		11.8116-0264.1	390594	Feder, Bremssattel	24.3541-1739.5	240223	11.0101-5403.2	260010	Führungshülseinsatz, Bremssattel
		11.8171-0008.1	990049	Führungsbolzen, Bremssattel	24.3541-1740.5	240224	11.0101-5403.2	260010	Führungshülseinsatz, Bremssattel
24.3481-8516.5	240478	11.0101-5407.2	260011	Führungshülseinsatz, Bremssattel	24.3541-1779.5	240249	11.0101-5403.2	260010	Führungshülseinsatz, Bremssattel
		11.8116-0264.1	390594	Feder, Bremssattel	24.3541-1780.5	240250	11.0101-5403.2	260010	Führungshülseinsatz, Bremssattel
		11.8171-0008.1	990049	Führungsbolzen, Bremssattel	24.3541-8085.5	240525	11.0101-5407.2	260011	Führungshülseinsatz, Bremssattel
24.3481-9833.5	240479	11.0101-5407.2	260011	Führungshülseinsatz, Bremssattel			11.8116-0129.1	390591	Feder, Bremssattel
		11.0441-4811.2	250024	Dichtungssatz, Bremssattel			11.8116-0292.1	390521	Feder, Bremssattel
		11.8116-0129.1	390591	Feder, Bremssattel			11.8171-0008.1	990049	Führungsbolzen, Bremssattel
		11.8171-0008.1	990049	Führungsbolzen, Bremssattel	24.3541-8086.5	240526	11.0101-5407.2	260011	Führungshülseinsatz, Bremssattel
24.3481-9834.5	240480	11.0101-5407.2	260011	Führungshülseinsatz, Bremssattel			11.8116-0129.1	390591	Feder, Bremssattel
		11.0441-4811.2	250024	Dichtungssatz, Bremssattel			11.8116-0292.1	390521	Feder, Bremssattel
		11.8116-0129.1	390591	Feder, Bremssattel			11.8171-0008.1	990049	Führungsbolzen, Bremssattel
		11.8171-0008.1	990049	Führungsbolzen, Bremssattel	24.3541-8105.5	240485	11.0101-5407.2	260011	Führungshülseinsatz, Bremssattel
24.3521-1701.5	240001	11.0441-5202.2	250026	Dichtungssatz, Bremssattel			11.8171-0008.1	990049	Führungsbolzen, Bremssattel
		11.8116-0097.1	390590	Feder, Bremssattel	24.3541-8106.5	240486	11.0101-5407.2	260011	Führungshülseinsatz, Bremssattel
24.3521-1702.5	240002	11.0441-5202.2	250026	Dichtungssatz, Bremssattel			11.8171-0008.1	990049	Führungsbolzen, Bremssattel
		11.8116-0097.1	390590	Feder, Bremssattel	24.3541-8523.5	240551	11.0101-5409.2	260035	Führungshülseinsatz, Bremssattel







Reparatursätze

Repair kits - Juegos de reparación - Nécessaires de réparation - Corredi riparazione

									
24.3541-8523.5	240551	11.0441-5409.2	250031	Dichtungssatz, Bremssattel	24.3541-9667.5	240529	11.0441-5402.2	250028	Dichtungssatz, Bremssattel
		11.8116-0143.1	390513	Feder, Bremssattel			11.8116-0109.1	390495	Feder, Bremssattel
		11.8170-0306.1	260102	Halter, Bremssattel			11.8171-0008.1	990049	Führungsbolzen, Bremssattel
		11.8171-0008.1	990049	Führungsbolzen, Bremssattel	24.3541-9668.5	240530	11.0101-5402.2	260009	Führungshülzensatz, Bremssattel
24.3541-8524.5	240552	11.0101-5409.2	260035	Führungshülzensatz, Bremssattel			11.0230-0444.1	260104	Halter, Bremssattel
		11.0441-5409.2	250031	Dichtungssatz, Bremssattel			11.0441-5402.2	250028	Dichtungssatz, Bremssattel
		11.8116-0143.1	390513	Feder, Bremssattel			11.8116-0109.1	390495	Feder, Bremssattel
		11.8170-0306.1	260102	Halter, Bremssattel			11.8171-0008.1	990049	Führungsbolzen, Bremssattel
		11.8171-0008.1	990049	Führungsbolzen, Bremssattel	24.3571-1733.5	240349	11.0101-5402.2	260009	Führungshülzensatz, Bremssattel
24.3541-8529.5	240553	11.0101-5407.2	260011	Führungshülzensatz, Bremssattel			11.8116-0273.1	390515	Feder, Bremssattel
		11.0441-5402.2	250028	Dichtungssatz, Bremssattel	24.3571-1734.5	240350	11.0101-5402.2	260009	Führungshülzensatz, Bremssattel
		11.8116-0264.1	390594	Feder, Bremssattel			11.8116-0273.1	390515	Feder, Bremssattel
		11.8171-0008.1	990049	Führungsbolzen, Bremssattel	24.3571-1761.5	240461	11.0101-5407.2	260011	Führungshülzensatz, Bremssattel
24.3541-8530.5	240554	11.0101-5407.2	260011	Führungshülzensatz, Bremssattel			11.0441-5704.2	250034	Dichtungssatz, Bremssattel
		11.0441-5402.2	250028	Dichtungssatz, Bremssattel			11.8116-0292.1	390521	Feder, Bremssattel
		11.8116-0264.1	390594	Feder, Bremssattel	24.3571-1762.5	240462	11.0101-5407.2	260011	Führungshülzensatz, Bremssattel
		11.8171-0008.1	990049	Führungsbolzen, Bremssattel			11.0441-5704.2	250034	Dichtungssatz, Bremssattel
24.3541-9587.5	240527	11.0101-5402.2	260009	Führungshülzensatz, Bremssattel			11.8116-0292.1	390521	Feder, Bremssattel
		11.0441-5402.2	250028	Dichtungssatz, Bremssattel	24.3571-8505.5	240489	11.0101-5409.2	260035	Führungshülzensatz, Bremssattel
		11.8116-0109.1	390495	Feder, Bremssattel			11.0441-5704.2	250034	Dichtungssatz, Bremssattel
		11.8170-0729.1	260107	Halter, Bremssattel			11.8116-0143.1	390513	Feder, Bremssattel
		11.8170-0730.1	260108	Halter, Bremssattel			11.8171-0008.1	990049	Führungsbolzen, Bremssattel
		11.8171-0008.1	990049	Führungsbolzen, Bremssattel	24.3571-8506.5	240490	11.0101-5409.2	260035	Führungshülzensatz, Bremssattel
24.3541-9588.5	240528	11.0101-5402.2	260009	Führungshülzensatz, Bremssattel			11.0441-5704.2	250034	Dichtungssatz, Bremssattel
		11.0441-5402.2	250028	Dichtungssatz, Bremssattel			11.8116-0143.1	390513	Feder, Bremssattel
		11.8116-0109.1	390495	Feder, Bremssattel			11.8171-0008.1	990049	Führungsbolzen, Bremssattel
		11.8170-0729.1	260107	Halter, Bremssattel	24.3571-8507.5	240555	11.8170-0306.1	260102	Halter, Bremssattel
		11.8170-0730.1	260108	Halter, Bremssattel	24.3571-8508.5	240556	11.8170-0306.1	260102	Halter, Bremssattel
		11.8171-0008.1	990049	Führungsbolzen, Bremssattel	24.3571-8511.5	240491	11.0441-5703.2	250145	Dichtungssatz, Bremssattel
24.3541-9667.5	240529	11.0101-5402.2	260009	Führungshülzensatz, Bremssattel			11.8116-0253.1	390512	Feder, Bremssattel
		11.0230-0444.1	260104	Halter, Bremssattel	24.3571-8512.5	240492	11.0441-5703.2	250145	Dichtungssatz, Bremssattel

Reparatursätze





Repair kits - Juegos de reparación - Nécessaires de réparation - Corredi riparazione

									
24.3571-8512.5	240492	11.8116-0253.1	390512	Feder, Bremsattel	24.3571-9823.5	240499	11.8116-0292.1	390521	Feder, Bremsattel
24.3571-8517.5	240493	11.0101-5409.2	260035	Führungshülzensatz, Bremssattel			11.8171-0008.1	990049	Führungsbolzen, Bremssattel
		11.0441-5704.2	250034	Dichtungssatz, Bremssattel	24.3571-9824.5	240500	11.0101-5407.2	260011	Führungshülzensatz, Bremssattel
		11.8116-0143.1	390513	Feder, Bremsattel			11.0441-5704.2	250034	Dichtungssatz, Bremssattel
		11.8171-0008.1	990049	Führungsbolzen, Bremssattel			11.8116-0292.1	390521	Feder, Bremsattel
24.3571-8518.5	240494	11.0101-5409.2	260035	Führungshülzensatz, Bremssattel			11.8171-0008.1	990049	Führungsbolzen, Bremssattel
		11.0441-5704.2	250034	Dichtungssatz, Bremssattel	24.3571-9841.5	240501	11.0101-5407.2	260011	Führungshülzensatz, Bremssattel
		11.8116-0143.1	390513	Feder, Bremsattel			11.8171-0008.1	990049	Führungsbolzen, Bremssattel
		11.8171-0008.1	990049	Führungsbolzen, Bremssattel	24.3571-9842.5	240502	11.0101-5407.2	260011	Führungshülzensatz, Bremssattel
24.3571-8521.5	240495	11.0101-5409.2	260035	Führungshülzensatz, Bremssattel			11.8171-0008.1	990049	Führungsbolzen, Bremssattel
		11.0441-5704.2	250034	Dichtungssatz, Bremssattel	24.3601-1601.5	240203	11.0101-5403.2	260010	Führungshülzensatz, Bremssattel
		11.8116-0143.1	390513	Feder, Bremsattel	24.3601-1710.5	240276	11.0101-6004.2	260014	Führungshülzensatz, Bremssattel
		11.8170-0306.1	260102	Halter, Bremsattel			11.0441-6003.2	250037	Dichtungssatz, Bremssattel
		11.8171-0008.1	990049	Führungsbolzen, Bremssattel	24.3601-1713.5	240355	11.0441-6003.2	250037	Dichtungssatz, Bremssattel
24.3571-8522.5	240496	11.0101-5409.2	260035	Führungshülzensatz, Bremssattel			11.8116-0197.1	390523	Feder, Bremsattel
		11.0441-5704.2	250034	Dichtungssatz, Bremssattel			11.8116-0290.2	390520	Feder, Bremsattel
		11.8116-0143.1	390513	Feder, Bremsattel			11.8170-0530.1	260115	Halter, Bremsattel
		11.8170-0306.1	260102	Halter, Bremsattel	24.3601-1714.5	240356	11.0441-6003.2	250037	Dichtungssatz, Bremssattel
		11.8171-0008.1	990049	Führungsbolzen, Bremssattel			11.8116-0290.2	390520	Feder, Bremsattel
24.3571-9801.5	240497	11.0101-5407.2	260011	Führungshülzensatz, Bremssattel			11.8170-0530.1	260115	Halter, Bremsattel
		11.8171-0008.1	990049	Führungsbolzen, Bremssattel	24.3601-8501.5	240533	11.0101-5402.2	260009	Führungshülzensatz, Bremssattel
24.3571-9802.5	240498	11.0101-5407.2	260011	Führungshülzensatz, Bremssattel			11.0441-6003.2	250037	Dichtungssatz, Bremssattel
		11.8171-0008.1	990049	Führungsbolzen, Bremssattel			11.8116-0083.1	390501	Feder, Bremsattel
24.3571-9813.5	240557	11.0101-5407.2	260011	Führungshülzensatz, Bremssattel			11.8171-0008.1	990049	Führungsbolzen, Bremssattel
		11.8116-0356.1	390586	Feder, Bremsattel	24.3601-8502.5	240534	11.0101-5402.2	260009	Führungshülzensatz, Bremssattel
		11.8171-0008.1	990049	Führungsbolzen, Bremssattel			11.0441-6003.2	250037	Dichtungssatz, Bremssattel
24.3571-9814.5	240558	11.0101-5407.2	260011	Führungshülzensatz, Bremssattel			11.8116-0083.1	390501	Feder, Bremsattel
		11.8116-0356.1	390586	Feder, Bremsattel			11.8171-0008.1	990049	Führungsbolzen, Bremssattel
		11.8171-0008.1	990049	Führungsbolzen, Bremssattel	24.3601-8503.5	240535	11.0101-5402.2	260009	Führungshülzensatz, Bremssattel
24.3571-9823.5	240499	11.0101-5407.2	260011	Führungshülzensatz, Bremssattel			11.0441-6003.2	250037	Dichtungssatz, Bremssattel
		11.0441-5704.2	250034	Dichtungssatz, Bremssattel			11.8116-0083.1	390501	Feder, Bremsattel



Reparatursätze

Repair kits - Juegos de reparación - Nécessaires de réparation - Corredi riparazione

		i			i				
24.3601-8503.5	240535	11.8171-0008.1	990049	Führungsbolzen, Bremssattel	24.9235-0013.5	230001	13.0441-3506.2	250052	Dichtungssatz, Bremssattel
24.3601-8504.5	240536	11.0101-5402.2	260009	Führungshülse, Bremssattel	24.9235-0014.5	230002	13.0441-3506.2	250052	Dichtungssatz, Bremssattel
		11.0441-6003.2	250037	Dichtungssatz, Bremssattel	24.9235-0051.5	230003	13.0441-3507.2	250053	Dichtungssatz, Bremssattel
		11.8116-0083.1	390501	Feder, Bremssattel	24.9235-0052.5	230004	13.0441-3507.2	250053	Dichtungssatz, Bremssattel
		11.8171-0008.1	990049	Führungsbolzen, Bremssattel	24.9235-8005.5	230023	13.0441-3505.2	250051	Dichtungssatz, Bremssattel
24.3601-8505.5	240537	11.0101-5402.2	260009	Führungshülse, Bremssattel	24.9235-8006.5	230024	13.0441-3505.2	250051	Dichtungssatz, Bremssattel
		11.0441-6003.2	250037	Dichtungssatz, Bremssattel	24.9236-8001.5	230007	13.0441-3606.2	250147	Dichtungssatz, Bremssattel
		11.8116-0083.1	390501	Feder, Bremssattel	24.9236-8002.5	230008	13.0441-3606.2	250147	Dichtungssatz, Bremssattel
		11.8171-0008.1	990049	Führungsbolzen, Bremssattel	24.9238-0087.5	230035	13.0441-3819.2	250072	Dichtungssatz, Bremssattel
24.3601-8506.5	240538	11.0101-5402.2	260009	Führungshülse, Bremssattel	24.9238-0088.5	230036	13.0441-3819.2	250072	Dichtungssatz, Bremssattel
		11.0441-6003.2	250037	Dichtungssatz, Bremssattel	24.9238-8033.5	230015	13.0441-3817.2	250071	Dichtungssatz, Bremssattel
		11.8116-0083.1	390501	Feder, Bremssattel	24.9238-8034.5	230016	13.0441-3817.2	250071	Dichtungssatz, Bremssattel
		11.8171-0008.1	990049	Führungsbolzen, Bremssattel	24.9238-8035.5	230025	13.0441-3817.2	250071	Dichtungssatz, Bremssattel
24.3601-8527.5	240503	11.0101-5407.2	260011	Führungshülse, Bremssattel	24.9238-8036.5	230026	13.0441-3817.2	250071	Dichtungssatz, Bremssattel
		11.8116-0301.1	390610	Feder, Bremssattel	24.9240-0039.5	230055	13.0441-4022.2	250149	Dichtungssatz, Bremssattel
		11.8171-0008.1	990049	Führungsbolzen, Bremssattel	24.9240-0040.5	230056	13.0441-4022.2	250149	Dichtungssatz, Bremssattel
24.3601-8528.5	240504	11.0101-5407.2	260011	Führungshülse, Bremssattel	24.9240-8013.5	230019	13.0441-4020.2	250084	Dichtungssatz, Bremssattel
		11.8116-0301.1	390610	Feder, Bremssattel	24.9240-8014.5	230020	13.0441-4020.2	250084	Dichtungssatz, Bremssattel
		11.8171-0008.1	990049	Führungsbolzen, Bremssattel	24.9242-8005.5	230027	13.0441-4205.2	250086	Dichtungssatz, Bremssattel
24.3601-9787.5	240505	11.0101-5407.2	260011	Führungshülse, Bremssattel	24.9242-8006.5	230028	13.0441-4205.2	250086	Dichtungssatz, Bremssattel
		11.0441-6008.2	250038	Dichtungssatz, Bremssattel	24.9242-8007.5	230029	13.0441-4205.2	250086	Dichtungssatz, Bremssattel
		11.8171-0008.1	990049	Führungsbolzen, Bremssattel	24.9242-8008.5	230030	13.0441-4205.2	250086	Dichtungssatz, Bremssattel
24.3601-9788.5	240506	11.0101-5407.2	260011	Führungshülse, Bremssattel	24.9242-8021.5	230031	13.0441-4206.2	250087	Dichtungssatz, Bremssattel
		11.0441-6008.2	250038	Dichtungssatz, Bremssattel	24.9246-8001.5	230021	13.0441-4601.2	250099	Dichtungssatz, Bremssattel
		11.8171-0008.1	990049	Führungsbolzen, Bremssattel	24.9246-8002.5	230022	13.0441-4601.2	250099	Dichtungssatz, Bremssattel
24.3601-9829.5	240507	11.0101-5407.2	260011	Führungshülse, Bremssattel	24.9257-8027.5	230039	13.0441-5720.2	250122	Dichtungssatz, Bremssattel
		11.8116-0366.2	390587	Feder, Bremssattel	24.9257-8028.5	230040	13.0441-5720.2	250122	Dichtungssatz, Bremssattel
		11.8171-0008.1	990049	Führungsbolzen, Bremssattel	24.9260-8025.5	230041	13.0441-6001.2	250126	Dichtungssatz, Bremssattel
24.3601-9830.5	240508	11.0101-5407.2	260011	Führungshülse, Bremssattel	24.9260-8026.5	230042	13.0441-6001.2	250126	Dichtungssatz, Bremssattel
		11.8116-0366.2	390587	Feder, Bremssattel	24.9260-8029.5	230043	13.0441-6003.2	250128	Dichtungssatz, Bremssattel
		11.8171-0008.1	990049	Führungsbolzen, Bremssattel	24.9260-8030.5	230044	13.0441-6003.2	250128	Dichtungssatz, Bremssattel

Reparatursätze

Repair kits - Juegos de reparación - Nécessaires de réparation - Corredi riparazione



24.9260-8031.5	230045	13.0441-6003.2	250128	Dichtungssatz, Bremssattel
24.9260-8032.5	230046	13.0441-6003.2	250128	Dichtungssatz, Bremssattel
24.9440-8027.5	230051	13.0441-4016.2	250081	Dichtungssatz, Bremssattel
24.9440-8028.5	230052	13.0441-4016.2	250081	Dichtungssatz, Bremssattel
24.9442-8003.5	230053	13.0441-4214.2	250091	Dichtungssatz, Bremssattel
24.9442-8004.5	230054	13.0441-4214.2	250091	Dichtungssatz, Bremssattel





DE Technische Übersetzungen

EN Technical translations

ES Traducciones técnicas

FR Traductions techniques





IT Traduzioni tecniche

2018



Technische Übersetzungen

Technical translations - Traducciones tecnicas - Traductions techniques - Traduzioni tecniche

DE		DE	
	Hauptbremszylinder	Ausgleichsbehälter, Bremsflüssigkeit	Ausgleichsbehälter, Bremsflüssigkeit
	Ausgleichsbehälter	Außendurchmesser [mm]	Außendurchmesser [mm]
	Bremskraftregler	Automatikgetriebe	Automatikgetriebe
	Bremskraftverstärker	BDX	Bremssystem, Bendix
	links	Bodenventil	Artikelzusatzbezeichnung, Bodenventil
+ ABS	für Fahrzeuge mit ABS	Bördelform	Bördelform
+ ASC	für Fahrzeuge mit ASC	BOS	Bremssystem, Bosch
+ ASR	für Fahrzeuge mit ASR	Brems-/Fahr dyn. Artikelbezug	Brems-/Fahr dyn. Artikelbezug
+ Diff	mit Differentialsperre	Bremskraftregler	Bremskraftregler
+ DSC	für Fahrzeuge mit DSC	Bremskraftverstärker	Bremskraftverstärker
+ DSTC	für Fahrzeuge mit DSTC	Bremsleitung	Bremsleitung
+ EDS	für Fahrzeuge mit EDS	Brems-system	Bremssystem
+ ESP	für Fahrzeuge mit ESP	DEL	Bremssystem, Delco
+ ETS	für Fahrzeuge mit ETS	Dichtung, Unterdruck-Anschlussstutzen BKV	Dichtung, Unterdruck-Anschlussstutzen BKV
+ Halter	mit Halter	Dichtungssatz, Brems-sattel	Dichtungssatz, Brems-sattel
+ HBZ	mit Hauptbremszylinder	- Diff	ohne Differentialsperre
+PR	für PR-Nummer	DIN/ISO	DIN/ISO
+ SCS	für Fahrzeuge mit SCS	DIN 74235 Form EL	DIN 74235 Form EL
+ TCS	für Fahrzeuge mit TCS	DIN 74235 Form FL	DIN 74235 Form FL
+ WE	mit Warneinrichtung	druckab-hängig	druckabhängig
- ABS	für Fahrzeuge ohne ABS	Drucksensor, Bremskraft-verstärker	Drucksensor, Bremskraftverstärker
Adapter, Bremsleitung	Adapter, Bremsleitung	- DSC	für Fahrzeuge ohne DSC
ALU	Aluminium	- DSTC	für Fahrzeuge ohne DSTC
Anschluss-gewinde	Anschlussgewinde		
Anschlussstutzen, Schlauchleitung	Anschlussstutzen, Schlauchleitung		
Anzahl der Bohrungen	Anzahl der Bohrungen		
- ASC	für Fahrzeuge ohne ASC		
- ASR	für Fahrzeuge ohne ASR		



Technische Übersetzungen

Technical translations - Traducciones tecnicas - Traductions techniques - Traduzioni tecniche

DE		DE	
Durchmesser Aufnahme [mm]	Durchmesser Aufnahme [mm]	für Fahrzeuge mit AMG-Sportpaket	für Fahrzeuge mit AMG-Sportpaket
E	E	für Fahrzeuge mit autom. Distanzregelung	für Fahrzeuge mit autom. Distanzregelung
- EDS	für Fahrzeuge ohne EDS	für Fahrzeuge mit Bremsassistent	für Fahrzeuge mit Bremsassistent
elektrisch-hydraulisch	elektrisch-hydraulisch	für Fahrzeuge mit Bremskraftverstärker	für Fahrzeuge mit Bremskraftverstärker
Entlüfterschraube/-ventil	Entlüfterschraube/-ventil	für Fahrzeuge mit elektronischer Fahrdynamikregelung	für Fahrzeuge mit elektronischer Fahrdynamikregelung
EPDM (Ethylen-Propylen-Dien-Kautschuk)	EPDM (Ethylen-Propylen-Dien-Kautschuk)	für Fahrzeuge mit Kollisionswarner	für Fahrzeuge mit Kollisionswarner
- ESP	für Fahrzeuge ohne ESP	für Fahrzeuge mit Scheibenbremse an der Hinterachse	für Fahrzeuge mit Scheibenbremse an der Hinterachse
F	F	für Fahrzeuge mit Servolenkung	für Fahrzeuge mit Servolenkung
Feder, Bremssattel	Feder, Bremssattel	für Fahrzeuge mit Sportfahrwerk	für Fahrzeuge mit Sportfahrwerk
Felge Lochzahl	Felge Lochzahl	für Fahrzeuge mit Sportpaket	für Fahrzeuge mit Sportpaket
Flachstecker	Flachstecker	für Fahrzeuge mit Start-Stopp-Funktion	für Fahrzeuge mit Start-Stopp-Funktion
Flanschbefestigung	Flanschbefestigung		
FPM (Fluor-Kautschuk)/ACM (Polyacryl-Kautschuk)	FPM (Fluor-Kautschuk)/ACM (Polyacryl-Kautschuk)		
Frankreich	Frankreich		
Frontantrieb	Frontantrieb		
Führungsbolzen, Bremssattel	Führungsbolzen, Bremssattel		
Führungshülse, Bremssattel	Führungshülse, Bremssattel		
Führungshülzensatz, Bremssattel	Führungshülzensatz, Bremssattel		
für ESP	für ESP		
für Fahrschulwagen	für Fahrschulwagen		

Technische Übersetzungen

Technical translations - Traducciones técnicas - Traductions techniques - Traduzioni tecniche

DE	DE
für Fahrzeuge mit Trommelbremse an der Hinterachse	für Fahrzeuge mit Trommelbremse an der Hinterachse
für Fahrzeuge mit verstärktem Fahrwerk	für Fahrzeuge mit verstärktem Fahrwerk
für Fahrzeuge mit verstärkter Bremse	für Fahrzeuge mit verstärkter Bremse
für Fahrzeuge ohne Aktivlenkung	für Fahrzeuge ohne Aktivlenkung
für Fahrzeuge ohne AMG-Sportpaket	für Fahrzeuge ohne AMG-Sportpaket
für Fahrzeuge ohne autom. Distanzregelung	für Fahrzeuge ohne autom. Distanzregelung
für Fahrzeuge ohne Bremsassistent	für Fahrzeuge ohne Bremsassistent
für Fahrzeuge ohne Bremskraftverstärker	für Fahrzeuge ohne Bremskraftverstärker
für Fahrzeuge ohne elektronische Fahrdynamikregelung	für Fahrzeuge ohne elektronische Fahrdynamikregelung
für Fahrzeuge ohne Keramikbremse	für Fahrzeuge ohne Keramikbremse
für Fahrzeuge ohne Kollisionswarner	für Fahrzeuge ohne Kollisionswarner
für Fahrzeuge ohne Niveauregulierung	für Fahrzeuge ohne Niveauregulierung
	für Fahrzeuge ohne Sportfahrwerk
	für Fahrzeuge ohne Sportpaket
	für Fahrzeuge ohne Start-Stopp-Funktion
	für Fahrzeuge ohne verstärktes Fahrwerk
	für Kolben-Ø [mm]
	für Linkslenker
	für OE-Nummer
	für Rechtslenker
	Generischer Artikel
	Getriebetyp
	Gewindeausführung
	Gewindelänge [mm]
	Gewindemaß 1
	Gewindemaß 2
	GG
	Halter, Bremsleitung
	Halter, Bremssattel
	Halter, Brems-schlauch
	Hauptbremszylinder
	Herstellereinschränkung



Technische Übersetzungen

Technical translations - Traducciones técnicas - Traductions techniques - Traduzioni tecniche

DE		DE	
Hohl-schraube	Hohlschraube	Montagein-formation beachten	Montageinformation beachten
hyd.	Hydraulisch	Motorcode	Motorcode
Hydraulikag-gregat, Bremsanlage	Hydraulikaggregat, Bremsanlage	Nabendurch-messer [mm]	Nabendurchmesser [mm]
hydraulisch	hydraulisch	nicht für Baumuster	nicht für Baumuster
Informati-onsart	Informationsart	nicht für Doppelberei-fung	nicht für Doppelbereifung
Innendurch-messer [mm]	Innendurchmesser [mm]	nicht für ESP	nicht für ESP
Innensechs-kant	Innensechskant	nicht für Fahrschul-wagen	nicht für Fahrschulwagen
Kasten/ Kombi	Kasten/Kombi	nicht für Fahrzeuge mit verstärkter Bremse	nicht für Fahrzeuge mit verstärkter Bremse
Kunststoff	Kunststoff	nicht für gepanzerte Fahrzeuge	nicht für gepanzerte Fahrzeuge
kurzer Radstand	kurzer Radstand	nicht für Getriebetyp	nicht für Getriebetyp
L=	Länge [mm]	nicht für Poli-zeifahrzeuge	nicht für Polizeifahrzeuge
L=	Länge über Alles [mm]	nicht für Sonderfahr-zeuge	nicht für Sonderfahrzeuge
L1=	Länge 1 [mm]	nur für Mine-ralöl	nur für Mineralöl
L2=	Länge 2 [mm]	nur in Verbin-dung mit	nur in Verbindung mit
langer Radstand	langer Radstand	Nutzlast [kg]	Nutzlast [kg]
lastabhängig	lastabhängig	Nutzlast ab [kg]	Nutzlast ab [kg]
Made in	Fahrzeugproduktionsland	Nutzlast bis [kg]	Nutzlast bis [kg]
Menge	Menge	OE-Hersteller	OE-Hersteller
mit Behälter	mit Behälter	OE-Nummer	OE-Nummer
mit Brems-flüssigkeits-behälter	mit Bremsflüssigkeitsbehälter	OE-Referenz	OE-Referenz
mit Brems-sattel-schrauben	mit Bremssattelschrauben	ohne Brems-flüssigkeits-behälter	ohne Bremsflüssigkeitsbehälter
mit Doppel-bereifung	mit Doppelbereifung		
mit Druck-regler	mit Druckregler		
mit Entlüfter-ventil	mit Entlüfterventil		
mit Führungs-bolzen	mit Führungsbolzen		

Technische Übersetzungen





Technical translations - Traducciones tecnicas - Traductions techniques - Traduzioni tecniche

DE		DE	
ohne Druck-sensor	ohne Drucksensor	schwarz	schwarz
ohne Steuer-gerät	ohne Steuergerät	- SCS	für Fahrzeuge ohne SCS
Orga →	Organisationsnummer ab	Sortiment, Armaturen	Sortiment, Armaturen
passend für Felgengröße [Zoll]	passend für Felgengröße [Zoll]	Sortiment, Befesti-gungsele-mente	Sortiment, Befestigungselemente
Pedalweg-sensor, Bremspedal	Pedalwegsensoren, Bremspedal	Sortiment, Entlüfter-schrauben	Sortiment, Entlüfterschrauben
pneumatisch	pneumatisch	Spezial-aufbau	Spezialaufbau
Pol-Anzahl	Pol-Anzahl	Steckeraus-führung	Steckerausführung
Prüfan-schluss, Rohrlei-tungen	Prüfanschluss, Rohrleitungen	Stopfen, Bremsflüs-sigkeitsbe-hälter	Stopfen, Bremsflüssigkeitsbehälter
Radstand [mm]	Radstand [mm]	Stufenheck	Stufenheck
Reparatur-satz, Brems-sattel	Reparatursatz, Bremssattel	Textbaustein	Textbaustein
Reparatur-satz, Haupt-bremszy-linder	Reparatursatz, Hauptbremszylinder	T-Form (T-Stück)	T-Form (T-Stück)
Ringstutzen, Rohrleitung	Ringstutzen, Rohrleitung	Trommel-bremse	Trommelbremse
Rückschlag-ventil	Rückschlagventil	TRW	Bremssystem, Lucas / TRW
Satz	Satz	Türenanzahl	Türenanzahl
Schalter, Brems-leuchte	Schalter, Bremsleuchte	Überwurf-mutter	Überwurfmutter
Schaltge-triebe	Schaltgetriebe	Überwurf-schraube	Überwurfschraube
Scheiben-bremse	Scheibenbremse	Ungarn	Ungarn
Schlauch	Schlauch	Ventil, Unter-druckleitung	Ventil, Unterdruckleitung
Schlüssel-weite	Schlüsselweite	Verbin-dungs-/ Verteiler-stück, Rohr-leitungen	Verbindungs-/Verteilerstück, Rohrleitungen
Schrägheck	Schrägheck	Verschluss, Bremsflüs-sigkeitsbe-hälter	Verschluss, Bremsflüssigkeitsbehälter
Schraub-an-schluss	Schraubanschluss	Verschluss-/ Schutzkappe	Verschluss-/Schutzkappe
Schraubkon-takt	Schraubkontakt		



Technische Übersetzungen

Technical translations - Traducciones tecnicas - Traductions techniques - Traduzioni tecniche

DE		EN	
Verschluss-schraube	Verschluss-schraube		Brake Master Cylinder
Verschluss-schraube, Hauptbrems-zylinder	Verschluss-schraube, Hauptbrems-zylinder		Expansion Tank
Vollautomatik	Vollautomatik		Brake Power Regulator
weiß/lila	weiß/lila		Brake Booster
x	Anschlussanzahl		Left
x	Breite [mm] Höhe [mm]		
Zubehör	Zubehör	+ ABS	for vehicles with ABS
zusätzlich benötigter Artikel (Artikel-Nummer)	zusätzlich benötigter Artikel (Artikel-Nummer)	+ ASC	for vehicles with ASC
∅	Durchmesser [mm]	+ ASR	for vehicles with ASR
∅ "	Durchmesser [Zoll]	+ Diff	with differential lock
∅1	Durchmesser 1 [mm]	+ DSC	for vehicles with DSC
∅2	Durchmesser 2 [mm]	+ DSC	for vehicles with DSC
→	Baujahr ab Fahrgestellnummer ab	+ DSTC	for vehicles with DSTC
→	Baujahr bis Fahrgestellnummer bis	+ EDS	for vehicles with EDS
→Orga	Organisationsnummer bis	+ ESD	for vehicles with ESP
→∅	Durchmesser bis [mm]	+ ETS	for vehicles with ETS
		+ Halter	with holder
		+ HBZ	with brake master cylinder
		+PR	for PR number
		+ SCS	for vehicles with SCS
		+ TCS	for vehicles with TCS
		+ WE	with alarm
		- ABS	for vehicles without ABS
		Adapter, Bremsleitung	Adapter, brake lines
		ALU	Aluminium
		Anschluss-gewinde	Connecting thread
		Anschlusstutzen, Schlauchleitung	Connection Piece, hose line
		Anzahl der Bohrungen	Number of Bores
		- ASC	for vehicles without ASC
		- ASR	for vehicles without ASR

Technische Übersetzungen

Technical translations - Traducciones tecnicas - Traductions techniques - Traduzioni tecniche

EN		EN	
Ausgleichsbehälter, Bremsflüssigkeit	Expansion Tank, brake fluid	Durchmesser Aufnahme [mm]	Support plate diameter [mm]
		E	E
Außendurchmesser [mm]	Outer diameter [mm]	- EDS	for vehicles without EDS
Automatikgetriebe	Automatic Transmission	elektrisch-hydraulisch	Electric-hydraulic
BDX	Brake System, Bendix	Entlüfterschraube/-ventil	Breather Screw / Valve
Bodenventil	additional article information, Vordruckventil	EPDM (Ethylen-Propylen-Dien-Kautschuk)	EPDM (ethylene propylene diene Monomer (M-class) rubber)
Bördelform	Flange Shape	- ESP	for vehicles without ESP
BOS	Brake System, Bosch	F	F
Brems-/ Fahrdyn. Artikelbezug	Brakes- / Drive Dynamics Articles	Feder, Bremssattel	Spring, brake caliper
Bremskraftregler	Brake Power Regulator	Felge Lochzahl	Rim Hole Number
Bremskraftverstärker	Brake Booster	Flachstecker	Blade Terminal
Bremsleitung	Brake Lines	Flanschbefestigung	Flange mounting
Bremsystem	Brake System	FPM (Fluor-Kautschuk)/ACM (Polyacryl-Kautschuk)	FPM (fluoride rubber)/ACM (polyacrylate rubber)
DEL	Brake System, Delco	Frankreich	France
Dichtung, Unterdruck-Anschlusstutzen BKV	Seal, vacuum hose connector pipe	Frontantrieb	Front Wheel Drive
Dichtungssatz, Bremssattel	Gasket Set, brake caliper	Führungsbolzen, Bremssattel	Guide Bolt, brake caliper
- Diff	without differential lock	Führungshülse, Bremssattel	Guide Sleeve, brake caliper
DIN/ISO	DIN / ISO	Führungshülzensatz, Bremssattel	Guide Sleeve Kit, brake caliper
DIN 74235 Form EL	DIN 74235 Form EL	für ESP	for ESP
DIN 74235 Form FL	DIN 74235 Form FL	für Fahr-schulwagen	for driving school cars
druckabhängig	Pressure-dependent		
Drucksensor, Bremskraftverstärker	Pressure Sensor, brake booster		
- DSC	for vehicles without DSC		
- DSTC	for vehicles without DSTC		



Technische Übersetzungen

Technical translations - Traducciones técnicas - Traductions techniques - Traduzioni tecniche

EN		EN	
für Fahrzeuge mit AMG-Sportpaket	for vehicles with AMG Sports Package	für Fahrzeuge mit Trommelbremse an der Hinterachse	for vehicles with drum brakes on the rear axle
für Fahrzeuge mit autom. Distanzregelung	for vehicles with autom. distance control	für Fahrzeuge mit verstärktem Fahrwerk	for vehicles with heavy duty suspension
für Fahrzeuge mit Bremsassistent	for vehicles with brake assist	für Fahrzeuge mit verstärkter Bremse	for vehicles with reinforced brakes
für Fahrzeuge mit Bremskraftverstärker	for vehicles with brake booster	für Fahrzeuge ohne Aktivlenkung	for vehicles without active steering
für Fahrzeuge mit elektronischer Fahrdynamikregelung	for vehicles with electronic drive dynamics control	für Fahrzeuge ohne AMG-Sportpaket	for vehicles without AMG sports package
für Fahrzeuge mit Kollisionswarner	for vehicles with collision warning system	für Fahrzeuge ohne autom. Distanzregelung	for vehicles without autom. distance control
für Fahrzeuge mit Scheibenbremse an der Hinterachse	for vehicles with disc brakes on the rear axle	für Fahrzeuge ohne Bremsassistent	for vehicles without brake assist
für Fahrzeuge mit Servolenkung	for vehicles with power steering	für Fahrzeuge ohne Bremskraftverstärker	for vehicles without brake booster
für Fahrzeuge mit Sportfahrwerk	for vehicles with sports suspension	für Fahrzeuge ohne elektronische Fahrdynamikregelung	for vehicles without electronic drive dynamics regulation
für Fahrzeuge mit Sportpaket	for vehicles with sports package	für Fahrzeuge ohne Keramikbremse	for vehicles without ceramic brakes
für Fahrzeuge mit Start-Stopp-Funktion	for vehicles with start-stop function	für Fahrzeuge ohne Kollisionswarner	for vehicles without collision warning system
		für Fahrzeuge ohne Niveauregulierung	for vehicles without leveling control

Technische Übersetzungen

Technical translations - Traducciones técnicas - Traductions techniques - Traduzioni tecniche

EN		EN	
für Fahrzeuge ohne Sportfahrwerk	for vehicles without sports suspension	Hohl-schraube	Hollow Screw
für Fahrzeuge ohne Sportpaket	for vehicles without sports package	hyd.	Hydraulic
für Fahrzeuge ohne Start-Stopp-Funktion	for vehicles without start-stop function	Hydraulikaggregat, Bremsanlage	Hydraulic Unit, brake system
für Fahrzeuge ohne verstärktes Fahrwerk	for vehicles without heavy duty suspension	hydraulisch	Hydraulic
für Kolben-Ø [mm]	for piston Ø [mm]	Informati-onsart	Information Type
für Links-lenker	for left-hand drive vehicles	Innendurch-messer [mm]	Inner diameter [mm]
für OE-Nummer	for OE number	Innensechs-kant	Female Hex
für Rechts-lenker	for right-hand drive vehicles	Kasten/ Kombi	Box Body / Estate
Generischer Artikel	Generic article	Kunststoff	Plastic
Getriebetyp	Transmission Type	kurzer Radstand	Short Wheelbase
Gewindeaus-führung	Thread Type	L=	Length [mm]
Gewinde-länge [mm]	Thread Length [mm]	L=	Overall Length [mm]
Gewindemaß 1	Thread Measurement 1	L1=	Length 1 [mm]
Gewindemaß 2	Thread Measurement 2	L2=	Length 2 [mm]
GG	Cast iron brake caliper	langer Radstand	Long Wheelbase
Halter, Bremsleitung	Holder, brake lines	lastabhängig	Load-dependent
Halter, Bremssattel	Carrier, brake caliper	Made in	Vehicle Production Country
Halter, Brems-schlauch	Holding Bracket, brake hose	Menge	Quantity
Hauptbrems-zylinder	Brake Master Cylinder	mit Behälter	with reservoir
Herstellerein-schränkung	Manufacturer Restriction	mit Brems-flüssigkeits-behälter	with brake fluid container
		mit Brems-sattel-schrauben	with brake caliper screws
		mit Doppel-bereifung	with dual tyres
		mit Druck-regler	with pressure regulator
		mit Entlüfter-ventil	with breather valve
		mit Führungs-bolzen	with guide pin



Technische Übersetzungen

Technical translations - Traducciones técnicas - Traductions techniques - Traduzioni tecniche

EN		EN	
Montageinformation beachten	Observe mounting information	ohne Druck-sensor	without pressure sensor
Motorcode	Engine Code	ohne Steuer-gerät	without control unit
Nabendurch-messer [mm]	Hub Diameter [mm]	Orga →	Organisation number from
nicht für Baumuster	not for model	passend für Felgengröße [Zoll]	Fits rim size [inch]
nicht für Doppelberei-fung	not for dual tyres	Pedalweg-sensor, Bremspedal	Pedal Travel Sensor, brake pedal
nicht für ESP	not for ESP	pneumatisch	Pneumatic
nicht für Fahrschul-wagen	not for driving school cars	Pol-Anzahl	Number of Poles
nicht für Fahrzeuge mit verstärkter Bremse	not for vehicles with reinforced brakes	Prüfan-schluss, Rohrlei-tungen	Test Connection, piping
nicht für gepanzerte Fahrzeuge	not for armoured vehicles	Radstand [mm]	Wheelbase [mm]
nicht für Getriebetyp	not for transmission type	Reparatur-satz, Brems-sattel	Repair Kit, brake caliper
nicht für Poli-zeifahrzeuge	not for police vehicles	Reparatur-satz, Haupt-bremszy-linder	Repair Kit, brake master cylinder
nicht für Sonderfahr-zeuge	not for special purpose vehicles	Ringstutzen, Rohrleitung	Connector, metal pipes
nur für Mine-ralöl	Only for mineral oil	Rückschlag-ventil	Non-return Valve
nur in Verbin-dung mit	only in connection with	Satz	Kit
Nutzlast [kg]	Payload [kg]	Schalter, Brems-leuchte	Switch, stop light
Nutzlast ab [kg]	Payload from [kg]	Schaltge-triebe	Manual Transmission
Nutzlast bis [kg]	Payload to [kg]	Scheiben-bremse	Disc Brake
OE-Hersteller	OE manufacturer	Schlauch	Hose
OE-Nummer	OE reference number	Schlüssel-weite	Spanner Size
OE-Referenz	OE reference	Schrägheck	Hatchback
ohne Brems-flüssigkeits-behälter	without brake fluid container	Schraub-an-schluss	Screw Connection
		Schraubkon-takt	Screw Contact

Technische Übersetzungen



Technical translations - Traducciones tecnicas - Traductions techniques - Traduzioni tecniche

EN		EN	
schwarz	Black	Verschluss-schraube	Screw Plug
- SCS	for vehicles without SCS	Verschluss-schraube, Hauptbrems-zylinder	Screw Plug, brake master cylinder
Sortiment, Armaturen	Assortment, fittings	Vollautomatik	Fully Automatic
Sortiment, Befesti-gungsele-mente	Assortment, fasteners	weiß/lila	White/Purple
Sortiment, Entlüfter-schrauben	Assortment, breather screws	x	Number of connectors
Spezial-aufbau	Special Design	x	Width [mm] Height [mm]
Steckeraus-führung	Plug Type	Zubehör	Accessories
Stopfen, Bremsflüs-sigkeitsbe-hälter	Plug, brake fluid reservoir	zusätzlich benötigter Artikel (Artikel-Nummer)	Additionally required articles (article numbers)
Stufenheck	Saloon	Ø	Diameter [mm]
Textbaustein	text module	Ø "	Diameter [in]
T-Form (T-Stück)	T-Piece	Ø1	Diameter 1 [mm]
Trommel-bremse	Drum Brake	Ø2	Diameter 2 [mm]
TRW	Brake System, Lucas / TRW	→	Construction year from Chassis number from
Türenanzahl	Number of Doors	→	Construction year to Chassis number to
Überwurf-mutter	Union Nut	→Orga	Organisation number to
Überwurf-schraube	Union Bolt	→Ø	Diameter to [mm]
Ungarn	Hungary		
Ventil, Unter-druckleitung	Valve, vacuum hose		
Verbin-dungs-/ Verteiler-stück, Rohr-leitungen	Connector, pipes		
Verschluss, Bremsflüs-sigkeitsbe-hälter	Sealing Cap, brake fluid reservoir		
Verschluss-/ Schutzkappe	Sealing/Protective Cap		



Technische Übersetzungen

Technical translations - Traducciones técnicas - Traductions techniques - Traduzioni tecniche

ES		ES	
	Cilindro principal de freno	Ausgleichsbehälter, Bremsflüssigkeit	Depósito compensación, líquido de frenos
	Depósito compensación	Außendurchmesser [mm]	Diámetro exterior [mm]
	Regulador de la fuerza de frenado	Automatikgetriebe	Transmisión automática
	Servofrenos	BDX	Sistema de frenos, Bendix
	izquierda	Bodenventil	Denominación adicional del artículo, Vordruckventil
+ ABS	para vehículos con ABS	Bördelform	Tipo rebordeado
+ ASC	para vehículos con ASC	BOS	Sistema de frenos, Bosch
+ ASR	para vehículos con ASR	Brems-/ Fahr dyn. Artikelbezug	Ref. artículo dinámica frenado/marcha
+ Diff	con bloqueo de diferencial	Bremskraftregler	Regulador de la fuerza de frenado
+ DSC	para vehículos con DSC	Bremskraftverstärker	Servofrenos
+ DSTC	para vehículos con DSTC	Bremsleitung	Tubería de frenos
+ EDS	para vehículos con EDS	Brems-system	Sistema de frenos
+ ESP	para vehículos con ESP	DEL	Sistema de frenos, Delco
+ ETS	para vehículos sin ETS	Dichtung, Unterdruck-Anschlüssen BKV	Junta, racor de conexión de vacío
+ Halter	con soporte	Dichtungssatz, Brems-sattel	Juego de juntas, pinza de freno
+ HBZ	con cilindro principal del freno	- Diff	sin bloqueo de diferencial
+PR	Número de PR	DIN/ISO	DIN / ISO
+ SCS	para vehículos con SCS	DIN 74235 Form EL	DIN 74235 Forma EL
+ TCS	para vehículos con TCS	DIN 74235 Form FL	DIN 74235 Forma FL
+ WE	con dispositivo avisador	druckabhängig	en función de la presión
- ABS	para vehículos sin ABS	Drucksensor, Bremskraftverstärker	Sensor de presión, servofreno
Adapter, Bremsleitung	Adaptador, tubería de freno	- DSC	para vehículos sin DSC
ALU	Aluminio	- DSTC	Para vehículos sin DSCT
Anschluss-gewinde	Rosca empalme		
Anschlusstutzen, Schlauchleitung	Racores, tubería flexible		
Anzahl der Bohrungen	Número de taladros		
- ASC	para vehículos sin ASC		
- ASR	para vehículos sin ASR		

Technische Übersetzungen

Technical translations - Traducciones técnicas - Traductions techniques - Traduzioni tecniche

ES		ES	
Durchmesser Aufnahme [mm]	Diámetro alojamiento [mm]	für Fahrzeuge mit AMG-Sportpaket	para vehículos con paquete sport AMG
E	E	für Fahrzeuge mit autom. Distanzregelung	para vehículos con regulación automática de distancia
- EDS	para vehículos sin EDS	für Fahrzeuge mit Bremsassistent	para vehículos con asistencia a la frenada
elektrisch-hydraulisch	electrohidráulico	für Fahrzeuge mit Bremskraftverstärker	para vehículos con servofreno
Entlüfterschraube/-ventil	Válvula/tornillo de purga de aire	für Fahrzeuge mit elektronischer Fahrdynamikregelung	para vehículos con regulación dinámica de conducción
EPDM (Ethylen-Propylen-Dien-Kautschuk)	EPDM (Ethylen-Propylen-Dien-Caucho)	für Fahrzeuge mit Kollisionswarner	para vehículos con aviso de colisión
- ESP	para vehículos sin ESP	für Fahrzeuge mit Scheibenbremse an der Hinterachse	para vehículos con freno de disco en eje trasero
F	F	für Fahrzeuge mit Servolenkung	para vehículos con dirección asistida
Feder, Bremssattel	Muelle, pinza de freno	für Fahrzeuge mit Sportfahrwerk	para vehículos con chasis deportivo
Felge Lochzahl	Llanta, nº de taladros	für Fahrzeuge mit Sportpaket	para vehículos con paquete sport
Flachstecker	Conector plano	für Fahrzeuge mit Start-Stopp-Funktion	para vehículos con sistema Start&Stop
Flanschbefestigung	Fijación con brida		
FPM (Fluor-Kautschuk)/A CM (Polyacryl-Kautschuk)	FPM (caucho fluorado)/ACM (caucho poliacrílico)		
Frankreich	Francia		
Frontantrieb	Tracción delantera		
Führungsbolzen, Bremssattel	Pasador guía, pinza del freno		
Führungshülse, Bremssattel	Casquillo guía, pinza del freno		
Führungshülzensatz, Bremssattel	Juego de casquillos guía, pinza de freno		
für ESP	para ESP		
für Fahrschulwagen	para coche de autoescuela		



Technische Übersetzungen

Technical translations - Traducciones técnicas - Traductions techniques - Traduzioni tecniche

ES	ES
für Fahrzeuge mit Trommelbremse an der Hinterachse para vehículos con freno de tambor en eje trasero	für Fahrzeuge ohne Sportfahrwerk para vehículos sin chasis deportivo
für Fahrzeuge mit verstärktem Fahrwerk para vehículos con chasis reforzado	für Fahrzeuge ohne Sportpaket para vehículos sin paquete sport
für Fahrzeuge mit verstärkter Bremse para vehículos con freno reforzado	für Fahrzeuge ohne Start-Stopp-Funktion para vehículos sin sistema Start&Stop
für Fahrzeuge ohne Aktivlenkung para vehículos sin dirección activo	für Fahrzeuge ohne verstärktes Fahrwerk para vehículos sin chasis reforzado
für Fahrzeuge ohne AMG-Sportpaket para vehículos sin paquete deportivo AMG	für Kolben-Ø [mm] para pistón - Ø [mm]
für Fahrzeuge ohne autom. Distanzregelung para vehículos sin regulación automática de distancia	für Linkslenker para vehic. dirección izquierda
für Fahrzeuge ohne Bremsassistent Para vehículos sin asistencia a la frenada	für OE-Nummer para OE N°
für Fahrzeuge ohne Bremskraftverstärker para vehículos sin servofreno	für Rechtslenker para vehíc. dirección a la derecha
für Fahrzeuge ohne elektronische Fahrdynamikregelung para vehículos sin control dinámico de conducción	Generischer Artikel Número de artículo genérico
für Fahrzeuge ohne Keramikbremse para vehículos sin frenos de cerámica	Getriebetyp Tipo de caja de cambios
für Fahrzeuge ohne Kollisionswarner para vehículos sin aviso de colisión	Gewindeausführung Tipo de rosca
für Fahrzeuge ohne Niveauregulierung para vehículos sin regulación de nivel	Gewindelänge [mm] Long. de rosca [mm]
	Gewindemaß 1 Rosca 1
	Gewindemaß 2 Rosca 2
	GG Pinza de frenos de hierro fundido
	Halter, Bremsleitung Soporte, tubería de freno
	Halter, Bremssattel Soporte, pinza de freno
	Halter, Bremschlauch Soporte, tubo flexible de freno
	Hauptbremszylinder Cilindro principal de freno
	Herstellereinschränkung Restricción de fabricante

Technische Übersetzungen

Technical translations - Traducciones técnicas - Traductions techniques - Traduzioni tecniche

ES		ES	
Hohl-schraube	Tronillo hueco	Montagein-formation beachten	Observar información de montaje
hyd.	hidráulico	Motorcode	Código de motor
Hydraulikag-gregat, Bremsanlage	Grupo hidráulico, sistema de frenos	Nabendurch-messer [mm]	Diamétero cubo [mm]
hydraulisch	hidráulico	nicht für Baumuster	no para tipo de construcción
Informati-onsart	Tipo información	nicht für Doppelbereifung	no para neumáticos gemelos
Innendurch-messer [mm]	Diámetro interior [mm]	nicht für ESP	no para ESP
Innensechs-kant	Hexágono interior	nicht für Fahrschul-wagen	no para veh. autoescuela
Kasten/ Kombi	Furgón/ranchera familiar	nicht für Fahrzeuge mit verstärkter Bremse	no para vehículos con frenos refor-zados
Kunststoff	Plástico	nicht für gepanzerte Fahrzeuge	no para vehículos blindados
kurzer Radstand	distancia corta entre ejes	nicht für Getriebetyp	no para tipo de transmisión
L=	Longitud [mm]	nicht für Poli-zeifahrzeuge	no para veh. policía
L=	Longitud total [mm]	nicht für Sonderfahr-zeuge	no para veh. especiales
L1=	Longitud 1 [mm]	nur für Mine-ralöl	sólo para aceite mineral
L2=	Longitud 2 [mm]	nur in Verbin-dung mit	sólo con
langer Radstand	Distancia larga entre ejes	Nutzlast [kg]	Carga útil [kg]
lastabhängig	dependiente de la carga	Nutzlast ab [kg]	carga útil desde [kg]
Made in	País producción vehículo	Nutzlast bis [kg]	carga útil hasta [kg]
Menge	Cantidad	OE-Hersteller	
mit Behälter	con depósito	OE-Nummer	
mit Brems-flüssigkeits-behälter	con depósito líquido frenos	OE-Referenz	
mit Brems-sattel-schrauben	con tornillos pinza freno	ohne Brems-flüssigkeits-behälter	sin depósito líquido frenos
mit Doppel-bereifung	con neumáticos gemelos		
mit Druck-regler	con regulador de presión		
mit Entlüfter-ventil	con válvula de ventilación		
mit Führungs-bolzen	con perno guía		







Technische Übersetzungen

Technical translations - Traducciones técnicas - Traductions techniques - Traduzioni tecniche

ES		ES	
ohne Druck-sensor	sin sensor de presión	schwarz	negro
ohne Steuer-gerät	sin unidad de control	- SCS	para vehículos sin SCS
Orga →	nº de organización desde	Sortiment, Armaturen	Surtido de armaduras
passend für Felgenreöße [Zoll]	adecuado para tamaño llanta [inch]	Sortiment, Befestigungselemente	Surtido, elementos de sujeción
Pedalweg-sensor, Bremspedal	Sensor recorrido del pedal de freno	Sortiment, Entlüfterschrauben	Surtido, tornillos de purga de aire
pneumatisch	neumático	Spezialaufbau	Carrocería especial
Pol-Anzahl	Número de polos	Steckerausführung	Modelo de conector
Prüfan-schluss, Rohrlei-tungen	Conexión de prueba, tuberías	Stopfen, Bremsflüs-sigkeitsbe-hälter	Tapón, depósito líquido de frenos
Radstand [mm]	Distancia entre ejes [mm]	Stufenheck	Sedán
Reparatur-satz, Brems-sattel	Juego de reparación, pinza de freno	Textbaustein	módulo de texto
Reparatur-satz, Haupt-bremszy-linder	Juego de reparación, cilindro principal del freno	T-Form (T-Stück)	en T
Ringstutzen, Rohrleitung	Tubuladura anular, tubería	Trommel-bremse	Tambor
Rückschlag-ventil	Válvula de retención	TRW	Sistema de frenos, Lucas / TRW
Satz	Kit	Türenanzahl	Número de puertas
Schalter, Brems-leuchte	Interruptor, luz de freno	Überwurf-mutter	Tuerca racor
Schaltge-triebe	Caja de cambios manual	Überwurf-schraube	Tornillo de unión
Scheiben-bremse	Discos	Ungarn	Hungría
Schlauch	Tubo flexible	Ventil, Unter-druckleitung	Válvula, tubería de depresión
Schlüssel-weite	Ancho de llave	Verbin-dungs-/ Verteiler-stück, Rohr-leitungen	Piezas distribuidoras/unión, tuberías
Schrägheck	Fastback	Verschluss, Bremsflüs-sigkeitsbe-hälter	Tapa, depósito de líquido de frenos
Schraub-an-schluss	Conexión roscada	Verschluss-/ Schutzkappe	Tapa de cierre/protección
Schraubkon-takt	contacto roscado		

Technische Übersetzungen

Technical translations - Traducciones técnicas - Traductions techniques - Traduzioni tecniche

ES		FR	
Verschluss-schraube	Tapón roscado		Maître-cylindre de frein
Verschluss-schraube, Hauptbrems-zylinder	Tapón roscado, cilindro principal del freno		Vase d'expansion
Vollautomatik	completamente automática		Régulateur de freinage
weiß/lila	blanco/lila		Dispositif d'assistance de frein
x	Número de conexiones		gauche
Zubehör	Accesorios	+ ABS	pour véhicules avec système antiblo-cage
zusätzlich benötigter Artikel (Artikel-Nummer)	Se requiere adicionalmente artículo N°	+ ASC	pour véhicules avec ASC
Ø	Diámetro [mm]	+ ASR	pour véhicules avec ASR
Ø "	Diámetro [in]	+ Diff	avec blocage de différentiel
Ø1	Diámetro 1 [mm]	+ DSC	pour véhicules avec DSC
Ø2	Diámetro 2 [mm]	+ DSTC	pour véhicules avec DSTC
→	año construcción desde n° de chasis desde	+ EDS	pour véhicules avec EDS
→	año construcción hasta n° de chasis hasta	+ ESP	pour véhicules avec ESP
→ Orga	n° de organización hasta	+ ETS	pour véhicules avec ETS
→ Ø	Diámetro hasta [mm]	+ Halter	avec support
		+ HBZ	avec maître-cylindre de frein
		+PR	pour numéro PR
		+ SCS	pour véhicules avec SCS
		+ TCS	pour véhicules avec antipatinage (TCS)
		+ WE	avec dispositif d'avertissement
		- ABS	pour véhicules sans système antiblo-cage
		Adapter, Bremsleitung	Adaptateur, conduite de frein
		ALU	Aluminium
		Anschluss-gewinde	Filetage de raccordement
		Anschlus-sutzen, Schlauchlei-tung	Raccord, tuyau flexible
		Anzahl der Bohrungen	Nombre d'alésages
		- ASC	pour véhicules sans ASC
		- ASR	pour véhicules sans ASR

Technische Übersetzungen

Technical translations - Traducciones técnicas - Traductions techniques - Traduzioni tecniche

FR	FR
Ausgleichsbehälter, Bremsflüssigkeit	Durchmesser Aufnahme [mm]
Vase d'expansion, liquide de frein	Diamètre réception [mm]
Außendurchmesser [mm]	E
Diamètre extérieur [mm]	E
Automatikgetriebe	- EDS
Boîte automatique	pour véhicules sans EDS
BDX	elektrisch-hydraulisch
Système de freinage, Bendix	électrique-hydraulique
Bodenventil	Entlüfterschraube/-ventil
Designation d'article complémentaire, Vordruckventil	Soupape/vis de purge d'air
Bördelform	EPDM (Ethylen-Propylen-Dien-Kautschuk)
Forme du bord relevé	EPDM (éthylène-propylène-diène-caoutchouc)
BOS	- ESP
Système de freinage, Bosch	pour véhicules sans ESP
Brems-/Fahr dyn. Artikelbezug	F
Lien d'article avec dynamique de freinage et de mouvement	F
Bremskraftregler	Feder, Bremssattel
Régulateur de freinage	Ressort, étrier de frein
Bremskraftverstärker	Felge Lochzahl
Dispositif d'assistance de frein Servofrein	Jante, nombre de trous
Bremsleitung	Flachstecker
Conduite de frein	Fiche plate
Bremsystem	Flanschbefestigung
Système de freinage	Fixation par bride
DEL	FPM (Fluor-Kautschuk)/ACM (Polyacryl-Kautschuk)
Système de freinage, Delco	FPM (caoutchouc fluoré) / ACM (caoutchouc polyacrylique)
Dichtung, Unterdruck-Anschlusstutzen BKV	Frankreich
Joint, tubulure de prise de dépression	France
Dichtungssatz, Bremssattel	Frontantrieb
Jeu de joints d'étanchéification, étrier de frein	Traction avant
- Diff	Führungsbolzen, Bremssattel
sans blocage de différentiel	Boulon de guidage, étrier de frein
DIN/ISO	Führungshülse, Bremssattel
DIN/ISO	Douille de guidage, étrier de frein
DIN 74235 Form EL	FührungshülSENSatz, Bremssattel
DIN 74235 forme EL	Jeu de douilles de guidage, étrier de frein
DIN 74235 Form FL	für ESP
DIN 74235 forme FL	pour ESP
druckabhängig	für Fahr-schulwagen
dépendant de la pression	pour véhicules d'auto-école
Drucksensor, Bremskraftverstärker	
Capteur de pression, servofrein	
- DSC	
pour véhicules sans DSC	
- DSTC	
pour véhicules sans DSTC	

Technische Übersetzungen

Technical translations - Traducciones técnicas - Traductions techniques - Traduzioni tecniche

FR		FR	
für Fahrzeuge mit AMG-Sportpaket	pour véhicules avec équipement-sport AMG	für Fahrzeuge mit Trommelbremse an der Hinterachse	pour véhicules avec frein à tambour à l'essieu arrière
für Fahrzeuge mit autom. Distanzregelung	pour véhicules avec régulation de distance autom.	für Fahrzeuge mit verstärktem Fahrwerk	pour véhicules avec châssis renforcé
für Fahrzeuge mit Bremsassistent	pour véhicules avec assistant au freinage	für Fahrzeuge mit verstärkter Bremse	pour véhicules avec frein assisté
für Fahrzeuge mit Bremskraftverstärker	pour véhicules avec dispositif d'assistance de frein	für Fahrzeuge ohne Aktivlenkung	pour véhicules sans direction active
für Fahrzeuge mit elektronischer Fahrdynamikregelung	pr véhic.s avec régulation électron. dynamique de conduite	für Fahrzeuge ohne AMG-Sportpaket	pour véhicules sans paquet-sport AMG
für Fahrzeuge mit Kollisionswarner	pour véhicules avec système anti-collision	für Fahrzeuge ohne autom. Distanzregelung	pour véhicules sans régulation de distance autom.
für Fahrzeuge mit Scheibenbremse an der Hinterachse	pour véhicules avec frein à disques à l'essieu arrière	für Fahrzeuge ohne Bremsassistent	pour véhicules sans assistant de freinage
für Fahrzeuge mit Servolenkung	pour véhicules avec direction assistée	für Fahrzeuge ohne Bremskraftverstärker	pour véhicules sans dispositif d'assistance de frein
für Fahrzeuge mit Sportfahrwerk	pour véhicules avec châssis sportif	für Fahrzeuge ohne elektronische Fahrdynamikregelung	pr véhicules sans régulation élect. dynamique de conduite
für Fahrzeuge mit Sportpaket	pour véhicules avec équipement sport	für Fahrzeuge ohne Keramikbremse	pour véhicules sans frein en céramique
für Fahrzeuge mit Start-Stopp-Funktion	pour véhicules avec fonction Stop/Start	für Fahrzeuge ohne Kollisionswarner	pour véhicules sans système anti-collision
		für Fahrzeuge ohne Niveauregulierung	pour véhicules sans réglage de niveau



Technische Übersetzungen

Technical translations - Traducciones técnicas - Traductions techniques - Traduzioni tecniche

FR	FR
für Fahrzeuge ohne Sportfahrwerk pour véhicules sans châssis sportif	Hohl-schraube Vis creuse
für Fahrzeuge ohne Sportpaket pour véhicules sans équipement sport	hyd. hydraulique
für Fahrzeuge ohne Start-Stopp-Funktion pour véhicules sans fonction Stop/Start	Hydraulikaggregat, Bremsanlage Groupe hydraulique, système de freinage
für Fahrzeuge ohne verstärktes Fahrwerk pour véhicules sans châssis renforcé	hydraulisch hydraulique
für Kolben-Ø [mm] pour piston-Ø [mm]	Informati-onsart Genre d'information
für Links-lenker pour véhicules avec direction à gauche	Innendurch-messer [mm] Diamètre intérieur [mm]
für OE-Nummer pour numéro OE	Innensechs-kant hexagonal intérieur
für Rechts-lenker pour véhicules avec direction à droite	Kasten/Kombi Camionnette/Break
Generischer Artikel Référence générique de l'article	Kunststoff Matière plastique
Getriebetyp Type de boîte de vitesses	kurzer Radstand Empattement court
Gewindeaus-führung Filetage/taraudage	L= Longueur [mm]
Gewinde-länge [mm] Longueur du filetage [mm]	L= Longueur globale
Gewindemaß 1 Taraudage/Filetage 1	L1= Longueur 1 [mm]
Gewindemaß 2 Taraudage/Filetage 2	L2= Longueur 2 [mm]
GG Étrier de frein en fonte	langer Radstand Empattement long
Halter, Bremsleitung Support, conduite de frein	lastabhängig Fonction de la charge
Halter, Bremssattel Support, étrier de frein	Made in Pays constructeur du véhicule
Halter, Brems-schlauch Support, flexible de frein	Menge Quantité
Hauptbrems-zylinder Maître-cylindre de frein	mit Behälter avec réservoir
Herstellerein-schränkung Montage d'origine	mit Brems-flüssigkeits-behälter avec filtre déshydratant pour liquide de freins
	mit Brems-sattel-schrauben avec boulon/vis d'étrier de frein
	mit Doppel-bereifung avec pneus doubles
	mit Druck-regler avec régulateur de pression
	mit Entlüfter-ventil avec soupape de reniflard
	mit Führungs-bolzen avec boulon-guide

Technische Übersetzungen

Technical translations - Traducciones técnicas - Traductions techniques - Traduzioni tecniche

FR		FR	
Montageinformation beachten	Attention au infos de montage!	ohne Drucksensor	sans senseur de pression
Motorcode	Code moteur	ohne Steuergerät	sans appareil de commande
Nabendurchmesser [mm]	Diamètre du moyeu [mm]	Orga →	N° d'organisation à partir de
nicht für Baumuster	pas pour modèle type	passend für Felgengröße [Zoll]	va pour taille de jantes [pouces]
nicht für Doppelbereifung	pas pour pneus doubles	Pedalwegsensor, Bremspedal	Capteur de course, pédale de frein
nicht für ESP	pas pour ESP	pneumatisch	pneumatique
nicht für Fahrschulwagen	pas pour véhicules d'auto-école	Pol-Anzahl	Nombres de pôles
nicht für Fahrzeuge mit verstärkter Bremse	pas pour véhicules avec frein assisté	Prüfanschluss, Rohrleitungen	Raccord d'essai, tuyaux
nicht für gepanzerte Fahrzeuge	pas pour véhicules blindés	Radstand [mm]	Empattement [mm]
nicht für Getriebetyp	pas pour type de transmission	Reparatursatz, Bremsattel	Kit de réparation, étrier de frein
nicht für Polizeifahrzeuge	pas pour voitures de police	Reparatursatz, Hauptbremszylinder	Kit de réparation, maître-cylindre de frein
nicht für Sonderfahrzeuge	pas pour véhicules spéciaux	Ringstutzen, Rohrleitung	Raccord annulaire, tuyauterie
nur für Mineralöl	seulmt. pour huile minérale	Rückschlagventil	Soupape de retenue
nur in Verbindung mit	uniquement en connexion avec	Satz	Jeu
Nutzlast [kg]	Charge utile [kg]	Schalter, Bremsleuchte	Contacteur, feu stop
Nutzlast ab [kg]	Charge utile à partir de [kg]	Schaltgetriebe	boîte de vitesses manuelle
Nutzlast bis [kg]	Charge utile jusqu'à [lb]	Scheibenbremse	Frein à disque
OE-Hersteller		Schlauch	Tuyau
OE-Nummer		Schlüsselweite	Ouverture de la clé
OE-Referenz		Schrägheck	3/5 portes
ohne Bremsflüssigkeitsbehälter	sans réservoir du liquide de frein	Schraubanschluss	Raccord fileté
		Schraubkontakt	Type de vis







Technische Übersetzungen

Technical translations - Traducciones tecnicas - Traductions techniques - Traduzioni tecniche

FR		FR	
schwarz	noir	Verschluss-schraube	Boulon de fermeture
- SCS	pour véhicules sans SCS	Verschluss-schraube, Hauptbrems-zylinder	Vis-bouchon, maître-cylindre de frein
Sortiment, Armaturen	Assortiment, robinetterie et accessoires	Vollautomatik	entièrement automatique
Sortiment, Befestigungselemente	Assortiment, éléments de fixation	weiß/lila	blanc/violet
Sortiment, Entlüfterschrauben	Assortiment, vis de purge d'air	x	Nombre de connexions
Spezialaufbau	Carrosserie spéciale	x	Largeur [mm] Hauteur [mm]
Steckerausführung	Type de fiche	Zubehör	Accessoires
Stopfen, Bremsflüssigkeitsbehälter	Bouchon, filtre déshydratant du liquide de frein	zusätzlich benötigter Artikel (Artikel-Nummer)	article supplémentaire (référence)
Stufenheck	A trois volumes	Ø	Diamètre [mm]
Textbaustein	module de texte	Ø "	Diamètre [pouces]
T-Form (T-Stück)	forme de T (pièce T)	Ø1	Diamètre 1 [mm]
Trommelbremse	Frein à tambour	Ø2	Diamètre 2 [mm]
TRW	Système de freinage, Lucas / TRW	→	Année à partir de N° de châssis à partir de
Türenanzahl	Nombre de portes	→	Année jusqu'à N° de châssis jusqu'à
Überwurfmutter	Écrou de raccord	→Orga	N° d'organisation jusqu'à
Überwurfschraube	Vis de raccord	→Ø	Diamètre jusqu'à [mm]
Ungarn	Hongrie		
Ventil, Unterdruckleitung	Soupape, tuyau de dépression		
Verbindungs-/Verteilerstück, Rohrleitungen	Pièce de raccord / distributeur, tuyaux		
Verschluss, Bremsflüssigkeitsbehälter	Bouchon, réservoir du liquide		
Verschluss-/Schutzkappe	Capuchon de fermeture/de protection		

Technische Übersetzungen

Technical translations - Traducciones técnicas - Traductions techniques - Traduzioni tecniche

IT		IT	
	Cilindro maestro del freno	Ausgleichsbehälter, Bremsflüssigkeit	Serbatoio compensazione, Liquido freni
	Serbatoio compensazione	Außendurchmesser [mm]	Diametro esterno [mm]
	Modulatore frenata	Automatikgetriebe	Trasmissione automatica
	Servofreno	BDX	Sistema frenante, Bendix
	Sx	Bodenventil	Denominazione aggiuntiva dell'articolo, Vordruckventil
+ ABS	per veicoli con ABS	Bördelform	Forma bordatura
+ ASC	per veicoli con ASC	BOS	Sistema frenante, Bosch
+ ASR	per veicoli con ASR	Brems-/ Fahrdyn. Artikelbezug	Dinamica frenata/guida. Riferim. articolo
+ Diff	con blocco differenziale	Bremskraftregler	Modulatore frenata
+ DSC	per veicoli con DSC	Bremskraftverstärker	Servofreno
+ DSTC	per veicoli con DSTC	Bremsleitung	Tubazione freno
+ EDS	per veicoli con EDS	Brems-system	Sistema frenante
+ ESP	per veicoli con ESP	DEL	Sistema frenante, Delco
+ ETS	per veicoli con ETS	Dichtung, Unterdruck-Anschlüssen BKV	Guarnizione, Depressione-manicotto d'attacco servofreno
+ Halter	con supporto	Dichtungssatz, Brems-sattel	Kit guarnizioni, Pinza freno a disco
+ HBZ	con cilindro maestro del freno	- Diff	senza blocco differenziale
+PR	per N° PR	DIN/ISO	DIN/ISO
+ SCS	per veicoli con SCS	DIN 74235 Form EL	DIN 74235 Form EL
+ TCS	per veicoli con TCS	DIN 74235 Form FL	DIN 74235 Form FL
+ WE	con dispositivo d'allarme	druckabhängig	subordinato alla pressione
- ABS	per veicoli senza ABS	Drucksensor, Bremskraftverstärker	Sensore pressione, Servofreno
Adapter, Bremsleitung	Adattatore, Tubazione freno	- DSC	per veicoli senza DSC
ALU	Alluminio	- DSTC	per veicoli senza DSTC
Anschlussgewinde	Filettatura di raccordo		
Anschlüssen, Schlauchleitung	Bocchettone raccordo, tubo flessibile		
Anzahl der Bohrungen	N° fori		
- ASC	per veicoli senza ASC		
- ASR	per veicoli senza ASR		



Technische Übersetzungen

Technical translations - Traducciones técnicas - Traductions techniques - Traduzioni tecniche

IT		IT	
Durchmesser Aufnahme [mm]	Diametro sede [mm]	für Fahrzeuge mit AMG-Sportpaket	per veicoli con pacchetto sportivo AMG
E	E	für Fahrzeuge mit autom. Distanzregelung	per veicoli con regolatore automatico distanza
- EDS	per veicoli senza EDS	für Fahrzeuge mit Bremsassistent	per veicoli con brake assist
elektrisch-hydraulisch	elettrico-idraulico	für Fahrzeuge mit Bremskraftverstärker	per veicoli con servofreno
Entlüfterschraube/-ventil	Vite / Valvola di sfiato	für Fahrzeuge mit elektronischer Fahrdynamikregelung	per veicoli con regolazione elettronica dinamica di guida
EPDM (Ethylen-Propylen-Dien-Kautschuk)	EPDM (Etilene-Propilene-Diene-Caucciù)	für Fahrzeuge mit Kollisionswarner	per veicoli con segnale anticollisione
- ESP	per veicoli senza ESP	für Fahrzeuge mit Scheibenbremse an der Hinterachse	per veicoli con freni a disco ad assale posteriore
F	F	für Fahrzeuge mit Servolenkung	per veicoli con servosterzo
Feder, Bremssattel	Molla, Pinza freno	für Fahrzeuge mit Sportfahrwerk	per veicoli con autotelaio sportivo
Felge Lochzahl	Cerchione, N° fori	für Fahrzeuge mit Sportpaket	per veicoli con pacchetto sportivo
Flachstecker	Spina piatta	für Fahrzeuge mit Start-Stopp-Funktion	per veicoli con funzione di start-stop
Flanschbefestigung	Fissaggio a flangia		
FPM (Fluor-Kautschuk)/ACM (Polyacryl-Kautschuk)	FPM (Fluoro-Caucciù)/ACM (Poliacrilato-Caucciù)		
Frankreich	Francia		
Frontantrieb	Trazione anteriore		
Führungsbolzen, Bremssattel	Perno di guida, Pinza freno		
Führungshülse, Bremssattel	Manicotto guida, Pinza freno		
Führungshülzensatz, Bremssattel	Kit manicotti di guida, Pinza freno		
für ESP	per ESP		
für Fahrschulwagen	per vettura per scuola guida		

Technische Übersetzungen

Technical translations - Traducciones técnicas - Traductions techniques - Traduzioni tecniche

IT		IT	
für Fahrzeuge mit Trommelbremse an der Hinterachse	per veicoli con freni a tamburo ad assale posteriore	für Fahrzeuge ohne Sportfahrwerk	per veicoli senza autotelaio sportivo
für Fahrzeuge mit verstärktem Fahrwerk	per veicoli con autotelaio rinforzato	für Fahrzeuge ohne Sportpaket	per veicoli senza pacchetto sportivo
für Fahrzeuge mit verstärkter Bremse	per veicoli con freno rinforzato	für Fahrzeuge ohne Start-Stopp-Funktion	per veicoli senza funzione di start-stop
für Fahrzeuge ohne Aktivlenkung	per veicoli senza meccanismo sterzo attivo	für Fahrzeuge ohne verstärktes Fahrwerk	per veicoli senza autotelaio rinforzato
für Fahrzeuge ohne AMG-Sportpaket	per veicoli senza pacchetto sportivo AMG	für Kolben-Ø [mm]	per pistone-Ø [mm]
für Fahrzeuge ohne autom. Distanzregelung	per veicoli senza regolatore automatico distanza	für Linkslenker	per veicolo con guida a Sx
für Fahrzeuge ohne Bremsassistent	per veicoli senza brake assist	für OE-Nummer	per N° OE
für Fahrzeuge ohne Bremskraftverstärker	per veicoli senza servofreno	für Rechtslenker	per veicolo con guida a Dx
für Fahrzeuge ohne elektronische Fahrdynamikregelung	per veicoli senza regolazione elettronica dinamica guida	Generischer Artikel	Numero generico dell'articolo
für Fahrzeuge ohne Keramikbremse	per veicoli senza freni in ceramica	Getriebetyp	Tipo di trasmissione
für Fahrzeuge ohne Kollisionswarner	per veicoli senza segnale anticollisione	Gewindeausführung	Versione filettatura
für Fahrzeuge ohne Niveauregulierung	per veicoli senza impianto correzione altezza	Gewindelänge [mm]	Lunghezza filettatura [mm]
		Gewindemaß 1	Dimensioni filettatura 1
		Gewindemaß 2	Dimensioni filettatura 2
		GG	Pinza freno in ghisa
		Halter, Bremsleitung	Supporto, Tubazione freno
		Halter, Bremssattel	Supporto, Pinza freno
		Halter, Brems-schlauch	Supporto, Flessibile freno
		Hauptbremszylinder	Cilindro maestro del freno
		Herstellereinschränkung	Limitazione costruttore



Technische Übersetzungen

Technical translations - Traducciones técnicas - Traductions techniques - Traduzioni tecniche

IT		IT	
Hohl-schraube	Vite cava	Montagein-formation beachten	Osservare info montaggio
hyd.	idraulico	Motorcode	Codice motore
Hydraulikag-gregat, Bremsanlage	Gruppo idraulico, Sistema frenante	Nabendurch-messer [mm]	Diametro mozzo [mm]
hydraulisch	idraulico	nicht für Baumuster	non per modello
Informati-onsart	Tipo informazione	nicht für Doppelberei-fung	Non per pneumatici gemellati
Innendurch-messer [mm]	Diametro interno [mm]	nicht für ESP	Non per ESP
Innensechs-kant	Ad esagono incassato	nicht für Fahrschul-wagen	Non per vettura per scuola guida
Kasten/ Kombi	Cassone / Furgonato / Promiscuo	nicht für Fahrzeuge mit verstärkter Bremse	Non per veicoli con freno rinforzato
Kunststoff	Plastica	nicht für gepanzerte Fahrzeuge	Non per veicoli corazzati
kurzer Radstand	Passo ruote corto	nicht für Getriebetyp	non per tipo di trasmissione
L=	Lunghezza [mm]	nicht für Poli-zeifahrzeuge	Non per mezzi della polizia
L=	Lunghezza totale [mm]	nicht für Sonderfahr-zeuge	Non per veicoli speciali
L1=	Lunghezza 1 [mm]	nur für Mine-ralöl	Solo per olio minerale
L2=	Lunghezza 2 [mm]	nur in Verbin-dung mit	solo unitamente a
langer Radstand	Passo ruote lungo	Nutzlast [kg]	Portata utile [kg]
lastabhängig	subordinato al carico	Nutzlast ab [kg]	Portata utile da [kg]
Made in	Paese produzione veicolo	Nutzlast bis [kg]	Portata utile fino a [kg]
Menge	Quantità	OE-Hersteller	
mit Behälter	con contenitore	OE-Nummer	
mit Brems-flüssigkeits-behälter	con serbatoio liquido freni	OE-Referenz	
mit Brems-sattel-schrauben	con bulloni pinza freno	ohne Brems-flüssigkeits-behälter	senza serbatoio liquido freni
mit Doppel-bereifung	con pneumatici gemellati		
mit Druck-regler	con regolatore di pressione		
mit Entlüfter-ventil	con valvola di sfiato		
mit Führungs-bolzen	con guidanastro		

Technische Übersetzungen

Technical translations - Traducciones técnicas - Traductions techniques - Traduzioni tecniche

IT		IT	
ohne Druck-sensor	senza sensore pressione	schwarz	nero
ohne Steuer-gerät	senza centralina	- SCS	per veicoli senza SCS
Orga →	N° organizzazione da	Sortiment, Armaturen	Assortimento, Strumentazione
passend für Felgenreöße [Zoll]	idoneo per misura cerchione [pollici]	Sortiment, Befestigungselemente	Assortimento, Elementi di fissaggio
Pedalweg-sensor, Bremspedal	Sensore corsa pedale, Pedale del freno	Sortiment, Entlüfterschrauben	Assortimento, Bulloni spurgo aria
pneumatisch	pneumatico	Spezialaufbau	Carrozzeria speciale
Pol-Anzahl	N° poli	Steckerausführung	Tipo spina
Prüfan-schluss, Rohrlei-tungen	Collegamento di controllo, tubazioni	Stopfen, Bremsflüs-sigkeitsbe-hälter	Tappo, Serbatoio liquido freni
Radstand [mm]	Passo ruote [mm]	Stufenheck	Tre volumi
Reparatur-satz, Brems-sattel	Kit riparazione, Pinza freno	Textbaustein	
Reparatur-satz, Haupt-bremszy-linder	Kit riparazione, cilindro maestro del freno	T-Form (T-Stück)	Forma a T (pezzo T)
Ringstutzen, Rohrleitung	Bocchettone anulare, Tubazione	Trommel-bremse	Freno a tamburo
Rückschlag-ventil	Valvola di non ritorno	TRW	Sistema frenante, Lucas / TRW
Satz	Serie / Kit	Türenanzahl	N° portiere
Schalter, Brems-leuchte	Interruttore, Luce posteriore di stop	Überwurf-mutter	Dado a risvolto
Schaltge-triebe	Cambio manuale	Überwurf-schraube	Vite a cappello
Scheiben-bremse	Freno a disco	Ungarn	Ungheria
Schlauch	Flessibile	Ventil, Unter-druckleitung	Valvola, Condotto depressione
Schlüssel-weite	Apertura chiave	Verbin-dungs-/ Verteiler-stück, Rohr-leitungen	Pezzo di raccordo / Ripartitore, Tubazioni
Schrägheck	2 volumi /Coda spiovente	Verschluss, Bremsflüs-sigkeitsbe-hälter	Chiusura, serbatoio liquido freni
Schraub-an-schluss	Raccordo a vite	Verschluss-/ Schutzkappe	Cappa di chiusura/protezione
Schraubkon-takt	Contatto a vite		

Technische Übersetzungen

Technical translations - Traducciones tecnicas - Traductions techniques - Traduzioni tecniche

IT	
Verschluss-schraube	Vite di chiusura
Verschluss-schraube, Hauptbrems-zylinder	Tappo filet., cilindro maestro del freno
Vollautomatik	Interamente automatizzato
weiß/lila	bianco/lilla
x	N° raccordi
x	Larghezza [mm] Altezza [mm]
Zubehör	Accessori
zusätzlich benötigter Artikel (Artikel-Nummer)	Articolo supplementare occorrente (N° articolo)
Ø	Diametro [mm]
Ø "	Diametro [pollici]
Ø1	Diametro 1 [mm]
Ø2	Diametro 2 [mm]
→	Anno da N° telaio da
→	Anno fino a N° telaio fino a
→Orga	N° organizzazione fino a
→Ø	Diametro fino a [mm]

ATE – A Trademark of the
Continental Corporation

Continental Aftermarket GmbH

Guerickestraße 7
D-60488 Frankfurt am Main
Tel. +49 (0) 69 7603-1
Fax +49 (0) 69 761061

www.ate.de

**Continental Automotive Trading
Italia S.r.l.**

Divisione ATE
Via Matteotti, 62
I-20092 Cinisello Balsamo (MI)
Tel. +39 02 35680 1
Fax +39 02 35680 325
E-Mail: info.consumatori@continental-corporation.com

www.ate-freni.it

Continental AutomotiveFrance SAS

Parc Ariane Bâtiment Vénus
Rue Hélène Boucher
F-78280 Guyancourt
Tél. +33 (0)1 39 44 10 30
Fax +33 (0)1 39 44 10 40
E-Mail: 07GYFMate-technique@continental-corporation.com

www.ate-freinage.fr

Continental Automotive Spain, S.A.

C/ Sepúlveda, 11
E-28108 Alcobendas (Madrid)
Phone +34 (0) 657 21 21
Fax +34 (0)91 657 21 49

www.frenos-ate.es

