

2018

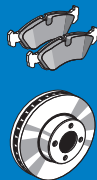

Scheibenbremsen Disc Brakes
Bremsen-Ersatzteilprogramm Brake Parts Program



Scheibenbremsen Disc Brakes

2018

Bremsen-Ersatzteilprogramm

Brake Parts Program



Brakethrough Technology



Erstklassig First-class

Besser ist besser

Wenn es um Qualität geht, genügt uns ein „sehr gut“ noch lange nicht. Wir erfüllen hohe Ansprüche an das Qualitätsmanagement und die europäische Sicherheitsnorm ECE-R90 wird von ATE sogar übertroffen. Zudem führen wir zahlreiche zusätzliche Tests durch, unter anderem zu Verschleiß und Wärmeleistung.

Auch Nachhaltigkeit ist uns wichtig: Wir stellen die Mischungen für ATE Bremsbeläge auf kupferfreie Materialien um und setzen bei ATE Ceramic auf geringen Abrieb. Nutzen ausschließlich umweltfreundliches Material für die Beschichtung von Bremsscheiben. Und bereiten Produkte wie Bremsattel wieder auf.

Better is better

When it comes to quality, “very good” is simply not good enough for us. We meet high standards of quality management – and ATE even exceeds the European safety standard ECE-R90. We also perform many additional tests, including wear and thermal performance.

Sustainability is also important to us: we convert the compounds for ATE brake pads to copperfree materials and opt for low abrasion with ATE Ceramic. We only use environmentally friendly material for the coating of brake discs – and we remanufacture products like brake callipers.

Original? Mit Sicherheit

Qualität ist für uns nicht nur während der Produktentwicklung und vor der Auslieferung ein Thema. Nach dem Kauf können Sie jederzeit überprüfen, ob Sie ein Original ATE Produkt vor sich haben – über ein zweistufiges Sicherheitsetikett.

Die erste Stufe ist der tesa Priospot®. Hier wurden die Merkmale des tesa Holospot® – der nach wie vor höchste Sicherheit bietet – noch weiter entwickelt. Die fälschungssichere Holografie-Technik mit verschiedenen Prüf- und Sicherheitsmechanismen schützt sogar das Etikett selbst vor Nachahmern.

Die zweite Stufe ist ein DataMatrix-Code, kurz MAPP-Code. Dessen letzte vier Ziffern werden auch im Holospot® bzw. Priospot® dargestellt – für ein Höchstmaß an Sicherheit.

Der Code kann per Scanner oder durch manuelle Eingabe auf der ATE Website überprüft werden und zeigt sofort an, ob es sich bei dem Produkt um ein Originalteil handelt. In Verbindung mit entsprechender Software wie der ATE App ist auch die Abfrage per Smartphone möglich.



Mehrstufiges ATE Sicherheits-etikett mit DataMatrix-Code (Mitte) und Tesa Priospot® (oben rechts).

Multi-stage ATE security label with Data Matrix code (centre) and tesa Priospot® (top right).

Zur Online-Abfrage und zum App-Download:
www.ate.de/original

To online verification and app download:
www.ate-brakes.com/original



Wir engagieren uns bei MAPP –
Manufacturers against Product Piracy.

We are committed to MAPP –
Manufacturers against Product Piracy.

Einfach mehr Tests: ATE Bremsbeläge More tests: ATE brake pads

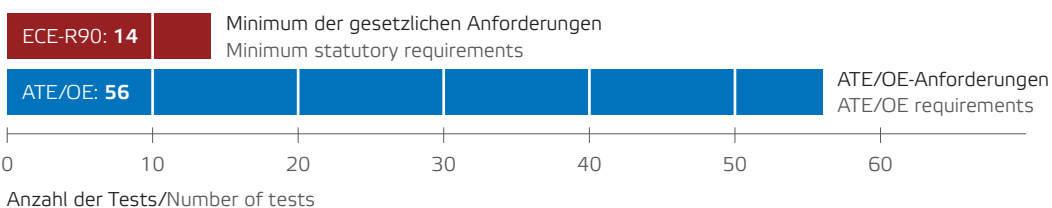

Bremsbeläge

Eine Klasse für sich

Brake pads

A class of their own

ATE Original Bremsbeläge

Andere Hersteller nutzen für Bremsbeläge zehn verschiedene Belagmischungen. Bei uns sind es mehr als 150 und unsere internen Tests sind weit strenger, als es die gesetzlichen Bestimmungen erfordern. So bieten wir für jeden Fahrzeugtyp den optimalen Bremsbelag – mit 98 Prozent Abdeckung in Europa, und das überwiegend mit Original-Erstausrüster-Mischungen. Dabei können sich die Autofahrer auf maximale Sicherheit ebenso verlassen wie auf maximalen Komfort. Es gibt eben nur ein Original.

ATE Original brake pads

Other manufacturers use ten different compounds for their brake pads. We use more than 150 – and our internal tests are far more stringent than required by the regulations. That's why we offer the optimum brake pad for every type of vehicle – with 98 per cent coverage in Europe, mainly with original equipment manufacturer compounds. So motorists can rely on maximum safety and maximum comfort. There is only one original.

ATE Ceramic Bremsbeläge

Wirklich eine saubere Sache. Durch die innovative Belagmischung entsteht bei ATE Ceramic Bremsbelägen nur sehr wenig Abrieb, der zudem kaum haftet. Deshalb setzt sich praktisch kein Bremsstaub ab und schöne Felgen behalten viel länger ihren Glanz. Ceramic Bremsbeläge sind so sicher wie ein konventioneller Belag, besonders langlebig und ideal in Kombination mit den beschichteten ATE Bremsscheiben. Und es gibt noch einen weiteren Vorteil: Sie lassen sich ganz einfach statt der üblichen Bremsbeläge einbauen.

ATE Ceramic brake pads

A clean solution. The innovative ATE Ceramic formula produces very few abraded particles, and they have hardly any adhesive characteristics. This means that hardly any brake dust settles and shiny wheel rims retain their lustre much longer. Ceramic brake pads are as safe as conventional pads, are particularly durable and ideal when used in combination with the coated ATE brake discs. Yet another advantage? They can be easily installed instead of the usual brake pads.

Auf unserer Website www.ate.de/originalbelag können Sie sich näher informieren.

Learn more on our website at www.ate-brakes.com/originalpad

Auf unserer Website www.ate.de/ceramic erfahren Sie mehr.

Learn more on our website at www.ate-brakes.com/ceramic



Bremsverhalten von Original ATE Bremsbelägen

Braking behaviour of ATE Original brake pads

Reibwert beim ersten Einbremsen der Beläge
Coefficient of friction at first application of the pads



Reibwert bei kaltem Bremssystem
Coefficient of friction with cold braking system



Reibwert beim Herunterbremsen aus hohen Geschwindigkeiten
Coefficient of friction when slowing from high speeds



Reibwert, wenn zum ersten Mal im Hochtemperaturbereich gebremst wird
Coefficient of friction when first used at high temperature



■ ATE Original Bremsbeläge / ATE Original brake pads
■ Standardbelag eines Wettbewerbers / Competitor's standard brake pads



Bremsscheiben Für jeden Anspruch die Richtige

Brake discs

The right one for every requirement

Die Details zur ATE Bremsscheiben finden Sie auf unserer Website
www.ate.de/produkte/scheibenbremsen/original-ate-bremsscheiben

You'll find more details about the ATE brake discs on our website at
www.ate.de/produkte/scheibenbremsen/original-ate-bremsscheiben





Alles für die optimale Bremsleistung

Es gibt so viele unterschiedliche Fahrzeugmodelle und Anforderungen – ATE hat für jeden Bedarf die richtigen Bremscheiben. Präzise gefertigt aus hervorragenden Erstausrüster-Materialien und in einer Qualität, die die ECE-R90-Norm schon heute im nahezu gesamten Portfolio übertrifft. Besser gehts nicht.

Original ATE Bremscheiben

In Original ATE Bremscheiben stecken durchdachte Technologie, hochwertige Materialien und unser ganzes Know-how. Sie entsprechen genau den Bremscheiben, die vom Hersteller verbaut wurden: Ob glatt, gelocht oder genutet, hochgekohlt, einteilig, gestiftet oder genietet, mit oder ohne Radlager – wir haben immer die passende Lösung für sicheres und komfortables Bremsen. Und auch den passenden Belag dazu. Eine gute Kombination sind zum Beispiel beschichtete Bremscheiben und die staubarmen ATE Ceramic Bremsbeläge oder natürlich unsere Original Bremsbeläge. Die Original ATE Bremscheiben sind mit 98 Prozent Abdeckung in Europa verfügbar und auch – wenn der Fahrzeughersteller es vorgibt – mit Befestigungsschrauben erhältlich.

Everything for optimal braking performance

There are so many different vehicle models and requirements – and ATE has the right brake disc for each one. Precisely manufactured from excellent OEM materials, the quality of which already surpasses the ECE-R90 standard throughout most of our portfolio. It just couldn't get any better.

Original ATE brake discs

ATE brake discs are packed full of sophisticated technology, high-quality materials and our entire expertise. They correspond exactly to the brake discs originally installed by the manufacturer. Whether smooth, perforated or grooved, high-carbon, one-piece, pinned or riveted and with or without wheel bearings – we always have the right solution for safe and comfortable braking. With the matching brake pad too. One good combination, for example – our coated brake discs and the low-dust ATE Ceramic brake pads, or our Original brake pads of course. Original ATE brake discs are available in 98 per cent of European countries and are also available with wheel bearings or – if prescribed by the vehicle manufacturer – with fixing screws.



ATE PowerDisc
ATE PowerDisc



Beschichtete Bremscheibe mit Befestigungsschrauben
Coated brake disc with fixing screws



Beschichtete zweiteilige Bremscheibe
Coated two-piece brake disc



Bremscheibe mit Radlager
Brake discs with wheel



Mehr als sicher More than safe

Bremsflüssigkeiten

ATE hat für jedes Fahrzeugmodell und jede Fahrweise die optimale Bremsflüssigkeit. Und alle lassen die gesetzlichen und technischen Standards weit hinter sich. Das Highlight für elektronische Bremssysteme: ATE SL.6. Die dünnflüssige Textur sorgt bei Niedrigtemperaturen für eine schnelle Reaktion von ABS oder ESP® – und so für höchste Sicherheit.

Brake fluids

ATE has the optimal brake fluid for every vehicle model and every driving style – and all our fluids leave the legal and technical standards far behind. Our highlight for electronic braking systems – the ATE SL.6. The low-viscosity texture ensures a quick response from ABS or ESP® at low temperatures, guaranteeing maximum safety.

Die Eigenschaften von ATE Bremsflüssigkeiten

The properties of ATE brake fluids

	Siedepunkt Boiling point	Nass-Siedepunkt Wet boiling point	Viskosität bei -40°C Viscosity at -40°C	Wechselintervall Replacement interval
ATE G DOT 3	min. 245°C	min. 150°C	max. 1.500 mm ² /s max. 1,500 mm ² /s	bis 1 Jahr up to 1 year
ATE SL DOT 4	min. 260°C	min. 165°C	max. 1.400 mm ² /s max. 1,400 mm ² /s	bis 1 Jahr up to 1 year
ATE SL.6 DOT 4 Ideal für/Ideal for ESP®, ABS, ASR	min. 265°C	min. 175°C	max. 700 mm ² /s	bis 2 Jahre up to 2 years
ATE TYP 200 DOT 4 New Racing Quality	min. 280°C	min. 198°C	max. 1.400 mm ² /s max. 1,400 mm ² /s	bis 3 Jahre up to 3 years
ATE SUPER DOT 4	min. 260°C	min. 180°C	max. 1.400 mm ² /s max. 1,400 mm ² /s	bis 2 Jahre up to 2 years



Typ Type	ATE Sachnummer ATE partnumber	EAN-Nr. 4006633 EAN-No. 4006633	Gebinde Container size	Paletteneinheit* Pallet unit*
G SAE Spezifikation J1703 FMVSS §571.116/DOT 3	705302 03.9901-5302.2/02	10199 8	1 l	D
	705303 03.9901-5303.2/02	10201 8	5 l	F
größere Gebinde auf Anfrage – Bigger container sizes on demand				
SL SAE Spezifikation J1704 FMVSS §571.116/DOT 4	705808 03.9901-5808.2/02	49000 9	1/4 l	A
	705801 03.9901-5801.2/02	49001 6	1/2 l	B
	705802 03.9901-5802.2/02	49002 3	1 l	D
	705803 03.9901-5803.2/02	49003 0	5 l	F
	705811 03.9901-5811.2/02	29907 7	20 l	R
	705820 03.9901-5820.2/01	10824 9	30 l	H
	705814 03.9901-5814.2/01	10366 4	50 l	P
	705805 03.9901-5805.2/01	49005 4	200 l	S
SL.6 SAE Spezifikation J1704 FMVSS §571.116/ DOT 4 ISO 4925. Klasse 6 – niedrigviskos	706408 03.9901-6408.2/02	22762 9	1/4 l	A
	706402 03.9901-6402.2/02	20746 1	1 l	D
	706403 03.9901-6403.2/02	20748 5	5 l	F
	706411 03.9901-6411.2/02	20750 8	20 l	R
	706420 03.9901-6420.2/02	23120 6	30 l	H
	706414 03.9901-6414.2/02	23005 6	50 l	P
	706405 03.9901-6405.2/02	23121 3	200 l	S
TYP 200 New racing quality SAE Spezifikation J1704 FMVSS §571.116/DOT 4	706202 03.9901-6202.2/02	10825 6	1 l	D
	706203 03.9901-6203.2/02	12166 8	5 l	F
	706220 03.9901-6220.2/01	12780 6	30 l	H
	706214 03.9901-6214.2/01	12779 0	50 l	P
	706205 03.9901-6205.2/01	12778 3	200 l	S
SUPER DOT 4 SAE Spezifikation J1704 FMVSS §571.116/DOT 4	706003 03.9901-6003.2/02	06249 7	5 l	F
	706020 03.9901-6020.2/01	14544 2	30 l	H
	706005 03.9901-6005.2/01	07769 9	200 l	S
ATE Bremszylinder-Paste ATE Brake Cylinder Paste	700009 03.9902-05XX.2/02	13536 8	180 g	L
	700010 03.9902-0503.2/01	13532 0	5 kg	K
	700011 03.9902-0504.2/01	13530 6	40 kg	P
ATE Prüfflüssigkeit ATE Testing Fluid	700002 03.9902-0116.2/02	10374 9	5 l	F
ATE plastilube™	700014 03.9902-1001.2/02	05176 7	35 ml	I
	700015 03.9902-1002.2/02	05184 2	75 ml	J
ATE Leerkanne ATE neutral empty container	740169 03.9302-1474.1/01	07782 8	25 l	S
Ausgiesser für 5-l-Kanne Spout for 5l container	760070 03.9314-5940.3/01	07786 6	1 St.	S
Kannen-Auslass-Hahn für 5-l- und 20-l-Kanne Tap for 5l and 20l tin	760153 03.9314-5960.3/02	30855 7	1 St.	S

***Paletteneinheit:**

A =	1.728 Kannen je Palette	(24 Kannen je Karton)
B =	1.200 Kannen je Palette	(20 Kannen je Karton)
D =	600 Kannen je Palette	(10 Kannen je Karton)
E =	360 Kannen je Palette	(10 Kannen je Karton)
F =	144 Kannen je Palette	(4 Kannen je Karton)
G =	50 Kannen je Palette	
H =	22 Kannen je Palette	
I =	5.040 Tuben je Palette	(24 Tuben je Karton)
J =	1.728 Tuben je Palette	(12 Tuben je Karton)
K =	60 Eimer je Palette	
L =	1.800 Tuben je Palette	(40 Tuben je Karton)
M =	18 Kannen je Palette	
N =	300 Kannen je Palette	(10 Kannen je Karton)
O =	64 Kannen je Palette	(4 Kannen je Karton)
P =	12 Kannen je Palette	
R =	36 Kannen je Palette	
S =	1 Stück	

***Pallet unit:**

A =	1.728 containers per pallet	(24 containers per box)
B =	1.200 containers per pallet	(20 containers per box)
D =	600 containers per pallet	(10 containers per box)
E =	360 containers per pallet	(10 containers per box)
F =	144 containers per pallet	(4 containers per box)
G =	50 containers per pallet	
H =	22 containers per pallet	
I =	5.040 tubes per pallet	(24 tubes per box)
J =	1.728 tubes per pallet	(12 tubes per box)
K =	60 buckets per pallet	
L =	1.800 tubes per pallet	(40 tubes per box)
M =	18 containers per pallet	
N =	300 containers per pallet	(10 tubes per box)
O =	64 containers per pallet	(4 containers per box)
P =	12 containers per pallet	
R =	36 containers per pallet	
S =	1 piece	

Mit sicherer Hand With a steady hand

Einen Überblick über alle Geräte und Werkzeuge bietet Ihnen unser Werkzeugkatalog unter www.ate-info.de

For an overview of all the equipment and tools, see our tool catalogue at www.ate-info.de



Test- und Prüfgeräte

Ob Sie Bremsflüssigkeit, Sensoren oder andere Komponenten testen: ATE Geräte und die passenden Werkzeuge sind exakt und zuverlässig – das macht die Bremsendiagnose einfacher.

Test and inspection equipment

Whether you're testing brake fluid, sensors or other components, ATE devices and their matching tools are accurate and reliable – and that makes brake diagnosis much easier.



Entlüftungsgeräte

Bremsen schnell und effektiv entlüften: Sie haben die Wahl unter verschiedenen Geräten für unterschiedliche Fahrzeugtypen und Bremssysteme – auch mit integrierter Absauganlage.

Brake bleeding units

Bleeding brakes quickly and effectively: choose from different units for different vehicle models and braking systems – integrated exhaust extraction systems are also available.

Professionelle Ausstattung

Werkzeuge und Geräte von ATE sind genau auf unsere Produkte und Services abgestimmt. Das erleichtert Ihnen die Arbeit und gibt Ihnen die Sicherheit, immer einen zuverlässigen Job zu machen. Und wenn es um Fahrzeugelektronik geht, sind VDO Ersatzteile und Services die ideale Ergänzung.

Professional equipment

ATE tools and devices are customised to exactly match our products and services. This makes your work easier and gives you the assurance that you're doing a dependable job. When it comes to vehicle electronics, VDO spare parts and services are also the perfect additions to your equipment.



Entsorgungsgeräte

Um gebrauchte Bremsflüssigkeit umwelt-schonend und kostengünstig zu entsorgen, muss sie zunächst sortenrein gesammelt werden. Kein Problem mit unseren Entsorgungssystemen.

Disposal devices

To dispose of used brake fluid in an environmentally friendly and cost-effective way, it must first be sorted into different types. That's no problem with our disposal systems.



Spezial-Werkzeuge

Bei ATE finden Sie alles, was Sie für den Einbau und die Wartung der verschiedenen Bremsenkomponenten brauchen – in Top-Qualität und genau auf die Anwendung abgestimmt.

Special tools

At ATE, you'll find everything you need for the installation and maintenance of different brake components – all in top quality and exactly tailored to suit their purpose.

Noch besser sein Be even better

Technische Trainings für ATE

Alles, was Sie zum Thema Bremsen-
wartung und -diagnose wissen
müssen, anschaulich und praxis-
orientiert vermittelt. Zum Beispiel:

- | Diagnose und Instandhaltung
moderner Bremsanlagen
- | Direktannahme: So nutzen Sie
Potenziale für Ihr Geschäft
- | ATE Classic Training zu Bremsen
für Old- und Youngtimer

Technische Trainings für VDO

In Fahrzeugen werden immer mehr
Elektronik- und Mechatronik-Teile ver-
baut – bleiben Sie auf dem Laufenden.
Einige Themen:

- | Elektrische Grundlagenpraxis
am Beispiel ATE/VDO
- | Reifendruckkontrollsysteme in
der Werkstatt-Praxis
- | Diesel: moderne Common-Rail-
Einspritzsysteme

Produkt- und Verkaufstrainings

Steigern Sie Ihren Geschäftserfolg
durch motivierte Mitarbeiter und
neue Angebote für Ihre Kunden.
Unter anderem mit diesen Trainings:

- | Produkttraining für aktuelle VDO
Mehrmarken-Tester
- | Gewährleistung als geschäftliche
Chance nutzen
- | Mitarbeiterführung und Entwicklung
für Kfz-Betriebe

Die Vorteile für ATE BremsenCenter

Sie nehmen an speziellen Informationsveranstaltungen und Trainings teil,
die eigens für ATE BremsenCenter konzipiert wurden. Regelmäßige fach-
spezifische Qualifikationen für Sie und Ihre Mitarbeiter sind kostenfrei.

The benefits for ATE BrakeCenters

You take part in special information events and training courses that have
been specially designed for ATE BrakeCenters. Regular training for you and
your employees is free of charge.



Unter www.morecontinental.com finden Sie eine Auswahl aus dem aktuellen Trainingsprogramm.

A selection from the current training programme is available at www.morecontinental.com



Technical ATE training courses

Everything you need to know about brake maintenance and diagnosis, presented clearly and with a practical emphasis. For example:

- | Diagnosis and maintenance of modern brake systems
- | Service reception bay: helping you to utilise all the potential opportunities for your business
- | ATE Classic training for vintage and classic car brakes

Technical VDO training courses

More and more electronic and mechatronic parts are being installed in today's vehicles – stay up to date! Some topics:

- | Basic electrical practice using ATE/VDO as an example
- | Tyre pressure monitoring systems used in workshop tasks
- | Diesel: modern common-rail injection systems

Product and sales training courses

Increase your business success through motivated employees and new offers for your customers – with these training courses (and more):

- | Product training for current VDO multibrand testers
- | Using a warranty as a business opportunity
- | Leadership and development for vehicle workshops



DE Inhaltsverzeichnis

Neue Artikel	15
Ersetzte Artikel	21
Fahrzeugregister	23
Fahrzeugverwendungen	34
Abbildungen Scheibenbremsbeläge	1663
Abbildungen Bremsbelag-Einbausätze	1975
Abbildungen Warnkontakte	1993
Abmessungen Bremsscheiben	2033
Vergleichsliste WVA → ATE	2057
Vergleichsliste ATE → WVA	2065
Technische Übersetzungen	2073

EN Table of contents

New parts	15
Replaced parts	21
Index of vehicles	23
Applications of vehicles	34
Illustrations disc brake pads	1663
Illustrations brake pad installation kits	1975
Illustrations wear indicators	1993
Dimensions brake discs	2033
Cross reference list WVA → ATE	2057
Cross reference list ATE → WVA	2065
Technical translations	2073

ES Índice

Nuevas referencias	15
Referencias de sustitución	21
Índice de vehículos	23
Aplicaciones	34
Ilustraciones de pastillas	1663
Ilustraciones juegos de montaje pastillas	1975
Ilustraciones contactos de desgaste	1993
Medidas disco de freno	2033
Lista referencias WVA → ATE	2057
Lista referencias ATE → WVA	2065
Traducciones técnicas	2073

FR Table des matières

Nouvelles références	15
Références remplacées	21
Liste des véhicules	23
Applications	34
Illustrations Plaquettes de frein à disque	1663
Illustrations Lots de montage pour plaquettes de frein à disque	1975
Illustrations témoins d'usure	1993
Dimensions Disques de frein	2033
Liste des correspondances WVA → ATE	2057
Liste des correspondances ATE → WVA	2065
Traductions techniques	2073

IT Sommario

Codici nuovi	15
Codici sostitutivi	21
Indice autovetture	23
Applicazioni autoveicoli	34
Illustrazioni Pastiglie Freno	1663
Illustrazioni kit installazione pastiglie freno	1975
Illustrazioni rilevatori usura	1993
Misure dischi freno	2033
Tabella di conversione codici WVA → ATE	2057
Tabella di conversione codici ATE → WVA	2065
Traduzioni tecniche	2073



DE Neue Artikel

EN New parts

ES Nuevas referencias

FR Nouvelles références



IT Codici nuovi

2018



Neue Artikel

New parts - Nuevas referencias - Nouvelles références - Codici nuovi

			
13.0460-2604.2	602604 LAND ROVER RANGE ROVER IV (LG_)	13.0460-2749.2	602749 VW PASSAT CC (357)
13.0460-2604.2	602604 LAND ROVER RANGE ROVER SPORT (LW_)	13.0460-2749.2	602749 VW PASSAT Variant (3C5)
13.0460-2605.2	602605 FORD FIESTA VI	13.0460-2749.2	602749 VW PASSAT Variant (365)
13.0460-2605.2	602605 FORD FIESTA VI Van	13.0460-2749.2	602749 VW SCIROCCO (137, 138)
13.0460-2605.2	602605 FORD FIESTA Stufenheck	13.0460-2749.2	602749 VW SHARAN (7N1, 7N2)
13.0460-2605.2	602605 FORD KA+	13.0460-2749.2	602749 VW TIGUAN (5N_)
13.0460-2610.2	602610 MERCEDES-BENZ C-CLASS (W205)	13.0460-2749.2	602749 VW TOURAN (1T1, 1T2)
13.0460-2610.2	602610 MERCEDES-BENZ C-CLASS Cabriolet (A205)	13.0460-2749.2	602749 VW TOURAN (1T3)
13.0460-2610.2	602610 MERCEDES-BENZ C-CLASS Coupe (C205)	13.0460-2790.2	602790 AUDI A1 (8X1, 8XK)
13.0460-2610.2	602610 MERCEDES-BENZ C-CLASS T-Model (S205)	13.0460-2790.2	602790 AUDI A1 Sportback (8XA, 8XF)
13.0460-2610.2	602610 MERCEDES-BENZ E-CLASS (W213)	13.0460-2790.2	602790 AUDI Q3 (8U)
13.0460-2610.2	602610 MERCEDES-BENZ E-CLASS All-Terrain (S213)	13.0460-2790.2	602790 SEAT ALHAMBRA (710, 711)
13.0460-2610.2	602610 MERCEDES-BENZ E-CLASS Cabriolet (A238)	13.0460-2790.2	602790 SEAT LEON (5F1)
13.0460-2610.2	602610 MERCEDES-BENZ E-CLASS Coupe (C238)	13.0460-2790.2	602790 SEAT LEON SC (5F5)
13.0460-2610.2	602610 MERCEDES-BENZ E-CLASS T-Model (S213)	13.0460-2790.2	602790 SEAT LEON ST (5F8)
13.0460-2749.2	602749 AUDI A3 (8P1)	13.0460-2790.2	602790 SKODA OCTAVIA III (5E3)
13.0460-2749.2	602749 AUDI A3 Cabriolet (8P7)	13.0460-2790.2	602790 SKODA OCTAVIA III Combi (5E5)
13.0460-2749.2	602749 AUDI A3 Sportback (8PA)	13.0460-2790.2	602790 VW CADDY IV Kasten (SAA, SAH)
13.0460-2749.2	602749 AUDI A4 (8E2, B6)	13.0460-2790.2	602790 VW CADDY IV Kombi (SAB, SAJ)
13.0460-2749.2	602749 AUDI A4 (8EC, B7)	13.0460-2790.2	602790 VW CADDY ALLTRACK Kasten (SAA)
13.0460-2749.2	602749 AUDI A4 Avant (8E5, B6)	13.0460-2790.2	602790 VW CADDY ALLTRACK Kombi (SAB)
13.0460-2749.2	602749 AUDI A4 Avant (8ED, B7)	13.0460-2790.2	602790 VW SHARAN (7N1, 7N2)
13.0460-2749.2	602749 AUDI A4 Cabriolet (8H7, B6, 8HE, B7)	13.0460-2794.2	602794 KIA CEE'D Sportswagon (JD)
13.0460-2749.2	602749 AUDI A6 (4F2, C6)	13.0460-2794.2	602794 KIA CEE'D (JD)
13.0460-2749.2	602749 AUDI A6 Allroad (4FH, C6)	13.0460-2794.2	602794 KIA PRO CEE'D (JD)
13.0460-2749.2	602749 AUDI A6 Avant (4F5, C6)	13.0460-2795.2	602795 BMW 2 Active Tourer (F45)
13.0460-2749.2	602749 AUDI Q3 (8U)	13.0460-2795.2	602795 MINI MINI (F55)
13.0460-2749.2	602749 AUDI TT (8J3)	13.0460-2795.2	602795 MINI MINI (F56)
13.0460-2749.2	602749 AUDI TT Roadster (8J9)	13.0460-2795.2	602795 MINI MINI Cabriolet (F57)
13.0460-2749.2	602749 SEAT ALHAMBRA (710, 711)	13.0460-2795.2	602795 MINI MINI CLUBMAN (F54)
13.0460-2749.2	602749 SEAT ALTEA (5P1)	13.0460-2797.2	602797 MINI MINI (F55)
13.0460-2749.2	602749 SEAT EXEO (3R2)	13.0460-2797.2	602797 MINI MINI (F56)
13.0460-2749.2	602749 SEAT EXEO ST (3R5)	13.0460-2797.2	602797 MINI MINI Cabriolet (F57)
13.0460-2749.2	602749 SEAT LEON (1P1)	13.0460-3868.2	603868 TOYOTA AURIS (_E18_)
13.0460-2749.2	602749 SEAT LEON (5F1)	13.0460-3868.2	603868 TOYOTA AURIS TOURING SPORTS (_E18_)
13.0460-2749.2	602749 SEAT LEON SC (5F5)	13.0460-3868.2	603868 TOYOTA AURIS VAN Kasten (_E18_)
13.0460-2749.2	602749 SEAT LEON ST (5F8)	13.0460-3869.2	603869 PEUGEOT 308 II
13.0460-2749.2	602749 SEAT TOLEDO III (5P2)	13.0460-3869.2	603869 PEUGEOT 308 SW II
13.0460-2749.2	602749 SKODA OCTAVIA (1Z3)	13.0460-4880.2	604880 MERCEDES-BENZ C-CLASS (W205)
13.0460-2749.2	602749 SKODA OCTAVIA II Combi (1Z5)	13.0460-4880.2	604880 MERCEDES-BENZ C-CLASS Cabriolet (A205)
13.0460-2749.2	602749 SKODA SUPERB II (3T4)	13.0460-4880.2	604880 MERCEDES-BENZ C-CLASS Coupe (C205)
13.0460-2749.2	602749 SKODA SUPERB II Kombi (3T5)	13.0460-4880.2	604880 MERCEDES-BENZ C-CLASS T-Model (S205)
13.0460-2749.2	602749 SKODA YETI (5L)	13.0460-4880.2	604880 MERCEDES-BENZ C-CLASS (W205)
13.0460-2749.2	602749 VW CADDY III Kasten (2KA, 2KH, 2CA, 2CH)	13.0460-4883.2	604883 MERCEDES-BENZ C-CLASS (W205)
13.0460-2749.2	602749 VW CADDY III Kombi (2KB, 2KJ, 2CB, 2CJ)	13.0460-4883.2	604883 MERCEDES-BENZ C-CLASS Cabriolet (A205)
13.0460-2749.2	602749 VW CC (358)	13.0460-4883.2	604883 MERCEDES-BENZ C-CLASS Coupe (C205)
13.0460-2749.2	602749 VW EOS (1F7, 1F8)	13.0460-4883.2	604883 MERCEDES-BENZ C-CLASS T-Model (S205)
13.0460-2749.2	602749 VW GOLF V (1K1)	13.0460-4883.2	604883 MERCEDES-BENZ E-CLASS (W213)
13.0460-2749.2	602749 VW GOLF V Variant (1K5)	13.0460-4883.2	604883 MERCEDES-BENZ E-CLASS All-Terrain (S213)
13.0460-2749.2	602749 VW GOLF VI (5K1)	13.0460-4883.2	604883 MERCEDES-BENZ E-CLASS Cabriolet (A238)
13.0460-2749.2	602749 VW GOLF VI Cabriolet (517)	13.0460-4883.2	604883 MERCEDES-BENZ E-CLASS Coupe (C238)
13.0460-2749.2	602749 VW GOLF VI Variant (AJ5)		
13.0460-2749.2	602749 VW GOLF PLUS (5M1, 521)		
13.0460-2749.2	602749 VW JETTA III (1K2)		
13.0460-2749.2	602749 VW PASSAT (3C2)		
13.0460-2749.2	602749 VW PASSAT (362)		
13.0460-2749.2	602749 VW PASSAT ALLTRACK (365)		



Neue Artikel

New parts - Nuevas referencias - Nouvelles références - Codici nuovi

 			 		
13.0460-4883.2	604883	MERCEDES-BENZ E-CLASS T-Model (S213)	13.0470-2610.2	LD2610	MERCEDES-BENZ E-CLASS Cabriolet (A238)
13.0460-4883.2	604883	MERCEDES-BENZ GLC (X253)	13.0470-2610.2	LD2610	MERCEDES-BENZ E-CLASS Coupe (C238)
13.0460-4883.2	604883	MERCEDES-BENZ GLC Coupe (C253)	13.0470-2610.2	LD2610	MERCEDES-BENZ E-CLASS T-Model (S213)
13.0460-5652.2	605652	NISSAN QASHQAI / QASHQAI +2 I (J10, JJ10)	13.0470-2621.2	LD2621	SKODA OCTAVIA III (5E3)
13.0460-5652.2	605652	NISSAN QASHQAI II (J11, J11_)	13.0470-2621.2	LD2621	SKODA OCTAVIA III Combi (5E5)
13.0460-5652.2	605652	RENAULT KADJAR (HA_, HL_)	13.0470-2621.2	LD2621	VW CC (358)
13.0460-5654.2	605654	MITSUBISHI ASX (GA_W_)	13.0470-2621.2	LD2621	VW PASSAT (3C2)
13.0460-5654.2	605654	MITSUBISHI ASX Van (GA_W_)	13.0470-2621.2	LD2621	VW PASSAT ALLTRACK (365)
13.0460-5654.2	605654	PEUGEOT 4008	13.0470-2621.2	LD2621	VW PASSAT CC (357)
13.0460-5658.2	605658	MAZDA 3 (BM)	13.0470-2621.2	LD2621	VW PASSAT Variant (3C5)
13.0460-5658.2	605658	MAZDA 3 Stufenheck (BM)	13.0470-2621.2	LD2621	VW PASSAT Variant (365)
13.0460-5658.2	605658	MAZDA CX-3 (DK)	13.0470-2749.2	LD2749	AUDI A3 (8P1)
13.0460-7292.2	607292	JAGUAR S-TYPE (CCX_)	13.0470-2749.2	LD2749	AUDI A3 Cabriolet (8P7)
13.0460-7292.2	607292	JAGUAR XF (CC9_)	13.0470-2749.2	LD2749	AUDI A3 Sportback (8PA)
13.0460-7292.2	607292	JAGUAR XF SPORTBRAKE (CC9_)	13.0470-2749.2	LD2749	AUDI A4 (8E2, B6)
13.0460-7292.2	607292	JAGUAR XJ (X350_)	13.0470-2749.2	LD2749	AUDI A4 (8EC, B7)
13.0460-7292.2	607292	JAGUAR XK Cabriolet (QQ6_)	13.0470-2749.2	LD2749	AUDI A4 Avant (8E5, B6)
13.0460-7292.2	607292	JAGUAR XK Coupe (QQ6_)	13.0470-2749.2	LD2749	AUDI A4 Avant (8ED, B7)
13.0460-7302.2	607302	FIAT 500L (351_, 352_)	13.0470-2749.2	LD2749	AUDI A4 Cabriolet (8H7, B6, 8HE, B7)
13.0460-7304.2	607304	MERCEDES-BENZ C-CLASS (W205)	13.0470-2749.2	LD2749	AUDI A6 (4F2, C6)
13.0460-7304.2	607304	MERCEDES-BENZ C-CLASS Cabriolet (A205)	13.0470-2749.2	LD2749	AUDI A6 Allroad (4FH, C6)
13.0460-7304.2	607304	MERCEDES-BENZ C-CLASS Coupe (C205)	13.0470-2749.2	LD2749	AUDI A6 Avant (4F5, C6)
13.0460-7304.2	607304	MERCEDES-BENZ C-CLASS T-Model (S205)	13.0470-2749.2	LD2749	AUDI Q3 (8U)
13.0460-7306.2	607306	BMW 7 (E65, E66, E67)	13.0470-2749.2	LD2749	AUDI TT (8J3)
13.0460-7308.2	607308	OPEL ADAM	13.0470-2749.2	LD2749	AUDI TT Roadster (8J9)
13.0460-7308.2	607308	OPEL CORSA E	13.0470-2749.2	LD2749	SEAT ALHAMBRA (710, 711)
13.0460-7308.2	607308	OPEL CORSA E Van	13.0470-2749.2	LD2749	SEAT ALTEA (5P1)
13.0460-7308.2	607308	VAUXHALL ADAM	13.0470-2749.2	LD2749	SEAT EXEO (3R2)
13.0460-7308.2	607308	VAUXHALL CORSA Mk IV (E)	13.0470-2749.2	LD2749	SEAT EXEO ST (3R5)
13.0460-7308.2	607308	VAUXHALL CORSAVAN Mk IV (E)	13.0470-2749.2	LD2749	SEAT LEON (1P1)
13.0460-7309.2	607309	OPEL ASTRA J GTC	13.0470-2749.2	LD2749	SEAT LEON (5F1)
13.0460-7309.2	607309	OPEL ZAFIRA TOURER C (P12)	13.0470-2749.2	LD2749	SEAT LEON SC (5F5)
13.0460-7309.2	607309	VAUXHALL ASTRA Mk VI (J) GTC	13.0470-2749.2	LD2749	SEAT LEON ST (5F8)
13.0460-7309.2	607309	VAUXHALL ZAFIRA Mk III (P12)	13.0470-2749.2	LD2749	SEAT TOLEDO III (5P2)
13.0460-7310.2	607310	OPEL CORSA E	13.0470-2749.2	LD2749	SEAT SKODA OCTAVIA (1Z3)
13.0460-7310.2	607310	OPEL CORSA E Van	13.0470-2749.2	LD2749	SEAT SKODA OCTAVIA II Combi (1Z5)
13.0460-7310.2	607310	VAUXHALL CORSA Mk IV (E)	13.0470-2749.2	LD2749	SEAT SKODA SUPERB II (3T4)
13.0460-7310.2	607310	VAUXHALL CORSAVAN Mk IV (E)	13.0470-2749.2	LD2749	SEAT SKODA SUPERB II Kombi (3T5)
13.0460-7313.2	607313	FORD GALAXY	13.0470-2749.2	LD2749	SEAT SKODA YETI (5L)
13.0460-7313.2	607313	FORD MONDEO V Schrägheck	13.0470-2749.2	LD2749	VW CADDY III Kasten (2KA, 2KH, 2CA, 2CH)
13.0460-7313.2	607313	FORD MONDEO V Stufenheck	13.0470-2749.2	LD2749	VW CADDY III Kombi (2KB, 2KJ, 2CB, 2CJ)
13.0460-7313.2	607313	FORD MONDEO V Turnier	13.0470-2749.2	LD2749	VW CC (358)
13.0460-7313.2	607313	FORD S-MAX	13.0470-2749.2	LD2749	VW EOS (1F7, 1F8)
13.0460-7315.2	607315	BMW 2 Active Tourer (F45)	13.0470-2749.2	LD2749	VW GOLF V (1K1)
13.0460-7315.2	607315	BMW 2 Gran Tourer (F46)	13.0470-2749.2	LD2749	VW GOLF V Variant (1K5)
13.0460-7315.2	607315	BMW i3 (I01)	13.0470-2749.2	LD2749	VW GOLF VI (5K1)
13.0460-7315.2	607315	BMW X1 (F48)	13.0470-2749.2	LD2749	VW GOLF VI Cabriolet (517)
13.0460-7315.2	607315	MINI MINI CLUBMAN (F54)	13.0470-2749.2	LD2749	VW GOLF VI Variant (AJ5)
13.0460-7315.2	607315	MINI MINI COUNTRYMAN (F60)	13.0470-2749.2	LD2749	VW GOLF PLUS (5M1, 521)
13.0470-2610.2	LD2610	MERCEDES-BENZ C-CLASS (W205)	13.0470-2749.2	LD2749	VW JETTA III (1K2)
13.0470-2610.2	LD2610	MERCEDES-BENZ C-CLASS Cabriolet (A205)	13.0470-2749.2	LD2749	VW PASSAT (3C2)
13.0470-2610.2	LD2610	MERCEDES-BENZ C-CLASS Coupe (C205)	13.0470-2749.2	LD2749	VW PASSAT (362)
13.0470-2610.2	LD2610	MERCEDES-BENZ C-CLASS T-Model (S205)	13.0470-2749.2	LD2749	VW PASSAT ALLTRACK (365)
13.0470-2610.2	LD2610	MERCEDES-BENZ E-CLASS (W213)	13.0470-2749.2	LD2749	VW PASSAT CC (357)
13.0470-2610.2	LD2610	MERCEDES-BENZ E-CLASS All-Terrain (S213)	13.0470-2749.2	LD2749	VW PASSAT Variant (3C5)
			13.0470-2749.2	LD2749	VW PASSAT Variant (365)
			13.0470-2749.2	LD2749	VW SCIROCCO (137, 138)
			13.0470-2749.2	LD2749	VW SHARAN (7N1, 7N2)
			13.0470-2749.2	LD2749	VW TIGUAN (5N_)
			13.0470-2790.2	LD2790	AUDI TOURAN (1T1, 1T2)
			13.0470-2790.2	LD2790	AUDI TOURAN (1T3)
			13.0470-2790.2	LD2790	AUDI A1 (8X1, 8XK)
			13.0470-2790.2	LD2790	AUDI A1 Sportback (8XA, 8XF)

Neue Artikel



New parts - Nuevas referencias - Nouvelles références - Codici nuovi

			
13.0470-2790.2	LD2790 AUDI Q3 (8U)	13.0470-7304.2	LD7304 MERCEDES-BENZ C-CLASS Coupe (C205)
13.0470-2790.2	LD2790 SEAT ALHAMBRA (710, 711)	13.0470-7304.2	LD7304 MERCEDES-BENZ C-CLASS T-Model (S205)
13.0470-2790.2	LD2790 SEAT LEON (5F1)	13.0470-7309.2	LD7309 OPEL ASTRA J GTC
13.0470-2790.2	LD2790 SEAT LEON SC (5F5)	13.0470-7309.2	LD7309 OPEL ZAFIRA TOURER C (P12)
13.0470-2790.2	LD2790 SEAT LEON ST (5F8)	13.0470-7309.2	LD7309 VAUXHALL ASTRA Mk VI (J) GTC
13.0470-2790.2	LD2790 SKODA OCTAVIA III (5E3)	13.0470-7309.2	LD7309 VAUXHALL ZAFIRA Mk III (P12)
13.0470-2790.2	LD2790 SKODA OCTAVIA III Combi (5E5)	13.0470-7315.2	LD7315 BMW 2 Active Tourer (F45)
13.0470-2790.2	LD2790 VW CADDY IV Kasten (SAA, SAH)	13.0470-7315.2	LD7315 BMW 2 Gran Tourer (F46)
13.0470-2790.2	LD2790 VW CADDY IV Kombi (SAB, SAJ)	13.0470-7315.2	LD7315 BMW i3 (i01)
13.0470-2790.2	LD2790 VW CADDY ALLTRACK Kasten (SAA)	13.0470-7315.2	LD7315 BMW X1 (F48)
13.0470-2790.2	LD2790 VW CADDY ALLTRACK Kombi (SAB)	13.0470-7315.2	LD7315 MINI MINI CLUBMAN (F54)
13.0470-2790.2	LD2790 VW SHARAN (7N1, 7N2)	13.0470-7315.2	LD7315 MINI MINI COUNTRYMAN (F60)
13.0470-2795.2	LD2795 BMW 2 Active Tourer (F45)	24.0109-0178.1	409178 HONDA JAZZ III (GE_, GG_, GP_)
13.0470-2795.2	LD2795 MINI MINI (F55)	24.0109-0178.1	409178 HONDA JAZZ IV (GK_)
13.0470-2795.2	LD2795 MINI MINI (F56)	24.0110-0372.1	410372 CHRYSLER SEBRING Cabriolet (JS)
13.0470-2795.2	LD2795 MINI MINI Cabriolet (F57)	24.0110-0372.1	410372 JEEP COMPASS (MK49)
13.0470-2795.2	LD2795 MINI MINI CLUBMAN (F54)	24.0110-0372.1	410372 JEEP PATRIOT (MK74)
13.0470-2797.2	LD2797 MINI MINI (F55)	24.0110-0372.1	410372 LANCIA FLAVIA Cabriolet (JS_)
13.0470-2797.2	LD2797 MINI MINI (F56)	24.0110-0374.1	410374 TOYOTA CAMRY Stufenheck (_V5_)
13.0470-2797.2	LD2797 MINI MINI Cabriolet (F57)	24.0110-0395.1	410395 MITSUBISHI ASX (GA_W_)
13.0470-4880.2	LD4880 MERCEDES-BENZ C-CLASS (W205)	24.0110-0395.1	410395 MITSUBISHI ASX Van (GA_W_)
13.0470-4880.2	LD4880 MERCEDES-BENZ C-CLASS Cabriolet (A205)	24.0110-0395.1	410395 MITSUBISHI OUTLANDER III (GG_W, GF_W, ZJ)
13.0470-4880.2	LD4880 MERCEDES-BENZ C-CLASS Coupe (C205)	24.0110-0400.1	410400 PEUGEOT 4008
13.0470-4880.2	LD4880 MERCEDES-BENZ C-CLASS T-Model (S205)	24.0110-0400.1	410400 HYUNDAI GRANDEUR (HG)
13.0470-4882.2	LD4882 MERCEDES-BENZ V-CLASS (W447)	24.0110-0400.1	410400 HYUNDAI i30 (PDE)
13.0470-4882.2	LD4882 MERCEDES-BENZ VITO Kasten (W447)	24.0110-0400.1	410400 HYUNDAI i30 CW
13.0470-4882.2	LD4882 MERCEDES-BENZ VITO Mixto (W447)	24.0110-0400.1	410400 HYUNDAI IONIQ (AE)
13.0470-4882.2	LD4882 MERCEDES-BENZ VITO Tourer (W447)	24.0110-0400.1	410400 HYUNDAI SONATA VII (LF)
13.0470-4884.2	LD4884 MERCEDES-BENZ V-CLASS (W447)	24.0110-0400.1	410400 KIA OPTIMA
13.0470-4884.2	LD4884 MERCEDES-BENZ VITO Kasten (W447)	24.0110-0400.1	410400 KIA OPTIMA
13.0470-4884.2	LD4884 MERCEDES-BENZ VITO Mixto (W447)	24.0110-0400.1	410400 KIA OPTIMA Sportswagon
13.0470-4884.2	LD4884 MERCEDES-BENZ VITO Tourer (W447)	24.0110-0400.1	410400 KIA SOUL II (PS)
13.0470-7293.2	LD7293 AUDI A3 (8V1, 8VK)	24.0110-0401.1	410401 BMW 2 Active Tourer (F45)
13.0470-7293.2	LD7293 AUDI A3 Cabriolet (8V7, 8VE)	24.0110-0401.1	410401 BMW 2 Gran Tourer (F46)
13.0470-7293.2	LD7293 AUDI A3 Limousine (8VS, 8VM)	24.0110-0401.1	410401 BMW X1 (F48)
13.0470-7293.2	LD7293 AUDI A3 Sportback (8VA, 8VF)	24.0110-0401.1	410401 BMW MINI CLUBMAN (F54)
13.0470-7293.2	LD7293 AUDI Q2 (GA)	24.0110-0401.1	410401 BMW MINI COUNTRYMAN (F60)
13.0470-7293.2	LD7293 AUDI TT (FV3)	24.0111-0176.1	411176 ABARTH 500 / 595 (312_)
13.0470-7293.2	LD7293 AUDI TT Roadster (FV9)	24.0111-0176.1	411176 ABARTH 500C / 595C (312_)
13.0470-7293.2	LD7293 SEAT ATECA (KH7)	24.0111-0176.1	411176 FIAT 500 (312_)
13.0470-7293.2	LD7293 SEAT LEON (5F1)	24.0111-0186.2	411186 RENAULT MEGANE III Coupe (DZ0/1_)
13.0470-7293.2	LD7293 SEAT LEON SC (5F5)	24.0112-0203.1	412203 TOYOTA PRIUS PLUS (_W4_)
13.0470-7293.2	LD7293 SEAT LEON ST (5F8)	24.0112-0215.1	412215 JEEP CHEROKEE (KL)
13.0470-7293.2	LD7293 VW GOLF VII (5G1, BQ1, BE1, BE2)	24.0112-0216.1	412216 PEUGEOT 508 SW
13.0470-7293.2	LD7293 VW GOLF VII Kombi (BA5, BV5)	24.0114-0120.1	414120 JEEP GRAND CHEROKEE IV (WK, WK2)
13.0470-7293.2	LD7293 VW GOLF ALLTRACK (BA5)	24.0116-0131.1	416131 NISSAN CABSTAR (F23, H41, H42)
13.0470-7293.2	LD7293 VW GOLF SPORTSVAN (AM1)	24.0116-0131.1	416131 NISSAN CABSTAR (F24M, F24W)
13.0470-7293.2	LD7293 VW TOURAN (5T1)	24.0116-0131.1	416131 NISSAN NT400 CABSTAR (F24F)
13.0470-7304.2	LD7304 MERCEDES-BENZ C-CLASS (W205)	24.0118-0157.1	418157 LEXUS RX (_L1_)
13.0470-7304.2	LD7304 MERCEDES-BENZ C-CLASS Cabriolet (A205)	24.0118-0159.1	418159 SUBARU OUTBACK (BR)
		24.0118-0160.1	418160 SUBARU FORESTER (SJ)
		24.0120-0239.1	420239 SAAB 9-3 (YS3F)
		24.0120-0246.1	420246 VOLVO S90 II
		24.0120-0246.1	420246 VOLVO XC90 II
		24.0120-0247.1	420246 VOLVO XC90 II
		24.0122-0291.1	422291 PEUGEOT 308 II
		24.0122-0291.1	422291 PEUGEOT 308 SW II
		24.0122-0296.1	422296 MERCEDES-BENZ GL-CLASS (X166)
		24.0122-0296.1	422296 MERCEDES-BENZ GLE (W166)
		24.0122-0296.1	422296 MERCEDES-BENZ GLE Coupe (C292)
		24.0122-0296.1	422296 MERCEDES-BENZ GLS (X166)



Neue Artikel

New parts - Nuevas referencias - Nouvelles références - Codici nuovi

			
24.0122-0296.1	422296 MERCEDES-BENZ	M-CLASS (W166)	24.0128-0293.1 428293 FORD TRANSIT Kasten
24.0123-0118.1	423118 HYUNDAI	ELANTRA Stufenheck (MD, UD)	24.0128-0293.1 428293 FORD TRANSIT Pritsche/Fahrgestell
24.0123-0120.1	423120 CHRYSLER	SEBRING (JR)	24.0128-0296.1 428296 AUDI Q7 (4M)
24.0123-0120.1	423120 CHRYSLER	SEBRING Cabriolet (JR)	24.0128-0300.1 428300 MERCEDES-BENZ C-CLASS (W205)
24.0124-0248.1	424248 BMW	2 Cabriolet (F23)	24.0128-0300.1 428300 MERCEDES-BENZ C-CLASS Cabriolet (A205)
24.0124-0248.1	424248 BMW	2 Coupe (F22, F87)	24.0128-0300.1 428300 MERCEDES-BENZ C-CLASS Coupe (C205)
24.0124-0248.1	424248 BMW	3 (F30, F80)	24.0128-0300.1 428300 MERCEDES-BENZ C-CLASS T-Model (S205)
24.0124-0248.1	424248 BMW	3 Gran Turismo (F34)	24.0130-0231.1 430231 HYUNDAI EQUUS / CENTENNIAL
24.0124-0248.1	424248 BMW	3 Kombi (F31)	24.0130-0231.1 430231 HYUNDAI GENESIS Coupe
24.0124-0248.1	424248 BMW	4 Cabriolet (F33, F83)	24.0130-0236.1 430236 AUDI A6 Allroad (4GH, 4GJ)
24.0124-0248.1	424248 BMW	4 Coupe (F32, F82)	24.0130-0239.1 430239 HYUNDAI H-1 Cargo (TQ)
24.0124-0248.1	424248 BMW	4 Gran Coupe (F36)	24.0130-0239.1 430239 HYUNDAI H-1 Travel (TQ)
24.0124-0252.1	424252 CHEVROLET	AVEO Schrägheck (T300)	24.0130-0240.1 430240 VOLVO XC90 I
24.0124-0252.1	424252 CHEVROLET	AVEO Stufenheck (T300)	24.0130-0241.1 430241 PEUGEOT 308 II
24.0124-0252.1	424252 CHEVROLET	COBALT	24.0130-0241.1 430241 PEUGEOT 308 SW II
24.0125-0192.1	425192 TOYOTA	HILUX VII Pick-up (_N1_, _N2_, _N3_)	24.0132-0174.1 432174 LEXUS GX (URJ15_)
24.0125-0192.1	425192 TOYOTA	HILUX Pritsche/Fahrgestell (_N1_, _N2_)	24.0132-0174.1 432174 TOYOTA LAND CRUISER (_J15_)
24.0125-0201.1	425201 HONDA	CIVIC VIII Stufenheck (FD, FA)	24.0132-0174.1 432174 TOYOTA LAND CRUISER 200 (_J2_)
24.0125-0201.1	425201 HONDA	CIVIC IX (FK)	24.0132-0176.1 432176 FORD RANGER (TKE)
24.0125-0201.1	425201 HONDA	CIVIC IX Stufenheck (FB, FG)	24.0132-0180.1 432180 MERCEDES-BENZ CLS (C218)
24.0125-0201.1	425201 HONDA	CIVIC IX Tourer (FK)	24.0132-0180.1 432180 MERCEDES-BENZ CLS Shooting Brake (X218)
24.0125-0202.1	425202 FORD	TOURNEO CONNECT / GRAND TOURNEO CONNECT Kombi	24.0132-0181.1 432181 JEEP GRAND CHEROKEE IV (WK, WK2)
24.0125-0202.1	425202 FORD	TRANSIT CONNECT Kasten	24.0132-0184.1 432184 MERCEDES-BENZ GL-CLASS (X166)
24.0125-0202.1	425202 FORD	TRANSIT CONNECT Kombi	24.0132-0184.1 432184 MERCEDES-BENZ GLE (W166)
24.0125-0203.1	425203 VOLVO	V40 Schrägheck	24.0132-0184.1 432184 MERCEDES-BENZ GLE Coupe (C292)
24.0125-0211.1	425211 HONDA	ACCORD VII (CL, CN)	24.0132-0184.1 432184 MERCEDES-BENZ GLS (X166)
24.0125-0211.1	425211 HONDA	ACCORD VIII (CP)	24.0132-0184.1 432184 MERCEDES-BENZ M-CLASS (W166)
24.0125-0211.1	425211 HONDA	ACCORD VIII (CU)	24.0133-0102.1 433102 FORD TOURNEO CUSTOM Bus
24.0125-0211.1	425211 HONDA	ACCORD VIII Kombi (CW)	24.0133-0102.1 433102 FORD TRANSIT Bus
24.0125-0211.1	425211 HONDA	ACCORD Coupe (CM)	24.0133-0102.1 433102 FORD TRANSIT CUSTOM Bus
24.0126-0179.1	426179 CHRYSLER	300 M (LR)	24.0133-0102.1 433102 FORD TRANSIT CUSTOM Kasten
24.0126-0179.1	426179 CHRYSLER	CONCORDE	24.0133-0102.1 433102 FORD TRANSIT Kasten
24.0128-0259.1	428259 JEEP	CHEROKEE (KK)	24.0133-0102.1 433102 FORD TRANSIT Pritsche/Fahrgestell
24.0128-0261.1	428261 RENAULT	MEGANE III Coupe (DZ0/1_)	24.0134-0104.1 434104 LEXUS RX (_L1_)
24.0128-0266.1	428266 CHRYSLER	300C	24.0134-0107.1 434107 AUDI A6 Allroad (4GH, 4GJ)
24.0128-0266.1	428266 CHRYSLER	300 C (LX)	24.0134-0110.1 430110 AUDI A4 (8W2, B9)
24.0128-0266.1	428266 CHRYSLER	300 C Touring (LX)	24.0134-0110.1 430110 AUDI A4 Allroad (8WH, B9)
24.0128-0268.1	428268 NISSAN	LEAF (ZE0)	24.0134-0110.1 430110 AUDI A4 Avant (8W5, B9)
24.0128-0268.1	428268 NISSAN	NV200 / EVALIA Bus	24.0134-0110.1 430110 AUDI A5 (F53)
24.0128-0268.1	428268 NISSAN	NV200 Kasten/Kombi	24.0134-0110.1 430110 AUDI A5 Sportback (F5A)
24.0128-0270.1	428270 JEEP	CHEROKEE (KK)	24.0134-0110.1 430110 AUDI Q7 (4M)
24.0128-0274.1	428274 TOYOTA	CAMRY Stufenheck (_V5_)	24.0328-0155.1 528155 MERCEDES-BENZ C-CLASS (W204)
24.0128-0277.1	428277 MAZDA	6 Kombi (GJ, GL)	24.0328-0155.1 528155 MERCEDES-BENZ C-CLASS Coupe (C204)
24.0128-0277.1	428277 MAZDA	6 Stufenheck (GJ, GL)	24.0328-0155.1 528155 MERCEDES-BENZ C-CLASS T-Model (S204)
24.0128-0277.1	428277 MAZDA	CX-5 (KE, GH)	24.0328-0155.1 528155 MERCEDES-BENZ E-CLASS (W212)
24.0128-0279.1	428279 MAZDA	6 Kombi (GJ, GL)	24.0328-0155.1 528155 MERCEDES-BENZ E-CLASS Cabriolet (A207)
24.0128-0279.1	428279 MAZDA	6 Stufenheck (GJ, GL)	24.0328-0155.1 528155 MERCEDES-BENZ E-CLASS Coupe (C207)
24.0128-0287.1	428287 OPEL	VIVARO Combi	24.0328-0155.1 528155 MERCEDES-BENZ E-CLASS T-Model (S212)
24.0128-0287.1	428287 OPEL	VIVARO Kasten	
24.0128-0287.1	428287 OPEL	VIVARO Pritsche/Fahrgestell	
24.0128-0287.1	428287 RENAULT	TRAFIC III Bus (JG_)	
24.0128-0287.1	428287 RENAULT	TRAFIC III Kasten (FG_)	
24.0128-0287.1	428287 RENAULT	TRAFIC III Pritsche/Fahrgestell (EG_)	
24.0128-0287.1	428287 VAUXHALL	VIVARO Combi	
24.0128-0287.1	428287 VAUXHALL	VIVARO Kasten	
24.0128-0287.1	428287 VAUXHALL	VIVARO Pritsche/Fahrgestell	
24.0128-0289.1	428289 PORSCHE	MACAN (95B)	
24.0128-0292.1	428292 FIAT	500X (334_)	
24.0128-0292.1	428292 JEEP	RENEGADE Geländewagen geschlossen (BU)	
24.0128-0293.1	428293 FORD	TRANSIT Bus	

Neue Artikel

New parts - Nuevas referencias - Nouvelles références - Codici nuovi



24.0328-0155.1 528155 MERCEDES- SLC (R172)
BENZ

24.8190-0960.2 620960 JAGUAR XF (CC9_)

24.8190-0960.2 620960 JAGUAR XF SPORTBRAKE (CC9_)

24.8190-0960.2 620960 JAGUAR XJ (X350_)

24.8190-0960.2 620960 JAGUAR XJ (X351_)

24.8190-0960.2 620960 JAGUAR XK Cabriolet (QQ6_)

24.8190-0960.2 620960 JAGUAR XK Coupe (QQ6_)









- DE** Ersetzte Artikel
- EN** Replaced parts
- ES** Referencias de sustitución
- FR** Références remplacées
- IT** Codici sostitutivi

2018



Ersetzte Artikel

Replaced parts - Referencias de sustitución - Références remplacées - Codici sostitutivi

 Vorgänger Nr. Replaced No. Codice precedente Ancienne référence Número anterior	 Nachfolge Nr. Replacing No. Codice nuovo Nouvelle référence Número posterior	 Vorgänger Nr. Replaced No. Codice precedente Ancienne référence Número anterior	 Nachfolge Nr. Replacing No. Codice nuovo Nouvelle référence Número posterior
13.0460-2823.2	602823	13.0460-2820.2	602820
24.0109-0136.1	409136	24.0110-0331.1	410331
24.0110-0361.1	410361	24.0110-0372.1	410372
24.0116-0120.1	416120	24.0116-0130.1	416130
24.0122-0250.1	422250	24.0122-0272.1	422272
24.0130-0187.1	430187	24.0130-0219.1	430219





- DE** Fahrzeugregister
- EN** Index of vehicles
- ES** Índice de vehículos
- FR** Liste des véhicules
- IT** Indice autovetture

2018



**ABARTH 35**

124 Spider (348_)	35
500 / 595 (312_)	35
500C / 595C (312_)	35

ALFA ROMEO 35

145 (930_)	35
146 (930_)	36
147 (937_)	37
155 (167_)	39
156 (932_)	40
156 Sportwagon (932_)	42
159 (939_)	44
159 Sportwagon (939_)	45
164 (164_)	45
166 (936_)	47
BRERA (939_)	47
GIULIETTA (940_)	48
GT (937_)	49
GTV (916_)	49
MITO (955_)	50
SPIDER (916_)	51
SPIDER (939_)	52

ASTON MARTIN 53

CYGNET	53
--------	----

AUDI 53

80 Avant (8C, B4)	53
A1 (8X1, 8XK)	54
A1 Sportback (8XA, 8XF)	56
A2 (8Z0)	58
A3 (8L1)	58
A3 (8P1)	60
A3 (8V1, 8VK)	67
A3 Cabriolet (8P7)	68
A3 Cabriolet (8V7, 8VE)	69
A3 Limousine (8VS, 8VM)	70
A3 Sportback (8PA)	71
A3 Sportback (8VA, 8VF)	77
A4 (8D2, B5)	79
A4 (8E2, B6)	83
A4 (8EC, B7)	85
A4 (8K2, B8)	90
A4 (8W2, B9)	91
A4 Allroad (8KH, B8)	92
A4 Allroad (8WH, B9)	92
A4 Avant (8D5, B5)	92
A4 Avant (8E5, B6)	95
A4 Avant (8ED, B7)	97
A4 Avant (8K5, B8)	101
A4 Avant (8W5, B9)	104
A4 Cabriolet (8H7, B6, 8HE, B7)	104
A5 (8T3)	108
A5 (F53)	111
A5 Cabriolet (8F7)	111
A5 Cabriolet (F57)	114
A5 Sportback (8TA)	114
A5 Sportback (F5A)	115
A6 (4A, C4)	115
A6 (4B2, C5)	116
A6 (4F2, C6)	120
A6 (4G2, C7, 4GC)	125
A6 Allroad (4FH, C6)	128
A6 Allroad (4GH, 4GJ)	129
A6 Avant (4A, C4)	129
A6 Avant (4B5, C5)	130
A6 Avant (4F5, C6)	133
A6 Avant (4G5, C7, 4GD)	136
A7 Sportback (4GA, 4GF)	138
A8 (4D2, 4D8)	141
A8 (4E_)	143
A8 (4H_)	146
ALLROAD (4BH, C5)	147
CABRIOLET (8G7, B4)	148
COUPE (89, 8B)	148
Q2 (GA)	149
Q3 (8U)	149

**AUDI 53**

Q5 (8R)	150
Q7 (4L)	153
Q7 (4M)	153
R8 (422, 423)	154
R8 Spyder (427, 429)	154
TT (8J3)	154
TT (8N3)	156
TT (FV3)	157
TT Roadster (8J9)	157
TT Roadster (8N9)	159
TT Roadster (FV9)	160

AUTOBIANCHI 161

Y10	161
-----	-----

BENTLEY 161

ARNAGE (RBS_)	161
AZURE	161
CONTINENTAL	162
CONTINENTAL Coupe (3W_)	162

BMW 162

1 (E81)	162
1 (E87)	166
1 (F20)	173
1 (F21)	175
1 Cabriolet (E88)	178
1 Coupe (E82)	180
2 Active Tourer (F45)	183
2 Cabriolet (F23)	184
2 Coupe (F22, F87)	185
2 Gran Tourer (F46)	187
3 (E36)	188
3 (E46)	189
3 (E90)	191
3 (F30, F80)	207
3 Cabriolet (E36)	213
3 Cabriolet (E46)	213
3 Cabriolet (E93)	215
3 Compact (E36)	221
3 Compact (E46)	221
3 Coupe (E36)	222
3 Coupe (E46)	223
3 Coupe (E92)	224
3 Gran Turismo (F34)	234
3 Kombi (F31)	237
3 Touring (E36)	244
3 Touring (E46)	244
3 Touring (E91)	246
4 Cabriolet (F33, F83)	261
4 Coupe (F32, F82)	263
4 Gran Coupe (F36)	266
5 (E34)	268
5 (E39)	269
5 (E60)	273
5 (F10)	283
5 (G30)	289
5 Gran Turismo (F07)	289
5 Touring (E34)	292
5 Touring (E39)	293
5 Touring (E61)	295
5 Touring (F11)	302
5 Touring (G31)	309
6 (E63)	309
6 Cabriolet (E64)	310
6 Cabriolet (F12)	312
6 Coupe (F13)	313
6 Gran Coupe (F06)	314
7 (E38)	315
7 (E65, E66, E67)	316
7 (F01, F02, F03, F04)	318
7 (G11, G12)	321
8 (E31)	321
i3 (I01)	322
i8 (I12)	322
X1 (E84)	322
X1 (F48)	325

**BMW 162**

X3 (E83)	325
X3 (F25)	327
X4 (F26)	328
X5 (E53)	329
X5 (E70)	330
X5 (F15, F85)	332
X6 (E71, E72)	334
X6 (F16, F86)	337
Z3 Coupe (E36)	337
Z3 Roadster (E36)	338
Z4 Coupe (E86)	340
Z4 Roadster (E85)	340
Z4 Roadster (E89)	341
Z8 Roadster (E52)	342

CHEVROLET 342

ASTRA Schrägheck	343
ASTRA Stufenheck	343
AVEO Schrägheck (T200)	343
AVEO Schrägheck (T250, T255)	343
AVEO Schrägheck (T300)	344
AVEO Stufenheck (T200)	344
AVEO Stufenheck (T250, T255)	344
AVEO Stufenheck (T300)	345
CAMARO	345
CAPTIVA (C100, C140)	345
COBALT	346
CRUZE (J300)	346
CRUZE Schrägheck (J305)	347
CRUZE Station Wagon (J308)	347
EPICA (KL1_)	348
EVANDA	348
IMPALA Stufenheck	348
KALOS	348
KALOS Stufenheck	348
LACETTI (J200)	349
LACETTI Kombi (J200)	349
LACETTI Stufenheck	349
LANOS Stufenheck	349
MALIBU (V300)	349
MATIZ (M200, M250)	350
MONTE CARLO Coupe	350
NUBIRA Kombi	350
NUBIRA Stufenheck	350
ORLANDO (J309)	351
REZZO	351
SPARK	351
SPARK (M300)	352
TIGRA	352
TRANS SPORT	352
TRAX	352
VECTRA	352
VOLT	353

CHRYSLER 353

300C	353
300 C (LX)	353
300 C Touring (LX)	353
300 M (LR)	354
CONCORDE	354
CROSSFIRE	354
CROSSFIRE Roadster	354
DELTA	355
GRAND VOYAGER V (RT)	355
NEON (PL)	355
NEON II	355
NEW YORKER	355
PT CRUISER (PT_)	356
PT CRUISER Cabriolet	356
SEBRING (JR)	356
SEBRING (JS)	356
SEBRING Cabriolet (JR)	357
SEBRING Cabriolet (JS)	357
STRATUS (JA)	357
STRATUS Cabriolet (JX)	357
VISION	357
VOYAGER / GRAND VOYAGER III (GS)	357
VOYAGER II (ES)	358



**CHRYSLER****353**

VOYAGER IV (RG, RS)	358
YPSILON	358

CITROËN**358**

AX (ZA-)	359
BERLINGO (B9)	359
BERLINGO (MF)	360
BERLINGO Kasten (B9)	362
BERLINGO Kasten (M)	362
BERLINGO Pritsche/Fahrgestell (B9)	364
C1 (PM, PN)	364
C15 (VD-)	384
C15 Kombi	385
C1 II	364
C2 (JM)	364
C2 ENTERPRISE	365
C3 I (FC)	366
C3 II	367
C3 III (SX)	368
C3 Picasso	368
C3 Pluriel (HB)	368
C4 AIRCROSS	373
C4 CACTUS	373
C4 Coupe (LA)	373
C4 Grand Picasso I (UA)	376
C4 Grand Picasso II	377
C4 I (LC)	369
C4 II (B7)	372
C4 Picasso I (UD)	377
C4 Picasso II	378
C4 Stufenheck	379
C5 I (DC)	380
C5 I Break (DE)	380
C5 II (RC)	381
C5 II Break (RE)	381
C5 III (RD)	382
C5 III Break (TD)	383
C6 (TD)	383
C8 (EA, EB)	384
C-CROSSER (EP)	385
C-CROSSER ENTERPRISE	385
C-ELYSEE	386
C-ZERO	386
DS3	386
DS3 Cabriolet	387
DS4	388
DS5	390
EVASION (22, U6)	391
JUMPER Bus	391
JUMPER Bus (230P)	392
JUMPER Bus (244, Z)	394
JUMPER Kasten	394
JUMPER Kasten (230L)	395
JUMPER Kasten (244)	396
JUMPER Pritsche/Fahrgestell	397
JUMPER Pritsche/Fahrgestell (230)	398
JUMPER Pritsche/Fahrgestell (244)	399
JUMPY	399
JUMPY (U6U)	400
JUMPY Kasten	400
JUMPY Kasten (BS, BT, BY, BZ)	401
JUMPY Pritsche/Fahrgestell	401
JUMPY Pritsche/Fahrgestell (BU, BV, BW, BX)	401
NEMO Kasten (AA)	402
NEMO Kombi	402
SAXO (S0, S1)	402
SPACETOURER	403
XANTIA (X1)	403
XANTIA (X2)	404
XANTIA Break (X1)	405
XANTIA Break (X2)	406
XM (Y4)	407
XM Break (Y4)	407
XSARA (N1)	408
XSARA Break (N2)	410
XSARA Coupe (N0)	411
XSARA Kasten/Kombi	413
XSARA Kasten/Schrägheck	413

**CITROËN****358**

XSARA PICASSO (N68)	414
ZX (N2)	417
ZX Break (N2)	418

DACIA**418**

DOKKER	418
DOKKER Express	419
DUSTER	419
DUSTER Kasten	420
LODGY	421
LOGAN (LS)	421
LOGAN EXPRESS (FS)	422
LOGAN II	422
LOGAN MCV (KS)	422
LOGAN MCV II	423
LOGAN Pick-up (US)	423
SANDERO	424
SANDERO II	424

DAEWOO**425**

ARANOS	425
CIELO	425
ESPERO (KLEJ)	425
EVANDA (KLAL)	425
GENTRA Stufenheck	425
KALOS (KLAS)	426
KALOS Stufenheck (KLAS)	426
KORANDO (KJ)	426
KORANDO Cabrio (KJ)	426
LACETTI Schrägheck (KLAN)	426
LACETTI Stufenheck	426
LACETTI Stufenheck (J200)	426
LANOS (KLAT)	427
LANOS Stufenheck (KLAT)	427
LEGANZA (KLAJ)	427
MAGNUS	428
MATIZ (KLYA)	428
MATIZ Kasten (KLA4)	428
MUSSO (FJ)	428
NEXIA (KLETN)	429
NEXIA Stufenheck (KLETN)	429
NUBIRA (KLAJ)	429
NUBIRA Stufenheck (KLAJ)	429
NUBIRA Stufenheck (KLAN)	430
NUBIRA Wagon (KLAJ)	430
NUBIRA Wagon (KLAN)	431
RACER Schrägheck	431
REXTON (GAB)	431
REZZO (KLAU)	431
TOSCA	432

DAIHATSU**432**

APPLAUSE I (A101, A111)	432
APPLAUSE II (A101)	432
CHARADE	432
CHARADE (L2)	432
CHARADE IV (G200, G202)	432
CHARADE IV Stufenheck (G203)	433
COPEN (L880, L881)	433
CUORE IV (L501)	433
CUORE V (L5)	433
CUORE V (L7)	433
CUORE VI (L251, L250, L260)	433
CUORE VII (L275, L285, L276)	433
FEROZA Hard Top (F300)	434
FEROZA Soft Top (F300)	434
GRAN MOVE (G3)	434
MATERIA (M4)	434
MOVE (L6, L9)	434
ROCKY Hard Top (F7, F8)	434
ROCKY Soft Top (F7, F8)	435
SIRION (M1)	435
SIRION (M3)	435
TERIOS (J1)	435
TERIOS (J2)	436
TREVIS	436
YRV (M2)	436

**DS****436**

DS 3	437
DS 3 Cabriolet	437
DS 4 / DS 4 CROSSBACK	438
DS5	436

FIAT**439**

124 Spider (348)	439
500 (312)	439
500 C (312)	440
500L (351, 352)	440
500X (334)	441
BARCETTA (183)	441
BRAVA (182)	441
BRAVO I (182)	442
BRAVO II (198)	442
CINQUECENTO (170)	443
COUPE (175)	444
CROMA (154)	445
CROMA (194)	446
DOBLO Cargo (223)	446
DOBLO Großraumlimousine (119, 223)	447
DOBLO Kasten/Kombi (263)	448
DOBLO Kombi (263)	448
DOBLO Pritsche/Fahrgestell (263)	449
DUCATO Bus (230)	449
DUCATO Bus (244)	451
DUCATO Bus (250, 290)	451
DUCATO Kasten (230)	452
DUCATO Kasten (244)	454
DUCATO Kasten (250, 290)	454
DUCATO Pritsche/Fahrgestell (230)	455
DUCATO Pritsche/Fahrgestell (244)	457
DUCATO Pritsche/Fahrgestell (250, 290)	457
ELBA (146)	458
FIORINO Kasten/Kombi (225)	458
FIORINO Kasten (146)	459
FIORINO Pick up (146)	459
FREEMONT (345)	459
GRANDE PUNTO (199)	460
IDEA (350)	461
LINEA (323)	462
MAREA (185)	462
MAREA Weekend (185)	463
MULTIPLA (186)	464
PALIO (178BX)	465
PALIO Weekend (178)	466
PANDA (141)	467
PANDA (169)	467
PANDA (312, 319)	469
PANDA Van (141)	469
PANDA Van (169)	469
PANDA VAN (312, 519)	470
PREMIO	471
PUNTO (176)	471
PUNTO (188)	472
PUNTO (199)	473
PUNTO Cabriolet (176)	473
PUNTO EVO (199)	474
PUNTO Van (176)	474
PUNTO Van (188)	475
PUNTO Van (199)	475
QUBO (225)	476
SCUDO (270, 272)	476
SCUDO Combinato (220)	476
SCUDO Kasten (220)	477
SCUDO Kasten (270, 272)	477
SCUDO Pritsche/Fahrgestell (220)	478
SCUDO Pritsche/Fahrgestell (270, 272)	478
SEDICI (FY)	478
SEICENTO / 600 (187)	479
SEICENTO / 600 Van (287)	479
SIENA (178)	479
STILO (192)	480
STILO Multi Wagon (192)	481
STRADA Pick-up (178)	482
STRADA Pick-up (278)	483
TALENTO Bus (296)	483
TALENTO Kasten/Kombi (296)	483

**FIAT****439**

TALENTO Kasten (296_)	483
TALENTO Pritsche/Fahrgestell (296_)	483
TEMPRA (159_)	483
TEMPRA S.W. (159_)	485
TIPO (160_)	486
TIPO Kombi (357_)	488
TIPO Schrägheck (357_)	488
TIPO Stufenheck (356_)	488
ULYSSE (179_)	488
ULYSSE (220_)	489
UNO (146_)	489
UNO Kasten (146_)	490

FORD**490**

B-MAX (JK)	490
B-MAX Van	491
C-MAX (DM2)	491
C-MAX II (DXA/CB7, DXA/CEU)	491
C-MAX II Van	492
COUGAR (EC_)	493
COURIER Kasten (F3L, F5L)	493
COURIER Kasten (J5_, J3_)	493
ECOSPORT	494
ESCORT '95 Express (AVL)	494
ESCORT CLASSIC (AAL, ABL)	499
ESCORT CLASSIC Turnier (ANL)	499
ESCORT VI (GAL)	495
ESCORT VI Cabriolet (ALL)	495
ESCORT VII (GAL, AAL, ABL)	497
ESCORT VII Cabriolet (ALL)	498
ESCORT VII Kombi (GAL, ANL)	498
ESCORT VII Stufenheck (GAL, AFL)	498
ESCORT VI Kombi (GAL)	496
ESCORT VI Stufenheck (GAL)	496
FIESTA III (GFJ)	500
FIESTA IV (JA_, JB_)	500
FIESTA Kasten (FVD)	503
FIESTA Kasten (JV_)	503
FIESTA Stufenheck	504
FIESTA V (JH_, JD_)	501
FIESTA VI	502
FIESTA VI Van	503
FIESTA V Van	502
FOCUS (DAW, DBW)	504
FOCUS C-MAX	512
FOCUS II (DA_)	504
FOCUS II Cabriolet	505
FOCUS III	508
FOCUS III Kasten	509
FOCUS III Kasten/Schrägheck	509
FOCUS III Stufenheck	510
FOCUS III Turnier	511
FOCUS II Kombi (DA_)	506
FOCUS II Stufenheck (DA_)	507
FOCUS Kombi (DNW)	513
FOCUS Stufenheck (DFW)	513
FUSION (JU_)	513
GALAXY	514
GALAXY (WA6)	514
GALAXY (WGR)	515
GRAND C-MAX (DXA/CB7, DXA/CEU)	516
GRAND C-MAX Van	517
KA (RB_)	517
KA (RU8)	518
KA+	518
KA Van (RB)	518
KUGA I	518
KUGA II (DM2)	519
KUGA II Van	519
MAVERICK	519
MAVERICK (UDS, UNS)	520
MAVERICK VAN	520
MONDEO I (GBP)	520
MONDEO II (BAP)	522
MONDEO III (B5Y)	525
MONDEO III Kombi (BWY)	525
MONDEO III Stufenheck (B4Y)	525
MONDEO II Kombi (BNP)	523
MONDEO II Stufenheck (BFP)	524

**FORD****490**

MONDEO I Kombi (BNP)	521
MONDEO I Stufenheck (GBP)	521
MONDEO IV (BA7)	526
MONDEO IV Stufenheck (BA7)	527
MONDEO IV Turnier (BA7)	528
MONDEO V Schrägheck	529
MONDEO V Stufenheck	529
MONDEO V Turnier	530
PUMA (EC_)	530
RANGER (ET)	530
RANGER (TKE)	530
SCORPIO II (GFR, GGR)	531
SCORPIO II Kombi (GMR, GGR)	531
S-MAX	531
S-MAX (WA6)	532
STREET KA (RL2)	532
TOURNEO CONNECT	533
TOURNEO CONNECT / GRAND	533
TOURNEO CONNECT Kombi	533
TOURNEO COURIER Kombi	533
TOURNEO CUSTOM Bus	533
TRANSIT Bus	534
TRANSIT Bus (E_)	534
TRANSIT Bus (FD_, FB_, FS_, FZ_, FC_)	535
TRANSIT CONNECT (P65_, P70_, P80_)	536
TRANSIT CONNECT Kasten	536
TRANSIT CONNECT Kombi	537
TRANSIT COURIER Kasten	537
TRANSIT COURIER Kombi	538
TRANSIT CUSTOM Bus	538
TRANSIT CUSTOM Kasten	538
TRANSIT Kasten	538
TRANSIT Kasten (E_)	540
TRANSIT Kasten (FA_)	540
TRANSIT Pritsche/Fahrgestell	541
TRANSIT Pritsche/Fahrgestell (E_)	542
TRANSIT Pritsche/Fahrgestell (FM_, FN_)	543
TRANSIT TOURNEO	543

FORD USA**544**

PROBE II (ECP)	544
----------------	-----

HONDA**544**

ACCORD Coupe (CM)	549
ACCORD IX Stufenheck (CR)	549
ACCORD V (CC, CD)	544
ACCORD V (CE, CF_)	545
ACCORD V Aerodeck (CE)	546
ACCORD V Coupe (CD)	546
ACCORD VI (CK, CG, CH, CF8)	546
ACCORD VI Aerodeck (CF)	547
ACCORD VI Coupe (CG)	547
ACCORD VI Hatchback (CH, CL)	547
ACCORD VII (CL, CN)	547
ACCORD VII (CM)	548
ACCORD VIII (CP)	548
ACCORD VIII (CU)	548
ACCORD VIII TOURER (CW)	549
ACCORD VII Tourer (CM, CN)	548
CITY Stufenheck (GM2, GM3)	549
CIVIC Coupe	558
CIVIC II Shuttle (EE)	549
CIVIC IX (FK)	558
CIVIC IX Stufenheck (FB, FG)	558
CIVIC IX Tourer (FK)	558
CIVIC V Coupe (EJ)	549
CIVIC V Hatchback (EG)	550
CIVIC VI Aerodeck (MB, MC)	551
CIVIC VI Coupe (EJ, EM1)	551
CIVIC VI Fastback (MA, MB)	552
CIVIC VI Hatchback (EJ, EK)	553
CIVIC VII Coupe (EM2)	555
CIVIC VII Hatchback (EU, EP, EV)	555
CIVIC VIII Hatchback (FN, FK)	557
CIVIC VIII Stufenheck (FD, FA)	557
CIVIC VII Stufenheck (ES, ET)	556

**HONDA****544**

CIVIC VI Stufenheck (EJ, EK)	554
CIVIC V Stufenheck (EG, EH)	550
CIVIC X Schrägheck (FC_, FK)	558
CONCERTO (HW, MA)	558
CONCERTO Stufenheck (HWW)	559
CR-V I (RD)	559
CR-V II (RD_)	559
CR-V III (RE_)	560
CR-V IV (RM_)	561
CRX III (EH, EG)	561
FR-V (BE)	561
HR-V (GH)	562
INSIGHT (ZE_)	562
INSIGHT (ZE)	562
INTEGRA Coupe (DC2, DC4)	562
JAZZ II (GD_, GE3, GE2)	562
JAZZ III (GE_, GG_, GP_)	563
JAZZ IV (GK_)	563
LEGEND II (KA)	563
LEGEND II Coupe (KA)	563
LEGEND III (KA)	564
LOGO (GA)	564
NSX Cabriolet (NA)	564
NSX Coupe (NA)	564
ODYSSEY (RA_)	564
PRELUDE IV (BB)	564
PRELUDE V (BB)	565
S2000 (AP)	565
SHUTTLE (RA)	565
STREAM (RN)	566

HYUNDAI**566**

ACCENT I (X-3)	566
ACCENT II (LC)	566
ACCENT III (MC)	567
ACCENT III Stufenheck (MC)	567
ACCENT II Stufenheck (LC)	566
ACCENT IV (RB)	567
ACCENT IV Stufenheck (RB)	567
ACCENT Stufenheck (X-3)	568
ATOS (MX)	568
ATOS PRIME (MX)	568
COUPE (GK)	568
COUPE (RD)	569
CRETA	569
ELANTRA (XD)	569
ELANTRA Stufenheck (HD)	570
ELANTRA Stufenheck (MD, UD)	570
ELANTRA Stufenheck (XD)	571
EQUUS / CENTENNIAL	571
EQUUS / CENTENNIAL (JS)	571
GALLOPER II (JK-01)	571
GENESIS Coupe	572
GETZ (TB)	572
GRANDEUR (HG)	573
GRANDEUR (TG)	573
GRAND SANTA FÉ	573
H-1 / STAREX	573
H100 Bus (P)	575
H100 Kasten	575
H100 Pick-up	576
H100 Pritsche/Fahrgestell	576
H-1 Cargo (TQ)	574
H-1 Kasten	574
H-1 Pritsche/Fahrgestell	575
H-1 Travel (TQ)	575
HIGHWAY VAN	576
i10 (BA, IA)	576
i10 (PA)	576
i10 Stufenheck	577
i20 (GB)	577
i20 (PB, PBT)	577
i20 ACTIVE (GB)	578
i20 Coupe (GB)	578
i30 (FD)	578
i30 (GD)	578
i30 (PDE)	579
i30 Coupe	579
i30 CW	580



**HYUNDAI****566**

i30 CW (FD)	580
i30 CW (GD)	581
i40 (VF)	581
i40 CW (VF)	581
IONIQ (AE)	582
ix20 (JC)	582
ix35 (LM, EL, ELH)	582
ix55	583
LANTRA I (J-1)	583
LANTRA II (J-2)	583
LANTRA II Wagon (J-2)	584
MATRIX (FC)	584
PONY / EXCEL Stufenheck (X-2)	584
PONY (X-2)	585
SANTA FÉ I (SM)	585
SANTA FÉ II (CM)	585
SANTA FÉ III (DM)	586
SANTAMO	587
S COUPE (SLC)	587
SONATA III (Y-3)	587
SONATA IV (EF)	587
SONATA V (NF)	588
SONATA VI (YF)	588
SONATA VII (LF)	589
TERRACAN (HP)	589
TIBURON Coupe	589
TRAJET (FO)	589
TUCSON (JM)	589
TUCSON (TL)	590
VELOSTER (FS)	590
XG (XG)	591
XG Stufenheck	591

INFINITI**591**

EX	591
FX	591
G Cabriolet	591
G Coupe	591
G Stufenheck	592
M (Y51)	592
M35	592
M37	592
M45	592
Q50	592
Q60 Cabriolet	592
Q60 Coupe	593
Q70 (Y51)	593
QX50	593

ISUZU**593**

TROOPER II (UB)	593
TROOPER III	593
TROOPER III Soft Top	594
TROOPER II Soft Top (UB)	593

IVECO**594**

DAILY II Bus	594
DAILY III Kasten/Kombi	597
DAILY III Pritsche/Fahrgestell	598
DAILY II Kasten/Kombi	594
DAILY II Kipper	595
DAILY II Pritsche/Fahrgestell	596
DAILY IV Bus	600
DAILY IV Kasten/Kombi	600
DAILY IV Kipper	601
DAILY IV Pritsche/Fahrgestell	601
DAILY V Kasten/Kombi	602
DAILY V Kipper	602
DAILY V Pritsche/Fahrgestell	603
MASSIF Pick-up	603
MASSIF Single Cab	603
MASSIF Station Wagon	603

JAGUAR**603**

S-TYPE (CCX_)	603
---------------	-----

**JAGUAR****603**

XF (CC9_)	604
XF SPORTBRAKE (CC9_)	605
XJ (NAW_, NBW_, X308_)	605
XJ (X300_, X330_)	606
XJ (X350_)	606
XJ (X351_)	607
XJ Coupe	607
XJSC Convertible	607
XK 8 Convertible (X100_, QDV_)	607
XK 8 Coupe (X100_, QEV_)	608
XK Cabriolet (QQ6_)	608
XK Coupe (QQ6_)	609
X-TYPE (CF1_)	609
X-TYPE Estate (CF1_)	610

JEEP**610**

CHEROKEE (KJ)	610
CHEROKEE (KK)	610
CHEROKEE (KL)	611
CHEROKEE (XJ)	611
COMANCHE (MJ)	611
COMMANDER (XK, XH)	611
COMPASS (MK49)	611
GRAND CHEROKEE I (ZJ)	612
GRAND CHEROKEE II (WJ, WG)	612
GRAND CHEROKEE III (WH, WK)	612
GRAND CHEROKEE IV (WK, WK2)	612
PATRIOT (MK74)	613
RENEGADE Geländewagen geschlossen (BU)	613
WRANGLER I (YJ, SJ_)	613
WRANGLER II (TJ)	613
WRANGLER III (JK)	614

KIA**614**

BESTA Bus	614
BESTA Kasten	614
BONGO Pritsche/Fahrgestell	614
CARENS I (FC)	614
CARENS II (FJ)	614
CARENS III (UN)	614
CARENS IV	615
CARNIVAL / GRAND CARNIVAL III (VQ)	615
CARNIVAL I (UP)	615
CARNIVAL II (GQ)	615
CEE`D Sportswagon (JD)	616
CEE`D (JD)	616
CEE`D Schrägheck (ED)	617
CEE`D SW (ED)	618
CERATO (LD)	618
CERATO II (TD)	618
CERATO II Stufenheck (TD)	618
CERATO KOUP	619
CERATO KOUP (TD)	619
CERATO Stufenheck	619
CERATO Stufenheck (LD)	619
CLARUS (K9A)	620
CLARUS Kombi (GC)	620
JOICE	620
MAGENTIS (GD, MS)	620
MAGENTIS (MG)	621
OPIRUS (GH)	621
OPTIMA	621
OPTIMA Sportswagon	622
PICANTO (BA)	622
PICANTO (JA)	622
PICANTO (TA)	623
PREGIO Bus	623
PREGIO Kasten (TB)	623
PRIDE (DA)	623
PRIDE Kombi	623
PRIDE Van (DA)	623
PRO CEE`D (JD)	624
PRO CEE`D (ED)	624
RETONA (CE)	625
RIO II (JB)	625
RIO III (UB)	625
RIO III Stufenheck (UB)	625

**KIA****614**

RIO II Stufenheck (JB)	625
RIO IV (YB)	626
RIO Kombi (DC)	626
RIO Stufenheck (DC_)	626
SEPHIA (FA)	626
SEPHIA Stufenheck (FA)	627
SHUMA (FB)	627
SHUMA II (FB)	627
SHUMA II Stufenheck (FB)	627
SHUMA Stufenheck (FB)	627
SORENTO I (JC)	628
SORENTO II (XM)	628
SORENTO III (UM)	628
SOUL (AM)	629
SOUL II (PS)	629
SPORTAGE (JE_, KM_)	630
SPORTAGE (K00)	630
SPORTAGE (QL)	631
SPORTAGE (SL)	631
VENGA (YN)	631

LADA**631**

110 (2110)	631
111 (2111)	632
112 (2112)	632
1200-1600	632
KALINA Kombi (1117)	633
KALINA Kombi (2194)	633
KALINA Schrägheck (1119)	633
KALINA Schrägheck (2192)	633
KALINA Stufenheck (1118)	633
NIVA (2121)	633
NOVA (2105)	634
NOVA Kombi (2104)	634
PRIORA Kombi (2171)	634
PRIORA Schrägheck (2172)	634
PRIORA Stufenheck (2170)	634
SAMARA (2108, 2109, 2115, 2113, 2114)	634
SAMARA FORMA Stufenheck (21099, 2115)	635
TAIGA II (2123)	635
TOSCANA (2107)	635

LANCIA**635**

DEDRA (835_)	635
DEDRA SW (835_)	637
DELTA II (836_)	638
DELTA III (844_)	639
FLAVIA Cabriolet (JS_)	639
KAPPA (838_)	640
KAPPA Coupe (838_)	640
KAPPA SW (838_)	640
LYBRA (839_)	641
LYBRA SW (839_)	641
MUSA (350_)	642
PHEDRA (179_)	643
THESIS (841_)	643
Y (840_)	643
Y10 (156_)	644
YPSILON (312_)	644
YPSILON (843_)	644
ZETA (22_)	645

LAND ROVER**645**

DEFENDER Cabrio (LD_)	645
DEFENDER Pick-up (LD_)	646
DEFENDER Pritsche/Fahrgestell (LD_)	648
DEFENDER Station Wagon (LD_)	648
DISCOVERY I (LJ_)	649
DISCOVERY II (LT_)	650
DISCOVERY III (LA_)	651
DISCOVERY IV (LA_)	651
DISCOVERY SPORT (LC_)	652
DISCOVERY V (LR_)	652
FREELANDER (LN_)	652
FREELANDER 2 (LF_)	652
FREELANDER Soft Top (LN_)	653
RANGE ROVER EVOQUE (LV_)	655

**LAND ROVER 645**

RANGE ROVER EVOQUE Cabriolet (LV_)	655
RANGE ROVER II (LP_)	653
RANGE ROVER III (LM_)	653
RANGE ROVER IV (LG_)	655
RANGE ROVER SPORT (LS_)	656
RANGE ROVER SPORT (LW_)	657

LEXUS 657

CT (ZWA10_)	657
ES (_V4_)	657
ES (_V6_)	657
ES (MCV_, VZV_)	658
GS (_L1_)	658
GS (GRS19_, UZS19_, URS19_)	658
GS (JZS160_, UZS161_, UZS160_)	659
GX (_J12_)	659
GX (URJ15_)	659
HS (ANF10)	659
IS C (GSE2_)	660
IS I (JCE1_, GXE1_)	659
IS II (GSE2_, ALE2_, USE2_)	660
IS III (_E3_)	660
IS SportCross	660
LS (_F4_)	660
LX (_J2_)	660
LX (UZJ100)	661
NX (_Z1_)	661
RC (_C1_)	661
RX (_L1_)	661
RX (_U3_)	661
RX (MCU15)	662
SC Cabriolet (UZZ40_)	662

MAYBACH 662

MAYBACH (240_)	662
----------------	-----

MAZDA 662

121 II (DB)	671
121 III (JASM, JBSM)	671
2 (DE)	662
2 (DY)	662
2 Stufenheck (DE)	663
3 (BK)	663
3 (BL)	664
3 (BM)	665
323 C IV (BG)	672
323 C V (BA)	672
323 F V (BA)	672
323 F VI (BJ)	673
323 III Station Wagon (BW)	672
323 P V (BA)	673
323 S IV (BG)	674
323 S V (BA)	674
323 S VI (BJ)	674
3 Stufenheck (BK)	665
3 Stufenheck (BL)	666
3 Stufenheck (BM)	666
5 (CR19)	667
5 (CW)	667
626 III Station Wagon (GV)	675
626 IV (GE)	676
626 IV Hatchback (GE)	676
626 V (GF)	676
626 V Hatchback (GF)	677
626 V Station Wagon (GW)	677
6 Hatchback (GG)	667
6 Kombi (GJ, GL)	668
6 Sport (GH)	668
6 Sport Kombi (GH)	669
6 Station Wagon (GY)	669
6 Stufenheck (GG)	670
6 Stufenheck (GH)	670
6 Stufenheck (GJ, GL)	671
B-SERIE (UN)	678
BT-50 Pick-up (CD, UN)	678
BT-50 Pritsche/Fahrgestell (CD, UN)	678
CX-3 (DK)	678

**MAZDA 662**

CX-5 (KE, GH)	678
CX-5 (KF)	679
CX-7 (ER)	679
CX-9 (TB)	679
DEMIO (DW)	680
E-SERIE Bus	680
E-SERIE Kasten (SR2)	680
E-SERIE Pritsche/Fahrgestell (SD1)	680
MPV I (LV)	680
MPV II (LW)	680
MX-3 (EC)	680
MX-5 I (NA)	681
MX-5 II (NB)	681
MX-5 III (NC)	682
MX-5 IV (ND)	682
MX-5 RF (ND)	682
MX-6 (GE)	682
PREMACY (CP)	682
RX-8 (SE, FE)	683
TRIBUTE (EP)	683
XEDOS 6 (CA)	684
XEDOS 9 (TA)	684

MERCEDES-BENZ 684

100 Bus (631)	684
100 Kasten (631)	684
100 Pritsche/Fahrgestell (631)	685
A-KLASSE (W168)	685
A-KLASSE (W169)	686
A-KLASSE (W176)	688
B-KLASSE (W245)	690
B-KLASSE (W246, W242)	691
CITAN Kasten (415)	692
CITAN Kombi / Tourer (415)	693
CITAN Mixto (415)	693
C-KLASSE (W202)	693
C-KLASSE (W203)	696
C-KLASSE (W204)	702
C-KLASSE (W205)	707
C-KLASSE Cabriolet (A205)	708
C-KLASSE Coupe (C204)	709
C-KLASSE Coupe (C205)	710
C-KLASSE Kombi (S202)	711
C-KLASSE Kombi (S203)	713
C-KLASSE Kombi (S204)	717
C-KLASSE Kombi (S205)	722
C-KLASSE Sportcoupe (CL203)	723
CLA Coupe (C117)	726
CLA Shooting Brake (X117)	727
CLC-KLASSE (CL203)	729
CLK (C208)	730
CLK (C209)	731
CLK Cabriolet (A208)	734
CLK Cabriolet (A209)	736
CLS (C218)	738
CLS (C219)	740
CLS Shooting Brake (X218)	741
E-KLASSE (W124)	743
E-KLASSE (W210)	745
E-KLASSE (W211)	750
E-KLASSE (W212)	754
E-KLASSE (W213)	759
E-KLASSE All-Terrain (S213)	759
E-KLASSE Cabriolet (A124)	759
E-KLASSE Cabriolet (A207)	760
E-KLASSE Cabriolet (A238)	763
E-KLASSE Coupe (C124)	763
E-KLASSE Coupe (C207)	764
E-KLASSE Coupe (C238)	766
E-KLASSE Kombi (S124)	766
E-KLASSE Kombi (S210)	768
E-KLASSE Kombi (S211)	772
E-KLASSE Kombi (S212)	776
E-KLASSE Kombi (S213)	780
G-KLASSE (W461)	781
G-KLASSE (W463)	781
G-KLASSE Geländewagen offen (W463)	783
GLA-KLASSE (X156)	784
GLC (X253)	785

**MERCEDES-BENZ 684**

GLC Coupe (C253)	785
GLE (W166)	785
GLE Coupe (C292)	787
GLK-KLASSE (X204)	787
GL-KLASSE (X164)	789
GL-KLASSE (X166)	790
GLS (X166)	790
M-KLASSE (W163)	790
M-KLASSE (W164)	793
M-KLASSE (W166)	794
R-KLASSE (W251, V251)	795
S-KLASSE (W140)	797
S-KLASSE (W220)	799
S-KLASSE (W221)	803
S-KLASSE (W222, V222, X222)	805
S-KLASSE Cabriolet (A217)	806
S-KLASSE Coupe (C140)	807
S-KLASSE Coupe (C215)	808
S-KLASSE Coupe (C216)	808
S-KLASSE Coupe (C217)	809
SL (R129)	809
SL (R230)	811
SL (R231)	813
SLC (R172)	813
SLK (R170)	814
SLK (R171)	815
SLK (R172)	817
SLR (R199)	818
SLR Roadster (R199)	818
SLS AMG (C197)	818
SLS AMG Roadster (R197)	818
SPRINTER 2-t Bus (901, 902)	818
SPRINTER 2-t Kasten (901, 902)	819
SPRINTER 2-t Pritsche/Fahrgestell (901, 902)	819
SPRINTER 3,5-t Bus (906)	820
SPRINTER 3,5-t Kasten (906)	822
SPRINTER 3,5-t Pritsche/Fahrgestell (906)	824
SPRINTER 3-t Bus (903)	826
SPRINTER 3-t Bus (906)	827
SPRINTER 3-t Kasten (903)	828
SPRINTER 3-t Kasten (906)	829
SPRINTER 3-t Pritsche/Fahrgestell (903)	830
SPRINTER 3-t Pritsche/Fahrgestell (906)	831
SPRINTER 4,6-t Kasten (906)	833
SPRINTER 4,6-t Pritsche/Fahrgestell (906)	833
SPRINTER 4-t Bus (904)	834
SPRINTER 4-t Kasten (904)	834
SPRINTER 4-t Pritsche/Fahrgestell (904)	836
SPRINTER 5-t Bus	837
SPRINTER 5-t Kasten (906)	837
SPRINTER 5-t Pritsche/Fahrgestell (905)	839
SPRINTER 5-t Pritsche/Fahrgestell (906)	839
SPRINTER CLASSIC 3,5-t Kasten (909)	841
SPRINTER CLASSIC 4,6-t Bus (909)	842
SPRINTER Kipper (905)	842
T1/TN Kasten/Kombi	842
T1/TN Pritsche/Fahrgestell	843
T1 Bus (601)	843
T1 Bus (602)	844
T1 Kasten (601, 611)	844
T1 Kasten (602)	845
T1 Pritsche/Fahrgestell (601)	845
T1 Pritsche/Fahrgestell (602)	845
VANEO (414)	846
VARIO Bus	846
VARIO Kasten/Kombi	847
VARIO Kipper	848
VARIO Pritsche/Fahrgestell	850
VARIO Triebkopf	851
VIANO (W639)	852
VITO / MIXTO Kasten (W639)	853
VITO Bus (638)	854
VITO Bus (W639)	855
VITO Kasten (638)	856
VITO Kasten (W447)	857
VITO Mixto (W447)	858
VITO Tourer (W447)	859
V-KLASSE (638/2)	860
V-KLASSE (W447)	860





MG	861
EXPRESS Kasten	861
MGF (RD)	861
MG TF	861
MG ZR	861
MG ZS	862
MG ZS Hatchback	862
MG ZT	862
MG ZT- T	863

MINI	863
MINI (F55)	863
MINI (F56)	864
MINI (R50, R53)	865
MINI (R56)	866
MINI Cabriolet (F57)	869
MINI Cabriolet (R52)	869
MINI Cabriolet (R57)	870
MINI CLUBMAN (F54)	872
MINI CLUBMAN (R55)	873
MINI CLUBVAN (R55)	874
MINI COUNTRYMAN (F60)	875
MINI COUNTRYMAN (R60)	875
MINI Coupe (R58)	877
MINI PACEMAN (R61)	877
MINI Roadster (R59)	878

MITSUBISHI	879
ASX (GA_W_)	879
ASX Van (GA_W_)	879
CARISMA (DA_)	879
CARISMA Stufenheck (DA_)	881
COLT CZC Cabriolet (RG)	883
COLT IV (CA_A)	882
COLT PLUS VI (Z2_W)	883
COLT V (CJ_, CP_)	882
COLT VI (Z3_A, Z2_A)	882
DELICA / SPACE GEAR	883
ECLIPSE I (D2_A)	883
ECLIPSE II (D3_A)	884
FTO Coupe (DE_A)	884
GALANT Stufenheck (DJ_, ED_, EF_)	887
GALANT V (E5_A, E7_A, E8_A)	884
GALANT VI (EA_)	885
GALANT VI Station Wagon (EA_)	886
GALANT V Stufenheck (E5_A, E7_A, E8_A)	884
GALLOPER (JK-01)	887
GRANDIS (NA_W)	887
i (HA_)	887
L100 / MINICAB Bus (U6_V)	887
L100 / MINICAB Pritsche/Fahrgestell (U6_T)	888
L 200 / TRITON (KA_T, KB_T)	888
L 200 / TRITON Pritsche/Fahrgestell (KA_T, KB_T)	888
L 200 (K3_T, K2_T, K1_T, K0_T)	888
L 200 (K7_T, K6_T)	888
L200 (KJ_, KK_, KL_)	888
L 200 Pritsche/Fahrgestell (K3_T, K0_T, K1_T, K2_T)	889
L 200 Pritsche/Fahrgestell (K6_T, K7_T)	889
L 300 III Bus (P0_W, P1_W, P2_W)	889
L 300 III Kasten (P0_V, P1_V, P2_V)	890
L 300 III Pritsche/Fahrgestell (P1_T)	891
L 400 Bus (PD_W, PC_W, PA_V, PB_V, PA_W)	891
L 400 Kasten (PD_W, PC_W, PB_V, PA_W, PA_V)	891
LANCER V (CB_A, CD_A, CE_A)	892
LANCER VI (CJ-CP_)	892
LANCER VI Coupe (CJ_A, CE)	893
LANCER VII (CS_A, CT_A)	893
LANCER VIII (CY_A, CZ_A)	894
LANCER VIII Sportback (CX_A)	894
LANCER VII Kombi (CS_W, CT_W)	894
LANCER V Station Wagon (CB_W, CD_W)	892
MIRAGE Schrägheck (CJ_A, CL_A)	895
MIRAGE Schrägheck (CJ_A)	895
MIRAGE Stufenheck (A1_A)	895

MITSUBISHI	879
MIRAGE Stufenheck (CK_A)	895
OUTLANDER I (CU_W)	896
OUTLANDER II (CW_W)	896
OUTLANDER III (GG_W, GF_W, ZJ)	897
PAJERO CLASSIC (V2_W)	902
PAJERO II (V3_W, V2_W, V4_W)	898
PAJERO II (V3_W)	898
PAJERO II Canvas Top (V2_W, V4_W)	899
PAJERO III (V7_W, V6_W)	899
PAJERO III Geländewagen offen (V6_W, V7_W)	900
PAJERO IV (V8_W, V9_W)	901
PAJERO IV Van (V90, V80, V8_V)	902
PAJERO PININ (H6_W, H7_W)	903
PAJERO SPORT I (K7_, K9_)	903
PAJERO SPORT II (KH_, KG_)	904
PAJERO SPORT VAN I (K90)	904
SANTAMO	904
SIGMA (F2_A, F1_A)	904
SIGMA Station Wagon (F0_W)	905
SPACE RUNNER (N1_W, N2_W)	905
SPACE RUNNER (N6_W)	905
SPACE STAR Großraumlimousine (DG_A)	905
SPACE STAR Schrägheck (A0_A)	906
SPACE WAGON (N3_W, N4_W)	906
SPACE WAGON (N9_W, N8_W)	907

NISSAN	907
200 SX (S14)	907
350 Z Coupe (Z33)	907
350 Z Roadster (Z33)	908
ALMERA I (N15)	908
ALMERA I Hatchback (N15)	909
ALMERA II (N16)	910
ALMERA II Hatchback (N16)	910
ALMERA TINO (V10)	912
CABSTAR (F23, H41, H42)	912
CABSTAR (F24M, F24W)	912
CABSTAR E (TL_, VL_)	913
CEFIRO III Stufenheck (A33)	913
CUBE (Z12)	914
EVALIA Bus	914
INTERSTAR Bus (X70)	914
INTERSTAR Kasten (X70)	915
INTERSTAR Pritsche/Fahrgestell	915
JUKE (F15)	915
KUBISTAR (X76)	916
KUBISTAR Kasten (X80)	916
LEAF (ZE0)	917
MAXIMA / MAXIMA QX V (A33)	917
MICRA C+C III (K12)	918
MICRA II (K11)	917
MICRA III (K12)	917
MICRA IV (K13)	918
MICRA V (K14)	918
MURANO I (Z50)	918
MURANO II (Z51)	919
NAVARA (D21)	919
NAVARA (D22_)	919
NAVARA Pritsche/Fahrgestell (D22)	920
NOTE (E11, NE11)	920
NOTE (E12)	921
NP300 NAVARA (D40)	921
NP300 NAVARA Pritsche/Fahrgestell (D40)	921
NP300 PICKUP (D22)	922
NT400 CABSTAR (F24F)	922
NV200 Kasten/Kombi	922
NV400 Bus	922
NV400 Kasten	923
NV400 Pritsche/Fahrgestell	923
PATHFINDER II (R50)	923
PATHFINDER III (R51)	923
PATROL GR IV (Y60, GR)	924
PATROL GR V Pritsche/Fahrgestell (Y61)	924
PATROL GR V Wagon (Y61)	924
PATROL III/2 Hardtop (K260)	925
PATROL III/2 Station Wagon (W260)	925
PICK UP (D21)	925
PICK UP (D22)	925

NISSAN	907
PIXO (UA0)	926
PRIMASTAR Bus (X83)	926
PRIMASTAR Kasten (X83)	927
PRIMASTAR Pritsche/Fahrgestell (X83)	927
PRIMERA (P10)	927
PRIMERA (P11)	928
PRIMERA (P12)	928
PRIMERA Hatchback (P10)	929
PRIMERA Hatchback (P11)	930
PRIMERA Hatchback (P12)	930
PRIMERA Traveller (W10)	931
PRIMERA Traveller (WP11)	932
PRIMERA Traveller (WP12)	932
PULSAR I Stufenheck (N15)	933
PULSAR Schrägheck (C13)	933
QASHQAI / QASHQAI +2 I (J10, JJ10)	933
QASHQAI II (J11, J11_)	934
SENTRA VII (B17)	935
SERENA (C23)	935
SUNNY III (N14)	935
SUNNY III Hatchback (N14)	936
SUNNY III Kasten (Y10)	936
SUNNY III Liftback (N14)	936
SUNNY III Traveller (Y10)	937
TEANA I (J31)	937
TERRANO (D10)	937
TERRANO I (WD21)	937
TERRANO II (R20)	937
TERRANO II Van (R20)	938
TIIDA Schrägheck (C11)	938
TIIDA Stufenheck (SC11)	938
TRADE Pritsche/Fahrgestell	939
URVAN Bus (E24)	939
URVAN Kasten (E24)	939
VANETTE Bus (C22)	939
VANETTE CARGO Bus (HC 23)	939
VANETTE CARGO Kasten (HC 23)	940
VANETTE Kasten (C22)	940
VERSA I	940
X-TRAIL (T30)	940
X-TRAIL (T31)	941
X-TRAIL (T32_)	942

OPEL	942
ADAM	942
AGILA (A) (H00)	943
AGILA (B) (H08)	943
AMPERA	943
ANTARA	943
ARENA Bus	944
ARENA Combi (THB)	944
ARENA Kasten	944
ARENA Kasten (TB, TF)	945
ASTRA CLASSIC (L48)	945
ASTRA F (56_, 57_)	945
ASTRA F Cabriolet (53_B)	946
ASTRA F Caravan (51_, 52_)	947
ASTRA F CC (53_, 54_, 58_, 59_)	948
ASTRA F CLASSIC Caravan	950
ASTRA F CLASSIC CC	950
ASTRA F CLASSIC Stufenheck	950
ASTRA F Van (55_)	951
ASTRA G Cabriolet (F67)	951
ASTRA G Caravan (F35_)	952
ASTRA G CC (F48_, F08_)	956
ASTRA G Coupe (F07_)	959
ASTRA G Kasten (F70)	959
ASTRA G Stufenheck (F69_)	960
ASTRA H (L48)	962
ASTRA H Caravan (L35)	964
ASTRA H GTC (L08)	965
ASTRA H Kasten (L70)	967
ASTRA H Stufenheck (L69)	968
ASTRA H TwinTop (L67)	969
ASTRA J	970
ASTRA J GTC	971
ASTRA J Sports Tourer	972
ASTRA J Stufenheck	972
CALIBRA A (85_)	973

**OPEL 942**

CAMPO (TF_)	973
CASCADA (W13)	974
COMBO (71_)	974
COMBO Kasten/Kombi	975
COMBO Kasten/Kombi (X12)	975
COMBO Pritsche/Fahrgestell (X12)	976
COMBO Tour	976
COMBO Tour (X12)	977
CORSA B (73_, 78_, 79_)	977
CORSA B Kasten (73_)	978
CORSA B Kombi (F35)	978
CORSA C (F08, F68)	978
CORSA C Kasten (F08, W5L)	978
CORSA D	979
CORSA D Van	981
CORSA E	981
CORSA E Van	982
FRONTERA A (5_MWL4)	983
FRONTERA A Sport (5_SUD2)	983
FRONTERA B (6B_)	983
GT Cabriolet	984
INSIGNIA	984
INSIGNIA Caravan	986
INSIGNIA Stufenheck	987
MERIVA	989
MERIVA B	989
MOKKA / MOKKA X	990
MONTEREY A (UBS_)	990
MONTEREY B	990
MOVANO B Bus	991
MOVANO B Kasten	991
MOVANO B Pritsche/Fahrgestell	991
MOVANO Combi (J9)	992
MOVANO Kasten (F9)	993
MOVANO Kipper (H9)	993
MOVANO Pritsche/Fahrgestell (U9, E9)	994
OMEGA B (25_, 26_, 27_)	995
OMEGA B Caravan (21_, 22_, 23_)	996
SIGNUM	997
SINTRA	999
SPEEDSTER	999
TIGRA (75_)	1000
TIGRA TwinTop	1000
VECTRA A (86_, 87_)	1000
VECTRA A CC (88_, 89_)	1002
VECTRA B (36_)	1003
VECTRA B Caravan (31_)	1004
VECTRA B CC (38_)	1006
VECTRA C	1007
VECTRA C Caravan	1010
VECTRA C GTS	1012
VIVARO Combi	1015
VIVARO Combi (J7)	1015
VIVARO Kasten	1015
VIVARO Kasten (F7)	1016
VIVARO Pritsche/Fahrgestell	1016
VIVARO Pritsche/Fahrgestell (E7)	1016
ZAFIRA A (F75_)	1017
ZAFIRA B (A05)	1018
ZAFIRA B Van	1019
ZAFIRA TOURER C (P12)	1020

PEUGEOT 1021

1007 (KM_)	1071
106 I (1A, 1C)	1021
106 II (1)	1022
106 Van (1_)	1022
107	1023
108	1023
2008	1071
205 II (20A/C)	1023
205 Kasten	1025
206+ (T3E)	1029
206 CC (2D)	1025
206 Schrägheck (2A/C)	1026
206 Stufenheck	1028
206 SW (2E/K)	1028
206 Van	1029
207 (WA_, WC_)	1029

PEUGEOT 1021

207 CC (WD_)	1031
207 Stufenheck	1031
207 SW (WK_)	1031
207 Van	1033
208	1033
208 Kasten	1034
3008	1072
3008 SUV	1072
301	1034
306 (7B, N3, N5)	1034
306 Break (7E, N3, N5)	1037
306 Cabriolet (7D, N3, N5)	1038
306 Kasten/Kombi (N_, 7_)	1039
306 Kasten/Schrägheck	1040
306 Schrägheck (7A, 7C, N3, N5)	1040
307 (3A/C)	1044
307 Break (3E)	1047
307 CC (3B)	1049
307 SW (3H)	1050
308 (4A_, 4C_)	1052
308 CC	1054
308 II	1053
308 SW	1054
308 SW II	1056
4007 (GP_)	1073
4008	1073
405 II (4B)	1058
405 II Break (4E)	1059
406 (8B)	1059
406 Break (8E/F)	1061
406 Coupe (8C)	1062
407 (6D_)	1063
407 Coupe (6C_)	1064
407 SW (6E_)	1065
5008	1073
5008 II	1074
505 (551A)	1065
508	1066
508 SW	1066
605 (6B)	1068
607 (9D, 9U)	1069
806 (221)	1069
807 (E)	1070
BIPPER (AA_)	1074
BIPPER Tepee	1074
BOXER Bus	1074
BOXER Bus (230P)	1075
BOXER Bus (244, Z_)	1077
BOXER Kasten	1078
BOXER Kasten (230L)	1078
BOXER Kasten (244)	1080
BOXER Pritsche/Fahrgestell	1081
BOXER Pritsche/Fahrgestell (244)	1081
BOXER Pritsche/Fahrgestell (ZCT_)	1082
EXPERT (224)	1083
EXPERT Kasten	1084
EXPERT Kasten (222)	1084
EXPERT Kasten (VF3A_, VF3U_, VF3X_)	1085
EXPERT Pritsche/Fahrgestell	1085
EXPERT Pritsche/Fahrgestell (223)	1085
EXPERT Tepee (VF3V_)	1086
ION	1086
PARTNER Combispace (5F)	1086
PARTNER Kasten	1089
PARTNER Kasten (5)	1089
PARTNER Pritsche/Fahrgestell	1091
PARTNER Tepee	1091
RCZ	1092
TRAVELLER	1092

PONTIAC 1092

TRANS SPORT	1092
-------------	------

PORSCHE 1093

718 BOXSTER (982)	1093
718 CAYMAN (982)	1093
911 (991)	1093
911 (993)	1094

PORSCHE 1093

911 (996)	1094
911 (997)	1095
911 Cabriolet (991)	1098
911 Cabriolet (993)	1098
911 Cabriolet (996)	1099
911 Cabriolet (997)	1100
911 Targa (991)	1101
911 Targa (993)	1101
911 Targa (996)	1101
911 Targa (997)	1102
928	1102
968	1102
968 Cabriolet	1102
BOXSTER (981)	1103
BOXSTER (986)	1103
BOXSTER (987)	1104
BOXSTER Spyder (981)	1105
BOXSTER Spyder (987)	1105
CARRERA GT (980)	1106
CAYENNE (92A)	1113
CAYENNE (9PA)	1106
CAYMAN (981)	1115
CAYMAN (987)	1116
MACAN (95B)	1117
PANAMERA (970)	1117

PROTON 1118

JUMBUCK Pick-up	1118
PERSONA 300 (C9_M)	1118
PERSONA 400 (C9_S)	1119
PERSONA 400 Hatchback (C9_C, C9_S)	1119
SATRIA (C9_M)	1119
SATRIA NEO	1120
WIRA	1120
WIRA Hatchback	1120

RENAULT 1120

19 II (B/C53_)	1120
19 II Cabriolet (D53_, 853_)	1122
19 II Chamade (L53_)	1123
19 II Kasten (S53_)	1125
21 Kasten (S48_)	1125
21 Kombi (K48_)	1125
AVANTIME (DE0_)	1125
CAPTUR (J5_)	1126
CLIO Grandtour (KR0/1_)	1134
CLIO I (B/C57_, 5/357_)	1126
CLIO II (BB0/1/2_, CB0/1/2_)	1129
CLIO III (BR0/1, CR0/1)	1131
CLIO III Kasten (SB_, SR_)	1133
CLIO II Kasten (SB0/1/2_)	1130
CLIO I Kasten (S57_)	1128
CLIO IV (BH_)	1133
CLIO IV Grandtour (KH_)	1133
CLIO IV Kasten	1134
DOKKER	1134
DUSTER (HS_)	1134
ESPACE II (J/S63_)	1135
ESPACE III (JE0_)	1135
ESPACE IV (JK0/1_)	1136
ESPACE V (JR_)	1137
EXPRESS Kasten/Kombi	1137
EXPRESS Pick-up	1137
FLUENCE (L30_)	1137
GRAND SCÉNIC II (JM0/1_)	1138
GRAND SCÉNIC III (JZ0/1_)	1139
GRAND SCÉNIC IV (R9_)	1140
KADJAR (HA_, HL_)	1140
KANGOO / GRAND KANGOO (KW0/1_)	1140
KANGOO (KC0/1_)	1141
KANGOO BE BOP (KW0/1_)	1142
KANGOO Express (FW0/1_)	1142
KANGOO Rapid (FC0/1_)	1143
KOLEOS I (HY_)	1144
KOLEOS II	1144
LAGUNA Coupe (DT0/1)	1155
LAGUNA I (B56_, 556_)	1144
LAGUNA I Grandtour (K56_)	1147



**RENAULT****1120**

LAGUNA II (BG0/1_)	1150
LAGUNA II Grandtour (KG0/1_)	1151
LAGUNA III (BT0/1)	1154
LAGUNA III Grandtour (KT0/1)	1154
LATITUDE (L70_)	1155
LOGAN EXPRESS (US_)	1157
LOGAN I (LS_)	1156
LOGAN II (B8_)	1157
LOGAN II Kombi (K8_)	1157
LOGAN I Kombi (KS_)	1156
MASTER I Bus (T_)	1157
MASTER II Bus (JD)	1158
MASTER III Bus (JV)	1160
MASTER III Kasten (FV)	1160
MASTER III Pritsche/Fahrgestell (EV, HV, UV)	1161
MASTER II Kasten (FD)	1158
MASTER II Pritsche/Fahrgestell (ED/HD/UD)	1159
MASTER I Kasten (T_)	1157
MASTER I Pritsche/Fahrgestell (P_)	1158
MEGANE CC (EZ0/1_)	1181
MEGANE I (BA0/1_)	1162
MEGANE I Cabriolet (EA0/1_)	1163
MEGANE I Classic (LA0/1_)	1164
MEGANE I Coach (DA0/1_)	1167
MEGANE I Grandtour (KA0/1_)	1168
MEGANE II (BM0/1_, CM0/1_)	1169
MEGANE II Coupé-Cabriolet (EM0/1_)	1171
MEGANE II Grandtour (KM0/1_)	1172
MEGANE III Coupe (DZ0/1_)	1176
MEGANE III Grandtour (KZ0/1)	1178
MEGANE III Schrägheck (BZ0_)	1179
MEGANE II Stufenheck (LM0/1_)	1174
MEGANE IV (B9A/M_)	1180
MEGANE IV Grandtour (K9A/M_)	1180
MEGANE Scenic (JA0/1_)	1181
MODUS / GRAND MODUS (F/JP0_)	1183
RAPID	1183
RAPID Kasten (F40_, G40_)	1183
SAFRANE I (B54_)	1185
SAFRANE II (B54_)	1186
SANDERO/STEPWAY I (BS_)	1186
SANDERO/STEPWAY II (B8_)	1186
SCÉNIC I (JA0/1_)	1187
SCÉNIC II (JM0/1_)	1188
SCÉNIC III (JZ0/1_)	1190
SCÉNIC IV (J9_)	1192
SUPER 5 (B/C40_)	1192
SUPER 5 Kasten (S40_)	1192
TALISMAN (L2M_)	1193
TALISMAN Grandtour (KP_)	1193
THALIA I (LB0/1/2_)	1193
THALIA II (LU1/2_)	1193
THALIA III (L8_)	1193
TRAFIC Bus (TXW)	1196
TRAFIC II Bus (JL)	1194
TRAFIC III Bus (JG_)	1195
TRAFIC III Kasten (FG_)	1196
TRAFIC III Pritsche/Fahrgestell (EG_)	1196
TRAFIC II Kasten (FL)	1194
TRAFIC II Pritsche/Fahrgestell (EL)	1195
TRAFIC Kasten (TXX)	1196
TRAFIC Pritsche/Fahrgestell (PXX)	1196
TWINGO I (C06_)	1197
TWINGO II (CN0_)	1198
TWINGO III (BCM_)	1198
TWINGO I Kasten (S06_)	1197
VEL SATIS (BJ0_)	1198
WIND (E4M_)	1199
ZOE (BFM_)	1199

RENAULT TRUCKS**1199**

MASCOTT Kasten/Kombi	1199
MASCOTT Pritsche/Fahrgestell	1200

ROLLS-ROYCE**1200**

SILVER SERAPH	1200
---------------	------

**ROVER****1200**

100 / METRO (XP)	1202
100 Cabriolet (XP)	1202
200 Cabriolet (XW)	1202
200 Coupe (XW)	1203
200 Hatchback (RF)	1203
200 Hatchback (XW)	1204
25 (RF)	1200
400 (RT)	1205
400 (XW)	1205
400 Hatchback (RT)	1206
400 Tourer (XW)	1206
45 (RT)	1201
45 Stufenheck (RT)	1201
600 (RH)	1207
75 (RJ)	1201
75 Tourer (RJ)	1202
800 (XS)	1207
800 Coupe	1207
800 Hatchback (XS)	1208
COUPE	1208
MINI	1208
MINI Cabriolet (XN)	1208
STREETWISE	1208

SAAB**1208**

9000	1225
9000 Schrägheck	1225
900 II	1223
900 II Cabriolet	1224
900 II Coupe	1224
9-3 (YS3D)	1209
9-3 (YS3F)	1209
9-3 Cabriolet (YS3D)	1213
9-3 Cabriolet (YS3F)	1213
9-3 Kombi (YS3F)	1216
9-3X	1218
9-5 (YS3E)	1219
9-5 (YS3G)	1221
9-5 Kombi (YS3E)	1221

SEAT**1226**

ALHAMBRA (710, 711)	1227
ALHAMBRA (7V8, 7V9)	1226
ALTEA (5P1)	1228
ALTEA XL (5P5, 5P8)	1229
AROSA (6H)	1230
ATECA (KH7)	1231
CORDOBA (6K1, 6K2)	1231
CORDOBA (6K2)	1235
CORDOBA (6L2)	1235
CORDOBA Vario (6K5)	1237
EXEO (3R2)	1240
EXEO ST (3R5)	1241
IBIZA II (6K1)	1242
IBIZA III (6K1)	1246
IBIZA IV (6L1)	1246
IBIZA V (6J5, 6P1)	1248
IBIZA V SPORTCOUPE (6J1, 6P5)	1251
IBIZA V ST (6J8, 6P8)	1254
INCA (6K9)	1257
LEON (1M1)	1257
LEON (1P1)	1259
LEON (5F1)	1262
LEON SC (5F5)	1265
LEON ST (5F8)	1268
MARBELLA (28)	1271
Mii (KF1)	1271
TERRA (24)	1272
TERRA Kasten (024A)	1272
TOLEDO I (1L)	1272
TOLEDO II (1M2)	1277
TOLEDO III (5P2)	1279
TOLEDO IV (KG3)	1280

**SKODA****1280**

CITIGO	1280
FABIA I (6Y2)	1280
FABIA I Combi (6Y5)	1282
FABIA II (542)	1286
FABIA II Combi (545)	1288
FABIA III (NJ3)	1290
FABIA III Kombi (NJ5)	1290
FABIA I Praktik (6Y5)	1283
FABIA I Stufenheck (6Y3)	1284
FAVORIT Forman (785)	1291
FAVORIT Pick-up (787)	1291
FELICIA I (6U1)	1291
FELICIA II (6U1)	1292
FELICIA II Kombi (6U5)	1292
FELICIA I Kombi (6U5)	1291
FELICIA I Pick-up (6UF, 6U7)	1291
KODIAQ (NS7)	1292
OCTAVIA (1Z3)	1292
OCTAVIA I (1U2)	1296
OCTAVIA I Combi (1U5)	1299
OCTAVIA II Combi (1Z5)	1302
OCTAVIA III (5E3)	1306
OCTAVIA III Combi (5E5)	1307
RAPID (NH3)	1309
RAPID Spaceback (NH1)	1309
ROOMSTER (5J)	1310
ROOMSTER Praktik (5J)	1311
SUPERB I (3U4)	1312
SUPERB II (3T4)	1313
SUPERB III (3V3)	1318
SUPERB III Kombi (3V5)	1319
SUPERB II Kombi (3T5)	1315
YETI (5L)	1319

SMART**1322**

CABRIO (450)	1322
CITY-COUPE (450)	1322
CROSSBLADE (450)	1323
FORFOUR (454)	1323
FORFOUR Schrägheck (453)	1323
FORTWO Cabrio (450)	1323
FORTWO Cabrio (451)	1324
FORTWO Cabriolet (453)	1324
FORTWO Coupe (450)	1324
FORTWO Coupe (451)	1325
FORTWO Coupe (453)	1325
ROADSTER (452)	1325
ROADSTER Coupe (452)	1326

SSANGYONG**1326**

ACTYON SPORTS II	1326
KORANDO (KJ)	1326
KORANDO Cabrio (KJ)	1326
MUSSO (FJ)	1326
MUSSO SPORTS	1326
REXTON (GAB_)	1326

SUBARU**1326**

BRZ	1326
FORESTER (SF)	1327
FORESTER (SG)	1327
FORESTER (SH)	1327
FORESTER (SJ)	1328
IMPREZA Coupe (GFC)	1328
IMPREZA Schrägheck	1329
IMPREZA Schrägheck (GP)	1329
IMPREZA Schrägheck (GR, GH, G3)	1329
IMPREZA Station Wagon (GF)	1329
IMPREZA Station Wagon (GG)	1330
IMPREZA Stufenheck (GC)	1331
IMPREZA Stufenheck (GD)	1332
IMPREZA Stufenheck (GR)	1333
JUSTY I (KAD)	1333
JUSTY II (JMA, MS)	1333
JUSTY III (G3X)	1333
JUSTY IV	1333
LEGACY II (BD)	1334

**SUBARU****1326**

LEGACY III (BE)	1335
LEGACY III Station Wagon (BH)	1335
LEGACY II Station Wagon (BG)	1334
LEGACY IV (BL)	1335
LEGACY IV Station Wagon (BP)	1336
LEGACY OUTBACK (BG)	1337
LEGACY V (BM)	1336
LEGACY V Station Wagon (BR)	1336
LIBERO Bus (E10, E12)	1337
OUTBACK (BE, BH)	1337
OUTBACK (BL, BP)	1337
OUTBACK (BR)	1337
TREZIA	1338
TRIBECA (B9)	1338
XV	1338

SUZUKI**1338**

ALTO (EF)	1338
ALTO (FF)	1338
ALTO (GF)	1339
BALENO (EG)	1339
BALENO (FW, EW)	1339
BALENO Kombi (EG)	1339
BALENO Schrägheck (EG)	1340
CAPPUCINO (EE)	1340
GRAND VITARA I (FT, HT)	1340
GRAND VITARA I Cabriolet (GT)	1341
GRAND VITARA II (JT, TE, TD)	1341
IGNIS (FH)	1342
IGNIS II (MH)	1342
JIMNY (FJ)	1342
KIZASHI (FR)	1342
LIANA (ER, RH)	1343
LIANA Kombi (ER)	1343
SAMURAI (SJ)	1343
SIERRA Geländewagen offen (SJ)	1344
SIERRA II Pick-up (SJ)	1344
SPLASH (EX)	1344
SUPER CARRY Bus (ED)	1344
SWIFT III (MZ, EZ)	1345
SWIFT II Schrägheck (EA, MA)	1344
SWIFT IV (FZ, NZ)	1345
SX4 (EY, GY)	1345
SX4 S-Cross (JY)	1346
SX4 Stufenheck (GY)	1346
VITARA (ET, TA)	1346
VITARA (LY)	1347
VITARA Cabrio (ET, TA)	1347
WAGON R	1347
WAGON R+ (EM)	1347
WAGON R+ (MM)	1347
X-90 (EL)	1348

TOYOTA**1348**

4 RUNNER (_N1_)	1348
4 RUNNER (_N18_)	1348
ALPHARD / VELLFIRE (_H2_)	1348
AURIS (_E15_)	1348
AURIS (_E18_)	1349
AURIS TOURING SPORTS (_E18_)	1350
AURIS VAN Kasten (_E18_)	1350
AVENSIS (_T22_)	1350
AVENSIS (_T25_)	1351
AVENSIS Combi (_T25_)	1351
AVENSIS Liftback (_T22_)	1352
AVENSIS Station Wagon (_T22_)	1353
AVENSIS Station Wagon (_T27_)	1354
AVENSIS Stufenheck (_T25_)	1354
AVENSIS Stufenheck (_T27_)	1355
AVENSIS VERSO (_M2_)	1355
AYGO (_B1_)	1356
AYGO (_B4_)	1356
CAMRY (_V1_)	1356
CAMRY (_V2_)	1356
CAMRY Station Wagon (_V1_)	1356
CAMRY Station Wagon (_V2_)	1356
CAMRY Stufenheck (_V3_)	1357
CAMRY Stufenheck (_V4_)	1357

**TOYOTA****1348**

CAMRY Stufenheck (_V5_)	1357
CARINA E (_T19_)	1358
CARINA E Sportswagon (_T19_)	1358
CARINA E Stufenheck (_T19_)	1358
CELICA (_T20_)	1359
CELICA (_T23_)	1359
CELICA Cabriolet (_T20_)	1359
COROLLA (_E10_)	1360
COROLLA (_E11_)	1360
COROLLA (_E12_)	1361
COROLLA Combi (_E12_)	1363
COROLLA Compact (_E10_)	1364
COROLLA Compact (_E11_)	1364
COROLLA LEVIN Coupe (_E10_)	1365
COROLLA Liftback (_E10_)	1365
COROLLA Liftback (_E11_)	1366
COROLLA Stufenheck (_E12_)	1367
COROLLA Stufenheck (_E15_)	1368
COROLLA Stufenheck (_E18_, ZRE17_)	1368
COROLLA Verso (_E12_)	1369
COROLLA Verso (ZER_, ZZE12_, R1_)	1369
COROLLA Wagon (_E10_)	1369
COROLLA Wagon (_E11_)	1370
FJ CRUISER (GSJ1_)	1371
HARRIER (_U3_)	1371
HIACE / COMMUTER V (TRH2_, KDH2_)	1371
HIACE III Kasten (YH7_, LH6_, LH7_, LH5_, YH5_, YH6_)	1371
HIACE III Wagon (_H1_)	1372
HIACE IV Bus (_H1_, _H2_)	1372
HIACE IV Kasten (LXH1_, RZH1_, LH1_)	1373
HIACE V Kasten (TRH2_, KDH2_)	1373
HILUX Geländewagen geschlossen (_N1_)	1374
HILUX Geländewagen geschlossen (LN_, KZN1_, VZN1_)	1374
HILUX Pick-up	1374
HILUX Pritsche/Fahrgestell (_N1_, _N2_)	1375
HILUX Pritsche/Fahrgestell (LN_, _N1_)	1375
HILUX VII Pick-up (_N1_, _N2_, _N3_)	1374
IQ (_J1_)	1375
LAND CRUISER (_J12_)	1376
LAND CRUISER (_J15_)	1377
LAND CRUISER (_J7_)	1376
LAND CRUISER 100 (_J1_)	1377
LAND CRUISER 200 (_J2_)	1378
LAND CRUISER 80 (_J8_)	1378
LAND CRUISER 90 (_J9_)	1378
LAND CRUISER Hardtop (_J7_)	1379
LAND CRUISER Pick-up (_J7_)	1379
MATRIX (_E13_)	1379
MIRAI (JPD1_)	1379
MR 2 II (SW2_)	1380
MR 2 III (ZZW3_)	1380
PASEO Cabriolet (EL54_)	1380
PASEO Coupe (EL44_)	1380
PASEO Coupe (EL54_)	1380
PICNIC (_XM1_)	1380
PREVIA (_R1_, _R2_)	1380
PREVIA (_R3_)	1381
PREVIA III (_R2_, _R5_)	1381
PRIUS (_W3_)	1381
PRIUS (_W5_)	1381
PRIUS Liftback (_W2_)	1381
PRIUS PLUS (_W4_)	1381
PRIUS Stufenheck (_W1_)	1382
PROACE Kasten/Kombi (MDX_)	1382
RAV 4 I (_A1_)	1382
RAV 4 I Cabrio (_A1_)	1382
RAV 4 II (_A2_)	1382
RAV 4 III (_A3_)	1383
RAV 4 IV (_A4_)	1383
STARLET (_P8_)	1384
STARLET (_P9_)	1384
URBAN CRUISER (_P1_)	1384
VERSO (_R2_)	1385
VERSO S (_P12_)	1385
VIOS/YARIS Stufenheck (_P9_)	1385
YARIS (_P1_)	1385
YARIS (_P13_)	1388
YARIS (_P15_)	1388
YARIS (_P9_)	1387

**TOYOTA****1348**

YARIS VERSO (_P2_)	1388
--------------------	------

VAUXHALL**1389**

ADAM	1389
AGILA Mk I (A)	1390
AGILA Mk II (B)	1390
AMPERA	1390
ANTARA (J26, H26)	1390
ARENA Combi	1391
ARENA Van	1391
ASTRA Mk III (F)	1391
ASTRA Mk III (F) CC	1392
ASTRA Mk III (F) Convertible	1394
ASTRA Mk III (F) Estate	1395
ASTRA Mk IV (G) CC	1396
ASTRA Mk IV (G) Convertible	1399
ASTRA Mk IV (G) Coupe (F67)	1400
ASTRA Mk IV (G) Estate	1401
ASTRA Mk IV (G) Sedan	1404
ASTRA Mk V (H) CC	1406
ASTRA Mk V (H) Estate	1408
ASTRA Mk V (H) Sport Hatch	1410
ASTRA Mk V (H) TwinTop	1412
ASTRA Mk VI (J)	1413
ASTRA Mk VI (J) Estate	1414
ASTRA Mk VI (J) GTC	1415
ASTRA Mk VI (J) Sedan	1416
ASTRAVAN Mk III (F)	1416
ASTRAVAN Mk IV (G)	1417
ASTRAVAN Mk V (H)	1418
BRAVA Pick-up	1418
CALIBRA	1419
CASCADE Convertible	1419
CAVALIER Mk III (87)	1420
CAVALIER Mk III CC	1421
COMBO Mk I (B)	1423
COMBO Mk II (C) Kasten/Kombi (F25)	1423
COMBO Mk III (D) Kasten/Kombi	1424
COMBO TOUR Mk II (C) (F25)	1425
CORSA Mk I (B)	1426
CORSA Mk II (C) (W5L, F08)	1427
CORSA Mk III (D) (L_8)	1428
CORSA Mk IV (E)	1430
CORSAVAN Mk I (B)	1430
CORSAVAN Mk II (C)	1431
CORSAVAN Mk III (D)	1431
CORSAVAN Mk IV (E)	1432
FRONTERA Mk I (A)	1432
FRONTERA Mk I (A) Sport	1433
FRONTERA Mk II (B)	1433
INSIGNIA Mk I (A)	1434
INSIGNIA Mk I (A) Estate	1436
INSIGNIA Mk I (A) Sedan	1437
MERIVA Mk I (A)	1440
MERIVA Mk II (B)	1441
MOKKA / MOKKA X	1442
MONTEREY	1442
MONTEREY Mk II	1442
MOVANO Mk I (A) Chassis/Cab (ED, UD, HD)	1443
MOVANO Mk I (A) Combi (JD)	1443
MOVANO Mk I (A) Van (FD)	1444
MOVANO Mk II (B) Chassis/Cab	1445
MOVANO Mk II (B) Combi	1446
MOVANO Mk II (B) VAN	1446
OMEGA (B)	1447
OMEGA (B) Estate	1448
SIGNUM	1449
SINTRA	1451
SPEEDSTER	1451
TIGRA Mk I (F07)	1452
TIGRA TwinTop	1452
VECTRA (B)	1452
VECTRA (B) CC	1454
VECTRA (B) Estate	1455
VECTRA Mk II (C)	1456
VECTRA Mk II (C) Estate	1460
VECTRA Mk II (C) GTS	1461
VIVARO Combi	1464



**VAUXHALL****1389**

VIVARO Combi (J7)	1464
VIVARO Kasten	1464
VIVARO Kasten (F7)	1465
VIVARO Pritsche/Fahrgestell	1465
VIVARO Pritsche/Fahrgestell (E7)	1465
VX220	1466
ZAFIRA Mk I (A) (F75)	1466
ZAFIRA Mk II (B) (M75)	1468
ZAFIRA Mk III (P12)	1469

VOLVO**1470**

440 K (445)	1470
460 L (464)	1471
480 E	1471
850 (LS)	1471
850 Kombi (LW)	1472
940 II (944)	1473
940 II Kombi (945)	1473
940 Kombi (945)	1474
960 II (964)	1474
960 II Kombi (965)	1475
C30	1475
C70 I Cabriolet	1476
C70 I Coupe	1476
C70 II Cabriolet	1477
S40 I (VS)	1477
S40 II (MS)	1478
S60 I	1479
S60 II	1482
S70 (LS)	1484
S80 I (TS, XY)	1485
S80 II (AS)	1487
S90	1488
S90 II	1488
V40 Kombi (VW)	1488
V40 Schrägheck	1489
V50 (MW)	1490
V60	1491
V70 I (LV)	1495
V70 II (SW)	1497
V70 III (BW)	1501
V90 Kombi	1505
XC60	1506
XC70 CROSS COUNTRY	1509
XC70 II	1507
XC90 I	1510
XC90 II	1510

VW**1510**

AMAROK (2H_, S1B)	1510
AMAROK Pritsche/Fahrgestell (S1B)	1511
BEETLE (5C1, 5C2)	1511
BEETLE Cabriolet (5C7, 5C8)	1513
BORA (1J2)	1515
BORA Kombi (1J6)	1519
CADDY ALLTRACK Kasten (SAA)	1530
CADDY ALLTRACK Kombi (SAB)	1530
CADDY III Kasten (2KA, 2KH, 2CA, 2CH)	1523
CADDY III Kombi (2KB, 2KJ, 2CB, 2CJ)	1526
CADDY II Kasten (9K9A)	1522
CADDY II Kombi (9K9B)	1522
CADDY II Pick-up (9U7)	1522
CADDY IV Kasten (SAA, SAH)	1529
CADDY IV Kombi (SAB, SAJ)	1529
CC (358)	1530
CORRADO (53I)	1531
CRAFTER 30-35 Bus (2E_)	1531
CRAFTER 30-50 Kasten (2E_)	1532
CRAFTER 30-50 Pritsche/Fahrgestell (2F_)	1534
EOS (1F7, 1F8)	1535
FOX (5Z1, 5Z3)	1536
GOLF ALLTRACK (BA5)	1566
GOLF III (1H1)	1537
GOLF III Cabriolet (1E7)	1540
GOLF III Van (1H1)	1541
GOLF III Variant (1H5)	1541
GOLF IV (1J1)	1542
GOLF IV Cabriolet (1E7)	1549

**VW****1510**

GOLF IV Van (1J1)	1550
GOLF IV Variant (1J5)	1551
GOLF PLUS (5M1, 521)	1567
GOLF SPORTSVAN (AM1)	1568
GOLF V (1K1)	1554
GOLF VI (5K1)	1559
GOLF VI Cabriolet (517)	1561
GOLF VII (5G1, BQ1, BE1, BE2)	1562
GOLF VII Kombi (BA5, BV5)	1565
GOLF VI Variant (AJ5)	1562
GOLF V Variant (1K5)	1558
JETTA III (1K2)	1569
JETTA IV (162, 163)	1571
LOAD UP	1572
LT 28-35 I Bus (281-363)	1572
LT 28-35 II Bus (2DB, 2DE, 2DK)	1573
LT 28-35 I Kasten (281-363)	1572
LT 28-35 I Pritsche/Fahrgestell (281-363)	1573
LT 28-46 II Kasten (2DA, 2DD, 2DH)	1574
LT 28-46 II Pritsche/Fahrgestell (2DC, 2DF, 2DG, 2DL, 2DM)	1575
LT 40-55 I Kasten (291-512)	1576
LT 40-55 I Pritsche/Fahrgestell (293-909)	1576
LUPO (6X1, 6E1)	1576
MULTIVAN T5 (7HM, 7HN, 7HF, 7EF, 7EM, 7EN)	1577
MULTIVAN T6 (SGF, SGM, SGN)	1579
NEW BEETLE (9C1, 1C1)	1580
NEW BEETLE Cabriolet (1Y7)	1581
PASSAT (362)	1592
PASSAT (3A2, 351)	1582
PASSAT (3B2)	1584
PASSAT (3B3)	1588
PASSAT (3C2)	1590
PASSAT (3G2)	1591
PASSAT ALLTRACK (365)	1594
PASSAT ALLTRACK (3G5)	1594
PASSAT CC (357)	1594
PASSAT Kombi (3B5)	1595
PASSAT Variant (365)	1606
PASSAT Variant (3A5, 351)	1599
PASSAT Variant (3B6)	1601
PASSAT Variant (3C5)	1603
PASSAT Variant (3G5)	1605
PHAETON (3D_)	1607
POLO (6N1)	1608
POLO (6N2)	1609
POLO (6R, 6C)	1611
POLO (9N_)	1613
POLO CLASSIC (6V2)	1616
POLO Kasten (6NF)	1618
POLO Stufenheck (60_, 61_)	1620
POLO Stufenheck (9A4)	1618
POLO Van (6R)	1620
POLO Variant (6V5)	1621
SCIROCCO (137, 138)	1622
SHARAN (7M8, 7M9, 7M6)	1625
SHARAN (7N1, 7N2)	1627
TARO	1628
TIGUAN (5N_)	1628
TIGUAN (AD1)	1630
TOUAREG (7LA, 7L6, 7L7)	1631
TOUAREG (7P5)	1638
TOURAN (1T1, 1T2)	1639
TOURAN (1T3)	1641
TOURAN (5T1)	1642
TRANSPORTER T4 Bus (70XB, 70XC, 7DB, 7DW, 7DK)	1643
TRANSPORTER T4 Kasten (70XA)	1646
TRANSPORTER T4 Pritsche/Fahrgestell (70XD)	1650
TRANSPORTER T5 Bus (7HB, 7HJ, 7EB, 7EJ, 7EF, 7EG, 7HF, 7EC)	1653
TRANSPORTER T5 Kasten (7HA, 7HH, 7EA, 7EH)	1655
TRANSPORTER T5 Pritsche/Fahrgestell (7JD, 7JE, 7JL, 7JY, 7JZ)	1657
TRANSPORTER T6 Bus (SGB, SGG, SGJ)	1659
TRANSPORTER T6 Kasten (SGA, SGH)	1659
TRANSPORTER T6 Pritsche/Fahrgestell (SFD, SFE, SFL, SFZ)	1659

**VW****1510**

UP	1660
VENTO (1H2)	1660



DE Fahrzeugverwendungen

EN Applications of vehicles













ES Aplicaciones

FR Applications

IT Applicazioni autoveicoli

2018



	kw			 	! #		
ABARTH - 124 Spider (348_) 03/16→							
 Bremsbelagsatz, Scheibenbremse							
1.4	125	03/16→	→			13.0460-5762.2 605762	24298 14,0 + WK + Zub
ABARTH - 500 / 595 (312_) 01/08→							
 Bremsbelagsatz, Scheibenbremse							
1.4 (312.AXY11, 312.AXY1A)	107	05/16→	←			13.0460-3827.2 603827	BOS 23709 19,6 + WK + Zub
1.4 (312.AXZ11)	121	05/16→	←			13.0460-3864.2 603864	BOS 23709 19,6 + WK + Zub
1.4 (312.AYB11)	120	06/16→	←			13.0470-3827.2 LD3827	BOS 23709 19,6 + WK + Zub Ceramic
			→			13.0460-2879.2 602879	TRW 23601 13,7 - WE / - WK
			→			13.0470-2879.2 LD2879	TRW 23601 13,7 - WE / - WK Ceramic
 Bremsscheibe							
1.4 (312.AXY11, 312.AXY1A)	107	05/16→	←	- Kit ESSEESSE		24.0122-0147.1 422147	Ø 284 22 20,2 V
1.4 (312.AXZ11)	121	05/16→	←	+ Kit ESSEESSE		24.0122-0283.1 422283	Ø 284 22 20,2 V•
1.4 (312.AYB11)	120	06/16→	→	- Kit ESSEESSE		24.0111-0119.1 411119	Ø 240,5 11 9,2
			→	+ Kit ESSEESSE		24.0111-0176.1 411176	Ø 240,5 11 9,2 •
ABARTH - 500C / 595C (312_) 09/09→							
 Bremsbelagsatz, Scheibenbremse							
1.4 (312.AXY1A)	107	05/16→	←			13.0460-3827.2 603827	BOS 23709 19,6 + WK + Zub
1.4 (312.AXZ1A)	121	05/16→	←			13.0460-3864.2 603864	BOS 23709 19,6 + WK + Zub
						13.0470-3827.2 LD3827	BOS 23709 19,6 + WK + Zub Ceramic
 Bremsscheibe							
1.4 (312.AXY1A)	107	05/16→	←	- Kit ESSEESSE		24.0122-0147.1 422147	Ø 284 22 20,2 V
1.4 (312.AXZ1A)	121	05/16→	←	+ Kit ESSEESSE		24.0122-0283.1 422283	Ø 284 22 20,2 V•
			→	- Kit ESSEESSE		24.0111-0119.1 411119	Ø 240,5 11 9,2
			→	+ Kit ESSEESSE		24.0111-0176.1 411176	Ø 240,5 11 9,2 •
ALFA ROMEO - 145 (930_) 07/94→01/01							
 Bremsbelagsatz, Scheibenbremse							
1.4 i.e. (930.A3)	66	07/94→12/96	←			13.0460-2949.2 602949	TRW 20833 17,0 + WK
1.6 i.e. (930.A2)	76	10/94→12/96	←			13.0460-7068.2 607068	ATE 21930 17,9 + WK
			→	+ ABS; ALU		13.0460-2826.2 602826	TRW 23177 14,2 - WK
			→	+ ABS; GG		13.0460-2951.2 602951	TRW 21103 14,2 - WK
1.4 i.e. 16V T.S. (930.A3A)	76	12/96→01/01	←	01/97→		13.0460-7067.2 607067	ATE 21927 17,9 + WK
1.6 i.e. 16V T.S. (930.A2)	88	12/96→01/01	→	01/97→; + ABS; ALU		13.0460-2826.2 602826	TRW 23177 14,2 - WK
			→	01/97→; + ABS; GG		13.0460-2951.2 602951	TRW 21103 14,2 - WK
1.6 16V T.S. (930.A2C)	82	09/97→12/00	←			13.0460-7067.2 607067	ATE 21927 17,9 + WK
1.9 JTD (930.A4B)	77	02/99→01/01	→	+ ABS; ALU		13.0460-2826.2 602826	TRW 23177 14,2 - WK
			→	+ ABS; GG		13.0460-2951.2 602951	TRW 21103 14,2 - WK
1.7 i.e. 16V (930.A1)	95	10/94→12/96	←			13.0460-2949.2 602949	TRW 20833 17,0 + WK
			→	ALU		13.0460-7068.2 607068	ATE 21930 17,9 + WK
			→	GG		13.0460-2826.2 602826	TRW 23177 14,2 - WK
			→			13.0460-2951.2 602951	TRW 21103 14,2 - WK
1.8 i.e. 16V (930.A1A)	106	03/98→01/01	←			13.0460-7069.2 607069	ATE 21636 19,3 + WK
2.0 16V Quadrifoglio (930.A5)	114	03/98→01/01	→	ALU		13.0460-2826.2 602826	TRW 23177 14,2 - WK
2.0 16V T.S. (930.A5)	110	10/95→01/01	→	GG		13.0460-2951.2 602951	TRW 21103 14,2 - WK
1.8 i.e. 16V T.S. (930.A1A)	103	12/96→12/98	←	01/97→		13.0460-7069.2 607069	ATE 21636 19,3 + WK
			→	01/97→; ALU		13.0460-2826.2 602826	TRW 23177 14,2 - WK
			→	01/97→; GG		13.0460-2951.2 602951	TRW 21103 14,2 - WK
1.9 TD (930.A4)	66	10/94→02/99	←	→ 12/96		13.0460-2949.2 602949	TRW 20833 17,0 + WK
			←			13.0460-7068.2 607068	ATE 21930 17,9 + WK
			←	01/97→		13.0460-7067.2 607067	ATE 21927 17,9 + WK
			→	+ ABS; ALU		13.0460-2826.2 602826	TRW 23177 14,2 - WK
			→	+ ABS; GG		13.0460-2951.2 602951	TRW 21103 14,2 - WK

ALFA ROMEO - 145 (930_) 07/94→01/01

Zubehörsatz, Scheibenbremsbelag

1.4 i.e. (930.A3)	66	07/94→12/96	➡	+ ABS; GG	13.0460-0072.2	610072	TRW
1.6 16V T.S. (930.A2C)	82	09/97→12/00					
1.6 i.e. (930.A2)	76	10/94→12/96					
1.9 JTD (930.A4B)	77	02/99→01/01					
1.9 TD (930.A4)	66	10/94→02/99					
1.4 i.e. 16V T.S. (930.A3A)	76	12/96→01/01	➡	01/97→; + ABS; GG	13.0460-0072.2	610072	TRW
1.6 i.e. 16V T.S. (930.A2)	88	12/96→01/01					
1.7 i.e. 16V (930.A1)	95	10/94→12/96	➡	GG	13.0460-0072.2	610072	TRW
1.8 i.e. 16V (930.A1A)	106	03/98→01/01					
2.0 16V Quadrifoglio (930.A5)	114	03/98→01/01					
2.0 16V T.S. (930.A5)	110	10/95→01/01					
1.8 i.e. 16V T.S. (930.A1A)	103	12/96→12/98	➡	01/97→; GG	13.0460-0072.2	610072	TRW











Bremsscheibe









1.4 i.e. (930.A3)	66	07/94→12/96	←		24.0112-0127.1	412127	Ø 257,5 12 10,2
1.6 i.e. (930.A2)	76	10/94→12/96	➡	+ ABS	24.0111-0149.1	411149	Ø 240,5 11 9,2
1.4 i.e. 16V T.S. (930.A3A)	76	12/96→01/01	←	01/97→	24.0120-0142.1	420142	Ø 257,5 20 18,2 V
1.6 i.e. 16V T.S. (930.A2)	88	12/96→01/01	➡	01/97→; + ABS	24.0320-0142.1	520142	Ø 257,5 20 18,2 V PD
					24.0111-0149.1	411149	Ø 240,5 11 9,2
1.6 16V T.S. (930.A2C)	82	09/97→12/00	←		24.0120-0142.1	420142	Ø 257,5 20 18,2 V
1.9 JTD (930.A4B)	77	02/99→01/01	➡	+ ABS	24.0320-0142.1	520142	Ø 257,5 20 18,2 V PD
					24.0111-0149.1	411149	Ø 240,5 11 9,2
1.7 i.e. 16V (930.A1)	95	10/94→12/96	←		24.0120-0142.1	420142	Ø 257,5 20 18,2 V
			➡		24.0320-0142.1	520142	Ø 257,5 20 18,2 V PD
					24.0111-0149.1	411149	Ø 240,5 11 9,2
1.8 i.e. 16V (930.A1A)	106	03/98→01/01	←		24.0122-0107.1	422107	Ø 284 22 20,2 V
			➡		24.0111-0149.1	411149	Ø 240,5 11 9,2
1.8 i.e. 16V T.S. (930.A1A)	103	12/96→12/98	←	01/97→	24.0122-0107.1	422107	Ø 284 22 20,2 V
			➡	01/97→	24.0111-0149.1	411149	Ø 240,5 11 9,2
1.9 TD (930.A4)	66	10/94→02/99	←	→ 12/96	24.0112-0127.1	412127	Ø 257,5 12 10,2
			←	01/97→	24.0120-0142.1	420142	Ø 257,5 20 18,2 V
			➡	+ ABS	24.0320-0142.1	520142	Ø 257,5 20 18,2 V PD
					24.0111-0149.1	411149	Ø 240,5 11 9,2
2.0 16V Quadrifoglio (930.A5)	114	03/98→01/01	←		24.0122-0107.1	422107	Ø 284 22 20,2 V
2.0 16V T.S. (930.A5)	110	10/95→01/01	➡		24.0111-0119.1	411119	Ø 240,5 11 9,2
					24.0111-0149.1	411149	Ø 240,5 11 9,2







ALFA ROMEO - 146 (930_) 12/94→01/01









Brembelagsatz, Scheibenbremse









1.4 i.e. (930.B3)	66	12/94→12/96	←		13.0460-2949.2	602949	TRW 20833 17,0 + WK
1.6 i.e. (930.B2)	76	12/94→12/96	➡	+ ABS; ALU	13.0460-7068.2	607068	ATE 21930 17,9 + WK
			➡	+ ABS; GG	13.0460-2826.2	602826	TRW 23177 14,2 - WK
					13.0460-2951.2	602951	TRW 21103 14,2 - WK
1.4 i.e. 16V T.S. (930.B3A)	76	11/96→01/01	←	01/97→	13.0460-7067.2	607067	ATE 21927 17,9 + WK
1.6 i.e. 16V T.S. (930.B2B)	88	11/96→01/01	➡	01/97→; + ABS; ALU	13.0460-2826.2	602826	TRW 23177 14,2 - WK
			➡	01/97→; + ABS; GG	13.0460-2951.2	602951	TRW 21103 14,2 - WK
1.6 16V T.S. (930.B2C)	82	09/97→12/00	←		13.0460-7067.2	607067	ATE 21927 17,9 + WK
1.9 JTD (930.B4B)	77	02/99→01/01	➡	+ ABS; ALU	13.0460-2826.2	602826	TRW 23177 14,2 - WK
			➡	+ ABS; GG	13.0460-2951.2	602951	TRW 21103 14,2 - WK
1.7 i.e. 16V (930.B1)	95	12/94→12/96	←		13.0460-2949.2	602949	TRW 20833 17,0 + WK
			➡	ALU	13.0460-7068.2	607068	ATE 21930 17,9 + WK
			➡	GG	13.0460-2826.2	602826	TRW 23177 14,2 - WK
					13.0460-2951.2	602951	TRW 21103 14,2 - WK
1.8 i.e. 16V T.S. (930.B1A)	103	11/96→01/01	←	01/97→	13.0460-7069.2	607069	ATE 21636 19,3 + WK
			➡	01/97→; ALU	13.0460-2826.2	602826	TRW 23177 14,2 - WK
			➡	01/97→; GG	13.0460-2951.2	602951	TRW 21103 14,2 - WK
1.8 i.e. 16V T.S. (930.B1A)	106	03/98→01/01	←		13.0460-7069.2	607069	ATE 21636 19,3 + WK









	kw			 	! #		
ALFA ROMEO - 146 (930_) 12/94→01/01							
 Bremsbelagsatz, Scheibenbremse							
2.0 16V Quadrifoglio (930.B5)	114	03/98→01/01	➔	ALU		13.0460-2826.2 602826	TRW 23177 14,2 - WK
2.0 16V T.S. (930.B5)	110	10/95→01/01	➔	GG		13.0460-2951.2 602951	TRW 21103 14,2 - WK
1.9 TD (930.B4A)	66	12/94→02/99	➔	→ 12/96		13.0460-2949.2 602949	TRW 20833 17,0 + WK
			➔			13.0460-7068.2 607068	ATE 21930 17,9 + WK
			➔	01/97→		13.0460-7067.2 607067	ATE 21927 17,9 + WK
			➔	+ ABS; ALU		13.0460-2826.2 602826	TRW 23177 14,2 - WK
			➔	+ ABS; GG		13.0460-2951.2 602951	TRW 21103 14,2 - WK
Zubehörsatz, Scheibenbremsbelag							
1.4 i.e. (930.B3)	66	12/94→12/96	➔	+ ABS; GG		13.0460-0072.2 610072	TRW
1.6 16V T.S. (930.B2C)	82	09/97→12/00					
1.6 i.e. (930.B2)	76	12/94→12/96					
1.9 JTD (930.B4B)	77	02/99→01/01					
1.9 TD (930.B4A)	66	12/94→02/99					
1.4 i.e. 16V T.S. (930.B3A)	76	11/96→01/01	➔	01/97→; + ABS; GG		13.0460-0072.2 610072	TRW
1.6 i.e. 16V T.S. (930.B2B)	88	11/96→01/01					
1.7 i.e. 16V (930.B1)	95	12/94→12/96	➔	GG		13.0460-0072.2 610072	TRW
1.8 i.e. 16V T.S. (930.B1A)	106	03/98→01/01					
2.0 16V Quadrifoglio (930.B5)	114	03/98→01/01					
2.0 16V T.S. (930.B5)	110	10/95→01/01					
1.8 i.e. 16V T.S. (930.B1A)	103	11/96→01/01	➔	01/97→; GG		13.0460-0072.2 610072	TRW
 Bremsscheibe							
1.4 i.e. (930.B3)	66	12/94→12/96	➔			24.0112-0127.1 412127	Ø 257,5 12 10,2
1.6 i.e. (930.B2)	76	12/94→12/96	➔	+ ABS		24.0111-0149.1 411149	Ø 240,5 11 9,2
1.4 i.e. 16V T.S. (930.B3A)	76	11/96→01/01	➔	01/97→		24.0120-0142.1 420142	Ø 257,5 20 18,2 V
1.6 i.e. 16V T.S. (930.B2B)	88	11/96→01/01	➔	01/97→; + ABS		24.0320-0142.1 520142	Ø 257,5 20 18,2 V PD
1.6 16V T.S. (930.B2C)	82	09/97→12/00	➔			24.0111-0149.1 411149	Ø 240,5 11 9,2
1.9 JTD (930.B4B)	77	02/99→01/01	➔			24.0120-0142.1 420142	Ø 257,5 20 18,2 V
1.7 i.e. 16V (930.B1)	95	12/94→12/96	➔			24.0320-0142.1 520142	Ø 257,5 20 18,2 V PD
			➔			24.0111-0149.1 411149	Ø 240,5 11 9,2
			➔			24.0120-0142.1 420142	Ø 257,5 20 18,2 V
1.8 i.e. 16V T.S. (930.B1A)	103	11/96→01/01	➔	01/97→		24.0122-0107.1 422107	Ø 284 22 20,2 V
			➔	01/97→		24.0111-0149.1 411149	Ø 240,5 11 9,2
1.8 i.e. 16V T.S. (930.B1A)	106	03/98→01/01	➔			24.0122-0107.1 422107	Ø 284 22 20,2 V
			➔			24.0111-0149.1 411149	Ø 240,5 11 9,2
1.9 TD (930.B4A)	66	12/94→02/99	➔	→ 12/96		24.0112-0127.1 412127	Ø 257,5 12 10,2
			➔	01/97→		24.0120-0142.1 420142	Ø 257,5 20 18,2 V
			➔			24.0320-0142.1 520142	Ø 257,5 20 18,2 V PD
2.0 16V Quadrifoglio (930.B5)	114	03/98→01/01	➔			24.0111-0149.1 411149	Ø 240,5 11 9,2
			➔			24.0122-0107.1 422107	Ø 284 22 20,2 V
2.0 16V T.S. (930.B5)	110	10/95→01/01	➔			24.0111-0119.1 411119	Ø 240,5 11 9,2
						24.0111-0149.1 411149	Ø 240,5 11 9,2
ALFA ROMEO - 147 (937_) 11/00→03/10							
 Bremsbelagsatz, Scheibenbremse							
1.6 16V T.SPARK (937.AXA1A, 937.AXB1A, 937.BXB1A)	88	01/01→03/10	➔			13.0460-7140.2 607140	ATE 21637 19,3 + WK
1.9 JTD (937.AXD1A, 937.BXD1A)	85	04/01→03/10	➔			13.0470-7140.2 LD7140	ATE 21637 19,3 + WK Ceramic
			➔			13.0460-2867.2 602867	TRW 23517 16,6 - WE / - WK
1.9 JTD (937.AXF1A, 937.BXF1A)	74	06/03→03/10				13.0470-2867.2 LD2867	TRW 23517 16,6 - WE / - WK Ceramic
1.9 JTD 16V (937.AXG1B, 937.BXG1B)	93	09/03→09/04					
1.9 JTD 16V (937.AXG1B, 937.BXG1B)	103	11/02→03/10					









	kw			 	! #		
ALFA ROMEO - 147 (937_) 11/00→03/10							
 Bremsbelagsatz, Scheibenbremse							
1.9 JTD 16V (937.AXM1B, 937.AXS1B)	100	10/04→03/10	←			13.0460-7140.2 607140 13.0470-7140.2 LD7140	ATE 21637 19,3 + WK ATE 21637 19,3 + WK Ceramic
1.9 JTDM 16V (937.AXN1B, 937.AXZ1B)	125	06/08→03/10	→			13.0460-2867.2 602867 13.0470-2867.2 LD2867	TRW 23517 16,6 - WE / - WK TRW 23517 16,6 - WE / - WK Ceramic
1.9 JTDM 8V (937.AXD1A, 937.AXU1A, 937.BXU1A)	88	07/05→03/10					
2.0 16V T.SPARK (937.AXA1, 937.AXC1, 937.BXC1)	110	01/01→03/10					
1.6 16V T.SPARK ECO (937.AXA1A, 937.BXA1A)	77	01/01→03/10	←	→VET 3021488		13.0460-7139.2 607139 13.0470-7139.2 LD7139	ATE 23140 19,4 + WK ATE 23140 19,4 + WK Ceramic
			←	VET 3021489→		13.0460-7140.2 607140 13.0470-7140.2 LD7140	ATE 21637 19,3 + WK ATE 21637 19,3 + WK Ceramic
			→			13.0460-2867.2 602867 13.0470-2867.2 LD2867	TRW 23517 16,6 - WE / - WK TRW 23517 16,6 - WE / - WK Ceramic
1.9 JTDM (937.AXD1A, 937.AXV1A, 937.BXB1A)	85	10/04→03/10	←	07/05→		13.0460-7140.2 607140 13.0470-7140.2 LD7140	ATE 21637 19,3 + WK ATE 21637 19,3 + WK Ceramic
			→	07/05→		13.0460-2867.2 602867 13.0470-2867.2 LD2867	TRW 23517 16,6 - WE / - WK TRW 23517 16,6 - WE / - WK Ceramic
1.9 JTDM 16V (937.AXN1B, 937.BXN1B)	110	09/04→03/10	←			13.0460-2867.2 602867 13.0470-2867.2 LD2867	TRW 23517 16,6 - WE / - WK TRW 23517 16,6 - WE / - WK Ceramic
			→			13.0460-2867.2 602867 13.0470-2867.2 LD2867	TRW 23517 16,6 - WE / - WK TRW 23517 16,6 - WE / - WK Ceramic
3.2 GTA (937.AXL1)	184	02/03→03/10	←	→ 12/03		13.0460-4985.2 604985	BRE 21381 18,0 + WK
			→			13.0460-2867.2 602867 13.0470-2867.2 LD2867	TRW 23517 16,6 - WE / - WK TRW 23517 16,6 - WE / - WK Ceramic
Zubehörsatz, Scheibenbremsbelag							
3.2 GTA (937.AXL1)	184	02/03→03/10	←	→ 12/03		13.0460-0254.2 610254	
 Bremsscheibe							
1.6 16V T.SPARK (937.AXA1A, 937.AXB1A, 937.BXB1A)	88	01/01→03/10	←			24.0122-0145.1 422145	Ø 284 22 20,2 V
			→			24.0110-0209.1 410209	Ø 251,4 10 9
1.9 JTD (937.AXD1A, 937.BXD1A)	85	04/01→03/10					
1.9 JTD (937.AXF1A, 937.BXF1A)	74	06/03→03/10					
1.9 JTD 16V (937.AXG1B, 937.BXG1B)	93	09/03→09/04					
1.9 JTD 16V (937.AXG1B, 937.BXG1B)	103	11/02→03/10					
1.9 JTD 16V (937.AXM1B, 937.AXS1B)	100	10/04→03/10					
1.9 JTDM 16V (937.AXN1B, 937.AXZ1B)	125	06/08→03/10					
1.9 JTDM 8V (937.AXD1A, 937.AXU1A, 937.BXU1A)	88	07/05→03/10					
2.0 16V T.SPARK (937.AXA1, 937.AXC1, 937.BXC1)	110	01/01→03/10					
1.6 16V T.SPARK ECO (937.AXA1A, 937.BXA1A)	77	01/01→03/10	←	→VET 3021488		24.0115-0108.1 415108	Ø 281 15 13,2
			←	VET 3021489→		24.0122-0145.1 422145	Ø 284 22 20,2 V
			→			24.0110-0209.1 410209	Ø 251,4 10 9
1.9 JTDM (937.AXD1A, 937.AXV1A, 937.BXB1A)	85	10/04→03/10	←	07/05→		24.0122-0145.1 422145	Ø 284 22 20,2 V
			→	07/05→		24.0110-0209.1 410209	Ø 251,4 10 9
1.9 JTDM 16V (937.AXN1B, 937.BXN1B)	110	09/04→03/10	←				
			→				
3.2 GTA (937.AXL1)	184	02/03→03/10	←	→ 09/03		24.0128-0119.1 428119	Ø 305 28 26 V
			←	10/03→		24.0132-0129.1 432129	Ø 330 32 30 V
			→			24.0110-0283.1 410283	Ø 276 10 9







	kw			 	! #		
ALFA ROMEO - 155 (167_) 01/92→12/97							
Bremsbelagsatz, Scheibenbremse							
1.6 16V T.S. (167.A6A)	88	05/96→12/97	←			13.0460-2949.2 602949	TRW 20833 17,0 + WK
1.7 T.S. (167.A4D, 167.A4H)	85	04/93→04/96	→	ALU		13.0460-2826.2 602826	TRW 23177 14,2 - WK
1.7 T.S. (167.A4G)	83	04/93→04/96	→	GG		13.0460-2951.2 602951	TRW 21103 14,2 - WK
1.7 T.S. 16V (167.A4N)	103	05/96→12/97					
1.9 TD (167.A3B, 167.A3)	66	04/93→12/97					
1.8 T.S. (167.A4C, 167.A)	77	02/92→12/97	←	05/92→		13.0460-2949.2 602949	TRW 20833 17,0 + WK
1.8 T.S. Sport (167.A4A, 167.A4C, 167.A4E)	93	01/92→12/96	→	05/92→; ALU		13.0460-2826.2 602826	TRW 23177 14,2 - WK
			→	05/92→; GG		13.0460-2951.2 602951	TRW 21103 14,2 - WK
2.0 16V Turbo Q4 (167.A2B, 167.A2C, 167.A2E)	137	01/92→12/97	←	11/92→		13.0460-2979.2 602979	TRW 21147 19,0 + WK
			→	11/92→; ALU		13.0460-2826.2 602826	TRW 23177 14,2 - WK
2.0 16V Turbo Q4 (167.A2B, 167.A2C, 167.A2E)	140	01/92→12/97	→	11/92→; GG		13.0460-2951.2 602951	TRW 21103 14,2 - WK
2.0 T.S. (167.A2A, 167.A2D)	104	02/92→02/95	←	05/92→		13.0460-2987.2 602987	TRW 21147 19,0 + WK
			→	05/92→; ALU		13.0460-2826.2 602826	TRW 23177 14,2 - WK
			→	05/92→; GG		13.0460-2951.2 602951	TRW 21103 14,2 - WK
2.0 T.S. 16V (167.A2G)	110	03/95→12/97	←			13.0460-2987.2 602987	TRW 21147 19,0 + WK
			→	ALU		13.0460-2826.2 602826	TRW 23177 14,2 - WK
			→	GG		13.0460-2951.2 602951	TRW 21103 14,2 - WK
2.5 TD (167.A1A, 167.A1G)	92	04/93→12/97	←	→ 10/97		13.0460-2979.2 602979	TRW 21147 19,0 + WK
			→	ALU		13.0460-2826.2 602826	TRW 23177 14,2 - WK
			→	GG		13.0460-2951.2 602951	TRW 21103 14,2 - WK
2.5 V6 (167.A1C, 167.A1)	121	02/92→09/96	←	05/92→		13.0460-2979.2 602979	TRW 21147 19,0 + WK
			→	05/92→; ALU		13.0460-2826.2 602826	TRW 23177 14,2 - WK
			→	05/92→; GG		13.0460-2951.2 602951	TRW 21103 14,2 - WK
2.5 V6 (167.A1C, 167.A1E)	120	10/92→12/97	←			13.0460-2979.2 602979	TRW 21147 19,0 + WK
			→	ALU		13.0460-2826.2 602826	TRW 23177 14,2 - WK
			→	GG		13.0460-2951.2 602951	TRW 21103 14,2 - WK
Zubehörsatz, Scheibenbremsbelag							
1.6 16V T.S. (167.A6A)	88	05/96→12/97	→	GG		13.0460-0072.2 610072	TRW
1.7 T.S. (167.A4D, 167.A4H)	85	04/93→04/96					
1.7 T.S. (167.A4G)	83	04/93→04/96					
1.7 T.S. 16V (167.A4N)	103	05/96→12/97					
1.9 TD (167.A3B, 167.A3)	66	04/93→12/97					
2.0 T.S. 16V (167.A2G)	110	03/95→12/97					
2.5 TD (167.A1A, 167.A1G)	92	04/93→12/97					
2.5 V6 (167.A1C, 167.A1E)	120	10/92→12/97					
1.8 T.S. (167.A4C, 167.A)	77	02/92→12/97	→	05/92→; GG		13.0460-0072.2 610072	TRW
1.8 T.S. Sport (167.A4A, 167.A4C, 167.A4E)	93	01/92→12/96					
2.0 T.S. (167.A2A, 167.A2D)	104	02/92→02/95					
2.5 V6 (167.A1C, 167.A1)	121	02/92→09/96					
2.0 16V Turbo Q4 (167.A2B, 167.A2C, 167.A2E)	137	01/92→12/97	→	11/92→; GG		13.0460-0072.2 610072	TRW
2.0 16V Turbo Q4 (167.A2B, 167.A2C, 167.A2E)	140	01/92→12/97					
Bremsscheibe							
1.6 16V T.S. (167.A6A)	88	05/96→12/97	←			24.0120-0142.1 420142	Ø 257,5 20 18,2 V
1.7 T.S. (167.A4D, 167.A4H)	85	04/93→04/96				24.0320-0142.1 520142	Ø 257,5 20 18,2 V PD
1.7 T.S. (167.A4G)	83	04/93→04/96	→			24.0111-0149.1 411149	Ø 240,5 11 9,2
1.7 T.S. 16V (167.A4N)	103	05/96→12/97					
1.8 T.S. (167.A4C, 167.A)	77	02/92→12/97	←	05/92→		24.0120-0142.1 420142	Ø 257,5 20 18,2 V
1.8 T.S. Sport (167.A4A, 167.A4C, 167.A4E)	93	01/92→12/96	→	05/92→		24.0320-0142.1 520142	Ø 257,5 20 18,2 V PD
						24.0111-0149.1 411149	Ø 240,5 11 9,2
↓							

	kW			 	! #		
ALFA ROMEO - 155 (167_) 01/92→12/97							
 Bremsscheibe							
1.9 TD (167.A3B, 167.A3)	66	04/93→12/97	←			24.0112-0127.1 412127	Ø 257,5 12 10,2
			→			24.0111-0149.1 411149	Ø 240,5 11 9,2
2.0 16V Turbo Q4 (167.A2B, 167.A2C, 167.A2E)	137	01/92→12/97	←	11/92→		24.0122-0147.1 422147	Ø 284 22 20,2 V
			→	11/92→		24.0111-0149.1 411149	Ø 240,5 11 9,2
2.0 16V Turbo Q4 (167.A2B, 167.A2C, 167.A2E)	140	01/92→12/97					
2.0 T.S. (167.A2A, 167.A2D)	104	02/92→02/95	→	05/92→		24.0111-0149.1 411149	Ø 240,5 11 9,2
2.0 T.S. 16V (167.A2G)	110	03/95→12/97	←	11/95→		24.0122-0107.1 422107	Ø 284 22 20,2 V
			→			24.0111-0149.1 411149	Ø 240,5 11 9,2
2.5 TD (167.A1A, 167.A1G)	92	04/93→12/97	←			24.0112-0127.1 412127	Ø 257,5 12 10,2
			→			24.0122-0147.1 422147	Ø 284 22 20,2 V
			→			24.0111-0149.1 411149	Ø 240,5 11 9,2
2.5 V6 (167.A1C, 167.A1)	121	02/92→09/96	←	05/92→		24.0122-0147.1 422147	Ø 284 22 20,2 V
			→	05/92→		24.0111-0149.1 411149	Ø 240,5 11 9,2
2.5 V6 (167.A1C, 167.A1E)	120	10/92→12/97	←			24.0122-0147.1 422147	Ø 284 22 20,2 V
			→			24.0111-0149.1 411149	Ø 240,5 11 9,2
ALFA ROMEO - 156 (932_) 09/97→09/05							
 Bremsbelagsatz, Scheibenbremse							
1.6 16V T.SPARK (932.A4, 932.A4100)	82 88	09/97→09/05	←	10/97→ 02/00		13.0460-7105.2 607105	ATE 23140 19,4 + WK
			←	03/00→ 02/01		13.0460-7139.2 607139	ATE 23140 19,4 + WK
						13.0470-7139.2 LD7139	ATE 23140 19,4 + WK Ceramic
			←	03/01→ 07/05		13.0460-7140.2 607140	ATE 21637 19,3 + WK
						13.0470-7140.2 LD7140	ATE 21637 19,3 + WK Ceramic
			→	10/97→ 02/02		13.0460-2827.2 602827	TRW 21606 16,7 - WK
			→	03/02→ 07/05		13.0460-2867.2 602867	TRW 23517 16,6 - WE / - WK
			→	03/02→ 07/05		13.0470-2867.2 LD2867	TRW 23517 16,6 - WE / - WK Ceramic
1.8 16V T.SPARK (932.A3)	106	09/97→10/00	←	10/97→ 02/00		13.0460-7105.2 607105	ATE 23140 19,4 + WK
			←	03/00→		13.0460-7139.2 607139	ATE 23140 19,4 + WK
1.9 JTD (932B2)	77	09/97→10/00				13.0470-7139.2 LD7139	ATE 23140 19,4 + WK Ceramic
			→	10/97→		13.0460-2827.2 602827	TRW 21606 16,7 - WK
1.8 16V T.SPARK (932.A3100)	103	10/00→09/05	←	→ 02/01		13.0460-7139.2 607139	ATE 23140 19,4 + WK
			←	03/01→ 07/05		13.0460-7140.2 607140	ATE 23140 19,4 + WK Ceramic
						13.0470-7140.2 LD7140	ATE 21637 19,3 + WK
			→	→ 02/02		13.0460-2827.2 602827	TRW 21606 16,7 - WK
			→	03/02→ 07/05		13.0460-2867.2 602867	TRW 23517 16,6 - WE / - WK
						13.0470-2867.2 LD2867	TRW 23517 16,6 - WE / - WK Ceramic
1.9 JTD	93	11/03→09/05	←	→ 07/05		13.0460-7140.2 607140	ATE 21637 19,3 + WK
						13.0470-7140.2 LD7140	ATE 21637 19,3 + WK Ceramic
1.9 JTD (932.AXN00, 932.BXE00)	110	07/04→09/05					
1.9 JTD 16V	103	11/02→09/05	→	→ 07/05		13.0460-2867.2 602867	TRW 23517 16,6 - WE / - WK
2.0 JTS (932AXA)	122	03/02→09/05				13.0470-2867.2 LD2867	TRW 23517 16,6 - WE / - WK Ceramic
1.9 JTD	100	11/02→11/04	←			13.0460-7140.2 607140	ATE 21637 19,3 + WK
						13.0470-7140.2 LD7140	ATE 21637 19,3 + WK Ceramic
			→			13.0460-2867.2 602867	TRW 23517 16,6 - WE / - WK
			→			13.0470-2867.2 LD2867	TRW 23517 16,6 - WE / - WK Ceramic
1.9 JTD (932.A2B00, 932.A2C00)	85	05/01→09/05	←	→ 07/05		13.0460-7140.2 607140	ATE 21637 19,3 + WK
						13.0470-7140.2 LD7140	ATE 21637 19,3 + WK Ceramic
			→	→ 02/02		13.0460-2827.2 602827	TRW 21606 16,7 - WK
			→	03/02→ 07/05		13.0460-2867.2 602867	TRW 23517 16,6 - WE / - WK
			→	03/02→ 07/05		13.0470-2867.2 LD2867	TRW 23517 16,6 - WE / - WK Ceramic
2.0 JTS	119	01/02→09/05					
2.4 JTD (932A1B_)	103	10/00→09/05	→	→ 02/02		13.0460-2827.2 602827	TRW 21606 16,7 - WK
2.5 V6 24V (932A11_)	141	10/00→09/05	→	03/02→ 07/05		13.0460-2867.2 602867	TRW 23517 16,6 - WE / - WK
			→	03/02→ 07/05		13.0470-2867.2 LD2867	TRW 23517 16,6 - WE / - WK Ceramic
1.9 JTD (932.A2B00)	81	10/00→05/01	←	→ 02/01		13.0460-7139.2 607139	ATE 23140 19,4 + WK
						13.0470-7139.2 LD7139	ATE 23140 19,4 + WK Ceramic
			←	03/01→		13.0460-7140.2 607140	ATE 21637 19,3 + WK

	kw			 	! #		
ALFA ROMEO - 156 (932_) 09/97→09/05							
 Bremsbelagsatz, Scheibenbremse							
1.9 JTD (932.A2B00)	81	10/00→05/01	←	03/01→		13.0470-7140.2 LD7140	ATE 21637 19,3 + WK Ceramic
			→			13.0460-2827.2 602827	TRW 21606 16,7 - WK
2.0 16V T.SPARK (932A2)	114	09/97→06/02	←	10/97→ 02/00		13.0460-7069.2 607069	ATE 21636 19,3 + WK
			←	03/00→		13.0460-7140.2 607140	ATE 21637 19,3 + WK
						13.0470-7140.2 LD7140	ATE 21637 19,3 + WK Ceramic
			→	10/97→ 02/02		13.0460-2827.2 602827	TRW 21606 16,7 - WK
			→	03/02→		13.0460-2867.2 602867	TRW 23517 16,6 - WE / - WK
						13.0470-2867.2 LD2867	TRW 23517 16,6 - WE / - WK Ceramic
2.0 16V T.SPARK (932A21_)	110	10/00→03/02	←			13.0460-7140.2 607140	ATE 21637 19,3 + WK
						13.0470-7140.2 LD7140	ATE 21637 19,3 + WK Ceramic
			→	→ 02/02		13.0460-2827.2 602827	TRW 21606 16,7 - WK
			→	03/02→		13.0460-2867.2 602867	TRW 23517 16,6 - WE / - WK
						13.0470-2867.2 LD2867	TRW 23517 16,6 - WE / - WK Ceramic
2.4 JTD	120	06/03→09/05	←	10/03→ 07/05		13.0460-7180.2 607180	ATE 21637 19,3 + WK
			→	10/03→ 07/05		13.0460-2867.2 602867	TRW 23517 16,6 - WE / - WK
						13.0470-2867.2 LD2867	TRW 23517 16,6 - WE / - WK Ceramic
2.4 JTD (932AXC)	129	10/03→09/05	←	→ 07/05		13.0460-7180.2 607180	ATE 21637 19,3 + WK
	110	03/02→09/05	→	→ 07/05		13.0460-2867.2 602867	TRW 23517 16,6 - WE / - WK
						13.0470-2867.2 LD2867	TRW 23517 16,6 - WE / - WK Ceramic
2.4 JTD (932B1)	100	09/97→09/03	←	10/97→ 02/00		13.0460-7069.2 607069	ATE 21636 19,3 + WK
			←	03/00→ 10/00		13.0460-7140.2 607140	ATE 21637 19,3 + WK
						13.0470-7140.2 LD7140	ATE 21637 19,3 + WK Ceramic
			→	10/97→ 10/00		13.0460-2827.2 602827	TRW 21606 16,7 - WK
2.5 V6 24V (932A1)	140	09/97→12/01	←	10/97→ 02/00		13.0460-7069.2 607069	ATE 21636 19,3 + WK
			←	03/00→		13.0460-7140.2 607140	ATE 21637 19,3 + WK
						13.0470-7140.2 LD7140	ATE 21637 19,3 + WK Ceramic
			→	10/97→		13.0460-2827.2 602827	TRW 21606 16,7 - WK
3.2 GTA (932AXB)	184	03/02→09/05	←	→ 07/05		13.0460-4985.2 604985	BRE 21381 18,0 + WK
			→	→ 07/05		13.0460-2867.2 602867	TRW 23517 16,6 - WE / - WK
						13.0470-2867.2 LD2867	TRW 23517 16,6 - WE / - WK Ceramic
Zubehörsatz, Scheibenbremsbelag							
3.2 GTA (932AXB)	184	03/02→09/05	←	→ 07/05		13.0460-0254.2 610254	
 Bremsscheibe							
1.6 16V T.SPARK (932.A4, 932.A4100)	82	09/97→09/05	←	10/97→ 07/05		24.0115-0108.1 415108	Ø 281 15 13,2
	88	09/97→09/05	→	10/97→ 02/02		24.0110-0209.1 410209	Ø 251,4 10 9
			→	03/02→ 07/05		24.0110-0283.1 410283	Ø 276 10 9
1.8 16V T.SPARK (932.A3)	106	09/97→10/00	←	10/97→		24.0115-0108.1 415108	Ø 281 15 13,2
						24.0122-0145.1 422145	Ø 284 22 20,2 V
			→	10/97→		24.0110-0209.1 410209	Ø 251,4 10 9
1.8 16V T.SPARK (932.A3100)	103	10/00→09/05	←	→ 07/05		24.0115-0108.1 415108	Ø 281 15 13,2
						24.0122-0145.1 422145	Ø 284 22 20,2 V
			→	→ 02/02		24.0110-0209.1 410209	Ø 251,4 10 9
			→	03/02→ 07/05		24.0110-0283.1 410283	Ø 276 10 9
1.9 JTD (932.AXN00, 932.BXE00)	93	11/03→09/05	←	→ 07/05		24.0115-0108.1 415108	Ø 281 15 13,2
	110	07/04→09/05	→	→ 07/05		24.0110-0283.1 410283	Ø 276 10 9
1.9 JTD	100	11/02→11/04	←			24.0115-0108.1 415108	Ø 281 15 13,2
			→			24.0110-0283.1 410283	Ø 276 10 9
1.9 JTD (932.A2B00, 932.A2C00)	85	05/01→09/05	←	→ 07/05		24.0115-0108.1 415108	Ø 281 15 13,2
			→	→ 02/02		24.0110-0209.1 410209	Ø 251,4 10 9
			→	03/02→ 07/05		24.0110-0283.1 410283	Ø 276 10 9
1.9 JTD (932.A2B00)	81	10/00→05/01	←			24.0115-0108.1 415108	Ø 281 15 13,2
			→			24.0110-0209.1 410209	Ø 251,4 10 9
↓							

	kw			 	! #		
ALFA ROMEO - 156 (932_) 09/97→09/05							
 Bremsscheibe							
1.9 JTD (932B2)	77	09/97→10/00	←	10/97→		24.0115-0108.1 415108	Ø 281 15 13,2
			→	10/97→		24.0110-0209.1 410209	Ø 251,4 10 9
1.9 JTD 16V	103	11/02→09/05	←	→ 07/05		24.0122-0145.1 422145	Ø 284 22 20,2 V
2.0 JTS (932AXA)	122	03/02→09/05	→	→ 07/05		24.0110-0283.1 410283	Ø 276 10 9
2.4 JTD	129	10/03→09/05					
2.4 JTD (932AXC)	110	03/02→09/05					
2.0 16V T.SPARK (932A2)	114	09/97→06/02	←	10/97→		24.0122-0145.1 422145	Ø 284 22 20,2 V
			→	10/97→ 02/02		24.0110-0209.1 410209	Ø 251,4 10 9
			→	03/02→		24.0110-0283.1 410283	Ø 276 10 9
2.0 16V T.SPARK (932A21__)	110	10/00→03/02	←			24.0122-0145.1 422145	Ø 284 22 20,2 V
			→	→ 02/02		24.0110-0209.1 410209	Ø 251,4 10 9
			→	03/02→		24.0110-0283.1 410283	Ø 276 10 9
2.0 JTS	119	01/02→09/05	←	→ 07/05		24.0122-0145.1 422145	Ø 284 22 20,2 V
2.4 JTD (932A1B__)	103	10/00→09/05	→	→ 02/02		24.0110-0209.1 410209	Ø 251,4 10 9
2.5 V6 24V (932A11__)	141	10/00→09/05	→	03/02→ 07/05		24.0110-0283.1 410283	Ø 276 10 9
2.4 JTD	120	06/03→09/05	←	10/03→ 07/05		24.0122-0145.1 422145	Ø 284 22 20,2 V
			→	10/03→ 07/05		24.0110-0283.1 410283	Ø 276 10 9
2.4 JTD (932B1)	100	09/97→09/03	←	10/97→ 10/00		24.0122-0145.1 422145	Ø 284 22 20,2 V
			→	10/97→ 10/00		24.0110-0209.1 410209	Ø 251,4 10 9
2.5 V6 24V (932A1)	140	09/97→12/01	←	10/97→		24.0122-0145.1 422145	Ø 284 22 20,2 V
			→	10/97→		24.0110-0209.1 410209	Ø 251,4 10 9
3.2 GTA (932AXB)	184	03/02→09/05	←	→ 09/03		24.0128-0119.1 428119	Ø 305 28 26 V
			←	10/03→ 07/05		24.0132-0129.1 432129	Ø 330 32 30 V
			→	→ 07/05		24.0110-0283.1 410283	Ø 276 10 9
ALFA ROMEO - 156 Sportwagon (932_) 01/00→05/06							
 Bremsbelagsatz, Scheibenbremse							
1.6 16V T.SPARK	82	01/00→09/05	←	→ 02/00		13.0460-7105.2 607105	ATE 23140 19,4 + WK
			←	03/00→ 02/01		13.0460-7139.2 607139	ATE 23140 19,4 + WK
						13.0470-7139.2 LD7139	ATE 23140 19,4 + WK Ceramic
			←	03/01→ 07/05		13.0460-7140.2 607140	ATE 21637 19,3 + WK
						13.0470-7140.2 LD7140	ATE 21637 19,3 + WK Ceramic
			→	→ 02/02		13.0460-2827.2 602827	TRW 21606 16,7 - WK
			→	03/02→ 07/05		13.0460-2867.2 602867	TRW 23517 16,6 - WE / - WK
						13.0470-2867.2 LD2867	TRW 23517 16,6 - WE / - WK Ceramic
1.6 16V T.SPARK. (932.B4B00)	81	07/00→07/05	←	→ 02/01		13.0460-7139.2 607139	ATE 23140 19,4 + WK
						13.0470-7139.2 LD7139	ATE 23140 19,4 + WK Ceramic
			←	03/01→		13.0460-7140.2 607140	ATE 21637 19,3 + WK
						13.0470-7140.2 LD7140	ATE 21637 19,3 + WK Ceramic
			→	→ 02/02		13.0460-2827.2 602827	TRW 21606 16,7 - WK
			→	03/02→		13.0460-2867.2 602867	TRW 23517 16,6 - WE / - WK
						13.0470-2867.2 LD2867	TRW 23517 16,6 - WE / - WK Ceramic
1.6 16V T.SPARK. (932A4)	88	05/00→05/06	←	→ 02/01		13.0460-7139.2 607139	ATE 23140 19,4 + WK
1.8 16V T.SPARK (932B31__)	103	10/00→05/06	←	03/01→ 07/05		13.0460-7140.2 607140	ATE 21637 19,3 + WK
						13.0470-7140.2 LD7140	ATE 21637 19,3 + WK Ceramic
			→	→ 02/02		13.0460-2827.2 602827	TRW 21606 16,7 - WK
			→	03/02→ 07/05		13.0460-2867.2 602867	TRW 23517 16,6 - WE / - WK
						13.0470-2867.2 LD2867	TRW 23517 16,6 - WE / - WK Ceramic
1.8 16V T.SPARK (932A3)	106	05/00→10/00	←			13.0460-7139.2 607139	ATE 23140 19,4 + WK
1.9 JTD (932B2)	77	05/00→10/00	→			13.0470-7139.2 LD7139	ATE 23140 19,4 + WK Ceramic
						13.0460-2827.2 602827	TRW 21606 16,7 - WK
1.9 JTD	93	11/03→05/06	←	→ 07/05		13.0460-7140.2 607140	ATE 21637 19,3 + WK
1.9 JTD 16V	103	11/02→05/06				13.0470-7140.2 LD7140	ATE 21637 19,3 + WK Ceramic
2.0 JTS	119	03/02→05/06					
2.0 JTS (932BXA)	122	03/02→05/06	→	→ 07/05		13.0460-2867.2 602867	TRW 23517 16,6 - WE / - WK
			↓				

	kw			 	! #		
ALFA ROMEO - 156 Sportwagon (932_) 01/00→05/06							
 Bremsbelagsatz, Scheibenbremse							
1.9 JTD 1.9 JTD 16V 2.0 JTS 2.0 JTS (932BXA)	93 103 119 122	11/03→05/06 11/02→05/06 03/02→05/06 03/02→05/06	➡	→ 07/05		13.0470-2867.2 LD2867	TRW 23517 16,6 - WE / - WK Ceramic
1.9 JTD	100	11/02→11/04	➡			13.0460-7140.2 607140 13.0470-7140.2 LD7140	ATE 21637 19,3 + WK ATE 21637 19,3 + WK Ceramic
			➡			13.0460-2867.2 602867 13.0470-2867.2 LD2867	TRW 23517 16,6 - WE / - WK TRW 23517 16,6 - WE / - WK Ceramic
1.9 JTD 1.9 JTD 16V Q4	110 110	03/05→05/06 07/04→05/06	➡	→ 07/05		13.0460-4803.2 604803 13.0470-4803.2 LD4803	BRE 23092 15,6 + WK + Zub BRE 23092 15,6 + WK + Zub Ceramic
			➡	→ 07/05		13.0460-2867.2 602867 13.0470-2867.2 LD2867	TRW 23517 16,6 - WE / - WK TRW 23517 16,6 - WE / - WK Ceramic
1.9 JTD (932.B2B00)	81	10/00→05/01	➡	→ 02/01		13.0460-7139.2 607139 13.0470-7139.2 LD7139	ATE 23140 19,4 + WK ATE 23140 19,4 + WK Ceramic
			➡	03/01→		13.0460-7140.2 607140 13.0470-7140.2 LD7140	ATE 21637 19,3 + WK ATE 21637 19,3 + WK Ceramic
			➡			13.0460-2827.2 602827	TRW 21606 16,7 - WK
1.9 JTD (932B2B, 932B2C) 2.4 JTD (932.B1B00) 2.5 V6 24V (932B11_)	85 103 141	05/01→05/06 10/00→05/06 10/00→05/06	➡	→ 07/05		13.0460-7140.2 607140 13.0470-7140.2 LD7140	ATE 21637 19,3 + WK ATE 21637 19,3 + WK Ceramic
			➡	→ 02/02		13.0460-2827.2 602827	TRW 21606 16,7 - WK
			➡	03/02→ 07/05		13.0460-2867.2 602867 13.0470-2867.2 LD2867	TRW 23517 16,6 - WE / - WK TRW 23517 16,6 - WE / - WK Ceramic
2.0 16V T.SPARK (932A2) 2.0 16V T.SPARK (932B21_) 2.5 V6 24V (932A1)	114 110 140	05/00→06/02 10/00→03/02 05/00→08/03	➡			13.0460-7140.2 607140 13.0470-7140.2 LD7140	ATE 21637 19,3 + WK ATE 21637 19,3 + WK Ceramic
			➡	→ 02/02		13.0460-2827.2 602827	TRW 21606 16,7 - WK
			➡	03/02→		13.0460-2867.2 602867 13.0470-2867.2 LD2867	TRW 23517 16,6 - WE / - WK TRW 23517 16,6 - WE / - WK Ceramic
2.4 JTD	120	06/03→05/06	➡	10/03→ 07/05		13.0460-7180.2 607180	ATE 21637 19,3 + WK
			➡	10/03→ 07/05		13.0460-2867.2 602867 13.0470-2867.2 LD2867	TRW 23517 16,6 - WE / - WK TRW 23517 16,6 - WE / - WK Ceramic
2.4 JTD 2.4 JTD (932.BXC00)	129 110	10/03→05/06 03/02→05/06	➡	→ 07/05		13.0460-7180.2 607180	ATE 21637 19,3 + WK
			➡	→ 07/05		13.0460-2867.2 602867 13.0470-2867.2 LD2867	TRW 23517 16,6 - WE / - WK TRW 23517 16,6 - WE / - WK Ceramic
2.4 JTD (932B1)	100	05/00→09/03	➡	→ 10/00		13.0460-7140.2 607140 13.0470-7140.2 LD7140	ATE 21637 19,3 + WK ATE 21637 19,3 + WK Ceramic
			➡	→ 10/00		13.0460-2827.2 602827	TRW 21606 16,7 - WK
3.2 GTA (932.BXB00)	184	03/02→05/06	➡	→ 07/05		13.0460-4985.2 604985	BRE 21381 18,0 + WK
			➡	→ 07/05		13.0460-2867.2 602867 13.0470-2867.2 LD2867	TRW 23517 16,6 - WE / - WK TRW 23517 16,6 - WE / - WK Ceramic
Zubehörsatz, Scheibenbremsbelag							
3.2 GTA (932.BXB00)	184	03/02→05/06	➡	→ 07/05		13.0460-0254.2 610254	
 Bremsscheibe							
1.6 16V T.SPARK 1.6 16V T.SPARK. (932A4)	82 88	01/00→09/05 05/00→05/06	➡	→ 07/05		24.0115-0108.1 415108	Ø 281 15 13,2
			➡	→ 02/02		24.0110-0209.1 410209	Ø 251,4 10 9
1.9 JTD (932B2B, 932B2C)	85	05/01→05/06	➡	03/02→ 07/05		24.0110-0283.1 410283	Ø 276 10 9
1.6 16V T.SPARK. (932.B4B00)	81	07/00→07/05	➡			24.0115-0108.1 415108	Ø 281 15 13,2
			➡	→ 02/02		24.0110-0209.1 410209	Ø 251,4 10 9
			➡	03/02→		24.0110-0283.1 410283	Ø 276 10 9
1.8 16V T.SPARK (932A3)	106	05/00→10/00	➡			24.0115-0108.1 415108 24.0122-0145.1 422145	Ø 281 15 13,2 Ø 284 22 20,2 V
			➡			24.0110-0209.1 410209	Ø 251,4 10 9
↓							

	kW				! #		
ALFA ROMEO - 156 Sportwagon (932_) 01/00→05/06							
Bremsscheibe							
1.8 16V T.SPARK (932B31__)	103	10/00→05/06	←	→ 07/05		24.0115-0108.1 415108	∅ 281 15 13,2
			→	→ 02/02		24.0122-0145.1 422145	∅ 284 22 20,2 V
			→	03/02→ 07/05		24.0110-0209.1 410209	∅ 251,4 10 9
1.9 JTD	93	11/03→05/06	←	→ 07/05		24.0115-0108.1 415108	∅ 281 15 13,2
			→	→ 07/05		24.0110-0283.1 410283	∅ 276 10 9
1.9 JTD	100	11/02→11/04	←			24.0115-0108.1 415108	∅ 281 15 13,2
			→			24.0110-0283.1 410283	∅ 276 10 9
1.9 JTD 1.9 JTD 16V Q4	110	03/05→05/06 07/04→05/06	←	→ 07/05		24.0132-0129.1 432129	∅ 330 32 30 V
	110		→	→ 07/05		24.0110-0283.1 410283	∅ 276 10 9
1.9 JTD (932.B2B00) 1.9 JTD (932B2)	81	10/00→05/01 05/00→10/00	←			24.0115-0108.1 415108	∅ 281 15 13,2
	77		→			24.0110-0209.1 410209	∅ 251,4 10 9
1.9 JTD 16V 2.0 JTS 2.0 JTS (932BXA) 2.4 JTD 2.4 JTD (932.BXC00)	103	11/02→05/06 03/02→05/06 03/02→05/06 10/03→05/06 03/02→05/06	←	→ 07/05		24.0122-0145.1 422145	∅ 284 22 20,2 V
	119		→	→ 07/05		24.0110-0283.1 410283	∅ 276 10 9
	122						
	129						
2.0 16V T.SPARK (932A2) 2.0 16V T.SPARK (932B21__) 2.5 V6 24V (932A1)	114	05/00→06/02	←			24.0122-0145.1 422145	∅ 284 22 20,2 V
	110		→	→ 02/02		24.0110-0209.1 410209	∅ 251,4 10 9
	140		→	03/02→		24.0110-0283.1 410283	∅ 276 10 9
2.4 JTD	120	06/03→05/06	←	10/03→ 07/05		24.0122-0145.1 422145	∅ 284 22 20,2 V
			→	10/03→ 07/05		24.0110-0283.1 410283	∅ 276 10 9
2.4 JTD (932.B1B00) 2.5 V6 24V (932B11_)	103	10/00→05/06 10/00→05/06	←	→ 07/05		24.0122-0145.1 422145	∅ 284 22 20,2 V
	141		→	→ 02/02		24.0110-0209.1 410209	∅ 251,4 10 9
			→	03/02→ 07/05		24.0110-0283.1 410283	∅ 276 10 9
2.4 JTD (932B1)	100	05/00→09/03	←	→ 10/00		24.0122-0145.1 422145	∅ 284 22 20,2 V
			→	→ 10/00		24.0110-0209.1 410209	∅ 251,4 10 9
3.2 GTA (932.BXB00)	184	03/02→05/06	←	→ 09/03		24.0128-0119.1 428119	∅ 305 28 26 V
			←	10/03→ 07/05		24.0132-0129.1 432129	∅ 330 32 30 V
			→	→ 07/05		24.0110-0283.1 410283	∅ 276 10 9
ALFA ROMEO - 159 (939_) 09/05→11/11							
Bremsbelagsatz, Scheibenbremse							
1.8 MPI 1.9 JTS 2.2 JTS	103	03/07→11/11 09/05→11/11 09/05→11/11	←	→ 10/11		13.0460-7211.2 607211	ATE 24339 20,5 + WK
	118				13.0470-7211.2 LD7211	ATE 24339 20,5 + WK Ceramic	
	136		→	→ 10/11		13.0460-2707.2 602707	TRW 23760 17,7 - WE / - WK
1.8 TBi 1.9 JTDM 16V 1.9 JTDM 16V 1.9 JTDM 8V 1.9 JTDM 8V 2.0 JTDM 2.0 JTDM 2.0 JTDM	147	05/09→11/11 09/05→11/11 09/05→11/11 09/05→11/11 09/05→11/11 06/10→11/11 05/09→11/11 05/09→11/11	←	→ 10/11		13.0460-4867.2 604867	BRE 24852 16,0 + WK
	100				13.0470-4867.2 LD4867	BRE 24852 16,0 + WK Ceramic	
	110		→	→ 10/11		13.0460-2707.2 602707	TRW 23760 17,7 - WE / - WK
	85					13.0470-2707.2 LD2707	TRW 23760 17,7 - WE / - WK Ceramic
	88						
2.4 JTDM 2.4 JTDM Q4 3.2 JTS	147	09/05→11/11 12/05→11/11	←	01/07→ 10/11		13.0460-4851.2 604851	BRE 23092 16,0 + WK
	191				13.0470-4851.2 LD4851	BRE 23092 16,0 + WK Ceramic	
			←	→ 12/06		13.0460-4971.2 604971	BRE 23092 16,0 + WK
						13.0470-4971.2 LD4971	BRE 23092 16,0 + WK Ceramic
2.4 JTDM 2.4 JTDM Q4 3.2 JTS	154	05/07→11/11 05/07→11/11 02/08→11/11	←	→ 10/11		13.0460-2707.2 602707	TRW 23760 17,7 - WE / - WK
	154				13.0470-2707.2 LD2707	TRW 23760 17,7 - WE / - WK Ceramic	
	191		→	→ 10/11		13.0460-4851.2 604851	BRE 23092 16,0 + WK
Bremsscheibe							
1.8 MPI 1.9 JTDM 16V ↓	103 100	03/07→11/11 09/05→11/11	←	→ 10/11		24.0128-0192.1 428192	∅ 305 28 26 V + S

ALFA ROMEO - 159 (939_) 09/05→11/11

Bremsscheibe							
1.9 JTDM 16V 1.9 JTDM 8V 1.9 JTDM 8V 1.9 JTS 2.0 JTDM 2.2 JTS	110 85 88 118 100 136	09/05→11/11 09/05→11/11 09/05→11/11 09/05→11/11 06/10→11/11 09/05→11/11	➡	→ 10/11		24.0112-0170.1 412170	Ø 278 12 10 + S
1.8 TBi 2.4 JTDM 2.4 JTDM 2.4 JTDM Q4 3.2 JTS 3.2 JTS Q4	147 147 154 154 191 191	05/09→11/11 09/05→11/11 05/07→11/11 05/07→11/11 02/08→11/11 12/05→11/11	➡	→ 10/11		24.0128-0191.1 428191	Ø 330 28 26 V + S
			➡	→ 10/11		24.0122-0233.1 422233	Ø 292 22 20 V + S
2.0 JTDM 2.0 JTDM	120 125	05/09→11/11 05/09→11/11	➡	→ 10/11; für Fahrzeuge mit Sportpaket		24.0128-0191.1 428191	Ø 330 28 26 V + S
			➡	→ 10/11; für Fahrzeuge ohne Sportpaket		24.0128-0192.1 428192	Ø 305 28 26 V + S
			➡	→ 10/11		24.0112-0170.1 412170	Ø 278 12 10 + S









ALFA ROMEO - 159 Sportwagon (939_) 03/06→11/11

Bremsbelagsatz, Scheibenbremse							
1.8 MPI 1.9 JTS 2.2 JTS	103 118 136	03/07→11/11 03/06→11/11 03/06→11/11	➡	→ 10/11		13.0460-7211.2 607211	ATE 24339 20,5 + WK
			➡	→ 10/11		13.0470-7211.2 LD7211	ATE 24339 20,5 + WK Ceramic
			➡	→ 10/11		13.0460-2707.2 602707	TRW 23760 17,7 - WE / - WK
			➡	→ 10/11		13.0470-2707.2 LD2707	TRW 23760 17,7 - WE / - WK Ceramic
1.8 TBi 1.9 JTDM 16V 1.9 JTDM 16V 1.9 JTDM 8V 1.9 JTDM 8V 2.0 JTDM 2.0 JTDM 2.0 JTDM	147 100 110 85 88 100 120 125	05/09→11/11 03/06→11/11 03/06→11/11 03/06→11/11 03/06→11/11 06/10→11/11 05/09→11/11 05/09→11/11	➡	→ 10/11		13.0460-4867.2 604867	BRE 24852 16,0 + WK
			➡	→ 10/11		13.0470-4867.2 LD4867	BRE 24852 16,0 + WK Ceramic
			➡	→ 10/11		13.0460-2707.2 602707	TRW 23760 17,7 - WE / - WK
			➡	→ 10/11		13.0470-2707.2 LD2707	TRW 23760 17,7 - WE / - WK Ceramic
2.4 JTDM 3.2 JTS Q4	147 191	03/06→11/11 03/06→11/11	➡	01/07→ 10/11		13.0460-4851.2 604851	BRE 23092 16,0 + WK
			➡	→ 12/06		13.0470-4851.2 LD4851	BRE 23092 16,0 + WK Ceramic
			➡	→ 10/11		13.0460-4971.2 604971	BRE 23092 16,0 + WK
			➡	→ 10/11		13.0470-4971.2 LD4971	BRE 23092 16,0 + WK Ceramic
			➡	→ 10/11		13.0460-2707.2 602707	TRW 23760 17,7 - WE / - WK
			➡	→ 10/11		13.0470-2707.2 LD2707	TRW 23760 17,7 - WE / - WK Ceramic
2.4 JTDM 2.4 JTDM Q4 3.2 JTS	154 154 191	05/07→11/11 05/07→11/11 02/08→11/11	➡	→ 10/11		13.0460-4851.2 604851	BRE 23092 16,0 + WK
			➡	→ 10/11		13.0470-4851.2 LD4851	BRE 23092 16,0 + WK Ceramic
			➡	→ 10/11		13.0460-2707.2 602707	TRW 23760 17,7 - WE / - WK
			➡	→ 10/11		13.0470-2707.2 LD2707	TRW 23760 17,7 - WE / - WK Ceramic

Bremsscheibe							
1.8 MPI 1.9 JTDM 16V 1.9 JTDM 16V 1.9 JTDM 8V 1.9 JTDM 8V 1.9 JTS 2.0 JTDM 2.2 JTS	103 100 110 85 88 118 100 136	03/07→11/11 03/06→11/11 03/06→11/11 03/06→11/11 03/06→11/11 03/06→11/11 06/10→11/11 03/06→11/11	➡	→ 10/11		24.0128-0192.1 428192	Ø 305 28 26 V + S
			➡	→ 10/11		24.0112-0170.1 412170	Ø 278 12 10 + S
1.8 TBi 2.4 JTDM 2.4 JTDM 2.4 JTDM Q4 3.2 JTS 3.2 JTS Q4	147 147 154 154 191 191	05/09→11/11 03/06→11/11 05/07→11/11 05/07→11/11 02/08→11/11 03/06→11/11	➡	→ 10/11		24.0128-0191.1 428191	Ø 330 28 26 V + S
			➡	→ 10/11		24.0122-0233.1 422233	Ø 292 22 20 V + S
2.0 JTDM 2.0 JTDM	120 125	05/09→11/11 05/09→11/11	➡	→ 10/11; für Fahrzeuge mit Sportpaket		24.0128-0191.1 428191	Ø 330 28 26 V + S
			➡	→ 10/11; für Fahrzeuge ohne Sportpaket		24.0128-0192.1 428192	Ø 305 28 26 V + S
			➡	→ 10/11		24.0112-0170.1 412170	Ø 278 12 10 + S

ALFA ROMEO - 164 (164_) 01/87→09/98

Bremsbelagsatz, Scheibenbremse							
2.0	102	06/87→09/98	➡	→ 08/91; 6.142.574→		13.0460-2809.2 602809	TRW 21182 19,4 + WK
			➡	09/87→ 08/91		13.0460-2962.2 602962	TRW 20668 16,6 - WK
2.0 T.S. (164.H3)	106	09/92→09/98	➡			13.0460-2809.2 602809	TRW 21182 19,4 + WK
			➡			13.0460-2962.2 602962	TRW 20668 16,6 - WK
↓							

	kW			 	! #		
ALFA ROMEO - 164 (164_) 01/87→09/98							
 Bremsbelagsatz, Scheibenbremse							
2.0 Turbo	128	10/87→09/98	←	09/91→		13.0460-2980.2 602980	TRW 21147 19,0 + WK
			←	→ 08/91		13.0460-2980.2 602980	TRW 21147 19,0 + WK
			→	→ 08/91		13.0460-2962.2 602962	TRW 20668 16,6 - WK
2.0 V6 Turbo (164.K3) 2.5 TD (164.K2A, 164.K2B) 2.5 V6 3.0 3.0 3.0 3.0 3.0 24V	148	09/92→09/98	←			13.0460-2980.2 602980	TRW 21147 19,0 + WK
	92	09/92→09/98	→			13.0460-2962.2 602962	TRW 20668 16,6 - WK
	120	09/92→09/98					
	156	09/93→12/95					
	157	03/95→10/97					
	168	04/93→02/95					
	170	03/95→08/97					
	154	03/95→10/97					
3.0 24V (164.K1) 3.0 24V QV (164.H1)	155	09/92→09/98	←	12/92→		13.0460-2980.2 602980	TRW 21147 19,0 + WK
	171	09/92→09/98	→	12/92→		13.0460-2962.2 602962	TRW 20668 16,6 - WK
3.0 24V Q4 (164.K1M, 164.K1C) 3.0 24V QV Allrad	170	02/94→09/98	←	04/94→		13.0460-2980.2 602980	TRW 21147 19,0 + WK
	171	11/92→10/97	→	04/94→		13.0460-2827.2 602827	TRW 21606 16,7 - WK
3.0 V6 (164.H1A, 164.H1B, 164.K1P)	132	09/92→09/98	←	→ 11/92		13.0460-2980.2 602980	TRW 21147 19,0 + WK
			→	→ 11/92		13.0460-2962.2 602962	TRW 20668 16,6 - WK
Zubehörsatz, Scheibenbremsbelag							
2.0	102	06/87→09/98	→	09/87→ 08/91		13.0460-0072.2 610072	TRW
2.0 T.S. (164.H3) 2.0 V6 Turbo (164.K3) 2.5 TD (164.K2A, 164.K2B) 2.5 V6 3.0 3.0 3.0 3.0 3.0 24V	106	09/92→09/98	→			13.0460-0072.2 610072	TRW
	148	09/92→09/98					
	92	09/92→09/98					
	120	09/92→09/98					
	156	09/93→12/95					
	157	03/95→10/97					
	168	04/93→02/95					
	170	03/95→08/97					
154	03/95→10/97						
2.0 Turbo	128	10/87→09/98	→	→ 08/91		13.0460-0072.2 610072	TRW
3.0 24V (164.K1) 3.0 24V QV (164.H1)	155	09/92→09/98	→	12/92→		13.0460-0072.2 610072	TRW
	171	09/92→09/98					
3.0 V6 (164.H1A, 164.H1B, 164.K1P)	132	09/92→09/98	→	→ 11/92		13.0460-0072.2 610072	TRW
 Bremsscheibe							
2.0	102	06/87→09/98	←	→ 08/91; 6.142.574→		24.0122-0130.1 422130	Ø 257,2 22 20,2 V
			→	09/87→ 08/91		24.0110-0190.1 410190	Ø 251,5 10 9
2.0 T.S. (164.H3)	106	09/92→09/98	←			24.0122-0130.1 422130	Ø 257,2 22 20,2 V
			→			24.0110-0190.1 410190	Ø 251,5 10 9
2.0 Turbo	128	10/87→09/98	←	→ 08/91		24.0122-0145.1 422145	Ø 284 22 20,2 V
			←	09/91→		24.0126-0103.1 426103	Ø 281 26 24,2 V
			→	09/91→		24.0110-0209.1 410209	Ø 251,4 10 9
			→	→ 08/91		24.0110-0209.1 410209	Ø 251,4 10 9
2.0 V6 Turbo (164.K3)	148	09/92→09/98	←			24.0122-0145.1 422145	Ø 284 22 20,2 V
			→			24.0110-0209.1 410209	Ø 251,4 10 9
2.5 TD (164.K2A, 164.K2B) 2.5 V6 3.0 3.0 3.0 3.0 24V	92	09/92→09/98	←			24.0126-0103.1 426103	Ø 281 26 24,2 V
	120	09/92→09/98	→			24.0110-0209.1 410209	Ø 251,4 10 9
	156	09/93→12/95					
	157	03/95→10/97					
	168	04/93→02/95					
	170	03/95→08/97					
	154	03/95→10/97					
3.0 24V (164.K1) 3.0 24V QV (164.H1)	155	09/92→09/98	←	12/92→		24.0126-0103.1 426103	Ø 281 26 24,2 V
	171	09/92→09/98	→	12/92→		24.0110-0209.1 410209	Ø 251,4 10 9
3.0 24V Q4 (164.K1M, 164.K1C) 3.0 24V QV Allrad	170	02/94→09/98	←	04/94→		24.0126-0103.1 426103	Ø 281 26 24,2 V
	171	11/92→10/97					
3.0 V6 (164.H1A, 164.H1B, 164.K1P)	132	09/92→09/98	←	→ 11/92		24.0126-0103.1 426103	Ø 281 26 24,2 V
			→	→ 11/92		24.0110-0209.1 410209	Ø 251,4 10 9



ALFA ROMEO - 166 (936_) 09/98→06/07

Bremsbelagsatz, Scheibenbremse

2.0 T.Spark (936A3A_) 2.4 JTD (936A2A_)	114 100	09/98→10/00 09/98→10/00	← →	10/98→ 10/98→	13.0460-7112.2 607112 13.0460-2827.2 602827	ATE 21637 19,3 + WK TRW 21606 16,7 - WK
2.0 T.Spark (936A3B_) 2.4 JTD 2.4 JTD 2.4 JTD 2.4 JTD 2.4 JTD (936A2B_)	110 110 120 132 136 103	10/00→06/07 04/02→06/07 10/03→06/07 07/06→06/07 07/05→06/07 10/00→06/07	← →		13.0460-7112.2 607112 13.0460-2827.2 602827	ATE 21637 19,3 + WK TRW 21606 16,7 - WK
2.0 V6 (936A3_) 2.5 V6 24V (936A2_) 3.0 V6 24V (936A1_)	151 140 166	09/98→10/00 09/98→12/06 09/98→06/07	← →	10/98→ 10/98→	13.0460-4971.2 604971 13.0470-4971.2 LD4971 13.0460-2827.2 602827	BRE 23092 16,0 + WK BRE 23092 16,0 + WK Ceramic TRW 21606 16,7 - WK
2.4 JTD 2.5 V6 24V (936A21_) 3.0 V6 24V (936A11_) 3.2 V6 24V	129 138 162 176	10/03→06/07 10/00→06/07 10/00→06/07 10/03→06/07	← →		13.0460-4971.2 604971 13.0470-4971.2 LD4971 13.0460-2827.2 602827	BRE 23092 16,0 + WK BRE 23092 16,0 + WK Ceramic TRW 21606 16,7 - WK

Bremsscheibe

2.0 T.Spark (936A3A_) 2.4 JTD (936A2A_)	114 100	09/98→10/00 09/98→10/00	← →	10/98→ 10/98→	24.0126-0133.1 426133 24.0110-0290.1 410290	Ø 281 26 24,2 V Ø 276 10 9
2.0 T.Spark (936A3B_) 2.4 JTD 2.4 JTD 2.4 JTD 2.4 JTD 2.4 JTD (936A2B_)	110 110 120 132 136 103	10/00→06/07 04/02→06/07 10/03→06/07 07/06→06/07 07/05→06/07 10/00→06/07	← →		24.0126-0133.1 426133 24.0110-0290.1 410290	Ø 281 26 24,2 V Ø 276 10 9
2.0 V6 (936A3_) 2.5 V6 24V (936A2_) 3.0 V6 24V (936A1_)	151 140 166	09/98→10/00 09/98→12/06 09/98→06/07	← →	10/98→ 10/98→	24.0128-0118.1 428118 24.0110-0290.1 410290	Ø 310 28 26 V Ø 276 10 9
2.4 JTD 2.5 V6 24V (936A21_) 3.0 V6 24V (936A11_) 3.2 V6 24V	129 138 162 176	10/03→06/07 10/00→06/07 10/00→06/07 10/03→06/07	← →		24.0128-0118.1 428118 24.0110-0290.1 410290	Ø 310 28 26 V Ø 276 10 9









ALFA ROMEO - BRERA (939_) 01/06→06/10











Bremsbelagsatz, Scheibenbremse









1.8 Tbi 2.4 JTDM 20V 2.4 JTDM 20V 3.2 JTS 3.2 JTS Q4	147 147 154 191 191	05/09→06/10 01/06→06/10 05/07→06/10 03/08→06/10 01/06→06/10	← →		13.0460-4971.2 604971 13.0470-4971.2 LD4971 13.0460-2707.2 602707 13.0470-2707.2 LD2707	BRE 23092 16,0 + WK BRE 23092 16,0 + WK Ceramic TRW 23760 17,7 - WE / - WK TRW 23760 17,7 - WE / - WK Ceramic
2.0 JTDM	120	03/08→06/10	← →	05/09→ 05/09→	13.0460-4867.2 604867 13.0470-4867.2 LD4867 13.0460-2707.2 602707 13.0470-2707.2 LD2707	BRE 24852 16,0 + WK BRE 24852 16,0 + WK Ceramic TRW 23760 17,7 - WE / - WK TRW 23760 17,7 - WE / - WK Ceramic
2.0 JTDM	125	05/09→06/10	← →		13.0460-4867.2 604867 13.0470-4867.2 LD4867 13.0460-2707.2 602707 13.0470-2707.2 LD2707	BRE 24852 16,0 + WK BRE 24852 16,0 + WK Ceramic TRW 23760 17,7 - WE / - WK TRW 23760 17,7 - WE / - WK Ceramic
2.2 JTS	136	01/06→06/10	← →		13.0460-7211.2 607211 13.0470-7211.2 LD7211 13.0460-2707.2 602707 13.0470-2707.2 LD2707	ATE 24339 20,5 + WK ATE 24339 20,5 + WK Ceramic TRW 23760 17,7 - WE / - WK TRW 23760 17,7 - WE / - WK Ceramic











Bremsscheibe











1.8 Tbi 2.4 JTDM 20V 2.4 JTDM 20V 3.2 JTS 3.2 JTS Q4	147 147 154 191 191	05/09→06/10 01/06→06/10 05/07→06/10 03/08→06/10 01/06→06/10	← →		24.0128-0191.1 428191 24.0122-0233.1 422233	Ø 330 28 26 V + S Ø 292 22 20 V + S
2.0 JTDM	120	03/08→06/10	← →	05/09→ 05/09→	24.0128-0192.1 428192 24.0112-0170.1 412170	Ø 305 28 26 V + S Ø 278 12 10 + S
2.0 JTDM 2.2 JTS	125 136	05/09→06/10 01/06→06/10	← →		24.0128-0192.1 428192 24.0112-0170.1 412170	Ø 305 28 26 V + S Ø 278 12 10 + S













	kw			 	! #		
ALFA ROMEO - GIULIETTA (940_) 04/10→							
 Bremsbelagsatz, Scheibenbremse							
1.4 BiFuel 1.4 TB 1.4 TB (940FXA1A) 1.6 JTDM (940FXD1A)	88	12/11→	←	→ 04/12; für Fahrzeuge mit verstärkter Bremse	13.0460-4854.2 604854	BRE 23092 16,3 + WK	
	85	04/10→			13.0470-4854.2 LD4854	BRE 23092 16,3 + WK Ceramic	
	88	04/10→	←	05/12→; für Fahrzeuge mit verstärkter Bremse	13.0460-4971.2 604971	BRE 23092 16,0 + WK	
	77	04/10→			13.0470-4971.2 LD4971	BRE 23092 16,0 + WK Ceramic	
				←	nicht für Fahrzeuge mit verstärkter Bremse	13.0460-7273.2 607273	ATE 24538 19,4 + WK
					13.0470-7273.2 LD7273	ATE 24538 19,4 + WK Ceramic	
			→	nicht für Fahrzeuge mit verstärkter Bremse	13.0460-2767.2 602767	TRW 25156 17,4 + WK + Zub	
					13.0470-2767.2 LD2767	TRW 25156 17,4 + WK + Zub Ceramic	
			→	für Fahrzeuge mit verstärkter Bremse	13.0460-2768.2 602768	TRW 23811 17,7 + WK	
					13.0470-2768.2 LD2768	TRW 23811 17,7 + WK Ceramic	
1.4 TB 1.4 TB 1.8 TBi 1.8 TBi (940FXC1A)	77	04/11→	←	→ 04/12	13.0460-4854.2 604854	BRE 23092 16,3 + WK	
	120	04/10→			13.0470-4854.2 LD4854	BRE 23092 16,3 + WK Ceramic	
	169	04/10→09/13	←	05/12→	13.0460-4971.2 604971	BRE 23092 16,0 + WK	
	173	04/10→			13.0470-4971.2 LD4971	BRE 23092 16,0 + WK Ceramic	
			→		13.0460-2768.2 602768	TRW 23811 17,7 + WK	
					13.0470-2768.2 LD2768	TRW 23811 17,7 + WK Ceramic	
1.4 TB 1.8 TBi	110	09/14→	←		13.0460-4971.2 604971	BRE 23092 16,0 + WK	
	177	09/13→			13.0470-4971.2 LD4971	BRE 23092 16,0 + WK Ceramic	
			→		13.0460-2768.2 602768	TRW 23811 17,7 + WK	
					13.0470-2768.2 LD2768	TRW 23811 17,7 + WK Ceramic	
1.4 TB (940FXB1A)	125	04/10→	←	→ 04/12	13.0460-4854.2 604854	BRE 23092 16,3 + WK	
					13.0470-4854.2 LD4854	BRE 23092 16,3 + WK Ceramic	
			←	05/12→	13.0460-4971.2 604971	BRE 23092 16,0 + WK	
					13.0470-4971.2 LD4971	BRE 23092 16,0 + WK Ceramic	
			→	nicht für Fahrzeuge mit verstärkter Bremse	13.0460-2767.2 602767	TRW 25156 17,4 + WK + Zub	
					13.0470-2767.2 LD2767	TRW 25156 17,4 + WK + Zub Ceramic	
			→	für Fahrzeuge mit verstärkter Bremse	13.0460-2768.2 602768	TRW 23811 17,7 + WK	
					13.0470-2768.2 LD2768	TRW 23811 17,7 + WK Ceramic	
1.6 JTDM (940.FYB1_) 1.6 JTDM (940.FYE1_)	88	02/15→	←	für Fahrzeuge mit verstärkter Bremse	13.0460-4971.2 604971	BRE 23092 16,0 + WK	
	85	09/15→			13.0470-4971.2 LD4971	BRE 23092 16,0 + WK Ceramic	
			←	nicht für Fahrzeuge mit verstärkter Bremse	13.0460-7273.2 607273	ATE 24538 19,4 + WK	
					13.0470-7273.2 LD7273	ATE 24538 19,4 + WK Ceramic	
			→	nicht für Fahrzeuge mit verstärkter Bremse	13.0460-2767.2 602767	TRW 25156 17,4 + WK + Zub	
					13.0470-2767.2 LD2767	TRW 25156 17,4 + WK + Zub Ceramic	
			→	für Fahrzeuge mit verstärkter Bremse	13.0460-2768.2 602768	TRW 23811 17,7 + WK	
					13.0470-2768.2 LD2768	TRW 23811 17,7 + WK Ceramic	
2.0 JTDM 2.0 JTDM 2.0 JTDM 2.0 JTDM (940.FXL1A)	100	04/10→	←	→ 04/12; für Fahrzeuge mit verstärkter Bremse	13.0460-4854.2 604854	BRE 23092 16,3 + WK	
	120	04/10→			13.0470-4854.2 LD4854	BRE 23092 16,3 + WK Ceramic	
	125	04/10→	←	05/12→; für Fahrzeuge mit verstärkter Bremse	13.0460-4971.2 604971	BRE 23092 16,0 + WK	
	103	04/10→			13.0470-4971.2 LD4971	BRE 23092 16,0 + WK Ceramic	
				←	nicht für Fahrzeuge mit verstärkter Bremse	13.0460-7269.2 607269	ATE 24339 19,5 + WK
					13.0470-7269.2 LD7269	ATE 24339 19,5 + WK Ceramic	
			→	nicht für Fahrzeuge mit verstärkter Bremse	13.0460-2767.2 602767	TRW 25156 17,4 + WK + Zub	
					13.0470-2767.2 LD2767	TRW 25156 17,4 + WK + Zub Ceramic	
			→	für Fahrzeuge mit verstärkter Bremse	13.0460-2768.2 602768	TRW 23811 17,7 + WK	
					13.0470-2768.2 LD2768	TRW 23811 17,7 + WK Ceramic	
2.0 JTDM 2.0 JTDM (940.FYC1A, 940.FXQ1A)	129	11/13→	←	für Fahrzeuge mit verstärkter Bremse	13.0460-4971.2 604971	BRE 23092 16,0 + WK	
	110	08/13→			13.0470-4971.2 LD4971	BRE 23092 16,0 + WK Ceramic	
			←	nicht für Fahrzeuge mit verstärkter Bremse	13.0460-7269.2 607269	ATE 24339 19,5 + WK	
					13.0470-7269.2 LD7269	ATE 24339 19,5 + WK Ceramic	
			→	nicht für Fahrzeuge mit verstärkter Bremse	13.0460-2767.2 602767	TRW 25156 17,4 + WK + Zub	
					13.0470-2767.2 LD2767	TRW 25156 17,4 + WK + Zub Ceramic	
			→	für Fahrzeuge mit verstärkter Bremse	13.0460-2768.2 602768	TRW 23811 17,7 + WK	
					13.0470-2768.2 LD2768	TRW 23811 17,7 + WK Ceramic	
 Bremsscheibe							
1.4 BiFuel 1.4 TB ↓	88	12/11→	←		24.0126-0168.1 426168	∅ 281 26,2 24,2 V + S	
	85	04/10→					









	kw			 	! #		
ALFA ROMEO - GIULIETTA (940_) 04/10→							
 Bremsscheibe							
1.4 TB (940FXA1A)	88	04/10→	➔	nicht für Fahrzeuge mit verstärkter Bremse	24.0110-0359.1	410359	Ø 264 10 8 + S
1.6 JTDM (940.FYB1_)	88	02/15→	➔	für Fahrzeuge mit verstärkter Bremse	24.0112-0170.1	412170	Ø 278 12 10 + S
1.6 JTDM (940.FYE1_)	85	09/15→					
1.6 JTDM (940FXD1A)	77	04/10→					
1.4 TB	77	04/11→	➔		24.0126-0168.1	426168	Ø 281 26,2 24,2 V + S
			➔		24.0112-0170.1	412170	Ø 278 12 10 + S
1.4 TB	110	09/14→	➔		24.0128-0191.1	428191	Ø 330 28 26 V + S
1.4 TB	120	04/10→	➔		24.0112-0170.1	412170	Ø 278 12 10 + S
1.8 TBi	169	04/10→09/13					
1.8 TBi	177	09/13→					
1.8 TBi (940FXC1A)	173	04/10→					
1.4 TB (940FXB1A)	125	04/10→	➔		24.0128-0191.1	428191	Ø 330 28 26 V + S
			➔	nicht für Fahrzeuge mit verstärkter Bremse	24.0110-0359.1	410359	Ø 264 10 8 + S
			➔	für Fahrzeuge mit verstärkter Bremse	24.0112-0170.1	412170	Ø 278 12 10 + S
2.0 JTDM	100	04/10→	➔	für Fahrzeuge mit verstärkter Bremse	24.0128-0191.1	428191	Ø 330 28 26 V + S
2.0 JTDM	120	04/10→	➔	nicht für Fahrzeuge mit verstärkter Bremse	24.0128-0192.1	428192	Ø 305 28 26 V + S
2.0 JTDM	125	04/10→					
2.0 JTDM	129	11/13→					
2.0 JTDM (940.FXL1A)	103	04/10→	➔	nicht für Fahrzeuge mit verstärkter Bremse	24.0110-0359.1	410359	Ø 264 10 8 + S
2.0 JTDM (940.FYC1A, 940.FXQ1A)	110	08/13→	➔	für Fahrzeuge mit verstärkter Bremse	24.0112-0170.1	412170	Ø 278 12 10 + S
ALFA ROMEO - GT (937_) 11/03→09/10							
 Bremsbelagsatz, Scheibenbremse							
1.8 TS	103	11/03→09/10	➔	3286798→; → 07/10	13.0460-7140.2	607140	ATE 21637 19,3 + WK
1.9 JTD	110	11/03→09/10	➔	→ 3286797	13.0470-7140.2	LD7140	ATE 21637 19,3 + WK Ceramic
2.0 JTS	119	12/06→09/10					
2.0 JTS	121	11/03→09/10					
			➔	→ 07/10	13.0460-2867.2	602867	TRW 23517 16,6 - WE / - WK
					13.0470-2867.2	LD2867	TRW 23517 16,6 - WE / - WK Ceramic
1.9 JTD	125	05/08→09/10	➔	→ 07/10	13.0460-7140.2	607140	ATE 21637 19,3 + WK
			➔	→ 07/10	13.0470-7140.2	LD7140	ATE 21637 19,3 + WK Ceramic
					13.0460-2867.2	602867	TRW 23517 16,6 - WE / - WK
					13.0470-2867.2	LD2867	TRW 23517 16,6 - WE / - WK Ceramic
3.2 GTA	176	11/03→09/10	➔	→ 07/10	13.0460-4991.2	604991	BRE 23092 16,0 + WK
			➔	→ 07/10	13.0460-2867.2	602867	TRW 23517 16,6 - WE / - WK
					13.0470-2867.2	LD2867	TRW 23517 16,6 - WE / - WK Ceramic
 Bremsscheibe							
1.8 TS	103	11/03→09/10	➔	→ 07/10	24.0122-0145.1	422145	Ø 284 22 20,2 V
1.9 JTD	110	11/03→09/10	➔	→ 07/10	24.0110-0283.1	410283	Ø 276 10 9
1.9 JTD	125	05/08→09/10					
2.0 JTS	119	12/06→09/10					
2.0 JTS	121	11/03→09/10					
3.2 GTA	176	11/03→09/10	➔	→ 07/10	24.0132-0129.1	432129	Ø 330 32 30 V
			➔	→ 07/10	24.0110-0283.1	410283	Ø 276 10 9
ALFA ROMEO - GTV (916_) 09/94→10/05							
 Bremsbelagsatz, Scheibenbremse							
1.8 16V (916C3)	106	05/98→10/05	➔		13.0460-7069.2	607069	ATE 21636 19,3 + WK
2.0 JTS	121	04/03→10/05	➔	ALU	13.0460-2826.2	602826	TRW 23177 14,2 - WK
2.0 T.SPARK 16V (916C2C)	114	05/98→08/00					
2.0 T.SPARK 16V (916.C2_, 916C2C00)	110	06/95→10/05	➔	→ 06/95	13.0460-2987.2	602987	TRW 21147 19,0 + WK
2.0 V6 Turbo (916.C2A)	148	06/95→09/98	➔	07/95→	13.0460-7069.2	607069	ATE 21636 19,3 + WK
			➔	ALU	13.0460-2826.2	602826	TRW 23177 14,2 - WK
			➔	GG	13.0460-2951.2	602951	TRW 21103 14,2 - WK
3.0 V6 24V (916.C1)	162	10/96→10/00	➔	ALU	13.0460-4968.2	604968	BRE 21381 18,0 + WK
3.0 V6 24V (916.C1B_)	160	10/00→10/05					
3.2 V6 24V	176	04/03→10/05					
			➔	GG	13.0460-2826.2	602826	TRW 23177 14,2 - WK
					13.0460-2951.2	602951	TRW 21103 14,2 - WK
↓							









	kw			 	! #		
ALFA ROMEO - GTV (916_) 09/94→10/05							
Zubehörsatz, Scheibenbremsbelag							
1.8 16V (916C3)	106	05/98→10/05	➡	GG		13.0460-0072.2 610072	TRW
2.0 JTS	121	04/03→10/05					
2.0 T.SPARK 16V (916.C2_, 916C2C00)	110	06/95→10/05	➡				
2.0 T.SPARK 16V (916C2C)	114	05/98→08/00					
2.0 V6 Turbo (916.C2A)	148	06/95→09/98					
3.0 V6 24V (916.C1)	162	10/96→10/00					
3.0 V6 24V (916.C1B_)	160	10/00→10/05					
3.2 V6 24V	176	04/03→10/05					
 Bremsscheibe							
1.8 16V (916C3)	106	05/98→10/05	←			24.0122-0225.1 422225	Ø 284 22 20,2 V
2.0 JTS	121	04/03→10/05					
2.0 T.SPARK 16V (916.C2_, 916C2C00)	110	06/95→10/05	➡			24.0111-0142.1 411142	Ø 240,5 11 9,2
2.0 T.SPARK 16V (916C2C)	114	05/98→08/00					
2.0 V6 Turbo (916.C2A)	148	06/95→09/98	←			24.0122-0145.1 422145	Ø 284 22 20,2 V
			➡			24.0111-0142.1 411142	Ø 240,5 11 9,2
3.0 V6 24V (916.C1)	162	10/96→10/00	←			24.0128-0119.1 428119	Ø 305 28 26 V
3.0 V6 24V (916.C1B_)	160	10/00→10/05					
3.2 V6 24V	176	04/03→10/05	➡			24.0111-0142.1 411142	Ø 240,5 11 9,2
ALFA ROMEO - MITO (955_) 09/08→							
 Bremsbelagsatz, Scheibenbremse							
0.9	74	12/13→	←			13.0460-3863.2 603863	BOS 23706 18,0 + WK + Zub
0.9 TwinAir	63	07/11→					
0.9 TwinAir	77	04/13→	➡	nicht für Fahrzeuge mit verstärkter Bremse		13.0460-2763.2 602763	TRW 23517 17,2 + WK + Zub
1.4 MultiAir	77	08/10→	➡	für Fahrzeuge mit verstärkter Bremse		13.0460-3861.2 603861	BOS 23714 17,6 + WK + Zub
						13.0460-3991.2 603991	BOS 23714 16,6 - WE / - WK
						13.0470-3812.2 LD3812	BOS 23714 17,6 - WE / - WK Ceramic
1.3 MultiJet	59	12/13→	←			13.0460-3984.2 603984	BOS 23711 19,4 + WK
1.3 MultiJet	62	01/11→					
1.3 MultiJet	66	09/08→				13.0470-3984.2 LD3984	BOS 23711 19,4 + WK Ceramic
1.3 MultiJet	70	10/09→	➡	nicht für Fahrzeuge mit verstärkter Bremse		13.0460-2763.2 602763	TRW 23517 17,2 + WK + Zub
1.4 Bifuel	88	07/11→					
1.4 Bifuel (955.AXG1A)	88	04/16→	➡	für Fahrzeuge mit verstärkter Bremse		13.0460-3861.2 603861	BOS 23714 17,6 + WK + Zub
1.4 TB	103	12/13→				13.0460-3991.2 603991	BOS 23714 16,6 - WE / - WK
1.4 TJet	88	09/08→				13.0470-3812.2 LD3812	BOS 23714 17,6 - WE / - WK Ceramic
1.4 Turbo MultiAir	99	10/09→					
1.6 JTDM	88	09/08→					
1.4	51	05/11→	←			13.0460-3826.2 603826	BOS 23706 18,0 + WK + Zub
1.4	58	09/08→				13.0470-3826.2 LD3826	BOS 23706 18,0 + WK + Zub Ceramic
1.4	70	09/08→	➡	nicht für Fahrzeuge mit verstärkter Bremse		13.0460-2763.2 602763	TRW 23517 17,2 + WK + Zub
			➡	für Fahrzeuge mit verstärkter Bremse		13.0460-3861.2 603861	BOS 23714 17,6 + WK + Zub
						13.0460-3991.2 603991	BOS 23714 16,6 - WE / - WK
						13.0470-3812.2 LD3812	BOS 23714 17,6 - WE / - WK Ceramic
1.4	57	03/11→	←	05/11→		13.0460-3826.2 603826	BOS 23706 18,0 + WK + Zub
						13.0470-3826.2 LD3826	BOS 23706 18,0 + WK + Zub Ceramic
			←			13.0460-3826.2 603826	BOS 23706 18,0 + WK + Zub
						13.0470-3826.2 LD3826	BOS 23706 18,0 + WK + Zub Ceramic
			➡	nicht für Fahrzeuge mit verstärkter Bremse		13.0460-2763.2 602763	TRW 23517 17,2 + WK + Zub
			➡	05/11→; nicht für Fahrzeuge mit verstärkter Bremse		13.0460-2763.2 602763	TRW 23517 17,2 + WK + Zub
			➡	für Fahrzeuge mit verstärkter Bremse		13.0460-3861.2 603861	BOS 23714 17,6 + WK + Zub
						13.0460-3991.2 603991	BOS 23714 16,6 - WE / - WK
						13.0470-3812.2 LD3812	BOS 23714 17,6 - WE / - WK Ceramic
			➡	05/11→; für Fahrzeuge mit verstärkter Bremse		13.0460-3861.2 603861	BOS 23714 17,6 + WK + Zub
						13.0460-3991.2 603991	BOS 23714 16,6 - WE / - WK
						13.0470-3812.2 LD3812	BOS 23714 17,6 - WE / - WK Ceramic
1.4 TJet	110	09/08→	←			13.0460-4853.2 604853	BRE 24162 15,2 + WK
1.4 TJet	114	09/08→					







	kw			 	! #		
ALFA ROMEO - MITO (955_) 09/08→							
 Bremsbelagsatz, Scheibenbremse							
1.4 Turbo MultiAir	120	10/09→	←			13.0470-4853.2 LD4853	BRE 24162 15,2 + WK Ceramic
1.4 Turbo MultiAir	125	10/09→	→	nicht für Fahrzeuge mit verstärkter Bremse		13.0460-2763.2 602763	TRW 23517 17,2 + WK + Zub
			→	für Fahrzeuge mit verstärkter Bremse		13.0460-3861.2 603861 13.0460-3991.2 603991 13.0470-3812.2 LD3812	BOS 23714 17,6 + WK + Zub BOS 23714 16,6 - WE / - WK BOS 23714 17,6 - WE / - WK Ceramic
1.6 JTDM	85	09/08→	←			13.0460-3984.2 603984 13.0470-3984.2 LD3984	BOS 23711 19,4 + WK BOS 23711 19,4 + WK Ceramic
			→	09/09→; nicht für Fahrzeuge mit verstärkter Bremse		13.0460-2763.2 602763	TRW 23517 17,2 + WK + Zub
			→	09/09→; für Fahrzeuge mit verstärkter Bremse		13.0460-3861.2 603861 13.0460-3991.2 603991 13.0470-3812.2 LD3812	BOS 23714 17,6 + WK + Zub BOS 23714 16,6 - WE / - WK BOS 23714 17,6 - WE / - WK Ceramic
Zubehörsatz, Scheibenbremsbelag							
1.4 TJet	110	09/08→	←			13.0460-0175.2 610175	BRE
1.4 TJet	114	09/08→					
1.4 Turbo MultiAir	120	10/09→					
1.4 Turbo MultiAir	125	10/09→					
 Bremsscheibe							
0.9	74	12/13→	←			24.0122-0197.1 422197	Ø 257,5 22 20,2 V
0.9 TwinAir	63	07/11→				24.0322-0197.1 522197	Ø 257,5 22 20,2 V PD
0.9 TwinAir	77	04/13→	→				
1.4	51	05/11→	→			24.0110-0349.1 410349	Ø 251 10 9
1.4	58	09/08→				24.0310-0349.1 510349	Ø 251 10 9 PD
1.4	70	09/08→					
1.4 MultiAir	77	08/10→					
1.3 MultiJet	59	12/13→	←			24.0126-0125.1 426125	Ø 281 26 24,2 V
1.3 MultiJet	62	01/11→	→			24.0110-0349.1 410349	Ø 251 10 9
1.3 MultiJet	66	09/08→				24.0310-0349.1 510349	Ø 251 10 9 PD
1.3 MultiJet	70	10/09→					
1.4 Bifuel	88	07/11→					
1.4 Bifuel (955.AXG1A)	88	04/16→					
1.4 TB	103	12/13→					
1.4 TJet	88	09/08→					
1.4 Turbo MultiAir	99	10/09→					
1.6 JTDM	85	09/08→					
1.6 JTDM	88	09/08→					
1.4	57	03/11→	←	05/11→		24.0122-0197.1 422197 24.0322-0197.1 522197	Ø 257,5 22 20,2 V Ø 257,5 22 20,2 V PD
			←			24.0122-0197.1 422197 24.0322-0197.1 522197	Ø 257,5 22 20,2 V Ø 257,5 22 20,2 V PD
			→			24.0110-0349.1 410349 24.0310-0349.1 510349	Ø 251 10 9 Ø 251 10 9 PD
			→	05/11→		24.0110-0349.1 410349 24.0310-0349.1 510349	Ø 251 10 9 Ø 251 10 9 PD
1.4 TJet	110	09/08→	←			24.0128-0231.1 428231	Ø 305 28 26 V
1.4 TJet	114	09/08→					
1.4 Turbo MultiAir	120	10/09→	→			24.0110-0349.1 410349	Ø 251 10 9
1.4 Turbo MultiAir	125	10/09→				24.0310-0349.1 510349	Ø 251 10 9 PD
ALFA ROMEO - SPIDER (916_) 09/94→04/05							
 Bremsbelagsatz, Scheibenbremse							
1.8 16V (916S3)	106	05/98→04/05	←			13.0460-7069.2 607069	ATE 21636 19,3 + WK
2.0 JTS	121	04/03→04/05	→	ALU		13.0460-2826.2 602826	TRW 23177 14,2 - WK
2.0 V6 Turbo (916S2A)	148	05/98→04/05	→	GG		13.0460-2951.2 602951	TRW 21103 14,2 - WK
2.0 T.SPARK 16V (916S2B)	114	05/98→08/00	←			13.0460-7069.2 607069	ATE 21636 19,3 + WK
			→	ALU		13.0460-2826.2 602826	TRW 23177 14,2 - WK
			→	GG		13.0460-2951.2 602951	TRW 21103 14,2 - WK
2.0 T.SPARK 16V (916S2C00)	110	06/95→04/05	←	→ 10/95		13.0460-2987.2 602987	TRW 21147 19,0 + WK
			←	11/95→		13.0460-7069.2 607069	ATE 21636 19,3 + WK
			→	ALU		13.0460-2826.2 602826	TRW 23177 14,2 - WK
			→	GG		13.0460-2951.2 602951	TRW 21103 14,2 - WK
3.0 V6	141	04/95→04/98	←	05/95→ 06/95		13.0460-2987.2 602987	TRW 21147 19,0 + WK
↓							

	kw			 	! #		
ALFA ROMEO - SPIDER (916_) 09/94→04/05							
 Bremsbelagsatz, Scheibenbremse							
3.0 V6	141	04/95→04/98	←	07/95→		13.0460-4968.2 604968	BRE 21381 18,0 + WK
			→	05/95→; ALU		13.0460-2826.2 602826	TRW 23177 14,2 - WK
			→	05/95→; GG		13.0460-2951.2 602951	TRW 21103 14,2 - WK
3.0 V6 (916S1)	141	06/95→04/05	←	→ 06/95		13.0460-2987.2 602987	TRW 21147 19,0 + WK
			←	07/95→		13.0460-4968.2 604968	BRE 21381 18,0 + WK
			→	ALU		13.0460-2826.2 602826	TRW 23177 14,2 - WK
			→	GG		13.0460-2951.2 602951	TRW 21103 14,2 - WK
3.0 V6 (916S1B00)	160	09/94→04/05	←	10/00→		13.0460-4968.2 604968	BRE 21381 18,0 + WK
			→	10/00→; ALU		13.0460-2826.2 602826	TRW 23177 14,2 - WK
			→	10/00→; GG		13.0460-2951.2 602951	TRW 21103 14,2 - WK
3.0 V6 24V	162	01/99→10/03	←			13.0460-4968.2 604968	BRE 21381 18,0 + WK
			→	ALU		13.0460-2826.2 602826	TRW 23177 14,2 - WK
			→	GG		13.0460-2951.2 602951	TRW 21103 14,2 - WK
3.2 V6 24V	176	04/03→04/05	←			13.0460-4968.2 604968	BRE 21381 18,0 + WK
			→	ALU		13.0460-2826.2 602826	TRW 23177 14,2 - WK
			→	GG		13.0460-2951.2 602951	TRW 21103 14,2 - WK
Zubehörsatz, Scheibenbremsbelag							
1.8 16V (916S3)	106	05/98→04/05	→	GG		13.0460-0072.2 610072	TRW
2.0 JTS	121	04/03→04/05					
2.0 T.SPARK 16V (916S2C00)	110	06/95→04/05					
2.0 V6 Turbo (916S2A)	148	05/98→04/05					
3.0 V6 (916S1)	141	06/95→04/05					
3.2 V6 24V	176	04/03→04/05					
2.0 T.SPARK 16V (916S2B)	114	05/98→08/00	→	GG		13.0460-0072.2 610072	TRW
3.0 V6 24V	162	01/99→10/03					
3.0 V6	141	04/95→04/98	→	05/95→; GG		13.0460-0072.2 610072	TRW
3.0 V6 (916S1B00)	160	09/94→04/05	→	10/00→; GG		13.0460-0072.2 610072	TRW
 Bremsscheibe							
1.8 16V (916S3)	106	05/98→04/05	←			24.0122-0225.1 422225	Ø 284 22 20,2 V
2.0 JTS	121	04/03→04/05					
2.0 T.SPARK 16V (916S2B)	114	05/98→08/00	→			24.0111-0142.1 411142	Ø 240,5 11 9,2
2.0 T.SPARK 16V (916S2C00)	110	06/95→04/05	←	→ 10/95		24.0120-0159.1 420159	Ø 257 20 18,2 V
			←	11/95→		24.0122-0225.1 422225	Ø 284 22 20,2 V
			→			24.0111-0142.1 411142	Ø 240,5 11 9,2
2.0 V6 Turbo (916S2A)	148	05/98→04/05	←			24.0122-0145.1 422145	Ø 284 22 20,2 V
			→			24.0111-0142.1 411142	Ø 240,5 11 9,2
3.0 V6	141	04/95→04/98	←	05/95→		24.0128-0119.1 428119	Ø 305 28 26 V
			→	05/95→		24.0111-0142.1 411142	Ø 240,5 11 9,2
3.0 V6 (916S1)	141	06/95→04/05	←			24.0128-0119.1 428119	Ø 305 28 26 V
3.0 V6 24V	162	01/99→10/03	→			24.0111-0142.1 411142	Ø 240,5 11 9,2
3.2 V6 24V	176	04/03→04/05					
3.0 V6 (916S1B00)	160	09/94→04/05	←	10/00→		24.0128-0119.1 428119	Ø 305 28 26 V
			→	10/00→		24.0111-0142.1 411142	Ø 240,5 11 9,2
ALFA ROMEO - SPIDER (939_) 03/06→06/10							
 Bremsbelagsatz, Scheibenbremse							
1.8 TBi	147	05/09→06/10	←			13.0460-4971.2 604971	BRE 23092 16,0 + WK
2.4 JTDM	147	04/07→06/10				13.0470-4971.2 LD4971	BRE 23092 16,0 + WK Ceramic
2.4 JTDM	154	03/08→06/10					
3.2 JTS	191	03/08→06/10	→			13.0460-2707.2 602707	TRW 23760 17,7 - WE / - WK
						13.0470-2707.2 LD2707	TRW 23760 17,7 - WE / - WK Ceramic
2.0 JTDM	120	04/09→06/10	←			13.0460-4867.2 604867	BRE 24852 16,0 + WK
2.0 JTDM	125	05/09→06/10				13.0470-4867.2 LD4867	BRE 24852 16,0 + WK Ceramic
			→			13.0460-2707.2 602707	TRW 23760 17,7 - WE / - WK
						13.0470-2707.2 LD2707	TRW 23760 17,7 - WE / - WK Ceramic
2.2 JTS	136	03/06→06/10	←	03/08→		13.0460-4867.2 604867	BRE 24852 16,0 + WK
↓							









	kw			 	! #		
ALFA ROMEO - SPIDER (939_) 03/06→06/10							
 Bremsbelagsatz, Scheibenbremse							
2.2 JTS	136	03/06→06/10	←	03/08→		13.0470-4867.2 LD4867	BRE 24852 16,0 + WK Ceramic
			←	04/06→ 02/08		13.0460-7211.2 607211	ATE 24339 20,5 + WK
			→	04/06→		13.0470-7211.2 LD7211	ATE 24339 20,5 + WK Ceramic
3.2 JTS Q4	191	03/06→06/10	←	04/06→		13.0460-2707.2 602707	TRW 23760 17,7 - WE / - WK
			←	04/06→		13.0470-2707.2 LD2707	TRW 23760 17,7 - WE / - WK Ceramic
			→	04/06→		13.0460-2707.2 602707	TRW 23760 17,7 - WE / - WK
 Bremsscheibe							
1.8 Tbi	147	05/09→06/10	←			24.0128-0191.1 428191	Ø 330 28 26 V + S
2.4 JTDM	147	04/07→06/10	→			24.0122-0233.1 422233	Ø 292 22 20 V + S
2.4 JTDM	154	03/08→06/10	→				
3.2 JTS	191	03/08→06/10	→				
2.0 JTDM	120	04/09→06/10	←			24.0128-0192.1 428192	Ø 305 28 26 V + S
2.0 JTDM	125	05/09→06/10	→			24.0112-0170.1 412170	Ø 278 12 10 + S
2.2 JTS	136	03/06→06/10	←	04/06→		24.0128-0192.1 428192	Ø 305 28 26 V + S
			→	04/06→		24.0112-0170.1 412170	Ø 278 12 10 + S
3.2 JTS Q4	191	03/06→06/10	←	04/06→		24.0128-0191.1 428191	Ø 330 28 26 V + S
			→	04/06→		24.0122-0233.1 422233	Ø 292 22 20 V + S
ASTON MARTIN - CYGNET 04/11→10/13							
 Bremsscheibe							
1.3	72	04/11→10/13	←			24.0120-0219.1 420219	Ø 255 20 18 V
			→			24.0109-0156.1 409156	Ø 259 9 7,5
AUDI - 80 Avant (8C, B4) 09/91→01/96							
 Bremsbelagsatz, Scheibenbremse							
1.6 E	74	06/93→01/96	←	→ 12/95		13.0460-2925.2 602925	TRW 20669 19,0 + WK
			←	→ 12/95		13.0460-2934.2 602934	TRW 20669 19,0 - WK
			→	→ 8C-P-050000; + ABS		13.0460-3602.2 603602	TRW 21144 15,8 - WK
1.9 TDI	66	07/92→01/96	→	→ 12/95		13.0460-3602.2 603602	TRW 21144 15,8 - WK
			→	→ 8C-P-050001→; → 12/95		13.0460-3602.2 603602	TRW 21144 15,8 - WK
			→	→ 12/95		13.0460-2934.2 602934	TRW 20669 19,0 - WK
2.0	66	07/92→01/96	←	→ 12/95		13.0460-2925.2 602925	TRW 20669 19,0 + WK
			←	→ 12/95		13.0460-2934.2 602934	TRW 20669 19,0 - WK
			→	→ 12/95		13.0460-3602.2 603602	TRW 21144 15,8 - WK
2.0 E 16V	103	02/93→01/96	←	→ 12/95		13.0460-2925.2 602925	TRW 20669 19,0 + WK
			←	→ 12/95		13.0460-2934.2 602934	TRW 20669 19,0 - WK
			→	→ 12/95		13.0460-3602.2 603602	TRW 21144 15,8 - WK
2.3 E	98	07/92→01/96	←	→ 12/95		13.0460-2925.2 602925	TRW 20669 19,0 + WK
			←	→ 12/95		13.0460-2934.2 602934	TRW 20669 19,0 - WK
			→	→ 12/95		13.0460-3602.2 603602	TRW 21144 15,8 - WK
2.0 E 16V quattro	103	12/92→07/95	←	→ 12/95		13.0460-2925.2 602925	TRW 20669 19,0 + WK
			←	→ 12/95		13.0460-2934.2 602934	TRW 20669 19,0 - WK
			→	→ 12/95		13.0460-3602.2 603602	TRW 21144 15,8 - WK
2.0 quattro	79	11/93→01/96	←	→ 12/95		13.0460-2925.2 602925	TRW 20669 19,0 + WK
			←	→ 12/95		13.0460-2934.2 602934	TRW 20669 19,0 - WK
			→	→ 12/95		13.0460-3602.2 603602	TRW 21144 15,8 - WK
2.6	110	07/92→01/96	←	→ 12/95		13.0460-2925.2 602925	TRW 20669 19,0 + WK
			←	→ 12/95		13.0460-2934.2 602934	TRW 20669 19,0 - WK
			→	08/92→ 12/95		13.0460-3602.2 603602	TRW 21144 15,8 - WK
2.6 quattro	110	07/92→07/95	←	08/92→		13.0460-2925.2 602925	TRW 20669 19,0 + WK
			←	08/92→		13.0460-2934.2 602934	TRW 20669 19,0 - WK
			→	08/92→		13.0460-3602.2 603602	TRW 21144 15,8 - WK
2.8	128	09/91→01/96	←	→ 12/95		13.0460-2963.2 602963	TRW 21138 18,8 + WK
			←	→ 12/95		13.0460-2963.2 602963	TRW 21138 18,8 + WK
			→	→ 12/95		13.0460-3602.2 603602	TRW 21144 15,8 - WK
2.8 quattro	128	08/92→07/95	←	→ 12/95		13.0460-2963.2 602963	TRW 21138 18,8 + WK
			←	→ 12/95		13.0460-2963.2 602963	TRW 21138 18,8 + WK
S2 quattro	169	02/93→07/95	→	→ 12/95		13.0460-3602.2 603602	TRW 21144 15,8 - WK
 Bremsscheibe							
1.6 E	74	06/93→01/96	←	→ 8C-N-300000		24.0122-0108.1 422108	Ø 256 22 20 V
			←	8C-P-000001→; → 12/95		24.0122-0139.1 422139	Ø 280 22 20 V
			→	→ 8C-P-050000; + ABS		24.0110-0178.1 410178	Ø 245 10 8
			→	8C-P-050001→; → 12/95		24.0110-0178.1 410178	Ø 245 10 8
1.9 TDI	66	07/92→01/96	←	→ 8C-P-000001		24.0113-0166.1 413166	Ø 256 13 11
↓							











	kw			 	! #		
AUDI - 80 Avant (8C, B4) 09/91→01/96							
 Bremsscheibe							
1.9 TDI	66	07/92→01/96	←	8C-P-000001→; → 12/95	24.0113-0179.1	413179	Ø 280 13 11
			→	→ 8C-P-050000; + ABS	24.0110-0178.1	410178	Ø 245 10 8
			→	8C-P-050001→; → 12/95	24.0110-0178.1	410178	Ø 245 10 8
2.0	66	07/92→01/96	←	→ 8C-P-000001; Schaltgetriebe	24.0113-0166.1	413166	Ø 256 13 11
			←	8C-P-000001→; → 12/95; Schaltgetriebe	24.0113-0179.1	413179	Ø 280 13 11
			←	→ 8C-N-300000; Vollautomatik	24.0122-0108.1	422108	Ø 256 22 20 V
			←	8C-P-000001→; → 12/95; Vollautomatik	24.0122-0139.1	422139	Ø 280 22 20 V
			→	→ 8C-P-050000; + ABS	24.0110-0178.1	410178	Ø 245 10 8
			→	8C-P-050001→; → 12/95	24.0110-0178.1	410178	Ø 245 10 8
2.0 E 2.3 E	85 98	07/92→01/96 07/92→01/96	←	→ 8C-N-300000	24.0122-0108.1	422108	Ø 256 22 20 V
			←	8C-P-000001→; → 12/95	24.0122-0139.1	422139	Ø 280 22 20 V
2.0 E 16V	103	02/93→01/96	←	8C-P-000001→; → 12/95	24.0122-0139.1	422139	Ø 280 22 20 V
			→	→ 12/95	24.0110-0178.1	410178	Ø 245 10 8
2.0 E 16V quattro	103	12/92→07/95	←	→ 8C-N-300000	24.0122-0108.1	422108	Ø 256 22 20 V
			←	8C-P-000001→	24.0122-0139.1	422139	Ø 280 22 20 V
			→		24.0110-0182.1	410182	Ø 245 10 8
2.0 quattro	79	11/93→01/96	←	→ 8C-N-300000	24.0122-0108.1	422108	Ø 256 22 20 V
			←	8C-P-000001→; → 12/95	24.0122-0139.1	422139	Ø 280 22 20 V
			→	→ 12/95	24.0110-0182.1	410182	Ø 245 10 8
2.6	110	07/92→01/96	←	08/92→ 12/95	24.0122-0139.1	422139	Ø 280 22 20 V
			→	08/92→ 12/95	24.0110-0178.1	410178	Ø 245 10 8
2.6 quattro	110	07/92→07/95	←	08/92→	24.0122-0139.1	422139	Ø 280 22 20 V
			→	08/92→	24.0110-0182.1	410182	Ø 245 10 8
2.8	128	09/91→01/96	←	→ 12/95	24.0125-0106.1	425106	Ø 276 25 23 V
			→	→ 12/95	24.0110-0178.1	410178	Ø 245 10 8
2.8 quattro	128	08/92→07/95	←		24.0125-0106.1	425106	Ø 276 25 23 V
			→		24.0110-0182.1	410182	Ø 245 10 8
S2 quattro	169	02/93→07/95	←		24.0125-0139.1	425139	Ø 276 24,9 23 V
			→		24.0110-0261.1	410261	Ø 245 10 8 + S
			→		24.0310-0261.1	510261	Ø 245 10 8 PD
AUDI - A1 (8X1, 8XK) 05/10→							
 Bremsbelagsatz, Scheibenbremse							
1.0 TFSI 1.0 TFSI 1.8 TFSI	60 70 141	01/16→ 03/15→ 02/15→	←	+PR 1ZG	13.0460-7111.2	607111	VW 23130 19,6 - WE / - WK
					13.0470-7111.2	LD7111	VW 23130 19,6 - WE / - WK Ceramic
			←	+PR 1ZC	13.0460-7184.2	607184	ATE 23587 20,6 + WK
					13.0470-7184.2	LD7184	ATE 23587 20,6 + WK Ceramic
			←	+PR 1ZM,1ZN,1ZS	13.0460-7285.2	607285	ATE 23587 20,6 - WE / - WK
				13.0470-7285.2	LD7285	ATE 23587 20,6 - WE / - WK Ceramic	
			→	+PR 1KF,1KX	13.0460-2790.2	602790	TRW 25110 17,5 - WE / - WK
			→		13.0470-2790.2	LD2790	TRW 25110 17,5 - WE / - WK Ceramic
			→	+PR 1KT	13.0460-2820.2	602820	TRW 20961 17,2 - WK
			→		13.0470-2820.2	LD2820	TRW 20961 17,2 - WK Ceramic
1.2 TFSI 1.4 TFSI 1.4 TFSI 1.4 TFSI 1.6 TDI 1.6 TDI 2.0 TDI 2.0 TDI	63 90 103 136 66 77 100 105	05/10→ 05/10→ 04/12→ 01/11→ 03/11→ 05/10→ 05/12→ 09/11→	←	+PR 1ZG	13.0460-7111.2	607111	VW 23130 19,6 - WE / - WK
					13.0470-7111.2	LD7111	VW 23130 19,6 - WE / - WK Ceramic
			←	+PR 1ZC	13.0460-7184.2	607184	ATE 23587 20,6 + WK
					13.0470-7184.2	LD7184	ATE 23587 20,6 + WK Ceramic
			←	+PR 1LJ	13.0460-7226.2	607226	ATE 23587 20,8 + WK
					13.0470-7226.2	LD7226	ATE 23587 20,8 + WK Ceramic
			←	+PR 1ZM,1ZN,1ZS	13.0460-7285.2	607285	ATE 23587 20,6 - WE / - WK
					13.0470-7285.2	LD7285	ATE 23587 20,6 - WE / - WK Ceramic
			→	+PR 1KF,1KX	13.0460-2790.2	602790	TRW 25110 17,5 - WE / - WK









	kw			 	! #			
AUDI - A1 (8X1, 8XK) 05/10→								
 Bremsbelagsatz, Scheibenbremse								
1.2 TFSI 1.4 TFSI 1.4 TFSI 1.4 TFSI 1.6 TDI 1.6 TDI 2.0 TDI 2.0 TDI	63 90 103 136 66 77 100 105	05/10→ 05/10→ 04/12→ 01/11→ 03/11→ 05/10→ 05/12→ 09/11→	➡ ➡ ➡ ➡	+PR 1KF,1KX +PR 1KT +PR 1KS		13.0470-2790.2 13.0460-2820.2 13.0470-2820.2 13.0460-3858.2 13.0470-3858.2	LD2790 602820 LD2820 603858 LD3858	TRW 25110 17,5 - WE / - WK Ceramic TRW 20961 17,2 - WK TRW 20961 17,2 - WK Ceramic BOS 24563 17,7 - WE / - WK + Zub BOS 24563 17,7 - WE / - WK + Zub Ceramic
1.4 TDI 1.4 TFSI 1.4 TFSI 1.6 TDI	66 92 110 85	11/14→ 11/14→ 11/14→ 11/14→	⬅ ⬅ ⬅ ➡ ➡ ➡	+PR 1ZG +PR 1ZC +PR 1ZM,1ZN,1ZS +PR 1KF,1KX +PR 1KT +PR 1KS		13.0460-7111.2 13.0470-7111.2 13.0460-7184.2 13.0470-7184.2 13.0460-7285.2 13.0470-7285.2 13.0460-2790.2 13.0470-2790.2 13.0460-2820.2 13.0470-2820.2 13.0460-3858.2 13.0470-3858.2	607111 LD7111 607184 LD7184 607285 LD7285 602790 LD2790 602820 LD2820 603858 LD3858	VW 23130 19,6 - WE / - WK VW 23130 19,6 - WE / - WK Ceramic ATE 23587 20,6 + WK ATE 23587 20,6 + WK Ceramic ATE 23587 20,6 - WE / - WK ATE 23587 20,6 - WE / - WK Ceramic TRW 25110 17,5 - WE / - WK TRW 25110 17,5 - WE / - WK Ceramic TRW 20961 17,2 - WK TRW 20961 17,2 - WK Ceramic BOS 24563 17,7 - WE / - WK + Zub BOS 24563 17,7 - WE / - WK + Zub Ceramic
2.0 TFSI quattro	188	03/12→	⬅ ⬅ ⬅ ⬅ ➡ ➡ ➡	10/12→; +PR 1ZG 10/12→; +PR 1ZC 10/12→; +PR 1LJ 10/12→; +PR 1ZM,1ZN,1ZS 10/12→; +PR 1KF,1KX 10/12→; +PR 1KT 10/12→; +PR 1KS		13.0460-7111.2 13.0470-7111.2 13.0460-7184.2 13.0470-7184.2 13.0460-7226.2 13.0470-7226.2 13.0460-7285.2 13.0470-7285.2 13.0460-2790.2 13.0470-2790.2 13.0460-2820.2 13.0470-2820.2 13.0460-3858.2 13.0470-3858.2	607111 LD7111 607184 LD7184 607226 LD7226 607285 LD7285 602790 LD2790 602820 LD2820 603858 LD3858	VW 23130 19,6 - WE / - WK VW 23130 19,6 - WE / - WK Ceramic ATE 23587 20,6 + WK ATE 23587 20,6 + WK Ceramic ATE 23587 20,8 + WK ATE 23587 20,8 + WK Ceramic ATE 23587 20,6 - WE / - WK ATE 23587 20,6 - WE / - WK Ceramic TRW 25110 17,5 - WE / - WK TRW 25110 17,5 - WE / - WK Ceramic TRW 20961 17,2 - WK TRW 20961 17,2 - WK Ceramic BOS 24563 17,7 - WE / - WK + Zub BOS 24563 17,7 - WE / - WK + Zub Ceramic
S1 quattro	170	03/14→	⬅ ⬅ ➡	+PR 1ZC +PR 1ZM,1ZN,1ZS +PR 1KF,1KX		13.0460-7184.2 13.0470-7184.2 13.0460-7285.2 13.0470-7285.2 13.0460-2790.2 13.0470-2790.2	607184 LD7184 607285 LD7285 602790 LD2790	ATE 23587 20,6 + WK ATE 23587 20,6 + WK Ceramic ATE 23587 20,6 - WE / - WK ATE 23587 20,6 - WE / - WK Ceramic TRW 25110 17,5 - WE / - WK TRW 25110 17,5 - WE / - WK Ceramic
 Bremsscheibe								
1.0 TFSI 1.0 TFSI 1.8 TFSI	60 70 141	01/16→ 03/15→ 02/15→	⬅ ⬅ ⬅ ➡ ➡	+PR 1ZG +PR 1ZC +PR 1ZM,1ZN,1ZS +PR 1KT		24.0122-0151.1 24.0322-0151.1 24.0125-0113.1 24.0325-0113.1 24.0125-0123.1 24.0325-0123.1 24.0109-0123.1 24.0309-0123.1	422151 522151 425113 525113 425123 525123 409123 509123	Ø 256 22 19 V + S Ø 256 22 19 V + S PD Ø 288 25 22 V + S Ø 288 25 22 V + S PD Ø 310 25 22 V + S Ø 310 25 22 V PD Ø 230 9 7 + S Ø 230 9 7 + S PD
1.2 TFSI 1.4 TFSI 1.4 TFSI 1.4 TFSI 1.6 TDI	63 90 103 136 66	05/10→ 05/10→ 04/12→ 01/11→ 03/11→	⬅ ⬅	+PR 1ZG +PR 1ZC		24.0122-0151.1 24.0322-0151.1 24.0125-0113.1	422151 522151 425113	Ø 256 22 19 V + S Ø 256 22 19 V + S PD Ø 288 25 22 V + S

	kw			 	! #		
AUDI - A1 (8X1, 8XK) 05/10→							
Bremsscheibe							
1.6 TDI 2.0 TDI 2.0 TDI	77 100 105	05/10→ 05/12→ 09/11→	←	+PR 1ZC	24.0325-0113.1	525113	Ø 288 25 22 V + S PD
			←	+PR 1ZM,1ZN,1ZS	24.0125-0123.1	425123	Ø 310 25 22 V + S
					24.0325-0123.1	525123	Ø 310 25 22 V PD
			←	+PR 1LJ	24.0125-0158.1	425158	Ø 312 25 22 V + S
			→	+PR 1KT	24.0109-0123.1	409123	Ø 230 9 7 + S
					24.0309-0123.1	509123	Ø 230 9 7 + S PD
			→	+PR 1KS	24.0110-0356.1	410356	Ø 272 9,7 8 + S
					24.0310-0356.1	510356	Ø 272 9,7 8 + S PD
1.4 TDI 1.4 TFSI 1.6 TDI	66 92 85	11/14→ 11/14→ 11/14→	←	+PR 1ZG	24.0122-0151.1	422151	Ø 256 22 19 V + S
					24.0322-0151.1	522151	Ø 256 22 19 V + S PD
			←	+PR 1ZC	24.0125-0113.1	425113	Ø 288 25 22 V + S
					24.0325-0113.1	525113	Ø 288 25 22 V + S PD
			←	+PR 1ZM,1ZN,1ZS	24.0125-0123.1	425123	Ø 310 25 22 V + S
					24.0325-0123.1	525123	Ø 310 25 22 V PD
			→	+PR 1KT	24.0109-0123.1	409123	Ø 230 9 7 + S
					24.0309-0123.1	509123	Ø 230 9 7 + S PD
			→	+PR 1KS	24.0110-0356.1	410356	Ø 272 9,7 8 + S
					24.0310-0356.1	510356	Ø 272 9,7 8 + S PD
1.4 TFSI	110	11/14→	←	+PR 1ZG	24.0122-0151.1	422151	Ø 256 22 19 V + S
					24.0322-0151.1	522151	Ø 256 22 19 V + S PD
			←	+PR 1ZM,1ZN,1ZS	24.0125-0123.1	425123	Ø 310 25 22 V + S
					24.0325-0123.1	525123	Ø 310 25 22 V PD
			→	+PR 1KT	24.0109-0123.1	409123	Ø 230 9 7 + S
					24.0309-0123.1	509123	Ø 230 9 7 + S PD
			→	+PR 1KS	24.0110-0356.1	410356	Ø 272 9,7 8 + S
					24.0310-0356.1	510356	Ø 272 9,7 8 + S PD
2.0 TFSI quattro	188	03/12→	←	10/12→; +PR 1ZG	24.0122-0151.1	422151	Ø 256 22 19 V + S
					24.0322-0151.1	522151	Ø 256 22 19 V + S PD
			←	10/12→; +PR 1ZC	24.0125-0113.1	425113	Ø 288 25 22 V + S
					24.0325-0113.1	525113	Ø 288 25 22 V + S PD
			←	10/12→; +PR 1ZM,1ZN,1ZS	24.0125-0123.1	425123	Ø 310 25 22 V + S
					24.0325-0123.1	525123	Ø 310 25 22 V PD
			←	10/12→; +PR 1LJ	24.0125-0158.1	425158	Ø 312 25 22 V + S
			→	10/12→; +PR 1KT	24.0109-0123.1	409123	Ø 230 9 7 + S
					24.0309-0123.1	509123	Ø 230 9 7 + S PD
			→	10/12→; +PR 1KS	24.0110-0356.1	410356	Ø 272 9,7 8 + S
					24.0310-0356.1	510356	Ø 272 9,7 8 + S PD
S1 quattro	170	03/14→	←	+PR 1ZC	24.0125-0113.1	425113	Ø 288 25 22 V + S
					24.0325-0113.1	525113	Ø 288 25 22 V + S PD
AUDI - A1 Sportback (8XA, 8XF) 09/11→							
Bremsbelagsatz, Scheibenbremse							
1.0 TFSI 1.0 TFSI 1.8 TFSI	60 70 141	01/16→ 03/15→ 02/15→	←	+PR 1ZG	13.0460-7111.2	607111	VW 23130 19,6 - WE / - WK
					13.0470-7111.2	LD7111	VW 23130 19,6 - WE / - WK Ceramic
			←	+PR 1ZC	13.0460-7184.2	607184	ATE 23587 20,6 + WK
					13.0470-7184.2	LD7184	ATE 23587 20,6 + WK Ceramic
			←	+PR 1ZM,1ZN,1ZS	13.0460-7285.2	607285	ATE 23587 20,6 - WE / - WK
					13.0470-7285.2	LD7285	ATE 23587 20,6 - WE / - WK Ceramic
			→	+PR 1KF,1KX	13.0460-2790.2	602790	TRW 25110 17,5 - WE / - WK
					13.0470-2790.2	LD2790	TRW 25110 17,5 - WE / - WK Ceramic
			→	+PR 1KT	13.0460-2820.2	602820	TRW 20961 17,2 - WK
					13.0470-2820.2	LD2820	TRW 20961 17,2 - WK Ceramic
1.2 TFSI 1.4 TFSI 1.4 TFSI 1.4 TFSI 1.6 TDI 1.6 TDI 2.0 TDI 2.0 TDI	63 90 103 136 66 77 100 105	01/12→ 11/11→ 04/12→ 11/11→ 11/11→ 11/11→ 05/12→ 09/11→	←	+PR 1ZG	13.0460-7111.2	607111	VW 23130 19,6 - WE / - WK
					13.0470-7111.2	LD7111	VW 23130 19,6 - WE / - WK Ceramic
			←	+PR 1ZC	13.0460-7184.2	607184	ATE 23587 20,6 + WK
					13.0470-7184.2	LD7184	ATE 23587 20,6 + WK Ceramic
			←	+PR 1LJ	13.0460-7226.2	607226	ATE 23587 20,8 + WK
					13.0470-7226.2	LD7226	ATE 23587 20,8 + WK Ceramic
↓							



	kw			 	! #		
AUDI - A1 Sportback (8XA, 8XF) 09/11→							
 Bremsbelagsatz, Scheibenbremse							
1.2 TFSI 1.4 TFSI 1.4 TFSI 1.4 TFSI 1.6 TDI 1.6 TDI 2.0 TDI 2.0 TDI	63 90 103 136 66 77 100 105	01/12→ 11/11→ 04/12→ 11/11→ 11/11→ 11/11→ 05/12→ 09/11→	← → → →	+PR 1ZM,1ZN,1ZS +PR 1KF,1KX +PR 1KT +PR 1KS	 	 	ATE 23587 20,6 - WE / - WK ATE 23587 20,6 - WE / - WK Ceramic TRW 25110 17,5 - WE / - WK TRW 25110 17,5 - WE / - WK Ceramic TRW 20961 17,2 - WK TRW 20961 17,2 - WK Ceramic BOS 24563 17,7 - WE / - WK + Zub BOS 24563 17,7 - WE / - WK + Zub Ceramic
1.4 TDI 1.4 TFSI 1.4 TFSI 1.6 TDI	66 92 110 85	11/14→ 11/14→ 11/14→ 11/14→	← ← ← → → → →	+PR 1ZG +PR 1ZC +PR 1ZM,1ZN,1ZS +PR 1KF,1KX +PR 1KT +PR 1KS	 	 	VW 23130 19,6 - WE / - WK VW 23130 19,6 - WE / - WK Ceramic ATE 23587 20,6 + WK ATE 23587 20,6 + WK Ceramic ATE 23587 20,6 - WE / - WK ATE 23587 20,6 - WE / - WK Ceramic TRW 25110 17,5 - WE / - WK TRW 25110 17,5 - WE / - WK Ceramic TRW 20961 17,2 - WK TRW 20961 17,2 - WK Ceramic BOS 24563 17,7 - WE / - WK + Zub BOS 24563 17,7 - WE / - WK + Zub Ceramic
S1 quattro	170	03/14→	← ← →	+PR 1ZC +PR 1ZM,1ZN,1ZS +PR 1KF,1KX	 	 	ATE 23587 20,6 + WK ATE 23587 20,6 + WK Ceramic ATE 23587 20,6 - WE / - WK ATE 23587 20,6 - WE / - WK Ceramic TRW 25110 17,5 - WE / - WK TRW 25110 17,5 - WE / - WK Ceramic
 Bremsscheibe							
1.0 TFSI 1.0 TFSI 1.8 TFSI	60 70 141	01/16→ 03/15→ 02/15→	← ← ← ← → →	+PR 1ZG +PR 1ZC +PR 1ZM,1ZN,1ZS +PR 1KT +PR 1LJ +PR 1KT +PR 1KS	 	 	∅ 256 22 19 V + S ∅ 256 22 19 V + S PD ∅ 288 25 22 V + S ∅ 288 25 22 V + S PD ∅ 310 25 22 V + S ∅ 310 25 22 V PD ∅ 230 9 7 + S ∅ 230 9 7 + S PD ∅ 312 25 22 V + S ∅ 230 9 7 + S ∅ 230 9 7 + S PD ∅ 272 9,7 8 + S ∅ 272 9,7 8 + S PD
1.2 TFSI 1.4 TFSI 1.4 TFSI 1.4 TFSI 1.6 TDI 1.6 TDI 2.0 TDI 2.0 TDI	63 90 103 136 66 77 100 105	01/12→ 11/11→ 04/12→ 11/11→ 11/11→ 11/11→ 05/12→ 09/11→	← ← ← ← ← → → →	+PR 1ZG +PR 1ZC +PR 1ZM,1ZN,1ZS +PR 1LJ +PR 1KT +PR 1KS	 	 	∅ 256 22 19 V + S ∅ 256 22 19 V + S PD ∅ 288 25 22 V + S ∅ 288 25 22 V + S PD ∅ 310 25 22 V + S ∅ 310 25 22 V PD ∅ 312 25 22 V + S ∅ 230 9 7 + S ∅ 230 9 7 + S PD ∅ 272 9,7 8 + S ∅ 272 9,7 8 + S PD
1.4 TDI 1.4 TFSI 1.6 TDI	66 92 85	11/14→ 11/14→ 11/14→	← ← ←	+PR 1ZG +PR 1ZC +PR 1ZM,1ZN,1ZS	 	 	∅ 256 22 19 V + S ∅ 256 22 19 V + S PD ∅ 288 25 22 V + S ∅ 288 25 22 V + S PD ∅ 310 25 22 V + S ∅ 310 25 22 V PD
↓							

	kw			 	! #		
AUDI - A1 Sportback (8XA, 8XF) 09/11→							
 Bremsscheibe							
1.4 TDI 1.4 TFSI 1.6 TDI	66 92 85	11/14→ 11/14→ 11/14→	➡	+PR 1KT		24.0109-0123.1 409123 24.0309-0123.1 509123	Ø 230 9 7 + S Ø 230 9 7 + S PD
			➡	+PR 1KS		24.0110-0356.1 410356 24.0310-0356.1 510356	Ø 272 9,7 8 + S Ø 272 9,7 8 + S PD
1.4 TFSI	110	11/14→	⬅	+PR 1ZG		24.0122-0151.1 422151 24.0322-0151.1 522151	Ø 256 22 19 V + S Ø 256 22 19 V + S PD
			⬅	+PR 1ZM,1ZN,1ZS		24.0125-0123.1 425123 24.0325-0123.1 525123	Ø 310 25 22 V + S Ø 310 25 22 V PD
			➡	+PR 1KT		24.0109-0123.1 409123 24.0309-0123.1 509123	Ø 230 9 7 + S Ø 230 9 7 + S PD
			➡	+PR 1KS		24.0110-0356.1 410356 24.0310-0356.1 510356	Ø 272 9,7 8 + S Ø 272 9,7 8 + S PD
S1 quattro	170	03/14→	⬅	+PR 1ZC		24.0125-0113.1 425113 24.0325-0113.1 525113	Ø 288 25 22 V + S Ø 288 25 22 V + S PD
AUDI - A2 (8Z0) 02/00→08/05							
 Bremsbelagsatz, Scheibenbremse							
1.2 TDI	45	03/01→08/05	⬅	→ 07/05		13.0460-7178.2 607178	VW 23394 13,7 + WK
1.4 1.4 TDI	55 55	02/00→08/05 02/00→08/05	⬅	06/00→ 07/05		13.0460-7117.2 607117 13.0470-7117.2 LD7117	VW 23130 19,6 + WK VW 23130 19,6 + WK Ceramic
1.4 TDI 1.6 FSI	66 81	11/03→08/05 05/02→08/05	⬅	→ 07/05		13.0460-7117.2 607117 13.0470-7117.2 LD7117	VW 23130 19,6 + WK VW 23130 19,6 + WK Ceramic
			➡	→ 07/05		13.0460-2864.2 602864 13.0460-2894.2 602894 13.0470-2894.2 LD2894	TRW 20961 17,2 - WK TRW 20961 17,2 - WK + Zub TRW 20961 17,2 - WK + Zub Ceramic
Zubehörsatz, Scheibenbremsbelag							
1.4 TDI 1.6 FSI	66 81	11/03→08/05 05/02→08/05	➡	→ 07/05		13.0460-0072.2 610072	TRW
 Bremsscheibe							
1.2 TDI	45	03/01→08/05	⬅	→ 07/05		24.0115-0109.1 415109	Ø 239 15 13 V
1.4 1.4 TDI	55 55	02/00→08/05 02/00→08/05	⬅	06/00→ 07/05		24.0122-0151.1 422151 24.0322-0151.1 522151	Ø 256 22 19 V + S Ø 256 22 19 V + S PD
1.4 TDI 1.6 FSI	66 81	11/03→08/05 05/02→08/05	⬅	→ 07/05		24.0122-0151.1 422151 24.0322-0151.1 522151	Ø 256 22 19 V + S Ø 256 22 19 V + S PD
			➡	→ 07/05		24.0109-0123.1 409123 24.0309-0123.1 509123	Ø 230 9 7 + S Ø 230 9 7 + S PD
AUDI - A3 (8L1) 09/96→06/03							
 Bremsbelagsatz, Scheibenbremse							
1.6 1.6 1.8 1.8 T 1.8 T 1.8 T quattro	74 75 92 110 132 132	09/96→05/03 08/00→05/03 09/96→05/03 12/96→05/03 12/98→05/03 10/98→05/03	⬅	→ 8L-X-150000; +PR 1LE,1LN,1ZD		13.0460-7081.2 607081 13.0470-7081.2 LD7081	ATE 20676 19,8 - WE / - WK ATE 20676 19,8 - WE / - WK Ceramic
			⬅	→ 8L-X-200000; +PR 1LQ,1LR,1LS		13.0460-7111.2 607111 13.0470-7111.2 LD7111	VW 23130 19,6 - WE / - WK VW 23130 19,6 - WE / - WK Ceramic
			⬅	8L-Y-000001→; +PR 1LQ,1LS		13.0460-7117.2 607117 13.0470-7117.2 LD7117	VW 23130 19,6 + WK VW 23130 19,6 + WK Ceramic
			⬅	+PR 1ZP		13.0460-7117.2 607117 13.0470-7117.2 LD7117	VW 23130 19,6 + WK VW 23130 19,6 + WK Ceramic
			⬅	8L-Y-000001→; +PR 1LE,1LN,1ZD		13.0460-7122.2 607122 13.0470-7122.2 LD7122	ATE 20676 19,8 + WK ATE 20676 19,8 + WK Ceramic
			➡	+PR 1KK,1KV,1KE		13.0460-2894.2 602894 13.0470-2894.2 LD2894	TRW 20961 17,2 - WK + Zub TRW 20961 17,2 - WK + Zub Ceramic
1.8 T quattro	110	12/96→05/03	⬅	08/98→; → 8L-X-150000; +PR 1LE,1LN,1ZD		13.0460-7081.2 607081 13.0470-7081.2 LD7081	ATE 20676 19,8 - WE / - WK ATE 20676 19,8 - WE / - WK Ceramic
			⬅	08/98→; → 8L-X-200000; +PR 1LQ,1LR,1LS		13.0460-7111.2 607111 13.0470-7111.2 LD7111	VW 23130 19,6 - WE / - WK VW 23130 19,6 - WE / - WK Ceramic
↓							

	kw			 	! #		
AUDI - A3 (8L1) 09/96→06/03							
 Bremsbelagsatz, Scheibenbremse							
1.8 T quattro	110	12/96→05/03	←	08/98→; +PR 1ZP	13.0460-7117.2	607117	VW 23130 19,6 + WK
					13.0470-7117.2	LD7117	VW 23130 19,6 + WK Ceramic
			←	8L-Y-000001→; +PR 1LQ,1LS	13.0460-7117.2	607117	VW 23130 19,6 + WK
					13.0470-7117.2	LD7117	VW 23130 19,6 + WK Ceramic
			←	8L-Y-000001→; +PR 1LE,1LN,1ZD	13.0460-7122.2	607122	ATE 20676 19,8 + WK
					13.0470-7122.2	LD7122	ATE 20676 19,8 + WK Ceramic
			→	08/98→; +PR 1KK,1KV,1KE	13.0460-2894.2	602894	TRW 20961 17,2 - WK + Zub
					13.0470-2894.2	LD2894	TRW 20961 17,2 - WK + Zub Ceramic
1.9 TDI 1.9 TDI	66 81	09/96→07/01 08/97→07/01	←	→ 8L-X-150000; +PR 1LE,1LN,1ZD	13.0460-7081.2	607081	ATE 20676 19,8 - WE / - WK
					13.0470-7081.2	LD7081	ATE 20676 19,8 - WE / - WK Ceramic
			←	→ 8L-X-200000; +PR 1LQ,1LR,1LS	13.0460-7111.2	607111	VW 23130 19,6 - WE / - WK
					13.0470-7111.2	LD7111	VW 23130 19,6 - WE / - WK Ceramic
			←	8L-Y-000001→; → 06/01; +PR 1LQ,1LS	13.0460-7117.2	607117	VW 23130 19,6 + WK
					13.0470-7117.2	LD7117	VW 23130 19,6 + WK Ceramic
			←	→ 06/01; +PR 1ZP	13.0460-7117.2	607117	VW 23130 19,6 + WK
					13.0470-7117.2	LD7117	VW 23130 19,6 + WK Ceramic
			←	8L-Y-000001→; → 06/01; +PR 1LE,1LN,1ZD	13.0460-7122.2	607122	ATE 20676 19,8 + WK
					13.0470-7122.2	LD7122	ATE 20676 19,8 + WK Ceramic
			→	→ 06/01; +PR 1KK,1KV,1KE	13.0460-2894.2	602894	TRW 20961 17,2 - WK + Zub
					13.0470-2894.2	LD2894	TRW 20961 17,2 - WK + Zub Ceramic
1.9 TDI	74	10/00→05/03	←	+PR 1LQ,1LS	13.0460-7117.2	607117	VW 23130 19,6 + WK
					13.0470-7117.2	LD7117	VW 23130 19,6 + WK Ceramic
			←	+PR 1ZP	13.0460-7117.2	607117	VW 23130 19,6 + WK
					13.0470-7117.2	LD7117	VW 23130 19,6 + WK Ceramic
			←	+PR 1LE,1LN,1ZD	13.0460-7122.2	607122	ATE 20676 19,8 + WK
		13.0470-7122.2	LD7122	ATE 20676 19,8 + WK Ceramic			
			→	+PR 1KK,1KV,1KE	13.0460-2894.2	602894	TRW 20961 17,2 - WK + Zub
					13.0470-2894.2	LD2894	TRW 20961 17,2 - WK + Zub Ceramic
			←	+PR 1ZP	13.0460-7117.2	607117	VW 23130 19,6 + WK
					13.0470-7117.2	LD7117	VW 23130 19,6 + WK Ceramic
			←	+PR 1LE,1LN,1ZD	13.0460-7122.2	607122	ATE 20676 19,8 + WK
		13.0470-7122.2	LD7122	ATE 20676 19,8 + WK Ceramic			
1.9 TDI 1.9 TDI quattro	96 96	08/00→05/03 08/00→05/03	←	09/00→; +PR 1ZP	13.0460-7117.2	607117	VW 23130 19,6 + WK
					13.0470-7117.2	LD7117	VW 23130 19,6 + WK Ceramic
			←	09/00→; +PR 1LQ,1LS	13.0460-7117.2	607117	VW 23130 19,6 + WK
					13.0470-7117.2	LD7117	VW 23130 19,6 + WK Ceramic
			←	09/00→; +PR 1LE,1LN,1ZD	13.0460-7122.2	607122	ATE 20676 19,8 + WK
					13.0470-7122.2	LD7122	ATE 20676 19,8 + WK Ceramic
			→	09/00→; +PR 1KK,1KV,1KE	13.0460-2894.2	602894	TRW 20961 17,2 - WK + Zub
					13.0470-2894.2	LD2894	TRW 20961 17,2 - WK + Zub Ceramic
S3 quattro S3 quattro	154 165	03/99→04/02 10/01→05/03	←	→ 8L-X-200000; +PR 1LT	13.0460-7081.2	607081	ATE 20676 19,8 - WE / - WK
					13.0470-7081.2	LD7081	ATE 20676 19,8 - WE / - WK Ceramic
			←	8L-Y-000001→; +PR 1LT	13.0460-7122.2	607122	ATE 20676 19,8 + WK
				13.0470-7122.2	LD7122	ATE 20676 19,8 + WK Ceramic	
			→	+PR 1KF	13.0460-2820.2	602820	TRW 20961 17,2 - WK
					13.0470-2820.2	LD2820	TRW 20961 17,2 - WK Ceramic
 Bremsscheibe							
1.6 1.6 1.8 1.8 T 1.8 T 1.9 TDI	74 75 92 110 132 74	09/96→05/03 08/00→05/03 09/96→05/03 12/96→05/03 12/98→05/03 10/00→05/03	←	+PR 1LR,1LS,1ZP	24.0122-0150.1	422150	Ø 280 22 19 V + S
					24.0322-0150.1	522150	Ø 280 22 19 V + S PD
			←	+PR 1LQ	24.0122-0151.1	422151	Ø 256 22 19 V + S
					24.0322-0151.1	522151	Ø 256 22 19 V + S PD
			←	+PR 1LE,1LN,1ZD	24.0125-0113.1	425113	Ø 288 25 22 V + S
					24.0325-0113.1	525113	Ø 288 25 22 V + S PD
			→	+PR 1KK,1KV	24.0109-0123.1	409123	Ø 230 9 7 + S
					24.0309-0123.1	509123	Ø 230 9 7 + S PD
			←	08/98→; +PR 1LR,1LS,1ZP	24.0122-0150.1	422150	Ø 280 22 19 V + S
					24.0322-0150.1	522150	Ø 280 22 19 V + S PD
1.8 T quattro	110	12/96→05/03	←	08/98→; +PR 1LQ	24.0122-0151.1	422151	Ø 256 22 19 V + S
					24.0322-0151.1	522151	Ø 256 22 19 V + S PD
↓							

AUDI - A3 (8L1) 09/96→06/03









Bremsscheibe









1.8 T quattro	110	12/96→05/03	←	08/98→; +PR 1LE,1LN,1ZD	24.0125-0113.1 425113	∅ 288 25 22 V + S
			→	08/98→; +PR 1KE	24.0325-0113.1 525113	∅ 288 25 22 V + S PD
1.8 T quattro	132	10/98→05/03	→	08/98→; +PR 1KE	24.0109-0133.1 409133	∅ 239 8,9 7 + S
			←	+PR 1LR,1LS,1ZP	24.0309-0133.1 509133	∅ 239 8,9 7 + S PD
			←	+PR 1LQ	24.0122-0150.1 422150	∅ 280 22 19 V + S
			←	+PR 1LE,1LN,1ZD	24.0322-0150.1 522150	∅ 280 22 19 V + S PD
			←	+PR 1LQ	24.0122-0151.1 422151	∅ 256 22 19 V + S
1.9 TDI 1.9 TDI	66 81	09/96→07/01 08/97→07/01	←	+PR 1LE,1LN,1ZD	24.0322-0151.1 522151	∅ 256 22 19 V + S PD
			←	+PR 1KE	24.0125-0113.1 425113	∅ 288 25 22 V + S
			→	+PR 1KE	24.0325-0113.1 525113	∅ 288 25 22 V + S PD
			→	+PR 1KE	24.0109-0133.1 409133	∅ 239 8,9 7 + S
1.9 TDI	96	08/00→05/03	←	→ 06/01; +PR 1LR,1LS,1ZP	24.0309-0133.1 509133	∅ 239 8,9 7 + S PD
			←	→ 06/01; +PR 1LQ	24.0122-0150.1 422150	∅ 280 22 19 V + S
			←	→ 06/01; +PR 1LQ	24.0322-0150.1 522150	∅ 280 22 19 V + S PD
			←	→ 06/01; +PR 1LE,1LN,1ZD	24.0122-0151.1 422151	∅ 256 22 19 V + S
1.9 TDI quattro	96	08/00→05/03	←	→ 06/01; +PR 1LE,1LN,1ZD	24.0322-0151.1 522151	∅ 256 22 19 V + S PD
			←	→ 06/01; +PR 1LQ	24.0125-0113.1 425113	∅ 288 25 22 V + S
			←	→ 06/01; +PR 1LQ	24.0325-0113.1 525113	∅ 288 25 22 V + S PD
			→	→ 06/01; +PR 1KK,1KV	24.0109-0123.1 409123	∅ 230 9 7 + S
1.9 TDI quattro	96	08/00→05/03	→	→ 06/01; +PR 1KK,1KV	24.0309-0123.1 509123	∅ 230 9 7 + S PD
			←	09/00→; +PR 1LR,1LS,1ZP	24.0122-0150.1 422150	∅ 280 22 19 V + S
			←	09/00→; +PR 1LQ	24.0322-0150.1 522150	∅ 280 22 19 V + S PD
			←	09/00→; +PR 1LQ	24.0122-0151.1 422151	∅ 256 22 19 V + S
1.9 TDI quattro	96	08/00→05/03	←	09/00→; +PR 1LE,1LN,1ZD	24.0322-0151.1 522151	∅ 256 22 19 V + S PD
			←	09/00→; +PR 1LE,1LN,1ZD	24.0125-0113.1 425113	∅ 288 25 22 V + S
			←	09/00→; +PR 1LE,1LN,1ZD	24.0325-0113.1 525113	∅ 288 25 22 V + S PD
			→	09/00→; +PR 1KE	24.0109-0123.1 409123	∅ 230 9 7 + S
S3 quattro S3 quattro	154 165	03/99→04/02 10/01→05/03	←	09/00→; +PR 1KE	24.0309-0123.1 509123	∅ 230 9 7 + S PD
			←	+PR 1LT	24.0122-0150.1 422150	∅ 280 22 19 V + S
			←	+PR 1LQ	24.0322-0150.1 522150	∅ 280 22 19 V + S PD
			←	+PR 1LE,1LN,1ZD	24.0122-0151.1 422151	∅ 256 22 19 V + S
S3 quattro S3 quattro	154 165	03/99→04/02 10/01→05/03	←	+PR 1LE,1LN,1ZD	24.0325-0113.1 525113	∅ 288 25 22 V + S PD
			←	+PR 1LQ	24.0125-0113.1 425113	∅ 288 25 22 V + S
			←	+PR 1LQ	24.0325-0113.1 525113	∅ 288 25 22 V + S PD
			→	+PR 1KE	24.0109-0133.1 409133	∅ 239 8,9 7 + S
S3 quattro S3 quattro	154 165	03/99→04/02 10/01→05/03	→	+PR 1KE	24.0309-0133.1 509133	∅ 239 8,9 7 + S PD
			←	+PR 1LT	24.0125-0123.1 425123	∅ 310 25 22 V + S
			←	+PR 1LQ	24.0325-0123.1 525123	∅ 310 25 22 V PD
			←	+PR 1LQ	24.0122-0163.1 422163	∅ 256 22 20 V
S3 quattro S3 quattro	154 165	03/99→04/02 10/01→05/03	←	+PR 1LQ	24.0322-0163.1 522163	∅ 256 22 20 V PD
			←	+PR 1LQ	24.0122-0163.1 422163	∅ 256 22 20 V
			←	+PR 1LQ	24.0322-0163.1 522163	∅ 256 22 20 V PD
			←	+PR 1LQ	24.0122-0163.1 422163	∅ 256 22 20 V







AUDI - A3 (8P1) 05/03→08/12

Brembelagsatz, Scheibenbremse







1.2 TSI 1.6 TDI 1.6 TDI	77 66 77	04/10→08/12 05/09→08/12 05/09→08/12	←	+PR 1ZF,1ZM	13.0460-7117.2 607117	VW 23130 19,6 + WK
			←	+PR 1ZE,1ZP,1ZD,1LJ / 1ZA	13.0470-7117.2 LD7117	VW 23130 19,6 + WK Ceramic
1.2 TSI 1.6 TDI 1.6 TDI	77 66 77	04/10→08/12 05/09→08/12 05/09→08/12	←	+PR 1ZE,1ZP,1ZD,1LJ / 1ZA	13.0460-7184.2 607184	ATE 23587 20,6 + WK
			←	+PR 1LQ	13.0470-7184.2 LD7184	ATE 23587 20,6 + WK Ceramic
			←	+PR 1LQ	13.0460-7200.2 607200	ATE 23801 20,3 + WK
			←	+PR 1LQ	13.0470-7200.2 LD7200	ATE 23801 20,3 + WK Ceramic
			→	+PR 1KE,1KZ	13.0460-2749.2 602749	TRW 24483 16,9 - WE / - WK + Zub
			→	+PR 1KE,1KZ	13.0460-2880.2 602880	TRW 23914 17,1 + WE / - WK + Zub
			→	+PR 1KE,1KZ	13.0470-2749.2 LD2749	TRW 24483 16,9 - WE / - WK + Zub Ceramic
			→	+PR 1KE,1KZ	13.0470-2880.2 LD2880	TRW 23914 17,1 + WE / - WK + Zub Ceramic
1.2 TSI 1.6 TDI 1.6 TDI	77 66 77	04/10→08/12 05/09→08/12 05/09→08/12	→	+PR 1KQ,1KD	13.0460-2820.2 602820	TRW 20961 17,2 - WK
			→	+PR 1KQ,1KD	13.0470-2820.2 LD2820	TRW 20961 17,2 - WK Ceramic
1.2 TSI 1.6 TDI 1.6 TDI	77 66 77	04/10→08/12 05/09→08/12 05/09→08/12	→	+PR 1KS	13.0460-3858.2 603858	BOS 24563 17,7 - WE / - WK + Zub
			→	+PR 1KS	13.0470-3858.2 LD3858	BOS 24563 17,7 - WE / - WK + Zub Ceramic







	kw			 	! #		
AUDI - A3 (8P1) 05/03→08/12							
 Bremsbelagsatz, Scheibenbremse							
1.4 TFSI 2.0 TDI	92 125	09/07→08/12 03/06→08/12	←	+PR 1ZF;1ZM	13.0460-7117.2	607117	VW 23130 19,6 + WK
					13.0470-7117.2	LD7117	VW 23130 19,6 + WK Ceramic
			←	+PR 1ZE;1ZP;1ZD;1LJ / 1ZA	13.0460-7184.2	607184	ATE 23587 20,6 + WK
					13.0470-7184.2	LD7184	ATE 23587 20,6 + WK Ceramic
			←	+PR 1LK	13.0460-7200.2	607200	ATE 23801 20,3 + WK
					13.0470-7200.2	LD7200	ATE 23801 20,3 + WK Ceramic
			→	+PR 1KE;1KZ	13.0460-2749.2	602749	TRW 24483 16,9 - WE / - WK + Zub
		13.0460-2880.2	602880	TRW 23914 17,1 + WE / - WK + Zub			
		13.0470-2749.2	LD2749	TRW 24483 16,9 - WE / - WK + Zub Ceramic			
		13.0470-2880.2	LD2880	TRW 23914 17,1 + WE / - WK + Zub Ceramic			
		→	+PR 1KQ;1KD	13.0460-2820.2	602820	TRW 20961 17,2 - WK	
				13.0470-2820.2	LD2820	TRW 20961 17,2 - WK Ceramic	
		→	+PR 1KS	13.0460-3858.2	603858	BOS 24563 17,7 - WE / - WK + Zub	
				13.0470-3858.2	LD3858	BOS 24563 17,7 - WE / - WK + Zub Ceramic	
1.6 1.6 E-Power 1.6 FSI 2.0 FSI 2.0 TDI 2.0 TDI 16V 2.0 TFSI	75 75 85 110 100 103 103 147	05/03→08/12 01/11→08/12 08/03→09/07 05/03→06/08 05/03→08/12 06/05→06/08 05/03→08/12 09/04→08/12	←	+PR 1ZF;1ZM	13.0460-7117.2	607117	VW 23130 19,6 + WK
					13.0470-7117.2	LD7117	VW 23130 19,6 + WK Ceramic
			←	+PR 1ZE;1ZP;1ZD;1LJ / 1ZA	13.0460-7184.2	607184	ATE 23587 20,6 + WK
					13.0470-7184.2	LD7184	ATE 23587 20,6 + WK Ceramic
			←	+PR 1LK	13.0460-7200.2	607200	ATE 23801 20,3 + WK
					13.0470-7200.2	LD7200	ATE 23801 20,3 + WK Ceramic
			→	+PR 1KE;1KZ	13.0460-2749.2	602749	TRW 24483 16,9 - WE / - WK + Zub
		13.0460-2880.2	602880	TRW 23914 17,1 + WE / - WK + Zub			
		13.0470-2749.2	LD2749	TRW 24483 16,9 - WE / - WK + Zub Ceramic			
		13.0470-2880.2	LD2880	TRW 23914 17,1 + WE / - WK + Zub Ceramic			
		→	+PR 1KQ;1KD	13.0460-2820.2	602820	TRW 20961 17,2 - WK	
				13.0470-2820.2	LD2820	TRW 20961 17,2 - WK Ceramic	
		→	+PR 1KS	13.0460-3858.2	603858	BOS 24563 17,7 - WE / - WK + Zub	
				13.0470-3858.2	LD3858	BOS 24563 17,7 - WE / - WK + Zub Ceramic	
1.8 T 1.8 TFSI	110 118	08/06→08/12 11/06→08/12	←	01/07→; +PR 1ZF;1ZM	13.0460-7117.2	607117	VW 23130 19,6 + WK
					13.0470-7117.2	LD7117	VW 23130 19,6 + WK Ceramic
			←	01/07→; +PR 1ZE;1ZP;1ZD;1LJ / 1ZA	13.0460-7184.2	607184	ATE 23587 20,6 + WK
					13.0470-7184.2	LD7184	ATE 23587 20,6 + WK Ceramic
			←	01/07→; +PR 1LK	13.0460-7200.2	607200	ATE 23801 20,3 + WK
					13.0470-7200.2	LD7200	ATE 23801 20,3 + WK Ceramic
			→	01/07→; +PR 1KE;1KZ	13.0460-2749.2	602749	TRW 24483 16,9 - WE / - WK + Zub
		13.0460-2880.2	602880	TRW 23914 17,1 + WE / - WK + Zub			
		13.0470-2749.2	LD2749	TRW 24483 16,9 - WE / - WK + Zub Ceramic			
		13.0470-2880.2	LD2880	TRW 23914 17,1 + WE / - WK + Zub Ceramic			
		→	01/07→; +PR 1KQ;1KD	13.0460-2820.2	602820	TRW 20961 17,2 - WK	
				13.0470-2820.2	LD2820	TRW 20961 17,2 - WK Ceramic	
		→	01/07→; +PR 1KS	13.0460-3858.2	603858	BOS 24563 17,7 - WE / - WK + Zub	
				13.0470-3858.2	LD3858	BOS 24563 17,7 - WE / - WK + Zub Ceramic	
1.8 TFSI quattro	118	07/08→08/12	←	+PR 1ZF;1ZM	13.0460-7117.2	607117	VW 23130 19,6 + WK
					13.0470-7117.2	LD7117	VW 23130 19,6 + WK Ceramic
			←	+PR 1ZE;1ZP;1ZD;1LJ / 1ZA	13.0460-7184.2	607184	ATE 23587 20,6 + WK
		13.0470-7184.2	LD7184	ATE 23587 20,6 + WK Ceramic			
		←	+PR 1LK	13.0460-7200.2	607200	ATE 23801 20,3 + WK	
				13.0470-7200.2	LD7200	ATE 23801 20,3 + WK Ceramic	

	kw			 	! #		
AUDI - A3 (8P1) 05/03→08/12							
 Bremsbelagsatz, Scheibenbremse							
1.8 TFSI quattro	118	07/08→08/12	➡	+PR 1KF,1KJ,1KU		13.0460-2749.2 602749	TRW 24483 16,9 - WE / - WK + Zub
						13.0460-2880.2 602880	TRW 23914 17,1 + WE / - WK + Zub
						13.0470-2749.2 LD2749	TRW 24483 16,9 - WE / - WK + Zub Ceramic
						13.0470-2880.2 LD2880	TRW 23914 17,1 + WE / - WK + Zub Ceramic
			➡	+PR 1KS		13.0460-3858.2 603858	BOS 24563 17,7 - WE / - WK + Zub
						13.0470-3858.2 LD3858	BOS 24563 17,7 - WE / - WK + Zub Ceramic
1.9 TDI	77	05/03→05/10	←	06/03→; +PR 1ZF,1ZM		13.0460-7117.2 607117	VW 23130 19,6 + WK
						13.0470-7117.2 LD7117	VW 23130 19,6 + WK Ceramic
			←	06/03→; +PR 1ZE;1ZP;1ZD;1LJ / 1ZA		13.0460-7184.2 607184	ATE 23587 20,6 + WK
						13.0470-7184.2 LD7184	ATE 23587 20,6 + WK Ceramic
			←	06/03→; +PR 1LK		13.0460-7200.2 607200	ATE 23801 20,3 + WK
						13.0470-7200.2 LD7200	ATE 23801 20,3 + WK Ceramic
			➡	06/03→; +PR 1KE;1KZ		13.0460-2749.2 602749	TRW 24483 16,9 - WE / - WK + Zub
						13.0460-2880.2 602880	TRW 23914 17,1 + WE / - WK + Zub
						13.0470-2749.2 LD2749	TRW 24483 16,9 - WE / - WK + Zub Ceramic
						13.0470-2880.2 LD2880	TRW 23914 17,1 + WE / - WK + Zub Ceramic
			➡	06/03→; +PR 1KQ;1KD		13.0460-2820.2 602820	TRW 20961 17,2 - WK
						13.0470-2820.2 LD2820	TRW 20961 17,2 - WK Ceramic
			➡	06/03→; +PR 1KS		13.0460-3858.2 603858	BOS 24563 17,7 - WE / - WK + Zub
						13.0470-3858.2 LD3858	BOS 24563 17,7 - WE / - WK + Zub Ceramic
2.0 TDI	120	06/06→06/08	←	+PR 1ZF; 1ZM		13.0460-7117.2 607117	VW 23130 19,6 + WK
						13.0470-7117.2 LD7117	VW 23130 19,6 + WK Ceramic
			←	+PR 1ZE;1ZP;1ZD;1LJ / 1ZA		13.0460-7184.2 607184	ATE 23587 20,6 + WK
						13.0470-7184.2 LD7184	ATE 23587 20,6 + WK Ceramic
			←	+PR 1LK		13.0460-7200.2 607200	ATE 23801 20,3 + WK
						13.0470-7200.2 LD7200	ATE 23801 20,3 + WK Ceramic
			➡	+PR 1KE; 1KZ		13.0460-2749.2 602749	TRW 24483 16,9 - WE / - WK + Zub
						13.0460-2880.2 602880	TRW 23914 17,1 + WE / - WK + Zub
						13.0470-2749.2 LD2749	TRW 24483 16,9 - WE / - WK + Zub Ceramic
						13.0470-2880.2 LD2880	TRW 23914 17,1 + WE / - WK + Zub Ceramic
			➡	+PR 1KQ; 1KD		13.0460-2820.2 602820	TRW 20961 17,2 - WK
						13.0470-2820.2 LD2820	TRW 20961 17,2 - WK Ceramic
			➡	+PR 1KS		13.0460-3858.2 603858	BOS 24563 17,7 - WE / - WK + Zub
						13.0470-3858.2 LD3858	BOS 24563 17,7 - WE / - WK + Zub Ceramic
2.0 TDI 16V quattro 2.0 TDI quattro 2.0 TDI quattro 2.0 TFSI quattro	103	08/04→08/12	←	+PR 1ZF,1ZM		13.0460-7117.2 607117	VW 23130 19,6 + WK
	100	05/03→06/08				13.0470-7117.2 LD7117	VW 23130 19,6 + WK Ceramic
	103	01/06→06/08	←	+PR 1ZE;1ZP;1ZD;1LJ / 1ZA		13.0460-7184.2 607184	ATE 23587 20,6 + WK
	147	09/04→08/12				13.0470-7184.2 LD7184	ATE 23587 20,6 + WK Ceramic
			←	+PR 1LK		13.0460-7200.2 607200	ATE 23801 20,3 + WK
						13.0470-7200.2 LD7200	ATE 23801 20,3 + WK Ceramic
			➡	+PR 1KF;1KJ;1KU		13.0460-2749.2 602749	TRW 24483 16,9 - WE / - WK + Zub
						13.0460-2880.2 602880	TRW 23914 17,1 + WE / - WK + Zub
						13.0470-2749.2 LD2749	TRW 24483 16,9 - WE / - WK + Zub Ceramic
						13.0470-2880.2 LD2880	TRW 23914 17,1 + WE / - WK + Zub Ceramic
↓							







	kw				! #		
AUDI - A3 (8P1) 05/03→08/12							
Bremsbelagsatz, Scheibenbremse							
2.0 TDI 16V quattro 2.0 TDI quattro 2.0 TDI quattro 2.0 TFSI quattro	103 100 103 147	08/04→08/12 05/03→06/08 01/06→06/08 09/04→08/12	➡	+PR 1KS		13.0460-3858.2 603858 13.0470-3858.2 LD3858	BOS 24563 17,7 - WE / - WK + Zub BOS 24563 17,7 - WE / - WK + Zub Ceramic
2.0 TDI quattro	125	03/06→08/12	←	+PR 1ZF;1ZM		13.0460-7117.2 607117 13.0470-7117.2 LD7117	VW 23130 19,6 + WK VW 23130 19,6 + WK Ceramic
			←	+PR 1ZE;1ZP;1ZD;1LJ / 1ZA		13.0460-7184.2 607184 13.0470-7184.2 LD7184	ATE 23587 20,6 + WK ATE 23587 20,6 + WK Ceramic
			←	+PR 1LK		13.0460-7200.2 607200 13.0470-7200.2 LD7200	ATE 23801 20,3 + WK ATE 23801 20,3 + WK Ceramic
			➡	+PR 1KF;1KJ;1KU		13.0460-2749.2 602749 13.0460-2880.2 602880 13.0470-2749.2 LD2749 13.0470-2880.2 LD2880	TRW 24483 16,9 - WE / - WK + Zub TRW 23914 17,1 + WE / - WK + Zub TRW 24483 16,9 - WE / - WK + Zub Ceramic TRW 23914 17,1 + WE / - WK + Zub Ceramic
			➡	+PR 1KS		13.0460-3858.2 603858 13.0470-3858.2 LD3858	BOS 24563 17,7 - WE / - WK + Zub BOS 24563 17,7 - WE / - WK + Zub Ceramic
3.2 V6 quattro	184	07/03→05/09	←	03/06→; +PR 1ZF;1ZM		13.0460-7117.2 607117 13.0470-7117.2 LD7117	VW 23130 19,6 + WK VW 23130 19,6 + WK Ceramic
			←	03/06→; +PR 1ZE;1ZP;1ZD;1LJ / 1ZA		13.0460-7184.2 607184 13.0470-7184.2 LD7184	ATE 23587 20,6 + WK ATE 23587 20,6 + WK Ceramic
			←	03/06→; +PR 1LK		13.0460-7200.2 607200 13.0470-7200.2 LD7200	ATE 23801 20,3 + WK ATE 23801 20,3 + WK Ceramic
			➡	+PR 1KF,1KJ,1KU		13.0460-2749.2 602749 13.0460-2880.2 602880 13.0470-2749.2 LD2749 13.0470-2880.2 LD2880	TRW 24483 16,9 - WE / - WK + Zub TRW 23914 17,1 + WE / - WK + Zub TRW 24483 16,9 - WE / - WK + Zub Ceramic TRW 23914 17,1 + WE / - WK + Zub Ceramic
			➡	+PR 2EA		13.0460-2749.2 602749 13.0460-2880.2 602880 13.0470-2749.2 LD2749 13.0470-2880.2 LD2880	TRW 24483 16,9 - WE / - WK + Zub TRW 23914 17,1 + WE / - WK + Zub TRW 24483 16,9 - WE / - WK + Zub Ceramic TRW 23914 17,1 + WE / - WK + Zub Ceramic
S3 quattro	188	02/07→08/12	←	07/08→; +PR 1ZK		13.0460-7227.2 607227 13.0470-7227.2 LD7227	ATE 23801 20,3 + WK ATE 23912 20,3 + WK Ceramic
			➡	07/08→; +PR 1KW		13.0460-2749.2 602749 13.0460-2880.2 602880 13.0470-2749.2 LD2749 13.0470-2880.2 LD2880	TRW 24483 16,9 - WE / - WK + Zub TRW 23914 17,1 + WE / - WK + Zub TRW 24483 16,9 - WE / - WK + Zub Ceramic TRW 23914 17,1 + WE / - WK + Zub Ceramic
S3 quattro	195	11/06→08/12	←	+PR 1ZK		13.0460-7227.2 607227 13.0470-7227.2 LD7227	ATE 23801 20,3 + WK ATE 23912 20,3 + WK Ceramic
			➡	+PR 1KW		13.0460-2749.2 602749 13.0460-2880.2 602880 13.0470-2749.2 LD2749 13.0470-2880.2 LD2880	TRW 24483 16,9 - WE / - WK + Zub TRW 23914 17,1 + WE / - WK + Zub TRW 24483 16,9 - WE / - WK + Zub Ceramic TRW 23914 17,1 + WE / - WK + Zub Ceramic

↓









	kw			 	! #		
AUDI - A3 (8P1) 05/03→08/12							
Zubehörsatz, Scheibenbremsbelag							
1.2 TSI 1.6 TDI 1.6 TDI	77 66 77	04/10→08/12 05/09→08/12 05/09→08/12	➡	+PR 1KE,1KZ		13.0460-0259.2 610259	
1.4 TFSI 1.6 1.6 E-Power 1.6 FSI 2.0 FSI 2.0 TDI 2.0 TDI 2.0 TDI 2.0 TDI 16V 2.0 TFSI	92 75 75 85 110 100 103 125 103 147	09/07→08/12 05/03→08/12 01/11→08/12 08/03→09/07 05/03→06/08 05/03→08/12 06/05→06/08 03/06→08/12 05/03→08/12 09/04→08/12	➡	+PR 1KE;1KZ		13.0460-0259.2 610259	
1.8 T 1.8 TFSI	110 118	08/06→08/12 11/06→08/12	➡	01/07→; +PR 1KE;1KZ		13.0460-0259.2 610259	
1.8 TFSI quattro	118	07/08→08/12	➡	+PR 1KF,1KJ,1KU		13.0460-0259.2 610259	
1.9 TDI	77	05/03→05/10	➡	06/03→; +PR 1KE;1KZ		13.0460-0259.2 610259	
2.0 TDI	120	06/06→06/08	➡	+PR 1KE; 1KZ		13.0460-0259.2 610259	
2.0 TDI 16V quattro 2.0 TDI quattro 2.0 TDI quattro 2.0 TDI quattro 2.0 TFSI quattro	103 100 103 125 147	08/04→08/12 05/03→06/08 01/06→06/08 03/06→08/12 09/04→08/12	➡	+PR 1KF;1KJ;1KU		13.0460-0259.2 610259	
3.2 V6 quattro	184	07/03→05/09	➡	+PR 2EA		13.0460-0035.2 610035	
			➡	+PR 1KF,1KJ,1KU		13.0460-0259.2 610259	
S3 quattro	188	02/07→08/12	➡	07/08→; +PR 1KW		13.0460-0035.2 610035	
S3 quattro	195	11/06→08/12	➡	+PR 1KW		13.0460-0035.2 610035	
Bremsscheibe							
1.2 TSI 1.6 TDI 1.6 TDI	77 66 77	04/10→08/12 05/09→08/12 05/09→08/12	←	+PR 1ZF,1ZM		24.0122-0210.1 422210 Ø 280 22 19 V + S 24.0322-0210.1 522210 Ø 280 22 19 V + S PD	
			←	+PR 1ZE,1ZP		24.0125-0145.1 425145 Ø 288 25 22 V + S 24.0325-0145.1 525145 Ø 288 25 22 V + S PD	
			←	+PR 1ZD,1LJ,1ZA		24.0125-0158.1 425158 Ø 312 25 22 V + S 24.0325-0158.1 525158 Ø 312 25 22 V + S PD	
			←	+PR 1LK		24.0130-0115.1 430115 Ø 345 30 27 V 24.0330-0115.1 530115 Ø 345 30 27 V PD	
			➡	+PR 1KQ,1KD		24.0110-0277.1 410277 Ø 253 10 8 + S 24.0310-0277.1 510277 Ø 253 10 8 + S PD	
			➡	+PR 1KS		24.0110-0356.1 410356 Ø 272 9,7 8 + S 24.0310-0356.1 510356 Ø 272 9,7 8 + S PD	
			➡	+PR 1KE		24.0112-0158.1 412158 Ø 256 12 10 + S 24.0312-0158.1 512158 Ø 256 12 10 PD	
			➡	+PR 1KZ		24.0112-0169.1 412169 Ø 282 12 10 + S 24.0312-0169.1 512169 Ø 282 12 10 + S PD	
1.4 TFSI 1.6 1.6 E-Power 1.6 FSI 2.0 FSI 2.0 TDI 2.0 TDI 2.0 TDI 16V 2.0 TFSI	92 75 75 85 110 100 103 103 147	09/07→08/12 05/03→08/12 01/11→08/12 08/03→09/07 05/03→06/08 05/03→08/12 06/05→06/08 05/03→08/12 09/04→08/12	←	+PR 1ZF;1ZM		24.0122-0210.1 422210 Ø 280 22 19 V + S 24.0322-0210.1 522210 Ø 280 22 19 V + S PD	
			←	+PR 1ZE;1ZP		24.0125-0145.1 425145 Ø 288 25 22 V + S 24.0325-0145.1 525145 Ø 288 25 22 V + S PD	
			←	+PR 1ZD,1LJ,1ZA		24.0125-0158.1 425158 Ø 312 25 22 V + S 24.0325-0158.1 525158 Ø 312 25 22 V + S PD	
			←	+PR 1LK		24.0130-0115.1 430115 Ø 345 30 27 V 24.0330-0115.1 530115 Ø 345 30 27 V PD	
			➡	+PR 1KQ;1KD		24.0110-0277.1 410277 Ø 253 10 8 + S 24.0310-0277.1 510277 Ø 253 10 8 + S PD	
			➡	+PR 1KS		24.0110-0356.1 410356 Ø 272 9,7 8 + S 24.0310-0356.1 510356 Ø 272 9,7 8 + S PD	
			➡	+PR 1KE		24.0112-0158.1 412158 Ø 256 12 10 + S 24.0312-0158.1 512158 Ø 256 12 10 PD	
			➡	+PR 1KZ		24.0112-0169.1 412169 Ø 282 12 10 + S 24.0312-0169.1 512169 Ø 282 12 10 + S PD	
1.8 T 1.8 TFSI	110 118	08/06→08/12 11/06→08/12	←	01/07→; +PR 1ZF;1ZM		24.0122-0210.1 422210 Ø 280 22 19 V + S 24.0322-0210.1 522210 Ø 280 22 19 V + S PD	
			←	01/07→; +PR 1ZE;1ZP		24.0125-0145.1 425145 Ø 288 25 22 V + S 24.0325-0145.1 525145 Ø 288 25 22 V + S PD	
↓							







	kw			 	! #		
AUDI - A3 (8P1) 05/03→08/12							
Bremsscheibe							
1.8 T 1.8 TFSI	110 118	08/06→08/12 11/06→08/12	←	01/07→; +PR 1ZD,1LJ,1ZA	24.0125-0158.1	425158	Ø 312 25 22 V + S
					24.0325-0158.1	525158	Ø 312 25 22 V + S PD
			←	01/07→; +PR 1LK	24.0130-0115.1	430115	Ø 345 30 27 V
					24.0330-0115.1	530115	Ø 345 30 27 V PD
			→	01/07→; +PR 1KQ;1KD	24.0110-0277.1	410277	Ø 253 10 8 + S
					24.0310-0277.1	510277	Ø 253 10 8 + S PD
			→	01/07→; +PR 1KS	24.0110-0356.1	410356	Ø 272 9,7 8 + S
		24.0310-0356.1	510356	Ø 272 9,7 8 + S PD			
		→	01/07→; +PR 1KE	24.0112-0158.1	412158	Ø 256 12 10 + S	
				24.0312-0158.1	512158	Ø 256 12 10 PD	
		→	01/07→; +PR 1KZ	24.0112-0169.1	412169	Ø 282 12 10 + S	
				24.0312-0169.1	512169	Ø 282 12 10 + S PD	
1.8 TFSI quattro	118	07/08→08/12	←	+PR 1ZF;1ZM	24.0122-0210.1	422210	Ø 280 22 19 V + S
					24.0322-0210.1	522210	Ø 280 22 19 V + S PD
			←	+PR 1ZE;1ZP	24.0125-0145.1	425145	Ø 288 25 22 V + S
					24.0325-0145.1	525145	Ø 288 25 22 V + S PD
			←	+PR 1ZD,1LJ,1ZA	24.0125-0158.1	425158	Ø 312 25 22 V + S
					24.0325-0158.1	525158	Ø 312 25 22 V + S PD
			←	+PR 1LK	24.0130-0115.1	430115	Ø 345 30 27 V
		24.0330-0115.1	530115	Ø 345 30 27 V PD			
		→	+PR 1KS	24.0110-0356.1	410356	Ø 272 9,7 8 + S	
				24.0310-0356.1	510356	Ø 272 9,7 8 + S PD	
		→	+PR 1KJ	24.0112-0169.1	412169	Ø 282 12 10 + S	
				24.0312-0169.1	512169	Ø 282 12 10 + S PD	
1.9 TDI	77	05/03→05/10	←	06/03→; +PR 1ZF;1ZM	24.0122-0210.1	422210	Ø 280 22 19 V + S
					24.0322-0210.1	522210	Ø 280 22 19 V + S PD
			←	06/03→; +PR 1ZE;1ZP	24.0125-0145.1	425145	Ø 288 25 22 V + S
					24.0325-0145.1	525145	Ø 288 25 22 V + S PD
			←	06/03→; +PR 1ZD,1LJ,1ZA	24.0125-0158.1	425158	Ø 312 25 22 V + S
					24.0325-0158.1	525158	Ø 312 25 22 V + S PD
			←	06/03→; +PR 1LK	24.0130-0115.1	430115	Ø 345 30 27 V
					24.0330-0115.1	530115	Ø 345 30 27 V PD
			→	06/03→; +PR 1KQ;1KD	24.0110-0277.1	410277	Ø 253 10 8 + S
		24.0310-0277.1	510277	Ø 253 10 8 + S PD			
		→	06/03→; +PR 1KS	24.0110-0356.1	410356	Ø 272 9,7 8 + S	
				24.0310-0356.1	510356	Ø 272 9,7 8 + S PD	
		→	06/03→; +PR 1KE	24.0112-0158.1	412158	Ø 256 12 10 + S	
				24.0312-0158.1	512158	Ø 256 12 10 PD	
		→	06/03→; +PR 1KZ	24.0112-0169.1	412169	Ø 282 12 10 + S	
				24.0312-0169.1	512169	Ø 282 12 10 + S PD	
2.0 TDI	120	06/06→06/08	←	+PR 1ZF; 1ZM	24.0122-0210.1	422210	Ø 280 22 19 V + S
					24.0322-0210.1	522210	Ø 280 22 19 V + S PD
			←	+PR 1ZE; 1ZP	24.0125-0145.1	425145	Ø 288 25 22 V + S
					24.0325-0145.1	525145	Ø 288 25 22 V + S PD
			←	+PR 1ZD,1LJ,1ZA	24.0125-0158.1	425158	Ø 312 25 22 V + S
					24.0325-0158.1	525158	Ø 312 25 22 V + S PD
			←	+PR 1LK	24.0130-0115.1	430115	Ø 345 30 27 V
					24.0330-0115.1	530115	Ø 345 30 27 V PD
			→	+PR 1KQ, 1KD	24.0110-0277.1	410277	Ø 253 10 8 + S
		24.0310-0277.1	510277	Ø 253 10 8 + S PD			
		→	+PR 1KS	24.0110-0356.1	410356	Ø 272 9,7 8 + S	
				24.0310-0356.1	510356	Ø 272 9,7 8 + S PD	
		→	+PR 1KE	24.0112-0158.1	412158	Ø 256 12 10 + S	
				24.0312-0158.1	512158	Ø 256 12 10 PD	
		→	+PR 1KZ	24.0112-0169.1	412169	Ø 282 12 10 + S	
				24.0312-0169.1	512169	Ø 282 12 10 + S PD	
2.0 TDI	125	03/06→08/12	←	+PR 1ZF;1ZM	24.0122-0210.1	422210	Ø 280 22 19 V + S
					24.0322-0210.1	522210	Ø 280 22 19 V + S PD
			←	+PR 1ZE;1ZP	24.0125-0145.1	425145	Ø 288 25 22 V + S
		24.0325-0145.1	525145	Ø 288 25 22 V + S PD			
		←	+PR 1ZD,1LJ,1ZA	24.0125-0158.1	425158	Ø 312 25 22 V + S	



	kw			 	! #				
AUDI - A3 (8P1) 05/03→08/12									
Bremsscheibe									
2.0 TDI	125	03/06→08/12	←	+PR 1ZD;1LJ,1ZA	24.0325-0158.1	525158	Ø 312 25 22 V + S PD		
			←	+PR 1ZD;1LJ	24.0130-0115.1	430115	Ø 345 30 27 V		
					24.0330-0115.1	530115	Ø 345 30 27 V PD		
			→	+PR 1KQ;1KD	24.0110-0277.1	410277	Ø 253 10 8 + S		
					24.0310-0277.1	510277	Ø 253 10 8 + S PD		
			→	+PR 1KS	24.0110-0356.1	410356	Ø 272 9,7 8 + S		
					24.0310-0356.1	510356	Ø 272 9,7 8 + S PD		
2.0 TDI 16V quattro 2.0 TDI quattro 2.0 TDI quattro 2.0 TFSI quattro	103 100 103 147	08/04→08/12 05/03→06/08 01/06→06/08 09/04→08/12	←	+PR 1ZF;1ZM	24.0122-0210.1	422210	Ø 280 22 19 V + S		
					24.0322-0210.1	522210	Ø 280 22 19 V + S PD		
			←	+PR 1ZE;1ZP	24.0125-0145.1	425145	Ø 288 25 22 V + S		
					24.0325-0145.1	525145	Ø 288 25 22 V + S PD		
			←	+PR 1ZD;1LJ,1ZA	24.0125-0158.1	425158	Ø 312 25 22 V + S		
					24.0325-0158.1	525158	Ø 312 25 22 V + S PD		
			←	+PR 1LK	24.0130-0115.1	430115	Ø 345 30 27 V		
		24.0330-0115.1	530115	Ø 345 30 27 V PD					
2.0 TDI quattro	125	03/06→08/12	→	+PR 1KS	24.0110-0356.1	410356	Ø 272 9,7 8 + S		
					24.0310-0356.1	510356	Ø 272 9,7 8 + S PD		
			→	+PR 1KF	24.0112-0158.1	412158	Ø 256 12 10 + S		
					24.0312-0158.1	512158	Ø 256 12 10 PD		
			→	+PR 1KJ;1KU	24.0112-0169.1	412169	Ø 282 12 10 + S		
					24.0312-0169.1	512169	Ø 282 12 10 + S PD		
			←	+PR 1ZF;1ZM	24.0122-0210.1	422210	Ø 280 22 19 V + S		
		24.0322-0210.1	522210	Ø 280 22 19 V + S PD					
3.2 V6 quattro	184	07/03→05/09	←	+PR 1ZE;1ZP	24.0125-0145.1	425145	Ø 288 25 22 V + S		
					24.0325-0145.1	525145	Ø 288 25 22 V + S PD		
			←	+PR 1ZD;1LJ,1ZA	24.0125-0158.1	425158	Ø 312 25 22 V + S		
					24.0325-0158.1	525158	Ø 312 25 22 V + S PD		
			←	+PR 1LK	24.0130-0115.1	430115	Ø 345 30 27 V		
					24.0330-0115.1	530115	Ø 345 30 27 V PD		
			→	+PR 1KS	24.0110-0356.1	410356	Ø 272 9,7 8 + S		
		24.0310-0356.1	510356	Ø 272 9,7 8 + S PD					
S3 quattro	188	02/07→08/12	→	+PR 1KF	24.0112-0158.1	412158	Ø 256 12 10 + S		
					24.0312-0158.1	512158	Ø 256 12 10 PD		
			→	+PR 1KJ;1KU	24.0112-0169.1	412169	Ø 282 12 10 + S		
		24.0312-0169.1	512169	Ø 282 12 10 + S PD					
S3 quattro	195	11/06→08/12	←	+PR 1ZK	24.0130-0115.1	430115	Ø 345 30 27 V		
					24.0330-0115.1	530115	Ø 345 30 27 V PD		
			→	+PR 1KW	24.0122-0219.1	422219	Ø 310 22 20 V		
			←	03/06→; +PR 1ZF;1ZM	24.0122-0210.1	422210	Ø 280 22 19 V + S		
					24.0322-0210.1	522210	Ø 280 22 19 V + S PD		
			←	+PR 1ZE;1ZP	24.0125-0145.1	425145	Ø 288 25 22 V + S		
		24.0325-0145.1	525145	Ø 288 25 22 V + S PD					
←	+PR 1ZD;1LJ,1ZA	24.0125-0158.1	425158	Ø 312 25 22 V + S					
		24.0325-0158.1	525158	Ø 312 25 22 V + S PD					
←	+PR 1LK	24.0130-0115.1	430115	Ø 345 30 27 V					
		24.0330-0115.1	530115	Ø 345 30 27 V PD					
→	+PR 1KS	24.0110-0356.1	410356	Ø 272 9,7 8 + S					
		24.0310-0356.1	510356	Ø 272 9,7 8 + S PD					
→	+PR 1KJ	24.0112-0169.1	412169	Ø 282 12 10 + S					
		24.0312-0169.1	512169	Ø 282 12 10 + S PD					
→	+PR 2EA	24.0122-0219.1	422219	Ø 310 22 20 V					
←	07/08→; +PR 1ZK	24.0130-0115.1	430115	Ø 345 30 27 V					
		24.0330-0115.1	530115	Ø 345 30 27 V PD					
→	07/08→; +PR 1KW	24.0122-0219.1	422219	Ø 310 22 20 V					
←	+PR 1ZK	24.0130-0115.1	430115	Ø 345 30 27 V					
		24.0330-0115.1	530115	Ø 345 30 27 V PD					
→	+PR 1KW	24.0122-0219.1	422219	Ø 310 22 20 V					



	kw			 	! #		
AUDI - A3 (8V1, 8VK) 04/12→							
 Bremsbelagsatz, Scheibenbremse							
1.0 TFSI 2.0 TFSI 2.0 TFSI quattro	85 140 140	07/16→ 05/16→ 05/16→	←	+PR 1ZA,1ZD,1ZE,1ZP		13.0460-2785.2 602785 13.0470-2785.2 LD2785	TRW 25683 20,4 + WE / + WK TRW 25683 20,4 + WE / + WK Ceramic
			→	+PR 1KE; + eFSB		13.0460-7293.2 607293 13.0470-7293.2 LD7293	ATE 25008 16,3 - WE / - WK ATE 25008 16,3 - WE / - WK Ceramic
			→	+PR 1KJ,1KY,2ED; + eFSB		13.0460-7294.2 607294 13.0470-7294.2 LD7294	ATE 25009 16,4 - WE / - WK ATE 25009 16,4 - WE / - WK Ceramic
1.2 TFSI 1.2 TFSI 1.4 TFSI 1.4 TFSI 1.4 TFSI 1.6 TDI 1.6 TDI 1.6 TDI 1.8 TFSI quattro 2.0 TDI 2.0 TDI 2.0 TDI 2.0 TDI 2.0 TDI quattro 2.0 TDI quattro	77 81 92 103 110 77 81 85 132 81 100 105 135 110 135	02/13→ 05/14→ 05/14→ 03/13→ 05/14→ 10/12→ 09/13→ 02/17→ 08/12→ 01/13→ 05/13→ 09/12→ 05/13→ 10/12→ 12/12→	←	+PR 1ZA,1ZD,1ZE,1ZP		13.0460-2785.2 602785 13.0470-2785.2 LD2785	TRW 25683 20,4 + WE / + WK TRW 25683 20,4 + WE / + WK Ceramic
			←	+PR 1ZF		13.0460-7303.2 607303 13.0470-7303.2 LD7303	ATE 22035 17,5 + WK ATE 22035 17,5 + WK Ceramic
			→	+PR 1KE; + eFSB		13.0460-7293.2 607293 13.0470-7293.2 LD7293	ATE 25008 16,3 - WE / - WK ATE 25008 16,3 - WE / - WK Ceramic
			→	+PR 1KJ,1KY,2ED; + eFSB		13.0460-7294.2 607294 13.0470-7294.2 LD7294	ATE 25009 16,4 - WE / - WK ATE 25009 16,4 - WE / - WK Ceramic
1.4 TFSI 1.8 TFSI 2.0 TDI	90 132 110	04/12→ 04/12→ 04/12→	←	08/12→; +PR 1ZA,1ZD,1ZE,1ZP		13.0460-2785.2 602785 13.0470-2785.2 LD2785	TRW 25683 20,4 + WE / + WK TRW 25683 20,4 + WE / + WK Ceramic
			←	08/12→; +PR 1ZF		13.0460-7303.2 607303 13.0470-7303.2 LD7303	ATE 22035 17,5 + WK ATE 22035 17,5 + WK Ceramic
			→	08/12→; +PR 1KE; + eFSB		13.0460-7293.2 607293 13.0470-7293.2 LD7293	ATE 25008 16,3 - WE / - WK ATE 25008 16,3 - WE / - WK Ceramic
			→	08/12→; +PR 1KJ,1KY,2ED; + eFSB		13.0460-7294.2 607294 13.0470-7294.2 LD7294	ATE 25009 16,4 - WE / - WK ATE 25009 16,4 - WE / - WK Ceramic
S3 quattro S3 quattro S3 quattro S3 quattro S3 quattro	206 210 213 221 228	02/13→ 05/14→ 07/16→ 11/12→ 06/16→	→	+PR 1KE; + eFSB		13.0460-7293.2 607293 13.0470-7293.2 LD7293	ATE 25008 16,3 - WE / - WK ATE 25008 16,3 - WE / - WK Ceramic
			→	+PR 1KJ,1KY,2ED; + eFSB		13.0460-7294.2 607294 13.0470-7294.2 LD7294	ATE 25009 16,4 - WE / - WK ATE 25009 16,4 - WE / - WK Ceramic
Warnkontakt, Bremsbelagsverschleiß							
1.0 TFSI 1.2 TFSI 1.2 TFSI 1.4 TFSI 1.4 TFSI 1.4 TFSI 1.6 TDI 1.6 TDI 1.6 TDI 1.8 TFSI quattro 2.0 TDI 2.0 TDI 2.0 TDI 2.0 TDI 2.0 TDI quattro 2.0 TDI quattro 2.0 TFSI 2.0 TFSI quattro	85 77 81 92 103 110 77 81 85 132 81 100 105 135 110 135 140 140	07/16→ 02/13→ 05/14→ 05/14→ 03/13→ 05/14→ 10/12→ 09/13→ 02/17→ 08/12→ 01/13→ 05/13→ 09/12→ 05/13→ 10/12→ 12/12→ 05/16→ 05/16→	←	+PR 1ZA,1ZD,1ZE,1ZP	1	24.8190-0065.2 620065	L= 172
1.4 TFSI 1.8 TFSI 2.0 TDI	90 132 110	04/12→ 04/12→ 04/12→	←	08/12→; +PR 1ZA,1ZD,1ZE,1ZP	1	24.8190-0065.2 620065	L= 172
S3 quattro S3 quattro S3 quattro S3 quattro S3 quattro	206 210 213 221 228	02/13→ 05/14→ 07/16→ 11/12→ 06/16→	←	+PR 1LC,1LJ	1	24.8190-0065.2 620065	L= 172
 Bremsscheibe							
1.0 TFSI 2.0 TFSI	85 140	07/16→ 05/16→	←	+PR 1ZE,1ZP		24.0125-0145.1 425145 24.0325-0145.1 525145	Ø 288 25 22 V + S Ø 288 25 22 V + S PD
↓			←	+PR 1ZA,1ZD		24.0125-0158.1 425158	Ø 312 25 22 V + S

	kW			 	! #		
AUDI - A3 (8V1, 8VK) 04/12→							
Bremsscheibe							
1.0 TFSI 2.0 TFSI	85 140	07/16→ 05/16→	←	+PR 1ZA,1ZD		24.0325-0158.1 525158	Ø 312 25 22 V + S PD
			→	+PR 1KE		24.0110-0356.1 410356	Ø 272 9,7 8 + S
			→	+PR 2ED; + eFSB		24.0310-0356.1 510356	Ø 272 9,7 8 + S PD
			→	+PR 1KJ,1KY; + eFSB		24.0112-0210.1 412210	Ø 300 12 10 + S
			→	+PR 1KJ,1KY; + eFSB		24.0122-0219.1 422219	Ø 310 22 20 V
1.2 TFSI 1.2 TFSI 1.4 TFSI 1.4 TFSI 1.4 TFSI 1.6 TDI 1.6 TDI 1.6 TDI 1.8 TFSI quattro 2.0 TDI 2.0 TDI 2.0 TDI 2.0 TDI quattro 2.0 TDI quattro	77 81 92 103 110 77 81 85 132 81 100 105 135 110 135	02/13→ 05/14→ 05/14→ 03/13→ 05/14→ 10/12→ 09/13→ 02/17→ 08/12→ 01/13→ 05/13→ 09/12→ 05/13→ 10/12→ 12/12→	←	+PR 1ZF		24.0124-0258.1 424258	Ø 276 24 21 V + S
			←	+PR 1ZE,1ZP		24.0125-0145.1 425145	Ø 288 25 22 V + S
			←	+PR 1ZA,1ZD		24.0325-0145.1 525145	Ø 288 25 22 V + S PD
			←	+PR 1ZA,1ZD		24.0125-0158.1 425158	Ø 312 25 22 V + S
			→	+PR 1KE		24.0325-0158.1 525158	Ø 312 25 22 V + S PD
			→	+PR 1KE		24.0110-0356.1 410356	Ø 272 9,7 8 + S
			→	+PR 2ED; + eFSB		24.0310-0356.1 510356	Ø 272 9,7 8 + S PD
			→	+PR 1KJ,1KY; + eFSB		24.0112-0210.1 412210	Ø 300 12 10 + S
			→	+PR 1KJ,1KY; + eFSB		24.0122-0219.1 422219	Ø 310 22 20 V
1.4 TFSI 1.8 TFSI 2.0 TDI	90 132 110	04/12→ 04/12→ 04/12→	←	08/12→; +PR 1ZF		24.0124-0258.1 424258	Ø 276 24 21 V + S
			←	08/12→; +PR 1ZE,1ZP		24.0125-0145.1 425145	Ø 288 25 22 V + S
			←	08/12→; +PR 1ZA,1ZD		24.0325-0145.1 525145	Ø 288 25 22 V + S PD
			←	08/12→; +PR 1ZA,1ZD		24.0125-0158.1 425158	Ø 312 25 22 V + S
			→	08/12→; +PR 1KE		24.0325-0158.1 525158	Ø 312 25 22 V + S PD
			→	08/12→; +PR 1KE		24.0110-0356.1 410356	Ø 272 9,7 8 + S
			→	08/12→; +PR 2ED; + eFSB		24.0310-0356.1 510356	Ø 272 9,7 8 + S PD
			→	08/12→; +PR 2ED; + eFSB		24.0112-0210.1 412210	Ø 300 12 10 + S
			→	08/12→; +PR 1KJ,1KY; + eFSB		24.0122-0219.1 422219	Ø 310 22 20 V
2.0 TFSI quattro	140	05/16→	←	+PR 1ZE,1ZP		24.0125-0145.1 425145	Ø 288 25 22 V + S
			←	+PR 1ZA,1ZD		24.0325-0145.1 525145	Ø 288 25 22 V + S PD
			←	+PR 1ZA,1ZD		24.0125-0158.1 425158	Ø 312 25 22 V + S
			→	+PR 1KE		24.0325-0158.1 525158	Ø 312 25 22 V + S PD
			→	+PR 1KE		24.0110-0356.1 410356	Ø 272 9,7 8 + S
			→	+PR 1KJ,1KY; + eFSB		24.0310-0356.1 510356	Ø 272 9,7 8 + S PD
			→	+PR 1KJ,1KY; + eFSB		24.0122-0219.1 422219	Ø 310 22 20 V
S3 quattro S3 quattro S3 quattro S3 quattro S3 quattro	206 210 213 221 228	02/13→ 05/14→ 07/16→ 11/12→ 06/16→	←	+PR 1LC,1LJ		24.0130-0225.1 430225	Ø 340 30 27 V + S
			→	+PR 1KE		24.0110-0356.1 410356	Ø 272 9,7 8 + S
			→	+PR 1KE		24.0310-0356.1 510356	Ø 272 9,7 8 + S PD
			→	+PR 2ED; + eFSB		24.0112-0210.1 412210	Ø 300 12 10 + S
			→	+PR 1KJ,1KY; + eFSB		24.0122-0219.1 422219	Ø 310 22 20 V
AUDI - A3 Cabriolet (8P7) 04/08→05/13							
Bremsbelagsatz, Scheibenbremse							
1.2 TFSI 1.4 TFSI 1.6 1.6 TDI 1.8 TFSI 1.9 TDI 2.0 TDI 2.0 TDI 2.0 TFSI	77 92 75 77 118 77 100 103 147	03/10→05/13 02/11→05/13 09/08→05/10 05/09→05/13 04/08→05/13 04/08→10/09 04/08→05/13 04/08→05/13 04/08→05/13	←	+PR 1ZF		13.0460-7117.2 607117	VW 23130 19,6 + WK
			←	+PR 1LJ,1ZE		13.0470-7117.2 LD7117	VW 23130 19,6 + WK Ceramic
			←	+PR 1LJ,1ZE		13.0460-7184.2 607184	ATE 23587 20,6 + WK
			→	+PR 1KZ		13.0470-7184.2 LD7184	ATE 23587 20,6 + WK Ceramic
			→	+PR 1KZ		13.0460-2749.2 602749	TRW 24483 16,9 - WE / - WK + Zub
			→	+PR 1KZ		13.0460-2880.2 602880	TRW 23914 17,1 + WE / - WK + Zub
			→	+PR 1KZ		13.0470-2749.2 LD2749	TRW 24483 16,9 - WE / - WK + Zub Ceramic
			→	+PR 1KZ		13.0470-2880.2 LD2880	TRW 23914 17,1 + WE / - WK + Zub Ceramic
			→	+PR 1KD		13.0460-2820.2 602820	TRW 20961 17,2 - WK
			→	+PR 1KD		13.0470-2820.2 LD2820	TRW 20961 17,2 - WK Ceramic
			→	+PR 1KS		13.0460-3858.2 603858	BOS 24563 17,7 - WE / - WK + Zub
			→	+PR 1KS		13.0470-3858.2 LD3858	BOS 24563 17,7 - WE / - WK + Zub Ceramic
Zubehörsatz, Scheibenbremsbelag							
1.2 TFSI 1.4 TFSI ↓	77 92	03/10→05/13 02/11→05/13	→	+PR 1KZ		13.0460-0259.2 610259	

AUDI - A3 Cabriolet (8P7) 04/08→05/13

Zubehörsatz, Scheibenbremsbelag

1.6	75	09/08→05/10	➡	+PR 1KZ	13.0460-0259.2	610259	
1.6 TDI	77	05/09→05/13					
1.8 TFSI	118	04/08→05/13					
1.9 TDI	77	04/08→10/09					
2.0 TDI	100	04/08→05/13					
2.0 TDI	103	04/08→05/13					
2.0 TFSI	147	04/08→05/13					

Bremsscheibe

1.2 TFSI	77	03/10→05/13	←	+PR 1ZF	24.0122-0210.1	422210	Ø 280 22 19 V + S
1.4 TFSI	92	02/11→05/13			24.0322-0210.1	522210	Ø 280 22 19 V + S PD
1.6	75	09/08→05/10					
1.6 TDI	77	05/09→05/13	←	+PR 1ZE	24.0125-0145.1	425145	Ø 288 25 22 V + S
1.8 TFSI	118	04/08→05/13			24.0325-0145.1	525145	Ø 288 25 22 V + S PD
1.9 TDI	77	04/08→10/09					
2.0 TDI	100	04/08→05/13	←	+PR 1LJ	24.0125-0158.1	425158	Ø 312 25 22 V + S
2.0 TDI	103	04/08→05/13			24.0325-0158.1	525158	Ø 312 25 22 V + S PD
2.0 TFSI	147	04/08→05/13	➡	+PR 1KD	24.0110-0277.1	410277	Ø 253 10 8 + S
					24.0310-0277.1	510277	Ø 253 10 8 + S PD
			➡	+PR 1KS	24.0110-0356.1	410356	Ø 272 9,7 8 + S
					24.0310-0356.1	510356	Ø 272 9,7 8 + S PD
			➡	+PR 1KZ	24.0112-0169.1	412169	Ø 282 12 10 + S
					24.0312-0169.1	512169	Ø 282 12 10 + S PD

AUDI - A3 Cabriolet (8V7, 8VE) 10/13→







Bremsbelagsatz, Scheibenbremse







1.4 TFSI	85	02/16→	←	+PR 1ZA,1ZD,1ZE,1ZP	13.0460-2785.2	602785	TRW 25683 20,4 + WE / + WK
1.4 TFSI	92	02/14→			13.0470-2785.2	LD2785	TRW 25683 20,4 + WE / + WK Ceramic
1.4 TFSI	103	10/13→					
1.4 TFSI	110	05/14→					
1.6 TDI	81	02/14→	←	+PR 1ZF	13.0460-7303.2	607303	ATE 22035 17,5 + WK
1.8 TFSI	125	05/14→			13.0470-7303.2	LD7303	ATE 22035 17,5 + WK Ceramic
1.8 TFSI	132	10/13→					
1.8 TFSI quattro	132	03/14→	➡	+PR 1KE; + eFSB	13.0460-7293.2	607293	ATE 25008 16,3 - WE / - WK
2.0 TDI	100	10/13→			13.0470-7293.2	LD7293	ATE 25008 16,3 - WE / - WK Ceramic
2.0 TDI	110	10/13→					
2.0 TDI	135	05/14→	➡	+PR 1KJ,1KY; + eFSB	13.0460-7294.2	607294	ATE 25009 16,4 - WE / - WK
2.0 TDI quattro	110	03/14→			13.0470-7294.2	LD7294	ATE 25009 16,4 - WE / - WK Ceramic
2.0 TDI quattro	135	05/14→					
2.0 TFSI	140	05/16→					
2.0 TFSI quattro	140	05/16→					
2.0 TFSI quattro	162	05/14→					
S3 quattro	210	03/14→	➡	04/14→; +PR 1KE; + eFSB	13.0460-7293.2	607293	ATE 25008 16,3 - WE / - WK
					13.0470-7293.2	LD7293	ATE 25008 16,3 - WE / - WK Ceramic
			➡	04/14→; +PR 1KJ,1KY; + eFSB	13.0460-7294.2	607294	ATE 25009 16,4 - WE / - WK
					13.0470-7294.2	LD7294	ATE 25009 16,4 - WE / - WK Ceramic
S3 quattro	213	07/16→	➡	+PR 1KE; + eFSB	13.0460-7293.2	607293	ATE 25008 16,3 - WE / - WK
S3 quattro	221	04/14→			13.0470-7293.2	LD7293	ATE 25008 16,3 - WE / - WK Ceramic
S3 quattro	228	07/16→					
			➡	+PR 1KJ,1KY; + eFSB	13.0460-7294.2	607294	ATE 25009 16,4 - WE / - WK
					13.0470-7294.2	LD7294	ATE 25009 16,4 - WE / - WK Ceramic









Bremsscheibe









1.4 TFSI	85	02/16→	←	+PR 1ZF	24.0124-0258.1	424258	Ø 276 24 21 V + S
1.4 TFSI	92	02/14→					
1.4 TFSI	103	10/13→	←	+PR 1ZE,1ZP	24.0125-0145.1	425145	Ø 288 25 22 V + S
1.4 TFSI	110	05/14→			24.0325-0145.1	525145	Ø 288 25 22 V + S PD
1.6 TDI	81	02/14→	←	+PR 1ZA,1ZD	24.0125-0158.1	425158	Ø 312 25 22 V + S
1.8 TFSI	125	05/14→			24.0325-0158.1	525158	Ø 312 25 22 V + S PD
1.8 TFSI	132	10/13→					
1.8 TFSI quattro	132	03/14→	➡	+PR 1KE	24.0110-0356.1	410356	Ø 272 9,7 8 + S
2.0 TDI	100	10/13→			24.0310-0356.1	510356	Ø 272 9,7 8 + S PD
2.0 TDI	110	10/13→					
2.0 TDI	135	05/14→	➡	+PR 1KJ,1KY	24.0122-0219.1	422219	Ø 310 22 20 V
2.0 TDI quattro	110	03/14→					
2.0 TDI quattro	135	05/14→					
2.0 TFSI	140	05/16→					
2.0 TFSI quattro	140	05/16→					
2.0 TFSI quattro	162	05/14→					
S3 quattro	210	03/14→	←	04/14→; +PR 1LC,1LJ	24.0130-0225.1	430225	Ø 340 30 27 V + S
			➡	04/14→; +PR 1KE	24.0110-0356.1	410356	Ø 272 9,7 8 + S
					24.0310-0356.1	510356	Ø 272 9,7 8 + S PD

↓







	kw			 	! #		
AUDI - A3 Cabriolet (8V7, 8VE) 10/13→							
Bremsscheibe							
S3 quattro	210	03/14→	➡	04/14→; +PR 1KJ,1KY		24.0122-0219.1 422219	Ø 310 22 20 V
S3 quattro	213	07/16→	←	+PR 1LC,1LJ		24.0130-0225.1 430225	Ø 340 30 27 V + S
S3 quattro	221	04/14→	➡	+PR 1KE		24.0110-0356.1 410356	Ø 272 9,7 8 + S
S3 quattro	228	07/16→	➡	+PR 1KJ,1KY		24.0310-0356.1 510356	Ø 272 9,7 8 + S PD
			➡	+PR 1KJ,1KY		24.0122-0219.1 422219	Ø 310 22 20 V
AUDI - A3 Limousine (8VS, 8VM) 05/13→							
Bremsbelagsatz, Scheibenbremse							
1.0 TFSI	85	07/16→	←	+PR 1ZA,1ZD,1ZE,1ZP		13.0460-2785.2 602785	TRW 25683 20,4 + WE / + WK
2.0 TFSI	140	05/16→				13.0470-2785.2 LD2785	TRW 25683 20,4 + WE / + WK Ceramic
2.0 TFSI quattro	140	05/16→	➡	+PR 1KE; + eFSB		13.0460-7293.2 607293	ATE 25008 16,3 - WE / - WK
						13.0470-7293.2 LD7293	ATE 25008 16,3 - WE / - WK Ceramic
			➡	+PR 1KJ,1KY,2ED; + eFSB		13.0460-7294.2 607294	ATE 25009 16,4 - WE / - WK
						13.0470-7294.2 LD7294	ATE 25009 16,4 - WE / - WK Ceramic
1.2 TFSI	77	10/13→	←	+PR 1ZA,1ZD,1ZE,1ZP		13.0460-2785.2 602785	TRW 25683 20,4 + WE / + WK
1.2 TFSI	81	05/14→				13.0470-2785.2 LD2785	TRW 25683 20,4 + WE / + WK Ceramic
1.4 TFSI	90	09/13→					
1.4 TFSI	92	09/13→	←	+PR 1ZF		13.0460-7303.2 607303	ATE 22035 17,5 + WK
1.4 TFSI	103	05/13→				13.0470-7303.2 LD7303	ATE 22035 17,5 + WK Ceramic
1.4 TFSI	110	05/14→					
1.6 TDI	77	09/13→	➡	+PR 1KE; + eFSB		13.0460-7293.2 607293	ATE 25008 16,3 - WE / - WK
1.6 TDI	81	05/14→				13.0470-7293.2 LD7293	ATE 25008 16,3 - WE / - WK Ceramic
1.6 TDI	85	03/17→					
1.6 TDI quattro	81	05/15→	➡	+PR 1KJ,1KY,2ED; + eFSB		13.0460-7294.2 607294	ATE 25009 16,4 - WE / - WK
1.8 TFSI	125	11/13→				13.0470-7294.2 LD7294	ATE 25009 16,4 - WE / - WK Ceramic
1.8 TFSI	132	05/13→					
1.8 TFSI quattro	132	11/13→					
2.0 TDI	81	05/13→					
2.0 TDI	100	09/13→					
2.0 TDI	105	10/13→					
2.0 TDI	110	05/13→					
2.0 TDI	135	05/14→					
2.0 TDI quattro	110	10/13→					
2.0 TDI quattro	135	05/14→					
S3 quattro	206	10/13→	➡	+PR 1KE; + eFSB		13.0460-7293.2 607293	ATE 25008 16,3 - WE / - WK
S3 quattro	210	05/14→				13.0470-7293.2 LD7293	ATE 25008 16,3 - WE / - WK Ceramic
S3 quattro	213	08/16→					
S3 quattro	221	10/13→	➡	+PR 1KJ,1KY,2ED; + eFSB		13.0460-7294.2 607294	ATE 25009 16,4 - WE / - WK
S3 quattro	228	06/16→				13.0470-7294.2 LD7294	ATE 25009 16,4 - WE / - WK Ceramic
Warnkontakt, Bremsbelagsverschleiß							
1.0 TFSI	85	07/16→	←	+PR 1ZA,1ZD,1ZE,1ZP	1	24.8190-0065.2 620065	L= 172
1.2 TFSI	77	10/13→					
1.2 TFSI	81	05/14→					
1.4 TFSI	90	09/13→					
1.4 TFSI	92	09/13→					
1.4 TFSI	103	05/13→					
1.4 TFSI	110	05/14→					
1.6 TDI	77	09/13→					
1.6 TDI	81	05/14→					
1.6 TDI	85	03/17→					
1.6 TDI quattro	81	05/15→					
1.8 TFSI	125	11/13→					
1.8 TFSI	132	05/13→					
1.8 TFSI quattro	132	11/13→					
2.0 TDI	81	05/13→					
2.0 TDI	100	09/13→					
2.0 TDI	105	10/13→					
2.0 TDI	110	05/13→					
2.0 TDI	135	05/14→					
2.0 TDI quattro	110	10/13→					
2.0 TDI quattro	135	05/14→					
2.0 TFSI	140	05/16→					
2.0 TFSI quattro	140	05/16→					
S3 quattro	206	10/13→	←	+PR 1LC,1LJ	1	24.8190-0065.2 620065	L= 172
S3 quattro	210	05/14→					
S3 quattro	213	08/16→					
S3 quattro	221	10/13→					
S3 quattro	228	06/16→					
↓							









	kw			 	! #		
AUDI - A3 Limousine (8VS, 8VM) 05/13→							
Bremsscheibe							
1.0 TFSI 2.0 TFSI	85 140	07/16→ 05/16→	←	+PR 1ZE,1ZP	24.0125-0145.1 425145	Ø 288 25 22 V + S	
			←	+PR 1ZA,1ZD	24.0325-0145.1 525145	Ø 288 25 22 V + S PD	
			←	+PR 1ZE,1ZP	24.0125-0158.1 425158	Ø 312 25 22 V + S	
			←	+PR 1ZA,1ZD	24.0325-0158.1 525158	Ø 312 25 22 V + S PD	
			→	+PR 1KE	24.0110-0356.1 410356	Ø 272 9,7 8 + S	
			→	+PR 2ED; + eFSB	24.0310-0356.1 510356	Ø 272 9,7 8 + S PD	
			→	+PR 1KJ,1KY; + eFSB	24.0112-0210.1 412210	Ø 300 12 10 + S	
			→	+PR 1KJ,1KY; + eFSB	24.0122-0219.1 422219	Ø 310 22 20 V	
1.2 TFSI 1.2 TFSI 1.4 TFSI 1.4 TFSI 1.4 TFSI 1.6 TDI 1.6 TDI 1.6 TDI 1.6 TDI quattro 1.8 TFSI 1.8 TFSI 1.8 TFSI quattro 2.0 TDI 2.0 TDI 2.0 TDI 2.0 TDI 2.0 TDI 2.0 TDI 2.0 TDI quattro 2.0 TDI quattro	77 81 90 92 103 110 77 81 85 81 125 132 132 81 100 105 110 135 110 135	10/13→ 05/14→ 09/13→ 09/13→ 05/13→ 05/14→ 09/13→ 05/14→ 03/17→ 05/15→ 11/13→ 05/13→ 11/13→ 05/13→ 09/13→ 10/13→ 05/13→ 05/14→ 10/13→ 05/14→	←	+PR 1ZF	24.0124-0258.1 424258	Ø 276 24 21 V + S	
			←	+PR 1ZE,1ZP	24.0125-0145.1 425145	Ø 288 25 22 V + S	
			←	+PR 1ZA,1ZD	24.0325-0145.1 525145	Ø 288 25 22 V + S PD	
			←	+PR 1ZE,1ZP	24.0125-0158.1 425158	Ø 312 25 22 V + S	
			←	+PR 1ZA,1ZD	24.0325-0158.1 525158	Ø 312 25 22 V + S PD	
			→	+PR 1KE	24.0110-0356.1 410356	Ø 272 9,7 8 + S	
			→	+PR 2ED; + eFSB	24.0310-0356.1 510356	Ø 272 9,7 8 + S PD	
			→	+PR 1KJ,1KY; + eFSB	24.0112-0210.1 412210	Ø 300 12 10 + S	
			→	+PR 1KJ,1KY; + eFSB	24.0122-0219.1 422219	Ø 310 22 20 V	
2.0 TFSI quattro	140	05/16→	←	+PR 1ZE,1ZP	24.0125-0145.1 425145	Ø 288 25 22 V + S	
			←	+PR 1ZA,1ZD	24.0325-0145.1 525145	Ø 288 25 22 V + S PD	
			←	+PR 1ZE,1ZP	24.0125-0158.1 425158	Ø 312 25 22 V + S	
			←	+PR 1ZA,1ZD	24.0325-0158.1 525158	Ø 312 25 22 V + S PD	
			→	+PR 1KE	24.0110-0356.1 410356	Ø 272 9,7 8 + S	
			→	+PR 2ED; + eFSB	24.0310-0356.1 510356	Ø 272 9,7 8 + S PD	
			→	+PR 1KJ,1KY; + eFSB	24.0122-0219.1 422219	Ø 310 22 20 V	
S3 quattro S3 quattro S3 quattro S3 quattro S3 quattro	206 210 213 221 228	10/13→ 05/14→ 08/16→ 10/13→ 06/16→	←	+PR 1LC,1LJ	24.0130-0225.1 430225	Ø 340 30 27 V + S	
			→	+PR 1KE	24.0110-0356.1 410356	Ø 272 9,7 8 + S	
			→	+PR 2ED; + eFSB	24.0310-0356.1 510356	Ø 272 9,7 8 + S PD	
			→	+PR 1KJ,1KY; + eFSB	24.0112-0210.1 412210	Ø 300 12 10 + S	
			→	+PR 1KJ,1KY; + eFSB	24.0122-0219.1 422219	Ø 310 22 20 V	
AUDI - A3 Sportback (8PA) 09/04→03/13							
Bremsbelagsatz, Scheibenbremse							
1.2 TSI 1.6 TDI 1.6 TDI	77 66 77	04/10→03/13 05/09→03/13 05/09→03/13	←	+PR 1ZF,1ZM	13.0460-7117.2 607117	VW 23130 19,6 + WK	
			←	+PR 1ZE,1ZP,1ZD,1LJ / 1ZA	13.0470-7117.2 LD7117	VW 23130 19,6 + WK Ceramic	
			←	+PR 1ZE,1ZP,1ZD,1LJ / 1ZA	13.0460-7184.2 607184	ATE 23587 20,6 + WK	
			←	+PR 1LK	13.0470-7184.2 LD7184	ATE 23587 20,6 + WK Ceramic	
			←	+PR 1LK	13.0460-7200.2 607200	ATE 23801 20,3 + WK	
			←	+PR 1LK	13.0470-7200.2 LD7200	ATE 23801 20,3 + WK Ceramic	
			→	+PR 1KE,1KZ	13.0460-2749.2 602749	TRW 24483 16,9 - WE / - WK + Zub	
			→	+PR 1KE,1KZ	13.0460-2880.2 602880	TRW 23914 17,1 + WE / - WK + Zub	
			→	+PR 1KE,1KZ	13.0470-2749.2 LD2749	TRW 24483 16,9 - WE / - WK + Zub Ceramic	
			→	+PR 1KE,1KZ	13.0470-2880.2 LD2880	TRW 23914 17,1 + WE / - WK + Zub Ceramic	
			→	+PR 1KQ,1KD	13.0460-2820.2 602820	TRW 20961 17,2 - WK	
			→	+PR 1KQ,1KD	13.0470-2820.2 LD2820	TRW 20961 17,2 - WK Ceramic	
			→	+PR 1KS	13.0460-3858.2 603858	BOS 24563 17,7 - WE / - WK + Zub	
			→	+PR 1KS	13.0470-3858.2 LD3858	BOS 24563 17,7 - WE / - WK + Zub Ceramic	
1.4 TFSI 2.0 TDI	92 125	09/07→03/13 03/06→03/13	←	+PR 1ZF,1ZM	13.0460-7117.2 607117	VW 23130 19,6 + WK	
			←	+PR 1ZE,1ZP,1ZD,1LJ / 1ZA	13.0470-7117.2 LD7117	VW 23130 19,6 + WK Ceramic	
			←	+PR 1ZE,1ZP,1ZD,1LJ / 1ZA	13.0460-7184.2 607184	ATE 23587 20,6 + WK	
			←	+PR 1ZE,1ZP,1ZD,1LJ / 1ZA	13.0470-7184.2 LD7184	ATE 23587 20,6 + WK Ceramic	

	kw			 	! #		
AUDI - A3 Sportback (8PA) 09/04→03/13							
 Bremsbelagsatz, Scheibenbremse							
1.4 TFSI 2.0 TDI	92 125	09/07→03/13 03/06→03/13	←	+PR 1LK	13.0460-7200.2	607200	ATE 23801 20,3 + WK
					13.0470-7200.2	LD7200	ATE 23801 20,3 + WK Ceramic
			→	+PR 1KE;1KZ	13.0460-2749.2	602749	TRW 24483 16,9 - WE / - WK + Zub
					13.0460-2880.2	602880	TRW 23914 17,1 + WE / - WK + Zub
					13.0470-2749.2	LD2749	TRW 24483 16,9 - WE / - WK + Zub Ceramic
				13.0470-2880.2	LD2880	TRW 23914 17,1 + WE / - WK + Zub Ceramic	
			→	+PR 1KQ;1KD	13.0460-2820.2	602820	TRW 20961 17,2 - WK
					13.0470-2820.2	LD2820	TRW 20961 17,2 - WK Ceramic
			→	+PR 1KS	13.0460-3858.2	603858	BOS 24563 17,7 - WE / - WK + Zub
					13.0470-3858.2	LD3858	BOS 24563 17,7 - WE / - WK + Zub Ceramic
1.6 1.6 E-Power 1.6 FSI 1.9 TDI 2.0 FSI 2.0 TDI 2.0 TDI 2.0 TDI 16V 2.0 TFSI	75 75 85 77 110 100 103 103 147	09/04→03/13 01/11→03/13 09/04→09/07 09/04→05/10 09/04→06/08 09/04→03/13 06/05→06/08 09/04→03/13 09/04→03/13	←	+PR 1ZF;1ZM	13.0460-7117.2	607117	VW 23130 19,6 + WK
					13.0470-7117.2	LD7117	VW 23130 19,6 + WK Ceramic
			←	+PR 1ZE;1ZP;1ZD;1LJ / 1ZA	13.0460-7184.2	607184	ATE 23587 20,6 + WK
					13.0470-7184.2	LD7184	ATE 23587 20,6 + WK Ceramic
			←	+PR 1LK	13.0460-7200.2	607200	ATE 23801 20,3 + WK
					13.0470-7200.2	LD7200	ATE 23801 20,3 + WK Ceramic
			→	+PR 1KE;1KZ	13.0460-2749.2	602749	TRW 24483 16,9 - WE / - WK + Zub
					13.0460-2880.2	602880	TRW 23914 17,1 + WE / - WK + Zub
					13.0470-2749.2	LD2749	TRW 24483 16,9 - WE / - WK + Zub Ceramic
							13.0470-2880.2
			→	+PR 1KQ;1KD	13.0460-2820.2	602820	TRW 20961 17,2 - WK
					13.0470-2820.2	LD2820	TRW 20961 17,2 - WK Ceramic
			→	+PR 1KS	13.0460-3858.2	603858	BOS 24563 17,7 - WE / - WK + Zub
					13.0470-3858.2	LD3858	BOS 24563 17,7 - WE / - WK + Zub Ceramic
1.8 TFSI	118	11/06→03/13	←	01/07→; +PR 1ZF;1ZM	13.0460-7117.2	607117	VW 23130 19,6 + WK
					13.0470-7117.2	LD7117	VW 23130 19,6 + WK Ceramic
			←	01/07→; +PR 1ZE;1ZP;1ZD;1LJ / 1ZA	13.0460-7184.2	607184	ATE 23587 20,6 + WK
					13.0470-7184.2	LD7184	ATE 23587 20,6 + WK Ceramic
			←	01/07→; +PR 1LK	13.0460-7200.2	607200	ATE 23801 20,3 + WK
					13.0470-7200.2	LD7200	ATE 23801 20,3 + WK Ceramic
			→	01/07→; +PR 1KE;1KZ	13.0460-2749.2	602749	TRW 24483 16,9 - WE / - WK + Zub
				13.0460-2880.2	602880	TRW 23914 17,1 + WE / - WK + Zub	
				13.0470-2749.2	LD2749	TRW 24483 16,9 - WE / - WK + Zub Ceramic	
					13.0470-2880.2	LD2880	TRW 23914 17,1 + WE / - WK + Zub Ceramic
			→	01/07→; +PR 1KQ;1KD	13.0460-2820.2	602820	TRW 20961 17,2 - WK
					13.0470-2820.2	LD2820	TRW 20961 17,2 - WK Ceramic
			→	01/07→; +PR 1KS	13.0460-3858.2	603858	BOS 24563 17,7 - WE / - WK + Zub
					13.0470-3858.2	LD3858	BOS 24563 17,7 - WE / - WK + Zub Ceramic
1.8 TFSI quattro	118	07/08→03/13	←	+PR 1ZF;1ZM	13.0460-7117.2	607117	VW 23130 19,6 + WK
					13.0470-7117.2	LD7117	VW 23130 19,6 + WK Ceramic
			←	+PR 1ZE;1ZP;1ZD;1LJ / 1ZA	13.0460-7184.2	607184	ATE 23587 20,6 + WK
					13.0470-7184.2	LD7184	ATE 23587 20,6 + WK Ceramic
			←	+PR 1LK	13.0460-7200.2	607200	ATE 23801 20,3 + WK
				13.0470-7200.2	LD7200	ATE 23801 20,3 + WK Ceramic	
			→	+PR 1KF;1KJ;1KU	13.0460-2749.2	602749	TRW 24483 16,9 - WE / - WK + Zub
					13.0460-2880.2	602880	TRW 23914 17,1 + WE / - WK + Zub







	kw			 	! #		
AUDI - A3 Sportback (8PA) 09/04→03/13							
 Bremsbelagsatz, Scheibenbremse							
1.8 TFSI quattro	118	07/08→03/13	➡	+PR 1KF;1KJ;1KU	13.0470-2749.2	LD2749	TRW 24483 16,9 - WE / - WK + Zub Ceramic
					13.0470-2880.2	LD2880	TRW 23914 17,1 + WE / - WK + Zub Ceramic
			➡	+PR 1KS	13.0460-3858.2	603858	BOS 24563 17,7 - WE / - WK + Zub
				13.0470-3858.2	LD3858	BOS 24563 17,7 - WE / - WK + Zub Ceramic	
2.0 TDI	120	06/06→06/08	←	+PR 1ZF; 1ZM	13.0460-7117.2	607117	VW 23130 19,6 + WK
					13.0470-7117.2	LD7117	VW 23130 19,6 + WK Ceramic
			←	+PR 1ZE;1ZP;1ZD;1LJ / 1ZA	13.0460-7184.2	607184	ATE 23587 20,6 + WK
					13.0470-7184.2	LD7184	ATE 23587 20,6 + WK Ceramic
			←	+PR 1LK	13.0460-7200.2	607200	ATE 23801 20,3 + WK
					13.0470-7200.2	LD7200	ATE 23801 20,3 + WK Ceramic
			➡	+PR 1KE; 1KZ	13.0460-2749.2	602749	TRW 24483 16,9 - WE / - WK + Zub
					13.0460-2880.2	602880	TRW 23914 17,1 + WE / - WK + Zub
				13.0470-2749.2	LD2749	TRW 24483 16,9 - WE / - WK + Zub Ceramic	
				13.0470-2880.2	LD2880	TRW 23914 17,1 + WE / - WK + Zub Ceramic	
			➡	+PR 1KQ; 1KD	13.0460-2820.2	602820	TRW 20961 17,2 - WK
					13.0470-2820.2	LD2820	TRW 20961 17,2 - WK Ceramic
			➡	+PR 1KS	13.0460-3858.2	603858	BOS 24563 17,7 - WE / - WK + Zub
					13.0470-3858.2	LD3858	BOS 24563 17,7 - WE / - WK + Zub Ceramic
2.0 TDI 16V quattro 2.0 TDI quattro 2.0 TFSI quattro	103 103 147	11/05→03/13 01/06→06/08 09/04→03/13	←	+PR 1ZF;1ZM	13.0460-7117.2	607117	VW 23130 19,6 + WK
					13.0470-7117.2	LD7117	VW 23130 19,6 + WK Ceramic
			←	+PR 1ZE;1ZP;1ZD;1LJ / 1ZA	13.0460-7184.2	607184	ATE 23587 20,6 + WK
					13.0470-7184.2	LD7184	ATE 23587 20,6 + WK Ceramic
			←	+PR 1LK	13.0460-7200.2	607200	ATE 23801 20,3 + WK
					13.0470-7200.2	LD7200	ATE 23801 20,3 + WK Ceramic
			➡	+PR 1KF;1KJ;1KU	13.0460-2749.2	602749	TRW 24483 16,9 - WE / - WK + Zub
					13.0460-2880.2	602880	TRW 23914 17,1 + WE / - WK + Zub
					13.0470-2749.2	LD2749	TRW 24483 16,9 - WE / - WK + Zub Ceramic
					13.0470-2880.2	LD2880	TRW 23914 17,1 + WE / - WK + Zub Ceramic
			➡	+PR 1KS	13.0460-3858.2	603858	BOS 24563 17,7 - WE / - WK + Zub
					13.0470-3858.2	LD3858	BOS 24563 17,7 - WE / - WK + Zub Ceramic
2.0 TDI quattro	125	03/06→03/13	←	+PR 1ZF;1ZM	13.0460-7117.2	607117	VW 23130 19,6 + WK
					13.0470-7117.2	LD7117	VW 23130 19,6 + WK Ceramic
			←	+PR 1ZE;1ZP;1ZD;1LJ / 1ZA	13.0460-7184.2	607184	ATE 23587 20,6 + WK
					13.0470-7184.2	LD7184	ATE 23587 20,6 + WK Ceramic
			←	+PR 1LK	13.0460-7200.2	607200	ATE 23801 20,3 + WK
				13.0470-7200.2	LD7200	ATE 23801 20,3 + WK Ceramic	
			➡	+PR 1KF;1KJ;1KU	13.0460-2749.2	602749	TRW 24483 16,9 - WE / - WK + Zub
					13.0460-2880.2	602880	TRW 23914 17,1 + WE / - WK + Zub
					13.0470-2749.2	LD2749	TRW 24483 16,9 - WE / - WK + Zub Ceramic
					13.0470-2880.2	LD2880	TRW 23914 17,1 + WE / - WK + Zub Ceramic
			➡	+PR 1KS	13.0460-3858.2	603858	BOS 24563 17,7 - WE / - WK + Zub
					13.0470-3858.2	LD3858	BOS 24563 17,7 - WE / - WK + Zub Ceramic
3.2 V6 quattro	184	09/04→05/09	←	03/06→; +PR 1ZF;1ZM	13.0460-7117.2	607117	VW 23130 19,6 + WK
					13.0470-7117.2	LD7117	VW 23130 19,6 + WK Ceramic
			←	03/06→; +PR 1ZE;1ZP;1ZD;1LJ / 1ZA	13.0460-7184.2	607184	ATE 23587 20,6 + WK

















	kw			 	! #		
AUDI - A3 Sportback (8PA) 09/04→03/13							
Bremsbelagsatz, Scheibenbremse							
3.2 V6 quattro	184	09/04→05/09	←	03/06→; +PR 1ZE;1ZP;1ZD;1LJ / 1ZA		13.0470-7184.2 LD7184	ATE 23587 20,6 + WK Ceramic
			←	03/06→; +PR 1LK		13.0460-7200.2 607200	ATE 23801 20,3 + WK
						13.0470-7200.2 LD7200	ATE 23801 20,3 + WK Ceramic
			→	+PR 1KF,1KJ,1KU		13.0460-2749.2 602749	TRW 24483 16,9 - WE / - WK + Zub
						13.0460-2880.2 602880	TRW 23914 17,1 + WE / - WK + Zub
						13.0470-2749.2 LD2749	TRW 24483 16,9 - WE / - WK + Zub Ceramic
			13.0470-2880.2 LD2880	TRW 23914 17,1 + WE / - WK + Zub Ceramic			
			→	+PR 2EA		13.0460-2749.2 602749	TRW 24483 16,9 - WE / - WK + Zub
						13.0460-2880.2 602880	TRW 23914 17,1 + WE / - WK + Zub
						13.0470-2749.2 LD2749	TRW 24483 16,9 - WE / - WK + Zub Ceramic
						13.0470-2880.2 LD2880	TRW 23914 17,1 + WE / - WK + Zub Ceramic
			→	+PR 1KS		13.0460-3858.2 603858	BOS 24563 17,7 - WE / - WK + Zub
						13.0470-3858.2 LD3858	BOS 24563 17,7 - WE / - WK + Zub Ceramic
RS3 quattro	250	01/11→12/12	←	04/11→; +PR 1LG		13.0460-4833.2 604833	BRE 24098 17,1 + WE / - WK
			→	04/11→		13.0460-2749.2 602749	TRW 24483 16,9 - WE / - WK + Zub
						13.0460-2880.2 602880	TRW 23914 17,1 + WE / - WK + Zub
						13.0470-2749.2 LD2749	TRW 24483 16,9 - WE / - WK + Zub Ceramic
						13.0470-2880.2 LD2880	TRW 23914 17,1 + WE / - WK + Zub Ceramic
S3 quattro S3 quattro	188 195	07/08→03/13 06/08→03/13	←	+PR 1ZK		13.0460-7227.2 607227	ATE 23801 20,3 + WK
						13.0470-7227.2 LD7227	ATE 23912 20,3 + WK Ceramic
			→	+PR 1KW		13.0460-2749.2 602749	TRW 24483 16,9 - WE / - WK + Zub
						13.0460-2880.2 602880	TRW 23914 17,1 + WE / - WK + Zub
						13.0470-2749.2 LD2749	TRW 24483 16,9 - WE / - WK + Zub Ceramic
						13.0470-2880.2 LD2880	TRW 23914 17,1 + WE / - WK + Zub Ceramic
Warnkontakt, Bremsbelagverschleiß							
RS3 quattro	250	01/11→12/12	←	04/11→; +PR 1LG	1	24.8190-0302.2 620302	L= 367,4
Zubehörsatz, Scheibenbremsbelag							
1.2 TSI	77	04/10→03/13	→	+PR 1KE,1KZ		13.0460-0259.2 610259	
1.6 TDI	66	05/09→03/13					
1.6 TDI	77	05/09→03/13					
1.4 TFSI	92	09/07→03/13	→	+PR 1KE;1KZ		13.0460-0259.2 610259	
1.6	75	09/04→03/13					
1.6 E-Power	75	01/11→03/13					
1.6 FSI	85	09/04→09/07					
1.9 TDI	77	09/04→05/10					
2.0 FSI	110	09/04→06/08					
2.0 TDI	100	09/04→03/13					
2.0 TDI	103	06/05→06/08					
2.0 TDI	125	03/06→03/13					
2.0 TDI 16V	103	09/04→03/13					
2.0 TFSI	147	09/04→03/13					
1.8 TFSI	118	11/06→03/13	→	01/07→; +PR 1KE;1KZ		13.0460-0259.2 610259	
1.8 TFSI quattro	118	07/08→03/13	→	+PR 1KF,1KJ,1KU		13.0460-0259.2 610259	
2.0 TDI	120	06/06→06/08	→	+PR 1KE; 1KZ		13.0460-0259.2 610259	
2.0 TDI 16V quattro	103	11/05→03/13	→	+PR 1KF;1KJ;1KU		13.0460-0259.2 610259	
2.0 TDI quattro	103	01/06→06/08					
2.0 TDI quattro	125	03/06→03/13					
2.0 TFSI quattro	147	09/04→03/13					
3.2 V6 quattro	184	09/04→05/09	→	+PR 2EA		13.0460-0035.2 610035	
			→	+PR 1KF,1KJ,1KU		13.0460-0259.2 610259	
↓							

	kw			 	! #		
AUDI - A3 Sportback (8PA) 09/04→03/13							
Zubehörsatz, Scheibenbremsbelag							
RS3 quattro	250	01/11→12/12	➡	04/11→		13.0460-0035.2 610035	
S3 quattro	188	07/08→03/13	➡	+PR 1KW		13.0460-0035.2 610035	
S3 quattro	195	06/08→03/13					
 Bremsscheibe							
1.2 TSI	77	04/10→03/13	←	+PR 1ZF,1ZM		24.0122-0210.1 422210	Ø 280 22 19 V + S
1.6 TDI	66	05/09→03/13				24.0322-0210.1 522210	Ø 280 22 19 V + S PD
1.6 TDI	77	05/09→03/13	←	+PR 1ZE,1ZP		24.0125-0145.1 425145	Ø 288 25 22 V + S
						24.0325-0145.1 525145	Ø 288 25 22 V + S PD
			←	+PR 1ZD,1LJ,1ZA		24.0125-0158.1 425158	Ø 312 25 22 V + S
						24.0325-0158.1 525158	Ø 312 25 22 V + S PD
			←	+PR 1LK		24.0130-0115.1 430115	Ø 345 30 27 V
						24.0330-0115.1 530115	Ø 345 30 27 V PD
			➡	+PR 1KQ,1KD		24.0110-0277.1 410277	Ø 253 10 8 + S
						24.0310-0277.1 510277	Ø 253 10 8 + S PD
			➡	+PR 1KS		24.0110-0356.1 410356	Ø 272 9,7 8 + S
						24.0310-0356.1 510356	Ø 272 9,7 8 + S PD
			➡	+PR 1KE		24.0112-0158.1 412158	Ø 256 12 10 + S
						24.0312-0158.1 512158	Ø 256 12 10 PD
			➡	+PR 1KZ		24.0112-0169.1 412169	Ø 282 12 10 + S
						24.0312-0169.1 512169	Ø 282 12 10 + S PD
1.4 TFSI	92	09/07→03/13	←	+PR 1ZF,1ZM		24.0122-0210.1 422210	Ø 280 22 19 V + S
1.6	75	09/04→03/13				24.0322-0210.1 522210	Ø 280 22 19 V + S PD
1.6 E-Power	75	01/11→03/13	←	+PR 1ZE,1ZP		24.0125-0145.1 425145	Ø 288 25 22 V + S
1.6 FSI	85	09/04→09/07				24.0325-0145.1 525145	Ø 288 25 22 V + S PD
1.9 TDI	77	09/04→05/10					
2.0 FSI	110	09/04→06/08	←	+PR 1ZD,1LJ,1ZA		24.0125-0158.1 425158	Ø 312 25 22 V + S
2.0 TDI	100	09/04→03/13				24.0325-0158.1 525158	Ø 312 25 22 V + S PD
2.0 TDI	103	06/05→06/08					
2.0 TDI 16V	103	09/04→03/13	←	+PR 1LK		24.0130-0115.1 430115	Ø 345 30 27 V
2.0 TFSI	147	09/04→03/13				24.0330-0115.1 530115	Ø 345 30 27 V PD
			➡	+PR 1KQ;1KD		24.0110-0277.1 410277	Ø 253 10 8 + S
						24.0310-0277.1 510277	Ø 253 10 8 + S PD
			➡	+PR 1KS		24.0110-0356.1 410356	Ø 272 9,7 8 + S
						24.0310-0356.1 510356	Ø 272 9,7 8 + S PD
			➡	+PR 1KE		24.0112-0158.1 412158	Ø 256 12 10 + S
						24.0312-0158.1 512158	Ø 256 12 10 PD
			➡	+PR 1KZ		24.0112-0169.1 412169	Ø 282 12 10 + S
						24.0312-0169.1 512169	Ø 282 12 10 + S PD
1.8 TFSI	118	11/06→03/13	←	01/07→; +PR 1ZF,1ZM		24.0122-0210.1 422210	Ø 280 22 19 V + S
						24.0322-0210.1 522210	Ø 280 22 19 V + S PD
			←	01/07→; +PR 1ZE,1ZP		24.0125-0145.1 425145	Ø 288 25 22 V + S
						24.0325-0145.1 525145	Ø 288 25 22 V + S PD
			←	01/07→; +PR 1ZD,1LJ,1ZA		24.0125-0158.1 425158	Ø 312 25 22 V + S
						24.0325-0158.1 525158	Ø 312 25 22 V + S PD
			←	01/07→; +PR 1LK		24.0130-0115.1 430115	Ø 345 30 27 V
						24.0330-0115.1 530115	Ø 345 30 27 V PD
			➡	01/07→; +PR 1KQ;1KD		24.0110-0277.1 410277	Ø 253 10 8 + S
						24.0310-0277.1 510277	Ø 253 10 8 + S PD
			➡	01/07→; +PR 1KS		24.0110-0356.1 410356	Ø 272 9,7 8 + S
						24.0310-0356.1 510356	Ø 272 9,7 8 + S PD
			➡	01/07→; +PR 1KE		24.0112-0158.1 412158	Ø 256 12 10 + S
						24.0312-0158.1 512158	Ø 256 12 10 PD
			➡	01/07→; +PR 1KZ		24.0112-0169.1 412169	Ø 282 12 10 + S
						24.0312-0169.1 512169	Ø 282 12 10 + S PD
1.8 TFSI quattro	118	07/08→03/13	←	+PR 1ZF,1ZM		24.0122-0210.1 422210	Ø 280 22 19 V + S
						24.0322-0210.1 522210	Ø 280 22 19 V + S PD
			←	+PR 1ZE,1ZP		24.0125-0145.1 425145	Ø 288 25 22 V + S
						24.0325-0145.1 525145	Ø 288 25 22 V + S PD
			←	+PR 1ZD,1LJ,1ZA		24.0125-0158.1 425158	Ø 312 25 22 V + S
						24.0325-0158.1 525158	Ø 312 25 22 V + S PD
			←	+PR 1LK		24.0130-0115.1 430115	Ø 345 30 27 V
						24.0330-0115.1 530115	Ø 345 30 27 V PD
			➡	+PR 1KS		24.0110-0356.1 410356	Ø 272 9,7 8 + S



















	kw			 	! #		
AUDI - A3 Sportback (8PA) 09/04→03/13							
Bremsscheibe							
1.8 TFSI quattro	118	07/08→03/13	➡	+PR 1KS	24.0310-0356.1	510356	Ø 272 9,7 8 + S PD
			➡	+PR 1KJ	24.0112-0169.1	412169	Ø 282 12 10 + S
					24.0312-0169.1	512169	Ø 282 12 10 + S PD
2.0 TDI	120	06/06→06/08	←	+PR 1ZF; 1ZM	24.0122-0210.1	422210	Ø 280 22 19 V + S
					24.0322-0210.1	522210	Ø 280 22 19 V + S PD
			←	+PR 1ZE; 1ZP	24.0125-0145.1	425145	Ø 288 25 22 V + S
					24.0325-0145.1	525145	Ø 288 25 22 V + S PD
			←	+PR 1ZD,1LJ,1ZA	24.0125-0158.1	425158	Ø 312 25 22 V + S
					24.0325-0158.1	525158	Ø 312 25 22 V + S PD
			←	+PR 1LK	24.0130-0115.1	430115	Ø 345 30 27 V
					24.0330-0115.1	530115	Ø 345 30 27 V PD
			➡	+PR 1KQ, 1KD	24.0110-0277.1	410277	Ø 253 10 8 + S
					24.0310-0277.1	510277	Ø 253 10 8 + S PD
2.0 TDI	125	03/06→03/13	←	+PR 1ZF;1ZM	24.0122-0210.1	422210	Ø 280 22 19 V + S
					24.0322-0210.1	522210	Ø 280 22 19 V + S PD
			←	+PR 1ZE;1ZP	24.0125-0145.1	425145	Ø 288 25 22 V + S
					24.0325-0145.1	525145	Ø 288 25 22 V + S PD
			←	+PR 1ZD,1LJ,1ZA	24.0125-0158.1	425158	Ø 312 25 22 V + S
					24.0325-0158.1	525158	Ø 312 25 22 V + S PD
			←	+PR 1ZD;1LJ	24.0130-0115.1	430115	Ø 345 30 27 V
					24.0330-0115.1	530115	Ø 345 30 27 V PD
			➡	+PR 1KQ;1KD	24.0110-0277.1	410277	Ø 253 10 8 + S
					24.0310-0277.1	510277	Ø 253 10 8 + S PD
2.0 TDI 16V quattro 2.0 TDI quattro 2.0 TFSI quattro	103 103 147	11/05→03/13 01/06→06/08 09/04→03/13	←	+PR 1ZF;1ZM	24.0122-0210.1	422210	Ø 280 22 19 V + S
					24.0322-0210.1	522210	Ø 280 22 19 V + S PD
			←	+PR 1ZE;1ZP	24.0125-0145.1	425145	Ø 288 25 22 V + S
					24.0325-0145.1	525145	Ø 288 25 22 V + S PD
			←	+PR 1ZD,1LJ,1ZA	24.0125-0158.1	425158	Ø 312 25 22 V + S
					24.0325-0158.1	525158	Ø 312 25 22 V + S PD
			←	+PR 1LK	24.0130-0115.1	430115	Ø 345 30 27 V
					24.0330-0115.1	530115	Ø 345 30 27 V PD
			➡	+PR 1KS	24.0110-0356.1	410356	Ø 272 9,7 8 + S
					24.0310-0356.1	510356	Ø 272 9,7 8 + S PD
2.0 TDI quattro	125	03/06→03/13	←	+PR 1ZF;1ZM	24.0122-0210.1	422210	Ø 280 22 19 V + S
					24.0322-0210.1	522210	Ø 280 22 19 V + S PD
			←	+PR 1ZE;1ZP	24.0125-0145.1	425145	Ø 288 25 22 V + S
					24.0325-0145.1	525145	Ø 288 25 22 V + S PD
			←	+PR 1ZD,1LJ,1ZA	24.0125-0158.1	425158	Ø 312 25 22 V + S
					24.0325-0158.1	525158	Ø 312 25 22 V + S PD
			←	+PR 1ZD;1LJ	24.0130-0115.1	430115	Ø 345 30 27 V
		24.0330-0115.1	530115	Ø 345 30 27 V PD			
			➡	+PR 1KS	24.0110-0356.1	410356	Ø 272 9,7 8 + S
				24.0310-0356.1	510356	Ø 272 9,7 8 + S PD	
			➡	+PR 1KF	24.0112-0158.1	412158	Ø 256 12 10 + S
				24.0312-0158.1	512158	Ø 256 12 10 PD	
			➡	+PR 1KJ;1KU	24.0112-0169.1	412169	Ø 282 12 10 + S
				24.0312-0169.1	512169	Ø 282 12 10 + S PD	









	kw			 	! #				
AUDI - A3 Sportback (8PA) 09/04→03/13									
Bremsscheibe									
2.0 TDI quattro	125	03/06→03/13	➔	+PR 1KJ;1KU		24.0112-0169.1 412169 24.0312-0169.1 512169	Ø 282 12 10 + S Ø 282 12 10 + S PD		
3.2 V6 quattro	184	09/04→05/09	⬅	03/06→; +PR 1ZF;1ZM		24.0122-0210.1 422210 24.0322-0210.1 522210	Ø 280 22 19 V + S Ø 280 22 19 V + S PD		
			⬅	+PR 1ZE;1ZP		24.0125-0145.1 425145 24.0325-0145.1 525145	Ø 288 25 22 V + S Ø 288 25 22 V + S PD		
			⬅	+PR 1ZD,1LJ,1ZA		24.0125-0158.1 425158 24.0325-0158.1 525158	Ø 312 25 22 V + S Ø 312 25 22 V + S PD		
			⬅	+PR 1LK		24.0130-0115.1 430115 24.0330-0115.1 530115	Ø 345 30 27 V Ø 345 30 27 V PD		
			➔	+PR 1KS		24.0110-0356.1 410356 24.0310-0356.1 510356	Ø 272 9,7 8 + S Ø 272 9,7 8 + S PD		
			➔	+PR 1KJ		24.0112-0169.1 412169 24.0312-0169.1 512169	Ø 282 12 10 + S Ø 282 12 10 + S PD		
			➔	+PR 2EA		24.0122-0219.1 422219	Ø 310 22 20 V		
			RS3 quattro	250	01/11→12/12	➔	04/11→		24.0122-0219.1 422219
S3 quattro	188	07/08→03/13	⬅	+PR 1ZK		24.0130-0115.1 430115 24.0330-0115.1 530115	Ø 345 30 27 V Ø 345 30 27 V PD		
S3 quattro	195	06/08→03/13	➔	+PR 1KW		24.0122-0219.1 422219	Ø 310 22 20 V		
AUDI - A3 Sportback (8VA, 8VF) 09/12→									
Bremsbelagsatz, Scheibenbremse									
1.0 TFSI	85	07/16→	⬅	+PR 1ZA,1ZD,1ZE,1ZP		13.0460-2785.2 602785 13.0470-2785.2 LD2785	TRW 25683 20,4 + WE / + WK TRW 25683 20,4 + WE / + WK Ceramic		
2.0 TFSI	140	05/16→	➔	+PR 1KE; + eFSB		13.0460-7293.2 607293 13.0470-7293.2 LD7293	ATE 25008 16,3 - WE / - WK ATE 25008 16,3 - WE / - WK Ceramic		
2.0 TFSI quattro	140	05/16→						13.0460-7294.2 607294 13.0470-7294.2 LD7294	ATE 25009 16,4 - WE / - WK ATE 25009 16,4 - WE / - WK Ceramic
								13.0460-7294.2 607294 13.0470-7294.2 LD7294	ATE 25009 16,4 - WE / - WK ATE 25009 16,4 - WE / - WK Ceramic
1.2 TFSI	77	05/13→	⬅	+PR 1ZA,1ZD,1ZE,1ZP		13.0460-2785.2 602785 13.0470-2785.2 LD2785	TRW 25683 20,4 + WE / + WK TRW 25683 20,4 + WE / + WK Ceramic		
1.2 TFSI	81	05/14→	⬅	+PR 1ZF		13.0460-7303.2 607303 13.0470-7303.2 LD7303	ATE 22035 17,5 + WK ATE 22035 17,5 + WK Ceramic		
1.4 TFSI	90	09/12→							
1.4 TFSI	92	05/14→	➔	+PR 1KE; + eFSB		13.0460-7293.2 607293 13.0470-7293.2 LD7293	ATE 25008 16,3 - WE / - WK ATE 25008 16,3 - WE / - WK Ceramic		
1.4 TFSI	103	03/13→							
1.4 TFSI	110	05/14→	➔	+PR 1KJ,1KY,2ED; + eFSB		13.0460-7294.2 607294 13.0470-7294.2 LD7294	ATE 25009 16,4 - WE / - WK ATE 25009 16,4 - WE / - WK Ceramic		
1.4 TFSI e-tron	110	05/14→							
1.6 TDI	77	10/12→	➔	+PR 1KJ,1KY,2ED; + eFSB		13.0460-7294.2 607294 13.0470-7294.2 LD7294	ATE 25009 16,4 - WE / - WK ATE 25009 16,4 - WE / - WK Ceramic		
1.6 TDI	81	09/13→							
1.6 TDI	85	02/17→	➔	+PR 1KJ,1KY,2ED; + eFSB		13.0460-7294.2 607294 13.0470-7294.2 LD7294	ATE 25009 16,4 - WE / - WK ATE 25009 16,4 - WE / - WK Ceramic		
1.6 TDI quattro	81	05/15→							
1.8 TFSI	132	09/12→	➔	+PR 1KJ,1KY,2ED; + eFSB		13.0460-7294.2 607294 13.0470-7294.2 LD7294	ATE 25009 16,4 - WE / - WK ATE 25009 16,4 - WE / - WK Ceramic		
1.8 TFSI quattro	132	05/13→							
2.0 TDI	81	05/13→	➔	+PR 1KJ,1KY,2ED; + eFSB		13.0460-7294.2 607294 13.0470-7294.2 LD7294	ATE 25009 16,4 - WE / - WK ATE 25009 16,4 - WE / - WK Ceramic		
2.0 TDI	100	05/13→							
2.0 TDI	105	03/13→	➔	+PR 1KJ,1KY,2ED; + eFSB		13.0460-7294.2 607294 13.0470-7294.2 LD7294	ATE 25009 16,4 - WE / - WK ATE 25009 16,4 - WE / - WK Ceramic		
2.0 TDI	110	09/12→							
2.0 TDI	135	05/13→	➔	+PR 1KJ,1KY,2ED; + eFSB		13.0460-7294.2 607294 13.0470-7294.2 LD7294	ATE 25009 16,4 - WE / - WK ATE 25009 16,4 - WE / - WK Ceramic		
2.0 TDI quattro	110	02/13→							
2.0 TDI quattro	135	05/13→	➔	+PR 1KJ,1KY,2ED; + eFSB		13.0460-7294.2 607294 13.0470-7294.2 LD7294	ATE 25009 16,4 - WE / - WK ATE 25009 16,4 - WE / - WK Ceramic		
1.4 TFSI g-tron	81	11/13→	⬅	02/14→; +PR 1ZA,1ZD,1ZE,1ZP		13.0460-2785.2 602785 13.0470-2785.2 LD2785	TRW 25683 20,4 + WE / + WK TRW 25683 20,4 + WE / + WK Ceramic		
			⬅	02/14→; +PR 1ZF		13.0460-7303.2 607303 13.0470-7303.2 LD7303	ATE 22035 17,5 + WK ATE 22035 17,5 + WK Ceramic		
			➔	02/14→; +PR 1KE; + eFSB		13.0460-7293.2 607293 13.0470-7293.2 LD7293	ATE 25008 16,3 - WE / - WK ATE 25008 16,3 - WE / - WK Ceramic		
			➔	02/14→; +PR 1KJ,1KY,2ED; + eFSB		13.0460-7294.2 607294 13.0470-7294.2 LD7294	ATE 25009 16,4 - WE / - WK ATE 25009 16,4 - WE / - WK Ceramic		
RS3 quattro	270	03/15→	➔	+PR 1KX,2EE; + eFSB		13.0460-7307.2 607307	ATE 25009 16,4 + WK		
S3 quattro	206	05/13→	➔	+PR 1KE; + eFSB		13.0460-7293.2 607293 13.0470-7293.2 LD7293	ATE 25008 16,3 - WE / - WK ATE 25008 16,3 - WE / - WK Ceramic		
S3 quattro	210	05/14→	➔	+PR 1KJ,1KY,2ED; + eFSB		13.0460-7294.2 607294 13.0470-7294.2 LD7294	ATE 25009 16,4 - WE / - WK ATE 25009 16,4 - WE / - WK Ceramic		
S3 quattro	213	07/16→							
S3 quattro	221	11/12→	➔	+PR 1KJ,1KY,2ED; + eFSB		13.0460-7294.2 607294	ATE 25009 16,4 - WE / - WK		
S3 quattro	228	06/16→							







	kw			 	! #		
AUDI - A3 Sportback (8VA, 8VF) 09/12→							
Bremsbelagsatz, Scheibenbremse							
S3 quattro	206	05/13→	➔	+PR 1KJ,1KY,2ED; + eFSB		13.0470-7294.2 LD7294	ATE 25009 16,4 - WE / - WK Ceramic
S3 quattro	210	05/14→					
S3 quattro	213	07/16→					
S3 quattro	221	11/12→					
S3 quattro	228	06/16→					
Warnkontakt, Bremsbelagverschleiß							
1.0 TFSI	85	07/16→	←	+PR 1ZA,1ZD,1ZE,1ZP	1	24.8190-0065.2 620065	L= 172
1.2 TFSI	77	05/13→					
1.2 TFSI	81	05/14→					
1.4 TFSI	90	09/12→					
1.4 TFSI	92	05/14→					
1.4 TFSI	103	03/13→					
1.4 TFSI	110	05/14→					
1.4 TFSI e-tron	110	05/14→					
1.6 TDI	77	10/12→					
1.6 TDI	81	09/13→					
1.6 TDI	85	02/17→					
1.6 TDI quattro	81	05/15→					
1.8 TFSI	132	09/12→					
1.8 TFSI quattro	132	05/13→					
2.0 TDI	81	05/13→					
2.0 TDI	100	05/13→					
2.0 TDI	105	03/13→					
2.0 TDI	110	09/12→					
2.0 TDI	135	05/13→					
2.0 TDI quattro	110	02/13→					
2.0 TDI quattro	135	05/13→					
2.0 TFSI	140	05/16→					
2.0 TFSI quattro	140	05/16→					
1.4 TFSI g-tron	81	11/13→	←	02/14→; +PR 1ZA,1ZD,1ZE,1ZP	1	24.8190-0065.2 620065	L= 172
S3 quattro	206	05/13→	←	+PR 1LC,1LJ	1	24.8190-0065.2 620065	L= 172
S3 quattro	210	05/14→					
S3 quattro	213	07/16→					
S3 quattro	221	11/12→					
S3 quattro	228	06/16→					
Bremsscheibe							
1.0 TFSI	85	07/16→	←	+PR 1ZE,1ZP		24.0125-0145.1 425145	Ø 288 25 22 V + S
2.0 TFSI	140	05/16→				24.0325-0145.1 525145	Ø 288 25 22 V + S PD
			←	+PR 1ZA,1ZD		24.0125-0158.1 425158	Ø 312 25 22 V + S
						24.0325-0158.1 525158	Ø 312 25 22 V + S PD
			➔	+PR 1KE		24.0110-0356.1 410356	Ø 272 9,7 8 + S
			➔	+PR 2ED; + eFSB		24.0310-0356.1 510356	Ø 272 9,7 8 + S PD
			➔	+PR 1KJ,1KY; + eFSB		24.0112-0210.1 412210	Ø 300 12 10 + S
			➔	+PR 1KJ,1KY; + eFSB		24.0122-0219.1 422219	Ø 310 22 20 V
1.2 TFSI	77	05/13→	←	+PR 1ZF		24.0124-0258.1 424258	Ø 276 24 21 V + S
1.2 TFSI	81	05/14→					
1.4 TFSI	90	09/12→	←	+PR 1ZE,1ZP		24.0125-0145.1 425145	Ø 288 25 22 V + S
1.4 TFSI	92	05/14→				24.0325-0145.1 525145	Ø 288 25 22 V + S PD
1.4 TFSI	103	03/13→	←	+PR 1ZA,1ZD		24.0125-0158.1 425158	Ø 312 25 22 V + S
1.4 TFSI	110	05/14→				24.0325-0158.1 525158	Ø 312 25 22 V + S PD
1.4 TFSI e-tron	110	05/14→					
1.6 TDI	77	10/12→	➔	+PR 1KE		24.0110-0356.1 410356	Ø 272 9,7 8 + S
1.6 TDI	81	09/13→				24.0310-0356.1 510356	Ø 272 9,7 8 + S PD
1.6 TDI	85	02/17→					
1.6 TDI quattro	81	05/15→	➔	+PR 2ED; + eFSB		24.0112-0210.1 412210	Ø 300 12 10 + S
1.8 TFSI	132	09/12→					
1.8 TFSI quattro	132	05/13→	➔	+PR 1KJ,1KY; + eFSB		24.0122-0219.1 422219	Ø 310 22 20 V
2.0 TDI	81	05/13→					
2.0 TDI	100	05/13→					
2.0 TDI	105	03/13→					
2.0 TDI	110	09/12→					
2.0 TDI	135	05/13→					
2.0 TDI quattro	110	02/13→					
2.0 TDI quattro	135	05/13→					
1.4 TFSI g-tron	81	11/13→	←	02/14→; +PR 1ZF		24.0124-0258.1 424258	Ø 276 24 21 V + S
			←	02/14→; +PR 1ZE,1ZP		24.0125-0145.1 425145	Ø 288 25 22 V + S
						24.0325-0145.1 525145	Ø 288 25 22 V + S PD
			←	02/14→; +PR 1ZA,1ZD		24.0125-0158.1 425158	Ø 312 25 22 V + S
						24.0325-0158.1 525158	Ø 312 25 22 V + S PD
			➔	02/14→; +PR 1KE		24.0110-0356.1 410356	Ø 272 9,7 8 + S
			➔	+PR 2ED; + eFSB		24.0310-0356.1 510356	Ø 272 9,7 8 + S PD
			➔	02/14→; +PR 2ED; + eFSB		24.0112-0210.1 412210	Ø 300 12 10 + S
			➔	02/14→; +PR 1KJ,1KY; + eFSB		24.0122-0219.1 422219	Ø 310 22 20 V



















	kw			 	! #		
AUDI - A3 Sportback (8VA, 8VF) 09/12→							
 Bremsscheibe							
2.0 TFSI quattro	140	05/16→	←	+PR 1ZE,1ZP	24.0125-0145.1	425145	Ø 288 25 22 V + S
					24.0325-0145.1	525145	Ø 288 25 22 V + S PD
			←	+PR 1ZA,1ZD	24.0125-0158.1	425158	Ø 312 25 22 V + S
					24.0325-0158.1	525158	Ø 312 25 22 V + S PD
			→	+PR 1KE	24.0110-0356.1	410356	Ø 272 9,7 8 + S
		→	+PR 1KJ,1KY; + eFSB	24.0310-0356.1	510356	Ø 272 9,7 8 + S PD	
		→	+PR 1KJ,1KY; + eFSB	24.0122-0219.1	422219	Ø 310 22 20 V	
RS3 quattro	270	03/15→	→	+PR 1KX,2EE; + eFSB	24.0122-0219.1	422219	Ø 310 22 20 V
S3 quattro	206	05/13→	←	+PR 1LC,1LJ	24.0130-0225.1	430225	Ø 340 30 27 V + S
					24.0110-0356.1	410356	Ø 272 9,7 8 + S
			→	+PR 1KE	24.0310-0356.1	510356	Ø 272 9,7 8 + S PD
					24.0112-0210.1	412210	Ø 300 12 10 + S
					→	+PR 1KJ,1KY; + eFSB	24.0122-0219.1
S3 quattro	210	05/14→					
S3 quattro	213	07/16→					
S3 quattro	221	11/12→					
S3 quattro	228	06/16→					
AUDI - A4 (8D2, B5) 11/94→09/01							
 Bremsbelagsatz, Scheibenbremse							
1.6 1.6 1.9 TDI	74 75 66	11/94→10/00 07/00→11/00 01/95→11/00	←	→ 8D-V-169695	13.0460-2822.2	602822	TRW 21945 19,6 - WK
					13.0460-2934.2	602934	TRW 20669 19,0 - WK
			←	8D-V-169696→	13.0460-2822.2	602822	TRW 21945 19,6 - WK
					13.0460-2837.2	602837	TRW 21945 19,6 + WK
					13.0470-2837.2	LD2837	TRW 21945 19,6 + WK Ceramic
			←	8D-V-054062→	13.0460-2822.2	602822	TRW 21945 19,6 - WK
					13.0460-2837.2	602837	TRW 21945 19,6 + WK
					13.0470-2837.2	LD2837	TRW 21945 19,6 + WK Ceramic
			←	→ 8D-V-054061	13.0460-7077.2	607077	ATE 20676 19,8 - WE / - WK
			→	8D-V-160001→	13.0460-2820.2	602820	TRW 20961 17,2 - WK
		13.0470-2820.2	LD2820	TRW 20961 17,2 - WK Ceramic			
→	→ 8D-V-160000	13.0460-3602.2	603602	TRW 21144 15,8 - WK			
1.8	85	04/95→11/00	←	8D-V-054062→	13.0460-2822.2	602822	TRW 21945 19,6 - WK
					13.0460-2837.2	602837	TRW 21945 19,6 + WK
					13.0470-2837.2	LD2837	TRW 21945 19,6 + WK Ceramic
			←	07/95→; → 8D-V-054061	13.0460-7077.2	607077	ATE 20676 19,8 - WE / - WK
					13.0460-7110.2	607110	ATE 20676 19,8 + WK
					13.0470-7110.2	LD7110	ATE 20676 19,8 + WK Ceramic
→	8D-V-160001→	13.0460-2820.2	602820	TRW 20961 17,2 - WK			
		13.0470-2820.2	LD2820	TRW 20961 17,2 - WK Ceramic			
→	→ 8D-V-160000	13.0460-3602.2	603602	TRW 21144 15,8 - WK			
1.8	92	11/94→11/00	←	8D-V-054062→	13.0460-2822.2	602822	TRW 21945 19,6 - WK
					13.0460-2837.2	602837	TRW 21945 19,6 + WK
					13.0470-2837.2	LD2837	TRW 21945 19,6 + WK Ceramic
			←	→ 8D-V-054061	13.0460-7077.2	607077	ATE 20676 19,8 - WE / - WK
					13.0460-7110.2	607110	ATE 20676 19,8 + WK
					13.0470-7110.2	LD7110	ATE 20676 19,8 + WK Ceramic
→	8D-V-160001→	13.0460-2820.2	602820	TRW 20961 17,2 - WK			
		13.0470-2820.2	LD2820	TRW 20961 17,2 - WK Ceramic			
→	→ 8D-V-160000	13.0460-3602.2	603602	TRW 21144 15,8 - WK			
1.8 quattro	85	07/95→11/00	←	8D-V-054062→	13.0460-2822.2	602822	TRW 21945 19,6 - WK
					13.0460-2837.2	602837	TRW 21945 19,6 + WK
					13.0470-2837.2	LD2837	TRW 21945 19,6 + WK Ceramic
			←	→ 8D-V-054061	13.0460-7077.2	607077	ATE 20676 19,8 - WE / - WK
→		13.0460-3602.2	603602	TRW 21144 15,8 - WK			
1.8 quattro	92	01/95→11/00	←	8D-V-054062→	13.0460-2822.2	602822	TRW 21945 19,6 - WK
					13.0460-2837.2	602837	TRW 21945 19,6 + WK
					13.0470-2837.2	LD2837	TRW 21945 19,6 + WK Ceramic
			←	02/95→; → 8D-V-054061	13.0460-7077.2	607077	ATE 20676 19,8 - WE / - WK
→		13.0460-3602.2	603602	TRW 21144 15,8 - WK			
1.8 T	110	01/95→11/00	←	05/95→	13.0460-7077.2	607077	ATE 20676 19,8 - WE / - WK
					13.0460-7110.2	607110	ATE 20676 19,8 + WK
					13.0470-7110.2	LD7110	ATE 20676 19,8 + WK Ceramic
↓							







	kw			 	! #		
AUDI - A4 (8D2, B5) 11/94→09/01							
 Bremsbelagsatz, Scheibenbremse							
1.8 T	110	01/95→11/00	➔	8D-V-160001→		13.0460-2820.2 602820	TRW 20961 17,2 - WK
						13.0470-2820.2 LD2820	TRW 20961 17,2 - WK Ceramic
			➔	05/95→; → 8D-V-160000		13.0460-3602.2 603602	TRW 21144 15,8 - WK
1.8 T	132	12/97→11/00	←			13.0460-7077.2 607077	ATE 20676 19,8 - WE / - WK
2.4	110	07/95→07/97				13.0460-7110.2 607110	ATE 20676 19,8 + WK
2.6	102	01/96→07/97				13.0470-7110.2 LD7110	ATE 20676 19,8 + WK Ceramic
2.6	110	01/95→11/00					
2.8	128	09/95→07/97	➔	8D-V-160001→		13.0460-2820.2 602820	TRW 20961 17,2 - WK
2.8	140	09/99→10/00				13.0470-2820.2 LD2820	TRW 20961 17,2 - WK Ceramic
2.8	142	10/96→07/99					
2.8	142	10/96→11/00	➔	→ 8D-V-160000		13.0460-3602.2 603602	TRW 21144 15,8 - WK
1.8 T quattro	110	01/95→11/00	←	02/95→ 01/99		13.0460-7077.2 607077	ATE 20676 19,8 - WE / - WK
			←	02/99→		13.0460-7110.2 607110	ATE 20676 19,8 + WK
						13.0470-7110.2 LD7110	ATE 20676 19,8 + WK Ceramic
			➔	02/95→		13.0460-3602.2 603602	TRW 21144 15,8 - WK
1.8 T quattro	132	12/97→11/00	←	→ 01/99		13.0460-7077.2 607077	ATE 20676 19,8 - WE / - WK
1.9 TDI quattro	81	09/96→11/00	←	02/99→		13.0460-7110.2 607110	ATE 20676 19,8 + WK
2.4 quattro	120	08/97→11/00				13.0470-7110.2 LD7110	ATE 20676 19,8 + WK Ceramic
2.6 quattro	110	01/95→11/00	➔			13.0460-3602.2 603602	TRW 21144 15,8 - WK
1.9 TDI	55	12/95→11/00	←	8D-V-054062→		13.0460-2822.2 602822	TRW 21945 19,6 - WK
						13.0460-2837.2 602837	TRW 21945 19,6 + WK
						13.0470-2837.2 LD2837	TRW 21945 19,6 + WK Ceramic
			←	03/96→; → 8D-V-169695		13.0460-2822.2 602822	TRW 21945 19,6 - WK
						13.0460-2934.2 602934	TRW 20669 19,0 - WK
			←	8D-V-169696→		13.0460-2822.2 602822	TRW 21945 19,6 - WK
						13.0460-2837.2 602837	TRW 21945 19,6 + WK
						13.0470-2837.2 LD2837	TRW 21945 19,6 + WK Ceramic
			←	03/96→; → 8D-V-054061		13.0460-7077.2 607077	ATE 20676 19,8 - WE / - WK
			➔	8D-V-160001→		13.0460-2820.2 602820	TRW 20961 17,2 - WK
						13.0470-2820.2 LD2820	TRW 20961 17,2 - WK Ceramic
			➔	03/96→; → 8D-V-160000		13.0460-3602.2 603602	TRW 21144 15,8 - WK
1.9 TDI	81	10/95→11/00	←	02/96→		13.0460-7077.2 607077	ATE 20676 19,8 - WE / - WK
						13.0460-7110.2 607110	ATE 20676 19,8 + WK
						13.0470-7110.2 LD7110	ATE 20676 19,8 + WK Ceramic
			➔	8D-V-160001→		13.0460-2820.2 602820	TRW 20961 17,2 - WK
						13.0470-2820.2 LD2820	TRW 20961 17,2 - WK Ceramic
			➔	02/96→; → 8D-V-160000		13.0460-3602.2 603602	TRW 21144 15,8 - WK
1.9 TDI	85	03/00→11/00	←			13.0460-7077.2 607077	ATE 20676 19,8 - WE / - WK
2.4	120	08/97→11/00				13.0460-7110.2 607110	ATE 20676 19,8 + WK
2.5 TDI	110	09/97→11/00				13.0470-7110.2 LD7110	ATE 20676 19,8 + WK Ceramic
			➔			13.0460-2820.2 602820	TRW 20961 17,2 - WK
						13.0470-2820.2 LD2820	TRW 20961 17,2 - WK Ceramic
			➔	→ 8D-V-160000		13.0460-3602.2 603602	TRW 21144 15,8 - WK
1.9 TDI quattro	85	03/00→11/00	←			13.0460-7110.2 607110	ATE 20676 19,8 + WK
2.8 quattro	140	09/99→10/00				13.0470-7110.2 LD7110	ATE 20676 19,8 + WK Ceramic
			➔			13.0460-3602.2 603602	TRW 21144 15,8 - WK
2.4	121	03/97→11/00	←	08/97→		13.0460-7077.2 607077	ATE 20676 19,8 - WE / - WK
						13.0460-7110.2 607110	ATE 20676 19,8 + WK
						13.0470-7110.2 LD7110	ATE 20676 19,8 + WK Ceramic
			←	→ 07/97		13.0460-7077.2 607077	ATE 20676 19,8 - WE / - WK
						13.0460-7110.2 607110	ATE 20676 19,8 + WK
						13.0470-7110.2 LD7110	ATE 20676 19,8 + WK Ceramic
			➔	8D-V-160001→; → 07/97		13.0460-2820.2 602820	TRW 20961 17,2 - WK
						13.0470-2820.2 LD2820	TRW 20961 17,2 - WK Ceramic
			➔	08/97→		13.0460-2820.2 602820	TRW 20961 17,2 - WK
						13.0470-2820.2 LD2820	TRW 20961 17,2 - WK Ceramic
			➔	→ 8D-V-160000		13.0460-3602.2 603602	TRW 21144 15,8 - WK
2.4 quattro	121	03/97→11/00	←	08/97→ 01/99		13.0460-7077.2 607077	ATE 20676 19,8 - WE / - WK
			←	02/99→		13.0460-7110.2 607110	ATE 20676 19,8 + WK
						13.0470-7110.2 LD7110	ATE 20676 19,8 + WK Ceramic
			➔	08/97→		13.0460-3602.2 603602	TRW 21144 15,8 - WK
↓							









	kw			 	! #		
AUDI - A4 (8D2, B5) 11/94→09/01							
 Bremsbelagsatz, Scheibenbremse							
2.5 TDI quattro	110	09/97→11/00	←	11/97→ 01/99		13.0460-7077.2 607077	ATE 20676 19,8 - WE / - WK
			←	02/99→		13.0460-7110.2 607110	ATE 20676 19,8 + WK
			←	11/97→		13.0470-7110.2 LD7110	ATE 20676 19,8 + WK Ceramic
			→	11/97→		13.0460-3602.2 603602	TRW 21144 15,8 - WK
2.8 quattro	128	01/95→07/97	←	→ 07/96		13.0460-7077.2 607077	ATE 20676 19,8 - WE / - WK
			→	→ 07/96		13.0460-3602.2 603602	TRW 21144 15,8 - WK
2.8 quattro	142	10/96→08/01	←	→ 01/99		13.0460-7077.2 607077	ATE 20676 19,8 - WE / - WK
			←	02/99→ 04/01		13.0460-7110.2 607110	ATE 20676 19,8 + WK
			←	02/99→ 04/01		13.0470-7110.2 LD7110	ATE 20676 19,8 + WK Ceramic
			→	→ 04/01		13.0460-3602.2 603602	TRW 21144 15,8 - WK
S4 quattro	195	09/97→09/01	←	10/97→; → 8D-X-199 999		13.0460-2705.2 602705	TRW 21452 18,5 - WK
			←	8D-X-200 001→; → 04/01		13.0460-2875.2 602875	TRW 23119 17,5 + WK
			→	10/97→ 04/01		13.0460-2820.2 602820	TRW 20961 17,2 - WK
			→	10/97→ 04/01		13.0470-2820.2 LD2820	TRW 20961 17,2 - WK Ceramic
Zubehörsatz, Scheibenbremsbelag							
1.6	74	11/94→10/00	→	8D-V-160001→		13.0460-0072.2 610072	TRW
1.6	75	07/00→11/00					
1.8	85	04/95→11/00					
1.8	92	11/94→11/00					
1.8 T	110	01/95→11/00					
1.8 T	132	12/97→11/00					
1.9 TDI	55	12/95→11/00					
1.9 TDI	66	01/95→11/00					
1.9 TDI	81	10/95→11/00					
2.4	110	07/95→07/97					
2.6	102	01/96→07/97					
2.6	110	01/95→11/00					
2.8	128	09/95→07/97					
2.8	140	09/99→10/00					
2.8	142	10/96→07/99					
2.8	142	10/96→11/00					
1.9 TDI	85	03/00→11/00	→			13.0460-0072.2 610072	TRW
2.4	120	08/97→11/00					
2.5 TDI	110	09/97→11/00					
2.4	121	03/97→11/00	→	8D-V-160001→; → 07/97		13.0460-0072.2 610072	TRW
			→	08/97→		13.0460-0072.2 610072	TRW
S4 quattro	195	09/97→09/01	→	10/97→ 04/01		13.0460-0072.2 610072	TRW
 Bremsscheibe							
1.6	74	11/94→10/00	←	→ 8D-V-169695		24.0113-0181.1 413181	Ø 280 13 11
1.6	75	07/00→11/00	←	→ 8D-V-054061		24.0313-0181.1 513181	Ø 280 13 11 PD
			←	→ 8D-V-054061		24.0115-0105.1 415105	Ø 288 15 13
			←	→ 8D-V-054061		24.0315-0105.1 515105	Ø 288 15 13 PD
			←	8D-V-054062→		24.0122-0152.1 422152	Ø 280 22 20 V + S
			←	8D-V-054062→		24.0322-0152.1 522152	Ø 280 22 20 V PD
			←	8D-V-169696→		24.0122-0152.1 422152	Ø 280 22 20 V + S
			←	8D-V-169696→		24.0322-0152.1 522152	Ø 280 22 20 V PD
			→			24.0110-0210.1 410210	Ø 245 10 8 - LG / - ABS Ring
1.8	85	04/95→11/00	←	07/95→; → 8D-V-054061; fur China/GUS		24.0115-0105.1 415105	Ø 288 15 13
			←	07/95→; → 8D-V-054061; fur China/GUS		24.0315-0105.1 515105	Ø 288 15 13 PD
			←	8D-V-054062→; fur China/GUS		24.0122-0152.1 422152	Ø 280 22 20 V + S
			←	8D-V-054062→; fur China/GUS		24.0322-0152.1 522152	Ø 280 22 20 V PD
			→			24.0110-0210.1 410210	Ø 245 10 8 - LG / - ABS Ring
1.8	92	11/94→11/00	←	→ 8D-V-054061		24.0115-0105.1 415105	Ø 288 15 13
			←	→ 8D-V-054061		24.0315-0105.1 515105	Ø 288 15 13 PD
			←	8D-V-054062→		24.0122-0152.1 422152	Ø 280 22 20 V + S
			←	8D-V-054062→		24.0322-0152.1 522152	Ø 280 22 20 V PD
			→			24.0110-0210.1 410210	Ø 245 10 8 - LG / - ABS Ring
1.8 quattro	85	07/95→11/00	←	→ 8D-V-054061; fur GUS		24.0115-0105.1 415105	Ø 288 15 13
			←	→ 8D-V-054061; fur GUS		24.0315-0105.1 515105	Ø 288 15 13 PD
			←	8D-V-054062→; fur GUS		24.0122-0152.1 422152	Ø 280 22 20 V + S
			←	8D-V-054062→; fur GUS		24.0322-0152.1 522152	Ø 280 22 20 V PD
			→			24.0110-0224.1 410224	Ø 245 10 8
↓							









	kw			 	! #		
AUDI - A4 (8D2, B5) 11/94→09/01							
Bremsscheibe							
1.8 quattro	85	07/95→11/00	➔			24.0310-0224.1 510224	Ø 245 10 8 PD
1.8 quattro	92	01/95→11/00	➔	→ 8D-V-054061		24.0115-0105.1 415105	Ø 288 15 13
						24.0315-0105.1 515105	Ø 288 15 13 PD
			➔	8D-V-054062→		24.0122-0152.1 422152	Ø 280 22 20 V + S
						24.0322-0152.1 522152	Ø 280 22 20 V PD
1.8 T	110	01/95→11/00	➔	05/95→		24.0110-0224.1 410224	Ø 245 10 8
						24.0310-0224.1 510224	Ø 245 10 8 PD
1.8 T	110	01/95→11/00	➔	05/95→		24.0125-0105.1 425105	Ø 288 25 23 V + S
						24.0325-0105.1 525105	Ø 288 25 23 V PD
1.8 T	132	12/97→11/00	➔			24.0110-0210.1 410210	Ø 245 10 8 - LG / - ABS Ring
						24.0310-0224.1 510224	Ø 245 10 8 PD
1.9 TDI	85	03/00→11/00	➔			24.0125-0105.1 425105	Ø 288 25 23 V + S
2.4	120	08/97→11/00	➔			24.0325-0105.1 525105	Ø 288 25 23 V PD
2.5 TDI	110	09/97→11/00	➔			24.0110-0210.1 410210	Ø 245 10 8 - LG / - ABS Ring
2.6	102	01/96→07/97	➔				
2.6	110	01/95→11/00	➔				
2.8	128	09/95→07/97	➔				
2.8	140	09/99→10/00	➔				
2.8	142	10/96→07/99	➔				
2.8	142	10/96→11/00	➔				
1.8 T quattro	110	01/95→11/00	➔	02/95→		24.0125-0105.1 425105	Ø 288 25 23 V + S
						24.0325-0105.1 525105	Ø 288 25 23 V PD
			➔	02/95→		24.0110-0224.1 410224	Ø 245 10 8
						24.0310-0224.1 510224	Ø 245 10 8 PD
1.8 T quattro	132	12/97→11/00	➔			24.0125-0105.1 425105	Ø 288 25 23 V + S
1.9 TDI quattro	81	09/96→11/00	➔			24.0325-0105.1 525105	Ø 288 25 23 V PD
1.9 TDI quattro	85	03/00→11/00	➔			24.0110-0224.1 410224	Ø 245 10 8
2.4 quattro	120	08/97→11/00	➔			24.0310-0224.1 510224	Ø 245 10 8 PD
2.6 quattro	110	01/95→11/00	➔				
2.8 quattro	140	09/99→10/00	➔				
1.9 TDI	55	12/95→11/00	➔	03/96→; → 8D-V-169695		24.0113-0181.1 413181	Ø 280 13 11
						24.0313-0181.1 513181	Ø 280 13 11 PD
			➔	8D-V-169696→		24.0122-0152.1 422152	Ø 280 22 20 V + S
						24.0322-0152.1 522152	Ø 280 22 20 V PD
			➔	8D-V-054062→		24.0122-0152.1 422152	Ø 280 22 20 V + S
			24.0322-0152.1 522152	Ø 280 22 20 V PD			
			➔	03/96→		24.0110-0210.1 410210	Ø 245 10 8 - LG / - ABS Ring
1.9 TDI	66	01/95→11/00	➔	→ 8D-V-169695		24.0113-0181.1 413181	Ø 280 13 11
						24.0313-0181.1 513181	Ø 280 13 11 PD
			➔	8D-V-054062→		24.0122-0152.1 422152	Ø 280 22 20 V + S
						24.0322-0152.1 522152	Ø 280 22 20 V PD
			➔	8D-V-169696→		24.0122-0152.1 422152	Ø 280 22 20 V + S
			24.0322-0152.1 522152	Ø 280 22 20 V PD			
			➔			24.0110-0210.1 410210	Ø 245 10 8 - LG / - ABS Ring
1.9 TDI	81	10/95→11/00	➔	02/96→		24.0125-0105.1 425105	Ø 288 25 23 V + S
						24.0325-0105.1 525105	Ø 288 25 23 V PD
			➔	02/96→		24.0110-0210.1 410210	Ø 245 10 8 - LG / - ABS Ring
2.4	110	07/95→07/97	➔	fur Thailand		24.0125-0105.1 425105	Ø 288 25 23 V + S
						24.0325-0105.1 525105	Ø 288 25 23 V PD
			➔	fur Thailand		24.0110-0210.1 410210	Ø 245 10 8 - LG / - ABS Ring
2.4	121	03/97→11/00	➔	→ 07/97; fur Thailand		24.0125-0105.1 425105	Ø 288 25 23 V + S
						24.0325-0105.1 525105	Ø 288 25 23 V PD
			➔	08/97→		24.0125-0105.1 425105	Ø 288 25 23 V + S
						24.0325-0105.1 525105	Ø 288 25 23 V PD
			➔	→ 07/97; fur Thailand		24.0110-0210.1 410210	Ø 245 10 8 - LG / - ABS Ring
			➔	08/97→		24.0110-0210.1 410210	Ø 245 10 8 - LG / - ABS Ring
2.4 quattro	121	03/97→11/00	➔	08/97→		24.0125-0105.1 425105	Ø 288 25 23 V + S
						24.0325-0105.1 525105	Ø 288 25 23 V PD
			➔	08/97→		24.0110-0224.1 410224	Ø 245 10 8
						24.0310-0224.1 510224	Ø 245 10 8 PD
2.5 TDI quattro	110	09/97→11/00	➔	11/97→		24.0125-0105.1 425105	Ø 288 25 23 V + S
						24.0325-0105.1 525105	Ø 288 25 23 V PD
			➔	11/97→		24.0110-0224.1 410224	Ø 245 10 8
						24.0310-0224.1 510224	Ø 245 10 8 PD
↓							









	kw			 	! #		
AUDI - A4 (8D2, B5) 11/94→09/01							
 Bremsscheibe							
2.8 quattro	128	01/95→07/97	←	→ 07/96		24.0125-0105.1 425105	∅ 288 25 23 V + S
			→	→ 07/96		24.0325-0105.1 525105	∅ 288 25 23 V PD
2.8 quattro	142	10/96→08/01	←	→ 04/01		24.0110-0224.1 410224	∅ 245 10 8
			→	→ 04/01		24.0310-0224.1 510224	∅ 245 10 8 PD
			←	→ 04/01		24.0125-0105.1 425105	∅ 288 25 23 V + S
S4 quattro	195	09/97→09/01	←	10/97→ 04/01		24.0130-0113.1 430113	∅ 320 30 28 V + S
			→	10/97→ 04/01		24.0330-0113.1 530113	∅ 320 30 28 V PD
			←	10/97→ 04/01		24.0122-0221.1 422221	∅ 256 22 20 V
AUDI - A4 (8E2, B6) 11/00→12/04							
 Bremsbelagsatz, Scheibenbremse							
1.6 1.8 T 1.8 T quattro 1.9 TDI 2.0 2.5 TDI quattro	75 110 110 96 96 132	11/00→12/04 11/00→07/02 11/00→07/02 11/00→12/04 11/00→12/04 11/00→12/04	←	12/00→; +PR 1LZ		13.0460-2837.2 602837	TRW 21945 19,6 + WK
			→	12/00→; +PR 1LB;1LE;1LF;1LT		13.0470-2837.2 LD2837	TRW 21945 19,6 + WK Ceramic
			←	12/00→; +PR 1LB;1LE;1LF;1LT		13.0460-7110.2 607110	ATE 20676 19,8 + WK
			→	12/00→; +PR 1LB;1LE;1LF;1LT		13.0470-7110.2 LD7110	ATE 20676 19,8 + WK Ceramic
			←	12/00→; +PR 1LA;1LC		13.0460-7201.2 607201	ATE 23763 20,3 + WK
			→	12/00→; +PR 1LA;1LC		13.0470-7201.2 LD7201	ATE 23763 20,3 + WK Ceramic
			→	8E-5-400001→; +PR 1KW		13.0460-2749.2 602749	TRW 24483 16,9 - WE / - WK + Zub
			→	8E-5-400001→; +PR 1KW		13.0460-2880.2 602880	TRW 23914 17,1 + WE / - WK + Zub
			→	8E-5-400001→; +PR 1KW		13.0470-2749.2 LD2749	TRW 24483 16,9 - WE / - WK + Zub Ceramic
			→	8E-5-400001→; +PR 1KW		13.0470-2880.2 LD2880	TRW 23914 17,1 + WE / - WK + Zub Ceramic
1.8 T 1.8 T 1.8 T 1.8 T quattro 1.8 T quattro 1.8 T quattro 1.9 TDI 1.9 TDI quattro 2.0 FSI 2.4 2.4 2.5 TDI 2.5 TDI	120 125 140 120 125 140 74 96 110 120 125 114 120	07/02→12/04 07/01→12/04 11/02→12/04 07/02→12/04 07/01→12/04 11/02→12/04 05/01→12/04 11/01→12/04 07/02→12/04 09/01→12/04 09/01→12/04 08/01→07/02 07/02→12/04	←	+PR 1LZ		13.0460-2837.2 602837	TRW 21945 19,6 + WK
			→	+PR 1LZ		13.0470-2837.2 LD2837	TRW 21945 19,6 + WK Ceramic
			←	+PR 1LB;1LE;1LF;1LT		13.0460-7110.2 607110	ATE 20676 19,8 + WK
			→	+PR 1LB;1LE;1LF;1LT		13.0470-7110.2 LD7110	ATE 20676 19,8 + WK Ceramic
			←	+PR 1LA;1LC		13.0460-7201.2 607201	ATE 23763 20,3 + WK
			→	+PR 1LA;1LC		13.0470-7201.2 LD7201	ATE 23763 20,3 + WK Ceramic
			→	8E-5-400001→; +PR 1KW		13.0460-2749.2 602749	TRW 24483 16,9 - WE / - WK + Zub
			→	8E-5-400001→; +PR 1KW		13.0460-2880.2 602880	TRW 23914 17,1 + WE / - WK + Zub
			→	8E-5-400001→; +PR 1KW		13.0470-2749.2 LD2749	TRW 24483 16,9 - WE / - WK + Zub Ceramic
			→	8E-5-400001→; +PR 1KW		13.0470-2880.2 LD2880	TRW 23914 17,1 + WE / - WK + Zub Ceramic
1.9 TDI	85	06/04→12/04	←	+PR 1LZ		13.0460-2837.2 602837	TRW 21945 19,6 + WK
			←	+PR 1LB;1LE;1LF;1LT		13.0460-7110.2 607110	ATE 20676 19,8 + WK
			←	+PR 1LB;1LE;1LF;1LT		13.0470-7110.2 LD7110	ATE 20676 19,8 + WK Ceramic
			←	+PR 1LA;1LC		13.0460-7201.2 607201	ATE 23763 20,3 + WK
			→	8E-5-400001→; +PR 1KW		13.0470-7201.2 LD7201	ATE 23763 20,3 + WK Ceramic
			→	8E-5-400001→; +PR 1KW		13.0460-2749.2 602749	TRW 24483 16,9 - WE / - WK + Zub







	kw			 	! #		
AUDI - A4 (8E2, B6) 11/00→12/04							
 Bremsbelagsatz, Scheibenbremse							
1.9 TDI	85	06/04→12/04	➡	8E-5-400001→; +PR 1KW		13.0460-2880.2 602880	TRW 23914 17,1 + WE / - WK + Zub
						13.0470-2749.2 LD2749	TRW 24483 16,9 - WE / - WK + Zub Ceramic
						13.0470-2880.2 LD2880	TRW 23914 17,1 + WE / - WK + Zub Ceramic
			➡	+PR 1KD;1KP		13.0460-2886.2 602886	TRW 20961 16,0 - WK
						13.0470-2886.2 LD2886	TRW 20961 16,0 - WK Ceramic
3.0	160	04/01→12/04	⬅	+PR 1LZ		13.0460-2837.2 602837	TRW 21945 19,6 + WK
3.0 quattro	160	04/01→12/04				13.0470-2837.2 LD2837	TRW 21945 19,6 + WK Ceramic
			⬅	+PR 1LB;1LE;1LF;1LT		13.0460-7110.2 607110	ATE 20676 19,8 + WK
						13.0470-7110.2 LD7110	ATE 20676 19,8 + WK Ceramic
			⬅	+PR 1LA;1LC		13.0460-7201.2 607201	ATE 23763 20,3 + WK
						13.0470-7201.2 LD7201	ATE 23763 20,3 + WK Ceramic
			➡	8E-5-400001→; +PR 1KW		13.0460-2749.2 602749	TRW 24483 16,9 - WE / - WK + Zub
						13.0460-2880.2 602880	TRW 23914 17,1 + WE / - WK + Zub
						13.0470-2749.2 LD2749	TRW 24483 16,9 - WE / - WK + Zub Ceramic
						13.0470-2880.2 LD2880	TRW 23914 17,1 + WE / - WK + Zub Ceramic
			➡	→ 8E-7-300000; +PR 1KD;1KP		13.0460-2886.2 602886	TRW 20961 16,0 - WK
						13.0470-2886.2 LD2886	TRW 20961 16,0 - WK Ceramic
3.0	162	11/00→12/04	⬅	12/00→; +PR 1LZ		13.0460-2837.2 602837	TRW 21945 19,6 + WK
3.0 quattro	162	11/00→12/04				13.0470-2837.2 LD2837	TRW 21945 19,6 + WK Ceramic
			⬅	12/00→; +PR 1LB;1LE;1LF;1LT		13.0460-7110.2 607110	ATE 20676 19,8 + WK
						13.0470-7110.2 LD7110	ATE 20676 19,8 + WK Ceramic
			⬅	12/00→; +PR 1LA;1LC		13.0460-7201.2 607201	ATE 23763 20,3 + WK
						13.0470-7201.2 LD7201	ATE 23763 20,3 + WK Ceramic
			➡	8E-5-400001→; +PR 1KW		13.0460-2749.2 602749	TRW 24483 16,9 - WE / - WK + Zub
						13.0460-2880.2 602880	TRW 23914 17,1 + WE / - WK + Zub
						13.0470-2749.2 LD2749	TRW 24483 16,9 - WE / - WK + Zub Ceramic
						13.0470-2880.2 LD2880	TRW 23914 17,1 + WE / - WK + Zub Ceramic
			➡	12/00→; → 8E-7-300000; +PR 1KD;1KP		13.0460-2886.2 602886	TRW 20961 16,0 - WK
						13.0470-2886.2 LD2886	TRW 20961 16,0 - WK Ceramic
S4 quattro	253	03/03→12/04	⬅	+PR 1LJ		13.0460-7201.2 607201	ATE 23763 20,3 + WK
			➡			13.0460-2888.2 602888	TRW 23326 17,4 + WE / - WK
						13.0470-2888.2 LD2888	TRW 23326 17,4 + WE / - WK Ceramic
Zubehörsatz, Scheibenbremsbelag							
1.6	75	11/00→12/04	➡	12/00→; → 8E-4-180000; +PR 1KP		13.0460-0072.2 610072	TRW
1.8 T	110	11/00→07/02					
1.8 T quattro	110	11/00→07/02	➡	12/00→; → 8E-4-180000; +PR 1KD		13.0460-0072.2 610072	TRW
1.9 TDI	96	11/00→12/04	➡	8E-5-400001→; +PR 1KW		13.0460-0259.2 610259	
2.0	96	11/00→12/04					
2.5 TDI quattro	132	11/00→12/04					
1.8 T	120	07/02→12/04	➡	→ 8E-4-180000; +PR 1KP		13.0460-0072.2 610072	TRW
1.8 T	125	07/01→12/04					
1.8 T	140	11/02→12/04	➡	→ 8E-4-180000; +PR 1KD		13.0460-0072.2 610072	TRW
1.8 T quattro	120	07/02→12/04	➡	8E-5-400001→; +PR 1KW		13.0460-0259.2 610259	
1.8 T quattro	125	07/01→12/04					
1.8 T quattro	140	11/02→12/04					
1.9 TDI	74	05/01→12/04					
1.9 TDI quattro	96	11/01→12/04					
2.0 FSI	110	07/02→12/04					
2.4	120	09/01→12/04					
2.4	125	09/01→12/04					
2.5 TDI	114	08/01→07/02					
2.5 TDI	120	07/02→12/04					
1.9 TDI	85	06/04→12/04	➡	8E-5-400001→; +PR 1KW		13.0460-0259.2 610259	
3.0	160	04/01→12/04					
3.0	162	11/00→12/04					
3.0 quattro	160	04/01→12/04					
3.0 quattro	162	11/00→12/04					
↓							











	kw			 	! #		
AUDI - A4 (8E2, B6) 11/00→12/04							
Bremsscheibe							
1.6	75	11/00→12/04	←	12/00→; +PR 1LZ		24.0122-0152.1 422152	Ø 280 22 20 V + S
1.8 T	110	11/00→07/02				24.0322-0152.1 522152	Ø 280 22 20 V PD
1.8 T quattro	110	11/00→07/02					
1.9 TDI	96	11/00→12/04	←	12/00→; +PR 1LB;1LE		24.0125-0105.1 425105	Ø 288 25 23 V + S
2.0	96	11/00→12/04				24.0325-0105.1 525105	Ø 288 25 23 V PD
2.5 TDI quattro	132	11/00→12/04	←	12/00→; +PR 1LF;1LT		24.0125-0137.1 425137	Ø 312 25 23 V + S
						24.0325-0137.1 525137	Ø 312 25 23 V PD
			←	12/00→; +PR 1LA		24.0130-0113.1 430113	Ø 320 30 28 V + S
						24.0330-0113.1 530113	Ø 320 30 28 V PD
			←	12/00→; +PR 1LC		24.0130-0185.1 430185	Ø 320 30 28 V•
			→	12/00→; +PR 1KD		24.0110-0261.1 410261	Ø 245 10 8 + S
						24.0310-0261.1 510261	Ø 245 10 8 PD
			→	12/00→; +PR 1KP		24.0112-0148.1 412148	Ø 255 12 10
						24.0312-0148.1 512148	Ø 255 12 10 PD
			→	8E-5-400001→; +PR 1KW		24.0112-0166.1 412166	Ø 288 12 10
						24.0312-0166.1 512166	Ø 288 12 10 PD
1.8 T	120	07/02→12/04	←	+PR 1LZ		24.0122-0152.1 422152	Ø 280 22 20 V + S
1.8 T	125	07/01→12/04				24.0322-0152.1 522152	Ø 280 22 20 V PD
1.8 T	140	11/02→12/04					
1.8 T quattro	120	07/02→12/04	←	+PR 1LB;1LE		24.0125-0105.1 425105	Ø 288 25 23 V + S
1.8 T quattro	125	07/01→12/04				24.0325-0105.1 525105	Ø 288 25 23 V PD
1.8 T quattro	140	11/02→12/04	←	+PR 1LF;1LT		24.0125-0137.1 425137	Ø 312 25 23 V + S
1.9 TDI	74	05/01→12/04				24.0325-0137.1 525137	Ø 312 25 23 V PD
1.9 TDI	85	06/04→12/04					
1.9 TDI quattro	96	11/01→12/04	←	+PR 1LA		24.0130-0113.1 430113	Ø 320 30 28 V + S
2.0 FSI	110	07/02→12/04				24.0330-0113.1 530113	Ø 320 30 28 V PD
2.4	120	09/01→12/04					
2.4	125	09/01→12/04	←	+PR 1LC		24.0130-0185.1 430185	Ø 320 30 28 V•
2.5 TDI	114	08/01→07/02	→	+PR 1KD		24.0110-0261.1 410261	Ø 245 10 8 + S
2.5 TDI	120	07/02→12/04				24.0310-0261.1 510261	Ø 245 10 8 PD
			→	+PR 1KP		24.0112-0148.1 412148	Ø 255 12 10
						24.0312-0148.1 512148	Ø 255 12 10 PD
			→	8E-5-400001→; +PR 1KW		24.0112-0166.1 412166	Ø 288 12 10
						24.0312-0166.1 512166	Ø 288 12 10 PD
3.0	160	04/01→12/04	←	+PR 1LZ		24.0122-0152.1 422152	Ø 280 22 20 V + S
3.0 quattro	160	04/01→12/04				24.0322-0152.1 522152	Ø 280 22 20 V PD
			←	+PR 1LB;1LE		24.0125-0105.1 425105	Ø 288 25 23 V + S
			←	+PR 1LF;1LT		24.0125-0137.1 425137	Ø 312 25 23 V + S
						24.0325-0137.1 525137	Ø 312 25 23 V PD
			←	+PR 1LA		24.0130-0113.1 430113	Ø 320 30 28 V + S
						24.0330-0113.1 530113	Ø 320 30 28 V PD
			←	+PR 1LC		24.0130-0185.1 430185	Ø 320 30 28 V•
			→	+PR 1KD,1KP		24.0112-0148.1 412148	Ø 255 12 10
						24.0312-0148.1 512148	Ø 255 12 10 PD
			→	8E-5-400001→; +PR 1KW		24.0112-0166.1 412166	Ø 288 12 10
						24.0312-0166.1 512166	Ø 288 12 10 PD
3.0	162	11/00→12/04	←	12/00→; +PR 1LZ		24.0122-0152.1 422152	Ø 280 22 20 V + S
3.0 quattro	162	11/00→12/04				24.0322-0152.1 522152	Ø 280 22 20 V PD
			←	12/00→; +PR 1LB;1LE		24.0125-0105.1 425105	Ø 288 25 23 V + S
			←	12/00→; +PR 1LF;1LT		24.0125-0137.1 425137	Ø 312 25 23 V + S
						24.0325-0137.1 525137	Ø 312 25 23 V PD
			←	12/00→; +PR 1LA		24.0130-0113.1 430113	Ø 320 30 28 V + S
						24.0330-0113.1 530113	Ø 320 30 28 V PD
			←	12/00→; +PR 1LC		24.0130-0185.1 430185	Ø 320 30 28 V•
			→	12/00→; +PR 1KD,1KP		24.0112-0148.1 412148	Ø 255 12 10
						24.0312-0148.1 512148	Ø 255 12 10 PD
			→	8E-5-400001→; +PR 1KW		24.0112-0166.1 412166	Ø 288 12 10
						24.0312-0166.1 512166	Ø 288 12 10 PD
S4 quattro	253	03/03→12/04	←	+PR 1LJ		24.0130-0119.1 430119	Ø 345 30 28 V
			→			24.0122-0220.1 422220	Ø 300 22 20 V
AUDI - A4 (8EC, B7) 11/04→06/08							
Bremsbelagsatz, Scheibenbremse							
1.6	75	11/04→06/08	←	+PR 1LZ		13.0460-2837.2 602837	TRW 21945 19,6 + WK
↓							







	kw			 	! #		
AUDI - A4 (8EC, B7) 11/04→06/08							
 Bremsbelagsatz, Scheibenbremse							
1.8 T	120	11/04→06/08	←	+PR 1LZ		13.0470-2837.2 LD2837	TRW 21945 19,6 + WK Ceramic
1.8 T quattro	120	11/04→06/08	←	+PR 1LB;1LE;1LF;1LT		13.0460-7110.2 607110	ATE 20676 19,8 + WK
2.0	96	11/04→06/08	←	+PR 1LB;1LE;1LF;1LT		13.0470-7110.2 LD7110	ATE 20676 19,8 + WK Ceramic
2.5 TDI	120	11/04→05/06	←	+PR 1LA;1LC		13.0460-7201.2 607201	ATE 23763 20,3 + WK
			←	+PR 1LA;1LC		13.0470-7201.2 LD7201	ATE 23763 20,3 + WK Ceramic
			→	8E-5-400001→; +PR 1KW		13.0460-2749.2 602749	TRW 24483 16,9 - WE / - WK + Zub
						13.0460-2880.2 602880	TRW 23914 17,1 + WE / - WK + Zub
						13.0470-2749.2 LD2749	TRW 24483 16,9 - WE / - WK + Zub Ceramic
						13.0470-2880.2 LD2880	TRW 23914 17,1 + WE / - WK + Zub Ceramic
			→	→ 8E-4-180000; +PR 1KD		13.0460-2820.2 602820	TRW 20961 17,2 - WK
						13.0470-2820.2 LD2820	TRW 20961 17,2 - WK Ceramic
			→	→ 8E-4-180000; +PR 1KP		13.0460-2860.2 602860	TRW 23554 16,4 - WK / + WE
						13.0470-2860.2 LD2860	TRW 23554 16,4 - WK / + WE Ceramic
			→	8E-4-180001→; +PR 1KD;1KP		13.0460-2886.2 602886	TRW 20961 16,0 - WK
						13.0470-2886.2 LD2886	TRW 20961 16,0 - WK Ceramic
1.9 TDI	85	11/04→06/08	←	+PR 1LZ		13.0460-2837.2 602837	TRW 21945 19,6 + WK
2.0 TDI	103	11/04→06/08	←	+PR 1LB;1LE;1LF;1LT		13.0470-2837.2 LD2837	TRW 21945 19,6 + WK Ceramic
2.0 TDI 16V	103	11/04→06/08	←	+PR 1LB;1LE;1LF;1LT		13.0460-7110.2 607110	ATE 20676 19,8 + WK
			←	+PR 1LB;1LE;1LF;1LT		13.0470-7110.2 LD7110	ATE 20676 19,8 + WK Ceramic
			←	+PR 1LA;1LC		13.0460-7201.2 607201	ATE 23763 20,3 + WK
			←	+PR 1LA;1LC		13.0470-7201.2 LD7201	ATE 23763 20,3 + WK Ceramic
			→	8E-5-400001→; +PR 1KW		13.0460-2749.2 602749	TRW 24483 16,9 - WE / - WK + Zub
						13.0460-2880.2 602880	TRW 23914 17,1 + WE / - WK + Zub
						13.0470-2749.2 LD2749	TRW 24483 16,9 - WE / - WK + Zub Ceramic
						13.0470-2880.2 LD2880	TRW 23914 17,1 + WE / - WK + Zub Ceramic
			→	+PR 1KD;1KP		13.0460-2886.2 602886	TRW 20961 16,0 - WK
						13.0470-2886.2 LD2886	TRW 20961 16,0 - WK Ceramic
2.0 TDI	89	09/05→09/06	←	+PR 1LZ		13.0460-2837.2 602837	TRW 21945 19,6 + WK
2.0 TDI	100	11/04→06/08	←	+PR 1LZ		13.0470-2837.2 LD2837	TRW 21945 19,6 + WK Ceramic
3.0 TDI quattro	150	11/04→06/08	←	+PR 1LB;1LE;1LF;1LT		13.0460-7110.2 607110	ATE 20676 19,8 + WK
3.2 FSI	188	01/05→06/08	←	+PR 1LB;1LE;1LF;1LT		13.0470-7110.2 LD7110	ATE 20676 19,8 + WK Ceramic
3.2 FSI quattro	188	01/05→06/08	←	+PR 1LB;1LE;1LF;1LT		13.0460-7110.2 LD7110	ATE 20676 19,8 + WK Ceramic
			←	+PR 1LA;1LC		13.0460-7201.2 607201	ATE 23763 20,3 + WK
			←	+PR 1LA;1LC		13.0470-7201.2 LD7201	ATE 23763 20,3 + WK Ceramic
			→	8E-5-400001→; +PR 1KW		13.0460-2749.2 602749	TRW 24483 16,9 - WE / - WK + Zub
						13.0460-2880.2 602880	TRW 23914 17,1 + WE / - WK + Zub
						13.0470-2749.2 LD2749	TRW 24483 16,9 - WE / - WK + Zub Ceramic
						13.0470-2880.2 LD2880	TRW 23914 17,1 + WE / - WK + Zub Ceramic
2.0 TDI	93	11/05→11/06	←	06/06→; +PR 1LZ		13.0460-2837.2 602837	TRW 21945 19,6 + WK
			←	06/06→; +PR 1LB;1LE;1LF;1LT		13.0470-2837.2 LD2837	TRW 21945 19,6 + WK Ceramic
			←	06/06→; +PR 1LB;1LE;1LF;1LT		13.0460-7110.2 607110	ATE 20676 19,8 + WK
						13.0470-7110.2 LD7110	ATE 20676 19,8 + WK Ceramic
			←	06/06→; +PR 1LA;1LC		13.0460-7201.2 607201	ATE 23763 20,3 + WK
			←	06/06→; +PR 1LA;1LC		13.0470-7201.2 LD7201	ATE 23763 20,3 + WK Ceramic
			→	06/06→; +PR 1KW		13.0460-2749.2 602749	TRW 24483 16,9 - WE / - WK + Zub
						13.0460-2880.2 602880	TRW 23914 17,1 + WE / - WK + Zub
						13.0470-2749.2 LD2749	TRW 24483 16,9 - WE / - WK + Zub Ceramic
						13.0470-2880.2 LD2880	TRW 23914 17,1 + WE / - WK + Zub Ceramic
			→	06/06→; +PR 1KD;1KP		13.0460-2886.2 602886	TRW 20961 16,0 - WK
						13.0470-2886.2 LD2886	TRW 20961 16,0 - WK Ceramic
↓							













	kw			 	! #		
AUDI - A4 (8EC, B7) 11/04→06/08							
 Bremsbelagsatz, Scheibenbremse							
2.0 TDI	120	06/06→06/08	←	+PR 1LZ		13.0460-2837.2 602837	TRW 21945 19,6 + WK
2.0 TDI	125	06/06→06/08				13.0470-2837.2 LD2837	TRW 21945 19,6 + WK Ceramic
2.0 TDI quattro	103	01/06→06/08					
2.0 TDI quattro	120	06/06→06/08	←	+PR 1LB;1LE;1LF;1LT		13.0460-7110.2 607110	ATE 20676 19,8 + WK
2.0 TDI quattro	125	06/06→06/08				13.0470-7110.2 LD7110	ATE 20676 19,8 + WK Ceramic
			←	+PR 1LA;1LC		13.0460-7201.2 607201	ATE 23763 20,3 + WK
						13.0470-7201.2 LD7201	ATE 23763 20,3 + WK Ceramic
			→	+PR 1KW		13.0460-2749.2 602749	TRW 24483 16,9 - WE / - WK + Zub
						13.0460-2880.2 602880	TRW 23914 17,1 + WE / - WK + Zub
						13.0470-2749.2 LD2749	TRW 24483 16,9 - WE / - WK + Zub Ceramic
						13.0470-2880.2 LD2880	TRW 23914 17,1 + WE / - WK + Zub Ceramic
			→	+PR 1KD;1KP		13.0460-2886.2 602886	TRW 20961 16,0 - WK
						13.0470-2886.2 LD2886	TRW 20961 16,0 - WK Ceramic
2.0 TFSI	125	10/06→06/08	←	+PR 1LZ		13.0460-2837.2 602837	TRW 21945 19,6 + WK
2.0 TFSI	147	11/04→06/08				13.0470-2837.2 LD2837	TRW 21945 19,6 + WK Ceramic
2.0 TFSI	162	06/05→06/08					
2.0 TFSI quattro	147	11/04→06/08	←	+PR 1LB;1LE;1LF;1LT		13.0460-7110.2 607110	ATE 20676 19,8 + WK
2.0 TFSI quattro	162	06/05→06/08				13.0470-7110.2 LD7110	ATE 20676 19,8 + WK Ceramic
			←	+PR 1LA;1LC		13.0460-7201.2 607201	ATE 23763 20,3 + WK
						13.0470-7201.2 LD7201	ATE 23763 20,3 + WK Ceramic
			→	8E-5-400001→; +PR 1KW		13.0460-2749.2 602749	TRW 24483 16,9 - WE / - WK + Zub
						13.0460-2880.2 602880	TRW 23914 17,1 + WE / - WK + Zub
						13.0470-2749.2 LD2749	TRW 24483 16,9 - WE / - WK + Zub Ceramic
						13.0470-2880.2 LD2880	TRW 23914 17,1 + WE / - WK + Zub Ceramic
			→	+PR 1KD;1KP		13.0460-2886.2 602886	TRW 20961 16,0 - WK
						13.0470-2886.2 LD2886	TRW 20961 16,0 - WK Ceramic
2.7 TDI	120	11/05→06/08	←	+PR 1LZ		13.0460-2837.2 602837	TRW 21945 19,6 + WK
2.7 TDI	132	01/06→06/08				13.0470-2837.2 LD2837	TRW 21945 19,6 + WK Ceramic
3.0 TDI quattro	171	01/06→06/08	←	+PR 1LB;1LE;1LF;1LT		13.0460-7110.2 607110	ATE 20676 19,8 + WK
						13.0470-7110.2 LD7110	ATE 20676 19,8 + WK Ceramic
			←	+PR 1LA;1LC		13.0460-7201.2 607201	ATE 23763 20,3 + WK
						13.0470-7201.2 LD7201	ATE 23763 20,3 + WK Ceramic
			→	+PR 1KW		13.0460-2749.2 602749	TRW 24483 16,9 - WE / - WK + Zub
						13.0460-2880.2 602880	TRW 23914 17,1 + WE / - WK + Zub
						13.0470-2749.2 LD2749	TRW 24483 16,9 - WE / - WK + Zub Ceramic
						13.0470-2880.2 LD2880	TRW 23914 17,1 + WE / - WK + Zub Ceramic
3.0	160	11/04→05/06	←	+PR 1LZ		13.0460-2837.2 602837	TRW 21945 19,6 + WK
3.0 quattro	160	11/04→07/06				13.0470-2837.2 LD2837	TRW 21945 19,6 + WK Ceramic
			←	+PR 1LB;1LE;1LF;1LT		13.0460-7110.2 607110	ATE 20676 19,8 + WK
						13.0470-7110.2 LD7110	ATE 20676 19,8 + WK Ceramic
			←	+PR 1LA;1LC		13.0460-7201.2 607201	ATE 23763 20,3 + WK
						13.0470-7201.2 LD7201	ATE 23763 20,3 + WK Ceramic
			→	8E-5-400001→; +PR 1KW		13.0460-2749.2 602749	TRW 24483 16,9 - WE / - WK + Zub
						13.0460-2880.2 602880	TRW 23914 17,1 + WE / - WK + Zub
						13.0470-2749.2 LD2749	TRW 24483 16,9 - WE / - WK + Zub Ceramic
						13.0470-2880.2 LD2880	TRW 23914 17,1 + WE / - WK + Zub Ceramic
			→	→ 8E-7-300000; +PR 1KD;1KP		13.0460-2886.2 602886	TRW 20961 16,0 - WK
						13.0470-2886.2 LD2886	TRW 20961 16,0 - WK Ceramic
S4 quattro	253	11/04→06/08	←	+PR 1LJ		13.0460-7201.2 607201	ATE 23763 20,3 + WK
			→			13.0460-2888.2 602888	TRW 23326 17,4 + WE / - WK
						13.0470-2888.2 LD2888	TRW 23326 17,4 + WE / - WK Ceramic









	kw			 	! #		
AUDI - A4 (8EC, B7) 11/04→06/08							
 Bremsbelagsatz, Scheibenbremse							
S4 quattro	253	11/04→06/08	➡	01/05→		13.0460-2889.2 602889	TRW 23326 17,4 + WE / - WK
Zubehörsatz, Scheibenbremsbelag							
1.6	75	11/04→06/08	➡	→ 8E-4-180000; +PR 1KP		13.0460-0072.2 610072	TRW
1.8 T	120	11/04→06/08	➡				
1.8 T quattro	120	11/04→06/08	➡	→ 8E-4-180000; +PR 1KD		13.0460-0072.2 610072	TRW
2.0	96	11/04→06/08	➡				
2.5 TDI	120	11/04→05/06	➡	8E-5-400001→; +PR 1KW		13.0460-0259.2 610259	
1.9 TDI	85	11/04→06/08	➡	8E-5-400001→; +PR 1KW		13.0460-0259.2 610259	
2.0 TDI	89	09/05→09/06					
2.0 TDI	100	11/04→06/08					
2.0 TDI	103	11/04→06/08					
2.0 TDI 16V	103	11/04→06/08					
2.0 TFSI	125	10/06→06/08					
2.0 TFSI	147	11/04→06/08					
2.0 TFSI	162	06/05→06/08					
2.0 TFSI quattro	147	11/04→06/08					
2.0 TFSI quattro	162	06/05→06/08					
3.0	160	11/04→05/06					
3.0 quattro	160	11/04→07/06					
3.0 TDI quattro	150	11/04→06/08					
3.2 FSI	188	01/05→06/08					
3.2 FSI quattro	188	01/05→06/08					
2.0 TDI	93	11/05→11/06	➡	06/06→; +PR 1KW		13.0460-0259.2 610259	
2.0 TDI	120	06/06→06/08	➡	+PR 1KW		13.0460-0259.2 610259	
2.0 TDI	125	06/06→06/08					
2.0 TDI quattro	103	01/06→06/08					
2.0 TDI quattro	120	06/06→06/08					
2.0 TDI quattro	125	06/06→06/08					
2.7 TDI	120	11/05→06/08					
2.7 TDI	132	01/06→06/08					
3.0 TDI quattro	171	01/06→06/08					
RS4 quattro	309	09/05→06/08	➡	11/05→		13.0460-0023.2 610023	
S4 quattro	253	11/04→06/08	➡	01/05→		13.0460-0023.2 610023	
 Bremsscheibe							
1.6	75	11/04→06/08	←	+PR 1LZ		24.0122-0152.1 422152	Ø 280 22 20 V + S
1.8 T	120	11/04→06/08				24.0322-0152.1 522152	Ø 280 22 20 V PD
1.8 T quattro	120	11/04→06/08					
1.9 TDI	85	11/04→06/08	←	+PR 1LB;1LE		24.0125-0105.1 425105	Ø 288 25 23 V + S
2.0	96	11/04→06/08				24.0325-0105.1 525105	Ø 288 25 23 V PD
2.0 TDI	89	09/05→09/06					
2.0 TDI	100	11/04→06/08	←	+PR 1LF;1LT		24.0125-0137.1 425137	Ø 312 25 23 V + S
2.0 TDI	103	11/04→06/08				24.0325-0137.1 525137	Ø 312 25 23 V PD
2.0 TDI 16V	103	11/04→06/08	←	+PR 1LA		24.0130-0113.1 430113	Ø 320 30 28 V + S
2.0 TFSI	125	10/06→06/08				24.0330-0113.1 530113	Ø 320 30 28 V PD
2.0 TFSI	147	11/04→06/08					
2.0 TFSI quattro	147	11/04→06/08	←	+PR 1LC		24.0130-0185.1 430185	Ø 320 30 28 V•
2.5 TDI	120	11/04→05/06	➡	+PR 1KD		24.0110-0261.1 410261	Ø 245 10 8 + S
						24.0310-0261.1 510261	Ø 245 10 8 PD
			➡	+PR 1KP		24.0112-0148.1 412148	Ø 255 12 10
						24.0312-0148.1 512148	Ø 255 12 10 PD
			➡	8E-5-400001→; +PR 1KW		24.0112-0166.1 412166	Ø 288 12 10
						24.0312-0166.1 512166	Ø 288 12 10 PD
2.0 TDI	93	11/05→11/06	←	06/06→; +PR 1LZ		24.0122-0152.1 422152	Ø 280 22 20 V + S
						24.0322-0152.1 522152	Ø 280 22 20 V PD
			←	06/06→; +PR 1LB;1LE		24.0125-0105.1 425105	Ø 288 25 23 V + S
						24.0325-0105.1 525105	Ø 288 25 23 V PD
			←	06/06→; +PR 1LF;1LT		24.0125-0137.1 425137	Ø 312 25 23 V + S
						24.0325-0137.1 525137	Ø 312 25 23 V PD
			←	06/06→; +PR 1LA		24.0130-0113.1 430113	Ø 320 30 28 V + S
						24.0330-0113.1 530113	Ø 320 30 28 V PD
			←	06/06→; +PR 1LC		24.0130-0185.1 430185	Ø 320 30 28 V•
			➡	06/06→; +PR 1KD		24.0110-0261.1 410261	Ø 245 10 8 + S
						24.0310-0261.1 510261	Ø 245 10 8 PD
			➡	06/06→; +PR 1KP		24.0112-0148.1 412148	Ø 255 12 10
						24.0312-0148.1 512148	Ø 255 12 10 PD
			➡	06/06→; +PR 1KW		24.0112-0166.1 412166	Ø 288 12 10
						24.0312-0166.1 512166	Ø 288 12 10 PD
2.0 TDI	120	06/06→06/08	←	+PR 1LZ		24.0122-0152.1 422152	Ø 280 22 20 V + S
2.0 TDI	125	06/06→06/08				24.0322-0152.1 522152	Ø 280 22 20 V PD
2.0 TDI quattro	103	01/06→06/08					









	kw			 	! #			
AUDI - A4 (8EC, B7) 11/04→06/08								
Bremsscheibe								
2.0 TDI quattro 2.0 TDI quattro	120 125	06/06→06/08 06/06→06/08	←	+PR 1LB;1LE	24.0125-0105.1	425105	Ø 288 25 23 V + S	
					24.0325-0105.1	525105	Ø 288 25 23 V PD	
			←	+PR 1LF;1LT	24.0125-0137.1	425137	Ø 312 25 23 V + S	
					24.0325-0137.1	525137	Ø 312 25 23 V PD	
			←	+PR 1LA	24.0130-0113.1	430113	Ø 320 30 28 V + S	
					24.0330-0113.1	530113	Ø 320 30 28 V PD	
			←	+PR 1LC	24.0130-0185.1	430185	Ø 320 30 28 V•	
			→	+PR 1KD	24.0110-0261.1	410261	Ø 245 10 8 + S	
		24.0310-0261.1	510261	Ø 245 10 8 PD				
			→	+PR 1KP	24.0112-0148.1	412148	Ø 255 12 10	
					24.0312-0148.1	512148	Ø 255 12 10 PD	
				→	+PR 1KW	24.0112-0166.1	412166	Ø 288 12 10
					24.0312-0166.1	512166	Ø 288 12 10 PD	
2.0 TFSI 2.0 TFSI quattro 3.0 TDI quattro 3.2 FSI 3.2 FSI quattro	162 162 150 188 188	06/05→06/08 06/05→06/08 11/04→06/08 01/05→06/08 01/05→06/08	←	+PR 1LZ	24.0122-0152.1	422152	Ø 280 22 20 V + S	
					24.0322-0152.1	522152	Ø 280 22 20 V PD	
			←	+PR 1LB;1LE	24.0125-0105.1	425105	Ø 288 25 23 V + S	
			←	+PR 1LF;1LT	24.0125-0137.1	425137	Ø 312 25 23 V + S	
					24.0325-0137.1	525137	Ø 312 25 23 V PD	
			←	+PR 1LA	24.0130-0113.1	430113	Ø 320 30 28 V + S	
					24.0330-0113.1	530113	Ø 320 30 28 V PD	
			←	+PR 1LC	24.0130-0185.1	430185	Ø 320 30 28 V•	
			→	+PR 1KD	24.0110-0261.1	410261	Ø 245 10 8 + S	
					24.0310-0261.1	510261	Ø 245 10 8 PD	
				→	+PR 1KP	24.0112-0148.1	412148	Ø 255 12 10
					24.0312-0148.1	512148	Ø 255 12 10 PD	
				→	8E-5-400001→; +PR 1KW	24.0112-0166.1	412166	Ø 288 12 10
					24.0312-0166.1	512166	Ø 288 12 10 PD	
2.7 TDI 2.7 TDI	120 132	11/05→06/08 01/06→06/08	←	+PR 1LZ	24.0122-0152.1	422152	Ø 280 22 20 V + S	
					24.0322-0152.1	522152	Ø 280 22 20 V PD	
			←	+PR 1LB;1LE	24.0125-0105.1	425105	Ø 288 25 23 V + S	
					24.0325-0105.1	525105	Ø 288 25 23 V PD	
			←	+PR 1LF;1LT	24.0125-0137.1	425137	Ø 312 25 23 V + S	
					24.0325-0137.1	525137	Ø 312 25 23 V PD	
			←	+PR 1LA	24.0130-0113.1	430113	Ø 320 30 28 V + S	
					24.0330-0113.1	530113	Ø 320 30 28 V PD	
←	+PR 1LC	24.0130-0185.1	430185	Ø 320 30 28 V•				
			→	+PR 1KW	24.0112-0166.1	412166	Ø 288 12 10	
					24.0312-0166.1	512166	Ø 288 12 10 PD	
3.0 3.0 quattro	160 160	11/04→05/06 11/04→07/06	←	+PR 1LZ	24.0122-0152.1	422152	Ø 280 22 20 V + S	
					24.0322-0152.1	522152	Ø 280 22 20 V PD	
			←	+PR 1LB;1LE	24.0125-0105.1	425105	Ø 288 25 23 V + S	
			←	+PR 1LF;1LT	24.0125-0137.1	425137	Ø 312 25 23 V + S	
					24.0325-0137.1	525137	Ø 312 25 23 V PD	
			←	+PR 1LA	24.0130-0113.1	430113	Ø 320 30 28 V + S	
					24.0330-0113.1	530113	Ø 320 30 28 V PD	
			←	+PR 1LC	24.0130-0185.1	430185	Ø 320 30 28 V•	
			→	+PR 1KD,1KP	24.0112-0148.1	412148	Ø 255 12 10	
					24.0312-0148.1	512148	Ø 255 12 10 PD	
				→	8E-5-400001→; +PR 1KW	24.0112-0166.1	412166	Ø 288 12 10
					24.0312-0166.1	512166	Ø 288 12 10 PD	
3.0 TDI quattro	171	01/06→06/08	←	+PR 1LZ	24.0122-0152.1	422152	Ø 280 22 20 V + S	
					24.0322-0152.1	522152	Ø 280 22 20 V PD	
			←	+PR 1LB;1LE	24.0125-0105.1	425105	Ø 288 25 23 V + S	
			←	+PR 1LF;1LT	24.0125-0137.1	425137	Ø 312 25 23 V + S	
					24.0325-0137.1	525137	Ø 312 25 23 V PD	
			←	+PR 1LA	24.0130-0113.1	430113	Ø 320 30 28 V + S	
		24.0330-0113.1	530113	Ø 320 30 28 V PD				
←	+PR 1LC	24.0130-0185.1	430185	Ø 320 30 28 V•				
			→	+PR 1KW	24.0112-0166.1	412166	Ø 288 12 10	
					24.0312-0166.1	512166	Ø 288 12 10 PD	
↓								







	kw			 	! #		
AUDI - A4 (8EC, B7) 11/04→06/08							
 Bremsscheibe							
S4 quattro	253	11/04→06/08	←	+PR 1LJ		24.0130-0119.1 430119	Ø 345 30 28 V
			→			24.0122-0220.1 422220	Ø 300 22 20 V
AUDI - A4 (8K2, B8) 11/07→12/15							
 Bremsbelagsatz, Scheibenbremse							
1.8 TFSI	88	01/08→12/15	←	+PR 1LA,1LB,1LD		13.0460-2746.2 602746	TRW 24408 19,2 + WK
1.8 TFSI	118	11/07→03/12				13.0470-2746.2 LD2746	TRW 24408 19,2 + WK + Zub Ceramic
1.8 TFSI quattro	118	09/08→03/12					
2.0 TDI	88	06/08→12/15	←	+PR 1LT,1LY		13.0460-7256.2 607256	ATE 24705 19,8 + WK
2.0 TDI	100	11/07→12/15				13.0470-7256.2 LD7256	ATE 24705 19,8 + WK Ceramic
2.0 TDI	105	11/07→12/15					
2.0 TDI	110	05/13→12/15	→	+PR 1KW,2EH; + eFSB		13.0460-2747.2 602747	TRW 24606 17,4 - WE / - WK + Zub
2.0 TDI	120	08/08→12/15				13.0470-2747.2 LD2747	TRW 24606 17,4 - WE / - WK + Zub Ceramic
2.0 TDI	125	01/08→03/12					
2.0 TDI	130	11/11→12/15					
2.0 TDI	140	09/13→12/15					
2.0 TDI 16V	103	07/08→	→	+PR 1KP; + eFSB		13.0460-2748.2 602748	TRW 24606 17,4 - WE / - WK + Zub
2.0 TDI quattro	105	11/08→12/15				13.0470-2748.2 LD2748	TRW 24606 17,4 - WE / - WK + Zub Ceramic
2.0 TDI quattro	110	05/13→12/15					
2.0 TDI quattro	125	01/08→03/12					
2.0 TDI quattro	130	11/11→12/15					
2.0 TDI quattro	140	09/13→12/15					
2.0 TFSI	132	06/08→12/15					
2.0 TFSI	155	06/08→05/13					
2.0 TFSI	162	05/13→12/15					
2.0 TFSI	165	05/13→12/15					
2.0 TFSI flexible fuel	132	11/09→12/15					
2.0 TFSI flexible fuel quattro	132	11/09→12/15					
2.0 TFSI quattro	155	06/08→12/15					
2.0 TFSI quattro	162	05/13→12/15					
2.0 TFSI quattro	165	05/13→12/15					
2.7 TDI	120	11/07→03/12					
2.7 TDI	140	11/07→03/12					
3.0 TDI	150	11/11→12/15					
3.0 TDI quattro	155	06/08→05/10					
3.0 TDI quattro	176	11/07→03/12					
3.0 TDI quattro	180	11/11→12/15					
3.0 TFSI quattro	200	02/12→12/15					
3.2 FSI	195	09/08→03/12					
3.2 FSI quattro	195	11/07→03/12					
1.8 TFSI	125	11/11→12/15	←	01/12→; +PR 1LA,1LB,1LD		13.0460-2746.2 602746	TRW 24408 19,2 + WK
1.8 TFSI quattro	125	11/11→12/15				13.0470-2746.2 LD2746	TRW 24408 19,2 + WK + Zub Ceramic
			←	01/12→; +PR 1LT,1LY		13.0460-7256.2 607256	ATE 24705 19,8 + WK
						13.0470-7256.2 LD7256	ATE 24705 19,8 + WK Ceramic
			→	01/12→; +PR 1KW,2EH; + eFSB		13.0460-2747.2 602747	TRW 24606 17,4 - WE / - WK + Zub
						13.0470-2747.2 LD2747	TRW 24606 17,4 - WE / - WK + Zub Ceramic
			→	01/12→; +PR 1KP; + eFSB		13.0460-2748.2 602748	TRW 24606 17,4 - WE / - WK + Zub
						13.0470-2748.2 LD2748	TRW 24606 17,4 - WE / - WK + Zub Ceramic
S4 quattro	245	11/08→12/15	←	07/11→; +PR 1LJ,1ZT		13.0460-2746.2 602746	TRW 24408 19,2 + WK
			→	+PR 1KE; + eFSB		13.0460-2748.2 602748	TRW 24606 17,4 - WE / - WK + Zub
						13.0470-2748.2 LD2748	TRW 24606 17,4 - WE / - WK + Zub Ceramic
 Bremsscheibe							
1.8 TFSI	88	01/08→12/15	←	+PR 1LT,1LY		24.0125-0184.1 425184	Ø 314 25 23 V + S
1.8 TFSI	118	11/07→03/12				24.0325-0184.1 525184	Ø 314 25 23 V + S PD
1.8 TFSI quattro	118	09/08→03/12					
2.0 TDI	88	06/08→12/15	←	+PR 1LA; → 06/11		24.0130-0193.1 430193	Ø 320 30 28 V + S
2.0 TDI	100	11/07→12/15				24.0330-0193.1 530193	Ø 320 30 28 V + S PD
2.0 TDI	105	11/07→12/15					
2.0 TDI	120	08/08→12/15	←	07/11→; +PR 1LA,1LB		24.0130-0221.1 430221	Ø 320 30 28 V + S
2.0 TDI	125	01/08→03/12	←	+PR 1LD		24.0130-0222.1 430222	Ø 345 30 28 V + S
2.0 TDI 16V	103	07/08→					
2.0 TDI quattro	105	11/08→12/15	→	+PR 1KW,2EH		24.0112-0178.1 412178	Ø 300 12 10 + S
2.0 TDI quattro	125	01/08→03/12				24.0312-0178.1 512178	Ø 300 12 10 + S PD
2.0 TFSI	132	06/08→12/15					
2.0 TFSI	155	06/08→05/13	→	+PR 1KP; + eFSB		24.0122-0272.1 422272	Ø 330 21,9 20 V + S
2.0 TFSI flexible fuel	132	11/09→12/15					
2.0 TFSI quattro	155	06/08→12/15					







	kw			 	! #		
AUDI - A4 (8K2, B8) 11/07→12/15							
Bremsscheibe							
2.7 TDI	120	11/07→03/12	←	+PR 1LT,1LY		24.0125-0184.1 425184	Ø 314 25 23 V + S
2.7 TDI	140	11/07→03/12				24.0325-0184.1 525184	Ø 314 25 23 V + S PD
3.0 TDI quattro	176	11/07→03/12					
3.2 FSI	195	09/08→03/12	←	+PR 1LA; → 06/11		24.0130-0193.1 430193	Ø 320 30 28 V + S
3.2 FSI quattro	195	11/07→03/12				24.0330-0193.1 530193	Ø 320 30 28 V + S PD
			←	07/11→; +PR 1LA,1LB		24.0130-0221.1 430221	Ø 320 30 28 V + S
			←	+PR 1LD		24.0130-0222.1 430222	Ø 345 30 28 V + S
			→	+PR 1KW,2EH		24.0112-0178.1 412178	Ø 300 12 10 + S
						24.0312-0178.1 512178	Ø 300 12 10 + S PD
			→	+PR 1KP; + eFSB		24.0122-0272.1 422272	Ø 330 21,9 20 V + S
1.8 TFSI	125	11/11→12/15	←	01/12→; +PR 1LT,1LY		24.0125-0184.1 425184	Ø 314 25 23 V + S
1.8 TFSI quattro	125	11/11→12/15				24.0325-0184.1 525184	Ø 314 25 23 V + S PD
			←	01/12→; +PR 1LA,1LB		24.0130-0221.1 430221	Ø 320 30 28 V + S
			←	01/12→; +PR 1LD		24.0130-0222.1 430222	Ø 345 30 28 V + S
			→	01/12→; +PR 1KW,2EH		24.0112-0178.1 412178	Ø 300 12 10 + S
						24.0312-0178.1 512178	Ø 300 12 10 + S PD
			→	01/12→; +PR 1KP; + eFSB		24.0122-0272.1 422272	Ø 330 21,9 20 V + S
2.0 TDI	110	05/13→12/15	←	+PR 1LT,1LY		24.0125-0184.1 425184	Ø 314 25 23 V + S
2.0 TDI	130	11/11→12/15				24.0325-0184.1 525184	Ø 314 25 23 V + S PD
2.0 TDI	140	09/13→12/15					
2.0 TDI quattro	110	05/13→12/15	←	+PR 1LA,1LB		24.0130-0221.1 430221	Ø 320 30 28 V + S
2.0 TDI quattro	130	11/11→12/15	←	+PR 1LD		24.0130-0222.1 430222	Ø 345 30 28 V + S
2.0 TDI quattro	140	09/13→12/15					
2.0 TFSI	162	05/13→12/15	→	+PR 1KW,2EH		24.0112-0178.1 412178	Ø 300 12 10 + S
2.0 TFSI	165	05/13→12/15				24.0312-0178.1 512178	Ø 300 12 10 + S PD
2.0 TFSI quattro	162	05/13→12/15	→	+PR 1KP; + eFSB		24.0122-0272.1 422272	Ø 330 21,9 20 V + S
2.0 TFSI quattro	165	05/13→12/15					
3.0 TDI	150	11/11→12/15					
3.0 TDI quattro	180	11/11→12/15					
3.0 TFSI quattro	200	02/12→12/15					
2.0 TFSI flexible fuel quattro	132	11/09→12/15	←	+PR 1LT,1LY		24.0125-0184.1 425184	Ø 314 25 23 V + S
						24.0325-0184.1 525184	Ø 314 25 23 V + S PD
			←	+PR 1LA; → 06/11		24.0130-0193.1 430193	Ø 320 30 28 V + S
						24.0330-0193.1 530193	Ø 320 30 28 V + S PD
			←	+PR 1LA,1LB		24.0130-0221.1 430221	Ø 320 30 28 V + S
			←	+PR 1LD		24.0130-0222.1 430222	Ø 345 30 28 V + S
			→	+PR 1KW,2EH		24.0112-0178.1 412178	Ø 300 12 10 + S
						24.0312-0178.1 512178	Ø 300 12 10 + S PD
			→	+PR 1KP; + eFSB		24.0122-0272.1 422272	Ø 330 21,9 20 V + S
3.0 TDI quattro	155	06/08→05/10	←	+PR 1LT,1LY		24.0125-0184.1 425184	Ø 314 25 23 V + S
						24.0325-0184.1 525184	Ø 314 25 23 V + S PD
			←	+PR 1LA		24.0130-0193.1 430193	Ø 320 30 28 V + S
						24.0330-0193.1 530193	Ø 320 30 28 V + S PD
			←	+PR 1LD		24.0130-0221.1 430221	Ø 345 30 28 V + S
			→	+PR 1KW,2EH		24.0112-0178.1 412178	Ø 300 12 10 + S
						24.0312-0178.1 512178	Ø 300 12 10 + S PD
			→	+PR 1KP; + eFSB		24.0122-0272.1 422272	Ø 330 21,9 20 V + S
S4 quattro	245	11/08→12/15	←	→ 06/11; +PR 1LJ		24.0129-0102.1 429102	Ø 345 29,5 28 V + S
			←	07/11→; +PR 1LJ,1ZT		24.0130-0221.1 430221	Ø 345 30 28 V + S
			→	→ 10/10; +PR 1KE; + eFSB		24.0122-0272.1 422272	Ø 330 21,9 20 V + S
			→	11/10→; +PR 1KE; + eFSB		24.0122-0272.1 422272	Ø 330 21,9 20 V + S
AUDI - A4 (8W2, B9) 05/15→							
Bremsscheibe							
1.4 TFSI	110	08/15→	←	+PR 1LA,1LB		24.0125-0184.1 425184	Ø 314 25 23 V + S
2.0 TDI	90	05/16→				24.0325-0184.1 525184	Ø 314 25 23 V + S PD
2.0 TDI	100	05/15→	←	+PR 1LL,1ZA,1ZC,1ZK		24.0134-0110.1 430110	Ø 349 34 32 V + S
2.0 TDI	110	05/15→					
2.0 TDI quattro	140	05/15→	→	+PR 1KF,1KJ,1KK,2EJ		24.0122-0272.1 422272	Ø 330 21,9 20 V + S
2.0 TDI quattro	110	09/16→					
2.0 TDI quattro	120	09/16→					
2.0 TDI quattro	140	09/15→					
2.0 TFSI	140	05/15→					
2.0 TFSI	183	11/15→					
2.0 TFSI	185	05/15→					
2.0 TFSI quattro	183	11/15→					
			↓				

	kw			 	! #		
AUDI - A4 (8W2, B9) 05/15→							
 Bremsscheibe							
2.0 TFSI quattro	185	05/15→	←	+PR 1LA,1LB		24.0125-0184.1 425184	Ø 314 25 23 V + S
3.0 TDI	160	09/15→				24.0325-0184.1 525184	Ø 314 25 23 V + S PD
3.0 TDI quattro	160	09/15→					
3.0 TDI quattro	200	05/15→	←	+PR 1LL,1ZA,1ZC,1ZK		24.0134-0110.1 430110	Ø 349 34 32 V + S
S4 quattro	260	05/16→	→	+PR 1KF,1KJ,1KK,2EJ		24.0122-0272.1 422272	Ø 330 21,9 20 V + S
AUDI - A4 Allroad (8KH, B8) 04/09→05/16							
 Bremsbelagsatz, Scheibenbremse							
2.0 TDI quattro	100	09/09→05/16	←	+PR 1LA		13.0460-2746.2 602746	TRW 24408 19,2 + WK
2.0 TDI quattro	105	09/09→05/16				13.0470-2746.2 LD2746	TRW 24408 19,2 + WK + Zub Ceramic
2.0 TDI quattro	110	05/13→05/16					
2.0 TDI quattro	120	04/09→05/16					
2.0 TDI quattro	125	04/09→05/16	←	+PR 1LT		13.0460-7256.2 607256	ATE 24705 19,8 + WK
2.0 TDI quattro	140	09/13→05/16				13.0470-7256.2 LD7256	ATE 24705 19,8 + WK Ceramic
2.0 TFSI quattro	155	04/09→05/16					
2.0 TFSI quattro	162	05/13→05/16	→	+PR 1KW,GP0,GP1,GP2		13.0460-2747.2 602747	TRW 24606 17,4 - WE / - WK + Zub
2.0 TFSI quattro	165	05/13→05/16					
3.0 TDI quattro	176	04/09→01/12				13.0470-2747.2 LD2747	TRW 24606 17,4 - WE / - WK + Zub Ceramic
3.0 TDI quattro	180	01/12→05/16					
2.0 TDI quattro	130	11/11→05/16	←	01/12→; +PR 1LA		13.0460-2746.2 602746	TRW 24408 19,2 + WK
						13.0470-2746.2 LD2746	TRW 24408 19,2 + WK + Zub Ceramic
			←	01/12→; +PR 1LT		13.0460-7256.2 607256	ATE 24705 19,8 + WK
						13.0470-7256.2 LD7256	ATE 24705 19,8 + WK Ceramic
			→	01/12→; +PR 1KW,GP0,GP1,GP2		13.0460-2747.2 602747	TRW 24606 17,4 - WE / - WK + Zub
						13.0470-2747.2 LD2747	TRW 24606 17,4 - WE / - WK + Zub Ceramic
 Bremsscheibe							
2.0 TDI quattro	100	09/09→05/16	←	+PR 1LT		24.0125-0184.1 425184	Ø 314 25 23 V + S
2.0 TDI quattro	105	09/09→05/16				24.0325-0184.1 525184	Ø 314 25 23 V + S PD
2.0 TDI quattro	120	04/09→05/16					
2.0 TDI quattro	125	04/09→05/16	←	→ 06/11; +PR 1LA		24.0130-0193.1 430193	Ø 320 30 28 V + S
2.0 TFSI quattro	155	04/09→05/16				24.0330-0193.1 530193	Ø 320 30 28 V + S PD
3.0 TDI quattro	176	04/09→01/12	←	07/11→; +PR 1LA		24.0130-0221.1 430221	Ø 320 30 28 V + S
			→	+PR 1KW,GP0,GP1,GP2		24.0112-0178.1 412178	Ø 300 12 10 + S
						24.0312-0178.1 512178	Ø 300 12 10 + S PD
2.0 TDI quattro	110	05/13→05/16	←	+PR 1LT		24.0125-0184.1 425184	Ø 314 25 23 V + S
2.0 TDI quattro	140	09/13→05/16				24.0325-0184.1 525184	Ø 314 25 23 V + S PD
2.0 TFSI quattro	162	05/13→05/16					
2.0 TFSI quattro	165	05/13→05/16	←	+PR 1LA		24.0130-0221.1 430221	Ø 320 30 28 V + S
3.0 TDI quattro	180	01/12→05/16	→	+PR 1KW,GP0,GP1,GP2		24.0112-0178.1 412178	Ø 300 12 10 + S
						24.0312-0178.1 512178	Ø 300 12 10 + S PD
2.0 TDI quattro	130	11/11→05/16	←	01/12→; +PR 1LT		24.0125-0184.1 425184	Ø 314 25 23 V + S
						24.0325-0184.1 525184	Ø 314 25 23 V + S PD
			←	01/12→; +PR 1LA		24.0130-0221.1 430221	Ø 320 30 28 V + S
			→	01/12→; +PR 1KW,GP0,GP1,GP2		24.0112-0178.1 412178	Ø 300 12 10 + S
						24.0312-0178.1 512178	Ø 300 12 10 + S PD
AUDI - A4 Allroad (8WH, B9) 01/16→							
 Bremsscheibe							
2.0 TDI quattro	100	11/16→	←	+PR 1LA,1LB		24.0125-0184.1 425184	Ø 314 25 23 V + S
2.0 TDI quattro	110	11/16→				24.0325-0184.1 525184	Ø 314 25 23 V + S PD
2.0 TDI quattro	120	05/16→					
2.0 TDI quattro	140	01/16→	←	+PR 1LL,1ZA,1ZC,1ZK		24.0134-0110.1 430110	Ø 349 34 32 V + S
2.0 TFSI quattro	183	05/16→					
2.0 TFSI quattro	185	01/16→	→	+PR 1KF,1KJ,1KK,2EJ; + eFSB		24.0122-0272.1 422272	Ø 330 21,9 20 V + S
3.0 TDI quattro	160	01/16→					
3.0 TDI quattro	200	01/16→					
AUDI - A4 Avant (8D5, B5) 11/94→09/01							
 Bremsbelagsatz, Scheibenbremse							
1.6	74	11/94→09/01	←	→ 8D-V-169695		13.0460-2822.2 602822	TRW 21945 19,6 - WK
1.6	75	07/00→09/01				13.0460-2934.2 602934	TRW 20669 19,0 - WK
1.9 DUO	66	03/98→09/01					
1.9 TDI	55	03/96→09/01	←	8D-V-169696→; → 04/01		13.0460-2822.2 602822	TRW 21945 19,6 - WK
1.9 TDI	66	02/96→09/01				13.0460-2837.2 602837	TRW 21945 19,6 + WK
						13.0470-2837.2 LD2837	TRW 21945 19,6 + WK Ceramic
			←	8D-V-054062→; → 04/01		13.0460-2822.2 602822	TRW 21945 19,6 - WK

	kw			 	! #		
AUDI - A4 Avant (8D5, B5) 11/94→09/01							
 Bremsbelagsatz, Scheibenbremse							
1.6	74	11/94→09/01	←	8D-V-054062→; → 04/01		13.0460-2837.2 602837	TRW 21945 19,6 + WK
1.6	75	07/00→09/01				13.0470-2837.2 LD2837	TRW 21945 19,6 + WK Ceramic
1.9 DUO	66	03/98→09/01					
1.9 TDI	55	03/96→09/01	←	→ 8D-V-054061		13.0460-7077.2 607077	ATE 20676 19,8 - WE / - WK
1.9 TDI	66	02/96→09/01	→	8D-V-160001→; → 04/01		13.0460-2820.2 602820	TRW 20961 17,2 - WK
						13.0470-2820.2 LD2820	TRW 20961 17,2 - WK Ceramic
			→	→ 8D-V-160000		13.0460-3602.2 603602	TRW 21144 15,8 - WK
1.8	85	07/95→09/01	←	8D-V-054062→; → 04/01		13.0460-2822.2 602822	TRW 21945 19,6 - WK
1.8	92	02/96→09/01				13.0460-2837.2 602837	TRW 21945 19,6 + WK
						13.0470-2837.2 LD2837	TRW 21945 19,6 + WK Ceramic
			←	→ 8D-V-054061		13.0460-7077.2 607077	ATE 20676 19,8 - WE / - WK
						13.0460-7110.2 607110	ATE 20676 19,8 + WK
						13.0470-7110.2 LD7110	ATE 20676 19,8 + WK Ceramic
			→	8D-V-160001→; → 04/01		13.0460-2820.2 602820	TRW 20961 17,2 - WK
						13.0470-2820.2 LD2820	TRW 20961 17,2 - WK Ceramic
			→	→ 8D-V-160000		13.0460-3602.2 603602	TRW 21144 15,8 - WK
1.8 quattro	85	07/95→09/01	←	8D-V-054062→; → 04/01		13.0460-2822.2 602822	TRW 21945 19,6 - WK
1.8 quattro	92	01/96→09/01				13.0460-2837.2 602837	TRW 21945 19,6 + WK
						13.0470-2837.2 LD2837	TRW 21945 19,6 + WK Ceramic
			←	→ 8D-V-054061		13.0460-7077.2 607077	ATE 20676 19,8 - WE / - WK
			→	→ 04/01		13.0460-3602.2 603602	TRW 21144 15,8 - WK
1.8 T	110	03/96→09/01	←	→ 04/01		13.0460-7077.2 607077	ATE 20676 19,8 - WE / - WK
1.8 T	132	12/97→09/01				13.0460-7110.2 607110	ATE 20676 19,8 + WK
1.9 TDI	81	02/96→09/01				13.0470-7110.2 LD7110	ATE 20676 19,8 + WK Ceramic
2.6	110	02/96→09/01					
2.8	142	10/96→09/01	→	8D-V-160001→; → 04/01		13.0460-2820.2 602820	TRW 20961 17,2 - WK
						13.0470-2820.2 LD2820	TRW 20961 17,2 - WK Ceramic
			→	→ 8D-V-160000		13.0460-3602.2 603602	TRW 21144 15,8 - WK
1.8 T quattro	110	01/96→09/01	←	→ 01/99		13.0460-7077.2 607077	ATE 20676 19,8 - WE / - WK
1.8 T quattro	132	12/97→09/01					
1.9 TDI quattro	81	09/96→09/01	←	02/99→ 04/01		13.0460-7110.2 607110	ATE 20676 19,8 + WK
2.4 quattro	120	08/97→09/01				13.0470-7110.2 LD7110	ATE 20676 19,8 + WK Ceramic
2.6 quattro	110	01/96→09/01	→	→ 04/01		13.0460-3602.2 603602	TRW 21144 15,8 - WK
2.8 quattro	142	10/96→09/01					
1.9 TDI	85	03/00→09/01	←	→ 04/01		13.0460-7077.2 607077	ATE 20676 19,8 - WE / - WK
2.5 TDI	110	09/97→09/01				13.0460-7110.2 607110	ATE 20676 19,8 + WK
						13.0470-7110.2 LD7110	ATE 20676 19,8 + WK Ceramic
			→	→ 04/01		13.0460-2820.2 602820	TRW 20961 17,2 - WK
						13.0470-2820.2 LD2820	TRW 20961 17,2 - WK Ceramic
			→	→ 8D-V-160000		13.0460-3602.2 603602	TRW 21144 15,8 - WK
1.9 TDI quattro	85	03/00→09/01	←	→ 04/01		13.0460-7110.2 607110	ATE 20676 19,8 + WK
						13.0470-7110.2 LD7110	ATE 20676 19,8 + WK Ceramic
			→	→ 04/01		13.0460-3602.2 603602	TRW 21144 15,8 - WK
2.4	110	07/95→07/97	←			13.0460-7077.2 607077	ATE 20676 19,8 - WE / - WK
2.8	128	03/96→09/96				13.0460-7110.2 607110	ATE 20676 19,8 + WK
2.8	140	03/99→09/00				13.0470-7110.2 LD7110	ATE 20676 19,8 + WK Ceramic
			→	8D-V-160001→		13.0460-2820.2 602820	TRW 20961 17,2 - WK
						13.0470-2820.2 LD2820	TRW 20961 17,2 - WK Ceramic
			→	→ 8D-V-160000		13.0460-3602.2 603602	TRW 21144 15,8 - WK
2.4	120	08/97→09/01	←	→ 04/01		13.0460-7077.2 607077	ATE 20676 19,8 - WE / - WK
						13.0460-7110.2 607110	ATE 20676 19,8 + WK
						13.0470-7110.2 LD7110	ATE 20676 19,8 + WK Ceramic
			→	→ 04/01		13.0460-2820.2 602820	TRW 20961 17,2 - WK
						13.0470-2820.2 LD2820	TRW 20961 17,2 - WK Ceramic
2.4	121	03/97→09/01	←	08/97→ 04/01		13.0460-7077.2 607077	ATE 20676 19,8 - WE / - WK
						13.0460-7110.2 607110	ATE 20676 19,8 + WK
						13.0470-7110.2 LD7110	ATE 20676 19,8 + WK Ceramic
			→	08/97→ 04/01		13.0460-2820.2 602820	TRW 20961 17,2 - WK
						13.0470-2820.2 LD2820	TRW 20961 17,2 - WK Ceramic
2.4 quattro	121	03/97→09/01	←	08/97→ 01/99		13.0460-7077.2 607077	ATE 20676 19,8 - WE / - WK
			←	02/99→ 04/01		13.0460-7110.2 607110	ATE 20676 19,8 + WK
						13.0470-7110.2 LD7110	ATE 20676 19,8 + WK Ceramic
			→	08/97→ 04/01		13.0460-3602.2 603602	TRW 21144 15,8 - WK
↓							

	kw			 	! #		
AUDI - A4 Avant (8D5, B5) 11/94→09/01							
 Bremsbelagsatz, Scheibenbremse							
2.5 TDI quattro	110	09/97→09/01	←	11/97→ 01/99	13.0460-7077.2	607077	ATE 20676 19,8 - WE / - WK
			←	02/99→ 04/01	13.0460-7110.2	607110	ATE 20676 19,8 + WK
			→	11/97→ 04/01	13.0470-7110.2	LD7110	ATE 20676 19,8 + WK Ceramic
2.8 quattro	128	01/96→09/96	←	→ 07/96	13.0460-7077.2	607077	ATE 20676 19,8 - WE / - WK
			→	→ 07/96	13.0460-3602.2	603602	TRW 21144 15,8 - WK
2.8 quattro	140	03/99→09/00	←		13.0460-7110.2	607110	ATE 20676 19,8 + WK
			→		13.0470-7110.2	LD7110	ATE 20676 19,8 + WK Ceramic
2.8 quattro	280	10/00→09/01	←	→ 04/01	13.0460-3602.2	603602	TRW 21144 15,8 - WK
			←	→ 04/01	13.0460-7183.2	607183	ATE 21484 20,5 + WE / - WK
RS4 quattro	280	05/00→09/01	←	06/00→ 04/01	13.0460-7183.2	607183	ATE 21484 20,5 + WE / - WK
S4 quattro	195	09/97→09/01	←	10/97→; → 8D-X-199 999	13.0460-2705.2	602705	TRW 21452 18,5 - WK
			←	8D-X-200 001→; → 04/01	13.0460-2875.2	602875	TRW 23119 17,5 + WK
			→	10/97→ 04/01	13.0460-2820.2	602820	TRW 20961 17,2 - WK
					13.0470-2820.2	LD2820	TRW 20961 17,2 - WK Ceramic
Zubehörsatz, Scheibenbremsbelag							
1.6	74	11/94→09/01	→	8D-V-160001→; → 04/01	13.0460-0072.2	610072	TRW
1.6	75	07/00→09/01					
1.8	85	07/95→09/01					
1.8	92	02/96→09/01					
1.8 T	110	03/96→09/01					
1.8 T	132	12/97→09/01					
1.9 DUO	66	03/98→09/01					
1.9 TDI	55	03/96→09/01					
1.9 TDI	66	02/96→09/01					
1.9 TDI	81	02/96→09/01					
2.6	110	02/96→09/01					
2.8	142	10/96→09/01					
1.9 TDI	85	03/00→09/01	→	→ 04/01	13.0460-0072.2	610072	TRW
2.4	120	08/97→09/01					
2.5 TDI	110	09/97→09/01					
2.4	110	07/95→07/97	→	8D-V-160001→	13.0460-0072.2	610072	TRW
2.8	128	03/96→09/96					
2.8	140	03/99→09/00					
2.4	121	03/97→09/01	→	08/97→ 04/01	13.0460-0072.2	610072	TRW
S4 quattro	195	09/97→09/01	→	10/97→ 04/01	13.0460-0072.2	610072	TRW
 Bremsscheibe							
1.6	74	11/94→09/01	←	→ 8D-V-169695	24.0113-0181.1	413181	∅ 280 13 11
					24.0313-0181.1	513181	∅ 280 13 11 PD
			←	→ 8D-V-054061	24.0115-0105.1	415105	∅ 288 15 13
					24.0315-0105.1	515105	∅ 288 15 13 PD
			←	8D-V-054062→; → 04/01	24.0122-0152.1	422152	∅ 280 22 20 V + S
					24.0322-0152.1	522152	∅ 280 22 20 V PD
1.6	75	07/00→09/01	←	8D-V-169696→; → 04/01	24.0122-0152.1	422152	∅ 280 22 20 V + S
					24.0322-0152.1	522152	∅ 280 22 20 V PD
			→	→ 04/01	24.0110-0210.1	410210	∅ 245 10 8 - LG / - ABS Ring
			←	→ 8D-V-054061; fur China/GUS	24.0115-0105.1	415105	∅ 288 15 13
					24.0315-0105.1	515105	∅ 288 15 13 PD
			←	8D-V-054062→; → 04/01; fur China/GUS	24.0122-0152.1	422152	∅ 280 22 20 V + S
1.8	85	07/95→09/01			24.0322-0152.1	522152	∅ 280 22 20 V PD
			→	→ 04/01	24.0110-0210.1	410210	∅ 245 10 8 - LG / - ABS Ring
			←	→ 8D-V-054061	24.0115-0105.1	415105	∅ 288 15 13
					24.0315-0105.1	515105	∅ 288 15 13 PD
			←	8D-V-054062→; → 04/01	24.0122-0152.1	422152	∅ 280 22 20 V + S
					24.0322-0152.1	522152	∅ 280 22 20 V PD
1.8	92	02/96→09/01	→	→ 04/01	24.0110-0210.1	410210	∅ 245 10 8 - LG / - ABS Ring
			←	→ 8D-V-054061	24.0115-0105.1	415105	∅ 288 15 13
					24.0315-0105.1	515105	∅ 288 15 13 PD
			←	8D-V-054062→; → 04/01	24.0122-0152.1	422152	∅ 280 22 20 V + S
					24.0322-0152.1	522152	∅ 280 22 20 V PD
			→	→ 04/01	24.0110-0210.1	410210	∅ 245 10 8 - LG / - ABS Ring
1.8 quattro	85	07/95→09/01	←	→ 8D-V-054061; fur GUS	24.0115-0105.1	415105	∅ 288 15 13
					24.0315-0105.1	515105	∅ 288 15 13 PD
			←	8D-V-054062→; → 04/01; fur GUS	24.0122-0152.1	422152	∅ 280 22 20 V + S
					24.0322-0152.1	522152	∅ 280 22 20 V PD
			→	→ 04/01	24.0110-0224.1	410224	∅ 245 10 8
					24.0310-0224.1	510224	∅ 245 10 8 PD
↓							

	kw			 	! #		
AUDI - A4 Avant (8D5, B5) 11/94→09/01							
Bremsscheibe							
1.8 quattro	92	01/96→09/01	←	→ 8D-V-054061		24.0115-0105.1 415105 24.0315-0105.1 515105	Ø 288 15 13 Ø 288 15 13 PD
			←	8D-V-054062→; → 04/01		24.0122-0152.1 422152 24.0322-0152.1 522152	Ø 280 22 20 V + S Ø 280 22 20 V PD
			→	→ 04/01		24.0110-0224.1 410224 24.0310-0224.1 510224	Ø 245 10 8 Ø 245 10 8 PD
1.8 T	110	03/96→09/01	←	→ 04/01		24.0125-0105.1 425105 24.0325-0105.1 525105	Ø 288 25 23 V + S Ø 288 25 23 V PD
1.8 T	132	12/97→09/01					
1.9 TDI	81	02/96→09/01					
1.9 TDI	85	03/00→09/01	→	→ 04/01		24.0110-0210.1 410210	Ø 245 10 8 - LG / - ABS Ring
2.4	120	08/97→09/01					
2.5 TDI	110	09/97→09/01					
2.6	110	02/96→09/01					
2.8	142	10/96→09/01					
1.8 T quattro	110	01/96→09/01	←	→ 04/01		24.0125-0105.1 425105 24.0325-0105.1 525105	Ø 288 25 23 V + S Ø 288 25 23 V PD
1.8 T quattro	132	12/97→09/01					
1.9 TDI quattro	81	09/96→09/01					
1.9 TDI quattro	85	03/00→09/01	→	→ 04/01		24.0110-0224.1 410224 24.0310-0224.1 510224	Ø 245 10 8 Ø 245 10 8 PD
2.4 quattro	120	08/97→09/01					
2.6 quattro	110	01/96→09/01					
2.8 quattro	142	10/96→09/01					
1.9 DUO	66	03/98→09/01	←	→ 8D-V-169695		24.0113-0181.1 413181 24.0313-0181.1 513181	Ø 280 13 11 Ø 280 13 11 PD
1.9 TDI	55	03/96→09/01	←	8D-V-054062→; → 04/01		24.0122-0152.1 422152 24.0322-0152.1 522152	Ø 280 22 20 V + S Ø 280 22 20 V PD
1.9 TDI	66	02/96→09/01	←	8D-V-169696→; → 04/01		24.0122-0152.1 422152 24.0322-0152.1 522152	Ø 280 22 20 V + S Ø 280 22 20 V PD
			→	→ 04/01		24.0110-0210.1 410210	Ø 245 10 8 - LG / - ABS Ring
2.4	110	07/95→07/97	←	fur Thailand		24.0125-0105.1 425105 24.0325-0105.1 525105	Ø 288 25 23 V + S Ø 288 25 23 V PD
			→	fur Thailand		24.0110-0210.1 410210	Ø 245 10 8 - LG / - ABS Ring
2.4	121	03/97→09/01	←	08/97→ 04/01		24.0125-0105.1 425105 24.0325-0105.1 525105	Ø 288 25 23 V + S Ø 288 25 23 V PD
			→	08/97→ 04/01		24.0110-0210.1 410210	Ø 245 10 8 - LG / - ABS Ring
2.4 quattro	121	03/97→09/01	←	08/97→ 04/01		24.0125-0105.1 425105 24.0325-0105.1 525105	Ø 288 25 23 V + S Ø 288 25 23 V PD
			→	08/97→ 04/01		24.0110-0224.1 410224 24.0310-0224.1 510224	Ø 245 10 8 Ø 245 10 8 PD
2.5 TDI quattro	110	09/97→09/01	←	11/97→ 04/01		24.0125-0105.1 425105 24.0325-0105.1 525105	Ø 288 25 23 V + S Ø 288 25 23 V PD
			→	11/97→ 04/01		24.0110-0224.1 410224 24.0310-0224.1 510224	Ø 245 10 8 Ø 245 10 8 PD
2.8	128	03/96→09/96	←			24.0125-0105.1 425105 24.0325-0105.1 525105	Ø 288 25 23 V + S Ø 288 25 23 V PD
2.8	140	03/99→09/00	→			24.0110-0210.1 410210	Ø 245 10 8 - LG / - ABS Ring
2.8 quattro	128	01/96→09/96	←	→ 07/96		24.0125-0105.1 425105 24.0325-0105.1 525105	Ø 288 25 23 V + S Ø 288 25 23 V PD
			→	→ 07/96		24.0110-0224.1 410224 24.0310-0224.1 510224	Ø 245 10 8 Ø 245 10 8 PD
2.8 quattro	140	03/99→09/00	←			24.0125-0105.1 425105 24.0325-0105.1 525105	Ø 288 25 23 V + S Ø 288 25 23 V PD
			→			24.0110-0224.1 410224 24.0310-0224.1 510224	Ø 245 10 8 Ø 245 10 8 PD
S4 quattro	195	09/97→09/01	←	10/97→ 04/01		24.0130-0113.1 430113 24.0330-0113.1 530113	Ø 320 30 28 V + S Ø 320 30 28 V PD
			→	10/97→ 04/01		24.0122-0221.1 422221	Ø 256 22 20 V
AUDI - A4 Avant (8E5, B6) 04/01→12/04							
Bremsbelagsatz, Scheibenbremse							
1.6	75	09/01→12/04	←	+PR 1LZ		13.0460-2837.2 602837 13.0470-2837.2 LD2837	TRW 21945 19,6 + WK TRW 21945 19,6 + WK Ceramic
1.8 T	110	09/01→07/02					
1.8 T	120	07/02→12/04	←	+PR 1LB;1LE;1LF;1LT		13.0460-7110.2 607110 13.0470-7110.2 LD7110	ATE 20676 19,8 + WK ATE 20676 19,8 + WK Ceramic
1.8 T	140	11/02→12/04					
1.8 T quattro	110	09/01→07/02	←	+PR 1LA;1LC		13.0460-7201.2 607201	ATE 23763 20,3 + WK
1.8 T quattro	120	07/02→12/04					
1.8 T quattro	125	09/01→12/04					

	kw			 	! #			
AUDI - A4 Avant (8E5, B6) 04/01→12/04								
Bremsbelagsatz, Scheibenbremse								
1.8 T quattro	140	11/02→12/04	←	+PR 1LA;1LC		13.0470-7201.2	LD7201	ATE 23763 20,3 + WK Ceramic
1.9 TDI	74	11/01→12/04	→	8E-5-400001→; +PR 1KW		13.0460-2749.2	602749	TRW 24483 16,9 - WE / - WK + Zub
1.9 TDI	96	09/01→12/04						
1.9 TDI quattro	96	11/01→12/04						
2.0	96	09/01→12/04				13.0460-2880.2	602880	TRW 23914 17,1 + WE / - WK + Zub
2.0 FSI	110	07/02→12/04						
2.4	120	09/01→12/04				13.0470-2749.2	LD2749	TRW 24483 16,9 - WE / - WK + Zub Ceramic
2.4	125	09/01→12/04						
2.5 TDI	114	09/01→07/02						
2.5 TDI	120	07/02→12/04				13.0470-2880.2	LD2880	TRW 23914 17,1 + WE / - WK + Zub Ceramic
2.5 TDI quattro	132	09/01→12/04						
			→	→ 8E-4-180000; +PR 1KD		13.0460-2820.2	602820	TRW 20961 17,2 - WK
						13.0470-2820.2	LD2820	TRW 20961 17,2 - WK Ceramic
			→	→ 8E-4-180000; +PR 1KP		13.0460-2860.2	602860	TRW 23554 16,4 - WK / + WE
						13.0470-2860.2	LD2860	TRW 23554 16,4 - WK / + WE Ceramic
			→	8E-4-180001→; +PR 1KD;1KP		13.0460-2886.2	602886	TRW 20961 16,0 - WK
						13.0470-2886.2	LD2886	TRW 20961 16,0 - WK Ceramic
1.9 TDI	85	06/04→12/04	←	+PR 1LZ		13.0460-2837.2	602837	TRW 21945 19,6 + WK
						13.0470-2837.2	LD2837	TRW 21945 19,6 + WK Ceramic
			←	+PR 1LB;1LE;1LF;1LT		13.0460-7110.2	607110	ATE 20676 19,8 + WK
						13.0470-7110.2	LD7110	ATE 20676 19,8 + WK Ceramic
			←	+PR 1LA;1LC		13.0460-7201.2	607201	ATE 23763 20,3 + WK
						13.0470-7201.2	LD7201	ATE 23763 20,3 + WK Ceramic
			→	8E-5-400001→; +PR 1KW		13.0460-2749.2	602749	TRW 24483 16,9 - WE / - WK + Zub
						13.0460-2880.2	602880	TRW 23914 17,1 + WE / - WK + Zub
						13.0470-2749.2	LD2749	TRW 24483 16,9 - WE / - WK + Zub Ceramic
						13.0470-2880.2	LD2880	TRW 23914 17,1 + WE / - WK + Zub Ceramic
			→	+PR 1KD;1KP		13.0460-2886.2	602886	TRW 20961 16,0 - WK
						13.0470-2886.2	LD2886	TRW 20961 16,0 - WK Ceramic
3.0	160	04/01→12/04	←	+PR 1LZ		13.0460-2837.2	602837	TRW 21945 19,6 + WK
3.0	162	09/01→12/04				13.0470-2837.2	LD2837	TRW 21945 19,6 + WK Ceramic
3.0 quattro	160	04/01→12/04	←	+PR 1LB;1LE;1LF;1LT		13.0460-7110.2	607110	ATE 20676 19,8 + WK
3.0 quattro	162	09/01→12/04				13.0470-7110.2	LD7110	ATE 20676 19,8 + WK Ceramic
			←	+PR 1LA;1LC		13.0460-7201.2	607201	ATE 23763 20,3 + WK
						13.0470-7201.2	LD7201	ATE 23763 20,3 + WK Ceramic
			→	8E-5-400001→; +PR 1KW		13.0460-2749.2	602749	TRW 24483 16,9 - WE / - WK + Zub
						13.0460-2880.2	602880	TRW 23914 17,1 + WE / - WK + Zub
						13.0470-2749.2	LD2749	TRW 24483 16,9 - WE / - WK + Zub Ceramic
						13.0470-2880.2	LD2880	TRW 23914 17,1 + WE / - WK + Zub Ceramic
			→	→ 8E-7-300000; +PR 1KD;1KP		13.0460-2886.2	602886	TRW 20961 16,0 - WK
						13.0470-2886.2	LD2886	TRW 20961 16,0 - WK Ceramic
S4 quattro	253	03/03→12/04	←	+PR 1LJ		13.0460-7201.2	607201	ATE 23763 20,3 + WK
			→			13.0460-2888.2	602888	TRW 23326 17,4 + WE / - WK
						13.0470-2888.2	LD2888	TRW 23326 17,4 + WE / - WK Ceramic
Zubehörsatz, Scheibenbremsbelag								
1.6	75	09/01→12/04	→	→ 8E-4-180000; +PR 1KP		13.0460-0072.2	610072	TRW
1.8 T	110	09/01→07/02						
1.8 T	120	07/02→12/04	→	→ 8E-4-180000; +PR 1KD		13.0460-0072.2	610072	TRW
1.8 T	140	11/02→12/04	→	8E-5-400001→; +PR 1KW		13.0460-0259.2	610259	
1.8 T quattro	110	09/01→07/02						
1.8 T quattro	120	07/02→12/04						
1.8 T quattro	125	09/01→12/04						
1.8 T quattro	140	11/02→12/04						
1.9 TDI	74	11/01→12/04						
1.9 TDI	96	09/01→12/04						
1.9 TDI quattro	96	11/01→12/04						
2.0	96	09/01→12/04						
2.0 FSI	110	07/02→12/04						
2.4	120	09/01→12/04						
2.4	125	09/01→12/04						
↓								

AUDI - A4 Avant (8E5, B6) 04/01→12/04

Zubehörsatz, Scheibenbremsbelag

2.5 TDI	114	09/01→07/02	➡	→ 8E-4-180000; +PR 1KP	13.0460-0072.2	610072	TRW
2.5 TDI	120	07/02→12/04	➡	→ 8E-4-180000; +PR 1KD	13.0460-0072.2	610072	TRW
2.5 TDI quattro	132	09/01→12/04	➡	8E-5-400001→; +PR 1KW	13.0460-0259.2	610259	
1.9 TDI	85	06/04→12/04	➡	8E-5-400001→; +PR 1KW	13.0460-0259.2	610259	
3.0	160	04/01→12/04					
3.0	162	09/01→12/04					
3.0 quattro	160	04/01→12/04					
3.0 quattro	162	09/01→12/04					









Bremsscheibe

1.6	75	09/01→12/04	←	+PR 1LZ	24.0122-0152.1	422152	Ø 280 22 20 V + S
1.8 T	110	09/01→07/02			24.0322-0152.1	522152	Ø 280 22 20 V PD
1.8 T	120	07/02→12/04					
1.8 T	140	11/02→12/04	←	+PR 1LB;1LE	24.0125-0105.1	425105	Ø 288 25 23 V + S
1.8 T quattro	110	09/01→07/02			24.0325-0105.1	525105	Ø 288 25 23 V PD
1.8 T quattro	120	07/02→12/04					
1.8 T quattro	125	09/01→12/04	←	+PR 1LF;1LT	24.0125-0137.1	425137	Ø 312 25 23 V + S
1.8 T quattro	140	11/02→12/04			24.0325-0137.1	525137	Ø 312 25 23 V PD
1.9 TDI	74	11/01→12/04	←	+PR 1LA	24.0130-0113.1	430113	Ø 320 30 28 V + S
1.9 TDI	85	06/04→12/04			24.0330-0113.1	530113	Ø 320 30 28 V PD
1.9 TDI	96	09/01→12/04					
1.9 TDI quattro	96	11/01→12/04	←	+PR 1LC	24.0130-0185.1	430185	Ø 320 30 28 V•
2.0	96	09/01→12/04					
2.0 FSI	110	07/02→12/04	➡	+PR 1KD	24.0110-0261.1	410261	Ø 245 10 8 + S
2.4	120	09/01→12/04			24.0310-0261.1	510261	Ø 245 10 8 PD
2.4	125	09/01→12/04	➡	+PR 1KP	24.0112-0148.1	412148	Ø 255 12 10
2.5 TDI	114	09/01→07/02			24.0312-0148.1	512148	Ø 255 12 10 PD
2.5 TDI	120	07/02→12/04					
2.5 TDI quattro	132	09/01→12/04	➡	8E-5-400001→; +PR 1KW	24.0112-0166.1	412166	Ø 288 12 10
					24.0312-0166.1	512166	Ø 288 12 10 PD
3.0	160	04/01→12/04	←	+PR 1LZ	24.0122-0152.1	422152	Ø 280 22 20 V + S
3.0	162	09/01→12/04			24.0322-0152.1	522152	Ø 280 22 20 V PD
3.0 quattro	160	04/01→12/04					
3.0 quattro	162	09/01→12/04	←	+PR 1LB;1LE	24.0125-0105.1	425105	Ø 288 25 23 V + S
			←	+PR 1LF;1LT	24.0125-0137.1	425137	Ø 312 25 23 V + S
					24.0325-0137.1	525137	Ø 312 25 23 V PD
			←	+PR 1LA	24.0130-0113.1	430113	Ø 320 30 28 V + S
					24.0330-0113.1	530113	Ø 320 30 28 V PD
			←	+PR 1LC	24.0130-0185.1	430185	Ø 320 30 28 V•
			➡	+PR 1KD,1KP	24.0112-0148.1	412148	Ø 255 12 10
					24.0312-0148.1	512148	Ø 255 12 10 PD
			➡	8E-5-400001→; +PR 1KW	24.0112-0166.1	412166	Ø 288 12 10
					24.0312-0166.1	512166	Ø 288 12 10 PD
S4 quattro	253	03/03→12/04	←	+PR 1LJ	24.0130-0119.1	430119	Ø 345 30 28 V
			➡		24.0122-0220.1	422220	Ø 300 22 20 V







AUDI - A4 Avant (8ED, B7) 11/04→06/08









Brembelagsatz, Scheibenbremse







1.6	75	11/04→06/08	←	+PR 1LZ	13.0460-2837.2	602837	TRW 21945 19,6 + WK
1.8 T	120	11/04→06/08			13.0470-2837.2	LD2837	TRW 21945 19,6 + WK Ceramic
1.8 T quattro	120	11/04→06/08					
2.0	96	11/04→06/08	←	+PR 1LB;1LE;1LF;1LT	13.0460-7110.2	607110	ATE 20676 19,8 + WK
2.5 TDI	120	11/04→05/06			13.0470-7110.2	LD7110	ATE 20676 19,8 + WK Ceramic
			←	+PR 1LA;1LC	13.0460-7201.2	607201	ATE 23763 20,3 + WK
					13.0470-7201.2	LD7201	ATE 23763 20,3 + WK Ceramic
			➡	8E-5-400001→; +PR 1KW	13.0460-2749.2	602749	TRW 24483 16,9 - WE / - WK + Zub
					13.0460-2880.2	602880	TRW 23914 17,1 + WE / - WK + Zub
					13.0470-2749.2	LD2749	TRW 24483 16,9 - WE / - WK + Zub Ceramic
					13.0470-2880.2	LD2880	TRW 23914 17,1 + WE / - WK + Zub Ceramic
			➡	→ 8E-4-180000; +PR 1KD	13.0460-2820.2	602820	TRW 20961 17,2 - WK
					13.0470-2820.2	LD2820	TRW 20961 17,2 - WK Ceramic
			➡	→ 8E-4-180000; +PR 1KP	13.0460-2860.2	602860	TRW 23554 16,4 - WK / + WE
					13.0470-2860.2	LD2860	TRW 23554 16,4 - WK / + WE Ceramic
			➡	8E-4-180001→; +PR 1KD;1KP	13.0460-2886.2	602886	TRW 20961 16,0 - WK
					13.0470-2886.2	LD2886	TRW 20961 16,0 - WK Ceramic









	kw			 	! #				
AUDI - A4 Avant (8ED, B7) 11/04—06/08									
 Bremsbelagsatz, Scheibenbremse									
1.9 TDI 2.0 TDI 2.0 TDI 16V	85 103 103	11/04→06/08 11/04→06/08 11/04→06/08	←	+PR 1LZ	13.0460-2837.2	602837	TRW 21945 19,6 + WK		
					13.0470-2837.2	LD2837	TRW 21945 19,6 + WK Ceramic		
			←	+PR 1LB;1LE;1LF;1LT	13.0460-7110.2	607110	ATE 20676 19,8 + WK		
					13.0470-7110.2	LD7110	ATE 20676 19,8 + WK Ceramic		
			←	+PR 1LA;1LC	13.0460-7201.2	607201	ATE 23763 20,3 + WK		
					13.0470-7201.2	LD7201	ATE 23763 20,3 + WK Ceramic		
			→	8E-5-400001→; +PR 1KW	13.0460-2749.2	602749	TRW 24483 16,9 - WE / - WK + Zub		
					13.0460-2880.2	602880	TRW 23914 17,1 + WE / - WK + Zub		
					13.0470-2749.2	LD2749	TRW 24483 16,9 - WE / - WK + Zub Ceramic		
					13.0470-2880.2	LD2880	TRW 23914 17,1 + WE / - WK + Zub Ceramic		
			→	+PR 1KD;1KP	13.0460-2886.2	602886	TRW 20961 16,0 - WK		
					13.0470-2886.2	LD2886	TRW 20961 16,0 - WK Ceramic		
2.0 TDI 2.0 TDI 3.0 TDI quattro 3.2 FSI 3.2 FSI quattro	89 100 150 188 188	09/05→09/06 11/04→06/08 11/04→06/08 01/05→06/08 01/05→06/08	←	+PR 1LZ	13.0460-2837.2	602837	TRW 21945 19,6 + WK		
					13.0470-2837.2	LD2837	TRW 21945 19,6 + WK Ceramic		
			←	+PR 1LB;1LE;1LF;1LT	13.0460-7110.2	607110	ATE 20676 19,8 + WK		
					13.0470-7110.2	LD7110	ATE 20676 19,8 + WK Ceramic		
			←	+PR 1LA;1LC	13.0460-7201.2	607201	ATE 23763 20,3 + WK		
					13.0470-7201.2	LD7201	ATE 23763 20,3 + WK Ceramic		
			→	8E-5-400001→; +PR 1KW	13.0460-2749.2	602749	TRW 24483 16,9 - WE / - WK + Zub		
					13.0460-2880.2	602880	TRW 23914 17,1 + WE / - WK + Zub		
					13.0470-2749.2	LD2749	TRW 24483 16,9 - WE / - WK + Zub Ceramic		
					13.0470-2880.2	LD2880	TRW 23914 17,1 + WE / - WK + Zub Ceramic		
			→	+PR 1KD;1KP	13.0460-2886.2	602886	TRW 20961 16,0 - WK		
					13.0470-2886.2	LD2886	TRW 20961 16,0 - WK Ceramic		
2.0 TDI	93	11/05→11/06	←	06/06→; +PR 1LZ	13.0460-2837.2	602837	TRW 21945 19,6 + WK		
					13.0470-2837.2	LD2837	TRW 21945 19,6 + WK Ceramic		
			←	06/06→; +PR 1LB;1LE;1LF;1LT	13.0460-7110.2	607110	ATE 20676 19,8 + WK		
					13.0470-7110.2	LD7110	ATE 20676 19,8 + WK Ceramic		
			←	06/06→; +PR 1LA;1LC	13.0460-7201.2	607201	ATE 23763 20,3 + WK		
					13.0470-7201.2	LD7201	ATE 23763 20,3 + WK Ceramic		
			→	06/06→; +PR 1KW	13.0460-2749.2	602749	TRW 24483 16,9 - WE / - WK + Zub		
					13.0460-2880.2	602880	TRW 23914 17,1 + WE / - WK + Zub		
					13.0470-2749.2	LD2749	TRW 24483 16,9 - WE / - WK + Zub Ceramic		
					13.0470-2880.2	LD2880	TRW 23914 17,1 + WE / - WK + Zub Ceramic		
			→	06/06→; +PR 1KD;1KP	13.0460-2886.2	602886	TRW 20961 16,0 - WK		
					13.0470-2886.2	LD2886	TRW 20961 16,0 - WK Ceramic		
2.0 TDI 2.0 TDI 2.0 TDI quattro 2.0 TDI quattro 2.0 TDI quattro	120 125 103 120 125	06/06→06/08 06/06→06/08 01/06→06/08 06/06→06/08 06/06→06/08	←	+PR 1LZ	13.0460-2837.2	602837	TRW 21945 19,6 + WK		
					13.0470-2837.2	LD2837	TRW 21945 19,6 + WK Ceramic		
			←	+PR 1LB;1LE;1LF;1LT	13.0460-7110.2	607110	ATE 20676 19,8 + WK		
					13.0470-7110.2	LD7110	ATE 20676 19,8 + WK Ceramic		
			←	+PR 1LA;1LC	13.0460-7201.2	607201	ATE 23763 20,3 + WK		
					13.0470-7201.2	LD7201	ATE 23763 20,3 + WK Ceramic		
			→	+PR 1KW	13.0460-2749.2	602749	TRW 24483 16,9 - WE / - WK + Zub		
					13.0460-2880.2	602880	TRW 23914 17,1 + WE / - WK + Zub		
					13.0470-2749.2	LD2749	TRW 24483 16,9 - WE / - WK + Zub Ceramic		
					13.0470-2880.2	LD2880	TRW 23914 17,1 + WE / - WK + Zub Ceramic		
			→	+PR 1KD;1KP	13.0460-2886.2	602886	TRW 20961 16,0 - WK		
					13.0470-2886.2	LD2886	TRW 20961 16,0 - WK Ceramic		
2.0 TFSI 2.0 TFSI 2.0 TFSI 2.0 TFSI quattro 2.0 TFSI quattro	125 147 162 147 162	10/06→06/08 11/04→06/08 06/05→06/08 11/04→06/08 06/05→06/08	←	+PR 1LZ	13.0460-2837.2	602837	TRW 21945 19,6 + WK		
					13.0470-2837.2	LD2837	TRW 21945 19,6 + WK Ceramic		
			←	+PR 1LB;1LE;1LF;1LT	13.0460-7110.2	607110	ATE 20676 19,8 + WK		
					13.0470-7110.2	LD7110	ATE 20676 19,8 + WK Ceramic		
			↓						











	kw			 	! #		
AUDI - A4 Avant (8ED, B7) 11/04→06/08							
Bremsbelagsatz, Scheibenbremse							
2.0 TFSI 2.0 TFSI 2.0 TFSI quattro 2.0 TFSI quattro	125 147 162 147 162	10/06→06/08 11/04→06/08 06/05→06/08 11/04→06/08 06/05→06/08	← ← → →	+PR 1LA;1LC 8E-5-400001→; +PR 1KW +PR 1KD;1KP		13.0460-7201.2 607201 13.0470-7201.2 LD7201 13.0460-2749.2 602749 13.0460-2880.2 602880 13.0470-2749.2 LD2749 13.0470-2880.2 LD2880 13.0460-2886.2 602886 13.0470-2886.2 LD2886	ATE 23763 20,3 + WK ATE 23763 20,3 + WK Ceramic TRW 24483 16,9 - WE / - WK + Zub TRW 23914 17,1 + WE / - WK + Zub TRW 24483 16,9 - WE / - WK + Zub Ceramic TRW 23914 17,1 + WE / - WK + Zub Ceramic TRW 20961 16,0 - WK TRW 20961 16,0 - WK Ceramic
2.7 TDi 2.7 TDi 3.0 TDi quattro	120 132 171	11/05→03/08 01/06→06/08 01/06→06/08	← ← ← ← →	+PR 1LZ +PR 1LB;1LE;1LF;1LT +PR 1LA;1LC +PR 1KW		13.0460-2837.2 602837 13.0470-2837.2 LD2837 13.0460-7110.2 607110 13.0470-7110.2 LD7110 13.0460-7201.2 607201 13.0470-7201.2 LD7201 13.0460-2749.2 602749 13.0460-2880.2 602880 13.0470-2749.2 LD2749 13.0470-2880.2 LD2880	TRW 21945 19,6 + WK TRW 21945 19,6 + WK Ceramic ATE 20676 19,8 + WK ATE 20676 19,8 + WK Ceramic ATE 23763 20,3 + WK ATE 23763 20,3 + WK Ceramic TRW 24483 16,9 - WE / - WK + Zub TRW 23914 17,1 + WE / - WK + Zub TRW 24483 16,9 - WE / - WK + Zub Ceramic TRW 23914 17,1 + WE / - WK + Zub Ceramic
3.0 3.0 quattro	160 160	11/04→05/06 11/04→07/06	← ← ← → →	+PR 1LZ +PR 1LB;1LE;1LF;1LT +PR 1LA;1LC 8E-5-400001→; +PR 1KW → 8E-7-300000; +PR 1KD;1KP		13.0460-2837.2 602837 13.0470-2837.2 LD2837 13.0460-7110.2 607110 13.0470-7110.2 LD7110 13.0460-7201.2 607201 13.0470-7201.2 LD7201 13.0460-2749.2 602749 13.0460-2880.2 602880 13.0470-2749.2 LD2749 13.0470-2880.2 LD2880 13.0460-2886.2 602886 13.0470-2886.2 LD2886	TRW 21945 19,6 + WK TRW 21945 19,6 + WK Ceramic ATE 20676 19,8 + WK ATE 20676 19,8 + WK Ceramic ATE 23763 20,3 + WK ATE 23763 20,3 + WK Ceramic TRW 24483 16,9 - WE / - WK + Zub TRW 23914 17,1 + WE / - WK + Zub TRW 24483 16,9 - WE / - WK + Zub Ceramic TRW 23914 17,1 + WE / - WK + Zub Ceramic TRW 20961 16,0 - WK TRW 20961 16,0 - WK Ceramic
S4 quattro	253	11/04→06/08	← → →	+PR 1LJ 01/05→		13.0460-7201.2 607201 13.0460-2888.2 602888 13.0470-2888.2 LD2888 13.0460-2889.2 602889	ATE 23763 20,3 + WK TRW 23326 17,4 + WE / - WK TRW 23326 17,4 + WE / - WK Ceramic TRW 23326 17,4 + WE / - WK
Zubehörsatz, Scheibenbremsbelag							
1.6 1.8 T 1.8 T quattro 2.0 2.5 TDI	75 120 120 96 120	11/04→06/08 11/04→06/08 11/04→06/08 11/04→06/08 11/04→05/06	→ → → →	→ 8E-4-180000; +PR 1KP → 8E-4-180000; +PR 1KD 8E-5-400001→; +PR 1KW		13.0460-0072.2 610072 13.0460-0072.2 610072 13.0460-0259.2 610259	TRW TRW
1.9 TDI 2.0 TDI 2.0 TDI 2.0 TDI 16V 2.0 TFSI 2.0 TFSI 2.0 TFSI 2.0 TFSI quattro 2.0 TFSI quattro 3.0 3.0 quattro 3.0 TDI quattro 3.2 FSI 3.2 FSI quattro	85 89 100 103 103 125 147 162 147 162 160 160 150 188 188	11/04→06/08 09/05→09/06 11/04→06/08 11/04→06/08 11/04→06/08 10/06→06/08 11/04→06/08 06/05→06/08 11/04→06/08 06/05→06/08 11/04→05/06 11/04→07/06 11/04→06/08 01/05→06/08 01/05→06/08	→ → → →	8E-5-400001→; +PR 1KW		13.0460-0259.2 610259	
2.0 TDI	93	11/05→11/06	→	06/06→; +PR 1KW		13.0460-0259.2 610259	
↓							











	kw			 	! #			
AUDI - A4 Avant (8ED, B7) 11/04→06/08								
Zubehörsatz, Scheibenbremsbelag								
2.0 TDI	120	06/06→06/08	➡	+PR 1KW		13.0460-0259.2	610259	
2.0 TDI	125	06/06→06/08						
2.0 TDI quattro	103	01/06→06/08						
2.0 TDI quattro	120	06/06→06/08						
2.0 TDI quattro	125	06/06→06/08						
2.7 TDi	120	11/05→03/08						
2.7 TDI	132	01/06→06/08						
3.0 TDI quattro	171	01/06→06/08						
RS4 quattro	309	09/05→06/08	➡	11/05→		13.0460-0023.2	610023	
S4 quattro	253	11/04→06/08	➡	01/05→		13.0460-0023.2	610023	
 Bremsscheibe								
1.6	75	11/04→06/08	←	+PR 1LZ		24.0122-0152.1	422152	Ø 280 22 20 V + S
1.8 T	120	11/04→06/08				24.0322-0152.1	522152	Ø 280 22 20 V PD
1.8 T quattro	120	11/04→06/08						
1.9 TDI	85	11/04→06/08	←	+PR 1LB;1LE		24.0125-0105.1	425105	Ø 288 25 23 V + S
2.0	96	11/04→06/08				24.0325-0105.1	525105	Ø 288 25 23 V PD
2.0 TDI	89	09/05→09/06	←	+PR 1LF;1LT		24.0125-0137.1	425137	Ø 312 25 23 V + S
2.0 TDI	100	11/04→06/08				24.0325-0137.1	525137	Ø 312 25 23 V PD
2.0 TDI	103	11/04→06/08						
2.0 TDI 16V	103	11/04→06/08	←	+PR 1LA		24.0130-0113.1	430113	Ø 320 30 28 V + S
2.0 TFSI	125	10/06→06/08				24.0330-0113.1	530113	Ø 320 30 28 V PD
2.0 TFSI	147	11/04→06/08						
2.0 TFSI quattro	147	11/04→06/08	←	+PR 1LC		24.0130-0185.1	430185	Ø 320 30 28 V•
2.5 TDI	120	11/04→05/06	➡	+PR 1KD		24.0110-0261.1	410261	Ø 245 10 8 + S
						24.0310-0261.1	510261	Ø 245 10 8 PD
			➡	+PR 1KP		24.0112-0148.1	412148	Ø 255 12 10
						24.0312-0148.1	512148	Ø 255 12 10 PD
			➡	8E-5-400001→; +PR 1KW		24.0112-0166.1	412166	Ø 288 12 10
						24.0312-0166.1	512166	Ø 288 12 10 PD
2.0 TDI	93	11/05→11/06	←	06/06→; +PR 1LZ		24.0122-0152.1	422152	Ø 280 22 20 V + S
						24.0322-0152.1	522152	Ø 280 22 20 V PD
			←	06/06→; +PR 1LB;1LE		24.0125-0105.1	425105	Ø 288 25 23 V + S
						24.0325-0105.1	525105	Ø 288 25 23 V PD
			←	06/06→; +PR 1LF;1LT		24.0125-0137.1	425137	Ø 312 25 23 V + S
						24.0325-0137.1	525137	Ø 312 25 23 V PD
			←	06/06→; +PR 1LA		24.0130-0113.1	430113	Ø 320 30 28 V + S
						24.0330-0113.1	530113	Ø 320 30 28 V PD
			←	06/06→; +PR 1LC		24.0130-0185.1	430185	Ø 320 30 28 V•
			➡	06/06→; +PR 1KD		24.0110-0261.1	410261	Ø 245 10 8 + S
						24.0310-0261.1	510261	Ø 245 10 8 PD
			➡	06/06→; +PR 1KP		24.0112-0148.1	412148	Ø 255 12 10
						24.0312-0148.1	512148	Ø 255 12 10 PD
			➡	06/06→; +PR 1KW		24.0112-0166.1	412166	Ø 288 12 10
						24.0312-0166.1	512166	Ø 288 12 10 PD
2.0 TDI	120	06/06→06/08	←	+PR 1LZ		24.0122-0152.1	422152	Ø 280 22 20 V + S
2.0 TDI	125	06/06→06/08				24.0322-0152.1	522152	Ø 280 22 20 V PD
2.0 TDI quattro	103	01/06→06/08						
2.0 TDI quattro	120	06/06→06/08	←	+PR 1LB;1LE		24.0125-0105.1	425105	Ø 288 25 23 V + S
2.0 TDI quattro	125	06/06→06/08				24.0325-0105.1	525105	Ø 288 25 23 V PD
			←	+PR 1LF;1LT		24.0125-0137.1	425137	Ø 312 25 23 V + S
						24.0325-0137.1	525137	Ø 312 25 23 V PD
			←	+PR 1LA		24.0130-0113.1	430113	Ø 320 30 28 V + S
						24.0330-0113.1	530113	Ø 320 30 28 V PD
			←	+PR 1LC		24.0130-0185.1	430185	Ø 320 30 28 V•
			➡	+PR 1KD		24.0110-0261.1	410261	Ø 245 10 8 + S
						24.0310-0261.1	510261	Ø 245 10 8 PD
			➡	+PR 1KP		24.0112-0148.1	412148	Ø 255 12 10
						24.0312-0148.1	512148	Ø 255 12 10 PD
			➡	+PR 1KW		24.0112-0166.1	412166	Ø 288 12 10
						24.0312-0166.1	512166	Ø 288 12 10 PD
2.0 TFSI	162	06/05→06/08	←	+PR 1LZ		24.0122-0152.1	422152	Ø 280 22 20 V + S
2.0 TFSI quattro	162	06/05→06/08				24.0322-0152.1	522152	Ø 280 22 20 V PD
3.0 TDI quattro	150	11/04→06/08						
3.2 FSI	188	01/05→06/08	←	+PR 1LB;1LE		24.0125-0105.1	425105	Ø 288 25 23 V + S
3.2 FSI quattro	188	01/05→06/08	←	+PR 1LF;1LT		24.0125-0137.1	425137	Ø 312 25 23 V + S
						24.0325-0137.1	525137	Ø 312 25 23 V PD
↓								









	kw			 	! #		
AUDI - A4 Avant (8ED, B7) 11/04→06/08							
Bremsscheibe							
2.0 TFSI	162	06/05→06/08	←	+PR 1LA		24.0130-0113.1 430113	Ø 320 30 28 V + S
2.0 TFSI quattro	162	06/05→06/08				24.0330-0113.1 530113	Ø 320 30 28 V PD
3.0 TDI quattro	150	11/04→06/08					
3.2 FSI	188	01/05→06/08	←	+PR 1LC		24.0130-0185.1 430185	Ø 320 30 28 V•
3.2 FSI quattro	188	01/05→06/08	→	+PR 1KD		24.0110-0261.1 410261	Ø 245 10 8 + S
						24.0310-0261.1 510261	Ø 245 10 8 PD
			→	+PR 1KP		24.0112-0148.1 412148	Ø 255 12 10
						24.0312-0148.1 512148	Ø 255 12 10 PD
			→	8E-5-400001→; +PR 1KW		24.0112-0166.1 412166	Ø 288 12 10
						24.0312-0166.1 512166	Ø 288 12 10 PD
2.7 TDi	120	11/05→03/08	←	+PR 1LZ		24.0122-0152.1 422152	Ø 280 22 20 V + S
2.7 TDI	132	01/06→06/08				24.0322-0152.1 522152	Ø 280 22 20 V PD
			←	+PR 1LB;1LE		24.0125-0105.1 425105	Ø 288 25 23 V + S
						24.0325-0105.1 525105	Ø 288 25 23 V PD
			←	+PR 1LF;1LT		24.0125-0137.1 425137	Ø 312 25 23 V + S
						24.0325-0137.1 525137	Ø 312 25 23 V PD
			←	+PR 1LA		24.0130-0113.1 430113	Ø 320 30 28 V + S
						24.0330-0113.1 530113	Ø 320 30 28 V PD
			←	+PR 1LC		24.0130-0185.1 430185	Ø 320 30 28 V•
			→	+PR 1KW		24.0112-0166.1 412166	Ø 288 12 10
						24.0312-0166.1 512166	Ø 288 12 10 PD
3.0	160	11/04→05/06	←	+PR 1LZ		24.0122-0152.1 422152	Ø 280 22 20 V + S
3.0 quattro	160	11/04→07/06				24.0322-0152.1 522152	Ø 280 22 20 V PD
			←	+PR 1LB;1LE		24.0125-0105.1 425105	Ø 288 25 23 V + S
			←	+PR 1LF;1LT		24.0125-0137.1 425137	Ø 312 25 23 V + S
						24.0325-0137.1 525137	Ø 312 25 23 V PD
			←	+PR 1LA		24.0130-0113.1 430113	Ø 320 30 28 V + S
						24.0330-0113.1 530113	Ø 320 30 28 V PD
			←	+PR 1LC		24.0130-0185.1 430185	Ø 320 30 28 V•
			→	+PR 1KD,1KP		24.0112-0148.1 412148	Ø 255 12 10
						24.0312-0148.1 512148	Ø 255 12 10 PD
			→	8E-5-400001→; +PR 1KW		24.0112-0166.1 412166	Ø 288 12 10
						24.0312-0166.1 512166	Ø 288 12 10 PD
3.0 TDI quattro	171	01/06→06/08	←	+PR 1LZ		24.0122-0152.1 422152	Ø 280 22 20 V + S
						24.0322-0152.1 522152	Ø 280 22 20 V PD
			←	+PR 1LB;1LE		24.0125-0105.1 425105	Ø 288 25 23 V + S
			←	+PR 1LF;1LT		24.0125-0137.1 425137	Ø 312 25 23 V + S
						24.0325-0137.1 525137	Ø 312 25 23 V PD
			←	+PR 1LA		24.0130-0113.1 430113	Ø 320 30 28 V + S
						24.0330-0113.1 530113	Ø 320 30 28 V PD
			←	+PR 1LC		24.0130-0185.1 430185	Ø 320 30 28 V•
			→	+PR 1KW		24.0112-0166.1 412166	Ø 288 12 10
						24.0312-0166.1 512166	Ø 288 12 10 PD
S4 quattro	253	11/04→06/08	←	+PR 1LJ		24.0130-0119.1 430119	Ø 345 30 28 V
			→			24.0122-0220.1 422220	Ø 300 22 20 V
AUDI - A4 Avant (8K5, B8) 11/07→12/15							
Bremsbelagsatz, Scheibenbremse							
1.8 TFSI	88	04/08→12/15	←	+PR 1LA,1LB,1LD		13.0460-2746.2 602746	TRW 24408 19,2 + WK
1.8 TFSI quattro	118	09/08→03/12				13.0470-2746.2 LD2746	TRW 24408 19,2 + WK + Zub Ceramic
2.0 TDI	88	06/08→12/15					
2.0 TDI	100	04/08→12/15	←	+PR 1LT,1LY		13.0460-7256.2 607256	ATE 24705 19,8 + WK
2.0 TDI	105	04/08→12/15				13.0470-7256.2 LD7256	ATE 24705 19,8 + WK Ceramic
2.0 TDI	110	05/13→12/15					
2.0 TDI	120	08/08→12/15	→	+PR 1KW,2EH; + eFSB		13.0460-2747.2 602747	TRW 24606 17,4 - WE / - WK + Zub
2.0 TDI	125	04/08→03/12				13.0470-2747.2 LD2747	TRW 24606 17,4 - WE / - WK + Zub Ceramic
2.0 TDI	130	11/11→12/15					
2.0 TDI	140	09/13→12/15					
2.0 TDI 16V	103	07/08→					
2.0 TDI quattro	105	04/08→12/15	→	+PR 1KP; + eFSB		13.0460-2748.2 602748	TRW 24606 17,4 - WE / - WK + Zub
2.0 TDI quattro	110	05/13→12/15				13.0470-2748.2 LD2748	TRW 24606 17,4 - WE / - WK + Zub Ceramic
2.0 TDI quattro	125	08/08→03/12					
2.0 TDI quattro	130	11/11→12/15					
2.0 TDI quattro	140	09/13→12/15					
2.0 TFSI	132	06/08→12/15					
2.0 TFSI	155	06/08→05/13					







	kw			 	! #		
AUDI - A4 Avant (8K5, B8) 11/07→12/15							
 Bremsbelagsatz, Scheibenbremse							
2.0 TFSI	165	05/13→12/15	←	+PR 1LA,1LB,1LD		13.0460-2746.2 602746	TRW 24408 19,2 + WK
2.0 TFSI flexible fuel	132	11/09→12/15				13.0470-2746.2 LD2746	TRW 24408 19,2 + WK + Zub Ceramic
2.0 TFSI flexible fuel quattro	132	11/09→12/15					
2.0 TFSI quattro	155	06/08→12/15	←	+PR 1LT,1LY		13.0460-7256.2 607256	ATE 24705 19,8 + WK
2.7 TDI	120	06/08→03/12				13.0470-7256.2 LD7256	ATE 24705 19,8 + WK Ceramic
3.0 TDI	150	11/11→12/15					
3.0 TDI quattro	155	06/08→05/10	→	+PR 1KW,2EH; + eFSB		13.0460-2747.2 602747	TRW 24606 17,4 - WE / - WK + Zub
3.0 TDI quattro	176	04/08→03/12					
3.0 TDI quattro	180	11/11→12/15				13.0470-2747.2 LD2747	TRW 24606 17,4 - WE / - WK + Zub Ceramic
3.0 TFSI quattro	200	02/12→12/15					
3.2 FSI	195	09/08→03/12	→	+PR 1KP; + eFSB		13.0460-2748.2 602748	TRW 24606 17,4 - WE / - WK + Zub
3.2 FSI quattro	195	04/08→03/12				13.0470-2748.2 LD2748	TRW 24606 17,4 - WE / - WK + Zub Ceramic
1.8 TFSI	118	11/07→03/12	←	04/08→; +PR 1LA,1LB,1LD		13.0460-2746.2 602746	TRW 24408 19,2 + WK
						13.0470-2746.2 LD2746	TRW 24408 19,2 + WK + Zub Ceramic
			←	04/08→; +PR 1LT,1LY		13.0460-7256.2 607256	ATE 24705 19,8 + WK
						13.0470-7256.2 LD7256	ATE 24705 19,8 + WK Ceramic
			→	04/08→; +PR 1KW,2EH; + eFSB		13.0460-2747.2 602747	TRW 24606 17,4 - WE / - WK + Zub
						13.0470-2747.2 LD2747	TRW 24606 17,4 - WE / - WK + Zub Ceramic
			→	04/08→; +PR 1KP; + eFSB		13.0460-2748.2 602748	TRW 24606 17,4 - WE / - WK + Zub
						13.0470-2748.2 LD2748	TRW 24606 17,4 - WE / - WK + Zub Ceramic
1.8 TFSI 1.8 TFSI quattro	125 125	11/11→12/15 11/11→12/15	←	01/12→; +PR 1LA,1LB,1LD		13.0460-2746.2 602746	TRW 24408 19,2 + WK
						13.0470-2746.2 LD2746	TRW 24408 19,2 + WK + Zub Ceramic
			←	01/12→; +PR 1LT,1LY		13.0460-7256.2 607256	ATE 24705 19,8 + WK
						13.0470-7256.2 LD7256	ATE 24705 19,8 + WK Ceramic
			→	01/12→; +PR 1KW,2EH; + eFSB		13.0460-2747.2 602747	TRW 24606 17,4 - WE / - WK + Zub
						13.0470-2747.2 LD2747	TRW 24606 17,4 - WE / - WK + Zub Ceramic
			→	01/12→; +PR 1KP; + eFSB		13.0460-2748.2 602748	TRW 24606 17,4 - WE / - WK + Zub
						13.0470-2748.2 LD2748	TRW 24606 17,4 - WE / - WK + Zub Ceramic
2.0 TFSI quattro	165	05/13→12/15	←	+PR 1LA,1LB,1LD		13.0460-2746.2 602746	TRW 24408 19,2 + WK
						13.0470-2746.2 LD2746	TRW 24408 19,2 + WK + Zub Ceramic
			←	+PR 1LT,1LY		13.0460-7256.2 607256	ATE 24705 19,8 + WK
						13.0470-7256.2 LD7256	ATE 24705 19,8 + WK Ceramic
			→	+PR 1KW,2EH; + eFSB		13.0460-2747.2 602747	TRW 24606 17,4 - WE / - WK + Zub
						13.0470-2747.2 LD2747	TRW 24606 17,4 - WE / - WK + Zub Ceramic
2.7 TDI	140	04/08→03/12	←	06/08→; +PR 1LA,1LB,1LD		13.0460-2746.2 602746	TRW 24408 19,2 + WK
						13.0470-2746.2 LD2746	TRW 24408 19,2 + WK + Zub Ceramic
			←	06/08→; +PR 1LT,1LY		13.0460-7256.2 607256	ATE 24705 19,8 + WK
						13.0470-7256.2 LD7256	ATE 24705 19,8 + WK Ceramic
			→	06/08→; +PR 1KW,2EH; + eFSB		13.0460-2747.2 602747	TRW 24606 17,4 - WE / - WK + Zub
						13.0470-2747.2 LD2747	TRW 24606 17,4 - WE / - WK + Zub Ceramic
			→	06/08→; +PR 1KP; + eFSB		13.0460-2748.2 602748	TRW 24606 17,4 - WE / - WK + Zub
						13.0470-2748.2 LD2748	TRW 24606 17,4 - WE / - WK + Zub Ceramic
RS4 quattro	331	05/12→08/15	→	+ eFSB		13.0460-2770.2 602770	TRW 24606 17,4 + WK + Zub
						13.0470-2770.2 LD2770	TRW 24606 17,4 + WK + Zub Ceramic
S4 quattro	245	11/08→12/15	←	07/11→; +PR 1LJ,1ZT		13.0460-2746.2 602746	TRW 24408 19,2 + WK
			→	+PR 1KE; + eFSB		13.0460-2748.2 602748	TRW 24606 17,4 - WE / - WK + Zub
↓							







	kw			 	! #		
AUDI - A4 Avant (8K5, B8) 11/07→12/15							
 Bremsbelagsatz, Scheibenbremse							
S4 quattro	245	11/08→12/15	➡	+PR 1KE; + eFSB		13.0470-2748.2 LD2748	TRW 24606 17,4 - WE / - WK + Zub Ceramic
Warnkontakt, Bremsbelagverschleiß							
RS4 quattro	331	05/12→08/15	⬅	☐; +PR 1LW	1	24.8190-0017.2 620017	L= 388,3
 Bremsscheibe							
1.8 TFSI	88	04/08→12/15	⬅	+PR 1LT,1LY		24.0125-0184.1 425184	Ø 314 25 23 V + S
1.8 TFSI quattro	118	09/08→03/12				24.0325-0184.1 525184	Ø 314 25 23 V + S PD
2.0 TDI	88	06/08→12/15					
2.0 TDI	100	04/08→12/15	⬅	→ 06/11; +PR 1LA		24.0130-0193.1 430193	Ø 320 30 28 V + S
2.0 TDI	105	04/08→12/15				24.0330-0193.1 530193	Ø 320 30 28 V + S PD
2.0 TDI	120	08/08→12/15					
2.0 TDI	125	04/08→03/12	⬅	07/11→; +PR 1LA,1LB		24.0130-0221.1 430221	Ø 320 30 28 V + S
2.0 TDI 16V	103	07/08→	⬅	+PR 1LD		24.0130-0222.1 430222	Ø 345 30 28 V + S
2.0 TDI quattro	105	04/08→12/15					
2.0 TDI quattro	125	08/08→03/12	➡	+PR 1KW,2EH		24.0112-0178.1 412178	Ø 300 12 10 + S
2.0 TFSI	132	06/08→12/15				24.0312-0178.1 512178	Ø 300 12 10 + S PD
2.0 TFSI	155	06/08→05/13					
2.0 TFSI flexible fuel	132	11/09→12/15	➡	+PR 1KP; + eFSB		24.0122-0272.1 422272	Ø 330 21,9 20 V + S
2.0 TFSI flexible fuel quattro	132	11/09→12/15					
2.0 TFSI quattro	155	06/08→12/15					
2.7 TDI	120	06/08→03/12					
3.0 TDI quattro	176	04/08→03/12					
3.2 FSI	195	09/08→03/12					
3.2 FSI quattro	195	04/08→03/12					
1.8 TFSI	118	11/07→03/12	⬅	04/08→; +PR 1LT,1LY		24.0125-0184.1 425184	Ø 314 25 23 V + S
			⬅	04/08→ 06/11; +PR 1LA		24.0325-0184.1 525184	Ø 314 25 23 V + S PD
			⬅	04/08→ 06/11; +PR 1LA		24.0130-0193.1 430193	Ø 320 30 28 V + S
			⬅	04/08→ 06/11; +PR 1LA		24.0330-0193.1 530193	Ø 320 30 28 V + S PD
			⬅	07/11→; +PR 1LA,1LB		24.0130-0221.1 430221	Ø 320 30 28 V + S
			⬅	04/08→; +PR 1LD		24.0130-0222.1 430222	Ø 345 30 28 V + S
			➡	04/08→; +PR 1KW,2EH		24.0112-0178.1 412178	Ø 300 12 10 + S
			➡	04/08→; +PR 1KW,2EH		24.0312-0178.1 512178	Ø 300 12 10 + S PD
			➡	04/08→; +PR 1KP; + eFSB		24.0122-0272.1 422272	Ø 330 21,9 20 V + S
1.8 TFSI	125	11/11→12/15	⬅	01/12→; +PR 1LT,1LY		24.0125-0184.1 425184	Ø 314 25 23 V + S
1.8 TFSI quattro	125	11/11→12/15				24.0325-0184.1 525184	Ø 314 25 23 V + S PD
			⬅	01/12→; +PR 1LA,1LB		24.0130-0221.1 430221	Ø 320 30 28 V + S
			⬅	01/12→; +PR 1LD		24.0130-0222.1 430222	Ø 345 30 28 V + S
			➡	01/12→; +PR 1KW,2EH		24.0112-0178.1 412178	Ø 300 12 10 + S
			➡	01/12→; +PR 1KW,2EH		24.0312-0178.1 512178	Ø 300 12 10 + S PD
			➡	01/12→; +PR 1KP; + eFSB		24.0122-0272.1 422272	Ø 330 21,9 20 V + S
2.0 TDI	110	05/13→12/15	⬅	+PR 1LT,1LY		24.0125-0184.1 425184	Ø 314 25 23 V + S
2.0 TDI	130	11/11→12/15				24.0325-0184.1 525184	Ø 314 25 23 V + S PD
2.0 TDI	140	09/13→12/15					
2.0 TDI quattro	110	05/13→12/15	⬅	+PR 1LA,1LB		24.0130-0221.1 430221	Ø 320 30 28 V + S
2.0 TDI quattro	130	11/11→12/15	⬅	+PR 1LD		24.0130-0222.1 430222	Ø 345 30 28 V + S
2.0 TDI quattro	140	09/13→12/15					
2.0 TFSI	165	05/13→12/15	➡	+PR 1KW,2EH		24.0112-0178.1 412178	Ø 300 12 10 + S
2.0 TFSI quattro	165	05/13→12/15				24.0312-0178.1 512178	Ø 300 12 10 + S PD
3.0 TDI	150	11/11→12/15					
3.0 TDI quattro	180	11/11→12/15	➡	+PR 1KP; + eFSB		24.0122-0272.1 422272	Ø 330 21,9 20 V + S
3.0 TFSI quattro	200	02/12→12/15					
2.7 TDI	140	04/08→03/12	⬅	06/08→; +PR 1LT,1LY		24.0125-0184.1 425184	Ø 314 25 23 V + S
			⬅	06/08→ 06/11; +PR 1LA		24.0325-0184.1 525184	Ø 314 25 23 V + S PD
			⬅	06/08→ 06/11; +PR 1LA		24.0130-0193.1 430193	Ø 320 30 28 V + S
			⬅	06/08→ 06/11; +PR 1LA		24.0330-0193.1 530193	Ø 320 30 28 V + S PD
			⬅	07/11→; +PR 1LA,1LB		24.0130-0221.1 430221	Ø 320 30 28 V + S
			⬅	06/08→; +PR 1LD		24.0130-0222.1 430222	Ø 345 30 28 V + S
			➡	06/08→; +PR 1KW,2EH		24.0112-0178.1 412178	Ø 300 12 10 + S
			➡	06/08→; +PR 1KW,2EH		24.0312-0178.1 512178	Ø 300 12 10 + S PD
			➡	06/08→; +PR 1KP; + eFSB		24.0122-0272.1 422272	Ø 330 21,9 20 V + S
3.0 TDI quattro	155	06/08→05/10	⬅	+PR 1LT,1LY		24.0125-0184.1 425184	Ø 314 25 23 V + S
			⬅	+PR 1LA		24.0325-0184.1 525184	Ø 314 25 23 V + S PD
			⬅	+PR 1LA		24.0130-0193.1 430193	Ø 320 30 28 V + S
			⬅	+PR 1LA		24.0330-0193.1 530193	Ø 320 30 28 V + S PD
			⬅	+PR 1LD		24.0130-0222.1 430222	Ø 345 30 28 V + S

















	kw			 	! #		
AUDI - A4 Avant (8K5, B8) 11/07→12/15							
 Bremsscheibe							
3.0 TDI quattro	155	06/08→05/10	➔	+PR 1KW,2EH	24.0112-0178.1	412178	Ø 300 12 10 + S
			➔	+PR 1KP; + eFSB	24.0312-0178.1	512178	Ø 300 12 10 + S PD
S4 quattro	245	11/08→12/15	➔	→ 06/11; +PR 1LJ	24.0122-0272.1	422272	Ø 330 21,9 20 V + S
			➔	+PR 1ZT	24.0129-0102.1	429102	Ø 345 29,5 28 V + S
			➔	07/11→; +PR 1LJ	24.0130-0222.1	430222	Ø 345 30 28 V + S
			➔	+PR 1KE; + eFSB	24.0130-0222.1	430222	Ø 345 30 28 V + S
➔	+PR 1KE; + eFSB	24.0122-0272.1	422272	Ø 330 21,9 20 V + S			
AUDI - A4 Avant (8W5, B9) 08/15→							
 Bremsscheibe							
1.4 TFSI	110	02/16→	➔	+PR 1LA,1LB	24.0125-0184.1	425184	Ø 314 25 23 V + S
2.0 TDI	90	04/16→	➔		24.0325-0184.1	525184	Ø 314 25 23 V + S PD
2.0 TDI	100	08/15→	➔				
2.0 TDI	110	08/15→	➔	+PR 1LL,1ZA,1ZC,1ZK	24.0134-0110.1	430110	Ø 349 34 32 V + S
2.0 TDI	140	08/15→	➔				
2.0 TDI quattro	110	09/16→	➔	+PR 1KF,1KJ,1KK,2EJ	24.0122-0272.1	422272	Ø 330 21,9 20 V + S
2.0 TDI quattro	120	09/16→					
2.0 TDI quattro	140	10/15→					
2.0 TFSI	140	08/15→					
2.0 TFSI	183	05/16→					
2.0 TFSI	185	05/16→					
2.0 TFSI g-tron	125	11/16→					
2.0 TFSI quattro	183	11/15→					
2.0 TFSI quattro	185	08/15→					
3.0 TDI	160	10/15→					
3.0 TDI quattro	160	11/15→					
3.0 TDI quattro	200	08/15→					
S4 quattro	260	05/16→					
AUDI - A4 Cabriolet (8H7, B6, 8HE, B7) 04/02→03/09							
 Bremsbelagsatz, Scheibenbremse							
1.8 T 1.8 T quattro	120 120	07/02→03/09 05/03→03/09	➔	→ 11/08; +PR 1LB;1LE;1LF;1LT	13.0460-7110.2	607110	ATE 20676 19,8 + WK
			➔	→ 11/08; +PR 1LA	13.0470-7110.2	LD7110	ATE 20676 19,8 + WK Ceramic
			➔	→ 11/08; +PR 1LA	13.0460-7201.2	607201	ATE 23763 20,3 + WK
			➔	→ 11/08; +PR 1LA	13.0470-7201.2	LD7201	ATE 23763 20,3 + WK Ceramic
			➔	8E-5-400001→; → 11/08; +PR 1KW	13.0460-2749.2	602749	TRW 24483 16,9 - WE / - WK + Zub
			➔	→ 11/08; +PR 1KD;1KP / 1KD,1KP	13.0460-2880.2	602880	TRW 23914 17,1 + WE / - WK + Zub
1.8 T 2.0	125 96	10/02→10/05 09/04→12/05	➔	+PR 1LB;1LE;1LF;1LT	13.0460-7110.2	607110	ATE 20676 19,8 + WK
			➔	+PR 1LA	13.0470-7110.2	LD7110	ATE 20676 19,8 + WK Ceramic
			➔	+PR 1LA	13.0460-7201.2	607201	ATE 23763 20,3 + WK
			➔	+PR 1LA	13.0470-7201.2	LD7201	ATE 23763 20,3 + WK Ceramic
			➔	8E-5-400001→; +PR 1KW	13.0460-2749.2	602749	TRW 24483 16,9 - WE / - WK + Zub
			➔	→ 11/08; +PR 1KD;1KP / 1KD,1KP	13.0460-2880.2	602880	TRW 23914 17,1 + WE / - WK + Zub
2.0 TDI 2.0 TDI 2.0 TFSI 16V	100 103 147	01/06→03/09 01/06→03/09 01/06→03/09	➔	→ 11/08; +PR 1LB;1LE;1LF;1LT	13.0460-7110.2	607110	ATE 20676 19,8 + WK
			➔	→ 11/08; +PR 1LA	13.0470-7110.2	LD7110	ATE 20676 19,8 + WK Ceramic
			➔	→ 11/08; +PR 1LA	13.0460-7201.2	607201	ATE 23763 20,3 + WK
			➔	→ 11/08; +PR 1LA	13.0470-7201.2	LD7201	ATE 23763 20,3 + WK Ceramic
			➔	8E-5-400001→; → 11/08; +PR 1KW	13.0460-2749.2	602749	TRW 24483 16,9 - WE / - WK + Zub
			➔	→ 11/08; +PR 1KD;1KP / 1KD,1KP	13.0460-2880.2	602880	TRW 23914 17,1 + WE / - WK + Zub









	kw			 	! #			
AUDI - A4 Cabriolet (8H7, B6, 8HE, B7) 04/02→03/09								
 Bremsbelagsatz, Scheibenbremse								
2.0 TDI 2.0 TDI 2.0 TFSI 16V	100 103 147	01/06→03/09 01/06→03/09 01/06→03/09	➡	8E-5-400001→; → 11/08; +PR 1KW		13.0470-2749.2	LD2749	TRW 24483 16,9 - WE / - WK + Zub Ceramic
			➡	→ 11/08; +PR 1KD,1KP		13.0460-2886.2	602886	TRW 20961 16,0 - WK
			➡	→ 11/08		13.0470-2886.2	LD2886	TRW 20961 16,0 - WK Ceramic
2.0 TFSI quattro	147	11/05→03/09	←	→ 11/08; +PR 1LB,1LE,1LF,1LT		13.0460-7110.2	607110	ATE 20676 19,8 + WK
			←	→ 11/08; +PR 1LA		13.0470-7110.2	LD7110	ATE 20676 19,8 + WK Ceramic
			←	→ 11/08; +PR 1LA		13.0460-7201.2	607201	ATE 23763 20,3 + WK
			←	→ 11/08; +PR 1LA		13.0470-7201.2	LD7201	ATE 23763 20,3 + WK Ceramic
			➡	8E-5-400001→; → 11/08; +PR 1KW		13.0460-2749.2	602749	TRW 24483 16,9 - WE / - WK + Zub
			➡	→ 11/08; +PR 1KD,1KP		13.0460-2886.2	602886	TRW 23914 17,1 + WE / - WK + Zub
2.4 2.4 2.5 TDI 3.0 3.0 quattro	120 125 120 162 162	04/02→12/05 04/02→12/05 08/02→12/05 04/02→12/05 05/03→12/05	←	+PR 1LB;1LE;1LF;1LT		13.0460-7110.2	607110	ATE 20676 19,8 + WK
			←	+PR 1LA		13.0470-7110.2	LD7110	ATE 20676 19,8 + WK Ceramic
			←	+PR 1LA		13.0460-7201.2	607201	ATE 23763 20,3 + WK
			←	+PR 1LA		13.0470-7201.2	LD7201	ATE 23763 20,3 + WK Ceramic
			➡	8E-5-400001→; +PR 1KW		13.0460-2749.2	602749	TRW 24483 16,9 - WE / - WK + Zub
			➡	→ 11/08; +PR 1KD,1KP		13.0460-2886.2	602886	TRW 23914 17,1 + WE / - WK + Zub
			➡	→ 11/08		13.0470-2749.2	LD2749	TRW 24483 16,9 - WE / - WK + Zub Ceramic
			➡	→ 11/08		13.0470-2886.2	LD2886	TRW 23914 17,1 + WE / - WK + Zub Ceramic
2.7 TDI 3.0 TDI quattro 3.2 FSI 3.2 FSI quattro	132 171 188 188	06/06→03/09 01/06→03/09 01/06→03/09 01/06→03/09	←	→ 11/08; +PR 1LB;1LE;1LF;1LT		13.0460-7110.2	607110	ATE 20676 19,8 + WK
			←	→ 11/08; +PR 1LA		13.0470-7110.2	LD7110	ATE 20676 19,8 + WK Ceramic
			←	→ 11/08; +PR 1LA		13.0460-7201.2	607201	ATE 23763 20,3 + WK
			←	→ 11/08; +PR 1LA		13.0470-7201.2	LD7201	ATE 23763 20,3 + WK Ceramic
			➡	8E-5-400001→; → 11/08; +PR 1KW		13.0460-2749.2	602749	TRW 24483 16,9 - WE / - WK + Zub
3.0	160	04/02→12/05	←	+PR 1LZ		13.0460-2837.2	602837	TRW 21945 19,6 + WK
			←	+PR 1LB;1LE;1LF;1LT		13.0470-2837.2	LD2837	TRW 21945 19,6 + WK Ceramic
			←	+PR 1LB;1LE;1LF;1LT		13.0460-7110.2	607110	ATE 20676 19,8 + WK
			←	+PR 1LA;1LC		13.0470-7110.2	LD7110	ATE 20676 19,8 + WK Ceramic
			←	+PR 1LA;1LC		13.0460-7201.2	607201	ATE 23763 20,3 + WK
			←	+PR 1LA;1LC		13.0470-7201.2	LD7201	ATE 23763 20,3 + WK Ceramic
3.0 TDI quattro	150	01/06→03/09	➡	8E-5-400001→; +PR 1KW		13.0460-2749.2	602749	TRW 24483 16,9 - WE / - WK + Zub
			➡	→ 8E-7-300000; +PR 1KD;1KP		13.0460-2886.2	602886	TRW 23914 17,1 + WE / - WK + Zub
			➡	→ 8E-7-300000; +PR 1KD;1KP		13.0460-2886.2	602886	TRW 20961 16,0 - WK
			➡	→ 11/08; +PR 1KD,1KP		13.0470-2886.2	LD2886	TRW 20961 16,0 - WK Ceramic
			➡	→ 11/08; +PR 1LA		13.0470-2886.2	LD2886	TRW 20961 16,0 - WK Ceramic
↓			←	→ 11/08; +PR 1LB;1LE;1LF;1LT		13.0460-7110.2	607110	ATE 20676 19,8 + WK
			←	→ 11/08; +PR 1LA		13.0470-7110.2	LD7110	ATE 20676 19,8 + WK Ceramic
			←	→ 11/08; +PR 1LA		13.0460-7201.2	607201	ATE 23763 20,3 + WK

	kw			 	! #			
AUDI - A4 Cabriolet (8H7, B6, 8HE, B7) 04/02→03/09								
Bremsbelagsatz, Scheibenbremse								
3.0 TDI quattro	150	01/06→03/09	←	→ 11/08; +PR 1LA		13.0470-7201.2	LD7201	ATE 23763 20,3 + WK Ceramic
			→	→ 11/08; +PR 1KW		13.0460-2749.2	602749	TRW 24483 16,9 - WE / - WK + Zub
						13.0460-2880.2	602880	TRW 23914 17,1 + WE / - WK + Zub
						13.0470-2749.2	LD2749	TRW 24483 16,9 - WE / - WK + Zub Ceramic
					13.0470-2880.2	LD2880	TRW 23914 17,1 + WE / - WK + Zub Ceramic	
S4 quattro	253	03/04→03/09	←	→ 11/08		13.0460-7201.2	607201	ATE 23763 20,3 + WK
			→	→ 11/08		13.0460-2888.2	602888	TRW 23326 17,4 + WE / - WK
						13.0470-2888.2	LD2888	TRW 23326 17,4 + WE / - WK Ceramic
Warnkontakt, Bremsbelagverschleiß								
RS4 quattro	309	06/06→03/09	←	→ 11/08; +PR 1LU	2	24.8190-0017.2	620017	L= 388,3
Zubehörsatz, Scheibenbremsbelag								
1.8 T	120	07/02→03/09	→	8E-5-400001→; → 11/08; +PR 1KW		13.0460-0259.2	610259	
1.8 T quattro	120	05/03→03/09						
2.0 TDI	100	01/06→03/09						
2.0 TDI	103	01/06→03/09						
2.0 TFSI 16V	147	01/06→03/09						
2.0 TFSI quattro	147	11/05→03/09						
2.7 TDI	132	06/06→03/09						
3.0 TDI quattro	171	01/06→03/09						
3.2 FSI	188	01/06→03/09						
3.2 FSI quattro	188	01/06→03/09						
1.8 T	125	10/02→10/05	→	8E-5-400001→; +PR 1KW		13.0460-0259.2	610259	
2.0	96	09/04→12/05						
2.4	120	04/02→12/05						
2.4	125	04/02→12/05						
2.5 TDI	120	08/02→12/05						
3.0	160	04/02→12/05						
3.0	162	04/02→12/05						
3.0 quattro	162	05/03→12/05						
3.0 TDI quattro	150	01/06→03/09	→	→ 11/08; +PR 1KW		13.0460-0259.2	610259	
RS4 quattro	309	06/06→03/09	→	→ 11/08		13.0460-0023.2	610023	
S4 quattro	253	03/04→03/09						
Bremsscheibe								
1.8 T	120	07/02→03/09	←	→ 11/08; +PR 1LB;1LE		24.0125-0105.1	425105	Ø 288 25 23 V + S
1.8 T quattro	120	05/03→03/09				24.0325-0105.1	525105	Ø 288 25 23 V PD
2.0 TDI	100	01/06→03/09	←	→ 11/08; +PR 1LF;1LT		24.0125-0137.1	425137	Ø 312 25 23 V + S
2.0 TDI	103	01/06→03/09				24.0325-0137.1	525137	Ø 312 25 23 V PD
			←	→ 11/08; +PR 1LA		24.0130-0113.1	430113	Ø 320 30 28 V + S
						24.0330-0113.1	530113	Ø 320 30 28 V PD
			→	→ 11/08; +PR 1KD		24.0110-0261.1	410261	Ø 245 10 8 + S
						24.0310-0261.1	510261	Ø 245 10 8 PD
			→	→ 11/08; +PR 1KP		24.0112-0148.1	412148	Ø 255 12 10
						24.0312-0148.1	512148	Ø 255 12 10 PD
			→	8E-5-400001→; → 11/08; +PR 1KW		24.0112-0166.1	412166	Ø 288 12 10
						24.0312-0166.1	512166	Ø 288 12 10 PD
1.8 T	125	10/02→10/05	←	+PR 1LB;1LE		24.0125-0105.1	425105	Ø 288 25 23 V + S
2.0	96	09/04→12/05				24.0325-0105.1	525105	Ø 288 25 23 V PD
			←	+PR 1LF;1LT		24.0125-0137.1	425137	Ø 312 25 23 V + S
						24.0325-0137.1	525137	Ø 312 25 23 V PD
			←	+PR 1LA		24.0130-0113.1	430113	Ø 320 30 28 V + S
						24.0330-0113.1	530113	Ø 320 30 28 V PD
			→	+PR 1KD		24.0110-0261.1	410261	Ø 245 10 8 + S
						24.0310-0261.1	510261	Ø 245 10 8 PD
			→	+PR 1KP		24.0112-0148.1	412148	Ø 255 12 10
						24.0312-0148.1	512148	Ø 255 12 10 PD
			→	8E-5-400001→; +PR 1KW		24.0112-0166.1	412166	Ø 288 12 10
						24.0312-0166.1	512166	Ø 288 12 10 PD
2.0 TFSI 16V	147	01/06→03/09	←	→ 11/08; +PR 1LB;1LE		24.0125-0105.1	425105	Ø 288 25 23 V + S
			←	→ 11/08; +PR 1LF;1LT		24.0125-0137.1	425137	Ø 312 25 23 V + S
						24.0325-0137.1	525137	Ø 312 25 23 V PD











	kw			 	! #				
AUDI - A4 Cabriolet (8H7, B6, 8HE, B7) 04/02→03/09									
Bremsscheibe									
2.0 TFSI 16V	147	01/06→03/09	←	→ 11/08; +PR 1LA	24.0130-0113.1	430113	Ø 320 30 28 V + S		
					24.0330-0113.1	530113	Ø 320 30 28 V PD		
			→	→ 11/08; +PR 1KD	24.0110-0261.1	410261	Ø 245 10 8 + S		
					24.0310-0261.1	510261	Ø 245 10 8 PD		
			→	→ 11/08; +PR 1KP	24.0112-0148.1	412148	Ø 255 12 10		
					24.0312-0148.1	512148	Ø 255 12 10 PD		
			→	8E-5-400001→; → 11/08; +PR 1KW	24.0112-0166.1	412166	Ø 288 12 10		
					24.0312-0166.1	512166	Ø 288 12 10 PD		
2.0 TFSI quattro	147	11/05→03/09	←	→ 11/08; +PR 1LB,1LE	24.0125-0105.1	425105	Ø 288 25 23 V + S		
			←	→ 11/08; +PR 1LF,1LT	24.0125-0137.1	425137	Ø 312 25 23 V + S		
					24.0325-0137.1	525137	Ø 312 25 23 V PD		
			←	→ 11/08; +PR 1LA	24.0130-0113.1	430113	Ø 320 30 28 V + S		
					24.0330-0113.1	530113	Ø 320 30 28 V PD		
			→	→ 11/08; +PR 1KD	24.0110-0261.1	410261	Ø 245 10 8 + S		
					24.0310-0261.1	510261	Ø 245 10 8 PD		
			→	→ 11/08; +PR 1KP	24.0112-0148.1	412148	Ø 255 12 10		
					24.0312-0148.1	512148	Ø 255 12 10 PD		
			→	8E-5-400001→; → 11/08; +PR 1KW	24.0112-0166.1	412166	Ø 288 12 10		
					24.0312-0166.1	512166	Ø 288 12 10 PD		
2.4 2.4 2.5 TDI	120 125 120	04/02→12/05 04/02→12/05 08/02→12/05	←	+PR 1LB;1LE	24.0125-0105.1	425105	Ø 288 25 23 V + S		
					24.0325-0105.1	525105	Ø 288 25 23 V PD		
			←	+PR 1LF;1LT	24.0125-0137.1	425137	Ø 312 25 23 V + S		
					24.0325-0137.1	525137	Ø 312 25 23 V PD		
			←	+PR 1LA	24.0130-0113.1	430113	Ø 320 30 28 V + S		
					24.0330-0113.1	530113	Ø 320 30 28 V PD		
			→		24.0112-0148.1	412148	Ø 255 12 10		
					24.0312-0148.1	512148	Ø 255 12 10 PD		
			→	8E-5-400001→; +PR 1KW	24.0112-0166.1	412166	Ø 288 12 10		
					24.0312-0166.1	512166	Ø 288 12 10 PD		
2.7 TDI 3.0 TDI quattro 3.2 FSI 3.2 FSI quattro	132 171 188 188	06/06→03/09 01/06→03/09 01/06→03/09 01/06→03/09	←	→ 11/08; +PR 1LB;1LE	24.0125-0105.1	425105	Ø 288 25 23 V + S		
			←	→ 11/08; +PR 1LF;1LT	24.0125-0137.1	425137	Ø 312 25 23 V + S		
					24.0325-0137.1	525137	Ø 312 25 23 V PD		
			←	→ 11/08; +PR 1LA	24.0130-0113.1	430113	Ø 320 30 28 V + S		
					24.0330-0113.1	530113	Ø 320 30 28 V PD		
			→	8E-5-400001→; → 11/08; +PR 1KW	24.0112-0166.1	412166	Ø 288 12 10		
					24.0312-0166.1	512166	Ø 288 12 10 PD		
3.0	160	04/02→12/05	←	+PR 1LZ	24.0122-0152.1	422152	Ø 280 22 20 V + S		
					24.0322-0152.1	522152	Ø 280 22 20 V PD		
			←	+PR 1LB;1LE	24.0125-0105.1	425105	Ø 288 25 23 V + S		
			←	+PR 1LF;1LT	24.0125-0137.1	425137	Ø 312 25 23 V + S		
					24.0325-0137.1	525137	Ø 312 25 23 V PD		
			←	+PR 1LA	24.0130-0113.1	430113	Ø 320 30 28 V + S		
					24.0330-0113.1	530113	Ø 320 30 28 V PD		
			←	+PR 1LC	24.0130-0185.1	430185	Ø 320 30 28 V*		
			→	+PR 1KD,1KP	24.0112-0148.1	412148	Ø 255 12 10		
					24.0312-0148.1	512148	Ø 255 12 10 PD		
			→	8E-5-400001→; +PR 1KW	24.0112-0166.1	412166	Ø 288 12 10		
					24.0312-0166.1	512166	Ø 288 12 10 PD		
3.0 3.0 quattro	162 162	04/02→12/05 05/03→12/05	←	+PR 1LB;1LE	24.0125-0105.1	425105	Ø 288 25 23 V + S		
			←	+PR 1LF;1LT	24.0125-0137.1	425137	Ø 312 25 23 V + S		
					24.0325-0137.1	525137	Ø 312 25 23 V PD		
			←	+PR 1LA	24.0130-0113.1	430113	Ø 320 30 28 V + S		
					24.0330-0113.1	530113	Ø 320 30 28 V PD		
			→		24.0112-0148.1	412148	Ø 255 12 10		
					24.0312-0148.1	512148	Ø 255 12 10 PD		
			→	8E-5-400001→; +PR 1KW	24.0112-0166.1	412166	Ø 288 12 10		
					24.0312-0166.1	512166	Ø 288 12 10 PD		
3.0 TDI quattro	150	01/06→03/09	←	→ 11/08; +PR 1LB;1LE	24.0125-0105.1	425105	Ø 288 25 23 V + S		
			←	→ 11/08; +PR 1LF;1LT	24.0125-0137.1	425137	Ø 312 25 23 V + S		
					24.0325-0137.1	525137	Ø 312 25 23 V PD		
↓									











	kw			 	! #		
AUDI - A4 Cabriolet (8H7, B6, 8HE, B7) 04/02→03/09							
Bremsscheibe							
3.0 TDI quattro	150	01/06→03/09	←	→ 11/08; +PR 1LA		24.0130-0113.1 430113	∅ 320 30 28 V + S
			→	→ 11/08; +PR 1KW		24.0330-0113.1 530113	∅ 320 30 28 V PD
S4 quattro	253	03/04→03/09	←	→ 11/08		24.0112-0166.1 412166	∅ 288 12 10
			→	→ 11/08		24.0312-0166.1 512166	∅ 288 12 10 PD
AUDI - A5 (8T3) 06/07→01/17							
Bremsbelagsatz, Scheibenbremse							
1.8 TFSI	118	05/09→09/11	←	+PR 1LD		13.0460-2746.2 602746	TRW 24408 19,2 + WK
1.8 TFSI	125	10/07→01/17				13.0470-2746.2 LD2746	TRW 24408 19,2 + WK + Zub Ceramic
1.8 TFSI	130	05/15→01/17					
2.0 TDI	125	08/08→03/12	←	+PR 1LA		13.0460-2746.2 602746	TRW 24408 19,2 + WK
2.0 TDI	130	10/11→01/17				13.0470-2746.2 LD2746	TRW 24408 19,2 + WK + Zub Ceramic
2.0 TDI	140	09/13→01/17	←	+PR 1LT		13.0460-7256.2 607256	ATE 24705 19,8 + WK
2.0 TDI quattro	125	08/08→03/12				13.0470-7256.2 LD7256	ATE 24705 19,8 + WK Ceramic
2.0 TDI quattro	130	12/11→01/17					
2.0 TDI quattro	140	09/13→01/17	→	+PR 1KW,2EH		13.0460-2747.2 602747	TRW 24606 17,4 - WE / - WK + Zub
2.0 TFSI	132	11/08→03/12				13.0470-2747.2 LD2747	TRW 24606 17,4 - WE / - WK + Zub Ceramic
2.0 TFSI	155	06/08→11/13	→	+PR 1KE		13.0460-2748.2 602748	TRW 24606 17,4 - WE / - WK + Zub
2.0 TFSI	165	05/13→05/16				13.0470-2748.2 LD2748	TRW 24606 17,4 - WE / - WK + Zub Ceramic
2.0 TFSI	169	08/15→01/17	→	+PR 1KP		13.0460-2748.2 602748	TRW 24606 17,4 - WE / - WK + Zub
2.0 TFSI quattro	155	06/08→01/17				13.0470-2748.2 LD2748	TRW 24606 17,4 - WE / - WK + Zub Ceramic
2.0 TFSI quattro	165	05/13→05/16					
2.0 TFSI quattro	169	08/15→01/17	→	+PR 1KE		13.0460-2748.2 602748	TRW 24606 17,4 - WE / - WK + Zub
2.7 TDI	120	09/07→03/12				13.0470-2748.2 LD2748	TRW 24606 17,4 - WE / - WK + Zub Ceramic
3.0 TDI	150	10/11→01/17	→	+PR 1KP		13.0460-2748.2 602748	TRW 24606 17,4 - WE / - WK + Zub
3.0 TDI quattro	155	03/08→05/10				13.0470-2748.2 LD2748	TRW 24606 17,4 - WE / - WK + Zub Ceramic
3.0 TDI quattro	160	05/15→01/17					
3.0 TDI quattro	180	10/11→01/17	→	+PR 1KP		13.0460-2748.2 602748	TRW 24606 17,4 - WE / - WK + Zub
3.0 TFSI quattro	200	12/11→01/17				13.0470-2748.2 LD2748	TRW 24606 17,4 - WE / - WK + Zub Ceramic
3.2 FSI	195	06/07→03/12					
3.2 FSI quattro	195	06/07→03/12					
2.0 TDI	120	08/08→01/17	←	10/08→; +PR 1LA		13.0460-2746.2 602746	TRW 24408 19,2 + WK
						13.0470-2746.2 LD2746	TRW 24408 19,2 + WK + Zub Ceramic
			←	10/08→; +PR 1LD		13.0460-2746.2 602746	TRW 24408 19,2 + WK
						13.0470-2746.2 LD2746	TRW 24408 19,2 + WK + Zub Ceramic
			←	10/08→; +PR 1LT		13.0460-7256.2 607256	ATE 24705 19,8 + WK
						13.0470-7256.2 LD7256	ATE 24705 19,8 + WK Ceramic
2.0 TFSI quattro	162	03/12→01/17	→	10/08→; +PR 1KW,2EH		13.0460-2747.2 602747	TRW 24606 17,4 - WE / - WK + Zub
						13.0470-2747.2 LD2747	TRW 24606 17,4 - WE / - WK + Zub Ceramic
			→	10/08→; +PR 1KE		13.0460-2748.2 602748	TRW 24606 17,4 - WE / - WK + Zub
						13.0470-2748.2 LD2748	TRW 24606 17,4 - WE / - WK + Zub Ceramic
			→	10/08→; +PR 1KP		13.0460-2748.2 602748	TRW 24606 17,4 - WE / - WK + Zub
						13.0470-2748.2 LD2748	TRW 24606 17,4 - WE / - WK + Zub Ceramic
2.0 TFSI quattro	162	03/12→01/17	←	05/13→; +PR 1LD		13.0460-2746.2 602746	TRW 24408 19,2 + WK
						13.0470-2746.2 LD2746	TRW 24408 19,2 + WK + Zub Ceramic
			←	05/13→; +PR 1LA		13.0460-2746.2 602746	TRW 24408 19,2 + WK
						13.0470-2746.2 LD2746	TRW 24408 19,2 + WK + Zub Ceramic
			←	05/13→; +PR 1LT		13.0460-7256.2 607256	ATE 24705 19,8 + WK
						13.0470-7256.2 LD7256	ATE 24705 19,8 + WK Ceramic
2.0 TFSI quattro	162	03/12→01/17	→	05/13→; +PR 1KW,2EH		13.0460-2747.2 602747	TRW 24606 17,4 - WE / - WK + Zub
						13.0470-2747.2 LD2747	TRW 24606 17,4 - WE / - WK + Zub Ceramic
			→	05/13→; +PR 1KE		13.0460-2748.2 602748	TRW 24606 17,4 - WE / - WK + Zub
						13.0470-2748.2 LD2748	TRW 24606 17,4 - WE / - WK + Zub Ceramic
			→	05/13→; +PR 1KP		13.0460-2748.2 602748	TRW 24606 17,4 - WE / - WK + Zub
						13.0470-2748.2 LD2748	TRW 24606 17,4 - WE / - WK + Zub Ceramic







	kw			 	! #		
AUDI - A5 (8T3) 06/07→01/17							
Bremsbelagsatz, Scheibenbremse							
2.0 TFSI quattro	162	03/12→01/17	➡	05/13→; +PR 1KE		13.0470-2748.2 LD2748	TRW 24606 17,4 - WE / - WK + Zub Ceramic
2.7 TDI 3.0 TDI quattro	140 176	06/07→03/12 06/07→03/12	←	+PR 1LD		13.0460-2746.2 602746	TRW 24408 19,2 + WK
						13.0470-2746.2 LD2746	TRW 24408 19,2 + WK + Zub Ceramic
			←	07/07→; +PR 1LA		13.0460-2746.2 602746	TRW 24408 19,2 + WK
						13.0470-2746.2 LD2746	TRW 24408 19,2 + WK + Zub Ceramic
			←	+PR 1LT		13.0460-7256.2 607256	ATE 24705 19,8 + WK
						13.0470-7256.2 LD7256	ATE 24705 19,8 + WK Ceramic
			➡	+PR 1KW,2EH		13.0460-2747.2 602747	TRW 24606 17,4 - WE / - WK + Zub
			13.0470-2747.2 LD2747	TRW 24606 17,4 - WE / - WK + Zub Ceramic			
			➡	+PR 1KE		13.0460-2748.2 602748	TRW 24606 17,4 - WE / - WK + Zub
						13.0470-2748.2 LD2748	TRW 24606 17,4 - WE / - WK + Zub Ceramic
			➡	+PR 1KP		13.0460-2748.2 602748	TRW 24606 17,4 - WE / - WK + Zub
						13.0470-2748.2 LD2748	TRW 24606 17,4 - WE / - WK + Zub Ceramic
RS 5 quattro	331	03/10→08/15	➡	+PR GP1		13.0460-2748.2 602748	TRW 24606 17,4 - WE / - WK + Zub
						13.0470-2748.2 LD2748	TRW 24606 17,4 - WE / - WK + Zub Ceramic
			➡	+PR 1KP		13.0460-2748.2 602748	TRW 24606 17,4 - WE / - WK + Zub
						13.0470-2748.2 LD2748	TRW 24606 17,4 - WE / - WK + Zub Ceramic
S5 quattro	245	10/11→01/17	←	+PR 1LJ		13.0460-2746.2 602746	TRW 24408 19,2 + WK
			←	+PR 1ZT,1LD		13.0460-2746.2 602746	TRW 24408 19,2 + WK
			➡	+PR 1KE,1KP		13.0460-2748.2 602748	TRW 24606 17,4 - WE / - WK + Zub
						13.0470-2748.2 LD2748	TRW 24606 17,4 - WE / - WK + Zub Ceramic
S5 quattro	260	06/07→03/12	←	07/11→; +PR 1LJ		13.0460-2746.2 602746	TRW 24408 19,2 + WK
			←	+PR 1ZT,1LD		13.0460-2746.2 602746	TRW 24408 19,2 + WK
			➡	→ 10/10; +PR 1KE		13.0460-2748.2 602748	TRW 24606 17,4 - WE / - WK + Zub
						13.0470-2748.2 LD2748	TRW 24606 17,4 - WE / - WK + Zub Ceramic
			➡	11/10→; +PR 1KE,1KP		13.0460-2748.2 602748	TRW 24606 17,4 - WE / - WK + Zub
						13.0470-2748.2 LD2748	TRW 24606 17,4 - WE / - WK + Zub Ceramic
Zubehörsatz, Scheibenbremsbelag							
1.8 TFSI	118	05/09→09/11		+PR 1KE		13.0460-0023.2 610023	
1.8 TFSI	125	10/07→01/17					
1.8 TFSI	130	05/15→01/17					
2.0 TDI	125	08/08→03/12					
2.0 TDI	130	10/11→01/17					
2.0 TDI	140	09/13→01/17					
2.0 TDI quattro	125	08/08→03/12					
2.0 TDI quattro	130	12/11→01/17					
2.0 TDI quattro	140	09/13→01/17					
2.0 TFSI	132	11/08→03/12					
2.0 TFSI	155	06/08→11/13					
2.0 TFSI	165	05/13→05/16					
2.0 TFSI	169	08/15→01/17					
2.0 TFSI quattro	155	06/08→01/17					
2.0 TFSI quattro	165	05/13→05/16					
2.0 TFSI quattro	169	08/15→01/17					
2.7 TDI	120	09/07→03/12					
2.7 TDI	140	06/07→03/12					
3.0 TDI	150	10/11→01/17					
3.0 TDI quattro	155	03/08→05/10					
3.0 TDI quattro	160	05/15→01/17					
3.0 TDI quattro	176	06/07→03/12					
3.0 TDI quattro	180	10/11→01/17					
3.0 TFSI quattro	200	12/11→01/17					
3.2 FSI	195	06/07→03/12					







	kW			 	! #		
AUDI - A5 (8T3) 06/07→01/17							
Zubehörsatz, Scheibenbremsbelag							
3.2 FSI quattro	195	06/07→03/12		+PR 1KE		13.0460-0023.2 610023	
2.0 TDI	120	08/08→01/17		10/08→; +PR 1KE		13.0460-0023.2 610023	
2.0 TFSI quattro	162	03/12→01/17		05/13→; +PR 1KE		13.0460-0023.2 610023	
RS 5 quattro	331	03/10→08/15		+PR GP1		13.0460-0023.2 610023	
S5 quattro	260	06/07→03/12		→ 10/10; +PR 1KE		13.0460-0023.2 610023	
 Bremsscheibe							
1.8 TFSI	118	05/09→09/11	←	+PR 1LT		24.0125-0184.1 425184	Ø 314 25 23 V + S
1.8 TFSI	125	10/07→01/17				24.0325-0184.1 525184	Ø 314 25 23 V + S PD
2.0 TDI	125	08/08→03/12				24.0129-0102.1 429102	Ø 345 29,5 28 V + S
2.0 TDI quattro	125	08/08→03/12	←	+PR 1LJ			
2.0 TFSI	132	11/08→03/12		→ 06/11; +PR 1LA		24.0130-0193.1 430193	Ø 320 30 28 V + S
2.0 TFSI	155	06/08→11/13	←			24.0330-0193.1 530193	Ø 320 30 28 V + S PD
2.0 TFSI quattro	155	06/08→01/17					
2.7 TDI	120	09/07→03/12	←	07/11→; +PR 1LA		24.0130-0221.1 430221	Ø 320 30 28 V + S
3.2 FSI	195	06/07→03/12	←	+PR 1LD		24.0130-0222.1 430222	Ø 345 30 28 V + S
3.2 FSI quattro	195	06/07→03/12	→	+PR 1KW,2EH		24.0112-0178.1 412178	Ø 300 12 10 + S
			→	+PR 1KE; + eFSB		24.0122-0272.1 422272	Ø 330 21,9 20 V + S
			→	+PR 1KP		24.0122-0272.1 422272	Ø 330 21,9 20 V + S
1.8 TFSI	130	05/15→01/17	←	+PR 1LT		24.0125-0184.1 425184	Ø 314 25 23 V + S
2.0 TDI	130	10/11→01/17				24.0325-0184.1 525184	Ø 314 25 23 V + S PD
2.0 TDI	140	09/13→01/17				24.0129-0102.1 429102	Ø 345 29,5 28 V + S
2.0 TDI quattro	130	12/11→01/17	←	+PR 1LJ			
2.0 TDI quattro	140	09/13→01/17	←	+PR 1LA		24.0130-0221.1 430221	Ø 320 30 28 V + S
2.0 TFSI	165	05/13→05/16				24.0130-0222.1 430222	Ø 345 30 28 V + S
2.0 TFSI	169	08/15→01/17	←	+PR 1LD		24.0112-0178.1 412178	Ø 300 12 10 + S
2.0 TFSI quattro	165	05/13→05/16	→	+PR 1KW,2EH		24.0312-0178.1 512178	Ø 300 12 10 + S PD
2.0 TFSI quattro	169	08/15→01/17	→	+PR 1KE; + eFSB		24.0122-0272.1 422272	Ø 330 21,9 20 V + S
3.0 TDI	150	10/11→01/17	→	+PR 1KP		24.0122-0272.1 422272	Ø 330 21,9 20 V + S
3.0 TDI quattro	160	05/15→01/17	→				
3.0 TDI quattro	180	10/11→01/17	→				
2.0 TDI	120	08/08→01/17	←	10/08→; +PR 1LT		24.0125-0184.1 425184	Ø 314 25 23 V + S
						24.0325-0184.1 525184	Ø 314 25 23 V + S PD
			←	10/08→; +PR 1LJ		24.0129-0102.1 429102	Ø 345 29,5 28 V + S
			←	10/08→; +PR 1LA; → 06/11		24.0130-0193.1 430193	Ø 320 30 28 V + S
						24.0330-0193.1 530193	Ø 320 30 28 V + S PD
			←	07/11→; +PR 1LA		24.0130-0221.1 430221	Ø 320 30 28 V + S
			←	10/08→; +PR 1LD		24.0130-0222.1 430222	Ø 345 30 28 V + S
			→	10/08→; +PR 1KW,2EH		24.0112-0178.1 412178	Ø 300 12 10 + S
			→	+PR 1KE; + eFSB		24.0122-0272.1 422272	Ø 330 21,9 20 V + S
			→	+PR 1KP		24.0122-0272.1 422272	Ø 330 21,9 20 V + S
2.0 TFSI quattro	162	03/12→01/17	←	05/13→; +PR 1LT		24.0125-0184.1 425184	Ø 314 25 23 V + S
						24.0325-0184.1 525184	Ø 314 25 23 V + S PD
			←	05/13→; +PR 1LJ		24.0129-0102.1 429102	Ø 345 29,5 28 V + S
			←	05/13→; +PR 1LA		24.0130-0221.1 430221	Ø 320 30 28 V + S
			←	05/13→; +PR 1LD		24.0130-0222.1 430222	Ø 345 30 28 V + S
			→	05/13→; +PR 1KW,2EH		24.0112-0178.1 412178	Ø 300 12 10 + S
			→	+PR 1KE; + eFSB		24.0122-0272.1 422272	Ø 330 21,9 20 V + S
			→	+PR 1KP		24.0122-0272.1 422272	Ø 330 21,9 20 V + S
2.7 TDI	140	06/07→03/12	←	+PR 1LT		24.0125-0184.1 425184	Ø 314 25 23 V + S
3.0 TDI quattro	176	06/07→03/12				24.0325-0184.1 525184	Ø 314 25 23 V + S PD
			←	+PR 1LJ		24.0129-0102.1 429102	Ø 345 29,5 28 V + S
			←	07/07→ 06/11; +PR 1LA		24.0130-0193.1 430193	Ø 320 30 28 V + S
						24.0330-0193.1 530193	Ø 320 30 28 V + S PD
			←	07/11→; +PR 1LA		24.0130-0221.1 430221	Ø 320 30 28 V + S
			←	+PR 1LD		24.0130-0222.1 430222	Ø 345 30 28 V + S
			→	+PR 1KW,2EH		24.0112-0178.1 412178	Ø 300 12 10 + S
			→	+PR 1KE; + eFSB		24.0122-0272.1 422272	Ø 330 21,9 20 V + S
			→	+PR 1KP		24.0122-0272.1 422272	Ø 330 21,9 20 V + S
↓							



	kw			 	! #		
AUDI - A5 (8T3) 06/07→01/17							
 Bremsscheibe							
2.7 TDI	140	06/07→03/12	➔	+PR 1KE; + eFSB		24.0122-0272.1 422272	Ø 330 21,9 20 V + S
3.0 TDI quattro	176	06/07→03/12					
3.0 TDI quattro	155	03/08→05/10	➔	+PR 1LT		24.0125-0184.1 425184	Ø 314 25 23 V + S
			➔	+PR 1LT		24.0325-0184.1 525184	Ø 314 25 23 V + S PD
			➔	+PR 1LJ		24.0129-0102.1 429102	Ø 345 29,5 28 V + S
			➔	+PR 1LA		24.0130-0193.1 430193	Ø 320 30 28 V + S
			➔	+PR 1LA		24.0330-0193.1 530193	Ø 320 30 28 V + S PD
			➔	+PR 1LD		24.0130-0222.1 430222	Ø 345 30 28 V + S
			➔	+PR 1KW,2EH		24.0112-0178.1 412178	Ø 300 12 10 + S
			➔	+PR 1KW,2EH		24.0312-0178.1 512178	Ø 300 12 10 + S PD
3.0 TFSI quattro	200	12/11→01/17	➔	+PR 1KE; + eFSB		24.0122-0272.1 422272	Ø 330 21,9 20 V + S
			➔	+PR 1KP		24.0122-0272.1 422272	Ø 330 21,9 20 V + S
			➔	+PR 1LT		24.0125-0184.1 425184	Ø 314 25 23 V + S
			➔	+PR 1LT		24.0325-0184.1 525184	Ø 314 25 23 V + S PD
			➔	+PR 1LJ		24.0129-0102.1 429102	Ø 345 29,5 28 V + S
			➔	+PR 1LA		24.0130-0221.1 430221	Ø 320 30 28 V + S
			➔	+PR 1LD		24.0130-0222.1 430222	Ø 345 30 28 V + S
			➔	+PR 1KW,2EH		24.0112-0178.1 412178	Ø 300 12 10 + S
S5 quattro	245	10/11→01/17	➔	+PR 1KW,2EH		24.0312-0178.1 512178	Ø 300 12 10 + S PD
			➔	+PR 1ZT		24.0130-0222.1 430222	Ø 345 30 28 V + S
S5 quattro	260	06/07→03/12	➔	+PR 1ZT		24.0130-0222.1 430222	Ø 345 30 28 V + S
			➔	+PR 1LJ		24.0130-0222.1 430222	Ø 345 30 28 V + S
			➔	+PR 1ZT,1LD		24.0130-0222.1 430222	Ø 345 30 28 V + S
			➔	+PR 1KE,1KP		24.0122-0272.1 422272	Ø 330 21,9 20 V + S
S5 quattro	260	06/07→03/12	➔	+PR 1LJ; → 06/11		24.0129-0102.1 429102	Ø 345 29,5 28 V + S
			➔	+PR 1ZT		24.0130-0222.1 430222	Ø 345 30 28 V + S
			➔	+PR 1ZT,1LD		24.0130-0222.1 430222	Ø 345 30 28 V + S
			➔	07/11→; +PR 1LJ		24.0130-0222.1 430222	Ø 345 30 28 V + S
			➔	→ 10/10; +PR 1KE; + eFSB		24.0122-0272.1 422272	Ø 330 21,9 20 V + S
			➔	11/10→; +PR 1KE,1KP		24.0122-0272.1 422272	Ø 330 21,9 20 V + S
AUDI - A5 (F53) 06/16→							
 Bremsscheibe							
1.4 TFSI	110	11/16→	➔	+PR 1LA,1LB		24.0125-0184.1 425184	Ø 314 25 23 V + S
2.0 TDI	140	07/16→				24.0325-0184.1 525184	Ø 314 25 23 V + S PD
2.0 TDI quattro	140	10/16→					
2.0 TFSI	140	09/16→	➔	+PR 1LL,1ZA,1ZC,1ZK		24.0134-0110.1 430110	Ø 349 34 32 V + S
2.0 TFSI	185	11/16→	➔	+PR 1KF,1KJ,1KK,2EJ		24.0122-0272.1 422272	Ø 330 21,9 20 V + S
3.0 TDI	160	11/16→					
3.0 TDI quattro	160	07/16→					
3.0 TDI quattro	200	02/17→					
3.0 TDI quattro	210	01/17→					
S5 quattro	260	07/16→					
2.0 TFSI quattro	183	06/16→	➔	07/16→; +PR 1LA,1LB		24.0125-0184.1 425184	Ø 314 25 23 V + S
2.0 TFSI quattro	185	06/16→	➔	07/16→; +PR 1LL,1ZA,1ZC,1ZK		24.0325-0184.1 525184	Ø 314 25 23 V + S PD
			➔	07/16→; +PR 1LL,1ZA,1ZC,1ZK		24.0134-0110.1 430110	Ø 349 34 32 V + S
			➔	07/16→; +PR 1KF,1KJ,1KK,2EJ		24.0122-0272.1 422272	Ø 330 21,9 20 V + S
AUDI - A5 Cabriolet (8F7) 03/09→01/17							
 Bremsbelagsatz, Scheibenbremse							
1.8 TFSI	118	09/09→03/12	➔	+PR 1LA,1LB,1LD		13.0460-2746.2 602746	TRW 24408 19,2 + WK
1.8 TFSI	125	10/11→03/16				13.0470-2746.2 LD2746	TRW 24408 19,2 + WK + Zub Ceramic
2.0 TDI	110	05/13→01/17					
2.0 TDI	120	05/09→06/14					
2.0 TDI	125	05/09→03/12	➔	+PR 1LT		13.0460-7256.2 607256	ATE 24705 19,8 + WK
2.0 TDI	130	10/11→01/17				13.0470-7256.2 LD7256	ATE 24705 19,8 + WK Ceramic
2.0 TDI	140	09/13→01/17					
2.0 TFSI	132	03/09→03/12	➔	+PR 1KW,2EH; + eFSB		13.0460-2747.2 602747	TRW 24606 17,4 - WE / - WK + Zub
2.0 TFSI	155	03/09→06/14					
2.0 TFSI	162	05/13→12/14				13.0470-2747.2 LD2747	TRW 24606 17,4 - WE / - WK + Zub Ceramic
2.0 TFSI	165	05/13→05/16					
2.0 TFSI	169	08/15→01/17	➔	+PR 1KE,1KP; + eFSB		13.0460-2748.2 602748	TRW 24606 17,4 - WE / - WK + Zub
2.0 TFSI quattro	155	03/09→01/17					
2.0 TFSI quattro	165	05/13→05/16				13.0470-2748.2 LD2748	TRW 24606 17,4 - WE / - WK + Zub Ceramic
2.0 TFSI quattro	169	08/15→01/17					
2.7 TDI	120	05/09→03/12					
2.7 TDI	140	03/09→03/12					

	kw			 	! #		
AUDI - A5 Cabriolet (8F7) 03/09→01/17							
 Bremsbelagsatz, Scheibenbremse							
3.0 TDI 3.0 TDI quattro 3.0 TDI quattro 3.2 FSI 3.2 FSI quattro	150 176 180 195 195	10/11→01/17 03/09→03/12 10/11→01/17 03/09→03/12 03/09→03/12	← ← ← → →	+PR 1LA,1LB,1LD +PR 1LT +PR 1KW,2EH; + eFSB +PR 1KE,1KP; + eFSB	 	13.0460-2746.2 602746 13.0470-2746.2 LD2746 13.0460-7256.2 607256 13.0470-7256.2 LD7256 13.0460-2747.2 602747 13.0470-2747.2 LD2747 13.0460-2748.2 602748 13.0470-2748.2 LD2748	TRW 24408 19,2 + WK TRW 24408 19,2 + WK + Zub Ceramic ATE 24705 19,8 + WK ATE 24705 19,8 + WK Ceramic TRW 24606 17,4 - WE / - WK + Zub TRW 24606 17,4 - WE / - WK + Zub Ceramic TRW 24606 17,4 - WE / - WK + Zub TRW 24606 17,4 - WE / - WK + Zub Ceramic
1.8 TFSI 2.0 TDI quattro 2.0 TDI quattro 3.0 TDI quattro 3.0 TFSI quattro	130 130 140 160 200	05/15→01/17 01/12→05/15 09/13→01/17 05/15→01/17 11/11→01/17	← ← ← → →	+PR 1LA,1LB,1LD,1LJ +PR 1LT +PR 1KW,2EH; + eFSB +PR 1KE,1KP; + eFSB	 	13.0460-2746.2 602746 13.0470-2746.2 LD2746 13.0460-7256.2 607256 13.0470-7256.2 LD7256 13.0460-2747.2 602747 13.0470-2747.2 LD2747 13.0460-2748.2 602748 13.0470-2748.2 LD2748	TRW 24408 19,2 + WK TRW 24408 19,2 + WK + Zub Ceramic ATE 24705 19,8 + WK ATE 24705 19,8 + WK Ceramic TRW 24606 17,4 - WE / - WK + Zub TRW 24606 17,4 - WE / - WK + Zub Ceramic TRW 24606 17,4 - WE / - WK + Zub TRW 24606 17,4 - WE / - WK + Zub Ceramic
2.0 TDI	105	10/11→05/15	← ← → →	11/11→; +PR 1LA,1LB,1LD,1LJ 11/11→; +PR 1LT 11/11→; +PR 1KW,2EH; + eFSB 11/11→; +PR 1KE,1KP; + eFSB	 	13.0460-2746.2 602746 13.0470-2746.2 LD2746 13.0460-7256.2 607256 13.0470-7256.2 LD7256 13.0460-2747.2 602747 13.0470-2747.2 LD2747 13.0460-2748.2 602748 13.0470-2748.2 LD2748	TRW 24408 19,2 + WK TRW 24408 19,2 + WK + Zub Ceramic ATE 24705 19,8 + WK ATE 24705 19,8 + WK Ceramic TRW 24606 17,4 - WE / - WK + Zub TRW 24606 17,4 - WE / - WK + Zub Ceramic TRW 24606 17,4 - WE / - WK + Zub TRW 24606 17,4 - WE / - WK + Zub Ceramic
2.0 TFSI quattro	162	03/12→01/17	← ← → →	05/13→; +PR 1LA,1LB,1LD 05/13→; +PR 1LT 05/13→; +PR 1KW,2EH; + eFSB 05/13→; +PR 1KE,1KP; + eFSB	 	13.0460-2746.2 602746 13.0470-2746.2 LD2746 13.0460-7256.2 607256 13.0470-7256.2 LD7256 13.0460-2747.2 602747 13.0470-2747.2 LD2747 13.0460-2748.2 602748 13.0470-2748.2 LD2748	TRW 24408 19,2 + WK TRW 24408 19,2 + WK + Zub Ceramic ATE 24705 19,8 + WK ATE 24705 19,8 + WK Ceramic TRW 24606 17,4 - WE / - WK + Zub TRW 24606 17,4 - WE / - WK + Zub Ceramic TRW 24606 17,4 - WE / - WK + Zub TRW 24606 17,4 - WE / - WK + Zub Ceramic
RS 5 quattro	331	11/12→08/15	→	02/13→; +PR 1KZ,2ED; + eFSB	 	13.0460-2770.2 602770 13.0470-2770.2 LD2770	TRW 24606 17,4 + WK + Zub TRW 24606 17,4 + WK + Zub Ceramic
S5 quattro	245	06/09→01/17	← ← →	07/11→; +PR 1LJ +PR 1ZT,1LD +PR 1KE,1KP; + eFSB	 	13.0460-2746.2 602746 13.0460-2746.2 602746 13.0460-2748.2 602748 13.0470-2748.2 LD2748	TRW 24408 19,2 + WK TRW 24408 19,2 + WK TRW 24606 17,4 - WE / - WK + Zub TRW 24606 17,4 - WE / - WK + Zub Ceramic
Warnkontakt, Bremsbelagverschleiß							
RS 5 quattro	331	11/12→08/15	←	 02/13→; +PR 1LW	1	24.8190-0017.2 620017	L= 388,3
 Bremsscheibe							
1.8 TFSI 2.0 TDI ↓	118 120	09/09→03/12 05/09→06/14	←	+PR 1LT	 	24.0125-0184.1 425184	Ø 314 25 23 V + S

	kw			 	! #		
AUDI - A5 Cabriolet (8F7) 03/09→01/17							
Bremsscheibe							
2.0 TDI	125	05/09→03/12	←	+PR 1LT		24.0325-0184.1 525184	Ø 314 25 23 V + S PD
2.0 TFSI	132	03/09→03/12	←	+PR 1LJ		24.0129-0102.1 429102	Ø 345 29,5 28 V + S
2.0 TFSI	155	03/09→06/14	←	+PR 1LJ		24.0129-0102.1 429102	Ø 345 29,5 28 V + S
2.7 TDI	120	05/09→03/12	←	→ 06/11; +PR 1LA,1LB		24.0130-0193.1 430193	Ø 320 30 28 V + S
2.7 TDI	140	03/09→03/12	←	→ 06/11; +PR 1LA,1LB		24.0130-0193.1 430193	Ø 320 30 28 V + S
3.0 TDI quattro	176	03/09→03/12	←	07/11→; +PR 1LA,1LB		24.0130-0221.1 430221	Ø 320 30 28 V + S PD
3.2 FSI	195	03/09→03/12	←	07/11→; +PR 1LA,1LB		24.0130-0221.1 430221	Ø 320 30 28 V + S
3.2 FSI quattro	195	03/09→03/12	←	+PR 1LD		24.0130-0222.1 430222	Ø 345 30 28 V + S
			→	+PR 1KW,2EH		24.0112-0178.1 412178	Ø 300 12 10 + S
			→	+PR 1KW,2EH		24.0312-0178.1 512178	Ø 300 12 10 + S PD
			→	11/10→; +PR 1KE,1KP; + eFSB		24.0122-0272.1 422272	Ø 330 21,9 20 V + S
			→	→ 10/10; +PR 1KE; + eFSB		24.0122-0272.1 422272	Ø 330 21,9 20 V + S
1.8 TFSI	125	10/11→03/16	←	+PR 1LT		24.0125-0184.1 425184	Ø 314 25 23 V + S
1.8 TFSI	130	05/15→01/17	←	+PR 1LT		24.0325-0184.1 525184	Ø 314 25 23 V + S PD
2.0 TDI	110	05/13→01/17	←	+PR 1LJ		24.0129-0102.1 429102	Ø 345 29,5 28 V + S
2.0 TDI	130	10/11→01/17	←	+PR 1LJ		24.0129-0102.1 429102	Ø 345 29,5 28 V + S
2.0 TDI	140	09/13→01/17	←	+PR 1LA,1LB		24.0130-0221.1 430221	Ø 320 30 28 V + S
2.0 TDI quattro	140	09/13→01/17	←	+PR 1LA,1LB		24.0130-0221.1 430221	Ø 320 30 28 V + S
2.0 TFSI	162	05/13→12/14	←	+PR 1LD		24.0130-0222.1 430222	Ø 345 30 28 V + S
2.0 TFSI	165	05/13→05/16	←	+PR 1LD		24.0130-0222.1 430222	Ø 345 30 28 V + S
2.0 TFSI	169	08/15→01/17	→	+PR 1KW,2EH		24.0112-0178.1 412178	Ø 300 12 10 + S
2.0 TFSI quattro	165	05/13→05/16	→	+PR 1KW,2EH		24.0312-0178.1 512178	Ø 300 12 10 + S PD
2.0 TFSI quattro	169	08/15→01/17	→	+PR 1KE,1KP; + eFSB		24.0122-0272.1 422272	Ø 330 21,9 20 V + S
3.0 TDI	150	10/11→01/17	→	+PR 1KE,1KP; + eFSB		24.0122-0272.1 422272	Ø 330 21,9 20 V + S
3.0 TDI quattro	160	05/15→01/17	→	+PR 1KE,1KP; + eFSB		24.0122-0272.1 422272	Ø 330 21,9 20 V + S
3.0 TDI quattro	180	10/11→01/17	→	+PR 1KE,1KP; + eFSB		24.0122-0272.1 422272	Ø 330 21,9 20 V + S
2.0 TDI	105	10/11→05/15	←	11/11→; +PR 1LT		24.0125-0184.1 425184	Ø 314 25 23 V + S
			←	11/11→; +PR 1LA,1LB		24.0325-0184.1 525184	Ø 314 25 23 V + S PD
			←	11/11→; +PR 1LA,1LB		24.0130-0221.1 430221	Ø 320 30 28 V + S
			←	11/11→; +PR 1LD,1LJ		24.0130-0222.1 430222	Ø 345 30 28 V + S
			→	11/11→; +PR 1KW,2EH		24.0112-0178.1 412178	Ø 300 12 10 + S
			→	11/11→; +PR 1KW,2EH		24.0312-0178.1 512178	Ø 300 12 10 + S PD
			→	11/11→; +PR 1KE,1KP; + eFSB		24.0122-0272.1 422272	Ø 330 21,9 20 V + S
2.0 TDI quattro	130	01/12→05/15	←	+PR 1LT		24.0125-0184.1 425184	Ø 314 25 23 V + S
3.0 TFSI quattro	200	11/11→01/17	←	+PR 1LT		24.0325-0184.1 525184	Ø 314 25 23 V + S PD
			←	+PR 1LA,1LB		24.0130-0221.1 430221	Ø 320 30 28 V + S
			←	+PR 1LD,1LJ		24.0130-0222.1 430222	Ø 345 30 28 V + S
			→	+PR 1KW,2EH		24.0112-0178.1 412178	Ø 300 12 10 + S
			→	+PR 1KW,2EH		24.0312-0178.1 512178	Ø 300 12 10 + S PD
			→	+PR 1KE,1KP; + eFSB		24.0122-0272.1 422272	Ø 330 21,9 20 V + S
2.0 TFSI quattro	155	03/09→01/17	←	+PR 1LT		24.0125-0184.1 425184	Ø 314 25 23 V + S
			←	+PR 1LT		24.0325-0184.1 525184	Ø 314 25 23 V + S PD
			←	+PR 1LJ		24.0129-0102.1 429102	Ø 345 29,5 28 V + S
			←	→ 06/11; +PR 1LA,1LB		24.0130-0193.1 430193	Ø 320 30 28 V + S
			←	→ 06/11; +PR 1LA,1LB		24.0330-0193.1 530193	Ø 320 30 28 V + S PD
			←	07/11→; +PR 1LA,1LB		24.0130-0221.1 430221	Ø 320 30 28 V + S
			←	+PR 1LD		24.0130-0222.1 430222	Ø 345 30 28 V + S
			→	+PR 1KW,2EH		24.0112-0178.1 412178	Ø 300 12 10 + S
			→	+PR 1KW,2EH		24.0312-0178.1 512178	Ø 300 12 10 + S PD
			→	11/10→; +PR 1KE,1KP; + eFSB		24.0122-0272.1 422272	Ø 330 21,9 20 V + S
2.0 TFSI quattro	162	03/12→01/17	←	05/13→; +PR 1LT		24.0125-0184.1 425184	Ø 314 25 23 V + S
			←	05/13→; +PR 1LT		24.0325-0184.1 525184	Ø 314 25 23 V + S PD
			←	05/13→; +PR 1LJ		24.0129-0102.1 429102	Ø 345 29,5 28 V + S
			←	05/13→; +PR 1LA,1LB		24.0130-0221.1 430221	Ø 320 30 28 V + S
			←	05/13→; +PR 1LD		24.0130-0222.1 430222	Ø 345 30 28 V + S
			→	05/13→; +PR 1KW,2EH		24.0112-0178.1 412178	Ø 300 12 10 + S
			→	05/13→; +PR 1KW,2EH		24.0312-0178.1 512178	Ø 300 12 10 + S PD
			→	05/13→; +PR 1KE,1KP; + eFSB		24.0122-0272.1 422272	Ø 330 21,9 20 V + S
S5 quattro	245	06/09→01/17	←	+PR 1LJ; → 06/11		24.0129-0102.1 429102	Ø 345 29,5 28 V + S
			←	07/11→; +PR 1ZT,1LD,1LJ		24.0130-0222.1 430222	Ø 345 30 28 V + S
			→	→ 10/10; +PR 1KE; + eFSB		24.0122-0272.1 422272	Ø 330 21,9 20 V + S
			→	11/10→; +PR 1KE,1KP; + eFSB		24.0122-0272.1 422272	Ø 330 21,9 20 V + S

	kw			 	! #		
AUDI - A5 Cabriolet (F57) 11/16→							
Bremsscheibe							
2.0 TDI	140	11/16→	←	03/17→; +PR 1LA,1LB		24.0125-0184.1 425184	∅ 314 25 23 V + S
2.0 TFSI quattro	185	11/16→					
3.0 TDI quattro	160	12/16→					
2.0 TDI quattro	140	03/17→	←	+PR 1LA, 1LB		24.0125-0184.1 425184	∅ 314 25 23 V + S
2.0 TFSI	140	03/17→					
2.0 TFSI	185	03/17→					
3.0 TDI	160	03/17→					
3.0 TDI quattro	210	11/16→					
S5 quattro	260	03/17→					
AUDI - A5 Sportback (8TA) 09/09→01/17							
Bremsbelagsatz, Scheibenbremse							
1.8 TFSI	106	09/14→01/17	←	+PR 1LD		13.0460-2746.2 602746	TRW 24408 19,2 + WK
1.8 TFSI	118	11/09→09/11				13.0470-2746.2 LD2746	TRW 24408 19,2 + WK + Zub Ceramic
1.8 TFSI	125	08/11→01/17					
1.8 TFSI	130	05/15→01/17					
2.0 TDI	100	09/09→01/17	←	+PR 1LA		13.0460-2746.2 602746	TRW 24408 19,2 + WK
2.0 TDI	105	09/09→01/17				13.0470-2746.2 LD2746	TRW 24408 19,2 + WK + Zub Ceramic
2.0 TDI	110	05/13→01/17					
2.0 TDI	120	09/09→01/17					
2.0 TDI	125	09/09→03/12	←	+PR 1LT		13.0460-7256.2 607256	ATE 24705 19,8 + WK
2.0 TDI	130	10/11→01/17				13.0470-7256.2 LD7256	ATE 24705 19,8 + WK Ceramic
2.0 TDI	140	09/13→01/17					
2.0 TDI quattro	125	09/09→03/12	→	+PR 1KW,2EH		13.0460-2747.2 602747	TRW 24606 17,4 - WE / - WK + Zub
2.0 TDI quattro	130	12/11→01/17					
2.0 TDI quattro	140	09/13→01/17				13.0470-2747.2 LD2747	TRW 24606 17,4 - WE / - WK + Zub Ceramic
2.0 TFSI	132	09/09→06/14					
2.0 TFSI	155	09/09→11/13	→	+PR 1KE		13.0460-2748.2 602748	TRW 24606 17,4 - WE / - WK + Zub
2.0 TFSI	165	05/13→05/16				13.0470-2748.2 LD2748	TRW 24606 17,4 - WE / - WK + Zub Ceramic
2.0 TFSI	169	08/15→01/17					
2.0 TFSI quattro	155	09/09→01/17					
2.0 TFSI quattro	165	05/13→05/16					
2.0 TFSI quattro	169	08/15→01/17	→	+PR 1KP		13.0460-2748.2 602748	TRW 24606 17,4 - WE / - WK + Zub
2.7 TDI	120	09/09→01/17				13.0470-2748.2 LD2748	TRW 24606 17,4 - WE / - WK + Zub Ceramic
2.7 TDI	140	09/09→03/12					
3.0 TDI	150	10/11→01/17					
3.0 TDI quattro	160	05/15→01/17					
3.0 TDI quattro	176	09/09→03/12					
3.0 TDI quattro	180	10/11→01/17					
3.0 TFSI quattro	200	12/11→01/17					
3.2 FSI quattro	195	09/09→03/12					
S5 quattro	245	01/10→01/17	←	07/11→; +PR 1LJ		13.0460-2746.2 602746	TRW 24408 19,2 + WK
			←	+PR 1ZT,1LD		13.0460-2746.2 602746	TRW 24408 19,2 + WK
			→	→ 10/10; +PR 1KE		13.0460-2748.2 602748	TRW 24606 17,4 - WE / - WK + Zub
						13.0470-2748.2 LD2748	TRW 24606 17,4 - WE / - WK + Zub Ceramic
			→	11/10→; +PR 1KE,1KP		13.0460-2748.2 602748	TRW 24606 17,4 - WE / - WK + Zub
						13.0470-2748.2 LD2748	TRW 24606 17,4 - WE / - WK + Zub Ceramic
Zubehörsatz, Scheibenbremsbelag							
1.8 TFSI	106	09/14→01/17		+PR 1KE		13.0460-0023.2 610023	
1.8 TFSI	118	11/09→09/11					
1.8 TFSI	125	08/11→01/17					
1.8 TFSI	130	05/15→01/17					
2.0 TDI	100	09/09→01/17					
2.0 TDI	105	09/09→01/17					
2.0 TDI	110	05/13→01/17					
2.0 TDI	120	09/09→01/17					
2.0 TDI	125	09/09→03/12					
2.0 TDI	130	10/11→01/17					
2.0 TDI	140	09/13→01/17					
2.0 TDI quattro	125	09/09→03/12					
2.0 TDI quattro	130	12/11→01/17					
2.0 TDI quattro	140	09/13→01/17					
2.0 TFSI	132	09/09→06/14					
2.0 TFSI	155	09/09→11/13					
2.0 TFSI	165	05/13→05/16					
2.0 TFSI	169	08/15→01/17					
2.0 TFSI quattro	155	09/09→01/17					
2.0 TFSI quattro	165	05/13→05/16					
2.0 TFSI quattro	169	08/15→01/17					
2.7 TDI	120	09/09→01/17					
2.7 TDI	140	09/09→03/12					
3.0 TDI	150	10/11→01/17					
3.0 TDI quattro	160	05/15→01/17					
3.0 TDI quattro	176	09/09→03/12					



AUDI - A5 Sportback (8TA) 09/09→01/17

Zubehörsatz, Scheibenbremsbelag

3.0 TDI quattro	180	10/11→01/17		+PR 1KE		13.0460-0023.2	610023	
3.0 TFSI quattro	200	12/11→01/17						
3.2 FSI quattro	195	09/09→03/12						
S5 quattro	245	01/10→01/17		→ 10/10; +PR 1KE		13.0460-0023.2	610023	

Bremsscheibe

1.8 TFSI	106	09/14→01/17		+PR 1LT		24.0125-0184.1	425184	Ø 314 25 23 V + S
1.8 TFSI	125	08/11→01/17	←			24.0325-0184.1	525184	Ø 314 25 23 V + S PD
1.8 TFSI	130	05/15→01/17						
2.0 TDI	110	05/13→01/17	←	+PR 1LJ		24.0129-0102.1	429102	Ø 345 29,5 28 V + S
2.0 TDI	130	10/11→01/17	←	+PR 1LA		24.0130-0221.1	430221	Ø 320 30 28 V + S
2.0 TDI	140	09/13→01/17	←	+PR 1LD		24.0130-0222.1	430222	Ø 345 30 28 V + S
2.0 TDI quattro	130	12/11→01/17	←	+PR 1LD		24.0130-0222.1	430222	Ø 345 30 28 V + S
2.0 TDI quattro	140	09/13→01/17	→	+PR 1KW,2EH		24.0112-0178.1	412178	Ø 300 12 10 + S
2.0 TFSI	165	05/13→05/16				24.0312-0178.1	512178	Ø 300 12 10 + S PD
2.0 TFSI	169	08/15→01/17				24.0312-0178.1	512178	Ø 300 12 10 + S PD
2.0 TFSI quattro	165	05/13→05/16	→	+PR 1KE; + eFSB		24.0122-0272.1	422272	Ø 330 21,9 20 V + S
2.0 TFSI quattro	169	08/15→01/17	→	+PR 1KE; + eFSB		24.0122-0272.1	422272	Ø 330 21,9 20 V + S
3.0 TDI	150	10/11→01/17	→	+PR 1KP		24.0122-0272.1	422272	Ø 330 21,9 20 V + S
3.0 TDI quattro	160	05/15→01/17						
3.0 TDI quattro	180	10/11→01/17						
1.8 TFSI	118	11/09→09/11	←	+PR 1LT		24.0125-0184.1	425184	Ø 314 25 23 V + S
2.0 TDI	100	09/09→01/17				24.0325-0184.1	525184	Ø 314 25 23 V + S PD
2.0 TDI	105	09/09→01/17						
2.0 TDI	120	09/09→01/17	←	+PR 1LJ		24.0129-0102.1	429102	Ø 345 29,5 28 V + S
2.0 TDI	125	09/09→03/12	←	+PR 1LA; → 06/11		24.0130-0193.1	430193	Ø 320 30 28 V + S
2.0 TDI quattro	125	09/09→03/12				24.0330-0193.1	530193	Ø 320 30 28 V + S PD
2.0 TFSI	132	09/09→06/14						
2.0 TFSI	155	09/09→11/13	←	07/11→; +PR 1LA		24.0130-0221.1	430221	Ø 320 30 28 V + S
2.0 TFSI quattro	155	09/09→01/17	←	+PR 1LD		24.0130-0222.1	430222	Ø 345 30 28 V + S
2.7 TDI	120	09/09→01/17						
2.7 TDI	140	09/09→03/12	→	+PR 1KW,2EH		24.0112-0178.1	412178	Ø 300 12 10 + S
3.0 TDI quattro	176	09/09→03/12				24.0312-0178.1	512178	Ø 300 12 10 + S PD
3.2 FSI quattro	195	09/09→03/12	→	+PR 1KE; + eFSB		24.0122-0272.1	422272	Ø 330 21,9 20 V + S
			→	+PR 1KP		24.0122-0272.1	422272	Ø 330 21,9 20 V + S
3.0 TFSI quattro	200	12/11→01/17	←	+PR 1LT		24.0125-0184.1	425184	Ø 314 25 23 V + S
						24.0325-0184.1	525184	Ø 314 25 23 V + S PD
			←	+PR 1LJ		24.0129-0102.1	429102	Ø 345 29,5 28 V + S
			←	+PR 1LA		24.0130-0221.1	430221	Ø 320 30 28 V + S
			←	+PR 1LD		24.0130-0222.1	430222	Ø 345 30 28 V + S
			→	+PR 1KW,2EH		24.0112-0178.1	412178	Ø 300 12 10 + S
						24.0312-0178.1	512178	Ø 300 12 10 + S PD
S5 quattro	245	01/10→01/17	←	+PR 1LJ; → 06/11		24.0129-0102.1	429102	Ø 345 29,5 28 V + S
			←	+PR 1ZT		24.0130-0222.1	430222	Ø 345 30 28 V + S
			←	+PR 1ZT,1LD		24.0130-0222.1	430222	Ø 345 30 28 V + S
			←	07/11→; +PR 1LJ		24.0130-0222.1	430222	Ø 345 30 28 V + S
			→	+PR 1KE; → 10/10; + eFSB		24.0122-0272.1	422272	Ø 330 21,9 20 V + S
			→	11/10→; +PR 1KE,1KP		24.0122-0272.1	422272	Ø 330 21,9 20 V + S

AUDI - A5 Sportback (F5A) 09/16→











Bremsscheibe









1.4 TFSI	110	01/17→		+PR 1LA,1LB		24.0125-0184.1	425184	Ø 314 25 23 V + S
2.0 TDI	140	09/16→				24.0325-0184.1	525184	Ø 314 25 23 V + S PD
2.0 TDI quattro	140	10/16→						
2.0 TFSI	140	01/17→	←	+PR 1LL,1ZA,1ZC,1ZK		24.0134-0110.1	430110	Ø 349 34 32 V + S
2.0 TFSI	185	11/16→	→	+PR 1KF,1KJ,1KK,2EJ		24.0122-0272.1	422272	Ø 330 21,9 20 V + S
2.0 TFSI g-tron	125	02/17→						
2.0 TFSI quattro	183	09/16→						
2.0 TFSI quattro	185	09/16→						
3.0 TDI	160	03/17→						
3.0 TDI quattro	160	09/16→						
3.0 TDI quattro	200	02/17→						
3.0 TDI quattro	210	01/17→						
S5 quattro	260	09/16→						









AUDI - A6 (4A, C4) 06/94→10/97







Bremsbelagsatz, Scheibenbremse







1.8	92	12/95→10/97				13.0460-7050.2	607050	ATE 20676 19,5 + WK
1.8 quattro	92	12/95→10/97	←					
1.9 TDI	66	06/94→10/97	→			13.0460-3602.2	603602	TRW 21144 15,8 - WK
2.0	74	06/94→10/97						
2.0	79	08/95→07/96						

	kW			 	! #					
AUDI - A6 (4A, C4) 06/94→10/97										
 Bremsbelagsatz, Scheibenbremse										
2.0	85	06/94→10/97	←			13.0460-7050.2 607050	ATE 20676 19,5 + WK			
2.0 16V	103	06/94→10/97	→			13.0460-3602.2 603602	TRW 21144 15,8 - WK			
2.0 16V quattro	103	06/94→10/97								
2.3	98	06/94→12/95	←			13.0460-7050.2 607050	ATE 20676 19,5 + WK			
2.5 TDI	84	01/95→10/97								
2.5 TDI	85	06/94→10/97								
2.5 TDI	103	08/94→10/97								
2.5 TDI quattro	103	10/95→10/97								
2.6	102	06/94→10/97								
2.6	110	06/94→10/97								
2.6 quattro	110	06/94→10/97								
2.8	120	08/95→07/96								
2.8	128	06/94→10/97								
2.8	142	12/95→10/97	→			13.0460-3602.2 603602	TRW 21144 15,8 - WK			
2.8 quattro	128	06/94→10/97								
2.8 quattro	142	12/95→10/97								
2.3 quattro	98	06/94→12/95								
S6 4.2 quattro	213	06/94→10/97	←	08/94→		13.0460-7050.2 607050	ATE 20676 19,5 + WK			
			→	08/94→		13.0460-3602.2 603602	TRW 21144 15,8 - WK			
S6 4.2 quattro	213	06/94→10/97	←	09/94→		13.0460-2717.2 602717	TRW 21452 18,5 + WK			
			→	09/94→		13.0460-3602.2 603602	TRW 21144 15,8 - WK			
S6 Plus quattro	240	04/96→10/97	←	06/96→		13.0460-2717.2 602717	TRW 21452 18,5 + WK			
			→	06/96→		13.0460-3602.2 603602	TRW 21144 15,8 - WK			
S6 Turbo quattro	169	06/94→10/97	←			13.0460-2717.2 602717	TRW 21452 18,5 + WK			
			→			13.0460-3602.2 603602	TRW 21144 15,8 - WK			
 Bremsscheibe										
1.8	92	12/95→10/97	←			24.0115-0105.1 415105	∅ 288 15 13			
1.8 quattro	92	12/95→10/97	→			24.0315-0105.1 515105	∅ 288 15 13 PD			
1.9 TDI	66	06/94→10/97								
2.0	74	06/94→10/97	→			24.0110-0201.1 410201	∅ 245 10 8			
2.0	79	08/95→07/96								
2.0	85	06/94→10/97								
2.0 16V	103	06/94→10/97								
2.0 16V quattro	103	06/94→10/97								
2.3	98	06/94→12/95								
2.5 TDI	84	01/95→10/97	←	08/94→		24.0115-0105.1 415105	∅ 288 15 13			
2.5 TDI	85	06/94→10/97				24.0315-0105.1 515105	∅ 288 15 13 PD			
2.3 quattro	98	06/94→12/95	→	08/94→		24.0110-0201.1 410201	∅ 245 10 8			
			→	08/94→		24.0310-0201.1 510201	∅ 245 10 8 PD			
2.5 TDI	103	08/94→10/97	←	10/94→		24.0125-0105.1 425105	∅ 288 25 23 V + S			
			→			24.0325-0105.1 525105	∅ 288 25 23 V PD			
			→			24.0110-0201.1 410201	∅ 245 10 8			
2.5 TDI quattro	103	10/95→10/97	←			24.0310-0201.1 510201	∅ 245 10 8 PD			
			→			24.0125-0105.1 425105	∅ 288 25 23 V + S			
2.6	102	06/94→10/97	→			24.0325-0105.1 525105	∅ 288 25 23 V PD			
2.6	110	06/94→10/97								
2.6 quattro	110	06/94→10/97								
2.8	120	08/95→07/96								
2.8	128	06/94→10/97								
2.8	142	12/95→10/97								
2.8 quattro	128	06/94→10/97								
2.8 quattro	142	12/95→10/97								
S6 4.2 quattro	213	06/94→10/97		←	09/94→				24.0130-0104.1 430104	∅ 314 30 28 V
				→	09/94→				24.0120-0172.1 420172	∅ 269 19,9 18 V
S6 Plus quattro	240	04/96→10/97	←	06/96→		24.0130-0183.1 430183	∅ 323 30 28 V			
			→	06/96→		24.0120-0172.1 420172	∅ 269 19,9 18 V			
S6 Turbo quattro	169	06/94→10/97	←			24.0130-0104.1 430104	∅ 314 30 28 V			
			→			24.0120-0172.1 420172	∅ 269 19,9 18 V			
AUDI - A6 (4B2, C5) 01/97→01/05										
 Bremsbelagsatz, Scheibenbremse										
1.8	85	05/97→01/05	←			13.0460-7110.2 607110	ATE 20676 19,8 + WK			
1.8	92	07/97→01/05	→			13.0470-7110.2 LD7110	ATE 20676 19,8 + WK Ceramic			
1.8 T	132	12/97→01/05								
1.9 TDI	85	07/00→01/05			→ 05/01				13.0460-2820.2 602820	TRW 20961 17,2 - WK
2.4	100	07/98→01/05	→			13.0470-2820.2 LD2820	TRW 20961 17,2 - WK Ceramic			
2.5 TDI	110	07/97→01/05								
2.8	140	07/99→01/05	→	06/01→		13.0460-2886.2 602886	TRW 20961 16,0 - WK			
↓										









	kw			 	! #		
AUDI - A6 (4B2, C5) 01/97→01/05							
 Bremsbelagsatz, Scheibenbremse							
1.8 1.8 1.8 T 1.9 TDI 2.4 2.5 TDI 2.8	85 92 132 85 100 110 140	05/97→01/05 07/97→01/05 12/97→01/05 07/00→01/05 07/98→01/05 07/97→01/05 07/99→01/05	➡	06/01→		13.0470-2886.2 LD2886	TRW 20961 16,0 - WK Ceramic
1.8 T 2.4 2.4 2.4 2.8	110 115 120 121 142	01/97→01/05 02/97→01/05 02/97→01/05 02/97→01/05 02/97→01/05	⬅	04/97→		13.0460-7110.2 607110 13.0470-7110.2 LD7110	ATE 20676 19,8 + WK ATE 20676 19,8 + WK Ceramic
			➡	04/97→ 05/01		13.0460-2820.2 602820 13.0470-2820.2 LD2820	TRW 20961 17,2 - WK TRW 20961 17,2 - WK Ceramic
			➡	06/01→		13.0460-2886.2 602886 13.0470-2886.2 LD2886	TRW 20961 16,0 - WK TRW 20961 16,0 - WK Ceramic
1.8 T quattro 2.4 quattro 2.4 quattro	110 120 121	02/97→01/05 02/97→01/05 02/97→01/05	⬅	04/97→; +PR 1LB;1LE;1LF;1LT		13.0460-7110.2 607110 13.0470-7110.2 LD7110	ATE 20676 19,8 + WK ATE 20676 19,8 + WK Ceramic
			⬅	06/01→; +PR 1LG,1LA		13.0460-7166.2 607166 13.0470-7166.2 LD7166	ATE 23762 20,4 + WK ATE 23762 20,4 + WK Ceramic
			➡	04/97→ 05/01		13.0460-2820.2 602820 13.0470-2820.2 LD2820	TRW 20961 17,2 - WK TRW 20961 17,2 - WK Ceramic
			➡	06/01→		13.0460-2886.2 602886 13.0470-2886.2 LD2886	TRW 20961 16,0 - WK TRW 20961 16,0 - WK Ceramic
1.8 T quattro 2.5 TDI quattro 2.5 TDI quattro	132 110 132	12/97→01/05 07/97→01/05 02/00→01/05	⬅	+PR 1LB;1LE;1LF;1LT		13.0460-7110.2 607110 13.0470-7110.2 LD7110	ATE 20676 19,8 + WK ATE 20676 19,8 + WK Ceramic
			⬅	06/01→; +PR 1LG,1LA		13.0460-7166.2 607166 13.0470-7166.2 LD7166	ATE 23762 20,4 + WK ATE 23762 20,4 + WK Ceramic
			➡	→ 05/01		13.0460-2820.2 602820 13.0470-2820.2 LD2820	TRW 20961 17,2 - WK TRW 20961 17,2 - WK Ceramic
			➡	06/01→		13.0460-2886.2 602886 13.0470-2886.2 LD2886	TRW 20961 16,0 - WK TRW 20961 16,0 - WK Ceramic
1.9 TDI 2.8	81 132	04/97→10/00 10/97→05/00	⬅			13.0460-7110.2 607110 13.0470-7110.2 LD7110	ATE 20676 19,8 + WK ATE 20676 19,8 + WK Ceramic
			➡			13.0460-2820.2 602820 13.0470-2820.2 LD2820	TRW 20961 17,2 - WK TRW 20961 17,2 - WK Ceramic
1.9 TDI 2.0 2.4 2.5 TDI	96 96 125 114	08/01→01/05 08/01→01/05 08/01→01/05 08/01→01/05	⬅			13.0460-7110.2 607110 13.0470-7110.2 LD7110	ATE 20676 19,8 + WK ATE 20676 19,8 + WK Ceramic
			➡			13.0460-2886.2 602886 13.0470-2886.2 LD2886	TRW 20961 16,0 - WK TRW 20961 16,0 - WK Ceramic
2.4 quattro 2.8 quattro 2.8 quattro	115 132 140	08/98→07/99 01/98→04/00 07/99→05/01	⬅	+PR 1LB;1LE;1LF;1LT		13.0460-7110.2 607110 13.0470-7110.2 LD7110	ATE 20676 19,8 + WK ATE 20676 19,8 + WK Ceramic
			➡			13.0460-2820.2 602820 13.0470-2820.2 LD2820	TRW 20961 17,2 - WK TRW 20961 17,2 - WK Ceramic
2.4 quattro 2.5 TDI	125 120	08/01→01/05 07/02→01/05	⬅	+PR 1LB;1LE;1LF;1LT		13.0460-7110.2 607110 13.0470-7110.2 LD7110	ATE 20676 19,8 + WK ATE 20676 19,8 + WK Ceramic
			⬅	+PR 1LG,1LA		13.0460-7166.2 607166 13.0470-7166.2 LD7166	ATE 23762 20,4 + WK ATE 23762 20,4 + WK Ceramic
			➡			13.0460-2886.2 602886 13.0470-2886.2 LD2886	TRW 20961 16,0 - WK TRW 20961 16,0 - WK Ceramic
2.5 TDI	132	02/00→01/05	⬅	+PR 1LB;1LE;1LF;1LT		13.0460-7110.2 607110 13.0470-7110.2 LD7110	ATE 20676 19,8 + WK ATE 20676 19,8 + WK Ceramic
			⬅	+PR 1LG,1LA		13.0460-7166.2 607166 13.0470-7166.2 LD7166	ATE 23762 20,4 + WK ATE 23762 20,4 + WK Ceramic
			➡	→ 05/01		13.0460-2820.2 602820 13.0470-2820.2 LD2820	TRW 20961 17,2 - WK TRW 20961 17,2 - WK Ceramic
			➡	06/01→		13.0460-2886.2 602886 13.0470-2886.2 LD2886	TRW 20961 16,0 - WK TRW 20961 16,0 - WK Ceramic
2.7 quattro 2.7 T 2.7 T quattro	187 169 169	05/01→07/04 02/99→01/05 12/97→01/05	⬅	→ 4B-X-060000		13.0460-2701.2 602701	TRW 21452 18,5 + WK
			⬅	4B-X-060001→; → 05/01		13.0460-2875.2 602875	TRW 23119 17,5 + WK
			⬅	06/01→; +PR 1LG,1LA		13.0460-7166.2 607166 13.0470-7166.2 LD7166	ATE 23762 20,4 + WK ATE 23762 20,4 + WK Ceramic
			➡	→ 05/01		13.0460-2820.2 602820 13.0470-2820.2 LD2820	TRW 20961 17,2 - WK TRW 20961 17,2 - WK Ceramic
			➡	06/01→		13.0460-2886.2 602886 13.0470-2886.2 LD2886	TRW 20961 16,0 - WK TRW 20961 16,0 - WK Ceramic
↓							









	kw			 	! #		
AUDI - A6 (4B2, C5) 01/97→01/05							
 Bremsbelagsatz, Scheibenbremse							
2.7 T quattro	184	08/01→01/05	←	→ 4B-X-060000		13.0460-2701.2 602701	TRW 21452 18,5 + WK
			←	+PR 1LG,1LA		13.0460-7166.2 607166	ATE 23762 20,4 + WK
						13.0470-7166.2 LD7166	ATE 23762 20,4 + WK Ceramic
			→			13.0460-2886.2 602886	TRW 20961 16,0 - WK
						13.0470-2886.2 LD2886	TRW 20961 16,0 - WK Ceramic
2.8 quattro	142	02/97→01/05	←	04/97→; +PR 1LB;1LE;1LF;1LT		13.0460-7110.2 607110	ATE 20676 19,8 + WK
						13.0470-7110.2 LD7110	ATE 20676 19,8 + WK Ceramic
			→	04/97→ 05/01		13.0460-2820.2 602820	TRW 20961 17,2 - WK
						13.0470-2820.2 LD2820	TRW 20961 17,2 - WK Ceramic
			→	06/01→		13.0460-2886.2 602886	TRW 20961 16,0 - WK
						13.0470-2886.2 LD2886	TRW 20961 16,0 - WK Ceramic
3.0	160	06/01→01/05	←	+PR 1LG,1LA		13.0460-7166.2 607166	ATE 23762 20,4 + WK
3.0	162	08/01→01/05				13.0470-7166.2 LD7166	ATE 23762 20,4 + WK Ceramic
3.0 quattro	160	06/01→07/04					
3.0 quattro	162	08/01→01/05	→			13.0460-2886.2 602886	TRW 20961 16,0 - WK
						13.0470-2886.2 LD2886	TRW 20961 16,0 - WK Ceramic
4.2 quattro	220	11/98→01/05	←			13.0460-2875.2 602875	TRW 23119 17,5 + WK
S6 quattro	250	09/99→01/05	→	→ 05/01		13.0460-2820.2 602820	TRW 20961 17,2 - WK
						13.0470-2820.2 LD2820	TRW 20961 17,2 - WK Ceramic
			→	06/01→		13.0460-2886.2 602886	TRW 20961 16,0 - WK
						13.0470-2886.2 LD2886	TRW 20961 16,0 - WK Ceramic
RS6 quattro	331	07/02→01/05	→			13.0460-2889.2 602889	TRW 23326 17,4 + WE / - WK
Zubehörsatz, Scheibenbremsbelag							
1.8	85	05/97→01/05	→	→ 05/01		13.0460-0072.2 610072	TRW
1.8	92	07/97→01/05					
1.8 T	132	12/97→01/05					
1.8 T quattro	132	12/97→01/05					
1.9 TDI	85	07/00→01/05					
2.4	100	07/98→01/05					
2.5 TDI	110	07/97→01/05					
2.5 TDI	132	02/00→01/05					
2.5 TDI quattro	110	07/97→01/05					
2.5 TDI quattro	132	02/00→01/05					
2.7 quattro	187	05/01→07/04					
2.7 T	169	02/99→01/05					
2.7 T quattro	169	12/97→01/05					
2.8	140	07/99→01/05					
4.2 quattro	220	11/98→01/05					
S6 quattro	250	09/99→01/05					
1.8 T	110	01/97→01/05	→	04/97→ 05/01		13.0460-0072.2 610072	TRW
1.8 T quattro	110	02/97→01/05					
2.4	115	02/97→01/05					
2.4	120	02/97→01/05					
2.4	121	02/97→01/05					
2.4 quattro	120	02/97→01/05					
2.4 quattro	121	02/97→01/05					
2.8	142	02/97→01/05					
2.8 quattro	142	02/97→01/05					
1.9 TDI	81	04/97→10/00	→			13.0460-0072.2 610072	TRW
2.4 quattro	115	08/98→07/99					
2.8	132	10/97→05/00					
2.8 quattro	132	01/98→04/00					
2.8 quattro	140	07/99→05/01					
 Bremsscheibe							
1.8	85	05/97→01/05	←	+PR 1LB;1LE		24.0125-0105.1 425105	Ø 288 25 23 V + S
1.8	92	07/97→01/05				24.0325-0105.1 525105	Ø 288 25 23 V PD
1.8 T	132	12/97→01/05					
1.9 TDI	81	04/97→10/00	←	+PR 1LF;1LT		24.0125-0137.1 425137	Ø 312 25 23 V + S
1.9 TDI	85	07/00→01/05				24.0325-0137.1 525137	Ø 312 25 23 V PD
1.9 TDI	96	08/01→01/05	→			24.0110-0201.1 410201	Ø 245 10 8
2.0	96	08/01→01/05				24.0310-0201.1 510201	Ø 245 10 8 PD
2.4	100	07/98→01/05					
2.4	125	08/01→01/05					
1.8 T	110	01/97→01/05	←	04/97→; +PR 1LB;1LE		24.0125-0105.1 425105	Ø 288 25 23 V + S
						24.0325-0105.1 525105	Ø 288 25 23 V PD
			←	04/97→; +PR 1LF;1LT		24.0125-0137.1 425137	Ø 312 25 23 V + S
						24.0325-0137.1 525137	Ø 312 25 23 V PD
			←	04/97→; +PR 1LG;1LA		24.0130-0113.1 430113	Ø 320 30 28 V + S
						24.0330-0113.1 530113	Ø 320 30 28 V PD
			→	04/97→		24.0110-0201.1 410201	Ø 245 10 8
↓							







	kw			 	! #		
AUDI - A6 (4B2, C5) 01/97→01/05							
Bremsscheibe							
1.8 T	110	01/97→01/05	➡	04/97→		24.0310-0201.1 510201	Ø 245 10 8 PD
1.8 T quattro	110	02/97→01/05	←	04/97→; +PR 1LB;1LE		24.0125-0105.1 425105	Ø 288 25 23 V + S
2.4 quattro	120	02/97→01/05				24.0325-0105.1 525105	Ø 288 25 23 V PD
2.4 quattro	121	02/97→01/05	←	04/97→; +PR 1LF;1LT		24.0125-0137.1 425137	Ø 312 25 23 V + S
						24.0325-0137.1 525137	Ø 312 25 23 V PD
			←	06/01→; +PR 1LG;1LA		24.0130-0113.1 430113	Ø 320 30 28 V + S
						24.0330-0113.1 530113	Ø 320 30 28 V PD
			➡	4B-Y-000001→; +PR 0N1		24.0110-0258.1 410258	Ø 245 10 8
			➡	04/97→; → 4B-X-200000		24.0110-0258.1 410258	Ø 245 10 8
			➡	04/97→; → 4B-X-200000; + Avant; Kombi		24.0110-0259.1 410259	Ø 255 10 8
			➡	4B-Y-000001→; +PR 0N5; - Avant; Geschlossen		24.0110-0259.1 410259	Ø 255 10 8
			➡	04/97→; +PR 0N6		24.0110-0260.1 410260	Ø 255 10 8
						24.0310-0260.1 510260	Ø 255 10 8 PD
1.8 T quattro	132	12/97→01/05	←	+PR 1LB;1LE		24.0125-0105.1 425105	Ø 288 25 23 V + S
2.5 TDI quattro	110	07/97→01/05				24.0325-0105.1 525105	Ø 288 25 23 V PD
2.5 TDI quattro	132	02/00→01/05	←	+PR 1LF;1LT		24.0125-0137.1 425137	Ø 312 25 23 V + S
						24.0325-0137.1 525137	Ø 312 25 23 V PD
			←	06/01→; +PR 1LG;1LA		24.0130-0113.1 430113	Ø 320 30 28 V + S
						24.0330-0113.1 530113	Ø 320 30 28 V PD
			➡	4B-Y-000001→; +PR 0N1		24.0110-0258.1 410258	Ø 245 10 8
			➡	→ 4B-X-200000		24.0110-0258.1 410258	Ø 245 10 8
			➡	4B-Y-000001→; +PR 0N5; - Avant; Geschlossen		24.0110-0259.1 410259	Ø 255 10 8
			➡	→ 4B-X-200000; Kombi; + Avant		24.0110-0259.1 410259	Ø 255 10 8
			➡	+PR 0N6		24.0110-0260.1 410260	Ø 255 10 8
						24.0310-0260.1 510260	Ø 255 10 8 PD
2.4	115	02/97→01/05	←	04/97→; +PR 1LB;1LE		24.0125-0105.1 425105	Ø 288 25 23 V + S
2.4	120	02/97→01/05				24.0325-0105.1 525105	Ø 288 25 23 V PD
2.4	121	02/97→01/05	←	04/97→; +PR 1LF;1LT		24.0125-0137.1 425137	Ø 312 25 23 V + S
						24.0325-0137.1 525137	Ø 312 25 23 V PD
			➡	04/97→		24.0110-0201.1 410201	Ø 245 10 8
						24.0310-0201.1 510201	Ø 245 10 8 PD
2.4 quattro	115	08/98→07/99	←	+PR 1LB;1LE		24.0125-0105.1 425105	Ø 288 25 23 V + S
						24.0325-0105.1 525105	Ø 288 25 23 V PD
			←	+PR 1LF;1LT		24.0125-0137.1 425137	Ø 312 25 23 V + S
						24.0325-0137.1 525137	Ø 312 25 23 V PD
			➡	→ 4B-X-200000		24.0110-0258.1 410258	Ø 245 10 8
			➡	4B-Y-000001→; +PR 0N1		24.0110-0258.1 410258	Ø 245 10 8
			➡	4B-Y-000001→; +PR 0N5; - Avant; Geschlossen		24.0110-0259.1 410259	Ø 255 10 8
			➡	→ 4B-X-200000; Kombi; + Avant		24.0110-0259.1 410259	Ø 255 10 8
			➡	+PR 0N6		24.0110-0260.1 410260	Ø 255 10 8
						24.0310-0260.1 510260	Ø 255 10 8 PD
2.4 quattro	125	08/01→01/05	←	+PR 1LB;1LE		24.0125-0105.1 425105	Ø 288 25 23 V + S
						24.0325-0105.1 525105	Ø 288 25 23 V PD
			←	+PR 1LF;1LT		24.0125-0137.1 425137	Ø 312 25 23 V + S
						24.0325-0137.1 525137	Ø 312 25 23 V PD
			←	+PR 1LG;1LA		24.0130-0113.1 430113	Ø 320 30 28 V + S
						24.0330-0113.1 530113	Ø 320 30 28 V PD
			➡	→ 4B-X-200000		24.0110-0258.1 410258	Ø 245 10 8
			➡	4B-Y-000001→; +PR 0N1		24.0110-0258.1 410258	Ø 245 10 8
			➡	4B-Y-000001→; +PR 0N5; - Avant; Geschlossen		24.0110-0259.1 410259	Ø 255 10 8
			➡	→ 4B-X-200000; Kombi; + Avant		24.0110-0259.1 410259	Ø 255 10 8
			➡	+PR 0N6		24.0110-0260.1 410260	Ø 255 10 8
						24.0310-0260.1 510260	Ø 255 10 8 PD
2.5 TDI	110	07/97→01/05	←	+PR 1LB;1LE		24.0125-0105.1 425105	Ø 288 25 23 V + S
2.5 TDI	114	08/01→01/05				24.0325-0105.1 525105	Ø 288 25 23 V PD
2.5 TDI	120	07/02→01/05					
2.5 TDI	132	02/00→01/05	←	+PR 1LF;1LT		24.0125-0137.1 425137	Ø 312 25 23 V + S
↓							







	kW			 	! #		
AUDI - A6 (4B2, C5) 01/97→01/05							
Bremsscheibe							
2.5 TDI	110	07/97→01/05	←	+PR 1LF;1LT		24.0325-0137.1 525137	Ø 312 25 23 V PD
2.5 TDI	114	08/01→01/05	←	+PR 1LG;1LA		24.0130-0113.1 430113	Ø 320 30 28 V + S
2.5 TDI	120	07/02→01/05	←			24.0330-0113.1 530113	Ø 320 30 28 V PD
2.5 TDI	132	02/00→01/05	→			24.0110-0201.1 410201	Ø 245 10 8
			→			24.0310-0201.1 510201	Ø 245 10 8 PD
2.7 quattro	187	05/01→07/04	←			24.0130-0113.1 430113	Ø 320 30 28 V + S
2.7 T quattro	169	12/97→01/05	←			24.0330-0113.1 530113	Ø 320 30 28 V PD
2.7 T quattro	184	08/01→01/05	←			24.0330-0113.1 530113	Ø 320 30 28 V PD
3.0 quattro	160	06/01→07/04	→	4B-Y-000001→; +PR 0N1		24.0110-0258.1 410258	Ø 245 10 8
3.0 quattro	162	08/01→01/05	→	→ 4B-X-200000		24.0110-0258.1 410258	Ø 245 10 8
			→	4B-Y-000001→; +PR 0N5; - Avant; Geschlossen		24.0110-0259.1 410259	Ø 255 10 8
			→	→ 4B-X-200000; Kombi; + Avant		24.0110-0259.1 410259	Ø 255 10 8
			→	+PR 0N6		24.0110-0260.1 410260	Ø 255 10 8
2.7 T	169	02/99→01/05	←			24.0130-0113.1 430113	Ø 320 30 28 V + S
3.0	160	06/01→01/05	←			24.0330-0113.1 530113	Ø 320 30 28 V PD
3.0	162	08/01→01/05	→			24.0110-0201.1 410201	Ø 245 10 8
			→			24.0310-0201.1 510201	Ø 245 10 8 PD
2.8	132	10/97→05/00	←	+PR 1LB;1LE		24.0125-0105.1 425105	Ø 288 25 23 V + S
2.8	140	07/99→01/05	←	+PR 1LF,1LT		24.0125-0137.1 425137	Ø 312 25 23 V + S
			→			24.0325-0137.1 525137	Ø 312 25 23 V PD
			→			24.0110-0201.1 410201	Ø 245 10 8
			→			24.0310-0201.1 510201	Ø 245 10 8 PD
2.8	142	02/97→01/05	←	04/97→; +PR 1LB;1LE		24.0125-0105.1 425105	Ø 288 25 23 V + S
			←	04/97→; +PR 1LF,1LT		24.0125-0137.1 425137	Ø 312 25 23 V + S
			→	04/97→		24.0325-0137.1 525137	Ø 312 25 23 V PD
			→			24.0110-0201.1 410201	Ø 245 10 8
			→			24.0310-0201.1 510201	Ø 245 10 8 PD
2.8 quattro	132	01/98→04/00	←	+PR 1LB;1LE		24.0125-0105.1 425105	Ø 288 25 23 V + S
2.8 quattro	140	07/99→05/01	←	+PR 1LF,1LT		24.0325-0105.1 525105	Ø 288 25 23 V PD
			←	+PR 1LF,1LT		24.0125-0137.1 425137	Ø 312 25 23 V + S
			→	4B-Y-000001→; +PR 0N1		24.0325-0137.1 525137	Ø 312 25 23 V PD
			→	4B-Y-000001→; +PR 0N5; - Avant; Geschlossen		24.0110-0258.1 410258	Ø 245 10 8
			→	→ 4B-X-200000; Kombi; + Avant		24.0110-0259.1 410259	Ø 255 10 8
			→	+PR 0N6		24.0110-0259.1 410259	Ø 255 10 8
			→			24.0110-0260.1 410260	Ø 255 10 8
2.8 quattro	142	02/97→01/05	←	04/97→; +PR 1LB;1LE		24.0125-0105.1 425105	Ø 288 25 23 V + S
			←	04/97→; +PR 1LF,1LT		24.0325-0105.1 525105	Ø 288 25 23 V PD
			→	04/97→; → 4B-X-200000		24.0125-0137.1 425137	Ø 312 25 23 V + S
			→	04/97→; → 4B-X-200000		24.0325-0137.1 525137	Ø 312 25 23 V PD
			→	4B-Y-000001→; +PR 0N1		24.0110-0258.1 410258	Ø 245 10 8
			→	4B-Y-000001→; +PR 0N5; - Avant; Geschlossen		24.0110-0259.1 410259	Ø 255 10 8
			→	04/97→; → 4B-X-200000; + Avant; Kombi		24.0110-0259.1 410259	Ø 255 10 8
			→	4B-Y-000001→; +PR 0N5; - Avant; Geschlossen		24.0110-0259.1 410259	Ø 255 10 8
			→	04/97→; +PR 0N6		24.0110-0259.1 410259	Ø 255 10 8
			→			24.0110-0260.1 410260	Ø 255 10 8
4.2 quattro	220	11/98→01/05	←			24.0130-0174.1 430174	Ø 321 30 28 V
S6 quattro	250	09/99→01/05	→			24.0122-0222.1 422222	Ø 269 22 20 V
AUDI - A6 (4F2, C6) 05/04→03/11							
Bremsbelagsatz, Scheibenbremse							
2.0 TDI	89	09/05→06/06	←	+PR 1LT		13.0460-7110.2 607110	ATE 20676 19,8 + WK
2.0 TFSI	125	06/05→03/11	←			13.0470-7110.2 LD7110	ATE 20676 19,8 + WK Ceramic
2.4	130	05/04→10/08	←			13.0460-7201.2 607201	ATE 23763 20,3 + WK
2.4 quattro	130	01/05→10/08	←	+PR 1LG;1LD;1ZL;1LH		13.0470-7201.2 LD7201	ATE 23763 20,3 + WK Ceramic
2.7 TDI	120	11/04→03/11	←			13.0460-7201.2 607201	ATE 23763 20,3 + WK Ceramic
2.7 TDI	132	11/04→10/08	→	+PR 1KQ		13.0460-2749.2 602749	TRW 24483 16,9 - WE / - WK + Zub
2.7 TDI quattro	120	06/05→03/11	→				
2.7 TDI quattro	132	11/04→10/08	→				
2.8 FSI quattro	154	06/07→10/08	→				

















	kW			 	! #		
AUDI - A6 (4F2, C6) 05/04→03/11							
 Bremsbelagsatz, Scheibenbremse							
3.0 quattro	160	05/04→05/06	➡	+PR 1KQ		13.0460-2880.2 602880	TRW 23914 17,1 + WE / - WK + Zub
3.0 TDI quattro	155	05/04→03/11					
3.0 TDI quattro	165	05/04→05/06				13.0470-2749.2 LD2749	TRW 24483 16,9 - WE / - WK + Zub Ceramic
3.0 TDI quattro	171	06/06→10/08					
3.2 FSI	188	05/04→05/09				13.0470-2880.2 LD2880	TRW 23914 17,1 + WE / - WK + Zub Ceramic
3.2 FSI	195	05/09→03/11					
3.2 FSI quattro	183	09/06→10/08					
3.2 FSI quattro	188	05/04→10/08	➡	+PR 1KD;2ED		13.0460-2749.2 602749	TRW 24483 16,9 - WE / - WK + Zub
						13.0460-2880.2 602880	TRW 23914 17,1 + WE / - WK + Zub
						13.0470-2749.2 LD2749	TRW 24483 16,9 - WE / - WK + Zub Ceramic
						13.0470-2880.2 LD2880	TRW 23914 17,1 + WE / - WK + Zub Ceramic
			➡	+PR 1KW;2EE; + eFSB		13.0460-2888.2 602888	TRW 23326 17,4 + WE / - WK Ceramic
						13.0470-2888.2 LD2888	TRW 23326 17,4 + WE / - WK Ceramic
2.0 TDI	100	07/04→03/11	⬅	06/05→; +PR 1LT		13.0460-7110.2 607110	ATE 20676 19,8 + WK
						13.0470-7110.2 LD7110	ATE 20676 19,8 + WK Ceramic
			⬅	06/05→; +PR 1LG;1LD;1ZL;1LH		13.0460-7201.2 607201	ATE 23763 20,3 + WK
						13.0470-7201.2 LD7201	ATE 23763 20,3 + WK Ceramic
			➡	06/05→; +PR 1KD;2ED		13.0460-2749.2 602749	TRW 24483 16,9 - WE / - WK + Zub
						13.0460-2880.2 602880	TRW 23914 17,1 + WE / - WK + Zub
						13.0470-2749.2 LD2749	TRW 24483 16,9 - WE / - WK + Zub Ceramic
						13.0470-2880.2 LD2880	TRW 23914 17,1 + WE / - WK + Zub Ceramic
			➡	06/05→; +PR 1KQ		13.0460-2749.2 602749	TRW 24483 16,9 - WE / - WK + Zub
						13.0460-2880.2 602880	TRW 23914 17,1 + WE / - WK + Zub
						13.0470-2749.2 LD2749	TRW 24483 16,9 - WE / - WK + Zub Ceramic
						13.0470-2880.2 LD2880	TRW 23914 17,1 + WE / - WK + Zub Ceramic
			➡	06/05→; +PR 1KW;2EE; + eFSB		13.0460-2888.2 602888	TRW 23326 17,4 + WE / - WK Ceramic
						13.0470-2888.2 LD2888	TRW 23326 17,4 + WE / - WK Ceramic
2.0 TDI	103	07/04→10/08	⬅	10/08→; +PR 1LT		13.0460-7110.2 607110	ATE 20676 19,8 + WK
						13.0470-7110.2 LD7110	ATE 20676 19,8 + WK Ceramic
			⬅	+PR 1LT		13.0460-7110.2 607110	ATE 20676 19,8 + WK
						13.0470-7110.2 LD7110	ATE 20676 19,8 + WK Ceramic
			⬅	+PR 1LG;1LD;1ZL;1LH		13.0460-7201.2 607201	ATE 23763 20,3 + WK
						13.0470-7201.2 LD7201	ATE 23763 20,3 + WK Ceramic
			➡	+PR 1KQ		13.0460-2749.2 602749	TRW 24483 16,9 - WE / - WK + Zub
						13.0460-2880.2 602880	TRW 23914 17,1 + WE / - WK + Zub
						13.0470-2749.2 LD2749	TRW 24483 16,9 - WE / - WK + Zub Ceramic
						13.0470-2880.2 LD2880	TRW 23914 17,1 + WE / - WK + Zub Ceramic
			➡	+PR 1KD;2ED		13.0460-2749.2 602749	TRW 24483 16,9 - WE / - WK + Zub
						13.0460-2880.2 602880	TRW 23914 17,1 + WE / - WK + Zub
						13.0470-2749.2 LD2749	TRW 24483 16,9 - WE / - WK + Zub Ceramic
						13.0470-2880.2 LD2880	TRW 23914 17,1 + WE / - WK + Zub Ceramic
			➡	+PR 1KW;2EE; + eFSB		13.0460-2888.2 602888	TRW 23326 17,4 + WE / - WK Ceramic
						13.0470-2888.2 LD2888	TRW 23326 17,4 + WE / - WK Ceramic
2.0 TDI	120	04/09→03/11	⬅	+PR 1LT		13.0460-7110.2 607110	ATE 20676 19,8 + WK
2.0 TDI	125	11/08→03/11				13.0470-7110.2 LD7110	ATE 20676 19,8 + WK Ceramic
2.7 TDI quattro	140	10/08→03/11					
2.8 FSI	140	10/08→03/11	⬅	+PR 1LG;1ZL		13.0460-7201.2 607201	ATE 23763 20,3 + WK
2.8 FSI	162	10/08→03/11					
↓							







	kw			 	! #			
AUDI - A6 (4F2, C6) 05/04→03/11								
 Bremsbelagsatz, Scheibenbremse								
2.8 FSI quattro 2.8 FSI quattro	140	10/08→03/11 10/08→03/11	←	+PR 1LG;1ZL	13.0470-7201.2	LD7201	ATE 23763 20,3 + WK Ceramic	
	162		→	+PR 1KD	13.0460-2749.2	602749	TRW 24483 16,9 - WE / - WK + Zub	
						13.0460-2880.2	602880	TRW 23914 17,1 + WE / - WK + Zub
						13.0470-2749.2	LD2749	TRW 24483 16,9 - WE / - WK + Zub Ceramic
					13.0470-2880.2	LD2880	TRW 23914 17,1 + WE / - WK + Zub Ceramic	
			→	+PR 1KQ	13.0460-2749.2	602749	TRW 24483 16,9 - WE / - WK + Zub	
					13.0460-2880.2	602880	TRW 23914 17,1 + WE / - WK + Zub	
					13.0470-2749.2	LD2749	TRW 24483 16,9 - WE / - WK + Zub Ceramic	
					13.0470-2880.2	LD2880	TRW 23914 17,1 + WE / - WK + Zub Ceramic	
			→	+PR 1KW; + eFSB	13.0460-2888.2	602888	TRW 23326 17,4 + WE / - WK Ceramic	
					13.0470-2888.2	LD2888	TRW 23326 17,4 + WE / - WK Ceramic	
2.7 TDI	140	10/08→03/11	←	+PR 1LG;1ZL	13.0460-7201.2	607201	ATE 23763 20,3 + WK	
					13.0470-7201.2	LD7201	ATE 23763 20,3 + WK Ceramic	
			→	+PR 1KD	13.0460-2749.2	602749	TRW 24483 16,9 - WE / - WK + Zub	
					13.0460-2880.2	602880	TRW 23914 17,1 + WE / - WK + Zub	
				13.0470-2749.2	LD2749	TRW 24483 16,9 - WE / - WK + Zub Ceramic		
					13.0470-2880.2	LD2880	TRW 23914 17,1 + WE / - WK + Zub Ceramic	
			→	+PR 1KQ	13.0460-2749.2	602749	TRW 24483 16,9 - WE / - WK + Zub	
					13.0460-2880.2	602880	TRW 23914 17,1 + WE / - WK + Zub	
					13.0470-2749.2	LD2749	TRW 24483 16,9 - WE / - WK + Zub Ceramic	
					13.0470-2880.2	LD2880	TRW 23914 17,1 + WE / - WK + Zub Ceramic	
			→	+PR 1KW; + eFSB	13.0460-2888.2	602888	TRW 23326 17,4 + WE / - WK Ceramic	
					13.0470-2888.2	LD2888	TRW 23326 17,4 + WE / - WK Ceramic	
2.8 FSI	154	11/06→10/08	←	+PR 1LT	13.0460-7110.2	607110	ATE 20676 19,8 + WK	
					13.0470-7110.2	LD7110	ATE 20676 19,8 + WK Ceramic	
			←	+PR 1LG;1LD;1ZL;1LH	13.0460-7201.2	607201	ATE 23763 20,3 + WK	
					13.0470-7201.2	LD7201	ATE 23763 20,3 + WK Ceramic	
			→	+PR 1KD;2ED	13.0460-2749.2	602749	TRW 24483 16,9 - WE / - WK + Zub	
					13.0460-2880.2	602880	TRW 23914 17,1 + WE / - WK + Zub	
					13.0470-2749.2	LD2749	TRW 24483 16,9 - WE / - WK + Zub Ceramic	
					13.0470-2880.2	LD2880	TRW 23914 17,1 + WE / - WK + Zub Ceramic	
			→	+PR 1KQ	13.0460-2749.2	602749	TRW 24483 16,9 - WE / - WK + Zub	
					13.0460-2880.2	602880	TRW 23914 17,1 + WE / - WK + Zub	
					13.0470-2749.2	LD2749	TRW 24483 16,9 - WE / - WK + Zub Ceramic	
					13.0470-2880.2	LD2880	TRW 23914 17,1 + WE / - WK + Zub Ceramic	
			→	+PR 1KW;2EE; + eFSB	13.0460-2888.2	602888	TRW 23326 17,4 + WE / - WK Ceramic	
					13.0470-2888.2	LD2888	TRW 23326 17,4 + WE / - WK Ceramic	
3.0 ↓	160	08/04→05/06	←	+PR 1LT	13.0460-7110.2	607110	ATE 20676 19,8 + WK	
					13.0470-7110.2	LD7110	ATE 20676 19,8 + WK Ceramic	
			←	+PR 1LG;1LD;1ZL;1LH	13.0460-7201.2	607201	ATE 23763 20,3 + WK	
					13.0470-7201.2	LD7201	ATE 23763 20,3 + WK Ceramic	











	kw			 	! #				
AUDI - A6 (4F2, C6) 05/04→03/11									
Bremsbelagsatz, Scheibenbremse									
3.0	160	08/04→05/06	➡	+PR 1KQ	13.0460-2749.2	602749	TRW 24483 16,9 - WE / - WK + Zub		
					13.0460-2880.2	602880	TRW 23914 17,1 + WE / - WK + Zub		
					13.0470-2749.2	LD2749	TRW 24483 16,9 - WE / - WK + Zub Ceramic		
					13.0470-2880.2	LD2880	TRW 23914 17,1 + WE / - WK + Zub Ceramic		
			➡	+PR 1KD;2ED	13.0460-2749.2	602749	TRW 24483 16,9 - WE / - WK + Zub		
					13.0460-2880.2	602880	TRW 23914 17,1 + WE / - WK + Zub		
					13.0470-2749.2	LD2749	TRW 24483 16,9 - WE / - WK + Zub Ceramic		
					13.0470-2880.2	LD2880	TRW 23914 17,1 + WE / - WK + Zub Ceramic		
					➡	+PR 1KW;2EE; + eFSB	13.0460-2888.2	602888	TRW 23326 17,4 + WE / - WK Ceramic
				13.0470-2888.2	LD2888	TRW 23326 17,4 + WE / - WK Ceramic			
3.0 TDI quattro 3.0 TFSI quattro 3.0 TFSI quattro	176 213 220	10/08→03/11 10/08→03/11 10/08→03/11	←	+PR 1LG,1ZL	13.0460-7201.2	607201	ATE 23763 20,3 + WK		
					13.0470-7201.2	LD7201	ATE 23763 20,3 + WK Ceramic		
			➡	+PR 1KD	13.0460-2749.2	602749	TRW 24483 16,9 - WE / - WK + Zub		
					13.0460-2880.2	602880	TRW 23914 17,1 + WE / - WK + Zub		
					13.0470-2749.2	LD2749	TRW 24483 16,9 - WE / - WK + Zub Ceramic		
					13.0470-2880.2	LD2880	TRW 23914 17,1 + WE / - WK + Zub Ceramic		
			➡	+PR 1KQ	13.0460-2749.2	602749	TRW 24483 16,9 - WE / - WK + Zub		
					13.0460-2880.2	602880	TRW 23914 17,1 + WE / - WK + Zub		
					13.0470-2749.2	LD2749	TRW 24483 16,9 - WE / - WK + Zub Ceramic		
					13.0470-2880.2	LD2880	TRW 23914 17,1 + WE / - WK + Zub Ceramic		
					➡	+PR 1KW; + eFSB	13.0460-2888.2	602888	TRW 23326 17,4 + WE / - WK Ceramic
							13.0470-2888.2	LD2888	TRW 23326 17,4 + WE / - WK Ceramic
4.2 FSI quattro 4.2 quattro	257 246	06/06→03/11 05/04→05/06	←	+PR 1LT	13.0460-7110.2	607110	ATE 20676 19,8 + WK		
			←	+PR 1LG;1LD;1ZL;1LH	13.0460-7201.2	607201	ATE 23763 20,3 + WK		
			➡	+PR 1KQ	13.0460-2749.2	602749	TRW 24483 16,9 - WE / - WK + Zub		
					13.0460-2880.2	602880	TRW 23914 17,1 + WE / - WK + Zub		
					13.0470-2749.2	LD2749	TRW 24483 16,9 - WE / - WK + Zub Ceramic		
					13.0470-2880.2	LD2880	TRW 23914 17,1 + WE / - WK + Zub Ceramic		
			➡	+PR 1KD;2ED	13.0460-2749.2	602749	TRW 24483 16,9 - WE / - WK + Zub		
					13.0460-2880.2	602880	TRW 23914 17,1 + WE / - WK + Zub		
					13.0470-2749.2	LD2749	TRW 24483 16,9 - WE / - WK + Zub Ceramic		
					13.0470-2880.2	LD2880	TRW 23914 17,1 + WE / - WK + Zub Ceramic		
					➡	+PR 1KW;2EE; + eFSB	13.0460-2888.2	602888	TRW 23326 17,4 + WE / - WK Ceramic
							13.0470-2888.2	LD2888	TRW 23326 17,4 + WE / - WK Ceramic
RS6 quattro	426	09/08→08/10	←	+PR 1LM	13.0460-4864.2	604864	BRE 24455 16,8 + WE / + WK		
			➡	+ eFSB	13.0460-2888.2	602888	TRW 23326 17,4 + WE / - WK		
S6 quattro	320	03/06→03/11	←		13.0460-7182.2	607182	ATE 23896 20,6 + WK		
			➡	+PR 1KW;2EE; + eFSB	13.0460-2888.2	602888	TRW 23326 17,4 + WE / - WK		
Zubehörsatz, Scheibenbremsbelag									
2.0 TDI ↓	89	09/05→06/06	➡	+PR 1KW;2EE	13.0460-0023.2	610023			











	kw			 	! #		
AUDI - A6 (4F2, C6) 05/04→03/11							
Zubehörsatz, Scheibenbremsbelag							
2.0 TDI	103	07/04→10/08	➡	+PR 1KD;2ED		13.0460-0259.2 610259	
2.0 TFSI	125	06/05→03/11	➡	+PR 1KQ		13.0460-0259.2 610259	
2.4	130	05/04→10/08					
2.4 quattro	130	01/05→10/08					
2.7 TDI	120	11/04→03/11					
2.7 TDI	132	11/04→10/08					
2.7 TDI quattro	120	06/05→03/11					
2.7 TDI quattro	132	11/04→10/08					
2.8 FSI quattro	154	06/07→10/08					
3.0	160	08/04→05/06					
3.0 quattro	160	05/04→05/06					
3.0 TDI quattro	155	05/04→03/11					
3.0 TDI quattro	165	05/04→05/06					
3.0 TDI quattro	171	06/06→10/08					
3.2 FSI	188	05/04→05/09					
3.2 FSI	195	05/09→03/11					
3.2 FSI quattro	183	09/06→10/08					
3.2 FSI quattro	188	05/04→10/08					
4.2 FSI quattro	257	06/06→03/11					
4.2 quattro	246	05/04→05/06					
2.0 TDI	100	07/04→03/11	➡	06/05→; +PR 1KW;2EE		13.0460-0023.2 610023	
			➡	06/05→; +PR 1KD;2ED		13.0460-0259.2 610259	
			➡	06/05→; +PR 1KQ		13.0460-0259.2 610259	
2.0 TDI	120	04/09→03/11	➡	+PR 1KW		13.0460-0023.2 610023	
2.0 TDI	125	11/08→03/11					
2.7 TDI	140	10/08→03/11	➡	+PR 1KD		13.0460-0259.2 610259	
2.7 TDI quattro	140	10/08→03/11	➡	+PR 1KQ		13.0460-0259.2 610259	
2.8 FSI	140	10/08→03/11					
2.8 FSI	162	10/08→03/11					
2.8 FSI quattro	140	10/08→03/11					
2.8 FSI quattro	162	10/08→03/11					
3.0 TDI quattro	176	10/08→03/11					
3.0 TFSI quattro	213	10/08→03/11					
3.0 TFSI quattro	220	10/08→03/11					
2.8 FSI	154	11/06→10/08	➡	+PR 1KW;2EE		13.0460-0023.2 610023	
			➡	+PR 1KD;2ED		13.0460-0259.2 610259	
			➡	+PR 1KQ		13.0460-0259.2 610259	
RS6 quattro	426	09/08→08/10				13.0460-0023.2 610023	
S6 quattro	320	03/06→03/11		+PR 1KW;2EE		13.0460-0023.2 610023	
Bremsscheibe							
2.0 TDI	89	09/05→06/06	←	+PR 1LT		24.0125-0149.1 425149	Ø 314 25 23 V
2.0 TDI	103	07/04→10/08				24.0325-0149.1 525149	Ø 314 25 23 V PD
2.0 TFSI	125	06/05→03/11					
2.4	130	05/04→10/08	←	+PR 1LG;1LD		24.0130-0175.1 430175	Ø 321 30 28 V + S
2.4 quattro	130	01/05→10/08				24.0330-0175.1 530175	Ø 321 30 28 V + S PD
2.7 TDI	120	11/04→03/11	←	+PR 1ZL;1LH		24.0130-0176.1 430176	Ø 347 30 28 V + S
2.7 TDI	132	11/04→10/08				24.0330-0176.1 530176	Ø 347 30 28 V + S PD
2.7 TDI quattro	120	06/05→03/11					
2.7 TDI quattro	132	11/04→10/08	➡	+PR 1KD,2ED,1KQ; + eFSB		24.0112-0159.1 412159	Ø 302 12 10 + S
2.8 FSI	154	11/06→10/08				24.0312-0159.1 512159	Ø 302 12 10 PD
2.8 FSI quattro	154	06/07→10/08					
3.0 quattro	160	05/04→05/06	➡	+PR 1KW;2EE		24.0122-0223.1 422223	Ø 330 22 20 V
3.0 TDI quattro	155	05/04→03/11				24.0322-0223.1 522223	Ø 330 22 20 V PD
3.0 TDI quattro	165	05/04→05/06					
3.0 TDI quattro	171	06/06→10/08					
3.2 FSI	188	05/04→05/09					
3.2 FSI	195	05/09→03/11					
3.2 FSI quattro	183	09/06→10/08					
3.2 FSI quattro	188	05/04→10/08					
4.2 FSI quattro	257	06/06→03/11					
4.2 quattro	246	05/04→05/06					
2.0 TDI	100	07/04→03/11	←	06/05→; +PR 1LT		24.0125-0149.1 425149	Ø 314 25 23 V
			←	06/05→; +PR 1LG;1LD		24.0130-0175.1 430175	Ø 321 30 28 V + S
			←	06/05→; +PR 1ZL;1LH		24.0130-0176.1 430176	Ø 347 30 28 V + S
			←	06/05→; +PR 1KQ; + eFSB		24.0330-0176.1 530176	Ø 347 30 28 V + S PD
			➡	06/05→; +PR 1KD,2ED,1KQ; + eFSB		24.0112-0159.1 412159	Ø 302 12 10 + S
			➡	06/05→; +PR 1KW;2EE		24.0312-0159.1 512159	Ø 302 12 10 PD
			➡	06/05→; +PR 1KW;2EE		24.0122-0223.1 422223	Ø 330 22 20 V
			➡	06/05→; +PR 1KW;2EE		24.0322-0223.1 522223	Ø 330 22 20 V PD
2.0 TDI	120	04/09→03/11	←	+PR 1LT		24.0125-0149.1 425149	Ø 314 25 23 V
2.0 TDI	125	11/08→03/11				24.0325-0149.1 525149	Ø 314 25 23 V PD
2.7 TDI	140	10/08→03/11					
↓							











	kw			 	! #		
AUDI - A6 (4F2, C6) 05/04→03/11							
Bremsscheibe							
2.7 TDI quattro	140	10/08→03/11	←	+PR 1LG		24.0130-0175.1 430175	Ø 321 30 28 V + S
2.8 FSI	140	10/08→03/11				24.0330-0175.1 530175	Ø 321 30 28 V + S PD
2.8 FSI	162	10/08→03/11					
2.8 FSI quattro	140	10/08→03/11	←	+PR 1ZL		24.0130-0176.1 430176	Ø 347 30 28 V + S
2.8 FSI quattro	162	10/08→03/11				24.0330-0176.1 530176	Ø 347 30 28 V + S PD
3.0 TDI quattro	176	10/08→03/11					
3.0 TFSI quattro	213	10/08→03/11	→	+PR 1KD,1KQ; + eFSB		24.0112-0159.1 412159	Ø 302 12 10 + S
3.0 TFSI quattro	220	10/08→03/11				24.0312-0159.1 512159	Ø 302 12 10 PD
			→	+PR 1KW		24.0122-0223.1 422223	Ø 330 22 20 V
						24.0322-0223.1 522223	Ø 330 22 20 V PD
3.0	160	08/04→05/06	←	+PR 1LT		24.0125-0149.1 425149	Ø 314 25 23 V
						24.0325-0149.1 525149	Ø 314 25 23 V PD
			←	+PR 1LG;1LD		24.0130-0175.1 430175	Ø 321 30 28 V + S
						24.0330-0175.1 530175	Ø 321 30 28 V + S PD
			←	+PR 1ZL;1LH		24.0130-0176.1 430176	Ø 347 30 28 V + S
						24.0330-0176.1 530176	Ø 347 30 28 V + S PD
			→	+PR 1KW;2EE		24.0122-0223.1 422223	Ø 330 22 20 V
						24.0322-0223.1 522223	Ø 330 22 20 V PD
S6 quattro	320	03/06→03/11	←			24.0136-0107.1 436107	Ø 385 36 33,5 V
			→	+PR 1KW;2EE; + eFSB		24.0122-0243.1 422243	Ø 330 22 20 V
AUDI - A6 (4G2, C7, 4GC) 11/10→							
Bremsbelagsatz, Scheibenbremse							
1.8 TFSI	140	09/14→	←	+PR 1LA,1LJ		13.0460-2765.2 602765	TRW 24409 19,2 + WK + Zub
2.0 TDI	100	01/12→				13.0470-2765.2 LD2765	TRW 24409 19,2 + WK + Zub Ceramic
2.0 TDI	110	09/14→					
2.0 TDI	140	11/13→					
2.0 TDI quattro	140	04/15→	←	+PR 1LU		13.0460-4873.2 604873	BRE 24847 17,0 + WE / - WK
2.0 TFSI	162	05/13→	←	+PR 1LF		13.0460-7280.2 607280	ATE 25158 20,3 + WK
2.0 TFSI	185	09/14→				13.0470-7280.2 LD7280	ATE 25158 20,3 + WK Ceramic
2.0 TFSI hybrid	155	11/11→					
2.0 TFSI quattro	155	05/12→05/13	←	+PR 1LL,1ZK		13.0460-7280.2 607280	ATE 25158 20,3 + WK
2.0 TFSI quattro	162	05/13→				13.0470-7280.2 LD7280	ATE 25158 20,3 + WK Ceramic
2.0 TFSI quattro	183	05/15→					
2.0 TFSI quattro	185	05/14→	→	+PR 1KW		13.0460-2769.2 602769	TRW 24606 17,4 + WK + Zub
2.8 FSI quattro	162	09/14→				13.0470-2769.2 LD2769	TRW 24606 17,4 + WK + Zub Ceramic
3.0 TDI	155	09/14→					
3.0 TDI	160	09/14→	→	+PR 1KY,2EA,2EE,2EJ		13.0460-2770.2 602770	TRW 24606 17,4 + WK + Zub
3.0 TDI quattro	155	09/14→				13.0470-2770.2 LD2770	TRW 24606 17,4 + WK + Zub Ceramic
3.0 TDI quattro	160	09/14→					
3.0 TDI quattro	176	05/13→					
3.0 TDI quattro	200	09/14→					
2.0 TDI	120	03/11→	←	04/11→; +PR 1LA,1LJ		13.0460-2765.2 602765	TRW 24409 19,2 + WK + Zub
2.0 TDI	130	03/11→				13.0470-2765.2 LD2765	TRW 24409 19,2 + WK + Zub Ceramic
2.0 TFSI	155	03/11→05/13					
2.8 FSI	150	11/10→04/15					
2.8 FSI quattro	150	11/10→04/15	←	04/11→; +PR 1LU		13.0460-4873.2 604873	BRE 24847 17,0 + WE / - WK
3.0 TDI	150	11/10→					
3.0 TDI quattro	150	03/11→	←	04/11→; +PR 1LL,1ZK		13.0460-7280.2 607280	ATE 25158 20,3 + WK
3.0 TDI quattro	180	03/11→				13.0470-7280.2 LD7280	ATE 25158 20,3 + WK Ceramic
3.0 TFSI quattro	220	11/10→05/12	←	07/11→; +PR 1LF		13.0460-7280.2 607280	ATE 25158 20,3 + WK
3.0 TFSI quattro	228	03/11→				13.0470-7280.2 LD7280	ATE 25158 20,3 + WK Ceramic
			→	04/11→; +PR 1KW		13.0460-2769.2 602769	TRW 24606 17,4 + WK + Zub
						13.0470-2769.2 LD2769	TRW 24606 17,4 + WK + Zub Ceramic
			→	04/11→; +PR 1KY,2EA,2EE,2EJ		13.0460-2770.2 602770	TRW 24606 17,4 + WK + Zub
						13.0470-2770.2 LD2770	TRW 24606 17,4 + WK + Zub Ceramic
2.0 TFSI	132	05/11→	←	+PR 1LA,1LJ		13.0460-2765.2 602765	TRW 24409 19,2 + WK + Zub
						13.0470-2765.2 LD2765	TRW 24409 19,2 + WK + Zub Ceramic
			←	+PR 1LU		13.0460-4873.2 604873	BRE 24847 17,0 + WE / - WK
			←	07/11→; +PR 1LF		13.0460-7280.2 607280	ATE 25158 20,3 + WK
						13.0470-7280.2 LD7280	ATE 25158 20,3 + WK Ceramic
			←	+PR 1LL,1ZK		13.0460-7280.2 607280	ATE 25158 20,3 + WK
						13.0470-7280.2 LD7280	ATE 25158 20,3 + WK Ceramic
			→	+PR 1KW		13.0460-2769.2 602769	TRW 24606 17,4 + WK + Zub
						13.0470-2769.2 LD2769	TRW 24606 17,4 + WK + Zub Ceramic
			→	+PR 1KY,2EA,2EE,2EJ		13.0460-2770.2 602770	TRW 24606 17,4 + WK + Zub









	kw			 	! #		
AUDI - A6 (4G2, C7, 4GC) 11/10→							
 Bremsbelagsatz, Scheibenbremse							
2.0 TFSI	132	05/11→	➔	+PR 1KY,2EA,2EE,2EJ		13.0470-2770.2 LD2770	TRW 24606 17,4 + WK + Zub Ceramic
3.0 TDI quattro	230	11/11→	➔	12/11→; +PR 1LA,1LJ		13.0460-2765.2 602765	TRW 24409 19,2 + WK + Zub
			➔	12/11→; +PR 1LU		13.0460-4873.2 604873	BRE 24847 17,0 + WE / - WK
			➔	12/11→; +PR 1LF		13.0460-7280.2 607280	ATE 25158 20,3 + WK
			➔	12/11→; +PR 1LL,1ZK		13.0460-7280.2 607280	ATE 25158 20,3 + WK
			➔	12/11→; +PR 1KW		13.0460-2769.2 602769	TRW 24606 17,4 + WK + Zub
			➔	12/11→; +PR 1KW		13.0470-2769.2 LD2769	TRW 24606 17,4 + WK + Zub Ceramic
3.0 TDI quattro 3.0 TDI quattro 3.0 TFSI quattro	235 240 245	09/14→ 09/14→ 09/14→	➔	+PR 1KY,2EA,2EE,2EJ		13.0460-2770.2 602770	TRW 24606 17,4 + WK + Zub Ceramic
			➔	12/11→; +PR 1KY,2EA,2EE,2EJ		13.0460-2770.2 602770	TRW 24606 17,4 + WK + Zub Ceramic
			➔	+PR 1LA,1LJ		13.0460-2765.2 602765	TRW 24409 19,2 + WK + Zub
			➔	+PR 1LU		13.0460-4873.2 604873	BRE 24847 17,0 + WE / - WK
			➔	+PR 1LF		13.0460-7280.2 607280	ATE 25158 20,3 + WK
			➔	+PR 1LL,1ZK		13.0460-7280.2 607280	ATE 25158 20,3 + WK
S6 quattro	309	02/12→	➔	+PR 1KW		13.0460-2769.2 602769	TRW 24606 17,4 + WK + Zub
			➔	+PR 1KW		13.0470-2769.2 LD2769	TRW 24606 17,4 + WK + Zub Ceramic
			➔	04/12→; +PR 1KY,2EA,2EE,2EJ		13.0460-2770.2 602770	TRW 24606 17,4 + WK + Zub
			➔	04/12→; +PR 1KY,2EA,2EE,2EJ		13.0470-2770.2 LD2770	TRW 24606 17,4 + WK + Zub Ceramic
			➔	04/12→; +PR 1LA,1LJ		13.0460-2765.2 602765	TRW 24409 19,2 + WK + Zub
			➔	04/12→; +PR 1LU		13.0460-4873.2 604873	BRE 24847 17,0 + WE / - WK
S6 quattro	331	10/14→	➔	+PR 1LL,1ZK		13.0460-7280.2 607280	ATE 25158 20,3 + WK
			➔	+PR 1LF		13.0460-7280.2 607280	ATE 25158 20,3 + WK
			➔	+PR 1LA,1LJ		13.0460-2765.2 602765	TRW 24409 19,2 + WK + Zub
			➔	+PR 1KW		13.0460-2769.2 602769	TRW 24606 17,4 + WK + Zub
			➔	+PR 1KW		13.0470-2769.2 LD2769	TRW 24606 17,4 + WK + Zub Ceramic
			➔	+PR 1KY,2EA,2EE,2EJ		13.0460-2770.2 602770	TRW 24606 17,4 + WK + Zub
			➔	+PR 1KY,2EA,2EE,2EJ		13.0470-2770.2 LD2770	TRW 24606 17,4 + WK + Zub Ceramic
Warnkontakt, Bremsbelagsverschleiß							
1.8 TFSI	140	09/14→	➔	+PR 1LU	2	24.8190-0019.2 620019	L= 254
2.0 TDI	100	01/12→	➔	+PR 1LW	2	24.8190-0020.2 620020	L= 443,3
2.0 TDI	110	09/14→	➔	+PR 1LW	2	24.8190-0020.2 620020	L= 443,3
2.0 TDI	140	11/13→	➔	+PR 1LL,1ZK	1	24.8190-0301.2 620301	L= 311,6
2.0 TDI quattro	140	04/15→	➔	+PR 1LL,1ZK	1	24.8190-0301.2 620301	L= 311,6
2.0 TFSI	162	05/13→	➔	+PR 1LF	1	24.8190-0301.2 620301	L= 311,6
2.0 TFSI	185	09/14→	➔	+PR 1KY,2EA,2EE,2EJ	1	24.8190-0313.2 620313	L= 217
2.0 TFSI hybrid	155	11/11→	➔	+PR 1KY,2EA,2EE,2EJ	1	24.8190-0313.2 620313	L= 217
2.0 TFSI quattro	155	05/12→05/13	➔	+PR 1KY,2EA,2EE,2EJ	1	24.8190-0313.2 620313	L= 217
2.0 TFSI quattro	162	05/13→	➔	+PR 1KY,2EA,2EE,2EJ	1	24.8190-0313.2 620313	L= 217
2.0 TFSI quattro	183	05/15→	➔	+PR 1KY,2EA,2EE,2EJ	1	24.8190-0313.2 620313	L= 217
2.0 TFSI quattro	185	05/14→	➔	+PR 1KY,2EA,2EE,2EJ	1	24.8190-0313.2 620313	L= 217
2.8 FSI quattro	162	09/14→	➔	+PR 1KY,2EA,2EE,2EJ	1	24.8190-0313.2 620313	L= 217
3.0 TDI	155	09/14→	➔	+PR 1KY,2EA,2EE,2EJ	1	24.8190-0313.2 620313	L= 217
3.0 TDI	160	09/14→	➔	+PR 1KY,2EA,2EE,2EJ	1	24.8190-0313.2 620313	L= 217
3.0 TDI quattro	155	09/14→	➔	+PR 1KY,2EA,2EE,2EJ	1	24.8190-0313.2 620313	L= 217
3.0 TDI quattro	160	09/14→	➔	+PR 1KY,2EA,2EE,2EJ	1	24.8190-0313.2 620313	L= 217
3.0 TDI quattro	176	05/13→	➔	+PR 1KY,2EA,2EE,2EJ	1	24.8190-0313.2 620313	L= 217
3.0 TDI quattro	200	09/14→	➔	+PR 1KY,2EA,2EE,2EJ	1	24.8190-0313.2 620313	L= 217
3.0 TDI quattro	235	09/14→	➔	+PR 1KY,2EA,2EE,2EJ	1	24.8190-0313.2 620313	L= 217
3.0 TDI quattro	240	09/14→	➔	+PR 1KY,2EA,2EE,2EJ	1	24.8190-0313.2 620313	L= 217
3.0 TFSI quattro	245	09/14→	➔	+PR 1KY,2EA,2EE,2EJ	1	24.8190-0313.2 620313	L= 217
2.0 TDI	120	03/11→	➔	04/11→; +PR 1LU	2	24.8190-0019.2 620019	L= 254
2.0 TDI	130	03/11→	➔	04/11→; +PR 1LW	2	24.8190-0020.2 620020	L= 443,3
2.0 TFSI	155	03/11→05/13	➔	04/11→; +PR 1LW	2	24.8190-0020.2 620020	L= 443,3
↓							









	kw			 	! #		
AUDI - A6 (4G2, C7, 4GC) 11/10→							
Warnkontakt, Bremsbelagverschleiß							
2.8 FSI	150	11/10→04/15	←	04/11→; +PR 1LL,1ZK	1	24.8190-0301.2 620301	L= 311,6
2.8 FSI quattro	150	11/10→04/15	←				
3.0 TDI	150	11/10→	←	07/11→; +PR 1LF	1	24.8190-0301.2 620301	L= 311,6
3.0 TDI quattro	150	03/11→	→	04/11→; +PR 1KY,2EA,2EE,2EJ	1	24.8190-0313.2 620313	L= 217
3.0 TDI quattro	180	03/11→					
3.0 TFSI quattro	220	11/10→05/12					
3.0 TFSI quattro	228	03/11→					
2.0 TFSI	132	05/11→	←	+PR 1LU	2	24.8190-0019.2 620019	L= 254
			←	+PR 1LW	2	24.8190-0020.2 620020	L= 443,3
			←	+PR 1LL,1ZK	1	24.8190-0301.2 620301	L= 311,6
			←	07/11→; +PR 1LF	1	24.8190-0301.2 620301	L= 311,6
			→	+PR 1KY,2EA,2EE,2EJ	1	24.8190-0313.2 620313	L= 217
3.0 TDI quattro	230	11/11→	←	12/11→; +PR 1LU	2	24.8190-0019.2 620019	L= 254
			←	12/11→; +PR 1LW	2	24.8190-0020.2 620020	L= 443,3
			←	12/11→; +PR 1LF	1	24.8190-0301.2 620301	L= 311,6
			←	12/11→; +PR 1LL,1ZK	1	24.8190-0301.2 620301	L= 311,6
			→	12/11→; +PR 1KY,2EA,2EE,2EJ	1	24.8190-0313.2 620313	L= 217
S6 quattro	309	02/12→	←	04/12→; +PR 1LU	2	24.8190-0019.2 620019	L= 254
			←	04/12→; +PR 1LW	2	24.8190-0020.2 620020	L= 443,3
			←	04/12→; +PR 1LF	1	24.8190-0301.2 620301	L= 311,6
			←	04/12→; +PR 1LL,1ZK	1	24.8190-0301.2 620301	L= 311,6
			→	04/12→; +PR 1KY,2EA,2EE,2EJ	1	24.8190-0313.2 620313	L= 217
S6 quattro	331	10/14→	←	+PR 1LW	2	24.8190-0020.2 620020	L= 443,3
			←	+PR 1LL,1ZK	1	24.8190-0301.2 620301	L= 311,6
			←	+PR 1LF	1	24.8190-0301.2 620301	L= 311,6
			→	+PR 1KY,2EA,2EE,2EJ	1	24.8190-0313.2 620313	L= 217
Bremsscheibe							
1.8 TFSI	140	09/14→	←	+PR 1LA		24.0130-0221.1 430221	Ø 320 30 28 V + S
2.0 TDI	100	01/12→					
2.0 TDI	110	09/14→	←	+PR 1LJ,1LP		24.0130-0222.1 430222	Ø 345 30 28 V + S
2.0 TDI	140	11/13→	←	+PR 1LL,1LF,1ZK		24.0134-0103.1 434103	Ø 356 34 31,5 V + S
2.0 TDI quattro	140	04/15→					
2.0 TFSI	132	05/11→	→	+PR 1KW		24.0112-0178.1 412178	Ø 300 12 10 + S
2.0 TFSI	162	05/13→				24.0312-0178.1 512178	Ø 300 12 10 + S PD
2.0 TFSI	185	09/14→					
2.0 TFSI hybrid	155	11/11→	→	+PR 2EA,2EE,2EJ		24.0122-0272.1 422272	Ø 330 21,9 20 V + S
2.0 TFSI quattro	155	05/12→05/13	→	+PR 1KY		24.0122-0273.1 422273	Ø 356 22 20 V + S
2.0 TFSI quattro	162	05/13→					
2.0 TFSI quattro	183	05/15→					
2.0 TFSI quattro	185	05/14→					
2.8 FSI quattro	162	09/14→					
3.0 TDI	155	09/14→					
3.0 TDI	160	09/14→					
3.0 TDI quattro	155	09/14→					
3.0 TDI quattro	160	09/14→					
3.0 TDI quattro	176	05/13→					
3.0 TDI quattro	200	09/14→					
3.0 TDI quattro	235	09/14→					
3.0 TDI quattro	240	09/14→					
3.0 TFSI quattro	245	09/14→					
S6 quattro	331	10/14→					
2.0 TDI	120	03/11→	←	04/11→; +PR 1LA		24.0130-0221.1 430221	Ø 320 30 28 V + S
2.0 TDI	130	03/11→	←				
2.0 TFSI	155	03/11→05/13	←	04/11→; +PR 1LJ,1LP		24.0130-0222.1 430222	Ø 345 30 28 V + S
2.8 FSI	150	11/10→04/15	←	04/11→; +PR 1LL,1LF,1ZK		24.0134-0103.1 434103	Ø 356 34 31,5 V + S
2.8 FSI quattro	150	11/10→04/15					
3.0 TDI	150	11/10→	→	04/11→; +PR 1KW		24.0112-0178.1 412178	Ø 300 12 10 + S
3.0 TDI quattro	150	03/11→				24.0312-0178.1 512178	Ø 300 12 10 + S PD
3.0 TDI quattro	180	03/11→					
3.0 TFSI quattro	220	11/10→05/12	→	04/11→; +PR 2EA,2EE,2EJ		24.0122-0272.1 422272	Ø 330 21,9 20 V + S
3.0 TFSI quattro	228	03/11→	→	04/11→; +PR 1KY		24.0122-0273.1 422273	Ø 356 22 20 V + S
3.0 TDI quattro	230	11/11→	←	12/11→; +PR 1LA		24.0130-0221.1 430221	Ø 320 30 28 V + S
			←	12/11→; +PR 1LJ,1LP		24.0130-0222.1 430222	Ø 345 30 28 V + S
			←	12/11→; +PR 1LL,1LF,1ZK		24.0134-0103.1 434103	Ø 356 34 31,5 V + S
			→	12/11→; +PR 1KW		24.0112-0178.1 412178	Ø 300 12 10 + S
						24.0312-0178.1 512178	Ø 300 12 10 + S PD
			→	12/11→; +PR 2EA,2EE,2EJ		24.0122-0272.1 422272	Ø 330 21,9 20 V + S
↓							







	kw					! #				
AUDI - A6 (4G2, C7, 4GC) 11/10→										
 Bremsscheibe										
3.0 TDI quattro	230	11/11→	➡	12/11→; +PR 1KY		24.0122-0273.1	422273	Ø 356 22 20 V + S		
S6 quattro	309	02/12→	⬅	04/12→; +PR 1LA		24.0130-0221.1	430221	Ø 320 30 28 V + S		
			⬅	04/12→; +PR 1LJ,1LP		24.0130-0222.1	430222	Ø 345 30 28 V + S		
			⬅	04/12→; +PR 1LL,1LF,1ZK		24.0134-0103.1	434103	Ø 356 34 31,5 V + S		
			➡	04/12→; +PR 1KW		24.0112-0178.1	412178	Ø 300 12 10 + S		
								24.0312-0178.1	512178	Ø 300 12 10 + S PD
			➡	04/12→; +PR 2EA,2EE,2EJ		24.0122-0272.1	422272	Ø 330 21,9 20 V + S		
			➡	04/12→; +PR 1KY		24.0122-0273.1	422273	Ø 356 22 20 V + S		
AUDI - A6 Allroad (4FH, C6) 05/06→08/11										
 Bremsbelagsatz, Scheibenbremse										
2.7 TDI quattro	120	05/06→08/11	⬅	→ 05/11; +PR 1LG;1ZL		13.0460-7201.2	607201	ATE 23763 20,3 + WK		
2.7 TDI quattro	140	10/08→08/11				13.0470-7201.2	LD7201	ATE 23763 20,3 + WK Ceramic		
3.0 TDI quattro	155	05/06→08/11								
3.0 TDI quattro	176	10/08→08/11	➡	→ 05/11; +PR 1KD		13.0460-2749.2	602749	TRW 24483 16,9 - WE / - WK + Zub		
3.0 TFSI quattro	213	10/08→08/11				13.0460-2880.2	602880	TRW 23914 17,1 + WE / - WK + Zub		
						13.0470-2749.2	LD2749	TRW 24483 16,9 - WE / - WK + Zub Ceramic		
						13.0470-2880.2	LD2880	TRW 23914 17,1 + WE / - WK + Zub Ceramic		
			➡	→ 05/11; +PR 1KW;2EE; + eFSB		13.0460-2888.2	602888	TRW 23326 17,4 + WE / - WK		
						13.0470-2888.2	LD2888	TRW 23326 17,4 + WE / - WK Ceramic		
2.7 TDI quattro	132	05/06→10/08	⬅	+PR 1LG;1ZL		13.0460-7201.2	607201	ATE 23763 20,3 + WK		
3.0 TDI quattro	171	05/06→10/08				13.0470-7201.2	LD7201	ATE 23763 20,3 + WK Ceramic		
3.2 FSI quattro	188	05/06→10/08	➡	+PR 1KD		13.0460-2749.2	602749	TRW 24483 16,9 - WE / - WK + Zub		
						13.0460-2880.2	602880	TRW 23914 17,1 + WE / - WK + Zub		
						13.0470-2749.2	LD2749	TRW 24483 16,9 - WE / - WK + Zub Ceramic		
						13.0470-2880.2	LD2880	TRW 23914 17,1 + WE / - WK + Zub Ceramic		
			➡	+PR 1KW;2EE; + eFSB		13.0460-2888.2	602888	TRW 23326 17,4 + WE / - WK		
						13.0470-2888.2	LD2888	TRW 23326 17,4 + WE / - WK Ceramic		
4.2 FSI quattro	257	05/06→12/10	⬅	+PR 1LG;1ZL		13.0460-7201.2	607201	ATE 23763 20,3 + WK		
			➡	+PR 1KD		13.0460-2749.2	602749	TRW 24483 16,9 - WE / - WK + Zub		
						13.0460-2880.2	602880	TRW 23914 17,1 + WE / - WK + Zub		
						13.0470-2749.2	LD2749	TRW 24483 16,9 - WE / - WK + Zub Ceramic		
						13.0470-2880.2	LD2880	TRW 23914 17,1 + WE / - WK + Zub Ceramic		
			➡	+PR 1KW;2EE; + eFSB		13.0460-2888.2	602888	TRW 23326 17,4 + WE / - WK		
						13.0470-2888.2	LD2888	TRW 23326 17,4 + WE / - WK Ceramic		
Zubehörsatz, Scheibenbremsbelag										
2.7 TDI quattro	120	05/06→08/11	➡	→ 05/11; +PR 1KW;2EE		13.0460-0023.2	610023			
2.7 TDI quattro	140	10/08→08/11								
3.0 TDI quattro	155	05/06→08/11	➡	→ 05/11; +PR 1KD		13.0460-0259.2	610259			
3.0 TDI quattro	176	10/08→08/11								
3.0 TFSI quattro	213	10/08→08/11								
2.7 TDI quattro	132	05/06→10/08	➡	+PR 1KW;2EE		13.0460-0023.2	610023			
3.0 TDI quattro	171	05/06→10/08								
3.2 FSI quattro	188	05/06→10/08	➡	+PR 1KD		13.0460-0259.2	610259			
4.2 FSI quattro	257	05/06→12/10								
 Bremsscheibe										
2.7 TDI quattro	120	05/06→08/11	⬅	→ 05/11; +PR 1LG		24.0130-0175.1	430175	Ø 321 30 28 V + S		
2.7 TDI quattro	140	10/08→08/11				24.0330-0175.1	530175	Ø 321 30 28 V + S PD		
3.0 TDI quattro	155	05/06→08/11								
3.0 TDI quattro	176	10/08→08/11	⬅	→ 05/11; +PR 1ZL		24.0130-0176.1	430176	Ø 347 30 28 V + S		
3.0 TFSI quattro	213	10/08→08/11				24.0330-0176.1	530176	Ø 347 30 28 V + S PD		
			➡	→ 05/11; +PR 1KD; + eFSB		24.0112-0176.1	412176	Ø 302 12 10		
↓										









	kW			 	! #		
AUDI - A6 Allroad (4FH, C6) 05/06→08/11							
 Bremsscheibe							
2.7 TDI quattro	120	05/06→08/11	➔	→ 05/11; +PR 1KW;2EE; + eFSB		24.0122-0243.1 422243	Ø 330 22 20 V
2.7 TDI quattro	140	10/08→08/11					
3.0 TDI quattro	155	05/06→08/11					
3.0 TDI quattro	176	10/08→08/11					
3.0 TFSI quattro	213	10/08→08/11					
2.7 TDI quattro	132	05/06→10/08	➔	+PR 1LG		24.0130-0175.1 430175	Ø 321 30 28 V + S
3.0 TDI quattro	171	05/06→10/08				24.0330-0175.1 530175	Ø 321 30 28 V + S PD
3.2 FSI quattro	188	05/06→10/08					
4.2 FSI quattro	257	05/06→12/10	➔	+PR 1ZL		24.0130-0176.1 430176	Ø 347 30 28 V + S
						24.0330-0176.1 530176	Ø 347 30 28 V + S PD
			➔	+PR 1KD; + eFSB		24.0112-0176.1 412176	Ø 302 12 10
			➔	+PR 1KW;2EE; + eFSB		24.0122-0243.1 422243	Ø 330 22 20 V
AUDI - A6 Allroad (4GH, 4GJ) 01/12→							
 Bremsbelagsatz, Scheibenbremse							
3.0 TDI quattro	140	11/15→	➔	+PR 1LJ		13.0460-2765.2 602765	TRW 24409 19,2 + WK + Zub
3.0 TDI quattro	150	01/12→				13.0470-2765.2 LD2765	TRW 24409 19,2 + WK + Zub Ceramic
3.0 TDI quattro	155	09/14→					
3.0 TDI quattro	160	09/14→					
3.0 TDI quattro	180	01/12→	➔	+PR 1LL,1ZK		13.0460-7280.2 607280	ATE 25158 20,3 + WK
3.0 TDI quattro	200	09/14→				13.0470-7280.2 LD7280	ATE 25158 20,3 + WK Ceramic
			➔	+PR 2EA,2EJ; + eFSB		13.0460-2770.2 602770	TRW 24606 17,4 + WK + Zub
						13.0470-2770.2 LD2770	TRW 24606 17,4 + WK + Zub Ceramic
3.0 TDI quattro	230	01/12→	➔	+PR 1LJ		13.0460-2765.2 602765	TRW 24409 19,2 + WK + Zub
3.0 TDI quattro	235	01/12→					
3.0 TFSI quattro	228	01/12→	➔	+PR 1LL,1ZK		13.0460-7280.2 607280	ATE 25158 20,3 + WK
3.0 TFSI quattro	245	09/14→				13.0460-2770.2 602770	TRW 24606 17,4 + WK + Zub
			➔	+PR 2EA,2EJ; + eFSB		13.0470-2770.2 LD2770	TRW 24606 17,4 + WK + Zub Ceramic
Warnkontakt, Bremsbelagsverschleiß							
3.0 TDI quattro	140	11/15→	➔	+PR 1LL,1ZK	1	24.8190-0301.2 620301	L= 311,6
3.0 TDI quattro	150	01/12→					
3.0 TDI quattro	155	09/14→	➔	+PR 1LJ	1	24.8190-0311.2 620311	L= 300
3.0 TDI quattro	160	09/14→					
3.0 TDI quattro	180	01/12→	➔	+PR 2EA,2EJ	1	24.8190-0313.2 620313	L= 217
3.0 TDI quattro	200	09/14→					
3.0 TDI quattro	230	01/12→					
3.0 TDI quattro	235	01/12→					
3.0 TFSI quattro	228	01/12→					
3.0 TFSI quattro	245	09/14→					
 Bremsscheibe							
3.0 TDI quattro	140	11/15→	➔	+PR 1LJ		24.0130-0236.1 430236	Ø 345 30 28 V + S
3.0 TDI quattro	150	01/12→					
3.0 TDI quattro	155	09/14→	➔	+PR 1ZK		24.0134-0103.1 434103	Ø 356 34 31,5 V + S
3.0 TDI quattro	160	09/14→					
3.0 TDI quattro	180	01/12→	➔	+PR 1LL		24.0134-0107.1 434107	Ø 356 34 31,5 V + S
3.0 TDI quattro	230	01/12→					
3.0 TDI quattro	235	01/12→	➔	+PR 2EA,2EJ; + eFSB		24.0122-0272.1 422272	Ø 330 21,9 20 V + S
3.0 TFSI quattro	228	01/12→					
3.0 TFSI quattro	245	09/14→					
3.0 TDI quattro	200	09/14→	➔	+PR 1LJ		24.0130-0236.1 430236	Ø 345 30 28 V + S
			➔	+PR 2EA,2EJ; + eFSB		24.0122-0272.1 422272	Ø 330 21,9 20 V + S
AUDI - A6 Avant (4A, C4) 06/94→12/97							
 Bremsbelagsatz, Scheibenbremse							
1.8	92	12/95→12/97	➔			13.0460-7050.2 607050	ATE 20676 19,5 + WK
1.8 quattro	92	12/95→12/97					
1.9 TDI	66	06/94→12/97	➔			13.0460-3602.2 603602	TRW 21144 15,8 - WK
2.0	74	06/94→12/97					
2.0	79	08/95→07/96					
2.0	85	06/94→12/97					
2.0 16V	103	06/94→12/97					
2.0 16V quattro	103	06/94→12/97					
2.3	98	06/94→12/95					
2.5 TDI	84	01/95→12/97					
2.5 TDI	85	06/94→12/97					
2.5 TDI	103	08/94→12/97					
2.5 TDI quattro	103	07/95→12/97					
2.6	102	06/94→02/97					
2.6	110	06/94→12/97					
2.6 quattro	110	06/94→12/97					
2.8	128	06/94→12/97					
↓							

	kW			 	! #		
AUDI - A6 Avant (4A, C4) 06/94→12/97							
 Bremsbelagsatz, Scheibenbremse							
2.8	142	12/95→12/97	←			13.0460-7050.2 607050	ATE 20676 19,5 + WK
2.8 quattro	128	06/94→12/97	→			13.0460-3602.2 603602	TRW 21144 15,8 - WK
2.8 quattro	142	12/95→12/97					
2.3 quattro	98	06/94→12/95	←	08/94→		13.0460-7050.2 607050	ATE 20676 19,5 + WK
			→	08/94→		13.0460-3602.2 603602	TRW 21144 15,8 - WK
2.4	110	07/96→12/97	←	04/97→		13.0460-7110.2 607110	ATE 20676 19,8 + WK
			→	04/97→		13.0470-7110.2 LD7110	ATE 20676 19,8 + WK Ceramic
						13.0460-2820.2 602820	TRW 20961 17,2 - WK
						13.0470-2820.2 LD2820	TRW 20961 17,2 - WK Ceramic
S6 4.2 quattro	213	06/94→12/97	←	09/94→		13.0460-2717.2 602717	TRW 21452 18,5 + WK
			→	09/94→		13.0460-3602.2 603602	TRW 21144 15,8 - WK
S6 Plus quattro	240	04/96→12/97	←	06/96→		13.0460-2717.2 602717	TRW 21452 18,5 + WK
			→	06/96→		13.0460-3602.2 603602	TRW 21144 15,8 - WK
S6 Turbo quattro	169	06/94→12/97	←			13.0460-2717.2 602717	TRW 21452 18,5 + WK
			→			13.0460-3602.2 603602	TRW 21144 15,8 - WK
Zubehörsatz, Scheibenbremsbelag							
2.4	110	07/96→12/97	→	04/97→		13.0460-0072.2 610072	TRW
 Bremsscheibe							
1.8	92	12/95→12/97	←			24.0115-0105.1 415105	∅ 288 15 13
1.8 quattro	92	12/95→12/97				24.0315-0105.1 515105	∅ 288 15 13 PD
1.9 TDI	66	06/94→12/97	→			24.0110-0201.1 410201	∅ 245 10 8
2.0	74	06/94→12/97				24.0310-0201.1 510201	∅ 245 10 8 PD
2.0	79	08/95→07/96					
2.0	85	06/94→12/97					
2.0 16V	103	06/94→12/97					
2.0 16V quattro	103	06/94→12/97					
2.3	98	06/94→12/95					
2.5 TDI	84	01/95→12/97					
2.5 TDI	85	06/94→12/97					
2.3 quattro	98	06/94→12/95	←	08/94→		24.0115-0105.1 415105	∅ 288 15 13
			→	08/94→		24.0315-0105.1 515105	∅ 288 15 13 PD
						24.0110-0201.1 410201	∅ 245 10 8
						24.0310-0201.1 510201	∅ 245 10 8 PD
2.4	110	07/96→12/97	←	04/97→; +PR 1LB;1LE		24.0125-0105.1 425105	∅ 288 25 23 V + S
						24.0325-0105.1 525105	∅ 288 25 23 V PD
			←	04/97→; +PR 1LF;1LT		24.0125-0137.1 425137	∅ 312 25 23 V + S
						24.0325-0137.1 525137	∅ 312 25 23 V PD
			→	04/97→		24.0110-0201.1 410201	∅ 245 10 8
						24.0310-0201.1 510201	∅ 245 10 8 PD
2.5 TDI	103	08/94→12/97	←	10/94→		24.0125-0105.1 425105	∅ 288 25 23 V + S
			→			24.0325-0105.1 525105	∅ 288 25 23 V PD
						24.0110-0201.1 410201	∅ 245 10 8
						24.0310-0201.1 510201	∅ 245 10 8 PD
2.5 TDI quattro	103	07/95→12/97	←			24.0125-0105.1 425105	∅ 288 25 23 V + S
2.6	102	06/94→02/97				24.0325-0105.1 525105	∅ 288 25 23 V PD
2.6	110	06/94→12/97	→			24.0110-0201.1 410201	∅ 245 10 8
2.6 quattro	110	06/94→12/97				24.0310-0201.1 510201	∅ 245 10 8 PD
2.8	128	06/94→12/97					
2.8	142	12/95→12/97					
2.8 quattro	128	06/94→12/97					
2.8 quattro	142	12/95→12/97					
S6 4.2 quattro	213	06/94→12/97	←	09/94→		24.0130-0104.1 430104	∅ 314 30 28 V
			→	09/94→		24.0120-0172.1 420172	∅ 269 19,9 18 V
S6 Plus quattro	240	04/96→12/97	←	06/96→		24.0130-0183.1 430183	∅ 323 30 28 V
			→	06/96→		24.0120-0172.1 420172	∅ 269 19,9 18 V
S6 Turbo quattro	169	06/94→12/97	←			24.0130-0104.1 430104	∅ 314 30 28 V
			→			24.0120-0172.1 420172	∅ 269 19,9 18 V
AUDI - A6 Avant (4B5, C5) 11/97→01/05							
 Bremsbelagsatz, Scheibenbremse							
1.8	85	02/98→01/05	←			13.0460-7110.2 607110	ATE 20676 19,8 + WK
1.8	92	12/97→01/05				13.0470-7110.2 LD7110	ATE 20676 19,8 + WK Ceramic
1.8 T	110	12/97→01/05	→				
1.8 T	132	04/99→01/05		→ 05/01		13.0460-2820.2 602820	TRW 20961 17,2 - WK
↓							

	kw			 	! #		
AUDI - A6 Avant (4B5, C5) 11/97→01/05							
 Bremsbelagsatz, Scheibenbremse							
1.9 TDI	85	07/00→01/05	➡	→ 05/01		13.0470-2820.2 LD2820	TRW 20961 17,2 - WK Ceramic
2.4	100	07/98→01/05	➡	06/01→		13.0460-2886.2 602886	TRW 20961 16,0 - WK
2.4	115	12/97→01/05				13.0470-2886.2 LD2886	TRW 20961 16,0 - WK Ceramic
2.4	120	12/97→01/05					
2.4	121	12/97→01/05					
2.5 TDI	110	12/97→01/05					
2.8	140	07/99→01/05					
2.8	142	12/97→01/05					
1.8 T quattro	110	12/97→01/05	⬅	+PR 1LB;1LE;1LF;1LT		13.0460-7110.2 607110	ATE 20676 19,8 + WK
1.8 T quattro	132	12/97→01/05				13.0470-7110.2 LD7110	ATE 20676 19,8 + WK Ceramic
2.4 quattro	120	12/97→01/05					
2.4 quattro	121	12/97→01/05	⬅	06/01→; +PR 1LG,1LA		13.0460-7166.2 607166	ATE 23762 20,4 + WK
2.5 TDI quattro	110	12/97→01/05				13.0470-7166.2 LD7166	ATE 23762 20,4 + WK Ceramic
2.5 TDI quattro	132	02/00→01/05	➡	→ 05/01		13.0460-2820.2 602820	TRW 20961 17,2 - WK
			➡	06/01→		13.0470-2820.2 LD2820	TRW 20961 17,2 - WK Ceramic
			➡	06/01→		13.0460-2886.2 602886	TRW 20961 16,0 - WK
						13.0470-2886.2 LD2886	TRW 20961 16,0 - WK Ceramic
1.9 TDI	81	02/98→04/01	⬅			13.0460-7110.2 607110	ATE 20676 19,8 + WK
2.8	132	12/97→05/00				13.0470-7110.2 LD7110	ATE 20676 19,8 + WK Ceramic
			➡			13.0460-2820.2 602820	TRW 20961 17,2 - WK
						13.0470-2820.2 LD2820	TRW 20961 17,2 - WK Ceramic
1.9 TDI	96	08/01→01/05	⬅			13.0460-7110.2 607110	ATE 20676 19,8 + WK
2.0	96	08/01→01/05				13.0470-7110.2 LD7110	ATE 20676 19,8 + WK Ceramic
2.4	125	08/01→01/05					
2.5 TDI	114	08/01→01/05	➡			13.0460-2886.2 602886	TRW 20961 16,0 - WK
						13.0470-2886.2 LD2886	TRW 20961 16,0 - WK Ceramic
2.4 quattro	115	08/98→05/01	⬅	+PR 1LB;1LE;1LF;1LT		13.0460-7110.2 607110	ATE 20676 19,8 + WK
						13.0470-7110.2 LD7110	ATE 20676 19,8 + WK Ceramic
			➡			13.0460-2820.2 602820	TRW 20961 17,2 - WK
						13.0470-2820.2 LD2820	TRW 20961 17,2 - WK Ceramic
2.4 quattro	125	08/01→01/05	⬅	+PR 1LB;1LE;1LF;1LT		13.0460-7110.2 607110	ATE 20676 19,8 + WK
2.5 TDI	120	07/02→01/05				13.0470-7110.2 LD7110	ATE 20676 19,8 + WK Ceramic
			⬅	+PR 1LG,1LA		13.0460-7166.2 607166	ATE 23762 20,4 + WK
						13.0470-7166.2 LD7166	ATE 23762 20,4 + WK Ceramic
			➡			13.0460-2886.2 602886	TRW 20961 16,0 - WK
						13.0470-2886.2 LD2886	TRW 20961 16,0 - WK Ceramic
2.5 TDI	132	02/00→01/05	⬅	+PR 1LB;1LE;1LF;1LT		13.0460-7110.2 607110	ATE 20676 19,8 + WK
						13.0470-7110.2 LD7110	ATE 20676 19,8 + WK Ceramic
			⬅	+PR 1LG,1LA		13.0460-7166.2 607166	ATE 23762 20,4 + WK
						13.0470-7166.2 LD7166	ATE 23762 20,4 + WK Ceramic
			➡	→ 05/01		13.0460-2820.2 602820	TRW 20961 17,2 - WK
						13.0470-2820.2 LD2820	TRW 20961 17,2 - WK Ceramic
			➡	06/01→		13.0460-2886.2 602886	TRW 20961 16,0 - WK
						13.0470-2886.2 LD2886	TRW 20961 16,0 - WK Ceramic
2.7 T	169	02/99→01/05	⬅	→ 4B-X-060000		13.0460-2701.2 602701	TRW 21452 18,5 + WK
2.7 T quattro	169	12/97→01/05	⬅	4B-X-060001→; → 05/01		13.0460-2875.2 602875	TRW 23119 17,5 + WK
			⬅	06/01→; +PR 1LG,1LA		13.0460-7166.2 607166	ATE 23762 20,4 + WK
						13.0470-7166.2 LD7166	ATE 23762 20,4 + WK Ceramic
			➡	→ 05/01		13.0460-2820.2 602820	TRW 20961 17,2 - WK
						13.0470-2820.2 LD2820	TRW 20961 17,2 - WK Ceramic
			➡	06/01→		13.0460-2886.2 602886	TRW 20961 16,0 - WK
						13.0470-2886.2 LD2886	TRW 20961 16,0 - WK Ceramic
2.7 T quattro	184	08/01→01/05	⬅	→ 4B-X-060000		13.0460-2701.2 602701	TRW 21452 18,5 + WK
			⬅	+PR 1LG,1LA		13.0460-7166.2 607166	ATE 23762 20,4 + WK
						13.0470-7166.2 LD7166	ATE 23762 20,4 + WK Ceramic
			➡			13.0460-2886.2 602886	TRW 20961 16,0 - WK
						13.0470-2886.2 LD2886	TRW 20961 16,0 - WK Ceramic
2.8 quattro	142	12/97→01/05	⬅	+PR 1LB;1LE;1LF;1LT		13.0460-7110.2 607110	ATE 20676 19,8 + WK
						13.0470-7110.2 LD7110	ATE 20676 19,8 + WK Ceramic
			➡	→ 05/01		13.0460-2820.2 602820	TRW 20961 17,2 - WK
						13.0470-2820.2 LD2820	TRW 20961 17,2 - WK Ceramic
			➡	06/01→		13.0460-2886.2 602886	TRW 20961 16,0 - WK
						13.0470-2886.2 LD2886	TRW 20961 16,0 - WK Ceramic
3.0	160	06/01→01/05	⬅	+PR 1LG,1LA		13.0460-7166.2 607166	ATE 23762 20,4 + WK
3.0	162	08/01→01/05				13.0470-7166.2 LD7166	ATE 23762 20,4 + WK Ceramic
↓							









	kW			 	! #		
AUDI - A6 Avant (4B5, C5) 11/97→01/05							
 Bremsbelagsatz, Scheibenbremse							
3.0 quattro	160	06/01→01/05	➔			13.0460-2886.2 602886	TRW 20961 16,0 - WK
3.0 quattro	162	08/01→01/05	➔			13.0470-2886.2 LD2886	TRW 20961 16,0 - WK Ceramic
4.2 quattro	220	11/98→01/05	➔			13.0460-2875.2 602875	TRW 23119 17,5 + WK
S6 quattro	250	09/99→01/05	➔	→ 05/01		13.0460-2820.2 602820	TRW 20961 17,2 - WK
			➔			13.0470-2820.2 LD2820	TRW 20961 17,2 - WK Ceramic
			➔	06/01→		13.0460-2886.2 602886	TRW 20961 16,0 - WK
			➔			13.0470-2886.2 LD2886	TRW 20961 16,0 - WK Ceramic
RS6 plus quattro	353	04/04→01/05	➔			13.0460-2889.2 602889	TRW 23326 17,4 + WE / - WK
RS6 quattro	331	07/02→01/05	➔				
Zubehörsatz, Scheibenbremsbelag							
1.8	85	02/98→01/05	➔	→ 05/01		13.0460-0072.2 610072	TRW
1.8	92	12/97→01/05					
1.8 T	110	12/97→01/05					
1.8 T	132	04/99→01/05					
1.8 T quattro	110	12/97→01/05					
1.8 T quattro	132	12/97→01/05					
1.9 TDI	85	07/00→01/05					
2.4	100	07/98→01/05					
2.4	115	12/97→01/05					
2.4	120	12/97→01/05					
2.4	121	12/97→01/05					
2.4 quattro	120	12/97→01/05					
2.4 quattro	121	12/97→01/05					
2.5 TDI	110	12/97→01/05					
2.5 TDI	132	02/00→01/05					
2.5 TDI quattro	110	12/97→01/05					
2.5 TDI quattro	132	02/00→01/05					
2.7 T	169	02/99→01/05					
2.7 T quattro	169	12/97→01/05					
2.8	140	07/99→01/05					
2.8	142	12/97→01/05					
2.8 quattro	142	12/97→01/05					
4.2 quattro	220	11/98→01/05					
S6 quattro	250	09/99→01/05					
1.9 TDI	81	02/98→04/01	➔			13.0460-0072.2 610072	TRW
2.4 quattro	115	08/98→05/01					
2.8	132	12/97→05/00					
 Bremsscheibe							
1.8	85	02/98→01/05	➔	+PR 1LB;1LE		24.0125-0105.1 425105	Ø 288 25 23 V + S
1.8	92	12/97→01/05	➔			24.0325-0105.1 525105	Ø 288 25 23 V PD
1.8 T	132	04/99→01/05	➔				
1.9 TDI	81	02/98→04/01	➔	+PR 1LF;1LT		24.0125-0137.1 425137	Ø 312 25 23 V + S
1.9 TDI	85	07/00→01/05	➔			24.0325-0137.1 525137	Ø 312 25 23 V PD
1.9 TDI	96	08/01→01/05	➔				
2.0	96	08/01→01/05	➔			24.0110-0201.1 410201	Ø 245 10 8
2.4	100	07/98→01/05	➔			24.0310-0201.1 510201	Ø 245 10 8 PD
2.4	115	12/97→01/05	➔				
2.4	120	12/97→01/05	➔				
2.4	121	12/97→01/05	➔				
2.4	125	08/01→01/05	➔				
1.8 T	110	12/97→01/05	➔	+PR 1LB;1LE		24.0125-0105.1 425105	Ø 288 25 23 V + S
2.5 TDI	110	12/97→01/05	➔			24.0325-0105.1 525105	Ø 288 25 23 V PD
2.5 TDI	114	08/01→01/05	➔				
2.5 TDI	120	07/02→01/05	➔	+PR 1LF;1LT		24.0125-0137.1 425137	Ø 312 25 23 V + S
2.5 TDI	132	02/00→01/05	➔			24.0325-0137.1 525137	Ø 312 25 23 V PD
			➔	+PR 1LG;1LA		24.0130-0113.1 430113	Ø 320 30 28 V + S
			➔			24.0330-0113.1 530113	Ø 320 30 28 V PD
			➔			24.0110-0201.1 410201	Ø 245 10 8
			➔			24.0310-0201.1 510201	Ø 245 10 8 PD
1.8 T quattro	110	12/97→01/05	➔	+PR 1LB;1LE		24.0125-0105.1 425105	Ø 288 25 23 V + S
1.8 T quattro	132	12/97→01/05	➔			24.0325-0105.1 525105	Ø 288 25 23 V PD
2.4 quattro	120	12/97→01/05	➔				
2.4 quattro	121	12/97→01/05	➔	+PR 1LF;1LT		24.0125-0137.1 425137	Ø 312 25 23 V + S
2.5 TDI quattro	110	12/97→01/05	➔			24.0325-0137.1 525137	Ø 312 25 23 V PD
2.5 TDI quattro	132	02/00→01/05	➔	06/01→; +PR 1LG;1LA		24.0130-0113.1 430113	Ø 320 30 28 V + S
			➔			24.0330-0113.1 530113	Ø 320 30 28 V PD
			➔	4B-Y-000001→; +PR 0N1		24.0110-0258.1 410258	Ø 245 10 8
			➔	4B-Y-000001→; +PR 0N5; - Avant; Geschlossen		24.0110-0259.1 410259	Ø 255 10 8
			➔	→ 4B-X-200000; Kombi; + Avant		24.0110-0259.1 410259	Ø 255 10 8
			➔	+PR 0N6		24.0110-0260.1 410260	Ø 255 10 8
						24.0310-0260.1 510260	Ø 255 10 8 PD
↓							







	kw			 	! #		
AUDI - A6 Avant (4B5, C5) 11/97→01/05							
Bremsscheibe							
2.4 quattro	115	08/98→05/01	←	+PR 1LB;1LE	24.0125-0105.1	425105	Ø 288 25 23 V + S
					24.0325-0105.1	525105	Ø 288 25 23 V PD
			←	+PR 1LF;1LT	24.0125-0137.1	425137	Ø 312 25 23 V + S
					24.0325-0137.1	525137	Ø 312 25 23 V PD
			→	4B-Y-000001→; +PR 0N1	24.0110-0258.1	410258	Ø 245 10 8
			→	4B-Y-000001→; +PR 0N5; - Avant; Geschlossen	24.0110-0259.1	410259	Ø 255 10 8
		→ 4B-X-200000; Kombi; + Avant		24.0110-0259.1	410259	Ø 255 10 8	
		→	+PR 0N6	24.0110-0260.1	410260	Ø 255 10 8	
				24.0310-0260.1	510260	Ø 255 10 8 PD	
2.4 quattro	125	08/01→01/05	←	+PR 1LB;1LE	24.0125-0105.1	425105	Ø 288 25 23 V + S
					24.0325-0105.1	525105	Ø 288 25 23 V PD
			←	+PR 1LF;1LT	24.0125-0137.1	425137	Ø 312 25 23 V + S
					24.0325-0137.1	525137	Ø 312 25 23 V PD
			←	+PR 1LG;1LA	24.0130-0113.1	430113	Ø 320 30 28 V + S
					24.0330-0113.1	530113	Ø 320 30 28 V PD
			→	4B-Y-000001→; +PR 0N1	24.0110-0258.1	410258	Ø 245 10 8
			→	4B-Y-000001→; +PR 0N5; - Avant; Geschlossen	24.0110-0259.1	410259	Ø 255 10 8
		→ 4B-X-200000; Kombi; + Avant		24.0110-0259.1	410259	Ø 255 10 8	
		→	+PR 0N6	24.0110-0260.1	410260	Ø 255 10 8	
				24.0310-0260.1	510260	Ø 255 10 8 PD	
2.7 T 3.0 3.0	169 160 162	02/99→01/05 06/01→01/05 08/01→01/05	←		24.0130-0113.1	430113	Ø 320 30 28 V + S
					24.0330-0113.1	530113	Ø 320 30 28 V PD
			→		24.0110-0201.1	410201	Ø 245 10 8
				24.0310-0201.1	510201	Ø 245 10 8 PD	
2.7 T quattro 2.7 T quattro 3.0 quattro 3.0 quattro	169 184 160 162	12/97→01/05 08/01→01/05 06/01→01/05 08/01→01/05	←		24.0130-0113.1	430113	Ø 320 30 28 V + S
					24.0330-0113.1	530113	Ø 320 30 28 V PD
			→	4B-Y-000001→; +PR 0N1	24.0110-0258.1	410258	Ø 245 10 8
			→	4B-Y-000001→; +PR 0N5; - Avant; Geschlossen	24.0110-0259.1	410259	Ø 255 10 8
			→	→ 4B-X-200000; Kombi; + Avant	24.0110-0259.1	410259	Ø 255 10 8
		→	+PR 0N6	24.0110-0260.1	410260	Ø 255 10 8	
2.8 2.8 2.8	132 140 142	12/97→05/00 07/99→01/05 12/97→01/05	←	+PR 1LB;1LE	24.0125-0105.1	425105	Ø 288 25 23 V + S
					24.0325-0105.1	525105	Ø 288 25 23 V PD
			←	+PR 1LF,1LT	24.0125-0137.1	425137	Ø 312 25 23 V + S
					24.0325-0137.1	525137	Ø 312 25 23 V PD
				24.0110-0201.1	410201	Ø 245 10 8	
				24.0310-0201.1	510201	Ø 245 10 8 PD	
2.8 quattro	142	12/97→01/05	←	+PR 1LB;1LE	24.0125-0105.1	425105	Ø 288 25 23 V + S
					24.0325-0105.1	525105	Ø 288 25 23 V PD
			←	+PR 1LF,1LT	24.0125-0137.1	425137	Ø 312 25 23 V + S
					24.0325-0137.1	525137	Ø 312 25 23 V PD
			→	4B-Y-000001→; +PR 0N1	24.0110-0258.1	410258	Ø 245 10 8
			→	4B-Y-000001→; +PR 0N5; - Avant; Geschlossen	24.0110-0259.1	410259	Ø 255 10 8
		→ 4B-X-200000; Kombi; + Avant		24.0110-0259.1	410259	Ø 255 10 8	
		→	+PR 0N6	24.0110-0260.1	410260	Ø 255 10 8	
4.2 quattro S6 quattro	220 250	11/98→01/05 09/99→01/05	←		24.0130-0174.1	430174	Ø 321 30 28 V
			→		24.0122-0222.1	422222	Ø 269 22 20 V
AUDI - A6 Avant (4F5, C6) 03/05→08/11							
Bremsbelagsatz, Scheibenbremse							
2.0 TDI	89 100	09/05→06/06 06/05→08/11	←	+PR 1LT	13.0460-7110.2	607110	ATE 20676 19,8 + WK
					13.0470-7110.2	LD7110	ATE 20676 19,8 + WK Ceramic
2.0 TDI	103	06/05→10/08	←	+PR 1LG;1LD;1ZL;1LH	13.0460-7201.2	607201	ATE 23763 20,3 + WK
2.0 TFSI	125	06/05→08/11					
2.4	130	03/05→10/08			13.0470-7201.2	LD7201	ATE 23763 20,3 + WK Ceramic
2.4 quattro	130	03/05→10/08	→	+PR 1KQ	13.0460-2749.2	602749	TRW 24483 16,9 - WE / - WK + Zub
2.7 TDI	120	03/05→08/11					
2.7 TDI	132	03/05→10/08					
2.7 TDI quattro	120	06/05→08/11					
2.7 TDI quattro	132	03/05→10/08					
2.8 FSI	154	11/06→10/08			13.0460-2880.2	602880	TRW 23914 17,1 + WE / - WK + Zub









	kw			 	! #		
AUDI - A6 Avant (4F5, C6) 03/05→08/11							
 Bremsbelagsatz, Scheibenbremse							
2.8 FSI quattro	154	06/07→10/08	➡	+PR 1KQ		13.0470-2749.2 LD2749	TRW 24483 16,9 - WE / - WK + Zub Ceramic
3.0	160	03/05→05/06				13.0470-2880.2 LD2880	TRW 23914 17,1 + WE / - WK + Zub Ceramic
3.0 quattro	160	03/05→05/06					
3.0 TDI quattro	155	03/05→08/11					
3.0 TDI quattro	165	03/05→05/06					
3.0 TDI quattro	171	06/06→10/08	➡	+PR 1KD;2ED		13.0460-2749.2 602749	TRW 24483 16,9 - WE / - WK + Zub
3.2 FSI	188	03/05→10/08				13.0460-2880.2 602880	TRW 23914 17,1 + WE / - WK + Zub
3.2 FSI quattro	188	03/05→10/08				13.0470-2749.2 LD2749	TRW 24483 16,9 - WE / - WK + Zub Ceramic
						13.0470-2880.2 LD2880	TRW 23914 17,1 + WE / - WK + Zub Ceramic
			➡	+PR 1KW;2EE; + eFSB		13.0460-2888.2 602888	TRW 23326 17,4 + WE / - WK
						13.0470-2888.2 LD2888	TRW 23326 17,4 + WE / - WK Ceramic
2.0 TDI	120	04/09→08/11	⬅	+PR 1LT		13.0460-7110.2 607110	ATE 20676 19,8 + WK
2.0 TDI	125	10/08→08/11				13.0470-7110.2 LD7110	ATE 20676 19,8 + WK Ceramic
2.7 TDI	140	10/08→08/11					
2.7 TDI quattro	140	10/08→08/11	⬅	+PR 1LG;1ZL		13.0460-7201.2 607201	ATE 23763 20,3 + WK
2.8 FSI	140	10/08→08/11				13.0470-7201.2 LD7201	ATE 23763 20,3 + WK Ceramic
2.8 FSI quattro	162	10/08→08/11	➡	+PR 1KD		13.0460-2749.2 602749	TRW 24483 16,9 - WE / - WK + Zub
2.8 FSI quattro	140	10/08→08/11				13.0460-2880.2 602880	TRW 23914 17,1 + WE / - WK + Zub
2.8 FSI quattro	162	10/08→08/11				13.0470-2749.2 LD2749	TRW 24483 16,9 - WE / - WK + Zub Ceramic
						13.0470-2880.2 LD2880	TRW 23914 17,1 + WE / - WK + Zub Ceramic
			➡	+PR 1KQ		13.0460-2749.2 602749	TRW 24483 16,9 - WE / - WK + Zub
						13.0460-2880.2 602880	TRW 23914 17,1 + WE / - WK + Zub
						13.0470-2749.2 LD2749	TRW 24483 16,9 - WE / - WK + Zub Ceramic
						13.0470-2880.2 LD2880	TRW 23914 17,1 + WE / - WK + Zub Ceramic
			➡	+PR 1KW; + eFSB		13.0460-2888.2 602888	TRW 23326 17,4 + WE / - WK
						13.0470-2888.2 LD2888	TRW 23326 17,4 + WE / - WK Ceramic
3.0 TDI quattro	176	10/08→08/11	⬅	+PR 1LT		13.0460-7110.2 607110	ATE 20676 19,8 + WK
3.0 TFSI quattro	213	10/08→08/11				13.0470-7110.2 LD7110	ATE 20676 19,8 + WK Ceramic
3.0 TFSI quattro	220	10/08→08/11	⬅	+PR 1LG,1ZL		13.0460-7201.2 607201	ATE 23763 20,3 + WK
						13.0470-7201.2 LD7201	ATE 23763 20,3 + WK Ceramic
			➡	+PR 1KD		13.0460-2749.2 602749	TRW 24483 16,9 - WE / - WK + Zub
						13.0460-2880.2 602880	TRW 23914 17,1 + WE / - WK + Zub
						13.0470-2749.2 LD2749	TRW 24483 16,9 - WE / - WK + Zub Ceramic
						13.0470-2880.2 LD2880	TRW 23914 17,1 + WE / - WK + Zub Ceramic
			➡	+PR 1KQ		13.0460-2749.2 602749	TRW 24483 16,9 - WE / - WK + Zub
						13.0460-2880.2 602880	TRW 23914 17,1 + WE / - WK + Zub
						13.0470-2749.2 LD2749	TRW 24483 16,9 - WE / - WK + Zub Ceramic
						13.0470-2880.2 LD2880	TRW 23914 17,1 + WE / - WK + Zub Ceramic
			➡	+PR 1KW; + eFSB		13.0460-2888.2 602888	TRW 23326 17,4 + WE / - WK
						13.0470-2888.2 LD2888	TRW 23326 17,4 + WE / - WK Ceramic
4.2 FSI quattro	257	06/06→08/11	⬅	+PR 1LT		13.0460-7110.2 607110	ATE 20676 19,8 + WK
4.2 quattro	246	03/05→05/06	⬅	+PR 1LG;1LD;1ZL;1LH		13.0460-7201.2 607201	ATE 23763 20,3 + WK
			➡	+PR 1KQ		13.0460-2749.2 602749	TRW 24483 16,9 - WE / - WK + Zub
						13.0460-2880.2 602880	TRW 23914 17,1 + WE / - WK + Zub
						13.0470-2749.2 LD2749	TRW 24483 16,9 - WE / - WK + Zub Ceramic

↓



	kW					! #		
AUDI - A6 Avant (4F5, C6) 03/05→08/11								
 Bremsbelagsatz, Scheibenbremse								
4.2 FSI quattro 4.2 quattro	257 246	06/06→08/11 03/05→05/06	➡	+PR 1KQ			13.0470-2880.2 LD2880	TRW 23914 17,1 + WE / - WK + Zub Ceramic
			➡	+PR 1KD;2ED			13.0460-2749.2 602749	TRW 24483 16,9 - WE / - WK + Zub
							13.0460-2880.2 602880	TRW 23914 17,1 + WE / - WK + Zub
							13.0470-2749.2 LD2749	TRW 24483 16,9 - WE / - WK + Zub Ceramic
							13.0470-2880.2 LD2880	TRW 23914 17,1 + WE / - WK + Zub Ceramic
			➡	+PR 1KW;2EE; + eFSB			13.0460-2888.2 602888	TRW 23326 17,4 + WE / - WK
							13.0470-2888.2 LD2888	TRW 23326 17,4 + WE / - WK Ceramic
RS6 quattro	426	04/08→08/10	⬅	+PR 1LM			13.0460-4864.2 604864	BRE 24455 16,8 + WE / + WK
			➡	+ eFSB			13.0460-2888.2 602888	TRW 23326 17,4 + WE / - WK
S6 quattro	320	03/06→08/11	⬅				13.0460-7182.2 607182	ATE 23896 20,6 + WK
			➡	+PR 1KW;2EE; + eFSB			13.0460-2888.2 602888	TRW 23326 17,4 + WE / - WK
Zubehörsatz, Scheibenbremsbelag								
2.0 TDI	89	09/05→06/06	➡	+PR 1KW;2EE			13.0460-0023.2 610023	
2.0 TDI	100	06/05→08/11	➡	+PR 1KD;2ED			13.0460-0259.2 610259	
2.0 TDI	103	06/05→10/08						
2.0 TFSI	125	06/05→08/11	➡	+PR 1KQ			13.0460-0259.2 610259	
2.4	130	03/05→10/08						
2.4 quattro	130	03/05→10/08						
2.7 TDI	120	03/05→08/11						
2.7 TDI	132	03/05→10/08						
2.7 TDI quattro	120	06/05→08/11						
2.7 TDI quattro	132	03/05→10/08						
2.8 FSI	154	11/06→10/08						
2.8 FSI quattro	154	06/07→10/08						
3.0	160	03/05→05/06						
3.0 quattro	160	03/05→05/06						
3.0 TDI quattro	155	03/05→08/11						
3.0 TDI quattro	165	03/05→05/06						
3.0 TDI quattro	171	06/06→10/08						
3.2 FSI	188	03/05→10/08						
3.2 FSI quattro	188	03/05→10/08						
4.2 FSI quattro	257	06/06→08/11						
4.2 quattro	246	03/05→05/06						
2.0 TDI	120	04/09→08/11	➡	+PR 1KW			13.0460-0023.2 610023	
2.0 TDI	125	10/08→08/11	➡	+PR 1KD			13.0460-0259.2 610259	
2.7 TDI	140	10/08→08/11						
2.7 TDI quattro	140	10/08→08/11	➡	+PR 1KQ			13.0460-0259.2 610259	
2.8 FSI	140	10/08→08/11						
2.8 FSI	162	10/08→08/11						
2.8 FSI quattro	140	10/08→08/11						
2.8 FSI quattro	162	10/08→08/11						
3.0 TDI quattro	176	10/08→08/11						
3.0 TFSI quattro	213	10/08→08/11						
3.0 TFSI quattro	220	10/08→08/11						
RS6 quattro	426	04/08→08/10					13.0460-0023.2 610023	
S6 quattro	320	03/06→08/11		+PR 1KW;2EE			13.0460-0023.2 610023	
 Bremsscheibe								
2.0 TDI	89	09/05→06/06	⬅	+PR 1LT			24.0125-0149.1 425149	Ø 314 25 23 V
2.0 TDI	100	06/05→08/11					24.0325-0149.1 525149	Ø 314 25 23 V PD
2.0 TDI	103	06/05→10/08						
2.0 TFSI	125	06/05→08/11	⬅	+PR 1LG;1LD			24.0130-0175.1 430175	Ø 321 30 28 V + S
2.4	130	03/05→10/08					24.0330-0175.1 530175	Ø 321 30 28 V + S PD
2.4 quattro	130	03/05→10/08						
2.7 TDI	120	03/05→08/11	⬅	+PR 1ZL;1LH			24.0130-0176.1 430176	Ø 347 30 28 V + S
2.7 TDI	132	03/05→10/08					24.0330-0176.1 530176	Ø 347 30 28 V + S PD
2.7 TDI quattro	120	06/05→08/11	➡	+PR 1KD,2ED,1KQ; + eFSB			24.0112-0159.1 412159	Ø 302 12 10 + S
2.7 TDI quattro	132	03/05→10/08					24.0312-0159.1 512159	Ø 302 12 10 PD
2.8 FSI	154	11/06→10/08						
2.8 FSI quattro	154	06/07→10/08	➡	+PR 1KW;2EE			24.0122-0223.1 422223	Ø 330 22 20 V
3.0	160	03/05→05/06					24.0322-0223.1 522223	Ø 330 22 20 V PD
3.0 quattro	160	03/05→05/06						
3.0 TDI quattro	155	03/05→08/11						
3.0 TDI quattro	165	03/05→05/06						
3.0 TDI quattro	171	06/06→10/08						
3.2 FSI	188	03/05→10/08						
3.2 FSI quattro	188	03/05→10/08						
4.2 FSI quattro	257	06/06→08/11						
4.2 quattro	246	03/05→05/06						
2.0 TDI	120	04/09→08/11	⬅	+PR 1LT			24.0125-0149.1 425149	Ø 314 25 23 V

	kw			 	! #		
AUDI - A6 Avant (4F5, C6) 03/05→08/11							
Bremsscheibe							
2.0 TDI	125	10/08→08/11	←	+PR 1LT		24.0325-0149.1 525149	Ø 314 25 23 V PD
2.7 TDI	140	10/08→08/11	←	+PR 1LG		24.0130-0175.1 430175	Ø 321 30 28 V + S
2.7 TDI quattro	140	10/08→08/11	←	+PR 1LG		24.0330-0175.1 530175	Ø 321 30 28 V + S PD
2.8 FSI	140	10/08→08/11	←	+PR 1ZL		24.0130-0176.1 430176	Ø 347 30 28 V + S
2.8 FSI	162	10/08→08/11	←	+PR 1ZL		24.0330-0176.1 530176	Ø 347 30 28 V + S PD
2.8 FSI quattro	140	10/08→08/11	←	+PR 1ZL		24.0130-0176.1 430176	Ø 347 30 28 V + S
2.8 FSI quattro	162	10/08→08/11	←	+PR 1ZL		24.0330-0176.1 530176	Ø 347 30 28 V + S PD
3.0 TDI quattro	176	10/08→08/11	→	+PR 1KD,1KQ; + eFSB		24.0112-0159.1 412159	Ø 302 12 10 + S
3.0 TFSI quattro	213	10/08→08/11	→	+PR 1KW		24.0312-0159.1 512159	Ø 302 12 10 PD
3.0 TFSI quattro	220	10/08→08/11	→	+PR 1KW		24.0122-0223.1 422223	Ø 330 22 20 V
						24.0322-0223.1 522223	Ø 330 22 20 V PD
S6 quattro	320	03/06→08/11	←	+PR 1KW;2EE; + eFSB		24.0136-0107.1 436107	Ø 385 36 33,5 V
			→	+PR 1KW;2EE; + eFSB		24.0122-0243.1 422243	Ø 330 22 20 V
AUDI - A6 Avant (4G5, C7, 4GD) 05/11→							
Bremsbelagsatz, Scheibenbremse							
1.8 TFSI	140	09/14→	←	+PR 1LA,1LJ		13.0460-2765.2 602765	TRW 24409 19,2 + WK + Zub
2.0 TDI	100	01/12→	←	+PR 1LA,1LJ		13.0470-2765.2 LD2765	TRW 24409 19,2 + WK + Zub Ceramic
2.0 TDI	110	09/14→	←	+PR 1LA,1LJ		13.0460-2765.2 602765	TRW 24409 19,2 + WK + Zub Ceramic
2.0 TDI	140	11/13→	←	+PR 1LA,1LJ		13.0460-2765.2 602765	TRW 24409 19,2 + WK + Zub Ceramic
2.0 TDI quattro	140	04/15→	←	+PR 1LU		13.0460-4873.2 604873	BRE 24847 17,0 + WE / - WK
2.0 TFSI	132	06/11→	←	+PR 1LF		13.0460-7280.2 607280	ATE 25158 20,3 + WK
2.0 TFSI	185	09/14→	←	+PR 1LF		13.0470-7280.2 LD7280	ATE 25158 20,3 + WK Ceramic
2.0 TFSI quattro	183	05/15→	←	+PR 1LF		13.0460-7280.2 607280	ATE 25158 20,3 + WK
2.0 TFSI quattro	185	05/15→	←	+PR 1LF		13.0470-7280.2 LD7280	ATE 25158 20,3 + WK Ceramic
2.8 FSI quattro	162	09/14→	←	+PR 1LL,1ZK		13.0460-7280.2 607280	ATE 25158 20,3 + WK
3.0 TDI	155	09/14→	←	+PR 1LL,1ZK		13.0470-7280.2 LD7280	ATE 25158 20,3 + WK Ceramic
3.0 TDI	160	09/14→	→	+PR 1KW		13.0460-2769.2 602769	TRW 24606 17,4 + WK + Zub
3.0 TDI quattro	155	09/14→	→	+PR 1KW		13.0470-2769.2 LD2769	TRW 24606 17,4 + WK + Zub Ceramic
3.0 TDI quattro	160	09/14→	→	+PR 1KW		13.0460-2769.2 602769	TRW 24606 17,4 + WK + Zub
3.0 TDI quattro	200	09/14→	→	+PR 1KW		13.0470-2769.2 LD2769	TRW 24606 17,4 + WK + Zub Ceramic
3.0 TFSI quattro	228	11/11→	→	+PR 1KY,2EA,2EE,2EJ		13.0460-2770.2 602770	TRW 24606 17,4 + WK + Zub
						13.0470-2770.2 LD2770	TRW 24606 17,4 + WK + Zub Ceramic
2.0 TDI	120	05/11→	←	09/11→; +PR 1LA,1LJ		13.0460-2765.2 602765	TRW 24409 19,2 + WK + Zub
2.0 TDI	130	05/11→	←	09/11→; +PR 1LA,1LJ		13.0470-2765.2 LD2765	TRW 24409 19,2 + WK + Zub Ceramic
2.8 FSI	150	05/11→04/15	←	09/11→; +PR 1LA,1LJ		13.0460-2765.2 602765	TRW 24409 19,2 + WK + Zub
2.8 FSI quattro	150	05/11→04/15	←	09/11→; +PR 1LA,1LJ		13.0470-2765.2 LD2765	TRW 24409 19,2 + WK + Zub Ceramic
3.0 TDI	150	05/11→	←	09/11→; +PR 1LU		13.0460-4873.2 604873	BRE 24847 17,0 + WE / - WK
3.0 TDI quattro	150	05/11→	←	09/11→; +PR 1LU		13.0460-4873.2 604873	BRE 24847 17,0 + WE / - WK
3.0 TDI quattro	180	05/11→	←	09/11→; +PR 1LF		13.0460-7280.2 607280	ATE 25158 20,3 + WK
3.0 TFSI quattro	220	05/11→05/12	←	09/11→; +PR 1LF		13.0470-7280.2 LD7280	ATE 25158 20,3 + WK Ceramic
			←	09/11→; +PR 1LL,1ZK		13.0460-7280.2 607280	ATE 25158 20,3 + WK
			←	09/11→; +PR 1LL,1ZK		13.0470-7280.2 LD7280	ATE 25158 20,3 + WK Ceramic
			→	09/11→; +PR 1KW		13.0460-2769.2 602769	TRW 24606 17,4 + WK + Zub
			→	09/11→; +PR 1KW		13.0470-2769.2 LD2769	TRW 24606 17,4 + WK + Zub Ceramic
			→	09/11→; +PR 1KY,2EA,2EE,2EJ		13.0460-2770.2 602770	TRW 24606 17,4 + WK + Zub
						13.0470-2770.2 LD2770	TRW 24606 17,4 + WK + Zub Ceramic
3.0 TDI quattro	230	11/11→	←	12/11→; +PR 1LA,1LJ		13.0460-2765.2 602765	TRW 24409 19,2 + WK + Zub
			←	12/11→; +PR 1LA,1LJ		13.0460-2765.2 602765	TRW 24409 19,2 + WK + Zub
			←	12/11→; +PR 1LU		13.0460-4873.2 604873	BRE 24847 17,0 + WE / - WK
			←	12/11→; +PR 1LU		13.0460-4873.2 604873	BRE 24847 17,0 + WE / - WK
			←	12/11→; +PR 1LF		13.0460-7280.2 607280	ATE 25158 20,3 + WK
			←	12/11→; +PR 1LF		13.0460-7280.2 607280	ATE 25158 20,3 + WK
			←	12/11→; +PR 1LL,1ZK		13.0460-7280.2 607280	ATE 25158 20,3 + WK
			←	12/11→; +PR 1LL,1ZK		13.0470-7280.2 LD7280	ATE 25158 20,3 + WK Ceramic
			→	12/11→; +PR 1KW		13.0460-2769.2 602769	TRW 24606 17,4 + WK + Zub
			→	12/11→; +PR 1KW		13.0470-2769.2 LD2769	TRW 24606 17,4 + WK + Zub Ceramic
			→	12/11→; +PR 1KY,2EA,2EE,2EJ		13.0460-2770.2 602770	TRW 24606 17,4 + WK + Zub
						13.0470-2770.2 LD2770	TRW 24606 17,4 + WK + Zub Ceramic
3.0 TDI quattro	235	09/14→	←	+PR 1LA,1LJ		13.0460-2765.2 602765	TRW 24409 19,2 + WK + Zub
3.0 TDI quattro	240	09/14→	←	+PR 1LA,1LJ		13.0460-2765.2 602765	TRW 24409 19,2 + WK + Zub
3.0 TFSI quattro	245	09/14→	←	+PR 1LU		13.0460-4873.2 604873	BRE 24847 17,0 + WE / - WK
S6 quattro	331	10/14→	←	+PR 1LF		13.0460-7280.2 607280	ATE 25158 20,3 + WK
			←	+PR 1LF		13.0460-7280.2 607280	ATE 25158 20,3 + WK
			←	+PR 1LL,1ZK		13.0460-7280.2 607280	ATE 25158 20,3 + WK
			←	+PR 1LL,1ZK		13.0470-7280.2 LD7280	ATE 25158 20,3 + WK Ceramic
			→	+PR 1KW		13.0460-2769.2 602769	TRW 24606 17,4 + WK + Zub
			→	+PR 1KW		13.0470-2769.2 LD2769	TRW 24606 17,4 + WK + Zub Ceramic
			→	+PR 1KY,2EA,2EE,2EJ		13.0460-2770.2 602770	TRW 24606 17,4 + WK + Zub
						13.0470-2770.2 LD2770	TRW 24606 17,4 + WK + Zub Ceramic

	kw			 	! #		
AUDI - A6 Avant (4G5, C7, 4GD) 05/11→							
 Bremsbelagsatz, Scheibenbremse							
RS6 performance quattro	445	11/15→	➔	+PR 1KJ,1KQ		13.0460-2770.2 602770 13.0470-2770.2 LD2770	TRW 24606 17,4 + WK + Zub TRW 24606 17,4 + WK + Zub Ceramic
RS6 quattro	412	01/13→	➔	03/13→; +PR 1LU		13.0460-4873.2 604873	BRE 24847 17,0 + WE / - WK
			➔	03/13→; +PR 1KJ,1KQ		13.0460-2770.2 602770 13.0470-2770.2 LD2770	TRW 24606 17,4 + WK + Zub TRW 24606 17,4 + WK + Zub Ceramic
S6 quattro	309	02/12→	➔	04/12→; +PR 1LA,1LJ		13.0460-2765.2 602765	TRW 24409 19,2 + WK + Zub
			➔	04/12→; +PR 1LU		13.0460-4873.2 604873	BRE 24847 17,0 + WE / - WK
			➔	04/12→; +PR 1LF		13.0460-7280.2 607280	ATE 25158 20,3 + WK
			➔	04/12→; +PR 1LL,1ZK		13.0460-7280.2 607280	ATE 25158 20,3 + WK
			➔	04/12→; +PR 1KW		13.0460-2769.2 602769 13.0470-2769.2 LD2769	TRW 24606 17,4 + WK + Zub TRW 24606 17,4 + WK + Zub Ceramic
			➔	04/12→; +PR 1KY,2EA,2EE,2EJ		13.0460-2770.2 602770 13.0470-2770.2 LD2770	TRW 24606 17,4 + WK + Zub TRW 24606 17,4 + WK + Zub Ceramic
Warnkontakt, Bremsbelagverschleiß							
1.8 TFSI	140	09/14→	➔	+PR 1LU	2	24.8190-0019.2 620019	L= 254
2.0 TDI	100	01/12→	➔	+PR 1LW	2	24.8190-0020.2 620020	L= 443,3
2.0 TDI	110	09/14→	➔	+PR 1LL,1ZK	1	24.8190-0301.2 620301	L= 311,6
2.0 TDI quattro	140	04/15→	➔	+PR 1LF	1	24.8190-0301.2 620301	L= 311,6
2.0 TFSI	132	06/11→	➔	+PR 1LA,1LJ	1	24.8190-0311.2 620311	L= 300
2.0 TFSI quattro	185	09/14→	➔	+PR 1KY,2EA,2EE,2EJ	1	24.8190-0313.2 620313	L= 217
2.0 TFSI quattro	183	05/15→	➔				
2.0 TFSI quattro	185	05/15→	➔				
2.8 FSI quattro	162	09/14→	➔				
3.0 TDI	155	09/14→	➔				
3.0 TDI	160	09/14→	➔				
3.0 TDI quattro	155	09/14→	➔				
3.0 TDI quattro	160	09/14→	➔				
3.0 TDI quattro	200	09/14→	➔				
3.0 TDI quattro	235	09/14→	➔				
3.0 TDI quattro	240	09/14→	➔				
3.0 TFSI quattro	228	11/11→	➔				
3.0 TFSI quattro	245	09/14→	➔				
S6 quattro	331	10/14→	➔				
2.0 TDI	120	05/11→	➔	09/11→; +PR 1LU	2	24.8190-0019.2 620019	L= 254
2.0 TDI	130	05/11→	➔	09/11→; +PR 1LW	2	24.8190-0020.2 620020	L= 443,3
2.8 FSI	150	05/11→04/15	➔	09/11→; +PR 1LL,1ZK	1	24.8190-0301.2 620301	L= 311,6
2.8 FSI quattro	150	05/11→04/15	➔	09/11→; +PR 1LF	1	24.8190-0301.2 620301	L= 311,6
3.0 TDI	150	05/11→	➔	09/11→; +PR 1LA,1LJ	1	24.8190-0311.2 620311	L= 300
3.0 TDI quattro	150	05/11→	➔	09/11→; +PR 1KY,2EA,2EE,2EJ	1	24.8190-0313.2 620313	L= 217
3.0 TDI quattro	180	05/11→	➔				
3.0 TFSI quattro	220	05/11→05/12	➔				
3.0 TDI quattro	230	11/11→	➔	12/11→; +PR 1LU	2	24.8190-0019.2 620019	L= 254
			➔	12/11→; +PR 1LW	2	24.8190-0020.2 620020	L= 443,3
			➔	12/11→; +PR 1LF	1	24.8190-0301.2 620301	L= 311,6
			➔	12/11→; +PR 1LL,1ZK	1	24.8190-0301.2 620301	L= 311,6
			➔	12/11→; +PR 1LA,1LJ	1	24.8190-0311.2 620311	L= 300
			➔	12/11→; +PR 1KY,2EA,2EE,2EJ	1	24.8190-0313.2 620313	L= 217
RS6 performance quattro	445	11/15→	➔	+PR 1KJ,1KQ	1	24.8190-0313.2 620313	L= 217
RS6 quattro	412	01/13→	➔	03/13→; +PR 1LU	2	24.8190-0019.2 620019	L= 254
			➔	03/13→; +PR 1LW	2	24.8190-0020.2 620020	L= 443,3
			➔	03/13→; +PR 1KJ,1KQ	1	24.8190-0313.2 620313	L= 217
S6 quattro	309	02/12→	➔	04/12→; +PR 1LU	2	24.8190-0019.2 620019	L= 254
			➔	04/12→; +PR 1LW	2	24.8190-0020.2 620020	L= 443,3
			➔	04/12→; +PR 1LF	1	24.8190-0301.2 620301	L= 311,6
			➔	04/12→; +PR 1LL,1ZK	1	24.8190-0301.2 620301	L= 311,6
			➔	04/12→; +PR 1LA,1LJ	1	24.8190-0311.2 620311	L= 300
			➔	04/12→; +PR 1KY,2EA,2EE,2EJ	1	24.8190-0313.2 620313	L= 217
↓							

AUDI - A6 Avant (4G5, C7, 4GD) 05/11→









Bremsscheibe









1.8 TFSI	140	09/14→	←	+PR 1LA	24.0130-0221.1	430221	Ø 320 30 28 V + S
2.0 TDI	100	01/12→	←	+PR 1LJ,1LP	24.0130-0222.1	430222	Ø 345 30 28 V + S
2.0 TDI	110	09/14→	←	+PR 1LL,1LF,1ZK	24.0134-0103.1	434103	Ø 356 34 31,5 V + S
2.0 TDI	140	11/13→	←	+PR 1KW	24.0112-0178.1	412178	Ø 300 12 10 + S
2.0 TDI quattro	140	04/15→	→	+PR 1KW	24.0312-0178.1	512178	Ø 300 12 10 + S PD
2.0 TFSI	132	06/11→	→	+PR 2EA,2EE,2EJ	24.0122-0272.1	422272	Ø 330 21,9 20 V + S
2.0 TFSI	185	09/14→	→	+PR 1KY	24.0122-0273.1	422273	Ø 356 22 20 V + S
2.0 TFSI quattro	183	05/15→	→				
2.0 TFSI quattro	185	05/15→	→				
2.8 FSI quattro	162	09/14→	→				
3.0 TDI	155	09/14→					
3.0 TDI	160	09/14→					
3.0 TDI quattro	155	09/14→					
3.0 TDI quattro	160	09/14→					
3.0 TDI quattro	200	09/14→					
3.0 TDI quattro	235	09/14→					
3.0 TDI quattro	240	09/14→					
3.0 TFSI quattro	228	11/11→					
3.0 TFSI quattro	245	09/14→					
S6 quattro	331	10/14→					
2.0 TDI	120	05/11→	←	09/11→; +PR 1LA	24.0130-0221.1	430221	Ø 320 30 28 V + S
2.8 FSI	150	05/11→04/15	←	09/11→; +PR 1LJ,1LP	24.0130-0222.1	430222	Ø 345 30 28 V + S
2.8 FSI quattro	150	05/11→04/15	←	09/11→; +PR 1LL,1LF,1ZK	24.0134-0103.1	434103	Ø 356 34 31,5 V + S
3.0 TDI	150	05/11→	←	+PR 1KW	24.0112-0178.1	412178	Ø 300 12 10 + S
3.0 TDI quattro	150	05/11→	→	+PR 1KW	24.0312-0178.1	512178	Ø 300 12 10 + S PD
3.0 TDI quattro	180	05/11→	→	+PR 2EA,2EE,2EJ	24.0122-0272.1	422272	Ø 330 21,9 20 V + S
3.0 TFSI quattro	220	05/11→05/12	→	+PR 1KY	24.0122-0273.1	422273	Ø 356 22 20 V + S
2.0 TDI	130	05/11→	←	09/11→; +PR 1LA	24.0130-0221.1	430221	Ø 320 30 28 V + S
			←	09/11→; +PR 1LJ,1LP	24.0130-0222.1	430222	Ø 345 30 28 V + S
			←	09/11→; +PR 1LJ	24.0134-0103.1	434103	Ø 356 34 31,5 V + S
			→	09/11→; +PR 1KW	24.0112-0178.1	412178	Ø 300 12 10 + S
			→	09/11→; +PR 1KW	24.0312-0178.1	512178	Ø 300 12 10 + S PD
			→	09/11→; +PR 2EA,2EE,2EJ	24.0122-0272.1	422272	Ø 330 21,9 20 V + S
			→	09/11→; +PR 1KY	24.0122-0273.1	422273	Ø 356 22 20 V + S
3.0 TDI quattro	230	11/11→	←	12/11→; +PR 1LA	24.0130-0221.1	430221	Ø 320 30 28 V + S
			←	12/11→; +PR 1LJ,1LP	24.0130-0222.1	430222	Ø 345 30 28 V + S
			←	12/11→; +PR 1LL,1LF,1ZK	24.0134-0103.1	434103	Ø 356 34 31,5 V + S
			→	12/11→; +PR 1KW	24.0112-0178.1	412178	Ø 300 12 10 + S
			→	12/11→; +PR 1KW	24.0312-0178.1	512178	Ø 300 12 10 + S PD
			→	12/11→; +PR 2EA,2EE,2EJ	24.0122-0272.1	422272	Ø 330 21,9 20 V + S
			→	12/11→; +PR 1KY	24.0122-0273.1	422273	Ø 356 22 20 V + S
S6 quattro	309	02/12→	←	04/12→; +PR 1LA	24.0130-0221.1	430221	Ø 320 30 28 V + S
			←	04/12→; +PR 1LJ,1LP	24.0130-0222.1	430222	Ø 345 30 28 V + S
			←	04/12→; +PR 1LL,1LF,1ZK	24.0134-0103.1	434103	Ø 356 34 31,5 V + S
			→	04/12→; +PR 1KW	24.0112-0178.1	412178	Ø 300 12 10 + S
			→	04/12→; +PR 1KW	24.0312-0178.1	512178	Ø 300 12 10 + S PD
			→	04/12→; +PR 2EA,2EE,2EJ	24.0122-0272.1	422272	Ø 330 21,9 20 V + S
			→	04/12→; +PR 1KY	24.0122-0273.1	422273	Ø 356 22 20 V + S

AUDI - A7 Sportback (4GA, 4GF) 10/10→

Bremsbelagsatz, Scheibenbremse

1.8 TFSI	140	04/15→	←	+PR 1LA,1LJ	13.0460-2765.2	602765	TRW 24409 19,2 + WK + Zub
2.0 TFSI	185	09/14→			13.0470-2765.2	LD2765	TRW 24409 19,2 + WK + Zub Ceramic
2.0 TFSI quattro	183	05/15→					
2.0 TFSI quattro	185	05/15→	←	+PR 1LU	13.0460-4873.2	604873	BRE 24847 17,0 + WE / - WK
2.8 FSI quattro	162	09/14→	←	+PR 1LP	13.0460-4879.2	604879	BRE 25643 16,8 + WE / - WK
3.0 TDI	140	11/15→	←		13.0470-4879.2	LD4879	BRE 25643 17,0 + WE / - WK Ceramic
3.0 TDI	155	11/15→					
3.0 TDI	160	07/14→					
3.0 TDI quattro	140	11/15→					
3.0 TDI quattro	155	07/14→	←	+PR 1LL,1LF,1ZK	13.0460-7280.2	607280	ATE 25158 20,3 + WK
3.0 TDI quattro	160	07/14→			13.0470-7280.2	LD7280	ATE 25158 20,3 + WK Ceramic
3.0 TDI quattro	200	05/14→	→	+PR 1KW; + eFSB	13.0460-2769.2	602769	TRW 24606 17,4 + WK + Zub
					13.0470-2769.2	LD2769	TRW 24606 17,4 + WK + Zub Ceramic
			→	+PR 1KY,2EA,2EE,2EJ; + eFSB	13.0460-2770.2	602770	TRW 24606 17,4 + WK + Zub

	kw			 	! #		
AUDI - A7 Sportback (4GA, 4GF) 10/10→							
 Bremsbelagsatz, Scheibenbremse							
1.8 TFSI 2.0 TFSI 2.0 TFSI quattro 2.0 TFSI quattro 2.8 FSI quattro 3.0 TDI 3.0 TDI 3.0 TDI 3.0 TDI quattro 3.0 TDI quattro 3.0 TDI quattro 3.0 TDI quattro	140 185 183 185 162 140 155 160 140 155 160 200	04/15→ 09/14→ 05/15→ 05/15→ 09/14→ 11/15→ 11/15→ 07/14→ 11/15→ 07/14→ 07/14→ 05/14→	➔	+PR 1KY,2EA,2EE,2EJ; + eFSB		13.0470-2770.2 LD2770	TRW 24606 17,4 + WK + Zub Ceramic
2.8 FSI	150	02/11→	➔	05/11→; +PR 1LA,1LJ		13.0460-2765.2 602765 13.0470-2765.2 LD2765	TRW 24409 19,2 + WK + Zub TRW 24409 19,2 + WK + Zub Ceramic
			➔	05/11→; +PR 1LU		13.0460-4873.2 604873	BRE 24847 17,0 + WE / - WK
			➔	05/14→; +PR 1LP		13.0460-4879.2 604879 13.0470-4879.2 LD4879	BRE 25643 16,8 + WE / - WK BRE 25643 17,0 + WE / - WK Ceramic
			➔	05/11→; +PR 1LL,1LF,1ZK		13.0460-7280.2 607280 13.0470-7280.2 LD7280	ATE 25158 20,3 + WK ATE 25158 20,3 + WK Ceramic
			➔	05/11→; +PR 1KW; + eFSB		13.0460-2769.2 602769 13.0470-2769.2 LD2769	TRW 24606 17,4 + WK + Zub TRW 24606 17,4 + WK + Zub Ceramic
			➔	05/11→; +PR 1KY,2EA,2EE,2EJ; + eFSB		13.0460-2770.2 602770 13.0470-2770.2 LD2770	TRW 24606 17,4 + WK + Zub TRW 24606 17,4 + WK + Zub Ceramic
2.8 FSI quattro 3.0 TDI 3.0 TDI quattro 3.0 TDI quattro 3.0 TDI quattro 3.0 TFSI quattro 3.0 TFSI quattro	150 150 150 176 180 220 228	10/10→ 11/10→ 12/10→ 05/13→ 10/10→ 10/10→ 01/11→	➔	+PR 1LA,1LJ		13.0460-2765.2 602765 13.0470-2765.2 LD2765	TRW 24409 19,2 + WK + Zub TRW 24409 19,2 + WK + Zub Ceramic
			➔	+PR 1LU		13.0460-4873.2 604873	BRE 24847 17,0 + WE / - WK
			➔	05/14→; +PR 1LP		13.0460-4879.2 604879 13.0470-4879.2 LD4879	BRE 25643 16,8 + WE / - WK BRE 25643 17,0 + WE / - WK Ceramic
			➔	+PR 1LL,1LF,1ZK		13.0460-7280.2 607280 13.0470-7280.2 LD7280	ATE 25158 20,3 + WK ATE 25158 20,3 + WK Ceramic
			➔	+PR 1KW; + eFSB		13.0460-2769.2 602769 13.0470-2769.2 LD2769	TRW 24606 17,4 + WK + Zub TRW 24606 17,4 + WK + Zub Ceramic
			➔	+PR 1KY,2EA,2EE,2EJ; + eFSB		13.0460-2770.2 602770 13.0470-2770.2 LD2770	TRW 24606 17,4 + WK + Zub TRW 24606 17,4 + WK + Zub Ceramic
3.0 TDI quattro S7 quattro	230 309	11/11→ 02/12→	➔	+PR 1LA,1LJ		13.0460-2765.2 602765	TRW 24409 19,2 + WK + Zub
			➔	+PR 1LU		13.0460-4873.2 604873	BRE 24847 17,0 + WE / - WK
			➔	05/14→; +PR 1LP		13.0460-4879.2 604879 13.0470-4879.2 LD4879	BRE 25643 16,8 + WE / - WK BRE 25643 17,0 + WE / - WK Ceramic
			➔	+PR 1LL,1LF		13.0460-7280.2 607280	ATE 25158 20,3 + WK
			➔	+PR 1KW; + eFSB		13.0460-2769.2 602769 13.0470-2769.2 LD2769	TRW 24606 17,4 + WK + Zub TRW 24606 17,4 + WK + Zub Ceramic
			➔	+PR 1KY,2EA,2EE,2EJ; + eFSB		13.0460-2770.2 602770 13.0470-2770.2 LD2770	TRW 24606 17,4 + WK + Zub TRW 24606 17,4 + WK + Zub Ceramic
3.0 TDI quattro 3.0 TDI quattro 3.0 TFSI quattro S7 quattro	235 240 245 331	05/14→ 09/14→ 05/14→ 07/14→	➔	+PR 1LA,1LJ		13.0460-2765.2 602765	TRW 24409 19,2 + WK + Zub
			➔	+PR 1LU		13.0460-4873.2 604873	BRE 24847 17,0 + WE / - WK
			➔	+PR 1LP		13.0460-4879.2 604879 13.0470-4879.2 LD4879	BRE 25643 16,8 + WE / - WK BRE 25643 17,0 + WE / - WK Ceramic
			➔	+PR 1LL,1LF		13.0460-7280.2 607280	ATE 25158 20,3 + WK
			➔	+PR 1KW; + eFSB		13.0460-2769.2 602769 13.0470-2769.2 LD2769	TRW 24606 17,4 + WK + Zub TRW 24606 17,4 + WK + Zub Ceramic
			➔	+PR 1KY,2EA,2EE,2EJ; + eFSB		13.0460-2770.2 602770 13.0470-2770.2 LD2770	TRW 24606 17,4 + WK + Zub TRW 24606 17,4 + WK + Zub Ceramic
↓							

	kW			 	! #		
AUDI - A7 Sportback (4GA, 4GF) 10/10→							
 Bremsbelagsatz, Scheibenbremse							
RS7 performance quattro	445	11/15→	➡	+PR 1KJ; + eFSB		13.0460-2770.2 602770	TRW 24606 17,4 + WK + Zub
RS7 quattro	412	10/13→				13.0470-2770.2 LD2770	TRW 24606 17,4 + WK + Zub Ceramic
Warnkontakt, Bremsbelagverschleiß							
1.8 TFSI	140	04/15→	←	+PR 1LU	2	24.8190-0019.2 620019	L= 254
2.0 TFSI	185	09/14→	←	+PR 1LW	2	24.8190-0020.2 620020	L= 443,3
2.0 TFSI quattro	183	05/15→	←				
2.0 TFSI quattro	185	05/15→	←	☐; +PR 1LP	1	24.8190-0068.2 620068	L= 332
2.8 FSI quattro	162	09/14→	←	+PR 1LL,1LF,1ZK	2	24.8190-0301.2 620301	L= 311,6
3.0 TDI	140	11/15→	←	+PR 1LA,1LJ	2	24.8190-0311.2 620311	L= 300
3.0 TDI	155	11/15→	←	+PR 1LA,1LJ	2	24.8190-0311.2 620311	L= 300
3.0 TDI	160	07/14→	←	+PR 1LA,1LJ	2	24.8190-0311.2 620311	L= 300
3.0 TDI quattro	140	11/15→	➡	+PR 1KW	1	24.8190-0313.2 620313	L= 217
3.0 TDI quattro	155	07/14→	➡	+PR 1KW	1	24.8190-0313.2 620313	L= 217
3.0 TDI quattro	160	07/14→	➡	+PR 1KY,2EA,2EE,2EJ	1	24.8190-0313.2 620313	L= 217
3.0 TDI quattro	200	05/14→	➡	+PR 1KY,2EA,2EE,2EJ	1	24.8190-0313.2 620313	L= 217
2.8 FSI	150	02/11→	←	05/11→; +PR 1LU	2	24.8190-0019.2 620019	L= 254
			←	05/11→; +PR 1LW	2	24.8190-0020.2 620020	L= 443,3
			←	☐; 05/14→; +PR 1LP	1	24.8190-0068.2 620068	L= 332
			←	05/11→; +PR 1LL,1LF,1ZK	2	24.8190-0301.2 620301	L= 311,6
			←	05/11→; +PR 1LA,1LJ	2	24.8190-0311.2 620311	L= 300
			➡	05/11→; +PR 1KW	1	24.8190-0313.2 620313	L= 217
			➡	05/11→; +PR 1KY,2EA,2EE,2EJ	1	24.8190-0313.2 620313	L= 217
2.8 FSI quattro	150	10/10→	←	+PR 1LU	2	24.8190-0019.2 620019	L= 254
3.0 TDI	150	11/10→	←	+PR 1LW	2	24.8190-0020.2 620020	L= 443,3
3.0 TDI quattro	150	12/10→	←	+PR 1LW	2	24.8190-0020.2 620020	L= 443,3
3.0 TDI quattro	176	05/13→	←	☐; 05/14→; +PR 1LP	1	24.8190-0068.2 620068	L= 332
3.0 TDI quattro	180	10/10→	←	+PR 1LL,1LF,1ZK	2	24.8190-0301.2 620301	L= 311,6
3.0 TFSI quattro	220	10/10→	←	+PR 1LL,1LF,1ZK	2	24.8190-0301.2 620301	L= 311,6
3.0 TFSI quattro	228	01/11→	←	+PR 1LA,1LJ	2	24.8190-0311.2 620311	L= 300
			➡	+PR 1KW	1	24.8190-0313.2 620313	L= 217
			➡	+PR 1KY,2EA,2EE,2EJ	1	24.8190-0313.2 620313	L= 217
3.0 TDI quattro	230	11/11→	←	+PR 1LU	2	24.8190-0019.2 620019	L= 254
S7 quattro	309	02/12→	←	+PR 1LW	2	24.8190-0020.2 620020	L= 443,3
			←	☐; 05/14→; +PR 1LP	1	24.8190-0068.2 620068	L= 332
			←	+PR 1LL,1LF	2	24.8190-0301.2 620301	L= 311,6
			←	+PR 1LA,1LJ	2	24.8190-0311.2 620311	L= 300
			➡	+PR 1KW	1	24.8190-0313.2 620313	L= 217
			➡	+PR 1KY,2EA,2EE,2EJ	1	24.8190-0313.2 620313	L= 217
3.0 TDI quattro	235	05/14→	←	+PR 1LU	2	24.8190-0019.2 620019	L= 254
3.0 TDI quattro	240	09/14→	←	+PR 1LW	2	24.8190-0020.2 620020	L= 443,3
3.0 TFSI quattro	245	05/14→	←	+PR 1LW	2	24.8190-0020.2 620020	L= 443,3
S7 quattro	331	07/14→	←	☐; +PR 1LP	1	24.8190-0068.2 620068	L= 332
			←	+PR 1LL,1LF	2	24.8190-0301.2 620301	L= 311,6
			←	+PR 1LA,1LJ	2	24.8190-0311.2 620311	L= 300
			➡	+PR 1KW	1	24.8190-0313.2 620313	L= 217
			➡	+PR 1KY,2EA,2EE,2EJ	1	24.8190-0313.2 620313	L= 217
RS7 performance quattro	445	11/15→	➡	+PR 1KJ	1	24.8190-0313.2 620313	L= 217
RS7 quattro	412	10/13→					
 Bremsscheibe							
1.8 TFSI	140	04/15→	←	+PR 1LA		24.0130-0221.1 430221	Ø 320 30 28 V + S
2.0 TFSI	185	09/14→	←	+PR 1LJ,1LP		24.0130-0222.1 430222	Ø 345 30 28 V + S
2.0 TFSI quattro	183	05/15→	←	+PR 1LL,1LF,1ZK		24.0134-0103.1 434103	Ø 356 34 31,5 V + S
2.0 TFSI quattro	185	05/15→	←	+PR 1LL,1LF,1ZK		24.0134-0103.1 434103	Ø 356 34 31,5 V + S
2.8 FSI quattro	150	10/10→	➡	+PR 1KW		24.0112-0178.1 412178	Ø 300 12 10 + S
2.8 FSI quattro	162	09/14→	➡	+PR 1KW		24.0112-0178.1 412178	Ø 300 12 10 + S
3.0 TDI	140	11/15→				24.0312-0178.1 512178	Ø 300 12 10 + S PD
3.0 TDI	150	11/10→	➡	+PR 2EA,2EE,2EJ; + eFSB		24.0122-0272.1 422272	Ø 330 21,9 20 V + S
3.0 TDI	155	11/15→	➡	+PR 2EA,2EE,2EJ; + eFSB		24.0122-0272.1 422272	Ø 330 21,9 20 V + S
3.0 TDI	160	07/14→	➡	+PR 1KY; + eFSB		24.0122-0273.1 422273	Ø 356 22 20 V + S
3.0 TDI quattro	140	11/15→					
3.0 TDI quattro	150	12/10→					
3.0 TDI quattro	155	07/14→					
3.0 TDI quattro	160	07/14→					
3.0 TDI quattro	176	05/13→					
↓							

AUDI - A7 Sportback (4GA, 4GF) 10/10→









Bremsscheibe

3.0 TDI quattro	180	10/10→	←	+PR 1LA	24.0130-0221.1	430221	Ø 320 30 28 V + S
3.0 TDI quattro	200	05/14→	←	+PR 1LJ,1LP	24.0130-0222.1	430222	Ø 345 30 28 V + S
3.0 TDI quattro	230	11/11→	←	+PR 1LL,1LF,1ZK	24.0134-0103.1	434103	Ø 356 34 31,5 V + S
3.0 TDI quattro	235	05/14→	←				
3.0 TDI quattro	240	09/14→	←				
3.0 TFSI quattro	220	10/10→	→	+PR 1KW	24.0112-0178.1	412178	Ø 300 12 10 + S
3.0 TFSI quattro	228	01/11→	→		24.0312-0178.1	512178	Ø 300 12 10 + S PD
3.0 TFSI quattro	245	05/14→	→	+PR 2EA,2EE,2EJ; + eFSB	24.0122-0272.1	422272	Ø 330 21,9 20 V + S
S7 quattro	309	02/12→	→				
S7 quattro	331	07/14→	→	+PR 1KY; + eFSB	24.0122-0273.1	422273	Ø 356 22 20 V + S
2.8 FSI	150	02/11→	←	05/11→; +PR 1LA	24.0130-0221.1	430221	Ø 320 30 28 V + S
			←	05/11→; +PR 1LJ,1LP	24.0130-0222.1	430222	Ø 345 30 28 V + S
			←	05/11→; +PR 1LL,1LF,1ZK	24.0134-0103.1	434103	Ø 356 34 31,5 V + S
			→	05/11→; +PR 1KW	24.0112-0178.1	412178	Ø 300 12 10 + S
			→		24.0312-0178.1	512178	Ø 300 12 10 + S PD
			→	05/11→; +PR 2EA,2EE,2EJ; + eFSB	24.0122-0272.1	422272	Ø 330 21,9 20 V + S
			→	05/11→; +PR 1KY; + eFSB	24.0122-0273.1	422273	Ø 356 22 20 V + S

AUDI - A8 (4D2, 4D8) 03/94→12/02

Bremsbelagsatz, Scheibenbremse

2.5 TDI	110	01/97→04/00	←	06/97→ 09/98	13.0460-2700.2	602700	TRW 21452 18,5 + WK
			←	10/98→	13.0460-2876.2	602876	TRW 23119 17,5 + WK
			→	10/98→	13.0460-2820.2	602820	TRW 20961 17,2 - WK
			→		13.0470-2820.2	LD2820	TRW 20961 17,2 - WK Ceramic
			→	06/97→ 09/98	13.0460-3602.2	603602	TRW 21144 15,8 - WK
2.5 TDI 3.7	132 191	09/00→09/02 11/98→09/02	←		13.0460-2876.2	602876	TRW 23119 17,5 + WK
			→		13.0460-2820.2	602820	TRW 20961 17,2 - WK
			→		13.0470-2820.2	LD2820	TRW 20961 17,2 - WK Ceramic
2.5 TDI quattro 4.2 quattro	110 224	07/97→04/00 09/96→12/99	←	→ 09/98; nicht für Sonderfahrzeuge	13.0460-2700.2	602700	TRW 21452 18,5 + WK
			←	10/98→	13.0460-2876.2	602876	TRW 23119 17,5 + WK
			→	10/98→; nicht für Sonderfahrzeuge	13.0460-2820.2	602820	TRW 20961 17,2 - WK
			→		13.0470-2820.2	LD2820	TRW 20961 17,2 - WK Ceramic
			→	→ 09/98	13.0460-3602.2	603602	TRW 21144 15,8 - WK
2.5 TDI quattro 3.3 TDI quattro	132 165	09/00→09/02 06/00→09/02	←		13.0460-2876.2	602876	TRW 23119 17,5 + WK
3.7 quattro	191	11/98→09/02	→	nicht für Sonderfahrzeuge	13.0460-2820.2	602820	TRW 20961 17,2 - WK
4.2 quattro	175	02/99→04/00	→		13.0470-2820.2	LD2820	TRW 20961 17,2 - WK Ceramic
4.2 quattro	228	11/98→09/02	→				
2.8	120	07/95→03/96	←		13.0460-2700.2	602700	TRW 21452 18,5 + WK
			→		13.0460-3602.2	603602	TRW 21144 15,8 - WK
2.8	128	03/94→03/96	←	06/94→	13.0460-2700.2	602700	TRW 21452 18,5 + WK
			→	06/94→	13.0460-3602.2	603602	TRW 21144 15,8 - WK
2.8	142	04/96→09/02	←	→ 09/98	13.0460-2700.2	602700	TRW 21452 18,5 + WK
			←	10/98→	13.0460-2876.2	602876	TRW 23119 17,5 + WK
			→	10/98→; nicht für Sonderfahrzeuge	13.0460-2820.2	602820	TRW 20961 17,2 - WK
			→		13.0470-2820.2	LD2820	TRW 20961 17,2 - WK Ceramic
			→	→ 09/98	13.0460-3602.2	603602	TRW 21144 15,8 - WK
2.8 quattro 4.2 quattro	120 210	07/95→03/96 07/95→09/98	←	nicht für Sonderfahrzeuge	13.0460-2700.2	602700	TRW 21452 18,5 + WK
			→		13.0460-3602.2	603602	TRW 21144 15,8 - WK
2.8 quattro 4.2 quattro	128 180	03/94→03/96 03/94→07/96	←	06/94→; nicht für Sonderfahrzeuge	13.0460-2700.2	602700	TRW 21452 18,5 + WK
			→	06/94→	13.0460-3602.2	603602	TRW 21144 15,8 - WK
2.8 quattro	142	04/96→09/02	←	→ 09/98; nicht für Sonderfahrzeuge	13.0460-2700.2	602700	TRW 21452 18,5 + WK
			←	10/98→	13.0460-2876.2	602876	TRW 23119 17,5 + WK
			→	10/98→	13.0460-2820.2	602820	TRW 20961 17,2 - WK
			→		13.0470-2820.2	LD2820	TRW 20961 17,2 - WK Ceramic
			→	→ 09/98	13.0460-3602.2	603602	TRW 21144 15,8 - WK
3.7	169	07/95→12/98	←	→ 09/98	13.0460-2700.2	602700	TRW 21452 18,5 + WK
			←	10/98→	13.0460-2876.2	602876	TRW 23119 17,5 + WK
			→	10/98→	13.0460-2820.2	602820	TRW 20961 17,2 - WK
			→		13.0470-2820.2	LD2820	TRW 20961 17,2 - WK Ceramic

	kw			 	! #		
AUDI - A8 (4D2, 4D8) 03/94→12/02							
 Bremsbelagsatz, Scheibenbremse							
3.7	169	07/95→12/98	➔	→ 09/98		13.0460-3602.2 603602	TRW 21144 15,8 - WK
3.7 quattro	169	07/95→11/98	➔	10/95→ 09/98; nicht für Sonderfahrzeuge		13.0460-2700.2 602700	TRW 21452 18,5 + WK
			➔	10/98→		13.0460-2876.2 602876	TRW 23119 17,5 + WK
			➔	10/98→; nicht für Sonderfahrzeuge		13.0460-2820.2 602820	TRW 20961 17,2 - WK
			➔	10/98→; nicht für Sonderfahrzeuge		13.0470-2820.2 LD2820	TRW 20961 17,2 - WK Ceramic
4.2 quattro	220	03/94→11/98	➔	10/95→ 09/98		13.0460-3602.2 603602	TRW 21144 15,8 - WK
			➔	06/94→ 09/98; nicht für Sonderfahrzeuge		13.0460-2700.2 602700	TRW 21452 18,5 + WK
			➔	10/98→		13.0460-2876.2 602876	TRW 23119 17,5 + WK
			➔	10/98→; nicht für Sonderfahrzeuge		13.0460-2820.2 602820	TRW 20961 17,2 - WK
S8 quattro	250	07/96→06/99	➔	10/98→; nicht für Sonderfahrzeuge		13.0470-2820.2 LD2820	TRW 20961 17,2 - WK Ceramic
			➔	06/94→ 09/98		13.0460-3602.2 603602	TRW 21144 15,8 - WK
6.0 W12 quattro	309	01/01→09/02	➔	→ 04/99; nicht für Sonderfahrzeuge		13.0460-7183.2 607183	ATE 21484 20,5 + WE / - WK
			➔	05/99→; nicht für Sonderfahrzeuge		13.0460-2820.2 602820	TRW 20961 17,2 - WK
			➔	10/98→; nicht für Sonderfahrzeuge		13.0470-2820.2 LD2820	TRW 20961 17,2 - WK Ceramic
			➔	→ 09/98		13.0460-3602.2 603602	TRW 21144 15,8 - WK
S 8 quattro	265	06/99→09/02	➔	nicht für Sonderfahrzeuge		13.0460-4802.2 604802	BRE 23773 17,5 + WK
			➔	nicht für Sonderfahrzeuge		13.0460-2820.2 602820	TRW 20961 17,2 - WK
						13.0470-2820.2 LD2820	TRW 20961 17,2 - WK Ceramic
Zubehörsatz, Scheibenbremsbelag							
2.5 TDI	110	01/97→04/00	➔	10/98→		13.0460-0072.2 610072	TRW
2.8 quattro	142	04/96→09/02					
3.7	169	07/95→12/98					
2.5 TDI	132	09/00→09/02	➔			13.0460-0072.2 610072	TRW
3.7	191	11/98→09/02					
2.5 TDI quattro	110	07/97→04/00	➔	10/98→; nicht für Sonderfahrzeuge		13.0460-0072.2 610072	TRW
2.8	142	04/96→09/02					
3.7 quattro	169	07/95→11/98					
4.2 quattro	220	03/94→11/98					
4.2 quattro	224	09/96→12/99					
S8 quattro	250	07/96→06/99					
2.5 TDI quattro	132	09/00→09/02	➔	nicht für Sonderfahrzeuge		13.0460-0072.2 610072	TRW
3.3 TDI quattro	165	06/00→09/02					
3.7 quattro	191	11/98→09/02					
4.2 quattro	175	02/99→04/00					
4.2 quattro	228	11/98→09/02					
6.0 W12 quattro	309	01/01→09/02					
S 8 quattro	265	06/99→09/02					
 Bremsscheibe							
2.5 TDI	110	01/97→04/00	➔	06/97→ 09/98		24.0130-0104.1 430104	Ø 314 30 28 V
			➔	10/98→		24.0130-0183.1 430183	Ø 323 30 28 V
			➔	06/97→ 09/98		24.0110-0116.1 410116	Ø 245 10 8
			➔	10/98→		24.0122-0198.1 422198	Ø 269 21,9 20 V
2.5 TDI	132	09/00→09/02	➔			24.0130-0183.1 430183	Ø 323 30 28 V
			➔			24.0122-0198.1 422198	Ø 269 21,9 20 V
2.5 TDI quattro	110	07/97→04/00	➔	→ 09/98		24.0130-0104.1 430104	Ø 314 30 28 V
			➔	10/98→		24.0130-0183.1 430183	Ø 323 30 28 V
			➔	→ 09/98; nicht für Sonderfahrzeuge		24.0110-0116.1 410116	Ø 245 10 8
			➔	10/98→; nicht für Sonderfahrzeuge		24.0122-0198.1 422198	Ø 269 21,9 20 V
2.5 TDI quattro	132	09/00→09/02	➔			24.0130-0183.1 430183	Ø 323 30 28 V
3.3 TDI quattro	165	06/00→09/02					
3.7 quattro	191	11/98→09/02	➔	nicht für Sonderfahrzeuge		24.0122-0198.1 422198	Ø 269 21,9 20 V
4.2 quattro	175	02/99→04/00					
4.2 quattro	228	11/98→09/02					
2.8	120	07/95→03/96	➔			24.0130-0104.1 430104	Ø 314 30 28 V
			➔			24.0110-0116.1 410116	Ø 245 10 8
2.8	128	03/94→03/96	➔	06/94→		24.0130-0104.1 430104	Ø 314 30 28 V
			➔	06/94→		24.0110-0116.1 410116	Ø 245 10 8
↓							

AUDI - A8 (4D2, 4D8) 03/94→12/02









Bremsscheibe







2.8 3.7	142 169	04/96→09/02 07/95→12/98	←	→ 09/98	24.0130-0104.1	430104	Ø 314 30 28 V
			←	10/98→	24.0130-0183.1	430183	Ø 323 30 28 V
			→	10/98→	24.0120-0137.1	420137	Ø 269 19,9 18 V
2.8 quattro	120	07/95→03/96	←		24.0130-0104.1	430104	Ø 314 30 28 V
			→	nicht für Sonderfahrzeuge	24.0110-0116.1	410116	Ø 245 10 8
2.8 quattro	128	03/94→03/96	←	06/94→	24.0130-0104.1	430104	Ø 314 30 28 V
			→	06/94→; nicht für Sonderfahrzeuge	24.0110-0116.1	410116	Ø 245 10 8
2.8 quattro 4.2 quattro	142 224	04/96→09/02 09/96→12/99	←	→ 09/98	24.0130-0104.1	430104	Ø 314 30 28 V
			←	10/98→	24.0130-0183.1	430183	Ø 323 30 28 V
			→	→ 09/98; nicht für Sonderfahrzeuge	24.0120-0137.1	420137	Ø 269 19,9 18 V
			→	10/98→; nicht für Sonderfahrzeuge	24.0122-0198.1	422198	Ø 269 21,9 20 V
3.7	191	11/98→09/02	←		24.0130-0183.1	430183	Ø 323 30 28 V
			→		24.0120-0137.1	420137	Ø 269 19,9 18 V
			→		24.0122-0198.1	422198	Ø 269 21,9 20 V
3.7 quattro	169	07/95→11/98	←	10/95→ 09/98	24.0130-0104.1	430104	Ø 314 30 28 V
			←	10/98→	24.0130-0183.1	430183	Ø 323 30 28 V
			→	10/95→ 09/98; nicht für Sonderfahrzeuge	24.0120-0137.1	420137	Ø 269 19,9 18 V
			→	10/98→; nicht für Sonderfahrzeuge	24.0122-0198.1	422198	Ø 269 21,9 20 V
4.2 quattro	180	03/94→07/96	←	06/94→	24.0130-0104.1	430104	Ø 314 30 28 V
			→	06/94→; nicht für Sonderfahrzeuge	24.0120-0137.1	420137	Ø 269 19,9 18 V
4.2 quattro	210	07/95→09/98	←		24.0130-0104.1	430104	Ø 314 30 28 V
4.2 quattro	220	03/94→11/98	←	06/94→ 09/98	24.0130-0104.1	430104	Ø 314 30 28 V
			←	10/98→	24.0130-0183.1	430183	Ø 323 30 28 V
			→	06/94→ 09/98; nicht für Sonderfahrzeuge	24.0120-0137.1	420137	Ø 269 19,9 18 V
			→	10/98→; nicht für Sonderfahrzeuge	24.0122-0198.1	422198	Ø 269 21,9 20 V
6.0 W12 quattro	309	01/01→09/02	→	nicht für Sonderfahrzeuge	24.0122-0152.1	422152	Ø 280 22 20 V + S
S8 quattro	250	07/96→06/99	←	05/99→	24.0130-0177.1	430177	Ø 345 30 28 V
			←	→ 04/99	24.0130-0183.1	430183	Ø 323 30 28 V
			→	→ 09/98; nicht für Sonderfahrzeuge	24.0120-0137.1	420137	Ø 269 19,9 18 V
			→	10/98→	24.0122-0152.1	422152	Ø 280 22 20 V + S
S 8 quattro	265	06/99→09/02	←		24.0130-0177.1	430177	Ø 345 30 28 V
			→		24.0122-0152.1	422152	Ø 280 22 20 V + S







AUDI - A8 (4E_) 10/02→07/10

Bremsbelagsatz, Scheibenbremse

2.8 FSI 3.0 TDI quattro 3.2 FSI 3.2 FSI quattro	154 155 191 191	08/07→07/10 11/03→07/10 06/05→07/10 06/05→07/10	←	→ 10/09; +PR 1LJ;1LL;1LM	13.0460-7182.2	607182	ATE 23896 20,6 + WK
			←	→ 10/09; +PR 1LG	13.0460-7201.2	607201	ATE 23763 20,3 + WK
3.0 3.0	160 162	07/03→05/06 07/03→05/05	←	+PR 1LJ;1LL;1LM	13.0460-7182.2	607182	ATE 23896 20,6 + WK
			←	+PR 1LG	13.0460-7201.2	607201	ATE 23763 20,3 + WK
3.0 quattro	160	11/03→05/04	→	+PR 1KE;1KW;1KY;1KZ; + eFSB	13.0460-2889.2	602889	TRW 23326 17,4 + WE / - WK
			←	+PR 1LJ,1LL,1LM	13.0460-7182.2	607182	ATE 23896 20,6 + WK
			←	+PR 1LG	13.0460-7201.2	607201	ATE 23763 20,3 + WK
			→	+PR 1KE,1KW,1KY,1KZ; + eFSB	13.0460-2889.2	602889	TRW 23326 17,4 + WE / - WK
3.0 TDI quattro	171	08/03→07/10	←	11/03→ 10/09; +PR 1LJ;1LL;1LM	13.0460-7182.2	607182	ATE 23896 20,6 + WK
			←	11/03→ 10/09; +PR 1LG	13.0460-7201.2	607201	ATE 23763 20,3 + WK
			→	11/03→ 10/09; +PR 1KE;1KW;1KY;1KZ; + eFSB	13.0460-2889.2	602889	TRW 23326 17,4 + WE / - WK
			→	11/03→ 10/09; +PR 1LJ;1LL;1LM	13.0460-7182.2	607182	ATE 23896 20,6 + WK
3.7 quattro ↓	206	10/02→05/06	←	11/02→; +PR 1LJ;1LL;1LM	13.0460-7182.2	607182	ATE 23896 20,6 + WK

	kw			 	! #		
AUDI - A8 (4E_) 10/02→07/10							
 Bremsbelagsatz, Scheibenbremse							
3.7 quattro	206	10/02→05/06	←	11/02→; +PR 1LG		13.0460-7201.2 607201	ATE 23763 20,3 + WK
			→	11/02→; +PR 1KE;1KW;1KY;1KZ; + eFSB		13.0470-7201.2 LD7201	ATE 23763 20,3 + WK Ceramic
			←	11/02→; +PR 1KE;1KW;1KY;1KZ; + eFSB		13.0460-2889.2 602889	TRW 23326 17,4 + WE / - WK
4.0 TDI quattro	202	05/03→07/05	←	+PR 1LJ;1LL;1LM		13.0460-7182.2 607182	ATE 23896 20,6 + WK
			←	+PR 1LG		13.0460-7201.2 607201	ATE 23763 20,3 + WK
			→	+PR 1KE;1KW;1KY;1KZ; + eFSB		13.0460-2889.2 602889	TRW 23326 17,4 + WE / - WK
4.2 FSI quattro	257	06/06→07/10	←	→ 10/09; +PR 1LJ;1LL;1LM		13.0460-7182.2 607182	ATE 23896 20,6 + WK
4.2 TDI quattro	240	07/05→07/10	←	→ 10/09; +PR 1LG		13.0460-7201.2 607201	ATE 23763 20,3 + WK
			→	→ 10/09; +PR 1KE;1KW;1KY;1KZ; + eFSB		13.0460-2889.2 602889	TRW 23326 17,4 + WE / - WK
4.2 quattro	246	10/02→07/10	←	11/02→ 10/09; +PR 1LJ;1LL;1LM		13.0460-7182.2 607182	ATE 23896 20,6 + WK
			←	11/02→ 10/09; +PR 1LG		13.0460-7201.2 607201	ATE 23763 20,3 + WK
			→	11/02→ 10/09; +PR 1KE;1KW;1KY;1KZ; + eFSB		13.0460-2889.2 602889	TRW 23326 17,4 + WE / - WK
6.0 W12 quattro	331	12/03→07/10	←	02/04→ 10/09; +PR 1LJ;1LL;1LM		13.0460-7182.2 607182	ATE 23896 20,6 + WK
			←	02/04→ 10/09; +PR 1LG		13.0460-7201.2 607201	ATE 23763 20,3 + WK
			→	02/04→ 10/09; +PR 1KE;1KW;1KY;1KZ; + eFSB		13.0460-2889.2 602889	TRW 23326 17,4 + WE / - WK
S8 quattro	324	09/06→07/10	←	→ 10/09		13.0460-7182.2 607182	ATE 23896 20,6 + WK
S8 quattro	331	06/06→07/10	→	→ 10/09; +PR 1KE;1KW;1KY;1KZ; + eFSB		13.0460-2889.2 602889	TRW 23326 17,4 + WE / - WK
Zubehörsatz, Scheibenbremsbelag							
2.8 FSI	154	08/07→07/10	→	→ 10/09; +PR 1KE;1KW;1KY;1KZ; + eFSB		13.0460-0023.2 610023	
3.0 TDI quattro	155	11/03→07/10					
3.2 FSI	191	06/05→07/10					
3.2 FSI quattro	191	06/05→07/10					
4.2 FSI quattro	257	06/06→07/10					
4.2 TDI quattro	240	07/05→07/10					
S8 quattro	324	09/06→07/10					
S8 quattro	331	06/06→07/10					
3.0	160	07/03→05/06	→	+PR 1KE;1KW;1KY;1KZ; + eFSB		13.0460-0023.2 610023	
3.0	162	07/03→05/05					
4.0 TDI quattro	202	05/03→07/05					
3.0 quattro	160	11/03→05/04	→	+PR 1KE,1KW,1KY,1KZ; + eFSB		13.0460-0023.2 610023	
3.0 TDI quattro	171	08/03→07/10	→	11/03→ 10/09; +PR 1KE;1KW;1KY;1KZ; + eFSB		13.0460-0023.2 610023	
3.7 quattro	206	10/02→05/06	→	11/02→; +PR 1KE;1KW;1KY;1KZ; + eFSB		13.0460-0023.2 610023	
4.2 quattro	246	10/02→07/10	→	11/02→ 10/09; +PR 1KE;1KW;1KY;1KZ; + eFSB		13.0460-0023.2 610023	
6.0 W12 quattro	331	12/03→07/10	→	02/04→ 10/09; +PR 1KE;1KW;1KY;1KZ; + eFSB		13.0460-0023.2 610023	
 Bremsscheibe							
2.8 FSI	154	08/07→07/10	←	→ 10/09; +PR 1LG		24.0130-0175.1 430175	Ø 321 30 28 V + S
						24.0330-0175.1 530175	Ø 321 30 28 V + S PD
			←	→ 10/09; +PR 1LL;1LM		24.0134-0100.1 434100	Ø 360 34 31 V
			←	→ 10/09; +PR 1LJ		24.0136-0103.1 436103	Ø 385 36 33,5 V
			→	→ 10/09; +PR 1KE; + eFSB		24.0122-0202.1 422202	Ø 280 22 20 V
			→	→ 10/09; +PR 1KW; + eFSB		24.0122-0212.1 422212	Ø 310 22 20 V
			→	→ 10/09; +PR 1KY;1KZ; + eFSB		24.0122-0214.1 422214	Ø 335 22 20 V
3.0	160	07/03→05/06	←	4E-5-003251→; +PR 1LG		24.0130-0175.1 430175	Ø 321 30 28 V + S
3.0	162	07/03→05/05				24.0330-0175.1 530175	Ø 321 30 28 V + S PD
4.0 TDI quattro	202	05/03→07/05	←	+PR 1LG; → 4E-5-003250		24.0130-0183.1 430183	Ø 323 30 28 V
			←	+PR 1LL;1LM		24.0134-0100.1 434100	Ø 360 34 31 V
			←	+PR 1LJ		24.0136-0103.1 436103	Ø 385 36 33,5 V
			→	+PR 1KE; + eFSB		24.0122-0202.1 422202	Ø 280 22 20 V
			→	+PR 1KW; + eFSB		24.0122-0212.1 422212	Ø 310 22 20 V
			→	+PR 1KY;1KZ; + eFSB		24.0122-0214.1 422214	Ø 335 22 20 V
3.0 quattro	160	11/03→05/04	←	4E-5-003251→; +PR 1LG		24.0130-0175.1 430175	Ø 321 30 28 V + S
						24.0330-0175.1 530175	Ø 321 30 28 V + S PD
			←	+PR 1LG; → 4E-5-003250		24.0130-0183.1 430183	Ø 323 30 28 V

	kw			 	! #		
AUDI - A8 (4E_) 10/02→07/10							
Bremsscheibe							
3.0 quattro	160	11/03→05/04	← +PR 1LL,1LM	24.0134-0100.1	434100	Ø 360 34 31 V	
			← +PR 1LJ	24.0136-0103.1	436103	Ø 385 36 33,5 V	
			→ +PR 1KE; + eFSB	24.0122-0202.1	422202	Ø 280 22 20 V	
			→ +PR 1KW; + eFSB	24.0122-0212.1	422212	Ø 310 22 20 V	
			→ +PR 1KY,1KZ; + eFSB	24.0122-0214.1	422214	Ø 335 22 20 V	
3.0 TDI quattro 3.2 FSI 3.2 FSI quattro 4.2 FSI quattro 4.2 TDI quattro	155 191 191 257 240	11/03→07/10 06/05→07/10 06/05→07/10 06/06→07/10 07/05→07/10	← 4E-5-003251→; → 10/09; +PR 1LG	24.0130-0175.1	430175	Ø 321 30 28 V + S	
				24.0330-0175.1	530175	Ø 321 30 28 V + S PD	
			← +PR 1LG; → 4E-5-003250	24.0130-0183.1	430183	Ø 323 30 28 V	
			← → 10/09; +PR 1LL;1LM	24.0134-0100.1	434100	Ø 360 34 31 V	
			← → 10/09; +PR 1LJ	24.0136-0103.1	436103	Ø 385 36 33,5 V	
			→ 10/09; +PR 1KE; + eFSB	24.0122-0202.1	422202	Ø 280 22 20 V	
			→ 10/09; +PR 1KW; + eFSB	24.0122-0212.1	422212	Ø 310 22 20 V	
			→ 10/09; +PR 1KY;1KZ; + eFSB	24.0122-0214.1	422214	Ø 335 22 20 V	
3.0 TDI quattro	171	08/03→07/10	← 4E-5-003251→; → 10/09; +PR 1LG	24.0130-0175.1	430175	Ø 321 30 28 V + S	
				24.0330-0175.1	530175	Ø 321 30 28 V + S PD	
			← 11/03→; +PR 1LG; → 4E-5-003250	24.0130-0183.1	430183	Ø 323 30 28 V	
			← 11/03→ 10/09; +PR 1LL;1LM	24.0134-0100.1	434100	Ø 360 34 31 V	
			← 11/03→ 10/09; +PR 1LJ	24.0136-0103.1	436103	Ø 385 36 33,5 V	
			→ 11/03→; +PR 1KE; → 10/09; + eFSB	24.0122-0202.1	422202	Ø 280 22 20 V	
			→ 11/03→; +PR 1KW; → 10/09; + eFSB	24.0122-0212.1	422212	Ø 310 22 20 V	
→ 11/03→; +PR 1KY;1KZ; → 10/09; + eFSB	24.0122-0214.1	422214	Ø 335 22 20 V				
3.7 quattro	206	10/02→05/06	← 4E-5-003251→; +PR 1LG	24.0130-0175.1	430175	Ø 321 30 28 V + S	
				24.0330-0175.1	530175	Ø 321 30 28 V + S PD	
			← 11/02→; +PR 1LG; → 4E-5-003250	24.0130-0183.1	430183	Ø 323 30 28 V	
			← 11/02→; +PR 1LL;1LM	24.0134-0100.1	434100	Ø 360 34 31 V	
			← 11/02→; +PR 1LJ	24.0136-0103.1	436103	Ø 385 36 33,5 V	
			→ 11/02→; +PR 1KE; + eFSB	24.0122-0202.1	422202	Ø 280 22 20 V	
→ 11/02→; +PR 1KW; + eFSB	24.0122-0212.1	422212	Ø 310 22 20 V				
→ 11/02→; +PR 1KY;1KZ; + eFSB	24.0122-0214.1	422214	Ø 335 22 20 V				
4.2 quattro	246	10/02→07/10	← 4E-5-003251→; → 10/09; +PR 1LG	24.0130-0175.1	430175	Ø 321 30 28 V + S	
				24.0330-0175.1	530175	Ø 321 30 28 V + S PD	
			← 11/02→; +PR 1LG; → 4E-5-003250	24.0130-0183.1	430183	Ø 323 30 28 V	
			← 11/02→ 10/09; +PR 1LL;1LM	24.0134-0100.1	434100	Ø 360 34 31 V	
			← 11/02→ 10/09; +PR 1LJ	24.0136-0103.1	436103	Ø 385 36 33,5 V	
			→ 11/02→; +PR 1KE; → 10/09; + eFSB	24.0122-0202.1	422202	Ø 280 22 20 V	
→ 11/02→; +PR 1KW; → 10/09; + eFSB	24.0122-0212.1	422212	Ø 310 22 20 V				
→ 11/02→; +PR 1KY;1KZ; → 10/09; + eFSB	24.0122-0214.1	422214	Ø 335 22 20 V				
4.2 TDI quattro	235	01/05→06/05	← 4E-5-003251→; +PR 1LG	24.0130-0175.1	430175	Ø 321 30 28 V + S	
				24.0330-0175.1	530175	Ø 321 30 28 V + S PD	
6.0 W12 quattro	331	12/03→07/10	← 4E-5-003251→; → 10/09; +PR 1LG	24.0130-0175.1	430175	Ø 321 30 28 V + S	
				24.0330-0175.1	530175	Ø 321 30 28 V + S PD	
			← 02/04→; +PR 1LG; → 4E-5-003250	24.0130-0183.1	430183	Ø 323 30 28 V	
			← 02/04→ 10/09; +PR 1LL;1LM	24.0134-0100.1	434100	Ø 360 34 31 V	
			← 02/04→ 10/09; +PR 1LJ	24.0136-0103.1	436103	Ø 385 36 33,5 V	
			→ 02/04→; +PR 1KE; → 10/09; + eFSB	24.0122-0202.1	422202	Ø 280 22 20 V	
			→ 02/04→; +PR 1KW; → 10/09; + eFSB	24.0122-0212.1	422212	Ø 310 22 20 V	
→ 02/04→; +PR 1KY;1KZ; → 10/09; + eFSB	24.0122-0214.1	422214	Ø 335 22 20 V				
S8 quattro S8 quattro	324 331	09/06→07/10 06/06→07/10	← → 10/09	24.0136-0103.1	436103	Ø 385 36 33,5 V	
			→ 10/09; +PR 1KE; + eFSB	24.0122-0202.1	422202	Ø 280 22 20 V	
			→ 10/09; +PR 1KW; + eFSB	24.0122-0212.1	422212	Ø 310 22 20 V	
			→ 10/09; +PR 1KY;1KZ; + eFSB	24.0122-0214.1	422214	Ø 335 22 20 V	

	kw			 	! #			
AUDI - A8 (4H_) 11/09→								
Bremsbelagsatz, Scheibenbremse								
2.0 TFSI hybrid	155	02/12→	←	05/12→; +PR 1LX,1LN	13.0460-4873.2	604873	BRE 24847 17,0 + WE / - WK	
			←	05/12→; +PR 1LL	13.0460-7280.2	607280	ATE 25158 20,3 + WK	
			←	05/12→; +PR 1LL	13.0470-7280.2	LD7280	ATE 25158 20,3 + WK Ceramic	
			←	05/12→; +PR 1LJ	13.0460-7281.2	607281	ATE 25160 20,3 + WK	
			←	05/12→; +PR 1LJ	13.0470-7281.2	LD7281	ATE 25160 20,3 + WK Ceramic	
			→	05/12→; +PR 1KW,1KY,1KZ; + eFSB	13.0460-2773.2	602773	TRW 24606 17,4 + WK + Zub	
			→	05/12→; +PR 1KW,1KY,1KZ; + eFSB	13.0470-2773.2	LD2773	TRW 24606 17,4 + WK + Zub Ceramic	
2.0 TFSI quattro	185	09/16→	←	+PR 1LX,1LN	13.0460-4873.2	604873	BRE 24847 17,0 + WE / - WK	
			←	+PR 1LL	13.0460-7280.2	607280	ATE 25158 20,3 + WK	
			←	+PR 1LL	13.0470-7280.2	LD7280	ATE 25158 20,3 + WK Ceramic	
			←	+PR 1LJ	13.0460-7281.2	607281	ATE 25160 20,3 + WK	
			←	+PR 1LJ	13.0470-7281.2	LD7281	ATE 25160 20,3 + WK Ceramic	
			→	+PR 1KE,1KW,1KY,1KZ; + eFSB	13.0460-2773.2	602773	TRW 24606 17,4 + WK + Zub	
			→	+PR 1KE,1KW,1KY,1KZ; + eFSB	13.0470-2773.2	LD2773	TRW 24606 17,4 + WK + Zub Ceramic	
2.5 TFSI 3.0 TDI 3.0 TDI quattro 3.0 TDI quattro 3.0 TDI quattro 3.0 TDI quattro	150 150 155 176 184 190 193	07/12→ 09/11→ 08/10→ 11/12→ 07/10→ 10/13→ 05/15→	←	+PR 1LX,1LN	13.0460-4873.2	604873	BRE 24847 17,0 + WE / - WK	
			←	+PR 1LL	13.0460-7280.2	607280	ATE 25158 20,3 + WK	
			←	+PR 1LL	13.0470-7280.2	LD7280	ATE 25158 20,3 + WK Ceramic	
			←	+PR 1LJ	13.0460-7281.2	607281	ATE 25160 20,3 + WK	
			←	+PR 1LJ	13.0470-7281.2	LD7281	ATE 25160 20,3 + WK Ceramic	
			→	+PR 1KW,1KY,1KZ; + eFSB	13.0460-2773.2	602773	TRW 24606 17,4 + WK + Zub	
			→	+PR 1KW,1KY,1KZ; + eFSB	13.0470-2773.2	LD2773	TRW 24606 17,4 + WK + Zub Ceramic	
3.0 TFSI quattro 3.0 TFSI quattro 4.0 TFSI quattro 4.0 TFSI quattro 4.2 TDI quattro 6.3 W12 quattro S8 plus quattro S8 quattro	213 228 309 320 283 368 445 382	07/10→ 11/11→ 03/12→ 10/13→ 10/13→ 01/11→ 11/15→ 04/12→	←	+PR 1LX,1LN	13.0460-4873.2	604873	BRE 24847 17,0 + WE / - WK	
			←	+PR 1LL	13.0460-7280.2	607280	ATE 25158 20,3 + WK	
			←	+PR 1LL	13.0470-7280.2	LD7280	ATE 25158 20,3 + WK Ceramic	
			←	+PR 1LJ	13.0460-7281.2	607281	ATE 25160 20,3 + WK	
			←	+PR 1LJ	13.0470-7281.2	LD7281	ATE 25160 20,3 + WK Ceramic	
			→	+PR 1KW,1KY,1KZ; + eFSB	13.0460-2773.2	602773	TRW 24606 17,4 + WK + Zub	
			→	+PR 1KW,1KY,1KZ; + eFSB	13.0470-2773.2	LD2773	TRW 24606 17,4 + WK + Zub Ceramic	
3.0 TFSI quattro	245	06/10→	←	07/10→; +PR 1LX,1LN	13.0460-4873.2	604873	BRE 24847 17,0 + WE / - WK	
			←	07/10→; +PR 1LL	13.0460-7280.2	607280	ATE 25158 20,3 + WK	
			←	07/10→; +PR 1LJ	13.0460-7281.2	607281	ATE 25160 20,3 + WK	
			→	07/10→; +PR 1KW,1KY,1KZ; + eFSB	13.0460-2773.2	602773	TRW 24606 17,4 + WK + Zub	
			→	07/10→; +PR 1KW,1KY,1KZ; + eFSB	13.0470-2773.2	LD2773	TRW 24606 17,4 + WK + Zub Ceramic	
4.2 FSI quattro 4.2 TDI quattro	273 258	11/09→ 11/09→	←	+PR 1LX,1LN	13.0460-4873.2	604873	BRE 24847 17,0 + WE / - WK	
			←	→ 06/10; +PR 1LL	13.0460-7280.2	607280	ATE 25158 20,3 + WK	
			←	07/10→; +PR 1LL	13.0460-7280.2	607280	ATE 25158 20,3 + WK	
			←	07/10→; +PR 1LJ	13.0460-7281.2	607281	ATE 25160 20,3 + WK	
			←	→ 06/10; +PR 1LJ	13.0460-7281.2	607281	ATE 25160 20,3 + WK	
			→	+PR 1KW,1KY,1KZ; + eFSB	13.0460-2773.2	602773	TRW 24606 17,4 + WK + Zub	
			→	+PR 1KW,1KY,1KZ; + eFSB	13.0470-2773.2	LD2773	TRW 24606 17,4 + WK + Zub Ceramic	
Warnkontakt, Bremsbelagverschleiß								
2.0 TFSI hybrid	155	02/12→	←	05/12→; +PR 1LX,1LN	2	24.8190-0019.2	620019	L= 254
			←	05/12→; +PR 1LW	2	24.8190-0020.2	620020	L= 443,3
			←	05/12→; +PR 1LL	2	24.8190-0301.2	620301	L= 311,6
			←	05/12→; +PR 1LJ	2	24.8190-0301.2	620301	L= 311,6
2.0 TFSI quattro 2.5 TFSI 3.0 TDI 3.0 TDI quattro 3.0 TDI quattro 3.0 TDI quattro 3.0 TDI quattro 3.0 TFSI quattro 3.0 TFSI quattro 4.0 TFSI quattro 4.0 TFSI quattro 4.2 TDI quattro 6.3 W12 quattro ↓	185 150 150 155 176 184 190 193 213 228 309 320 283 368	09/16→ 07/12→ 09/11→ 08/10→ 11/12→ 07/10→ 10/13→ 05/15→ 07/10→ 11/11→ 03/12→ 10/13→ 10/13→ 01/11→	←	+PR 1LX,1LN	2	24.8190-0019.2	620019	L= 254
			←	+PR 1LW	2	24.8190-0020.2	620020	L= 443,3
			←	+PR 1LL	2	24.8190-0301.2	620301	L= 311,6
			←	+PR 1LJ	2	24.8190-0301.2	620301	L= 311,6
			←	+PR 1LX,1LN	2	24.8190-0019.2	620019	L= 254
			←	+PR 1LW	2	24.8190-0020.2	620020	L= 443,3
			←	+PR 1LL	2	24.8190-0301.2	620301	L= 311,6
			←	+PR 1LJ	2	24.8190-0301.2	620301	L= 311,6
			←	+PR 1LX,1LN	2	24.8190-0019.2	620019	L= 254
			←	+PR 1LW	2	24.8190-0020.2	620020	L= 443,3



AUDI - A8 (4H_) 11/09→

Warnkontakt, Bremsbelagverschleiß

S8 plus quattro S8 quattro	445 382	11/15→ 04/12→	← +PR 1LX,1LN	2	24.8190-0019.2	620019	L= 254
			← +PR 1LW	2	24.8190-0020.2	620020	L= 443,3
			← +PR 1LL	2	24.8190-0301.2	620301	L= 311,6
			← +PR 1LJ	2	24.8190-0301.2	620301	L= 311,6
3.0 TFSI quattro	245	06/10→	← 07/10→; +PR 1LX,1LN	2	24.8190-0019.2	620019	L= 254
			← 07/10→; +PR 1LW	2	24.8190-0020.2	620020	L= 443,3
			← 07/10→; +PR 1LL	2	24.8190-0301.2	620301	L= 311,6
			← 07/10→; +PR 1LJ	2	24.8190-0301.2	620301	L= 311,6
4.2 FSI quattro 4.2 TDI quattro	273 258	11/09→ 11/09→	← +PR 1LX,1LN	2	24.8190-0019.2	620019	L= 254
			← +PR 1LW	2	24.8190-0020.2	620020	L= 443,3
			← 07/10→; +PR 1LJ	2	24.8190-0301.2	620301	L= 311,6
			← 07/10→; +PR 1LL	2	24.8190-0301.2	620301	L= 311,6
			← → 06/10; +PR 1LL	2	24.8190-0303.2	620303	L= 296,6
			← → 06/10; +PR 1LJ	2	24.8190-0303.2	620303	L= 296,6

Bremsscheibe

2.0 TFSI hybrid	155	02/12→	← 05/12→; +PR 1LL		24.0134-0103.1	434103	Ø 356 34 31,5 V + S				
			→ 05/12→; +PR 1KW; + eFSB		24.0122-0272.1	422272	Ø 330 21,9 20 V + S				
			→ 05/12→; +PR 1KY,1KZ; + eFSB		24.0122-0273.1	422273	Ø 356 22 20 V + S				
2.0 TFSI quattro	185	09/16→	← +PR 1LL		24.0134-0103.1	434103	Ø 356 34 31,5 V + S				
			→ +PR 1KW; + eFSB		24.0122-0272.1	422272	Ø 330 21,9 20 V + S				
			→ +PR 1KE,1KY,1KZ; + eFSB		24.0122-0273.1	422273	Ø 356 22 20 V + S				
2.5 TFSI	150	07/12→	← +PR 1LL		24.0134-0103.1	434103	Ø 356 34 31,5 V + S				
3.0 TDI	150	09/11→									
3.0 TDI quattro	155	08/10→						→ +PR 1KW; + eFSB	24.0122-0272.1	422272	Ø 330 21,9 20 V + S
3.0 TDI quattro	176	11/12→						→ +PR 1KY,1KZ; + eFSB	24.0122-0273.1	422273	Ø 356 22 20 V + S
3.0 TDI quattro	184	07/10→									
3.0 TDI quattro	190	10/13→									
3.0 TDI quattro	193	05/15→									
3.0 TFSI quattro	213	07/10→									
3.0 TFSI quattro	228	11/11→									
4.0 TFSI quattro	309	03/12→									
4.0 TFSI quattro	320	10/13→									
4.2 FSI quattro	273	11/09→									
4.2 TDI quattro	258	11/09→									
4.2 TDI quattro	283	10/13→									
6.3 W12 quattro	368	01/11→									
S8 plus quattro	445	11/15→									
S8 quattro	382	04/12→									
3.0 TFSI quattro	245	06/10→	← 07/10→; +PR 1LL		24.0134-0103.1	434103	Ø 356 34 31,5 V + S				
			→ 07/10→; +PR 1KW; + eFSB		24.0122-0272.1	422272	Ø 330 21,9 20 V + S				
			→ 07/10→; +PR 1KY,1KZ; + eFSB		24.0122-0273.1	422273	Ø 356 22 20 V + S				













AUDI - ALLROAD (4BH, C5) 05/00→08/05







Bremsbelagsatz, Scheibenbremse











2.5 TDI quattro 2.5 TDI quattro 2.7 quattro 2.7 T quattro	120 132 187 184	05/03→08/05 05/00→08/05 09/00→08/05 05/00→08/05	← +PR 1LX; → 07/05		13.0460-2875.2	602875	TRW 23119 17,5 + WK
			← +PR 1LA; → 07/05		13.0460-7166.2	607166	ATE 23762 20,4 + WK
			→ 07/05		13.0470-7166.2	LD7166	ATE 23762 20,4 + WK Ceramic
			→ 07/05		13.0460-2886.2	602886	TRW 20961 16,0 - WK
			→ 07/05		13.0470-2886.2	LD2886	TRW 20961 16,0 - WK Ceramic
4.2 V8 quattro	220	07/02→08/05	← +PR 1LX; → 07/05		13.0460-2875.2	602875	TRW 23119 17,5 + WK
			← +PR 1LA; → 07/05		13.0460-7166.2	607166	ATE 23762 20,4 + WK
			→ 07/05		13.0460-2886.2	602886	TRW 20961 16,0 - WK
			→ 07/05		13.0470-2886.2	LD2886	TRW 20961 16,0 - WK Ceramic









Bremsscheibe







2.5 TDI quattro 2.5 TDI quattro	120 132	05/03→08/05 05/00→08/05	← → 07/05		24.0130-0113.1	430113	Ø 320 30 28 V + S
			→ 07/05		24.0330-0113.1	530113	Ø 320 30 28 V PD
2.7 quattro 2.7 T quattro	187 184	09/00→08/05 05/00→08/05	→ 07/05		24.0110-0260.1	410260	Ø 255 10 8
			→ 07/05		24.0310-0260.1	510260	Ø 255 10 8 PD
			→ 07/05		24.0130-0113.1	430113	Ø 320 30 28 V + S
			→ 07/05		24.0330-0113.1	530113	Ø 320 30 28 V PD











	kW					! #		
AUDI - ALLROAD (4BH, C5) 05/00→08/05								
 Bremsscheibe								
2.7 quattro	187	09/00→08/05	→	→ 07/05			24.0110-0260.1 410260	Ø 255 10 8
2.7 T quattro	184	05/00→08/05						
4.2 V8 quattro	220	07/02→08/05	←	→ 07/05			24.0130-0113.1 430113	Ø 320 30 28 V + S
							24.0330-0113.1 530113	Ø 320 30 28 V PD
			→	→ 07/05			24.0122-0203.1 422203	Ø 269 22 20 V
AUDI - CABRIOLET (8G7, B4) 05/91→08/00								
 Bremsbelagsatz, Scheibenbremse								
1.8	92	01/97→08/00	←	04/97→			13.0460-2934.2 602934	TRW 20669 19,0 - WK
			→	04/97→			13.0460-3602.2 603602	TRW 21144 15,8 - WK
1.9 TDI	66	06/95→08/00	←	07/95→			13.0460-2934.2 602934	TRW 20669 19,0 - WK
			→	07/95→			13.0460-3602.2 603602	TRW 21144 15,8 - WK
2.0 16V	103	06/95→07/96	←				13.0460-2934.2 602934	TRW 20669 19,0 - WK
			→				13.0460-3602.2 603602	TRW 21144 15,8 - WK
2.0 E	85	01/93→07/98	→				13.0460-3602.2 603602	TRW 21144 15,8 - WK
2.6	102	05/95→08/00	→					
2.6	110	06/93→08/00	←	01/94→			13.0460-2934.2 602934	TRW 20669 19,0 - WK
			→	01/94→			13.0460-3602.2 603602	TRW 21144 15,8 - WK
2.8	128	11/92→08/00	←				13.0460-2963.2 602963	TRW 21138 18,8 + WK
			→				13.0460-3602.2 603602	TRW 21144 15,8 - WK
 Bremsscheibe								
1.8	92	01/97→08/00	←	04/97→			24.0122-0139.1 422139	Ø 280 22 20 V
			→	04/97→			24.0110-0178.1 410178	Ø 245 10 8
1.9 TDI	66	06/95→08/00	←	07/95→			24.0122-0139.1 422139	Ø 280 22 20 V
			→	07/95→			24.0110-0178.1 410178	Ø 245 10 8
2.0 16V	103	06/95→07/96	←	fur Italien			24.0122-0139.1 422139	Ø 280 22 20 V
			→	fur Italien			24.0110-0178.1 410178	Ø 245 10 8
2.0 E	85	01/93→07/98	→				24.0122-0139.1 422139	Ø 280 22 20 V
2.6	102	05/95→08/00	→				24.0110-0178.1 410178	Ø 245 10 8
2.6	110	06/93→08/00	←	01/94→			24.0122-0139.1 422139	Ø 280 22 20 V
			→	01/94→			24.0110-0178.1 410178	Ø 245 10 8
2.8	128	11/92→08/00	←				24.0125-0106.1 425106	Ø 276 25 23 V
			→				24.0110-0178.1 410178	Ø 245 10 8
AUDI - COUPE (89, 8B) 10/88→12/96								
 Bremsbelagsatz, Scheibenbremse								
2.0	85	05/89→12/96	←				13.0460-2934.2 602934	TRW 20669 19,0 - WK
2.0 16 V	103	08/92→12/96	→				13.0460-3602.2 603602	TRW 21144 15,8 - WK
2.3	98	03/90→12/96	→					
2.3 quattro	98	05/90→12/96	→					
2.6	110	08/92→12/96	→					
2.6 quattro	110	08/92→12/96	→					
2.3 20V quattro	123	05/90→12/96	←				13.0460-2963.2 602963	TRW 21138 18,8 + WK
2.8	128	09/91→12/96	→				13.0460-3602.2 603602	TRW 21144 15,8 - WK
2.8 quattro	128	08/91→12/96	→					
S2 quattro	169	10/92→12/96	→					
 Bremsscheibe								
2.0	85	05/89→12/96	←	→ 07/92			24.0122-0108.1 422108	Ø 256 22 20 V
			←	08/92→			24.0122-0139.1 422139	Ø 280 22 20 V
			→				24.0110-0178.1 410178	Ø 245 10 8
2.0 16 V	103	08/92→12/96	←				24.0122-0139.1 422139	Ø 280 22 20 V
			→				24.0110-0178.1 410178	Ø 245 10 8
2.6	110	08/92→12/96	→					
2.3	98	03/90→12/96	←	→ 07/92			24.0122-0108.1 422108	Ø 256 22 20 V
			←	08/92→			24.0122-0139.1 422139	Ø 280 22 20 V
			→	→ 07/94			24.0110-0178.1 410178	Ø 245 10 8
2.3 20V quattro	123	05/90→12/96	←				24.0125-0106.1 425106	Ø 276 25 23 V
			→				24.0110-0182.1 410182	Ø 245 10 8
2.3 quattro	98	05/90→12/96	←	→ 8B-N-015000			24.0122-0108.1 422108	Ø 256 22 20 V
			←	8B-P-000001→			24.0122-0139.1 422139	Ø 280 22 20 V
↓								









	kw				! #			
AUDI - COUPE (89, 8B) 10/88→12/96								
Bremsscheibe								
2.3 quattro	98	05/90→12/96	➡			24.0110-0182.1 410182	Ø 245 10 8	
2.6 quattro	110	08/92→12/96	⬅	passend für Felgengröße [Zoll]: 15		24.0122-0139.1 422139	Ø 280 22 20 V	
			⬅	passend für Felgengröße [Zoll]: 16		24.0125-0139.1 425139	Ø 276 24,9 23 V	
			➡	passend für Felgengröße [Zoll]: 15		24.0110-0182.1 410182	Ø 245 10 8	
			➡	passend für Felgengröße [Zoll]: 16		24.0110-0261.1 410261 24.0310-0261.1 510261	Ø 245 10 8 + S Ø 245 10 8 PD	
2.8	128	09/91→12/96	⬅			24.0125-0106.1 425106	Ø 276 25 23 V	
			➡			24.0110-0178.1 410178	Ø 245 10 8	
2.8 quattro	128	08/91→12/96	⬅	passend für Felgengröße [Zoll]: 15		24.0125-0106.1 425106	Ø 276 25 23 V	
			⬅	passend für Felgengröße [Zoll]: 16		24.0125-0139.1 425139	Ø 276 24,9 23 V	
			➡	passend für Felgengröße [Zoll]: 15		24.0110-0182.1 410182	Ø 245 10 8	
			➡	passend für Felgengröße [Zoll]: 16		24.0110-0261.1 410261 24.0310-0261.1 510261	Ø 245 10 8 + S Ø 245 10 8 PD	
S2 quattro	169	10/92→12/96	⬅			24.0125-0139.1 425139	Ø 276 24,9 23 V	
			➡	passend für Felgengröße [Zoll]: 15		24.0110-0182.1 410182	Ø 245 10 8	
			➡	passend für Felgengröße [Zoll]: 16		24.0110-0261.1 410261 24.0310-0261.1 510261	Ø 245 10 8 + S Ø 245 10 8 PD	
AUDI - Q2 (GA) 06/16→								
Bremsbelagsatz, Scheibenbremse								
1.0 TFSI	85	09/16→	⬅	+PR 1ZA,1ZD		13.0460-2785.2 602785	TRW 25683 20,4 + WE / + WK	
1.4 TFSI quattro	110	09/16→	➡	+PR 1KE; + eFSB		13.0470-2785.2 LD2785	TRW 25683 20,4 + WE / + WK Ceramic	
2.0 TDI	110	09/16→					13.0460-7293.2 607293	ATE 25008 16,3 - WE / - WK
2.0 TDI quattro	110	10/16→					13.0470-7293.2 LD7293	ATE 25008 16,3 - WE / - WK Ceramic
2.0 TFSI quattro	140	09/16→						
1.4 TFSI	110	06/16→	⬅	09/16→; +PR 1ZA,1ZD		13.0460-2785.2 602785	TRW 25683 20,4 + WE / + WK	
1.6 TDI	85	06/16→					13.0470-2785.2 LD2785	TRW 25683 20,4 + WE / + WK Ceramic
2.0 TDI quattro	140	07/16→	➡	09/16→; +PR 1KE; + eFSB		13.0460-7293.2 607293 13.0470-7293.2 LD7293	ATE 25008 16,3 - WE / - WK ATE 25008 16,3 - WE / - WK Ceramic	
Warnkontakt, Bremsbelagverschleiß								
1.0 TFSI	85	09/16→	⬅	+PR 1ZA,1ZD	1	24.8190-0065.2 620065	L= 172	
1.4 TFSI quattro	110	09/16→						
2.0 TDI	110	09/16→						
2.0 TDI quattro	110	10/16→						
2.0 TFSI quattro	140	09/16→						
1.4 TFSI	110	06/16→	⬅	09/16→; +PR 1ZA,1ZD	1	24.8190-0065.2 620065	L= 172	
1.6 TDI	85	06/16→						
2.0 TDI quattro	140	07/16→						
Bremsscheibe								
1.0 TFSI	85	09/16→	⬅	+PR 1ZA,1ZD		24.0125-0158.1 425158	Ø 312 25 22 V + S	
1.4 TFSI quattro	110	09/16→						
2.0 TDI	110	09/16→	➡	+PR 1KE / 0N4		24.0110-0356.1 410356	Ø 272 9,7 8 + S	
2.0 TDI quattro	110	10/16→						
2.0 TFSI quattro	140	09/16→						
1.4 TFSI	110	06/16→	⬅	09/16→; +PR 1ZA,1ZD		24.0125-0158.1 425158	Ø 312 25 22 V + S	
1.6 TDI	85	06/16→						
2.0 TDI quattro	140	07/16→						
➡				09/16→; +PR 1KE / 0N4		24.0110-0356.1 410356	Ø 272 9,7 8 + S	
AUDI - Q3 (8U) 06/11→								
Bremsbelagsatz, Scheibenbremse								
1.4 TFSI	92	07/16→	⬅	+PR 1LJ,1ZD		13.0460-7242.2 607242	ATE 24332 19,8 + WK	
2.0 TDI	88	03/15→						
2.0 TDI	110	11/14→	➡	+PR 1KU; + eFSB		13.0470-7242.2 LD7242	ATE 24332 19,8 + WK Ceramic	
2.0 TDI	135	05/15→						
2.0 TDI quattro	110	11/14→						
2.0 TDI quattro	135	11/14→						
2.0 TFSI	132	05/15→						
2.0 TFSI quattro	132	11/14→						
2.0 TFSI quattro	162	11/14→						
1.4 TFSI	110	10/13→	⬅	+PR 1LJ,1ZD		13.0460-7242.2 607242	ATE 24332 19,8 + WK	
2.0 TDI	100	09/11→						
2.0 TDI	103	09/11→						
2.0 TDI	130	05/13→						
↓								









	kw			 	! #		
AUDI - Q3 (8U) 06/11→							
 Bremsbelagsatz, Scheibenbremse							
2.0 TDI quattro	103	01/12→	➡	+PR 1KU		13.0460-2749.2 602749	TRW 24483 16,9 - WE / - WK + Zub
2.0 TDI quattro	120	06/11→					
2.0 TDI quattro	130	06/11→				13.0460-2880.2 602880	TRW 23914 17,1 + WE / - WK + Zub
2.0 TFSI quattro	125	06/11→					
2.0 TFSI quattro	155	06/11→				13.0470-2749.2 LD2749	TRW 24483 16,9 - WE / - WK + Zub Ceramic
						13.0470-2880.2 LD2880	TRW 23914 17,1 + WE / - WK + Zub Ceramic
 Bremsscheibe							
1.4 TFSI	92	07/16→	←	+PR 1LJ,1ZD		24.0125-0158.1 425158	Ø 312 25 22 V + S
2.0 TDI	88	03/15→				24.0325-0158.1 525158	Ø 312 25 22 V + S PD
2.0 TDI	110	11/14→					
2.0 TDI	135	05/15→	➡	+PR 1KU; + eFSB		24.0112-0210.1 412210	Ø 300 12 10 + S
2.0 TDI quattro	110	11/14→					
2.0 TDI quattro	135	11/14→					
2.0 TFSI	132	05/15→					
2.0 TFSI quattro	132	11/14→					
2.0 TFSI quattro	162	11/14→					
1.4 TFSI	110	10/13→	←	+PR 1LJ,1ZD		24.0125-0158.1 425158	Ø 312 25 22 V + S
2.0 TDI	100	09/11→				24.0325-0158.1 525158	Ø 312 25 22 V + S PD
2.0 TDI	103	09/11→					
2.0 TDI	130	05/13→	➡	+PR 1KU		24.0112-0169.1 412169	Ø 282 12 10 + S
2.0 TDI quattro	103	01/12→				24.0312-0169.1 512169	Ø 282 12 10 + S PD
2.0 TDI quattro	120	06/11→					
2.0 TDI quattro	130	06/11→					
2.0 TFSI quattro	125	06/11→					
2.0 TFSI quattro	155	06/11→					
RS 2.5 quattro	228	10/13→	➡	+PR 2EA,2EJ; + eFSB		24.0122-0219.1 422219	Ø 310 22 20 V
RS performance 2.5 quattro	270	01/15→					
RS 2.5 quattro	250	05/13→	➡	03/15→; +PR 2EA,2EJ; + eFSB		24.0122-0219.1 422219	Ø 310 22 20 V
AUDI - Q5 (8R) 11/08→							
 Bremsbelagsatz, Scheibenbremse							
2.0 TDI	100	11/10→	←	+PR 1LJ		13.0460-2765.2 602765	TRW 24409 19,2 + WK + Zub
2.0 TDI	105	11/10→				13.0470-2765.2 LD2765	TRW 24409 19,2 + WK + Zub Ceramic
2.0 TDI	110	05/13→					
2.0 TDI quattro	100	08/09→					
2.0 TDI quattro	105	08/09→	←	+PR 1LA,1ZB,1ZT		13.0460-2765.2 602765	TRW 24409 19,2 + WK + Zub
2.0 TDI quattro	110	05/13→				13.0470-2765.2 LD2765	TRW 24409 19,2 + WK + Zub Ceramic
2.0 TDI quattro	140	11/13→					
2.0 TFSI hybrid quattro	155	06/11→	←	+PR 1LB,1LC,1LE,1LP		13.0460-4879.2 604879	BRE 25643 16,8 + WE / - WK
2.0 TFSI quattro	132	08/09→				13.0470-4879.2 LD4879	BRE 25643 17,0 + WE / - WK Ceramic
2.0 TFSI quattro	162	05/13→					
2.0 TFSI quattro	169	08/15→					
3.0 TDI quattro	190	11/13→	➡	+PR 1KW,2EK; + eFSB		13.0460-2747.2 602747	TRW 24606 17,4 - WE / - WK + Zub
						13.0470-2747.2 LD2747	TRW 24606 17,4 - WE / - WK + Zub Ceramic
			➡	+PR 1KE,2EL; + eFSB		13.0460-2748.2 602748	TRW 24606 17,4 - WE / - WK + Zub
						13.0470-2748.2 LD2748	TRW 24606 17,4 - WE / - WK + Zub Ceramic
2.0 TDI	140	09/15→	←	+PR 1LJ		13.0460-2765.2 602765	TRW 24409 19,2 + WK + Zub
						13.0470-2765.2 LD2765	TRW 24409 19,2 + WK + Zub Ceramic
			←	+PR 1LA,1ZB,1ZT		13.0460-2765.2 602765	TRW 24409 19,2 + WK + Zub
						13.0470-2765.2 LD2765	TRW 24409 19,2 + WK + Zub Ceramic
			←	+PR 1LB,1LC,1LE,1LP		13.0460-4879.2 604879	BRE 25643 16,8 + WE / - WK
						13.0470-4879.2 LD4879	BRE 25643 17,0 + WE / - WK Ceramic
			➡	+PR 1KW,2EK; + eFSB		13.0460-2747.2 602747	TRW 24606 17,4 - WE / - WK + Zub
						13.0470-2747.2 LD2747	TRW 24606 17,4 - WE / - WK + Zub Ceramic
			➡	+PR 1KF,2EJ; + eFSB		13.0460-2748.2 602748	TRW 24606 17,4 - WE / - WK + Zub
						13.0470-2748.2 LD2748	TRW 24606 17,4 - WE / - WK + Zub Ceramic
2.0 TDI quattro	120	11/08→	←	03/09→; +PR 1LA,1ZB,1ZT		13.0460-2765.2 602765	TRW 24409 19,2 + WK + Zub
2.0 TDI quattro	125	11/08→				13.0470-2765.2 LD2765	TRW 24409 19,2 + WK + Zub Ceramic
2.0 TFSI quattro	155	11/08→					











	kW			 	! #		
AUDI - Q5 (8R) 11/08→							
 Bremsbelagsatz, Scheibenbremse							
3.0 TDI quattro	155	11/08→	←	+PR 1LJ		13.0460-2765.2 602765	TRW 24409 19,2 + WK + Zub
3.0 TDI quattro	176	11/08→				13.0470-2765.2 LD2765	TRW 24409 19,2 + WK + Zub Ceramic
3.2 FSI quattro	199	11/08→	←	03/09→; +PR 1LB,1LC,1LE,1LP		13.0460-4879.2 604879	BRE 25643 16,8 + WE / - WK
						13.0470-4879.2 LD4879	BRE 25643 17,0 + WE / - WK Ceramic
			→	03/09→; +PR 1KW,2EK; + eFSB		13.0460-2747.2 602747	TRW 24606 17,4 - WE / - WK + Zub
						13.0470-2747.2 LD2747	TRW 24606 17,4 - WE / - WK + Zub Ceramic
			→	03/09→; +PR 1KE,2EL; + eFSB		13.0460-2748.2 602748	TRW 24606 17,4 - WE / - WK + Zub
						13.0470-2748.2 LD2748	TRW 24606 17,4 - WE / - WK + Zub Ceramic
2.0 TDI quattro	130	06/12→	←	09/12→; +PR 1LA,1ZB,1ZT		13.0460-2765.2 602765	TRW 24409 19,2 + WK + Zub
2.0 TFSI quattro	165	06/12→				13.0470-2765.2 LD2765	TRW 24409 19,2 + WK + Zub Ceramic
3.0 TDI quattro	180	06/12→					
3.0 TDI quattro	184	06/12→	←	09/12→; +PR 1LJ		13.0460-2765.2 602765	TRW 24409 19,2 + WK + Zub
3.0 TFSI quattro	200	06/12→				13.0470-2765.2 LD2765	TRW 24409 19,2 + WK + Zub Ceramic
			←	09/12→; +PR 1LB,1LC,1LE,1LP		13.0460-4879.2 604879	BRE 25643 16,8 + WE / - WK
						13.0470-4879.2 LD4879	BRE 25643 17,0 + WE / - WK Ceramic
			→	09/12→; +PR 1KW,2EK; + eFSB		13.0460-2747.2 602747	TRW 24606 17,4 - WE / - WK + Zub
						13.0470-2747.2 LD2747	TRW 24606 17,4 - WE / - WK + Zub Ceramic
			→	09/12→; +PR 1KE,2EL; + eFSB		13.0460-2748.2 602748	TRW 24606 17,4 - WE / - WK + Zub
						13.0470-2748.2 LD2748	TRW 24606 17,4 - WE / - WK + Zub Ceramic
SQ5 TDI quattro	230	12/12→	←	+PR 1LV,1ZK		13.0460-7281.2 607281	ATE 25160 20,3 + WK
SQ5 TDI quattro	240	04/15→					
SQ5 TDI quattro	250	11/15→	→	+PR 1KF,2EJ; + eFSB		13.0460-2748.2 602748	TRW 24606 17,4 - WE / - WK + Zub
SQ5 TFSI quattro	260	05/13→				13.0470-2748.2 LD2748	TRW 24606 17,4 - WE / - WK + Zub Ceramic
Warnkontakt, Bremsbelagverschleiß							
2.0 TDI	100	11/10→	←	☐; +PR 1LB,1LC,1LE,1LP	1	24.8190-0068.2 620068	L= 332
2.0 TDI	105	11/10→					
2.0 TDI	110	05/13→	←	☐; +PR 1LA,1ZB,1ZT	1	24.8190-0311.2 620311	L= 300
2.0 TDI	140	09/15→					
2.0 TDI quattro	100	08/09→					
2.0 TDI quattro	105	08/09→					
2.0 TDI quattro	110	05/13→					
2.0 TDI quattro	140	11/13→					
2.0 TFSI hybrid quattro	155	06/11→					
2.0 TFSI quattro	132	08/09→					
2.0 TFSI quattro	162	05/13→					
2.0 TFSI quattro	169	08/15→					
3.0 TDI quattro	190	11/13→					
2.0 TDI quattro	120	11/08→	←	☐; 03/09→; +PR 1LB,1LC,1LE,1LP	1	24.8190-0068.2 620068	L= 332
2.0 TDI quattro	125	11/08→					
2.0 TFSI quattro	155	11/08→	←	☐; 03/09→; +PR 1LA,1ZB,1ZT	1	24.8190-0311.2 620311	L= 300
3.0 TDI quattro	155	11/08→					
3.0 TDI quattro	176	11/08→					
3.2 FSI quattro	199	11/08→					
2.0 TDI quattro	130	06/12→	←	☐; 09/12→; +PR 1LB,1LC,1LE,1LP	1	24.8190-0068.2 620068	L= 332
2.0 TFSI quattro	165	06/12→					
3.0 TDI quattro	180	06/12→	←	☐; 09/12→; +PR 1LA,1ZB,1ZT	1	24.8190-0311.2 620311	L= 300
3.0 TDI quattro	184	06/12→					
3.0 TFSI quattro	200	06/12→					
SQ5 TDI quattro	230	12/12→	←	☐; +PR 1LV,1ZK	1	24.8190-0301.2 620301	L= 311,6
SQ5 TDI quattro	240	04/15→					
SQ5 TDI quattro	250	11/15→					
SQ5 TFSI quattro	260	05/13→					
 Bremsscheibe							
2.0 TDI	100	11/10→	←	→ 06/11; +PR 1LJ		24.0129-0102.1 429102	Ø 345 29,5 28 V + S
2.0 TDI	105	11/10→					
2.0 TFSI hybrid quattro	155	06/11→	←	→ 06/11; +PR 1LA		24.0130-0193.1 430193	Ø 320 30 28 V + S
						24.0330-0193.1 530193	Ø 320 30 28 V + S PD
			←	+PR 1ZB		24.0130-0221.1 430221	Ø 320 30 28 V + S
↓							











	kw			 	! #		
AUDI - Q5 (8R) 11/08→							
Bremsscheibe							
2.0 TDI	100	11/10→	←	07/11→; +PR 1LA		24.0130-0221.1 430221	Ø 320 30 28 V + S
2.0 TDI	105	11/10→	←	+PR 1LE,1LP,1ZT		24.0130-0222.1 430222	Ø 345 30 28 V + S
2.0 TFSI hybrid quattro	155	06/11→	←	07/11→; +PR 1LJ		24.0130-0222.1 430222	Ø 345 30 28 V + S
			→	+PR 1KW,2EK		24.0112-0178.1 412178	Ø 300 12 10 + S
						24.0312-0178.1 512178	Ø 300 12 10 + S PD
			→	+PR 1KE,2EL; + eFSB		24.0122-0272.1 422272	Ø 330 21,9 20 V + S
2.0 TDI	110	05/13→	←	+PR 1LA		24.0130-0221.1 430221	Ø 320 30 28 V + S
2.0 TDI quattro	110	05/13→	←	+PR 1ZB		24.0130-0221.1 430221	Ø 320 30 28 V + S
2.0 TDI quattro	140	11/13→	←	+PR 1ZB		24.0130-0221.1 430221	Ø 320 30 28 V + S
2.0 TFSI quattro	162	05/13→	←	+PR 1LE,1LP,1ZT		24.0130-0222.1 430222	Ø 345 30 28 V + S
2.0 TFSI quattro	169	08/15→	←	+PR 1LE,1LP,1ZT		24.0130-0222.1 430222	Ø 345 30 28 V + S
3.0 TDI quattro	190	11/13→	←	+PR 1LJ		24.0130-0222.1 430222	Ø 345 30 28 V + S
			→	+PR 1KW,2EK		24.0112-0178.1 412178	Ø 300 12 10 + S
						24.0312-0178.1 512178	Ø 300 12 10 + S PD
			→	+PR 1KE,2EL; + eFSB		24.0122-0272.1 422272	Ø 330 21,9 20 V + S
2.0 TDI	140	09/15→	←	+PR 1LA		24.0130-0221.1 430221	Ø 320 30 28 V + S
			←	+PR 1ZB		24.0130-0221.1 430221	Ø 320 30 28 V + S
			←	+PR 1LE,1LP,1ZT		24.0130-0222.1 430222	Ø 345 30 28 V + S
			←	+PR 1LJ		24.0130-0222.1 430222	Ø 345 30 28 V + S
			→	+PR 11KW,2EK		24.0112-0178.1 412178	Ø 300 12 10 + S
						24.0312-0178.1 512178	Ø 300 12 10 + S PD
			→	+PR 1KE,2EL; + eFSB		24.0122-0272.1 422272	Ø 330 21,9 20 V + S
2.0 TDI quattro	100	08/09→	←	→ 06/11; +PR 1LJ		24.0129-0102.1 429102	Ø 345 29,5 28 V + S
2.0 TDI quattro	105	08/09→	←	→ 06/11; +PR 1LA		24.0130-0193.1 430193	Ø 320 30 28 V + S
						24.0330-0193.1 530193	Ø 320 30 28 V + S PD
			←	+PR 1ZB		24.0130-0221.1 430221	Ø 320 30 28 V + S
			←	07/11→; +PR 1LA		24.0130-0221.1 430221	Ø 320 30 28 V + S
			←	+PR 1LE,1LP,1ZT		24.0130-0222.1 430222	Ø 345 30 28 V + S
			←	+PR 1LJ		24.0130-0222.1 430222	Ø 345 30 28 V + S
			→	+PR 1KW,2EK		24.0112-0178.1 412178	Ø 300 12 10 + S
						24.0312-0178.1 512178	Ø 300 12 10 + S PD
			→	→ 10/10; +PR 1KE; + eFSB		24.0122-0272.1 422272	Ø 330 21,9 20 V + S
			→	11/10→; +PR 1KE,2EL; + eFSB		24.0122-0272.1 422272	Ø 330 21,9 20 V + S
2.0 TDI quattro	120	11/08→	←	03/09→ 06/11; +PR 1LJ		24.0129-0102.1 429102	Ø 345 29,5 28 V + S
2.0 TDI quattro	125	11/08→	←	03/09→ 06/11; +PR 1LA		24.0130-0193.1 430193	Ø 320 30 28 V + S
2.0 TFSI quattro	155	11/08→	←	03/09→ 06/11; +PR 1LA		24.0130-0193.1 430193	Ø 320 30 28 V + S
3.0 TDI quattro	155	11/08→	←	07/11→; +PR 1LA		24.0330-0193.1 530193	Ø 320 30 28 V + S PD
3.0 TDI quattro	176	11/08→	←	07/11→; +PR 1LA		24.0130-0221.1 430221	Ø 320 30 28 V + S
3.2 FSI quattro	199	11/08→	←	03/09→; +PR 1ZB		24.0130-0221.1 430221	Ø 320 30 28 V + S
			←	03/09→; +PR 1LE,1LP,1ZT		24.0130-0222.1 430222	Ø 345 30 28 V + S
			←	07/11→; +PR 1LJ		24.0130-0222.1 430222	Ø 345 30 28 V + S
			→	03/09→; +PR 1KW,2EK		24.0112-0178.1 412178	Ø 300 12 10 + S
						24.0312-0178.1 512178	Ø 300 12 10 + S PD
			→	11/10→; +PR 1KE,2EL; + eFSB		24.0122-0272.1 422272	Ø 330 21,9 20 V + S
			→	03/09→ 10/10; +PR 1KE; + eFSB		24.0122-0272.1 422272	Ø 330 21,9 20 V + S
2.0 TDI quattro	130	06/12→	←	09/12→; +PR 1ZB		24.0130-0221.1 430221	Ø 320 30 28 V + S
2.0 TFSI quattro	165	06/12→	←	09/12→; +PR 1LA		24.0130-0221.1 430221	Ø 320 30 28 V + S
3.0 TDI quattro	180	06/12→	←	09/12→; +PR 1LA		24.0130-0221.1 430221	Ø 320 30 28 V + S
3.0 TDI quattro	184	06/12→	←	09/12→; +PR 1LE,1LP,1ZT		24.0130-0222.1 430222	Ø 345 30 28 V + S
3.0 TFSI quattro	200	06/12→	←	09/12→; +PR 1LJ		24.0130-0222.1 430222	Ø 345 30 28 V + S
			→	09/12→; +PR 1KW,2EK		24.0112-0178.1 412178	Ø 300 12 10 + S
						24.0312-0178.1 512178	Ø 300 12 10 + S PD
			→	09/12→; +PR 1KE,2EL; + eFSB		24.0122-0272.1 422272	Ø 330 21,9 20 V + S
2.0 TFSI quattro	132	08/09→	←	→ 06/11; +PR 1LJ		24.0129-0102.1 429102	Ø 345 29,5 28 V + S
			←	→ 06/11; +PR 1LA		24.0130-0193.1 430193	Ø 320 30 28 V + S
						24.0330-0193.1 530193	Ø 320 30 28 V + S PD
			←	+PR 1ZB		24.0130-0221.1 430221	Ø 320 30 28 V + S
			←	07/11→; +PR 1LA		24.0130-0221.1 430221	Ø 320 30 28 V + S
			←	+PR 1LE,1LP,1ZT		24.0130-0222.1 430222	Ø 345 30 28 V + S









	kw			 	! #		
AUDI - Q5 (8R) 11/08→							
 Bremsscheibe							
2.0 TFSI quattro	132	08/09→	←	07/11→; +PR 1LJ		24.0130-0222.1 430222	Ø 345 30 28 V + S
			→	+PR 1KW,2EK		24.0112-0178.1 412178	Ø 300 12 10 + S
			→	→ 10/10; +PR 1KE; + eFSB		24.0312-0178.1 512178	Ø 300 12 10 + S PD
			→	→ 10/10; +PR 1KE; + eFSB		24.0122-0272.1 422272	Ø 330 21,9 20 V + S
			→	11/10→; +PR 1KE,2EL; + eFSB		24.0122-0272.1 422272	Ø 330 21,9 20 V + S
SQ5 TDI quattro	230	12/12→	→	+PR 1KF,2EJ; + eFSB		24.0122-0272.1 422272	Ø 330 21,9 20 V + S
SQ5 TDI quattro	240	04/15→					
SQ5 TDI quattro	250	11/15→					
SQ5 TFSI quattro	260	05/13→					
AUDI - Q7 (4L) 03/06→08/15							
 Bremsbelagsatz, Scheibenbremse							
3.0 TDI quattro	150	05/10→08/15	←	+PR 1LF		13.0460-4993.2 604993	BRE 23693 16,6 + WE / - WK
3.0 TDI quattro	155	03/06→05/10				13.0470-4993.2 LD4993	BRE 23693 16,6 + WE / - WK
3.0 TDI quattro	165	06/09→05/12					Ceramic
3.0 TDI quattro	171	03/06→05/08					
3.0 TDI quattro	176	11/07→08/15	→	+PR 1KD		13.0460-4850.2 604850	BRE 24296 15,5 + WE / - WK
3.0 TDI quattro	180	05/11→08/15				13.0470-4850.2 LD4850	BRE 24296 15,5 + WE / - WK
3.0 TFSI quattro	200	05/10→08/15					Ceramic
3.0 TFSI quattro	206	05/11→08/15	→	+PR 1KF,2EA		13.0460-4976.2 604976	BRE 23694 16,7 + WE / - WK
3.6 FSI quattro	206	08/06→05/10				13.0470-4976.2 LD4976	BRE 23694 16,4 + WE / - WK
							Ceramic
3.0 TFSI quattro	245	05/10→08/15	←	+PR 1LF		13.0460-4993.2 604993	BRE 23693 16,6 + WE / - WK
4.2 FSI quattro	257	03/06→05/10					
4.2 TDI quattro	240	03/07→06/09	→	+PR 1KD		13.0460-4850.2 604850	BRE 24296 15,5 + WE / - WK
4.2 TDI quattro	250	05/09→08/15				13.0470-4850.2 LD4850	BRE 24296 15,5 + WE / - WK
6.0 TDI quattro	368	09/08→05/14	→	+PR 1KF,2EA		13.0460-4976.2 604976	BRE 23694 16,7 + WE / - WK
						13.0470-4976.2 LD4976	BRE 23694 16,4 + WE / - WK
							Ceramic
Warnkontakt, Bremsbelagverschleiß							
3.0 TDI quattro	150	05/10→08/15	←	+PR 1LW	2	24.8190-0011.2 620011	L= 362,5
3.0 TDI quattro	155	03/06→05/10					
3.0 TDI quattro	165	06/09→05/12	←	+PR 1LF	2	24.8190-0929.2 620929	L= 417,4
3.0 TDI quattro	171	03/06→05/08	→	+PR 2EF	2	24.8190-0012.2 620012	L= 272,4
3.0 TDI quattro	176	11/07→08/15	→	+PR 1KF,2EA	2	24.8190-0930.2 620930	L= 252,4
3.0 TDI quattro	180	05/11→08/15	→	+PR 1KD	2	24.8190-0937.2 620937	L= 247,4
3.0 TFSI quattro	200	05/10→08/15					
3.0 TFSI quattro	206	05/11→08/15					
3.0 TFSI quattro	245	05/10→08/15					
3.6 FSI quattro	206	08/06→05/10					
4.2 FSI quattro	257	03/06→05/10					
4.2 TDI quattro	240	03/07→06/09					
4.2 TDI quattro	250	05/09→08/15					
6.0 TDI quattro	368	09/08→05/14					
 Bremsscheibe							
3.0 TDI quattro	150	05/10→08/15	←	☐; +PR 1LF		24.0134-0123.1 434123	Ø 350 34 32 V
3.0 TDI quattro	155	03/06→05/10	←	☐; +PR 1LF		24.0134-0124.1 434124	Ø 350 34 32 V
3.0 TDI quattro	165	06/09→05/12					
3.0 TDI quattro	171	03/06→05/08	→	+PR 1KF		24.0128-0149.1 428149	Ø 330 28 26 V + S
3.0 TDI quattro	176	11/07→08/15	→	+PR 1KD,2EA		24.0128-0169.1 428169	Ø 358 28 26 V
3.0 TDI quattro	180	05/11→08/15					
3.0 TFSI quattro	200	05/10→08/15					
3.0 TFSI quattro	206	05/11→08/15					
3.0 TFSI quattro	245	05/10→08/15					
3.6 FSI quattro	206	08/06→05/10					
4.2 FSI quattro	257	03/06→05/10					
4.2 TDI quattro	240	03/07→06/09					
4.2 TDI quattro	250	05/09→08/15					
6.0 TDI quattro	368	09/08→05/14					
AUDI - Q7 (4M) 01/15→							
 Bremsscheibe							
2.0 TFSI quattro	185	08/15→	←	+PR 1ZA,1ZK		24.0134-0110.1 430110	Ø 349 34 32 V + S
3.0 TDI e-tron quattro	190	08/15→	→	+PR 2ED,2EE; + eFSB		24.0122-0272.1 422272	Ø 330 21,9 20 V + S
3.0 TDI quattro	155	08/15→					
3.0 TDI quattro	160	05/15→	→	+PR 1KD,1KQ,1KU,1KW		24.0128-0296.1 428296	Ø 350 28 26 V + S
3.0 TDI quattro	183	06/15→					
3.0 TDI quattro	190	08/15→					
3.0 TDI quattro	200	06/15→					
SQ7 TDI quattro	320	04/16→					
3.0 TFSI quattro	245	01/15→	←	06/15→; +PR 1ZA,1ZK		24.0134-0110.1 430110	Ø 349 34 32 V + S
↓							

	kw			 	! #		
AUDI - Q7 (4M) 01/15→							
 Bremsscheibe							
3.0 TFSI quattro	245	01/15→	➔	06/15→; +PR 2ED,2EE; + eFSB		24.0122-0272.1 422272	Ø 330 21,9 20 V + S
			➔	06/15→; +PR 1KD,1KQ,1KU,1KW		24.0128-0296.1 428296	Ø 350 28 26 V + S
AUDI - R8 (422, 423) 04/07→07/15							
Warnkontakt, Bremsbelagverschleiß							
4.2 FSI quattro	309	04/07→09/10	←	+PR 1LE,1LW	1	24.8190-0017.2 620017	L= 388,3
4.2 FSI quattro	316	07/10→07/15					
5.2 FSI quattro	386	04/09→07/15					
5.2 FSI quattro	404	05/12→07/15					
5.2 FSI quattro	412	11/10→07/15					
5.2 FSI quattro	419	07/14→07/15					
AUDI - R8 Spyder (427, 429) 02/10→07/15							
Warnkontakt, Bremsbelagverschleiß							
4.2 FSI quattro	316	09/10→07/15	←	+PR 1LE,1LW	1	24.8190-0017.2 620017	L= 388,3
5.2 FSI quattro	386	02/10→07/15					
5.2 FSI quattro	412	11/11→07/15					
AUDI - TT (8J3) 08/06→06/14							
 Brembelagsatz, Scheibenbremse							
1.8 TFSI	118	06/08→06/14	←	+PR 1LJ,1LL		13.0460-7226.2 607226	ATE 23587 20,8 + WK
2.0 TFSI	147	08/06→06/10	←	+PR 1LJ,1LL		13.0470-7226.2 LD7226	ATE 23587 20,8 + WK Ceramic
			←	+PR 1LK,1LM,1LN		13.0460-7227.2 607227	ATE 23801 20,3 + WK
			←	+PR 1LK,1LM,1LN		13.0470-7227.2 LD7227	ATE 23912 20,3 + WK Ceramic
			➔	+PR 1KZ,2ED		13.0460-2749.2 602749	TRW 24483 16,9 - WE / - WK + Zub
						13.0460-2880.2 602880	TRW 23914 17,1 + WE / - WK + Zub
						13.0470-2749.2 LD2749	TRW 24483 16,9 - WE / - WK + Zub Ceramic
						13.0470-2880.2 LD2880	TRW 23914 17,1 + WE / - WK + Zub Ceramic
2.0 TDI quattro	125	06/08→06/14	←	+PR 1LJ,1LL		13.0460-7226.2 607226	ATE 23587 20,8 + WK
2.0 TFSI quattro	147	06/08→06/10	←	+PR 1LJ,1LL		13.0470-7226.2 LD7226	ATE 23587 20,8 + WK Ceramic
2.0 TTS quattro	195	05/08→06/14	←	+PR 1LK,1LM,1LN		13.0460-7227.2 607227	ATE 23801 20,3 + WK
			←	+PR 1LK,1LM,1LN		13.0470-7227.2 LD7227	ATE 23912 20,3 + WK Ceramic
			➔	+PR 1KJ,2EE		13.0460-2749.2 602749	TRW 24483 16,9 - WE / - WK + Zub
						13.0460-2880.2 602880	TRW 23914 17,1 + WE / - WK + Zub
						13.0470-2749.2 LD2749	TRW 24483 16,9 - WE / - WK + Zub Ceramic
						13.0470-2880.2 LD2880	TRW 23914 17,1 + WE / - WK + Zub Ceramic
2.0 TFSI	155	05/10→06/14	←	+PR 1LJ,1LL		13.0460-7226.2 607226	ATE 23587 20,8 + WK
			←	+PR 1LJ,1LL		13.0470-7226.2 LD7226	ATE 23587 20,8 + WK Ceramic
			←	+PR 1LK,1LM,1LN		13.0460-7227.2 607227	ATE 23801 20,3 + WK
			←	+PR 1LK,1LM,1LN		13.0470-7227.2 LD7227	ATE 23912 20,3 + WK Ceramic
			➔	+PR 1KZ,2ED		13.0460-2749.2 602749	TRW 24483 16,9 - WE / - WK + Zub
						13.0460-2880.2 602880	TRW 23914 17,1 + WE / - WK + Zub
						13.0470-2749.2 LD2749	TRW 24483 16,9 - WE / - WK + Zub Ceramic
						13.0470-2880.2 LD2880	TRW 23914 17,1 + WE / - WK + Zub Ceramic
2.0 TFSI quattro	155	05/10→06/14	←	+PR 1LJ,1LL		13.0460-7226.2 607226	ATE 23587 20,8 + WK
			←	+PR 1LJ,1LL		13.0470-7226.2 LD7226	ATE 23587 20,8 + WK Ceramic
			←	+PR 1LK,1LM,1LN		13.0460-7227.2 607227	ATE 23801 20,3 + WK
			←	+PR 1LK,1LM,1LN		13.0470-7227.2 LD7227	ATE 23912 20,3 + WK Ceramic
			➔	+PR 1KJ,2EE		13.0460-2749.2 602749	TRW 24483 16,9 - WE / - WK + Zub
						13.0460-2880.2 602880	TRW 23914 17,1 + WE / - WK + Zub
						13.0470-2749.2 LD2749	TRW 24483 16,9 - WE / - WK + Zub Ceramic
						13.0470-2880.2 LD2880	TRW 23914 17,1 + WE / - WK + Zub Ceramic
↓							

	kw			 	! #		
AUDI - TT (8J3) 08/06→06/14							
 Bremsbelagsatz, Scheibenbremse							
2.0 TTS quattro	200	05/08→06/14	←	+PR 1LN		13.0460-7227.2 607227	ATE 23801 20,3 + WK
			→	+PR 2ED,2EG		13.0470-7227.2 LD7227	ATE 23912 20,3 + WK Ceramic
			←	+PR 1LA		13.0460-2887.2 602887	TRW 23914 17,1 + WE / - WK + Zub
			→			13.0470-2887.2 LD2887	TRW 23914 17,1 + WE / - WK + Zub Ceramic
2.5 RS quattro 2.5 RS quattro	250 265	07/09→06/14 05/11→06/14	←	+PR 1LA		13.0460-4833.2 604833	BRE 24098 17,1 + WE / - WK
			→			13.0460-2887.2 602887	TRW 23914 17,1 + WE / - WK + Zub
3.2 V6 quattro	184	08/06→06/10	←	+PR 1LJ,1LL		13.0460-7226.2 607226	ATE 23587 20,8 + WK
			←	+PR 1LK,1LM,1LN		13.0470-7226.2 LD7226	ATE 23587 20,8 + WK Ceramic
			←	+PR 1LJ,1LL		13.0460-7227.2 607227	ATE 23801 20,3 + WK
			←	+PR 1LJ,1LL		13.0470-7227.2 LD7227	ATE 23912 20,3 + WK Ceramic
			→	+PR 1KJ,2EE		13.0460-2749.2 602749	TRW 24483 16,9 - WE / - WK + Zub
			→			13.0460-2880.2 602880	TRW 23914 17,1 + WE / - WK + Zub
			→			13.0470-2749.2 LD2749	TRW 24483 16,9 - WE / - WK + Zub Ceramic
			→			13.0470-2880.2 LD2880	TRW 23914 17,1 + WE / - WK + Zub Ceramic
			→	+PR 2EA,2EF		13.0460-2887.2 602887	TRW 23914 17,1 + WE / - WK + Zub
			→			13.0470-2887.2 LD2887	TRW 23914 17,1 + WE / - WK + Zub Ceramic
Warnkontakt, Bremsbelagverschleiß							
2.5 RS quattro 2.5 RS quattro	250 265	07/09→06/14 05/11→06/14	←	+PR 1LA	1	24.8190-0302.2 620302	L= 367,4
Zubehörsatz, Scheibenbremsbelag							
1.8 TFSI 2.0 TFSI	118 147	06/08→06/14 08/06→06/10	→	+PR 1KZ,2ED		13.0460-0259.2 610259	
2.0 TDI quattro 2.0 TFSI quattro 2.0 TTS quattro 3.2 V6 quattro	125 147 195 184	06/08→06/14 06/08→06/10 05/08→06/14 08/06→06/10	→	+PR 1KJ,2EE		13.0460-0259.2 610259	
2.0 TFSI	155	05/10→06/14	→	+PR 1KZ,2ED		13.0460-0259.2 610259	
2.0 TFSI quattro	155	05/10→06/14	→	+PR 1KJ,2EE		13.0460-0259.2 610259	
 Bremsscheibe							
1.8 TFSI 2.0 TFSI	118 147	06/08→06/14 08/06→06/10	←	+PR 1LJ,1LL		24.0125-0158.1 425158	Ø 312 25 22 V + S
			←	+PR 1LK,1LM		24.0325-0158.1 525158	Ø 312 25 22 V + S PD
			→	+PR 1KZ,2ED		24.0130-0219.1 430219	Ø 340 30 28 V + S
			→	+PR 1KJ,2EE		24.0112-0175.1 412175	Ø 286 12 10 + S
2.0 TDI quattro 2.0 TFSI quattro 2.0 TTS quattro	125 147 195	06/08→06/14 06/08→06/10 05/08→06/14	←	+PR 1LJ,1LL		24.0125-0158.1 425158	Ø 312 25 22 V + S
			←	+PR 1LK,1LM		24.0325-0158.1 525158	Ø 312 25 22 V + S PD
			←	+PR 1LK,1LM		24.0130-0219.1 430219	Ø 340 30 28 V + S
			→	+PR 1KJ,2EE		24.0112-0175.1 412175	Ø 286 12 10 + S
2.0 TFSI	155	05/10→06/14	←	+PR 1LJ,1LL		24.0125-0158.1 425158	Ø 312 25 22 V + S
			←	+PR 1LK,1LM		24.0325-0158.1 525158	Ø 312 25 22 V + S PD
			→	+PR 1KZ,2ED		24.0130-0219.1 430219	Ø 340 30 28 V + S
			→	+PR 1KJ,2EE		24.0112-0175.1 412175	Ø 286 12 10 + S
2.0 TFSI quattro	155	05/10→06/14	←	+PR 1LJ,1LL		24.0125-0158.1 425158	Ø 312 25 22 V + S
			←	+PR 1LK,1LM		24.0325-0158.1 525158	Ø 312 25 22 V + S PD
			→	+PR 1KJ,2EE		24.0130-0219.1 430219	Ø 340 30 28 V + S
			→	+PR 1KZ,2ED		24.0112-0175.1 412175	Ø 286 12 10 + S
2.0 TTS quattro	200	05/08→06/14	←	+PR 1LK,1LM		24.0130-0219.1 430219	Ø 340 30 28 V + S
			←	+PR 1LN		24.0130-0219.1 430219	Ø 340 30 28 V + S
			→	+PR 2ED,2EG		24.0122-0242.1 422242	Ø 310 22 20 V + S
2.5 RS quattro 2.5 RS quattro	250 265	07/09→06/14 05/11→06/14	→			24.0122-0242.1 422242	Ø 310 22 20 V + S
3.2 V6 quattro	184	08/06→06/10	←	+PR 1LJ,1LL		24.0125-0158.1 425158	Ø 312 25 22 V + S
			←			24.0325-0158.1 525158	Ø 312 25 22 V + S PD
↓							

	kw			 	! #			
AUDI - TT (8J3) 08/06→06/14								
 Bremsscheibe								
3.2 V6 quattro	184	08/06→06/10	←	+PR 1LK;1LM	24.0130-0219.1	430219	Ø 340 30 28 V + S	
			→	+PR 1KJ;2EE	24.0112-0175.1	412175	Ø 286 12 10 + S	
			→	+PR 2EA;2EF	24.0122-0242.1	422242	Ø 310 22 20 V + S	
AUDI - TT (8N3) 10/98→06/06								
 Bremsbelagsatz, Scheibenbremse								
1.8 T 1.8 T 1.8 T 1.8 T	110 120 132 140	09/02→06/06 09/05→06/06 10/98→06/06 09/05→06/06	←	+PR 1LD,1LT,1LV	13.0460-7081.2	607081	ATE 20676 19,8 - WE / - WK	
					13.0460-7122.2	607122	ATE 20676 19,8 + WK	
					13.0470-7081.2	LD7081	ATE 20676 19,8 - WE / - WK Ceramic	
					13.0470-7122.2	LD7122	ATE 20676 19,8 + WK Ceramic	
			←	+PR 1LV	13.0460-7122.2	607122	ATE 20676 19,8 + WK	
					13.0470-7122.2	LD7122	ATE 20676 19,8 + WK Ceramic	
			→	+PR 1KE,1KK,2EK	13.0460-2894.2	602894	TRW 20961 17,2 - WK + Zub	
					13.0470-2894.2	LD2894	TRW 20961 17,2 - WK + Zub Ceramic	
1.8 T quattro 1.8 T quattro 1.8 T quattro 1.8 T quattro	132 140 165 176	10/98→06/06 09/05→06/06 10/98→06/06 03/05→06/06	←	+PR 1LD,1LT,1LV	13.0460-7081.2	607081	ATE 20676 19,8 - WE / - WK	
					13.0460-7122.2	607122	ATE 20676 19,8 + WK	
					13.0470-7081.2	LD7081	ATE 20676 19,8 - WE / - WK Ceramic	
					13.0470-7122.2	LD7122	ATE 20676 19,8 + WK Ceramic	
			←	+PR 1LV	13.0460-7122.2	607122	ATE 20676 19,8 + WK	
					13.0470-7122.2	LD7122	ATE 20676 19,8 + WK Ceramic	
			→	+PR 1KF,2EH	13.0460-2820.2	602820	TRW 20961 17,2 - WK	
					13.0470-2820.2	LD2820	TRW 20961 17,2 - WK Ceramic	
			→	+PR 1KE,1KK	13.0460-2894.2	602894	TRW 20961 17,2 - WK + Zub	
					13.0470-2894.2	LD2894	TRW 20961 17,2 - WK + Zub Ceramic	
3.2 VR6 quattro	184	07/03→06/06	←		13.0460-7183.2	607183	ATE 21484 20,5 + WE / - WK	
			→	+PR 1KF,2EH	13.0460-2820.2	602820	TRW 20961 17,2 - WK	
			→	+PR 1KE,1KK	13.0460-2894.2	602894	TRW 20961 17,2 - WK + Zub	
					13.0470-2820.2	LD2820	TRW 20961 17,2 - WK Ceramic	
					13.0470-2894.2	LD2894	TRW 20961 17,2 - WK + Zub Ceramic	
Warnkontakt, Bremsbelagverschleiß								
3.2 VR6 quattro	184	07/03→06/06	←		1	24.8190-0106.2	620106 L= 270	
Zubehörsatz, Scheibenbremsbelag								
1.8 T 1.8 T 1.8 T 1.8 T	110 120 132 140	09/02→06/06 09/05→06/06 10/98→06/06 09/05→06/06	→	+PR 1KE,1KK,2EK	13.0460-0072.2	610072	TRW	
1.8 T quattro 1.8 T quattro 1.8 T quattro 1.8 T quattro	132 140 165 176	10/98→06/06 09/05→06/06 10/98→06/06 03/05→06/06	→	+PR 1KE,1KK	13.0460-0072.2	610072	TRW	
3.2 VR6 quattro	184	07/03→06/06						
 Bremsscheibe								
1.8 T 1.8 T 1.8 T 1.8 T	110 120 132 140	09/02→06/06 09/05→06/06 10/98→06/06 09/05→06/06	←	+PR 1LD,1LT,1LV	24.0125-0123.1	425123	Ø 310 25 22 V + S	
					24.0325-0123.1	525123	Ø 310 25 22 V PD	
			→	+PR 1KK,2EK	24.0109-0123.1	409123	Ø 230 9 7 + S	
					24.0309-0123.1	509123	Ø 230 9 7 + S PD	
1.8 T quattro 1.8 T quattro 1.8 T quattro	132 165 176	10/98→06/06 10/98→06/06 03/05→06/06	←	+PR 1LD,1LT,1LV	24.0125-0123.1	425123	Ø 310 25 22 V + S	
					24.0325-0123.1	525123	Ø 310 25 22 V PD	
			→	+PR 1KE	24.0109-0133.1	409133	Ø 239 8,9 7 + S	
					24.0309-0133.1	509133	Ø 239 8,9 7 + S PD	
			→	+PR 1KF,2EH	24.0122-0163.1	422163	Ø 256 22 20 V	
					24.0322-0163.1	522163	Ø 256 22 20 V PD	
1.8 T quattro	140	09/05→06/06	←	+PR 1LD,1LT,1LV	24.0125-0123.1	425123	Ø 310 25 22 V + S	
					24.0325-0123.1	525123	Ø 310 25 22 V PD	
			→	+PR 1KE	24.0109-0133.1	409133	Ø 239 8,9 7 + S	
					24.0309-0133.1	509133	Ø 239 8,9 7 + S PD	
			→	+PR 1KF;2EH	24.0122-0163.1	422163	Ø 256 22 20 V	

	kW					! #			
AUDI - TT (8N3) 10/98→06/06									
 Bremsscheibe									
1.8 T quattro	140	09/05→06/06	➡	+PR 1KF,2EH		24.0322-0163.1	522163	Ø 256 22 20 V PD	
3.2 VR6 quattro	184	07/03→06/06	←	☐		24.0132-0165.2	432165	Ø 334 32 30 V Bremsscheibe zweiteilig	
			←	☐		24.0132-0166.2	432166	Ø 334 32 30 V Bremsscheibe zweiteilig	
			➡	+PR 1KE		24.0109-0133.1	409133	Ø 239 8,9 7 + S	
						24.0309-0133.1	509133	Ø 239 8,9 7 + S PD	
			➡	+PR 1KF,2EH		24.0122-0163.1	422163	Ø 256 22 20 V	
					24.0322-0163.1	522163	Ø 256 22 20 V PD		
AUDI - TT (FV3) 07/14→									
 Bremselagsatz, Scheibenbremse									
1.8 TFSI 2.0 TDI 2.0 TDI quattro 2.0 TFSI 2.0 TFSI quattro 2.0 TFSI quattro 2.0 TTS quattro	132 135 135 169 162 169 210	08/15→ 07/14→ 01/17→ 07/14→ 04/15→ 07/14→ 02/15→	←	+PR 1LJ,1ZD		13.0460-2785.2	602785	TRW 25683 20,4 + WE / + WK	
						13.0470-2785.2	LD2785	TRW 25683 20,4 + WE / + WK Ceramic	
			➡	+PR 1KZ; + eFSB		13.0460-7293.2	607293	ATE 25008 16,3 - WE / - WK	
						13.0470-7293.2	LD7293	ATE 25008 16,3 - WE / - WK Ceramic	
			➡	+PR 2ED,2EG,2EK; + eFSB		13.0460-7294.2	607294	ATE 25009 16,4 - WE / - WK	
						13.0470-7294.2	LD7294	ATE 25009 16,4 - WE / - WK Ceramic	
2.0 TTS quattro	228	11/14→	←	+PR 1LJ,1ZD		13.0460-2785.2	602785	TRW 25683 20,4 + WE / + WK	
			➡	+PR 1KZ; + eFSB		13.0460-7293.2	607293	ATE 25008 16,3 - WE / - WK	
						13.0470-7293.2	LD7293	ATE 25008 16,3 - WE / - WK Ceramic	
			➡	+PR 2ED,2EG,2EK; + eFSB		13.0460-7294.2	607294	ATE 25009 16,4 - WE / - WK	
						13.0470-7294.2	LD7294	ATE 25009 16,4 - WE / - WK Ceramic	
2.5 RS quattro	294	10/16→	➡	+PR 2EE; + eFSB		13.0460-7294.2	607294	ATE 25009 16,4 - WE / - WK	
						13.0470-7294.2	LD7294	ATE 25009 16,4 - WE / - WK Ceramic	
Warnkontakt, Bremsbelagverschleiß									
1.8 TFSI 2.0 TDI 2.0 TDI quattro 2.0 TFSI 2.0 TFSI quattro 2.0 TFSI quattro 2.0 TTS quattro 2.0 TTS quattro	132 135 135 169 162 169 210 228	08/15→ 07/14→ 01/17→ 07/14→ 04/15→ 07/14→ 02/15→ 11/14→	←	+PR 1LJ,1ZD	1	24.8190-0065.2	620065	L= 172	
 Bremsscheibe									
1.8 TFSI 2.0 TDI 2.0 TDI quattro 2.0 TFSI 2.0 TFSI quattro 2.0 TFSI quattro 2.0 TTS quattro 2.0 TTS quattro	132 135 135 169 162 169 210 228	08/15→ 07/14→ 01/17→ 07/14→ 04/15→ 07/14→ 02/15→ 11/14→	←	+PR 1LJ,1ZD		24.0125-0158.1	425158	Ø 312 25 22 V + S	
						24.0325-0158.1	525158	Ø 312 25 22 V + S PD	
			←	+PR 1LK,1LH		24.0130-0225.1	430225	Ø 340 30 27 V + S	
			➡	+PR 1KZ		24.0110-0356.1	410356	Ø 272 9,7 8 + S	
						24.0310-0356.1	510356	Ø 272 9,7 8 + S PD	
			➡	+PR 2ED; + eFSB		24.0112-0210.1	412210	Ø 300 12 10 + S	
			➡	+PR 2EG,2EK		24.0122-0219.1	422219	Ø 310 22 20 V	
						24.0122-0219.1	422219	Ø 310 22 20 V	
2.5 RS quattro	294	10/16→	➡	+PR 1KX,2EE		24.0122-0219.1	422219	Ø 310 22 20 V	
AUDI - TT Roadster (8J9) 03/07→06/14									
 Bremselagsatz, Scheibenbremse									
1.8 TFSI 2.0 TFSI	118 147	06/08→06/14 03/07→06/10	←	+PR 1LJ,1LL		13.0460-7226.2	607226	ATE 23587 20,8 + WK	
						13.0470-7226.2	LD7226	ATE 23587 20,8 + WK Ceramic	
			←	+PR 1LK,1LM,1LN		13.0460-7227.2	607227	ATE 23801 20,3 + WK	
						13.0470-7227.2	LD7227	ATE 23912 20,3 + WK Ceramic	
			➡	+PR 1KZ,2ED		13.0460-2749.2	602749	TRW 24483 16,9 - WE / - WK + Zub	
						13.0460-2880.2	602880	TRW 23914 17,1 + WE / - WK + Zub	
						13.0470-2749.2	LD2749	TRW 24483 16,9 - WE / - WK + Zub Ceramic	
						13.0470-2880.2	LD2880	TRW 23914 17,1 + WE / - WK + Zub Ceramic	
↓									

	kw			 	! #		
AUDI - TT Roadster (8J9) 03/07→06/14							
 Bremsbelagsatz, Scheibenbremse							
2.0 TDI quattro 2.0 TFSI quattro 2.0 TTS quattro	125	06/08→06/14	←	+PR 1LJ;1LL		13.0460-7226.2 607226	ATE 23587 20,8 + WK
	147	06/08→06/10				13.0470-7226.2 LD7226	ATE 23587 20,8 + WK Ceramic
	195	05/08→06/14	←	+PR 1LK,1LM,1LN		13.0460-7227.2 607227	ATE 23801 20,3 + WK
			→	+PR 1KJ,2EE		13.0460-2749.2 602749	TRW 24483 16,9 - WE / - WK + Zub
						13.0460-2880.2 602880	TRW 23914 17,1 + WE / - WK + Zub
						13.0470-2749.2 LD2749	TRW 24483 16,9 - WE / - WK + Zub Ceramic
						13.0470-2880.2 LD2880	TRW 23914 17,1 + WE / - WK + Zub Ceramic
2.0 TFSI	155	05/10→06/14	←	+PR 1LJ,1LL		13.0460-7226.2 607226	ATE 23587 20,8 + WK
						13.0470-7226.2 LD7226	ATE 23587 20,8 + WK Ceramic
			←	+PR 1LK,1LM,1LN		13.0460-7227.2 607227	ATE 23801 20,3 + WK
						13.0470-7227.2 LD7227	ATE 23912 20,3 + WK Ceramic
			→	+PR 1KZ,2ED		13.0460-2749.2 602749	TRW 24483 16,9 - WE / - WK + Zub
						13.0460-2880.2 602880	TRW 23914 17,1 + WE / - WK + Zub
						13.0470-2749.2 LD2749	TRW 24483 16,9 - WE / - WK + Zub Ceramic
						13.0470-2880.2 LD2880	TRW 23914 17,1 + WE / - WK + Zub Ceramic
2.0 TFSI quattro	155	05/10→06/14	←	+PR 1LJ,1LL		13.0460-7226.2 607226	ATE 23587 20,8 + WK
						13.0470-7226.2 LD7226	ATE 23587 20,8 + WK Ceramic
			←	+PR 1LK,1LM,1LN		13.0460-7227.2 607227	ATE 23801 20,3 + WK
						13.0470-7227.2 LD7227	ATE 23912 20,3 + WK Ceramic
			→	+PR 1KJ,2EE		13.0460-2749.2 602749	TRW 24483 16,9 - WE / - WK + Zub
						13.0460-2880.2 602880	TRW 23914 17,1 + WE / - WK + Zub
						13.0470-2749.2 LD2749	TRW 24483 16,9 - WE / - WK + Zub Ceramic
						13.0470-2880.2 LD2880	TRW 23914 17,1 + WE / - WK + Zub Ceramic
2.0 TTS quattro	200	05/08→06/14	←	+PR 1LN		13.0460-7227.2 607227	ATE 23801 20,3 + WK
						13.0470-7227.2 LD7227	ATE 23912 20,3 + WK Ceramic
			→	+PR 2ED,2EG		13.0460-2887.2 602887	TRW 23914 17,1 + WE / - WK + Zub
						13.0470-2887.2 LD2887	TRW 23914 17,1 + WE / - WK + Zub Ceramic
2.5 RS quattro 2.5 RS quattro	250	07/09→06/14	←	+PR 1LA		13.0460-4833.2 604833	BRE 24098 17,1 + WE / - WK
	265	03/12→06/14	→			13.0460-2887.2 602887	TRW 23914 17,1 + WE / - WK + Zub
3.2 V6 quattro	184	03/07→06/10	←	+PR 1LJ;1LL		13.0460-7226.2 607226	ATE 23587 20,8 + WK
						13.0470-7226.2 LD7226	ATE 23587 20,8 + WK Ceramic
			←	+PR 1LK,1LM,1LN		13.0460-7227.2 607227	ATE 23801 20,3 + WK
						13.0470-7227.2 LD7227	ATE 23912 20,3 + WK Ceramic
			→	+PR 1KJ,2EE		13.0460-2749.2 602749	TRW 24483 16,9 - WE / - WK + Zub
						13.0460-2880.2 602880	TRW 23914 17,1 + WE / - WK + Zub
						13.0470-2749.2 LD2749	TRW 24483 16,9 - WE / - WK + Zub Ceramic
						13.0470-2880.2 LD2880	TRW 23914 17,1 + WE / - WK + Zub Ceramic
			→	+PR 2EA,2EF		13.0460-2887.2 602887	TRW 23914 17,1 + WE / - WK + Zub
						13.0470-2887.2 LD2887	TRW 23914 17,1 + WE / - WK + Zub Ceramic
Warnkontakt, Bremsbelagverschleiß							
2.5 RS quattro 2.5 RS quattro	250 265	07/09→06/14 03/12→06/14	←	+PR 1LA	1	24.8190-0302.2 620302	L= 367,4
Zubehörsatz, Scheibenbremsbelag							
1.8 TFSI ↓	118	06/08→06/14	→	+PR 1KZ,2ED		13.0460-0259.2 610259	

AUDI - TT Roadster (8J9) 03/07→06/14

Zubehörsatz, Scheibenbremsbelag

2.0 TFSI	147	03/07→06/10	➡	+PR 1KZ,2ED		13.0460-0259.2	610259	
2.0 TFSI	155	05/10→06/14						
2.0 TDI quattro	125	06/08→06/14	➡	+PR 1KJ,2EE		13.0460-0259.2	610259	
2.0 TFSI quattro	147	06/08→06/10						
2.0 TFSI quattro	155	05/10→06/14						
2.0 TTS quattro	195	05/08→06/14						
3.2 V6 quattro	184	03/07→06/10						













Bremsscheibe













1.8 TFSI	118	06/08→06/14	←	+PR 1LJ;1LL		24.0125-0158.1	425158	Ø 312 25 22 V + S	
			←	+PR 1LK;1LM		24.0325-0158.1	525158	Ø 312 25 22 V + S PD	
			➡	+PR 1KZ,2ED		24.0130-0219.1	430219	Ø 340 30 28 V + S	
2.0 TDI quattro	125	06/08→06/14	←	+PR 1LJ;1LL		24.0125-0158.1	425158	Ø 312 25 22 V + S	
			←	+PR 1LK;1LM		24.0325-0158.1	525158	Ø 312 25 22 V + S PD	
			➡	+PR 1KJ, 2EE		24.0130-0219.1	430219	Ø 340 30 28 V + S	
2.0 TFSI	155	05/10→06/14	←	+PR 1LJ,1LL		24.0125-0158.1	425158	Ø 312 25 22 V + S	
			←	+PR 1LK,1LM		24.0325-0158.1	525158	Ø 312 25 22 V + S PD	
			➡	+PR 1KZ,2ED		24.0130-0219.1	430219	Ø 340 30 28 V + S	
2.0 TFSI quattro	147	06/08→06/10	←	+PR 1LJ;1LL		24.0125-0158.1	425158	Ø 312 25 22 V + S	
			←	+PR 1LK;1LM		24.0325-0158.1	525158	Ø 312 25 22 V + S PD	
			➡	+PR 1KJ,2EE		24.0130-0219.1	430219	Ø 340 30 28 V + S	
2.0 TFSI quattro	195	05/08→06/14	←	+PR 1LJ,1LL		24.0125-0158.1	425158	Ø 312 25 22 V + S	
			←	+PR 1LK;1LM		24.0325-0158.1	525158	Ø 312 25 22 V + S PD	
			➡	+PR 1KJ,2EE		24.0130-0219.1	430219	Ø 340 30 28 V + S	
2.0 TFSI quattro	155	05/10→06/14	←	+PR 1LJ,1LL		24.0125-0158.1	425158	Ø 312 25 22 V + S	
			←	+PR 1LK,1LM		24.0325-0158.1	525158	Ø 312 25 22 V + S PD	
			➡	+PR 1KJ,2EE		24.0130-0219.1	430219	Ø 340 30 28 V + S	
2.0 TTS quattro	200	05/08→06/14	←	+PR 1LJ,1LL		24.0125-0158.1	425158	Ø 312 25 22 V + S	
			←	+PR 1LK,1LM		24.0325-0158.1	525158	Ø 312 25 22 V + S PD	
			➡	+PR 1KJ,2EE		24.0130-0219.1	430219	Ø 340 30 28 V + S	
2.5 RS quattro	250	07/09→06/14	←	+PR 1LK,1LM		24.0130-0219.1	430219	Ø 340 30 28 V + S	
			←	+PR 1LN		24.0130-0219.1	430219	Ø 340 30 28 V + S	
			➡	+PR 2ED,2EG		24.0122-0242.1	422242	Ø 310 22 20 V + S	
2.5 RS quattro	265	03/12→06/14	➡			24.0122-0242.1	422242	Ø 310 22 20 V + S	
3.2 V6 quattro	184	03/07→06/10	←	+PR 1LJ;1LL		24.0125-0158.1	425158	Ø 312 25 22 V + S	
			←	+PR 1LK;1LM		24.0325-0158.1	525158	Ø 312 25 22 V + S PD	
			➡	+PR 1KJ,2EE		24.0130-0219.1	430219	Ø 340 30 28 V + S	
			➡	+PR 2EA,2EF		24.0112-0175.1	412175	Ø 286 12 10 + S	
			➡			24.0122-0242.1	422242	Ø 310 22 20 V + S	











AUDI - TT Roadster (8N9) 10/99→06/06









Bremsbelagsatz, Scheibenbremse









1.8 T	110	01/01→06/06	←	+PR 1LD,1LT,1LV		13.0460-7081.2	607081	ATE 20676 19,8 - WE / - WK
			←			13.0460-7122.2	607122	ATE 20676 19,8 + WK
			←			13.0470-7081.2	LD7081	ATE 20676 19,8 - WE / - WK Ceramic
			←			13.0470-7122.2	LD7122	ATE 20676 19,8 + WK Ceramic
1.8 T	120	09/05→06/06	←	+PR 1LV		13.0460-7183.2	607183	ATE 21484 20,5 + WE / - WK
			➡	8N5-011 001→; +PR 1KE,1KF,1KK,2EH		13.0460-2886.2	602886	TRW 20961 16,0 - WK
			➡			13.0470-2886.2	LD2886	TRW 20961 16,0 - WK Ceramic
			➡	+PR 2EK		13.0460-2894.2	602894	TRW 20961 17,2 - WK + Zub
1.8 T	132	10/99→06/06	➡			13.0470-2894.2	LD2894	TRW 20961 17,2 - WK + Zub Ceramic
			➡	→ 8N5-011 000; +PR 1KE,1KF,1KK,2EH		13.0460-2894.2	602894	TRW 20961 17,2 - WK + Zub
			➡			13.0470-2894.2	LD2894	TRW 20961 17,2 - WK + Zub Ceramic
			➡					
1.8 T	140	09/05→06/06	←	+PR 1LD,1LT,1LV		13.0460-7081.2	607081	ATE 20676 19,8 - WE / - WK
			←			13.0460-7122.2	607122	ATE 20676 19,8 + WK
			←			13.0470-7081.2	LD7081	ATE 20676 19,8 - WE / - WK Ceramic
			←			13.0470-7122.2	LD7122	ATE 20676 19,8 + WK Ceramic
1.8 T quattro	165	10/99→06/06	←	+PR 1LV		13.0460-7183.2	607183	ATE 21484 20,5 + WE / - WK
			←					







	kw			 	! #		
AUDI - TT Roadster (8N9) 10/99→06/06							
 Bremsbelagsatz, Scheibenbremse							
1.8 T quattro 1.8 T quattro 1.8 T quattro	132 140 165	02/00→06/06 09/05→06/06 10/99→06/06	➡	8N5-011 001→; +PR 1KE,1KF,1KK,2EH		13.0460-2886.2 602886 13.0470-2886.2 LD2886	TRW 20961 16,0 - WK TRW 20961 16,0 - WK Ceramic
			➡	→ 8N5-011 000; +PR 1KE,1KF,1KK,2EH		13.0460-2894.2 602894 13.0470-2894.2 LD2894	TRW 20961 17,2 - WK + Zub TRW 20961 17,2 - WK + Zub Ceramic
3.2 VR6 quattro	184	07/03→06/06	←			13.0460-7183.2 607183	ATE 21484 20,5 + WE / - WK
			➡	8N5-011 001→; +PR 1KE,1KF,1KK,2EH		13.0460-2886.2 602886 13.0470-2886.2 LD2886	TRW 20961 16,0 - WK TRW 20961 16,0 - WK Ceramic
			➡	→ 8N5-011 000; +PR 1KE,1KF,1KK,2EH		13.0460-2894.2 602894 13.0470-2894.2 LD2894	TRW 20961 17,2 - WK + Zub TRW 20961 17,2 - WK + Zub Ceramic
Warnkontakt, Bremsbelagverschleiß							
3.2 VR6 quattro	184	07/03→06/06	←		1	24.8190-0106.2 620106	L= 270
Zubehörsatz, Scheibenbremsbelag							
1.8 T 1.8 T 1.8 T 1.8 T 1.8 T quattro 1.8 T quattro 1.8 T quattro 3.2 VR6 quattro	110 120 132 140 132 140 165 184	01/01→06/06 09/05→06/06 10/99→06/06 09/05→06/06 02/00→06/06 09/05→06/06 10/99→06/06 07/03→06/06	➡	8N5-011 001→; +PR 1KE,1KF,1KK,2EH		13.0460-0072.2 610072 13.0460-0072.2 610072	TRW TRW
			➡	→ 8N5-011 000; +PR 1KE,1KF,1KK,2EH			
 Bremsscheibe							
1.8 T 1.8 T 1.8 T 1.8 T	110 120 132 140	01/01→06/06 09/05→06/06 10/99→06/06 09/05→06/06	←	+PR 1LD,1LT,1LV		24.0125-0123.1 425123 24.0325-0123.1 525123	Ø 310 25 22 V + S Ø 310 25 22 V PD
			➡	+PR 1KK,2EK		24.0109-0123.1 409123 24.0309-0123.1 509123	Ø 230 9 7 + S Ø 230 9 7 + S PD
1.8 T quattro 1.8 T quattro 1.8 T quattro	132 140 165	02/00→06/06 09/05→06/06 10/99→06/06	←	+PR 1LD,1LT,1LV		24.0125-0123.1 425123 24.0325-0123.1 525123	Ø 310 25 22 V + S Ø 310 25 22 V PD
			➡	+PR 1KE		24.0109-0133.1 409133 24.0309-0133.1 509133	Ø 239 8,9 7 + S Ø 239 8,9 7 + S PD
			➡	+PR 1KF;2EH		24.0122-0163.1 422163 24.0322-0163.1 522163	Ø 256 22 20 V Ø 256 22 20 V PD
3.2 VR6 quattro	184	07/03→06/06	←			24.0132-0165.2 432165	Ø 334 32 30 V Bremsscheibe zweiteilig
			←			24.0132-0166.2 432166	Ø 334 32 30 V Bremsscheibe zweiteilig
			➡	+PR 1KE		24.0109-0133.1 409133 24.0309-0133.1 509133	Ø 239 8,9 7 + S Ø 239 8,9 7 + S PD
			➡	+PR 1KF;2EH		24.0122-0163.1 422163 24.0322-0163.1 522163	Ø 256 22 20 V Ø 256 22 20 V PD
AUDI - TT Roadster (FV9) 11/14→							
 Bremsbelagsatz, Scheibenbremse							
1.8 TFSI 2.0 TDI 2.0 TDI quattro 2.0 TFSI 2.0 TFSI quattro 2.0 TFSI quattro 2.0 TTS quattro	132 135 135 169 162 169 210	08/15→ 11/14→ 01/17→ 11/14→ 04/15→ 11/14→ 02/15→	←	+PR 1LJ,1ZD		13.0460-2785.2 602785 13.0470-2785.2 LD2785	TRW 25683 20,4 + WE / + WK TRW 25683 20,4 + WE / + WK Ceramic
			➡	+PR 1KZ; + eFSB		13.0460-7293.2 607293 13.0470-7293.2 LD7293	ATE 25008 16,3 - WE / - WK ATE 25008 16,3 - WE / - WK Ceramic
			➡	+PR 2ED,2EG,2EK; + eFSB		13.0460-7294.2 607294 13.0470-7294.2 LD7294	ATE 25009 16,4 - WE / - WK ATE 25009 16,4 - WE / - WK Ceramic
2.0 TTS quattro	228	11/14→	←	+PR 1LJ,1ZD		13.0460-2785.2 602785	TRW 25683 20,4 + WE / + WK
			➡	+PR 1KZ; + eFSB		13.0460-7293.2 607293 13.0470-7293.2 LD7293	ATE 25008 16,3 - WE / - WK ATE 25008 16,3 - WE / - WK Ceramic
			➡	+PR 2ED,2EG,2EK; + eFSB		13.0460-7294.2 607294 13.0470-7294.2 LD7294	ATE 25009 16,4 - WE / - WK ATE 25009 16,4 - WE / - WK Ceramic
2.5 RS quattro	294	10/16→	➡	+PR 2EE; + eFSB		13.0460-7294.2 607294 13.0470-7294.2 LD7294	ATE 25009 16,4 - WE / - WK ATE 25009 16,4 - WE / - WK Ceramic
↓							









	kw			 	! #		
AUDI - TT Roadster (FV9) 11/14→							
Warnkontakt, Bremsbelagverschleiß							
1.8 TFSI 2.0 TDI 2.0 TDI quattro 2.0 TFSI 2.0 TFSI quattro 2.0 TFSI quattro 2.0 TFSI quattro 2.0 TTS quattro 2.0 TTS quattro	132 135 135 169 162 169 210 228	08/15→ 11/14→ 01/17→ 11/14→ 04/15→ 11/14→ 02/15→ 11/14→	←	+PR 1LJ,1ZD	1	24.8190-0065.2 620065	L= 172
 Bremsscheibe							
1.8 TFSI 2.0 TDI 2.0 TDI quattro 2.0 TFSI 2.0 TFSI quattro 2.0 TFSI quattro 2.0 TTS quattro 2.0 TTS quattro	132 135 135 169 162 169 210 228	08/15→ 11/14→ 01/17→ 11/14→ 04/15→ 11/14→ 02/15→ 11/14→	←	+PR 1LJ,1ZD		24.0125-0158.1 425158 24.0325-0158.1 525158	Ø 312 25 22 V + S Ø 312 25 22 V + S PD
			←	+PR 1LK,1LH		24.0130-0225.1 430225	Ø 340 30 27 V + S
			→	+PR 1KZ		24.0110-0356.1 410356 24.0310-0356.1 510356	Ø 272 9,7 8 + S Ø 272 9,7 8 + S PD
			→	+PR 2ED; + eFSB		24.0112-0210.1 412210	Ø 300 12 10 + S
			→	+PR 2EG,2EK		24.0122-0219.1 422219	Ø 310 22 20 V
2.5 RS quattro	294	10/16→	→	+PR 1KX,2EE		24.0122-0219.1 422219	Ø 310 22 20 V
AUTOBIANCHI - Y10 03/85→10/95							
 Bremsbelagsatz, Scheibenbremse							
1.0 1.0	33 41	03/85→10/95 03/85→10/95	←	12/87→ 12/89		13.0460-3940.2 603940	BDX 20775 18,0 + WK
			←	06/85→ 12/89		13.0460-3940.2 603940	BDX 20775 18,0 + WK
1.0 4WD 1.0 Cat	37 33	12/86→10/95 10/87→10/95	←	12/87→ 12/89		13.0460-3940.2 603940	BDX 20775 18,0 + WK
			←	→ 12/89		13.0460-3940.2 603940	BDX 20775 18,0 + WK
1.0 Turbo	63	03/85→10/95	←	06/85→ 12/89		13.0460-2941.2 602941	TRW 20838 17,0 + WK
1.1	42	06/89→10/95	←	01/90→		13.0460-3940.2 603940	BDX 20775 18,0 + WK
1.1 i.e. Cat	42	09/90→10/95	←			13.0460-3940.2 603940	BDX 20775 18,0 + WK
1.3 i.e. GT 1.3 i.e. GT	54 57	06/89→10/95 06/89→10/95	←			13.0460-2941.2 602941	TRW 20838 17,0 + WK
Zubehörsatz, Scheibenbremsbelag							
1.0 1.0	33 41	03/85→10/95 03/85→10/95	←	12/87→ 12/89		13.0460-0410.2 610410	BDX
			←	06/85→ 12/89		13.0460-0410.2 610410	BDX
1.0 4WD 1.0 Cat	37 33	12/86→10/95 10/87→10/95	←	12/87→ 12/89		13.0460-0410.2 610410	BDX
			←	→ 12/89		13.0460-0410.2 610410	BDX
1.1	42	06/89→10/95	←	01/90→		13.0460-0410.2 610410	BDX
1.1 i.e. Cat	42	09/90→10/95	←			13.0460-0410.2 610410	BDX
 Bremsscheibe							
1.0 1.0	33 41	03/85→10/95 03/85→10/95	←	12/87→ 12/89		24.0111-0130.1 411130	Ø 227 10,8 9
			←	06/85→ 12/89		24.0111-0130.1 411130	Ø 227 10,8 9
1.0 4WD 1.0 Cat	37 33	12/86→10/95 10/87→10/95	←	12/87→ 12/89		24.0111-0130.1 411130	Ø 227 10,8 9
			←	→ 12/89		24.0111-0130.1 411130	Ø 227 10,8 9
1.0 Turbo	63	03/85→10/95	←	06/85→ 12/89		24.0112-0122.1 412122	Ø 240 12 10,8
1.1	42	06/89→10/95	←	01/90→		24.0111-0130.1 411130	Ø 227 10,8 9
1.1 i.e. Cat	42	09/90→10/95	←			24.0111-0130.1 411130	Ø 227 10,8 9
1.3 i.e. GT 1.3 i.e. GT	54 57	06/89→10/95 06/89→10/95	←			24.0112-0122.1 412122	Ø 240 12 10,8
BENTLEY - ARNAGE (RBS_) 04/98→10/09							
 Bremsbelagsatz, Scheibenbremse							
4.4 V8 6.7 V8	260 298	04/98→01/02 09/99→10/09	←			13.0460-7183.2 607183	ATE 21484 20,5 + WE / - WK
BENTLEY - AZURE 09/95→06/06							
 Bremsbelagsatz, Scheibenbremse							
6.75 V8	300	08/99→06/06	←			13.0460-7183.2 607183	ATE 21484 20,5 + WE / - WK









	kw			 	! #		
BENTLEY - CONTINENTAL 10/91→10/02							
 Bremsbelagsatz, Scheibenbremse							
6.75 V8 R	300	08/99→10/02	←			13.0460-7183.2 607183	ATE 21484 20,5 + WE / - WK
			→			13.0460-2888.2 602888	TRW 23326 17,4 + WE / - WK
BENTLEY - CONTINENTAL Coupe (3W_) 06/03→							
 Bremsbelagsatz, Scheibenbremse							
6.0 AWD	412	06/03→12/11	←			13.0460-7183.2 607183	ATE 21484 20,5 + WE / - WK
			→			13.0460-2888.2 602888	TRW 23326 17,4 + WE / - WK
BMW - 1 (E81) 09/06→12/11							
 Bremsbelagsatz, Scheibenbremse							
116 d	66	01/11→12/11	←	- Performance Parts		13.0460-2710.2 602710	TRW 23915 17,6 + WE / - WK + Zub
						13.0470-2710.2 LD2710	TRW 23915 17,6 + WE / - WK + Zub Ceramic
			←	+ Performance Parts		13.0460-4848.2 604848	BRE 24316 16,9 + WE / - WK
			→	- Performance Parts		13.0460-2713.2 602713	TRW 23623 17,4 + WE / - WK + Zub
						13.0470-2713.2 LD2713	TRW 23623 17,4 + WE / - WK + Zub Ceramic
116 d	85	11/08→12/11	←	03/10→ 05/11; - Performance Parts		13.0460-2710.2 602710	TRW 23915 17,6 + WE / - WK + Zub
						13.0470-2710.2 LD2710	TRW 23915 17,6 + WE / - WK + Zub Ceramic
			←	03/09→ 02/10; - Performance Parts		13.0460-2710.2 602710	TRW 23915 17,6 + WE / - WK + Zub
						13.0470-2710.2 LD2710	TRW 23915 17,6 + WE / - WK + Zub Ceramic
			←	03/09→ 05/11; + Performance Parts		13.0460-4848.2 604848	BRE 24316 16,9 + WE / - WK
			→	03/10→ 05/11; - Performance Parts		13.0460-2713.2 602713	TRW 23623 17,4 + WE / - WK + Zub
						13.0470-2713.2 LD2713	TRW 23623 17,4 + WE / - WK + Zub Ceramic
			→	03/09→ 02/10; - Performance Parts		13.0460-2713.2 602713	TRW 23623 17,4 + WE / - WK + Zub
						13.0470-2713.2 LD2713	TRW 23623 17,4 + WE / - WK + Zub Ceramic
116 i	85	04/07→12/11	←	→ 08/07; - Performance Parts		13.0460-2710.2 602710	TRW 23915 17,6 + WE / - WK + Zub
						13.0470-2710.2 LD2710	TRW 23915 17,6 + WE / - WK + Zub Ceramic
			←	→ 08/07; + Performance Parts		13.0460-4848.2 604848	BRE 24316 16,9 + WE / - WK
			→	→ 08/07; - Performance Parts		13.0460-2713.2 602713	TRW 23623 17,4 + WE / - WK + Zub
						13.0470-2713.2 LD2713	TRW 23623 17,4 + WE / - WK + Zub Ceramic
116 i 116 i	89 90	08/07→11/11 03/07→11/11	←	09/07→ 12/08; - Performance Parts		13.0460-2710.2 602710	TRW 23915 17,6 + WE / - WK + Zub
						13.0470-2710.2 LD2710	TRW 23915 17,6 + WE / - WK + Zub Ceramic
			←	09/07→ 12/08; + Performance Parts		13.0460-4848.2 604848	BRE 24316 16,9 + WE / - WK
			→	09/07→ 12/08; - Performance Parts		13.0460-2713.2 602713	TRW 23623 17,4 + WE / - WK + Zub
						13.0470-2713.2 LD2713	TRW 23623 17,4 + WE / - WK + Zub Ceramic
116 i	90	11/08→12/11	←	03/10→ 05/11; - Performance Parts		13.0460-2710.2 602710	TRW 23915 17,6 + WE / - WK + Zub
						13.0470-2710.2 LD2710	TRW 23915 17,6 + WE / - WK + Zub Ceramic
			←	01/09→ 02/10; - Performance Parts		13.0460-2710.2 602710	TRW 23915 17,6 + WE / - WK + Zub
						13.0470-2710.2 LD2710	TRW 23915 17,6 + WE / - WK + Zub Ceramic
			←	01/09→ 05/11; + Performance Parts		13.0460-4848.2 604848	BRE 24316 16,9 + WE / - WK
			→	01/09→ 02/10; - Performance Parts		13.0460-2713.2 602713	TRW 23623 17,4 + WE / - WK + Zub
						13.0470-2713.2 LD2713	TRW 23623 17,4 + WE / - WK + Zub Ceramic

	kw			 	! #		
BMW - 1 (E81) 09/06→12/11							
 Bremsbelagsatz, Scheibenbremse							
116 i	90	11/08→12/11	➔	03/10→ 05/11; - Performance Parts		13.0460-2713.2 602713 13.0470-2713.2 LD2713	TRW 23623 17,4 + WE / - WK + Zub TRW 23623 17,4 + WE / - WK + Zub Ceramic
118 d 118 d	100 105	09/06→12/11 09/06→12/11	➔	04/07→ 02/10; - Performance Parts		13.0460-2710.2 602710 13.0470-2710.2 LD2710	TRW 23915 17,6 + WE / - WK + Zub TRW 23915 17,6 + WE / - WK + Zub Ceramic
			➔	03/10→ 05/11; - Performance Parts		13.0460-2710.2 602710 13.0470-2710.2 LD2710	TRW 23915 17,6 + WE / - WK + Zub TRW 23915 17,6 + WE / - WK + Zub Ceramic
			➔	04/07→ 05/11; + Performance Parts		13.0460-4848.2 604848	BRE 24316 16,9 + WE / - WK
			➔	04/07→ 02/10; - Performance Parts		13.0460-7217.2 607217 13.0470-7217.2 LD7217	ATE 23926 17,3 + WE / - WK Ceramic
			➔	03/10→ 05/11; - Performance Parts		13.0460-7217.2 607217 13.0470-7217.2 LD7217	ATE 23926 17,3 + WE / - WK Ceramic
118 i 118 i	100 105	09/06→12/11 09/06→12/11	➔	04/07→ 02/10; - Performance Parts		13.0460-2710.2 602710 13.0470-2710.2 LD2710	TRW 23915 17,6 + WE / - WK + Zub TRW 23915 17,6 + WE / - WK + Zub Ceramic
			➔	03/10→ 05/11; - Performance Parts		13.0460-2710.2 602710 13.0470-2710.2 LD2710	TRW 23915 17,6 + WE / - WK + Zub TRW 23915 17,6 + WE / - WK + Zub Ceramic
			➔	04/07→ 05/11; + Performance Parts		13.0460-4848.2 604848	BRE 24316 16,9 + WE / - WK
			➔	04/07→ 02/10; - Performance Parts		13.0460-2713.2 602713 13.0470-2713.2 LD2713	TRW 23623 17,4 + WE / - WK + Zub TRW 23623 17,4 + WE / - WK + Zub Ceramic
			➔	03/10→ 05/11; - Performance Parts		13.0460-2713.2 602713 13.0470-2713.2 LD2713	TRW 23623 17,4 + WE / - WK + Zub TRW 23623 17,4 + WE / - WK + Zub Ceramic
120 d	120	09/06→12/11	➔	→ 02/07; + Performance Parts		13.0460-4848.2 604848	BRE 24316 16,9 + WE / - WK
			➔	→ 02/07; TÜrenanzahl: 5; - Performance Parts		13.0460-7215.2 607215 13.0470-7215.2 LD7215	ATE 23935 17,8 + WE / - WK Ceramic
			➔	→ 02/07; TÜrenanzahl: 3; - Performance Parts		13.0460-7216.2 607216 13.0470-7216.2 LD7216	ATE 23794 20,3 + WE / - WK Ceramic
			➔	→ 02/07; - Performance Parts		13.0460-7217.2 607217 13.0470-7217.2 LD7217	ATE 23926 17,3 + WE / - WK Ceramic
120 d 120 d	130 145	09/06→12/11 09/06→12/11	➔	03/07→ 05/11; + Performance Parts		13.0460-4848.2 604848	BRE 24316 16,9 + WE / - WK
			➔	03/10→ 05/11; - Performance Parts		13.0460-7216.2 607216 13.0470-7216.2 LD7216	ATE 23794 20,3 + WE / - WK Ceramic
			➔	03/07→ 02/10; - Performance Parts		13.0460-7216.2 607216 13.0470-7216.2 LD7216	ATE 23794 20,3 + WE / - WK Ceramic
			➔	03/10→ 05/11; - Performance Parts		13.0460-7217.2 607217 13.0470-7217.2 LD7217	ATE 23926 17,3 + WE / - WK Ceramic
			➔	03/07→ 02/10; - Performance Parts		13.0460-7217.2 607217 13.0470-7217.2 LD7217	ATE 23926 17,3 + WE / - WK Ceramic
120 i	115	09/06→10/11	➔	→ 03/07; TÜrenanzahl: 5; - Performance Parts		13.0460-2710.2 602710 13.0470-2710.2 LD2710	TRW 23915 17,6 + WE / - WK + Zub TRW 23915 17,6 + WE / - WK + Zub Ceramic
			➔	→ 03/07; + Performance Parts		13.0460-4848.2 604848	BRE 24316 16,9 + WE / - WK
			➔	→ 03/07; TÜrenanzahl: 3; - Performance Parts		13.0460-7216.2 607216 13.0470-7216.2 LD7216	ATE 23794 20,3 + WE / - WK Ceramic
↓							









	kw			 	! #		
BMW - 1 (E81) 09/06→12/11							
 Bremsbelagsatz, Scheibenbremse							
120 i	115	09/06→10/11	➔	→ 03/07; - Performance Parts		13.0460-2713.2 602713	TRW 23623 17,4 + WE / - WK + Zub
						13.0470-2713.2 LD2713	TRW 23623 17,4 + WE / - WK + Zub Ceramic
120 i	120	09/06→12/11	➔	04/07→ 05/11; + Performance Parts		13.0460-4848.2 604848	BRE 24316 16,9 + WE / - WK
120 i	125	09/06→12/11	➔	04/07→ 02/10; - Performance Parts		13.0460-7216.2 607216	ATE 23794 20,3 + WE / - WK
						13.0470-7216.2 LD7216	ATE 23794 20,3 + WE / - WK Ceramic
			➔	03/10→ 05/11; - Performance Parts		13.0460-7216.2 607216	ATE 23794 20,3 + WE / - WK
						13.0470-7216.2 LD7216	ATE 23794 20,3 + WE / - WK Ceramic
			➔	04/07→ 02/10; - Performance Parts		13.0460-2713.2 602713	TRW 23623 17,4 + WE / - WK + Zub
						13.0470-2713.2 LD2713	TRW 23623 17,4 + WE / - WK + Zub Ceramic
			➔	03/10→ 05/11; - Performance Parts		13.0460-2713.2 602713	TRW 23623 17,4 + WE / - WK + Zub
						13.0470-2713.2 LD2713	TRW 23623 17,4 + WE / - WK + Zub Ceramic
123 d	150	03/07→12/11	➔	10/07→ 05/11; + Performance Parts		13.0460-4848.2 604848	BRE 24316 16,9 + WE / - WK
			➔	10/07→ 02/10; - Performance Parts		13.0460-7223.2 607223	ATE 23794 20,3 + WE / - WK
						13.0470-7223.2 LD7223	ATE 23794 20,3 + WE / - WK Ceramic
			➔	03/10→ 05/11; - Performance Parts		13.0460-7223.2 607223	ATE 23794 20,3 + WE / - WK
						13.0470-7223.2 LD7223	ATE 23794 20,3 + WE / - WK Ceramic
			➔	10/07→ 02/10; - Performance Parts		13.0460-7217.2 607217	ATE 23926 17,3 + WE / - WK
						13.0470-7217.2 LD7217	ATE 23926 17,3 + WE / - WK Ceramic
			➔	03/10→ 05/11; - Performance Parts		13.0460-7217.2 607217	ATE 23926 17,3 + WE / - WK
						13.0470-7217.2 LD7217	ATE 23926 17,3 + WE / - WK Ceramic
130 i	190	09/06→12/11	➔	→ 05/11; + Performance Parts		13.0460-4848.2 604848	BRE 24316 16,9 + WE / - WK
130 i	195	09/06→12/11	➔	→ 02/10; - Performance Parts		13.0460-7223.2 607223	ATE 23794 20,3 + WE / - WK
						13.0470-7223.2 LD7223	ATE 23794 20,3 + WE / - WK Ceramic
			➔	03/10→ 05/11; - Performance Parts		13.0460-7223.2 607223	ATE 23794 20,3 + WE / - WK
						13.0470-7223.2 LD7223	ATE 23794 20,3 + WE / - WK Ceramic
			➔	→ 02/10; - Performance Parts		13.0460-7217.2 607217	ATE 23926 17,3 + WE / - WK
						13.0470-7217.2 LD7217	ATE 23926 17,3 + WE / - WK Ceramic
			➔	03/10→ 05/11; - Performance Parts		13.0460-7217.2 607217	ATE 23926 17,3 + WE / - WK
						13.0470-7217.2 LD7217	ATE 23926 17,3 + WE / - WK Ceramic
Warnkontakt, Bremsbelagverschleiß							
116 d	66	01/11→12/11	➔	+ Performance Parts	1	24.8190-0267.2 620267	L= 679
			➔		1	24.8190-0284.2 620284	L= 650
			➔		1	24.8190-0285.2 620285	L= 1.107
116 d	85	11/08→12/11	➔	03/09→ 02/10	1	24.8190-0264.2 620264	L= 630
			➔	03/09→ 05/11; + Performance Parts	1	24.8190-0267.2 620267	L= 679
			➔	03/10→ 05/11	1	24.8190-0284.2 620284	L= 650
			➔	03/09→ 02/10	1	24.8190-0265.2 620265	L= 1.086
			➔	03/10→ 05/11	1	24.8190-0285.2 620285	L= 1.107
116 i	85	04/07→12/11	➔	→ 08/07	1	24.8190-0264.2 620264	L= 630
			➔	→ 08/07; + Performance Parts	1	24.8190-0267.2 620267	L= 679
			➔	→ 08/07	1	24.8190-0265.2 620265	L= 1.086
116 i	89	08/07→11/11	➔	09/07→ 12/08	1	24.8190-0264.2 620264	L= 630
116 i	90	03/07→11/11	➔	09/07→ 12/08; + Performance Parts	1	24.8190-0267.2 620267	L= 679
			➔	09/07→ 12/08	1	24.8190-0265.2 620265	L= 1.086
116 i	90	11/08→12/11	➔	01/09→ 02/10	1	24.8190-0264.2 620264	L= 630
			➔	01/09→ 05/11; + Performance Parts	1	24.8190-0267.2 620267	L= 679
↓							









	kW			 	! #		
BMW - 1 (E81) 09/06→12/11							
Warnkontakt, Bremsbelagverschleiß							
116 i	90	11/08→12/11	←	03/10→ 05/11	1	24.8190-0284.2 620284	L= 650
			→	01/09→ 02/10	1	24.8190-0265.2 620265	L= 1.086
			→	03/10→ 05/11	1	24.8190-0285.2 620285	L= 1.107
118 d	100	09/06→12/11	←	04/07→ 02/10	1	24.8190-0264.2 620264	L= 630
118 d	105	09/06→12/11	←	04/07→ 05/11; + Performance Parts	1	24.8190-0267.2 620267	L= 679
118 i	100	09/06→12/11	←	04/07→ 05/11; + Performance Parts	1	24.8190-0267.2 620267	L= 679
118 i	105	09/06→12/11	←	03/10→ 05/11	1	24.8190-0284.2 620284	L= 650
120 i	120	09/06→12/11	←	03/10→ 05/11	1	24.8190-0284.2 620284	L= 650
120 i	125	09/06→12/11	→	04/07→ 02/10	1	24.8190-0265.2 620265	L= 1.086
			→	03/10→ 05/11	1	24.8190-0285.2 620285	L= 1.107
120 d	120	09/06→12/11	←	→ 02/07; Türenanzahl: 3	1	24.8190-0264.2 620264	L= 630
			←	→ 02/07; Türenanzahl: 5	1	24.8190-0264.2 620264	L= 630
			←	→ 02/07; + Performance Parts	1	24.8190-0267.2 620267	L= 679
			→	→ 02/07	1	24.8190-0265.2 620265	L= 1.086
120 d	130	09/06→12/11	←	03/07→ 02/10	1	24.8190-0264.2 620264	L= 630
120 d	145	09/06→12/11	←	03/07→ 05/11; + Performance Parts	1	24.8190-0267.2 620267	L= 679
			←	03/10→ 05/11	1	24.8190-0284.2 620284	L= 650
			→	03/07→ 02/10	1	24.8190-0265.2 620265	L= 1.086
			→	03/10→ 05/11	1	24.8190-0285.2 620285	L= 1.107
120 i	115	09/06→10/11	←	→ 03/07; Türenanzahl: 5	1	24.8190-0264.2 620264	L= 630
			←	→ 03/07; Türenanzahl: 3	1	24.8190-0264.2 620264	L= 630
			←	→ 03/07; + Performance Parts	1	24.8190-0267.2 620267	L= 679
			→	→ 03/07	1	24.8190-0265.2 620265	L= 1.086
123 d	150	03/07→12/11	←	10/07→ 02/10	1	24.8190-0267.2 620267	L= 679
			←	10/07→ 05/11; + Performance Parts	1	24.8190-0267.2 620267	L= 679
			←	03/10→ 05/11	1	24.8190-0287.2 620287	L= 723
			→	10/07→ 02/10	1	24.8190-0265.2 620265	L= 1.086
			→	03/10→ 05/11	1	24.8190-0285.2 620285	L= 1.107
130 i	190	09/06→12/11	←	→ 05/11; + Performance Parts	1	24.8190-0267.2 620267	L= 679
130 i	195	09/06→12/11	←	→ 02/10	1	24.8190-0267.2 620267	L= 679
			←	03/10→ 05/11	1	24.8190-0287.2 620287	L= 723
			→	→ 02/10	1	24.8190-0265.2 620265	L= 1.086
			→	03/10→ 05/11	1	24.8190-0285.2 620285	L= 1.107
Bremsscheibe							
116 d	66	01/11→12/11	←	- Performance Parts		24.0122-0239.1 422239	Ø 284 22 20,4 V + S
			→	- Performance Parts		24.0322-0239.1 522239	Ø 284 22 19,6 V + S PD
			→	- Performance Parts		24.0110-0314.1 410314	Ø 280 10 8,4 + S
			→	- Performance Parts		24.0310-0314.1 510314	Ø 280 10 7,6 + S PD
116 d	85	11/08→12/11	←	03/09→ 05/11; - Performance Parts		24.0122-0239.1 422239	Ø 284 22 20,4 V + S
			→	03/09→ 05/11; - Performance Parts		24.0322-0239.1 522239	Ø 284 22 19,6 V + S PD
			→	03/09→ 05/11; - Performance Parts		24.0110-0314.1 410314	Ø 280 10 8,4 + S
			→	03/09→ 05/11; - Performance Parts		24.0310-0314.1 510314	Ø 280 10 7,6 + S PD
116 i	85	04/07→12/11	←	→ 08/07; - Performance Parts		24.0122-0239.1 422239	Ø 284 22 20,4 V + S
			→	→ 08/07; - Performance Parts		24.0322-0239.1 522239	Ø 284 22 19,6 V + S PD
			→	→ 08/07; - Performance Parts		24.0110-0314.1 410314	Ø 280 10 8,4 + S
			→	→ 08/07; - Performance Parts		24.0310-0314.1 510314	Ø 280 10 7,6 + S PD
116 i	89	08/07→11/11	←	09/07→ 12/08; - Performance Parts		24.0122-0239.1 422239	Ø 284 22 20,4 V + S
116 i	90	03/07→11/11	←	09/07→ 12/08; - Performance Parts		24.0322-0239.1 522239	Ø 284 22 19,6 V + S PD
			→	09/07→ 12/08; - Performance Parts		24.0110-0314.1 410314	Ø 280 10 8,4 + S
			→	09/07→ 12/08; - Performance Parts		24.0310-0314.1 510314	Ø 280 10 7,6 + S PD
116 i	90	11/08→12/11	←	01/09→ 05/11; - Performance Parts		24.0122-0239.1 422239	Ø 284 22 20,4 V + S
			→	01/09→ 05/11; - Performance Parts		24.0322-0239.1 522239	Ø 284 22 19,6 V + S PD
			→	01/09→ 05/11; - Performance Parts		24.0110-0314.1 410314	Ø 280 10 8,4 + S
			→	01/09→ 05/11; - Performance Parts		24.0310-0314.1 510314	Ø 280 10 7,6 + S PD
118 d	100	09/06→12/11	←	04/07→ 05/11; - Performance Parts		24.0122-0238.1 422238	Ø 292 22 20,4 V + S
118 d	105	09/06→12/11	←	04/07→ 05/11; - Performance Parts		24.0322-0238.1 522238	Ø 292 22 19,6 V + S PD
			→	04/07→ 05/11; - Performance Parts		24.0120-0195.1 420195	Ø 300 20 18,4 V + S
↓							









	kW			 	! #		
BMW - 1 (E81) 09/06→12/11							
 Bremsscheibe							
118 d 118 d	100 105	09/06→12/11 09/06→12/11	➔	04/07→ 05/11; - Performance Parts		24.0320-0195.1 520195	Ø 300 20 17,6 V + S PD
118 i 118 i	100 105	09/06→12/11 09/06→12/11	➔	04/07→ 05/11; - Performance Parts		24.0122-0238.1 422238	Ø 292 22 20,4 V + S
			➔	04/07→ 05/11; - Performance Parts		24.0322-0238.1 522238	Ø 292 22 19,6 V + S PD
			➔	04/07→ 05/11; - Performance Parts		24.0110-0315.1 410315	Ø 296 10,4 8,9 + S
120 d	120	09/06→12/11	➔	→ 02/07; TÜrenanzahl: 5; - Performance Parts		24.0122-0238.1 422238	Ø 292 22 20,4 V + S
			➔	→ 02/07; TÜrenanzahl: 3; - Performance Parts		24.0322-0238.1 522238	Ø 292 22 19,6 V + S PD
			➔	→ 02/07; - Performance Parts		24.0124-0197.1 424197	Ø 300 24 22,4 V + S
120 d 120 d	130 145	09/06→12/11 09/06→12/11	➔	→ 02/07; - Performance Parts		24.0324-0197.1 524197	Ø 300 24 21,6 V + S PD
			➔	→ 02/07; - Performance Parts		24.0120-0195.1 420195	Ø 300 20 18,4 V + S
			➔	→ 02/07; - Performance Parts		24.0320-0195.1 520195	Ø 300 20 17,6 V + S PD
120 i 120 i	115	09/06→10/11	➔	→ 03/07; TÜrenanzahl: 5; - Performance Parts		24.0124-0197.1 424197	Ø 300 24 22,4 V + S
			➔	→ 03/07; TÜrenanzahl: 3; - Performance Parts		24.0324-0197.1 524197	Ø 300 24 21,6 V + S PD
			➔	→ 03/07; - Performance Parts		24.0110-0315.1 410315	Ø 296 10,4 8,9 + S
120 i 120 i	120 125	09/06→12/11 09/06→12/11	➔	→ 03/07; - Performance Parts		24.0310-0315.1 510315	Ø 296 10,4 8,1 + S PD
			➔	04/07→ 05/11; - Performance Parts		24.0124-0197.1 424197	Ø 300 24 22,4 V + S
			➔	04/07→ 05/11; - Performance Parts		24.0324-0197.1 524197	Ø 300 24 21,6 V + S PD
123 d	150	03/07→12/11	➔	04/07→ 05/11; - Performance Parts		24.0110-0315.1 410315	Ø 296 10,4 8,9 + S
			➔	10/07→ 05/11; - Performance Parts		24.0310-0315.1 510315	Ø 296 10,4 8,1 + S PD
			➔	10/07→ 05/11; - Performance Parts		24.0124-0200.1 424200	Ø 330 24 22,4 V + S
130 i 130 i	190 195	09/06→12/11 09/06→12/11	➔	04/07→ 05/11; - Performance Parts		24.0324-0200.1 524200	Ø 330 24 21,6 V + S PD
			➔	04/07→ 05/11; - Performance Parts		24.0120-0204.1 420204	Ø 300 20 17,6 V + S PD
			➔	04/07→ 05/11; - Performance Parts		24.0320-0204.1 520204	Ø 300 20 17,6 V + S PD
BMW - 1 (E87) 02/03→01/13							
 Bremsbelagsatz, Scheibenbremse							
116 d	66	01/11→12/11	➔	- Performance Parts		13.0460-2710.2 602710	TRW 23915 17,6 + WE / - WK + Zub
			➔	+ Performance Parts		13.0470-2710.2 LD2710	TRW 23915 17,6 + WE / - WK + Zub Ceramic
			➔	- Performance Parts		13.0460-4848.2 604848	BRE 24316 16,9 + WE / - WK
116 d	85	12/08→09/12	➔	- Performance Parts		13.0460-2713.2 602713	TRW 23623 17,4 + WE / - WK + Zub
			➔	- Performance Parts		13.0470-2713.2 LD2713	TRW 23623 17,4 + WE / - WK + Zub Ceramic
			➔	- Performance Parts		13.0460-2710.2 602710	TRW 23915 17,6 + WE / - WK + Zub
116 d	85	12/08→09/12	➔	03/10→ 05/11; - Performance Parts		13.0470-2710.2 LD2710	TRW 23915 17,6 + WE / - WK + Zub Ceramic
			➔	03/09→ 02/10; - Performance Parts		13.0460-2710.2 602710	TRW 23915 17,6 + WE / - WK + Zub
			➔	03/09→ 02/10; - Performance Parts		13.0470-2710.2 LD2710	TRW 23915 17,6 + WE / - WK + Zub Ceramic
116 d	85	12/08→09/12	➔	03/09→ 05/11; + Performance Parts		13.0460-4848.2 604848	BRE 24316 16,9 + WE / - WK
			➔	03/10→ 05/11; - Performance Parts		13.0460-2713.2 602713	TRW 23623 17,4 + WE / - WK + Zub
			➔	03/10→ 05/11; - Performance Parts		13.0470-2713.2 LD2713	TRW 23623 17,4 + WE / - WK + Zub Ceramic
116 d	85	12/08→09/12	➔	03/09→ 02/10; - Performance Parts		13.0460-2713.2 602713	TRW 23623 17,4 + WE / - WK + Zub
			➔	03/09→ 02/10; - Performance Parts		13.0470-2713.2 LD2713	TRW 23623 17,4 + WE / - WK + Zub Ceramic
			➔	03/09→ 02/10; - Performance Parts		13.0460-2713.2 602713	TRW 23623 17,4 + WE / - WK + Zub
116 i	85	11/03→06/11	➔	03/09→ 02/10; - Performance Parts		13.0470-2713.2 LD2713	TRW 23623 17,4 + WE / - WK + Zub Ceramic
			➔	09/04→ 08/07; - Performance Parts		13.0460-2710.2 602710	TRW 23915 17,6 + WE / - WK + Zub
			➔	09/04→ 08/07; - Performance Parts		13.0460-2710.2 602710	TRW 23915 17,6 + WE / - WK + Zub
↓							









	kw			 	! #		
BMW - 1 (E87) 02/03→01/13							
 Bremsbelagsatz, Scheibenbremse							
116 i	85	11/03→06/11	←	09/04→ 08/07; - Performance Parts	13.0470-2710.2	LD2710	TRW 23915 17,6 + WE / - WK + Zub Ceramic
			←	09/04→ 08/07; + Performance Parts	13.0460-4848.2	604848	BRE 24316 16,9 + WE / - WK
			→	09/04→ 08/07; - Performance Parts	13.0460-2713.2	602713	TRW 23623 17,4 + WE / - WK + Zub
					13.0470-2713.2	LD2713	TRW 23623 17,4 + WE / - WK + Zub Ceramic
116 i 116 i	89 90	03/07→06/11 03/07→06/11	←	09/07→ 12/08; - Performance Parts	13.0460-2710.2	602710	TRW 23915 17,6 + WE / - WK + Zub
			←	09/07→ 12/08; + Performance Parts	13.0460-4848.2	604848	BRE 24316 16,9 + WE / - WK
			→	09/07→ 12/08; - Performance Parts	13.0460-2713.2	602713	TRW 23623 17,4 + WE / - WK + Zub
					13.0470-2713.2	LD2713	TRW 23623 17,4 + WE / - WK + Zub Ceramic
116 i	90	01/09→06/11	←	03/10→ 05/11; - Performance Parts	13.0460-2710.2	602710	TRW 23915 17,6 + WE / - WK + Zub
			←	→ 02/10; - Performance Parts	13.0460-2710.2	602710	TRW 23915 17,6 + WE / - WK + Zub
			←	→ 05/11; + Performance Parts	13.0460-4848.2	604848	BRE 24316 16,9 + WE / - WK
			→	→ 02/10; - Performance Parts	13.0460-2713.2	602713	TRW 23623 17,4 + WE / - WK + Zub
					13.0470-2713.2	LD2713	TRW 23623 17,4 + WE / - WK + Zub Ceramic
			→	03/10→ 05/11; - Performance Parts	13.0460-2713.2	602713	TRW 23623 17,4 + WE / - WK + Zub
					13.0470-2713.2	LD2713	TRW 23623 17,4 + WE / - WK + Zub Ceramic
118 d	90	11/03→02/07	←	09/04→; - Performance Parts	13.0460-2710.2	602710	TRW 23915 17,6 + WE / - WK + Zub
			←	09/04→; + Performance Parts	13.0460-4848.2	604848	BRE 24316 16,9 + WE / - WK
			→	09/04→; Türenanzahl: 5; - Performance Parts	13.0460-2713.2	602713	TRW 23623 17,4 + WE / - WK + Zub
					13.0470-2713.2	LD2713	TRW 23623 17,4 + WE / - WK + Zub Ceramic
			→	09/04→; Türenanzahl: 3; - Performance Parts	13.0460-7217.2	607217	ATE 23926 17,3 + WE / - WK
					13.0470-7217.2	LD7217	ATE 23926 17,3 + WE / - WK Ceramic
118 d 118 d	100 105	09/06→06/11 09/06→06/11	←	03/10→ 05/11; - Performance Parts	13.0460-2710.2	602710	TRW 23915 17,6 + WE / - WK + Zub
			←	04/07→ 02/10; - Performance Parts	13.0460-2710.2	602710	TRW 23915 17,6 + WE / - WK + Zub
					13.0470-2710.2	LD2710	TRW 23915 17,6 + WE / - WK + Zub Ceramic
			←	04/07→ 05/11; + Performance Parts	13.0460-4848.2	604848	BRE 24316 16,9 + WE / - WK
			→	04/07→ 02/10; - Performance Parts	13.0460-7217.2	607217	ATE 23926 17,3 + WE / - WK
					13.0470-7217.2	LD7217	ATE 23926 17,3 + WE / - WK Ceramic
			→	03/10→ 05/11; - Performance Parts	13.0460-7217.2	607217	ATE 23926 17,3 + WE / - WK
					13.0470-7217.2	LD7217	ATE 23926 17,3 + WE / - WK Ceramic
118 i	95	07/04→02/07	←	09/04→; - Performance Parts	13.0460-2710.2	602710	TRW 23915 17,6 + WE / - WK + Zub
			←	09/04→; + Performance Parts	13.0460-4848.2	604848	BRE 24316 16,9 + WE / - WK
			→	09/04→; - Performance Parts	13.0460-2713.2	602713	TRW 23623 17,4 + WE / - WK + Zub



















	kw			 	! #		
BMW - 1 (E87) 02/03→01/13							
 Bremsbelagsatz, Scheibenbremse							
118 i	95	07/04→02/07	➡	09/04→; - Performance Parts		13.0470-2713.2 LD2713	TRW 23623 17,4 + WE / - WK + Zub Ceramic
118 i	100	10/06→06/11	←	→ 03/07; - Performance Parts		13.0460-2710.2 602710	TRW 23915 17,6 + WE / - WK + Zub
					13.0470-2710.2 LD2710	TRW 23915 17,6 + WE / - WK + Zub Ceramic	
			←	→ 03/07; + Performance Parts		13.0460-4848.2 604848	BRE 24316 16,9 + WE / - WK
			➡	→ 03/07; - Performance Parts		13.0460-2713.2 602713	TRW 23623 17,4 + WE / - WK + Zub
					13.0470-2713.2 LD2713	TRW 23623 17,4 + WE / - WK + Zub Ceramic	
118 i	105	09/06→06/11	←	04/07→ 02/10; - Performance Parts		13.0460-2710.2 602710	TRW 23915 17,6 + WE / - WK + Zub
					13.0470-2710.2 LD2710	TRW 23915 17,6 + WE / - WK + Zub Ceramic	
			←	03/10→ 05/11; - Performance Parts		13.0460-2710.2 602710	TRW 23915 17,6 + WE / - WK + Zub
					13.0470-2710.2 LD2710	TRW 23915 17,6 + WE / - WK + Zub Ceramic	
			←	04/07→ 05/11; + Performance Parts		13.0460-4848.2 604848	BRE 24316 16,9 + WE / - WK
			➡	04/07→ 02/10; - Performance Parts		13.0460-2713.2 602713	TRW 23623 17,4 + WE / - WK + Zub
					13.0470-2713.2 LD2713	TRW 23623 17,4 + WE / - WK + Zub Ceramic	
					13.0460-2713.2 602713	TRW 23623 17,4 + WE / - WK + Zub	
					13.0470-2713.2 LD2713	TRW 23623 17,4 + WE / - WK + Zub Ceramic	
118 i	125	03/07→12/07	←	04/07→; - Performance Parts		13.0460-2710.2 602710	TRW 23915 17,6 + WE / - WK + Zub
					13.0470-2710.2 LD2710	TRW 23915 17,6 + WE / - WK + Zub Ceramic	
			←	04/07→; + Performance Parts		13.0460-4848.2 604848	BRE 24316 16,9 + WE / - WK
			➡	04/07→; - Performance Parts		13.0460-2713.2 602713	TRW 23623 17,4 + WE / - WK + Zub
					13.0470-2713.2 LD2713	TRW 23623 17,4 + WE / - WK + Zub Ceramic	
120 d	110	03/03→02/07	←	09/04→; + Performance Parts		13.0460-4848.2 604848	BRE 24316 16,9 + WE / - WK
			←	09/04→; Türenanzahl: 5; - Performance Parts		13.0460-7215.2 607215	ATE 23935 17,8 + WE / - WK
					13.0470-7215.2 LD7215	ATE 23935 17,8 + WE / - WK Ceramic	
			←	09/04→; Türenanzahl: 3; - Performance Parts		13.0460-7216.2 607216	ATE 23794 20,3 + WE / - WK
					13.0470-7216.2 LD7216	ATE 23794 20,3 + WE / - WK Ceramic	
			➡	09/04→; - Performance Parts		13.0460-7217.2 607217	ATE 23926 17,3 + WE / - WK
					13.0470-7217.2 LD7217	ATE 23926 17,3 + WE / - WK Ceramic	
120 d	120	03/03→06/11	←	09/04→ 02/07; + Performance Parts		13.0460-4848.2 604848	BRE 24316 16,9 + WE / - WK
			←	09/04→ 02/07; Türenanzahl: 5; - Performance Parts		13.0460-7215.2 607215	ATE 23935 17,8 + WE / - WK
					13.0470-7215.2 LD7215	ATE 23935 17,8 + WE / - WK Ceramic	
			←	09/04→ 02/07; Türenanzahl: 3; - Performance Parts		13.0460-7216.2 607216	ATE 23794 20,3 + WE / - WK
					13.0470-7216.2 LD7216	ATE 23794 20,3 + WE / - WK Ceramic	
			➡	09/04→ 02/07; - Performance Parts		13.0460-7217.2 607217	ATE 23926 17,3 + WE / - WK
					13.0470-7217.2 LD7217	ATE 23926 17,3 + WE / - WK Ceramic	
120 d	130	09/06→06/11	←	03/07→ 05/11; + Performance Parts		13.0460-4848.2 604848	BRE 24316 16,9 + WE / - WK
			←	03/10→ 05/11; - Performance Parts		13.0460-7216.2 607216	ATE 23794 20,3 + WE / - WK
					13.0470-7216.2 LD7216	ATE 23794 20,3 + WE / - WK Ceramic	
			←	03/07→ 02/10; - Performance Parts		13.0460-7216.2 607216	ATE 23794 20,3 + WE / - WK
					13.0470-7216.2 LD7216	ATE 23794 20,3 + WE / - WK Ceramic	
			➡	03/10→ 05/11; - Performance Parts		13.0460-7217.2 607217	ATE 23926 17,3 + WE / - WK
					13.0470-7217.2 LD7217	ATE 23926 17,3 + WE / - WK Ceramic	
↓							









	kw			 	! #		
BMW - 1 (E87) 02/03→01/13							
 Bremsbelagsatz, Scheibenbremse							
120 d	130	09/06→06/11	➡	03/07→ 02/10; - Performance Parts		13.0460-7217.2 607217 13.0470-7217.2 LD7217	ATE 23926 17,3 + WE / - WK ATE 23926 17,3 + WE / - WK Ceramic
120 i 120 i	110 115	11/03→06/11 11/03→06/11	←	01/06→ 03/07; Türenanzahl: 5; - Performance Parts		13.0460-2710.2 602710 13.0470-2710.2 LD2710	TRW 23915 17,6 + WE / - WK + Zub TRW 23915 17,6 + WE / - WK + Zub Ceramic
			←	09/04→ 03/07; + Performance Parts		13.0460-4848.2 604848	BRE 24316 16,9 + WE / - WK
			←	09/04→ 12/05; Türenanzahl: 5; - Performance Parts		13.0460-7215.2 607215 13.0470-7215.2 LD7215	ATE 23935 17,8 + WE / - WK ATE 23935 17,8 + WE / - WK Ceramic
			←	09/04→ 03/07; Türenanzahl: 3; - Performance Parts		13.0460-7216.2 607216 13.0470-7216.2 LD7216	ATE 23794 20,3 + WE / - WK ATE 23794 20,3 + WE / - WK Ceramic
			➡	09/04→ 03/07; - Performance Parts		13.0460-2713.2 602713 13.0470-2713.2 LD2713	TRW 23623 17,4 + WE / - WK + Zub TRW 23623 17,4 + WE / - WK + Zub Ceramic
120 i 120 i	120 125	09/06→06/11 09/06→06/11	←	04/07→ 05/11; + Performance Parts		13.0460-4848.2 604848	BRE 24316 16,9 + WE / - WK
			←	04/07→ 02/10; - Performance Parts		13.0460-7216.2 607216 13.0470-7216.2 LD7216	ATE 23794 20,3 + WE / - WK ATE 23794 20,3 + WE / - WK Ceramic
			←	03/10→ 05/11; - Performance Parts		13.0460-7216.2 607216 13.0470-7216.2 LD7216	ATE 23794 20,3 + WE / - WK ATE 23794 20,3 + WE / - WK Ceramic
			➡	04/07→ 02/10; - Performance Parts		13.0460-2713.2 602713 13.0470-2713.2 LD2713	TRW 23623 17,4 + WE / - WK + Zub TRW 23623 17,4 + WE / - WK + Zub Ceramic
			➡	03/10→ 05/11; - Performance Parts		13.0460-2713.2 602713 13.0470-2713.2 LD2713	TRW 23623 17,4 + WE / - WK + Zub TRW 23623 17,4 + WE / - WK + Zub Ceramic
123 d	150	03/07→09/12	←	10/07→ 05/11; + Performance Parts		13.0460-4848.2 604848	BRE 24316 16,9 + WE / - WK
			←	10/07→ 02/10; - Performance Parts		13.0460-7223.2 607223 13.0470-7223.2 LD7223	ATE 23794 20,3 + WE / - WK ATE 23794 20,3 + WE / - WK Ceramic
			←	03/10→ 05/11; - Performance Parts		13.0460-7223.2 607223 13.0470-7223.2 LD7223	ATE 23794 20,3 + WE / - WK ATE 23794 20,3 + WE / - WK Ceramic
			➡	10/07→ 02/10; - Performance Parts		13.0460-7217.2 607217 13.0470-7217.2 LD7217	ATE 23926 17,3 + WE / - WK ATE 23926 17,3 + WE / - WK Ceramic
			➡	03/10→ 05/11; - Performance Parts		13.0460-7217.2 607217 13.0470-7217.2 LD7217	ATE 23926 17,3 + WE / - WK ATE 23926 17,3 + WE / - WK Ceramic
130 i	190	03/05→09/12	←	→ 05/11; + Performance Parts		13.0460-4848.2 604848	BRE 24316 16,9 + WE / - WK
			←	→ 02/10; - Performance Parts		13.0460-7223.2 607223 13.0470-7223.2 LD7223	ATE 23794 20,3 + WE / - WK ATE 23794 20,3 + WE / - WK Ceramic
			←	03/10→ 05/11; - Performance Parts		13.0460-7223.2 607223 13.0470-7223.2 LD7223	ATE 23794 20,3 + WE / - WK ATE 23794 20,3 + WE / - WK Ceramic
			➡	→ 02/10; - Performance Parts		13.0460-7217.2 607217 13.0470-7217.2 LD7217	ATE 23926 17,3 + WE / - WK ATE 23926 17,3 + WE / - WK Ceramic
			➡	03/10→ 05/11; - Performance Parts		13.0460-7217.2 607217 13.0470-7217.2 LD7217	ATE 23926 17,3 + WE / - WK ATE 23926 17,3 + WE / - WK Ceramic
130 i	195	03/05→09/12	←	09/05→ 05/11; + Performance Parts		13.0460-4848.2 604848	BRE 24316 16,9 + WE / - WK
			←	03/10→ 05/11; - Performance Parts		13.0460-7223.2 607223 13.0470-7223.2 LD7223	ATE 23794 20,3 + WE / - WK ATE 23794 20,3 + WE / - WK Ceramic
			←	09/05→ 02/10; - Performance Parts		13.0460-7223.2 607223 13.0470-7223.2 LD7223	ATE 23794 20,3 + WE / - WK ATE 23794 20,3 + WE / - WK Ceramic
↓							









	kw			 	! #		
BMW - 1 (E87) 02/03→01/13							
 Bremsbelagsatz, Scheibenbremse							
130 i	195	03/05→09/12	➔	03/10→ 05/11; - Performance Parts		13.0460-7217.2 607217 13.0470-7217.2 LD7217	ATE 23926 17,3 + WE / - WK ATE 23926 17,3 + WE / - WK Ceramic
			➔	09/05→ 02/10; - Performance Parts		13.0460-7217.2 607217 13.0470-7217.2 LD7217	ATE 23926 17,3 + WE / - WK ATE 23926 17,3 + WE / - WK Ceramic
Warnkontakt, Bremsbelagverschleiß							
116 d	66	01/11→12/11	←	+ Performance Parts	1	24.8190-0267.2 620267	L= 679
			←		1	24.8190-0284.2 620284	L= 650
			➔		1	24.8190-0285.2 620285	L= 1.107
116 d	85	12/08→09/12	←	03/09→ 02/10	1	24.8190-0264.2 620264	L= 630
			←	03/09→ 05/11; + Performance Parts	1	24.8190-0267.2 620267	L= 679
			←	03/10→ 05/11	1	24.8190-0284.2 620284	L= 650
			➔	03/09→ 02/10	1	24.8190-0265.2 620265	L= 1.086
			➔	03/10→ 05/11	1	24.8190-0285.2 620285	L= 1.107
116 i	85	11/03→06/11	←	09/04→ 08/07	1	24.8190-0264.2 620264	L= 630
			←	09/04→ 08/07; + Performance Parts	1	24.8190-0267.2 620267	L= 679
			➔	09/04→ 08/07	1	24.8190-0265.2 620265	L= 1.086
116 i 116 i	89 90	03/07→06/11 03/07→06/11	←	09/07→ 12/08	1	24.8190-0264.2 620264	L= 630
			←	09/07→ 12/08; + Performance Parts	1	24.8190-0267.2 620267	L= 679
			➔	09/07→ 12/08	1	24.8190-0265.2 620265	L= 1.086
116 i	90	01/09→06/11	←	→ 02/10	1	24.8190-0264.2 620264	L= 630
			←	→ 05/11; + Performance Parts	1	24.8190-0267.2 620267	L= 679
			←	03/10→ 05/11	1	24.8190-0284.2 620284	L= 650
			➔	→ 02/10	1	24.8190-0265.2 620265	L= 1.086
			➔	03/10→ 05/11	1	24.8190-0285.2 620285	L= 1.107
118 d	90	11/03→02/07	←	09/04→	1	24.8190-0264.2 620264	L= 630
			←	09/04→; + Performance Parts	1	24.8190-0267.2 620267	L= 679
			➔	09/04→; Türenanzahl: 5	1	24.8190-0265.2 620265	L= 1.086
			➔	09/04→; Türenanzahl: 3	1	24.8190-0265.2 620265	L= 1.086
118 d 118 d 118 i 120 i 120 i	100 105 105 120 125	09/06→06/11 09/06→06/11 09/06→06/11 09/06→06/11 09/06→06/11	←	04/07→ 02/10	1	24.8190-0264.2 620264	L= 630
			←	04/07→ 05/11; + Performance Parts	1	24.8190-0267.2 620267	L= 679
			←	03/10→ 05/11	1	24.8190-0284.2 620284	L= 650
			➔	04/07→ 02/10	1	24.8190-0265.2 620265	L= 1.086
			➔	03/10→ 05/11	1	24.8190-0285.2 620285	L= 1.107
118 i	95	07/04→02/07	←	09/04→	1	24.8190-0264.2 620264	L= 630
			←	09/04→; + Performance Parts	1	24.8190-0267.2 620267	L= 679
			➔	09/04→	1	24.8190-0265.2 620265	L= 1.086
118 i	100	10/06→06/11	←	→ 03/07	1	24.8190-0264.2 620264	L= 630
			←	→ 03/07; + Performance Parts	1	24.8190-0267.2 620267	L= 679
			➔	→ 03/07	1	24.8190-0265.2 620265	L= 1.086
118 i	125	03/07→12/07	←	04/07→	1	24.8190-0264.2 620264	L= 630
			←	04/07→; + Performance Parts	1	24.8190-0267.2 620267	L= 679
			➔	04/07→	1	24.8190-0265.2 620265	L= 1.086
120 d	110	03/03→02/07	←	09/04→; Türenanzahl: 3	1	24.8190-0264.2 620264	L= 630
			←	09/04→; Türenanzahl: 5	1	24.8190-0264.2 620264	L= 630
			←	09/04→; + Performance Parts	1	24.8190-0267.2 620267	L= 679
			➔	09/04→	1	24.8190-0265.2 620265	L= 1.086
120 d	120	03/03→06/11	←	09/04→ 02/07; Türenanzahl: 3	1	24.8190-0264.2 620264	L= 630
			←	09/04→ 02/07; Türenanzahl: 5	1	24.8190-0264.2 620264	L= 630
			←	09/04→ 02/07; + Performance Parts	1	24.8190-0267.2 620267	L= 679
			➔	09/04→ 02/07	1	24.8190-0265.2 620265	L= 1.086
120 d ↓	130	09/06→06/11	←	03/07→ 02/10	1	24.8190-0264.2 620264	L= 630









	kw			 	! #		
BMW - 1 (E87) 02/03→01/13							
Warnkontakt, Bremsbelagverschleiß							
120 d	130	09/06→06/11	←	03/07→ 05/11; + Performance Parts	1	24.8190-0267.2 620267	L= 679
			←	03/10→ 05/11	1	24.8190-0284.2 620284	L= 650
			→	03/07→ 02/10	1	24.8190-0265.2 620265	L= 1.086
			→	03/10→ 05/11	1	24.8190-0285.2 620285	L= 1.107
120 i 120 i	110 115	11/03→06/11 11/03→06/11	←	09/04→ 03/07; Türenanzahl: 3	1	24.8190-0264.2 620264	L= 630
			←	01/06→ 03/07; Türenanzahl: 5	1	24.8190-0264.2 620264	L= 630
			←	09/04→ 12/05; Türenanzahl: 5	1	24.8190-0264.2 620264	L= 630
			←	09/04→ 03/07; + Performance Parts	1	24.8190-0267.2 620267	L= 679
			→	09/04→ 03/07	1	24.8190-0265.2 620265	L= 1.086
123 d	150	03/07→09/12	←	10/07→ 02/10	1	24.8190-0267.2 620267	L= 679
			←	10/07→ 05/11; + Performance Parts	1	24.8190-0267.2 620267	L= 679
			←	03/10→ 05/11	1	24.8190-0287.2 620287	L= 723
			→	10/07→ 02/10	1	24.8190-0265.2 620265	L= 1.086
			→	03/10→ 05/11	1	24.8190-0285.2 620285	L= 1.107
			→	03/10→ 05/11	1	24.8190-0285.2 620285	L= 1.107
130 i	190	03/05→09/12	←	→ 05/11; + Performance Parts	1	24.8190-0267.2 620267	L= 679
			←	→ 02/10	1	24.8190-0267.2 620267	L= 679
			←	03/10→ 05/11	1	24.8190-0287.2 620287	L= 723
			→	→ 02/10	1	24.8190-0265.2 620265	L= 1.086
			→	03/10→ 05/11	1	24.8190-0285.2 620285	L= 1.107
130 i	195	03/05→09/12	←	09/05→ 02/10	1	24.8190-0267.2 620267	L= 679
			←	09/05→ 05/11; + Performance Parts	1	24.8190-0267.2 620267	L= 679
			←	03/10→ 05/11	1	24.8190-0287.2 620287	L= 723
			→	09/05→ 02/10	1	24.8190-0265.2 620265	L= 1.086
			→	03/10→ 05/11	1	24.8190-0285.2 620285	L= 1.107
 Bremsscheibe							
116 d	66	01/11→12/11	←	- Performance Parts		24.0122-0239.1 422239	Ø 284 22 20,4 V + S
						24.0322-0239.1 522239	Ø 284 22 19,6 V + S PD
			→	- Performance Parts		24.0110-0314.1 410314	Ø 280 10 8,4 + S
116 d	85	12/08→09/12	←	03/09→ 05/11; - Performance Parts		24.0122-0239.1 422239	Ø 284 22 20,4 V + S
						24.0322-0239.1 522239	Ø 284 22 19,6 V + S PD
			→	03/09→ 05/11; - Performance Parts		24.0110-0314.1 410314	Ø 280 10 8,4 + S
116 i	85	11/03→06/11	←	09/04→ 08/07; - Performance Parts		24.0122-0239.1 422239	Ø 284 22 20,4 V + S
						24.0322-0239.1 522239	Ø 284 22 19,6 V + S PD
			→	09/04→ 08/07; - Performance Parts		24.0110-0314.1 410314	Ø 280 10 8,4 + S
116 i	89 90	03/07→06/11 03/07→06/11	←	09/07→ 12/08; - Performance Parts		24.0122-0239.1 422239	Ø 284 22 20,4 V + S
						24.0322-0239.1 522239	Ø 284 22 19,6 V + S PD
			→	09/07→ 12/08; - Performance Parts		24.0110-0314.1 410314	Ø 280 10 8,4 + S
116 i	90	01/09→06/11	←	→ 05/11; - Performance Parts		24.0122-0239.1 422239	Ø 284 22 20,4 V + S
						24.0322-0239.1 522239	Ø 284 22 19,6 V + S PD
			→	→ 05/11; - Performance Parts		24.0110-0314.1 410314	Ø 280 10 8,4 + S
118 d	90	11/03→02/07	←	09/04→; Türenanzahl: 3; - Performance Parts		24.0122-0238.1 422238	Ø 292 22 20,4 V + S
						24.0322-0238.1 522238	Ø 292 22 19,6 V + S PD
			←	09/04→; Türenanzahl: 5; - Performance Parts		24.0122-0239.1 422239	Ø 284 22 20,4 V + S
						24.0322-0239.1 522239	Ø 284 22 19,6 V + S PD
			→	09/04→; Türenanzahl: 5; - Performance Parts		24.0110-0314.1 410314	Ø 280 10 8,4 + S
118 d 118 d	100 105	09/06→06/11 09/06→06/11	←	04/07→ 05/11; - Performance Parts		24.0122-0238.1 422238	Ø 292 22 20,4 V + S
						24.0322-0238.1 522238	Ø 292 22 19,6 V + S PD
			→	04/07→ 05/11; - Performance Parts		24.0120-0195.1 420195	Ø 300 20 18,4 V + S
						24.0320-0195.1 520195	Ø 300 20 17,6 V + S PD
			→	04/07→ 05/11; - Performance Parts		24.0120-0195.1 420195	Ø 300 20 18,4 V + S
					24.0320-0195.1 520195	Ø 300 20 17,6 V + S PD	
↓							







	kw			 	! #		
BMW - 1 (E87) 02/03→01/13							
Bremsscheibe							
118 i	95	07/04→02/07	←	09/04→; Türenanzahl: 3; - Performance Parts	24.0122-0238.1 422238	Ø 292 22 20,4 V + S	
					24.0322-0238.1 522238	Ø 292 22 19,6 V + S PD	
			←	09/04→; Türenanzahl: 5; - Performance Parts	24.0122-0239.1 422239	Ø 284 22 20,4 V + S	
					24.0322-0239.1 522239	Ø 284 22 19,6 V + S PD	
118 i	100	10/06→06/11	←	→ 03/07; Türenanzahl: 3; - Performance Parts	24.0122-0238.1 422238	Ø 292 22 20,4 V + S	
					24.0322-0238.1 522238	Ø 292 22 19,6 V + S PD	
			←	→ 03/07; Türenanzahl: 5; - Performance Parts	24.0122-0239.1 422239	Ø 284 22 20,4 V + S	
					24.0322-0239.1 522239	Ø 284 22 19,6 V + S PD	
118 i	105	09/06→06/11	←	04/07→ 05/11; - Performance Parts	24.0122-0238.1 422238	Ø 292 22 20,4 V + S	
					24.0322-0238.1 522238	Ø 292 22 19,6 V + S PD	
			→	04/07→ 05/11; - Performance Parts	24.0110-0314.1 410314	Ø 280 10 8,4 + S	
					24.0310-0314.1 510314	Ø 280 10 7,6 + S PD	
118 i	125	03/07→12/07	←	04/07→; - Performance Parts	24.0122-0238.1 422238	Ø 292 22 20,4 V + S	
					24.0322-0238.1 522238	Ø 292 22 19,6 V + S PD	
			→	04/07→; - Performance Parts	24.0110-0315.1 410315	Ø 296 10,4 8,9 + S	
					24.0310-0315.1 510315	Ø 296 10,4 8,1 + S PD	
120 d	110	03/03→02/07	←	09/04→; Türenanzahl: 5; - Performance Parts	24.0122-0238.1 422238	Ø 292 22 20,4 V + S	
					24.0322-0238.1 522238	Ø 292 22 19,6 V + S PD	
			←	09/04→; Türenanzahl: 3; - Performance Parts	24.0124-0197.1 424197	Ø 300 24 22,4 V + S	
120 d	120	03/03→06/11	←	09/04→ 02/07; Türenanzahl: 5; - Performance Parts	24.0122-0238.1 422238	Ø 292 22 20,4 V + S	
					24.0322-0238.1 522238	Ø 292 22 19,6 V + S PD	
			←	09/04→ 02/07; Türenanzahl: 3; - Performance Parts	24.0124-0197.1 424197	Ø 300 24 22,4 V + S	
120 d	130	09/06→06/11	←	03/07→ 05/11; - Performance Parts	24.0124-0197.1 424197	Ø 300 24 22,4 V + S	
					24.0324-0197.1 524197	Ø 300 24 21,6 V + S PD	
			→	03/07→ 05/11; - Performance Parts	24.0120-0195.1 420195	Ø 300 20 18,4 V + S	
120 i 120 i	110 115	11/03→06/11 11/03→06/11	←	09/04→ 03/07; Türenanzahl: 5; - Performance Parts	24.0122-0238.1 422238	Ø 292 22 20,4 V + S	
					24.0322-0238.1 522238	Ø 292 22 19,6 V + S PD	
			←	09/04→ 03/07; Türenanzahl: 3; - Performance Parts	24.0124-0197.1 424197	Ø 300 24 22,4 V + S	
120 i 120 i	120 125	09/06→06/11 09/06→06/11	←	04/07→ 05/11; - Performance Parts	24.0124-0197.1 424197	Ø 300 24 22,4 V + S	
					24.0324-0197.1 524197	Ø 300 24 21,6 V + S PD	
			→	04/07→ 05/11; - Performance Parts	24.0110-0315.1 410315	Ø 296 10,4 8,9 + S	
123 d	150	03/07→09/12	←	10/07→ 05/11; - Performance Parts	24.0124-0200.1 424200	Ø 330 24 22,4 V + S	
					24.0324-0200.1 524200	Ø 330 24 21,6 V + S PD	
			→	04/07→ 05/11; - Performance Parts	24.0120-0204.1 420204	Ø 300 20 18,4 V + S	
130 i	190	03/05→09/12	←	→ 05/11; - Performance Parts	24.0124-0200.1 424200	Ø 330 24 22,4 V + S	
					24.0324-0200.1 524200	Ø 330 24 21,6 V + S PD	
			→	→ 05/11; - Performance Parts	24.0120-0204.1 420204	Ø 300 20 18,4 V + S	
130 i	195	03/05→09/12	←	09/05→ 05/11; - Performance Parts	24.0124-0200.1 424200	Ø 330 24 22,4 V + S	
					24.0324-0200.1 524200	Ø 330 24 21,6 V + S PD	
			→	09/05→ 05/11; - Performance Parts	24.0120-0204.1 420204	Ø 300 20 18,4 V + S	









	kW			 	! #		
BMW - 1 (E87) 02/03→01/13							
 Bremsscheibe							
130 i	195	03/05→09/12	➡	09/05→ 05/11; - Performance Parts		24.0320-0204.1 520204	Ø 300 20 17,6 V + S PD
BMW - 1 (F20) 11/10→							
 Bremsbelagsatz, Scheibenbremse							
114 d	70	06/15→	←	- Performance Parts		13.0460-3865.2 603865	BOS 25014 18,2 + WE / - WK
114 d	70	10/12→				13.0470-3865.2 LD3865	BOS 25014 18,2 + WE / - WK Ceramic
116 d	85	03/15→					
116 i	80	03/15→	←	+ Performance Parts		13.0460-4875.2 604875	BRE 25028 18,0 + WE / - WK
118 d	110	03/15→	➡	- Performance Parts		13.0460-3859.2 603859	BOS 25307 17,5 + WE / - WK Ceramic
118 d xDrive	110	03/15→				13.0470-3859.2 LD3859	BOS 25307 17,5 + WE / - WK Ceramic
118 i	100	03/15→	➡	+ Performance Parts		13.0460-4874.2 604874	BRE 25029 16,7 + WE / - WK
114 i	75	11/11→	←	09/12→; - Performance Parts		13.0460-3865.2 603865	BOS 25014 18,2 + WE / - WK Ceramic
						13.0470-3865.2 LD3865	BOS 25014 18,2 + WE / - WK Ceramic
			←	09/12→; + Performance Parts		13.0460-4875.2 604875	BRE 25028 18,0 + WE / - WK
			➡	09/12→; - Performance Parts		13.0460-3859.2 603859	BOS 25307 17,5 + WE / - WK Ceramic
						13.0470-3859.2 LD3859	BOS 25307 17,5 + WE / - WK Ceramic
			➡	09/12→; + Performance Parts		13.0460-4874.2 604874	BRE 25029 16,7 + WE / - WK
116 d	85	11/12→	←	- Performance Parts		13.0460-3865.2 603865	BOS 25014 18,2 + WE / - WK Ceramic
						13.0470-3865.2 LD3865	BOS 25014 18,2 + WE / - WK Ceramic
			←	+ Performance Parts		13.0460-4875.2 604875	BRE 25028 18,0 + WE / - WK
			➡			13.0460-3859.2 603859	BOS 25307 17,5 + WE / - WK Ceramic
						13.0470-3859.2 LD3859	BOS 25307 17,5 + WE / - WK Ceramic
116 d	85	12/10→	←	06/11→; - Performance Parts		13.0460-3865.2 603865	BOS 25014 18,2 + WE / - WK Ceramic
116 i	100	12/10→				13.0470-3865.2 LD3865	BOS 25014 18,2 + WE / - WK Ceramic
118 d	100	12/10→					
118 d	105	12/10→	←	06/11→; + Performance Parts		13.0460-4875.2 604875	BRE 25028 18,0 + WE / - WK
			➡	06/11→		13.0460-3859.2 603859	BOS 25307 17,5 + WE / - WK Ceramic
						13.0470-3859.2 LD3859	BOS 25307 17,5 + WE / - WK Ceramic
118 d xDrive	105	07/13→	←	- Performance Parts		13.0460-3866.2 603866	BOS 25506 18,2 + WE / - WK Ceramic
120 d	140	03/15→				13.0470-3866.2 LD3866	BOS 25506 18,2 + WE / - WK Ceramic
120 d xDrive	140	03/15→	←	+ Performance Parts		13.0460-4875.2 604875	BRE 25028 18,0 + WE / - WK
120 i	130	03/15→	➡	- Performance Parts		13.0460-3859.2 603859	BOS 25307 17,5 + WE / - WK Ceramic
120 i	135	09/15→				13.0470-3859.2 LD3859	BOS 25307 17,5 + WE / - WK Ceramic
			➡	+ Performance Parts		13.0460-4874.2 604874	BRE 25029 16,7 + WE / - WK
118 i	125	11/10→	←	06/11→		13.0460-3866.2 603866	BOS 25506 18,2 + WE / - WK Ceramic
120 d	120	12/10→				13.0470-3866.2 LD3866	BOS 25506 18,2 + WE / - WK Ceramic
120 d	135	12/10→					
120 d	147	01/11→	➡	06/11→		13.0460-3859.2 603859	BOS 25307 17,5 + WE / - WK Ceramic
						13.0470-3859.2 LD3859	BOS 25307 17,5 + WE / - WK Ceramic
120 d xDrive	135	02/12→	←	07/12→; - Performance Parts		13.0460-3866.2 603866	BOS 25506 18,2 + WE / - WK Ceramic
120 d xDrive	147	01/11→				13.0470-3866.2 LD3866	BOS 25506 18,2 + WE / - WK Ceramic
			←	07/12→; + Performance Parts		13.0460-4875.2 604875	BRE 25028 18,0 + WE / - WK
			➡	07/12→; - Performance Parts		13.0460-3859.2 603859	BOS 25307 17,5 + WE / - WK Ceramic
						13.0470-3859.2 LD3859	BOS 25307 17,5 + WE / - WK Ceramic
			➡	07/12→; + Performance Parts		13.0460-4874.2 604874	BRE 25029 16,7 + WE / - WK
125 d	155	08/11→	←	03/12→; - Performance Parts		13.0460-3857.2 603857	BOS 25199 19,6 + WE / - WK Ceramic
125 d	160	08/11→				13.0470-3857.2 LD3857	BOS 25199 19,6 + WE / - WK Ceramic
125 i	160	08/11→	←	03/12→; + Performance Parts		13.0460-4875.2 604875	BRE 25028 18,0 + WE / - WK
			➡	03/12→; - Performance Parts		13.0460-3859.2 603859	BOS 25307 17,5 + WE / - WK Ceramic
						13.0470-3859.2 LD3859	BOS 25307 17,5 + WE / - WK Ceramic
↓							









	kW			 	! #		
BMW - 1 (F20) 11/10→							
 Bremsbelagsatz, Scheibenbremse							
125 d	155	08/11→	➔	03/12→; + Performance Parts		13.0460-4874.2 604874	BRE 25029 16,7 + WE / - WK
125 d	160	08/11→					
125 i	160	08/11→					
125 d	165	03/15→	➔	- Performance Parts		13.0460-3857.2 603857	BOS 25199 19,6 + WE / - WK
125 i	165	09/15→				13.0470-3857.2 LD3857	BOS 25199 19,6 + WE / - WK
125 i	175	03/13→					Ceramic
			➔	+ Performance Parts		13.0460-4875.2 604875	BRE 25028 18,0 + WE / - WK
			➔	- Performance Parts		13.0460-3859.2 603859	BOS 25307 17,5 + WE / - WK
						13.0470-3859.2 LD3859	BOS 25307 17,5 + WE / - WK
			➔	+ Performance Parts		13.0460-4874.2 604874	BRE 25029 16,7 + WE / - WK
M 135 i	235	11/11→	➔	09/12→		13.0460-4875.2 604875	BRE 25028 18,0 + WE / - WK
			➔	09/12→		13.0460-4874.2 604874	BRE 25029 16,7 + WE / - WK
M 135 i	240	03/15→	➔			13.0460-4875.2 604875	BRE 25028 18,0 + WE / - WK
M 135 i xDrive	240	03/15→	➔			13.0460-4874.2 604874	BRE 25029 16,7 + WE / - WK
M 140 i	250	09/15→					
M 140 i xDrive	250	09/15→					
M 135 i xDrive	235	02/12→	➔	07/12→		13.0460-4875.2 604875	BRE 25028 18,0 + WE / - WK
			➔	07/12→		13.0460-4874.2 604874	BRE 25029 16,7 + WE / - WK
Warnkontakt, Bremsbelagverschleiß							
114 d	70	06/15→	➔		1	24.8190-0006.2 620006	L= 675
114 d	70	10/12→					
116 d	85	03/15→	➔		1	24.8190-0007.2 620007	L= 1.045
116 d	85	11/12→					
116 i	80	03/15→					
118 d	110	03/15→					
118 d xDrive	110	03/15→					
118 i	100	03/15→					
M 135 i	240	03/15→					
M 135 i xDrive	240	03/15→					
M 140 i	250	09/15→					
M 140 i xDrive	250	09/15→					
114 i	75	11/11→	➔	09/12→	1	24.8190-0006.2 620006	L= 675
M 135 i	235	11/11→	➔	09/12→	1	24.8190-0007.2 620007	L= 1.045
116 d	85	12/10→	➔	06/11→	1	24.8190-0006.2 620006	L= 675
116 i	100	12/10→					
118 d	100	12/10→	➔	06/11→	1	24.8190-0007.2 620007	L= 1.045
118 d	105	12/10→					
118 d xDrive	105	07/13→	➔	☐	1	24.8190-0006.2 620006	L= 675
120 d	140	03/15→	➔		1	24.8190-0007.2 620007	L= 1.045
120 d xDrive	140	03/15→					
120 i	130	03/15→					
120 i	135	09/15→					
125 d	165	03/15→					
125 i	165	09/15→					
125 i	175	03/13→					
118 i	125	11/10→	➔	☐; 06/11→	1	24.8190-0006.2 620006	L= 675
120 d	120	12/10→	➔	06/11→	1	24.8190-0007.2 620007	L= 1.045
120 d	135	12/10→					
120 d	147	01/11→					
120 d xDrive	135	02/12→	➔	☐; 07/12→	1	24.8190-0006.2 620006	L= 675
120 d xDrive	147	01/11→	➔	07/12→	1	24.8190-0007.2 620007	L= 1.045
125 d	155	08/11→	➔	☐; 03/12→	1	24.8190-0006.2 620006	L= 675
125 d	160	08/11→					
125 i	160	08/11→	➔	03/12→	1	24.8190-0007.2 620007	L= 1.045
M 135 i xDrive	235	02/12→	➔	07/12→	1	24.8190-0006.2 620006	L= 675
			➔	07/12→	1	24.8190-0007.2 620007	L= 1.045
 Bremsscheibe							
114 d	70	06/15→	➔	- Performance Parts		24.0122-0239.1 422239	Ø 284 22 20,4 V + S
114 d	70	10/12→	➔	+ Performance Parts		24.0130-0233.2 430233	Ø 340 30 28,4 V Bremsscheibe zweiteilig / + S
116 d	85	03/15→					
116 i	80	03/15→					
118 d	110	03/15→				24.0322-0239.1 522239	Ø 284 22 19,6 V + S PD
118 d xDrive	110	03/15→	➔	- Performance Parts		24.0111-0175.1 411175	Ø 290 11 9,4 + S
118 i	100	03/15→	➔	+ Performance Parts		24.0124-0250.2 424250	Ø 345 24 22,4 V Bremsscheibe zweiteilig / + S
114 i	75	11/11→	➔	09/12→; - Performance Parts		24.0122-0239.1 422239	Ø 284 22 20,4 V + S
			➔	09/12→; + Performance Parts		24.0130-0233.2 430233	Ø 340 30 28,4 V Bremsscheibe zweiteilig / + S
↓							











	kW			 	! #		
BMW - 1 (F20) 11/10→							
 Bremsscheibe							
114 i	75	11/11→	←	09/12→; + Performance Parts	24.0322-0239.1	522239	Ø 284 22 19,6 V + S PD
			→	09/12→; - Performance Parts	24.0111-0175.1	411175	Ø 290 11 9,4 + S
			→	09/12→; + Performance Parts	24.0124-0250.2	424250	Ø 345 24 22,4 V Bremsscheibe zweiteilig / + S
116 d	85	11/12→	←	- Performance Parts	24.0122-0239.1	422239	Ø 284 22 20,4 V + S
			←	+ Performance Parts	24.0130-0233.2	430233	Ø 340 30 28,4 V Bremsscheibe zweiteilig / + S
					24.0322-0239.1	522239	Ø 284 22 19,6 V + S PD
			→		24.0111-0175.1	411175	Ø 290 11 9,4 + S
116 d 116 i 118 d 118 d	85 100 100 105	12/10→ 12/10→ 12/10→ 12/10→	←	06/11→; - Performance Parts	24.0122-0239.1	422239	Ø 284 22 20,4 V + S
			←	06/11→; + Performance Parts	24.0130-0233.2	430233	Ø 340 30 28,4 V Bremsscheibe zweiteilig / + S
					24.0322-0239.1	522239	Ø 284 22 19,6 V + S PD
			→	06/11→	24.0111-0175.1	411175	Ø 290 11 9,4 + S
118 d xDrive 120 i 120 i	105 130 135	07/13→ 03/15→ 09/15→	←	- Performance Parts	24.0122-0278.1	422278	Ø 300 22 20,4 V + S
			←	+ Performance Parts	24.0130-0233.2	430233	Ø 340 30 28,4 V Bremsscheibe zweiteilig / + S
			→	- Performance Parts	24.0111-0175.1	411175	Ø 290 11 9,4 + S
			→	+ Performance Parts	24.0124-0250.2	424250	Ø 345 24 22,4 V Bremsscheibe zweiteilig / + S
118 i	125	11/10→	←	06/11→	24.0122-0278.1	422278	Ø 300 22 20,4 V + S
			→	06/11→	24.0111-0175.1	411175	Ø 290 11 9,4 + S
120 d 120 d 120 d	120 135 147	12/10→ 12/10→ 01/11→	←	06/11→	24.0122-0278.1	422278	Ø 300 22 20,4 V + S
			→	06/11→	24.0120-0237.1	420237	Ø 300 20 18,4 V + S
120 d 120 d xDrive	140 140	03/15→ 03/15→	←	- Performance Parts	24.0122-0278.1	422278	Ø 300 22 20,4 V + S
			←	+ Performance Parts	24.0130-0233.2	430233	Ø 340 30 28,4 V Bremsscheibe zweiteilig / + S
			→	- Performance Parts	24.0120-0237.1	420237	Ø 300 20 18,4 V + S
			→	+ Performance Parts	24.0124-0250.2	424250	Ø 345 24 22,4 V Bremsscheibe zweiteilig / + S
120 d xDrive 120 d xDrive	135 147	02/12→ 01/11→	←	07/12→; - Performance Parts	24.0122-0278.1	422278	Ø 300 22 20,4 V + S
			←	07/12→; + Performance Parts	24.0130-0233.2	430233	Ø 340 30 28,4 V Bremsscheibe zweiteilig / + S
			→	07/12→; - Performance Parts	24.0120-0237.1	420237	Ø 300 20 18,4 V + S
			→	07/12→; + Performance Parts	24.0124-0250.2	424250	Ø 345 24 22,4 V Bremsscheibe zweiteilig / + S
125 d 125 d 125 i	155 160 160	08/11→ 08/11→ 08/11→	←	03/12→; - Performance Parts	24.0124-0203.1	424203	Ø 312 23,9 22,4 V + S
					24.0324-0203.1	524203	Ø 312 23,9 21,6 V + S PD
			←	03/12→; + Performance Parts	24.0130-0233.2	430233	Ø 340 30 28,4 V Bremsscheibe zweiteilig / + S
			→	03/12→; - Performance Parts	24.0120-0237.1	420237	Ø 300 20 18,4 V + S
125 d 125 i 125 i	165 165 175	03/15→ 09/15→ 03/13→	←	- Performance Parts	24.0124-0203.1	424203	Ø 312 23,9 22,4 V + S
					24.0324-0203.1	524203	Ø 312 23,9 21,6 V + S PD
			←	+ Performance Parts	24.0130-0233.2	430233	Ø 340 30 28,4 V Bremsscheibe zweiteilig / + S
			→	- Performance Parts	24.0120-0237.1	420237	Ø 300 20 18,4 V + S
M 135 i	235	11/11→	←	09/12→	24.0130-0233.2	430233	Ø 340 30 28,4 V Bremsscheibe zweiteilig / + S
			→	09/12→	24.0124-0250.2	424250	Ø 345 24 22,4 V Bremsscheibe zweiteilig / + S
M 135 i M 135 i xDrive M 140 i M 140 i xDrive	240 240 250 250	03/15→ 03/15→ 09/15→ 09/15→	←		24.0130-0233.2	430233	Ø 340 30 28,4 V Bremsscheibe zweiteilig / + S
			→		24.0124-0250.2	424250	Ø 345 24 22,4 V Bremsscheibe zweiteilig / + S
M 135 i xDrive	235	02/12→	←	07/12→	24.0130-0233.2	430233	Ø 340 30 28,4 V Bremsscheibe zweiteilig / + S
			→	07/12→	24.0124-0250.2	424250	Ø 345 24 22,4 V Bremsscheibe zweiteilig / + S
BMW - 1 (F21) 12/11→							
 Bremsbelagsatz, Scheibenbremse							
114 d 116 d ↓	70 85	06/15→ 03/15→	←	- Performance Parts	13.0460-3865.2	603865	BOS 25014 18,2 + WE / - WK









	kW			 	! #		
BMW - 1 (F21) 12/11→							
 Bremsbelagsatz, Scheibenbremse							
116 i 118 d 118 d xDrive 118 i	80 110 110 100	03/15→ 03/15→ 03/15→ 03/15→	← ← → →	- Performance Parts + Performance Parts - Performance Parts + Performance Parts		13.0470-3865.2 LD3865 13.0460-4875.2 604875 13.0460-3859.2 603859 13.0470-3859.2 LD3859 13.0460-4874.2 604874	BOS 25014 18,2 + WE / - WK Ceramic BRE 25028 18,0 + WE / - WK BOS 25307 17,5 + WE / - WK BOS 25307 17,5 + WE / - WK Ceramic BRE 25029 16,7 + WE / - WK
114 d	70	07/12→	← ← → →	10/12→; - Performance Parts 10/12→; + Performance Parts 10/12→; - Performance Parts 10/12→; + Performance Parts		13.0460-3865.2 603865 13.0470-3865.2 LD3865 13.0460-4875.2 604875 13.0460-3859.2 603859 13.0470-3859.2 LD3859 13.0460-4874.2 604874	BOS 25014 18,2 + WE / - WK Ceramic BRE 25028 18,0 + WE / - WK BOS 25307 17,5 + WE / - WK BOS 25307 17,5 + WE / - WK Ceramic BRE 25029 16,7 + WE / - WK
114 i	75	12/11→	← ← → →	09/12→; - Performance Parts 09/12→; + Performance Parts 09/12→; - Performance Parts 09/12→; + Performance Parts		13.0460-3865.2 603865 13.0470-3865.2 LD3865 13.0460-4875.2 604875 13.0460-3859.2 603859 13.0470-3859.2 LD3859 13.0460-4874.2 604874	BOS 25014 18,2 + WE / - WK Ceramic BRE 25028 18,0 + WE / - WK BOS 25307 17,5 + WE / - WK BOS 25307 17,5 + WE / - WK Ceramic BRE 25029 16,7 + WE / - WK
116 d 116 d 116 i 118 d 118 d	85 85 100 100 105	12/11→ 01/12→ 12/11→ 12/11→ 12/11→	← ← →	- Performance Parts + Performance Parts		13.0460-3865.2 603865 13.0470-3865.2 LD3865 13.0460-4875.2 604875 13.0460-3859.2 603859 13.0470-3859.2 LD3859	BOS 25014 18,2 + WE / - WK Ceramic BOS 25014 18,2 + WE / - WK Ceramic BRE 25028 18,0 + WE / - WK BOS 25307 17,5 + WE / - WK BOS 25307 17,5 + WE / - WK Ceramic
118 d xDrive 120 d 120 d xDrive 120 i 120 i	105 140 140 130 135	05/13→ 03/15→ 03/15→ 03/15→ 10/15→	← ← → →	- Performance Parts + Performance Parts - Performance Parts + Performance Parts		13.0460-3866.2 603866 13.0470-3866.2 LD3866 13.0460-4875.2 604875 13.0460-3859.2 603859 13.0470-3859.2 LD3859 13.0460-4874.2 604874	BOS 25506 18,2 + WE / - WK BOS 25506 18,2 + WE / - WK Ceramic BRE 25028 18,0 + WE / - WK BOS 25307 17,5 + WE / - WK BOS 25307 17,5 + WE / - WK Ceramic BRE 25029 16,7 + WE / - WK
118 i 120 d 120 d 120 d	125 120 135 147	07/12→ 07/12→ 07/12→ 01/12→	← →			13.0460-3866.2 603866 13.0470-3866.2 LD3866 13.0460-3859.2 603859 13.0470-3859.2 LD3859	BOS 25506 18,2 + WE / - WK BOS 25506 18,2 + WE / - WK Ceramic BOS 25307 17,5 + WE / - WK BOS 25307 17,5 + WE / - WK Ceramic
120 d xDrive 120 d xDrive	135 147	02/12→ 01/12→	← ← → →	07/12→; - Performance Parts 07/12→; + Performance Parts 07/12→; - Performance Parts 07/12→; + Performance Parts		13.0460-3866.2 603866 13.0470-3866.2 LD3866 13.0460-4875.2 604875 13.0460-3859.2 603859 13.0470-3859.2 LD3859 13.0460-4874.2 604874	BOS 25506 18,2 + WE / - WK BOS 25506 18,2 + WE / - WK Ceramic BRE 25028 18,0 + WE / - WK BOS 25307 17,5 + WE / - WK BOS 25307 17,5 + WE / - WK Ceramic BRE 25029 16,7 + WE / - WK
125 d 125 d 125 i	155 160 160	12/11→ 12/11→ 12/11→	← ← → →	03/12→; - Performance Parts 03/12→; + Performance Parts 03/12→; - Performance Parts 03/12→; + Performance Parts		13.0460-3857.2 603857 13.0470-3857.2 LD3857 13.0460-4875.2 604875 13.0460-3859.2 603859 13.0470-3859.2 LD3859 13.0460-4874.2 604874	BOS 25199 19,6 + WE / - WK BOS 25199 19,6 + WE / - WK Ceramic BRE 25028 18,0 + WE / - WK BOS 25307 17,5 + WE / - WK BOS 25307 17,5 + WE / - WK Ceramic BRE 25029 16,7 + WE / - WK
125 d 125 i 125 i	165 165 175	03/15→ 10/15→ 03/13→	←	- Performance Parts		13.0460-3857.2 603857 13.0470-3857.2 LD3857	BOS 25199 19,6 + WE / - WK BOS 25199 19,6 + WE / - WK Ceramic
↓							









	kW			 	! #		
BMW - 1 (F21) 12/11→							
Bremsbelagsatz, Scheibenbremse							
125 d	165	03/15→	←	+ Performance Parts		13.0460-4875.2 604875	BRE 25028 18,0 + WE / - WK
125 i	165	10/15→	→	- Performance Parts		13.0460-3859.2 603859	BOS 25307 17,5 + WE / - WK
125 i	175	03/13→	→			13.0470-3859.2 LD3859	BOS 25307 17,5 + WE / - WK Ceramic
			→	+ Performance Parts		13.0460-4874.2 604874	BRE 25029 16,7 + WE / - WK
M 135 i	235	12/11→	←	09/12→		13.0460-4875.2 604875	BRE 25028 18,0 + WE / - WK
			→	09/12→		13.0460-4874.2 604874	BRE 25029 16,7 + WE / - WK
M 135 i	240	03/15→	←			13.0460-4875.2 604875	BRE 25028 18,0 + WE / - WK
M 135 i xDrive	240	03/15→	→			13.0460-4874.2 604874	BRE 25029 16,7 + WE / - WK
M 140 i	250	10/15→					
M 140 i xDrive	250	09/15→					
M 135 i xDrive	235	02/12→	←	07/12→		13.0460-4875.2 604875	BRE 25028 18,0 + WE / - WK
			→	07/12→		13.0460-4874.2 604874	BRE 25029 16,7 + WE / - WK
Warnkontakt, Bremsbelagverschleiß							
114 d	70	06/15→	←		1	24.8190-0006.2 620006	L= 675
116 d	85	03/15→	→		1	24.8190-0007.2 620007	L= 1.045
116 d	85	12/11→					
116 d	85	01/12→					
116 i	80	03/15→					
116 i	100	12/11→					
118 d	100	12/11→					
118 d	105	12/11→					
118 d	110	03/15→					
118 d xDrive	110	03/15→					
118 i	100	03/15→					
M 135 i	240	03/15→					
M 135 i xDrive	240	03/15→					
M 140 i	250	10/15→					
M 140 i xDrive	250	09/15→					
114 d	70	07/12→	←	10/12→	1	24.8190-0006.2 620006	L= 675
			→	10/12→	1	24.8190-0007.2 620007	L= 1.045
114 i	75	12/11→	←	09/12→	1	24.8190-0006.2 620006	L= 675
M 135 i	235	12/11→	→	09/12→	1	24.8190-0007.2 620007	L= 1.045
118 d xDrive	105	05/13→	←	☐	1	24.8190-0006.2 620006	L= 675
118 i	125	07/12→	→		1	24.8190-0007.2 620007	L= 1.045
120 d	120	07/12→					
120 d	135	07/12→					
120 d	140	03/15→					
120 d	147	01/12→					
120 d xDrive	140	03/15→					
120 i	130	03/15→					
120 i	135	10/15→					
125 d	165	03/15→					
125 i	165	10/15→					
125 i	175	03/13→					
120 d xDrive	135	02/12→	←	☐; 07/12→	1	24.8190-0006.2 620006	L= 675
120 d xDrive	147	01/12→	→	07/12→	1	24.8190-0007.2 620007	L= 1.045
125 d	155	12/11→	←	☐; 03/12→	1	24.8190-0006.2 620006	L= 675
125 d	160	12/11→	→	03/12→	1	24.8190-0007.2 620007	L= 1.045
125 i	160	12/11→					
M 135 i xDrive	235	02/12→	←	07/12→	1	24.8190-0006.2 620006	L= 675
			→	07/12→	1	24.8190-0007.2 620007	L= 1.045
Bremsscheibe							
114 d	70	06/15→	←	- Performance Parts		24.0122-0239.1 422239	Ø 284 22 20,4 V + S
116 d	85	03/15→	←	+ Performance Parts		24.0130-0233.2 430233	Ø 340 30 28,4 V Bremsscheibe zweiteilig / + S
116 i	80	03/15→				24.0322-0239.1 522239	Ø 284 22 19,6 V + S PD
118 d	110	03/15→					
118 d xDrive	110	03/15→	→	- Performance Parts		24.0111-0175.1 411175	Ø 290 11 9,4 + S
118 i	100	03/15→	→	+ Performance Parts		24.0124-0250.2 424250	Ø 345 24 22,4 V Bremsscheibe zweiteilig / + S
114 d	70	07/12→	←	10/12→; - Performance Parts		24.0122-0239.1 422239	Ø 284 22 20,4 V + S
			←	10/12→; + Performance Parts		24.0130-0233.2 430233	Ø 340 30 28,4 V Bremsscheibe zweiteilig / + S
						24.0322-0239.1 522239	Ø 284 22 19,6 V + S PD
			→	10/12→; - Performance Parts		24.0111-0175.1 411175	Ø 290 11 9,4 + S
			→	10/12→; + Performance Parts		24.0124-0250.2 424250	Ø 345 24 22,4 V Bremsscheibe zweiteilig / + S
↓							







	kW			 	! #		
BMW - 1 (F21) 12/11→							
 Bremsscheibe							
114 i	75	12/11→	←	09/12→; - Performance Parts		24.0122-0239.1 422239	Ø 284 22 20,4 V + S
			←	09/12→; + Performance Parts		24.0130-0233.2 430233	Ø 340 30 28,4 V Bremsscheibe zweiteilig / + S
						24.0322-0239.1 522239	Ø 284 22 19,6 V + S PD
			→	09/12→; - Performance Parts		24.0111-0175.1 411175	Ø 290 11 9,4 + S
			→	09/12→; + Performance Parts		24.0124-0250.2 424250	Ø 345 24 22,4 V Bremsscheibe zweiteilig / + S
116 d 116 d 116 i 118 d 118 d	85 85 100 100 105	12/11→ 01/12→ 12/11→ 12/11→ 12/11→	←	- Performance Parts		24.0122-0239.1 422239	Ø 284 22 20,4 V + S
			←	+ Performance Parts		24.0130-0233.2 430233	Ø 340 30 28,4 V Bremsscheibe zweiteilig / + S
						24.0322-0239.1 522239	Ø 284 22 19,6 V + S PD
			→			24.0111-0175.1 411175	Ø 290 11 9,4 + S
118 d xDrive 120 i 120 i	105 130 135	05/13→ 03/15→ 10/15→	←	- Performance Parts		24.0122-0278.1 422278	Ø 300 22 20,4 V + S
			←	+ Performance Parts		24.0130-0233.2 430233	Ø 340 30 28,4 V Bremsscheibe zweiteilig / + S
			→	- Performance Parts		24.0111-0175.1 411175	Ø 290 11 9,4 + S
			→	+ Performance Parts		24.0124-0250.2 424250	Ø 345 24 22,4 V Bremsscheibe zweiteilig / + S
118 i	125	07/12→	←			24.0122-0278.1 422278	Ø 300 22 20,4 V + S
			→			24.0111-0175.1 411175	Ø 290 11 9,4 + S
120 d 120 d 120 d	120 135 147	07/12→ 07/12→ 01/12→	←			24.0122-0278.1 422278	Ø 300 22 20,4 V + S
			→			24.0120-0237.1 420237	Ø 300 20 18,4 V + S
120 d 120 d xDrive	140 140	03/15→ 03/15→	←	- Performance Parts		24.0122-0278.1 422278	Ø 300 22 20,4 V + S
			←	+ Performance Parts		24.0130-0233.2 430233	Ø 340 30 28,4 V Bremsscheibe zweiteilig / + S
			→	- Performance Parts		24.0120-0237.1 420237	Ø 300 20 18,4 V + S
			→	+ Performance Parts		24.0124-0250.2 424250	Ø 345 24 22,4 V Bremsscheibe zweiteilig / + S
120 d xDrive 120 d xDrive	135 147	02/12→ 01/12→	←	07/12→; - Performance Parts		24.0122-0278.1 422278	Ø 300 22 20,4 V + S
			←	07/12→; + Performance Parts		24.0130-0233.2 430233	Ø 340 30 28,4 V Bremsscheibe zweiteilig / + S
			→	07/12→; - Performance Parts		24.0120-0237.1 420237	Ø 300 20 18,4 V + S
			→	07/12→; + Performance Parts		24.0124-0250.2 424250	Ø 345 24 22,4 V Bremsscheibe zweiteilig / + S
125 d 125 d 125 i	155 160 160	12/11→ 12/11→ 12/11→	←	03/12→; - Performance Parts		24.0124-0203.1 424203	Ø 312 23,9 22,4 V + S
						24.0324-0203.1 524203	Ø 312 23,9 21,6 V + S PD
			←	03/12→; + Performance Parts		24.0130-0233.2 430233	Ø 340 30 28,4 V Bremsscheibe zweiteilig / + S
			→	03/12→; - Performance Parts		24.0120-0237.1 420237	Ø 300 20 18,4 V + S
125 d 125 i 125 i	165 165 175	03/15→ 10/15→ 03/13→	←	- Performance Parts		24.0124-0203.1 424203	Ø 312 23,9 22,4 V + S
						24.0324-0203.1 524203	Ø 312 23,9 21,6 V + S PD
			←	+ Performance Parts		24.0130-0233.2 430233	Ø 340 30 28,4 V Bremsscheibe zweiteilig / + S
			→	- Performance Parts		24.0120-0237.1 420237	Ø 300 20 18,4 V + S
M 135 i	235	12/11→	←	09/12→		24.0130-0233.2 430233	Ø 340 30 28,4 V Bremsscheibe zweiteilig / + S
			→	09/12→		24.0124-0250.2 424250	Ø 345 24 22,4 V Bremsscheibe zweiteilig / + S
M 135 i M 135 i xDrive M 140 i M 140 i xDrive	240 240 250 250	03/15→ 03/15→ 10/15→ 09/15→	←			24.0130-0233.2 430233	Ø 340 30 28,4 V Bremsscheibe zweiteilig / + S
			→			24.0124-0250.2 424250	Ø 345 24 22,4 V Bremsscheibe zweiteilig / + S
M 135 i xDrive	235	02/12→	←	07/12→		24.0130-0233.2 430233	Ø 340 30 28,4 V Bremsscheibe zweiteilig / + S
			→	07/12→		24.0124-0250.2 424250	Ø 345 24 22,4 V Bremsscheibe zweiteilig / + S
BMW - 1 Cabriolet (E88) 03/08→12/13							
 Bremsbelagsatz, Scheibenbremse							
118 d 118 d 118 i 118 i	100 105 100 105	09/08→12/13 09/08→12/13 09/08→12/13 03/08→12/13	←	03/10→ 10/13; - Performance Parts		13.0460-2710.2 602710	TRW 23915 17,6 + WE / - WK + Zub
						13.0470-2710.2 LD2710	TRW 23915 17,6 + WE / - WK + Zub Ceramic
↓							









	kw			 	! #		
BMW - 1 Cabriolet (E88) 03/08→12/13							
 Bremsbelagsatz, Scheibenbremse							
118 d 118 d 118 i 118 i	100 105 100 105	09/08→12/13 09/08→12/13 09/08→12/13 03/08→12/13	←	→ 02/10; - Performance Parts		13.0460-2710.2 602710	TRW 23915 17,6 + WE / - WK + Zub
			←	→ 10/13; + Performance Parts		13.0470-2710.2 LD2710	TRW 23915 17,6 + WE / - WK + Zub Ceramic
			←	→ 10/13; - Performance Parts		13.0460-4848.2 604848	BRE 24316 16,9 + WE / - WK
			→	03/10→ 10/13; - Performance Parts		13.0460-7217.2 607217	ATE 23926 17,3 + WE / - WK
			→	02/10; - Performance Parts		13.0470-7217.2 LD7217	ATE 23926 17,3 + WE / - WK Ceramic
			→	02/10; - Performance Parts		13.0460-7217.2 607217	ATE 23926 17,3 + WE / - WK
			→	02/10; - Performance Parts		13.0470-7217.2 LD7217	ATE 23926 17,3 + WE / - WK Ceramic
120 d 120 d 120 i 120 i 120 i 125 i	120 130 115 120 125 160	03/08→12/13 03/08→12/13 03/08→12/13 03/08→12/13 03/08→12/13 03/08→12/13	←	→ 10/13; + Performance Parts		13.0460-4848.2 604848	BRE 24316 16,9 + WE / - WK
			←	03/10→ 10/13; - Performance Parts		13.0460-7216.2 607216	ATE 23794 20,3 + WE / - WK
			←	03/10→ 10/13; - Performance Parts		13.0470-7216.2 LD7216	ATE 23794 20,3 + WE / - WK Ceramic
			←	→ 02/10; - Performance Parts		13.0460-7216.2 607216	ATE 23794 20,3 + WE / - WK
			←	→ 02/10; - Performance Parts		13.0470-7216.2 LD7216	ATE 23794 20,3 + WE / - WK Ceramic
			→	03/10→ 10/13; - Performance Parts		13.0460-7217.2 607217	ATE 23926 17,3 + WE / - WK
			→	03/10→ 10/13; - Performance Parts		13.0470-7217.2 LD7217	ATE 23926 17,3 + WE / - WK Ceramic
			→	02/10; - Performance Parts		13.0460-7217.2 607217	ATE 23926 17,3 + WE / - WK
			→	02/10; - Performance Parts		13.0470-7217.2 LD7217	ATE 23926 17,3 + WE / - WK Ceramic
120 d	145	03/08→12/13	←	→ 10/13; + Performance Parts		13.0460-4848.2 604848	BRE 24316 16,9 + WE / - WK
			←	03/10→ 10/13; - Performance Parts		13.0460-7216.2 607216	ATE 23794 20,3 + WE / - WK
			←	03/10→ 10/13; - Performance Parts		13.0470-7216.2 LD7216	ATE 23794 20,3 + WE / - WK Ceramic
			←	→ 02/10; - Performance Parts		13.0460-7216.2 607216	ATE 23794 20,3 + WE / - WK
			←	→ 02/10; - Performance Parts		13.0470-7216.2 LD7216	ATE 23794 20,3 + WE / - WK Ceramic
			→	→ 10/13; - Performance Parts		13.0460-7217.2 607217	ATE 23926 17,3 + WE / - WK
			→	→ 10/13; - Performance Parts		13.0470-7217.2 LD7217	ATE 23926 17,3 + WE / - WK Ceramic
			→	→ 02/10; - Performance Parts		13.0460-7217.2 607217	ATE 23926 17,3 + WE / - WK
			→	→ 02/10; - Performance Parts		13.0470-7217.2 LD7217	ATE 23926 17,3 + WE / - WK Ceramic
123 d	150	09/08→12/13	←	→ 10/13; + Performance Parts		13.0460-4848.2 604848	BRE 24316 16,9 + WE / - WK
			←	03/10→ 10/13; - Performance Parts		13.0460-7223.2 607223	ATE 23794 20,3 + WE / - WK
			←	03/10→ 10/13; - Performance Parts		13.0470-7223.2 LD7223	ATE 23794 20,3 + WE / - WK Ceramic
			←	→ 02/10; - Performance Parts		13.0460-7223.2 607223	ATE 23794 20,3 + WE / - WK
			←	→ 02/10; - Performance Parts		13.0470-7223.2 LD7223	ATE 23794 20,3 + WE / - WK Ceramic
			→	03/10→ 10/13; - Performance Parts		13.0460-7217.2 607217	ATE 23926 17,3 + WE / - WK
			→	03/10→ 10/13; - Performance Parts		13.0470-7217.2 LD7217	ATE 23926 17,3 + WE / - WK Ceramic
			→	→ 02/10; - Performance Parts		13.0460-7217.2 607217	ATE 23926 17,3 + WE / - WK
			→	→ 02/10; - Performance Parts		13.0470-7217.2 LD7217	ATE 23926 17,3 + WE / - WK Ceramic
128 i	171	03/08→12/13	←	03/10→ 10/13; - Performance Parts		13.0460-7216.2 607216	ATE 23794 20,3 + WE / - WK
			←	03/10→ 10/13; - Performance Parts		13.0470-7216.2 LD7216	ATE 23794 20,3 + WE / - WK Ceramic
			←	→ 02/10; - Performance Parts		13.0460-7216.2 607216	ATE 23794 20,3 + WE / - WK
			←	→ 02/10; - Performance Parts		13.0470-7216.2 LD7216	ATE 23794 20,3 + WE / - WK Ceramic
			→	03/10→ 10/13; - Performance Parts		13.0460-7217.2 607217	ATE 23926 17,3 + WE / - WK
			→	03/10→ 10/13; - Performance Parts		13.0470-7217.2 LD7217	ATE 23926 17,3 + WE / - WK Ceramic
			→	→ 02/10; - Performance Parts		13.0460-7217.2 607217	ATE 23926 17,3 + WE / - WK
			→	→ 02/10; - Performance Parts		13.0470-7217.2 LD7217	ATE 23926 17,3 + WE / - WK Ceramic
135 i 135 i	225 240	03/08→12/13 03/08→12/13	←	→ 02/10		13.0460-4848.2 604848	BRE 24316 16,9 + WE / - WK
			←	03/10→ 10/13		13.0460-4848.2 604848	BRE 24316 16,9 + WE / - WK
			→	→ 02/10		13.0460-4849.2 604849	BRE 24315 16,2 + WE / - WK
↓							











	kW			 	! #		
BMW - 1 Cabriolet (E88) 03/08→12/13							
 Bremsbelagsatz, Scheibenbremse							
135 i 135 i	225 240	03/08→12/13 03/08→12/13	➡	03/10→ 10/13		13.0460-4849.2 604849	BRE 24315 16,2 + WE / - WK
Warnkontakt, Bremsbelagverschleiß							
118 d 118 d 118 i 118 i 120 d 120 d 120 i 120 i 120 i 125 i	100 105 100 105 120 130 115 120 125 160	09/08→12/13 09/08→12/13 09/08→12/13 03/08→12/13 03/08→12/13 03/08→12/13 03/08→12/13 03/08→12/13 03/08→12/13 03/08→12/13	⬅️ ⬅️ ⬅️ ⬅️ ➡️ ➡️ ➡️ ➡️ ➡️ ➡️	→ 02/10 → 10/13; + Performance Parts 03/10→ 10/13 → 02/10 03/10→ 10/13	1 1 1 1 1 1 1 1 1 1	24.8190-0264.2 620264 24.8190-0267.2 620267 24.8190-0284.2 620284 24.8190-0265.2 620265 24.8190-0285.2 620285	L= 630 L= 679 L= 650 L= 1.086 L= 1.107
120 d	145	03/08→12/13	⬅️ ⬅️ ⬅️ ➡️ ➡️	→ 02/10 → 10/13; + Performance Parts 03/10→ 10/13 → 02/10 → 10/13	1 1 1 1 1	24.8190-0264.2 620264 24.8190-0267.2 620267 24.8190-0284.2 620284 24.8190-0265.2 620265 24.8190-0285.2 620285	L= 630 L= 679 L= 650 L= 1.086 L= 1.107
123 d	150	09/08→12/13	⬅️ ⬅️ ⬅️ ➡️ ➡️	→ 10/13; + Performance Parts → 02/10 03/10→ 10/13 → 02/10 03/10→ 10/13	1 1 1 1 1	24.8190-0267.2 620267 24.8190-0267.2 620267 24.8190-0287.2 620287 24.8190-0265.2 620265 24.8190-0285.2 620285	L= 679 L= 679 L= 723 L= 1.086 L= 1.107
128 i	171	03/08→12/13	⬅️ ⬅️ ➡️ ➡️	→ 02/10 03/10→ 10/13 → 02/10 03/10→ 10/13	1 1 1 1	24.8190-0264.2 620264 24.8190-0284.2 620284 24.8190-0265.2 620265 24.8190-0285.2 620285	L= 630 L= 650 L= 1.086 L= 1.107
135 i 135 i	225 240	03/08→12/13 03/08→12/13	⬅️ ⬅️ ➡️ ➡️	→ 02/10 03/10→ 10/13 → 02/10 03/10→ 10/13	1 1 1 1	24.8190-0267.2 620267 24.8190-0288.2 620288 24.8190-0265.2 620265 24.8190-0285.2 620285	L= 679 L= 698 L= 1.086 L= 1.107
Zubehörsatz, Scheibenbremsbelag							
135 i 135 i	225 240	03/08→12/13 03/08→12/13	⬅️ ⬅️	→ 02/10 03/10→ 10/13		13.0460-0238.2 610238	BRE BRE
 Bremsscheibe							
118 d 118 d 118 i 118 i	100 105 100 105	09/08→12/13 09/08→12/13 09/08→12/13 03/08→12/13	⬅️ ⬅️ ➡️	→ 10/13; - Performance Parts → 10/13; - Performance Parts → 10/13; - Performance Parts		24.0122-0238.1 422238 24.0322-0238.1 522238 24.0120-0214.1 420214	Ø 292 22 20,4 V + S Ø 292 22 19,6 V + S PD Ø 300 20 18,4 V + S
120 d 120 d 120 d 120 i 120 i 120 i 125 i 125 i 128 i	120 130 145 115 120 125 160 171	03/08→12/13 03/08→12/13 03/08→12/13 03/08→12/13 03/08→12/13 03/08→12/13 03/08→12/13 03/08→12/13 03/08→12/13	⬅️ ⬅️ ➡️	→ 10/13; - Performance Parts → 10/13; - Performance Parts → 10/13; - Performance Parts		24.0124-0197.1 424197 24.0324-0197.1 524197 24.0120-0214.1 420214	Ø 300 24 22,4 V + S Ø 300 24 21,6 V + S PD Ø 300 20 18,4 V + S
123 d	150	09/08→12/13	⬅️ ➡️	→ 10/13; - Performance Parts → 10/13; - Performance Parts		24.0124-0200.1 424200 24.0324-0200.1 524200 24.0120-0215.1 420215	Ø 330 24 22,4 V + S Ø 330 24 21,6 V + S PD Ø 300 20 18,4 V + S
135 i 135 i	225 240	03/08→12/13 03/08→12/13	⬅️ ➡️	→ 10/13 → 10/13		24.0126-0152.2 426152 24.0122-0257.1 422257	Ø 338 25,9 24,4 V Brems Scheibe zweiteilig / + S Ø 324 22 20,4 V + S
BMW - 1 Coupe (E82) 10/06→10/13							
 Bremsbelagsatz, Scheibenbremse							
118 d 118 d	100 105	09/09→10/13 09/09→10/13	⬅️ ⬅️	03/10→; - Performance Parts → 02/10; - Performance Parts		13.0460-2710.2 602710 13.0470-2710.2 LD2710 13.0460-2710.2 602710	TRW 23915 17,6 + WE / - WK + Zub TRW 23915 17,6 + WE / - WK + Zub Ceramic TRW 23915 17,6 + WE / - WK + Zub
↓							







	kw			 	! #		
BMW - 1 Coupe (E82) 10/06→10/13							
 Bremsbelagsatz, Scheibenbremse							
118 d 118 d	100 105	09/09→10/13 09/09→10/13	←	→ 02/10; - Performance Parts	13.0470-2710.2	LD2710	TRW 23915 17,6 + WE / - WK + Zub Ceramic
			←	+ Performance Parts	13.0460-4848.2	604848	BRE 24316 16,9 + WE / - WK
			→	03/10→; - Performance Parts	13.0460-7217.2	607217	ATE 23926 17,3 + WE / - WK
			→	→ 02/10; - Performance Parts	13.0470-7217.2	LD7217	ATE 23926 17,3 + WE / - WK Ceramic
120 d 120 d 120 i	120 130 115	10/07→10/13 10/07→10/13 09/09→10/13	←	+ Performance Parts	13.0460-4848.2	604848	BRE 24316 16,9 + WE / - WK
			←	→ 02/10; - Performance Parts	13.0460-7216.2	607216	ATE 23794 20,3 + WE / - WK
			←	03/10→; - Performance Parts	13.0460-7216.2	607216	ATE 23794 20,3 + WE / - WK
			→	→ 02/10; - Performance Parts	13.0470-7216.2	LD7216	ATE 23794 20,3 + WE / - WK Ceramic
			→	→ 02/10; - Performance Parts	13.0460-7217.2	607217	ATE 23926 17,3 + WE / - WK
			→	03/10→; - Performance Parts	13.0470-7217.2	LD7217	ATE 23926 17,3 + WE / - WK Ceramic
120 d	145	10/06→10/13	←	10/07→; + Performance Parts	13.0460-4848.2	604848	BRE 24316 16,9 + WE / - WK
			←	10/07→ 02/10; - Performance Parts	13.0460-7216.2	607216	ATE 23794 20,3 + WE / - WK
			←	03/10→; - Performance Parts	13.0470-7216.2	LD7216	ATE 23794 20,3 + WE / - WK Ceramic
			→	03/10→; - Performance Parts	13.0460-7216.2	607216	ATE 23794 20,3 + WE / - WK
			→	03/10→; - Performance Parts	13.0460-7217.2	607217	ATE 23926 17,3 + WE / - WK
			→	10/07→ 02/10; - Performance Parts	13.0470-7217.2	LD7217	ATE 23926 17,3 + WE / - WK Ceramic
120 i	125	10/07→10/13	←	09/09→; + Performance Parts	13.0460-4848.2	604848	BRE 24316 16,9 + WE / - WK
			←	09/09→ 02/10; - Performance Parts	13.0460-7216.2	607216	ATE 23794 20,3 + WE / - WK
			←	03/10→; - Performance Parts	13.0470-7216.2	LD7216	ATE 23794 20,3 + WE / - WK Ceramic
			→	03/10→; - Performance Parts	13.0460-7216.2	607216	ATE 23794 20,3 + WE / - WK
			→	03/10→; - Performance Parts	13.0460-7217.2	607217	ATE 23926 17,3 + WE / - WK
			→	09/09→ 02/10; - Performance Parts	13.0470-7217.2	LD7217	ATE 23926 17,3 + WE / - WK Ceramic
123 d	150	10/07→10/13	←	+ Performance Parts	13.0460-4848.2	604848	BRE 24316 16,9 + WE / - WK
			←	→ 02/10; - Performance Parts	13.0460-7223.2	607223	ATE 23794 20,3 + WE / - WK
			←	03/10→; - Performance Parts	13.0470-7223.2	LD7223	ATE 23794 20,3 + WE / - WK Ceramic
			→	03/10→; - Performance Parts	13.0460-7223.2	607223	ATE 23794 20,3 + WE / - WK
			→	03/10→; - Performance Parts	13.0460-7217.2	607217	ATE 23926 17,3 + WE / - WK
			→	→ 02/10; - Performance Parts	13.0470-7217.2	LD7217	ATE 23926 17,3 + WE / - WK Ceramic
125 i ↓	160	10/07→10/13	←	03/08→; + Performance Parts	13.0460-4848.2	604848	BRE 24316 16,9 + WE / - WK
			←	03/08→ 02/10; - Performance Parts	13.0460-7216.2	607216	ATE 23794 20,3 + WE / - WK
					13.0470-7216.2	LD7216	ATE 23794 20,3 + WE / - WK Ceramic









	kw			 	! #		
BMW - 1 Coupe (E82) 10/06→10/13							
 Bremsbelagsatz, Scheibenbremse							
125 i	160	10/07→10/13	←	03/10→; - Performance Parts		13.0460-7216.2 607216 13.0470-7216.2 LD7216	ATE 23794 20,3 + WE / - WK ATE 23794 20,3 + WE / - WK Ceramic
			→	03/10→; - Performance Parts		13.0460-7217.2 607217 13.0470-7217.2 LD7217	ATE 23926 17,3 + WE / - WK ATE 23926 17,3 + WE / - WK Ceramic
			→	03/08→ 02/10; - Performance Parts		13.0460-7217.2 607217 13.0470-7217.2 LD7217	ATE 23926 17,3 + WE / - WK ATE 23926 17,3 + WE / - WK Ceramic
135 i	225	10/07→10/13	←	→ 02/10		13.0460-4848.2 604848	BRE 24316 16,9 + WE / - WK
135 i	240	10/07→10/13	←	03/10→		13.0460-4848.2 604848	BRE 24316 16,9 + WE / - WK
			→	→ 02/10		13.0460-4849.2 604849	BRE 24315 16,2 + WE / - WK
			→	03/10→		13.0460-4849.2 604849	BRE 24315 16,2 + WE / - WK
M	250	04/11→06/12	←	05/11→		13.0460-7167.2 607167	ATE 23312 20,3 + WE / - WK
			→	05/11→		13.0460-7169.2 607169 13.0470-7169.2 LD7169	ATE 23309 17,3 + WE / - WK ATE 23309 17,3 + WE / - WK Ceramic
Warnkontakt, Bremsbelagverschleiß							
118 d	100	09/09→10/13	←	→ 02/10	1	24.8190-0264.2 620264	L= 630
118 d	105	09/09→10/13	←	+ Performance Parts	1	24.8190-0267.2 620267	L= 679
120 d	120	10/07→10/13	←	03/10→	1	24.8190-0284.2 620284	L= 650
120 d	130	10/07→10/13	←	03/10→	1	24.8190-0284.2 620284	L= 650
120 i	115	09/09→10/13	←	→ 02/10	1	24.8190-0265.2 620265	L= 1.086
123 d	150	10/07→10/13	→	→ 02/10	1	24.8190-0265.2 620265	L= 1.086
			→	03/10→	1	24.8190-0285.2 620285	L= 1.107
120 d	145	10/06→10/13	←	10/07→ 02/10	1	24.8190-0264.2 620264	L= 630
			←	10/07→; + Performance Parts	1	24.8190-0267.2 620267	L= 679
			←	03/10→	1	24.8190-0284.2 620284	L= 650
			→	10/07→ 02/10	1	24.8190-0265.2 620265	L= 1.086
			→	03/10→	1	24.8190-0285.2 620285	L= 1.107
120 i	125	10/07→10/13	←	09/09→ 02/10	1	24.8190-0264.2 620264	L= 630
			←	09/09→; + Performance Parts	1	24.8190-0267.2 620267	L= 679
			←	03/10→	1	24.8190-0284.2 620284	L= 650
			→	09/09→ 02/10	1	24.8190-0265.2 620265	L= 1.086
			→	03/10→	1	24.8190-0285.2 620285	L= 1.107
125 i	160	10/07→10/13	←	03/08→ 02/10	1	24.8190-0264.2 620264	L= 630
			←	03/08→; + Performance Parts	1	24.8190-0267.2 620267	L= 679
			←	03/10→	1	24.8190-0284.2 620284	L= 650
			→	03/08→ 02/10	1	24.8190-0265.2 620265	L= 1.086
			→	03/10→	1	24.8190-0285.2 620285	L= 1.107
135 i	225	10/07→10/13	←	→ 02/10	1	24.8190-0267.2 620267	L= 679
135 i	240	10/07→10/13	←	03/10→	1	24.8190-0287.2 620287	L= 723
			→	→ 02/10	1	24.8190-0265.2 620265	L= 1.086
			→	03/10→	1	24.8190-0285.2 620285	L= 1.107
M	250	04/11→06/12	←	☐; 05/11→	1	24.8190-0271.2 620271	L= 659
			→	05/11→	1	24.8190-0265.2 620265	L= 1.086
Zubehörsatz, Scheibenbremsbelag							
135 i	225	10/07→10/13	←	03/10→		13.0460-0238.2 610238	BRE
135 i	240	10/07→10/13	←	→ 02/10		13.0460-0238.2 610238	BRE
 Bremsscheibe							
118 d	100	09/09→10/13	←	- Performance Parts		24.0122-0238.1 422238	Ø 292 22 20,4 V + S
118 d	105	09/09→10/13	←	- Performance Parts		24.0322-0238.1 522238	Ø 292 22 19,6 V + S PD
			→	- Performance Parts		24.0120-0214.1 420214	Ø 300 20 18,4 V + S
120 d	120	10/07→10/13	←	- Performance Parts		24.0124-0197.1 424197	Ø 300 24 22,4 V + S
120 d	130	10/07→10/13	←	- Performance Parts		24.0324-0197.1 524197	Ø 300 24 21,6 V + S PD
120 i	115	09/09→10/13	→	- Performance Parts		24.0120-0214.1 420214	Ø 300 20 18,4 V + S
↓							











	kw			 	! #		
BMW - 1 Coupe (E82) 10/06→10/13							
Bremsscheibe							
120 d	145	10/06→10/13	←	10/07→; - Performance Parts		24.0124-0197.1 424197 24.0324-0197.1 524197	Ø 300 24 22,4 V + S Ø 300 24 21,6 V + S PD
			→	10/07→; - Performance Parts		24.0120-0214.1 420214	Ø 300 20 18,4 V + S
120 i	125	10/07→10/13	←	09/09→; - Performance Parts		24.0124-0197.1 424197 24.0324-0197.1 524197	Ø 300 24 22,4 V + S Ø 300 24 21,6 V + S PD
			→	09/09→; - Performance Parts		24.0120-0214.1 420214	Ø 300 20 18,4 V + S
123 d	150	10/07→10/13	←	- Performance Parts		24.0124-0200.1 424200 24.0324-0200.1 524200	Ø 330 24 22,4 V + S Ø 330 24 21,6 V + S PD
			→	- Performance Parts		24.0120-0215.1 420215	Ø 300 20 18,4 V + S
125 i	160	10/07→10/13	←	03/08→; - Performance Parts		24.0124-0197.1 424197 24.0324-0197.1 524197	Ø 300 24 22,4 V + S Ø 300 24 21,6 V + S PD
			→	03/08→; - Performance Parts		24.0120-0214.1 420214	Ø 300 20 18,4 V + S
135 i 135 i	225 240	10/07→10/13 10/07→10/13	←			24.0126-0152.2 426152	Ø 338 25,9 24,4 V Bremsscheibe zweiteilig / + S
			→			24.0122-0257.1 422257	Ø 324 22 20,4 V + S
M	250	04/11→06/12	←	☐; 05/11→		24.0130-0213.2 430213	Ø 360 30 28,4 V* Bremsscheibe zweiteilig / + S
			←	☐; 05/11→		24.0130-0214.2 430214	Ø 360 30 28,4 V* Bremsscheibe zweiteilig / + S
			→	☐; 05/11→		24.0124-0231.2 424231	Ø 350 24 22,4 V* Bremsscheibe zweiteilig / + S
			→	☐; 05/11→		24.0124-0232.2 424232	Ø 350 24 22,4 V* Bremsscheibe zweiteilig / + S
BMW - 2 Active Tourer (F45) 11/13→							
Bremsbelagsatz, Scheibenbremse							
214 d	70	07/14→	←	03/15→		13.0460-2795.2 602795 13.0470-2795.2 LD2795	TRW 23915 17,6 + WE / - WK + Zub TRW + WE / - WK + Zub Ceramic
			→	03/15→; + eFSB		13.0460-7315.2 607315 13.0470-7315.2 LD7315	ATE 25331 16,2 + WE / - WK ATE 25331 16,2 + WE / - WK Ceramic
216 d 218 d 218 i 220 d 220 d xDrive 220 i 225 i 225 i xDrive	85 110 100 140 140 141 170 170	03/14→ 11/13→ 11/13→ 03/14→ 03/14→ 03/14→ 11/13→ 03/14→	→	10/14→; + eFSB		13.0460-7315.2 607315 13.0470-7315.2 LD7315	ATE 25331 16,2 + WE / - WK ATE 25331 16,2 + WE / - WK Ceramic
216 i	75	02/15→	←	11/15→		13.0460-2795.2 602795 13.0470-2795.2 LD2795	TRW 23915 17,6 + WE / - WK + Zub TRW + WE / - WK + Zub Ceramic
			→	11/15→; + eFSB		13.0460-7315.2 607315 13.0470-7315.2 LD7315	ATE 25331 16,2 + WE / - WK ATE 25331 16,2 + WE / - WK Ceramic
218 d	100	11/13→	→	09/14→; + eFSB		13.0460-7315.2 607315 13.0470-7315.2 LD7315	ATE 25331 16,2 + WE / - WK ATE 25331 16,2 + WE / - WK Ceramic
218 d xDrive 218 d xDrive	100 110	12/14→ 12/14→	→	11/15→; + eFSB		13.0460-7315.2 607315 13.0470-7315.2 LD7315	ATE 25331 16,2 + WE / - WK ATE 25331 16,2 + WE / - WK Ceramic
220 d 220 d xDrive 220 i	120 120 120	03/14→ 03/14→ 03/14→	→	11/14→; + eFSB		13.0460-7315.2 607315 13.0470-7315.2 LD7315	ATE 25331 16,2 + WE / - WK ATE 25331 16,2 + WE / - WK Ceramic
225 xe 225 xe	100 165	11/14→ 11/14→	→	03/16→; + eFSB		13.0460-7315.2 607315 13.0470-7315.2 LD7315	ATE 25331 16,2 + WE / - WK ATE 25331 16,2 + WE / - WK Ceramic
Warnkontakt, Bremsbelagverschleiß							
214 d	70	07/14→	→	03/15→	1	24.8190-0942.2 620942	L= 641
216 d 218 d 218 i 220 d 220 d xDrive 220 i 225 i ↓	85 110 100 140 140 141 170	03/14→ 11/13→ 11/13→ 03/14→ 03/14→ 03/14→ 11/13→	→	10/14→	1	24.8190-0942.2 620942	L= 641







	kW			 	! #		
BMW - 2 Active Tourer (F45) 11/13→							
Warnkontakt, Bremsbelagverschleiß							
225 i xDrive	170	03/14→	➡	10/14→	1	24.8190-0942.2 620942	L= 641
216 i	75	02/15→	➡	11/15→	1	24.8190-0942.2 620942	L= 641
218 d xDrive	100	12/14→					
218 d xDrive	110	12/14→					
218 d	100	11/13→	➡	09/14→	1	24.8190-0942.2 620942	L= 641
220 d	120	03/14→	➡	11/14→	1	24.8190-0942.2 620942	L= 641
220 d xDrive	120	03/14→					
220 i	120	03/14→					
225 xe	100	11/14→	➡	03/16→	1	24.8190-0942.2 620942	L= 641
225 xe	165	11/14→					
 Brems Scheibe							
214 d	70	07/14→	⬅	03/15→		24.0122-0292.1 422292	Ø 280 22 20,4 V + S
			➡	03/15→		24.0110-0401.1 410401	Ø 280 10 8,4 + S
216 d	85	03/14→	➡	10/14→		24.0110-0401.1 410401	Ø 280 10 8,4 + S
218 d	110	11/13→					
218 i	100	11/13→					
216 i	75	02/15→	⬅	11/15→		24.0122-0292.1 422292	Ø 280 22 20,4 V + S
			➡	11/15→		24.0110-0401.1 410401	Ø 280 10 8,4 + S
218 d	100	11/13→	➡	09/14→		24.0110-0401.1 410401	Ø 280 10 8,4 + S
218 d xDrive	100	12/14→	➡	11/15→		24.0110-0401.1 410401	Ø 280 10 8,4 + S
218 d xDrive	110	12/14→					
220 d	120	03/14→	⬅	11/14→		24.0124-0260.1 424260	Ø 307 24 22,4 V + S
220 d xDrive	120	03/14→	➡	11/14→		24.0110-0401.1 410401	Ø 280 10 8,4 + S
220 i	120	03/14→					
220 d	140	03/14→	⬅	10/14→		24.0124-0260.1 424260	Ø 307 24 22,4 V + S
220 d xDrive	140	03/14→	➡	10/14→		24.0110-0401.1 410401	Ø 280 10 8,4 + S
220 i	141	03/14→					
225 i	170	11/13→	⬅	10/14→		24.0124-0259.1 424259	Ø 330 24 22,4 V + S
225 i xDrive	170	03/14→					
225 xe	100	11/14→	⬅	03/16→		24.0124-0259.1 424259	Ø 330 24 22,4 V + S
225 xe	165	11/14→					
BMW - 2 Cabriolet (F23) 03/14→							
 Bremsbelagsatz, Scheibenbremse							
218 d	100	07/15→	⬅	- Performance Parts		13.0460-3865.2 603865	BOS 25014 18,2 + WE / - WK
218 d	110	07/15→				13.0470-3865.2 LD3865	BOS 25014 18,2 + WE / - WK Ceramic
218 i	100	03/15→	⬅	+ Performance Parts		13.0460-4875.2 604875	BRE 25028 18,0 + WE / - WK
			➡	- Performance Parts		13.0460-3859.2 603859	BOS 25307 17,5 + WE / - WK Ceramic
						13.0470-3859.2 LD3859	BOS 25307 17,5 + WE / - WK Ceramic
			➡	+ Performance Parts		13.0460-4874.2 604874	BRE 25029 16,7 + WE / - WK
220 d	120	03/14→	⬅	11/14→; - Performance Parts		13.0460-3857.2 603857	BOS 25199 19,6 + WE / - WK Ceramic
						13.0470-3857.2 LD3857	BOS 25199 19,6 + WE / - WK Ceramic
			⬅	11/14→; + Performance Parts		13.0460-4875.2 604875	BRE 25028 18,0 + WE / - WK
			➡	07/15→; - Performance Parts		13.0460-3859.2 603859	BOS 25307 17,5 + WE / - WK Ceramic
						13.0470-3859.2 LD3859	BOS 25307 17,5 + WE / - WK Ceramic
			➡	07/15→; + Performance Parts		13.0460-4874.2 604874	BRE 25029 16,7 + WE / - WK
220 d	140	03/14→	⬅	11/14→; - Performance Parts		13.0460-3857.2 603857	BOS 25199 19,6 + WE / - WK Ceramic
						13.0470-3857.2 LD3857	BOS 25199 19,6 + WE / - WK Ceramic
			⬅	11/14→; + Performance Parts		13.0460-4875.2 604875	BRE 25028 18,0 + WE / - WK
			➡	11/14→; - Performance Parts		13.0460-3859.2 603859	BOS 25307 17,5 + WE / - WK Ceramic
						13.0470-3859.2 LD3859	BOS 25307 17,5 + WE / - WK Ceramic
			➡	11/14→; + Performance Parts		13.0460-4874.2 604874	BRE 25029 16,7 + WE / - WK
220 i	135	11/14→	⬅	- Performance Parts		13.0460-3857.2 603857	BOS 25199 19,6 + WE / - WK Ceramic
220 i	135	09/15→					
225 d	165	07/15→					
228 i	180	11/14→	⬅	+ Performance Parts		13.0460-4875.2 604875	BRE 25028 18,0 + WE / - WK
			➡	- Performance Parts		13.0460-3859.2 603859	BOS 25307 17,5 + WE / - WK Ceramic
						13.0470-3859.2 LD3859	BOS 25307 17,5 + WE / - WK Ceramic
↓							







	kW			 	! #		
BMW - 2 Cabriolet (F23) 03/14→							
 Bremsbelagsatz, Scheibenbremse							
220 i 220 i 225 d 228 i	135 135 165 180	11/14→ 09/15→ 07/15→ 11/14→	➡	+ Performance Parts		13.0460-4874.2 604874	BRE 25029 16,7 + WE / - WK
230 i	185	09/15→	⬅	- Performance Parts		13.0460-3857.2 603857 13.0470-3857.2 LD3857	BOS 25199 19,6 + WE / - WK BOS 25199 19,6 + WE / - WK Ceramic
			⬅	+ Performance Parts		13.0460-4875.2 604875	BRE 25028 18,0 + WE / - WK
			➡	+ Performance Parts		13.0460-4874.2 604874	BRE 25029 16,7 + WE / - WK
M 235 i M 235 i xDrive M 240 i M 240 i xDrive	240 240 250 250	11/14→ 07/15→ 09/15→ 09/15→	⬅			13.0460-4875.2 604875	BRE 25028 18,0 + WE / - WK
			➡			13.0460-4874.2 604874	BRE 25029 16,7 + WE / - WK
Warnkontakt, Bremsbelagverschleiß							
218 d 218 d 218 i 220 i 220 i 225 d 228 i 230 i M 235 i M 235 i xDrive M 240 i M 240 i xDrive	100 110 100 135 135 165 180 185 240 240 250 250	07/15→ 07/15→ 03/15→ 11/14→ 09/15→ 07/15→ 11/14→ 09/15→ 11/14→ 07/15→ 09/15→ 09/15→	⬅	☐	1	24.8190-0006.2 620006	L= 675
			➡		1	24.8190-0007.2 620007	L= 1.045
220 d	120	03/14→	⬅	☐; 11/14→	1	24.8190-0006.2 620006	L= 675
			➡	07/15→	1	24.8190-0007.2 620007	L= 1.045
220 d	140	03/14→	⬅	☐; 11/14→	1	24.8190-0006.2 620006	L= 675
			➡	11/14→	1	24.8190-0007.2 620007	L= 1.045
 Bremsscheibe							
218 d 218 d 218 i	100 110 100	07/15→ 07/15→ 03/15→	⬅	- Performance Parts		24.0122-0239.1 422239 24.0322-0239.1 522239	Ø 284 22 20,4 V + S Ø 284 22 19,6 V + S PD
			⬅	+ Performance Parts		24.0130-0233.2 430233	Ø 340 30 28,4 V Bremsscheibe zweiteilig / + S
			➡	- Performance Parts		24.0111-0175.1 411175	Ø 290 11 9,4 + S
			➡	+ Performance Parts		24.0124-0250.2 424250	Ø 345 24 22,4 V Bremsscheibe zweiteilig / + S
220 d 220 d	120 140	03/14→ 03/14→	⬅	11/14→; - Performance Parts		24.0124-0203.1 424203 24.0324-0203.1 524203	Ø 312 23,9 22,4 V + S Ø 312 23,9 21,6 V + S PD
			⬅	11/14→; + Performance Parts		24.0130-0233.2 430233	Ø 340 30 28,4 V Bremsscheibe zweiteilig / + S
			➡	11/14→; - Performance Parts		24.0120-0237.1 420237	Ø 300 20 18,4 V + S
			➡	11/14→; + Performance Parts		24.0124-0250.2 424250	Ø 345 24 22,4 V Bremsscheibe zweiteilig / + S
220 i 220 i 225 d	135 135 165	11/14→ 09/15→ 07/15→	⬅	- Performance Parts		24.0124-0203.1 424203 24.0324-0203.1 524203	Ø 312 23,9 22,4 V + S Ø 312 23,9 21,6 V + S PD
			⬅	+ Performance Parts		24.0130-0233.2 430233	Ø 340 30 28,4 V Bremsscheibe zweiteilig / + S
			➡	- Performance Parts		24.0120-0237.1 420237	Ø 300 20 18,4 V + S
			➡	+ Performance Parts		24.0124-0250.2 424250	Ø 345 24 22,4 V Bremsscheibe zweiteilig / + S
228 i 230 i	180 185	11/14→ 09/15→	⬅	- Performance Parts		24.0124-0248.1 424248	Ø 330 24 22,4 V + S
			⬅	+ Performance Parts		24.0130-0233.2 430233	Ø 340 30 28,4 V Bremsscheibe zweiteilig / + S
			➡	- Performance Parts		24.0120-0237.1 420237	Ø 300 20 18,4 V + S
			➡	+ Performance Parts		24.0124-0250.2 424250	Ø 345 24 22,4 V Bremsscheibe zweiteilig / + S
M 235 i M 235 i xDrive M 240 i M 240 i xDrive	240 240 250 250	11/14→ 07/15→ 09/15→ 09/15→	⬅			24.0130-0233.2 430233	Ø 340 30 28,4 V Bremsscheibe zweiteilig / + S
			➡			24.0124-0250.2 424250	Ø 345 24 22,4 V Bremsscheibe zweiteilig / + S
BMW - 2 Coupe (F22, F87) 10/12→							
 Bremsbelagsatz, Scheibenbremse							
218 d ↓	100	07/15→	⬅	- Performance Parts		13.0460-3865.2 603865	BOS 25014 18,2 + WE / - WK







	kW			 	! #		
BMW - 2 Coupe (F22, F87) 10/12→							
Bremsbelagsatz, Scheibenbremse							
218 d 218 d 218 i	105 110 100	01/14→ 07/15→ 03/15→	← ← →	- Performance Parts + Performance Parts - Performance Parts		13.0470-3865.2 LD3865 13.0460-4875.2 604875 13.0460-3859.2 603859 13.0470-3859.2 LD3859	BOS 25014 18,2 + WE / - WK Ceramic BRE 25028 18,0 + WE / - WK BOS 25307 17,5 + WE / - WK BOS 25307 17,5 + WE / - WK Ceramic BRE 25029 16,7 + WE / - WK
220 d 220 d xDrive 220 i 220 i 225 d 225 d 228 i 230 i	120 120 135 135 160 165 180 185	11/14→ 03/15→ 10/13→ 09/15→ 01/14→ 07/15→ 07/14→ 09/15→	← ← → →	- Performance Parts + Performance Parts - Performance Parts + Performance Parts		13.0460-3857.2 603857 13.0470-3857.2 LD3857 13.0460-4875.2 604875 13.0460-3859.2 603859 13.0470-3859.2 LD3859 13.0460-4874.2 604874	BOS 25199 19,6 + WE / - WK BOS 25199 19,6 + WE / - WK Ceramic BRE 25028 18,0 + WE / - WK BOS 25307 17,5 + WE / - WK BOS 25307 17,5 + WE / - WK Ceramic BRE 25029 16,7 + WE / - WK
220 d 220 d	135 147	10/12→11/14 10/12→11/14	← ← → →	10/13→; - Performance Parts 10/13→; + Performance Parts 10/13→; - Performance Parts 10/13→; + Performance Parts		13.0460-3857.2 603857 13.0470-3857.2 LD3857 13.0460-4875.2 604875 13.0460-3859.2 603859 13.0470-3859.2 LD3859 13.0460-4874.2 604874	BOS 25199 19,6 + WE / - WK BOS 25199 19,6 + WE / - WK Ceramic BRE 25028 18,0 + WE / - WK BOS 25307 17,5 + WE / - WK BOS 25307 17,5 + WE / - WK Ceramic BRE 25029 16,7 + WE / - WK
220 d	140	03/14→	← ← → →	11/14→; - Performance Parts 11/14→; + Performance Parts 11/14→; - Performance Parts 11/14→; + Performance Parts		13.0460-3857.2 603857 13.0470-3857.2 LD3857 13.0460-4875.2 604875 13.0460-3859.2 603859 13.0470-3859.2 LD3859 13.0460-4874.2 604874	BOS 25199 19,6 + WE / - WK BOS 25199 19,6 + WE / - WK Ceramic BRE 25028 18,0 + WE / - WK BOS 25307 17,5 + WE / - WK BOS 25307 17,5 + WE / - WK Ceramic BRE 25029 16,7 + WE / - WK
220 d xDrive	140	06/14→	← ← → →	03/15→; - Performance Parts 03/15→; + Performance Parts 03/15→; - Performance Parts 03/15→; + Performance Parts		13.0460-3857.2 603857 13.0470-3857.2 LD3857 13.0460-4875.2 604875 13.0460-3859.2 603859 13.0470-3859.2 LD3859 13.0460-4874.2 604874	BOS 25199 19,6 + WE / - WK BOS 25199 19,6 + WE / - WK Ceramic BRE 25028 18,0 + WE / - WK BOS 25307 17,5 + WE / - WK BOS 25307 17,5 + WE / - WK Ceramic BRE 25029 16,7 + WE / - WK
M 235 i M 235 i xDrive M 240 i M 240 i xDrive	240 240 250 250	10/13→ 07/14→ 09/15→ 09/15→	← →			13.0460-4875.2 604875 13.0460-4874.2 604874	BRE 25028 18,0 + WE / - WK BRE 25029 16,7 + WE / - WK
Warnkontakt, Bremsbelagsverschleiß							
218 d 218 d 218 d 218 i 220 d 220 d xDrive 220 i 220 i 225 d 225 d M2 M 235 i M 235 i xDrive M 240 i M 240 i xDrive	100 105 110 100 120 120 135 135 160 165 272 240 240 250 250	07/15→ 01/14→ 07/15→ 03/15→ 11/14→ 03/15→ 10/13→ 09/15→ 01/14→ 07/15→ 11/15→ 10/13→ 07/14→ 09/15→ 09/15→	← → ← →			1 24.8190-0006.2 620006 1 24.8190-0007.2 620007	L= 675 L= 1.045
220 d 220 d	135 147	10/12→11/14 10/12→11/14	← →	□; 10/13→ 10/13→		1 24.8190-0006.2 620006 1 24.8190-0007.2 620007	L= 675 L= 1.045
220 d	140	03/14→	← →	□; 11/14→ 11/14→		1 24.8190-0006.2 620006 1 24.8190-0007.2 620007	L= 675 L= 1.045
220 d xDrive	140	06/14→	← →	□; 03/15→ 03/15→		1 24.8190-0006.2 620006 1 24.8190-0007.2 620007	L= 675 L= 1.045
↓							









	kW			 	! #		
BMW - 2 Coupe (F22, F87) 10/12→							
Warnkontakt, Bremsbelagverschleiß							
228 i	180	07/14→	←		1	24.8190-0006.2 620006	L= 675
230 i	185	09/15→	→		1	24.8190-0007.2 620007	L= 1.045
 Bremsscheibe							
218 d	100	07/15→	←	- Performance Parts		24.0122-0239.1 422239	Ø 284 22 20,4 V + S
218 d	105	01/14→				24.0322-0239.1 522239	Ø 284 22 19,6 V + S PD
218 d	110	07/15→					
218 i	100	03/15→	←	+ Performance Parts		24.0130-0233.2 430233	Ø 340 30 28,4 V Bremsscheibe zweiteilig / + S
			→	- Performance Parts		24.0111-0175.1 411175	Ø 290 11 9,4 + S
			→	+ Performance Parts		24.0124-0250.2 424250	Ø 345 24 22,4 V Bremsscheibe zweiteilig / + S
220 d	120	11/14→	←	- Performance Parts		24.0124-0203.1 424203	Ø 312 23,9 22,4 V + S
220 d xDrive	120	03/15→				24.0324-0203.1 524203	Ø 312 23,9 21,6 V + S PD
220 i	135	10/13→					
220 i	135	09/15→	←	+ Performance Parts		24.0130-0233.2 430233	Ø 340 30 28,4 V Bremsscheibe zweiteilig / + S
225 d	160	01/14→					
225 d	165	07/15→	→	- Performance Parts		24.0120-0237.1 420237	Ø 300 20 18,4 V + S
			→	+ Performance Parts		24.0124-0250.2 424250	Ø 345 24 22,4 V Bremsscheibe zweiteilig / + S
220 d	135	10/12→11/14	←	10/13→; - Performance Parts		24.0124-0203.1 424203	Ø 312 23,9 22,4 V + S
220 d	147	10/12→11/14	←	10/13→; + Performance Parts		24.0324-0203.1 524203	Ø 312 23,9 21,6 V + S PD
			→	10/13→; - Performance Parts		24.0120-0237.1 420237	Ø 300 20 18,4 V + S
			→	10/13→; + Performance Parts		24.0124-0250.2 424250	Ø 345 24 22,4 V Bremsscheibe zweiteilig / + S
220 d	140	03/14→	←	11/14→; - Performance Parts		24.0124-0203.1 424203	Ø 312 23,9 22,4 V + S
			←	11/14→; + Performance Parts		24.0324-0203.1 524203	Ø 312 23,9 21,6 V + S PD
			→	11/14→; - Performance Parts		24.0130-0233.2 430233	Ø 340 30 28,4 V Bremsscheibe zweiteilig / + S
			→	11/14→; + Performance Parts		24.0120-0237.1 420237	Ø 300 20 18,4 V + S
			→	11/14→; + Performance Parts		24.0124-0250.2 424250	Ø 345 24 22,4 V Bremsscheibe zweiteilig / + S
220 d xDrive	140	06/14→	←	03/15→; - Performance Parts		24.0124-0203.1 424203	Ø 312 23,9 22,4 V + S
			←	03/15→; + Performance Parts		24.0324-0203.1 524203	Ø 312 23,9 21,6 V + S PD
			→	03/15→; - Performance Parts		24.0130-0233.2 430233	Ø 340 30 28,4 V Bremsscheibe zweiteilig / + S
			→	03/15→; + Performance Parts		24.0120-0237.1 420237	Ø 300 20 18,4 V + S
			→	03/15→; + Performance Parts		24.0124-0250.2 424250	Ø 345 24 22,4 V Bremsscheibe zweiteilig / + S
228 i	180	07/14→	←	- Performance Parts		24.0124-0248.1 424248	Ø 330 24 22,4 V + S
230 i	185	09/15→	←	+ Performance Parts		24.0130-0233.2 430233	Ø 340 30 28,4 V Bremsscheibe zweiteilig / + S
			→	- Performance Parts		24.0120-0237.1 420237	Ø 300 20 18,4 V + S
			→	+ Performance Parts		24.0124-0250.2 424250	Ø 345 24 22,4 V Bremsscheibe zweiteilig / + S
M 235 i	240	10/13→	←			24.0130-0233.2 430233	Ø 340 30 28,4 V Bremsscheibe zweiteilig / + S
M 235 i xDrive	240	07/14→					
M 240 i	250	09/15→					
M 240 i xDrive	250	09/15→	→			24.0124-0250.2 424250	Ø 345 24 22,4 V Bremsscheibe zweiteilig / + S
BMW - 2 Gran Tourer (F46) 07/14→							
 Bremsbelagsatz, Scheibenbremse							
214 d	70	10/14→	→	03/15→; + eFSB		13.0460-7315.2 607315	ATE 25331 16,2 + WE / - WK
216 d	85	08/14→				13.0470-7315.2 LD7315	ATE 25331 16,2 + WE / - WK Ceramic
218 d	100	07/14→					
218 d	110	07/14→					
218 i	100	07/14→					
220 d xDrive	120	07/14→					
220 d xDrive	140	07/14→					
220 i	120	07/14→					
220 i	141	07/14→					
216 i	75	09/14→	→	07/15→; + eFSB		13.0460-7315.2 607315	ATE 25331 16,2 + WE / - WK
220 d	120	09/14→				13.0470-7315.2 LD7315	ATE 25331 16,2 + WE / - WK Ceramic
220 d	140	09/14→					
218 d xDrive	100	03/15→	→	+ eFSB		13.0460-7315.2 607315	ATE 25331 16,2 + WE / - WK
218 d xDrive	110	03/15→					
↓							







	kW				! #		
BMW - 2 Gran Tourer (F46) 07/14→							
 Bremsbelagsatz, Scheibenbremse							
218 d xDrive 218 d xDrive	100 110	03/15→ 03/15→	➡	+ eFSB		13.0470-7315.2 LD7315	ATE 25331 16,2 + WE / - WK Ceramic
Warnkontakt, Bremsbelagverschleiß							
214 d 216 d 218 d 218 d 218 i 220 d xDrive 220 d xDrive 220 i 220 i	70 85 100 110 100 120 140 120 141	10/14→ 08/14→ 07/14→ 07/14→ 07/14→ 07/14→ 07/14→ 07/14→ 07/14→	➡	03/15→	1	24.8190-0942.2 620942	L= 641
216 i 220 d 220 d	75 120 140	09/14→ 09/14→ 09/14→	➡	07/15→	1	24.8190-0942.2 620942	L= 641
218 d xDrive 218 d xDrive	100 110	03/15→ 03/15→	➡		1	24.8190-0942.2 620942	L= 641
 Bremsscheibe							
214 d 216 d	70 85	10/14→ 08/14→	➡	03/15→		24.0110-0401.1 410401	Ø 280 10 8,4 + S
216 i	75	09/14→	➡	07/15→		24.0110-0401.1 410401	Ø 280 10 8,4 + S
218 d 218 d 218 i	100 110 100	07/14→ 07/14→ 07/14→	➡	03/15→		24.0124-0260.1 424260 24.0110-0401.1 410401	Ø 307 24 22,4 V + S Ø 280 10 8,4 + S
218 d xDrive 218 d xDrive	100 110	03/15→ 03/15→	➡			24.0124-0260.1 424260 24.0110-0401.1 410401	Ø 307 24 22,4 V + S Ø 280 10 8,4 + S
220 d 220 d	120 140	09/14→ 09/14→	➡	07/15→		24.0124-0259.1 424259 24.0110-0401.1 410401	Ø 330 24 22,4 V + S Ø 280 10 8,4 + S
220 d xDrive 220 d xDrive 220 i 220 i	120 140 120 141	07/14→ 07/14→ 07/14→ 07/14→	➡	03/15→		24.0124-0259.1 424259 24.0110-0401.1 410401	Ø 330 24 22,4 V + S Ø 280 10 8,4 + S
BMW - 3 (E36) 09/90→02/98							
 Bremsbelagsatz, Scheibenbremse							
316 i 318 i 318 tds	75 85 66	07/93→02/98 10/93→02/98 01/95→02/98	➡	Artikelnummer des empfohlenen Zubehörs: WK 24.8190-0207.2		13.0460-5405.2 605405 13.0470-5405.2 LD5405	ATE 21643 17,8 + WE / - WK ATE 21643 17,8 + WE / - WK Ceramic
			➡	+ ABS		13.0460-3605.2 603605 13.0470-3605.2 LD3605	ATE 20180 17,3 + WE / - WK ATE 20180 17,3 + WE / - WK Ceramic
318 is 318 is 320 i 323 i 2.5 325 i 325 td 325 tds 328 i	103 103 110 125 141 85 105 142	03/93→02/98 09/95→02/98 09/90→02/98 03/95→02/98 09/90→09/95 09/91→02/98 05/93→02/98 01/95→02/98	➡	Artikelnummer des empfohlenen Zubehörs: WK 24.8190-0207.2		13.0460-5405.2 605405 13.0470-5405.2 LD5405	ATE 21643 17,8 + WE / - WK ATE 21643 17,8 + WE / - WK Ceramic
M3 3.0 M3 3.2	210 236	08/94→09/95 09/95→02/98	➡			13.0460-7185.2 607185 13.0460-3803.2 603803	ATE 20968 20,3 + WE / - WK ATE 20995 17,3 + WE / - WK
Warnkontakt, Bremsbelagverschleiß							
316 i 318 i 318 tds	75 85 66	07/93→02/98 10/93→02/98 01/95→02/98	➡	+ ABS	1	24.8190-0207.2 620207 24.8190-0206.2 620206	L= 786 L= 790
318 is 318 is 320 i 323 i 2.5 325 i 325 td 325 tds 328 i	103 103 110 125 141 85 105 142	03/93→02/98 09/95→02/98 09/90→02/98 03/95→02/98 09/90→09/95 09/91→02/98 05/93→02/98 01/95→02/98	➡		1	24.8190-0207.2 620207 24.8190-0206.2 620206	L= 786 L= 790
M3 3.0 M3 3.2	210 236	08/94→09/95 09/95→02/98	➡		1	24.8190-0210.2 620210 24.8190-0206.2 620206	L= 810 L= 790
 Bremsscheibe							
316 i ↓	75	07/93→02/98	➡			24.0112-0126.1 412126	Ø 286 12 10,4 + S









	kw			 	! #		
BMW - 3 (E36) 09/90→02/98							
Bremsscheibe							
316 i	75	07/93→02/98	←			24.0312-0126.1 512126	Ø 286 12 9,6 + S PD
			→	+ ABS		24.0110-0202.1 410202	Ø 280 10 8,4 + S
						24.0310-0202.1 510202	Ø 280 10 7,6 + S PD
318 i	85	10/93→02/98	←	nicht für erhöhte Nutzlast		24.0112-0126.1 412126	Ø 286 12 10,4 + S
318 tds	66	01/95→02/98	←			24.0312-0126.1 512126	Ø 286 12 9,6 + S PD
			←	für erhöhte Nutzlast		24.0122-0115.1 422115	Ø 286 22 20,4 V + S
						24.0322-0115.1 522115	Ø 286 22 19,6 V + S PD
			→	+ ABS		24.0110-0202.1 410202	Ø 280 10 8,4 + S
						24.0310-0202.1 510202	Ø 280 10 7,6 + S PD
318 is	103	03/93→02/98	←			24.0122-0115.1 422115	Ø 286 22 20,4 V + S
318 is	103	09/95→02/98	←			24.0322-0115.1 522115	Ø 286 22 19,6 V + S PD
320 i	110	09/90→02/98	→			24.0110-0202.1 410202	Ø 280 10 8,4 + S
325 i	141	09/90→09/95	→			24.0310-0202.1 510202	Ø 280 10 7,6 + S PD
325 td	85	09/91→02/98	→				
325 tds	105	05/93→02/98	→				
323 i 2.5	125	03/95→02/98	←			24.0122-0115.1 422115	Ø 286 22 20,4 V + S
328 i	142	01/95→02/98	←			24.0322-0115.1 522115	Ø 286 22 19,6 V + S PD
			→			24.0119-0107.1 419107	Ø 276 19 17,4 V + S
			→			24.0319-0107.1 519107	Ø 276 19 16,6 V + S PD
M3 3.0	210	08/94→09/95	←	<input type="checkbox"/>		24.0128-0198.1 428198	Ø 315 28 26,4 V + S
			←	<input type="checkbox"/>		24.0328-0198.1 528198	Ø 315 28 25,6 V + S PD
			←	<input type="checkbox"/>		24.0128-0199.1 428199	Ø 315 28 26,4 V + S
			←	<input type="checkbox"/>		24.0328-0199.1 528199	Ø 315 28 25,6 V + S PD
			→	<input type="checkbox"/>		24.0120-0189.1 420189	Ø 312 20 18,4 V + S
			→	<input type="checkbox"/>		24.0120-0190.1 420190	Ø 312 20 18,4 V + S
M3 3.2	236	09/95→02/98	←	<input type="checkbox"/>		24.0128-0204.2 428204	Ø 315 28 26,4 V Brems Scheibe zweiteilig / + S
			←	<input type="checkbox"/>		24.0128-0205.2 428205	Ø 315 28 26,4 V Brems Scheibe zweiteilig / + S
			→	<input type="checkbox"/>		24.0120-0189.1 420189	Ø 312 20 18,4 V + S
			→	<input type="checkbox"/>		24.0120-0190.1 420190	Ø 312 20 18,4 V + S
BMW - 3 (E46) 02/98→04/05							
Bremsbelagsatz, Scheibenbremse							
316 i	77	04/00→02/05	←			13.0460-5405.2 605405	ATE 21643 17,8 + WE / - WK
316 i	85	06/02→02/05	←			13.0470-5405.2 LD5405	ATE 21643 17,8 + WE / - WK Ceramic
316 i	85	02/02→02/05	←				
316 i	77	09/98→02/05	←				
318 d	85	09/01→03/03	→			13.0460-3605.2 603605	ATE 20180 17,3 + WE / - WK
318 d	85	03/03→02/05	→			13.0470-3605.2 LD3605	ATE 20180 17,3 + WE / - WK Ceramic
318 i	87	02/98→09/01	→				
318 i	100	09/01→02/05	→				
318 i	105	09/01→02/05	→				
320 d	100	04/98→09/01	→				
320 d	110	09/01→02/05	→				
320 i	110	03/98→09/00	→				
320 i	120	09/00→02/05	→				
320 i	125	09/00→02/05	→				
323 i	120	03/98→09/00	→				
323 i	125	03/98→09/00	→				
328 i	142	02/98→06/00	→				
320 d	95	02/98→04/05	←	→ 02/05		13.0460-5405.2 605405	ATE 21643 17,8 + WE / - WK
			←			13.0470-5405.2 LD5405	ATE 21643 17,8 + WE / - WK Ceramic
			→	→ 02/05		13.0460-3605.2 603605	ATE 20180 17,3 + WE / - WK
			→			13.0470-3605.2 LD3605	ATE 20180 17,3 + WE / - WK Ceramic
325 i	141	09/00→02/05	←	nicht für erhöhte Nutzlast		13.0460-5405.2 605405	ATE 21643 17,8 + WE / - WK
325 xi	141	09/00→02/05	←			13.0470-5405.2 LD5405	ATE 21643 17,8 + WE / - WK Ceramic
			←	für erhöhte Nutzlast		13.0460-7155.2 607155	ATE 21676 20,3 + WE / - WK
			←			13.0470-7155.2 LD7155	ATE 21676 20,3 + WE / - WK Ceramic
			→	nicht für erhöhte Nutzlast		13.0460-3605.2 603605	ATE 20180 17,3 + WE / - WK
			→			13.0470-3605.2 LD3605	ATE 20180 17,3 + WE / - WK Ceramic
			→	für erhöhte Nutzlast		13.0460-7079.2 607079	ATE 21282 17,3 + WE / - WK
			→			13.0470-7079.2 LD7079	ATE 21282 17,3 + WE / - WK Ceramic
↓							









	kW			 	! #		
BMW - 3 (E46) 02/98→04/05							
Bremsbelagsatz, Scheibenbremse							
330 d	135	10/99→02/05	←			13.0460-7155.2 607155	ATE 21676 20,3 + WE / - WK
330 d	150	03/03→02/05				13.0470-7155.2 LD7155	ATE 21676 20,3 + WE / - WK
330 i	170	06/00→02/05					Ceramic
330 xi	170	06/00→02/05	→			13.0460-7079.2 607079	ATE 21282 17,3 + WE / - WK
						13.0470-7079.2 LD7079	ATE 21282 17,3 + WE / - WK
							Ceramic
330 i	168	01/01→04/05	←	→ 02/05		13.0460-7155.2 607155	ATE 21676 20,3 + WE / - WK
						13.0470-7155.2 LD7155	ATE 21676 20,3 + WE / - WK
							Ceramic
			→	→ 02/05		13.0460-7079.2 607079	ATE 21282 17,3 + WE / - WK
						13.0470-7079.2 LD7079	ATE 21282 17,3 + WE / - WK
							Ceramic
330 xd	135	01/00→02/03	←	06/00→		13.0460-7155.2 607155	ATE 21676 20,3 + WE / - WK
						13.0470-7155.2 LD7155	ATE 21676 20,3 + WE / - WK
							Ceramic
			→	06/00→		13.0460-7079.2 607079	ATE 21282 17,3 + WE / - WK
						13.0470-7079.2 LD7079	ATE 21282 17,3 + WE / - WK
							Ceramic
330 xd	150	09/02→12/04	←	03/03→		13.0460-7155.2 607155	ATE 21676 20,3 + WE / - WK
						13.0470-7155.2 LD7155	ATE 21676 20,3 + WE / - WK
							Ceramic
			→	03/03→		13.0460-7079.2 607079	ATE 21282 17,3 + WE / - WK
						13.0470-7079.2 LD7079	ATE 21282 17,3 + WE / - WK
							Ceramic
Warnkontakt, Bremsbelagverschleiß							
316 i	77	04/00→02/05	←		1	24.8190-0220.2 620220	L= 601
316 i	85	06/02→02/05					
316 i	85	02/02→02/05	→		1	24.8190-0221.2 620221	L= 1.338
316 i	77	09/98→02/05					
318 d	85	09/01→03/03					
318 d	85	03/03→02/05					
318 i	87	02/98→09/01					
318 i	100	09/01→02/05					
318 i	105	09/01→02/05					
320 d	100	04/98→09/01					
320 d	110	09/01→02/05					
320 i	110	03/98→09/00					
320 i	120	09/00→02/05					
320 i	125	09/00→02/05					
323 i	120	03/98→09/00					
323 i	125	03/98→09/00					
328 i	142	02/98→06/00					
320 d	95	02/98→04/05	←	→ 02/05	1	24.8190-0220.2 620220	L= 601
			→	→ 02/05	1	24.8190-0221.2 620221	L= 1.338
325 i	141	09/00→02/05	←	nicht für erhöhte Nutzlast	1	24.8190-0220.2 620220	L= 601
			←	für erhöhte Nutzlast	1	24.8190-0220.2 620220	L= 601
			→	nicht für erhöhte Nutzlast	1	24.8190-0221.2 620221	L= 1.338
			→	für erhöhte Nutzlast	1	24.8190-0221.2 620221	L= 1.338
325 xi	141	09/00→02/05	←	nicht für erhöhte Nutzlast	1	24.8190-0227.2 620227	L= 651
			←	für erhöhte Nutzlast	1	24.8190-0227.2 620227	L= 651
			→	nicht für erhöhte Nutzlast	1	24.8190-0221.2 620221	L= 1.338
			→	für erhöhte Nutzlast	1	24.8190-0221.2 620221	L= 1.338
330 d	135	10/99→02/05	←		1	24.8190-0227.2 620227	L= 651
330 d	150	03/03→02/05					
330 i	170	06/00→02/05	→		1	24.8190-0221.2 620221	L= 1.338
330 xi	170	06/00→02/05					
330 i	168	01/01→04/05	←	→ 02/05	1	24.8190-0227.2 620227	L= 651
			→	→ 02/05	1	24.8190-0221.2 620221	L= 1.338
330 xd	135	01/00→02/03	←	06/00→	1	24.8190-0227.2 620227	L= 651
			→	06/00→	1	24.8190-0221.2 620221	L= 1.338
330 xd	150	09/02→12/04	←	03/03→	1	24.8190-0227.2 620227	L= 651
			→	03/03→	1	24.8190-0221.2 620221	L= 1.338
Bremsscheibe							
316 i	77	04/00→02/05	←			24.0122-0115.1 422115	Ø 286 22 20,4 V + S
						24.0322-0115.1 522115	Ø 286 22 19,6 V + S PD
↓							

	kw			 	! #		
BMW - 3 (E46) 02/98→04/05							
Bremsscheibe							
316 i	77	04/00→02/05	➔			24.0110-0202.1 410202 24.0310-0202.1 510202	Ø 280 10 8,4 + S Ø 280 10 7,6 + S PD
316 i	85	06/02→02/05	➔			24.0122-0115.1 422115	Ø 286 22 20,4 V + S
316 i	85	02/02→02/05	➔			24.0322-0115.1 522115	Ø 286 22 19,6 V + S PD
316 i	77	09/98→02/05	➔				
318 i	87	02/98→09/01	➔	nicht für erhöhte Nutzlast		24.0110-0202.1 410202 24.0310-0202.1 510202	Ø 280 10 8,4 + S Ø 280 10 7,6 + S PD
			➔	für erhöhte Nutzlast		24.0119-0107.1 419107 24.0319-0107.1 519107	Ø 276 19 17,4 V + S Ø 276 19 16,6 V + S PD
318 d	85	09/01→03/03	➔			24.0122-0115.1 422115	Ø 286 22 20,4 V + S
318 d	85	03/03→02/05	➔			24.0322-0115.1 522115	Ø 286 22 19,6 V + S PD
320 d	100	04/98→09/01	➔			24.0119-0107.1 419107 24.0319-0107.1 519107	Ø 276 19 17,4 V + S Ø 276 19 16,6 V + S PD
318 i	100	09/01→02/05	➔	nicht für erhöhte Nutzlast		24.0122-0115.1 422115	Ø 286 22 20,4 V + S
318 i	105	09/01→02/05	➔			24.0322-0115.1 522115	Ø 286 22 19,6 V + S PD
320 i	110	03/98→09/00	➔				
320 i	120	09/00→02/05	➔	für erhöhte Nutzlast		24.0122-0160.1 422160	Ø 300 22 20,4 V + S
320 i	125	09/00→02/05	➔			24.0322-0160.1 522160	Ø 300 22 19,6 V + S PD
323 i	120	03/98→09/00	➔	nicht für erhöhte Nutzlast		24.0119-0107.1 419107	Ø 276 19 17,4 V + S
323 i	125	03/98→09/00	➔			24.0319-0107.1 519107 24.0119-0108.1 419108 24.0319-0108.1 519108	Ø 276 19 16,6 V + S PD Ø 294 18,9 17,4 V + S Ø 294 18,9 16,6 V + S PD
320 d	95	02/98→04/05	➔	→ 02/05		24.0122-0115.1 422115 24.0322-0115.1 522115	Ø 286 22 20,4 V + S Ø 286 22 19,6 V + S PD
			➔	→ 02/05		24.0119-0107.1 419107 24.0319-0107.1 519107	Ø 276 19 17,4 V + S Ø 276 19 16,6 V + S PD
320 d	110	09/01→02/05	➔			24.0122-0160.1 422160	Ø 300 22 20,4 V + S
328 i	142	02/98→06/00	➔			24.0322-0160.1 522160	Ø 300 22 19,6 V + S PD
			➔			24.0119-0108.1 419108 24.0319-0108.1 519108	Ø 294 18,9 17,4 V + S Ø 294 18,9 16,6 V + S PD
325 i	141	09/00→02/05	➔	nicht für erhöhte Nutzlast		24.0122-0160.1 422160 24.0322-0160.1 522160	Ø 300 22 20,4 V + S Ø 300 22 19,6 V + S PD
			➔	für erhöhte Nutzlast		24.0125-0138.1 425138 24.0325-0138.1 525138	Ø 325 24,9 23,4 V + S Ø 325 24,9 22,6 V + S PD
			➔	nicht für erhöhte Nutzlast		24.0119-0108.1 419108 24.0319-0108.1 519108	Ø 294 18,9 17,4 V + S Ø 294 18,9 16,6 V + S PD
325 xi	141	09/00→02/05	➔	nicht für erhöhte Nutzlast		24.0122-0160.1 422160 24.0322-0160.1 522160	Ø 300 22 20,4 V + S Ø 300 22 19,6 V + S PD
			➔	für erhöhte Nutzlast		24.0125-0138.1 425138 24.0325-0138.1 525138	Ø 325 24,9 23,4 V + S Ø 325 24,9 22,6 V + S PD
			➔	nicht für erhöhte Nutzlast		24.0119-0113.1 419113	Ø 294 19 17,4 V + S
			➔	für erhöhte Nutzlast		24.0122-0209.1 422209 24.0322-0209.1 522209	Ø 320 22 20,4 V + S Ø 320 22 19,6 V + S PD
330 d	135	10/99→02/05	➔			24.0125-0138.1 425138	Ø 325 24,9 23,4 V + S
330 d	150	03/03→02/05	➔			24.0325-0138.1 525138	Ø 325 24,9 22,6 V + S PD
330 i	170	06/00→02/05	➔				
330 xi	170	06/00→02/05	➔			24.0122-0209.1 422209 24.0322-0209.1 522209	Ø 320 22 20,4 V + S Ø 320 22 19,6 V + S PD
330 i	168	01/01→04/05	➔	→ 02/05		24.0125-0138.1 425138 24.0325-0138.1 525138	Ø 325 24,9 23,4 V + S Ø 325 24,9 22,6 V + S PD
			➔	→ 02/05		24.0122-0209.1 422209 24.0322-0209.1 522209	Ø 320 22 20,4 V + S Ø 320 22 19,6 V + S PD
330 xd	135	01/00→02/03	➔	06/00→		24.0125-0138.1 425138 24.0325-0138.1 525138	Ø 325 24,9 23,4 V + S Ø 325 24,9 22,6 V + S PD
			➔	06/00→		24.0122-0209.1 422209 24.0322-0209.1 522209	Ø 320 22 20,4 V + S Ø 320 22 19,6 V + S PD
330 xd	150	09/02→12/04	➔	03/03→		24.0125-0138.1 425138 24.0325-0138.1 525138	Ø 325 24,9 23,4 V + S Ø 325 24,9 22,6 V + S PD
			➔	03/03→		24.0122-0209.1 422209 24.0322-0209.1 522209	Ø 320 22 20,4 V + S Ø 320 22 19,6 V + S PD
BMW - 3 (E90) 02/04→12/11							
Bremsbelagsatz, Scheibenbremse							
316 d	85	07/09→12/11	➔	+ Performance Parts		13.0460-4848.2 604848	BRE 24316 16,9 + WE / - WK
↓							









	kw			 	! #		
BMW - 3 (E90) 02/04→12/11							
 Bremsbelagsatz, Scheibenbremse							
316 d	85	07/09→12/11	←	03/10→		13.0460-7216.2 607216 13.0470-7216.2 LD7216	ATE 23794 20,3 + WE / - WK ATE 23794 20,3 + WE / - WK Ceramic
			←	→ 02/10		13.0460-7216.2 607216 13.0470-7216.2 LD7216	ATE 23794 20,3 + WE / - WK ATE 23794 20,3 + WE / - WK Ceramic
			→	→ 02/10		13.0460-2713.2 602713 13.0470-2713.2 LD2713	TRW 23623 17,4 + WE / - WK + Zub TRW 23623 17,4 + WE / - WK + Zub Ceramic
			→	03/10→		13.0460-2713.2 602713 13.0470-2713.2 LD2713	TRW 23623 17,4 + WE / - WK + Zub TRW 23623 17,4 + WE / - WK + Zub Ceramic
316 i	85	03/05→10/11	←	→ 08/07; + Performance Parts		13.0460-4848.2 604848	BRE 24316 16,9 + WE / - WK
			←	→ 08/07		13.0460-7215.2 607215 13.0470-7215.2 LD7215	ATE 23935 17,8 + WE / - WK ATE 23935 17,8 + WE / - WK Ceramic
			→	→ 08/07		13.0460-2713.2 602713 13.0470-2713.2 LD2713	TRW 23623 17,4 + WE / - WK + Zub TRW 23623 17,4 + WE / - WK + Zub Ceramic
316 i	90	02/07→10/11	←	09/07→; + Performance Parts		13.0460-4848.2 604848	BRE 24316 16,9 + WE / - WK
			←	09/07→ 02/10		13.0460-7216.2 607216 13.0470-7216.2 LD7216	ATE 23794 20,3 + WE / - WK ATE 23794 20,3 + WE / - WK Ceramic
			←	03/10→		13.0460-7216.2 607216 13.0470-7216.2 LD7216	ATE 23794 20,3 + WE / - WK ATE 23794 20,3 + WE / - WK Ceramic
			→	09/07→ 02/10		13.0460-2713.2 602713 13.0470-2713.2 LD2713	TRW 23623 17,4 + WE / - WK + Zub TRW 23623 17,4 + WE / - WK + Zub Ceramic
			→	03/10→		13.0460-2713.2 602713 13.0470-2713.2 LD2713	TRW 23623 17,4 + WE / - WK + Zub TRW 23623 17,4 + WE / - WK + Zub Ceramic
318 d	90	01/05→08/07	←	09/05→; + Performance Parts		13.0460-4848.2 604848	BRE 24316 16,9 + WE / - WK
			←	09/05→; nicht für erhöhte Nutzlast		13.0460-7215.2 607215 13.0470-7215.2 LD7215	ATE 23935 17,8 + WE / - WK ATE 23935 17,8 + WE / - WK Ceramic
			←	09/05→; für erhöhte Nutzlast		13.0460-7216.2 607216 13.0470-7216.2 LD7216	ATE 23794 20,3 + WE / - WK ATE 23794 20,3 + WE / - WK Ceramic
			→	09/05→; nicht für erhöhte Nutzlast		13.0460-2713.2 602713 13.0470-2713.2 LD2713	TRW 23623 17,4 + WE / - WK + Zub TRW 23623 17,4 + WE / - WK + Zub Ceramic
			→	09/05→; für erhöhte Nutzlast		13.0460-7217.2 607217 13.0470-7217.2 LD7217	ATE 23926 17,3 + WE / - WK ATE 23926 17,3 + WE / - WK Ceramic
318 d 318 d 318 i 318 i	100 105 100 105	02/07→03/10 02/07→10/11 03/07→10/11 02/07→10/11	←	09/07→; + Performance Parts		13.0460-4848.2 604848	BRE 24316 16,9 + WE / - WK
			←	03/10→		13.0460-7216.2 607216 13.0470-7216.2 LD7216	ATE 23794 20,3 + WE / - WK ATE 23794 20,3 + WE / - WK Ceramic
			←	09/07→ 02/10		13.0460-7216.2 607216 13.0470-7216.2 LD7216	ATE 23794 20,3 + WE / - WK ATE 23794 20,3 + WE / - WK Ceramic
			→	03/10→		13.0460-7217.2 607217 13.0470-7217.2 LD7217	ATE 23926 17,3 + WE / - WK ATE 23926 17,3 + WE / - WK Ceramic
			→	09/07→ 02/10		13.0460-7217.2 607217 13.0470-7217.2 LD7217	ATE 23926 17,3 + WE / - WK ATE 23926 17,3 + WE / - WK Ceramic
318 i	95	08/04→08/07	←	09/05→; + Performance Parts		13.0460-4848.2 604848	BRE 24316 16,9 + WE / - WK
			←	09/05→; nicht für erhöhte Nutzlast; Motorcode: N46		13.0460-7215.2 607215	ATE 23935 17,8 + WE / - WK

	kw			 	! #		
BMW - 3 (E90) 02/04→12/11							
Bremsbelagsatz, Scheibenbremse							
318 i	95	08/04→08/07	←	09/05→; nicht für erhöhte Nutzlast; Motorcode: N46	13.0470-7215.2	LD7215	ATE 23935 17,8 + WE / - WK Ceramic
			←	09/05→; für erhöhte Nutzlast; Motorcode: N46	13.0460-7216.2	607216	ATE 23794 20,3 + WE / - WK
					13.0470-7216.2	LD7216	ATE 23794 20,3 + WE / - WK Ceramic
			←	03/07→; Motorcode: N46N; nicht für erhöhte Nutzlast	13.0460-7216.2	607216	ATE 23794 20,3 + WE / - WK
					13.0470-7216.2	LD7216	ATE 23794 20,3 + WE / - WK Ceramic
			←	03/07→; für erhöhte Nutzlast; Motorcode: N46N	13.0460-7238.2	607238	ATE 23313 20,3 + WE / - WK
					13.0470-7238.2	LD7238	ATE 23313 20,3 + WE / - WK Ceramic
		→	09/05→; nicht für erhöhte Nutzlast; Motorcode: N46	13.0460-2713.2	602713	TRW 23623 17,4 + WE / - WK + Zub	
				13.0470-2713.2	LD2713	TRW 23623 17,4 + WE / - WK + Zub Ceramic	
			→	09/05→; für erhöhte Nutzlast; Motorcode: N46	13.0460-7217.2	607217	ATE 23926 17,3 + WE / - WK
				13.0470-7217.2	LD7217	ATE 23926 17,3 + WE / - WK Ceramic	
			→	03/07→; Motorcode: N46N	13.0460-7217.2	607217	ATE 23926 17,3 + WE / - WK
				13.0470-7217.2	LD7217	ATE 23926 17,3 + WE / - WK Ceramic	
320 d 320 d 320 d 320 d xDrive 320 d xDrive 320 d xDrive 320 xd	110 130 135 120 130 135 130	09/05→12/11 09/07→12/11 01/10→12/11 07/08→12/11 09/08→12/11 01/10→12/11 09/07→12/11	←	+ Performance Parts	13.0460-4848.2	604848	BRE 24316 16,9 + WE / - WK
			←	03/10→; für Behördenfahrzeuge	13.0460-7216.2	607216	ATE 23794 20,3 + WE / - WK
					13.0470-7216.2	LD7216	ATE 23794 20,3 + WE / - WK Ceramic
			←	→ 02/10; für Behördenfahrzeuge	13.0460-7216.2	607216	ATE 23794 20,3 + WE / - WK
					13.0470-7216.2	LD7216	ATE 23794 20,3 + WE / - WK Ceramic
			←	→ 02/10; nicht für Behördenfahrzeuge	13.0460-7238.2	607238	ATE 23313 20,3 + WE / - WK
					13.0470-7238.2	LD7238	ATE 23313 20,3 + WE / - WK Ceramic
			←	03/10→; nicht für Behördenfahrzeuge	13.0460-7238.2	607238	ATE 23313 20,3 + WE / - WK
					13.0470-7238.2	LD7238	ATE 23313 20,3 + WE / - WK Ceramic
			→	→ 02/10; nicht für Behördenfahrzeuge	13.0460-7217.2	607217	ATE 23926 17,3 + WE / - WK
					13.0470-7217.2	LD7217	ATE 23926 17,3 + WE / - WK Ceramic
→	03/10→; nicht für Behördenfahrzeuge	13.0460-7217.2	607217	ATE 23926 17,3 + WE / - WK			
		13.0470-7217.2	LD7217	ATE 23926 17,3 + WE / - WK Ceramic			
→	03/10→; für Behördenfahrzeuge	13.0460-7225.2	607225	ATE 23550 17,3 + WE / - WK			
		13.0470-7225.2	LD7225	ATE 23550 17,3 + WE / - WK Ceramic			
→	→ 02/10; für Behördenfahrzeuge	13.0460-7225.2	607225	ATE 23550 17,3 + WE / - WK			
		13.0470-7225.2	LD7225	ATE 23550 17,3 + WE / - WK Ceramic			
320 d	120	02/04→12/11	←	12/04→; + Performance Parts	13.0460-4848.2	604848	BRE 24316 16,9 + WE / - WK
			←	12/04→; für Behördenfahrzeuge	13.0460-7216.2	607216	ATE 23794 20,3 + WE / - WK
					13.0470-7216.2	LD7216	ATE 23794 20,3 + WE / - WK Ceramic
			←	12/04→ 02/10; nicht für Behördenfahrzeuge	13.0460-7238.2	607238	ATE 23313 20,3 + WE / - WK
					13.0470-7238.2	LD7238	ATE 23313 20,3 + WE / - WK Ceramic
←	03/10→; nicht für Behördenfahrzeuge	13.0460-7238.2	607238	ATE 23313 20,3 + WE / - WK			
		13.0470-7238.2	LD7238	ATE 23313 20,3 + WE / - WK Ceramic			
→	12/04→	13.0460-7217.2	607217	ATE 23926 17,3 + WE / - WK			
		13.0470-7217.2	LD7217	ATE 23926 17,3 + WE / - WK Ceramic			
320 i	110	06/04→03/07	←	12/04→; + Performance Parts	13.0460-4848.2	604848	BRE 24316 16,9 + WE / - WK
			←	12/04→; nicht für erhöhte Nutzlast; Motorcode: N46	13.0460-7215.2	607215	ATE 23935 17,8 + WE / - WK
					13.0470-7215.2	LD7215	ATE 23935 17,8 + WE / - WK Ceramic
←	03/07→; Motorcode: N46N; nicht für erhöhte Nutzlast	13.0460-7216.2	607216	ATE 23794 20,3 + WE / - WK			
		13.0470-7216.2	LD7216	ATE 23794 20,3 + WE / - WK Ceramic			
↓							

	kw			 	! #		
BMW - 3 (E90) 02/04→12/11							
 Bremsbelagsatz, Scheibenbremse							
320 i	110	06/04→03/07	←	12/04→; für erhöhte Nutzlast; Motorcode: N46	13.0460-7216.2	607216	ATE 23794 20,3 + WE / - WK ATE 23794 20,3 + WE / - WK Ceramic
			←	03/07→; für erhöhte Nutzlast; Motorcode: N46N	13.0460-7238.2	607238	ATE 23313 20,3 + WE / - WK ATE 23313 20,3 + WE / - WK Ceramic
			→	12/04→; nicht für erhöhte Nutzlast; Motorcode: N46	13.0460-2713.2	602713	TRW 23623 17,4 + WE / - WK + Zub
			→	03/07→; Motorcode: N46N	13.0460-7217.2	607217	ATE 23926 17,3 + WE / - WK ATE 23926 17,3 + WE / - WK Ceramic
			→	12/04→; für erhöhte Nutzlast; Motorcode: N46	13.0460-7217.2	607217	ATE 23926 17,3 + WE / - WK ATE 23926 17,3 + WE / - WK Ceramic
320 i	115	09/06→12/11	←	→ 08/07; + Performance Parts	13.0460-4848.2	604848	BRE 24316 16,9 + WE / - WK
			←	→ 08/07; nicht für erhöhte Nutzlast; Motorcode: N46	13.0460-7215.2	607215	ATE 23935 17,8 + WE / - WK ATE 23935 17,8 + WE / - WK Ceramic
			←	→ 08/07; für erhöhte Nutzlast; Motorcode: N46	13.0460-7216.2	607216	ATE 23794 20,3 + WE / - WK ATE 23794 20,3 + WE / - WK Ceramic
			←	03/07→ 08/07; Motorcode: N46N; nicht für erhöhte Nutzlast	13.0460-7216.2	607216	ATE 23794 20,3 + WE / - WK ATE 23794 20,3 + WE / - WK Ceramic
			←	03/07→ 08/07; für erhöhte Nutzlast; Motorcode: N46N	13.0460-7238.2	607238	ATE 23313 20,3 + WE / - WK ATE 23313 20,3 + WE / - WK Ceramic
			→	→ 08/07; nicht für erhöhte Nutzlast; Motorcode: N46	13.0460-2713.2	602713	TRW 23623 17,4 + WE / - WK + Zub
			→	→ 08/07; für erhöhte Nutzlast; Motorcode: N46	13.0460-7217.2	607217	ATE 23926 17,3 + WE / - WK ATE 23926 17,3 + WE / - WK Ceramic
			→	03/07→ 08/07; Motorcode: N46N	13.0460-7217.2	607217	ATE 23926 17,3 + WE / - WK ATE 23926 17,3 + WE / - WK Ceramic
320 i 320 i	120 125	03/07→12/11 03/07→12/11	←	09/07→; + Performance Parts	13.0460-4848.2	604848	BRE 24316 16,9 + WE / - WK
			←	03/10→; nicht für erhöhte Nutzlast	13.0460-7216.2	607216	ATE 23794 20,3 + WE / - WK ATE 23794 20,3 + WE / - WK Ceramic
			←	09/07→ 02/10; nicht für erhöhte Nutzlast	13.0460-7216.2	607216	ATE 23794 20,3 + WE / - WK ATE 23794 20,3 + WE / - WK Ceramic
			←	09/07→ 02/10; für erhöhte Nutzlast	13.0460-7238.2	607238	ATE 23313 20,3 + WE / - WK ATE 23313 20,3 + WE / - WK Ceramic
			←	03/10→; für erhöhte Nutzlast	13.0460-7238.2	607238	ATE 23313 20,3 + WE / - WK ATE 23313 20,3 + WE / - WK Ceramic
			→	03/10→	13.0460-7217.2	607217	ATE 23926 17,3 + WE / - WK ATE 23926 17,3 + WE / - WK Ceramic
			→	09/07→ 02/10	13.0460-7217.2	607217	ATE 23926 17,3 + WE / - WK ATE 23926 17,3 + WE / - WK Ceramic
320 si	127	09/05→08/06	←	06/06→; + Performance Parts	13.0460-4848.2	604848	BRE 24316 16,9 + WE / - WK
			←	06/06→	13.0460-7216.2	607216	ATE 23794 20,3 + WE / - WK ATE 23794 20,3 + WE / - WK Ceramic
			→	06/06→	13.0460-7217.2	607217	ATE 23926 17,3 + WE / - WK ATE 23926 17,3 + WE / - WK Ceramic
325 d 325 d ↓	145 150	09/06→12/11 01/10→12/11	←	+ Performance Parts	13.0460-4848.2	604848	BRE 24316 16,9 + WE / - WK









	kw			 	! #		
BMW - 3 (E90) 02/04→12/11							
 Bremsbelagsatz, Scheibenbremse							
325 d 325 d	145 150	09/06→12/11 01/10→12/11	←	→ 02/10; nicht für Behördenfahrzeuge	13.0460-7216.2	607216	ATE 23794 20,3 + WE / - WK
					13.0470-7216.2	LD7216	ATE 23794 20,3 + WE / - WK Ceramic
			←	03/10→; nicht für Behördenfahrzeuge	13.0460-7216.2	607216	ATE 23794 20,3 + WE / - WK
					13.0470-7216.2	LD7216	ATE 23794 20,3 + WE / - WK Ceramic
			←	03/10→; für Behördenfahrzeuge	13.0460-7237.2	607237	ATE 23347 20,3 + WE / - WK
					13.0460-7238.2	607238	ATE 23313 20,3 + WE / - WK
				13.0470-7237.2	LD7237	ATE 23347 20,3 + WE / - WK Ceramic	
				13.0470-7238.2	LD7238	ATE 23313 20,3 + WE / - WK Ceramic	
			←	→ 02/10; für Behördenfahrzeuge	13.0460-7237.2	607237	ATE 23347 20,3 + WE / - WK
					13.0460-7238.2	607238	ATE 23313 20,3 + WE / - WK
					13.0470-7237.2	LD7237	ATE 23347 20,3 + WE / - WK Ceramic
					13.0470-7238.2	LD7238	ATE 23313 20,3 + WE / - WK Ceramic
			→	03/10→	13.0460-7225.2	607225	ATE 23550 17,3 + WE / - WK
					13.0470-7225.2	LD7225	ATE 23550 17,3 + WE / - WK Ceramic
			→	→ 02/10	13.0460-7225.2	607225	ATE 23550 17,3 + WE / - WK
					13.0470-7225.2	LD7225	ATE 23550 17,3 + WE / - WK Ceramic
325 i 325 i 325 i 325 i	155 160 155 160	01/06→12/11 01/05→12/11 03/07→12/11 03/07→12/11	←	+ Performance Parts	13.0460-4848.2	604848	BRE 24316 16,9 + WE / - WK
			←	→ 08/07; nicht für erhöhte Nutzlast; Motorcode: N52	13.0460-7216.2	607216	ATE 23794 20,3 + WE / - WK
					13.0470-7216.2	LD7216	ATE 23794 20,3 + WE / - WK Ceramic
			←	03/10→; für erhöhte Nutzlast	13.0460-7216.2	607216	ATE 23794 20,3 + WE / - WK
					13.0470-7216.2	LD7216	ATE 23794 20,3 + WE / - WK Ceramic
			←	→ 02/10; für erhöhte Nutzlast	13.0460-7216.2	607216	ATE 23794 20,3 + WE / - WK
					13.0470-7216.2	LD7216	ATE 23794 20,3 + WE / - WK Ceramic
			←	09/07→ 02/10; nicht für erhöhte Nutzlast; Motorcode: N53	13.0460-7238.2	607238	ATE 23313 20,3 + WE / - WK
					13.0470-7238.2	LD7238	ATE 23313 20,3 + WE / - WK Ceramic
			←	03/10→; nicht für erhöhte Nutzlast; Motorcode: N53	13.0460-7238.2	607238	ATE 23313 20,3 + WE / - WK
					13.0470-7238.2	LD7238	ATE 23313 20,3 + WE / - WK Ceramic
←	→ 08/07; nicht für erhöhte Nutzlast; Motorcode: N52N	13.0460-7238.2	607238	ATE 23313 20,3 + WE / - WK			
		13.0470-7238.2	LD7238	ATE 23313 20,3 + WE / - WK Ceramic			
→	03/10→; nicht für erhöhte Nutzlast	13.0460-7217.2	607217	ATE 23926 17,3 + WE / - WK			
		13.0470-7217.2	LD7217	ATE 23926 17,3 + WE / - WK Ceramic			
→	→ 02/10; nicht für erhöhte Nutzlast	13.0460-7217.2	607217	ATE 23926 17,3 + WE / - WK			
		13.0470-7217.2	LD7217	ATE 23926 17,3 + WE / - WK Ceramic			
→	→ 02/10; für erhöhte Nutzlast	13.0460-7225.2	607225	ATE 23550 17,3 + WE / - WK			
		13.0470-7225.2	LD7225	ATE 23550 17,3 + WE / - WK Ceramic			
→	03/10→; für erhöhte Nutzlast	13.0460-7225.2	607225	ATE 23550 17,3 + WE / - WK			
		13.0470-7225.2	LD7225	ATE 23550 17,3 + WE / - WK Ceramic			
325 i xDrive	160	06/08→10/11	←	+ Performance Parts	13.0460-4848.2	604848	BRE 24316 16,9 + WE / - WK
			←	03/10→; Motorcode: N53; für erhöhte Nutzlast	13.0460-7216.2	607216	ATE 23794 20,3 + WE / - WK
					13.0470-7216.2	LD7216	ATE 23794 20,3 + WE / - WK Ceramic
			←	→ 02/10; Motorcode: N53; für erhöhte Nutzlast	13.0460-7216.2	607216	ATE 23794 20,3 + WE / - WK
					13.0470-7216.2	LD7216	ATE 23794 20,3 + WE / - WK Ceramic
←	03/10→; nicht für erhöhte Nutzlast; Motorcode: N53	13.0460-7238.2	607238	ATE 23313 20,3 + WE / - WK			
		13.0470-7238.2	LD7238	ATE 23313 20,3 + WE / - WK Ceramic			
←	→ 02/10; Motorcode: N53; nicht für erhöhte Nutzlast	13.0460-7238.2	607238	ATE 23313 20,3 + WE / - WK			



















	kw			 	! #		
BMW - 3 (E90) 02/04→12/11							
 Bremsbelagsatz, Scheibenbremse							
325 i xDrive	160	06/08→10/11	←	→ 02/10; Motorcode: N53; nicht für erhöhte Nutzlast	13.0470-7238.2	LD7238	ATE 23313 20,3 + WE / - WK Ceramic
			→	→ 02/10; nicht für erhöhte Nutzlast	13.0460-7217.2	607217	ATE 23926 17,3 + WE / - WK
					13.0470-7217.2	LD7217	ATE 23926 17,3 + WE / - WK Ceramic
			→	03/10→; nicht für erhöhte Nutzlast	13.0460-7217.2	607217	ATE 23926 17,3 + WE / - WK
					13.0470-7217.2	LD7217	ATE 23926 17,3 + WE / - WK Ceramic
325 xi	160	03/05→10/11	←	+ Performance Parts	13.0460-4848.2	604848	BRE 24316 16,9 + WE / - WK
			←	03/10→; Motorcode: N53; für erhöhte Nutzlast	13.0460-7216.2	607216	ATE 23794 20,3 + WE / - WK
					13.0470-7216.2	LD7216	ATE 23794 20,3 + WE / - WK Ceramic
			←	09/07→ 02/10; Motorcode: N53; für erhöhte Nutzlast	13.0460-7216.2	607216	ATE 23794 20,3 + WE / - WK
					13.0470-7216.2	LD7216	ATE 23794 20,3 + WE / - WK Ceramic
325 xi	160	03/07→06/08	←	→ 08/07; Motorcode: N52N; für erhöhte Nutzlast	13.0460-7216.2	607216	ATE 23794 20,3 + WE / - WK
					13.0470-7216.2	LD7216	ATE 23794 20,3 + WE / - WK Ceramic
			←	→ 08/07; Motorcode: N52	13.0460-7216.2	607216	ATE 23794 20,3 + WE / - WK
					13.0470-7216.2	LD7216	ATE 23794 20,3 + WE / - WK Ceramic
			←	→ 08/07; nicht für erhöhte Nutzlast; Motorcode: N52N	13.0460-7238.2	607238	ATE 23313 20,3 + WE / - WK
					13.0470-7238.2	LD7238	ATE 23313 20,3 + WE / - WK Ceramic
			←	09/07→ 02/10; nicht für erhöhte Nutzlast; Motorcode: N53	13.0460-7238.2	607238	ATE 23313 20,3 + WE / - WK
					13.0470-7238.2	LD7238	ATE 23313 20,3 + WE / - WK Ceramic
			←	03/10→; nicht für erhöhte Nutzlast; Motorcode: N53	13.0460-7238.2	607238	ATE 23313 20,3 + WE / - WK
					13.0470-7238.2	LD7238	ATE 23313 20,3 + WE / - WK Ceramic
			→	→ 02/10; nicht für erhöhte Nutzlast	13.0460-7217.2	607217	ATE 23926 17,3 + WE / - WK
					13.0470-7217.2	LD7217	ATE 23926 17,3 + WE / - WK Ceramic
			→	03/10→; nicht für erhöhte Nutzlast	13.0460-7217.2	607217	ATE 23926 17,3 + WE / - WK
		13.0470-7217.2	LD7217	ATE 23926 17,3 + WE / - WK Ceramic			
→	→ 02/10; für erhöhte Nutzlast	13.0460-7225.2	607225	ATE 23550 17,3 + WE / - WK			
		13.0470-7225.2	LD7225	ATE 23550 17,3 + WE / - WK Ceramic			
→	03/10→; für erhöhte Nutzlast	13.0460-7225.2	607225	ATE 23550 17,3 + WE / - WK			
		13.0470-7225.2	LD7225	ATE 23550 17,3 + WE / - WK Ceramic			
325 xi	160	03/07→06/08	←	+ Performance Parts	13.0460-4848.2	604848	BRE 24316 16,9 + WE / - WK
			←	→ 08/07; Motorcode: N52	13.0460-7216.2	607216	ATE 23794 20,3 + WE / - WK
					13.0470-7216.2	LD7216	ATE 23794 20,3 + WE / - WK Ceramic
			←	→ 08/07; Motorcode: N52N; für erhöhte Nutzlast	13.0460-7216.2	607216	ATE 23794 20,3 + WE / - WK
					13.0470-7216.2	LD7216	ATE 23794 20,3 + WE / - WK Ceramic
			←	09/07→; Motorcode: N53; für erhöhte Nutzlast	13.0460-7216.2	607216	ATE 23794 20,3 + WE / - WK
					13.0470-7216.2	LD7216	ATE 23794 20,3 + WE / - WK Ceramic
←	→ 08/07; nicht für erhöhte Nutzlast; Motorcode: N52N	13.0460-7238.2	607238	ATE 23313 20,3 + WE / - WK			
		13.0470-7238.2	LD7238	ATE 23313 20,3 + WE / - WK Ceramic			
←	09/07→; Motorcode: N53; nicht für erhöhte Nutzlast	13.0460-7238.2	607238	ATE 23313 20,3 + WE / - WK			
		13.0470-7238.2	LD7238	ATE 23313 20,3 + WE / - WK Ceramic			
→	nicht für erhöhte Nutzlast	13.0460-7217.2	607217	ATE 23926 17,3 + WE / - WK			
		13.0470-7217.2	LD7217	ATE 23926 17,3 + WE / - WK Ceramic			

↓









	kw			 	! #		
BMW - 3 (E90) 02/04→12/11							
 Bremsbelagsatz, Scheibenbremse							
325 xi	160	03/07→06/08	➡	für erhöhte Nutzlast		13.0460-7225.2 607225 13.0470-7225.2 LD7225	ATE 23550 17,3 + WE / - WK ATE 23550 17,3 + WE / - WK Ceramic
330 d	155	09/04→12/11	⬅	09/05→; + Performance Parts		13.0460-4848.2 604848	BRE 24316 16,9 + WE / - WK
			⬅	09/05→; nicht für erhöhte Nutzlast		13.0460-7216.2 607216 13.0470-7216.2 LD7216	ATE 23794 20,3 + WE / - WK ATE 23794 20,3 + WE / - WK Ceramic
			⬅	09/05→ 02/10; für erhöhte Nutzlast		13.0460-7237.2 607237 13.0460-7238.2 607238 13.0470-7237.2 LD7237 13.0470-7238.2 LD7238	ATE 23347 20,3 + WE / - WK ATE 23313 20,3 + WE / - WK ATE 23347 20,3 + WE / - WK Ceramic ATE 23313 20,3 + WE / - WK Ceramic
			⬅	03/10→; für erhöhte Nutzlast		13.0460-7237.2 607237 13.0460-7238.2 607238 13.0470-7237.2 LD7237 13.0470-7238.2 LD7238	ATE 23347 20,3 + WE / - WK ATE 23313 20,3 + WE / - WK ATE 23347 20,3 + WE / - WK Ceramic ATE 23313 20,3 + WE / - WK Ceramic
			➡	09/05→ 02/10		13.0460-7225.2 607225 13.0470-7225.2 LD7225	ATE 23550 17,3 + WE / - WK ATE 23550 17,3 + WE / - WK Ceramic
			➡	03/10→		13.0460-7225.2 607225 13.0470-7225.2 LD7225	ATE 23550 17,3 + WE / - WK ATE 23550 17,3 + WE / - WK Ceramic
			➡	09/05→		13.0460-7225.2 607225 13.0470-7225.2 LD7225	ATE 23550 17,3 + WE / - WK ATE 23550 17,3 + WE / - WK Ceramic
330 d	170	09/04→08/08	⬅	09/05→; + Performance Parts		13.0460-4848.2 604848	BRE 24316 16,9 + WE / - WK
			⬅	09/05→; nicht für erhöhte Nutzlast		13.0460-7216.2 607216 13.0470-7216.2 LD7216	ATE 23794 20,3 + WE / - WK ATE 23794 20,3 + WE / - WK Ceramic
			⬅	09/05→; für erhöhte Nutzlast		13.0460-7237.2 607237 13.0460-7238.2 607238 13.0470-7237.2 LD7237 13.0470-7238.2 LD7238	ATE 23347 20,3 + WE / - WK ATE 23313 20,3 + WE / - WK ATE 23347 20,3 + WE / - WK Ceramic ATE 23313 20,3 + WE / - WK Ceramic
			➡	09/05→		13.0460-7225.2 607225 13.0470-7225.2 LD7225	ATE 23550 17,3 + WE / - WK ATE 23550 17,3 + WE / - WK Ceramic
			➡	09/05→		13.0460-7225.2 607225 13.0470-7225.2 LD7225	ATE 23550 17,3 + WE / - WK ATE 23550 17,3 + WE / - WK Ceramic
330 d	180	02/08→12/11	⬅	09/08→; + Performance Parts		13.0460-4848.2 604848	BRE 24316 16,9 + WE / - WK
			⬅	09/08→; nicht für erhöhte Nutzlast		13.0460-7216.2 607216 13.0470-7216.2 LD7216	ATE 23794 20,3 + WE / - WK ATE 23794 20,3 + WE / - WK Ceramic
			⬅	03/10→; für erhöhte Nutzlast		13.0460-7237.2 607237 13.0460-7238.2 607238 13.0470-7237.2 LD7237 13.0470-7238.2 LD7238	ATE 23347 20,3 + WE / - WK ATE 23313 20,3 + WE / - WK ATE 23347 20,3 + WE / - WK Ceramic ATE 23313 20,3 + WE / - WK Ceramic
			⬅	09/08→ 02/10; für erhöhte Nutzlast		13.0460-7237.2 607237 13.0460-7238.2 607238 13.0470-7237.2 LD7237 13.0470-7238.2 LD7238	ATE 23347 20,3 + WE / - WK ATE 23313 20,3 + WE / - WK ATE 23347 20,3 + WE / - WK Ceramic ATE 23313 20,3 + WE / - WK Ceramic
			➡	03/10→		13.0460-7225.2 607225 13.0470-7225.2 LD7225	ATE 23550 17,3 + WE / - WK ATE 23550 17,3 + WE / - WK Ceramic
			➡	09/08→ 02/10		13.0460-7225.2 607225 13.0470-7225.2 LD7225	ATE 23550 17,3 + WE / - WK ATE 23550 17,3 + WE / - WK Ceramic
			➡	09/08→		13.0460-7225.2 607225 13.0470-7225.2 LD7225	ATE 23550 17,3 + WE / - WK ATE 23550 17,3 + WE / - WK Ceramic
330 d xDrive	180	01/09→12/11	⬅	+ Performance Parts		13.0460-4848.2 604848	BRE 24316 16,9 + WE / - WK
			⬅	03/10→; nicht für erhöhte Nutzlast		13.0460-7216.2 607216 13.0470-7216.2 LD7216	ATE 23794 20,3 + WE / - WK ATE 23794 20,3 + WE / - WK Ceramic
			⬅	→ 02/10; nicht für erhöhte Nutzlast		13.0460-7216.2 607216	ATE 23794 20,3 + WE / - WK
↓							







	kw			 	! #		
BMW - 3 (E90) 02/04→12/11							
 Bremsbelagsatz, Scheibenbremse							
330 d xDrive	180	01/09→12/11	←	→ 02/10; nicht für erhöhte Nutzlast	13.0470-7216.2	LD7216	ATE 23794 20,3 + WE / - WK Ceramic
			←	→ 02/10	13.0460-7237.2	607237	ATE 23347 20,3 + WE / - WK
					13.0460-7238.2	607238	ATE 23313 20,3 + WE / - WK
					13.0470-7237.2	LD7237	ATE 23347 20,3 + WE / - WK Ceramic
					13.0470-7238.2	LD7238	ATE 23313 20,3 + WE / - WK Ceramic
			←	→ 02/10; für erhöhte Nutzlast	13.0460-7237.2	607237	ATE 23347 20,3 + WE / - WK
					13.0460-7238.2	607238	ATE 23313 20,3 + WE / - WK
		13.0470-7237.2	LD7237	ATE 23347 20,3 + WE / - WK Ceramic			
		13.0470-7238.2	LD7238	ATE 23313 20,3 + WE / - WK Ceramic			
330 i	190	01/05→08/07	←	+ Performance Parts	13.0460-4848.2	604848	BRE 24316 16,9 + WE / - WK
			←	nicht für erhöhte Nutzlast; Motorcode: N52	13.0460-7216.2	607216	ATE 23794 20,3 + WE / - WK
					13.0470-7216.2	LD7216	ATE 23794 20,3 + WE / - WK Ceramic
			←	für erhöhte Nutzlast; Motorcode: N52	13.0460-7216.2	607216	ATE 23794 20,3 + WE / - WK
					13.0470-7216.2	LD7216	ATE 23794 20,3 + WE / - WK Ceramic
			←	Motorcode: N52N	13.0460-7216.2	607216	ATE 23794 20,3 + WE / - WK
		13.0470-7216.2	LD7216	ATE 23794 20,3 + WE / - WK Ceramic			
330 i	200	09/07→12/11	←	+ Performance Parts	13.0460-4848.2	604848	BRE 24316 16,9 + WE / - WK
			←	03/10→	13.0460-7237.2	607237	ATE 23347 20,3 + WE / - WK
					13.0460-7238.2	607238	ATE 23313 20,3 + WE / - WK
					13.0470-7237.2	LD7237	ATE 23347 20,3 + WE / - WK Ceramic
					13.0470-7238.2	LD7238	ATE 23313 20,3 + WE / - WK Ceramic
			←	→ 02/10	13.0460-7237.2	607237	ATE 23347 20,3 + WE / - WK
					13.0460-7238.2	607238	ATE 23313 20,3 + WE / - WK
		13.0470-7237.2	LD7237	ATE 23347 20,3 + WE / - WK Ceramic			
		13.0470-7238.2	LD7238	ATE 23313 20,3 + WE / - WK Ceramic			
330 i xDrive 330 xi	200 200	09/08→12/11 09/07→12/11	←	+ Performance Parts	13.0460-4848.2	604848	BRE 24316 16,9 + WE / - WK
			←	→ 02/10; nicht für erhöhte Nutzlast	13.0460-7216.2	607216	ATE 23794 20,3 + WE / - WK
					13.0470-7216.2	LD7216	ATE 23794 20,3 + WE / - WK Ceramic
			←	03/10→; nicht für erhöhte Nutzlast	13.0460-7216.2	607216	ATE 23794 20,3 + WE / - WK
					13.0470-7216.2	LD7216	ATE 23794 20,3 + WE / - WK Ceramic
←	→ 02/10; für erhöhte Nutzlast	13.0460-7237.2	607237	ATE 23347 20,3 + WE / - WK			







	kw			 	! #		
BMW - 3 (E90) 02/04→12/11							
 Bremsbelagsatz, Scheibenbremse							
330 i xDrive 330 xi	200 200	09/08→12/11 09/07→12/11	←	→ 02/10; für erhöhte Nutzlast		13.0460-7238.2 607238	ATE 23313 20,3 + WE / - WK
						13.0470-7237.2 LD7237	ATE 23347 20,3 + WE / - WK Ceramic
						13.0470-7238.2 LD7238	ATE 23313 20,3 + WE / - WK Ceramic
			←	03/10→; für erhöhte Nutzlast		13.0460-7237.2 607237	ATE 23347 20,3 + WE / - WK
						13.0460-7238.2 607238	ATE 23313 20,3 + WE / - WK
			13.0470-7237.2 LD7237	ATE 23347 20,3 + WE / - WK Ceramic			
			13.0470-7238.2 LD7238	ATE 23313 20,3 + WE / - WK Ceramic			
			→	→ 02/10		13.0460-7225.2 607225	ATE 23550 17,3 + WE / - WK
						13.0470-7225.2 LD7225	ATE 23550 17,3 + WE / - WK Ceramic
			→	03/10→		13.0460-7225.2 607225	ATE 23550 17,3 + WE / - WK
						13.0470-7225.2 LD7225	ATE 23550 17,3 + WE / - WK Ceramic
330 xd	170	09/05→12/11	←	+ Performance Parts		13.0460-4848.2 604848	BRE 24316 16,9 + WE / - WK
			←	→ 08/07		13.0460-7216.2 607216	ATE 23794 20,3 + WE / - WK
						13.0470-7216.2 LD7216	ATE 23794 20,3 + WE / - WK Ceramic
			←	09/07→ 02/10		13.0460-7237.2 607237	ATE 23347 20,3 + WE / - WK
						13.0460-7238.2 607238	ATE 23313 20,3 + WE / - WK
						13.0470-7237.2 LD7237	ATE 23347 20,3 + WE / - WK Ceramic
						13.0470-7238.2 LD7238	ATE 23313 20,3 + WE / - WK Ceramic
←	03/10→		13.0460-7237.2 607237	ATE 23347 20,3 + WE / - WK			
			13.0460-7238.2 607238	ATE 23313 20,3 + WE / - WK			
			13.0470-7237.2 LD7237	ATE 23347 20,3 + WE / - WK Ceramic			
			13.0470-7238.2 LD7238	ATE 23313 20,3 + WE / - WK Ceramic			
			→	→ 02/10		13.0460-7225.2 607225	ATE 23550 17,3 + WE / - WK
						13.0470-7225.2 LD7225	ATE 23550 17,3 + WE / - WK Ceramic
			→	03/10→		13.0460-7225.2 607225	ATE 23550 17,3 + WE / - WK
						13.0470-7225.2 LD7225	ATE 23550 17,3 + WE / - WK Ceramic
330 xi	190	01/05→08/07	←	+ Performance Parts		13.0460-4848.2 604848	BRE 24316 16,9 + WE / - WK
			←			13.0460-7216.2 607216	ATE 23794 20,3 + WE / - WK
						13.0470-7216.2 LD7216	ATE 23794 20,3 + WE / - WK Ceramic
			→			13.0460-7225.2 607225	ATE 23550 17,3 + WE / - WK
						13.0470-7225.2 LD7225	ATE 23550 17,3 + WE / - WK Ceramic
335 d	210	09/06→12/11	←			13.0460-7237.2 607237	ATE 23347 20,3 + WE / - WK
						13.0460-7238.2 607238	ATE 23313 20,3 + WE / - WK
						13.0470-7237.2 LD7237	ATE 23347 20,3 + WE / - WK Ceramic
						13.0470-7238.2 LD7238	ATE 23313 20,3 + WE / - WK Ceramic
			→	03/10→		13.0460-7225.2 607225	ATE 23550 17,3 + WE / - WK
						13.0470-7225.2 LD7225	ATE 23550 17,3 + WE / - WK Ceramic
			→	→ 02/10		13.0460-7225.2 607225	ATE 23550 17,3 + WE / - WK
						13.0470-7225.2 LD7225	ATE 23550 17,3 + WE / - WK Ceramic
335 i 335 i 335 i 335 i	220 224 225 240	03/06→12/11 03/06→12/11 03/06→12/11 03/06→12/11	←	09/06→		13.0460-7237.2 607237	ATE 23347 20,3 + WE / - WK
						13.0460-7238.2 607238	ATE 23313 20,3 + WE / - WK
						13.0470-7237.2 LD7237	ATE 23347 20,3 + WE / - WK Ceramic
						13.0470-7238.2 LD7238	ATE 23313 20,3 + WE / - WK Ceramic
			→	09/06→ 02/10		13.0460-7225.2 607225	ATE 23550 17,3 + WE / - WK
						13.0470-7225.2 LD7225	ATE 23550 17,3 + WE / - WK Ceramic







↓







	kw			 	! #		
BMW - 3 (E90) 02/04→12/11							
Bremsbelagsatz, Scheibenbremse							
335 i	220	03/06→12/11	➡	03/10→		13.0460-7225.2 607225	ATE 23550 17,3 + WE / - WK
335 i	224	03/06→12/11				13.0470-7225.2 LD7225	ATE 23550 17,3 + WE / - WK
335 i	225	03/06→12/11					Ceramic
335 i	240	03/06→12/11					
335 i xDrive	225	05/08→10/11	⬅	03/10→		13.0460-7237.2 607237	ATE 23347 20,3 + WE / - WK
335 i xDrive	240	05/08→10/11				13.0460-7238.2 607238	ATE 23313 20,3 + WE / - WK
						13.0470-7237.2 LD7237	ATE 23347 20,3 + WE / - WK
						13.0470-7238.2 LD7238	ATE 23313 20,3 + WE / - WK
							Ceramic
			⬅	→ 02/10		13.0460-7237.2 607237	ATE 23347 20,3 + WE / - WK
						13.0460-7238.2 607238	ATE 23313 20,3 + WE / - WK
						13.0470-7237.2 LD7237	ATE 23347 20,3 + WE / - WK
						13.0470-7238.2 LD7238	ATE 23313 20,3 + WE / - WK
							Ceramic
			➡	→ 02/10		13.0460-7225.2 607225	ATE 23550 17,3 + WE / - WK
						13.0470-7225.2 LD7225	ATE 23550 17,3 + WE / - WK
							Ceramic
			➡	03/10→		13.0460-7225.2 607225	ATE 23550 17,3 + WE / - WK
						13.0470-7225.2 LD7225	ATE 23550 17,3 + WE / - WK
							Ceramic
335 xi	224	09/06→06/08	⬅	03/07→		13.0460-7237.2 607237	ATE 23347 20,3 + WE / - WK
335 xi	225	09/06→06/08				13.0460-7238.2 607238	ATE 23313 20,3 + WE / - WK
335 xi	240	09/06→06/08				13.0470-7237.2 LD7237	ATE 23347 20,3 + WE / - WK
						13.0470-7238.2 LD7238	ATE 23313 20,3 + WE / - WK
							Ceramic
			➡	03/07→		13.0460-7225.2 607225	ATE 23550 17,3 + WE / - WK
						13.0470-7225.2 LD7225	ATE 23550 17,3 + WE / - WK
							Ceramic
M3	309	03/07→12/11	⬅	12/07→		13.0460-7167.2 607167	ATE 23312 20,3 + WE / - WK
			➡	12/07→ 02/10		13.0460-7169.2 607169	ATE 23309 17,3 + WE / - WK
						13.0470-7169.2 LD7169	ATE 23309 17,3 + WE / - WK
							Ceramic
			➡	03/10→		13.0460-7169.2 607169	ATE 23309 17,3 + WE / - WK
						13.0470-7169.2 LD7169	ATE 23309 17,3 + WE / - WK
							Ceramic
M3 CRT	331	03/11→12/11	⬅			13.0460-7167.2 607167	ATE 23312 20,3 + WE / - WK
			➡			13.0460-7169.2 607169	ATE 23309 17,3 + WE / - WK
						13.0470-7169.2 LD7169	ATE 23309 17,3 + WE / - WK
							Ceramic
Warnkontakt, Bremsbelagsverschleiß							
316 d	85	07/09→12/11	⬅	→ 02/10	1	24.8190-0264.2 620264	L= 630
			⬅	+ Performance Parts	1	24.8190-0267.2 620267	L= 679
			⬅	03/10→	1	24.8190-0284.2 620284	L= 650
			➡	→ 02/10	1	24.8190-0265.2 620265	L= 1.086
			➡	03/10→	1	24.8190-0285.2 620285	L= 1.107
316 i	85	03/05→10/11	⬅	→ 08/07	1	24.8190-0264.2 620264	L= 630
			⬅	→ 08/07; + Performance Parts	1	24.8190-0267.2 620267	L= 679
			➡	→ 08/07	1	24.8190-0265.2 620265	L= 1.086
316 i	90	02/07→10/11	⬅	09/07→ 02/10	1	24.8190-0264.2 620264	L= 630
318 d	100	02/07→03/10	⬅	09/07→; + Performance Parts	1	24.8190-0267.2 620267	L= 679
318 d	105	02/07→10/11	⬅	03/10→	1	24.8190-0284.2 620284	L= 650
318 i	100	03/07→10/11	⬅	03/10→	1	24.8190-0284.2 620284	L= 650
318 i	105	02/07→10/11	➡	09/07→ 02/10	1	24.8190-0265.2 620265	L= 1.086
			➡	03/10→	1	24.8190-0285.2 620285	L= 1.107
318 d	90	01/05→08/07	⬅	09/05→; nicht für erhöhte Nutzlast	1	24.8190-0264.2 620264	L= 630
			⬅	09/05→; für erhöhte Nutzlast	1	24.8190-0264.2 620264	L= 630
			⬅	09/05→; + Performance Parts	1	24.8190-0267.2 620267	L= 679
			➡	09/05→; nicht für erhöhte Nutzlast	1	24.8190-0265.2 620265	L= 1.086
			➡	09/05→; für erhöhte Nutzlast	1	24.8190-0265.2 620265	L= 1.086
↓							









	kw			 	! #			
BMW - 3 (E90) 02/04→12/11								
Warnkontakt, Bremsbelagverschleiß								
318 i	95	08/04→08/07	←	09/05→; nicht für erhöhte Nutzlast; Motorcode: N46	1	24.8190-0264.2	620264	L= 630
			←	03/07→; Motorcode: N46N; nicht für erhöhte Nutzlast	1	24.8190-0264.2	620264	L= 630
			←	09/05→; für erhöhte Nutzlast; Motorcode: N46	1	24.8190-0264.2	620264	L= 630
			←	03/07→; Motorcode: N46N; für erhöhte Nutzlast	1	24.8190-0264.2	620264	L= 630
						24.8190-0284.2	620284	L= 650
			←	09/05→; + Performance Parts	1	24.8190-0267.2	620267	L= 679
			→	09/05→; nicht für erhöhte Nutzlast; Motorcode: N46	1	24.8190-0265.2	620265	L= 1.086
			→	09/05→; für erhöhte Nutzlast; Motorcode: N46	1	24.8190-0265.2	620265	L= 1.086
			03/07→; Motorcode: N46N	1	24.8190-0265.2	620265	L= 1.086	
320 d 320 d 320 d 320 d xDrive 320 d xDrive 320 d xDrive 320 xd	110 130 135 120 130 135 130	09/05→12/11 09/07→12/11 01/10→12/11 07/08→12/11 09/08→12/11 01/10→12/11 09/07→12/11	←	→ 02/10; für Behördenfahrzeuge	1	24.8190-0267.2	620267	L= 679
			←	+ Performance Parts	1	24.8190-0267.2	620267	L= 679
			←	→ 02/10; nicht für Behördenfahrzeuge	1	24.8190-0267.2	620267	L= 679
			←	03/10→; nicht für Behördenfahrzeuge	1	24.8190-0287.2	620287	L= 723
			←	03/10→; für Behördenfahrzeuge	1	24.8190-0287.2	620287	L= 723
			→	→ 02/10; nicht für Behördenfahrzeuge	1	24.8190-0265.2	620265	L= 1.086
			→	→ 02/10; für Behördenfahrzeuge	1	24.8190-0265.2	620265	L= 1.086
			→	03/10→; nicht für Behördenfahrzeuge	1	24.8190-0285.2	620285	L= 1.107
			→	03/10→; für Behördenfahrzeuge	1	24.8190-0285.2	620285	L= 1.107
			320 d	120	02/04→12/11	←	12/04→; + Performance Parts	1
←	12/04→; für Behördenfahrzeuge	1				24.8190-0267.2	620267	L= 679
←	12/04→ 02/10; nicht für Behördenfahrzeuge	1				24.8190-0267.2	620267	L= 679
←	03/10→; nicht für Behördenfahrzeuge	1				24.8190-0287.2	620287	L= 723
→	12/04→	1				24.8190-0265.2	620265	L= 1.086
320 i	110	06/04→03/07	←	12/04→; für erhöhte Nutzlast; Motorcode: N46	1	24.8190-0264.2	620264	L= 630
			←	12/04→; nicht für erhöhte Nutzlast; Motorcode: N46	1	24.8190-0264.2	620264	L= 630
			←	03/07→; Motorcode: N46N; nicht für erhöhte Nutzlast	1	24.8190-0264.2	620264	L= 630
			←	12/04→; + Performance Parts	1	24.8190-0267.2	620267	L= 679
			←	03/07→; für erhöhte Nutzlast; Motorcode: N46N	1	24.8190-0267.2	620267	L= 679
			→	12/04→; für erhöhte Nutzlast; Motorcode: N46	1	24.8190-0265.2	620265	L= 1.086
			→	03/07→; Motorcode: N46N	1	24.8190-0265.2	620265	L= 1.086
			→	12/04→; nicht für erhöhte Nutzlast; Motorcode: N46	1	24.8190-0265.2	620265	L= 1.086
320 i	115	09/06→12/11	←	→ 08/07; nicht für erhöhte Nutzlast; Motorcode: N46	1	24.8190-0264.2	620264	L= 630
			←	03/07→ 08/07; Motorcode: N46N; nicht für erhöhte Nutzlast	1	24.8190-0264.2	620264	L= 630
			←	→ 08/07; für erhöhte Nutzlast; Motorcode: N46	1	24.8190-0264.2	620264	L= 630
			←	→ 08/07; + Performance Parts	1	24.8190-0267.2	620267	L= 679
			←	03/07→ 08/07; für erhöhte Nutzlast; Motorcode: N46N	1	24.8190-0267.2	620267	L= 679
			→	→ 08/07; nicht für erhöhte Nutzlast; Motorcode: N46	1	24.8190-0265.2	620265	L= 1.086
			→	03/07→ 08/07; Motorcode: N46N	1	24.8190-0265.2	620265	L= 1.086
			→	→ 08/07; für erhöhte Nutzlast; Motorcode: N46	1	24.8190-0265.2	620265	L= 1.086
320 i 320 i	120 125	03/07→12/11 03/07→12/11	←	09/07→ 02/10; nicht für erhöhte Nutzlast	1	24.8190-0264.2	620264	L= 630
			←	09/07→ 02/10; für erhöhte Nutzlast	1	24.8190-0267.2	620267	L= 679
			←	09/07→; + Performance Parts	1	24.8190-0267.2	620267	L= 679
			←	03/10→; nicht für erhöhte Nutzlast	1	24.8190-0284.2	620284	L= 650
			←	03/10→; für erhöhte Nutzlast	1	24.8190-0287.2	620287	L= 723
			→	09/07→ 02/10	1	24.8190-0265.2	620265	L= 1.086
			→	03/10→	1	24.8190-0285.2	620285	L= 1.107
↓								







	kw			 	! #		
BMW - 3 (E90) 02/04→12/11							
Warnkontakt, Bremsbelagverschleiß							
320 si	127	09/05→08/06	←	06/06→	1	24.8190-0264.2 620264	L= 630
			←	06/06→; + Performance Parts	1	24.8190-0267.2 620267	L= 679
			→	06/06→	1	24.8190-0265.2 620265	L= 1.086
325 d 325 d	145 150	09/06→12/11 01/10→12/11	←	→ 02/10; nicht für Behördenfahrzeuge	1	24.8190-0264.2 620264	L= 630
			←	→ 02/10; für Behördenfahrzeuge	1	24.8190-0267.2 620267	L= 679
			←	+ Performance Parts	1	24.8190-0267.2 620267	L= 679
			←	03/10→; nicht für Behördenfahrzeuge	1	24.8190-0284.2 620284	L= 650
			←	03/10→; für Behördenfahrzeuge	1	24.8190-0287.2 620287	L= 723
			→	→ 02/10	1	24.8190-0265.2 620265	L= 1.086
			→	03/10→	1	24.8190-0285.2 620285	L= 1.107
325 i 325 i 325 i 325 i	155 160 155 160	01/06→12/11 01/05→12/11 03/07→12/11 03/07→12/11	←	→ 08/07; nicht für erhöhte Nutzlast; Motorcode: N52	1	24.8190-0264.2 620264	L= 630
			←	+ Performance Parts	1	24.8190-0267.2 620267	L= 679
			←	→ 08/07; nicht für erhöhte Nutzlast; Motorcode: N52N	1	24.8190-0267.2 620267	L= 679
			←	09/07→ 02/10; nicht für erhöhte Nutzlast; Motorcode: N53	1	24.8190-0267.2 620267	L= 679
			←	→ 02/10; für erhöhte Nutzlast	1	24.8190-0267.2 620267	L= 679
			←	03/10→; nicht für erhöhte Nutzlast; Motorcode: N53	1	24.8190-0287.2 620287	L= 723
			←	03/10→; für erhöhte Nutzlast	1	24.8190-0287.2 620287	L= 723
			→	→ 02/10; für erhöhte Nutzlast	1	24.8190-0265.2 620265	L= 1.086
			→	→ 02/10; nicht für erhöhte Nutzlast	1	24.8190-0265.2 620265	L= 1.086
			→	03/10→; nicht für erhöhte Nutzlast	1	24.8190-0285.2 620285	L= 1.107
			→	03/10→; für erhöhte Nutzlast	1	24.8190-0285.2 620285	L= 1.107
			325 i xDrive	160	06/08→10/11	←	→ 02/10; Motorcode: N53; für erhöhte Nutzlast
←	→ 02/10; Motorcode: N53; nicht für erhöhte Nutzlast	1				24.8190-0266.2 620266	L= 840
←	+ Performance Parts	1				24.8190-0267.2 620267	L= 679
←	03/10→; Motorcode: N53; nicht für erhöhte Nutzlast	1				24.8190-0286.2 620286	L= 867
←	03/10→; Motorcode: N53; für erhöhte Nutzlast	1				24.8190-0286.2 620286	L= 867
→	→ 02/10; für erhöhte Nutzlast	1				24.8190-0265.2 620265	L= 1.086
→	→ 02/10; nicht für erhöhte Nutzlast	1				24.8190-0265.2 620265	L= 1.086
→	03/10→; nicht für erhöhte Nutzlast	1				24.8190-0285.2 620285	L= 1.107
325 xi	160	03/05→10/11	←	→ 08/07; Motorcode: N52	1	24.8190-0266.2 620266	L= 840
			←	09/07→ 02/10; Motorcode: N53; für erhöhte Nutzlast	1	24.8190-0266.2 620266	L= 840
			←	→ 08/07; Motorcode: N52N; nicht für erhöhte Nutzlast	1	24.8190-0266.2 620266	L= 840
			←	→ 08/07; Motorcode: N52N; für erhöhte Nutzlast	1	24.8190-0266.2 620266	L= 840
			←	09/07→ 02/10; Motorcode: N53; nicht für erhöhte Nutzlast	1	24.8190-0266.2 620266	L= 840
			←	+ Performance Parts	1	24.8190-0267.2 620267	L= 679
			←	03/10→; Motorcode: N53; nicht für erhöhte Nutzlast	1	24.8190-0286.2 620286	L= 867
			←	03/10→; Motorcode: N53; für erhöhte Nutzlast	1	24.8190-0286.2 620286	L= 867
			→	→ 02/10; für erhöhte Nutzlast	1	24.8190-0265.2 620265	L= 1.086
			→	→ 02/10; nicht für erhöhte Nutzlast	1	24.8190-0265.2 620265	L= 1.086
325 xi	160	03/07→06/08	←	→ 08/07; Motorcode: N52	1	24.8190-0266.2 620266	L= 840
			←	→ 08/07; Motorcode: N52N; nicht für erhöhte Nutzlast	1	24.8190-0266.2 620266	L= 840
			←	→ 08/07; Motorcode: N52N; für erhöhte Nutzlast	1	24.8190-0266.2 620266	L= 840
			←	09/07→; Motorcode: N53; nicht für erhöhte Nutzlast	1	24.8190-0266.2 620266	L= 840







	kw			 	! #		
BMW - 3 (E90) 02/04→12/11							
Warnkontakt, Bremsbelagverschleiß							
325 xi	160	03/07→06/08	←	09/07→; Motorcode: N53; für erhöhte Nutzlast	1	24.8190-0266.2 620266	L= 840
			←	+ Performance Parts	1	24.8190-0267.2 620267	L= 679
			→	für erhöhte Nutzlast	1	24.8190-0265.2 620265	L= 1.086
			→	nicht für erhöhte Nutzlast	1	24.8190-0265.2 620265	L= 1.086
330 d	155	09/04→12/11	←	09/05→ 02/10; für erhöhte Nutzlast	1	24.8190-0267.2 620267	L= 679
			←	09/05→; + Performance Parts	1	24.8190-0267.2 620267	L= 679
			←	09/05→; nicht für erhöhte Nutzlast	1	24.8190-0267.2 620267 24.8190-0287.2 620287	L= 679 L= 723
			←	03/10→; für erhöhte Nutzlast	1	24.8190-0287.2 620287	L= 723
			→	09/05→ 02/10	1	24.8190-0265.2 620265	L= 1.086
			→	03/10→	1	24.8190-0285.2 620285	L= 1.107
			→				
330 d	170	09/04→08/08	←	09/05→; für erhöhte Nutzlast	1	24.8190-0267.2 620267	L= 679
			←	09/05→; nicht für erhöhte Nutzlast	1	24.8190-0267.2 620267 24.8190-0287.2 620287	L= 679 L= 723
			←	09/05→; + Performance Parts	1	24.8190-0267.2 620267	L= 679
			→	09/05→	1	24.8190-0265.2 620265	L= 1.086
330 d	180	02/08→12/11	←	09/08→; nicht für erhöhte Nutzlast	1	24.8190-0267.2 620267 24.8190-0287.2 620287	L= 679 L= 723
			←	09/08→ 02/10; für erhöhte Nutzlast	1	24.8190-0267.2 620267	L= 679
			←	09/08→; + Performance Parts	1	24.8190-0267.2 620267	L= 679
			←	03/10→; für erhöhte Nutzlast	1	24.8190-0287.2 620287	L= 723
			→	09/08→ 02/10	1	24.8190-0265.2 620265	L= 1.086
			→	03/10→	1	24.8190-0285.2 620285	L= 1.107
			→				
330 d xDrive	180	01/09→12/11	←	→ 02/10; nicht für erhöhte Nutzlast	1	24.8190-0266.2 620266	L= 840
			←	→ 02/10	1	24.8190-0266.2 620266	L= 840
			←	→ 02/10; für erhöhte Nutzlast	1	24.8190-0266.2 620266	L= 840
			←	+ Performance Parts	1	24.8190-0267.2 620267	L= 679
			←	03/10→; für erhöhte Nutzlast	1	24.8190-0286.2 620286	L= 867
			←	03/10→; nicht für erhöhte Nutzlast	1	24.8190-0286.2 620286	L= 867
			→	→ 02/10	1	24.8190-0265.2 620265	L= 1.086
			→	03/10→	1	24.8190-0285.2 620285	L= 1.107
330 i	190	01/05→08/07	←	nicht für erhöhte Nutzlast; Motorcode: N52	1	24.8190-0264.2 620264 24.8190-0284.2 620284	L= 630 L= 650
			←	Motorcode: N52N	1	24.8190-0264.2 620264 24.8190-0284.2 620284	L= 630 L= 650
			←	+ Performance Parts	1	24.8190-0267.2 620267	L= 679
			←	für erhöhte Nutzlast; Motorcode: N52	1	24.8190-0267.2 620267 24.8190-0287.2 620287	L= 679 L= 723
			→		1	24.8190-0265.2 620265	L= 1.086
			→				
330 i	200	09/07→12/11	←	→ 02/10	1	24.8190-0267.2 620267	L= 679
			←	+ Performance Parts	1	24.8190-0267.2 620267	L= 679
			←	03/10→	1	24.8190-0287.2 620287	L= 723
			→	→ 02/10	1	24.8190-0265.2 620265	L= 1.086
			→	03/10→	1	24.8190-0285.2 620285	L= 1.107
330 i xDrive 330 xi	200 200	09/08→12/11 09/07→12/11	←	→ 02/10; nicht für erhöhte Nutzlast	1	24.8190-0266.2 620266	L= 840
			←	→ 02/10; für erhöhte Nutzlast	1	24.8190-0266.2 620266	L= 840
			←	+ Performance Parts	1	24.8190-0267.2 620267	L= 679
			←	03/10→; für erhöhte Nutzlast	1	24.8190-0286.2 620286	L= 867
			←	03/10→; nicht für erhöhte Nutzlast	1	24.8190-0286.2 620286	L= 867
			→	→ 02/10	1	24.8190-0265.2 620265	L= 1.086
			→	03/10→	1	24.8190-0285.2 620285	L= 1.107
			→				
330 xd	170	09/05→12/11	←	09/07→ 02/10	1	24.8190-0266.2 620266	L= 840
			←	→ 08/07	1	24.8190-0266.2 620266	L= 840
			←	+ Performance Parts	1	24.8190-0267.2 620267	L= 679
↓							









	kw			 	! #		
BMW - 3 (E90) 02/04→12/11							
Warnkontakt, Bremsbelagverschleiß							
330 xd	170	09/05→12/11	←	03/10→	1	24.8190-0286.2 620286	L= 867
			→	→ 02/10	1	24.8190-0265.2 620265	L= 1.086
			→	03/10→	1	24.8190-0285.2 620285	L= 1.107
330 xi	190	01/05→08/07	←		1	24.8190-0266.2 620266	L= 840
			←	+ Performance Parts	1	24.8190-0267.2 620267	L= 679
			→		1	24.8190-0265.2 620265	L= 1.086
335 d	210	09/06→12/11	←		1	24.8190-0267.2 620267	L= 679
			→	→ 02/10	1	24.8190-0265.2 620265	L= 1.086
			→	03/10→	1	24.8190-0285.2 620285	L= 1.107
335 i 335 i 335 i 335 i	220 224 225 240	03/06→12/11 03/06→12/11 03/06→12/11 03/06→12/11	←	09/06→	1	24.8190-0267.2 620267	L= 679
			→	09/06→ 02/10	1	24.8190-0265.2 620265	L= 1.086
			→	03/10→	1	24.8190-0285.2 620285	L= 1.107
			→	03/10→	1	24.8190-0285.2 620285	L= 1.107
335 i xDrive 335 i xDrive	225 240	05/08→10/11 05/08→10/11	←	→ 02/10	1	24.8190-0266.2 620266	L= 840
			←	03/10→	1	24.8190-0286.2 620286	L= 867
			→	→ 02/10	1	24.8190-0265.2 620265	L= 1.086
			→	03/10→	1	24.8190-0285.2 620285	L= 1.107
335 xi 335 xi 335 xi	224 225 240	09/06→06/08 09/06→06/08 09/06→06/08	←	03/07→	1	24.8190-0266.2 620266	L= 840
			→	03/07→	1	24.8190-0265.2 620265	L= 1.086
			→	03/07→	1	24.8190-0265.2 620265	L= 1.086
M3	309	03/07→12/11	←	☐; 12/07→	1	24.8190-0271.2 620271	L= 659
			←	☐; 12/07→	1	24.8190-0272.2 620272	L= 672
			→	12/07→ 02/10	1	24.8190-0265.2 620265	L= 1.086
			→	03/10→	1	24.8190-0285.2 620285	L= 1.107
M3 CRT	331	03/11→12/11	←	☐	1	24.8190-0271.2 620271	L= 659
			←	☐	1	24.8190-0272.2 620272	L= 672
			→		1	24.8190-0285.2 620285	L= 1.107
Bremsscheibe							
316 d	85	07/09→12/11	←			24.0124-0197.1 424197	Ø 300 24 22,4 V + S
			→			24.0324-0197.1 524197	Ø 300 24 21,6 V + S PD
			→			24.0110-0315.1 410315	Ø 296 10,4 8,9 + S
316 i	85	03/05→10/11	←	→ 08/07		24.0122-0238.1 422238	Ø 292 22 20,4 V + S
			→			24.0322-0238.1 522238	Ø 292 22 19,6 V + S PD
			→	→ 08/07		24.0110-0315.1 410315	Ø 296 10,4 8,9 + S
			→			24.0310-0315.1 510315	Ø 296 10,4 8,1 + S PD
316 i	90	02/07→10/11	←	09/07→		24.0124-0197.1 424197	Ø 300 24 22,4 V + S
			→			24.0324-0197.1 524197	Ø 300 24 21,6 V + S PD
			→	09/07→		24.0110-0315.1 410315	Ø 296 10,4 8,9 + S
318 d	90	01/05→08/07	←	09/05→; nicht für erhöhte Nutzlast		24.0122-0238.1 422238	Ø 292 22 20,4 V + S
			→			24.0322-0238.1 522238	Ø 292 22 19,6 V + S PD
			←	09/05→; für erhöhte Nutzlast		24.0124-0197.1 424197	Ø 300 24 22,4 V + S
			→			24.0324-0197.1 524197	Ø 300 24 21,6 V + S PD
			→	09/05→; nicht für erhöhte Nutzlast		24.0110-0315.1 410315	Ø 296 10,4 8,9 + S
318 d 318 d 318 i 318 i	100 105 100 105	02/07→03/10 02/07→10/11 03/07→10/11 02/07→10/11	←	09/07→		24.0124-0197.1 424197	Ø 300 24 22,4 V + S
			→			24.0324-0197.1 524197	Ø 300 24 21,6 V + S PD
			→	09/07→		24.0120-0195.1 420195	Ø 300 20 18,4 V + S
			→			24.0320-0195.1 520195	Ø 300 20 17,6 V + S PD
			→	09/05→; für erhöhte Nutzlast		24.0120-0195.1 420195	Ø 300 20 18,4 V + S
318 i	95	08/04→08/07	←	09/05→; nicht für erhöhte Nutzlast; Motorcode: N46		24.0122-0238.1 422238	Ø 292 22 20,4 V + S
			→			24.0322-0238.1 522238	Ø 292 22 19,6 V + S PD
			←	03/07→; Motorcode: N46N; nicht für erhöhte Nutzlast		24.0124-0197.1 424197	Ø 300 24 22,4 V + S
			→			24.0324-0197.1 524197	Ø 300 24 21,6 V + S PD
			←	09/05→; für erhöhte Nutzlast; Motorcode: N46		24.0124-0197.1 424197	Ø 300 24 22,4 V + S
→			24.0324-0197.1 524197	Ø 300 24 21,6 V + S PD			
↓							

















	kw			 	! #		
BMW - 3 (E90) 02/04→12/11							
Bremsscheibe							
318 i	95	08/04→08/07	←	03/07→; Motorcode: N46N; für erhöhte Nutzlast	24.0124-0203.1 424203	Ø 312 23,9 22,4 V + S	
			→	09/05→; nicht für erhöhte Nutzlast; Motorcode: N46	24.0110-0315.1 410315	Ø 296 10,4 8,9 + S	
			→	09/05→; für erhöhte Nutzlast; Motorcode: N46	24.0120-0195.1 420195	Ø 300 20 18,4 V + S	
			→	03/07→; Motorcode: N46N	24.0120-0195.1 420195	Ø 300 20 17,6 V + S PD	
320 d	110	09/05→12/11	←	nicht für Behördenfahrzeuge	24.0124-0197.1 424197	Ø 300 24 22,4 V + S	
			←	für Behördenfahrzeuge	24.0124-0200.1 424200	Ø 330 24 22,4 V + S	
			→	nicht für Behördenfahrzeuge	24.0120-0195.1 420195	Ø 300 20 18,4 V + S	
			→	für Behördenfahrzeuge	24.0122-0236.1 422236	Ø 336 22 20,4 V + S	
320 d	120	02/04→12/11	←	12/04→; nicht für Behördenfahrzeuge	24.0124-0197.1 424197	Ø 300 24 22,4 V + S	
			←	12/04→; für Behördenfahrzeuge	24.0124-0200.1 424200	Ø 330 24 22,4 V + S	
			←	09/07→; nicht für Behördenfahrzeuge	24.0124-0203.1 424203	Ø 312 23,9 22,4 V + S	
			→	12/04→	24.0120-0195.1 420195	Ø 300 20 17,6 V + S PD	
320 d 320 d	130 135	09/07→12/11 01/10→12/11	←	für Behördenfahrzeuge	24.0124-0200.1 424200	Ø 330 24 22,4 V + S	
			←	nicht für Behördenfahrzeuge	24.0124-0203.1 424203	Ø 312 23,9 22,4 V + S	
			→	nicht für Behördenfahrzeuge	24.0120-0195.1 420195	Ø 300 20 18,4 V + S	
			→	für Behördenfahrzeuge	24.0122-0236.1 422236	Ø 336 22 20,4 V + S	
320 d xDrive 320 d xDrive 320 d xDrive 320 xd	120 130 135 130	07/08→12/11 09/08→12/11 01/10→12/11 09/07→12/11	←	für Behördenfahrzeuge	24.0124-0200.1 424200	Ø 330 24 22,4 V + S	
			←	nicht für Behördenfahrzeuge	24.0124-0203.1 424203	Ø 312 23,9 22,4 V + S	
			→	nicht für Behördenfahrzeuge	24.0120-0204.1 420204	Ø 300 20 18,4 V + S	
			→	für Behördenfahrzeuge	24.0122-0236.1 422236	Ø 336 22 20,4 V + S	
320 i	110	06/04→03/07	←	12/04→; nicht für erhöhte Nutzlast; Motorcode: N46	24.0122-0238.1 422238	Ø 292 22 20,4 V + S	
			←	03/07→; Motorcode: N46N; nicht für erhöhte Nutzlast	24.0124-0197.1 424197	Ø 300 24 22,4 V + S	
			←	12/04→; für erhöhte Nutzlast; Motorcode: N46	24.0124-0197.1 424197	Ø 300 24 21,6 V + S PD	
			←	03/07→; Motorcode: N46N; für erhöhte Nutzlast	24.0124-0203.1 424203	Ø 312 23,9 22,4 V + S	
			→	12/04→; nicht für erhöhte Nutzlast; Motorcode: N46	24.0110-0315.1 410315	Ø 296 10,4 8,9 + S	
			→	12/04→; für erhöhte Nutzlast; Motorcode: N46	24.0120-0195.1 420195	Ø 300 20 18,4 V + S	
			→	03/07→; Motorcode: N46N	24.0120-0195.1 420195	Ø 300 20 17,6 V + S PD	
320 i	115	09/06→12/11	←	→ 08/07; nicht für erhöhte Nutzlast; Motorcode: N46	24.0122-0238.1 422238	Ø 292 22 20,4 V + S	
			←	→ 08/07; für erhöhte Nutzlast; Motorcode: N46	24.0124-0197.1 424197	Ø 300 24 22,4 V + S	
			←	03/07→ 08/07; Motorcode: N46N; nicht für erhöhte Nutzlast	24.0124-0197.1 424197	Ø 300 24 21,6 V + S PD	
↓							







	kw			 	! #		
BMW - 3 (E90) 02/04→12/11							
Bremsscheibe							
320 i	115	09/06→12/11	←	03/07→ 08/07; Motorcode: N46N; für erhöhte Nutzlast	24.0124-0203.1 424203	Ø 312 23,9 22,4 V + S	
			→	→ 08/07; nicht für erhöhte Nutzlast; Motorcode: N46	24.0324-0203.1 524203	Ø 312 23,9 21,6 V + S PD	
			→	03/07→ 08/07; Motorcode: N46N	24.0110-0315.1 410315	Ø 296 10,4 8,9 + S	
			→	→ 08/07; für erhöhte Nutzlast; Motorcode: N46	24.0310-0315.1 510315	Ø 296 10,4 8,1 + S PD	
320 i	120 125	03/07→12/11 03/07→12/11	←	09/07→; nicht für erhöhte Nutzlast	24.0120-0195.1 420195	Ø 300 20 18,4 V + S	
			←	09/07→; für erhöhte Nutzlast	24.0320-0195.1 520195	Ø 300 20 17,6 V + S PD	
			→	09/07→	24.0124-0197.1 424197	Ø 300 24 22,4 V + S	
			→	09/07→	24.0324-0197.1 524197	Ø 300 24 21,6 V + S PD	
320 si	127	09/05→08/06	←	06/06→	24.0124-0203.1 424203	Ø 312 23,9 22,4 V + S	
			→	06/06→	24.0324-0203.1 524203	Ø 312 23,9 21,6 V + S PD	
325 d 325 d	145 150	09/06→12/11 01/10→12/11	←	nicht für Behördenfahrzeuge	24.0120-0195.1 420195	Ø 300 20 18,4 V + S	
			←	für Behördenfahrzeuge	24.0320-0195.1 520195	Ø 300 20 17,6 V + S PD	
			→		24.0124-0197.1 424197	Ø 300 24 22,4 V + S	
			→		24.0324-0197.1 524197	Ø 300 24 21,6 V + S PD	
325 i 325 i 325 i 325 i	155 160 155 160	01/06→12/11 01/05→12/11 03/07→12/11 03/07→12/11	←	→ 08/07; Motorcode: N52; nicht für erhöhte Nutzlast	24.0122-0236.1 422236	Ø 336 22 20,4 V + S	
			←	für erhöhte Nutzlast	24.0322-0236.1 522236	Ø 336 22 19,6 V + S PD	
			←	→ 08/07; nicht für erhöhte Nutzlast; Motorcode: N52N	24.0124-0200.1 424200	Ø 330 24 22,4 V + S	
			←	→ 08/07; nicht für erhöhte Nutzlast; Motorcode: N52N	24.0324-0200.1 524200	Ø 330 24 21,6 V + S PD	
			←	09/07→; Motorcode: N53; nicht für erhöhte Nutzlast	24.0124-0203.1 424203	Ø 312 23,9 22,4 V + S	
			←	09/07→; Motorcode: N53; nicht für erhöhte Nutzlast	24.0324-0203.1 524203	Ø 312 23,9 21,6 V + S PD	
			→	nicht für erhöhte Nutzlast	24.0120-0195.1 420195	Ø 300 20 18,4 V + S	
			→	für erhöhte Nutzlast	24.0320-0195.1 520195	Ø 300 20 17,6 V + S PD	
325 i xDrive	160	06/08→10/11	←	für erhöhte Nutzlast	24.0122-0236.1 422236	Ø 336 22 20,4 V + S	
			←	Motorcode: N53; nicht für erhöhte Nutzlast	24.0322-0236.1 522236	Ø 336 22 19,6 V + S PD	
			→	nicht für erhöhte Nutzlast	24.0124-0200.1 424200	Ø 330 24 22,4 V + S	
			→	für erhöhte Nutzlast	24.0324-0200.1 524200	Ø 330 24 21,6 V + S PD	
325 xi 325 xi	160 160	03/05→10/11 03/07→06/08	←	→ 08/07; Motorcode: N52; nicht für erhöhte Nutzlast	24.0124-0203.1 424203	Ø 312 23,9 22,4 V + S	
			←	für erhöhte Nutzlast	24.0324-0203.1 524203	Ø 312 23,9 21,6 V + S PD	
			←	→ 08/07; nicht für erhöhte Nutzlast; Motorcode: N52N	24.0124-0200.1 424200	Ø 330 24 22,4 V + S	
			←	→ 08/07; nicht für erhöhte Nutzlast; Motorcode: N52N	24.0324-0200.1 524200	Ø 330 24 21,6 V + S PD	
			←	09/07→; Motorcode: N53; nicht für erhöhte Nutzlast	24.0124-0203.1 424203	Ø 312 23,9 22,4 V + S	
			←	09/07→; Motorcode: N53; nicht für erhöhte Nutzlast	24.0324-0203.1 524203	Ø 312 23,9 21,6 V + S PD	
330 d	155	09/04→12/11	←	10/09→; nicht für erhöhte Nutzlast	24.0120-0204.1 420204	Ø 300 20 18,4 V + S	
			←	09/05→; für erhöhte Nutzlast	24.0320-0204.1 520204	Ø 300 20 17,6 V + S PD	
			←	09/07→ 09/09; nicht für erhöhte Nutzlast	24.0122-0236.1 422236	Ø 336 22 20,4 V + S	
			→	09/05→	24.0322-0236.1 522236	Ø 336 22 19,6 V + S PD	







	kw			 	! #		
BMW - 3 (E90) 02/04→12/11							
Bremsscheibe							
330 d	170	09/04→08/08	←	09/07→; nicht für erhöhte Nutzlast		24.0130-0192.1 430192	Ø 348 30 28,4 V + S
			←	09/05→; für erhöhte Nutzlast		24.0130-0192.1 430192	Ø 348 30 28,4 V + S
			→	09/05→		24.0122-0236.1 422236	Ø 336 22 20,4 V + S
						24.0322-0236.1 522236	Ø 336 22 19,6 V + S PD
330 d	180	02/08→12/11	←	10/09→; nicht für erhöhte Nutzlast		24.0124-0200.1 424200	Ø 330 24 22,4 V + S
						24.0324-0200.1 524200	Ø 330 24 21,6 V + S PD
			←	09/08→ 09/09; nicht für erhöhte Nutzlast		24.0130-0192.1 430192	Ø 348 30 28,4 V + S
			←	09/08→; für erhöhte Nutzlast		24.0130-0192.1 430192	Ø 348 30 28,4 V + S
			→	09/08→		24.0122-0236.1 422236	Ø 336 22 20,4 V + S
						24.0322-0236.1 522236	Ø 336 22 19,6 V + S PD
330 d xDrive 330 i xDrive 330 xi	180 200 200	01/09→12/11 09/08→12/11 09/07→12/11	←	nicht für erhöhte Nutzlast		24.0124-0200.1 424200	Ø 330 24 22,4 V + S
						24.0324-0200.1 524200	Ø 330 24 21,6 V + S PD
			←	für erhöhte Nutzlast		24.0130-0192.1 430192	Ø 348 30 28,4 V + S
			→			24.0122-0236.1 422236	Ø 336 22 20,4 V + S
						24.0322-0236.1 522236	Ø 336 22 19,6 V + S PD
330 i	190	01/05→08/07	←			24.0124-0200.1 424200	Ø 330 24 22,4 V + S
						24.0324-0200.1 524200	Ø 330 24 21,6 V + S PD
			→			24.0122-0236.1 422236	Ø 336 22 20,4 V + S
						24.0322-0236.1 522236	Ø 336 22 19,6 V + S PD
330 i 335 d 335 i xDrive 335 i xDrive	200 210 225 240	09/07→12/11 09/06→12/11 05/08→10/11 05/08→10/11	←			24.0130-0192.1 430192	Ø 348 30 28,4 V + S
			→			24.0122-0236.1 422236	Ø 336 22 20,4 V + S
						24.0322-0236.1 522236	Ø 336 22 19,6 V + S PD
330 xd	170	09/05→12/11	←	→ 08/07		24.0124-0200.1 424200	Ø 330 24 22,4 V + S
						24.0324-0200.1 524200	Ø 330 24 21,6 V + S PD
			←	09/07→		24.0130-0192.1 430192	Ø 348 30 28,4 V + S
			→			24.0122-0236.1 422236	Ø 336 22 20,4 V + S
						24.0322-0236.1 522236	Ø 336 22 19,6 V + S PD
330 xi	190	01/05→08/07	←			24.0124-0200.1 424200	Ø 330 24 22,4 V + S
						24.0324-0200.1 524200	Ø 330 24 21,6 V + S PD
			→	07/05→		24.0122-0236.1 422236	Ø 336 22 20,4 V + S
						24.0322-0236.1 522236	Ø 336 22 19,6 V + S PD
335 i 335 i 335 i 335 i	220 224 225 240	03/06→12/11 03/06→12/11 03/06→12/11 03/06→12/11	←	09/06→		24.0130-0192.1 430192	Ø 348 30 28,4 V + S
			→	09/06→		24.0122-0236.1 422236	Ø 336 22 20,4 V + S
						24.0322-0236.1 522236	Ø 336 22 19,6 V + S PD
335 xi 335 xi 335 xi	224 225 240	09/06→06/08 09/06→06/08 09/06→06/08	←	03/07→		24.0130-0192.1 430192	Ø 348 30 28,4 V + S
			→	03/07→		24.0122-0236.1 422236	Ø 336 22 20,4 V + S
						24.0322-0236.1 522236	Ø 336 22 19,6 V + S PD
M3	309	03/07→12/11	←	☐; 12/07→		24.0130-0213.2 430213	Ø 360 30 28,4 V• Bremsscheibe zweiteilig / + S
			←	☐; 12/07→		24.0130-0214.2 430214	Ø 360 30 28,4 V• Bremsscheibe zweiteilig / + S
			→	☐; 12/07→		24.0124-0231.2 424231	Ø 350 24 22,4 V• Bremsscheibe zweiteilig / + S
			→	☐; 12/07→		24.0124-0232.2 424232	Ø 350 24 22,4 V• Bremsscheibe zweiteilig / + S
M3 CRT	331	03/11→12/11	←	☐		24.0130-0213.2 430213	Ø 360 30 28,4 V• Bremsscheibe zweiteilig / + S
			←	☐		24.0130-0214.2 430214	Ø 360 30 28,4 V• Bremsscheibe zweiteilig / + S
			→	☐		24.0124-0231.2 424231	Ø 350 24 22,4 V• Bremsscheibe zweiteilig / + S
			→	☐		24.0124-0232.2 424232	Ø 350 24 22,4 V• Bremsscheibe zweiteilig / + S
BMW - 3 (F30, F80) 03/11→							
Brembelagsatz, Scheibenbremse							
316 d 318 d 318 d 320 d Efficient Dynamics 320 i 320 i xDrive	85 100 105 120 135 135	05/11→ 05/11→ 05/11→06/15 04/11→ 04/11→ 05/11→06/15	←	02/12→; - Performance Parts		13.0460-3866.2 603866	BOS 25506 18,2 + WE / - WK
						13.0470-3866.2 LD3866	BOS 25506 18,2 + WE / - WK Ceramic
			←	02/12→; + Performance Parts		13.0460-4875.2 604875	BRE 25028 18,0 + WE / - WK
			→	02/12→; - Performance Parts		13.0460-3859.2 603859	BOS 25307 17,5 + WE / - WK
↓							

	kW			 	! #		
BMW - 3 (F30, F80) 03/11→							
 Bremsbelagsatz, Scheibenbremse							
316 d	85	05/11→	➡	02/12→; - Performance Parts		13.0470-3859.2 LD3859	BOS 25307 17,5 + WE / - WK Ceramic
318 d	100	05/11→					
318 d	105	05/11→06/15	➡	02/12→; + Performance Parts		13.0460-4874.2 604874	BRE 25029 16,7 + WE / - WK
320 d Efficient Dynamics	120	04/11→					
320 i	135	04/11→					
320 i xDrive	135	05/11→06/15					
316 i	100	10/12→08/16	⬅	11/12→; - Performance Parts		13.0460-3866.2 603866	BOS 25506 18,2 + WE / - WK Ceramic
			⬅	11/12→; + Performance Parts		13.0460-4875.2 604875	BRE 25028 18,0 + WE / - WK
			➡	11/12→; - Performance Parts		13.0460-3859.2 603859	BOS 25307 17,5 + WE / - WK Ceramic
			➡	11/12→; - Performance Parts		13.0470-3859.2 LD3859	BOS 25307 17,5 + WE / - WK Ceramic
			➡	11/12→; + Performance Parts		13.0460-4874.2 604874	BRE 25029 16,7 + WE / - WK
318 d 318 d xDrive 318 i 320 d 320 d xDrive	110 110 100 140 140	10/14→ 11/14→ 03/15→ 10/14→ 10/14→	⬅	07/15→; - Performance Parts		13.0460-3866.2 603866	BOS 25506 18,2 + WE / - WK Ceramic
						13.0470-3866.2 LD3866	BOS 25506 18,2 + WE / - WK Ceramic
			⬅	07/15→; + Performance Parts		13.0460-4875.2 604875	BRE 25028 18,0 + WE / - WK
			➡	07/15→; - Performance Parts		13.0460-3859.2 603859	BOS 25307 17,5 + WE / - WK Ceramic
			➡	07/15→; - Performance Parts		13.0470-3859.2 LD3859	BOS 25307 17,5 + WE / - WK Ceramic
318 d xDrive	105	11/12→05/15	⬅	05/13→; - Performance Parts		13.0460-3866.2 603866	BOS 25506 18,2 + WE / - WK Ceramic
						13.0470-3866.2 LD3866	BOS 25506 18,2 + WE / - WK Ceramic
			⬅	05/13→; + Performance Parts		13.0460-4875.2 604875	BRE 25028 18,0 + WE / - WK
			➡	05/13→; - Performance Parts		13.0460-3859.2 603859	BOS 25307 17,5 + WE / - WK Ceramic
			➡	05/13→; - Performance Parts		13.0470-3859.2 LD3859	BOS 25307 17,5 + WE / - WK Ceramic
320 d 320 d 320 d xDrive 320 d xDrive 320 d xDrive 328 i 328 i xDrive	135 147 120 135 147 180 180	03/11→03/16 03/11→03/16 05/11→ 10/11→07/15 05/11→06/15 04/11→07/16 05/11→07/16	⬅	02/12→; - Performance Parts		13.0460-3857.2 603857	BOS 25199 19,6 + WE / - WK Ceramic
						13.0470-3857.2 LD3857	BOS 25199 19,6 + WE / - WK Ceramic
			⬅	02/12→; + Performance Parts		13.0460-4875.2 604875	BRE 25028 18,0 + WE / - WK
			➡	02/12→; - Performance Parts		13.0460-3859.2 603859	BOS 25307 17,5 + WE / - WK Ceramic
			➡	02/12→; - Performance Parts		13.0470-3859.2 LD3859	BOS 25307 17,5 + WE / - WK Ceramic
320 i 320 i xDrive	135 135	09/14→ 09/14→	⬅	- Performance Parts		13.0460-3866.2 603866	BOS 25506 18,2 + WE / - WK Ceramic
						13.0470-3866.2 LD3866	BOS 25506 18,2 + WE / - WK Ceramic
			⬅	+ Performance Parts		13.0460-4875.2 604875	BRE 25028 18,0 + WE / - WK
			➡	- Performance Parts		13.0460-3859.2 603859	BOS 25307 17,5 + WE / - WK Ceramic
			➡	- Performance Parts		13.0470-3859.2 LD3859	BOS 25307 17,5 + WE / - WK Ceramic
320 i Efficient Dynamics	125	04/12→06/16	⬅	11/12→		13.0460-3866.2 603866	BOS 25506 18,2 + WE / - WK Ceramic
						13.0470-3866.2 LD3866	BOS 25506 18,2 + WE / - WK Ceramic
			➡	11/12→		13.0460-3859.2 603859	BOS 25307 17,5 + WE / - WK Ceramic
						13.0470-3859.2 LD3859	BOS 25307 17,5 + WE / - WK Ceramic
325 d 325 d	155 160	07/12→02/16 07/12→02/16	⬅	04/13→; - Performance Parts		13.0460-3857.2 603857	BOS 25199 19,6 + WE / - WK Ceramic
						13.0470-3857.2 LD3857	BOS 25199 19,6 + WE / - WK Ceramic
			⬅	04/13→; + Performance Parts		13.0460-4875.2 604875	BRE 25028 18,0 + WE / - WK
			➡	04/13→; - Performance Parts		13.0460-3859.2 603859	BOS 25307 17,5 + WE / - WK Ceramic
			➡	04/13→; - Performance Parts		13.0470-3859.2 LD3859	BOS 25307 17,5 + WE / - WK Ceramic
325 d	165	04/15→	⬅	03/16→; - Performance Parts		13.0460-3857.2 603857	BOS 25199 19,6 + WE / - WK Ceramic
						13.0470-3857.2 LD3857	BOS 25199 19,6 + WE / - WK Ceramic
			⬅	03/16→; + Performance Parts		13.0460-4875.2 604875	BRE 25028 18,0 + WE / - WK
↓							











	kw			 	! #		
BMW - 3 (F30, F80) 03/11→							
Bremsbelagsatz, Scheibenbremse							
325 d	165	04/15→	➡	03/16→; - Performance Parts		13.0460-3859.2 603859 13.0470-3859.2 LD3859	BOS 25307 17,5 + WE / - WK BOS 25307 17,5 + WE / - WK Ceramic
			➡	03/16→; + Performance Parts		13.0460-4874.2 604874	BRE 25029 16,7 + WE / - WK
330 d	190	01/12→	⬅	07/12→; - Performance Parts		13.0460-3857.2 603857 13.0470-3857.2 LD3857	BOS 25199 19,6 + WE / - WK BOS 25199 19,6 + WE / - WK Ceramic
			⬅	07/12→; + Performance Parts		13.0460-4875.2 604875	BRE 25028 18,0 + WE / - WK
			➡	07/12→; + Performance Parts		13.0460-4874.2 604874	BRE 25029 16,7 + WE / - WK
330 d 330 d xDrive	210 210	01/12→ 01/12→	⬅	09/15→; - Performance Parts		13.0460-3857.2 603857 13.0470-3857.2 LD3857	BOS 25199 19,6 + WE / - WK BOS 25199 19,6 + WE / - WK Ceramic
			⬅	09/15→; + Performance Parts		13.0460-4875.2 604875	BRE 25028 18,0 + WE / - WK
			➡	09/15→; + Performance Parts		13.0460-4874.2 604874	BRE 25029 16,7 + WE / - WK
330 d xDrive	190	01/12→	⬅	03/13→; - Performance Parts		13.0460-3857.2 603857 13.0470-3857.2 LD3857	BOS 25199 19,6 + WE / - WK BOS 25199 19,6 + WE / - WK Ceramic
			⬅	03/13→; + Performance Parts		13.0460-4875.2 604875	BRE 25028 18,0 + WE / - WK
			➡	03/13→; + Performance Parts		13.0460-4874.2 604874	BRE 25029 16,7 + WE / - WK
330 e 330 e	135 185	02/15→ 02/15→	⬅	01/16→; - Performance Parts		13.0460-3857.2 603857 13.0470-3857.2 LD3857	BOS 25199 19,6 + WE / - WK BOS 25199 19,6 + WE / - WK Ceramic
			⬅	01/16→; + Performance Parts		13.0460-4875.2 604875	BRE 25028 18,0 + WE / - WK
			➡	01/16→; - Performance Parts		13.0460-3859.2 603859 13.0470-3859.2 LD3859	BOS 25307 17,5 + WE / - WK BOS 25307 17,5 + WE / - WK Ceramic
			➡	01/16→; + Performance Parts		13.0460-4874.2 604874	BRE 25029 16,7 + WE / - WK
330 i 330 i xDrive	185 185	09/14→ 10/14→	⬅	07/15→; - Performance Parts		13.0460-3857.2 603857 13.0470-3857.2 LD3857	BOS 25199 19,6 + WE / - WK BOS 25199 19,6 + WE / - WK Ceramic
			⬅	07/15→; + Performance Parts		13.0460-4875.2 604875	BRE 25028 18,0 + WE / - WK
			➡	07/15→; - Performance Parts		13.0460-3859.2 603859 13.0470-3859.2 LD3859	BOS 25307 17,5 + WE / - WK BOS 25307 17,5 + WE / - WK Ceramic
			➡	07/15→; + Performance Parts		13.0460-4874.2 604874	BRE 25029 16,7 + WE / - WK
335 d xDrive	230	11/12→	⬅	07/13→		13.0460-4875.2 604875	BRE 25028 18,0 + WE / - WK
			➡	07/13→; + Performance Parts		13.0460-4874.2 604874	BRE 25029 16,7 + WE / - WK
335 i 335 i 335 i xDrive 335 i xDrive	225 240 225 240	04/11→07/15 04/11→07/13 05/11→07/15 04/11→07/13	⬅	02/12→		13.0460-4875.2 604875	BRE 25028 18,0 + WE / - WK
			➡	02/12→; + Performance Parts		13.0460-4874.2 604874	BRE 25029 16,7 + WE / - WK
335 i 335 i xDrive	250 250	07/13→ 07/13→	⬅			13.0460-4875.2 604875	BRE 25028 18,0 + WE / - WK
			➡	+ Performance Parts		13.0460-4874.2 604874	BRE 25029 16,7 + WE / - WK
340 i 340 i 340 i xDrive 340 i xDrive	240 265 240 265	10/14→ 10/14→ 10/14→ 10/14→	⬅	07/15→		13.0460-4875.2 604875	BRE 25028 18,0 + WE / - WK
			➡	07/15→; + Performance Parts		13.0460-4874.2 604874	BRE 25029 16,7 + WE / - WK
ActiveHybrid ActiveHybrid	225 250	11/11→05/15 11/11→05/15	⬅	07/12→		13.0460-4875.2 604875	BRE 25028 18,0 + WE / - WK
			➡	07/12→; + Performance Parts		13.0460-4874.2 604874	BRE 25029 16,7 + WE / - WK
Warnkontakt, Bremsbelagverschleiß							
316 d 318 d 318 d 320 d 320 d 320 d Efficient Dynamics 320 d xDrive 320 d xDrive 320 d xDrive 320 i 320 i xDrive 328 i 328 i xDrive 335 i 335 i 335 i xDrive ↓	85 100 105 135 147 120 120 135 147 135 135 180 180 225 240 225	05/11→ 05/11→ 05/11→06/15 03/11→03/16 03/11→03/16 04/11→ 05/11→ 10/11→07/15 05/11→06/15 04/11→ 05/11→06/15 04/11→07/16 05/11→07/16 04/11→07/15 04/11→07/13 05/11→07/15	⬅ ➡	☐; 02/12→ 02/12→	1 1	24.8190-0006.2 620006 24.8190-0007.2 620007	L= 675 L= 1.045









	kW			 	! #		
BMW - 3 (F30, F80) 03/11→							
Warnkontakt, Bremsbelagverschleiß							
335 i xDrive	240	04/11→07/13	←	☐; 02/12→	1	24.8190-0006.2 620006	L= 675
			→	02/12→	1	24.8190-0007.2 620007	L= 1.045
316 i	100	10/12→08/16	←	☐; 11/12→	1	24.8190-0006.2 620006	L= 675
320 i Efficient Dynamics	125	04/12→06/16	→	11/12→	1	24.8190-0007.2 620007	L= 1.045
318 d	110	10/14→	←	☐; 07/15→	1	24.8190-0006.2 620006	L= 675
318 d xDrive	110	11/14→	→	07/15→	1	24.8190-0007.2 620007	L= 1.045
318 i	100	03/15→					
320 d	140	10/14→					
320 d xDrive	140	10/14→					
330 i	185	09/14→					
330 i xDrive	185	10/14→					
340 i	240	10/14→					
340 i	265	10/14→					
340 i xDrive	240	10/14→					
340 i xDrive	265	10/14→					
318 d xDrive	105	11/12→05/15	←	☐; 05/13→	1	24.8190-0006.2 620006	L= 675
			→	05/13→	1	24.8190-0007.2 620007	L= 1.045
320 i	135	09/14→	←	☐	1	24.8190-0006.2 620006	L= 675
320 i xDrive	135	09/14→	→		1	24.8190-0007.2 620007	L= 1.045
335 i	250	07/13→					
335 i xDrive	250	07/13→					
M3 Competition	331	03/16→					
325 d	155	07/12→02/16	←	☐; 04/13→	1	24.8190-0006.2 620006	L= 675
325 d	160	07/12→02/16	→	04/13→	1	24.8190-0007.2 620007	L= 1.045
325 d	165	04/15→	←	☐; 03/16→	1	24.8190-0006.2 620006	L= 675
			→	03/16→	1	24.8190-0007.2 620007	L= 1.045
330 d	190	01/12→	←	☐; 07/12→	1	24.8190-0006.2 620006	L= 675
ActiveHybrid	225	11/11→05/15	→	07/12→	1	24.8190-0007.2 620007	L= 1.045
ActiveHybrid	250	11/11→05/15					
330 d	210	01/12→	←	☐; 09/15→	1	24.8190-0006.2 620006	L= 675
330 d xDrive	210	01/12→	→	09/15→	1	24.8190-0007.2 620007	L= 1.045
330 d xDrive	190	01/12→	←	☐; 03/13→	1	24.8190-0006.2 620006	L= 675
			→	03/13→	1	24.8190-0007.2 620007	L= 1.045
330 e	135	02/15→	←	☐; 01/16→	1	24.8190-0006.2 620006	L= 675
330 e	185	02/15→	→	01/16→	1	24.8190-0007.2 620007	L= 1.045
335 d xDrive	230	11/12→	←	☐; 07/13→	1	24.8190-0006.2 620006	L= 675
			→	07/13→	1	24.8190-0007.2 620007	L= 1.045
M3	317	04/12→	←	☐; 01/14→	1	24.8190-0006.2 620006	L= 675
			→	01/14→	1	24.8190-0007.2 620007	L= 1.045
Bremsscheibe							
316 d	85	05/11→	←	02/12→; - Performance Parts		24.0122-0278.1 422278	Ø 300 22 20,4 V + S
318 d	100	05/11→	←	02/12→; + Performance Parts		24.0130-0233.2 430233	Ø 340 30 28,4 V Bremsscheibe zweiteilig / + S
318 d	105	05/11→06/15					
320 d Efficient Dynamics	120	04/11→	→	02/12→; - Performance Parts		24.0120-0237.1 420237	Ø 300 20 18,4 V + S
320 i	135	04/11→	→	02/12→; + Performance Parts		24.0124-0250.2 424250	Ø 345 24 22,4 V Bremsscheibe zweiteilig / + S
316 i	100	10/12→08/16	←	11/12→; - Performance Parts		24.0122-0278.1 422278	Ø 300 22 20,4 V + S
			←	11/12→; + Performance Parts		24.0130-0233.2 430233	Ø 340 30 28,4 V Bremsscheibe zweiteilig / + S
			→	11/12→; - Performance Parts		24.0120-0237.1 420237	Ø 300 20 18,4 V + S
			→	11/12→; + Performance Parts		24.0124-0250.2 424250	Ø 345 24 22,4 V Bremsscheibe zweiteilig / + S
318 d	110	10/14→	←	07/15→; - Performance Parts		24.0122-0278.1 422278	Ø 300 22 20,4 V + S
318 i	100	03/15→	←	07/15→; + Performance Parts		24.0130-0233.2 430233	Ø 340 30 28,4 V Bremsscheibe zweiteilig / + S
320 d	140	10/14→					
			→	07/15→; - Performance Parts		24.0120-0237.1 420237	Ø 300 20 18,4 V + S
			→	07/15→; + Performance Parts		24.0124-0250.2 424250	Ø 345 24 22,4 V Bremsscheibe zweiteilig / + S
318 d xDrive	105	11/12→05/15	←	05/13→; - Performance Parts		24.0122-0278.1 422278	Ø 300 22 20,4 V + S
			←	05/13→; + Performance Parts		24.0130-0233.2 430233	Ø 340 30 28,4 V Bremsscheibe zweiteilig / + S
			→	05/13→; - Performance Parts		24.0120-0240.1 420240	Ø 300 20 18,4 V + S
↓							

	kw			 	! #		
BMW - 3 (F30, F80) 03/11→							
Bremsscheibe							
318 d xDrive	105	11/12→05/15	➔	05/13→; + Performance Parts		24.0124-0251.2 424251	Ø 345 24 22,4 V Bremsscheibe zweiteilig / + S
318 d xDrive 320 d xDrive	110 140	11/14→ 10/14→	➔	07/15→; - Performance Parts		24.0122-0278.1 422278	Ø 300 22 20,4 V + S
			➔	07/15→; + Performance Parts		24.0130-0233.2 430233	Ø 340 30 28,4 V Bremsscheibe zweiteilig / + S
			➔	07/15→; - Performance Parts		24.0120-0240.1 420240	Ø 300 20 18,4 V + S
			➔	07/15→; + Performance Parts		24.0124-0251.2 424251	Ø 345 24 22,4 V Bremsscheibe zweiteilig / + S
320 d 320 d	135 147	03/11→03/16 03/11→03/16	➔	02/12→; - Performance Parts		24.0124-0203.1 424203	Ø 312 23,9 22,4 V + S
			➔	02/12→; + Performance Parts		24.0324-0203.1 524203	Ø 312 23,9 21,6 V + S PD
			➔	02/12→; - Performance Parts		24.0130-0233.2 430233	Ø 340 30 28,4 V Bremsscheibe zweiteilig / + S
			➔	02/12→; + Performance Parts		24.0120-0237.1 420237	Ø 300 20 18,4 V + S
320 d xDrive 320 d xDrive 320 d xDrive	120 135 147	05/11→ 10/11→07/15 05/11→06/15	➔	02/12→; - Performance Parts		24.0124-0203.1 424203	Ø 312 23,9 22,4 V + S
			➔	02/12→; + Performance Parts		24.0324-0203.1 524203	Ø 312 23,9 21,6 V + S PD
			➔	02/12→; - Performance Parts		24.0130-0233.2 430233	Ø 340 30 28,4 V Bremsscheibe zweiteilig / + S
			➔	02/12→; + Performance Parts		24.0120-0240.1 420240	Ø 300 20 18,4 V + S
320 i	135	09/14→	➔	- Performance Parts		24.0124-0251.2 424251	Ø 345 24 22,4 V Bremsscheibe zweiteilig / + S
			➔	+ Performance Parts		24.0122-0278.1 422278	Ø 300 22 20,4 V + S
			➔	- Performance Parts		24.0130-0233.2 430233	Ø 340 30 28,4 V Bremsscheibe zweiteilig / + S
			➔	+ Performance Parts		24.0120-0237.1 420237	Ø 300 20 18,4 V + S
320 i Efficient Dynamics	125	04/12→06/16	➔	11/12→		24.0124-0250.2 424250	Ø 345 24 22,4 V Bremsscheibe zweiteilig / + S
			➔	11/12→		24.0122-0278.1 422278	Ø 300 22 20,4 V + S
			➔	11/12→		24.0120-0237.1 420237	Ø 300 20 18,4 V + S
			➔	11/12→		24.0124-0251.2 424251	Ø 345 24 22,4 V Bremsscheibe zweiteilig / + S
320 i xDrive	135	05/11→06/15	➔	02/12→; - Performance Parts		24.0124-0251.2 424251	Ø 345 24 22,4 V Bremsscheibe zweiteilig / + S
			➔	02/12→; + Performance Parts		24.0130-0233.2 430233	Ø 340 30 28,4 V Bremsscheibe zweiteilig / + S
			➔	02/12→; - Performance Parts		24.0120-0240.1 420240	Ø 300 20 18,4 V + S
			➔	02/12→; + Performance Parts		24.0124-0251.2 424251	Ø 345 24 22,4 V Bremsscheibe zweiteilig / + S
320 i xDrive	135	09/14→	➔	- Performance Parts		24.0124-0251.2 424251	Ø 345 24 22,4 V Bremsscheibe zweiteilig / + S
			➔	+ Performance Parts		24.0122-0278.1 422278	Ø 300 22 20,4 V + S
			➔	- Performance Parts		24.0130-0233.2 430233	Ø 340 30 28,4 V Bremsscheibe zweiteilig / + S
			➔	+ Performance Parts		24.0120-0240.1 420240	Ø 300 20 18,4 V + S
325 d 325 d	155 160	07/12→02/16 07/12→02/16	➔	04/13→; - Performance Parts		24.0124-0248.1 424248	Ø 330 24 22,4 V + S
			➔	04/13→; + Performance Parts		24.0130-0234.2 430234	Ø 370 30 28,4 V Bremsscheibe zweiteilig / + S
			➔	04/13→; - Performance Parts		24.0120-0237.1 420237	Ø 300 20 18,4 V + S
			➔	04/13→; + Performance Parts		24.0124-0250.2 424250	Ø 345 24 22,4 V Bremsscheibe zweiteilig / + S
325 d	165	04/15→	➔	03/16→; - Performance Parts		24.0124-0248.1 424248	Ø 330 24 22,4 V + S
			➔	03/16→; + Performance Parts		24.0130-0234.2 430234	Ø 370 30 28,4 V Bremsscheibe zweiteilig / + S
			➔	03/16→; - Performance Parts		24.0120-0237.1 420237	Ø 300 20 18,4 V + S
			➔	03/16→; + Performance Parts		24.0124-0250.2 424250	Ø 345 24 22,4 V Bremsscheibe zweiteilig / + S
328 i 328 i xDrive	180 180	04/11→07/16 05/11→07/16	➔	02/12→; - Performance Parts		24.0124-0248.1 424248	Ø 330 24 22,4 V + S
			➔	02/12→; + Performance Parts		24.0130-0234.2 430234	Ø 370 30 28,4 V Bremsscheibe zweiteilig / + S
			➔	02/12→; - Performance Parts		24.0120-0240.1 420240	Ø 300 20 18,4 V + S
			➔	02/12→; + Performance Parts		24.0124-0251.2 424251	Ø 345 24 22,4 V Bremsscheibe zweiteilig / + S
330 d	190	01/12→	➔	07/12→; - Performance Parts		24.0124-0248.1 424248	Ø 330 24 22,4 V + S
			➔	07/12→; + Performance Parts		24.0130-0234.2 430234	Ø 370 30 28,4 V Bremsscheibe zweiteilig / + S
↓							









	kW			 	! #		
BMW - 3 (F30, F80) 03/11→							
Bremsscheibe							
330 d	190	01/12→	➔	07/12→; - Performance Parts		24.0120-0243.1 420243	Ø 330 20 18,4 V + S
			➔	07/12→; + Performance Parts		24.0124-0251.2 424251	Ø 345 24 22,4 V Bremsscheibe zweiteilig / + S
330 d 330 d xDrive	210 210	01/12→ 01/12→	➔	09/15→; - Performance Parts		24.0124-0248.1 424248	Ø 330 24 22,4 V + S
			➔	09/15→; + Performance Parts		24.0130-0234.2 430234	Ø 370 30 28,4 V Bremsscheibe zweiteilig / + S
			➔	09/15→; - Performance Parts		24.0120-0243.1 420243	Ø 330 20 18,4 V + S
			➔	09/15→; + Performance Parts		24.0124-0251.2 424251	Ø 345 24 22,4 V Bremsscheibe zweiteilig / + S
330 d xDrive	190	01/12→	➔	03/13→; - Performance Parts		24.0124-0248.1 424248	Ø 330 24 22,4 V + S
			➔	03/13→; + Performance Parts		24.0130-0234.2 430234	Ø 370 30 28,4 V Bremsscheibe zweiteilig / + S
			➔	03/13→; - Performance Parts		24.0120-0243.1 420243	Ø 330 20 18,4 V + S
			➔	03/13→; + Performance Parts		24.0124-0251.2 424251	Ø 345 24 22,4 V Bremsscheibe zweiteilig / + S
330 e 330 e	135 185	02/15→ 02/15→	➔	01/16→; - Performance Parts		24.0124-0203.1 424203	Ø 312 23,9 22,4 V + S
			➔	01/16→; + Performance Parts		24.0324-0203.1 524203	Ø 312 23,9 21,6 V + S PD
			➔	01/16→; - Performance Parts		24.0130-0233.2 430233	Ø 340 30 28,4 V Bremsscheibe zweiteilig / + S
			➔	01/16→; - Performance Parts		24.0120-0240.1 420240	Ø 300 20 18,4 V + S
			➔	01/16→; + Performance Parts		24.0124-0251.2 424251	Ø 345 24 22,4 V Bremsscheibe zweiteilig / + S
330 i 330 i xDrive	185 185	09/14→ 10/14→	➔	07/15→; - Performance Parts		24.0124-0248.1 424248	Ø 330 24 22,4 V + S
			➔	07/15→; + Performance Parts		24.0130-0234.2 430234	Ø 370 30 28,4 V Bremsscheibe zweiteilig / + S
			➔	07/15→; - Performance Parts		24.0120-0240.1 420240	Ø 300 20 18,4 V + S
			➔	07/15→; + Performance Parts		24.0124-0251.2 424251	Ø 345 24 22,4 V Bremsscheibe zweiteilig / + S
335 d xDrive	230	11/12→	➔	07/13→; - Performance Parts		24.0130-0233.2 430233	Ø 340 30 28,4 V Bremsscheibe zweiteilig / + S
			➔	07/13→; + Performance Parts		24.0130-0234.2 430234	Ø 370 30 28,4 V Bremsscheibe zweiteilig / + S
			➔	07/13→; - Performance Parts		24.0120-0243.1 420243	Ø 330 20 18,4 V + S
			➔	07/13→; + Performance Parts		24.0124-0251.2 424251	Ø 345 24 22,4 V Bremsscheibe zweiteilig / + S
335 i 335 i 335 i xDrive 335 i xDrive	225 240 225 240	04/11→07/15 04/11→07/13 05/11→07/15 04/11→07/13	➔	02/12→; - Performance Parts		24.0130-0233.2 430233	Ø 340 30 28,4 V Bremsscheibe zweiteilig / + S
			➔	02/12→; + Performance Parts		24.0130-0234.2 430234	Ø 370 30 28,4 V Bremsscheibe zweiteilig / + S
			➔	02/12→; - Performance Parts		24.0120-0243.1 420243	Ø 330 20 18,4 V + S
			➔	02/12→; + Performance Parts		24.0124-0251.2 424251	Ø 345 24 22,4 V Bremsscheibe zweiteilig / + S
335 i 335 i xDrive	250 250	07/13→ 07/13→	➔	- Performance Parts		24.0130-0233.2 430233	Ø 340 30 28,4 V Bremsscheibe zweiteilig / + S
			➔	+ Performance Parts		24.0130-0234.2 430234	Ø 370 30 28,4 V Bremsscheibe zweiteilig / + S
			➔	- Performance Parts		24.0120-0243.1 420243	Ø 330 20 18,4 V + S
			➔	+ Performance Parts		24.0124-0251.2 424251	Ø 345 24 22,4 V Bremsscheibe zweiteilig / + S
340 i 340 i 340 i xDrive 340 i xDrive	240 265 240 265	10/14→ 10/14→ 10/14→ 10/14→	➔	07/15→; - Performance Parts		24.0130-0233.2 430233	Ø 340 30 28,4 V Bremsscheibe zweiteilig / + S
			➔	07/15→; + Performance Parts		24.0130-0234.2 430234	Ø 370 30 28,4 V Bremsscheibe zweiteilig / + S
			➔	07/15→; - Performance Parts		24.0120-0243.1 420243	Ø 330 20 18,4 V + S
			➔	07/15→; + Performance Parts		24.0124-0251.2 424251	Ø 345 24 22,4 V Bremsscheibe zweiteilig / + S
ActiveHybrid ActiveHybrid	225 250	11/11→05/15 11/11→05/15	➔	07/12→; - Performance Parts		24.0130-0233.2 430233	Ø 340 30 28,4 V Bremsscheibe zweiteilig / + S
			➔	07/12→; + Performance Parts		24.0130-0234.2 430234	Ø 370 30 28,4 V Bremsscheibe zweiteilig / + S
			➔	07/12→; - Performance Parts		24.0120-0243.1 420243	Ø 330 20 18,4 V + S
			➔	07/12→; + Performance Parts		24.0124-0251.2 424251	Ø 345 24 22,4 V Bremsscheibe zweiteilig / + S











	kW			 	! #		
BMW - 3 Cabriolet (E36) 03/93→04/99							
 Bremsbelagsatz, Scheibenbremse							
318 i	85	01/94→04/99	←			13.0460-5405.2 605405	ATE 21643 17,8 + WE / - WK
320 i	110	12/93→04/99	←			13.0470-5405.2 LD5405	ATE 21643 17,8 + WE / - WK
323 i	125	06/95→04/99	←				Ceramic
325 i	141	03/93→03/95	←				
328 i	142	03/95→04/99	→			13.0460-3605.2 603605	ATE 20180 17,3 + WE / - WK
						13.0470-3605.2 LD3605	ATE 20180 17,3 + WE / - WK
							Ceramic
M3 3.0	210	01/94→10/95	←			13.0460-7185.2 607185	ATE 20968 20,3 + WE / - WK
M3 3.2	236	10/95→04/99	→			13.0460-3803.2 603803	ATE 20995 17,3 + WE / - WK
Warnkontakt, Bremsbelagverschleiß							
318 i	85	01/94→04/99	←		1	24.8190-0207.2 620207	L= 786
320 i	110	12/93→04/99	←				
323 i	125	06/95→04/99	→		1	24.8190-0206.2 620206	L= 790
325 i	141	03/93→03/95	←				
328 i	142	03/95→04/99	→				
M3 3.0	210	01/94→10/95	←		1	24.8190-0210.2 620210	L= 810
M3 3.2	236	10/95→04/99	→		1	24.8190-0206.2 620206	L= 790
 Bremsscheibe							
318 i	85	01/94→04/99	←			24.0112-0126.1 412126	Ø 286 12 10,4 + S
			→			24.0312-0126.1 512126	Ø 286 12 9,6 + S PD
			→			24.0110-0202.1 410202	Ø 280 10 8,4 + S
			→			24.0310-0202.1 510202	Ø 280 10 7,6 + S PD
320 i	110	12/93→04/99	←	Motorcode: M50		24.0112-0126.1 412126	Ø 286 12 10,4 + S
			←	Motorcode: M52		24.0312-0126.1 512126	Ø 286 12 9,6 + S PD
			←			24.0122-0115.1 422115	Ø 286 22 20,4 V + S
			→			24.0322-0115.1 522115	Ø 286 22 19,6 V + S PD
			→			24.0110-0202.1 410202	Ø 280 10 8,4 + S
			→			24.0310-0202.1 510202	Ø 280 10 7,6 + S PD
323 i	125	06/95→04/99	←			24.0122-0115.1 422115	Ø 286 22 20,4 V + S
328 i	142	03/95→04/99	→			24.0322-0115.1 522115	Ø 286 22 19,6 V + S PD
			→			24.0119-0107.1 419107	Ø 276 19 17,4 V + S
			→			24.0319-0107.1 519107	Ø 276 19 16,6 V + S PD
325 i	141	03/93→03/95	←			24.0122-0115.1 422115	Ø 286 22 20,4 V + S
			→			24.0322-0115.1 522115	Ø 286 22 19,6 V + S PD
			→			24.0110-0202.1 410202	Ø 280 10 8,4 + S
			→			24.0310-0202.1 510202	Ø 280 10 7,6 + S PD
M3 3.0	210	01/94→10/95	←	☐		24.0128-0198.1 428198	Ø 315 28 26,4 V + S
			←	☐		24.0328-0198.1 528198	Ø 315 28 25,6 V + S PD
			←	☐		24.0128-0199.1 428199	Ø 315 28 26,4 V + S
			→	☐		24.0328-0199.1 528199	Ø 315 28 25,6 V + S PD
			→	☐		24.0120-0189.1 420189	Ø 312 20 18,4 V + S
			→	☐		24.0120-0190.1 420190	Ø 312 20 18,4 V + S
M3 3.2	236	10/95→04/99	←	☐		24.0128-0204.2 428204	Ø 315 28 26,4 V Bremsscheibe zweiteilig / + S
			←	☐		24.0128-0205.2 428205	Ø 315 28 26,4 V Bremsscheibe zweiteilig / + S
			→	☐		24.0120-0189.1 420189	Ø 312 20 18,4 V + S
			→	☐		24.0120-0190.1 420190	Ø 312 20 18,4 V + S
BMW - 3 Cabriolet (E46) 04/00→12/07							
 Bremsbelagsatz, Scheibenbremse							
318 Ci	100	12/00→08/06	←	09/01→		13.0460-5405.2 605405	ATE 21643 17,8 + WE / - WK
			→	09/01→		13.0470-5405.2 LD5405	ATE 21643 17,8 + WE / - WK
			→			13.0460-3605.2 603605	ATE 20180 17,3 + WE / - WK
			→			13.0470-3605.2 LD3605	ATE 20180 17,3 + WE / - WK
							Ceramic
318 Ci	105	09/01→12/07	←	→ 09/06		13.0460-5405.2 605405	ATE 21643 17,8 + WE / - WK
318 Ci	110	02/05→12/07	←			13.0470-5405.2 LD5405	ATE 21643 17,8 + WE / - WK
320 Cd	110	02/05→12/07	←				Ceramic
320 Ci	120	01/06→12/07	←				
320 Ci	125	09/00→12/07	→	→ 09/06		13.0460-3605.2 603605	ATE 20180 17,3 + WE / - WK
325 Ci	141	09/00→12/07	→			13.0470-3605.2 LD3605	ATE 20180 17,3 + WE / - WK
							Ceramic
↓							









	kw			 	! #		
BMW - 3 Cabriolet (E46) 04/00→12/07							
 Bremsbelagsatz, Scheibenbremse							
323 Ci 323 Ci	120 125	04/00→09/00 04/00→09/00	← →			13.0460-5405.2 605405 13.0470-5405.2 LD5405	ATE 21643 17,8 + WE / - WK ATE 21643 17,8 + WE / - WK Ceramic
						13.0460-3605.2 603605 13.0470-3605.2 LD3605	ATE 20180 17,3 + WE / - WK ATE 20180 17,3 + WE / - WK Ceramic
330 Cd 330 Ci	150 170	08/05→12/07 06/00→12/07	← →	→ 09/06 → 09/06		13.0460-7155.2 607155 13.0470-7155.2 LD7155	ATE 21676 20,3 + WE / - WK ATE 21676 20,3 + WE / - WK Ceramic
						13.0460-7079.2 607079 13.0470-7079.2 LD7079	ATE 21282 17,3 + WE / - WK ATE 21282 17,3 + WE / - WK Ceramic
M3 3.2	252	04/01→12/07	← →	→ 09/06 → 09/06		13.0460-7185.2 607185 13.0460-7079.2 607079 13.0470-7079.2 LD7079	ATE 20968 20,3 + WE / - WK ATE 21282 17,3 + WE / - WK ATE 21282 17,3 + WE / - WK Ceramic
Warnkontakt, Bremsbelagverschleiß							
318 Ci	100	12/00→08/06	← →	09/01→ 09/01→	1 1	24.8190-0220.2 620220 24.8190-0221.2 620221	L= 601 L= 1.338
318 Ci 318 Ci 320 Cd 320 Ci 320 Ci 325 Ci	105 110 110 120 125 141	09/01→12/07 02/05→12/07 02/05→12/07 01/06→12/07 09/00→12/07 09/00→12/07	← →	→ 09/06 → 09/06	1	24.8190-0220.2 620220 24.8190-0221.2 620221	L= 601 L= 1.338
323 Ci 323 Ci	120 125	04/00→09/00 04/00→09/00	← →		1 1	24.8190-0220.2 620220 24.8190-0221.2 620221	L= 601 L= 1.338
330 Cd 330 Ci	150 170	08/05→12/07 06/00→12/07	← →	→ 09/06 → 09/06	1 1	24.8190-0227.2 620227 24.8190-0221.2 620221	L= 651 L= 1.338
M3 3.2	252	04/01→12/07	← →	→ 09/06 → 09/06	1 1	24.8190-0227.2 620227 24.8190-0228.2 620228	L= 651 L= 1.353
 Bremsscheibe							
318 Ci	100	12/00→08/06	← →	09/01→ 09/01→		24.0122-0115.1 422115 24.0322-0115.1 522115	Ø 286 22 20,4 V + S Ø 286 22 19,6 V + S PD
						24.0119-0107.1 419107 24.0319-0107.1 519107	Ø 276 19 17,4 V + S Ø 276 19 16,6 V + S PD
318 Ci 318 Ci	105 110	09/01→12/07 02/05→12/07	← →	→ 09/06 → 09/06		24.0122-0115.1 422115 24.0322-0115.1 522115	Ø 286 22 20,4 V + S Ø 286 22 19,6 V + S PD
						24.0119-0107.1 419107 24.0319-0107.1 519107	Ø 276 19 17,4 V + S Ø 276 19 16,6 V + S PD
320 Cd 320 Ci 320 Ci 325 Ci	110 120 125 141	02/05→12/07 01/06→12/07 09/00→12/07 09/00→12/07	← →	→ 09/06 → 09/06		24.0122-0160.1 422160 24.0322-0160.1 522160	Ø 300 22 20,4 V + S Ø 300 22 19,6 V + S PD
						24.0119-0108.1 419108 24.0319-0108.1 519108	Ø 294 18,9 17,4 V + S Ø 294 18,9 16,6 V + S PD
323 Ci 323 Ci	120 125	04/00→09/00 04/00→09/00	← →			24.0122-0160.1 422160 24.0322-0160.1 522160	Ø 300 22 20,4 V + S Ø 300 22 19,6 V + S PD
						24.0119-0108.1 419108 24.0319-0108.1 519108	Ø 294 18,9 17,4 V + S Ø 294 18,9 16,6 V + S PD
330 Cd 330 Ci	150 170	08/05→12/07 06/00→12/07	← →	→ 09/06 → 09/06		24.0125-0138.1 425138 24.0325-0138.1 525138	Ø 325 24,9 23,4 V + S Ø 325 24,9 22,6 V + S PD
						24.0122-0209.1 422209 24.0322-0209.1 522209	Ø 320 22 20,4 V + S Ø 320 22 19,6 V + S PD
M3 3.2	252	04/01→12/07	← ← → →	☐; → 09/06 ☐; → 09/06 ☐; → 09/06 ☐; → 09/06		24.0128-0206.2 428206 24.0128-0207.2 428207	Ø 325 28 26,4 V• Bremsscheibe zweiteilig / + S Ø 325 28 26,4 V• Bremsscheibe zweiteilig / + S
						24.0120-0221.2 420221 24.0120-0222.2 420222	Ø 328 20 18,4 V• Bremsscheibe zweiteilig / + S Ø 328 20 18,4 V• Bremsscheibe zweiteilig / + S











	kw			 	! #		
BMW - 3 Cabriolet (E93) 05/06→12/13							
 Bremsbelagsatz, Scheibenbremse							
318 i	105	03/10→12/13	←	→ 11/13; + Performance Parts	13.0460-4848.2	604848	BRE 24316 16,9 + WE / - WK
			←	→ 11/13	13.0460-7216.2	607216	ATE 23794 20,3 + WE / - WK
			→	→ 11/13	13.0470-7216.2	LD7216	ATE 23794 20,3 + WE / - WK Ceramic
320 d	120	01/08→12/13	←	→ 11/13; + Performance Parts	13.0460-4848.2	604848	BRE 24316 16,9 + WE / - WK
			←	→ 02/10	13.0460-7238.2	607238	ATE 23313 20,3 + WE / - WK
			←	03/10→ 11/13	13.0470-7238.2	LD7238	ATE 23313 20,3 + WE / - WK Ceramic
			→	→ 02/10	13.0460-7217.2	607217	ATE 23926 17,3 + WE / - WK
			→	03/10→ 11/13	13.0470-7217.2	LD7217	ATE 23926 17,3 + WE / - WK Ceramic
320 d 320 d	130 145	09/07→02/10 09/07→02/10	←	03/08→; + Performance Parts	13.0460-4848.2	604848	BRE 24316 16,9 + WE / - WK
			←	03/08→	13.0460-7238.2	607238	ATE 23313 20,3 + WE / - WK
			→	03/08→	13.0470-7238.2	LD7238	ATE 23313 20,3 + WE / - WK Ceramic
320 d 320 d	135 147	03/10→10/13 03/10→10/13	←	+ Performance Parts	13.0460-4848.2	604848	BRE 24316 16,9 + WE / - WK
			←		13.0460-7217.2	607217	ATE 23926 17,3 + WE / - WK
			→		13.0470-7217.2	LD7217	ATE 23926 17,3 + WE / - WK Ceramic
320 i 320 i 320 i 320 i	110 115 120 125	01/07→08/13 01/07→08/13 09/06→10/13 09/06→10/13	←	03/07→; + Performance Parts	13.0460-4848.2	604848	BRE 24316 16,9 + WE / - WK
			←	03/08→ 02/10	13.0460-7216.2	607216	ATE 23794 20,3 + WE / - WK
			←	03/10→	13.0470-7216.2	LD7216	ATE 23794 20,3 + WE / - WK Ceramic
			←	03/07→ 02/08	13.0460-7216.2	607216	ATE 23794 20,3 + WE / - WK
			→	03/07→ 02/10	13.0470-7216.2	LD7216	ATE 23794 20,3 + WE / - WK Ceramic
			→	03/07→ 02/10	13.0460-7217.2	607217	ATE 23926 17,3 + WE / - WK
			→	03/10→	13.0470-7217.2	LD7217	ATE 23926 17,3 + WE / - WK Ceramic
323 i 323 i	130 140	03/07→09/11 03/07→09/11	←	+ Performance Parts	13.0460-4848.2	604848	BRE 24316 16,9 + WE / - WK
			←	→ 02/10	13.0460-7238.2	607238	ATE 23313 20,3 + WE / - WK
			←	03/10→	13.0470-7238.2	LD7238	ATE 23313 20,3 + WE / - WK Ceramic
			→	→ 02/10	13.0460-7238.2	607238	ATE 23313 20,3 + WE / - WK
			→	→ 02/10	13.0470-7238.2	LD7238	ATE 23313 20,3 + WE / - WK Ceramic
325 d 325 d	145 155	03/07→12/10 03/07→12/10	←	09/07→; + Performance Parts	13.0460-4848.2	604848	BRE 24316 16,9 + WE / - WK
			←	03/10→	13.0460-7216.2	607216	ATE 23794 20,3 + WE / - WK
			←	09/07→ 02/10	13.0470-7216.2	LD7216	ATE 23794 20,3 + WE / - WK Ceramic
↓					13.0460-7216.2	607216	ATE 23794 20,3 + WE / - WK







	kw			 	! #			
BMW - 3 Cabriolet (E93) 05/06→12/13								
 Bremsbelagsatz, Scheibenbremse								
325 d 325 d	145 155	03/07→12/10 03/07→12/10	←	09/07→ 02/10		13.0470-7216.2	LD7216	ATE 23794 20,3 + WE / - WK Ceramic
			→	03/10→		13.0460-7225.2	607225	ATE 23550 17,3 + WE / - WK
			→	09/07→ 02/10		13.0470-7225.2	LD7225	ATE 23550 17,3 + WE / - WK Ceramic
325 d	150	09/09→09/13	←	03/10→; + Performance Parts		13.0460-4848.2	604848	BRE 24316 16,9 + WE / - WK
			←	03/10→		13.0460-7216.2	607216	ATE 23794 20,3 + WE / - WK
			→	03/10→		13.0470-7216.2	LD7216	ATE 23794 20,3 + WE / - WK Ceramic
325 i	160	03/07→12/13	←	→ 11/13; + Performance Parts		13.0460-4848.2	604848	BRE 24316 16,9 + WE / - WK
			←	→ 02/10; Motorcode: N53		13.0460-7216.2	607216	ATE 23794 20,3 + WE / - WK
			←	03/10→; Motorcode: N53; → 11/13		13.0470-7216.2	LD7216	ATE 23794 20,3 + WE / - WK Ceramic
			←	→ 02/10; Motorcode: N52N		13.0460-7238.2	607238	ATE 23313 20,3 + WE / - WK
			←	03/10→ 11/13; Motorcode: N52N		13.0470-7238.2	LD7238	ATE 23313 20,3 + WE / - WK Ceramic
			→	03/10→ 11/13		13.0460-7217.2	607217	ATE 23926 17,3 + WE / - WK
			→	→ 02/10		13.0470-7217.2	LD7217	ATE 23926 17,3 + WE / - WK Ceramic
325 i	155	10/06→12/13	←	03/07→ 11/13; + Performance Parts		13.0460-4848.2	604848	BRE 24316 16,9 + WE / - WK
			←	03/10→; Motorcode: N53; → 11/13		13.0460-7216.2	607216	ATE 23794 20,3 + WE / - WK
			←	03/07→ 02/10; Motorcode: N53		13.0470-7216.2	LD7216	ATE 23794 20,3 + WE / - WK Ceramic
			←	03/10→ 11/13; Motorcode: N52N		13.0460-7216.2	607216	ATE 23794 20,3 + WE / - WK
			←	03/07→ 02/10; Motorcode: N52N		13.0470-7216.2	LD7216	ATE 23794 20,3 + WE / - WK Ceramic
			→	03/07→ 02/10		13.0460-7238.2	607238	ATE 23313 20,3 + WE / - WK
			→	03/10→ 11/13		13.0470-7238.2	LD7238	ATE 23313 20,3 + WE / - WK Ceramic
330 d	170	03/07→12/13	←	→ 11/13; + Performance Parts		13.0460-4848.2	604848	BRE 24316 16,9 + WE / - WK
			←	09/09→ 02/10; nicht für erhöhte Nutzlast		13.0460-7216.2	607216	ATE 23794 20,3 + WE / - WK
			←	03/10→; nicht für erhöhte Nutzlast; → 11/13		13.0470-7216.2	LD7216	ATE 23794 20,3 + WE / - WK Ceramic
			←	09/09→ 02/10; für erhöhte Nutzlast		13.0460-7237.2	607237	ATE 23347 20,3 + WE / - WK
			←			13.0460-7238.2	607238	ATE 23313 20,3 + WE / - WK
					13.0470-7237.2	LD7237	ATE 23347 20,3 + WE / - WK Ceramic	
					13.0470-7238.2	LD7238	ATE 23313 20,3 + WE / - WK Ceramic	

















	kw			 	! #		
BMW - 3 Cabriolet (E93) 05/06→12/13							
 Bremsbelagsatz, Scheibenbremse							
330 d	170	03/07→12/13	←	→ 08/09		13.0460-7237.2 607237 ATE 23347 20,3 + WE / - WK 13.0460-7238.2 607238 ATE 23313 20,3 + WE / - WK 13.0470-7237.2 LD7237 ATE 23347 20,3 + WE / - WK Ceramic 13.0470-7238.2 LD7238 ATE 23313 20,3 + WE / - WK Ceramic	
			←	03/10→; für erhöhte Nutzlast; → 11/13		13.0460-7237.2 607237 ATE 23347 20,3 + WE / - WK 13.0460-7238.2 607238 ATE 23313 20,3 + WE / - WK 13.0470-7237.2 LD7237 ATE 23347 20,3 + WE / - WK Ceramic 13.0470-7238.2 LD7238 ATE 23313 20,3 + WE / - WK Ceramic	
			→	03/10→ 11/13		13.0460-7225.2 607225 ATE 23550 17,3 + WE / - WK 13.0470-7225.2 LD7225 ATE 23550 17,3 + WE / - WK Ceramic	
			→	→ 02/10		13.0460-7225.2 607225 ATE 23550 17,3 + WE / - WK 13.0470-7225.2 LD7225 ATE 23550 17,3 + WE / - WK Ceramic	
330 d	180	01/09→12/13	←	→ 11/13; + Performance Parts		13.0460-4848.2 604848 BRE 24316 16,9 + WE / - WK	
			←	09/09→ 02/10		13.0460-7216.2 607216 ATE 23794 20,3 + WE / - WK 13.0470-7216.2 LD7216 ATE 23794 20,3 + WE / - WK Ceramic	
			←	03/10→ 11/13		13.0460-7216.2 607216 ATE 23794 20,3 + WE / - WK 13.0470-7216.2 LD7216 ATE 23794 20,3 + WE / - WK Ceramic	
			←	→ 08/09		13.0460-7237.2 607237 ATE 23347 20,3 + WE / - WK 13.0460-7238.2 607238 ATE 23313 20,3 + WE / - WK 13.0470-7237.2 LD7237 ATE 23347 20,3 + WE / - WK Ceramic 13.0470-7238.2 LD7238 ATE 23313 20,3 + WE / - WK Ceramic	
			→	→ 02/10		13.0460-7225.2 607225 ATE 23550 17,3 + WE / - WK 13.0470-7225.2 LD7225 ATE 23550 17,3 + WE / - WK Ceramic	
			→	→ 11/13		13.0460-7225.2 607225 ATE 23550 17,3 + WE / - WK 13.0470-7225.2 LD7225 ATE 23550 17,3 + WE / - WK Ceramic	
330 i 330 i	190 200	03/07→12/13 03/07→12/13	←	→ 11/13; + Performance Parts		13.0460-4848.2 604848 BRE 24316 16,9 + WE / - WK	
			←	03/10→ 11/13		13.0460-7216.2 607216 ATE 23794 20,3 + WE / - WK 13.0470-7216.2 LD7216 ATE 23794 20,3 + WE / - WK Ceramic	
			←	03/10→; Motorcode: N53; → 11/13; nicht für erhöhte Nutzlast		13.0460-7216.2 607216 ATE 23794 20,3 + WE / - WK 13.0470-7216.2 LD7216 ATE 23794 20,3 + WE / - WK Ceramic	
			←	→ 02/10		13.0460-7216.2 607216 ATE 23794 20,3 + WE / - WK 13.0470-7216.2 LD7216 ATE 23794 20,3 + WE / - WK Ceramic	
			←	09/09→ 02/10; nicht für erhöhte Nutzlast		13.0460-7216.2 607216 ATE 23794 20,3 + WE / - WK 13.0470-7216.2 LD7216 ATE 23794 20,3 + WE / - WK Ceramic	
			←	03/10→; Motorcode: N53; → 11/13; für erhöhte Nutzlast		13.0460-7237.2 607237 ATE 23347 20,3 + WE / - WK 13.0460-7238.2 607238 ATE 23313 20,3 + WE / - WK 13.0470-7237.2 LD7237 ATE 23347 20,3 + WE / - WK Ceramic 13.0470-7238.2 LD7238 ATE 23313 20,3 + WE / - WK Ceramic	
			←	→ 08/09; Motorcode: N53		13.0460-7237.2 607237 ATE 23347 20,3 + WE / - WK 13.0460-7238.2 607238 ATE 23313 20,3 + WE / - WK 13.0470-7237.2 LD7237 ATE 23347 20,3 + WE / - WK Ceramic 13.0470-7238.2 LD7238 ATE 23313 20,3 + WE / - WK Ceramic	
			←	09/09→ 02/10; Motorcode: N53; für erhöhte Nutzlast		13.0460-7237.2 607237 ATE 23347 20,3 + WE / - WK 13.0460-7238.2 607238 ATE 23313 20,3 + WE / - WK 13.0470-7237.2 LD7237 ATE 23347 20,3 + WE / - WK Ceramic	











↓







	kw			 	! #			
BMW - 3 Cabriolet (E93) 05/06→12/13								
 Bremsbelagsatz, Scheibenbremse								
330 i 330 i	190 200	03/07→12/13 03/07→12/13	←	09/09→ 02/10; Motorcode: N53; für erhöhte Nutzlast		13.0470-7238.2	LD7238	ATE 23313 20,3 + WE / - WK Ceramic
			→	→ 02/10		13.0460-7225.2	607225	ATE 23550 17,3 + WE / - WK
			→	03/10→ 11/13		13.0460-7225.2	607225	ATE 23550 17,3 + WE / - WK
			→			13.0470-7225.2	LD7225	ATE 23550 17,3 + WE / - WK Ceramic
			→			13.0470-7225.2	LD7225	ATE 23550 17,3 + WE / - WK Ceramic
335 i 335 i	225 240	05/06→10/13 05/06→10/13	←	03/10→		13.0460-7237.2	607237	ATE 23347 20,3 + WE / - WK
						13.0460-7238.2	607238	ATE 23313 20,3 + WE / - WK
						13.0470-7237.2	LD7237	ATE 23347 20,3 + WE / - WK Ceramic
						13.0470-7238.2	LD7238	ATE 23313 20,3 + WE / - WK Ceramic
			←	03/07→ 02/10		13.0460-7237.2	607237	ATE 23347 20,3 + WE / - WK
						13.0460-7238.2	607238	ATE 23313 20,3 + WE / - WK
			13.0470-7237.2	LD7237	ATE 23347 20,3 + WE / - WK Ceramic			
			13.0470-7238.2	LD7238	ATE 23313 20,3 + WE / - WK Ceramic			
			→	03/07→ 02/10		13.0460-7225.2	607225	ATE 23550 17,3 + WE / - WK
						13.0470-7225.2	LD7225	ATE 23550 17,3 + WE / - WK Ceramic
			→	03/10→		13.0460-7225.2	607225	ATE 23550 17,3 + WE / - WK
						13.0470-7225.2	LD7225	ATE 23550 17,3 + WE / - WK Ceramic
M3	309	03/07→10/13	←	03/08→		13.0460-7167.2	607167	ATE 23312 20,3 + WE / - WK
Warnkontakt, Bremsbelagverschleiß								
318 i	105	03/10→12/13	←	→ 11/13; + Performance Parts	1	24.8190-0267.2	620267	L= 679
			←	→ 11/13	1	24.8190-0284.2	620284	L= 650
			→	→ 11/13	1	24.8190-0285.2	620285	L= 1.107
320 d	120	01/08→12/13	←	→ 02/10	1	24.8190-0267.2	620267	L= 679
			←	→ 11/13; + Performance Parts	1	24.8190-0267.2	620267	L= 679
			←	03/10→ 11/13	1	24.8190-0287.2	620287	L= 723
			→	→ 02/10	1	24.8190-0265.2	620265	L= 1.086
			→	03/10→ 11/13	1	24.8190-0285.2	620285	L= 1.107
320 d 320 d	130 145	09/07→02/10 09/07→02/10	←	03/08→	1	24.8190-0267.2	620267	L= 679
			←	03/08→; + Performance Parts	1	24.8190-0267.2	620267	L= 679
			→	03/08→	1	24.8190-0265.2	620265	L= 1.086
320 d 320 d	135 147	03/10→10/13 03/10→10/13	←	+ Performance Parts	1	24.8190-0267.2	620267	L= 679
			←		1	24.8190-0287.2	620287	L= 723
			→		1	24.8190-0285.2	620285	L= 1.107
320 i 320 i 320 i 320 i	110 115 120 125	01/07→08/13 01/07→08/13 09/06→10/13 09/06→10/13	←	03/08→ 02/10	1	24.8190-0264.2	620264	L= 630
			←	03/07→; + Performance Parts	1	24.8190-0267.2	620267	L= 679
			←	03/07→ 02/08	1	24.8190-0267.2	620267	L= 679
			←	03/10→	1	24.8190-0284.2	620284	L= 650
			→	03/07→ 02/10	1	24.8190-0265.2	620265	L= 1.086
			→	03/10→	1	24.8190-0285.2	620285	L= 1.107
323 i 323 i	130 140	03/07→09/11 03/07→09/11	←	→ 02/10	1	24.8190-0267.2	620267	L= 679
			←	+ Performance Parts	1	24.8190-0267.2	620267	L= 679
			←	03/10→	1	24.8190-0287.2	620287	L= 723
			→	→ 02/10	1	24.8190-0265.2	620265	L= 1.086
325 d 325 d	145 155	03/07→12/10 03/07→12/10	←	09/07→ 02/10	1	24.8190-0264.2	620264	L= 630
			←	09/07→; + Performance Parts	1	24.8190-0267.2	620267	L= 679
			←	03/10→	1	24.8190-0284.2	620284	L= 650
			→	09/07→ 02/10	1	24.8190-0265.2	620265	L= 1.086
			→	03/10→	1	24.8190-0285.2	620285	L= 1.107
325 d ↓	150	09/09→09/13	←	03/10→; + Performance Parts	1	24.8190-0267.2	620267	L= 679









	kw			 	! #		
BMW - 3 Cabriolet (E93) 05/06→12/13							
Warnkontakt, Bremsbelagverschleiß							
325 d	150	09/09→09/13	←	03/10→	1	24.8190-0284.2 620284	L= 650
			→	03/10→	1	24.8190-0285.2 620285	L= 1.107
325 i	160	03/07→12/13	←	→ 02/10; Motorcode: N53	1	24.8190-0264.2 620264	L= 630
			←	→ 02/10; Motorcode: N52N	1	24.8190-0267.2 620267	L= 679
			←	→ 11/13; + Performance Parts	1	24.8190-0267.2 620267	L= 679
			←	03/10→; Motorcode: N53; → 11/13	1	24.8190-0284.2 620284	L= 650
			←	03/10→ 11/13; Motorcode: N52N	1	24.8190-0287.2 620287	L= 723
			→	→ 02/10	1	24.8190-0265.2 620265	L= 1.086
			→	03/10→ 11/13	1	24.8190-0285.2 620285	L= 1.107
325 i	155	10/06→12/13	←	03/07→ 02/10; Motorcode: N53	1	24.8190-0264.2 620264	L= 630
			←	03/07→ 02/10; Motorcode: N52N	1	24.8190-0267.2 620267	L= 679
			←	03/07→ 11/13; + Performance Parts	1	24.8190-0267.2 620267	L= 679
			←	03/10→; Motorcode: N53; → 11/13	1	24.8190-0284.2 620284	L= 650
			←	03/10→ 11/13; Motorcode: N52N	1	24.8190-0287.2 620287	L= 723
			→	03/07→ 02/10	1	24.8190-0265.2 620265	L= 1.086
			→	03/10→ 11/13	1	24.8190-0285.2 620285	L= 1.107
330 d	170	03/07→12/13	←	→ 11/13; + Performance Parts	1	24.8190-0267.2 620267	L= 679
			←	→ 08/09	1	24.8190-0267.2 620267	L= 679
			←	09/09→ 02/10; für erhöhte Nutzlast	1	24.8190-0267.2 620267	L= 679
			←	09/09→ 02/10; nicht für erhöhte Nutzlast	1	24.8190-0267.2 620267	L= 679
			←	03/10→; nicht für erhöhte Nutzlast; → 11/13	1	24.8190-0287.2 620287	L= 723
			←	03/10→; für erhöhte Nutzlast; → 11/13	1	24.8190-0287.2 620287	L= 723
			→	→ 02/10	1	24.8190-0265.2 620265	L= 1.086
			→	03/10→ 11/13	1	24.8190-0285.2 620285	L= 1.107
330 d	180	01/09→12/13	←	→ 11/13; + Performance Parts	1	24.8190-0267.2 620267	L= 679
			←	09/09→ 02/10	1	24.8190-0267.2 620267	L= 679
			←	→ 08/09	1	24.8190-0267.2 620267	L= 679
			←	03/10→ 11/13	1	24.8190-0287.2 620287	L= 723
			→	→ 02/10	1	24.8190-0265.2 620265	L= 1.086
			→	→ 11/13	1	24.8190-0285.2 620285	L= 1.107
330 i 330 i	190 200	03/07→12/13 03/07→12/13	←	→ 02/10	1	24.8190-0264.2 620264	L= 630
			←	09/09→ 02/10; nicht für erhöhte Nutzlast	1	24.8190-0267.2 620267	L= 679
			←	→ 08/09; Motorcode: N53	1	24.8190-0267.2 620267	L= 679
			←	→ 11/13; + Performance Parts	1	24.8190-0267.2 620267	L= 679
			←	09/09→ 02/10; Motorcode: N53; für erhöhte Nutzlast	1	24.8190-0267.2 620267	L= 679
			←	03/10→ 11/13	1	24.8190-0284.2 620284	L= 650
			←	03/10→; Motorcode: N53; → 11/13; nicht für erhöhte Nutzlast	1	24.8190-0287.2 620287	L= 723
			←	03/10→; Motorcode: N53; → 11/13; für erhöhte Nutzlast	1	24.8190-0287.2 620287	L= 723
			→	→ 02/10	1	24.8190-0265.2 620265	L= 1.086
			→	03/10→ 11/13	1	24.8190-0285.2 620285	L= 1.107
335 i 335 i	225 240	05/06→10/13 05/06→10/13	←	03/07→ 02/10	1	24.8190-0267.2 620267	L= 679
			←	03/10→	1	24.8190-0287.2 620287	L= 723
			→	03/07→ 02/10	1	24.8190-0265.2 620265	L= 1.086
			→	03/10→	1	24.8190-0285.2 620285	L= 1.107
M3	309	03/07→10/13	←	☐; 03/08→	1	24.8190-0271.2 620271	L= 659
			←	☐; 03/08→	1	24.8190-0272.2 620272	L= 672
			→	03/08→ 02/10	1	24.8190-0265.2 620265	L= 1.086
			→	03/10→	1	24.8190-0285.2 620285	L= 1.107
Bremsscheibe							
318 i ↓	105	03/10→12/13	←	→ 11/13		24.0124-0197.1 424197 24.0324-0197.1 524197	Ø 300 24 22,4 V + S Ø 300 24 21,6 V + S PD

	kw			 	! #		
BMW - 3 Cabriolet (E93) 05/06→12/13							
Bremsscheibe							
318 i	105	03/10→12/13	➡	→ 11/13		24.0120-0195.1 420195 24.0320-0195.1 520195	Ø 300 20 18,4 V + S Ø 300 20 17,6 V + S PD
320 d	120	01/08→12/13	⬅	→ 11/13		24.0124-0203.1 424203 24.0324-0203.1 524203	Ø 312 23,9 22,4 V + S Ø 312 23,9 21,6 V + S PD
			➡	→ 11/13		24.0120-0204.1 420204 24.0320-0204.1 520204	Ø 300 20 18,4 V + S Ø 300 20 17,6 V + S PD
320 d 320 d	130 145	09/07→02/10 09/07→02/10	⬅	03/08→		24.0124-0203.1 424203 24.0324-0203.1 524203	Ø 312 23,9 22,4 V + S Ø 312 23,9 21,6 V + S PD
			➡	03/08→		24.0120-0204.1 420204 24.0320-0204.1 520204	Ø 300 20 18,4 V + S Ø 300 20 17,6 V + S PD
320 d 320 d 323 i 323 i	135 147 130 140	03/10→10/13 03/10→10/13 03/07→09/11 03/07→09/11	⬅			24.0124-0203.1 424203 24.0324-0203.1 524203	Ø 312 23,9 22,4 V + S Ø 312 23,9 21,6 V + S PD
			➡			24.0120-0204.1 420204 24.0320-0204.1 520204	Ø 300 20 18,4 V + S Ø 300 20 17,6 V + S PD
320 i 320 i 320 i 320 i	110 115 120 125	01/07→08/13 01/07→08/13 09/06→10/13 09/06→10/13	⬅	03/08→		24.0124-0197.1 424197 24.0324-0197.1 524197	Ø 300 24 22,4 V + S Ø 300 24 21,6 V + S PD
			⬅	03/07→ 02/08		24.0124-0203.1 424203 24.0324-0203.1 524203	Ø 312 23,9 22,4 V + S Ø 312 23,9 21,6 V + S PD
			➡	09/09→		24.0120-0195.1 420195 24.0320-0195.1 520195	Ø 300 20 18,4 V + S Ø 300 20 17,6 V + S PD
			➡	03/07→ 08/09		24.0120-0204.1 420204 24.0320-0204.1 520204	Ø 300 20 18,4 V + S Ø 300 20 17,6 V + S PD
325 d 325 d	145 155	03/07→12/10 03/07→12/10	⬅	09/07→		24.0124-0200.1 424200 24.0324-0200.1 524200	Ø 330 24 22,4 V + S Ø 330 24 21,6 V + S PD
			➡	09/07→		24.0122-0236.1 422236 24.0322-0236.1 522236	Ø 336 22 20,4 V + S Ø 336 22 19,6 V + S PD
325 d	150	09/09→09/13	⬅	03/10→		24.0124-0200.1 424200 24.0324-0200.1 524200	Ø 330 24 22,4 V + S Ø 330 24 21,6 V + S PD
			➡	03/10→		24.0122-0236.1 422236 24.0322-0236.1 522236	Ø 336 22 20,4 V + S Ø 336 22 19,6 V + S PD
325 i	160	03/07→12/13	⬅	→ 11/13; Motorcode: N53		24.0124-0200.1 424200 24.0324-0200.1 524200	Ø 330 24 22,4 V + S Ø 330 24 21,6 V + S PD
			⬅	→ 11/13; Motorcode: N52N		24.0124-0203.1 424203 24.0324-0203.1 524203	Ø 312 23,9 22,4 V + S Ø 312 23,9 21,6 V + S PD
			➡	→ 11/13		24.0120-0204.1 420204 24.0320-0204.1 520204	Ø 300 20 18,4 V + S Ø 300 20 17,6 V + S PD
325 i	155	10/06→12/13	⬅	03/07→ 11/13; Motorcode: N53		24.0124-0200.1 424200 24.0324-0200.1 524200	Ø 330 24 22,4 V + S Ø 330 24 21,6 V + S PD
			⬅	03/07→ 11/13; Motorcode: N52N		24.0124-0203.1 424203 24.0324-0203.1 524203	Ø 312 23,9 22,4 V + S Ø 312 23,9 21,6 V + S PD
			➡	03/07→ 11/13		24.0120-0204.1 420204 24.0320-0204.1 520204	Ø 300 20 18,4 V + S Ø 300 20 17,6 V + S PD
330 d 330 d	170 180	03/07→12/13 01/09→12/13	⬅	09/09→; nicht für erhöhte Nutzlast; → 11/13		24.0124-0200.1 424200 24.0324-0200.1 524200	Ø 330 24 22,4 V + S Ø 330 24 21,6 V + S PD
			⬅	09/09→; für erhöhte Nutzlast; → 11/13		24.0130-0192.1 430192	Ø 348 30 28,4 V + S
			⬅	→ 08/09		24.0130-0192.1 430192	Ø 348 30 28,4 V + S
			➡	→ 11/13		24.0122-0236.1 422236 24.0322-0236.1 522236	Ø 336 22 20,4 V + S Ø 336 22 19,6 V + S PD
330 i 330 i	190 200	03/07→12/13 03/07→12/13	⬅	09/09→; Motorcode: N53; → 11/13; nicht für erhöhte Nutzlast		24.0124-0200.1 424200 24.0324-0200.1 524200	Ø 330 24 22,4 V + S Ø 330 24 21,6 V + S PD
			⬅	→ 11/13; Motorcode: N52N		24.0124-0200.1 424200 24.0324-0200.1 524200	Ø 330 24 22,4 V + S Ø 330 24 21,6 V + S PD
			⬅	→ 08/09; Motorcode: N53		24.0130-0192.1 430192	Ø 348 30 28,4 V + S
			⬅	09/09→; Motorcode: N53; → 11/13; für erhöhte Nutzlast		24.0130-0192.1 430192	Ø 348 30 28,4 V + S
			➡	→ 11/13		24.0122-0236.1 422236 24.0322-0236.1 522236	Ø 336 22 20,4 V + S Ø 336 22 19,6 V + S PD
335 i 335 i	225 240	05/06→10/13 05/06→10/13	⬅	03/07→		24.0130-0192.1 430192	Ø 348 30 28,4 V + S
			➡	03/07→		24.0122-0236.1 422236 24.0322-0236.1 522236	Ø 336 22 20,4 V + S Ø 336 22 19,6 V + S PD
↓							









	kW			 	! #		
BMW - 3 Cabriolet (E93) 05/06→12/13							
Bremsscheibe							
M3	309	03/07→10/13	←	☐; 03/08→		24.0130-0213.2 430213	Ø 360 30 28,4 V• Bremsscheibe zweiteilig / + S
			←	☐; 03/08→		24.0130-0214.2 430214	Ø 360 30 28,4 V• Bremsscheibe zweiteilig / + S
			→	☐; 03/08→		24.0124-0231.2 424231	Ø 350 24 22,4 V• Bremsscheibe zweiteilig / + S
			→	☐; 03/08→		24.0124-0232.2 424232	Ø 350 24 22,4 V• Bremsscheibe zweiteilig / + S
BMW - 3 Compact (E36) 03/94→08/00							
Bremsbelagsatz, Scheibenbremse							
316 g	75	03/94→08/00	←			13.0460-5405.2 605405	ATE 21643 17,8 + WE / - WK
316 i	75	03/94→08/00				13.0470-5405.2 LD5405	ATE 21643 17,8 + WE / - WK Ceramic
316 i	77	12/98→08/00					
318 tds	66	01/95→08/00					
318 ti	103	11/94→08/95	→			13.0460-3605.2 603605	ATE 20180 17,3 + WE / - WK
318 ti	103	07/95→08/00				13.0470-3605.2 LD3605	ATE 20180 17,3 + WE / - WK Ceramic
323 ti	120	01/99→08/00					
323 ti	125	08/97→08/00					
Warnkontakt, Bremsbelagverschleiß							
316 g	75	03/94→08/00	←		1	24.8190-0207.2 620207	L= 786
316 i	75	03/94→08/00					
316 i	77	12/98→08/00	→		1	24.8190-0211.2 620211	L= 840
318 tds	66	01/95→08/00					
318 ti	103	11/94→08/95					
318 ti	103	07/95→08/00					
323 ti	120	01/99→08/00					
323 ti	125	08/97→08/00					
Bremsscheibe							
316 g	75	03/94→08/00	←			24.0112-0126.1 412126	Ø 286 12 10,4 + S
316 i	75	03/94→08/00				24.0312-0126.1 512126	Ø 286 12 9,6 + S PD
316 i	77	12/98→08/00					
318 tds	66	01/95→08/00	→			24.0110-0211.1 410211	Ø 272 10 8,4 + S
318 ti	103	11/94→08/95	←	Motorcode: M42		24.0112-0126.1 412126	Ø 286 12 10,4 + S
						24.0312-0126.1 512126	Ø 286 12 9,6 + S PD
			→			24.0110-0211.1 410211	Ø 272 10 8,4 + S
318 ti	103	07/95→08/00	←	→ 04/98; Motorcode: M44		24.0112-0126.1 412126	Ø 286 12 10,4 + S
						24.0312-0126.1 512126	Ø 286 12 9,6 + S PD
			←	05/98→; Motorcode: M44		24.0122-0115.1 422115	Ø 286 22 20,4 V + S
						24.0322-0115.1 522115	Ø 286 22 19,6 V + S PD
			→			24.0110-0211.1 410211	Ø 272 10 8,4 + S
323 ti	120	01/99→08/00	←			24.0122-0115.1 422115	Ø 286 22 20,4 V + S
323 ti	125	08/97→08/00				24.0322-0115.1 522115	Ø 286 22 19,6 V + S PD
			→			24.0110-0211.1 410211	Ø 272 10 8,4 + S
BMW - 3 Compact (E46) 03/01→02/05							
Bremsbelagsatz, Scheibenbremse							
316 ti	77	06/02→02/05	←			13.0460-5405.2 605405	ATE 21643 17,8 + WE / - WK
316 ti	85	06/02→02/05				13.0470-5405.2 LD5405	ATE 21643 17,8 + WE / - WK Ceramic
316 ti	85	06/01→02/05					
318 td	85	03/03→02/05					
320 td	110	09/01→02/05	→			13.0460-3605.2 603605	ATE 20180 17,3 + WE / - WK
325 ti	141	06/01→02/05				13.0470-3605.2 LD3605	ATE 20180 17,3 + WE / - WK Ceramic
318 ti	100	03/01→12/04	←	09/01→		13.0460-5405.2 605405	ATE 21643 17,8 + WE / - WK
318 ti	105	03/01→12/04				13.0470-5405.2 LD5405	ATE 21643 17,8 + WE / - WK Ceramic
			→	09/01→		13.0460-3605.2 603605	ATE 20180 17,3 + WE / - WK
						13.0470-3605.2 LD3605	ATE 20180 17,3 + WE / - WK Ceramic
Warnkontakt, Bremsbelagverschleiß							
316 ti	77	06/02→02/05	←		1	24.8190-0220.2 620220	L= 601
316 ti	85	06/02→02/05					
316 ti	85	06/01→02/05	→		1	24.8190-0221.2 620221	L= 1.338
318 td	85	03/03→02/05					
320 td	110	09/01→02/05					
325 ti	141	06/01→02/05					
318 ti	100	03/01→12/04	←	09/01→	1	24.8190-0220.2 620220	L= 601
318 ti	105	03/01→12/04					









	kw			 	! #		
BMW - 3 Compact (E46) 03/01→02/05							
Warnkontakt, Bremsbelagverschleiß							
318 ti	100	03/01→12/04	➡	09/01→	1	24.8190-0221.2 620221	L= 1.338
318 ti	105	03/01→12/04	➡				
 Bremsscheibe							
316 ti	77	06/02→02/05	←			24.0122-0115.1 422115	Ø 286 22 20,4 V + S
			➡			24.0322-0115.1 522115	Ø 286 22 19,6 V + S PD
			➡			24.0110-0202.1 410202	Ø 280 10 8,4 + S
			➡			24.0310-0202.1 510202	Ø 280 10 7,6 + S PD
316 ti	85	06/02→02/05	←			24.0122-0115.1 422115	Ø 286 22 20,4 V + S
316 ti	85	06/01→02/05	←			24.0322-0115.1 522115	Ø 286 22 19,6 V + S PD
			➡	nicht für erhöhte Nutzlast		24.0110-0202.1 410202	Ø 280 10 8,4 + S
			➡	für erhöhte Nutzlast		24.0310-0202.1 510202	Ø 280 10 7,6 + S PD
			➡			24.0119-0107.1 419107	Ø 276 19 17,4 V + S
			➡			24.0319-0107.1 519107	Ø 276 19 16,6 V + S PD
318 td	85	03/03→02/05	←			24.0122-0115.1 422115	Ø 286 22 20,4 V + S
			➡			24.0322-0115.1 522115	Ø 286 22 19,6 V + S PD
			➡			24.0119-0107.1 419107	Ø 276 19 17,4 V + S
			➡			24.0319-0107.1 519107	Ø 276 19 16,6 V + S PD
318 ti	100	03/01→12/04	←	09/01→		24.0122-0115.1 422115	Ø 286 22 20,4 V + S
318 ti	105	03/01→12/04	←			24.0322-0115.1 522115	Ø 286 22 19,6 V + S PD
			➡	09/01→		24.0119-0107.1 419107	Ø 276 19 17,4 V + S
			➡			24.0319-0107.1 519107	Ø 276 19 16,6 V + S PD
320 td	110	09/01→02/05	←			24.0122-0160.1 422160	Ø 300 22 20,4 V + S
325 ti	141	06/01→02/05	←			24.0322-0160.1 522160	Ø 300 22 19,6 V + S PD
			➡			24.0119-0108.1 419108	Ø 294 18,9 17,4 V + S
			➡			24.0319-0108.1 519108	Ø 294 18,9 16,6 V + S PD
BMW - 3 Coupe (E36) 03/92→04/99							
 Bremsbelagsatz, Scheibenbremse							
316 i	75	09/93→04/99	←			13.0460-5405.2 605405	ATE 21643 17,8 + WE / - WK
318 is	103	03/92→10/95	←			13.0470-5405.2 LD5405	ATE 21643 17,8 + WE / - WK
318 is	103	09/95→04/99	←				Ceramic
320 i	110	03/92→04/99	←			13.0460-3605.2 603605	ATE 20180 17,3 + WE / - WK
323 i	125	03/95→04/99	←			13.0470-3605.2 LD3605	ATE 20180 17,3 + WE / - WK
325 i	141	03/92→04/99	←				Ceramic
328 i	142	01/95→04/99	←				
M3 3.0	210	10/92→01/95	←			13.0460-7185.2 607185	ATE 20968 20,3 + WE / - WK
M3 3.0	217	01/95→10/95	←			13.0460-3803.2 603803	ATE 20995 17,3 + WE / - WK
M3 3.2	236	10/95→04/99	←				
Warnkontakt, Bremsbelagverschleiß							
316 i	75	09/93→04/99	←		1	24.8190-0207.2 620207	L= 786
318 is	103	03/92→10/95	←				
318 is	103	09/95→04/99	➡		1	24.8190-0206.2 620206	L= 790
320 i	110	03/92→04/99	➡				
323 i	125	03/95→04/99	➡				
325 i	141	03/92→04/99	➡				
328 i	142	01/95→04/99	➡				
M3 3.0	210	10/92→01/95	←		1	24.8190-0210.2 620210	L= 810
M3 3.0	217	01/95→10/95	←				
M3 3.2	236	10/95→04/99	➡		1	24.8190-0206.2 620206	L= 790
 Bremsscheibe							
316 i	75	09/93→04/99	←			24.0112-0126.1 412126	Ø 286 12 10,4 + S
			➡			24.0312-0126.1 512126	Ø 286 12 9,6 + S PD
			➡			24.0110-0202.1 410202	Ø 280 10 8,4 + S
			➡			24.0310-0202.1 510202	Ø 280 10 7,6 + S PD
318 is	103	03/92→10/95	←			24.0122-0115.1 422115	Ø 286 22 20,4 V + S
318 is	103	09/95→04/99	←			24.0322-0115.1 522115	Ø 286 22 19,6 V + S PD
320 i	110	03/92→04/99	➡			24.0110-0202.1 410202	Ø 280 10 8,4 + S
325 i	141	03/92→04/99	➡			24.0310-0202.1 510202	Ø 280 10 7,6 + S PD
323 i	125	03/95→04/99	←			24.0122-0115.1 422115	Ø 286 22 20,4 V + S
328 i	142	01/95→04/99	←			24.0322-0115.1 522115	Ø 286 22 19,6 V + S PD
			➡			24.0119-0107.1 419107	Ø 276 19 17,4 V + S
			➡			24.0319-0107.1 519107	Ø 276 19 16,6 V + S PD
M3 3.0	210	10/92→01/95	←	☐		24.0128-0198.1 428198	Ø 315 28 26,4 V + S
M3 3.0	217	01/95→10/95	←			24.0328-0198.1 528198	Ø 315 28 25,6 V + S PD
↓							









	kw			 	! #		
BMW - 3 Coupe (E36) 03/92→04/99							
Bremsscheibe							
M3 3.0 M3 3.0	210 217	10/92→01/95 01/95→10/95	←	<input type="checkbox"/>		24.0128-0199.1 428199	Ø 315 28 26,4 V + S
			→	<input type="checkbox"/>		24.0328-0199.1 528199	Ø 315 28 25,6 V + S PD
			→	<input type="checkbox"/>		24.0120-0189.1 420189	Ø 312 20 18,4 V + S
			→	<input type="checkbox"/>		24.0120-0190.1 420190	Ø 312 20 18,4 V + S
M3 3.2	236	10/95→04/99	←	<input type="checkbox"/>		24.0128-0204.2 428204	Ø 315 28 26,4 V Bremsscheibe zweiteilig / + S
			←	<input type="checkbox"/>		24.0128-0205.2 428205	Ø 315 28 26,4 V Bremsscheibe zweiteilig / + S
			→	<input type="checkbox"/>		24.0120-0189.1 420189	Ø 312 20 18,4 V + S
			→	<input type="checkbox"/>		24.0120-0190.1 420190	Ø 312 20 18,4 V + S
BMW - 3 Coupe (E46) 02/99→07/06							
Bremsbelagsatz, Scheibenbremse							
316 Ci 316 Ci 318 Ci 318 Ci 318 Ci 320 Cd 323 Ci 323 Ci 325 Ci 328 Ci	77 85 85 87 110 110 120 125 141 142	04/00→07/06 06/02→07/06 11/99→09/01 11/99→09/01 03/05→07/06 11/03→07/06 04/99→09/00 04/99→09/00 09/00→07/06 04/99→06/00	←			13.0460-5405.2 605405 13.0470-5405.2 LD5405	ATE 21643 17,8 + WE / - WK ATE 21643 17,8 + WE / - WK Ceramic
			→			13.0460-3605.2 603605 13.0470-3605.2 LD3605	ATE 20180 17,3 + WE / - WK ATE 20180 17,3 + WE / - WK Ceramic
318 Ci 318 Ci	100 105	12/00→05/06 12/00→05/06	←	09/01→		13.0460-5405.2 605405 13.0470-5405.2 LD5405	ATE 21643 17,8 + WE / - WK ATE 21643 17,8 + WE / - WK Ceramic
			→	09/01→		13.0460-3605.2 603605 13.0470-3605.2 LD3605	ATE 20180 17,3 + WE / - WK ATE 20180 17,3 + WE / - WK Ceramic
320 Ci	110	02/99→08/01	←	08/99→ 09/00		13.0460-5405.2 605405 13.0470-5405.2 LD5405	ATE 21643 17,8 + WE / - WK ATE 21643 17,8 + WE / - WK Ceramic
			→	08/99→ 09/00		13.0460-3605.2 603605 13.0470-3605.2 LD3605	ATE 20180 17,3 + WE / - WK ATE 20180 17,3 + WE / - WK Ceramic
320 Ci 320 Ci	120 125	01/00→05/06 01/00→05/06	←	09/00→		13.0460-5405.2 605405 13.0470-5405.2 LD5405	ATE 21643 17,8 + WE / - WK ATE 21643 17,8 + WE / - WK Ceramic
			→	09/00→		13.0460-3605.2 603605 13.0470-3605.2 LD3605	ATE 20180 17,3 + WE / - WK ATE 20180 17,3 + WE / - WK Ceramic
330 Cd 330 Ci 330 xi	150 170 170	03/03→07/06 06/00→07/06 06/00→07/06	←			13.0460-7155.2 607155 13.0470-7155.2 LD7155	ATE 21676 20,3 + WE / - WK ATE 21676 20,3 + WE / - WK Ceramic
			→			13.0460-7079.2 607079 13.0470-7079.2 LD7079	ATE 21282 17,3 + WE / - WK ATE 21282 17,3 + WE / - WK Ceramic
M3 M3	252 265	06/00→07/06 06/03→07/06	←			13.0460-7185.2 607185	ATE 20968 20,3 + WE / - WK
			→			13.0460-7079.2 607079 13.0470-7079.2 LD7079	ATE 21282 17,3 + WE / - WK ATE 21282 17,3 + WE / - WK Ceramic
Warnkontakt, Bremsbelagsverschleiß							
316 Ci 316 Ci 318 Ci 318 Ci 318 Ci 320 Cd 323 Ci 323 Ci 325 Ci 328 Ci	77 85 85 87 110 110 120 125 141 142	04/00→07/06 06/02→07/06 11/99→09/01 11/99→09/01 03/05→07/06 11/03→07/06 04/99→09/00 04/99→09/00 09/00→07/06 04/99→06/00	←		1	24.8190-0220.2 620220	L= 601
			→		1	24.8190-0221.2 620221	L= 1.338
318 Ci 318 Ci	100 105	12/00→05/06 12/00→05/06	←	09/01→	1	24.8190-0220.2 620220	L= 601
			→	09/01→	1	24.8190-0221.2 620221	L= 1.338
320 Ci	110	02/99→08/01	←	08/99→ 09/00	1	24.8190-0220.2 620220	L= 601
			→	08/99→ 09/00	1	24.8190-0221.2 620221	L= 1.338
320 Ci 320 Ci	120 125	01/00→05/06 01/00→05/06	←	09/00→	1	24.8190-0220.2 620220	L= 601
↓							









	kw			 	! #		
BMW - 3 Coupe (E46) 02/99→07/06							
Warnkontakt, Bremsbelagverschleiß							
320 Ci	120	01/00→05/06	➡	09/00→	1	24.8190-0221.2 620221	L= 1.338
320 Ci	125	01/00→05/06					
330 Cd	150	03/03→07/06	⬅		1	24.8190-0227.2 620227	L= 651
330 Ci	170	06/00→07/06					
330 xi	170	06/00→07/06	➡		1	24.8190-0221.2 620221	L= 1.338
M3	252	06/00→07/06	⬅		1	24.8190-0227.2 620227	L= 651
M3	265	06/03→07/06	➡		1	24.8190-0228.2 620228	L= 1.353
 Bremsscheibe							
316 Ci	77	04/00→07/06	⬅			24.0122-0115.1 422115	Ø 286 22 20,4 V + S
316 Ci	85	06/02→07/06				24.0322-0115.1 522115	Ø 286 22 19,6 V + S PD
318 Ci	85	11/99→09/01				24.0110-0202.1 410202	Ø 280 10 8,4 + S
318 Ci	87	11/99→09/01	➡			24.0310-0202.1 510202	Ø 280 10 7,6 + S PD
318 Ci	100	12/00→05/06	⬅	09/01→		24.0122-0115.1 422115	Ø 286 22 20,4 V + S
318 Ci	105	12/00→05/06				24.0322-0115.1 522115	Ø 286 22 19,6 V + S PD
			➡	09/01→		24.0119-0107.1 419107	Ø 276 19 17,4 V + S
						24.0319-0107.1 519107	Ø 276 19 16,6 V + S PD
318 Ci	110	03/05→07/06	⬅			24.0122-0115.1 422115	Ø 286 22 20,4 V + S
323 Ci	120	04/99→09/00				24.0322-0115.1 522115	Ø 286 22 19,6 V + S PD
323 Ci	125	04/99→09/00	➡			24.0119-0107.1 419107	Ø 276 19 17,4 V + S
						24.0319-0107.1 519107	Ø 276 19 16,6 V + S PD
320 Cd	110	11/03→07/06	⬅			24.0122-0160.1 422160	Ø 300 22 20,4 V + S
325 Ci	141	09/00→07/06				24.0322-0160.1 522160	Ø 300 22 19,6 V + S PD
328 Ci	142	04/99→06/00	➡			24.0119-0108.1 419108	Ø 294 18,9 17,4 V + S
						24.0319-0108.1 519108	Ø 294 18,9 16,6 V + S PD
320 Ci	110	02/99→08/01	⬅	08/99→ 09/00		24.0122-0115.1 422115	Ø 286 22 20,4 V + S
			➡	08/99→ 09/00		24.0322-0115.1 522115	Ø 286 22 19,6 V + S PD
						24.0119-0107.1 419107	Ø 276 19 17,4 V + S
						24.0319-0107.1 519107	Ø 276 19 16,6 V + S PD
320 Ci	120	01/00→05/06	⬅	09/00→		24.0122-0115.1 422115	Ø 286 22 20,4 V + S
320 Ci	125	01/00→05/06				24.0322-0115.1 522115	Ø 286 22 19,6 V + S PD
			➡	09/00→		24.0119-0107.1 419107	Ø 276 19 17,4 V + S
						24.0319-0107.1 519107	Ø 276 19 16,6 V + S PD
330 Cd	150	03/03→07/06	⬅			24.0125-0138.1 425138	Ø 325 24,9 23,4 V + S
330 Ci	170	06/00→07/06				24.0325-0138.1 525138	Ø 325 24,9 22,6 V + S PD
330 xi	170	06/00→07/06	➡			24.0122-0209.1 422209	Ø 320 22 20,4 V + S
						24.0322-0209.1 522209	Ø 320 22 19,6 V + S PD
M3	252	06/00→07/06	⬅	☐; - Competition Paket		24.0128-0206.2 428206	Ø 325 28 26,4 V• Bremsscheibe zweiteilig / + S
			⬅	☐; - Competition Paket		24.0128-0207.2 428207	Ø 325 28 26,4 V• Bremsscheibe zweiteilig / + S
			⬅	☐; + Competition Paket		24.0128-0208.2 428208	Ø 345 28 26,4 V• Bremsscheibe zweiteilig / + S
			⬅	☐; + Competition Paket		24.0128-0209.2 428209	Ø 345 28 26,4 V• Bremsscheibe zweiteilig / + S
			➡	☐		24.0120-0221.2 420221	Ø 328 20 18,4 V• Bremsscheibe zweiteilig / + S
			➡	☐		24.0120-0222.2 420222	Ø 328 20 18,4 V• Bremsscheibe zweiteilig / + S
M3	265	06/03→07/06	⬅	☐		24.0128-0208.2 428208	Ø 345 28 26,4 V• Bremsscheibe zweiteilig / + S
			⬅	☐		24.0128-0209.2 428209	Ø 345 28 26,4 V• Bremsscheibe zweiteilig / + S
			➡	☐		24.0120-0221.2 420221	Ø 328 20 18,4 V• Bremsscheibe zweiteilig / + S
			➡	☐		24.0120-0222.2 420222	Ø 328 20 18,4 V• Bremsscheibe zweiteilig / + S
BMW - 3 Coupe (E92) 01/05→12/13							
 Bremsbelagsatz, Scheibenbremse							
316 i	90	09/07→12/13	⬅	→ 06/13; + Performance Parts		13.0460-4848.2 604848	BRE 24316 16,9 + WE / - WK
			⬅	→ 02/10		13.0460-7216.2 607216	ATE 23794 20,3 + WE / - WK
						13.0470-7216.2 LD7216	ATE 23794 20,3 + WE / - WK Ceramic
			⬅	03/10→ 06/13		13.0460-7216.2 607216	ATE 23794 20,3 + WE / - WK
↓							











	kw			 	! #		
BMW - 3 Coupe (E92) 01/05→12/13							
 Bremsbelagsatz, Scheibenbremse							
316 i	90	09/07→12/13	←	03/10→ 06/13		13.0470-7216.2 LD7216	ATE 23794 20,3 + WE / - WK Ceramic
			→	→ 02/10		13.0460-2713.2 602713	TRW 23623 17,4 + WE / - WK + Zub
			→	03/10→ 06/13		13.0470-2713.2 LD2713	TRW 23623 17,4 + WE / - WK + Zub Ceramic
318 i	105	03/10→12/13	←	→ 06/13; + Performance Parts		13.0460-4848.2 604848	BRE 24316 16,9 + WE / - WK
			←	→ 06/13		13.0460-7216.2 607216	ATE 23794 20,3 + WE / - WK
			→	→ 06/13		13.0470-7216.2 LD7216	ATE 23794 20,3 + WE / - WK Ceramic
			→	→ 06/13		13.0460-7217.2 607217	ATE 23926 17,3 + WE / - WK
			→	→ 06/13		13.0470-7217.2 LD7217	ATE 23926 17,3 + WE / - WK Ceramic
320 d	120	03/07→06/13	←	+ Performance Parts		13.0460-4848.2 604848	BRE 24316 16,9 + WE / - WK
			←	03/10→		13.0460-7238.2 607238	ATE 23313 20,3 + WE / - WK
						13.0470-7238.2 LD7238	ATE 23313 20,3 + WE / - WK Ceramic
			←	→ 02/10		13.0460-7238.2 607238	ATE 23313 20,3 + WE / - WK
						13.0470-7238.2 LD7238	ATE 23313 20,3 + WE / - WK Ceramic
			→	→ 02/10		13.0460-7217.2 607217	ATE 23926 17,3 + WE / - WK
						13.0470-7217.2 LD7217	ATE 23926 17,3 + WE / - WK Ceramic
			→	→ 02/10		13.0460-7217.2 607217	ATE 23926 17,3 + WE / - WK
						13.0470-7217.2 LD7217	ATE 23926 17,3 + WE / - WK Ceramic
			→	03/10→		13.0460-7217.2 607217	ATE 23926 17,3 + WE / - WK
						13.0470-7217.2 LD7217	ATE 23926 17,3 + WE / - WK Ceramic
320 d 320 d	130 145	09/06→02/10 09/06→02/10	←	03/07→; + Performance Parts		13.0460-4848.2 604848	BRE 24316 16,9 + WE / - WK
			←	03/07→		13.0460-7238.2 607238	ATE 23313 20,3 + WE / - WK
						13.0470-7238.2 LD7238	ATE 23313 20,3 + WE / - WK Ceramic
			→	03/07→		13.0460-7217.2 607217	ATE 23926 17,3 + WE / - WK
						13.0470-7217.2 LD7217	ATE 23926 17,3 + WE / - WK Ceramic
320 d 320 d 320 d xDrive 320 d xDrive 320 d xDrive 320 d xDrive 320 d xDrive 320 xd 320 xd 320 xd	135 147 120 130 135 145 147 120 130 145	03/10→06/13 03/10→06/13 03/10→06/13 09/09→02/10 03/10→06/13 09/09→02/10 03/10→06/13 03/08→02/10 03/08→02/10 03/08→02/10	←	+ Performance Parts		13.0460-4848.2 604848	BRE 24316 16,9 + WE / - WK
			←			13.0460-7238.2 607238	ATE 23313 20,3 + WE / - WK
						13.0470-7238.2 LD7238	ATE 23313 20,3 + WE / - WK Ceramic
			→			13.0460-7217.2 607217	ATE 23926 17,3 + WE / - WK
						13.0470-7217.2 LD7217	ATE 23926 17,3 + WE / - WK Ceramic
320 i	110	11/06→06/07	←	03/07→; + Performance Parts		13.0460-4848.2 604848	BRE 24316 16,9 + WE / - WK
			←	03/07→		13.0460-7216.2 607216	ATE 23794 20,3 + WE / - WK
						13.0470-7216.2 LD7216	ATE 23794 20,3 + WE / - WK Ceramic
			→	03/07→		13.0460-7217.2 607217	ATE 23926 17,3 + WE / - WK
						13.0470-7217.2 LD7217	ATE 23926 17,3 + WE / - WK Ceramic
320 i 320 i	115 125	06/07→12/13 03/07→12/13	←	→ 06/13; + Performance Parts		13.0460-4848.2 604848	BRE 24316 16,9 + WE / - WK
			←	03/10→ 06/13		13.0460-7216.2 607216	ATE 23794 20,3 + WE / - WK
						13.0470-7216.2 LD7216	ATE 23794 20,3 + WE / - WK Ceramic
			←	→ 02/10		13.0460-7216.2 607216	ATE 23794 20,3 + WE / - WK
						13.0470-7216.2 LD7216	ATE 23794 20,3 + WE / - WK Ceramic
			→	03/10→ 06/13		13.0460-7217.2 607217	ATE 23926 17,3 + WE / - WK
						13.0470-7217.2 LD7217	ATE 23926 17,3 + WE / - WK Ceramic
			→	→ 02/10		13.0460-7217.2 607217	ATE 23926 17,3 + WE / - WK
						13.0470-7217.2 LD7217	ATE 23926 17,3 + WE / - WK Ceramic
320 i ↓	120	01/07→12/13	←	03/07→ 06/13; + Performance Parts		13.0460-4848.2 604848	BRE 24316 16,9 + WE / - WK









	kw			 	! #		
BMW - 3 Coupe (E92) 01/05→12/13							
 Bremsbelagsatz, Scheibenbremse							
320 i	120	01/07→12/13	←	03/07→ 02/10	13.0460-7216.2	607216	ATE 23794 20,3 + WE / - WK
			←	03/10→ 06/13	13.0470-7216.2	LD7216	ATE 23794 20,3 + WE / - WK Ceramic
			→	03/10→ 06/13	13.0460-7217.2	607217	ATE 23926 17,3 + WE / - WK
			→	03/07→ 02/10	13.0470-7217.2	LD7217	ATE 23926 17,3 + WE / - WK Ceramic
323 i	140	04/06→02/12	←	09/06→; + Performance Parts	13.0460-4848.2	604848	BRE 24316 16,9 + WE / - WK
			←	09/07→ 02/10	13.0460-7238.2	607238	ATE 23313 20,3 + WE / - WK
			←	03/10→	13.0470-7238.2	LD7238	ATE 23313 20,3 + WE / - WK Ceramic
			→	03/10→	13.0460-7217.2	607217	ATE 23926 17,3 + WE / - WK
			→	09/06→ 02/10	13.0470-7217.2	LD7217	ATE 23926 17,3 + WE / - WK Ceramic
325 d 330 i xDrive 330 xi 330 xi	145 200 190 200	03/07→12/13 09/08→12/13 09/06→12/13 09/06→12/13	←	→ 06/13; + Performance Parts	13.0460-4848.2	604848	BRE 24316 16,9 + WE / - WK
			←	03/10→ 06/13	13.0460-7216.2	607216	ATE 23794 20,3 + WE / - WK
			←	→ 02/10	13.0470-7216.2	LD7216	ATE 23794 20,3 + WE / - WK Ceramic
			→	03/10→ 06/13	13.0460-7225.2	607225	ATE 23550 17,3 + WE / - WK
			→	→ 02/10	13.0470-7225.2	LD7225	ATE 23550 17,3 + WE / - WK Ceramic
325 d	150	04/10→12/13	←	→ 06/13; + Performance Parts	13.0460-4848.2	604848	BRE 24316 16,9 + WE / - WK
			←	→ 06/13	13.0460-7216.2	607216	ATE 23794 20,3 + WE / - WK
			→	→ 06/13	13.0470-7216.2	LD7216	ATE 23794 20,3 + WE / - WK Ceramic
325 d	155	01/07→12/09	←	03/07→; + Performance Parts	13.0460-4848.2	604848	BRE 24316 16,9 + WE / - WK
			←	03/07→	13.0460-7216.2	607216	ATE 23794 20,3 + WE / - WK
			→	03/07→	13.0470-7216.2	LD7216	ATE 23794 20,3 + WE / - WK Ceramic
325 i 325 i 325 i 325 i	155 160 155 160	05/05→06/13 05/05→06/13 01/05→06/13 01/05→06/13	←	09/06→; + Performance Parts	13.0460-4848.2	604848	BRE 24316 16,9 + WE / - WK
			←	03/10→; Motorcode: N53	13.0460-7216.2	607216	ATE 23794 20,3 + WE / - WK
			←	09/06→ 02/10; Motorcode: N53	13.0470-7216.2	LD7216	ATE 23794 20,3 + WE / - WK Ceramic
			←	09/06→ 08/07; Motorcode: N52N	13.0460-7216.2	607216	ATE 23794 20,3 + WE / - WK
			←	03/10→; Motorcode: N52N	13.0470-7216.2	LD7216	ATE 23794 20,3 + WE / - WK Ceramic
			←	09/07→ 02/10; Motorcode: N52N	13.0460-7238.2	607238	ATE 23313 20,3 + WE / - WK
↓			←	09/06→ 02/10; Motorcode: N52N	13.0470-7238.2	LD7238	ATE 23313 20,3 + WE / - WK Ceramic
			←	09/07→ 02/10; Motorcode: N52N	13.0460-7238.2	607238	ATE 23313 20,3 + WE / - WK

	kw			 	! #			
BMW - 3 Coupe (E92) 01/05→12/13								
 Bremsbelagsatz, Scheibenbremse								
325 i	155	05/05→06/13	←	09/07→ 02/10; Motorcode: N52N		13.0470-7238.2	LD7238	ATE 23313 20,3 + WE / - WK Ceramic
325 i	160	05/05→06/13						
325 i	155	01/05→06/13	→	09/06→ 02/10		13.0460-7217.2	607217	ATE 23926 17,3 + WE / - WK
325 i	160	01/05→06/13				13.0470-7217.2	LD7217	ATE 23926 17,3 + WE / - WK Ceramic
			→	03/10→		13.0460-7217.2	607217	ATE 23926 17,3 + WE / - WK
						13.0470-7217.2	LD7217	ATE 23926 17,3 + WE / - WK Ceramic
325 i xDrive	150	03/06→12/13	←	09/06→ 06/13; + Performance Parts		13.0460-4848.2	604848	BRE 24316 16,9 + WE / - WK
			←	09/06→ 08/07		13.0460-7216.2	607216	ATE 23794 20,3 + WE / - WK
						13.0470-7216.2	LD7216	ATE 23794 20,3 + WE / - WK Ceramic
			←	09/07→ 02/10		13.0460-7238.2	607238	ATE 23313 20,3 + WE / - WK
						13.0470-7238.2	LD7238	ATE 23313 20,3 + WE / - WK Ceramic
			←	03/10→ 06/13		13.0460-7238.2	607238	ATE 23313 20,3 + WE / - WK
						13.0470-7238.2	LD7238	ATE 23313 20,3 + WE / - WK Ceramic
			→	09/06→ 02/10		13.0460-7217.2	607217	ATE 23926 17,3 + WE / - WK
						13.0470-7217.2	LD7217	ATE 23926 17,3 + WE / - WK Ceramic
			→	03/10→ 06/13		13.0460-7217.2	607217	ATE 23926 17,3 + WE / - WK
						13.0470-7217.2	LD7217	ATE 23926 17,3 + WE / - WK Ceramic
325 i xDrive 325 xi	160 160	09/08→12/13 09/07→12/13	←	→ 06/13; + Performance Parts		13.0460-4848.2	604848	BRE 24316 16,9 + WE / - WK
			←	→ 02/10		13.0460-7238.2	607238	ATE 23313 20,3 + WE / - WK
						13.0470-7238.2	LD7238	ATE 23313 20,3 + WE / - WK Ceramic
			←	03/10→ 06/13		13.0460-7238.2	607238	ATE 23313 20,3 + WE / - WK
						13.0470-7238.2	LD7238	ATE 23313 20,3 + WE / - WK Ceramic
			→	→ 02/10		13.0460-7217.2	607217	ATE 23926 17,3 + WE / - WK
						13.0470-7217.2	LD7217	ATE 23926 17,3 + WE / - WK Ceramic
			→	03/10→ 06/13		13.0460-7217.2	607217	ATE 23926 17,3 + WE / - WK
						13.0470-7217.2	LD7217	ATE 23926 17,3 + WE / - WK Ceramic
325 xi	160	09/06→12/13	←	→ 06/13; + Performance Parts		13.0460-4848.2	604848	BRE 24316 16,9 + WE / - WK
			←	→ 08/07		13.0460-7216.2	607216	ATE 23794 20,3 + WE / - WK
						13.0470-7216.2	LD7216	ATE 23794 20,3 + WE / - WK Ceramic
			←	09/07→ 02/10		13.0460-7238.2	607238	ATE 23313 20,3 + WE / - WK
						13.0470-7238.2	LD7238	ATE 23313 20,3 + WE / - WK Ceramic
			←	03/10→ 06/13		13.0460-7238.2	607238	ATE 23313 20,3 + WE / - WK
						13.0470-7238.2	LD7238	ATE 23313 20,3 + WE / - WK Ceramic
			→	→ 02/10		13.0460-7217.2	607217	ATE 23926 17,3 + WE / - WK
						13.0470-7217.2	LD7217	ATE 23926 17,3 + WE / - WK Ceramic
			→	03/10→ 06/13		13.0460-7217.2	607217	ATE 23926 17,3 + WE / - WK
						13.0470-7217.2	LD7217	ATE 23926 17,3 + WE / - WK Ceramic
328 i	172	06/07→12/13	←	→ 06/13		13.0460-7216.2	607216	ATE 23794 20,3 + WE / - WK
						13.0470-7216.2	LD7216	ATE 23794 20,3 + WE / - WK Ceramic
			→	→ 02/10		13.0460-7217.2	607217	ATE 23926 17,3 + WE / - WK
						13.0470-7217.2	LD7217	ATE 23926 17,3 + WE / - WK Ceramic
			→	03/10→ 06/13		13.0460-7217.2	607217	ATE 23926 17,3 + WE / - WK
						13.0470-7217.2	LD7217	ATE 23926 17,3 + WE / - WK Ceramic
328 i xDrive	172	09/09→06/13	←			13.0460-7216.2	607216	ATE 23794 20,3 + WE / - WK
						13.0470-7216.2	LD7216	ATE 23794 20,3 + WE / - WK Ceramic
			→	03/10→		13.0460-7217.2	607217	ATE 23926 17,3 + WE / - WK







	kw			 	! #					
BMW - 3 Coupe (E92) 01/05→12/13										
 Bremsbelagsatz, Scheibenbremse										
328 i xDrive	172	09/09→06/13	➡	03/10→		13.0470-7217.2 LD7217	ATE 23926 17,3 + WE / - WK Ceramic			
			➡	→ 02/10		13.0460-7217.2 607217 13.0470-7217.2 LD7217	ATE 23926 17,3 + WE / - WK ATE 23926 17,3 + WE / - WK Ceramic			
330 d 330 d 330 d xDrive 330 xd 330 xd	170 180 180 170 180	09/06→12/13 01/09→12/13 01/09→12/13 09/06→12/13 01/09→12/13	←	→ 06/13; + Performance Parts		13.0460-4848.2 604848	BRE 24316 16,9 + WE / - WK			
			←	03/10→ 06/13; nicht für erhöhte Nutzlast		13.0460-7216.2 607216 13.0470-7216.2 LD7216	ATE 23794 20,3 + WE / - WK ATE 23794 20,3 + WE / - WK Ceramic			
			←	09/09→ 02/10; nicht für erhöhte Nutzlast		13.0460-7216.2 607216 13.0470-7216.2 LD7216	ATE 23794 20,3 + WE / - WK ATE 23794 20,3 + WE / - WK Ceramic			
			←	03/10→ 06/13; für erhöhte Nutzlast		13.0460-7237.2 607237 13.0460-7238.2 607238 13.0470-7237.2 LD7237 13.0470-7238.2 LD7238	ATE 23347 20,3 + WE / - WK ATE 23313 20,3 + WE / - WK ATE 23347 20,3 + WE / - WK Ceramic ATE 23313 20,3 + WE / - WK Ceramic			
			←	→ 08/09		13.0460-7237.2 607237 13.0460-7238.2 607238 13.0470-7237.2 LD7237 13.0470-7238.2 LD7238	ATE 23347 20,3 + WE / - WK ATE 23313 20,3 + WE / - WK ATE 23347 20,3 + WE / - WK Ceramic ATE 23313 20,3 + WE / - WK Ceramic			
			←	09/09→ 02/10; für erhöhte Nutzlast		13.0460-7237.2 607237 13.0460-7238.2 607238 13.0470-7237.2 LD7237 13.0470-7238.2 LD7238	ATE 23347 20,3 + WE / - WK ATE 23313 20,3 + WE / - WK ATE 23347 20,3 + WE / - WK Ceramic ATE 23313 20,3 + WE / - WK Ceramic			
			➡	→ 02/10		13.0460-7225.2 607225 13.0470-7225.2 LD7225	ATE 23550 17,3 + WE / - WK ATE 23550 17,3 + WE / - WK Ceramic			
			➡	03/10→ 06/13		13.0460-7225.2 607225 13.0470-7225.2 LD7225	ATE 23550 17,3 + WE / - WK ATE 23550 17,3 + WE / - WK Ceramic			
			330 i 330 i	190 200	09/06→12/13 03/07→12/13	←	→ 06/13; + Performance Parts		13.0460-4848.2 604848	BRE 24316 16,9 + WE / - WK
						←	03/10→ 06/13; Motorcode: N53; nicht für erhöhte Nutzlast		13.0460-7216.2 607216 13.0470-7216.2 LD7216	ATE 23794 20,3 + WE / - WK ATE 23794 20,3 + WE / - WK Ceramic
←	→ 02/10; Motorcode: N52N					13.0460-7216.2 607216 13.0470-7216.2 LD7216	ATE 23794 20,3 + WE / - WK ATE 23794 20,3 + WE / - WK Ceramic			
←	03/10→ 06/13; Motorcode: N52N					13.0460-7216.2 607216 13.0470-7216.2 LD7216	ATE 23794 20,3 + WE / - WK ATE 23794 20,3 + WE / - WK Ceramic			
←	09/09→ 02/10; Motorcode: N53; nicht für erhöhte Nutzlast					13.0460-7216.2 607216 13.0470-7216.2 LD7216	ATE 23794 20,3 + WE / - WK ATE 23794 20,3 + WE / - WK Ceramic			
←	03/10→ 06/13; Motorcode: N53; für erhöhte Nutzlast					13.0460-7237.2 607237 13.0460-7238.2 607238 13.0470-7237.2 LD7237 13.0470-7238.2 LD7238	ATE 23347 20,3 + WE / - WK ATE 23313 20,3 + WE / - WK ATE 23347 20,3 + WE / - WK Ceramic ATE 23313 20,3 + WE / - WK Ceramic			
←	→ 08/09; Motorcode: N53					13.0460-7237.2 607237 13.0460-7238.2 607238 13.0470-7237.2 LD7237 13.0470-7238.2 LD7238	ATE 23347 20,3 + WE / - WK ATE 23313 20,3 + WE / - WK ATE 23347 20,3 + WE / - WK Ceramic ATE 23313 20,3 + WE / - WK Ceramic			
←	09/09→ 02/10; Motorcode: N53; für erhöhte Nutzlast					13.0460-7237.2 607237 13.0460-7238.2 607238 13.0470-7237.2 LD7237 13.0470-7238.2 LD7238	ATE 23347 20,3 + WE / - WK ATE 23313 20,3 + WE / - WK ATE 23347 20,3 + WE / - WK Ceramic ATE 23313 20,3 + WE / - WK Ceramic			
↓										

















	kw			 	! #		
BMW - 3 Coupe (E92) 01/05→12/13							
 Bremsbelagsatz, Scheibenbremse							
330 i 330 i	190 200	09/06→12/13 03/07→12/13	➡	03/10→ 06/13		13.0460-7225.2 607225	ATE 23550 17,3 + WE / - WK
						13.0470-7225.2 LD7225	ATE 23550 17,3 + WE / - WK Ceramic
			➡	→ 02/10		13.0460-7225.2 607225	ATE 23550 17,3 + WE / - WK
						13.0470-7225.2 LD7225	ATE 23550 17,3 + WE / - WK Ceramic
330 i	200	09/06→02/10	←	+ Performance Parts		13.0460-4848.2 604848	BRE 24316 16,9 + WE / - WK
			←	09/09→; Motorcode: N53; nicht für erhöhte Nutzlast		13.0460-7216.2 607216	ATE 23794 20,3 + WE / - WK
						13.0470-7216.2 LD7216	ATE 23794 20,3 + WE / - WK Ceramic
			←	Motorcode: N52N		13.0460-7216.2 607216	ATE 23794 20,3 + WE / - WK
						13.0470-7216.2 LD7216	ATE 23794 20,3 + WE / - WK Ceramic
			←	09/09→; Motorcode: N53; für erhöhte Nutzlast		13.0460-7237.2 607237	ATE 23347 20,3 + WE / - WK
						13.0460-7238.2 607238	ATE 23313 20,3 + WE / - WK
			13.0470-7237.2 LD7237	ATE 23347 20,3 + WE / - WK Ceramic			
					13.0470-7238.2 LD7238	ATE 23313 20,3 + WE / - WK Ceramic	
			←	→ 08/09; Motorcode: N53		13.0460-7237.2 607237	ATE 23347 20,3 + WE / - WK
						13.0460-7238.2 607238	ATE 23313 20,3 + WE / - WK
						13.0470-7237.2 LD7237	ATE 23347 20,3 + WE / - WK Ceramic
						13.0470-7238.2 LD7238	ATE 23313 20,3 + WE / - WK Ceramic
			➡			13.0460-7225.2 607225	ATE 23550 17,3 + WE / - WK
						13.0470-7225.2 LD7225	ATE 23550 17,3 + WE / - WK Ceramic
335 d 335 i xDrive	210 225	09/06→12/13 11/08→12/13	←	→ 02/10		13.0460-7237.2 607237	ATE 23347 20,3 + WE / - WK
						13.0460-7238.2 607238	ATE 23313 20,3 + WE / - WK
						13.0470-7237.2 LD7237	ATE 23347 20,3 + WE / - WK Ceramic
						13.0470-7238.2 LD7238	ATE 23313 20,3 + WE / - WK Ceramic
			←	03/10→ 06/13		13.0460-7237.2 607237	ATE 23347 20,3 + WE / - WK
			13.0460-7238.2 607238	ATE 23313 20,3 + WE / - WK			
						13.0470-7237.2 LD7237	ATE 23347 20,3 + WE / - WK Ceramic
						13.0470-7238.2 LD7238	ATE 23313 20,3 + WE / - WK Ceramic
			➡	→ 02/10		13.0460-7225.2 607225	ATE 23550 17,3 + WE / - WK
						13.0470-7225.2 LD7225	ATE 23550 17,3 + WE / - WK Ceramic
			➡	03/10→ 06/13		13.0460-7225.2 607225	ATE 23550 17,3 + WE / - WK
						13.0470-7225.2 LD7225	ATE 23550 17,3 + WE / - WK Ceramic
335 i 335 i	225 240	11/05→06/13 11/05→06/13	←	03/10→		13.0460-7237.2 607237	ATE 23347 20,3 + WE / - WK
						13.0460-7238.2 607238	ATE 23313 20,3 + WE / - WK
						13.0470-7237.2 LD7237	ATE 23347 20,3 + WE / - WK Ceramic
						13.0470-7238.2 LD7238	ATE 23313 20,3 + WE / - WK Ceramic
			←	09/06→ 02/10		13.0460-7237.2 607237	ATE 23347 20,3 + WE / - WK
			13.0460-7238.2 607238	ATE 23313 20,3 + WE / - WK			
						13.0470-7237.2 LD7237	ATE 23347 20,3 + WE / - WK Ceramic
						13.0470-7238.2 LD7238	ATE 23313 20,3 + WE / - WK Ceramic
			➡	09/06→ 02/10		13.0460-7225.2 607225	ATE 23550 17,3 + WE / - WK
						13.0470-7225.2 LD7225	ATE 23550 17,3 + WE / - WK Ceramic
			➡	03/10→		13.0460-7225.2 607225	ATE 23550 17,3 + WE / - WK
						13.0470-7225.2 LD7225	ATE 23550 17,3 + WE / - WK Ceramic
335 i xDrive ↓	240	11/08→06/13	←	03/10→		13.0460-7237.2 607237	ATE 23347 20,3 + WE / - WK
						13.0460-7238.2 607238	ATE 23313 20,3 + WE / - WK







	kW			 	! #		
BMW - 3 Coupe (E92) 01/05→12/13							
 Bremsbelagsatz, Scheibenbremse							
335 i xDrive	240	11/08→06/13	←	03/10→		13.0470-7237.2 LD7237	ATE 23347 20,3 + WE / - WK Ceramic
						13.0470-7238.2 LD7238	ATE 23313 20,3 + WE / - WK Ceramic
			←	→ 02/10		13.0460-7237.2 607237	ATE 23347 20,3 + WE / - WK
						13.0460-7238.2 607238	ATE 23313 20,3 + WE / - WK
						13.0470-7237.2 LD7237	ATE 23347 20,3 + WE / - WK Ceramic
			→	03/10→		13.0470-7238.2 LD7238	ATE 23313 20,3 + WE / - WK Ceramic
			→	03/10→		13.0460-7225.2 607225	ATE 23550 17,3 + WE / - WK
						13.0470-7225.2 LD7225	ATE 23550 17,3 + WE / - WK Ceramic
			→	02/10		13.0460-7225.2 607225	ATE 23550 17,3 + WE / - WK
						13.0470-7225.2 LD7225	ATE 23550 17,3 + WE / - WK Ceramic
335 xi 335 xi	225 240	03/07→02/10 03/07→02/10	←	09/07→		13.0460-7237.2 607237	ATE 23347 20,3 + WE / - WK
						13.0460-7238.2 607238	ATE 23313 20,3 + WE / - WK
						13.0470-7237.2 LD7237	ATE 23347 20,3 + WE / - WK Ceramic
						13.0470-7238.2 LD7238	ATE 23313 20,3 + WE / - WK Ceramic
			→	09/07→		13.0460-7225.2 607225	ATE 23550 17,3 + WE / - WK
						13.0470-7225.2 LD7225	ATE 23550 17,3 + WE / - WK Ceramic
M M GTS	309 331	03/07→12/13 03/07→12/13	←	→ 06/13		13.0460-7167.2 607167	ATE 23312 20,3 + WE / - WK
			→	→ 02/10		13.0460-7169.2 607169	ATE 23309 17,3 + WE / - WK
						13.0470-7169.2 LD7169	ATE 23309 17,3 + WE / - WK Ceramic
			→	03/10→ 06/13		13.0460-7169.2 607169	ATE 23309 17,3 + WE / - WK
						13.0470-7169.2 LD7169	ATE 23309 17,3 + WE / - WK Ceramic
Warnkontakt, Bremsbelagverschleiß							
316 i 320 i 320 i 325 d	90 115 125 145	09/07→12/13 06/07→12/13 03/07→12/13 03/07→12/13	←	→ 02/10	1	24.8190-0264.2 620264	L= 630
			←	→ 06/13; + Performance Parts	1	24.8190-0267.2 620267	L= 679
			←	03/10→ 06/13	1	24.8190-0284.2 620284	L= 650
			→	→ 02/10	1	24.8190-0265.2 620265	L= 1.086
			→	03/10→ 06/13	1	24.8190-0285.2 620285	L= 1.107
318 i 325 d	105 150	03/10→12/13 04/10→12/13	←	→ 06/13; + Performance Parts	1	24.8190-0267.2 620267	L= 679
			←	→ 06/13	1	24.8190-0284.2 620284	L= 650
			→	→ 06/13	1	24.8190-0285.2 620285	L= 1.107
320 d	120	03/07→06/13	←	→ 02/10	1	24.8190-0267.2 620267	L= 679
			←	+ Performance Parts	1	24.8190-0267.2 620267	L= 679
			←	03/10→	1	24.8190-0287.2 620287	L= 723
			→	→ 02/10	1	24.8190-0265.2 620265	L= 1.086
			→	03/10→	1	24.8190-0285.2 620285	L= 1.107
320 d 320 d	130 145	09/06→02/10 09/06→02/10	←	03/07→	1	24.8190-0267.2 620267	L= 679
			←	03/07→; + Performance Parts	1	24.8190-0267.2 620267	L= 679
			→	03/07→	1	24.8190-0265.2 620265	L= 1.086
320 d 320 d	135 147	03/10→06/13 03/10→06/13	←	+ Performance Parts	1	24.8190-0267.2 620267	L= 679
			←		1	24.8190-0287.2 620287	L= 723
			→		1	24.8190-0285.2 620285	L= 1.107
320 d xDrive 320 d xDrive 320 d xDrive	120 135 147	03/10→06/13 03/10→06/13 03/10→06/13	←	+ Performance Parts	1	24.8190-0267.2 620267	L= 679
			←		1	24.8190-0286.2 620286	L= 867
			→		1	24.8190-0285.2 620285	L= 1.107
320 d xDrive 320 d xDrive 320 xd 320 xd 320 xd	130 145 120 130 145	09/09→02/10 09/09→02/10 03/08→02/10 03/08→02/10 03/08→02/10	←		1	24.8190-0266.2 620266	L= 840
			←	+ Performance Parts	1	24.8190-0267.2 620267	L= 679
			→		1	24.8190-0265.2 620265	L= 1.086
			→		1	24.8190-0265.2 620265	L= 1.086
			→		1	24.8190-0265.2 620265	L= 1.086
320 i ↓	110	11/06→06/07	←	03/07→	1	24.8190-0264.2 620264	L= 630

















	kw			 	! #		
BMW - 3 Coupe (E92) 01/05→12/13							
Warnkontakt, Bremsbelagverschleiß							
325 d	155	01/07→12/09	←	03/07→; + Performance Parts	1	24.8190-0267.2 620267	L= 679
			→	03/07→	1	24.8190-0265.2 620265	L= 1.086
320 i	120	01/07→12/13	←	03/07→ 02/10	1	24.8190-0264.2 620264	L= 630
			←	03/07→ 06/13; + Performance Parts	1	24.8190-0267.2 620267	L= 679
			←	03/10→ 06/13	1	24.8190-0284.2 620284	L= 650
			→	03/07→ 02/10	1	24.8190-0265.2 620265	L= 1.086
			→	03/10→ 06/13	1	24.8190-0285.2 620285	L= 1.107
323 i	140	04/06→02/12	←	09/07→ 02/10	1	24.8190-0267.2 620267	L= 679
			←	09/06→; + Performance Parts	1	24.8190-0267.2 620267	L= 679
			←	03/10→	1	24.8190-0287.2 620287	L= 723
			→	09/06→ 02/10	1	24.8190-0265.2 620265	L= 1.086
			→	03/10→	1	24.8190-0285.2 620285	L= 1.107
325 i 325 i 325 i 325 i	155 160 155 160	05/05→06/13 05/05→06/13 01/05→06/13 01/05→06/13	←	09/06→ 08/07; Motorcode: N52N	1	24.8190-0264.2 620264	L= 630
			←	09/06→ 02/10; Motorcode: N53	1	24.8190-0264.2 620264	L= 630
			←	09/07→ 02/10; Motorcode: N52N	1	24.8190-0267.2 620267	L= 679
			←	09/06→; + Performance Parts	1	24.8190-0267.2 620267	L= 679
			←	03/10→; Motorcode: N53	1	24.8190-0284.2 620284	L= 650
			←	03/10→; Motorcode: N52N	1	24.8190-0287.2 620287	L= 723
			→	09/06→ 02/10	1	24.8190-0265.2 620265	L= 1.086
			→	03/10→	1	24.8190-0285.2 620285	L= 1.107
			325 i xDrive	150	03/06→12/13	←	09/07→ 02/10
←	09/06→ 08/07	1				24.8190-0266.2 620266	L= 840
←	09/06→ 06/13; + Performance Parts	1				24.8190-0267.2 620267	L= 679
←	03/10→ 06/13	1				24.8190-0286.2 620286	L= 867
→	09/06→ 02/10	1				24.8190-0265.2 620265	L= 1.086
→	03/10→ 06/13	1				24.8190-0285.2 620285	L= 1.107
325 i xDrive 325 xi 330 i xDrive 330 xi 330 xi	160 160 200 190 200	09/08→12/13 09/07→12/13 09/08→12/13 09/06→12/13 09/06→12/13	←	→ 02/10	1	24.8190-0266.2 620266	L= 840
			←	→ 06/13; + Performance Parts	1	24.8190-0267.2 620267	L= 679
			←	03/10→ 06/13	1	24.8190-0286.2 620286	L= 867
			→	→ 02/10	1	24.8190-0265.2 620265	L= 1.086
			→	03/10→ 06/13	1	24.8190-0285.2 620285	L= 1.107
325 xi	160	09/06→12/13	←	→ 08/07	1	24.8190-0266.2 620266	L= 840
			←	09/07→ 02/10	1	24.8190-0266.2 620266	L= 840
			←	→ 06/13; + Performance Parts	1	24.8190-0267.2 620267	L= 679
			←	03/10→ 06/13	1	24.8190-0286.2 620286	L= 867
			→	→ 02/10	1	24.8190-0265.2 620265	L= 1.086
328 i	172	06/07→12/13	←	→ 06/13	1	24.8190-0266.2 620266	L= 840
			→	→ 02/10	1	24.8190-0265.2 620265	L= 1.086
			→	03/10→ 06/13	1	24.8190-0285.2 620285	L= 1.107
328 i xDrive	172	09/09→06/13	←		1	24.8190-0266.2 620266	L= 840
			→	→ 02/10	1	24.8190-0265.2 620265	L= 1.086
			→	03/10→	1	24.8190-0285.2 620285	L= 1.107
330 d 330 d	170 180	09/06→12/13 01/09→12/13	←	09/09→ 02/10; nicht für erhöhte Nutzlast	1	24.8190-0267.2 620267	L= 679
			←	→ 08/09	1	24.8190-0267.2 620267	L= 679
			←	09/09→ 02/10; für erhöhte Nutzlast	1	24.8190-0267.2 620267	L= 679
			←	→ 06/13; + Performance Parts	1	24.8190-0267.2 620267	L= 679
			←	03/10→ 06/13; nicht für erhöhte Nutzlast	1	24.8190-0287.2 620287	L= 723
			←	03/10→ 06/13; für erhöhte Nutzlast	1	24.8190-0287.2 620287	L= 723
			→	→ 02/10	1	24.8190-0265.2 620265	L= 1.086
			→	03/10→ 06/13	1	24.8190-0285.2 620285	L= 1.107
330 d xDrive 330 xd 330 xd	180 170 180	01/09→12/13 09/06→12/13 01/09→12/13	←	09/09→ 02/10; nicht für erhöhte Nutzlast	1	24.8190-0266.2 620266	L= 840
			←	→ 08/09	1	24.8190-0266.2 620266	L= 840
			↓				







	kW			 	! #		
BMW - 3 Coupe (E92) 01/05→12/13							
Warnkontakt, Bremsbelagverschleiß							
330 d xDrive 330 xd 330 xd	180 170 180	01/09→12/13 09/06→12/13 01/09→12/13	←	09/09→ 02/10; für erhöhte Nutzlast	1	24.8190-0266.2 620266	L= 840
			←	→ 06/13; + Performance Parts	1	24.8190-0267.2 620267	L= 679
			←	03/10→ 06/13; nicht für erhöhte Nutzlast	1	24.8190-0286.2 620286	L= 867
			←	03/10→ 06/13; für erhöhte Nutzlast	1	24.8190-0286.2 620286	L= 867
			→	→ 02/10	1	24.8190-0265.2 620265	L= 1.086
			→	03/10→ 06/13	1	24.8190-0285.2 620285	L= 1.107
330 i 330 i	190 200	09/06→12/13 03/07→12/13	←	→ 02/10; Motorcode: N52N	1	24.8190-0264.2 620264	L= 630
			←	→ 08/09; Motorcode: N53	1	24.8190-0267.2 620267	L= 679
			←	09/09→ 02/10; Motorcode: N53; nicht für erhöhte Nutzlast	1	24.8190-0267.2 620267	L= 679
			←	09/09→ 02/10; Motorcode: N53; für erhöhte Nutzlast	1	24.8190-0267.2 620267	L= 679
			←	→ 06/13; + Performance Parts	1	24.8190-0267.2 620267	L= 679
			←	03/10→ 06/13; Motorcode: N52N	1	24.8190-0284.2 620284	L= 650
			←	03/10→ 06/13; Motorcode: N53; nicht für erhöhte Nutzlast	1	24.8190-0287.2 620287	L= 723
			←	03/10→ 06/13; Motorcode: N53; für erhöhte Nutzlast	1	24.8190-0287.2 620287	L= 723
			→	→ 02/10	1	24.8190-0265.2 620265	L= 1.086
→	03/10→ 06/13	1	24.8190-0285.2 620285	L= 1.107			
330 i	200	09/06→02/10	←	Motorcode: N52N	1	24.8190-0264.2 620264	L= 630
			←	+ Performance Parts	1	24.8190-0267.2 620267	L= 679
			←	09/09→; Motorcode: N53; nicht für erhöhte Nutzlast	1	24.8190-0267.2 620267	L= 679
			←	→ 08/09; Motorcode: N53	1	24.8190-0267.2 620267	L= 679
			←	09/09→; Motorcode: N53; für erhöhte Nutzlast	1	24.8190-0267.2 620267	L= 679
			→		1	24.8190-0265.2 620265	L= 1.086
335 d	210	09/06→12/13	←	→ 02/10	1	24.8190-0267.2 620267	L= 679
			←	03/10→ 06/13	1	24.8190-0287.2 620287	L= 723
			→	→ 02/10	1	24.8190-0265.2 620265	L= 1.086
			→	03/10→ 06/13	1	24.8190-0285.2 620285	L= 1.107
			→				
335 i 335 i	225 240	11/05→06/13 11/05→06/13	←	09/06→ 02/10	1	24.8190-0267.2 620267	L= 679
			←	03/10→	1	24.8190-0287.2 620287	L= 723
			→	09/06→ 02/10	1	24.8190-0265.2 620265	L= 1.086
			→	03/10→	1	24.8190-0285.2 620285	L= 1.107
335 i xDrive	225	11/08→12/13	←	→ 02/10	1	24.8190-0266.2 620266	L= 840
			←	03/10→ 06/13	1	24.8190-0286.2 620286	L= 867
			→	→ 02/10	1	24.8190-0265.2 620265	L= 1.086
			→	03/10→ 06/13	1	24.8190-0285.2 620285	L= 1.107
335 i xDrive	240	11/08→06/13	←	→ 02/10	1	24.8190-0266.2 620266	L= 840
			←	03/10→	1	24.8190-0286.2 620286	L= 867
			→	→ 02/10	1	24.8190-0265.2 620265	L= 1.086
			→	03/10→	1	24.8190-0285.2 620285	L= 1.107
335 xi 335 xi	225 240	03/07→02/10 03/07→02/10	←	09/07→	1	24.8190-0266.2 620266	L= 840
			→	09/07→	1	24.8190-0265.2 620265	L= 1.086
M M GTS	309 331	03/07→12/13 03/07→12/13	←	☐; → 06/13		24.8190-0271.2 620271	L= 659
			←	☐; → 06/13		24.8190-0272.2 620272	L= 672
			→	→ 02/10	1	24.8190-0265.2 620265	L= 1.086
			→	03/10→ 06/13	1	24.8190-0285.2 620285	L= 1.107
Bremsscheibe							
316 i	90	09/07→12/13	←	→ 06/13		24.0124-0197.1 424197	Ø 300 24 22,4 V + S
			→	→ 06/13		24.0324-0197.1 524197	Ø 300 24 21,6 V + S PD
318 i 320 i ↓	105 115	03/10→12/13 06/07→12/13	←	→ 06/13		24.0110-0315.1 410315	Ø 296 10,4 8,9 + S
						24.0310-0315.1 510315	Ø 296 10,4 8,1 + S PD









	kw			 	! #		
BMW - 3 Coupe (E92) 01/05→12/13							
Bremsscheibe							
320 i	125	03/07→12/13	←	→ 06/13		24.0324-0197.1 524197	Ø 300 24 21,6 V + S PD
			→	→ 06/13		24.0120-0195.1 420195	Ø 300 20 18,4 V + S
320 d	120	03/07→06/13	←			24.0124-0203.1 424203	Ø 312 23,9 22,4 V + S
			→			24.0324-0203.1 524203	Ø 312 23,9 21,6 V + S PD
320 d	135	03/10→06/13	←			24.0120-0195.1 420195	Ø 300 20 18,4 V + S
			→			24.0320-0195.1 520195	Ø 300 20 17,6 V + S PD
320 d	147	03/10→06/13	←			24.0124-0203.1 424203	Ø 312 23,9 22,4 V + S
			→			24.0324-0203.1 524203	Ø 312 23,9 21,6 V + S PD
320 d	130	09/06→02/10	←	03/07→		24.0124-0203.1 424203	Ø 312 23,9 22,4 V + S
			→	03/07→		24.0324-0203.1 524203	Ø 312 23,9 21,6 V + S PD
320 d	145	09/06→02/10	←			24.0120-0195.1 420195	Ø 300 20 18,4 V + S
			→			24.0320-0195.1 520195	Ø 300 20 17,6 V + S PD
320 d xDrive	120	03/10→06/13	←			24.0124-0203.1 424203	Ø 312 23,9 22,4 V + S
			→			24.0324-0203.1 524203	Ø 312 23,9 21,6 V + S PD
320 d xDrive	130	09/09→02/10	←			24.0120-0204.1 420204	Ø 300 20 18,4 V + S
			→			24.0320-0204.1 520204	Ø 300 20 17,6 V + S PD
320 d xDrive	135	03/10→06/13	←			24.0124-0203.1 424203	Ø 312 23,9 22,4 V + S
			→			24.0324-0203.1 524203	Ø 312 23,9 21,6 V + S PD
320 d xDrive	145	09/09→02/10	←			24.0120-0204.1 420204	Ø 300 20 18,4 V + S
			→			24.0320-0204.1 520204	Ø 300 20 17,6 V + S PD
320 d xDrive	147	03/10→06/13	←			24.0124-0203.1 424203	Ø 312 23,9 22,4 V + S
			→			24.0324-0203.1 524203	Ø 312 23,9 21,6 V + S PD
320 xd	120	03/08→02/10	←			24.0120-0195.1 420195	Ø 300 20 18,4 V + S
			→			24.0320-0195.1 520195	Ø 300 20 17,6 V + S PD
320 xd	130	03/08→02/10	←			24.0124-0203.1 424203	Ø 312 23,9 22,4 V + S
			→			24.0324-0203.1 524203	Ø 312 23,9 21,6 V + S PD
320 xd	145	03/08→02/10	←			24.0120-0195.1 420195	Ø 300 20 18,4 V + S
			→			24.0320-0195.1 520195	Ø 300 20 17,6 V + S PD
328 i xDrive	172	09/09→06/13	←			24.0124-0203.1 424203	Ø 312 23,9 22,4 V + S
			→			24.0324-0203.1 524203	Ø 312 23,9 21,6 V + S PD
320 i	110	11/06→06/07	←	03/07→		24.0124-0197.1 424197	Ø 300 24 22,4 V + S
			→	03/07→		24.0324-0197.1 524197	Ø 300 24 21,6 V + S PD
320 i	120	01/07→12/13	←	03/07→ 06/13		24.0120-0195.1 420195	Ø 300 20 18,4 V + S
			→	03/07→ 06/13		24.0320-0195.1 520195	Ø 300 20 17,6 V + S PD
320 i	120	01/07→12/13	←			24.0124-0197.1 424197	Ø 300 24 22,4 V + S
			→			24.0324-0197.1 524197	Ø 300 24 21,6 V + S PD
320 i	120	01/07→12/13	←			24.0120-0195.1 420195	Ø 300 20 18,4 V + S
			→			24.0320-0195.1 520195	Ø 300 20 17,6 V + S PD
323 i	140	04/06→02/12	←	09/06→ 08/07		24.0124-0197.1 424197	Ø 300 24 22,4 V + S
			→	09/06→		24.0324-0197.1 524197	Ø 300 24 21,6 V + S PD
323 i	140	04/06→02/12	←	09/07→		24.0124-0203.1 424203	Ø 312 23,9 22,4 V + S
			→	09/07→		24.0324-0203.1 524203	Ø 312 23,9 21,6 V + S PD
323 i	140	04/06→02/12	←			24.0120-0195.1 420195	Ø 300 20 18,4 V + S
			→			24.0320-0195.1 520195	Ø 300 20 17,6 V + S PD
325 d	145	03/07→12/13	←	→ 06/13		24.0124-0200.1 424200	Ø 330 24 22,4 V + S
			→	→ 06/13		24.0324-0200.1 524200	Ø 330 24 21,6 V + S PD
325 d	150	04/10→12/13	←			24.0122-0236.1 422236	Ø 336 22 20,4 V + S
			→			24.0322-0236.1 522236	Ø 336 22 19,6 V + S PD
330 i xDrive	200	09/08→12/13	←			24.0124-0200.1 424200	Ø 330 24 22,4 V + S
			→			24.0324-0200.1 524200	Ø 330 24 21,6 V + S PD
330 xi	190	09/06→12/13	←			24.0122-0236.1 422236	Ø 336 22 20,4 V + S
			→			24.0322-0236.1 522236	Ø 336 22 19,6 V + S PD
330 xi	200	09/06→12/13	←			24.0124-0200.1 424200	Ø 330 24 22,4 V + S
			→			24.0324-0200.1 524200	Ø 330 24 21,6 V + S PD
325 d	155	01/07→12/09	←	03/07→		24.0124-0200.1 424200	Ø 330 24 22,4 V + S
			→	03/07→		24.0324-0200.1 524200	Ø 330 24 21,6 V + S PD
325 d	155	01/07→12/09	←			24.0122-0236.1 422236	Ø 336 22 20,4 V + S
			→			24.0322-0236.1 522236	Ø 336 22 19,6 V + S PD
325 i	155	05/05→06/13	←	09/06→; Motorcode: N53		24.0124-0200.1 424200	Ø 330 24 22,4 V + S
			→	09/06→; Motorcode: N53		24.0324-0200.1 524200	Ø 330 24 21,6 V + S PD
325 i	160	05/05→06/13	←			24.0124-0200.1 424200	Ø 330 24 22,4 V + S
			→			24.0324-0200.1 524200	Ø 330 24 21,6 V + S PD
325 i	155	01/05→06/13	←	09/06→ 08/07; Motorcode: N52N		24.0124-0200.1 424200	Ø 330 24 22,4 V + S
			→	09/06→ 08/07; Motorcode: N52N		24.0324-0200.1 524200	Ø 330 24 21,6 V + S PD
325 i	160	01/05→06/13	←	09/07→; Motorcode: N52N		24.0124-0203.1 424203	Ø 312 23,9 22,4 V + S
			→	09/07→; Motorcode: N52N		24.0324-0203.1 524203	Ø 312 23,9 21,6 V + S PD
325 i	160	01/05→06/13	←			24.0120-0195.1 420195	Ø 300 20 18,4 V + S
			→			24.0320-0195.1 520195	Ø 300 20 17,6 V + S PD
325 i xDrive	150	03/06→12/13	←	09/06→ 06/13; Motorcode: N53		24.0124-0200.1 424200	Ø 330 24 22,4 V + S
			→	09/06→ 06/13; Motorcode: N53		24.0324-0200.1 524200	Ø 330 24 21,6 V + S PD
325 i xDrive	150	03/06→12/13	←	09/06→ 08/07; Motorcode: N52N		24.0124-0200.1 424200	Ø 330 24 22,4 V + S
			→	09/06→ 08/07; Motorcode: N52N		24.0324-0200.1 524200	Ø 330 24 21,6 V + S PD
325 i xDrive	150	03/06→12/13	←			24.0120-0204.1 420204	Ø 300 20 18,4 V + S
			→			24.0320-0204.1 520204	Ø 300 20 17,6 V + S PD
325 i xDrive	160	09/08→12/13	←	→ 06/13; Motorcode: N53		24.0124-0200.1 424200	Ø 330 24 22,4 V + S
			→	→ 06/13; Motorcode: N53		24.0324-0200.1 524200	Ø 330 24 21,6 V + S PD
325 i xDrive	160	09/07→12/13	←			24.0120-0204.1 420204	Ø 300 20 18,4 V + S
			→			24.0320-0204.1 520204	Ø 300 20 17,6 V + S PD
325 xi	160	09/06→12/13	←	→ 08/07; Motorcode: N52N		24.0124-0200.1 424200	Ø 330 24 22,4 V + S
			→	→ 08/07; Motorcode: N52N		24.0324-0200.1 524200	Ø 330 24 21,6 V + S PD
↓			←	→ 06/13; Motorcode: N53		24.0124-0200.1 424200	Ø 330 24 22,4 V + S
			→	→ 06/13; Motorcode: N53		24.0324-0200.1 524200	Ø 330 24 21,6 V + S PD









	kw			 	! #		
BMW - 3 Coupe (E92) 01/05→12/13							
Bremsscheibe							
325 xi	160	09/06→12/13	←	→ 06/13; Motorcode: N53		24.0324-0200.1 524200	Ø 330 24 21,6 V + S PD
			→	→ 06/13		24.0120-0204.1 420204	Ø 300 20 18,4 V + S
						24.0320-0204.1 520204	Ø 300 20 17,6 V + S PD
328 i	172	06/07→12/13	←	→ 06/13		24.0124-0203.1 424203	Ø 312 23,9 22,4 V + S
						24.0324-0203.1 524203	Ø 312 23,9 21,6 V + S PD
			→	→ 06/13		24.0120-0204.1 420204	Ø 300 20 18,4 V + S
						24.0320-0204.1 520204	Ø 300 20 17,6 V + S PD
330 d	170	09/06→12/13	←	→ 06/13; nicht für erhöhte Nutzlast;		24.0124-0200.1 424200	Ø 330 24 22,4 V + S
330 d	180	01/09→12/13		09/09→		24.0324-0200.1 524200	Ø 330 24 21,6 V + S PD
330 d xDrive	180	01/09→12/13					
330 xd	170	09/06→12/13	←	→ 08/09		24.0130-0192.1 430192	Ø 348 30 28,4 V + S
330 xd	180	01/09→12/13	←	09/09→ 06/13; für erhöhte Nutzlast		24.0130-0192.1 430192	Ø 348 30 28,4 V + S
			→	→ 06/13		24.0122-0236.1 422236	Ø 336 22 20,4 V + S
						24.0322-0236.1 522236	Ø 336 22 19,6 V + S PD
330 i	190	09/06→12/13	←	→ 06/13; Motorcode: N52N		24.0124-0200.1 424200	Ø 330 24 22,4 V + S
330 i	200	03/07→12/13				24.0324-0200.1 524200	Ø 330 24 21,6 V + S PD
			←	09/09→ 06/13; Motorcode: N53; nicht für erhöhte Nutzlast		24.0124-0200.1 424200	Ø 330 24 22,4 V + S
						24.0324-0200.1 524200	Ø 330 24 21,6 V + S PD
			←	→ 08/09; Motorcode: N53		24.0130-0192.1 430192	Ø 348 30 28,4 V + S
			←	09/09→ 06/13; Motorcode: N53; für erhöhte Nutzlast		24.0130-0192.1 430192	Ø 348 30 28,4 V + S
			→	→ 06/13		24.0122-0236.1 422236	Ø 336 22 20,4 V + S
						24.0322-0236.1 522236	Ø 336 22 19,6 V + S PD
330 i	200	09/06→02/10	←	09/09→; Motorcode: N53; nicht für erhöhte Nutzlast		24.0124-0200.1 424200	Ø 330 24 22,4 V + S
						24.0324-0200.1 524200	Ø 330 24 21,6 V + S PD
			←	Motorcode: N52N		24.0124-0200.1 424200	Ø 330 24 22,4 V + S
						24.0324-0200.1 524200	Ø 330 24 21,6 V + S PD
			←	09/09→; Motorcode: N53; für erhöhte Nutzlast		24.0130-0192.1 430192	Ø 348 30 28,4 V + S
			←	→ 08/09; Motorcode: N53		24.0130-0192.1 430192	Ø 348 30 28,4 V + S
			→			24.0122-0236.1 422236	Ø 336 22 20,4 V + S
						24.0322-0236.1 522236	Ø 336 22 19,6 V + S PD
335 d	210	09/06→12/13	←	→ 06/13		24.0130-0192.1 430192	Ø 348 30 28,4 V + S
335 i xDrive	225	11/08→12/13	→	→ 06/13		24.0122-0236.1 422236	Ø 336 22 20,4 V + S
						24.0322-0236.1 522236	Ø 336 22 19,6 V + S PD
335 i	225	11/05→06/13	←	09/06→		24.0130-0192.1 430192	Ø 348 30 28,4 V + S
335 i	240	11/05→06/13	→	09/06→		24.0122-0236.1 422236	Ø 336 22 20,4 V + S
						24.0322-0236.1 522236	Ø 336 22 19,6 V + S PD
335 i xDrive	240	11/08→06/13	←			24.0130-0192.1 430192	Ø 348 30 28,4 V + S
			→			24.0122-0236.1 422236	Ø 336 22 20,4 V + S
						24.0322-0236.1 522236	Ø 336 22 19,6 V + S PD
335 xi	225	03/07→02/10	←	09/07→		24.0130-0192.1 430192	Ø 348 30 28,4 V + S
335 xi	240	03/07→02/10	→	09/07→		24.0122-0236.1 422236	Ø 336 22 20,4 V + S
						24.0322-0236.1 522236	Ø 336 22 19,6 V + S PD
M	309	03/07→12/13	←	☐; → 06/13		24.0130-0213.2 430213	Ø 360 30 28,4 V• Bremsscheibe zweiteilig / + S
M GTS	331	03/07→12/13	←	☐; → 06/13		24.0130-0214.2 430214	Ø 360 30 28,4 V• Bremsscheibe zweiteilig / + S
			→	☐; → 06/13		24.0124-0231.2 424231	Ø 350 24 22,4 V• Bremsscheibe zweiteilig / + S
			→	☐; → 06/13		24.0124-0232.2 424232	Ø 350 24 22,4 V• Bremsscheibe zweiteilig / + S
BMW - 3 Gran Turismo (F34) 07/12→							
Bremsbelagsatz, Scheibenbremse							
318 d	100	03/13→	←	- Performance Parts		13.0460-3866.2 603866	BOS 25506 18,2 + WE / - WK
318 d	105	03/13→				13.0470-3866.2 LD3866	BOS 25506 18,2 + WE / - WK
318 d	110	07/15→					Ceramic
320 i	135	09/15→					
320 i xDrive	135	10/15→	←	+ Performance Parts		13.0460-4875.2 604875	BRE 25028 18,0 + WE / - WK
			→	- Performance Parts		13.0460-3859.2 603859	BOS 25307 17,5 + WE / - WK
						13.0470-3859.2 LD3859	BOS 25307 17,5 + WE / - WK
							Ceramic
			→	+ Performance Parts		13.0460-4874.2 604874	BRE 25029 16,7 + WE / - WK
↓							









	kW			 	! #		
BMW - 3 Gran Turismo (F34) 07/12→							
 Bremsbelagsatz, Scheibenbremse							
320 d	120	03/13→	←	- Performance Parts		13.0460-3857.2 603857	BOS 25199 19,6 + WE / - WK
320 d	135	03/13→07/15	←			13.0470-3857.2 LD3857	BOS 25199 19,6 + WE / - WK Ceramic
320 d	140	07/15→					
320 d	147	05/13→	←	+ Performance Parts		13.0460-4875.2 604875	BRE 25028 18,0 + WE / - WK
320 d xDrive	135	03/13→07/15	←				
320 d xDrive	140	07/15→	→	- Performance Parts		13.0460-3859.2 603859	BOS 25307 17,5 + WE / - WK
325 d	155	07/13→					
325 d	160	03/13→					
325 d	165	07/16→					
328 i xDrive	180	03/13→07/16	→	+ Performance Parts		13.0460-4874.2 604874	BRE 25029 16,7 + WE / - WK
320 d xDrive	120	03/13→	←	- Performance Parts		13.0460-3857.2 603857	BOS 25199 19,6 + WE / - WK
320 d xDrive	147	05/13→					
			←	10/15→; - Performance Parts		13.0460-3857.2 603857	BOS 25199 19,6 + WE / - WK
						13.0470-3857.2 LD3857	BOS 25199 19,6 + WE / - WK Ceramic
			←	10/15→; + Performance Parts		13.0460-4875.2 604875	BRE 25028 18,0 + WE / - WK
			←	+ Performance Parts		13.0460-4875.2 604875	BRE 25028 18,0 + WE / - WK
			→	- Performance Parts		13.0460-3859.2 603859	BOS 25307 17,5 + WE / - WK
						13.0470-3859.2 LD3859	BOS 25307 17,5 + WE / - WK Ceramic
			→	+ Performance Parts		13.0460-4874.2 604874	BRE 25029 16,7 + WE / - WK
320 i	120	07/12→06/16	←	03/13→; - Performance Parts		13.0460-3866.2 603866	BOS 25506 18,2 + WE / - WK
320 i	135	07/12→06/16					
320 i xDrive	120	11/12→06/16					
320 i xDrive	135	11/12→06/16	←	03/13→; + Performance Parts		13.0460-4875.2 604875	BRE 25028 18,0 + WE / - WK
			→	03/13→; - Performance Parts		13.0460-3859.2 603859	BOS 25307 17,5 + WE / - WK
						13.0470-3859.2 LD3859	BOS 25307 17,5 + WE / - WK Ceramic
			→	03/13→; + Performance Parts		13.0460-4874.2 604874	BRE 25029 16,7 + WE / - WK
328 i	180	08/12→02/15	←	03/13→; - Performance Parts		13.0460-3857.2 603857	BOS 25199 19,6 + WE / - WK
			←	03/13→; + Performance Parts		13.0460-4875.2 604875	BRE 25028 18,0 + WE / - WK
			→	03/13→; - Performance Parts		13.0460-3859.2 603859	BOS 25307 17,5 + WE / - WK
						13.0470-3859.2 LD3859	BOS 25307 17,5 + WE / - WK Ceramic
			→	03/13→; + Performance Parts		13.0460-4874.2 604874	BRE 25029 16,7 + WE / - WK
330 d	190	01/14→	←	03/14→; - Performance Parts		13.0460-3857.2 603857	BOS 25199 19,6 + WE / - WK
330 d xDrive	190	01/14→					
			←	03/14→; + Performance Parts		13.0460-4875.2 604875	BRE 25028 18,0 + WE / - WK
			→	03/14→; + Performance Parts		13.0460-4874.2 604874	BRE 25029 16,7 + WE / - WK
330 d	210	01/14→	←	09/15→; - Performance Parts		13.0460-3857.2 603857	BOS 25199 19,6 + WE / - WK
330 d xDrive	210	01/14→					
			←	09/15→; + Performance Parts		13.0460-4875.2 604875	BRE 25028 18,0 + WE / - WK
			→	09/15→; + Performance Parts		13.0460-4874.2 604874	BRE 25029 16,7 + WE / - WK
330 i	185	10/15→	←	- Performance Parts		13.0460-3857.2 603857	BOS 25199 19,6 + WE / - WK
			←	+ Performance Parts		13.0460-4875.2 604875	BRE 25028 18,0 + WE / - WK
335 d xDrive	230	01/14→	←	03/14→		13.0460-4875.2 604875	BRE 25028 18,0 + WE / - WK
			→	03/14→; + Performance Parts		13.0460-4874.2 604874	BRE 25029 16,7 + WE / - WK
335 i	225	03/13→	←				
335 i	240	03/13→03/14					
335 i	250	07/13→	→	+ Performance Parts		13.0460-4874.2 604874	BRE 25029 16,7 + WE / - WK
335 i xDrive	225	03/13→					
335 i xDrive	240	03/13→03/14					
335 i xDrive	250	03/14→					
340 i	240	10/15→					
340 i xDrive	240	10/15→					
340 i	265	09/15→	←	10/15→		13.0460-4875.2 604875	BRE 25028 18,0 + WE / - WK
340 i xDrive	265	09/15→	→	10/15→; + Performance Parts		13.0460-4874.2 604874	BRE 25029 16,7 + WE / - WK
↓							

	kw				! #		
BMW - 3 Gran Turismo (F34) 07/12→							
Warnkontakt, Bremsbelagverschleiß							
318 d	100	03/13→	←	☐	1	24.8190-0006.2 620006	L= 675
318 d	105	03/13→	→		1	24.8190-0007.2 620007	L= 1.045
318 d	110	07/15→					
320 d	120	03/13→					
320 d	135	03/13→07/15					
320 d	140	07/15→					
320 d	147	05/13→					
320 d xDrive	135	03/13→07/15					
320 d xDrive	140	07/15→					
320 i	135	09/15→					
320 i xDrive	135	10/15→					
325 d	155	07/13→					
325 d	160	03/13→					
325 d	165	07/16→					
328 i xDrive	180	03/13→07/16					
335 i	225	03/13→					
335 i	240	03/13→03/14					
335 i	250	07/13→					
335 i xDrive	225	03/13→					
335 i xDrive	240	03/13→03/14					
335 i xDrive	250	03/14→					
340 i	240	10/15→					
340 i xDrive	240	10/15→					
320 d xDrive	120	03/13→	←	☐; 10/15→	1	24.8190-0006.2 620006	L= 675
320 d xDrive	147	05/13→	←	☐	1	24.8190-0006.2 620006	L= 675
			→		1	24.8190-0007.2 620007	L= 1.045
320 i	120	07/12→06/16	←	☐; 03/13→	1	24.8190-0006.2 620006	L= 675
320 i	135	07/12→06/16	→	03/13→	1	24.8190-0007.2 620007	L= 1.045
320 i xDrive	120	11/12→06/16					
320 i xDrive	135	11/12→06/16					
328 i	180	08/12→02/15					
330 d	190	01/14→	←	☐; 03/14→	1	24.8190-0006.2 620006	L= 675
330 d xDrive	190	01/14→	→	03/14→	1	24.8190-0007.2 620007	L= 1.045
335 d xDrive	230	01/14→					
330 d	210	01/14→	←	☐; 09/15→	1	24.8190-0006.2 620006	L= 675
330 d xDrive	210	01/14→	→	09/15→	1	24.8190-0007.2 620007	L= 1.045
330 i	185	10/15→	←	☐	1	24.8190-0006.2 620006	L= 675
340 i	265	09/15→	←	☐; 10/15→	1	24.8190-0006.2 620006	L= 675
340 i xDrive	265	09/15→	→	10/15→	1	24.8190-0007.2 620007	L= 1.045
Bremsscheibe							
318 d	100	03/13→	←	- Performance Parts		24.0122-0278.1 422278	Ø 300 22 20,4 V + S
318 d	105	03/13→	←	+ Performance Parts		24.0130-0233.2 430233	Ø 340 30 28,4 V Bremsscheibe zweiteilig / + S
318 d	110	07/15→					
320 i	135	09/15→	→	- Performance Parts		24.0120-0240.1 420240	Ø 300 20 18,4 V + S
320 i xDrive	135	10/15→	→	+ Performance Parts		24.0124-0251.2 424251	Ø 345 24 22,4 V Bremsscheibe zweiteilig / + S
320 d	120	03/13→	←	- Performance Parts		24.0124-0203.1 424203	Ø 312 23,9 22,4 V + S
320 d	135	03/13→07/15				24.0324-0203.1 524203	Ø 312 23,9 21,6 V + S PD
320 d	140	07/15→					
320 d	147	05/13→	←	+ Performance Parts		24.0130-0233.2 430233	Ø 340 30 28,4 V Bremsscheibe zweiteilig / + S
320 d xDrive	120	03/13→	→	- Performance Parts		24.0120-0240.1 420240	Ø 300 20 18,4 V + S
320 d xDrive	135	03/13→07/15	→	- Performance Parts		24.0120-0240.1 420240	Ø 300 20 18,4 V + S
320 d xDrive	140	07/15→	→	+ Performance Parts		24.0124-0251.2 424251	Ø 345 24 22,4 V Bremsscheibe zweiteilig / + S
320 d xDrive	147	05/13→	→	+ Performance Parts		24.0124-0251.2 424251	Ø 345 24 22,4 V Bremsscheibe zweiteilig / + S
320 i	120	07/12→06/16	←	03/13→; - Performance Parts		24.0122-0278.1 422278	Ø 300 22 20,4 V + S
320 i	135	07/12→06/16	←	03/13→; + Performance Parts		24.0130-0233.2 430233	Ø 340 30 28,4 V Bremsscheibe zweiteilig / + S
320 i xDrive	120	11/12→06/16					
320 i xDrive	135	11/12→06/16	→	03/13→; - Performance Parts		24.0120-0240.1 420240	Ø 300 20 18,4 V + S
			→	03/13→; + Performance Parts		24.0124-0251.2 424251	Ø 345 24 22,4 V Bremsscheibe zweiteilig / + S
325 d	155	07/13→	←	- Performance Parts		24.0124-0248.1 424248	Ø 330 24 22,4 V + S
325 d	160	03/13→	←	+ Performance Parts		24.0130-0234.2 430234	Ø 370 30 28,4 V Bremsscheibe zweiteilig / + S
			→	- Performance Parts		24.0120-0237.1 420237	Ø 300 20 18,4 V + S
			→	für Fahrzeuge mit verstärkter Bremse; + M Sportbremse		24.0120-0243.1 420243	Ø 330 20 18,4 V + S
			→	+ Performance Parts		24.0124-0250.2 424250	Ø 345 24 22,4 V Bremsscheibe zweiteilig / + S
325 d	165	07/16→	←	- Performance Parts		24.0124-0248.1 424248	Ø 330 24 22,4 V + S
328 i xDrive	180	03/13→07/16					
↓							







	kW			 	! #		
BMW - 3 Gran Turismo (F34) 07/12→							
Bremsscheibe							
330 i 330 i xDrive	185 185	10/15→ 10/15→	←	+ Performance Parts	24.0130-0234.2	430234	Ø 370 30 28,4 V Bremsscheibe zweiteilig / + S
			→	- Performance Parts	24.0120-0240.1	420240	Ø 300 20 18,4 V + S
			→	+ Performance Parts	24.0124-0251.2	424251	Ø 345 24 22,4 V Bremsscheibe zweiteilig / + S
328 i	180	08/12→02/15	←	03/13→; - Performance Parts	24.0124-0248.1	424248	Ø 330 24 22,4 V + S
			←	03/13→; + Performance Parts	24.0130-0234.2	430234	Ø 370 30 28,4 V Bremsscheibe zweiteilig / + S
			→	03/13→; - Performance Parts	24.0120-0240.1	420240	Ø 300 20 18,4 V + S
			→	03/13→; + Performance Parts	24.0124-0251.2	424251	Ø 345 24 22,4 V Bremsscheibe zweiteilig / + S
330 d 330 d xDrive 335 d xDrive	190 190 230	01/14→ 01/14→ 01/14→	←	03/14→; - Performance Parts	24.0124-0248.1	424248	Ø 330 24 22,4 V + S
			←	03/14→; + Performance Parts	24.0130-0234.2	430234	Ø 370 30 28,4 V Bremsscheibe zweiteilig / + S
			→	03/14→; - Performance Parts	24.0120-0243.1	420243	Ø 330 20 18,4 V + S
			→	03/14→; + Performance Parts	24.0124-0251.2	424251	Ø 345 24 22,4 V Bremsscheibe zweiteilig / + S
330 d 330 d xDrive	210 210	01/14→ 01/14→	←	09/15→; - Performance Parts	24.0124-0248.1	424248	Ø 330 24 22,4 V + S
			←	09/15→; + Performance Parts	24.0130-0234.2	430234	Ø 370 30 28,4 V Bremsscheibe zweiteilig / + S
			→	09/15→; - Performance Parts	24.0120-0243.1	420243	Ø 330 20 18,4 V + S
			→	09/15→; + Performance Parts	24.0124-0251.2	424251	Ø 345 24 22,4 V Bremsscheibe zweiteilig / + S
335 i 335 i 335 i 335 i xDrive 335 i xDrive 335 i xDrive 340 i 340 i xDrive	225 240 250 225 240 250 240 240	03/13→ 03/13→03/14 07/13→ 03/13→ 03/13→03/14 03/14→ 10/15→ 10/15→	←	- Performance Parts	24.0130-0233.2	430233	Ø 340 30 28,4 V Bremsscheibe zweiteilig / + S
			←	+ Performance Parts	24.0130-0234.2	430234	Ø 370 30 28,4 V Bremsscheibe zweiteilig / + S
			→	- Performance Parts	24.0120-0243.1	420243	Ø 330 20 18,4 V + S
			→	+ Performance Parts	24.0124-0251.2	424251	Ø 345 24 22,4 V Bremsscheibe zweiteilig / + S
			→	- Performance Parts	24.0120-0243.1	420243	Ø 330 20 18,4 V + S
340 i 340 i xDrive	265 265	09/15→ 09/15→	←	10/15→; - Performance Parts	24.0130-0233.2	430233	Ø 340 30 28,4 V Bremsscheibe zweiteilig / + S
			←	10/15→; + Performance Parts	24.0130-0234.2	430234	Ø 370 30 28,4 V Bremsscheibe zweiteilig / + S
			→	10/15→; - Performance Parts	24.0120-0243.1	420243	Ø 330 20 18,4 V + S
			→	10/15→; + Performance Parts	24.0124-0251.2	424251	Ø 345 24 22,4 V Bremsscheibe zweiteilig / + S
BMW - 3 Kombi (F31) 07/11→							
Bremsbelagsatz, Scheibenbremse							
316 d 318 d 318 d 320 i 320 i	85 100 105 120 135	02/12→ 07/11→ 07/11→06/15 02/12→06/15 02/12→06/15	←	05/12→; - Performance Parts	13.0460-3866.2	603866	BOS 25506 18,2 + WE / - WK
					13.0470-3866.2	LD3866	BOS 25506 18,2 + WE / - WK Ceramic
			←	05/12→; + Performance Parts	13.0460-4875.2	604875	BRE 25028 18,0 + WE / - WK
			→	05/12→; - Performance Parts	13.0460-3859.2	603859	BOS 25307 17,5 + WE / - WK
316 i 320 i xDrive 320 i xDrive	100 120 135	03/12→08/16 01/12→06/15 01/12→06/15			13.0470-3859.2	LD3859	BOS 25307 17,5 + WE / - WK Ceramic
			←	03/13→; + Performance Parts	13.0460-4875.2	604875	BRE 25028 18,0 + WE / - WK
			→	03/13→; - Performance Parts	13.0460-3859.2	603859	BOS 25307 17,5 + WE / - WK
					13.0470-3859.2	LD3859	BOS 25307 17,5 + WE / - WK Ceramic
			→	03/13→; + Performance Parts	13.0460-4874.2	604874	BRE 25029 16,7 + WE / - WK
318 d 318 d xDrive	110 110	09/14→ 03/15→	←	07/15→; - Performance Parts	13.0460-3866.2	603866	BOS 25506 18,2 + WE / - WK
					13.0470-3866.2	LD3866	BOS 25506 18,2 + WE / - WK Ceramic
			←	07/15→; + Performance Parts	13.0460-4875.2	604875	BRE 25028 18,0 + WE / - WK
			→	07/15→; - Performance Parts	13.0460-3859.2	603859	BOS 25307 17,5 + WE / - WK
		13.0470-3859.2	LD3859	BOS 25307 17,5 + WE / - WK Ceramic			
		→	07/15→; + Performance Parts	13.0460-4874.2	604874	BRE 25029 16,7 + WE / - WK	
↓							







	kw			 	! #		
BMW - 3 Kombi (F31) 07/11→							
 Bremsbelagsatz, Scheibenbremse							
318 d xDrive	105	01/13→05/15	←	05/13→; - Performance Parts	13.0460-3866.2	603866	BOS 25506 18,2 + WE / - WK
					13.0470-3866.2	LD3866	BOS 25506 18,2 + WE / - WK Ceramic
			←	05/13→; + Performance Parts	13.0460-4875.2	604875	BRE 25028 18,0 + WE / - WK
			→	05/13→; - Performance Parts	13.0460-3859.2	603859	BOS 25307 17,5 + WE / - WK
				13.0470-3859.2	LD3859	BOS 25307 17,5 + WE / - WK Ceramic	
			→	05/13→; + Performance Parts	13.0460-4874.2	604874	BRE 25029 16,7 + WE / - WK
318 i	100	01/15→	←	07/15→; - Performance Parts	13.0460-3866.2	603866	BOS 25506 18,2 + WE / - WK
					13.0470-3866.2	LD3866	BOS 25506 18,2 + WE / - WK Ceramic
			←	07/15→; + Performance Parts	13.0460-4875.2	604875	BRE 25028 18,0 + WE / - WK
			→	07/15→; - Performance Parts	13.0460-3859.2	603859	BOS 25307 17,5 + WE / - WK
				13.0470-3859.2	LD3859	BOS 25307 17,5 + WE / - WK Ceramic	
			→	07/15→; + Performance Parts	13.0460-4874.2	604874	BRE 25029 16,7 + WE / - WK
320 d	120	07/11→	←	05/12→; für Fahrzeuge mit Start-Stopp-Funktion	13.0460-3857.2	603857	BOS 25199 19,6 + WE / - WK
					13.0470-3857.2	LD3857	BOS 25199 19,6 + WE / - WK Ceramic
			←	05/12→; für Fahrzeuge ohne Start-Stopp-Funktion	13.0460-3866.2	603866	BOS 25506 18,2 + WE / - WK
				13.0470-3866.2	LD3866	BOS 25506 18,2 + WE / - WK Ceramic	
			→	05/12→	13.0460-3859.2	603859	BOS 25307 17,5 + WE / - WK
					13.0470-3859.2	LD3859	BOS 25307 17,5 + WE / - WK Ceramic
320 d 320 d	135 147	07/11→02/16 07/11→02/16	←	05/12→; - Performance Parts	13.0460-3857.2	603857	BOS 25199 19,6 + WE / - WK
					13.0470-3857.2	LD3857	BOS 25199 19,6 + WE / - WK Ceramic
			←	05/12→; + Performance Parts	13.0460-4875.2	604875	BRE 25028 18,0 + WE / - WK
			←	05/12→; für Fahrzeuge mit verstärkter Bremse	13.0460-4875.2	604875	BRE 25028 18,0 + WE / - WK
			→	05/12→; - Performance Parts	13.0460-3859.2	603859	BOS 25307 17,5 + WE / - WK
				13.0470-3859.2	LD3859	BOS 25307 17,5 + WE / - WK Ceramic	
			→	05/12→; + Performance Parts	13.0460-4874.2	604874	BRE 25029 16,7 + WE / - WK
320 d	140	09/14→	←	07/15→; - Performance Parts	13.0460-3857.2	603857	BOS 25199 19,6 + WE / - WK
					13.0470-3857.2	LD3857	BOS 25199 19,6 + WE / - WK Ceramic
			←	07/15→; + Performance Parts	13.0460-4875.2	604875	BRE 25028 18,0 + WE / - WK
			←	07/15→; für Fahrzeuge mit verstärkter Bremse	13.0460-4875.2	604875	BRE 25028 18,0 + WE / - WK
			→	07/15→; - Performance Parts	13.0460-3859.2	603859	BOS 25307 17,5 + WE / - WK
				13.0470-3859.2	LD3859	BOS 25307 17,5 + WE / - WK Ceramic	
			→	07/15→; + Performance Parts	13.0460-4874.2	604874	BRE 25029 16,7 + WE / - WK
320 d xDrive 320 d xDrive 320 d xDrive	120 135 147	01/12→ 01/12→06/15 01/12→06/15	←	03/13→; - Performance Parts	13.0460-3857.2	603857	BOS 25199 19,6 + WE / - WK
					13.0470-3857.2	LD3857	BOS 25199 19,6 + WE / - WK Ceramic
			←	03/13→; + Performance Parts	13.0460-4875.2	604875	BRE 25028 18,0 + WE / - WK
			←	03/13→; für Fahrzeuge mit verstärkter Bremse	13.0460-4875.2	604875	BRE 25028 18,0 + WE / - WK
			→	03/13→; - Performance Parts	13.0460-3859.2	603859	BOS 25307 17,5 + WE / - WK
				13.0470-3859.2	LD3859	BOS 25307 17,5 + WE / - WK Ceramic	
			→	03/13→; + Performance Parts	13.0460-4874.2	604874	BRE 25029 16,7 + WE / - WK
320 d xDrive	140	07/15→	←	- Performance Parts	13.0460-3857.2	603857	BOS 25199 19,6 + WE / - WK
					13.0470-3857.2	LD3857	BOS 25199 19,6 + WE / - WK Ceramic
			←	für Fahrzeuge mit verstärkter Bremse	13.0460-4875.2	604875	BRE 25028 18,0 + WE / - WK
			←	+ Performance Parts	13.0460-4875.2	604875	BRE 25028 18,0 + WE / - WK
			→	- Performance Parts	13.0460-3859.2	603859	BOS 25307 17,5 + WE / - WK
				13.0470-3859.2	LD3859	BOS 25307 17,5 + WE / - WK Ceramic	
			→	+ Performance Parts	13.0460-4874.2	604874	BRE 25029 16,7 + WE / - WK
↓							







	kw			 	! #		
BMW - 3 Kombi (F31) 07/11→							
 Bremsbelagsatz, Scheibenbremse							
320 i 320 i xDrive	135 135	10/14→ 09/14→	←	- Performance Parts	13.0460-3866.2	603866	BOS 25506 18,2 + WE / - WK
			←	+ Performance Parts	13.0470-3866.2	LD3866	BOS 25506 18,2 + WE / - WK Ceramic
			→	- Performance Parts	13.0460-4875.2	604875	BRE 25028 18,0 + WE / - WK
			→	+ Performance Parts	13.0460-3859.2	603859	BOS 25307 17,5 + WE / - WK Ceramic
325 d 325 d	155 160	09/12→02/16 09/12→02/16	←	04/13→; - Performance Parts	13.0460-3857.2	603857	BOS 25199 19,6 + WE / - WK Ceramic
			←	04/13→; + Performance Parts	13.0470-3857.2	LD3857	BOS 25199 19,6 + WE / - WK Ceramic
			←	04/13→; + Performance Parts	13.0460-4875.2	604875	BRE 25028 18,0 + WE / - WK
			←	04/13→; für Fahrzeuge mit verstärkter Bremse	13.0460-4875.2	604875	BRE 25028 18,0 + WE / - WK
325 d	165	04/15→	→	04/13→; - Performance Parts	13.0460-3859.2	603859	BOS 25307 17,5 + WE / - WK Ceramic
			→	+ Performance Parts	13.0470-3859.2	LD3859	BOS 25307 17,5 + WE / - WK Ceramic
			→	04/13→; + Performance Parts	13.0460-4874.2	604874	BRE 25029 16,7 + WE / - WK
			←	03/16→; - Performance Parts	13.0460-3857.2	603857	BOS 25199 19,6 + WE / - WK Ceramic
328 i	180	01/12→06/15	←	03/16→; + Performance Parts	13.0470-3857.2	LD3857	BOS 25199 19,6 + WE / - WK Ceramic
			←	03/16→; + Performance Parts	13.0460-4875.2	604875	BRE 25028 18,0 + WE / - WK
			←	03/16→; für Fahrzeuge mit verstärkter Bremse	13.0460-4875.2	604875	BRE 25028 18,0 + WE / - WK
			→	03/16→; - Performance Parts	13.0460-3859.2	603859	BOS 25307 17,5 + WE / - WK Ceramic
328 i xDrive	180	06/12→06/16	→	+ Performance Parts	13.0470-3859.2	LD3859	BOS 25307 17,5 + WE / - WK Ceramic
			→	03/16→; + Performance Parts	13.0460-4874.2	604874	BRE 25029 16,7 + WE / - WK
			←	05/12→; - Performance Parts	13.0460-3857.2	603857	BOS 25199 19,6 + WE / - WK Ceramic
			←	05/12→; + Performance Parts	13.0470-3857.2	LD3857	BOS 25199 19,6 + WE / - WK Ceramic
330 d	190	01/12→	→	05/12→; - Performance Parts	13.0460-3859.2	603859	BOS 25307 17,5 + WE / - WK Ceramic
			→	+ Performance Parts	13.0470-3859.2	LD3859	BOS 25307 17,5 + WE / - WK Ceramic
			→	05/12→; + Performance Parts	13.0460-4874.2	604874	BRE 25029 16,7 + WE / - WK
			←	09/15→; - Performance Parts	13.0460-3857.2	603857	BOS 25199 19,6 + WE / - WK Ceramic
330 d xDrive	210 210	01/12→ 06/12→	←	09/15→; + Performance Parts	13.0470-3857.2	LD3857	BOS 25199 19,6 + WE / - WK Ceramic
			←	09/15→; + Performance Parts	13.0460-4875.2	604875	BRE 25028 18,0 + WE / - WK
			→	09/15→; + Performance Parts	13.0460-4874.2	604874	BRE 25029 16,7 + WE / - WK
330 d xDrive	190	06/12→	←	03/13→; - Performance Parts	13.0460-3857.2	603857	BOS 25199 19,6 + WE / - WK Ceramic
			←	03/13→; + Performance Parts	13.0470-3857.2	LD3857	BOS 25199 19,6 + WE / - WK Ceramic
			←	03/13→; + Performance Parts	13.0460-4875.2	604875	BRE 25028 18,0 + WE / - WK
330 i 330 i xDrive	185 185	09/14→ 10/14→	→	03/13→; + Performance Parts	13.0460-4874.2	604874	BRE 25029 16,7 + WE / - WK
			←	07/15→; - Performance Parts	13.0460-3857.2	603857	BOS 25199 19,6 + WE / - WK Ceramic
			←	07/15→; + Performance Parts	13.0470-3857.2	LD3857	BOS 25199 19,6 + WE / - WK Ceramic
↓							











	kW			 	! #		
BMW - 3 Kombi (F31) 07/11→							
 Bremsbelagsatz, Scheibenbremse							
330 i 330 i xDrive	185 185	09/14→ 10/14→	➡	07/15→; - Performance Parts		13.0460-3859.2 603859 13.0470-3859.2 LD3859	BOS 25307 17,5 + WE / - WK BOS 25307 17,5 + WE / - WK Ceramic
			➡	07/15→; + Performance Parts		13.0460-4874.2 604874	BRE 25029 16,7 + WE / - WK
335 d xDrive	230	04/13→	⬅	11/13→		13.0460-4875.2 604875	BRE 25028 18,0 + WE / - WK
			➡	11/13→; + Performance Parts		13.0460-4874.2 604874	BRE 25029 16,7 + WE / - WK
335 i 335 i	225 240	07/12→06/15 07/12→07/13	⬅	03/13→		13.0460-4875.2 604875	BRE 25028 18,0 + WE / - WK
335 i xDrive 335 i xDrive	225 240	07/12→06/15 07/12→07/13	➡	03/13→; + Performance Parts		13.0460-4874.2 604874	BRE 25029 16,7 + WE / - WK
335 i 335 i xDrive	250 250	07/13→06/15 07/13→06/15	⬅			13.0460-4875.2 604875	BRE 25028 18,0 + WE / - WK
			➡	+ Performance Parts		13.0460-4874.2 604874	BRE 25029 16,7 + WE / - WK
340 i 340 i	240 265	10/14→ 10/14→	⬅	07/15→; - Performance Parts		13.0460-4875.2 604875	BRE 25028 18,0 + WE / - WK
340 i xDrive 340 i xDrive	240 265	10/14→ 10/14→	➡	07/15→; + Performance Parts		13.0460-4874.2 604874	BRE 25029 16,7 + WE / - WK
Warnkontakt, Bremsbelagverschleiß							
316 d 318 d	85 100	02/12→ 07/11→	⬅	☐; 05/12→	1	24.8190-0006.2 620006	L= 675
318 d 320 d	105 120	07/11→06/15 07/11→	➡	05/12→	1	24.8190-0007.2 620007	L= 1.045
320 i 320 i	120 135	02/12→06/15 02/12→06/15					
328 i 330 d	180 190	01/12→06/15 01/12→					
316 i 320 i xDrive	100 120	03/12→08/16 01/12→06/15	⬅	☐; 03/13→	1	24.8190-0006.2 620006	L= 675
320 i xDrive 328 i xDrive	135 180	01/12→06/15 06/12→06/16	➡	03/13→	1	24.8190-0007.2 620007	L= 1.045
330 d xDrive	190	06/12→					
318 d 318 d xDrive	110 110	09/14→ 03/15→	⬅	☐; 07/15→	1	24.8190-0006.2 620006	L= 675
318 i 330 i	100 185	01/15→ 09/14→	➡	07/15→	1	24.8190-0007.2 620007	L= 1.045
330 i xDrive 340 i	185 240	10/14→ 10/14→					
340 i 340 i xDrive	265 240	10/14→ 10/14→					
340 i xDrive	265	10/14→					
318 d xDrive	105	01/13→05/15	⬅	☐; 05/13→	1	24.8190-0006.2 620006	L= 675
			➡	05/13→	1	24.8190-0007.2 620007	L= 1.045
320 d 320 d	135 147	07/11→02/16 07/11→02/16	⬅	☐; 05/12→	1	24.8190-0006.2 620006	L= 675
			⬅	☐; 05/12→; für Fahrzeuge mit verstärkter Bremse	1	24.8190-0006.2 620006	L= 675
			➡	05/12→	1	24.8190-0007.2 620007	L= 1.045
320 d	140	09/14→	⬅	☐; 07/15→; für Fahrzeuge mit verstärkter Bremse	1	24.8190-0006.2 620006	L= 675
			⬅	☐; 07/15→	1	24.8190-0006.2 620006	L= 675
			➡	07/15→	1	24.8190-0007.2 620007	L= 1.045
320 d xDrive 320 d xDrive	120 135	01/12→ 01/12→06/15	⬅	☐; 03/13→; für Fahrzeuge mit verstärkter Bremse	1	24.8190-0006.2 620006	L= 675
320 d xDrive	147	01/12→06/15	⬅	☐; 03/13→	1	24.8190-0006.2 620006	L= 675
			➡	03/13→	1	24.8190-0007.2 620007	L= 1.045
320 d xDrive	140	07/15→	⬅	☐; für Fahrzeuge mit verstärkter Bremse	1	24.8190-0006.2 620006	L= 675
			⬅	☐	1	24.8190-0006.2 620006	L= 675
			➡		1	24.8190-0007.2 620007	L= 1.045
320 i 320 i xDrive	135 135	10/14→ 09/14→	⬅	☐	1	24.8190-0006.2 620006	L= 675
			➡		1	24.8190-0007.2 620007	L= 1.045
325 d 325 d	155 160	09/12→02/16 09/12→02/16	⬅	☐; 04/13→; für Fahrzeuge mit verstärkter Bremse	1	24.8190-0006.2 620006	L= 675
			⬅	☐; 04/13→	1	24.8190-0006.2 620006	L= 675
			➡	04/13→	1	24.8190-0007.2 620007	L= 1.045
325 d	165	04/15→	⬅	☐; 03/16→; für Fahrzeuge mit verstärkter Bremse	1	24.8190-0006.2 620006	L= 675
			⬅	☐; 03/16→	1	24.8190-0006.2 620006	L= 675
			➡	03/16→	1	24.8190-0007.2 620007	L= 1.045
↓							





















	kW			 	! #		
BMW - 3 Kombi (F31) 07/11→							
Warnkontakt, Bremsbelagverschleiß							
330 d	210	01/12→	←	☐; 09/15→	1	24.8190-0006.2 620006	L= 675
330 d xDrive	210	06/12→	→	09/15→	1	24.8190-0007.2 620007	L= 1.045
335 d xDrive	230	04/13→	←	☐; 11/13→; für Fahrzeuge mit verstärkter Bremse	1	24.8190-0006.2 620006	L= 675
			→	11/13→	1	24.8190-0007.2 620007	L= 1.045
335 i	225	07/12→06/15	←	☐; 03/13→; für Fahrzeuge mit verstärkter Bremse	1	24.8190-0006.2 620006	L= 675
335 i xDrive	240	07/12→07/13	→	03/13→	1	24.8190-0007.2 620007	L= 1.045
335 i xDrive	225	07/12→06/15	←				
335 i xDrive	240	07/12→07/13	→				
335 i	250	07/13→06/15	←	☐; für Fahrzeuge mit verstärkter Bremse	1	24.8190-0006.2 620006	L= 675
335 i xDrive	250	07/13→06/15	→		1	24.8190-0007.2 620007	L= 1.045
Bremsscheibe							
316 d	85	02/12→	←	05/12→; - Performance Parts		24.0122-0278.1 422278	Ø 300 22 20,4 V + S
318 d	100	07/11→	←	05/12→; + Performance Parts		24.0130-0233.2 430233	Ø 340 30 28,4 V Bremsscheibe zweiteilig / + S
318 d	105	07/11→06/15	←				
320 i	120	02/12→06/15	→	05/12→; - Performance Parts		24.0120-0237.1 420237	Ø 300 20 18,4 V + S
320 i	135	02/12→06/15	→	05/12→; + Performance Parts		24.0124-0250.2 424250	Ø 345 24 22,4 V Bremsscheibe zweiteilig / + S
316 i	100	03/12→08/16	←	03/13→; - Performance Parts		24.0122-0278.1 422278	Ø 300 22 20,4 V + S
			←	03/13→; + Performance Parts		24.0130-0233.2 430233	Ø 340 30 28,4 V Bremsscheibe zweiteilig / + S
			→	03/13→; - Performance Parts		24.0120-0237.1 420237	Ø 300 20 18,4 V + S
			→	03/13→; + Performance Parts		24.0124-0250.2 424250	Ø 345 24 22,4 V Bremsscheibe zweiteilig / + S
318 d	110	09/14→	←	07/15→; - Performance Parts		24.0122-0278.1 422278	Ø 300 22 20,4 V + S
318 d xDrive	110	03/15→	←	07/15→; + Performance Parts		24.0130-0233.2 430233	Ø 340 30 28,4 V Bremsscheibe zweiteilig / + S
			→	07/15→; + Performance Parts		24.0124-0251.2 424251	Ø 345 24 22,4 V Bremsscheibe zweiteilig / + S
318 d xDrive	105	01/13→05/15	←	05/13→; - Performance Parts		24.0122-0278.1 422278	Ø 300 22 20,4 V + S
			←	05/13→; + Performance Parts		24.0130-0233.2 430233	Ø 340 30 28,4 V Bremsscheibe zweiteilig / + S
			→	05/13→; - Performance Parts		24.0120-0240.1 420240	Ø 300 20 18,4 V + S
			→	05/13→; + Performance Parts		24.0124-0251.2 424251	Ø 345 24 22,4 V Bremsscheibe zweiteilig / + S
318 i	100	01/15→	←	07/15→; - Performance Parts		24.0122-0278.1 422278	Ø 300 22 20,4 V + S
			←	07/15→; + Performance Parts		24.0130-0233.2 430233	Ø 340 30 28,4 V Bremsscheibe zweiteilig / + S
			→	07/15→; - Performance Parts		24.0120-0240.1 420240	Ø 300 20 18,4 V + S
			→	07/15→; + Performance Parts		24.0124-0251.2 424251	Ø 345 24 22,4 V Bremsscheibe zweiteilig / + S
320 d	120	07/11→	←	05/12→; für Fahrzeuge ohne Start-Stopp-Funktion		24.0122-0278.1 422278	Ø 300 22 20,4 V + S
			←	05/12→; für Fahrzeuge mit Start-Stopp-Funktion		24.0124-0203.1 424203	Ø 312 23,9 22,4 V + S
						24.0324-0203.1 524203	Ø 312 23,9 21,6 V + S PD
			→	05/12→		24.0120-0240.1 420240	Ø 300 20 18,4 V + S
320 d	135	07/11→02/16	←	05/12→; - Performance Parts		24.0124-0203.1 424203	Ø 312 23,9 22,4 V + S
320 d	147	07/11→02/16	←	05/12→; + Performance Parts		24.0324-0203.1 524203	Ø 312 23,9 21,6 V + S PD
			←	05/12→; + Performance Parts		24.0130-0233.2 430233	Ø 340 30 28,4 V Bremsscheibe zweiteilig / + S
			←	05/12→; für Fahrzeuge mit verstärkter Bremse		24.0130-0233.2 430233	Ø 340 30 28,4 V Bremsscheibe zweiteilig / + S
			→	05/12→; - Performance Parts		24.0120-0240.1 420240	Ø 300 20 18,4 V + S
			→	05/12→; für Fahrzeuge mit verstärkter Bremse		24.0120-0243.1 420243	Ø 330 20 18,4 V + S
			→	05/12→; + Performance Parts		24.0124-0251.2 424251	Ø 345 24 22,4 V Bremsscheibe zweiteilig / + S
320 d	140	09/14→	←	07/15→; - Performance Parts		24.0124-0203.1 424203	Ø 312 23,9 22,4 V + S
			←	07/15→; + Performance Parts		24.0324-0203.1 524203	Ø 312 23,9 21,6 V + S PD
			←	07/15→; + Performance Parts		24.0130-0233.2 430233	Ø 340 30 28,4 V Bremsscheibe zweiteilig / + S
			←	07/15→; für Fahrzeuge mit verstärkter Bremse		24.0130-0233.2 430233	Ø 340 30 28,4 V Bremsscheibe zweiteilig / + S









	kw			 	! #		
BMW - 3 Kombi (F31) 07/11→							
Bremsscheibe							
320 d	140	09/14→	➔	07/15→; - Performance Parts	24.0120-0240.1	420240	Ø 300 20 18,4 V + S
			➔	07/15→; für Fahrzeuge mit verstärkter Bremse	24.0120-0243.1	420243	Ø 330 20 18,4 V + S
			➔	07/15→; + Performance Parts	24.0124-0251.2	424251	Ø 345 24 22,4 V Bremsscheibe zweiteilig / + S
320 d xDrive 320 d xDrive 320 d xDrive	120 135 147	01/12→ 01/12→06/15 01/12→06/15	←	03/13→; - Performance Parts	24.0124-0203.1	424203	Ø 312 23,9 22,4 V + S
			←	03/13→; + Performance Parts	24.0324-0203.1	524203	Ø 312 23,9 21,6 V + S PD
			←	03/13→; - Performance Parts	24.0130-0233.2	430233	Ø 340 30 28,4 V Bremsscheibe zweiteilig / + S
			←	03/13→; für Fahrzeuge mit verstärkter Bremse	24.0130-0233.2	430233	Ø 340 30 28,4 V Bremsscheibe zweiteilig / + S
			➔	03/13→; - Performance Parts	24.0120-0240.1	420240	Ø 300 20 18,4 V + S
			➔	03/13→; für Fahrzeuge mit verstärkter Bremse	24.0120-0243.1	420243	Ø 330 20 18,4 V + S
			➔	03/13→; + Performance Parts	24.0124-0251.2	424251	Ø 345 24 22,4 V Bremsscheibe zweiteilig / + S
320 d xDrive	140	07/15→	←	- Performance Parts	24.0124-0203.1	424203	Ø 312 23,9 22,4 V + S
			←	+ Performance Parts	24.0324-0203.1	524203	Ø 312 23,9 21,6 V + S PD
			←	für Fahrzeuge mit verstärkter Bremse	24.0130-0233.2	430233	Ø 340 30 28,4 V Bremsscheibe zweiteilig / + S
			➔	- Performance Parts	24.0120-0240.1	420240	Ø 300 20 18,4 V + S
			➔	für Fahrzeuge mit verstärkter Bremse	24.0120-0243.1	420243	Ø 330 20 18,4 V + S
			➔	+ Performance Parts	24.0124-0251.2	424251	Ø 345 24 22,4 V Bremsscheibe zweiteilig / + S
			➔				
320 i	135	10/14→	←	- Performance Parts	24.0122-0278.1	422278	Ø 300 22 20,4 V + S
			←	+ Performance Parts	24.0130-0233.2	430233	Ø 340 30 28,4 V Bremsscheibe zweiteilig / + S
			➔	- Performance Parts	24.0120-0237.1	420237	Ø 300 20 18,4 V + S
			➔	+ Performance Parts	24.0124-0250.2	424250	Ø 345 24 22,4 V Bremsscheibe zweiteilig / + S
320 i xDrive 320 i xDrive	120 135	01/12→06/15 01/12→06/15	←	03/13→; - Performance Parts	24.0122-0278.1	422278	Ø 300 22 20,4 V + S
			←	03/13→; + Performance Parts	24.0130-0233.2	430233	Ø 340 30 28,4 V Bremsscheibe zweiteilig / + S
			➔	03/13→; - Performance Parts	24.0120-0240.1	420240	Ø 300 20 18,4 V + S
			➔	03/13→; + Performance Parts	24.0124-0251.2	424251	Ø 345 24 22,4 V Bremsscheibe zweiteilig / + S
320 i xDrive	135	09/14→	←	- Performance Parts	24.0122-0278.1	422278	Ø 300 22 20,4 V + S
			←	+ Performance Parts	24.0130-0233.2	430233	Ø 340 30 28,4 V Bremsscheibe zweiteilig / + S
			➔	- Performance Parts	24.0120-0240.1	420240	Ø 300 20 18,4 V + S
			➔	+ Performance Parts	24.0124-0251.2	424251	Ø 345 24 22,4 V Bremsscheibe zweiteilig / + S
325 d 325 d	155 160	09/12→02/16 09/12→02/16	←	04/13→; - Performance Parts	24.0124-0248.1	424248	Ø 330 24 22,4 V + S
			←	04/13→; für Fahrzeuge mit verstärkter Bremse	24.0130-0233.2	430233	Ø 340 30 28,4 V Bremsscheibe zweiteilig / + S
			←	04/13→; + Performance Parts	24.0130-0234.2	430234	Ø 370 30 28,4 V Bremsscheibe zweiteilig / + S
			➔	04/13→; - Performance Parts	24.0120-0243.1	420243	Ø 330 20 18,4 V + S
			➔	04/13→; für Fahrzeuge mit verstärkter Bremse	24.0120-0243.1	420243	Ø 330 20 18,4 V + S
			➔	04/13→; + Performance Parts	24.0124-0250.2	424250	Ø 345 24 22,4 V Bremsscheibe zweiteilig / + S
325 d	165	04/15→	←	03/16→; - Performance Parts	24.0124-0248.1	424248	Ø 330 24 22,4 V + S
			←	03/16→; für Fahrzeuge mit verstärkter Bremse	24.0130-0233.2	430233	Ø 340 30 28,4 V Bremsscheibe zweiteilig / + S
			←	03/16→; + Performance Parts	24.0130-0234.2	430234	Ø 370 30 28,4 V Bremsscheibe zweiteilig / + S
			➔	03/16→; für Fahrzeuge mit verstärkter Bremse	24.0120-0243.1	420243	Ø 330 20 18,4 V + S
			➔	03/16→; - Performance Parts	24.0120-0243.1	420243	Ø 330 20 18,4 V + S
			➔	03/16→; + Performance Parts	24.0124-0250.2	424250	Ø 345 24 22,4 V Bremsscheibe zweiteilig / + S
328 i ↓	180	01/12→06/15	←	05/12→; - Performance Parts	24.0124-0248.1	424248	Ø 330 24 22,4 V + S









	kw			 	! #		
BMW - 3 Kombi (F31) 07/11→							
Bremsscheibe							
328 i	180	01/12→06/15	←	05/12→; für Fahrzeuge mit verstärkter Bremse	24.0130-0233.2	430233	Ø 340 30 28,4 V Bremsscheibe zweiteilig / + S
			←	05/12→; + Performance Parts	24.0130-0234.2	430234	Ø 370 30 28,4 V Bremsscheibe zweiteilig / + S
			→	05/12→; - Performance Parts	24.0120-0240.1	420240	Ø 300 20 18,4 V + S
			→	05/12→; + Performance Parts	24.0124-0251.2	424251	Ø 345 24 22,4 V Bremsscheibe zweiteilig / + S
328 i xDrive	180	06/12→06/16	←	03/13→; - Performance Parts	24.0124-0248.1	424248	Ø 330 24 22,4 V + S
			←	03/13→; + Performance Parts	24.0130-0233.2	430233	Ø 340 30 28,4 V Bremsscheibe zweiteilig / + S
					24.0130-0234.2	430234	Ø 370 30 28,4 V Bremsscheibe zweiteilig / + S
			←	03/13→; für Fahrzeuge mit verstärkter Bremse	24.0130-0233.2	430233	Ø 340 30 28,4 V Bremsscheibe zweiteilig / + S
			→	03/13→; - Performance Parts	24.0120-0240.1	420240	Ø 300 20 18,4 V + S
			→	03/13→; + Performance Parts	24.0124-0251.2	424251	Ø 345 24 22,4 V Bremsscheibe zweiteilig / + S
330 d	190	01/12→	←	05/12→; - Performance Parts	24.0124-0248.1	424248	Ø 330 24 22,4 V + S
			←	05/12→; für Fahrzeuge mit verstärkter Bremse	24.0130-0233.2	430233	Ø 340 30 28,4 V Bremsscheibe zweiteilig / + S
			←	05/12→; + Performance Parts	24.0130-0234.2	430234	Ø 370 30 28,4 V Bremsscheibe zweiteilig / + S
			→	05/12→; - Performance Parts	24.0120-0243.1	420243	Ø 330 20 18,4 V + S
			→	05/12→; + Performance Parts	24.0124-0251.2	424251	Ø 345 24 22,4 V Bremsscheibe zweiteilig / + S
			330 d 330 d xDrive	210 210	01/12→ 06/12→	←	09/15→; - Performance Parts
		←		09/15→; für Fahrzeuge mit verstärkter Bremse	24.0130-0233.2	430233	Ø 340 30 28,4 V Bremsscheibe zweiteilig / + S
		←		09/15→; + Performance Parts	24.0130-0234.2	430234	Ø 370 30 28,4 V Bremsscheibe zweiteilig / + S
		→		09/15→; - Performance Parts	24.0120-0243.1	420243	Ø 330 20 18,4 V + S
		→		09/15→; + Performance Parts	24.0124-0251.2	424251	Ø 345 24 22,4 V Bremsscheibe zweiteilig / + S
330 d xDrive	190	06/12→		←	03/13→; - Performance Parts	24.0124-0248.1	424248
			←	03/13→; für Fahrzeuge mit verstärkter Bremse	24.0130-0233.2	430233	Ø 340 30 28,4 V Bremsscheibe zweiteilig / + S
			←	03/13→; + Performance Parts	24.0130-0234.2	430234	Ø 370 30 28,4 V Bremsscheibe zweiteilig / + S
			→	03/13→; - Performance Parts	24.0120-0243.1	420243	Ø 330 20 18,4 V + S
			→	03/13→; + Performance Parts	24.0124-0251.2	424251	Ø 345 24 22,4 V Bremsscheibe zweiteilig / + S
			330 i 330 i xDrive	185 185	09/14→ 10/14→	←	07/15→; - Performance Parts
		←		07/15→; + Performance Parts	24.0130-0234.2	430234	Ø 370 30 28,4 V Bremsscheibe zweiteilig / + S
		→		07/15→; - Performance Parts	24.0120-0240.1	420240	Ø 300 20 18,4 V + S
		→		07/15→; + Performance Parts	24.0124-0251.2	424251	Ø 345 24 22,4 V Bremsscheibe zweiteilig / + S
335 d xDrive	230	04/13→	←	11/13→; - Performance Parts	24.0130-0233.2	430233	Ø 340 30 28,4 V Bremsscheibe zweiteilig / + S
			←	11/13→; + Performance Parts	24.0130-0234.2	430234	Ø 370 30 28,4 V Bremsscheibe zweiteilig / + S
			→	11/13→; - Performance Parts	24.0120-0243.1	420243	Ø 330 20 18,4 V + S
			→	11/13→; + Performance Parts	24.0124-0251.2	424251	Ø 345 24 22,4 V Bremsscheibe zweiteilig / + S
335 i 335 i	225 240	07/12→06/15 07/12→07/13	←	03/13→; - Performance Parts	24.0130-0233.2	430233	Ø 340 30 28,4 V Bremsscheibe zweiteilig / + S
			←	+ Performance Parts	24.0130-0234.2	430234	Ø 370 30 28,4 V Bremsscheibe zweiteilig / + S
			→	03/13→; - Performance Parts	24.0120-0243.1	420243	Ø 330 20 18,4 V + S
			→	03/13→; + Performance Parts	24.0124-0251.2	424251	Ø 345 24 22,4 V Bremsscheibe zweiteilig / + S
335 i 335 i xDrive	250 250	07/13→06/15 07/13→06/15	←	- Performance Parts	24.0130-0233.2	430233	Ø 340 30 28,4 V Bremsscheibe zweiteilig / + S
			←	+ Performance Parts	24.0130-0234.2	430234	Ø 370 30 28,4 V Bremsscheibe zweiteilig / + S
↓							

	kw			 	! #		
BMW - 3 Kombi (F31) 07/11→							
 Bremsscheibe							
335 i 335 i xDrive	250 250	07/13→06/15 07/13→06/15	➡ ➡	- Performance Parts + Performance Parts		24.0120-0243.1 420243 24.0124-0251.2 424251	Ø 330 20 18,4 V + S Ø 345 24 22,4 V Bremsscheibe zweiteilig / + S
335 i xDrive 335 i xDrive	225 240	07/12→06/15 07/12→07/13	⬅ ⬅ ➡ ➡	03/13→; - Performance Parts 03/13→; + Performance Parts 03/13→; - Performance Parts 03/13→; + Performance Parts		24.0130-0233.2 430233 24.0130-0234.2 430234 24.0120-0243.1 420243 24.0124-0251.2 424251	Ø 340 30 28,4 V Bremsscheibe zweiteilig / + S Ø 370 30 28,4 V Bremsscheibe zweiteilig / + S Ø 330 20 18,4 V + S Ø 345 24 22,4 V Bremsscheibe zweiteilig / + S
340 i 340 i 340 i xDrive 340 i xDrive	240 265 240 265	10/14→ 10/14→ 10/14→ 10/14→	⬅ ⬅ ➡ ➡	07/15→; - Performance Parts 07/15→; + Performance Parts 07/15→; - Performance Parts 07/15→; + Performance Parts		24.0130-0233.2 430233 24.0130-0234.2 430234 24.0120-0243.1 420243 24.0124-0251.2 424251	Ø 340 30 28,4 V Bremsscheibe zweiteilig / + S Ø 370 30 28,4 V Bremsscheibe zweiteilig / + S Ø 330 20 18,4 V + S Ø 345 24 22,4 V Bremsscheibe zweiteilig / + S
BMW - 3 Touring (E36) 01/95→10/99							
 Bremsbelagsatz, Scheibenbremse							
316 i 318 i 318 tds 320 i 323 i 325 tds 328 i	75 85 66 110 125 105 142	01/96→10/99 07/95→10/99 01/95→10/99 01/95→10/99 09/95→10/99 01/95→10/99 01/95→10/99	⬅ ➡ ➡			13.0460-5405.2 605405 13.0470-5405.2 LD5405 13.0460-3605.2 603605 13.0470-3605.2 LD3605	ATE 21643 17,8 + WE / - WK ATE 21643 17,8 + WE / - WK Ceramic ATE 20180 17,3 + WE / - WK ATE 20180 17,3 + WE / - WK Ceramic
Warnkontakt, Bremsbelagverschleiß							
316 i 318 i 318 tds 320 i 323 i 325 tds 328 i	75 85 66 110 125 105 142	01/96→10/99 07/95→10/99 01/95→10/99 01/95→10/99 09/95→10/99 01/95→10/99 01/95→10/99	⬅ ➡ ➡		1 1	24.8190-0207.2 620207 24.8190-0206.2 620206	L= 786 L= 790
 Bremsscheibe							
316 i 318 i 318 tds	75 85 66	01/96→10/99 07/95→10/99 01/95→10/99	⬅ ⬅ ⬅	nicht für erhöhte Nutzlast für erhöhte Nutzlast		24.0112-0126.1 412126 24.0312-0126.1 512126 24.0122-0115.1 422115 24.0322-0115.1 522115	Ø 286 12 10,4 + S Ø 286 12 9,6 + S PD Ø 286 22 20,4 V + S Ø 286 22 19,6 V + S PD
320 i 325 tds	110 105	01/95→10/99 01/95→10/99	➡ ➡ ➡			24.0110-0202.1 410202 24.0310-0202.1 510202 24.0122-0115.1 422115 24.0322-0115.1 522115 24.0110-0202.1 410202 24.0310-0202.1 510202	Ø 280 10 8,4 + S Ø 280 10 7,6 + S PD Ø 286 22 20,4 V + S Ø 286 22 19,6 V + S PD Ø 280 10 8,4 + S Ø 280 10 7,6 + S PD
323 i 328 i	125 142	09/95→10/99 01/95→10/99	⬅ ⬅ ➡			24.0122-0115.1 422115 24.0322-0115.1 522115 24.0119-0107.1 419107 24.0319-0107.1 519107	Ø 286 22 20,4 V + S Ø 286 22 19,6 V + S PD Ø 276 19 17,4 V + S Ø 276 19 16,6 V + S PD
BMW - 3 Touring (E46) 10/99→05/05							
 Bremsbelagsatz, Scheibenbremse							
316 i 316 i 318 d 318 d 318 i 318 i 318 i 320 d 320 d 320 i 320 i 320 i 325 i 325 xi 328 i	85 85 85 85 87 105 100 110 110 120 125 141 141 142	06/02→02/05 03/02→02/05 10/02→03/03 03/03→02/05 10/99→09/01 10/99→09/01 09/01→02/05 03/00→09/01 09/01→02/05 10/99→09/00 09/00→02/05 09/00→02/05 09/00→02/05 09/00→02/05 10/99→06/00	⬅ ➡ ➡			13.0460-5405.2 605405 13.0470-5405.2 LD5405 13.0460-3605.2 603605 13.0470-3605.2 LD3605	ATE 21643 17,8 + WE / - WK ATE 21643 17,8 + WE / - WK Ceramic ATE 20180 17,3 + WE / - WK ATE 20180 17,3 + WE / - WK Ceramic
↓							









	kw			 	! #		
BMW - 3 Touring (E46) 10/99→05/05							
 Bremsbelagsatz, Scheibenbremse							
330 d 330 d 330 i 330 xi	135 150 170 170	10/99→02/05 03/03→02/05 06/00→02/05 06/00→02/05	← ← → →			13.0460-7155.2 607155 13.0470-7155.2 LD7155	ATE 21676 20,3 + WE / - WK ATE 21676 20,3 + WE / - WK Ceramic
						13.0460-7079.2 607079 13.0470-7079.2 LD7079	ATE 21282 17,3 + WE / - WK ATE 21282 17,3 + WE / - WK Ceramic
330 xd	135	01/00→03/03	←	06/00→		13.0460-7155.2 607155 13.0470-7155.2 LD7155	ATE 21676 20,3 + WE / - WK ATE 21676 20,3 + WE / - WK Ceramic
			→	06/00→		13.0460-7079.2 607079 13.0470-7079.2 LD7079	ATE 21282 17,3 + WE / - WK ATE 21282 17,3 + WE / - WK Ceramic
330 xd	150	08/02→05/05	←	03/03→ 02/05		13.0460-7155.2 607155 13.0470-7155.2 LD7155	ATE 21676 20,3 + WE / - WK ATE 21676 20,3 + WE / - WK Ceramic
			→	03/03→ 02/05		13.0460-7079.2 607079 13.0470-7079.2 LD7079	ATE 21282 17,3 + WE / - WK ATE 21282 17,3 + WE / - WK Ceramic
Warnkontakt, Bremsbelagverschleiß							
316 i 316 i 318 d 318 d 318 i 318 i 318 i 320 d 320 d 320 i 320 i 320 i 325 i 328 i	85 85 85 85 85 87 105 100 110 110 120 125 141 142	06/02→02/05 03/02→02/05 10/02→03/03 03/03→02/05 10/99→09/01 10/99→09/01 09/01→02/05 03/00→09/01 09/01→02/05 10/99→09/00 09/00→02/05 09/00→02/05 09/00→02/05 10/99→06/00	← → → → → → → → → → → → → →		1 1	24.8190-0220.2 620220 24.8190-0221.2 620221	L= 601 L= 1.338
325 xi 330 d 330 d 330 i 330 xi	141 135 150 170 170	09/00→02/05 10/99→02/05 03/03→02/05 06/00→02/05 06/00→02/05	← → → → →		1 1	24.8190-0227.2 620227 24.8190-0221.2 620221	L= 651 L= 1.338
330 xd	135	01/00→03/03	←	06/00→	1	24.8190-0227.2 620227	L= 651
			→	06/00→	1	24.8190-0221.2 620221	L= 1.338
330 xd	150	08/02→05/05	←	03/03→ 02/05	1	24.8190-0227.2 620227	L= 651
			→	03/03→ 02/05	1	24.8190-0221.2 620221	L= 1.338
 Bremsscheibe							
316 i 316 i 318 i 318 i 320 d 320 i	85 85 85 87 105 100 110	06/02→02/05 03/02→02/05 10/99→09/01 10/99→09/01 09/01→02/05 03/00→09/01 10/99→09/00	← → → → → →			24.0122-0115.1 422115 24.0322-0115.1 522115 24.0119-0107.1 419107 24.0319-0107.1 519107	Ø 286 22 20,4 V + S Ø 286 22 19,6 V + S PD Ø 276 19 17,4 V + S Ø 276 19 16,6 V + S PD
318 d 318 d	85 85	10/02→03/03 03/03→02/05	←	nicht für erhöhte Nutzlast		24.0122-0115.1 422115 24.0322-0115.1 522115	Ø 286 22 20,4 V + S Ø 286 22 19,6 V + S PD
			←	für erhöhte Nutzlast		24.0122-0160.1 422160 24.0322-0160.1 522160	Ø 300 22 20,4 V + S Ø 300 22 19,6 V + S PD
			→	nicht für erhöhte Nutzlast		24.0119-0107.1 419107 24.0319-0107.1 519107	Ø 276 19 17,4 V + S Ø 276 19 16,6 V + S PD
			→	für erhöhte Nutzlast		24.0119-0108.1 419108 24.0319-0108.1 519108	Ø 294 18,9 17,4 V + S Ø 294 18,9 16,6 V + S PD
320 d 320 i 320 i 325 i 328 i	110 120 125 141 142	09/01→02/05 09/00→02/05 09/00→02/05 09/00→02/05 10/99→06/00	← → → → →			24.0122-0160.1 422160 24.0322-0160.1 522160 24.0119-0108.1 419108 24.0319-0108.1 519108	Ø 300 22 20,4 V + S Ø 300 22 19,6 V + S PD Ø 294 18,9 17,4 V + S Ø 294 18,9 16,6 V + S PD
325 xi	141	09/00→02/05	←			24.0122-0160.1 422160 24.0322-0160.1 522160	Ø 300 22 20,4 V + S Ø 300 22 19,6 V + S PD
			→			24.0119-0113.1 419113	Ø 294 19 17,4 V + S
330 d 330 d 330 i	135 150 170	10/99→02/05 03/03→02/05 06/00→02/05	←			24.0125-0138.1 425138 24.0325-0138.1 525138	Ø 325 24,9 23,4 V + S Ø 325 24,9 22,6 V + S PD
↓							









	kw			 	! #		
BMW - 3 Touring (E46) 10/99→05/05							
 Bremsscheibe							
330 xi	170	06/00→02/05	➔			24.0122-0209.1 422209 24.0322-0209.1 522209	Ø 320 22 20,4 V + S Ø 320 22 19,6 V + S PD
330 xd	135	01/00→03/03	➔	06/00→		24.0125-0138.1 425138 24.0325-0138.1 525138	Ø 325 24,9 23,4 V + S Ø 325 24,9 22,6 V + S PD
			➔	06/00→		24.0122-0209.1 422209 24.0322-0209.1 522209	Ø 320 22 20,4 V + S Ø 320 22 19,6 V + S PD
330 xd	150	08/02→05/05	➔	03/03→ 02/05		24.0125-0138.1 425138 24.0325-0138.1 525138	Ø 325 24,9 23,4 V + S Ø 325 24,9 22,6 V + S PD
			➔	03/03→ 02/05		24.0122-0209.1 422209 24.0322-0209.1 522209	Ø 320 22 20,4 V + S Ø 320 22 19,6 V + S PD
BMW - 3 Touring (E91) 12/04→06/12							
 Bremsbelagsatz, Scheibenbremse							
316 d	85	09/09→06/12	➔	→ 05/12; + Performance Parts		13.0460-4848.2 604848	BRE 24316 16,9 + WE / - WK
			➔	03/10→ 05/12		13.0460-7216.2 607216 13.0470-7216.2 LD7216	ATE 23794 20,3 + WE / - WK ATE 23794 20,3 + WE / - WK Ceramic
			➔	→ 02/10		13.0460-7216.2 607216 13.0470-7216.2 LD7216	ATE 23794 20,3 + WE / - WK ATE 23794 20,3 + WE / - WK Ceramic
			➔	03/10→ 05/12		13.0460-7217.2 607217 13.0470-7217.2 LD7217	ATE 23926 17,3 + WE / - WK ATE 23926 17,3 + WE / - WK Ceramic
			➔	→ 02/10		13.0460-7217.2 607217 13.0470-7217.2 LD7217	ATE 23926 17,3 + WE / - WK ATE 23926 17,3 + WE / - WK Ceramic
316 i	90	05/08→05/12	➔	+ Performance Parts		13.0460-4848.2 604848	BRE 24316 16,9 + WE / - WK
			➔	→ 02/10		13.0460-7216.2 607216 13.0470-7216.2 LD7216	ATE 23794 20,3 + WE / - WK ATE 23794 20,3 + WE / - WK Ceramic
			➔	03/10→		13.0460-7216.2 607216 13.0470-7216.2 LD7216	ATE 23794 20,3 + WE / - WK ATE 23794 20,3 + WE / - WK Ceramic
			➔	03/10→		13.0460-7217.2 607217 13.0470-7217.2 LD7217	ATE 23926 17,3 + WE / - WK ATE 23926 17,3 + WE / - WK Ceramic
			➔	→ 02/10		13.0460-7217.2 607217 13.0470-7217.2 LD7217	ATE 23926 17,3 + WE / - WK ATE 23926 17,3 + WE / - WK Ceramic
318 d	90	09/05→06/12	➔	→ 08/07; + Performance Parts		13.0460-4848.2 604848	BRE 24316 16,9 + WE / - WK
			➔	→ 08/07		13.0460-7216.2 607216 13.0470-7216.2 LD7216	ATE 23794 20,3 + WE / - WK ATE 23794 20,3 + WE / - WK Ceramic
			➔	→ 08/07		13.0460-7217.2 607217 13.0470-7217.2 LD7217	ATE 23926 17,3 + WE / - WK ATE 23926 17,3 + WE / - WK Ceramic
318 d	100	07/07→06/12	➔	09/07→ 05/12; + Performance Parts		13.0460-4848.2 604848	BRE 24316 16,9 + WE / - WK
			➔	03/10→ 05/12		13.0460-7238.2 607238 13.0470-7238.2 LD7238	ATE 23313 20,3 + WE / - WK ATE 23313 20,3 + WE / - WK Ceramic
			➔	09/07→ 02/10		13.0460-7238.2 607238 13.0470-7238.2 LD7238	ATE 23313 20,3 + WE / - WK ATE 23313 20,3 + WE / - WK Ceramic
			➔	03/10→ 05/12		13.0460-7217.2 607217 13.0470-7217.2 LD7217	ATE 23926 17,3 + WE / - WK ATE 23926 17,3 + WE / - WK Ceramic
			➔	09/07→ 02/10		13.0460-7217.2 607217 13.0470-7217.2 LD7217	ATE 23926 17,3 + WE / - WK ATE 23926 17,3 + WE / - WK Ceramic
318 d	105	09/07→06/12	➔	→ 05/12; + Performance Parts		13.0460-4848.2 604848	BRE 24316 16,9 + WE / - WK
			➔	03/10→ 05/12		13.0460-7238.2 607238 13.0470-7238.2 LD7238	ATE 23313 20,3 + WE / - WK ATE 23313 20,3 + WE / - WK Ceramic
			➔	→ 02/10		13.0460-7238.2 607238	ATE 23313 20,3 + WE / - WK

	kw			 	! #			
BMW - 3 Touring (E91) 12/04→06/12								
 Bremsbelagsatz, Scheibenbremse								
318 d	105	09/07→06/12	←	→ 02/10		13.0470-7238.2	LD7238	ATE 23313 20,3 + WE / - WK Ceramic
			→	→ 02/10		13.0460-7217.2	607217	ATE 23926 17,3 + WE / - WK
			→	03/10→ 05/12		13.0470-7217.2	LD7217	ATE 23926 17,3 + WE / - WK Ceramic
318 i	95	01/06→08/07	←	+ Performance Parts		13.0460-4848.2	604848	BRE 24316 16,9 + WE / - WK
			←	Motorcode: N46		13.0460-7216.2	607216	ATE 23794 20,3 + WE / - WK
			←	03/07→; Motorcode: N46N		13.0470-7216.2	LD7216	ATE 23794 20,3 + WE / - WK Ceramic
			→			13.0460-7238.2	607238	ATE 23313 20,3 + WE / - WK
318 i	100	09/07→03/12	←	+ Performance Parts		13.0460-7238.2	LD7238	ATE 23313 20,3 + WE / - WK Ceramic
			←	03/08→ 02/10; nicht für erhöhte Nutzlast		13.0470-7238.2	LD7238	ATE 23313 20,3 + WE / - WK Ceramic
			←	03/10→; nicht für erhöhte Nutzlast		13.0460-7216.2	607216	ATE 23794 20,3 + WE / - WK
			←	→ 02/08; nicht für erhöhte Nutzlast		13.0470-7216.2	LD7216	ATE 23794 20,3 + WE / - WK Ceramic
			←	03/10→; für erhöhte Nutzlast		13.0460-7238.2	607238	ATE 23313 20,3 + WE / - WK
			←	→ 02/10; für erhöhte Nutzlast		13.0470-7238.2	LD7238	ATE 23313 20,3 + WE / - WK Ceramic
			→	03/10→		13.0460-7217.2	607217	ATE 23926 17,3 + WE / - WK
			→	→ 02/10		13.0470-7217.2	LD7217	ATE 23926 17,3 + WE / - WK Ceramic
			318 i	105	05/07→05/12	←	09/07→; + Performance Parts	
←	03/08→ 02/10; nicht für erhöhte Nutzlast					13.0460-7216.2	607216	ATE 23794 20,3 + WE / - WK
←	03/10→; nicht für erhöhte Nutzlast					13.0470-7216.2	LD7216	ATE 23794 20,3 + WE / - WK Ceramic
←	09/07→ 02/10; für erhöhte Nutzlast					13.0460-7216.2	607216	ATE 23794 20,3 + WE / - WK Ceramic
←	09/07→ 02/08; nicht für erhöhte Nutzlast					13.0470-7216.2	LD7216	ATE 23794 20,3 + WE / - WK Ceramic
←	03/10→; für erhöhte Nutzlast					13.0460-7238.2	607238	ATE 23313 20,3 + WE / - WK
→	03/10→					13.0470-7238.2	LD7238	ATE 23313 20,3 + WE / - WK Ceramic
→	09/07→ 02/10					13.0460-7217.2	607217	ATE 23926 17,3 + WE / - WK
320 d 320 d	110 120	12/04→08/07 12/04→08/07	←	06/05→; + Performance Parts		13.0460-4848.2	604848	BRE 24316 16,9 + WE / - WK
			←	06/05→		13.0460-7216.2	607216	ATE 23794 20,3 + WE / - WK
						13.0470-7216.2	LD7216	ATE 23794 20,3 + WE / - WK Ceramic









	kw			 	! #		
BMW - 3 Touring (E91) 12/04→06/12							
 Bremsbelagsatz, Scheibenbremse							
320 d 320 d	110 120	12/04→08/07 12/04→08/07	➔	06/05→; nicht für Behördenfahrzeuge	13.0460-7217.2	607217	ATE 23926 17,3 + WE / - WK
			➔	06/05→; für Behördenfahrzeuge	13.0470-7217.2	LD7217	ATE 23926 17,3 + WE / - WK Ceramic
320 d 320 d	130 145	02/07→02/10 02/07→02/10	➔	09/07→; + Performance Parts	13.0460-4848.2	604848	BRE 24316 16,9 + WE / - WK
			➔	09/07→; für Behördenfahrzeuge	13.0460-7216.2	607216	ATE 23794 20,3 + WE / - WK
320 d 320 d	135 147	03/10→05/12 03/10→05/12	➔	für Behördenfahrzeuge	13.0470-7216.2	LD7216	ATE 23794 20,3 + WE / - WK Ceramic
			➔	nicht für Behördenfahrzeuge	13.0460-7238.2	607238	ATE 23313 20,3 + WE / - WK Ceramic
320 d ed	120	10/10→05/12	➔	nicht für Behördenfahrzeuge	13.0460-7217.2	607217	ATE 23926 17,3 + WE / - WK Ceramic
			➔	für Behördenfahrzeuge	13.0460-7225.2	607225	ATE 23550 17,3 + WE / - WK Ceramic
320 d xDrive	120	07/09→06/12	➔	→ 05/12; + Performance Parts	13.0460-4848.2	604848	BRE 24316 16,9 + WE / - WK
			➔	→ 02/10; für Behördenfahrzeuge	13.0460-7216.2	607216	ATE 23794 20,3 + WE / - WK Ceramic
320 d xDrive	120	07/09→06/12	➔	03/10→; für Behördenfahrzeuge; → 05/12	13.0460-7216.2	607216	ATE 23794 20,3 + WE / - WK Ceramic
			➔	→ 02/10; nicht für Behördenfahrzeuge	13.0460-7238.2	607238	ATE 23313 20,3 + WE / - WK Ceramic
320 d xDrive	120	07/09→06/12	➔	03/10→; nicht für Behördenfahrzeuge; → 05/12	13.0460-7238.2	607238	ATE 23313 20,3 + WE / - WK Ceramic
			➔	→ 02/10; nicht für Behördenfahrzeuge	13.0460-7217.2	607217	ATE 23926 17,3 + WE / - WK Ceramic
320 d xDrive	120	07/09→06/12	➔	03/10→ 05/12; nicht für Behördenfahrzeuge	13.0460-7217.2	607217	ATE 23926 17,3 + WE / - WK Ceramic
			➔	→ 02/10; für Behördenfahrzeuge	13.0460-7225.2	607225	ATE 23550 17,3 + WE / - WK Ceramic



















	kw			 	! #		
BMW - 3 Touring (E91) 12/04→06/12							
 Bremsbelagsatz, Scheibenbremse							
320 d xDrive	120	07/09→06/12	➡	03/10→; für Behördenfahrzeuge; → 05/12		13.0460-7225.2 607225 13.0470-7225.2 LD7225	ATE 23550 17,3 + WE / - WK ATE 23550 17,3 + WE / - WK Ceramic
320 d xDrive	130	02/08→02/10	←	+ Performance Parts		13.0460-4848.2 604848	BRE 24316 16,9 + WE / - WK
320 d xDrive	135	03/10→05/12	←	für Behördenfahrzeuge		13.0460-7216.2 607216	ATE 23794 20,3 + WE / - WK
320 d xDrive	145	02/08→02/10	←			13.0470-7216.2 LD7216	ATE 23794 20,3 + WE / - WK Ceramic
320 d xDrive	147	03/10→05/12	←	nicht für Behördenfahrzeuge		13.0460-7238.2 607238 13.0470-7238.2 LD7238	ATE 23313 20,3 + WE / - WK ATE 23313 20,3 + WE / - WK Ceramic
			➡	nicht für Behördenfahrzeuge		13.0460-7217.2 607217 13.0470-7217.2 LD7217	ATE 23926 17,3 + WE / - WK ATE 23926 17,3 + WE / - WK Ceramic
			➡	für Behördenfahrzeuge		13.0460-7225.2 607225 13.0470-7225.2 LD7225	ATE 23550 17,3 + WE / - WK ATE 23550 17,3 + WE / - WK Ceramic
320 i	110	09/05→06/12	←	→ 08/07; + Performance Parts		13.0460-4848.2 604848	BRE 24316 16,9 + WE / - WK
			←	→ 05/12; Motorcode: N46		13.0460-7216.2 607216 13.0470-7216.2 LD7216	ATE 23794 20,3 + WE / - WK ATE 23794 20,3 + WE / - WK Ceramic
			←	→ 08/07; Motorcode: N46N		13.0460-7216.2 607216 13.0470-7216.2 LD7216	ATE 23794 20,3 + WE / - WK ATE 23794 20,3 + WE / - WK Ceramic
			←	09/07→ 05/12; Motorcode: N46N		13.0460-7238.2 607238 13.0470-7238.2 LD7238	ATE 23313 20,3 + WE / - WK ATE 23313 20,3 + WE / - WK Ceramic
			➡	→ 08/07		13.0460-7217.2 607217 13.0470-7217.2 LD7217	ATE 23926 17,3 + WE / - WK ATE 23926 17,3 + WE / - WK Ceramic
320 i	120	02/07→05/12	←	09/07→; + Performance Parts		13.0460-4848.2 604848	BRE 24316 16,9 + WE / - WK
320 i	125	02/07→05/12	←	09/07→ 02/10		13.0460-7238.2 607238 13.0470-7238.2 LD7238	ATE 23313 20,3 + WE / - WK ATE 23313 20,3 + WE / - WK Ceramic
			←	03/10→		13.0460-7238.2 607238 13.0470-7238.2 LD7238	ATE 23313 20,3 + WE / - WK ATE 23313 20,3 + WE / - WK Ceramic
			➡	03/10→		13.0460-7217.2 607217 13.0470-7217.2 LD7217	ATE 23926 17,3 + WE / - WK ATE 23926 17,3 + WE / - WK Ceramic
			➡	09/07→ 02/10		13.0460-7217.2 607217 13.0470-7217.2 LD7217	ATE 23926 17,3 + WE / - WK ATE 23926 17,3 + WE / - WK Ceramic
323 i	130	04/06→06/07	←	09/06→		13.0460-7238.2 607238 13.0470-7238.2 LD7238	ATE 23313 20,3 + WE / - WK ATE 23313 20,3 + WE / - WK Ceramic
			➡	09/06→		13.0460-7217.2 607217 13.0470-7217.2 LD7217	ATE 23926 17,3 + WE / - WK ATE 23926 17,3 + WE / - WK Ceramic
323 i	140	09/06→07/08	←			13.0460-7238.2 607238 13.0470-7238.2 LD7238	ATE 23313 20,3 + WE / - WK ATE 23313 20,3 + WE / - WK Ceramic
			➡			13.0460-7217.2 607217 13.0470-7217.2 LD7217	ATE 23926 17,3 + WE / - WK ATE 23926 17,3 + WE / - WK Ceramic
325 d	145	09/06→06/12	←	→ 05/12; + Performance Parts		13.0460-4848.2 604848	BRE 24316 16,9 + WE / - WK
325 d	150	02/10→06/12	←	03/10→ 05/12; nicht für Behördenfahrzeuge		13.0460-7216.2 607216 13.0470-7216.2 LD7216	ATE 23794 20,3 + WE / - WK ATE 23794 20,3 + WE / - WK Ceramic
			←	→ 02/10; nicht für Behördenfahrzeuge		13.0460-7216.2 607216 13.0470-7216.2 LD7216	ATE 23794 20,3 + WE / - WK ATE 23794 20,3 + WE / - WK Ceramic
			←	→ 02/10; für Behördenfahrzeuge		13.0460-7237.2 607237 13.0460-7238.2 607238 13.0470-7237.2 LD7237	ATE 23347 20,3 + WE / - WK ATE 23313 20,3 + WE / - WK ATE 23347 20,3 + WE / - WK Ceramic
↓							









	kw			 	! #		
BMW - 3 Touring (E91) 12/04→06/12							
 Bremsbelagsatz, Scheibenbremse							
325 d 325 d	145 150	09/06→06/12 02/10→06/12	←	→ 02/10; für Behördenfahrzeuge	13.0470-7238.2	LD7238	ATE 23313 20,3 + WE / - WK Ceramic
			←	03/10→ 05/12; für Behördenfahrzeuge	13.0460-7237.2	607237	ATE 23347 20,3 + WE / - WK
					13.0460-7238.2	607238	ATE 23313 20,3 + WE / - WK
					13.0470-7237.2	LD7237	ATE 23347 20,3 + WE / - WK Ceramic
					13.0470-7238.2	LD7238	ATE 23313 20,3 + WE / - WK Ceramic
		→	→ 02/10	13.0460-7225.2	607225	ATE 23550 17,3 + WE / - WK	
				13.0470-7225.2	LD7225	ATE 23550 17,3 + WE / - WK Ceramic	
		→	03/10→ 05/12	13.0460-7225.2	607225	ATE 23550 17,3 + WE / - WK	
				13.0470-7225.2	LD7225	ATE 23550 17,3 + WE / - WK Ceramic	
325 i 325 i	155 160	12/04→12/10 12/04→12/10	←	06/05→; + Performance Parts	13.0460-4848.2	604848	BRE 24316 16,9 + WE / - WK
			←	06/05→ 08/07; Motorcode: N52	13.0460-7216.2	607216	ATE 23794 20,3 + WE / - WK
					13.0470-7216.2	LD7216	ATE 23794 20,3 + WE / - WK Ceramic
			←	03/10→; Motorcode: N53; für erhöhte Nutzlast	13.0460-7216.2	607216	ATE 23794 20,3 + WE / - WK
					13.0470-7216.2	LD7216	ATE 23794 20,3 + WE / - WK Ceramic
			←	09/07→ 02/10; Motorcode: N53; für erhöhte Nutzlast	13.0460-7216.2	607216	ATE 23794 20,3 + WE / - WK
					13.0470-7216.2	LD7216	ATE 23794 20,3 + WE / - WK Ceramic
			←	03/07→ 08/07; Motorcode: N52N; für erhöhte Nutzlast	13.0460-7216.2	607216	ATE 23794 20,3 + WE / - WK
					13.0470-7216.2	LD7216	ATE 23794 20,3 + WE / - WK Ceramic
			←	03/10→; Motorcode: N52N/N53; nicht für erhöhte Nutzlast	13.0460-7238.2	607238	ATE 23313 20,3 + WE / - WK
					13.0470-7238.2	LD7238	ATE 23313 20,3 + WE / - WK Ceramic
←	03/07→ 02/10; Motorcode: N52N/N53; nicht für erhöhte Nutzlast	13.0460-7238.2	607238	ATE 23313 20,3 + WE / - WK			
		13.0470-7238.2	LD7238	ATE 23313 20,3 + WE / - WK Ceramic			
→	06/05→ 02/10; nicht für erhöhte Nutzlast	13.0460-7217.2	607217	ATE 23926 17,3 + WE / - WK			
		13.0470-7217.2	LD7217	ATE 23926 17,3 + WE / - WK Ceramic			
→	03/10→; nicht für erhöhte Nutzlast	13.0460-7217.2	607217	ATE 23926 17,3 + WE / - WK			
		13.0470-7217.2	LD7217	ATE 23926 17,3 + WE / - WK Ceramic			
→	06/05→ 02/10; für erhöhte Nutzlast	13.0460-7225.2	607225	ATE 23550 17,3 + WE / - WK			
		13.0470-7225.2	LD7225	ATE 23550 17,3 + WE / - WK Ceramic			
→	03/10→; für erhöhte Nutzlast	13.0460-7225.2	607225	ATE 23550 17,3 + WE / - WK			
		13.0470-7225.2	LD7225	ATE 23550 17,3 + WE / - WK Ceramic			
325 i	155	09/07→06/12	←	01/12→ 05/12; + Performance Parts	13.0460-4848.2	604848	BRE 24316 16,9 + WE / - WK
			←	01/12→ 05/12; für erhöhte Nutzlast	13.0460-7216.2	607216	ATE 23794 20,3 + WE / - WK
					13.0470-7216.2	LD7216	ATE 23794 20,3 + WE / - WK Ceramic
			←	01/12→ 05/12; nicht für erhöhte Nutzlast	13.0460-7238.2	607238	ATE 23313 20,3 + WE / - WK
					13.0470-7238.2	LD7238	ATE 23313 20,3 + WE / - WK Ceramic
→	01/12→ 05/12; nicht für erhöhte Nutzlast	13.0460-7217.2	607217	ATE 23926 17,3 + WE / - WK			
		13.0470-7217.2	LD7217	ATE 23926 17,3 + WE / - WK Ceramic			
→	01/12→ 05/12; für erhöhte Nutzlast	13.0460-7225.2	607225	ATE 23550 17,3 + WE / - WK			
		13.0470-7225.2	LD7225	ATE 23550 17,3 + WE / - WK Ceramic			
325 i	160	09/07→06/12	←	→ 05/12; + Performance Parts	13.0460-4848.2	604848	BRE 24316 16,9 + WE / - WK
			←	→ 02/10; Motorcode: N53; für erhöhte Nutzlast	13.0460-7216.2	607216	ATE 23794 20,3 + WE / - WK
					13.0470-7216.2	LD7216	ATE 23794 20,3 + WE / - WK Ceramic
			←	03/10→ 05/12; Motorcode: N53; für erhöhte Nutzlast	13.0460-7216.2	607216	ATE 23794 20,3 + WE / - WK
		13.0470-7216.2	LD7216	ATE 23794 20,3 + WE / - WK Ceramic			
←	03/10→ 05/12; Motorcode: N52N/N53; nicht für erhöhte Nutzlast	13.0460-7238.2	607238	ATE 23313 20,3 + WE / - WK			

















	kw			 	! #		
BMW - 3 Touring (E91) 12/04→06/12							
 Bremsbelagsatz, Scheibenbremse							
325 i	160	09/07→06/12	←	03/10→ 05/12; Motorcode: N52N/N53; nicht für erhöhte Nutzlast	13.0470-7238.2	LD7238	ATE 23313 20,3 + WE / - WK Ceramic
			←	→ 02/10; Motorcode: N52N/N53; nicht für erhöhte Nutzlast	13.0460-7238.2	607238	ATE 23313 20,3 + WE / - WK
					13.0470-7238.2	LD7238	ATE 23313 20,3 + WE / - WK Ceramic
			→	03/10→ 05/12; nicht für erhöhte Nutzlast	13.0460-7217.2	607217	ATE 23926 17,3 + WE / - WK
					13.0470-7217.2	LD7217	ATE 23926 17,3 + WE / - WK Ceramic
			→	→ 02/10; nicht für erhöhte Nutzlast	13.0460-7217.2	607217	ATE 23926 17,3 + WE / - WK
		13.0470-7217.2	LD7217	ATE 23926 17,3 + WE / - WK Ceramic			
			→	03/10→ 05/12; für erhöhte Nutzlast	13.0460-7225.2	607225	ATE 23550 17,3 + WE / - WK
					13.0470-7225.2	LD7225	ATE 23550 17,3 + WE / - WK Ceramic
			→	→ 02/10; für erhöhte Nutzlast	13.0460-7225.2	607225	ATE 23550 17,3 + WE / - WK
					13.0470-7225.2	LD7225	ATE 23550 17,3 + WE / - WK Ceramic
325 i xDrive 325 xi	160 160	09/07→06/12 09/07→06/12	←	→ 05/12; + Performance Parts	13.0460-4848.2	604848	BRE 24316 16,9 + WE / - WK
			←	03/10→ 05/12; Motorcode: N52/N53	13.0460-7216.2	607216	ATE 23794 20,3 + WE / - WK
					13.0470-7216.2	LD7216	ATE 23794 20,3 + WE / - WK Ceramic
			←	→ 02/10; Motorcode: N52/N53	13.0460-7216.2	607216	ATE 23794 20,3 + WE / - WK
					13.0470-7216.2	LD7216	ATE 23794 20,3 + WE / - WK Ceramic
			←	03/10→ 05/12; Motorcode: N52N; nicht für erhöhte Nutzlast	13.0460-7238.2	607238	ATE 23313 20,3 + WE / - WK
					13.0470-7238.2	LD7238	ATE 23313 20,3 + WE / - WK Ceramic
			←	→ 02/10; Motorcode: N52N; nicht für erhöhte Nutzlast	13.0460-7238.2	607238	ATE 23313 20,3 + WE / - WK
		13.0470-7238.2	LD7238	ATE 23313 20,3 + WE / - WK Ceramic			
			→	03/10→ 05/12; Motorcode: N52/N53	13.0460-7225.2	607225	ATE 23550 17,3 + WE / - WK
					13.0470-7225.2	LD7225	ATE 23550 17,3 + WE / - WK Ceramic
			→	→ 02/10; Motorcode: N52/N53	13.0460-7225.2	607225	ATE 23550 17,3 + WE / - WK
					13.0470-7225.2	LD7225	ATE 23550 17,3 + WE / - WK Ceramic
325 xi	160	09/05→08/11	←	+ Performance Parts	13.0460-4848.2	604848	BRE 24316 16,9 + WE / - WK
			←	→ 08/07; für erhöhte Nutzlast; Motorcode: N52N	13.0460-7216.2	607216	ATE 23794 20,3 + WE / - WK
					13.0470-7216.2	LD7216	ATE 23794 20,3 + WE / - WK Ceramic
			←	03/10→; Motorcode: N52/N53	13.0460-7216.2	607216	ATE 23794 20,3 + WE / - WK
					13.0470-7216.2	LD7216	ATE 23794 20,3 + WE / - WK Ceramic
			←	→ 02/10; Motorcode: N52/N53	13.0460-7216.2	607216	ATE 23794 20,3 + WE / - WK
					13.0470-7216.2	LD7216	ATE 23794 20,3 + WE / - WK Ceramic
			←	→ 02/10; Motorcode: N52N; nicht für erhöhte Nutzlast	13.0460-7238.2	607238	ATE 23313 20,3 + WE / - WK
					13.0470-7238.2	LD7238	ATE 23313 20,3 + WE / - WK Ceramic
			←	03/10→; Motorcode: N52N; nicht für erhöhte Nutzlast	13.0460-7238.2	607238	ATE 23313 20,3 + WE / - WK
		13.0470-7238.2	LD7238	ATE 23313 20,3 + WE / - WK Ceramic			
			→	→ 08/07; Motorcode: N52N; nicht für erhöhte Nutzlast	13.0460-7217.2	607217	ATE 23926 17,3 + WE / - WK
					13.0470-7217.2	LD7217	ATE 23926 17,3 + WE / - WK Ceramic
			→	→ 02/10; Motorcode: N52/N53	13.0460-7225.2	607225	ATE 23550 17,3 + WE / - WK
					13.0470-7225.2	LD7225	ATE 23550 17,3 + WE / - WK Ceramic
			→	03/10→; Motorcode: N52/N53	13.0460-7225.2	607225	ATE 23550 17,3 + WE / - WK
					13.0470-7225.2	LD7225	ATE 23550 17,3 + WE / - WK Ceramic
			→	→ 08/07; Motorcode: N52N; für erhöhte Nutzlast	13.0460-7225.2	607225	ATE 23550 17,3 + WE / - WK
					13.0470-7225.2	LD7225	ATE 23550 17,3 + WE / - WK Ceramic
330 d	155	12/04→05/12	←	06/05→; + Performance Parts	13.0460-4848.2	604848	BRE 24316 16,9 + WE / - WK
			←	06/05→ 08/07	13.0460-7216.2	607216	ATE 23794 20,3 + WE / - WK
↓							







	kw			 	! #			
BMW - 3 Touring (E91) 12/04→06/12								
 Bremsbelagsatz, Scheibenbremse								
330 d	155	12/04→05/12	←	06/05→ 08/07		13.0470-7216.2	LD7216	ATE 23794 20,3 + WE / - WK Ceramic
			←	09/07→ 02/10		13.0460-7237.2	607237	ATE 23347 20,3 + WE / - WK
						13.0460-7238.2	607238	ATE 23313 20,3 + WE / - WK
						13.0470-7237.2	LD7237	ATE 23347 20,3 + WE / - WK Ceramic
						13.0470-7238.2	LD7238	ATE 23313 20,3 + WE / - WK Ceramic
			←	03/10→		13.0460-7237.2	607237	ATE 23347 20,3 + WE / - WK
			13.0460-7238.2	607238	ATE 23313 20,3 + WE / - WK			
			13.0470-7237.2	LD7237	ATE 23347 20,3 + WE / - WK Ceramic			
			13.0470-7238.2	LD7238	ATE 23313 20,3 + WE / - WK Ceramic			
			→	03/10→		13.0460-7225.2	607225	ATE 23550 17,3 + WE / - WK
						13.0470-7225.2	LD7225	ATE 23550 17,3 + WE / - WK Ceramic
			→	06/05→ 02/10		13.0460-7225.2	607225	ATE 23550 17,3 + WE / - WK
						13.0470-7225.2	LD7225	ATE 23550 17,3 + WE / - WK Ceramic
330 d	170	12/04→08/08	←	06/05→; + Performance Parts		13.0460-4848.2	604848	BRE 24316 16,9 + WE / - WK
			←	06/05→ 08/07		13.0460-7216.2	607216	ATE 23794 20,3 + WE / - WK
						13.0470-7216.2	LD7216	ATE 23794 20,3 + WE / - WK Ceramic
			←	09/07→		13.0460-7237.2	607237	ATE 23347 20,3 + WE / - WK
						13.0460-7238.2	607238	ATE 23313 20,3 + WE / - WK
			13.0470-7237.2	LD7237	ATE 23347 20,3 + WE / - WK Ceramic			
			13.0470-7238.2	LD7238	ATE 23313 20,3 + WE / - WK Ceramic			
			→	06/05→		13.0460-7225.2	607225	ATE 23550 17,3 + WE / - WK
						13.0470-7225.2	LD7225	ATE 23550 17,3 + WE / - WK Ceramic
330 d	180	02/08→05/12	←	09/08→; + Performance Parts		13.0460-4848.2	604848	BRE 24316 16,9 + WE / - WK
			←	09/08→; nicht für erhöhte Nutzlast		13.0460-7216.2	607216	ATE 23794 20,3 + WE / - WK
						13.0470-7216.2	LD7216	ATE 23794 20,3 + WE / - WK Ceramic
			←	03/10→; für erhöhte Nutzlast		13.0460-7237.2	607237	ATE 23347 20,3 + WE / - WK
						13.0460-7238.2	607238	ATE 23313 20,3 + WE / - WK
						13.0470-7237.2	LD7237	ATE 23347 20,3 + WE / - WK Ceramic
						13.0470-7238.2	LD7238	ATE 23313 20,3 + WE / - WK Ceramic
←	09/08→ 02/10; für erhöhte Nutzlast		13.0460-7237.2	607237	ATE 23347 20,3 + WE / - WK			
			13.0460-7238.2	607238	ATE 23313 20,3 + WE / - WK			
			13.0470-7237.2	LD7237	ATE 23347 20,3 + WE / - WK Ceramic			
			13.0470-7238.2	LD7238	ATE 23313 20,3 + WE / - WK Ceramic			
			→	03/10→		13.0460-7225.2	607225	ATE 23550 17,3 + WE / - WK
						13.0470-7225.2	LD7225	ATE 23550 17,3 + WE / - WK Ceramic
			→	09/08→ 02/10		13.0460-7225.2	607225	ATE 23550 17,3 + WE / - WK
						13.0470-7225.2	LD7225	ATE 23550 17,3 + WE / - WK Ceramic
330 d xDrive 330 i 330 i xDrive 330 xi	180 200 200 200	01/09→06/12 09/07→06/12 09/07→06/12 09/07→06/12	←	→ 05/12; + Performance Parts		13.0460-4848.2	604848	BRE 24316 16,9 + WE / - WK
			←	03/10→ 05/12		13.0460-7237.2	607237	ATE 23347 20,3 + WE / - WK
						13.0460-7238.2	607238	ATE 23313 20,3 + WE / - WK
						13.0470-7237.2	LD7237	ATE 23347 20,3 + WE / - WK Ceramic
						13.0470-7238.2	LD7238	ATE 23313 20,3 + WE / - WK Ceramic
			←	→ 02/10		13.0460-7237.2	607237	ATE 23347 20,3 + WE / - WK
						13.0460-7238.2	607238	ATE 23313 20,3 + WE / - WK
						13.0470-7237.2	LD7237	ATE 23347 20,3 + WE / - WK Ceramic
						13.0470-7238.2	LD7238	ATE 23313 20,3 + WE / - WK Ceramic









	kW			 	! #		
BMW - 3 Touring (E91) 12/04→06/12							
 Bremsbelagsatz, Scheibenbremse							
330 d xDrive 330 i 330 i xDrive 330 xi	180 200 200 200	01/09→06/12 09/07→06/12 09/07→06/12 09/07→06/12	← → 02/10 → 02/10 → 03/10→ 05/12			13.0470-7238.2 LD7238 13.0460-7225.2 607225 13.0470-7225.2 LD7225 13.0460-7225.2 607225 13.0470-7225.2 LD7225	ATE 23313 20,3 + WE / - WK Ceramic ATE 23550 17,3 + WE / - WK ATE 23550 17,3 + WE / - WK Ceramic ATE 23550 17,3 + WE / - WK ATE 23550 17,3 + WE / - WK Ceramic
330 i 330 xi	190 190	09/05→08/07 09/05→08/07	← + Performance Parts ← →			13.0460-4848.2 604848 13.0460-7216.2 607216 13.0470-7216.2 LD7216 13.0460-7225.2 607225 13.0470-7225.2 LD7225	BRE 24316 16,9 + WE / - WK ATE 23794 20,3 + WE / - WK ATE 23794 20,3 + WE / - WK Ceramic ATE 23550 17,3 + WE / - WK ATE 23550 17,3 + WE / - WK Ceramic
330 xd	170	09/05→06/12	← → 05/12; + Performance Parts ← → 08/07 ← 03/10→ 05/12 ← 09/07→ 02/10 → 02/10 → 03/10→ 05/12			13.0460-4848.2 604848 13.0460-7216.2 607216 13.0470-7216.2 LD7216 13.0460-7237.2 607237 13.0460-7238.2 607238 13.0470-7237.2 LD7237 13.0470-7238.2 LD7238 13.0460-7237.2 607237 13.0460-7238.2 607238 13.0470-7237.2 LD7237 13.0470-7238.2 LD7238 13.0460-7225.2 607225 13.0470-7225.2 LD7225 13.0460-7225.2 607225 13.0470-7225.2 LD7225	BRE 24316 16,9 + WE / - WK ATE 23794 20,3 + WE / - WK ATE 23794 20,3 + WE / - WK Ceramic ATE 23347 20,3 + WE / - WK ATE 23313 20,3 + WE / - WK ATE 23347 20,3 + WE / - WK Ceramic ATE 23313 20,3 + WE / - WK Ceramic ATE 23347 20,3 + WE / - WK ATE 23313 20,3 + WE / - WK ATE 23347 20,3 + WE / - WK Ceramic ATE 23313 20,3 + WE / - WK Ceramic ATE 23550 17,3 + WE / - WK ATE 23550 17,3 + WE / - WK Ceramic ATE 23550 17,3 + WE / - WK ATE 23550 17,3 + WE / - WK Ceramic
335 d	210	09/06→06/12	← → 05/12 → 02/10 → 03/10→ 05/12			13.0460-7237.2 607237 13.0460-7238.2 607238 13.0470-7237.2 LD7237 13.0470-7238.2 LD7238 13.0460-7225.2 607225 13.0470-7225.2 LD7225 13.0460-7225.2 607225 13.0470-7225.2 LD7225	ATE 23347 20,3 + WE / - WK ATE 23313 20,3 + WE / - WK ATE 23347 20,3 + WE / - WK Ceramic ATE 23313 20,3 + WE / - WK Ceramic ATE 23550 17,3 + WE / - WK ATE 23550 17,3 + WE / - WK Ceramic ATE 23550 17,3 + WE / - WK ATE 23550 17,3 + WE / - WK Ceramic
335 i 335 i	225 240	03/06→05/12 03/06→05/12	← 09/06→ → 09/06→ 02/10 → 03/10→			13.0460-7237.2 607237 13.0460-7238.2 607238 13.0470-7237.2 LD7237 13.0470-7238.2 LD7238 13.0460-7225.2 607225 13.0470-7225.2 LD7225 13.0460-7225.2 607225 13.0470-7225.2 LD7225	ATE 23347 20,3 + WE / - WK ATE 23313 20,3 + WE / - WK ATE 23347 20,3 + WE / - WK Ceramic ATE 23313 20,3 + WE / - WK Ceramic ATE 23550 17,3 + WE / - WK ATE 23550 17,3 + WE / - WK Ceramic ATE 23550 17,3 + WE / - WK ATE 23550 17,3 + WE / - WK Ceramic
335 i xDrive 335 i xDrive	225 240	05/08→05/12 05/08→05/12	← → 02/10			13.0460-7237.2 607237 13.0460-7238.2 607238 13.0470-7237.2 LD7237 13.0470-7238.2 LD7238	ATE 23347 20,3 + WE / - WK ATE 23313 20,3 + WE / - WK ATE 23347 20,3 + WE / - WK Ceramic ATE 23313 20,3 + WE / - WK Ceramic
↓							







	kW			 	! #		
BMW - 3 Touring (E91) 12/04→06/12							
 Bremsbelagsatz, Scheibenbremse							
335 i xDrive 335 i xDrive	225 240	05/08→05/12 05/08→05/12	←	03/10→		13.0460-7237.2 607237	ATE 23347 20,3 + WE / - WK
						13.0460-7238.2 607238	ATE 23313 20,3 + WE / - WK
						13.0470-7237.2 LD7237	ATE 23347 20,3 + WE / - WK Ceramic
						13.0470-7238.2 LD7238	ATE 23313 20,3 + WE / - WK Ceramic
			→	→ 02/10		13.0460-7225.2 607225	ATE 23550 17,3 + WE / - WK
						13.0470-7225.2 LD7225	ATE 23550 17,3 + WE / - WK Ceramic
335 xi 335 xi	225 240	09/06→08/08 09/06→08/08	←	03/07→		13.0460-7237.2 607237	ATE 23347 20,3 + WE / - WK
						13.0460-7238.2 607238	ATE 23313 20,3 + WE / - WK
						13.0470-7237.2 LD7237	ATE 23347 20,3 + WE / - WK Ceramic
						13.0470-7238.2 LD7238	ATE 23313 20,3 + WE / - WK Ceramic
			→	03/07→		13.0460-7225.2 607225	ATE 23550 17,3 + WE / - WK
						13.0470-7225.2 LD7225	ATE 23550 17,3 + WE / - WK Ceramic
Warnkontakt, Bremsbelagverschleiß							
316 d	85	09/09→06/12	←	→ 02/10	1	24.8190-0264.2 620264	L= 630
			←	→ 05/12; + Performance Parts	1	24.8190-0267.2 620267	L= 679
			←	03/10→ 05/12	1	24.8190-0284.2 620284	L= 650
			→	→ 02/10	1	24.8190-0265.2 620265	L= 1.086
			→	03/10→ 05/12	1	24.8190-0285.2 620285	L= 1.107
316 i	90	05/08→05/12	←	→ 02/10	1	24.8190-0264.2 620264	L= 630
			←	+ Performance Parts	1	24.8190-0267.2 620267	L= 679
			←	03/10→	1	24.8190-0284.2 620284	L= 650
			→	→ 02/10	1	24.8190-0265.2 620265	L= 1.086
			→	03/10→	1	24.8190-0285.2 620285	L= 1.107
318 d	90	09/05→06/12	←	→ 08/07	1	24.8190-0264.2 620264	L= 630
			←	→ 08/07; + Performance Parts	1	24.8190-0267.2 620267	L= 679
			→	→ 08/07	1	24.8190-0265.2 620265	L= 1.086
318 d	100	07/07→06/12	←	09/07→ 05/12; + Performance Parts	1	24.8190-0267.2 620267	L= 679
			←	09/07→ 02/10	1	24.8190-0267.2 620267	L= 679
			←	03/10→ 05/12	1	24.8190-0287.2 620287	L= 723
			→	09/07→ 02/10	1	24.8190-0265.2 620265	L= 1.086
			→	03/10→ 05/12	1	24.8190-0285.2 620285	L= 1.107
318 d 330 i	105 200	09/07→06/12 09/07→06/12	←	→ 02/10	1	24.8190-0267.2 620267	L= 679
			←	→ 05/12; + Performance Parts	1	24.8190-0267.2 620267	L= 679
			←	03/10→ 05/12	1	24.8190-0287.2 620287	L= 723
			→	→ 02/10	1	24.8190-0265.2 620265	L= 1.086
			→	03/10→ 05/12	1	24.8190-0285.2 620285	L= 1.107
318 i	95	01/06→08/07	←	Motorcode: N46	1	24.8190-0264.2 620264	L= 630
			←	+ Performance Parts	1	24.8190-0267.2 620267	L= 679
			←	03/07→; Motorcode: N46N	1	24.8190-0267.2 620267	L= 679
			→		1	24.8190-0265.2 620265	L= 1.086
318 i	100	09/07→03/12	←	03/08→ 02/10; nicht für erhöhte Nutzlast	1	24.8190-0264.2 620264	L= 630
			←	+ Performance Parts	1	24.8190-0267.2 620267	L= 679
			←	→ 02/10; für erhöhte Nutzlast	1	24.8190-0267.2 620267	L= 679
			←	→ 02/08; nicht für erhöhte Nutzlast	1	24.8190-0267.2 620267	L= 679
			←	03/10→; nicht für erhöhte Nutzlast	1	24.8190-0284.2 620284	L= 650
			←	03/10→; für erhöhte Nutzlast	1	24.8190-0287.2 620287	L= 723
			→	→ 02/10	1	24.8190-0265.2 620265	L= 1.086
			→	03/10→	1	24.8190-0285.2 620285	L= 1.107
↓							







	kw			 	! #			
BMW - 3 Touring (E91) 12/04→06/12								
Warnkontakt, Bremsbelagverschleiß								
318 i	105	05/07→05/12	←	03/08→ 02/10; nicht für erhöhte Nutzlast	1	24.8190-0264.2	620264	L= 630
			←	09/07→; + Performance Parts	1	24.8190-0267.2	620267	L= 679
			←	09/07→ 02/10; für erhöhte Nutzlast	1	24.8190-0267.2	620267	L= 679
			←	09/07→ 02/08; nicht für erhöhte Nutzlast	1	24.8190-0267.2	620267	L= 679
			←	03/10→; nicht für erhöhte Nutzlast	1	24.8190-0284.2	620284	L= 650
			←	03/10→; für erhöhte Nutzlast	1	24.8190-0287.2	620287	L= 723
			→	09/07→ 02/10	1	24.8190-0265.2	620265	L= 1.086
			→	03/10→	1	24.8190-0285.2	620285	L= 1.107
320 d 320 d	110 120	12/04→08/07 12/04→08/07	←	06/05→	1	24.8190-0264.2	620264	L= 630
			←	06/05→; + Performance Parts	1	24.8190-0267.2	620267	L= 679
			→	06/05→; nicht für Behördenfahrzeuge	1	24.8190-0265.2	620265	L= 1.086
			→	06/05→; für Behördenfahrzeuge	1	24.8190-0265.2	620265	L= 1.086
320 d 320 d	130 145	02/07→02/10 02/07→02/10	←	09/07→; nicht für Behördenfahrzeuge	1	24.8190-0267.2	620267	L= 679
			←	09/07→; für Behördenfahrzeuge	1	24.8190-0267.2	620267	L= 679
			←	09/07→; + Performance Parts	1	24.8190-0267.2	620267	L= 679
			→	09/07→; für Behördenfahrzeuge	1	24.8190-0265.2	620265	L= 1.086
			→	09/07→; nicht für Behördenfahrzeuge	1	24.8190-0265.2	620265	L= 1.086
320 d 320 d	135 147	03/10→05/12 03/10→05/12	←	+ Performance Parts	1	24.8190-0267.2	620267	L= 679
			←	für Behördenfahrzeuge	1	24.8190-0287.2	620287	L= 723
			←	nicht für Behördenfahrzeuge	1	24.8190-0287.2	620287	L= 723
			→	für Behördenfahrzeuge	1	24.8190-0285.2	620285	L= 1.107
			→	nicht für Behördenfahrzeuge	1	24.8190-0285.2	620285	L= 1.107
320 d ed	120	10/10→05/12	←	für Behördenfahrzeuge	1	24.8190-0287.2	620287	L= 723
			←	nicht für Behördenfahrzeuge	1	24.8190-0287.2	620287	L= 723
			→	für Behördenfahrzeuge	1	24.8190-0285.2	620285	L= 1.107
			→	nicht für Behördenfahrzeuge	1	24.8190-0285.2	620285	L= 1.107
320 d xDrive	120	07/09→06/12	←	→ 02/10; nicht für Behördenfahrzeuge	1	24.8190-0266.2	620266	L= 840
			←	03/10→; nicht für Behördenfahrzeuge; → 05/12	1	24.8190-0266.2	620266	L= 840
			←	→ 02/10; für Behördenfahrzeuge	1	24.8190-0267.2	620267	L= 679
			←	→ 05/12; + Performance Parts	1	24.8190-0267.2	620267	L= 679
			←	03/10→ 05/12; für Behördenfahrzeuge	1	24.8190-0287.2	620287	L= 723
			→	→ 02/10; für Behördenfahrzeuge	1	24.8190-0265.2	620265	L= 1.086
			→	→ 02/10; nicht für Behördenfahrzeuge	1	24.8190-0265.2	620265	L= 1.086
			→	03/10→; für Behördenfahrzeuge; → 05/12	1	24.8190-0285.2	620285	L= 1.107
			→	03/10→ 05/12; nicht für Behördenfahrzeuge	1	24.8190-0285.2	620285	L= 1.107
320 d xDrive 320 d xDrive	130 145	02/08→02/10 02/08→02/10	←	nicht für Behördenfahrzeuge	1	24.8190-0266.2	620266	L= 840
			←	für Behördenfahrzeuge	1	24.8190-0267.2	620267	L= 679
			←	+ Performance Parts	1	24.8190-0267.2	620267	L= 679
			→	nicht für Behördenfahrzeuge	1	24.8190-0265.2	620265	L= 1.086
			→	für Behördenfahrzeuge	1	24.8190-0265.2	620265	L= 1.086
320 d xDrive 320 d xDrive	135 147	03/10→05/12 03/10→05/12	←	nicht für Behördenfahrzeuge	1	24.8190-0266.2	620266	L= 840
			←	+ Performance Parts	1	24.8190-0267.2	620267	L= 679
			←	für Behördenfahrzeuge	1	24.8190-0287.2	620287	L= 723
			→	für Behördenfahrzeuge	1	24.8190-0285.2	620285	L= 1.107
			→	nicht für Behördenfahrzeuge	1	24.8190-0285.2	620285	L= 1.107
320 i	110	09/05→06/12	←	→ 05/12; Motorcode: N46	1	24.8190-0264.2	620264	L= 630
			←	→ 08/07; Motorcode: N46N	1	24.8190-0264.2	620264	L= 630
			←	09/07→ 05/12; Motorcode: N46N	1	24.8190-0267.2	620267	L= 679
			←	→ 08/07; + Performance Parts	1	24.8190-0267.2	620267	L= 679
			→	→ 08/07	1	24.8190-0265.2	620265	L= 1.086
320 i 320 i ↓	120 125	02/07→05/12 02/07→05/12	←	09/07→ 02/10	1	24.8190-0267.2	620267	L= 679







	kw			 	! #		
BMW - 3 Touring (E91) 12/04→06/12							
Warnkontakt, Bremsbelagverschleiß							
320 i	120	02/07→05/12	←	09/07→; + Performance Parts	1	24.8190-0267.2 620267	L= 679
320 i	125	02/07→05/12	←	03/10→	1	24.8190-0287.2 620287	L= 723
			→	09/07→ 02/10	1	24.8190-0265.2 620265	L= 1.086
			→	03/10→	1	24.8190-0285.2 620285	L= 1.107
323 i	130	04/06→06/07	←	09/06→	1	24.8190-0267.2 620267	L= 679
			→	09/06→	1	24.8190-0265.2 620265	L= 1.086
323 i	140	09/06→07/08	←		1	24.8190-0267.2 620267	L= 679
			→		1	24.8190-0265.2 620265	L= 1.086
325 d	145	09/06→06/12	←	→ 02/10; nicht für Behördenfahrzeuge	1	24.8190-0264.2 620264	L= 630
325 d	150	02/10→06/12	←	→ 02/10; für Behördenfahrzeuge	1	24.8190-0267.2 620267	L= 679
			←	→ 05/12; + Performance Parts	1	24.8190-0267.2 620267	L= 679
			←	03/10→ 05/12; nicht für Behördenfahrzeuge	1	24.8190-0284.2 620284	L= 650
			←	03/10→ 05/12; für Behördenfahrzeuge	1	24.8190-0287.2 620287	L= 723
			→	→ 02/10	1	24.8190-0265.2 620265	L= 1.086
			→	03/10→ 05/12	1	24.8190-0285.2 620285	L= 1.107
325 i	155	12/04→12/10	←	06/05→ 08/07; Motorcode: N52	1	24.8190-0264.2 620264	L= 630
325 i	160	12/04→12/10	←	03/07→ 08/07; Motorcode: N52N; für erhöhte Nutzlast	1	24.8190-0266.2 620266	L= 840
			←	09/07→ 02/10; Motorcode: N53; für erhöhte Nutzlast	1	24.8190-0267.2 620267	L= 679
			←	06/05→; + Performance Parts	1	24.8190-0267.2 620267	L= 679
			←	03/07→ 02/10; Motorcode: N52N/N53; nicht für erhöhte Nutzlast	1	24.8190-0267.2 620267	L= 679
			←	03/10→; Motorcode: N53; für erhöhte Nutzlast	1	24.8190-0287.2 620287	L= 723
			←	03/10→; Motorcode: N52N/N53; nicht für erhöhte Nutzlast	1	24.8190-0287.2 620287	L= 723
			→	06/05→ 02/10; nicht für erhöhte Nutzlast	1	24.8190-0265.2 620265	L= 1.086
			→	06/05→ 02/10; für erhöhte Nutzlast	1	24.8190-0265.2 620265	L= 1.086
			→	03/10→; nicht für erhöhte Nutzlast	1	24.8190-0285.2 620285	L= 1.107
			→	03/10→; für erhöhte Nutzlast	1	24.8190-0285.2 620285	L= 1.107
325 i	155	09/07→06/12	←	01/12→ 05/12; + Performance Parts	1	24.8190-0267.2 620267	L= 679
			←	01/12→ 05/12; für erhöhte Nutzlast	1	24.8190-0287.2 620287	L= 723
			←	01/12→ 05/12; nicht für erhöhte Nutzlast	1	24.8190-0287.2 620287	L= 723
			→	01/12→ 05/12; nicht für erhöhte Nutzlast	1	24.8190-0285.2 620285	L= 1.107
			→	01/12→ 05/12; für erhöhte Nutzlast	1	24.8190-0285.2 620285	L= 1.107
325 i	160	09/07→06/12	←	→ 05/12; + Performance Parts	1	24.8190-0267.2 620267	L= 679
			←	→ 02/10; Motorcode: N52N/N53; nicht für erhöhte Nutzlast	1	24.8190-0267.2 620267	L= 679
			←	→ 02/10; Motorcode: N53; für erhöhte Nutzlast	1	24.8190-0267.2 620267	L= 679
			←	03/10→ 05/12; Motorcode: N52N/N53; nicht für erhöhte Nutzlast	1	24.8190-0287.2 620287	L= 723
			←	03/10→ 05/12; Motorcode: N53; für erhöhte Nutzlast	1	24.8190-0287.2 620287	L= 723
			→	→ 02/10; für erhöhte Nutzlast	1	24.8190-0265.2 620265	L= 1.086
			→	→ 02/10; nicht für erhöhte Nutzlast	1	24.8190-0265.2 620265	L= 1.086
			→	03/10→ 05/12; für erhöhte Nutzlast	1	24.8190-0285.2 620285	L= 1.107
			→	03/10→ 05/12; nicht für erhöhte Nutzlast	1	24.8190-0285.2 620285	L= 1.107
325 i xDrive	160	09/07→06/12	←	→ 02/10; Motorcode: N52N; nicht für erhöhte Nutzlast	1	24.8190-0266.2 620266	L= 840
325 xi	160	09/07→06/12	←	→ 02/10; Motorcode: N52/N53	1	24.8190-0266.2 620266	L= 840
			←	→ 05/12; + Performance Parts	1	24.8190-0267.2 620267	L= 679
			←	03/10→ 05/12; Motorcode: N52/N53	1	24.8190-0286.2 620286	L= 867
			←	03/10→ 05/12; Motorcode: N52N; nicht für erhöhte Nutzlast	1	24.8190-0286.2 620286	L= 867
			→	→ 02/10; Motorcode: N52/N53	1	24.8190-0265.2 620265	L= 1.086
			→	03/10→ 05/12; Motorcode: N52/N53	1	24.8190-0285.2 620285	L= 1.107
325 xi	160	09/05→08/11	←	→ 02/10; Motorcode: N52/N53	1	24.8190-0266.2 620266	L= 840
↓							







	kw			 	! #			
BMW - 3 Touring (E91) 12/04→06/12								
Warnkontakt, Bremsbelagverschleiß								
325 xi	160	09/05→08/11	←	→ 02/10; Motorcode: N52N; nicht für erhöhte Nutzlast	1	24.8190-0266.2	620266	L= 840
			←	→ 08/07; für erhöhte Nutzlast; Motorcode: N52N	1	24.8190-0266.2	620266	L= 840
			←	+ Performance Parts	1	24.8190-0267.2	620267	L= 679
			←	03/10→; Motorcode: N52N; nicht für erhöhte Nutzlast	1	24.8190-0286.2	620286	L= 867
			←	03/10→; Motorcode: N52/N53	1	24.8190-0286.2	620286	L= 867
			→	→ 08/07; Motorcode: N52N; nicht für erhöhte Nutzlast	1	24.8190-0265.2	620265	L= 1.086
			→	→ 08/07; Motorcode: N52N; für erhöhte Nutzlast	1	24.8190-0265.2	620265	L= 1.086
			→	→ 02/10; Motorcode: N52/N53	1	24.8190-0265.2	620265	L= 1.086
			→	03/10→; Motorcode: N52/N53	1	24.8190-0285.2	620285	L= 1.107
330 d	155	12/04→05/12	←	06/05→ 08/07	1	24.8190-0264.2	620264	L= 630
						24.8190-0284.2	620284	L= 650
			←	09/07→ 02/10	1	24.8190-0267.2	620267	L= 679
			←	06/05→; + Performance Parts	1	24.8190-0267.2	620267	L= 679
			←	03/10→	1	24.8190-0287.2	620287	L= 723
			→	06/05→ 02/10	1	24.8190-0265.2	620265	L= 1.086
→	03/10→	1	24.8190-0285.2	620285	L= 1.107			
330 d	170	12/04→08/08	←	06/05→ 08/07	1	24.8190-0264.2	620264	L= 630
						24.8190-0284.2	620284	L= 650
			←	06/05→; + Performance Parts	1	24.8190-0267.2	620267	L= 679
			←	09/07→	1	24.8190-0267.2	620267	L= 679
→	06/05→	1	24.8190-0265.2	620265	L= 1.086			
330 d	180	02/08→05/12	←	09/08→; nicht für erhöhte Nutzlast	1	24.8190-0264.2	620264	L= 630
						24.8190-0284.2	620284	L= 650
			←	09/08→ 02/10; für erhöhte Nutzlast	1	24.8190-0267.2	620267	L= 679
			←	09/08→; + Performance Parts	1	24.8190-0267.2	620267	L= 679
			←	03/10→; für erhöhte Nutzlast	1	24.8190-0287.2	620287	L= 723
			→	09/08→ 02/10	1	24.8190-0265.2	620265	L= 1.086
→	03/10→	1	24.8190-0285.2	620285	L= 1.107			
330 d xDrive 330 i xDrive 330 xi	180 200 200	01/09→06/12 09/07→06/12 09/07→06/12	←	→ 02/10	1	24.8190-0266.2	620266	L= 840
			←	→ 05/12; + Performance Parts	1	24.8190-0267.2	620267	L= 679
			←	03/10→ 05/12	1	24.8190-0286.2	620286	L= 867
			→	→ 02/10	1	24.8190-0265.2	620265	L= 1.086
			→	03/10→ 05/12	1	24.8190-0285.2	620285	L= 1.107
330 i	190	09/05→08/07	←		1	24.8190-0264.2	620264	L= 630
						24.8190-0284.2	620284	L= 650
			←	+ Performance Parts	1	24.8190-0267.2	620267	L= 679
→		1	24.8190-0265.2	620265	L= 1.086			
330 xd	170	09/05→06/12	←	09/07→ 02/10	1	24.8190-0266.2	620266	L= 840
			←	→ 08/07	1	24.8190-0266.2	620266	L= 840
			←	→ 05/12; + Performance Parts	1	24.8190-0267.2	620267	L= 679
			←	03/10→ 05/12	1	24.8190-0286.2	620286	L= 867
			→	→ 02/10	1	24.8190-0265.2	620265	L= 1.086
			→	03/10→ 05/12	1	24.8190-0285.2	620285	L= 1.107
330 xi	190	09/05→08/07	←		1	24.8190-0266.2	620266	L= 840
			←	+ Performance Parts	1	24.8190-0267.2	620267	L= 679
			→		1	24.8190-0265.2	620265	L= 1.086
335 d	210	09/06→06/12	←	→ 05/12	1	24.8190-0267.2	620267	L= 679
			→	→ 02/10	1	24.8190-0265.2	620265	L= 1.086
			→	03/10→ 05/12	1	24.8190-0285.2	620285	L= 1.107
335 i 335 i	225 240	03/06→05/12 03/06→05/12	←	09/06→	1	24.8190-0267.2	620267	L= 679
			→	09/06→ 02/10	1	24.8190-0265.2	620265	L= 1.086
			→	03/10→	1	24.8190-0285.2	620285	L= 1.107
↓								







	kw			 	! #		
BMW - 3 Touring (E91) 12/04→06/12							
Warnkontakt, Bremsbelagverschleiß							
335 i xDrive 335 i xDrive	225 240	05/08→05/12 05/08→05/12	← → 02/10 ← 03/10→ → 02/10 → 03/10→		1 1 1 1	24.8190-0267.2 620267 24.8190-0287.2 620287 24.8190-0265.2 620265 24.8190-0285.2 620285	L= 679 L= 723 L= 1.086 L= 1.107
335 xi 335 xi	225 240	09/06→08/08 09/06→08/08	← 03/07→ → 03/07→		1 1	24.8190-0267.2 620267 24.8190-0265.2 620265	L= 679 L= 1.086
 Bremsscheibe							
316 d	85	09/09→06/12	← → 05/12 → 05/12			24.0124-0197.1 424197 24.0324-0197.1 524197 24.0120-0195.1 420195 24.0320-0195.1 520195	Ø 300 24 22,4 V + S Ø 300 24 21,6 V + S PD Ø 300 20 18,4 V + S Ø 300 20 17,6 V + S PD
316 i	90	05/08→05/12	← → 10/09→ → 09/09			24.0124-0197.1 424197 24.0324-0197.1 524197 24.0120-0195.1 420195 24.0320-0195.1 520195 24.0120-0204.1 420204 24.0320-0204.1 520204	Ø 300 24 22,4 V + S Ø 300 24 21,6 V + S PD Ø 300 20 18,4 V + S Ø 300 20 17,6 V + S PD Ø 300 20 18,4 V + S Ø 300 20 17,6 V + S PD
318 d	90	09/05→06/12	← → 08/07 → 08/07			24.0124-0197.1 424197 24.0324-0197.1 524197 24.0120-0204.1 420204 24.0320-0204.1 520204	Ø 300 24 22,4 V + S Ø 300 24 21,6 V + S PD Ø 300 20 18,4 V + S Ø 300 20 17,6 V + S PD
318 d	100	07/07→06/12	← 09/07→ 05/12 → 10/09→ 05/12 → 09/07→ 09/09			24.0124-0203.1 424203 24.0324-0203.1 524203 24.0120-0195.1 420195 24.0320-0195.1 520195 24.0120-0204.1 420204 24.0320-0204.1 520204	Ø 312 23,9 22,4 V + S Ø 312 23,9 21,6 V + S PD Ø 300 20 18,4 V + S Ø 300 20 17,6 V + S PD Ø 300 20 18,4 V + S Ø 300 20 17,6 V + S PD
318 d	105	09/07→06/12	← → 05/12 → 10/09→ 05/12 → 09/09			24.0124-0203.1 424203 24.0324-0203.1 524203 24.0120-0195.1 420195 24.0320-0195.1 520195 24.0120-0204.1 420204 24.0320-0204.1 520204	Ø 312 23,9 22,4 V + S Ø 312 23,9 21,6 V + S PD Ø 300 20 18,4 V + S Ø 300 20 17,6 V + S PD Ø 300 20 18,4 V + S Ø 300 20 17,6 V + S PD
318 i	95	01/06→08/07	← Motorcode: N46 ← 03/07→; Motorcode: N46N →			24.0124-0197.1 424197 24.0324-0197.1 524197 24.0124-0203.1 424203 24.0324-0203.1 524203 24.0120-0204.1 420204 24.0320-0204.1 520204	Ø 300 24 22,4 V + S Ø 300 24 21,6 V + S PD Ø 312 23,9 22,4 V + S Ø 312 23,9 21,6 V + S PD Ø 300 20 18,4 V + S Ø 300 20 17,6 V + S PD
318 i	100	09/07→03/12	← 03/08→; nicht für erhöhte Nutzlast ← → 02/08; nicht für erhöhte Nutzlast ← für erhöhte Nutzlast → 10/09→ → 09/09			24.0124-0197.1 424197 24.0324-0197.1 524197 24.0124-0203.1 424203 24.0324-0203.1 524203 24.0120-0195.1 420195 24.0320-0195.1 520195 24.0120-0204.1 420204 24.0320-0204.1 520204	Ø 300 24 22,4 V + S Ø 300 24 21,6 V + S PD Ø 312 23,9 22,4 V + S Ø 312 23,9 21,6 V + S PD Ø 300 20 18,4 V + S Ø 300 20 17,6 V + S PD Ø 300 20 18,4 V + S Ø 300 20 17,6 V + S PD
318 i	105	05/07→05/12	← 03/08→; nicht für erhöhte Nutzlast ← 09/07→; für erhöhte Nutzlast ← 09/07→ 02/08; nicht für erhöhte Nutzlast → 10/09→ → 09/07→ 09/09			24.0124-0197.1 424197 24.0324-0197.1 524197 24.0124-0203.1 424203 24.0324-0203.1 524203 24.0124-0203.1 424203 24.0324-0203.1 524203 24.0120-0195.1 420195 24.0320-0195.1 520195 24.0120-0204.1 420204 24.0320-0204.1 520204	Ø 300 24 22,4 V + S Ø 300 24 21,6 V + S PD Ø 312 23,9 22,4 V + S Ø 312 23,9 21,6 V + S PD Ø 312 23,9 22,4 V + S Ø 312 23,9 21,6 V + S PD Ø 300 20 18,4 V + S Ø 300 20 17,6 V + S PD Ø 300 20 18,4 V + S Ø 300 20 17,6 V + S PD
↓							







	kw			 	! #		
BMW - 3 Touring (E91) 12/04→06/12							
Bremsscheibe							
320 d 320 d	110 120	12/04→08/07 12/04→08/07	←	06/05→; nicht für Sonderfahrzeuge		24.0124-0197.1 424197 24.0324-0197.1 524197	Ø 300 24 22,4 V + S Ø 300 24 21,6 V + S PD
			←	06/05→; für Behördenfahrzeuge		24.0124-0200.1 424200 24.0324-0200.1 524200	Ø 330 24 22,4 V + S Ø 330 24 21,6 V + S PD
			→	06/05→; nicht für Behördenfahrzeuge		24.0120-0204.1 420204 24.0320-0204.1 520204	Ø 300 20 18,4 V + S Ø 300 20 17,6 V + S PD
			→	06/05→; für Behördenfahrzeuge		24.0122-0236.1 422236 24.0322-0236.1 522236	Ø 336 22 20,4 V + S Ø 336 22 19,6 V + S PD
320 d 320 d	130 145	02/07→02/10 02/07→02/10	←	09/07→; für Behördenfahrzeuge		24.0124-0200.1 424200 24.0324-0200.1 524200	Ø 330 24 22,4 V + S Ø 330 24 21,6 V + S PD
			←	09/07→; nicht für Behördenfahrzeuge		24.0124-0203.1 424203 24.0324-0203.1 524203	Ø 312 23,9 22,4 V + S Ø 312 23,9 21,6 V + S PD
			→	10/09→; nicht für Behördenfahrzeuge		24.0120-0195.1 420195 24.0320-0195.1 520195	Ø 300 20 18,4 V + S Ø 300 20 17,6 V + S PD
			→	09/07→ 09/09; nicht für Behördenfahrzeuge		24.0120-0204.1 420204 24.0320-0204.1 520204	Ø 300 20 18,4 V + S Ø 300 20 17,6 V + S PD
			→	09/07→; für Behördenfahrzeuge		24.0122-0236.1 422236 24.0322-0236.1 522236	Ø 336 22 20,4 V + S Ø 336 22 19,6 V + S PD
320 d 320 d	135 147	03/10→05/12 03/10→05/12	←	für Behördenfahrzeuge		24.0124-0200.1 424200 24.0324-0200.1 524200	Ø 330 24 22,4 V + S Ø 330 24 21,6 V + S PD
			←	nicht für Behördenfahrzeuge		24.0124-0203.1 424203 24.0324-0203.1 524203	Ø 312 23,9 22,4 V + S Ø 312 23,9 21,6 V + S PD
			→	nicht für Behördenfahrzeuge		24.0120-0195.1 420195 24.0320-0195.1 520195	Ø 300 20 18,4 V + S Ø 300 20 17,6 V + S PD
			→	für Behördenfahrzeuge		24.0122-0236.1 422236 24.0322-0236.1 522236	Ø 336 22 20,4 V + S Ø 336 22 19,6 V + S PD
320 d ed	120	10/10→05/12	←	für Behördenfahrzeuge		24.0124-0200.1 424200 24.0324-0200.1 524200	Ø 330 24 22,4 V + S Ø 330 24 21,6 V + S PD
			←	nicht für Behördenfahrzeuge		24.0124-0203.1 424203 24.0324-0203.1 524203	Ø 312 23,9 22,4 V + S Ø 312 23,9 21,6 V + S PD
320 d xDrive	120	07/09→06/12	←	für Behördenfahrzeuge; → 05/12		24.0124-0200.1 424200 24.0324-0200.1 524200	Ø 330 24 22,4 V + S Ø 330 24 21,6 V + S PD
			←	nicht für Behördenfahrzeuge; → 05/12		24.0124-0203.1 424203 24.0324-0203.1 524203	Ø 312 23,9 22,4 V + S Ø 312 23,9 21,6 V + S PD
			→	→ 05/12; nicht für Behördenfahrzeuge		24.0120-0204.1 420204 24.0320-0204.1 520204	Ø 300 20 18,4 V + S Ø 300 20 17,6 V + S PD
			→	für Behördenfahrzeuge; → 05/12		24.0122-0236.1 422236 24.0322-0236.1 522236	Ø 336 22 20,4 V + S Ø 336 22 19,6 V + S PD
320 d xDrive 320 d xDrive 320 d xDrive 320 d xDrive	130 135 145 147	02/08→02/10 03/10→05/12 02/08→02/10 03/10→05/12	←	für Behördenfahrzeuge		24.0124-0200.1 424200 24.0324-0200.1 524200	Ø 330 24 22,4 V + S Ø 330 24 21,6 V + S PD
			←	nicht für Behördenfahrzeuge		24.0124-0203.1 424203 24.0324-0203.1 524203	Ø 312 23,9 22,4 V + S Ø 312 23,9 21,6 V + S PD
			→	nicht für Behördenfahrzeuge		24.0120-0204.1 420204 24.0320-0204.1 520204	Ø 300 20 18,4 V + S Ø 300 20 17,6 V + S PD
			→	für Behördenfahrzeuge		24.0122-0236.1 422236 24.0322-0236.1 522236	Ø 336 22 20,4 V + S Ø 336 22 19,6 V + S PD
320 i 320 i	110	09/05→06/12	←	→ 08/07; Motorcode: N46		24.0124-0197.1 424197 24.0324-0197.1 524197	Ø 300 24 22,4 V + S Ø 300 24 21,6 V + S PD
			←	09/07→ 05/12; Motorcode: N46N		24.0124-0203.1 424203 24.0324-0203.1 524203	Ø 312 23,9 22,4 V + S Ø 312 23,9 21,6 V + S PD
			→	→ 08/07		24.0120-0204.1 420204 24.0320-0204.1 520204	Ø 300 20 18,4 V + S Ø 300 20 17,6 V + S PD
320 i 320 i	120 125	02/07→05/12 02/07→05/12	←	09/07→		24.0124-0203.1 424203 24.0324-0203.1 524203	Ø 312 23,9 22,4 V + S Ø 312 23,9 21,6 V + S PD
			→	10/09→		24.0120-0195.1 420195 24.0320-0195.1 520195	Ø 300 20 18,4 V + S Ø 300 20 17,6 V + S PD
			→	09/07→ 09/09		24.0120-0204.1 420204 24.0320-0204.1 520204	Ø 300 20 18,4 V + S Ø 300 20 17,6 V + S PD
323 i	130	04/06→06/07	←	09/06→		24.0124-0203.1 424203 24.0324-0203.1 524203	Ø 312 23,9 22,4 V + S Ø 312 23,9 21,6 V + S PD
			→	09/06→		24.0120-0204.1 420204	Ø 300 20 18,4 V + S









	kw			 	! #		
BMW - 3 Touring (E91) 12/04→06/12							
Bremsscheibe							
323 i	130	04/06→06/07	➡	09/06→		24.0320-0204.1 520204	Ø 300 20 17,6 V + S PD
323 i	140	09/06→07/08	←			24.0124-0203.1 424203	Ø 312 23,9 22,4 V + S
						24.0324-0203.1 524203	Ø 312 23,9 21,6 V + S PD
			➡			24.0120-0204.1 420204	Ø 300 20 18,4 V + S
						24.0320-0204.1 520204	Ø 300 20 17,6 V + S PD
325 d 325 d	145 150	09/06→06/12 02/10→06/12	←	→ 05/12; nicht für Behördenfahrzeuge		24.0124-0200.1 424200	Ø 330 24 22,4 V + S
						24.0324-0200.1 524200	Ø 330 24 21,6 V + S PD
			←	→ 05/12; für Behördenfahrzeuge		24.0130-0192.1 430192	Ø 348 30 28,4 V + S
			➡	→ 05/12		24.0122-0236.1 422236	Ø 336 22 20,4 V + S
						24.0322-0236.1 522236	Ø 336 22 19,6 V + S PD
325 i 325 i	155 160	12/04→12/10 12/04→12/10	←	06/05→ 08/07; nicht für erhöhte Nutzlast; Motorcode: N52		24.0124-0197.1 424197	Ø 300 24 22,4 V + S
						24.0324-0197.1 524197	Ø 300 24 21,6 V + S PD
			←	06/05→; für erhöhte Nutzlast		24.0124-0200.1 424200	Ø 330 24 22,4 V + S
						24.0324-0200.1 524200	Ø 330 24 21,6 V + S PD
			←	03/07→; Motorcode: N52N/N53; nicht für erhöhte Nutzlast		24.0124-0203.1 424203	Ø 312 23,9 22,4 V + S
						24.0324-0203.1 524203	Ø 312 23,9 21,6 V + S PD
			➡	10/09→; nicht für erhöhte Nutzlast		24.0120-0195.1 420195	Ø 300 20 18,4 V + S
			24.0320-0195.1 520195	Ø 300 20 17,6 V + S PD			
			➡	06/05→ 09/09; nicht für erhöhte Nutzlast		24.0120-0204.1 420204	Ø 300 20 18,4 V + S
						24.0320-0204.1 520204	Ø 300 20 17,6 V + S PD
			➡	06/05→; für erhöhte Nutzlast		24.0122-0236.1 422236	Ø 336 22 20,4 V + S
						24.0322-0236.1 522236	Ø 336 22 19,6 V + S PD
325 i	155	09/07→06/12	←	01/12→ 05/12; für erhöhte Nutzlast		24.0124-0200.1 424200	Ø 330 24 22,4 V + S
						24.0324-0200.1 524200	Ø 330 24 21,6 V + S PD
			←	01/12→ 05/12; nicht für erhöhte Nutzlast		24.0124-0203.1 424203	Ø 312 23,9 22,4 V + S
						24.0324-0203.1 524203	Ø 312 23,9 21,6 V + S PD
			➡	01/12→ 05/12; nicht für erhöhte Nutzlast		24.0120-0204.1 420204	Ø 300 20 18,4 V + S
						24.0320-0204.1 520204	Ø 300 20 17,6 V + S PD
			➡	01/12→ 05/12; für erhöhte Nutzlast		24.0122-0236.1 422236	Ø 336 22 20,4 V + S
						24.0322-0236.1 522236	Ø 336 22 19,6 V + S PD
325 i	160	09/07→06/12	←	→ 05/12; für erhöhte Nutzlast		24.0124-0200.1 424200	Ø 330 24 22,4 V + S
						24.0324-0200.1 524200	Ø 330 24 21,6 V + S PD
			←	→ 05/12; Motorcode: N52N/N53; nicht für erhöhte Nutzlast		24.0124-0203.1 424203	Ø 312 23,9 22,4 V + S
						24.0324-0203.1 524203	Ø 312 23,9 21,6 V + S PD
			➡	10/09→ 05/12; nicht für erhöhte Nutzlast		24.0120-0195.1 420195	Ø 300 20 18,4 V + S
						24.0320-0195.1 520195	Ø 300 20 17,6 V + S PD
			➡	→ 09/09; nicht für erhöhte Nutzlast		24.0120-0204.1 420204	Ø 300 20 18,4 V + S
						24.0320-0204.1 520204	Ø 300 20 17,6 V + S PD
			➡	→ 05/12; für erhöhte Nutzlast		24.0122-0236.1 422236	Ø 336 22 20,4 V + S
						24.0322-0236.1 522236	Ø 336 22 19,6 V + S PD
325 i xDrive 325 xi	160 160	09/07→06/12 09/07→06/12	←	→ 05/12; Motorcode: N52/N53		24.0124-0200.1 424200	Ø 330 24 22,4 V + S
						24.0324-0200.1 524200	Ø 330 24 21,6 V + S PD
			➡	→ 05/12; Motorcode: N52N; nicht für erhöhte Nutzlast		24.0120-0204.1 420204	Ø 300 20 18,4 V + S
						24.0320-0204.1 520204	Ø 300 20 17,6 V + S PD
			➡	→ 05/12; Motorcode: N52N; für erhöhte Nutzlast		24.0122-0236.1 422236	Ø 336 22 20,4 V + S
						24.0322-0236.1 522236	Ø 336 22 19,6 V + S PD
			➡	→ 05/12; Motorcode: N52/N53		24.0122-0236.1 422236	Ø 336 22 20,4 V + S
						24.0322-0236.1 522236	Ø 336 22 19,6 V + S PD
325 xi	160	09/05→08/11	←	Motorcode: N52/N53		24.0124-0200.1 424200	Ø 330 24 22,4 V + S
						24.0324-0200.1 524200	Ø 330 24 21,6 V + S PD
			←	→ 08/07; Motorcode: N52N; für erhöhte Nutzlast		24.0124-0200.1 424200	Ø 330 24 22,4 V + S
						24.0324-0200.1 524200	Ø 330 24 21,6 V + S PD
			←	→ 08/07; Motorcode: N52N; nicht für erhöhte Nutzlast		24.0124-0203.1 424203	Ø 312 23,9 22,4 V + S
						24.0324-0203.1 524203	Ø 312 23,9 21,6 V + S PD
			➡	Motorcode: N52N; nicht für erhöhte Nutzlast		24.0120-0204.1 420204	Ø 300 20 18,4 V + S
						24.0320-0204.1 520204	Ø 300 20 17,6 V + S PD
			➡	Motorcode: N52N; für erhöhte Nutzlast		24.0122-0236.1 422236	Ø 336 22 20,4 V + S
						24.0322-0236.1 522236	Ø 336 22 19,6 V + S PD
			➡	Motorcode: N52/N53		24.0122-0236.1 422236	Ø 336 22 20,4 V + S
						24.0322-0236.1 522236	Ø 336 22 19,6 V + S PD
330 d ↓	155	12/04→05/12	←	06/05→ 08/07; für erhöhte Nutzlast		24.0124-0200.1 424200	Ø 330 24 22,4 V + S









	kw			 	! #		
BMW - 3 Touring (E91) 12/04→06/12							
Bremsscheibe							
330 d	170	12/04→08/08	←	06/05→ 08/07; für erhöhte Nutzlast	24.0324-0200.1	524200	Ø 330 24 21,6 V + S PD
			←	06/05→; nicht für erhöhte Nutzlast	24.0124-0200.1	424200	Ø 330 24 22,4 V + S
			←	09/07→; für erhöhte Nutzlast	24.0324-0200.1	524200	Ø 330 24 21,6 V + S PD
			→	06/05→	24.0122-0236.1	422236	Ø 336 22 20,4 V + S
					24.0322-0236.1	522236	Ø 336 22 19,6 V + S PD
330 d	180	02/08→05/12	←	09/09→; nicht für erhöhte Nutzlast	24.0124-0200.1	424200	Ø 330 24 22,4 V + S
			←	09/08→; für erhöhte Nutzlast	24.0324-0200.1	524200	Ø 330 24 21,6 V + S PD
			←	09/08→ 08/09; nicht für erhöhte Nutzlast	24.0130-0192.1	430192	Ø 348 30 28,4 V + S
			→	09/08→	24.0122-0236.1	422236	Ø 336 22 20,4 V + S
					24.0322-0236.1	522236	Ø 336 22 19,6 V + S PD
330 d xDrive	180	01/09→06/12	←	→ 05/12; nicht für erhöhte Nutzlast	24.0124-0200.1	424200	Ø 330 24 22,4 V + S
			←	→ 05/12; für erhöhte Nutzlast	24.0324-0200.1	524200	Ø 330 24 21,6 V + S PD
			→	→ 05/12	24.0122-0236.1	422236	Ø 336 22 20,4 V + S
					24.0322-0236.1	522236	Ø 336 22 19,6 V + S PD
330 i 330 xi	190 190	09/05→08/07 09/05→08/07	←		24.0124-0200.1	424200	Ø 330 24 22,4 V + S
			→		24.0324-0200.1	524200	Ø 330 24 21,6 V + S PD
					24.0122-0236.1	422236	Ø 336 22 20,4 V + S
					24.0322-0236.1	522236	Ø 336 22 19,6 V + S PD
330 i 335 d	200 210	09/07→06/12 09/06→06/12	←	→ 05/12	24.0130-0192.1	430192	Ø 348 30 28,4 V + S
			→	→ 05/12	24.0122-0236.1	422236	Ø 336 22 20,4 V + S
					24.0322-0236.1	522236	Ø 336 22 19,6 V + S PD
330 i xDrive 330 xi	200 200	09/07→06/12 09/07→06/12	←	→ 05/12	24.0124-0200.1	424200	Ø 330 24 22,4 V + S
			→	→ 05/12	24.0324-0200.1	524200	Ø 330 24 21,6 V + S PD
					24.0122-0236.1	422236	Ø 336 22 20,4 V + S
					24.0322-0236.1	522236	Ø 336 22 19,6 V + S PD
330 xd	170	09/05→06/12	←	→ 05/12; nicht für erhöhte Nutzlast	24.0124-0200.1	424200	Ø 330 24 22,4 V + S
			←	→ 08/07; für erhöhte Nutzlast	24.0324-0200.1	524200	Ø 330 24 21,6 V + S PD
			←	09/07→ 05/12; für erhöhte Nutzlast	24.0324-0200.1	524200	Ø 330 24 21,6 V + S PD
			→	→ 05/12	24.0130-0192.1	430192	Ø 348 30 28,4 V + S
					24.0122-0236.1	422236	Ø 336 22 20,4 V + S
					24.0322-0236.1	522236	Ø 336 22 19,6 V + S PD
335 i 335 i	225 240	03/06→05/12 03/06→05/12	←	09/06→	24.0130-0192.1	430192	Ø 348 30 28,4 V + S
			→	09/06→	24.0122-0236.1	422236	Ø 336 22 20,4 V + S
					24.0322-0236.1	522236	Ø 336 22 19,6 V + S PD
335 i xDrive 335 i xDrive	225 240	05/08→05/12 05/08→05/12	←		24.0130-0192.1	430192	Ø 348 30 28,4 V + S
			→		24.0122-0236.1	422236	Ø 336 22 20,4 V + S
					24.0322-0236.1	522236	Ø 336 22 19,6 V + S PD
335 xi 335 xi	225 240	09/06→08/08 09/06→08/08	←	03/07→	24.0130-0192.1	430192	Ø 348 30 28,4 V + S
			→	03/07→	24.0122-0236.1	422236	Ø 336 22 20,4 V + S
					24.0322-0236.1	522236	Ø 336 22 19,6 V + S PD
BMW - 4 Cabriolet (F33, F83) 10/13→							
Brembelagsatz, Scheibenbremse							
420 d	120	10/13→	←	- Performance Parts	13.0460-3857.2	603857	BOS 25199 19,6 + WE / - WK
420 d	135	10/13→07/15			13.0470-3857.2	LD3857	BOS 25199 19,6 + WE / - WK
420 d	140	07/15→					Ceramic
420 d	147	10/13→07/15					
425 d	155	07/14→	←	+ Performance Parts	13.0460-4875.2	604875	BRE 25028 18,0 + WE / - WK
425 d	160	07/14→	→	- Performance Parts	13.0460-3859.2	603859	BOS 25307 17,5 + WE / - WK
428 i	180	10/13→			13.0470-3859.2	LD3859	BOS 25307 17,5 + WE / - WK
428 i xDrive	180	01/14→					Ceramic
430 i	185	03/16→					
430 i xDrive	185	03/16→	→	+ Performance Parts	13.0460-4874.2	604874	BRE 25029 16,7 + WE / - WK
420 i	120	07/14→	←	- Performance Parts	13.0460-3866.2	603866	BOS 25506 18,2 + WE / - WK
420 i	135	07/14→			13.0470-3866.2	LD3866	BOS 25506 18,2 + WE / - WK
420 i	135	02/16→					Ceramic
			←	+ Performance Parts	13.0460-4875.2	604875	BRE 25028 18,0 + WE / - WK
			→	- Performance Parts	13.0460-3859.2	603859	BOS 25307 17,5 + WE / - WK









	kW			 	! #		
BMW - 4 Cabriolet (F33, F83) 10/13→							
Bremsbelagsatz, Scheibenbremse							
420 i	120	07/14→	➡	- Performance Parts		13.0470-3859.2 LD3859	BOS 25307 17,5 + WE / - WK Ceramic
420 i	135	07/14→					
420 i	135	02/16→	➡	+ Performance Parts		13.0460-4874.2 604874	BRE 25029 16,7 + WE / - WK
425 d	165	03/16→	➡	- Performance Parts		13.0460-3857.2 603857	BOS 25199 19,6 + WE / - WK Ceramic
			➡	+ Performance Parts		13.0470-3857.2 LD3857	BOS 25199 19,6 + WE / - WK Ceramic
			➡	+ Performance Parts		13.0460-4875.2 604875	BRE 25028 18,0 + WE / - WK
			➡	- Performance Parts		13.0460-3859.2 603859	BOS 25307 17,5 + WE / - WK Ceramic
			➡	- Performance Parts		13.0470-3859.2 LD3859	BOS 25307 17,5 + WE / - WK Ceramic
430 d	190	07/14→	➡	+ Performance Parts		13.0460-4874.2 604874	BRE 25029 16,7 + WE / - WK
			➡	- Performance Parts		13.0460-3857.2 603857	BOS 25199 19,6 + WE / - WK Ceramic
			➡	- Performance Parts		13.0470-3857.2 LD3857	BOS 25199 19,6 + WE / - WK Ceramic
430 d	210	10/13→	➡	- Performance Parts		13.0460-4875.2 604875	BRE 25028 18,0 + WE / - WK
			➡	+ Performance Parts		13.0460-4875.2 604875	BRE 25028 18,0 + WE / - WK
			➡	+ Performance Parts		13.0460-4874.2 604874	BRE 25029 16,7 + WE / - WK
435 d xDrive	230	07/14→	➡	- Performance Parts		13.0460-3857.2 603857	BOS 25199 19,6 + WE / - WK Ceramic
			➡	+ Performance Parts		13.0470-3857.2 LD3857	BOS 25199 19,6 + WE / - WK Ceramic
			➡	+ Performance Parts		13.0460-4874.2 604874	BRE 25029 16,7 + WE / - WK
435 i	225	10/13→	➡				
435 i	250	10/13→	➡	+ Performance Parts		13.0460-4874.2 604874	BRE 25029 16,7 + WE / - WK
435 i xDrive	225	07/14→					
435 i xDrive	250	07/14→					
440 i	240	03/16→	➡	+ Performance Parts		13.0460-4875.2 604875	BRE 25028 18,0 + WE / - WK
			➡	- Performance Parts		13.0460-4875.2 604875	BRE 25028 18,0 + WE / - WK
			➡	+ Performance Parts		13.0460-4874.2 604874	BRE 25029 16,7 + WE / - WK
440 i	265	03/16→	➡				
440 i xDrive	240	03/16→	➡	- Performance Parts		13.0460-4875.2 604875	BRE 25028 18,0 + WE / - WK
440 i xDrive	265	03/16→	➡	+ Performance Parts		13.0460-4874.2 604874	BRE 25029 16,7 + WE / - WK
Warnkontakt, Bremsbelagverschleiß							
420 d	120	10/13→	➡		1	24.8190-0006.2 620006	L= 675
420 d	135	10/13→07/15					
420 d	140	07/15→	➡		1	24.8190-0007.2 620007	L= 1.045
420 d	147	10/13→07/15					
420 i	120	07/14→					
420 i	135	07/14→					
420 i	135	02/16→					
425 d	155	07/14→					
425 d	160	07/14→					
428 i	180	10/13→					
428 i xDrive	180	01/14→					
430 d	190	07/14→					
435 d xDrive	230	07/14→					
435 i	225	10/13→					
435 i	250	10/13→					
435 i xDrive	225	07/14→					
435 i xDrive	250	07/14→					
M4	317	07/14→					
M4	331	03/16→					
425 d	165	03/16→	➡		1	24.8190-0006.2 620006	L= 675
430 i	185	03/16→	➡		1	24.8190-0006.2 620006	L= 675
430 i xDrive	185	03/16→	➡		1	24.8190-0007.2 620007	L= 1.045
440 i	240	03/16→	➡		1	24.8190-0007.2 620007	L= 1.045
440 i	265	03/16→					
440 i xDrive	240	03/16→					
440 i xDrive	265	03/16→					
430 d	210	10/13→	➡		1	24.8190-0006.2 620006	L= 675
			➡		1	24.8190-0007.2 620007	L= 1.045
Bremsscheibe							
420 d	120	10/13→	➡	- Performance Parts		24.0124-0203.1 424203	Ø 312 23,9 22,4 V + S
420 d	135	10/13→07/15				24.0324-0203.1 524203	Ø 312 23,9 21,6 V + S PD
420 d	140	07/15→	➡	+ Performance Parts		24.0130-0233.2 430233	Ø 340 30 28,4 V Bremsscheibe zweiteilig / + S
420 d	147	10/13→07/15	➡	- Performance Parts		24.0120-0240.1 420240	Ø 300 20 18,4 V + S
			➡	+ Performance Parts		24.0124-0251.2 424251	Ø 345 24 22,4 V Bremsscheibe zweiteilig / + S
420 i	120	07/14→	➡	- Performance Parts		24.0122-0278.1 422278	Ø 300 22 20,4 V + S
420 i	135	07/14→					
↓							







	kW			 	! #		
BMW - 4 Cabriolet (F33, F83) 10/13→							
Bremsscheibe							
420 i	135	02/16→	←	+ Performance Parts		24.0130-0233.2 430233	Ø 340 30 28,4 V Bremsscheibe zweiteilig / + S
			→	- Performance Parts		24.0120-0240.1 420240	Ø 300 20 18,4 V + S
			→	+ Performance Parts		24.0124-0251.2 424251	Ø 345 24 22,4 V Bremsscheibe zweiteilig / + S
425 d	155	07/14→	←	- Performance Parts		24.0124-0248.1 424248	Ø 330 24 22,4 V + S
425 d	160	07/14→	←	+ Performance Parts		24.0130-0234.2 430234	Ø 370 30 28,4 V Bremsscheibe zweiteilig / + S
425 d	165	03/16→	←	+ Performance Parts		24.0130-0234.2 430234	Ø 370 30 28,4 V Bremsscheibe zweiteilig / + S
428 i	180	10/13→	→	- Performance Parts		24.0120-0240.1 420240	Ø 300 20 18,4 V + S
428 i xDrive	180	01/14→	→	- Performance Parts		24.0120-0240.1 420240	Ø 300 20 18,4 V + S
430 i	185	03/16→	→	+ Performance Parts		24.0124-0251.2 424251	Ø 345 24 22,4 V Bremsscheibe zweiteilig / + S
430 i xDrive	185	03/16→	→	+ Performance Parts		24.0124-0251.2 424251	Ø 345 24 22,4 V Bremsscheibe zweiteilig / + S
430 d	190	07/14→	←	- Performance Parts		24.0124-0248.1 424248	Ø 330 24 22,4 V + S
			←	+ Performance Parts		24.0130-0234.2 430234	Ø 370 30 28,4 V Bremsscheibe zweiteilig / + S
			→	- Performance Parts		24.0120-0243.1 420243	Ø 330 20 18,4 V + S
			→	+ Performance Parts		24.0124-0251.2 424251	Ø 345 24 22,4 V Bremsscheibe zweiteilig / + S
430 d	210	10/13→	←	07/14→; - Performance Parts		24.0124-0248.1 424248	Ø 330 24 22,4 V + S
			←	07/14→; + Performance Parts		24.0130-0234.2 430234	Ø 370 30 28,4 V Bremsscheibe zweiteilig / + S
			→	07/14→; - Performance Parts		24.0120-0243.1 420243	Ø 330 20 18,4 V + S
			→	07/14→; + Performance Parts		24.0124-0251.2 424251	Ø 345 24 22,4 V Bremsscheibe zweiteilig / + S
435 d xDrive	230	07/14→	←	- Performance Parts		24.0130-0233.2 430233	Ø 340 30 28,4 V Bremsscheibe zweiteilig / + S
435 i	225	10/13→	←	+ Performance Parts		24.0130-0234.2 430234	Ø 370 30 28,4 V Bremsscheibe zweiteilig / + S
435 i	250	10/13→	←	+ Performance Parts		24.0130-0234.2 430234	Ø 370 30 28,4 V Bremsscheibe zweiteilig / + S
435 i xDrive	225	07/14→	→	- Performance Parts		24.0120-0243.1 420243	Ø 330 20 18,4 V + S
435 i xDrive	250	07/14→	→	- Performance Parts		24.0120-0243.1 420243	Ø 330 20 18,4 V + S
440 i	240	03/16→	→	+ Performance Parts		24.0124-0251.2 424251	Ø 345 24 22,4 V Bremsscheibe zweiteilig / + S
440 i	265	03/16→	→	+ Performance Parts		24.0124-0251.2 424251	Ø 345 24 22,4 V Bremsscheibe zweiteilig / + S
440 i xDrive	240	03/16→	→	+ Performance Parts		24.0124-0251.2 424251	Ø 345 24 22,4 V Bremsscheibe zweiteilig / + S
440 i xDrive	265	03/16→	→	+ Performance Parts		24.0124-0251.2 424251	Ø 345 24 22,4 V Bremsscheibe zweiteilig / + S
BMW - 4 Coupe (F32, F82) 07/13→							
Bremsbelagsatz, Scheibenbremse							
418 d	100	03/15→	←	- Performance Parts		13.0460-3866.2 603866	BOS 25506 18,2 + WE / - WK
418 d	110	03/15→	←	- Performance Parts		13.0470-3866.2 LD3866	BOS 25506 18,2 + WE / - WK Ceramic
420 i	120	11/13→	←	+ Performance Parts		13.0460-4875.2 604875	BRE 25028 18,0 + WE / - WK
420 i	135	11/13→	→	- Performance Parts		13.0460-3859.2 603859	BOS 25307 17,5 + WE / - WK
420 i xDrive	120	11/13→	→	- Performance Parts		13.0470-3859.2 LD3859	BOS 25307 17,5 + WE / - WK Ceramic
420 i xDrive	135	11/13→	→	- Performance Parts		13.0470-3859.2 LD3859	BOS 25307 17,5 + WE / - WK Ceramic
420 i xDrive	135	02/16→	→	+ Performance Parts		13.0460-4874.2 604874	BRE 25029 16,7 + WE / - WK
418 i	100	02/16→	←	- Performance Parts		13.0460-3866.2 603866	BOS 25506 18,2 + WE / - WK
			←	+ Performance Parts		13.0470-3866.2 LD3866	BOS 25506 18,2 + WE / - WK Ceramic
			←	+ Performance Parts		13.0460-4875.2 604875	BRE 25028 18,0 + WE / - WK
			→	- Performance Parts		13.0460-3859.2 603859	BOS 25307 17,5 + WE / - WK
			→	- Performance Parts		13.0470-3859.2 LD3859	BOS 25307 17,5 + WE / - WK Ceramic
			→	+ Performance Parts		13.0460-4874.2 604874	BRE 25029 16,7 + WE / - WK
420 d	120	07/13→	←	- Performance Parts		13.0460-3857.2 603857	BOS 25199 19,6 + WE / - WK
420 d	135	07/13→03/15	←	- Performance Parts		13.0470-3857.2 LD3857	BOS 25199 19,6 + WE / - WK Ceramic
420 d	140	03/15→	←	- Performance Parts		13.0470-3857.2 LD3857	BOS 25199 19,6 + WE / - WK Ceramic
420 d	147	07/13→03/15	←	+ Performance Parts		13.0460-4875.2 604875	BRE 25028 18,0 + WE / - WK
420 d xDrive	120	11/13→	→	- Performance Parts		13.0460-3859.2 603859	BOS 25307 17,5 + WE / - WK
420 d xDrive	135	11/13→03/15	→	- Performance Parts		13.0460-3859.2 603859	BOS 25307 17,5 + WE / - WK
420 d xDrive	140	03/15→	→	- Performance Parts		13.0470-3859.2 LD3859	BOS 25307 17,5 + WE / - WK Ceramic
420 d xDrive	147	11/13→03/15	→	- Performance Parts		13.0470-3859.2 LD3859	BOS 25307 17,5 + WE / - WK Ceramic
428 i	180	07/13→	→	+ Performance Parts		13.0460-4874.2 604874	BRE 25029 16,7 + WE / - WK
428 i xDrive	180	07/13→	→	+ Performance Parts		13.0460-4874.2 604874	BRE 25029 16,7 + WE / - WK
430 i	185	03/16→	→	+ Performance Parts		13.0460-4874.2 604874	BRE 25029 16,7 + WE / - WK
430 i xDrive	185	03/16→	→	+ Performance Parts		13.0460-4874.2 604874	BRE 25029 16,7 + WE / - WK
425 d	155	01/14→	←	03/14→; - Performance Parts		13.0460-3857.2 603857	BOS 25199 19,6 + WE / - WK
425 d	160	01/14→	←	03/14→; - Performance Parts		13.0470-3857.2 LD3857	BOS 25199 19,6 + WE / - WK Ceramic
			←	03/14→; + Performance Parts		13.0460-4875.2 604875	BRE 25028 18,0 + WE / - WK
			→	03/14→; - Performance Parts		13.0460-3859.2 603859	BOS 25307 17,5 + WE / - WK

	kW			 	! #		
BMW - 4 Coupe (F32, F82) 07/13→							
Bremsbelagsatz, Scheibenbremse							
425 d	155	01/14→	➡	03/14→; - Performance Parts		13.0470-3859.2 LD3859	BOS 25307 17,5 + WE / - WK Ceramic
425 d	160	01/14→	➡	03/14→; + Performance Parts		13.0460-4874.2 604874	BRE 25029 16,7 + WE / - WK
425 d	165	03/16→	⬅	- Performance Parts		13.0460-3857.2 603857	BOS 25199 19,6 + WE / - WK Ceramic
			⬅	+ Performance Parts		13.0470-3857.2 LD3857	BOS 25199 19,6 + WE / - WK Ceramic
			➡	- Performance Parts		13.0460-4875.2 604875	BRE 25028 18,0 + WE / - WK
			➡	- Performance Parts		13.0460-3859.2 603859	BOS 25307 17,5 + WE / - WK Ceramic
			➡	- Performance Parts		13.0470-3859.2 LD3859	BOS 25307 17,5 + WE / - WK Ceramic
			➡	+ Performance Parts		13.0460-4874.2 604874	BRE 25029 16,7 + WE / - WK
430 d	190	11/13→	⬅	- Performance Parts		13.0460-3857.2 603857	BOS 25199 19,6 + WE / - WK Ceramic
430 d	210	11/13→	⬅	+ Performance Parts		13.0470-3857.2 LD3857	BOS 25199 19,6 + WE / - WK Ceramic
			⬅	+ Performance Parts		13.0460-4875.2 604875	BRE 25028 18,0 + WE / - WK
			➡	+ Performance Parts		13.0460-4874.2 604874	BRE 25029 16,7 + WE / - WK
430 d xDrive	190	01/14→	⬅	03/14→; - Performance Parts		13.0460-3857.2 603857	BOS 25199 19,6 + WE / - WK Ceramic
430 d xDrive	210	11/13→	⬅	03/14→; + Performance Parts		13.0470-3857.2 LD3857	BOS 25199 19,6 + WE / - WK Ceramic
			⬅	03/14→; + Performance Parts		13.0460-4875.2 604875	BRE 25028 18,0 + WE / - WK
			➡	03/14→; + Performance Parts		13.0460-4874.2 604874	BRE 25029 16,7 + WE / - WK
435 d xDrive	230	11/13→	⬅	+ Performance Parts		13.0460-4875.2 604875	BRE 25028 18,0 + WE / - WK
435 i	225	07/13→	⬅	- Performance Parts		13.0460-4875.2 604875	BRE 25028 18,0 + WE / - WK
435 i	250	07/13→	⬅	- Performance Parts		13.0460-4875.2 604875	BRE 25028 18,0 + WE / - WK
435 i xDrive	225	07/13→	➡	+ Performance Parts		13.0460-4874.2 604874	BRE 25029 16,7 + WE / - WK
435 i xDrive	250	07/13→	➡	+ Performance Parts		13.0460-4874.2 604874	BRE 25029 16,7 + WE / - WK
440 i	240	03/16→	⬅	+ Performance Parts		13.0460-4875.2 604875	BRE 25028 18,0 + WE / - WK
440 i	265	03/16→	⬅	- Performance Parts		13.0460-4875.2 604875	BRE 25028 18,0 + WE / - WK
440 i xDrive	240	03/16→	⬅	- Performance Parts		13.0460-4875.2 604875	BRE 25028 18,0 + WE / - WK
440 i xDrive	265	03/16→	➡	+ Performance Parts		13.0460-4874.2 604874	BRE 25029 16,7 + WE / - WK
Warnkontakt, Bremsbelagverschleiß							
418 d	100	03/15→	⬅	☐; - Performance Parts	1	24.8190-0006.2 620006	L= 675
418 d	110	03/15→	⬅	☐; + Performance Parts	1	24.8190-0006.2 620006	L= 675
418 i	100	02/16→	⬅	☐; + Performance Parts	1	24.8190-0006.2 620006	L= 675
420 d	120	07/13→	➡	+ Performance Parts	1	24.8190-0007.2 620007	L= 1.045
420 d	135	07/13→03/15	➡	+ Performance Parts	1	24.8190-0007.2 620007	L= 1.045
420 d	140	03/15→	➡	- Performance Parts	1	24.8190-0007.2 620007	L= 1.045
420 d	147	07/13→03/15	➡	- Performance Parts	1	24.8190-0007.2 620007	L= 1.045
420 d xDrive	120	11/13→	➡	- Performance Parts	1	24.8190-0007.2 620007	L= 1.045
420 d xDrive	135	11/13→03/15	➡	- Performance Parts	1	24.8190-0007.2 620007	L= 1.045
420 d xDrive	140	03/15→	➡	- Performance Parts	1	24.8190-0007.2 620007	L= 1.045
420 d xDrive	147	11/13→03/15	➡	- Performance Parts	1	24.8190-0007.2 620007	L= 1.045
420 i	120	11/13→	➡	- Performance Parts	1	24.8190-0007.2 620007	L= 1.045
420 i	135	11/13→	➡	- Performance Parts	1	24.8190-0007.2 620007	L= 1.045
420 i	135	02/16→	➡	- Performance Parts	1	24.8190-0007.2 620007	L= 1.045
420 i xDrive	120	11/13→	➡	- Performance Parts	1	24.8190-0007.2 620007	L= 1.045
420 i xDrive	135	11/13→	➡	- Performance Parts	1	24.8190-0007.2 620007	L= 1.045
420 i xDrive	135	02/16→	➡	- Performance Parts	1	24.8190-0007.2 620007	L= 1.045
425 d	165	03/16→	➡	- Performance Parts	1	24.8190-0007.2 620007	L= 1.045
428 i	180	07/13→	➡	- Performance Parts	1	24.8190-0007.2 620007	L= 1.045
428 i xDrive	180	07/13→	➡	- Performance Parts	1	24.8190-0007.2 620007	L= 1.045
430 d	190	11/13→	➡	- Performance Parts	1	24.8190-0007.2 620007	L= 1.045
430 d	210	11/13→	➡	- Performance Parts	1	24.8190-0007.2 620007	L= 1.045
430 i	185	03/16→	➡	- Performance Parts	1	24.8190-0007.2 620007	L= 1.045
430 i xDrive	185	03/16→	➡	- Performance Parts	1	24.8190-0007.2 620007	L= 1.045
425 d	155	01/14→	⬅	☐; 03/14→; - Performance Parts	1	24.8190-0006.2 620006	L= 675
425 d	160	01/14→	⬅	☐; 03/14→; + Performance Parts	1	24.8190-0006.2 620006	L= 675
430 d xDrive	190	01/14→	⬅	☐; 03/14→; + Performance Parts	1	24.8190-0006.2 620006	L= 675
430 d xDrive	210	11/13→	➡	03/14→; - Performance Parts	1	24.8190-0007.2 620007	L= 1.045
			➡	03/14→; + Performance Parts	1	24.8190-0007.2 620007	L= 1.045
435 d xDrive	230	11/13→	⬅	+ Performance Parts	1	24.8190-0006.2 620006	L= 675
435 i	225	07/13→	⬅	- Performance Parts	1	24.8190-0006.2 620006	L= 675
435 i	250	07/13→	⬅	- Performance Parts	1	24.8190-0006.2 620006	L= 675
435 i xDrive	225	07/13→	➡	- Performance Parts	1	24.8190-0007.2 620007	L= 1.045
435 i xDrive	250	07/13→	➡	+ Performance Parts	1	24.8190-0007.2 620007	L= 1.045
440 i	240	03/16→	⬅	☐; - Performance Parts	1	24.8190-0006.2 620006	L= 675
440 i	265	03/16→	⬅	+ Performance Parts	1	24.8190-0006.2 620006	L= 675
440 i xDrive	240	03/16→	⬅	+ Performance Parts	1	24.8190-0006.2 620006	L= 675
440 i xDrive	265	03/16→	➡	+ Performance Parts	1	24.8190-0007.2 620007	L= 1.045
			➡	- Performance Parts	1	24.8190-0007.2 620007	L= 1.045
↓							

	kw			 	! #		
BMW - 4 Coupe (F32, F82) 07/13→							
Warnkontakt, Bremsbelagverschleiß							
M4	317	01/14→	←	☐; 03/14→	1	24.8190-0006.2 620006	L= 675
			→	03/14→	1	24.8190-0007.2 620007	L= 1.045
M4	331	03/16→	←	☐	1	24.8190-0006.2 620006	L= 675
M4 GTS	368	03/16→	→		1	24.8190-0007.2 620007	L= 1.045
 Bremsscheibe							
418 d	100	03/15→	←	- Performance Parts		24.0122-0278.1 422278	Ø 300 22 20,4 V + S
418 d	110	03/15→	←	+ Performance Parts		24.0130-0233.2 430233	Ø 340 30 28,4 V Bremsscheibe zweiteilig / + S
420 i	120	11/13→	→	- Performance Parts		24.0120-0237.1 420237	Ø 300 20 18,4 V + S
420 i	135	11/13→	→	+ Performance Parts		24.0124-0250.2 424250	Ø 345 24 22,4 V Bremsscheibe zweiteilig / + S
418 i	100	02/16→	←	- Performance Parts		24.0122-0278.1 422278	Ø 300 22 20,4 V + S
420 i	135	02/16→	←	+ Performance Parts		24.0130-0233.2 430233	Ø 340 30 28,4 V Bremsscheibe zweiteilig / + S
420 i xDrive	120	11/13→	→	- Performance Parts		24.0120-0240.1 420240	Ø 300 20 18,4 V + S
420 i xDrive	135	11/13→	→	+ Performance Parts		24.0124-0251.2 424251	Ø 345 24 22,4 V Bremsscheibe zweiteilig / + S
420 i xDrive	135	02/16→	→	- Performance Parts		24.0120-0240.1 420240	Ø 300 20 18,4 V + S
			→	+ Performance Parts		24.0124-0251.2 424251	Ø 345 24 22,4 V Bremsscheibe zweiteilig / + S
420 d	120	07/13→	←	- Performance Parts		24.0124-0203.1 424203	Ø 312 23,9 22,4 V + S
420 d	135	07/13→03/15	←	+ Performance Parts		24.0324-0203.1 524203	Ø 312 23,9 21,6 V + S PD
420 d	147	07/13→03/15	→	- Performance Parts		24.0120-0237.1 420237	Ø 300 20 18,4 V + S
			→	+ Performance Parts		24.0124-0250.2 424250	Ø 345 24 22,4 V Bremsscheibe zweiteilig / + S
420 d	140	03/15→	←	- Performance Parts		24.0124-0203.1 424203	Ø 312 23,9 22,4 V + S
			←	+ Performance Parts		24.0324-0203.1 524203	Ø 312 23,9 21,6 V + S PD
			→	+ Performance Parts		24.0130-0233.2 430233	Ø 340 30 28,4 V Bremsscheibe zweiteilig / + S
			→	+ Performance Parts		24.0124-0250.2 424250	Ø 345 24 22,4 V Bremsscheibe zweiteilig / + S
420 d xDrive	120	11/13→	←	- Performance Parts		24.0124-0203.1 424203	Ø 312 23,9 22,4 V + S
420 d xDrive	135	11/13→03/15	←	+ Performance Parts		24.0324-0203.1 524203	Ø 312 23,9 21,6 V + S PD
420 d xDrive	140	03/15→	→	- Performance Parts		24.0120-0240.1 420240	Ø 300 20 18,4 V + S
420 d xDrive	147	11/13→03/15	→	+ Performance Parts		24.0124-0251.2 424251	Ø 345 24 22,4 V Bremsscheibe zweiteilig / + S
425 d	155	01/14→	←	03/14→; - Performance Parts		24.0124-0248.1 424248	Ø 330 24 22,4 V + S
425 d	160	01/14→	←	03/14→; + Performance Parts		24.0130-0234.2 430234	Ø 370 30 28,4 V Bremsscheibe zweiteilig / + S
			→	03/14→; - Performance Parts		24.0120-0237.1 420237	Ø 300 20 18,4 V + S
			→	03/14→; + Performance Parts		24.0124-0250.2 424250	Ø 345 24 22,4 V Bremsscheibe zweiteilig / + S
425 d	165	03/16→	←	- Performance Parts		24.0124-0248.1 424248	Ø 330 24 22,4 V + S
428 i	180	07/13→	←	+ Performance Parts		24.0130-0234.2 430234	Ø 370 30 28,4 V Bremsscheibe zweiteilig / + S
428 i xDrive	180	07/13→	→	- Performance Parts		24.0120-0240.1 420240	Ø 300 20 18,4 V + S
430 i	185	03/16→	→	+ Performance Parts		24.0124-0251.2 424251	Ø 345 24 22,4 V Bremsscheibe zweiteilig / + S
430 i xDrive	185	03/16→	→	- Performance Parts		24.0120-0240.1 420240	Ø 300 20 18,4 V + S
			→	+ Performance Parts		24.0124-0251.2 424251	Ø 345 24 22,4 V Bremsscheibe zweiteilig / + S
430 d	190	11/13→	←	- Performance Parts		24.0124-0248.1 424248	Ø 330 24 22,4 V + S
430 d	210	11/13→	←	+ Performance Parts		24.0130-0234.2 430234	Ø 370 30 28,4 V Bremsscheibe zweiteilig / + S
			→	- Performance Parts		24.0120-0243.1 420243	Ø 330 20 18,4 V + S
			→	+ Performance Parts		24.0124-0251.2 424251	Ø 345 24 22,4 V Bremsscheibe zweiteilig / + S
430 d xDrive	190	01/14→	←	03/14→; - Performance Parts		24.0124-0248.1 424248	Ø 330 24 22,4 V + S
430 d xDrive	210	11/13→	←	03/14→; + Performance Parts		24.0130-0234.2 430234	Ø 370 30 28,4 V Bremsscheibe zweiteilig / + S
			→	03/14→; - Performance Parts		24.0120-0243.1 420243	Ø 330 20 18,4 V + S
			→	03/14→; + Performance Parts		24.0124-0251.2 424251	Ø 345 24 22,4 V Bremsscheibe zweiteilig / + S
↓							

	kW			 	! #		
BMW - 4 Coupe (F32, F82) 07/13→							
 Bremsscheibe							
435 d xDrive	230	11/13→	←	- Performance Parts		24.0130-0233.2 430233	Ø 340 30 28,4 V Bremsscheibe zweiteilig / + S
435 i	225	07/13→					
435 i	250	07/13→	←	+ Performance Parts		24.0130-0234.2 430234	Ø 370 30 28,4 V Bremsscheibe zweiteilig / + S
435 i xDrive	225	07/13→					
435 i xDrive	250	07/13→					
440 i	240	03/16→	→	- Performance Parts		24.0120-0243.1 420243	Ø 330 20 18,4 V + S
440 i	265	03/16→					
440 i xDrive	240	03/16→	→	+ Performance Parts		24.0124-0251.2 424251	Ø 345 24 22,4 V Bremsscheibe zweiteilig / + S
440 i xDrive	265	03/16→					
BMW - 4 Gran Coupe (F36) 03/14→							
 Bremsbelagsatz, Scheibenbremse							
418 d	100	03/14→	←	- Performance Parts		13.0460-3866.2 603866	BOS 25506 18,2 + WE / - WK
418 d	105	03/14→				13.0470-3866.2 LD3866	BOS 25506 18,2 + WE / - WK Ceramic
420 i xDrive	135	07/14→					
			←	+ Performance Parts		13.0460-4875.2 604875	BRE 25028 18,0 + WE / - WK
			→	- Performance Parts		13.0460-3859.2 603859	BOS 25307 17,5 + WE / - WK
						13.0470-3859.2 LD3859	BOS 25307 17,5 + WE / - WK Ceramic
			→	+ Performance Parts		13.0460-4874.2 604874	BRE 25029 16,7 + WE / - WK
418 d	110	07/15→	←	- Performance Parts		13.0460-3866.2 603866	BOS 25506 18,2 + WE / - WK
418 i	100	07/15→				13.0470-3866.2 LD3866	BOS 25506 18,2 + WE / - WK Ceramic
			←	+ Performance Parts		13.0460-4875.2 604875	BRE 25028 18,0 + WE / - WK
			→	- Performance Parts		13.0460-3859.2 603859	BOS 25307 17,5 + WE / - WK
						13.0470-3859.2 LD3859	BOS 25307 17,5 + WE / - WK Ceramic
			→	+ Performance Parts		13.0460-4874.2 604874	BRE 25029 16,7 + WE / - WK
420 d	120	03/14→	←	- Performance Parts		13.0460-3857.2 603857	BOS 25199 19,6 + WE / - WK
420 d	135	03/14→03/15				13.0470-3857.2 LD3857	BOS 25199 19,6 + WE / - WK Ceramic
420 d	140	03/15→					
420 d	147	03/14→03/15	←	+ Performance Parts		13.0460-4875.2 604875	BRE 25028 18,0 + WE / - WK
420 d xDrive	120	03/14→	→	- Performance Parts		13.0460-3859.2 603859	BOS 25307 17,5 + WE / - WK
420 d xDrive	135	03/14→03/15				13.0470-3859.2 LD3859	BOS 25307 17,5 + WE / - WK Ceramic
420 d xDrive	140	03/15→					
420 d xDrive	147	03/14→03/15	→	+ Performance Parts		13.0460-4874.2 604874	BRE 25029 16,7 + WE / - WK
420 i	120	03/14→					
420 i	135	03/14→	→	+ Performance Parts		13.0460-4874.2 604874	BRE 25029 16,7 + WE / - WK
428 i	180	03/14→					
428 i xDrive	180	03/14→					
430 i	185	03/16→					
430 i xDrive	185	03/16→					
420 i	135	02/16→	←	- Performance Parts; Motorcode: B48		13.0460-3866.2 603866	BOS 25506 18,2 + WE / - WK
						13.0470-3866.2 LD3866	BOS 25506 18,2 + WE / - WK Ceramic
			←	+ Performance Parts; Motorcode: B48		13.0460-4875.2 604875	BRE 25028 18,0 + WE / - WK
			→	- Performance Parts		13.0460-3859.2 603859	BOS 25307 17,5 + WE / - WK
						13.0470-3859.2 LD3859	BOS 25307 17,5 + WE / - WK Ceramic
			→	+ Performance Parts; Motorcode: B48		13.0460-4874.2 604874	BRE 25029 16,7 + WE / - WK
420 i xDrive	120	03/14→	←	07/14→; - Performance Parts		13.0460-3866.2 603866	BOS 25506 18,2 + WE / - WK
						13.0470-3866.2 LD3866	BOS 25506 18,2 + WE / - WK Ceramic
			←	07/14→; + Performance Parts		13.0460-4875.2 604875	BRE 25028 18,0 + WE / - WK
			→	07/14→; - Performance Parts		13.0460-3859.2 603859	BOS 25307 17,5 + WE / - WK
						13.0470-3859.2 LD3859	BOS 25307 17,5 + WE / - WK Ceramic
			→	07/14→; + Performance Parts		13.0460-4874.2 604874	BRE 25029 16,7 + WE / - WK
420 i xDrive	135	02/16→	←	- Performance Parts		13.0460-3866.2 603866	BOS 25506 18,2 + WE / - WK
						13.0470-3866.2 LD3866	BOS 25506 18,2 + WE / - WK Ceramic
			←	+ Performance Parts; Motorcode: B48		13.0460-4875.2 604875	BRE 25028 18,0 + WE / - WK
			→	- Performance Parts		13.0460-3859.2 603859	BOS 25307 17,5 + WE / - WK
						13.0470-3859.2 LD3859	BOS 25307 17,5 + WE / - WK Ceramic
			→	+ Performance Parts; Motorcode: B48		13.0460-4874.2 604874	BRE 25029 16,7 + WE / - WK
425 d	155	03/16→	←	- Performance Parts		13.0460-3857.2 603857	BOS 25199 19,6 + WE / - WK
425 d	165	03/16→					
↓							

	kW			 	! #		
BMW - 4 Gran Coupe (F36) 03/14→							
 Bremsbelagsatz, Scheibenbremse							
425 d	155	03/16→	←	- Performance Parts		13.0470-3857.2 LD3857	BOS 25199 19,6 + WE / - WK Ceramic
425 d	165	03/16→	←	+ Performance Parts		13.0460-4875.2 604875	BRE 25028 18,0 + WE / - WK
			→	- Performance Parts		13.0460-3859.2 603859	BOS 25307 17,5 + WE / - WK Ceramic
			→	+ Performance Parts		13.0470-3859.2 LD3859	BOS 25307 17,5 + WE / - WK Ceramic
			→	+ Performance Parts		13.0460-4874.2 604874	BRE 25029 16,7 + WE / - WK
430 d	190	07/14→	←	- Performance Parts		13.0460-3857.2 603857	BOS 25199 19,6 + WE / - WK
430 d	210	07/14→	←	- Performance Parts		13.0470-3857.2 LD3857	BOS 25199 19,6 + WE / - WK Ceramic
430 d xDrive	190	07/14→	←	- Performance Parts		13.0470-3857.2 LD3857	BOS 25199 19,6 + WE / - WK Ceramic
430 d xDrive	210	07/14→	←	- Performance Parts		13.0470-3857.2 LD3857	BOS 25199 19,6 + WE / - WK Ceramic
			←	+ Performance Parts		13.0460-4875.2 604875	BRE 25028 18,0 + WE / - WK
			→	+ Performance Parts		13.0460-4874.2 604874	BRE 25029 16,7 + WE / - WK
435 d xDrive	230	07/14→	←	+ Performance Parts		13.0460-4875.2 604875	BRE 25028 18,0 + WE / - WK
435 i	225	03/14→	←	- Performance Parts		13.0460-4875.2 604875	BRE 25028 18,0 + WE / - WK
435 i	250	03/14→	←	- Performance Parts		13.0460-4875.2 604875	BRE 25028 18,0 + WE / - WK
435 i xDrive	225	07/14→	→	+ Performance Parts		13.0460-4874.2 604874	BRE 25029 16,7 + WE / - WK
435 i xDrive	250	07/14→	→	+ Performance Parts		13.0460-4874.2 604874	BRE 25029 16,7 + WE / - WK
440 i	240	03/16→	←	+ Performance Parts		13.0460-4875.2 604875	BRE 25028 18,0 + WE / - WK
440 i	265	03/16→	←	- Performance Parts		13.0460-4875.2 604875	BRE 25028 18,0 + WE / - WK
440 i xDrive	240	03/16→	←	- Performance Parts		13.0460-4875.2 604875	BRE 25028 18,0 + WE / - WK
440 i xDrive	265	03/16→	→	+ Performance Parts		13.0460-4874.2 604874	BRE 25029 16,7 + WE / - WK
Warnkontakt, Bremsbelagsverschleiß							
418 d	100	03/14→	←	☐; - Performance Parts	1	24.8190-0006.2 620006	L= 675
418 d	105	03/14→	←	☐; + Performance Parts	1	24.8190-0006.2 620006	L= 675
418 d	110	07/15→	←	☐; + Performance Parts	1	24.8190-0006.2 620006	L= 675
418 i	100	07/15→	→	+ Performance Parts	1	24.8190-0007.2 620007	L= 1.045
420 d	120	03/14→	→	- Performance Parts	1	24.8190-0007.2 620007	L= 1.045
420 d	135	03/14→03/15	→	- Performance Parts	1	24.8190-0007.2 620007	L= 1.045
420 d	140	03/15→	→	- Performance Parts	1	24.8190-0007.2 620007	L= 1.045
420 d	147	03/14→03/15	→	- Performance Parts	1	24.8190-0007.2 620007	L= 1.045
420 d xDrive	120	03/14→	→	- Performance Parts	1	24.8190-0007.2 620007	L= 1.045
420 d xDrive	135	03/14→03/15	→	- Performance Parts	1	24.8190-0007.2 620007	L= 1.045
420 d xDrive	140	03/15→	→	- Performance Parts	1	24.8190-0007.2 620007	L= 1.045
420 d xDrive	147	03/14→03/15	→	- Performance Parts	1	24.8190-0007.2 620007	L= 1.045
420 i	120	03/14→	→	- Performance Parts	1	24.8190-0007.2 620007	L= 1.045
420 i	135	03/14→	→	- Performance Parts	1	24.8190-0007.2 620007	L= 1.045
420 i xDrive	135	07/14→	→	- Performance Parts	1	24.8190-0007.2 620007	L= 1.045
425 d	155	03/16→	→	- Performance Parts	1	24.8190-0007.2 620007	L= 1.045
425 d	165	03/16→	→	- Performance Parts	1	24.8190-0007.2 620007	L= 1.045
428 i	180	03/14→	→	- Performance Parts	1	24.8190-0007.2 620007	L= 1.045
428 i xDrive	180	03/14→	→	- Performance Parts	1	24.8190-0007.2 620007	L= 1.045
430 d	190	07/14→	→	- Performance Parts	1	24.8190-0007.2 620007	L= 1.045
430 d	210	07/14→	→	- Performance Parts	1	24.8190-0007.2 620007	L= 1.045
430 d xDrive	190	07/14→	→	- Performance Parts	1	24.8190-0007.2 620007	L= 1.045
430 d xDrive	210	07/14→	→	- Performance Parts	1	24.8190-0007.2 620007	L= 1.045
430 i	185	03/16→	→	- Performance Parts	1	24.8190-0007.2 620007	L= 1.045
430 i xDrive	185	03/16→	→	- Performance Parts	1	24.8190-0007.2 620007	L= 1.045
420 i	135	02/16→	←	☐; + Performance Parts; Motorcode: B48	1	24.8190-0006.2 620006	L= 675
			←	☐; - Performance Parts; Motorcode: B48	1	24.8190-0006.2 620006	L= 675
			→	- Performance Parts	1	24.8190-0007.2 620007	L= 1.045
			→	+ Performance Parts; Motorcode: B48	1	24.8190-0007.2 620007	L= 1.045
420 i xDrive	120	03/14→	←	☐; 07/14→; + Performance Parts	1	24.8190-0006.2 620006	L= 675
			←	☐; 07/14→; - Performance Parts	1	24.8190-0006.2 620006	L= 675
			→	07/14→; + Performance Parts	1	24.8190-0007.2 620007	L= 1.045
			→	07/14→; - Performance Parts	1	24.8190-0007.2 620007	L= 1.045
420 i xDrive	135	02/16→	←	☐; + Performance Parts; Motorcode: B48	1	24.8190-0006.2 620006	L= 675
			←	☐; - Performance Parts	1	24.8190-0006.2 620006	L= 675
			→	+ Performance Parts; Motorcode: B48	1	24.8190-0007.2 620007	L= 1.045
			→	- Performance Parts	1	24.8190-0007.2 620007	L= 1.045
435 d xDrive	230	07/14→	←	+ Performance Parts	1	24.8190-0006.2 620006	L= 675
435 i	225	03/14→	←	- Performance Parts	1	24.8190-0006.2 620006	L= 675
435 i	250	03/14→	←	- Performance Parts	1	24.8190-0006.2 620006	L= 675
435 i xDrive	225	07/14→	→	- Performance Parts	1	24.8190-0007.2 620007	L= 1.045
435 i xDrive	250	07/14→	→	- Performance Parts	1	24.8190-0007.2 620007	L= 1.045
440 i	240	03/16→	→	+ Performance Parts	1	24.8190-0007.2 620007	L= 1.045
440 i	265	03/16→	→	+ Performance Parts	1	24.8190-0007.2 620007	L= 1.045
440 i xDrive	240	03/16→	→	+ Performance Parts	1	24.8190-0007.2 620007	L= 1.045
440 i xDrive	265	03/16→	→	+ Performance Parts	1	24.8190-0007.2 620007	L= 1.045
↓							

	kW			 	! #		
BMW - 4 Gran Coupe (F36) 03/14→							
Bremsscheibe							
418 d	100	03/14→	←	- Performance Parts		24.0122-0278.1 422278	Ø 300 22 20,4 V + S
418 d	105	03/14→	←	+ Performance Parts		24.0130-0233.2 430233	Ø 340 30 28,4 V
420 d	120	03/14→	←				Bremsscheibe zweiteilig / + S
420 d	135	03/14→03/15	→	- Performance Parts		24.0120-0237.1 420237	Ø 300 20 18,4 V + S
420 d	147	03/14→03/15	→	+ Performance Parts		24.0124-0250.2 424250	Ø 345 24 22,4 V
							Bremsscheibe zweiteilig / + S
418 d	110	07/15→	←	- Performance Parts		24.0122-0278.1 422278	Ø 300 22 20,4 V + S
418 i	100	07/15→	←	+ Performance Parts		24.0130-0233.2 430233	Ø 340 30 28,4 V
420 i	120	03/14→	←				Bremsscheibe zweiteilig / + S
420 i	135	03/14→	←				
420 i	135	02/16→	→	- Performance Parts		24.0120-0240.1 420240	Ø 300 20 18,4 V + S
420 i xDrive	135	07/14→	→	+ Performance Parts		24.0124-0251.2 424251	Ø 345 24 22,4 V
420 i xDrive	135	02/16→	→				Bremsscheibe zweiteilig / + S
420 d	140	03/15→	←	- Performance Parts		24.0124-0203.1 424203	Ø 312 23,9 22,4 V + S
420 d xDrive	120	03/14→	←			24.0324-0203.1 524203	Ø 312 23,9 21,6 V + S PD
420 d xDrive	135	03/14→03/15	←	+ Performance Parts		24.0130-0233.2 430233	Ø 340 30 28,4 V
420 d xDrive	140	03/15→	←				Bremsscheibe zweiteilig / + S
420 d xDrive	147	03/14→03/15	→	- Performance Parts		24.0120-0240.1 420240	Ø 300 20 18,4 V + S
			→	+ Performance Parts		24.0124-0251.2 424251	Ø 345 24 22,4 V
							Bremsscheibe zweiteilig / + S
420 i xDrive	120	03/14→	←	07/14→; - Performance Parts		24.0122-0278.1 422278	Ø 300 22 20,4 V + S
			←	07/14→; + Performance Parts		24.0130-0233.2 430233	Ø 340 30 28,4 V
							Bremsscheibe zweiteilig / + S
			→	07/14→; - Performance Parts		24.0120-0240.1 420240	Ø 300 20 18,4 V + S
			→	07/14→; + Performance Parts		24.0124-0251.2 424251	Ø 345 24 22,4 V
							Bremsscheibe zweiteilig / + S
425 d	155	03/16→	←	- Performance Parts		24.0124-0248.1 424248	Ø 330 24 22,4 V + S
425 d	165	03/16→	←	+ Performance Parts		24.0130-0234.2 430234	Ø 370 30 28,4 V
428 i	180	03/14→	←				Bremsscheibe zweiteilig / + S
428 i xDrive	180	03/14→	←				
430 i	185	03/16→	→	- Performance Parts		24.0120-0240.1 420240	Ø 300 20 18,4 V + S
430 i xDrive	185	03/16→	→	+ Performance Parts		24.0124-0251.2 424251	Ø 345 24 22,4 V
							Bremsscheibe zweiteilig / + S
430 d	190	07/14→	←	- Performance Parts		24.0124-0248.1 424248	Ø 330 24 22,4 V + S
430 d	210	07/14→	←	+ Performance Parts		24.0130-0234.2 430234	Ø 370 30 28,4 V
430 d xDrive	190	07/14→	←				Bremsscheibe zweiteilig / + S
430 d xDrive	210	07/14→	←				
			→	- Performance Parts		24.0120-0243.1 420243	Ø 330 20 18,4 V + S
			→	+ Performance Parts		24.0124-0251.2 424251	Ø 345 24 22,4 V
							Bremsscheibe zweiteilig / + S
435 d xDrive	230	07/14→	←	- Performance Parts		24.0130-0233.2 430233	Ø 340 30 28,4 V
435 i	225	03/14→	←				Bremsscheibe zweiteilig / + S
435 i	250	03/14→	←	+ Performance Parts		24.0130-0234.2 430234	Ø 370 30 28,4 V
435 i xDrive	225	07/14→	←				Bremsscheibe zweiteilig / + S
435 i xDrive	250	07/14→	←				
440 i	240	03/16→	→	- Performance Parts		24.0120-0243.1 420243	Ø 330 20 18,4 V + S
440 i	265	03/16→	→	+ Performance Parts		24.0124-0251.2 424251	Ø 345 24 22,4 V
440 i xDrive	240	03/16→	→				Bremsscheibe zweiteilig / + S
440 i xDrive	265	03/16→	→				
							Bremsscheibe zweiteilig / + S
BMW - 5 (E34) 12/87→11/95							
Brembelagsatz, Scheibenbremse							
518 i	83	08/89→09/95	←			13.0460-6033.2 606033	ATE 20968 20,3 + WE / - WK
518 i	85	08/89→09/95	→	+ ABS		13.0460-3803.2 603803	ATE 20995 17,3 + WE / - WK
520 i 24V	110	09/89→09/95	←			13.0460-6033.2 606033	ATE 20968 20,3 + WE / - WK
525 i 24V	141	09/89→09/95	←				
525 iX 24V	141	10/91→09/95	→			13.0460-3803.2 603803	ATE 20995 17,3 + WE / - WK
525 td	85	04/93→09/95	→				
525 tds	105	09/91→09/95	→				
530 i V8	160	09/92→09/95	→				
535 i	155	01/88→09/95	→				
540 i V8	210	09/92→09/95	→				
524 td	85	03/88→09/95	←	→ 08/91		13.0460-6033.2 606033	ATE 20968 20,3 + WE / - WK
			→	→ 08/91		13.0460-3803.2 603803	ATE 20995 17,3 + WE / - WK
530 i	160	09/94→11/95	←	→ 09/95		13.0460-6033.2 606033	ATE 20968 20,3 + WE / - WK
			→	→ 09/95		13.0460-3803.2 603803	ATE 20995 17,3 + WE / - WK
M5	250	03/92→09/95	←	→ 05/94		13.0460-6033.2 606033	ATE 20968 20,3 + WE / - WK
			←			13.0460-9037.2 609037	ATE 20309 17,9 + WE / - WK
↓							



BMW - 5 (E34) 12/87→11/95

Bremsbelagsatz, Scheibenbremse

M5	250	03/92→09/95	➡	→ 05/94		13.0460-3803.2	603803	ATE 20995 17,3 + WE / - WK
Warnkontakt, Bremsbelagverschleiß								
518 i	83	08/89→09/95	←		1	24.8190-0214.2	620214	L= 235
518 i	85	08/89→09/95	➡	+ ABS	1	24.8190-0214.2	620214	L= 235
520 i 24V	110	09/89→09/95	←		1	24.8190-0214.2	620214	L= 235
525 i 24V	141	09/89→09/95	←					
525 td	85	04/93→09/95	➡		1	24.8190-0214.2	620214	L= 235
525 tds	105	09/91→09/95	➡					
530 i V8	160	09/92→09/95	➡					
535 i	155	01/88→09/95	➡					
540 i V8	210	09/92→09/95	➡					
524 td	85	03/88→09/95	←	→ 08/91	1	24.8190-0214.2	620214	L= 235
			➡	→ 08/91	1	24.8190-0214.2	620214	L= 235
525 iX 24V	141	10/91→09/95	←		1	24.8190-0224.2	620224	L= 311
			➡		1	24.8190-0214.2	620214	L= 235
530 i	160	09/94→11/95	←	→ 09/95	1	24.8190-0214.2	620214	L= 235
			➡	→ 09/95	1	24.8190-0214.2	620214	L= 235
M5	250	03/92→09/95	←	→ 05/94	1	24.8190-0214.2	620214	L= 235
			←		1	24.8190-0214.2	620214	L= 235
			➡	06/94→	1	24.8190-0214.2	620214	L= 235
			➡	→ 05/94	1	24.8190-0214.2	620214	L= 235









Bremsscheibe









518 i	83	08/89→09/95	←			24.0112-0124.1	412124	Ø 302 12 10,4 + S
518 i	85	08/89→09/95	➡	+ ABS		24.0110-0117.1	410117	Ø 300 10 8,4 + S
						24.0310-0117.1	510117	Ø 300 10 7,6 + S PD
520 i 24V	110	09/89→09/95	←	nicht für Behördenfahrzeuge		24.0112-0124.1	412124	Ø 302 12 10,4 + S
			←	für Behördenfahrzeuge		24.0122-0103.1	422103	Ø 302 22 20,4 V + S
						24.0322-0103.1	522103	Ø 302 22 19,6 V + S PD
			➡			24.0110-0117.1	410117	Ø 300 10 8,4 + S
						24.0310-0117.1	510117	Ø 300 10 7,6 + S PD
524 td	85	03/88→09/95	←	→ 08/91		24.0112-0124.1	412124	Ø 302 12 10,4 + S
			➡	→ 08/91		24.0110-0117.1	410117	Ø 300 10 8,4 + S
						24.0310-0117.1	510117	Ø 300 10 7,6 + S PD
525 i 24V	141	09/89→09/95	←			24.0122-0103.1	422103	Ø 302 22 20,4 V + S
530 i V8	160	09/92→09/95	←			24.0322-0103.1	522103	Ø 302 22 19,6 V + S PD
535 i	155	01/88→09/95	➡			24.0110-0117.1	410117	Ø 300 10 8,4 + S
						24.0310-0117.1	510117	Ø 300 10 7,6 + S PD
525 iX 24V	141	10/91→09/95	←			24.0128-0122.1	428122	Ø 296 28 26,4 V
			➡			24.0110-0262.1	410262	Ø 300 10 8,4
525 td	85	04/93→09/95	←			24.0112-0124.1	412124	Ø 302 12 10,4 + S
525 tds	105	09/91→09/95	➡			24.0110-0117.1	410117	Ø 300 10 8,4 + S
						24.0310-0117.1	510117	Ø 300 10 7,6 + S PD
530 i	160	09/94→11/95	←	→ 09/95		24.0122-0103.1	422103	Ø 302 22 20,4 V + S
						24.0322-0103.1	522103	Ø 302 22 19,6 V + S PD
			➡	→ 09/95		24.0110-0117.1	410117	Ø 300 10 8,4 + S
						24.0310-0117.1	510117	Ø 300 10 7,6 + S PD
540 i V8	210	09/92→09/95	←			24.0128-0101.1	428101	Ø 302 28 26,4 V
			➡			24.0120-0181.1	420181	Ø 300 20 18,4 V
M5	250	03/92→09/95	➡	→ 05/94		24.0120-0181.1	420181	Ø 300 20 18,4 V







BMW - 5 (E39) 11/95→06/03







Bremsbelagsatz, Scheibenbremse









520 d	100	02/00→06/03	←	04/00→; für Behördenfahrzeuge		13.0460-7078.2	607078	ATE 21486 19,5 + WE / - WK
525 d	120	02/00→06/03	←			13.0470-7078.2	LD7078	ATE 21486 19,5 + WE / - WK Ceramic
			←	04/00→; nicht für Behördenfahrzeuge		13.0460-7089.2	607089	ATE 21676 20,3 + WE / - WK
						13.0470-7089.2	LD7089	ATE 21676 20,3 + WE / - WK Ceramic
↓								









	kW			 	! #		
BMW - 5 (E39) 11/95→06/03							
 Bremsbelagsatz, Scheibenbremse							
520 d 525 d	100 120	02/00→06/03 02/00→06/03	➡	04/00→		13.0460-7090.2 607090 13.0470-7090.2 LD7090	ATE 21691 17,3 + WE / - WK ATE 21691 17,3 + WE / - WK Ceramic
520 i 520 i 520 i	100 120 125	04/99→06/03 09/00→06/03 09/00→06/03	←	für Behördenfahrzeuge		13.0460-7078.2 607078 13.0470-7078.2 LD7078	ATE 21486 19,5 + WE / - WK ATE 21486 19,5 + WE / - WK Ceramic
			←	nicht für Behördenfahrzeuge		13.0460-7089.2 607089 13.0470-7089.2 LD7089	ATE 21676 20,3 + WE / - WK ATE 21676 20,3 + WE / - WK Ceramic
			➡			13.0460-7090.2 607090 13.0470-7090.2 LD7090	ATE 21691 17,3 + WE / - WK ATE 21691 17,3 + WE / - WK Ceramic
520 i	110	01/96→09/00	←	03/96→; für Behördenfahrzeuge		13.0460-7078.2 607078 13.0470-7078.2 LD7078	ATE 21486 19,5 + WE / - WK ATE 21486 19,5 + WE / - WK Ceramic
			←	03/96→; nicht für Behördenfahrzeuge		13.0460-7089.2 607089 13.0470-7089.2 LD7089	ATE 21676 20,3 + WE / - WK ATE 21676 20,3 + WE / - WK Ceramic
			➡	03/96→		13.0460-7090.2 607090 13.0470-7090.2 LD7090	ATE 21691 17,3 + WE / - WK ATE 21691 17,3 + WE / - WK Ceramic
523 i 528 i	125 142	11/95→09/00 11/95→09/00	←	12/95→		13.0460-7089.2 607089 13.0470-7089.2 LD7089	ATE 21676 20,3 + WE / - WK ATE 21676 20,3 + WE / - WK Ceramic
			➡	12/95→		13.0460-7090.2 607090 13.0470-7090.2 LD7090	ATE 21691 17,3 + WE / - WK ATE 21691 17,3 + WE / - WK Ceramic
525 i	141	09/00→06/03	←	10/00→; für Behördenfahrzeuge		13.0460-7078.2 607078 13.0470-7078.2 LD7078	ATE 21486 19,5 + WE / - WK ATE 21486 19,5 + WE / - WK Ceramic
			←	10/00→; nicht für Behördenfahrzeuge		13.0460-7089.2 607089 13.0470-7089.2 LD7089	ATE 21676 20,3 + WE / - WK ATE 21676 20,3 + WE / - WK Ceramic
			➡	10/00→		13.0460-7090.2 607090 13.0470-7090.2 LD7090	ATE 21691 17,3 + WE / - WK ATE 21691 17,3 + WE / - WK Ceramic
525 td	85	01/97→06/03	←	→ 09/00		13.0460-7089.2 607089 13.0470-7089.2 LD7089	ATE 21676 20,3 + WE / - WK ATE 21676 20,3 + WE / - WK Ceramic
			➡	→ 09/00		13.0460-7090.2 607090 13.0470-7090.2 LD7090	ATE 21691 17,3 + WE / - WK ATE 21691 17,3 + WE / - WK Ceramic
525 tds	105	01/96→06/03	←	02/96→ 09/00		13.0460-7089.2 607089 13.0470-7089.2 LD7089	ATE 21676 20,3 + WE / - WK ATE 21676 20,3 + WE / - WK Ceramic
			➡	02/96→ 09/00		13.0460-7090.2 607090 13.0470-7090.2 LD7090	ATE 21691 17,3 + WE / - WK ATE 21691 17,3 + WE / - WK Ceramic
530 d	135	08/98→09/00	←	09/98→		13.0460-7089.2 607089 13.0470-7089.2 LD7089	ATE 21676 20,3 + WE / - WK ATE 21676 20,3 + WE / - WK Ceramic
			➡	09/98→		13.0460-7090.2 607090 13.0470-7090.2 LD7090	ATE 21691 17,3 + WE / - WK ATE 21691 17,3 + WE / - WK Ceramic
530 d	142	09/00→06/03	←	10/00→		13.0460-7078.2 607078 13.0470-7078.2 LD7078	ATE 21486 19,5 + WE / - WK ATE 21486 19,5 + WE / - WK Ceramic
			←	→ 09/00		13.0460-7089.2 607089 13.0470-7089.2 LD7089	ATE 21676 20,3 + WE / - WK ATE 21676 20,3 + WE / - WK Ceramic
			➡			13.0460-7090.2 607090 13.0470-7090.2 LD7090	ATE 21691 17,3 + WE / - WK ATE 21691 17,3 + WE / - WK Ceramic
530 i	170	09/00→06/03	←	10/00→		13.0460-7078.2 607078 13.0470-7078.2 LD7078	ATE 21486 19,5 + WE / - WK ATE 21486 19,5 + WE / - WK Ceramic
			➡	10/00→		13.0460-7090.2 607090	ATE 21691 17,3 + WE / - WK

	kW			 	! #		
BMW - 5 (E39) 11/95→06/03							
 Bremsbelagsatz, Scheibenbremse							
530 i	170	09/00→06/03	➡	10/00→		13.0470-7090.2 LD7090	ATE 21691 17,3 + WE / - WK Ceramic
535 i	173	04/96→03/99	⬅	09/97→		13.0460-7078.2 607078	ATE 21486 19,5 + WE / - WK
			⬅	05/96→ 08/97		13.0460-7089.2 607089	ATE 21676 20,3 + WE / - WK
			➡	05/96→		13.0460-7090.2 607090	ATE 21691 17,3 + WE / - WK
						13.0470-7090.2 LD7090	ATE 21691 17,3 + WE / - WK Ceramic
535 i	180	04/99→06/03	⬅			13.0460-7078.2 607078	ATE 21486 19,5 + WE / - WK
			➡			13.0460-7090.2 607090	ATE 21691 17,3 + WE / - WK
						13.0470-7090.2 LD7090	ATE 21691 17,3 + WE / - WK Ceramic
540 i	210	04/96→06/03	⬅	05/96→		13.0460-7078.2 607078	ATE 21486 19,5 + WE / - WK
						13.0470-7078.2 LD7078	ATE 21486 19,5 + WE / - WK Ceramic
			➡	05/96→		13.0460-7090.2 607090	ATE 21691 17,3 + WE / - WK
						13.0470-7090.2 LD7090	ATE 21691 17,3 + WE / - WK Ceramic
M5	294	10/98→06/03	⬅			13.0460-7078.2 607078	ATE 21486 19,5 + WE / - WK
			➡			13.0460-7079.2 607079	ATE 21282 17,3 + WE / - WK
Warnkontakt, Bremsbelagverschleiß							
520 d 525 d	100 120	02/00→06/03 02/00→06/03	⬅	04/00→; nicht für Behördenfahrzeuge	1	24.8190-0219.2 620219	L= 764
			⬅	04/00→; für Behördenfahrzeuge	1	24.8190-0219.2 620219	L= 764
			➡	04/00→	1	24.8190-0218.2 620218	L= 545
520 i 520 i 520 i	100 120 125	04/99→06/03 09/00→06/03 09/00→06/03	⬅	nicht für Behördenfahrzeuge	1	24.8190-0219.2 620219	L= 764
			⬅	für Behördenfahrzeuge	1	24.8190-0219.2 620219	L= 764
			➡		1	24.8190-0218.2 620218	L= 545
520 i	110	01/96→09/00	⬅	03/96→; nicht für Behördenfahrzeuge	1	24.8190-0219.2 620219	L= 764
			⬅	03/96→; für Behördenfahrzeuge	1	24.8190-0219.2 620219	L= 764
			➡	03/96→	1	24.8190-0218.2 620218	L= 545
523 i 528 i	125 142	11/95→09/00 11/95→09/00	⬅	12/95→	1	24.8190-0219.2 620219	L= 764
			➡	12/95→	1	24.8190-0218.2 620218	L= 545
525 i	141	09/00→06/03	⬅	10/00→; nicht für Behördenfahrzeuge	1	24.8190-0219.2 620219	L= 764
			⬅	10/00→; für Behördenfahrzeuge	1	24.8190-0219.2 620219	L= 764
			➡	10/00→	1	24.8190-0218.2 620218	L= 545
525 td	85	01/97→06/03	⬅	→ 09/00	1	24.8190-0219.2 620219	L= 764
			➡	→ 09/00	1	24.8190-0218.2 620218	L= 545
525 tds	105	01/96→06/03	⬅	02/96→ 09/00	1	24.8190-0219.2 620219	L= 764
			➡	02/96→ 09/00	1	24.8190-0218.2 620218	L= 545
530 d	135	08/98→09/00	⬅	09/98→	1	24.8190-0219.2 620219	L= 764
			➡	09/98→	1	24.8190-0218.2 620218	L= 545
530 d	142	09/00→06/03	⬅	10/00→	1	24.8190-0219.2 620219	L= 764
			⬅	→ 09/00	1	24.8190-0219.2 620219	L= 764
			➡		1	24.8190-0218.2 620218	L= 545
530 i	170	09/00→06/03	⬅	10/00→	1	24.8190-0219.2 620219	L= 764
			➡	10/00→	1	24.8190-0218.2 620218	L= 545
535 i	173	04/96→03/99	⬅	05/96→ 08/97	1	24.8190-0219.2 620219	L= 764
			⬅	09/97→	1	24.8190-0219.2 620219	L= 764
			➡	05/96→	1	24.8190-0218.2 620218	L= 545
535 i	180	04/99→06/03	⬅		1	24.8190-0219.2 620219	L= 764
			➡		1	24.8190-0218.2 620218	L= 545
540 i	210	04/96→06/03	⬅	05/96→	1	24.8190-0219.2 620219	L= 764
			➡	05/96→	1	24.8190-0218.2 620218	L= 545
M5	294	10/98→06/03	⬅		1	24.8190-0219.2 620219	L= 764
 Bremsscheibe							
520 d ↓	100	02/00→06/03	⬅	04/00→; nicht für Behördenfahrzeuge		24.0122-0159.1 422159	Ø 296 22 20,4 V + S









	kw			 	! #		
BMW - 5 (E39) 11/95→06/03							
Bremsscheibe							
520 d	100	02/00→06/03	←	04/00→; nicht für Behördenfahrzeuge	24.0322-0159.1	522159	Ø 296 22 19,6 V + S PD
			←	04/00→; für Behördenfahrzeuge	24.0130-0107.1	430107	Ø 324 29,9 28,4 V + S
			→	04/00→; nicht für Behördenfahrzeuge	24.0110-0227.1	410227	Ø 298 10 8,4 + S
			→	04/00→; für Behördenfahrzeuge	24.0310-0227.1	510227	Ø 298 10 7,6 + S PD
520 i 520 i 520 i	100 120 125	04/99→06/03 09/00→06/03 09/00→06/03	←	nicht für Behördenfahrzeuge	24.0122-0159.1	422159	Ø 296 22 20,4 V + S
			←	für Behördenfahrzeuge	24.0322-0159.1	522159	Ø 296 22 19,6 V + S PD
			→	nicht für Behördenfahrzeuge	24.0110-0227.1	410227	Ø 298 10 8,4 + S
			→	für Behördenfahrzeuge	24.0310-0227.1	510227	Ø 298 10 7,6 + S PD
520 i	110	01/96→09/00	←	03/96→; nicht für Behördenfahrzeuge	24.0122-0159.1	422159	Ø 296 22 20,4 V + S
			←	03/96→; für Behördenfahrzeuge	24.0322-0159.1	522159	Ø 296 22 19,6 V + S PD
			→	03/96→; nicht für Behördenfahrzeuge	24.0130-0107.1	430107	Ø 324 29,9 28,4 V + S
			→	03/96→; für Behördenfahrzeuge	24.0330-0107.1	530107	Ø 324 29,9 27,6 V + S PD
523 i	125	11/95→09/00	←	12/95→	24.0110-0227.1	410227	Ø 298 10 8,4 + S
			→	12/95→ 08/98; nicht für Behördenfahrzeuge	24.0310-0227.1	510227	Ø 298 10 7,6 + S PD
			→	09/98→	24.0120-0154.1	420154	Ø 298 20 18,4 V + S
			→	12/95→ 08/98; für Behördenfahrzeuge	24.0320-0154.1	520154	Ø 298 20 17,6 V + S PD
525 d	120	02/00→06/03	←	04/00→; nicht für Behördenfahrzeuge	24.0120-0154.1	420154	Ø 298 20 18,4 V + S
			←	04/00→; für Behördenfahrzeuge	24.0320-0154.1	520154	Ø 298 20 17,6 V + S PD
			→	04/00→	24.0122-0159.1	422159	Ø 296 22 20,4 V + S
			→	04/00→	24.0322-0159.1	522159	Ø 296 22 19,6 V + S PD
525 i	141	09/00→06/03	←	10/00→; nicht für Behördenfahrzeuge	24.0130-0107.1	430107	Ø 324 29,9 28,4 V + S
			←	10/00→; für Behördenfahrzeuge	24.0330-0107.1	530107	Ø 324 29,9 27,6 V + S PD
			→	10/00→	24.0120-0154.1	420154	Ø 298 20 18,4 V + S
			→	10/00→	24.0320-0154.1	520154	Ø 298 20 17,6 V + S PD
525 td	85	01/97→06/03	←	→ 09/00	24.0122-0159.1	422159	Ø 296 22 20,4 V + S
			→	→ 09/00; nicht für Behördenfahrzeuge	24.0322-0159.1	522159	Ø 296 22 19,6 V + S PD
			→	→ 09/00; für Behördenfahrzeuge	24.0110-0227.1	410227	Ø 298 10 8,4 + S
525 tds	105	01/96→06/03	←	02/96→ 09/00	24.0310-0227.1	510227	Ø 298 10 7,6 + S PD
			→	02/96→ 09/00; nicht für Behördenfahrzeuge	24.0120-0154.1	420154	Ø 298 20 18,4 V + S
			→	02/96→ 09/00; für Behördenfahrzeuge	24.0320-0154.1	520154	Ø 298 20 17,6 V + S PD
528 i	142	11/95→09/00	←	12/95→	24.0122-0159.1	422159	Ø 296 22 20,4 V + S
			→	12/95→	24.0322-0159.1	522159	Ø 296 22 19,6 V + S PD
530 d	135	08/98→09/00	←	09/98→	24.0110-0227.1	410227	Ø 298 10 8,4 + S
			→	09/98→	24.0310-0227.1	510227	Ø 298 10 7,6 + S PD
↓							









	kw			 	! #		
BMW - 5 (E39) 11/95→06/03							
Bremsscheibe							
530 d	135	08/98→09/00	➔	09/98→		24.0120-0154.1 420154 24.0320-0154.1 520154	Ø 298 20 18,4 V + S Ø 298 20 17,6 V + S PD
530 d	142	09/00→06/03	➔	→ 09/00		24.0122-0159.1 422159 24.0322-0159.1 522159	Ø 296 22 20,4 V + S Ø 296 22 19,6 V + S PD
			➔	10/00→		24.0130-0107.1 430107 24.0330-0107.1 530107	Ø 324 29,9 28,4 V + S Ø 324 29,9 27,6 V + S PD
			➔			24.0120-0154.1 420154 24.0320-0154.1 520154	Ø 298 20 18,4 V + S Ø 298 20 17,6 V + S PD
			➔			24.0130-0107.1 430107 24.0330-0107.1 530107	Ø 324 29,9 28,4 V + S Ø 324 29,9 27,6 V + S PD
530 i	170	09/00→06/03	➔	10/00→		24.0130-0107.1 430107 24.0330-0107.1 530107	Ø 324 29,9 28,4 V + S Ø 324 29,9 27,6 V + S PD
			➔	10/00→		24.0120-0154.1 420154 24.0320-0154.1 520154	Ø 298 20 18,4 V + S Ø 298 20 17,6 V + S PD
535 i	173	04/96→03/99	➔	05/96→ 08/97		24.0122-0159.1 422159 24.0322-0159.1 522159	Ø 296 22 20,4 V + S Ø 296 22 19,6 V + S PD
			➔	09/97→		24.0130-0101.1 430101	Ø 324 30 28,4 V + S
			➔	05/96→		24.0120-0154.1 420154 24.0320-0154.1 520154	Ø 298 20 18,4 V + S Ø 298 20 17,6 V + S PD
535 i	180	04/99→06/03	➔	→ 02/00		24.0130-0101.1 430101	Ø 324 30 28,4 V + S
			➔	03/00→		24.0130-0107.1 430107 24.0330-0107.1 530107	Ø 324 29,9 28,4 V + S Ø 324 29,9 27,6 V + S PD
			➔			24.0120-0154.1 420154 24.0320-0154.1 520154	Ø 298 20 18,4 V + S Ø 298 20 17,6 V + S PD
			➔			24.0130-0101.1 430101	Ø 324 30 28,4 V + S
540 i	210	04/96→06/03	➔	05/96→ 02/00		24.0130-0101.1 430101	Ø 324 30 28,4 V + S
			➔	03/00→		24.0130-0107.1 430107 24.0330-0107.1 530107	Ø 324 29,9 28,4 V + S Ø 324 29,9 27,6 V + S PD
			➔	05/96→		24.0120-0154.1 420154 24.0320-0154.1 520154	Ø 298 20 18,4 V + S Ø 298 20 17,6 V + S PD
M5	294	10/98→06/03	➔	☐		24.0132-0161.2 432161	Ø 345 32 30,4 V Bremsscheibe zweiteilig / + S
			➔	☐		24.0132-0162.2 432162	Ø 345 32 30,4 V Bremsscheibe zweiteilig / + S
BMW - 5 (E60) 12/01→03/10							
Brembelagsatz, Scheibenbremse							
520 d 520 d	110 120	02/05→02/08 02/05→02/08	➔	07/05→; für Behördenfahrzeuge		13.0460-7167.2 607167 13.0460-7296.2 607296 13.0470-7167.2 LD7167 13.0470-7296.2 LD7296	ATE 23312 20,3 + WE / - WK ATE 23212 20,3 + WE / - WK ATE 23312 20,3 + WE / - WK Ceramic ATE 23212 20,3 + WE / - WK Ceramic
			➔	07/05→; nicht für Behördenfahrzeuge		13.0460-7176.2 607176 13.0470-7176.2 LD7176	ATE 23793 20,3 + WE / - WK ATE 23793 20,3 + WE / - WK Ceramic
			➔	07/05→		13.0460-7174.2 607174 13.0470-7174.2 LD7174	ATE 23732 17,3 + WE / - WK ATE 23732 17,3 + WE / - WK Ceramic
520 d	130	04/06→12/09	➔	09/07→		13.0460-7167.2 607167 13.0460-7296.2 607296 13.0470-7167.2 LD7167 13.0470-7296.2 LD7296	ATE 23312 20,3 + WE / - WK ATE 23212 20,3 + WE / - WK ATE 23312 20,3 + WE / - WK Ceramic ATE 23212 20,3 + WE / - WK Ceramic
			➔	09/07→		13.0460-7174.2 607174 13.0470-7174.2 LD7174	ATE 23732 17,3 + WE / - WK ATE 23732 17,3 + WE / - WK Ceramic
520 i	125	07/03→03/10	➔	→ 03/05; Vollautomatik		13.0460-7167.2 607167 13.0460-7296.2 607296 13.0470-7167.2 LD7167 13.0470-7296.2 LD7296	ATE 23312 20,3 + WE / - WK ATE 23212 20,3 + WE / - WK ATE 23312 20,3 + WE / - WK Ceramic ATE 23212 20,3 + WE / - WK Ceramic
			➔	→ 03/05; Schaltgetriebe		13.0460-7176.2 607176 13.0470-7176.2 LD7176	ATE 23793 20,3 + WE / - WK ATE 23793 20,3 + WE / - WK Ceramic
↓							







	kw			 	! #		
BMW - 5 (E60) 12/01→03/10							
 Bremsbelagsatz, Scheibenbremse							
520 i	125	07/03→03/10	➡	→ 03/05		13.0460-7174.2 607174 13.0470-7174.2 LD7174	ATE 23732 17,3 + WE / - WK ATE 23732 17,3 + WE / - WK Ceramic
523 i 525 d 525 d	130 120 130	07/05→03/10 12/04→03/10 06/04→03/10	⬅	für Behördenfahrzeuge; → 03/07		13.0460-7167.2 607167 13.0460-7296.2 607296 13.0470-7167.2 LD7167 13.0470-7296.2 LD7296	ATE 23312 20,3 + WE / - WK ATE 23212 20,3 + WE / - WK ATE 23312 20,3 + WE / - WK Ceramic ATE 23212 20,3 + WE / - WK Ceramic
			⬅	nicht für Behördenfahrzeuge; → 03/07		13.0460-7176.2 607176 13.0470-7176.2 LD7176	ATE 23793 20,3 + WE / - WK ATE 23793 20,3 + WE / - WK Ceramic
			➡	→ 03/07		13.0460-7174.2 607174 13.0470-7174.2 LD7174	ATE 23732 17,3 + WE / - WK ATE 23732 17,3 + WE / - WK Ceramic
523 i	140	01/07→03/10	⬅	03/07→ 02/10; für Behördenfahrzeuge; Motorcode: N52N		13.0460-7167.2 607167 13.0460-7296.2 607296 13.0470-7167.2 LD7167 13.0470-7296.2 LD7296	ATE 23312 20,3 + WE / - WK ATE 23212 20,3 + WE / - WK ATE 23312 20,3 + WE / - WK Ceramic ATE 23212 20,3 + WE / - WK Ceramic
			⬅	03/07→ 02/10; Motorcode: N53		13.0460-7167.2 607167 13.0460-7296.2 607296 13.0470-7167.2 LD7167 13.0470-7296.2 LD7296	ATE 23312 20,3 + WE / - WK ATE 23212 20,3 + WE / - WK ATE 23312 20,3 + WE / - WK Ceramic ATE 23212 20,3 + WE / - WK Ceramic
			⬅	03/07→ 02/10; nicht für Behördenfahrzeuge; Motorcode: N52N		13.0460-7176.2 607176 13.0470-7176.2 LD7176	ATE 23793 20,3 + WE / - WK ATE 23793 20,3 + WE / - WK Ceramic
			➡	03/07→ 02/10		13.0460-7174.2 607174 13.0470-7174.2 LD7174	ATE 23732 17,3 + WE / - WK ATE 23732 17,3 + WE / - WK Ceramic
525 d	145	01/07→03/10	⬅	03/07→ 02/10		13.0460-7167.2 607167 13.0460-7296.2 607296 13.0470-7167.2 LD7167 13.0470-7296.2 LD7296	ATE 23312 20,3 + WE / - WK ATE 23212 20,3 + WE / - WK ATE 23312 20,3 + WE / - WK Ceramic ATE 23212 20,3 + WE / - WK Ceramic
			➡	03/07→ 02/10; für Behördenfahrzeuge		13.0460-7169.2 607169 13.0470-7169.2 LD7169	ATE 23309 17,3 + WE / - WK ATE 23309 17,3 + WE / - WK Ceramic
			➡	03/07→ 02/10; nicht für Behördenfahrzeuge		13.0460-7174.2 607174 13.0470-7174.2 LD7174	ATE 23732 17,3 + WE / - WK ATE 23732 17,3 + WE / - WK Ceramic
525 d xDrive 530 d xDrive 530 i xDrive	145 173 200	09/07→12/09 09/07→12/09 09/07→12/09	⬅			13.0460-7167.2 607167 13.0460-7296.2 607296 13.0470-7167.2 LD7167 13.0470-7296.2 LD7296	ATE 23312 20,3 + WE / - WK ATE 23212 20,3 + WE / - WK ATE 23312 20,3 + WE / - WK Ceramic ATE 23212 20,3 + WE / - WK Ceramic
			➡			13.0460-7174.2 607174 13.0470-7174.2 LD7174	ATE 23732 17,3 + WE / - WK ATE 23732 17,3 + WE / - WK Ceramic
525 i	141	09/03→03/10	⬅	für Behördenfahrzeuge; → 06/05		13.0460-7167.2 607167 13.0460-7296.2 607296 13.0470-7167.2 LD7167 13.0470-7296.2 LD7296	ATE 23312 20,3 + WE / - WK ATE 23212 20,3 + WE / - WK ATE 23312 20,3 + WE / - WK Ceramic ATE 23212 20,3 + WE / - WK Ceramic
			⬅	nicht für Behördenfahrzeuge; → 06/05		13.0460-7176.2 607176 13.0470-7176.2 LD7176	ATE 23793 20,3 + WE / - WK ATE 23793 20,3 + WE / - WK Ceramic
			➡	→ 06/05		13.0460-7174.2 607174 13.0470-7174.2 LD7174	ATE 23732 17,3 + WE / - WK ATE 23732 17,3 + WE / - WK Ceramic
525 i 525 i ↓	155 160	07/05→03/10 07/05→03/10	⬅	03/07→ 02/10; für Behördenfahrzeuge; Motorcode: N52N		13.0460-7167.2 607167	ATE 23312 20,3 + WE / - WK







	kW			 	! #		
BMW - 5 (E60) 12/01→03/10							
 Bremsbelagsatz, Scheibenbremse							
525 i 525 i	155 160	01/07→03/10 01/07→03/10	←	03/07→ 02/10; für Behördenfahrzeuge; Motorcode: N52N	13.0460-7296.2	607296	ATE 23212 20,3 + WE / - WK
					13.0470-7167.2	LD7167	ATE 23312 20,3 + WE / - WK Ceramic
					13.0470-7296.2	LD7296	ATE 23212 20,3 + WE / - WK Ceramic
			←	03/07→ 02/10; Motorcode: N53	13.0460-7167.2	607167	ATE 23312 20,3 + WE / - WK
					13.0460-7296.2	607296	ATE 23212 20,3 + WE / - WK
					13.0470-7167.2	LD7167	ATE 23312 20,3 + WE / - WK Ceramic
					13.0470-7296.2	LD7296	ATE 23212 20,3 + WE / - WK Ceramic
			←	→ 03/07	13.0460-7167.2	607167	ATE 23312 20,3 + WE / - WK
					13.0460-7296.2	607296	ATE 23212 20,3 + WE / - WK
		13.0470-7167.2	LD7167	ATE 23312 20,3 + WE / - WK Ceramic			
		13.0470-7296.2	LD7296	ATE 23212 20,3 + WE / - WK Ceramic			
		←	03/07→ 02/10; nicht für Behördenfahrzeuge; Motorcode: N52N	13.0460-7176.2	607176	ATE 23793 20,3 + WE / - WK	
				13.0470-7176.2	LD7176	ATE 23793 20,3 + WE / - WK Ceramic	
		→	03/07→ 02/10; Motorcode: N53; für Behördenfahrzeuge	13.0460-7169.2	607169	ATE 23309 17,3 + WE / - WK	
				13.0470-7169.2	LD7169	ATE 23309 17,3 + WE / - WK Ceramic	
		→	03/07→ 02/10; Motorcode: N53; nicht für Behördenfahrzeuge	13.0460-7174.2	607174	ATE 23732 17,3 + WE / - WK	
				13.0470-7174.2	LD7174	ATE 23732 17,3 + WE / - WK Ceramic	
		→	→ 03/07	13.0460-7174.2	607174	ATE 23732 17,3 + WE / - WK	
				13.0470-7174.2	LD7174	ATE 23732 17,3 + WE / - WK Ceramic	
		→	03/07→ 02/10; Motorcode: N52N	13.0460-7174.2	607174	ATE 23732 17,3 + WE / - WK	
				13.0470-7174.2	LD7174	ATE 23732 17,3 + WE / - WK Ceramic	
525 i xDrive 525 xi 525 xi	160 160 160	09/08→03/10 07/05→03/10 01/07→03/10	←	→ 02/10	13.0460-7167.2	607167	ATE 23312 20,3 + WE / - WK
					13.0460-7296.2	607296	ATE 23212 20,3 + WE / - WK
				13.0470-7167.2	LD7167	ATE 23312 20,3 + WE / - WK Ceramic	
				13.0470-7296.2	LD7296	ATE 23212 20,3 + WE / - WK Ceramic	
			→	→ 02/10	13.0460-7174.2	607174	ATE 23732 17,3 + WE / - WK
					13.0470-7174.2	LD7174	ATE 23732 17,3 + WE / - WK Ceramic
525 xd 530 xd 530 xi	145 173 200	11/06→08/07 09/06→08/07 11/05→08/07	←	03/07→	13.0460-7167.2	607167	ATE 23312 20,3 + WE / - WK
					13.0460-7296.2	607296	ATE 23212 20,3 + WE / - WK
				13.0470-7167.2	LD7167	ATE 23312 20,3 + WE / - WK Ceramic	
				13.0470-7296.2	LD7296	ATE 23212 20,3 + WE / - WK Ceramic	
			→	03/07→	13.0460-7174.2	607174	ATE 23732 17,3 + WE / - WK
					13.0470-7174.2	LD7174	ATE 23732 17,3 + WE / - WK Ceramic
530 d 530 d	155 160	02/02→12/09 02/02→09/05	←	07/03→ 08/05	13.0460-7167.2	607167	ATE 23312 20,3 + WE / - WK
					13.0460-7296.2	607296	ATE 23212 20,3 + WE / - WK
					13.0470-7167.2	LD7167	ATE 23312 20,3 + WE / - WK Ceramic
				13.0470-7296.2	LD7296	ATE 23212 20,3 + WE / - WK Ceramic	
			→	07/03→; für Behördenfahrzeuge; → 08/05	13.0460-7169.2	607169	ATE 23309 17,3 + WE / - WK
					13.0470-7169.2	LD7169	ATE 23309 17,3 + WE / - WK Ceramic
			→	07/03→; nicht für Behördenfahrzeuge; → 08/05	13.0460-7174.2	607174	ATE 23732 17,3 + WE / - WK
					13.0470-7174.2	LD7174	ATE 23732 17,3 + WE / - WK Ceramic
530 d	170	02/05→02/07	←		13.0460-7167.2	607167	ATE 23312 20,3 + WE / - WK
					13.0460-7296.2	607296	ATE 23212 20,3 + WE / - WK
					13.0470-7167.2	LD7167	ATE 23312 20,3 + WE / - WK Ceramic
					13.0470-7296.2	LD7296	ATE 23212 20,3 + WE / - WK Ceramic

















	kw			 	! #		
BMW - 5 (E60) 12/01→03/10							
 Bremsbelagsatz, Scheibenbremse							
530 d	170	02/05→02/07	➡	für Behördenfahrzeuge		13.0460-7169.2 607169 13.0470-7169.2 LD7169	ATE 23309 17,3 + WE / - WK ATE 23309 17,3 + WE / - WK Ceramic
			➡	nicht für Behördenfahrzeuge		13.0460-7174.2 607174 13.0470-7174.2 LD7174	ATE 23732 17,3 + WE / - WK ATE 23732 17,3 + WE / - WK Ceramic
530 d	173	09/06→12/09	←	03/07→		13.0460-7167.2 607167 13.0460-7296.2 607296 13.0470-7167.2 LD7167 13.0470-7296.2 LD7296	ATE 23312 20,3 + WE / - WK ATE 23212 20,3 + WE / - WK ATE 23312 20,3 + WE / - WK Ceramic ATE 23212 20,3 + WE / - WK Ceramic
			➡	03/07→; für Behördenfahrzeuge		13.0460-7169.2 607169 13.0470-7169.2 LD7169	ATE 23309 17,3 + WE / - WK ATE 23309 17,3 + WE / - WK Ceramic
			➡	03/07→; nicht für Behördenfahrzeuge		13.0460-7174.2 607174 13.0470-7174.2 LD7174	ATE 23732 17,3 + WE / - WK ATE 23732 17,3 + WE / - WK Ceramic
530 i	170	12/01→02/05	←	07/03→		13.0460-7167.2 607167 13.0460-7296.2 607296 13.0470-7167.2 LD7167 13.0470-7296.2 LD7296	ATE 23312 20,3 + WE / - WK ATE 23212 20,3 + WE / - WK ATE 23312 20,3 + WE / - WK Ceramic ATE 23212 20,3 + WE / - WK Ceramic
			➡	07/03→		13.0460-7174.2 607174 13.0470-7174.2 LD7174	ATE 23732 17,3 + WE / - WK ATE 23732 17,3 + WE / - WK Ceramic
530 i	187	03/05→03/10	←	07/05→ 03/07		13.0460-7167.2 607167 13.0460-7296.2 607296 13.0470-7167.2 LD7167 13.0470-7296.2 LD7296	ATE 23312 20,3 + WE / - WK ATE 23212 20,3 + WE / - WK ATE 23312 20,3 + WE / - WK Ceramic ATE 23212 20,3 + WE / - WK Ceramic
			➡	07/05→ 03/07; für Behördenfahrzeuge		13.0460-7169.2 607169 13.0470-7169.2 LD7169	ATE 23309 17,3 + WE / - WK ATE 23309 17,3 + WE / - WK Ceramic
			➡	07/05→ 03/07; nicht für Behördenfahrzeuge		13.0460-7174.2 607174 13.0470-7174.2 LD7174	ATE 23732 17,3 + WE / - WK ATE 23732 17,3 + WE / - WK Ceramic
530 i	190	09/04→02/07	←	07/05→		13.0460-7167.2 607167 13.0460-7296.2 607296 13.0470-7167.2 LD7167 13.0470-7296.2 LD7296	ATE 23312 20,3 + WE / - WK ATE 23212 20,3 + WE / - WK ATE 23312 20,3 + WE / - WK Ceramic ATE 23212 20,3 + WE / - WK Ceramic
			➡	07/05→; für Behördenfahrzeuge		13.0460-7169.2 607169 13.0470-7169.2 LD7169	ATE 23309 17,3 + WE / - WK ATE 23309 17,3 + WE / - WK Ceramic
			➡	07/05→; nicht für Behördenfahrzeuge		13.0460-7174.2 607174 13.0470-7174.2 LD7174	ATE 23732 17,3 + WE / - WK ATE 23732 17,3 + WE / - WK Ceramic
530 i	200	09/06→12/09	←	01/07→		13.0460-7167.2 607167 13.0460-7296.2 607296 13.0470-7167.2 LD7167 13.0470-7296.2 LD7296	ATE 23312 20,3 + WE / - WK ATE 23212 20,3 + WE / - WK ATE 23312 20,3 + WE / - WK Ceramic ATE 23212 20,3 + WE / - WK Ceramic
			➡	01/07→; für Behördenfahrzeuge; Motorcode: N52N		13.0460-7169.2 607169 13.0470-7169.2 LD7169	ATE 23309 17,3 + WE / - WK ATE 23309 17,3 + WE / - WK Ceramic
			➡	01/07→; Motorcode: N53		13.0460-7169.2 607169 13.0470-7169.2 LD7169	ATE 23309 17,3 + WE / - WK ATE 23309 17,3 + WE / - WK Ceramic
			➡	01/07→; nicht für Behördenfahrzeuge; Motorcode: N52N		13.0460-7174.2 607174 13.0470-7174.2 LD7174	ATE 23732 17,3 + WE / - WK ATE 23732 17,3 + WE / - WK Ceramic
530 i ↓	200	01/07→12/09	←			13.0460-7167.2 607167	ATE 23312 20,3 + WE / - WK







	kw			 	! #		
BMW - 5 (E60) 12/01→03/10							
 Bremsbelagsatz, Scheibenbremse							
530 i	200	01/07→12/09	←			13.0460-7296.2 607296	ATE 23212 20,3 + WE / - WK
						13.0470-7167.2 LD7167	ATE 23312 20,3 + WE / - WK Ceramic
						13.0470-7296.2 LD7296	ATE 23212 20,3 + WE / - WK Ceramic
			→	Motorcode: N53		13.0460-7169.2 607169	ATE 23309 17,3 + WE / - WK
			→	für Behördenfahrzeuge; Motorcode: N52N		13.0470-7169.2 LD7169	ATE 23309 17,3 + WE / - WK Ceramic
			→	nicht für Behördenfahrzeuge; Motorcode: N52N		13.0460-7174.2 607174	ATE 23732 17,3 + WE / - WK
						13.0470-7174.2 LD7174	ATE 23732 17,3 + WE / - WK Ceramic
530 xd 530 xi	170 190	02/05→02/07 09/04→02/07	←	07/05→		13.0460-7167.2 607167	ATE 23312 20,3 + WE / - WK
						13.0460-7296.2 607296	ATE 23212 20,3 + WE / - WK
						13.0470-7167.2 LD7167	ATE 23312 20,3 + WE / - WK Ceramic
						13.0470-7296.2 LD7296	ATE 23212 20,3 + WE / - WK Ceramic
			→	07/05→		13.0460-7174.2 607174	ATE 23732 17,3 + WE / - WK
						13.0470-7174.2 LD7174	ATE 23732 17,3 + WE / - WK Ceramic
535 d	200	09/04→03/10	←	→ 03/07		13.0460-7210.2 607210	ATE 23791 20,8 + WE / - WK
						13.0470-7210.2 LD7210	ATE 23791 20,8 + WE / - WK Ceramic
			→	→ 03/07		13.0460-7169.2 607169	ATE 23309 17,3 + WE / - WK
						13.0470-7169.2 LD7169	ATE 23309 17,3 + WE / - WK Ceramic
535 d	210	01/07→03/10	←	03/07→ 02/10		13.0460-7210.2 607210	ATE 23791 20,8 + WE / - WK
						13.0470-7210.2 LD7210	ATE 23791 20,8 + WE / - WK Ceramic
			→	03/07→ 02/10		13.0460-7169.2 607169	ATE 23309 17,3 + WE / - WK
						13.0470-7169.2 LD7169	ATE 23309 17,3 + WE / - WK Ceramic
535 i 540 i	225 225	04/06→12/09 09/05→02/10	←	03/07→; nicht für erhöhte Nutzlast		13.0460-7167.2 607167	ATE 23312 20,3 + WE / - WK
						13.0460-7296.2 607296	ATE 23212 20,3 + WE / - WK
						13.0470-7167.2 LD7167	ATE 23312 20,3 + WE / - WK Ceramic
						13.0470-7296.2 LD7296	ATE 23212 20,3 + WE / - WK Ceramic
			←	→ 03/07		13.0460-7167.2 607167	ATE 23312 20,3 + WE / - WK
			→			13.0460-7296.2 607296	ATE 23212 20,3 + WE / - WK
						13.0470-7167.2 LD7167	ATE 23312 20,3 + WE / - WK Ceramic
						13.0470-7296.2 LD7296	ATE 23212 20,3 + WE / - WK Ceramic
			←	03/07→; für erhöhte Nutzlast		13.0460-7210.2 607210	ATE 23791 20,8 + WE / - WK
						13.0470-7210.2 LD7210	ATE 23791 20,8 + WE / - WK Ceramic
			→			13.0460-7169.2 607169	ATE 23309 17,3 + WE / - WK
						13.0470-7169.2 LD7169	ATE 23309 17,3 + WE / - WK Ceramic
540 i	225	07/05→03/10	←	03/07→ 02/10; nicht für erhöhte Nutzlast		13.0460-7167.2 607167	ATE 23312 20,3 + WE / - WK
						13.0460-7296.2 607296	ATE 23212 20,3 + WE / - WK
						13.0470-7167.2 LD7167	ATE 23312 20,3 + WE / - WK Ceramic
						13.0470-7296.2 LD7296	ATE 23212 20,3 + WE / - WK Ceramic
			←	→ 03/07		13.0460-7167.2 607167	ATE 23312 20,3 + WE / - WK
						13.0460-7296.2 607296	ATE 23212 20,3 + WE / - WK
						13.0470-7167.2 LD7167	ATE 23312 20,3 + WE / - WK Ceramic
						13.0470-7296.2 LD7296	ATE 23212 20,3 + WE / - WK Ceramic
			←	03/07→ 02/10; für erhöhte Nutzlast		13.0460-7210.2 607210	ATE 23791 20,8 + WE / - WK
						13.0470-7210.2 LD7210	ATE 23791 20,8 + WE / - WK Ceramic

	kw			 	! #		
BMW - 5 (E60) 12/01→03/10							
Bremsbelagsatz, Scheibenbremse							
540 i	225	07/05→03/10	➔	→ 02/10		13.0460-7169.2 607169 13.0470-7169.2 LD7169	ATE 23309 17,3 + WE / - WK ATE 23309 17,3 + WE / - WK Ceramic
545 i	245	09/03→03/10	➔	→ 08/05		13.0460-7167.2 607167 13.0460-7296.2 607296	ATE 23312 20,3 + WE / - WK ATE 23212 20,3 + WE / - WK
			➔	→ 08/05		13.0460-7169.2 607169 13.0470-7169.2 LD7169	ATE 23309 17,3 + WE / - WK ATE 23309 17,3 + WE / - WK Ceramic
550 i	270	07/05→03/10	➔	03/07→ 02/10		13.0460-7167.2 607167 13.0460-7210.2 607210 13.0460-7296.2 607296	ATE 23312 20,3 + WE / - WK ATE 23791 20,8 + WE / - WK ATE 23212 20,3 + WE / - WK
			➔	→ 03/07		13.0460-7210.2 607210	ATE 23791 20,8 + WE / - WK
			➔	→ 02/10		13.0460-7169.2 607169 13.0470-7169.2 LD7169	ATE 23309 17,3 + WE / - WK ATE 23309 17,3 + WE / - WK Ceramic
M5	373	09/04→03/10	➔	→ 02/10		13.0460-7210.2 607210	ATE 23791 20,8 + WE / - WK
			➔	→ 02/10		13.0460-7169.2 607169 13.0470-7169.2 LD7169	ATE 23309 17,3 + WE / - WK ATE 23309 17,3 + WE / - WK Ceramic
Warnkontakt, Bremsbelagverschleiß							
520 d 520 d	110 120	02/05→02/08 02/05→02/08	➔	☐; 07/05→; nicht für Behördenfahrzeuge	1	24.8190-0273.2 620273	L= 662
			➔	☐; 07/05→; für Behördenfahrzeuge	1	24.8190-0273.2 620273	L= 662
			➔	07/05→	1	24.8190-0274.2 620274	L= 664
520 d	130	04/06→12/09	➔	☐; 09/07→	1	24.8190-0273.2 620273	L= 662
			➔	09/07→	1	24.8190-0274.2 620274	L= 664
520 i	125	07/03→03/10	➔	☐; → 03/05; Schaltgetriebe	1	24.8190-0273.2 620273	L= 662
			➔	☐; → 03/05; Vollautomatik	1	24.8190-0273.2 620273	L= 662
			➔	→ 03/05	1	24.8190-0274.2 620274	L= 664
523 i 525 d 525 d	130 120 130	07/05→03/10 12/04→03/10 06/04→03/10	➔	☐; für Behördenfahrzeuge; → 03/07	1	24.8190-0273.2 620273	L= 662
			➔	☐; nicht für Behördenfahrzeuge; → 03/07	1	24.8190-0273.2 620273	L= 662
			➔	→ 03/07	1	24.8190-0274.2 620274	L= 664
523 i	140	01/07→03/10	➔	☐; 03/07→ 02/10; Motorcode: N53	1	24.8190-0273.2 620273	L= 662
			➔	☐; 03/07→ 02/10; nicht für Behördenfahrzeuge; Motorcode: N52N	1	24.8190-0273.2 620273	L= 662
			➔	☐; 03/07→ 02/10; für Behördenfahrzeuge; Motorcode: N52N	1	24.8190-0273.2 620273	L= 662
			➔	03/07→ 02/10	1	24.8190-0274.2 620274	L= 664
525 d	145	01/07→03/10	➔	☐; 03/07→ 02/10	1	24.8190-0273.2 620273	L= 662
			➔	03/07→ 02/10; für Behördenfahrzeuge	1	24.8190-0274.2 620274	L= 664
			➔	03/07→ 02/10; nicht für Behördenfahrzeuge	1	24.8190-0274.2 620274	L= 664
525 d xDrive 530 d xDrive 530 i xDrive	145 173 200	09/07→12/09 09/07→12/09 09/07→12/09	➔	☐	1	24.8190-0273.2 620273	L= 662
			➔		1	24.8190-0274.2 620274	L= 664
			➔		1	24.8190-0274.2 620274	L= 664
525 i	141	09/03→03/10	➔	☐; nicht für Behördenfahrzeuge; → 06/05	1	24.8190-0273.2 620273	L= 662
			➔	☐; für Behördenfahrzeuge; → 06/05	1	24.8190-0273.2 620273	L= 662
			➔	→ 06/05	1	24.8190-0274.2 620274	L= 664
525 i 525 i 525 i 525 i	155 160 155 160	07/05→03/10 07/05→03/10 01/07→03/10 01/07→03/10	➔	☐; 03/07→ 02/10; für Behördenfahrzeuge; Motorcode: N52N	1	24.8190-0273.2 620273	L= 662
			➔	☐; 03/07→ 02/10; Motorcode: N53	1	24.8190-0273.2 620273	L= 662
			➔	☐; 03/07→ 02/10; nicht für Behördenfahrzeuge; Motorcode: N52N	1	24.8190-0273.2 620273	L= 662
			➔	☐; → 03/07	1	24.8190-0273.2 620273	L= 662
			➔	03/07→ 02/10; Motorcode: N53; nicht für Behördenfahrzeuge	1	24.8190-0274.2 620274	L= 664
			➔	03/07→ 02/10; Motorcode: N52N	1	24.8190-0274.2 620274	L= 664
			➔				
↓							









	kw			 	! #		
BMW - 5 (E60) 12/01→03/10							
Warnkontakt, Bremsbelagverschleiß							
525 i	155	07/05→03/10	➡	03/07→ 02/10; Motorcode: N53; für Behördenfahrzeuge	1	24.8190-0274.2 620274	L= 664
525 i	160	07/05→03/10					
525 i	155	01/07→03/10					
525 i	160	01/07→03/10	➡	→ 03/07	1	24.8190-0274.2 620274	L= 664
525 i xDrive	160	09/08→03/10	⬅	☐; → 02/10	1	24.8190-0273.2 620273	L= 662
525 xi	160	07/05→03/10					
525 xi	160	01/07→03/10	➡	→ 02/10	1	24.8190-0274.2 620274	L= 664
M5	373	09/04→03/10					
525 xd	145	11/06→08/07	⬅	☐; 03/07→	1	24.8190-0273.2 620273	L= 662
530 xd	173	09/06→08/07					
530 xi	200	11/05→08/07	➡	03/07→	1	24.8190-0274.2 620274	L= 664
530 d	155	02/02→12/09	⬅	☐; 07/03→ 08/05	1	24.8190-0273.2 620273	L= 662
530 d	160	02/02→09/05	➡	07/03→; für Behördenfahrzeuge; → 08/05	1	24.8190-0274.2 620274	L= 664
			➡	07/03→; nicht für Behördenfahrzeuge; → 08/05	1	24.8190-0274.2 620274	L= 664
530 d	170	02/05→02/07	⬅	☐	1	24.8190-0273.2 620273	L= 662
			➡	für Behördenfahrzeuge	1	24.8190-0274.2 620274	L= 664
			➡	nicht für Behördenfahrzeuge	1	24.8190-0274.2 620274	L= 664
530 d	173	09/06→12/09	⬅	☐; 03/07→	1	24.8190-0273.2 620273	L= 662
			➡	03/07→; nicht für Behördenfahrzeuge	1	24.8190-0274.2 620274	L= 664
			➡	03/07→; für Behördenfahrzeuge	1	24.8190-0274.2 620274	L= 664
530 i	170	12/01→02/05	⬅	☐; 07/03→	1	24.8190-0273.2 620273	L= 662
			➡	07/03→	1	24.8190-0274.2 620274	L= 664
530 i	187	03/05→03/10	⬅	☐; 07/05→ 03/07	1	24.8190-0273.2 620273	L= 662
			➡	07/05→ 03/07; nicht für Behördenfahrzeuge	1	24.8190-0274.2 620274	L= 664
			➡	07/05→ 03/07; für Behördenfahrzeuge	1	24.8190-0274.2 620274	L= 664
530 i	190	09/04→02/07	⬅	☐; 07/05→	1	24.8190-0273.2 620273	L= 662
			➡	07/05→; nicht für Behördenfahrzeuge	1	24.8190-0274.2 620274	L= 664
			➡	07/05→; für Behördenfahrzeuge	1	24.8190-0274.2 620274	L= 664
530 i	200	09/06→12/09	⬅	☐; 01/07→	1	24.8190-0273.2 620273	L= 662
			➡	01/07→; für Behördenfahrzeuge; Motorcode: N52N	1	24.8190-0274.2 620274	L= 664
			➡	01/07→; Motorcode: N53	1	24.8190-0274.2 620274	L= 664
			➡	01/07→; nicht für Behördenfahrzeuge; Motorcode: N52N	1	24.8190-0274.2 620274	L= 664
530 i	200	01/07→12/09	⬅	☐	1	24.8190-0273.2 620273	L= 662
			➡	Motorcode: N53	1	24.8190-0274.2 620274	L= 664
			➡	nicht für Behördenfahrzeuge; Motorcode: N52N	1	24.8190-0274.2 620274	L= 664
			➡	für Behördenfahrzeuge; Motorcode: N52N	1	24.8190-0274.2 620274	L= 664
530 xd	170	02/05→02/07	⬅	☐; 07/05→	1	24.8190-0273.2 620273	L= 662
530 xi	190	09/04→02/07	➡	07/05→	1	24.8190-0274.2 620274	L= 664
535 d	200	09/04→03/10	⬅	☐; → 03/07	1	24.8190-0273.2 620273	L= 662
			➡	→ 03/07	1	24.8190-0274.2 620274	L= 664
535 d	210	01/07→03/10	⬅	☐; 03/07→ 02/10	1	24.8190-0273.2 620273	L= 662
			➡	03/07→ 02/10	1	24.8190-0274.2 620274	L= 664
535 i	225	04/06→12/09	⬅	☐; 03/07→; für erhöhte Nutzlast	1	24.8190-0273.2 620273	L= 662
540 i	225	09/05→02/10	⬅	☐; → 03/07	1	24.8190-0273.2 620273	L= 662
			⬅	☐; 03/07→; nicht für erhöhte Nutzlast	1	24.8190-0273.2 620273	L= 662
			➡		1	24.8190-0274.2 620274	L= 664
540 i	225	07/05→03/10	⬅	☐; 03/07→ 02/10; nicht für erhöhte Nutzlast	1	24.8190-0273.2 620273	L= 662
			⬅	☐; → 03/07	1	24.8190-0273.2 620273	L= 662
			⬅	☐; 03/07→ 02/10; für erhöhte Nutzlast	1	24.8190-0273.2 620273	L= 662
			➡	→ 02/10	1	24.8190-0274.2 620274	L= 664
545 i	245	09/03→03/10	⬅	→ 08/05	1	24.8190-0273.2 620273	L= 662
			➡	→ 08/05	1	24.8190-0274.2 620274	L= 664
550 i	270	07/05→03/10	⬅	☐; 03/07→ 02/10	1	24.8190-0273.2 620273	L= 662
↓							









	kw			 	! #		
BMW - 5 (E60) 12/01→03/10							
Warnkontakt, Bremsbelagverschleiß							
550 i	270	07/05→03/10	←	03/07→ 02/10	1	24.8190-0273.2 620273	L= 662
			←	☐; → 03/07	1	24.8190-0273.2 620273	L= 662
			→	→ 02/10	1	24.8190-0274.2 620274	L= 664
 Bremsscheibe							
520 d	110	02/05→02/08	←	07/05→; nicht für Behördenfahrzeuge		24.0124-0181.1 424181	Ø 310 24 22,4 V + S
520 d	120	02/05→02/08	←	07/05→; für Behördenfahrzeuge		24.0324-0181.1 524181	Ø 310 24 21,6 V + S PD
			←	07/05→		24.0130-0173.1 430173	Ø 324 30 28,4 V + S
			←	07/05→		24.0330-0173.1 530173	Ø 324 30 27,6 V + S PD
			→	07/05→		24.0120-0183.1 420183	Ø 320 20 18,4 V + S
			→	07/05→		24.0320-0183.1 520183	Ø 320 20 17,6 V + S PD
520 d	130	04/06→12/09	←	09/07→		24.0130-0173.1 430173	Ø 324 30 28,4 V + S
			←	09/07→		24.0330-0173.1 530173	Ø 324 30 27,6 V + S PD
			→	09/07→		24.0120-0183.1 420183	Ø 320 20 18,4 V + S
			→	09/07→		24.0320-0183.1 520183	Ø 320 20 17,6 V + S PD
520 i	125	07/03→03/10	←	Schaltgetriebe; → 03/05		24.0124-0181.1 424181	Ø 310 24 22,4 V + S
			←	Vollautomatik; → 03/05		24.0324-0181.1 524181	Ø 310 24 21,6 V + S PD
			←	→ 03/05		24.0130-0173.1 430173	Ø 324 30 28,4 V + S
			←	→ 03/05		24.0330-0173.1 530173	Ø 324 30 27,6 V + S PD
			→	→ 03/05		24.0120-0183.1 420183	Ø 320 20 18,4 V + S
			→	→ 03/05		24.0320-0183.1 520183	Ø 320 20 17,6 V + S PD
523 i	130	07/05→03/10	←	nicht für Behördenfahrzeuge; → 03/07		24.0124-0181.1 424181	Ø 310 24 22,4 V + S
525 d	120	12/04→03/10	←	für Behördenfahrzeuge; → 03/07		24.0324-0181.1 524181	Ø 310 24 21,6 V + S PD
525 d	130	06/04→03/10	←	für Behördenfahrzeuge; → 03/07		24.0130-0173.1 430173	Ø 324 30 28,4 V + S
			←	für Behördenfahrzeuge; → 03/07		24.0330-0173.1 530173	Ø 324 30 27,6 V + S PD
			→	→ 03/07		24.0120-0183.1 420183	Ø 320 20 18,4 V + S
			→	→ 03/07		24.0320-0183.1 520183	Ø 320 20 17,6 V + S PD
523 i	140	01/07→03/10	←	03/07→ 02/10; nicht für Behördenfahrzeuge; Motorcode: N52N		24.0124-0181.1 424181	Ø 310 24 22,4 V + S
			←	03/07→ 02/10; Motorcode: N53		24.0324-0181.1 524181	Ø 310 24 21,6 V + S PD
			←	03/07→ 02/10; Motorcode: N53		24.0130-0173.1 430173	Ø 324 30 28,4 V + S
			←	03/07→ 02/10; Motorcode: N53		24.0330-0173.1 530173	Ø 324 30 27,6 V + S PD
			←	03/07→ 02/10; für Behördenfahrzeuge; Motorcode: N52N		24.0130-0173.1 430173	Ø 324 30 28,4 V + S
			←	03/07→ 02/10; für Behördenfahrzeuge; Motorcode: N52N		24.0330-0173.1 530173	Ø 324 30 27,6 V + S PD
			→	03/07→ 02/10		24.0120-0183.1 420183	Ø 320 20 18,4 V + S
			→	03/07→ 02/10		24.0320-0183.1 520183	Ø 320 20 17,6 V + S PD
525 d	145	01/07→03/10	←	03/07→ 02/10; nicht für Behördenfahrzeuge		24.0130-0173.1 430173	Ø 324 30 28,4 V + S
			←	03/07→ 02/10; für Behördenfahrzeuge		24.0330-0173.1 530173	Ø 324 30 27,6 V + S PD
			←	03/07→ 02/10; für Behördenfahrzeuge		24.0130-0186.2 430186	Ø 348 30 28,4 V Bremsscheibe zweiteilig / + S
			→	03/07→ 02/10; nicht für Behördenfahrzeuge		24.0120-0183.1 420183	Ø 320 20 18,4 V + S
			→	03/07→ 02/10; nicht für Behördenfahrzeuge		24.0320-0183.1 520183	Ø 320 20 17,6 V + S PD
			→	03/07→ 02/10; für Behördenfahrzeuge		24.0124-0201.2 424201	Ø 345 24 22,4 V Bremsscheibe zweiteilig / + S
525 d xDrive	145	09/07→12/09	←			24.0130-0173.1 430173	Ø 324 30 28,4 V + S
530 d xDrive	173	09/07→12/09	←			24.0330-0173.1 530173	Ø 324 30 27,6 V + S PD
530 i xDrive	200	09/07→12/09	→			24.0120-0213.1 420213	Ø 320 20 18,4 V + S
			→			24.0320-0213.1 520213	Ø 320 20 17,6 V + S PD
525 i	141	09/03→03/10	←	nicht für Behördenfahrzeuge; → 06/05		24.0124-0181.1 424181	Ø 310 24 22,4 V + S
			←	für Behördenfahrzeuge; → 06/05		24.0324-0181.1 524181	Ø 310 24 21,6 V + S PD
			←	für Behördenfahrzeuge; → 06/05		24.0130-0173.1 430173	Ø 324 30 28,4 V + S
			←	für Behördenfahrzeuge; → 06/05		24.0330-0173.1 530173	Ø 324 30 27,6 V + S PD
			→	→ 06/05		24.0120-0183.1 420183	Ø 320 20 18,4 V + S
			→	→ 06/05		24.0320-0183.1 520183	Ø 320 20 17,6 V + S PD
525 i	155	07/05→03/10	←	03/07→ 02/10; nicht für Behördenfahrzeuge; Motorcode: N52N		24.0124-0181.1 424181	Ø 310 24 22,4 V + S
525 i	160	07/05→03/10	←	03/07→ 02/10; nicht für Behördenfahrzeuge; Motorcode: N52N		24.0324-0181.1 524181	Ø 310 24 21,6 V + S PD
525 i	155	01/07→03/10	←	03/07→ 02/10; nicht für Behördenfahrzeuge; Motorcode: N53		24.0130-0173.1 430173	Ø 324 30 28,4 V + S
525 i	160	01/07→03/10	←	03/07→ 02/10; nicht für Behördenfahrzeuge; Motorcode: N53		24.0330-0173.1 530173	Ø 324 30 27,6 V + S PD
			←	→ 03/07		24.0130-0173.1 430173	Ø 324 30 28,4 V + S
			←	→ 03/07		24.0330-0173.1 530173	Ø 324 30 27,6 V + S PD
			←	03/07→ 02/10; für Behördenfahrzeuge; Motorcode: N52N		24.0130-0173.1 430173	Ø 324 30 28,4 V + S
			←	03/07→ 02/10; für Behördenfahrzeuge; Motorcode: N52N		24.0330-0173.1 530173	Ø 324 30 27,6 V + S PD
			←	03/07→ 02/10; für Behördenfahrzeuge; Motorcode: N52N		24.0130-0173.1 430173	Ø 324 30 28,4 V + S
			←	03/07→ 02/10; für Behördenfahrzeuge; Motorcode: N52N		24.0330-0173.1 530173	Ø 324 30 27,6 V + S PD









	kw			 	! #		
BMW - 5 (E60) 12/01→03/10							
Bremsscheibe							
525 i	155	07/05→03/10	←	03/07→ 02/10; für Behördenfahrzeuge; Motorcode: N52N		24.0330-0173.1 530173	Ø 324 30 27,6 V + S PD
525 i	160	07/05→03/10	←	03/07→; für Behördenfahrzeuge; Motorcode: N53; → 02/10		24.0130-0186.2 430186	Ø 348 30 28,4 V
525 i	155	01/07→03/10	→	→ 03/07		24.0120-0183.1 420183	Ø 320 20 18,4 V + S
525 i	160	01/07→03/10	→	03/07→ 02/10; Motorcode: N52N		24.0320-0183.1 520183	Ø 320 20 17,6 V + S PD
			→	03/07→ 02/10; Motorcode: N53; nicht für Behördenfahrzeuge		24.0120-0183.1 420183	Ø 320 20 18,4 V + S
			→	03/07→ 02/10; Motorcode: N53; für Behördenfahrzeuge		24.0320-0183.1 520183	Ø 320 20 17,6 V + S PD
			→	03/07→ 02/10; Motorcode: N53; für Behördenfahrzeuge		24.0124-0201.2 424201	Ø 345 24 22,4 V Bremsscheibe zweiteilig / + S
525 i xDrive	160	09/08→03/10	←	→ 02/10		24.0130-0173.1 430173	Ø 324 30 28,4 V + S
525 xi	160	07/05→03/10	←	→ 02/10		24.0330-0173.1 530173	Ø 324 30 27,6 V + S PD
525 xi	160	01/07→03/10	→	→ 02/10		24.0120-0213.1 420213	Ø 320 20 18,4 V + S
			→			24.0320-0213.1 520213	Ø 320 20 17,6 V + S PD
525 xd	145	11/06→08/07	←	03/07→		24.0130-0173.1 430173	Ø 324 30 28,4 V + S
530 xd	173	09/06→08/07	←	03/07→		24.0330-0173.1 530173	Ø 324 30 27,6 V + S PD
530 xi	200	11/05→08/07	→	03/07→		24.0120-0213.1 420213	Ø 320 20 18,4 V + S
			→			24.0320-0213.1 520213	Ø 320 20 17,6 V + S PD
530 d	155	02/02→12/09	←	07/03→; nicht für Behördenfahrzeuge; → 08/05		24.0130-0173.1 430173	Ø 324 30 28,4 V + S
530 d	160	02/02→09/05	←	07/03→; für Behördenfahrzeuge; → 08/05		24.0330-0173.1 530173	Ø 324 30 27,6 V + S PD
			→	07/03→; nicht für Behördenfahrzeuge; → 08/05		24.0120-0183.1 420183	Ø 320 20 18,4 V + S
			→	07/03→; für Behördenfahrzeuge; → 08/05		24.0320-0183.1 520183	Ø 320 20 17,6 V + S PD
			→	07/03→; für Behördenfahrzeuge; → 08/05		24.0124-0201.2 424201	Ø 345 24 22,4 V Bremsscheibe zweiteilig / + S
530 d	170	02/05→02/07	←	nicht für Behördenfahrzeuge		24.0130-0173.1 430173	Ø 324 30 28,4 V + S
			←	für Behördenfahrzeuge		24.0330-0173.1 530173	Ø 324 30 27,6 V + S PD
			→	nicht für Behördenfahrzeuge		24.0120-0183.1 420183	Ø 320 20 18,4 V + S
			→			24.0320-0183.1 520183	Ø 320 20 17,6 V + S PD
			→	für Behördenfahrzeuge		24.0124-0201.2 424201	Ø 345 24 22,4 V Bremsscheibe zweiteilig / + S
530 d	173	09/06→12/09	←	03/07→; nicht für Behördenfahrzeuge		24.0130-0173.1 430173	Ø 324 30 28,4 V + S
			←	03/07→; für Behördenfahrzeuge		24.0330-0173.1 530173	Ø 324 30 27,6 V + S PD
			→	03/07→; nicht für Behördenfahrzeuge		24.0120-0183.1 420183	Ø 320 20 18,4 V + S
			→			24.0320-0183.1 520183	Ø 320 20 17,6 V + S PD
			→	03/07→; für Behördenfahrzeuge		24.0124-0201.2 424201	Ø 345 24 22,4 V Bremsscheibe zweiteilig / + S
530 i	170	12/01→02/05	←	07/03→		24.0130-0173.1 430173	Ø 324 30 28,4 V + S
			→	07/03→		24.0330-0173.1 530173	Ø 324 30 27,6 V + S PD
			→	07/03→		24.0120-0183.1 420183	Ø 320 20 18,4 V + S
			→			24.0320-0183.1 520183	Ø 320 20 17,6 V + S PD
530 i	187	03/05→03/10	←	07/05→ 03/07; nicht für Behördenfahrzeuge		24.0130-0173.1 430173	Ø 324 30 28,4 V + S
			←	07/05→ 03/07; für Behördenfahrzeuge		24.0330-0173.1 530173	Ø 324 30 27,6 V + S PD
			→	07/05→ 03/07; nicht für Behördenfahrzeuge		24.0120-0183.1 420183	Ø 320 20 18,4 V + S
			→			24.0320-0183.1 520183	Ø 320 20 17,6 V + S PD
			→	07/05→ 03/07; für Behördenfahrzeuge		24.0124-0201.2 424201	Ø 345 24 22,4 V Bremsscheibe zweiteilig / + S
530 i	190	09/04→02/07	←	07/05→; nicht für Behördenfahrzeuge		24.0130-0173.1 430173	Ø 324 30 28,4 V + S
			←	07/05→; für Behördenfahrzeuge		24.0330-0173.1 530173	Ø 324 30 27,6 V + S PD
			→	07/05→; nicht für Behördenfahrzeuge		24.0120-0183.1 420183	Ø 320 20 18,4 V + S
			→			24.0320-0183.1 520183	Ø 320 20 17,6 V + S PD
			→	07/05→; für Behördenfahrzeuge		24.0124-0201.2 424201	Ø 345 24 22,4 V Bremsscheibe zweiteilig / + S
↓							







	kw			 	! #		
BMW - 5 (E60) 12/01→03/10							
Bremsscheibe							
530 i	200	09/06→12/09	←	01/07→; nicht für Behördenfahrzeuge; Motorcode: N52N	24.0130-0173.1	430173	Ø 324 30 28,4 V + S
					24.0330-0173.1	530173	Ø 324 30 27,6 V + S PD
			←	01/07→; Motorcode: N53	24.0130-0186.2	430186	Ø 348 30 28,4 V Bremsscheibe zweiteilig / + S
			←	01/07→; für Behördenfahrzeuge; Motorcode: N52N	24.0130-0186.2	430186	Ø 348 30 28,4 V Bremsscheibe zweiteilig / + S
			→	01/07→; nicht für Behördenfahrzeuge; Motorcode: N52N	24.0120-0183.1	420183	Ø 320 20 18,4 V + S
					24.0320-0183.1	520183	Ø 320 20 17,6 V + S PD
530 i	200	01/07→12/09	←	nicht für Behördenfahrzeuge; Motorcode: N52N	24.0130-0173.1	430173	Ø 324 30 28,4 V + S
					24.0330-0173.1	530173	Ø 324 30 27,6 V + S PD
			←	Motorcode: N53	24.0130-0186.2	430186	Ø 348 30 28,4 V Bremsscheibe zweiteilig / + S
			←	für Behördenfahrzeuge; Motorcode: N52N	24.0130-0186.2	430186	Ø 348 30 28,4 V Bremsscheibe zweiteilig / + S
			→	nicht für Behördenfahrzeuge; Motorcode: N52N	24.0120-0183.1	420183	Ø 320 20 18,4 V + S
					24.0320-0183.1	520183	Ø 320 20 17,6 V + S PD
530 xd 530 xi	170 190	02/05→02/07 09/04→02/07	←	07/05→	24.0130-0173.1	430173	Ø 324 30 28,4 V + S
					24.0330-0173.1	530173	Ø 324 30 27,6 V + S PD
535 d	200	09/04→03/10	→	07/05→	24.0120-0213.1	420213	Ø 320 20 18,4 V + S
					24.0320-0213.1	520213	Ø 320 20 17,6 V + S PD
535 d	200	09/04→03/10	←	→ 03/07	24.0136-0106.2	436106	Ø 348 36 34,4 V Bremsscheibe zweiteilig / + S
			→	→ 03/07	24.0124-0201.2	424201	Ø 345 24 22,4 V Bremsscheibe zweiteilig / + S
535 d	210	01/07→03/10	←	03/07→ 02/10	24.0136-0106.2	436106	Ø 348 36 34,4 V Bremsscheibe zweiteilig / + S
			→	03/07→ 02/10	24.0124-0201.2	424201	Ø 345 24 22,4 V Bremsscheibe zweiteilig / + S
535 i 540 i	225 225	04/06→12/09 09/05→02/10	←	03/07→; nicht für erhöhte Nutzlast	24.0130-0186.2	430186	Ø 348 30 28,4 V Bremsscheibe zweiteilig / + S
			←	→ 03/07	24.0130-0186.2	430186	Ø 348 30 28,4 V Bremsscheibe zweiteilig / + S
			←	03/07→; für erhöhte Nutzlast	24.0136-0106.2	436106	Ø 348 36 34,4 V Bremsscheibe zweiteilig / + S
			→		24.0124-0201.2	424201	Ø 345 24 22,4 V Bremsscheibe zweiteilig / + S
540 i	225	07/05→03/10	←	03/07→ 02/10; nicht für erhöhte Nutzlast	24.0130-0186.2	430186	Ø 348 30 28,4 V Bremsscheibe zweiteilig / + S
			←	→ 03/07	24.0130-0186.2	430186	Ø 348 30 28,4 V Bremsscheibe zweiteilig / + S
			←	03/07→; für erhöhte Nutzlast; → 02/10	24.0136-0106.2	436106	Ø 348 36 34,4 V Bremsscheibe zweiteilig / + S
			→	→ 02/10	24.0124-0201.2	424201	Ø 345 24 22,4 V Bremsscheibe zweiteilig / + S
545 i	245	09/03→03/10	←	→ 08/05	24.0130-0186.2	430186	Ø 348 30 28,4 V Bremsscheibe zweiteilig / + S
			→	→ 08/05	24.0124-0201.2	424201	Ø 345 24 22,4 V Bremsscheibe zweiteilig / + S
550 i	270	07/05→03/10	←	03/07→; für USA; → 02/10	24.0130-0186.2	430186	Ø 348 30 28,4 V Bremsscheibe zweiteilig / + S
			←	03/07→; nicht für USA; → 02/10	24.0136-0106.2	436106	Ø 348 36 34,4 V Bremsscheibe zweiteilig / + S
			←	→ 03/07	24.0136-0106.2	436106	Ø 348 36 34,4 V Bremsscheibe zweiteilig / + S
			→	→ 02/10	24.0124-0201.2	424201	Ø 345 24 22,4 V Bremsscheibe zweiteilig / + S
M5	373	09/04→03/10	←	☐; → 02/10	24.0136-0116.2	436116	Ø 374 36 34,4 V• Bremsscheibe zweiteilig / + S
			←	☐; → 02/10	24.0136-0117.2	436117	Ø 374 36 34,4 V• Bremsscheibe zweiteilig / + S











	kw			 	! #		
BMW - 5 (E60) 12/01→03/10							
 Bremsscheibe							
M5	373	09/04→03/10	➡	☐; → 02/10		24.0124-0234.2 424234	Ø 370 24 22,4 V• Bremsscheibe zweiteilig / + S
			➡	☐; → 02/10		24.0124-0235.2 424235	Ø 370 24 22,4 V• Bremsscheibe zweiteilig / + S
BMW - 5 (F10) 01/09→10/16							
 Bremsbelagsatz, Scheibenbremse							
518 d	100	02/13→06/14	←			13.0460-7268.2 607268	ATE 23794 20,3 + WE / - WK
518 d	105	02/13→06/14				13.0470-7268.2 LD7268	ATE 23794 20,3 + WE / - WK
520 d	100	01/13→10/16					Ceramic
520 d	135	01/13→10/16					
520 d	147	01/13→10/16	➡			13.0460-2760.2 602760	TRW 24561 17,7 + WE / - WK + Zub
520 d xDrive	100	01/13→06/14					
520 d xDrive	120	10/13→10/16				13.0470-2760.2 LD2760	TRW 24561 17,7 + WE / - WK + Zub Ceramic
520 i	125	07/13→10/16					
518 d	110	10/13→10/16	←	07/14→		13.0460-7268.2 607268	ATE 23794 20,3 + WE / - WK
518 d	120	10/13→10/16				13.0470-7268.2 LD7268	ATE 23794 20,3 + WE / - WK
520 d	140	10/13→10/16					Ceramic
520 d	155	10/13→10/16					
520 d xDrive	140	10/13→10/16	➡	07/14→		13.0460-2760.2 602760	TRW 24561 17,7 + WE / - WK + Zub
520 d xDrive	155	10/13→10/16				13.0470-2760.2 LD2760	TRW 24561 17,7 + WE / - WK + Zub Ceramic
520 d	120	01/09→10/16	←	03/10→		13.0460-7268.2 607268	ATE 23794 20,3 + WE / - WK
523 i	150	01/09→08/11				13.0470-7268.2 LD7268	ATE 23794 20,3 + WE / - WK
523 i	150	06/09→08/11					Ceramic
523 i	155	06/09→08/11					
523 i	160	06/09→08/11	➡	03/10→		13.0460-2760.2 602760	TRW 24561 17,7 + WE / - WK + Zub
						13.0470-2760.2 LD2760	TRW 24561 17,7 + WE / - WK + Zub Ceramic
520 d xDrive	135	01/13→06/14	←	02/13→		13.0460-7268.2 607268	ATE 23794 20,3 + WE / - WK
520 d xDrive	147	01/13→06/14				13.0470-7268.2 LD7268	ATE 23794 20,3 + WE / - WK
			➡	02/13→		13.0460-2760.2 602760	TRW 24561 17,7 + WE / - WK + Zub
						13.0470-2760.2 LD2760	TRW 24561 17,7 + WE / - WK + Zub Ceramic
520 i	120	10/10→10/16	←	09/11→		13.0460-7268.2 607268	ATE 23794 20,3 + WE / - WK
520 i	135	10/10→10/16				13.0470-7268.2 LD7268	ATE 23794 20,3 + WE / - WK
			➡	09/11→		13.0460-2760.2 602760	TRW 24561 17,7 + WE / - WK + Zub
						13.0470-2760.2 LD2760	TRW 24561 17,7 + WE / - WK + Zub Ceramic
525 d	155	01/11→10/16	←	09/11→; für Fahrzeuge mit verstärkter Bremse		13.0460-7267.2 607267	ATE 25045 19,5 + WE / - WK
525 d	160	01/11→10/16				13.0470-7267.2 LD7267	ATE 25045 19,5 + WE / - WK
525 d xDrive	155	01/11→10/16					Ceramic
525 d xDrive	160	01/11→10/16					
528 i	180	10/10→10/16	←	09/11→; nicht für Fahrzeuge mit verstärkter Bremse		13.0460-7275.2 607275	ATE 23313 20,2 + WE / - WK
528 i xDrive	180	10/10→10/16				13.0470-7275.2 LD7275	ATE 23313 20,2 + WE / - WK
530 i	190	06/09→06/13					Ceramic
530 i	200	05/11→06/13	➡	09/11→		13.0460-2760.2 602760	TRW 24561 17,7 + WE / - WK + Zub
						13.0470-2760.2 LD2760	TRW 24561 17,7 + WE / - WK + Zub Ceramic
525 d	150	06/09→08/11	←	03/10→; für Fahrzeuge mit verstärkter Bremse		13.0460-7267.2 607267	ATE 25045 19,5 + WE / - WK
						13.0470-7267.2 LD7267	ATE 25045 19,5 + WE / - WK
			←	03/10→; nicht für Fahrzeuge mit verstärkter Bremse		13.0460-7275.2 607275	ATE 23313 20,2 + WE / - WK
						13.0470-7275.2 LD7275	ATE 23313 20,2 + WE / - WK
			➡	03/10→		13.0460-2716.2 602716	TRW 24703 17,8 + WE / - WK + Zub
						13.0460-2760.2 602760	TRW 24561 17,7 + WE / - WK + Zub
						13.0470-2716.2 LD2716	TRW 24703 17,8 + WE / - WK + Zub Ceramic
						13.0470-2760.2 LD2760	TRW 24561 17,7 + WE / - WK + Zub Ceramic
528 i	190	01/09→08/11	←	03/10→; für Fahrzeuge mit verstärkter Bremse		13.0460-7267.2 607267	ATE 25045 19,5 + WE / - WK
						13.0470-7267.2 LD7267	ATE 25045 19,5 + WE / - WK
							Ceramic

























	kW			 	! #		
BMW - 5 (F10) 01/09→10/16							
 Bremsbelagsatz, Scheibenbremse							
528 i	190	01/09→08/11	←	03/10→; nicht für Fahrzeuge mit verstärkter Bremsen	13.0460-7275.2	607275	ATE 23313 20,2 + WE / - WK ATE 23313 20,2 + WE / - WK Ceramic
			→	03/10→	13.0460-2760.2	602760	TRW 24561 17,7 + WE / - WK + Zub 13.0470-2760.2 LD2760 TRW 24561 17,7 + WE / - WK + Zub Ceramic
530 d	180	01/09→08/11	←	03/10→; für Fahrzeuge mit verstärkter Bremse	13.0460-7267.2	607267	ATE 25045 19,5 + WE / - WK ATE 25045 19,5 + WE / - WK Ceramic
			←	03/10→; nicht für Fahrzeuge mit verstärkter Bremsen	13.0460-7275.2	607275	ATE 23313 20,2 + WE / - WK ATE 23313 20,2 + WE / - WK Ceramic
			→	03/10→; für Bremsscheibendurchmesser [mm]: 345	13.0460-2716.2	602716	TRW 24703 17,8 + WE / - WK + Zub 13.0470-2716.2 LD2716 TRW 24703 17,8 + WE / - WK + Zub Ceramic
			→	03/10→; für Bremsscheibendurchmesser [mm]: 330	13.0460-2760.2	602760	TRW 24561 17,7 + WE / - WK + Zub 13.0470-2760.2 LD2760 TRW 24561 17,7 + WE / - WK + Zub Ceramic
530 d	190	01/11→10/16	←	09/11→; für Fahrzeuge mit verstärkter Bremse	13.0460-7267.2	607267	ATE 25045 19,5 + WE / - WK ATE 25045 19,5 + WE / - WK Ceramic
			←	09/11→; nicht für Fahrzeuge mit verstärkter Bremsen	13.0460-7275.2	607275	ATE 23313 20,2 + WE / - WK ATE 23313 20,2 + WE / - WK Ceramic
			→	09/11→; für Bremsscheibendurchmesser [mm]: 345	13.0460-2716.2	602716	TRW 24703 17,8 + WE / - WK + Zub 13.0470-2716.2 LD2716 TRW 24703 17,8 + WE / - WK + Zub Ceramic
			→	09/11→; für Bremsscheibendurchmesser [mm]: 330	13.0460-2760.2	602760	TRW 24561 17,7 + WE / - WK + Zub 13.0470-2760.2 LD2760 TRW 24561 17,7 + WE / - WK + Zub Ceramic
530 d 530 d xDrive	210 210	09/10→10/16 09/10→10/16	←	10/15→; für Fahrzeuge mit verstärkter Bremse	13.0460-7267.2	607267	ATE 25045 19,5 + WE / - WK ATE 25045 19,5 + WE / - WK Ceramic
			←	10/15→; nicht für Fahrzeuge mit verstärkter Bremsen	13.0460-7275.2	607275	ATE 23313 20,2 + WE / - WK ATE 23313 20,2 + WE / - WK Ceramic
			→	10/15→	13.0460-2716.2	602716	TRW 24703 17,8 + WE / - WK + Zub 13.0470-2716.2 LD2716 TRW 24703 17,8 + WE / - WK + Zub Ceramic
530 d xDrive	190	09/10→10/16	←	03/11→; für Fahrzeuge mit verstärkter Bremse	13.0460-7267.2	607267	ATE 25045 19,5 + WE / - WK ATE 25045 19,5 + WE / - WK Ceramic
			←	03/11→; nicht für Fahrzeuge mit verstärkter Bremsen	13.0460-7275.2	607275	ATE 23313 20,2 + WE / - WK ATE 23313 20,2 + WE / - WK Ceramic
			→	03/11→; für Bremsscheibendurchmesser [mm]: 345	13.0460-2716.2	602716	TRW 24703 17,8 + WE / - WK + Zub 13.0470-2716.2 LD2716 TRW 24703 17,8 + WE / - WK + Zub Ceramic
			→	03/11→; für Bremsscheibendurchmesser [mm]: 330	13.0460-2760.2	602760	TRW 24561 17,7 + WE / - WK + Zub 13.0470-2760.2 LD2760 TRW 24561 17,7 + WE / - WK + Zub Ceramic
535 d 535 d	220 225	03/10→08/11 03/10→08/11	←	09/10→	13.0460-7267.2	607267	ATE 25045 19,5 + WE / - WK ATE 25045 19,5 + WE / - WK Ceramic
			→	09/10→	13.0460-2716.2	602716	TRW 24703 17,8 + WE / - WK + Zub 13.0470-2716.2 LD2716 TRW 24703 17,8 + WE / - WK + Zub Ceramic
535 d 535 d xDrive ActiveHybrid ActiveHybrid ↓	230 230 225 250	01/11→10/16 02/11→10/16 09/10→08/16 09/10→08/16	←	09/11→	13.0460-7267.2	607267	ATE 25045 19,5 + WE / - WK
			→	09/11→	13.0460-2716.2	602716	TRW 24703 17,8 + WE / - WK + Zub

	kW			 	! #			
BMW - 5 (F10) 01/09→10/16								
 Bremsbelagsatz, Scheibenbremse								
535 d 535 d xDrive ActiveHybrid ActiveHybrid	230 230 225 250	01/11→10/16 02/11→10/16 09/10→08/16 09/10→08/16	➡	09/11→		13.0470-2716.2 LD2716	TRW 24703 17,8 + WE / - WK + Zub Ceramic	
535 i	225	01/09→10/16	⬅	03/10→		13.0460-7267.2 607267 13.0470-7267.2 LD7267	ATE 25045 19,5 + WE / - WK Ceramic	
			➡	03/10→		13.0460-2716.2 602716 13.0470-2716.2 LD2716	TRW 24703 17,8 + WE / - WK + Zub Ceramic	
535 i 535 i xDrive	240 240	07/13→10/16 07/13→10/16	⬅			13.0460-7267.2 607267 13.0470-7267.2 LD7267	ATE 25045 19,5 + WE / - WK Ceramic	
			➡			13.0460-2716.2 602716 13.0470-2716.2 LD2716	TRW 24703 17,8 + WE / - WK + Zub Ceramic	
535 i xDrive	225	03/10→10/16	⬅	03/11→		13.0460-7267.2 607267 13.0470-7267.2 LD7267	ATE 25045 19,5 + WE / - WK Ceramic	
			➡	03/11→		13.0460-2716.2 602716 13.0470-2716.2 LD2716	TRW 24703 17,8 + WE / - WK + Zub Ceramic	
550 i	300	01/09→06/13	⬅	03/10→		13.0460-7267.2 607267	ATE 25045 19,5 + WE / - WK	
			➡	03/10→		13.0460-2716.2 602716 13.0470-2716.2 LD2716	TRW 24703 17,8 + WE / - WK + Zub Ceramic	
550 i 550 i xDrive	330 330	08/12→10/16 01/13→10/16	⬅	05/13→		13.0460-7267.2 607267	ATE 25045 19,5 + WE / - WK	
			➡	05/13→		13.0460-2716.2 602716 13.0470-2716.2 LD2716	TRW 24703 17,8 + WE / - WK + Zub Ceramic	
550 i xDrive	300	08/10→06/13	⬅	09/10→		13.0460-7267.2 607267	ATE 25045 19,5 + WE / - WK	
			➡	09/10→		13.0460-2716.2 602716 13.0470-2716.2 LD2716	TRW 24703 17,8 + WE / - WK + Zub Ceramic	
M5	412	10/10→10/16	➡	09/11→		13.0460-2716.2 602716 13.0470-2716.2 LD2716	TRW 24703 17,8 + WE / - WK + Zub Ceramic	
M 550 d xDrive	280	07/11→10/16	⬅	03/12→		13.0460-7267.2 607267	ATE 25045 19,5 + WE / - WK	
			➡	03/12→		13.0460-2716.2 602716 13.0470-2716.2 LD2716	TRW 24703 17,8 + WE / - WK + Zub Ceramic	
M5 Competition	423	02/13→10/16	➡	01/14→		13.0460-2716.2 602716 13.0470-2716.2 LD2716	TRW 24703 17,8 + WE / - WK + Zub Ceramic	
M5 Edition 30	441	07/14→10/16	➡			13.0460-2716.2 602716 13.0470-2716.2 LD2716	TRW 24703 17,8 + WE / - WK + Zub Ceramic	
Warnkontakt, Bremsbelagsverschleiß								
518 d 518 d 520 d 520 d 520 d 520 d xDrive 520 d xDrive 520 i 535 i 535 i xDrive	100 105 100 135 147 100 120 125 240 240	02/13→06/14 02/13→06/14 01/13→10/16 01/13→10/16 01/13→10/16 01/13→06/14 10/13→10/16 07/13→10/16 07/13→10/16 07/13→10/16	⬅ ➡	<input type="checkbox"/> <input type="checkbox"/>		1 1	24.8190-0298.2 620298 24.8190-0312.2 620312	L= 1.087 L= 915
518 d 518 d ↓	110 120	10/13→10/16 10/13→10/16	⬅	<input type="checkbox"/> ; 07/14→		1	24.8190-0298.2 620298	L= 1.087











	kW			 	! #		
BMW - 5 (F10) 01/09→10/16							
Warnkontakt, Bremsbelagverschleiß							
520 d	140	10/13→10/16	➔	07/14→	1	24.8190-0312.2 620312	L= 915
520 d	155	10/13→10/16					
520 d xDrive	140	10/13→10/16					
520 d xDrive	155	10/13→10/16					
520 d	120	01/09→10/16	➔	☐; 03/10→	1	24.8190-0298.2 620298	L= 1.087
523 i	150	01/09→08/11					
523 i	150	06/09→08/11	➔	03/10→	1	24.8190-0312.2 620312	L= 915
523 i	155	06/09→08/11					
523 i	160	06/09→08/11					
535 i	225	01/09→10/16					
550 i	300	01/09→06/13					
520 d xDrive	135	01/13→06/14	➔	☐; 02/13→	1	24.8190-0298.2 620298	L= 1.087
520 d xDrive	147	01/13→06/14	➔	02/13→	1	24.8190-0312.2 620312	L= 915
520 i	120	10/10→10/16	➔	☐; 09/11→	1	24.8190-0298.2 620298	L= 1.087
520 i	135	10/10→10/16					
535 d	230	01/11→10/16	➔	09/11→	1	24.8190-0312.2 620312	L= 915
535 d xDrive	230	02/11→10/16					
ActiveHybrid	225	09/10→08/16					
ActiveHybrid	250	09/10→08/16					
525 d	155	01/11→10/16	➔	☐; 09/11→; für Fahrzeuge mit verstärkter Bremse	1	24.8190-0298.2 620298	L= 1.087
525 d	160	01/11→10/16					
525 d xDrive	155	01/11→10/16	➔	☐; 09/11→; nicht für Fahrzeuge mit verstärkter Bremse	1	24.8190-0298.2 620298	L= 1.087
525 d xDrive	160	01/11→10/16					
528 i	180	10/10→10/16					
528 i xDrive	180	10/10→10/16					
530 i	190	06/09→06/13	➔	09/11→	1	24.8190-0312.2 620312	L= 915
530 i	200	05/11→06/13					
525 d	150	06/09→08/11	➔	☐; 03/10→; für Fahrzeuge mit verstärkter Bremse	1	24.8190-0298.2 620298	L= 1.087
528 i	190	01/09→08/11	➔	☐; 03/10→; nicht für Fahrzeuge mit verstärkter Bremse	1	24.8190-0298.2 620298	L= 1.087
			➔	03/10→	1	24.8190-0312.2 620312	L= 915
530 d	180	01/09→08/11	➔	☐; 03/10→; für Fahrzeuge mit verstärkter Bremse	1	24.8190-0298.2 620298	L= 1.087
			➔	☐; 03/10→; nicht für Fahrzeuge mit verstärkter Bremse	1	24.8190-0298.2 620298	L= 1.087
			➔	03/10→; für Bremsscheibendurchmesser [mm]: 330	1	24.8190-0312.2 620312	L= 915
			➔	03/10→; für Bremsscheibendurchmesser [mm]: 345	1	24.8190-0312.2 620312	L= 915
530 d	190	01/11→10/16	➔	☐; 09/11→; für Fahrzeuge mit verstärkter Bremse	1	24.8190-0298.2 620298	L= 1.087
			➔	☐; 09/11→; nicht für Fahrzeuge mit verstärkter Bremse	1	24.8190-0298.2 620298	L= 1.087
			➔	09/11→; für Bremsscheibendurchmesser [mm]: 345	1	24.8190-0312.2 620312	L= 915
			➔	09/11→; für Bremsscheibendurchmesser [mm]: 330	1	24.8190-0312.2 620312	L= 915
530 d	210	09/10→10/16	➔	☐; 10/15→; für Fahrzeuge mit verstärkter Bremse	1	24.8190-0298.2 620298	L= 1.087
530 d xDrive	210	09/10→10/16	➔	☐; 10/15→; nicht für Fahrzeuge mit verstärkter Bremse	1	24.8190-0298.2 620298	L= 1.087
			➔	10/15→	1	24.8190-0312.2 620312	L= 915
530 d xDrive	190	09/10→10/16	➔	☐; 03/11→; für Fahrzeuge mit verstärkter Bremse	1	24.8190-0298.2 620298	L= 1.087
			➔	☐; 03/11→; nicht für Fahrzeuge mit verstärkter Bremse	1	24.8190-0298.2 620298	L= 1.087
			➔	03/11→; für Bremsscheibendurchmesser [mm]: 330	1	24.8190-0312.2 620312	L= 915
			➔	03/11→; für Bremsscheibendurchmesser [mm]: 345	1	24.8190-0312.2 620312	L= 915
535 d	220	03/10→08/11	➔	☐; 09/10→	1	24.8190-0298.2 620298	L= 1.087
535 d	225	03/10→08/11					
550 i xDrive	300	08/10→06/13	➔	09/10→	1	24.8190-0312.2 620312	L= 915
535 i xDrive	225	03/10→10/16	➔	☐; 03/11→	1	24.8190-0298.2 620298	L= 1.087
↓							

















	kW			 	! #		
BMW - 5 (F10) 01/09→10/16							
Warnkontakt, Bremsbelagverschleiß							
535 i xDrive	225	03/10→10/16	➡	03/11→	1	24.8190-0312.2 620312	L= 915
550 i	330	08/12→10/16	⬅	☐; 05/13→	1	24.8190-0298.2 620298	L= 1.087
550 i xDrive	330	01/13→10/16	➡	05/13→	1	24.8190-0312.2 620312	L= 915
M5	412	10/10→10/16	⬅	☐; 09/11→	1	24.8190-0298.2 620298	L= 1.087
			➡	☐; 09/11→	1	24.8190-0008.2 620008	L= 1.000
M 550 d xDrive	280	07/11→10/16	⬅	☐; 03/12→	1	24.8190-0298.2 620298	L= 1.087
			➡	03/12→	1	24.8190-0312.2 620312	L= 915
M5 Competition	423	02/13→10/16	⬅	☐; 01/14→	1	24.8190-0298.2 620298	L= 1.087
			➡	☐; 01/14→	1	24.8190-0008.2 620008	L= 1.000
M5 Edition 30	441	07/14→10/16	⬅	☐	1	24.8190-0298.2 620298	L= 1.087
			➡	☐	1	24.8190-0008.2 620008	L= 1.000
 Brems Scheibe							
518 d	100	02/13→06/14	⬅			24.0124-0239.2 424239	Ø 330 24 22,4 V Brems Scheibe zweiteilig / + S
518 d	105	02/13→06/14					
520 d	100	01/13→10/16	➡			24.0120-0229.2 420229	Ø 330 20 18,4 V Brems Scheibe zweiteilig / + S
520 d	135	01/13→10/16					
520 d	147	01/13→10/16					
520 d xDrive	100	01/13→06/14					
520 d xDrive	120	10/13→10/16					
520 i	125	07/13→10/16					
518 d	110	10/13→10/16	⬅	07/14→		24.0124-0239.2 424239	Ø 330 24 22,4 V Brems Scheibe zweiteilig / + S
518 d	120	10/13→10/16					
520 d	140	10/13→10/16	➡	07/14→		24.0120-0229.2 420229	Ø 330 20 18,4 V Brems Scheibe zweiteilig / + S
520 d	155	10/13→10/16					
520 d xDrive	140	10/13→10/16					
520 d xDrive	155	10/13→10/16					
520 d	120	01/09→10/16	⬅	03/10→		24.0124-0239.2 424239	Ø 330 24 22,4 V Brems Scheibe zweiteilig / + S
523 i	150	01/09→08/11					
523 i	150	06/09→08/11	➡	03/10→		24.0120-0229.2 420229	Ø 330 20 18,4 V Brems Scheibe zweiteilig / + S
523 i	155	06/09→08/11					
523 i	160	06/09→08/11					
520 d xDrive	135	01/13→06/14	⬅	02/13→		24.0124-0239.2 424239	Ø 330 24 22,4 V Brems Scheibe zweiteilig / + S
520 d xDrive	147	01/13→06/14	➡	02/13→		24.0120-0229.2 420229	Ø 330 20 18,4 V Brems Scheibe zweiteilig / + S
520 i	120	10/10→10/16	⬅	09/11→		24.0124-0239.2 424239	Ø 330 24 22,4 V Brems Scheibe zweiteilig / + S
520 i	135	10/10→10/16	➡	09/11→		24.0120-0229.2 420229	Ø 330 20 18,4 V Brems Scheibe zweiteilig / + S
525 d	155	01/11→10/16	⬅	09/11→; nicht für Fahrzeuge mit verstärkter Brems e		24.0130-0218.2 430218	Ø 348 30 28,4 V Brems Scheibe zweiteilig / + S
525 d	160	01/11→10/16					
525 d xDrive	155	01/11→10/16	⬅	☐; 09/11→; für Fahrzeuge mit verstärkter Brems e		24.0136-0114.2 436114	Ø 348 36 34,4 V Brems Scheibe zweiteilig / + S
525 d xDrive	160	01/11→10/16					
528 i	180	10/10→10/16	⬅	☐; 09/11→; für Fahrzeuge mit verstärkter Brems e		24.0136-0115.2 436115	Ø 348 36 34,4 V Brems Scheibe zweiteilig / + S
528 i xDrive	180	10/10→10/16	➡	09/11→		24.0120-0229.2 420229	Ø 330 20 18,4 V Brems Scheibe zweiteilig / + S
525 d	150	06/09→08/11	⬅	03/10→; nicht für Fahrzeuge mit verstärkter Brems e		24.0130-0218.2 430218	Ø 348 30 28,4 V Brems Scheibe zweiteilig / + S
528 i	190	01/09→08/11	⬅	☐; 03/10→; für Fahrzeuge mit verstärkter Brems e		24.0136-0114.2 436114	Ø 348 36 34,4 V Brems Scheibe zweiteilig / + S
			⬅	☐; 03/10→; für Fahrzeuge mit verstärkter Brems e		24.0136-0115.2 436115	Ø 348 36 34,4 V Brems Scheibe zweiteilig / + S
			➡	03/10→		24.0120-0229.2 420229	Ø 330 20 18,4 V Brems Scheibe zweiteilig / + S
530 d	180	01/09→08/11	⬅	03/10→; nicht für Fahrzeuge mit verstärkter Brems e		24.0130-0218.2 430218	Ø 348 30 28,4 V Brems Scheibe zweiteilig / + S
			⬅	☐; 03/10→; für Fahrzeuge mit verstärkter Brems e		24.0136-0114.2 436114	Ø 348 36 34,4 V Brems Scheibe zweiteilig / + S
			⬅	☐; 03/10→; für Fahrzeuge mit verstärkter Brems e		24.0136-0115.2 436115	Ø 348 36 34,4 V Brems Scheibe zweiteilig / + S
			➡	03/10→; für Brems Scheibendurchmesser [mm]: 330		24.0120-0229.2 420229	Ø 330 20 18,4 V Brems Scheibe zweiteilig / + S
			➡	03/10→; für Brems Scheibendurchmesser [mm]: 345		24.0124-0233.2 424233	Ø 345 24 22,4 V Brems Scheibe zweiteilig / + S











	kw			 	! #		
BMW - 5 (F10) 01/09→10/16							
Bremsscheibe							
530 d	190	01/11→10/16	←	09/11→; nicht für Fahrzeuge mit verstärkter Bremsen	24.0130-0218.2	430218	Ø 348 30 28,4 V Brems Scheibe zweiteilig / + S
			←	 ; 09/11→; für Fahrzeuge mit verstärkter Bremse	24.0136-0114.2	436114	Ø 348 36 34,4 V Brems Scheibe zweiteilig / + S
			←	 ; 09/11→; für Fahrzeuge mit verstärkter Bremse	24.0136-0115.2	436115	Ø 348 36 34,4 V Brems Scheibe zweiteilig / + S
			→	09/11→; für Bremsscheibendurchmesser [mm]: 330	24.0120-0229.2	420229	Ø 330 20 18,4 V Brems Scheibe zweiteilig / + S
			→	09/11→; für Bremsscheibendurchmesser [mm]: 345	24.0124-0233.2	424233	Ø 345 24 22,4 V Brems Scheibe zweiteilig / + S
530 d 530 d xDrive	210 210	09/10→10/16 09/10→10/16	←	10/15→; nicht für Fahrzeuge mit verstärkter Bremsen	24.0130-0218.2	430218	Ø 348 30 28,4 V Brems Scheibe zweiteilig / + S
			←	 ; 10/15→; für Fahrzeuge mit verstärkter Bremse	24.0136-0114.2	436114	Ø 348 36 34,4 V Brems Scheibe zweiteilig / + S
			←	 ; 10/15→; für Fahrzeuge mit verstärkter Bremse	24.0136-0115.2	436115	Ø 348 36 34,4 V Brems Scheibe zweiteilig / + S
			→	10/15→	24.0124-0233.2	424233	Ø 345 24 22,4 V Brems Scheibe zweiteilig / + S
530 d xDrive	190	09/10→10/16	←	03/11→; nicht für Fahrzeuge mit verstärkter Bremsen	24.0130-0218.2	430218	Ø 348 30 28,4 V Brems Scheibe zweiteilig / + S
			←	 ; 03/11→; für Fahrzeuge mit verstärkter Bremse	24.0136-0114.2	436114	Ø 348 36 34,4 V Brems Scheibe zweiteilig / + S
			←	 ; 03/11→; für Fahrzeuge mit verstärkter Bremse	24.0136-0115.2	436115	Ø 348 36 34,4 V Brems Scheibe zweiteilig / + S
			→	03/11→; für Bremsscheibendurchmesser [mm]: 330	24.0120-0229.2	420229	Ø 330 20 18,4 V Brems Scheibe zweiteilig / + S
			→	03/11→; für Bremsscheibendurchmesser [mm]: 345	24.0124-0233.2	424233	Ø 345 24 22,4 V Brems Scheibe zweiteilig / + S
530 i 530 i	190 200	06/09→06/13 05/11→06/13	←	09/11→	24.0124-0239.2	424239	Ø 330 24 22,4 V Brems Scheibe zweiteilig / + S
			←	09/11→; nicht für Fahrzeuge mit verstärkter Bremsen	24.0130-0218.2	430218	Ø 348 30 28,4 V Brems Scheibe zweiteilig / + S
			←	 ; 09/11→; für Fahrzeuge mit verstärkter Bremse	24.0136-0114.2	436114	Ø 348 36 34,4 V Brems Scheibe zweiteilig / + S
			←	 ; 09/11→; für Fahrzeuge mit verstärkter Bremse	24.0136-0115.2	436115	Ø 348 36 34,4 V Brems Scheibe zweiteilig / + S
			→	09/11→	24.0120-0229.2	420229	Ø 330 20 18,4 V Brems Scheibe zweiteilig / + S
535 d 535 d	220 225	03/10→08/11 03/10→08/11	←	 ; 09/10→	24.0136-0114.2	436114	Ø 348 36 34,4 V Brems Scheibe zweiteilig / + S
			←	 ; 09/10→	24.0136-0115.2	436115	Ø 348 36 34,4 V Brems Scheibe zweiteilig / + S
			→	09/10→	24.0124-0233.2	424233	Ø 345 24 22,4 V Brems Scheibe zweiteilig / + S
535 d 535 d xDrive ActiveHybrid ActiveHybrid	230 230 225 250	01/11→10/16 02/11→10/16 09/10→08/16 09/10→08/16	←	 ; 09/11→	24.0136-0114.2	436114	Ø 348 36 34,4 V Brems Scheibe zweiteilig / + S
			←	 ; 09/11→	24.0136-0115.2	436115	Ø 348 36 34,4 V Brems Scheibe zweiteilig / + S
			→	09/11→	24.0124-0233.2	424233	Ø 345 24 22,4 V Brems Scheibe zweiteilig / + S
535 i	225	01/09→10/16	←	 ; 03/10→	24.0136-0114.2	436114	Ø 348 36 34,4 V Brems Scheibe zweiteilig / + S
			←	 ; 03/10→	24.0136-0115.2	436115	Ø 348 36 34,4 V Brems Scheibe zweiteilig / + S
			→	03/10→	24.0124-0233.2	424233	Ø 345 24 22,4 V Brems Scheibe zweiteilig / + S
535 i 535 i xDrive	240 240	07/13→10/16 07/13→10/16	←		24.0136-0114.2	436114	Ø 348 36 34,4 V Brems Scheibe zweiteilig / + S
			←		24.0136-0115.2	436115	Ø 348 36 34,4 V Brems Scheibe zweiteilig / + S
			→		24.0124-0233.2	424233	Ø 345 24 22,4 V Brems Scheibe zweiteilig / + S
535 i xDrive	225	03/10→10/16	←	 ; 03/11→	24.0136-0114.2	436114	Ø 348 36 34,4 V Brems Scheibe zweiteilig / + S
↓							



















	kw			 	! #			
BMW - 5 (F10) 01/09→10/16								
 Bremsscheibe								
535 i xDrive	225	03/10→10/16	←	☐; 03/11→		24.0136-0115.2	436115	Ø 348 36 34,4 V Bremsscheibe zweiteilig / + S
			→	03/11→		24.0124-0233.2	424233	Ø 345 24 22,4 V Bremsscheibe zweiteilig / + S
			←	☐; 03/10→		24.0136-0118.2	436118	Ø 374 36 34,4 V Bremsscheibe zweiteilig / + S
550 i	300	01/09→06/13	←	☐; 03/10→		24.0136-0118.2	436118	Ø 374 36 34,4 V Bremsscheibe zweiteilig / + S
			←	☐; 03/10→		24.0136-0119.2	436119	Ø 374 36 34,4 V Bremsscheibe zweiteilig / + S
			→	03/10→		24.0124-0233.2	424233	Ø 345 24 22,4 V Bremsscheibe zweiteilig / + S
550 i 550 i xDrive	330 330	08/12→10/16 01/13→10/16	←	☐; 05/13→		24.0136-0118.2	436118	Ø 374 36 34,4 V Bremsscheibe zweiteilig / + S
			←	☐; 05/13→		24.0136-0119.2	436119	Ø 374 36 34,4 V Bremsscheibe zweiteilig / + S
			→	05/13→		24.0124-0233.2	424233	Ø 345 24 22,4 V Bremsscheibe zweiteilig / + S
550 i xDrive	300	08/10→06/13	←	☐; 09/10→		24.0136-0118.2	436118	Ø 374 36 34,4 V Bremsscheibe zweiteilig / + S
			←	☐; 09/10→		24.0136-0119.2	436119	Ø 374 36 34,4 V Bremsscheibe zweiteilig / + S
			→	09/10→		24.0124-0233.2	424233	Ø 345 24 22,4 V Bremsscheibe zweiteilig / + S
M5	412	10/10→10/16	←	☐; 09/11→		24.0136-0125.2	436125	Ø 400 36 34,4 V• Bremsscheibe zweiteilig / + S
			←	☐; 09/11→		24.0136-0126.2	436126	Ø 400 36 34,4 V• Bremsscheibe zweiteilig / + S
M 550 d xDrive	280	07/11→10/16	←	☐; 03/12→		24.0136-0118.2	436118	Ø 374 36 34,4 V Bremsscheibe zweiteilig / + S
			←	☐; 03/12→		24.0136-0119.2	436119	Ø 374 36 34,4 V Bremsscheibe zweiteilig / + S
			→	03/12→		24.0124-0233.2	424233	Ø 345 24 22,4 V Bremsscheibe zweiteilig / + S
M5 Competition	423	02/13→10/16	←	☐; 01/14→		24.0136-0125.2	436125	Ø 400 36 34,4 V• Bremsscheibe zweiteilig / + S
			←	☐; 01/14→		24.0136-0126.2	436126	Ø 400 36 34,4 V• Bremsscheibe zweiteilig / + S
M5 Edition 30	441	07/14→10/16	←	☐		24.0136-0125.2	436125	Ø 400 36 34,4 V• Bremsscheibe zweiteilig / + S
			←	☐		24.0136-0126.2	436126	Ø 400 36 34,4 V• Bremsscheibe zweiteilig / + S
BMW - 5 (G30) 09/16→								
 Bremsbelagsatz, Scheibenbremse								
530 d	195	09/16→	→	+ eFSB		13.0460-2716.2	602716	TRW 24703 17,8 + WE / - WK + Zub
530 d xDrive	183	09/16→				13.0470-2716.2	LD2716	TRW 24703 17,8 + WE / - WK + Zub Ceramic
530 d xDrive	195	09/16→						
530 i	185	09/16→						
530 i xDrive	185	09/16→						
540 i	250	09/16→						
540 i	265	09/16→						
540 i xDrive	250	09/16→						
540 i xDrive	265	09/16→						
M550 i xDrive	340	03/17→						
530 e iPerformance	135	03/17→	→	für Fahrzeuge mit Sportpaket / + eFSB		13.0460-2716.2	602716	TRW 24703 17,8 + WE / - WK + Zub
530 e iPerformance	185	03/17→				13.0470-2716.2	LD2716	TRW 24703 17,8 + WE / - WK + Zub Ceramic
BMW - 5 Gran Turismo (F07) 01/09→								
 Bremsbelagsatz, Scheibenbremse								
520 d	100	10/12→	←			13.0460-7267.2	607267	ATE 25045 19,5 + WE / - WK
530 d	190	10/11→				13.0470-7267.2	LD7267	ATE 25045 19,5 + WE / - WK Ceramic
530 d xDrive	190	11/11→						
			→			13.0460-7274.2	607274	ATE 23731 17,3 + WE / - WK
520 d	120	04/11→	←	10/11→		13.0460-7267.2	607267	ATE 25045 19,5 + WE / - WK
520 d	135	04/11→				13.0470-7267.2	LD7267	ATE 25045 19,5 + WE / - WK Ceramic
			→	10/11→		13.0460-7274.2	607274	ATE 23731 17,3 + WE / - WK
528 i	180	01/13→	←	08/13→		13.0460-7267.2	607267	ATE 25045 19,5 + WE / - WK
↓								







	kw			 	! #		
BMW - 5 Gran Turismo (F07) 01/09→							
Bremsbelagsatz, Scheibenbremse							
528 i	180	01/13→	←	08/13→		13.0470-7267.2 LD7267	ATE 25045 19,5 + WE / - WK Ceramic
			→	08/13→		13.0460-7274.2 607274	ATE 23731 17,3 + WE / - WK
530 d	155	03/10→06/12	←	07/10→		13.0460-7267.2 607267	ATE 25045 19,5 + WE / - WK
			→	07/10→		13.0470-7267.2 LD7267	ATE 25045 19,5 + WE / - WK Ceramic
			→	07/10→		13.0460-7274.2 607274	ATE 23731 17,3 + WE / - WK
530 d	180	01/09→06/12	←	10/09→		13.0460-7267.2 607267	ATE 25045 19,5 + WE / - WK
535 i	225	01/09→	→	10/09→		13.0470-7267.2 LD7267	ATE 25045 19,5 + WE / - WK Ceramic
			→	10/09→		13.0460-7274.2 607274	ATE 23731 17,3 + WE / - WK
530 d xDrive	180	01/10→06/12	←	09/10→		13.0460-7267.2 607267	ATE 25045 19,5 + WE / - WK
535 d xDrive	220	05/09→06/12	→	09/10→		13.0470-7267.2 LD7267	ATE 25045 19,5 + WE / - WK Ceramic
535 d xDrive	225	05/09→06/12	→	09/10→		13.0460-7274.2 607274	ATE 23731 17,3 + WE / - WK
535 i xDrive	225	01/10→	→	09/10→		13.0460-7274.2 607274	ATE 23731 17,3 + WE / - WK
535 d	220	05/09→06/12	←	03/10→		13.0460-7267.2 607267	ATE 25045 19,5 + WE / - WK
535 d	225	05/09→06/12	→	03/10→		13.0470-7267.2 LD7267	ATE 25045 19,5 + WE / - WK Ceramic
			→	03/10→		13.0460-7274.2 607274	ATE 23731 17,3 + WE / - WK
535 d	230	01/12→	←	02/12→		13.0460-7267.2 607267	ATE 25045 19,5 + WE / - WK
535 d xDrive	230	01/12→	→	02/12→		13.0460-7274.2 607274	ATE 23731 17,3 + WE / - WK
550 i	298	10/09→05/12	←	03/10→		13.0460-7261.2 607261	ATE 24436 19,7 + WE / - WK
			←	→ 02/10		13.0460-7261.2 607261	ATE 24436 19,7 + WE / - WK
			→			13.0460-7274.2 607274	ATE 23731 17,3 + WE / - WK
550 i	300	01/09→05/12	←	03/10→		13.0460-7261.2 607261	ATE 24436 19,7 + WE / - WK
			←	10/09→ 02/10		13.0460-7261.2 607261	ATE 24436 19,7 + WE / - WK
			→	10/09→		13.0460-7274.2 607274	ATE 23731 17,3 + WE / - WK
550 i	330	01/12→07/16	←	05/12→		13.0460-7261.2 607261	ATE 24436 19,7 + WE / - WK
550 i xDrive	330	04/11→	→	05/12→		13.0460-7274.2 607274	ATE 23731 17,3 + WE / - WK
550 i xDrive	300	04/09→06/12	←	09/10→		13.0460-7261.2 607261	ATE 24436 19,7 + WE / - WK
			→	09/10→		13.0460-7274.2 607274	ATE 23731 17,3 + WE / - WK
Warnkontakt, Bremsbelagverschleiß							
520 d	100	10/12→	←	☐	1	24.8190-0298.2 620298	L= 1.087
530 d	190	10/11→	→		1	24.8190-0300.2 620300	L= 1.054
530 d xDrive	190	11/11→	→		1	24.8190-0300.2 620300	L= 1.054
520 d	120	04/11→	←	☐; 10/11→	1	24.8190-0298.2 620298	L= 1.087
520 d	135	04/11→	→	10/11→	1	24.8190-0300.2 620300	L= 1.054
528 i	180	01/13→	←	☐; 08/13→	1	24.8190-0298.2 620298	L= 1.087
			→	08/13→	1	24.8190-0300.2 620300	L= 1.054
530 d	155	03/10→06/12	←	☐; 07/10→	1	24.8190-0298.2 620298	L= 1.087
			→	07/10→	1	24.8190-0300.2 620300	L= 1.054
530 d	180	01/09→06/12	←	☐; 10/09→	1	24.8190-0298.2 620298	L= 1.087
535 i	225	01/09→	→	10/09→	1	24.8190-0300.2 620300	L= 1.054
530 d xDrive	180	01/10→06/12	←	☐; 09/10→	1	24.8190-0298.2 620298	L= 1.087
535 d xDrive	220	05/09→06/12	→	09/10→	1	24.8190-0300.2 620300	L= 1.054
535 d xDrive	225	05/09→06/12	→	09/10→	1	24.8190-0300.2 620300	L= 1.054
535 i xDrive	225	01/10→	→	09/10→	1	24.8190-0300.2 620300	L= 1.054
535 d	220	05/09→06/12	←	☐; 03/10→	1	24.8190-0298.2 620298	L= 1.087
535 d	225	05/09→06/12	→	03/10→	1	24.8190-0300.2 620300	L= 1.054
535 d	230	01/12→	←	02/12→	1	24.8190-0298.2 620298	L= 1.087
535 d xDrive	230	01/12→	→	02/12→	1	24.8190-0300.2 620300	L= 1.054
550 i	298	10/09→05/12	←	☐; → 02/10	1	24.8190-0260.2 620260	L= 1.060
			←	☐; 03/10→	1	24.8190-0298.2 620298	L= 1.087
			→		1	24.8190-0300.2 620300	L= 1.054
550 i	300	01/09→05/12	←	☐; 10/09→ 02/10	1	24.8190-0260.2 620260	L= 1.060
			←	☐; 03/10→	1	24.8190-0298.2 620298	L= 1.087
			→	10/09→	1	24.8190-0300.2 620300	L= 1.054
550 i	330	01/12→07/16	←	☐; 05/12→	1	24.8190-0298.2 620298	L= 1.087









	kW			 	! #		
BMW - 5 Gran Turismo (F07) 01/09→							
Warnkontakt, Bremsbelagverschleiß							
550 i xDrive	330	04/11→	➡	05/12→	1	24.8190-0300.2 620300	L= 1.054
550 i xDrive	300	04/09→06/12	⬅	☐; 09/10→	1	24.8190-0298.2 620298	L= 1.087
			➡	09/10→	1	24.8190-0300.2 620300	L= 1.054
 Bremsscheibe							
520 d 530 d 530 d xDrive	100 190 190	10/12→ 10/11→ 11/11→	⬅	☐		24.0136-0114.2 436114	Ø 348 36 34,4 V Bremsscheibe zweiteilig / + S
			⬅	☐		24.0136-0115.2 436115	Ø 348 36 34,4 V Bremsscheibe zweiteilig / + S
			➡			24.0124-0233.2 424233	Ø 345 24 22,4 V Bremsscheibe zweiteilig / + S
520 d 520 d	120 135	04/11→ 04/11→	⬅	☐; 10/11→		24.0136-0114.2 436114	Ø 348 36 34,4 V Bremsscheibe zweiteilig / + S
			⬅	☐; 10/11→		24.0136-0115.2 436115	Ø 348 36 34,4 V Bremsscheibe zweiteilig / + S
			➡	10/11→		24.0124-0233.2 424233	Ø 345 24 22,4 V Bremsscheibe zweiteilig / + S
528 i	180	01/13→	⬅	☐; 08/13→		24.0136-0114.2 436114	Ø 348 36 34,4 V Bremsscheibe zweiteilig / + S
			⬅	☐; 08/13→		24.0136-0115.2 436115	Ø 348 36 34,4 V Bremsscheibe zweiteilig / + S
			➡	08/13→		24.0124-0233.2 424233	Ø 345 24 22,4 V Bremsscheibe zweiteilig / + S
530 d	155	03/10→06/12	⬅	☐; 07/10→		24.0136-0114.2 436114	Ø 348 36 34,4 V Bremsscheibe zweiteilig / + S
			⬅	☐; 07/10→		24.0136-0115.2 436115	Ø 348 36 34,4 V Bremsscheibe zweiteilig / + S
			➡	07/10→		24.0124-0233.2 424233	Ø 345 24 22,4 V Bremsscheibe zweiteilig / + S
530 d 535 i	180 225	01/09→06/12 01/09→	⬅	☐; 10/09→		24.0136-0114.2 436114	Ø 348 36 34,4 V Bremsscheibe zweiteilig / + S
			⬅	☐; 10/09→		24.0136-0115.2 436115	Ø 348 36 34,4 V Bremsscheibe zweiteilig / + S
			➡	10/09→		24.0124-0233.2 424233	Ø 345 24 22,4 V Bremsscheibe zweiteilig / + S
530 d xDrive 535 d xDrive 535 d xDrive 535 i xDrive	180 220 225 225	01/10→06/12 05/09→06/12 05/09→06/12 01/10→	⬅	☐; 09/10→		24.0136-0114.2 436114	Ø 348 36 34,4 V Bremsscheibe zweiteilig / + S
			⬅	☐; 09/10→		24.0136-0115.2 436115	Ø 348 36 34,4 V Bremsscheibe zweiteilig / + S
			➡	09/10→		24.0124-0233.2 424233	Ø 345 24 22,4 V Bremsscheibe zweiteilig / + S
535 d 535 d	220 225	05/09→06/12 05/09→06/12	⬅	☐; 03/10→		24.0136-0114.2 436114	Ø 348 36 34,4 V Bremsscheibe zweiteilig / + S
			⬅	☐; 03/10→		24.0136-0115.2 436115	Ø 348 36 34,4 V Bremsscheibe zweiteilig / + S
			➡	03/10→		24.0124-0233.2 424233	Ø 345 24 22,4 V Bremsscheibe zweiteilig / + S
535 d 535 d xDrive	230 230	01/12→ 01/12→	⬅	☐; 02/12→		24.0136-0114.2 436114	Ø 348 36 34,4 V Bremsscheibe zweiteilig / + S
			⬅	☐; 02/12→		24.0136-0115.2 436115	Ø 348 36 34,4 V Bremsscheibe zweiteilig / + S
			➡	02/12→		24.0124-0233.2 424233	Ø 345 24 22,4 V Bremsscheibe zweiteilig / + S
550 i	298	10/09→05/12	⬅	☐		24.0136-0120.2 436120	Ø 374 36 34,4 V Bremsscheibe zweiteilig / + S
			⬅	☐		24.0136-0121.2 436121	Ø 374 36 34,4 V Bremsscheibe zweiteilig / + S
			➡			24.0124-0241.1 424241	Ø 370 23,9 22,4 V + S
550 i	300	01/09→05/12	⬅	☐; 10/09→		24.0136-0120.2 436120	Ø 374 36 34,4 V Bremsscheibe zweiteilig / + S
			⬅	☐; 10/09→		24.0136-0121.2 436121	Ø 374 36 34,4 V Bremsscheibe zweiteilig / + S
			➡	10/09→		24.0124-0241.1 424241	Ø 370 23,9 22,4 V + S
550 i	330	01/12→07/16	⬅	☐; 05/12→		24.0136-0120.2 436120	Ø 374 36 34,4 V Bremsscheibe zweiteilig / + S
			⬅	☐; 05/12→		24.0136-0121.2 436121	Ø 374 36 34,4 V Bremsscheibe zweiteilig / + S
			➡	05/12→		24.0124-0241.1 424241	Ø 370 23,9 22,4 V + S
↓							









	kw			 	! #			
BMW - 5 Gran Turismo (F07) 01/09→								
 Bremsscheibe								
550 i xDrive	300	04/09→06/12	←	☐; 09/10→; nicht für Fahrzeuge mit verstärkter Bremsen	24.0136-0118.2	436118	Ø 374 36 34,4 V Bremsscheibe zweiteilig / + S	
			←	☐; 09/10→; nicht für Fahrzeuge mit verstärkter Bremsen	24.0136-0119.2	436119	Ø 374 36 34,4 V Bremsscheibe zweiteilig / + S	
			←	☐; 09/10→; für Fahrzeuge mit verstärkter Bremsen	24.0136-0120.2	436120	Ø 374 36 34,4 V Bremsscheibe zweiteilig / + S	
			←	☐; 09/10→; für Fahrzeuge mit verstärkter Bremsen	24.0136-0121.2	436121	Ø 374 36 34,4 V Bremsscheibe zweiteilig / + S	
			→	09/10→	24.0124-0241.1	424241	Ø 370 23,9 22,4 V + S	
550 i xDrive	330	04/11→	←	☐; 05/12→; nicht für Fahrzeuge mit verstärkter Bremsen	24.0136-0118.2	436118	Ø 374 36 34,4 V Bremsscheibe zweiteilig / + S	
			←	☐; 05/12→; nicht für Fahrzeuge mit verstärkter Bremsen	24.0136-0119.2	436119	Ø 374 36 34,4 V Bremsscheibe zweiteilig / + S	
			←	☐; 05/12→; für Fahrzeuge mit verstärkter Bremsen	24.0136-0120.2	436120	Ø 374 36 34,4 V Bremsscheibe zweiteilig / + S	
			←	☐; 05/12→; für Fahrzeuge mit verstärkter Bremsen	24.0136-0121.2	436121	Ø 374 36 34,4 V Bremsscheibe zweiteilig / + S	
			→	05/12→	24.0124-0241.1	424241	Ø 370 23,9 22,4 V + S	
BMW - 5 Touring (E34) 11/91→01/97								
 Bremsbelagsatz, Scheibenbremse								
518 g	85	11/95→06/96	←		13.0460-6033.2	606033	ATE 20968 20,3 + WE / - WK	
			→		13.0460-3803.2	603803	ATE 20995 17,3 + WE / - WK	
518 i 520 i 525 i 525 ix 525 td 525 tds 530 i V8 540 i	85 110 141 141 85 105 160 210	09/94→01/97 11/91→01/97 11/91→01/97 02/92→01/97 03/93→01/97 12/91→01/97 09/92→01/97 09/93→01/97	←	→ 11/96	13.0460-6033.2	606033	ATE 20968 20,3 + WE / - WK	
			→	→ 11/96				
			←	→ 11/96				
			→	→ 11/96				
			←	→ 11/96				
			→	→ 11/96				
			←	→ 11/96				
M5	250	09/94→01/97	←	→ 11/96	13.0460-9037.2	609037	ATE 20309 17,9 + WE / - WK	
Warnkontakt, Bremsbelagverschleiß								
518 g	85	11/95→06/96	←		1	24.8190-0214.2	620214	L= 235
			→		1	24.8190-0214.2	620214	L= 235
518 i 520 i 525 i 525 td 525 tds 530 i V8 540 i M5	85 110 141 85 105 160 210 250	09/94→01/97 11/91→01/97 11/91→01/97 02/92→01/97 03/93→01/97 12/91→01/97 09/92→01/97 09/93→01/97 09/94→01/97	←	→ 11/96	1	24.8190-0214.2	620214	L= 235
			→	→ 11/96				
			←	→ 11/96				
			→	→ 11/96				
			←	→ 11/96				
			→	→ 11/96				
			←	→ 11/96				
525 ix	141	02/92→01/97	←	→ 11/96	1	24.8190-0224.2	620224	L= 311
			→	→ 11/96	1	24.8190-0214.2	620214	L= 235
 Bremsscheibe								
518 g	85	11/95→06/96	←		24.0112-0124.1	412124	Ø 302 12 10,4 + S	
			→		24.0110-0117.1	410117	Ø 300 10 8,4 + S	
					24.0310-0117.1	510117	Ø 300 10 7,6 + S PD	
518 i	85	09/94→01/97	←	→ 11/96	24.0112-0124.1	412124	Ø 302 12 10,4 + S	
			→	→ 11/96	24.0110-0117.1	410117	Ø 300 10 8,4 + S	
					24.0310-0117.1	510117	Ø 300 10 7,6 + S PD	
520 i 525 i 525 td 525 tds 530 i V8	110 141 85 105 160	11/91→01/97 11/91→01/97 03/93→01/97 12/91→01/97 09/92→01/97	←	→ 11/96	24.0122-0103.1	422103	Ø 302 22 20,4 V + S	
			→	→ 11/96	24.0322-0103.1	522103	Ø 302 22 19,6 V + S PD	
			←	→ 11/96	24.0110-0117.1	410117	Ø 300 10 8,4 + S	
			→	→ 11/96	24.0310-0117.1	510117	Ø 300 10 7,6 + S PD	
525 ix	141	02/92→01/97	←	→ 11/96	24.0128-0122.1	428122	Ø 296 28 26,4 V	
			→	→ 11/96	24.0110-0262.1	410262	Ø 300 10 8,4	
540 i	210	09/93→01/97	←	→ 11/96	24.0128-0101.1	428101	Ø 302 28 26,4 V	
			→	→ 11/96	24.0120-0181.1	420181	Ø 300 20 18,4 V	





























	kw			 	! #		
BMW - 5 Touring (E39) 01/97→05/04							
 Bremsbelagsatz, Scheibenbremse							
520 d 525 d	100 120	02/00→09/03 02/00→05/04	←	04/00→ 07/03; für Behördenfahrzeuge	13.0460-7078.2	607078	ATE 21486 19,5 + WE / - WK
					13.0470-7078.2	LD7078	ATE 21486 19,5 + WE / - WK Ceramic
			←	04/00→ 07/03; nicht für Behördenfahrzeuge	13.0460-7089.2	607089	ATE 21676 20,3 + WE / - WK
			→	04/00→ 07/03	13.0470-7089.2	LD7089	ATE 21676 20,3 + WE / - WK Ceramic
			→	04/00→ 07/03	13.0460-7090.2	607090	ATE 21691 17,3 + WE / - WK
					13.0470-7090.2	LD7090	ATE 21691 17,3 + WE / - WK Ceramic
520 i 520 i 520 i	100 120 125	04/99→05/04 09/00→05/04 09/00→05/04	←	→ 07/03; für Behördenfahrzeuge	13.0460-7078.2	607078	ATE 21486 19,5 + WE / - WK
					13.0470-7078.2	LD7078	ATE 21486 19,5 + WE / - WK Ceramic
			←	→ 07/03; nicht für Behördenfahrzeuge	13.0460-7089.2	607089	ATE 21676 20,3 + WE / - WK
			→	07/03	13.0470-7089.2	LD7089	ATE 21676 20,3 + WE / - WK Ceramic
			→	07/03	13.0460-7090.2	607090	ATE 21691 17,3 + WE / - WK
					13.0470-7090.2	LD7090	ATE 21691 17,3 + WE / - WK Ceramic
520 i	110	01/97→09/00	←	05/97→; für Behördenfahrzeuge	13.0460-7078.2	607078	ATE 21486 19,5 + WE / - WK
					13.0470-7078.2	LD7078	ATE 21486 19,5 + WE / - WK Ceramic
			←	05/97→; nicht für Behördenfahrzeuge	13.0460-7089.2	607089	ATE 21676 20,3 + WE / - WK
			→	05/97→	13.0470-7089.2	LD7089	ATE 21676 20,3 + WE / - WK Ceramic
			→	05/97→	13.0460-7090.2	607090	ATE 21691 17,3 + WE / - WK
					13.0470-7090.2	LD7090	ATE 21691 17,3 + WE / - WK Ceramic
523 i 523 i 528 i	120 125 142	01/97→09/00 01/97→09/00 01/97→09/00	←	05/97→	13.0460-7089.2	607089	ATE 21676 20,3 + WE / - WK
					13.0470-7089.2	LD7089	ATE 21676 20,3 + WE / - WK Ceramic
			→	05/97→	13.0460-7090.2	607090	ATE 21691 17,3 + WE / - WK
					13.0470-7090.2	LD7090	ATE 21691 17,3 + WE / - WK Ceramic
525 i	141	09/00→05/04	←	10/00→ 07/03; für Behördenfahrzeuge	13.0460-7078.2	607078	ATE 21486 19,5 + WE / - WK
					13.0470-7078.2	LD7078	ATE 21486 19,5 + WE / - WK Ceramic
			←	10/00→ 07/03; nicht für Behördenfahrzeuge	13.0460-7089.2	607089	ATE 21676 20,3 + WE / - WK
			→	10/00→ 07/03	13.0470-7089.2	LD7089	ATE 21676 20,3 + WE / - WK Ceramic
			→	10/00→ 07/03	13.0460-7090.2	607090	ATE 21691 17,3 + WE / - WK
					13.0470-7090.2	LD7090	ATE 21691 17,3 + WE / - WK Ceramic
525 tds	105	03/97→05/04	←	06/98→ 09/00	13.0460-7089.2	607089	ATE 21676 20,3 + WE / - WK
					13.0470-7089.2	LD7089	ATE 21676 20,3 + WE / - WK Ceramic
			→	06/98→ 09/00	13.0460-7090.2	607090	ATE 21691 17,3 + WE / - WK
					13.0470-7090.2	LD7090	ATE 21691 17,3 + WE / - WK Ceramic
530 d	135	08/98→09/00	←	09/98→	13.0460-7089.2	607089	ATE 21676 20,3 + WE / - WK
					13.0470-7089.2	LD7089	ATE 21676 20,3 + WE / - WK Ceramic
			→	09/98→	13.0460-7090.2	607090	ATE 21691 17,3 + WE / - WK
					13.0470-7090.2	LD7090	ATE 21691 17,3 + WE / - WK Ceramic
530 d	142	09/00→05/04	←	10/00→ 07/03	13.0460-7078.2	607078	ATE 21486 19,5 + WE / - WK
					13.0470-7078.2	LD7078	ATE 21486 19,5 + WE / - WK Ceramic
			←	→ 09/00	13.0460-7089.2	607089	ATE 21676 20,3 + WE / - WK
			→	07/03	13.0470-7089.2	LD7089	ATE 21676 20,3 + WE / - WK Ceramic
			→	07/03	13.0460-7090.2	607090	ATE 21691 17,3 + WE / - WK
					13.0470-7090.2	LD7090	ATE 21691 17,3 + WE / - WK Ceramic
530 i	170	09/00→05/04	←	10/00→ 07/03	13.0460-7078.2	607078	ATE 21486 19,5 + WE / - WK
					13.0470-7078.2	LD7078	ATE 21486 19,5 + WE / - WK Ceramic
			→	10/00→ 07/03	13.0460-7090.2	607090	ATE 21691 17,3 + WE / - WK







	kw			 	! #		
BMW - 5 Touring (E39) 01/97→05/04							
 Bremsbelagsatz, Scheibenbremse							
530 i	170	09/00→05/04	➡	10/00→ 07/03		13.0470-7090.2 LD7090	ATE 21691 17,3 + WE / - WK Ceramic
540 i	210	01/97→05/04	⬅	05/97→ 07/03		13.0460-7078.2 607078	ATE 21486 19,5 + WE / - WK
			➡	05/97→ 07/03		13.0470-7078.2 LD7078	ATE 21486 19,5 + WE / - WK Ceramic
						13.0460-7090.2 607090	ATE 21691 17,3 + WE / - WK
						13.0470-7090.2 LD7090	ATE 21691 17,3 + WE / - WK Ceramic
Warnkontakt, Bremsbelagverschleiß							
520 d 525 d	100 120	02/00→09/03 02/00→05/04	⬅	04/00→ 07/03; für Behördenfahrzeuge	1	24.8190-0219.2 620219	L= 764
			⬅	04/00→ 07/03; nicht für Behördenfahrzeuge	1	24.8190-0219.2 620219	L= 764
			➡	04/00→ 07/03	1	24.8190-0222.2 620222	L= 1.090
520 i 520 i 520 i	100 120 125	04/99→05/04 09/00→05/04 09/00→05/04	⬅	→ 07/03; für Behördenfahrzeuge	1	24.8190-0219.2 620219	L= 764
			⬅	→ 07/03; nicht für Behördenfahrzeuge	1	24.8190-0219.2 620219	L= 764
			➡	→ 07/03	1	24.8190-0222.2 620222	L= 1.090
520 i	110	01/97→09/00	⬅	05/97→; nicht für Behördenfahrzeuge	1	24.8190-0219.2 620219	L= 764
			⬅	05/97→; für Behördenfahrzeuge	1	24.8190-0219.2 620219	L= 764
			➡	05/97→	1	24.8190-0222.2 620222	L= 1.090
523 i 523 i 528 i	120 125 142	01/97→09/00 01/97→09/00 01/97→09/00	⬅	05/97→	1	24.8190-0219.2 620219	L= 764
			➡	05/97→	1	24.8190-0222.2 620222	L= 1.090
525 i	141	09/00→05/04	⬅	10/00→ 07/03; für Behördenfahrzeuge	1	24.8190-0219.2 620219	L= 764
			⬅	10/00→ 07/03; nicht für Behördenfahrzeuge	1	24.8190-0219.2 620219	L= 764
			➡	10/00→ 07/03	1	24.8190-0222.2 620222	L= 1.090
525 tds	105	03/97→05/04	⬅	06/98→ 09/00	1	24.8190-0219.2 620219	L= 764
			➡	06/98→ 09/00	1	24.8190-0222.2 620222	L= 1.090
530 d	135	08/98→09/00	⬅	09/98→	1	24.8190-0219.2 620219	L= 764
			➡	09/98→	1	24.8190-0222.2 620222	L= 1.090
530 d	142	09/00→05/04	⬅	→ 09/00	1	24.8190-0219.2 620219	L= 764
			⬅	10/00→ 07/03	1	24.8190-0219.2 620219	L= 764
			➡	→ 07/03	1	24.8190-0222.2 620222	L= 1.090
530 i	170	09/00→05/04	⬅	10/00→ 07/03	1	24.8190-0219.2 620219	L= 764
			➡	10/00→ 07/03	1	24.8190-0222.2 620222	L= 1.090
540 i	210	01/97→05/04	⬅	05/97→ 07/03	1	24.8190-0219.2 620219	L= 764
			➡	05/97→ 07/03	1	24.8190-0222.2 620222	L= 1.090
 Bremsscheibe							
520 d 525 d	100 120	02/00→09/03 02/00→05/04	⬅	04/00→ 07/03; nicht für Behördenfahrzeuge		24.0122-0159.1 422159	Ø 296 22 20,4 V + S
			⬅	04/00→ 07/03; für Behördenfahrzeuge		24.0322-0159.1 522159	Ø 296 22 19,6 V + S PD
			⬅	04/00→ 07/03; für Behördenfahrzeuge		24.0130-0107.1 430107	Ø 324 29,9 28,4 V + S
			➡	04/00→ 07/03		24.0330-0107.1 530107	Ø 324 29,9 27,6 V + S PD
			➡	04/00→ 07/03		24.0120-0154.1 420154	Ø 298 20 18,4 V + S
						24.0320-0154.1 520154	Ø 298 20 17,6 V + S PD
520 i 520 i 520 i	100 120 125	04/99→05/04 09/00→05/04 09/00→05/04	⬅	→ 07/03; nicht für Behördenfahrzeuge		24.0122-0159.1 422159	Ø 296 22 20,4 V + S
			⬅	→ 07/03; für Behördenfahrzeuge		24.0322-0159.1 522159	Ø 296 22 19,6 V + S PD
			⬅	→ 07/03; für Behördenfahrzeuge		24.0130-0107.1 430107	Ø 324 29,9 28,4 V + S
			⬅	→ 07/03; für Behördenfahrzeuge		24.0330-0107.1 530107	Ø 324 29,9 27,6 V + S PD
			➡	→ 07/03		24.0120-0154.1 420154	Ø 298 20 18,4 V + S
						24.0320-0154.1 520154	Ø 298 20 17,6 V + S PD
520 i	110	01/97→09/00	⬅	05/97→; nicht für Behördenfahrzeuge		24.0122-0159.1 422159	Ø 296 22 20,4 V + S
			⬅	05/97→; für Behördenfahrzeuge		24.0322-0159.1 522159	Ø 296 22 19,6 V + S PD
			⬅	05/97→; für Behördenfahrzeuge		24.0130-0107.1 430107	Ø 324 29,9 28,4 V + S
			⬅	05/97→; für Behördenfahrzeuge		24.0330-0107.1 530107	Ø 324 29,9 27,6 V + S PD
			➡	05/97→		24.0120-0154.1 420154	Ø 298 20 18,4 V + S
						24.0320-0154.1 520154	Ø 298 20 17,6 V + S PD
523 i 523 i 528 i ↓	120 125 142	01/97→09/00 01/97→09/00 01/97→09/00	⬅	05/97→		24.0122-0159.1 422159	Ø 296 22 20,4 V + S
			⬅	05/97→		24.0322-0159.1 522159	Ø 296 22 19,6 V + S PD







	kw			 	! #		
BMW - 5 Touring (E39) 01/97→05/04							
Bremsscheibe							
523 i	120	01/97→09/00	➔	05/97→		24.0120-0154.1 420154	Ø 298 20 18,4 V + S
523 i	125	01/97→09/00				24.0320-0154.1 520154	Ø 298 20 17,6 V + S PD
528 i	142	01/97→09/00					
525 i	141	09/00→05/04	➔	10/00→ 07/03; nicht für Behördenfahrzeuge		24.0122-0159.1 422159	Ø 296 22 20,4 V + S
			➔	10/00→ 07/03; für Behördenfahrzeuge		24.0322-0159.1 522159	Ø 296 22 19,6 V + S PD
			➔	10/00→ 07/03		24.0130-0107.1 430107	Ø 324 29,9 28,4 V + S
			➔	10/00→ 07/03		24.0330-0107.1 530107	Ø 324 29,9 27,6 V + S PD
			➔	10/00→ 07/03		24.0120-0154.1 420154	Ø 298 20 18,4 V + S
			➔	10/00→ 07/03		24.0320-0154.1 520154	Ø 298 20 17,6 V + S PD
525 tds	105	03/97→05/04	➔	06/98→ 09/00		24.0122-0159.1 422159	Ø 296 22 20,4 V + S
			➔	06/98→ 09/00		24.0322-0159.1 522159	Ø 296 22 19,6 V + S PD
			➔	06/98→ 09/00		24.0120-0154.1 420154	Ø 298 20 18,4 V + S
			➔	06/98→ 09/00		24.0320-0154.1 520154	Ø 298 20 17,6 V + S PD
530 d	135	08/98→09/00	➔	09/98→		24.0122-0159.1 422159	Ø 296 22 20,4 V + S
			➔	09/98→		24.0322-0159.1 522159	Ø 296 22 19,6 V + S PD
			➔	09/98→		24.0120-0154.1 420154	Ø 298 20 18,4 V + S
			➔	09/98→		24.0320-0154.1 520154	Ø 298 20 17,6 V + S PD
530 d	142	09/00→05/04	➔	→ 09/00		24.0122-0159.1 422159	Ø 296 22 20,4 V + S
			➔	→ 09/00		24.0322-0159.1 522159	Ø 296 22 19,6 V + S PD
			➔	10/00→ 07/03		24.0130-0107.1 430107	Ø 324 29,9 28,4 V + S
			➔	10/00→ 07/03		24.0330-0107.1 530107	Ø 324 29,9 27,6 V + S PD
			➔	→ 07/03		24.0120-0154.1 420154	Ø 298 20 18,4 V + S
			➔	→ 07/03		24.0320-0154.1 520154	Ø 298 20 17,6 V + S PD
530 i	170	09/00→05/04	➔	10/00→ 07/03		24.0130-0107.1 430107	Ø 324 29,9 28,4 V + S
			➔	10/00→ 07/03		24.0330-0107.1 530107	Ø 324 29,9 27,6 V + S PD
			➔	10/00→ 07/03		24.0120-0154.1 420154	Ø 298 20 18,4 V + S
			➔	10/00→ 07/03		24.0320-0154.1 520154	Ø 298 20 17,6 V + S PD
540 i	210	01/97→05/04	➔	05/97→ 02/00		24.0130-0101.1 430101	Ø 324 30 28,4 V + S
			➔	03/00→ 07/03		24.0130-0107.1 430107	Ø 324 29,9 28,4 V + S
			➔	03/00→ 07/03		24.0330-0107.1 530107	Ø 324 29,9 27,6 V + S PD
			➔	05/97→ 07/03		24.0120-0154.1 420154	Ø 298 20 18,4 V + S
			➔	05/97→ 07/03		24.0320-0154.1 520154	Ø 298 20 17,6 V + S PD
BMW - 5 Touring (E61) 06/04→12/10							
Bremsbelagsatz, Scheibenbremse							
520 d	110	04/05→02/08	➔	09/05→; für Behördenfahrzeuge		13.0460-7167.2 607167	ATE 23312 20,3 + WE / - WK
			➔	09/05→; für Behördenfahrzeuge		13.0460-7296.2 607296	ATE 23212 20,3 + WE / - WK
			➔	09/05→; für Behördenfahrzeuge		13.0470-7167.2 LD7167	ATE 23312 20,3 + WE / - WK Ceramic
			➔	09/05→; für Behördenfahrzeuge		13.0470-7296.2 LD7296	ATE 23212 20,3 + WE / - WK Ceramic
			➔	09/05→; nicht für Behördenfahrzeuge		13.0460-7176.2 607176	ATE 23793 20,3 + WE / - WK
			➔	09/05→; nicht für Behördenfahrzeuge		13.0470-7176.2 LD7176	ATE 23793 20,3 + WE / - WK Ceramic
			➔	09/05→		13.0460-7174.2 607174	ATE 23732 17,3 + WE / - WK
			➔	09/05→		13.0470-7174.2 LD7174	ATE 23732 17,3 + WE / - WK Ceramic
520 d	120	04/05→02/08	➔	07/05→; für Behördenfahrzeuge		13.0460-7167.2 607167	ATE 23312 20,3 + WE / - WK
			➔	07/05→; für Behördenfahrzeuge		13.0460-7296.2 607296	ATE 23212 20,3 + WE / - WK
			➔	07/05→; für Behördenfahrzeuge		13.0470-7167.2 LD7167	ATE 23312 20,3 + WE / - WK Ceramic
			➔	07/05→; für Behördenfahrzeuge		13.0470-7296.2 LD7296	ATE 23212 20,3 + WE / - WK Ceramic
			➔	07/05→; nicht für Behördenfahrzeuge		13.0460-7176.2 607176	ATE 23793 20,3 + WE / - WK
			➔	07/05→; nicht für Behördenfahrzeuge		13.0470-7176.2 LD7176	ATE 23793 20,3 + WE / - WK Ceramic
			➔	07/05→		13.0460-7174.2 607174	ATE 23732 17,3 + WE / - WK
			➔	07/05→		13.0470-7174.2 LD7174	ATE 23732 17,3 + WE / - WK Ceramic
520 d	130	03/07→05/10	➔	09/07→		13.0460-7167.2 607167	ATE 23312 20,3 + WE / - WK
						13.0460-7296.2 607296	ATE 23212 20,3 + WE / - WK
						13.0470-7167.2 LD7167	ATE 23312 20,3 + WE / - WK Ceramic
↓							







	kw			 	! #		
BMW - 5 Touring (E61) 06/04→12/10							
 Bremsbelagsatz, Scheibenbremse							
520 d	130	03/07→05/10	←	09/07→	13.0470-7296.2	LD7296	ATE 23212 20,3 + WE / - WK Ceramic
			→	09/07→	13.0460-7174.2	607174	ATE 23732 17,3 + WE / - WK
					13.0470-7174.2	LD7174	ATE 23732 17,3 + WE / - WK Ceramic
520 i 520 i	120 125	07/07→08/10 09/07→12/10	←	→ 05/10; für Behördenfahrzeuge	13.0460-7167.2	607167	ATE 23312 20,3 + WE / - WK
					13.0460-7296.2	607296	ATE 23212 20,3 + WE / - WK
					13.0470-7167.2	LD7167	ATE 23312 20,3 + WE / - WK Ceramic
					13.0470-7296.2	LD7296	ATE 23212 20,3 + WE / - WK Ceramic
			←	→ 05/10; nicht für Behördenfahrzeuge	13.0460-7176.2	607176	ATE 23793 20,3 + WE / - WK
					13.0470-7176.2	LD7176	ATE 23793 20,3 + WE / - WK Ceramic
			→	→ 05/10	13.0460-7174.2	607174	ATE 23732 17,3 + WE / - WK
					13.0470-7174.2	LD7174	ATE 23732 17,3 + WE / - WK Ceramic
523 i 525 d	130 130	07/05→12/10 06/04→12/10	←	für Behördenfahrzeuge; → 03/07	13.0460-7167.2	607167	ATE 23312 20,3 + WE / - WK
					13.0460-7296.2	607296	ATE 23212 20,3 + WE / - WK
					13.0470-7167.2	LD7167	ATE 23312 20,3 + WE / - WK Ceramic
			←	nicht für Behördenfahrzeuge; → 03/07	13.0460-7176.2	607176	ATE 23793 20,3 + WE / - WK
					13.0470-7176.2	LD7176	ATE 23793 20,3 + WE / - WK Ceramic
			→	→ 03/07	13.0460-7174.2	607174	ATE 23732 17,3 + WE / - WK
					13.0470-7174.2	LD7174	ATE 23732 17,3 + WE / - WK Ceramic
523 i	140	01/07→12/10	←	03/07→ 05/10; Motorcode: N53	13.0460-7167.2	607167	ATE 23312 20,3 + WE / - WK
					13.0460-7296.2	607296	ATE 23212 20,3 + WE / - WK
					13.0470-7167.2	LD7167	ATE 23312 20,3 + WE / - WK Ceramic
					13.0470-7296.2	LD7296	ATE 23212 20,3 + WE / - WK Ceramic
			←	03/07→ 05/10; für Behördenfahrzeuge; Motorcode: N52N	13.0460-7167.2	607167	ATE 23312 20,3 + WE / - WK
		13.0460-7296.2	607296	ATE 23212 20,3 + WE / - WK			
			13.0470-7167.2	LD7167	ATE 23312 20,3 + WE / - WK Ceramic		
			13.0470-7296.2	LD7296	ATE 23212 20,3 + WE / - WK Ceramic		
			←	03/07→ 05/10; nicht für Behördenfahrzeuge; Motorcode: N52N	13.0460-7176.2	607176	ATE 23793 20,3 + WE / - WK
					13.0470-7176.2	LD7176	ATE 23793 20,3 + WE / - WK Ceramic
			→	03/07→ 05/10	13.0460-7174.2	607174	ATE 23732 17,3 + WE / - WK
					13.0470-7174.2	LD7174	ATE 23732 17,3 + WE / - WK Ceramic
525 d	120	12/04→12/10	←	→ 05/10	13.0460-7167.2	607167	ATE 23312 20,3 + WE / - WK
					13.0460-7176.2	607176	ATE 23793 20,3 + WE / - WK
					13.0460-7296.2	607296	ATE 23212 20,3 + WE / - WK
					13.0470-7167.2	LD7167	ATE 23312 20,3 + WE / - WK Ceramic
					13.0470-7176.2	LD7176	ATE 23793 20,3 + WE / - WK Ceramic
					13.0470-7296.2	LD7296	ATE 23212 20,3 + WE / - WK Ceramic
			→	→ 05/10	13.0460-7174.2	607174	ATE 23732 17,3 + WE / - WK
					13.0470-7174.2	LD7174	ATE 23732 17,3 + WE / - WK Ceramic
525 d	145	01/07→12/10	←	03/07→ 05/10; für Behördenfahrzeuge	13.0460-7167.2	607167	ATE 23312 20,3 + WE / - WK
					13.0460-7296.2	607296	ATE 23212 20,3 + WE / - WK
					13.0470-7167.2	LD7167	ATE 23312 20,3 + WE / - WK Ceramic
					13.0470-7296.2	LD7296	ATE 23212 20,3 + WE / - WK Ceramic
			←	03/07→ 05/10; nicht für Behördenfahrzeuge	13.0460-7176.2	607176	ATE 23793 20,3 + WE / - WK
					13.0470-7176.2	LD7176	ATE 23793 20,3 + WE / - WK Ceramic









	kw			 	! #		
BMW - 5 Touring (E61) 06/04→12/10							
 Bremsbelagsatz, Scheibenbremse							
525 xd 530 xd 530 xi	145 173 200	01/07→12/10 01/07→12/10 01/07→12/10	➡	03/07→ 05/10		13.0470-7174.2 LD7174	ATE 23732 17,3 + WE / - WK Ceramic
530 d 530 d 530 d	155 160 170	11/05→12/10 06/04→12/10 07/05→12/10	←	→ 05/10		13.0460-7167.2 607167 13.0460-7296.2 607296 13.0470-7167.2 LD7167 13.0470-7296.2 LD7296	ATE 23312 20,3 + WE / - WK ATE 23212 20,3 + WE / - WK ATE 23312 20,3 + WE / - WK Ceramic ATE 23212 20,3 + WE / - WK Ceramic
			➡	→ 05/10; für Behördenfahrzeuge		13.0460-7169.2 607169 13.0470-7169.2 LD7169	ATE 23309 17,3 + WE / - WK ATE 23309 17,3 + WE / - WK Ceramic
			➡	→ 05/10; nicht für Behördenfahrzeuge		13.0460-7174.2 607174 13.0470-7174.2 LD7174	ATE 23732 17,3 + WE / - WK ATE 23732 17,3 + WE / - WK Ceramic
530 d	173	01/07→12/10	←	03/07→ 05/10		13.0460-7167.2 607167 13.0460-7296.2 607296 13.0470-7167.2 LD7167 13.0470-7296.2 LD7296	ATE 23312 20,3 + WE / - WK ATE 23212 20,3 + WE / - WK ATE 23312 20,3 + WE / - WK Ceramic ATE 23212 20,3 + WE / - WK Ceramic
			➡	03/07→ 05/10; für Behördenfahrzeuge		13.0460-7169.2 607169 13.0470-7169.2 LD7169	ATE 23309 17,3 + WE / - WK ATE 23309 17,3 + WE / - WK Ceramic
			➡	03/07→ 05/10; nicht für Behördenfahrzeuge		13.0460-7174.2 607174 13.0470-7174.2 LD7174	ATE 23732 17,3 + WE / - WK ATE 23732 17,3 + WE / - WK Ceramic
530 i 530 xd 530 xi	190 170 190	07/05→12/10 07/05→12/10 07/05→12/10	←	→ 03/07		13.0460-7167.2 607167 13.0460-7296.2 607296 13.0470-7167.2 LD7167 13.0470-7296.2 LD7296	ATE 23312 20,3 + WE / - WK ATE 23212 20,3 + WE / - WK ATE 23312 20,3 + WE / - WK Ceramic ATE 23212 20,3 + WE / - WK Ceramic
			➡	→ 03/07		13.0460-7174.2 607174 13.0470-7174.2 LD7174	ATE 23732 17,3 + WE / - WK ATE 23732 17,3 + WE / - WK Ceramic
530 i	200	01/07→12/10	←	03/07→ 05/10		13.0460-7167.2 607167 13.0460-7296.2 607296 13.0470-7167.2 LD7167 13.0470-7296.2 LD7296	ATE 23312 20,3 + WE / - WK ATE 23212 20,3 + WE / - WK ATE 23312 20,3 + WE / - WK Ceramic ATE 23212 20,3 + WE / - WK Ceramic
			➡	03/07→ 05/10; Motorcode: N53		13.0460-7169.2 607169 13.0470-7169.2 LD7169	ATE 23309 17,3 + WE / - WK ATE 23309 17,3 + WE / - WK Ceramic
			➡	03/07→ 05/10; für Behördenfahrzeuge; Motorcode: N52N		13.0460-7169.2 607169 13.0470-7169.2 LD7169	ATE 23309 17,3 + WE / - WK ATE 23309 17,3 + WE / - WK Ceramic
			➡	03/07→ 05/10; nicht für Behördenfahrzeuge; Motorcode: N52N		13.0460-7174.2 607174 13.0470-7174.2 LD7174	ATE 23732 17,3 + WE / - WK ATE 23732 17,3 + WE / - WK Ceramic
535 d	200	09/04→12/10	←	→ 03/07		13.0460-7210.2 607210 13.0470-7210.2 LD7210	ATE 23791 20,8 + WE / - WK ATE 23791 20,8 + WE / - WK Ceramic
			➡	→ 03/07		13.0460-7169.2 607169 13.0470-7169.2 LD7169	ATE 23309 17,3 + WE / - WK ATE 23309 17,3 + WE / - WK Ceramic
535 d	210	01/07→12/10	←	03/07→ 05/10		13.0460-7210.2 607210 13.0470-7210.2 LD7210	ATE 23791 20,8 + WE / - WK ATE 23791 20,8 + WE / - WK Ceramic
			➡	03/07→ 05/10		13.0460-7169.2 607169 13.0470-7169.2 LD7169	ATE 23309 17,3 + WE / - WK ATE 23309 17,3 + WE / - WK Ceramic
545 i	245	06/04→12/10	←	→ 08/05		13.0460-7167.2 607167 13.0460-7296.2 607296	ATE 23312 20,3 + WE / - WK ATE 23212 20,3 + WE / - WK
			➡	→ 08/05		13.0460-7169.2 607169 13.0470-7169.2 LD7169	ATE 23309 17,3 + WE / - WK ATE 23309 17,3 + WE / - WK Ceramic
↓							









	kw			 	! #		
BMW - 5 Touring (E61) 06/04→12/10							
 Bremsbelagsatz, Scheibenbremse							
550 i	270	07/05→12/10	←	03/07→ 05/10		13.0460-7167.2 607167 13.0460-7210.2 607210 13.0460-7296.2 607296	ATE 23312 20,3 + WE / - WK ATE 23791 20,8 + WE / - WK ATE 23212 20,3 + WE / - WK
			←	→ 03/07		13.0460-7210.2 607210	ATE 23791 20,8 + WE / - WK
			→	→ 05/10		13.0460-7169.2 607169 13.0470-7169.2 LD7169	ATE 23309 17,3 + WE / - WK ATE 23309 17,3 + WE / - WK Ceramic
M5	373	02/07→12/10	←	→ 05/10		13.0460-7210.2 607210	ATE 23791 20,8 + WE / - WK
			→	→ 05/10		13.0460-7169.2 607169 13.0470-7169.2 LD7169	ATE 23309 17,3 + WE / - WK ATE 23309 17,3 + WE / - WK Ceramic
Warnkontakt, Bremsbelagsverschleiß							
520 d	110	04/05→02/08	←	 ; 09/05→; nicht für Behördenfahrzeuge	1	24.8190-0273.2 620273	L= 662
			←	 ; 09/05→; für Behördenfahrzeuge	1	24.8190-0273.2 620273	L= 662
			→	09/05→	1	24.8190-0275.2 620275	L= 872
520 d	120	04/05→02/08	←	 ; 07/05→; nicht für Behördenfahrzeuge	1	24.8190-0273.2 620273	L= 662
			←	 ; 07/05→; für Behördenfahrzeuge	1	24.8190-0273.2 620273	L= 662
			→	07/05→	1	24.8190-0275.2 620275	L= 872
520 d	130	03/07→05/10	←	 ; 09/07→	1	24.8190-0273.2 620273	L= 662
			→	09/07→	1	24.8190-0275.2 620275	L= 872
520 i	120	07/07→08/10	←	 ; → 05/10; für Behördenfahrzeuge	1	24.8190-0273.2 620273	L= 662
520 i	125	09/07→12/10	←	 ; → 05/10; nicht für Behördenfahrzeuge	1	24.8190-0273.2 620273	L= 662
			→	→ 05/10	1	24.8190-0275.2 620275	L= 872
523 i	130	07/05→12/10	←	 ; für Behördenfahrzeuge; → 03/07	1	24.8190-0273.2 620273	L= 662
525 d	130	06/04→12/10	←	 ; nicht für Behördenfahrzeuge; → 03/07	1	24.8190-0273.2 620273	L= 662
			→	→ 03/07	1	24.8190-0275.2 620275	L= 872
523 i	140	01/07→12/10	←	 ; 03/07→ 05/10; Motorcode: N53	1	24.8190-0273.2 620273	L= 662
			←	 ; 03/07→ 05/10; nicht für Behördenfahrzeuge; Motorcode: N52N	1	24.8190-0273.2 620273	L= 662
			←	 ; 03/07→ 05/10; für Behördenfahrzeuge; Motorcode: N52N	1	24.8190-0273.2 620273	L= 662
			→	03/07→ 05/10	1	24.8190-0275.2 620275	L= 872
525 d	120	12/04→12/10	←	 ; → 05/10	1	24.8190-0273.2 620273	L= 662
525 d xDrive	145	09/08→12/10	→	→ 05/10	1	24.8190-0275.2 620275	L= 872
525 i xDrive	160	09/08→12/10					
525 xi	160	07/05→12/10					
525 xi	160	01/07→12/10					
530 d xDrive	173	09/08→12/10					
530 i xDrive	200	09/08→12/10					
525 d	145	01/07→12/10	←	 ; 03/07→ 05/10; für Behördenfahrzeuge	1	24.8190-0273.2 620273	L= 662
			←	 ; 03/07→ 05/10; nicht für Behördenfahrzeuge	1	24.8190-0273.2 620273	L= 662
			→	03/07→ 05/10; für Behördenfahrzeuge	1	24.8190-0275.2 620275	L= 872
			→	03/07→ 05/10; nicht für Behördenfahrzeuge	1	24.8190-0275.2 620275	L= 872
525 i	141	06/04→12/10	←	 ; für Behördenfahrzeuge; → 03/05	1	24.8190-0273.2 620273	L= 662
			←	 ; nicht für Behördenfahrzeuge; → 03/05	1	24.8190-0273.2 620273	L= 662
			→	→ 03/05	1	24.8190-0275.2 620275	L= 872
525 i	155	07/05→12/10	←	 ; → 03/07	1	24.8190-0273.2 620273	L= 662
525 i	160	07/05→12/10	←	 ; 03/07→ 05/10; nicht für Behördenfahrzeuge; Motorcode: N52N	1	24.8190-0273.2 620273	L= 662
525 i	155	01/07→12/10	←	 ; 03/07→ 05/10; Motorcode: N53	1	24.8190-0273.2 620273	L= 662
525 i	160	01/07→12/10	←	 ; 03/07→ 05/10; für Behördenfahrzeuge; Motorcode: N52N	1	24.8190-0273.2 620273	L= 662
			→	→ 03/07	1	24.8190-0275.2 620275	L= 872
↓							







	kw			 	! #		
BMW - 5 Touring (E61) 06/04→12/10							
Warnkontakt, Bremsbelagverschleiß							
525 i	155	07/05→12/10	➡	03/07→ 05/10; Motorcode: N53; nicht für Behördenfahrzeuge	1	24.8190-0275.2 620275	L= 872
525 i	160	07/05→12/10					
525 i	155	01/07→12/10	➡	03/07→ 05/10; Motorcode: N52N	1	24.8190-0275.2 620275	L= 872
525 i	160	01/07→12/10	➡	03/07→ 05/10; für Behördenfahrzeuge; Motorcode: N53	1	24.8190-0275.2 620275	L= 872
525 xd	145	01/07→12/10	⬅	☐; 03/07→ 05/10	1	24.8190-0273.2 620273	L= 662
530 xd	173	01/07→12/10					
530 xi	200	01/07→12/10	➡	03/07→ 05/10	1	24.8190-0275.2 620275	L= 872
535 d	210	01/07→12/10					
530 d	155	11/05→12/10	⬅	☐; → 05/10	1	24.8190-0273.2 620273	L= 662
530 d	160	06/04→12/10	➡	→ 05/10; für Behördenfahrzeuge	1	24.8190-0275.2 620275	L= 872
530 d	170	07/05→12/10	➡	→ 05/10; nicht für Behördenfahrzeuge	1	24.8190-0275.2 620275	L= 872
530 d	173	01/07→12/10	⬅	☐; 03/07→ 05/10	1	24.8190-0273.2 620273	L= 662
			➡	03/07→ 05/10; nicht für Behördenfahrzeuge	1	24.8190-0275.2 620275	L= 872
			➡	03/07→ 05/10; für Behördenfahrzeuge	1	24.8190-0275.2 620275	L= 872
530 i	190	07/05→12/10	⬅	☐; → 03/07	1	24.8190-0273.2 620273	L= 662
530 xd	170	07/05→12/10					
530 xi	190	07/05→12/10	➡	→ 03/07	1	24.8190-0275.2 620275	L= 872
535 d	200	09/04→12/10					
530 i	200	01/07→12/10	⬅	☐; 03/07→ 05/10	1	24.8190-0273.2 620273	L= 662
			➡	03/07→ 05/10; für Behördenfahrzeuge; Motorcode: N52N	1	24.8190-0275.2 620275	L= 872
			➡	03/07→ 05/10; Motorcode: N53	1	24.8190-0275.2 620275	L= 872
			➡	03/07→ 05/10; nicht für Behördenfahrzeuge; Motorcode: N52N	1	24.8190-0275.2 620275	L= 872
545 i	245	06/04→12/10	⬅	→ 08/05	1	24.8190-0273.2 620273	L= 662
			➡	→ 08/05	1	24.8190-0275.2 620275	L= 872
550 i	270	07/05→12/10	⬅	03/07→ 05/10	1	24.8190-0273.2 620273	L= 662
			⬅	→ 03/07	1	24.8190-0273.2 620273	L= 662
			➡	→ 05/10	1	24.8190-0275.2 620275	L= 872
M5	373	02/07→12/10	⬅	☐; → 05/10	1	24.8190-0273.2 620273	L= 662
			⬅	☐; → 05/10	1	24.8190-0276.2 620276	L= 674
			➡	→ 05/10	1	24.8190-0279.2 620279	L= 992
Bremsscheibe							
520 d	110	04/05→02/08	⬅	09/05→; nicht für Behördenfahrzeuge		24.0124-0181.1 424181 24.0324-0181.1 524181	Ø 310 24 22,4 V + S Ø 310 24 21,6 V + S PD
			➡	09/05→		24.0120-0183.1 420183 24.0320-0183.1 520183	Ø 320 20 18,4 V + S Ø 320 20 17,6 V + S PD
520 d	120	04/05→02/08	⬅	07/05→; nicht für Behördenfahrzeuge		24.0124-0181.1 424181 24.0324-0181.1 524181	Ø 310 24 22,4 V + S Ø 310 24 21,6 V + S PD
			⬅	07/05→; für Behördenfahrzeuge		24.0130-0173.1 430173 24.0330-0173.1 530173	Ø 324 30 28,4 V + S Ø 324 30 27,6 V + S PD
			➡	07/05→		24.0120-0183.1 420183 24.0320-0183.1 520183	Ø 320 20 18,4 V + S Ø 320 20 17,6 V + S PD
520 d	130	03/07→05/10	⬅	09/07→		24.0130-0173.1 430173 24.0330-0173.1 530173	Ø 324 30 28,4 V + S Ø 324 30 27,6 V + S PD
			➡	09/07→		24.0120-0183.1 420183 24.0320-0183.1 520183	Ø 320 20 18,4 V + S Ø 320 20 17,6 V + S PD
520 i	120	07/07→08/10	⬅	→ 05/10; nicht für Behördenfahrzeuge		24.0124-0181.1 424181 24.0324-0181.1 524181	Ø 310 24 22,4 V + S Ø 310 24 21,6 V + S PD
520 i	125	09/07→12/10	⬅	→ 05/10; für Behördenfahrzeuge		24.0130-0173.1 430173 24.0330-0173.1 530173	Ø 324 30 28,4 V + S Ø 324 30 27,6 V + S PD
			➡	→ 05/10		24.0120-0183.1 420183 24.0320-0183.1 520183	Ø 320 20 18,4 V + S Ø 320 20 17,6 V + S PD
523 i	130	07/05→12/10	⬅	nicht für Behördenfahrzeuge; → 03/07		24.0124-0181.1 424181 24.0324-0181.1 524181	Ø 310 24 22,4 V + S Ø 310 24 21,6 V + S PD
525 d	130	06/04→12/10	⬅	für Behördenfahrzeuge; → 03/07		24.0130-0173.1 430173 24.0330-0173.1 530173	Ø 324 30 28,4 V + S Ø 324 30 27,6 V + S PD
			➡	→ 03/07		24.0120-0183.1 420183 24.0320-0183.1 520183	Ø 320 20 18,4 V + S Ø 320 20 17,6 V + S PD
↓							







	kw			 	! #		
BMW - 5 Touring (E61) 06/04→12/10							
Bremsscheibe							
523 i	140	01/07→12/10	←	03/07→ 05/10; nicht für Behördenfahrzeuge; Motorcode: N52N	24.0124-0181.1 424181 24.0324-0181.1 524181	Ø 310 24 22,4 V + S Ø 310 24 21,6 V + S PD	
			←	03/07→ 05/10; Motorcode: N53	24.0130-0173.1 430173 24.0330-0173.1 530173	Ø 324 30 28,4 V + S Ø 324 30 27,6 V + S PD	
			←	03/07→ 05/10; für Behördenfahrzeuge; Motorcode: N52N	24.0130-0173.1 430173 24.0330-0173.1 530173	Ø 324 30 28,4 V + S Ø 324 30 27,6 V + S PD	
			→	03/07→ 05/10	24.0120-0183.1 420183 24.0320-0183.1 520183	Ø 320 20 18,4 V + S Ø 320 20 17,6 V + S PD	
525 d	120	12/04→12/10	←	→ 05/10	24.0124-0181.1 424181 24.0130-0173.1 430173 24.0324-0181.1 524181 24.0330-0173.1 530173	Ø 310 24 22,4 V + S Ø 324 30 28,4 V + S Ø 310 24 21,6 V + S PD Ø 324 30 27,6 V + S PD	
			→	→ 05/10	24.0120-0183.1 420183 24.0320-0183.1 520183	Ø 320 20 18,4 V + S Ø 320 20 17,6 V + S PD	
525 d 530 d	145 173	01/07→12/10 01/07→12/10	←	03/07→ 05/10; nicht für Behördenfahrzeuge	24.0130-0173.1 430173 24.0330-0173.1 530173	Ø 324 30 28,4 V + S Ø 324 30 27,6 V + S PD	
			←	03/07→ 05/10; für Behördenfahrzeuge	24.0130-0186.2 430186	Ø 348 30 28,4 V Bremsscheibe zweiteilig / + S	
			→	03/07→ 05/10; nicht für Behördenfahrzeuge	24.0120-0183.1 420183 24.0320-0183.1 520183	Ø 320 20 18,4 V + S Ø 320 20 17,6 V + S PD	
			→	03/07→ 05/10; für Behördenfahrzeuge	24.0124-0201.2 424201	Ø 345 24 22,4 V Bremsscheibe zweiteilig / + S	
525 d xDrive 525 i xDrive 525 xi 525 xi 530 d xDrive 530 i xDrive	145 160 160 160 173 200	09/08→12/10 09/08→12/10 07/05→12/10 01/07→12/10 09/08→12/10 09/08→12/10	←	→ 05/10	24.0130-0173.1 430173 24.0330-0173.1 530173	Ø 324 30 28,4 V + S Ø 324 30 27,6 V + S PD	
			→	→ 05/10	24.0120-0213.1 420213 24.0320-0213.1 520213	Ø 320 20 18,4 V + S Ø 320 20 17,6 V + S PD	
525 i	141	06/04→12/10	←	nicht für Behördenfahrzeuge; → 03/05	24.0124-0181.1 424181 24.0324-0181.1 524181	Ø 310 24 22,4 V + S Ø 310 24 21,6 V + S PD	
			←	für Behördenfahrzeuge; → 03/05	24.0130-0173.1 430173 24.0330-0173.1 530173	Ø 324 30 28,4 V + S Ø 324 30 27,6 V + S PD	
			→	→ 03/05	24.0120-0183.1 420183 24.0320-0183.1 520183	Ø 320 20 18,4 V + S Ø 320 20 17,6 V + S PD	
525 i 525 i 525 i 525 i	155 160 155 160	07/05→12/10 07/05→12/10 01/07→12/10 01/07→12/10	←	03/07→ 05/10; nicht für Behördenfahrzeuge; Motorcode: N52N	24.0124-0181.1 424181 24.0324-0181.1 524181	Ø 310 24 22,4 V + S Ø 310 24 21,6 V + S PD	
			←	→ 03/07	24.0130-0173.1 430173 24.0330-0173.1 530173	Ø 324 30 28,4 V + S Ø 324 30 27,6 V + S PD	
			←	03/07→ 05/10; für Behördenfahrzeuge; Motorcode: N52N	24.0130-0173.1 430173 24.0330-0173.1 530173	Ø 324 30 28,4 V + S Ø 324 30 27,6 V + S PD	
			←	03/07→ 05/10; nicht für Behördenfahrzeuge; Motorcode: N53	24.0130-0173.1 430173 24.0330-0173.1 530173	Ø 324 30 28,4 V + S Ø 324 30 27,6 V + S PD	
			←	03/07→ 05/10; für Behördenfahrzeuge; Motorcode: N53	24.0130-0186.2 430186	Ø 348 30 28,4 V Bremsscheibe zweiteilig / + S	
			→	03/07→ 05/10; Motorcode: N53; nicht für Behördenfahrzeuge	24.0120-0183.1 420183 24.0320-0183.1 520183	Ø 320 20 18,4 V + S Ø 320 20 17,6 V + S PD	
			→	03/07→ 05/10; Motorcode: N52N	24.0120-0183.1 420183 24.0320-0183.1 520183	Ø 320 20 18,4 V + S Ø 320 20 17,6 V + S PD	
			→	→ 03/07	24.0120-0183.1 420183 24.0320-0183.1 520183	Ø 320 20 18,4 V + S Ø 320 20 17,6 V + S PD	
			→	03/07→ 05/10; für Behördenfahrzeuge; Motorcode: N53	24.0124-0201.2 424201	Ø 345 24 22,4 V Bremsscheibe zweiteilig / + S	
525 xd 530 xd 530 xi	145 173 200	01/07→12/10 01/07→12/10 01/07→12/10	←	03/07→ 05/10	24.0130-0173.1 430173 24.0330-0173.1 530173	Ø 324 30 28,4 V + S Ø 324 30 27,6 V + S PD	
			→	03/07→ 05/10	24.0120-0213.1 420213 24.0320-0213.1 520213	Ø 320 20 18,4 V + S Ø 320 20 17,6 V + S PD	
530 d 530 d 530 d	155 160 170	11/05→12/10 06/04→12/10 07/05→12/10	←	→ 05/10; nicht für Behördenfahrzeuge	24.0130-0173.1 430173 24.0330-0173.1 530173	Ø 324 30 28,4 V + S Ø 324 30 27,6 V + S PD	
			←	für Behördenfahrzeuge; → 05/10	24.0130-0186.2 430186	Ø 348 30 28,4 V Bremsscheibe zweiteilig / + S	
			→	→ 05/10; nicht für Behördenfahrzeuge	24.0120-0183.1 420183 24.0320-0183.1 520183	Ø 320 20 18,4 V + S Ø 320 20 17,6 V + S PD	
↓							







	kw			 	! #		
BMW - 5 Touring (E61) 06/04→12/10							
Bremsscheibe							
530 d	155	11/05→12/10	➔	→ 05/10; für Behördenfahrzeuge		24.0124-0201.2 424201	Ø 345 24 22,4 V Bremscheibe zweiteilig / + S
530 d	160	06/04→12/10					
530 d	170	07/05→12/10					
530 i	190	07/05→12/10	➔	→ 03/07		24.0130-0173.1 430173 24.0330-0173.1 530173	Ø 324 30 28,4 V + S Ø 324 30 27,6 V + S PD
			➔	→ 03/07		24.0120-0183.1 420183 24.0320-0183.1 520183	Ø 320 20 18,4 V + S Ø 320 20 17,6 V + S PD
530 i	200	01/07→12/10	➔	03/07→ 05/10; nicht für Behördenfahrzeuge; Motorcode: N52N		24.0130-0173.1 430173 24.0330-0173.1 530173	Ø 324 30 28,4 V + S Ø 324 30 27,6 V + S PD
			➔	03/07→ 05/10; für Behördenfahrzeuge; Motorcode: N52N		24.0130-0186.2 430186	Ø 348 30 28,4 V Bremscheibe zweiteilig / + S
			➔	03/07→ 05/10; Motorcode: N53		24.0130-0186.2 430186	Ø 348 30 28,4 V Bremscheibe zweiteilig / + S
			➔	03/07→ 05/10; nicht für Behördenfahrzeuge; Motorcode: N52N		24.0120-0183.1 420183 24.0320-0183.1 520183	Ø 320 20 18,4 V + S Ø 320 20 17,6 V + S PD
			➔	03/07→ 05/10; Motorcode: N53		24.0124-0201.2 424201	Ø 345 24 22,4 V Bremscheibe zweiteilig / + S
			➔	03/07→ 05/10; für Behördenfahrzeuge; Motorcode: N52N		24.0124-0201.2 424201	Ø 345 24 22,4 V Bremscheibe zweiteilig / + S
530 xd 530 xi	170 190	07/05→12/10 07/05→12/10	➔	→ 03/07		24.0130-0173.1 430173 24.0330-0173.1 530173	Ø 324 30 28,4 V + S Ø 324 30 27,6 V + S PD
			➔	→ 03/07		24.0120-0213.1 420213 24.0320-0213.1 520213	Ø 320 20 18,4 V + S Ø 320 20 17,6 V + S PD
535 d	200	09/04→12/10	➔	→ 03/07		24.0136-0106.2 436106	Ø 348 36 34,4 V Bremscheibe zweiteilig / + S
			➔	→ 03/07		24.0124-0201.2 424201	Ø 345 24 22,4 V Bremscheibe zweiteilig / + S
535 d	210	01/07→12/10	➔	03/07→ 05/10		24.0136-0106.2 436106	Ø 348 36 34,4 V Bremscheibe zweiteilig / + S
			➔	03/07→ 05/10		24.0124-0201.2 424201	Ø 345 24 22,4 V Bremscheibe zweiteilig / + S
545 i	245	06/04→12/10	➔	→ 08/05		24.0130-0186.2 430186	Ø 348 30 28,4 V Bremscheibe zweiteilig / + S
			➔	→ 08/05		24.0124-0201.2 424201	Ø 345 24 22,4 V Bremscheibe zweiteilig / + S
550 i	270	07/05→12/10	➔	03/07→; für USA; → 05/10		24.0130-0186.2 430186	Ø 348 30 28,4 V Bremscheibe zweiteilig / + S
			➔	→ 03/07		24.0136-0106.2 436106	Ø 348 36 34,4 V Bremscheibe zweiteilig / + S
			➔	03/07→; nicht für USA; → 05/10		24.0136-0106.2 436106	Ø 348 36 34,4 V Bremscheibe zweiteilig / + S
			➔	→ 05/10		24.0124-0201.2 424201	Ø 345 24 22,4 V Bremscheibe zweiteilig / + S
M5	373	02/07→12/10	➔	☐; → 05/10		24.0136-0116.2 436116	Ø 374 36 34,4 V• Bremscheibe zweiteilig / + S
			➔	☐; → 05/10		24.0136-0117.2 436117	Ø 374 36 34,4 V• Bremscheibe zweiteilig / + S
			➔	☐; → 05/10		24.0124-0234.2 424234	Ø 370 24 22,4 V• Bremscheibe zweiteilig / + S
			➔	☐; → 05/10		24.0124-0235.2 424235	Ø 370 24 22,4 V• Bremscheibe zweiteilig / + S
BMW - 5 Touring (F11) 02/09→							
Bremsbelagsatz, Scheibenbremse							
518 d 518 d	100 105	10/12→ 10/12→07/14	➔	01/13→; nicht für Fahrzeuge mit verstärkter Bremscheibe		13.0460-7268.2 607268 13.0470-7268.2 LD7268	ATE 23794 20,3 + WE / - WK ATE 23794 20,3 + WE / - WK Ceramic
			➔	01/13→; für Fahrzeuge mit verstärkter Bremscheibe		13.0460-7275.2 607275 13.0470-7275.2 LD7275	ATE 23313 20,2 + WE / - WK ATE 23313 20,2 + WE / - WK Ceramic
			➔	01/13→; für Fahrzeuge mit verstärkter Bremscheibe		13.0460-2716.2 602716 13.0470-2716.2 LD2716	TRW 24703 17,8 + WE / - WK + Zub TRW 24703 17,8 + WE / - WK + Zub Ceramic
			➔	01/13→; nicht für Fahrzeuge mit verstärkter Bremscheibe		13.0460-2760.2 602760	TRW 24561 17,7 + WE / - WK + Zub







	kw			 	! #		
BMW - 5 Touring (F11) 02/09→							
 Bremsbelagsatz, Scheibenbremse							
518 d 518 d	100 105	10/12→ 10/12→07/14	➔	01/13→; nicht für Fahrzeuge mit verstärkter Bremsen		13.0470-2760.2 LD2760	TRW 24561 17,7 + WE / - WK + Zub Ceramic
518 d	110	01/14→	➔	05/14→; nicht für Fahrzeuge mit verstärkter Bremsen		13.0460-7268.2 607268 13.0470-7268.2 LD7268	ATE 23794 20,3 + WE / - WK Ceramic
			➔	05/14→; für Fahrzeuge mit verstärkter Bremsen		13.0460-7275.2 607275 13.0470-7275.2 LD7275	ATE 23313 20,2 + WE / - WK Ceramic
			➔	05/14→; für Fahrzeuge mit verstärkter Bremsen		13.0460-2716.2 602716 13.0470-2716.2 LD2716	TRW 24703 17,8 + WE / - WK + Zub Ceramic
			➔	05/14→; nicht für Fahrzeuge mit verstärkter Bremsen		13.0460-2760.2 602760 13.0470-2760.2 LD2760	TRW 24561 17,7 + WE / - WK + Zub Ceramic
518 d 520 d 520 d xDrive 520 d xDrive 520 d xDrive 520 d xDrive	120 120 100 120 135 147	05/14→ 10/13→06/13 02/13→07/14 10/13→06/13 02/13→07/14 02/13→07/14	➔	nicht für Fahrzeuge mit verstärkter Bremsen		13.0460-7268.2 607268 13.0470-7268.2 LD7268	ATE 23794 20,3 + WE / - WK Ceramic
			➔	für Fahrzeuge mit verstärkter Bremsen		13.0460-7275.2 607275 13.0470-7275.2 LD7275	ATE 23313 20,2 + WE / - WK Ceramic
			➔	für Fahrzeuge mit verstärkter Bremsen		13.0460-2716.2 602716 13.0470-2716.2 LD2716	TRW 24703 17,8 + WE / - WK + Zub Ceramic
			➔	nicht für Fahrzeuge mit verstärkter Bremsen		13.0460-2760.2 602760 13.0470-2760.2 LD2760	TRW 24561 17,7 + WE / - WK + Zub Ceramic
520 d 520 d 520 d	100 135 147	11/09→10/16 02/09→10/16 02/09→10/16	➔	09/10→; nicht für Fahrzeuge mit verstärkter Bremsen		13.0460-7268.2 607268 13.0470-7268.2 LD7268	ATE 23794 20,3 + WE / - WK Ceramic
			➔	09/10→; für Fahrzeuge mit verstärkter Bremsen		13.0460-7275.2 607275 13.0470-7275.2 LD7275	ATE 23313 20,2 + WE / - WK Ceramic
			➔	09/10→; für Fahrzeuge mit verstärkter Bremsen		13.0460-2716.2 602716 13.0470-2716.2 LD2716	TRW 24703 17,8 + WE / - WK + Zub Ceramic
			➔	09/10→; nicht für Fahrzeuge mit verstärkter Bremsen		13.0460-2760.2 602760 13.0470-2760.2 LD2760	TRW 24561 17,7 + WE / - WK + Zub Ceramic
520 d 520 d 520 d xDrive 520 d xDrive	140 155 140 155	10/13→ 10/13→ 10/13→ 10/13→	➔	05/14→; für Fahrzeuge mit verstärkter Bremsen		13.0460-7267.2 607267 13.0470-7267.2 LD7267	ATE 25045 19,5 + WE / - WK Ceramic
			➔	05/14→; nicht für Fahrzeuge mit verstärkter Bremsen		13.0460-7268.2 607268 13.0470-7268.2 LD7268	ATE 23794 20,3 + WE / - WK Ceramic
			➔	05/14→; für Fahrzeuge mit verstärkter Bremsen		13.0460-2716.2 602716 13.0470-2716.2 LD2716	TRW 24703 17,8 + WE / - WK + Zub Ceramic
			➔	05/14→; nicht für Fahrzeuge mit verstärkter Bremsen		13.0460-2760.2 602760 13.0470-2760.2 LD2760	TRW 24561 17,7 + WE / - WK + Zub Ceramic
520 i	120	09/11→	➔			13.0460-7268.2 607268 13.0470-7268.2 LD7268	ATE 23794 20,3 + WE / - WK Ceramic
			➔			13.0460-2760.2 602760 13.0470-2760.2 LD2760	TRW 24561 17,7 + WE / - WK + Zub Ceramic
520 i	135	10/10→	➔	09/11→		13.0460-7268.2 607268 13.0470-7268.2 LD7268	ATE 23794 20,3 + WE / - WK Ceramic
↓							











	kw			 	! #		
BMW - 5 Touring (F11) 02/09→							
 Bremsbelagsatz, Scheibenbremse							
520 i	135	10/10→	➡	09/11→		13.0460-2760.2 602760 13.0470-2760.2 LD2760	TRW 24561 17,7 + WE / - WK + Zub TRW 24561 17,7 + WE / - WK + Zub Ceramic
523 i 523 i	150 150	11/09→08/11 10/09→08/11	⬅	09/10→		13.0460-7268.2 607268 13.0470-7268.2 LD7268	ATE 23794 20,3 + WE / - WK ATE 23794 20,3 + WE / - WK Ceramic
			➡	09/10→		13.0460-2760.2 602760 13.0470-2760.2 LD2760	TRW 24561 17,7 + WE / - WK + Zub TRW 24561 17,7 + WE / - WK + Zub Ceramic
525 d 525 d 525 d xDrive 525 d xDrive 530 d	155 160 155 160 190	03/11→ 03/11→ 02/11→ 02/11→ 02/11→	⬅	09/11→; für Fahrzeuge mit verstärkter Bremse		13.0460-7267.2 607267 13.0470-7267.2 LD7267	ATE 25045 19,5 + WE / - WK ATE 25045 19,5 + WE / - WK Ceramic
			⬅	09/11→; nicht für Fahrzeuge mit verstärkter Bremse		13.0460-7275.2 607275 13.0470-7275.2 LD7275	ATE 23313 20,2 + WE / - WK ATE 23313 20,2 + WE / - WK Ceramic
			➡	09/11→; für Fahrzeuge mit verstärkter Bremse		13.0460-2716.2 602716 13.0470-2716.2 LD2716	TRW 24703 17,8 + WE / - WK + Zub TRW 24703 17,8 + WE / - WK + Zub Ceramic
			➡	09/11→; nicht für Fahrzeuge mit verstärkter Bremse		13.0460-2760.2 602760 13.0470-2760.2 LD2760	TRW 24561 17,7 + WE / - WK + Zub TRW 24561 17,7 + WE / - WK + Zub Ceramic
525 d 528 i	150 190	11/09→08/11 11/09→08/11	⬅	09/10→		13.0460-7275.2 607275 13.0470-7275.2 LD7275	ATE 23313 20,2 + WE / - WK ATE 23313 20,2 + WE / - WK Ceramic
			➡	09/10→		13.0460-2760.2 602760 13.0470-2760.2 LD2760	TRW 24561 17,7 + WE / - WK + Zub TRW 24561 17,7 + WE / - WK + Zub Ceramic
528 i 528 i xDrive 530 i 530 i	180 180 190 200	10/10→ 03/11→ 03/10→05/13 07/11→06/13	⬅	09/11→		13.0460-7275.2 607275 13.0470-7275.2 LD7275	ATE 23313 20,2 + WE / - WK ATE 23313 20,2 + WE / - WK Ceramic
			➡	09/11→		13.0460-2760.2 602760 13.0470-2760.2 LD2760	TRW 24561 17,7 + WE / - WK + Zub TRW 24561 17,7 + WE / - WK + Zub Ceramic
530 d	180	11/09→08/11	⬅	09/10→		13.0460-7275.2 607275 13.0470-7275.2 LD7275	ATE 23313 20,2 + WE / - WK ATE 23313 20,2 + WE / - WK Ceramic
			➡	09/10→; für Fahrzeuge mit verstärkter Bremse		13.0460-2716.2 602716 13.0470-2716.2 LD2716	TRW 24703 17,8 + WE / - WK + Zub TRW 24703 17,8 + WE / - WK + Zub Ceramic
			➡	09/10→; nicht für Fahrzeuge mit verstärkter Bremse		13.0460-2760.2 602760 13.0470-2760.2 LD2760	TRW 24561 17,7 + WE / - WK + Zub TRW 24561 17,7 + WE / - WK + Zub Ceramic
530 d	210	09/11→	⬅	10/15→; für Fahrzeuge mit verstärkter Bremse		13.0460-7267.2 607267 13.0470-7267.2 LD7267	ATE 25045 19,5 + WE / - WK ATE 25045 19,5 + WE / - WK Ceramic
			⬅	10/15→; nicht für Fahrzeuge mit verstärkter Bremse		13.0460-7275.2 607275 13.0470-7275.2 LD7275	ATE 23313 20,2 + WE / - WK ATE 23313 20,2 + WE / - WK Ceramic
			➡	10/15→; für Fahrzeuge mit verstärkter Bremse		13.0460-2716.2 602716 13.0470-2716.2 LD2716	TRW 24703 17,8 + WE / - WK + Zub TRW 24703 17,8 + WE / - WK + Zub Ceramic
			➡	10/15→; nicht für Fahrzeuge mit verstärkter Bremse		13.0460-2760.2 602760 13.0470-2760.2 LD2760	TRW 24561 17,7 + WE / - WK + Zub TRW 24561 17,7 + WE / - WK + Zub Ceramic
530 d xDrive	190	07/10→	⬅	03/11→; für Fahrzeuge mit verstärkter Bremse		13.0460-7267.2 607267 13.0470-7267.2 LD7267	ATE 25045 19,5 + WE / - WK ATE 25045 19,5 + WE / - WK Ceramic
			⬅	03/11→; nicht für Fahrzeuge mit verstärkter Bremse		13.0460-7275.2 607275	ATE 23313 20,2 + WE / - WK











	kw			 	! #			
BMW - 5 Touring (F11) 02/09→								
Bremsbelagsatz, Scheibenbremse								
530 d xDrive	190	07/10→	←	03/11→; nicht für Fahrzeuge mit verstärkter Bremse	13.0470-7275.2	LD7275	ATE 23313 20,2 + WE / - WK Ceramic	
			→	03/11→; für Fahrzeuge mit verstärkter Bremse	13.0460-2716.2	602716	TRW 24703 17,8 + WE / - WK + Zub	
			→	03/11→; nicht für Fahrzeuge mit verstärkter Bremse	13.0460-2760.2	602760	TRW 24561 17,7 + WE / - WK + Zub	
530 d xDrive	210	09/11→	←	10/15→; für Fahrzeuge mit verstärkter Bremse	13.0460-7267.2	607267	ATE 25045 19,5 + WE / - WK	
			←	10/15→; nicht für Fahrzeuge mit verstärkter Bremse	13.0470-7267.2	LD7267	ATE 25045 19,5 + WE / - WK Ceramic	
			→	10/15→	13.0460-2716.2	602716	TRW 24703 17,8 + WE / - WK + Zub	
535 d 535 d 535 i	220 225 225	03/10→08/11 03/10→08/11 11/09→	←	09/10→	13.0460-7267.2	607267	ATE 25045 19,5 + WE / - WK	
			→	09/10→	13.0470-7267.2	LD7267	ATE 25045 19,5 + WE / - WK Ceramic	
			→	09/10→	13.0460-2716.2	602716	TRW 24703 17,8 + WE / - WK + Zub	
535 d 535 d xDrive 550 i	230 230 300	03/11→ 01/11→ 09/10→06/13	←	09/11→	13.0460-7267.2	607267	ATE 25045 19,5 + WE / - WK	
			→	09/11→	13.0460-2716.2	602716	TRW 24703 17,8 + WE / - WK + Zub	
			→	09/11→	13.0470-2716.2	LD2716	TRW 24703 17,8 + WE / - WK + Zub Ceramic	
535 i 535 i xDrive	240 240	01/13→ 07/13→	←	10/15→	13.0460-7267.2	607267	ATE 25045 19,5 + WE / - WK	
			←	10/15→	13.0470-7267.2	LD7267	ATE 25045 19,5 + WE / - WK Ceramic	
			→	10/15→	13.0460-2716.2	602716	TRW 24703 17,8 + WE / - WK + Zub	
535 i xDrive	225	07/10→	←	09/11→	13.0460-7267.2	607267	ATE 25045 19,5 + WE / - WK	
			←	09/11→	13.0470-7267.2	LD7267	ATE 25045 19,5 + WE / - WK Ceramic	
			→	09/11→	13.0460-2716.2	602716	TRW 24703 17,8 + WE / - WK + Zub	
550 i	330	08/12→	←	05/13→	13.0460-7267.2	607267	ATE 25045 19,5 + WE / - WK	
			→	05/13→	13.0460-2716.2	602716	TRW 24703 17,8 + WE / - WK + Zub	
			→	05/13→	13.0470-2716.2	LD2716	TRW 24703 17,8 + WE / - WK + Zub Ceramic	
M 550 d xDrive	280	10/10→	←	03/12→	13.0460-7267.2	607267	ATE 25045 19,5 + WE / - WK	
			→	03/12→	13.0460-2716.2	602716	TRW 24703 17,8 + WE / - WK + Zub	
			→	03/12→	13.0470-2716.2	LD2716	TRW 24703 17,8 + WE / - WK + Zub Ceramic	
Warnkontakt, Bremsbelagverschleiß								
518 d 518 d	100 105	10/12→ 10/12→07/14	←	☐; 01/13→; für Fahrzeuge mit verstärkter Bremse	1	24.8190-0298.2	620298	L= 1.087
			←	☐; 01/13→; nicht für Fahrzeuge mit verstärkter Bremse	1	24.8190-0298.2	620298	L= 1.087
			→	01/13→; nicht für Fahrzeuge mit verstärkter Bremse	1	24.8190-0308.2	620308	L= 1.110
			→	01/13→; für Fahrzeuge mit verstärkter Bremse	1	24.8190-0308.2	620308	L= 1.110
↓								









	kW			 	! #			
BMW - 5 Touring (F11) 02/09→								
Warnkontakt, Bremsbelagverschleiß								
518 d 520 d 520 d 520 d xDrive 520 d xDrive	110 140 155 140 155	01/14→ 10/13→ 10/13→ 10/13→ 10/13→	← ← → →	☐; 05/14→; für Fahrzeuge mit verstärkter Bremse ☐; 05/14→; nicht für Fahrzeuge mit verstärkter Bremse 05/14→; für Fahrzeuge mit verstärkter Bremse 05/14→; nicht für Fahrzeuge mit verstärkter Bremse	1 1 1 1	24.8190-0298.2 24.8190-0298.2 24.8190-0308.2 24.8190-0308.2	620298 620298 620308 620308	L= 1.087 L= 1.087 L= 1.110 L= 1.110
518 d 520 d 520 d xDrive 520 d xDrive 520 d xDrive 520 d xDrive	120 120 100 120 135 147	05/14→ 10/13→06/13 02/13→07/14 10/13→06/13 02/13→07/14 02/13→07/14	← ← → →	☐; für Fahrzeuge mit verstärkter Bremse ☐; nicht für Fahrzeuge mit verstärkter Bremse für Fahrzeuge mit verstärkter Bremse nicht für Fahrzeuge mit verstärkter Bremse	1 1 1 1	24.8190-0298.2 24.8190-0298.2 24.8190-0308.2 24.8190-0308.2	620298 620298 620308 620308	L= 1.087 L= 1.087 L= 1.110 L= 1.110
520 d 520 d 520 d	100 135 147	11/09→10/16 02/09→10/16 02/09→10/16	← ← → →	☐; 09/10→; für Fahrzeuge mit verstärkter Bremse ☐; 09/10→; nicht für Fahrzeuge mit verstärkter Bremse 09/10→; nicht für Fahrzeuge mit verstärkter Bremse 09/10→; für Fahrzeuge mit verstärkter Bremse	1 1 1 1	24.8190-0298.2 24.8190-0298.2 24.8190-0308.2 24.8190-0308.2	620298 620298 620308 620308	L= 1.087 L= 1.087 L= 1.110 L= 1.110
520 i	120	09/11→	← →	☐ ☐	1 1	24.8190-0298.2 24.8190-0308.2	620298 620308	L= 1.087 L= 1.110
520 i 528 i 528 i xDrive 530 i 530 i 535 d 535 d xDrive 535 i xDrive 550 i	135 180 180 190 200 230 230 225 300	10/10→ 10/10→ 03/11→ 03/10→05/13 07/11→06/13 03/11→ 01/11→ 07/10→ 09/10→06/13	← → →	☐; 09/11→ 09/11→	1 1	24.8190-0298.2 24.8190-0308.2	620298 620308	L= 1.087 L= 1.110
523 i 523 i 525 d 528 i 535 d 535 d 535 i	150 150 150 190 220 225 225	11/09→08/11 10/09→08/11 11/09→08/11 11/09→08/11 03/10→08/11 03/10→08/11 11/09→	← →	☐; 09/10→ 09/10→	1 1	24.8190-0298.2 24.8190-0308.2	620298 620308	L= 1.087 L= 1.110
525 d 525 d 525 d xDrive 525 d xDrive 530 d	155 160 155 160 190	03/11→ 03/11→ 02/11→ 02/11→ 02/11→	← ← → →	☐; 09/11→; für Fahrzeuge mit verstärkter Bremse ☐; 09/11→; nicht für Fahrzeuge mit verstärkter Bremse 09/11→; nicht für Fahrzeuge mit verstärkter Bremse 09/11→; für Fahrzeuge mit verstärkter Bremse	1 1 1 1	24.8190-0298.2 24.8190-0298.2 24.8190-0308.2 24.8190-0308.2	620298 620298 620308 620308	L= 1.087 L= 1.087 L= 1.110 L= 1.110
530 d	180	11/09→08/11	← → →	☐; 09/10→ 09/10→; für Fahrzeuge mit verstärkter Bremse 09/10→; nicht für Fahrzeuge mit verstärkter Bremse	1 1 1	24.8190-0298.2 24.8190-0308.2 24.8190-0308.2	620298 620308 620308	L= 1.087 L= 1.110 L= 1.110
530 d	210	09/11→	← ← → →	☐; 10/15→; für Fahrzeuge mit verstärkter Bremse ☐; 10/15→; nicht für Fahrzeuge mit verstärkter Bremse 10/15→; für Fahrzeuge mit verstärkter Bremse 10/15→; nicht für Fahrzeuge mit verstärkter Bremse	1 1 1 1	24.8190-0298.2 24.8190-0298.2 24.8190-0308.2 24.8190-0308.2	620298 620298 620308 620308	L= 1.087 L= 1.087 L= 1.110 L= 1.110
530 d xDrive ↓	190	07/10→	←	☐; 03/11→; für Fahrzeuge mit verstärkter Bremse	1	24.8190-0298.2	620298	L= 1.087











	kw			 	! #			
BMW - 5 Touring (F11) 02/09→								
Warnkontakt, Bremsbelagverschleiß								
530 d xDrive	190	07/10→	←	☐; 03/11→; nicht für Fahrzeuge mit verstärkter Bremse	1	24.8190-0298.2	620298	L= 1.087
			→	03/11→; für Fahrzeuge mit verstärkter Bremse	1	24.8190-0308.2	620308	L= 1.110
			→	03/11→; nicht für Fahrzeuge mit verstärkter Bremse	1	24.8190-0308.2	620308	L= 1.110
530 d xDrive	210	09/11→	←	☐; 10/15→; für Fahrzeuge mit verstärkter Bremse	1	24.8190-0298.2	620298	L= 1.087
			←	☐; 10/15→; nicht für Fahrzeuge mit verstärkter Bremse	1	24.8190-0298.2	620298	L= 1.087
			→	10/15→	1	24.8190-0308.2	620308	L= 1.110
535 i 535 i xDrive	240 240	01/13→ 07/13→	←	☐; 10/15→	1	24.8190-0298.2	620298	L= 1.087
			→	10/15→	1	24.8190-0308.2	620308	L= 1.110
550 i	330	08/12→	←	☐; 05/13→	1	24.8190-0298.2	620298	L= 1.087
			→	05/13→	1	24.8190-0308.2	620308	L= 1.110
M 550 d xDrive	280	10/10→	←	☐; 03/12→	1	24.8190-0298.2	620298	L= 1.087
			→	03/12→	1	24.8190-0308.2	620308	L= 1.110
Bremsscheibe								
518 d 518 d	100 105	10/12→ 10/12→07/14	←	01/13→; nicht für Fahrzeuge mit verstärkter Bremse		24.0124-0239.2	424239	Ø 330 24 22,4 V Bremsscheibe zweiteilig / + S
			←	01/13→; für Fahrzeuge mit verstärkter Bremse		24.0130-0218.2	430218	Ø 348 30 28,4 V Bremsscheibe zweiteilig / + S
			→	01/13→; nicht für Fahrzeuge mit verstärkter Bremse		24.0120-0229.2	420229	Ø 330 20 18,4 V Bremsscheibe zweiteilig / + S
			→	01/13→; für Fahrzeuge mit verstärkter Bremse		24.0124-0233.2	424233	Ø 345 24 22,4 V Bremsscheibe zweiteilig / + S
518 d	110	01/14→	←	05/14→; nicht für Fahrzeuge mit verstärkter Bremse		24.0124-0239.2	424239	Ø 330 24 22,4 V Bremsscheibe zweiteilig / + S
			←	05/14→; für Fahrzeuge mit verstärkter Bremse		24.0130-0218.2	430218	Ø 348 30 28,4 V Bremsscheibe zweiteilig / + S
			→	05/14→; nicht für Fahrzeuge mit verstärkter Bremse		24.0120-0229.2	420229	Ø 330 20 18,4 V Bremsscheibe zweiteilig / + S
			→	05/14→; für Fahrzeuge mit verstärkter Bremse		24.0124-0233.2	424233	Ø 345 24 22,4 V Bremsscheibe zweiteilig / + S
518 d 520 d 520 d xDrive 520 d xDrive 520 d xDrive 520 d xDrive	120 120 100 120 135 147	05/14→ 10/13→06/13 02/13→07/14 10/13→06/13 02/13→07/14 02/13→07/14	←	nicht für Fahrzeuge mit verstärkter Bremse		24.0124-0239.2	424239	Ø 330 24 22,4 V Bremsscheibe zweiteilig / + S
			←	für Fahrzeuge mit verstärkter Bremse		24.0130-0218.2	430218	Ø 348 30 28,4 V Bremsscheibe zweiteilig / + S
			→	nicht für Fahrzeuge mit verstärkter Bremse		24.0120-0229.2	420229	Ø 330 20 18,4 V Bremsscheibe zweiteilig / + S
			→	für Fahrzeuge mit verstärkter Bremse		24.0124-0233.2	424233	Ø 345 24 22,4 V Bremsscheibe zweiteilig / + S
			→					
520 d 520 d 520 d	100 135 147	11/09→10/16 02/09→10/16 02/09→10/16	←	09/10→; nicht für Fahrzeuge mit verstärkter Bremse		24.0124-0239.2	424239	Ø 330 24 22,4 V Bremsscheibe zweiteilig / + S
			←	09/10→; für Fahrzeuge mit verstärkter Bremse		24.0130-0218.2	430218	Ø 348 30 28,4 V Bremsscheibe zweiteilig / + S
			→	09/10→; nicht für Fahrzeuge mit verstärkter Bremse		24.0120-0229.2	420229	Ø 330 20 18,4 V Bremsscheibe zweiteilig / + S
			→	09/10→; für Fahrzeuge mit verstärkter Bremse		24.0124-0233.2	424233	Ø 345 24 22,4 V Bremsscheibe zweiteilig / + S
520 d 520 d 520 d xDrive 520 d xDrive	140 155 140 155	10/13→ 10/13→ 10/13→ 10/13→	←	05/14→; nicht für Fahrzeuge mit verstärkter Bremse		24.0124-0239.2	424239	Ø 330 24 22,4 V Bremsscheibe zweiteilig / + S
			←	☐; 05/14→; für Fahrzeuge mit verstärkter Bremse		24.0136-0114.2	436114	Ø 348 36 34,4 V Bremsscheibe zweiteilig / + S
			←	☐; 05/14→; für Fahrzeuge mit verstärkter Bremse		24.0136-0115.2	436115	Ø 348 36 34,4 V Bremsscheibe zweiteilig / + S
			→	05/14→; nicht für Fahrzeuge mit verstärkter Bremse		24.0120-0229.2	420229	Ø 330 20 18,4 V Bremsscheibe zweiteilig / + S
			→					
↓								

	kw			 	! #		
BMW - 5 Touring (F11) 02/09→							
Bremsscheibe							
520 d	140	10/13→	➔	05/14→; für Fahrzeuge mit verstärkter Bremse		24.0124-0233.2 424233	Ø 345 24 22,4 V Bremsscheibe zweiteilig / + S
520 d	155	10/13→					
520 d xDrive	140	10/13→					
520 d xDrive	155	10/13→					
520 i	120	09/11→	➔			24.0124-0239.2 424239	Ø 330 24 22,4 V Bremsscheibe zweiteilig / + S
			➔			24.0120-0229.2 420229	Ø 330 20 18,4 V Bremsscheibe zweiteilig / + S
520 i	135	10/10→	➔	09/11→		24.0124-0239.2 424239	Ø 330 24 22,4 V Bremsscheibe zweiteilig / + S
			➔	09/11→		24.0120-0229.2 420229	Ø 330 20 18,4 V Bremsscheibe zweiteilig / + S
523 i	150	11/09→08/11	➔	09/10→		24.0124-0239.2 424239	Ø 330 24 22,4 V Bremsscheibe zweiteilig / + S
523 i	150	10/09→08/11	➔	09/10→		24.0120-0229.2 420229	Ø 330 20 18,4 V Bremsscheibe zweiteilig / + S
525 d	155	03/11→	➔	09/11→; nicht für Fahrzeuge mit verstärkter Bremse		24.0130-0218.2 430218	Ø 348 30 28,4 V Bremsscheibe zweiteilig / + S
525 d	160	03/11→					
525 d xDrive	155	02/11→	➔	☐; 09/11→; für Fahrzeuge mit verstärkter Bremse		24.0136-0114.2 436114	Ø 348 36 34,4 V Bremsscheibe zweiteilig / + S
525 d xDrive	160	02/11→	➔	☐; 09/11→; für Fahrzeuge mit verstärkter Bremse		24.0136-0115.2 436115	Ø 348 36 34,4 V Bremsscheibe zweiteilig / + S
530 d	190	02/11→	➔	09/11→; nicht für Fahrzeuge mit verstärkter Bremse		24.0120-0229.2 420229	Ø 330 20 18,4 V Bremsscheibe zweiteilig / + S
			➔	09/11→; für Fahrzeuge mit verstärkter Bremse		24.0124-0233.2 424233	Ø 345 24 22,4 V Bremsscheibe zweiteilig / + S
525 d	150	11/09→08/11	➔	09/10→		24.0130-0218.2 430218	Ø 348 30 28,4 V Bremsscheibe zweiteilig / + S
528 i	190	11/09→08/11					
530 d	180	11/09→08/11	➔	09/10→		24.0120-0229.2 420229	Ø 330 20 18,4 V Bremsscheibe zweiteilig / + S
528 i	180	10/10→	➔	09/11→		24.0130-0218.2 430218	Ø 348 30 28,4 V Bremsscheibe zweiteilig / + S
528 i xDrive	180	03/11→					
530 i	190	03/10→05/13	➔	09/11→		24.0120-0229.2 420229	Ø 330 20 18,4 V Bremsscheibe zweiteilig / + S
530 i	200	07/11→06/13					
530 d	210	09/11→	➔	10/15→; nicht für Fahrzeuge mit verstärkter Bremse		24.0130-0218.2 430218	Ø 348 30 28,4 V Bremsscheibe zweiteilig / + S
			➔	☐; 10/15→; für Fahrzeuge mit verstärkter Bremse		24.0136-0114.2 436114	Ø 348 36 34,4 V Bremsscheibe zweiteilig / + S
			➔	☐; 10/15→; für Fahrzeuge mit verstärkter Bremse		24.0136-0115.2 436115	Ø 348 36 34,4 V Bremsscheibe zweiteilig / + S
			➔	10/15→; nicht für Fahrzeuge mit verstärkter Bremse		24.0120-0229.2 420229	Ø 330 20 18,4 V Bremsscheibe zweiteilig / + S
			➔	10/15→; für Fahrzeuge mit verstärkter Bremse		24.0124-0233.2 424233	Ø 345 24 22,4 V Bremsscheibe zweiteilig / + S
530 d xDrive	190	07/10→	➔	03/11→; nicht für Fahrzeuge mit verstärkter Bremse		24.0130-0218.2 430218	Ø 348 30 28,4 V Bremsscheibe zweiteilig / + S
			➔	☐; 03/11→; für Fahrzeuge mit verstärkter Bremse		24.0136-0114.2 436114	Ø 348 36 34,4 V Bremsscheibe zweiteilig / + S
			➔	☐; 03/11→; für Fahrzeuge mit verstärkter Bremse		24.0136-0115.2 436115	Ø 348 36 34,4 V Bremsscheibe zweiteilig / + S
			➔	03/11→		24.0124-0233.2 424233	Ø 345 24 22,4 V Bremsscheibe zweiteilig / + S
530 d xDrive	210	09/11→	➔	10/15→; nicht für Fahrzeuge mit verstärkter Bremse		24.0130-0218.2 430218	Ø 348 30 28,4 V Bremsscheibe zweiteilig / + S
			➔	☐; 10/15→; für Fahrzeuge mit verstärkter Bremse		24.0136-0114.2 436114	Ø 348 36 34,4 V Bremsscheibe zweiteilig / + S
			➔	☐; 10/15→; für Fahrzeuge mit verstärkter Bremse		24.0136-0115.2 436115	Ø 348 36 34,4 V Bremsscheibe zweiteilig / + S
			➔	10/15→		24.0124-0233.2 424233	Ø 345 24 22,4 V Bremsscheibe zweiteilig / + S
535 d	220	03/10→08/11	➔	☐; 09/10→		24.0136-0114.2 436114	Ø 348 36 34,4 V Bremsscheibe zweiteilig / + S
535 d	225	03/10→08/11					
535 i	225	11/09→	➔	☐; 09/10→		24.0136-0115.2 436115	Ø 348 36 34,4 V Bremsscheibe zweiteilig / + S
			➔	09/10→		24.0124-0233.2 424233	Ø 345 24 22,4 V Bremsscheibe zweiteilig / + S
↓							

























	kW			 	! #			
BMW - 5 Touring (F11) 02/09→								
 Bremsscheibe								
535 d 535 d xDrive 535 i xDrive	230 230 225	03/11→ 01/11→ 07/10→	←	☐; 09/11→		24.0136-0114.2	436114	Ø 348 36 34,4 V Bremsscheibe zweiteilig / + S
			←	☐; 09/11→		24.0136-0115.2	436115	Ø 348 36 34,4 V Bremsscheibe zweiteilig / + S
			→	09/11→		24.0124-0233.2	424233	Ø 345 24 22,4 V Bremsscheibe zweiteilig / + S
535 i 535 i xDrive	240 240	01/13→ 07/13→	←	☐; 10/15→		24.0136-0114.2	436114	Ø 348 36 34,4 V Bremsscheibe zweiteilig / + S
			←	☐; 10/15→		24.0136-0115.2	436115	Ø 348 36 34,4 V Bremsscheibe zweiteilig / + S
			→	10/15→		24.0124-0233.2	424233	Ø 345 24 22,4 V Bremsscheibe zweiteilig / + S
550 i	300	09/10→06/13	←	☐; 09/11→		24.0136-0118.2	436118	Ø 374 36 34,4 V Bremsscheibe zweiteilig / + S
			←	☐; 09/11→		24.0136-0119.2	436119	Ø 374 36 34,4 V Bremsscheibe zweiteilig / + S
			→	09/11→		24.0124-0233.2	424233	Ø 345 24 22,4 V Bremsscheibe zweiteilig / + S
550 i	330	08/12→	←	☐; 05/13→		24.0136-0118.2	436118	Ø 374 36 34,4 V Bremsscheibe zweiteilig / + S
			←	☐; 05/13→		24.0136-0119.2	436119	Ø 374 36 34,4 V Bremsscheibe zweiteilig / + S
			→	05/13→		24.0124-0233.2	424233	Ø 345 24 22,4 V Bremsscheibe zweiteilig / + S
M 550 d xDrive	280	10/10→	←	☐; 03/12→		24.0136-0118.2	436118	Ø 374 36 34,4 V Bremsscheibe zweiteilig / + S
			←	☐; 03/12→		24.0136-0119.2	436119	Ø 374 36 34,4 V Bremsscheibe zweiteilig / + S
			→	03/12→		24.0124-0233.2	424233	Ø 345 24 22,4 V Bremsscheibe zweiteilig / + S
BMW - 5 Touring (G31) 03/17→								
 Bremsbelagsatz, Scheibenbremse								
530 d 530 d xDrive 530 i	195 195 185	03/17→ 03/17→ 03/17→	→	für Fahrzeuge mit Sportpaket		13.0460-2716.2	602716	TRW 24703 17,8 + WE / - WK + Zub
						13.0470-2716.2	LD2716	TRW 24703 17,8 + WE / - WK + Zub Ceramic
540 i xDrive 540 i xDrive	250 265	03/17→ 03/17→	→			13.0460-2716.2	602716	TRW 24703 17,8 + WE / - WK + Zub
						13.0470-2716.2	LD2716	TRW 24703 17,8 + WE / - WK + Zub Ceramic
BMW - 6 (E63) 01/04→12/10								
 Bremsbelagsatz, Scheibenbremse								
630 i	190	09/04→07/10	←	→ 08/07		13.0460-7167.2	607167	ATE 23312 20,3 + WE / - WK
						13.0460-7296.2	607296	ATE 23212 20,3 + WE / - WK
						13.0470-7167.2	LD7167	ATE 23312 20,3 + WE / - WK Ceramic
						13.0470-7296.2	LD7296	ATE 23212 20,3 + WE / - WK Ceramic
			→	→ 08/07		13.0460-7174.2	607174	ATE 23732 17,3 + WE / - WK
						13.0470-7174.2	LD7174	ATE 23732 17,3 + WE / - WK Ceramic
630 i	200	07/07→07/10	←	09/07→		13.0460-7167.2	607167	ATE 23312 20,3 + WE / - WK
						13.0460-7296.2	607296	ATE 23212 20,3 + WE / - WK
						13.0470-7167.2	LD7167	ATE 23312 20,3 + WE / - WK Ceramic
						13.0470-7296.2	LD7296	ATE 23212 20,3 + WE / - WK Ceramic
			→	09/07→		13.0460-7169.2	607169	ATE 23309 17,3 + WE / - WK
						13.0470-7169.2	LD7169	ATE 23309 17,3 + WE / - WK Ceramic
635 d	210	07/07→07/10	←	09/07→		13.0460-7210.2	607210	ATE 23791 20,8 + WE / - WK
						13.0470-7210.2	LD7210	ATE 23791 20,8 + WE / - WK Ceramic
						13.0460-7169.2	607169	ATE 23309 17,3 + WE / - WK
						13.0470-7169.2	LD7169	ATE 23309 17,3 + WE / - WK Ceramic
↓								







	kW			 	! #		
BMW - 6 (E63) 01/04→12/10							
 Bremsbelagsatz, Scheibenbremse							
645 Ci	245	01/04→08/05	←			13.0460-7167.2 607167	ATE 23312 20,3 + WE / - WK
			→			13.0460-7169.2 607169	ATE 23309 17,3 + WE / - WK
						13.0470-7169.2 LD7169	ATE 23309 17,3 + WE / - WK Ceramic
650 i	270	07/05→07/10	←			13.0460-7210.2 607210	ATE 23791 20,8 + WE / - WK
			→			13.0460-7169.2 607169	ATE 23309 17,3 + WE / - WK
						13.0470-7169.2 LD7169	ATE 23309 17,3 + WE / - WK Ceramic
M	373	09/05→07/10	←			13.0460-7210.2 607210	ATE 23791 20,8 + WE / - WK
Warnkontakt, Bremsbelagverschleiß							
630 i	190	09/04→07/10	←	→ 08/07	1	24.8190-0273.2 620273	L= 662
			→	→ 08/07	1	24.8190-0274.2 620274	L= 664
630 i 635 d	200 210	07/07→07/10 07/07→07/10	←	09/07→	1	24.8190-0273.2 620273	L= 662
			→	09/07→	1	24.8190-0274.2 620274	L= 664
645 Ci 650 i	245 270	01/04→08/05 07/05→07/10	←		1	24.8190-0273.2 620273	L= 662
			→		1	24.8190-0274.2 620274	L= 664
M	373	09/05→07/10	←	☐	1	24.8190-0273.2 620273	L= 662
			←	☐	1	24.8190-0276.2 620276	L= 674
			→		1	24.8190-0274.2 620274	L= 664
 Bremsscheibe							
630 i	190	09/04→07/10	←	→ 08/07		24.0130-0173.1 430173	Ø 324 30 28,4 V + S
			→	→ 08/07		24.0330-0173.1 530173	Ø 324 30 27,6 V + S PD
						24.0120-0183.1 420183	Ø 320 20 18,4 V + S
630 i	200	07/07→07/10	←	09/07→		24.0130-0186.2 430186	Ø 320 20 17,6 V + S PD
			→	09/07→		24.0124-0201.2 424201	Ø 348 30 28,4 V Bremsscheibe zweiteilig / + S
635 d	210	07/07→07/10	←	09/07→		24.0124-0201.2 424201	Ø 345 24 22,4 V Bremsscheibe zweiteilig / + S
			→	09/07→		24.0136-0106.2 436106	Ø 348 36 34,4 V Bremsscheibe zweiteilig / + S
645 Ci	245	01/04→08/05	←			24.0136-0106.2 436106	Ø 345 24 22,4 V Bremsscheibe zweiteilig / + S
			→			24.0124-0201.2 424201	Ø 348 30 28,4 V Bremsscheibe zweiteilig / + S
650 i	270	07/05→07/10	←			24.0124-0201.2 424201	Ø 348 36 34,4 V Bremsscheibe zweiteilig / + S
			→			24.0136-0106.2 436106	Ø 345 24 22,4 V Bremsscheibe zweiteilig / + S
M	373	09/05→07/10	←	☐		24.0136-0116.2 436116	Ø 374 36 34,4 V* Bremsscheibe zweiteilig / + S
			←	☐		24.0136-0117.2 436117	Ø 374 36 34,4 V* Bremsscheibe zweiteilig / + S
			→	☐		24.0124-0234.2 424234	Ø 370 24 22,4 V* Bremsscheibe zweiteilig / + S
			→	☐		24.0124-0235.2 424235	Ø 370 24 22,4 V* Bremsscheibe zweiteilig / + S
BMW - 6 Cabriolet (E64) 04/04→12/10							
 Bremsbelagsatz, Scheibenbremse							
630 i	190	09/04→07/10	←	→ 08/07		13.0460-7167.2 607167	ATE 23312 20,3 + WE / - WK
			→	→ 08/07		13.0460-7296.2 607296	ATE 23212 20,3 + WE / - WK
630 i	200	07/07→07/10	←	09/07→		13.0470-7167.2 LD7167	ATE 23312 20,3 + WE / - WK Ceramic
						13.0470-7296.2 LD7296	ATE 23212 20,3 + WE / - WK Ceramic
			→	→ 08/07		13.0460-7174.2 607174	ATE 23732 17,3 + WE / - WK
						13.0470-7174.2 LD7174	ATE 23732 17,3 + WE / - WK Ceramic
			←	09/07→		13.0460-7167.2 607167	ATE 23312 20,3 + WE / - WK
						13.0460-7296.2 607296	ATE 23212 20,3 + WE / - WK







	kw			 	! #		
BMW - 6 Cabriolet (E64) 04/04→12/10							
 Bremsbelagsatz, Scheibenbremse							
630 i	200	07/07→07/10	←	09/07→		13.0470-7167.2 LD7167	ATE 23312 20,3 + WE / - WK Ceramic
						13.0470-7296.2 LD7296	ATE 23212 20,3 + WE / - WK Ceramic
630 i	200	07/07→07/10	→	09/07→		13.0460-7169.2 607169	ATE 23309 17,3 + WE / - WK Ceramic
						13.0470-7169.2 LD7169	ATE 23309 17,3 + WE / - WK Ceramic
635 d	210	07/07→07/10	←	09/07→		13.0460-7210.2 607210	ATE 23791 20,8 + WE / - WK Ceramic
						13.0470-7210.2 LD7210	ATE 23791 20,8 + WE / - WK Ceramic
635 d	210	07/07→07/10	→	09/07→		13.0460-7169.2 607169	ATE 23309 17,3 + WE / - WK Ceramic
						13.0470-7169.2 LD7169	ATE 23309 17,3 + WE / - WK Ceramic
645 Ci	245	04/04→08/05	←			13.0460-7167.2 607167	ATE 23312 20,3 + WE / - WK
						13.0460-7169.2 607169	ATE 23309 17,3 + WE / - WK
645 Ci	245	04/04→08/05	→			13.0470-7169.2 LD7169	ATE 23309 17,3 + WE / - WK Ceramic
650 i	270	07/05→07/10	←			13.0460-7210.2 607210	ATE 23791 20,8 + WE / - WK
						13.0460-7169.2 607169	ATE 23309 17,3 + WE / - WK
650 i	270	07/05→07/10	→			13.0470-7169.2 LD7169	ATE 23309 17,3 + WE / - WK Ceramic
M	373	07/06→07/10	←			13.0460-7210.2 607210	ATE 23791 20,8 + WE / - WK
Warnkontakt, Bremsbelagverschleiß							
630 i	190	09/04→07/10	←	☐; → 08/07	1	24.8190-0273.2 620273	L= 662
			→	→ 08/07	1	24.8190-0274.2 620274	L= 664
630 i 635 d	200 210	07/07→07/10 07/07→07/10	←	☐; 09/07→	1	24.8190-0273.2 620273	L= 662
			→	09/07→	1	24.8190-0274.2 620274	L= 664
645 Ci	245	04/04→08/05	←	☐	1	24.8190-0273.2 620273	L= 662
			→		1	24.8190-0274.2 620274	L= 664
650 i	270	07/05→07/10	←		1	24.8190-0273.2 620273	L= 662
			→		1	24.8190-0274.2 620274	L= 664
M	373	07/06→07/10	←	☐	1	24.8190-0273.2 620273	L= 662
			←	☐	1	24.8190-0276.2 620276	L= 674
			→		1	24.8190-0274.2 620274	L= 664
 Bremsscheibe							
630 i	190	09/04→07/10	←	→ 08/07		24.0130-0173.1 430173	Ø 324 30 28,4 V + S
						24.0330-0173.1 530173	Ø 324 30 27,6 V + S PD
630 i	190	09/04→07/10	→	→ 08/07		24.0120-0183.1 420183	Ø 320 20 18,4 V + S
						24.0320-0183.1 520183	Ø 320 20 17,6 V + S PD
630 i	200	07/07→07/10	←	09/07→		24.0130-0186.2 430186	Ø 348 30 28,4 V Bremsscheibe zweiteilig / + S
			→	09/07→		24.0124-0201.2 424201	Ø 345 24 22,4 V Bremsscheibe zweiteilig / + S
635 d	210	07/07→07/10	←	09/07→		24.0136-0106.2 436106	Ø 348 36 34,4 V Bremsscheibe zweiteilig / + S
			→	09/07→		24.0124-0201.2 424201	Ø 345 24 22,4 V Bremsscheibe zweiteilig / + S
645 Ci	245	04/04→08/05	←			24.0130-0186.2 430186	Ø 348 30 28,4 V Bremsscheibe zweiteilig / + S
			→			24.0124-0201.2 424201	Ø 345 24 22,4 V Bremsscheibe zweiteilig / + S
650 i	270	07/05→07/10	←			24.0136-0106.2 436106	Ø 348 36 34,4 V Bremsscheibe zweiteilig / + S
			→			24.0124-0201.2 424201	Ø 345 24 22,4 V Bremsscheibe zweiteilig / + S
M	373	07/06→07/10	←	☐		24.0136-0116.2 436116	Ø 374 36 34,4 V• Bremsscheibe zweiteilig / + S
			←	☐		24.0136-0117.2 436117	Ø 374 36 34,4 V• Bremsscheibe zweiteilig / + S
			→	☐		24.0124-0234.2 424234	Ø 370 24 22,4 V• Bremsscheibe zweiteilig / + S
↓							









	kW			 	! #		
BMW - 6 Cabriolet (E64) 04/04→12/10							
 Bremsscheibe							
M	373	07/06→07/10	→	<input type="checkbox"/>		24.0124-0235.2 424235	Ø 370 24 22,4 V• Bremsscheibe zweiteilig / + S
BMW - 6 Cabriolet (F12) 03/11→							
 Bremsbelagsatz, Scheibenbremse							
640 d	230	09/11→	←			13.0460-7267.2 607267	ATE 25045 19,5 + WE / - WK
640 i	235	03/11→					
640 i xDrive	235	01/13→	→			13.0460-2716.2 602716	TRW 24703 17,8 + WE / - WK + Zub
650 i	298	09/11→12/12					
650 i	300	03/11→				13.0470-2716.2 LD2716	TRW 24703 17,8 + WE / - WK + Zub Ceramic
650 i	330	10/11→					
650 i xDrive	300	06/11→					
640 d xDrive	230	09/11→	←	03/12→		13.0460-7267.2 607267	ATE 25045 19,5 + WE / - WK
			→	03/12→		13.0460-2716.2 602716	TRW 24703 17,8 + WE / - WK + Zub
						13.0470-2716.2 LD2716	TRW 24703 17,8 + WE / - WK + Zub Ceramic
650 i xDrive	330	11/11→	←	09/12→		13.0460-7267.2 607267	ATE 25045 19,5 + WE / - WK
			→	09/12→		13.0460-2716.2 602716	TRW 24703 17,8 + WE / - WK + Zub
						13.0470-2716.2 LD2716	TRW 24703 17,8 + WE / - WK + Zub Ceramic
M6	412	01/12→	→	06/12→; für Fahrzeuge ohne Keramikbremse		13.0460-2716.2 602716	TRW 24703 17,8 + WE / - WK + Zub
						13.0470-2716.2 LD2716	TRW 24703 17,8 + WE / - WK + Zub Ceramic
M6	423	02/14→	→	für Fahrzeuge ohne Keramikbremse		13.0460-2716.2 602716	TRW 24703 17,8 + WE / - WK + Zub
M6	441	07/15→				13.0470-2716.2 LD2716	TRW 24703 17,8 + WE / - WK + Zub Ceramic
Warnkontakt, Bremsbelagverschleiß							
640 d	230	09/11→	←	<input type="checkbox"/>	1	24.8190-0298.2 620298	L= 1.087
640 i	235	03/11→					
640 i xDrive	235	01/13→	→		1	24.8190-0312.2 620312	L= 915
650 i	298	09/11→12/12					
650 i	300	03/11→					
650 i	330	10/11→					
650 i xDrive	300	06/11→					
640 d xDrive	230	09/11→	←	<input type="checkbox"/> ; 03/12→	1	24.8190-0298.2 620298	L= 1.087
			→	03/12→	1	24.8190-0312.2 620312	L= 915
650 i xDrive	330	11/11→	←	<input type="checkbox"/> ; 09/12→	1	24.8190-0298.2 620298	L= 1.087
			→	09/12→	1	24.8190-0312.2 620312	L= 915
M6	412	01/12→	←	<input type="checkbox"/> ; 06/12→	1	24.8190-0298.2 620298	L= 1.087
			→	06/12→	1	24.8190-0008.2 620008	L= 1.000
M6	423	02/14→	←	<input type="checkbox"/>	1	24.8190-0298.2 620298	L= 1.087
M6	441	07/15→	→		1	24.8190-0008.2 620008	L= 1.000
 Bremsscheibe							
640 d	230	09/11→	←	<input type="checkbox"/>		24.0136-0114.2 436114	Ø 348 36 34,4 V Bremsscheibe zweiteilig / + S
640 i	235	03/11→					
640 i xDrive	235	01/13→	←	<input type="checkbox"/>		24.0136-0115.2 436115	Ø 348 36 34,4 V Bremsscheibe zweiteilig / + S
			→			24.0124-0233.2 424233	Ø 345 24 22,4 V Bremsscheibe zweiteilig / + S
640 d xDrive	230	09/11→	←	<input type="checkbox"/> ; 03/12→		24.0136-0114.2 436114	Ø 348 36 34,4 V Bremsscheibe zweiteilig / + S
			←	<input type="checkbox"/> ; 03/12→		24.0136-0115.2 436115	Ø 348 36 34,4 V Bremsscheibe zweiteilig / + S
			→	03/12→		24.0124-0233.2 424233	Ø 345 24 22,4 V Bremsscheibe zweiteilig / + S
650 i	298	09/11→12/12	←	<input type="checkbox"/>		24.0136-0118.2 436118	Ø 374 36 34,4 V Bremsscheibe zweiteilig / + S
650 i	300	03/11→					
650 i	330	10/11→	←	<input type="checkbox"/>		24.0136-0119.2 436119	Ø 374 36 34,4 V Bremsscheibe zweiteilig / + S
650 i xDrive	300	06/11→	→			24.0124-0233.2 424233	Ø 345 24 22,4 V Bremsscheibe zweiteilig / + S
↓							











	kW			 	! #			
BMW - 6 Cabriolet (F12) 03/11→								
 Bremsscheibe								
650 i xDrive	330	11/11→	←	 ; 09/12→		24.0136-0118.2	436118	Ø 374 36 34,4 V Bremsscheibe zweiteilig / + S
			←	 ; 09/12→		24.0136-0119.2	436119	Ø 374 36 34,4 V Bremsscheibe zweiteilig / + S
			→	09/12→		24.0124-0233.2	424233	Ø 345 24 22,4 V Bremsscheibe zweiteilig / + S
M6	412	01/12→	←	 ; 06/12→; für Fahrzeuge ohne Keramikbremse		24.0136-0125.2	436125	Ø 400 36 34,4 V* Bremsscheibe zweiteilig / + S
			←	 ; 06/12→; für Fahrzeuge ohne Keramikbremse		24.0136-0126.2	436126	Ø 400 36 34,4 V* Bremsscheibe zweiteilig / + S
M6 M6	423 441	02/14→ 07/15→	←	 ; für Fahrzeuge ohne Keramikbremse		24.0136-0125.2	436125	Ø 400 36 34,4 V* Bremsscheibe zweiteilig / + S
			←	 ; für Fahrzeuge ohne Keramikbremse		24.0136-0126.2	436126	Ø 400 36 34,4 V* Bremsscheibe zweiteilig / + S
BMW - 6 Coupe (F13) 11/10→								
 Bremsbelagsatz, Scheibenbremse								
640 d 640 i 650 i	230 235 300	11/10→ 11/10→ 11/10→	←	06/11→		13.0460-7267.2	607267	ATE 25045 19,5 + WE / - WK
			→	06/11→		13.0460-2716.2	602716	TRW 24703 17,8 + WE / - WK + Zub
						13.0470-2716.2	LD2716	TRW 24703 17,8 + WE / - WK + Zub Ceramic
640 d xDrive	230	09/11→	←	03/12→		13.0460-7267.2	607267	ATE 25045 19,5 + WE / - WK
			→	03/12→		13.0460-2716.2	602716	TRW 24703 17,8 + WE / - WK + Zub
						13.0470-2716.2	LD2716	TRW 24703 17,8 + WE / - WK + Zub Ceramic
640 i xDrive 650 i 650 i xDrive	235 298 300	01/13→ 09/11→12/12 06/11→	←			13.0460-7267.2	607267	ATE 25045 19,5 + WE / - WK
			→			13.0460-2716.2	602716	TRW 24703 17,8 + WE / - WK + Zub
						13.0470-2716.2	LD2716	TRW 24703 17,8 + WE / - WK + Zub Ceramic
650 i 650 i xDrive	330 330	10/11→ 11/11→	←	09/12→		13.0460-7267.2	607267	ATE 25045 19,5 + WE / - WK
			→	09/12→		13.0460-2716.2	602716	TRW 24703 17,8 + WE / - WK + Zub
						13.0470-2716.2	LD2716	TRW 24703 17,8 + WE / - WK + Zub Ceramic
M6	412	01/12→	→	06/12→; für Fahrzeuge ohne Keramikbremse		13.0460-2716.2	602716	TRW 24703 17,8 + WE / - WK + Zub
						13.0470-2716.2	LD2716	TRW 24703 17,8 + WE / - WK + Zub Ceramic
M6 M6	423 441	02/14→ 07/15→	→	für Fahrzeuge ohne Keramikbremse		13.0460-2716.2	602716	TRW 24703 17,8 + WE / - WK + Zub
						13.0470-2716.2	LD2716	TRW 24703 17,8 + WE / - WK + Zub Ceramic
Warnkontakt, Bremsbelagverschleiß								
640 d 640 i 650 i	230 235 300	11/10→ 11/10→ 11/10→	←	 ; 06/11→	1	24.8190-0298.2	620298	L= 1.087
			→	06/11→	1	24.8190-0312.2	620312	L= 915
640 d xDrive	230	09/11→	←	 ; 03/12→	1	24.8190-0298.2	620298	L= 1.087
			→	03/12→	1	24.8190-0312.2	620312	L= 915
640 i xDrive 650 i 650 i xDrive	235 298 300	01/13→ 09/11→12/12 06/11→	←		1	24.8190-0298.2	620298	L= 1.087
			→		1	24.8190-0312.2	620312	L= 915
650 i 650 i xDrive	330 330	10/11→ 11/11→	←	 ; 09/12→	1	24.8190-0298.2	620298	L= 1.087
			→	09/12→	1	24.8190-0312.2	620312	L= 915
M6	412	01/12→	←	 ; 06/12→	1	24.8190-0298.2	620298	L= 1.087
			→	06/12→	1	24.8190-0008.2	620008	L= 1.000
M6 M6	423 441	02/14→ 07/15→	←		1	24.8190-0298.2	620298	L= 1.087
			→		1	24.8190-0008.2	620008	L= 1.000
 Bremsscheibe								
640 d 640 i	230 235	11/10→ 11/10→	←	 ; 06/11→		24.0136-0114.2	436114	Ø 348 36 34,4 V Bremsscheibe zweiteilig / + S
			←	 ; 06/11→		24.0136-0115.2	436115	Ø 348 36 34,4 V Bremsscheibe zweiteilig / + S
↓								

	kW			 	! #		
BMW - 6 Coupe (F13) 11/10→							
Bremsscheibe							
640 d 640 i	230 235	11/10→ 11/10→	→	06/11→		24.0124-0233.2 424233	Ø 345 24 22,4 V Bremsscheibe zweiteilig / + S
640 d xDrive	230	09/11→	←	☐; 03/12→		24.0136-0114.2 436114	Ø 348 36 34,4 V Bremsscheibe zweiteilig / + S
			←	☐; 03/12→		24.0136-0115.2 436115	Ø 348 36 34,4 V Bremsscheibe zweiteilig / + S
			→	03/12→		24.0124-0233.2 424233	Ø 345 24 22,4 V Bremsscheibe zweiteilig / + S
640 i xDrive	235	01/13→	←	☐		24.0136-0114.2 436114	Ø 348 36 34,4 V Bremsscheibe zweiteilig / + S
			←	☐		24.0136-0115.2 436115	Ø 348 36 34,4 V Bremsscheibe zweiteilig / + S
			→			24.0124-0233.2 424233	Ø 345 24 22,4 V Bremsscheibe zweiteilig / + S
650 i 650 i xDrive	298 300	09/11→12/12 06/11→	←	☐		24.0136-0118.2 436118	Ø 374 36 34,4 V Bremsscheibe zweiteilig / + S
			←	☐		24.0136-0119.2 436119	Ø 374 36 34,4 V Bremsscheibe zweiteilig / + S
			→			24.0124-0233.2 424233	Ø 345 24 22,4 V Bremsscheibe zweiteilig / + S
650 i	300	11/10→	←	☐; 06/11→		24.0136-0118.2 436118	Ø 374 36 34,4 V Bremsscheibe zweiteilig / + S
			←	☐; 06/11→		24.0136-0119.2 436119	Ø 374 36 34,4 V Bremsscheibe zweiteilig / + S
			→	06/11→		24.0124-0233.2 424233	Ø 345 24 22,4 V Bremsscheibe zweiteilig / + S
650 i 650 i xDrive	330 330	10/11→ 11/11→	←	☐; 09/12→		24.0136-0118.2 436118	Ø 374 36 34,4 V Bremsscheibe zweiteilig / + S
			←	☐; 09/12→		24.0136-0119.2 436119	Ø 374 36 34,4 V Bremsscheibe zweiteilig / + S
			→	09/12→		24.0124-0233.2 424233	Ø 345 24 22,4 V Bremsscheibe zweiteilig / + S
M6	412	01/12→	←	☐; 06/12→; für Fahrzeuge ohne Keramikbremse		24.0136-0125.2 436125	Ø 400 36 34,4 V* Bremsscheibe zweiteilig / + S
			←	☐; 06/12→; für Fahrzeuge ohne Keramikbremse		24.0136-0126.2 436126	Ø 400 36 34,4 V* Bremsscheibe zweiteilig / + S
M6 M6	423 441	02/14→ 07/15→	←	☐; für Fahrzeuge ohne Keramikbremse		24.0136-0125.2 436125	Ø 400 36 34,4 V* Bremsscheibe zweiteilig / + S
			←	☐; für Fahrzeuge ohne Keramikbremse		24.0136-0126.2 436126	Ø 400 36 34,4 V* Bremsscheibe zweiteilig / + S
BMW - 6 Gran Coupe (F06) 09/11→							
Brembelagsatz, Scheibenbremse							
640 d 640 d xDrive 640 i xDrive 650 i 650 i xDrive	230 230 235 330 330	09/11→ 01/13→ 01/13→ 11/11→ 11/11→	← →			13.0460-7267.2 607267 13.0460-2716.2 602716 13.0470-2716.2 LD2716	ATE 25045 19,5 + WE / - WK TRW 24703 17,8 + WE / - WK + Zub TRW 24703 17,8 + WE / - WK + Zub Ceramic
640 i	235	09/11→	←	03/12→		13.0460-7267.2 607267	ATE 25045 19,5 + WE / - WK
			→	03/12→		13.0460-2716.2 602716 13.0470-2716.2 LD2716	TRW 24703 17,8 + WE / - WK + Zub TRW 24703 17,8 + WE / - WK + Zub Ceramic
M6 M6 M6	412 423 441	12/12→ 02/14→ 07/15→	→	für Fahrzeuge ohne Keramikbremse		13.0460-2716.2 602716 13.0470-2716.2 LD2716	TRW 24703 17,8 + WE / - WK + Zub TRW 24703 17,8 + WE / - WK + Zub Ceramic
Warnkontakt, Bremsbelagverschleiß							
640 d 640 d xDrive 640 i xDrive 650 i 650 i xDrive	230 230 235 330 330	09/11→ 01/13→ 01/13→ 11/11→ 11/11→	← →	☐	1	24.8190-0298.2 620298 24.8190-0312.2 620312	L= 1.087 L= 915
640 i	235	09/11→	←	☐; 03/12→	1	24.8190-0298.2 620298	L= 1.087
			→	03/12→	1	24.8190-0312.2 620312	L= 915
M6 M6 M6 ↓	412 423 441	12/12→ 02/14→ 07/15→	← →	☐	1	24.8190-0298.2 620298 24.8190-0008.2 620008	L= 1.087 L= 1.000

	kw			 	! #			
BMW - 6 Gran Coupe (F06) 09/11→								
Bremsscheibe								
640 d 640 d xDrive 640 i xDrive	230 230 235	09/11→ 01/13→ 01/13→	←	<input type="checkbox"/>		24.0136-0114.2	436114	Ø 348 36 34,4 V Bremsscheibe zweiteilig / + S
			←	<input type="checkbox"/>		24.0136-0115.2	436115	Ø 348 36 34,4 V Bremsscheibe zweiteilig / + S
			→			24.0124-0233.2	424233	Ø 345 24 22,4 V Bremsscheibe zweiteilig / + S
640 i	235	09/11→	←	<input type="checkbox"/> ; 03/12→		24.0136-0114.2	436114	Ø 348 36 34,4 V Bremsscheibe zweiteilig / + S
			←	<input type="checkbox"/> ; 03/12→		24.0136-0115.2	436115	Ø 348 36 34,4 V Bremsscheibe zweiteilig / + S
			→	03/12→		24.0124-0233.2	424233	Ø 345 24 22,4 V Bremsscheibe zweiteilig / + S
650 i 650 i xDrive	330 330	11/11→ 11/11→	←	<input type="checkbox"/>		24.0136-0118.2	436118	Ø 374 36 34,4 V Bremsscheibe zweiteilig / + S
			←	<input type="checkbox"/>		24.0136-0119.2	436119	Ø 374 36 34,4 V Bremsscheibe zweiteilig / + S
			→			24.0124-0233.2	424233	Ø 345 24 22,4 V Bremsscheibe zweiteilig / + S
M6 M6 M6	412 423 441	12/12→ 02/14→ 07/15→	←	<input type="checkbox"/> ; für Fahrzeuge ohne Keramikbremse		24.0136-0125.2	436125	Ø 400 36 34,4 V* Bremsscheibe zweiteilig / + S
			←	<input type="checkbox"/> ; für Fahrzeuge ohne Keramikbremse		24.0136-0126.2	436126	Ø 400 36 34,4 V* Bremsscheibe zweiteilig / + S
BMW - 7 (E38) 10/94→11/01								
Bremsbelagsatz, Scheibenbremse								
725 tds	105	04/96→11/01	←	05/96→		13.0460-4965.2	604965	BRE 21471 18,0 + WE / - WK
			→	05/96→		13.0460-7079.2	607079	ATE 21282 17,3 + WE / - WK
						13.0470-7079.2	LD7079	ATE 21282 17,3 + WE / - WK Ceramic
728 i, iL	142	08/95→11/01	←			13.0460-4965.2	604965	BRE 21471 18,0 + WE / - WK
			←	01/96→		13.0460-4965.2	604965	BRE 21471 18,0 + WE / - WK
			→	01/96→		13.0460-7079.2	607079	ATE 21282 17,3 + WE / - WK
						13.0470-7079.2	LD7079	ATE 21282 17,3 + WE / - WK Ceramic
728i X 730 d 730 i, iL 730 i, iL 735 i, iL 735 i, iL	142 142 155 160 173 175	11/95→09/01 04/00→11/01 10/94→11/01 10/94→11/01 01/96→12/98 09/98→07/01	←			13.0460-4965.2	604965	BRE 21471 18,0 + WE / - WK
			→			13.0460-7079.2	607079	ATE 21282 17,3 + WE / - WK
						13.0470-7079.2	LD7079	ATE 21282 17,3 + WE / - WK Ceramic
			→			13.0460-7079.2	607079	ATE 21282 17,3 + WE / - WK
						13.0470-7079.2	LD7079	ATE 21282 17,3 + WE / - WK Ceramic
730 d	135	08/98→04/00	←	09/98→		13.0460-4965.2	604965	BRE 21471 18,0 + WE / - WK
			→	09/98→		13.0460-7079.2	607079	ATE 21282 17,3 + WE / - WK
						13.0470-7079.2	LD7079	ATE 21282 17,3 + WE / - WK Ceramic
740 d	180	05/99→11/01	←			13.0460-7183.2	607183	ATE 21484 20,5 + WE / - WK
			→			13.0460-7079.2	607079	ATE 21282 17,3 + WE / - WK
						13.0470-7079.2	LD7079	ATE 21282 17,3 + WE / - WK Ceramic
740 i, iL 740 i, iL	210 210	10/94→11/01 01/96→11/01	←			13.0460-7078.2	607078	ATE 21486 19,5 + WE / - WK
						13.0470-7078.2	LD7078	ATE 21486 19,5 + WE / - WK Ceramic
			→			13.0460-7079.2	607079	ATE 21282 17,3 + WE / - WK
750 i, iL	240	12/94→11/01	←	09/98→		13.0460-7183.2	607183	ATE 21484 20,5 + WE / - WK
			←	→ 08/98		13.0460-7183.2	607183	ATE 21484 20,5 + WE / - WK
			→			13.0460-7079.2	607079	ATE 21282 17,3 + WE / - WK
						13.0470-7079.2	LD7079	ATE 21282 17,3 + WE / - WK Ceramic
Warnkontakt, Bremsbelagsverschleiß								
725 tds	105	04/96→11/01	←	05/96→	1	24.8190-0208.2	620208	L= 569
			→	05/96→	1	24.8190-0209.2	620209	L= 620
↓								

	kW			 	! #		
BMW - 7 (E38) 10/94→11/01							
Warnkontakt, Bremsbelagverschleiß							
728 i, iL	142	08/95→11/01	←		1	24.8190-0208.2 620208	L= 569
			←	01/96→	1	24.8190-0208.2 620208	L= 569
			→		1	24.8190-0209.2 620209	L= 620
			→	01/96→	1	24.8190-0209.2 620209	L= 620
728i X	142	11/95→09/01	←		1	24.8190-0208.2 620208	L= 569
730 d	142	04/00→11/01	→		1	24.8190-0209.2 620209	L= 620
730 i, iL	155	10/94→11/01	→				
730 i, iL	160	10/94→11/01	→				
735 i, iL	173	01/96→12/98	→				
735 i, iL	175	09/98→07/01	→				
740 i, iL	210	10/94→11/01	→				
740 i, iL	210	01/96→11/01	→				
730 d	135	08/98→04/00	←	09/98→	1	24.8190-0208.2 620208	L= 569
			→	09/98→	1	24.8190-0209.2 620209	L= 620
740 d	180	05/99→11/01	←		1	24.8190-0234.2 620234	L= 585
			→		1	24.8190-0209.2 620209	L= 620
750 i, iL	240	12/94→11/01	←	→ 08/98	1	24.8190-0232.2 620232	L= 578
			←	09/98→	1	24.8190-0234.2 620234	L= 585
			→		1	24.8190-0209.2 620209	L= 620
Zubehörsatz, Scheibenbremsbelag							
725 tds	105	04/96→11/01	←	05/96→		13.0460-0267.2 610267	
728 i, iL	142	08/95→11/01	←			13.0460-0267.2 610267	
			←	01/96→		13.0460-0267.2 610267	
728i X	142	11/95→09/01	←			13.0460-0267.2 610267	
730 d	142	04/00→11/01	→				
730 i, iL	155	10/94→11/01	→				
730 i, iL	160	10/94→11/01	→				
735 i, iL	173	01/96→12/98	→				
735 i, iL	175	09/98→07/01	→				
730 d	135	08/98→04/00	←	09/98→		13.0460-0267.2 610267	
 Bremsscheibe							
725 tds	105	04/96→11/01	←	05/96→		24.0128-0105.1 428105	Ø 316 28 26,4 V + S
			→	05/96→		24.0112-0132.1 412132	Ø 324 12 10,4 + S
728 i, iL	142	08/95→11/01	←			24.0128-0105.1 428105	Ø 316 28 26,4 V + S
			←	01/96→		24.0128-0105.1 428105	Ø 316 28 26,4 V + S
			→			24.0112-0132.1 412132	Ø 324 12 10,4 + S
			→	01/96→		24.0112-0132.1 412132	Ø 324 12 10,4 + S
728i X	142	11/95→09/01	←			24.0128-0105.1 428105	Ø 316 28 26,4 V + S
730 d	142	04/00→11/01	→			24.0112-0132.1 412132	Ø 324 12 10,4 + S
730 i, iL	155	10/94→11/01	→				
730 i, iL	160	10/94→11/01	→				
735 i, iL	173	01/96→12/98	→				
735 i, iL	175	09/98→07/01	→				
730 d	135	08/98→04/00	←	09/98→		24.0128-0105.1 428105	Ø 316 28 26,4 V + S
			→	09/98→		24.0112-0132.1 412132	Ø 324 12 10,4 + S
740 d	180	05/99→11/01	←			24.0132-0113.1 432113	Ø 334 31,9 30,4 V + S
750 i, iL	240	12/94→11/01	→			24.0120-0182.1 420182	Ø 328 20 18,4 V + S
740 i, iL	210	10/94→11/01	←			24.0130-0101.1 430101	Ø 324 30 28,4 V + S
740 i, iL	210	01/96→11/01	→			24.0112-0132.1 412132	Ø 324 12 10,4 + S
BMW - 7 (E65, E66, E67) 11/01→12/09							
 Bremsbelagsatz, Scheibenbremse							
730 d	150	10/02→07/08	←			13.0460-7167.2 607167	ATE 23312 20,3 + WE / - WK
730 d	155	10/02→07/08	←			13.0460-7306.2 607306	ATE 23312 20,3 + WE / - WK
730 d	160	10/02→07/08	←			13.0470-7167.2 LD7167	ATE 23312 20,3 + WE / - WK Ceramic
			→	→ 02/05		13.0460-7168.2 607168	ATE 21282 17,3 + WE / - WK
			→			13.0470-7168.2 LD7168	ATE 21282 17,3 + WE / - WK Ceramic
730 i, Li	170	03/03→07/08	←			13.0460-7167.2 607167	ATE 23312 20,3 + WE / - WK
			←			13.0460-7306.2 607306	ATE 23312 20,3 + WE / - WK
↓							

	kw			 	! #		
BMW - 7 (E65, E66, E67) 11/01→12/09							
 Bremsbelagsatz, Scheibenbremse							
730 i, Li	170	03/03→07/08	←			13.0470-7167.2 LD7167	ATE 23312 20,3 + WE / - WK Ceramic
			→			13.0460-7168.2 607168	ATE 21282 17,3 + WE / - WK
730 i, Li	190	03/05→07/08	←	07/05→		13.0460-7167.2 607167	ATE 23312 20,3 + WE / - WK
			→	07/05→		13.0460-7306.2 607306	ATE 23312 20,3 + WE / - WK
730 Ld	170	07/05→12/09	←	→ 08/08		13.0460-7167.2 607167	ATE 23312 20,3 + WE / - WK
			→	→ 08/08		13.0460-7306.2 607306	ATE 23312 20,3 + WE / - WK
735 i, Li	200	11/01→02/05	←			13.0470-7167.2 LD7168	ATE 23312 20,3 + WE / - WK Ceramic
			→			13.0460-7168.2 607168	ATE 21282 17,3 + WE / - WK
740 d 740 i, Li 745 i, Li	190 225 245	10/02→02/05 07/05→07/08 11/01→07/08	←			13.0460-7306.2 607306	ATE 23312 20,3 + WE / - WK
			→			13.0460-7169.2 607169	ATE 23309 17,3 + WE / - WK
745 d 745 d	220 242	03/05→08/05 07/05→07/08	←			13.0470-7169.2 LD7169	ATE 23309 17,3 + WE / - WK Ceramic
			→			13.0460-7210.2 607210	ATE 23791 20,8 + WE / - WK
750 i, Li	270	07/05→07/08	←			13.0460-7210.2 607210	ATE 23791 20,8 + WE / - WK
			→			13.0460-7306.2 607306	ATE 23312 20,3 + WE / - WK
760 i, Li	327	01/03→07/08	←	03/03→		13.0460-7169.2 607169	ATE 23309 17,3 + WE / - WK
			→	03/03→		13.0470-7169.2 LD7169	ATE 23309 17,3 + WE / - WK Ceramic
760 i, LI	326	11/01→12/09	←	03/03→ 08/08		13.0460-7210.2 607210	ATE 23791 20,8 + WE / - WK
			→	03/03→ 08/08		13.0460-7306.2 607306	ATE 23312 20,3 + WE / - WK
Warnkontakt, Bremsbelagverschleiß							
730 d	150	10/02→07/08	←		1	24.8190-0230.2 620230	L= 814
730 d	155	10/02→07/08	→	→ 02/05	1	24.8190-0231.2 620231	L= 830
730 d	160	10/02→07/08	→		1	24.8190-0231.2 620231	L= 830
730 i, Li	170	03/03→07/08	←		1	24.8190-0230.2 620230	L= 814
735 i, Li	200	11/01→02/05	→		1	24.8190-0231.2 620231	L= 830
740 d	190	10/02→02/05	→		1	24.8190-0231.2 620231	L= 830
740 i, Li	225	07/05→07/08	→		1	24.8190-0231.2 620231	L= 830
745 d	220	03/05→08/05	→		1	24.8190-0231.2 620231	L= 830
745 d	242	07/05→07/08	→		1	24.8190-0231.2 620231	L= 830
745 i, Li	245	11/01→07/08	→		1	24.8190-0231.2 620231	L= 830
750 i, Li	270	07/05→07/08	→		1	24.8190-0231.2 620231	L= 830
730 i, Li	190	03/05→07/08	←	07/05→	1	24.8190-0230.2 620230	L= 814
			→	07/05→	1	24.8190-0231.2 620231	L= 830
730 Ld	170	07/05→12/09	←	→ 08/08	1	24.8190-0230.2 620230	L= 814
↓							

BMW - 7 (E65, E66, E67) 11/01→12/09

Warnkontakt, Bremsbelagverschleiß

730 Ld	170	07/05→12/09	➡	→ 08/08	1	24.8190-0231.2	620231	L= 830
760 i, Li	327	01/03→07/08	⬅	03/03→	1	24.8190-0230.2	620230	L= 814
			➡	03/03→	1	24.8190-0231.2	620231	L= 830
760 i, LI	326	11/01→12/09	⬅	03/03→ 08/08	1	24.8190-0230.2	620230	L= 814
			➡	03/03→ 08/08	1	24.8190-0231.2	620231	L= 830

Bremsscheibe







730 d	150	10/02→07/08	⬅	→ 02/05		24.0130-0117.1	430117	Ø 324 30 28,4 V
730 d	155	10/02→07/08	➡	→ 02/05		24.0120-0178.1	420178	Ø 324 20 18,4 V
730 d	160	10/02→07/08	➡					
730 i, Li	170	03/03→07/08	⬅			24.0130-0117.1	430117	Ø 324 30 28,4 V
735 i, Li	200	11/01→02/05	➡			24.0120-0178.1	420178	Ø 324 20 18,4 V
730 i, Li	190	03/05→07/08	⬅	07/05→		24.0130-0117.1	430117	Ø 324 30 28,4 V
			➡	07/05→		24.0120-0217.1	420217	Ø 324 20 18,4 V
730 Ld	170	07/05→12/09	⬅	→ 08/08		24.0130-0118.1	430118	Ø 348 30 28,4 V
			➡	→ 08/08		24.0124-0213.1	424213	Ø 345 24 22,4 V
740 d	190	10/02→02/05	⬅			24.0130-0118.1	430118	Ø 348 30 28,4 V
			➡			24.0124-0177.1	424177	Ø 345 24 22,4 V
745 i, Li	245	11/01→07/08	⬅			24.0130-0118.1	430118	Ø 348 30 28,4 V
			➡			24.0124-0213.1	424213	Ø 345 24 22,4 V
740 i, Li	225	07/05→07/08	⬅			24.0130-0118.1	430118	Ø 348 30 28,4 V
			➡			24.0124-0213.1	424213	Ø 345 24 22,4 V
745 d	220	03/05→08/05	⬅			24.0136-0101.1	436101	Ø 374 36 34,4 V
			➡			24.0124-0214.1	424214	Ø 370 24 22,4 V
745 d	242	07/05→07/08	⬅			24.0136-0101.1	436101	Ø 374 36 34,4 V
			➡			24.0124-0214.1	424214	Ø 370 24 22,4 V
750 i, Li	270	07/05→07/08	⬅			24.0130-0118.1	430118	Ø 348 30 28,4 V
			➡			24.0136-0110.1	436110	Ø 348 35,9 34,4 V
			➡			24.0124-0213.1	424213	Ø 345 24 22,4 V
760 i, Li	327	01/03→07/08	⬅	03/03→		24.0130-0118.1	430118	Ø 348 30 28,4 V
			➡	03/03→ 03/05		24.0136-0101.1	436101	Ø 374 36 34,4 V
			➡	03/03→ 03/05		24.0124-0177.1	424177	Ø 345 24 22,4 V
			➡	04/05→		24.0124-0186.1	424186	Ø 370 24 22,4 V
760 i, LI	326	11/01→12/09	⬅	03/03→ 08/08		24.0124-0213.1	424213	Ø 345 24 22,4 V
			➡	03/03→ 08/08		24.0130-0118.1	430118	Ø 348 30 28,4 V
			➡	03/03→ 03/05		24.0136-0101.1	436101	Ø 374 36 34,4 V
			➡	03/03→ 03/05		24.0124-0177.1	424177	Ø 345 24 22,4 V
			➡	04/05→ 08/08		24.0124-0186.1	424186	Ø 370 24 22,4 V
			➡	04/05→ 08/08		24.0124-0213.1	424213	Ø 345 24 22,4 V
			➡	04/05→ 08/08		24.0124-0214.1	424214	Ø 370 24 22,4 V









BMW - 7 (F01, F02, F03, F04) 02/08→12/15







Bremsbelagsatz, Scheibenbremse











730 d	155	02/08→05/15	⬅	03/10→		13.0460-7267.2	607267	ATE 25045 19,5 + WE / - WK
			➡			13.0470-7267.2	LD7267	ATE 25045 19,5 + WE / - WK
			⬅	09/08→ 02/10		13.0460-7267.2	607267	ATE 25045 19,5 + WE / - WK
			➡	09/08→ 02/10		13.0470-7267.2	LD7267	ATE 25045 19,5 + WE / - WK
730 d	180	02/08→07/12	⬅			13.0460-7274.2	607274	ATE 23731 17,3 + WE / - WK
			➡			13.0460-7274.2	607274	ATE 23731 17,3 + WE / - WK
730 i, Li	190	06/08→12/15	⬅			13.0460-7274.2	607274	ATE 23731 17,3 + WE / - WK
			➡			13.0460-7274.2	607274	ATE 23731 17,3 + WE / - WK
730 d	190	07/12→05/15	⬅			13.0460-7267.2	607267	ATE 25045 19,5 + WE / - WK
			➡			13.0470-7267.2	LD7267	ATE 25045 19,5 + WE / - WK
730 d xDrive	155	11/11→05/15	⬅	06/12→		13.0460-7267.2	607267	ATE 25045 19,5 + WE / - WK
			➡	06/12→		13.0470-7267.2	LD7267	ATE 25045 19,5 + WE / - WK
730 d xDrive	190	11/11→05/15	⬅			13.0460-7274.2	607274	ATE 23731 17,3 + WE / - WK
			➡			13.0460-7274.2	607274	ATE 23731 17,3 + WE / - WK
740 d	225	09/09→12/15	⬅	→ 02/10		13.0460-7267.2	607267	ATE 25045 19,5 + WE / - WK
			➡			13.0470-7267.2	LD7267	ATE 25045 19,5 + WE / - WK
			⬅	03/10→		13.0460-7267.2	607267	ATE 25045 19,5 + WE / - WK









↓







	kw			 	! #			
BMW - 7 (F01, F02, F03, F04) 02/08→12/15								
Bremsbelagsatz, Scheibenbremse								
740 d	225	09/09→12/15	←	03/10→		13.0470-7267.2	LD7267	ATE 25045 19,5 + WE / - WK Ceramic
			→	03/10→		13.0460-7274.2	607274	ATE 23731 17,3 + WE / - WK
			→	→ 02/10		13.0460-7274.2	607274	ATE 23731 17,3 + WE / - WK
740 d 740 d xDrive	230	07/12→12/15	←			13.0460-7267.2	607267	ATE 25045 19,5 + WE / - WK
			→			13.0460-7274.2	607274	ATE 23731 17,3 + WE / - WK
740 i, Li	235	07/12→12/15	→			13.0460-7274.2	607274	ATE 23731 17,3 + WE / - WK
740 i, Li xDrive	235	07/12→12/15	→			13.0460-7274.2	607274	ATE 23731 17,3 + WE / - WK
740 d xDrive	225	09/09→12/15	←	09/10→		13.0460-7267.2	607267	ATE 25045 19,5 + WE / - WK
			→	09/10→		13.0470-7267.2	LD7267	ATE 25045 19,5 + WE / - WK Ceramic
			→	09/10→		13.0460-7274.2	607274	ATE 23731 17,3 + WE / - WK
740 i	240	10/08→12/15	←	03/10→		13.0460-7267.2	607267	ATE 25045 19,5 + WE / - WK
			←	→ 02/10		13.0460-7267.2	607267	ATE 25045 19,5 + WE / - WK
			→	03/10→		13.0460-7274.2	607274	ATE 23731 17,3 + WE / - WK
			→	→ 02/10		13.0460-7274.2	607274	ATE 23731 17,3 + WE / - WK
750 d xDrive	280	07/12→12/15	←			13.0460-7261.2	607261	ATE 24436 19,7 + WE / - WK
			→			13.0460-7274.2	607274	ATE 23731 17,3 + WE / - WK
750 i 750 i xDrive	300 300	10/08→12/15 09/09→12/15	←	für Fahrzeuge mit verstärkter Bremse		13.0460-7261.2	607261	ATE 24436 19,7 + WE / - WK
			←	03/10→; nicht für Fahrzeuge mit verstärkter Bremse		13.0460-7267.2	607267	ATE 25045 19,5 + WE / - WK
			←	→ 02/10; nicht für Fahrzeuge mit verstärkter Bremse		13.0460-7267.2	607267	ATE 25045 19,5 + WE / - WK
			→	→ 02/10		13.0460-7274.2	607274	ATE 23731 17,3 + WE / - WK
			→	03/10→		13.0460-7274.2	607274	ATE 23731 17,3 + WE / - WK
750 i 750 i xDrive	330 330	10/12→12/15 10/12→12/15	←	für Fahrzeuge mit verstärkter Bremse		13.0460-7261.2	607261	ATE 24436 19,7 + WE / - WK
			←	nicht für Fahrzeuge mit verstärkter Bremse		13.0460-7267.2	607267	ATE 25045 19,5 + WE / - WK
			→			13.0460-7274.2	607274	ATE 23731 17,3 + WE / - WK
760 i	400	09/09→12/15	←			13.0460-7261.2	607261	ATE 24436 19,7 + WE / - WK
			→	→ 02/10		13.0460-7274.2	607274	ATE 23731 17,3 + WE / - WK
			→	03/10→		13.0460-7274.2	607274	ATE 23731 17,3 + WE / - WK
ActiveHybrid ActiveHybrid	235 260	05/11→05/15 05/11→05/15	←	06/12→		13.0460-7267.2	607267	ATE 25045 19,5 + WE / - WK
			→	06/12→		13.0460-7274.2	607274	ATE 23731 17,3 + WE / - WK
ActiveHybrid ActiveHybrid	330 342	09/09→06/12 09/09→06/12	←	03/10→; für Fahrzeuge mit verstärkter Bremse		13.0460-7261.2	607261	ATE 24436 19,7 + WE / - WK
			←	03/10→; nicht für Fahrzeuge mit verstärkter Bremse		13.0460-7267.2	607267	ATE 25045 19,5 + WE / - WK
			→	03/10→		13.0460-7274.2	607274	ATE 23731 17,3 + WE / - WK
Warnkontakt, Bremsbelagverschleiß								
730 d 730 d 730 i, Li	155 180 190	02/08→05/15 02/08→07/12 06/08→12/15	←	☐; 09/08→ 02/10	1	24.8190-0260.2	620260	L= 1.060
			←	☐; 03/10→	1	24.8190-0298.2	620298	L= 1.087
			→	09/08→ 02/10	1	24.8190-0261.2	620261	L= 1.045
			→	03/10→	1	24.8190-0299.2	620299	L= 1.065
730 d 740 d	190 230	07/12→05/15 07/12→12/15	←	☐	1	24.8190-0298.2	620298	L= 1.087
			→		1	24.8190-0299.2	620299	L= 1.065
740 d xDrive	230	07/12→12/15	→			24.8190-0299.2	620299	L= 1.065
740 i, Li	235	07/12→12/15	→			24.8190-0299.2	620299	L= 1.065
740 i, Li xDrive	235	07/12→12/15	→			24.8190-0299.2	620299	L= 1.065
750 d xDrive	280	07/12→12/15	→			24.8190-0299.2	620299	L= 1.065
730 d xDrive 730 d xDrive	155 190	11/11→05/15 11/11→05/15	←	☐; 06/12→	1	24.8190-0298.2	620298	L= 1.087
			→	06/12→	1	24.8190-0299.2	620299	L= 1.065
ActiveHybrid ActiveHybrid	235 260	05/11→05/15 05/11→05/15	→			24.8190-0299.2	620299	L= 1.065
740 d 740 i	225 240	09/09→12/15 10/08→12/15	←	☐; → 02/10	1	24.8190-0260.2	620260	L= 1.060
			←	☐; 03/10→	1	24.8190-0298.2	620298	L= 1.087
			→	→ 02/10	1	24.8190-0261.2	620261	L= 1.045
			→	03/10→	1	24.8190-0299.2	620299	L= 1.065
740 d xDrive	225	09/09→12/15	←	☐; 09/10→	1	24.8190-0298.2	620298	L= 1.087
↓								

	kW			 	! #		
BMW - 7 (F01, F02, F03, F04) 02/08→12/15							
Warnkontakt, Bremsbelagverschleiß							
740 d xDrive	225	09/09→12/15	➡	09/10→	1	24.8190-0299.2 620299	L= 1.065
750 i 750 i xDrive	300 300	10/08→12/15 09/09→12/15	⬅	☐; → 02/10; nicht für Fahrzeuge mit verstärkter Bremsen	1	24.8190-0260.2 620260	L= 1.060
			⬅	☐; für Fahrzeuge mit verstärkter Bremsen	1	24.8190-0298.2 620298	L= 1.087
			⬅	☐; 03/10→; nicht für Fahrzeuge mit verstärkter Bremsen	1	24.8190-0298.2 620298	L= 1.087
			➡	→ 02/10	1	24.8190-0261.2 620261	L= 1.045
			➡	03/10→	1	24.8190-0299.2 620299	L= 1.065
750 i 750 i xDrive	330 330	10/12→12/15 10/12→12/15	⬅	☐; für Fahrzeuge mit verstärkter Bremsen	1	24.8190-0298.2 620298	L= 1.087
			⬅	☐; nicht für Fahrzeuge mit verstärkter Bremsen	1	24.8190-0298.2 620298	L= 1.087
			➡		1	24.8190-0299.2 620299	L= 1.065
760 i	400	09/09→12/15	⬅	☐	1	24.8190-0298.2 620298	L= 1.087
			➡	→ 02/10	1	24.8190-0261.2 620261	L= 1.045
			➡	03/10→	1	24.8190-0299.2 620299	L= 1.065
ActiveHybrid ActiveHybrid	330 342	09/09→06/12 09/09→06/12	⬅	☐; 03/10→; für Fahrzeuge mit verstärkter Bremsen	1	24.8190-0298.2 620298	L= 1.087
			⬅	☐; 03/10→; nicht für Fahrzeuge mit verstärkter Bremsen	1	24.8190-0298.2 620298	L= 1.087
			➡	03/10→	1	24.8190-0299.2 620299	L= 1.065
 Bremsscheibe							
730 d 730 d 730 i, Li	155 180 190	02/08→05/15 02/08→07/12 06/08→12/15	⬅	☐; 09/08→		24.0136-0114.2 436114	Ø 348 36 34,4 V Bremsscheibe zweiteilig / + S
			⬅	☐; 09/08→		24.0136-0115.2 436115	Ø 348 36 34,4 V Bremsscheibe zweiteilig / + S
			➡	09/08→		24.0124-0233.2 424233	Ø 345 24 22,4 V Bremsscheibe zweiteilig / + S
730 d 740 d 740 d 740 d xDrive 740 i, Li 740 i, Li xDrive	190 225 230 230 235 235	07/12→05/15 09/09→12/15 07/12→12/15 07/12→12/15 07/12→12/15 07/12→12/15	⬅	☐		24.0136-0114.2 436114	Ø 348 36 34,4 V Bremsscheibe zweiteilig / + S
			⬅	☐		24.0136-0115.2 436115	Ø 348 36 34,4 V Bremsscheibe zweiteilig / + S
			➡			24.0124-0233.2 424233	Ø 345 24 22,4 V Bremsscheibe zweiteilig / + S
			⬅	☐		24.0136-0114.2 436114	Ø 348 36 34,4 V Bremsscheibe zweiteilig / + S
730 d xDrive 730 d xDrive ActiveHybrid ActiveHybrid	155 190 235 260	11/11→05/15 11/11→05/15 05/11→05/15 05/11→05/15	⬅	☐; 06/12→		24.0136-0114.2 436114	Ø 348 36 34,4 V Bremsscheibe zweiteilig / + S
			⬅	☐; 06/12→		24.0136-0115.2 436115	Ø 348 36 34,4 V Bremsscheibe zweiteilig / + S
			➡	06/12→		24.0124-0233.2 424233	Ø 345 24 22,4 V Bremsscheibe zweiteilig / + S
740 d xDrive	225	09/09→12/15	⬅	☐; 09/10→		24.0136-0114.2 436114	Ø 348 36 34,4 V Bremsscheibe zweiteilig / + S
			⬅	☐; 09/10→		24.0136-0115.2 436115	Ø 348 36 34,4 V Bremsscheibe zweiteilig / + S
			➡	09/10→		24.0124-0233.2 424233	Ø 345 24 22,4 V Bremsscheibe zweiteilig / + S
740 i	240	10/08→12/15	⬅	☐		24.0136-0118.2 436118	Ø 374 36 34,4 V Bremsscheibe zweiteilig / + S
			⬅	☐		24.0136-0119.2 436119	Ø 374 36 34,4 V Bremsscheibe zweiteilig / + S
			➡			24.0124-0233.2 424233	Ø 345 24 22,4 V Bremsscheibe zweiteilig / + S
750 d xDrive 760 i	280 400	07/12→12/15 09/09→12/15	⬅	☐		24.0136-0120.2 436120	Ø 374 36 34,4 V Bremsscheibe zweiteilig / + S
			⬅	☐		24.0136-0121.2 436121	Ø 374 36 34,4 V Bremsscheibe zweiteilig / + S
			➡			24.0124-0241.1 424241	Ø 370 23,9 22,4 V + S
750 i 750 i 750 i xDrive 750 i xDrive	300 330 300 330	10/08→12/15 10/12→12/15 09/09→12/15 10/12→12/15	⬅	☐; nicht für Fahrzeuge mit verstärkter Bremsen		24.0136-0118.2 436118	Ø 374 36 34,4 V Bremsscheibe zweiteilig / + S
			⬅	☐; nicht für Fahrzeuge mit verstärkter Bremsen		24.0136-0119.2 436119	Ø 374 36 34,4 V Bremsscheibe zweiteilig / + S
↓							











	kw			 	! #		
BMW - 7 (F01, F02, F03, F04) 02/08→12/15							
Bremsscheibe							
750 i	300	10/08→12/15	←	☐; für Fahrzeuge mit verstärkter Bremse	24.0136-0120.2	436120	Ø 374 36 34,4 V Bremsscheibe zweiteilig / + S
750 i	330	10/12→12/15					
750 i xDrive	300	09/09→12/15	←	☐; für Fahrzeuge mit verstärkter Bremse	24.0136-0121.2	436121	Ø 374 36 34,4 V Bremsscheibe zweiteilig / + S
750 i xDrive	330	10/12→12/15					
			→		24.0124-0241.1	424241	Ø 370 23,9 22,4 V + S
ActiveHybrid	330	09/09→06/12	←	☐; 03/10→; nicht für Fahrzeuge mit verstärkter Bremse	24.0136-0118.2	436118	Ø 374 36 34,4 V Bremsscheibe zweiteilig / + S
ActiveHybrid	342	09/09→06/12	←	☐; 03/10→; nicht für Fahrzeuge mit verstärkter Bremse	24.0136-0119.2	436119	Ø 374 36 34,4 V Bremsscheibe zweiteilig / + S
			←	☐; 03/10→; für Fahrzeuge mit verstärkter Bremse	24.0136-0120.2	436120	Ø 374 36 34,4 V Bremsscheibe zweiteilig / + S
			←	☐; 03/10→; für Fahrzeuge mit verstärkter Bremse	24.0136-0121.2	436121	Ø 374 36 34,4 V Bremsscheibe zweiteilig / + S
			→	03/10→	24.0124-0241.1	424241	Ø 370 23,9 22,4 V + S
BMW - 7 (G11, G12) 10/14→							
Bremsbelagsatz, Scheibenbremse							
725 d, Ld	170	09/15→	→	+ Performance Parts; + eFSB	13.0460-2716.2	602716	TRW 24703 17,8 + WE / - WK + Zub
730 i, Li	190	02/16→			13.0470-2716.2	LD2716	TRW 24703 17,8 + WE / - WK + Zub Ceramic
730 d	155	09/15→	→	+ eFSB	13.0460-2716.2	602716	TRW 24703 17,8 + WE / - WK + Zub
730 d	195	09/15→					
730 d, Ld xDrive	195	09/15→			13.0470-2716.2	LD2716	TRW 24703 17,8 + WE / - WK + Zub Ceramic
730 d xDrive	155	09/15→					
740 d, Ld xDrive	235	11/15→					
740 e, Le	190	04/16→					
740 e, Le	240	04/16→					
740 e, Le xDrive	190	04/16→					
740 e, Le xDrive	240	04/16→					
740 i, Li	240	09/15→					
740 i, Li xDrive	240	03/16→					
750 d, Ld xDrive	294	07/16→					
750 i, Li	330	11/15→					
750 i, Li xDrive	330	09/15→					
BMW - 8 (E31) 04/90→12/99							
Bremsbelagsatz, Scheibenbremse							
840 i	210	02/93→02/96	←	→ 02/94	13.0460-7147.2	607147	ATE 21284 19,1 + WE / - WK
850 CSi	278	04/93→12/95	←		13.0460-9037.2	609037	ATE 20309 17,9 + WE / - WK
850 CSi	280	04/93→12/96	←	→ 10/96	13.0460-9037.2	609037	ATE 20309 17,9 + WE / - WK
Warnkontakt, Bremsbelagverschleiß							
840 Ci	210	01/96→12/99	←	→ 08/99	1	24.8190-0223.2	620223 L= 261
840 i	210	02/93→02/96	←	→ 02/94	1	24.8190-0223.2	620223 L= 261
			←	03/94→	1	24.8190-0223.2	620223 L= 261
850 Ci	240	09/94→12/99	←		1	24.8190-0223.2	620223 L= 261
850 CSi	278	04/93→12/95					
850 CSi	280	04/93→12/96	←	→ 10/96	1	24.8190-0223.2	620223 L= 261
Zubehörsatz, Scheibenbremsbelag							
840 Ci	210	01/96→12/99	←	→ 08/99	13.0460-0267.2	610267	
840 i	210	02/93→02/96	←	03/94→	13.0460-0267.2	610267	
850 Ci	240	09/94→12/99	←		13.0460-0267.2	610267	
Bremsscheibe							
840 Ci	210	01/96→12/99	→	→ 08/99	24.0112-0132.1	412132	Ø 324 12 10,4 + S
840 i	210	02/93→02/96	←	→ 02/94	24.0130-0101.1	430101	Ø 324 30 28,4 V + S
			→		24.0112-0132.1	412132	Ø 324 12 10,4 + S
850 Ci	240	09/94→12/99	→		24.0112-0132.1	412132	Ø 324 12 10,4 + S
850 CSi	278	04/93→12/95	→		24.0120-0182.1	420182	Ø 328 20 18,4 V + S
850 CSi	280	04/93→12/96	→	→ 10/96	24.0120-0182.1	420182	Ø 328 20 18,4 V + S









	kW			 	! #		
BMW - i3 (I01) 08/13→							
 Bremsbelagsatz, Scheibenbremse							
electric	75	08/13→	→			13.0460-7315.2 607315	ATE 25331 16,2 + WE / - WK
Electric	125	09/14→				13.0470-7315.2 LD7315	ATE 25331 16,2 + WE / - WK
Hybrid	75	08/13→					Ceramic
Hybrid	125	09/14→					
BMW - i8 (I12) 03/14→							
 Bremsbelagsatz, Scheibenbremse							
hybrid	170	03/14→	→			13.0460-2760.2 602760	TRW 24561 17,7 + WE / - WK + Zub
hybrid	266	03/14→				13.0470-2760.2 LD2760	TRW 24561 17,7 + WE / - WK + Zub Ceramic
BMW - X1 (E84) 03/09→06/15							
 Bremsbelagsatz, Scheibenbremse							
sDrive 16 d	85	04/12→06/15	←	07/12→		13.0460-7238.2 607238	ATE 23313 20,3 + WE / - WK
xDrive 25 d	160	10/09→06/15				13.0470-7238.2 LD7238	ATE 23313 20,3 + WE / - WK Ceramic
			→	07/12→		13.0460-7217.2 607217	ATE 23926 17,3 + WE / - WK
						13.0470-7217.2 LD7217	ATE 23926 17,3 + WE / - WK Ceramic
sDrive 16 i	105	03/13→06/15	←			13.0460-7238.2 607238	ATE 23313 20,3 + WE / - WK
sDrive 20 d	120	03/10→06/15				13.0470-7238.2 LD7238	ATE 23313 20,3 + WE / - WK
sDrive 20 d	135	07/12→06/15					Ceramic
sDrive 20 i	135	09/11→06/15					
xDrive 20 d	120	03/10→06/15	→			13.0460-7217.2 607217	ATE 23926 17,3 + WE / - WK
xDrive 20 d	135	07/12→06/15				13.0470-7217.2 LD7217	ATE 23926 17,3 + WE / - WK Ceramic
xDrive 20 i	135	09/11→06/15					
sDrive 18 d	100	03/09→06/15	←	10/09→ 02/10		13.0460-7238.2 607238	ATE 23313 20,3 + WE / - WK
xDrive 18 d	100	03/09→06/15				13.0470-7238.2 LD7238	ATE 23313 20,3 + WE / - WK Ceramic
			←	03/10→		13.0460-7238.2 607238	ATE 23313 20,3 + WE / - WK
						13.0470-7238.2 LD7238	ATE 23313 20,3 + WE / - WK Ceramic
			→	03/10→		13.0460-7217.2 607217	ATE 23926 17,3 + WE / - WK
						13.0470-7217.2 LD7217	ATE 23926 17,3 + WE / - WK Ceramic
			→	10/09→ 02/10		13.0460-7217.2 607217	ATE 23926 17,3 + WE / - WK
						13.0470-7217.2 LD7217	ATE 23926 17,3 + WE / - WK Ceramic
sDrive 18 d	105	10/09→06/15	←	→ 02/10		13.0460-7238.2 607238	ATE 23313 20,3 + WE / - WK
sDrive 20 d	130	10/09→06/15				13.0470-7238.2 LD7238	ATE 23313 20,3 + WE / - WK
xDrive 18 d	105	10/09→06/15					Ceramic
xDrive 20 d	130	10/09→06/15	←	03/10→		13.0460-7238.2 607238	ATE 23313 20,3 + WE / - WK
						13.0470-7238.2 LD7238	ATE 23313 20,3 + WE / - WK Ceramic
			→	→ 02/10		13.0460-7217.2 607217	ATE 23926 17,3 + WE / - WK
						13.0470-7217.2 LD7217	ATE 23926 17,3 + WE / - WK Ceramic
			→	03/10→		13.0460-7217.2 607217	ATE 23926 17,3 + WE / - WK
						13.0470-7217.2 LD7217	ATE 23926 17,3 + WE / - WK Ceramic
sDrive 18 i	100	03/09→06/15	←	03/10→		13.0460-7238.2 607238	ATE 23313 20,3 + WE / - WK
sDrive 18 i	110	01/10→06/15				13.0470-7238.2 LD7238	ATE 23313 20,3 + WE / - WK
			→	03/10→		13.0460-7217.2 607217	ATE 23926 17,3 + WE / - WK
						13.0470-7217.2 LD7217	ATE 23926 17,3 + WE / - WK Ceramic
xDrive 23 d	150	10/09→06/15	←	→ 02/10		13.0460-7216.2 607216	ATE 23794 20,3 + WE / - WK
						13.0470-7216.2 LD7216	ATE 23794 20,3 + WE / - WK Ceramic
			←	03/10→ 02/12		13.0460-7216.2 607216	ATE 23794 20,3 + WE / - WK
						13.0470-7216.2 LD7216	ATE 23794 20,3 + WE / - WK Ceramic
			←	03/12→		13.0460-7238.2 607238	ATE 23313 20,3 + WE / - WK
						13.0470-7238.2 LD7238	ATE 23313 20,3 + WE / - WK Ceramic
			→	→ 02/10		13.0460-7217.2 607217	ATE 23926 17,3 + WE / - WK
↓							







	kw			 	! #		
BMW - X1 (E84) 03/09→06/15							
 Bremsbelagsatz, Scheibenbremse							
xDrive 23 d	150	10/09→06/15	➡	→ 02/10		13.0470-7217.2 LD7217	ATE 23926 17,3 + WE / - WK Ceramic
			➡	03/10→		13.0460-7217.2 607217 13.0470-7217.2 LD7217	ATE 23926 17,3 + WE / - WK ATE 23926 17,3 + WE / - WK Ceramic
xDrive 25 i	160	01/10→06/15	⬅	03/10→ 02/12		13.0460-7216.2 607216 13.0470-7216.2 LD7216	ATE 23794 20,3 + WE / - WK ATE 23794 20,3 + WE / - WK Ceramic
			⬅	03/12→		13.0460-7238.2 607238 13.0470-7238.2 LD7238	ATE 23313 20,3 + WE / - WK ATE 23313 20,3 + WE / - WK Ceramic
			➡	03/10→		13.0460-7217.2 607217 13.0470-7217.2 LD7217	ATE 23926 17,3 + WE / - WK ATE 23926 17,3 + WE / - WK Ceramic
xDrive 28 i xDrive 28 i Flex	180 180	04/11→06/15 04/11→06/15	⬅	→ 02/12		13.0460-7216.2 607216 13.0470-7216.2 LD7216	ATE 23794 20,3 + WE / - WK ATE 23794 20,3 + WE / - WK Ceramic
			⬅	03/12→		13.0460-7238.2 607238 13.0470-7238.2 LD7238	ATE 23313 20,3 + WE / - WK ATE 23313 20,3 + WE / - WK Ceramic
			➡			13.0460-7217.2 607217 13.0470-7217.2 LD7217	ATE 23926 17,3 + WE / - WK ATE 23926 17,3 + WE / - WK Ceramic
xDrive 28 i	190	10/09→06/15	⬅	03/10→		13.0460-7237.2 607237 13.0460-7238.2 607238 13.0470-7237.2 LD7237 13.0470-7238.2 LD7238	ATE 23347 20,3 + WE / - WK ATE 23313 20,3 + WE / - WK ATE 23347 20,3 + WE / - WK ATE 23313 20,3 + WE / - WK Ceramic
			⬅	→ 02/10		13.0460-7237.2 607237 13.0460-7238.2 607238 13.0470-7237.2 LD7237 13.0470-7238.2 LD7238	ATE 23347 20,3 + WE / - WK ATE 23313 20,3 + WE / - WK ATE 23347 20,3 + WE / - WK ATE 23313 20,3 + WE / - WK Ceramic
			➡	→ 02/10		13.0460-7225.2 607225 13.0470-7225.2 LD7225	ATE 23550 17,3 + WE / - WK ATE 23550 17,3 + WE / - WK Ceramic
			➡	03/10→		13.0460-7225.2 607225 13.0470-7225.2 LD7225	ATE 23550 17,3 + WE / - WK ATE 23550 17,3 + WE / - WK Ceramic
Warnkontakt, Bremsbelagverschleiß							
sDrive 16 d	85	04/12→06/15	⬅	07/12→	1	24.8190-0297.2 620297	L= 676
			➡	07/12→	1	24.8190-0296.2 620296	L= 1.141
sDrive 16 i sDrive 20 d sDrive 20 d sDrive 20 i	105 120 135 135	03/13→06/15 03/10→06/15 07/12→06/15 09/11→06/15	⬅		1	24.8190-0297.2 620297	L= 676
			➡		1	24.8190-0296.2 620296	L= 1.141
sDrive 18 d	100	03/09→06/15	⬅	10/09→ 02/10	1	24.8190-0283.2 620283	L= 632
			⬅	03/10→	1	24.8190-0297.2 620297	L= 676
			➡	10/09→ 02/10	1	24.8190-0282.2 620282	L= 1.120
			➡	03/10→	1	24.8190-0296.2 620296	L= 1.141
sDrive 18 d sDrive 20 d	105 130	10/09→06/15 10/09→06/15	⬅	→ 02/10	1	24.8190-0283.2 620283	L= 632
			⬅	03/10→	1	24.8190-0297.2 620297	L= 676
			➡	→ 02/10	1	24.8190-0282.2 620282	L= 1.120
			➡	03/10→	1	24.8190-0296.2 620296	L= 1.141
sDrive 18 i sDrive 18 i	100 110	03/09→06/15 01/10→06/15	⬅	03/10→	1	24.8190-0297.2 620297	L= 676
			➡	03/10→	1	24.8190-0296.2 620296	L= 1.141
xDrive 18 d	100	03/09→06/15	⬅	10/09→ 02/10	1	24.8190-0266.2 620266	L= 840
			⬅	03/10→	1	24.8190-0286.2 620286	L= 867
			➡	10/09→ 02/10	1	24.8190-0282.2 620282	L= 1.120
			➡	03/10→	1	24.8190-0296.2 620296	L= 1.141
xDrive 18 d ↓	105	10/09→06/15	⬅	→ 02/10	1	24.8190-0266.2 620266	L= 840









	kW			 	! #		
BMW - X1 (E84) 03/09→06/15							
Warnkontakt, Bremsbelagverschleiß							
xDrive 20 d xDrive 28 i	130 190	10/09→06/15 10/09→06/15	←	03/10→	1	24.8190-0286.2 620286	L= 867
			→	→ 02/10	1	24.8190-0282.2 620282	L= 1.120
			→	03/10→	1	24.8190-0296.2 620296	L= 1.141
xDrive 20 d xDrive 20 d xDrive 20 i	120 135 135	03/10→06/15 07/12→06/15 09/11→06/15	←		1	24.8190-0286.2 620286	L= 867
			→		1	24.8190-0296.2 620296	L= 1.141
xDrive 23 d	150	10/09→06/15	←	→ 02/10	1	24.8190-0266.2 620266	L= 840
			←	03/12→	1	24.8190-0286.2 620286	L= 867
			←	03/10→ 02/12	1	24.8190-0286.2 620286	L= 867
			→	→ 02/10	1	24.8190-0282.2 620282	L= 1.120
			→	03/10→	1	24.8190-0296.2 620296	L= 1.141
xDrive 25 d	160	10/09→06/15	←	07/12→	1	24.8190-0286.2 620286	L= 867
			→	07/12→	1	24.8190-0296.2 620296	L= 1.141
xDrive 25 i	160	01/10→06/15	←	03/12→	1	24.8190-0286.2 620286	L= 867
			←	03/10→ 02/12	1	24.8190-0286.2 620286	L= 867
			→	03/10→	1	24.8190-0296.2 620296	L= 1.141
xDrive 28 i xDrive 28 i Flex	180 180	04/11→06/15 04/11→06/15	←	→ 02/12	1	24.8190-0286.2 620286	L= 867
			←	03/12→	1	24.8190-0286.2 620286	L= 867
			→		1	24.8190-0296.2 620296	L= 1.141
Bremsscheibe							
sDrive 16 d xDrive 25 d	85 160	04/12→06/15 10/09→06/15	←	07/12→		24.0124-0203.1 424203	Ø 312 23,9 22,4 V + S
			→	07/12→		24.0324-0203.1 524203	Ø 312 23,9 21,6 V + S PD
			→			24.0120-0204.1 420204	Ø 300 20 18,4 V + S
			→			24.0320-0204.1 520204	Ø 300 20 17,6 V + S PD
sDrive 16 i sDrive 18 d sDrive 20 d sDrive 20 d sDrive 20 d sDrive 20 i xDrive 18 d xDrive 20 d xDrive 20 d xDrive 20 d xDrive 20 i	105 105 120 130 135 135 105 120 130 135 135	03/13→06/15 10/09→06/15 03/10→06/15 10/09→06/15 07/12→06/15 09/11→06/15 10/09→06/15 03/10→06/15 10/09→06/15 07/12→06/15 09/11→06/15	←			24.0124-0203.1 424203	Ø 312 23,9 22,4 V + S
			→			24.0324-0203.1 524203	Ø 312 23,9 21,6 V + S PD
			→			24.0120-0204.1 420204	Ø 300 20 18,4 V + S
			→			24.0320-0204.1 520204	Ø 300 20 17,6 V + S PD
sDrive 18 d xDrive 18 d	100 100	03/09→06/15 03/09→06/15	←	10/09→		24.0124-0203.1 424203	Ø 312 23,9 22,4 V + S
			→	10/09→		24.0324-0203.1 524203	Ø 312 23,9 21,6 V + S PD
			→	10/09→		24.0120-0204.1 420204	Ø 300 20 18,4 V + S
			→	10/09→		24.0320-0204.1 520204	Ø 300 20 17,6 V + S PD
sDrive 18 i	100	03/09→06/15	←	10/09→		24.0124-0203.1 424203	Ø 312 23,9 22,4 V + S
			→	03/10→		24.0324-0203.1 524203	Ø 312 23,9 21,6 V + S PD
			→	03/10→		24.0120-0204.1 420204	Ø 300 20 18,4 V + S
			→	03/10→		24.0320-0204.1 520204	Ø 300 20 17,6 V + S PD
sDrive 18 i	110	01/10→06/15	←			24.0124-0203.1 424203	Ø 312 23,9 22,4 V + S
			→	03/10→		24.0324-0203.1 524203	Ø 312 23,9 21,6 V + S PD
			→	03/10→		24.0120-0204.1 420204	Ø 300 20 18,4 V + S
			→	03/10→		24.0320-0204.1 520204	Ø 300 20 17,6 V + S PD
xDrive 23 d xDrive 28 i xDrive 28 i Flex	150 180 180	10/09→06/15 04/11→06/15 04/11→06/15	←	→ 02/12		24.0124-0200.1 424200	Ø 330 24 22,4 V + S
			→	→ 02/12		24.0324-0200.1 524200	Ø 330 24 21,6 V + S PD
			←	03/12→		24.0124-0203.1 424203	Ø 312 23,9 22,4 V + S
			→			24.0324-0203.1 524203	Ø 312 23,9 21,6 V + S PD
			→			24.0120-0204.1 420204	Ø 300 20 18,4 V + S
			→			24.0320-0204.1 520204	Ø 300 20 17,6 V + S PD
xDrive 25 i	160	01/10→06/15	←	03/10→ 02/12		24.0124-0200.1 424200	Ø 330 24 22,4 V + S
			→	→ 02/12		24.0324-0200.1 524200	Ø 330 24 21,6 V + S PD
			←	03/12→		24.0124-0203.1 424203	Ø 312 23,9 22,4 V + S
			→			24.0324-0203.1 524203	Ø 312 23,9 21,6 V + S PD
			→	03/10→		24.0120-0204.1 420204	Ø 300 20 18,4 V + S
			→	03/10→		24.0320-0204.1 520204	Ø 300 20 17,6 V + S PD
xDrive 28 i	190	10/09→06/15	←			24.0130-0192.1 430192	Ø 348 30 28,4 V + S
			→			24.0122-0236.1 422236	Ø 336 22 20,4 V + S



















	kW					! #		
BMW - X1 (E84) 03/09→06/15								
 Bremsscheibe								
xDrive 28 i	190	10/09→06/15	➔			24.0322-0236.1	522236	Ø 336 22 19,6 V + S PD
BMW - X1 (F48) 11/14→								
 Bremsbelagsatz, Scheibenbremse								
sDrive 16 d	85	11/14→	➔	09/15→; + eFSB		13.0460-7315.2	607315	ATE 25331 16,2 + WE / - WK
sDrive 18 d	100	11/14→				13.0470-7315.2	LD7315	ATE 25331 16,2 + WE / - WK
sDrive 18 d	110	11/14→						Ceramic
sDrive 18 i	100	11/14→						
sDrive 20 i	141	11/14→						
xDrive 18 d	100	11/14→						
xDrive 18 d	110	11/14→						
xDrive 20 d	140	11/14→						
xDrive 20 i	141	11/14→						
xDrive 25 d	170	11/14→						
xDrive 25 i	170	11/14→						
sDrive 20 d	120	01/15→	➔	11/15→; + eFSB		13.0460-7315.2	607315	ATE 25331 16,2 + WE / - WK
sDrive 20 d	140	01/15→				13.0470-7315.2	LD7315	ATE 25331 16,2 + WE / - WK
xDrive 20 d	120	11/14→						Ceramic
Warnkontakt, Bremsbelagsverschleiß								
sDrive 16 d	85	11/14→	➔	09/15→	1	24.8190-0942.2	620942	L= 641
sDrive 18 d	100	11/14→						
sDrive 18 d	110	11/14→						
sDrive 18 i	100	11/14→						
sDrive 20 i	141	11/14→						
xDrive 18 d	100	11/14→						
xDrive 18 d	110	11/14→						
xDrive 20 d	140	11/14→						
xDrive 20 i	141	11/14→						
xDrive 25 d	170	11/14→						
xDrive 25 i	170	11/14→						
sDrive 20 d	120	01/15→	➔	11/15→	1	24.8190-0942.2	620942	L= 641
sDrive 20 d	140	01/15→						
xDrive 20 d	120	11/14→						
 Bremsscheibe								
sDrive 16 d	85	11/14→	➔	09/15→		24.0124-0260.1	424260	Ø 307 24 22,4 V + S
sDrive 18 d	100	11/14→	➔	09/15→		24.0110-0401.1	410401	Ø 280 10 8,4 + S
sDrive 18 d	110	11/14→						
sDrive 18 i	100	11/14→						
xDrive 18 d	100	11/14→						
xDrive 18 d	110	11/14→						
sDrive 20 d	120	01/15→	➔	11/15→		24.0124-0259.1	424259	Ø 330 24 22,4 V + S
sDrive 20 d	140	01/15→						
xDrive 20 d	120	11/14→						
sDrive 20 i	141	11/14→	➔	09/15→		24.0124-0259.1	424259	Ø 330 24 22,4 V + S
xDrive 20 d	140	11/14→						
xDrive 20 i	141	11/14→						
xDrive 25 d	170	11/14→						
xDrive 25 i	170	11/14→						
BMW - X3 (E83) 01/03→12/11								
 Bremsbelagsatz, Scheibenbremse								
2.0 d	110	11/03→08/07	➔	08/04→		13.0460-7155.2	607155	ATE 21676 20,3 + WE / - WK
						13.0470-7155.2	LD7155	ATE 21676 20,3 + WE / - WK
								Ceramic
			➔	08/04→		13.0460-7079.2	607079	ATE 21282 17,3 + WE / - WK
						13.0470-7079.2	LD7079	ATE 21282 17,3 + WE / - WK
								Ceramic
2.0 i	110	07/05→08/08	➔			13.0460-7155.2	607155	ATE 21676 20,3 + WE / - WK
2.5 si	160	09/06→08/08				13.0470-7155.2	LD7155	ATE 21676 20,3 + WE / - WK
3.0 d	155	10/04→07/06						Ceramic
3.0 d	160	10/04→07/06						
3.0 i xDrive	170	01/04→08/06	➔			13.0460-7079.2	607079	ATE 21282 17,3 + WE / - WK
3.0 si	200	09/06→08/08				13.0470-7079.2	LD7079	ATE 21282 17,3 + WE / - WK
								Ceramic
2.5 i	141	01/04→08/06	➔	03/04→		13.0460-7155.2	607155	ATE 21676 20,3 + WE / - WK
						13.0470-7155.2	LD7155	ATE 21676 20,3 + WE / - WK
								Ceramic
			➔	03/04→		13.0460-7079.2	607079	ATE 21282 17,3 + WE / - WK
						13.0470-7079.2	LD7079	ATE 21282 17,3 + WE / - WK
								Ceramic
2.5 si xDrive	155	07/06→12/08	➔	09/08→		13.0460-7155.2	607155	ATE 21676 20,3 + WE / - WK
xDrive 20 d	120	09/07→08/10				13.0470-7155.2	LD7155	ATE 21676 20,3 + WE / - WK
xDrive 20 d	130	09/07→08/10						Ceramic
↓								







	kW			 	! #		
BMW - X3 (E83) 01/03→12/11							
 Bremsbelagsatz, Scheibenbremse							
xDrive 30 d xDrive 30 d	155 160	03/06→08/10 03/06→08/10	➡	09/08→		13.0460-7079.2 607079 13.0470-7079.2 LD7079	ATE 21282 17,3 + WE / - WK ATE 21282 17,3 + WE / - WK Ceramic
3.0 d	150	01/03→08/05	⬅	10/03→		13.0460-7155.2 607155 13.0470-7155.2 LD7155	ATE 21676 20,3 + WE / - WK ATE 21676 20,3 + WE / - WK Ceramic
			➡	10/03→		13.0460-7079.2 607079 13.0470-7079.2 LD7079	ATE 21282 17,3 + WE / - WK ATE 21282 17,3 + WE / - WK Ceramic
3.0 sd	210	09/06→08/08	⬅			13.0460-7078.2 607078	ATE 21486 19,5 + WE / - WK
			➡			13.0460-7079.2 607079 13.0470-7079.2 LD7079	ATE 21282 17,3 + WE / - WK ATE 21282 17,3 + WE / - WK Ceramic
xDrive 18 d xDrive 18 d xDrive 20 i xDrive 25 i xDrive 30 i	100 105 110 160 200	04/09→12/11 09/08→12/11 09/08→08/11 09/08→12/11 09/08→12/11	⬅	→ 08/10		13.0460-7155.2 607155 13.0470-7155.2 LD7155	ATE 21676 20,3 + WE / - WK ATE 21676 20,3 + WE / - WK Ceramic
			➡	→ 08/10		13.0460-7079.2 607079 13.0470-7079.2 LD7079	ATE 21282 17,3 + WE / - WK ATE 21282 17,3 + WE / - WK Ceramic
xDrive 35 d	210	09/08→08/11	⬅	→ 08/10		13.0460-7078.2 607078	ATE 21486 19,5 + WE / - WK
			➡	→ 08/10		13.0460-7079.2 607079 13.0470-7079.2 LD7079	ATE 21282 17,3 + WE / - WK ATE 21282 17,3 + WE / - WK Ceramic
Warnkontakt, Bremsbelagverschleiß							
2.0 d	110	11/03→08/07	⬅	08/04→	1	24.8190-0240.2 620240	L= 735
			➡	08/04→	1	24.8190-0241.2 620241	L= 1.055
2.0 i 2.5 si 3.0 d 3.0 d 3.0 i xDrive 3.0 si	110 160 155 160 170 200	07/05→08/08 09/06→08/08 10/04→07/06 10/04→07/06 01/04→08/06 09/06→08/08	⬅		1	24.8190-0240.2 620240	L= 735
			➡		1	24.8190-0241.2 620241	L= 1.055
2.5 i	141	01/04→08/06	⬅	03/04→	1	24.8190-0240.2 620240	L= 735
			➡	03/04→	1	24.8190-0241.2 620241	L= 1.055
2.5 si xDrive xDrive 20 d xDrive 20 d xDrive 30 d xDrive 30 d	155 120 130 155 160	07/06→12/08 09/07→08/10 09/07→08/10 03/06→08/10 03/06→08/10	⬅	09/08→	1	24.8190-0240.2 620240	L= 735
			➡	09/08→	1	24.8190-0241.2 620241	L= 1.055
3.0 d	150	01/03→08/05	⬅	10/03→	1	24.8190-0240.2 620240	L= 735
			➡	10/03→	1	24.8190-0241.2 620241	L= 1.055
3.0 sd	210	09/06→08/08	⬅		1	24.8190-0254.2 620254	L= 745
			➡		1	24.8190-0241.2 620241	L= 1.055
xDrive 18 d xDrive 18 d xDrive 20 i xDrive 25 i xDrive 30 i	100 105 110 160 200	04/09→12/11 09/08→12/11 09/08→08/11 09/08→12/11 09/08→12/11	⬅	→ 08/10	1	24.8190-0240.2 620240	L= 735
			➡	→ 08/10	1	24.8190-0241.2 620241	L= 1.055
xDrive 35 d	210	09/08→08/11	⬅	→ 08/10	1	24.8190-0254.2 620254	L= 745
			➡	→ 08/10	1	24.8190-0241.2 620241	L= 1.055
 Bremsscheibe							
2.0 d	110	11/03→08/07	⬅	08/04→		24.0125-0160.1 425160 24.0325-0160.1 525160	Ø 325 25 23,4 V + S Ø 325 25 22,6 V + S PD
			➡	08/04→		24.0122-0224.1 422224 24.0322-0224.1 522224	Ø 320 22 20,4 V + S Ø 320 22 19,6 V + S PD
2.0 i 2.5 si 3.0 d 3.0 d 3.0 i xDrive 3.0 si	110 160 155 160 170 200	07/05→08/08 09/06→08/08 10/04→07/06 10/04→07/06 01/04→08/06 09/06→08/08	⬅			24.0125-0160.1 425160 24.0325-0160.1 525160	Ø 325 25 23,4 V + S Ø 325 25 22,6 V + S PD
			➡			24.0122-0224.1 422224 24.0322-0224.1 522224	Ø 320 22 20,4 V + S Ø 320 22 19,6 V + S PD
2.5 i	141	01/04→08/06	⬅	03/04→		24.0125-0160.1 425160 24.0325-0160.1 525160	Ø 325 25 23,4 V + S Ø 325 25 22,6 V + S PD
			➡	03/04→		24.0122-0224.1 422224 24.0322-0224.1 522224	Ø 320 22 20,4 V + S Ø 320 22 19,6 V + S PD
↓							









	kw			 	! #		
BMW - X3 (E83) 01/03→12/11							
Bremsscheibe							
2.5 si xDrive	155	07/06→12/08	←	09/08→		24.0125-0160.1 425160	Ø 325 25 23,4 V + S
xDrive 20 d	120	09/07→08/10				24.0325-0160.1 525160	Ø 325 25 22,6 V + S PD
xDrive 20 d	130	09/07→08/10					
xDrive 30 d	155	03/06→08/10	→	09/08→		24.0122-0224.1 422224	Ø 320 22 20,4 V + S
xDrive 30 d	160	03/06→08/10				24.0322-0224.1 522224	Ø 320 22 19,6 V + S PD
3.0 d	150	01/03→08/05	←	10/03→		24.0125-0160.1 425160	Ø 325 25 23,4 V + S
						24.0325-0160.1 525160	Ø 325 25 22,6 V + S PD
			→	10/03→		24.0122-0224.1 422224	Ø 320 22 20,4 V + S
						24.0322-0224.1 522224	Ø 320 22 19,6 V + S PD
3.0 sd	210	09/06→08/08	←			24.0130-0109.1 430109	Ø 332 29,9 28,4 V + S
						24.0330-0109.1 530109	Ø 332 29,9 27,6 V + S PD
			→			24.0122-0224.1 422224	Ø 320 22 20,4 V + S
						24.0322-0224.1 522224	Ø 320 22 19,6 V + S PD
xDrive 18 d	100	04/09→12/11	←	→ 08/10		24.0125-0160.1 425160	Ø 325 25 23,4 V + S
xDrive 18 d	105	09/08→12/11				24.0325-0160.1 525160	Ø 325 25 22,6 V + S PD
xDrive 20 i	110	09/08→08/11					
xDrive 25 i	160	09/08→12/11	→	→ 08/10		24.0122-0224.1 422224	Ø 320 22 20,4 V + S
xDrive 30 i	200	09/08→12/11				24.0322-0224.1 522224	Ø 320 22 19,6 V + S PD
xDrive 35 d	210	09/08→08/11	←	→ 08/10		24.0130-0109.1 430109	Ø 332 29,9 28,4 V + S
						24.0330-0109.1 530109	Ø 332 29,9 27,6 V + S PD
			→	→ 08/10		24.0122-0224.1 422224	Ø 320 22 20,4 V + S
						24.0322-0224.1 522224	Ø 320 22 19,6 V + S PD
BMW - X3 (F25) 09/10→							
Bremsbelagsatz, Scheibenbremse							
sDrive 18 d	100	08/11→	←			13.0460-3857.2 603857	BOS 25199 19,6 + WE / - WK
sDrive 18 d	105	08/11→				13.0470-3857.2 LD3857	BOS 25199 19,6 + WE / - WK Ceramic
sDrive 18 d	110	02/14→					
sDrive 20 i	135	02/14→					
xDrive 20 d	120	09/10→	→			13.0460-2760.2 602760	TRW 24561 17,7 + WE / - WK + Zub
xDrive 20 d	135	09/10→					
xDrive 20 d	140	02/14→				13.0470-2760.2 LD2760	TRW 24561 17,7 + WE / - WK + Zub Ceramic
xDrive 20 i	135	09/11→					
xDrive 28 d	134	09/14→					
xDrive 28 i	190	04/11→					
xDrive 30 d	155	05/11→					
xDrive 30 d	183	04/15→					
xDrive 30 d	190	05/11→					
xDrive 30 d	204	06/16→					
xDrive 30 d	210	04/14→					
xDrive 35 i	225	09/10→					
sDrive 18 i	125	07/13→	←	02/14→		13.0460-3857.2 603857	BOS 25199 19,6 + WE / - WK
						13.0470-3857.2 LD3857	BOS 25199 19,6 + WE / - WK Ceramic
			→	02/14→		13.0460-2760.2 602760	TRW 24561 17,7 + WE / - WK + Zub
						13.0470-2760.2 LD2760	TRW 24561 17,7 + WE / - WK + Zub Ceramic
xDrive 28 i	180	08/11→	←	03/12→		13.0460-3857.2 603857	BOS 25199 19,6 + WE / - WK
						13.0470-3857.2 LD3857	BOS 25199 19,6 + WE / - WK Ceramic
			→	03/12→		13.0460-2760.2 602760	TRW 24561 17,7 + WE / - WK + Zub
						13.0470-2760.2 LD2760	TRW 24561 17,7 + WE / - WK + Zub Ceramic
xDrive 35 d	230	09/11→	←			13.0460-3857.2 603857	BOS 25199 19,6 + WE / - WK
						13.0460-2760.2 602760	TRW 24561 17,7 + WE / - WK + Zub
			→			13.0470-2760.2 LD2760	TRW 24561 17,7 + WE / - WK + Zub Ceramic
Warnkontakt, Bremsbelagverschleiß							
sDrive 18 d	100	08/11→	←	<input type="checkbox"/>	1	24.8190-0309.2 620309	L= 954
sDrive 18 d	105	08/11→					
sDrive 18 d	110	02/14→	→		1	24.8190-0310.2 620310	L= 1.243
sDrive 20 i	135	02/14→					
xDrive 20 d	120	09/10→					
xDrive 20 d	135	09/10→					
xDrive 20 d	140	02/14→					
xDrive 20 i	135	09/11→					
xDrive 28 d	134	09/14→					
xDrive 28 i	190	04/11→					
xDrive 30 d	155	05/11→					









	kW			 	! #		
BMW - X3 (F25) 09/10→							
Warnkontakt, Bremsbelagverschleiß							
xDrive 30 d	183	04/15→	←	☐	1	24.8190-0309.2 620309	L= 954
xDrive 30 d	190	05/11→	→		1	24.8190-0310.2 620310	L= 1.243
xDrive 30 d	204	06/16→					
xDrive 30 d	210	04/14→					
xDrive 35 d	230	09/11→					
xDrive 35 i	225	09/10→					
sDrive 18 i	125	07/13→	←	☐; 02/14→	1	24.8190-0309.2 620309	L= 954
			→	02/14→	1	24.8190-0310.2 620310	L= 1.243
xDrive 28 i	180	08/11→	←	☐; 03/12→	1	24.8190-0309.2 620309	L= 954
			→	03/12→	1	24.8190-0310.2 620310	L= 1.243
 Brems Scheibe							
sDrive 18 d	100	08/11→	←			24.0128-0254.1 428254	Ø 328 28 26,4 V + S
sDrive 18 d	105	08/11→				24.0328-0254.1 528254	Ø 328 28 25,6 V + S PD
sDrive 18 d	110	02/14→	→	+ eFSB		24.0120-0234.1 420234	Ø 330 20 18,4 V + S
sDrive 20 i	135	02/14→				24.0320-0234.1 520234	Ø 330 20 17,6 V + S PD
xDrive 20 d	120	09/10→					
xDrive 20 d	135	09/10→					
xDrive 20 d	140	02/14→					
xDrive 20 i	135	09/11→					
xDrive 28 d	134	09/14→					
xDrive 28 i	190	04/11→					
xDrive 30 d	155	05/11→					
xDrive 30 d	183	04/15→					
xDrive 30 d	190	05/11→					
xDrive 30 d	204	06/16→					
xDrive 30 d	210	04/14→					
xDrive 35 d	230	09/11→					
xDrive 35 i	225	09/10→					
sDrive 18 i	125	07/13→	←	02/14→		24.0128-0254.1 428254	Ø 328 28 26,4 V + S
						24.0328-0254.1 528254	Ø 328 28 25,6 V + S PD
			→	02/14→; + eFSB		24.0120-0234.1 420234	Ø 330 20 18,4 V + S
						24.0320-0234.1 520234	Ø 330 20 17,6 V + S PD
xDrive 28 i	180	08/11→	←	03/12→		24.0128-0254.1 428254	Ø 328 28 26,4 V + S
						24.0328-0254.1 528254	Ø 328 28 25,6 V + S PD
			→	03/12→; + eFSB		24.0120-0234.1 420234	Ø 330 20 18,4 V + S
						24.0320-0234.1 520234	Ø 330 20 17,6 V + S PD
BMW - X4 (F26) 05/13→							
 Bremsbelagsatz, Scheibenbremse							
xDrive 20 d	120	07/13→	←	04/14→		13.0460-3857.2 603857	BOS 25199 19,6 + WE / - WK
xDrive 20 d	140	07/13→				13.0470-3857.2 LD3857	BOS 25199 19,6 + WE / - WK Ceramic
xDrive 20 i	135	07/13→	→	04/14→		13.0460-2760.2 602760	TRW 24561 17,7 + WE / - WK + Zub
xDrive 28 i	180	05/13→				13.0470-2760.2 LD2760	TRW 24561 17,7 + WE / - WK + Zub Ceramic
xDrive 30 d	155	06/13→					
xDrive 30 d	190	06/13→					
xDrive 30 d	204	06/13→					
xDrive 30 d	210	06/13→					
xDrive 35 i	225	06/13→					
xDrive 30 d	183	06/15→	←			13.0460-3857.2 603857	BOS 25199 19,6 + WE / - WK
			→			13.0470-3857.2 LD3857	BOS 25199 19,6 + WE / - WK Ceramic
						13.0460-2760.2 602760	TRW 24561 17,7 + WE / - WK + Zub
						13.0470-2760.2 LD2760	TRW 24561 17,7 + WE / - WK + Zub Ceramic
xDrive 35 d	230	05/13→	←	04/14→		13.0460-3857.2 603857	BOS 25199 19,6 + WE / - WK
			→	04/14→		13.0460-2760.2 602760	TRW 24561 17,7 + WE / - WK + Zub
Warnkontakt, Bremsbelagverschleiß							
M 40 i	265	11/14→	←	☐; 12/15→	1	24.8190-0309.2 620309	L= 954
			→	12/15→	1	24.8190-0310.2 620310	L= 1.243
xDrive 20 d	120	07/13→	←	☐; 04/14→	1	24.8190-0309.2 620309	L= 954
xDrive 20 d	140	07/13→	→	04/14→	1	24.8190-0310.2 620310	L= 1.243
xDrive 20 i	135	07/13→					
xDrive 28 i	180	05/13→					
xDrive 30 d	155	06/13→					
xDrive 30 d	190	06/13→					
xDrive 30 d	204	06/13→					
xDrive 30 d	210	06/13→					
xDrive 35 d	230	05/13→					
xDrive 35 i	225	06/13→					
↓							









	kW				! #		
BMW - X4 (F26) 05/13→							
Warnkontakt, Bremsbelagverschleiß							
xDrive 30 d	183	06/15→	←	☐	1	24.8190-0309.2 620309	L= 954
			→		1	24.8190-0310.2 620310	L= 1.243
 Bremsscheibe							
M 40 i	265	11/14→	→	12/15→		24.0120-0234.1 420234	Ø 330 20 18,4 V + S
						24.0320-0234.1 520234	Ø 330 20 17,6 V + S PD
xDrive 20 d	120	07/13→	←	04/14→		24.0128-0254.1 428254	Ø 328 28 26,4 V + S
xDrive 20 d	140	07/13→				24.0328-0254.1 528254	Ø 328 28 25,6 V + S PD
xDrive 20 i	135	07/13→					
xDrive 28 i	180	05/13→	→	04/14→		24.0120-0234.1 420234	Ø 330 20 18,4 V + S
xDrive 30 d	155	06/13→				24.0320-0234.1 520234	Ø 330 20 17,6 V + S PD
xDrive 30 d	190	06/13→					
xDrive 30 d	204	06/13→					
xDrive 30 d	210	06/13→					
xDrive 35 d	230	05/13→					
xDrive 35 i	225	06/13→					
xDrive 30 d	183	06/15→	←			24.0128-0254.1 428254	Ø 328 28 26,4 V + S
						24.0328-0254.1 528254	Ø 328 28 25,6 V + S PD
			→			24.0120-0234.1 420234	Ø 330 20 18,4 V + S
						24.0320-0234.1 520234	Ø 330 20 17,6 V + S PD
BMW - X5 (E53) 05/00→02/07							
 Bremsbelagsatz, Scheibenbremse							
3.0 d	135	05/01→12/03	←	→ 09/03		13.0460-7078.2 607078	ATE 21486 19,5 + WE / - WK
						13.0470-7078.2 LD7078	ATE 21486 19,5 + WE / - WK Ceramic
			→	→ 09/03		13.0460-7079.2 607079	ATE 21282 17,3 + WE / - WK
						13.0470-7079.2 LD7079	ATE 21282 17,3 + WE / - WK Ceramic
3.0 d	155	09/03→12/06	←	10/03→		13.0460-7078.2 607078	ATE 21486 19,5 + WE / - WK
						13.0470-7078.2 LD7078	ATE 21486 19,5 + WE / - WK Ceramic
			→	10/03→		13.0460-7079.2 607079	ATE 21282 17,3 + WE / - WK
						13.0470-7079.2 LD7079	ATE 21282 17,3 + WE / - WK Ceramic
3.0 d	160	12/03→12/06	←			13.0460-7078.2 607078	ATE 21486 19,5 + WE / - WK
						13.0470-7078.2 LD7078	ATE 21486 19,5 + WE / - WK Ceramic
			→			13.0460-7079.2 607079	ATE 21282 17,3 + WE / - WK
						13.0470-7079.2 LD7079	ATE 21282 17,3 + WE / - WK Ceramic
3.0 i	163	05/00→12/06	←			13.0460-7078.2 607078	ATE 21486 19,5 + WE / - WK
3.0 i	170	05/00→12/06	→			13.0460-7079.2 607079	ATE 21282 17,3 + WE / - WK
						13.0470-7079.2 LD7079	ATE 21282 17,3 + WE / - WK Ceramic
4.4 i	210	05/00→12/03	←	→ 09/03		13.0460-7078.2 607078	ATE 21486 19,5 + WE / - WK
			→	→ 09/03		13.0460-7079.2 607079	ATE 21282 17,3 + WE / - WK
4.4 i	235	12/03→09/06	←	nicht für Sonderfahrzeuge		13.0460-7078.2 607078	ATE 21486 19,5 + WE / - WK
			←	für Sonderfahrzeuge		13.0460-7170.2 607170	ATE 23448 20,8 + WE / - WK
			→			13.0460-7079.2 607079	ATE 21282 17,3 + WE / - WK
4.6 is	255	02/02→12/03	←	→ 09/03		13.0460-7170.2 607170	ATE 23448 20,8 + WE / - WK
			→	→ 09/03		13.0460-7079.2 607079	ATE 21282 17,3 + WE / - WK
4.8 is	265	04/04→09/06	←			13.0460-7170.2 607170	ATE 23448 20,8 + WE / - WK
			→			13.0460-7079.2 607079	ATE 21282 17,3 + WE / - WK
Warnkontakt, Bremsbelagverschleiß							
3.0 d	135	05/01→12/03	←	→ 09/03	1	24.8190-0225.2 620225	L= 794
4.4 i	210	05/00→12/03	→	→ 09/03	1	24.8190-0226.2 620226	L= 712
4.6 is	255	02/02→12/03	→	→ 09/03	1	24.8190-0226.2 620226	L= 712
3.0 d	155	09/03→12/06	←	10/03→	1	24.8190-0225.2 620225	L= 794
			→	10/03→	1	24.8190-0226.2 620226	L= 712
3.0 d	160	12/03→12/06	←		1	24.8190-0225.2 620225	L= 794
3.0 i	163	05/00→12/06	→		1	24.8190-0226.2 620226	L= 712
3.0 i	170	05/00→12/06	→		1	24.8190-0226.2 620226	L= 712
4.8 is	265	04/04→09/06	←		1	24.8190-0225.2 620225	L= 794
4.4 i	235	12/03→09/06	←	für Sonderfahrzeuge	1	24.8190-0225.2 620225	L= 794









	kW			 	! #		
BMW - X5 (E53) 05/00→02/07							
Warnkontakt, Bremsbelagverschleiß							
4.4 i	235	12/03→09/06	←	nicht für Sonderfahrzeuge	1	24.8190-0225.2 620225	L= 794
			→		1	24.8190-0226.2 620226	L= 712
 Brems Scheibe							
3.0 d	135	05/01→12/03	←	→ 09/03		24.0130-0109.1 430109	Ø 332 29,9 28,4 V + S
4.4 i	210	05/00→12/03	→	→ 09/03		24.0330-0109.1 530109	Ø 332 29,9 27,6 V + S PD
			→	→ 09/03		24.0112-0152.1 412152	Ø 324 12 10,4
			→	→ 09/03		24.0312-0152.1 512152	Ø 324 12 9,6 PD
3.0 d	155	09/03→12/06	←	10/03→		24.0130-0109.1 430109	Ø 332 29,9 28,4 V + S
			→	10/03→		24.0330-0109.1 530109	Ø 332 29,9 27,6 V + S PD
			→	10/03→		24.0112-0152.1 412152	Ø 324 12 10,4
			→	10/03→		24.0312-0152.1 512152	Ø 324 12 9,6 PD
3.0 d	160	12/03→12/06	←			24.0130-0109.1 430109	Ø 332 29,9 28,4 V + S
3.0 i	163	05/00→12/06	→			24.0330-0109.1 530109	Ø 332 29,9 27,6 V + S PD
3.0 i	170	05/00→12/06	→			24.0112-0152.1 412152	Ø 324 12 10,4
			→			24.0312-0152.1 512152	Ø 324 12 9,6 PD
4.4 i	235	12/03→09/06	←	nicht für Sonderfahrzeuge		24.0130-0109.1 430109	Ø 332 29,9 28,4 V + S
			←	für Sonderfahrzeuge		24.0330-0109.1 530109	Ø 332 29,9 27,6 V + S PD
			→			24.0136-0104.1 436104	Ø 356 36 34,4 V
			→			24.0120-0191.1 420191	Ø 324 20 18,4 V
4.6 is	255	02/02→12/03	←	→ 09/03		24.0136-0104.1 436104	Ø 356 36 34,4 V
			→	→ 09/03		24.0120-0191.1 420191	Ø 324 20 18,4 V
4.8 is	265	04/04→09/06	←			24.0136-0104.1 436104	Ø 356 36 34,4 V
			→			24.0120-0191.1 420191	Ø 324 20 18,4 V
BMW - X5 (E70) 02/06→06/13							
 Bremsbelagsatz, Scheibenbremse							
3.0 d	155	02/07→09/08	←			13.0460-7231.2 607231	ATE 24170 20,2 + WE / - WK
3.0 d	173	02/07→09/08	→			13.0470-7231.2 LD7231	ATE 24170 20,2 + WE / - WK Ceramic
xDrive 30 d	180	09/10→06/13	→			13.0460-7232.2 607232	ATE 21282 17,3 + WE / - WK
xDrive 35 i	225	09/10→06/13	→			13.0470-7232.2 LD7232	ATE 21282 17,3 + WE / - WK Ceramic
xDrive 35 i	235	02/12→06/13	→			13.0460-7232.2 607232	ATE 21282 17,3 + WE / - WK
xDrive 40 d	225	09/10→06/13	→			13.0470-7232.2 LD7232	ATE 21282 17,3 + WE / - WK Ceramic
xDrive 40 i	225	01/12→06/13	→			13.0460-7232.2 607232	ATE 21282 17,3 + WE / - WK
			→			13.0470-7232.2 LD7232	ATE 21282 17,3 + WE / - WK Ceramic
3.0 sd	210	09/07→02/09	←	10/08→		13.0460-7231.2 607231	ATE 24170 20,2 + WE / - WK
			←	→ 09/08		13.0470-7231.2 LD7231	ATE 24170 20,2 + WE / - WK Ceramic
			←	→ 09/08		13.0460-7239.2 607239	ATE 24172 19,0 + WE / - WK
			←	→ 09/08		13.0470-7239.2 LD7239	ATE 24172 19,0 + WE / - WK Ceramic
			→			13.0460-7169.2 607169	ATE 23309 17,3 + WE / - WK
			→			13.0470-7169.2 LD7169	ATE 23309 17,3 + WE / - WK Ceramic
3.0 si	200	02/06→09/08	←	01/07→		13.0460-7231.2 607231	ATE 24170 20,2 + WE / - WK
			→	01/07→		13.0470-7231.2 LD7231	ATE 24170 20,2 + WE / - WK Ceramic
			→	01/07→		13.0460-7232.2 607232	ATE 21282 17,3 + WE / - WK
			→	01/07→		13.0470-7232.2 LD7232	ATE 21282 17,3 + WE / - WK Ceramic
4.8 i xDrive	261	02/07→09/08	←			13.0460-7231.2 607231	ATE 24170 20,2 + WE / - WK
			→			13.0460-7239.2 607239	ATE 24172 19,0 + WE / - WK
			→			13.0460-7169.2 607169	ATE 23309 17,3 + WE / - WK
			→			13.0470-7169.2 LD7169	ATE 23309 17,3 + WE / - WK Ceramic
M 50 d	280	08/11→06/13	←	06/12→		13.0460-7261.2 607261	ATE 24436 19,7 + WE / - WK
			→	06/12→		13.0460-7169.2 607169	ATE 23309 17,3 + WE / - WK
			→	06/12→		13.0470-7169.2 LD7169	ATE 23309 17,3 + WE / - WK Ceramic
xDrive 30 d	155	09/08→06/13	←			13.0460-7231.2 607231	ATE 24170 20,2 + WE / - WK
xDrive 30 d	173	09/08→06/13	→			13.0470-7231.2 LD7231	ATE 24170 20,2 + WE / - WK Ceramic
xDrive 35 d	210	09/08→06/13	→	03/10→		13.0460-7232.2 607232	ATE 21282 17,3 + WE / - WK
			→	03/10→		13.0470-7232.2 LD7232	ATE 21282 17,3 + WE / - WK Ceramic
↓							







	kW			 	! #		
BMW - X5 (E70) 02/06→06/13							
Bremsbelagsatz, Scheibenbremse							
xDrive 30 d xDrive 30 d xDrive 35 d	155 173 210	09/08→06/13 09/08→06/13 09/08→06/13	➡	→ 02/10		13.0460-7232.2 607232 13.0470-7232.2 LD7232	ATE 21282 17,3 + WE / - WK ATE 21282 17,3 + WE / - WK Ceramic
xDrive 30 i xDrive 30 i	171 200	09/08→12/10 09/08→03/10	⬅			13.0460-7231.2 607231 13.0470-7231.2 LD7231	ATE 24170 20,2 + WE / - WK ATE 24170 20,2 + WE / - WK Ceramic
			⬅	03/10→		13.0460-7231.2 607231 13.0470-7231.2 LD7231	ATE 24170 20,2 + WE / - WK ATE 24170 20,2 + WE / - WK Ceramic
			➡	→ 02/10		13.0460-7232.2 607232 13.0470-7232.2 LD7232	ATE 21282 17,3 + WE / - WK ATE 21282 17,3 + WE / - WK Ceramic
			➡	03/10→		13.0460-7232.2 607232 13.0470-7232.2 LD7232	ATE 21282 17,3 + WE / - WK ATE 21282 17,3 + WE / - WK Ceramic
			➡	03/10→		13.0460-7232.2 607232 13.0470-7232.2 LD7232	ATE 21282 17,3 + WE / - WK ATE 21282 17,3 + WE / - WK Ceramic
xDrive 48 i	261	09/08→06/13	⬅	03/10→		13.0460-7231.2 607231 13.0460-7239.2 607239	ATE 24170 20,2 + WE / - WK ATE 24172 19,0 + WE / - WK
			⬅	→ 02/10		13.0460-7231.2 607231 13.0460-7239.2 607239	ATE 24170 20,2 + WE / - WK ATE 24172 19,0 + WE / - WK
			➡	→ 02/10		13.0460-7169.2 607169 13.0470-7169.2 LD7169	ATE 23309 17,3 + WE / - WK ATE 23309 17,3 + WE / - WK Ceramic
			➡	03/10→		13.0460-7169.2 607169 13.0470-7169.2 LD7169	ATE 23309 17,3 + WE / - WK ATE 23309 17,3 + WE / - WK Ceramic
			➡	03/10→		13.0460-7169.2 607169 13.0470-7169.2 LD7169	ATE 23309 17,3 + WE / - WK ATE 23309 17,3 + WE / - WK Ceramic
xDrive 50 i	300	06/10→06/13	⬅	nicht für gepanzerte Fahrzeuge		13.0460-7261.2 607261	ATE 24436 19,7 + WE / - WK
			➡			13.0460-7169.2 607169 13.0470-7169.2 LD7169	ATE 23309 17,3 + WE / - WK ATE 23309 17,3 + WE / - WK Ceramic
Warnkontakt, Bremsbelagverschleiß							
3.0 d 3.0 d	155 173	02/07→09/08 02/07→09/08	⬅	☐	1	24.8190-0268.2 620268	L= 905
			➡		1	24.8190-0269.2 620269	L= 965
3.0 sd	210	09/07→02/09	⬅	☐; 10/08→	1	24.8190-0268.2 620268	L= 905
			⬅	☐; → 09/08	1	24.8190-0270.2 620270	L= 898
			➡		1	24.8190-0269.2 620269	L= 965
3.0 si	200	02/06→09/08	⬅	☐; 01/07→	1	24.8190-0268.2 620268	L= 905
			➡	01/07→	1	24.8190-0269.2 620269	L= 965
4.8 i xDrive	261	02/07→09/08	⬅	☐	1	24.8190-0268.2 620268 24.8190-0270.2 620270	L= 905 L= 898
			➡		1	24.8190-0269.2 620269	L= 965
			⬅	☐; → 02/10	1	24.8190-0281.2 620281	L= 962
M	408	09/09→06/13	⬅	☐; 03/10→	1	24.8190-0291.2 620291	L= 974
			➡	03/10→	1	24.8190-0028.2 620028 24.8190-0290.2 620290	L= 977 L= 1.002
			➡	→ 02/10	1	24.8190-0269.2 620269	L= 965
M 50 d	280	08/11→06/13	⬅	☐; 06/12→	1	24.8190-0071.2 620071	L= 945
			➡	06/12→	1	24.8190-0028.2 620028 24.8190-0290.2 620290	L= 977 L= 1.002
xDrive 30 d xDrive 30 d	155 173	09/08→06/13 09/08→06/13	⬅	☐	1	24.8190-0289.2 620289	L= 938
			➡	03/10→	1	24.8190-0028.2 620028 24.8190-0290.2 620290	L= 977 L= 1.002
			➡	→ 02/10	1	24.8190-0269.2 620269	L= 965
xDrive 30 d xDrive 35 i xDrive 35 i xDrive 40 d xDrive 40 i	180 225 235 225 225	09/10→06/13 09/10→06/13 02/12→06/13 09/10→06/13 01/12→06/13	⬅	☐	1	24.8190-0289.2 620289	L= 938
			➡		1	24.8190-0028.2 620028 24.8190-0290.2 620290	L= 977 L= 1.002
			⬅	☐	1	24.8190-0268.2 620268	L= 905
xDrive 30 i xDrive 30 i	171 200	09/08→12/10 09/08→03/10	⬅	☐; 03/10→	1	24.8190-0289.2 620289	L= 938
			➡	03/10→	1	24.8190-0028.2 620028 24.8190-0290.2 620290	L= 977 L= 1.002
			➡				











	kW			 	! #		
BMW - X5 (E70) 02/06→06/13							
Warnkontakt, Bremsbelagverschleiß							
xDrive 30 i	171	09/08→12/10	➔	→ 02/10	1	24.8190-0269.2 620269	L= 965
xDrive 30 i	200	09/08→03/10					
xDrive 35 d	210	09/08→06/13	➔	☐	1	24.8190-0268.2 620268	L= 905
			➔	03/10→	1	24.8190-0028.2 620028	L= 977
			➔	→ 02/10	1	24.8190-0290.2 620290	L= 1.002
xDrive 48 i	261	09/08→06/13	➔	☐; → 02/10	1	24.8190-0268.2 620268	L= 905
						24.8190-0270.2 620270	L= 898
			➔	☐; 03/10→	1	24.8190-0289.2 620289	L= 938
						24.8190-0291.2 620291	L= 974
			➔	03/10→	1	24.8190-0028.2 620028	L= 977
xDrive 50 i	300	06/10→06/13	➔	☐; nicht für gepanzerte Fahrzeuge	1	24.8190-0028.2 620028	L= 1.002
			➔	☐; für gepanzerte Fahrzeuge	1	24.8190-0291.2 620291	L= 945
						24.8190-0071.2 620071	L= 974
			➔		1	24.8190-0290.2 620290	L= 977
			➔		1	24.8190-0290.2 620290	L= 1.002
 Brems Scheibe							
3.0 d	155	02/07→09/08	➔			24.0130-0199.1 430199	Ø 348 29,9 28,4 V + S
3.0 d	173	02/07→09/08					
xDrive 35 d	210	09/08→06/13	➔			24.0120-0206.1 420206	Ø 320 19,9 18,4 V + S
xDrive 35 i	225	09/10→06/13					
xDrive 35 i	235	02/12→06/13					
xDrive 40 d	225	09/10→06/13					
xDrive 40 i	225	01/12→06/13					
3.0 sd	210	09/07→02/09	➔	10/08→		24.0130-0199.1 430199	Ø 348 29,9 28,4 V + S
			➔	→ 09/08		24.0136-0109.1 436109	Ø 365 36 34,4 V + S
			➔			24.0124-0216.1 424216	Ø 345 24 22,4 V + S
3.0 si	200	02/06→09/08	➔	01/07→		24.0130-0200.1 430200	Ø 332 29,9 28,4 V + S
			➔	01/07→		24.0120-0206.1 420206	Ø 320 19,9 18,4 V + S
4.8 i xDrive xDrive 48 i	261 261	02/07→09/08 09/08→06/13	➔	für USA		24.0130-0199.1 430199	Ø 348 29,9 28,4 V + S
			➔	nicht für USA		24.0136-0109.1 436109	Ø 365 36 34,4 V + S
			➔			24.0124-0216.1 424216	Ø 345 24 22,4 V + S
M 50 d	280	08/11→06/13	➔	☐; 06/12→		24.0136-0112.2 436112	Ø 385 36 34,4 V Brems Scheibe zweiteilig / + S
			➔	☐; 06/12→		24.0136-0113.2 436113	Ø 385 36 34,4 V Brems Scheibe zweiteilig / + S
			➔	06/12→		24.0124-0216.1 424216	Ø 345 24 22,4 V + S
xDrive 30 d xDrive 30 d xDrive 30 d xDrive 30 i xDrive 30 i	155 173 180 171 200	09/08→06/13 09/08→06/13 09/10→06/13 09/08→12/10 09/08→03/10	➔			24.0130-0200.1 430200	Ø 332 29,9 28,4 V + S
			➔			24.0120-0206.1 420206	Ø 320 19,9 18,4 V + S
xDrive 50 i	300	06/10→06/13	➔	für gepanzerte Fahrzeuge		24.0136-0109.1 436109	Ø 365 36 34,4 V + S
			➔	☐; nicht für gepanzerte Fahrzeuge		24.0136-0112.2 436112	Ø 385 36 34,4 V Brems Scheibe zweiteilig / + S
			➔	☐; nicht für gepanzerte Fahrzeuge		24.0136-0113.2 436113	Ø 385 36 34,4 V Brems Scheibe zweiteilig / + S
			➔			24.0124-0216.1 424216	Ø 345 24 22,4 V + S
BMW - X5 (F15, F85) 06/12→							
 Bremsbelagsatz, Scheibenbremse							
M	423	12/14→	➔			13.0460-7260.2 607260	ATE 24458 17,3 + WE / - WK
M 50 d	280	07/13→	➔	08/13→		13.0460-7261.2 607261	ATE 24436 19,7 + WE / - WK
			➔	08/13→		13.0460-7169.2 607169	ATE 23309 17,3 + WE / - WK
						13.0470-7169.2 LD7169	ATE 23309 17,3 + WE / - WK Ceramic
sDrive 25 d sDrive 25 d sDrive 25 d xDrive 25 d xDrive 25 d xDrive 25 d xDrive 25 d	155 160 170 155 160 170 160	11/13→ 11/13→ 07/15→ 11/13→ 11/13→ 07/15→ 06/15→	➔			13.0460-7231.2 607231	ATE 24170 20,2 + WE / - WK
						13.0470-7231.2 LD7231	ATE 24170 20,2 + WE / - WK Ceramic
			➔			13.0460-7232.2 607232	ATE 21282 17,3 + WE / - WK
						13.0470-7232.2 LD7232	ATE 21282 17,3 + WE / - WK Ceramic











	kW			 	! #		
BMW - X5 (F15, F85) 06/12→							
 Bremsbelagsatz, Scheibenbremse							
xDrive 30 d xDrive 30 d	183 204	04/15→ 11/13→	← →			13.0460-7231.2 607231 13.0470-7231.2 LD7231	ATE 24170 20,2 + WE / - WK ATE 24170 20,2 + WE / - WK Ceramic
						13.0460-7232.2 607232 13.0470-7232.2 LD7232	ATE 21282 17,3 + WE / - WK ATE 21282 17,3 + WE / - WK Ceramic
xDrive 30 d xDrive 30 d	190 210	07/13→ 07/13→	← →	08/13→ 08/13→		13.0460-7231.2 607231 13.0470-7231.2 LD7231	ATE 24170 20,2 + WE / - WK ATE 24170 20,2 + WE / - WK Ceramic
						13.0460-7232.2 607232 13.0470-7232.2 LD7232	ATE 21282 17,3 + WE / - WK ATE 21282 17,3 + WE / - WK Ceramic
xDrive 35 i xDrive 35 i	225 240	11/13→ 11/13→	← →			13.0460-7231.2 607231 13.0470-7231.2 LD7231	ATE 24170 20,2 + WE / - WK ATE 24170 20,2 + WE / - WK Ceramic
						13.0460-7169.2 607169 13.0470-7169.2 LD7169	ATE 23309 17,3 + WE / - WK ATE 23309 17,3 + WE / - WK Ceramic
xDrive 40 d	230	12/13→	← →			13.0460-7231.2 607231 13.0460-7169.2 607169 13.0470-7169.2 LD7169	ATE 24170 20,2 + WE / - WK ATE 23309 17,3 + WE / - WK ATE 23309 17,3 + WE / - WK Ceramic
xDrive 40e xDrive 40e xDrive 40e xDrive 40e	155 180 205 230	09/15→ 09/15→ 09/15→ 09/15→	← →			13.0460-7231.2 607231 13.0460-7232.2 607232 13.0470-7232.2 LD7232	ATE 24170 20,2 + WE / - WK ATE 21282 17,3 + WE / - WK ATE 21282 17,3 + WE / - WK Ceramic
xDrive 50 i	330	07/13→	← →	08/13→ 08/13→		13.0460-7261.2 607261 13.0460-7169.2 607169	ATE 24436 19,7 + WE / - WK ATE 23309 17,3 + WE / - WK
Warnkontakt, Bremsbelagsverschleiß							
M	423	12/14→	← →		1	24.8190-0291.2 620291 24.8190-0290.2 620290	L= 974 L= 1.002
M 50 d xDrive 50 i	280 330	07/13→ 07/13→	← →	08/13→ 08/13→	1	24.8190-0071.2 620071 24.8190-0028.2 620028	L= 945 L= 977
sDrive 25 d sDrive 25 d sDrive 25 d xDrive 25 d xDrive 25 d xDrive 25 d xDrive 25 d xDrive 25 d xDrive 30 d xDrive 30 d xDrive 35 i xDrive 35 i xDrive 40 d xDrive 40e xDrive 40e xDrive 40e xDrive 40e	155 160 170 155 160 170 160 183 204 225 240 230 155 180 205 230	11/13→ 11/13→ 07/15→ 11/13→ 11/13→ 07/15→ 06/15→ 04/15→ 11/13→ 11/13→ 11/13→ 11/13→ 12/13→ 09/15→ 09/15→ 09/15→ 09/15→	← →		1	24.8190-0289.2 620289 24.8190-0028.2 620028	L= 938 L= 977
xDrive 30 d xDrive 30 d	190 210	07/13→ 07/13→	← →	08/13→ 08/13→	1	24.8190-0289.2 620289 24.8190-0028.2 620028	L= 938 L= 977
 Bremsscheibe							
M 50 d xDrive 50 i	280 330	07/13→ 07/13→	← ← →	08/13→ 08/13→ 08/13→		24.0136-0112.2 436112 24.0136-0113.2 436113 24.0124-0216.1 424216	Ø 385 36 34,4 V Bremsscheibe zweiteilig / + S Ø 385 36 34,4 V Bremsscheibe zweiteilig / + S Ø 345 24 22,4 V + S
sDrive 25 d sDrive 25 d sDrive 25 d xDrive 25 d xDrive 25 d xDrive 25 d xDrive 25 d xDrive 30 d xDrive 30 d	155 160 170 155 160 170 160 183 204	11/13→ 11/13→ 07/15→ 11/13→ 11/13→ 07/15→ 06/15→ 04/15→ 11/13→	← →			24.0130-0200.1 430200 24.0120-0206.1 420206	Ø 332 29,9 28,4 V + S Ø 320 19,9 18,4 V + S
xDrive 30 d ↓	190	07/13→	←	08/13→		24.0130-0200.1 430200	Ø 332 29,9 28,4 V + S

	kW			 	! #		
BMW - X5 (F15, F85) 06/12→							
 Bremsscheibe							
xDrive 30 d	210	07/13→	➔	08/13→		24.0120-0206.1 420206	Ø 320 19,9 18,4 V + S
xDrive 35 i	225	11/13→	➔			24.0130-0199.1 430199	Ø 348 29,9 28,4 V + S
xDrive 35 i	240	11/13→	➔				
xDrive 40 d	230	12/13→	➔			24.0124-0216.1 424216	Ø 345 24 22,4 V + S
xDrive 40e	155	09/15→	➔			24.0130-0199.1 430199	Ø 348 29,9 28,4 V + S
xDrive 40e	180	09/15→	➔				
xDrive 40e	205	09/15→	➔			24.0120-0206.1 420206	Ø 320 19,9 18,4 V + S
xDrive 40e	230	09/15→	➔				
BMW - X6 (E71, E72) 06/07→06/14							
 Bremsbelagsatz, Scheibenbremse							
ActiveHybrid	300	01/09→10/11	➔	10/10→		13.0460-7261.2 607261	ATE 24436 19,7 + WE / - WK
ActiveHybrid	357	01/09→10/11	➔	10/10→		13.0460-7169.2 607169	ATE 23309 17,3 + WE / - WK
						13.0470-7169.2 LD7169	ATE 23309 17,3 + WE / - WK Ceramic
M 50 d	280	08/11→06/14	➔	06/12→		13.0460-7261.2 607261	ATE 24436 19,7 + WE / - WK
			➔	06/12→		13.0460-7169.2 607169	ATE 23309 17,3 + WE / - WK
						13.0470-7169.2 LD7169	ATE 23309 17,3 + WE / - WK Ceramic
xDrive 30 d	155	07/09→06/14	➔	→ 02/10		13.0460-7231.2 607231	ATE 24170 20,2 + WE / - WK
						13.0470-7231.2 LD7231	ATE 24170 20,2 + WE / - WK Ceramic
			➔	03/10→		13.0460-7231.2 607231	ATE 24170 20,2 + WE / - WK
						13.0470-7231.2 LD7231	ATE 24170 20,2 + WE / - WK Ceramic
			➔	03/10→		13.0460-7232.2 607232	ATE 21282 17,3 + WE / - WK
						13.0470-7232.2 LD7232	ATE 21282 17,3 + WE / - WK Ceramic
			➔	→ 02/10		13.0460-7232.2 607232	ATE 21282 17,3 + WE / - WK
						13.0470-7232.2 LD7232	ATE 21282 17,3 + WE / - WK Ceramic
xDrive 30 d	173	09/07→03/10	➔	11/08→ 02/10		13.0460-7231.2 607231	ATE 24170 20,2 + WE / - WK
						13.0470-7231.2 LD7231	ATE 24170 20,2 + WE / - WK Ceramic
			➔	03/10→		13.0460-7231.2 607231	ATE 24170 20,2 + WE / - WK
						13.0470-7231.2 LD7231	ATE 24170 20,2 + WE / - WK Ceramic
			➔	09/08→ 10/08		13.0460-7239.2 607239	ATE 24172 19,0 + WE / - WK
						13.0470-7239.2 LD7239	ATE 24172 19,0 + WE / - WK Ceramic
			➔	09/08→ 02/10		13.0460-7232.2 607232	ATE 21282 17,3 + WE / - WK
						13.0470-7232.2 LD7232	ATE 21282 17,3 + WE / - WK Ceramic
			➔	03/10→		13.0460-7232.2 607232	ATE 21282 17,3 + WE / - WK
						13.0470-7232.2 LD7232	ATE 21282 17,3 + WE / - WK Ceramic
xDrive 30 d	180	04/09→06/14	➔	09/10→		13.0460-7231.2 607231	ATE 24170 20,2 + WE / - WK
						13.0470-7231.2 LD7231	ATE 24170 20,2 + WE / - WK Ceramic
			➔	09/10→		13.0460-7232.2 607232	ATE 21282 17,3 + WE / - WK
						13.0470-7232.2 LD7232	ATE 21282 17,3 + WE / - WK Ceramic
xDrive 35 d	210	06/07→03/10	➔	11/08→ 02/10		13.0460-7231.2 607231	ATE 24170 20,2 + WE / - WK
xDrive 35 i	225	06/07→03/10				13.0470-7231.2 LD7231	ATE 24170 20,2 + WE / - WK Ceramic
xDrive 35 i	240	06/07→03/10					
			➔	03/10→		13.0460-7231.2 607231	ATE 24170 20,2 + WE / - WK
						13.0470-7231.2 LD7231	ATE 24170 20,2 + WE / - WK Ceramic
			➔	09/08→ 10/08		13.0460-7239.2 607239	ATE 24172 19,0 + WE / - WK
						13.0470-7239.2 LD7239	ATE 24172 19,0 + WE / - WK Ceramic
			➔	09/08→ 09/09		13.0460-7169.2 607169	ATE 23309 17,3 + WE / - WK
						13.0470-7169.2 LD7169	ATE 23309 17,3 + WE / - WK Ceramic
			➔	03/10→		13.0460-7232.2 607232	ATE 21282 17,3 + WE / - WK
						13.0470-7232.2 LD7232	ATE 21282 17,3 + WE / - WK Ceramic
↓							









	kw			 	! #		
BMW - X6 (E71, E72) 06/07→06/14							
 Bremsbelagsatz, Scheibenbremse							
xDrive 35 d xDrive 35 i xDrive 35 i	210 225 240	06/07→03/10 06/07→03/10 06/07→03/10	➡	10/09→ 02/10		13.0460-7232.2 607232 13.0470-7232.2 LD7232	ATE 21282 17,3 + WE / - WK ATE 21282 17,3 + WE / - WK Ceramic
xDrive 35 i	235	07/09→06/14	⬅	03/10→		13.0460-7231.2 607231 13.0470-7231.2 LD7231	ATE 24170 20,2 + WE / - WK ATE 24170 20,2 + WE / - WK Ceramic
			⬅	→ 02/10		13.0460-7231.2 607231 13.0470-7231.2 LD7231	ATE 24170 20,2 + WE / - WK ATE 24170 20,2 + WE / - WK Ceramic
			➡	→ 09/09		13.0460-7169.2 607169 13.0470-7169.2 LD7169	ATE 23309 17,3 + WE / - WK ATE 23309 17,3 + WE / - WK Ceramic
			➡	03/10→		13.0460-7232.2 607232 13.0470-7232.2 LD7232	ATE 21282 17,3 + WE / - WK ATE 21282 17,3 + WE / - WK Ceramic
			➡	10/09→ 02/10		13.0460-7232.2 607232 13.0470-7232.2 LD7232	ATE 21282 17,3 + WE / - WK ATE 21282 17,3 + WE / - WK Ceramic
xDrive 40 d	225	07/09→06/14	⬅	10/10→		13.0460-7231.2 607231 13.0470-7231.2 LD7231	ATE 24170 20,2 + WE / - WK ATE 24170 20,2 + WE / - WK Ceramic
			➡	10/10→		13.0460-7232.2 607232 13.0470-7232.2 LD7232	ATE 21282 17,3 + WE / - WK ATE 21282 17,3 + WE / - WK Ceramic
xDrive 50 i xDrive 50 i	300 330	10/07→06/14 10/07→06/14	⬅	09/08→ 02/10		13.0460-7261.2 607261	ATE 24436 19,7 + WE / - WK
			⬅	03/10→		13.0460-7261.2 607261	ATE 24436 19,7 + WE / - WK
			➡	10/09→ 02/10		13.0460-7169.2 607169 13.0470-7169.2 LD7169	ATE 23309 17,3 + WE / - WK ATE 23309 17,3 + WE / - WK Ceramic
			➡	03/10→		13.0460-7169.2 607169 13.0470-7169.2 LD7169	ATE 23309 17,3 + WE / - WK ATE 23309 17,3 + WE / - WK Ceramic
			➡	09/08→ 09/09		13.0460-7260.2 607260	ATE 24458 17,3 + WE / - WK
Warnkontakt, Bremsbelagverschleiß							
ActiveHybrid ActiveHybrid	300 357	01/09→10/11 01/09→10/11	⬅	☐; 10/10→	1	24.8190-0071.2 620071	L= 945
			➡	10/10→	1	24.8190-0028.2 620028 24.8190-0290.2 620290	L= 977 L= 1.002
M	408	07/08→06/14	⬅	☐; 09/09→ 02/10	1	24.8190-0281.2 620281	L= 962
			⬅	03/10→	1	24.8190-0291.2 620291	L= 974
			➡	03/10→	1	24.8190-0028.2 620028 24.8190-0290.2 620290	L= 977 L= 1.002
			➡	09/09→ 02/10	1	24.8190-0269.2 620269	L= 965
M 50 d	280	08/11→06/14	⬅	☐; 06/12→	1	24.8190-0071.2 620071	L= 945
			➡	06/12→	1	24.8190-0028.2 620028 24.8190-0290.2 620290	L= 977 L= 1.002
xDrive 30 d	155	07/09→06/14	⬅	☐; → 02/10	1	24.8190-0268.2 620268	L= 905
			⬅	03/10→	1	24.8190-0289.2 620289	L= 938
			➡	03/10→	1	24.8190-0028.2 620028 24.8190-0290.2 620290	L= 977 L= 1.002
			➡	→ 02/10	1	24.8190-0269.2 620269	L= 965
xDrive 30 d	173	09/07→03/10	⬅	☐; 11/08→ 02/10	1	24.8190-0268.2 620268	L= 905
			⬅	☐; 09/08→ 10/08	1	24.8190-0270.2 620270	L= 898
			⬅	03/10→	1	24.8190-0289.2 620289	L= 938
			➡	03/10→	1	24.8190-0028.2 620028 24.8190-0290.2 620290	L= 977 L= 1.002
			➡	09/08→ 02/10	1	24.8190-0269.2 620269	L= 965
xDrive 30 d	180	04/09→06/14	⬅	09/10→	1	24.8190-0289.2 620289	L= 938
			➡	09/10→	1	24.8190-0028.2 620028 24.8190-0290.2 620290	L= 977 L= 1.002
xDrive 35 d xDrive 35 i ↓	210 225	06/07→03/10 06/07→03/10	⬅	☐; 11/08→ 02/10	1	24.8190-0268.2 620268	L= 905











	kW			 	! #		
BMW - X6 (E71, E72) 06/07→06/14							
Warnkontakt, Bremsbelagverschleiß							
xDrive 35 i	240	06/07→03/10	←	☐; 09/08→ 10/08	1	24.8190-0270.2 620270	L= 898
			←	03/10→	1	24.8190-0289.2 620289	L= 938
			→	03/10→	1	24.8190-0028.2 620028 24.8190-0290.2 620290	L= 977 L= 1.002
			→	10/09→ 02/10	1	24.8190-0269.2 620269	L= 965
			→	09/08→ 09/09	1	24.8190-0269.2 620269	L= 965
xDrive 35 i	235	07/09→06/14	←	☐; → 02/10	1	24.8190-0268.2 620268	L= 905
			←	03/10→	1	24.8190-0289.2 620289	L= 938
			→	03/10→	1	24.8190-0028.2 620028 24.8190-0290.2 620290	L= 977 L= 1.002
			→	10/09→ 02/10	1	24.8190-0269.2 620269	L= 965
			→	→ 09/09	1	24.8190-0269.2 620269	L= 965
xDrive 40 d	225	07/09→06/14	←	10/10→	1	24.8190-0289.2 620289	L= 938
			→	10/10→	1	24.8190-0028.2 620028 24.8190-0290.2 620290	L= 977 L= 1.002
xDrive 50 i xDrive 50 i	300 330	10/07→06/14 10/07→06/14	←	☐; 03/10→	1	24.8190-0071.2 620071	L= 945
			←	☐; 09/08→ 02/10	1	24.8190-0280.2 620280	L= 930
			→	03/10→	1	24.8190-0028.2 620028 24.8190-0290.2 620290	L= 977 L= 1.002
			→	10/09→ 02/10	1	24.8190-0269.2 620269	L= 965
			→	09/08→ 09/09	1	24.8190-0269.2 620269	L= 965
Bremsscheibe							
ActiveHybrid ActiveHybrid	300 357	01/09→10/11 01/09→10/11	←	☐; 10/10→		24.0136-0112.2 436112	Ø 385 36 34,4 V Bremsscheibe zweiteilig / + S
			←	☐; 10/10→		24.0136-0113.2 436113	Ø 385 36 34,4 V Bremsscheibe zweiteilig / + S
			→	10/10→		24.0124-0216.1 424216	Ø 345 24 22,4 V + S
M 50 d	280	08/11→06/14	←	☐; 06/12→		24.0136-0112.2 436112	Ø 385 36 34,4 V Bremsscheibe zweiteilig / + S
			←	☐; 06/12→		24.0136-0113.2 436113	Ø 385 36 34,4 V Bremsscheibe zweiteilig / + S
			→	06/12→		24.0124-0216.1 424216	Ø 345 24 22,4 V + S
xDrive 30 d	155	07/09→06/14	←			24.0130-0199.1 430199	Ø 348 29,9 28,4 V + S
			→			24.0120-0206.1 420206	Ø 320 19,9 18,4 V + S
xDrive 30 d	173	09/07→03/10	←	09/08→		24.0130-0199.1 430199	Ø 348 29,9 28,4 V + S
			→	09/08→		24.0120-0206.1 420206	Ø 320 19,9 18,4 V + S
xDrive 30 d	180	04/09→06/14	←	09/10→; Motorcode: M57		24.0130-0199.1 430199	Ø 348 29,9 28,4 V + S
			←	09/10→; Motorcode: N57		24.0130-0200.1 430200	Ø 332 29,9 28,4 V + S
			→	09/10→		24.0120-0206.1 420206	Ø 320 19,9 18,4 V + S
xDrive 35 d	210	06/07→03/10	←	11/08→		24.0130-0199.1 430199	Ø 348 29,9 28,4 V + S
			←	09/08→ 10/08		24.0136-0109.1 436109	Ø 365 36 34,4 V + S
			→	10/09→		24.0120-0206.1 420206	Ø 320 19,9 18,4 V + S
			→	09/08→ 09/09		24.0124-0216.1 424216	Ø 345 24 22,4 V + S
xDrive 35 i xDrive 35 i	225 240	06/07→03/10 06/07→03/10	←	11/08→		24.0130-0199.1 430199	Ø 348 29,9 28,4 V + S
			←	09/08→ 10/08		24.0136-0109.1 436109	Ø 365 36 34,4 V + S
			→	10/09→		24.0120-0206.1 420206	Ø 320 19,9 18,4 V + S
			→	11/08→ 09/09		24.0124-0216.1 424216	Ø 345 24 22,4 V + S
xDrive 35 i	235	07/09→06/14	←			24.0130-0199.1 430199	Ø 348 29,9 28,4 V + S
			→	10/09→		24.0120-0206.1 420206	Ø 320 19,9 18,4 V + S
			→	→ 09/09		24.0124-0216.1 424216	Ø 345 24 22,4 V + S
xDrive 40 d	225	07/09→06/14	←	10/10→		24.0130-0199.1 430199	Ø 348 29,9 28,4 V + S
			→	10/10→		24.0120-0206.1 420206	Ø 320 19,9 18,4 V + S
xDrive 50 i xDrive 50 i	300 330	10/07→06/14 10/07→06/14	←	☐; 09/08→		24.0136-0112.2 436112	Ø 385 36 34,4 V Bremsscheibe zweiteilig / + S
			←	☐; 09/08→		24.0136-0113.2 436113	Ø 385 36 34,4 V Bremsscheibe zweiteilig / + S
↓							











	kW					! #		
BMW - X6 (E71, E72) 06/07→06/14								
 Bremsscheibe								
xDrive 50 i	300	10/07→06/14	➔	10/09→		24.0124-0216.1	424216	Ø 345 24 22,4 V + S
xDrive 50 i	330	10/07→06/14	➔	11/08→ 09/09		24.0124-0219.2	424219	Ø 385 24 22,4 V Bremsscheibe zweiteilig / + S
BMW - X6 (F16, F86) 08/14→								
 Bremsbelagsatz, Scheibenbremse								
M	423	12/14→	➔			13.0460-7260.2	607260	ATE 24458 17,3 + WE / - WK
M 50 d	280	08/14→	➔			13.0460-7261.2	607261	ATE 24436 19,7 + WE / - WK
xDrive 50 i	330	08/14→	➔			13.0460-7169.2	607169	ATE 23309 17,3 + WE / - WK
						13.0470-7169.2	LD7169	ATE 23309 17,3 + WE / - WK Ceramic
xDrive 30 d	155	08/14→	➔			13.0460-7231.2	607231	ATE 24170 20,2 + WE / - WK
xDrive 30 d	183	12/15→	➔			13.0470-7231.2	LD7231	ATE 24170 20,2 + WE / - WK Ceramic
xDrive 30 d	190	08/14→	➔			13.0460-7232.2	607232	ATE 21282 17,3 + WE / - WK
xDrive 30 d	204	02/15→	➔			13.0470-7232.2	LD7232	ATE 21282 17,3 + WE / - WK Ceramic
xDrive 35 i	225	12/14→	➔			13.0460-7231.2	607231	ATE 24170 20,2 + WE / - WK
xDrive 35 i	240	02/15→	➔			13.0470-7231.2	LD7231	ATE 24170 20,2 + WE / - WK Ceramic
						13.0460-7169.2	607169	ATE 23309 17,3 + WE / - WK
						13.0470-7169.2	LD7169	ATE 23309 17,3 + WE / - WK Ceramic
xDrive 40 d	230	12/14→	➔			13.0460-7231.2	607231	ATE 24170 20,2 + WE / - WK
						13.0460-7169.2	607169	ATE 23309 17,3 + WE / - WK
						13.0470-7169.2	LD7169	ATE 23309 17,3 + WE / - WK Ceramic
Warnkontakt, Bremsbelagverschleiß								
M	423	12/14→	➔	☐	1	24.8190-0291.2	620291	L= 974
			➔		1	24.8190-0290.2	620290	L= 1.002
M 50 d	280	08/14→	➔	☐	1	24.8190-0071.2	620071	L= 945
xDrive 50 i	330	08/14→	➔		1	24.8190-0028.2	620028	L= 977
xDrive 30 d	155	08/14→	➔	☐	1	24.8190-0289.2	620289	L= 938
xDrive 30 d	183	12/15→	➔					
xDrive 30 d	190	08/14→	➔		1	24.8190-0028.2	620028	L= 977
xDrive 30 d	204	02/15→	➔					
xDrive 35 i	225	12/14→	➔					
xDrive 35 i	240	02/15→	➔					
xDrive 40 d	230	12/14→	➔					
 Bremsscheibe								
M 50 d	280	08/14→	➔	☐		24.0136-0112.2	436112	Ø 385 36 34,4 V Bremsscheibe zweiteilig / + S
xDrive 50 i	330	08/14→	➔	☐		24.0136-0113.2	436113	Ø 385 36 34,4 V Bremsscheibe zweiteilig / + S
			➔			24.0124-0216.1	424216	Ø 345 24 22,4 V + S
xDrive 30 d	155	08/14→	➔			24.0130-0200.1	430200	Ø 332 29,9 28,4 V + S
xDrive 30 d	183	12/15→	➔			24.0120-0206.1	420206	Ø 320 19,9 18,4 V + S
xDrive 30 d	190	08/14→	➔					
xDrive 30 d	204	02/15→	➔					
xDrive 35 i	225	12/14→	➔			24.0130-0199.1	430199	Ø 348 29,9 28,4 V + S
xDrive 35 i	240	02/15→	➔					
xDrive 40 d	230	12/14→	➔			24.0124-0216.1	424216	Ø 345 24 22,4 V + S
BMW - Z3 Coupe (E36) 04/97→06/03								
 Bremsbelagsatz, Scheibenbremse								
2.8 i	142	07/97→06/00	➔			13.0460-5405.2	605405	ATE 21643 17,8 + WE / - WK
			➔			13.0470-5405.2	LD5405	ATE 21643 17,8 + WE / - WK Ceramic
			➔			13.0460-3605.2	603605	ATE 20180 17,3 + WE / - WK
			➔			13.0470-3605.2	LD3605	ATE 20180 17,3 + WE / - WK Ceramic
3.0 i	170	06/00→06/03	➔	→ 12/02		13.0460-5405.2	605405	ATE 21643 17,8 + WE / - WK
			➔	→ 12/02		13.0470-5405.2	LD5405	ATE 21643 17,8 + WE / - WK Ceramic
			➔	→ 12/02		13.0460-3605.2	603605	ATE 20180 17,3 + WE / - WK
↓								











	kw			 	! #		
BMW - Z3 Coupe (E36) 04/97→06/03							
 Bremsbelagsatz, Scheibenbremse							
3.0 i	170	06/00→06/03	→	→ 12/02		13.0470-3605.2 LD3605	ATE 20180 17,3 + WE / - WK Ceramic
M	236	02/98→06/01	←			13.0460-6033.2 606033	ATE 20968 20,3 + WE / - WK
			→			13.0460-3803.2 603803	ATE 20995 17,3 + WE / - WK
M	239	06/01→06/03	←	→ 12/02		13.0460-6033.2 606033	ATE 20968 20,3 + WE / - WK
			→	→ 12/02		13.0460-3803.2 603803	ATE 20995 17,3 + WE / - WK
Warnkontakt, Bremsbelagverschleiß							
2.8 i	142	07/97→06/00	←		1	24.8190-0207.2 620207	L= 786
			→		1	24.8190-0211.2 620211	L= 840
3.0 i	170	06/00→06/03	←	→ 12/02	1	24.8190-0207.2 620207	L= 786
			→	→ 12/02	1	24.8190-0211.2 620211	L= 840
M	236	02/98→06/01	←		1	24.8190-0210.2 620210	L= 810
			→		1	24.8190-0211.2 620211	L= 840
M	239	06/01→06/03	←	→ 12/02	1	24.8190-0210.2 620210	L= 810
			→	→ 12/02	1	24.8190-0211.2 620211	L= 840
 Bremsscheibe							
2.8 i	142	07/97→06/00	←			24.0122-0115.1 422115	Ø 286 22 20,4 V + S
			→			24.0322-0115.1 522115	Ø 286 22 19,6 V + S PD
			→			24.0110-0273.1 410273	Ø 272 10 8,4 + S
3.0 i	170	06/00→06/03	←	→ 12/02		24.0122-0160.1 422160	Ø 300 22 20,4 V + S
			→	→ 12/02		24.0322-0160.1 522160	Ø 300 22 19,6 V + S PD
			→	→ 12/02		24.0110-0273.1 410273	Ø 272 10 8,4 + S
M	236	02/98→06/01	←	☐		24.0128-0204.2 428204	Ø 315 28 26,4 V Bremsscheibe zweiteilig / + S
			←	☐		24.0128-0205.2 428205	Ø 315 28 26,4 V Bremsscheibe zweiteilig / + S
			→	☐		24.0120-0189.1 420189	Ø 312 20 18,4 V + S
			→	☐		24.0120-0190.1 420190	Ø 312 20 18,4 V + S
M	239	06/01→06/03	←	☐; → 12/02		24.0128-0204.2 428204	Ø 315 28 26,4 V Bremsscheibe zweiteilig / + S
			←	☐; → 12/02		24.0128-0205.2 428205	Ø 315 28 26,4 V Bremsscheibe zweiteilig / + S
			→	☐; → 12/02		24.0120-0189.1 420189	Ø 312 20 18,4 V + S
			→	☐; → 12/02		24.0120-0190.1 420190	Ø 312 20 18,4 V + S
BMW - Z3 Roadster (E36) 10/95→01/03							
 Bremsbelagsatz, Scheibenbremse							
1.8 i 1.9 i	85 103	10/95→10/98 10/95→03/99	←			13.0460-5405.2 605405	ATE 21643 17,8 + WE / - WK
			→			13.0470-5405.2 LD5405	ATE 21643 17,8 + WE / - WK Ceramic
			→			13.0460-3605.2 603605	ATE 20180 17,3 + WE / - WK
			→			13.0470-3605.2 LD3605	ATE 20180 17,3 + WE / - WK Ceramic
1.9 i 1.9 i 3.0 i	85 87 170	01/99→01/03 07/98→01/03 06/00→01/03	←	→ 12/02		13.0460-5405.2 605405	ATE 21643 17,8 + WE / - WK
			→	→ 12/02		13.0470-5405.2 LD5405	ATE 21643 17,8 + WE / - WK Ceramic
			→	→ 12/02		13.0460-3605.2 603605	ATE 20180 17,3 + WE / - WK
			→	→ 12/02		13.0470-3605.2 LD3605	ATE 20180 17,3 + WE / - WK Ceramic
2.0 i	110	04/99→01/03	←	→ 08/00		13.0460-5405.2 605405	ATE 21643 17,8 + WE / - WK
			→	→ 08/00		13.0470-5405.2 LD5405	ATE 21643 17,8 + WE / - WK Ceramic
			→	→ 08/00		13.0460-3605.2 603605	ATE 20180 17,3 + WE / - WK
			→	→ 08/00		13.0470-3605.2 LD3605	ATE 20180 17,3 + WE / - WK Ceramic
2.2 i 2.2 i	120 125	08/00→01/03 08/00→01/03	←	10/00→ 12/02		13.0460-5405.2 605405	ATE 21643 17,8 + WE / - WK
			→	10/00→ 12/02		13.0470-5405.2 LD5405	ATE 21643 17,8 + WE / - WK Ceramic
↓			→	10/00→ 12/02		13.0460-3605.2 603605	ATE 20180 17,3 + WE / - WK































	kw			 	! #		
BMW - Z3 Roadster (E36) 10/95→01/03							
 Bremsbelagsatz, Scheibenbremse							
2.2 i 2.2 i	120 125	08/00→01/03 08/00→01/03	➡	10/00→ 12/02		13.0470-3605.2 LD3605	ATE 20180 17,3 + WE / - WK Ceramic
2.8 i	142	04/97→06/00	⬅	05/97→		13.0460-5405.2 605405	ATE 21643 17,8 + WE / - WK Ceramic
			➡	05/97→		13.0460-3605.2 603605	ATE 20180 17,3 + WE / - WK Ceramic
2.8 i	143	01/96→07/00	⬅	05/97→ 06/00		13.0460-5405.2 605405	ATE 21643 17,8 + WE / - WK Ceramic
			➡	05/97→ 06/00		13.0460-3605.2 603605	ATE 20180 17,3 + WE / - WK Ceramic
M 3.2	236	03/97→06/01	⬅			13.0460-6033.2 606033	ATE 20968 20,3 + WE / - WK
			➡			13.0460-3803.2 603803	ATE 20995 17,3 + WE / - WK
M 3.2	239	06/01→01/03	⬅	→ 12/02		13.0460-6033.2 606033	ATE 20968 20,3 + WE / - WK
			➡	→ 12/02		13.0460-3803.2 603803	ATE 20995 17,3 + WE / - WK
Warnkontakt, Bremsbelagverschleiß							
1.8 i 1.9 i	85 103	10/95→10/98 10/95→03/99	⬅		1	24.8190-0207.2 620207	L= 786
			➡		1	24.8190-0211.2 620211	L= 840
1.9 i 1.9 i	85 87	01/99→01/03 07/98→01/03	⬅	→ 12/02	1	24.8190-0207.2 620207	L= 786
			➡	→ 12/02	1	24.8190-0211.2 620211	L= 840
3.0 i	170	06/00→01/03	⬅	→ 12/02	1	24.8190-0211.2 620211	L= 840
			➡	→ 12/02	1	24.8190-0211.2 620211	L= 840
2.0 i	110	04/99→01/03	⬅	→ 08/00	1	24.8190-0207.2 620207	L= 786
			➡	→ 08/00	1	24.8190-0211.2 620211	L= 840
2.2 i 2.2 i	120 125	08/00→01/03 08/00→01/03	⬅	10/00→ 12/02	1	24.8190-0207.2 620207	L= 786
			➡	10/00→ 12/02	1	24.8190-0211.2 620211	L= 840
2.8 i	142	04/97→06/00	⬅	05/97→	1	24.8190-0207.2 620207	L= 786
			➡	05/97→	1	24.8190-0211.2 620211	L= 840
2.8 i	143	01/96→07/00	⬅	05/97→ 06/00	1	24.8190-0207.2 620207	L= 786
			➡	05/97→ 06/00	1	24.8190-0211.2 620211	L= 840
M 3.2	236	03/97→06/01	⬅		1	24.8190-0210.2 620210	L= 810
			➡		1	24.8190-0211.2 620211	L= 840
M 3.2	239	06/01→01/03	⬅	→ 12/02	1	24.8190-0210.2 620210	L= 810
			➡	→ 12/02	1	24.8190-0211.2 620211	L= 840
 Bremsscheibe							
1.8 i 1.9 i	85 103	10/95→10/98 10/95→03/99	⬅			24.0112-0126.1 412126	Ø 286 12 10,4 + S
			➡			24.0312-0126.1 512126	Ø 286 12 9,6 + S PD
1.9 i 1.9 i	85 87	01/99→01/03 07/98→01/03	⬅	→ 12/02		24.0110-0273.1 410273	Ø 272 10 8,4 + S
			➡	→ 12/02		24.0112-0126.1 412126	Ø 286 12 10,4 + S
2.0 i	110	04/99→01/03	⬅	→ 08/00		24.0312-0126.1 512126	Ø 286 12 9,6 + S PD
			➡	→ 08/00		24.0110-0273.1 410273	Ø 272 10 8,4 + S
2.2 i 2.2 i	120 125	08/00→01/03 08/00→01/03	⬅	10/00→ 12/02		24.0122-0115.1 422115	Ø 286 22 20,4 V + S
			➡	10/00→ 12/02		24.0322-0115.1 522115	Ø 286 22 19,6 V + S PD
2.8 i	142	04/97→06/00	⬅	05/97→		24.0110-0273.1 410273	Ø 272 10 8,4 + S
			➡	05/97→		24.0122-0115.1 422115	Ø 286 22 20,4 V + S
2.8 i	143	01/96→07/00	⬅	05/97→ 06/00		24.0322-0115.1 522115	Ø 286 22 19,6 V + S PD
			➡	05/97→ 06/00		24.0110-0273.1 410273	Ø 272 10 8,4 + S
3.0 i	170	06/00→01/03	⬅	→ 12/02		24.0122-0115.1 422115	Ø 286 22 20,4 V + S
			➡	→ 12/02		24.0322-0115.1 522115	Ø 286 22 19,6 V + S PD
↓						24.0110-0273.1 410273	Ø 272 10 8,4 + S













	kw			 	! #			
BMW - Z3 Roadster (E36) 10/95→01/03								
 Bremsscheibe								
M 3.2	236	03/97→06/01	←	☐		24.0128-0204.2	428204	Ø 315 28 26,4 V Bremsscheibe zweiteilig / + S
			←	☐		24.0128-0205.2	428205	Ø 315 28 26,4 V Bremsscheibe zweiteilig / + S
			→	☐		24.0120-0189.1	420189	Ø 312 20 18,4 V + S
			→	☐		24.0120-0190.1	420190	Ø 312 20 18,4 V + S
M 3.2	239	06/01→01/03	←	☐; → 12/02		24.0128-0204.2	428204	Ø 315 28 26,4 V Bremsscheibe zweiteilig / + S
			←	☐; → 12/02		24.0128-0205.2	428205	Ø 315 28 26,4 V Bremsscheibe zweiteilig / + S
			→	☐; → 12/02		24.0120-0189.1	420189	Ø 312 20 18,4 V + S
			→	☐; → 12/02		24.0120-0190.1	420190	Ø 312 20 18,4 V + S
BMW - Z4 Coupe (E86) 03/06→01/09								
 Bremsbelagsatz, Scheibenbremse								
3.0 si	195	03/06→01/09	←	→ 09/08		13.0460-7155.2	607155	ATE 21676 20,3 + WE / - WK
			→	→ 09/08		13.0470-7155.2	LD7155	ATE 21676 20,3 + WE / - WK Ceramic
M	252	03/06→01/09	←	→ 09/08		13.0460-3605.2	603605	ATE 20180 17,3 + WE / - WK
			→	→ 09/08		13.0470-3605.2	LD3605	ATE 20180 17,3 + WE / - WK Ceramic
M	252	03/06→01/09	←	→ 09/08		13.0460-7185.2	607185	ATE 20968 20,3 + WE / - WK
			→	→ 09/08		13.0460-7079.2	607079	ATE 21282 17,3 + WE / - WK
						13.0470-7079.2	LD7079	ATE 21282 17,3 + WE / - WK Ceramic
Warnkontakt, Bremsbelagverschleiß								
3.0 si	195	03/06→01/09	←	→ 09/08	1	24.8190-0244.2	620244	L= 611
			→	→ 09/08	1	24.8190-0229.2	620229	L= 1.143
M	252	03/06→01/09	←	→ 09/08	1	24.8190-0244.2	620244	L= 611
			→	→ 09/08	1	24.8190-0245.2	620245	L= 1.163
 Bremsscheibe								
3.0 si	195	03/06→01/09	←	→ 09/08		24.0125-0138.1	425138	Ø 325 24,9 23,4 V + S
			→	→ 09/08		24.0325-0138.1	525138	Ø 325 24,9 22,6 V + S PD
M	252	03/06→01/09	←	☐; → 09/08		24.0119-0112.1	419112	Ø 294 19 17,4 V + S
			←	☐; → 09/08		24.0128-0208.2	428208	Ø 345 28 26,4 V* Bremsscheibe zweiteilig / + S
			←	☐; → 09/08		24.0128-0209.2	428209	Ø 345 28 26,4 V* Bremsscheibe zweiteilig / + S
			→	☐; → 09/08		24.0120-0221.2	420221	Ø 328 20 18,4 V* Bremsscheibe zweiteilig / + S
			→	☐; → 09/08		24.0120-0222.2	420222	Ø 328 20 18,4 V* Bremsscheibe zweiteilig / + S
BMW - Z4 Roadster (E85) 02/03→12/09								
 Bremsbelagsatz, Scheibenbremse								
2.0 i	110	03/05→02/09	←	04/05→ 12/08		13.0460-5405.2	605405	ATE 21643 17,8 + WE / - WK
			→	04/05→ 12/08		13.0470-5405.2	LD5405	ATE 21643 17,8 + WE / - WK Ceramic
2.2 i 2.5 i 3.0 i	125 141 170	10/03→10/05 02/03→12/05 02/03→10/05	←			13.0460-3605.2	603605	ATE 20180 17,3 + WE / - WK
			→			13.0470-3605.2	LD3605	ATE 20180 17,3 + WE / - WK Ceramic
2.5 i 2.5 si 2.5 si	130 155 160	09/05→02/09 09/05→02/09 09/05→02/09	←	01/06→ 12/08		13.0460-5405.2	605405	ATE 21643 17,8 + WE / - WK
			→	01/06→ 12/08		13.0470-5405.2	LD5405	ATE 21643 17,8 + WE / - WK Ceramic
↓						13.0460-3605.2	603605	ATE 20180 17,3 + WE / - WK







	kW			 	! #		
BMW - Z4 Roadster (E85) 02/03→12/09							
 Bremsbelagsatz, Scheibenbremse							
2.5 i 2.5 si 2.5 si	130 155 160	09/05→02/09 09/05→02/09 09/05→02/09	➡	01/06→12/08		13.0470-3605.2 LD3605	ATE 20180 17,3 + WE / - WK Ceramic
3.0 si	195	01/06→12/08	➡			13.0460-7155.2 607155	ATE 21676 20,3 + WE / - WK
			➡			13.0470-7155.2 LD7155	ATE 21676 20,3 + WE / - WK Ceramic
			➡			13.0460-3605.2 603605 13.0470-3605.2 LD3605	ATE 20180 17,3 + WE / - WK ATE 20180 17,3 + WE / - WK Ceramic
M	252	03/06→02/09	➡	→ 12/08		13.0460-7185.2 607185	ATE 20968 20,3 + WE / - WK
			➡	→ 12/08		13.0460-7079.2 607079 13.0470-7079.2 LD7079	ATE 21282 17,3 + WE / - WK ATE 21282 17,3 + WE / - WK Ceramic
Warnkontakt, Bremsbelagverschleiß							
2.0 i	110	03/05→02/09	➡	04/05→12/08	1	24.8190-0220.2 620220	L= 601
			➡	04/05→12/08	1	24.8190-0229.2 620229	L= 1.143
2.2 i	125	10/03→10/05	➡		1	24.8190-0220.2 620220	L= 601
2.5 i 3.0 i	141 170	02/03→12/05 02/03→10/05	➡		1	24.8190-0229.2 620229	L= 1.143
2.5 i 2.5 si	130 155	09/05→02/09 09/05→02/09	➡	01/06→12/08	1	24.8190-0220.2 620220	L= 601
			➡	01/06→12/08	1	24.8190-0229.2 620229	L= 1.143
2.5 si 3.0 si	160 195	09/05→02/09 01/06→12/08	➡		1	24.8190-0244.2 620244	L= 611
			➡		1	24.8190-0229.2 620229	L= 1.143
M	252	03/06→02/09	➡	→ 12/08	1	24.8190-0244.2 620244	L= 611
			➡	→ 12/08	1	24.8190-0245.2 620245	L= 1.163
 Bremsscheibe							
2.0 i	110	03/05→02/09	➡	04/05→12/08		24.0122-0115.1 422115	Ø 286 22 20,4 V + S
			➡	04/05→12/08		24.0322-0115.1 522115	Ø 286 22 19,6 V + S PD
2.2 i 2.5 i	125 141	10/03→10/05 02/03→12/05	➡			24.0110-0287.1 410287	Ø 280 10 8,4 + S
			➡			24.0122-0115.1 422115 24.0322-0115.1 522115	Ø 286 22 20,4 V + S Ø 286 22 19,6 V + S PD
2.5 i	130	09/05→02/09	➡	01/06→12/08		24.0110-0287.1 410287	Ø 280 10 8,4 + S
			➡	01/06→12/08		24.0122-0115.1 422115 24.0322-0115.1 522115	Ø 286 22 20,4 V + S Ø 286 22 19,6 V + S PD
2.5 si 2.5 si	155 160	09/05→02/09 09/05→02/09	➡	01/06→12/08		24.0119-0112.1 419112	Ø 294 19 17,4 V + S
			➡	01/06→12/08		24.0122-0160.1 422160 24.0322-0160.1 522160	Ø 300 22 20,4 V + S Ø 300 22 19,6 V + S PD
3.0 i	170	02/03→10/05	➡			24.0119-0112.1 419112	Ø 294 19 17,4 V + S
			➡			24.0122-0160.1 422160 24.0322-0160.1 522160	Ø 300 22 20,4 V + S Ø 300 22 19,6 V + S PD
3.0 si	195	01/06→12/08	➡			24.0125-0138.1 425138	Ø 325 24,9 23,4 V + S
			➡			24.0325-0138.1 525138	Ø 325 24,9 22,6 V + S PD
M	252	03/06→02/09	➡	☐; → 12/08		24.0119-0112.1 419112	Ø 294 19 17,4 V + S
			➡	☐; → 12/08		24.0128-0208.2 428208	Ø 345 28 26,4 V* Bremsscheibe zweiteilig / + S
			➡	☐; → 12/08		24.0128-0209.2 428209	Ø 345 28 26,4 V* Bremsscheibe zweiteilig / + S
			➡	☐; → 12/08		24.0120-0221.2 420221	Ø 328 20 18,4 V* Bremsscheibe zweiteilig / + S
			➡	☐; → 12/08		24.0120-0222.2 420222	Ø 328 20 18,4 V* Bremsscheibe zweiteilig / + S
BMW - Z4 Roadster (E89) 05/09→							
 Bremsbelagsatz, Scheibenbremse							
sDrive 18 i sDrive 20 i sDrive 20 i sDrive 28 i	115 120 135 180	04/13→ 09/11→ 09/11→ 09/11→	➡			13.0460-7216.2 607216 13.0470-7216.2 LD7216	ATE 23794 20,3 + WE / - WK ATE 23794 20,3 + WE / - WK Ceramic
sDrive 23 i ↓	150	05/09→	➡			13.0460-2759.2 602759	TRW 24559 17,8 + WE / - WK + Zub
			➡	03/10→		13.0460-7216.2 607216	ATE 23794 20,3 + WE / - WK











	kw			 	! #			
BMW - Z4 Roadster (E89) 05/09→								
 Bremsbelagsatz, Scheibenbremse								
sDrive 30 i	190	05/09→	←	03/10→		13.0470-7216.2	LD7216	ATE 23794 20,3 + WE / - WK Ceramic
			←	→ 02/10		13.0460-7216.2	607216	ATE 23794 20,3 + WE / - WK
			→	→ 02/10		13.0470-7216.2	LD7216	ATE 23794 20,3 + WE / - WK Ceramic
			→	→ 02/10		13.0460-2759.2	602759	TRW 24559 17,8 + WE / - WK + Zub
sDrive 35 i	225	05/09→	←	→ 02/10		13.0460-7237.2	607237	ATE 23347 20,3 + WE / - WK
			←	→ 02/10		13.0460-7238.2	607238	ATE 23313 20,3 + WE / - WK
			←	→ 02/10		13.0470-7238.2	LD7238	ATE 23313 20,3 + WE / - WK Ceramic
			←	03/10→		13.0460-7237.2	607237	ATE 23347 20,3 + WE / - WK
sDrive 35 is	250	09/10→	←	→ 02/10		13.0460-7238.2	607238	ATE 23313 20,3 + WE / - WK
			←	→ 02/10		13.0460-2760.2	602760	TRW 24561 17,7 + WE / - WK + Zub
			←	→ 02/10		13.0470-2760.2	LD2760	TRW 24561 17,7 + WE / - WK + Zub Ceramic
			←	03/10→		13.0460-2760.2	602760	TRW 24561 17,7 + WE / - WK + Zub
sDrive 35 is	250	09/10→	←			13.0470-2760.2	LD2760	TRW 24561 17,7 + WE / - WK + Zub Ceramic
			←			13.0460-2760.2	602760	TRW 24561 17,7 + WE / - WK + Zub
Warnkontakt, Bremsbelagverschleiß								
sDrive 18 i	115	04/13→	←		1	24.8190-0295.2	620295	L= 1.013
sDrive 20 i	120	09/11→	←					
sDrive 20 i	135	09/11→	→		1	24.8190-0294.2	620294	L= 1.361
sDrive 28 i	180	09/11→	→					
sDrive 35 is	250	09/10→	→					
sDrive 23 i	150	05/09→	←	→ 02/10	1	24.8190-0263.2	620263	L= 969
sDrive 30 i	190	05/09→	←	03/10→	1	24.8190-0295.2	620295	L= 1.013
sDrive 35 i	225	05/09→	→	→ 02/10	1	24.8190-0262.2	620262	L= 1.338
sDrive 35 i	225	05/09→	→	03/10→	1	24.8190-0294.2	620294	L= 1.361
 Bremsscheibe								
sDrive 18 i	115	04/13→	←			24.0124-0197.1	424197	Ø 300 24 22,4 V + S
sDrive 20 i	120	09/11→	←			24.0324-0197.1	524197	Ø 300 24 21,6 V + S PD
sDrive 20 i	135	09/11→	→					
sDrive 23 i	150	05/09→	→			24.0120-0226.1	420226	Ø 300 20 18,4 V + S
sDrive 28 i	180	09/11→	←			24.0124-0242.2	424242	Ø 330 24 22,4 V
sDrive 30 i	190	05/09→	←					Bremsscheibe zweiteilig / + S
sDrive 35 i	225	05/09→	→			24.0120-0226.1	420226	Ø 300 20 18,4 V + S
sDrive 35 i	225	05/09→	←			24.0130-0216.2	430216	Ø 348 30 28,4 V
sDrive 35 is	250	09/10→	←					Bremsscheibe zweiteilig / + S
sDrive 35 is	250	09/10→	→			24.0120-0228.1	420228	Ø 324 20 18,4 V + S
BMW - Z8 Roadster (E52) 06/00→06/03								
 Bremsbelagsatz, Scheibenbremse								
4.9	294	06/00→06/03	←			13.0460-7183.2	607183	ATE 21484 20,5 + WE / - WK
			→			13.0460-7079.2	607079	ATE 21282 17,3 + WE / - WK
Warnkontakt, Bremsbelagverschleiß								
4.9	294	06/00→06/03	←		1	24.8190-0233.2	620233	L= 758
			→		1	24.8190-0218.2	620218	L= 545
 Bremsscheibe								
4.9	294	06/00→06/03	←			24.0132-0160.1	432160	Ø 334 31,9 30,4 V + S
			→			24.0120-0182.1	420182	Ø 328 20 18,4 V + S

















	kw			 	! #		
CHEVROLET - ASTRA Schrägheck 09/98→12/11							
 Bremsbelagsatz, Scheibenbremse							
2.0	82	03/99→07/02	←	554447→		13.0460-5859.2 605859	AKE 23234 16,9 + WK
			←	10/99→; → 554446		13.0460-5994.2 605994	AKE 23234 16,8 - WE / - WK
			→	10/99→; → 560318		13.0460-5993.2 605993	TRW 23237 14,5 - WE / - WK
			→	10/99→		13.0460-5993.2 605993	TRW 23237 14,5 - WE / - WK
2.0 DTi	74	08/02→12/11	←	→ 07/05		13.0460-7116.2 607116	ATE 23057 20,2 - WK / + WK
						13.0470-7116.2 LD7116	ATE 23057 20,2 - WK / + WK Ceramic
			→	→ 07/05		13.0460-2868.2 602868	TRW 23417 15,3 + WK + Zub
						13.0470-2868.2 LD2868	TRW 23417 15,3 + WK + Zub Ceramic
 Bremsscheibe							
2.0	82	03/99→07/02	←	10/99→		24.0124-0163.1 424163	∅ 256 24 22 V + S
			→	10/99→		24.0110-0714.1 410714	∅ 258 10,3 8
2.0 DTi	74	08/02→12/11	←	→ 07/05		24.0125-0131.1 425131	∅ 280 24,8 22 V + S
			→	→ 07/05		24.0110-0250.1 410250	∅ 264 9,8 8 + S
						24.0310-0250.1 510250	∅ 264 9,8 8 + S PD
CHEVROLET - ASTRA Stufenheck 01/99→12/11							
 Bremsbelagsatz, Scheibenbremse							
2.0 DTi GLS	74	08/02→12/11	←	→ 07/05		13.0460-7116.2 607116	ATE 23057 20,2 - WK / + WK
						13.0470-7116.2 LD7116	ATE 23057 20,2 - WK / + WK Ceramic
			→	→ 07/05		13.0460-2868.2 602868	TRW 23417 15,3 + WK + Zub
						13.0470-2868.2 LD2868	TRW 23417 15,3 + WK + Zub Ceramic
2.0 GL	82	03/99→07/02	←	554447→		13.0460-5859.2 605859	AKE 23234 16,9 + WK
			←	10/99→; → 554446		13.0460-5994.2 605994	AKE 23234 16,8 - WE / - WK
			→	10/99→; → 560318		13.0460-5993.2 605993	TRW 23237 14,5 - WE / - WK
			→	10/99→		13.0460-5993.2 605993	TRW 23237 14,5 - WE / - WK
2.0 GL	85	08/02→12/11	←	→ 554446		13.0460-5994.2 605994	AKE 23234 16,8 - WE / - WK
			→	→ 07/05		13.0460-5993.2 605993	TRW 23237 14,5 - WE / - WK
			→	→ 560318		13.0460-5993.2 605993	TRW 23237 14,5 - WE / - WK
 Bremsscheibe							
2.0 DTi GLS	74	08/02→12/11	←	→ 07/05		24.0125-0131.1 425131	∅ 280 24,8 22 V + S
			→	→ 07/05		24.0110-0250.1 410250	∅ 264 9,8 8 + S
						24.0310-0250.1 510250	∅ 264 9,8 8 + S PD
2.0 GL	82	03/99→07/02	←	10/99→		24.0124-0163.1 424163	∅ 256 24 22 V + S
			→	10/99→		24.0110-0714.1 410714	∅ 258 10,3 8
2.0 GL	85	08/02→12/11	←	→ 07/05		24.0124-0163.1 424163	∅ 256 24 22 V + S
			→	→ 07/05		24.0110-0714.1 410714	∅ 258 10,3 8
CHEVROLET - AVEO Schrägheck (T200) 02/03→05/08							
 Bremsbelagsatz, Scheibenbremse							
1.2	53	01/04→05/08	←			13.0460-5899.2 605899	AKE 23974 17,6 - WE / - WK
1.5	62	01/05→05/08	←	05/05→		13.0460-5899.2 605899	AKE 23974 17,6 - WE / - WK
 Bremsscheibe							
1.2	53	01/04→05/08	←	Nabendurchmesser [mm]: 60		24.0120-0115.1 420115	∅ 236 20 17 V + S
			←	Nabendurchmesser [mm]: 59		24.0120-0227.1 420227	∅ 236 20 18 V + S
1.5	62	01/05→05/08	←	05/05→; Nabendurchmesser [mm]: 60		24.0120-0115.1 420115	∅ 236 20 17 V + S
			←	05/05→; Nabendurchmesser [mm]: 59		24.0120-0227.1 420227	∅ 236 20 18 V + S
CHEVROLET - AVEO Schrägheck (T250, T255) 01/07→							
 Bremsbelagsatz, Scheibenbremse							
1.2	53	10/08→	←	→ 07/11		13.0460-5899.2 605899	AKE 23974 17,6 - WE / - WK
1.2	55	04/08→					
1.2	56	01/07→					
1.2	62	04/08→					

















	kw			 	! #		
CHEVROLET - AVEO Schrägheck (T250, T255) 01/07→							
 Bremsbelagsatz, Scheibenbremse							
1.2 LPG 1.2 LPG 1.4 1.6	60 62 74 77	06/08→ 04/08→ 04/08→ 01/08→	←	→ 07/11		13.0460-5899.2 605899	AKE 23974 17,6 - WE / - WK
 Bremsscheibe							
1.2 1.2 1.2 1.2 1.2 LPG 1.2 LPG 1.4 1.6	53 55 56 62 60 62 74 77	10/08→ 04/08→ 01/07→ 04/08→ 06/08→ 04/08→ 04/08→ 01/08→	←	→ 07/11; Nabendurchmesser [mm]: 60 → 07/11; Nabendurchmesser [mm]: 59		24.0120-0115.1 420115 24.0120-0227.1 420227	Ø 236 20 17 V + S Ø 236 20 18 V + S
CHEVROLET - AVEO Schrägheck (T300) 03/11→							
 Bremsbelagsatz, Scheibenbremse							
1.2 1.2 1.2 LPG 1.3 D 1.3 D 1.4 1.4 1.6 1.6 1.6	51 63 63 55 70 74 76 85 88 89	03/11→ 03/11→ 11/12→ 07/11→ 07/11→ 03/11→ 12/12→ 03/11→ 06/11→ 12/12→	←	passend für Felgengröße [Zoll]: 15		13.0460-7262.2 607262 13.0470-7262.2 LD7262	25031 19,1 + WK + Zub 25031 19,1 + WK + Zub Ceramic
1.4 Turbo	103	08/13→	←			13.0460-7262.2 607262 13.0470-7262.2 LD7262	25031 19,1 + WK + Zub 25031 19,1 + WK + Zub Ceramic
			→			13.0460-7264.2 607264 13.0470-7264.2 LD7264	ATE 25096 17,0 + WK + Zub ATE 25096 17,0 + WK + Zub Ceramic
 Bremsscheibe							
1.2 1.2 1.2 LPG 1.3 D 1.3 D 1.4 1.4 1.6 1.6 1.6	51 63 63 55 70 74 76 85 88 89	03/11→ 03/11→ 11/12→ 07/11→ 07/11→ 03/11→ 12/12→ 03/11→ 06/11→ 12/12→	←	passend für Felgengröße [Zoll]: 14 passend für Felgengröße [Zoll]: 15		24.0124-0252.1 424252 24.0126-0165.1 426165 24.0326-0165.1 526165	Ø 256 24 21 V Ø 276 26 23 V + S Ø 276 26 23 V + S PD
1.4 Turbo	103	08/13→	←			24.0126-0165.1 426165 24.0326-0165.1 526165	Ø 276 26 23 V + S Ø 276 26 23 V + S PD
			→			24.0112-0188.1 412188 24.0312-0188.1 512188	Ø 268 12 10 + S Ø 268 12 10 + S PD
CHEVROLET - AVEO Stufenheck (T200) 01/03→12/08							
 Bremsbelagsatz, Scheibenbremse							
1.4	69	05/03→01/07	←	03/06→		13.0460-5899.2 605899	AKE 23974 17,6 - WE / - WK
 Bremsscheibe							
1.4	69	05/03→01/07	←	03/06→; Nabendurchmesser [mm]: 60 03/06→; Nabendurchmesser [mm]: 59		24.0120-0115.1 420115 24.0120-0227.1 420227	Ø 236 20 17 V + S Ø 236 20 18 V + S
CHEVROLET - AVEO Stufenheck (T250, T255) 05/05→							
 Bremsbelagsatz, Scheibenbremse							
1.2 1.4	53 69	03/06→12/07 03/06→12/07	←			13.0460-5899.2 605899	AKE 23974 17,6 - WE / - WK
1.2 1.2 1.2 1.2 LPG 1.2 LPG 1.4 1.5 1.6 1.6	55 56 62 60 62 74 62 75 76	01/08→ 01/08→ 01/08→ 12/08→ 01/09→ 09/08→ 05/05→ 01/08→ 05/05→	←	→ 07/11		13.0460-5899.2 605899	AKE 23974 17,6 - WE / - WK
1.4 CNG	69	01/08→	←	01/10→ 07/11		13.0460-5899.2 605899	AKE 23974 17,6 - WE / - WK
1.6 ↓	77	09/03→12/08	←	12/04→		13.0460-5899.2 605899	AKE 23974 17,6 - WE / - WK















	kw					! #		
CHEVROLET - AVEO Stufenheck (T250, T255) 05/05→								
 Bremsscheibe								
1.2 1.4	53 69	03/06→12/07 03/06→12/07	←	Nabendurchmesser [mm]: 60		24.0120-0115.1	420115	Ø 236 20 17 V + S
			←	Nabendurchmesser [mm]: 59		24.0120-0227.1	420227	Ø 236 20 18 V + S
1.2 1.2 1.2 1.2 LPG 1.2 LPG 1.4 1.5 1.6 1.6	55 56 62 60 62 74 62 75 76	01/08→ 01/08→ 01/08→ 12/08→ 01/09→ 09/08→ 05/05→ 01/08→ 05/05→	←	→ 07/11; Nabendurchmesser [mm]: 60		24.0120-0115.1	420115	Ø 236 20 17 V + S
			←	→ 07/11; Nabendurchmesser [mm]: 59		24.0120-0227.1	420227	Ø 236 20 18 V + S
1.4 CNG	69	01/08→	←	01/10→ 07/11; Nabendurchmesser [mm]: 60		24.0120-0115.1	420115	Ø 236 20 17 V + S
			←	01/10→ 07/11; Nabendurchmesser [mm]: 59		24.0120-0227.1	420227	Ø 236 20 18 V + S
1.6	77	09/03→12/08	←	12/04→; Nabendurchmesser [mm]: 60		24.0120-0115.1	420115	Ø 236 20 17 V + S
			←	12/04→; Nabendurchmesser [mm]: 59		24.0120-0227.1	420227	Ø 236 20 18 V + S
CHEVROLET - AVEO Stufenheck (T300) 03/11→								
 Bremsbelagsatz, Scheibenbremse								
1.2 1.2 1.2 LPG 1.3 D 1.3 D 1.4 1.4 1.6 1.6	51 63 63 55 70 74 76 85 89	03/11→ 03/11→ 11/12→ 07/11→ 07/11→ 07/11→ 12/12→ 03/11→ 12/12→	←	passend für Felgenreöße [Zoll]: 15		13.0460-7262.2 13.0470-7262.2	607262 LD7262	25031 19,1 + WK + Zub 25031 19,1 + WK + Zub Ceramic
 Bremsscheibe								
1.2 1.2 1.2 LPG 1.3 D 1.3 D 1.4 1.4 1.6 1.6	51 63 63 55 70 74 76 85 89	03/11→ 03/11→ 11/12→ 07/11→ 07/11→ 07/11→ 12/12→ 03/11→ 12/12→	←	passend für Felgenreöße [Zoll]: 14		24.0124-0252.1	424252	Ø 256 24 21 V
			←	passend für Felgenreöße [Zoll]: 15		24.0126-0165.1 24.0326-0165.1	426165 526165	Ø 276 26 23 V + S Ø 276 26 23 V + S PD
CHEVROLET - CAMARO 02/09→12/15								
 Bremsscheibe								
3.6 3.6 3.6	224 227 241	09/09→12/10 09/09→12/10 09/11→12/15	←	für Linkslenker		24.0130-0209.1 24.0330-0209.1	430209 530209	Ø 321 30 27 V + S Ø 321 30 27 V + S PD Ø 321 30 27 V + S PD
			←			24.0130-0209.1 24.0330-0209.1	430209 530209	Ø 321 30 27 V + S Ø 321 30 27 V + S PD
			←	12/12→		24.0130-0209.1 24.0330-0209.1	430209 530209	Ø 321 30 27 V + S Ø 321 30 27 V + S PD
CHEVROLET - CAPTIVA (C100, C140) 06/06→								
 Bremsbelagsatz, Scheibenbremse								
2.0 D 2.0 D 2.0 D 4WD 2.0 D 4WD 2.2 D 2.2 D 4WD 2.2 D 4WD 2.4 2.4 2.4 2.4 2.4 4WD 2.4 4WD 2.4 4WD 2.4 4WD 2.4 LPG 2.4 LPG 4WD 3.0 4WD 3.2 4WD 3.6 4WD 3.6 4WD	93 110 93 110 120 120 135 100 103 123 136 100 103 123 100 100 100 190 169 189 192	10/06→ 09/07→ 10/06→ 10/06→ 03/11→ 03/11→ 03/11→ 06/06→ 12/06→ 03/11→ 01/11→ 06/06→ 12/06→ 03/11→ 01/07→ 01/07→ 01/10→ 06/06→ 01/08→ 01/08→	←			13.0460-5785.2 13.0460-5788.2	605785 605788	24510 17,0 + WK 24498 14,7 + WK
2.0 D 2.2 D ↓	120 135	01/11→ 07/14→	→			13.0460-5788.2	605788	24498 14,7 + WK











	kW			 	! #			
CHEVROLET - CAPTIVA (C100, C140) 06/06→								
Zubehörsatz, Scheibenbremsbelag								
2.0 D	93	10/06→	→			13.0460-0135.2	610135	
2.0 D	110	09/07→						
2.0 D	120	01/11→						
2.0 D 4WD	93	10/06→						
2.0 D 4WD	110	10/06→						
2.2 D	120	03/11→						
2.2 D	135	07/14→						
2.2 D 4WD	120	03/11→						
2.2 D 4WD	135	03/11→						
2.4	100	06/06→						
2.4	103	12/06→						
2.4	123	03/11→						
2.4	136	01/11→						
2.4 4WD	100	06/06→						
2.4 4WD	103	12/06→						
2.4 4WD	123	03/11→						
2.4 LPG	100	01/07→						
2.4 LPG 4WD	100	01/07→						
3.0 4WD	190	01/10→						
3.2 4WD	169	06/06→						
3.6 4WD	189	01/08→						
3.6 4WD	192	01/08→						
Bremsscheibe								
2.0 D	93	10/06→	←			24.0129-0101.1	429101	Ø 296 29 27,5 V
2.0 D	110	09/07→						
2.0 D	120	01/11→	→			24.0120-0209.1	420209	Ø 303 20 18,4 V
2.0 D 4WD	93	10/06→						
2.0 D 4WD	110	10/06→						
2.2 D	120	03/11→						
2.2 D	135	07/14→						
2.2 D 4WD	120	03/11→						
2.2 D 4WD	135	03/11→						
2.4	100	06/06→						
2.4	103	12/06→						
2.4	123	03/11→						
2.4	136	01/11→						
2.4 4WD	100	06/06→						
2.4 4WD	103	12/06→						
2.4 4WD	123	03/11→						
2.4 LPG	100	01/07→						
2.4 LPG 4WD	100	01/07→						
3.0 4WD	190	01/10→						
3.2 4WD	169	06/06→						
3.6 4WD	189	01/08→						
3.6 4WD	192	01/08→						
CHEVROLET - COBALT 01/11→								
Bremsscheibe								
1.5	77	01/14→	←			24.0124-0252.1	424252	Ø 256 24 21 V
CHEVROLET - CRUZE (J300) 05/09→								
Bremselagsatz, Scheibenbremse								
1.4	74	07/13→	←	für Bremsscheibendurchmesser [mm]:		13.0460-7262.2	607262	25031 19,1 + WK + Zub
1.4	103	09/10→		276		13.0470-7262.2	LD7262	25031 19,1 + WK + Zub Ceramic
1.6	80	05/09→	←	für Bremsscheibendurchmesser [mm]:		13.0460-7263.2	607263	24034 19,1 + WK + Zub
1.6	83	05/09→		300		13.0470-7263.2	LD7263	24034 19,1 + WK + Zub Ceramic
1.6	86	12/12→						
1.6	89	12/12→						
1.6	91	05/09→	→			13.0460-7264.2	607264	ATE 25096 17,0 + WK + Zub
1.6 T	135	12/12→				13.0470-7264.2	LD7264	ATE 25096 17,0 + WK + Zub Ceramic
1.7 D	96	01/12→						
1.7 TD	81	11/13→						
1.8	103	11/09→12/13						
1.8	104	05/09→						
1.8	108	12/12→						
1.8 Flex	106	01/11→						
1.8 LPG	104	06/11→						
2.0 CDI	90	05/09→						
2.0 CDI	92	05/09→						
2.0 CDI	110	05/09→						
2.0 CDI	120	08/10→						
Bremsscheibe								
1.4	74	07/13→	←			24.0126-0165.1	426165	Ø 276 26 23 V + S
1.4	103	09/10→				24.0126-0166.1	426166	Ø 300 26 23 V + S
1.6	80	05/09→				24.0326-0165.1	526165	Ø 276 26 23 V + S PD
1.6	83	05/09→				24.0326-0166.1	526166	Ø 300 26 23 V + S PD
1.6	86	12/12→						
1.6	89	12/12→						

















	kw			 	! #		
CHEVROLET - CRUZE (J300) 05/09→							
 Bremsscheibe							
1.6	91	05/09→	→			24.0112-0188.1 412188	Ø 268 12 10 + S
1.6 T	135	12/12→				24.0112-0189.1 412189	Ø 292 12 10 + S
1.7 D	96	01/12→				24.0312-0188.1 512188	Ø 268 12 10 + S PD
1.7 TD	81	11/13→				24.0312-0189.1 512189	Ø 292 12 10 + S PD
1.8	103	11/09→12/13					
1.8	104	05/09→					
1.8	108	12/12→					
1.8 Flex	106	01/11→					
1.8 LPG	104	06/11→					
2.0 CDI	90	05/09→					
2.0 CDI	92	05/09→					
2.0 CDI	110	05/09→					
2.0 CDI	120	08/10→					
CHEVROLET - CRUZE Schrägheck (J305) 12/10→							
 Bremsbelagsatz, Scheibenbremse							
1.4	74	07/13→	←	für Bremsscheibendurchmesser [mm]: 276	13.0460-7262.2 607262	25031 19,1 + WK + Zub	
1.6	80	01/12→			13.0470-7262.2 LD7262	25031 19,1 + WK + Zub Ceramic	
1.6	86	12/12→					
1.6	89	12/12→	←	für Bremsscheibendurchmesser [mm]: 300	13.0460-7263.2 607263	24034 19,1 + WK + Zub	
1.6	91	06/11→			13.0470-7263.2 LD7263	24034 19,1 + WK + Zub Ceramic	
1.6 T	135	12/12→					
1.7 D	96	01/12→	→		13.0460-7264.2 607264	ATE 25096 17,0 + WK + Zub	
1.7 TD	81	08/13→			13.0470-7264.2 LD7264	ATE 25096 17,0 + WK + Zub Ceramic	
1.8	103	10/11→					
1.8	104	06/11→					
1.8	108	12/12→					
1.8 LPG	104	06/11→					
2.0 CDI	120	06/11→					
1.4	103	06/12→	←	08/12→; für Bremsscheibendurchmesser [mm]: 276	13.0460-7262.2 607262	25031 19,1 + WK + Zub	
			←	08/12→; für Bremsscheibendurchmesser [mm]: 300	13.0470-7262.2 LD7262	25031 19,1 + WK + Zub Ceramic	
			→		13.0460-7263.2 607263	24034 19,1 + WK + Zub	
			→		13.0470-7263.2 LD7263	24034 19,1 + WK + Zub Ceramic	
			→	08/12→	13.0460-7264.2 607264	ATE 25096 17,0 + WK + Zub	
					13.0470-7264.2 LD7264	ATE 25096 17,0 + WK + Zub Ceramic	
 Bremsscheibe							
1.4	74	07/13→	←		24.0126-0165.1 426165	Ø 276 26 23 V + S	
1.6	80	01/12→			24.0126-0166.1 426166	Ø 300 26 23 V + S	
1.6	86	12/12→			24.0326-0165.1 526165	Ø 276 26 23 V + S PD	
1.6	89	12/12→			24.0326-0166.1 526166	Ø 300 26 23 V + S PD	
1.6	91	06/11→					
1.6 T	135	12/12→					
1.7 D	96	01/12→	→		24.0112-0188.1 412188	Ø 268 12 10 + S	
1.7 TD	81	08/13→			24.0112-0189.1 412189	Ø 292 12 10 + S	
1.8	103	10/11→			24.0312-0188.1 512188	Ø 268 12 10 + S PD	
1.8	104	06/11→			24.0312-0189.1 512189	Ø 292 12 10 + S PD	
1.8	108	12/12→					
1.8 LPG	104	06/11→					
2.0 CDI	120	06/11→					
1.4	103	06/12→	←	08/12→	24.0126-0165.1 426165	Ø 276 26 23 V + S	
					24.0126-0166.1 426166	Ø 300 26 23 V + S	
					24.0326-0165.1 526165	Ø 276 26 23 V + S PD	
					24.0326-0166.1 526166	Ø 300 26 23 V + S PD	
			→	08/12→	24.0112-0188.1 412188	Ø 268 12 10 + S	
					24.0112-0189.1 412189	Ø 292 12 10 + S	
					24.0312-0188.1 512188	Ø 268 12 10 + S PD	
					24.0312-0189.1 512189	Ø 292 12 10 + S PD	
CHEVROLET - CRUZE Station Wagon (J308) 08/12→							
 Bremsbelagsatz, Scheibenbremse							
1.4	74	07/13→	←	für Bremsscheibendurchmesser [mm]: 276	13.0460-7262.2 607262	25031 19,1 + WK + Zub	
1.4	103	08/12→			13.0470-7262.2 LD7262	25031 19,1 + WK + Zub Ceramic	
1.6	86	12/12→					
1.6	89	12/12→	←	für Bremsscheibendurchmesser [mm]: 300	13.0460-7263.2 607263	24034 19,1 + WK + Zub	
1.6	91	08/12→			13.0470-7263.2 LD7263	24034 19,1 + WK + Zub Ceramic	
1.6 T	135	12/12→					
1.7 TD	81	11/13→	→		13.0460-7264.2 607264	ATE 25096 17,0 + WK + Zub	
1.7 TD	96	08/12→			13.0470-7264.2 LD7264	ATE 25096 17,0 + WK + Zub Ceramic	
1.8	104	08/12→					
1.8	108	12/12→					
2.0 TD	120	08/12→					















	kW			 	! #		
CHEVROLET - CRUZE Station Wagon (J308) 08/12→							
 Bremsscheibe							
1.4	74	07/13→	←			24.0126-0165.1 426165	Ø 276 26 23 V + S
1.4	103	08/12→				24.0126-0166.1 426166	Ø 300 26 23 V + S
1.6	86	12/12→				24.0326-0165.1 526165	Ø 276 26 23 V + S PD
1.6	89	12/12→				24.0326-0166.1 526166	Ø 300 26 23 V + S PD
1.6	91	08/12→				24.0112-0188.1 412188	Ø 268 12 10 + S
1.6 T	135	12/12→	→			24.0112-0189.1 412189	Ø 292 12 10 + S
1.7 TD	81	11/13→				24.0312-0188.1 512188	Ø 268 12 10 + S PD
1.7 TD	96	08/12→				24.0312-0189.1 512189	Ø 292 12 10 + S PD
1.8	104	08/12→					
1.8	108	12/12→					
2.0 TD	120	08/12→					
CHEVROLET - EPICA (KL1_) 01/05→							
 Bremsbelagsatz, Scheibenbremse							
2.0	94	01/05→12/06	←			13.0460-5859.2 605859	AKE 23234 16,9 + WK
2.0	98	01/05→12/06					
Zubehörsatz, Scheibenbremsbelag							
2.0	94	01/05→12/06	←			13.0460-0140.2 610140	AKE
2.0	98	01/05→12/06					
 Bremsscheibe							
2.0	85	08/06→	←	→ 12/10		24.0124-0237.1 424237	Ø 278 24 22 V
2.0	96	08/06→					
2.0	105	06/06→					
2.0 D	110	01/07→					
2.5	115	06/06→					
2.0	94	01/05→12/06	←			24.0124-0237.1 424237	Ø 278 24 22 V
2.0	98	01/05→12/06					
CHEVROLET - EVANDA 03/05→							
 Bremsbelagsatz, Scheibenbremse							
2.0	96	03/05→	←	→ 12/06		13.0460-5859.2 605859	AKE 23234 16,9 + WK
Zubehörsatz, Scheibenbremsbelag							
2.0	96	03/05→	←	→ 12/06		13.0460-0140.2 610140	AKE
 Bremsscheibe							
2.0	96	03/05→	←	→ 12/06		24.0124-0199.1 424199	Ø 256 24 21 V + S
CHEVROLET - IMPALA Stufenheck 01/99→12/05							
 Bremsbelagsatz, Scheibenbremse							
3.4 V6	134	01/99→12/05	←	→ 05/05		13.0460-8002.2 608002	23358 18,0 + WK
3.8 V6	149	01/99→12/05					
3.8	179	06/03→05/05	←			13.0460-8002.2 608002	23358 18,0 + WK
CHEVROLET - KALOS 03/05→							
 Bremsbelagsatz, Scheibenbremse							
1.2	53	03/05→	←	→ 05/08		13.0460-5899.2 605899	AKE 23974 17,6 - WE / - WK
1.4	61	03/05→					
1.4 16V	69	03/05→					
1.6	77	06/06→05/08	←			13.0460-5899.2 605899	AKE 23974 17,6 - WE / - WK
 Bremsscheibe							
1.2	53	03/05→	←	→ 05/08; Nabendurchmesser [mm]: 60		24.0120-0115.1 420115	Ø 236 20 17 V + S
1.4	61	03/05→				24.0320-0115.1 520115	Ø 236 20 17 V + S PD
1.4 16V	69	03/05→	←	→ 05/08; Nabendurchmesser [mm]: 59		24.0120-0227.1 420227	Ø 236 20 18 V + S
1.6	77	06/06→05/08	←	Nabendurchmesser [mm]: 60		24.0120-0115.1 420115	Ø 236 20 17 V + S
			←	Nabendurchmesser [mm]: 59		24.0320-0115.1 520115	Ø 236 20 17 V + S PD
			←	Nabendurchmesser [mm]: 59		24.0120-0227.1 420227	Ø 236 20 18 V + S
CHEVROLET - KALOS Stufenheck 03/05→							
 Bremsbelagsatz, Scheibenbremse							
1.2	53	03/05→	←	→ 05/08		13.0460-5899.2 605899	AKE 23974 17,6 - WE / - WK
1.4	61	03/05→					
1.4 16V	69	03/05→					
 Bremsscheibe							
1.2	53	03/05→	←	→ 05/08; Nabendurchmesser [mm]: 60		24.0120-0115.1 420115	Ø 236 20 17 V + S

















	kw			 	! #		
CHEVROLET - KALOS Stufenheck 03/05→							
 Bremsscheibe							
1.4	61	03/05→	←	→ 05/08; Nabendurchmesser [mm]: 60	24.0320-0115.1	520115	Ø 236 20 17 V + S PD
1.4 16V	69	03/05→	←	→ 05/08; Nabendurchmesser [mm]: 59	24.0120-0227.1	420227	Ø 236 20 18 V + S
CHEVROLET - LACETTI (J200) 03/03→							
 Bremsbelagsatz, Scheibenbremse							
1.4 16V	70	03/05→	←	→ 12/10	13.0460-5863.2	605863	AKE 23234 16,8 + WK
1.6	80	03/05→	→	→ 12/06	13.0460-5739.2	605739	SUM 24071 14,6 - WE / - WK
1.8	89	08/05→					
1.8	90	03/05→					
1.8	67	03/05→12/09	←	08/05→	13.0460-5863.2	605863	AKE 23234 16,8 + WK
			→	08/05→ 12/06	13.0460-5739.2	605739	SUM 24071 14,6 - WE / - WK
2.0 D	89	01/07→	←	→ 12/10	13.0460-5863.2	605863	AKE 23234 16,8 + WK
 Bremsscheibe							
1.4 16V	70	03/05→	←	→ 12/10	24.0124-0199.1	424199	Ø 256 24 21 V + S
1.6	80	03/05→	→	→ 12/10	24.0110-0340.1	410340	Ø 258 10,5 8 + S
1.8	89	08/05→					
1.8	90	03/05→					
2.0 D	89	01/07→					
1.8	67	03/05→12/09	←	08/05→	24.0124-0199.1	424199	Ø 256 24 21 V + S
			→	08/05→	24.0110-0340.1	410340	Ø 258 10,5 8 + S
CHEVROLET - LACETTI Kombi (J200) 03/05→							
 Bremsbelagsatz, Scheibenbremse							
1.4	70	03/05→	←	→ 12/10	13.0460-5863.2	605863	AKE 23234 16,8 + WK
1.6	80	03/05→	→	→ 12/06	13.0460-5739.2	605739	SUM 24071 14,6 - WE / - WK
1.8	89	08/05→					
1.6 LPG	80	06/09→12/11	←	→ 12/10	13.0460-5863.2	605863	AKE 23234 16,8 + WK
2.0 D	89	01/07→					
 Bremsscheibe							
1.4	70	03/05→	←	→ 12/10	24.0124-0199.1	424199	Ø 256 24 21 V + S
1.6	80	03/05→	→	→ 12/10	24.0110-0340.1	410340	Ø 258 10,5 8 + S
1.6 LPG	80	06/09→12/11					
1.8	89	08/05→					
2.0 D	89	01/07→					
CHEVROLET - LACETTI Stufenheck 03/03→03/13							
 Bremsbelagsatz, Scheibenbremse							
1.4	69	03/05→03/13	←	→ 12/10	13.0460-5863.2	605863	AKE 23234 16,8 + WK
1.6	80	03/05→03/13	→	→ 12/06	13.0460-5739.2	605739	SUM 24071 14,6 - WE / - WK
1.8	90	05/03→03/13					
 Bremsscheibe							
1.4	69	03/05→03/13	←	→ 12/10	24.0124-0199.1	424199	Ø 256 24 21 V + S
1.6	80	03/05→03/13	→	→ 12/10	24.0110-0340.1	410340	Ø 258 10,5 8 + S
1.8	90	05/03→03/13					
CHEVROLET - LANOS Stufenheck 11/05→							
 Bremsbelagsatz, Scheibenbremse							
1.4	55	11/05→	←	→ 12/10	13.0460-7051.2	607051	ATE 20547 16,5 + WE / - WK
1.5	63	11/05→					
1.6 16V	78	11/05→	←	→ 12/10	13.0460-7052.2	607052	ATE 21190 17,5 + WE / - WK
 Bremsscheibe							
1.4	55	11/05→	←	→ 12/10	24.0120-0115.1	420115	Ø 236 20 17 V + S
1.5	63	11/05→					
1.6 16V	78	11/05→	←	→ 12/10	24.0124-0115.1	424115	Ø 256 24 21 V + S
CHEVROLET - MALIBU (V300) 01/12→							
 Bremsbelagsatz, Scheibenbremse							
2.0	104	02/12→	←	passend für Felgenreöße [Zoll]: 16	13.0460-5611.2	605611	MAN 24415 19,1 + WK + Zub
2.0	108	12/12→			13.0470-5611.2	LD5611	MAN 24415 19,1 + WK + Zub
2.0 D	118	04/12→					Ceramic
2.0 LPG	101	02/12→					
2.4	123	01/12→	←	passend für Felgenreöße [Zoll]: 17	13.0460-5612.2	605612	MAN 24412 19,0 + WK + Zub
2.4	125	01/12→			13.0470-5612.2	LD5612	MAN 24412 19,0 + WK + Zub
2.4	137	01/12→					Ceramic
↓							

















	kw					! #		
CHEVROLET - MALIBU (V300) 01/12→								
 Bremsscheibe								
2.0	104	02/12→	←	passend für Felgenreöße [Zoll]: 16	24.0130-0207.1	430207	Ø 296 30 27 V + S	
2.0	108	12/12→			24.0330-0207.1	530207	Ø 296 30 27 V + S PD	
2.0 D	118	04/12→	←	passend für Felgenreöße [Zoll]: 17	24.0130-0209.1	430209	Ø 321 30 27 V + S	
2.0 LPG	101	02/12→			24.0330-0209.1	530209	Ø 321 30 27 V + S PD	
2.4	123	01/12→	→	passend für Felgenreöße [Zoll]: 16	24.0112-0202.1	412202	Ø 292 12 10,5	
2.4	125	01/12→			24.0123-0114.1	423114	Ø 315 22,9 21,5 V + S	
2.4	137	01/12→			24.0323-0114.1	523114	Ø 315 22,9 21,5 V + S PD	
CHEVROLET - MATIZ (M200, M250) 03/05→								
 Bremsbelagsatz, Scheibenbremse								
0.8	38	03/05→	←	→ 12/10	13.0460-5996.2	605996	23241 16,1 - WE / - WK	
0.8 LPG	38	03/05→						
1.0	47	03/05→						
1.0	48	01/07→						
1.0	49	03/05→						
1.0 LPG	44	01/07→						
1.0 LPG	49	03/05→						
Zubehörsatz, Scheibenbremsbelag								
0.8	38	03/05→	←	→ 12/10	13.0460-0252.2	610252		
0.8 LPG	38	03/05→						
1.0	47	03/05→						
1.0	48	01/07→						
1.0	49	03/05→						
1.0 LPG	44	01/07→						
1.0 LPG	49	03/05→						
 Bremsscheibe								
0.8	38	03/05→	←	→ 12/10	24.0113-0195.1	413195	Ø 236 12,6 9,7	
0.8 LPG	38	03/05→						
1.0	47	03/05→						
1.0	48	01/07→						
1.0	49	03/05→						
1.0 LPG	44	01/07→						
1.0 LPG	49	03/05→						
CHEVROLET - MONTE CARLO Coupe 09/80→12/88								
 Bremsbelagsatz, Scheibenbremse								
3.8	149	09/99→12/05	←	→ 05/05	13.0460-8002.2	608002	23358 18,0 + WK	
CHEVROLET - NUBIRA Kombi 01/05→								
 Bremsbelagsatz, Scheibenbremse								
1.5	78	01/05→	←	→ 695960	13.0460-5859.2	605859	AKE 23234 16,9 + WK	
1.6	80	03/05→	←	695961→; → 12/10	13.0460-5863.2	605863	AKE 23234 16,8 + WK	
1.8	89	08/05→						
1.8	90	03/05→	→	→ 12/06	13.0460-5739.2	605739	SUM 24071 14,6 - WE / - WK	
2.0	88	01/05→						
2.0 D	89	01/07→	←	→ 695960	13.0460-5859.2	605859	AKE 23234 16,9 + WK	
			←	695961→; → 12/10	13.0460-5863.2	605863	AKE 23234 16,8 + WK	
Zubehörsatz, Scheibenbremsbelag								
1.5	78	01/05→	←	→ 695960	13.0460-0140.2	610140	AKE	
1.6	80	03/05→						
1.8	89	08/05→						
1.8	90	03/05→						
2.0	88	01/05→						
2.0 D	89	01/07→						
 Bremsscheibe								
1.5	78	01/05→	←	→ 12/10	24.0124-0199.1	424199	Ø 256 24 21 V + S	
1.6	80	03/05→	→	→ 12/10	24.0110-0340.1	410340	Ø 258 10,5 8 + S	
1.8	89	08/05→						
1.8	90	03/05→						
2.0	88	01/05→						
2.0 D	89	01/07→						
CHEVROLET - NUBIRA Stufenheck 01/05→								
 Bremsbelagsatz, Scheibenbremse								
1.4	69	01/05→	←	→ 695960	13.0460-5859.2	605859	AKE 23234 16,9 + WK	
1.4	70	01/06→	←	695961→; → 12/10	13.0460-5863.2	605863	AKE 23234 16,8 + WK	
1.5	78	01/05→						
1.6	80	03/05→	→	→ 12/06	13.0460-5739.2	605739	SUM 24071 14,6 - WE / - WK	
↓								











	kw			 	! #		
CHEVROLET - NUBIRA Stufenheck 01/05→							
 Bremsbelagsatz, Scheibenbremse							
1.8	89	01/06→	←	→ 695960		13.0460-5859.2 605859	AKE 23234 16,9 + WK
1.8	90	03/05→	←	695961→; → 12/10		13.0460-5863.2 605863	AKE 23234 16,8 + WK
2.0	88	01/05→					
2.0 D	89	01/05→			→ 12/06		
1.6	76	01/10→	←	→ 695960		13.0460-5859.2 605859	AKE 23234 16,9 + WK
			←	695961→; → 12/10		13.0460-5863.2 605863	AKE 23234 16,8 + WK
Zubehörsatz, Scheibenbremsbelag							
1.4	69	01/05→	←	→ 695960		13.0460-0140.2 610140	AKE
1.4	70	01/06→					
1.5	78	01/05→					
1.6	76	01/10→					
1.6	80	03/05→					
1.8	89	01/06→					
1.8	90	03/05→					
2.0	88	01/05→					
2.0 D	89	01/05→					
Bremsscheibe							
1.4	69	01/05→	←	→ 12/10		24.0124-0199.1 424199	Ø 256 24 21 V + S
1.4	70	01/06→	→	→ 12/10		24.0110-0340.1 410340	Ø 258 10,5 8 + S
1.5	78	01/05→					
1.6	76	01/10→					
1.6	80	03/05→					
1.8	89	01/06→					
1.8	90	03/05→					
2.0	88	01/05→					
2.0 D	89	01/05→					
CHEVROLET - ORLANDO (J309) 12/10→							
 Bremsbelagsatz, Scheibenbremse							
1.4	103	06/12→	←			13.0460-7263.2 607263	24034 19,1 + WK + Zub
1.8	104	02/11→	←			13.0470-7263.2 LD7263	24034 19,1 + WK + Zub Ceramic
1.8 LPG	104	06/11→					
2.0 D	96	02/11→	→			13.0460-7264.2 607264	ATE 25096 17,0 + WK + Zub
2.0 D	120	02/11→				13.0470-7264.2 LD7264	ATE 25096 17,0 + WK + Zub Ceramic
2.0 LPG	103	02/12→					
Bremsscheibe							
1.4	103	06/12→	←			24.0126-0166.1 426166	Ø 300 26 23 V + S
1.8	104	02/11→	←			24.0326-0166.1 526166	Ø 300 26 23 V + S PD
1.8 LPG	104	06/11→					
2.0 D	96	02/11→	→			24.0112-0189.1 412189	Ø 292 12 10 + S
2.0 D	120	02/11→				24.0312-0189.1 512189	Ø 292 12 10 + S PD
2.0 LPG	103	02/12→					
CHEVROLET - REZZO 03/05→							
 Bremsbelagsatz, Scheibenbremse							
1.6	77	03/05→	←	826909→; → 05/09		13.0460-5859.2 605859	AKE 23234 16,9 + WK
1.6	79	08/05→					
2.0	89	03/05→					
2.0	90	08/05→					
Zubehörsatz, Scheibenbremsbelag							
1.6	77	03/05→	←	826909→; → 05/09		13.0460-0140.2 610140	AKE
1.6	79	08/05→					
2.0	89	03/05→					
2.0	90	08/05→					
Bremsscheibe							
1.6	77	03/05→	←	→ 05/09		24.0124-0199.1 424199	Ø 256 24 21 V + S
1.6	79	08/05→					
2.0	89	03/05→					
2.0	90	08/05→					
CHEVROLET - SPARK 05/05→							
 Bremsbelagsatz, Scheibenbremse							
0.8	37	05/05→	←	→ 02/10		13.0460-5996.2 605996	23241 16,1 - WE / - WK
1.0 LPG	46	05/05→					
1.0 SX	44	06/09→					
1.0 SX	46	05/05→					
1.0 SX	49	05/05→					
↓							

















	kw			 	! #		
CHEVROLET - SPARK 05/05→							
 Bremsscheibe							
0.8	37	05/05→	←	→ 02/10		24.0113-0195.1 413195	Ø 236 12,6 9,7
1.0 LPG	46	05/05→					
1.0 SX	44	06/09→					
1.0 SX	46	05/05→					
1.0 SX	49	05/05→					
CHEVROLET - SPARK (M300) 12/09→							
 Bremsbelagsatz, Scheibenbremse							
1.0	50	03/10→	←			13.0460-5642.2 605642	AKE 25268 17,8 + WK
1.0 LPG	48	07/10→					
1.0 LPG	50	03/10→					
1.2	60	03/10→					
1.2	61	01/11→					
1.2 LPG	59	01/11→					
1.2 LPG	60	03/10→					
1.2	59	01/11→	←	01/11→		13.0460-5642.2 605642	AKE 25268 17,8 + WK
 Bremsscheibe							
1.0	50	03/10→	←			24.0120-0227.1 420227	Ø 236 20 18 V + S
1.0 LPG	48	07/10→					
1.0 LPG	50	03/10→					
1.2	60	03/10→					
1.2	61	01/11→					
1.2 LPG	59	01/11→					
1.2 LPG	60	03/10→					
1.2	59	01/11→	←	01/11→		24.0120-0227.1 420227	Ø 236 20 18 V + S
CHEVROLET - TIGRA 08/97→09/01							
 Bremsbelagsatz, Scheibenbremse							
1.6	73	09/98→12/99	←			13.0460-7051.2 607051	ATE 20547 16,5 + WE / - WK
 Bremsscheibe							
1.6	73	09/98→12/99	←			24.0120-0140.1 420140	Ø 256 20 17 V + S
CHEVROLET - TRANS SPORT 08/96→09/05							
 Bremsbelagsatz, Scheibenbremse							
3.4	137	08/96→09/05	←	11/96→		13.0460-8002.2 608002	23358 18,0 + WK
3.4 V6	138	10/00→09/05	←			13.0460-8002.2 608002	23358 18,0 + WK
3.4 V6 AWD	138	10/01→09/05					
 Bremsscheibe							
3.4	137	08/96→09/05	←	11/96→		24.0132-0110.1 432110	Ø 278 32,2 30,7 V
			→	11/96→		24.0111-0133.1 411133	Ø 278 11 9
3.4 V6	138	10/00→09/05	←			24.0132-0110.1 432110	Ø 278 32,2 30,7 V
3.4 V6 AWD	138	10/01→09/05	→			24.0111-0133.1 411133	Ø 278 11 9
CHEVROLET - TRAX 12/12→							
 Bremsbelagsatz, Scheibenbremse							
1.4	103	12/12→	←			13.0460-7263.2 607263	24034 19,1 + WK + Zub
1.4 AWD	103	12/12→				13.0470-7263.2 LD7263	24034 19,1 + WK + Zub Ceramic
1.4 LPG	103	04/13→					
1.6	85	12/12→	→			13.0460-7264.2 607264	ATE 25096 17,0 + WK + Zub
1.7 TD	96	12/12→				13.0470-7264.2 LD7264	ATE 25096 17,0 + WK + Zub Ceramic
1.7 TD AWD	96	12/12→					
1.8	103	03/13→					
1.8 AWD	103	03/13→					
 Bremsscheibe							
1.4	103	12/12→	←			24.0126-0182.1 426182	Ø 300 26 23 V + S
1.4 AWD	103	12/12→	→				
1.4 LPG	103	04/13→				24.0112-0188.1 412188	Ø 268 12 10 + S
1.6	85	12/12→				24.0312-0188.1 512188	Ø 268 12 10 + S PD
1.7 TD	96	12/12→					
1.7 TD AWD	96	12/12→					
1.8	103	03/13→					
1.8 AWD	103	03/13→					
CHEVROLET - VECTRA 03/96→11/06							
 Bremsbelagsatz, Scheibenbremse							
2.0	81	03/96→12/05	←	→ 07/98		13.0460-7052.2 607052	ATE 21190 17,5 + WE / - WK
↓							















	kW			 	! #		
CHEVROLET - VECTRA 03/96→11/06							
 Bremsbelagsatz, Scheibenbremse							
2.0	81	03/96→12/05	←	08/98→		13.0460-7091.2 607091	ATE 21829 20,3 + WE / - WK
			→			13.0460-4040.2 604040	ATE 21050 15,8 - WE / - WK
2.0	100	03/96→04/98	←	554447→		13.0460-5859.2 605859	AKE 23234 16,9 + WK
			←	→ 554446		13.0460-5994.2 605994	AKE 23234 16,8 - WE / - WK
			→			13.0460-5993.2 605993	TRW 23237 14,5 - WE / - WK
2.2	91	05/98→07/04	←			13.0460-7091.2 607091	ATE 21829 20,3 + WE / - WK
2.2	102	05/98→12/05	→			13.0460-4040.2 604040	ATE 21050 15,8 - WE / - WK
 Bremsscheibe							
2.0	81	03/96→12/05	←			24.0124-0115.1 424115	Ø 256 24 21 V + S
			←	08/98→		24.0324-0115.1 524115	Ø 256 24 21 V + S PD
			←			24.0125-0119.1 425119	Ø 288 25 22 V + S
			→	Felge Lochzahl: 4		24.0325-0119.1 525119	Ø 288 25 22 V + S PD
			→	Felge Lochzahl: 5		24.0110-0225.1 410225	Ø 270 10 8 + S
						24.0310-0225.1 510225	Ø 270 10 8 + S PD
2.0	100	03/96→04/98	←			24.0124-0163.1 424163	Ø 256 24 22 V + S
			→			24.0110-0714.1 410714	Ø 258 10,3 8
2.2	91	05/98→07/04	←			24.0125-0119.1 425119	Ø 288 25 22 V + S
2.2	102	05/98→12/05	→			24.0325-0119.1 525119	Ø 288 25 22 V + S PD
			→			24.0110-0226.1 410226	Ø 286 10 8 + S
						24.0310-0226.1 510226	Ø 286 10 8 + S PD
CHEVROLET - VOLT 04/11→							
 Bremsbelagsatz, Scheibenbremse							
EV 150	111	11/11→	←			13.0460-7263.2 607263	24034 19,1 + WK + Zub
			→	+ eFSB		13.0470-7263.2 LD7263	24034 19,1 + WK + Zub Ceramic
			→			13.0460-7264.2 607264	ATE 25096 17,0 + WK + Zub
						13.0470-7264.2 LD7264	ATE 25096 17,0 + WK + Zub Ceramic
 Bremsscheibe							
EV 150	111	11/11→	←			24.0126-0166.1 426166	Ø 300 26 23 V + S
			→	+ eFSB		24.0326-0166.1 526166	Ø 300 26 23 V + S PD
			→			24.0112-0189.1 412189	Ø 292 12 10 + S
						24.0312-0189.1 512189	Ø 292 12 10 + S PD
CHRYSLER - 300C 09/10→							
 Bremsscheibe							
3.0 CRD 6.4	176 401	09/11→ 01/12→	←	→ 11/12; für Fahrzeuge ohne Sportpaket		24.0128-0266.1 428266	Ø 320 28 26,5 V
CHRYSLER - 300 C (LX) 09/04→							
 Bremsscheibe							
2.7 2.7 3.0 CRD 3.0 V6 CRD 3.5 3.5 5.7 5.7 6.1 SRT8	130 142 160 155 183 186 250 256 317	01/07→11/12 09/04→11/12 09/05→11/12 11/10→11/12 09/04→11/12 01/05→12/10 09/04→12/08 12/09→11/12 06/05→11/12	←	für Fahrzeuge ohne Sportpaket		24.0128-0266.1 428266	Ø 320 28 26,5 V
CHRYSLER - 300 C Touring (LX) 09/04→12/10							
 Bremsscheibe							
2.7 2.7 3.0 CRD 3.5 3.5 AWD 5.7 5.7 AWD 6.1 SRT8	130 142 160 183 183 250 250 317	01/07→12/10 09/04→12/10 09/05→12/10 09/04→12/10 09/04→12/10 09/04→12/10 04/05→12/10 06/05→12/10	←	für Fahrzeuge ohne Sportpaket		24.0128-0266.1 428266	Ø 320 28 26,5 V









	kw			 	! #		
CHRYSLER - 300 M (LR) 07/98→09/04							
 Bremsbelagsatz, Scheibenbremse							
2.7 V6 24V	149	11/98→08/00	←			13.0460-8003.2 608003	23043 16,0 - WE / - WK
2.7 V6 24V	150	08/00→09/04					
3.5 V6 24V	185	08/00→09/04	→			13.0460-8010.2 608010	23561 18,1 - WE / - WK
3.5 V6 24V	187	07/98→08/00					
 Bremsscheibe							
2.7 V6 24V	149	11/98→08/00	←	passend für Felgenreöße [Zoll]: 16		24.0126-0179.1 426179	Ø 297 26 24,4 V
2.7 V6 24V	150	08/00→09/04					
3.5 V6 24V	185	08/00→09/04					
3.5 V6 24V	187	07/98→08/00					
CHRYSLER - CONCORDE 09/92→09/97							
 Bremsbelagsatz, Scheibenbremse							
3.3 LX	120	10/92→09/97	←	01/95→		13.0460-8003.2 608003	23043 16,0 - WE / - WK
CHRYSLER - CONCORDE 10/97→09/03							
 Bremsbelagsatz, Scheibenbremse							
2.7 LX	149	10/97→09/03	←			13.0460-8003.2 608003	23043 16,0 - WE / - WK
3.5 LX	174	10/97→09/03					
3.5 LX Supercharged	186	10/97→09/03	→			13.0460-8010.2 608010	23561 18,1 - WE / - WK
 Bremsscheibe							
2.7 LX	149	10/97→09/03	←			24.0126-0179.1 426179	Ø 297 26 24,4 V
3.5 LX	174	10/97→09/03					
3.5 LX Supercharged	186	10/97→09/03					
CHRYSLER - CROSSFIRE 07/03→12/08							
 Bremsbelagsatz, Scheibenbremse							
3.2	160	07/03→12/08	←	→ 01/08		13.0460-7087.2 607087	ATE 21670 19,3 + WE / - WK
						13.0470-7087.2 LD7087	ATE 21670 19,3 + WE / - WK Ceramic
			→	→ 01/08		13.0460-4064.2 604064	ATE 21919 15,3 - WE / - WK + Zub
						13.0470-4064.2 LD4064	ATE 21919 15,3 - WE / - WK + Zub Ceramic
SRT-6	246	09/04→12/07	←	→ 08/06		13.0460-7183.2 607183	ATE 21484 20,5 + WE / - WK
			→	→ 08/06		13.0460-4047.2 604047	ATE 21305 15,7 + WE / - WK
						13.0470-4047.2 LD4047	ATE 21305 15,7 + WE / - WK Ceramic
 Bremsscheibe							
3.2	160	07/03→12/08	←	→ 01/08		24.0128-0106.1 428106	Ø 300 28 25,4 V + S
			→	→ 01/08		24.0109-0114.1 409114	Ø 278 9 7,3 + S
SRT-6	246	09/04→12/07	←	→ 08/06		24.0132-0159.1 432159	Ø 330 32 29,4 V
			→	→ 08/06		24.0122-0228.1 422228	Ø 300 22 19,4 V
CHRYSLER - CROSSFIRE Roadster 05/04→12/08							
 Bremsbelagsatz, Scheibenbremse							
3.2	160	05/04→12/08	←	→ 01/08		13.0460-7087.2 607087	ATE 21670 19,3 + WE / - WK
						13.0470-7087.2 LD7087	ATE 21670 19,3 + WE / - WK Ceramic
			→	→ 01/08		13.0460-4064.2 604064	ATE 21919 15,3 - WE / - WK + Zub
						13.0470-4064.2 LD4064	ATE 21919 15,3 - WE / - WK + Zub Ceramic
SRT-6	246	09/04→12/06	←	→ 08/06		13.0460-7183.2 607183	ATE 21484 20,5 + WE / - WK
			→	→ 08/06		13.0460-4047.2 604047	ATE 21305 15,7 + WE / - WK
						13.0470-4047.2 LD4047	ATE 21305 15,7 + WE / - WK Ceramic
 Bremsscheibe							
3.2	160	05/04→12/08	←	→ 01/08		24.0128-0106.1 428106	Ø 300 28 25,4 V + S
			→	→ 01/08		24.0109-0114.1 409114	Ø 278 9 7,3 + S
SRT-6	246	09/04→12/06	←	→ 08/06		24.0132-0159.1 432159	Ø 330 32 29,4 V
			→	→ 08/06		24.0122-0228.1 422228	Ø 300 22 19,4 V











	kw			 	! #		
CHRYSLER - DELTA 08/11→							
 Bremsbelagsatz, Scheibenbremse							
1.4 1.4 16V 1.6 D Multijet	88 103 88	08/11→ 08/11→ 08/11→	← →			13.0460-3984.2 603984 13.0470-3984.2 LD3984	BOS 23711 19,4 + WK BOS 23711 19,4 + WK Ceramic
			→			13.0460-3861.2 603861 13.0460-3991.2 603991 13.0470-3812.2 LD3812	BOS 23714 17,6 + WK + Zub BOS 23714 16,6 - WE / - WK BOS 23714 17,6 - WE / - WK Ceramic
2.0 D Multijet	121	08/11→	← →			13.0460-7265.2 607265 13.0460-3861.2 603861 13.0460-3991.2 603991 13.0470-3812.2 LD3812	ATE 24727 20,7 + WK BOS 23714 17,6 + WK + Zub BOS 23714 16,6 - WE / - WK BOS 23714 17,6 - WE / - WK Ceramic
 Bremsscheibe							
1.4 1.4 16V 1.6 D Multijet	88 103 88	08/11→ 08/11→ 08/11→	← →	für Leichtmetallfelgen		24.0126-0125.1 426125 24.0110-0190.1 410190	Ø 281 26 24,2 V Ø 251,5 10 9
2.0 D Multijet	121	08/11→	← →			24.0128-0243.1 428243 24.0110-0190.1 410190	Ø 305 28 26 V Ø 251,5 10 9
CHRYSLER - GRAND VOYAGER V (RT) 10/07→							
 Bremsbelagsatz, Scheibenbremse							
2.8 CRD 3.3 3.8	120 125 142	10/07→ 01/08→ 10/07→	← →	+ ABS		13.0460-2766.2 602766 13.0460-2771.2 602771	BOS 24604 18,7 + WK + Zub TRW 24822 15,7 + WK + Zub
 Bremsscheibe							
2.8 CRD 3.3 3.8	120 125 142	10/07→ 01/08→ 10/07→	←	+ ABS		24.0128-0263.1 428263	Ø 302 28 26,4 V
CHRYSLER - NEON (PL) 05/94→09/00							
 Bremsbelagsatz, Scheibenbremse							
1.8 16V 2.0 16V 2.0 16V	85 107 109	09/97→08/99 06/94→08/99 04/96→08/99	← →	Felge Lochzahl: 5		13.0460-8003.2 608003 13.0460-8010.2 608010	23043 16,0 - WE / - WK 23561 18,1 - WE / - WK
2.0 16V	98	05/94→08/99	← →	01/95→; Felge Lochzahl: 5		13.0460-8003.2 608003 13.0460-8010.2 608010	23043 16,0 - WE / - WK 23561 18,1 - WE / - WK
 Bremsscheibe							
1.8 16V 2.0 16V 2.0 16V	85 107 109	09/97→08/99 06/94→08/99 04/96→08/99	→	Felge Lochzahl: 5		24.0109-0146.1 409146	Ø 270 9 7,3
2.0 16V	98	05/94→08/99	→	01/95→; Felge Lochzahl: 5		24.0109-0146.1 409146	Ø 270 9 7,3
CHRYSLER - NEON II 08/99→12/06							
 Bremsbelagsatz, Scheibenbremse							
1.6	85	11/01→12/06	← →	+ ABS		13.0460-8003.2 608003 13.0460-8010.2 608010	23043 16,0 - WE / - WK 23561 18,1 - WE / - WK
1.8 2.0 16V 2.0 16V 2.0 16V R/T	91 97 98 110	01/00→12/01 10/02→12/06 08/99→12/06 10/01→12/06	← →			13.0460-8003.2 608003 13.0460-8010.2 608010	23043 16,0 - WE / - WK 23561 18,1 - WE / - WK
 Bremsscheibe							
1.6	85	11/01→12/06	→	+ ABS		24.0109-0146.1 409146	Ø 270 9 7,3
1.8 2.0 16V 2.0 16V 2.0 16V R/T	91 97 98 110	01/00→12/01 10/02→12/06 08/99→12/06 10/01→12/06	→			24.0109-0146.1 409146	Ø 270 9 7,3
CHRYSLER - NEW YORKER 01/92→09/98							
 Bremsbelagsatz, Scheibenbremse							
3.5 3.5 i 24V	160 155	03/95→09/98 04/93→09/98	←	01/95→		13.0460-8003.2 608003 13.0460-8003.2 608003	23043 16,0 - WE / - WK 23043 16,0 - WE / - WK









	kW			 	! #		
CHRYSLER - PT CRUISER (PT_) 06/00→12/10							
 Bremsbelagsatz, Scheibenbremse							
1.6	85	11/01→12/10	←	→ 09/10		13.0460-2959.2 602959	TRW 23532 20,1 + WK
			→	→ 09/10; + ABS		13.0460-8010.2 608010	23561 18,1 - WE / - WK
2.0	100	10/04→12/10	←	→ 09/10		13.0460-2959.2 602959	TRW 23532 20,1 + WK
2.0	104	06/00→12/10	→	→ 09/10		13.0460-8010.2 608010	23561 18,1 - WE / - WK
2.2 CRD	89	03/02→12/10					
2.2 CRD	110	08/05→12/10					
2.4	105	08/05→12/10					
2.4	110	06/00→12/10					
2.4	169	09/04→12/10					
GT 2.4	164	08/03→12/10					
Zubehörsatz, Scheibenbremsbelag							
1.6	85	11/01→12/10	←	→ 09/10		13.0460-0134.2 610134	TRW
2.0	100	10/04→12/10					
2.0	104	06/00→12/10					
2.2 CRD	89	03/02→12/10					
2.2 CRD	110	08/05→12/10					
2.4	105	08/05→12/10					
2.4	110	06/00→12/10					
2.4	169	09/04→12/10					
GT 2.4	164	08/03→12/10					
Bremsscheibe							
1.6	85	11/01→12/10	←	→ 09/10		24.0123-0107.1 423107	Ø 280 23 21,4 V
			→	→ 09/10; + ABS		24.0109-0146.1 409146	Ø 270 9 7,3
2.0	100	10/04→12/10	←	→ 09/10		24.0123-0107.1 423107	Ø 280 23 21,4 V
2.0	104	06/00→12/10	→	→ 09/10		24.0109-0146.1 409146	Ø 270 9 7,3
2.2 CRD	89	03/02→12/10					
2.2 CRD	110	08/05→12/10					
2.4	105	08/05→12/10					
2.4	110	06/00→12/10					
2.4	169	09/04→12/10					
GT 2.4	164	08/03→12/10					
CHRYSLER - PT CRUISER Cabriolet 06/00→12/10							
 Bremsbelagsatz, Scheibenbremse							
2.4	105	03/04→03/08	←			13.0460-2959.2 602959	TRW 23532 20,1 + WK
2.4 GT	164	03/04→03/08	→			13.0460-8010.2 608010	23561 18,1 - WE / - WK
Zubehörsatz, Scheibenbremsbelag							
2.4	105	03/04→03/08	←			13.0460-0134.2 610134	TRW
2.4 GT	164	03/04→03/08					
Bremsscheibe							
2.4	105	03/04→03/08	←			24.0123-0107.1 423107	Ø 280 23 21,4 V
2.4 GT	164	03/04→03/08	→			24.0109-0146.1 409146	Ø 270 9 7,3
CHRYSLER - SEBRING (JR) 09/00→06/07							
 Bremsbelagsatz, Scheibenbremse							
2.0	104	04/01→06/07	→			13.0460-5980.2 605980	21706 15,5 + WK
2.4	105	04/01→06/07	→			13.0460-8010.2 608010	23561 18,1 - WE / - WK
2.4	112	04/01→06/07					
2.4 Turbo	164	09/01→06/07					
2.7 V6 24V	149	04/01→06/07					
Bremsscheibe							
2.0	104	04/01→06/07	←			24.0123-0120.1 423120	Ø 282,5 23 21,4 V + S
2.4	105	04/01→06/07					
2.4	112	04/01→06/07					
2.4 Turbo	164	09/01→06/07					
2.7 V6 24V	149	04/01→06/07					
CHRYSLER - SEBRING (JS) 09/06→12/10							
 Bremsbelagsatz, Scheibenbremse							
2.0 CRD	103	07/07→12/10	←			13.0460-5760.2 605760	AKE 23584 16,4 + WK
2.0 VVT	115	07/07→12/10					
2.4 VVT	125	07/07→12/10	→	+ ABS		13.0460-5735.2 605735	AKE 24014 16,0 + WK
2.7	138	07/07→12/10					
2.7 VVT	137	07/07→09/10					
3.5 AWD	175	11/07→12/10					
2.4	128	05/07→12/10	←	07/07→		13.0460-5760.2 605760	AKE 23584 16,4 + WK
2.7 VVT	141	09/06→12/10					
↓							











	kw			 	! #		
CHRYSLER - SEBRING (JS) 09/06→12/10							
 Bremsbelagsatz, Scheibenbremse							
2.4	128	05/07→12/10	➡	07/07→; + ABS		13.0460-5735.2 605735	AKE 24014 16,0 + WK
2.7 VVT	141	09/06→12/10					
 Bremsscheibe							
2.0 CRD	103	07/07→12/10	←			24.0126-0170.1 426170	Ø 294 26 24,4 V
2.0 VVT	115	07/07→12/10					
2.4 VVT	125	07/07→12/10	➡	+ ABS		24.0110-0363.1 410363	Ø 262 10 8,4
2.7	138	07/07→12/10					
2.7 VVT	137	07/07→09/10					
3.5 AWD	175	11/07→12/10					
2.4	128	05/07→12/10	←	07/07→		24.0126-0170.1 426170	Ø 294 26 24,4 V
2.7 VVT	141	09/06→12/10	➡	07/07→; + ABS		24.0110-0363.1 410363	Ø 262 10 8,4
CHRYSLER - SEBRING Cabriolet (JR) 04/01→06/07							
 Bremsbelagsatz, Scheibenbremse							
2.0	104	04/01→06/07	➡			13.0460-8010.2 608010	23561 18,1 - WE / - WK
2.4	112	04/01→06/07					
2.4 Turbo	164	09/01→06/07					
2.7 V6 24V	149	04/01→06/07					
 Bremsscheibe							
2.0	104	04/01→06/07	←			24.0123-0120.1 423120	Ø 282,5 23 21,4 V + S
2.4	112	04/01→06/07					
2.4 Turbo	164	09/01→06/07					
2.7 V6 24V	149	04/01→06/07					
CHRYSLER - SEBRING Cabriolet (JS) 05/07→12/10							
 Bremsbelagsatz, Scheibenbremse							
2.0 CRD	103	07/07→12/10	←			13.0460-5760.2 605760	AKE 23584 16,4 + WK
2.4 VVT	125	07/07→12/10					
2.7	137	07/07→12/10	➡	+ ABS		13.0460-5855.2 605855	23582 16,0 - WK
2.7 VVT	141	07/07→12/10					
 Bremsscheibe							
2.0 CRD	103	07/07→12/10	←			24.0126-0170.1 426170	Ø 294 26 24,4 V
2.4 VVT	125	07/07→12/10					
2.7	137	07/07→12/10	➡	+ ABS		24.0110-0372.1 410372	Ø 302 10 8,4
2.7 VVT	141	07/07→12/10					
CHRYSLER - STRATUS (JA) 09/94→04/01							
 Bremsbelagsatz, Scheibenbremse							
2.5 LX V6	120	12/95→04/01	➡			13.0460-8010.2 608010	23561 18,1 - WE / - WK
2.5 V6	125	12/95→04/01					
CHRYSLER - STRATUS Cabriolet (JX) 04/96→04/01							
 Bremsbelagsatz, Scheibenbremse							
2.5 LX	120	04/96→04/01	➡			13.0460-8010.2 608010	23561 18,1 - WE / - WK
CHRYSLER - VISION 09/93→12/97							
 Bremsbelagsatz, Scheibenbremse							
3.5 TSi	155	09/93→12/97	←	01/95→		13.0460-8003.2 608003	23043 16,0 - WE / - WK
CHRYSLER - VOYAGER / GRAND VOYAGER III (GS) 01/95→03/01							
 Bremsbelagsatz, Scheibenbremse							
2.0 i	98	01/95→03/01	←			13.0460-8003.2 608003	23043 16,0 - WE / - WK
2.4 i	111	01/95→03/01					
2.5 TD	85	01/95→03/01	➡	→ 09/96; + ABS		13.0460-8010.2 608010	23561 18,1 - WE / - WK
2.5 TDiC AWD	85	10/95→03/01					
3.0	112	01/95→03/01					
3.3 i	116	01/95→03/01					
3.3 i	134	01/95→03/01					
3.8	121	01/95→12/99					
3.8	122	01/96→12/00					
3.8 i AWD	131	01/95→03/01					
2.4 AWD	111	02/97→03/01	←			13.0460-8003.2 608003	23043 16,0 - WE / - WK
3.8 i AWD	122	01/95→03/01	←	Allrad		13.0460-8003.2 608003	23043 16,0 - WE / - WK
↓			➡	→ 09/96; + ABS		13.0460-8010.2 608010	23561 18,1 - WE / - WK









	kW			 	! #							
CHRYSLER - VOYAGER / GRAND VOYAGER III (GS) 01/95→03/01												
 Bremsscheibe												
2.0 i	98	01/95→03/01	←	passend für Felgenreöße [Zoll]: 15		24.0124-0178.1 424178	Ø 282,5 24 22,4 V					
2.4 AWD	111	02/97→03/01	→	+ ABS		24.0113-0196.1 413196	Ø 290 12,5 11,3					
2.4 i	111	01/95→03/01										
2.5 TD	85	01/95→03/01										
2.5 TDiC AWD	85	10/95→03/01										
3.0	112	01/95→03/01										
3.3 i	116	01/95→03/01										
3.3 i	134	01/95→03/01										
3.8	121	01/95→12/99										
3.8	122	01/96→12/00										
3.8 i AWD	131	01/95→03/01										
3.8 i AWD	122	01/95→03/01	←	Allrad; passend für Felgenreöße [Zoll]: 15		24.0124-0178.1 424178	Ø 282,5 24 22,4 V					
			→	+ ABS		24.0113-0196.1 413196	Ø 290 12,5 11,3					
CHRYSLER - VOYAGER II (ES) 08/90→09/95												
 Bremsbelagsatz, Scheibenbremse												
2.5 i	72	01/91→09/95	←	passend für Felgenreöße [Zoll]: 15		13.0460-8009.2 608009	21815 18,8 + WK					
2.5 i	74	08/90→09/95										
2.5 TD	85	01/92→09/95										
2.5 TD	87	01/92→09/95										
3.0	104	10/90→09/95										
3.0 i	108	01/91→09/95										
3.3 i	110	08/90→09/95										
3.3 i	120	08/90→09/95										
3.3 i AWD	110	08/90→09/95										
3.3 i AWD	120	08/90→09/95										
 Bremsscheibe												
2.5 i	72	01/91→09/95						←	passend für Felgenreöße [Zoll]: 15		24.0124-0193.1 424193	Ø 282,5 24 22,4 V
2.5 i	74	08/90→09/95										
2.5 TD	85	01/92→09/95										
2.5 TD	87	01/92→09/95										
3.0	104	10/90→09/95										
3.0 i	108	01/91→09/95										
3.3 i	110	08/90→09/95										
3.3 i	120	08/90→09/95										
3.3 i AWD	110	08/90→09/95										
3.3 i AWD	120	08/90→09/95										
CHRYSLER - VOYAGER IV (RG, RS) 09/99→12/08												
 Bremsbelagsatz, Scheibenbremse												
2.4	108	02/00→12/08	←	passend für Felgenreöße [Zoll]: 15		13.0460-2899.2 602899	TRW 23638 17,5 + WK					
2.5 CRD	88	08/05→12/08	←	passend für Felgenreöße [Zoll]: 16		13.0460-7207.2 607207	ATE 23807 18,6 - WE / - WK					
2.5 CRD	105	02/00→12/08	→			13.0460-8008.2 608008	24036 16,7 + WK					
2.8 CRD	110	06/04→12/08										
3.3	128	02/00→12/08										
3.3	132	09/03→12/08										
3.3 AWD	128	02/00→12/08										
3.3 Flex-Fuel	128	02/00→12/08										
3.8	160	02/00→12/08										
3.8 AWD	160	02/00→12/08										
 Bremsscheibe												
2.4	108	02/00→12/08	←	passend für Felgenreöße [Zoll]: 16		24.0128-0147.1 428147	Ø 302 28 26,5 V					
2.5 CRD	88	08/05→12/08	←	passend für Felgenreöße [Zoll]: 15		24.0128-0148.1 428148	Ø 281 28 25,3 V					
2.5 CRD	105	02/00→12/08	→			24.0113-0196.1 413196	Ø 290 12,5 11,3					
2.8 CRD	110	06/04→12/08										
3.3	128	02/00→12/08										
3.3	132	09/03→12/08										
3.3 AWD	128	02/00→12/08										
3.3 Flex-Fuel	128	02/00→12/08										
3.8	160	02/00→12/08										
3.8 AWD	160	02/00→12/08										
CHRYSLER - YPSILON 05/11→												
 Bremsbelagsatz, Scheibenbremse												
0.9 Twinair	63	05/11→	←			13.0460-7289.2 607289	ATE 25323 17,3 + WK					
1.2	51	05/11→										
1.3 Multijet	70	05/11→										
 Bremsscheibe												
0.9 Twinair	63	05/11→	←			24.0122-0197.1 422197	Ø 257,5 22 20,2 V					
1.3 Multijet	70	05/11→				24.0322-0197.1 522197	Ø 257,5 22 20,2 V PD					
1.2	51	05/11→	←			24.0112-0127.1 412127	Ø 257,5 12 10,2					















	kw			 	! #		
CITROËN - AX (ZA-) 07/86→12/98							
 Bremsbelagsatz, Scheibenbremse							
1.4 GTi	66	08/91→12/96	←			13.0460-2825.2 602825	TRW 21614 17,7 + WK
1.4 GTi	69	06/91→12/96	←				
10	33	07/86→12/98	←	→Orga 05089		13.0460-4041.2 604041	ATE 21179 16,8 + WK
			←	Orga 05090→		13.0460-4042.2 604042	ATE 21191 16,8 + WK
10	37	02/87→12/98	←	07/92→		13.0460-4042.2 604042	ATE 21191 16,8 + WK
11	44	09/86→12/97	←	10/89→; →Orga 05089		13.0460-4041.2 604041	ATE 21179 16,8 + WK
			←	Orga 05090→		13.0460-4042.2 604042	ATE 21191 16,8 + WK
14	55	04/87→04/97	←	Orga 05278→; → 12/96		13.0460-3952.2 603952	BDX 20905 18,0 + WK
			←	03/89→; →Orga 05089		13.0460-4041.2 604041	ATE 21179 16,8 + WK
			←	Orga 05090→ Orga 05277		13.0460-4042.2 604042	ATE 21191 16,8 + WK
14 4x4	55	08/91→12/96	←			13.0460-3952.2 603952	BDX 20905 18,0 + WK
15 D	40	08/94→12/97	←				
15 D	43	08/94→12/97	←				
14 D	37	08/91→12/97	←	Orga 05278→		13.0460-3952.2 603952	BDX 20905 18,0 + WK
			←	→Orga 05089		13.0460-4041.2 604041	ATE 21179 16,8 + WK
			←	Orga 05090→ Orga 05277		13.0460-4042.2 604042	ATE 21191 16,8 + WK
Electric	25	04/93→10/96	←			13.0460-4066.2 604066	ATE 21857 17,7 - WE / - WK
Electric	28	11/96→04/97	←				
Zubehörsatz, Scheibenbremsbelag							
1.4 GTi	66	08/91→12/96	←			13.0460-0060.2 610060	TRW
1.4 GTi	69	06/91→12/96	←				
10	33	07/86→12/98	←	→Orga 05089		13.0460-0424.2 610424	ATE
			←	Orga 05090→		13.0460-0424.2 610424	ATE
10	37	02/87→12/98	←	07/92→		13.0460-0424.2 610424	ATE
11	44	09/86→12/97	←	Orga 05090→		13.0460-0424.2 610424	ATE
			←	10/89→; →Orga 05089		13.0460-0424.2 610424	ATE
14	55	04/87→04/97	←	Orga 05278→; → 12/96		13.0460-0403.2 610403	BDX
			←	Orga 05090→ Orga 05277		13.0460-0424.2 610424	ATE
			←	03/89→; →Orga 05089		13.0460-0424.2 610424	ATE
14 4x4	55	08/91→12/96	←			13.0460-0403.2 610403	BDX
15 D	40	08/94→12/97	←				
15 D	43	08/94→12/97	←				
14 D	37	08/91→12/97	←	Orga 05278→		13.0460-0403.2 610403	BDX
			←	Orga 05090→ Orga 05277		13.0460-0424.2 610424	ATE
			←	→Orga 05089		13.0460-0424.2 610424	ATE
Bremsscheibe							
1.4 GTi	66	08/91→12/96	←			24.0120-0132.1 420132	Ø 247 20,4 18,5 V + S
1.4 GTi	69	06/91→12/96	←			24.0320-0132.1 520132	Ø 247 20,4 18,5 V + S PD
10	33	07/86→12/98	←			24.0108-0107.1 408107	Ø 238 8 6 + S
Electric	25	04/93→10/96	←				
Electric	28	11/96→04/97	←				
10	37	02/87→12/98	←	07/92→		24.0108-0107.1 408107	Ø 238 8 6 + S
11	44	09/86→12/97	←	10/89→		24.0108-0107.1 408107	Ø 238 8 6 + S
14	55	04/87→04/97	←	03/89→; →Orga 05277		24.0108-0107.1 408107	Ø 238 8 6 + S
14 D	37	08/91→12/97	←	→Orga 05277		24.0108-0107.1 408107	Ø 238 8 6 + S
CITROËN - BERLINGO (B9) 04/08→							
 Bremsbelagsatz, Scheibenbremse							
1.2 PureTech 110	81	02/16→	←			13.0460-7229.2 607229	ATE 24538 18,5 - WE / - WK
1.6	66	04/08→	←			13.0470-7229.2 LD7229	ATE 24538 18,5 - WE / - WK
1.6	80	04/08→	←				Ceramic
1.6 BlueHDi 100	73	12/14→	←				
1.6 BlueHDi 120	88	12/14→	→			13.0460-2745.2 602745	TRW 24765 16,5 - WE / - WK
1.6 HDi 110	80	04/08→	←				+ Zub
1.6 HDi 110	82	07/10→	←				
1.6 HDi 115	84	07/10→	←				
1.6 HDi 115 4x4	84	02/12→	←				
1.6 HDi 75 16V	55	04/08→	←				
1.6 HDi 90	66	04/08→	←				
1.6 HDi 90	68	07/10→	←				
1.6 HDi 90 4x4	66	02/12→	←				
1.6 VTi 120	88	11/09→	←				
1.6 VTi 95	72	07/10→	←				
↓							









	kw			 	! #		
CITROËN - BERLINGO (B9) 04/08→							
 Bremsbelagsatz, Scheibenbremse							
1.6 HDi 75 / BlueHDi 75	55	04/08→	←	04/15→		13.0460-7229.2 607229 13.0470-7229.2 LD7229	ATE 24538 18,5 - WE / - WK ATE 24538 18,5 - WE / - WK Ceramic
			→	04/15→		13.0460-2745.2 602745	TRW 24765 16,5 - WE / - WK + Zub
 Bremsscheibe							
1.2 PureTech 110	81	02/16→	←			24.0126-0120.1 426120	Ø 283 26 24 V + S
1.6	66	04/08→				24.0326-0120.1 526120	Ø 283 26 24 V + S PD
1.6	80	04/08→	→				
1.6 BlueHDi 100	73	12/14→				24.0112-0194.2 412194	Ø 268 12 10 + LG / + ABS Ring
1.6 BlueHDi 120	88	12/14→					
1.6 HDi 110	80	04/08→					
1.6 HDi 110	82	07/10→					
1.6 HDi 115	84	07/10→					
1.6 HDi 115 4x4	84	02/12→					
1.6 HDi 75 16V	55	04/08→					
1.6 HDi 90	66	04/08→					
1.6 HDi 90	68	07/10→					
1.6 HDi 90 4x4	66	02/12→					
1.6 VTi 120	88	11/09→					
1.6 VTi 95	72	07/10→					
1.6 HDi 75 / BlueHDi 75	55	04/08→	←	04/15→		24.0126-0120.1 426120 24.0326-0120.1 526120	Ø 283 26 24 V + S Ø 283 26 24 V + S PD
			→	04/15→		24.0112-0194.2 412194	Ø 268 12 10 + LG / + ABS Ring
CITROËN - BERLINGO (MF) 07/96→12/11							
 Bremsbelagsatz, Scheibenbremse							
1.1 i (MFHDZ, MFHFX)	44	07/96→05/08	←	→Orga 09127		13.0460-2829.2 602829	TRW 23124 19,0 + WK
1.4 i (MFKFX, MFKFW)	55	07/96→10/08	←	→Orga 09428		13.0460-2829.2 602829	TRW 23124 19,0 + WK
			←	Orga 09429→; → 03/08		13.0460-3994.2 603994 13.0470-3994.2 LD3994	BOS 23599 19,0 - WE / - WK + Zub BOS 23599 19,0 - WE / - WK + Zub Ceramic
			←	Orga 09128→; → 03/08		13.0460-3994.2 603994 13.0470-3994.2 LD3994	BOS 23599 19,0 - WE / - WK + Zub BOS 23599 19,0 - WE / - WK + Zub Ceramic
1.4	53	11/02→10/05	←			13.0460-3994.2 603994 13.0470-3994.2 LD3994	BOS 23599 19,0 - WE / - WK + Zub BOS 23599 19,0 - WE / - WK + Zub Ceramic
1.4 bivalent	53	11/02→10/05					
1.4 bivalent	48	11/02→12/11	←	→ 03/08		13.0460-3994.2 603994 13.0470-3994.2 LD3994	BOS 23599 19,0 - WE / - WK + Zub BOS 23599 19,0 - WE / - WK + Zub Ceramic
1.4 i bivalent (MFKFW)	55	04/03→10/08					
1.6 HDi 75 (MF9HW)	55	07/05→12/11					
1.6 16V (MFNFU)	80	10/00→12/11	←	→Orga 09127		13.0460-2829.2 602829	TRW 23124 19,0 + WK
1.6 16V (MFNFU)	81	11/02→10/08	←	Orga 09128→; → 03/08; + ESP		13.0460-3811.2 603811 13.0460-3994.2 603994 13.0470-3994.2 LD3994	BOS 23708 19,2 - WE / - WK BOS 23599 19,0 - WE / - WK + Zub BOS 23599 19,0 - WE / - WK + Zub Ceramic
			→	→ 03/08; + ESP		13.0460-2820.2 602820 13.0470-2823.2 LD2823	TRW 20961 17,2 - WK TRW 23554 17,2 - WK Ceramic
1.6 HDi 110	80	08/05→12/11	←	→ 03/08; + ESP		13.0460-3811.2 603811 13.0460-3994.2 603994 13.0470-3994.2 LD3994	BOS 23708 19,2 - WE / - WK BOS 23599 19,0 - WE / - WK + Zub BOS 23599 19,0 - WE / - WK + Zub Ceramic
			←	→ 03/08; - ESP			
			→	→ 03/08; + ESP		13.0460-2820.2 602820 13.0470-2823.2 LD2823	TRW 20961 17,2 - WK TRW 23554 17,2 - WK Ceramic
1.6 HDi 90 (MF9HX)	66	07/05→05/08	←	→ 03/08; + ESP		13.0460-3811.2 603811 13.0460-3994.2 603994 13.0470-3994.2 LD3994	BOS 23708 19,2 - WE / - WK BOS 23599 19,0 - WE / - WK + Zub BOS 23599 19,0 - WE / - WK + Zub Ceramic
			←	→ 03/08; - ESP			
			←	04/08→		13.0460-7229.2 607229 13.0470-7229.2 LD7229	ATE 24538 18,5 - WE / - WK ATE 24538 18,5 - WE / - WK Ceramic









	kw			 	! #		
CITROËN - BERLINGO (MF) 07/96→12/11							
 Bremsbelagsatz, Scheibenbremse							
1.6 HDI 90 (MF9HX)	66	07/05→05/08	➡	→ 03/08; + ESP		13.0460-2820.2 602820 13.0470-2823.2 LD2823	TRW 20961 17,2 - WK TRW 23554 17,2 - WK Ceramic
1.8 D (MFA9A)	43	07/98→10/02	➡	→Orga 09127		13.0460-2829.2 602829	TRW 23124 19,0 + WK
1.8 i (MFLFX)	66	05/97→10/02	➡	Orga 09128→		13.0460-3994.2 603994	BOS 23599 19,0 - WE / - WK + Zub
1.9 D (MFDJY)	50	07/96→12/03	➡			13.0470-3994.2 LD3994	BOS 23599 19,0 - WE / - WK + Zub Ceramic
1.9 D (MFWJZ)	51	07/98→10/05	➡				
1.9 D 4WD (MFWJZ)	51	07/98→10/05	➡				
1.8 i 4WD (MFLFX)	66	04/97→10/01	➡	05/97→; →Orga 09127		13.0460-2829.2 602829	TRW 23124 19,0 + WK
			➡	Orga 09128→		13.0460-3994.2 603994	BOS 23599 19,0 - WE / - WK + Zub
			➡			13.0470-3994.2 LD3994	BOS 23599 19,0 - WE / - WK + Zub Ceramic
1.9 D (MFDJY)	51	07/96→10/99	➡	07/98→; →Orga 09127		13.0460-2829.2 602829	TRW 23124 19,0 + WK
			➡	Orga 09128→		13.0460-3994.2 603994	BOS 23599 19,0 - WE / - WK + Zub
			➡			13.0470-3994.2 LD3994	BOS 23599 19,0 - WE / - WK + Zub Ceramic
2.0 HDi 4x4 (MFRHY)	66	11/02→10/05	➡	→Orga 09127		13.0460-2829.2 602829	TRW 23124 19,0 + WK
2.0 HDI 90 (MFRHY)	66	12/99→10/05	➡	Orga 09128→; + ESP		13.0460-3811.2 603811	BOS 23708 19,2 - WE / - WK
			➡	Orga 09128→; - ESP		13.0460-3994.2 603994	BOS 23599 19,0 - WE / - WK + Zub
			➡			13.0470-3994.2 LD3994	BOS 23599 19,0 - WE / - WK + Zub Ceramic
			➡	+ ESP		13.0460-2820.2 602820 13.0470-2823.2 LD2823	TRW 20961 17,2 - WK TRW 23554 17,2 - WK Ceramic
Electric	28	01/98→12/05	➡	11/02→		13.0460-2829.2 602829	TRW 23124 19,0 + WK
electricue	16	01/00→10/02	➡			13.0460-2829.2 602829	TRW 23124 19,0 + WK
 Bremsscheibe							
1.1 i (MFHDZ, MFHFX)	44	07/96→05/08	➡	→Orga 09428		24.0113-0184.1 413184	Ø 266 13 11 + S
1.4 i (MFKFX, MFKFW)	55	07/96→10/08	➡	→Orga 09127		24.0313-0184.1 513184	Ø 266 13 11 + S PD
			➡			24.0120-0133.1 420133	Ø 266 20,5 18,5 V + S
			➡			24.0320-0133.1 520133	Ø 266 20,5 18,5 V + S PD
			➡	Orga 09429→; → 03/08		24.0122-0194.1 422194	Ø 266 22 20 V + S
			➡	Orga 09128→; → 03/08		24.0122-0194.1 422194	Ø 266 22 20 V + S
1.4	53	11/02→10/05	➡			24.0122-0194.1 422194	Ø 266 22 20 V + S
1.4 bivalent	53	11/02→10/05	➡				
1.4 bivalent	48	11/02→12/11	➡	→ 03/08		24.0122-0194.1 422194	Ø 266 22 20 V + S
1.4 i bivalent (MFKFW)	55	04/03→10/08	➡				
1.6 HDI 75 (MF9HW)	55	07/05→12/11	➡				
1.6 16V (MFNFU)	80	10/00→12/11	➡	→Orga 09127		24.0120-0133.1 420133	Ø 266 20,5 18,5 V + S
1.6 16V (MFNFU)	81	11/02→10/08	➡			24.0320-0133.1 520133	Ø 266 20,5 18,5 V + S PD
			➡	Orga 09128→; → 03/08; - ESP		24.0122-0194.1 422194	Ø 266 22 20 V + S
			➡	Orga 09128→; → 03/08; + ESP		24.0126-0120.1 426120	Ø 283 26 24 V + S
			➡			24.0326-0120.1 526120	Ø 283 26 24 V + S PD
			➡	→ 03/08; + ESP		24.0109-0137.1 409137	Ø 247 9 8 + S
1.6 HDI 110	80	08/05→12/11	➡	→ 03/08; - ESP		24.0122-0194.1 422194	Ø 266 22 20 V + S
1.6 HDI 90 (MF9HX)	66	07/05→05/08	➡	→ 03/08; + ESP		24.0126-0120.1 426120	Ø 283 26 24 V + S
			➡			24.0326-0120.1 526120	Ø 283 26 24 V + S PD
			➡	→ 03/08; + ESP		24.0109-0137.1 409137	Ø 247 9 8 + S
1.8 D (MFA9A)	43	07/98→10/02	➡	→Orga 09127		24.0120-0133.1 420133	Ø 266 20,5 18,5 V + S
1.8 i (MFLFX)	66	05/97→10/02	➡			24.0320-0133.1 520133	Ø 266 20,5 18,5 V + S PD
1.9 D (MFDJY)	50	07/96→12/03	➡	Orga 09128→		24.0122-0194.1 422194	Ø 266 22 20 V + S
1.9 D (MFWJZ)	51	07/98→10/05	➡				
1.9 D 4WD (MFWJZ)	51	07/98→10/05	➡				
1.8 i 4WD (MFLFX)	66	04/97→10/01	➡	05/97→; →Orga 09127		24.0120-0133.1 420133	Ø 266 20,5 18,5 V + S
			➡			24.0320-0133.1 520133	Ø 266 20,5 18,5 V + S PD
			➡	Orga 09128→		24.0122-0194.1 422194	Ø 266 22 20 V + S
1.9 D (MFDJY)	51	07/96→10/99	➡	07/98→; →Orga 09127		24.0120-0133.1 420133	Ø 266 20,5 18,5 V + S
			➡			24.0320-0133.1 520133	Ø 266 20,5 18,5 V + S PD
			➡	Orga 09128→		24.0122-0194.1 422194	Ø 266 22 20 V + S
2.0 HDi 4x4 (MFRHY)	66	11/02→10/05	➡	→Orga 09127		24.0120-0133.1 420133	Ø 266 20,5 18,5 V + S
2.0 HDI 90 (MFRHY)	66	12/99→10/05	➡			24.0320-0133.1 520133	Ø 266 20,5 18,5 V + S PD
↓							









	kW			 	! #		
CITROËN - BERLINGO (MF) 07/96→12/11							
 Bremsscheibe							
2.0 HDi 4x4 (MFRHY)	66	11/02→10/05	←	Orga 09128→; - ESP		24.0122-0194.1 422194	Ø 266 22 20 V + S
2.0 HDi 90 (MFRHY)	66	12/99→10/05	←	Orga 09128→; + ESP		24.0126-0120.1 426120	Ø 283 26 24 V + S
			→	+ ESP		24.0326-0120.1 526120	Ø 283 26 24 V + S PD
			→			24.0109-0137.1 409137	Ø 247 9 8 + S
Electric	28	01/98→12/05	←	11/02→		24.0113-0184.1 413184	Ø 266 13 11 + S
			→			24.0313-0184.1 513184	Ø 266 13 11 + S PD
electrique	16	01/00→10/02	←			24.0113-0184.1 413184	Ø 266 13 11 + S
			→			24.0313-0184.1 513184	Ø 266 13 11 + S PD
CITROËN - BERLINGO Kasten (B9) 04/08→							
 Bremsbelagsatz, Scheibenbremse							
1.6	66	04/08→	←			13.0460-7229.2 607229	ATE 24538 18,5 - WE / - WK
1.6	80	04/08→	←			13.0470-7229.2 LD7229	ATE 24538 18,5 - WE / - WK Ceramic
1.6 BlueHDi 100	73	12/14→	→			13.0460-2745.2 602745	TRW 24765 16,5 - WE / - WK + Zub
1.6 BlueHDi 100 4x4	73	12/14→	→				
1.6 BlueHDi 120	88	12/14→	→				
1.6 HDi 110	80	04/08→	→				
1.6 HDi 110	82	07/10→	→				
1.6 HDi 115	84	07/10→	→				
1.6 HDi 115 4x4	84	02/12→	→				
1.6 HDi 75	55	04/08→	→				
1.6 HDi 75 4x4	55	02/12→	→				
1.6 HDi 90	66	07/10→	→				
1.6 HDi 90	68	07/10→	→				
1.6 HDi 90 16V	66	04/08→	→				
1.6 HDi 90 4x4	66	02/12→	→				
1.6 VTi 120	88	11/09→	→				
1.6 VTi 95	72	07/10→	→				
Electric	49	03/14→	→				
1.6 HDi / BlueHDi 75	55	07/10→	←	04/15→		13.0460-7229.2 607229	ATE 24538 18,5 - WE / - WK
			→	04/15→		13.0470-7229.2 LD7229	ATE 24538 18,5 - WE / - WK Ceramic
			→	04/15→		13.0460-2745.2 602745	TRW 24765 16,5 - WE / - WK + Zub
Electric	35	01/13→	←	02/13→		13.0460-7229.2 607229	ATE 24538 18,5 - WE / - WK
Electric	42	09/11→	→	02/13→		13.0470-7229.2 LD7229	ATE 24538 18,5 - WE / - WK Ceramic
			→	02/13→		13.0460-2745.2 602745	TRW 24765 16,5 - WE / - WK + Zub
 Bremsscheibe							
1.6	66	04/08→	←			24.0126-0120.1 426120	Ø 283 26 24 V + S
1.6	80	04/08→	←			24.0326-0120.1 526120	Ø 283 26 24 V + S PD
1.6 BlueHDi 100	73	12/14→	→			24.0112-0194.2 412194	Ø 268 12 10 + LG / + ABS Ring
1.6 BlueHDi 100 4x4	73	12/14→	→				
1.6 BlueHDi 120	88	12/14→	→				
1.6 HDi 110	80	04/08→	→				
1.6 HDi 110	82	07/10→	→				
1.6 HDi 115	84	07/10→	→				
1.6 HDi 115 4x4	84	02/12→	→				
1.6 HDi 75	55	04/08→	→				
1.6 HDi 75 4x4	55	02/12→	→				
1.6 HDi 90	66	07/10→	→				
1.6 HDi 90	68	07/10→	→				
1.6 HDi 90 16V	66	04/08→	→				
1.6 HDi 90 4x4	66	02/12→	→				
1.6 VTi 120	88	11/09→	→				
1.6 VTi 95	72	07/10→	→				
Electric	49	03/14→	→				
1.6 HDi / BlueHDi 75	55	07/10→	←	04/15→		24.0126-0120.1 426120	Ø 283 26 24 V + S
			→	04/15→		24.0326-0120.1 526120	Ø 283 26 24 V + S PD
			→	04/15→		24.0112-0194.2 412194	Ø 268 12 10 + LG / + ABS Ring
Electric	35	01/13→	←	02/13→		24.0126-0120.1 426120	Ø 283 26 24 V + S
Electric	42	09/11→	→	02/13→		24.0326-0120.1 526120	Ø 283 26 24 V + S PD
			→	02/13→		24.0112-0194.2 412194	Ø 268 12 10 + LG / + ABS Ring
CITROËN - BERLINGO Kasten (M_) 07/96→12/11							
 Bremsbelagsatz, Scheibenbremse							
1.1 i (MAHDZ, MBHDZ, MBHFX)	44	07/96→03/08	←	→Orga 09127		13.0460-2829.2 602829	TRW 23124 19,0 + WK
			←	→Orga 09428		13.0460-2829.2 602829	TRW 23124 19,0 + WK
↓							















	kw			 	! #		
CITROËN - BERLINGO Kasten (M_) 07/96→12/11							
 Bremsbelagsatz, Scheibenbremse							
1.1 i (MAHDZ, MBHDZ, MBHFX)	44	07/96→03/08	←	Orga 09429→		13.0460-3994.2 603994	BOS 23599 19,0 - WE / - WK + Zub
						13.0470-3994.2 LD3994	BOS 23599 19,0 - WE / - WK + Zub Ceramic
			←	Orga 09128→		13.0460-3994.2 603994	BOS 23599 19,0 - WE / - WK + Zub
						13.0470-3994.2 LD3994	BOS 23599 19,0 - WE / - WK + Zub Ceramic
1.4 bivalent 1.6 HDI 75 (MB9HW) 1.6 HDI 90 (MB9HX, MC9HX)	48 55 66	11/02→12/11 07/05→12/11 07/05→12/11	←	→ 03/08		13.0460-3994.2 603994	BOS 23599 19,0 - WE / - WK + Zub
						13.0470-3994.2 LD3994	BOS 23599 19,0 - WE / - WK + Zub Ceramic
1.4 CNG 1.4 i bivalent (MBKFW)	48 55	11/02→03/08 04/03→10/05	←			13.0460-3994.2 603994	BOS 23599 19,0 - WE / - WK + Zub
						13.0470-3994.2 LD3994	BOS 23599 19,0 - WE / - WK + Zub Ceramic
1.4 i (MBKFX, MBKFW)	55	07/96→12/11	←	→Orga 09127		13.0460-2829.2 602829	TRW 23124 19,0 + WK
			←	→Orga 09428		13.0460-2829.2 602829	TRW 23124 19,0 + WK
			←	Orga 09429→; → 03/08		13.0460-3994.2 603994	BOS 23599 19,0 - WE / - WK + Zub
						13.0470-3994.2 LD3994	BOS 23599 19,0 - WE / - WK + Zub Ceramic
			←	Orga 09128→; → 03/08		13.0460-3994.2 603994	BOS 23599 19,0 - WE / - WK + Zub
						13.0470-3994.2 LD3994	BOS 23599 19,0 - WE / - WK + Zub Ceramic
1.6 16V 1.6 16V (MBNFU) 1.8 D (MBA9A, MCA9A) 1.8 i 1.9 D (MBDJY) 1.9 D 70 4WD (MBWJZ, MCWJZ)	81 80 43 66 51 51	08/05→12/07 10/00→03/08 07/96→10/02 08/99→10/02 07/96→12/03 07/98→03/06	←	→Orga 09127		13.0460-2829.2 602829	TRW 23124 19,0 + WK
			←	Orga 09128→		13.0460-3994.2 603994	BOS 23599 19,0 - WE / - WK + Zub
						13.0470-3994.2 LD3994	BOS 23599 19,0 - WE / - WK + Zub Ceramic
1.9 D 70 (MBWJZ, MCWJZ)	51	04/99→12/11	←	→Orga 09127		13.0460-2829.2 602829	TRW 23124 19,0 + WK
			←	Orga 09128→; → 03/08		13.0460-3994.2 603994	BOS 23599 19,0 - WE / - WK + Zub
						13.0470-3994.2 LD3994	BOS 23599 19,0 - WE / - WK + Zub Ceramic
2.0 HDI 90 (MBRHY, MCRHY)	66	12/99→12/11	←	→Orga 09127		13.0460-2829.2 602829	TRW 23124 19,0 + WK
			←	Orga 09128→; → 03/08		13.0460-3994.2 603994	BOS 23599 19,0 - WE / - WK + Zub
						13.0470-3994.2 LD3994	BOS 23599 19,0 - WE / - WK + Zub Ceramic
			→	→ 03/08; + ESP		13.0460-2820.2 602820	TRW 20961 17,2 - WK
						13.0470-2823.2 LD2823	TRW 23554 17,2 - WK Ceramic
2.0 HDI 90 4WD (MBRHY, MCRHY)	66	11/00→10/05	←	→Orga 09127		13.0460-2829.2 602829	TRW 23124 19,0 + WK
			←	Orga 09128→		13.0460-3994.2 603994	BOS 23599 19,0 - WE / - WK + Zub
						13.0470-3994.2 LD3994	BOS 23599 19,0 - WE / - WK + Zub Ceramic
			→	+ ESP		13.0460-2820.2 602820	TRW 20961 17,2 - WK
						13.0470-2823.2 LD2823	TRW 23554 17,2 - WK Ceramic
Electric	27	07/03→12/05	←	11/04→		13.0460-2829.2 602829	TRW 23124 19,0 + WK
 Bremsscheibe							
1.1 i (MAHDZ, MBHDZ, MBHFX)	44	07/96→03/08	←	→Orga 09428		24.0113-0184.1 413184	Ø 266 13 11 + S
						24.0313-0184.1 513184	Ø 266 13 11 + S PD
			←	→Orga 09127		24.0120-0133.1 420133	Ø 266 20,5 18,5 V + S
						24.0320-0133.1 520133	Ø 266 20,5 18,5 V + S PD
			←	Orga 09128→		24.0122-0194.1 422194	Ø 266 22 20 V + S
			←	Orga 09429→		24.0122-0194.1 422194	Ø 266 22 20 V + S
1.4 bivalent 1.6 HDI 75 (MB9HW) 1.6 HDI 90 (MB9HX, MC9HX)	48 55 66	11/02→12/11 07/05→12/11 07/05→12/11	←	→ 03/08		24.0122-0194.1 422194	Ø 266 22 20 V + S
1.4 CNG 1.4 i bivalent (MBKFW)	48 55	11/02→03/08 04/03→10/05	←			24.0122-0194.1 422194	Ø 266 22 20 V + S
1.4 i (MBKFX, MBKFW)	55	07/96→12/11	←	→Orga 09428		24.0113-0184.1 413184	Ø 266 13 11 + S
↓							











	kW			 	! #		
CITROËN - BERLINGO Kasten (M_) 07/96→12/11							
 Bremsscheibe							
1.4 i (MBKFX, MBKFW)	55	07/96→12/11	←	→Orga 09428		24.0313-0184.1 513184	Ø 266 13 11 + S PD
			←	→Orga 09127		24.0120-0133.1 420133	Ø 266 20,5 18,5 V + S
				Orga 09429→; → 03/08		24.0320-0133.1 520133	Ø 266 20,5 18,5 V + S PD
			←	Orga 09128→; → 03/08		24.0122-0194.1 422194	Ø 266 22 20 V + S
1.6 16V	81	08/05→12/07	←	→Orga 09127		24.0120-0133.1 420133	Ø 266 20,5 18,5 V + S
1.6 16V (MBNFU)	80	10/00→03/08				24.0320-0133.1 520133	Ø 266 20,5 18,5 V + S PD
1.8 D (MBA9A, MCA9A)	43	07/96→10/02	←	Orga 09128→		24.0122-0194.1 422194	Ø 266 22 20 V + S
1.8 i	66	08/99→10/02					
1.9 D (MBDJY)	51	07/96→12/03					
1.9 D 70 4WD (MBWJZ, MCWJZ)	51	07/98→03/06					
1.9 D 70 (MBWJZ, MCWJZ)	51	04/99→12/11	←	→Orga 09127		24.0120-0133.1 420133	Ø 266 20,5 18,5 V + S
			←	Orga 09128→; → 03/08		24.0320-0133.1 520133	Ø 266 20,5 18,5 V + S PD
				Orga 09128→; → 03/08		24.0122-0194.1 422194	Ø 266 22 20 V + S
2.0 HDI 90 (MBRHY, MCRHY)	66	12/99→12/11	←	→Orga 09127		24.0120-0133.1 420133	Ø 266 20,5 18,5 V + S
			←	Orga 09128→; → 03/08		24.0320-0133.1 520133	Ø 266 20,5 18,5 V + S PD
				Orga 09128→; → 03/08		24.0122-0194.1 422194	Ø 266 22 20 V + S
			→	→ 03/08; + ESP		24.0109-0137.1 409137	Ø 247 9 8 + S
2.0 HDI 90 4WD (MBRHY, MCRHY)	66	11/00→10/05	←	→Orga 09127		24.0120-0133.1 420133	Ø 266 20,5 18,5 V + S
			←	Orga 09128→		24.0320-0133.1 520133	Ø 266 20,5 18,5 V + S PD
				Orga 09128→		24.0122-0194.1 422194	Ø 266 22 20 V + S
			→	+ ESP		24.0109-0137.1 409137	Ø 247 9 8 + S
Electric	27	07/03→12/05	←	11/04→		24.0113-0184.1 413184	Ø 266 13 11 + S
						24.0313-0184.1 513184	Ø 266 13 11 + S PD
CITROËN - BERLINGO Pritsche/Fahrgestell (B9) 04/08→							
 Bremsbelagsatz, Scheibenbremse							
1.6 BlueHdi 100	73	12/14→	←			13.0460-7229.2 607229	ATE 24538 18,5 - WE / - WK
1.6 HDi 90	66	04/08→				13.0470-7229.2 LD7229	ATE 24538 18,5 - WE / - WK
1.6 HDi 92	68	07/10→					Ceramic
			→			13.0460-2745.2 602745	TRW 24765 16,5 - WE / - WK + Zub
 Bremsscheibe							
1.6 BlueHdi 100	73	12/14→	←			24.0126-0120.1 426120	Ø 283 26 24 V + S
1.6 HDi 90	66	04/08→				24.0326-0120.1 526120	Ø 283 26 24 V + S PD
1.6 HDi 92	68	07/10→				24.0112-0194.2 412194	Ø 268 12 10 + LG / + ABS Ring
			→				
CITROËN - C1 (PM_, PN_) 06/05→09/14							
 Bremsbelagsatz, Scheibenbremse							
1.0	50	06/05→09/14	←	→ 04/14		13.0460-3829.2 603829	BOS 23959 17,0 - WE / - WK + Zub
1.4 HDi	40	06/05→09/14	←	→ 12/08		13.0460-3829.2 603829	BOS 23959 17,0 - WE / - WK + Zub
 Bremsscheibe							
1.0	50	06/05→09/14	←	→ 04/14		24.0120-0180.1 420180	Ø 247 20 18 V + S
1.4 HDi	40	06/05→09/14	←	→ 12/08		24.0120-0180.1 420180	Ø 247 20 18 V + S
CITROËN - C1 II 04/14→							
 Bremsbelagsatz, Scheibenbremse							
1.0 VTi 68	51	04/14→	←			13.0460-3829.2 603829	BOS 23959 17,0 - WE / - WK + Zub
1.2 VTi 82	60	04/14→					
 Bremsscheibe							
1.0 VTi 68	51	04/14→	←			24.0120-0180.1 420180	Ø 247 20 18 V + S
1.2 VTi 82	60	04/14→					
CITROËN - C2 (JM_) 09/03→							
 Bremsbelagsatz, Scheibenbremse							
1.1	44	09/03→	←	→ 12/09		13.0460-2871.2 602871	TRW 23407 19,0 - WK
1.4	54	09/03→	←	→ 12/09		13.0460-2871.2 602871	TRW 23407 19,0 - WK
1.4	55	10/06→					
↓							









	kw			 	! #		
CITROËN - C2 (JM_) 09/03→							
 Bremsbelagsatz, Scheibenbremse							
1.4 16V	65	06/06→	←	→ 12/09; V		13.0460-2881.2 602881	TRW 23409 19,3 - WK
			→	→ 12/09		13.0460-2820.2 602820	TRW 20961 17,2 - WK
						13.0470-2823.2 LD2823	TRW 23554 17,2 - WK Ceramic
1.4 HDi	50	09/03→	←	→ 12/09		13.0460-2871.2 602871	TRW 23407 19,0 - WK
			←	→Orga 10800; V; passend für Felgengröße [Zoll]: 16		13.0460-2881.2 602881	TRW 23409 19,3 - WK
			←	→ 12/09; V; nicht für Felgengröße [Zoll]: 16		13.0460-2881.2 602881	TRW 23409 19,3 - WK
			←	Orga 10801→; → 12/09; V; passend für Felgengröße [Zoll]: 16		13.0460-3994.2 603994	BOS 23599 19,0 - WE / - WK + Zub
						13.0470-3994.2 LD3994	BOS 23599 19,0 - WE / - WK + Zub Ceramic
			→	→ 12/09		13.0460-2820.2 602820	TRW 20961 17,2 - WK
						13.0470-2823.2 LD2823	TRW 23554 17,2 - WK Ceramic
1.6	80	09/03→	←	→ 12/09; nicht für Felgengröße [Zoll]: 16		13.0460-2881.2 602881	TRW 23409 19,3 - WK
			←	→Orga 10800; passend für Felgengröße [Zoll]: 16		13.0460-2881.2 602881	TRW 23409 19,3 - WK
			←	Orga 10801→; → 12/09; passend für Felgengröße [Zoll]: 16		13.0460-3994.2 603994	BOS 23599 19,0 - WE / - WK + Zub
						13.0470-3994.2 LD3994	BOS 23599 19,0 - WE / - WK + Zub Ceramic
			→	→ 12/09		13.0460-2820.2 602820	TRW 20961 17,2 - WK
						13.0470-2823.2 LD2823	TRW 23554 17,2 - WK Ceramic
1.6 HDi 1.6 VTS	80 90	09/05→ 01/05→	←	→ 12/09		13.0460-3994.2 603994	BOS 23599 19,0 - WE / - WK + Zub
						13.0470-3994.2 LD3994	BOS 23599 19,0 - WE / - WK + Zub Ceramic
			→	→ 12/09		13.0460-2820.2 602820	TRW 20961 17,2 - WK
						13.0470-2823.2 LD2823	TRW 23554 17,2 - WK Ceramic
Zubehörsatz, Scheibenbremsbelag							
1.1	44	09/03→	←	→ 12/09		13.0460-0146.2 610146	TRW
1.4	54	09/03→	←	→ 12/09		13.0460-0146.2 610146	TRW
1.4	55	10/06→					
1.4 16V	65	06/06→	→	→ 12/09		13.0460-0072.2 610072	TRW
1.4 HDi	50	09/03→					
1.6	80	09/03→	→	→ 12/09		13.0460-0072.2 610072	TRW
1.6 HDi	80	09/05→					
1.6 VTS	90	01/05→					
Bremsscheibe							
1.1	44	09/03→	←	→ 12/09		24.0113-0184.1 413184	Ø 266 13 11 + S
						24.0313-0184.1 513184	Ø 266 13 11 + S PD
1.4	54	09/03→	←	→ 12/09		24.0113-0184.1 413184	Ø 266 13 11 + S
1.4	55	10/06→				24.0122-0194.1 422194	Ø 266 22 20 V + S
1.4 HDi	50	09/03→				24.0313-0184.1 513184	Ø 266 13 11 + S PD
			→	→ 12/09		24.0109-0137.1 409137	Ø 247 9 8 + S
1.4 16V	65	06/06→	←	→ 12/09		24.0122-0194.1 422194	Ø 266 22 20 V + S
1.6	80	09/03→	→	→ 12/09		24.0109-0137.1 409137	Ø 247 9 8 + S
1.6 HDi	80	09/05→					
1.6 VTS	90	01/05→					
CITROËN - C2 ENTERPRISE 04/09→							
 Bremsbelagsatz, Scheibenbremse							
1.4 HDi	50	04/09→	←	→ 12/09		13.0460-2871.2 602871	TRW 23407 19,0 - WK
			←	→Orga 10800; V; passend für Felgengröße [Zoll]: 16		13.0460-2881.2 602881	TRW 23409 19,3 - WK
			←	→ 12/09; V; nicht für Felgengröße [Zoll]: 16		13.0460-2881.2 602881	TRW 23409 19,3 - WK
			←	Orga 10801→; → 12/09; V; passend für Felgengröße [Zoll]: 16		13.0460-3994.2 603994	BOS 23599 19,0 - WE / - WK + Zub
						13.0470-3994.2 LD3994	BOS 23599 19,0 - WE / - WK + Zub Ceramic
			→	→ 12/09		13.0460-2820.2 602820	TRW 20961 17,2 - WK
						13.0470-2823.2 LD2823	TRW 23554 17,2 - WK Ceramic
Zubehörsatz, Scheibenbremsbelag							
1.4 HDi	50	04/09→	←	→ 12/09		13.0460-0146.2 610146	TRW
↓							









	kw			 	! #		
CITROËN - C2 ENTERPRISE 04/09 →							
Zubehörsatz, Scheibenbremsbelag							
1.4 HDi	50	04/09 →	➡	→ 12/09		13.0460-0072.2 610072	TRW
 Bremsscheibe							
1.4 HDi	50	04/09 →	←	→ 12/09		24.0113-0184.1 413184 24.0122-0194.1 422194 24.0313-0184.1 513184	Ø 266 13 11 + S Ø 266 22 20 V + S Ø 266 13 11 + S PD
			➡	→ 12/09		24.0109-0137.1 409137	Ø 247 9 8 + S
CITROËN - C3 I (FC_) 02/02 →							
 Bremsbelagsatz, Scheibenbremse							
1.1 i 1.4 HDi 1.4 HDi 1.4 HDi 1.4 i	44 50 52 55 54	02/02 → 02/02 → 07/03 → 02/11 05/05 → 02/02 →	←	→ 08/09		13.0460-2871.2 602871	TRW 23407 19,0 - WK
1.4 16V	65	12/03 →	←	→ 08/09; nicht für Felgengröße [Zoll]: 16		13.0460-2881.2 602881	TRW 23409 19,3 - WK
			←	→ 08/09; passend für Felgengröße [Zoll]: 16		13.0460-3994.2 603994	BOS 23599 19,0 - WE / - WK + Zub
			←	→ 08/09		13.0470-3994.2 LD3994	BOS 23599 19,0 - WE / - WK + Zub Ceramic
1.4 16V HDi	66	02/02 →	←	→ 08/09; nicht für Felgengröße [Zoll]: 16		13.0460-2881.2 602881	TRW 23409 19,3 - WK
			➡	→ 08/09		13.0460-2820.2 602820 13.0470-2823.2 LD2823	TRW 20961 17,2 - WK TRW 23554 17,2 - WK Ceramic
1.4 i Bivalent	54	02/02 →	←	09/05 → 08/09		13.0460-2871.2 602871	TRW 23407 19,0 - WK
1.6 16V	80	02/02 →	←	→ 08/09; Schaltgetriebe; nicht für Felgengröße [Zoll]: 16		13.0460-2881.2 602881	TRW 23409 19,3 - WK
			←	→ Orga 10800; Automatikgetriebe		13.0460-3811.2 603811 13.0460-3966.2 603966 13.0470-3966.2 LD3966	BOS 23708 19,2 - WE / - WK BOS 23600 19,4 - WE / - WK + Zub BOS 23600 19,4 - WE / - WK + Zub Ceramic
			←	→ 08/09; Schaltgetriebe; passend für Felgengröße [Zoll]: 16		13.0460-3994.2 603994	BOS 23599 19,0 - WE / - WK + Zub
			←	→ 08/09; Schaltgetriebe		13.0470-3994.2 LD3994	BOS 23599 19,0 - WE / - WK + Zub Ceramic
			➡	→ 08/09		13.0460-2820.2 602820 13.0470-2823.2 LD2823	TRW 20961 17,2 - WK TRW 23554 17,2 - WK Ceramic
1.6 16V	81	05/03 → 09/05	←	Schaltgetriebe; nicht für Felgengröße [Zoll]: 16		13.0460-2881.2 602881	TRW 23409 19,3 - WK
			←	→ Orga 10800; Automatikgetriebe		13.0460-3811.2 603811 13.0460-3966.2 603966 13.0470-3966.2 LD3966	BOS 23708 19,2 - WE / - WK BOS 23600 19,4 - WE / - WK + Zub BOS 23600 19,4 - WE / - WK + Zub Ceramic
			←	Schaltgetriebe; passend für Felgengröße [Zoll]: 16		13.0460-3994.2 603994	BOS 23599 19,0 - WE / - WK + Zub
			←	Schaltgetriebe		13.0470-3994.2 LD3994	BOS 23599 19,0 - WE / - WK + Zub Ceramic
			➡			13.0460-2820.2 602820 13.0470-2823.2 LD2823	TRW 20961 17,2 - WK TRW 23554 17,2 - WK Ceramic
1.6 16V HDi	66	10/05 →	←	→ 08/09; nicht für Felgengröße [Zoll]: 16		13.0460-2881.2 602881	TRW 23409 19,3 - WK
			←	→ 08/09; passend für Felgengröße [Zoll]: 16		13.0460-3994.2 603994	BOS 23599 19,0 - WE / - WK + Zub
			←	→ 08/09		13.0470-3994.2 LD3994	BOS 23599 19,0 - WE / - WK + Zub Ceramic
			➡	→ 08/09		13.0460-2820.2 602820 13.0470-2823.2 LD2823	TRW 20961 17,2 - WK TRW 23554 17,2 - WK Ceramic
1.6 16V HDi	80	09/05 →	←	→ 08/09; nicht für Felgengröße [Zoll]: 16		13.0460-2881.2 602881	TRW 23409 19,3 - WK
			←	→ Orga 10800		13.0460-3811.2 603811	BOS 23708 19,2 - WE / - WK
			←	Orga 10801 →; → 08/09		13.0460-3966.2 603966 13.0470-3966.2 LD3966	BOS 23600 19,4 - WE / - WK + Zub BOS 23600 19,4 - WE / - WK + Zub Ceramic
			←	→ 08/09; passend für Felgengröße [Zoll]: 16		13.0460-3994.2 603994	BOS 23599 19,0 - WE / - WK + Zub











	kw				! #		
CITROËN - C3 I (FC_) 02/02→							
 Bremsbelagsatz, Scheibenbremse							
1.6 16V HDi	80	09/05→	←	→ 08/09		13.0470-3994.2 LD3994	BOS 23599 19,0 - WE / - WK + Zub Ceramic
			→	→ 08/09		13.0460-2820.2 602820	TRW 20961 17,2 - WK
						13.0470-2823.2 LD2823	TRW 23554 17,2 - WK Ceramic
Zubehörsatz, Scheibenbremsbelag							
1.1 i	44	02/02→	←	→ 08/09		13.0460-0146.2 610146	TRW
1.4 HDi	50	02/02→					
1.4 HDi	52	07/03→02/11					
1.4 HDi	55	05/05→					
1.4 i	54	02/02→					
1.4 16V HDi	66	02/02→	→	→ 08/09		13.0460-0072.2 610072	TRW
1.6 16V	80	02/02→					
1.6 16V HDi	66	10/05→					
1.6 16V HDi	80	09/05→					
1.4 i Bivalent	54	02/02→	←	09/05→ 08/09		13.0460-0146.2 610146	TRW
1.6 16V	81	05/03→09/05	→			13.0460-0072.2 610072	TRW
 Bremsscheibe							
1.1 i	44	02/02→	←	→ 08/09		24.0113-0184.1 413184	Ø 266 13 11 + S
1.4 HDi	50	02/02→				24.0313-0184.1 513184	Ø 266 13 11 + S PD
1.4 HDi	52	07/03→02/11					
1.4 HDi	55	05/05→					
1.4 i	54	02/02→					
1.4 16V	65	12/03→	←	→ 08/09		24.0122-0194.1 422194	Ø 266 22 20 V + S
1.4 16V HDi	66	02/02→	←	→ 08/09		24.0122-0194.1 422194	Ø 266 22 20 V + S
1.6 16V HDi	66	10/05→	→	→ 08/09		24.0109-0137.1 409137	Ø 247 9 8 + S
1.4 i Bivalent	54	02/02→	←	09/05→ 08/09		24.0113-0184.1 413184	Ø 266 13 11 + S
						24.0313-0184.1 513184	Ø 266 13 11 + S PD
1.6 16V	80	02/02→	←	→ 08/09; Schaltgetriebe		24.0122-0194.1 422194	Ø 266 22 20 V + S
			←	→ 08/09; Automatikgetriebe		24.0126-0120.1 426120	Ø 283 26 24 V + S
			→	→ 08/09		24.0109-0137.1 409137	Ø 247 9 8 + S
1.6 16V	81	05/03→09/05	←	Schaltgetriebe		24.0122-0194.1 422194	Ø 266 22 20 V + S
			←	Automatikgetriebe		24.0126-0120.1 426120	Ø 283 26 24 V + S
			→			24.0109-0137.1 409137	Ø 247 9 8 + S
1.6 16V HDi	80	09/05→	←	→ 08/09		24.0122-0194.1 422194	Ø 266 22 20 V + S
						24.0126-0120.1 426120	Ø 283 26 24 V + S
						24.0326-0120.1 526120	Ø 283 26 24 V + S PD
			→	→ 08/09		24.0109-0137.1 409137	Ø 247 9 8 + S
CITROËN - C3 II 11/09→							
 Bremsbelagsatz, Scheibenbremse							
1.0 VTi 68	50	08/12→	←	10/12→		13.0460-3994.2 603994	BOS 23599 19,0 - WE / - WK + Zub
1.2 VTi 82	60	06/12→				13.0470-3994.2 LD3994	BOS 23599 19,0 - WE / - WK + Zub Ceramic
1.1	44	11/09→	←			13.0460-3994.2 603994	BOS 23599 19,0 - WE / - WK + Zub
1.1 BiFuel	44	11/10→					
1.2 VTi 68	50	07/16→				13.0470-3994.2 LD3994	BOS 23599 19,0 - WE / - WK + Zub Ceramic
1.4	54	11/09→					
1.4 HDi 70	50	11/09→					
1.4 LPG	54	07/10→					
1.4 VTi	72	11/09→					
1.4 VTi 95	70	11/09→					
1.6 HDi	68	11/09→					
1.6 HDi 90	66	11/09→					
1.2 THP 110	81	10/14→	←	für Bremsscheibendurchmesser [mm]: 283		13.0460-3855.2 603855	BOS 24883 18,0 - WE / - WK + Zub
1.4 LPG	70	06/13→					
1.6 BlueHDi 100	73	07/14→	←	für Bremsscheibendurchmesser [mm]: 266		13.0460-3994.2 603994	BOS 23599 19,0 - WE / - WK + Zub
1.6 BlueHDi 75	55	04/15→				13.0470-3994.2 LD3994	BOS 23599 19,0 - WE / - WK + Zub Ceramic
1.6 VTi 120	88	11/09→					
			→			13.0460-2740.2 602740	TRW 23554 17,0 - WE / - WK + Zub
						13.0470-2740.2 LD2740	TRW 23554 17,0 - WE / - WK + Zub Ceramic
1.6 HDi 110	82	11/09→	←			13.0460-3855.2 603855	BOS 24883 18,0 - WE / - WK + Zub
1.6 HDi 115	84	09/12→					
↓							













	kw			 	! #		
CITROËN - C3 II 11/09→							
 Bremsbelagsatz, Scheibenbremse							
1.6 HDi 110 1.6 HDi 115	82 84	11/09→ 09/12→	→			13.0460-2740.2 602740 13.0470-2740.2 LD2740	TRW 23554 17,0 - WE / - WK + Zub TRW 23554 17,0 - WE / - WK + Zub Ceramic
 Bremsscheibe							
1.0 VTi 68 1.2 VTi 82	50 60	08/12→ 06/12→	←	10/12→		24.0122-0194.1 422194	Ø 266 22 20 V + S
1.1 1.1 BiFuel 1.4 1.4 HDi 70 1.4 LPG 1.4 VTi 1.4 VTi 95 1.6 HDi 1.6 HDi 90	44 44 54 50 54 72 70 68 66	11/09→ 11/10→ 11/09→ 11/09→ 07/10→ 11/09→ 11/09→ 11/09→ 11/09→	←			24.0122-0194.1 422194	Ø 266 22 20 V + S
1.2 THP 110 1.4 LPG 1.6 BlueHDi 100 1.6 BlueHDi 75 1.6 VTi 120	81 70 73 55 88	10/14→ 06/13→ 07/14→ 04/15→ 11/09→	←			24.0122-0194.1 422194 24.0126-0120.1 426120 24.0326-0120.1 526120	Ø 266 22 20 V + S Ø 283 26 24 V + S Ø 283 26 24 V + S PD
1.2 VTi 68	50	07/16→	←			24.0122-0194.1 422194	Ø 266 22 20 V + S
			→			24.0109-0100.2 409100	Ø 249 9 7 + LG / + ABS Ring
1.6 HDi 110 1.6 HDi 115	82 84	11/09→ 09/12→	←			24.0126-0120.1 426120 24.0326-0120.1 526120	Ø 283 26 24 V + S Ø 283 26 24 V + S PD
			→			24.0109-0100.2 409100	Ø 249 9 7 + LG / + ABS Ring
CITROËN - C3 III (SX) 07/16→							
 Bremsbelagsatz, Scheibenbremse							
1.2 THP 110 1.2 VTi 82 1.6 BlueHDi 100 1.6 BlueHDi 75	81 60 73 55	07/16→ 07/16→ 07/16→ 07/16→	←			13.0460-3994.2 603994 13.0470-3994.2 LD3994	BOS 23599 19,0 - WE / - WK + Zub BOS 23599 19,0 - WE / - WK + Zub Ceramic
 Bremsscheibe							
1.2 THP 110 1.2 VTi 82 1.6 BlueHDi 100 1.6 BlueHDi 75	81 60 73 55	07/16→ 07/16→ 07/16→ 07/16→	←			24.0122-0194.1 422194	Ø 266 22 20 V + S
			→			24.0109-0100.2 409100	Ø 249 9 7 + LG / + ABS Ring
CITROËN - C3 Picasso 02/09→							
 Bremsbelagsatz, Scheibenbremse							
1.2 THP 110 1.4 VTi 95 1.4 VTi 95 LPG 1.6 BlueHDi 100 1.6 HDi 1.6 HDi 1.6 HDi 110 1.6 HDi 115 1.6 HDi 90 1.6 VTi 120 1.6 VTRi	81 70 70 73 66 80 82 84 68 88 84	01/15→ 02/09→ 01/12→ 01/15→ 02/09→ 02/09→ 05/10→ 01/13→ 07/10→ 02/09→ 10/16→	←	für Bremsscheibendurchmesser [mm]: 283		13.0460-3855.2 603855 13.0460-3994.2 603994 13.0470-3994.2 LD3994	BOS 24883 18,0 - WE / - WK + Zub BOS 23599 19,0 - WE / - WK + Zub BOS 23599 19,0 - WE / - WK + Zub Ceramic
			←	für Bremsscheibendurchmesser [mm]: 266		13.0460-2740.2 602740 13.0470-2740.2 LD2740	TRW 23554 17,0 - WE / - WK + Zub TRW 23554 17,0 - WE / - WK + Zub Ceramic
			→				
 Bremsscheibe							
1.2 THP 110 1.4 VTi 95 1.4 VTi 95 LPG 1.6 BlueHDi 100 1.6 HDi 1.6 HDi 1.6 HDi 110 1.6 HDi 115 1.6 HDi 90 1.6 VTi 120 1.6 VTRi	81 70 70 73 66 80 82 84 68 88 84	01/15→ 02/09→ 01/12→ 01/15→ 02/09→ 02/09→ 05/10→ 01/13→ 07/10→ 02/09→ 10/16→	←			24.0122-0194.1 422194 24.0126-0120.1 426120 24.0326-0120.1 526120	Ø 266 22 20 V + S Ø 283 26 24 V + S Ø 283 26 24 V + S PD
			→			24.0109-0100.2 409100	Ø 249 9 7 + LG / + ABS Ring
CITROËN - C3 Pluriel (HB_) 05/03→							
 Bremsbelagsatz, Scheibenbremse							
1.4 1.4 1.4 HDi ↓	54 55 50	05/03→ 07/03→ 04/04→	←	→ 07/10		13.0460-2881.2 602881	TRW 23409 19,3 - WK









	kw			 	! #		
CITROËN - C3 Pluriel (HB_) 05/03→							
 Bremsbelagsatz, Scheibenbremse							
1.4 Hybrid	54	05/05→	←	→ 07/10		13.0460-2881.2 602881	TRW 23409 19,3 - WK
1.6	80	05/03→	←	→ 07/10		13.0460-2881.2 602881	TRW 23409 19,3 - WK
			→	→ 07/10		13.0460-2820.2 602820	TRW 20961 17,2 - WK
						13.0470-2823.2 LD2823	TRW 23554 17,2 - WK Ceramic
Zubehörsatz, Scheibenbremsbelag							
1.6	80	05/03→	→	→ 07/10		13.0460-0072.2 610072	TRW
 Bremsscheibe							
1.4	54	05/03→	←	→ 07/10		24.0122-0194.1 422194	∅ 266 22 20 V + S
1.4	55	07/03→					
1.4 HDi	50	04/04→					
1.4 Hybrid	54	05/05→					
1.6	80	05/03→	←	→ 07/10		24.0122-0194.1 422194	∅ 266 22 20 V + S
			→	→ 07/10		24.0109-0137.1 409137	∅ 247 9 8 + S
CITROËN - C4 I (LC_) 11/04→07/11							
 Bremsbelagsatz, Scheibenbremse							
1.4 16V 1.6 HDi	65 66	11/04→07/11 11/04→07/11	←	→Orga 10550; + ESP		13.0460-3966.2 603966	BOS 23600 19,4 - WE / - WK + Zub
						13.0470-3966.2 LD3966	BOS 23600 19,4 - WE / - WK + Zub Ceramic
			←	Orga 10551→; + ESP		13.0460-3994.2 603994	BOS 23599 19,0 - WE / - WK + Zub
						13.0470-3994.2 LD3994	BOS 23599 19,0 - WE / - WK + Zub Ceramic
			←	- ESP		13.0460-3994.2 603994	BOS 23599 19,0 - WE / - WK + Zub
						13.0470-3994.2 LD3994	BOS 23599 19,0 - WE / - WK + Zub Ceramic
			→	Orga 11431→ Orga 12333		13.0460-2740.2 602740	TRW 23554 17,0 - WE / - WK + Zub
						13.0470-2740.2 LD2740	TRW 23554 17,0 - WE / - WK + Zub Ceramic
			→	Orga 12334→		13.0460-2820.2 602820	TRW 20961 17,2 - WK
						13.0470-2823.2 LD2823	TRW 23554 17,2 - WK Ceramic
1.6 16V	80	11/04→07/11	←	Automatikgetriebe		13.0460-3966.2 603966	BOS 23600 19,4 - WE / - WK + Zub
						13.0470-3966.2 LD3966	BOS 23600 19,4 - WE / - WK + Zub Ceramic
			←	→Orga 10550; + ESP; Schaltgetriebe		13.0460-3966.2 603966	BOS 23600 19,4 - WE / - WK + Zub
						13.0470-3966.2 LD3966	BOS 23600 19,4 - WE / - WK + Zub Ceramic
			←	- ESP; Schaltgetriebe		13.0460-3994.2 603994	BOS 23599 19,0 - WE / - WK + Zub
						13.0470-3994.2 LD3994	BOS 23599 19,0 - WE / - WK + Zub Ceramic
			←	Orga 10551→; + ESP; Schaltgetriebe		13.0460-3994.2 603994	BOS 23599 19,0 - WE / - WK + Zub
						13.0470-3994.2 LD3994	BOS 23599 19,0 - WE / - WK + Zub Ceramic
			→	Orga 11431→ Orga 12333		13.0460-2740.2 602740	TRW 23554 17,0 - WE / - WK + Zub
						13.0470-2740.2 LD2740	TRW 23554 17,0 - WE / - WK + Zub Ceramic
→	Orga 12334→		13.0460-2820.2 602820	TRW 20961 17,2 - WK			
			13.0470-2823.2 LD2823	TRW 23554 17,2 - WK Ceramic			
→	→Orga 11584		13.0460-2820.2 602820	TRW 20961 17,2 - WK			
			13.0470-2823.2 LD2823	TRW 23554 17,2 - WK Ceramic			







	kw			 	! #		
CITROËN - C4 I (LC_) 11/04→07/11							
 Bremsbelagsatz, Scheibenbremse							
1.6 16V	80	11/04→07/11	➔	→Orga 12056		13.0460-3813.2 603813 13.0470-3813.2 LD3813	BOS 24150 17,6 - WE / - WK + Zub BOS 24150 17,6 - WE / - WK + Zub Ceramic
1.6 16V Bio-Flex 1.6 Flex	80 81	09/07→07/08 02/09→07/11	➔	→Orga 10550; + ESP; Schaltgetriebe		13.0460-3966.2 603966 13.0470-3966.2 LD3966	BOS 23600 19,4 - WE / - WK + Zub BOS 23600 19,4 - WE / - WK + Zub Ceramic
			➔	- ESP; Schaltgetriebe		13.0460-3994.2 603994 13.0470-3994.2 LD3994	BOS 23599 19,0 - WE / - WK + Zub BOS 23599 19,0 - WE / - WK + Zub Ceramic
			➔	Orga 10551→; + ESP; Schaltgetriebe		13.0460-3994.2 603994 13.0470-3994.2 LD3994	BOS 23599 19,0 - WE / - WK + Zub BOS 23599 19,0 - WE / - WK + Zub Ceramic
			➔	Orga 11431→ Orga 12333		13.0460-2740.2 602740 13.0470-2740.2 LD2740	TRW 23554 17,0 - WE / - WK + Zub TRW 23554 17,0 - WE / - WK + Zub Ceramic
			➔	Orga 12334→		13.0460-2820.2 602820 13.0470-2823.2 LD2823	TRW 20961 17,2 - WK TRW 23554 17,2 - WK Ceramic
			➔	→Orga 11584		13.0460-2820.2 602820 13.0470-2823.2 LD2823	TRW 20961 17,2 - WK TRW 23554 17,2 - WK Ceramic
			➔	→Orga 12056		13.0460-3813.2 603813 13.0470-3813.2 LD3813	BOS 24150 17,6 - WE / - WK + Zub BOS 24150 17,6 - WE / - WK + Zub Ceramic
			➔				
1.6 HDi	80	11/04→07/11	➔	+ ESP		13.0460-3966.2 603966 13.0470-3966.2 LD3966	BOS 23600 19,4 - WE / - WK + Zub BOS 23600 19,4 - WE / - WK + Zub Ceramic
			➔	Orga 11431→ Orga 12333		13.0460-2740.2 602740 13.0470-2740.2 LD2740	TRW 23554 17,0 - WE / - WK + Zub TRW 23554 17,0 - WE / - WK + Zub Ceramic
			➔	Orga 12334→		13.0460-2820.2 602820 13.0470-2823.2 LD2823	TRW 20961 17,2 - WK TRW 23554 17,2 - WK Ceramic
			➔	→Orga 11584		13.0460-2820.2 602820 13.0470-2823.2 LD2823	TRW 20961 17,2 - WK TRW 23554 17,2 - WK Ceramic
			➔	→Orga 12056		13.0460-3813.2 603813 13.0470-3813.2 LD3813	BOS 24150 17,6 - WE / - WK + Zub BOS 24150 17,6 - WE / - WK + Zub Ceramic
1.6 THP 140 1.6 THP 150 2.0 16V 2.0 16V 2.0 16V	103 110 100 103 105	07/08→07/11 07/08→07/11 11/04→07/07 11/04→07/11 09/06→07/09	➔			13.0460-3966.2 603966 13.0470-3966.2 LD3966	BOS 23600 19,4 - WE / - WK + Zub BOS 23600 19,4 - WE / - WK + Zub Ceramic
			➔	Orga 11431→ Orga 12333		13.0460-2740.2 602740 13.0470-2740.2 LD2740	TRW 23554 17,0 - WE / - WK + Zub TRW 23554 17,0 - WE / - WK + Zub Ceramic
			➔	Orga 12334→		13.0460-2820.2 602820 13.0470-2823.2 LD2823	TRW 20961 17,2 - WK TRW 23554 17,2 - WK Ceramic
			➔	→Orga 11584		13.0460-2820.2 602820 13.0470-2823.2 LD2823	TRW 20961 17,2 - WK TRW 23554 17,2 - WK Ceramic
			➔	→Orga 12056		13.0460-3813.2 603813 13.0470-3813.2 LD3813	BOS 24150 17,6 - WE / - WK + Zub BOS 24150 17,6 - WE / - WK + Zub Ceramic
1.6 VTi 120	88	07/08→07/11	➔	Vollautomatik		13.0460-3966.2 603966 13.0470-3966.2 LD3966	BOS 23600 19,4 - WE / - WK + Zub BOS 23600 19,4 - WE / - WK + Zub Ceramic
			➔	Schaltgetriebe		13.0460-3994.2 603994 13.0470-3994.2 LD3994	BOS 23599 19,0 - WE / - WK + Zub BOS 23599 19,0 - WE / - WK + Zub Ceramic
↓							







	kw			 	! #		
CITROËN - C4 I (LC_) 11/04→07/11							
 Bremsbelagsatz, Scheibenbremse							
1.6 VTi 120	88	07/08→07/11	➔	Orga 11431→ Orga 12333		13.0460-2740.2 602740 13.0470-2740.2 LD2740	TRW 23554 17,0 - WE / - WK + Zub TRW 23554 17,0 - WE / - WK + Zub Ceramic
			➔	Orga 12334→		13.0460-2820.2 602820 13.0470-2823.2 LD2823	TRW 20961 17,2 - WK TRW 23554 17,2 - WK Ceramic
			➔	→Orga 11584		13.0460-2820.2 602820 13.0470-2823.2 LD2823	TRW 20961 17,2 - WK TRW 23554 17,2 - WK Ceramic
			➔	→Orga 12056		13.0460-3813.2 603813 13.0470-3813.2 LD3813	BOS 24150 17,6 - WE / - WK + Zub BOS 24150 17,6 - WE / - WK + Zub Ceramic
2.0 16V 2.0 HDi 2.0 HDi	130 100 103	11/04→07/08 11/04→07/11 07/08→07/11	←			13.0460-7202.2 607202 13.0470-7202.2 LD7202	ATE 23589 19,1 - WE / - WK ATE 23589 19,1 - WE / - WK Ceramic
			➔	Orga 11431→ Orga 12333		13.0460-2740.2 602740 13.0470-2740.2 LD2740	TRW 23554 17,0 - WE / - WK + Zub TRW 23554 17,0 - WE / - WK + Zub Ceramic
			➔	Orga 12334→		13.0460-2820.2 602820 13.0470-2823.2 LD2823	TRW 20961 17,2 - WK TRW 23554 17,2 - WK Ceramic
			➔	→Orga 11584		13.0460-2820.2 602820 13.0470-2823.2 LD2823	TRW 20961 17,2 - WK TRW 23554 17,2 - WK Ceramic
			➔	→Orga 12056		13.0460-3813.2 603813 13.0470-3813.2 LD3813	BOS 24150 17,6 - WE / - WK + Zub BOS 24150 17,6 - WE / - WK + Zub Ceramic
2.0 HDi	81	04/07→07/08	➔			13.0460-2820.2 602820 13.0470-2823.2 LD2823	TRW 20961 17,2 - WK TRW 23554 17,2 - WK Ceramic
Zubehörsatz, Scheibenbremsbelag							
1.4 16V 1.6 16V 1.6 16V Bio-Flex 1.6 Flex 1.6 HDi 1.6 HDi 1.6 THP 140 1.6 THP 150 1.6 VTi 120 2.0 16V 2.0 16V 2.0 16V 2.0 16V 2.0 HDi 2.0 HDi	65 80 80 81 66 80 103 110 88 100 103 105 130 100 103	11/04→07/11 11/04→07/11 09/07→07/08 02/09→07/11 11/04→07/11 11/04→07/11 07/08→07/11 07/08→07/11 07/08→07/11 11/04→07/07 11/04→07/11 09/06→07/09 11/04→07/08 11/04→07/11 07/08→07/11	➔	Orga 12334→ →Orga 11584		13.0460-0072.2 610072 13.0460-0072.2 610072	TRW TRW
2.0 HDi	81	04/07→07/08	➔			13.0460-0072.2 610072	TRW
 Bremsscheibe							
1.4 16V 1.6 HDi	65 66	11/04→07/11 11/04→07/11	←	- ESP		24.0122-0194.1 422194	Ø 266 22 20 V + S
			←	Orga 10551→; + ESP		24.0122-0194.1 422194	Ø 266 22 20 V + S
			←	→Orga 10550; + ESP		24.0126-0120.1 426120 24.0326-0120.1 526120	Ø 283 26 24 V + S Ø 283 26 24 V + S PD
			➔	Achszapfendurchmesser [mm]: 30		24.0109-0100.2 409100	Ø 249 9 7 + LG / + ABS Ring
			➔			24.0109-0137.1 409137	Ø 247 9 8 + S
			➔	Achszapfendurchmesser [mm]: 25		24.0109-0150.2 409150	Ø 249 9 8 + LG / + ABS Ring
1.6 16V	80	11/04→07/11	←	Orga 10551→; + ESP; Schaltgetriebe		24.0122-0194.1 422194	Ø 266 22 20 V + S
			←	- ESP		24.0122-0194.1 422194	Ø 266 22 20 V + S
			←	Automatikgetriebe		24.0126-0120.1 426120 24.0326-0120.1 526120	Ø 283 26 24 V + S Ø 283 26 24 V + S PD
			←	→Orga 10550; + ESP; Schaltgetriebe		24.0126-0120.1 426120 24.0326-0120.1 526120	Ø 283 26 24 V + S Ø 283 26 24 V + S PD
			➔	Achszapfendurchmesser [mm]: 30		24.0109-0100.2 409100	Ø 249 9 7 + LG / + ABS Ring
			➔			24.0109-0137.1 409137	Ø 247 9 8 + S
			➔	Achszapfendurchmesser [mm]: 25		24.0109-0150.2 409150	Ø 249 9 8 + LG / + ABS Ring
1.6 16V Bio-Flex 1.6 Flex	80 81	09/07→07/08 02/09→07/11	←	Orga 10551→; + ESP; Schaltgetriebe		24.0122-0194.1 422194	Ø 266 22 20 V + S
↓							













	kw			 	! #				
CITROËN - C4 I (LC_) 11/04→07/11									
 Bremsscheibe									
1.6 16V Bio-Flex 1.6 Flex	80	09/07→07/08	←	- ESP		24.0122-0194.1	422194	Ø 266 22 20 V + S	
	81	02/09→07/11	←	→Orga 10550; + ESP; Schaltgetriebe		24.0126-0120.1	426120	Ø 283 26 24 V + S	
						24.0326-0120.1	526120	Ø 283 26 24 V + S PD	
				→	Achszapfendurchmesser [mm]: 30		24.0109-0100.2	409100	Ø 249 9 7 + LG / + ABS Ring
				→			24.0109-0137.1	409137	Ø 247 9 8 + S
			→	Achszapfendurchmesser [mm]: 25		24.0109-0150.2	409150	Ø 249 9 8 + LG / + ABS Ring	
1.6 HDi 1.6 THP 140 1.6 THP 150	80	11/04→07/11	←	+ ESP		24.0126-0120.1	426120	Ø 283 26 24 V + S	
	103	07/08→07/11				24.0326-0120.1	526120	Ø 283 26 24 V + S PD	
	110	07/08→07/11	→	Achszapfendurchmesser [mm]: 30		24.0109-0100.2	409100	Ø 249 9 7 + LG / + ABS Ring	
			→			24.0109-0137.1	409137	Ø 247 9 8 + S	
			→	Achszapfendurchmesser [mm]: 25		24.0109-0150.2	409150	Ø 249 9 8 + LG / + ABS Ring	
1.6 VTi 120	88	07/08→07/11	←	Schaltgetriebe		24.0122-0194.1	422194	Ø 266 22 20 V + S	
			←	Vollautomatik		24.0126-0120.1	426120	Ø 283 26 24 V + S	
						24.0326-0120.1	526120	Ø 283 26 24 V + S PD	
			→	Achszapfendurchmesser [mm]: 30		24.0109-0100.2	409100	Ø 249 9 7 + LG / + ABS Ring	
			→			24.0109-0137.1	409137	Ø 247 9 8 + S	
			→	Achszapfendurchmesser [mm]: 25		24.0109-0150.2	409150	Ø 249 9 8 + LG / + ABS Ring	
2.0 16V 2.0 16V 2.0 16V	100	11/04→07/07	←			24.0126-0120.1	426120	Ø 283 26 24 V + S	
	103	11/04→07/11				24.0326-0120.1	526120	Ø 283 26 24 V + S PD	
	105	09/06→07/09	→	Achszapfendurchmesser [mm]: 30		24.0109-0100.2	409100	Ø 249 9 7 + LG / + ABS Ring	
			→			24.0109-0137.1	409137	Ø 247 9 8 + S	
			→	Achszapfendurchmesser [mm]: 25		24.0109-0150.2	409150	Ø 249 9 8 + LG / + ABS Ring	
2.0 16V 2.0 HDi 2.0 HDi	130	11/04→07/08	←	→Orga 11500		24.0126-0140.1	426140	Ø 302 26 24 V + S	
	100	11/04→07/11	←	Orga 11501→		24.0126-0159.1	426159	Ø 302 26 24 V + S	
	103	07/08→07/11	→	Achszapfendurchmesser [mm]: 30		24.0109-0100.2	409100	Ø 249 9 7 + LG / + ABS Ring	
			→			24.0109-0137.1	409137	Ø 247 9 8 + S	
			→	Achszapfendurchmesser [mm]: 25		24.0109-0150.2	409150	Ø 249 9 8 + LG / + ABS Ring	
2.0 HDi	81	04/07→07/08	←			24.0126-0120.1	426120	Ø 283 26 24 V + S	
			→			24.0109-0137.1	409137	Ø 247 9 8 + S	
CITROËN - C4 II (B7) 11/09→									
 Bremsbelagsatz, Scheibenbremse									
1.2 THP 110 1.4 VTi 95	81	02/15→	→	+ eFSB		13.0460-2761.2	602761	TRW 24922 17,5 - WK + Zub	
	70	11/09→	→	- eFSB		13.0460-2775.2	602775	TRW 23554 16,4 - WE / - WK + Zub	
1.2 THP 130 1.6 BlueHDi 100 1.6 BlueHDi 120 1.6 HDi 110 1.6 HDi 115 1.6 VTi 120 1.6 VTi 120 LPG	96	04/14→	←			13.0460-7229.2	607229	ATE 24538 18,5 - WE / - WK	
	73	07/14→				13.0470-7229.2	LD7229	ATE 24538 18,5 - WE / - WK Ceramic	
	88	02/15→							
	82	11/09→	→	+ eFSB		13.0460-2761.2	602761	TRW 24922 17,5 - WK + Zub	
	84	07/12→	→	- eFSB		13.0460-2775.2	602775	TRW 23554 16,4 - WE / - WK + Zub	
	88	11/09→							
	88	09/11→							
1.6 BlueHDi 115	85	08/14→	←			13.0460-7229.2	607229	ATE 24538 18,5 - WE / - WK	
						13.0470-7229.2	LD7229	ATE 24538 18,5 - WE / - WK Ceramic	
			→			13.0460-2761.2	602761	TRW 24922 17,5 - WK + Zub	
1.6 HDi 90	68	11/09→	←	+ eFSB		13.0460-7229.2	607229	ATE 24538 18,5 - WE / - WK	
						13.0470-7229.2	LD7229	ATE 24538 18,5 - WE / - WK Ceramic	
			→	+ eFSB		13.0460-2761.2	602761	TRW 24922 17,5 - WK + Zub	
			→	- eFSB		13.0460-2775.2	602775	TRW 23554 16,4 - WE / - WK + Zub	
1.6 THP 155 2.0 HDi / BlueHDi 150	115	11/09→	←			13.0460-7230.2	607230	ATE 24557 19,4 - WE / - WK	
	110	11/09→				13.0470-7230.2	LD7230	ATE 24557 19,4 - WE / - WK Ceramic	
			→			13.0460-2761.2	602761	TRW 24922 17,5 - WK + Zub	
 Bremsscheibe									
1.2 THP 110 1.4 VTi 95	81	02/15→	←			24.0122-0194.1	422194	Ø 266 22 20 V + S	
	70	11/09→	→	- eFSB		24.0109-0171.2	409171	Ø 249 9 8 + LG / + ABS Ring	
↓									











	kW			 	! #		
CITROËN - C4 II (B7) 11/09→							
 Bremsscheibe							
1.2 THP 110 1.4 VTi 95	81 70	02/15→ 11/09→	➔	+ eFSB; nicht für Felgenreöße [Zoll]: 19	24.0112-0194.2	412194	Ø 268 12 10 + LG / + ABS Ring
			➔	+ eFSB; passend für Felgenreöße [Zoll]: 19	24.0112-0198.1	412198	Ø 290 12 10 + S
1.2 THP 130 1.6 BlueHDi 100 1.6 BlueHDi 120 1.6 HDi 110 1.6 HDi 115 1.6 VTi 120 1.6 VTi 120 LPG	96 73 88 82 84 88 88	04/14→ 07/14→ 02/15→ 11/09→ 07/12→ 11/09→ 09/11→	←		24.0126-0120.1 24.0326-0120.1	426120 526120	Ø 283 26 24 V + S Ø 283 26 24 V + S PD
			➔	- eFSB	24.0109-0171.2	409171	Ø 249 9 8 + LG / + ABS Ring
			➔	+ eFSB; nicht für Felgenreöße [Zoll]: 19	24.0112-0194.2	412194	Ø 268 12 10 + LG / + ABS Ring
			➔	+ eFSB; passend für Felgenreöße [Zoll]: 19	24.0112-0198.1	412198	Ø 290 12 10 + S
1.6 BlueHDi 115	85	08/14→	←		24.0126-0120.1 24.0326-0120.1	426120 526120	Ø 283 26 24 V + S Ø 283 26 24 V + S PD
			➔	nicht für Felgenreöße [Zoll]: 19	24.0112-0194.2	412194	Ø 268 12 10 + LG / + ABS Ring
			➔	passend für Felgenreöße [Zoll]: 19	24.0112-0198.1	412198	Ø 290 12 10 + S
1.6 HDi 90	68	11/09→	←	- eFSB	24.0122-0194.1	422194	Ø 266 22 20 V + S
			←	+ eFSB	24.0126-0120.1 24.0326-0120.1	426120 526120	Ø 283 26 24 V + S Ø 283 26 24 V + S PD
			➔	- eFSB	24.0109-0171.2	409171	Ø 249 9 8 + LG / + ABS Ring
			➔	+ eFSB; nicht für Felgenreöße [Zoll]: 19	24.0112-0194.2	412194	Ø 268 12 10 + LG / + ABS Ring
			➔	+ eFSB; passend für Felgenreöße [Zoll]: 19	24.0112-0198.1	412198	Ø 290 12 10 + S
1.6 THP 155 2.0 HDi / BlueHDi 150	115 110	11/09→ 11/09→	←		24.0126-0159.1	426159	Ø 302 26 24 V + S
			➔	nicht für Felgenreöße [Zoll]: 19	24.0112-0194.2	412194	Ø 268 12 10 + LG / + ABS Ring
			➔	passend für Felgenreöße [Zoll]: 19	24.0112-0198.1	412198	Ø 290 12 10 + S
CITROËN - C4 AIRCROSS 08/10→							
 Bremsbelagsatz, Scheibenbremse							
1.6 1.6 HDi 115 1.6 HDi 115 AWC 1.8 HDi 150 1.8 HDi 150 AWC	86 84 84 110 110	04/12→ 04/12→ 05/12→ 04/12→ 04/12→	←		13.0460-5760.2	605760	AKE 23584 16,4 + WK
			➔		13.0460-5855.2	605855	23582 16,0 - WK
 Bremsscheibe							
1.6 1.6 HDi 115 1.6 HDi 115 AWC 1.8 HDi 150 1.8 HDi 150 AWC	86 84 84 110 110	04/12→ 04/12→ 05/12→ 04/12→ 04/12→	←		24.0126-0170.1	426170	Ø 294 26 24,4 V
			➔		24.0110-0360.1	410360	Ø 302 10 8,4
CITROËN - C4 CACTUS 09/14→							
 Bremsbelagsatz, Scheibenbremse							
1.2 THP 110 1.2 VTi 75 1.2 VTi 82 1.6 BlueHDi 100 1.6 HDi 90	81 55 60 73 68	09/14→ 09/14→ 09/14→ 09/14→ 09/14→	←		13.0460-3867.2	603867	MAN 25250 18,9 - WE / - WK + Zub
			←	V	13.0460-3994.2	603994	BOS 23599 19,0 - WE / - WK + Zub
			➔		13.0470-3994.2	LD3994	BOS 23599 19,0 - WE / - WK + Zub Ceramic
			➔		13.0460-2740.2	602740	TRW 23554 17,0 - WE / - WK + Zub
					13.0470-2740.2	LD2740	TRW 23554 17,0 - WE / - WK + Zub Ceramic
 Bremsscheibe							
1.2 THP 110 1.2 VTi 75 1.2 VTi 82 1.6 BlueHDi 100 1.6 HDi 90	81 55 60 73 68	09/14→ 09/14→ 09/14→ 09/14→ 09/14→	←		24.0113-0184.1	413184	Ø 266 13 11 + S
			➔		24.0122-0194.1	422194	Ø 266 22 20 V + S
					24.0313-0184.1	513184	Ø 266 13 11 + S PD
			➔		24.0109-0100.2	409100	Ø 249 9 7 + LG / + ABS Ring
CITROËN - C4 Coupe (LA_) 11/04→07/11							
 Bremsbelagsatz, Scheibenbremse							
1.4 16V 1.6 HDi	65 66	11/04→07/11 11/04→07/11	←	→Orga 10550; + ESP	13.0460-3966.2	603966	BOS 23600 19,4 - WE / - WK + Zub
					13.0470-3966.2	LD3966	BOS 23600 19,4 - WE / - WK + Zub Ceramic
↓							













	kw			 	! #		
CITROËN - C4 Coupe (LA_) 11/04→07/11							
 Bremsbelagsatz, Scheibenbremse							
1.4 16V 1.6 HDi	65 66	11/04→07/11 11/04→07/11	←	→ 07/10; - ESP	13.0460-3994.2	603994	BOS 23599 19,0 - WE / - WK + Zub
					13.0470-3994.2	LD3994	BOS 23599 19,0 - WE / - WK + Zub Ceramic
			←	Orga 10551→; → 07/10; + ESP	13.0460-3994.2	603994	BOS 23599 19,0 - WE / - WK + Zub
					13.0470-3994.2	LD3994	BOS 23599 19,0 - WE / - WK + Zub Ceramic
			→	Orga 11431→ Orga 12333	13.0460-2740.2	602740	TRW 23554 17,0 - WE / - WK + Zub
					13.0470-2740.2	LD2740	TRW 23554 17,0 - WE / - WK + Zub Ceramic
			→	→Orga 11584	13.0460-2820.2	602820	TRW 20961 17,2 - WK
		13.0470-2823.2	LD2823	TRW 23554 17,2 - WK Ceramic			
			→	Orga 12334→; → 07/10	13.0460-2820.2	602820	TRW 20961 17,2 - WK
					13.0470-2823.2	LD2823	TRW 23554 17,2 - WK Ceramic
			→	Orga 12056	13.0460-3813.2	603813	BOS 24150 17,6 - WE / - WK + Zub
					13.0470-3813.2	LD3813	BOS 24150 17,6 - WE / - WK + Zub Ceramic
1.6 16V	80	11/04→07/11	←	→Orga 10550; + ESP; Schaltgetriebe	13.0460-3966.2	603966	BOS 23600 19,4 - WE / - WK + Zub
					13.0470-3966.2	LD3966	BOS 23600 19,4 - WE / - WK + Zub Ceramic
			←	→ 07/10; Automatikgetriebe	13.0460-3966.2	603966	BOS 23600 19,4 - WE / - WK + Zub
					13.0470-3966.2	LD3966	BOS 23600 19,4 - WE / - WK + Zub Ceramic
			←	Orga 10551→; → 07/10; + ESP; Schaltgetriebe	13.0460-3994.2	603994	BOS 23599 19,0 - WE / - WK + Zub
					13.0470-3994.2	LD3994	BOS 23599 19,0 - WE / - WK + Zub Ceramic
			←	→ 07/10; - ESP; Schaltgetriebe	13.0460-3994.2	603994	BOS 23599 19,0 - WE / - WK + Zub
					13.0470-3994.2	LD3994	BOS 23599 19,0 - WE / - WK + Zub Ceramic
			→	Orga 11431→ Orga 12333	13.0460-2740.2	602740	TRW 23554 17,0 - WE / - WK + Zub
		13.0470-2740.2	LD2740	TRW 23554 17,0 - WE / - WK + Zub Ceramic			
			→	Orga 11584	13.0460-2820.2	602820	TRW 20961 17,2 - WK
					13.0470-2823.2	LD2823	TRW 23554 17,2 - WK Ceramic
			→	Orga 12334→; → 07/10	13.0460-2820.2	602820	TRW 20961 17,2 - WK
					13.0470-2823.2	LD2823	TRW 23554 17,2 - WK Ceramic
			→	Orga 12056	13.0460-3813.2	603813	BOS 24150 17,6 - WE / - WK + Zub
					13.0470-3813.2	LD3813	BOS 24150 17,6 - WE / - WK + Zub Ceramic
1.6 HDi 1.6 THP 150	80 110	11/04→07/11 07/08→07/11	←	→ 07/10; + ESP	13.0460-3966.2	603966	BOS 23600 19,4 - WE / - WK + Zub
					13.0470-3966.2	LD3966	BOS 23600 19,4 - WE / - WK + Zub Ceramic
			→	Orga 11431→ Orga 12333	13.0460-2740.2	602740	TRW 23554 17,0 - WE / - WK + Zub
					13.0470-2740.2	LD2740	TRW 23554 17,0 - WE / - WK + Zub Ceramic
			→	Orga 12334→; → 07/10	13.0460-2820.2	602820	TRW 20961 17,2 - WK
					13.0470-2823.2	LD2823	TRW 23554 17,2 - WK Ceramic
			→	Orga 11584	13.0460-2820.2	602820	TRW 20961 17,2 - WK
					13.0470-2823.2	LD2823	TRW 23554 17,2 - WK Ceramic
			→	Orga 12056	13.0460-3813.2	603813	BOS 24150 17,6 - WE / - WK + Zub
					13.0470-3813.2	LD3813	BOS 24150 17,6 - WE / - WK + Zub Ceramic
1.6 VTi 120	88	07/08→07/11	←	→ 07/10; Vollautomatik	13.0460-3966.2	603966	BOS 23600 19,4 - WE / - WK + Zub
					13.0470-3966.2	LD3966	BOS 23600 19,4 - WE / - WK + Zub Ceramic
↓							













	kW			 	! #		
CITROËN - C4 Coupe (LA_) 11/04→07/11							
Bremsbelagsatz, Scheibenbremse							
1.6 VTi 120	88	07/08→07/11	←	→ 07/10; Schaltgetriebe	13.0460-3994.2	603994	BOS 23599 19,0 - WE / - WK + Zub
					13.0470-3994.2	LD3994	BOS 23599 19,0 - WE / - WK + Zub Ceramic
			→	Orga 11431→ Orga 12333	13.0460-2740.2	602740	TRW 23554 17,0 - WE / - WK + Zub
					13.0470-2740.2	LD2740	TRW 23554 17,0 - WE / - WK + Zub Ceramic
			→	Orga 12334→; → 07/10	13.0460-2820.2	602820	TRW 20961 17,2 - WK
		13.0470-2823.2	LD2823	TRW 23554 17,2 - WK Ceramic			
		→	→Orga 11584	13.0460-2820.2	602820	TRW 20961 17,2 - WK	
				13.0470-2823.2	LD2823	TRW 23554 17,2 - WK Ceramic	
		→	→Orga 12056	13.0460-3813.2	603813	BOS 24150 17,6 - WE / - WK + Zub	
				13.0470-3813.2	LD3813	BOS 24150 17,6 - WE / - WK + Zub Ceramic	
2.0 16V 2.0 VTR	100 103	11/04→07/07 10/06→12/07	←		13.0460-3966.2	603966	BOS 23600 19,4 - WE / - WK + Zub
					13.0470-3966.2	LD3966	BOS 23600 19,4 - WE / - WK + Zub Ceramic
			→	Orga 11431→ Orga 12333	13.0460-2740.2	602740	TRW 23554 17,0 - WE / - WK + Zub
					13.0470-2740.2	LD2740	TRW 23554 17,0 - WE / - WK + Zub Ceramic
			→	Orga 12334→	13.0460-2820.2	602820	TRW 20961 17,2 - WK
		13.0470-2823.2	LD2823	TRW 23554 17,2 - WK Ceramic			
		→	→Orga 11584	13.0460-2820.2	602820	TRW 20961 17,2 - WK	
				13.0470-2823.2	LD2823	TRW 23554 17,2 - WK Ceramic	
		→	→Orga 12056	13.0460-3813.2	603813	BOS 24150 17,6 - WE / - WK + Zub	
				13.0470-3813.2	LD3813	BOS 24150 17,6 - WE / - WK + Zub Ceramic	
2.0 16V 2.0 HDi 2.0 HDi	130 100 103	11/04→12/10 11/04→12/10 07/08→07/11	←	→ 07/10	13.0460-7202.2	607202	ATE 23589 19,1 - WE / - WK
					13.0470-7202.2	LD7202	ATE 23589 19,1 - WE / - WK Ceramic
			→	Orga 11431→ Orga 12333	13.0460-2740.2	602740	TRW 23554 17,0 - WE / - WK + Zub
					13.0470-2740.2	LD2740	TRW 23554 17,0 - WE / - WK + Zub Ceramic
			→	Orga 12334→; → 07/10	13.0460-2820.2	602820	TRW 20961 17,2 - WK
		13.0470-2823.2	LD2823	TRW 23554 17,2 - WK Ceramic			
		→	→Orga 11584	13.0460-2820.2	602820	TRW 20961 17,2 - WK	
				13.0470-2823.2	LD2823	TRW 23554 17,2 - WK Ceramic	
		→	→Orga 12056	13.0460-3813.2	603813	BOS 24150 17,6 - WE / - WK + Zub	
				13.0470-3813.2	LD3813	BOS 24150 17,6 - WE / - WK + Zub Ceramic	
Zubehörsatz, Scheibenbremsbelag							
1.4 16V 1.6 16V 1.6 HDi 1.6 HDi 1.6 THP 150 1.6 VTi 120 2.0 16V 2.0 HDi 2.0 HDi	65 80 66 80 110 88 130 100 103	11/04→07/11 11/04→07/11 11/04→07/11 11/04→07/11 07/08→07/11 07/08→07/11 11/04→12/10 11/04→12/10 07/08→07/11	→	Orga 12334→; → 07/10	13.0460-0072.2	610072	TRW
			→	→Orga 11584	13.0460-0072.2	610072	TRW
			→	Orga 12334→	13.0460-0072.2	610072	TRW
			→	→Orga 11584	13.0460-0072.2	610072	TRW
			→	Orga 12334→	13.0460-0072.2	610072	TRW
			→	→Orga 11584	13.0460-0072.2	610072	TRW
			→	Orga 12334→	13.0460-0072.2	610072	TRW
			→	→Orga 11584	13.0460-0072.2	610072	TRW
			→	Orga 12334→	13.0460-0072.2	610072	TRW
			→	→Orga 11584	13.0460-0072.2	610072	TRW
Bremsscheibe							
1.4 16V 1.6 HDi	65 66	11/04→07/11 11/04→07/11	←	→ 07/10; - ESP	24.0122-0194.1	422194	Ø 266 22 20 V + S
			←	Orga 10551→; → 07/10; + ESP	24.0122-0194.1	422194	Ø 266 22 20 V + S
			←	→Orga 10550; + ESP	24.0126-0120.1	426120	Ø 283 26 24 V + S
					24.0326-0120.1	526120	Ø 283 26 24 V + S PD
			→	→ 07/10; Achszapfendurchmesser [mm]: 30	24.0109-0100.2	409100	Ø 249 9 7 + LG / + ABS Ring
↓							











	kw			 	! #		
CITROËN - C4 Coupe (LA_) 11/04→07/11							
Bremsscheibe							
1.4 16V 1.6 HDi	65 66	11/04→07/11 11/04→07/11	→	→ 07/10		24.0109-0137.1 409137	Ø 247 9 8 + S
			→	→ 07/10; Achszapfendurchmesser [mm]: 25		24.0109-0150.2 409150	Ø 249 9 8 + LG / + ABS Ring
1.6 16V	80	11/04→07/11	←	Orga 10551→; → 07/10; + ESP; Schaltgetriebe		24.0122-0194.1 422194	Ø 266 22 20 V + S
			←	→ 07/10; - ESP; Schaltgetriebe		24.0122-0194.1 422194	Ø 266 22 20 V + S
			←	→ 07/10; Automatikgetriebe		24.0126-0120.1 426120	Ø 283 26 24 V + S
						24.0326-0120.1 526120	Ø 283 26 24 V + S PD
			←	→Orga 10550; + ESP; Schaltgetriebe		24.0126-0120.1 426120	Ø 283 26 24 V + S
						24.0326-0120.1 526120	Ø 283 26 24 V + S PD
			→	→ 07/10; Achszapfendurchmesser [mm]: 30		24.0109-0100.2 409100	Ø 249 9 7 + LG / + ABS Ring
			→	→ 07/10		24.0109-0137.1 409137	Ø 247 9 8 + S
			→	→ 07/10; Achszapfendurchmesser [mm]: 25		24.0109-0150.2 409150	Ø 249 9 8 + LG / + ABS Ring
1.6 HDi 1.6 THP 150	80 110	11/04→07/11 07/08→07/11	←	→Orga 10550; + ESP		24.0126-0120.1 426120	Ø 283 26 24 V + S
						24.0326-0120.1 526120	Ø 283 26 24 V + S PD
			→	→ 07/10; Achszapfendurchmesser [mm]: 30		24.0109-0100.2 409100	Ø 249 9 7 + LG / + ABS Ring
			→	→ 07/10		24.0109-0137.1 409137	Ø 247 9 8 + S
			→	→ 07/10; Achszapfendurchmesser [mm]: 25		24.0109-0150.2 409150	Ø 249 9 8 + LG / + ABS Ring
1.6 VTi 120	88	07/08→07/11	←	→ 07/10; Schaltgetriebe		24.0122-0194.1 422194	Ø 266 22 20 V + S
			←	→Orga 10550; Vollautomatik		24.0126-0120.1 426120	Ø 283 26 24 V + S
						24.0326-0120.1 526120	Ø 283 26 24 V + S PD
			→	→ 07/10; Achszapfendurchmesser [mm]: 30		24.0109-0100.2 409100	Ø 249 9 7 + LG / + ABS Ring
			→	→ 07/10		24.0109-0137.1 409137	Ø 247 9 8 + S
			→	→ 07/10; Achszapfendurchmesser [mm]: 25		24.0109-0150.2 409150	Ø 249 9 8 + LG / + ABS Ring
2.0 16V 2.0 VTR	100 103	11/04→07/07 10/06→12/07	←			24.0126-0120.1 426120	Ø 283 26 24 V + S
						24.0326-0120.1 526120	Ø 283 26 24 V + S PD
			→	Achszapfendurchmesser [mm]: 30		24.0109-0100.2 409100	Ø 249 9 7 + LG / + ABS Ring
			→			24.0109-0137.1 409137	Ø 247 9 8 + S
			→	Achszapfendurchmesser [mm]: 25		24.0109-0150.2 409150	Ø 249 9 8 + LG / + ABS Ring
2.0 16V 2.0 HDi 2.0 HDi	130 100 103	11/04→12/10 11/04→12/10 07/08→07/11	←	→Orga 11500		24.0126-0140.1 426140	Ø 302 26 24 V + S
			←	Orga 11501→; → 07/10		24.0126-0159.1 426159	Ø 302 26 24 V + S
			→	→ 07/10; Achszapfendurchmesser [mm]: 30		24.0109-0100.2 409100	Ø 249 9 7 + LG / + ABS Ring
			→	→ 07/10		24.0109-0137.1 409137	Ø 247 9 8 + S
			→	→ 07/10; Achszapfendurchmesser [mm]: 25		24.0109-0150.2 409150	Ø 249 9 8 + LG / + ABS Ring
CITROËN - C4 Grand Picasso I (UA_) 10/06→							
Bremsbelagsatz, Scheibenbremse							
1.6 16V 1.6 16V 2.0 HDi 138 2.0 HDi 150 2.0 i 16V 2.0 i 16V	103 110 100 110 103 105	07/08→ 10/08→ 10/06→ 07/09→ 10/06→ 01/10→	←	→ 07/13		13.0460-7230.2 607230	ATE 24557 19,4 - WE / - WK
						13.0470-7230.2 LD7230	ATE 24557 19,4 - WE / - WK Ceramic
			→	→ 07/13		13.0460-3836.2 603836	BOS 24540 16,3 - WE / - WK + Zub
						13.0470-3836.2 LD3836	BOS 24540 16,3 - WE / - WK + Zub Ceramic
1.6 HDi 1.6 HDi 110 1.6 VTi 120 1.8 i 16V	80 82 88 92	10/06→ 09/10→ 07/08→ 10/06→	←	→ 07/13		13.0460-7229.2 607229	ATE 24538 18,5 - WE / - WK
						13.0470-7229.2 LD7229	ATE 24538 18,5 - WE / - WK Ceramic
			→	→ 07/13		13.0460-3836.2 603836	BOS 24540 16,3 - WE / - WK + Zub
						13.0470-3836.2 LD3836	BOS 24540 16,3 - WE / - WK + Zub Ceramic
1.6 THP 155 2.0 HDi 165	115 120	09/10→ 09/10→	←	11/10→ 07/13		13.0460-7230.2 607230	ATE 24557 19,4 - WE / - WK
						13.0470-7230.2 LD7230	ATE 24557 19,4 - WE / - WK Ceramic
			→	11/10→ 07/13		13.0460-3836.2 603836	BOS 24540 16,3 - WE / - WK + Zub
↓							











	kw			 	! #			
CITROËN - C4 Grand Picasso I (UA_) 10/06→								
 Bremsbelagsatz, Scheibenbremse								
1.6 THP 155 2.0 HDi 165	115 120	09/10→ 09/10→	➡	11/10→ 07/13		13.0470-3836.2 LD3836	BOS 24540 16,3 - WE / - WK + Zub Ceramic	
 Bremsscheibe								
1.6 16V 1.6 16V 2.0 HDi 138 2.0 HDi 150 2.0 i 16V 2.0 i 16V	103 110 100 110 103 105	07/08→ 10/08→ 10/06→ 07/09→ 10/06→ 01/10→	← ➡	→ 07/13 → 07/13		24.0126-0140.1 24.0112-0194.2	426140 412194	∅ 302 26 24 V + S ∅ 268 12 10 + LG / + ABS Ring
1.6 HDi 1.6 HDi 110 1.6 VTi 120 1.8 i 16V	80 82 88 92	10/06→ 09/10→ 07/08→ 10/06→	← ➡	→ 07/13 → 07/13		24.0126-0120.1 24.0326-0120.1 24.0112-0194.2	426120 526120 412194	∅ 283 26 24 V + S ∅ 283 26 24 V + S PD ∅ 268 12 10 + LG / + ABS Ring
1.6 THP 155 2.0 HDi 165	115 120	09/10→ 09/10→	← ➡	11/10→ 07/13 11/10→ 07/13		24.0126-0140.1 24.0112-0194.2	426140 412194	∅ 302 26 24 V + S ∅ 268 12 10 + LG / + ABS Ring
CITROËN - C4 Grand Picasso II 09/13→								
 Bremsbelagsatz, Scheibenbremse								
1.2 THP 130 1.6 BlueHDi 100 1.6 BlueHDi 120 1.6 HDi / BlueHDi 115 1.6 HDi 90 1.6 THP 150 1.6 THP 155 1.6 THP 165 1.6 VTi 120 2.0 BlueHDi 135 2.0 BlueHDi 135 Hybrid 2.0 BlueHDi 150	96 73 88 85 68 110 115 121 88 100 100 110	04/14→ 01/15→ 07/14→ 09/13→ 09/13→ 09/14→ 09/13→ 07/14→ 09/13→ 09/13→ 09/13→ 09/13→	← ← ➡ ➡	für Bremsscheibendurchmesser [mm]: 304 für Bremsscheibendurchmesser [mm]: 283 für Bremsscheibendurchmesser [mm]: 268 für Bremsscheibendurchmesser [mm]: 290		13.0460-7300.2 13.0470-7300.2 13.0460-7305.2 13.0470-7305.2 13.0460-3871.2 13.0470-3871.2 13.0460-3872.2 13.0470-3872.2	607300 LD7300 607305 LD7305 603871 LD3871 603872 LD3872	ATE 25833 17,3 + WE / - WK ATE 25833 17,3 + WE / - WK Ceramic ATE 25836 17,0 + WE / - WK ATE 25836 17,0 + WE / - WK Ceramic BOS 25839 17,8 - WE / - WK + Zub BOS 25839 17,8 - WE / - WK + Zub Ceramic BOS 25827 17,7 - WE / - WK + Zub BOS 25827 17,7 - WE / - WK + Zub Ceramic
 Bremsscheibe								
1.2 THP 130 1.6 BlueHDi 100 1.6 BlueHDi 120 1.6 HDi / BlueHDi 115 1.6 HDi 90 1.6 THP 150 1.6 THP 155 1.6 THP 165 1.6 VTi 120 2.0 BlueHDi 135 2.0 BlueHDi 135 Hybrid 2.0 BlueHDi 150	96 73 88 85 68 110 115 121 88 100 100 110	04/14→ 01/15→ 07/14→ 09/13→ 09/13→ 09/14→ 09/13→ 07/14→ 09/13→ 09/13→ 09/13→ 09/13→	← ➡			24.0126-0183.1 24.0128-0269.1 24.0112-0211.1 24.0112-0212.1	426183 428269 412211 412212	∅ 283 26 24 V + S ∅ 304 28 26 V + S ∅ 268 12 10 + S ∅ 290 12 10 + S
CITROËN - C4 Picasso I (UD_) 10/06→08/13								
 Bremsbelagsatz, Scheibenbremse								
1.6 16V 1.6 THP 140 2.0 HDi 150 2.0 i 16V	110 103 110 103	07/08→08/13 07/08→08/13 07/09→08/13 02/07→08/13	← ➡	→ 07/13 → 07/13		13.0460-7230.2 13.0470-7230.2 13.0460-3836.2 13.0470-3836.2	607230 LD7230 603836 LD3836	ATE 24557 19,4 - WE / - WK ATE 24557 19,4 - WE / - WK Ceramic BOS 24540 16,3 - WE / - WK + Zub BOS 24540 16,3 - WE / - WK + Zub Ceramic
1.6 HDi 1.6 VTi 120	80 88	02/07→08/13 07/08→08/13	← ➡	→ 07/13 → 07/13		13.0460-7229.2 13.0470-7229.2 13.0460-3836.2 13.0470-3836.2	607229 LD7229 603836 LD3836	ATE 24538 18,5 - WE / - WK ATE 24538 18,5 - WE / - WK Ceramic BOS 24540 16,3 - WE / - WK + Zub BOS 24540 16,3 - WE / - WK + Zub Ceramic
1.6 HDi 110	82	09/10→08/13	← ➡	11/10→ 07/13 11/10→ 07/13		13.0460-7229.2 13.0470-7229.2 13.0460-3836.2 13.0470-3836.2	607229 LD7229 603836 LD3836	ATE 24538 18,5 - WE / - WK ATE 24538 18,5 - WE / - WK Ceramic BOS 24540 16,3 - WE / - WK + Zub BOS 24540 16,3 - WE / - WK + Zub Ceramic
↓								

	kw			 	! #		
CITROËN - C4 Picasso I (UD_) 10/06—08/13							
 Bremsbelagsatz, Scheibenbremse							
1.6 THP 155 2.0 HDi 165	115 120	09/10→08/13 09/10→08/13	←	11/10→ 07/13		13.0460-7230.2 607230 13.0470-7230.2 LD7230	ATE 24557 19,4 - WE / - WK ATE 24557 19,4 - WE / - WK Ceramic
			→	11/10→ 07/13		13.0460-3836.2 603836 13.0470-3836.2 LD3836	BOS 24540 16,3 - WE / - WK + Zub BOS 24540 16,3 - WE / - WK + Zub Ceramic
1.8 Bifuel 1.8 i 16V	92 92	01/09→10/12 02/07→12/11	←			13.0460-7229.2 607229 13.0470-7229.2 LD7229	ATE 24538 18,5 - WE / - WK ATE 24538 18,5 - WE / - WK Ceramic
			→			13.0460-3836.2 603836 13.0470-3836.2 LD3836	BOS 24540 16,3 - WE / - WK + Zub BOS 24540 16,3 - WE / - WK + Zub Ceramic
2.0 HDi 138	100	10/06→08/13	←	02/07→ 07/13		13.0460-7230.2 607230 13.0470-7230.2 LD7230	ATE 24557 19,4 - WE / - WK ATE 24557 19,4 - WE / - WK Ceramic
			→	02/07→ 07/13		13.0460-3836.2 603836 13.0470-3836.2 LD3836	BOS 24540 16,3 - WE / - WK + Zub BOS 24540 16,3 - WE / - WK + Zub Ceramic
2.0 i 16V	105	05/08→05/13	←			13.0460-7230.2 607230 13.0470-7230.2 LD7230	ATE 24557 19,4 - WE / - WK ATE 24557 19,4 - WE / - WK Ceramic
			→			13.0460-3836.2 603836 13.0470-3836.2 LD3836	BOS 24540 16,3 - WE / - WK + Zub BOS 24540 16,3 - WE / - WK + Zub Ceramic
 Bremsscheibe							
1.6 16V 1.6 THP 140 2.0 HDi 150 2.0 i 16V	110 103 110 103	07/08→08/13 07/08→08/13 07/09→08/13 02/07→08/13	←	→ 07/13		24.0126-0140.1 426140	Ø 302 26 24 V + S
			→	→ 07/13		24.0112-0194.2 412194	Ø 268 12 10 + LG / + ABS Ring
1.6 HDi 1.6 VTi 120	80 88	02/07→08/13 07/08→08/13	←	→ 07/13		24.0126-0120.1 426120 24.0326-0120.1 526120	Ø 283 26 24 V + S Ø 283 26 24 V + S PD
			→	→ 07/13		24.0112-0194.2 412194	Ø 268 12 10 + LG / + ABS Ring
1.6 HDi 110	82	09/10→08/13	←	11/10→ 07/13		24.0126-0120.1 426120 24.0326-0120.1 526120	Ø 283 26 24 V + S Ø 283 26 24 V + S PD
			→	11/10→ 07/13		24.0112-0194.2 412194	Ø 268 12 10 + LG / + ABS Ring
1.6 THP 155 2.0 HDi 165	115 120	09/10→08/13 09/10→08/13	←	11/10→ 07/13		24.0126-0140.1 426140 24.0112-0194.2 412194	Ø 302 26 24 V + S Ø 268 12 10 + LG / + ABS Ring
			→	11/10→ 07/13		24.0112-0194.2 412194	Ø 268 12 10 + LG / + ABS Ring
1.8 Bifuel 1.8 i 16V	92 92	01/09→10/12 02/07→12/11	←			24.0126-0120.1 426120 24.0326-0120.1 526120	Ø 283 26 24 V + S Ø 283 26 24 V + S PD
			→			24.0112-0194.2 412194	Ø 268 12 10 + LG / + ABS Ring
2.0 HDi 138	100	10/06→08/13	←	02/07→ 07/13		24.0126-0140.1 426140 24.0112-0194.2 412194	Ø 302 26 24 V + S Ø 268 12 10 + LG / + ABS Ring
			→	02/07→ 07/13		24.0112-0194.2 412194	Ø 268 12 10 + LG / + ABS Ring
2.0 i 16V	105	05/08→05/13	←			24.0126-0140.1 426140 24.0112-0194.2 412194	Ø 302 26 24 V + S Ø 268 12 10 + LG / + ABS Ring
			→			24.0112-0194.2 412194	Ø 268 12 10 + LG / + ABS Ring
CITROËN - C4 Picasso II 02/13→							
 Bremsbelagsatz, Scheibenbremse							
1.2 THP 110	81	04/16→	←	für Bremsscheibendurchmesser [mm]: 304		13.0460-7300.2 607300 13.0470-7300.2 LD7300	ATE 25833 17,3 + WE / - WK ATE 25833 17,3 + WE / - WK Ceramic
			←	für Bremsscheibendurchmesser [mm]: 283		13.0460-7305.2 607305 13.0470-7305.2 LD7305	ATE 25836 17,0 + WE / - WK ATE 25836 17,0 + WE / - WK Ceramic
			→	für Bremsscheibendurchmesser [mm]: 268		13.0460-3871.2 603871 13.0470-3871.2 LD3871	BOS 25839 17,8 - WE / - WK + Zub BOS 25839 17,8 - WE / - WK + Zub Ceramic
			→			13.0460-3872.2 603872 13.0470-3872.2 LD3872	BOS 25827 17,7 - WE / - WK + Zub BOS 25827 17,7 - WE / - WK + Zub Ceramic
↓							

	kw			 	! #		
CITROËN - C4 Stufenheck 07/06→							
 Bremsbelagsatz, Scheibenbremse							
2.0 16V	103	07/06→	→	→Orga 11584	13.0460-2820.2 602820	TRW 20961 17,2 - WK	
			→	Orga 12334→; → 07/11	13.0470-2823.2 LD2823	TRW 23554 17,2 - WK Ceramic	
			→	→Orga 12056	13.0460-3813.2 603813	BOS 24150 17,6 - WE / - WK + Zub	
			→		13.0470-3813.2 LD3813	BOS 24150 17,6 - WE / - WK + Zub Ceramic	
Zubehörsatz, Scheibenbremsbelag							
1.6 16V	80	07/06→07/11	→	Orga 12334→	13.0460-0072.2 610072	TRW	
1.6 HDi	80	07/06→07/11	→	→Orga 11584	13.0460-0072.2 610072	TRW	
2.0 16V	103	07/06→	→	Orga 12334→; → 07/11	13.0460-0072.2 610072	TRW	
			→	→Orga 11584	13.0460-0072.2 610072	TRW	
 Bremsscheibe							
1.6 16V	80	07/06→07/11	←		24.0126-0120.1 426120	Ø 283 26 24 V + S	
1.6 HDi	80	07/06→07/11	←		24.0326-0120.1 526120	Ø 283 26 24 V + S PD	
			→	Achszapfendurchmesser [mm]: 30	24.0109-0100.2 409100	Ø 249 9 7 + LG / + ABS Ring	
			→		24.0109-0137.1 409137	Ø 247 9 8 + S	
			→	Achszapfendurchmesser [mm]: 25	24.0109-0150.2 409150	Ø 249 9 8 + LG / + ABS Ring	
2.0 16V	103	07/06→	←	→ 07/11	24.0126-0120.1 426120	Ø 283 26 24 V + S	
			←		24.0326-0120.1 526120	Ø 283 26 24 V + S PD	
			→	→ 07/11; Achszapfendurchmesser [mm]: 30	24.0109-0100.2 409100	Ø 249 9 7 + LG / + ABS Ring	
			→	→ 07/11	24.0109-0137.1 409137	Ø 247 9 8 + S	
			→	→ 07/11; Achszapfendurchmesser [mm]: 25	24.0109-0150.2 409150	Ø 249 9 8 + LG / + ABS Ring	
CITROËN - C5 I (DC_) 03/01→03/05							
 Bremsbelagsatz, Scheibenbremse							
1.8 16V (DC6FZB, DC6FZE)	85	03/01→08/04	←		13.0460-3996.2 603996	BOS 23276 17,2 + WK	
			→		13.0460-4921.2 604921	CIT 23305 15,2 - WE / - WK	
2.0 16V (DCRFNC, DCRFNF)	100	03/01→08/04	←		13.0460-3997.2 603997	BOS 23277 17,7 + WK	
2.0 16V HPi (DCRLZB)	103	03/01→08/04	→		13.0460-4921.2 604921	CIT 23305 15,2 - WE / - WK	
2.0 HDi	79	03/01→08/04					
2.0 HDi (DCRHYP)	66	03/01→08/04					
2.0 HDi (DCRHZB, DCRHZE)	80	03/01→08/04					
2.2 HDi (DC4HXB, DC4HXE)	98	03/01→08/04	←		13.0460-3998.2 603998	BOS 23273 17,8 + WK	
3.0 V6 (DCXFXC, DCXFXF)	152	03/01→08/04	→		13.0460-4921.2 604921	CIT 23305 15,2 - WE / - WK	
 Bremsscheibe							
1.8 16V (DC6FZB, DC6FZE)	85	03/01→08/04	←		24.0122-0194.1 422194	Ø 266 22 20 V + S	
			→		24.0114-0112.1 414112	Ø 276 14 12 + S	
2.0 16V (DCRFNC, DCRFNF)	100	03/01→08/04	←		24.0126-0120.1 426120	Ø 283 26 24 V + S	
2.0 16V HPi (DCRLZB)	103	03/01→08/04	→		24.0326-0120.1 526120	Ø 283 26 24 V + S PD	
2.0 HDi	79	03/01→08/04	→		24.0114-0112.1 414112	Ø 276 14 12 + S	
2.0 HDi (DCRHYP)	66	03/01→08/04					
2.0 HDi (DCRHZB, DCRHZE)	80	03/01→08/04					
2.2 HDi (DC4HXB, DC4HXE)	98	03/01→08/04	←		24.0128-0128.1 428128	Ø 288 28 26 V + S	
3.0 V6 (DCXFXC, DCXFXF)	152	03/01→08/04	→		24.0114-0112.1 414112	Ø 276 14 12 + S	
CITROËN - C5 I Break (DE_) 06/01→08/04							
 Bremsbelagsatz, Scheibenbremse							
1.8 16V (DE6FZB, DE6FZE)	85	06/01→08/04	←		13.0460-3997.2 603997	BOS 23277 17,7 + WK	
2.0 16V (DERFNF, DERFNC, RERFNC)	100	06/01→08/04	→		13.0460-4921.2 604921	CIT 23305 15,2 - WE / - WK	
2.0 16V HPi (DERLZB)	103	06/01→08/04					
2.0 HDi	80	06/01→08/04					

	kW			 	! #		
CITROËN - C5 I Break (DE_) 06/01→08/04							
 Bremsbelagsatz, Scheibenbremse							
2.0 HDi (DERHSB, DERHSE)	79	06/01→08/04	←			13.0460-3997.2 603997	BOS 23277 17,7 + WK
2.0 HDi (DERHYB)	66	06/01→08/04	→			13.0460-4921.2 604921	CIT 23305 15,2 - WE / - WK
2.2 HDi (DE4HXB, DE4HXE)	98	06/01→08/04	←			13.0460-3998.2 603998	BOS 23273 17,8 + WK
3.0 Carlsson	173	09/03→08/04	→			13.0460-4921.2 604921	CIT 23305 15,2 - WE / - WK
3.0 V6 (DEXFXC, DEXFXF)	152	06/01→08/04					
 Bremsscheibe							
1.8 16V (DE6FZB, DE6FZE)	85	06/01→08/04	←			24.0126-0120.1 426120	Ø 283 26 24 V + S
2.0 16V (DERFNF, DERFNC, RERFNC)	100	06/01→08/04	→			24.0326-0120.1 526120	Ø 283 26 24 V + S PD
2.0 16V HPI (DERLZB)	103	06/01→08/04				24.0114-0112.1 414112	Ø 276 14 12 + S
2.0 HDi	80	06/01→08/04					
2.0 HDi (DERHSB, DERHSE)	79	06/01→08/04					
2.0 HDi (DERHYB)	66	06/01→08/04					
2.2 HDi (DE4HXB, DE4HXE)	98	06/01→08/04	←			24.0128-0128.1 428128	Ø 288 28 26 V + S
3.0 Carlsson	173	09/03→08/04	→			24.0114-0112.1 414112	Ø 276 14 12 + S
3.0 V6 (DEXFXC, DEXFXF)	152	06/01→08/04					
CITROËN - C5 II (RC_) 08/04→							
 Bremsbelagsatz, Scheibenbremse							
1.6 HDi (RC8HZB)	80	09/04→	←	→ 01/08		13.0460-3997.2 603997	BOS 23277 17,7 + WK
2.0 16V (RCRFJB, RCRFJC)	103	09/04→	→	→ 01/08		13.0460-4921.2 604921	CIT 23305 15,2 - WE / - WK
1.8 16V	92	09/05→	←	→ 01/08		13.0460-3996.2 603996	BOS 23276 17,2 + WK
1.8 16V (RC6FZB)	85	09/04→	→	→ 01/08		13.0460-4921.2 604921	CIT 23305 15,2 - WE / - WK
2.0 HDi (RCRHRH)	100	09/04→	←	→ 01/08		13.0460-3998.2 603998	BOS 23273 17,8 + WK
2.2 HDi	120	05/06→					
2.2 HDi	125	04/06→	→	→ 01/08		13.0460-4921.2 604921	CIT 23305 15,2 - WE / - WK
2.2 HDi (RC4HXE)	98	09/04→					
3.0 Carlsson HP	173	09/04→					
3.0 V6 (RCXFUF)	152	09/04→					
3.0 V6	155	10/04→04/07	←			13.0460-3998.2 603998	BOS 23273 17,8 + WK
			→			13.0460-4921.2 604921	CIT 23305 15,2 - WE / - WK
 Bremsscheibe							
1.6 HDi (RC8HZB)	80	09/04→	←	→ 01/08		24.0126-0120.1 426120	Ø 283 26 24 V + S
2.0 16V (RCRFJB, RCRFJC)	103	09/04→	→	→ 01/08		24.0326-0120.1 526120	Ø 283 26 24 V + S PD
						24.0114-0112.1 414112	Ø 276 14 12 + S
1.8 16V	92	09/05→	←	→ 01/08		24.0122-0194.1 422194	Ø 266 22 20 V + S
1.8 16V (RC6FZB)	85	09/04→	→	→ 01/08		24.0114-0112.1 414112	Ø 276 14 12 + S
2.0 HDi (RCRHRH)	100	09/04→	←	→ 01/08		24.0128-0128.1 428128	Ø 288 28 26 V + S
2.2 HDi	120	05/06→					
2.2 HDi	125	04/06→	→	→ 01/08		24.0114-0112.1 414112	Ø 276 14 12 + S
2.2 HDi (RC4HXE)	98	09/04→					
3.0 Carlsson HP	173	09/04→					
3.0 V6 (RCXFUF)	152	09/04→					
3.0 V6	155	10/04→04/07	←			24.0128-0128.1 428128	Ø 288 28 26 V + S
			→			24.0114-0112.1 414112	Ø 276 14 12 + S
CITROËN - C5 II Break (RE_) 09/04→							
 Bremsbelagsatz, Scheibenbremse							
1.6 HDi (RE8HZB)	80	09/04→	←	→ 01/08		13.0460-3997.2 603997	BOS 23277 17,7 + WK
1.8 16V	92	09/05→					
1.8 16V (RE6FZB)	85	09/04→	→	→ 01/08		13.0460-4921.2 604921	CIT 23305 15,2 - WE / - WK
2.0 16V (RERFJB, RERFJC)	103	09/04→					
2.0 HDi (RERHRH)	100	09/04→	←	→ 01/08		13.0460-3998.2 603998	BOS 23273 17,8 + WK
2.2 HDi	120	05/06→					
2.2 HDi	125	04/06→	→	→ 01/08		13.0460-4921.2 604921	CIT 23305 15,2 - WE / - WK
2.2 HDi (RE4HXE)	98	09/04→					
3.0	173	09/04→					
3.0 V6 (REXFUF)	152	09/04→					
3.0 V6	155	10/04→04/07	←			13.0460-3998.2 603998	BOS 23273 17,8 + WK
			→			13.0460-4921.2 604921	CIT 23305 15,2 - WE / - WK
↓							

	kW			 	! #		
CITROËN - C5 II Break (RE_) 09/04→							
 Bremsscheibe							
1.6 HDi (RE8HZB)	80	09/04→	←	→ 01/08		24.0126-0120.1 426120	∅ 283 26 24 V + S
1.8 16V	92	09/05→				24.0326-0120.1 526120	∅ 283 26 24 V + S PD
1.8 16V (RE6FZB)	85	09/04→					
2.0 16V (RERFJB, RERFJC)	103	09/04→	→	→ 01/08		24.0114-0112.1 414112	∅ 276 14 12 + S
2.0 HDi (RERHRH)	100	09/04→	←	→ 01/08		24.0128-0128.1 428128	∅ 288 28 26 V + S
2.2 HDi	120	05/06→					
2.2 HDi	125	04/06→	→	→ 01/08		24.0114-0112.1 414112	∅ 276 14 12 + S
2.2 HDi (RE4HXE)	98	09/04→					
3.0	173	09/04→					
3.0 V6 (REXFUF)	152	09/04→					
3.0 V6	155	10/04→04/07	←			24.0128-0128.1 428128	∅ 288 28 26 V + S
			→			24.0114-0112.1 414112	∅ 276 14 12 + S
CITROËN - C5 III (RD_) 02/08→							
 Bremsbelagsatz, Scheibenbremse							
1.6 HDi 110	80	02/08→	←			13.0460-7252.2 607252	ATE 24084 19,3 + WK
1.6 HDi 115	84	01/12→				13.0470-7252.2 LD7252	ATE 24084 19,3 + WK Ceramic
1.8 16V	92	02/08→					
2.0 16V	103	02/08→	→	- eFSB		13.0460-2893.2 602893	TRW 24135 17,7 - WK
2.0 16V BioFlex	103	02/08→	→	+ eFSB		13.0470-2893.2 LD2893	TRW 24135 17,7 - WK Ceramic
			→			13.0460-7253.2 607253	ATE 23482 15,8 - WE / - WK
1.6 HDi 110	82	07/10→	←	→Orga 12774		13.0460-7252.2 607252	ATE 24084 19,3 + WK
1.6 THP 150	110	07/10→				13.0470-7252.2 LD7252	ATE 24084 19,3 + WK Ceramic
1.6 THP 155	115	04/09→					
1.6 VTi 120	88	07/10→	←	Orga 12775→		13.0460-7252.2 607252	ATE 24084 19,3 + WK
2.0 HDi	100	02/08→				13.0470-7252.2 LD7252	ATE 24084 19,3 + WK Ceramic
2.0 HDi 140	103	04/09→	→	- eFSB		13.0460-2893.2 602893	TRW 24135 17,7 - WK
2.0 HDi 165	120	04/09→	→	+ eFSB		13.0470-2893.2 LD2893	TRW 24135 17,7 - WK Ceramic
			→			13.0460-7253.2 607253	ATE 23482 15,8 - WE / - WK
2.0 HDi 150 / BlueHDi 150	110	04/09→	←	05/15→		13.0460-7252.2 607252	ATE 24084 19,3 + WK
			→	05/15→; - eFSB		13.0470-7252.2 LD7252	ATE 24084 19,3 + WK Ceramic
			→	05/15→; + eFSB		13.0460-2893.2 602893	TRW 24135 17,7 - WK
			→			13.0470-2893.2 LD2893	TRW 24135 17,7 - WK Ceramic
			→			13.0460-7253.2 607253	ATE 23482 15,8 - WE / - WK
2.0 HDi 180	133	03/15→	←			13.0460-7279.2 607279	ATE 25069 17,3 + WK
2.2 HDi 200	150	07/10→					
3.0 HDi 240	177	04/09→	→	- eFSB		13.0460-2893.2 602893	TRW 24135 17,7 - WK
			→	+ eFSB		13.0470-2893.2 LD2893	TRW 24135 17,7 - WK Ceramic
			→			13.0460-7253.2 607253	ATE 23482 15,8 - WE / - WK
2.2 HDi	125	02/08→	←			13.0460-2892.2 602892	TRW 24133 18,6 + WK + Zub
2.7 HDi	150	02/08→				13.0470-2892.2 LD2892	TRW 24133 18,6 + WK + Zub Ceramic
3.0	152	02/08→					
3.0 V6	155	02/08→	→	- eFSB		13.0460-2893.2 602893	TRW 24135 17,7 - WK
			→	+ eFSB		13.0470-2893.2 LD2893	TRW 24135 17,7 - WK Ceramic
			→			13.0460-7253.2 607253	ATE 23482 15,8 - WE / - WK
 Bremsscheibe							
1.6 HDi 110	80	02/08→	←			24.0128-0216.1 428216	∅ 304 28 26 V + S
1.6 HDi 110	82	07/10→					
1.6 HDi 115	84	01/12→	→			24.0112-0162.1 412162	∅ 290 12 10 + S
1.6 THP 150	110	07/10→					
1.6 THP 155	115	04/09→					
1.6 VTi 120	88	07/10→					
1.8 16V	92	02/08→					
2.0 16V	103	02/08→					
2.0 16V BioFlex	103	02/08→					
2.0 HDi 140	103	04/09→					
2.0 HDi 165	120	04/09→					
2.0 HDi	100	02/08→	←			24.0128-0216.1 428216	∅ 304 28 26 V + S
			→			24.0130-0206.1 430206	∅ 330 30 28 V + S
			→			24.0112-0162.1 412162	∅ 290 12 10 + S
2.0 HDi 150 / BlueHDi 150	110	04/09→	←	05/15→		24.0128-0216.1 428216	∅ 304 28 26 V + S
			→	05/15→		24.0112-0162.1 412162	∅ 290 12 10 + S
2.0 HDi 180	133	03/15→	←			24.0130-0227.1 430227	∅ 340 30 28 V + S
2.2 HDi 200	150	07/10→	→			24.0112-0162.1 412162	∅ 290 12 10 + S
3.0 HDi 240	177	04/09→	→				
2.2 HDi	125	02/08→	←			24.0130-0206.1 430206	∅ 330 30 28 V + S
2.7 HDi	150	02/08→					
3.0	152	02/08→	→			24.0112-0162.1 412162	∅ 290 12 10 + S
3.0 V6	155	02/08→					

	kw			 	! #		
CITROËN - C5 III Break (TD_) 02/08→							
 Bremsbelagsatz, Scheibenbremse							
1.6 HDi 110 1.8 16V 2.0 16V 2.0 16V BioFlex	80 92 103 103	02/08→ 02/08→ 02/08→ 02/08→	← → → →			13.0460-7252.2 607252 13.0470-7252.2 LD7252 13.0460-2893.2 602893 13.0470-2893.2 LD2893 13.0460-7253.2 607253	ATE 24084 19,3 + WK ATE 24084 19,3 + WK Ceramic TRW 24135 17,7 - WK TRW 24135 17,7 - WK Ceramic ATE 23482 15,8 - WE / - WK
1.6 HDi 110 1.6 HDi 115 1.6 THP 150 1.6 THP 155 1.6 VTI 120 2.0 HDi 2.0 HDi 140 2.0 HDi 150 / BlueHDi 150 2.0 HDi 165	82 84 110 115 88 100 103 110 120	07/10→ 01/12→ 04/09→ 04/09→ 07/10→ 02/08→ 04/09→ 04/09→ 04/09→	← → ← → → → → → →	Orga 12775→ →Orga 12774		13.0460-7252.2 607252 13.0470-7252.2 LD7252 13.0460-7252.2 607252 13.0470-7252.2 LD7252 13.0460-2893.2 602893 13.0470-2893.2 LD2893 13.0460-7253.2 607253	ATE 24084 19,3 + WK ATE 24084 19,3 + WK Ceramic ATE 24084 19,3 + WK ATE 24084 19,3 + WK Ceramic TRW 24135 17,7 - WK TRW 24135 17,7 - WK Ceramic ATE 23482 15,8 - WE / - WK
2.0 HDi 180 2.2 HDi 200 3.0 HDi 240	133 150 177	03/15→ 07/10→ 04/09→	← → →			13.0460-7279.2 607279 13.0460-2893.2 602893 13.0470-2893.2 LD2893 13.0460-7253.2 607253	ATE 25069 17,3 + WK TRW 24135 17,7 - WK TRW 24135 17,7 - WK Ceramic ATE 23482 15,8 - WE / - WK
2.2 HDi 2.2 HDi 165 2.7 HDi 3.0 3.0 V6	125 120 150 152 155	02/08→ 02/08→ 02/08→ 02/08→ 02/08→	← → → → →			13.0460-2892.2 602892 13.0470-2892.2 LD2892 13.0460-2893.2 602893 13.0470-2893.2 LD2893 13.0460-7253.2 607253	TRW 24133 18,6 + WK + Zub TRW 24133 18,6 + WK + Zub Ceramic TRW 24135 17,7 - WK TRW 24135 17,7 - WK Ceramic ATE 23482 15,8 - WE / - WK
 Bremsscheibe							
1.6 HDi 110 1.6 HDi 110 1.6 HDi 115 1.6 THP 150 1.6 THP 155 1.6 VTI 120 1.8 16V 2.0 16V 2.0 16V BioFlex 2.0 HDi 2.0 HDi 140 2.0 HDi 150 / BlueHDi 150	80 82 84 110 115 88 92 103 103 100 103 110	02/08→ 07/10→ 01/12→ 04/09→ 04/09→ 07/10→ 02/08→ 02/08→ 02/08→ 02/08→ 04/09→ 04/09→	← → → → → → → → → → → →			24.0128-0216.1 428216 24.0112-0162.1 412162	∅ 304 28 26 V + S ∅ 290 12 10 + S
2.0 HDi 165	120	04/09→	← →			24.0128-0269.1 428269 24.0112-0162.1 412162	∅ 304 28 26 V + S ∅ 290 12 10 + S
2.0 HDi 180 2.2 HDi 200 3.0 HDi 240	133 150 177	03/15→ 07/10→ 04/09→	← → →			24.0130-0227.1 430227 24.0112-0162.1 412162	∅ 340 30 28 V + S ∅ 290 12 10 + S
2.2 HDi 2.2 HDi 165 2.7 HDi 3.0 3.0 V6	125 120 150 152 155	02/08→ 02/08→ 02/08→ 02/08→ 02/08→	← → → → →			24.0130-0206.1 430206 24.0112-0162.1 412162	∅ 330 30 28 V + S ∅ 290 12 10 + S
CITROËN - C6 (TD_) 09/05→							
 Bremsbelagsatz, Scheibenbremse							
2.2 HDi 2.2 HDi 2.7 HDi 3.0 V6	120 125 150 155	06/06→ 06/06→ 09/05→ 09/05→	← → → →	→ 12/12		13.0460-2892.2 602892 13.0470-2892.2 LD2892 13.0460-2706.2 602706	TRW 24133 18,6 + WK + Zub TRW 24133 18,6 + WK + Zub Ceramic TRW 24462 16,7 - WK
3.0 HDi	177	04/09→	← →	07/09→ 12/12		13.0460-7279.2 607279 13.0460-2706.2 602706	ATE 25069 17,3 + WK TRW 24462 16,7 - WK
 Bremsscheibe							
2.2 HDi 2.2 HDi 2.7 HDi 3.0 V6	120 125 150 155	06/06→ 06/06→ 09/05→ 09/05→	← → → →	→Orga 11193 Orga 11194→; → 12/12 → 12/12		24.0130-0181.1 430181 24.0130-0206.1 430206 24.0122-0255.1 422255	∅ 330 30 28 V + S ∅ 330 30 28 V + S ∅ 302 22 20 V
3.0 HDi	177	04/09→	← →	07/09→ 12/12		24.0130-0227.1 430227 24.0122-0255.1 422255	∅ 340 30 28 V + S ∅ 302 22 20 V

CITROËN - C8 (EA_, EB_) 07/02→

Bremsbelagsatz, Scheibenbremse

2.0	100	07/02→	←	→ 07/14	13.0460-2863.2	602863	TRW 20261 19,0 + WK + Zub
2.0 16V	103	09/05→					
2.0 16V	104	09/05→	→	→ 07/14	13.0460-2819.2	602819	TRW 20961 17,2 - WK
2.0 HDi	79	07/02→					
2.0 HDi	80	07/02→					
2.0 HDi	81	07/02→					
2.0 HDi 135	100	03/06→					
2.2	116	07/02→					
2.2 HDi	94	07/02→					
2.0 HDi	88	07/06→	←	02/07→ 07/14	13.0460-2863.2	602863	TRW 20261 19,0 + WK + Zub
			→	02/07→ 07/14	13.0460-2819.2	602819	TRW 20961 17,2 - WK
2.0 HDi 165	120	03/06→	←	→ 07/14	13.0460-2752.2	602752	TRW 24839 19,4 + WK + Zub
2.2 HDi	120	06/07→					
2.2 HDi	125	06/06→	→	→ 07/14	13.0460-2819.2	602819	TRW 20961 17,2 - WK
3.0 V6	150	07/02→	←	→ 07/14	13.0460-4995.2	604995	BRE 23575 15,6 + WK
			→	→ 07/14	13.0460-2819.2	602819	TRW 20961 17,2 - WK

Zubehörsatz, Scheibenbremsbelag

2.0	100	07/02→	→	→ 07/14	13.0460-0072.2	610072	TRW
2.0 16V	103	09/05→					
2.0 16V	104	09/05→					
2.0 HDi	79	07/02→					
2.0 HDi	80	07/02→					
2.0 HDi	81	07/02→					
2.0 HDi 135	100	03/06→					
2.0 HDi 165	120	03/06→					
2.2	116	07/02→					
2.2 HDi	94	07/02→					
2.2 HDi	120	06/07→					
2.2 HDi	125	06/06→					
3.0 V6	150	07/02→					
2.0 HDi	88	07/06→	→	02/07→ 07/14	13.0460-0072.2	610072	TRW

Bremsscheibe

2.0	100	07/02→	←	→ 07/14	24.0128-0136.1	428136	Ø 285 28 26 V
2.0 16V	103	09/05→			24.0328-0136.1	528136	Ø 285 28 26 V PD
2.0 16V	104	09/05→					
2.0 HDi	79	07/02→	→	→ 07/14	24.0112-0156.1	412156	Ø 272 12 10
2.0 HDi	80	07/02→					
2.0 HDi	81	07/02→					
2.0 HDi 135	100	03/06→					
2.2	116	07/02→					
2.2 HDi	94	07/02→					
2.0 HDi	88	07/06→	←	02/07→ 07/14	24.0128-0136.1	428136	Ø 285 28 26 V
			→	02/07→ 07/14	24.0328-0136.1	528136	Ø 285 28 26 V PD
					24.0112-0156.1	412156	Ø 272 12 10
2.0 HDi 165	120	03/06→	←	→ 07/14	24.0132-0126.1	432126	Ø 310 32 30 V
2.2 HDi	120	06/07→					
2.2 HDi	125	06/06→	→	→ 07/14	24.0112-0156.1	412156	Ø 272 12 10
3.0 V6	150	07/02→					















CITROËN - C15 (VD-_) 10/84→10/06













Bremsbelagsatz, Scheibenbremse











1.0	33	10/84→12/97	←	Orga 04196→	13.0460-2825.2	602825	TRW 21614 17,7 + WK
1.0 E	37	11/92→07/96					
1.1	35	10/84→12/96					
1.1	40	11/88→07/96					
1.1 i	44	07/88→12/96					
1.4	49	07/87→12/96	←	07/96→	13.0460-2825.2	602825	TRW 21614 17,7 + WK
1.4 E	40	07/87→12/96					
1.4 E	44	05/87→12/96					
1.4 i	55	05/91→12/96					
1.8 D	44	07/86→12/00	←		13.0460-2825.2	602825	TRW 21614 17,7 + WK
1.9 D	44	12/00→12/05	←		13.0460-3952.2	603952	BDX 20905 18,0 + WK
1.9 D	51	10/00→10/02					











Zubehörsatz, Scheibenbremsbelag









1.0	33	10/84→12/97	←	Orga 04196→	13.0460-0060.2	610060	TRW
1.0 E	37	11/92→07/96					
1.1	35	10/84→12/96					
1.1	40	11/88→07/96					
1.1 i	44	07/88→12/96					
1.4	49	07/87→12/96	←	07/96→	13.0460-0060.2	610060	TRW
1.4 E	40	07/87→12/96					
1.4 E	44	05/87→12/96					
↓							









	kW					! #		
CITROËN - C15 (VD_) 10/84→10/06								
Zubehörsatz, Scheibenbremsbelag								
1.4 i	55	05/91→12/96	←	07/96→			13.0460-0060.2 610060	TRW
1.8 D	44	07/86→12/00	←				13.0460-0060.2 610060	TRW
1.9 D	44	12/00→12/05	←				13.0460-0403.2 610403	BDX
1.9 D	51	10/00→10/02						
 Bremsscheibe								
1.0	33	10/84→12/97	←	→Orga 04195			24.0109-0108.1 409108	Ø 244,5 9 7
1.0 E	37	11/92→07/96						
1.1	35	10/84→12/96	←	Orga 04196→			24.0110-0187.1 410187	Ø 247 10 9 + S
1.1	40	11/88→07/96						
1.1 i	44	07/88→12/96						
1.4	49	07/87→12/96						
1.4 E	40	07/87→12/96						
1.4 E	44	05/87→12/96						
1.4 i	55	05/91→12/96						
1.8 D	44	07/86→12/00	←				24.0110-0187.1 410187	Ø 247 10 9 + S
1.9 D	44	12/00→12/05						
1.9 D	51	10/00→10/02						
CITROËN - C15 Kombi 04/87→08/00								
 Bremsbelagsatz, Scheibenbremse								
1.1	44	08/88→07/96	←				13.0460-2825.2 602825	TRW 21614 17,7 + WK
1.4	55	05/91→07/96						
1.8 D	44	04/87→08/00						
Zubehörsatz, Scheibenbremsbelag								
1.1	44	08/88→07/96	←				13.0460-0060.2 610060	TRW
1.4	55	05/91→07/96						
1.8 D	44	04/87→08/00						
 Bremsscheibe								
1.1	44	08/88→07/96	←				24.0110-0187.1 410187	Ø 247 10 9 + S
1.8 D	44	04/87→08/00						
1.4	55	05/91→07/96	←	→Orga 04195			24.0109-0108.1 409108	Ø 244,5 9 7
			←	Orga 04196→			24.0110-0187.1 410187	Ø 247 10 9 + S
CITROËN - C-CROSSER (EP_) 02/07→								
 Bremsbelagsatz, Scheibenbremse								
2.0	108	11/10→	←	→ 01/13			13.0460-5958.2 605958	AKE 21363 15,8 + WK
2.0 Allrad	108	11/10→	→	→ 01/13			13.0460-5855.2 605855	23582 16,0 - WK
2.2 HDi	115	02/07→						
2.4 16V	125	08/08→						
Zubehörsatz, Scheibenbremsbelag								
2.0	108	11/10→	←	→ 01/13			13.0460-0235.2 610235	
2.0 Allrad	108	11/10→	→	→ 01/13			13.0460-0137.2 610137	
2.2 HDi	115	02/07→						
2.4 16V	125	08/08→						
 Bremsscheibe								
2.0	108	11/10→	←	→ 01/13			24.0124-0215.1 424215	Ø 294 24 22,4 V
2.0 Allrad	108	11/10→	→	→ 01/13			24.0110-0360.1 410360	Ø 302 10 8,4
2.2 HDi	115	02/07→	←	→ 01/13			24.0124-0215.1 424215	Ø 294 24 22,4 V
2.4 16V	125	08/08→	→	→ 01/13			24.0110-0330.1 410330	Ø 302 10 8
CITROËN - C-CROSSER ENTERPRISE 01/09→								
 Bremsbelagsatz, Scheibenbremse								
2.2 HDi	115	01/09→	←	→ 01/13			13.0460-5958.2 605958	AKE 21363 15,8 + WK
2.4 16V	125	01/09→	→	→ 01/13			13.0460-5855.2 605855	23582 16,0 - WK
Zubehörsatz, Scheibenbremsbelag								
2.2 HDi	115	01/09→	←	→ 01/13			13.0460-0235.2 610235	
2.4 16V	125	01/09→	→	→ 01/13			13.0460-0137.2 610137	
 Bremsscheibe								
2.2 HDi	115	01/09→	←	→ 01/13			24.0124-0215.1 424215	Ø 294 24 22,4 V
2.4 16V	125	01/09→	→	→ 01/13			24.0110-0330.1 410330	Ø 302 10 8











	kW			 	! #		
CITROËN - C-ELYSEE 11/12→							
 Bremsbelagsatz, Scheibenbremse							
1.2 VTi 72	53	11/12→	←			13.0460-3867.2 603867	MAN 25250 18,9 - WE / - WK + Zub
1.2 VTi 82	60	12/14→					
1.6 BlueHDi 100	73	11/14→	←	V		13.0460-3994.2 603994	BOS 23599 19,0 - WE / - WK + Zub
1.6 HDi 92	68	11/12→					
1.6 VTi 115	85	11/12→				13.0470-3994.2 LD3994	BOS 23599 19,0 - WE / - WK + Zub Ceramic
 Bremsscheibe							
1.2 VTi 72	53	11/12→	←			24.0113-0184.1 413184	Ø 266 13 11 + S
1.2 VTi 82	60	12/14→					
1.6 BlueHDi 100	73	11/14→				24.0122-0194.1 422194	Ø 266 22 20 V + S
1.6 HDi 92	68	11/12→					
1.6 VTi 115	85	11/12→				24.0313-0184.1 513184	Ø 266 13 11 + S PD
CITROËN - C-ZERO 10/10→							
 Bremsbelagsatz, Scheibenbremse							
C-Zero	35	10/10→	←			13.0460-5621.2 605621	24423 14,6 + WK
C-Zero	47	10/10→					
C-Zero	49	10/14→					
 Bremsscheibe							
C-Zero	35	10/10→	←			24.0117-0110.1 417110	Ø 257 17 15 V
C-Zero	47	10/10→					
C-Zero	49	10/14→					
CITROËN - DS3 11/09→07/15							
 Bremsbelagsatz, Scheibenbremse							
1.2 THP 110	81	10/14→03/15	←	für Bremsscheibendurchmesser [mm]: 283		13.0460-3855.2 603855	BOS 24883 18,0 - WE / - WK + Zub
1.6 BlueHDi 100	73	07/14→07/15					
1.6 BlueHDi 75	55	03/15→07/15	←	für Bremsscheibendurchmesser [mm]: 266		13.0460-3994.2 603994	BOS 23599 19,0 - WE / - WK + Zub
1.6 HDi 110	82	11/09→07/15					
1.6 THP 165	121	10/14→06/15				13.0470-3994.2 LD3994	BOS 23599 19,0 - WE / - WK + Zub Ceramic
1.6 VTi 120	88	04/10→07/15	→				
						13.0460-2740.2 602740	TRW 23554 17,0 - WE / - WK + Zub
						13.0470-2740.2 LD2740	TRW 23554 17,0 - WE / - WK + Zub Ceramic
1.2 VTi 82	60	01/13→03/15	←			13.0460-3994.2 603994	BOS 23599 19,0 - WE / - WK + Zub
1.4 HDi 70	50	04/10→07/15					
1.4 VTi 95	70	04/10→07/15				13.0470-3994.2 LD3994	BOS 23599 19,0 - WE / - WK + Zub Ceramic
1.4 VTi 95 LPG	70	08/12→07/15					
1.4 VTi 98	72	11/09→07/15	←	04/10→		13.0460-3994.2 603994	BOS 23599 19,0 - WE / - WK + Zub
						13.0470-3994.2 LD3994	BOS 23599 19,0 - WE / - WK + Zub Ceramic
1.6	120	01/12→07/15	←	10/14→; für Bremsscheibendurchmesser [mm]: 283		13.0460-3855.2 603855	BOS 24883 18,0 - WE / - WK + Zub
			←	10/14→; für Bremsscheibendurchmesser [mm]: 266		13.0460-3994.2 603994	BOS 23599 19,0 - WE / - WK + Zub
			→	10/14→		13.0470-3994.2 LD3994	BOS 23599 19,0 - WE / - WK + Zub Ceramic
						13.0460-2740.2 602740	TRW 23554 17,0 - WE / - WK + Zub
						13.0470-2740.2 LD2740	TRW 23554 17,0 - WE / - WK + Zub Ceramic
1.6 BlueHDi 120	88	10/13→07/15	←			13.0460-3855.2 603855	BOS 24883 18,0 - WE / - WK + Zub
1.6 HDi 115	84	08/12→07/15					
1.6 HDi 115	85	10/13→07/15	→				
1.6 THP 155	115	04/10→07/15				13.0460-2740.2 602740	TRW 23554 17,0 - WE / - WK + Zub
						13.0470-2740.2 LD2740	TRW 23554 17,0 - WE / - WK + Zub Ceramic
1.6 HDi 90	68	11/09→07/15	←			13.0460-3855.2 603855	BOS 24883 18,0 - WE / - WK + Zub
						13.0460-3994.2 603994	BOS 23599 19,0 - WE / - WK + Zub
						13.0470-3994.2 LD3994	BOS 23599 19,0 - WE / - WK + Zub Ceramic
1.6 Racing	147	02/11→07/15	→			13.0460-2740.2 602740	TRW 23554 17,0 - WE / - WK + Zub
1.6 Racing ↓	152	02/11→07/15					











	kw			 	! #			
CITROËN - DS3 11/09→07/15								
 Bremsbelagsatz, Scheibenbremse								
1.6 Racing 1.6 Racing	147 152	02/11→07/15 02/11→07/15	→			13.0470-2740.2 LD2740	TRW 23554 17,0 - WE / - WK + Zub Ceramic	
1.6 THP 150	110	01/10→07/15	←	04/10→		13.0460-3855.2 603855	BOS 24883 18,0 - WE / - WK + Zub	
			→	04/10→		13.0460-2740.2 602740	TRW 23554 17,0 - WE / - WK + Zub	
						13.0470-2740.2 LD2740	TRW 23554 17,0 - WE / - WK + Zub Ceramic	
 Bremsscheibe								
1.2 THP 110 1.6 BlueHDi 100 1.6 BlueHDi 75 1.6 HDi 110 1.6 THP 165	81 73 55 82 121	10/14→03/15 07/14→07/15 03/15→07/15 11/09→07/15 10/14→06/15	←			24.0122-0194.1 422194 24.0126-0120.1 426120 24.0326-0120.1 526120 24.0109-0100.2 409100	∅ 266 22 20 V + S ∅ 283 26 24 V + S ∅ 283 26 24 V + S PD ∅ 249 9 7 + LG / + ABS Ring	
1.2 VTi 82 1.4 HDi 70 1.4 VTi 95 1.4 VTi 95 LPG 1.4 VTi 98	60 50 70 70 72	01/13→03/15 04/10→07/15 04/10→07/15 08/12→07/15 11/09→07/15	←			24.0122-0194.1 422194 24.0122-0194.1 422194 24.0122-0194.1 422194	∅ 266 22 20 V + S ∅ 266 22 20 V + S	
1.6	120	01/12→07/15	←	10/14→		24.0122-0194.1 422194 24.0126-0120.1 426120 24.0326-0120.1 526120	∅ 266 22 20 V + S ∅ 283 26 24 V + S ∅ 283 26 24 V + S PD	
			→	10/14→		24.0109-0100.2 409100	∅ 249 9 7 + LG / + ABS Ring	
1.6 BlueHDi 120 1.6 HDi 115 1.6 HDi 115 1.6 THP 155 1.6 VTi 120 1.6 HDi 90	88 84 85 115 88 68	10/13→07/15 08/12→07/15 10/13→07/15 04/10→07/15 04/10→07/15 11/09→07/15	←			24.0126-0120.1 426120 24.0326-0120.1 526120 24.0109-0100.2 409100 24.0122-0194.1 422194 24.0126-0120.1 426120 24.0326-0120.1 526120	∅ 283 26 24 V + S ∅ 283 26 24 V + S PD ∅ 249 9 7 + LG / + ABS Ring ∅ 266 22 20 V + S ∅ 283 26 24 V + S ∅ 283 26 24 V + S PD	
1.6 Racing 1.6 Racing 1.6 THP 150	147 152 110	02/11→07/15 02/11→07/15 01/10→07/15	→			24.0109-0100.2 409100 24.0126-0120.1 426120 24.0326-0120.1 526120 24.0109-0100.2 409100	∅ 249 9 7 + LG / + ABS Ring ∅ 283 26 24 V + S ∅ 283 26 24 V + S PD ∅ 249 9 7 + LG / + ABS Ring	
CITROËN - DS3 Cabriolet 01/13→07/15								
 Bremsbelagsatz, Scheibenbremse								
1.2 THP 110 1.6 BlueHDi 100 1.6 BlueHDi 115 1.6 THP 165	81 73 85 121	10/14→07/15 07/14→07/15 10/13→07/15 10/14→07/15	←	für Bremsscheibendurchmesser [mm]: 283		13.0460-3855.2 603855 13.0460-3994.2 603994 13.0470-3994.2 LD3994	BOS 24883 18,0 - WE / - WK + Zub BOS 23599 19,0 - WE / - WK + Zub BOS 23599 19,0 - WE / - WK + Zub Ceramic	
			→			13.0460-2740.2 602740 13.0470-2740.2 LD2740	TRW 23554 17,0 - WE / - WK + Zub TRW 23554 17,0 - WE / - WK + Zub Ceramic	
1.2 VTi 82 1.6 HDi 90	60 69	01/13→07/15 01/13→07/15	←	03/13→		13.0460-3994.2 603994 13.0470-3994.2 LD3994	BOS 23599 19,0 - WE / - WK + Zub BOS 23599 19,0 - WE / - WK + Zub Ceramic	
1.6 BlueHDi 120	88	07/14→07/15	←			13.0460-3855.2 603855	BOS 24883 18,0 - WE / - WK + Zub	
			→			13.0460-2740.2 602740 13.0470-2740.2 LD2740	TRW 23554 17,0 - WE / - WK + Zub TRW 23554 17,0 - WE / - WK + Zub Ceramic	
1.6 Racing	152	03/14→07/15	→			13.0460-2740.2 602740 13.0470-2740.2 LD2740	TRW 23554 17,0 - WE / - WK + Zub TRW 23554 17,0 - WE / - WK + Zub Ceramic	
1.6 THP 150 1.6 THP 155 1.6 VTi 120	110 115 88	01/13→07/15 01/13→07/15 01/13→07/15	←	03/13→		13.0460-3855.2 603855 13.0460-2740.2 602740	BOS 24883 18,0 - WE / - WK + Zub TRW 23554 17,0 - WE / - WK + Zub	
			→	03/13→				









	kw			 	! #		
CITROËN - DS3 Cabriolet 01/13→07/15							
 Bremsbelagsatz, Scheibenbremse							
1.6 THP 150 1.6 THP 155 1.6 VTi 120	110 115 88	01/13→07/15 01/13→07/15 01/13→07/15	➡	03/13→		13.0470-2740.2 LD2740	TRW 23554 17,0 - WE / - WK + Zub Ceramic
 Bremsscheibe							
1.2 THP 110 1.6 BlueHDi 100 1.6 BlueHDi 115 1.6 THP 165	81 73 85 121	10/14→07/15 07/14→07/15 10/13→07/15 10/14→07/15	←			24.0122-0194.1 422194 24.0126-0120.1 426120 24.0326-0120.1 526120	∅ 266 22 20 V + S ∅ 283 26 24 V + S ∅ 283 26 24 V + S PD
			➡			24.0109-0100.2 409100	∅ 249 9 7 + LG / + ABS Ring
1.2 VTi 82 1.6 HDi 90	60 69	01/13→07/15 01/13→07/15	←	03/13→		24.0122-0194.1 422194	∅ 266 22 20 V + S
1.6 BlueHDi 120	88	07/14→07/15	←			24.0126-0120.1 426120 24.0326-0120.1 526120	∅ 283 26 24 V + S ∅ 283 26 24 V + S PD
			➡			24.0109-0100.2 409100	∅ 249 9 7 + LG / + ABS Ring
1.6 Racing	152	03/14→07/15	➡			24.0109-0100.2 409100	∅ 249 9 7 + LG / + ABS Ring
1.6 THP 150 1.6 THP 155 1.6 VTi 120	110 115 88	01/13→07/15 01/13→07/15 01/13→07/15	←	03/13→		24.0126-0120.1 426120 24.0326-0120.1 526120	∅ 283 26 24 V + S ∅ 283 26 24 V + S PD
			➡	03/13→		24.0109-0100.2 409100	∅ 249 9 7 + LG / + ABS Ring
CITROËN - DS4 04/11→07/15							
 Bremsbelagsatz, Scheibenbremse							
1.2 THP 130 1.6 BlueHDi 115 1.6 BlueHDi 120	96 85 88	07/14→07/15 08/14→07/15 07/14→07/15	←			13.0460-7229.2 607229 13.0470-7229.2 LD7229	ATE 24538 18,5 - WE / - WK ATE 24538 18,5 - WE / - WK Ceramic
			➡			13.0460-2761.2 602761	TRW 24922 17,5 - WK + Zub
1.6 HDi 110 1.6 HDi 110 1.6 HDi 115 1.6 HDi 90 1.6 THP 155 1.6 VTi 120	81 82 84 68 115 88	04/11→07/15 04/11→07/15 08/12→07/15 05/11→07/15 04/11→07/15 04/11→07/15	←			13.0460-7229.2 607229 13.0470-7229.2 LD7229	ATE 24538 18,5 - WE / - WK ATE 24538 18,5 - WE / - WK Ceramic
			➡	+ eFSB		13.0460-2761.2 602761	TRW 24922 17,5 - WK + Zub
			➡	- eFSB		13.0460-2775.2 602775	TRW 23554 16,4 - WE / - WK + Zub
1.6 THP 160	120	04/12→07/15	←			13.0460-7230.2 607230 13.0470-7230.2 LD7230	ATE 24557 19,4 - WE / - WK ATE 24557 19,4 - WE / - WK Ceramic
			➡	+ eFSB		13.0460-2761.2 602761	TRW 24922 17,5 - WK + Zub
			➡	- eFSB		13.0460-2775.2 602775	TRW 23554 16,4 - WE / - WK + Zub
1.6 THP 165	121	01/12→07/15	←	04/12→		13.0460-7230.2 607230 13.0470-7230.2 LD7230	ATE 24557 19,4 - WE / - WK ATE 24557 19,4 - WE / - WK Ceramic
			➡	04/12→; + eFSB		13.0460-2761.2 602761	TRW 24922 17,5 - WK + Zub
			➡	04/12→; - eFSB		13.0460-2775.2 602775	TRW 23554 16,4 - WE / - WK + Zub
1.6 THP 200	147	04/11→07/15	←			13.0460-7279.2 607279	ATE 25069 17,3 + WK
			➡	+ eFSB		13.0460-2761.2 602761	TRW 24922 17,5 - WK + Zub
			➡			13.0460-2775.2 602775	TRW 23554 16,4 - WE / - WK + Zub
2.0 BlueHDi 150	110	07/14→07/15	←			13.0460-7230.2 607230 13.0470-7230.2 LD7230	ATE 24557 19,4 - WE / - WK ATE 24557 19,4 - WE / - WK Ceramic
			➡			13.0460-2761.2 602761	TRW 24922 17,5 - WK + Zub
2.0 BlueHDi 180 2.0 HDi / BlueHDi 135	133 100	07/14→07/15 09/11→07/15	←	nicht für Felgenreöße [Zoll]: 19		13.0460-7230.2 607230 13.0470-7230.2 LD7230	ATE 24557 19,4 - WE / - WK ATE 24557 19,4 - WE / - WK Ceramic
			←	passend für Felgenreöße [Zoll]: 19		13.0460-7279.2 607279	ATE 25069 17,3 + WK
			➡	+ eFSB		13.0460-2761.2 602761	TRW 24922 17,5 - WK + Zub
			➡	- eFSB		13.0460-2775.2 602775	TRW 23554 16,4 - WE / - WK + Zub
2.0 HDi 165	120	04/11→07/15	←			13.0460-7229.2 607229 13.0470-7229.2 LD7229	ATE 24538 18,5 - WE / - WK ATE 24538 18,5 - WE / - WK Ceramic
			←	nicht für Felgenreöße [Zoll]: 19		13.0460-7230.2 607230 13.0470-7230.2 LD7230	ATE 24557 19,4 - WE / - WK ATE 24557 19,4 - WE / - WK Ceramic











	kw			 	! #		
CITROËN - DS4 04/11→07/15							
 Bremsbelagsatz, Scheibenbremse							
2.0 HDi 165	120	04/11→07/15	←	passend für Felgengröße [Zoll]: 19		13.0460-7279.2 607279	ATE 25069 17,3 + WK
			→	+ eFSB		13.0460-2761.2 602761	TRW 24922 17,5 - WK + Zub
			→	- eFSB		13.0460-2775.2 602775	TRW 23554 16,4 - WE / - WK + Zub
 Bremsscheibe							
1.2 THP 130	96	07/14→07/15	←			24.0126-0120.1 426120	Ø 283 26 24 V + S
1.6 BlueHDi 115	85	08/14→07/15				24.0326-0120.1 526120	Ø 283 26 24 V + S PD
1.6 BlueHDi 120	88	07/14→07/15	→	nicht für Felgengröße [Zoll]: 19		24.0112-0194.2 412194	Ø 268 12 10 + LG / + ABS Ring
			→	passend für Felgengröße [Zoll]: 19		24.0112-0198.1 412198	Ø 290 12 10 + S
1.6 HDi 110	81	04/11→07/15	←			24.0126-0120.1 426120	Ø 283 26 24 V + S
1.6 HDi 110	82	04/11→07/15				24.0326-0120.1 526120	Ø 283 26 24 V + S PD
1.6 HDi 115	84	08/12→07/15	→	- eFSB		24.0109-0171.2 409171	Ø 249 9 8 + LG / + ABS Ring
1.6 HDi 90	68	05/11→07/15	→	+ eFSB; nicht für Felgengröße [Zoll]: 19		24.0112-0194.2 412194	Ø 268 12 10 + LG / + ABS Ring
1.6 VTi 120	88	04/11→07/15	→	+ eFSB; passend für Felgengröße [Zoll]: 19		24.0112-0198.1 412198	Ø 290 12 10 + S
1.6 THP 155	115	04/11→07/15	←			24.0126-0120.1 426120	Ø 283 26 24 V + S
						24.0326-0120.1 526120	Ø 283 26 24 V + S PD
			→	+ eFSB; nicht für Felgengröße [Zoll]: 19		24.0112-0194.2 412194	Ø 268 12 10 + LG / + ABS Ring
			→	+ eFSB; passend für Felgengröße [Zoll]: 19		24.0112-0198.1 412198	Ø 290 12 10 + S
1.6 THP 160	120	04/12→07/15	←			24.0126-0159.1 426159	Ø 302 26 24 V + S
			→	- eFSB		24.0109-0171.2 409171	Ø 249 9 8 + LG / + ABS Ring
			→	+ eFSB; nicht für Felgengröße [Zoll]: 19		24.0112-0194.2 412194	Ø 268 12 10 + LG / + ABS Ring
			→	+ eFSB; passend für Felgengröße [Zoll]: 19		24.0112-0198.1 412198	Ø 290 12 10 + S
1.6 THP 165	121	01/12→07/15	←	04/12→		24.0126-0159.1 426159	Ø 302 26 24 V + S
			→	04/12→; - eFSB		24.0109-0171.2 409171	Ø 249 9 8 + LG / + ABS Ring
			→	04/12→; + eFSB; nicht für Felgengröße [Zoll]: 19		24.0112-0194.2 412194	Ø 268 12 10 + LG / + ABS Ring
			→	04/12→; + eFSB; passend für Felgengröße [Zoll]: 19		24.0112-0198.1 412198	Ø 290 12 10 + S
1.6 THP 200	147	04/11→07/15	←			24.0130-0230.1 430230	Ø 340 30 28 V + S
			→	- eFSB		24.0109-0171.2 409171	Ø 249 9 8 + LG / + ABS Ring
			→	+ eFSB; nicht für Felgengröße [Zoll]: 19		24.0112-0194.2 412194	Ø 268 12 10 + LG / + ABS Ring
			→	+ eFSB; passend für Felgengröße [Zoll]: 19		24.0112-0198.1 412198	Ø 290 12 10 + S
2.0 BlueHDi 150	110	07/14→07/15	←			24.0126-0159.1 426159	Ø 302 26 24 V + S
			→	nicht für Felgengröße [Zoll]: 19		24.0112-0194.2 412194	Ø 268 12 10 + LG / + ABS Ring
			→	passend für Felgengröße [Zoll]: 19		24.0112-0198.1 412198	Ø 290 12 10 + S
2.0 BlueHDi 180	133	07/14→07/15	←	nicht für Felgengröße [Zoll]: 19		24.0126-0159.1 426159	Ø 302 26 24 V + S
			←	passend für Felgengröße [Zoll]: 19		24.0130-0230.1 430230	Ø 340 30 28 V + S
			→	- eFSB		24.0109-0171.2 409171	Ø 249 9 8 + LG / + ABS Ring
			→	nicht für Felgengröße [Zoll]: 19		24.0112-0194.2 412194	Ø 268 12 10 + LG / + ABS Ring
			→	passend für Felgengröße [Zoll]: 19		24.0112-0198.1 412198	Ø 290 12 10 + S
2.0 HDi / BlueHDi 135	100	09/11→07/15	←	nicht für Felgengröße [Zoll]: 19		24.0126-0159.1 426159	Ø 302 26 24 V + S
			←	passend für Felgengröße [Zoll]: 19		24.0130-0230.1 430230	Ø 340 30 28 V + S
			→	- eFSB		24.0109-0171.2 409171	Ø 249 9 8 + LG / + ABS Ring
			→	+ eFSB; nicht für Felgengröße [Zoll]: 19		24.0112-0194.2 412194	Ø 268 12 10 + LG / + ABS Ring
			→	+ eFSB; passend für Felgengröße [Zoll]: 19		24.0112-0198.1 412198	Ø 290 12 10 + S
2.0 HDi 165	120	04/11→07/15	←			24.0126-0120.1 426120	Ø 283 26 24 V + S
						24.0326-0120.1 526120	Ø 283 26 24 V + S PD
			←	nicht für Felgengröße [Zoll]: 19		24.0126-0159.1 426159	Ø 302 26 24 V + S
			←	passend für Felgengröße [Zoll]: 19		24.0130-0230.1 430230	Ø 340 30 28 V + S
			→	+ eFSB; nicht für Felgengröße [Zoll]: 19		24.0112-0194.2 412194	Ø 268 12 10 + LG / + ABS Ring
			→	+ eFSB; passend für Felgengröße [Zoll]: 19		24.0112-0198.1 412198	Ø 290 12 10 + S

	kw			 	! #		
CITROËN - DS5 11/11→07/15							
 Bremsbelagsatz, Scheibenbremse							
1.6 BlueHDi 120 1.6 HDi	88 85	07/14→07/15 11/13→07/15	←	Nabdurchmesser [mm]: 82		13.0460-7229.2 607229 13.0470-7229.2 LD7229	ATE 24538 18,5 - WE / - WK ATE 24538 18,5 - WE / - WK Ceramic
			→	Nabdurchmesser [mm]: 82		13.0460-2761.2 602761	TRW 24922 17,5 - WK + Zub
1.6 HDi 110	82	11/11→07/15	←	Orga 13343→; Nabdurchmesser [mm]: 82		13.0460-7229.2 607229 13.0470-7229.2 LD7229	ATE 24538 18,5 - WE / - WK ATE 24538 18,5 - WE / - WK Ceramic
			←	→Orga 13342; Nabdurchmesser [mm]: 82		13.0460-7230.2 607230 13.0470-7230.2 LD7230	ATE 24557 19,4 - WE / - WK ATE 24557 19,4 - WE / - WK Ceramic
			←	Nabdurchmesser [mm]: 83		13.0460-7279.2 607279	ATE 25069 17,3 + WK
			→	Nabdurchmesser [mm]: 82		13.0460-2761.2 602761	TRW 24922 17,5 - WK + Zub
1.6 HDi 115	84	06/12→07/15	←	Orga 13343→; Nabdurchmesser [mm]: 82		13.0460-7229.2 607229 13.0470-7229.2 LD7229	ATE 24538 18,5 - WE / - WK ATE 24538 18,5 - WE / - WK Ceramic
			←	08/12→; →Orga 13342; Nabdurchmesser [mm]: 82		13.0460-7230.2 607230 13.0470-7230.2 LD7230	ATE 24557 19,4 - WE / - WK ATE 24557 19,4 - WE / - WK Ceramic
			←	08/12→; Nabdurchmesser [mm]: 83		13.0460-7279.2 607279	ATE 25069 17,3 + WK
			→	08/12→; Nabdurchmesser [mm]: 82		13.0460-2761.2 602761	TRW 24922 17,5 - WK + Zub
1.6 THP 150 1.6 THP 155 1.6 THP 165 1.6 THP 165 Hybrid 1.6 THP 200 1.6 THP 210 2.0 BlueHDi 150 2.0 BlueHDi 180 2.0 HDi 135 2.0 HDi 150 Hybrid 2.0 HDi 165 2.0 HDi 165 Hybrid4 4x4 2.0 HDi 200 Hybrid4	110 115 121 121 147 155 110 133 100 110 120 120 147	11/11→07/15 11/11→07/15 01/12→07/15 06/12→07/15 11/11→07/15 11/14→07/15 07/14→07/15 08/13→07/15 11/11→07/15 11/11→07/15 11/11→07/15 12/11→07/15 12/11→07/15	←	Nabdurchmesser [mm]: 82		13.0460-7230.2 607230 13.0470-7230.2 LD7230	ATE 24557 19,4 - WE / - WK ATE 24557 19,4 - WE / - WK Ceramic
			←	Nabdurchmesser [mm]: 83		13.0460-7279.2 607279	ATE 25069 17,3 + WK
			→	Nabdurchmesser [mm]: 82		13.0460-2761.2 602761	TRW 24922 17,5 - WK + Zub
 Bremsscheibe							
1.6 BlueHDi 120 1.6 HDi	88 85	07/14→07/15 11/13→07/15	←			24.0126-0120.1 426120	Ø 283 26 24 V + S
			→			24.0112-0194.2 412194	Ø 268 12 10 + LG / + ABS Ring
1.6 HDi 110	82	11/11→07/15	←	Orga 13343→		24.0126-0120.1 426120	Ø 283 26 24 V + S
			←	→Orga 13342; Nabdurchmesser [mm]: 82		24.0126-0159.1 426159	Ø 302 26 24 V + S
			←	Nabdurchmesser [mm]: 83		24.0130-0230.1 430230	Ø 340 30 28 V + S
			→			24.0112-0194.2 412194	Ø 268 12 10 + LG / + ABS Ring
1.6 HDi 115	84	06/12→07/15	←	Orga 13343→		24.0126-0120.1 426120	Ø 283 26 24 V + S
			←	08/12→; →Orga 13342; Nabdurchmesser [mm]: 82		24.0126-0159.1 426159	Ø 302 26 24 V + S
			←	08/12→; Nabdurchmesser [mm]: 83		24.0130-0230.1 430230	Ø 340 30 28 V + S
			→	08/12→		24.0112-0194.2 412194	Ø 268 12 10 + LG / + ABS Ring
1.6 THP 150 1.6 THP 155 1.6 THP 165 1.6 THP 165 Hybrid 2.0 BlueHDi 150 2.0 HDi 135 2.0 HDi 150 Hybrid 2.0 HDi 165	110 115 121 121 110 100 110 120	11/11→07/15 11/11→07/15 01/12→07/15 06/12→07/15 07/14→07/15 11/11→07/15 11/11→07/15 11/11→07/15	←	Nabdurchmesser [mm]: 82		24.0126-0159.1 426159	Ø 302 26 24 V + S
			←	Nabdurchmesser [mm]: 83		24.0130-0230.1 430230	Ø 340 30 28 V + S
			→			24.0112-0194.2 412194	Ø 268 12 10 + LG / + ABS Ring
1.6 THP 200 2.0 HDi 200 Hybrid4	147 147	11/11→07/15 12/11→07/15	←	Nabdurchmesser [mm]: 82		24.0126-0159.1 426159	Ø 302 26 24 V + S
			←	Nabdurchmesser [mm]: 83		24.0130-0230.1 430230	Ø 340 30 28 V + S
			→			24.0112-0198.1 412198	Ø 290 12 10 + S
1.6 THP 210	155	11/14→07/15	←			24.0126-0120.1 426120	Ø 283 26 24 V + S
			←	Nabdurchmesser [mm]: 83		24.0130-0230.1 430230	Ø 340 30 28 V + S
			→			24.0112-0198.1 412198	Ø 290 12 10 + S
2.0 BlueHDi 180	133	08/13→07/15	←	Nabdurchmesser [mm]: 82		24.0126-0159.1 426159	Ø 302 26 24 V + S
			←	Nabdurchmesser [mm]: 83		24.0130-0230.1 430230	Ø 340 30 28 V + S
			→			24.0112-0194.2 412194 24.0112-0198.1 412198	Ø 268 12 10 + LG / + ABS Ring Ø 290 12 10 + S
↓							









	kw					! #		
CITROËN - DS5 11/11→07/15								
 Bremsscheibe								
2.0 HDi 165 Hybrid4 4x4	120	12/11→07/15	←	Nabendurchmesser [mm]: 82		24.0126-0159.1	426159	Ø 302 26 24 V + S
			→			24.0112-0198.1	412198	Ø 290 12 10 + S
CITROËN - EVASION (22, U6) 06/94→07/02								
 Bremselagsatz, Scheibenbremse								
1.8	73	05/97→07/02	←			13.0460-3957.2	603957	BDX 23042 19,0 + WK + Zub
			→	+ ABS		13.0460-7061.2	607061	ATE 21275 17,0 + WK
1.8	76	02/96→12/96	←	V		13.0460-3957.2	603957	BDX 23042 19,0 + WK + Zub
			→	+ ABS		13.0460-7061.2	607061	ATE 21275 17,0 + WK
1.9 TD	66	11/94→07/02	←	02/95→		13.0460-2978.2	602978	TRW 21801 19,0 + WK
			→	02/95→; + ABS		13.0460-7061.2	607061	ATE 21275 17,0 + WK
1.9 TD	68	10/95→12/98	←			13.0460-2978.2	602978	TRW 21801 19,0 + WK
2.0	89	06/94→07/02	→	+ ABS		13.0460-7061.2	607061	ATE 21275 17,0 + WK
2.0 HDI	80	08/99→07/02	→					
2.0 HDI 16V	80	09/99→07/02	→					
2.0 16V	97	05/98→04/00	←	12/98→		13.0460-2978.2	602978	TRW 21801 19,0 + WK
			→	12/98→		13.0460-7061.2	607061	ATE 21275 17,0 + WK
2.0 16V	100	05/00→07/02	←			13.0460-2978.2	602978	TRW 21801 19,0 + WK
2.0 Turbo C.T.	108	06/94→07/02	→					
2.1 TD	80	05/96→07/02	→			13.0460-7061.2	607061	ATE 21275 17,0 + WK
 Bremsscheibe								
1.8	73	05/97→07/02	←			24.0120-0155.1	420155	Ø 257,5 20 18,2 V
1.8	76	02/96→12/96	→	+ ABS		24.0110-0218.1	410218	Ø 295 10 8
1.9 TD	66	11/94→07/02	←	02/95→		24.0126-0104.1	426104	Ø 281 26 24,2 V
			→	02/95→; + ABS		24.0110-0218.1	410218	Ø 295 10 8
1.9 TD	68	10/95→12/98	←			24.0126-0104.1	426104	Ø 281 26 24,2 V
2.0	89	06/94→07/02	→	+ ABS		24.0110-0218.1	410218	Ø 295 10 8
2.0 HDI	80	08/99→07/02	→					
2.0 HDI 16V	80	09/99→07/02	→					
2.0 16V	97	05/98→04/00	←	12/98→		24.0126-0104.1	426104	Ø 281 26 24,2 V
			→	12/98→		24.0110-0218.1	410218	Ø 295 10 8
2.0 16V	100	05/00→07/02	←			24.0126-0104.1	426104	Ø 281 26 24,2 V
2.0 Turbo C.T.	108	06/94→07/02	→					
2.1 TD	80	05/96→07/02	→			24.0110-0218.1	410218	Ø 295 10 8
CITROËN - JUMPER Bus 04/06→								
 Bremselagsatz, Scheibenbremse								
2.0 BlueHDi 110	81	07/15→	←	Nutzlast 12Q/14Q; Nutzlast ab [kg] 1.200		13.0460-4807.2	604807	BRE 24468 19,1 + WK + Zub
2.0 BlueHDi 130	96	07/15→	←	Nutzlast bis [kg] 1.400				
2.0 BlueHDi 160	120	07/15→	←	Nutzlast leicht 16Q; Nutzlast [kg]: 1.600; nicht für erhöhte Nutzlast		13.0460-4809.2	604809	BRE 24468 19,1 + WK + Zub
			←	Nutzlast s. 16Q+ 20Q; Nutzlast ab [kg] 1.600 Nutzlast bis [kg] 2.000; für erhöhte Nutzlast		13.0460-4811.2	604811	BRE 24466 19,1 + WK + Zub
2.2 HDi 100	74	04/06→	←	Nutzlast 12Q/14Q; Nutzlast ab [kg] 1.200		13.0460-4807.2	604807	BRE 24468 19,1 + WK + Zub
2.2 HDi 110	81	07/11→	←	Nutzlast bis [kg] 1.400				
2.2 HDi 130	96	07/11→	←	Nutzlast leicht 16Q; Nutzlast [kg]: 1.600; nicht für erhöhte Nutzlast		13.0460-4809.2	604809	BRE 24468 19,1 + WK + Zub
3.0 HDi 180	130	07/11→	←	Nutzlast schwer 16Q; Nutzlast [kg]: 1.600; für erhöhte Nutzlast		13.0460-4810.2	604810	BRE 24466 19,1 + WK + Zub
			←	Nutzlast 20Q; Nutzlast [kg]: 2.000		13.0460-4811.2	604811	BRE 24466 19,1 + WK + Zub
			→			13.0460-4812.2	604812	BOS 24465 19,2 - WE / - WK + Zub
2.2 HDi 120	88	04/06→	←	Nutzlast 12Q/14Q; Nutzlast ab [kg] 1.200		13.0460-4807.2	604807	BRE 24468 19,1 + WK + Zub
3.0 HDi 155	115	07/10→	←	Nutzlast bis [kg] 1.400				
3.0 HDi 160	116	09/06→	←	Nutzlast leicht 16Q; Nutzlast [kg]: 1.600; nicht für erhöhte Nutzlast		13.0460-4809.2	604809	BRE 24468 19,1 + WK + Zub
			←	Nutzlast schwer 16Q; Nutzlast [kg]: 1.600; für erhöhte Nutzlast		13.0460-4810.2	604810	BRE 24466 19,1 + WK + Zub
			←	Nutzlast 20Q; Nutzlast [kg]: 2.000		13.0460-4811.2	604811	BRE 24466 19,1 + WK + Zub
			→	Nutzlast ab [kg] 1.200 Nutzlast bis [kg] 2.000; light/heavy		13.0460-4812.2	604812	BOS 24465 19,2 - WE / - WK + Zub
2.2 HDi 150	110	07/11→	←	Nutzlast 12Q/14Q; Nutzlast ab [kg] 1.200		13.0460-4807.2	604807	BRE 24468 19,1 + WK + Zub
				Nutzlast bis [kg] 1.400				
↓								





	kw			 	! #		
CITROËN - JUMPER Bus 04/06→							
 Bremsbelagsatz, Scheibenbremse							
2.2 HDi 150	110	07/11→	←	Nutzlast leicht 16Q; Nutzlast [kg]: 1.600; nicht für erhöhte Nutzlast	13.0460-4809.2	604809	BRE 24468 19,1 + WK + Zub
			←	Nutzlast schwer 16Q; Nutzlast [kg]: 1.600; für erhöhte Nutzlast	13.0460-4810.2	604810	BRE 24466 19,1 + WK + Zub
			←	Nutzlast 20Q; Nutzlast [kg]: 2.000	13.0460-4811.2	604811	BRE 24466 19,1 + WK + Zub
			→	→ 12/13	13.0460-4812.2	604812	BOS 24465 19,2 - WE / - WK + Zub
 Bremsscheibe							
2.0 BlueHDi 110 2.0 BlueHDi 130 2.0 BlueHDi 160	81 96 120	07/15→ 07/15→ 07/15→	←	Nutzlast leicht 12Q; Nutzlast [kg]: 1.200; nicht für erhöhte Nutzlast	24.0124-0127.1	424127	Ø 280 24 21,9 V
			→	Nutzlast 12Q/14Q + / leicht 16Q; Nutzlast ab [kg] 1.200 Nutzlast bis [kg] 1.600; nicht für erhöhte Nutzlast	24.0116-0124.1	416124	Ø 280 16 14,2
			→	Nutzlast schwer 16Q; Nutzlast [kg]: 1.600; für erhöhte Nutzlast	24.0116-0125.1	416125	Ø 280 16 14,2
2.2 HDi 100 2.2 HDi 110 2.2 HDi 120 2.2 HDi 130 2.2 HDi 150 3.0 HDi 155 3.0 HDi 160 3.0 HDi 180	74 81 88 96 110 115 116 130	04/06→ 07/11→ 04/06→ 07/11→ 07/11→ 07/10→ 09/06→ 07/11→	←	Nutzlast 12Q/14Q; Nutzlast ab [kg] 1.200 Nutzlast bis [kg] 1.400	24.0124-0127.1	424127	Ø 280 24 21,9 V
			←	Nutzlast schwer 16Q; Nutzlast [kg]: 1.600; für erhöhte Nutzlast	24.0124-0138.1	424138	Ø 300 24 21,9 V
			←	Nutzlast leicht 16Q; Nutzlast [kg]: 1.600; nicht für erhöhte Nutzlast	24.0128-0213.1	428213	Ø 280 28 25,9 V
			←	Nutzlast 20Q; Nutzlast [kg]: 2.000	24.0132-0131.1	432131	Ø 300 32 29,9 V
			→	Nutzlast 20Q; Nutzlast [kg]: 2.000	24.0116-0123.1	416123	Ø 300 16 14,2
			→	Nutzlast 12Q/14Q + / leicht 16Q; Nutzlast ab [kg] 1.200 Nutzlast bis [kg] 1.600; nicht für erhöhte Nutzlast	24.0116-0124.1	416124	Ø 280 16 14,2
			→	Nutzlast schwer 16Q; Nutzlast [kg]: 1.600; für erhöhte Nutzlast	24.0116-0125.1	416125	Ø 280 16 14,2
			CITROËN - JUMPER Bus (230P) 02/94→04/02				
 Bremsbelagsatz, Scheibenbremse							
1.9 D	51	01/99→04/02	←	01/00→ 10/01; Nutzlast [kg]: 1.000	13.0460-2850.2	602850	TRW 21797 19,7 + WK
			←	→ 12/99; Nutzlast [kg]: 1.000	13.0460-2976.2	602976	TRW 21797 19,7 + WK
			←	11/01→ 03/02; Nutzlast [kg]: 1.000	13.0460-4978.2	604978	BRE 23917 19,3 + WK + Zub
			→	11/01→ 03/02; Nutzlast [kg]: 1.000	13.0460-4980.2	604980	BRE 23921 20,3 - WE / - WK + Zub
1.9 TD 1.9 TD 1.9 TD 4x4	66 68 68	08/94→04/02 02/94→04/02 08/96→04/02	←	01/00→ 10/01; Nutzlast ab [kg] 1.000 Nutzlast bis [kg] 1.400	13.0460-2850.2	602850	TRW 21797 19,7 + WK
			←	→ 12/99; Nutzlast ab [kg] 1.000 Nutzlast bis [kg] 1.400	13.0460-2976.2	602976	TRW 21797 19,7 + WK
			←	11/01→ 03/02; Nutzlast ab [kg] 1.000 Nutzlast bis [kg] 1.400	13.0460-4978.2	604978	BRE 23917 19,3 + WK + Zub
			→	11/01→ 03/02; Nutzlast ab [kg] 1.000 Nutzlast bis [kg] 1.400	13.0460-4980.2	604980	BRE 23921 20,3 - WE / - WK + Zub
2.0	80	02/94→04/02	←	01/00→ 10/01; Nutzlast ab [kg] 1.000 Nutzlast bis [kg] 1.400	13.0460-2850.2	602850	TRW 21797 19,7 + WK
			←	01/00→ 10/01; Nutzlast [kg]: 1.800	13.0460-2852.2	602852	TRW 21799 19,7 + WK
			←	→ 12/99; Nutzlast ab [kg] 1.000 Nutzlast bis [kg] 1.400	13.0460-2976.2	602976	TRW 21797 19,7 + WK
			←	→ 12/99; Nutzlast [kg]: 1.800	13.0460-2977.2	602977	TRW 21799 19,7 + WK
			←	11/01→ 03/02; Nutzlast ab [kg] 1.000 Nutzlast bis [kg] 1.400	13.0460-4978.2	604978	BRE 23917 19,3 + WK + Zub
			←	11/01→ 03/02; Nutzlast [kg]: 1.800	13.0460-4979.2	604979	BRE 23919 19,3 + WK + Zub
			→	11/01→ 03/02; Nutzlast ab [kg] 1.000 Nutzlast bis [kg] 1.800	13.0460-4980.2	604980	BRE 23921 20,3 - WE / - WK + Zub
2.0 4x4	80	08/96→04/02	←	01/00→ 10/01; Nutzlast ab [kg] 1.000 Nutzlast bis [kg] 1.400	13.0460-2850.2	602850	TRW 21797 19,7 + WK
			←	→ 12/99; Nutzlast ab [kg] 1.000 Nutzlast bis [kg] 1.400	13.0460-2976.2	602976	TRW 21797 19,7 + WK
			←	11/01→ 03/02; Nutzlast ab [kg] 1.000 Nutzlast bis [kg] 1.400	13.0460-4978.2	604978	BRE 23917 19,3 + WK + Zub
			→	11/01→ 03/02; Nutzlast ab [kg] 1.000 Nutzlast bis [kg] 1.800	13.0460-4980.2	604980	BRE 23921 20,3 - WE / - WK + Zub
2.5 D 2.5 TD	63 76	08/94→04/02 08/94→04/02	←	01/00→ 10/01; Nutzlast [kg]: 1.400	13.0460-2850.2	602850	TRW 21797 19,7 + WK
			←	01/00→ 10/01; Nutzlast [kg]: 1.800	13.0460-2852.2	602852	TRW 21799 19,7 + WK
			←	→ 12/99; Nutzlast [kg]: 1.400	13.0460-2976.2	602976	TRW 21797 19,7 + WK
			←	→ 12/99; Nutzlast [kg]: 1.800	13.0460-2977.2	602977	TRW 21799 19,7 + WK
↓							











	kw			 	! #		
CITROËN - JUMPER Bus (230P) 02/94→04/02							
 Bremsbelagsatz, Scheibenbremse							
2.5 D 2.5 TD	63 76	08/94→04/02 08/94→04/02	←	11/01→ 03/02; Nutzlast [kg]: 1.400	13.0460-4978.2	604978	BRE 23917 19,3 + WK + Zub
			←	11/01→ 03/02; Nutzlast [kg]: 1.800	13.0460-4979.2	604979	BRE 23919 19,3 + WK + Zub
			→	11/01→ 03/02; Nutzlast ab [kg] 1.400 Nutzlast bis [kg] 1.800	13.0460-4980.2	604980	BRE 23921 20,3 - WE / - WK + Zub
2.5 D 4x4 2.5 TD 4x4 2.8 HDi 4x4	63 76 94	08/96→04/02 08/96→04/02 09/00→04/02	→	11/01→ 03/02; Nutzlast ab [kg] 1.400 Nutzlast bis [kg] 1.800	13.0460-4980.2	604980	BRE 23921 20,3 - WE / - WK + Zub
			←	01/00→; Nutzlast [kg]: 1.400	13.0460-2850.2	602850	TRW 21797 19,7 + WK
				01/00→; Nutzlast [kg]: 1.800	13.0460-2852.2	602852	TRW 21799 19,7 + WK
2.5 TDi	79	12/96→11/00	→	12/99; Nutzlast [kg]: 1.400	13.0460-2976.2	602976	TRW 21797 19,7 + WK
			→	12/99; Nutzlast [kg]: 1.800	13.0460-2977.2	602977	TRW 21799 19,7 + WK
			←	→ S 16206253; Nutzlast [kg]: 1.400	13.0460-2850.2	602850	TRW 21797 19,7 + WK
				→ S 16205352; Nutzlast [kg]: 1.800	13.0460-2852.2	602852	TRW 21799 19,7 + WK
2.8 D	64	01/99→02/02	←	S 16204256→; Nutzlast [kg]: 1.400	13.0460-4978.2	604978	BRE 23917 19,3 + WK + Zub
			←	S 16194400→; Nutzlast [kg]: 1.800	13.0460-4979.2	604979	BRE 23919 19,3 + WK + Zub
			→	S 16194400→; Nutzlast ab [kg] 1.400 Nutzlast bis [kg] 1.800	13.0460-4980.2	604980	BRE 23921 20,3 - WE / - WK + Zub
			←	→ 10/01; Nutzlast [kg]: 1.400	13.0460-2850.2	602850	TRW 21797 19,7 + WK
				→ 10/01; Nutzlast [kg]: 1.800	13.0460-2852.2	602852	TRW 21799 19,7 + WK
2.8 HDi	94	09/00→04/02	←	11/01→ 03/02; Nutzlast [kg]: 1.400	13.0460-4978.2	604978	BRE 23917 19,3 + WK + Zub
			←	11/01→ 03/02; Nutzlast [kg]: 1.800	13.0460-4979.2	604979	BRE 23919 19,3 + WK + Zub
			→	11/01→ 03/02; Nutzlast ab [kg] 1.400 Nutzlast bis [kg] 1.800	13.0460-4980.2	604980	BRE 23921 20,3 - WE / - WK + Zub
			←	→ 10/01; Nutzlast [kg]: 1.000	24.0118-0108.1	418108	∅ 280 18 15,9
				11/01→ 03/02; Nutzlast [kg]: 1.000	24.0124-0127.1	424127	∅ 280 24 21,9 V
1.9 D	51	01/99→04/02	→	11/01→ 03/02; Nutzlast [kg]: 1.000	24.0116-0124.1	416124	∅ 280 16 14,2
			←	→ 10/01; Nutzlast ab [kg] 1.000 Nutzlast bis [kg] 1.400	24.0118-0108.1	418108	∅ 280 18 15,9
				11/01→ 03/02; Nutzlast ab [kg] 1.000 Nutzlast bis [kg] 1.400	24.0124-0127.1	424127	∅ 280 24 21,9 V
1.9 TD 1.9 TD 1.9 TD 4x4 2.0 4x4	66 68 68 80	08/94→04/02 02/94→04/02 08/96→04/02 08/96→04/02	→	11/01→ 03/02; Nutzlast ab [kg] 1.000 Nutzlast bis [kg] 1.400	24.0116-0124.1	416124	∅ 280 16 14,2
			→	11/01→ 03/02; Nutzlast [kg]: 1.800	24.0116-0125.1	416125	∅ 280 16 14,2
2.0	80	02/94→04/02	←	11/01→ 03/02; Nutzlast ab [kg] 1.000 Nutzlast bis [kg] 1.400	24.0124-0127.1	424127	∅ 280 24 21,9 V
			←	→ 03/02; Nutzlast [kg]: 1.800	24.0124-0138.1	424138	∅ 300 24 21,9 V
			→	11/01→ 03/02; Nutzlast ab [kg] 1.000 Nutzlast bis [kg] 1.400	24.0116-0124.1	416124	∅ 280 16 14,2
			→	11/01→ 03/02; Nutzlast [kg]: 1.800	24.0116-0125.1	416125	∅ 280 16 14,2
			2.5 D	63	08/94→04/02	←	→ 10/01; Nutzlast [kg]: 1.400
←	11/01→ 03/02; Nutzlast [kg]: 1.400	24.0124-0127.1				424127	∅ 280 24 21,9 V
←	→ 03/02; Nutzlast [kg]: 1.800	24.0124-0138.1				424138	∅ 300 24 21,9 V
→	11/01→ 03/02; Nutzlast [kg]: 1.400	24.0116-0124.1				416124	∅ 280 16 14,2
→	11/01→ 03/02; Nutzlast [kg]: 1.800	24.0116-0125.1				416125	∅ 280 16 14,2
2.5 TD 2.8 HDi	76 94	08/94→04/02 09/00→04/02	←	→ 03/02; Nutzlast [kg]: 1.400	24.0124-0127.1	424127	∅ 280 24 21,9 V
			←	→ 03/02; Nutzlast [kg]: 1.800	24.0124-0138.1	424138	∅ 300 24 21,9 V
			→	11/01→ 03/02; Nutzlast [kg]: 1.400	24.0116-0124.1	416124	∅ 280 16 14,2
			→	11/01→ 03/02; Nutzlast [kg]: 1.800	24.0116-0125.1	416125	∅ 280 16 14,2
2.5 TDi	79	12/96→11/00	←	Nutzlast [kg]: 1.400	24.0124-0127.1	424127	∅ 280 24 21,9 V
			←	Nutzlast [kg]: 1.800	24.0124-0138.1	424138	∅ 300 24 21,9 V
2.8 D	64	01/99→02/02	←	→ S 16206253; Nutzlast [kg]: 1.400	24.0118-0108.1	418108	∅ 280 18 15,9
			←	Nutzlast [kg]: 1.400	24.0124-0127.1	424127	∅ 280 24 21,9 V
			←	Nutzlast [kg]: 1.800	24.0124-0138.1	424138	∅ 300 24 21,9 V
			→	S 16194400→; Nutzlast [kg]: 1.400	24.0116-0124.1	416124	∅ 280 16 14,2
			→	S 16194400→; Nutzlast [kg]: 1.800	24.0116-0125.1	416125	∅ 280 16 14,2









	kw			 	! #		
CITROËN - JUMPER Bus (244, Z_) 04/02→							
 Bremsbelagsatz, Scheibenbremse							
2.0 2.0 HDi 2.2 HDi 2.8 HDi	81 62 74 94	04/02→ 04/02→ 04/02→ 04/02→	← ← →	→ 03/06; Nutzlast ab [kg] 1.000 Nutzlast bis [kg] 1.400 → 03/06; Nutzlast [kg]: 1.800 → 03/06; Nutzlast ab [kg] 1.000 Nutzlast bis [kg] 1.800	13.0460-4978.2 13.0460-4979.2 13.0460-4980.2	604978 604979 604980	BRE 23917 19,3 + WK + Zub BRE 23919 19,3 + WK + Zub BRE 23921 20,3 - WE / - WK + Zub
2.8 HDi Allrad	94	04/02→	← ← →	→ 03/06; Nutzlast ab [kg] 1.000 Nutzlast bis [kg] 1.400 → 03/06; Nutzlast [kg]: 1.800 → 03/06	13.0460-4978.2 13.0460-4979.2 13.0460-4980.2	604978 604979 604980	BRE 23917 19,3 + WK + Zub BRE 23919 19,3 + WK + Zub BRE 23921 20,3 - WE / - WK + Zub
 Bremsscheibe							
2.0 2.0 HDi 2.2 HDi 2.8 HDi 2.8 HDi Allrad	81 62 74 94 94	04/02→ 04/02→ 04/02→ 04/02→ 04/02→	← ← → →	→ 03/06; Nutzlast ab [kg] 1.000 Nutzlast bis [kg] 1.400 → 03/06; Nutzlast [kg]: 1.800 → 03/06; Nutzlast ab [kg] 1.000 Nutzlast bis [kg] 1.400 → 03/06; Nutzlast [kg]: 1.800	24.0124-0127.1 24.0124-0138.1 24.0116-0124.1 24.0116-0125.1	424127 424138 416124 416125	Ø 280 24 21,9 V Ø 300 24 21,9 V Ø 280 16 14,2 Ø 280 16 14,2
CITROËN - JUMPER Kasten 04/06→							
 Bremsbelagsatz, Scheibenbremse							
2.0 BlueHDi 110 2.0 BlueHDi 130 2.0 BlueHDi 160 2.0 BlueHDi 160 4x4	81 96 120 120	04/16→ 04/16→ 04/16→ 04/16→	← ← ←	Nutzlast 12Q/14Q; Nutzlast ab [kg] 1.200 Nutzlast bis [kg] 1.400 Nutzlast leicht 16Q; Nutzlast [kg]: 1.600; nicht für erhöhte Nutzlast Nutzlast s. 16Q+ 20Q; Nutzlast ab [kg] 1.600 Nutzlast bis [kg] 2.000; für erhöhte Nutzlast	13.0460-4807.2 13.0460-4809.2 13.0460-4811.2	604807 604809 604811	BRE 24468 19,1 + WK + Zub BRE 24468 19,1 + WK + Zub BRE 24466 19,1 + WK + Zub
2.2 HDi 100 2.2 HDi 110 2.2 HDi 130 3.0 HDi 180	74 81 96 130	04/06→ 07/11→ 07/11→ 07/11→	← ← ← ← →	Nutzlast 12Q/14Q; Nutzlast ab [kg] 1.200 Nutzlast bis [kg] 1.400 Nutzlast leicht 16Q; Nutzlast [kg]: 1.600; nicht für erhöhte Nutzlast Nutzlast schwer 16Q; Nutzlast [kg]: 1.600; für erhöhte Nutzlast Nutzlast 20Q; Nutzlast [kg]: 2.000	13.0460-4807.2 13.0460-4809.2 13.0460-4810.2 13.0460-4811.2	604807 604809 604810 604811	BRE 24468 19,1 + WK + Zub BRE 24468 19,1 + WK + Zub BRE 24466 19,1 + WK + Zub BRE 24466 19,1 + WK + Zub
2.2 HDi 120 3.0 HDi 145 3.0 HDi 155 3.0 HDi 160	88 107 115 116	04/06→ 07/10→ 07/10→ 09/06→	← ← ← ← →	Nutzlast 12Q/14Q; Nutzlast ab [kg] 1.200 Nutzlast bis [kg] 1.400 Nutzlast leicht 16Q; Nutzlast [kg]: 1.600; nicht für erhöhte Nutzlast Nutzlast schwer 16Q; Nutzlast [kg]: 1.600; für erhöhte Nutzlast Nutzlast 20Q; Nutzlast [kg]: 2.000	13.0460-4807.2 13.0460-4809.2 13.0460-4810.2 13.0460-4811.2	604807 604809 604810 604811	BRE 24468 19,1 + WK + Zub BRE 24468 19,1 + WK + Zub BRE 24466 19,1 + WK + Zub BRE 24466 19,1 + WK + Zub
2.2 HDi 150	110	07/11→	← ← ← ← →	Nutzlast 12Q/14Q; Nutzlast ab [kg] 1.200 Nutzlast bis [kg] 1.400 Nutzlast leicht 16Q; Nutzlast [kg]: 1.600; nicht für erhöhte Nutzlast Nutzlast schwer 16Q; Nutzlast [kg]: 1.600; für erhöhte Nutzlast Nutzlast 20Q; Nutzlast [kg]: 2.000	13.0460-4807.2 13.0460-4809.2 13.0460-4810.2 13.0460-4811.2	604807 604809 604810 604811	BRE 24468 19,1 + WK + Zub BRE 24468 19,1 + WK + Zub BRE 24466 19,1 + WK + Zub BRE 24466 19,1 + WK + Zub
 Bremsscheibe							
2.0 BlueHDi 110 2.0 BlueHDi 130 2.0 BlueHDi 160 2.0 BlueHDi 160 4x4	81 96 120 120	04/16→ 04/16→ 04/16→ 04/16→	← → →	Nutzlast leicht 12Q; Nutzlast [kg]: 1.200; nicht für erhöhte Nutzlast Nutzlast 12Q/14Q + / leicht 16Q; Nutzlast ab [kg] 1.200 Nutzlast bis [kg] 1.600; nicht für erhöhte Nutzlast Nutzlast schwer 16Q; Nutzlast [kg]: 1.600; für erhöhte Nutzlast	24.0124-0127.1 24.0116-0124.1 24.0116-0125.1	424127 416124 416125	Ø 280 24 21,9 V Ø 280 16 14,2 Ø 280 16 14,2
2.2 HDi 100 2.2 HDi 110 2.2 HDi 120 2.2 HDi 130 2.2 HDi 150 3.0 HDi 145 3.0 HDi 155	74 81 88 96 110 107 115	04/06→ 07/11→ 04/06→ 07/11→ 07/11→ 07/10→ 07/10→	← ← ← ← ←	Nutzlast 12Q/14Q; Nutzlast ab [kg] 1.200 Nutzlast bis [kg] 1.400 Nutzlast schwer 16Q; Nutzlast [kg]: 1.600; für erhöhte Nutzlast Nutzlast leicht 16Q; Nutzlast [kg]: 1.600; nicht für erhöhte Nutzlast	24.0124-0127.1 24.0124-0138.1 24.0128-0213.1	424127 424138 428213	Ø 280 24 21,9 V Ø 300 24 21,9 V Ø 280 28 25,9 V



























	kW				! #		
CITROËN - JUMPER Kasten 04/06→							
 Bremsscheibe							
3.0 HDi 160 3.0 HDi 180	116 130	09/06→ 07/11→	←	Nutzlast 20Q; Nutzlast [kg]: 2.000	24.0132-0131.1	432131	Ø 300 32 29,9 V
			→	Nutzlast 20Q; Nutzlast [kg]: 2.000	24.0116-0123.1	416123	Ø 300 16 14,2
			→	Nutzlast 12Q/14Q + / leicht 16Q; Nutzlast ab [kg] 1.200 Nutzlast bis [kg] 1.600; nicht für erhöhte Nutzlast	24.0116-0124.1	416124	Ø 280 16 14,2
			→	Nutzlast schwer 16Q; Nutzlast [kg]: 1.600; für erhöhte Nutzlast	24.0116-0125.1	416125	Ø 280 16 14,2
CITROËN - JUMPER Kasten (230L) 02/94→04/02							
 Bremsbelagsatz, Scheibenbremse							
1.9 D 1.9 D	50 51	07/99→04/02 02/94→04/02	←	01/00→ 10/01; Nutzlast [kg]: 1.000	13.0460-2850.2	602850	TRW 21797 19,7 + WK
			→	→ 12/99; Nutzlast [kg]: 1.000	13.0460-2976.2	602976	TRW 21797 19,7 + WK
			←	11/01→ 03/02; Nutzlast [kg]: 1.000	13.0460-4978.2	604978	BRE 23917 19,3 + WK + Zub
			→	11/01→ 03/02; Nutzlast [kg]: 1.000	13.0460-4980.2	604980	BRE 23921 20,3 - WE / - WK + Zub
1.9 TD 1.9 TD	66 68	03/94→04/02 03/94→04/02	←	01/00→ 10/01; Nutzlast ab [kg] 1.000 Nutzlast bis [kg] 1.400	13.0460-2850.2	602850	TRW 21797 19,7 + WK
			→	→ 12/99; Nutzlast ab [kg] 1.000 Nutzlast bis [kg] 1.400	13.0460-2976.2	602976	TRW 21797 19,7 + WK
			←	11/01→ 03/02; Nutzlast ab [kg] 1.000 Nutzlast bis [kg] 1.400	13.0460-4978.2	604978	BRE 23917 19,3 + WK + Zub
			→	11/01→ 03/02; Nutzlast ab [kg] 1.000 Nutzlast bis [kg] 1.400	13.0460-4980.2	604980	BRE 23921 20,3 - WE / - WK + Zub
2.0	80	03/94→04/02	←	01/00→ 10/01; Nutzlast ab [kg] 1.000 Nutzlast bis [kg] 1.400	13.0460-2850.2	602850	TRW 21797 19,7 + WK
			←	01/00→ 10/01; Nutzlast [kg]: 1.800	13.0460-2852.2	602852	TRW 21799 19,7 + WK
			→	→ 12/99; Nutzlast ab [kg] 1.000 Nutzlast bis [kg] 1.400	13.0460-2976.2	602976	TRW 21797 19,7 + WK
			→	→ 12/99; Nutzlast [kg]: 1.800	13.0460-2977.2	602977	TRW 21799 19,7 + WK
			←	11/01→ 03/02; Nutzlast ab [kg] 1.000 Nutzlast bis [kg] 1.400	13.0460-4978.2	604978	BRE 23917 19,3 + WK + Zub
			←	11/01→ 03/02; Nutzlast [kg]: 1.800	13.0460-4979.2	604979	BRE 23919 19,3 + WK + Zub
			→	11/01→ 03/02; Nutzlast ab [kg] 1.000 Nutzlast bis [kg] 1.800	13.0460-4980.2	604980	BRE 23921 20,3 - WE / - WK + Zub
2.0 4x4	80	10/96→01/02	←	01/00→ 10/01; Nutzlast ab [kg] 1.000 Nutzlast bis [kg] 1.400	13.0460-2850.2	602850	TRW 21797 19,7 + WK
			←	01/00→ 10/01; Nutzlast [kg]: 1.800	13.0460-2852.2	602852	TRW 21799 19,7 + WK
			→	→ 12/99; Nutzlast ab [kg] 1.000 Nutzlast bis [kg] 1.400	13.0460-2976.2	602976	TRW 21797 19,7 + WK
			→	→ 12/99; Nutzlast [kg]: 1.800	13.0460-2977.2	602977	TRW 21799 19,7 + WK
			←	11/01→; Nutzlast ab [kg] 1.000 Nutzlast bis [kg] 1.400	13.0460-4978.2	604978	BRE 23917 19,3 + WK + Zub
			←	11/01→; Nutzlast [kg]: 1.800	13.0460-4979.2	604979	BRE 23919 19,3 + WK + Zub
			→	11/01→; Nutzlast ab [kg] 1.000 Nutzlast bis [kg] 1.800	13.0460-4980.2	604980	BRE 23921 20,3 - WE / - WK + Zub
2.0 HDI	62	11/01→04/02	←	→ 03/02; Nutzlast ab [kg] 1.000 Nutzlast bis [kg] 1.400	13.0460-4978.2	604978	BRE 23917 19,3 + WK + Zub
			←	→ 03/02; Nutzlast [kg]: 1.800	13.0460-4979.2	604979	BRE 23919 19,3 + WK + Zub
			→	→ 03/02; Nutzlast ab [kg] 1.000 Nutzlast bis [kg] 1.800	13.0460-4980.2	604980	BRE 23921 20,3 - WE / - WK + Zub
2.5 D 2.5 TD	63 76	03/94→04/02 03/94→04/02	←	01/00→ 10/01; Nutzlast [kg]: 1.400	13.0460-2850.2	602850	TRW 21797 19,7 + WK
			←	01/00→ 10/01; Nutzlast [kg]: 1.800	13.0460-2852.2	602852	TRW 21799 19,7 + WK
			→	→ 12/99; Nutzlast [kg]: 1.400	13.0460-2976.2	602976	TRW 21797 19,7 + WK
			→	→ 12/99; Nutzlast [kg]: 1.800	13.0460-2977.2	602977	TRW 21799 19,7 + WK
			←	11/01→ 03/02; Nutzlast [kg]: 1.400	13.0460-4978.2	604978	BRE 23917 19,3 + WK + Zub
			←	11/01→ 03/02; Nutzlast [kg]: 1.800	13.0460-4979.2	604979	BRE 23919 19,3 + WK + Zub
			→	11/01→ 03/02; Nutzlast ab [kg] 1.400 Nutzlast bis [kg] 1.800	13.0460-4980.2	604980	BRE 23921 20,3 - WE / - WK + Zub
2.5 D 4x4 2.8 HDi 2.8 HDi 4x4	63 94 94	03/00→04/02 09/00→04/02 09/00→04/02	←	→ 10/01; Nutzlast [kg]: 1.400	13.0460-2850.2	602850	TRW 21797 19,7 + WK
			←	→ 10/01; Nutzlast [kg]: 1.800	13.0460-2852.2	602852	TRW 21799 19,7 + WK
			←	11/01→ 03/02; Nutzlast [kg]: 1.400	13.0460-4978.2	604978	BRE 23917 19,3 + WK + Zub
			←	11/01→ 03/02; Nutzlast [kg]: 1.800	13.0460-4979.2	604979	BRE 23919 19,3 + WK + Zub
			→	11/01→ 03/02; Nutzlast ab [kg] 1.400 Nutzlast bis [kg] 1.800	13.0460-4980.2	604980	BRE 23921 20,3 - WE / - WK + Zub
↓							

	kw			 	! #		
CITROËN - JUMPER Kasten (230L) 02/94→04/02							
 Bremsbelagsatz, Scheibenbremse							
2.5 DT 4x4	76	10/96→08/97	←	Nutzlast [kg]: 1.400		13.0460-2976.2 602976	TRW 21797 19,7 + WK
2.5 TDi	79	12/96→11/00	←	01/00→; Nutzlast [kg]: 1.400		13.0460-2850.2 602850	TRW 21797 19,7 + WK
			←	01/00→; Nutzlast [kg]: 1.800		13.0460-2852.2 602852	TRW 21799 19,7 + WK
			←	→ 12/99; Nutzlast [kg]: 1.400		13.0460-2976.2 602976	TRW 21797 19,7 + WK
			←	→ 12/99; Nutzlast [kg]: 1.800		13.0460-2977.2 602977	TRW 21799 19,7 + WK
2.5 TDi 4x4	79	03/00→11/00	←	Nutzlast [kg]: 1.400		13.0460-2850.2 602850	TRW 21797 19,7 + WK
			←	Nutzlast [kg]: 1.800		13.0460-2852.2 602852	TRW 21799 19,7 + WK
2.8 D	64	01/99→02/02	←	→ S 16206253; Nutzlast [kg]: 1.400		13.0460-2976.2 602976	TRW 21797 19,7 + WK
			←	→ S 16205352; Nutzlast [kg]: 1.800		13.0460-2977.2 602977	TRW 21799 19,7 + WK
			←	S 16204256→; Nutzlast [kg]: 1.400		13.0460-4978.2 604978	BRE 23917 19,3 + WK + Zub
			←	S 16194400→; Nutzlast [kg]: 1.800		13.0460-4979.2 604979	BRE 23919 19,3 + WK + Zub
			→	S 16194400→; Nutzlast ab [kg] 1.400 Nutzlast bis [kg] 1.800		13.0460-4980.2 604980	BRE 23921 20,3 - WE / - WK + Zub
 Bremsscheibe							
1.9 D	50	07/99→04/02	←	11/01→ 03/02; Nutzlast [kg]: 1.000		24.0124-0127.1 424127	Ø 280 24 21,9 V
1.9 D	51	02/94→04/02	→	11/01→ 03/02; Nutzlast [kg]: 1.000		24.0116-0124.1 416124	Ø 280 16 14,2
1.9 TD	66	03/94→04/02	←	11/01→ 03/02; Nutzlast ab [kg] 1.000 Nutzlast bis [kg] 1.400		24.0124-0127.1 424127	Ø 280 24 21,9 V
			→	11/01→ 03/02; Nutzlast ab [kg] 1.000 Nutzlast bis [kg] 1.400		24.0116-0124.1 416124	Ø 280 16 14,2
2.0	80	03/94→04/02	←	11/01→ 03/02; Nutzlast ab [kg] 1.000 Nutzlast bis [kg] 1.400		24.0124-0127.1 424127	Ø 280 24 21,9 V
			←	11/01→ 03/02; Nutzlast [kg]: 1.800		24.0124-0138.1 424138	Ø 300 24 21,9 V
			→	11/01→ 03/02; Nutzlast ab [kg] 1.000 Nutzlast bis [kg] 1.400		24.0116-0124.1 416124	Ø 280 16 14,2
			→	11/01→ 03/02; Nutzlast [kg]: 1.800		24.0116-0125.1 416125	Ø 280 16 14,2
2.0 4x4	80	10/96→01/02	←	11/01→; Nutzlast ab [kg] 1.000 Nutzlast bis [kg] 1.400		24.0124-0127.1 424127	Ø 280 24 21,9 V
			←	11/01→; Nutzlast [kg]: 1.800		24.0124-0138.1 424138	Ø 300 24 21,9 V
			→	11/01→; Nutzlast ab [kg] 1.000 Nutzlast bis [kg] 1.400		24.0116-0124.1 416124	Ø 280 16 14,2
			→	11/01→; Nutzlast [kg]: 1.800		24.0116-0125.1 416125	Ø 280 16 14,2
2.0 HDI	62	11/01→04/02	←	→ 03/02; Nutzlast ab [kg] 1.000 Nutzlast bis [kg] 1.400		24.0124-0127.1 424127	Ø 280 24 21,9 V
			←	→ 03/02; Nutzlast [kg]: 1.800		24.0124-0138.1 424138	Ø 300 24 21,9 V
			→	→ 03/02; Nutzlast ab [kg] 1.000 Nutzlast bis [kg] 1.400		24.0116-0124.1 416124	Ø 280 16 14,2
			→	→ 03/02; Nutzlast [kg]: 1.800		24.0116-0125.1 416125	Ø 280 16 14,2
2.5 D	63	03/94→04/02	←	11/01→ 03/02; Nutzlast [kg]: 1.400		24.0124-0127.1 424127	Ø 280 24 21,9 V
			←	11/01→ 03/02; Nutzlast [kg]: 1.800		24.0124-0138.1 424138	Ø 300 24 21,9 V
			→	11/01→ 03/02; Nutzlast [kg]: 1.400		24.0116-0124.1 416124	Ø 280 16 14,2
			→	11/01→ 03/02; Nutzlast [kg]: 1.800		24.0116-0125.1 416125	Ø 280 16 14,2
2.5 DT 4x4	76	10/96→08/97	←	Nutzlast [kg]: 1.400		24.0124-0127.1 424127	Ø 280 24 21,9 V
2.5 TD	76	03/94→04/02	←	→ 03/02; Nutzlast [kg]: 1.400		24.0124-0127.1 424127	Ø 280 24 21,9 V
2.8 HDi	94	09/00→04/02	←	→ 03/02; Nutzlast [kg]: 1.800		24.0124-0138.1 424138	Ø 300 24 21,9 V
2.8 HDi 4x4	94	09/00→04/02	→	11/01→ 03/02; Nutzlast [kg]: 1.400		24.0116-0124.1 416124	Ø 280 16 14,2
			→	11/01→ 03/02; Nutzlast [kg]: 1.800		24.0116-0125.1 416125	Ø 280 16 14,2
2.5 TDi	79	12/96→11/00	←	Nutzlast [kg]: 1.400		24.0124-0127.1 424127	Ø 280 24 21,9 V
			←	Nutzlast [kg]: 1.800		24.0124-0138.1 424138	Ø 300 24 21,9 V
2.5 TDi 4x4	79	03/00→11/00	←	Nutzlast [kg]: 1.400		24.0124-0127.1 424127	Ø 280 24 21,9 V
2.8 D	64	01/99→02/02	←	Nutzlast [kg]: 1.400		24.0124-0127.1 424127	Ø 280 24 21,9 V
			←	Nutzlast [kg]: 1.800		24.0124-0138.1 424138	Ø 300 24 21,9 V
			→	S 16194400→; Nutzlast [kg]: 1.400		24.0116-0124.1 416124	Ø 280 16 14,2
			→	S 16194400→; Nutzlast [kg]: 1.800		24.0116-0125.1 416125	Ø 280 16 14,2
CITROËN - JUMPER Kasten (244) 04/02→							
 Bremsbelagsatz, Scheibenbremse							
2.0	81	04/02→	←	→ 03/06; Nutzlast ab [kg] 1.000 Nutzlast bis [kg] 1.400		13.0460-4978.2 604978	BRE 23917 19,3 + WK + Zub
2.0 bivalent	81	02/03→					
2.0 HDi	62	04/02→					
↓							

















	kw			 	! #		
CITROËN - JUMPER Kasten (244) 04/02→							
 Bremsbelagsatz, Scheibenbremse							
2.2 HDi 2.8 HDi 2.8 HDi	74 94 107	04/02→ 04/02→ 05/04→	← → →	→ 03/06; Nutzlast [kg]: 1.800 → 03/06; Nutzlast ab [kg] 1.000 Nutzlast bis [kg] 1.800 → 03/06; Nutzlast [kg]: 1.800	13.0460-4979.2 13.0460-4980.2 13.0460-4979.2	604979 604980 604979	BRE 23919 19,3 + WK + Zub BRE 23921 20,3 - WE / - WK + Zub BRE 23917 19,3 + WK + Zub
2.8 HDi 4x4	94	04/02→	← ← → →	→ 03/06; Nutzlast ab [kg] 1.000 Nutzlast bis [kg] 1.400 → 03/06; Nutzlast [kg]: 1.800 → 03/06 → 03/06; Nutzlast ab [kg] 1.000 Nutzlast bis [kg] 1.800	13.0460-4978.2 13.0460-4979.2 13.0460-4980.2 13.0460-4980.2	604978 604979 604980 604980	BRE 23917 19,3 + WK + Zub BRE 23919 19,3 + WK + Zub BRE 23921 20,3 - WE / - WK + Zub BRE 23921 20,3 - WE / - WK + Zub
 Bremsscheibe							
2.0 2.0 bivalent 2.0 HDi 2.2 HDi 2.8 HDi 2.8 HDi 2.8 HDi 4x4	81 81 62 74 94 107 94	04/02→ 02/03→ 04/02→ 04/02→ 04/02→ 05/04→ 04/02→	← ← ← → → → →	→ 03/06; Nutzlast ab [kg] 1.000 Nutzlast bis [kg] 1.400 → 03/06; Nutzlast [kg]: 1.800 → 03/06; Nutzlast ab [kg] 1.000 Nutzlast bis [kg] 1.400 → 03/06; Nutzlast ab [kg] 1.000 Nutzlast bis [kg] 1.400 → 03/06; Nutzlast [kg]: 1.800	24.0124-0127.1 24.0124-0138.1 24.0116-0124.1 24.0116-0125.1	424127 424138 416124 416125	Ø 280 24 21,9 V Ø 300 24 21,9 V Ø 280 16 14,2 Ø 280 16 14,2
CITROËN - JUMPER Pritsche/Fahrgestell 04/06→							
 Bremsbelagsatz, Scheibenbremse							
2.0 BlueHDi 110 2.0 BlueHDi 130 2.0 BlueHDi 130 4x4 2.0 BlueHDi 160 2.0 BlueHDi 160 4x4	81 96 96 120 120	04/16→ 04/16→ 04/16→ 04/16→ 04/16→	← ← ← ← ←	Nutzlast 12Q/14Q; Nutzlast ab [kg] 1.200 Nutzlast bis [kg] 1.400 Nutzlast leicht 16Q; Nutzlast [kg]: 1.600; nicht für erhöhte Nutzlast Nutzlast s. 16Q+ 20Q; Nutzlast ab [kg] 1.600 Nutzlast bis [kg] 2.000; für erhöhte Nutzlast	13.0460-4807.2 13.0460-4809.2 13.0460-4811.2	604807 604809 604811	BRE 24468 19,1 + WK + Zub BRE 24468 19,1 + WK + Zub BRE 24466 19,1 + WK + Zub
2.2 HDi 100 2.2 HDi 110 2.2 HDi 130 3.0 HDi 180	74 81 96 130	04/06→ 07/11→ 07/11→ 07/11→	← ← ← ← →	Nutzlast 12Q/14Q; Nutzlast ab [kg] 1.200 Nutzlast bis [kg] 1.400 Nutzlast leicht 16Q; Nutzlast [kg]: 1.600; nicht für erhöhte Nutzlast Nutzlast schwer 16Q; Nutzlast [kg]: 1.600; für erhöhte Nutzlast Nutzlast 20Q; Nutzlast [kg]: 2.000	13.0460-4807.2 13.0460-4809.2 13.0460-4810.2 13.0460-4811.2	604807 604809 604810 604811	BRE 24468 19,1 + WK + Zub BRE 24468 19,1 + WK + Zub BRE 24466 19,1 + WK + Zub BRE 24466 19,1 + WK + Zub
2.2 HDi 120 3.0 HDi 145 3.0 HDi 160	88 107 116	04/06→ 07/10→ 09/06→	← ← ← ← →	Nutzlast 12Q/14Q; Nutzlast ab [kg] 1.200 Nutzlast bis [kg] 1.400 Nutzlast leicht 16Q; Nutzlast [kg]: 1.600; nicht für erhöhte Nutzlast Nutzlast schwer 16Q; Nutzlast [kg]: 1.600; für erhöhte Nutzlast Nutzlast 20Q; Nutzlast [kg]: 2.000 Nutzlast ab [kg] 1.200 Nutzlast bis [kg] 2.000; light/heavy	13.0460-4807.2 13.0460-4809.2 13.0460-4810.2 13.0460-4811.2 13.0460-4812.2	604807 604809 604810 604811 604812	BRE 24468 19,1 + WK + Zub BRE 24468 19,1 + WK + Zub BRE 24466 19,1 + WK + Zub BRE 24466 19,1 + WK + Zub BOS 24465 19,2 - WE / - WK + Zub
2.2 HDi 150	110	07/11→	← ← ← ← →	Nutzlast 12Q/14Q; Nutzlast ab [kg] 1.200 Nutzlast bis [kg] 1.400 Nutzlast leicht 16Q; Nutzlast [kg]: 1.600; nicht für erhöhte Nutzlast Nutzlast schwer 16Q; Nutzlast [kg]: 1.600; für erhöhte Nutzlast Nutzlast 20Q; Nutzlast [kg]: 2.000 → 12/13	13.0460-4807.2 13.0460-4809.2 13.0460-4810.2 13.0460-4811.2 13.0460-4812.2	604807 604809 604810 604811 604812	BRE 24468 19,1 + WK + Zub BRE 24468 19,1 + WK + Zub BRE 24466 19,1 + WK + Zub BRE 24466 19,1 + WK + Zub BOS 24465 19,2 - WE / - WK + Zub
 Bremsscheibe							
2.0 BlueHDi 110 2.0 BlueHDi 130 2.0 BlueHDi 130 4x4 2.0 BlueHDi 160 2.0 BlueHDi 160 4x4	81 96 96 120 120	04/16→ 04/16→ 04/16→ 04/16→ 04/16→	← → → → →	Nutzlast leicht 12Q; Nutzlast [kg]: 1.200; nicht für erhöhte Nutzlast Nutzlast 12Q/14Q + / leicht 16Q; Nutzlast ab [kg] 1.200 Nutzlast bis [kg] 1.600; nicht für erhöhte Nutzlast Nutzlast schwer 16Q; Nutzlast [kg]: 1.600; für erhöhte Nutzlast	24.0124-0127.1 24.0116-0124.1 24.0116-0125.1	424127 416124 416125	Ø 280 24 21,9 V Ø 280 16 14,2 Ø 280 16 14,2
2.2 HDi 100 2.2 HDi 110 2.2 HDi 120 2.2 HDi 130 2.2 HDi 150 3.0 HDi 145 3.0 HDi 160	74 81 88 96 110 107 116	04/06→ 07/11→ 04/06→ 07/11→ 07/11→ 07/10→ 09/06→	← ← ← ← ← ← ←	Nutzlast 12Q/14Q; Nutzlast ab [kg] 1.200 Nutzlast bis [kg] 1.400 Nutzlast schwer 16Q; Nutzlast [kg]: 1.600; für erhöhte Nutzlast Nutzlast leicht 16Q; Nutzlast [kg]: 1.600; nicht für erhöhte Nutzlast	24.0124-0127.1 24.0124-0138.1 24.0124-0138.1 24.0128-0213.1	424127 424138 424138 428213	Ø 280 24 21,9 V Ø 300 24 21,9 V Ø 280 28 25,9 V













	kw				! #		
CITROËN - JUMPER Pritsche/Fahrgestell 04/06→							
 Bremsscheibe							
3.0 HDi 180	130	07/11→	←	Nutzlast 20Q; Nutzlast [kg]: 2.000	24.0132-0131.1	432131	∅ 300 32 29,9 V
			→	Nutzlast 20Q; Nutzlast [kg]: 2.000	24.0116-0123.1	416123	∅ 300 16 14,2
			→	Nutzlast 12Q/14Q + / leicht 16Q; Nutzlast ab [kg] 1.200 Nutzlast bis [kg] 1.600; nicht für erhöhte Nutzlast	24.0116-0124.1	416124	∅ 280 16 14,2
			→	Nutzlast schwer 16Q; Nutzlast [kg]: 1.600; für erhöhte Nutzlast	24.0116-0125.1	416125	∅ 280 16 14,2
CITROËN - JUMPER Pritsche/Fahrgestell (230) 03/94→04/02							
 Bremsbelagsatz, Scheibenbremse							
1.9 TD 1.9 TD	66 68	03/94→04/02 03/94→04/02	←	01/00→ 10/01; Nutzlast ab [kg] 1.000 Nutzlast bis [kg] 1.400	13.0460-2850.2	602850	TRW 21797 19,7 + WK
			←	→ 12/99; Nutzlast ab [kg] 1.000 Nutzlast bis [kg] 1.400	13.0460-2976.2	602976	TRW 21797 19,7 + WK
			←	11/01→ 03/02; Nutzlast ab [kg] 1.000 Nutzlast bis [kg] 1.400	13.0460-4978.2	604978	BRE 23917 19,3 + WK + Zub
			→	11/01→ 03/02; Nutzlast ab [kg] 1.000 Nutzlast bis [kg] 1.400	13.0460-4980.2	604980	BRE 23921 20,3 - WE / - WK + Zub
2.0	80	03/94→04/02	←	01/00→ 10/01; Nutzlast ab [kg] 1.000 Nutzlast bis [kg] 1.400	13.0460-2850.2	602850	TRW 21797 19,7 + WK
			←	01/00→ 10/01; Nutzlast [kg]: 1.800	13.0460-2852.2	602852	TRW 21799 19,7 + WK
			←	→ 12/99; Nutzlast ab [kg] 1.000 Nutzlast bis [kg] 1.400	13.0460-2976.2	602976	TRW 21797 19,7 + WK
			←	→ 12/99; Nutzlast [kg]: 1.800	13.0460-2977.2	602977	TRW 21799 19,7 + WK
			←	11/01→ 03/02; Nutzlast ab [kg] 1.000 Nutzlast bis [kg] 1.400	13.0460-4978.2	604978	BRE 23917 19,3 + WK + Zub
			←	11/01→ 03/02; Nutzlast [kg]: 1.800	13.0460-4979.2	604979	BRE 23919 19,3 + WK + Zub
→	11/01→ 03/02; Nutzlast ab [kg] 1.000 Nutzlast bis [kg] 1.800	13.0460-4980.2	604980	BRE 23921 20,3 - WE / - WK + Zub			
2.5 D 2.5 TD 2.5 TDi	63 76 79	03/94→04/02 03/94→04/02 12/96→04/02	←	01/00→ 10/01; Nutzlast [kg]: 1.400	13.0460-2850.2	602850	TRW 21797 19,7 + WK
			←	01/00→ 10/01; Nutzlast [kg]: 1.800	13.0460-2852.2	602852	TRW 21799 19,7 + WK
			←	→ 12/99; Nutzlast [kg]: 1.400	13.0460-2976.2	602976	TRW 21797 19,7 + WK
			←	→ 12/99; Nutzlast [kg]: 1.800	13.0460-2977.2	602977	TRW 21799 19,7 + WK
			←	11/01→ 03/02; Nutzlast [kg]: 1.400	13.0460-4978.2	604978	BRE 23917 19,3 + WK + Zub
			←	11/01→ 03/02; Nutzlast [kg]: 1.800	13.0460-4979.2	604979	BRE 23919 19,3 + WK + Zub
→	11/01→ 03/02; Nutzlast ab [kg] 1.400 Nutzlast bis [kg] 1.800	13.0460-4980.2	604980	BRE 23921 20,3 - WE / - WK + Zub			
2.5 D 4x4 2.5 TDi 4x4 2.8 HDi	63 79 94	03/00→04/02 03/00→04/02 09/00→04/02	←	→ 10/01; Nutzlast [kg]: 1.400	13.0460-2850.2	602850	TRW 21797 19,7 + WK
			←	→ 10/01; Nutzlast [kg]: 1.800	13.0460-2852.2	602852	TRW 21799 19,7 + WK
			←	11/01→ 03/02; Nutzlast [kg]: 1.400	13.0460-4978.2	604978	BRE 23917 19,3 + WK + Zub
			←	11/01→ 03/02; Nutzlast [kg]: 1.800	13.0460-4979.2	604979	BRE 23919 19,3 + WK + Zub
			→	11/01→ 03/02; Nutzlast ab [kg] 1.400 Nutzlast bis [kg] 1.800	13.0460-4980.2	604980	BRE 23921 20,3 - WE / - WK + Zub
2.8 D	64	01/99→02/02	←	→ S 16205352; Nutzlast [kg]: 1.800	13.0460-2852.2	602852	TRW 21799 19,7 + WK
			←	→ S 16206253; Nutzlast [kg]: 1.400	13.0460-2977.2	602977	TRW 21799 19,7 + WK
			←	→ S 16206253; Nutzlast [kg]: 1.400	13.0460-2976.2	602976	TRW 21797 19,7 + WK
			←	S 16204256→; Nutzlast [kg]: 1.400	13.0460-4978.2	604978	BRE 23917 19,3 + WK + Zub
			←	S 16194400→; Nutzlast [kg]: 1.800	13.0460-4979.2	604979	BRE 23919 19,3 + WK + Zub
→	S 16194400→; Nutzlast ab [kg] 1.400 Nutzlast bis [kg] 1.800	13.0460-4980.2	604980	BRE 23921 20,3 - WE / - WK + Zub			
 Bremsscheibe							
1.9 TD 1.9 TD	66 68	03/94→04/02 03/94→04/02	←	→ 10/01; Nutzlast ab [kg] 1.000 Nutzlast bis [kg] 1.400	24.0118-0108.1	418108	∅ 280 18 15,9
			←	11/01→ 03/02; Nutzlast ab [kg] 1.000 Nutzlast bis [kg] 1.400	24.0124-0127.1	424127	∅ 280 24 21,9 V
			→	11/01→ 03/02; Nutzlast ab [kg] 1.000 Nutzlast bis [kg] 1.400	24.0116-0124.1	416124	∅ 280 16 14,2
2.0	80	03/94→04/02	←	→ 10/01; Nutzlast ab [kg] 1.000 Nutzlast bis [kg] 1.400	24.0118-0108.1	418108	∅ 280 18 15,9
			←	11/01→ 03/02; Nutzlast ab [kg] 1.000 Nutzlast bis [kg] 1.400	24.0124-0127.1	424127	∅ 280 24 21,9 V
			←	→ 03/02; Nutzlast [kg]: 1.800	24.0124-0138.1	424138	∅ 300 24 21,9 V
			→	11/01→ 03/02; Nutzlast ab [kg] 1.000 Nutzlast bis [kg] 1.400	24.0116-0124.1	416124	∅ 280 16 14,2
↓							











	kw					! #		
CITROËN - JUMPER Pritsche/Fahrgestell (230) 03/94→04/02								
 Bremsscheibe								
2.0	80	03/94→04/02	➔	11/01→ 03/02; Nutzlast [kg]: 1.800		24.0116-0125.1	416125	Ø 280 16 14,2
2.5 D 2.5 D 4x4	63 63	03/94→04/02 03/00→04/02	➔	→ 10/01; Nutzlast [kg]: 1.400		24.0118-0108.1	418108	Ø 280 18 15,9
			➔	11/01→ 03/02; Nutzlast [kg]: 1.400		24.0124-0127.1	424127	Ø 280 24 21,9 V
			➔	→ 03/02; Nutzlast [kg]: 1.800		24.0124-0138.1	424138	Ø 300 24 21,9 V
			➔	11/01→ 03/02; Nutzlast [kg]: 1.400		24.0116-0124.1	416124	Ø 280 16 14,2
			➔	11/01→ 03/02; Nutzlast [kg]: 1.800		24.0116-0125.1	416125	Ø 280 16 14,2
2.5 TD 2.5 TDi 2.5 TDi 4x4 2.8 HDi	76 79 79 94	03/94→04/02 12/96→04/02 03/00→04/02 09/00→04/02	➔	→ 03/02; Nutzlast [kg]: 1.400		24.0124-0127.1	424127	Ø 280 24 21,9 V
			➔	→ 03/02; Nutzlast [kg]: 1.800		24.0124-0138.1	424138	Ø 300 24 21,9 V
			➔	11/01→ 03/02; Nutzlast [kg]: 1.400		24.0116-0124.1	416124	Ø 280 16 14,2
			➔	11/01→ 03/02; Nutzlast [kg]: 1.800		24.0116-0125.1	416125	Ø 280 16 14,2
2.8 D	64	01/99→02/02	➔	→ S 16206253; Nutzlast [kg]: 1.400		24.0118-0108.1	418108	Ø 280 18 15,9
			➔	S 16204256→; Nutzlast [kg]: 1.400		24.0124-0127.1	424127	Ø 280 24 21,9 V
			➔	Nutzlast [kg]: 1.800		24.0124-0138.1	424138	Ø 300 24 21,9 V
			➔	S 16194400→; Nutzlast [kg]: 1.400		24.0116-0124.1	416124	Ø 280 16 14,2
			➔	S 16194400→; Nutzlast [kg]: 1.800		24.0116-0125.1	416125	Ø 280 16 14,2
CITROËN - JUMPER Pritsche/Fahrgestell (244) 02/02→								
 Bremsbelagsatz, Scheibenbremse								
2.0 HDi 2.2 HDi 2.8 HDi 2.8 HDi	62 74 94 107	04/02→ 04/02→ 04/02→ 05/04→	➔	→ 03/06; Nutzlast ab [kg] 1.000 Nutzlast bis [kg] 1.400		13.0460-4978.2	604978	BRE 23917 19,3 + WK + Zub
			➔	→ 03/06; Nutzlast [kg]: 1.800		13.0460-4979.2	604979	BRE 23919 19,3 + WK + Zub
			➔	→ 03/06; Nutzlast ab [kg] 1.000 Nutzlast bis [kg] 1.800		13.0460-4980.2	604980	BRE 23921 20,3 - WE / - WK + Zub
			➔	→ 03/06; Nutzlast ab [kg] 1.000 Nutzlast bis [kg] 1.800		13.0460-4978.2	604978	BRE 23917 19,3 + WK + Zub
2.2 HDi	74	02/02→06/06	➔	04/02→ 03/06; Nutzlast ab [kg] 1.000 Nutzlast bis [kg] 1.400		13.0460-4978.2	604978	BRE 23917 19,3 + WK + Zub
			➔	04/02→ 03/06; Nutzlast [kg]: 1.800		13.0460-4979.2	604979	BRE 23919 19,3 + WK + Zub
			➔	04/02→ 03/06; Nutzlast ab [kg] 1.000 Nutzlast bis [kg] 1.800		13.0460-4980.2	604980	BRE 23921 20,3 - WE / - WK + Zub
2.8 HDi 4x4	94	02/02→06/06	➔	04/02→ 03/06; Nutzlast ab [kg] 1.000 Nutzlast bis [kg] 1.400		13.0460-4978.2	604978	BRE 23917 19,3 + WK + Zub
			➔	04/02→ 03/06; Nutzlast [kg]: 1.800		13.0460-4979.2	604979	BRE 23919 19,3 + WK + Zub
			➔	04/02→ 03/06		13.0460-4980.2	604980	BRE 23921 20,3 - WE / - WK + Zub
 Bremsscheibe								
2.0 HDi 2.2 HDi 2.8 HDi 2.8 HDi	62 74 94 107	04/02→ 04/02→ 04/02→ 05/04→	➔	→ 03/06; Nutzlast ab [kg] 1.000 Nutzlast bis [kg] 1.400		24.0124-0127.1	424127	Ø 280 24 21,9 V
			➔	→ 03/06; Nutzlast [kg]: 1.800		24.0124-0138.1	424138	Ø 300 24 21,9 V
			➔	→ 03/06; Nutzlast ab [kg] 1.000 Nutzlast bis [kg] 1.400		24.0116-0124.1	416124	Ø 280 16 14,2
			➔	→ 03/06; Nutzlast [kg]: 1.800		24.0116-0125.1	416125	Ø 280 16 14,2
2.2 HDi 2.8 HDi 4x4	74 94	02/02→06/06 02/02→06/06	➔	04/02→ 03/06; Nutzlast ab [kg] 1.000 Nutzlast bis [kg] 1.400		24.0124-0127.1	424127	Ø 280 24 21,9 V
			➔	04/02→ 03/06; Nutzlast [kg]: 1.800		24.0124-0138.1	424138	Ø 300 24 21,9 V
			➔	04/02→ 03/06; Nutzlast ab [kg] 1.000 Nutzlast bis [kg] 1.400		24.0116-0124.1	416124	Ø 280 16 14,2
➔	04/02→ 03/06; Nutzlast [kg]: 1.800		24.0116-0125.1	416125	Ø 280 16 14,2			
CITROËN - JUMPY 04/16→								
 Bremsscheibe								
1.6 BlueHDi 115 1.6 BlueHDi 95 2.0 BlueHDi 120 2.0 BlueHDi 150 2.0 BlueHDi 180	85 70 90 110 130	04/16→ 04/16→ 04/16→ 04/16→ 04/16→	➔			24.0112-0212.1	412212	Ø 290 12 10 + S
CITROËN - JUMPY 01/07→								
 Bremsbelagsatz, Scheibenbremse								
1.6 HDi 90 16V 1.6 HDi 90 8V 2.0 HDi 120 2.0 HDi 125 2.0 HDi 140 2.0 HDi 165 ↓	66 66 88 94 100 120	01/07→ 01/07→ 01/07→ 07/11→ 01/07→ 07/10→	➔			13.0460-2738.2	602738	TRW 24608 18,5 + WK + Zub
			➔			13.0460-2739.2	602739	TRW 24578 16,5 - WE / - WK + Zub









	kw			 	! #		
CITROËN - JUMPY 01/07→							
 Bremsbelagsatz, Scheibenbremse							
2.0 HDi 95	72	07/11→	←			13.0460-2738.2 602738	TRW 24608 18,5 + WK + Zub
			→			13.0460-2739.2 602739	TRW 24578 16,5 - WE / - WK + Zub
2.0 i	103	01/07→	←			13.0460-2738.2 602738	TRW 24608 18,5 + WK + Zub
			→	langer Radstand		13.0460-2739.2 602739	TRW 24578 16,5 - WE / - WK + Zub
 Bremsscheibe							
1.6 HDi 90 16V 1.6 HDi 90 8V	66 66	01/07→ 01/07→	←	für Fahrzeuge mit Trommelbremse an der Hinterachse		24.0128-0214.1 428214	Ø 280 28 26 V + S
			←	für Fahrzeuge mit Scheibenbremse an der Hinterachse		24.0128-0216.1 428216	Ø 304 28 26 V + S
			→			24.0114-0116.1 414116	Ø 290 14 12 + S
2.0 HDi 120 2.0 HDi 125 2.0 HDi 140 2.0 HDi 165 2.0 HDi 95	88 94 100 120 72	01/07→ 07/11→ 01/07→ 07/10→ 07/11→	←			24.0128-0216.1 428216	Ø 304 28 26 V + S
			→			24.0114-0116.1 414116	Ø 290 14 12 + S
2.0 i	103	01/07→	←			24.0128-0216.1 428216	Ø 304 28 26 V + S
			→	langer Radstand		24.0114-0116.1 414116	Ø 290 14 12 + S
CITROËN - JUMPY (U6U) 06/94→12/06							
 Bremsbelagsatz, Scheibenbremse							
1.6 1.6	58 59	10/95→08/00 10/95→08/00	←	Orga 09793→		13.0460-2863.2 602863	TRW 20261 19,0 + WK + Zub
			←	→Orga 09792		13.0460-2978.2 602978	TRW 21801 19,0 + WK
			←	→Orga 09155		13.0460-3957.2 603957	BDX 23042 19,0 + WK + Zub
1.9 D 1.9 D 70	51 51	10/95→08/98 04/98→11/03	←	→Orga 09155		13.0460-2978.2 602978	TRW 21801 19,0 + WK
			←	Orga 09156→		13.0460-3957.2 603957	BDX 23042 19,0 + WK + Zub
1.9 TD 2.0 2.0 HDi 110 2.0 HDi 95 2.0 i 16V	66 100 80 69 102	10/95→08/00 04/00→12/06 03/00→10/06 10/99→10/06 03/00→10/06	←	Orga 09793→		13.0460-2863.2 602863	TRW 20261 19,0 + WK + Zub
			←	→Orga 09792		13.0460-2978.2 602978	TRW 21801 19,0 + WK
1.9 TD	68	04/96→11/03	←	→Orga 09792		13.0460-2978.2 602978	TRW 21801 19,0 + WK
 Bremsscheibe							
1.6 1.6	58 59	10/95→08/00 10/95→08/00	←	→Orga 09155		24.0120-0155.1 420155	Ø 257,5 20 18,2 V
1.9 D 1.9 D 70	51 51	10/95→08/98 04/98→11/03	←	→Orga 09792		24.0126-0104.1 426104	Ø 281 26 24,2 V
1.9 TD 1.9 TD 2.0 2.0 HDi 110 2.0 HDi 95 2.0 i 16V	66 68 100 80 69 102	10/95→08/00 04/96→11/03 04/00→12/06 03/00→10/06 10/99→10/06 03/00→10/06	←	Orga 09793→		24.0128-0136.1 428136	Ø 285 28 26 V
						24.0328-0136.1 528136	Ø 285 28 26 V PD
CITROËN - JUMPY Kasten 01/07→							
 Bremsbelagsatz, Scheibenbremse							
1.6 HDi 90 16V 1.6 HDi 90 8V 2.0 HDi 120 2.0 HDi 120 4x4 2.0 HDi 125 2.0 HDi 125 4x4 2.0 HDi 140 2.0 HDi 165 2.0 HDi 95	66 66 88 88 94 94 100 120 72	01/07→ 01/07→ 01/07→ 01/10→ 07/11→ 07/11→ 01/07→ 07/10→ 07/11→	←			13.0460-2738.2 602738	TRW 24608 18,5 + WK + Zub
			→			13.0460-2739.2 602739	TRW 24578 16,5 - WE / - WK + Zub
2.0 i	103	01/07→	←			13.0460-2738.2 602738	TRW 24608 18,5 + WK + Zub
			→	langer Radstand		13.0460-2739.2 602739	TRW 24578 16,5 - WE / - WK + Zub
 Bremsscheibe							
1.6 HDi 90 16V 1.6 HDi 90 8V	66 66	01/07→ 01/07→	←	für Fahrzeuge mit Trommelbremse an der Hinterachse		24.0128-0214.1 428214	Ø 280 28 26 V + S
			←	für Fahrzeuge mit Scheibenbremse an der Hinterachse		24.0128-0216.1 428216	Ø 304 28 26 V + S
			→			24.0114-0116.1 414116	Ø 290 14 12 + S
2.0 HDi 120 2.0 HDi 120 4x4	88 88	01/07→ 01/10→	←			24.0128-0216.1 428216	Ø 304 28 26 V + S













	kw			 	! #		
CITROËN - JUMPY Kasten 01/07→							
 Bremsscheibe							
2.0 HDi 125	94	07/11→	→			24.0114-0116.1 414116	Ø 290 14 12 + S
2.0 HDi 125 4x4	94	07/11→					
2.0 HDi 140	100	01/07→					
2.0 HDi 165	120	07/10→					
2.0 HDi 95	72	07/11→					
2.0 i	103	01/07→	←			24.0128-0216.1 428216	Ø 304 28 26 V + S
			→	langer Radstand		24.0114-0116.1 414116	Ø 290 14 12 + S
CITROËN - JUMPY Kasten 04/16→							
 Bremsscheibe							
1.6 BlueHDi 115	85	04/16→	→			24.0112-0212.1 412212	Ø 290 12 10 + S
1.6 BlueHDi 95	70	04/16→					
2.0 BlueHDi 120	90	04/16→					
2.0 BlueHDi 150	110	04/16→					
2.0 BlueHDi 180	130	04/16→					
CITROËN - JUMPY Kasten (BS_, BT_, BY_, BZ_) 06/94→10/06							
 Bremsbelagsatz, Scheibenbremse							
1.6 i	58	10/95→08/00	←	Orga 09793→; Nutzlast ab [kg] 800 Nutzlast bis [kg] 900		13.0460-2863.2 602863	TRW 20261 19,0 + WK + Zub
2.0	100	04/00→10/06					
2.0 HDi 110	80	01/02→10/06	←	→Orga 09792; Nutzlast ab [kg] 800 Nutzlast bis [kg] 900		13.0460-2978.2 602978	TRW 21801 19,0 + WK
2.0 HDi 95	69	10/99→10/06				13.0460-3957.2 603957	BDX 23042 19,0 + WK + Zub
2.0 i 16V	102	03/00→10/06					
1.9 D	51	10/95→08/98	←	→Orga 09155; Nutzlast ab [kg] 800 Nutzlast bis [kg] 900		13.0460-2978.2 602978	TRW 21801 19,0 + WK
1.9 D 70	51	04/98→10/06				13.0460-3957.2 603957	BDX 23042 19,0 + WK + Zub
1.9 DT	65	10/95→08/00					
1.9 TD	66	10/95→08/00	←	Orga 09156→; Nutzlast ab [kg] 800 Nutzlast bis [kg] 900		13.0460-3957.2 603957	BDX 23042 19,0 + WK + Zub
 Bremsscheibe							
1.6 i	58	10/95→08/00	←	→Orga 09155; Nutzlast [kg]: 800		24.0120-0155.1 420155	Ø 257,5 20 18,2 V
1.9 D 70	51	04/98→10/06	←	→Orga 09792; Nutzlast [kg]: 900		24.0126-0104.1 426104	Ø 281 26 24,2 V
1.9 DT	65	10/95→08/00					
1.9 TD	66	10/95→08/00	←	Orga 09156→ Orga 09792; Nutzlast [kg]: 800		24.0126-0104.1 426104	Ø 281 26 24,2 V
2.0	100	04/00→10/06					
2.0 HDi 110	80	01/02→10/06	←	Orga 09793→; Nutzlast [kg]: 800		24.0128-0136.1 428136	Ø 285 28 26 V
2.0 HDi 95	69	10/99→10/06				24.0328-0136.1 528136	Ø 285 28 26 V PD
2.0 i 16V	102	03/00→10/06	←	Orga 09793→; Nutzlast [kg]: 900		24.0128-0136.1 428136	Ø 285 28 26 V
						24.0328-0136.1 528136	Ø 285 28 26 V PD
CITROËN - JUMPY Pritsche/Fahrgestell 09/16→							
 Bremsscheibe							
1.6 BlueHDi 95	70	09/16→	→			24.0112-0212.1 412212	Ø 290 12 10 + S
2.0 BlueHDi 120	90	09/16→					
2.0 BlueHDi 150	110	09/16→					
CITROËN - JUMPY Pritsche/Fahrgestell 07/11→							
 Bremsbelagsatz, Scheibenbremse							
2.0 HDi 125	94	07/11→	←			13.0460-2738.2 602738	TRW 24608 18,5 + WK + Zub
			→			13.0460-2739.2 602739	TRW 24578 16,5 - WE / - WK + Zub
 Bremsscheibe							
2.0 HDi 125	94	07/11→	←			24.0128-0216.1 428216	Ø 304 28 26 V + S
			→			24.0114-0116.1 414116	Ø 290 14 12 + S
CITROËN - JUMPY Pritsche/Fahrgestell (BU_, BV_, BW_, BX_) 10/99→10/06							
 Bremsbelagsatz, Scheibenbremse							
1.9 TD	68	10/99→10/06	←	Orga 09793→		13.0460-2863.2 602863	TRW 20261 19,0 + WK + Zub
2.0 HDi 95	69	10/99→10/06	←	→Orga 09792		13.0460-2978.2 602978	TRW 21801 19,0 + WK
2.0	100	12/03→10/06	←			13.0460-2863.2 602863	TRW 20261 19,0 + WK + Zub
2.0 HDi 110	80	12/03→10/06					
2.0 HDi 110 16V	80	12/03→10/06					
 Bremsscheibe							
1.9 TD	68	10/99→10/06	←	→Orga 09792		24.0126-0104.1 426104	Ø 281 26 24,2 V
2.0 HDi 95	69	10/99→10/06	←	Orga 09793→		24.0128-0136.1 428136	Ø 285 28 26 V
						24.0328-0136.1 528136	Ø 285 28 26 V PD
↓							







	kW					! #		
CITROËN - JUMPY Pritsche/Fahrgestell (BU_, BV_, BW_, BX_) 10/99→10/06								
 Bremsscheibe								
2.0	100	12/03→10/06	←			24.0128-0136.1	428136	Ø 285 28 26 V
2.0 HDi 110	80	12/03→10/06				24.0328-0136.1	528136	Ø 285 28 26 V PD
2.0 HDi 110 16V	80	12/03→10/06						
CITROËN - NEMO Kasten (AA_) 02/08→								
 Bremsbelagsatz, Scheibenbremse								
1.3 BlueHDi 80	59	02/16→	←			13.0460-3863.2	603863	BOS 23706 18,0 + WK + Zub
1.3 HDi 75	55	10/10→						
1.4	54	02/08→	←			13.0460-3818.2	603818	BOS 23706 18,1 + WK
1.4 HDi	50	02/08→						
 Bremsscheibe								
1.3 BlueHDi 80	59	02/16→	←			24.0122-0197.1	422197	Ø 257,5 22 20,2 V
1.3 HDi 75	55	10/10→				24.0322-0197.1	522197	Ø 257,5 22 20,2 V PD
1.4	54	02/08→						
1.4 HDi	50	02/08→	←	Schaltgetriebe, automatisch betätigt		24.0122-0147.1	422147	Ø 284 22 20,2 V
			←	Schaltgetriebe		24.0122-0197.1	422197	Ø 257,5 22 20,2 V
						24.0322-0197.1	522197	Ø 257,5 22 20,2 V PD
CITROËN - NEMO Kombi 04/09→								
 Bremsbelagsatz, Scheibenbremse								
1.3 HDi 75	55	10/10→	←			13.0460-3863.2	603863	BOS 23706 18,0 + WK + Zub
1.3 HDi 80	59	10/15→						
1.4	54	04/09→	←			13.0460-3818.2	603818	BOS 23706 18,1 + WK
1.4 HDi	50	04/09→						
 Bremsscheibe								
1.3 HDi 75	55	10/10→	←			24.0122-0197.1	422197	Ø 257,5 22 20,2 V
1.3 HDi 80	59	10/15→				24.0322-0197.1	522197	Ø 257,5 22 20,2 V PD
1.4	54	04/09→						
1.4 HDi	50	04/09→	←	Schaltgetriebe, automatisch betätigt		24.0122-0147.1	422147	Ø 284 22 20,2 V
			←	Schaltgetriebe		24.0122-0197.1	422197	Ø 257,5 22 20,2 V
						24.0322-0197.1	522197	Ø 257,5 22 20,2 V PD
CITROËN - SAXO (S0, S1) 02/96→04/04								
 Bremsbelagsatz, Scheibenbremse								
1.0 X	33	05/96→11/98	←	Felge Lochzahl: 4		13.0460-3962.2	603962	BDX 20905 18,0 + WE / - WK
1.0 X	37	05/98→06/03						
1.1 BiFuel	44	07/00→06/03	←	Felge Lochzahl: 3		13.0460-4066.2	604066	ATE 21857 17,7 - WE / - WK
1.1 X,SX	40	05/96→09/03						
1.1 X,SX	44	05/96→09/03						
1.4 VTS	55	05/96→06/03	←			13.0460-3962.2	603962	BDX 20905 18,0 + WE / - WK
						13.0460-7088.2	607088	ATE 21430 17,3 - WE / - WK
1.5 D	40	09/96→09/03	←			13.0460-3962.2	603962	BDX 20905 18,0 + WE / - WK
1.5 D	42	09/96→06/01						
1.5 D	43	07/01→04/04						
1.6	66	02/96→06/03	←			13.0460-7088.2	607088	ATE 21430 17,3 - WE / - WK
1.6	74	02/01→04/04						
1.6	88	02/96→04/04	→			13.0460-3823.2	603823	BOS 20974 11,0 - WK
1.6 VTL,VTR	65	05/96→06/03						
1.6 VTS	72	09/00→09/03						
1.6 VTS	87	06/96→09/03	←	07/96→		13.0460-7088.2	607088	ATE 21430 17,3 - WE / - WK
			→	07/96→		13.0460-3823.2	603823	BOS 20974 11,0 - WK
Electric	20	11/96→06/03	←	Felge Lochzahl: 4		13.0460-3962.2	603962	BDX 20905 18,0 + WE / - WK
						13.0460-7088.2	607088	ATE 21430 17,3 - WE / - WK
			←	Felge Lochzahl: 3		13.0460-4066.2	604066	ATE 21857 17,7 - WE / - WK
			→			13.0460-3823.2	603823	BOS 20974 11,0 - WK
Zubehörsatz, Scheibenbremsbelag								
1.0 X	33	05/96→11/98	←			13.0460-0424.2	610424	ATE
1.0 X	37	05/98→06/03						
1.1 BiFuel	44	07/00→06/03						
1.1 X,SX	40	05/96→09/03						
1.1 X,SX	44	05/96→09/03						
1.6	66	02/96→06/03	→			13.0460-0435.2	610435	BDX
1.6	74	02/01→04/04						
1.6	88	02/96→04/04						
1.6 VTL,VTR	65	05/96→06/03						
1.6 VTS	72	09/00→09/03						
1.6 VTS	87	06/96→09/03	→	07/96→		13.0460-0435.2	610435	BDX
↓								

	kW			 	! #		
CITROËN - SAXO (S0, S1) 02/96→04/04							
Zubehörsatz, Scheibenbremsbelag							
Electric	20	11/96→06/03	←			13.0460-0424.2 610424	ATE
			→			13.0460-0435.2 610435	BDX
 Bremsscheibe							
1.0 X	33	05/96→11/98	←	Felge Lochzahl: 3		24.0108-0107.1 408107	Ø 238 8 6 + S
1.0 X	37	05/98→06/03	←				
1.1 BiFuel	44	07/00→06/03	←	Felge Lochzahl: 4		24.0110-0187.1 410187	Ø 247 10 9 + S
1.1 X,SX	40	05/96→09/03	←				
1.1 X,SX	44	05/96→09/03	←				
1.4 VTS	55	05/96→06/03	←			24.0110-0187.1 410187	Ø 247 10 9 + S
			←			24.0120-0132.1 420132	Ø 247 20,4 18,5 V + S
1.5 D	40	09/96→09/03	←			24.0110-0187.1 410187	Ø 247 10 9 + S
1.5 D	42	09/96→06/01	←				
1.5 D	43	07/01→04/04	←				
1.6	66	02/96→06/03	←			24.0120-0132.1 420132	Ø 247 20,4 18,5 V + S
1.6	74	02/01→04/04	←			24.0320-0132.1 520132	Ø 247 20,4 18,5 V + S PD
1.6	88	02/96→04/04	←				
1.6 VTL,VTR	65	05/96→06/03	→			24.0108-0106.1 408106	Ø 247 8 6 + S
1.6 VTS	72	09/00→09/03	→				
1.6 VTS	87	06/96→09/03	←	07/96→		24.0120-0132.1 420132	Ø 247 20,4 18,5 V + S
			←			24.0320-0132.1 520132	Ø 247 20,4 18,5 V + S PD
			→	07/96→		24.0108-0106.1 408106	Ø 247 8 6 + S
Electric	20	11/96→06/03	←	Felge Lochzahl: 3		24.0108-0107.1 408107	Ø 238 8 6 + S
			←	Felge Lochzahl: 4		24.0110-0187.1 410187	Ø 247 10 9 + S
			←			24.0120-0132.1 420132	Ø 247 20,4 18,5 V + S
			→			24.0108-0106.1 408106	Ø 247 8 6 + S
CITROËN - SPACETOURER 04/16→							
 Bremsscheibe							
1.6 BlueHDi 115	85	04/16→	→			24.0112-0212.1 412212	Ø 290 12 10 + S
1.6 BlueHDi 95	70	04/16→	→				
2.0 BlueHDi 150	110	04/16→	→				
2.0 BlueHDi 180	130	04/16→	→				
CITROËN - XANTIA (X1) 03/93→10/98							
 Bremsbelagsatz, Scheibenbremse							
1.6 i	65	03/93→01/98	←	→ 12/97		13.0460-3956.2 603956	BDX 21631 17,0 + WK
1.8 i	66	04/97→01/98	→	→ 12/97		13.0460-4956.2 604956	CIT 20162 15,4 - WE / - WK
1.8 i	74	03/93→01/98	→	→ 12/97			
1.8 i 16V	81	06/95→01/98	→	→ 12/97			
1.9 D	50	06/94→01/98	→	→ 12/97			
1.9 D	51	06/94→01/98	→	→ 12/97			
1.9 SD	55	02/96→01/98	→	→ 12/97			
1.9 Turbo D	66	10/94→01/98	→	→ 12/97			
2.0 i	89	03/93→01/98	→	→ 12/97			
2.0 i 16V	97	06/95→01/98	→	→ 12/97			
2.0 i 16V	110	06/94→01/98	→	→ 12/97			
2.0 i 16V	112	03/93→01/98	→	→ 12/97			
2.0	95	03/93→05/95	←			13.0460-3956.2 603956	BDX 21631 17,0 + WK
			→			13.0460-4956.2 604956	CIT 20162 15,4 - WE / - WK
2.0 Turbo	108	06/95→01/98	←	→ 12/97		13.0460-3973.2 603973	BDX 23146 17,0 + WK
2.1 Turbo D 12V	80	06/95→01/98	→	→ 12/97		13.0460-4956.2 604956	CIT 20162 15,4 - WE / - WK
			→	→ 12/97			
3.0 i 24V	140	01/97→01/98	←	→ 12/97		13.0460-3986.2 603986	BOS 23135 18,0 + WK
			→	→ 12/97		13.0460-4956.2 604956	CIT 20162 15,4 - WE / - WK
Zubehörsatz, Scheibenbremsbelag							
1.6 i	65	03/93→01/98	→	→ 12/97		13.0460-0437.2 610437	CIT
1.8 i	66	04/97→01/98	→	→ 12/97			
1.8 i	74	03/93→01/98	→	→ 12/97			
1.8 i 16V	81	06/95→01/98	→	→ 12/97			
1.9 D	50	06/94→01/98	→	→ 12/97			
1.9 D	51	06/94→01/98	→	→ 12/97			
1.9 SD	55	02/96→01/98	→	→ 12/97			
1.9 Turbo D	66	10/94→01/98	→	→ 12/97			
2.0 i	89	03/93→01/98	→	→ 12/97			
2.0 i 16V	97	06/95→01/98	→	→ 12/97			
2.0 i 16V	110	06/94→01/98	→	→ 12/97			
2.0 i 16V	112	03/93→01/98	→	→ 12/97			
2.0 Turbo	108	06/95→01/98	→	→ 12/97			
2.1 Turbo D 12V	80	06/95→01/98	→	→ 12/97			
3.0 i 24V	140	01/97→01/98	→	→ 12/97			
↓							











	kw			 	! #		
CITROËN - XANTIA (X1) 03/93→10/98							
Zubehörsatz, Scheibenbremsbelag							
2.0	95	03/93→05/95	➡			13.0460-0437.2 610437	CIT
 Bremsscheibe							
1.6 i	65	03/93→01/98	←	→ 12/97		24.0120-0133.1 420133	Ø 266 20,5 18,5 V + S
1.8 i	66	04/97→01/98				24.0320-0133.1 520133	Ø 266 20,5 18,5 V + S PD
1.8 i	74	03/93→01/98					
1.8 i 16V	81	06/95→01/98	➡	→ 12/97		24.0109-0122.1 409122	Ø 224 9 7
1.9 D	50	06/94→01/98					
1.9 D	51	06/94→01/98					
1.9 SD	55	02/96→01/98					
2.0 i	89	03/93→01/98					
1.9 Turbo D	66	10/94→01/98	←	Orga 07568→; → 12/97		24.0120-0133.1 420133	Ø 266 20,5 18,5 V + S
			←	→Orga 07567		24.0320-0133.1 520133	Ø 266 20,5 18,5 V + S PD
			➡	→ 12/97		24.0122-0142.1 422142	Ø 283 22 20 V
			➡	→ 12/97		24.0109-0122.1 409122	Ø 224 9 7
2.0	95	03/93→05/95	←			24.0122-0142.1 422142	Ø 283 22 20 V
			➡			24.0109-0122.1 409122	Ø 224 9 7
2.0 i 16V	97	06/95→01/98	←	→ 12/97		24.0122-0142.1 422142	Ø 283 22 20 V
2.0 i 16V	110	06/94→01/98					
2.0 i 16V	112	03/93→01/98	➡	→ 12/97		24.0109-0122.1 409122	Ø 224 9 7
2.0 Turbo	108	06/95→01/98	←	→ 12/97		24.0126-0106.1 426106	Ø 283 26 24,2 V + S
2.1 Turbo D 12V	80	06/95→01/98				24.0326-0106.1 526106	Ø 283 26 24,2 V + S PD
			➡	→ 12/97		24.0109-0122.1 409122	Ø 224 9 7
3.0 i 24V	140	01/97→01/98	←	→ 12/97		24.0128-0128.1 428128	Ø 288 28 26 V + S
			➡	→ 12/97		24.0109-0122.1 409122	Ø 224 9 7
CITROËN - XANTIA (X2) 01/98→04/03							
 Bremsbelagsatz, Scheibenbremse							
1.6 i SX	65	01/98→03/01	←			13.0460-3956.2 603956	BDX 21631 17,0 + WK
			➡			13.0460-4956.2 604956	CIT 20162 15,4 - WE / - WK
1.8 i	66	01/98→04/03	←	→ 09/01		13.0460-3956.2 603956	BDX 21631 17,0 + WK
1.8 i 16V	81	01/98→04/03					
1.9 SD	55	01/98→04/03	➡	→ 09/01		13.0460-4956.2 604956	CIT 20162 15,4 - WE / - WK
1.9 Turbo D	66	01/98→04/03	←	→ 09/01; Schaltgetriebe		13.0460-3956.2 603956	BDX 21631 17,0 + WK
			←	→ 09/01; Automatikgetriebe		13.0460-3986.2 603986	BOS 23135 18,0 + WK
			➡	→ 09/01		13.0460-4956.2 604956	CIT 20162 15,4 - WE / - WK
2.0 HDI 109	80	02/99→04/03	←	→ 09/01		13.0460-3986.2 603986	BOS 23135 18,0 + WK
3.0 V6	140	01/98→04/03	➡	→ 09/01		13.0460-4956.2 604956	CIT 20162 15,4 - WE / - WK
2.0 HDI 90	66	03/99→04/03	←			13.0460-3956.2 603956	BDX 21631 17,0 + WK
			➡	→ 09/01		13.0460-4956.2 604956	CIT 20162 15,4 - WE / - WK
2.0 i	89	01/98→04/03	←	→ 09/01		13.0460-3972.2 603972	BDX 21632 16,0 + WK
			➡	→ 09/01		13.0460-4956.2 604956	CIT 20162 15,4 - WE / - WK
2.0 i 16V	97	01/98→04/03	←	→ 09/01		13.0460-3972.2 603972	BDX 21632 16,0 + WK
			←	→Orga 08000		13.0460-3973.2 603973	BDX 23146 17,0 + WK
			←	Orga 08001→; → 09/01		13.0460-3986.2 603986	BOS 23135 18,0 + WK
			➡	→ 09/01		13.0460-4956.2 604956	CIT 20162 15,4 - WE / - WK
2.0 Turbo	108	01/98→04/03	←	→Orga 08000		13.0460-3973.2 603973	BDX 23146 17,0 + WK
			←	Orga 08001→; → 09/01		13.0460-3986.2 603986	BOS 23135 18,0 + WK
			➡	→ 09/01		13.0460-4956.2 604956	CIT 20162 15,4 - WE / - WK
2.1 Turbo D 12V	80	01/98→02/99	←	→Orga 08000		13.0460-3973.2 603973	BDX 23146 17,0 + WK
			←	Orga 08001→		13.0460-3986.2 603986	BOS 23135 18,0 + WK
			➡			13.0460-4956.2 604956	CIT 20162 15,4 - WE / - WK
Zubehörsatz, Scheibenbremsbelag							
1.6 i SX	65	01/98→03/01	➡			13.0460-0437.2 610437	CIT
2.1 Turbo D 12V	80	01/98→02/99					
1.8 i	66	01/98→04/03	➡	→ 09/01		13.0460-0437.2 610437	CIT
1.8 i 16V	81	01/98→04/03					
1.9 SD	55	01/98→04/03					
1.9 Turbo D	66	01/98→04/03					
2.0 HDI 109	80	02/99→04/03					
2.0 HDI 90	66	03/99→04/03					
2.0 i	89	01/98→04/03					
↓							





















	kw			 	! #				
CITROËN - XANTIA (X2) 01/98→04/03									
Zubehörsatz, Scheibenbremsbelag									
2.0 i 16V 2.0 Turbo 3.0 V6	97 108 140	01/98→04/03 01/98→04/03 01/98→04/03	➡	→ 09/01		13.0460-0437.2 610437	CIT		
 Bremsscheibe									
1.6 i SX	65	01/98→03/01	←			24.0120-0133.1 420133	Ø 266 20,5 18,5 V + S		
			➡			24.0109-0122.1 409122	Ø 224 9 7		
1.8 i 1.8 i 16V 1.9 SD	66 81 55	01/98→04/03 01/98→04/03 01/98→04/03	←	→ 09/01		24.0120-0133.1 420133	Ø 266 20,5 18,5 V + S		
			➡	→ 09/01		24.0109-0122.1 409122	Ø 224 9 7		
			←	→ 09/01; Schaltgetriebe		24.0120-0133.1 420133	Ø 266 20,5 18,5 V + S		
1.9 Turbo D	66	01/98→04/03	←	→ 09/01; Automatikgetriebe		24.0128-0128.1 428128	Ø 288 28 26 V + S		
			➡	→ 09/01		24.0109-0122.1 409122	Ø 224 9 7		
			←	→ 09/01		24.0128-0128.1 428128	Ø 288 28 26 V + S		
2.0 HDI 109 3.0 V6	80 140	02/99→04/03 01/98→04/03	←	→ 09/01		24.0128-0128.1 428128	Ø 288 28 26 V + S		
			➡	→ 09/01		24.0109-0122.1 409122	Ø 224 9 7		
2.0 HDI 90	66	03/99→04/03	←			24.0120-0133.1 420133	Ø 266 20,5 18,5 V + S		
			➡	→ 09/01		24.0109-0122.1 409122	Ø 224 9 7		
2.0 i	89	01/98→04/03	←	→ 09/01		24.0122-0142.1 422142	Ø 283 22 20 V		
			➡	→ 09/01		24.0109-0122.1 409122	Ø 224 9 7		
2.0 i 16V	97	01/98→04/03	←	→ 09/01		24.0122-0142.1 422142	Ø 283 22 20 V		
			←	→ Orga 08000		24.0126-0106.1 426106	Ø 283 26 24,2 V + S		
						24.0326-0106.1 526106	Ø 283 26 24,2 V + S PD		
			←	Orga 08001→; → 09/01		24.0128-0128.1 428128	Ø 288 28 26 V + S		
			➡	→ 09/01		24.0109-0122.1 409122	Ø 224 9 7		
2.0 Turbo	108	01/98→04/03	←	→ Orga 08000		24.0126-0106.1 426106	Ø 283 26 24,2 V + S		
						24.0326-0106.1 526106	Ø 283 26 24,2 V + S PD		
			←	Orga 08001→; → 09/01		24.0128-0128.1 428128	Ø 288 28 26 V + S		
2.1 Turbo D 12V	80	01/98→02/99	←	→ Orga 08000		24.0126-0106.1 426106	Ø 283 26 24,2 V + S		
						24.0326-0106.1 526106	Ø 283 26 24,2 V + S PD		
			←	Orga 08001→		24.0128-0128.1 428128	Ø 288 28 26 V + S		
			➡			24.0109-0122.1 409122	Ø 224 9 7		
CITROËN - XANTIA Break (X1) 06/95→01/98									
 Bremsbelagsatz, Scheibenbremse									
1.8 i 1.8 i 16V	66 81	04/97→01/98 06/95→01/98	←	→ 12/97		13.0460-3956.2 603956	BDX 21631 17,0 + WK		
			➡	→ 12/97		13.0460-4911.2 604911	CIT 20389 15,4 - WE / - WK		
1.8 i	74	06/95→01/98	←	Orga 07483→; → 12/97; + ABS		13.0460-3956.2 603956	BDX 21631 17,0 + WK		
			←	→ 12/97; - ABS		13.0460-3956.2 603956	BDX 21631 17,0 + WK		
			←	→ Orga 07482; + ABS		13.0460-3972.2 603972	BDX 21632 16,0 + WK		
			➡	→ 12/97		13.0460-4911.2 604911	CIT 20389 15,4 - WE / - WK		
1.9 SD 1.9 Turbo D	55 66	04/97→01/98 06/95→01/98	←	→ 12/97		13.0460-3972.2 603972	BDX 21632 16,0 + WK		
			➡	→ 12/97		13.0460-4911.2 604911	CIT 20389 15,4 - WE / - WK		
2.0 i 2.0 i 16V 2.0 Turbo 2.1 Turbo D 12V	89 97 108 80	06/95→01/98 06/95→01/98 06/95→01/98 06/96→01/98	➡	→ 12/97					
Zubehörsatz, Scheibenbremsbelag									
1.8 i 1.8 i 1.8 i 16V 1.9 SD 1.9 Turbo D 2.0 i 2.0 i 16V 2.0 Turbo 2.1 Turbo D 12V	66 74 81 55 66 89 97 108 80	04/97→01/98 06/95→01/98 06/95→01/98 04/97→01/98 06/95→01/98 06/95→01/98 06/95→01/98 06/96→01/98	➡	→ 12/97		13.0460-0264.2 610264			
 Bremsscheibe									
1.8 i	66	04/97→01/98	←	→ 12/97		24.0120-0133.1 420133	Ø 266 20,5 18,5 V + S		
			➡	→ 12/97		24.0320-0133.1 520133	Ø 266 20,5 18,5 V + S PD		
						24.0112-0143.1 412143	Ø 251 12 10,8		
↓									







	kw			 	! #					
CITROËN - XANTIA Break (X1) 06/95→01/98										
Bremsscheibe										
1.8 i 1.8 i 16V	74 81	06/95→01/98 06/95→01/98	←	→ 12/97; Orga 07483→; + ABS	24.0120-0133.1	420133	∅ 266 20,5 18,5 V + S			
			→		24.0320-0133.1	520133	∅ 266 20,5 18,5 V + S PD			
			←	→ 12/97; - ABS	24.0120-0133.1	420133	∅ 266 20,5 18,5 V + S			
			→		24.0320-0133.1	520133	∅ 266 20,5 18,5 V + S PD			
1.9 SD 1.9 Turbo D	55 66	04/97→01/98 06/95→01/98	←	→ 12/97	24.0122-0142.1	422142	∅ 283 22 20 V			
			→		24.0112-0143.1	412143	∅ 251 12 10,8			
2.0 i 2.0 i 16V	89 97	06/95→01/98 06/95→01/98	←	→ Orga 07482; + ABS	24.0122-0142.1	422142	∅ 283 22 20 V			
			→		24.0112-0143.1	412143	∅ 251 12 10,8			
2.0 Turbo 2.1 Turbo D 12V	108 80	06/95→01/98 06/96→01/98	←	→ 12/97	24.0126-0106.1	426106	∅ 283 26 24,2 V + S			
			→		24.0326-0106.1	526106	∅ 283 26 24,2 V + S PD			
			→		24.0112-0143.1	412143	∅ 251 12 10,8			
CITROËN - XANTIA Break (X2) 01/98→04/03										
Bremsbelagsatz, Scheibenbremse										
1.8 i 1.8 i 16V	66 81	01/98→04/03 01/98→04/03	←	→ 09/01	13.0460-3956.2	603956	BDX 21631 17,0 + WK			
			→		13.0460-4911.2	604911	CIT 20389 15,4 - WE / - WK			
1.9 SD 2.0 i 16V	55 97	01/98→04/03 01/98→04/03	←	→ 09/01	13.0460-3972.2	603972	BDX 21632 16,0 + WK			
			→		13.0460-4911.2	604911	CIT 20389 15,4 - WE / - WK			
1.9 Turbo D	66	01/98→04/03	←	→ 09/01; Schaltgetriebe	13.0460-3972.2	603972	BDX 21632 16,0 + WK			
			←	→ 09/01; Automatikgetriebe	13.0460-3986.2	603986	BOS 23135 18,0 + WK			
			→		13.0460-4911.2	604911	CIT 20389 15,4 - WE / - WK			
2.0 HDI 109 3.0 V6	80 140	02/99→04/03 01/98→04/03	←	→ 09/01	13.0460-3986.2	603986	BOS 23135 18,0 + WK			
			→		13.0460-4911.2	604911	CIT 20389 15,4 - WE / - WK			
2.0 HDI 90	66	03/99→04/03	←		13.0460-3972.2	603972	BDX 21632 16,0 + WK			
			→		13.0460-4911.2	604911	CIT 20389 15,4 - WE / - WK			
2.0 i	89	01/98→04/03	←	→ 09/01	13.0460-3972.2	603972	BDX 21632 16,0 + WK			
			→		13.0460-4956.2	604956	CIT 20162 15,4 - WE / - WK			
2.0 Turbo	108	01/98→04/03	←	→ Orga 08000	13.0460-3973.2	603973	BDX 23146 17,0 + WK			
			←	Orga 08001→; → 09/01	13.0460-3986.2	603986	BOS 23135 18,0 + WK			
			→		13.0460-4911.2	604911	CIT 20389 15,4 - WE / - WK			
2.1 Turbo D 12V	80	01/98→02/99	←	→ Orga 08000	13.0460-3973.2	603973	BDX 23146 17,0 + WK			
			←	Orga 08001→	13.0460-3986.2	603986	BOS 23135 18,0 + WK			
			→		13.0460-4911.2	604911	CIT 20389 15,4 - WE / - WK			
Zubehörsatz, Scheibenbremsbelag										
1.8 i 1.8 i 16V 1.9 SD 1.9 Turbo D 2.0 HDI 109 2.0 HDI 90 2.0 i 16V 2.0 Turbo 3.0 V6 2.0 i 2.1 Turbo D 12V	66 81 55 66 80 66 97 108 140 89 80	01/98→04/03 01/98→04/03 01/98→04/03 01/98→04/03 02/99→04/03 03/99→04/03 01/98→04/03 01/98→04/03 01/98→04/03 01/98→04/03 01/98→02/99	→	→ 09/01	13.0460-0264.2	610264				
			→		13.0460-0437.2	610437	CIT			
			→		13.0460-0264.2	610264				
			Bremsscheibe							
			1.8 i 1.8 i 16V	66 81	01/98→04/03 01/98→04/03	←	→ 09/01	24.0120-0133.1	420133	∅ 266 20,5 18,5 V + S
						→		24.0320-0133.1	520133	∅ 266 20,5 18,5 V + S PD
			1.9 SD 2.0 i 16V	55 97	01/98→04/03 01/98→04/03	←	→ 09/01	24.0122-0142.1	422142	∅ 283 22 20 V
						→		24.0112-0143.1	412143	∅ 251 12 10,8
			1.9 Turbo D	66	01/98→04/03	←	→ 09/01; Schaltgetriebe	24.0122-0142.1	422142	∅ 283 22 20 V
						←	→ 09/01; Automatikgetriebe	24.0128-0128.1	428128	∅ 288 28 26 V + S
						→		24.0112-0143.1	412143	∅ 251 12 10,8
2.0 HDI 109 3.0 V6	80 140	02/99→04/03 01/98→04/03	←	→ 09/01	24.0128-0128.1	428128	∅ 288 28 26 V + S			
			→		24.0112-0143.1	412143	∅ 251 12 10,8			
↓										



	kw			 	! #		
CITROËN - XANTIA Break (X2) 01/98→04/03							
 Bremsscheibe							
2.0 HDI 90	66	03/99→04/03	←			24.0122-0142.1 422142	Ø 283 22 20 V
			→	→ 09/01		24.0112-0143.1 412143	Ø 251 12 10,8
2.0 i	89	01/98→04/03	←	→ 09/01		24.0122-0142.1 422142	Ø 283 22 20 V
			→	→ 09/01		24.0109-0122.1 409122	Ø 224 9 7
2.0 Turbo	108	01/98→04/03	←	→Orga 08000		24.0126-0106.1 426106	Ø 283 26 24,2 V + S
			←	Orga 08001→; → 09/01		24.0326-0106.1 526106	Ø 283 26 24,2 V + S PD
			→	→ 09/01		24.0128-0128.1 428128	Ø 288 28 26 V + S
			→	→ 09/01		24.0112-0143.1 412143	Ø 251 12 10,8
2.1 Turbo D 12V	80	01/98→02/99	←	→Orga 08000		24.0126-0106.1 426106	Ø 283 26 24,2 V + S
			←	Orga 08001→		24.0326-0106.1 526106	Ø 283 26 24,2 V + S PD
			←			24.0128-0128.1 428128	Ø 288 28 26 V + S
			→			24.0112-0143.1 412143	Ø 251 12 10,8
CITROËN - XM (Y4) 05/94→10/00							
 Bremsbelagsatz, Scheibenbremse							
2.0 i 16V	97	05/94→10/00	←			13.0460-3947.2 603947	BDX 21505 17,0 + WK
2.0 Turbo	108	05/94→10/00	→			13.0460-4956.2 604956	CIT 20162 15,4 - WE / - WK
2.1 D12 VSX	60	03/96→08/96	→				
2.1 TD 12V	80	05/94→10/00	→				
3.0 V6	123	05/94→10/00	→				
3.0 V6 24V	147	05/94→10/00	→				
2.5 TD	95	05/94→10/00	←	→Orga 07475		13.0460-3947.2 603947	BDX 21505 17,0 + WK
			←	Orga 07476→		13.0460-3986.2 603986	BOS 23135 18,0 + WK
			→			13.0460-4956.2 604956	CIT 20162 15,4 - WE / - WK
3.0 V6	140	04/97→10/00	←			13.0460-3986.2 603986	BOS 23135 18,0 + WK
			→			13.0460-4956.2 604956	CIT 20162 15,4 - WE / - WK
Zubehörsatz, Scheibenbremsbelag							
2.0 i 16V	97	05/94→10/00	→			13.0460-0437.2 610437	CIT
2.0 Turbo	108	05/94→10/00	→				
2.1 D12 VSX	60	03/96→08/96	→				
2.1 TD 12V	80	05/94→10/00	→				
2.5 TD	95	05/94→10/00	→				
3.0 V6	123	05/94→10/00	→				
3.0 V6	140	04/97→10/00	→				
3.0 V6 24V	147	05/94→10/00	→				
 Bremsscheibe							
2.0 i 16V	97	05/94→10/00	←			24.0126-0100.1 426100	Ø 283 26 24 V
2.0 Turbo	108	05/94→10/00	→			24.0109-0121.2 409121	Ø 224 9 8
2.1 D12 VSX	60	03/96→08/96	→				
2.1 TD 12V	80	05/94→10/00	→				
3.0 V6	123	05/94→10/00	→				
3.0 V6 24V	147	05/94→10/00	→				
2.5 TD	95	05/94→10/00	←	→Orga 07475		24.0126-0100.1 426100	Ø 283 26 24 V
			←	Orga 07476→		24.0128-0178.1 428178	Ø 288 28 26 V
			→			24.0109-0121.2 409121	Ø 224 9 8
3.0 V6	140	04/97→10/00	←			24.0128-0178.1 428178	Ø 288 28 26 V
			→			24.0109-0121.2 409121	Ø 224 9 8
CITROËN - XM Break (Y4) 05/94→10/00							
 Bremsbelagsatz, Scheibenbremse							
2.0 i 16V	97	05/94→10/00	←			13.0460-3947.2 603947	BDX 21505 17,0 + WK
2.0 Turbo	108	05/94→10/00	→			13.0460-4911.2 604911	CIT 20389 15,4 - WE / - WK
2.1 D12	60	07/94→06/96	→				
2.1 TD 12V	80	05/94→10/00	→				
3.0 V6	123	05/94→10/00	→				
2.5 TD	95	05/94→10/00	←	→Orga 07475		13.0460-3947.2 603947	BDX 21505 17,0 + WK
			←	Orga 07476→		13.0460-3986.2 603986	BOS 23135 18,0 + WK
			→			13.0460-4911.2 604911	CIT 20389 15,4 - WE / - WK
3.0 V6	140	04/97→10/00	←			13.0460-3986.2 603986	BOS 23135 18,0 + WK
			→			13.0460-4911.2 604911	CIT 20389 15,4 - WE / - WK
↓							

	kW			 	! #		
CITROËN - XM Break (Y4) 05/94→10/00							
Zubehörsatz, Scheibenbremsbelag							
2.0 i 16V	97	05/94→10/00	➔			13.0460-0264.2 610264	
2.0 Turbo	108	05/94→10/00					
2.1 D12	60	07/94→06/96					
2.1 TD 12V	80	05/94→10/00					
2.5 TD	95	05/94→10/00					
3.0 V6	123	05/94→10/00					
3.0 V6	140	04/97→10/00					
 Bremsscheibe							
2.0 i 16V	97	05/94→10/00	➔			24.0126-0100.1 426100	Ø 283 26 24 V
2.0 Turbo	108	05/94→10/00					
2.1 D12	60	07/94→06/96	➔			24.0112-0136.2 412136	Ø 251 12 10,8
2.1 TD 12V	80	05/94→10/00					
3.0 V6	123	05/94→10/00					
2.5 TD	95	05/94→10/00	➔	→Orga 07475		24.0126-0100.1 426100	Ø 283 26 24 V
			➔	Orga 07476→		24.0128-0178.1 428178	Ø 288 28 26 V
			➔			24.0112-0136.2 412136	Ø 251 12 10,8
3.0 V6	140	04/97→10/00	➔			24.0128-0178.1 428178	Ø 288 28 26 V
			➔			24.0112-0136.2 412136	Ø 251 12 10,8
CITROËN - XSARA (N1) 04/97→04/05							
 Bremsbelagsatz, Scheibenbremse							
1.4 HDi	50	01/03→03/05	➔			13.0460-3994.2 603994	BOS 23599 19,0 - WE / - WK + Zub
						13.0470-3994.2 LD3994	BOS 23599 19,0 - WE / - WK + Zub Ceramic
1.4 i	55	04/97→03/05	➔	→ 08/00; - ABS		13.0460-3977.2 603977	BOS 21980 18,0 + WE / - WK
			➔	09/00→		13.0460-3994.2 603994	BOS 23599 19,0 - WE / - WK + Zub
						13.0470-3994.2 LD3994	BOS 23599 19,0 - WE / - WK + Zub Ceramic
1.4 LPG	55	05/98→08/00	➔	→ 08/00; + ABS		13.0460-7088.2 607088	ATE 21430 17,3 - WE / - WK
			➔	- ABS		13.0460-3977.2 603977	BOS 21980 18,0 + WE / - WK
1.5 D	42	04/97→09/00	➔	+ ABS		13.0460-7088.2 607088	ATE 21430 17,3 - WE / - WK
			➔	→ 08/00; - ABS		13.0460-3977.2 603977	BOS 21980 18,0 + WE / - WK
1.6 16V	80	09/00→03/05	➔	→ 08/00; + ABS		13.0460-7088.2 607088	ATE 21430 17,3 - WE / - WK
			➔			13.0460-3994.2 603994	BOS 23599 19,0 - WE / - WK + Zub
1.6 i	65	04/97→09/00	➔			13.0470-3994.2 LD3994	BOS 23599 19,0 - WE / - WK + Zub Ceramic
			➔			13.0460-3823.2 603823	BOS 20974 11,0 - WK
1.8 D	43	04/97→09/00	➔	→ 08/00		13.0460-7088.2 607088	ATE 21430 17,3 - WE / - WK
1.8 i	66	04/97→09/00					
1.9 D	50	04/97→09/00					
1.9 SD	55	01/98→09/00					
1.9 TD	66	04/97→09/00					
1.8 BiFuel	82	07/97→08/00	➔			13.0460-2829.2 602829	TRW 23124 19,0 + WK
			➔			13.0460-3978.2 603978	BOS 23332 18,0 - WK + Zub
1.8 i 16V	81	04/97→09/00	➔			13.0460-3823.2 603823	BOS 20974 11,0 - WK
			➔	→ 08/00		13.0460-2829.2 602829	TRW 23124 19,0 + WK
2.0 16V	97	07/98→09/00				13.0460-3978.2 603978	BOS 23332 18,0 - WK + Zub
1.8 i Aut.	74	04/97→09/00	➔			13.0460-3823.2 603823	BOS 20974 11,0 - WK
			➔	→ 08/00		13.0460-2829.2 602829	TRW 23124 19,0 + WK
						13.0460-3978.2 603978	BOS 23332 18,0 - WK + Zub
1.8 VTS	85	09/00→10/04	➔			13.0460-7088.2 607088	ATE 21430 17,3 - WE / - WK
			➔	→ 09/00		13.0460-3823.2 603823	BOS 20974 11,0 - WK
1.9 D	51	07/98→03/05	➔			13.0460-3823.2 603823	BOS 20974 11,0 - WK
			➔	→ 08/00		13.0460-3994.2 603994	BOS 23599 19,0 - WE / - WK + Zub
1.9 D	52	04/00→04/05	➔	09/00→		13.0470-3994.2 LD3994	BOS 23599 19,0 - WE / - WK + Zub Ceramic
			➔	→ 08/00		13.0460-7088.2 607088	ATE 21430 17,3 - WE / - WK
↓			➔	09/00→ 03/05		13.0460-3994.2 603994	BOS 23599 19,0 - WE / - WK + Zub

	kw			 	! #		
CITROËN - XSARA (N1) 04/97→04/05							
 Bremsbelagsatz, Scheibenbremse							
1.9 D	52	04/00→04/05	←	09/00→ 03/05		13.0470-3994.2 LD3994	BOS 23599 19,0 - WE / - WK + Zub Ceramic
			←	→ 08/00		13.0460-7088.2 607088	ATE 21430 17,3 - WE / - WK
2.0 16V	100	09/00→03/05	←	→Orga 09184		13.0460-2817.2 602817	TRW 21674 19,0 + WK
2.0 16V	120	04/97→09/00	←	Orga 09185→		13.0460-3966.2 603966	BOS 23600 19,4 - WE / - WK + Zub
2.0 HDi 109	80	05/01→03/05	←			13.0470-3966.2 LD3966	BOS 23600 19,4 - WE / - WK + Zub Ceramic
			→			13.0460-3823.2 603823	BOS 20974 11,0 - WK
2.0 HDi 90	66	02/99→03/05	←	→ 08/00		13.0460-2829.2 602829	TRW 23124 19,0 + WK
			←	09/00→		13.0460-3978.2 603978	BOS 23332 18,0 - WK + Zub
			←			13.0460-3994.2 603994	BOS 23599 19,0 - WE / - WK + Zub
			←			13.0470-3994.2 LD3994	BOS 23599 19,0 - WE / - WK + Zub Ceramic
			→			13.0460-3823.2 603823	BOS 20974 11,0 - WK
Zubehörsatz, Scheibenbremsbelag							
1.6 16V	80	09/00→03/05	→			13.0460-0435.2 610435	BDX
1.8 BiFuel	82	07/97→08/00					
1.8 i 16V	81	04/97→09/00					
1.8 i Aut.	74	04/97→09/00					
2.0 16V	97	07/98→09/00					
2.0 16V	100	09/00→03/05					
2.0 16V	120	04/97→09/00					
2.0 HDi 109	80	05/01→03/05					
2.0 HDi 90	66	02/99→03/05					
1.8 VTS	85	09/00→10/04	→	→ 09/00		13.0460-0435.2 610435	BDX
 Bremsscheibe							
1.4 HDi	50	01/03→03/05	←			24.0122-0194.1 422194	Ø 266 22 20 V + S
1.4 i	55	04/97→03/05	←	→ 08/00; - ABS		24.0113-0185.1 413185	Ø 247,5 13 11 + S
			←	→ 08/00; + ABS		24.0313-0185.1 513185	Ø 247,5 13 11 + S PD
			←	→ 08/00; + ABS		24.0120-0132.1 420132	Ø 247 20,4 18,5 V + S
			←	→ 08/00; + ABS		24.0320-0132.1 520132	Ø 247 20,4 18,5 V + S PD
			←	09/00→		24.0122-0194.1 422194	Ø 266 22 20 V + S
1.4 LPG	55	05/98→08/00	←	- ABS		24.0113-0185.1 413185	Ø 247,5 13 11 + S
			←	+ ABS		24.0313-0185.1 513185	Ø 247,5 13 11 + S PD
			←	+ ABS		24.0120-0132.1 420132	Ø 247 20,4 18,5 V + S
			←	+ ABS		24.0320-0132.1 520132	Ø 247 20,4 18,5 V + S PD
1.5 D	42	04/97→09/00	←	→ 08/00; - ABS		24.0113-0185.1 413185	Ø 247,5 13 11 + S
			←	→ 08/00; + ABS		24.0313-0185.1 513185	Ø 247,5 13 11 + S PD
			←	→ 08/00; + ABS		24.0120-0132.1 420132	Ø 247 20,4 18,5 V + S
			←	→ 08/00; + ABS		24.0320-0132.1 520132	Ø 247 20,4 18,5 V + S PD
1.6 16V	80	09/00→03/05	←			24.0122-0194.1 422194	Ø 266 22 20 V + S
			→			24.0108-0106.1 408106	Ø 247 8 6 + S
1.6 i	65	04/97→09/00	←	→ 08/00		24.0120-0132.1 420132	Ø 247 20,4 18,5 V + S
1.8 D	43	04/97→09/00	←			24.0320-0132.1 520132	Ø 247 20,4 18,5 V + S PD
1.8 i	66	04/97→09/00	←				
1.9 D	50	04/97→09/00	←				
1.9 SD	55	01/98→09/00	←				
1.9 TD	66	04/97→09/00	←				
1.8 BiFuel	82	07/97→08/00	←			24.0120-0133.1 420133	Ø 266 20,5 18,5 V + S
			→			24.0320-0133.1 520133	Ø 266 20,5 18,5 V + S PD
			→			24.0108-0106.1 408106	Ø 247 8 6 + S
1.8 i 16V	81	04/97→09/00	←	→ 08/00		24.0120-0133.1 420133	Ø 266 20,5 18,5 V + S
2.0 16V	97	07/98→09/00	←			24.0320-0133.1 520133	Ø 266 20,5 18,5 V + S PD
			→	→ 08/00		24.0108-0106.1 408106	Ø 247 8 6 + S
1.8 i Aut.	74	04/97→09/00	←	→ 08/00		24.0120-0132.1 420132	Ø 247 20,4 18,5 V + S
			←			24.0120-0133.1 420133	Ø 266 20,5 18,5 V + S
			←			24.0320-0132.1 520132	Ø 247 20,4 18,5 V + S PD
			←			24.0320-0133.1 520133	Ø 266 20,5 18,5 V + S PD
			→	→ 08/00		24.0108-0106.1 408106	Ø 247 8 6 + S
1.9 D	51	07/98→03/05	←	→ 08/00		24.0120-0132.1 420132	Ø 247 20,4 18,5 V + S
			←			24.0320-0132.1 520132	Ø 247 20,4 18,5 V + S PD
↓							

	kw			 	! #		
CITROËN - XSARA (N1) 04/97→04/05							
Bremsscheibe							
1.9 D	51	07/98→03/05	←	09/00→		24.0122-0194.1 422194	Ø 266 22 20 V + S
1.9 D	52	04/00→04/05	←	→ 08/00		24.0120-0132.1 420132	Ø 247 20,4 18,5 V + S
			←	09/00→ 03/05		24.0320-0132.1 520132	Ø 247 20,4 18,5 V + S PD
2.0 16V 2.0 HDi 109	100 80	09/00→03/05 05/01→03/05	←	→Orga 09184		24.0122-0142.1 422142	Ø 283 22 20 V
			←	Orga 09185→		24.0126-0120.1 426120	Ø 283 26 24 V + S
			→			24.0326-0120.1 526120	Ø 283 26 24 V + S PD
2.0 16V	120	04/97→09/00	←	→Orga 09184		24.0108-0106.1 408106	Ø 247 8 6 + S
			←	Orga 09185→		24.0122-0142.1 422142	Ø 283 22 20 V
			→	→ 08/00		24.0126-0120.1 426120	Ø 283 26 24 V + S
2.0 HDi 90	66	02/99→03/05	←	→ 08/00		24.0326-0120.1 526120	Ø 283 26 24 V + S PD
			←	09/00→		24.0108-0106.1 408106	Ø 247 8 6 + S
			→			24.0120-0133.1 420133	Ø 266 20,5 18,5 V + S
						24.0320-0133.1 520133	Ø 266 20,5 18,5 V + S PD
						24.0122-0194.1 422194	Ø 266 22 20 V + S
						24.0108-0106.1 408106	Ø 247 8 6 + S
CITROËN - XSARA Break (N2) 10/97→03/10							
Bremsbelagsatz, Scheibenbremse							
1.4 HDi	50	01/03→08/05	←			13.0460-3994.2 603994	BOS 23599 19,0 - WE / - WK + Zub
						13.0470-3994.2 LD3994	BOS 23599 19,0 - WE / - WK + Zub Ceramic
1.4 i 1.9 D	55 51	10/97→08/05 07/98→08/05	←	→ 08/00; + ABS		13.0460-2829.2 602829	TRW 23124 19,0 + WK
			←	09/00→		13.0460-3978.2 603978	BOS 23332 18,0 - WK + Zub
			←	→ 08/00; - ABS		13.0460-3994.2 603994	BOS 23599 19,0 - WE / - WK + Zub
						13.0470-3994.2 LD3994	BOS 23599 19,0 - WE / - WK + Zub Ceramic
						13.0460-7088.2 607088	ATE 21430 17,3 - WE / - WK
1.5 D 1.6 i 1.8 D 1.9 D	42 65 43 50	10/97→09/00 10/97→09/00 10/97→09/00 10/97→09/00	←	→ 08/00; + ABS		13.0460-2829.2 602829	TRW 23124 19,0 + WK
			←	→ 08/00; - ABS		13.0460-3978.2 603978	BOS 23332 18,0 - WK + Zub
			←	→ 08/00; - ABS		13.0460-7088.2 607088	ATE 21430 17,3 - WE / - WK
1.6 16V	80	09/00→08/05	←			13.0460-3994.2 603994	BOS 23599 19,0 - WE / - WK + Zub
			←			13.0470-3994.2 LD3994	BOS 23599 19,0 - WE / - WK + Zub Ceramic
			→			13.0460-3823.2 603823	BOS 20974 11,0 - WK
1.8 i 1.9 D 1.9 TD	66 55 66	10/97→09/00 01/98→09/00 10/97→09/00	←	→ 08/00		13.0460-2829.2 602829	TRW 23124 19,0 + WK
			←			13.0460-3978.2 603978	BOS 23332 18,0 - WK + Zub
			←			13.0460-3994.2 603994	BOS 23599 19,0 - WE / - WK + Zub
1.8 i 16V 1.8 i Aut. 2.0 16V	81 74 97	10/97→09/00 10/97→09/00 07/98→09/00	←	→ 08/00		13.0460-2829.2 602829	TRW 23124 19,0 + WK
			←			13.0460-3978.2 603978	BOS 23332 18,0 - WK + Zub
			→	→ 08/00		13.0460-3823.2 603823	BOS 20974 11,0 - WK
1.8 LPG	81	05/98→08/00	←			13.0460-2829.2 602829	TRW 23124 19,0 + WK
			←			13.0460-3978.2 603978	BOS 23332 18,0 - WK + Zub
			→			13.0460-3823.2 603823	BOS 20974 11,0 - WK
2.0 16V 2.0 HDi 109	100 80	09/00→08/05 05/01→08/05	←	→Orga 09184		13.0460-2817.2 602817	TRW 21674 19,0 + WK
			←	Orga 09185→		13.0460-3966.2 603966	BOS 23600 19,4 - WE / - WK + Zub
			→			13.0470-3966.2 LD3966	BOS 23600 19,4 - WE / - WK + Zub Ceramic
						13.0460-3823.2 603823	BOS 20974 11,0 - WK
2.0 HDi 90	66	02/99→08/05	←	→ 08/00		13.0460-2829.2 602829	TRW 23124 19,0 + WK
			←			13.0460-3978.2 603978	BOS 23332 18,0 - WK + Zub
			←	09/00→		13.0460-3994.2 603994	BOS 23599 19,0 - WE / - WK + Zub
						13.0470-3994.2 LD3994	BOS 23599 19,0 - WE / - WK + Zub Ceramic
						13.0460-3823.2 603823	BOS 20974 11,0 - WK
↓							



CITROËN - XSARA Break (N2) 10/97→03/10

Zubehörsatz, Scheibenbremsbelag

1.6 16V	80	09/00→08/05	➔		13.0460-0435.2	610435	BDX
1.8 LPG	81	05/98→08/00					
2.0 16V	100	09/00→08/05					
2.0 HDi 109	80	05/01→08/05					
2.0 HDi 90	66	02/99→08/05					
1.8 i 16V	81	10/97→09/00	➔	→ 08/00	13.0460-0435.2	610435	BDX
1.8 i Aut.	74	10/97→09/00					
2.0 16V	97	07/98→09/00					









Bremsscheibe

1.4 HDi	50	01/03→08/05	➔		24.0122-0194.1	422194	Ø 266 22 20 V + S
1.4 i	55	10/97→08/05	➔	→ 08/00; - ABS	24.0120-0132.1	420132	Ø 247 20,4 18,5 V + S
1.9 D	51	07/98→08/05			24.0124-0127.1	424127	Ø 280 24 21,9 V
			➔	→ 08/00; + ABS	24.0320-0132.1	520132	Ø 247 20,4 18,5 V + S PD
			➔	→ 08/00; + ABS	24.0120-0133.1	420133	Ø 266 20,5 18,5 V + S
			➔	09/00→	24.0320-0133.1	520133	Ø 266 20,5 18,5 V + S PD
			➔	09/00→	24.0122-0194.1	422194	Ø 266 22 20 V + S
1.5 D	42	10/97→09/00	➔	→ 08/00; - ABS	24.0120-0132.1	420132	Ø 247 20,4 18,5 V + S
1.6 i	65	10/97→09/00			24.0124-0127.1	424127	Ø 280 24 21,9 V
1.8 D	43	10/97→09/00			24.0320-0132.1	520132	Ø 247 20,4 18,5 V + S PD
1.9 D	50	10/97→09/00	➔	→ 08/00; + ABS	24.0120-0133.1	420133	Ø 266 20,5 18,5 V + S
			➔	→ 08/00; + ABS	24.0320-0133.1	520133	Ø 266 20,5 18,5 V + S PD
1.6 16V	80	09/00→08/05	➔		24.0122-0194.1	422194	Ø 266 22 20 V + S
			➔		24.0108-0106.1	408106	Ø 247 8 6 + S
1.8 i	66	10/97→09/00	➔	→ 08/00	24.0120-0133.1	420133	Ø 266 20,5 18,5 V + S
1.9 D	55	01/98→09/00			24.0320-0133.1	520133	Ø 266 20,5 18,5 V + S PD
1.9 TD	66	10/97→09/00					
1.8 i 16V	81	10/97→09/00	➔	→ 08/00	24.0120-0133.1	420133	Ø 266 20,5 18,5 V + S
1.8 i Aut.	74	10/97→09/00			24.0320-0133.1	520133	Ø 266 20,5 18,5 V + S PD
2.0 16V	97	07/98→09/00	➔	→ 08/00	24.0108-0106.1	408106	Ø 247 8 6 + S
			➔	→ 08/00			
1.8 LPG	81	05/98→08/00	➔		24.0120-0133.1	420133	Ø 266 20,5 18,5 V + S
			➔		24.0320-0133.1	520133	Ø 266 20,5 18,5 V + S PD
			➔		24.0108-0106.1	408106	Ø 247 8 6 + S
2.0 16V	100	09/00→08/05	➔	→Orga 09184	24.0122-0142.1	422142	Ø 283 22 20 V
2.0 HDi 109	80	05/01→08/05	➔	Orga 09185→	24.0126-0120.1	426120	Ø 283 26 24 V + S
			➔		24.0326-0120.1	526120	Ø 283 26 24 V + S PD
			➔		24.0108-0106.1	408106	Ø 247 8 6 + S
2.0 HDi 90	66	02/99→08/05	➔	→ 08/00	24.0120-0133.1	420133	Ø 266 20,5 18,5 V + S
			➔		24.0320-0133.1	520133	Ø 266 20,5 18,5 V + S PD
			➔	09/00→	24.0122-0194.1	422194	Ø 266 22 20 V + S
			➔		24.0108-0106.1	408106	Ø 247 8 6 + S











CITROËN - XSARA Coupe (N0) 01/98→04/05











Bremsbelagsatz, Scheibenbremse









1.4 HDi	50	01/03→03/05	➔		13.0460-3994.2	603994	BOS 23599 19,0 - WE / - WK + Zub
					13.0470-3994.2	LD3994	BOS 23599 19,0 - WE / - WK + Zub Ceramic
1.4 i	55	03/98→03/05	➔	→ 08/00; - ABS	13.0460-3977.2	603977	BOS 21980 18,0 + WE / - WK
			➔	09/00→	13.0460-3994.2	603994	BOS 23599 19,0 - WE / - WK + Zub
					13.0470-3994.2	LD3994	BOS 23599 19,0 - WE / - WK + Zub Ceramic
			➔	→ 08/00; + ABS	13.0460-7088.2	607088	ATE 21430 17,3 - WE / - WK
1.6 16V	80	09/00→03/05	➔		13.0460-3994.2	603994	BOS 23599 19,0 - WE / - WK + Zub
					13.0470-3994.2	LD3994	BOS 23599 19,0 - WE / - WK + Zub Ceramic
			➔		13.0460-3823.2	603823	BOS 20974 11,0 - WK
1.6 i	65	02/98→09/00	➔	→ 08/00	13.0460-7088.2	607088	ATE 21430 17,3 - WE / - WK
1.8 i	66	02/98→09/00					
1.9 D	50	02/98→09/00					
1.9 TD	66	02/98→09/00					
1.8 i	74	02/98→09/00	➔	→ 08/00	13.0460-2829.2	602829	TRW 23124 19,0 + WK
					13.0460-3978.2	603978	BOS 23332 18,0 - WK + Zub







	kw			 	! #		
CITROËN - XSARA Coupe (N0) 01/98→04/05							
 Bremsbelagsatz, Scheibenbremse							
1.8 i	74	02/98→09/00	←	→ 08/00		13.0460-7088.2 607088	ATE 21430 17,3 - WE / - WK
			→	→ 08/00		13.0460-3823.2 603823	BOS 20974 11,0 - WK
1.8 i 16V	81	02/98→09/00	←	→ 08/00		13.0460-2829.2 602829	TRW 23124 19,0 + WK
			→	→ 08/00		13.0460-3978.2 603978	BOS 23332 18,0 - WK + Zub
			→	→ 08/00		13.0460-3823.2 603823	BOS 20974 11,0 - WK
1.8 LPG	82	01/98→08/00	←	02/98→		13.0460-2829.2 602829	TRW 23124 19,0 + WK
			→	02/98→		13.0460-3978.2 603978	BOS 23332 18,0 - WK + Zub
			→	02/98→		13.0460-3823.2 603823	BOS 20974 11,0 - WK
1.9 D	51	02/99→03/05	←	09/00→		13.0460-3994.2 603994	BOS 23599 19,0 - WE / - WK + Zub
			→	→ 08/00		13.0470-3994.2 LD3994	BOS 23599 19,0 - WE / - WK + Zub Ceramic
			←	→ 08/00		13.0460-7088.2 607088	ATE 21430 17,3 - WE / - WK
1.9 D	55	02/98→05/99	←			13.0460-7088.2 607088	ATE 21430 17,3 - WE / - WK
2.0	97	08/98→08/00	←	→Orga 09184		13.0460-2817.2 602817	TRW 21674 19,0 + WK
2.0 16V	100	09/00→03/05	←	Orga 09185→		13.0460-3966.2 603966	BOS 23600 19,4 - WE / - WK + Zub
2.0 HDi 109	80	05/01→03/05	←			13.0470-3966.2 LD3966	BOS 23600 19,4 - WE / - WK + Zub Ceramic
2.0 i 16V	120	02/98→03/05	→			13.0460-3823.2 603823	BOS 20974 11,0 - WK
2.0 HDi 90	66	02/99→03/05	←	→ 08/00		13.0460-2829.2 602829	TRW 23124 19,0 + WK
			→	→ 08/00		13.0460-3978.2 603978	BOS 23332 18,0 - WK + Zub
			←	09/00→		13.0460-3994.2 603994	BOS 23599 19,0 - WE / - WK + Zub
			→	→ 08/00		13.0470-3994.2 LD3994	BOS 23599 19,0 - WE / - WK + Zub Ceramic
			→			13.0460-3823.2 603823	BOS 20974 11,0 - WK
Zubehörsatz, Scheibenbremsbelag							
1.6 16V	80	09/00→03/05	→			13.0460-0435.2 610435	BDX
2.0	97	08/98→08/00	→				
2.0 16V	100	09/00→03/05	→				
2.0 HDi 109	80	05/01→03/05	→				
2.0 HDi 90	66	02/99→03/05	→				
2.0 i 16V	120	02/98→03/05	→				
1.8 i	74	02/98→09/00	→	→ 08/00		13.0460-0435.2 610435	BDX
1.8 i 16V	81	02/98→09/00	→				
1.8 LPG	82	01/98→08/00	→	02/98→		13.0460-0435.2 610435	BDX
 Bremsscheibe							
1.4 HDi	50	01/03→03/05	←			24.0122-0194.1 422194	Ø 266 22 20 V + S
1.4 i	55	03/98→03/05	←	→ 08/00; - ABS		24.0113-0185.1 413185	Ø 247,5 13 11 + S
			←	→ 08/00; + ABS		24.0313-0185.1 513185	Ø 247,5 13 11 + S PD
			←	09/00→		24.0120-0132.1 420132	Ø 247 20,4 18,5 V + S
			→			24.0320-0132.1 520132	Ø 247 20,4 18,5 V + S PD
1.6 16V	80	09/00→03/05	←			24.0122-0194.1 422194	Ø 266 22 20 V + S
			→			24.0108-0106.1 408106	Ø 247 8 6 + S
1.6 i	65	02/98→09/00	←	→ 08/00		24.0120-0132.1 420132	Ø 247 20,4 18,5 V + S
1.8 i	66	02/98→09/00	←			24.0320-0132.1 520132	Ø 247 20,4 18,5 V + S PD
1.9 D	50	02/98→09/00	←				
1.9 TD	66	02/98→09/00	←				
1.8 i	74	02/98→09/00	←	→ 08/00		24.0120-0132.1 420132	Ø 247 20,4 18,5 V + S
			→			24.0120-0133.1 420133	Ø 266 20,5 18,5 V + S
			→			24.0320-0132.1 520132	Ø 247 20,4 18,5 V + S PD
			→			24.0320-0133.1 520133	Ø 266 20,5 18,5 V + S PD
			→	→ 08/00		24.0108-0106.1 408106	Ø 247 8 6 + S
1.8 i 16V	81	02/98→09/00	←	→ 08/00		24.0120-0133.1 420133	Ø 266 20,5 18,5 V + S
			→	→ 08/00		24.0320-0133.1 520133	Ø 266 20,5 18,5 V + S PD
			→	→ 08/00		24.0108-0106.1 408106	Ø 247 8 6 + S
1.8 LPG	82	01/98→08/00	←	02/98→		24.0120-0133.1 420133	Ø 266 20,5 18,5 V + S
			→	02/98→		24.0320-0133.1 520133	Ø 266 20,5 18,5 V + S PD
			→	02/98→		24.0108-0106.1 408106	Ø 247 8 6 + S
↓							











	kw			 	! #		
CITROËN - XSARA Coupe (N0) 01/98→04/05							
 Bremsscheibe							
1.9 D	51	02/99→03/05	←	→ 08/00		24.0120-0132.1 420132	Ø 247 20,4 18,5 V + S
			←	09/00→		24.0320-0132.1 520132	Ø 247 20,4 18,5 V + S PD
1.9 D	55	02/98→05/99	←			24.0122-0194.1 422194	Ø 266 22 20 V + S
			←			24.0120-0132.1 420132	Ø 247 20,4 18,5 V + S
2.0 2.0 16V 2.0 HDi 109 2.0 i 16V	97	08/98→08/00	←	→Orga 09184		24.0320-0132.1 520132	Ø 247 20,4 18,5 V + S PD
	100	09/00→03/05	←			24.0122-0142.1 422142	Ø 283 22 20 V
	80	05/01→03/05	←	Orga 09185→		24.0126-0120.1 426120	Ø 283 26 24 V + S
	120	02/98→03/05	←			24.0326-0120.1 526120	Ø 283 26 24 V + S PD
2.0 HDi 90	66	02/99→03/05	←	→ 08/00		24.0108-0106.1 408106	Ø 247 8 6 + S
			←	09/00→		24.0120-0133.1 420133	Ø 266 20,5 18,5 V + S
			←			24.0320-0133.1 520133	Ø 266 20,5 18,5 V + S PD
			←			24.0122-0194.1 422194	Ø 266 22 20 V + S
			→			24.0108-0106.1 408106	Ø 247 8 6 + S
CITROËN - XSARA Kasten/Kombi 05/98→08/05							
 Bremsbelagsatz, Scheibenbremse							
1.4	55	09/00→03/05	←			13.0460-3994.2 603994	BOS 23599 19,0 - WE / - WK + Zub
			←			13.0470-3994.2 LD3994	BOS 23599 19,0 - WE / - WK + Zub Ceramic
1.8 D	43	05/98→05/99	←	+ ABS		13.0460-2829.2 602829	TRW 23124 19,0 + WK
			←	- ABS		13.0460-3978.2 603978	BOS 23332 18,0 - WK + Zub
1.9 D	51	06/99→08/05	←	→ 08/00; + ABS		13.0460-7088.2 607088	ATE 21430 17,3 - WE / - WK
			←			13.0460-2829.2 602829	TRW 23124 19,0 + WK
			←	09/00→		13.0460-3978.2 603978	BOS 23332 18,0 - WK + Zub
			←			13.0460-3994.2 603994	BOS 23599 19,0 - WE / - WK + Zub
			←	→ 08/00; - ABS		13.0470-3994.2 LD3994	BOS 23599 19,0 - WE / - WK + Zub Ceramic
			←			13.0460-7088.2 607088	ATE 21430 17,3 - WE / - WK
2.0 HDi	66	09/00→03/05	←			13.0460-3994.2 603994	BOS 23599 19,0 - WE / - WK + Zub
			←			13.0470-3994.2 LD3994	BOS 23599 19,0 - WE / - WK + Zub Ceramic
			→			13.0460-3823.2 603823	BOS 20974 11,0 - WK
Zubehörsatz, Scheibenbremsbelag							
2.0 HDi	66	09/00→03/05	→			13.0460-0435.2 610435	BDX
 Bremsscheibe							
1.4	55	09/00→03/05	←			24.0122-0194.1 422194	Ø 266 22 20 V + S
1.8 D	43	05/98→05/99	←	- ABS		24.0120-0132.1 420132	Ø 247 20,4 18,5 V + S
			←			24.0124-0127.1 424127	Ø 280 24 21,9 V
			←	+ ABS		24.0320-0132.1 520132	Ø 247 20,4 18,5 V + S PD
			←			24.0120-0133.1 420133	Ø 266 20,5 18,5 V + S
			←			24.0320-0133.1 520133	Ø 266 20,5 18,5 V + S PD
1.9 D	51	06/99→08/05	←	→ 08/00; - ABS		24.0120-0132.1 420132	Ø 247 20,4 18,5 V + S
			←			24.0124-0127.1 424127	Ø 280 24 21,9 V
			←			24.0320-0132.1 520132	Ø 247 20,4 18,5 V + S PD
			←	→ 08/00; + ABS		24.0120-0133.1 420133	Ø 266 20,5 18,5 V + S
			←			24.0320-0133.1 520133	Ø 266 20,5 18,5 V + S PD
			←	09/00→		24.0122-0194.1 422194	Ø 266 22 20 V + S
2.0 HDi	66	09/00→03/05	←			24.0122-0194.1 422194	Ø 266 22 20 V + S
			→			24.0108-0106.1 408106	Ø 247 8 6 + S
CITROËN - XSARA Kasten/Schrägheck 05/98→03/05							
 Bremsbelagsatz, Scheibenbremse							
1.4	55	05/98→10/04	←	→ 08/00; - ABS		13.0460-3977.2 603977	BOS 21980 18,0 + WE / - WK
			←	09/00→		13.0460-3994.2 603994	BOS 23599 19,0 - WE / - WK + Zub
			←			13.0470-3994.2 LD3994	BOS 23599 19,0 - WE / - WK + Zub Ceramic
↓							











	kw			 	! #		
CITROËN - XSARA Kasten/Schrägheck 05/98→03/05							
 Bremsbelagsatz, Scheibenbremse							
1.4	55	05/98→10/04	←	→ 08/00; + ABS		13.0460-7088.2 607088	ATE 21430 17,3 - WE / - WK
1.4 LPG	55	06/99→08/00	←	- ABS		13.0460-3977.2 603977	BOS 21980 18,0 + WE / - WK
			←	+ ABS		13.0460-7088.2 607088	ATE 21430 17,3 - WE / - WK
1.8 D	43	05/98→05/99	←			13.0460-7088.2 607088	ATE 21430 17,3 - WE / - WK
1.9 D	65	05/98→08/00	←				
1.9 D	51	06/99→03/05	←	09/00→		13.0460-3994.2 603994	BOS 23599 19,0 - WE / - WK + Zub
						13.0470-3994.2 LD3994	BOS 23599 19,0 - WE / - WK + Zub Ceramic
			←	→ 08/00		13.0460-7088.2 607088	ATE 21430 17,3 - WE / - WK
2.0 HDi	66	09/00→03/05	←			13.0460-3994.2 603994	BOS 23599 19,0 - WE / - WK + Zub
						13.0470-3994.2 LD3994	BOS 23599 19,0 - WE / - WK + Zub Ceramic
			→			13.0460-3823.2 603823	BOS 20974 11,0 - WK
Zubehörsatz, Scheibenbremsbelag							
2.0 HDi	66	09/00→03/05	→			13.0460-0435.2 610435	BDX
 Bremsscheibe							
1.4	55	05/98→10/04	←	→ 08/00; - ABS		24.0113-0185.1 413185	Ø 247,5 13 11 + S
						24.0313-0185.1 513185	Ø 247,5 13 11 + S PD
			←	→ 08/00; + ABS		24.0120-0132.1 420132	Ø 247 20,4 18,5 V + S
						24.0320-0132.1 520132	Ø 247 20,4 18,5 V + S PD
1.4 LPG	55	06/99→08/00	←	- ABS		24.0113-0185.1 413185	Ø 247,5 13 11 + S
						24.0313-0185.1 513185	Ø 247,5 13 11 + S PD
			←	+ ABS		24.0120-0132.1 420132	Ø 247 20,4 18,5 V + S
						24.0320-0132.1 520132	Ø 247 20,4 18,5 V + S PD
1.8 D	43	05/98→05/99	←			24.0120-0132.1 420132	Ø 247 20,4 18,5 V + S
1.9 D	65	05/98→08/00	←			24.0320-0132.1 520132	Ø 247 20,4 18,5 V + S PD
1.9 D	51	06/99→03/05	←	→ 08/00		24.0120-0132.1 420132	Ø 247 20,4 18,5 V + S
						24.0320-0132.1 520132	Ø 247 20,4 18,5 V + S PD
			←	09/00→		24.0122-0194.1 422194	Ø 266 22 20 V + S
2.0 HDi	66	09/00→03/05	←			24.0122-0194.1 422194	Ø 266 22 20 V + S
			→			24.0108-0106.1 408106	Ø 247 8 6 + S
CITROËN - XSARA PICASSO (N68) 12/99→							
 Bremsbelagsatz, Scheibenbremse							
1.6	65	12/99→	←	06/00→ 03/10		13.0460-2862.2 602862	TRW 23346 19,0 - WK
			←	06/00→ 03/10; + ESP		13.0460-3811.2 603811	BOS 23708 19,2 - WE / - WK
			←	06/00→ 03/10; - ESP		13.0460-3994.2 603994	BOS 23599 19,0 - WE / - WK + Zub
1.6	67	06/02→				13.0470-3994.2 LD3994	BOS 23599 19,0 - WE / - WK + Zub Ceramic
			←	→ 03/10		13.0460-2862.2 602862	TRW 23346 19,0 - WK
			←	→ 03/10; + ESP		13.0460-3811.2 603811	BOS 23708 19,2 - WE / - WK
			←	→ 03/10; - ESP		13.0460-3994.2 603994	BOS 23599 19,0 - WE / - WK + Zub
1.6	70	12/99→				13.0470-3994.2 LD3994	BOS 23599 19,0 - WE / - WK + Zub Ceramic
			←	09/00→ 03/10		13.0460-2862.2 602862	TRW 23346 19,0 - WK
			←	09/00→ 03/10; + ESP		13.0460-3811.2 603811	BOS 23708 19,2 - WE / - WK
			←	09/00→ 03/10; - ESP		13.0460-3994.2 603994	BOS 23599 19,0 - WE / - WK + Zub
1.6 16V 1.6 HDi	80 80	09/05→ 05/04→	←	→ 03/10		13.0460-2862.2 602862	TRW 23346 19,0 - WK
			←	→ 03/10; + ESP		13.0460-3811.2 603811	BOS 23708 19,2 - WE / - WK
			←	→ 03/10; - ESP		13.0460-3994.2 603994	BOS 23599 19,0 - WE / - WK + Zub
↓							













	kw			 	! #		
CITROËN - XSARA PICASSO (N68) 12/99→							
 Bremsbelagsatz, Scheibenbremse							
1.6 16V 1.6 HDi	80 80	09/05→ 05/04→	←	→ 03/10; - ESP		13.0470-3994.2 LD3994	BOS 23599 19,0 - WE / - WK + Zub Ceramic
			→	→ 03/10		13.0460-2820.2 602820	TRW 20961 17,2 - WK
1.6 16V	81	06/05→09/06	←	09/05→		13.0460-2862.2 602862	TRW 23346 19,0 - WK
			←	09/05→; + ESP		13.0460-3811.2 603811	BOS 23708 19,2 - WE / - WK
			←	09/05→; - ESP		13.0460-3994.2 603994	BOS 23599 19,0 - WE / - WK + Zub
						13.0470-3994.2 LD3994	BOS 23599 19,0 - WE / - WK + Zub Ceramic
			→	09/05→		13.0460-2820.2 602820	TRW 20961 17,2 - WK
					13.0470-2823.2 LD2823	TRW 23554 17,2 - WK Ceramic	
1.6 Chrono	74	04/01→10/04	←			13.0460-2862.2 602862	TRW 23346 19,0 - WK
			←	+ ESP		13.0460-3811.2 603811	BOS 23708 19,2 - WE / - WK
			←	- ESP		13.0460-3994.2 603994	BOS 23599 19,0 - WE / - WK + Zub
					13.0470-3994.2 LD3994	BOS 23599 19,0 - WE / - WK + Zub Ceramic	
1.6 HDi	66	09/05→	←	→ 03/10		13.0460-2862.2 602862	TRW 23346 19,0 - WK
			←	→ 03/10; - ESP		13.0460-3811.2 603811	BOS 23708 19,2 - WE / - WK
						13.0460-3994.2 603994	BOS 23599 19,0 - WE / - WK + Zub
						13.0470-3994.2 LD3994	BOS 23599 19,0 - WE / - WK + Zub Ceramic
			→	→ 03/10		13.0460-2820.2 602820	TRW 20961 17,2 - WK
					13.0470-2823.2 LD2823	TRW 23554 17,2 - WK Ceramic	
1.8 16V	85	02/00→	←	→ 03/10		13.0460-2862.2 602862	TRW 23346 19,0 - WK
			←	→ 03/10; + ESP		13.0460-3811.2 603811	BOS 23708 19,2 - WE / - WK
			←	→ 03/10; - ESP		13.0460-3994.2 603994	BOS 23599 19,0 - WE / - WK + Zub
						13.0470-3994.2 LD3994	BOS 23599 19,0 - WE / - WK + Zub Ceramic
			→	→ 03/10; + ESP		13.0460-2820.2 602820	TRW 20961 17,2 - WK
					13.0470-2823.2 LD2823	TRW 23554 17,2 - WK Ceramic	
2.0 16V	100	01/03→	←	→ 03/10		13.0460-2862.2 602862	TRW 23346 19,0 - WK
			←	→ 03/10; Automatikgetriebe		13.0460-3811.2 603811	BOS 23708 19,2 - WE / - WK
			←	→ 03/10; + ESP; Schaltgetriebe		13.0460-3811.2 603811	BOS 23708 19,2 - WE / - WK
			←	→ 03/10; - ESP; Schaltgetriebe		13.0460-3994.2 603994	BOS 23599 19,0 - WE / - WK + Zub
						13.0470-3994.2 LD3994	BOS 23599 19,0 - WE / - WK + Zub Ceramic
			→	→ 03/10		13.0460-2820.2 602820	TRW 20961 17,2 - WK
					13.0470-2823.2 LD2823	TRW 23554 17,2 - WK Ceramic	
2.0 16V	101	12/99→11/11	←	01/03→ 03/10		13.0460-2862.2 602862	TRW 23346 19,0 - WK
			←	01/03→ 03/10; Automatikgetriebe		13.0460-3811.2 603811	BOS 23708 19,2 - WE / - WK
			←	01/03→ 03/10; + ESP; Schaltgetriebe		13.0460-3811.2 603811	BOS 23708 19,2 - WE / - WK
			←	01/03→ 03/10; - ESP; Schaltgetriebe		13.0460-3994.2 603994	BOS 23599 19,0 - WE / - WK + Zub
						13.0470-3994.2 LD3994	BOS 23599 19,0 - WE / - WK + Zub Ceramic
			→	01/03→ 03/10		13.0460-2820.2 602820	TRW 20961 17,2 - WK
					13.0470-2823.2 LD2823	TRW 23554 17,2 - WK Ceramic	
2.0 HDi 2.0 HDi	66 80	12/99→ 12/99→	←	06/00→ 03/10		13.0460-2862.2 602862	TRW 23346 19,0 - WK
			←	06/00→ 03/10; + ESP		13.0460-3811.2 603811	BOS 23708 19,2 - WE / - WK
			←	06/00→ 03/10; - ESP		13.0460-3994.2 603994	BOS 23599 19,0 - WE / - WK + Zub
						13.0470-3994.2 LD3994	BOS 23599 19,0 - WE / - WK + Zub Ceramic
			→	06/00→ 03/10		13.0460-2820.2 602820	TRW 20961 17,2 - WK
					13.0470-2823.2 LD2823	TRW 23554 17,2 - WK Ceramic	











	kw			 	! #		
CITROËN - XSARA PICASSO (N68) 12/99→							
Bremsscheibe							
1.6	65	12/99→	←	06/00→ 03/10; Herstellereinschränkung TRW	24.0120-0133.1 420133	Ø 266 20,5 18,5 V + S	
			←	06/00→ 03/10; - ESP	24.0320-0133.1 520133	Ø 266 20,5 18,5 V + S PD	
			←	06/00→ 03/10; + ESP	24.0122-0194.1 422194	Ø 266 22 20 V + S	
1.6	67	06/02→	←	→ 03/10; Herstellereinschränkung TRW	24.0126-0120.1 426120	Ø 283 26 24 V + S	
			←	→ 03/10; - ESP	24.0326-0120.1 526120	Ø 283 26 24 V + S PD	
			←	→ 03/10; + ESP	24.0120-0133.1 420133	Ø 266 20,5 18,5 V + S	
1.6	70	12/99→	←	→ 03/10; Herstellereinschränkung TRW	24.0320-0133.1 520133	Ø 266 20,5 18,5 V + S PD	
			←	→ 03/10; - ESP	24.0122-0194.1 422194	Ø 266 22 20 V + S	
			←	→ 03/10; + ESP	24.0126-0120.1 426120	Ø 283 26 24 V + S	
1.6 16V 1.6 HDi	80 66	09/05→ 09/05→	←	→ 03/10; Herstellereinschränkung TRW	24.0326-0120.1 526120	Ø 283 26 24 V + S PD	
			←	→ 03/10; - ESP	24.0120-0133.1 420133	Ø 266 20,5 18,5 V + S	
			←	→ 03/10; + ESP	24.0122-0194.1 422194	Ø 266 22 20 V + S	
1.6 16V	81	06/05→09/06	←	→ 03/10	24.0126-0120.1 426120	Ø 283 26 24 V + S	
			←	→ 03/10	24.0326-0120.1 526120	Ø 283 26 24 V + S PD	
			→	→ 03/10	24.0109-0137.1 409137	Ø 247 9 8 + S	
1.6 Chrono	74	04/01→10/04	←	09/05→; Herstellereinschränkung TRW	24.0120-0133.1 420133	Ø 266 20,5 18,5 V + S	
			←	09/05→; - ESP	24.0320-0133.1 520133	Ø 266 20,5 18,5 V + S PD	
			←	09/05→; + ESP	24.0122-0194.1 422194	Ø 266 22 20 V + S	
1.6 HDi 1.8 16V	80 85	05/04→ 02/00→	←	09/05→	24.0126-0120.1 426120	Ø 283 26 24 V + S	
			←	09/05→	24.0326-0120.1 526120	Ø 283 26 24 V + S PD	
			→	09/05→	24.0109-0137.1 409137	Ø 247 9 8 + S	
2.0 16V	100	01/03→	←	Herstellereinschränkung TRW	24.0120-0133.1 420133	Ø 266 20,5 18,5 V + S	
			←	- ESP	24.0320-0133.1 520133	Ø 266 20,5 18,5 V + S PD	
			←	+ ESP	24.0122-0194.1 422194	Ø 266 22 20 V + S	
2.0 16V	101	12/99→11/11	←	→ 03/10; Herstellereinschränkung TRW	24.0126-0120.1 426120	Ø 283 26 24 V + S	
			←	→ 03/10; - ESP	24.0326-0120.1 526120	Ø 283 26 24 V + S PD	
			←	→ 03/10; + ESP	24.0120-0133.1 420133	Ø 266 20,5 18,5 V + S	
2.0 HDi 2.0 HDi	66 80	12/99→ 12/99→	←	→ 03/10	24.0326-0120.1 526120	Ø 283 26 24 V + S PD	
			←	→ 03/10	24.0109-0137.1 409137	Ø 247 9 8 + S	
			→	→ 03/10	24.0126-0120.1 426120	Ø 283 26 24 V + S	
2.0 16V	100	01/03→	←	→ 03/10; Herstellereinschränkung TRW	24.0122-0194.1 422194	Ø 266 22 20 V + S	
			←	→ 03/10; - ESP	24.0320-0133.1 520133	Ø 266 20,5 18,5 V + S PD	
			←	→ 03/10; + ESP	24.0126-0120.1 426120	Ø 283 26 24 V + S	
2.0 16V	101	12/99→11/11	←	→ 03/10; Herstellereinschränkung TRW	24.0326-0120.1 526120	Ø 283 26 24 V + S PD	
			←	→ 03/10; - ESP	24.0120-0133.1 420133	Ø 266 20,5 18,5 V + S	
			←	→ 03/10; + ESP	24.0122-0194.1 422194	Ø 266 22 20 V + S	
2.0 HDi 2.0 HDi	66 80	12/99→ 12/99→	←	→ 03/10; Herstellereinschränkung TRW	24.0126-0120.1 426120	Ø 283 26 24 V + S	
			←	→ 03/10; - ESP	24.0326-0120.1 526120	Ø 283 26 24 V + S PD	
			←	→ 03/10; + ESP	24.0120-0133.1 420133	Ø 266 20,5 18,5 V + S	
2.0 HDi 2.0 HDi	66 80	12/99→ 12/99→	←	→ 03/10; Herstellereinschränkung TRW	24.0326-0120.1 526120	Ø 283 26 24 V + S PD	
			←	→ 03/10; - ESP	24.0122-0194.1 422194	Ø 266 22 20 V + S	
			←	→ 03/10; + ESP	24.0126-0120.1 426120	Ø 283 26 24 V + S	
2.0 HDi 2.0 HDi	66 80	12/99→ 12/99→	←	→ 03/10; Herstellereinschränkung TRW	24.0326-0120.1 526120	Ø 283 26 24 V + S PD	
			←	→ 03/10; - ESP	24.0120-0133.1 420133	Ø 266 20,5 18,5 V + S	
			←	→ 03/10; + ESP	24.0122-0194.1 422194	Ø 266 22 20 V + S	
2.0 HDi 2.0 HDi	66 80	12/99→ 12/99→	←	→ 03/10; Herstellereinschränkung TRW	24.0126-0120.1 426120	Ø 283 26 24 V + S	
			←	→ 03/10; - ESP	24.0326-0120.1 526120	Ø 283 26 24 V + S PD	
			←	→ 03/10; + ESP	24.0120-0133.1 420133	Ø 266 20,5 18,5 V + S	
2.0 HDi 2.0 HDi	66 80	12/99→ 12/99→	←	→ 03/10; Herstellereinschränkung TRW	24.0326-0120.1 526120	Ø 283 26 24 V + S PD	
			←	→ 03/10; - ESP	24.0122-0194.1 422194	Ø 266 22 20 V + S	
			←	→ 03/10; + ESP	24.0126-0120.1 426120	Ø 283 26 24 V + S	
2.0 HDi 2.0 HDi	66 80	12/99→ 12/99→	←	→ 03/10; Herstellereinschränkung TRW	24.0326-0120.1 526120	Ø 283 26 24 V + S PD	
			←	→ 03/10; - ESP	24.0120-0133.1 420133	Ø 266 20,5 18,5 V + S	
			←	→ 03/10; + ESP	24.0122-0194.1 422194	Ø 266 22 20 V + S	
2.0 HDi 2.0 HDi	66 80	12/99→ 12/99→	←	→ 03/10; Herstellereinschränkung TRW	24.0126-0120.1 426120	Ø 283 26 24 V + S	
			←	→ 03/10; - ESP	24.0326-0120.1 526120	Ø 283 26 24 V + S PD	
			←	→ 03/10; + ESP	24.0120-0133.1 420133	Ø 266 20,5 18,5 V + S	
2.0 HDi 2.0 HDi	66 80	12/99→ 12/99→	←	→ 03/10; Herstellereinschränkung TRW	24.0326-0120.1 526120	Ø 283 26 24 V + S PD	
			←	→ 03/10; - ESP	24.0122-0194.1 422194	Ø 266 22 20 V + S	
			←	→ 03/10; + ESP	24.0126-0120.1 426120	Ø 283 26 24 V + S	
2.0 HDi 2.0 HDi	66 80	12/99→ 12/99→	←	→ 03/10; Herstellereinschränkung TRW	24.0326-0120.1 526120	Ø 283 26 24 V + S PD	
			←	→ 03/10; - ESP	24.0120-0133.1 420133	Ø 266 20,5 18,5 V + S	
			←	→ 03/10; + ESP	24.0122-0194.1 422194	Ø 266 22 20 V + S	
2.0 HDi 2.0 HDi	66 80	12/99→ 12/99→	←	→ 03/10; Herstellereinschränkung TRW	24.0126-0120.1 426120	Ø 283 26 24 V + S	
			←	→ 03/10; - ESP	24.0326-0120.1 526120	Ø 283 26 24 V + S PD	
			←	→ 03/10; + ESP	24.0120-0133.1 420133	Ø 266 20,5 18,5 V + S	
2.0 HDi 2.0 HDi	66 80	12/99→ 12/99→	←	→ 03/10; Herstellereinschränkung TRW	24.0326-0120.1 526120	Ø 283 26 24 V + S PD	
			←	→ 03/10; - ESP	24.0122-0194.1 422194	Ø 266 22 20 V + S	
			←	→ 03/10; + ESP	24.0126-0120.1 426120	Ø 283 26 24 V + S	



























	kw			 	! #		
CITROËN - ZX (N2) 03/91→07/99							
 Bremsbelagsatz, Scheibenbremse							
1.1 1.4 1.4 i	44 55 55	03/91→06/97 03/91→06/97 03/91→06/97	←			13.0460-3952.2 603952	BDX 20905 18,0 + WK
1.4 D	37	07/94→10/97	←	→ 06/97		13.0460-3952.2 603952	BDX 20905 18,0 + WK
1.6 1.9 DT	66 65	07/94→10/97 07/94→10/97	←	→ 06/97		13.0460-2981.2 602981 13.0460-3952.2 603952	TRW 21460 18,0 + WK BDX 20905 18,0 + WK
			→	→ 06/97		13.0460-3823.2 603823	BOS 20974 11,0 - WK
1.6 i 1.9 TD	65 66	03/91→06/97 07/92→06/97	←			13.0460-2981.2 602981 13.0460-3952.2 603952	TRW 21460 18,0 + WK BDX 20905 18,0 + WK
			→			13.0460-3823.2 603823	BOS 20974 11,0 - WK
1.8 1.8 2.0	76 82 90	07/94→10/97 04/96→10/97 07/94→10/97	←	→ 06/97		13.0460-2981.2 602981 13.0460-3823.2 603823	TRW 21460 18,0 + WK BOS 20974 11,0 - WK
			→	→ 06/97			
1.8 D 1.9 D	44 47	06/93→06/97 03/91→06/97	←	→Orga 06049		13.0460-2825.2 602825	TRW 21614 17,7 + WK
			←			13.0460-3952.2 603952	BDX 20905 18,0 + WK
			→			13.0460-3823.2 603823	BOS 20974 11,0 - WK
1.8 i 1.8 i 16V 1.9 1.9 i 2.0 i	74 81 93 88 89	07/92→06/97 01/96→06/97 03/91→06/97 03/91→06/97 07/92→06/97	←			13.0460-2981.2 602981 13.0460-3823.2 603823	TRW 21460 18,0 + WK BOS 20974 11,0 - WK
			→				
1.9 D	50	07/93→06/97	←	06/94→		13.0460-3952.2 603952	BDX 20905 18,0 + WK
			→	06/94→		13.0460-3823.2 603823	BOS 20974 11,0 - WK
2.0 2.0 i 16V	122 120	09/96→10/97 05/96→06/97	←			13.0460-2817.2 602817 13.0460-3954.2 603954	TRW 21674 19,0 + WK BDX 20973 11,0 - WK
			→				
2.0 i 16V 2.0 i 16V	110 114	06/94→06/97 07/92→10/97	→			13.0460-3954.2 603954	BDX 20973 11,0 - WK
Zubehörsatz, Scheibenbremsbelag							
1.1 1.4 1.4 i	44 55 55	03/91→06/97 03/91→06/97 03/91→06/97	←			13.0460-0403.2 610403	BDX
1.4 D	37	07/94→10/97	←	→ 06/97		13.0460-0403.2 610403	BDX
1.6 1.9 DT	66 65	07/94→10/97 07/94→10/97	←	→ 06/97		13.0460-0403.2 610403	BDX
			→	→ 06/97		13.0460-0435.2 610435	BDX
1.6 i 1.9 TD	65 66	03/91→06/97 07/92→06/97	←			13.0460-0403.2 610403	BDX
			→			13.0460-0435.2 610435	BDX
1.8 1.8 2.0	76 82 90	07/94→10/97 04/96→10/97 07/94→10/97	→	→ 06/97		13.0460-0435.2 610435	BDX
1.8 D 1.9 D	44 47	06/93→06/97 03/91→06/97	←	→Orga 06049		13.0460-0060.2 610060	TRW
			→			13.0460-0435.2 610435	BDX
1.8 i 1.8 i 16V 1.9 1.9 i 2.0 2.0 i 2.0 i 16V 2.0 i 16V 2.0 i 16V	74 81 93 88 122 89 110 114 120	07/92→06/97 01/96→06/97 03/91→06/97 03/91→06/97 09/96→10/97 07/92→06/97 06/94→06/97 07/92→10/97 05/96→06/97	→			13.0460-0435.2 610435	BDX
1.9 D	50	07/93→06/97	→	06/94→		13.0460-0435.2 610435	BDX
 Bremsscheibe							
1.1 1.4 1.4 i	44 55 55	03/91→06/97 03/91→06/97 03/91→06/97	←			24.0110-0187.1 410187	Ø 247 10 9 + S
1.4 D	37	07/94→10/97	←	→ 06/97		24.0110-0187.1 410187	Ø 247 10 9 + S
1.6 1.8 1.8 2.0	66 76 82 90	07/94→10/97 07/94→10/97 04/96→10/97 07/94→10/97	←	→ 06/97		24.0120-0132.1 420132 24.0320-0132.1 520132	Ø 247 20,4 18,5 V + S Ø 247 20,4 18,5 V + S PD
			→	→ 06/97		24.0108-0106.1 408106	Ø 247 8 6 + S
1.6 i 1.8 i 1.8 i 16V 1.9 1.9 i 2.0 i	65 74 81 93 88 89	03/91→06/97 07/92→06/97 01/96→06/97 03/91→06/97 03/91→06/97 07/92→06/97	←			24.0120-0132.1 420132 24.0320-0132.1 520132	Ø 247 20,4 18,5 V + S Ø 247 20,4 18,5 V + S PD
			→			24.0108-0106.1 408106	Ø 247 8 6 + S
↓							













	kW			 	! #		
CITROËN - ZX (N2) 03/91→07/99							
 Bremsscheibe							
1.8 D 1.9 D	44 47	06/93→06/97 03/91→06/97	← →			24.0110-0187.1 410187 24.0108-0106.1 408106	Ø 247 10 9 + S Ø 247 8 6 + S
1.9 D	50	07/93→06/97	← →	06/94→ 06/94→		24.0110-0187.1 410187 24.0108-0106.1 408106	Ø 247 10 9 + S Ø 247 8 6 + S
1.9 DT	65	07/94→10/97	← →	→ 06/97 → 06/97		24.0110-0187.1 410187 24.0120-0132.1 420132 24.0320-0132.1 520132 24.0108-0106.1 408106	Ø 247 10 9 + S Ø 247 20,4 18,5 V + S Ø 247 20,4 18,5 V + S PD Ø 247 8 6 + S
1.9 TD	66	07/92→06/97	← →			24.0110-0187.1 410187 24.0120-0132.1 420132 24.0320-0132.1 520132 24.0108-0106.1 408106	Ø 247 10 9 + S Ø 247 20,4 18,5 V + S Ø 247 20,4 18,5 V + S PD Ø 247 8 6 + S
2.0	122	09/96→10/97	← →			24.0120-0133.1 420133 24.0122-0142.1 422142 24.0320-0133.1 520133 24.0108-0106.1 408106	Ø 266 20,5 18,5 V + S Ø 283 22 20 V Ø 266 20,5 18,5 V + S PD Ø 247 8 6 + S
2.0 i 16V 2.0 i 16V	110 114	06/94→06/97 07/92→10/97	← →			24.0120-0133.1 420133 24.0320-0133.1 520133 24.0108-0106.1 408106	Ø 266 20,5 18,5 V + S Ø 266 20,5 18,5 V + S PD Ø 247 8 6 + S
2.0 i 16V	120	05/96→06/97	← →			24.0122-0142.1 422142 24.0108-0106.1 408106	Ø 283 22 20 V Ø 247 8 6 + S
CITROËN - ZX Break (N2) 10/93→07/99							
 Bremsbelagsatz, Scheibenbremse							
1.4 i 1.5 D	55 42	10/93→10/97 06/96→02/98	←			13.0460-3952.2 603952	BDX 20905 18,0 + WK
1.6 i	65	10/93→10/97	← →			13.0460-2981.2 602981 13.0460-3952.2 603952 13.0460-3823.2 603823	TRW 21460 18,0 + WK BDX 20905 18,0 + WK BOS 20974 11,0 - WK
1.8 D 1.8 i 1.8 i 16V 1.9 D 1.9 D 1.9 TD	44 74 81 47 50 66	10/93→10/97 10/93→10/97 01/96→02/98 10/93→10/97 06/94→10/97 10/93→10/97	← → →			13.0460-2981.2 602981 13.0460-3823.2 603823	TRW 21460 18,0 + WK BOS 20974 11,0 - WK
Zubehörsatz, Scheibenbremsbelag							
1.4 i 1.5 D	55 42	10/93→10/97 06/96→02/98	←			13.0460-0403.2 610403	BDX
1.6 i	65	10/93→10/97	← →			13.0460-0403.2 610403 13.0460-0435.2 610435	BDX BDX
1.8 D 1.8 i 1.8 i 16V 1.9 D 1.9 D 1.9 TD	44 74 81 47 50 66	10/93→10/97 10/93→10/97 01/96→02/98 10/93→10/97 06/94→10/97 10/93→10/97	→			13.0460-0435.2 610435	BDX
 Bremsscheibe							
1.4 i 1.5 D	55 42	10/93→10/97 06/96→02/98	←			24.0110-0187.1 410187	Ø 247 10 9 + S
1.6 i 1.8 D 1.8 i 1.8 i 16V 1.9 D 1.9 D 1.9 TD	65 44 74 81 47 50 66	10/93→10/97 10/93→10/97 10/93→10/97 01/96→02/98 10/93→10/97 06/94→10/97 10/93→10/97	← → →			24.0120-0132.1 420132 24.0320-0132.1 520132 24.0108-0106.1 408106	Ø 247 20,4 18,5 V + S Ø 247 20,4 18,5 V + S PD Ø 247 8 6 + S
DACIA - DOKKER 11/12→							
 Bremsbelagsatz, Scheibenbremse							
1.2 TCe	85	11/12→	←			13.0460-7266.2 607266 13.0470-7266.2 LD7266	ATE 24538 17,9 - WE / - WK ATE 24538 17,9 - WE / - WK Ceramic
1.5 dCi 1.5 dCi 1.6 ↓	55 66 61	11/12→ 11/12→ 11/12→	←	- ESP		13.0460-2709.2 602709	TRW 23973 17,1 - WE / - WK + Zub











	kw			 	! #		
DACIA - DOKKER 11/12→							
 Bremsbelagsatz, Scheibenbremse							
1.6 1.6 LPG 1.6 LPG	75 61 75	04/15→ 11/13→ 04/15→	←	- ESP		13.0470-2709.2 LD2709	TRW 23973 17,1 - WE / - WK + Zub Ceramic
			←	+ ESP		13.0460-7266.2 607266 13.0470-7266.2 LD7266	ATE 24538 17,9 - WE / - WK ATE 24538 17,9 - WE / - WK Ceramic
 Bremsscheibe							
1.2 TCe	85	11/12→	←			24.0124-0253.1 424253	Ø 280 24 21,8 V + S
1.5 dCi 1.5 dCi 1.6 1.6 1.6 LPG 1.6 LPG	55 66 61 75 61 75	11/12→ 11/12→ 11/12→ 04/15→ 11/13→ 04/15→	←	- ESP; nicht für erhöhte Nutzlast		24.0122-0270.1 422270	Ø 258 22 19,8 V + S
			←	- ESP; für erhöhte Nutzlast		24.0124-0253.1 424253	Ø 280 24 21,8 V + S
			←	+ ESP		24.0124-0253.1 424253	Ø 280 24 21,8 V + S
DACIA - DOKKER Express 12/12→							
 Bremsbelagsatz, Scheibenbremse							
1.2 TCe 115 1.2 TCe 115	84 85	12/12→ 07/15→	←			13.0460-7266.2 607266 13.0470-7266.2 LD7266	ATE 24538 17,9 - WE / - WK ATE 24538 17,9 - WE / - WK Ceramic
1.5 dCi 1.5 dCi 1.6 1.6 1.6 LPG 1.6 LPG	55 66 61 75 61 75	12/12→ 12/12→ 12/12→ 04/15→ 11/13→ 04/15→	←	- ESP; nicht für erhöhte Nutzlast		13.0460-2709.2 602709 13.0470-2709.2 LD2709	TRW 23973 17,1 - WE / - WK + Zub TRW 23973 17,1 - WE / - WK + Zub Ceramic
			←	- ESP; für erhöhte Nutzlast		13.0460-7266.2 607266 13.0470-7266.2 LD7266	ATE 24538 17,9 - WE / - WK ATE 24538 17,9 - WE / - WK Ceramic
			←	+ ESP		13.0460-7266.2 607266 13.0470-7266.2 LD7266	ATE 24538 17,9 - WE / - WK ATE 24538 17,9 - WE / - WK Ceramic
 Bremsscheibe							
1.2 TCe 115 1.2 TCe 115	84 85	12/12→ 07/15→	←			24.0124-0253.1 424253	Ø 280 24 21,8 V + S
1.5 dCi 1.5 dCi 1.6 1.6 1.6 LPG 1.6 LPG	55 66 61 75 61 75	12/12→ 12/12→ 12/12→ 04/15→ 11/13→ 04/15→	←	- ESP; nicht für erhöhte Nutzlast		24.0122-0270.1 422270	Ø 258 22 19,8 V + S
			←	- ESP; für erhöhte Nutzlast		24.0124-0253.1 424253	Ø 280 24 21,8 V + S
			←	+ ESP		24.0124-0253.1 424253	Ø 280 24 21,8 V + S
DACIA - DUSTER 04/10→							
 Bremsbelagsatz, Scheibenbremse							
1.2 TCe 125 1.2 TCe 125 4x4 1.5 dCi 4x4	92 92 66	10/13→ 06/15→ 10/10→	←			13.0460-7266.2 607266 13.0470-7266.2 LD7266	ATE 24538 17,9 - WE / - WK ATE 24538 17,9 - WE / - WK Ceramic
1.5 dCi 1.5 dCi 1.5 dCi 1.5 dCi 4x4 1.5 dCi 4x4 1.5 dCi 4x4	63 66 79 79 80 81	04/10→ 10/10→ 06/10→ 06/10→ 08/13→ 10/10→	←	- ABS		13.0460-2709.2 602709 13.0470-2709.2 LD2709	TRW 23973 17,1 - WE / - WK + Zub TRW 23973 17,1 - WE / - WK + Zub Ceramic
			←	+ ABS		13.0460-7266.2 607266 13.0470-7266.2 LD7266	ATE 24538 17,9 - WE / - WK ATE 24538 17,9 - WE / - WK Ceramic
1.5 dCi 1.5 dCi	80 81	08/13→ 08/13→	←	09/13→; - ABS		13.0460-2709.2 602709 13.0470-2709.2 LD2709	TRW 23973 17,1 - WE / - WK + Zub TRW 23973 17,1 - WE / - WK + Zub Ceramic
			←	09/13→; + ABS		13.0460-7266.2 607266 13.0470-7266.2 LD7266	ATE 24538 17,9 - WE / - WK ATE 24538 17,9 - WE / - WK Ceramic
1.6 16V 1.6 16V 4x4 1.6 16V LPG 1.6 SCe 115 1.6 SCe 115 4x4 1.6 SCe 115 LPG	77 77 77 84 84 84	04/10→ 06/10→ 04/11→ 06/15→ 06/15→ 06/15→	←	- ESP		13.0460-2709.2 602709 13.0470-2709.2 LD2709	TRW 23973 17,1 - WE / - WK + Zub TRW 23973 17,1 - WE / - WK + Zub Ceramic
			←	+ ESP		13.0460-7266.2 607266 13.0470-7266.2 LD7266	ATE 24538 17,9 - WE / - WK ATE 24538 17,9 - WE / - WK Ceramic
1.6 16V Hi-Flex ↓	77	08/10→	←	04/11→; - ESP		13.0460-2709.2 602709	TRW 23973 17,1 - WE / - WK + Zub



















	kw			 	! #		
DACIA - DUSTER 04/10→							
 Bremsbelagsatz, Scheibenbremse							
1.6 16V Hi-Flex	77	08/10→	←	04/11→; - ESP		13.0470-2709.2 LD2709	TRW 23973 17,1 - WE / - WK + Zub Ceramic
			←	04/11→; + ESP		13.0460-7266.2 607266 13.0470-7266.2 LD7266	ATE 24538 17,9 - WE / - WK ATE 24538 17,9 - WE / - WK Ceramic
 Bremsscheibe							
1.2 TCe 125	92	10/13→	←			24.0124-0221.1 424221	Ø 280 24 21,8 V + S
1.2 TCe 125 4x4	92	06/15→					
1.5 dCi 4x4	66	10/10→					
1.5 dCi	63	04/10→	←	- ABS		24.0123-0119.1 423119	Ø 269 22,5 19,8 V + S
1.5 dCi	66	10/10→					
1.5 dCi	79	06/10→	←	+ ABS		24.0124-0221.1 424221	Ø 280 24 21,8 V + S
1.5 dCi 4x4	79	06/10→					
1.5 dCi 4x4	80	08/13→					
1.5 dCi 4x4	81	10/10→					
1.5 dCi	80	08/13→	←	09/13→; - ABS		24.0123-0119.1 423119	Ø 269 22,5 19,8 V + S
1.5 dCi	81	08/13→	←	09/13→; + ABS		24.0124-0221.1 424221	Ø 280 24 21,8 V + S
1.6 16V	77	04/10→	←	- ESP		24.0123-0119.1 423119	Ø 269 22,5 19,8 V + S
1.6 16V 4x4	77	06/10→					
1.6 16V LPG	77	04/11→	←	+ ESP		24.0124-0221.1 424221	Ø 280 24 21,8 V + S
1.6 SCe 115	84	06/15→					
1.6 SCe 115 4x4	84	06/15→					
1.6 SCe 115 LPG	84	06/15→					
1.6 16V Hi-Flex	77	08/10→	←	04/11→; - ESP		24.0123-0119.1 423119	Ø 269 22,5 19,8 V + S
			←	04/11→; + ESP		24.0124-0221.1 424221	Ø 280 24 21,8 V + S
DACIA - DUSTER Kasten 04/11→							
 Bremsbelagsatz, Scheibenbremse							
1.2 TCe 125 4x4	92	10/13→	←	06/15→		13.0460-7266.2 607266 13.0470-7266.2 LD7266	ATE 24538 17,9 - WE / - WK ATE 24538 17,9 - WE / - WK Ceramic
1.5 dCi	66	04/11→	←	- ABS		13.0460-2709.2 602709 13.0470-2709.2 LD2709	TRW 23973 17,1 - WE / - WK + Zub TRW 23973 17,1 - WE / - WK + Zub Ceramic
			←	+ ABS		13.0460-7266.2 607266 13.0470-7266.2 LD7266	ATE 24538 17,9 - WE / - WK ATE 24538 17,9 - WE / - WK Ceramic
1.5 dCi	80	04/13→	←	09/13→; - ABS		13.0460-2709.2 602709 13.0470-2709.2 LD2709	TRW 23973 17,1 - WE / - WK + Zub TRW 23973 17,1 - WE / - WK + Zub Ceramic
			←	09/13→; + ABS		13.0460-7266.2 607266 13.0470-7266.2 LD7266	ATE 24538 17,9 - WE / - WK ATE 24538 17,9 - WE / - WK Ceramic
1.5 dCi 4x4	66	04/11→	←			13.0460-7266.2 607266 13.0470-7266.2 LD7266	ATE 24538 17,9 - WE / - WK ATE 24538 17,9 - WE / - WK Ceramic
1.5 dCi 4x4	80	04/13→	←	08/13→; - ABS		13.0460-2709.2 602709 13.0470-2709.2 LD2709	TRW 23973 17,1 - WE / - WK + Zub TRW 23973 17,1 - WE / - WK + Zub Ceramic
			←	08/13→; + ABS		13.0460-7266.2 607266 13.0470-7266.2 LD7266	ATE 24538 17,9 - WE / - WK ATE 24538 17,9 - WE / - WK Ceramic
1.6 16V 4x4	77	04/11→	←	- ESP		13.0460-2709.2 602709 13.0470-2709.2 LD2709	TRW 23973 17,1 - WE / - WK + Zub TRW 23973 17,1 - WE / - WK + Zub Ceramic
1.6 16V Hi-Flex	77	04/11→					
1.6 SCe 115	84	06/15→					
1.6 SCe 115 4x4	84	06/15→					
			←	+ ESP		13.0460-7266.2 607266 13.0470-7266.2 LD7266	ATE 24538 17,9 - WE / - WK ATE 24538 17,9 - WE / - WK Ceramic
 Bremsscheibe							
1.2 TCe 125 4x4	92	10/13→	←	06/15→		24.0124-0221.1 424221	Ø 280 24 21,8 V + S
1.5 dCi	66	04/11→	←	- ABS		24.0123-0119.1 423119	Ø 269 22,5 19,8 V + S
			←	+ ABS		24.0124-0221.1 424221	Ø 280 24 21,8 V + S
↓							



















	kw			 	! #			
DACIA - DUSTER Kasten 04/11→								
 Bremsscheibe								
1.5 dCi	80	04/13→	←	09/13→; - ABS	24.0123-0119.1	423119	Ø 269 22,5 19,8 V + S	
			←	09/13→; + ABS	24.0124-0221.1	424221	Ø 280 24 21,8 V + S	
1.5 dCi 4x4	66	04/11→	←		24.0124-0221.1	424221	Ø 280 24 21,8 V + S	
1.5 dCi 4x4	80	04/13→	←	08/13→; - ABS	24.0123-0119.1	423119	Ø 269 22,5 19,8 V + S	
			←	08/13→; + ABS	24.0124-0221.1	424221	Ø 280 24 21,8 V + S	
1.6 16V 4x4	77	04/11→	←	- ESP	24.0123-0119.1	423119	Ø 269 22,5 19,8 V + S	
1.6 16V Hi-Flex	77	04/11→						
1.6 SCe 115	84	06/15→	←	+ ESP	24.0124-0221.1	424221	Ø 280 24 21,8 V + S	
1.6 SCe 115 4x4	84	06/15→						
DACIA - LODGY 03/12→								
 Bremsbelagsatz, Scheibenbremse								
1.2 TCe	85	03/12→	←		13.0460-7266.2	607266	ATE 24538 17,9 - WE / - WK	
1.5 dCi	79	01/13→			13.0470-7266.2	LD7266	ATE 24538 17,9 - WE / - WK	
1.5 dCi	80	06/15→					Ceramic	
1.5 dCi	81	03/12→						
1.5 dCi	66	03/12→	←	- ESP	13.0460-2709.2	602709	TRW 23973 17,1 - WE / - WK	
								+ Zub
1.6	61	03/12→			13.0470-2709.2	LD2709	TRW 23973 17,1 - WE / - WK	
1.6 LPG	61	11/13→					+ Zub Ceramic	
			←	+ ESP	13.0460-7266.2	607266	ATE 24538 17,9 - WE / - WK	
					13.0470-7266.2	LD7266	ATE 24538 17,9 - WE / - WK	
							Ceramic	
1.6 LPG	75	04/15→	←		13.0460-2709.2	602709	TRW 23973 17,1 - WE / - WK	
1.6 SCe 115	75	06/15→			13.0470-2709.2	LD2709	TRW 23973 17,1 - WE / - WK	
							+ Zub	
							+ Zub Ceramic	
 Bremsscheibe								
1.2 TCe	85	03/12→	←		24.0122-0270.1	422270	Ø 258 22 19,8 V + S	
					24.0124-0253.1	424253	Ø 280 24 21,8 V + S	
1.5 dCi	66	03/12→	←	- ESP	24.0122-0270.1	422270	Ø 258 22 19,8 V + S	
1.5 dCi	79	01/13→						
1.5 dCi	80	06/15→	←	+ ESP	24.0124-0253.1	424253	Ø 280 24 21,8 V + S	
1.5 dCi	81	03/12→						
1.6	61	03/12→						
1.6 LPG	61	11/13→						
1.6 LPG	75	04/15→	←		24.0124-0253.1	424253	Ø 280 24 21,8 V + S	
1.6 SCe 115	75	06/15→						
DACIA - LOGAN (LS_) 09/04→								
 Bremsbelagsatz, Scheibenbremse								
1.0 Hi-Flex (LS0R, LS1G)	56	01/11→10/12	←		13.0460-2834.2	602834	TRW 21463 18,0 + WK	
1.2 16V	55	02/06→	←	→ 04/13	13.0460-2834.2	602834	TRW 21463 18,0 + WK	
1.2 16V LPG	55	02/06→						
1.4 (LSOA, LSOC, LSOE, LSOG)	55	09/04→						
1.4 MPI LPG (LS0C)	55	02/06→						
1.5 dCi (LS04)	55	05/10→						
1.5 dCi (LS04)	65	05/10→						
1.5 dCi (LS0J, LS0Y)	48	09/05→						
1.5 dCi (LS0K)	50	01/06→						
1.5 dCi (LS0W)	63	09/07→						
1.6 (LSOB, LSOD, LSOE, LSOH)	64	09/04→						
1.6 16V (LS0M)	77	02/06→						
1.6 Bifuel	62	05/10→						
1.6 MPI 85	62	05/10→						
1.6 16V Flexifuel	77	07/10→	←	01/11→ 04/13	13.0460-2834.2	602834	TRW 21463 18,0 + WK	
 Bremsscheibe								
1.0 Hi-Flex (LS0R, LS1G)	56	01/11→10/12	←	- ABS	24.0112-0116.1	412116	Ø 238 12 10,5 + S	
			←	+ ABS	24.0112-0171.1	412171	Ø 259 12 10,6 + S	
			←		24.0121-0106.1	421106	Ø 259 20,7 17,7 V + S	
1.2 16V	55	02/06→	←	- ABS; → 04/13	24.0112-0116.1	412116	Ø 238 12 10,5 + S	
1.2 16V LPG	55	02/06→			24.0112-0171.1	412171	Ø 259 12 10,6 + S	
1.4 (LSOA, LSOC, LSOE, LSOG)	55	09/04→	←	+ ABS; → 04/13	24.0112-0171.1	412171	Ø 259 12 10,6 + S	
1.4 MPI LPG (LS0C)	55	02/06→			24.0121-0106.1	421106	Ø 259 20,7 17,7 V + S	
1.5 dCi (LS04)	55	05/10→	←	→ 04/13				
↓								















	kW			 	! #		
DACIA - LOGAN (LS_) 09/04→							
 Bremsscheibe							
1.5 dCi (LS04)	65	05/10→	←	- ABS; → 04/13		24.0112-0116.1 412116	Ø 238 12 10,5 + S
1.5 dCi (LS0J, LS0Y)	48	09/05→					
1.5 dCi (LS0K)	50	01/06→	←	+ ABS; → 04/13		24.0112-0171.1 412171	Ø 259 12 10,6 + S
1.5 dCi (LS0W)	63	09/07→					
1.6 (LS0B, LS0D, LS0F, LS0H)	64	09/04→	←	→ 04/13		24.0121-0106.1 421106	Ø 259 20,7 17,7 V + S
1.6 16V (LS0M)	77	02/06→					
1.6 Bifuel	62	05/10→					
1.6 MPI 85	62	05/10→					
1.6 16V Flexifuel	77	07/10→	←	01/11→; - ABS; → 04/13		24.0112-0116.1 412116	Ø 238 12 10,5 + S
			←	01/11→; + ABS; → 04/13		24.0112-0171.1 412171	Ø 259 12 10,6 + S
			←	01/11→ 04/13		24.0121-0106.1 421106	Ø 259 20,7 17,7 V + S
DACIA - LOGAN II 10/12→							
 Bremsbelagsatz, Scheibenbremse							
1.2	54	05/15→	←			13.0460-7298.2 607298	ATE 25702 18,2 - WE / - WK
1.5 dCi	63	01/13→					
1.6 16V	75	04/15→					
1.6 16V	77	01/13→					
1.2	55	10/12→	←	11/12→		13.0460-7298.2 607298	ATE 25702 18,2 - WE / - WK
1.2 LPG	55	10/12→					
1.5 dCi	55	10/12→					
1.5 dCi	66	10/12→					
TCe 90	66	10/12→					
 Bremsscheibe							
1.2	54	05/15→	←			24.0112-0171.1 412171	Ø 259 12 10,6 + S
1.2	55	10/12→	←	11/12→		24.0112-0171.1 412171	Ø 259 12 10,6 + S
1.2 LPG	55	10/12→					
1.5 dCi	55	10/12→	←	11/12→		24.0122-0289.1 422289	Ø 258 22 19,8 V + S
1.5 dCi	66	10/12→					
TCe 90	66	10/12→					
1.5 dCi	63	01/13→	←			24.0122-0289.1 422289	Ø 258 22 19,8 V + S
1.6 16V	75	04/15→					
1.6 16V	77	01/13→					
TCe 90 LPG	66	09/15→					
DACIA - LOGAN EXPRESS (FS_) 03/09→							
 Bremsbelagsatz, Scheibenbremse							
1.4	55	03/09→	←	→ 06/13		13.0460-2709.2 602709	TRW 23973 17,1 - WE / - WK + Zub
1.5 dCi	55	05/10→					
1.5 dCi	65	05/10→					
1.5 dCi (FS0K)	50	03/09→				13.0470-2709.2 LD2709	TRW 23973 17,1 - WE / - WK + Zub Ceramic
1.5 dCi (FS0W)	63	03/09→					
1.6	64	03/09→					
1.6 MPI 85	62	05/10→					
 Bremsscheibe							
1.4	55	03/09→	←	→ 06/13		24.0122-0216.1 422216	Ø 260 22 19,8 V + S
1.5 dCi	55	05/10→					
1.5 dCi	65	05/10→					
1.5 dCi (FS0K)	50	03/09→					
1.5 dCi (FS0W)	63	03/09→					
1.6	64	03/09→					
1.6 MPI 85	62	05/10→					
DACIA - LOGAN MCV (KS_) 02/07→							
 Bremsbelagsatz, Scheibenbremse							
1.4	55	02/07→	←	für Bremsscheibendurchmesser [mm]: 260; → 04/13		13.0460-2709.2 602709	TRW 23973 17,1 - WE / - WK + Zub
						13.0460-7270.2 607270	ATE 24673 18,0 - WE / - WK
						13.0470-2709.2 LD2709	TRW 23973 17,1 - WE / - WK + Zub Ceramic
			←	für Bremsscheibendurchmesser [mm]: 259; → 04/13		13.0460-2834.2 602834	TRW 21463 18,0 + WK
1.5 dCi (KS04)	55	05/10→	←	für Bremsscheibendurchmesser [mm]: 260; → 04/13		13.0460-2709.2 602709	TRW 23973 17,1 - WE / - WK + Zub
1.5 dCi (KS04)	65	05/10→				13.0470-2709.2 LD2709	TRW 23973 17,1 - WE / - WK + Zub Ceramic
			←	für Bremsscheibendurchmesser [mm]: 259; → 04/13		13.0460-2834.2 602834	TRW 21463 18,0 + WK
1.5 dCi (KS0K)	50	02/07→	←	12/08→;		13.0460-2709.2 602709	TRW 23973 17,1 - WE / - WK + Zub
1.5 dCi (KS0W)	63	09/07→		für Bremsscheibendurchmesser [mm]:			
1.6	64	02/07→		260; → 04/13			















	kW			 	! #		
DACIA - LOGAN MCV (KS_) 02/07→							
 Bremsbelagsatz, Scheibenbremse							
1.5 dCi (KS0K) 1.5 dCi (KS0W) 1.6	50 63 64	02/07→ 09/07→ 02/07→	←	12/08→; für Bremsscheibendurchmesser [mm]: 260; → 04/13		13.0470-2709.2 LD2709	TRW 23973 17,1 - WE / - WK + Zub Ceramic
			←	für Bremsscheibendurchmesser [mm]: 259; → 04/13		13.0460-2834.2 602834	TRW 21463 18,0 + WK
			←	für Bremsscheibendurchmesser [mm]: 260; → 11/08		13.0460-7270.2 607270	ATE 24673 18,0 - WE / - WK
1.6 16V 1.6 16V Hi-Flex 1.6 Bifuel 1.6 Bifuel	77 77 62 64	02/07→ 11/09→ 05/10→ 11/08→	←	für Bremsscheibendurchmesser [mm]: 260; → 04/13		13.0460-2709.2 602709 13.0460-7270.2 607270 13.0470-2709.2 LD2709	TRW 23973 17,1 - WE / - WK + Zub ATE 24673 18,0 - WE / - WK TRW 23973 17,1 - WE / - WK + Zub Ceramic
1.6 MPI 85	62	05/10→	←	für Bremsscheibendurchmesser [mm]: 260; → 04/13		13.0460-7270.2 607270	ATE 24673 18,0 - WE / - WK
 Bremsscheibe							
1.4 1.5 dCi (KS04) 1.5 dCi (KS04) 1.5 dCi (KS0K) 1.5 dCi (KS0W) 1.6 1.6 Bifuel 1.6 Bifuel 1.6 MPI 85	55 55 65 50 63 64 62 64 62	02/07→ 05/10→ 05/10→ 02/07→ 09/07→ 02/07→ 05/10→ 11/08→ 05/10→	←	→ 04/13		24.0121-0106.1 421106 24.0122-0216.1 422216	∅ 259 20,7 17,7 V + S ∅ 260 22 19,8 V + S
1.6 16V 1.6 16V Hi-Flex	77 77	02/07→ 11/09→	←	→ 04/13		24.0122-0216.1 422216	∅ 260 22 19,8 V + S
DACIA - LOGAN MCV II 02/13→							
 Bremsbelagsatz, Scheibenbremse							
1.0 SCe 75 1.2 1.2 1.2 LPG 1.5 dCi 1.5 dCi 1.5 dCi 1.6 TCe 90 TCe 90 LPG	54 54 55 55 55 63 66 62 66 66	12/16→ 05/15→ 02/13→ 02/13→ 02/13→ 02/13→ 02/13→ 06/13→ 02/13→ 09/15→	←			13.0460-7298.2 607298	ATE 25702 18,2 - WE / - WK
 Bremsscheibe							
1.0 SCe 75 1.2 1.2 1.2 LPG 1.5 dCi 1.5 dCi 1.5 dCi 1.6 TCe 90 TCe 90 LPG	54 54 55 55 55 63 66 62 66 66	12/16→ 05/15→ 02/13→ 02/13→ 02/13→ 02/13→ 02/13→ 06/13→ 02/13→ 09/15→	←			24.0122-0289.1 422289	∅ 258 22 19,8 V + S
DACIA - LOGAN Pick-up (US_) 03/08→							
 Bremsbelagsatz, Scheibenbremse							
1.4 1.5 dCi 1.5 dCi 1.6 Bifuel 1.6 MPI 85	55 55 65 62 62	01/09→ 05/10→ 05/10→ 05/10→ 05/10→	←	→ 06/13		13.0460-2709.2 602709 13.0470-2709.2 LD2709	TRW 23973 17,1 - WE / - WK + Zub TRW 23973 17,1 - WE / - WK + Zub Ceramic
1.5 dCi (US00, US0J, US0Y)	48	04/08→12/12	←	12/08→		13.0460-2709.2 602709 13.0470-2709.2 LD2709	TRW 23973 17,1 - WE / - WK + Zub TRW 23973 17,1 - WE / - WK + Zub Ceramic
			←	→ 11/08		13.0460-7270.2 607270	ATE 24673 18,0 - WE / - WK
1.5 dCi (US0K) 1.5 dCi (US0W) 1.6	50 63 64	03/08→ 03/08→ 03/08→	←	12/08→ 06/13		13.0460-2709.2 602709 13.0470-2709.2 LD2709	TRW 23973 17,1 - WE / - WK + Zub TRW 23973 17,1 - WE / - WK + Zub Ceramic
			←	→ 11/08		13.0460-7270.2 607270	ATE 24673 18,0 - WE / - WK
1.6 16V (US1Y)	77	01/10→08/13	←			13.0460-2709.2 602709 13.0470-2709.2 LD2709	TRW 23973 17,1 - WE / - WK + Zub TRW 23973 17,1 - WE / - WK + Zub Ceramic
↓							















	kw			 	! #		
DACIA - LOGAN Pick-up (US_) 03/08→							
 Bremsscheibe							
1.4	55	01/09→	←	→ 06/13		24.0122-0216.1 422216	Ø 260 22 19,8 V + S
1.5 dCi	55	05/10→					
1.5 dCi	65	05/10→					
1.5 dCi (US0K)	50	03/08→					
1.5 dCi (US0W)	63	03/08→					
1.6	64	03/08→					
1.6 Bifuel	62	05/10→					
1.6 MPI 85	62	05/10→					
1.5 dCi (US00, US0J, US0Y)	48	04/08→12/12	←			24.0122-0216.1 422216	Ø 260 22 19,8 V + S
1.6 16V (US1Y)	77	01/10→08/13					
DACIA - SANDERO 06/08→							
 Bremsbelagsatz, Scheibenbremse							
1.0 Hi-Flex	56	01/11→12/12	←			13.0460-2834.2 602834	TRW 21463 18,0 + WK
1.6 Hi-Flex (BS1H)	64	06/08→12/12					
1.6 LPG	62	05/10→10/12					
1.2 16V	55	11/08→	←	→ 02/13		13.0460-2834.2 602834	TRW 21463 18,0 + WK
1.2 16V LPG	55	11/08→					
1.4	55	06/08→					
1.4 MPI LPG	53	01/09→					
1.5 dCi	48	11/08→					
1.5 dCi	50	11/08→					
1.5 dCi	55	05/10→					
1.5 dCi	65	05/10→					
1.6	64	06/08→					
1.6 16V	77	07/11→					
1.6 16V Bifuel	77	01/11→					
1.6 MPI 85	62	05/10→					
1.5 dCi	63	11/08→	←	→ 02/13		13.0460-7270.2 607270	ATE 24673 18,0 - WE / - WK
1.6 LPG (BS03)	60	01/11→12/12	←	→ 10/12		13.0460-2834.2 602834	TRW 21463 18,0 + WK
 Bremsscheibe							
1.0 Hi-Flex	56	01/11→12/12	←			24.0112-0116.1 412116	Ø 238 12 10,5 + S
1.6 LPG	62	05/10→10/12				24.0112-0171.1 412171	Ø 259 12 10,6 + S
						24.0121-0106.1 421106	Ø 259 20,7 17,7 V + S
1.2 16V	55	11/08→	←	→ 02/13		24.0112-0116.1 412116	Ø 238 12 10,5 + S
						24.0112-0171.1 412171	Ø 259 12 10,6 + S
			←	02/09→ 02/13		24.0121-0106.1 421106	Ø 259 20,7 17,7 V + S
1.2 16V LPG	55	11/08→	←	→ 02/13		24.0112-0116.1 412116	Ø 238 12 10,5 + S
1.4	55	06/08→				24.0112-0171.1 412171	Ø 259 12 10,6 + S
1.4 MPI LPG	53	01/09→				24.0121-0106.1 421106	Ø 259 20,7 17,7 V + S
1.5 dCi	50	11/08→					
1.5 dCi	55	05/10→					
1.5 dCi	65	05/10→					
1.6	64	06/08→					
1.6 16V	77	07/11→					
1.6 16V Bifuel	77	01/11→					
1.6 MPI 85	62	05/10→					
1.5 dCi	48	11/08→	←	→ 02/13		24.0112-0116.1 412116	Ø 238 12 10,5 + S
						24.0112-0171.1 412171	Ø 259 12 10,6 + S
1.5 dCi	63	11/08→	←	→ 02/13		24.0122-0216.1 422216	Ø 260 22 19,8 V + S
1.6 Hi-Flex (BS1H)	64	06/08→12/12	←			24.0112-0116.1 412116	Ø 238 12 10,5 + S
						24.0112-0171.1 412171	Ø 259 12 10,6 + S
1.6 LPG (BS03)	60	01/11→12/12	←	→ 10/12		24.0112-0116.1 412116	Ø 238 12 10,5 + S
						24.0112-0171.1 412171	Ø 259 12 10,6 + S
						24.0121-0106.1 421106	Ø 259 20,7 17,7 V + S
DACIA - SANDERO II 10/12→							
 Bremsbelagsatz, Scheibenbremse							
1.0 SCe 75	54	12/16→	←			13.0460-7298.2 607298	ATE 25702 18,2 - WE / - WK
1.2	54	05/15→					
1.5 dCi	63	01/13→					
1.6	61	11/12→					
1.6 16V	75	04/15→					
TCe 90 LPG	66	09/15→					
1.2	55	10/12→	←	11/12→		13.0460-7298.2 607298	ATE 25702 18,2 - WE / - WK
1.2 LPG	55	10/12→					
1.5 dCi	55	10/12→					
1.5 dCi	66	10/12→					
TCe 90	66	10/12→					
↓							













	kW			 	! #		
DACIA - SANDERO II 10/12→							
 Bremsscheibe							
1.0 SCe 75	54	12/16→	←			24.0122-0289.1 422289	Ø 258 22 19,8 V + S
1.5 dCi	63	01/13→					
1.6	61	11/12→					
1.6 16V	75	04/15→					
TCe 90 LPG	66	09/15→					
1.2	54	05/15→	←			24.0112-0171.1 412171	Ø 259 12 10,6 + S
1.2	55	10/12→	←	11/12→		24.0112-0171.1 412171	Ø 259 12 10,6 + S
1.2 LPG	55	10/12→					
1.5 dCi	55	10/12→	←	11/12→		24.0122-0289.1 422289	Ø 258 22 19,8 V + S
1.5 dCi	66	10/12→					
TCe 90	66	10/12→					
DAEWOO - ARANOS 01/95→11/97							
 Bremsbelagsatz, Scheibenbremse							
1.5	66	01/95→11/97	←			13.0460-7052.2 607052	ATE 21190 17,5 + WE / - WK
1.8	70	01/95→11/97					
2.0	77	01/95→11/97					
 Bremsscheibe							
1.5	66	01/95→11/97	←			24.0124-0115.1 424115	Ø 256 24 21 V + S
1.8	70	01/95→11/97					
2.0	77	01/95→11/97					
DAEWOO - CIELO 06/94→12/07							
 Bremsbelagsatz, Scheibenbremse							
1.5	59	01/95→11/00	←	→ 07/98		13.0460-7052.2 607052	ATE 21190 17,5 + WE / - WK
1.5	66	06/94→07/98	←			13.0460-7052.2 607052	ATE 21190 17,5 + WE / - WK
 Bremsscheibe							
1.5	59	01/95→11/00	←	→ 07/98		24.0124-0115.1 424115	Ø 256 24 21 V + S
1.5	66	06/94→07/98	←			24.0124-0115.1 424115	Ø 256 24 21 V + S
DAEWOO - ESPERO (KLEJ) 10/91→09/99							
 Bremsbelagsatz, Scheibenbremse							
1.5	55	10/97→08/99	←	→ 06/99		13.0460-7052.2 607052	ATE 21190 17,5 + WE / - WK
1.8	66	02/95→09/99					
1.5 16V	66	02/95→06/99	←			13.0460-7052.2 607052	ATE 21190 17,5 + WE / - WK
1.8	70	02/95→06/99					
2.0	77	02/95→06/99					
 Bremsscheibe							
1.5	55	10/97→08/99	←	→ 06/99		24.0124-0115.1 424115	Ø 256 24 21 V + S
1.8	66	02/95→09/99				24.0324-0115.1 524115	Ø 256 24 21 V + S PD
1.5 16V	66	02/95→06/99	←			24.0124-0115.1 424115	Ø 256 24 21 V + S
1.8	70	02/95→06/99				24.0324-0115.1 524115	Ø 256 24 21 V + S PD
2.0	77	02/95→06/99					
DAEWOO - EVANDA (KLAL) 08/02→							
 Bremsbelagsatz, Scheibenbremse							
2.0	96	08/02→	←	→ 02/05		13.0460-5859.2 605859	AKE 23234 16,9 + WK
Zubehörsatz, Scheibenbremsbelag							
2.0	96	08/02→	←	→ 02/05		13.0460-0140.2 610140	AKE
 Bremsscheibe							
2.0	96	08/02→	←	→ 02/05		24.0124-0199.1 424199	Ø 256 24 21 V + S
DAEWOO - GENTRA Stufenheck 06/13→							
 Bremsbelagsatz, Scheibenbremse							
1.5	79	06/13→	←			13.0460-5859.2 605859	AKE 23234 16,9 + WK
						13.0460-5863.2 605863	AKE 23234 16,8 + WK
 Bremsscheibe							
1.5	79	06/13→	→			24.0110-0340.1 410340	Ø 258 10,5 8 + S

	kW			 	! #		
DAEWOO - KALOS (KLAS) 09/02→							
 Bremsbelagsatz, Scheibenbremse							
1.2	53	04/03→	←	→ 02/05		13.0460-5899.2 605899	AKE 23974 17,6 - WE / - WK
1.4	61	09/02→					
1.4 16V	69	04/03→					
1.5	62	11/02→12/04	←			13.0460-5899.2 605899	AKE 23974 17,6 - WE / - WK
 Bremsscheibe							
1.2	53	04/03→	←	→ 02/05		24.0120-0115.1 420115	Ø 236 20 17 V + S
1.4	61	09/02→				24.0320-0115.1 520115	Ø 236 20 17 V + S PD
1.4 16V	69	04/03→					
1.5	62	11/02→12/04	←			24.0120-0115.1 420115	Ø 236 20 17 V + S
						24.0320-0115.1 520115	Ø 236 20 17 V + S PD
DAEWOO - KALOS Stufenheck (KLAS) 11/02→12/04							
 Bremsbelagsatz, Scheibenbremse							
1.4	61	11/02→12/04	←			13.0460-5899.2 605899	AKE 23974 17,6 - WE / - WK
1.4	69	05/03→12/04					
1.5	62	11/02→12/04					
 Bremsscheibe							
1.4	61	11/02→12/04	←			24.0120-0115.1 420115	Ø 236 20 17 V + S
1.4	69	05/03→12/04				24.0320-0115.1 520115	Ø 236 20 17 V + S PD
1.5	62	11/02→12/04					
DAEWOO - KORANDO (KJ) 01/99→							
 Bremsscheibe							
2.3	103	01/99→02/01	→			24.0110-0352.1 410352	Ø 299 10,4 8,5
2.3	105	01/99→	→	→ 11/05		24.0110-0352.1 410352	Ø 299 10,4 8,5
2.9 D	72	01/99→					
2.9 TD	88	01/99→					
3.2 4x4	156	01/99→					
DAEWOO - KORANDO Cabrio (KJ) 02/99→							
 Bremsscheibe							
2.0 16V	94	02/99→	→	→ 11/05		24.0110-0352.1 410352	Ø 299 10,4 8,5
2.3	105	02/99→					
2.9 D	72	02/99→					
2.9 TD	88	02/99→					
2.3	103	02/99→02/01	→			24.0110-0352.1 410352	Ø 299 10,4 8,5
DAEWOO - LACETTI Schrägheck (KLAN) 02/02→							
 Bremsbelagsatz, Scheibenbremse							
1.4	69	06/02→12/04	←			13.0460-5863.2 605863	AKE 23234 16,8 + WK
			→			13.0460-5739.2 605739	SUM 24071 14,6 - WE / - WK
1.4	70	02/04→	←	→ 02/05		13.0460-5863.2 605863	AKE 23234 16,8 + WK
1.6	80	02/04→					
1.8	90	02/04→	→	→ 02/05		13.0460-5739.2 605739	SUM 24071 14,6 - WE / - WK
 Bremsscheibe							
1.4	69	06/02→12/04	←			24.0124-0199.1 424199	Ø 256 24 21 V + S
			→			24.0110-0340.1 410340	Ø 258 10,5 8 + S
1.4	70	02/04→	←	→ 02/05		24.0124-0199.1 424199	Ø 256 24 21 V + S
1.6	80	02/04→					
1.8	90	02/04→	→	→ 02/05		24.0110-0340.1 410340	Ø 258 10,5 8 + S
DAEWOO - LACETTI Stufenheck 06/99→07/03							
 Bremsbelagsatz, Scheibenbremse							
1.6	78	06/99→07/03	←	06/02→		13.0460-5863.2 605863	AKE 23234 16,8 + WK
			→	06/02→		13.0460-5739.2 605739	SUM 24071 14,6 - WE / - WK
 Bremsscheibe							
1.6	78	06/99→07/03	←	06/02→		24.0124-0199.1 424199	Ø 256 24 21 V + S
			→	06/02→		24.0110-0340.1 410340	Ø 258 10,5 8 + S
DAEWOO - LACETTI Stufenheck (J200) 06/02→12/04							
 Bremsbelagsatz, Scheibenbremse							
1.8	89	06/02→12/04	←	02/04→		13.0460-5863.2 605863	AKE 23234 16,8 + WK
1.8 CDX	90	08/03→12/04					

















	kw					! #		
DAEWOO - LACETTI Stufenheck (J200) 06/02→12/04								
 Bremsbelagsatz, Scheibenbremse								
1.8 1.8 CDX	89 90	06/02→12/04 08/03→12/04	➔	02/04→		13.0460-5739.2	605739	SUM 24071 14,6 - WE / - WK
 Bremsscheibe								
1.8 1.8 CDX	89 90	06/02→12/04 08/03→12/04	←	02/04→		24.0124-0199.1	424199	Ø 256 24 21 V + S
			➔	02/04→		24.0110-0340.1	410340	Ø 258 10,5 8 + S
DAEWOO - LANOS (KLAT) 05/97→								
 Bremsbelagsatz, Scheibenbremse								
1.3 1.5	55 63	05/97→ 05/97→	←	447434→; → 12/02		13.0460-5996.2	605996	23241 16,1 - WE / - WK
			←	→ 447433		13.0460-7051.2	607051	ATE 20547 16,5 + WE / - WK
1.5	73	10/97→06/99	←	447434→		13.0460-5996.2	605996	23241 16,1 - WE / - WK
			←	→ 447433		13.0460-7051.2	607051	ATE 20547 16,5 + WE / - WK
1.6 16V	78	05/97→	←	447434→; → 12/02		13.0460-5994.2	605994	AKE 23234 16,8 - WE / - WK
			←	→ 447433		13.0460-7052.2	607052	ATE 21190 17,5 + WE / - WK
Zubehörsatz, Scheibenbremsbelag								
1.6 16V	78	05/97→	←	447434→; → 12/02		13.0460-0140.2	610140	AKE
 Bremsscheibe								
1.3 1.5	55 63	05/97→ 05/97→	←	→ 12/02		24.0120-0115.1	420115	Ø 236 20 17 V + S
						24.0320-0115.1	520115	Ø 236 20 17 V + S PD
1.5	73	10/97→06/99	←			24.0120-0115.1	420115	Ø 236 20 17 V + S
						24.0320-0115.1	520115	Ø 236 20 17 V + S PD
1.6 16V	78	05/97→	←	→ 12/02		24.0124-0115.1	424115	Ø 256 24 21 V + S
						24.0324-0115.1	524115	Ø 256 24 21 V + S PD
DAEWOO - LANOS Stufenheck (KLAT) 02/97→								
 Bremsbelagsatz, Scheibenbremse								
1.3 1.5	55 63	05/97→ 05/97→	←	447434→; → 12/02		13.0460-5996.2	605996	23241 16,1 - WE / - WK
			←	→ 447433		13.0460-7051.2	607051	ATE 20547 16,5 + WE / - WK
1.5	73	10/97→06/99	←	447434→		13.0460-5996.2	605996	23241 16,1 - WE / - WK
			←	→ 447433		13.0460-7051.2	607051	ATE 20547 16,5 + WE / - WK
1.6 16V	78	02/97→	←	447434→; → 12/02		13.0460-5994.2	605994	AKE 23234 16,8 - WE / - WK
			←	05/97→; → 447433		13.0460-7052.2	607052	ATE 21190 17,5 + WE / - WK
Zubehörsatz, Scheibenbremsbelag								
1.6 16V	78	02/97→	←	447434→; → 12/02		13.0460-0140.2	610140	AKE
 Bremsscheibe								
1.3 1.5	55 63	05/97→ 05/97→	←	→ 12/02		24.0120-0115.1	420115	Ø 236 20 17 V + S
						24.0320-0115.1	520115	Ø 236 20 17 V + S PD
1.5	73	10/97→06/99	←			24.0120-0115.1	420115	Ø 236 20 17 V + S
						24.0320-0115.1	520115	Ø 236 20 17 V + S PD
1.6 16V	78	02/97→	←	05/97→ 12/02		24.0124-0115.1	424115	Ø 256 24 21 V + S
						24.0324-0115.1	524115	Ø 256 24 21 V + S PD
DAEWOO - LEGANZA (KLAV) 06/97→04/04								
 Bremsbelagsatz, Scheibenbremse								
2.0 2.0 2.2 16V	85 133 100	06/97→12/02 01/01→12/02 04/99→12/02	←			13.0460-5859.2	605859	AKE 23234 16,9 + WK
2.0 16V	93	07/00→04/04	←	→ 12/02		13.0460-5859.2	605859	AKE 23234 16,9 + WK
			➔	→ 12/02		13.0460-5993.2	605993	TRW 23237 14,5 - WE / - WK
2.0 16V	98	06/97→12/02	←			13.0460-5859.2	605859	AKE 23234 16,9 + WK
			←	07/00→		13.0460-5859.2	605859	AKE 23234 16,9 + WK
			➔	07/00→		13.0460-5993.2	605993	TRW 23237 14,5 - WE / - WK
			➔			13.0460-5993.2	605993	TRW 23237 14,5 - WE / - WK
↓								



















	kW			 	! #		
DAEWOO - LEGANZA (KLAV) 06/97→04/04							
Zubehörsatz, Scheibenbremsbelag							
2.0	85	06/97→12/02	←			13.0460-0140.2 610140	AKE
2.0	133	01/01→12/02					
2.2 16V	100	04/99→12/02					
2.0 16V	93	07/00→04/04	←	→ 12/02		13.0460-0140.2 610140	AKE
2.0 16V	98	06/97→12/02	←	07/00→		13.0460-0140.2 610140	AKE
			←			13.0460-0140.2 610140	AKE
 Bremsscheibe							
2.0	85	06/97→12/02	←			24.0124-0723.1 424723	Ø 256 24 21 V
2.0	133	01/01→12/02					
2.2 16V	100	04/99→12/02	→			24.0110-0282.1 410282	Ø 258 10,3 8
2.0 16V	93	07/00→04/04	←	→ 12/02		24.0124-0723.1 424723	Ø 256 24 21 V
			→	→ 12/02		24.0110-0282.1 410282	Ø 258 10,3 8
2.0 16V	98	06/97→12/02	←			24.0124-0723.1 424723	Ø 256 24 21 V
			←	07/00→		24.0124-0723.1 424723	Ø 256 24 21 V
			→			24.0110-0282.1 410282	Ø 258 10,3 8
			→	07/00→		24.0110-0282.1 410282	Ø 258 10,3 8
DAEWOO - MAGNUS 07/99→							
 Bremsbelagsatz, Scheibenbremse							
2.0	96	07/99→	←	→ 12/04		13.0460-5859.2 605859	AKE 23234 16,9 + WK
Zubehörsatz, Scheibenbremsbelag							
2.0	96	07/99→	←	→ 12/04		13.0460-0140.2 610140	AKE
 Bremsscheibe							
2.0	96	07/99→	←	→ 12/04		24.0124-0199.1 424199	Ø 256 24 21 V + S
DAEWOO - MATIZ (KLYA) 09/98→							
 Bremsbelagsatz, Scheibenbremse							
0.8	38	09/98→	←	→ 02/05		13.0460-5996.2 605996	23241 16,1 - WE / - WK
1.0	47	01/03→					
1.0	46	04/03→12/04	←			13.0460-5996.2 605996	23241 16,1 - WE / - WK
Zubehörsatz, Scheibenbremsbelag							
0.8	38	09/98→	←	→ 02/05		13.0460-0252.2 610252	
1.0	47	01/03→					
1.0	46	04/03→12/04	←			13.0460-0252.2 610252	
 Bremsscheibe							
0.8	38	09/98→	←	→ 02/05		24.0113-0195.1 413195	Ø 236 12,6 9,7
1.0	47	01/03→					
1.0	46	04/03→12/04	←			24.0113-0195.1 413195	Ø 236 12,6 9,7
DAEWOO - MATIZ Kasten (KLA4) 08/98→08/02							
 Bremsbelagsatz, Scheibenbremse							
0.8	38	08/98→08/02	←			13.0460-5996.2 605996	23241 16,1 - WE / - WK
Zubehörsatz, Scheibenbremsbelag							
0.8	38	08/98→08/02	←			13.0460-0252.2 610252	
 Bremsscheibe							
0.8	38	08/98→08/02	←			24.0113-0195.1 413195	Ø 236 12,6 9,7
DAEWOO - MUSSO (FJ) 07/98→							
 Bremsscheibe							
2.2 TD	74	09/99→	→	→ 11/05		24.0110-0352.1 410352	Ø 299 10,4 8,5
2.3	103	01/99→					
2.9 TD 4x4	88	01/99→					
3.2 4x4	162	01/99→					
2.9 D 4x4	73	01/99→09/99	→			24.0110-0352.1 410352	Ø 299 10,4 8,5



















	kw			 	! #		
DAEWOO - NEXIA (KLETN) 02/95→08/97							
 Bremsbelagsatz, Scheibenbremse							
1.5	44	08/96→08/97	←			13.0460-7051.2 607051	ATE 20547 16,5 + WE / - WK
1.5	52	02/95→08/97					
1.5	55	02/95→08/97					
1.5 16V	66	02/95→08/97	←			13.0460-7052.2 607052	ATE 21190 17,5 + WE / - WK
 Bremsscheibe							
1.5	44	08/96→08/97	←			24.0120-0115.1 420115	Ø 236 20 17 V + S
1.5	52	02/95→08/97				24.0320-0115.1 520115	Ø 236 20 17 V + S PD
1.5	55	02/95→08/97					
1.5 16V	66	02/95→08/97	←			24.0124-0115.1 424115	Ø 256 24 21 V + S
						24.0324-0115.1 524115	Ø 256 24 21 V + S PD
DAEWOO - NEXIA Stufenheck (KLETN) 02/95→06/08							
 Bremsbelagsatz, Scheibenbremse							
1.5	44	08/96→08/97	←			13.0460-7051.2 607051	ATE 20547 16,5 + WE / - WK
1.5	52	02/95→08/97					
1.5	55	02/95→08/97					
1.5 16V	66	02/95→08/97	←			13.0460-7052.2 607052	ATE 21190 17,5 + WE / - WK
1.8	74	02/95→06/08	←	10/95→		13.0460-7052.2 607052	ATE 21190 17,5 + WE / - WK
 Bremsscheibe							
1.5	44	08/96→08/97	←			24.0120-0115.1 420115	Ø 236 20 17 V + S
1.5	52	02/95→08/97				24.0320-0115.1 520115	Ø 236 20 17 V + S PD
1.5	55	02/95→08/97					
1.5 16V	66	02/95→08/97	←			24.0124-0115.1 424115	Ø 256 24 21 V + S
						24.0324-0115.1 524115	Ø 256 24 21 V + S PD
1.8	74	02/95→06/08	←	10/95→		24.0124-0115.1 424115	Ø 256 24 21 V + S
						24.0324-0115.1 524115	Ø 256 24 21 V + S PD
DAEWOO - NUBIRA (KLAJ) 04/97→							
 Bremsbelagsatz, Scheibenbremse							
1.6	76	08/02→07/03	←	→ 695960		13.0460-5859.2 605859	AKE 23234 16,9 + WK
			←	695961→		13.0460-5863.2 605863	AKE 23234 16,8 + WK
			→	+ ABS		13.0460-5993.2 605993	TRW 23237 14,5 - WE / - WK
1.6 16V	78	05/97→	←	06/97→ 05/99		13.0460-5994.2 605994	AKE 23234 16,8 - WE / - WK
2.0 16V	98	05/97→	←	06/97→ 05/99		13.0460-5994.2 605994	AKE 23234 16,8 - WE / - WK
			→	06/97→ 05/99		13.0460-5993.2 605993	TRW 23237 14,5 - WE / - WK
2.0 CDX	93	08/02→07/03	←	01/03→		13.0460-5863.2 605863	AKE 23234 16,8 + WK
			←	→ 12/02		13.0460-5994.2 605994	AKE 23234 16,8 - WE / - WK
			→	01/03→		13.0460-5739.2 605739	SUM 24071 14,6 - WE / - WK
			→	→ 12/02		13.0460-5993.2 605993	TRW 23237 14,5 - WE / - WK
Zubehörsatz, Scheibenbremsbelag							
1.6	76	08/02→07/03	←	→ 695960		13.0460-0140.2 610140	AKE
1.6 16V	78	05/97→	←	06/97→ 05/99		13.0460-0140.2 610140	AKE
2.0 16V	98	05/97→					
 Bremsscheibe							
1.6	76	08/02→07/03	←			24.0124-0163.1 424163	Ø 256 24 22 V + S
			→	+ ABS		24.0110-0714.1 410714	Ø 258 10,3 8
1.6 16V	78	05/97→	←	06/97→ 05/99		24.0124-0163.1 424163	Ø 256 24 22 V + S
2.0 16V	98	05/97→	←	06/97→ 05/99		24.0124-0163.1 424163	Ø 256 24 22 V + S
			→	06/97→ 05/99		24.0110-0714.1 410714	Ø 258 10,3 8
2.0 CDX	93	08/02→07/03	←	→ 12/02		24.0124-0163.1 424163	Ø 256 24 22 V + S
			←	01/03→		24.0124-0199.1 424199	Ø 256 24 21 V + S
			→	01/03→		24.0110-0340.1 410340	Ø 258 10,5 8 + S
			→	→ 12/02; Brems-/Fahrbyn. Artikelbezug: + ABS		24.0110-0714.1 410714	Ø 258 10,3 8
DAEWOO - NUBIRA Stufenheck (KLAJ) 04/97→							
 Bremsbelagsatz, Scheibenbremse							
1.6 16V	76	07/00→	←	→ 02/05		13.0460-5859.2 605859	AKE 23234 16,9 + WK
↓							





















	kW			 	! #		
DAEWOO - NUBIRA Stufenheck (KLAJ) 04/97→							
 Bremsbelagsatz, Scheibenbremse							
1.6 16V	76	07/00→	➡	→ 02/05; + ABS		13.0460-5993.2 605993	TRW 23237 14,5 - WE / - WK
1.6 16V	78	05/97→	⬅	06/97→ 05/99		13.0460-5994.2 605994	AKE 23234 16,8 - WE / - WK
2.0	81	06/99→07/03	⬅	→ 695960		13.0460-5859.2 605859	AKE 23234 16,9 + WK
			⬅	695961→		13.0460-5863.2 605863	AKE 23234 16,8 + WK
			➡			13.0460-5993.2 605993	TRW 23237 14,5 - WE / - WK
2.0 16V	93	12/00→	⬅	→ 695960		13.0460-5859.2 605859	AKE 23234 16,9 + WK
			⬅	695961→; → 02/05		13.0460-5863.2 605863	AKE 23234 16,8 + WK
			➡	→ 02/05		13.0460-5993.2 605993	TRW 23237 14,5 - WE / - WK
2.0 16V	98	05/97→	⬅	06/97→ 05/99		13.0460-5994.2 605994	AKE 23234 16,8 - WE / - WK
			➡	06/97→ 05/99		13.0460-5993.2 605993	TRW 23237 14,5 - WE / - WK
Zubehörsatz, Scheibenbremsbelag							
1.6 16V	76	07/00→	⬅	→ 02/05		13.0460-0140.2 610140	AKE
1.6 16V	78	05/97→	⬅	06/97→ 05/99		13.0460-0140.2 610140	AKE
2.0 16V	98	05/97→	⬅	06/97→ 05/99		13.0460-0140.2 610140	AKE
2.0	81	06/99→07/03	⬅	→ 695960		13.0460-0140.2 610140	AKE
2.0 16V	93	12/00→	⬅	→ 695960		13.0460-0140.2 610140	AKE
 Bremsscheibe							
1.6 16V	76	07/00→	⬅	→ 02/05		24.0124-0163.1 424163	Ø 256 24 22 V + S
			➡	→ 02/05; + ABS		24.0110-0714.1 410714	Ø 258 10,3 8
1.6 16V	78	05/97→	⬅	06/97→ 05/99		24.0124-0163.1 424163	Ø 256 24 22 V + S
2.0	81	06/99→07/03	⬅			24.0124-0163.1 424163	Ø 256 24 22 V + S
			➡			24.0110-0714.1 410714	Ø 258 10,3 8
2.0 16V	93	12/00→	⬅	→ 02/05		24.0124-0163.1 424163	Ø 256 24 22 V + S
			➡	→ 02/05		24.0110-0714.1 410714	Ø 258 10,3 8
2.0 16V	98	05/97→	⬅	06/97→ 05/99		24.0124-0163.1 424163	Ø 256 24 22 V + S
			➡	06/97→ 05/99		24.0110-0714.1 410714	Ø 258 10,3 8
DAEWOO - NUBIRA Stufenheck (KLAN) 07/03→							
 Bremsbelagsatz, Scheibenbremse							
1.4	69	10/03→12/04	⬅	→ 695960		13.0460-5859.2 605859	AKE 23234 16,9 + WK
			⬅	695961→		13.0460-5863.2 605863	AKE 23234 16,8 + WK
			➡			13.0460-5739.2 605739	SUM 24071 14,6 - WE / - WK
1.6 1.8	80 90	07/03→ 07/03→	⬅	08/03→; → 695960		13.0460-5859.2 605859	AKE 23234 16,9 + WK
			⬅	695961→; → 02/05		13.0460-5863.2 605863	AKE 23234 16,8 + WK
			➡	08/03→ 02/05		13.0460-5739.2 605739	SUM 24071 14,6 - WE / - WK
Zubehörsatz, Scheibenbremsbelag							
1.4	69	10/03→12/04	⬅	→ 695960		13.0460-0140.2 610140	AKE
1.6 1.8	80 90	07/03→ 07/03→	⬅	08/03→; → 695960		13.0460-0140.2 610140	AKE
 Bremsscheibe							
1.4	69	10/03→12/04	⬅			24.0124-0199.1 424199	Ø 256 24 21 V + S
			➡			24.0110-0340.1 410340	Ø 258 10,5 8 + S
1.6 1.8	80 90	07/03→ 07/03→	⬅	08/03→ 02/05		24.0124-0199.1 424199	Ø 256 24 21 V + S
			➡	08/03→ 02/05		24.0110-0340.1 410340	Ø 258 10,5 8 + S
DAEWOO - NUBIRA Wagon (KLAJ) 04/97→							
 Bremsbelagsatz, Scheibenbremse							
1.6 16V	66	06/97→	⬅	→ 05/99		13.0460-5994.2 605994	AKE 23234 16,8 - WE / - WK
1.6 16V	76	12/00→	⬅	→ 02/05		13.0460-5859.2 605859	AKE 23234 16,9 + WK
			➡	→ 02/05; + ABS		13.0460-5993.2 605993	TRW 23237 14,5 - WE / - WK
1.6 16V	78	05/97→	⬅	06/97→ 05/99		13.0460-5994.2 605994	AKE 23234 16,8 - WE / - WK
2.0 16V	93	12/00→	⬅	→ 695960		13.0460-5859.2 605859	AKE 23234 16,9 + WK
			⬅	695961→; → 02/05		13.0460-5863.2 605863	AKE 23234 16,8 + WK
↓							

































	kw			 	! #		
DAEWOO - NUBIRA Wagon (KLAJ) 04/97→							
 Bremsbelagsatz, Scheibenbremse							
2.0 16V	93	12/00→	➡	→ 02/05		13.0460-5993.2 605993	TRW 23237 14,5 - WE / - WK
2.0 16V	98	05/97→	⬅	06/97→ 05/99		13.0460-5994.2 605994	AKE 23234 16,8 - WE / - WK
			➡	06/97→ 05/99		13.0460-5993.2 605993	TRW 23237 14,5 - WE / - WK
Zubehörsatz, Scheibenbremsbelag							
1.6 16V	66	06/97→	⬅	→ 05/99		13.0460-0140.2 610140	AKE
1.6 16V	76	12/00→	⬅	→ 02/05		13.0460-0140.2 610140	AKE
1.6 16V	78	05/97→	⬅	06/97→ 05/99		13.0460-0140.2 610140	AKE
2.0 16V	98	05/97→					
2.0 16V	93	12/00→	⬅	→ 695960		13.0460-0140.2 610140	AKE
 Bremsscheibe							
1.6 16V	66	06/97→	⬅	→ 05/99		24.0124-0163.1 424163	Ø 256 24 22 V + S
1.6 16V	76	12/00→	⬅	→ 02/05		24.0124-0163.1 424163	Ø 256 24 22 V + S
			➡	→ 02/05; + ABS		24.0110-0714.1 410714	Ø 258 10,3 8
1.6 16V	78	05/97→	⬅	06/97→ 05/99		24.0124-0163.1 424163	Ø 256 24 22 V + S
2.0 16V	93	12/00→	⬅	→ 02/05		24.0124-0163.1 424163	Ø 256 24 22 V + S
2.0 16V	98	05/97→	⬅	06/97→ 05/99		24.0124-0163.1 424163	Ø 256 24 22 V + S
			➡	06/97→ 05/99		24.0110-0714.1 410714	Ø 258 10,3 8
DAEWOO - NUBIRA Wagon (KLAN) 07/03→							
 Bremsbelagsatz, Scheibenbremse							
1.6	80	07/03→	⬅	08/03→; → 695960		13.0460-5859.2 605859	AKE 23234 16,9 + WK
1.8	90	07/03→	⬅	695961→; → 02/05		13.0460-5863.2 605863	AKE 23234 16,8 + WK
			➡	08/03→ 02/05		13.0460-5739.2 605739	SUM 24071 14,6 - WE / - WK
Zubehörsatz, Scheibenbremsbelag							
1.6	80	07/03→	⬅	08/03→; → 695960		13.0460-0140.2 610140	AKE
1.8	90	07/03→					
 Bremsscheibe							
1.6	80	07/03→	⬅	08/03→ 02/05		24.0124-0199.1 424199	Ø 256 24 21 V + S
1.8	90	07/03→	➡	08/03→ 02/05		24.0110-0340.1 410340	Ø 258 10,5 8 + S
DAEWOO - RACER Schrägheck 01/86→12/97							
 Bremsbelagsatz, Scheibenbremse							
1.5	52	03/95→12/97	⬅	→ 08/97		13.0460-7051.2 607051	ATE 20547 16,5 + WE / - WK
 Bremsscheibe							
1.5	52	03/95→12/97	⬅	→ 08/97		24.0120-0115.1 420115	Ø 236 20 17 V + S
						24.0320-0115.1 520115	Ø 236 20 17 V + S PD
DAEWOO - REXTON (GAB_) 04/02→							
 Bremsbelagsatz, Scheibenbremse							
2.3 RX230 4x4	110	05/02→	➡	→ 12/04		13.0460-5623.2 605623	MAN 23673 15,9 + WK
2.9 TD	88	04/02→	➡	→ 05/04; für Linkslenker		13.0460-5623.2 605623	MAN 23673 15,9 + WK
3.2 V6	162	04/02→					
 Bremsscheibe							
2.3 RX230 4x4	110	05/02→	➡	→ 12/04		24.0110-0352.1 410352	Ø 299 10,4 8,5
2.9 TD	88	04/02→	➡	→ 05/04; für Linkslenker		24.0110-0352.1 410352	Ø 299 10,4 8,5
3.2 V6	162	04/02→					
DAEWOO - REZZO (KLAU) 06/00→							
 Bremsbelagsatz, Scheibenbremse							
1.6	77	09/00→	⬅	826909→; → 08/05		13.0460-5859.2 605859	AKE 23234 16,9 + WK
1.8	67	09/00→					
1.8	72	09/00→					
1.8	74	09/00→					
2.0	89	09/01→					
2.0	94	09/00→					
↓							













	kw			 	! #		
DAEWOO - REZZO (KLAU) 06/00→							
 Bremsbelagsatz, Scheibenbremse							
1.6 SX	66	08/01→12/04	←	826909→		13.0460-5859.2 605859	AKE 23234 16,9 + WK
Zubehörsatz, Scheibenbremsbelag							
1.6	77	09/00→	←	826909→; → 08/05		13.0460-0140.2 610140	AKE
1.8	67	09/00→					
1.8	72	09/00→					
1.8	74	09/00→					
2.0	89	09/01→					
2.0	94	09/00→					
1.6 SX	66	08/01→12/04	←	826909→		13.0460-0140.2 610140	AKE
 Bremsscheibe							
1.6	77	09/00→	←	→ 08/05		24.0124-0199.1 424199	Ø 256 24 21 V + S
1.8	67	09/00→					
1.8	72	09/00→					
1.8	74	09/00→					
2.0	89	09/01→					
2.0	94	09/00→					
1.6 SX	66	08/01→12/04	←			24.0124-0199.1 424199	Ø 256 24 21 V + S
DAEWOO - TOSCA 02/06→							
 Bremsscheibe							
2.0 XT	105	02/06→	←	→ 12/10		24.0124-0237.1 424237	Ø 278 24 22 V
2.5 Executive	115	02/06→					
DAIHATSU - APPLAUSE I (A101, A111) 06/89→07/97							
 Bremsbelagsatz, Scheibenbremse							
1.6 16V (A101)	66	06/89→07/97	→	+ ABS		13.0460-5972.2 605972	21559 11,5 - WE / - WK
1.6 16V (A101)	77	06/89→07/97					
 Bremsscheibe							
1.6 16V (A101)	66	06/89→07/97	←			24.0118-0126.1 418126	Ø 234,5 18 17 V
1.6 16V (A101)	77	06/89→07/97					
1.6 16V 4WD (A111)	77	06/89→07/97					
DAIHATSU - APPLAUSE II (A101) 07/97→05/00							
 Bremsscheibe							
1.6 16V (A101)	73	07/97→05/00	←			24.0118-0126.1 418126	Ø 234,5 18 17 V
DAIHATSU - CHARADE 05/11→							
 Bremsbelagsatz, Scheibenbremse							
1.33 16V	73	05/11→	←	→ 01/13		13.0460-7213.2 607213	ATE 23202 17,8 + WK
			→	→ 01/13		13.0460-7214.2 607214	ATE 24574 15,0 + WK
 Bremsscheibe							
1.33 16V	73	05/11→	←	→ 01/13		24.0122-0240.1 422240	Ø 258 22 20 V
			→	→ 01/13		24.0109-0142.1 409142	Ø 278 9 7
DAIHATSU - CHARADE (L2_) 03/03→							
 Bremsbelagsatz, Scheibenbremse							
1.0	51	03/03→	←	12/04→ 08/07; V		13.0460-5613.2 605613	25262 15,0 + WK + Zub
1.0 (L251S)	43	03/03→	←	05/03→ 08/07		13.0460-5709.2 605709	AKE 24230 15,3 + WK + Zub
 Bremsscheibe							
1.0	51	03/03→	←	05/03→ 08/07		24.0111-0159.1 411159	Ø 211 11 10
1.0 (L251S)	43	03/03→	←	12/04→ 08/07		24.0116-0130.1 416130	Ø 234 16 15 V
DAIHATSU - CHARADE IV (G200, G202) 01/93→09/00							
 Bremsbelagsatz, Scheibenbremse							
1.3	44	09/96→11/99	←			13.0460-5898.2 605898	21952 15,0 + WK
1.3 16V	55	05/96→11/99	→	+ ABS		13.0460-5824.2 605824	AKE 20008 13,0 - WE / - WK
1.3 i 16V	62	01/93→09/00					
1.5 i 16V	66	01/97→11/99					
1.6 GTi	77	03/93→11/99	←	→ 03/96		13.0460-5898.2 605898	21952 15,0 + WK
			→	→ 03/96; + ABS		13.0460-5824.2 605824	AKE 20008 13,0 - WE / - WK
↓							











	kW					! #		
DAIHATSU - CHARADE IV (G200, G202) 01/93→09/00								
 Bremsscheibe								
1.3	44	09/96→11/99	←			24.0111-0139.1	411139	Ø 234 11 10
1.3 16V	55	05/96→11/99						
1.3 i 16V	62	01/93→09/00						
1.5 i 16V	66	01/97→11/99	←			24.0118-0126.1	418126	Ø 234,5 18 17 V
1.6 GTi	77	03/93→11/99	←	→ 03/96		24.0118-0126.1	418126	Ø 234,5 18 17 V
DAIHATSU - CHARADE IV Stufenheck (G203) 03/93→01/01								
 Bremsbelagsatz, Scheibenbremse								
1.5 16V	55	10/94→01/01	←	→ 11/99		13.0460-5898.2	605898	21952 15,0 + WK
			→	→ 11/99; + ABS		13.0460-5824.2	605824	AKE 20008 13,0 - WE / - WK
1.5 i 16V	66	06/94→11/99	←	08/94→		13.0460-5898.2	605898	21952 15,0 + WK
			→	08/94→; + ABS		13.0460-5824.2	605824	AKE 20008 13,0 - WE / - WK
 Bremsscheibe								
1.5 16V	55	10/94→01/01	←	→ 11/99		24.0118-0126.1	418126	Ø 234,5 18 17 V
1.5 i 16V	66	06/94→11/99	←	08/94→		24.0118-0126.1	418126	Ø 234,5 18 17 V
DAIHATSU - COPEN (L880_, L881_) 03/02→09/12								
 Bremsbelagsatz, Scheibenbremse								
0.7	47	09/03→09/12	←	01/06→ 07/12		13.0460-5887.2	605887	SUM 23507 15,2 + WK
0.7 (L880)	50	09/03→12/07	←	01/06→		13.0460-5887.2	605887	SUM 23507 15,2 + WK
1.3	64	03/06→09/12	←	→ 07/12		13.0460-5887.2	605887	SUM 23507 15,2 + WK
 Bremsscheibe								
0.7	47	09/03→09/12	←	→ 07/12		24.0117-0107.1	417107	Ø 246 17 16 V
1.3	64	03/06→09/12	←					
0.7 (L880)	50	09/03→12/07	←			24.0117-0107.1	417107	Ø 246 17 16 V
DAIHATSU - CUORE IV (L501) 08/94→12/99								
 Bremsscheibe								
0.7 4WD	48	10/97→05/99	←			24.0110-0235.1	410235	Ø 211 10 9
0.8	32	01/95→08/98	←	→ 10/96		24.0110-0235.1	410235	Ø 211 10 9
DAIHATSU - CUORE V (L5) 11/96→10/98								
 Bremsscheibe								
0.8	31	11/96→10/98	←			24.0110-0235.1	410235	Ø 211 10 9
DAIHATSU - CUORE V (L7_) 10/98→05/03								
 Bremsscheibe								
1.0	40	11/98→09/00	←			24.0111-0159.1	411159	Ø 211 11 10
1.0 i (L701)	41	10/98→05/03						
1.0 DVVT	43	10/00→02/03	←	→ 12/02		24.0111-0159.1	411159	Ø 211 11 10
DAIHATSU - CUORE VI (L251, L250_, L260_) 03/03→								
 Bremsbelagsatz, Scheibenbremse								
1.0	43	05/03→	←	12/04→ 08/07; V		13.0460-5613.2	605613	25262 15,0 + WK + Zub
			←	→ 08/07		13.0460-5709.2	605709	AKE 24230 15,3 + WK + Zub
 Bremsscheibe								
1.0	43	05/03→	←	→ 08/07		24.0111-0159.1	411159	Ø 211 11 10
			←	12/04→ 08/07		24.0116-0130.1	416130	Ø 234 16 15 V
DAIHATSU - CUORE VII (L275_, L285_, L276_) 12/06→								
 Bremsbelagsatz, Scheibenbremse								
1.0	51	04/07→	←	09/07→ 01/13; passend für Felgengröße [Zoll]: 13		13.0460-5613.2	605613	25262 15,0 + WK + Zub
			←	09/07→ 01/13; passend für Felgengröße [Zoll]: 14		13.0460-5709.2	605709	AKE 24230 15,3 + WK + Zub
↓			←	09/07→ 01/13; passend für Felgengröße [Zoll]: 13; V		13.0460-5887.2	605887	SUM 23507 15,2 + WK











	kw					! #		
DAIHATSU - CUORE VII (L275_, L285_, L276_) 12/06→								
 Bremsscheibe								
1.0	51	04/07→	←	09/07→ 01/13; passend für Felgenreöße [Zoll]: 13		24.0111-0159.1 411159	Ø 211 11 10	
						24.0116-0130.1 416130	Ø 234 16 15 V	
			←	09/07→ 01/13; passend für Felgenreöße [Zoll]: 14		24.0117-0107.1 417107	Ø 246 17 16 V	
DAIHATSU - FERENZA Hard Top (F300) 10/88→12/99								
 Bremsbelagsatz, Scheibenbremse								
1.6 16V 4WD	63	10/88→12/99	←	→ 12/95; V		13.0460-5816.2 605816	21243 14,0 - WE / - WK	
1.6 i 16V 4x4	70	10/88→12/99						
 Bremsscheibe								
1.6 16V 4WD	63	10/88→12/99	←	→ 12/95		24.0118-0121.1 418121	Ø 277 18 17 V	
1.6 i 16V 4x4	70	10/88→12/99						
DAIHATSU - FERENZA Soft Top (F300) 10/88→12/99								
 Bremsbelagsatz, Scheibenbremse								
1.6 16V	63	10/88→12/99	←	→ 12/95; V		13.0460-5816.2 605816	21243 14,0 - WE / - WK	
1.6 i 16V	70	10/88→12/99						
 Bremsscheibe								
1.6 16V	63	10/88→12/99	←	→ 12/95		24.0118-0121.1 418121	Ø 277 18 17 V	
1.6 i 16V	70	10/88→12/99						
DAIHATSU - GRAN MOVE (G3) 10/96→								
 Bremsbelagsatz, Scheibenbremse								
1.5 16V (G303)	66	10/96→07/98	←			13.0460-5898.2 605898	21952 15,0 + WK	
1.5 GLX	71	10/96→08/98						
1.5 GX	55	10/96→08/98	→	+ ABS		13.0460-5824.2 605824	AKE 20008 13,0 - WE / - WK	
1.6	70	07/98→07/02						
1.6 GLX	77	06/98→07/02						
1.6 GX	67	06/98→07/02						
1.6 16V (G301)	67	05/98→	←	06/98→ 07/02		13.0460-5898.2 605898	21952 15,0 + WK	
			→	06/98→ 07/02; + ABS		13.0460-5824.2 605824	AKE 20008 13,0 - WE / - WK	
 Bremsscheibe								
1.5 16V (G303)	66	10/96→07/98	←			24.0118-0126.1 418126	Ø 234,5 18 17 V	
1.5 GLX	71	10/96→08/98						
1.5 GX	55	10/96→08/98						
DAIHATSU - MATERIA (M4_) 10/06→								
 Bremsbelagsatz, Scheibenbremse								
1.3	67	10/06→	←	→ 07/12		13.0460-5794.2 605794	TRW 24283 15,5 + WK + Zub	
1.5	76	10/06→						
1.5 ECO 4WD	76	10/06→						
 Bremsscheibe								
1.3	67	10/06→	←	→ 07/12		24.0122-0263.1 422263	Ø 254 22 20 V	
1.5	76	10/06→						
1.5 ECO 4WD	76	10/06→						
DAIHATSU - MOVE (L6_, L9_) 06/94→09/02								
 Bremsbelagsatz, Scheibenbremse								
0.8	31	10/96→09/02	←	→ 09/98		13.0460-5710.2 605710	AKE 23783 14,0 - WE / - WK	
1.0 i	41	10/98→09/02	←	→ 11/00		13.0460-5852.2 605852	23497 15,0 + WK + Zub	
 Bremsscheibe								
0.8	31	10/96→09/02	←	→ 09/98		24.0116-0118.1 416118	Ø 234 16 14 V	
1.0 i	41	10/98→09/02	←	→ 11/00		24.0116-0130.1 416130	Ø 234 16 15 V	
DAIHATSU - ROCKY Hard Top (F7, F8) 06/84→12/98								
 Bremsbelagsatz, Scheibenbremse								
2.8 D	54	02/85→12/98	←	→ 09/89		13.0460-5816.2 605816	21243 14,0 - WE / - WK	
 Bremsscheibe								
2.8 TD	72	05/93→12/98	←			24.0118-0121.1 418121	Ø 277 18 17 V	
2.8 TD	75	09/91→12/98						













	kW					! #		
DAIHATSU - ROCKY Soft Top (F7, F8) 02/85→12/98								
 Bremsbelagsatz, Scheibenbremse								
2.8 D	54	02/85→12/98	←	→ 09/89		13.0460-5816.2	605816	21243 14,0 - WE / - WK
 Bremsscheibe								
2.8 TD	75	09/91→12/98	←			24.0118-0121.1	418121	Ø 277 18 17 V
DAIHATSU - SIRION (M1) 04/98→04/05								
 Bremsbelagsatz, Scheibenbremse								
1.0	40	04/98→10/00	←	→ 08/00		13.0460-5852.2	605852	23497 15,0 + WK + Zub
1.0 i (M100)	41	04/98→09/00						
1.0 i 4WD	41	04/99→09/00						
1.0 i	43	09/00→01/05	←	→ 12/04		13.0460-5852.2	605852	23497 15,0 + WK + Zub
1.0 i 4WD	43	09/00→01/05						
1.3 Rally	81	06/02→03/05						
1.3 Rally 4WD	81	06/02→03/05						
1.3 Sport	75	08/00→01/05						
1.3 Sport 4WD	75	08/00→03/05						
 Bremsscheibe								
1.0	40	04/98→10/00	←	→ 08/00		24.0116-0130.1	416130	Ø 234 16 15 V
1.0 i (M100)	41	04/98→09/00						
1.0 i 4WD	41	04/99→09/00						
1.0 i	43	09/00→01/05	←	→ 12/04		24.0116-0130.1	416130	Ø 234 16 15 V
1.0 i 4WD	43	09/00→01/05						
1.3 Rally	81	06/02→03/05						
1.3 Rally 4WD	81	06/02→03/05						
1.3 Sport	75	08/00→01/05						
1.3 Sport 4WD	75	08/00→03/05						
DAIHATSU - SIRION (M3_) 01/05→								
 Bremsbelagsatz, Scheibenbremse								
1.0	51	01/05→	←	→ 01/13;		13.0460-5613.2	605613	25262 15,0 + WK + Zub
1.0 DVVT 4WD	51	04/05→	←	passend für Felgengröße [Zoll]: 13				
			←	07/07→ 01/13;		13.0460-5794.2	605794	TRW 24283 15,5 + WK + Zub
				passend für Felgengröße [Zoll]: 14		13.0460-5887.2	605887	SUM 23507 15,2 + WK
1.3	64	01/05→	←	07/07→ 01/13		13.0460-5794.2	605794	TRW 24283 15,5 + WK + Zub
						13.0460-5887.2	605887	SUM 23507 15,2 + WK
1.3	67	03/08→	←	→ 01/13		13.0460-5794.2	605794	TRW 24283 15,5 + WK + Zub
1.3 4WD	64	04/05→				13.0460-5887.2	605887	SUM 23507 15,2 + WK
1.3 4WD	67	03/08→						
1.5	76	03/08→						
1.5 4WD	76	05/06→10/08	←			13.0460-5794.2	605794	TRW 24283 15,5 + WK + Zub
						13.0460-5887.2	605887	SUM 23507 15,2 + WK
 Bremsscheibe								
1.0	51	01/05→	←	→ 01/13;		24.0116-0130.1	416130	Ø 234 16 15 V
1.0 DVVT 4WD	51	04/05→	←	passend für Felgengröße [Zoll]: 13				
			←	→ 01/13;		24.0117-0107.1	417107	Ø 246 17 16 V
				passend für Felgengröße [Zoll]: 14		24.0122-0263.1	422263	Ø 254 22 20 V
1.3	64	01/05→	←	→ 01/13		24.0117-0107.1	417107	Ø 246 17 16 V
1.3	67	03/08→				24.0122-0263.1	422263	Ø 254 22 20 V
1.3 4WD	67	03/08→						
1.5	76	03/08→						
1.3 4WD	64	04/05→	←	→ 12/06		24.0116-0130.1	416130	Ø 234 16 15 V
			←	01/07→ 01/13		24.0117-0107.1	417107	Ø 246 17 16 V
						24.0122-0263.1	422263	Ø 254 22 20 V
1.5 4WD	76	05/06→10/08	←			24.0117-0107.1	417107	Ø 246 17 16 V
						24.0122-0263.1	422263	Ø 254 22 20 V
DAIHATSU - TERIOS (J1_) 05/97→10/06								
 Bremsbelagsatz, Scheibenbremse								
1.3	63	09/01→10/05	←			13.0460-5713.2	605713	SUM 21650 15,5 + WK + Zub
1.3 4WD	63	10/00→10/05						
1.3 VVT-i Turbo 4WD	103	10/02→10/05						
1.3 4WD	61	10/97→10/00	←	→ 09/00		13.0460-5713.2	605713	SUM 21650 15,5 + WK + Zub
 Bremsscheibe								
1.3	63	09/01→10/05	←			24.0116-0117.1	416117	Ø 273 16 15
1.3 4WD	63	10/00→10/05						
1.3 VVT-i Turbo 4WD	103	10/02→10/05						
1.3 4WD	61	10/97→10/00	←	→ 09/00		24.0116-0117.1	416117	Ø 273 16 15













	kw					! #		
DAIHATSU - TERIOS (J2_) 11/05→								
 Bremsbelagsatz, Scheibenbremse								
1.3 VVT-i	63	11/05→	←	→ 01/13			13.0460-5713.2 605713	SUM 21650 15,5 + WK + Zub
1.3 VVT-i 4x4	63	11/05→						
1.5 4x4	77	05/06→						
1.5 VVT-i	80	12/06→						
1.5 VVT-i [RWD]	75	09/10→						
1.5 VVT-i [RWD]	77	11/05→						
1.5 VVT-i 4x4	75	09/10→						
 Bremsscheibe								
1.3 VVT-i	63	11/05→	←	→ 01/13			24.0116-0117.1 416117	Ø 273 16 15
1.3 VVT-i 4x4	63	11/05→						
1.5 4x4	77	05/06→						
1.5 VVT-i	80	12/06→						
1.5 VVT-i [RWD]	75	09/10→						
1.5 VVT-i [RWD]	77	11/05→						
1.5 VVT-i 4x4	75	09/10→						
DAIHATSU - TREVIS 06/06→								
 Bremsbelagsatz, Scheibenbremse								
1.0	43	06/06→	←	→ 09/09; passend für Felgengröße [Zoll]: 13			13.0460-5613.2 605613	25262 15,0 + WK + Zub
			←	→ 09/09; passend für Felgengröße [Zoll]: 14			13.0460-5709.2 605709	AKE 24230 15,3 + WK + Zub
 Bremsscheibe								
1.0	43	06/06→	←	→ 09/09; passend für Felgengröße [Zoll]: 14			24.0111-0159.1 411159	Ø 211 11 10
			←	→ 09/09; passend für Felgengröße [Zoll]: 13			24.0116-0130.1 416130	Ø 234 16 15 V
DAIHATSU - YRV (M2) 02/01→								
 Bremsbelagsatz, Scheibenbremse								
1.0	43	02/01→	←	→ 08/06			13.0460-5852.2 605852	23497 15,0 + WK + Zub
1.3	64	02/01→						
1.3 4WD	64	02/01→						
 Bremsscheibe								
1.0	43	02/01→	←	→ 08/06			24.0116-0130.1 416130	Ø 234 16 15 V
1.3	64	02/01→						
1.3 4WD	64	02/01→						
1.3 GTi	95	07/02→	←	→ 08/06			24.0117-0107.1 417107	Ø 246 17 16 V
DS - DS5 04/15→								
 Bremsbelagsatz, Scheibenbremse								
1.6 BlueHDi 120	88	07/15→	←	Nabendurchmesser [mm]: 82			13.0460-7229.2 607229	ATE 24538 18,5 - WE / - WK
			→	Nabendurchmesser [mm]: 82			13.0470-7229.2 LD7229	ATE 24538 18,5 - WE / - WK Ceramic
			→	Nabendurchmesser [mm]: 82			13.0460-2761.2 602761	TRW 24922 17,5 - WK + Zub
1.6 THP 165	121	07/15→	←	Nabendurchmesser [mm]: 82			13.0460-7230.2 607230	ATE 24557 19,4 - WE / - WK
1.6 THP 210	155	04/15→					13.0470-7230.2 LD7230	ATE 24557 19,4 - WE / - WK Ceramic
2.0 BlueHDi 150	110	04/15→						
2.0 BlueHDi 180	133	04/15→	←	Nabendurchmesser [mm]: 83			13.0460-7279.2 607279	ATE 25069 17,3 + WK
2.0 HDi 165 Hybrid4 4x4	120	04/15→	→	Nabendurchmesser [mm]: 82			13.0460-2761.2 602761	TRW 24922 17,5 - WK + Zub
 Bremsscheibe								
1.6 BlueHDi 120	88	07/15→	←				24.0126-0120.1 426120	Ø 283 26 24 V + S
			→				24.0112-0194.2 412194	Ø 268 12 10 + LG / + ABS Ring
1.6 THP 165	121	07/15→	←	Nabendurchmesser [mm]: 82			24.0126-0159.1 426159	Ø 302 26 24 V + S
2.0 BlueHDi 150	110	04/15→	←	Nabendurchmesser [mm]: 83			24.0130-0230.1 430230	Ø 340 30 28 V + S
			→				24.0112-0194.2 412194	Ø 268 12 10 + LG / + ABS Ring
1.6 THP 210	155	04/15→	←				24.0126-0120.1 426120	Ø 283 26 24 V + S
			←	Nabendurchmesser [mm]: 83			24.0130-0230.1 430230	Ø 340 30 28 V + S
			→				24.0112-0198.1 412198	Ø 290 12 10 + S
2.0 BlueHDi 180	133	04/15→	←	Nabendurchmesser [mm]: 82			24.0126-0159.1 426159	Ø 302 26 24 V + S
			←	Nabendurchmesser [mm]: 83			24.0130-0230.1 430230	Ø 340 30 28 V + S
			→				24.0112-0194.2 412194	Ø 268 12 10 + LG / + ABS Ring
			→				24.0112-0198.1 412198	Ø 290 12 10 + S
↓								











	kW			 	! #		
DS - DS5 04/15→							
 Bremsscheibe							
2.0 HDi 165 Hybrid4 4x4	120	04/15→	←	Nabendurchmesser [mm]: 82	24.0126-0159.1	426159	Ø 302 26 24 V + S
			→		24.0112-0198.1	412198	Ø 290 12 10 + S
DS - DS 3 04/15→							
 Bremsbelagsatz, Scheibenbremse							
1.2 THP 110	81	04/15→	←	für Bremsscheibendurchmesser [mm]: 283	13.0460-3855.2	603855	BOS 24883 18,0 - WE / - WK + Zub
1.2 THP 130	96	09/15→					
1.6 BlueHDi 100	73	04/15→	←	für Bremsscheibendurchmesser [mm]: 266	13.0460-3994.2	603994	BOS 23599 19,0 - WE / - WK + Zub
1.6 BlueHDi 75	55	07/15→					
1.6 THP 165	121	07/15→			13.0470-3994.2	LD3994	BOS 23599 19,0 - WE / - WK + Zub Ceramic
1.6 THP 208	153	09/15→	→		13.0460-2740.2	602740	TRW 23554 17,0 - WE / - WK + Zub
					13.0470-2740.2	LD2740	TRW 23554 17,0 - WE / - WK + Zub Ceramic
1.2 VTi 82	60	04/15→	←		13.0460-3994.2	603994	BOS 23599 19,0 - WE / - WK + Zub
					13.0470-3994.2	LD3994	BOS 23599 19,0 - WE / - WK + Zub Ceramic
1.6 BlueHDi 120	88	07/15→	←		13.0460-3855.2	603855	BOS 24883 18,0 - WE / - WK + Zub
			→		13.0460-2740.2	602740	TRW 23554 17,0 - WE / - WK + Zub
					13.0470-2740.2	LD2740	TRW 23554 17,0 - WE / - WK + Zub Ceramic
 Bremsscheibe							
1.2 THP 110	81	04/15→	←		24.0122-0194.1	422194	Ø 266 22 20 V + S
1.2 THP 130	96	09/15→			24.0126-0120.1	426120	Ø 283 26 24 V + S
1.6 BlueHDi 100	73	04/15→			24.0326-0120.1	526120	Ø 283 26 24 V + S PD
1.6 BlueHDi 75	55	07/15→	→		24.0109-0100.2	409100	Ø 249 9 7 + LG / + ABS Ring
1.6 THP 165	121	07/15→					
1.6 THP 208	153	09/15→					
1.2 VTi 82	60	04/15→	←		24.0122-0194.1	422194	Ø 266 22 20 V + S
1.6 BlueHDi 120	88	07/15→	←		24.0126-0120.1	426120	Ø 283 26 24 V + S
			→		24.0326-0120.1	526120	Ø 283 26 24 V + S PD
					24.0109-0100.2	409100	Ø 249 9 7 + LG / + ABS Ring
DS - DS 3 Cabriolet 07/15→							
 Bremsbelagsatz, Scheibenbremse							
1.2 THP 110	81	07/15→	←	für Bremsscheibendurchmesser [mm]: 283	13.0460-3855.2	603855	BOS 24883 18,0 - WE / - WK + Zub
1.2 THP 130	96	09/15→					
1.6 BlueHDi 100	73	07/15→	←	für Bremsscheibendurchmesser [mm]: 266	13.0460-3994.2	603994	BOS 23599 19,0 - WE / - WK + Zub
1.6 THP 165	121	07/15→			13.0470-3994.2	LD3994	BOS 23599 19,0 - WE / - WK + Zub Ceramic
1.6 THP 208	153	09/15→	→		13.0460-2740.2	602740	TRW 23554 17,0 - WE / - WK + Zub
					13.0470-2740.2	LD2740	TRW 23554 17,0 - WE / - WK + Zub Ceramic
1.2 VTi 82	60	07/15→	←		13.0460-3994.2	603994	BOS 23599 19,0 - WE / - WK + Zub
					13.0470-3994.2	LD3994	BOS 23599 19,0 - WE / - WK + Zub Ceramic
1.6 BlueHDi 120	88	07/15→	←		13.0460-3855.2	603855	BOS 24883 18,0 - WE / - WK + Zub
			→		13.0460-2740.2	602740	TRW 23554 17,0 - WE / - WK + Zub
					13.0470-2740.2	LD2740	TRW 23554 17,0 - WE / - WK + Zub Ceramic
 Bremsscheibe							
1.2 THP 110	81	07/15→	←		24.0122-0194.1	422194	Ø 266 22 20 V + S
1.2 THP 130	96	09/15→			24.0126-0120.1	426120	Ø 283 26 24 V + S
1.6 BlueHDi 100	73	07/15→			24.0326-0120.1	526120	Ø 283 26 24 V + S PD
1.6 THP 165	121	07/15→	→		24.0109-0100.2	409100	Ø 249 9 7 + LG / + ABS Ring
1.6 THP 208	153	09/15→					
1.2 VTi 82	60	07/15→	←		24.0122-0194.1	422194	Ø 266 22 20 V + S
↓							

	kw			 	! #		
DS - DS 3 Cabriolet 07/15→							
 Bremsscheibe							
1.6 BlueHDi 120	88	07/15→	←		24.0126-0120.1 426120	Ø 283 26 24 V + S	
			→		24.0326-0120.1 526120	Ø 283 26 24 V + S PD	
			→		24.0109-0100.2 409100	Ø 249 9 7 + LG / + ABS Ring	
DS - DS 4 / DS 4 CROSSBACK 07/15→							
 Bremsbelagsatz, Scheibenbremse							
1.2 THP 130 1.6 BlueHDi 120	96 88	07/15→ 07/15→	←		13.0460-7229.2 607229	ATE 24538 18,5 - WE / - WK	
			→		13.0470-7229.2 LD7229	ATE 24538 18,5 - WE / - WK Ceramic	
			→		13.0460-2761.2 602761	TRW 24922 17,5 - WK + Zub	
1.6 BlueHDi 100	73	04/16→	→	+ eFSB	13.0460-2761.2 602761	TRW 24922 17,5 - WK + Zub	
			→	- eFSB	13.0460-2775.2 602775	TRW 23554 16,4 - WE / - WK + Zub	
1.6 THP 165	121	07/15→	←		13.0460-7230.2 607230	ATE 24557 19,4 - WE / - WK	
			→	+ eFSB	13.0460-2761.2 602761	TRW 24922 17,5 - WK + Zub	
			→	- eFSB	13.0460-2775.2 602775	TRW 23554 16,4 - WE / - WK + Zub	
1.6 THP 210	155	07/15→	←		13.0460-7279.2 607279	ATE 25069 17,3 + WK	
			→	+ eFSB	13.0460-2761.2 602761	TRW 24922 17,5 - WK + Zub	
			→	- eFSB	13.0460-2775.2 602775	TRW 23554 16,4 - WE / - WK + Zub	
2.0 BlueHDi 150	110	07/15→	←		13.0460-7230.2 607230	ATE 24557 19,4 - WE / - WK	
			→		13.0470-7230.2 LD7230	ATE 24557 19,4 - WE / - WK Ceramic	
			→		13.0460-2761.2 602761	TRW 24922 17,5 - WK + Zub	
2.0 BlueHDi 180	133	07/15→	←	nicht für Felgenreöße [Zoll]: 19	13.0460-7230.2 607230	ATE 24557 19,4 - WE / - WK	
			→		13.0470-7230.2 LD7230	ATE 24557 19,4 - WE / - WK Ceramic	
			←	passend für Felgenreöße [Zoll]: 19	13.0460-7279.2 607279	ATE 25069 17,3 + WK	
			→	+ eFSB	13.0460-2761.2 602761	TRW 24922 17,5 - WK + Zub	
			→	- eFSB	13.0460-2775.2 602775	TRW 23554 16,4 - WE / - WK + Zub	
 Bremsscheibe							
1.2 THP 130 1.6 BlueHDi 120	96 88	07/15→ 07/15→	←		24.0126-0120.1 426120	Ø 283 26 24 V + S	
			→	nicht für Felgenreöße [Zoll]: 19	24.0326-0120.1 526120	Ø 283 26 24 V + S PD	
			→	passend für Felgenreöße [Zoll]: 19	24.0112-0194.2 412194	Ø 268 12 10 + LG / + ABS Ring	
			→		24.0112-0198.1 412198	Ø 290 12 10 + S	
1.6 BlueHDi 100	73	04/16→	→	- eFSB	24.0109-0171.2 409171	Ø 249 9 8 + LG / + ABS Ring	
			→	+ eFSB; nicht für Felgenreöße [Zoll]: 19	24.0112-0194.2 412194	Ø 268 12 10 + LG / + ABS Ring	
			→	+ eFSB; passend für Felgenreöße [Zoll]: 19	24.0112-0198.1 412198	Ø 290 12 10 + S	
1.6 THP 165	121	07/15→	←		24.0126-0159.1 426159	Ø 302 26 24 V + S	
			→	- eFSB	24.0109-0171.2 409171	Ø 249 9 8 + LG / + ABS Ring	
			→	+ eFSB; nicht für Felgenreöße [Zoll]: 19	24.0112-0194.2 412194	Ø 268 12 10 + LG / + ABS Ring	
			→	+ eFSB; passend für Felgenreöße [Zoll]: 19	24.0112-0198.1 412198	Ø 290 12 10 + S	
1.6 THP 210	155	07/15→	←		24.0130-0230.1 430230	Ø 340 30 28 V + S	
			→	- eFSB	24.0109-0171.2 409171	Ø 249 9 8 + LG / + ABS Ring	
			→	+ eFSB; nicht für Felgenreöße [Zoll]: 19	24.0112-0194.2 412194	Ø 268 12 10 + LG / + ABS Ring	
			→	+ eFSB; passend für Felgenreöße [Zoll]: 19	24.0112-0198.1 412198	Ø 290 12 10 + S	
2.0 BlueHDi 150	110	07/15→	←		24.0126-0159.1 426159	Ø 302 26 24 V + S	
			→	nicht für Felgenreöße [Zoll]: 19	24.0112-0194.2 412194	Ø 268 12 10 + LG / + ABS Ring	
			→	passend für Felgenreöße [Zoll]: 19	24.0112-0198.1 412198	Ø 290 12 10 + S	
2.0 BlueHDi 180	133	07/15→	←	nicht für Felgenreöße [Zoll]: 19	24.0126-0159.1 426159	Ø 302 26 24 V + S	
			←	passend für Felgenreöße [Zoll]: 19	24.0130-0230.1 430230	Ø 340 30 28 V + S	
			→	- eFSB	24.0109-0171.2 409171	Ø 249 9 8 + LG / + ABS Ring	
↓							











	kw					! #		
DS - DS 4 / DS 4 CROSSBACK 07/15→								
 Bremsscheibe								
2.0 BlueHDi 180	133	07/15→	➔	nicht für Felgenreöße [Zoll]: 19		24.0112-0194.2	412194	Ø 268 12 10 + LG / + ABS Ring
			➔	passend für Felgenreöße [Zoll]: 19		24.0112-0198.1	412198	Ø 290 12 10 + S
FIAT - 124 Spider (348_) 03/16→								
 Bremsbelagsatz, Scheibenbremse								
1.4	103	03/16→	➔			13.0460-5762.2	605762	24298 14,0 + WK + Zub
FIAT - 500 (312_) 10/07→								
 Bremsbelagsatz, Scheibenbremse								
0.9	44	12/13→	←			13.0460-7288.2	607288	ATE 25429 17,5 + WK
0.9	48	09/12→				13.0470-7288.2	LD7288	ATE 25429 17,5 + WK Ceramic
0.9	59	12/13→						
0.9	63	07/10→						
0.9	77	10/13→	←	12/13→		13.0460-3826.2	603826	BOS 23706 18,0 + WK + Zub
						13.0460-3863.2	603863	BOS 23706 18,0 + WK + Zub
						13.0470-3826.2	LD3826	BOS 23706 18,0 + WK + Zub Ceramic
			➔	12/13→		13.0460-2879.2	602879	TRW 23601 13,7 - WE / - WK
						13.0470-2879.2	LD2879	TRW 23601 13,7 - WE / - WK Ceramic
1.2	51	10/07→	←	05/13→		13.0460-3838.2	603838	BOS 21436 17,0 + WK + Zub
1.2 LPG	51	12/10→				13.0470-3838.2	LD3838	BOS 21436 17,0 + WK + Zub Ceramic
			←	→ 04/13		13.0460-3838.2	603838	BOS 21436 17,0 + WK + Zub
						13.0470-3838.2	LD3838	BOS 21436 17,0 + WK + Zub Ceramic
1.3 D Multijet	55	10/07→	←			13.0460-3846.2	603846	BOS 24072 17,9 + WK + Zub
						13.0470-3846.2	LD3846	BOS 24072 17,9 + WK + Zub Ceramic
1.3 D Multijet	57	06/16→	←			13.0460-3826.2	603826	BOS 23706 18,0 + WK + Zub
						13.0460-3863.2	603863	BOS 23706 18,0 + WK + Zub
						13.0470-3826.2	LD3826	BOS 23706 18,0 + WK + Zub Ceramic
1.3 D Multijet	70	12/09→	←			13.0460-3818.2	603818	BOS 23706 18,1 + WK
1.4	74	10/07→	←			13.0460-3826.2	603826	BOS 23706 18,0 + WK + Zub
						13.0460-3863.2	603863	BOS 23706 18,0 + WK + Zub
						13.0470-3826.2	LD3826	BOS 23706 18,0 + WK + Zub Ceramic
			←	für Fahrzeuge mit Sportpaket		13.0460-3850.2	603850	BOS 23707 18,0 - WE / - WK + Zub
			➔			13.0460-2879.2	602879	TRW 23601 13,7 - WE / - WK
						13.0470-2879.2	LD2879	TRW 23601 13,7 - WE / - WK Ceramic
1.4 (312.AXD1A)	99	08/08→	←			13.0460-3827.2	603827	BOS 23709 19,6 + WK + Zub
1.4 (312.AXF11, 312.AXF1A, 312.AXD1A)	118	08/08→				13.0460-3864.2	603864	BOS 23709 19,6 + WK + Zub
1.4 (312.AXF1A)	103	05/10→				13.0470-3827.2	LD3827	BOS 23709 19,6 + WK + Zub Ceramic
			➔			13.0460-2879.2	602879	TRW 23601 13,7 - WE / - WK
						13.0470-2879.2	LD2879	TRW 23601 13,7 - WE / - WK Ceramic
1.4 (312.AXF11)	132	08/08→	➔			13.0460-2879.2	602879	TRW 23601 13,7 - WE / - WK
1.4 (312.AXT1A)	139	08/08→				13.0470-2879.2	LD2879	TRW 23601 13,7 - WE / - WK Ceramic
 Bremsscheibe								
0.9	44	12/13→	←			24.0112-0127.1	412127	Ø 257,5 12 10,2
0.9	48	09/12→						
0.9	59	12/13→						
0.9	63	07/10→						
0.9	77	10/13→	←	12/13→		24.0122-0197.1	422197	Ø 257,5 22 20,2 V
						24.0322-0197.1	522197	Ø 257,5 22 20,2 V PD
			➔	12/13→		24.0111-0119.1	411119	Ø 240,5 11 9,2
1.2	51	10/07→	←			24.0111-0119.1	411119	Ø 240,5 11 9,2
1.2 LPG	51	12/10→						
1.3 D Multijet	55	10/07→	←			24.0120-0184.1	420184	Ø 240,5 20 18,2 V
1.3 D Multijet	57	06/16→						
1.3 D Multijet	70	12/09→	←			24.0122-0197.1	422197	Ø 257,5 22 20,2 V











	kw					! #									
FIAT - 500 (312_) 10/07→															
 Bremsscheibe															
1.3 D Multijet	70	12/09→	←			24.0322-0197.1	522197	Ø 257,5 22 20,2 V PD							
1.4	74	10/07→	←			24.0122-0197.1	422197	Ø 257,5 22 20,2 V							
								24.0322-0197.1	522197	Ø 257,5 22 20,2 V PD					
								24.0111-0119.1	411119	Ø 240,5 11 9,2					
1.4 (312.AXD1A)	99	08/08→	←	-	Kit ESSEESSE	24.0122-0147.1	422147	Ø 284 22 20,2 V							
								1.4 (312.AXF11, 312.AXF1A, 312.AXD1A)	118	08/08→	←	+	Kit ESSEESSE	24.0122-0283.1	422283
1.4 (312.AXF1A)	103	05/10→	→	-	Kit ESSEESSE	24.0111-0119.1	411119	Ø 240,5 11 9,2							
								→	+	Kit ESSEESSE	24.0111-0176.1	411176	Ø 240,5 11 9,2 •		
FIAT - 500 C (312_) 09/09→															
 Bremsbelagsatz, Scheibenbremse															
0.9	44	12/13→	←			13.0460-7288.2	607288	ATE 25429 17,5 + WK							
0.9	48	09/12→				13.0470-7288.2	LD7288	ATE 25429 17,5 + WK Ceramic							
0.9	63	09/09→													
0.9	59	12/13→	←			13.0460-3826.2	603826	BOS 23706 18,0 + WK + Zub							
								0.9	77	12/13→			13.0460-3863.2	603863	BOS 23706 18,0 + WK + Zub
								1.4	74	09/09→			13.0470-3826.2	LD3826	BOS 23706 18,0 + WK + Zub Ceramic
								1.4	75	09/11→					
1.2	51	09/09→	←			13.0460-3846.2	603846	BOS 24072 17,9 + WK + Zub							
1.3 D Multijet	55	09/09→				13.0470-3846.2	LD3846	BOS 24072 17,9 + WK + Zub Ceramic							
1.3 D Multijet	70	09/09→	←			13.0460-3818.2	603818	BOS 23706 18,1 + WK							
1.4 (312.AXD1A)	99	01/11→	←			13.0460-3827.2	603827	BOS 23709 19,6 + WK + Zub							
1.4 (312.AXF11)	132	09/09→				13.0460-3864.2	603864	BOS 23709 19,6 + WK + Zub							
1.4 (312.AXF1A, 312.AXD1A)	118	05/11→				13.0470-3827.2	LD3827	BOS 23709 19,6 + WK + Zub Ceramic							
1.4 (312.AXF1A)	103	09/09→													
 Bremsscheibe															
0.9	44	12/13→	←			24.0112-0127.1	412127	Ø 257,5 12 10,2							
0.9	48	09/12→													
0.9	63	09/09→													
0.9	59	12/13→	←			24.0122-0197.1	422197	Ø 257,5 22 20,2 V							
								0.9	77	12/13→			24.0322-0197.1	522197	Ø 257,5 22 20,2 V PD
								1.4	74	09/09→			24.0111-0119.1	411119	Ø 240,5 11 9,2
								1.4	75	09/11→					
1.2	51	09/09→	←			24.0120-0184.1	420184	Ø 240,5 20 18,2 V							
1.3 D Multijet	55	09/09→													
1.3 D Multijet	70	09/09→	←			24.0122-0197.1	422197	Ø 257,5 22 20,2 V							
						24.0322-0197.1	522197	Ø 257,5 22 20,2 V PD							
1.4 (312.AXD1A)	99	01/11→	←	-	Kit ESSEESSE	24.0122-0147.1	422147	Ø 284 22 20,2 V							
								1.4 (312.AXF11)	132	09/09→	←	+	Kit ESSEESSE	24.0122-0283.1	422283
1.4 (312.AXF1A, 312.AXD1A)	118	05/11→													
1.4 (312.AXF1A)	103	09/09→	→	-	Kit ESSEESSE	24.0111-0119.1	411119	Ø 240,5 11 9,2							
								→	+	Kit ESSEESSE	24.0111-0176.1	411176	Ø 240,5 11 9,2 •		
FIAT - 500L (351_, 352_) 09/12→															
 Bremsbelagsatz, Scheibenbremse															
0.9	77	09/12→	←			13.0460-3840.2	603840	BOS 23981 19,6 + WK + Zub							
0.9 Natural Power	59	04/17→				13.0470-3840.2	LD3840	BOS 23981 19,6 + WK + Zub Ceramic							
0.9 Natural Power	63	03/13→													
1.3 D Multijet	62	09/12→													
1.3 D Multijet	70	06/14→	→			13.0460-2789.2	602789	TRW 25652 17,1 + WK + Zub							
1.4	70	09/12→				13.0470-2789.2	LD2789	TRW 25652 17,1 + WK + Zub Ceramic							
1.6 D Multijet	77	09/12→													
1.4	88	10/13→	←	01/14→		13.0460-7302.2	607302	ATE 24727 20,7 + WK							
								→	01/14→			13.0460-2793.2	602793	TRW 25973 17,2 + WK + Zub	
1.4 LPG	88	02/14→	←			13.0460-7302.2	607302	ATE 24727 20,7 + WK							
1.6 D Multijet	88	09/13→	→			13.0460-2793.2	602793	TRW 25973 17,2 + WK + Zub							
 Bremsscheibe															
0.9	77	09/12→	←			24.0122-0286.1	422286	Ø 284 22 20 V							
0.9 Natural Power	59	04/17→													
0.9 Natural Power	63	03/13→	→			24.0110-0378.1	410378	Ø 251 10 9							
1.3 D Multijet	62	09/12→													
1.3 D Multijet	70	06/14→													
1.4	70	09/12→													
1.6 D Multijet	77	09/12→													
↓															

	kw			 	! #		
FIAT - 500L (351_, 352_) 09/12→							
 Bremsscheibe							
1.4	88	10/13→	←	01/14→		24.0128-0253.1 428253	Ø 305 28 26 V
			→	01/14→		24.0110-0393.1 410393	Ø 264 10 8
1.4 LPG	88	02/14→	←			24.0128-0253.1 428253	Ø 305 28 26 V
1.6 D Multijet	88	09/13→	→			24.0110-0393.1 410393	Ø 264 10 8
FIAT - 500X (334_) 09/14→							
 Bremsscheibe							
1.3 D Multijet	70	06/15→	←			24.0126-0168.1 426168	Ø 281 26,2 24,2 V + S
1.4	100	09/14→	→			24.0112-0170.1 412170	Ø 278 12 10 + S
1.4	103	09/14→	→				
1.6 D Multijet	84	09/14→	→				
1.6 D Multijet	88	09/14→	→				
1.4 4x4	120	02/15→	←			24.0128-0292.1 428292	Ø 305 28 26 V + S
1.4 4x4	125	02/15→	→				
1.6	81	11/14→	→			24.0112-0170.1 412170	Ø 278 12 10 + S
2.0 D Multijet 4x4	100	09/14→	→				
2.0 D Multijet 4x4	103	09/14→	→				
FIAT - BARCHETTA (183_) 03/95→05/05							
 Bremsbelagsatz, Scheibenbremse							
1.8 16V	96	04/95→05/05	←	→ 05/95		13.0460-2949.2 602949	TRW 20833 17,0 + WK
			←	06/95→ 10/04		13.0460-7065.2 607065	ATE 21927 17,9 + WK
			→	→ 10/04; ALU		13.0460-2826.2 602826	TRW 23177 14,2 - WK
			→	→ 10/04; GG		13.0460-2951.2 602951	TRW 21103 14,2 - WK
Zubehörsatz, Scheibenbremsbelag							
1.8 16V	96	04/95→05/05	→	→ 10/04; GG		13.0460-0072.2 610072	TRW
 Bremsscheibe							
1.8 16V	96	04/95→05/05	←	→ 10/04		24.0120-0142.1 420142	Ø 257,5 20 18,2 V
			→			24.0320-0142.1 520142	Ø 257,5 20 18,2 V PD
			→	→ 10/04		24.0111-0119.1 411119	Ø 240,5 11 9,2
FIAT - BRAVA (182_) 10/95→06/03							
 Bremsbelagsatz, Scheibenbremse							
1.2 16V	64	12/98→12/02	←	→ 10/01; Schaltgetriebe		13.0460-7064.2 607064	ATE 21930 17,9 + WK
1.2 16V 80	60	12/98→12/02	←	→ 10/01; Automatikgetriebe		13.0460-7065.2 607065	ATE 21927 17,9 + WK
1.2 16V 80	59	10/00→10/01	←	Schaltgetriebe		13.0460-7064.2 607064	ATE 21930 17,9 + WK
1.4 (182.BG)	55	10/95→10/01	←	Automatikgetriebe		13.0460-7065.2 607065	ATE 21927 17,9 + WK
1.4 12 V (182.BA)	59	10/95→08/98	←				
1.6 16V (182.BB)	76	02/96→10/01	←				
1.6 16V (182.BH)	66	10/95→10/01	←				
1.6 16V (182.BU)	76	01/99→12/02	←				
1.9 D	48	10/95→10/01	←				
1.8 GT 16V (182.BC)	83	10/95→10/01	←			13.0460-7065.2 607065	ATE 21927 17,9 + WK
1.9 JTD	74	09/00→10/01	←				
1.9 JTD 105	77	12/98→10/01	←				
2.0	113	09/98→08/00	←				
1.9 JTD	79	01/01→12/02	←	→ 10/01		13.0460-7065.2 607065	ATE 21927 17,9 + WK
1.9 TD 100 S (182.BF)	74	03/96→10/01	←	06/96→		13.0460-7065.2 607065	ATE 21927 17,9 + WK
1.9 TD 75 S (182.BF)	55	03/96→10/01	←	06/96→; Schaltgetriebe		13.0460-7064.2 607064	ATE 21930 17,9 + WK
			←	06/96→; Automatikgetriebe		13.0460-7065.2 607065	ATE 21927 17,9 + WK
 Bremsscheibe							
1.2 16V	64	12/98→12/02	←	→ 10/01; Schaltgetriebe		24.0112-0127.1 412127	Ø 257,5 12 10,2
1.2 16V 80	60	12/98→12/02	←	→ 10/01; Automatikgetriebe		24.0120-0142.1 420142	Ø 257,5 20 18,2 V
			→			24.0320-0142.1 520142	Ø 257,5 20 18,2 V PD
1.2 16V 80	59	10/00→10/01	←	Schaltgetriebe		24.0112-0127.1 412127	Ø 257,5 12 10,2
1.4 (182.BG)	55	10/95→10/01	←	Automatikgetriebe		24.0120-0142.1 420142	Ø 257,5 20 18,2 V
1.4 12 V (182.BA)	59	10/95→08/98	←			24.0320-0142.1 520142	Ø 257,5 20 18,2 V PD
1.6 16V (182.BB)	76	02/96→10/01	←				
1.6 16V (182.BH)	66	10/95→10/01	←				
1.6 16V (182.BU)	76	01/99→12/02	←				
1.9 D	48	10/95→10/01	←				
1.8 GT 16V (182.BC)	83	10/95→10/01	←			24.0120-0142.1 420142	Ø 257,5 20 18,2 V
1.9 JTD	74	09/00→10/01	←			24.0320-0142.1 520142	Ø 257,5 20 18,2 V PD
1.9 JTD 105	77	12/98→10/01	←				







	kw			 	! #		
FIAT - BRAVA (182_) 10/95→06/03							
 Bremsscheibe							
2.0	113	09/98→08/00	←			24.0120-0142.1 420142 24.0320-0142.1 520142	Ø 257,5 20 18,2 V Ø 257,5 20 18,2 V PD
1.9 JTD	79	01/01→12/02	←	→ 10/01		24.0120-0142.1 420142 24.0320-0142.1 520142	Ø 257,5 20 18,2 V Ø 257,5 20 18,2 V PD
1.9 TD 100 S (182.BF)	74	03/96→10/01	←	06/96→		24.0120-0142.1 420142 24.0320-0142.1 520142	Ø 257,5 20 18,2 V Ø 257,5 20 18,2 V PD
1.9 TD 75 S (182.BF)	55	03/96→10/01	←	06/96→; Schaltgetriebe		24.0112-0127.1 412127	Ø 257,5 12 10,2
			←	06/96→; Automatikgetriebe		24.0120-0142.1 420142 24.0320-0142.1 520142	Ø 257,5 20 18,2 V Ø 257,5 20 18,2 V PD
FIAT - BRAVO I (182_) 10/95→10/01							
 Bremsbelagsatz, Scheibenbremse							
1.2 16V 80	59	10/00→10/01	←			13.0460-7064.2 607064	ATE 21930 17,9 + WK
1.2 16V 80	60	12/98→10/00					
1.2 16V 80	64	12/98→10/01					
1.4 (182.AA)	59	10/95→10/01					
1.4 (182.AG)	55	10/95→10/01					
1.6	76	09/00→10/01					
1.6 16V (182.AB)	76	03/96→10/01					
1.6 16V (182.AH)	66	10/95→10/01					
1.9 D	48	10/95→10/01					
1.8 GT (182.AC)	83	10/95→10/01	←			13.0460-7065.2 607065	ATE 21927 17,9 + WK
1.9 JTD	74	09/00→10/01					
1.9 JTD 105	77	12/98→10/01					
1.9 TD 100 S (182.AF)	74	03/96→10/01	←	06/96→		13.0460-7065.2 607065	ATE 21927 17,9 + WK
1.9 TD 75 S (182.AF)	55	03/96→10/01	←	06/96→		13.0460-7064.2 607064	ATE 21930 17,9 + WK
2.0 HGT 20V (182.AD)	108	10/95→07/98	←			13.0460-7069.2 607069	ATE 21636 19,3 + WK
			→	ALU		13.0460-2826.2 602826	TRW 23177 14,2 - WK
			→	GG		13.0460-2951.2 602951	TRW 21103 14,2 - WK
2.0 HGT 20V (182AQ)	113	07/98→10/01	←	→ 04/99		13.0460-7069.2 607069	ATE 21636 19,3 + WK
			←	05/99→		13.0460-7140.2 607140	ATE 21637 19,3 + WK
						13.0470-7140.2 LD7140	ATE 21637 19,3 + WK Ceramic
			→	ALU		13.0460-2826.2 602826	TRW 23177 14,2 - WK
			→	GG		13.0460-2951.2 602951	TRW 21103 14,2 - WK
Zubehörsatz, Scheibenbremsbelag							
2.0 HGT 20V (182.AD)	108	10/95→07/98	→	GG		13.0460-0072.2 610072	TRW
2.0 HGT 20V (182AQ)	113	07/98→10/01					
 Bremsscheibe							
1.2 16V 80	59	10/00→10/01	←			24.0112-0127.1 412127	Ø 257,5 12 10,2
1.2 16V 80	60	12/98→10/00					
1.2 16V 80	64	12/98→10/01					
1.4 (182.AA)	59	10/95→10/01					
1.4 (182.AG)	55	10/95→10/01					
1.6	76	09/00→10/01					
1.6 16V (182.AB)	76	03/96→10/01					
1.6 16V (182.AH)	66	10/95→10/01					
1.9 D	48	10/95→10/01					
1.8 GT (182.AC)	83	10/95→10/01	←			24.0120-0142.1 420142 24.0320-0142.1 520142	Ø 257,5 20 18,2 V Ø 257,5 20 18,2 V PD
1.9 JTD	74	09/00→10/01					
1.9 JTD 105	77	12/98→10/01					
1.9 TD 100 S (182.AF)	74	03/96→10/01	←	06/96→		24.0120-0142.1 420142 24.0320-0142.1 520142	Ø 257,5 20 18,2 V Ø 257,5 20 18,2 V PD
1.9 TD 75 S (182.AF)	55	03/96→10/01	←	06/96→		24.0112-0127.1 412127	Ø 257,5 12 10,2
2.0 HGT 20V (182.AD)	108	10/95→07/98	←			24.0122-0147.1 422147	Ø 284 22 20,2 V
2.0 HGT 20V (182AQ)	113	07/98→10/01	→			24.0111-0119.1 411119	Ø 240,5 11 9,2
FIAT - BRAVO II (198_) 11/06→							
 Bremsbelagsatz, Scheibenbremse							
1.4	66	04/07→	←			13.0460-3982.2 603982 13.0470-3982.2 LD3982	BOS 23705 18,1 + WK BOS 23705 18,1 + WK Ceramic
			→			13.0460-3861.2 603861 13.0460-3991.2 603991 13.0470-3812.2 LD3812	BOS 23714 17,6 + WK + Zub BOS 23714 16,6 - WE / - WK BOS 23714 17,6 - WE / - WK Ceramic
↓							













	kw			 	! #		
FIAT - BRAVO II (198_) 11/06→							
 Bremsbelagsatz, Scheibenbremse							
1.4 16V	103	03/08→	←	04/08→		13.0460-3984.2 603984 13.0470-3984.2 LD3984	BOS 23711 19,4 + WK BOS 23711 19,4 + WK Ceramic
			→	04/08→		13.0460-3861.2 603861 13.0460-3991.2 603991 13.0470-3812.2 LD3812	BOS 23714 17,6 + WK + Zub BOS 23714 16,6 - WE / - WK BOS 23714 17,6 - WE / - WK Ceramic
1.4 LPG	66	12/08→12/14	←	11/09→		13.0460-3982.2 603982 13.0470-3982.2 LD3982	BOS 23705 18,1 + WK BOS 23705 18,1 + WK Ceramic
			→	11/09→		13.0460-3861.2 603861 13.0460-3991.2 603991 13.0470-3812.2 LD3812	BOS 23714 17,6 + WK + Zub BOS 23714 16,6 - WE / - WK BOS 23714 17,6 - WE / - WK Ceramic
1.4 T-Jet	88	09/07→	←			13.0460-3983.2 603983	BOS 23708 19,4 + WK
1.6 D Multijet	66	03/08→				13.0470-3983.2 LD3983	BOS 23708 19,4 + WK Ceramic
1.6 D Multijet	85	11/08→	→			13.0460-3861.2 603861	BOS 23714 17,6 + WK + Zub
1.6 D Multijet	88	03/08→				13.0460-3991.2 603991	BOS 23714 16,6 - WE / - WK
1.9 D Multijet	66	04/07→12/08				13.0470-3812.2 LD3812	BOS 23714 17,6 - WE / - WK Ceramic
1.9 D Multijet	88	04/07→					
1.4 T-Jet	110	09/07→	←			13.0460-3984.2 603984	BOS 23711 19,4 + WK
1.9 D Multijet	110	04/07→				13.0470-3984.2 LD3984	BOS 23711 19,4 + WK Ceramic
2.0 D Multijet	120	09/08→	→			13.0460-3861.2 603861	BOS 23714 17,6 + WK + Zub
2.0 D Multijet	121	09/08→				13.0460-3991.2 603991 13.0470-3812.2 LD3812	BOS 23714 16,6 - WE / - WK BOS 23714 17,6 - WE / - WK Ceramic
1.6 D Multijet	77	09/07→	←	03/08→		13.0460-3983.2 603983	BOS 23708 19,4 + WK
						13.0470-3983.2 LD3983	BOS 23708 19,4 + WK Ceramic
			→	03/08→		13.0460-3861.2 603861 13.0460-3991.2 603991 13.0470-3812.2 LD3812	BOS 23714 17,6 + WK + Zub BOS 23714 16,6 - WE / - WK BOS 23714 17,6 - WE / - WK Ceramic
1.9 D Multijet	85	11/06→	←	04/07→		13.0460-3983.2 603983	BOS 23708 19,4 + WK
						13.0470-3983.2 LD3983	BOS 23708 19,4 + WK Ceramic
			→	04/07→		13.0460-3861.2 603861 13.0460-3991.2 603991 13.0470-3812.2 LD3812	BOS 23714 17,6 + WK + Zub BOS 23714 16,6 - WE / - WK BOS 23714 17,6 - WE / - WK Ceramic
 Bremsscheibe							
1.4	66	04/07→	←			24.0122-0197.1 422197 24.0322-0197.1 522197	Ø 257,5 22 20,2 V Ø 257,5 22 20,2 V PD
			→			24.0110-0190.1 410190	Ø 251,5 10 9
1.4 16V	103	03/08→	←	04/08→		24.0126-0125.1 426125	Ø 281 26 24,2 V
			→	04/08→		24.0110-0190.1 410190	Ø 251,5 10 9
1.4 LPG	66	12/08→12/14	←	11/09→		24.0122-0197.1 422197 24.0322-0197.1 522197	Ø 257,5 22 20,2 V Ø 257,5 22 20,2 V PD
			→	11/09→		24.0110-0190.1 410190	Ø 251,5 10 9
1.4 T-Jet	88	09/07→	←			24.0122-0147.1 422147	Ø 284 22 20,2 V
1.6 D Multijet	66	03/08→				24.0110-0190.1 410190	Ø 251,5 10 9
1.6 D Multijet	85	11/08→	→				
1.6 D Multijet	88	03/08→					
1.9 D Multijet	66	04/07→12/08					
1.9 D Multijet	88	04/07→					
1.4 T-Jet	110	09/07→	←			24.0126-0125.1 426125	Ø 281 26 24,2 V
1.9 D Multijet	110	04/07→				24.0110-0190.1 410190	Ø 251,5 10 9
2.0 D Multijet	120	09/08→	→				
2.0 D Multijet	121	09/08→					
1.6 D Multijet	77	09/07→	←	03/08→		24.0122-0147.1 422147	Ø 284 22 20,2 V
						24.0110-0190.1 410190	Ø 251,5 10 9
			→	03/08→			
1.9 D Multijet	85	11/06→	←	04/07→		24.0122-0147.1 422147	Ø 284 22 20,2 V
						24.0110-0190.1 410190	Ø 251,5 10 9
			→	04/07→			
FIAT - CINQUECENTO (170_) 07/91→07/99							
 Bremsbelagsatz, Scheibenbremse							
0.7 (170AA)	23	12/91→01/96	←	02/92→		13.0460-3949.2 603949	BDX 21365 17,0 - WE / - WK
↓							











	kw			 	! #		
FIAT - CINQUECENTO (170_) 07/91→07/99							
 Bremsbelagsatz, Scheibenbremse							
0.7 i (170AD)	22	07/94→01/98	←			13.0460-3949.2 603949	BDX 21365 17,0 - WE / - WK
0.9 i.e. S (170AF, 170CF)	29	07/91→07/99	←	02/92→05/98		13.0460-3949.2 603949	BDX 21365 17,0 - WE / - WK
1.1 Sporting (170AH)	40	10/94→01/98	←	11/94→		13.0460-3949.2 603949	BDX 21365 17,0 - WE / - WK
Zubehörsatz, Scheibenbremsbelag							
0.7 (170AA)	23	12/91→01/96	←	02/92→		13.0460-0434.2 610434	BDX
0.7 i (170AD)	22	07/94→01/98	←			13.0460-0434.2 610434	BDX
0.9 i.e. S (170AF, 170CF)	29	07/91→07/99	←	02/92→05/98		13.0460-0434.2 610434	BDX
1.1 Sporting (170AH)	40	10/94→01/98	←	11/94→		13.0460-0434.2 610434	BDX
 Bremsscheibe							
0.7 (170AA)	23	12/91→01/96	←	02/92→		24.0111-0119.1 411119	Ø 240,5 11 9,2
0.7 i (170AD)	22	07/94→01/98	←			24.0111-0119.1 411119	Ø 240,5 11 9,2
0.9 i.e. S (170AF, 170CF)	29	07/91→07/99	←	02/92→05/98		24.0111-0119.1 411119	Ø 240,5 11 9,2
1.1 Sporting (170AH)	40	10/94→01/98	←	11/94→		24.0111-0119.1 411119	Ø 240,5 11 9,2
FIAT - COUPE (175_) 11/93→08/00							
 Bremsbelagsatz, Scheibenbremse							
1.8 16V	96	03/96→08/00	←	07/96→		13.0460-7069.2 607069	ATE 21636 19,3 + WK
			→	47168→; ALU		13.0460-2826.2 602826	TRW 23177 14,2 - WK
			→	07/96→; → 47167; GG		13.0460-2951.2 602951	TRW 21103 14,2 - WK
2.0 16V 2.0 16V Turbo	102 140	11/93→08/96 11/93→08/96	←	12/93→06/96		13.0460-2979.2 602979	TRW 21147 19,0 + WK
			→	12/93→06/96; GG		13.0460-7069.2 607069	ATE 21636 19,3 + WK
2.0 20V	108	08/96→04/98	←	01/97→		13.0460-7069.2 607069	ATE 21636 19,3 + WK
			→	47168→; ALU		13.0460-2826.2 602826	TRW 23177 14,2 - WK
			→	01/97→; → 47167; GG		13.0460-2951.2 602951	TRW 21103 14,2 - WK
2.0 20V	113	04/98→08/00	←			13.0460-7069.2 607069	ATE 21636 19,3 + WK
			→	47168→; ALU		13.0460-2826.2 602826	TRW 23177 14,2 - WK
			→	→ 47167; GG		13.0460-2951.2 602951	TRW 21103 14,2 - WK
2.0 20V Turbo	162	08/96→08/00	←	01/97→		13.0460-4968.2 604968	BRE 21381 18,0 + WK
			→	47168→; ALU		13.0460-2826.2 602826	TRW 23177 14,2 - WK
			→	01/97→; → 47167; GG		13.0460-2951.2 602951	TRW 21103 14,2 - WK
Zubehörsatz, Scheibenbremsbelag							
1.8 16V	96	03/96→08/00	→	07/96→; → 47167; GG		13.0460-0072.2 610072	TRW
2.0 16V 2.0 16V Turbo	102 140	11/93→08/96 11/93→08/96	→	12/93→06/96; GG		13.0460-0072.2 610072	TRW
2.0 20V 2.0 20V Turbo	108 162	08/96→04/98 08/96→08/00	→	01/97→; → 47167; GG		13.0460-0072.2 610072	TRW
2.0 20V	113	04/98→08/00	→	→ 47167; GG		13.0460-0072.2 610072	TRW
 Bremsscheibe							
1.8 16V	96	03/96→08/00	←	07/96→		24.0122-0107.1 422107	Ø 284 22 20,2 V
			→	07/96→		24.0111-0119.1 411119	Ø 240,5 11 9,2
2.0 16V	102	11/93→08/96	←	12/93→06/96		24.0122-0107.1 422107	Ø 284 22 20,2 V
			→	12/93→06/96		24.0111-0119.1 411119	Ø 240,5 11 9,2
2.0 16V Turbo	140	11/93→08/96	←	12/93→06/96		24.0122-0147.1 422147	Ø 284 22 20,2 V
			→	12/93→06/96		24.0111-0119.1 411119	Ø 240,5 11 9,2
2.0 20V	108	08/96→04/98	←	01/97→		24.0122-0107.1 422107	Ø 284 22 20,2 V
			→	01/97→		24.0111-0119.1 411119	Ø 240,5 11 9,2
2.0 20V	113	04/98→08/00	←			24.0122-0107.1 422107	Ø 284 22 20,2 V
			→			24.0111-0119.1 411119	Ø 240,5 11 9,2
2.0 20V Turbo	162	08/96→08/00	←	01/97→		24.0128-0120.1 428120	Ø 305 28 26 V
			→	01/97→		24.0111-0119.1 411119	Ø 240,5 11 9,2















	kW			 	! #			
FIAT - CROMA (154_) 12/85→12/96								
 Bremsbelagsatz, Scheibenbremse								
1900 Turbo D i.d.	69	11/92→12/96	←	→ 10/96		13.0460-2952.2	602952	TRW 21182 19,4 + WK
			→	→ 10/96; + ABS		13.0460-2962.2	602962	TRW 20668 16,6 - WK
			→	→ 10/96; - ABS		13.0460-3904.2	603904	BDX 21107 12,0 - WK
2000 16V	101	08/92→08/96	←	12/92→; nicht für gepanzerte Fahrzeuge		13.0460-2952.2	602952	TRW 21182 19,4 + WK
			→	12/92→; + ABS; für gepanzerte Fahrzeuge		13.0460-2962.2	602962	TRW 20668 16,6 - WK
			→	12/92→; - ABS; nicht für gepanzerte Fahrzeuge		13.0460-3904.2	603904	BDX 21107 12,0 - WK
2000 i.e. (154.AM, 154.LM)	85	10/87→08/96	←	11/90→; nicht für gepanzerte Fahrzeuge		13.0460-2952.2	602952	TRW 21182 19,4 + WK
			←	11/90→; für gepanzerte Fahrzeuge		13.0460-2979.2	602979	TRW 21147 19,0 + WK
			→	11/90→; + ABS; für gepanzerte Fahrzeuge		13.0460-2962.2	602962	TRW 20668 16,6 - WK
			→	11/90→; - ABS; nicht für gepanzerte Fahrzeuge		13.0460-3904.2	603904	BDX 21107 12,0 - WK
2000 i.e. Turbo (154.AM, 154.LM)	110	06/87→08/96	←	11/90→; nicht für gepanzerte Fahrzeuge		13.0460-2952.2	602952	TRW 21182 19,4 + WK
			←	01/93→		13.0460-2979.2	602979	TRW 21147 19,0 + WK
			←	11/90→; für gepanzerte Fahrzeuge		13.0460-2979.2	602979	TRW 21147 19,0 + WK
			→	11/90→; + ABS; für gepanzerte Fahrzeuge		13.0460-2962.2	602962	TRW 20668 16,6 - WK
			→	11/90→; - ABS; nicht für gepanzerte Fahrzeuge		13.0460-3904.2	603904	BDX 21107 12,0 - WK
2500 TD (154.LL, 154.PL)	85	05/89→08/96	←	11/90→		13.0460-2952.2	602952	TRW 21182 19,4 + WK
			→	11/90→; + ABS		13.0460-2962.2	602962	TRW 20668 16,6 - WK
			→	11/90→; - ABS		13.0460-3904.2	603904	BDX 21107 12,0 - WK
2500 TDE	77	12/91→08/96	←			13.0460-2952.2	602952	TRW 21182 19,4 + WK
			→	+ ABS		13.0460-2962.2	602962	TRW 20668 16,6 - WK
			→	- ABS		13.0460-3904.2	603904	BDX 21107 12,0 - WK
2500 V6	119	06/93→08/96	←			13.0460-2979.2	602979	TRW 21147 19,0 + WK
			→			13.0460-2962.2	602962	TRW 20668 16,6 - WK
Zubehörsatz, Scheibenbremsbelag								
1900 Turbo D i.d.	69	11/92→12/96	→	→ 10/96; + ABS		13.0460-0072.2	610072	TRW
2000 16V	101	08/92→08/96	→	12/92→; + ABS; für gepanzerte Fahrzeuge		13.0460-0072.2	610072	TRW
2000 i.e. (154.AM, 154.LM)	85	10/87→08/96	→	11/90→; + ABS; für gepanzerte Fahrzeuge		13.0460-0072.2	610072	TRW
2000 i.e. Turbo (154.AM, 154.LM)	110	06/87→08/96						
2500 TD (154.LL, 154.PL)	85	05/89→08/96	→	11/90→; + ABS		13.0460-0072.2	610072	TRW
2500 TDE	77	12/91→08/96	→	+ ABS		13.0460-0072.2	610072	TRW
2500 V6	119	06/93→08/96	→			13.0460-0072.2	610072	TRW
 Bremsscheibe								
1900 Turbo D i.d.	69	11/92→12/96	←	→ 10/96; - ABS		24.0114-0102.1	414102	Ø 257,5 14 12,8
			←	→ 10/96; + ABS		24.0122-0130.1	422130	Ø 257,2 22 20,2 V
			→	→ 10/96		24.0110-0190.1	410190	Ø 251,5 10 9
2000 16V	101	08/92→08/96	←	12/92→; nicht für gepanzerte Fahrzeuge		24.0122-0130.1	422130	Ø 257,2 22 20,2 V
			→	12/92→; nicht für gepanzerte Fahrzeuge		24.0110-0190.1	410190	Ø 251,5 10 9
2000 i.e. (154.AM, 154.LM)	85	10/87→08/96	←	11/90→; - ABS; nicht für gepanzerte Fahrzeuge		24.0114-0102.1	414102	Ø 257,5 14 12,8
			←	11/90→; + ABS; nicht für gepanzerte Fahrzeuge		24.0122-0130.1	422130	Ø 257,2 22 20,2 V
			←	11/90→; für gepanzerte Fahrzeuge		24.0122-0145.1	422145	Ø 284 22 20,2 V
			→	11/90→; nicht für gepanzerte Fahrzeuge		24.0110-0190.1	410190	Ø 251,5 10 9
			→	11/90→; für gepanzerte Fahrzeuge		24.0110-0209.1	410209	Ø 251,4 10 9
2000 i.e. Turbo (154.AM, 154.LM)	110	06/87→08/96	←	11/90→; nicht für gepanzerte Fahrzeuge		24.0122-0130.1	422130	Ø 257,2 22 20,2 V
			←	11/90→; für gepanzerte Fahrzeuge		24.0122-0145.1	422145	Ø 284 22 20,2 V
			→	11/90→; nicht für gepanzerte Fahrzeuge		24.0110-0190.1	410190	Ø 251,5 10 9
			→	11/90→; für gepanzerte Fahrzeuge		24.0110-0209.1	410209	Ø 251,4 10 9
2500 TD (154.LL, 154.PL)	85	05/89→08/96	←	11/90→		24.0122-0130.1	422130	Ø 257,2 22 20,2 V
↓								











	kw			 	! #		
FIAT - CROMA (154_) 12/85→12/96							
 Bremsscheibe							
2500 TD (154.LL, 154.PL)	85	05/89→08/96	➔	11/90→		24.0110-0190.1 410190	Ø 251,5 10 9
2500 TDE	77	12/91→08/96	➔			24.0122-0130.1 422130	Ø 257,2 22 20,2 V
			➔			24.0110-0190.1 410190	Ø 251,5 10 9
2500 V6	119	06/93→08/96	➔			24.0122-0147.1 422147	Ø 284 22 20,2 V
			➔			24.0110-0190.1 410190	Ø 251,5 10 9
FIAT - CROMA (194_) 06/05→							
 Bremsbelagsatz, Scheibenbremse							
1.8 16V	103	12/05→	➔	01/06→ 11/10; für Bremssattel mit Kunststoffkolben		13.0460-7172.2 607172 13.0470-7172.2 LD7172	ATE 23378 20,1 + WE / - WK ATE 23378 20,1 + WE / - WK Ceramic
			➔	01/06→ 11/10; für Bremssattel mit Stahlkolben		13.0460-7212.2 607212	ATE 23738 20,1 + WE / - WK
			➔	01/06→ 11/10		13.0460-3825.2 603825	TRW 24348 17,1 - WE / - WK
1.9 D Multijet 1.9 D Multijet 2.2 16V	85 88 108	06/05→ 06/05→ 06/05→	➔	→ 11/10; für Bremssattel mit Kunststoffkolben		13.0460-7172.2 607172 13.0470-7172.2 LD7172	ATE 23378 20,1 + WE / - WK ATE 23378 20,1 + WE / - WK Ceramic
			➔	→ 11/10; für Bremssattel mit Stahlkolben		13.0460-7212.2 607212	ATE 23738 20,1 + WE / - WK
			➔	→ 11/10		13.0460-3825.2 603825	TRW 24348 17,1 - WE / - WK
1.9 D Multijet 1.9 D Multijet	100 110	12/05→ 06/05→	➔	→ 2060168		13.0460-3824.2 603824	TRW 20261 19,0 + WK
			➔	2060169→; → 11/10; für Bremssattel mit Kunststoffkolben		13.0460-7172.2 607172 13.0470-7172.2 LD7172	ATE 23378 20,1 + WE / - WK ATE 23378 20,1 + WE / - WK Ceramic
			➔	2060169→; → 11/10; für Bremssattel mit Stahlkolben		13.0460-7212.2 607212	ATE 23738 20,1 + WE / - WK
			➔	→ 11/10		13.0460-3825.2 603825	TRW 24348 17,1 - WE / - WK
2.4 D Multijet	147	06/05→	➔	→ 11/10		13.0460-3824.2 603824	TRW 20261 19,0 + WK
			➔	→ 11/10		13.0460-3825.2 603825	TRW 24348 17,1 - WE / - WK
Warnkontakt, Bremsbelagverschleiß							
1.8 16V	103	12/05→	➔	01/06→ 11/10	1	24.8190-0719.2 620719	L= 685,5
1.9 D Multijet 1.9 D Multijet 2.2 16V	85 88 108	06/05→ 06/05→ 06/05→	➔	→ 11/10	1	24.8190-0719.2 620719	L= 685,5
1.9 D Multijet 1.9 D Multijet	100 110	12/05→ 06/05→	➔	2060169→; → 11/10	1	24.8190-0719.2 620719	L= 685,5
 Bremsscheibe							
1.8 16V	103	12/05→	➔	01/06→ 11/10		24.0125-0141.1 425141 24.0325-0141.1 525141	Ø 285 24,9 22 V + S Ø 285 24,9 22 V + S PD
			➔	01/06→ 11/10		24.0112-0157.1 412157 24.0312-0157.1 512157	Ø 278 11,9 10 + S Ø 278 11,9 10 + S PD
1.9 D Multijet 1.9 D Multijet 2.2 16V	85 88 108	06/05→ 06/05→ 06/05→	➔	→ 11/10		24.0125-0141.1 425141 24.0325-0141.1 525141	Ø 285 24,9 22 V + S Ø 285 24,9 22 V + S PD
			➔	→ 11/10		24.0112-0157.1 412157 24.0312-0157.1 512157	Ø 278 11,9 10 + S Ø 278 11,9 10 + S PD
1.9 D Multijet 1.9 D Multijet	100 110	12/05→ 06/05→	➔	2060169→; → 11/10		24.0125-0141.1 425141 24.0325-0141.1 525141	Ø 285 24,9 22 V + S Ø 285 24,9 22 V + S PD
			➔	→ 2060168		24.0128-0185.1 428185	Ø 305 28 26 V
			➔	→ 11/10		24.0120-0173.1 420173 24.0320-0173.1 520173	Ø 292 19,9 18 V + S Ø 292 19,9 18 V + S PD
2.4 D Multijet	147	06/05→	➔	→ 11/10		24.0128-0185.1 428185	Ø 305 28 26 V
			➔	→ 11/10		24.0120-0173.1 420173 24.0320-0173.1 520173	Ø 292 19,9 18 V + S Ø 292 19,9 18 V + S PD
FIAT - DOBLO Cargo (223_) 11/00→							
 Bremsbelagsatz, Scheibenbremse							
1.2 (223ZA1A) 1.3 JTD 16V 1.9 D (223ZXB1A)	48 51 46	03/01→ 05/04→12/06 03/01→	➔	→ 09/05		13.0460-7141.2 607141	ATE 20907 18,1 - WE / - WK
1.3 D Multijet	55	10/05→01/10	➔	für Bremsscheibendurchmesser [mm]: 284		13.0460-3811.2 603811	BOS 23708 19,2 - WE / - WK
↓							









	kw			 	! #		
FIAT - DOBLO Cargo (223_) 11/00→							
 Bremsbelagsatz, Scheibenbremse							
1.3 D Multijet	55	10/05→01/10	←	für Bremsscheibendurchmesser [mm]: 258		13.0460-3850.2 603850	BOS 23707 18,0 - WE / - WK + Zub
1.3 JTD 16V Multijet	62	08/06→	←	→ 01/10;		13.0460-3811.2 603811	BOS 23708 19,2 - WE / - WK
1.4	57	10/05→		für Bremsscheibendurchmesser [mm]: 284			
1.9 JTD Multijet	88	12/06→	←	→ 01/10;		13.0460-3850.2 603850	BOS 23707 18,0 - WE / - WK + Zub
				für Bremsscheibendurchmesser [mm]: 258			
1.6 16V (223ZXD1A)	76	10/01→	←	10/05→ 01/10;		13.0460-3811.2 603811	BOS 23708 19,2 - WE / - WK
1.6 Natural Power	76	09/02→		für Bremsscheibendurchmesser [mm]: 284			
1.9 JTD	77	07/03→					
1.9 JTD (223ZXE1A)	74	10/01→	←	10/05→ 01/10;		13.0460-3850.2 603850	BOS 23707 18,0 - WE / - WK + Zub
				für Bremsscheibendurchmesser [mm]: 258			
			←	→ 09/05		13.0460-7141.2 607141	ATE 20907 18,1 - WE / - WK
 Bremsscheibe							
1.2 (223ZXA1A)	48	03/01→	←	→ 09/05		24.0120-0142.1 420142	Ø 257,5 20 18,2 V
1.3 JTD 16V	51	05/04→12/06				24.0320-0142.1 520142	Ø 257,5 20 18,2 V PD
1.9 D (223ZXB1A)	46	03/01→					
1.3 D Multijet	55	10/05→01/10	←			24.0122-0147.1 422147	Ø 284 22 20,2 V
						24.0122-0197.1 422197	Ø 257,5 22 20,2 V
						24.0322-0197.1 522197	Ø 257,5 22 20,2 V PD
1.3 JTD 16V Multijet	62	08/06→	←	→ 01/10		24.0122-0147.1 422147	Ø 284 22 20,2 V
1.4	57	10/05→				24.0122-0197.1 422197	Ø 257,5 22 20,2 V
1.9 JTD Multijet	88	12/06→				24.0322-0197.1 522197	Ø 257,5 22 20,2 V PD
1.6 16V (223ZXD1A)	76	10/01→	←	→ 09/05		24.0120-0142.1 420142	Ø 257,5 20 18,2 V
1.6 Natural Power	76	09/02→				24.0320-0142.1 520142	Ø 257,5 20 18,2 V PD
1.9 JTD	77	07/03→					
1.9 JTD (223ZXE1A)	74	10/01→	←	10/05→ 01/10		24.0122-0147.1 422147	Ø 284 22 20,2 V
						24.0122-0197.1 422197	Ø 257,5 22 20,2 V
						24.0322-0197.1 522197	Ø 257,5 22 20,2 V PD
FIAT - DOBLO Großraumlimousine (119_, 223_) 03/01→							
 Bremsbelagsatz, Scheibenbremse							
1.2 (223AXA1A)	48	03/01→	←	→ 09/05		13.0460-7141.2 607141	ATE 20907 18,1 - WE / - WK
1.9 D (223AXB1A)	46	03/01→					
1.3 D Multijet	62	10/05→	←	→ 01/10;		13.0460-3811.2 603811	BOS 23708 19,2 - WE / - WK
1.4	57	10/05→		für Bremsscheibendurchmesser [mm]: 284			
1.9 D Multijet	88	10/05→	←	→ 01/10;		13.0460-3850.2 603850	BOS 23707 18,0 - WE / - WK + Zub
				für Bremsscheibendurchmesser [mm]: 258			
1.3 JTD	55	05/05→	←	10/05→ 01/10;		13.0460-3811.2 603811	BOS 23708 19,2 - WE / - WK
				für Bremsscheibendurchmesser [mm]: 284			
			←	10/05→ 01/10;		13.0460-3850.2 603850	BOS 23707 18,0 - WE / - WK + Zub
				für Bremsscheibendurchmesser [mm]: 258			
1.3 JTD 16V	51	12/04→05/05	←			13.0460-7141.2 607141	ATE 20907 18,1 - WE / - WK
1.6 16V (223AXD1A)	76	10/01→	←	10/05→ 01/10;		13.0460-3811.2 603811	BOS 23708 19,2 - WE / - WK
1.6 Natural Power	76	09/02→		für Bremsscheibendurchmesser [mm]: 284			
1.9 JTD	77	07/03→					
1.9 JTD (223AXE1A)	74	10/01→	←	10/05→ 01/10;		13.0460-3850.2 603850	BOS 23707 18,0 - WE / - WK + Zub
				für Bremsscheibendurchmesser [mm]: 258			
			←	→ 09/05		13.0460-7141.2 607141	ATE 20907 18,1 - WE / - WK
 Bremsscheibe							
1.2 (223AXA1A)	48	03/01→	←	→ 09/05		24.0120-0142.1 420142	Ø 257,5 20 18,2 V
1.9 D (223AXB1A)	46	03/01→				24.0320-0142.1 520142	Ø 257,5 20 18,2 V PD
1.3 D Multijet	62	10/05→	←	→ 01/10		24.0122-0147.1 422147	Ø 284 22 20,2 V
1.4	57	10/05→				24.0122-0197.1 422197	Ø 257,5 22 20,2 V
1.9 D Multijet	88	10/05→				24.0322-0197.1 522197	Ø 257,5 22 20,2 V PD
1.3 JTD	55	05/05→	←	10/05→ 01/10		24.0122-0147.1 422147	Ø 284 22 20,2 V
						24.0122-0197.1 422197	Ø 257,5 22 20,2 V
						24.0322-0197.1 522197	Ø 257,5 22 20,2 V PD
1.3 JTD 16V	51	12/04→05/05	←			24.0120-0142.1 420142	Ø 257,5 20 18,2 V
						24.0320-0142.1 520142	Ø 257,5 20 18,2 V PD
1.6 16V (223AXD1A)	76	10/01→	←	→ 09/05		24.0120-0142.1 420142	Ø 257,5 20 18,2 V
↓							

	kW			 	! #		
FIAT - DOBLO Großraumlimousine (119_, 223_) 03/01→							
 Bremsscheibe							
1.9 JTD	77	07/03→	←	→ 09/05		24.0320-0142.1 520142	Ø 257,5 20 18,2 V PD
1.9 JTD (223AXE1A)	74	10/01→	←	10/05→ 01/10		24.0122-0147.1 422147 24.0122-0197.1 422197 24.0322-0197.1 522197	Ø 284 22 20,2 V Ø 257,5 22 20,2 V Ø 257,5 22 20,2 V PD
1.6 Natural Power	76	09/02→	←	→ 09/05		24.0120-0142.1 420142 24.0320-0142.1 520142	Ø 257,5 20 18,2 V Ø 257,5 20 18,2 V PD
			←	→ 01/10		24.0122-0147.1 422147 24.0122-0197.1 422197 24.0322-0197.1 522197	Ø 284 22 20,2 V Ø 257,5 22 20,2 V Ø 257,5 22 20,2 V PD
			←	10/05→ 01/10		24.0122-0147.1 422147 24.0122-0197.1 422197 24.0322-0197.1 522197	Ø 284 22 20,2 V Ø 257,5 22 20,2 V Ø 257,5 22 20,2 V PD
FIAT - DOBLO Kasten/Kombi (263_) 02/10→							
 Bremsbelagsatz, Scheibenbremse							
1.3 D Multijet	55	11/13→	←	für Bremsscheibendurchmesser [mm]: 284		13.0460-3827.2 603827 13.0470-3827.2 LD3827	BOS 23709 19,6 + WK + Zub BOS 23709 19,6 + WK + Zub Ceramic
1.3 D Multijet	59	03/16→					
1.3 D Multijet	66	02/10→					
1.3 D Multijet	70	03/16→					
1.4	70	02/10→	←	für Bremsscheibendurchmesser [mm]: 305		13.0460-7265.2 607265	ATE 24727 20,7 + WK
1.4	88	10/11→					
1.4 Natural Power	88	06/10→					
1.6 D Multijet	66	02/10→					
1.6 D Multijet	74	02/10→					
1.6 D Multijet	77	02/10→					
1.6 D Multijet	88	02/16→					
2.0 D Multijet	99	02/10→	←			13.0460-3827.2 603827 13.0470-3827.2 LD3827	BOS 23709 19,6 + WK + Zub BOS 23709 19,6 + WK + Zub Ceramic
			←	für Bremsscheibendurchmesser [mm]: 305		13.0460-7265.2 607265	ATE 24727 20,7 + WK
 Bremsscheibe							
1.3 D Multijet	55	11/13→	←			24.0122-0145.1 422145	Ø 284 22 20,2 V
1.3 D Multijet	59	03/16→				24.0128-0253.1 428253	Ø 305 28 26 V
1.3 D Multijet	66	02/10→					
1.3 D Multijet	70	03/16→					
1.4	70	02/10→					
1.4	88	10/11→					
1.4 Natural Power	88	06/10→					
1.6 D Multijet	66	02/10→					
1.6 D Multijet	74	02/10→					
1.6 D Multijet	77	02/10→					
1.6 D Multijet	88	02/16→					
2.0 D Multijet	99	02/10→					
FIAT - DOBLO Kombi (263_) 11/09→							
 Bremsbelagsatz, Scheibenbremse							
1.3 D Multijet	55	03/15→	←	für Bremsscheibendurchmesser [mm]: 284		13.0460-3827.2 603827 13.0470-3827.2 LD3827	BOS 23709 19,6 + WK + Zub BOS 23709 19,6 + WK + Zub Ceramic
1.3 D Multijet	66	02/10→					
1.3 D Multijet	70	03/16→					
1.4	70	02/10→					
1.4	88	10/11→	←	für Bremsscheibendurchmesser [mm]: 305		13.0460-7265.2 607265	ATE 24727 20,7 + WK
1.4 Natural Power	88	02/10→					
1.6 D Multijet	66	02/10→					
1.6 D Multijet	70	03/15→					
1.6 D Multijet	74	03/16→					
1.6 D Multijet	77	02/10→					
1.6 D Multijet	88	03/15→					
2.0 D Multijet	99	02/10→	←			13.0460-3827.2 603827 13.0470-3827.2 LD3827	BOS 23709 19,6 + WK + Zub BOS 23709 19,6 + WK + Zub Ceramic
			←	für Bremsscheibendurchmesser [mm]: 305		13.0460-7265.2 607265	ATE 24727 20,7 + WK
 Bremsscheibe							
1.3 D Multijet	55	03/15→	←			24.0122-0145.1 422145	Ø 284 22 20,2 V
1.3 D Multijet	66	02/10→				24.0128-0253.1 428253	Ø 305 28 26 V
1.3 D Multijet	70	03/16→					
1.4	70	02/10→					
1.4	88	10/11→					
1.4 Natural Power	88	02/10→					
1.6 D Multijet	66	02/10→					
1.6 D Multijet	70	03/15→					
↓							



	kw					! #		
FIAT - DOBLO Kombi (263_) 11/09→								
 Bremsscheibe								
1.6 D Multijet	74	03/16→	←			24.0122-0145.1	422145	Ø 284 22 20,2 V
1.6 D Multijet	77	02/10→				24.0128-0253.1	428253	Ø 305 28 26 V
1.6 D Multijet	88	03/15→						
2.0 D Multijet	99	02/10→						
FIAT - DOBLO Pritsche/Fahrgestell (263_) 02/10→								
 Bremsbelagsatz, Scheibenbremse								
1.3 D Multijet	55	11/13→	←	für Bremsscheibendurchmesser [mm]:		13.0460-3827.2	603827	BOS 23709 19,6 + WK + Zub
1.3 D Multijet	59	03/16→		284		13.0470-3827.2	LD3827	BOS 23709 19,6 + WK + Zub
1.3 D Multijet	66	02/10→						Ceramic
1.3 D Multijet	70	03/16→						
1.4	70	04/10→	←	für Bremsscheibendurchmesser [mm]:		13.0460-7265.2	607265	ATE 24727 20,7 + WK
1.4	88	10/11→		305				
1.4 Natural Power	88	06/10→						
1.6 D Multijet	66	02/10→						
1.6 D Multijet	74	02/11→						
1.6 D Multijet	77	02/10→						
1.6 D Multijet	88	02/16→						
2.0 D Multijet	99	02/10→	←			13.0460-3827.2	603827	BOS 23709 19,6 + WK + Zub
						13.0470-3827.2	LD3827	BOS 23709 19,6 + WK + Zub
								Ceramic
			←	für Bremsscheibendurchmesser [mm]:		13.0460-7265.2	607265	ATE 24727 20,7 + WK
				305				
 Bremsscheibe								
1.3 D Multijet	55	11/13→	←			24.0122-0145.1	422145	Ø 284 22 20,2 V
1.3 D Multijet	59	03/16→				24.0128-0253.1	428253	Ø 305 28 26 V
1.3 D Multijet	66	02/10→						
1.3 D Multijet	70	03/16→						
1.4	70	04/10→						
1.4	88	10/11→						
1.4 Natural Power	88	06/10→						
1.6 D Multijet	66	02/10→						
1.6 D Multijet	74	02/11→						
1.6 D Multijet	77	02/10→						
1.6 D Multijet	88	02/16→						
2.0 D Multijet	99	02/10→						
FIAT - DUCATO Bus (230_) 03/94→04/02								
 Bremsbelagsatz, Scheibenbremse								
1.9 D	50	04/98→04/02	←	01/00→ 10/01; Nutzlast [kg]: 1.000		13.0460-2850.2	602850	TRW 21797 19,7 + WK
1.9 D Combinato	51	06/95→04/02	←	→ 12/99; Nutzlast [kg]: 1.000		13.0460-2976.2	602976	TRW 21797 19,7 + WK
1.9 TD	66	04/98→04/02	←					
1.9 TD Combinato	59	08/94→04/02	←	11/01→ 03/02; Nutzlast [kg]: 1.000		13.0460-4978.2	604978	BRE 23917 19,3 + WK + Zub
1.9 TD Panorama/Combinato	60	03/94→04/02	→	11/01→ 03/02; Nutzlast [kg]: 1.000		13.0460-4980.2	604980	BRE 23921 20,3 - WE / - WK + Zub
1.9 D	59	05/98→11/01	←	01/00→ 10/01; Nutzlast [kg]: 1.000		13.0460-2850.2	602850	TRW 21797 19,7 + WK
			←	→ 12/99; Nutzlast [kg]: 1.000		13.0460-2976.2	602976	TRW 21797 19,7 + WK
			←	11/01→; Nutzlast [kg]: 1.000		13.0460-4978.2	604978	BRE 23917 19,3 + WK + Zub
			→	11/01→; Nutzlast [kg]: 1.000		13.0460-4980.2	604980	BRE 23921 20,3 - WE / - WK + Zub
2.0 4x4	80	11/94→11/01	←	01/00→ 10/01; Nutzlast ab [kg] 1.000 Nutzlast bis [kg] 1.400		13.0460-2850.2	602850	TRW 21797 19,7 + WK
			←	01/00→ 10/01; Nutzlast [kg]: 1.800		13.0460-2852.2	602852	TRW 21799 19,7 + WK
			←	→ 12/99; Nutzlast ab [kg] 1.000 Nutzlast bis [kg] 1.400		13.0460-2976.2	602976	TRW 21797 19,7 + WK
			←	→ 12/99; Nutzlast [kg]: 1.800		13.0460-2977.2	602977	TRW 21799 19,7 + WK
			←	11/01→; Nutzlast ab [kg] 1.000 Nutzlast bis [kg] 1.400		13.0460-4978.2	604978	BRE 23917 19,3 + WK + Zub
			←	11/01→; Nutzlast [kg]: 1.800		13.0460-4979.2	604979	BRE 23919 19,3 + WK + Zub
			→	11/01→; Nutzlast ab [kg] 1.000 Nutzlast bis [kg] 1.800		13.0460-4980.2	604980	BRE 23921 20,3 - WE / - WK + Zub
2.0 JTD	62	10/01→04/02	←	→ 03/02; Nutzlast [kg]: 1.400		13.0460-4978.2	604978	BRE 23917 19,3 + WK + Zub
			←	→ 03/02; Nutzlast [kg]: 1.800		13.0460-4979.2	604979	BRE 23919 19,3 + WK + Zub
			→	→ 03/02; Nutzlast ab [kg] 1.400 Nutzlast bis [kg] 1.800		13.0460-4980.2	604980	BRE 23921 20,3 - WE / - WK + Zub
2.0 Panorama/Combinato	80	03/94→04/02	←	01/00→ 10/01; Nutzlast ab [kg] 1.000 Nutzlast bis [kg] 1.400		13.0460-2850.2	602850	TRW 21797 19,7 + WK
			←	01/00→ 10/01; Nutzlast [kg]: 1.800		13.0460-2852.2	602852	TRW 21799 19,7 + WK
			←	→ 12/99; Nutzlast ab [kg] 1.000 Nutzlast bis [kg] 1.400		13.0460-2976.2	602976	TRW 21797 19,7 + WK

	kw			 	! #		
FIAT - DUCATO Bus (230_) 03/94→04/02							
Bremsbelagsatz, Scheibenbremse							
2.0 Panorama/Combinato	80	03/94→04/02	←	→ 12/99; Nutzlast [kg]: 1.800	13.0460-2977.2	602977	TRW 21799 19,7 + WK
			←	11/01→ 03/02; Nutzlast ab [kg] 1.000 Nutzlast bis [kg] 1.400	13.0460-4978.2	604978	BRE 23917 19,3 + WK + Zub
			←	11/01→ 03/02; Nutzlast [kg]: 1.800	13.0460-4979.2	604979	BRE 23919 19,3 + WK + Zub
			→	11/01→ 03/02; Nutzlast ab [kg] 1.000 Nutzlast bis [kg] 1.800	13.0460-4980.2	604980	BRE 23921 20,3 - WE / - WK + Zub
2.5 D Combinato 2.5 TD 2.5 TDI Panorama/ Combinato 2.5 TDI Panorama/ Combinato 2.8 D 2.8 TDI 2.8 TDI 4x4	62	08/94→04/02	←	01/00→ 10/01; Nutzlast [kg]: 1.400	13.0460-2850.2	602850	TRW 21797 19,7 + WK
	70	03/94→04/02	←	01/00→ 10/01; Nutzlast [kg]: 1.800	13.0460-2852.2	602852	TRW 21799 19,7 + WK
	80	07/94→04/02	←	→ 12/99; Nutzlast [kg]: 1.400	13.0460-2976.2	602976	TRW 21797 19,7 + WK
			←	→ 12/99; Nutzlast [kg]: 1.800	13.0460-2977.2	602977	TRW 21799 19,7 + WK
	85	03/94→04/02	←	11/01→ 03/02; Nutzlast [kg]: 1.400	13.0460-4978.2	604978	BRE 23917 19,3 + WK + Zub
			←	11/01→ 03/02; Nutzlast [kg]: 1.800	13.0460-4979.2	604979	BRE 23919 19,3 + WK + Zub
	64	02/98→04/02	←	11/01→ 03/02; Nutzlast ab [kg] 1.400 Nutzlast bis [kg] 1.800	13.0460-4980.2	604980	BRE 23921 20,3 - WE / - WK + Zub
	90	10/97→04/02	←	11/01→ 03/02; Nutzlast [kg]: 1.400	13.0460-2850.2	602850	TRW 21797 19,7 + WK
90	07/99→04/02	←	01/00→; Nutzlast [kg]: 1.400	13.0460-2852.2	602852	TRW 21799 19,7 + WK	
2.5 TD	85	06/94→09/01	←	→ 12/99; Nutzlast [kg]: 1.400	13.0460-2976.2	602976	TRW 21797 19,7 + WK
			←	→ 12/99; Nutzlast [kg]: 1.800	13.0460-2977.2	602977	TRW 21799 19,7 + WK
			←	01/00→; Nutzlast [kg]: 1.800	13.0460-2852.2	602852	TRW 21799 19,7 + WK
			←	01/00→; Nutzlast [kg]: 1.400	13.0460-2850.2	602850	TRW 21797 19,7 + WK
2.5 TD 4x4	80	11/94→04/98	←	Nutzlast [kg]: 1.400	13.0460-2976.2	602976	TRW 21797 19,7 + WK
			←	Nutzlast [kg]: 1.800	13.0460-2977.2	602977	TRW 21799 19,7 + WK
2.5 TDI 4x4	85	04/97→04/02	←	01/00→ 10/01; Nutzlast [kg]: 1.400	13.0460-2850.2	602850	TRW 21797 19,7 + WK
			←	→ 12/99; Nutzlast [kg]: 1.400	13.0460-2976.2	602976	TRW 21797 19,7 + WK
			←	11/01→ 03/02; Nutzlast [kg]: 1.400	13.0460-4978.2	604978	BRE 23917 19,3 + WK + Zub
			→	11/01→ 03/02; Nutzlast ab [kg] 1.400 Nutzlast bis [kg] 1.800	13.0460-4980.2	604980	BRE 23921 20,3 - WE / - WK + Zub
2.8 JTD 2.8 JTD 4x4	94	11/00→04/02	←	→ 10/01; Nutzlast [kg]: 1.400	13.0460-2850.2	602850	TRW 21797 19,7 + WK
	94	11/00→04/02	←	→ 10/01; Nutzlast [kg]: 1.800	13.0460-2852.2	602852	TRW 21799 19,7 + WK
			←	11/01→ 03/02; Nutzlast [kg]: 1.400	13.0460-4978.2	604978	BRE 23917 19,3 + WK + Zub
			←	11/01→ 03/02; Nutzlast [kg]: 1.800	13.0460-4979.2	604979	BRE 23919 19,3 + WK + Zub
			→	11/01→ 03/02; Nutzlast ab [kg] 1.400 Nutzlast bis [kg] 1.800	13.0460-4980.2	604980	BRE 23921 20,3 - WE / - WK + Zub
Bremsscheibe							
1.9 D 1.9 D Combinato	50	04/98→04/02	←	→ 10/01; Nutzlast [kg]: 1.000	24.0118-0108.1	418108	Ø 280 18 15,9
	51	06/95→04/02	←	11/01→ 03/02; Nutzlast [kg]: 1.000	24.0124-0127.1	424127	Ø 280 24 21,9 V
1.9 TD 1.9 TD Combinato	66	04/98→04/02	←	11/01→ 03/02; Nutzlast [kg]: 1.000	24.0116-0124.1	416124	Ø 280 16 14,2
	59	08/94→04/02	→	11/01→ 03/02; Nutzlast [kg]: 1.000	24.0116-0124.1	416124	Ø 280 16 14,2
1.9 TD Panorama/ Combinato	60	03/94→04/02	→	11/01→ 03/02; Nutzlast [kg]: 1.000	24.0116-0124.1	416124	Ø 280 16 14,2
1.9 D	59	05/98→11/01	←	→ 10/01; Nutzlast [kg]: 1.000	24.0118-0108.1	418108	Ø 280 18 15,9
			←	11/01→; Nutzlast [kg]: 1.000	24.0124-0127.1	424127	Ø 280 24 21,9 V
			→	11/01→; Nutzlast [kg]: 1.000	24.0116-0124.1	416124	Ø 280 16 14,2
2.0 4x4	80	11/94→11/01	←	→ 10/01; Nutzlast ab [kg] 1.000 Nutzlast bis [kg] 1.400	24.0118-0108.1	418108	Ø 280 18 15,9
			←	11/01→; Nutzlast ab [kg] 1.000 Nutzlast bis [kg] 1.400	24.0124-0127.1	424127	Ø 280 24 21,9 V
			←	→ 10/01; Nutzlast [kg]: 1.800	24.0124-0138.1	424138	Ø 300 24 21,9 V
			←	11/01→; Nutzlast [kg]: 1.800	24.0124-0138.1	424138	Ø 300 24 21,9 V
			→	11/01→; Nutzlast ab [kg] 1.000 Nutzlast bis [kg] 1.400	24.0116-0124.1	416124	Ø 280 16 14,2
			→	11/01→; Nutzlast [kg]: 1.800	24.0116-0125.1	416125	Ø 280 16 14,2
2.0 JTD	62	10/01→04/02	←	→ 03/02; Nutzlast [kg]: 1.400	24.0124-0127.1	424127	Ø 280 24 21,9 V
			←	→ 03/02; Nutzlast [kg]: 1.800	24.0124-0138.1	424138	Ø 300 24 21,9 V
			→	→ 03/02; Nutzlast [kg]: 1.400	24.0116-0124.1	416124	Ø 280 16 14,2
			→	→ 03/02; Nutzlast [kg]: 1.800	24.0116-0125.1	416125	Ø 280 16 14,2
2.0 Panorama/Combi- nato	80	03/94→04/02	←	→ 10/01; Nutzlast ab [kg] 1.000 Nutzlast bis [kg] 1.400	24.0118-0108.1	418108	Ø 280 18 15,9
			←	11/01→ 03/02; Nutzlast ab [kg] 1.000 Nutzlast bis [kg] 1.400	24.0124-0127.1	424127	Ø 280 24 21,9 V
			←	11/01→ 03/02; Nutzlast [kg]: 1.800	24.0124-0138.1	424138	Ø 300 24 21,9 V
			←	→ 10/01; Nutzlast [kg]: 1.800	24.0124-0138.1	424138	Ø 300 24 21,9 V



FIAT - DUCATO Bus (230_) 03/94→04/02

Bremsscheibe

2.0 Panorama/Combinato	80	03/94→04/02	➔	11/01→ 03/02; Nutzlast ab [kg] 1.000 Nutzlast bis [kg] 1.400	24.0116-0124.1	416124	Ø 280 16 14,2
			➔	11/01→ 03/02; Nutzlast [kg]: 1.800	24.0116-0125.1	416125	Ø 280 16 14,2
2.5 D Combinato 2.8 D	62	08/94→04/02	➔	→ 10/01; Nutzlast [kg]: 1.400	24.0118-0108.1	418108	Ø 280 18 15,9
			64	02/98→04/02	➔	11/01→ 03/02; Nutzlast [kg]: 1.400	24.0124-0127.1
	➔	11/01→ 03/02; Nutzlast [kg]: 1.800			24.0124-0138.1	424138	Ø 300 24 21,9 V
	➔	→ 10/01; Nutzlast [kg]: 1.800		24.0124-0138.1	424138	Ø 300 24 21,9 V	
	➔	11/01→ 03/02; Nutzlast [kg]: 1.400		24.0116-0124.1	416124	Ø 280 16 14,2	
	➔	11/01→ 03/02; Nutzlast [kg]: 1.800	24.0116-0125.1	416125	Ø 280 16 14,2		
2.5 TD 2.5 TDI Panorama/ Combinato 2.5 TDI Panorama/ Combinato 2.8 JTD 2.8 JTD 4x4 2.8 TDI 2.8 TDI 4x4	70	03/94→04/02	➔	11/01→ 03/02; Nutzlast [kg]: 1.400	24.0124-0127.1	424127	Ø 280 24 21,9 V
	80	07/94→04/02	➔	→ 10/01; Nutzlast [kg]: 1.400	24.0124-0127.1	424127	Ø 280 24 21,9 V
			➔	11/01→ 03/02; Nutzlast [kg]: 1.800	24.0124-0138.1	424138	Ø 300 24 21,9 V
	85	03/94→04/02	➔	→ 10/01; Nutzlast [kg]: 1.800	24.0124-0138.1	424138	Ø 300 24 21,9 V
			➔	11/01→ 03/02; Nutzlast [kg]: 1.400	24.0116-0124.1	416124	Ø 280 16 14,2
	94	11/00→04/02	➔	→ 10/01; Nutzlast [kg]: 1.800	24.0124-0138.1	424138	Ø 300 24 21,9 V
	94	11/00→04/02	➔	11/01→ 03/02; Nutzlast [kg]: 1.400	24.0116-0124.1	416124	Ø 280 16 14,2
	90	10/97→04/02	➔	11/01→ 03/02; Nutzlast [kg]: 1.800	24.0116-0125.1	416125	Ø 280 16 14,2
90	07/99→04/02	➔	Nutzlast [kg]: 1.400	24.0124-0127.1	424127	Ø 280 24 21,9 V	
80	11/94→04/98	➔	Nutzlast [kg]: 1.800	24.0124-0138.1	424138	Ø 300 24 21,9 V	
2.5 TDI 4x4	85	04/97→04/02	➔	11/01→ 03/02; Nutzlast [kg]: 1.400	24.0124-0127.1	424127	Ø 280 24 21,9 V
			➔	→ 10/01; Nutzlast [kg]: 1.400	24.0124-0127.1	424127	Ø 280 24 21,9 V
			➔	11/01→ 03/02; Nutzlast [kg]: 1.400	24.0116-0124.1	416124	Ø 280 16 14,2

FIAT - DUCATO Bus (244_) 04/02→

Bremsbelagsatz, Scheibenbremse

2.0	81	04/02→	➔	→ 07/06; Nutzlast ab [kg] 1.100 Nutzlast bis [kg] 1.500	13.0460-4978.2	604978	BRE 23917 19,3 + WK + Zub
			➔	→ 07/06; Nutzlast bis [kg] 1.800	13.0460-4979.2	604979	BRE 23919 19,3 + WK + Zub
2.0 Bipower	81	11/02→	➔	→ 07/06; Nutzlast ab [kg] 1.100 Nutzlast bis [kg] 1.500	13.0460-4978.2	604978	BRE 23917 19,3 + WK + Zub
2.0 JTD	62	04/02→	➔	→ 07/06; Nutzlast bis [kg] 1.800	13.0460-4979.2	604979	BRE 23919 19,3 + WK + Zub
2.3 JTD	81	04/02→	➔	→ 07/06; Nutzlast ab [kg] 1.100 Nutzlast bis [kg] 1.500	13.0460-4978.2	604978	BRE 23917 19,3 + WK + Zub
2.8 JTD	94	04/02→	➔	→ 07/06; Nutzlast ab [kg] 1.100 Nutzlast bis [kg] 1.500	13.0460-4978.2	604978	BRE 23917 19,3 + WK + Zub
2.8 JTD 4x4	94	07/02→	➔	→ 07/06; Nutzlast [kg]: 1.800	24.0116-0125.1	416125	Ø 280 16 14,2
2.0 4x4 2.8 JTD 2.8 TD 2.8 TD 4x4	81	05/02→07/06	➔	Nutzlast ab [kg] 1.100 Nutzlast bis [kg] 1.500	24.0124-0127.1	424127	Ø 280 24 21,9 V
			➔	Nutzlast bis [kg] 1.800	24.0124-0138.1	424138	Ø 300 24 21,9 V
	107	04/04→07/06	➔	Nutzlast ab [kg] 1.100 Nutzlast bis [kg] 1.500	24.0116-0124.1	416124	Ø 280 16 14,2
	90	11/03→07/06	➔	Nutzlast [kg]: 1.800	24.0124-0138.1	424138	Ø 300 24 21,9 V
90	11/03→07/06	➔	Nutzlast ab [kg] 1.100 Nutzlast bis [kg] 1.800	24.0116-0124.1	416124	Ø 280 16 14,2	
➔	➔	➔	Nutzlast [kg]: 1.800	24.0116-0125.1	416125	Ø 280 16 14,2	

Bremsscheibe











2.0	81	04/02→	➔	→ 07/06; Nutzlast ab [kg] 1.100 Nutzlast bis [kg] 1.500	24.0124-0127.1	424127	Ø 280 24 21,9 V
			➔	→ 07/06; Nutzlast [kg]: 1.800	24.0124-0138.1	424138	Ø 300 24 21,9 V
2.0 Bipower	81	11/02→	➔	→ 07/06; Nutzlast ab [kg] 1.100 Nutzlast bis [kg] 1.500	24.0116-0124.1	416124	Ø 280 16 14,2
2.0 JTD	62	04/02→	➔	→ 07/06; Nutzlast bis [kg] 1.800	24.0116-0125.1	416125	Ø 280 16 14,2
2.3 JTD	81	04/02→	➔	→ 07/06; Nutzlast ab [kg] 1.100 Nutzlast bis [kg] 1.500	24.0116-0124.1	416124	Ø 280 16 14,2
2.8 JTD	94	04/02→	➔	→ 07/06; Nutzlast [kg]: 1.800	24.0116-0125.1	416125	Ø 280 16 14,2
2.8 JTD 4x4	94	07/02→	➔	→ 07/06; Nutzlast [kg]: 1.800	24.0116-0125.1	416125	Ø 280 16 14,2
2.0 4x4 2.8 JTD 2.8 TD 2.8 TD 4x4	81	05/02→07/06	➔	Nutzlast ab [kg] 1.100 Nutzlast bis [kg] 1.500	24.0124-0127.1	424127	Ø 280 24 21,9 V
			➔	Nutzlast bis [kg] 1.800	24.0124-0138.1	424138	Ø 300 24 21,9 V
	107	04/04→07/06	➔	Nutzlast ab [kg] 1.100 Nutzlast bis [kg] 1.500	24.0116-0124.1	416124	Ø 280 16 14,2
	90	11/03→07/06	➔	Nutzlast [kg]: 1.800	24.0116-0125.1	416125	Ø 280 16 14,2
90	11/03→07/06	➔	Nutzlast [kg]: 1.800	24.0116-0125.1	416125	Ø 280 16 14,2	







FIAT - DUCATO Bus (250_, 290_) 07/06→

Bremsbelagsatz, Scheibenbremse

100 Multijet 2,2 D	74	07/06→	➔	Nutzlast 11Q/15Q; Nutzlast ab [kg] 1.100 Nutzlast bis [kg] 1.500	13.0460-4807.2	604807	BRE 24468 19,1 + WK + Zub
110 Multijet 2,3 D	83	10/11→	➔	Nutzlast leicht 17Q; Nutzlast [kg]: 1.700; nicht für erhöhte Nutzlast	13.0460-4809.2	604809	BRE 24468 19,1 + WK + Zub
115 Multijet 2,0 D	85	06/11→	➔	Nutzlast schwer 17Q; Nutzlast [kg]: 1.700; für erhöhte Nutzlast	13.0460-4810.2	604810	BRE 24466 19,1 + WK + Zub
120 Multijet 2,3 D	88	07/06→	➔	Nutzlast 20Q; Nutzlast [kg]: 2.000	13.0460-4811.2	604811	BRE 24466 19,1 + WK + Zub
130 Multijet 2,3 D	93	01/10→	➔	Nutzlast 11Q/15Q/17Q; Nutzlast ab [kg] 1.100 Nutzlast bis [kg] 1.700; Baumuster: 30/33/35	13.0460-4812.2	604812	BOS 24465 19,2 - WE / - WK + Zub
130 Multijet 2,3 D	96	01/11→	➔				
140 Natural Power	100	04/09→	➔				
150 Multijet 2,3 D	109	06/11→	➔				
150 Multijet 3,0 D	107	04/10→	➔				
160 Multijet 3,0 D	115	10/06→	➔				
160 Multijet 3,0 D	116	07/06→	➔				
180 Multijet 2,3 D	130	12/15→	➔				
180 Multijet 3,0 D	130	06/11→	➔				

↓							
---	--	--	--	--	--	--	--

	kw			 	! #		
FIAT - DUCATO Bus (250_, 290_) 07/06→							
 Bremsbelagsatz, Scheibenbremse							
150 Multijet 2,3 D	110	04/15→	←	12/15→; Nutzlast 11Q/15Q; Nutzlast ab [kg] 1.100 Nutzlast bis [kg] 1.500	13.0460-4807.2	604807	BRE 24468 19,1 + WK + Zub
			←	12/15→; Nutzlast leicht 17Q; Nutzlast [kg]: 1.700; nicht für erhöhte Nutzlast	13.0460-4809.2	604809	BRE 24468 19,1 + WK + Zub
			←	12/15→; Nutzlast schwer 17Q; Nutzlast [kg]: 1.700; für erhöhte Nutzlast	13.0460-4810.2	604810	BRE 24466 19,1 + WK + Zub
			←	12/15→; Nutzlast [kg]: 2.000; Nutzlast 20Q	13.0460-4811.2	604811	BRE 24466 19,1 + WK + Zub
			→	12/15→; Nutzlast 11Q/15Q/17Q; Nutzlast ab [kg] 1.100 Nutzlast bis [kg] 1.700; Baumuster: 30/33/35	13.0460-4812.2	604812	BOS 24465 19,2 - WE / - WK + Zub
 Bremsscheibe							
100 Multijet 2,2 D	74	07/06→	←	Nutzlast 11Q/15Q; Nutzlast ab [kg] 1.100 Nutzlast bis [kg] 1.500	24.0124-0127.1	424127	Ø 280 24 21,9 V
110 Multijet 2,3 D	83	10/11→					
115 Multijet 2,0 D	85	06/11→	←	Nutzlast schwer 17Q; Nutzlast [kg]: 1.700; für erhöhte Nutzlast	24.0124-0138.1	424138	Ø 300 24 21,9 V
120 Multijet 2,3 D	88	07/06→					
130 Multijet 2,3 D	93	01/10→	←	Nutzlast leicht 17Q; Nutzlast [kg]: 1.700; nicht für erhöhte Nutzlast	24.0128-0213.1	428213	Ø 280 28 25,9 V
130 Multijet 2,3 D	96	01/11→					
140 Natural Power	100	04/09→	←	Nutzlast 20Q; Nutzlast [kg]: 2.000	24.0132-0131.1	432131	Ø 300 32 29,9 V
150 Multijet 2,3 D	109	06/11→					
150 Multijet 3,0 D	107	04/10→	→	Nutzlast 20Q; Nutzlast [kg]: 2.000	24.0116-0123.1	416123	Ø 300 16 14,2
160 Multijet 3,0 D	115	10/06→					
160 Multijet 3,0 D	116	07/06→	→	Nutzlast 11Q/15Q / leicht 17Q; Nutzlast ab [kg] 1.100 Nutzlast bis [kg] 1.700; nicht für erhöhte Nutzlast	24.0116-0124.1	416124	Ø 280 16 14,2
180 Multijet 3,0 D	130	06/11→	→	Nutzlast schwer 17Q; Nutzlast [kg]: 1.700; für erhöhte Nutzlast	24.0116-0125.1	416125	Ø 280 16 14,2
150 Multijet 2,3 D	110	04/15→	←	12/15→; Nutzlast 11Q/15Q; Nutzlast ab [kg] 1.100 Nutzlast bis [kg] 1.500	24.0124-0127.1	424127	Ø 280 24 21,9 V
			←	12/15→; Nutzlast schwer 17Q; Nutzlast [kg]: 1.700; für erhöhte Nutzlast	24.0124-0138.1	424138	Ø 300 24 21,9 V
			←	12/15→; Nutzlast leicht 17Q; Nutzlast [kg]: 1.700; nicht für erhöhte Nutzlast	24.0128-0213.1	428213	Ø 280 28 25,9 V
			←	12/15→; Nutzlast [kg]: 2.000; Nutzlast 20Q	24.0132-0131.1	432131	Ø 300 32 29,9 V
			→	12/15→; Nutzlast 20Q; Nutzlast [kg]: 2.000	24.0116-0123.1	416123	Ø 300 16 14,2
			→	12/15→; Nutzlast 11Q/15Q / leicht 17Q; Nutzlast ab [kg] 1.100 Nutzlast bis [kg] 1.700; nicht für erhöhte Nutzlast	24.0116-0124.1	416124	Ø 280 16 14,2
			→	12/15→; Nutzlast schwer 17Q; Nutzlast [kg]: 1.700; für erhöhte Nutzlast	24.0116-0125.1	416125	Ø 280 16 14,2
180 Multijet 2,3 D	130	12/15→	←	Nutzlast 11Q/15Q; Nutzlast ab [kg] 1.100 Nutzlast bis [kg] 1.500	24.0124-0127.1	424127	Ø 280 24 21,9 V
			←	Nutzlast schwer 17Q; Nutzlast [kg]: 1.700; für erhöhte Nutzlast	24.0124-0138.1	424138	Ø 300 24 21,9 V
			←	Nutzlast leicht 17Q; Nutzlast [kg]: 1.700; nicht für erhöhte Nutzlast	24.0128-0213.1	428213	Ø 280 28 25,9 V
			←	Nutzlast 20Q; Nutzlast [kg]: 2.000	24.0132-0131.1	432131	Ø 300 32 29,9 V
			→	Nutzlast 20Q; Nutzlast [kg]: 2.000	24.0116-0123.1	416123	Ø 300 16 14,2
			→	Nutzlast schwer 17Q; Nutzlast [kg]: 1.700; für erhöhte Nutzlast	24.0116-0125.1	416125	Ø 280 16 14,2
FIAT - DUCATO Kasten (230_) 03/94→04/02							
 Bremsbelagsatz, Scheibenbremse							
1.9 D	50	04/98→04/02	←	01/00→ 10/01; Nutzlast [kg]: 1.000	13.0460-2850.2	602850	TRW 21797 19,7 + WK
1.9 D	51	03/94→04/02	←	→ 12/99; Nutzlast [kg]: 1.000	13.0460-2976.2	602976	TRW 21797 19,7 + WK
1.9 TD	60	03/94→04/02					
1.9 TD	66	04/98→04/02	←	11/01→ 03/02; Nutzlast [kg]: 1.000	13.0460-4978.2	604978	BRE 23917 19,3 + WK + Zub
1.9 TD CAT	59	08/94→04/02	→	11/01→ 03/02; Nutzlast [kg]: 1.000	13.0460-4980.2	604980	BRE 23921 20,3 - WE / - WK + Zub
1.9 TD	59	05/98→11/01	←	01/00→ 10/01; Nutzlast [kg]: 1.000	13.0460-2850.2	602850	TRW 21797 19,7 + WK
			←	→ 12/99; Nutzlast [kg]: 1.000	13.0460-2976.2	602976	TRW 21797 19,7 + WK
			←	11/01→; Nutzlast [kg]: 1.000	13.0460-4978.2	604978	BRE 23917 19,3 + WK + Zub
			→	11/01→; Nutzlast [kg]: 1.000	13.0460-4980.2	604980	BRE 23921 20,3 - WE / - WK + Zub
2.0	80	03/94→04/02	←	01/00→ 10/01; Nutzlast ab [kg] 1.000 Nutzlast bis [kg] 1.400	13.0460-2850.2	602850	TRW 21797 19,7 + WK
2.0 4x4	80	11/94→04/02	←	01/00→ 10/01; Nutzlast [kg]: 1.800	13.0460-2852.2	602852	TRW 21799 19,7 + WK
↓							

	kw				! #		
FIAT - DUCATO Kasten (230_) 03/94 → 04/02							
Bremsbelagsatz, Scheibenbremse							
2.0 2.0 4x4	80 80	03/94 → 04/02 11/94 → 04/02	←	→ 12/99; Nutzlast ab [kg] 1.000 Nutzlast bis [kg] 1.400		13.0460-2976.2 602976	TRW 21797 19,7 + WK
			←	→ 12/99; Nutzlast [kg]: 1.800		13.0460-2977.2 602977	TRW 21799 19,7 + WK
			←	11/01 → 03/02; Nutzlast ab [kg] 1.000 Nutzlast bis [kg] 1.400		13.0460-4978.2 604978	BRE 23917 19,3 + WK + Zub
			←	11/01 → 03/02; Nutzlast [kg]: 1.800		13.0460-4979.2 604979	BRE 23919 19,3 + WK + Zub
			→	11/01 → 03/02; Nutzlast ab [kg] 1.000 Nutzlast bis [kg] 1.800		13.0460-4980.2 604980	BRE 23921 20,3 - WE / - WK + Zub
2.0 JTD	62	10/01 → 04/02	←	→ 03/02; Nutzlast [kg]: 1.400		13.0460-4978.2 604978	BRE 23917 19,3 + WK + Zub
			←	→ 03/02; Nutzlast [kg]: 1.800		13.0460-4979.2 604979	BRE 23919 19,3 + WK + Zub
			→	→ 03/02; Nutzlast ab [kg] 1.400 Nutzlast bis [kg] 1.800		13.0460-4980.2 604980	BRE 23921 20,3 - WE / - WK + Zub
2.5 D 2.5 D 4x4 2.5 TDI 2.5 TDI 2.5 TDI 4x4 2.8 D 2.8 D 4x4 2.8 TDI 2.8 TDI 4x4	62 62 80 85 85 64 64 90 90	03/94 → 04/02 03/94 → 04/02 03/94 → 04/02 03/94 → 04/02 05/98 → 04/02 05/98 → 04/02 08/98 → 04/02 10/97 → 04/02 06/99 → 04/02	←	01/00 → 10/01; Nutzlast [kg]: 1.400		13.0460-2850.2 602850	TRW 21797 19,7 + WK
			←	01/00 → 10/01; Nutzlast [kg]: 1.800		13.0460-2852.2 602852	TRW 21799 19,7 + WK
			←	→ 12/99; Nutzlast [kg]: 1.400		13.0460-2976.2 602976	TRW 21797 19,7 + WK
			←	→ 12/99; Nutzlast [kg]: 1.800		13.0460-2977.2 602977	TRW 21799 19,7 + WK
			←	11/01 → 03/02; Nutzlast [kg]: 1.400		13.0460-4978.2 604978	BRE 23917 19,3 + WK + Zub
			←	11/01 → 03/02; Nutzlast [kg]: 1.800		13.0460-4979.2 604979	BRE 23919 19,3 + WK + Zub
			→	11/01 → 03/02; Nutzlast ab [kg] 1.400 Nutzlast bis [kg] 1.800		13.0460-4980.2 604980	BRE 23921 20,3 - WE / - WK + Zub
2.5 TD 2.5 TD 4x4 2.5 TD 4x4	80 80 85	06/94 → 08/98 11/94 → 04/98 11/94 → 04/98	←	Nutzlast [kg]: 1.400		13.0460-2976.2 602976	TRW 21797 19,7 + WK
			←	Nutzlast [kg]: 1.800		13.0460-2977.2 602977	TRW 21799 19,7 + WK
2.8 JTD 2.8 JTD 4x4	94 94	11/00 → 04/02 11/00 → 04/02	←	→ 10/01; Nutzlast [kg]: 1.400		13.0460-2850.2 602850	TRW 21797 19,7 + WK
			←	→ 10/01; Nutzlast [kg]: 1.800		13.0460-2852.2 602852	TRW 21799 19,7 + WK
			←	11/01 → 03/02; Nutzlast [kg]: 1.400		13.0460-4978.2 604978	BRE 23917 19,3 + WK + Zub
			←	11/01 → 03/02; Nutzlast [kg]: 1.800		13.0460-4979.2 604979	BRE 23919 19,3 + WK + Zub
			→	11/01 → 03/02; Nutzlast ab [kg] 1.400 Nutzlast bis [kg] 1.800		13.0460-4980.2 604980	BRE 23921 20,3 - WE / - WK + Zub
2.8 TD 4x4	90	05/98 → 09/01	←	01/00 → ; Nutzlast [kg]: 1.400		13.0460-2850.2 602850	TRW 21797 19,7 + WK
			←	01/00 → ; Nutzlast [kg]: 1.800		13.0460-2852.2 602852	TRW 21799 19,7 + WK
			←	→ 12/99; Nutzlast [kg]: 1.400		13.0460-2976.2 602976	TRW 21797 19,7 + WK
			←	→ 12/99; Nutzlast [kg]: 1.800		13.0460-2977.2 602977	TRW 21799 19,7 + WK
Bremsscheibe							
1.9 D 1.9 D 1.9 TD 1.9 TD 1.9 TD CAT	50 51 60 66 59	04/98 → 04/02 03/94 → 04/02 03/94 → 04/02 04/98 → 04/02 08/94 → 04/02	←	→ 10/01; Nutzlast [kg]: 1.000		24.0118-0108.1 418108	Ø 280 18 15,9
			←	11/01 → 03/02; Nutzlast [kg]: 1.000		24.0124-0127.1 424127	Ø 280 24 21,9 V
			→	11/01 → 03/02; Nutzlast [kg]: 1.000		24.0116-0124.1 416124	Ø 280 16 14,2
1.9 TD	59	05/98 → 11/01	←	→ 10/01; Nutzlast [kg]: 1.000		24.0118-0108.1 418108	Ø 280 18 15,9
			←	11/01 → ; Nutzlast [kg]: 1.000		24.0124-0127.1 424127	Ø 280 24 21,9 V
			→	11/01 → ; Nutzlast [kg]: 1.000		24.0116-0124.1 416124	Ø 280 16 14,2
2.0 2.0 4x4	80 80	03/94 → 04/02 11/94 → 04/02	←	→ 10/01; Nutzlast ab [kg] 1.000 Nutzlast bis [kg] 1.400		24.0118-0108.1 418108	Ø 280 18 15,9
			←	11/01 → 03/02; Nutzlast ab [kg] 1.000 Nutzlast bis [kg] 1.400		24.0124-0127.1 424127	Ø 280 24 21,9 V
			←	11/01 → 03/02; Nutzlast [kg]: 1.800		24.0124-0138.1 424138	Ø 300 24 21,9 V
			←	→ 10/01; Nutzlast [kg]: 1.800		24.0124-0138.1 424138	Ø 300 24 21,9 V
			→	11/01 → 03/02; Nutzlast ab [kg] 1.000 Nutzlast bis [kg] 1.400		24.0116-0124.1 416124	Ø 280 16 14,2
			→	11/01 → 03/02; Nutzlast [kg]: 1.800		24.0116-0125.1 416125	Ø 280 16 14,2
2.0 JTD	62	10/01 → 04/02	←	→ 03/02; Nutzlast [kg]: 1.400		24.0124-0127.1 424127	Ø 280 24 21,9 V
			←	→ 03/02; Nutzlast [kg]: 1.800		24.0124-0138.1 424138	Ø 300 24 21,9 V
			→	→ 03/02; Nutzlast [kg]: 1.400		24.0116-0124.1 416124	Ø 280 16 14,2
			→	→ 03/02; Nutzlast [kg]: 1.800		24.0116-0125.1 416125	Ø 280 16 14,2
2.5 D 2.5 D 4x4 2.8 D 2.8 D 4x4	62 62 64 64	03/94 → 04/02 03/94 → 04/02 05/98 → 04/02 08/98 → 04/02	←	→ 10/01; Nutzlast [kg]: 1.400		24.0118-0108.1 418108	Ø 280 18 15,9
			←	11/01 → 03/02; Nutzlast [kg]: 1.400		24.0124-0127.1 424127	Ø 280 24 21,9 V
			←	11/01 → 03/02; Nutzlast [kg]: 1.800		24.0124-0138.1 424138	Ø 300 24 21,9 V
			←	→ 10/01; Nutzlast [kg]: 1.800		24.0124-0138.1 424138	Ø 300 24 21,9 V
			→	11/01 → 03/02; Nutzlast [kg]: 1.400		24.0116-0124.1 416124	Ø 280 16 14,2

FIAT - DUCATO Kasten (230_) 03/94 → 04/02

Bremscheibe							
2.5 D	62	03/94 → 04/02	➔	11/01 → 03/02; Nutzlast [kg]: 1.800		24.0116-0125.1 416125	Ø 280 16 14,2
2.5 D 4x4	62	03/94 → 04/02					
2.8 D	64	05/98 → 04/02					
2.8 D 4x4	64	08/98 → 04/02					
2.5 TD	80	06/94 → 08/98	➔	Nutzlast [kg]: 1.400		24.0124-0127.1 424127	Ø 280 24 21,9 V
2.5 TD 4x4	80	11/94 → 04/98					
2.5 TD 4x4	85	11/94 → 04/98	➔	Nutzlast [kg]: 1.800		24.0124-0138.1 424138	Ø 300 24 21,9 V
2.8 TD 4x4	90	05/98 → 09/01					
2.5 TDI	80	03/94 → 04/02	➔	11/01 → 03/02; Nutzlast [kg]: 1.400		24.0124-0127.1 424127	Ø 280 24 21,9 V
2.5 TDI	85	03/94 → 04/02					
2.5 TDI 4x4	85	05/98 → 04/02	➔	→ 10/01; Nutzlast [kg]: 1.400		24.0124-0127.1 424127	Ø 280 24 21,9 V
2.8 JTD	94	11/00 → 04/02	➔	11/01 → 03/02; Nutzlast [kg]: 1.800		24.0124-0138.1 424138	Ø 300 24 21,9 V
2.8 JTD 4x4	94	11/00 → 04/02					
2.8 TDI	90	10/97 → 04/02	➔	→ 10/01; Nutzlast [kg]: 1.800		24.0124-0138.1 424138	Ø 300 24 21,9 V
2.8 TDI 4x4	90	06/99 → 04/02	➔	11/01 → 03/02; Nutzlast [kg]: 1.400		24.0116-0124.1 416124	Ø 280 16 14,2
			➔	11/01 → 03/02; Nutzlast [kg]: 1.800		24.0116-0125.1 416125	Ø 280 16 14,2

FIAT - DUCATO Kasten (244_) 04/02 →

Bremsbelagsatz, Scheibenbremse							
2.0	81	04/02 →	➔	→ 07/06; Nutzlast ab [kg] 1.100 Nutzlast bis [kg] 1.500		13.0460-4978.2 604978	BRE 23917 19,3 + WK + Zub
2.0 Bipower	81	11/02 →					
2.0 JTD	62	04/02 →	➔	→ 07/06; Nutzlast bis [kg] 1.800		13.0460-4979.2 604979	BRE 23919 19,3 + WK + Zub
2.3 JTD	81	04/02 →					
2.8 JTD	94	04/02 →	➔	→ 07/06; Nutzlast ab [kg] 1.100 Nutzlast bis [kg] 1.800		13.0460-4980.2 604980	BRE 23921 20,3 - WE / - WK + Zub
2.8 JTD 4x4	94	07/02 →					
2.8 JTD Power	107	05/04 →					
2.0 4x4	81	05/02 → 07/06	➔	Nutzlast ab [kg] 1.100 Nutzlast bis [kg] 1.500		13.0460-4978.2 604978	BRE 23917 19,3 + WK + Zub
2.8 TD	90	04/02 → 07/06	➔	Nutzlast ab [kg] 1.100 Nutzlast bis [kg] 1.500		13.0460-4978.2 604978	BRE 23917 19,3 + WK + Zub
			➔	Nutzlast bis [kg] 1.800		13.0460-4979.2 604979	BRE 23919 19,3 + WK + Zub
			➔	Nutzlast ab [kg] 1.100 Nutzlast bis [kg] 1.800		13.0460-4980.2 604980	BRE 23921 20,3 - WE / - WK + Zub

Bremscheibe							
2.0	81	04/02 →	➔	→ 07/06; Nutzlast ab [kg] 1.100 Nutzlast bis [kg] 1.500		24.0124-0127.1 424127	Ø 280 24 21,9 V
2.0 Bipower	81	11/02 →					
2.0 JTD	62	04/02 →	➔	→ 07/06; Nutzlast [kg]: 1.800		24.0124-0138.1 424138	Ø 300 24 21,9 V
2.3 JTD	81	04/02 →					
2.8 JTD	94	04/02 →	➔	→ 07/06; Nutzlast ab [kg] 1.100 Nutzlast bis [kg] 1.500		24.0116-0124.1 416124	Ø 280 16 14,2
2.8 JTD 4x4	94	07/02 →					
2.8 JTD Power	107	05/04 →	➔	→ 07/06; Nutzlast [kg]: 1.800		24.0116-0125.1 416125	Ø 280 16 14,2
2.0 4x4	81	05/02 → 07/06	➔	Nutzlast ab [kg] 1.100 Nutzlast bis [kg] 1.500		24.0124-0127.1 424127	Ø 280 24 21,9 V
			➔	Nutzlast ab [kg] 1.100 Nutzlast bis [kg] 1.500		24.0116-0124.1 416124	Ø 280 16 14,2
2.8 TD	90	04/02 → 07/06	➔	Nutzlast ab [kg] 1.100 Nutzlast bis [kg] 1.500		24.0124-0127.1 424127	Ø 280 24 21,9 V
			➔	Nutzlast [kg]: 1.800		24.0124-0138.1 424138	Ø 300 24 21,9 V
			➔	Nutzlast ab [kg] 1.100 Nutzlast bis [kg] 1.500		24.0116-0124.1 416124	Ø 280 16 14,2
			➔	Nutzlast [kg]: 1.800		24.0116-0125.1 416125	Ø 280 16 14,2

FIAT - DUCATO Kasten (250_, 290_) 07/06 →

Bremsbelagsatz, Scheibenbremse							
100 Multijet 2,2 D	74	07/06 →	➔	Nutzlast 11Q/15Q; Nutzlast ab [kg] 1.100 Nutzlast bis [kg] 1.500		13.0460-4807.2 604807	BRE 24468 19,1 + WK + Zub
110 Multijet 2,3 D	83	10/11 →					
115 Multijet 2,0 D	85	06/11 →	➔	Nutzlast leicht 17Q; Nutzlast [kg]: 1.700; nicht für erhöhte Nutzlast		13.0460-4809.2 604809	BRE 24468 19,1 + WK + Zub
120 Multijet 2,3 D	88	07/06 →					
120 Multijet 2,3 D 4x4	88	03/10 →	➔	Nutzlast schwer 17Q; für erhöhte Nutzlast; Nutzlast [kg]: 1.700		13.0460-4810.2 604810	BRE 24466 19,1 + WK + Zub
130 Multijet 2,3 D	96	01/11 →					
140 Natural Power	100	04/09 →	➔	Nutzlast 20Q; Nutzlast [kg]: 2.000		13.0460-4811.2 604811	BRE 24466 19,1 + WK + Zub
150 Multijet 2,3 D	109	06/11 →					
150 Multijet 2,3 D	110	12/15 →	➔	Nutzlast 11Q/15Q/17Q; Nutzlast ab [kg] 1.100 Nutzlast bis [kg] 1.700; Baumuster: 30/33/35		13.0460-4812.2 604812	BOS 24465 19,2 - WE / - WK + Zub
150 Multijet 3,0 D	107	04/10 →					
160 Multijet 3,0 D	115	07/06 → 12/11					
160 Multijet 3,0 D	116	07/06 →					
180 Multijet 2,3 D	130	12/15 →					
180 Multijet 3,0 D	130	06/11 →					
130 Multijet 2,3 D	93	08/06 →	➔	01/07 →; Nutzlast 11Q/15Q; Nutzlast ab [kg] 1.100 Nutzlast bis [kg] 1.500		13.0460-4807.2 604807	BRE 24468 19,1 + WK + Zub
			➔	01/07 →; Nutzlast leicht 17Q; Nutzlast [kg]: 1.700; nicht für erhöhte Nutzlast		13.0460-4809.2 604809	BRE 24468 19,1 + WK + Zub



FIAT - DUCATO Kasten (250_, 290_) 07/06→

Bremsbelagsatz, Scheibenbremse

130 Multijet 2,3 D	93	08/06→	←	01/07→; Nutzlast schwer 17Q; Nutzlast [kg]: 1.700; für erhöhte Nutzlast	13.0460-4810.2	604810	BRE 24466 19,1 + WK + Zub
			←	01/07→; Nutzlast 20Q; Nutzlast [kg]: 2.000	13.0460-4811.2	604811	BRE 24466 19,1 + WK + Zub
			→	01/07→; Nutzlast 11Q/15Q/17Q; Nutzlast ab [kg] 1.100 Nutzlast bis [kg] 1.700; Baumuster: 30/33/35	13.0460-4812.2	604812	BOS 24465 19,2 - WE / - WK + Zub

Bremsscheibe







100 Multijet 2,2 D 110 Multijet 2,3 D 115 Multijet 2,0 D 120 Multijet 2,3 D 120 Multijet 2,3 D 4x4 130 Multijet 2,3 D 140 Natural Power 150 Multijet 2,3 D 150 Multijet 2,3 D 150 Multijet 3,0 D 160 Multijet 3,0 D 160 Multijet 3,0 D 180 Multijet 3,0 D	74 83 85 88 88 96 100 109 110 107 115 116 130	07/06→ 10/11→ 06/11→ 07/06→ 03/10→ 01/11→ 04/09→ 06/11→ 12/15→ 04/10→ 07/06→12/11 07/06→ 06/11→	←	Nutzlast 11Q/15Q; Nutzlast ab [kg] 1.100 Nutzlast bis [kg] 1.500	24.0124-0127.1	424127	Ø 280 24 21,9 V
			←	Nutzlast schwer 17Q; Nutzlast [kg]: 1.700; für erhöhte Nutzlast	24.0124-0138.1	424138	Ø 300 24 21,9 V
			←	Nutzlast leicht 17Q; Nutzlast [kg]: 1.700; nicht für erhöhte Nutzlast	24.0128-0213.1	428213	Ø 280 28 25,9 V
			←	Nutzlast 20Q; Nutzlast [kg]: 2.000	24.0132-0131.1	432131	Ø 300 32 29,9 V
			→	Nutzlast 20Q; Nutzlast [kg]: 2.000	24.0116-0123.1	416123	Ø 300 16 14,2
			→	Nutzlast 11Q/15Q / leicht 17Q; Nutzlast ab [kg] 1.100 Nutzlast bis [kg] 1.700; nicht für erhöhte Nutzlast	24.0116-0124.1	416124	Ø 280 16 14,2
			→	Nutzlast schwer 17Q; Nutzlast [kg]: 1.700; für erhöhte Nutzlast	24.0116-0125.1	416125	Ø 280 16 14,2
			←	01/07→; Nutzlast 11Q/15Q; Nutzlast ab [kg] 1.100 Nutzlast bis [kg] 1.500	24.0124-0127.1	424127	Ø 280 24 21,9 V
			←	01/07→; Nutzlast schwer 17Q; Nutzlast [kg]: 1.700; für erhöhte Nutzlast	24.0124-0138.1	424138	Ø 300 24 21,9 V
			←	01/07→; Nutzlast leicht 17Q; Nutzlast [kg]: 1.700; nicht für erhöhte Nutzlast	24.0128-0213.1	428213	Ø 280 28 25,9 V
			←	01/07→; Nutzlast 20Q; Nutzlast [kg]: 2.000	24.0132-0131.1	432131	Ø 300 32 29,9 V
			→	01/07→; Nutzlast 20Q; Nutzlast [kg]: 2.000	24.0116-0123.1	416123	Ø 300 16 14,2
			→	01/07→; Nutzlast 11Q/15Q / leicht 17Q; Nutzlast ab [kg] 1.100 Nutzlast bis [kg] 1.700; nicht für erhöhte Nutzlast	24.0116-0124.1	416124	Ø 280 16 14,2
			→	01/07→; Nutzlast schwer 17Q; Nutzlast [kg]: 1.700; für erhöhte Nutzlast	24.0116-0125.1	416125	Ø 280 16 14,2
130 Multijet 2,3 D	93	08/06→	←	Nutzlast 11Q/15Q; Nutzlast ab [kg] 1.100 Nutzlast bis [kg] 1.500	24.0124-0127.1	424127	Ø 280 24 21,9 V
			←	Nutzlast schwer 17Q; Nutzlast [kg]: 1.700; für erhöhte Nutzlast	24.0124-0138.1	424138	Ø 300 24 21,9 V
			←	Nutzlast leicht 17Q; Nutzlast [kg]: 1.700; nicht für erhöhte Nutzlast	24.0128-0213.1	428213	Ø 280 28 25,9 V
			←	Nutzlast 20Q; Nutzlast [kg]: 2.000	24.0132-0131.1	432131	Ø 300 32 29,9 V
			→	Nutzlast 20Q; Nutzlast [kg]: 2.000	24.0116-0123.1	416123	Ø 300 16 14,2
			→	Nutzlast 11Q/15Q / leicht 17Q; Nutzlast ab [kg] 1.100 Nutzlast bis [kg] 1.700; nicht für erhöhte Nutzlast	24.0116-0124.1	416124	Ø 280 16 14,2
180 Multijet 2,3 D	130	12/15→	←	Nutzlast 11Q/15Q; Nutzlast ab [kg] 1.100 Nutzlast bis [kg] 1.500	24.0124-0127.1	424127	Ø 280 24 21,9 V
			←	Nutzlast schwer 17Q; Nutzlast [kg]: 1.700; für erhöhte Nutzlast	24.0124-0138.1	424138	Ø 300 24 21,9 V
			←	Nutzlast leicht 17Q; Nutzlast [kg]: 1.700; nicht für erhöhte Nutzlast	24.0128-0213.1	428213	Ø 280 28 25,9 V
			←	Nutzlast 20Q; Nutzlast [kg]: 2.000	24.0132-0131.1	432131	Ø 300 32 29,9 V
			→	Nutzlast 20Q; Nutzlast [kg]: 2.000	24.0116-0123.1	416123	Ø 300 16 14,2
			→	Nutzlast schwer 17Q; Nutzlast [kg]: 1.700; für erhöhte Nutzlast	24.0116-0125.1	416125	Ø 280 16 14,2

FIAT - DUCATO Pritsche/Fahrgestell (230_) 03/94→04/02

Bremsbelagsatz, Scheibenbremse

1.9 D	50	04/98→04/02	←	01/00→ 10/01; Nutzlast [kg]: 1.000	13.0460-2850.2	602850	TRW 21797 19,7 + WK
			←	→ 12/99; Nutzlast [kg]: 1.000	13.0460-2976.2	602976	TRW 21797 19,7 + WK
1.9 TD	60	03/94→04/02	←	11/01→ 03/02; Nutzlast [kg]: 1.000	13.0460-4978.2	604978	BRE 23917 19,3 + WK + Zub
			→	11/01→ 03/02; Nutzlast [kg]: 1.000	13.0460-4980.2	604980	BRE 23921 20,3 - WE / - WK + Zub
1.9 TD	59	05/98→11/01	←	01/00→ 10/01; Nutzlast [kg]: 1.000	13.0460-2850.2	602850	TRW 21797 19,7 + WK
			←	→ 12/99; Nutzlast [kg]: 1.000	13.0460-2976.2	602976	TRW 21797 19,7 + WK
			←	11/01→; Nutzlast [kg]: 1.000	13.0460-4978.2	604978	BRE 23917 19,3 + WK + Zub
			→	11/01→; Nutzlast [kg]: 1.000	13.0460-4980.2	604980	BRE 23921 20,3 - WE / - WK + Zub
2.0	80	03/94→04/02	←	01/00→ 10/01; Nutzlast ab [kg] 1.000 Nutzlast bis [kg] 1.400	13.0460-2850.2	602850	TRW 21797 19,7 + WK
			←	01/00→ 10/01; Nutzlast [kg]: 1.800	13.0460-2852.2	602852	TRW 21799 19,7 + WK
			←	→ 12/99; Nutzlast ab [kg] 1.000 Nutzlast bis [kg] 1.400	13.0460-2976.2	602976	TRW 21797 19,7 + WK
			←	→ 12/99; Nutzlast [kg]: 1.800	13.0460-2977.2	602977	TRW 21799 19,7 + WK
			←	11/01→ 03/02; Nutzlast ab [kg] 1.000 Nutzlast bis [kg] 1.400	13.0460-4978.2	604978	BRE 23917 19,3 + WK + Zub



	kw				! #		
FIAT - DUCATO Pritsche/Fahrgestell (230_) 03/94→04/02							
Bremsbelagsatz, Scheibenbremse							
2.0	80	03/94→04/02	←	11/01→ 03/02; Nutzlast [kg]: 1.800		13.0460-4979.2 604979	BRE 23919 19,3 + WK + Zub
			→	11/01→ 03/02; Nutzlast ab [kg] 1.000 Nutzlast bis [kg] 1.800		13.0460-4980.2 604980	BRE 23921 20,3 - WE / - WK + Zub
2.0 JTD	62	07/01→04/02	←	10/01→ 03/02; Nutzlast [kg]: 1.400		13.0460-4978.2 604978	BRE 23917 19,3 + WK + Zub
			←	10/01→ 03/02; Nutzlast [kg]: 1.800		13.0460-4979.2 604979	BRE 23919 19,3 + WK + Zub
			→	10/01→ 03/02; Nutzlast ab [kg] 1.400 Nutzlast bis [kg] 1.800		13.0460-4980.2 604980	BRE 23921 20,3 - WE / - WK + Zub
2.5 D	62	03/94→04/02	←	01/00→ 10/01; Nutzlast [kg]: 1.400		13.0460-2850.2 602850	TRW 21797 19,7 + WK
2.5 D 4x4	62	03/94→04/02	←	01/00→ 10/01; Nutzlast [kg]: 1.800		13.0460-2852.2 602852	TRW 21799 19,7 + WK
2.5 TDI	80	03/94→04/02	←	→ 12/99; Nutzlast [kg]: 1.400		13.0460-2976.2 602976	TRW 21797 19,7 + WK
2.5 TDI	85	03/94→04/02	←	→ 12/99; Nutzlast [kg]: 1.800		13.0460-2977.2 602977	TRW 21799 19,7 + WK
2.5 TDI 4x4	85	06/98→04/02	←	→ 12/99; Nutzlast [kg]: 1.800		13.0460-2977.2 602977	TRW 21799 19,7 + WK
2.8 D	64	02/98→04/02	←	→ 12/99; Nutzlast [kg]: 1.800		13.0460-2977.2 602977	TRW 21799 19,7 + WK
2.8 TDI	90	12/98→04/02	←	11/01→ 03/02; Nutzlast [kg]: 1.400		13.0460-4978.2 604978	BRE 23917 19,3 + WK + Zub
			←	11/01→ 03/02; Nutzlast [kg]: 1.800		13.0460-4979.2 604979	BRE 23919 19,3 + WK + Zub
			→	11/01→ 03/02; Nutzlast ab [kg] 1.400 Nutzlast bis [kg] 1.800		13.0460-4980.2 604980	BRE 23921 20,3 - WE / - WK + Zub
2.5 TD	80	06/94→08/98	←	Nutzlast [kg]: 1.400		13.0460-2976.2 602976	TRW 21797 19,7 + WK
2.5 TD	85	06/94→04/98	←	Nutzlast [kg]: 1.800		13.0460-2977.2 602977	TRW 21799 19,7 + WK
2.5 TD 4x4	85	11/94→04/98	←	Nutzlast [kg]: 1.800		13.0460-2977.2 602977	TRW 21799 19,7 + WK
2.8 iDTD 4x4	90	05/98→09/01	←	01/00→; Nutzlast [kg]: 1.400		13.0460-2850.2 602850	TRW 21797 19,7 + WK
			←	01/00→; Nutzlast [kg]: 1.800		13.0460-2852.2 602852	TRW 21799 19,7 + WK
			←	→ 12/99; Nutzlast [kg]: 1.400		13.0460-2976.2 602976	TRW 21797 19,7 + WK
			←	→ 12/99; Nutzlast [kg]: 1.800		13.0460-2977.2 602977	TRW 21799 19,7 + WK
2.8 JTD	94	11/00→04/02	←	→ 10/01; Nutzlast [kg]: 1.400		13.0460-2850.2 602850	TRW 21797 19,7 + WK
2.8 JTD	94	03/01→04/02	←	→ 10/01; Nutzlast [kg]: 1.800		13.0460-2852.2 602852	TRW 21799 19,7 + WK
2.8 JTD 4x4	94	10/01→04/02	←	→ 10/01; Nutzlast [kg]: 1.800		13.0460-2852.2 602852	TRW 21799 19,7 + WK
			←	11/01→ 03/02; Nutzlast [kg]: 1.400		13.0460-4978.2 604978	BRE 23917 19,3 + WK + Zub
			←	11/01→ 03/02; Nutzlast [kg]: 1.800		13.0460-4979.2 604979	BRE 23919 19,3 + WK + Zub
			→	11/01→ 03/02; Nutzlast ab [kg] 1.400 Nutzlast bis [kg] 1.800		13.0460-4980.2 604980	BRE 23921 20,3 - WE / - WK + Zub
2.8 TD 4x4	64	05/98→11/01	←	01/00→ 09/01; Nutzlast [kg]: 1.400		13.0460-2850.2 602850	TRW 21797 19,7 + WK
			←	01/00→ 10/01; Nutzlast [kg]: 1.800		13.0460-2852.2 602852	TRW 21799 19,7 + WK
			←	→ 12/99; Nutzlast [kg]: 1.400		13.0460-2976.2 602976	TRW 21797 19,7 + WK
			←	→ 12/99; Nutzlast [kg]: 1.800		13.0460-2977.2 602977	TRW 21799 19,7 + WK
Bremsscheibe							
1.9 D	50	04/98→04/02	←	→ 10/01; Nutzlast [kg]: 1.000		24.0118-0108.1 418108	Ø 280 18 15,9
1.9 D	51	03/94→04/02	←	→ 10/01; Nutzlast [kg]: 1.000		24.0124-0127.1 424127	Ø 280 24 21,9 V
1.9 TD	60	03/94→04/02	←	11/01→ 03/02; Nutzlast [kg]: 1.000		24.0118-0108.1 418108	Ø 280 18 15,9
1.9 TD	66	04/98→04/02	→	11/01→ 03/02; Nutzlast [kg]: 1.000		24.0116-0124.1 416124	Ø 280 16 14,2
1.9 TD CAT	59	08/94→04/02	←	→ 10/01; Nutzlast [kg]: 1.000		24.0118-0108.1 418108	Ø 280 18 15,9
1.9 TD	59	05/98→11/01	←	→ 10/01; Nutzlast [kg]: 1.000		24.0118-0108.1 418108	Ø 280 18 15,9
			←	11/01→; Nutzlast [kg]: 1.000		24.0124-0127.1 424127	Ø 280 24 21,9 V
			→	11/01→; Nutzlast [kg]: 1.000		24.0116-0124.1 416124	Ø 280 16 14,2
2.0	80	03/94→04/02	←	→ 10/01; Nutzlast ab [kg] 1.000 Nutzlast bis [kg] 1.400		24.0118-0108.1 418108	Ø 280 18 15,9
			←	11/01→ 03/02; Nutzlast ab [kg] 1.000 Nutzlast bis [kg] 1.400		24.0124-0127.1 424127	Ø 280 24 21,9 V
			←	11/01→ 03/02; Nutzlast [kg]: 1.800		24.0124-0138.1 424138	Ø 300 24 21,9 V
			←	→ 10/01; Nutzlast [kg]: 1.800		24.0124-0138.1 424138	Ø 300 24 21,9 V
			→	11/01→ 03/02; Nutzlast ab [kg] 1.000 Nutzlast bis [kg] 1.400		24.0116-0124.1 416124	Ø 280 16 14,2
			→	11/01→ 03/02; Nutzlast [kg]: 1.800		24.0116-0125.1 416125	Ø 280 16 14,2
2.0 JTD	62	07/01→04/02	←	10/01→ 03/02; Nutzlast [kg]: 1.400		24.0124-0127.1 424127	Ø 280 24 21,9 V
			←	10/01→ 03/02; Nutzlast [kg]: 1.800		24.0124-0138.1 424138	Ø 300 24 21,9 V
			→	10/01→ 03/02; Nutzlast [kg]: 1.400		24.0116-0124.1 416124	Ø 280 16 14,2
			→	10/01→ 03/02; Nutzlast [kg]: 1.800		24.0116-0125.1 416125	Ø 280 16 14,2
2.5 D	62	03/94→04/02	←	→ 10/01; Nutzlast [kg]: 1.400		24.0118-0108.1 418108	Ø 280 18 15,9
2.5 D 4x4	62	03/94→04/02	←	11/01→ 03/02; Nutzlast [kg]: 1.400		24.0124-0127.1 424127	Ø 280 24 21,9 V
2.8 D	64	02/98→04/02	←	11/01→ 03/02; Nutzlast [kg]: 1.800		24.0124-0138.1 424138	Ø 300 24 21,9 V
			←	→ 10/01; Nutzlast [kg]: 1.800		24.0124-0138.1 424138	Ø 300 24 21,9 V
↓							



FIAT - DUCATO Pritsche/Fahrgestell (230_) 03/94→04/02

Bremsscheibe

2.5 D	62	03/94→04/02	➔	11/01→ 03/02; Nutzlast [kg]: 1.400	24.0116-0124.1	416124	Ø 280 16 14,2
2.5 D 4x4	62	03/94→04/02	➔	11/01→ 03/02; Nutzlast [kg]: 1.800	24.0116-0125.1	416125	Ø 280 16 14,2
2.8 D	64	02/98→04/02					
2.5 TD	80	06/94→08/98	←	Nutzlast [kg]: 1.400	24.0124-0127.1	424127	Ø 280 24 21,9 V
2.5 TD	85	06/94→04/98	←	Nutzlast [kg]: 1.800	24.0124-0138.1	424138	Ø 300 24 21,9 V
2.5 TD 4x4	85	11/94→04/98					
2.8 iDTD 4x4	90	05/98→09/01					
2.5 TDI	80	03/94→04/02	←	11/01→ 03/02; Nutzlast [kg]: 1.400	24.0124-0127.1	424127	Ø 280 24 21,9 V
2.5 TDI	85	03/94→04/02	←	→ 10/01; Nutzlast [kg]: 1.400	24.0124-0127.1	424127	Ø 280 24 21,9 V
2.5 TDI 4x4	85	06/98→04/02					
2.8 JTD	94	11/00→04/02	←	11/01→ 03/02; Nutzlast [kg]: 1.800	24.0124-0138.1	424138	Ø 300 24 21,9 V
2.8 JTD	94	03/01→04/02	←	→ 10/01; Nutzlast [kg]: 1.800	24.0124-0138.1	424138	Ø 300 24 21,9 V
2.8 JTD 4x4	94	10/01→04/02					
2.8 TDI	90	12/98→04/02	➔	11/01→ 03/02; Nutzlast [kg]: 1.400	24.0116-0124.1	416124	Ø 280 16 14,2
			➔	11/01→ 03/02; Nutzlast [kg]: 1.800	24.0116-0125.1	416125	Ø 280 16 14,2
2.8 TD 4x4	64	05/98→11/01	←	→ 09/01; Nutzlast [kg]: 1.400	24.0124-0127.1	424127	Ø 280 24 21,9 V
			←	→ 09/01; Nutzlast [kg]: 1.800	24.0124-0138.1	424138	Ø 300 24 21,9 V

FIAT - DUCATO Pritsche/Fahrgestell (244_) 04/02→

Bremsbelagsatz, Scheibenbremse

2.0	81	04/02→07/06	←	Nutzlast ab [kg] 1.100 Nutzlast bis [kg] 1.500	13.0460-4978.2	604978	BRE 23917 19,3 + WK + Zub
2.0 JTD	62	04/02→07/06	←	Nutzlast bis [kg] 1.800	13.0460-4979.2	604979	BRE 23919 19,3 + WK + Zub
2.3 JTD	81	04/02→07/06					
2.8 JTD	90	11/03→07/06	➔	Nutzlast ab [kg] 1.100 Nutzlast bis [kg] 1.800	13.0460-4980.2	604980	BRE 23921 20,3 - WE / - WK + Zub
2.8 JTD	94	04/02→07/06					
2.8 JTD 4x4	94	10/02→07/06					
2.8 JTD Power	107	05/04→07/06	➔	Nutzlast [kg]: 1.800			

Bremsscheibe

2.0	81	04/02→07/06	←	Nutzlast ab [kg] 1.100 Nutzlast bis [kg] 1.500	24.0124-0127.1	424127	Ø 280 24 21,9 V
2.0 JTD	62	04/02→07/06	←	Nutzlast [kg]: 1.800	24.0124-0138.1	424138	Ø 300 24 21,9 V
2.3 JTD	81	04/02→07/06					
2.8 JTD	90	11/03→07/06	➔	Nutzlast ab [kg] 1.100 Nutzlast bis [kg] 1.500	24.0116-0124.1	416124	Ø 280 16 14,2
2.8 JTD	94	04/02→07/06					
2.8 JTD 4x4	94	10/02→07/06					
2.8 JTD Power	107	05/04→07/06	➔	Nutzlast [kg]: 1.800	24.0116-0125.1	416125	Ø 280 16 14,2











FIAT - DUCATO Pritsche/Fahrgestell (250_, 290_) 07/06→















Bremsbelagsatz, Scheibenbremse











100 Multijet 2,2 D	74	07/06→	←	Nutzlast 11Q/15Q; Nutzlast ab [kg] 1.100 Nutzlast bis [kg] 1.500	13.0460-4807.2	604807	BRE 24468 19,1 + WK + Zub
110 Multijet 2,3 D	83	10/11→					
115 Multijet 2,0 D	85	06/11→	←	Nutzlast leicht 17Q; Nutzlast [kg]: 1.700; nicht für erhöhte Nutzlast	13.0460-4809.2	604809	BRE 24468 19,1 + WK + Zub
120 Multijet 2,3 D	88	07/06→					
120 Multijet 2,3 D 4x4	88	03/10→	←	Nutzlast schwer 17Q; Nutzlast [kg]: 1.700; für erhöhte Nutzlast	13.0460-4810.2	604810	BRE 24466 19,1 + WK + Zub
140 Natural Power	100	04/09→					
150 Multijet 2,3 D	109	06/11→	←	Nutzlast 20Q; Nutzlast [kg]: 2.000	13.0460-4811.2	604811	BRE 24466 19,1 + WK + Zub
150 Multijet 2,3 D	110	12/15→					
150 Multijet 3,0 D	107	04/10→	➔	Nutzlast 11Q/15Q/17Q; Nutzlast ab [kg] 1.100 Nutzlast bis [kg] 1.700; Baumuster: 30/33/35	13.0460-4812.2	604812	BOS 24465 19,2 - WE / - WK + Zub
160 Multijet 3,0 D	115	07/06→12/11					
160 Multijet 3,0 D	116	07/06→					
180 Multijet 2,3 D	130	12/15→	←	01/07→; Nutzlast 11Q/15Q; Nutzlast ab [kg] 1.100 Nutzlast bis [kg] 1.500	13.0460-4807.2	604807	BRE 24468 19,1 + WK + Zub
180 Multijet 3,0 D	130	12/15→					
130 Multijet 2,3 D	93	08/06→					
130 Multijet 2,3 D	96	10/06→					
			←	01/07→; Nutzlast leicht 17Q; Nutzlast [kg]: 1.700; nicht für erhöhte Nutzlast	13.0460-4809.2	604809	BRE 24468 19,1 + WK + Zub
			←	01/07→; Nutzlast schwer 17Q; Nutzlast [kg]: 1.700; für erhöhte Nutzlast	13.0460-4810.2	604810	BRE 24466 19,1 + WK + Zub
			←	01/07→; Nutzlast 20Q; Nutzlast [kg]: 2.000	13.0460-4811.2	604811	BRE 24466 19,1 + WK + Zub
			➔	01/07→; Nutzlast 11Q/15Q/17Q; Nutzlast ab [kg] 1.100 Nutzlast bis [kg] 1.700; Baumuster: 30/33/35	13.0460-4812.2	604812	BOS 24465 19,2 - WE / - WK + Zub







Bremsscheibe













100 Multijet 2,2 D	74	07/06→	←	Nutzlast 11Q/15Q; Nutzlast ab [kg] 1.100 Nutzlast bis [kg] 1.500	24.0124-0127.1	424127	Ø 280 24 21,9 V
110 Multijet 2,3 D	83	10/11→					
115 Multijet 2,0 D	85	06/11→	←	Nutzlast schwer 17Q; Nutzlast [kg]: 1.700; für erhöhte Nutzlast	24.0124-0138.1	424138	Ø 300 24 21,9 V
120 Multijet 2,3 D	88	07/06→					
120 Multijet 2,3 D 4x4	88	03/10→	←	Nutzlast leicht 17Q; Nutzlast [kg]: 1.700; nicht für erhöhte Nutzlast	24.0128-0213.1	428213	Ø 280 28 25,9 V
140 Natural Power	100	04/09→					
150 Multijet 2,3 D	109	06/11→	←	Nutzlast 20Q; Nutzlast [kg]: 2.000	24.0132-0131.1	432131	Ø 300 32 29,9 V
150 Multijet 2,3 D	110	12/15→					
150 Multijet 3,0 D	107	04/10→	➔	Nutzlast 20Q; Nutzlast [kg]: 2.000	24.0116-0123.1	416123	Ø 300 16 14,2

	kW				! #		
FIAT - DUCATO Pritsche/Fahrgestell (250_, 290_) 07/06→							
 Bremsscheibe							
160 Multijet 3,0 D 160 Multijet 3,0 D 180 Multijet 3,0 D	115 116 130	07/06→12/11 07/06→ 06/11→	➔	Nutzlast 11Q/15Q / leicht 17Q; Nutzlast ab [kg] 1.100 Nutzlast bis [kg] 1.700; nicht für erhöhte Nutzlast		24.0116-0124.1 416124	Ø 280 16 14,2
			➔	Nutzlast schwer 17Q; Nutzlast [kg]: 1.700; für erhöhte Nutzlast		24.0116-0125.1 416125	Ø 280 16 14,2
130 Multijet 2,3 D 130 Multijet 2,3 D	93 96	08/06→ 10/06→	➔	01/07→; Nutzlast 11Q/15Q; Nutzlast ab [kg] 1.100 Nutzlast bis [kg] 1.500		24.0124-0127.1 424127	Ø 280 24 21,9 V
			➔	01/07→; Nutzlast schwer 17Q; Nutzlast [kg]: 1.700; für erhöhte Nutzlast		24.0124-0138.1 424138	Ø 300 24 21,9 V
			➔	01/07→; Nutzlast leicht 17Q; Nutzlast [kg]: 1.700; nicht für erhöhte Nutzlast		24.0128-0213.1 428213	Ø 280 28 25,9 V
			➔	01/07→; Nutzlast 20Q; Nutzlast [kg]: 2.000		24.0132-0131.1 432131	Ø 300 32 29,9 V
			➔	01/07→; Nutzlast 20Q; Nutzlast [kg]: 2.000		24.0116-0123.1 416123	Ø 300 16 14,2
			➔	01/07→; Nutzlast 11Q/15Q / leicht 17Q; Nutzlast ab [kg] 1.100 Nutzlast bis [kg] 1.700; nicht für erhöhte Nutzlast		24.0116-0124.1 416124	Ø 280 16 14,2
			➔	01/07→; Nutzlast schwer 17Q; Nutzlast [kg]: 1.700; für erhöhte Nutzlast		24.0116-0125.1 416125	Ø 280 16 14,2
180 Multijet 2,3 D	130	12/15→	➔	Nutzlast 11Q/15Q; Nutzlast ab [kg] 1.100 Nutzlast bis [kg] 1.500		24.0124-0127.1 424127	Ø 280 24 21,9 V
			➔	Nutzlast schwer 17Q; Nutzlast [kg]: 1.700; für erhöhte Nutzlast		24.0124-0138.1 424138	Ø 300 24 21,9 V
			➔	Nutzlast leicht 17Q; Nutzlast [kg]: 1.700; nicht für erhöhte Nutzlast		24.0128-0213.1 428213	Ø 280 28 25,9 V
			➔	Nutzlast 20Q; Nutzlast [kg]: 2.000		24.0132-0131.1 432131	Ø 300 32 29,9 V
			➔	Nutzlast 20Q; Nutzlast [kg]: 2.000		24.0116-0123.1 416123	Ø 300 16 14,2
			➔	Nutzlast schwer 17Q; Nutzlast [kg]: 1.700; für erhöhte Nutzlast		24.0116-0125.1 416125	Ø 280 16 14,2
FIAT - ELBA (146_) 10/85→10/97							
 Bremsbelagsatz, Scheibenbremse							
1.4 1.5 1.5 1.6	49 49 55 69	10/93→02/95 01/92→12/96 01/92→12/96 01/94→12/96	➔			13.0460-5409.2 605409 13.0460-5410.2 605410	ATE 21193 18,0 - WE / - WK ATE 21193 18,0 + WK
 Bremsscheibe							
1.4 1.5 1.5 1.6	49 49 55 69	10/93→02/95 01/92→12/96 01/92→12/96 01/94→12/96	➔			24.0112-0122.1 412122	Ø 240 12 10,8
FIAT - FIORINO Kasten/Kombi (225_) 01/07→							
 Bremsbelagsatz, Scheibenbremse							
1.2 Flex	52	02/08→	➔			13.0460-3863.2 603863	BOS 23706 18,0 + WK + Zub
1.3 D Multijet	55	11/07→	➔	09/08→; Schaltgetriebe		13.0460-3826.2 603826 13.0470-3826.2 LD3826	BOS 23706 18,0 + WK + Zub BOS 23706 18,0 + WK + Zub Ceramic
			➔	09/08→; Halbautomatik		13.0460-3863.2 603863	BOS 23706 18,0 + WK + Zub
1.3 D Multijet	59	03/15→	➔	Schaltgetriebe		13.0460-3826.2 603826 13.0470-3826.2 LD3826	BOS 23706 18,0 + WK + Zub BOS 23706 18,0 + WK + Zub Ceramic
			➔	Halbautomatik		13.0460-3863.2 603863	BOS 23706 18,0 + WK + Zub
1.3 D Multijet	70	07/09→	➔	07/10→		13.0460-3827.2 603827 13.0470-3827.2 LD3827	BOS 23709 19,6 + WK + Zub BOS 23709 19,6 + WK + Zub Ceramic
1.4	54	11/07→	➔	09/08→; → 6446		13.0460-3826.2 603826 13.0470-3826.2 LD3826	BOS 23706 18,0 + WK + Zub BOS 23706 18,0 + WK + Zub Ceramic
			➔	6447→		13.0460-3863.2 603863	BOS 23706 18,0 + WK + Zub
1.4	57	10/09→	➔	→ 6446		13.0460-3826.2 603826 13.0470-3826.2 LD3826	BOS 23706 18,0 + WK + Zub BOS 23706 18,0 + WK + Zub Ceramic
			➔	6447→		13.0460-3863.2 603863	BOS 23706 18,0 + WK + Zub
1.4 Natural Power ↓	57	06/08→	➔	10/09→; → 6446		13.0460-3826.2 603826	BOS 23706 18,0 + WK + Zub

	kw					! #		
FIAT - FIORINO Kasten/Kombi (225_) 01/07→								
 Bremsbelagsatz, Scheibenbremse								
1.4 Natural Power	57	06/08→	←	10/09→; → 6446		13.0470-3826.2	LD3826	BOS 23706 18,0 + WK + Zub Ceramic
			←	6447→		13.0460-3863.2	603863	BOS 23706 18,0 + WK + Zub
 Bremsscheibe								
1.2 Flex	52	02/08→	←			24.0122-0197.1	422197	Ø 257,5 22 20,2 V
1.3 D Multijet	59	03/15→	←			24.0322-0197.1	522197	Ø 257,5 22 20,2 V PD
1.4	57	10/09→	←					
1.3 D Multijet	55	11/07→	←	09/08→		24.0122-0197.1	422197	Ø 257,5 22 20,2 V
1.4	54	11/07→	←			24.0322-0197.1	522197	Ø 257,5 22 20,2 V PD
1.3 D Multijet	70	07/09→	←	07/10→		24.0122-0147.1	422147	Ø 284 22 20,2 V
1.4 Natural Power	57	06/08→	←	10/09→		24.0122-0197.1	422197	Ø 257,5 22 20,2 V
			←			24.0322-0197.1	522197	Ø 257,5 22 20,2 V PD
FIAT - FIORINO Kasten (146_) 01/88→								
 Bremsbelagsatz, Scheibenbremse								
1.3	43	05/88→09/98	←	09/93→		13.0460-7063.2	607063	ATE 21193 18,0 - WE / - WK
1.4	52	11/92→10/96	←					
1.7 TD	46	11/96→05/00	←			13.0460-7063.2	607063	ATE 21193 18,0 - WE / - WK
60 1.7 D	42	05/88→10/96	←	09/88→ 08/93		13.0460-5409.2	605409	ATE 21193 18,0 - WE / - WK
60 1.7 D	44	05/88→05/00	←	09/93→		13.0460-7063.2	607063	ATE 21193 18,0 - WE / - WK
65 1.7 TD	46	01/97→05/01	←	→ 03/01		13.0460-7063.2	607063	ATE 21193 18,0 - WE / - WK
70 i.e. 1.4	49	05/94→05/01	←					
75 i.e. 1.6	55	10/93→05/01	←					
 Bremsscheibe								
1.3	43	05/88→09/98	←	09/93→		24.0112-0122.1	412122	Ø 240 12 10,8
1.4	52	11/92→10/96	←					
1.7 TD	46	11/96→05/00	←			24.0112-0122.1	412122	Ø 240 12 10,8
60 1.7 D	42	05/88→10/96	←	09/93→		24.0112-0122.1	412122	Ø 240 12 10,8
60 1.7 D	44	05/88→05/00	←	09/88→ 08/93		24.0112-0122.1	412122	Ø 240 12 10,8
65 1.7 TD	46	01/97→05/01	←	→ 03/01		24.0112-0122.1	412122	Ø 240 12 10,8
70 i.e. 1.4	49	05/94→05/01	←					
75 i.e. 1.6	55	10/93→05/01	←					
FIAT - FIORINO Pick up (146_) 01/88→05/01								
 Bremsbelagsatz, Scheibenbremse								
1.4	49	05/94→05/01	←	→ 03/01		13.0460-7063.2	607063	ATE 21193 18,0 - WE / - WK
1.6	55	01/94→05/01	←					
1.7 TD	46	01/97→05/01	←					
1.4	52	10/93→10/96	←			13.0460-7063.2	607063	ATE 21193 18,0 - WE / - WK
1.7 D	42	10/93→10/99	←					
1.7 D	44	05/88→10/99	←	09/93→		13.0460-7063.2	607063	ATE 21193 18,0 - WE / - WK
 Bremsscheibe								
1.4	49	05/94→05/01	←	→ 03/01		24.0112-0122.1	412122	Ø 240 12 10,8
1.6	55	01/94→05/01	←					
1.7 TD	46	01/97→05/01	←					
1.4	52	10/93→10/96	←			24.0112-0122.1	412122	Ø 240 12 10,8
1.7 D	42	10/93→10/99	←					
1.7 D	44	05/88→10/99	←	09/93→		24.0112-0122.1	412122	Ø 240 12 10,8
FIAT - FREEMONT (345_) 08/11→								
 Bremsbelagsatz, Scheibenbremse								
2.0 JTD	100	08/11→	←			13.0460-2766.2	602766	BOS 24604 18,7 + WK + Zub
2.0 JTD	103	08/11→	←					
2.0 JTD	120	08/11→	→	BRF		13.0460-2771.2	602771	TRW 24822 15,7 + WK + Zub
2.0 JTD	125	08/11→	→					
2.0 JTD 4x4	120	08/11→	→					
2.0 JTD 4x4	125	08/11→	→					
2.4	125	08/11→	→					
3.6	206	08/11→	→					
3.6 4x4	206	08/11→	→					
 Bremsscheibe								
2.0 JTD	100	08/11→	←			24.0128-0263.1	428263	Ø 302 28 26,4 V
2.0 JTD	103	08/11→	←					
2.0 JTD	120	08/11→	→			24.0112-0199.1	412199	Ø 305 12 10,4
2.0 JTD	125	08/11→	→					

	kW			 	! #		
FIAT - FREEMONT (345_) 08/11→							
 Bremsscheibe							
2.0 JTD 4x4	120	08/11→	←			24.0128-0263.1 428263	Ø 302 28 26,4 V
2.0 JTD 4x4	125	08/11→	→				
2.4	125	08/11→				24.0112-0199.1 412199	Ø 305 12 10,4
3.6	206	08/11→					
3.6 4x4	206	08/11→					
FIAT - GRANDE PUNTO (199_) 10/05→							
 Bremsbelagsatz, Scheibenbremse							
1.2	48	10/05→	←	→ 08/10		13.0460-3826.2 603826	BOS 23706 18,0 + WK + Zub
1.2	50	09/06→					
1.3 D Multijet	51	07/08→				13.0470-3826.2 LD3826	BOS 23706 18,0 + WK + Zub Ceramic
1.4	55	06/06→					
1.4	57	10/05→	←	09/10→ 01/11		13.0460-3863.2 603863	BOS 23706 18,0 + WK + Zub
1.2	51	09/10→	←	→ 01/11		13.0460-3863.2 603863	BOS 23706 18,0 + WK + Zub
1.2 LPG	51	07/08→	←	09/10→ 01/11		13.0460-3863.2 603863	BOS 23706 18,0 + WK + Zub
1.3 D Multijet	55	10/05→					
1.3 D Multijet	56	06/09→	←	10/09→ 04/10		13.0460-3863.2 603863	BOS 23706 18,0 + WK + Zub
			←	09/10→ 01/11		13.0460-3863.2 603863	BOS 23706 18,0 + WK + Zub
			←	05/10→		13.0460-7288.2 607288	ATE 25429 17,5 + WK
			→	09/09→		13.0470-7288.2 LD7288	ATE 25429 17,5 + WK Ceramic
			→	09/09→		13.0460-3862.2 603862	BOS 24349 17,6 + WK + Zub
1.3 D Multijet	62	04/10→	←	→ 01/11		13.0460-3864.2 603864	BOS 23709 19,6 + WK + Zub
1.3 D Multijet	66	10/05→	←	→ 01/11		13.0460-3827.2 603827	BOS 23709 19,6 + WK + Zub
						13.0470-3827.2 LD3827	BOS 23709 19,6 + WK + Zub Ceramic
1.4 (199.AXN1B)	114	12/07→06/10	←			13.0460-4853.2 604853	BRE 24162 15,2 + WK
			→			13.0470-4853.2 LD4853	BRE 24162 15,2 + WK Ceramic
						13.0460-3828.2 603828	BOS 24349 17,5 - WE / - WK
						13.0470-3828.2 LD3828	BOS 24349 17,5 - WE / - WK Ceramic
1.4 (199.AXX1B)	132	12/07→12/12	←	→ 01/11		13.0460-4853.2 604853	BRE 24162 15,2 + WK
			→	→ 01/11		13.0470-4853.2 LD4853	BRE 24162 15,2 + WK Ceramic
						13.0460-3828.2 603828	BOS 24349 17,5 - WE / - WK
						13.0470-3828.2 LD3828	BOS 24349 17,5 - WE / - WK Ceramic
1.4 16V	66	09/06→	←	→ 01/11		13.0460-3826.2 603826	BOS 23706 18,0 + WK + Zub
1.4 16V	70	10/05→					
1.4 16V	112	09/07→07/12				13.0470-3826.2 LD3826	BOS 23706 18,0 + WK + Zub Ceramic
1.4 LPG	57	12/08→					
1.4 Natural Power	57	07/08→					
1.4 T-Jet	88	09/07→	←	→ 01/11		13.0460-3827.2 603827	BOS 23709 19,6 + WK + Zub
1.6 D Multijet	88	07/08→				13.0470-3827.2 LD3827	BOS 23709 19,6 + WK + Zub Ceramic
1.9 D Multijet	88	10/05→	→	→ 01/11		13.0460-3828.2 603828	BOS 24349 17,5 - WE / - WK
						13.0470-3828.2 LD3828	BOS 24349 17,5 - WE / - WK Ceramic
1.9 D Multijet	85	06/06→12/09	←			13.0460-3827.2 603827	BOS 23709 19,6 + WK + Zub
			→			13.0470-3827.2 LD3827	BOS 23709 19,6 + WK + Zub Ceramic
						13.0460-3828.2 603828	BOS 24349 17,5 - WE / - WK
						13.0470-3828.2 LD3828	BOS 24349 17,5 - WE / - WK Ceramic
1.9 D Multijet	96	10/05→	←	02/06→ 01/11		13.0460-3827.2 603827	BOS 23709 19,6 + WK + Zub
						13.0470-3827.2 LD3827	BOS 23709 19,6 + WK + Zub Ceramic
			→	02/06→ 01/11		13.0460-3828.2 603828	BOS 24349 17,5 - WE / - WK
						13.0470-3828.2 LD3828	BOS 24349 17,5 - WE / - WK Ceramic
 Bremsscheibe							
1.2	48	10/05→	←	→ 01/11		24.0112-0184.1 412184	Ø 257 12 10 + S
1.2	50	09/06→				24.0122-0231.1 422231	Ø 257 22 20 V + S
						24.0322-0231.1 522231	Ø 257 22 20 V + S PD
1.2	51	09/10→	←	→ 01/11		24.0122-0231.1 422231	Ø 257 22 20 V + S
1.3 D Multijet	51	07/08→					
1.4	55	06/06→				24.0322-0231.1 522231	Ø 257 22 20 V + S PD
1.4	57	10/05→					
1.4 16V	66	09/06→					
1.4 16V	70	10/05→					

	kW			 	! #		
FIAT - GRANDE PUNTO (199_) 10/05→							
Bremsscheibe							
1.4 16V 1.4 LPG 1.4 Natural Power	112 57 57	09/07→07/12 12/08→ 07/08→	←	→ 01/11		24.0122-0231.1 422231 24.0322-0231.1 522231	Ø 257 22 20 V + S Ø 257 22 20 V + S PD
1.2 LPG	51	07/08→	←	09/10→ 01/11		24.0122-0231.1 422231 24.0322-0231.1 522231	Ø 257 22 20 V + S Ø 257 22 20 V + S PD
1.3 D Multijet	55	10/05→	←	04/08→ 01/11		24.0122-0231.1 422231 24.0322-0231.1 522231	Ø 257 22 20 V + S Ø 257 22 20 V + S PD
1.3 D Multijet	56	06/09→	←	10/09→		24.0122-0231.1 422231 24.0322-0231.1 522231	Ø 257 22 20 V + S Ø 257 22 20 V + S PD
			←	→ 01/11		24.0122-0231.1 422231 24.0322-0231.1 522231	Ø 257 22 20 V + S Ø 257 22 20 V + S PD
			→	09/09→		24.0110-0323.1 410323	Ø 264 10 8
1.3 D Multijet 1.3 D Multijet	62 66	04/10→ 10/05→	←	→ 01/11		24.0122-0241.1 422241	Ø 284 22 20 V + S
1.4 (199.AXN1B)	114	12/07→06/10	←			24.0128-0219.1 428219	Ø 305 28 26 V
			→			24.0110-0323.1 410323	Ø 264 10 8
1.4 (199.AXX1B)	132	12/07→12/12	←	→ 01/11		24.0128-0219.1 428219	Ø 305 28 26 V
			→	→ 01/11		24.0110-0323.1 410323	Ø 264 10 8
1.4 T-Jet 1.6 D Multijet 1.9 D Multijet	88 88 88	09/07→ 07/08→ 10/05→	←	→ 01/11		24.0122-0241.1 422241 24.0110-0323.1 410323	Ø 284 22 20 V + S Ø 264 10 8
1.9 D Multijet	85	06/06→12/09	←			24.0122-0241.1 422241	Ø 284 22 20 V + S
			→			24.0110-0323.1 410323	Ø 264 10 8
1.9 D Multijet	96	10/05→	←	02/06→ 01/11		24.0122-0241.1 422241	Ø 284 22 20 V + S
			→	02/06→ 01/11		24.0110-0323.1 410323	Ø 264 10 8
FIAT - IDEA (350_) 12/03→							
Bremsbelagsatz, Scheibenbremse							
1.2 16V 1.4 16V	59 70	01/04→ 01/04→	←	→ 02/08		13.0460-3810.2 603810 13.0460-3818.2 603818	BOS 23705 18,1 - WE / - WK BOS 23706 18,1 + WK
1.3 D Multijet 1.4 LPG	51 57	01/04→ 03/09→	←	→ 07/12		13.0460-3810.2 603810 13.0460-3818.2 603818	BOS 23705 18,1 - WE / - WK BOS 23706 18,1 + WK
1.3 D Multijet	66	10/05→	←	11/05→ 02/08		13.0460-3811.2 603811 13.0460-3827.2 603827 13.0470-3827.2 LD3827	BOS 23708 19,2 - WE / - WK BOS 23709 19,6 + WK + Zub BOS 23709 19,6 + WK + Zub Ceramic
1.3 D Multijet	70	05/08→12/12	←	→ 07/12		13.0460-3811.2 603811 13.0460-3827.2 603827 13.0470-3827.2 LD3827	BOS 23708 19,2 - WE / - WK BOS 23709 19,6 + WK + Zub BOS 23709 19,6 + WK + Zub Ceramic
1.4	57	10/05→	←	11/05→ 02/08		13.0460-3810.2 603810 13.0460-3818.2 603818	BOS 23705 18,1 - WE / - WK BOS 23706 18,1 + WK
1.4	66	12/03→	←	01/04→ 02/08		13.0460-3810.2 603810 13.0460-3818.2 603818	BOS 23705 18,1 - WE / - WK BOS 23706 18,1 + WK
1.6 D Multijet	85	11/08→12/10	←			13.0460-3811.2 603811 13.0460-3827.2 603827 13.0470-3827.2 LD3827	BOS 23708 19,2 - WE / - WK BOS 23709 19,6 + WK + Zub BOS 23709 19,6 + WK + Zub Ceramic
			→			13.0460-2879.2 602879 13.0470-2879.2 LD2879	TRW 23601 13,7 - WE / - WK TRW 23601 13,7 - WE / - WK Ceramic
1.6 D Multijet	88	05/08→	←	→ 07/12		13.0460-3811.2 603811 13.0460-3827.2 603827 13.0470-3827.2 LD3827	BOS 23708 19,2 - WE / - WK BOS 23709 19,6 + WK + Zub BOS 23709 19,6 + WK + Zub Ceramic
			→	→ 07/12		13.0460-2879.2 602879 13.0470-2879.2 LD2879	TRW 23601 13,7 - WE / - WK TRW 23601 13,7 - WE / - WK Ceramic
1.8	81	01/08→07/10	←			13.0460-3810.2 603810 13.0460-3818.2 603818	BOS 23705 18,1 - WE / - WK BOS 23706 18,1 + WK
			→			13.0460-2879.2 602879 13.0470-2879.2 LD2879	TRW 23601 13,7 - WE / - WK TRW 23601 13,7 - WE / - WK Ceramic
↓							

	kw			 	! #		
FIAT - IDEA (350_) 12/03→							
 Bremsbelagsatz, Scheibenbremse							
1.9 JTD	74	01/04→	←	→ 02/08		13.0460-3811.2 603811 13.0460-3827.2 603827 13.0470-3827.2 LD3827	BOS 23708 19,2 - WE / - WK BOS 23709 19,6 + WK + Zub BOS 23709 19,6 + WK + Zub Ceramic
 Bremsscheibe							
1.2 16V 1.4 16V	59 70	01/04→ 01/04→	←	→ 02/08		24.0122-0197.1 422197 24.0322-0197.1 522197	Ø 257,5 22 20,2 V Ø 257,5 22 20,2 V PD
1.3 D Multijet 1.4 LPG	51 57	01/04→ 03/09→	←	→ 07/12		24.0122-0197.1 422197 24.0322-0197.1 522197	Ø 257,5 22 20,2 V Ø 257,5 22 20,2 V PD
1.3 D Multijet	66	10/05→	←	11/05→ 02/08		24.0122-0147.1 422147	Ø 284 22 20,2 V
1.3 D Multijet	70	05/08→12/12	←	→ 07/12		24.0122-0147.1 422147	Ø 284 22 20,2 V
1.4	57	10/05→	←	11/05→ 02/08		24.0122-0197.1 422197 24.0322-0197.1 522197	Ø 257,5 22 20,2 V Ø 257,5 22 20,2 V PD
1.4	66	12/03→	←	01/04→ 02/08		24.0122-0197.1 422197 24.0322-0197.1 522197	Ø 257,5 22 20,2 V Ø 257,5 22 20,2 V PD
1.6 D Multijet	85	11/08→12/10	←			24.0122-0147.1 422147 24.0111-0119.1 411119	Ø 284 22 20,2 V Ø 240,5 11 9,2
1.6 D Multijet	88	05/08→	←	→ 07/12		24.0122-0147.1 422147	Ø 284 22 20,2 V
			→	→ 07/12		24.0111-0119.1 411119	Ø 240,5 11 9,2
1.8	81	01/08→07/10	←			24.0122-0197.1 422197 24.0322-0197.1 522197	Ø 257,5 22 20,2 V Ø 257,5 22 20,2 V PD
			→			24.0111-0119.1 411119	Ø 240,5 11 9,2
1.9 JTD	74	01/04→	←	→ 02/08		24.0122-0147.1 422147	Ø 284 22 20,2 V
FIAT - LINEA (323_) 06/07→							
 Bremsbelagsatz, Scheibenbremse							
1.3 D Multijet 1.4	66 57	06/07→ 06/07→	←	07/07→ 05/11		13.0460-3818.2 603818 13.0460-3826.2 603826 13.0460-3863.2 603863 13.0470-3826.2 LD3826	BOS 23706 18,1 + WK BOS 23706 18,0 + WK + Zub BOS 23706 18,0 + WK + Zub BOS 23706 18,0 + WK + Zub Ceramic
1.3 D Multijet 1.4	70 66	09/09→ 12/08→	←	→ 05/11		13.0460-3818.2 603818 13.0460-3826.2 603826 13.0460-3863.2 603863 13.0470-3826.2 LD3826	BOS 23706 18,1 + WK BOS 23706 18,0 + WK + Zub BOS 23706 18,0 + WK + Zub BOS 23706 18,0 + WK + Zub Ceramic
1.4 T-Jet 1.4 T-Jet 1.4 T-Jet 1.6	84 88 112 80	09/07→ 09/07→ 10/08→ 07/08→	←	→ 05/11		13.0460-3827.2 603827 13.0470-3827.2 LD3827	BOS 23709 19,6 + WK + Zub BOS 23709 19,6 + WK + Zub Ceramic
1.6 D Multijet 1.9 16V 1.9 16V 1.9 16V	77 93 94 97	06/09→ 06/09→ 07/08→ 09/10→	→	→ 05/11		13.0460-2867.2 602867 13.0470-2867.2 LD2867	TRW 23517 16,6 - WE / - WK TRW 23517 16,6 - WE / - WK Ceramic
 Bremsscheibe							
1.3 D Multijet 1.4	66 57	06/07→ 06/07→	←	07/07→ 05/11		24.0122-0197.1 422197 24.0322-0197.1 522197	Ø 257,5 22 20,2 V Ø 257,5 22 20,2 V PD
1.3 D Multijet 1.4	70 66	09/09→ 12/08→	←	→ 05/11		24.0122-0197.1 422197 24.0322-0197.1 522197	Ø 257,5 22 20,2 V Ø 257,5 22 20,2 V PD
1.4 T-Jet 1.4 T-Jet 1.4 T-Jet 1.6 1.6 D Multijet 1.9 16V 1.9 16V 1.9 16V	84 88 112 80 77 93 94 97	09/07→ 09/07→ 10/08→ 07/08→ 06/09→ 06/09→ 07/08→ 09/10→	←	→ 05/11		24.0122-0147.1 422147 24.0110-0190.1 410190	Ø 284 22 20,2 V Ø 251,5 10 9
FIAT - MAREA (185_) 09/96→12/07							
 Bremsbelagsatz, Scheibenbremse							
1.2 16V	60	10/98→05/02	←	04/99→		13.0460-7064.2 607064	ATE 21930 17,9 + WK
1.4 80 12V 1.6 1.6 ↓	59 68 76	09/96→05/02 03/99→08/00 09/00→08/02	←			13.0460-7064.2 607064	ATE 21930 17,9 + WK

FIAT - MAREA (185_) 09/96→12/07

Bremsbelagsatz, Scheibenbremse

1.6 100 16V	76	09/96→05/02	←			13.0460-7064.2	607064	ATE 21930 17,9 + WK
1.6 100 16V Bipower	76	04/99→05/02						
1.6 16V	75	04/97→02/99						
1.6 SX	72	09/00→08/02						
1.9 TD 75	55	09/96→05/02						
1.8 115 16V	83	09/96→05/02	←			13.0460-7065.2	607065	ATE 21927 17,9 + WK
1.9 JTD 105	77	04/99→01/01						
1.9 JTD 110	81	01/01→05/02						
1.9 TD 100	74	09/96→05/02						
1.9 JTD	79	01/01→12/07	←	→ 12/02		13.0460-7065.2	607065	ATE 21927 17,9 + WK
2.0 150 20V	108	09/96→04/99	←			13.0460-7069.2	607069	ATE 21636 19,3 + WK
2.4 TD 125	91	09/96→04/99						
			→	ALU		13.0460-2826.2	602826	TRW 23177 14,2 - WK
			→	GG		13.0460-2951.2	602951	TRW 21103 14,2 - WK
2.0 150 20V	110	01/01→05/02	←			13.0460-7140.2	607140	ATE 21637 19,3 + WK
2.4 JTD 130	96	04/99→05/02				13.0470-7140.2	LD7140	ATE 21637 19,3 + WK Ceramic
			→	ALU		13.0460-2826.2	602826	TRW 23177 14,2 - WK
			→	GG		13.0460-2951.2	602951	TRW 21103 14,2 - WK
2.0 155 20V	113	04/99→01/01	←	→ 04/99		13.0460-7069.2	607069	ATE 21636 19,3 + WK
			←	05/99→		13.0460-7140.2	607140	ATE 21637 19,3 + WK
						13.0470-7140.2	LD7140	ATE 21637 19,3 + WK Ceramic
			→	ALU		13.0460-2826.2	602826	TRW 23177 14,2 - WK
			→	GG		13.0460-2951.2	602951	TRW 21103 14,2 - WK

Zubehörsatz, Scheibenbremsbelag

2.0 150 20V	108	09/96→04/99	→	GG		13.0460-0072.2	610072	TRW
2.0 150 20V	110	01/01→05/02						
2.0 155 20V	113	04/99→01/01						
2.4 JTD 130	96	04/99→05/02						
2.4 TD 125	91	09/96→04/99						

Bremsscheibe

1.2 16V	60	10/98→05/02	←	04/99→		24.0112-0127.1	412127	Ø 257,5 12 10,2
1.4 80 12V	59	09/96→05/02	←			24.0112-0127.1	412127	Ø 257,5 12 10,2
1.6	68	03/99→08/00						
1.6	76	09/00→08/02						
1.6 100 16V	76	09/96→05/02						
1.6 100 16V Bipower	76	04/99→05/02						
1.6 16V	75	04/97→02/99						
1.6 SX	72	09/00→08/02						
1.9 TD 75	55	09/96→05/02						
1.8 115 16V	83	09/96→05/02	←			24.0120-0142.1	420142	Ø 257,5 20 18,2 V
1.9 JTD 105	77	04/99→01/01				24.0320-0142.1	520142	Ø 257,5 20 18,2 V PD
1.9 JTD 110	81	01/01→05/02						
1.9 TD 100	74	09/96→05/02						
1.9 JTD	79	01/01→12/07	←	→ 12/02		24.0120-0142.1	420142	Ø 257,5 20 18,2 V
						24.0320-0142.1	520142	Ø 257,5 20 18,2 V PD
2.0 150 20V	108	09/96→04/99	←			24.0122-0147.1	422147	Ø 284 22 20,2 V
2.0 150 20V	110	01/01→05/02						
2.0 155 20V	113	04/99→01/01	→			24.0111-0119.1	411119	Ø 240,5 11 9,2
2.4 JTD 130	96	04/99→05/02						
2.4 TD 125	91	09/96→04/99						

FIAT - MAREA Weekend (185_) 09/96→12/07

Bremsbelagsatz, Scheibenbremse

1.2 16V	60	10/98→05/02	←	04/99→		13.0460-7065.2	607065	ATE 21927 17,9 + WK
1.4 80 12V	59	09/96→05/02	←			13.0460-7064.2	607064	ATE 21930 17,9 + WK
1.9 TD 75	55	09/96→05/02						
1.6	76	09/00→08/02	←			13.0460-7065.2	607065	ATE 21927 17,9 + WK
1.6 100 16V	76	09/96→05/02						
1.8 115 16V	83	09/96→05/02						
1.9 JTD 105	77	04/99→05/02						
1.9 JTD 110	81	01/01→05/02						
1.9 TD 100	74	09/96→05/02						
1.9 JTD	79	01/01→12/07	←	→ 12/02		13.0460-7065.2	607065	ATE 21927 17,9 + WK
2.0 150 20V	108	09/96→04/99	←			13.0460-7069.2	607069	ATE 21636 19,3 + WK
2.4 TD 125	91	09/96→04/99						
			→	ALU		13.0460-2826.2	602826	TRW 23177 14,2 - WK
			→	GG		13.0460-2951.2	602951	TRW 21103 14,2 - WK
2.0 150 20V	110	01/01→05/02	←			13.0460-7140.2	607140	ATE 21637 19,3 + WK
2.4 JTD 130	96	04/99→05/02				13.0470-7140.2	LD7140	ATE 21637 19,3 + WK Ceramic

FIAT - MAREA Weekend (185_) 09/96→12/07

Bremsbelagsatz, Scheibenbremse

2.0 150 20V 2.4 JTD 130	110	01/01→05/02	➡	ALU	13.0460-2826.2	602826	TRW 23177 14,2 - WK
	96	04/99→05/02	➡	GG	13.0460-2951.2	602951	TRW 21103 14,2 - WK
2.0 155 20V	113	04/99→02/03	➡	→ 04/99	13.0460-7069.2	607069	ATE 21636 19,3 + WK
			➡	05/99→ 12/02	13.0460-7140.2	607140	ATE 21637 19,3 + WK
					13.0470-7140.2	LD7140	ATE 21637 19,3 + WK Ceramic
			➡	→ 12/02; ALU	13.0460-2826.2	602826	TRW 23177 14,2 - WK
			➡	→ 12/02; GG	13.0460-2951.2	602951	TRW 21103 14,2 - WK

Zubehörsatz, Scheibenbremsbelag

2.0 150 20V 2.0 150 20V 2.4 JTD 130 2.4 TD 125	108	09/96→04/99	➡	GG	13.0460-0072.2	610072	TRW
	110	01/01→05/02					
	96	04/99→05/02					
	91	09/96→04/99					
2.0 155 20V	113	04/99→02/03	➡	→ 12/02; GG	13.0460-0072.2	610072	TRW











Bremsscheibe











1.2 16V	60	10/98→05/02	➡	04/99→	24.0120-0142.1	420142	Ø 257,5 20 18,2 V
					24.0320-0142.1	520142	Ø 257,5 20 18,2 V PD
1.4 80 12V 1.9 TD 75	59 55	09/96→05/02 09/96→05/02	➡		24.0112-0127.1	412127	Ø 257,5 12 10,2
1.6 1.6 100 16V 1.8 115 16V 1.9 JTD 105 1.9 JTD 110 1.9 TD 100	76 76 83 77 81 74	09/00→08/02 09/96→05/02 09/96→05/02 04/99→05/02 01/01→05/02 09/96→05/02	➡		24.0120-0142.1	420142	Ø 257,5 20 18,2 V
					24.0320-0142.1	520142	Ø 257,5 20 18,2 V PD
1.9 JTD	79	01/01→12/07	➡	→ 12/02	24.0120-0142.1	420142	Ø 257,5 20 18,2 V
					24.0320-0142.1	520142	Ø 257,5 20 18,2 V PD
2.0 150 20V 2.0 150 20V 2.4 JTD 130 2.4 TD 125	108 110 96 91	09/96→04/99 01/01→05/02 04/99→05/02 09/96→04/99	➡		24.0122-0147.1	422147	Ø 284 22 20,2 V
2.0 155 20V	113	04/99→02/03	➡	→ 12/02	24.0122-0147.1	422147	Ø 284 22 20,2 V
			➡	→ 12/02	24.0111-0119.1	411119	Ø 240,5 11 9,2

FIAT - MULTIPLA (186_) 04/99→06/10











Bremsbelagsatz, Scheibenbremse









1.6 1.6 1.6	68	05/04→08/05	➡		13.0460-7069.2	607069	ATE 21636 19,3 + WK	
	74	03/01→08/05			13.0460-7140.2	607140	ATE 21637 19,3 + WK	
	76	09/00→06/10			13.0470-7140.2	LD7140	ATE 21637 19,3 + WK Ceramic	
1.6 100 16V (186AXA1A) 1.6 16V GPL 1.9 JTD 105 (186AXB1A)	76	04/99→06/10	➡	10/04→	13.0460-3827.2	603827	BOS 23709 19,6 + WK + Zub	
					13.0470-3827.2	LD3827	BOS 23709 19,6 + WK + Zub Ceramic	
	76 77	10/01→06/10 04/99→06/10	➡	→ 09/04	13.0460-7069.2	607069	ATE 21636 19,3 + WK	
					13.0460-7140.2	607140	ATE 21637 19,3 + WK	
			➡	12/05→	13.0470-7140.2	LD7140	ATE 21637 19,3 + WK Ceramic	
			➡		13.0460-3861.2	603861	BOS 23714 17,6 + WK + Zub	
			➡	04/02→ 11/05	13.0460-3991.2	603991	BOS 23714 16,6 - WE / - WK	
			➡		13.0470-3812.2	LD3812	BOS 23714 17,6 - WE / - WK Ceramic	
	1.6 16V (186AGB1A) 1.6 16V Blupower (186AMA1A)	70	04/02→06/10	➡		13.0460-3827.2	603827	BOS 23709 19,6 + WK + Zub
		70	04/99→06/10			13.0470-3827.2	LD3827	BOS 23709 19,6 + WK + Zub Ceramic
			➡		13.0460-3861.2	603861	BOS 23714 17,6 + WK + Zub	
			➡		13.0460-3991.2	603991	BOS 23714 16,6 - WE / - WK	
			➡		13.0470-3812.2	LD3812	BOS 23714 17,6 - WE / - WK Ceramic	
1.6 16V Bipower (186AMB1A) 1.6 16V Bipower (186AXC1A) ↓	76	04/99→06/10	➡	2232224→	13.0460-3827.2	603827	BOS 23709 19,6 + WK + Zub	
	76	10/01→06/10			13.0470-3827.2	LD3827	BOS 23709 19,6 + WK + Zub Ceramic	













	kW			 	! #		
FIAT - MULTIPLA (186_) 04/99→06/10							
 Bremsbelagsatz, Scheibenbremse							
1.6 16V Bipower (186AMB1A)	76	04/99→06/10	←	→ 2232223		13.0460-7069.2 607069	ATE 21636 19,3 + WK
1.6 16V Bipower (186AXC1A)	76	10/01→06/10	→			13.0460-7140.2 607140 13.0470-7140.2 LD7140	ATE 21637 19,3 + WK ATE 21637 19,3 + WK Ceramic
			→			13.0460-3861.2 603861 13.0460-3991.2 603991 13.0470-3812.2 LD3812	BOS 23714 17,6 + WK + Zub BOS 23714 16,6 - WE / - WK BOS 23714 17,6 - WE / - WK Ceramic
1.9 JTD (186AXE1A)	88	04/02→06/10	←	10/04→		13.0460-3827.2 603827 13.0470-3827.2 LD3827	BOS 23709 19,6 + WK + Zub BOS 23709 19,6 + WK + Zub Ceramic
1.9 JTD 115	85	07/02→06/10	←	→ 09/04		13.0460-7069.2 607069 13.0460-7140.2 607140 13.0470-7140.2 LD7140	ATE 21636 19,3 + WK ATE 21637 19,3 + WK ATE 21637 19,3 + WK Ceramic
			→	12/05→		13.0460-3861.2 603861 13.0460-3991.2 603991 13.0470-3812.2 LD3812	BOS 23714 17,6 + WK + Zub BOS 23714 16,6 - WE / - WK BOS 23714 17,6 - WE / - WK Ceramic
			→	→ 11/05		13.0460-3991.2 603991 13.0470-3812.2 LD3812	BOS 23714 16,6 - WE / - WK BOS 23714 17,6 - WE / - WK Ceramic
1.9 JTD 110	81	03/01→07/02	←			13.0460-7069.2 607069 13.0460-7140.2 607140 13.0470-7140.2 LD7140	ATE 21636 19,3 + WK ATE 21637 19,3 + WK ATE 21637 19,3 + WK Ceramic
			→	04/02→		13.0460-3991.2 603991 13.0470-3812.2 LD3812	BOS 23714 16,6 - WE / - WK BOS 23714 17,6 - WE / - WK Ceramic
Zubehörsatz, Scheibenbremsbelag							
1.6	68	05/04→08/05	→			13.0460-0256.2 610256	BOS
1.6	74	03/01→08/05					
1.6	76	09/00→06/10					
1.6 100 16V (186AXA1A)	76	04/99→06/10	→	04/02→ 11/05		13.0460-0256.2 610256	BOS
1.6 16V GPL	76	10/01→06/10					
1.9 JTD 105 (186AXB1A)	77	04/99→06/10					
1.9 JTD (186AXE1A)	88	04/02→06/10	→	→ 11/05		13.0460-0256.2 610256	BOS
1.9 JTD 115	85	07/02→06/10					
1.9 JTD 110	81	03/01→07/02	→	04/02→		13.0460-0256.2 610256	BOS
 Bremsscheibe							
1.6	68	05/04→08/05	←			24.0122-0107.1 422107	Ø 284 22 20,2 V
1.6	74	03/01→08/05					
1.6	76	09/00→06/10	→			24.0110-0190.1 410190	Ø 251,5 10 9
1.6 16V (186AGB1A)	70	04/02→06/10					
1.6 16V Bipower (186AMB1A)	76	04/99→06/10					
1.6 16V Bipower (186AXC1A)	76	10/01→06/10					
1.6 16V Blupower (186AMA1A)	70	04/99→06/10					
1.9 JTD (186AXE1A)	88	04/02→06/10					
1.9 JTD 115	85	07/02→06/10					
1.6 100 16V (186AXA1A)	76	04/99→06/10	←			24.0122-0107.1 422107	Ø 284 22 20,2 V
1.6 16V GPL	76	10/01→06/10	→	04/02→		24.0110-0190.1 410190	Ø 251,5 10 9
1.9 JTD 105 (186AXB1A)	77	04/99→06/10					
1.9 JTD 110	81	03/01→07/02					
FIAT - PALIO (178BX) 04/96→							
 Bremsbelagsatz, Scheibenbremse							
1.0	45	04/96→10/03	←	→ 02/98		13.0460-7113.2 607113	ATE 23218 18,0 + WK
1.0	56	04/96→10/03	←	12/98→		13.0460-7126.2 607126	ATE 20907 18,1 - WE / - WK
1.1	40	07/97→10/03	←	03/98→ 11/98		13.0460-7128.2 607128	ATE 23218 18,0 + WK
1.2	44	07/97→08/02	←	10/97→ 02/98		13.0460-7113.2 607113	ATE 23218 18,0 + WK
1.7 D	42	04/96→09/02	←	12/98→		13.0460-7126.2 607126	ATE 20907 18,1 - WE / - WK
			←	03/98→ 11/98		13.0460-7128.2 607128	ATE 23218 18,0 + WK
1.2	50	06/99→10/00	←			13.0460-7126.2 607126	ATE 20907 18,1 - WE / - WK
↓							











	kW			 	! #		
FIAT - PALIO (178BX) 04/96→							
 Bremsbelagsatz, Scheibenbremse							
1.2	54	06/98→	←	12/98→ 12/06		13.0460-7126.2 607126	ATE 20907 18,1 - WE / - WK
			←	→ 11/98		13.0460-7128.2 607128	ATE 23218 18,0 + WK
1.2	59	09/01→	←	→ 12/06		13.0460-7126.2 607126	ATE 20907 18,1 - WE / - WK
1.5	62	06/04→					
1.7 TD	51	10/02→01/12					
1.7 TD	53	09/01→					
1.3 JTD Multijet	51	06/03→	←	09/03→ 12/06		13.0460-7126.2 607126	ATE 20907 18,1 - WE / - WK
1.4	51	04/96→10/02	←	04/98→		13.0460-7128.2 607128	ATE 23218 18,0 + WK
1.4 Cat	51	04/96→08/01				13.0460-7132.2 607132	ATE 23218 18,0 - WE / - WK
1.6 16V	74	04/96→10/02					
 Bremsscheibe							
1.0	45	04/96→10/03	←	12/98→		24.0120-0142.1 420142	Ø 257,5 20 18,2 V
1.0	56	04/96→10/03				24.0320-0142.1 520142	Ø 257,5 20 18,2 V PD
1.1	40	07/97→10/03	←	→ 11/98		24.0120-0193.1 420193	Ø 240 20 18,2 V
1.2	44	07/97→08/02	←	12/98→		24.0120-0142.1 420142	Ø 257,5 20 18,2 V
1.7 D	42	04/96→09/02	←	10/97→ 11/98		24.0320-0142.1 520142	Ø 257,5 20 18,2 V PD
			←			24.0120-0193.1 420193	Ø 240 20 18,2 V
1.2	50	06/99→10/00	←			24.0120-0142.1 420142	Ø 257,5 20 18,2 V
						24.0320-0142.1 520142	Ø 257,5 20 18,2 V PD
1.2	54	06/98→	←	12/98→ 12/06		24.0120-0142.1 420142	Ø 257,5 20 18,2 V
			←	→ 11/98		24.0320-0142.1 520142	Ø 257,5 20 18,2 V PD
			←			24.0120-0193.1 420193	Ø 240 20 18,2 V
1.2	59	09/01→	←	→ 12/06		24.0120-0142.1 420142	Ø 257,5 20 18,2 V
1.5	62	06/04→				24.0320-0142.1 520142	Ø 257,5 20 18,2 V PD
1.7 TD	51	10/02→01/12					
1.7 TD	53	09/01→					
1.3 JTD Multijet	51	06/03→	←	09/03→ 12/06		24.0120-0142.1 420142	Ø 257,5 20 18,2 V
						24.0320-0142.1 520142	Ø 257,5 20 18,2 V PD
1.4	51	04/96→10/02	←	02/98→ 03/98		24.0112-0122.1 412122	Ø 240 12 10,8
1.4 Cat	51	04/96→08/01	←	04/98→		24.0120-0193.1 420193	Ø 240 20 18,2 V
1.6 16V	74	04/96→10/02	←	02/98→		24.0120-0193.1 420193	Ø 240 20 18,2 V
FIAT - PALIO Weekend (178_) 04/96→							
 Bremsbelagsatz, Scheibenbremse							
1.0	45	07/98→10/03	←	12/98→		13.0460-7126.2 607126	ATE 20907 18,1 - WE / - WK
			←	→ 11/98		13.0460-7128.2 607128	ATE 23218 18,0 + WK
1.2	50	06/99→10/02	←			13.0460-7126.2 607126	ATE 20907 18,1 - WE / - WK
1.2	59	09/01→	←	→ 12/06		13.0460-7126.2 607126	ATE 20907 18,1 - WE / - WK
1.2 (178DYA1A)	44	02/01→					
1.5	62	02/02→					
1.6	78	02/01→					
1.6 16V (178DYC1A06)	76	02/01→					
1.9 D (178DYD1A07)	46	03/01→					
1.9 JTD	59	09/01→					
1.2 (178DX.G1A)	54	04/96→02/01	←	10/97→ 02/98		13.0460-7113.2 607113	ATE 23218 18,0 + WK
1.2 Flex	44	07/97→08/02	←	12/98→		13.0460-7126.2 607126	ATE 20907 18,1 - WE / - WK
1.2 LPG	44	07/97→08/02	←	03/98→ 11/98		13.0460-7128.2 607128	ATE 23218 18,0 + WK
1.7 TD (178DX.H1A)	51	04/96→03/01	←	→ 02/98		13.0460-7113.2 607113	ATE 23218 18,0 + WK
			←	12/98→		13.0460-7126.2 607126	ATE 20907 18,1 - WE / - WK
			←	03/98→ 11/98		13.0460-7128.2 607128	ATE 23218 18,0 + WK
1.4	51	07/97→08/01	←	→ 02/98		13.0460-7113.2 607113	ATE 23218 18,0 + WK
			←	12/98→		13.0460-7126.2 607126	ATE 20907 18,1 - WE / - WK
			←	03/98→ 11/98		13.0460-7128.2 607128	ATE 23218 18,0 + WK
1.6 16V (178DX.D1A)	74	04/96→02/01	←	10/97→ 09/00		13.0460-7108.2 607108	ATE 20907 18,1 + WK
			←	10/00→		13.0460-7126.2 607126	ATE 20907 18,1 - WE / - WK
 Bremsscheibe							
1.0	45	07/98→10/03	←	12/98→		24.0120-0142.1 420142	Ø 257,5 20 18,2 V
1.4	51	07/97→08/01	←	→ 11/98		24.0320-0142.1 520142	Ø 257,5 20 18,2 V PD
			←			24.0120-0193.1 420193	Ø 240 20 18,2 V
1.2	50	06/99→10/02	←			24.0120-0142.1 420142	Ø 257,5 20 18,2 V
						24.0320-0142.1 520142	Ø 257,5 20 18,2 V PD
1.2	59	09/01→	←	→ 12/06		24.0120-0142.1 420142	Ø 257,5 20 18,2 V
1.2 (178DYA1A)	44	02/01→				24.0320-0142.1 520142	Ø 257,5 20 18,2 V PD
1.5	62	02/02→					
↓							

























	kw			 	! #		
FIAT - PALIO Weekend (178_) 04/96→							
 Bremsscheibe							
1.6	78	02/01→	←	→ 12/06		24.0120-0142.1 420142	Ø 257,5 20 18,2 V
1.6 16V (178DYC1A06)	76	02/01→				24.0320-0142.1 520142	Ø 257,5 20 18,2 V PD
1.9 D (178DYD1A07)	46	03/01→					
1.9 JTD	59	09/01→					
1.2 (178DX.G1A)	54	04/96→02/01	←	12/98→		24.0120-0142.1 420142	Ø 257,5 20 18,2 V
1.2 Flex	44	07/97→08/02				24.0320-0142.1 520142	Ø 257,5 20 18,2 V PD
1.2 LPG	44	07/97→08/02					
1.7 TD (178DX.H1A)	51	04/96→03/01	←	10/97→ 11/98		24.0120-0193.1 420193	Ø 240 20 18,2 V
1.6 16V (178DX.D1A)	74	04/96→02/01	←	10/97→		24.0120-0142.1 420142	Ø 257,5 20 18,2 V
						24.0320-0142.1 520142	Ø 257,5 20 18,2 V PD
FIAT - PANDA (141_) 03/80→07/04							
 Bremsbelagsatz, Scheibenbremse							
1000 i.e. Cat	33	10/87→08/98	←			13.0460-3939.2 603939	BDX 20775 18,0 + WE / - WK
			←	→ 12/92		13.0460-3939.2 603939	BDX 20775 18,0 + WE / - WK
1100	37	05/91→12/99	←	Vollautomatik		13.0460-2941.2 602941	TRW 20838 17,0 + WK
			←	Schaltgetriebe		13.0460-3939.2 603939	BDX 20775 18,0 + WE / - WK
1100	40	02/95→09/03	←	→ 12/02; Vollautomatik		13.0460-2941.2 602941	TRW 20838 17,0 + WK
			←	→ 12/02; Schaltgetriebe		13.0460-3939.2 603939	BDX 20775 18,0 + WE / - WK
1100 4x4	40	02/95→07/04	←	→ 12/02		13.0460-3939.2 603939	BDX 20775 18,0 + WE / - WK
1100 Trekking 4x4	37	10/91→07/04					
650	22	01/82→07/04	←	→ 08/82		13.0460-3936.2 603936	BDX 20073 17,3 - WE / - WK
			←	09/82→ 12/85		13.0460-3939.2 603939	BDX 20775 18,0 + WE / - WK
750	25	01/86→10/03	←	→ 12/97		13.0460-3939.2 603939	BDX 20775 18,0 + WE / - WK
900	29	04/92→12/96	←			13.0460-3939.2 603939	BDX 20775 18,0 + WE / - WK
Zubehörsatz, Scheibenbremsbelag							
1000 i.e. Cat	33	10/87→08/98	←			13.0460-0410.2 610410	BDX
			←	→ 12/92		13.0460-0410.2 610410	BDX
1100	37	05/91→12/99	←	Schaltgetriebe		13.0460-0410.2 610410	BDX
1100	40	02/95→09/03	←	→ 12/02; Schaltgetriebe		13.0460-0410.2 610410	BDX
1100 4x4	40	02/95→07/04	←	→ 12/02		13.0460-0410.2 610410	BDX
1100 Trekking 4x4	37	10/91→07/04					
650	22	01/82→07/04	←	09/82→ 12/85		13.0460-0410.2 610410	BDX
750	25	01/86→10/03	←	→ 12/97		13.0460-0410.2 610410	BDX
900	29	04/92→12/96	←			13.0460-0410.2 610410	BDX
 Bremsscheibe							
1000 i.e. Cat	33	10/87→08/98	←			24.0111-0130.1 411130	Ø 227 10,8 9
			←	→ 12/92		24.0111-0130.1 411130	Ø 227 10,8 9
1100	37	05/91→12/99	←	Schaltgetriebe		24.0111-0130.1 411130	Ø 227 10,8 9
			←	Vollautomatik		24.0112-0122.1 412122	Ø 240 12 10,8
1100	40	02/95→09/03	←	→ 12/02; Schaltgetriebe		24.0111-0130.1 411130	Ø 227 10,8 9
			←	→ 12/02; Vollautomatik		24.0112-0122.1 412122	Ø 240 12 10,8
1100 4x4	40	02/95→07/04	←	→ 12/02		24.0111-0130.1 411130	Ø 227 10,8 9
1100 Trekking 4x4	37	10/91→07/04					
650	22	01/82→07/04	←	→ 12/85		24.0111-0130.1 411130	Ø 227 10,8 9
750	25	01/86→10/03	←	→ 12/97		24.0111-0130.1 411130	Ø 227 10,8 9
900	29	04/92→12/96	←			24.0111-0130.1 411130	Ø 227 10,8 9
FIAT - PANDA (169_) 09/03→							
 Bremsbelagsatz, Scheibenbremse							
1.1	40	09/03→	←	→ 06/13		13.0460-3807.2 603807	BDX 21436 17,0 + WE / - WK + Zub
1.2	44	09/03→				13.0460-3950.2 603950	BDX 21436 17,0 - WK
1.2	51	03/10→					
1.2 4x4	44	10/04→	←	→ 06/13		13.0460-3809.2 603809	BOS 24072 17,9 - WE / - WK + Zub
			→	→ 06/13		13.0460-2879.2 602879	TRW 23601 13,7 - WE / - WK
						13.0470-2879.2 LD2879	TRW 23601 13,7 - WE / - WK Ceramic
1.2 4x4	51	11/09→	←	10/10→ 06/13		13.0460-3809.2 603809	BOS 24072 17,9 - WE / - WK + Zub
↓							













	kW			 	! #		
FIAT - PANDA (169_) 09/03→							
 Bremsbelagsatz, Scheibenbremse							
1.2 4x4	51	11/09→	➡	10/10→ 06/13		13.0460-2879.2 602879 13.0470-2879.2 LD2879	TRW 23601 13,7 - WE / - WK TRW 23601 13,7 - WE / - WK Ceramic
1.2 LPG 1.2 LPG 1.3 D Multijet 1.3 D Multijet 1.4 Natural Power 1.4 Natural Power	44 51 51 55 51 57	04/09→ 11/10→ 09/03→ 06/06→ 01/10→ 09/10→	←	→ 06/13		13.0460-3809.2 603809	BOS 24072 17,9 - WE / - WK + Zub
1.2 Natural Power	44	01/07→11/09	←			13.0460-3809.2 603809	BOS 24072 17,9 - WE / - WK + Zub
1.3 D Multijet 4x4	51	10/04→	←	04/06→ 08/11		13.0460-3826.2 603826 13.0460-3850.2 603850 13.0470-3826.2 LD3826	BOS 23706 18,0 + WK + Zub BOS 23707 18,0 - WE / - WK + Zub BOS 23706 18,0 + WK + Zub Ceramic
			←	→ 06/13		13.0460-3826.2 603826 13.0460-3850.2 603850 13.0470-3826.2 LD3826	BOS 23706 18,0 + WK + Zub BOS 23707 18,0 - WE / - WK + Zub BOS 23706 18,0 + WK + Zub Ceramic
			➡	→ 06/13		13.0460-2879.2 602879 13.0470-2879.2 LD2879	TRW 23601 13,7 - WE / - WK TRW 23601 13,7 - WE / - WK Ceramic
			➡	04/06→ 08/11		13.0460-2879.2 602879 13.0470-2879.2 LD2879	TRW 23601 13,7 - WE / - WK TRW 23601 13,7 - WE / - WK Ceramic
			➡	→ 06/13		13.0460-2879.2 602879 13.0470-2879.2 LD2879	TRW 23601 13,7 - WE / - WK TRW 23601 13,7 - WE / - WK Ceramic
1.3 D Multijet 4x4	55	09/10→	←	→ 06/13		13.0460-3826.2 603826 13.0460-3850.2 603850 13.0470-3826.2 LD3826	BOS 23706 18,0 + WK + Zub BOS 23707 18,0 - WE / - WK + Zub BOS 23706 18,0 + WK + Zub Ceramic
			➡	→ 06/13		13.0460-2879.2 602879 13.0470-2879.2 LD2879	TRW 23601 13,7 - WE / - WK TRW 23601 13,7 - WE / - WK Ceramic
1.4	74	10/06→	←	11/06→ 06/13		13.0460-3826.2 603826 13.0460-3850.2 603850 13.0470-3826.2 LD3826	BOS 23706 18,0 + WK + Zub BOS 23707 18,0 - WE / - WK + Zub BOS 23706 18,0 + WK + Zub Ceramic
			➡	11/06→ 06/13		13.0460-2879.2 602879 13.0470-2879.2 LD2879	TRW 23601 13,7 - WE / - WK TRW 23601 13,7 - WE / - WK Ceramic
 Bremsscheibe							
1.1 1.2 1.2	40 44 51	09/03→ 09/03→ 03/10→	←	→ 06/13		24.0111-0119.1 411119	Ø 240,5 11 9,2
1.2 4x4	44	10/04→	←	→ 06/13		24.0120-0184.1 420184	Ø 240,5 20 18,2 V
			➡	→ 06/13		24.0111-0119.1 411119	Ø 240,5 11 9,2
1.2 4x4	51	11/09→	←	10/10→ 06/13		24.0120-0184.1 420184	Ø 240,5 20 18,2 V
			➡	10/10→ 06/13		24.0111-0119.1 411119	Ø 240,5 11 9,2
1.2 LPG 1.2 LPG 1.3 D Multijet 1.3 D Multijet 1.4 Natural Power 1.4 Natural Power	44 51 51 55 51 57	04/09→ 11/10→ 09/03→ 06/06→ 01/10→ 09/10→	←	→ 06/13		24.0120-0184.1 420184	Ø 240,5 20 18,2 V
1.2 Natural Power	44	01/07→11/09	←			24.0120-0184.1 420184	Ø 240,5 20 18,2 V
1.3 D Multijet 4x4	51	10/04→	←	04/06→ 08/11		24.0122-0197.1 422197 24.0322-0197.1 522197	Ø 257,5 22 20,2 V Ø 257,5 22 20,2 V PD
			←	→ 06/13		24.0122-0197.1 422197 24.0322-0197.1 522197	Ø 257,5 22 20,2 V Ø 257,5 22 20,2 V PD
			➡	→ 06/13		24.0111-0119.1 411119	Ø 240,5 11 9,2
			➡	04/06→ 08/11		24.0111-0119.1 411119	Ø 240,5 11 9,2
1.3 D Multijet 4x4	55	09/10→	←	→ 06/13		24.0122-0197.1 422197 24.0322-0197.1 522197	Ø 257,5 22 20,2 V Ø 257,5 22 20,2 V PD
			➡	→ 06/13		24.0111-0119.1 411119	Ø 240,5 11 9,2
↓							











	kw					! #		
FIAT - PANDA (169_) 09/03→								
 Bremsscheibe								
1.4	74	10/06→	←	11/06→ 06/13		24.0122-0197.1 422197	Ø 257,5 22 20,2 V	
			→	11/06→ 06/13		24.0322-0197.1 522197	Ø 257,5 22 20,2 V PD	
						24.0111-0119.1 411119	Ø 240,5 11 9,2	
FIAT - PANDA (312_, 319_) 02/12→								
 Bremsbelagsatz, Scheibenbremse								
0.9	44	12/13→	←			13.0460-7289.2 607289	ATE 25323 17,3 + WK	
0.9	48	02/12→						
0.9	57	02/12→						
0.9	59	12/13→						
0.9	63	02/12→						
0.9 Natural Power	59	01/15→						
0.9 Natural Power	63	07/12→						
1.2	51	02/12→						
1.2 LPG	51	06/12→						
1.3 D Multijet	55	02/12→						
1.3 D Multijet	59	12/15→						
1.3 D Multijet	70	04/15→						
0.9 4x4	63	09/12→	←			13.0460-7289.2 607289	ATE 25323 17,3 + WK	
0.9 4x4	66	06/14→						
1.3 D Multijet 4x4	55	06/12→	→			13.0460-2783.2 602783	TRW 25410 14,4 + WK + Zub	
1.3 D Multijet 4x4	59	06/14→						
1.3 D Multijet 4x4	70	04/15→						
 Bremsscheibe								
0.9	44	12/13→	←			24.0112-0127.1 412127	Ø 257,5 12 10,2	
0.9	48	02/12→						
1.2	51	02/12→						
1.2 LPG	51	06/12→						
0.9	57	02/12→	←	für Leichtmetallfelgen; Serie 3		24.0112-0127.1 412127	Ø 257,5 12 10,2	
0.9	59	12/13→	←	für Leichtmetallfelgen; Serie 2		24.0122-0197.1 422197	Ø 257,5 22 20,2 V	
0.9	63	02/12→				24.0322-0197.1 522197	Ø 257,5 22 20,2 V PD	
0.9 Natural Power	59	01/15→						
0.9 Natural Power	63	07/12→						
1.3 D Multijet	55	02/12→						
1.3 D Multijet	59	12/15→						
1.3 D Multijet	70	04/15→						
0.9 4x4	63	09/12→	←	für Leichtmetallfelgen; Serie 3		24.0112-0127.1 412127	Ø 257,5 12 10,2	
0.9 4x4	66	06/14→						
1.3 D Multijet 4x4	55	06/12→	←	für Leichtmetallfelgen; Serie 2		24.0122-0197.1 422197	Ø 257,5 22 20,2 V	
1.3 D Multijet 4x4	59	06/14→				24.0322-0197.1 522197	Ø 257,5 22 20,2 V PD	
1.3 D Multijet 4x4	70	04/15→	→	nicht für Leichtmetallfelgen		24.0111-0119.1 411119	Ø 240,5 11 9,2	
			→	für Leichtmetallfelgen		24.0112-0127.1 412127	Ø 257,5 12 10,2	
FIAT - PANDA Van (141_) 01/86→02/04								
 Bremsbelagsatz, Scheibenbremse								
1.1	40	09/00→02/04	←	→ 12/02; Vollautomatik		13.0460-2941.2 602941	TRW 20838 17,0 + WK	
			←	→ 12/02; Schaltgetriebe		13.0460-3939.2 603939	BDX 20775 18,0 + WE / - WK	
1.1 4x4	40	09/00→02/04	←	→ 12/02		13.0460-3939.2 603939	BDX 20775 18,0 + WE / - WK	
1000 i.e	33	08/92→02/04						
Zubehörsatz, Scheibenbremsbelag								
1.1	40	09/00→02/04	←	→ 12/02; Schaltgetriebe		13.0460-0410.2 610410	BDX	
1.1 4x4	40	09/00→02/04	←	→ 12/02		13.0460-0410.2 610410	BDX	
1000 i.e	33	08/92→02/04						
 Bremsscheibe								
1.1	40	09/00→02/04	←	→ 12/02; Schaltgetriebe		24.0111-0130.1 411130	Ø 227 10,8 9	
			←	→ 12/02; Vollautomatik		24.0112-0122.1 412122	Ø 240 12 10,8	
1.1 4x4	40	09/00→02/04	←	→ 12/02		24.0111-0130.1 411130	Ø 227 10,8 9	
1000 i.e	33	08/92→02/04						
FIAT - PANDA Van (169_) 03/04→								
 Bremsbelagsatz, Scheibenbremse								
1.1	40	09/04→	←	→ 06/13		13.0460-3807.2 603807	BDX 21436 17,0 + WE / - WK + Zub	
1.2	44	09/04→						
1.2	51	09/10→				13.0460-3950.2 603950	BDX 21436 17,0 - WK	
1.2 4x4	44	09/04→	←	10/04→ 06/13		13.0460-3809.2 603809	BOS 24072 17,9 - WE / - WK + Zub	
			→	10/04→ 06/13		13.0460-2879.2 602879	TRW 23601 13,7 - WE / - WK	
↓								

	kW			 	! #		
FIAT - PANDA Van (169_) 03/04→							
 Bremsbelagsatz, Scheibenbremse							
1.2 4x4	44	09/04→	➡	10/04→ 06/13		13.0470-2879.2 LD2879	TRW 23601 13,7 - WE / - WK Ceramic
1.2 4x4	51	09/10→	⬅	10/10→ 06/13		13.0460-3809.2 603809	BOS 24072 17,9 - WE / - WK + Zub
			➡	10/10→ 06/13		13.0460-2879.2 602879	TRW 23601 13,7 - WE / - WK Ceramic
1.2 LPG 1.3 D Multijet 1.4 Natural Power	44 51 57	04/09→ 03/04→ 10/09→	⬅	→ 06/13		13.0460-3809.2 603809	BOS 24072 17,9 - WE / - WK + Zub
1.2 LPG	51	09/10→	⬅	11/10→ 06/13		13.0460-3809.2 603809	BOS 24072 17,9 - WE / - WK + Zub
1.2 Natural Power	44	01/07→11/09	⬅			13.0460-3809.2 603809	BOS 24072 17,9 - WE / - WK + Zub
1.3 D Multijet	55	01/06→	⬅	06/06→ 06/13		13.0460-3809.2 603809	BOS 24072 17,9 - WE / - WK + Zub
1.3 D Multijet 4x4	51	10/04→12/06	⬅			13.0460-3826.2 603826	BOS 23706 18,0 + WK + Zub
						13.0460-3850.2 603850	BOS 23707 18,0 - WE / - WK + Zub
			➡			13.0470-3826.2 LD3826	BOS 23706 18,0 + WK + Zub Ceramic
			➡			13.0460-2879.2 602879	TRW 23601 13,7 - WE / - WK Ceramic
			➡			13.0470-2879.2 LD2879	TRW 23601 13,7 - WE / - WK Ceramic
1.3 D Multijet 4x4	55	01/06→	⬅	→ 06/13		13.0460-3826.2 603826	BOS 23706 18,0 + WK + Zub
						13.0460-3850.2 603850	BOS 23707 18,0 - WE / - WK + Zub
			➡	→ 06/13		13.0470-3826.2 LD3826	BOS 23706 18,0 + WK + Zub Ceramic
			➡	→ 06/13		13.0460-2879.2 602879	TRW 23601 13,7 - WE / - WK Ceramic
			➡	→ 06/13		13.0470-2879.2 LD2879	TRW 23601 13,7 - WE / - WK Ceramic
 Bremsscheibe							
1.1 1.2 1.2	40 44 51	09/04→ 09/04→ 09/10→	⬅	→ 06/13		24.0111-0119.1 411119	Ø 240,5 11 9,2
1.2 4x4	44	09/04→	⬅	10/04→ 06/13		24.0120-0184.1 420184	Ø 240,5 20 18,2 V
			➡	10/04→ 06/13		24.0111-0119.1 411119	Ø 240,5 11 9,2
1.2 4x4	51	09/10→	⬅	10/10→ 06/13		24.0120-0184.1 420184	Ø 240,5 20 18,2 V
			➡	10/10→ 06/13		24.0111-0119.1 411119	Ø 240,5 11 9,2
1.2 LPG 1.3 D Multijet 1.4 Natural Power	44 51 57	04/09→ 03/04→ 10/09→	⬅	→ 06/13		24.0120-0184.1 420184	Ø 240,5 20 18,2 V
1.2 LPG	51	09/10→	⬅	11/10→ 06/13		24.0120-0184.1 420184	Ø 240,5 20 18,2 V
1.2 Natural Power	44	01/07→11/09	⬅			24.0120-0184.1 420184	Ø 240,5 20 18,2 V
1.3 D Multijet	55	01/06→	⬅	06/06→ 06/13		24.0120-0184.1 420184	Ø 240,5 20 18,2 V
1.3 D Multijet 4x4	51	10/04→12/06	⬅			24.0122-0197.1 422197	Ø 257,5 22 20,2 V
						24.0322-0197.1 522197	Ø 257,5 22 20,2 V PD
			➡			24.0111-0119.1 411119	Ø 240,5 11 9,2
1.3 D Multijet 4x4	55	01/06→	⬅	→ 06/13		24.0122-0197.1 422197	Ø 257,5 22 20,2 V
						24.0322-0197.1 522197	Ø 257,5 22 20,2 V PD
			➡	→ 06/13		24.0111-0119.1 411119	Ø 240,5 11 9,2
FIAT - PANDA VAN (312_, 519_) 02/12→							
 Bremsbelagsatz, Scheibenbremse							
0.9 0.9 0.9 0.9 Natural Power 0.9 Natural Power 1.2 1.2 LPG 1.3 D Multijet 1.3 D Multijet	48 59 63 59 63 51 51 55 59	02/12→ 12/13→ 02/12→ 01/15→ 07/12→ 02/12→ 06/12→ 02/12→ 12/15→	⬅			13.0460-7289.2 607289	ATE 25323 17,3 + WK
0.9 4x4 1.3 D Multijet 4x4 1.3 D Multijet 4x4 ↓	63 55 59	09/12→ 06/12→ 06/14→	⬅ ➡			13.0460-7289.2 607289 13.0460-2783.2 602783	ATE 25323 17,3 + WK TRW 25410 14,4 + WK + Zub













	kw			 	! #		
FIAT - PANDA VAN (312_, 519_) 02/12→							
 Bremsscheibe							
0.9 1.2 1.2 LPG	48 51 51	02/12→ 02/12→ 06/12→	←			24.0112-0127.1 412127	Ø 257,5 12 10,2
0.9 0.9 0.9 Natural Power 0.9 Natural Power 1.3 D Multijet 1.3 D Multijet	59 63 59 63 55 59	12/13→ 02/12→ 01/15→ 07/12→ 02/12→ 12/15→	←	für Leichtmetallfelgen; Serie 3		24.0112-0127.1 412127	Ø 257,5 12 10,2
			←	für Leichtmetallfelgen; Serie 2		24.0122-0197.1 422197	Ø 257,5 22 20,2 V
						24.0322-0197.1 522197	Ø 257,5 22 20,2 V PD
0.9 4x4 1.3 D Multijet 4x4 1.3 D Multijet 4x4	63 55 59	09/12→ 06/12→ 06/14→	←	für Leichtmetallfelgen; Serie 3		24.0112-0127.1 412127	Ø 257,5 12 10,2
			←	für Leichtmetallfelgen; Serie 2		24.0122-0197.1 422197	Ø 257,5 22 20,2 V
						24.0322-0197.1 522197	Ø 257,5 22 20,2 V PD
			→	nicht für Leichtmetallfelgen		24.0111-0119.1 411119	Ø 240,5 11 9,2
			→	für Leichtmetallfelgen		24.0112-0127.1 412127	Ø 257,5 12 10,2
FIAT - PREMIO 03/85→12/96							
 Bremsbelagsatz, Scheibenbremse							
1.5 i.e.	55	06/92→12/96	←			13.0460-5409.2 605409	ATE 21193 18,0 - WE / - WK
						13.0460-5410.2 605410	ATE 21193 18,0 + WK
1.6 i.e.	60	08/93→12/96	←	01/94→		13.0460-5409.2 605409	ATE 21193 18,0 - WE / - WK
						13.0460-5410.2 605410	ATE 21193 18,0 + WK
 Bremsscheibe							
1.5 i.e.	55	06/92→12/96	←			24.0112-0122.1 412122	Ø 240 12 10,8
1.6 i.e.	60	08/93→12/96	←	01/94→		24.0112-0122.1 412122	Ø 240 12 10,8
FIAT - PUNTO (176_) 09/93→09/99							
 Bremsbelagsatz, Scheibenbremse							
1.2 16V	63	04/97→09/99	←	06/97→		13.0460-7114.2 607114	ATE 21930 17,9 - WE / - WK
1.4 GT Turbo	96	09/96→09/99	←	→ 05/97		13.0460-2949.2 602949	TRW 20833 17,0 + WK
			←	06/97→		13.0460-7065.2 607065	ATE 21927 17,9 + WK
			→	06/97→; ALU		13.0460-2826.2 602826	TRW 23177 14,2 - WK
			→	→ 05/97; GG		13.0460-2951.2 602951	TRW 21103 14,2 - WK
1.4 GT Turbo	98	01/94→09/96	←			13.0460-2949.2 602949	TRW 20833 17,0 + WK
			→	GG		13.0460-2951.2 602951	TRW 21103 14,2 - WK
1.6	65	01/94→04/97	←	03/94→		13.0460-2949.2 602949	TRW 20833 17,0 + WK
1.7 D	42	04/94→09/97	←	01/95→ 05/97		13.0460-3950.2 603950	BDX 21436 17,0 - WK
						13.0460-3951.2 603951	BDX 21436 16,2 + WK
1.7 TD	46	09/96→09/99	←	→ 05/97		13.0460-2949.2 602949	TRW 20833 17,0 + WK
1.7 TD	51	01/94→09/99	←	06/97→		13.0460-7114.2 607114	ATE 21930 17,9 - WE / - WK
1.7 TD	52	01/94→09/99	←				
55 1.1	40	09/93→09/99	←	11/93→		13.0460-3950.2 603950	BDX 21436 17,0 - WK
						13.0460-3951.2 603951	BDX 21436 16,2 + WK
60 1.2	43	01/94→09/99	←			13.0460-2949.2 602949	TRW 20833 17,0 + WK
						13.0460-3950.2 603950	BDX 21436 17,0 - WK
						13.0460-3951.2 603951	BDX 21436 16,2 + WK
60 1.2 75 1.2	44 54	09/93→09/99 10/93→09/99	←	11/93→		13.0460-2949.2 602949	TRW 20833 17,0 + WK
						13.0460-3950.2 603950	BDX 21436 17,0 - WK
						13.0460-3951.2 603951	BDX 21436 16,2 + WK
Zubehörsatz, Scheibenbremsbelag							
1.4 GT Turbo	96	09/96→09/99	→	→ 05/97; GG		13.0460-0072.2 610072	TRW
1.4 GT Turbo	98	01/94→09/96	→	GG		13.0460-0072.2 610072	TRW
 Bremsscheibe							
1.2 16V	63	04/97→09/99	←	06/97→; + ABS		24.0112-0127.1 412127	Ø 257,5 12 10,2
1.4 GT Turbo	96	09/96→09/99	←			24.0120-0142.1 420142	Ø 257,5 20 18,2 V
1.4 GT Turbo	98	01/94→09/96	←			24.0320-0142.1 520142	Ø 257,5 20 18,2 V PD
			→			24.0111-0119.1 411119	Ø 240,5 11 9,2
1.6	65	01/94→04/97	←	03/94→; + ABS		24.0112-0127.1 412127	Ø 257,5 12 10,2
1.7 D	42	04/94→09/97	←	01/95→ 05/97		24.0111-0119.1 411119	Ø 240,5 11 9,2
1.7 TD	46	09/96→09/99	←	+ ABS		24.0112-0127.1 412127	Ø 257,5 12 10,2













	kw			 	! #		
FIAT - PUNTO (176_) 09/93→09/99							
 Bremsscheibe							
1.7 TD	51	01/94→09/99	←	+ ABS		24.0112-0127.1 412127	Ø 257,5 12 10,2
1.7 TD	52	01/94→09/99	←				
55 1.1	40	09/93→09/99	←	11/93→		24.0111-0119.1 411119	Ø 240,5 11 9,2
60 1.2	43	01/94→09/99	←	→ 05/97		24.0111-0119.1 411119	Ø 240,5 11 9,2
			←	06/97→		24.0111-0119.1 411119	Ø 240,5 11 9,2
			←	→ 05/97; + ABS		24.0112-0127.1 412127	Ø 257,5 12 10,2
60 1.2 75 1.2	44 54	09/93→09/99 10/93→09/99	←	11/93→ 05/97		24.0111-0119.1 411119	Ø 240,5 11 9,2
			←	06/97→		24.0111-0119.1 411119	Ø 240,5 11 9,2
			←	11/93→ 05/97; + ABS		24.0112-0127.1 412127	Ø 257,5 12 10,2
FIAT - PUNTO (188_) 09/99→07/12							
 Bremsbelagsatz, Scheibenbremse							
1.2 16V 80 (188.233, .235, .253, .255, .333, .353, .639...)	59	09/99→12/06	←	07/03→ 11/05		13.0460-7114.2 607114	ATE 21930 17,9 - WE / - WK
			←	10/99→ 06/03; Schaltgetriebe		13.0460-7114.2 607114	ATE 21930 17,9 - WE / - WK
			←	10/99→ 06/03; Vollautomatik		13.0460-7125.2 607125	ATE 21930 17,9 - WE / - WK
1.2 60 (188.030, .050, .130, .150, .230, .250)	44	09/99→12/10	←	10/99→ 06/03		13.0460-3950.2 603950	BDX 21436 17,0 - WK
			←	07/03→ 11/05		13.0460-3950.2 603950	BDX 21436 16,2 + WK
1.2 Bifuel	44	08/07→03/12	←	10/09→ 04/10		13.0460-3863.2 603863	BOS 23706 18,0 + WK + Zub
			←	05/10→		13.0460-7288.2 607288	ATE 25429 17,5 + WK
			→	10/09→		13.0470-7288.2 LD7288	ATE 25429 17,5 + WK Ceramic
1.2 Natural Power	44	09/03→03/12	←	→ 11/05		13.0460-3862.2 603862	BOS 24349 17,6 + WK + Zub
1.2 Natural Power	44	09/03→03/12	←	→ 11/05		13.0460-3950.2 603950	BDX 21436 17,0 - WK
1.3 JTD 16V	51	06/03→03/12	←	07/03→ 11/05		13.0460-7133.2 607133	ATE 21927 17,9 - WE / - WK
1.4 1.4	70 71	09/03→03/12 11/05→03/12	←	→ 11/05		13.0460-7133.2 607133	ATE 21927 17,9 - WE / - WK
1.8 130 HGT (188.738, .718)	96	09/99→03/12	←	10/99→ 06/03		13.0460-7126.2 607126	ATE 20907 18,1 - WE / - WK
			←	07/03→ 11/05		13.0460-7140.2 607140	ATE 21637 19,3 + WK
						13.0470-7140.2 LD7140	ATE 21637 19,3 + WK Ceramic
			→	07/03→ 11/05		13.0460-2879.2 602879	TRW 23601 13,7 - WE / - WK
			→	10/99→ 06/03		13.0470-2879.2 LD2879	TRW 23601 13,7 - WE / - WK Ceramic
1.9 DS 60 (188.031, .051, .231, .251)	44	09/99→03/12	←	10/99→ 06/03		13.0460-7125.2 607125	ATE 21930 17,9 - WE / - WK
1.9 JTD	63	10/01→03/12	←	07/03→ 11/05		13.0460-7133.2 607133	ATE 21927 17,9 - WE / - WK
			←	→ 06/03		13.0460-7133.2 607133	ATE 21927 17,9 - WE / - WK
1.9 JTD	74	06/03→03/12	←	07/03→ 11/05		13.0460-7140.2 607140	ATE 21637 19,3 + WK
						13.0470-7140.2 LD7140	ATE 21637 19,3 + WK Ceramic
			→	07/03→ 11/05		13.0460-2879.2 602879	TRW 23601 13,7 - WE / - WK
			→	10/99→ 06/03		13.0470-2879.2 LD2879	TRW 23601 13,7 - WE / - WK Ceramic
1.9 JTD 80 (188.237, .257, .337, .357)	59	09/99→03/12	←	10/99→ 06/03		13.0460-7133.2 607133	ATE 21927 17,9 - WE / - WK
 Bremsscheibe							
1.2 16V 80 (188.233, .235, .253, .255, .333, .353, .639...)	59	09/99→12/06	←	07/03→ 11/05		24.0112-0127.1 412127	Ø 257,5 12 10,2
			←	10/99→ 06/03		24.0112-0127.1 412127	Ø 257,5 12 10,2
1.2 60 (188.030, .050, .130, .150, .230, .250)	44	09/99→12/10	←	10/99→ 06/03		24.0111-0119.1 411119	Ø 240,5 11 9,2
			←	07/03→ 11/05		24.0112-0127.1 412127	Ø 257,5 12 10,2
1.2 Bifuel	44	08/07→03/12	←	10/09→		24.0122-0231.1 422231	Ø 257 22 20 V + S
			→	10/09→		24.0322-0231.1 522231	Ø 257 22 20 V + S PD
			→	10/09→		24.0110-0323.1 410323	Ø 264 10 8
1.2 Natural Power	44	09/03→03/12	←	→ 11/05		24.0112-0127.1 412127	Ø 257,5 12 10,2
1.3 JTD 16V	51	06/03→03/12	←	07/03→ 11/05		24.0120-0142.1 420142	Ø 257,5 20 18,2 V
						24.0320-0142.1 520142	Ø 257,5 20 18,2 V PD
1.4 1.4	70 71	09/03→03/12 11/05→03/12	←	→ 11/05		24.0120-0142.1 420142	Ø 257,5 20 18,2 V
						24.0320-0142.1 520142	Ø 257,5 20 18,2 V PD
↓							













	kw			 	! #		
FIAT - PUNTO (188_) 09/99→07/12							
 Bremsscheibe							
1.8 130 HGT (188.738, .718)	96	09/99→03/12	←	07/03→ 11/05		24.0122-0107.1 422107	Ø 284 22 20,2 V
			←	10/99→ 06/03		24.0122-0197.1 422197	Ø 257,5 22 20,2 V
						24.0322-0197.1 522197	Ø 257,5 22 20,2 V PD
			→	07/03→ 11/05		24.0111-0119.1 411119	Ø 240,5 11 9,2
			→	10/99→ 06/03		24.0111-0119.1 411119	Ø 240,5 11 9,2
1.9 DS 60 (188.031, .051, .231, .251)	44	09/99→03/12	←	10/99→ 06/03		24.0112-0127.1 412127	Ø 257,5 12 10,2
1.9 JTD	63	10/01→03/12	←	07/03→ 11/05		24.0120-0142.1 420142	Ø 257,5 20 18,2 V
						24.0320-0142.1 520142	Ø 257,5 20 18,2 V PD
			←	→ 06/03		24.0120-0142.1 420142	Ø 257,5 20 18,2 V
						24.0320-0142.1 520142	Ø 257,5 20 18,2 V PD
1.9 JTD	74	06/03→03/12	←	07/03→ 11/05		24.0122-0107.1 422107	Ø 284 22 20,2 V
			→	07/03→ 11/05		24.0111-0119.1 411119	Ø 240,5 11 9,2
1.9 JTD 80 (188.237, .257, .337, .357)	59	09/99→03/12	←	10/99→ 06/03		24.0120-0142.1 420142	Ø 257,5 20 18,2 V
						24.0320-0142.1 520142	Ø 257,5 20 18,2 V PD
FIAT - PUNTO (199_) 03/12→							
 Bremsbelagsatz, Scheibenbremse							
0.9	74	12/13→	←			13.0460-7288.2 607288	ATE 25429 17,5 + WK
0.9	77	07/13→				13.0470-7288.2 LD7288	ATE 25429 17,5 + WK Ceramic
0.9 Bifuel	63	03/12→					
0.9 Twinair Turbo	63	03/12→	→			13.0460-3862.2 603862	BOS 24349 17,6 + WK + Zub
1.2	49	02/14→					
1.2	51	03/12→					
1.3 D Multijet	55	03/12→					
1.3 D Multijet	59	12/13→					
1.3 D Multijet	62	03/12→					
1.4	55	03/12→					
1.4	57	03/12→					
1.4 Bifuel	57	03/12→					
1.4 Multi Air	77	03/12→					
1.4 Natural Power	57	03/12→					
1.4 Turbo Multi Air	99	03/12→					
1.3 D Multijet	66	05/16→	←			13.0460-3864.2 603864	BOS 23709 19,6 + WK + Zub
1.3 D Multijet	70	03/12→	→			13.0460-3862.2 603862	BOS 24349 17,6 + WK + Zub
 Bremsscheibe							
0.9	74	12/13→	←			24.0122-0231.1 422231	Ø 257 22 20 V + S
0.9	77	07/13→				24.0322-0231.1 522231	Ø 257 22 20 V + S PD
0.9 Bifuel	63	03/12→					
0.9 Twinair Turbo	63	03/12→	→			24.0110-0323.1 410323	Ø 264 10 8
1.2	49	02/14→					
1.2	51	03/12→					
1.3 D Multijet	55	03/12→					
1.3 D Multijet	59	12/13→					
1.3 D Multijet	62	03/12→					
1.4	55	03/12→					
1.4	57	03/12→					
1.4 Bifuel	57	03/12→					
1.4 Multi Air	77	03/12→					
1.4 Natural Power	57	03/12→					
1.3 D Multijet	66	05/16→	←			24.0122-0241.1 422241	Ø 284 22 20 V + S
1.3 D Multijet	70	03/12→	→			24.0110-0323.1 410323	Ø 264 10 8
1.4 Turbo Multi Air	99	03/12→					
FIAT - PUNTO Cabriolet (176_) 04/94→06/00							
 Bremsbelagsatz, Scheibenbremse							
60 1.2	43	04/94→06/00	←			13.0460-2949.2 602949	TRW 20833 17,0 + WK
60 1.2	44	05/95→06/00				13.0460-3950.2 603950	BDX 21436 17,0 - WK
						13.0460-3951.2 603951	BDX 21436 16,2 + WK
85 16V 1.2	63	04/97→06/00	←	06/97→		13.0460-7114.2 607114	ATE 21930 17,9 - WE / - WK
90 1.6	65	04/94→04/97	←			13.0460-2949.2 602949	TRW 20833 17,0 + WK
 Bremsscheibe							
60 1.2	43	04/94→06/00	←	06/97→		24.0111-0119.1 411119	Ø 240,5 11 9,2
60 1.2	44	05/95→06/00	←	→ 05/97		24.0111-0119.1 411119	Ø 240,5 11 9,2
			←	→ 05/97; + ABS		24.0112-0127.1 412127	Ø 257,5 12 10,2
85 16V 1.2	63	04/97→06/00	←	06/97→; + ABS		24.0112-0127.1 412127	Ø 257,5 12 10,2
90 1.6	65	04/94→04/97	←	+ ABS		24.0112-0127.1 412127	Ø 257,5 12 10,2















	kW			 	! #		
FIAT - PUNTO EVO (199_) 07/08→							
 Bremsbelagsatz, Scheibenbremse							
1.2	48	10/09→02/12	←	→ 04/10		13.0460-3863.2 603863	BOS 23706 18,0 + WK + Zub
1.2	51	10/09→02/12	←				
1.3 D Multijet	55	10/09→02/12	←	05/10→		13.0460-7288.2 607288	ATE 25429 17,5 + WK
1.3 D Multijet	56	10/09→02/12	←			13.0470-7288.2 LD7288	ATE 25429 17,5 + WK Ceramic
1.3 D Multijet	62	10/09→02/12	→			13.0460-3862.2 603862	BOS 24349 17,6 + WK + Zub
1.4	57	10/09→02/12	→				
1.4 16V	77	10/09→02/12	→				
1.4 LPG	57	06/09→02/12	→				
1.4 Natural Power	57	10/09→02/12	→				
1.3 D Multijet	51	07/08→02/12	←	10/09→		13.0460-3864.2 603864	BOS 23709 19,6 + WK + Zub
			→			13.0460-3862.2 603862	BOS 24349 17,6 + WK + Zub
1.3 D Multijet	66	10/09→02/12	←			13.0460-3864.2 603864	BOS 23709 19,6 + WK + Zub
1.3 D Multijet	68	10/14→	←				
1.3 D Multijet	70	10/09→02/12	→			13.0460-3862.2 603862	BOS 24349 17,6 + WK + Zub
1.4 16V	99	10/09→02/12	→				
1.6 D Multijet	88	10/09→02/12	→				
1.4	55	07/09→02/12	←	10/09→ 04/10		13.0460-3863.2 603863	BOS 23706 18,0 + WK + Zub
			←	05/10→		13.0460-7288.2 607288	ATE 25429 17,5 + WK
			←			13.0470-7288.2 LD7288	ATE 25429 17,5 + WK Ceramic
			→	10/09→		13.0460-3862.2 603862	BOS 24349 17,6 + WK + Zub
1.4 (199.AXX1B)	120	04/10→02/12	←			13.0460-4853.2 604853	BRE 24162 15,2 + WK
			←			13.0470-4853.2 LD4853	BRE 24162 15,2 + WK Ceramic
			→			13.0460-3862.2 603862	BOS 24349 17,6 + WK + Zub
1.4 (199.AXX1B)	132	05/08→02/12	←	10/09→		13.0460-4853.2 604853	BRE 24162 15,2 + WK
			←			13.0470-4853.2 LD4853	BRE 24162 15,2 + WK Ceramic
			→	10/09→		13.0460-3862.2 603862	BOS 24349 17,6 + WK + Zub
 Bremsscheibe							
1.2	48	10/09→02/12	←			24.0122-0231.1 422231	Ø 257 22 20 V + S
1.2	51	10/09→02/12	←			24.0322-0231.1 522231	Ø 257 22 20 V + S PD
1.3 D Multijet	51	07/08→02/12	→				
1.3 D Multijet	55	10/09→02/12	→			24.0110-0323.1 410323	Ø 264 10 8
1.3 D Multijet	56	10/09→02/12	→				
1.3 D Multijet	62	10/09→02/12	→				
1.4	57	10/09→02/12	→				
1.4 16V	77	10/09→02/12	→				
1.4 LPG	57	06/09→02/12	→				
1.4 Natural Power	57	10/09→02/12	→				
1.3 D Multijet	66	10/09→02/12	←			24.0122-0241.1 422241	Ø 284 22 20 V + S
1.3 D Multijet	68	10/14→	←				
1.3 D Multijet	70	10/09→02/12	→			24.0110-0323.1 410323	Ø 264 10 8
1.4 16V	99	10/09→02/12	→				
1.6 D Multijet	88	10/09→02/12	→				
1.4	55	07/09→02/12	←	10/09→		24.0122-0231.1 422231	Ø 257 22 20 V + S
			←			24.0322-0231.1 522231	Ø 257 22 20 V + S PD
			→	10/09→		24.0110-0323.1 410323	Ø 264 10 8
1.4 (199.AXX1B)	120	04/10→02/12	←			24.0128-0219.1 428219	Ø 305 28 26 V
			→			24.0110-0323.1 410323	Ø 264 10 8
1.4 (199.AXX1B)	132	05/08→02/12	←	10/09→		24.0128-0219.1 428219	Ø 305 28 26 V
			→	10/09→		24.0110-0323.1 410323	Ø 264 10 8
FIAT - PUNTO Van (176_) 04/96→02/00							
 Bremsbelagsatz, Scheibenbremse							
1.1	40	04/96→02/00	←	→ 09/99		13.0460-3950.2 603950	BDX 21436 17,0 - WK
						13.0460-3951.2 603951	BDX 21436 16,2 + WK
1.7 D	42	04/96→02/00	←	→ 05/97		13.0460-3950.2 603950	BDX 21436 17,0 - WK
						13.0460-3951.2 603951	BDX 21436 16,2 + WK
1.7 TD	46	09/96→09/99	←	→ 05/97		13.0460-2949.2 602949	TRW 20833 17,0 + WK
			←	06/97→		13.0460-7114.2 607114	ATE 21930 17,9 - WE / - WK
1.7 TD	52	04/96→02/00	←	→ 05/97		13.0460-2949.2 602949	TRW 20833 17,0 + WK
			←	06/97→ 09/99		13.0460-7114.2 607114	ATE 21930 17,9 - WE / - WK
 Bremsscheibe							
1.1	40	04/96→02/00	←	→ 09/99		24.0111-0119.1 411119	Ø 240,5 11 9,2
1.7 D	42	04/96→02/00	←	→ 05/97		24.0111-0119.1 411119	Ø 240,5 11 9,2
1.7 TD	46	09/96→09/99	←	+ ABS		24.0112-0127.1 412127	Ø 257,5 12 10,2
↓							























	kw			 	! #		
FIAT - PUNTO Van (176_) 04/96→02/00							
 Bremsscheibe							
1.7 TD	52	04/96→02/00	←	→ 09/99; + ABS		24.0112-0127.1 412127	Ø 257,5 12 10,2
FIAT - PUNTO Van (188_) 02/00→10/09							
 Bremsbelagsatz, Scheibenbremse							
1.2 60	44	02/00→10/09	←	→ 06/03		13.0460-3950.2 603950	BDX 21436 17,0 - WK
						13.0460-3951.2 603951	BDX 21436 16,2 + WK
1.3 D Multijet	55	02/05→10/09	←	→ 11/05		13.0460-7133.2 607133	ATE 21927 17,9 - WE / - WK
1.3 JTD	51	06/03→10/05	←	07/03→		13.0460-7133.2 607133	ATE 21927 17,9 - WE / - WK
1.9 D 60	44	02/00→10/09	←	→ 06/03		13.0460-7125.2 607125	ATE 21930 17,9 - WE / - WK
1.9 JTD	63	02/00→10/09	←	→ 06/03		13.0460-7133.2 607133	ATE 21927 17,9 - WE / - WK
 Bremsscheibe							
1.2 60	44	02/00→10/09	←	→ 06/03		24.0111-0119.1 411119	Ø 240,5 11 9,2
1.3 D Multijet	55	02/05→10/09	←	→ 11/05		24.0120-0142.1 420142	Ø 257,5 20 18,2 V
						24.0320-0142.1 520142	Ø 257,5 20 18,2 V PD
1.3 JTD	51	06/03→10/05	←	07/03→		24.0120-0142.1 420142	Ø 257,5 20 18,2 V
						24.0320-0142.1 520142	Ø 257,5 20 18,2 V PD
1.9 D 60	44	02/00→10/09	←	→ 06/03		24.0112-0127.1 412127	Ø 257,5 12 10,2
1.9 JTD	63	02/00→10/09	←	→ 06/03		24.0120-0142.1 420142	Ø 257,5 20 18,2 V
						24.0320-0142.1 520142	Ø 257,5 20 18,2 V PD
FIAT - PUNTO Van (199_) 02/06→							
 Bremsbelagsatz, Scheibenbremse							
0.9 Twinair Turbo	63	03/12→	←			13.0460-7288.2 607288	ATE 25429 17,5 + WK
1.3 D Multijet	62	03/12→	←			13.0470-7288.2 LD7288	ATE 25429 17,5 + WK Ceramic
			→			13.0460-3862.2 603862	BOS 24349 17,6 + WK + Zub
1.3 D Multijet	55	04/08→	←	09/10→ 01/11		13.0460-3863.2 603863	BOS 23706 18,0 + WK + Zub
1.3 D Multijet	66	01/10→02/12	←			13.0460-3864.2 603864	BOS 23709 19,6 + WK + Zub
			→			13.0460-3862.2 603862	BOS 24349 17,6 + WK + Zub
1.3 D Multijet	70	03/09→	←	10/09→		13.0460-3864.2 603864	BOS 23709 19,6 + WK + Zub
			→	10/09→		13.0460-3862.2 603862	BOS 24349 17,6 + WK + Zub
1.4 (199BxB1A)	57	02/06→06/13	←	10/09→ 04/10		13.0460-3863.2 603863	BOS 23706 18,0 + WK + Zub
1.4 Natural Power	57	03/09→	←	05/10→		13.0460-7288.2 607288	ATE 25429 17,5 + WK
			→	10/09→		13.0470-7288.2 LD7288	ATE 25429 17,5 + WK Ceramic
			→	10/09→		13.0460-3862.2 603862	BOS 24349 17,6 + WK + Zub
1.4 LPG (199AXB1A)	57	03/09→	←	06/09→ 04/10		13.0460-3863.2 603863	BOS 23706 18,0 + WK + Zub
			←	05/10→		13.0460-7288.2 607288	ATE 25429 17,5 + WK
			→	06/09→		13.0470-7288.2 LD7288	ATE 25429 17,5 + WK Ceramic
			→	06/09→		13.0460-3862.2 603862	BOS 24349 17,6 + WK + Zub
 Bremsscheibe							
0.9 Twinair Turbo	63	03/12→	←			24.0122-0231.1 422231	Ø 257 22 20 V + S
1.3 D Multijet	62	03/12→	←			24.0322-0231.1 522231	Ø 257 22 20 V + S PD
			→			24.0110-0323.1 410323	Ø 264 10 8
1.3 D Multijet	55	04/08→	←	→ 01/11		24.0122-0231.1 422231	Ø 257 22 20 V + S
						24.0322-0231.1 522231	Ø 257 22 20 V + S PD
1.3 D Multijet	66	01/10→02/12	←			24.0122-0241.1 422241	Ø 284 22 20 V + S
			→			24.0110-0323.1 410323	Ø 264 10 8
1.3 D Multijet	70	03/09→	←	10/09→		24.0122-0241.1 422241	Ø 284 22 20 V + S
			→	10/09→		24.0110-0323.1 410323	Ø 264 10 8
1.4 (199BxB1A)	57	02/06→06/13	←	10/09→		24.0122-0231.1 422231	Ø 257 22 20 V + S
1.4 Natural Power	57	03/09→	←	10/09→		24.0322-0231.1 522231	Ø 257 22 20 V + S PD
			→	10/09→		24.0110-0323.1 410323	Ø 264 10 8
1.4 LPG (199AXB1A)	57	03/09→	←	06/09→		24.0122-0231.1 422231	Ø 257 22 20 V + S
			→	06/09→		24.0322-0231.1 522231	Ø 257 22 20 V + S PD
			→	06/09→		24.0110-0323.1 410323	Ø 264 10 8

	kW			 	! #		
FIAT - QUBO (225_) 02/08→							
 Bremsbelagsatz, Scheibenbremse							
1.3 D Multijet	55	02/08→	←	09/08→; Schaltgetriebe		13.0460-3826.2 603826 13.0470-3826.2 LD3826	BOS 23706 18,0 + WK + Zub BOS 23706 18,0 + WK + Zub Ceramic
			←	09/08→; Halbaufomatik		13.0460-3863.2 603863	BOS 23706 18,0 + WK + Zub
1.3 D Multijet	59	03/15→	←	Schaltgetriebe		13.0460-3826.2 603826 13.0470-3826.2 LD3826	BOS 23706 18,0 + WK + Zub BOS 23706 18,0 + WK + Zub Ceramic
			←	Halbaufomatik		13.0460-3863.2 603863	BOS 23706 18,0 + WK + Zub
1.3 D Multijet	70	07/10→	←			13.0460-3827.2 603827 13.0470-3827.2 LD3827	BOS 23709 19,6 + WK + Zub BOS 23709 19,6 + WK + Zub Ceramic
1.4	54	02/08→	←	09/08→; → 6446		13.0460-3826.2 603826 13.0470-3826.2 LD3826	BOS 23706 18,0 + WK + Zub BOS 23706 18,0 + WK + Zub Ceramic
			←	6447→		13.0460-3863.2 603863	BOS 23706 18,0 + WK + Zub
1.4 1.4 Natural Power	57 57	10/09→ 10/09→	←	→ 6446		13.0460-3826.2 603826 13.0470-3826.2 LD3826	BOS 23706 18,0 + WK + Zub BOS 23706 18,0 + WK + Zub Ceramic
			←	6447→		13.0460-3863.2 603863	BOS 23706 18,0 + WK + Zub
 Bremsscheibe							
1.3 D Multijet 1.4	55 54	02/08→ 02/08→	←	09/08→		24.0122-0197.1 422197 24.0322-0197.1 522197	Ø 257,5 22 20,2 V Ø 257,5 22 20,2 V PD
1.3 D Multijet 1.4 1.4 Natural Power	59 57 57	03/15→ 10/09→ 10/09→	←			24.0122-0197.1 422197 24.0322-0197.1 522197	Ø 257,5 22 20,2 V Ø 257,5 22 20,2 V PD Ø 257,5 22 20,2 V PD
1.3 D Multijet	70	07/10→	←			24.0122-0147.1 422147	Ø 284 22 20,2 V
FIAT - SCUDO (270_, 272_) 01/07→							
 Bremsbelagsatz, Scheibenbremse							
1.6 D Multijet 1.6 D Multijet 2.0 D Multijet 2.0 D Multijet 2.0 D Multijet 2.0 D Multijet 2.0 D Multijet 4x4	66 66 88 94 100 120 94	01/07→ 02/11→ 01/07→ 04/11→ 01/07→ 07/10→ 04/11→	← → → → → → →			13.0460-2738.2 602738 13.0460-2739.2 602739	TRW 24608 18,5 + WK + Zub TRW 24578 16,5 - WE / - WK + Zub
2.0 D Multijet 4x4	88	01/07→	←	04/11→		13.0460-2738.2 602738	TRW 24608 18,5 + WK + Zub
			→	04/11→		13.0460-2739.2 602739	TRW 24578 16,5 - WE / - WK + Zub
 Bremsscheibe							
1.6 D Multijet 1.6 D Multijet	66 66	01/07→ 02/11→	←	für Fahrzeuge mit Trommelbremse an der Hinterachse		24.0128-0214.1 428214	Ø 280 28 26 V + S
			←	für Fahrzeuge mit Scheibenbremse an der Hinterachse		24.0128-0216.1 428216	Ø 304 28 26 V + S
			→			24.0114-0116.1 414116	Ø 290 14 12 + S
2.0 D Multijet 2.0 D Multijet 2.0 D Multijet 2.0 D Multijet 2.0 D Multijet 4x4	88 94 100 120 94	01/07→ 04/11→ 01/07→ 07/10→ 04/11→	← → → → →			24.0128-0216.1 428216 24.0114-0116.1 414116	Ø 304 28 26 V + S Ø 290 14 12 + S
2.0 D Multijet 4x4	88	01/07→	←	04/11→		24.0128-0216.1 428216	Ø 304 28 26 V + S
			→	04/11→		24.0114-0116.1 414116	Ø 290 14 12 + S
FIAT - SCUDO Combinato (220_) 02/96→12/06							
 Bremsbelagsatz, Scheibenbremse							
1.6 1.9 D 1.9 TD 1.9 TD Eco 2.0 16V 2.0 JTD	58 51 68 66 100 80	02/96→12/06 04/98→12/06 02/96→12/06 02/96→12/06 06/00→12/06 12/99→12/06	← ← ← ← ← ←	10/03→ → 09/03		13.0460-2863.2 602863 13.0460-2978.2 602978 13.0460-3957.2 603957	TRW 20261 19,0 + WK + Zub TRW 21801 19,0 + WK BDX 23042 19,0 + WK + Zub
1.9 D	51	02/96→04/98	←			13.0460-2978.2 602978 13.0460-3957.2 603957	TRW 21801 19,0 + WK BDX 23042 19,0 + WK + Zub
2.0 JTD	69	01/04→12/06	←			13.0460-2863.2 602863 13.0460-3957.2 603957	TRW 20261 19,0 + WK + Zub BDX 23042 19,0 + WK + Zub
↓							

	kW					! #		
FIAT - SCUDO Combinato (220_) 02/96→12/06								
 Bremsbelagsatz, Scheibenbremse								
2.0 JTD 16V	80	05/99→12/06	←	10/03→		13.0460-2863.2	602863	TRW 20261 19,0 + WK + Zub
			←	12/99→ 09/03		13.0460-2978.2	602978	TRW 21801 19,0 + WK
			←	12/99→		13.0460-3957.2	603957	BDX 23042 19,0 + WK + Zub
 Bremsscheibe								
1.6	58	02/96→12/06	←			24.0120-0155.1	420155	Ø 257,5 20 18,2 V
1.9 D	51	04/98→12/06	←	→ 09/03		24.0126-0104.1	426104	Ø 281 26 24,2 V
1.9 TD	68	02/96→12/06	←					
1.9 TD Eco	66	02/96→12/06	←	10/03→		24.0128-0136.1	428136	Ø 285 28 26 V
2.0 16V	100	06/00→12/06				24.0328-0136.1	528136	Ø 285 28 26 V PD
2.0 JTD	80	12/99→12/06						
1.9 D	51	02/96→04/98	←			24.0120-0155.1	420155	Ø 257,5 20 18,2 V
						24.0126-0104.1	426104	Ø 281 26 24,2 V
2.0 JTD	69	01/04→12/06	←			24.0120-0155.1	420155	Ø 257,5 20 18,2 V
						24.0128-0136.1	428136	Ø 285 28 26 V
						24.0328-0136.1	528136	Ø 285 28 26 V PD
2.0 JTD 16V	80	05/99→12/06	←	12/99→		24.0120-0155.1	420155	Ø 257,5 20 18,2 V
			←	12/99→ 09/03		24.0126-0104.1	426104	Ø 281 26 24,2 V
			←	10/03→		24.0128-0136.1	428136	Ø 285 28 26 V
						24.0328-0136.1	528136	Ø 285 28 26 V PD
FIAT - SCUDO Kasten (220_) 02/96→12/06								
 Bremsbelagsatz, Scheibenbremse								
1.6	58	02/96→12/06	←	10/03→		13.0460-2863.2	602863	TRW 20261 19,0 + WK + Zub
1.9 D	51	02/96→12/06	←	→ 09/03		13.0460-2978.2	602978	TRW 21801 19,0 + WK
1.9 D	51	04/98→12/06	←					
1.9 TD	66	02/96→12/06	←			13.0460-3957.2	603957	BDX 23042 19,0 + WK + Zub
1.9 TD	68	02/98→12/06						
2.0 JTD	80	12/02→12/06						
2.0	100	05/00→12/06	←	10/03→		13.0460-2863.2	602863	TRW 20261 19,0 + WK + Zub
			←	06/00→ 09/03		13.0460-2978.2	602978	TRW 21801 19,0 + WK
			←	06/00→		13.0460-3957.2	603957	BDX 23042 19,0 + WK + Zub
2.0 JTD	69	10/99→12/06	←	10/03→		13.0460-2863.2	602863	TRW 20261 19,0 + WK + Zub
2.0 JTD 16V	80	05/99→12/06	←	12/99→ 09/03		13.0460-2978.2	602978	TRW 21801 19,0 + WK
			←	12/99→		13.0460-3957.2	603957	BDX 23042 19,0 + WK + Zub
 Bremsscheibe								
1.6	58	02/96→12/06	←			24.0120-0155.1	420155	Ø 257,5 20 18,2 V
1.9 D	51	02/96→12/06	←	→ 09/03		24.0126-0104.1	426104	Ø 281 26 24,2 V
1.9 D	51	04/98→12/06	←					
1.9 TD	66	02/96→12/06	←	10/03→		24.0128-0136.1	428136	Ø 285 28 26 V
1.9 TD	68	02/98→12/06				24.0328-0136.1	528136	Ø 285 28 26 V PD
2.0 JTD	80	12/02→12/06						
2.0	100	05/00→12/06	←	06/00→		24.0120-0155.1	420155	Ø 257,5 20 18,2 V
			←	06/00→ 09/03		24.0126-0104.1	426104	Ø 281 26 24,2 V
			←	10/03→		24.0128-0136.1	428136	Ø 285 28 26 V
						24.0328-0136.1	528136	Ø 285 28 26 V PD
2.0 JTD	69	10/99→12/06	←	12/99→		24.0120-0155.1	420155	Ø 257,5 20 18,2 V
2.0 JTD 16V	80	05/99→12/06	←	12/99→ 09/03		24.0126-0104.1	426104	Ø 281 26 24,2 V
			←	10/03→		24.0128-0136.1	428136	Ø 285 28 26 V
						24.0328-0136.1	528136	Ø 285 28 26 V PD
FIAT - SCUDO Kasten (270_, 272_) 01/07→								
 Bremsbelagsatz, Scheibenbremse								
1.6 D Multijet	66	01/07→	←			13.0460-2738.2	602738	TRW 24608 18,5 + WK + Zub
1.6 D Multijet	66	02/11→	→			13.0460-2739.2	602739	TRW 24578 16,5 - WE / - WK + Zub
2.0 D Multijet	88	01/07→	→					
2.0 D Multijet	94	05/11→						
2.0 D Multijet	100	01/07→						
2.0 D Multijet	120	07/10→						
2.0 D Multijet 4x4	88	01/07→	←	04/11→		13.0460-2738.2	602738	TRW 24608 18,5 + WK + Zub
			→	04/11→		13.0460-2739.2	602739	TRW 24578 16,5 - WE / - WK + Zub
↓								

	kW			 	! #		
FIAT - SCUDO Kasten (270_, 272_) 01/07→							
 Bremsscheibe							
1.6 D Multijet 1.6 D Multijet	66 66	01/07→ 02/11→	← ← →	für Fahrzeuge mit Trommelbremse an der Hinterachse für Fahrzeuge mit Scheibenbremse an der Hinterachse		24.0128-0214.1 428214 24.0128-0216.1 428216 24.0114-0116.1 414116	Ø 280 28 26 V + S Ø 304 28 26 V + S Ø 290 14 12 + S
2.0 D Multijet 2.0 D Multijet 2.0 D Multijet 2.0 D Multijet	88 94 100 120	01/07→ 05/11→ 01/07→ 07/10→	← → →			24.0128-0216.1 428216 24.0114-0116.1 414116	Ø 304 28 26 V + S Ø 290 14 12 + S
2.0 D Multijet 4x4	88	01/07→	← →	04/11→ 04/11→		24.0128-0216.1 428216 24.0114-0116.1 414116	Ø 304 28 26 V + S Ø 290 14 12 + S
FIAT - SCUDO Pritsche/Fahrgestell (220_) 09/96→12/06							
 Bremsbelagsatz, Scheibenbremse							
1.6 1.9 D 1.9 TD 2.0 JTD	58 51 68 80	09/96→12/06 04/98→12/06 09/96→12/06 12/02→12/06	← ← ←	10/03→ → 09/03		13.0460-2863.2 602863 13.0460-2978.2 602978 13.0460-3957.2 603957	TRW 20261 19,0 + WK + Zub TRW 21801 19,0 + WK BDX 23042 19,0 + WK + Zub
2.0 JTD 2.0 JTD 16V	69 80	10/99→12/06 05/99→12/06	← ← ←	10/03→ 12/99→ 09/03 12/99→		13.0460-2863.2 602863 13.0460-2978.2 602978 13.0460-3957.2 603957	TRW 20261 19,0 + WK + Zub TRW 21801 19,0 + WK BDX 23042 19,0 + WK + Zub
 Bremsscheibe							
1.6 1.9 D 1.9 TD 2.0 JTD	58 51 68 80	09/96→12/06 04/98→12/06 09/96→12/06 12/02→12/06	← ← ←			24.0120-0155.1 420155 24.0126-0104.1 426104 24.0128-0136.1 428136 24.0328-0136.1 528136	Ø 257,5 20 18,2 V Ø 281 26 24,2 V Ø 285 28 26 V Ø 285 28 26 V PD
2.0 JTD 2.0 JTD 16V	69 80	10/99→12/06 05/99→12/06	← ← ←	12/99→ 12/99→ 09/03 10/03→		24.0120-0155.1 420155 24.0126-0104.1 426104 24.0128-0136.1 428136 24.0328-0136.1 528136	Ø 257,5 20 18,2 V Ø 281 26 24,2 V Ø 285 28 26 V Ø 285 28 26 V PD
FIAT - SCUDO Pritsche/Fahrgestell (270_, 272_) 01/07→							
 Bremsbelagsatz, Scheibenbremse							
1.6 D Multijet 2.0 D Multijet 2.0 D Multijet 2.0 D Multijet 2.0 D Multijet	66 88 94 100 120	01/07→ 01/07→ 05/11→ 01/07→ 07/10→	← →			13.0460-2738.2 602738 13.0460-2739.2 602739	TRW 24608 18,5 + WK + Zub TRW 24578 16,5 - WE / - WK + Zub
 Bremsscheibe							
1.6 D Multijet	66	01/07→	← ← →	für Fahrzeuge mit Trommelbremse an der Hinterachse für Fahrzeuge mit Scheibenbremse an der Hinterachse		24.0128-0214.1 428214 24.0128-0216.1 428216 24.0114-0116.1 414116	Ø 280 28 26 V + S Ø 304 28 26 V + S Ø 290 14 12 + S
2.0 D Multijet 2.0 D Multijet 2.0 D Multijet 2.0 D Multijet	88 94 100 120	01/07→ 05/11→ 01/07→ 07/10→	← →			24.0128-0216.1 428216 24.0114-0116.1 414116	Ø 304 28 26 V + S Ø 290 14 12 + S
FIAT - SEDICI (FY_) 06/06→10/14							
 Bremsbelagsatz, Scheibenbremse							
1.6 16V 1.6 16V 1.6 16V 4x4 1.6 16V 4x4 1.9 D Multijet 1.9 D Multijet 4x4 2.0 D Multijet 2.0 D Multijet 4x4	79 88 79 88 88 88 99 99	06/06→10/14 06/06→10/14 06/06→10/14 06/06→10/14 06/06→10/14 06/06→10/14 06/06→10/14 06/06→10/14	← →			13.0460-2715.2 602715 13.0460-5929.2 605929	TRW 24391 16,6 + WK + Zub AKE 21719 15,0 + WK
 Bremsscheibe							
1.6 16V 1.6 16V 1.6 16V 4x4 1.6 16V 4x4 1.9 D Multijet 1.9 D Multijet 4x4	79 88 79 88 88 88	06/06→10/14 06/06→10/14 06/06→10/14 06/06→10/14 06/06→10/14 06/06→10/14	← →			24.0122-0252.1 422252 24.0109-0167.1 409167	Ø 280 22 20 V Ø 278 9 8

	kw					! #		
FIAT - SEDICI (FY_) 06/06→10/14								
 Bremsscheibe								
2.0 D Multijet	99	06/06→10/14	←			24.0122-0252.1	422252	Ø 280 22 20 V
2.0 D Multijet 4x4	99	06/06→10/14	→			24.0109-0167.1	409167	Ø 278 9 8
FIAT - SEICENTO / 600 (187_) 01/98→01/10								
 Bremsbelagsatz, Scheibenbremse								
0.9 (187AXA, 187AXA1A)	29	01/98→01/10	←	04/98→03/08		13.0460-3950.2	603950	BDX 21436 17,0 - WK
1.1 (187AXB, 187AXB1A)	40	01/98→01/10						
 Bremsscheibe								
0.9 (187AXA, 187AXA1A)	29	01/98→01/10	←	04/98→03/08		24.0111-0119.1	411119	Ø 240,5 11 9,2
1.1 (187AXB, 187AXB1A)	40	01/98→01/10						
Elektra (187AEA1A, 187BEA1A)	30	01/99→01/05	←	03/00→		24.0111-0119.1	411119	Ø 240,5 11 9,2
Elettrica	22	03/00→04/04	←			24.0111-0119.1	411119	Ø 240,5 11 9,2
FIAT - SEICENTO / 600 Van (287_) 01/98→01/10								
 Bremsbelagsatz, Scheibenbremse								
0.9 (187AXA)	29	01/98→01/10	←	04/98→03/08		13.0460-3950.2	603950	BDX 21436 17,0 - WK
1.1 (187CXB/C)	40	01/98→01/10						
 Bremsscheibe								
0.9 (187AXA)	29	01/98→01/10	←	04/98→03/08		24.0111-0119.1	411119	Ø 240,5 11 9,2
1.1 (187CXB/C)	40	01/98→01/10						
FIAT - SIENA (178_) 04/96→12/12								
 Bremsbelagsatz, Scheibenbremse								
1.2	44	09/01→12/09	←	03/02→		13.0460-3849.2	603849	BOS 24393 17,9 - WE / - WK + Zub
						13.0460-3982.2	603982	BOS 23705 18,1 + WK
						13.0470-3982.2	LD3982	BOS 23705 18,1 + WK Ceramic
1.2	59	09/01→12/09	←	03/02→		13.0460-3849.2	603849	BOS 24393 17,9 - WE / - WK + Zub
						13.0460-3982.2	603982	BOS 23705 18,1 + WK
						13.0470-3982.2	LD3982	BOS 23705 18,1 + WK Ceramic
			←	→ 12/06		13.0460-7126.2	607126	ATE 20907 18,1 - WE / - WK
1.3 JTD	51	09/03→12/09	←			13.0460-3849.2	603849	BOS 24393 17,9 - WE / - WK + Zub
						13.0460-3982.2	603982	BOS 23705 18,1 + WK
						13.0470-3982.2	LD3982	BOS 23705 18,1 + WK Ceramic
			←	→ 12/06		13.0460-7126.2	607126	ATE 20907 18,1 - WE / - WK
1.4	51	04/96→12/09	←	04/98→12/06		13.0460-7128.2	607128	ATE 23218 18,0 + WK
1.4 Cat	51	04/96→12/09	←			13.0460-7132.2	607132	ATE 23218 18,0 - WE / - WK
1.4	57	01/07→12/09	←			13.0460-3849.2	603849	BOS 24393 17,9 - WE / - WK + Zub
						13.0460-3982.2	603982	BOS 23705 18,1 + WK
						13.0470-3982.2	LD3982	BOS 23705 18,1 + WK Ceramic
1.5	62	06/04→12/09	←			13.0460-7128.2	607128	ATE 23218 18,0 + WK
1.7 TD	51	02/06→12/09	←			13.0460-7132.2	607132	ATE 23218 18,0 - WE / - WK
1.6	76	11/00→12/09	←	03/02→		13.0460-3849.2	603849	BOS 24393 17,9 - WE / - WK + Zub
						13.0460-3982.2	603982	BOS 23705 18,1 + WK
						13.0470-3982.2	LD3982	BOS 23705 18,1 + WK Ceramic
			←	→ 12/06		13.0460-7128.2	607128	ATE 23218 18,0 + WK
						13.0460-7132.2	607132	ATE 23218 18,0 - WE / - WK
1.6 16V	76	09/98→12/09	←	→ 12/06		13.0460-7128.2	607128	ATE 23218 18,0 + WK
1.6 16V	78	09/98→12/09	←			13.0460-7132.2	607132	ATE 23218 18,0 - WE / - WK
 Bremsscheibe								
1.2	59	09/01→12/09	←	→ 12/06		24.0120-0142.1	420142	Ø 257,5 20 18,2 V
1.3 JTD	51	09/03→12/09	←			24.0320-0142.1	520142	Ø 257,5 20 18,2 V PD
1.4	51	04/96→12/09	←	02/98→03/98		24.0112-0122.1	412122	Ø 240 12 10,8
1.4 Cat	51	04/96→12/09						
↓								

	kW			 	! #		
FIAT - SIENA (178_) 04/96→12/12							
Bremsscheibe							
1.4	51	04/96→12/09	←	04/98→12/06		24.0120-0193.1 420193	Ø 240 20 18,2 V
1.4 Cat	51	04/96→12/09	←				
1.5	62	06/04→12/09	←			24.0120-0193.1 420193	Ø 240 20 18,2 V
1.7 TD	51	02/06→12/09	←				
1.6	76	11/00→12/09	←	→ 12/06		24.0120-0193.1 420193	Ø 240 20 18,2 V
1.6 16V	76	09/98→12/09	←				
1.6 16V	78	09/98→12/09	←				
FIAT - STILO (192_) 10/01→11/10							
Bremsbelagsatz, Scheibenbremse							
1.2 16V (192_XA1B)	59	02/02→11/06	←			13.0460-3982.2 603982	BOS 23705 18,1 + WK
1.4 16V	66	03/05→11/06	←			13.0470-3982.2 LD3982	BOS 23705 18,1 + WK Ceramic
1.4 16V	70	01/04→11/06	←				
1.6 16V	77	05/05→11/06	→	06/05→		13.0460-3861.2 603861	BOS 23714 17,6 + WK + Zub
1.6 16V (192_XB1A)	76	10/01→11/06	←			13.0460-3991.2 603991	BOS 23714 16,6 - WE / - WK
			→			13.0470-3812.2 LD3812	BOS 23714 17,6 - WE / - WK Ceramic
			→	→ 05/05		13.0460-3991.2 603991	BOS 23714 16,6 - WE / - WK
			→			13.0470-3812.2 LD3812	BOS 23714 17,6 - WE / - WK Ceramic
1.6	100	04/05→11/06	←			13.0460-3984.2 603984	BOS 23711 19,4 + WK
1.9 JTD	100	04/04→11/06	←			13.0470-3984.2 LD3984	BOS 23711 19,4 + WK Ceramic
1.9 JTD	103	01/04→11/06	←				
2.4 20V	123	01/04→11/06	→	06/05→		13.0460-3861.2 603861	BOS 23714 17,6 + WK + Zub
2.4 20V (192_XD1A)	125	10/01→11/06	←			13.0460-3991.2 603991	BOS 23714 16,6 - WE / - WK
			→			13.0470-3812.2 LD3812	BOS 23714 17,6 - WE / - WK Ceramic
			→	→ 05/05		13.0460-3991.2 603991	BOS 23714 16,6 - WE / - WK
			→			13.0470-3812.2 LD3812	BOS 23714 17,6 - WE / - WK Ceramic
1.8	90	01/04→11/06	←			13.0460-3983.2 603983	BOS 23708 19,4 + WK
1.8 16V (192_XC1A)	98	10/01→11/06	←			13.0470-3983.2 LD3983	BOS 23708 19,4 + WK Ceramic
1.8 8V	76	01/04→11/06	←				
1.9 JTD	93	09/03→11/06	→	06/05→		13.0460-3861.2 603861	BOS 23714 17,6 + WK + Zub
1.9 JTD (192_XE1A)	85	10/01→11/06	←			13.0460-3991.2 603991	BOS 23714 16,6 - WE / - WK
1.9 JTD (192_XF1A)	59	02/02→11/06	←			13.0470-3812.2 LD3812	BOS 23714 17,6 - WE / - WK Ceramic
1.9 JTD (192AXS1B, 192BXS1B)	66	09/04→11/06	→	→ 05/05		13.0460-3991.2 603991	BOS 23714 16,6 - WE / - WK
			→			13.0470-3812.2 LD3812	BOS 23714 17,6 - WE / - WK Ceramic
1.8 Flex	84	09/05→11/10	←	→ 03/08		13.0460-3983.2 603983	BOS 23708 19,4 + WK
			→	→ 03/08		13.0470-3983.2 LD3983	BOS 23708 19,4 + WK Ceramic
			→			13.0460-3861.2 603861	BOS 23714 17,6 + WK + Zub
			→			13.0460-3991.2 603991	BOS 23714 16,6 - WE / - WK
			→			13.0470-3812.2 LD3812	BOS 23714 17,6 - WE / - WK Ceramic
1.9 D Multijet	74	09/05→11/06	←			13.0460-3983.2 603983	BOS 23708 19,4 + WK
1.9 D Multijet	88	09/05→11/06	←			13.0470-3983.2 LD3983	BOS 23708 19,4 + WK Ceramic
			→			13.0460-3861.2 603861	BOS 23714 17,6 + WK + Zub
			→			13.0460-3991.2 603991	BOS 23714 16,6 - WE / - WK
			→			13.0470-3812.2 LD3812	BOS 23714 17,6 - WE / - WK Ceramic
1.9 D Multijet	110	09/05→11/06	←			13.0460-3984.2 603984	BOS 23711 19,4 + WK
			→			13.0470-3984.2 LD3984	BOS 23711 19,4 + WK Ceramic
			→			13.0460-3861.2 603861	BOS 23714 17,6 + WK + Zub
			→			13.0460-3991.2 603991	BOS 23714 16,6 - WE / - WK
			→			13.0470-3812.2 LD3812	BOS 23714 17,6 - WE / - WK Ceramic
Zubehörsatz, Scheibenbremsbelag							
1.2 16V (192_XA1B)	59	02/02→11/06	←			13.0460-0454.2 610454	BOS
1.4 16V	66	03/05→11/06	←				
1.4 16V	70	01/04→11/06	→	→ 05/05		13.0460-0256.2 610256	BOS
1.6	100	04/05→11/06	←				
1.6 16V	77	05/05→11/06	←				
1.6 16V (192_XB1A)	76	10/01→11/06	←				
1.8	90	01/04→11/06	←				
1.8 16V (192_XC1A)	98	10/01→11/06	←				
1.8 8V	76	01/04→11/06	←				
1.9 JTD	93	09/03→11/06	→				
1.9 JTD	100	04/04→11/06	←				
1.9 JTD	103	01/04→11/06	←				
↓							



FIAT - STILO (192_) 10/01→11/10

Zubehörsatz, Scheibenbremsbelag

1.9 JTD (192_XE1A)	85	10/01→11/06	←		13.0460-0454.2	610454	BOS
1.9 JTD (192_XF1A)	59	02/02→11/06					
1.9 JTD (192AXS1B, 192BXS1B)	66	09/04→11/06	→	→ 05/05	13.0460-0256.2	610256	BOS
2.4 20V	123	01/04→11/06					
2.4 20V (192_XD1A)	125	10/01→11/06					
1.8 Flex	84	09/05→11/10	←	→ 03/08	13.0460-0454.2	610454	BOS
1.9 D Multijet	74	09/05→11/06	←		13.0460-0454.2	610454	BOS
1.9 D Multijet	88	09/05→11/06					
1.9 D Multijet	110	09/05→11/06					

Bremsscheibe











1.2 16V (192_XA1B)	59	02/02→11/06	←		24.0122-0197.1	422197	Ø 257,5 22 20,2 V
1.4 16V	66	03/05→11/06			24.0322-0197.1	522197	Ø 257,5 22 20,2 V PD
1.4 16V	70	01/04→11/06					
1.6 16V	77	05/05→11/06	→		24.0110-0190.1	410190	Ø 251,5 10 9
1.6 16V (192_XB1A)	76	10/01→11/06					
1.6	100	04/05→11/06	←		24.0126-0125.1	426125	Ø 281 26 24,2 V
1.9 D Multijet	110	09/05→11/06					
1.9 JTD	100	04/04→11/06	→		24.0110-0190.1	410190	Ø 251,5 10 9
1.9 JTD	103	01/04→11/06					
2.4 20V	123	01/04→11/06					
2.4 20V (192_XD1A)	125	10/01→11/06					
1.8	90	01/04→11/06	←		24.0122-0147.1	422147	Ø 284 22 20,2 V
1.8 16V (192_XC1A)	98	10/01→11/06					
1.8 8V	76	01/04→11/06	→		24.0110-0190.1	410190	Ø 251,5 10 9
1.9 D Multijet	74	09/05→11/06					
1.9 D Multijet	88	09/05→11/06					
1.9 JTD	93	09/03→11/06					
1.9 JTD (192_XE1A)	85	10/01→11/06					
1.9 JTD (192_XF1A)	59	02/02→11/06					
1.9 JTD (192AXS1B, 192BXS1B)	66	09/04→11/06					
1.8 Flex	84	09/05→11/10	←	→ 03/08	24.0122-0147.1	422147	Ø 284 22 20,2 V
			→	→ 03/08	24.0110-0190.1	410190	Ø 251,5 10 9















FIAT - STILO Multi Wagon (192_) 01/03→08/08









Bremselagsatz, Scheibenbremse

1.4 16V	66	03/05→08/08	←	→ 03/08	13.0460-3982.2	603982	BOS 23705 18,1 + WK
1.4 16V	70	01/04→08/08			13.0470-3982.2	LD3982	BOS 23705 18,1 + WK Ceramic
1.6 16V	76	01/03→08/08	→	06/05→ 03/08	13.0460-3861.2	603861	BOS 23714 17,6 + WK + Zub
					13.0460-3991.2	603991	BOS 23714 16,6 - WE / - WK
					13.0470-3812.2	LD3812	BOS 23714 17,6 - WE / - WK Ceramic
			→	→ 05/05	13.0460-3991.2	603991	BOS 23714 16,6 - WE / - WK
					13.0470-3812.2	LD3812	BOS 23714 17,6 - WE / - WK Ceramic
1.6 16V	77	03/05→12/07	←		13.0460-3982.2	603982	BOS 23705 18,1 + WK
					13.0470-3982.2	LD3982	BOS 23705 18,1 + WK Ceramic
			→	06/05→	13.0460-3861.2	603861	BOS 23714 17,6 + WK + Zub
					13.0460-3991.2	603991	BOS 23714 16,6 - WE / - WK
					13.0470-3812.2	LD3812	BOS 23714 17,6 - WE / - WK Ceramic
			→	→ 05/05	13.0460-3991.2	603991	BOS 23714 16,6 - WE / - WK
					13.0470-3812.2	LD3812	BOS 23714 17,6 - WE / - WK Ceramic
1.8	90	01/04→08/08	←	→ 03/08	13.0460-3983.2	603983	BOS 23708 19,4 + WK
1.8 16V	98	01/03→08/08			13.0470-3983.2	LD3983	BOS 23708 19,4 + WK Ceramic
1.9 D	66	09/04→08/08					
1.9 JTD	59	01/03→08/08	→	06/05→ 03/08	13.0460-3861.2	603861	BOS 23714 17,6 + WK + Zub
1.9 JTD	85	01/03→08/08			13.0460-3991.2	603991	BOS 23714 16,6 - WE / - WK
1.9 JTD	93	09/03→08/08			13.0470-3812.2	LD3812	BOS 23714 17,6 - WE / - WK Ceramic
			→	→ 05/05	13.0460-3991.2	603991	BOS 23714 16,6 - WE / - WK
					13.0470-3812.2	LD3812	BOS 23714 17,6 - WE / - WK Ceramic
1.8 Flex	84	09/05→08/08	←	→ 03/08	13.0460-3983.2	603983	BOS 23708 19,4 + WK
1.9 D Multijet	74	09/05→08/08			13.0470-3983.2	LD3983	BOS 23708 19,4 + WK Ceramic
1.9 D Multijet	88	09/05→08/08	→	→ 03/08	13.0460-3861.2	603861	BOS 23714 17,6 + WK + Zub
					13.0460-3991.2	603991	BOS 23714 16,6 - WE / - WK
					13.0470-3812.2	LD3812	BOS 23714 17,6 - WE / - WK Ceramic





















	kW			 	! #		
FIAT - STILO Multi Wagon (192_) 01/03→08/08							
 Bremsbelagsatz, Scheibenbremse							
1.9 D Multijet (192DXT1B)	110	09/05→08/08	←	→ 03/08		13.0460-3984.2 603984	BOS 23711 19,4 + WK
			→	→ 03/08		13.0470-3984.2 LD3984	BOS 23711 19,4 + WK Ceramic
			←	→ 03/08		13.0460-3861.2 603861	BOS 23714 17,6 + WK + Zub
			→	→ 03/08		13.0460-3991.2 603991	BOS 23714 16,6 - WE / - WK
			→	→ 03/08		13.0470-3812.2 LD3812	BOS 23714 17,6 - WE / - WK Ceramic
1.9 JTD	100	04/04→08/08	←	→ 03/08		13.0460-3984.2 603984	BOS 23711 19,4 + WK
1.9 JTD	103	01/04→08/08				13.0470-3984.2 LD3984	BOS 23711 19,4 + WK Ceramic
2.4 20V	123	01/04→08/08	→	06/05→ 03/08		13.0460-3861.2 603861	BOS 23714 17,6 + WK + Zub
						13.0460-3991.2 603991	BOS 23714 16,6 - WE / - WK
						13.0470-3812.2 LD3812	BOS 23714 17,6 - WE / - WK Ceramic
			→	→ 05/05		13.0460-3991.2 603991	BOS 23714 16,6 - WE / - WK
						13.0470-3812.2 LD3812	BOS 23714 17,6 - WE / - WK Ceramic
Zubehörsatz, Scheibenbremsbelag							
1.4 16V	66	03/05→08/08	←	→ 03/08		13.0460-0454.2 610454	BOS
1.4 16V	70	01/04→08/08					
1.6 16V	76	01/03→08/08	→	→ 05/05		13.0460-0256.2 610256	BOS
1.8	90	01/04→08/08					
1.8 16V	98	01/03→08/08					
1.9 D	66	09/04→08/08					
1.9 JTD	59	01/03→08/08					
1.9 JTD	85	01/03→08/08					
1.9 JTD	93	09/03→08/08					
1.9 JTD	100	04/04→08/08					
1.9 JTD	103	01/04→08/08					
2.4 20V	123	01/04→08/08					
1.6 16V	77	03/05→12/07	←			13.0460-0454.2 610454	BOS
			→	→ 05/05		13.0460-0256.2 610256	BOS
1.8 Flex	84	09/05→08/08	←	→ 03/08		13.0460-0454.2 610454	BOS
1.9 D Multijet	74	09/05→08/08					
1.9 D Multijet	88	09/05→08/08					
1.9 D Multijet (192DXT1B)	110	09/05→08/08					
 Bremsscheibe							
1.4 16V	66	03/05→08/08	←	→ 03/08		24.0122-0197.1 422197	Ø 257,5 22 20,2 V
1.4 16V	70	01/04→08/08				24.0322-0197.1 522197	Ø 257,5 22 20,2 V PD
1.6 16V	76	01/03→08/08	→	→ 03/08		24.0110-0190.1 410190	Ø 251,5 10 9
1.6 16V	77	03/05→12/07	←			24.0122-0197.1 422197	Ø 257,5 22 20,2 V
			→			24.0322-0197.1 522197	Ø 257,5 22 20,2 V PD
			→			24.0110-0190.1 410190	Ø 251,5 10 9
1.8	90	01/04→08/08	←	→ 03/08		24.0122-0147.1 422147	Ø 284 22 20,2 V
1.8 16V	98	01/03→08/08					
1.8 Flex	84	09/05→08/08	→	→ 03/08		24.0110-0190.1 410190	Ø 251,5 10 9
1.9 D	66	09/04→08/08					
1.9 D Multijet	74	09/05→08/08					
1.9 D Multijet	88	09/05→08/08					
1.9 JTD	59	01/03→08/08					
1.9 JTD	85	01/03→08/08					
1.9 JTD	93	09/03→08/08					
1.9 D Multijet (192DXT1B)	110	09/05→08/08	←	→ 03/08		24.0126-0125.1 426125	Ø 281 26 24,2 V
1.9 JTD	100	04/04→08/08	→	→ 03/08		24.0110-0190.1 410190	Ø 251,5 10 9
1.9 JTD	103	01/04→08/08					
2.4 20V	123	01/04→08/08					
FIAT - STRADA Pick-up (178_) 02/98→							
 Bremsbelagsatz, Scheibenbremse							
1.2	44	04/03→	←	→ 12/11		13.0460-7126.2 607126	ATE 20907 18,1 - WE / - WK
1.2 Trekking	60	11/05→					
1.3 D Multijet	62	05/06→					
1.9 D	46	12/00→					
1.9 JTD	59	04/03→					
1.2	54	06/99→12/06	←			13.0460-7126.2 607126	ATE 20907 18,1 - WE / - WK
1.7 TD	51	06/99→12/06					
 Bremsscheibe							
1.2	44	04/03→	←	→ 12/11		24.0120-0142.1 420142	Ø 257,5 20 18,2 V
1.2 Trekking	60	11/05→				24.0320-0142.1 520142	Ø 257,5 20 18,2 V PD
↓							









	kw			 	! #		
FIAT - STRADA Pick-up (178_) 02/98→							
 Bremsscheibe							
1.3 D Multijet	62	05/06→	←	→ 12/11		24.0120-0142.1 420142	Ø 257,5 20 18,2 V
1.9 D	46	12/00→				24.0320-0142.1 520142	Ø 257,5 20 18,2 V PD
1.9 JTD	59	04/03→					
1.2	54	06/99→12/06	←			24.0120-0142.1 420142	Ø 257,5 20 18,2 V
1.7 TD	51	06/99→12/06				24.0320-0142.1 520142	Ø 257,5 20 18,2 V PD
FIAT - STRADA Pick-up (278_) 01/09→							
 Bremsscheibe							
1.3 D Multijet	70	10/10→	←	01/11→		24.0120-0142.1 420142	Ø 257,5 20 18,2 V
FIAT - TALENTO Bus (296_) 06/16→							
 Bremsbelagsatz, Scheibenbremse							
1.6 D	70	06/16→	→			13.0460-2840.2 602840	TRW 23980 16,5 + WE / - WK
1.6 D	85	06/16→					
1.6 D	88	06/16→					
1.6 D	92	06/16→					
1.6 D	107	06/16→					
FIAT - TALENTO Kasten/Kombi (296_) 06/16→							
 Bremsbelagsatz, Scheibenbremse							
1.6 D	66	06/16→	→			13.0460-2840.2 602840	TRW 23980 16,5 + WE / - WK
1.6 D	70	06/16→					
1.6 D	85	06/16→					
1.6 D	88	06/16→					
1.6 D	92	06/16→					
1.6 D	107	06/16→					
FIAT - TALENTO Kasten (296_) 06/16→							
 Bremsbelagsatz, Scheibenbremse							
1.6 D	66	06/16→	→			13.0460-2840.2 602840	TRW 23980 16,5 + WE / - WK
1.6 D	70	06/16→					
1.6 D	88	06/16→					
1.6 D	92	06/16→					
1.6 D	107	06/16→					
FIAT - TALENTO Pritsche/Fahrgestell (296_) 06/16→							
 Bremsbelagsatz, Scheibenbremse							
1.6 D	92	06/16→	→			13.0460-2840.2 602840	TRW 23980 16,5 + WE / - WK
1.6 D	107	06/16→					
FIAT - TEMPRA (159_) 03/90→12/98							
 Bremsbelagsatz, Scheibenbremse							
1.4 i.e. (159.AC, 159.AX)	51	04/90→08/96	←	→ 04/93; Schaltgetriebe; - ABS		13.0460-2948.2 602948	TRW 21100 16,7 + WK
1.4 i.e. (159.AC)	57	03/91→08/96	←	→ 04/93; Vollautomatik		13.0460-2949.2 602949	TRW 20833 17,0 + WK
1.6 i.e. (159.AS, 159.AT)	55	06/92→08/96	←	→ 04/93; Schaltgetriebe; + ABS		13.0460-2949.2 602949	TRW 20833 17,0 + WK
			←	05/93→		13.0460-2949.2 602949	TRW 20833 17,0 + WK
			→	→ 04/93; + ABS		13.0460-2951.2 602951	TRW 21103 14,2 - WK
			→	05/93→; + ABS		13.0460-2951.2 602951	TRW 21103 14,2 - WK
1.6 (159.AD)	63	03/90→08/96	←	→ 04/93; Schaltgetriebe; - ABS		13.0460-2948.2 602948	TRW 21100 16,7 + WK
			←	→ 04/93; Schaltgetriebe; + ABS		13.0460-2949.2 602949	TRW 20833 17,0 + WK
			←	→ 04/93; Vollautomatik		13.0460-2949.2 602949	TRW 20833 17,0 + WK
			→	→ 04/93; + ABS		13.0460-2951.2 602951	TRW 21103 14,2 - WK
1.6 i.e. (159.AJ)	63	06/94→08/96	←			13.0460-2949.2 602949	TRW 20833 17,0 + WK
1.6 i.e. (159.AJ)	66	06/94→08/96	→	+ ABS		13.0460-2951.2 602951	TRW 21103 14,2 - WK
1.8 i.e. (159.AV)	76	09/93→08/96					
1.8 i.e. (159.AZ)	66	09/93→08/96					
1.8 i.e. (159.BY)	74	10/94→08/96					
1.8 i.e. (159.AN)	77	03/92→08/96	←	05/93→		13.0460-2949.2 602949	TRW 20833 17,0 + WK
1.8 i.e. (159.AN)	81	03/90→08/96	←	→ 04/93		13.0460-2949.2 602949	TRW 20833 17,0 + WK
1.9 TD (159.AQ)	59	07/92→08/96					
1.9 TD (159.CU, 159.AU, 159.AI, 159.BI)	66	05/90→08/96	→	→ 04/93; + ABS		13.0460-2951.2 602951	TRW 21103 14,2 - WK
			→	05/93→; + ABS		13.0460-2951.2 602951	TRW 21103 14,2 - WK
1.9 D (159.AG)	48	07/91→08/96	←	05/93→		13.0460-2949.2 602949	TRW 20833 17,0 + WK
			→	05/93→; + ABS		13.0460-2951.2 602951	TRW 21103 14,2 - WK
2.0	81	05/94→12/98	←	→ 09/96		13.0460-2949.2 602949	TRW 20833 17,0 + WK
↓							







	kW			 	! #		
FIAT - TEMPRA (159_) 03/90→12/98							
 Bremsbelagsatz, Scheibenbremse							
2.0	81	05/94→12/98	➡	→ 09/96		13.0460-2951.2 602951	TRW 21103 14,2 - WK
2.0 i.e. (159.AP)	83	10/90→08/96	⬅	→ 04/93		13.0460-2949.2 602949	TRW 20833 17,0 + WK
			⬅	05/93→		13.0460-2949.2 602949	TRW 20833 17,0 + WK
			➡	→ 04/93		13.0460-2951.2 602951	TRW 21103 14,2 - WK
			➡	05/93→		13.0460-2951.2 602951	TRW 21103 14,2 - WK
Zubehörsatz, Scheibenbremsbelag							
1.4 i.e. (159.AC, 159.AX)	51	04/90→08/96	➡	→ 04/93; + ABS		13.0460-0072.2 610072	TRW
1.4 i.e. (159.AC)	57	03/91→08/96	➡	05/93→; + ABS		13.0460-0072.2 610072	TRW
1.6 i.e. (159.AS, 159.AT)	55	06/92→08/96	➡				
1.8 i.e. (159.AN)	77	03/92→08/96					
1.8 i.e. (159.AN)	81	03/90→08/96					
1.9 TD (159.AQ)	59	07/92→08/96					
1.9 TD (159.CU, 159.AU, 159.AI, 159.BI)	66	05/90→08/96					
1.6 (159.AD)	63	03/90→08/96	➡	→ 04/93; + ABS		13.0460-0072.2 610072	TRW
1.6 i.e. (159.AJ)	63	06/94→08/96	➡	+ ABS		13.0460-0072.2 610072	TRW
1.6 i.e. (159.AJ)	66	06/94→08/96					
1.8 i.e. (159.AV)	76	09/93→08/96					
1.8 i.e. (159.AZ)	66	09/93→08/96					
1.8 i.e. (159.BY)	74	10/94→08/96					
1.9 D (159.AG)	48	07/91→08/96	➡	05/93→; + ABS		13.0460-0072.2 610072	TRW
2.0	81	05/94→12/98	➡	→ 09/96		13.0460-0072.2 610072	TRW
2.0 i.e. (159.AP)	83	10/90→08/96	➡	05/93→		13.0460-0072.2 610072	TRW
			➡	→ 04/93		13.0460-0072.2 610072	TRW
 Bremsscheibe							
1.4 i.e. (159.AC, 159.AX)	51	04/90→08/96	⬅	→ 04/93; Schaltgetriebe; - ABS		24.0111-0119.1 411119	Ø 240,5 11 9,2
1.4 i.e. (159.AC)	57	03/91→08/96	⬅	05/93→; - ABS		24.0111-0119.1 411119	Ø 240,5 11 9,2
			⬅	→ 04/93; Schaltgetriebe; + ABS		24.0112-0127.1 412127	Ø 257,5 12 10,2
			⬅	→ 04/93; Vollautomatik		24.0112-0127.1 412127	Ø 257,5 12 10,2
			⬅	05/93→; + ABS		24.0112-0127.1 412127	Ø 257,5 12 10,2
			➡	→ 04/93; + ABS		24.0111-0119.1 411119	Ø 240,5 11 9,2
			➡	05/93→; + ABS		24.0111-0119.1 411119	Ø 240,5 11 9,2
1.6 (159.AD)	63	03/90→08/96	⬅	→ 04/93; Schaltgetriebe; - ABS		24.0111-0119.1 411119	Ø 240,5 11 9,2
			⬅	→ 04/93; Schaltgetriebe; + ABS		24.0112-0127.1 412127	Ø 257,5 12 10,2
			⬅	→ 04/93; Vollautomatik		24.0112-0127.1 412127	Ø 257,5 12 10,2
			➡	→ 04/93; + ABS		24.0111-0119.1 411119	Ø 240,5 11 9,2
1.6 i.e. (159.AJ)	63	06/94→08/96	⬅	Schaltgetriebe; - ABS		24.0111-0119.1 411119	Ø 240,5 11 9,2
1.6 i.e. (159.AJ)	66	06/94→08/96	⬅	Vollautomatik; + ABS		24.0112-0127.1 412127	Ø 257,5 12 10,2
			➡	+ ABS		24.0111-0119.1 411119	Ø 240,5 11 9,2
1.6 i.e. (159.AS, 159.AT)	55	06/92→08/96	⬅	05/93→; Schaltgetriebe; - ABS		24.0111-0119.1 411119	Ø 240,5 11 9,2
			⬅	→ 04/93; Schaltgetriebe; - ABS		24.0111-0119.1 411119	Ø 240,5 11 9,2
			⬅	→ 04/93; Schaltgetriebe; + ABS		24.0112-0127.1 412127	Ø 257,5 12 10,2
			⬅	→ 04/93; Vollautomatik		24.0112-0127.1 412127	Ø 257,5 12 10,2
			⬅	05/93→; Vollautomatik; + ABS		24.0112-0127.1 412127	Ø 257,5 12 10,2
			➡	05/93→; + ABS		24.0111-0119.1 411119	Ø 240,5 11 9,2
			➡	→ 04/93; + ABS		24.0111-0119.1 411119	Ø 240,5 11 9,2
1.8 i.e. (159.AN)	77	03/92→08/96	⬅	05/93→		24.0112-0127.1 412127	Ø 257,5 12 10,2
1.8 i.e. (159.AN)	81	03/90→08/96	⬅	→ 04/93		24.0112-0127.1 412127	Ø 257,5 12 10,2
1.9 TD (159.AQ)	59	07/92→08/96	⬅				
1.9 TD (159.CU, 159.AU, 159.AI, 159.BI)	66	05/90→08/96	➡	→ 04/93; + ABS		24.0111-0119.1 411119	Ø 240,5 11 9,2
			➡	05/93→; + ABS		24.0111-0119.1 411119	Ø 240,5 11 9,2
1.8 i.e. (159.AV)	76	09/93→08/96	⬅			24.0112-0127.1 412127	Ø 257,5 12 10,2
1.8 i.e. (159.AZ)	66	09/93→08/96	➡	+ ABS		24.0111-0119.1 411119	Ø 240,5 11 9,2
1.8 i.e. (159.BY)	74	10/94→08/96	➡				
1.9 D (159.AG)	48	07/91→08/96	⬅	05/93→; - ABS		24.0111-0119.1 411119	Ø 240,5 11 9,2
			⬅	05/93→; + ABS		24.0112-0127.1 412127	Ø 257,5 12 10,2
			➡	05/93→; + ABS		24.0111-0119.1 411119	Ø 240,5 11 9,2
2.0	81	05/94→12/98	⬅	→ 09/96		24.0120-0142.1 420142	Ø 257,5 20 18,2 V
↓							













	kw			 	! #		
FIAT - TEMPRA (159_) 03/90→12/98							
 Bremsscheibe							
2.0	81	05/94→12/98	←	→ 09/96		24.0320-0142.1 520142	Ø 257,5 20 18,2 V PD
			→	→ 09/96		24.0111-0119.1 411119	Ø 240,5 11 9,2
2.0 i.e. (159.AP)	83	10/90→08/96	←	05/93→		24.0120-0142.1 420142	Ø 257,5 20 18,2 V
			←	→ 04/93		24.0320-0142.1 520142	Ø 257,5 20 18,2 V PD
			←	→ 04/93		24.0120-0142.1 420142	Ø 257,5 20 18,2 V
			←	→ 04/93		24.0320-0142.1 520142	Ø 257,5 20 18,2 V PD
			→	05/93→		24.0111-0119.1 411119	Ø 240,5 11 9,2
			→	→ 04/93		24.0111-0119.1 411119	Ø 240,5 11 9,2
FIAT - TEMPRA S.W. (159_) 03/90→08/97							
 Bremsbelagsatz, Scheibenbremse							
1.4 i.e. (159.AC, 159.AX)	51	10/92→08/96	←	05/93→		13.0460-2949.2 602949	TRW 20833 17,0 + WK
1.4 i.e. (159.AC)	57	03/91→08/96	←	→ 04/93		13.0460-2949.2 602949	TRW 20833 17,0 + WK
1.6 i.e. (159.AE)	57	10/90→08/96	←	→ 04/93		13.0460-2949.2 602949	TRW 20833 17,0 + WK
1.6 i.e. (159.AS, 159.AT)	55	10/92→08/96	→	05/93→; + ABS		13.0460-2951.2 602951	TRW 21103 14,2 - WK
1.8 i.e. (159.AN)	81	03/90→08/96	→	→ 04/93; + ABS		13.0460-2951.2 602951	TRW 21103 14,2 - WK
1.9 D (159.AG)	48	07/91→08/96	→	→ 04/93; + ABS		13.0460-2951.2 602951	TRW 21103 14,2 - WK
1.9 TD (159.AI, 159.BI, 159.CU, 159.AU)	66	07/91→02/95	→	→ 04/93; + ABS		13.0460-2951.2 602951	TRW 21103 14,2 - WK
1.6 i.e. (159.AJ)	66	06/94→08/96	←			13.0460-2949.2 602949	TRW 20833 17,0 + WK
1.8 i.e. (159.AV)	76	09/93→08/96	→	+ ABS		13.0460-2951.2 602951	TRW 21103 14,2 - WK
1.8 i.e. (159.AZ)	66	09/93→08/96	→	+ ABS		13.0460-2951.2 602951	TRW 21103 14,2 - WK
1.8 i.e. (159.BY)	74	10/94→08/96	→	+ ABS		13.0460-2951.2 602951	TRW 21103 14,2 - WK
2.0	81	03/95→12/96	←	→ 09/96		13.0460-2949.2 602949	TRW 20833 17,0 + WK
			→	→ 09/96		13.0460-2951.2 602951	TRW 21103 14,2 - WK
2.0 i.e. (159.AP)	83	01/91→03/95	←	→ 04/93		13.0460-2949.2 602949	TRW 20833 17,0 + WK
			←	05/93→		13.0460-2949.2 602949	TRW 20833 17,0 + WK
			→	→ 04/93		13.0460-2951.2 602951	TRW 21103 14,2 - WK
			→	05/93→		13.0460-2951.2 602951	TRW 21103 14,2 - WK
			→	05/93→		13.0460-2951.2 602951	TRW 21103 14,2 - WK
2.0 i.e. 4x4 (159.AP)	83	03/92→03/95	←	05/93→		13.0460-2949.2 602949	TRW 20833 17,0 + WK
			→	05/93→		13.0460-2951.2 602951	TRW 21103 14,2 - WK
Zubehörsatz, Scheibenbremsbelag							
1.4 i.e. (159.AC, 159.AX)	51	10/92→08/96	→	05/93→; + ABS		13.0460-0072.2 610072	TRW
1.4 i.e. (159.AC)	57	03/91→08/96	→	→ 04/93; + ABS		13.0460-0072.2 610072	TRW
1.6 i.e. (159.AE)	57	10/90→08/96	→	→ 04/93; + ABS		13.0460-0072.2 610072	TRW
1.6 i.e. (159.AS, 159.AT)	55	10/92→08/96	→	→ 04/93; + ABS		13.0460-0072.2 610072	TRW
1.8 i.e. (159.AN)	81	03/90→08/96	→	→ 04/93; + ABS		13.0460-0072.2 610072	TRW
1.9 D (159.AG)	48	07/91→08/96	→	→ 04/93; + ABS		13.0460-0072.2 610072	TRW
1.9 TD (159.AI, 159.BI, 159.CU, 159.AU)	66	07/91→02/95	→	→ 04/93; + ABS		13.0460-0072.2 610072	TRW
1.6 i.e. (159.AJ)	66	06/94→08/96	→	+ ABS		13.0460-0072.2 610072	TRW
1.8 i.e. (159.AV)	76	09/93→08/96	→	+ ABS		13.0460-0072.2 610072	TRW
1.8 i.e. (159.AZ)	66	09/93→08/96	→	+ ABS		13.0460-0072.2 610072	TRW
1.8 i.e. (159.BY)	74	10/94→08/96	→	+ ABS		13.0460-0072.2 610072	TRW
2.0	81	03/95→12/96	→	→ 09/96		13.0460-0072.2 610072	TRW
2.0 i.e. (159.AP)	83	01/91→03/95	→	→ 04/93		13.0460-0072.2 610072	TRW
			→	05/93→		13.0460-0072.2 610072	TRW
2.0 i.e. 4x4 (159.AP)	83	03/92→03/95	→	05/93→		13.0460-0072.2 610072	TRW
 Bremsscheibe							
1.4 i.e. (159.AC, 159.AX)	51	10/92→08/96	←	05/93→		24.0112-0127.1 412127	Ø 257,5 12 10,2
1.4 i.e. (159.AC)	57	03/91→08/96	←	→ 04/93		24.0112-0127.1 412127	Ø 257,5 12 10,2
1.6 i.e. (159.AE)	57	10/90→08/96	←	→ 04/93		24.0112-0127.1 412127	Ø 257,5 12 10,2
1.6 i.e. (159.AS, 159.AT)	55	10/92→08/96	→	05/93→; + ABS		24.0111-0119.1 411119	Ø 240,5 11 9,2
1.9 D (159.AG)	48	07/91→08/96	→	→ 04/93; + ABS		24.0111-0119.1 411119	Ø 240,5 11 9,2
1.6 i.e. (159.AJ)	66	06/94→08/96	←			24.0112-0127.1 412127	Ø 257,5 12 10,2
			→	+ ABS		24.0111-0119.1 411119	Ø 240,5 11 9,2
1.8 i.e. (159.AN)	81	03/90→08/96	←	→ 04/93		24.0120-0142.1 420142	Ø 257,5 20 18,2 V
1.9 TD (159.AI, 159.BI, 159.CU, 159.AU)	66	07/91→02/95	←	→ 04/93		24.0320-0142.1 520142	Ø 257,5 20 18,2 V PD
			←	05/93→		24.0120-0142.1 420142	Ø 257,5 20 18,2 V
			←	05/93→		24.0320-0142.1 520142	Ø 257,5 20 18,2 V PD
			→	05/93→; + ABS		24.0111-0119.1 411119	Ø 240,5 11 9,2
			→	→ 04/93; + ABS		24.0111-0119.1 411119	Ø 240,5 11 9,2
1.8 i.e. (159.AV)	76	09/93→08/96	←			24.0120-0142.1 420142	Ø 257,5 20 18,2 V
↓							













	kw			 	! #		
FIAT - TEMPRA S.W. (159_) 03/90→08/97							
 Bremsscheibe							
1.8 i.e. (159.AZ)	66	09/93→08/96	←			24.0320-0142.1 520142	Ø 257,5 20 18,2 V PD
1.8 i.e. (159.BY)	74	10/94→08/96	→	+ ABS		24.0111-0119.1 411119	Ø 240,5 11 9,2
2.0	81	03/95→12/96	←	→ 09/96		24.0120-0142.1 420142	Ø 257,5 20 18,2 V
			→	→ 09/96		24.0320-0142.1 520142	Ø 257,5 20 18,2 V PD
2.0 i.e. (159.AP)	83	01/91→03/95	←	→ 04/93		24.0120-0142.1 420142	Ø 257,5 20 18,2 V
			←	05/93→		24.0320-0142.1 520142	Ø 257,5 20 18,2 V PD
			→	→ 04/93		24.0120-0142.1 420142	Ø 257,5 20 18,2 V
			→	05/93→		24.0320-0142.1 520142	Ø 257,5 20 18,2 V PD
			→	→ 04/93		24.0111-0119.1 411119	Ø 240,5 11 9,2
2.0 i.e. 4x4 (159.AP)	83	03/92→03/95	←	05/93→		24.0120-0142.1 420142	Ø 257,5 20 18,2 V
			→	05/93→		24.0320-0142.1 520142	Ø 257,5 20 18,2 V PD
FIAT - TIPO (160_) 07/87→10/97							
 Bremsbelagsatz, Scheibenbremse							
1.4 i.e.	57	05/89→04/95	←	→ 04/93; - ABS		13.0460-2948.2 602948	TRW 21100 16,7 + WK
			←	→ 04/93; + ABS		13.0460-2949.2 602949	TRW 20833 17,0 + WK
			→	→ 04/93; + ABS		13.0460-2951.2 602951	TRW 21103 14,2 - WK
1.4 i.e. (160.AP, 160.AD, 160.EA) 1.9 D	51	05/89→04/95	←	→ 04/93; - ABS		13.0460-2948.2 602948	TRW 21100 16,7 + WK
	48	07/91→08/95	←	05/93→		13.0460-2949.2 602949	TRW 20833 17,0 + WK
			←	→ 04/93; + ABS		13.0460-2949.2 602949	TRW 20833 17,0 + WK
			→	05/93→; + ABS		13.0460-2951.2 602951	TRW 21103 14,2 - WK
1.6	56	03/93→10/95	←	05/93→ 09/95		13.0460-2949.2 602949	TRW 20833 17,0 + WK
			→	05/93→ 09/95; + ABS		13.0460-2951.2 602951	TRW 21103 14,2 - WK
1.6 i.e. (160.A1, 160.EC, 160.EB)	55	10/92→04/95	←	05/93→		13.0460-2949.2 602949	TRW 20833 17,0 + WK
			→	→ 04/93; + ABS		13.0460-2951.2 602951	TRW 21103 14,2 - WK
			→	05/93→; + ABS		13.0460-2951.2 602951	TRW 21103 14,2 - WK
1.6 SX DGT	66	05/89→10/95	←	→ 12/91		13.0460-2949.2 602949	TRW 20833 17,0 + WK
			→	→ 04/93; + ABS		13.0460-2951.2 602951	TRW 21103 14,2 - WK
1.7 D (160.AG)	45	01/88→10/95	←	→ 04/93; - ABS		13.0460-2948.2 602948	TRW 21100 16,7 + WK
			←	→ 04/93; + ABS		13.0460-2949.2 602949	TRW 20833 17,0 + WK
			←	05/93→ 09/95		13.0460-2949.2 602949	TRW 20833 17,0 + WK
			→	05/93→ 09/95; + ABS		13.0460-2951.2 602951	TRW 21103 14,2 - WK
			→	→ 04/93; + ABS		13.0460-2951.2 602951	TRW 21103 14,2 - WK
1.8 i.e. 1.8 i.e. (160.ED)	71	03/93→04/95	←	05/93→		13.0460-2949.2 602949	TRW 20833 17,0 + WK
	76	04/93→04/95	→	05/93→; + ABS		13.0460-2951.2 602951	TRW 21103 14,2 - WK
1.8 i.e.	66	09/93→04/95	←			13.0460-2949.2 602949	TRW 20833 17,0 + WK
			→	+ ABS		13.0460-2951.2 602951	TRW 21103 14,2 - WK
1.8 i.e. (160.EQ, 160.AM)	74	10/94→10/95	←	→ 09/95		13.0460-2949.2 602949	TRW 20833 17,0 + WK
			→	→ 09/95; + ABS		13.0460-2951.2 602951	TRW 21103 14,2 - WK
1.9 TD (160.EL, 160.GL, 160.AQ, 160.EI, 160.AR)	66	09/90→04/95	←	05/93→		13.0460-2949.2 602949	TRW 20833 17,0 + WK
			←	→ 04/93		13.0460-2949.2 602949	TRW 20833 17,0 + WK
			→	→ 04/93; + ABS		13.0460-2951.2 602951	TRW 21103 14,2 - WK
			→	05/93→; + ABS		13.0460-2951.2 602951	TRW 21103 14,2 - WK
2.0	104	03/93→04/95	←	05/93→		13.0460-2979.2 602979	TRW 21147 19,0 + WK
			→	05/93→		13.0460-2951.2 602951	TRW 21103 14,2 - WK
2.0 16V (160.AV)	107	07/91→04/95	←	→ 04/93		13.0460-2979.2 602979	TRW 21147 19,0 + WK
			→	→ 04/93		13.0460-2951.2 602951	TRW 21103 14,2 - WK
2.0 i.e. (160.AT, 160.AJ)	83	03/90→04/95	←	05/93→		13.0460-2949.2 602949	TRW 20833 17,0 + WK
			→	09/90→ 04/93		13.0460-2951.2 602951	TRW 21103 14,2 - WK
			→	05/93→		13.0460-2951.2 602951	TRW 21103 14,2 - WK
↓							













	kw				! #		
FIAT - TIPO (160_) 07/87→10/97							
 Bremsbelagsatz, Scheibenbremse							
2.0 i.e. 16V Sport (160.EF)	102	03/93→04/95	←	05/93→		13.0460-2979.2 602979	TRW 21147 19,0 + WK
			→	→ 04/93		13.0460-2951.2 602951	TRW 21103 14,2 - WK
			→	05/93→		13.0460-2951.2 602951	TRW 21103 14,2 - WK
Zubehörsatz, Scheibenbremsbelag							
1.4 i.e. 1.6 SX DGT	57 66	05/89→04/95 05/89→10/95	→	→ 04/93; + ABS		13.0460-0072.2 610072	TRW
1.4 i.e. (160.AP, 160.AD, 160.EA)	51	05/89→04/95	→	05/93→; + ABS		13.0460-0072.2 610072	TRW
1.6 i.e. (160.A1, 160.EC, 160.EB)	55	10/92→04/95	→	→ 04/93; + ABS		13.0460-0072.2 610072	TRW
1.9 D	48	07/91→08/95					
1.9 TD (160.EL, 160.GL, 160.AQ, 160.EI, 160.AR)	66	09/90→04/95					
1.6	56	03/93→10/95	→	05/93→ 09/95; + ABS		13.0460-0072.2 610072	TRW
1.7 D (160.AG)	45	01/88→10/95	→	05/93→ 09/95; + ABS		13.0460-0072.2 610072	TRW
			→	→ 04/93; + ABS		13.0460-0072.2 610072	TRW
1.8 i.e.	71	03/93→04/95	→	05/93→; + ABS		13.0460-0072.2 610072	TRW
1.8 i.e. (160.ED)	76	04/93→04/95					
1.8 i.e.	66	09/93→04/95	→	+ ABS		13.0460-0072.2 610072	TRW
1.8 i.e. (160.EQ, 160.AM)	74	10/94→10/95	→	→ 09/95; + ABS		13.0460-0072.2 610072	TRW
2.0	104	03/93→04/95	→	05/93→		13.0460-0072.2 610072	TRW
2.0 16V (160.AV)	107	07/91→04/95	→	→ 04/93		13.0460-0072.2 610072	TRW
2.0 i.e. (160.AT, 160.AJ)	83	03/90→04/95	→	09/90→ 04/93		13.0460-0072.2 610072	TRW
			→	05/93→		13.0460-0072.2 610072	TRW
2.0 i.e. 16V Sport (160.EF)	102	03/93→04/95	→	→ 04/93		13.0460-0072.2 610072	TRW
			→	05/93→		13.0460-0072.2 610072	TRW
 Bremsscheibe							
1.4 i.e.	57	05/89→04/95	←	→ 04/93; - ABS		24.0111-0119.1 411119	∅ 240,5 11 9,2
			←	→ 04/93; + ABS		24.0112-0127.1 412127	∅ 257,5 12 10,2
			→	→ 04/93; + ABS		24.0111-0119.1 411119	∅ 240,5 11 9,2
1.4 i.e. (160.AP, 160.AD, 160.EA)	51	05/89→04/95	←	→ 04/93; - ABS		24.0111-0119.1 411119	∅ 240,5 11 9,2
			←	05/93→; - ABS		24.0111-0119.1 411119	∅ 240,5 11 9,2
			←	→ 04/93; + ABS		24.0112-0127.1 412127	∅ 257,5 12 10,2
			←	05/93→; + ABS		24.0112-0127.1 412127	∅ 257,5 12 10,2
			→	→ 04/93; + ABS		24.0111-0119.1 411119	∅ 240,5 11 9,2
			→	05/93→; + ABS		24.0111-0119.1 411119	∅ 240,5 11 9,2
1.6	56	03/93→10/95	←	05/93→ 09/95; - ABS		24.0111-0119.1 411119	∅ 240,5 11 9,2
			←	05/93→ 09/95; + ABS		24.0112-0127.1 412127	∅ 257,5 12 10,2
			→	05/93→ 09/95; + ABS		24.0111-0119.1 411119	∅ 240,5 11 9,2
1.6 i.e. (160.A1, 160.EC, 160.EB)	55	10/92→04/95	←	05/93→; - ABS		24.0111-0119.1 411119	∅ 240,5 11 9,2
			←	05/93→; + ABS		24.0112-0127.1 412127	∅ 257,5 12 10,2
			→	→ 04/93; + ABS		24.0111-0119.1 411119	∅ 240,5 11 9,2
			→	05/93→; + ABS		24.0111-0119.1 411119	∅ 240,5 11 9,2
1.6 SX DGT	66	05/89→10/95	←	→ 12/91		24.0112-0127.1 412127	∅ 257,5 12 10,2
			→	→ 04/93; + ABS		24.0111-0119.1 411119	∅ 240,5 11 9,2
1.7 D (160.AG)	45	01/88→10/95	←	05/93→ 09/95		24.0111-0119.1 411119	∅ 240,5 11 9,2
			←	→ 04/93; - ABS		24.0111-0119.1 411119	∅ 240,5 11 9,2
			←	→ 04/93; + ABS		24.0112-0127.1 412127	∅ 257,5 12 10,2
			→	05/93→ 09/95; + ABS		24.0111-0119.1 411119	∅ 240,5 11 9,2
			→	→ 04/93; + ABS		24.0111-0119.1 411119	∅ 240,5 11 9,2
1.8 i.e.	71	03/93→04/95	←	05/93→		24.0112-0127.1 412127	∅ 257,5 12 10,2
1.8 i.e. (160.ED)	76	04/93→04/95	→	05/93→; + ABS		24.0111-0119.1 411119	∅ 240,5 11 9,2
1.8 i.e.	66	09/93→04/95	←			24.0112-0127.1 412127	∅ 257,5 12 10,2
			→	+ ABS		24.0111-0119.1 411119	∅ 240,5 11 9,2
1.8 i.e. (160.EQ, 160.AM)	74	10/94→10/95	←	→ 09/95		24.0112-0127.1 412127	∅ 257,5 12 10,2
↓							

	kw			 	! #		
FIAT - TIPO (160_) 07/87→10/97							
Bremsscheibe							
1.8 i.e. (160.EQ, 160.AM)	74	10/94→10/95	➔	→ 09/95; + ABS		24.0111-0119.1 411119	Ø 240,5 11 9,2
1.9 D	48	07/91→08/95	➔	05/93→		24.0111-0119.1 411119	Ø 240,5 11 9,2
			➔	→ 04/93; - ABS		24.0111-0119.1 411119	Ø 240,5 11 9,2
			➔	→ 04/93; + ABS		24.0112-0127.1 412127	Ø 257,5 12 10,2
			➔	→ 04/93; + ABS		24.0111-0119.1 411119	Ø 240,5 11 9,2
			➔	05/93→; + ABS		24.0111-0119.1 411119	Ø 240,5 11 9,2
1.9 TD (160.EL, 160.GL, 160.AQ, 160.EI, 160.AR)	66	09/90→04/95	➔	05/93→		24.0112-0127.1 412127	Ø 257,5 12 10,2
			➔	→ 04/93		24.0112-0127.1 412127	Ø 257,5 12 10,2
			➔	05/93→; + ABS		24.0111-0119.1 411119	Ø 240,5 11 9,2
			➔	→ 04/93; + ABS		24.0111-0119.1 411119	Ø 240,5 11 9,2
2.0	104	03/93→04/95	➔	05/93→		24.0122-0107.1 422107	Ø 284 22 20,2 V
			➔	05/93→		24.0111-0119.1 411119	Ø 240,5 11 9,2
2.0 16V (160.AV)	107	07/91→04/95	➔	→ 04/93		24.0122-0107.1 422107	Ø 284 22 20,2 V
			➔	→ 04/93		24.0111-0119.1 411119	Ø 240,5 11 9,2
2.0 i.e. (160.AT, 160.AJ)	83	03/90→04/95	➔	05/93→		24.0120-0142.1 420142	Ø 257,5 20 18,2 V
						24.0320-0142.1 520142	Ø 257,5 20 18,2 V PD
			➔	05/93→		24.0111-0119.1 411119	Ø 240,5 11 9,2
2.0 i.e. 16V Sport (160.EF)	102	03/93→04/95	➔	05/93→		24.0122-0107.1 422107	Ø 284 22 20,2 V
			➔	→ 04/93		24.0111-0119.1 411119	Ø 240,5 11 9,2
			➔	05/93→		24.0111-0119.1 411119	Ø 240,5 11 9,2
FIAT - TIPO Kombi (357_) 03/16→							
Bremsscheibe							
1.3 D	70	03/16→	➔			24.0122-0145.1 422145	Ø 284 22 20,2 V
1.4	70	03/16→	➔			24.0110-0378.1 410378	Ø 251 10 9
1.4	88	03/16→	➔				
1.6	81	07/16→	➔	nicht für Automatikgetriebe		24.0122-0145.1 422145	Ø 284 22 20,2 V
1.6 D	84	09/16→	➔				
1.6 D	88	03/16→	➔			24.0110-0378.1 410378	Ø 251 10 9
FIAT - TIPO Schrägheck (357_) 03/16→							
Bremsscheibe							
1.3 D	70	03/16→	➔			24.0122-0145.1 422145	Ø 284 22 20,2 V
1.4	70	03/16→	➔			24.0110-0378.1 410378	Ø 251 10 9
1.4	88	03/16→	➔				
1.6	81	07/16→	➔	nicht für Automatikgetriebe		24.0122-0145.1 422145	Ø 284 22 20,2 V
1.6 D	84	09/16→	➔				
1.6 D	88	03/16→	➔			24.0110-0378.1 410378	Ø 251 10 9
FIAT - TIPO Stufenheck (356_) 10/15→							
Bremsscheibe							
1.3 D	70	10/15→	➔			24.0122-0145.1 422145	Ø 284 22 20,2 V
1.4	70	10/15→	➔			24.0110-0378.1 410378	Ø 251 10 9
1.6	81	10/15→	➔	nicht für Automatikgetriebe		24.0122-0145.1 422145	Ø 284 22 20,2 V
1.6 D	84	09/16→	➔				
1.6 D	88	10/15→	➔			24.0110-0378.1 410378	Ø 251 10 9
FIAT - ULYSSE (179_) 08/02→06/11							
Bremsbelagsatz, Scheibenbremse							
2.0	100	08/02→06/11	➔	→ 01/11		13.0460-2863.2 602863	TRW 20261 19,0 + WK + Zub
2.0 D Multijet	88	05/06→06/11	➔	→ 01/11		13.0460-2819.2 602819	TRW 20961 17,2 - WK
2.0 D Multijet	100	05/06→06/11	➔				
2.2 JTD	120	03/08→06/11	➔				
2.0 JTD	79	05/03→08/06	➔			13.0460-2863.2 602863	TRW 20261 19,0 + WK + Zub
2.0 JTD	80	08/02→08/06	➔			13.0460-2819.2 602819	TRW 20961 17,2 - WK
2.2 JTD	94	08/02→08/06	➔				
2.2 D Multijet	125	03/08→06/11	➔	→ 01/11		13.0460-2752.2 602752	TRW 24839 19,4 + WK + Zub
			➔	→ 01/11		13.0460-2819.2 602819	TRW 20961 17,2 - WK
3.0	150	08/02→06/11	➔	→ 01/11		13.0460-4995.2 604995	BRE 23575 15,6 + WK
			➔	→ 01/11		13.0460-2819.2 602819	TRW 20961 17,2 - WK
↓							



	kw			 	! #		
FIAT - ULYSSE (179_) 08/02→06/11							
Zubehörsatz, Scheibenbremsbelag							
2.0	100	08/02→06/11	➡	→ 01/11		13.0460-0072.2 610072	TRW
2.0 D Multijet	88	05/06→06/11					
2.0 D Multijet	100	05/06→06/11					
2.2 D Multijet	125	03/08→06/11					
2.2 JTD	120	03/08→06/11					
3.0	150	08/02→06/11					
2.0 JTD	79	05/03→08/06	➡			13.0460-0072.2 610072	TRW
2.0 JTD	80	08/02→08/06					
2.2 JTD	94	08/02→08/06					
 Bremsscheibe							
2.0	100	08/02→06/11	⬅	→ 01/11		24.0128-0136.1 428136	Ø 285 28 26 V
2.0 D Multijet	88	05/06→06/11				24.0328-0136.1 528136	Ø 285 28 26 V PD
2.0 D Multijet	100	05/06→06/11					
2.2 JTD	120	03/08→06/11	➡	→ 01/11		24.0112-0156.1 412156	Ø 272 12 10
2.0 JTD	79	05/03→08/06	⬅			24.0128-0136.1 428136	Ø 285 28 26 V
2.0 JTD	80	08/02→08/06				24.0328-0136.1 528136	Ø 285 28 26 V PD
2.2 JTD	94	08/02→08/06	➡			24.0112-0156.1 412156	Ø 272 12 10
2.2 D Multijet	125	03/08→06/11	⬅	→ 01/11		24.0132-0126.1 432126	Ø 310 32 30 V
3.0	150	08/02→06/11	➡	→ 01/11		24.0112-0156.1 412156	Ø 272 12 10
FIAT - ULYSSE (220_) 06/94→08/02							
 Bremsbelagsatz, Scheibenbremse							
1.8 (220.BB5)	73	05/97→08/02	⬅	→ 07/02		13.0460-3957.2 603957	BDX 23042 19,0 + WK + Zub
			➡	→ 07/02; + ABS		13.0460-7061.2 607061	ATE 21275 17,0 + WK
1.9 TD	68	05/97→12/99	⬅			13.0460-2978.2 602978	TRW 21801 19,0 + WK
			➡	+ ABS		13.0460-7061.2 607061	ATE 21275 17,0 + WK
1.9 TD (220AH5)	66	02/95→08/02	⬅	→ 07/02		13.0460-2978.2 602978	TRW 21801 19,0 + WK
2.0 (220.AC5)	89	06/94→08/02					
2.0 JTD	80	10/99→08/02	➡	→ 07/02; + ABS		13.0460-7061.2 607061	ATE 21275 17,0 + WK
2.0 16V	97	05/98→09/00	⬅			13.0460-2978.2 602978	TRW 21801 19,0 + WK
			➡			13.0460-7061.2 607061	ATE 21275 17,0 + WK
2.0 16V	100	09/00→08/02	⬅	→ 07/02		13.0460-2978.2 602978	TRW 21801 19,0 + WK
2.0 Turbo (220.AD5)	108	06/94→08/02	➡	→ 07/02		13.0460-7061.2 607061	ATE 21275 17,0 + WK
2.0 JTD 16V	80	05/99→08/02	⬅	10/99→ 07/02		13.0460-2978.2 602978	TRW 21801 19,0 + WK
			➡	10/99→ 07/02; + ABS		13.0460-7061.2 607061	ATE 21275 17,0 + WK
2.1 TD	80	03/96→10/99	⬅	06/96→		13.0460-2978.2 602978	TRW 21801 19,0 + WK
			➡	06/96→; + ABS		13.0460-7061.2 607061	ATE 21275 17,0 + WK
 Bremsscheibe							
1.8 (220.BB5)	73	05/97→08/02	⬅	→ 07/02		24.0120-0155.1 420155	Ø 257,5 20 18,2 V
			➡	→ 07/02; + ABS		24.0110-0218.1 410218	Ø 295 10 8
1.9 TD	68	05/97→12/99	⬅			24.0126-0104.1 426104	Ø 281 26 24,2 V
			➡	+ ABS		24.0110-0218.1 410218	Ø 295 10 8
1.9 TD (220AH5)	66	02/95→08/02	⬅	→ 07/02		24.0126-0104.1 426104	Ø 281 26 24,2 V
2.0 (220.AC5)	89	06/94→08/02					
2.0 JTD	80	10/99→08/02	➡	→ 07/02; + ABS		24.0110-0218.1 410218	Ø 295 10 8
2.0 16V	97	05/98→09/00	⬅			24.0126-0104.1 426104	Ø 281 26 24,2 V
			➡			24.0110-0218.1 410218	Ø 295 10 8
2.0 16V	100	09/00→08/02	⬅	→ 07/02		24.0126-0104.1 426104	Ø 281 26 24,2 V
2.0 Turbo (220.AD5)	108	06/94→08/02	➡	→ 07/02		24.0110-0218.1 410218	Ø 295 10 8
2.0 JTD 16V	80	05/99→08/02	⬅	10/99→ 07/02		24.0126-0104.1 426104	Ø 281 26 24,2 V
			➡	10/99→ 07/02; + ABS		24.0110-0218.1 410218	Ø 295 10 8
2.1 TD	80	03/96→10/99	⬅	06/96→		24.0126-0104.1 426104	Ø 281 26 24,2 V
			➡	06/96→; + ABS		24.0110-0218.1 410218	Ø 295 10 8
FIAT - UNO (146_) 01/83→06/06							
 Bremsbelagsatz, Scheibenbremse							
1.0	42	05/93→06/01	⬅	→ 06/95		13.0460-3939.2 603939	BDX 20775 18,0 + WE / - WK
1.6 R	66	12/92→12/95				13.0460-3940.2 603940	BDX 20775 18,0 + WK
1.7 D	43	11/94→08/00					
1.1	41	04/86→06/06	⬅	10/89→ 06/95		13.0460-3939.2 603939	BDX 20775 18,0 + WE / - WK
↓							

	kW				! #		
FIAT - UNO (146_) 01/83→06/06							
 Bremsbelagsatz, Scheibenbremse							
70 i.e. 1.4	51	09/89→07/96	←	10/89→ 06/95		13.0460-3940.2 603940	BDX 20775 18,0 + WK
1.4 Turbo i.e.	87	12/89→12/96	←	→ 06/95		13.0460-2941.2 602941	TRW 20838 17,0 + WK
1.5 75 iE	56	01/94→10/95	←	→ 06/95		13.0460-2941.2 602941 13.0460-3939.2 603939 13.0460-3940.2 603940	TRW 20838 17,0 + WK BDX 20775 18,0 + WE / - WK BDX 20775 18,0 + WK
1.5 SPI	49	03/87→01/96	←	10/89→ 06/95		13.0460-2941.2 602941 13.0460-3939.2 603939 13.0460-3940.2 603940	TRW 20838 17,0 + WK BDX 20775 18,0 + WE / - WK BDX 20775 18,0 + WK
45 i.e. 1.0	33	04/84→10/95	←	→ 09/89		13.0460-3939.2 603939 13.0460-3940.2 603940	BDX 20775 18,0 + WE / - WK BDX 20775 18,0 + WK
			←	10/89→ 06/95		13.0460-3939.2 603939 13.0460-3940.2 603940	BDX 20775 18,0 + WE / - WK BDX 20775 18,0 + WK
Zubehörsatz, Scheibenbremsbelag							
1.0	42	05/93→06/01	←	→ 06/95		13.0460-0410.2 610410	BDX
1.5 75 iE	56	01/94→10/95					
1.6 R	66	12/92→12/95					
1.7 D	43	11/94→08/00					
1.1	41	04/86→06/06	←	10/89→ 06/95		13.0460-0410.2 610410	BDX
1.5 SPI	49	03/87→01/96					
70 i.e. 1.4	51	09/89→07/96					
45 i.e. 1.0	33	04/84→10/95	←	→ 09/89		13.0460-0410.2 610410	BDX
			←	10/89→ 06/95		13.0460-0410.2 610410	BDX
 Bremsscheibe							
1.0	42	05/93→06/01	←	→ 06/95		24.0111-0130.1 411130	Ø 227 10,8 9
1.6 R	66	12/92→12/95					
1.7 D	43	11/94→08/00					
1.1	41	04/86→06/06	←	10/89→ 06/95		24.0111-0130.1 411130	Ø 227 10,8 9
70 i.e. 1.4	51	09/89→07/96					
1.4 Turbo i.e.	87	12/89→12/96	←	→ 06/95		24.0120-0143.1 420143	Ø 240 20 18,2 V
			→	→ 06/95		24.0111-0130.1 411130	Ø 227 10,8 9
1.5 75 iE	56	01/94→10/95	←	→ 06/95		24.0111-0130.1 411130 24.0112-0122.1 412122	Ø 227 10,8 9 Ø 240 12 10,8
1.5 SPI	49	03/87→01/96	←	10/89→ 06/95		24.0111-0130.1 411130 24.0112-0122.1 412122	Ø 227 10,8 9 Ø 240 12 10,8
45 i.e. 1.0	33	04/84→10/95	←	→ 09/89		24.0111-0130.1 411130	Ø 227 10,8 9
			←	10/89→ 06/95		24.0111-0130.1 411130	Ø 227 10,8 9
FIAT - UNO Kasten (146_) 02/88→07/96							
 Bremsbelagsatz, Scheibenbremse							
45 0.9	33	02/88→07/96	←	10/89→ 06/95		13.0460-3939.2 603939 13.0460-3940.2 603940	BDX 20775 18,0 + WE / - WK BDX 20775 18,0 + WK
Zubehörsatz, Scheibenbremsbelag							
45 0.9	33	02/88→07/96	←	10/89→ 06/95		13.0460-0410.2 610410	BDX
 Bremsscheibe							
45 0.9	33	02/88→07/96	←	10/89→ 06/95		24.0111-0130.1 411130	Ø 227 10,8 9
FORD - B-MAX (JK) 10/12→							
 Bremsbelagsatz, Scheibenbremse							
1.0 EcoBoost	74	10/12→	←			13.0460-2784.2 602784	TRW 25134 17,2 - WE / - WK + Zub
1.0 EcoBoost	88	10/12→					
1.0 EcoBoost	92	10/12→					
1.0 EcoBoost	103	02/16→				13.0470-2784.2 LD2784	TRW 25134 17,2 - WE / - WK + Zub Ceramic
1.4	66	10/12→					
1.4 LPG	63	08/13→					
1.4 LPG	66	08/13→					
1.5 TDCi	55	10/12→					
1.5 TDCi	70	04/15→					
1.6 TDCi	70	10/12→					
1.6 Ti	77	10/12→					
 Bremsscheibe							
1.0 EcoBoost	74	10/12→	←			24.0123-0122.1 423122	Ø 278 23 21 V
1.0 EcoBoost	88	10/12→					
↓							

	kw			 	! #		
FORD - B-MAX (JK) 10/12→							
 Bremsscheibe							
1.0 EcoBoost	92	10/12→	←			24.0123-0122.1 423122	Ø 278 23 21 V
1.0 EcoBoost	103	02/16→					
1.4	66	10/12→					
1.4 LPG	63	08/13→					
1.4 LPG	66	08/13→					
1.5 TDCi	55	10/12→					
1.5 TDCi	70	04/15→					
1.6 TDCi	70	10/12→					
1.6 Ti	77	10/12→					
FORD - B-MAX Van 10/12→							
 Bremsbelagsatz, Scheibenbremse							
1.0 EcoBoost	74	10/12→	←			13.0460-2784.2 602784	TRW 25134 17,2 - WE / - WK + Zub
1.0 EcoBoost	92	10/12→					
1.4	66	10/12→					
1.5 TDCi	55	10/12→				13.0470-2784.2 LD2784	TRW 25134 17,2 - WE / - WK + Zub Ceramic
1.5 TDCi	70	04/15→					
1.6 TDCi	70	10/12→					
1.6 Ti	77	10/12→					
 Bremsscheibe							
1.0 EcoBoost	74	10/12→	←			24.0123-0122.1 423122	Ø 278 23 21 V
1.0 EcoBoost	92	10/12→					
1.4	66	10/12→					
1.5 TDCi	55	10/12→					
1.5 TDCi	70	04/15→					
1.6 TDCi	70	10/12→					
1.6 Ti	77	10/12→					
FORD - C-MAX (DM2) 02/07→09/10							
 Bremsbelagsatz, Scheibenbremse							
1.6	74	02/07→09/10	←	03/07→		13.0460-7193.2 607193	ATE 23723 18,1 - WE / - WK
1.6 TDCi	66	02/07→09/10				13.0470-7193.2 LD7193	ATE 23723 18,1 - WE / - WK Ceramic
1.6 TDCi	74	02/07→09/10					
1.6 TDCi	80	02/07→09/10					
1.8	90	02/07→09/10	→	03/07→		13.0460-7195.2 607195	ATE 23482 16,6 - WE / - WK
1.8	92	02/07→09/10				13.0470-7195.2 LD7195	ATE 23482 16,6 - WE / - WK Ceramic
1.8 Flexifuel	92	02/07→09/10					
1.8 TDCi	85	02/07→09/10					
2.0	107	02/07→09/10					
2.0 TDCi	98	02/07→09/10					
2.0 TDCi	100	02/07→09/10					
1.6	85	04/07→09/10	←			13.0460-7193.2 607193	ATE 23723 18,1 - WE / - WK
2.0 CNG	107	04/09→09/10				13.0470-7193.2 LD7193	ATE 23723 18,1 - WE / - WK Ceramic
2.0 LPG	107	06/08→09/10					
2.0 TDCi	81	02/08→09/10	→			13.0460-7195.2 607195	ATE 23482 16,6 - WE / - WK
						13.0470-7195.2 LD7195	ATE 23482 16,6 - WE / - WK Ceramic
 Bremsscheibe							
1.6	74	02/07→09/10	←	03/07→		24.0125-0117.1 425117	Ø 278 25 23 V
1.6 TDCi	66	02/07→09/10				24.0325-0117.1 525117	Ø 278 25 23 V PD
1.6 TDCi	74	02/07→09/10					
1.6 TDCi	80	02/07→09/10	→	03/07→		24.0111-0155.1 411155	Ø 265 11 9
1.8	90	02/07→09/10				24.0311-0155.1 511155	Ø 265 11 9 PD
1.8	92	02/07→09/10					
1.8 Flexifuel	92	02/07→09/10					
1.6	85	04/07→09/10	←			24.0125-0117.1 425117	Ø 278 25 23 V
			→			24.0325-0117.1 525117	Ø 278 25 23 V PD
						24.0111-0155.1 411155	Ø 265 11 9
						24.0311-0155.1 511155	Ø 265 11 9 PD
1.8 TDCi	85	02/07→09/10	←	03/07→		24.0125-0162.1 425162	Ø 300 25 23 V
2.0	107	02/07→09/10				24.0325-0162.1 525162	Ø 300 25 23 V PD
2.0 TDCi	98	02/07→09/10					
2.0 TDCi	100	02/07→09/10	→	03/07→		24.0111-0158.1 411158	Ø 280 11 9 + S
						24.0311-0158.1 511158	Ø 280 11 9 PD
2.0 CNG	107	04/09→09/10	←			24.0125-0162.1 425162	Ø 300 25 23 V
2.0 LPG	107	06/08→09/10				24.0325-0162.1 525162	Ø 300 25 23 V PD
2.0 TDCi	81	02/08→09/10	→			24.0111-0158.1 411158	Ø 280 11 9 + S
						24.0311-0158.1 511158	Ø 280 11 9 PD
FORD - C-MAX II (DXA/CB7, DXA/CEU) 12/10→							
 Bremsbelagsatz, Scheibenbremse							
1.0 EcoBoost	74	10/12→	←			13.0460-7193.2 607193	ATE 23723 18,1 - WE / - WK

FORD - C-MAX II (DXA/CB7, DXA/CEU) 12/10→

Bremsbelagsatz, Scheibenbremse

1.0 EcoBoost	92	10/12→	←		13.0470-7193.2	LD7193	ATE 23723 18,1 - WE / - WK Ceramic
1.5 EcoBoost	110	03/15→	→		13.0460-7195.2	607195	ATE 23482 16,6 - WE / - WK
1.5 EcoBoost	134	03/15→			13.0470-7195.2	LD7195	ATE 23482 16,6 - WE / - WK Ceramic
1.5 TDCi	70	03/15→	→		13.0460-7195.2	607195	ATE 23482 16,6 - WE / - WK
1.5 TDCi	88	03/15→			13.0470-7195.2	LD7195	ATE 23482 16,6 - WE / - WK Ceramic
1.5 TDCi ECONetic	77	03/15→	→		13.0460-7195.2	607195	ATE 23482 16,6 - WE / - WK
1.6 CNG	86	01/13→			13.0470-7195.2	LD7195	ATE 23482 16,6 - WE / - WK Ceramic
1.6 EcoBoost	110	12/10→	→		13.0460-7195.2	607195	ATE 23482 16,6 - WE / - WK
1.6 EcoBoost	134	12/10→			13.0470-7195.2	LD7195	ATE 23482 16,6 - WE / - WK Ceramic
1.6 Flexifuel	88	02/11→	→		13.0460-7195.2	607195	ATE 23482 16,6 - WE / - WK
1.6 LPG	86	02/12→			13.0470-7195.2	LD7195	ATE 23482 16,6 - WE / - WK Ceramic
1.6 LPG	88	02/12→	→		13.0460-7195.2	607195	ATE 23482 16,6 - WE / - WK
1.6 TDCi	70	12/10→			13.0470-7195.2	LD7195	ATE 23482 16,6 - WE / - WK Ceramic
1.6 TDCi	85	12/10→	→		13.0460-7195.2	607195	ATE 23482 16,6 - WE / - WK
1.6 Ti	63	12/10→			13.0470-7195.2	LD7195	ATE 23482 16,6 - WE / - WK Ceramic
1.6 Ti	77	12/10→	→		13.0460-7195.2	607195	ATE 23482 16,6 - WE / - WK
1.6 Ti	88	02/12→			13.0470-7195.2	LD7195	ATE 23482 16,6 - WE / - WK Ceramic
1.6 Ti	92	12/10→	→		13.0460-7195.2	607195	ATE 23482 16,6 - WE / - WK
2.0 TDCi	85	02/11→			13.0470-7195.2	LD7195	ATE 23482 16,6 - WE / - WK Ceramic
2.0 TDCi	100	02/11→	→		13.0460-7195.2	607195	ATE 23482 16,6 - WE / - WK
2.0 TDCi	103	02/11→			13.0470-7195.2	LD7195	ATE 23482 16,6 - WE / - WK Ceramic
2.0 TDCi	110	03/15→	→		13.0460-7195.2	607195	ATE 23482 16,6 - WE / - WK
2.0 TDCi	120	12/10→			13.0470-7195.2	LD7195	ATE 23482 16,6 - WE / - WK Ceramic
2.0 TDCi	125	03/15→	→		13.0460-7195.2	607195	ATE 23482 16,6 - WE / - WK

Bremsscheibe

1.0 EcoBoost	74	10/12→	←		24.0125-0199.1	425199	Ø 278 25 23 V
1.0 EcoBoost	92	10/12→	→		24.0325-0199.1	525199	Ø 278 25 23 V PD
1.5 EcoBoost	110	03/15→			24.0111-0172.1	411172	Ø 280 11 9
1.5 EcoBoost	134	03/15→	→		24.0111-0172.1	411172	Ø 280 11 9
1.6 CNG	86	01/13→			24.0125-0162.1	425162	Ø 300 25 23 V
1.6 Flexifuel	88	02/11→	→		24.0125-0199.1	425199	Ø 278 25 23 V
1.6 LPG	86	02/12→			24.0325-0162.1	525162	Ø 300 25 23 V PD
1.6 LPG	88	02/12→	→		24.0325-0162.1	525162	Ø 300 25 23 V PD
1.6 TDCi	70	12/10→			24.0325-0199.1	525199	Ø 278 25 23 V PD
1.6 TDCi	85	12/10→	→		24.0111-0172.1	411172	Ø 280 11 9
1.6 Ti	63	12/10→			24.0125-0162.1	425162	Ø 300 25 23 V
1.6 Ti	77	12/10→	→		24.0125-0199.1	425199	Ø 278 25 23 V
1.6 Ti	88	02/12→			24.0325-0162.1	525162	Ø 300 25 23 V PD
1.6 Ti	92	12/10→	→		24.0325-0199.1	525199	Ø 278 25 23 V PD
1.5 TDCi	70	03/15→			24.0111-0172.1	411172	Ø 280 11 9
1.5 TDCi	88	03/15→	→		24.0125-0162.1	425162	Ø 300 25 23 V
1.5 TDCi ECONetic	77	03/15→			24.0125-0199.1	425199	Ø 278 25 23 V
1.6 EcoBoost	110	12/10→	→		24.0325-0162.1	525162	Ø 300 25 23 V PD
1.6 EcoBoost	134	12/10→			24.0325-0199.1	525199	Ø 278 25 23 V PD
2.0 TDCi	85	02/11→	→		24.0111-0172.1	411172	Ø 280 11 9
2.0 TDCi	100	02/11→			24.0125-0162.1	425162	Ø 300 25 23 V
2.0 TDCi	103	02/11→	→		24.0325-0162.1	525162	Ø 300 25 23 V PD
2.0 TDCi	110	03/15→			24.0325-0162.1	525162	Ø 300 25 23 V PD
2.0 TDCi	120	12/10→	→		24.0111-0172.1	411172	Ø 280 11 9
2.0 TDCi	125	03/15→			24.0125-0162.1	425162	Ø 300 25 23 V
2.0 Energi	136	01/15→	←		24.0125-0162.1	425162	Ø 300 25 23 V
			→		24.0325-0162.1	525162	Ø 300 25 23 V PD
			→		24.0111-0172.1	411172	Ø 280 11 9















FORD - C-MAX II Van 12/10→













Bremsbelagsatz, Scheibenbremse

1.0 EcoBoost	74	10/12→	←		13.0460-7193.2	607193	ATE 23723 18,1 - WE / - WK
1.0 EcoBoost	92	10/12→	→		13.0470-7193.2	LD7193	ATE 23723 18,1 - WE / - WK Ceramic
1.5 EcoBoost	110	03/15→			13.0460-7195.2	607195	ATE 23482 16,6 - WE / - WK
1.5 EcoBoost	134	03/15→	→		13.0470-7195.2	LD7195	ATE 23482 16,6 - WE / - WK Ceramic
1.5 TDCi	88	03/15→			13.0460-7195.2	607195	ATE 23482 16,6 - WE / - WK
1.5 TDCi ECONetic	77	03/15→	→		13.0470-7195.2	LD7195	ATE 23482 16,6 - WE / - WK Ceramic
1.6 EcoBoost	110	12/10→			13.0460-7195.2	607195	ATE 23482 16,6 - WE / - WK
1.6 TDCi	70	12/10→	→		13.0470-7195.2	LD7195	ATE 23482 16,6 - WE / - WK Ceramic
1.6 TDCi	85	12/10→			13.0460-7195.2	607195	ATE 23482 16,6 - WE / - WK
2.0 TDCi	85	02/11→	→		13.0470-7195.2	LD7195	ATE 23482 16,6 - WE / - WK Ceramic
2.0 TDCi	103	02/11→			13.0460-7195.2	607195	ATE 23482 16,6 - WE / - WK
2.0 TDCi	110	03/15→	→		13.0470-7195.2	LD7195	ATE 23482 16,6 - WE / - WK Ceramic
2.0 TDCi	120	12/10→			13.0460-7195.2	607195	ATE 23482 16,6 - WE / - WK
2.0 TDCi	125	03/15→	→		13.0460-7195.2	607195	ATE 23482 16,6 - WE / - WK











Bremsscheibe













1.0 EcoBoost	74	10/12→	←		24.0125-0199.1	425199	Ø 278 25 23 V
1.0 EcoBoost	92	10/12→	→		24.0325-0199.1	525199	Ø 278 25 23 V PD
1.5 EcoBoost	110	03/15→			24.0111-0172.1	411172	Ø 280 11 9
1.5 EcoBoost	134	03/15→	→		24.0111-0172.1	411172	Ø 280 11 9
1.6 TDCi	70	12/10→			24.0125-0162.1	425162	Ø 300 25 23 V
1.6 TDCi	85	12/10→	→		24.0125-0199.1	425199	Ø 278 25 23 V
2.0 TDCi	85	02/11→			24.0325-0162.1	525162	Ø 300 25 23 V PD

	kw					! #		
FORD - C-MAX II Van 12/10→								
 Bremsscheibe								
1.5 TDCi	88	03/15→	←			24.0125-0162.1	425162	Ø 300 25 23 V
1.5 TDCi ECONetic	77	03/15→				24.0125-0199.1	425199	Ø 278 25 23 V
1.6 EcoBoost	110	12/10→				24.0325-0162.1	525162	Ø 300 25 23 V PD
2.0 TDCi	103	02/11→				24.0325-0199.1	525199	Ø 278 25 23 V PD
2.0 TDCi	110	03/15→				24.0111-0172.1	411172	Ø 280 11 9
2.0 TDCi	120	12/10→						
2.0 TDCi	125	03/15→	→					
FORD - COUGAR (EC_) 08/98→12/01								
 Bremsbelagsatz, Scheibenbremse								
2.0 16V	96	08/98→12/01	←	09/98→		13.0460-7057.2	607057	ATE 21394 17,5 - WE / - WK
			→	09/98→		13.0460-3963.2	603963	BDX 21586 15,0 - WK
2.5 ST 200	151	01/00→12/01	←			13.0460-7056.2	607056	ATE 21396 17,5 + WK
2.5 V6 24V	125	08/98→12/01	←	09/98→		13.0460-7056.2	607056	ATE 21396 17,5 + WK
			→	08/99→		13.0460-3963.2	603963	BDX 21586 15,0 - WK
			→	09/98→ 07/99		13.0460-3964.2	603964	BDX 21586 15,0 + WK
2.5 V6 24V	125	06/00→12/01	←			13.0460-7056.2	607056	ATE 21396 17,5 + WK
			→			13.0460-3963.2	603963	BDX 21586 15,0 - WK
 Bremsscheibe								
2.0 16V	96	08/98→12/01	←	09/98→		24.0124-0120.1	424120	Ø 260 24 22,2 V
			→	09/98→		24.0324-0120.1	524120	Ø 260 24 22,2 V PD
						24.0120-0146.1	420146	Ø 253 20 18 V
						24.0320-0146.1	520146	Ø 253 20 18 V PD
2.5 ST 200	151	01/00→12/01	←			24.0124-0149.1	424149	Ø 278 24,1 22,2 V
2.5 V6 24V	125	08/98→12/01	←	09/98→		24.0124-0149.1	424149	Ø 278 24,1 22,2 V
			→	09/98→		24.0120-0146.1	420146	Ø 253 20 18 V
						24.0320-0146.1	520146	Ø 253 20 18 V PD
2.5 V6 24V	125	06/00→12/01	←			24.0124-0149.1	424149	Ø 278 24,1 22,2 V
			→			24.0120-0146.1	420146	Ø 253 20 18 V
						24.0320-0146.1	520146	Ø 253 20 18 V PD
FORD - COURIER Kasten (F3L, F5L) 07/91→02/96								
 Bremsbelagsatz, Scheibenbremse								
1.3	44	09/91→02/96	←	V		13.0460-7071.2	607071	ATE 20640 17,5 - WE / - WK
1.8 D	44	09/91→02/96	←			13.0460-7073.2	607073	ATE 21202 16,9 - WE / - WK
 Bremsscheibe								
1.3	44	09/91→02/96	←	→ 10/95		24.0110-0196.1	410196	Ø 239,7 10 8
1.8 D	44	09/91→02/96				24.0120-0147.1	420147	Ø 239,5 20 18 V
						24.0320-0147.1	520147	Ø 239,5 20 18 V PD
			←	11/95→		24.0112-0141.1	412141	Ø 239,5 12 10
						24.0120-0147.1	420147	Ø 239,5 20 18 V
						24.0320-0147.1	520147	Ø 239,5 20 18 V PD
FORD - COURIER Kasten (J5_, J3_) 02/96→								
 Bremsbelagsatz, Scheibenbremse								
1.3	44	02/96→08/03	←	→ 01/00		13.0460-7071.2	607071	ATE 20640 17,5 - WE / - WK
1.8 D	44	02/96→04/02	←	02/00→ 03/02; + ABS		13.0460-7142.2	607142	ATE 23202 18,3 - WE / - WK
			←	02/00→ 03/02; - ABS		13.0460-7148.2	607148	ATE 23200 18,0 - WE / - WK
1.4 i	66	04/96→10/99	←			13.0460-7071.2	607071	ATE 20640 17,5 - WE / - WK
1.8 DI	55	09/00→08/03	←	→ 03/02; + ABS		13.0460-7142.2	607142	ATE 23202 18,3 - WE / - WK
			←	→ 03/02; - ABS		13.0460-7148.2	607148	ATE 23200 18,0 - WE / - WK
 Bremsscheibe								
1.3	44	02/96→08/03	←	02/00→ 03/02; - ABS		24.0120-0147.1	420147	Ø 239,5 20 18 V
1.8 D	44	02/96→04/02				24.0320-0147.1	520147	Ø 239,5 20 18 V PD
			←	→ 01/00		24.0120-0147.1	420147	Ø 239,5 20 18 V
						24.0320-0147.1	520147	Ø 239,5 20 18 V PD
			←	02/00→ 03/02; + ABS		24.0122-0172.1	422172	Ø 258 22 20 V
↓								







	kw					! #		
FORD - COURIER Kasten (J5_, J3_) 02/96→								
 Bremsscheibe								
1.3 1.8 D	44 44	02/96→08/03 02/96→04/02	←	02/00→ 03/02; + ABS		24.0322-0172.1	522172	Ø 258 22 20 V PD
1.4 i	66	04/96→10/99	←			24.0120-0147.1 24.0320-0147.1	420147 520147	Ø 239,5 20 18 V Ø 239,5 20 18 V PD
1.8 DI	55	09/00→08/03	←	→ 03/02; - ABS		24.0120-0147.1 24.0320-0147.1	420147 520147	Ø 239,5 20 18 V Ø 239,5 20 18 V PD
			←	→ 03/02; + ABS		24.0122-0172.1 24.0322-0172.1	422172 522172	Ø 258 22 20 V Ø 258 22 20 V PD
FORD - ECOSPORT 09/11→								
 Bremsbelagsatz, Scheibenbremse								
1.0 EcoBoost 1.5 TDCi 1.5 Ti	92 66 82	10/13→ 10/13→ 10/13→	←	02/14→		13.0460-7193.2 13.0470-7193.2	607193 LD7193	ATE 23723 18,1 - WE / - WK ATE 23723 18,1 - WE / - WK Ceramic
1.0 EcoBoost 1.5 TDCi	103 70	03/16→ 05/15→	←			13.0460-7193.2 13.0470-7193.2	607193 LD7193	ATE 23723 18,1 - WE / - WK ATE 23723 18,1 - WE / - WK Ceramic
 Bremsscheibe								
1.0 EcoBoost 1.5 TDCi 1.5 Ti	92 66 82	10/13→ 10/13→ 10/13→	←	02/14→		24.0125-0210.1	425210	Ø 278 25 23 V
1.0 EcoBoost 1.5 TDCi	103 70	03/16→ 05/15→	←			24.0125-0210.1	425210	Ø 278 25 23 V
FORD - ESCORT '95 Express (AVL) 01/95→06/01								
 Bremsbelagsatz, Scheibenbremse								
1.4	54	01/95→08/00	←	02/95→ 02/99; mit Feder		13.0460-3965.2	603965	BDX 21171 18,0 - WE / - WK
1.8 D	44	01/95→08/00	←	02/95→ 02/99; mit Feder		13.0460-3965.2	603965	BDX 21171 18,0 - WE / - WK
			→	02/95→ 02/99; + ABS		13.0460-4058.2	604058	ATE 21832 14,9 - WE / - WK
1.8 TD	66	01/95→08/00	←	02/95→ 07/00; mit Feder		13.0460-3965.2	603965	BDX 21171 18,0 - WE / - WK
			→	02/95→ 07/00; + ABS		13.0460-4058.2	604058	ATE 21832 14,9 - WE / - WK
1.8 Turbo D	51	12/95→06/01	←	→ 02/99; mit Feder		13.0460-3965.2	603965	BDX 21171 18,0 - WE / - WK
			←	→ 07/00; mit Feder		13.0460-3965.2	603965	BDX 21171 18,0 - WE / - WK
			→	→ 07/00; + ABS		13.0460-4058.2	604058	ATE 21832 14,9 - WE / - WK
			→	→ 02/99; + ABS		13.0460-4058.2	604058	ATE 21832 14,9 - WE / - WK
Zubehörsatz, Scheibenbremsbelag								
1.4	54	01/95→08/00	←	02/95→ 02/99; - ABS		13.0460-0412.2	610412	BDX
			←	02/95→ 02/99; + ABS		13.0460-0413.2	610413	BDX
1.8 D	44	01/95→08/00	←	02/95→ 02/99; - ABS		13.0460-0412.2	610412	BDX
			←	02/95→ 02/99; + ABS		13.0460-0413.2	610413	BDX
			→	02/95→ 02/99; + ABS		13.0460-0436.2	610436	ATE
1.8 TD	66	01/95→08/00	←	02/95→ 07/00; - ABS		13.0460-0412.2	610412	BDX
			←	02/95→ 07/00; + ABS		13.0460-0413.2	610413	BDX
			→	02/95→ 07/00; + ABS		13.0460-0436.2	610436	ATE
1.8 Turbo D	51	12/95→06/01	←	→ 07/00; - ABS		13.0460-0412.2	610412	BDX
			←	→ 02/99; - ABS		13.0460-0412.2	610412	BDX
			←	→ 07/00; + ABS		13.0460-0413.2	610413	BDX
			←	→ 02/99; + ABS		13.0460-0413.2	610413	BDX
			→	→ 07/00; + ABS		13.0460-0436.2	610436	ATE
			→	→ 02/99; + ABS		13.0460-0436.2	610436	ATE
 Bremsscheibe								
1.4 1.8 D	54 44	01/95→08/00 01/95→08/00	←	02/95→ 02/99		24.0120-0147.1 24.0320-0147.1	420147 520147	Ø 239,5 20 18 V Ø 239,5 20 18 V PD
1.8 TD	66	01/95→08/00	←	02/95→ 07/00		24.0120-0147.1 24.0320-0147.1	420147 520147	Ø 239,5 20 18 V Ø 239,5 20 18 V PD
1.8 Turbo D	51	12/95→06/01	←	→ 07/00		24.0120-0147.1 24.0320-0147.1	420147 520147	Ø 239,5 20 18 V Ø 239,5 20 18 V PD
↓								













	kw			 	! #		
FORD - ESCORT '95 Express (AVL) 01/95→06/01							
 Bremsscheibe							
1.8 Turbo D	51	12/95→06/01	←	→ 02/99		24.0120-0147.1 420147 24.0320-0147.1 520147	Ø 239,5 20 18 V Ø 239,5 20 18 V PD
FORD - ESCORT VI (GAL) 09/92→09/96							
 Bremsbelagsatz, Scheibenbremse							
1.3	44	09/92→01/95	←	mit Feder		13.0460-3965.2 603965	BDX 21171 18,0 - WE / - WK
1.4	52	09/92→01/95					
1.4	55	01/94→01/95					
1.6 i 16V	65	01/94→01/95	←	mit Feder		13.0460-3965.2 603965	BDX 21171 18,0 - WE / - WK
1.6 i 16V	66	09/92→01/95					
1.8 D	44	09/92→01/95	→	+ ABS		13.0460-4058.2 604058	ATE 21832 14,9 - WE / - WK
1.8 i 16V	77	09/92→01/95					
1.8 TD	66	02/93→01/95					
1.8 XR3i 16V 4x4	77	08/93→01/95					
1.8 16V XR3i	96	09/92→01/95	←			13.0460-7040.2 20907	ATE 20907 18,0 - WE / - WK
1.8 XR3i 16V 4x4	96	08/93→01/95	→	+ ABS		13.0460-4058.2 604058	ATE 21832 14,9 - WE / - WK
RS 2000	110	09/92→01/95	←			13.0460-7040.2 20907	ATE 20907 18,0 - WE / - WK
			→			13.0460-4058.2 604058	ATE 21832 14,9 - WE / - WK
RS 2000 4x4	110	08/93→01/95	←			13.0460-7040.2 20907	ATE 20907 18,0 - WE / - WK
RS Cosworth 4x4	162	09/92→01/95	←			13.0460-7165.2 607165	ATE 21358 19,8 - WE / - WK
Zubehörsatz, Scheibenbremsbelag							
1.3	44	09/92→01/95	←	- ABS		13.0460-0412.2 610412	BDX
1.4	52	09/92→01/95	←	+ ABS		13.0460-0413.2 610413	BDX
1.4	55	01/94→01/95	←				
1.6 i 16V	65	01/94→01/95	←	- ABS		13.0460-0412.2 610412	BDX
1.6 i 16V	66	09/92→01/95					
1.8 D	44	09/92→01/95	←	+ ABS		13.0460-0413.2 610413	BDX
1.8 i 16V	77	09/92→01/95	→	+ ABS		13.0460-0436.2 610436	ATE
1.8 TD	66	02/93→01/95					
1.8 XR3i 16V 4x4	77	08/93→01/95					
1.8 16V XR3i	96	09/92→01/95	→	+ ABS		13.0460-0436.2 610436	ATE
1.8 XR3i 16V 4x4	96	08/93→01/95					
RS 2000	110	09/92→01/95	→			13.0460-0436.2 610436	ATE
 Bremsscheibe							
1.3	44	09/92→01/95	←	- ABS		24.0110-0196.1 410196	Ø 239,7 10 8
			←	+ ABS		24.0120-0147.1 420147 24.0320-0147.1 520147	Ø 239,5 20 18 V Ø 239,5 20 18 V PD
1.4	52	09/92→01/95	←			24.0120-0147.1 420147	Ø 239,5 20 18 V
1.4	55	01/94→01/95				24.0320-0147.1 520147	Ø 239,5 20 18 V PD
1.6 i 16V	65	01/94→01/95					
1.6 i 16V	66	09/92→01/95					
1.8 D	44	09/92→01/95					
1.8 i 16V	77	09/92→01/95					
1.8 TD	66	02/93→01/95					
1.8 XR3i 16V 4x4	77	08/93→01/95					
1.8 16V XR3i	96	09/92→01/95	←			24.0124-0125.1 424125	Ø 260 24,2 22,2 V
1.8 XR3i 16V 4x4	96	08/93→01/95					
RS 2000	110	09/92→01/95					
RS 2000 4x4	110	08/93→01/95					
RS Cosworth 4x4	162	09/92→01/95	←			24.0124-0148.1 424148	Ø 278 24 22,2 V
FORD - ESCORT VI Cabriolet (ALL) 12/92→01/95							
 Bremsbelagsatz, Scheibenbremse							
1.4 i	55	07/93→01/95	←	mit Feder		13.0460-3965.2 603965	BDX 21171 18,0 - WE / - WK
1.6 16V XR3i	66	12/92→01/95	←	mit Feder		13.0460-3965.2 603965	BDX 21171 18,0 - WE / - WK
1.6 i 16V	65	02/94→01/95					
1.8 16V XR3i	77	12/92→01/95	→	+ ABS		13.0460-4058.2 604058	ATE 21832 14,9 - WE / - WK
1.8 16V XR3i	96	12/92→01/95	←			13.0460-7040.2 20907	ATE 20907 18,0 - WE / - WK
			→	+ ABS		13.0460-4058.2 604058	ATE 21832 14,9 - WE / - WK
Zubehörsatz, Scheibenbremsbelag							
1.4 i	55	07/93→01/95	←	- ABS		13.0460-0412.2 610412	BDX
			←	+ ABS		13.0460-0413.2 610413	BDX
1.6 16V XR3i	66	12/92→01/95	←	- ABS		13.0460-0412.2 610412	BDX
1.6 i 16V	65	02/94→01/95	←	+ ABS		13.0460-0413.2 610413	BDX
1.8 16V XR3i	77	12/92→01/95	→	+ ABS		13.0460-0436.2 610436	ATE
↓							











	kw					! #		
FORD - ESCORT VI Cabriolet (ALL) 12/92→01/95								
Zubehörsatz, Scheibenbremsbelag								
1.8 16V XR3i	96	12/92→01/95	➡	+ ABS			13.0460-0436.2 610436	ATE
 Bremsscheibe								
1.4 i	55	07/93→01/95	←				24.0120-0147.1 420147	Ø 239,5 20 18 V
1.6 16V XR3i	66	12/92→01/95					24.0320-0147.1 520147	Ø 239,5 20 18 V PD
1.6 i 16V	65	02/94→01/95						
1.8 16V XR3i	77	12/92→01/95						
1.8 16V XR3i	96	12/92→01/95	←				24.0124-0125.1 424125	Ø 260 24,2 22,2 V
FORD - ESCORT VI Kombi (GAL) 09/92→01/95								
 Bremsbelagsatz, Scheibenbremse								
1.3	44	09/92→01/95	←	mit Feder			13.0460-3965.2 603965	BDX 21171 18,0 - WE / - WK
1.4	52	09/92→01/95						
1.4	55	01/94→01/95						
1.6 i 16V	65	01/94→01/95	←	mit Feder			13.0460-3965.2 603965	BDX 21171 18,0 - WE / - WK
1.6 i 16V	66	09/92→01/95						
1.8 D	44	09/92→01/95	➡	+ ABS			13.0460-4058.2 604058	ATE 21832 14,9 - WE / - WK
1.8 i 16V	77	01/93→01/95						
1.8 TD	66	02/93→01/95						
1.8 i 16V	96	02/93→01/95	←				13.0460-7040.2 20907	ATE 20907 18,0 - WE / - WK
			➡	+ ABS			13.0460-4058.2 604058	ATE 21832 14,9 - WE / - WK
Zubehörsatz, Scheibenbremsbelag								
1.3	44	09/92→01/95	←	- ABS			13.0460-0412.2 610412	BDX
1.4	52	09/92→01/95						
1.4	55	01/94→01/95	←	+ ABS			13.0460-0413.2 610413	BDX
1.6 i 16V	65	01/94→01/95	←	- ABS			13.0460-0412.2 610412	BDX
1.6 i 16V	66	09/92→01/95						
1.8 D	44	09/92→01/95	←	+ ABS			13.0460-0413.2 610413	BDX
1.8 i 16V	77	01/93→01/95						
1.8 TD	66	02/93→01/95	➡	+ ABS			13.0460-0436.2 610436	ATE
1.8 i 16V	96	02/93→01/95	➡	+ ABS			13.0460-0436.2 610436	ATE
 Bremsscheibe								
1.3	44	09/92→01/95	←				24.0120-0147.1 420147	Ø 239,5 20 18 V
1.4	52	09/92→01/95					24.0320-0147.1 520147	Ø 239,5 20 18 V PD
1.4	55	01/94→01/95						
1.6 i 16V	65	01/94→01/95						
1.6 i 16V	66	09/92→01/95						
1.8 D	44	09/92→01/95						
1.8 i 16V	77	01/93→01/95						
1.8 TD	66	02/93→01/95						
1.8 i 16V	96	02/93→01/95	←				24.0124-0125.1 424125	Ø 260 24,2 22,2 V
FORD - ESCORT VI Stufenheck (GAL) 08/93→01/95								
 Bremsbelagsatz, Scheibenbremse								
1.3	44	08/93→01/95	←	mit Feder			13.0460-3965.2 603965	BDX 21171 18,0 - WE / - WK
1.4	55	08/93→01/95						
1.6 i 16V	65	01/94→01/95	←	mit Feder			13.0460-3965.2 603965	BDX 21171 18,0 - WE / - WK
1.6 i 16V	66	08/93→01/95						
1.8 D	44	08/93→01/95	➡	+ ABS			13.0460-4058.2 604058	ATE 21832 14,9 - WE / - WK
1.8 i 16V	77	08/93→01/95						
1.8 TD	66	08/93→01/95						
Zubehörsatz, Scheibenbremsbelag								
1.3	44	08/93→01/95	←	- ABS			13.0460-0412.2 610412	BDX
1.4	55	08/93→01/95	←	+ ABS			13.0460-0413.2 610413	BDX
1.6 i 16V	65	01/94→01/95	←	- ABS			13.0460-0412.2 610412	BDX
1.6 i 16V	66	08/93→01/95						
1.8 D	44	08/93→01/95	←	+ ABS			13.0460-0413.2 610413	BDX
1.8 i 16V	77	08/93→01/95						
1.8 TD	66	08/93→01/95	➡	+ ABS			13.0460-0436.2 610436	ATE
 Bremsscheibe								
1.3	44	08/93→01/95	←	- ABS			24.0110-0196.1 410196	Ø 239,7 10 8
			←	+ ABS			24.0120-0147.1 420147	Ø 239,5 20 18 V
							24.0320-0147.1 520147	Ø 239,5 20 18 V PD
1.4	55	08/93→01/95	←				24.0120-0147.1 420147	Ø 239,5 20 18 V
1.6 i 16V	65	01/94→01/95					24.0320-0147.1 520147	Ø 239,5 20 18 V PD
1.6 i 16V	66	08/93→01/95						
1.8 D	44	08/93→01/95						
1.8 i 16V	77	08/93→01/95						
1.8 TD	66	08/93→01/95						























	kW			 	! #		
FORD - ESCORT VII (GAL, AAL, ABL) 01/95→10/02							
Bremsbelagsatz, Scheibenbremse							
1.3	44	01/95→10/98	←	02/95→; mit Feder		13.0460-3965.2 603965	BDX 21171 18,0 - WE / - WK
1.4	55	01/95→10/98	←				
1.4	54	01/95→12/99	←	02/95→ 02/99; mit Feder		13.0460-3965.2 603965	BDX 21171 18,0 - WE / - WK
1.6 16V	66	01/95→10/98	←	02/95→; mit Feder		13.0460-3965.2 603965	BDX 21171 18,0 - WE / - WK
1.6 16V 4x4	66	01/95→10/98	←				
1.6 i 16V	65	01/95→08/95	→	02/95→; + ABS		13.0460-4058.2 604058	ATE 21832 14,9 - WE / - WK
1.8 16V	77	01/95→08/95					
1.8 16V	85	01/95→10/98					
1.8 TD	66	01/95→10/98					
1.8 D	44	01/95→12/96	←	→ 01/95; mit Feder		13.0460-3965.2 603965	BDX 21171 18,0 - WE / - WK
			←	02/95→; mit Feder		13.0460-3965.2 603965	BDX 21171 18,0 - WE / - WK
			→	→ 01/95; + ABS		13.0460-4058.2 604058	ATE 21832 14,9 - WE / - WK
			→	02/95→; + ABS		13.0460-4058.2 604058	ATE 21832 14,9 - WE / - WK
1.8 Turbo D	51	12/95→10/98	←	mit Feder		13.0460-3965.2 603965	BDX 21171 18,0 - WE / - WK
			→	+ ABS		13.0460-4058.2 604058	ATE 21832 14,9 - WE / - WK
RS 2000	110	02/95→02/98	←			13.0460-7040.2 20907	ATE 20907 18,0 - WE / - WK
			←	→ 12/95		13.0460-7165.2 607165	ATE 21358 19,8 - WE / - WK
RS 2000 4x4	110	02/95→10/98	←			13.0460-7040.2 20907	ATE 20907 18,0 - WE / - WK
RS Cosworth 4x4	162	02/95→10/98	←	→ 12/95		13.0460-7165.2 607165	ATE 21358 19,8 - WE / - WK
Zubehörsatz, Scheibenbremsbelag							
1.3	44	01/95→10/98	←	02/95→; - ABS		13.0460-0412.2 610412	BDX
1.4	55	01/95→10/98	←	02/95→; + ABS		13.0460-0413.2 610413	BDX
1.4	54	01/95→12/99	←	02/95→ 02/99; - ABS		13.0460-0412.2 610412	BDX
			←	02/95→ 02/99; + ABS		13.0460-0413.2 610413	BDX
1.6 16V	66	01/95→10/98	←	02/95→; - ABS		13.0460-0412.2 610412	BDX
1.6 16V 4x4	66	01/95→10/98	←				
1.6 i 16V	65	01/95→08/95	←	02/95→; + ABS		13.0460-0413.2 610413	BDX
1.8 16V	77	01/95→08/95	→	02/95→; + ABS		13.0460-0436.2 610436	ATE
1.8 16V	85	01/95→10/98					
1.8 TD	66	01/95→10/98					
1.8 D	44	01/95→12/96	←	→ 01/95; - ABS		13.0460-0412.2 610412	BDX
			←	02/95→; - ABS		13.0460-0412.2 610412	BDX
			←	02/95→; + ABS		13.0460-0413.2 610413	BDX
			←	→ 01/95; + ABS		13.0460-0413.2 610413	BDX
			→	→ 01/95; + ABS		13.0460-0436.2 610436	ATE
			→	02/95→; + ABS		13.0460-0436.2 610436	ATE
1.8 Turbo D	51	12/95→10/98	←	- ABS		13.0460-0412.2 610412	BDX
			←	+ ABS		13.0460-0413.2 610413	BDX
			→	+ ABS		13.0460-0436.2 610436	ATE
Bremsscheibe							
1.3	44	01/95→10/98	←	02/95→		24.0120-0147.1 420147	Ø 239,5 20 18 V
1.4	55	01/95→10/98				24.0320-0147.1 520147	Ø 239,5 20 18 V PD
1.6 16V	66	01/95→10/98					
1.6 16V 4x4	66	01/95→10/98					
1.6 i 16V	65	01/95→08/95					
1.8 16V	77	01/95→08/95					
1.8 16V	85	01/95→10/98					
1.8 TD	66	01/95→10/98					
1.4	54	01/95→12/99	←	02/95→ 02/99		24.0120-0147.1 420147	Ø 239,5 20 18 V
						24.0320-0147.1 520147	Ø 239,5 20 18 V PD
1.8 D	44	01/95→12/96	←	02/95→		24.0120-0147.1 420147	Ø 239,5 20 18 V
						24.0320-0147.1 520147	Ø 239,5 20 18 V PD
			←	→ 01/95		24.0120-0147.1 420147	Ø 239,5 20 18 V
1.8 Turbo D	51	12/95→10/98				24.0320-0147.1 520147	Ø 239,5 20 18 V PD
RS 2000	110	02/95→02/98	←			24.0124-0125.1 424125	Ø 260 24,2 22,2 V
			←	→ 12/95		24.0124-0148.1 424148	Ø 278 24 22,2 V
RS 2000 4x4	110	02/95→10/98	←			24.0124-0125.1 424125	Ø 260 24,2 22,2 V
RS Cosworth 4x4	162	02/95→10/98	←	→ 12/95		24.0124-0148.1 424148	Ø 278 24 22,2 V













	kw				! #		
FORD - ESCORT VII Cabriolet (ALL) 02/95→08/00							
 Bremsbelagsatz, Scheibenbremse							
1.4 1.8 16V XR3i	55 77	02/95→08/98 02/95→08/98	←	mit Feder		13.0460-3965.2 603965	BDX 21171 18,0 - WE / - WK
1.6 16V XR3i	65	02/95→12/96	←	mit Feder		13.0460-3965.2 603965	BDX 21171 18,0 - WE / - WK
1.6 16V XR3i	66	02/95→09/99	←				
1.8 16V XR3i	85	10/95→08/98	→	+ ABS		13.0460-4058.2 604058	ATE 21832 14,9 - WE / - WK
1.8 TD	66	09/95→08/98					
1.8 Turbo D	51	10/96→08/99					
1.8 16V XR3i	96	02/95→08/00	←	→ 02/99		13.0460-7040.2 20907	ATE 20907 18,0 - WE / - WK
Zubehörsatz, Scheibenbremsbelag							
1.4 1.8 16V XR3i	55 77	02/95→08/98 02/95→08/98	←	- ABS		13.0460-0412.2 610412	BDX
			←	+ ABS		13.0460-0413.2 610413	BDX
1.6 16V XR3i	65	02/95→12/96	←	- ABS		13.0460-0412.2 610412	BDX
1.6 16V XR3i	66	02/95→09/99	←				
1.8 16V XR3i	85	10/95→08/98	←	+ ABS		13.0460-0413.2 610413	BDX
1.8 TD	66	09/95→08/98	→	+ ABS		13.0460-0436.2 610436	ATE
1.8 Turbo D	51	10/96→08/99					
 Bremsscheibe							
1.4 1.6 16V XR3i	55 65	02/95→08/98 02/95→12/96	←			24.0120-0147.1 420147	Ø 239,5 20 18 V
1.6 16V XR3i	66	02/95→09/99				24.0320-0147.1 520147	Ø 239,5 20 18 V PD
1.8 16V XR3i	77	02/95→08/98					
1.8 16V XR3i	85	10/95→08/98					
1.8 TD	66	09/95→08/98					
1.8 Turbo D	51	10/96→08/99					
1.8 16V XR3i	96	02/95→08/00	←	→ 02/99		24.0124-0125.1 424125	Ø 260 24,2 22,2 V
FORD - ESCORT VII Kombi (GAL, ANL) 01/95→10/02							
 Bremsbelagsatz, Scheibenbremse							
1.3 1.4	44 55	01/95→01/99 01/95→02/99	←	02/95→; mit Feder		13.0460-3965.2 603965	BDX 21171 18,0 - WE / - WK
1.6 16V	66	01/95→02/99	←	02/95→; mit Feder		13.0460-3965.2 603965	BDX 21171 18,0 - WE / - WK
1.6 i 16V	65	01/95→08/95					
1.8 16V	77	01/95→08/95	→	02/95→; + ABS		13.0460-4058.2 604058	ATE 21832 14,9 - WE / - WK
1.8 16V	85	01/95→02/99					
1.8 D	44	01/95→02/99					
1.8 TD	66	01/95→02/99					
1.8 Turbo D	51	12/95→02/99	←	mit Feder		13.0460-3965.2 603965	BDX 21171 18,0 - WE / - WK
			→	+ ABS		13.0460-4058.2 604058	ATE 21832 14,9 - WE / - WK
Zubehörsatz, Scheibenbremsbelag							
1.3 1.4	44 55	01/95→01/99 01/95→02/99	←	02/95→; - ABS		13.0460-0412.2 610412	BDX
			←	02/95→; + ABS		13.0460-0413.2 610413	BDX
1.6 16V	66	01/95→02/99	←	02/95→; - ABS		13.0460-0412.2 610412	BDX
1.6 i 16V	65	01/95→08/95					
1.8 16V	77	01/95→08/95	←	02/95→; + ABS		13.0460-0413.2 610413	BDX
1.8 16V	85	01/95→02/99	→	02/95→; + ABS		13.0460-0436.2 610436	ATE
1.8 D	44	01/95→02/99					
1.8 TD	66	01/95→02/99					
1.8 Turbo D	51	12/95→02/99	←	- ABS		13.0460-0412.2 610412	BDX
			←	+ ABS		13.0460-0413.2 610413	BDX
			→	+ ABS		13.0460-0436.2 610436	ATE
 Bremsscheibe							
1.3 1.4	44 55	01/95→01/99 01/95→02/99	←	02/95→		24.0120-0147.1 420147	Ø 239,5 20 18 V
1.6 16V	66	01/95→02/99				24.0320-0147.1 520147	Ø 239,5 20 18 V PD
1.6 i 16V	65	01/95→08/95					
1.8 16V	77	01/95→08/95					
1.8 16V	85	01/95→02/99					
1.8 D	44	01/95→02/99					
1.8 TD	66	01/95→02/99					
1.8 Turbo D	51	12/95→02/99	←			24.0120-0147.1 420147	Ø 239,5 20 18 V
						24.0320-0147.1 520147	Ø 239,5 20 18 V PD
FORD - ESCORT VII Stufenheck (GAL, AFL) 01/95→08/02							
 Bremsbelagsatz, Scheibenbremse							
1.3 1.4	44 55	01/95→02/99 01/95→02/99	←	02/95→; mit Feder		13.0460-3965.2 603965	BDX 21171 18,0 - WE / - WK
1.6 i 16V	65	01/95→08/95	←	02/95→; mit Feder		13.0460-3965.2 603965	BDX 21171 18,0 - WE / - WK
↓							

















	kw				! #		
FORD - ESCORT VII Stufenheck (GAL, AFL) 01/95→08/02							
 Bremsbelagsatz, Scheibenbremse							
1.6 i 16V 1.8 16V 1.8 16V 1.8 TD	66 77 85 66	01/95→02/99 01/95→08/95 01/95→02/99 01/95→02/99	➡	02/95→; + ABS		13.0460-4058.2 604058	ATE 21832 14,9 - WE / - WK
1.8 D	44	01/95→12/96	⬅	02/95→; mit Feder		13.0460-3965.2 603965	BDX 21171 18,0 - WE / - WK
			⬅	→ 01/95; mit Feder		13.0460-3965.2 603965	BDX 21171 18,0 - WE / - WK
			➡	02/95→; + ABS		13.0460-4058.2 604058	ATE 21832 14,9 - WE / - WK
			➡	→ 01/95; + ABS		13.0460-4058.2 604058	ATE 21832 14,9 - WE / - WK
1.8 Turbo D	51	12/95→02/99	⬅	mit Feder		13.0460-3965.2 603965	BDX 21171 18,0 - WE / - WK
			➡	+ ABS		13.0460-4058.2 604058	ATE 21832 14,9 - WE / - WK
Zubehörsatz, Scheibenbremsbelag							
1.3 1.4	44 55	01/95→02/99 01/95→02/99	⬅	02/95→; - ABS		13.0460-0412.2 610412	BDX
			⬅	02/95→; + ABS		13.0460-0413.2 610413	BDX
1.6 i 16V 1.6 i 16V 1.8 16V 1.8 16V 1.8 TD	65 66 77 85 66	01/95→08/95 01/95→02/99 01/95→08/95 01/95→02/99 01/95→02/99	⬅	02/95→; - ABS		13.0460-0412.2 610412	BDX
			⬅	02/95→; + ABS		13.0460-0413.2 610413	BDX
			➡	02/95→; + ABS		13.0460-0436.2 610436	ATE
1.8 D	44	01/95→12/96	⬅	→ 01/95; - ABS		13.0460-0412.2 610412	BDX
			⬅	02/95→; - ABS		13.0460-0412.2 610412	BDX
			⬅	→ 01/95; + ABS		13.0460-0413.2 610413	BDX
			⬅	02/95→; + ABS		13.0460-0413.2 610413	BDX
			➡	→ 01/95; + ABS		13.0460-0436.2 610436	ATE
			➡	02/95→; + ABS		13.0460-0436.2 610436	ATE
1.8 Turbo D	51	12/95→02/99	⬅	- ABS		13.0460-0412.2 610412	BDX
			⬅	+ ABS		13.0460-0413.2 610413	BDX
			➡	+ ABS		13.0460-0436.2 610436	ATE
 Bremsscheibe							
1.3 1.4 1.6 i 16V 1.6 i 16V 1.8 16V 1.8 16V 1.8 TD	44 55 65 66 77 85 66	01/95→02/99 01/95→02/99 01/95→08/95 01/95→02/99 01/95→08/95 01/95→02/99 01/95→02/99	⬅	02/95→		24.0120-0147.1 420147 24.0320-0147.1 520147	Ø 239,5 20 18 V Ø 239,5 20 18 V PD
1.8 D	44	01/95→12/96	⬅	02/95→		24.0120-0147.1 420147 24.0320-0147.1 520147	Ø 239,5 20 18 V Ø 239,5 20 18 V PD
			⬅	→ 01/95		24.0120-0147.1 420147 24.0320-0147.1 520147	Ø 239,5 20 18 V Ø 239,5 20 18 V PD
						24.0120-0147.1 420147 24.0320-0147.1 520147	Ø 239,5 20 18 V Ø 239,5 20 18 V PD
						24.0120-0147.1 420147 24.0320-0147.1 520147	Ø 239,5 20 18 V Ø 239,5 20 18 V PD
1.8 Turbo D	51	12/95→02/99	⬅		24.0120-0147.1 420147 24.0320-0147.1 520147	Ø 239,5 20 18 V Ø 239,5 20 18 V PD	
FORD - ESCORT CLASSIC (AAL, ABL) 10/98→07/00							
 Bremsbelagsatz, Scheibenbremse							
1.6 16V 1.8 TD	66 66	10/98→07/00 10/98→07/00	⬅	mit Feder		13.0460-3965.2 603965	BDX 21171 18,0 - WE / - WK
			➡	+ ABS		13.0460-4058.2 604058	ATE 21832 14,9 - WE / - WK
Zubehörsatz, Scheibenbremsbelag							
1.6 16V 1.8 TD	66 66	10/98→07/00 10/98→07/00	⬅	- ABS		13.0460-0412.2 610412	BDX
			⬅	+ ABS		13.0460-0413.2 610413	BDX
			➡	+ ABS		13.0460-0436.2 610436	ATE
 Bremsscheibe							
1.6 16V 1.8 TD	66 66	10/98→07/00 10/98→07/00	⬅			24.0120-0147.1 420147 24.0320-0147.1 520147	Ø 239,5 20 18 V Ø 239,5 20 18 V PD
FORD - ESCORT CLASSIC Turnier (ANL) 02/99→07/00							
 Bremsbelagsatz, Scheibenbremse							
1.6 16V 1.8 TD	66 66	02/99→07/00 02/99→07/00	⬅	mit Feder		13.0460-3965.2 603965	BDX 21171 18,0 - WE / - WK
			➡	+ ABS		13.0460-4058.2 604058	ATE 21832 14,9 - WE / - WK
↓							













	kW			 	! #		
FORD - ESCORT CLASSIC Turnier (ANL) 02/99→07/00							
Zubehörsatz, Scheibenbremsbelag							
1.6 16V 1.8 TD	66 66	02/99→07/00 02/99→07/00	←	- ABS		13.0460-0412.2 610412	BDX
			←	+ ABS		13.0460-0413.2 610413	BDX
			→	+ ABS		13.0460-0436.2 610436	ATE
 Bremsscheibe							
1.6 16V 1.8 TD	66 66	02/99→07/00 02/99→07/00	←			24.0120-0147.1 420147	Ø 239,5 20 18 V
						24.0320-0147.1 520147	Ø 239,5 20 18 V PD
FORD - FIESTA III (GFJ) 01/89→01/97							
 Bremsbelagsatz, Scheibenbremse							
1.0 1.3 1.4 1.4 1.4 Cat 1.6 i 16V 1.8 16V 1.8 TD 1.8 XR2i 16V	33 44 52 54 54 65 77 55 96	03/89→12/95 03/89→12/95 03/89→12/95 03/89→12/95 03/89→12/95 01/94→12/95 02/92→12/95 03/93→12/95 02/92→12/95	←	V		13.0460-7071.2 607071	ATE 20640 17,5 - WE / - WK
			←			13.0460-7073.2 607073	ATE 21202 16,9 - WE / - WK
1.1 1.1 1.8 D	37 40 44	03/89→12/95 03/89→12/95 03/89→12/95	←	05/89→; V		13.0460-7071.2 607071	ATE 20640 17,5 - WE / - WK
			←	05/89→		13.0460-7073.2 607073	ATE 21202 16,9 - WE / - WK
1.3 Cat 1.4	44 55	05/91→01/97 11/92→12/96	←	→ 11/96; V		13.0460-7071.2 607071	ATE 20640 17,5 - WE / - WK
			←	→ 11/96		13.0460-7073.2 607073	ATE 21202 16,9 - WE / - WK
 Bremsscheibe							
1.0 1.3 1.4 1.4 1.4 Cat 1.6 i 16V 1.8 16V 1.8 TD 1.8 XR2i 16V	33 44 52 54 54 65 77 55 96	03/89→12/95 03/89→12/95 03/89→12/95 03/89→12/95 03/89→12/95 01/94→12/95 02/92→12/95 03/93→12/95 02/92→12/95	←	→ 10/95		24.0110-0196.1 410196	Ø 239,7 10 8
						24.0120-0147.1 420147	Ø 239,5 20 18 V
						24.0320-0147.1 520147	Ø 239,5 20 18 V PD
			←	11/95→		24.0112-0141.1 412141	Ø 239,5 12 10
						24.0120-0147.1 420147	Ø 239,5 20 18 V
						24.0320-0147.1 520147	Ø 239,5 20 18 V PD
1.1 1.1 1.8 D	37 40 44	03/89→12/95 03/89→12/95 03/89→12/95	←	05/89→ 10/95		24.0110-0196.1 410196	Ø 239,7 10 8
						24.0120-0147.1 420147	Ø 239,5 20 18 V
						24.0320-0147.1 520147	Ø 239,5 20 18 V PD
			←	11/95→		24.0112-0141.1 412141	Ø 239,5 12 10
						24.0120-0147.1 420147	Ø 239,5 20 18 V
						24.0320-0147.1 520147	Ø 239,5 20 18 V PD
1.3 Cat 1.4	44 55	05/91→01/97 11/92→12/96	←	→ 10/95		24.0110-0196.1 410196	Ø 239,7 10 8
						24.0120-0147.1 420147	Ø 239,5 20 18 V
						24.0320-0147.1 520147	Ø 239,5 20 18 V PD
			←	11/95→ 11/96		24.0112-0141.1 412141	Ø 239,5 12 10
						24.0120-0147.1 420147	Ø 239,5 20 18 V
						24.0320-0147.1 520147	Ø 239,5 20 18 V PD
FORD - FIESTA IV (JA_, JB_) 08/95→09/02							
 Bremsbelagsatz, Scheibenbremse							
1.0 i	38	02/97→09/99	←			13.0460-7071.2 607071	ATE 20640 17,5 - WE / - WK
			←	+ ABS		13.0460-7073.2 607073	ATE 21202 16,9 - WE / - WK
			←	- ABS		13.0460-7142.2 607142	ATE 23202 18,3 - WE / - WK
			←	- ABS		13.0460-7148.2 607148	ATE 23200 18,0 - WE / - WK
1.0 i	48	09/99→01/02	←	→ 01/00		13.0460-7071.2 607071	ATE 20640 17,5 - WE / - WK
						13.0460-7073.2 607073	ATE 21202 16,9 - WE / - WK
			←	+ ABS		13.0460-7142.2 607142	ATE 23202 18,3 - WE / - WK
			←	- ABS		13.0460-7148.2 607148	ATE 23200 18,0 - WE / - WK
1.25 i 16V	55	08/95→01/02	←	01/96→ 01/00; Vollautomatik		13.0460-7071.2 607071	ATE 20640 17,5 - WE / - WK
			←	01/96→ 01/00; Schaltgetriebe		13.0460-7073.2 607073	ATE 21202 16,9 - WE / - WK
			←	02/00→; + ABS		13.0460-7142.2 607142	ATE 23202 18,3 - WE / - WK
			←	02/00→; - ABS		13.0460-7148.2 607148	ATE 23200 18,0 - WE / - WK
1.3 1.3 i	42 44	04/96→08/99 04/96→08/99	←			13.0460-7073.2 607073	ATE 21202 16,9 - WE / - WK
1.3 i 1.3 i ↓	37 44	08/95→01/02 08/95→01/02	←	01/96→ 01/00		13.0460-7073.2 607073	ATE 21202 16,9 - WE / - WK

	kw			 	! #		
FORD - FIESTA IV (JA_, JB_) 08/95→09/02							
 Bremsbelagsatz, Scheibenbremse							
1.8 D	44	08/95→04/00	←	02/00→; + ABS		13.0460-7142.2 607142	ATE 23202 18,3 - WE / - WK
			←	02/00→; - ABS		13.0460-7148.2 607148	ATE 23200 18,0 - WE / - WK
1.4 i 16V	66	04/96→01/02	←	→ 01/00		13.0460-7071.2 607071	ATE 20640 17,5 - WE / - WK
			←	02/00→; + ABS		13.0460-7142.2 607142	ATE 23202 18,3 - WE / - WK
			←	02/00→; - ABS		13.0460-7148.2 607148	ATE 23200 18,0 - WE / - WK
1.6	65	02/00→01/02	←	+ ABS		13.0460-7142.2 607142	ATE 23202 18,3 - WE / - WK
1.6 16V Sport	76	02/00→01/02	←				
1.8 DI	55	04/00→01/02	←	- ABS		13.0460-7148.2 607148	ATE 23200 18,0 - WE / - WK
 Bremsscheibe							
1.0 i	38	02/97→09/99	←			24.0112-0141.1 412141	Ø 239,5 12 10
						24.0120-0147.1 420147	Ø 239,5 20 18 V
						24.0312-0141.1 512141	Ø 239,5 12 10 PD
						24.0320-0147.1 520147	Ø 239,5 20 18 V PD
1.0 i	48	09/99→01/02	←	→ 01/00		24.0112-0141.1 412141	Ø 239,5 12 10
						24.0120-0147.1 420147	Ø 239,5 20 18 V
						24.0312-0141.1 512141	Ø 239,5 12 10 PD
						24.0320-0147.1 520147	Ø 239,5 20 18 V PD
			←	02/00→; - ABS		24.0120-0147.1 420147	Ø 239,5 20 18 V
						24.0320-0147.1 520147	Ø 239,5 20 18 V PD
			←	02/00→; + ABS		24.0122-0172.1 422172	Ø 258 22 20 V
						24.0322-0172.1 522172	Ø 258 22 20 V PD
1.25 i 16V	55	08/95→01/02	←	01/96→ 01/00; Schaltgetriebe		24.0112-0141.1 412141	Ø 239,5 12 10
						24.0312-0141.1 512141	Ø 239,5 12 10 PD
			←	01/96→ 01/00; Vollautomatik		24.0120-0147.1 420147	Ø 239,5 20 18 V
						24.0320-0147.1 520147	Ø 239,5 20 18 V PD
			←	02/00→; - ABS		24.0120-0147.1 420147	Ø 239,5 20 18 V
						24.0320-0147.1 520147	Ø 239,5 20 18 V PD
			←	02/00→; + ABS		24.0122-0172.1 422172	Ø 258 22 20 V
						24.0322-0172.1 522172	Ø 258 22 20 V PD
1.3	42	04/96→08/99	←			24.0112-0141.1 412141	Ø 239,5 12 10
1.3 i	44	04/96→08/99	←			24.0312-0141.1 512141	Ø 239,5 12 10 PD
1.3 i	37	08/95→01/02	←	01/96→ 01/00		24.0112-0141.1 412141	Ø 239,5 12 10
1.3 i	44	08/95→01/02	←			24.0312-0141.1 512141	Ø 239,5 12 10 PD
1.8 D	44	08/95→04/00	←			24.0120-0147.1 420147	Ø 239,5 20 18 V
						24.0320-0147.1 520147	Ø 239,5 20 18 V PD
			←	02/00→; - ABS		24.0122-0172.1 422172	Ø 258 22 20 V
						24.0322-0172.1 522172	Ø 258 22 20 V PD
1.4 i 16V	66	04/96→01/02	←	02/00→; - ABS		24.0120-0147.1 420147	Ø 239,5 20 18 V
						24.0320-0147.1 520147	Ø 239,5 20 18 V PD
			←	→ 01/00		24.0120-0147.1 420147	Ø 239,5 20 18 V
						24.0320-0147.1 520147	Ø 239,5 20 18 V PD
			←	02/00→; + ABS		24.0122-0172.1 422172	Ø 258 22 20 V
						24.0322-0172.1 522172	Ø 258 22 20 V PD
1.6	65	02/00→01/02	←	- ABS		24.0120-0147.1 420147	Ø 239,5 20 18 V
1.6 16V Sport	76	02/00→01/02	←			24.0320-0147.1 520147	Ø 239,5 20 18 V PD
1.8 DI	55	04/00→01/02	←	+ ABS		24.0122-0172.1 422172	Ø 258 22 20 V
						24.0322-0172.1 522172	Ø 258 22 20 V PD
FORD - FIESTA V (JH_, JD_) 11/01→03/10							
 Bremsbelagsatz, Scheibenbremse							
1.25 16V	51	03/03→06/08	←			13.0460-7142.2 607142	ATE 23202 18,3 - WE / - WK
1.25 16V	55	05/02→06/08					
1.6 TDCi	66	11/04→06/08					
1.3	44	11/01→06/08	←	04/02→		13.0460-7142.2 607142	ATE 23202 18,3 - WE / - WK
1.3	51	11/01→06/08					
1.4 16V	59	11/01→06/08					
1.4 TDCi	50	11/01→06/08					
1.6 16V	74	11/01→06/08					
ST150	110	03/05→06/08	←			13.0460-7186.2 607186	ATE 23440 17,6 - WE / - WK
↓			→			13.0460-2835.2 602835	TRW 23353 14,8 + WE / - WK











	kw			 	! #		
FORD - FIESTA V (JH_, JD_) 11/01→03/10							
 Bremsscheibe							
1.25 16V	51	03/03→06/08	←			24.0122-0172.1 422172	Ø 258 22 20 V
1.25 16V	55	05/02→06/08				24.0322-0172.1 522172	Ø 258 22 20 V PD
1.6 TDCi	66	11/04→06/08					
1.3	44	11/01→06/08	←	04/02→		24.0122-0172.1 422172	Ø 258 22 20 V
1.3	51	11/01→06/08				24.0322-0172.1 522172	Ø 258 22 20 V PD
1.4 16V	59	11/01→06/08					
1.4 TDCi	50	11/01→06/08					
1.6 16V	74	11/01→06/08					
ST150	110	03/05→06/08	→			24.0110-0115.1 410115	Ø 253 10,2 8,9
FORD - FIESTA V Van 10/03→12/10							
 Bremsbelagsatz, Scheibenbremse							
1.3	51	10/03→07/05	←			13.0460-7142.2 607142	ATE 23202 18,3 - WE / - WK
1.4 TDCi	50	10/03→12/10	←	→ 08/08		13.0460-7142.2 607142	ATE 23202 18,3 - WE / - WK
1.6 TDCi	66	04/07→09/09					
 Bremsscheibe							
1.3	51	10/03→07/05	←			24.0122-0172.1 422172	Ø 258 22 20 V
						24.0322-0172.1 522172	Ø 258 22 20 V PD
1.4 TDCi	50	10/03→12/10	←	→ 08/08		24.0122-0172.1 422172	Ø 258 22 20 V
1.6 TDCi	66	04/07→09/09				24.0322-0172.1 522172	Ø 258 22 20 V PD
FORD - FIESTA VI 06/08→							
 Bremsbelagsatz, Scheibenbremse							
1.0	48	01/13→	←			13.0460-2605.2 602605	TRW 24283 17,3 - WE / - WK + Zub
1.0	59	10/12→					
1.0 EcoBoost	74	01/13→				13.0460-5794.2 605794	TRW 24283 15,5 + WK + Zub
1.0 Sport	103	05/14→					
1.4 TDCi	50	01/09→					
1.4 TDCi	51	07/10→					
1.5 TDCi	70	05/15→					
1.6 TDCi	70	02/10→					
1.6 Ti	99	12/10→					
1.0 EcoBoost	92	09/12→	←	10/12→		13.0460-2605.2 602605	TRW 24283 17,3 - WE / - WK + Zub
1.5 TDCi	55	09/12→				13.0460-5794.2 605794	TRW 24283 15,5 + WK + Zub
1.6 Ti	77	09/12→					
1.25	44	06/08→	←	09/08→		13.0460-2605.2 602605	TRW 24283 17,3 - WE / - WK + Zub
1.25	60	06/08→					
1.4	71	06/08→				13.0460-5794.2 605794	TRW 24283 15,5 + WK + Zub
1.6 TDCi	55	06/08→					
1.6 TDCi	66	06/08→					
1.6 Ti	88	06/08→					
1.4 LPG	68	01/09→	←	06/09→		13.0460-2605.2 602605	TRW 24283 17,3 - WE / - WK + Zub
1.4 LPG	71	01/09→				13.0460-5794.2 605794	TRW 24283 15,5 + WK + Zub
1.6 ST	134	03/13→	←			13.0460-2784.2 602784	TRW 25134 17,2 - WE / - WK + Zub
						13.0470-2784.2 LD2784	TRW 25134 17,2 - WE / - WK + Zub Ceramic
			→			13.0460-2835.2 602835	TRW 23353 14,8 + WE / - WK
 Bremsscheibe							
1.0	48	01/13→	←			24.0123-0113.1 423113	Ø 258 23 21 V
1.0	59	10/12→				24.0323-0113.1 523113	Ø 258 23 21 V PD
1.0 EcoBoost	74	01/13→					
1.0 Sport	103	05/14→					
1.4 TDCi	50	01/09→					
1.4 TDCi	51	07/10→					
1.5 TDCi	70	05/15→					
1.6 TDCi	70	02/10→					
1.6 Ti	99	12/10→					
1.0 EcoBoost	92	09/12→	←	10/12→		24.0123-0113.1 423113	Ø 258 23 21 V
1.5 TDCi	55	09/12→				24.0323-0113.1 523113	Ø 258 23 21 V PD
1.6 Ti	77	09/12→					
1.25	44	06/08→	←	09/08→		24.0123-0113.1 423113	Ø 258 23 21 V
1.25	60	06/08→				24.0323-0113.1 523113	Ø 258 23 21 V PD
1.4	71	06/08→					
1.6 TDCi	55	06/08→					
1.6 TDCi	66	06/08→					
1.6 Ti	88	06/08→					
1.4 LPG	68	01/09→	←	06/09→		24.0123-0113.1 423113	Ø 258 23 21 V
1.4 LPG	71	01/09→				24.0323-0113.1 523113	Ø 258 23 21 V PD
1.6 ST	134	03/13→	←			24.0123-0122.1 423122	Ø 278 23 21 V













	kW					! #		
FORD - FIESTA VI 06/08→								
 Bremsscheibe								
1.6 ST	134	03/13→	→			24.0110-0115.1	410115	Ø 253 10,2 8,9
FORD - FIESTA VI Van 01/09→								
 Bremsbelagsatz, Scheibenbremse								
1.0	48	01/13→	←			13.0460-2605.2	602605	TRW 24283 17,3 - WE / - WK + Zub
1.0	59	10/12→						
1.0 EcoBoost	74	01/13→				13.0460-5794.2	605794	TRW 24283 15,5 + WK + Zub
1.0 EcoBoost	103	05/14→						
1.25	60	01/09→						
1.4 TDCi	50	01/09→						
1.4 TDCi	51	07/10→						
1.5 TDCi	55	10/12→						
1.5 TDCi	70	05/15→						
1.6 TDCi	66	01/09→						
1.6 TDCi	70	02/10→						
1.0 EcoBoost	92	09/12→	←	10/12→		13.0460-2605.2	602605	TRW 24283 17,3 - WE / - WK + Zub
						13.0460-5794.2	605794	TRW 24283 15,5 + WK + Zub
1.6 ST	134	03/13→	←			13.0460-2784.2	602784	TRW 25134 17,2 - WE / - WK + Zub
						13.0470-2784.2	LD2784	TRW 25134 17,2 - WE / - WK + Zub Ceramic
			→			13.0460-2835.2	602835	TRW 23353 14,8 + WE / - WK
 Bremsscheibe								
1.0	48	01/13→	←			24.0123-0113.1	423113	Ø 258 23 21 V
1.0	59	10/12→				24.0323-0113.1	523113	Ø 258 23 21 V PD
1.0 EcoBoost	74	01/13→						
1.0 EcoBoost	103	05/14→						
1.25	60	01/09→						
1.4 TDCi	50	01/09→						
1.4 TDCi	51	07/10→						
1.5 TDCi	55	10/12→						
1.5 TDCi	70	05/15→						
1.6 TDCi	66	01/09→						
1.6 TDCi	70	02/10→						
1.0 EcoBoost	92	09/12→	←	10/12→		24.0123-0113.1	423113	Ø 258 23 21 V
						24.0323-0113.1	523113	Ø 258 23 21 V PD
1.6 ST	134	03/13→	←			24.0123-0122.1	423122	Ø 278 23 21 V
			→			24.0110-0115.1	410115	Ø 253 10,2 8,9
FORD - FIESTA Kasten (FVD) 03/83→12/95								
 Bremsbelagsatz, Scheibenbremse								
1.8 D (FVJ)	43	03/89→12/95	←	09/91→; V		13.0460-7071.2	607071	ATE 20640 17,5 - WE / - WK
			←	09/91→		13.0460-7073.2	607073	ATE 21202 16,9 - WE / - WK
 Bremsscheibe								
1.8 D (FVJ)	43	03/89→12/95	←	09/91→ 10/95		24.0110-0196.1	410196	Ø 239,7 10 8
						24.0120-0147.1	420147	Ø 239,5 20 18 V
						24.0320-0147.1	520147	Ø 239,5 20 18 V PD
			←	11/95→		24.0112-0141.1	412141	Ø 239,5 12 10
						24.0120-0147.1	420147	Ø 239,5 20 18 V
						24.0320-0147.1	520147	Ø 239,5 20 18 V PD
FORD - FIESTA Kasten (JV_) 05/98→08/03								
 Bremsbelagsatz, Scheibenbremse								
D 1.8	44	05/98→04/02	←	→ 01/00		13.0460-7071.2	607071	ATE 20640 17,5 - WE / - WK
			←	02/00→ 03/02; + ABS		13.0460-7142.2	607142	ATE 23202 18,3 - WE / - WK
			←	02/00→ 03/02; - ABS		13.0460-7148.2	607148	ATE 23200 18,0 - WE / - WK
 Bremsscheibe								
D 1.8	44	05/98→04/02	←	02/00→ 03/02; - ABS		24.0120-0147.1	420147	Ø 239,5 20 18 V
						24.0320-0147.1	520147	Ø 239,5 20 18 V PD
			←	→ 01/00		24.0120-0147.1	420147	Ø 239,5 20 18 V
						24.0320-0147.1	520147	Ø 239,5 20 18 V PD
			←	02/00→ 03/02; + ABS		24.0122-0172.1	422172	Ø 258 22 20 V
						24.0322-0172.1	522172	Ø 258 22 20 V PD

	kw			 	! #		
FORD - FIESTA Stufenheck 04/10→							
 Bremsbelagsatz, Scheibenbremse							
1.25	44	10/12→	←			13.0460-2605.2 602605	TRW 24283 17,3 - WE / - WK + Zub
						13.0460-5794.2 605794	TRW 24283 15,5 + WK + Zub
 Bremsscheibe							
1.25	44	10/12→	←			24.0123-0113.1 423113	Ø 258 23 21 V
						24.0323-0113.1 523113	Ø 258 23 21 V PD
FORD - FOCUS (DAW, DBW) 10/98→12/07							
 Bremsbelagsatz, Scheibenbremse							
1.4 16V	55	10/98→11/04	←	→ 09/04		13.0460-7121.2 607121	ATE 23154 19,0 - WE / - WK
1.6 16V	74	10/98→11/04					
1.6 16V Flexifuel	75	01/02→11/04	→	→ 09/04		13.0460-2835.2 602835	TRW 23353 14,8 + WE / - WK
1.8 16V	85	10/98→11/04					
1.8 DI / TDDi	55	08/99→11/04					
1.8 TDCi	74	08/02→11/04					
1.8 TDCi	85	03/01→11/04					
1.8 Turbo DI / TDDi	66	10/98→11/04					
2.0 16V	96	10/98→11/04					
RS	158	10/02→11/04	←	→ 09/04		13.0460-4832.2 604832	BRE 21381 18,0 - WE / - WK
			→	→ 09/04		13.0460-2835.2 602835	TRW 23353 14,8 + WE / - WK
ST170	127	03/02→11/04	←	→ 09/04		13.0460-7186.2 607186	ATE 23440 17,6 - WE / - WK
			→	→ 09/04		13.0460-2835.2 602835	TRW 23353 14,8 + WE / - WK
 Bremsscheibe							
1.4 16V	55	10/98→11/04	←	→ 09/04		24.0122-0172.1 422172	Ø 258 22 20 V
1.6 16V	74	10/98→11/04				24.0322-0172.1 522172	Ø 258 22 20 V PD
1.6 16V Flexifuel	75	01/02→11/04					
1.8 16V	85	10/98→11/04	→	→ 09/04		24.0110-0115.1 410115	Ø 253 10,2 8,9
1.8 DI / TDDi	55	08/99→11/04				24.0310-0115.1 510115	Ø 253 10,2 8,9 PD
1.8 TDCi	74	08/02→11/04					
1.8 TDCi	85	03/01→11/04					
1.8 Turbo DI / TDDi	66	10/98→11/04					
2.0 16V	96	10/98→11/04					
ST170	127	03/02→11/04	←	→ 09/04		24.0124-0198.1 424198	Ø 300 24 22 V
			→	→ 09/04		24.0110-0313.1 410313	Ø 280 10,2 8,9
FORD - FOCUS II (DA_) 07/04→09/12							
 Bremsbelagsatz, Scheibenbremse							
1.4	59	07/04→09/12	←	10/04→ 02/11		13.0460-7193.2 607193	ATE 23723 18,1 - WE / - WK
1.6	74	07/04→09/12				13.0470-7193.2 LD7193	ATE 23723 18,1 - WE / - WK Ceramic
1.6 TDCi	74	07/04→09/12					
1.6 TDCi	80	07/04→09/12					
1.6 Ti	85	07/04→09/12	→	10/04→ 02/11		13.0460-7195.2 607195	ATE 23482 16,6 - WE / - WK
2.0	107	07/04→09/12				13.0470-7195.2 LD7195	ATE 23482 16,6 - WE / - WK Ceramic
2.0 TDCi	100	07/04→09/12					
1.6 LPG	85	10/09→07/11	←	→ 02/11		13.0460-7193.2 607193	ATE 23723 18,1 - WE / - WK
1.6 TDCi	66	01/05→09/12				13.0470-7193.2 LD7193	ATE 23723 18,1 - WE / - WK Ceramic
1.8	92	03/06→09/12					
1.8 Flexifuel	92	01/06→09/12					
1.8 TDCi	85	01/05→09/12	→	→ 02/11		13.0460-7195.2 607195	ATE 23482 16,6 - WE / - WK
2.0	105	04/10→09/12				13.0470-7195.2 LD7195	ATE 23482 16,6 - WE / - WK Ceramic
2.0 CNG	107	04/09→07/11					
2.0 LPG	107	06/08→07/11					
2.0 TDCi	81	02/08→07/11					
2.0	104	06/05→09/08	←			13.0460-7193.2 607193	ATE 23723 18,1 - WE / - WK
						13.0470-7193.2 LD7193	ATE 23723 18,1 - WE / - WK Ceramic
			→			13.0460-7195.2 607195	ATE 23482 16,6 - WE / - WK
						13.0470-7195.2 LD7195	ATE 23482 16,6 - WE / - WK Ceramic
2.0 TDCi	98	07/04→01/08	←	10/04→		13.0460-7193.2 607193	ATE 23723 18,1 - WE / - WK
						13.0470-7193.2 LD7193	ATE 23723 18,1 - WE / - WK Ceramic
			→	10/04→		13.0460-7195.2 607195	ATE 23482 16,6 - WE / - WK
						13.0470-7195.2 LD7195	ATE 23482 16,6 - WE / - WK Ceramic
2.5 RS	224	01/09→07/11	→	→ 02/11		13.0460-2723.2 602723	TRW 24537 16,1 - WE / - WK + Zub
2.5 RS 500	257	05/10→07/11				13.0470-2723.2 LD2723	TRW 24537 16,1 - WE / - WK + Zub Ceramic
↓							



	kw			 	! #		
FORD - FOCUS II (DA_) 07/04→09/12							
 Bremsbelagsatz, Scheibenbremse							
2.5 ST	166	10/05→09/12	←	→ 02/11		13.0460-7204.2 607204 13.0470-7204.2 LD7204	ATE 23801 18,8 - WE / - WK ATE 23801 18,8 - WE / - WK Ceramic
			→	→ 02/11		13.0460-7195.2 607195 13.0470-7195.2 LD7195	ATE 23482 16,6 - WE / - WK ATE 23482 16,6 - WE / - WK Ceramic
 Bremsscheibe							
1.4	59	07/04→09/12	←	10/04→ 02/11		24.0125-0117.1 425117	Ø 278 25 23 V
1.6	74	07/04→09/12				24.0325-0117.1 525117	Ø 278 25 23 V PD
1.6 Ti	85	07/04→09/12	→	10/04→ 02/11		24.0111-0155.1 411155 24.0311-0155.1 511155	Ø 265 11 9 Ø 265 11 9 PD
1.6 LPG	85	10/09→07/11	←	→ 02/11		24.0125-0117.1 425117	Ø 278 25 23 V
1.8	92	03/06→09/12				24.0325-0117.1 525117	Ø 278 25 23 V PD
1.8 Flexifuel	92	01/06→09/12	→	→ 02/11		24.0111-0155.1 411155 24.0311-0155.1 511155	Ø 265 11 9 Ø 265 11 9 PD
1.6 TDCi	66	01/05→09/12	←	→ 02/11		24.0125-0117.1 425117 24.0325-0117.1 525117	Ø 278 25 23 V Ø 278 25 23 V PD
			→	→ 02/11		24.0111-0155.1 411155 24.0111-0158.1 411158 24.0311-0155.1 511155 24.0311-0158.1 511158	Ø 265 11 9 Ø 280 11 9 + S Ø 265 11 9 PD Ø 280 11 9 PD
1.6 TDCi	74	07/04→09/12	←	10/04→ 02/11		24.0125-0117.1 425117	Ø 278 25 23 V
1.6 TDCi	80	07/04→09/12	→	10/04→ 02/11		24.0325-0117.1 525117 24.0111-0155.1 411155 24.0111-0158.1 411158 24.0311-0155.1 511155 24.0311-0158.1 511158	Ø 278 25 23 V PD Ø 265 11 9 Ø 280 11 9 + S Ø 265 11 9 PD Ø 280 11 9 PD
1.8 TDCi	85	01/05→09/12	←	→ 02/11		24.0125-0162.1 425162	Ø 300 25 23 V
2.0	105	04/10→09/12				24.0325-0162.1 525162	Ø 300 25 23 V PD
2.0 CNG	107	04/09→07/11	→	→ 02/11		24.0111-0158.1 411158	Ø 280 11 9 + S
2.0 LPG	107	06/08→07/11				24.0311-0158.1 511158	Ø 280 11 9 PD
2.0 TDCi	81	02/08→07/11					
2.0	104	06/05→09/08	←			24.0125-0162.1 425162 24.0325-0162.1 525162	Ø 300 25 23 V Ø 300 25 23 V PD
			→			24.0111-0158.1 411158 24.0311-0158.1 511158	Ø 280 11 9 + S Ø 280 11 9 PD
2.0	107	07/04→09/12	←	10/04→ 02/11		24.0125-0162.1 425162	Ø 300 25 23 V
2.0 TDCi	100	07/04→09/12	→	10/04→ 02/11		24.0325-0162.1 525162 24.0111-0158.1 411158 24.0311-0158.1 511158	Ø 300 25 23 V PD Ø 280 11 9 + S Ø 280 11 9 PD
2.0 TDCi	98	07/04→01/08	←	10/04→		24.0125-0162.1 425162 24.0325-0162.1 525162	Ø 300 25 23 V Ø 300 25 23 V PD
			→	10/04→		24.0111-0158.1 411158 24.0311-0158.1 511158	Ø 280 11 9 + S Ø 280 11 9 PD
2.5 RS	224	01/09→07/11	→	→ 02/11		24.0111-0145.1 411145	Ø 302 10,9 9 + S
2.5 RS 500	257	05/10→07/11				24.0311-0145.1 511145	Ø 302 10,9 9 PD
2.5 ST	166	10/05→09/12	←	→ 12/10		24.0125-0197.1 425197 24.0325-0197.1 525197	Ø 320 25 23 V Ø 320 25 23 V PD
			←	01/11→ 02/11		24.0125-0209.1 425209	Ø 320 25 23 V
			→	→ 02/11		24.0111-0158.1 411158 24.0311-0158.1 511158	Ø 280 11 9 + S Ø 280 11 9 PD
FORD - FOCUS II Cabriolet 10/06→09/10							
 Bremsbelagsatz, Scheibenbremse							
1.6	74	10/06→09/10	←			13.0460-7193.2 607193 13.0470-7193.2 LD7193	ATE 23723 18,1 - WE / - WK ATE 23723 18,1 - WE / - WK Ceramic
2.0	107	10/06→09/10					
2.0 TDCi	100	10/06→09/10	→			13.0460-7195.2 607195 13.0470-7195.2 LD7195	ATE 23482 16,6 - WE / - WK ATE 23482 16,6 - WE / - WK Ceramic
↓							

	kw			 	! #		
FORD - FOCUS II Cabriolet 10/06→09/10							
 Bremsscheibe							
1.6	74	10/06→09/10	←			24.0125-0117.1 425117 24.0325-0117.1 525117	Ø 278 25 23 V Ø 278 25 23 V PD
			→			24.0111-0155.1 411155 24.0311-0155.1 511155	Ø 265 11 9 Ø 265 11 9 PD
2.0 2.0 TDCi	107 100	10/06→09/10 10/06→09/10	←			24.0125-0162.1 425162 24.0325-0162.1 525162	Ø 300 25 23 V Ø 300 25 23 V PD
			→			24.0111-0158.1 411158 24.0311-0158.1 511158	Ø 280 11 9 + S Ø 280 11 9 PD
FORD - FOCUS II Kombi (DA_) 07/04→09/12							
 Bremsbelagsatz, Scheibenbremse							
1.4 1.6 1.6 TDCi 1.6 TDCi 1.6 Ti 2.0 2.0 TDCi	59 74 74 80 85 107 100	07/04→09/12 07/04→07/11 07/04→09/12 07/04→09/12 07/04→09/12 07/04→09/12 07/04→09/12	←	10/04→ 02/11		13.0460-7193.2 607193 13.0470-7193.2 LD7193	ATE 23723 18,1 - WE / - WK ATE 23723 18,1 - WE / - WK Ceramic
			→	10/04→ 02/11		13.0460-7195.2 607195 13.0470-7195.2 LD7195	ATE 23482 16,6 - WE / - WK ATE 23482 16,6 - WE / - WK Ceramic
1.6 LPG 1.6 TDCi 1.8 1.8 Flexifuel 2.0 LPG 2.0 TDCi	85 81 92 92 107 81	10/09→09/12 12/07→09/12 03/06→09/12 01/06→09/12 06/08→07/11 02/08→07/11	←	→ 02/11		13.0460-7193.2 607193 13.0470-7193.2 LD7193	ATE 23723 18,1 - WE / - WK ATE 23723 18,1 - WE / - WK Ceramic
			→	→ 02/11		13.0460-7195.2 607195 13.0470-7195.2 LD7195	ATE 23482 16,6 - WE / - WK ATE 23482 16,6 - WE / - WK Ceramic
1.6 TDCi 1.8 TDCi	66 85	07/04→09/12 07/04→09/12	←	01/05→ 02/11		13.0460-7193.2 607193 13.0470-7193.2 LD7193	ATE 23723 18,1 - WE / - WK ATE 23723 18,1 - WE / - WK Ceramic
			→	01/05→ 02/11		13.0460-7195.2 607195 13.0470-7195.2 LD7195	ATE 23482 16,6 - WE / - WK ATE 23482 16,6 - WE / - WK Ceramic
1.8 Flexifuel	97	12/05→01/08	←	01/06→		13.0460-7193.2 607193 13.0470-7193.2 LD7193	ATE 23723 18,1 - WE / - WK ATE 23723 18,1 - WE / - WK Ceramic
			→	01/06→		13.0460-7195.2 607195 13.0470-7195.2 LD7195	ATE 23482 16,6 - WE / - WK ATE 23482 16,6 - WE / - WK Ceramic
2.0 TDCi	98	07/04→01/08	←	10/04→		13.0460-7193.2 607193 13.0470-7193.2 LD7193	ATE 23723 18,1 - WE / - WK ATE 23723 18,1 - WE / - WK Ceramic
			→	10/04→		13.0460-7195.2 607195 13.0470-7195.2 LD7195	ATE 23482 16,6 - WE / - WK ATE 23482 16,6 - WE / - WK Ceramic
 Bremsscheibe							
1.4 1.6 1.6 Ti	59 74 85	07/04→09/12 07/04→07/11 07/04→09/12	←	10/04→ 02/11		24.0125-0117.1 425117 24.0325-0117.1 525117	Ø 278 25 23 V Ø 278 25 23 V PD
			→	10/04→ 02/11		24.0111-0155.1 411155 24.0311-0155.1 511155	Ø 265 11 9 Ø 265 11 9 PD
1.6 LPG 1.8 1.8 Flexifuel	85 92 92	10/09→09/12 03/06→09/12 01/06→09/12	←	→ 02/11		24.0125-0117.1 425117 24.0325-0117.1 525117	Ø 278 25 23 V Ø 278 25 23 V PD
			→	→ 02/11		24.0111-0155.1 411155 24.0311-0155.1 511155	Ø 265 11 9 Ø 265 11 9 PD
1.6 TDCi	66	07/04→09/12	←	01/05→ 02/11		24.0125-0117.1 425117 24.0325-0117.1 525117	Ø 278 25 23 V Ø 278 25 23 V PD
			→	01/05→ 02/11		24.0111-0155.1 411155 24.0111-0158.1 411158 24.0311-0155.1 511155 24.0311-0158.1 511158	Ø 265 11 9 Ø 280 11 9 + S Ø 265 11 9 PD Ø 280 11 9 PD
1.6 TDCi 1.6 TDCi	74 80	07/04→09/12 07/04→09/12	←	10/04→ 02/11		24.0125-0117.1 425117 24.0325-0117.1 525117	Ø 278 25 23 V Ø 278 25 23 V PD
			→	10/04→ 02/11		24.0111-0155.1 411155 24.0111-0158.1 411158 24.0311-0155.1 511155 24.0311-0158.1 511158	Ø 265 11 9 Ø 280 11 9 + S Ø 265 11 9 PD Ø 280 11 9 PD
1.6 TDCi ↓	81	12/07→09/12	←	→ 02/11		24.0125-0117.1 425117	Ø 278 25 23 V

FORD - FOCUS II Kombi (DA_) 07/04→09/12

Bremsscheibe

1.6 TDCi	81	12/07→09/12	←	→ 02/11	24.0325-0117.1	525117	Ø 278 25 23 V PD
			→	→ 02/11	24.0111-0155.1	411155	Ø 265 11 9
					24.0111-0158.1	411158	Ø 280 11 9 + S
					24.0311-0155.1	511155	Ø 265 11 9 PD
1.8 Flexifuel	97	12/05→01/08	←	01/06→	24.0125-0117.1	425117	Ø 278 25 23 V
			→	01/06→	24.0325-0117.1	525117	Ø 278 25 23 V PD
					24.0111-0155.1	411155	Ø 265 11 9
					24.0311-0155.1	511155	Ø 265 11 9 PD
1.8 TDCi	85	07/04→09/12	←	01/05→ 02/11	24.0125-0162.1	425162	Ø 300 25 23 V
			→	01/05→ 02/11	24.0325-0162.1	525162	Ø 300 25 23 V PD
					24.0111-0158.1	411158	Ø 280 11 9 + S
					24.0311-0158.1	511158	Ø 280 11 9 PD
2.0 2.0 TDCi	107 100	07/04→09/12 07/04→09/12	←	10/04→ 02/11	24.0125-0162.1	425162	Ø 300 25 23 V
			→	10/04→ 02/11	24.0325-0162.1	525162	Ø 300 25 23 V PD
					24.0111-0158.1	411158	Ø 280 11 9 + S
					24.0311-0158.1	511158	Ø 280 11 9 PD
2.0 LPG 2.0 TDCi	107 81	06/08→07/11 02/08→07/11	←	→ 02/11	24.0125-0162.1	425162	Ø 300 25 23 V
			→	→ 02/11	24.0325-0162.1	525162	Ø 300 25 23 V PD
					24.0111-0158.1	411158	Ø 280 11 9 + S
					24.0311-0158.1	511158	Ø 280 11 9 PD
2.0 TDCi	98	07/04→01/08	←	10/04→	24.0125-0162.1	425162	Ø 300 25 23 V
			→	10/04→	24.0325-0162.1	525162	Ø 300 25 23 V PD
					24.0111-0158.1	411158	Ø 280 11 9 + S
					24.0311-0158.1	511158	Ø 280 11 9 PD











FORD - FOCUS II Stufenheck (DA_) 04/05→













Bremsbelagsatz, Scheibenbremse







1.4 1.6 1.6 TDCi 1.6 TDCi 1.6 TDCi 1.6 Ti 1.8 1.8 Flexifuel 1.8 TDCi 2.0 2.0 2.0 TDCi 2.0 TDCi	59 74 66 74 80 85 92 92 85 104 107 81 100	04/05→09/12 04/05→09/12 04/05→09/12 04/05→09/12 04/05→09/12 04/05→09/12 03/06→09/12 06/06→07/11 04/05→09/12 02/08→ 04/05→07/11 02/08→07/11 04/05→09/12	←	→ 02/11	13.0460-7193.2	607193	ATE 23723 18,1 - WE / - WK			
			→	→ 02/11	13.0470-7193.2	LD7193	ATE 23723 18,1 - WE / - WK Ceramic			
					13.0460-7195.2	607195	ATE 23482 16,6 - WE / - WK			
					13.0470-7195.2	LD7195	ATE 23482 16,6 - WE / - WK Ceramic			
			1.8 Flexifuel	96	12/05→01/08	←	01/06→	13.0460-7193.2	607193	ATE 23723 18,1 - WE / - WK
						→	01/06→	13.0470-7193.2	LD7193	ATE 23723 18,1 - WE / - WK Ceramic
								13.0460-7195.2	607195	ATE 23482 16,6 - WE / - WK
								13.0470-7195.2	LD7195	ATE 23482 16,6 - WE / - WK Ceramic











Bremsscheibe











1.4 1.6 1.6 Ti	59 74 85	04/05→09/12 04/05→09/12 04/05→09/12	←	→ 02/11	24.0125-0117.1	425117	Ø 278 25 23 V
			→	→ 02/11	24.0325-0117.1	525117	Ø 278 25 23 V PD
					24.0111-0155.1	411155	Ø 265 11 9
					24.0311-0155.1	511155	Ø 265 11 9 PD
1.8 Flexifuel	92	03/06→09/12 06/06→07/11	←	→ 02/11	24.0111-0155.1	411155	Ø 265 11 9
			→	→ 02/11	24.0311-0155.1	511155	Ø 265 11 9 PD
					24.0111-0158.1	411158	Ø 280 11 9 + S
					24.0311-0158.1	511158	Ø 280 11 9 PD
1.6 TDCi 1.6 TDCi 1.6 TDCi	66 74 80	04/05→09/12 04/05→09/12 04/05→09/12	←	→ 02/11	24.0125-0117.1	425117	Ø 278 25 23 V
			→	→ 02/11	24.0325-0117.1	525117	Ø 278 25 23 V PD
					24.0111-0155.1	411155	Ø 265 11 9
					24.0311-0155.1	511155	Ø 265 11 9 PD
1.8 Flexifuel	96	12/05→01/08	←	01/06→	24.0125-0117.1	425117	Ø 278 25 23 V
			→	01/06→	24.0325-0117.1	525117	Ø 278 25 23 V PD
					24.0111-0155.1	411155	Ø 265 11 9
					24.0311-0155.1	511155	Ø 265 11 9 PD
1.8 TDCi 2.0 2.0	85 104 107	04/05→09/12 02/08→ 04/05→07/11	←	→ 02/11	24.0125-0162.1	425162	Ø 300 25 23 V
					24.0325-0162.1	525162	Ø 300 25 23 V PD















	kW			 	! #		
FORD - FOCUS II Stufenheck (DA_) 04/05→							
 Bremsscheibe							
2.0 TDCi	81	02/08→07/11	→	→ 02/11		24.0111-0158.1 411158	Ø 280 11 9 + S
2.0 TDCi	100	04/05→09/12	→			24.0311-0158.1 511158	Ø 280 11 9 PD
FORD - FOCUS III 07/10→							
 Bremsbelagsatz, Scheibenbremse							
1.0 EcoBoost	74	02/12→	←			13.0460-7193.2 607193	ATE 23723 18,1 - WE / - WK
1.0 EcoBoost	92	02/12→	←			13.0470-7193.2 LD7193	ATE 23723 18,1 - WE / - WK Ceramic
1.5 EcoBoost	110	09/14→	←				
1.5 EcoBoost	134	09/14→	←				
1.5 TDCi	70	09/14→	→			13.0460-7195.2 607195	ATE 23482 16,6 - WE / - WK
1.5 TDCi	88	09/14→	→			13.0470-7195.2 LD7195	ATE 23482 16,6 - WE / - WK Ceramic
1.5 TDCi ECONetic	77	09/14→	→				
1.6 Flexifuel	110	07/13→	→				
1.6 LPG	86	02/12→	→				
1.6 LPG	88	02/12→	→				
1.6 TDCi ECONetic	77	05/12→	→				
1.6 Ti	63	08/11→	→				
1.6 Ti	88	02/12→	→				
2.0	110	10/13→	→				
2.0 TDCi	110	11/14→	→				
2.0 TDCi ST	136	11/14→	→				
2.0 Ti-GDi	125	08/11→	→				
1.6 EcoBoost	110	07/10→	←	03/11→		13.0460-7193.2 607193	ATE 23723 18,1 - WE / - WK
1.6 EcoBoost	134	07/10→	←			13.0470-7193.2 LD7193	ATE 23723 18,1 - WE / - WK Ceramic
1.6 Flexifuel	88	07/10→	←				
1.6 TDCi	70	07/10→	←				
1.6 TDCi	85	07/10→	→	03/11→		13.0460-7195.2 607195	ATE 23482 16,6 - WE / - WK
1.6 Ti	77	07/10→	→			13.0470-7195.2 LD7195	ATE 23482 16,6 - WE / - WK Ceramic
1.6 Ti	92	07/10→	→				
2.0 TDCi	85	07/10→	→				
2.0 TDCi	100	07/10→	→				
2.0 TDCi	103	07/10→	→				
2.0 TDCi	120	07/10→	→				
2.0 ST	184	07/12→	→			13.0460-7195.2 607195	ATE 23482 16,6 - WE / - WK
2.3 RS AWD	257	07/15→	→			13.0470-7195.2 LD7195	ATE 23482 16,6 - WE / - WK Ceramic
 Bremsscheibe							
1.0 EcoBoost	74	02/12→	←			24.0125-0199.1 425199	Ø 278 25 23 V
1.0 EcoBoost	92	02/12→	←			24.0325-0199.1 525199	Ø 278 25 23 V PD
1.6 LPG	86	02/12→	←				
1.6 LPG	88	02/12→	→			24.0111-0171.1 411171	Ø 271 11 9
1.6 TDCi ECONetic	77	05/12→	→			24.0311-0171.1 511171	Ø 271 11 9 PD
1.6 Ti	63	08/11→	→				
1.6 Ti	88	02/12→	→				
Electric	107	07/13→	→				
1.5 EcoBoost	110	09/14→	←			24.0125-0162.1 425162	Ø 300 25 23 V
1.5 EcoBoost	134	09/14→	←			24.0325-0162.1 525162	Ø 300 25 23 V PD
1.6 Flexifuel	110	07/13→	←				
2.0	110	10/13→	→			24.0111-0171.1 411171	Ø 271 11 9
2.0 TDCi	110	11/14→	→			24.0311-0171.1 511171	Ø 271 11 9 PD
2.0 TDCi ST	136	11/14→	→				
2.0 Ti-GDi	125	08/11→	→				
1.5 TDCi	70	09/14→	←			24.0125-0162.1 425162	Ø 300 25 23 V
1.5 TDCi	88	09/14→	←			24.0125-0199.1 425199	Ø 278 25 23 V
1.5 TDCi ECONetic	77	09/14→	←			24.0325-0162.1 525162	Ø 300 25 23 V PD
			→			24.0325-0199.1 525199	Ø 278 25 23 V PD
			→			24.0111-0171.1 411171	Ø 271 11 9
			→			24.0311-0171.1 511171	Ø 271 11 9 PD
1.6 EcoBoost	110	07/10→	←	03/11→		24.0125-0162.1 425162	Ø 300 25 23 V
1.6 EcoBoost	134	07/10→	←			24.0325-0162.1 525162	Ø 300 25 23 V PD
2.0 TDCi	85	07/10→	←				
2.0 TDCi	100	07/10→	→	03/11→		24.0111-0171.1 411171	Ø 271 11 9
2.0 TDCi	103	07/10→	→			24.0311-0171.1 511171	Ø 271 11 9 PD
2.0 TDCi	120	07/10→	→				
1.6 Flexifuel	88	07/10→	←	03/11→		24.0125-0199.1 425199	Ø 278 25 23 V
1.6 TDCi	70	07/10→	←			24.0325-0199.1 525199	Ø 278 25 23 V PD
			→	03/11→		24.0111-0171.1 411171	Ø 271 11 9
			→			24.0311-0171.1 511171	Ø 271 11 9 PD
1.6 TDCi	85	07/10→	←	03/11→; für Fahrzeuge mit Active City Stop		24.0125-0162.1 425162	Ø 300 25 23 V
1.6 Ti	77	07/10→	←			24.0325-0162.1 525162	Ø 300 25 23 V PD
1.6 Ti	92	07/10→	←	03/11→; für Fahrzeuge ohne Active City Stop		24.0125-0199.1 425199	Ø 278 25 23 V
			→			24.0325-0199.1 525199	Ø 278 25 23 V PD
			→	03/11→		24.0111-0171.1 411171	Ø 271 11 9











	kW			 	! #		
FORD - FOCUS III 07/10→							
 Bremsscheibe							
1.6 TDCi	85	07/10→	→	03/11→		24.0311-0171.1 511171	Ø 271 11 9 PD
1.6 Ti	77	07/10→					
1.6 Ti	92	07/10→					
2.0 ST	184	07/12→	←			24.0125-0209.1 425209	Ø 320 25 23 V
			→			24.0111-0171.1 411171	Ø 271 11 9
						24.0311-0171.1 511171	Ø 271 11 9 PD
FORD - FOCUS III Kasten 02/12→							
 Bremsbelagsatz, Scheibenbremse							
1.0 EcoBoost	74	02/12→	←			13.0460-7193.2 607193	ATE 23723 18,1 - WE / - WK
1.0 EcoBoost	92	02/12→				13.0470-7193.2 LD7193	ATE 23723 18,1 - WE / - WK Ceramic
1.5 EcoBoost	110	09/14→					
1.5 EcoBoost	134	09/14→					
1.5 TDCi	70	09/14→	→			13.0460-7195.2 607195	ATE 23482 16,6 - WE / - WK
1.5 TDCi	88	09/14→				13.0470-7195.2 LD7195	ATE 23482 16,6 - WE / - WK Ceramic
1.5 TDCi ECONetic	77	09/14→					
2.0 TDCi	110	11/14→					
 Bremsscheibe							
1.0 EcoBoost	74	02/12→	←			24.0125-0199.1 425199	Ø 278 25 23 V
1.0 EcoBoost	92	02/12→				24.0325-0199.1 525199	Ø 278 25 23 V PD
			→			24.0111-0171.1 411171	Ø 271 11 9
						24.0311-0171.1 511171	Ø 271 11 9 PD
1.5 EcoBoost	110	09/14→	←			24.0125-0162.1 425162	Ø 300 25 23 V
1.5 EcoBoost	134	09/14→				24.0325-0162.1 525162	Ø 300 25 23 V PD
2.0 TDCi	110	11/14→					
			→			24.0111-0171.1 411171	Ø 271 11 9
						24.0311-0171.1 511171	Ø 271 11 9 PD
1.5 TDCi	70	09/14→	←			24.0125-0162.1 425162	Ø 300 25 23 V
1.5 TDCi	88	09/14→				24.0125-0199.1 425199	Ø 278 25 23 V
1.5 TDCi ECONetic	77	09/14→				24.0325-0162.1 525162	Ø 300 25 23 V PD
			→			24.0325-0199.1 525199	Ø 278 25 23 V PD
						24.0111-0171.1 411171	Ø 271 11 9
						24.0311-0171.1 511171	Ø 271 11 9 PD
FORD - FOCUS III Kasten/Schrägheck 01/11→							
 Bremsbelagsatz, Scheibenbremse							
1.0 EcoBoost	74	02/12→	←			13.0460-7193.2 607193	ATE 23723 18,1 - WE / - WK
1.0 EcoBoost	92	02/12→				13.0470-7193.2 LD7193	ATE 23723 18,1 - WE / - WK Ceramic
1.5 EcoBoost	110	09/14→					
1.5 EcoBoost	134	09/14→					
1.5 TDCi	70	09/14→	→			13.0460-7195.2 607195	ATE 23482 16,6 - WE / - WK
1.5 TDCi	88	09/14→				13.0470-7195.2 LD7195	ATE 23482 16,6 - WE / - WK Ceramic
1.5 TDCi ECONetic	77	09/14→					
1.6 EcoBoost	110	11/11→06/14					
1.6 EcoBoost	134	11/11→06/14					
1.6 TDCi	85	02/12→					
2.0 TDCi	110	11/14→					
1.6 Ti	77	01/11→	←	03/11→		13.0460-7193.2 607193	ATE 23723 18,1 - WE / - WK
2.0 TDCi	85	01/11→06/14				13.0470-7193.2 LD7193	ATE 23723 18,1 - WE / - WK Ceramic
2.0 TDCi	103	01/11→06/14					
			→	03/11→		13.0460-7195.2 607195	ATE 23482 16,6 - WE / - WK
						13.0470-7195.2 LD7195	ATE 23482 16,6 - WE / - WK Ceramic
 Bremsscheibe							
1.0 EcoBoost	74	02/12→	←			24.0125-0199.1 425199	Ø 278 25 23 V
1.0 EcoBoost	92	02/12→				24.0325-0199.1 525199	Ø 278 25 23 V PD
			→			24.0111-0171.1 411171	Ø 271 11 9
						24.0311-0171.1 511171	Ø 271 11 9 PD
1.5 EcoBoost	110	09/14→	←			24.0125-0162.1 425162	Ø 300 25 23 V
1.5 EcoBoost	134	09/14→				24.0325-0162.1 525162	Ø 300 25 23 V PD
1.6 EcoBoost	110	11/11→06/14					
1.6 EcoBoost	134	11/11→06/14	→			24.0111-0171.1 411171	Ø 271 11 9
2.0 TDCi	110	11/14→				24.0311-0171.1 511171	Ø 271 11 9 PD
1.5 TDCi	70	09/14→	←			24.0125-0162.1 425162	Ø 300 25 23 V
1.5 TDCi	88	09/14→				24.0125-0199.1 425199	Ø 278 25 23 V
1.5 TDCi ECONetic	77	09/14→				24.0325-0162.1 525162	Ø 300 25 23 V PD
			→			24.0325-0199.1 525199	Ø 278 25 23 V PD
						24.0111-0171.1 411171	Ø 271 11 9







	kW			 	! #		
FORD - FOCUS III Kasten/Schrägheck 01/11→							
Bremsscheibe							
1.5 TDCi	70	09/14→	→			24.0311-0171.1 511171	Ø 271 11 9 PD
1.5 TDCi	88	09/14→					
1.5 TDCi ECONetic	77	09/14→					
1.6 TDCi	85	02/12→	←	für Fahrzeuge mit Active City Stop		24.0125-0162.1 425162	Ø 300 25 23 V
						24.0325-0162.1 525162	Ø 300 25 23 V PD
			←	für Fahrzeuge ohne Active City Stop		24.0125-0199.1 425199	Ø 278 25 23 V
						24.0325-0199.1 525199	Ø 278 25 23 V PD
			→			24.0111-0171.1 411171	Ø 271 11 9
						24.0311-0171.1 511171	Ø 271 11 9 PD
1.6 Ti	77	01/11→	←	03/11→; für Fahrzeuge mit Active City Stop		24.0125-0162.1 425162	Ø 300 25 23 V
						24.0325-0162.1 525162	Ø 300 25 23 V PD
			←	03/11→; für Fahrzeuge ohne Active City Stop		24.0125-0199.1 425199	Ø 278 25 23 V
						24.0325-0199.1 525199	Ø 278 25 23 V PD
			→	03/11→		24.0111-0171.1 411171	Ø 271 11 9
						24.0311-0171.1 511171	Ø 271 11 9 PD
2.0 TDCi	85	01/11→06/14	←	03/11→		24.0125-0162.1 425162	Ø 300 25 23 V
2.0 TDCi	103	01/11→06/14				24.0325-0162.1 525162	Ø 300 25 23 V PD
			→	03/11→		24.0111-0171.1 411171	Ø 271 11 9
						24.0311-0171.1 511171	Ø 271 11 9 PD
FORD - FOCUS III Stufenheck 07/10→							
Bremsbelagsatz, Scheibenbremse							
1.0 EcoBoost	74	02/12→	←			13.0460-7193.2 607193	ATE 23723 18,1 - WE / - WK
1.0 EcoBoost	92	02/12→				13.0470-7193.2 LD7193	ATE 23723 18,1 - WE / - WK Ceramic
1.5 EcoBoost	110	11/14→					
1.5 EcoBoost	134	11/14→	→			13.0460-7195.2 607195	ATE 23482 16,6 - WE / - WK
1.5 TDCi	70	11/14→				13.0470-7195.2 LD7195	ATE 23482 16,6 - WE / - WK Ceramic
1.5 TDCi	88	11/14→					
1.5 TDCi ECONetic	77	11/14→					
1.6 Flexifuel	110	07/13→					
1.6 TDCi	77	05/12→					
1.6 Ti	63	08/11→					
2.0	110	10/13→					
2.0 GDi	125	08/11→					
2.0 TDCi	110	11/14→					
1.6 EcoBoost	110	07/10→	←	03/11→		13.0460-7193.2 607193	ATE 23723 18,1 - WE / - WK
1.6 EcoBoost	134	07/10→				13.0470-7193.2 LD7193	ATE 23723 18,1 - WE / - WK Ceramic
1.6 Flexifuel	88	07/10→					
1.6 TDCi	70	07/10→	→	03/11→		13.0460-7195.2 607195	ATE 23482 16,6 - WE / - WK
1.6 TDCi	85	07/10→				13.0470-7195.2 LD7195	ATE 23482 16,6 - WE / - WK Ceramic
1.6 Ti	77	07/10→					
1.6 Ti	92	07/10→					
2.0 TDCi	85	07/10→					
2.0 TDCi	100	07/10→					
2.0 TDCi	103	07/10→					
2.0 TDCi	120	07/10→					
Bremsscheibe							
1.0 EcoBoost	74	02/12→	←			24.0125-0199.1 425199	Ø 278 25 23 V
1.0 EcoBoost	92	02/12→				24.0325-0199.1 525199	Ø 278 25 23 V PD
1.6 TDCi	77	05/12→	→			24.0111-0171.1 411171	Ø 271 11 9
1.6 Ti	63	08/11→				24.0311-0171.1 511171	Ø 271 11 9 PD
1.5 EcoBoost	110	11/14→	←			24.0125-0162.1 425162	Ø 300 25 23 V
1.5 EcoBoost	134	11/14→				24.0325-0162.1 525162	Ø 300 25 23 V PD
1.6 Flexifuel	110	07/13→					
2.0	110	10/13→	→			24.0111-0171.1 411171	Ø 271 11 9
2.0 GDi	125	08/11→				24.0311-0171.1 511171	Ø 271 11 9 PD
2.0 TDCi	110	11/14→					
1.5 TDCi	70	11/14→	←			24.0125-0162.1 425162	Ø 300 25 23 V
1.5 TDCi	88	11/14→				24.0125-0199.1 425199	Ø 278 25 23 V
1.5 TDCi ECONetic	77	11/14→				24.0325-0162.1 525162	Ø 300 25 23 V PD
			→			24.0325-0199.1 525199	Ø 278 25 23 V PD
						24.0111-0171.1 411171	Ø 271 11 9
						24.0311-0171.1 511171	Ø 271 11 9 PD
1.6 EcoBoost	110	07/10→	←	03/11→		24.0125-0162.1 425162	Ø 300 25 23 V
1.6 EcoBoost	134	07/10→				24.0325-0162.1 525162	Ø 300 25 23 V PD
2.0 TDCi	85	07/10→	→	03/11→		24.0111-0171.1 411171	Ø 271 11 9
2.0 TDCi	100	07/10→				24.0311-0171.1 511171	Ø 271 11 9 PD
2.0 TDCi	103	07/10→					
2.0 TDCi	120	07/10→					
1.6 Flexifuel	88	07/10→	←	03/11→		24.0125-0199.1 425199	Ø 278 25 23 V
1.6 TDCi	70	07/10→					









	kW			 	! #		
FORD - FOCUS III Stufenheck 07/10→							
 Bremsscheibe							
1.6 Flexifuel	88	07/10→	←	03/11→		24.0325-0199.1 525199	Ø 278 25 23 V PD
1.6 TDCi	70	07/10→	→	03/11→		24.0111-0171.1 411171	Ø 271 11 9
						24.0311-0171.1 511171	Ø 271 11 9 PD
1.6 TDCi	85	07/10→	←	03/11→;		24.0125-0162.1 425162	Ø 300 25 23 V
1.6 Ti	77	07/10→		für Fahrzeuge mit Active City Stop		24.0325-0162.1 525162	Ø 300 25 23 V PD
1.6 Ti	92	07/10→	←	03/11→;		24.0125-0199.1 425199	Ø 278 25 23 V
				für Fahrzeuge ohne Active City Stop		24.0325-0199.1 525199	Ø 278 25 23 V PD
			→	03/11→		24.0111-0171.1 411171	Ø 271 11 9
						24.0311-0171.1 511171	Ø 271 11 9 PD
FORD - FOCUS III Turnier 07/10→							
 Bremsbelagsatz, Scheibenbremse							
1.0 EcoBoost	74	02/12→	←			13.0460-7193.2 607193	ATE 23723 18,1 - WE / - WK
1.0 EcoBoost	92	02/12→				13.0470-7193.2 LD7193	ATE 23723 18,1 - WE / - WK Ceramic
1.5 EcoBoost	110	09/14→					
1.5 EcoBoost	134	09/14→	→			13.0460-7195.2 607195	ATE 23482 16,6 - WE / - WK
1.5 TDCi	70	09/14→				13.0470-7195.2 LD7195	ATE 23482 16,6 - WE / - WK Ceramic
1.5 TDCi	88	09/14→					
1.5 TDCi ECONetic	77	09/14→					
1.6 Flexifuel	110	07/13→					
1.6 LPG	86	02/12→					
1.6 LPG	88	02/12→					
1.6 TDCi ECONetic	77	05/12→					
1.6 Ti	63	08/11→					
1.6 Ti	88	02/12→					
2.0	110	10/13→					
2.0 TDCi	110	11/14→					
2.0 TDCi ST	136	11/14→					
1.6 EcoBoost	110	07/10→	←	03/11→		13.0460-7193.2 607193	ATE 23723 18,1 - WE / - WK
1.6 EcoBoost	134	07/10→				13.0470-7193.2 LD7193	ATE 23723 18,1 - WE / - WK Ceramic
1.6 Flexifuel	88	07/10→					
1.6 TDCi	70	07/10→	→	03/11→		13.0460-7195.2 607195	ATE 23482 16,6 - WE / - WK
1.6 TDCi	85	07/10→				13.0470-7195.2 LD7195	ATE 23482 16,6 - WE / - WK Ceramic
1.6 Ti	77	07/10→					
1.6 Ti	92	07/10→					
2.0 TDCi	85	07/10→					
2.0 TDCi	100	07/10→					
2.0 TDCi	103	07/10→					
2.0 TDCi	120	07/10→					
2.0 ST	184	07/12→	→			13.0460-7195.2 607195	ATE 23482 16,6 - WE / - WK
						13.0470-7195.2 LD7195	ATE 23482 16,6 - WE / - WK Ceramic
2.0 Ti-GDi	125	07/10→	←	08/11→		13.0460-7193.2 607193	ATE 23723 18,1 - WE / - WK
						13.0470-7193.2 LD7193	ATE 23723 18,1 - WE / - WK Ceramic
			→	08/11→		13.0460-7195.2 607195	ATE 23482 16,6 - WE / - WK
						13.0470-7195.2 LD7195	ATE 23482 16,6 - WE / - WK Ceramic
 Bremsscheibe							
1.0 EcoBoost	74	02/12→	←			24.0125-0199.1 425199	Ø 278 25 23 V
1.0 EcoBoost	92	02/12→				24.0325-0199.1 525199	Ø 278 25 23 V PD
1.6 LPG	86	02/12→	→			24.0111-0171.1 411171	Ø 271 11 9
1.6 LPG	88	02/12→				24.0311-0171.1 511171	Ø 271 11 9 PD
1.6 TDCi ECONetic	77	05/12→					
1.6 Ti	63	08/11→					
1.6 Ti	88	02/12→					
1.5 EcoBoost	110	09/14→	←			24.0125-0162.1 425162	Ø 300 25 23 V
1.5 EcoBoost	134	09/14→				24.0325-0162.1 525162	Ø 300 25 23 V PD
1.6 Flexifuel	110	07/13→	→			24.0111-0171.1 411171	Ø 271 11 9
2.0	110	10/13→				24.0311-0171.1 511171	Ø 271 11 9 PD
2.0 TDCi	110	11/14→					
2.0 TDCi ST	136	11/14→					
1.5 TDCi	70	09/14→	←			24.0125-0162.1 425162	Ø 300 25 23 V
1.5 TDCi	88	09/14→				24.0125-0199.1 425199	Ø 278 25 23 V
1.5 TDCi ECONetic	77	09/14→				24.0325-0162.1 525162	Ø 300 25 23 V PD
			→			24.0325-0199.1 525199	Ø 278 25 23 V PD
						24.0111-0171.1 411171	Ø 271 11 9
						24.0311-0171.1 511171	Ø 271 11 9 PD
1.6 EcoBoost	110	07/10→	←	03/11→		24.0125-0162.1 425162	Ø 300 25 23 V
1.6 EcoBoost	134	07/10→				24.0325-0162.1 525162	Ø 300 25 23 V PD
2.0 TDCi	85	07/10→	→	03/11→		24.0111-0171.1 411171	Ø 271 11 9
2.0 TDCi	100	07/10→				24.0311-0171.1 511171	Ø 271 11 9 PD
2.0 TDCi	103	07/10→					













	kw			 	! #		
FORD - FOCUS III Turnier 07/10→							
 Bremsscheibe							
2.0 TDCi	120	07/10→	➔	03/11→		24.0311-0171.1 511171	Ø 271 11 9 PD
1.6 Flexifuel 1.6 TDCi	88 70	07/10→ 07/10→	➔	03/11→		24.0125-0199.1 425199	Ø 278 25 23 V
						24.0325-0199.1 525199	Ø 278 25 23 V PD
						24.0111-0171.1 411171	Ø 271 11 9
						24.0311-0171.1 511171	Ø 271 11 9 PD
1.6 TDCi 1.6 Ti 1.6 Ti	85 77 92	07/10→ 07/10→ 07/10→	➔	03/11→; für Fahrzeuge mit Active City Stop		24.0125-0162.1 425162	Ø 300 25 23 V
						24.0325-0162.1 525162	Ø 300 25 23 V PD
						24.0125-0199.1 425199	Ø 278 25 23 V
						24.0325-0199.1 525199	Ø 278 25 23 V PD
						24.0111-0171.1 411171	Ø 271 11 9
						24.0311-0171.1 511171	Ø 271 11 9 PD
2.0 ST	184	07/12→	➔			24.0125-0209.1 425209	Ø 320 25 23 V
						24.0111-0171.1 411171	Ø 271 11 9
						24.0311-0171.1 511171	Ø 271 11 9 PD
2.0 Ti-GDi	125	07/10→	➔	08/11→		24.0125-0162.1 425162	Ø 300 25 23 V
						24.0325-0162.1 525162	Ø 300 25 23 V PD
						24.0111-0171.1 411171	Ø 271 11 9
						24.0311-0171.1 511171	Ø 271 11 9 PD
FORD - FOCUS C-MAX 10/03→03/07							
 Bremsbelagsatz, Scheibenbremse							
1.6	74	10/03→03/07	➔			13.0460-7193.2 607193	ATE 23723 18,1 - WE / - WK
1.6 TDCi	66	02/05→03/07				13.0470-7193.2 LD7193	ATE 23723 18,1 - WE / - WK
1.6 TDCi	80	10/03→03/07					Ceramic
1.6 Ti	85	08/04→03/07					
1.8	88	10/03→03/07	➔			13.0460-7195.2 607195	ATE 23482 16,6 - WE / - WK
1.8	90	09/05→03/07				13.0470-7195.2 LD7195	ATE 23482 16,6 - WE / - WK
1.8	92	04/04→03/07					Ceramic
1.8 Flexifuel	92	01/06→03/07					
1.8 TDCi	85	01/05→03/07					
2.0 TDCi	98	10/03→03/07					
2.0 TDCi	100	10/03→03/07					
2.0	107	03/04→03/07	➔	04/04→		13.0460-7193.2 607193	ATE 23723 18,1 - WE / - WK
						13.0470-7193.2 LD7193	ATE 23723 18,1 - WE / - WK
						13.0460-7195.2 607195	ATE 23482 16,6 - WE / - WK
						13.0470-7195.2 LD7195	ATE 23482 16,6 - WE / - WK
							Ceramic
 Bremsscheibe							
1.6	74	10/03→03/07	➔	passend für Felgenreöße [Zoll]: 15 / 16		24.0125-0117.1 425117	Ø 278 25 23 V
1.6 Ti	85	08/04→03/07					24.0325-0117.1 525117
1.8	88	10/03→03/07					
1.8	90	09/05→03/07	➔	passend für Felgenreöße [Zoll]: 17		24.0125-0162.1 425162	Ø 300 25 23 V
1.8	92	04/04→03/07					24.0325-0162.1 525162
1.8 Flexifuel	92	01/06→03/07				24.0111-0155.1 411155	Ø 265 11 9
						24.0311-0155.1 511155	Ø 265 11 9 PD
1.6 TDCi 1.6 TDCi	66 80	02/05→03/07 10/03→03/07	➔	passend für Felgenreöße [Zoll]: 15 / 16		24.0125-0117.1 425117	Ø 278 25 23 V
						24.0325-0117.1 525117	Ø 278 25 23 V PD
						24.0125-0162.1 425162	Ø 300 25 23 V
						24.0325-0162.1 525162	Ø 300 25 23 V PD
						24.0111-0155.1 411155	Ø 265 11 9
						24.0111-0158.1 411158	Ø 280 11 9 + S
						24.0311-0155.1 511155	Ø 265 11 9 PD
						24.0311-0158.1 511158	Ø 280 11 9 PD
1.8 TDCi 2.0 TDCi 2.0 TDCi	85 98 100	01/05→03/07 10/03→03/07 10/03→03/07	➔	passend für Felgenreöße [Zoll]: 15 / 16		24.0125-0117.1 425117	Ø 278 25 23 V
						24.0325-0117.1 525117	Ø 278 25 23 V PD
						24.0125-0162.1 425162	Ø 300 25 23 V
						24.0325-0162.1 525162	Ø 300 25 23 V PD
						24.0111-0158.1 411158	Ø 280 11 9 + S
						24.0311-0158.1 511158	Ø 280 11 9 PD
2.0	107	03/04→03/07	➔	04/04→; passend für Felgenreöße [Zoll]: 15 / 16		24.0125-0117.1 425117	Ø 278 25 23 V
						24.0325-0117.1 525117	Ø 278 25 23 V PD
						24.0125-0162.1 425162	Ø 300 25 23 V
						24.0325-0162.1 525162	Ø 300 25 23 V PD
						24.0111-0158.1 411158	Ø 280 11 9 + S
						24.0311-0158.1 511158	Ø 280 11 9 PD















	kw			 	! #		
FORD - FOCUS C-MAX 10/03→03/07							
 Bremsscheibe							
2.0	107	03/04→03/07	➡	04/04→		24.0311-0158.1 511158	Ø 280 11 9 PD
FORD - FOCUS Kombi (DNW) 02/99→12/07							
 Bremsbelagsatz, Scheibenbremse							
1.4 16V	55	02/99→11/04	←	→ 09/04		13.0460-7121.2 607121	ATE 23154 19,0 - WE / - WK
1.6 16V	74	02/99→11/04	➡	→ 09/04		13.0460-2835.2 602835	TRW 23353 14,8 + WE / - WK
1.6 16V Flexifuel	75	01/02→11/04					
1.8 16V	85	02/99→11/04					
1.8 DI / TDDi	55	08/99→11/04					
1.8 TDCi	74	08/02→11/04					
1.8 TDCi	85	03/01→11/04					
1.8 TDCi	85	03/01→11/04	←	→ 09/04		13.0460-7121.2 607121	ATE 23154 19,0 - WE / - WK
1.8 Turbo DI / TDDi	66	02/99→11/04					
2.0 16V	96	02/99→11/04	➡	→ 09/04		13.0460-2835.2 602835	TRW 23353 14,8 + WE / - WK
1.8 BiFuel	82	02/03→01/05	←	→ 09/04		13.0460-7121.2 607121	ATE 23154 19,0 - WE / - WK
			➡	→ 09/04		13.0460-2835.2 602835	TRW 23353 14,8 + WE / - WK
ST170	127	08/02→11/04	←	→ 09/04		13.0460-7186.2 607186	ATE 23440 17,6 - WE / - WK
			➡	→ 09/04		13.0460-2835.2 602835	TRW 23353 14,8 + WE / - WK
 Bremsscheibe							
1.4 16V	55	02/99→11/04	←	→ 09/04		24.0122-0172.1 422172	Ø 258 22 20 V
1.6 16V	74	02/99→11/04	➡	→ 09/04		24.0322-0172.1 522172	Ø 258 22 20 V PD
1.6 16V Flexifuel	75	01/02→11/04					
1.8 16V	85	02/99→11/04					
1.8 DI / TDDi	55	08/99→11/04					
1.8 TDCi	74	08/02→11/04					
1.8 TDCi	85	03/01→11/04					
1.8 TDCi	85	03/01→11/04	←	→ 09/04		24.0110-0115.1 410115	Ø 253 10,2 8,9
1.8 Turbo DI / TDDi	66	02/99→11/04					
2.0 16V	96	02/99→11/04	➡	→ 09/04		24.0310-0115.1 510115	Ø 253 10,2 8,9 PD
1.8 BiFuel	82	02/03→01/05	←	→ 09/04		24.0122-0172.1 422172	Ø 258 22 20 V
			➡	→ 09/04		24.0322-0172.1 522172	Ø 258 22 20 V PD
			➡	→ 09/04		24.0110-0115.1 410115	Ø 253 10,2 8,9
			➡	→ 09/04		24.0310-0115.1 510115	Ø 253 10,2 8,9 PD
ST170	127	08/02→11/04	←	→ 09/04		24.0124-0198.1 424198	Ø 300 24 22 V
			➡	→ 09/04		24.0110-0313.1 410313	Ø 280 10,2 8,9
FORD - FOCUS Stufenheck (DFW) 02/99→12/07							
 Bremsbelagsatz, Scheibenbremse							
1.4 16V	55	02/99→11/04	←	→ 09/04		13.0460-7121.2 607121	ATE 23154 19,0 - WE / - WK
1.6 16V	74	02/99→11/04	➡	→ 09/04		13.0460-2835.2 602835	TRW 23353 14,8 + WE / - WK
1.8 16V	85	02/99→11/04					
1.8 TDCi	74	08/02→11/04					
1.8 TDCi	85	03/01→11/04					
1.8 Turbo DI / TDDi	55	08/01→03/05					
1.8 Turbo DI / TDDi	66	02/99→11/04					
2.0 16V	96	02/99→11/04	➡	→ 09/04		13.0460-2835.2 602835	TRW 23353 14,8 + WE / - WK
 Bremsscheibe							
1.4 16V	55	02/99→11/04	←	→ 09/04		24.0122-0172.1 422172	Ø 258 22 20 V
1.6 16V	74	02/99→11/04	➡	→ 09/04		24.0322-0172.1 522172	Ø 258 22 20 V PD
1.8 16V	85	02/99→11/04					
1.8 TDCi	74	08/02→11/04					
1.8 TDCi	85	03/01→11/04					
1.8 Turbo DI / TDDi	55	08/01→03/05					
1.8 Turbo DI / TDDi	66	02/99→11/04					
2.0 16V	96	02/99→11/04	➡	→ 09/04		24.0310-0115.1 510115	Ø 253 10,2 8,9 PD
FORD - FUSION (JU_) 08/02→12/12							
 Bremsbelagsatz, Scheibenbremse							
1.25	55	08/04→12/12	←	→ 09/12		13.0460-7142.2 607142	ATE 23202 18,3 - WE / - WK
1.4	59	08/02→12/12	➡	→ 09/12		13.0460-7142.2 607142	ATE 23202 18,3 - WE / - WK
1.4 LPG	59	01/10→12/12					
1.4 TDCi	50	08/02→12/12					
1.6 TDCi	66	11/04→12/12					
1.6	74	08/02→11/08					
 Bremsscheibe							
1.25	55	08/04→12/12	←	→ 09/12		24.0122-0172.1 422172	Ø 258 22 20 V
1.4	59	08/02→12/12	➡	→ 09/12		24.0322-0172.1 522172	Ø 258 22 20 V PD
1.4 LPG	59	01/10→12/12					
1.4 TDCi	50	08/02→12/12					
1.6 TDCi	66	11/04→12/12					
1.6	74	08/02→11/08					
↓			←	→ 09/12		24.0122-0172.1 422172	Ø 258 22 20 V













	kw			 	! #		
FORD - FUSION (JU_) 08/02→12/12							
 Bremsscheibe							
1.6	74	08/02→11/08	←			24.0322-0172.1 522172	Ø 258 22 20 V PD
FORD - GALAXY 01/15→							
 Bremsbelagsatz, Scheibenbremse							
1.5 EcoBoost	118	01/15→	←	04/15→;		13.0460-7313.2 607313	ATE + WK
2.0 EcoBoost	176	01/15→		passend für Felgengröße [Zoll]: 16			
2.0 TDCi	88	01/15→					
2.0 TDCi	110	01/15→					
2.0 TDCi	132	01/15→					
2.0 TDCi Bi-Turbo	154	01/15→					
2.0 TDCi 4x4	110	05/15→	←	passend für Felgengröße [Zoll]: 16		13.0460-7313.2 607313	ATE + WK
2.0 TDCi 4x4	132	05/15→					
FORD - GALAXY (WA6) 05/06→06/15							
 Bremsbelagsatz, Scheibenbremse							
1.6 EcoBoost	118	11/10→06/15	←	02/11→		13.0460-7228.2 607228	ATE 24123 20,3 - WE / - WK
						13.0470-7228.2 LD7228	ATE 24123 20,3 - WE / - WK Ceramic
			→	02/11→; + eFSB		13.0460-2722.2 602722	TRW 24496 17,3 - WE / - WK + Zub
						13.0470-2722.2 LD2722	TRW 24496 17,3 - WE / - WK + Zub Ceramic
1.6 EcoBoost	118	11/10→06/15	→	02/11→; - eFSB		13.0460-2723.2 602723	TRW 24537 16,1 - WE / - WK + Zub
						13.0470-2723.2 LD2723	TRW 24537 16,1 - WE / - WK + Zub Ceramic
			←			13.0460-7228.2 607228	ATE 24123 20,3 - WE / - WK
						13.0470-7228.2 LD7228	ATE 24123 20,3 - WE / - WK Ceramic
1.6 TDCi 1.8 TDCi 1.8 TDCi 2.0 2.0 Flexifuel 2.0 TDCi 2.0 TDCi 2.0 TDCi 2.0 TDCi 2.0 TDCi 2.2 TDCi 2.3	85 74 92 107 107 85 96 100 103 120 147 118	02/11→06/15 05/06→06/15 05/06→06/15 05/06→06/15 11/07→06/15 05/06→06/15 05/06→06/15 05/06→06/15 05/06→06/15 03/10→06/15 11/10→06/15 09/07→06/15	←			13.0460-7228.2 607228	ATE 24123 20,3 - WE / - WK
						13.0470-7228.2 LD7228	ATE 24123 20,3 - WE / - WK Ceramic
			→	+ eFSB		13.0460-2722.2 602722	TRW 24496 17,3 - WE / - WK + Zub
						13.0470-2722.2 LD2722	TRW 24496 17,3 - WE / - WK + Zub Ceramic
			→	- eFSB		13.0460-2723.2 602723	TRW 24537 16,1 - WE / - WK + Zub
						13.0470-2723.2 LD2723	TRW 24537 16,1 - WE / - WK + Zub Ceramic
			←			13.0460-7243.2 607243	ATE 24142 20,6 - WE / - WK
						13.0470-7243.2 LD7243	ATE 24142 20,6 - WE / - WK Ceramic
			→	+ eFSB		13.0460-2722.2 602722	TRW 24496 17,3 - WE / - WK + Zub
						13.0470-2722.2 LD2722	TRW 24496 17,3 - WE / - WK + Zub Ceramic
2.0 EcoBoost 2.0 EcoBoost	146 149	07/10→06/15 03/10→06/15	→	- eFSB		13.0460-2723.2 602723	TRW 24537 16,1 - WE / - WK + Zub
						13.0470-2723.2 LD2723	TRW 24537 16,1 - WE / - WK + Zub Ceramic
			←			13.0460-7243.2 607243	ATE 24142 20,6 - WE / - WK
						13.0470-7243.2 LD7243	ATE 24142 20,6 - WE / - WK Ceramic
2.2 TDCi	129	03/08→12/12	←	11/08→		13.0460-7228.2 607228	ATE 24123 20,3 - WE / - WK
						13.0470-7228.2 LD7228	ATE 24123 20,3 - WE / - WK Ceramic
			←	04/08→ 10/08		13.0460-7243.2 607243	ATE 24142 20,6 - WE / - WK
						13.0470-7243.2 LD7243	ATE 24142 20,6 - WE / - WK Ceramic
			→	04/08→; + eFSB		13.0460-2722.2 602722	TRW 24496 17,3 - WE / - WK + Zub
			13.0470-2722.2 LD2722	TRW 24496 17,3 - WE / - WK + Zub Ceramic			
2.2 TDCi	129	03/08→12/12	→	04/08→; - eFSB		13.0460-2723.2 602723	TRW 24537 16,1 - WE / - WK + Zub
						13.0470-2723.2 LD2723	TRW 24537 16,1 - WE / - WK + Zub Ceramic
 Bremsscheibe							
1.6 EcoBoost	118	11/10→06/15	←	02/11→		24.0128-0154.1 428154	Ø 300 28 26 V + S
						24.0328-0154.1 528154	Ø 300 28 26 V + S PD
1.6 TDCi	85	02/11→06/15	→	02/11→		24.0111-0145.1 411145	Ø 302 10,9 9 + S
						24.0311-0145.1 511145	Ø 302 10,9 9 PD
			←			24.0128-0154.1 428154	Ø 300 28 26 V + S















	kw			 	! #		
FORD - GALAXY (WA6) 05/06→06/15							
Bremsscheibe							
1.8 TDCi	74	05/06→06/15	←			24.0328-0154.1 528154	Ø 300 28 26 V + S PD
1.8 TDCi	92	05/06→06/15	→			24.0111-0145.1 411145	Ø 302 10,9 9 + S
2.0	107	05/06→06/15	←			24.0311-0145.1 511145	Ø 302 10,9 9 PD
2.0 Flexifuel	107	05/06→06/15					
2.0 TDCi	85	11/07→06/15					
2.0 TDCi	96	05/06→06/15					
2.0 TDCi	100	05/06→06/15					
2.0 TDCi	103	05/06→06/15					
2.0 TDCi	120	03/10→06/15					
2.2 TDCi	147	11/10→06/15					
2.3	118	09/07→06/15					
2.0 EcoBoost	146	07/10→06/15	←			24.0128-0162.1 428162	Ø 316 28 26 V + S
2.0 EcoBoost	149	03/10→06/15	→			24.0328-0162.1 528162	Ø 316 28 26 V + S PD
			←			24.0111-0145.1 411145	Ø 302 10,9 9 + S
			→			24.0311-0145.1 511145	Ø 302 10,9 9 PD
2.2 TDCi	129	03/08→12/12	←	11/08→		24.0128-0154.1 428154	Ø 300 28 26 V + S
			←	04/08→ 10/08		24.0328-0154.1 528154	Ø 300 28 26 V + S PD
			←			24.0128-0162.1 428162	Ø 316 28 26 V + S
			→			24.0328-0162.1 528162	Ø 316 28 26 V + S PD
			→	04/08→		24.0111-0145.1 411145	Ø 302 10,9 9 + S
						24.0311-0145.1 511145	Ø 302 10,9 9 PD
FORD - GALAXY (WGR) 03/95→05/06							
Bremsbelagsatz, Scheibenbremse							
1.9 TDI	66	03/95→05/06	←	01/96→ 03/00		13.0460-7076.2 607076	ATE 21848 19,8 - WE / - WK
			←	04/00→ 04/01		13.0460-7143.2 607143	ATE 21848 19,8 + WK
			←	05/01→ 04/06		13.0460-7154.2 607154	ATE 23034 18,8 + WK
			→	01/96→ 03/00		13.0460-2819.2 602819	TRW 20961 17,2 - WK
			→	04/00→ 04/06		13.0460-2859.2 602859	TRW 20961 17,0 + WK + Zub
1.9 TDI	81	08/97→04/00	←	10/97→ 03/00		13.0460-7076.2 607076	ATE 21848 19,8 - WE / - WK
			→	10/97→ 03/00		13.0460-2819.2 602819	TRW 20961 17,2 - WK
1.9 TDI	85	04/00→05/06	←	→ 04/01		13.0460-7143.2 607143	ATE 21848 19,8 + WK
			←	05/01→ 04/06		13.0460-7154.2 607154	ATE 23034 18,8 + WK
			→	→ 04/06		13.0460-2859.2 602859	TRW 20961 17,0 + WK + Zub
1.9 TDI	96	02/03→05/06	←	→ 04/06		13.0460-7154.2 607154	ATE 23034 18,8 + WK
			→	→ 04/06		13.0460-2859.2 602859	TRW 20961 17,0 + WK + Zub
1.9 TDI	110	05/05→05/06	←			13.0460-7154.2 607154	ATE 23034 18,8 + WK
			→	→ 04/06; passend für Felgengröße [Zoll]: 15		13.0460-2859.2 602859	TRW 20961 17,0 + WK + Zub
			→	→ 04/06; passend für Felgengröße [Zoll]: 16		13.0460-2872.2 602872	TRW 23224 16,5 + WK + Zub
2.0 i	85	11/95→05/06	←	→ 04/01		13.0460-7076.2 607076	ATE 21848 19,8 - WE / - WK
2.3 16V	107	01/97→05/06	←	05/01→ 04/06		13.0460-7156.2 607156	ATE 23034 19,4 - WE / - WK
			→	→ 04/06		13.0460-2819.2 602819	TRW 20961 17,2 - WK
2.3 16V	103	09/01→05/06	←	→ 04/06		13.0460-7156.2 607156	ATE 23034 19,4 - WE / - WK
			→	→ 04/06		13.0460-2819.2 602819	TRW 20961 17,2 - WK
2.3 4x4	107	09/96→04/00	←	01/97→		13.0460-7076.2 607076	ATE 21848 19,8 - WE / - WK
			→	01/97→		13.0460-2819.2 602819	TRW 20961 17,2 - WK
2.8 i V6	128	11/95→04/00	←	→ 03/00		13.0460-7076.2 607076	ATE 21848 19,8 - WE / - WK
2.8 i V6 4x4	128	04/96→04/00	→	→ 03/00		13.0460-2819.2 602819	TRW 20961 17,2 - WK
2.8 V6	150	04/00→05/06	←	→ 04/06		13.0460-7153.2 607153	ATE 23269 19,8 + WK
			→	→ 04/06		13.0460-2872.2 602872	TRW 23224 16,5 + WK + Zub
Zubehörsatz, Scheibenbremsbelag							
1.9 TDI	66	03/95→05/06	→	01/96→ 03/00		13.0460-0072.2 610072	TRW
1.9 TDI	81	08/97→04/00	→	10/97→ 03/00		13.0460-0072.2 610072	TRW
1.9 TDI	110	05/05→05/06	→	→ 04/06; passend für Felgengröße [Zoll]: 16		13.0460-0225.2 610225	
2.0 i	85	11/95→05/06	→	→ 04/06		13.0460-0072.2 610072	TRW
2.3 16V	103	09/01→05/06					
2.3 16V	107	01/97→05/06					
2.3 4x4	107	09/96→04/00	→	01/97→		13.0460-0072.2 610072	TRW
↓							











	kw				! #		
FORD - GALAXY (WGR) 03/95→05/06							
Zubehörsatz, Scheibenbremsbelag							
2.8 i V6	128	11/95→04/00	➡	→ 03/00		13.0460-0072.2 610072	TRW
2.8 i V6 4x4	128	04/96→04/00					
2.8 V6	150	04/00→05/06	➡	→ 04/06		13.0460-0225.2 610225	
 Bremsscheibe							
1.9 TDI	66	03/95→05/06	←	01/96→ 04/01		24.0125-0114.1 425114	Ø 288 25,1 21 V + S
						24.0325-0114.1 525114	Ø 288 25,1 21 V + S PD
			←	05/01→ 04/06		24.0126-0115.1 426115	Ø 300 26 22 V
			➡	01/96→ 04/06		24.0326-0115.1 526115	Ø 300 26 22 V PD
						24.0110-0223.1 410223	Ø 268 10 8 + S
						24.0310-0223.1 510223	Ø 268 10 8 + S PD
1.9 TDI	81	08/97→04/00	←	10/97→ 03/00		24.0125-0114.1 425114	Ø 288 25,1 21 V + S
						24.0325-0114.1 525114	Ø 288 25,1 21 V + S PD
			➡	10/97→ 03/00		24.0110-0223.1 410223	Ø 268 10 8 + S
						24.0310-0223.1 510223	Ø 268 10 8 + S PD
1.9 TDI 2.0 i 2.3 16V	85 85 107	04/00→05/06 11/95→05/06 01/97→05/06	←	→ 04/01		24.0125-0114.1 425114	Ø 288 25,1 21 V + S
						24.0325-0114.1 525114	Ø 288 25,1 21 V + S PD
			←	05/01→ 04/06		24.0126-0115.1 426115	Ø 300 26 22 V
			➡	→ 04/06		24.0326-0115.1 526115	Ø 300 26 22 V PD
						24.0110-0223.1 410223	Ø 268 10 8 + S
						24.0310-0223.1 510223	Ø 268 10 8 + S PD
1.9 TDI 1.9 TDI 2.3 16V	96 110 103	02/03→05/06 05/05→05/06 09/01→05/06	←	→ 04/06		24.0126-0115.1 426115	Ø 300 26 22 V
						24.0326-0115.1 526115	Ø 300 26 22 V PD
			➡	→ 04/06		24.0110-0223.1 410223	Ø 268 10 8 + S
						24.0310-0223.1 510223	Ø 268 10 8 + S PD
2.3 4x4	107	09/96→04/00	←	01/97→		24.0125-0114.1 425114	Ø 288 25,1 21 V + S
						24.0325-0114.1 525114	Ø 288 25,1 21 V + S PD
			➡	01/97→		24.0110-0223.1 410223	Ø 268 10 8 + S
						24.0310-0223.1 510223	Ø 268 10 8 + S PD
2.8 i V6 2.8 i V6 4x4	128 128	11/95→04/00 04/96→04/00	←	→ 03/00		24.0125-0114.1 425114	Ø 288 25,1 21 V + S
						24.0325-0114.1 525114	Ø 288 25,1 21 V + S PD
			➡	→ 03/00		24.0110-0223.1 410223	Ø 268 10 8 + S
						24.0310-0223.1 510223	Ø 268 10 8 + S PD
2.8 V6	150	04/00→05/06	←	→ 04/06		24.0126-0119.1 426119	Ø 313 25,9 22 V
						24.0326-0119.1 526119	Ø 313 25,9 22 V PD
			➡	→ 04/06		24.0113-0194.1 413194	Ø 294 13,5 11,5
FORD - GRAND C-MAX (DXA/CB7, DXA/CEU) 12/10→							
 Bremsbelagsatz, Scheibenbremse							
1.0 EcoBoost	74	10/12→	←			13.0460-7193.2 607193	ATE 23723 18,1 - WE / - WK
1.0 EcoBoost	92	10/12→				13.0470-7193.2 LD7193	ATE 23723 18,1 - WE / - WK
1.5 EcoBoost	110	03/15→					Ceramic
1.5 EcoBoost	134	03/15→					
1.5 TDCi	70	03/15→	➡			13.0460-7195.2 607195	ATE 23482 16,6 - WE / - WK
1.5 TDCi	88	03/15→				13.0470-7195.2 LD7195	ATE 23482 16,6 - WE / - WK
1.6 EcoBoost	110	12/10→					Ceramic
1.6 EcoBoost	134	12/10→					
1.6 TDCi	70	12/10→					
1.6 TDCi	85	12/10→					
1.6 Ti	77	12/10→					
1.6 Ti	92	12/10→					
2.0 TDCi	85	02/11→					
2.0 TDCi	100	02/11→					
2.0 TDCi	103	02/11→					
2.0 TDCi	110	03/15→					
2.0 TDCi	120	12/10→					
2.0 TDCi	125	03/15→					
 Bremsscheibe							
1.0 EcoBoost	74	10/12→	←			24.0125-0162.1 425162	Ø 300 25 23 V
1.0 EcoBoost	92	10/12→				24.0325-0162.1 525162	Ø 300 25 23 V PD
1.5 EcoBoost	110	03/15→					
1.5 EcoBoost	134	03/15→	➡			24.0111-0172.1 411172	Ø 280 11 9
1.5 TDCi	70	03/15→					
1.5 TDCi	88	03/15→					
1.6 EcoBoost	110	12/10→					
1.6 EcoBoost	134	12/10→					
1.6 TDCi	70	12/10→					
1.6 TDCi	85	12/10→					
↓							











	kW					! #		
FORD - GRAND C-MAX (DXA/CB7, DXA/CEU) 12/10→								
 Bremsscheibe								
1.6 Ti	77	12/10→	←			24.0125-0162.1	425162	Ø 300 25 23 V
1.6 Ti	92	12/10→				24.0325-0162.1	525162	Ø 300 25 23 V PD
2.0 TDCi	85	02/11→						
2.0 TDCi	100	02/11→	→			24.0111-0172.1	411172	Ø 280 11 9
2.0 TDCi	103	02/11→						
2.0 TDCi	110	03/15→						
2.0 TDCi	120	12/10→						
2.0 TDCi	125	03/15→						
FORD - GRAND C-MAX Van 12/10→								
 Bremsbelagsatz, Scheibenbremse								
1.0 EcoBoost	74	10/12→	←			13.0460-7193.2	607193	ATE 23723 18,1 - WE / - WK
1.0 EcoBoost	92	10/12→				13.0470-7193.2	LD7193	ATE 23723 18,1 - WE / - WK Ceramic
1.5 EcoBoost	110	03/15→						
1.5 TDCi	88	03/15→	→			13.0460-7195.2	607195	ATE 23482 16,6 - WE / - WK
1.6 EcoBoost	110	12/10→				13.0470-7195.2	LD7195	ATE 23482 16,6 - WE / - WK Ceramic
1.6 TDCi	70	12/10→						
1.6 TDCi	85	12/10→						
2.0 TDCi	103	12/10→						
2.0 TDCi	110	03/15→						
2.0 TDCi	120	12/10→						
2.0 TDCi	125	03/15→						
2.0 TDCi	85	02/11→						
 Bremsscheibe								
1.0 EcoBoost	74	10/12→	←			24.0125-0162.1	425162	Ø 300 25 23 V
1.0 EcoBoost	92	10/12→				24.0325-0162.1	525162	Ø 300 25 23 V PD
1.5 EcoBoost	110	03/15→						
1.5 TDCi	88	03/15→	→			24.0111-0172.1	411172	Ø 280 11 9
1.6 EcoBoost	110	12/10→						
1.6 TDCi	70	12/10→						
1.6 TDCi	85	12/10→						
2.0 TDCi	103	12/10→						
2.0 TDCi	110	03/15→						
2.0 TDCi	120	12/10→						
2.0 TDCi	125	03/15→						
2.0 TDCi	85	02/11→						
FORD - KA (RB_) 09/96→11/08								
 Bremsbelagsatz, Scheibenbremse								
1.0 i	38	07/97→09/99	←			13.0460-7073.2	607073	ATE 21202 16,9 - WE / - WK
1.0 i	48	09/99→11/08	←	→ 01/00		13.0460-7073.2	607073	ATE 21202 16,9 - WE / - WK
1.3 i	36	06/98→11/08	←	02/00→		13.0460-7148.2	607148	ATE 23200 18,0 - WE / - WK
1.3 i	37	09/96→10/02	←	11/96→ 01/00		13.0460-7073.2	607073	ATE 21202 16,9 - WE / - WK
1.3 i	44	09/96→11/08	←	02/00→		13.0460-7148.2	607148	ATE 23200 18,0 - WE / - WK
1.3 i	51	08/02→11/08	←			13.0460-7148.2	607148	ATE 23200 18,0 - WE / - WK
1.6	68	10/06→12/07	←			13.0460-7142.2	607142	ATE 23202 18,3 - WE / - WK
1.6	70	09/00→11/08						
1.6 i	71	11/05→09/08						
1.6 i	70	07/03→11/08	←	08/03→		13.0460-7142.2	607142	ATE 23202 18,3 - WE / - WK
 Bremsscheibe								
1.0 i	38	07/97→09/99	←			24.0112-0141.1	412141	Ø 239,5 12 10
						24.0312-0141.1	512141	Ø 239,5 12 10 PD
1.0 i	48	09/99→11/08	←	→ 01/00		24.0112-0141.1	412141	Ø 239,5 12 10
1.3 i	36	06/98→11/08	←	02/00→		24.0312-0141.1	512141	Ø 239,5 12 10 PD
			←	02/00→		24.0120-0147.1	420147	Ø 239,5 20 18 V
						24.0320-0147.1	520147	Ø 239,5 20 18 V PD
1.3 i	37	09/96→10/02	←	11/96→ 01/00		24.0112-0141.1	412141	Ø 239,5 12 10
1.3 i	44	09/96→11/08	←	02/00→		24.0312-0141.1	512141	Ø 239,5 12 10 PD
			←	02/00→		24.0120-0147.1	420147	Ø 239,5 20 18 V
						24.0320-0147.1	520147	Ø 239,5 20 18 V PD
1.3 i	51	08/02→11/08	←			24.0120-0147.1	420147	Ø 239,5 20 18 V
						24.0320-0147.1	520147	Ø 239,5 20 18 V PD
1.6	68	10/06→12/07	←			24.0122-0172.1	422172	Ø 258 22 20 V
1.6	70	09/00→11/08				24.0322-0172.1	522172	Ø 258 22 20 V PD
1.6 i	71	11/05→09/08						
1.6 i	70	07/03→11/08	←	08/03→		24.0122-0172.1	422172	Ø 258 22 20 V
						24.0322-0172.1	522172	Ø 258 22 20 V PD











	kW			 	! #		
FORD - KA (RU8) 10/08→							
 Bremsbelagsatz, Scheibenbremse							
1.2	51	10/08→	←			13.0460-3838.2 603838 13.0470-3838.2 LD3838	BOS 21436 17,0 + WK + Zub BOS 21436 17,0 + WK + Zub Ceramic
1.3 TDCi	55	10/08→	←			13.0460-3846.2 603846 13.0470-3846.2 LD3846	BOS 24072 17,9 + WK + Zub BOS 24072 17,9 + WK + Zub Ceramic
 Bremsscheibe							
1.2	51	10/08→	←			24.0111-0119.1 411119	Ø 240,5 11 9,2
1.3 TDCi	55	10/08→	←			24.0120-0184.1 420184	Ø 240,5 20 18,2 V
FORD - KA Van (RB) 05/02→05/05							
 Bremsbelagsatz, Scheibenbremse							
1.3 i	44	05/02→05/05	←			13.0460-7148.2 607148	ATE 23200 18,0 - WE / - WK
 Bremsscheibe							
1.3 i	44	05/02→05/05	←			24.0120-0147.1 420147 24.0320-0147.1 520147	Ø 239,5 20 18 V Ø 239,5 20 18 V PD
FORD - KA+ 08/14→							
 Bremsbelagsatz, Scheibenbremse							
1.2 1.2	51 63	06/16→ 06/16→	←			13.0460-2605.2 602605	TRW 24283 17,3 - WE / - WK + Zub
FORD - KUGA I 03/08→							
 Bremsbelagsatz, Scheibenbremse							
2.0 TDCi 2.0 TDCi 4x4	100 100	03/08→11/12 03/08→11/12	←	04/08→		13.0460-7193.2 607193 13.0470-7193.2 LD7193	ATE 23723 18,1 - WE / - WK ATE 23723 18,1 - WE / - WK Ceramic
			→	04/08→		13.0460-2723.2 602723 13.0470-2723.2 LD2723	TRW 24537 16,1 - WE / - WK + Zub TRW 24537 16,1 - WE / - WK + Zub Ceramic
2.0 TDCi 2.0 TDCi 4x4 2.0 TDCi 4x4 2.5	103 103 120 147	03/10→11/12 03/10→11/12 03/10→11/12 03/09→11/12	←			13.0460-7193.2 607193 13.0470-7193.2 LD7193	ATE 23723 18,1 - WE / - WK ATE 23723 18,1 - WE / - WK Ceramic
			→			13.0460-2723.2 602723 13.0470-2723.2 LD2723	TRW 24537 16,1 - WE / - WK + Zub TRW 24537 16,1 - WE / - WK + Zub Ceramic
2.5 4x4	147	03/09→	←	→ 12/12		13.0460-7193.2 607193 13.0470-7193.2 LD7193	ATE 23723 18,1 - WE / - WK ATE 23723 18,1 - WE / - WK Ceramic
			→	→ 12/12		13.0460-2723.2 602723 13.0470-2723.2 LD2723	TRW 24537 16,1 - WE / - WK + Zub TRW 24537 16,1 - WE / - WK + Zub Ceramic
 Bremsscheibe							
2.0 TDCi 2.0 TDCi 4x4	100 100	03/08→11/12 03/08→11/12	←	04/08→		24.0125-0162.1 425162 24.0325-0162.1 525162	Ø 300 25 23 V Ø 300 25 23 V PD
			→	04/08→		24.0111-0145.1 411145 24.0311-0145.1 511145	Ø 302 10,9 9 + S Ø 302 10,9 9 PD
2.0 TDCi 2.0 TDCi 4x4 2.0 TDCi 4x4 2.5	103 103 120 147	03/10→11/12 03/10→11/12 03/10→11/12 03/09→11/12	←			24.0125-0162.1 425162 24.0325-0162.1 525162	Ø 300 25 23 V Ø 300 25 23 V PD
			→			24.0111-0145.1 411145 24.0311-0145.1 511145	Ø 302 10,9 9 + S Ø 302 10,9 9 PD
2.5 4x4	147	03/09→	←	→ 12/12		24.0125-0162.1 425162 24.0325-0162.1 525162	Ø 300 25 23 V Ø 300 25 23 V PD
			→	→ 12/12		24.0111-0145.1 411145 24.0311-0145.1 511145	Ø 302 10,9 9 + S Ø 302 10,9 9 PD











	kW			 	! #		
FORD - KUGA II (DM2) 05/12→							
 Bremsbelagsatz, Scheibenbremse							
1.5 EcoBoost	88	01/16→	←			13.0460-7193.2 607193	ATE 23723 18,1 - WE / - WK
1.5 EcoBoost	110	09/14→				13.0470-7193.2 LD7193	ATE 23723 18,1 - WE / - WK
1.6 EcoBoost	110	03/13→					Ceramic
2.5	110	01/14→	→	- eFSB		13.0460-7195.2 607195	ATE 23482 16,6 - WE / - WK
						13.0470-7195.2 LD7195	ATE 23482 16,6 - WE / - WK
							Ceramic
1.5 EcoBoost 4x4	134	09/14→	→	- eFSB		13.0460-7195.2 607195	ATE 23482 16,6 - WE / - WK
1.5 TDCi	88	07/16→				13.0470-7195.2 LD7195	ATE 23482 16,6 - WE / - WK
1.6 EcoBoost 4x4	110	03/13→					Ceramic
1.6 EcoBoost 4x4	134	03/13→					
2.0 TDCi	85	03/13→					
2.0 TDCi	88	09/14→					
2.0 TDCi	100	03/13→					
2.0 TDCi	103	03/13→					
2.0 TDCi	110	09/14→					
2.0 TDCi 4x4	100	03/13→					
2.0 TDCi 4x4	103	03/13→					
2.0 TDCi 4x4	110	09/14→					
2.0 TDCi 4x4	120	03/13→					
2.0 TDCi 4x4	132	09/14→					
 Bremsscheibe							
1.5 EcoBoost	88	01/16→	←			24.0125-0162.1 425162	Ø 300 25 23 V
1.5 EcoBoost	110	09/14→				24.0325-0162.1 525162	Ø 300 25 23 V PD
1.6 EcoBoost	110	03/13→					
1.6 EcoBoost 4x4	110	03/13→	→	- eFSB		24.0111-0172.1 411172	Ø 280 11 9
2.5	110	01/14→					
1.5 EcoBoost 4x4	134	09/14→	←			24.0125-0209.1 425209	Ø 320 25 23 V
1.5 TDCi	88	07/16→					
2.0 TDCi	88	09/14→	→	- eFSB		24.0111-0172.1 411172	Ø 280 11 9
2.0 TDCi	110	09/14→					
2.0 TDCi 4x4	110	09/14→					
2.0 TDCi 4x4	132	09/14→					
1.6 EcoBoost 4x4	134	03/13→	←	→ 09/14		24.0125-0209.1 425209	Ø 320 25 23 V
2.0 TDCi	85	03/13→					
2.0 TDCi	100	03/13→	←	10/14→		24.0125-0209.1 425209	Ø 320 25 23 V
2.0 TDCi	103	03/13→					
2.0 TDCi	103	03/13→	→	- eFSB		24.0111-0172.1 411172	Ø 280 11 9
2.0 TDCi 4x4	100	03/13→					
2.0 TDCi 4x4	103	03/13→					
2.0 TDCi 4x4	120	03/13→					
FORD - KUGA II Van 05/12→							
 Bremsbelagsatz, Scheibenbremse							
1.5 EcoBoost	110	09/14→	←			13.0460-7193.2 607193	ATE 23723 18,1 - WE / - WK
						13.0470-7193.2 LD7193	ATE 23723 18,1 - WE / - WK
							Ceramic
			→	- eFSB		13.0460-7195.2 607195	ATE 23482 16,6 - WE / - WK
						13.0470-7195.2 LD7195	ATE 23482 16,6 - WE / - WK
							Ceramic
1.5 EcoBoost 4x4	134	09/14→	→	- eFSB		13.0460-7195.2 607195	ATE 23482 16,6 - WE / - WK
2.0 TDCi	110	09/14→				13.0470-7195.2 LD7195	ATE 23482 16,6 - WE / - WK
2.0 TDCi 4x4	110	09/14→					Ceramic
2.0 TDCi 4x4	132	09/14→					
 Bremsscheibe							
1.5 EcoBoost	110	09/14→	←			24.0125-0162.1 425162	Ø 300 25 23 V
						24.0325-0162.1 525162	Ø 300 25 23 V PD
			→	- eFSB		24.0111-0172.1 411172	Ø 280 11 9
1.5 EcoBoost 4x4	134	09/14→	←			24.0125-0209.1 425209	Ø 320 25 23 V
2.0 TDCi	110	09/14→					
2.0 TDCi 4x4	110	09/14→	→	- eFSB		24.0111-0172.1 411172	Ø 280 11 9
2.0 TDCi 4x4	132	09/14→					
FORD - MAVERICK 02/01→							
 Bremsbelagsatz, Scheibenbremse							
2.0 16V	91	02/01→	←	→ 06/07; für Fahrzeuge mit Trommelbremse an der Hinterachse		13.0460-7205.2 607205	ATE 23787 19,0 - WE / - WK
2.3 16V	110	03/04→					
3.0 V6 24V	145	02/01→					
3.0 V6 24V	149	03/04→	←	→ 06/07; für Fahrzeuge mit Scheibenbremse an der Hinterachse		13.0460-7234.2 607234	ATE 24438 16,1 - WE / - WK
			→	→ 06/07		13.0460-7235.2 607235	ATE 24670 18,0 - WE / - WK
↓							













	kw			 	! #		
FORD - MAVERICK 02/01→							
 Bremsscheibe							
2.0 16V 2.3 16V 3.0 V6 24V 3.0 V6 24V	91 110 145 149	02/01→ 03/04→ 02/01→ 03/04→	← ← ← →	→ 06/07; für Fahrzeuge mit Trommelbremse an der Hinterachse → 06/07; für Fahrzeuge mit Scheibenbremse an der Hinterachse → 06/07	24.0124-0735.1 24.0126-0151.1 24.0112-0181.1	424735 426151 412181	Ø 278 24 22 V Ø 303 26 24 V Ø 302 12 11
FORD - MAVERICK (UDS, UNS) 02/93→04/98							
 Bremsbelagsatz, Scheibenbremse							
2.4 i 2.4 i (UDS) 2.7 TD	87 85 92	09/96→04/98 09/96→04/98 09/96→04/98	←	10/96→ 03/98	13.0460-5959.2	605959	TRW 21481 15,5 - WK
2.4 i 2.7 TD	91 74	02/93→08/96 02/93→08/96	←		13.0460-5959.2	605959	TRW 21481 15,5 - WK
 Bremsscheibe							
2.4 i 2.4 i (UDS) 2.7 TD	87 85 92	09/96→04/98 09/96→04/98 09/96→04/98	←	10/96→ 03/98	24.0126-0109.1	426109	Ø 277 26 24 V
2.4 i 2.7 TD	91 74	02/93→08/96 02/93→08/96	←		24.0126-0109.1	426109	Ø 277 26 24 V
FORD - MAVERICK VAN 06/96→04/98							
 Bremsbelagsatz, Scheibenbremse							
2.7 TD 2.7 TD	74 92	06/96→04/98 06/96→04/98	←	10/96→ 03/98	13.0460-5959.2	605959	TRW 21481 15,5 - WK
 Bremsscheibe							
2.7 TD 2.7 TD	74 92	06/96→04/98 06/96→04/98	←	10/96→ 03/98	24.0126-0109.1	426109	Ø 277 26 24 V
FORD - MONDEO I (GBP) 02/93→08/96							
 Bremsbelagsatz, Scheibenbremse							
1.6 i 16V 1.6 i 16V 1.8 i 16V 1.8 i 16V 1.8 i 16V 4x4 1.8 TD 1.8 TD 2.0 i 16V 2.0 i 16V	65 66 82 85 85 65 66 97 100	07/94→08/96 02/93→08/96 07/94→08/96 02/93→08/96 02/93→08/96 06/93→08/96 10/95→08/96 12/94→08/96 02/93→08/96	← ← → → → → → → →	- Ghia Modelle + Ghia Modelle	13.0460-7056.2 13.0460-7057.2 13.0460-3963.2 13.0460-3964.2	607056 607057 603963 603964	ATE 21396 17,5 + WK ATE 21394 17,5 - WE / - WK BDX 21586 15,0 - WK BDX 21586 15,0 + WK
2.0 i 16V 4x4 2.0 i 16V 4x4	97 100	12/94→08/96 04/93→08/96	← → →	- Ghia Modelle + Ghia Modelle	13.0460-7163.2 13.0460-7165.2 13.0460-3963.2 13.0460-3964.2	607163 607165 603963 603964	ATE 21358 19,8 + WK ATE 21358 19,8 - WE / - WK BDX 21586 15,0 - WK BDX 21586 15,0 + WK
2.5 i 24V	125	07/94→08/96	← → →	08/94→ 08/94→; - Ghia Modelle 08/94→; + Ghia Modelle	13.0460-7163.2 13.0460-7165.2 13.0460-3963.2 13.0460-3964.2	607163 607165 603963 603964	ATE 21358 19,8 + WK ATE 21358 19,8 - WE / - WK BDX 21586 15,0 - WK BDX 21586 15,0 + WK
Zubehörsatz, Scheibenbremsbelag							
1.6 i 16V 1.6 i 16V 1.8 i 16V 1.8 i 16V 1.8 i 16V 4x4 1.8 TD 1.8 TD 2.0 i 16V 2.0 i 16V 2.0 i 16V 4x4 2.0 i 16V 4x4	65 66 82 85 85 65 66 97 100 97 100	07/94→08/96 02/93→08/96 07/94→08/96 02/93→08/96 02/93→08/96 06/93→08/96 10/95→08/96 12/94→08/96 02/93→08/96 12/94→08/96 04/93→08/96	→ → → → → → → → → → →		13.0460-0428.2	610428	BDX
2.5 i 24V	125	07/94→08/96	→	08/94→	13.0460-0428.2	610428	BDX
 Bremsscheibe							
1.6 i 16V 1.6 i 16V 1.8 i 16V 1.8 i 16V 1.8 i 16V 4x4	65 66 82 85 85	07/94→08/96 02/93→08/96 07/94→08/96 02/93→08/96 02/93→08/96	← ← → → →		24.0124-0120.1 24.0324-0120.1 24.0120-0146.1 24.0320-0146.1	424120 524120 420146 520146	Ø 260 24 22,2 V Ø 260 24 22,2 V PD Ø 253 20 18 V Ø 253 20 18 V PD











	kw			 	! #		
FORD - MONDEO I (GBP) 02/93→08/96							
 Bremsscheibe							
1.8 TD	65	06/93→08/96	←			24.0124-0120.1 424120	Ø 260 24 22,2 V
1.8 TD	66	10/95→08/96				24.0324-0120.1 524120	Ø 260 24 22,2 V PD
2.0 i 16V	97	12/94→08/96					
2.0 i 16V	100	02/93→08/96	→			24.0120-0146.1 420146	Ø 253 20 18 V
						24.0320-0146.1 520146	Ø 253 20 18 V PD
2.0 i 16V 4x4	97	12/94→08/96	←			24.0124-0149.1 424149	Ø 278 24,1 22,2 V
2.0 i 16V 4x4	100	04/93→08/96	→			24.0120-0146.1 420146	Ø 253 20 18 V
						24.0320-0146.1 520146	Ø 253 20 18 V PD
2.5 i 24V	125	07/94→08/96	←	08/94→		24.0124-0149.1 424149	Ø 278 24,1 22,2 V
			→	08/94→		24.0120-0146.1 420146	Ø 253 20 18 V
						24.0320-0146.1 520146	Ø 253 20 18 V PD
FORD - MONDEO I Kombi (BNP) 01/93→08/96							
 Bremsbelagsatz, Scheibenbremse							
1.6 i 16V	65	07/94→08/96	←			13.0460-7056.2 607056	ATE 21396 17,5 + WK
1.6 i 16V	66	04/93→08/96				13.0460-7057.2 607057	ATE 21394 17,5 - WE / - WK
1.8 i 16V	82	07/94→08/96					
1.8 i 16V	85	04/93→08/96	→	- Ghia Modelle		13.0460-3963.2 603963	BDX 21586 15,0 - WK
1.8 i 16V 4x4	85	04/93→08/96	→	+ Ghia Modelle		13.0460-3964.2 603964	BDX 21586 15,0 + WK
1.8 TD	65	06/93→08/96					
1.8 TD	66	11/95→08/96					
2.0 i 16V	97	01/93→08/96					
2.0 i 16V	100	04/93→08/96					
2.0 i 16V 4x4	97	12/94→08/96	←			13.0460-7163.2 607163	ATE 21358 19,8 + WK
2.0 i 16V 4x4	100	04/93→08/96	→	- Ghia Modelle		13.0460-7165.2 607165	ATE 21358 19,8 - WE / - WK
			→	+ Ghia Modelle		13.0460-3963.2 603963	BDX 21586 15,0 - WK
			→			13.0460-3964.2 603964	BDX 21586 15,0 + WK
2.5 i 24V	125	07/94→08/96	←	08/94→		13.0460-7163.2 607163	ATE 21358 19,8 + WK
						13.0460-7165.2 607165	ATE 21358 19,8 - WE / - WK
			→	08/94→; - Ghia Modelle		13.0460-3963.2 603963	BDX 21586 15,0 - WK
			→	08/94→; + Ghia Modelle		13.0460-3964.2 603964	BDX 21586 15,0 + WK
Zubehörsatz, Scheibenbremsbelag							
1.6 i 16V	65	07/94→08/96	→			13.0460-0428.2 610428	BDX
1.6 i 16V	66	04/93→08/96					
1.8 i 16V	82	07/94→08/96					
1.8 i 16V	85	04/93→08/96					
1.8 i 16V 4x4	85	04/93→08/96					
1.8 TD	65	06/93→08/96					
1.8 TD	66	11/95→08/96					
2.0 i 16V	97	01/93→08/96					
2.0 i 16V	100	04/93→08/96					
2.0 i 16V 4x4	97	12/94→08/96					
2.0 i 16V 4x4	100	04/93→08/96					
2.5 i 24V	125	07/94→08/96	→	08/94→		13.0460-0428.2 610428	BDX
 Bremsscheibe							
1.6 i 16V	65	07/94→08/96	←			24.0124-0120.1 424120	Ø 260 24 22,2 V
1.6 i 16V	66	04/93→08/96				24.0324-0120.1 524120	Ø 260 24 22,2 V PD
1.8 i 16V	82	07/94→08/96					
1.8 i 16V	85	04/93→08/96	→			24.0120-0146.1 420146	Ø 253 20 18 V
1.8 i 16V 4x4	85	04/93→08/96	→			24.0320-0146.1 520146	Ø 253 20 18 V PD
1.8 TD	65	06/93→08/96					
1.8 TD	66	11/95→08/96					
2.0 i 16V	97	01/93→08/96					
2.0 i 16V	100	04/93→08/96					
2.0 i 16V 4x4	97	12/94→08/96	←			24.0124-0149.1 424149	Ø 278 24,1 22,2 V
2.0 i 16V 4x4	100	04/93→08/96	→			24.0120-0146.1 420146	Ø 253 20 18 V
						24.0320-0146.1 520146	Ø 253 20 18 V PD
2.5 i 24V	125	07/94→08/96	←	08/94→		24.0124-0149.1 424149	Ø 278 24,1 22,2 V
			→	08/94→		24.0120-0146.1 420146	Ø 253 20 18 V
						24.0320-0146.1 520146	Ø 253 20 18 V PD
FORD - MONDEO I Stufenheck (GBP) 02/93→08/96							
 Bremsbelagsatz, Scheibenbremse							
1.6 i 16V	65	07/94→08/96	←			13.0460-7056.2 607056	ATE 21396 17,5 + WK
1.6 i 16V	66	02/93→08/96				13.0460-7057.2 607057	ATE 21394 17,5 - WE / - WK
1.8 4x4	85	02/93→08/96					
1.8 i 16V	82	01/94→08/96	→	- Ghia Modelle		13.0460-3963.2 603963	BDX 21586 15,0 - WK
1.8 i 16V	85	02/93→08/96					











	kW			 	! #		
FORD - MONDEO I Stufenheck (GBP) 02/93→08/96							
 Bremsbelagsatz, Scheibenbremse							
1.8 TD 1.8 TD 2.0 i 16V	65 66 100	06/93→08/96 10/95→08/96 02/93→08/96	➡	+ Ghia Modelle		13.0460-3964.2 603964	BDX 21586 15,0 + WK
2.0 i 16V 4x4	97	12/94→08/96	➡			13.0460-7163.2 607163	ATE 21358 19,8 + WK
			➡			13.0460-7165.2 607165	ATE 21358 19,8 - WE / - WK
			➡	- Ghia Modelle		13.0460-3963.2 603963	BDX 21586 15,0 - WK
			➡	+ Ghia Modelle		13.0460-3964.2 603964	BDX 21586 15,0 + WK
2.0 i 16V 4x4	100	02/93→08/96	➡	04/93→		13.0460-7163.2 607163	ATE 21358 19,8 + WK
			➡			13.0460-7165.2 607165	ATE 21358 19,8 - WE / - WK
			➡	04/93→; - Ghia Modelle		13.0460-3963.2 603963	BDX 21586 15,0 - WK
			➡	04/93→; + Ghia Modelle		13.0460-3964.2 603964	BDX 21586 15,0 + WK
2.5 i 24V	125	07/94→08/96	➡	08/94→		13.0460-7163.2 607163	ATE 21358 19,8 + WK
			➡			13.0460-7165.2 607165	ATE 21358 19,8 - WE / - WK
			➡	08/94→; - Ghia Modelle		13.0460-3963.2 603963	BDX 21586 15,0 - WK
			➡	08/94→; + Ghia Modelle		13.0460-3964.2 603964	BDX 21586 15,0 + WK
Zubehörsatz, Scheibenbremsbelag							
1.6 i 16V 1.6 i 16V 1.8 4x4 1.8 i 16V 1.8 i 16V 1.8 TD 1.8 TD 2.0 i 16V 2.0 i 16V 4x4	65 66 85 82 85 65 66 100 97	07/94→08/96 02/93→08/96 02/93→08/96 01/94→08/96 02/93→08/96 06/93→08/96 10/95→08/96 02/93→08/96 12/94→08/96	➡			13.0460-0428.2 610428	BDX
2.0 i 16V 4x4	100	02/93→08/96	➡	04/93→		13.0460-0428.2 610428	BDX
2.5 i 24V	125	07/94→08/96	➡	08/94→		13.0460-0428.2 610428	BDX
 Bremsscheibe							
1.6 i 16V 1.6 i 16V 1.8 4x4 1.8 i 16V 1.8 i 16V 1.8 TD 1.8 TD 2.0 i 16V	65 66 85 82 85 65 66 100	07/94→08/96 02/93→08/96 02/93→08/96 01/94→08/96 02/93→08/96 06/93→08/96 10/95→08/96 02/93→08/96	➡			24.0124-0120.1 424120	Ø 260 24 22,2 V
2.0 i 16V 4x4	97	12/94→08/96	➡			24.0324-0120.1 524120	Ø 260 24 22,2 V PD
			➡			24.0120-0146.1 420146	Ø 253 20 18 V
			➡			24.0320-0146.1 520146	Ø 253 20 18 V PD
			➡			24.0124-0149.1 424149	Ø 278 24,1 22,2 V
2.0 i 16V 4x4	100	02/93→08/96	➡	04/93→		24.0120-0146.1 420146	Ø 253 20 18 V
			➡			24.0320-0146.1 520146	Ø 253 20 18 V PD
			➡	04/93→		24.0124-0149.1 424149	Ø 278 24,1 22,2 V
			➡			24.0120-0146.1 420146	Ø 253 20 18 V
2.5 i 24V	125	07/94→08/96	➡	08/94→		24.0320-0146.1 520146	Ø 253 20 18 V PD
			➡			24.0124-0149.1 424149	Ø 278 24,1 22,2 V
			➡	08/94→		24.0120-0146.1 420146	Ø 253 20 18 V
			➡			24.0320-0146.1 520146	Ø 253 20 18 V PD
FORD - MONDEO II (BAP) 08/96→09/00							
 Bremsbelagsatz, Scheibenbremse							
1.6 i 1.8 i 1.8 TD 2.0 i	66 85 66 96	08/96→09/00 08/96→09/00 08/96→09/00 08/96→09/00	➡	10/96→		13.0460-7056.2 607056	ATE 21396 17,5 + WK
1.6 i 16V 2.5 24V 2.5 ST 200	70 125 151	05/98→09/00 06/00→09/00 05/99→09/00	➡			13.0460-7057.2 607057	ATE 21394 17,5 - WE / - WK
			➡	10/96→; - Ghia Modelle		13.0460-3963.2 603963	BDX 21586 15,0 - WK
			➡	10/96→; + Ghia Modelle		13.0460-3964.2 603964	BDX 21586 15,0 + WK
			➡	- Ghia Modelle		13.0460-3963.2 603963	BDX 21586 15,0 - WK
2.5 24V	125	08/96→09/00	➡	+ Ghia Modelle		13.0460-3964.2 603964	BDX 21586 15,0 + WK
			➡			13.0460-7056.2 607056	ATE 21396 17,5 + WK
			➡			13.0460-7057.2 607057	ATE 21394 17,5 - WE / - WK
			➡	12/97→		13.0460-7056.2 607056	ATE 21396 17,5 + WK
↓			➡			13.0460-7057.2 607057	ATE 21394 17,5 - WE / - WK
			➡	10/96→ 11/97		13.0460-7163.2 607163	ATE 21358 19,8 + WK
			➡			13.0460-7165.2 607165	ATE 21358 19,8 - WE / - WK
			➡	10/96→; - Ghia Modelle		13.0460-3963.2 603963	BDX 21586 15,0 - WK
➡	10/96→; + Ghia Modelle		13.0460-3964.2 603964	BDX 21586 15,0 + WK			







	kW			 	! #		
FORD - MONDEO II (BAP) 08/96→09/00							
Zubehörsatz, Scheibenbremsbelag							
1.6 i	66	08/96→09/00	➔	10/96→		13.0460-0428.2 610428	BDX
1.8 i	85	08/96→09/00					
1.8 TD	66	08/96→09/00					
2.0 i	96	08/96→09/00					
2.5 24V	125	08/96→09/00					
1.6 i 16V	70	05/98→09/00	➔			13.0460-0428.2 610428	BDX
2.5 24V	125	06/00→09/00					
2.5 ST 200	151	05/99→09/00					
 Bremsscheibe							
1.6 i	66	08/96→09/00	←	10/96→		24.0124-0120.1 424120	Ø 260 24 22,2 V
1.8 TD	66	08/96→09/00				24.0324-0120.1 524120	Ø 260 24 22,2 V PD
2.0 i	96	08/96→09/00	➔	10/96→		24.0120-0146.1 420146	Ø 253 20 18 V
						24.0320-0146.1 520146	Ø 253 20 18 V PD
1.6 i 16V	70	05/98→09/00	←			24.0124-0120.1 424120	Ø 260 24 22,2 V
						24.0324-0120.1 524120	Ø 260 24 22,2 V PD
			➔			24.0120-0146.1 420146	Ø 253 20 18 V
						24.0320-0146.1 520146	Ø 253 20 18 V PD
1.8 i	85	08/96→09/00	←	10/96→		24.0124-0120.1 424120	Ø 260 24 22,2 V
						24.0324-0120.1 524120	Ø 260 24 22,2 V PD
			←	10/96→; passend für Felgenreöße [Zoll]: 15		24.0124-0149.1 424149	Ø 278 24,1 22,2 V
			➔	10/96→		24.0120-0146.1 420146	Ø 253 20 18 V
						24.0320-0146.1 520146	Ø 253 20 18 V PD
2.5 24V	125	08/96→09/00	←	10/96→		24.0124-0149.1 424149	Ø 278 24,1 22,2 V
			➔	10/96→		24.0120-0146.1 420146	Ø 253 20 18 V
						24.0320-0146.1 520146	Ø 253 20 18 V PD
2.5 24V	125	06/00→09/00	←			24.0124-0149.1 424149	Ø 278 24,1 22,2 V
2.5 ST 200	151	05/99→09/00	➔			24.0120-0146.1 420146	Ø 253 20 18 V
						24.0320-0146.1 520146	Ø 253 20 18 V PD
FORD - MONDEO II Kombi (BNP) 08/96→09/00							
 Bremsbelagsatz, Scheibenbremse							
1.6 i	66	08/96→09/00	←	10/96→		13.0460-7056.2 607056	ATE 21396 17,5 + WK
1.8 i	85	08/96→09/00				13.0460-7057.2 607057	ATE 21394 17,5 - WE / - WK
1.8 TD	66	08/96→09/00					
2.0 i	96	08/96→09/00	➔	10/96→; - Ghia Modelle		13.0460-3963.2 603963	BDX 21586 15,0 - WK
			➔	10/96→; + Ghia Modelle		13.0460-3964.2 603964	BDX 21586 15,0 + WK
1.6 i 16V	70	05/98→09/00	←			13.0460-7056.2 607056	ATE 21396 17,5 + WK
2.5 24V	125	10/99→09/00				13.0460-7057.2 607057	ATE 21394 17,5 - WE / - WK
2.5 ST 200	151	05/99→09/00	➔	- Ghia Modelle		13.0460-3963.2 603963	BDX 21586 15,0 - WK
			➔	+ Ghia Modelle		13.0460-3964.2 603964	BDX 21586 15,0 + WK
2.5 24V	125	08/96→09/00	←	12/97→		13.0460-7056.2 607056	ATE 21396 17,5 + WK
						13.0460-7057.2 607057	ATE 21394 17,5 - WE / - WK
			←	10/96→ 11/97		13.0460-7163.2 607163	ATE 21358 19,8 + WK
						13.0460-7165.2 607165	ATE 21358 19,8 - WE / - WK
			➔	10/96→; - Ghia Modelle		13.0460-3963.2 603963	BDX 21586 15,0 - WK
			➔	10/96→; + Ghia Modelle		13.0460-3964.2 603964	BDX 21586 15,0 + WK
Zubehörsatz, Scheibenbremsbelag							
1.6 i	66	08/96→09/00	➔	10/96→		13.0460-0428.2 610428	BDX
1.8 i	85	08/96→09/00					
1.8 TD	66	08/96→09/00					
2.0 i	96	08/96→09/00					
2.5 24V	125	08/96→09/00					
1.6 i 16V	70	05/98→09/00	➔			13.0460-0428.2 610428	BDX
2.5 24V	125	10/99→09/00					
2.5 ST 200	151	05/99→09/00					
 Bremsscheibe							
1.6 i	66	08/96→09/00	←	10/96→		24.0124-0120.1 424120	Ø 260 24 22,2 V
1.8 TD	66	08/96→09/00				24.0324-0120.1 524120	Ø 260 24 22,2 V PD
2.0 i	96	08/96→09/00	➔	10/96→		24.0120-0146.1 420146	Ø 253 20 18 V
						24.0320-0146.1 520146	Ø 253 20 18 V PD
1.6 i 16V	70	05/98→09/00	←			24.0124-0120.1 424120	Ø 260 24 22,2 V
						24.0324-0120.1 524120	Ø 260 24 22,2 V PD
↓							

	kw			 	! #		
FORD - MONDEO II Kombi (BNP) 08/96→09/00							
 Bremsscheibe							
1.6 i 16V	70	05/98→09/00	➔			24.0120-0146.1 420146 24.0320-0146.1 520146	Ø 253 20 18 V Ø 253 20 18 V PD
1.8 i	85	08/96→09/00	➔	10/96→		24.0124-0120.1 424120 24.0324-0120.1 524120	Ø 260 24 22,2 V Ø 260 24 22,2 V PD
			➔	10/96→; passend für Felgenreöße [Zoll]: 15		24.0124-0149.1 424149	Ø 278 24,1 22,2 V
			➔	10/96→		24.0120-0146.1 420146 24.0320-0146.1 520146	Ø 253 20 18 V Ø 253 20 18 V PD
2.5 24V	125	08/96→09/00	➔	10/96→		24.0124-0149.1 424149	Ø 278 24,1 22,2 V
			➔	10/96→		24.0120-0146.1 420146 24.0320-0146.1 520146	Ø 253 20 18 V Ø 253 20 18 V PD
2.5 24V 2.5 ST 200	125	10/99→09/00	➔			24.0124-0149.1 424149	Ø 278 24,1 22,2 V
	151	05/99→09/00	➔			24.0120-0146.1 420146 24.0320-0146.1 520146	Ø 253 20 18 V Ø 253 20 18 V PD
FORD - MONDEO II Stufenheck (BFP) 08/96→09/00							
 Bremsbelagsatz, Scheibenbremse							
1.6 i 1.8 i 1.8 TD 2.0 i	66	08/96→09/00	➔	10/96→		13.0460-7056.2 607056 13.0460-7057.2 607057	ATE 21396 17,5 + WK ATE 21394 17,5 - WE / - WK
	85	08/96→09/00	➔	10/96→; - Ghia Modelle		13.0460-3963.2 603963	BDX 21586 15,0 - WK
	96	08/96→09/00	➔	10/96→; + Ghia Modelle		13.0460-3964.2 603964	BDX 21586 15,0 + WK
1.6 i 16V 2.5 24V 2.5 ST 200	70	05/98→09/00	➔			13.0460-7056.2 607056 13.0460-7057.2 607057	ATE 21396 17,5 + WK ATE 21394 17,5 - WE / - WK
	125	06/00→09/00	➔	- Ghia Modelle		13.0460-3963.2 603963	BDX 21586 15,0 - WK
	151	05/99→09/00	➔	+ Ghia Modelle		13.0460-3964.2 603964	BDX 21586 15,0 + WK
2.5 24V	125	08/96→09/00	➔	12/97→		13.0460-7056.2 607056 13.0460-7057.2 607057	ATE 21396 17,5 + WK ATE 21394 17,5 - WE / - WK
			➔	10/96→ 11/97		13.0460-7163.2 607163 13.0460-7165.2 607165	ATE 21358 19,8 + WK ATE 21358 19,8 - WE / - WK
			➔	10/96→; - Ghia Modelle		13.0460-3963.2 603963	BDX 21586 15,0 - WK
			➔	10/96→; + Ghia Modelle		13.0460-3964.2 603964	BDX 21586 15,0 + WK
			➔				
Zubehörsatz, Scheibenbremsbelag							
1.6 i 1.8 i 1.8 TD 2.0 i 2.5 24V	66	08/96→09/00	➔	10/96→		13.0460-0428.2 610428	BDX
	85	08/96→09/00	➔				
	66	08/96→09/00	➔				
	96	08/96→09/00	➔				
	125	08/96→09/00	➔				
1.6 i 16V 2.5 24V 2.5 ST 200	70 125 151	05/98→09/00 06/00→09/00 05/99→09/00	➔			13.0460-0428.2 610428	BDX
 Bremsscheibe							
1.6 i 1.8 TD 2.0 i	66	08/96→09/00	➔	10/96→		24.0124-0120.1 424120 24.0324-0120.1 524120	Ø 260 24 22,2 V Ø 260 24 22,2 V PD
			➔	10/96→		24.0120-0146.1 420146 24.0320-0146.1 520146	Ø 253 20 18 V Ø 253 20 18 V PD
			➔				
1.6 i 16V	70	05/98→09/00	➔			24.0124-0120.1 424120 24.0324-0120.1 524120	Ø 260 24 22,2 V Ø 260 24 22,2 V PD
			➔			24.0120-0146.1 420146 24.0320-0146.1 520146	Ø 253 20 18 V Ø 253 20 18 V PD
			➔				
1.8 i	85	08/96→09/00	➔	10/96→		24.0124-0120.1 424120 24.0324-0120.1 524120	Ø 260 24 22,2 V Ø 260 24 22,2 V PD
			➔	10/96→; passend für Felgenreöße [Zoll]: 15		24.0124-0149.1 424149	Ø 278 24,1 22,2 V
			➔	10/96→		24.0120-0146.1 420146 24.0320-0146.1 520146	Ø 253 20 18 V Ø 253 20 18 V PD
2.5 24V	125	08/96→09/00	➔	10/96→		24.0124-0149.1 424149	Ø 278 24,1 22,2 V
			➔	10/96→		24.0120-0146.1 420146 24.0320-0146.1 520146	Ø 253 20 18 V Ø 253 20 18 V PD
2.5 24V 2.5 ST 200	125	06/00→09/00	➔			24.0124-0149.1 424149	Ø 278 24,1 22,2 V
	151	05/99→09/00	➔			24.0120-0146.1 420146 24.0320-0146.1 520146	Ø 253 20 18 V Ø 253 20 18 V PD

	kW			 	! #		
FORD - MONDEO III (B5Y) 10/00→03/07							
 Bremsbelagsatz, Scheibenbremse							
1.8 16V	81	10/00→03/07	←			13.0460-3987.2 603987	BOS 23279 18,4 - WE / - WK
1.8 16V	92	10/00→03/07				13.0470-3987.2 LD3987	BOS 23279 18,4 - WE / - WK Ceramic
1.8 SCi	96	06/03→03/07					
2.0 16V	107	10/00→03/07	→	09/04→		13.0460-3831.2 603831	BOS 24260 17,3 - WE / - WK + Zub
2.0 16V DI / TDDi / TDCi	66	10/00→03/07				13.0470-3831.2 LD3831	BOS 24260 17,3 - WE / - WK + Zub Ceramic
2.0 16V TDDi / TDCi	85	10/00→03/07					
2.0 TDCi	96	10/01→03/07					
2.5 V6 24V	125	10/00→03/07				13.0460-3988.2 603988	BOS 23557 17,2 - WE / - WK
ST220	166	04/02→03/07	→	→ 08/04		13.0470-3988.2 LD3988	BOS 23557 17,2 - WE / - WK Ceramic
2.2 TDCi	110	09/04→03/07	←			13.0460-3987.2 603987	BOS 23279 18,4 - WE / - WK
2.2 TDCi	114	09/04→03/07				13.0470-3987.2 LD3987	BOS 23279 18,4 - WE / - WK Ceramic
3.0 V6 24V	150	09/04→03/07					
			→			13.0460-3831.2 603831	BOS 24260 17,3 - WE / - WK + Zub
						13.0470-3831.2 LD3831	BOS 24260 17,3 - WE / - WK + Zub Ceramic
 Bremsscheibe							
1.8 16V	81	10/00→03/07	←			24.0124-0161.1 424161	Ø 300 23,9 22 V
1.8 16V	92	10/00→03/07				24.0324-0161.1 524161	Ø 300 23,9 22 V PD
1.8 SCi	96	06/03→03/07					
2.0 16V	107	10/00→03/07	→			24.0112-0154.1 412154	Ø 280 12 10
2.0 16V DI / TDDi / TDCi	66	10/00→03/07				24.0312-0154.1 512154	Ø 280 12 10 PD
2.0 16V TDDi / TDCi	85	10/00→03/07					
2.0 TDCi	96	10/01→03/07					
2.2 TDCi	110	09/04→03/07					
2.2 TDCi	114	09/04→03/07					
2.5 V6 24V	125	10/00→03/07					
3.0 V6 24V	150	09/04→03/07					
ST220	166	04/02→03/07					
FORD - MONDEO III Kombi (BWY) 10/00→03/07							
 Bremsbelagsatz, Scheibenbremse							
1.8 16V	81	10/00→03/07	←			13.0460-3987.2 603987	BOS 23279 18,4 - WE / - WK
1.8 16V	92	10/00→03/07				13.0470-3987.2 LD3987	BOS 23279 18,4 - WE / - WK Ceramic
1.8 SCi	96	06/03→03/07					
2.0 16V	107	10/00→03/07	→	09/04→		13.0460-3831.2 603831	BOS 24260 17,3 - WE / - WK + Zub
2.0 16V DI / TDDi / TDCi	66	10/00→03/07				13.0470-3831.2 LD3831	BOS 24260 17,3 - WE / - WK + Zub Ceramic
2.0 16V TDDi / TDCi	85	10/00→03/07					
2.0 TDCi	96	10/01→03/07					
2.5 V6 24V	125	10/00→03/07				13.0460-3988.2 603988	BOS 23557 17,2 - WE / - WK
ST220	166	04/02→03/07	→	→ 08/04		13.0470-3988.2 LD3988	BOS 23557 17,2 - WE / - WK Ceramic
2.2 TDCi	110	09/04→03/07	←			13.0460-3987.2 603987	BOS 23279 18,4 - WE / - WK
2.2 TDCi	114	09/04→03/07				13.0470-3987.2 LD3987	BOS 23279 18,4 - WE / - WK Ceramic
3.0 V6 24V	150	09/04→03/07					
			→			13.0460-3831.2 603831	BOS 24260 17,3 - WE / - WK + Zub
						13.0470-3831.2 LD3831	BOS 24260 17,3 - WE / - WK + Zub Ceramic
 Bremsscheibe							
1.8 16V	81	10/00→03/07	←			24.0124-0161.1 424161	Ø 300 23,9 22 V
1.8 16V	92	10/00→03/07				24.0324-0161.1 524161	Ø 300 23,9 22 V PD
1.8 SCi	96	06/03→03/07					
2.0 16V	107	10/00→03/07	→			24.0112-0154.1 412154	Ø 280 12 10
2.0 16V DI / TDDi / TDCi	66	10/00→03/07				24.0312-0154.1 512154	Ø 280 12 10 PD
2.0 16V TDDi / TDCi	85	10/00→03/07					
2.0 TDCi	96	10/01→03/07					
2.2 TDCi	110	09/04→03/07					
2.2 TDCi	114	09/04→03/07					
2.5 V6 24V	125	10/00→03/07					
3.0 V6 24V	150	09/04→03/07					
ST220	166	04/02→03/07					
FORD - MONDEO III Stufenheck (B4Y) 10/00→03/07							
 Bremsbelagsatz, Scheibenbremse							
1.8 16V	81	10/00→03/07	←			13.0460-3987.2 603987	BOS 23279 18,4 - WE / - WK
1.8 16V	92	10/00→03/07				13.0470-3987.2 LD3987	BOS 23279 18,4 - WE / - WK Ceramic
1.8 SCi	96	06/03→03/07					
2.0 16V	107	10/00→03/07					
2.0 16V DI / TDDi / TDCi	66	10/00→03/07					
↓							

	kw			 	! #		
FORD - MONDEO III Stufenheck (B4Y) 10/00→03/07							
 Bremsbelagsatz, Scheibenbremse							
2.0 16V TDDi / TDCi	85	10/00→03/07	➔	09/04→		13.0460-3831.2 603831	BOS 24260 17,3 - WE / - WK + Zub
2.0 TDCi	96	10/01→03/07				13.0470-3831.2 LD3831	BOS 24260 17,3 - WE / - WK + Zub Ceramic
2.5 V6 24V	125	10/00→03/07					
ST220	166	04/02→03/07					
			➔	→ 08/04		13.0460-3988.2 603988	BOS 23557 17,2 - WE / - WK
						13.0470-3988.2 LD3988	BOS 23557 17,2 - WE / - WK Ceramic
2.0 TDCi	92	10/00→03/07	➔	10/01→		13.0460-3987.2 603987	BOS 23279 18,4 - WE / - WK
						13.0470-3987.2 LD3987	BOS 23279 18,4 - WE / - WK Ceramic
			➔	09/04→		13.0460-3831.2 603831	BOS 24260 17,3 - WE / - WK + Zub
						13.0470-3831.2 LD3831	BOS 24260 17,3 - WE / - WK + Zub Ceramic
			➔	10/01→ 08/04		13.0460-3988.2 603988	BOS 23557 17,2 - WE / - WK
						13.0470-3988.2 LD3988	BOS 23557 17,2 - WE / - WK Ceramic
2.2 TDCi	110	09/04→03/07	➔			13.0460-3987.2 603987	BOS 23279 18,4 - WE / - WK
2.2 TDCi	114	09/04→03/07				13.0470-3987.2 LD3987	BOS 23279 18,4 - WE / - WK Ceramic
3.0 V6 24V	150	09/04→03/07					
			➔			13.0460-3831.2 603831	BOS 24260 17,3 - WE / - WK + Zub
						13.0470-3831.2 LD3831	BOS 24260 17,3 - WE / - WK + Zub Ceramic
 Bremsscheibe							
1.8 16V	81	10/00→03/07	➔			24.0124-0161.1 424161	Ø 300 23,9 22 V
1.8 16V	92	10/00→03/07				24.0324-0161.1 524161	Ø 300 23,9 22 V PD
1.8 Sci	96	06/03→03/07					
2.0 16V	107	10/00→03/07	➔			24.0112-0154.1 412154	Ø 280 12 10
2.0 16V DI / TDDi / TDCi	66	10/00→03/07				24.0312-0154.1 512154	Ø 280 12 10 PD
2.0 16V TDDi / TDCi	85	10/00→03/07					
2.0 TDCi	96	10/01→03/07					
2.2 TDCi	110	09/04→03/07					
2.2 TDCi	114	09/04→03/07					
2.5 V6 24V	125	10/00→03/07					
3.0 V6 24V	150	09/04→03/07					
ST220	166	04/02→03/07					
2.0 TDCi	92	10/00→03/07	➔	10/01→		24.0124-0161.1 424161	Ø 300 23,9 22 V
						24.0324-0161.1 524161	Ø 300 23,9 22 V PD
			➔	10/01→		24.0112-0154.1 412154	Ø 280 12 10
						24.0312-0154.1 512154	Ø 280 12 10 PD
FORD - MONDEO IV (BA7) 03/07→01/15							
 Bremsbelagsatz, Scheibenbremse							
1.6 EcoBoost	118	02/11→01/15	➔	→ 09/14		13.0460-7228.2 607228	ATE 24123 20,3 - WE / - WK
1.6 TDCi	85	02/11→01/15				13.0470-7228.2 LD7228	ATE 24123 20,3 - WE / - WK Ceramic
1.6 Ti	88	07/10→01/15					
1.8 TDCi	92	06/07→01/15					
2.0 EcoBoost	176	07/10→01/15	➔	→ 09/14		13.0460-2723.2 602723	TRW 24537 16,1 - WE / - WK + Zub
2.0 Flexifuel	107	03/09→01/15				13.0470-2723.2 LD2723	TRW 24537 16,1 - WE / - WK + Zub Ceramic
2.0 LPG	107	07/09→01/15					
2.0 SCTi	149	03/10→01/15					
2.0 TDCi	85	11/07→01/15					
2.0 TDCi	100	03/07→01/15					
2.0 TDCi	120	03/10→01/15					
2.3	118	07/07→01/15					
1.6 Ti	81	03/07→01/15	➔	04/07→ 09/14		13.0460-7228.2 607228	ATE 24123 20,3 - WE / - WK
1.6 Ti	92	03/07→01/15				13.0470-7228.2 LD7228	ATE 24123 20,3 - WE / - WK Ceramic
1.8 TDCi	74	03/07→01/15					
2.0	107	03/07→01/15					
2.0 TDCi	96	03/07→01/15	➔	04/07→ 09/14		13.0460-2723.2 602723	TRW 24537 16,1 - WE / - WK + Zub
2.0 TDCi	103	03/07→01/15				13.0470-2723.2 LD2723	TRW 24537 16,1 - WE / - WK + Zub Ceramic
2.5	162	03/07→01/15					
2.2 TDCi	129	03/08→10/10	➔	04/08→		13.0460-7228.2 607228	ATE 24123 20,3 - WE / - WK
						13.0470-7228.2 LD7228	ATE 24123 20,3 - WE / - WK Ceramic
			➔	04/08→		13.0460-2723.2 602723	TRW 24537 16,1 - WE / - WK + Zub
						13.0470-2723.2 LD2723	TRW 24537 16,1 - WE / - WK + Zub Ceramic
2.2 TDCi	147	07/10→01/15	➔	11/10→ 09/14		13.0460-7228.2 607228	ATE 24123 20,3 - WE / - WK
↓							

	kw			 	! #			
FORD - MONDEO IV (BA7) 03/07→01/15								
 Bremsbelagsatz, Scheibenbremse								
2.2 TDCi	147	07/10→01/15	←	11/10→ 09/14		13.0470-7228.2	LD7228	ATE 24123 20,3 - WE / - WK Ceramic
			→	11/10→ 09/14		13.0460-2723.2	602723	TRW 24537 16,1 - WE / - WK + Zub
						13.0470-2723.2	LD2723	TRW 24537 16,1 - WE / - WK + Zub Ceramic
 Bremsscheibe								
1.6 EcoBoost	118	02/11→01/15	←	→ 09/14		24.0128-0250.1	428250	Ø 300 28 26 V
1.6 TDCi	85	02/11→01/15				24.0328-0250.1	528250	Ø 300 28 26 V PD
1.6 Ti	88	07/10→01/15						
1.8 TDCi	92	06/07→01/15	→	→ 09/14		24.0111-0145.1	411145	Ø 302 10,9 9 + S
2.0 EcoBoost	176	07/10→01/15				24.0311-0145.1	511145	Ø 302 10,9 9 PD
2.0 Flexifuel	107	03/09→01/15						
2.0 LPG	107	07/09→01/15						
2.0 SCTi	149	03/10→01/15						
2.0 TDCi	85	11/07→01/15						
2.0 TDCi	100	03/07→01/15						
2.0 TDCi	120	03/10→01/15						
2.3	118	07/07→01/15						
1.6 Ti	81	03/07→01/15	←	04/07→ 09/14		24.0128-0250.1	428250	Ø 300 28 26 V
1.6 Ti	92	03/07→01/15				24.0328-0250.1	528250	Ø 300 28 26 V PD
1.8 TDCi	74	03/07→01/15						
2.0	107	03/07→01/15	→	04/07→ 09/14		24.0111-0145.1	411145	Ø 302 10,9 9 + S
2.0 TDCi	96	03/07→01/15				24.0311-0145.1	511145	Ø 302 10,9 9 PD
2.0 TDCi	103	03/07→01/15						
2.5	162	03/07→01/15						
2.2 TDCi	129	03/08→10/10	←	04/08→		24.0128-0250.1	428250	Ø 300 28 26 V
			→	04/08→		24.0328-0250.1	528250	Ø 300 28 26 V PD
							24.0111-0145.1	411145
						24.0311-0145.1	511145	Ø 302 10,9 9 PD
2.2 TDCi	147	07/10→01/15	←	11/10→ 09/14		24.0128-0250.1	428250	Ø 300 28 26 V
			→	11/10→ 09/14		24.0328-0250.1	528250	Ø 300 28 26 V PD
							24.0111-0145.1	411145
						24.0311-0145.1	511145	Ø 302 10,9 9 PD
FORD - MONDEO IV Stufenheck (BA7) 03/07→01/15								
 Bremsbelagsatz, Scheibenbremse								
1.6 EcoBoost	118	11/10→01/15	←	02/11→ 09/14		13.0460-7228.2	607228	ATE 24123 20,3 - WE / - WK
1.6 TDCi	85	12/10→01/15				13.0470-7228.2	LD7228	ATE 24123 20,3 - WE / - WK Ceramic
			→	02/11→ 09/14		13.0460-2723.2	602723	TRW 24537 16,1 - WE / - WK + Zub
						13.0470-2723.2	LD2723	TRW 24537 16,1 - WE / - WK + Zub Ceramic
1.6 Ti	81	03/07→01/15	←	04/07→ 09/14		13.0460-7228.2	607228	ATE 24123 20,3 - WE / - WK
1.6 Ti	92	03/07→01/15				13.0470-7228.2	LD7228	ATE 24123 20,3 - WE / - WK Ceramic
1.8 TDCi	74	03/07→01/15						
2.0	107	03/07→01/15						
2.0 TDCi	96	03/07→01/15	→	04/07→ 09/14		13.0460-2723.2	602723	TRW 24537 16,1 - WE / - WK + Zub
2.0 TDCi	103	03/07→01/15				13.0470-2723.2	LD2723	TRW 24537 16,1 - WE / - WK + Zub Ceramic
2.5	162	03/07→01/15						
1.8 TDCi	92	06/07→01/15	←	→ 09/14		13.0460-7228.2	607228	ATE 24123 20,3 - WE / - WK
2.0 Flexifuel	107	03/09→01/15				13.0470-7228.2	LD7228	ATE 24123 20,3 - WE / - WK Ceramic
2.0 LPG	107	07/09→01/15						
2.0 TDCi	85	11/07→01/15						
2.0 TDCi	120	03/10→01/15	→	→ 09/14		13.0460-2723.2	602723	TRW 24537 16,1 - WE / - WK + Zub
2.3	118	07/07→01/15				13.0470-2723.2	LD2723	TRW 24537 16,1 - WE / - WK + Zub Ceramic
2.2 TDCi	129	03/08→10/10	←	04/08→		13.0460-7228.2	607228	ATE 24123 20,3 - WE / - WK
			→	04/08→		13.0470-7228.2	LD7228	ATE 24123 20,3 - WE / - WK Ceramic
							13.0460-2723.2	602723
						13.0470-2723.2	LD2723	TRW 24537 16,1 - WE / - WK + Zub Ceramic
 Bremsscheibe								
1.6 EcoBoost	118	11/10→01/15	←	02/11→ 09/14		24.0128-0250.1	428250	Ø 300 28 26 V
1.6 TDCi	85	12/10→01/15				24.0328-0250.1	528250	Ø 300 28 26 V PD
↓								

	kW					! #		
FORD - MONDEO IV Stufenheck (BA7) 03/07→01/15								
Bremsscheibe								
1.6 EcoBoost	118	11/10→01/15	➡	02/11→ 09/14		24.0111-0145.1	411145	Ø 302 10,9 9 + S
1.6 TDCi	85	12/10→01/15				24.0311-0145.1	511145	Ø 302 10,9 9 PD
1.6 Ti	81	03/07→01/15	⬅	04/07→ 09/14		24.0128-0250.1	428250	Ø 300 28 26 V
1.6 Ti	92	03/07→01/15				24.0328-0250.1	528250	Ø 300 28 26 V PD
1.8 TDCi	74	03/07→01/15						
2.0	107	03/07→01/15	➡	04/07→ 09/14		24.0111-0145.1	411145	Ø 302 10,9 9 + S
2.0 TDCi	96	03/07→01/15				24.0311-0145.1	511145	Ø 302 10,9 9 PD
2.0 TDCi	103	03/07→01/15						
2.5	162	03/07→01/15						
1.8 TDCi	92	06/07→01/15	⬅	→ 09/14		24.0128-0250.1	428250	Ø 300 28 26 V
2.0 Flexifuel	107	03/09→01/15				24.0328-0250.1	528250	Ø 300 28 26 V PD
2.0 LPG	107	07/09→01/15						
2.0 TDCi	85	11/07→01/15	➡	→ 09/14		24.0111-0145.1	411145	Ø 302 10,9 9 + S
2.0 TDCi	120	03/10→01/15				24.0311-0145.1	511145	Ø 302 10,9 9 PD
2.3	118	07/07→01/15						
2.2 TDCi	129	03/08→10/10	⬅	04/08→		24.0128-0250.1	428250	Ø 300 28 26 V
						24.0328-0250.1	528250	Ø 300 28 26 V PD
			➡	04/08→		24.0111-0145.1	411145	Ø 302 10,9 9 + S
						24.0311-0145.1	511145	Ø 302 10,9 9 PD
FORD - MONDEO IV Turnier (BA7) 03/07→01/15								
Bremsbelagsatz, Scheibenbremse								
1.6 EcoBoost	118	02/11→01/15	⬅	→ 09/14		13.0460-7228.2	607228	ATE 24123 20,3 - WE / - WK
1.6 TDCi	85	02/11→01/15				13.0470-7228.2	LD7228	ATE 24123 20,3 - WE / - WK
1.6 Ti	88	07/10→01/15						Ceramic
2.0 EcoBoost	176	07/10→01/15						
2.0 Flexifuel	107	03/09→01/15	➡	→ 09/14		13.0460-2723.2	602723	TRW 24537 16,1 - WE / - WK
2.0 LPG	107	07/09→01/15						+ Zub
2.0 SCTi	149	03/10→01/15				13.0470-2723.2	LD2723	TRW 24537 16,1 - WE / - WK
2.0 TDCi	85	11/07→01/15						+ Zub Ceramic
2.0 TDCi	100	03/07→01/15						
2.0 TDCi	120	03/10→01/15						
2.3	118	07/07→01/15						
1.6 Ti	81	03/07→12/12	⬅	04/07→		13.0460-7228.2	607228	ATE 24123 20,3 - WE / - WK
1.6 Ti	92	03/07→12/10				13.0470-7228.2	LD7228	ATE 24123 20,3 - WE / - WK
1.8 TDCi	74	03/07→12/12						Ceramic
2.0 TDCi	96	03/07→12/12						
2.5	162	03/07→12/12	➡	04/07→		13.0460-2723.2	602723	TRW 24537 16,1 - WE / - WK
						13.0470-2723.2	LD2723	TRW 24537 16,1 - WE / - WK
								+ Zub Ceramic
1.8 TDCi	92	06/07→12/12	⬅			13.0460-7228.2	607228	ATE 24123 20,3 - WE / - WK
						13.0470-7228.2	LD7228	ATE 24123 20,3 - WE / - WK
								Ceramic
			➡			13.0460-2723.2	602723	TRW 24537 16,1 - WE / - WK
						13.0470-2723.2	LD2723	TRW 24537 16,1 - WE / - WK
								+ Zub
2.0	107	03/07→01/15	⬅	04/07→ 09/14		13.0460-7228.2	607228	ATE 24123 20,3 - WE / - WK
2.0 TDCi	103	03/07→01/15				13.0470-7228.2	LD7228	ATE 24123 20,3 - WE / - WK
								Ceramic
			➡	04/07→ 09/14		13.0460-2723.2	602723	TRW 24537 16,1 - WE / - WK
						13.0470-2723.2	LD2723	TRW 24537 16,1 - WE / - WK
								+ Zub Ceramic
2.2 TDCi	129	03/08→10/10	⬅	04/08→		13.0460-7228.2	607228	ATE 24123 20,3 - WE / - WK
						13.0470-7228.2	LD7228	ATE 24123 20,3 - WE / - WK
								Ceramic
			➡	04/08→		13.0460-2723.2	602723	TRW 24537 16,1 - WE / - WK
						13.0470-2723.2	LD2723	TRW 24537 16,1 - WE / - WK
								+ Zub
								+ Zub Ceramic
2.2 TDCi	147	07/10→01/15	⬅	11/10→ 09/14		13.0460-7228.2	607228	ATE 24123 20,3 - WE / - WK
						13.0470-7228.2	LD7228	ATE 24123 20,3 - WE / - WK
								Ceramic
			➡	11/10→ 09/14		13.0460-2723.2	602723	TRW 24537 16,1 - WE / - WK
						13.0470-2723.2	LD2723	TRW 24537 16,1 - WE / - WK
								+ Zub
								+ Zub Ceramic
Bremsscheibe								
1.6 EcoBoost	118	02/11→01/15	⬅	→ 09/14		24.0128-0250.1	428250	Ø 300 28 26 V
1.6 TDCi	85	02/11→01/15						
↓								

FORD - MONDEO IV Turnier (BA7) 03/07→01/15

Bremsscheibe									
1.6 Ti	88	07/10→01/15	←	→ 09/14		24.0328-0250.1	528250	Ø 300 28 26 V PD	
2.0 EcoBoost	176	07/10→01/15	→	→ 09/14		24.0111-0145.1	411145	Ø 302 10,9 9 + S	
2.0 Flexifuel	107	03/09→01/15					24.0311-0145.1	511145	Ø 302 10,9 9 PD
2.0 LPG	107	07/09→01/15							
2.0 SCTi	149	03/10→01/15							
2.0 TDCi	85	11/07→01/15							
2.0 TDCi	100	03/07→01/15							
2.0 TDCi	120	03/10→01/15							
2.3	118	07/07→01/15							
1.6 Ti	81	03/07→12/12	←	04/07→		24.0128-0250.1	428250	Ø 300 28 26 V	
1.6 Ti	92	03/07→12/10	→			24.0328-0250.1	528250	Ø 300 28 26 V PD	
1.8 TDCi	74	03/07→12/12							
2.0 TDCi	96	03/07→12/12			04/07→		24.0111-0145.1	411145	Ø 302 10,9 9 + S
2.0 TDCi	100	03/07→12/12					24.0311-0145.1	511145	Ø 302 10,9 9 PD
2.5	162	03/07→12/12							
1.8 TDCi	92	06/07→12/12	←			24.0128-0250.1	428250	Ø 300 28 26 V	
			→			24.0328-0250.1	528250	Ø 300 28 26 V PD	
							24.0111-0145.1	411145	Ø 302 10,9 9 + S
							24.0311-0145.1	511145	Ø 302 10,9 9 PD
2.0	107	03/07→01/15	←	04/07→ 09/14		24.0128-0250.1	428250	Ø 300 28 26 V	
2.0 TDCi	103	03/07→01/15			04/07→ 09/14		24.0328-0250.1	528250	Ø 300 28 26 V PD
			→			24.0111-0145.1	411145	Ø 302 10,9 9 + S	
							24.0311-0145.1	511145	Ø 302 10,9 9 PD
2.2 TDCi	129	03/08→10/10	←	04/08→		24.0128-0250.1	428250	Ø 300 28 26 V	
			→			24.0328-0250.1	528250	Ø 300 28 26 V PD	
					04/08→		24.0111-0145.1	411145	Ø 302 10,9 9 + S
							24.0311-0145.1	511145	Ø 302 10,9 9 PD
2.2 TDCi	147	07/10→01/15	←	11/10→ 09/14		24.0128-0250.1	428250	Ø 300 28 26 V	
			→			24.0328-0250.1	528250	Ø 300 28 26 V PD	
					11/10→ 09/14		24.0111-0145.1	411145	Ø 302 10,9 9 + S
						24.0311-0145.1	511145	Ø 302 10,9 9 PD	

FORD - MONDEO V Schrägheck 09/14→















Bremsbelagsatz, Scheibenbremse								
1.5 EcoBoost	118	09/14→	←	10/14→ 01/15		13.0460-7313.2	607313	ATE + WK
1.6 TDCi	85	09/14→	→					
2.0 EcoBoost	149	09/14→						
2.0 EcoBoost	176	09/14→						
2.0 TDCi	110	09/14→						
2.0 TDCi	132	09/14→						

Bremsscheibe								
1.0 EcoBoost	92	02/15→	←			24.0128-0286.1	428286	Ø 300 28 26,5 V
1.5 TDCi	88	03/15→	→			24.0111-0185.1	411185	Ø 302 11 9,5
2.0 TDCi 4x4	110	02/15→			+ eFSB			
2.0 TDCi 4x4	132	02/15→						
2.0 TDCi Bi-Turbo	154	03/15→						
1.5 EcoBoost	118	09/14→		←	10/14→		24.0128-0286.1	428286
1.6 TDCi	85	09/14→	→			24.0111-0185.1	411185	Ø 302 11 9,5
2.0 EcoBoost	149	09/14→			10/14→; + eFSB			
2.0 EcoBoost	176	09/14→						
2.0 TDCi	110	09/14→						
2.0 TDCi	132	09/14→						















FORD - MONDEO V Stufenheck 09/12→











Bremsbelagsatz, Scheibenbremse								
1.5 EcoBoost	118	09/14→	←	10/14→ 01/15		13.0460-7313.2	607313	ATE + WK
2.0 Hybrid	130	09/14→	→					
2.0 Hybrid	140	09/14→						
2.0 TDCi	110	09/14→						
2.0 Hybrid	103	10/14→		←	→ 01/15		13.0460-7313.2	607313















Bremsscheibe								
1.0 EcoBoost	92	02/15→	←			24.0128-0286.1	428286	Ø 300 28 26,5 V
1.5 TDCi	88	03/15→	→			24.0111-0185.1	411185	Ø 302 11 9,5
2.0 EcoBoost	146	05/15→			+ eFSB			
2.0 EcoBoost	149	05/15→						
2.0 EcoBoost	176	05/15→						
2.0 Hybrid	103	10/14→						
2.0 TDCi	132	05/15→						
2.0 TDCi 4x4	132	05/15→						
2.0 TDCi Bi-Turbo	154	05/15→						
2.5	110	05/15→						
↓								











	kw			 	! #		
FORD - MONDEO V Stufenheck 09/12→							
 Bremsscheibe							
1.5 EcoBoost	118	09/14→	←	10/14→		24.0128-0286.1 428286	Ø 300 28 26,5 V
2.0 Hybrid	130	09/14→	→	10/14→; + eFSB		24.0111-0185.1 411185	Ø 302 11 9,5
2.0 Hybrid	140	09/14→					
2.0 TDCi	110	09/14→					
2.0 TDCi 4x4	110	09/14→	←	02/15→		24.0128-0286.1 428286	Ø 300 28 26,5 V
			→	02/15→; + eFSB		24.0111-0185.1 411185	Ø 302 11 9,5
FORD - MONDEO V Turnier 09/14→							
 Bremsbelagsatz, Scheibenbremse							
1.5 EcoBoost	118	09/14→	←	10/14→ 01/15		13.0460-7313.2 607313	ATE + WK
1.6 TDCi	85	09/14→					
2.0 EcoBoost	149	09/14→					
2.0 EcoBoost	176	09/14→					
2.0 TDCi	110	09/14→					
2.0 TDCi	132	09/14→					
 Bremsscheibe							
1.0 EcoBoost	92	02/15→	←			24.0128-0286.1 428286	Ø 300 28 26,5 V
1.5 TDCi	88	03/15→	→	+ eFSB		24.0111-0185.1 411185	Ø 302 11 9,5
2.0 TDCi 4x4	110	02/15→					
2.0 TDCi 4x4	132	02/15→					
2.0 TDCi Bi-Turbo	154	03/15→					
1.5 EcoBoost	118	09/14→	←	10/14→		24.0128-0286.1 428286	Ø 300 28 26,5 V
1.6 TDCi	85	09/14→	→	10/14→; + eFSB		24.0111-0185.1 411185	Ø 302 11 9,5
2.0 EcoBoost	149	09/14→					
2.0 EcoBoost	176	09/14→					
2.0 TDCi	110	09/14→					
2.0 TDCi	132	09/14→					
FORD - PUMA (EC_) 03/97→06/02							
 Bremsbelagsatz, Scheibenbremse							
1.4 16V	66	11/97→10/00	←	02/98→ 01/00		13.0460-7071.2 607071	ATE 20640 17,5 - WE / - WK
			←	02/00→		13.0460-7142.2 607142	ATE 23202 18,3 - WE / - WK
1.6 16V	76	08/00→06/02	←	→ 12/01		13.0460-7142.2 607142	ATE 23202 18,3 - WE / - WK
1.7 16V	92	03/97→06/02	←	06/97→ 01/00		13.0460-7071.2 607071	ATE 20640 17,5 - WE / - WK
			←	02/00→ 12/01		13.0460-7142.2 607142	ATE 23202 18,3 - WE / - WK
ST 160	118	06/99→06/02	←	→ 01/00		13.0460-7071.2 607071	ATE 20640 17,5 - WE / - WK
			←	02/00→ 12/01		13.0460-7142.2 607142	ATE 23202 18,3 - WE / - WK
 Bremsscheibe							
1.4 16V	66	11/97→10/00	←	02/98→ 01/00		24.0120-0147.1 420147	Ø 239,5 20 18 V
			←	02/00→		24.0320-0147.1 520147	Ø 239,5 20 18 V PD
			←	02/00→		24.0122-0172.1 422172	Ø 258 22 20 V
			←	02/00→		24.0322-0172.1 522172	Ø 258 22 20 V PD
1.6 16V	76	08/00→06/02	←	→ 12/01		24.0122-0172.1 422172	Ø 258 22 20 V
			←	02/00→		24.0322-0172.1 522172	Ø 258 22 20 V PD
1.7 16V	92	03/97→06/02	←	06/97→ 01/00		24.0120-0147.1 420147	Ø 239,5 20 18 V
			←	02/00→		24.0320-0147.1 520147	Ø 239,5 20 18 V PD
			←	02/00→		24.0122-0172.1 422172	Ø 258 22 20 V
			←	02/00→		24.0322-0172.1 522172	Ø 258 22 20 V PD
ST 160	118	06/99→06/02	←	→ 01/00		24.0120-0147.1 420147	Ø 239,5 20 18 V
			←	02/00→		24.0320-0147.1 520147	Ø 239,5 20 18 V PD
			←	02/00→		24.0122-0172.1 422172	Ø 258 22 20 V
			←	02/00→		24.0322-0172.1 522172	Ø 258 22 20 V PD
FORD - RANGER (ET) 01/05→07/12							
 Bremsscheibe							
2.5 TDCi 4x4	105	05/06→07/12	←	04/10→ 10/11		24.0128-0226.1 428226	Ø 289 28 26 V
3.0 TDCi 4x4	115	05/06→07/12					
2.5 TDCi	105	05/06→07/12	←	04/10→; - High Rider; → 10/11		24.0124-0245.1 424245	Ø 256 24 22 V
3.0 TDCi	115	05/06→07/12	←	04/10→; + High Rider; → 10/11		24.0128-0226.1 428226	Ø 289 28 26 V
FORD - RANGER (TKE) 04/11→							
 Bremsbelagsatz, Scheibenbremse							
2.2 TDCi	88	04/11→	←	11/11→		13.0460-8014.2 608014	25632 15,5 + WK + Zub
2.2 TDCi	92	04/11→					

























	kW			 	! #		
FORD - RANGER (TKE) 04/11→							
 Bremsbelagsatz, Scheibenbremse							
2.2 TDCi 4x4	92	04/11→	←	11/11→		13.0460-8014.2 608014	25632 15,5 + WK + Zub
2.2 TDCi 4x4	110	04/11→					
3.2 TDCi 4x4	147	04/11→					
2.2 TDCi	96	05/15→	←			13.0460-8014.2 608014	25632 15,5 + WK + Zub
2.2 TDCi	110	11/11→					
2.2 TDCi	118	05/15→					
2.2 TDCi 4x4	96	05/15→					
2.2 TDCi 4x4	118	05/15→					
 Bremsscheibe							
2.2 TDCi	88	04/11→	←	11/11→ 03/12		24.0132-0176.1 432176	Ø 302 32 30 V
2.2 TDCi	92	04/11→					
2.2 TDCi 4x4	92	04/11→					
2.2 TDCi 4x4	110	04/11→					
3.2 TDCi 4x4	147	04/11→					
2.2 TDCi	110	11/11→	←	→ 03/12		24.0132-0176.1 432176	Ø 302 32 30 V
FORD - SCORPIO II (GFR, GGR) 10/94→08/98							
 Bremsbelagsatz, Scheibenbremse							
2.0 i	85	10/94→08/98	←			13.0460-7057.2 607057	ATE 21394 17,5 - WE / - WK
2.0 i 16V	100	10/94→08/98					
2.3 i 16V	108	06/96→08/98	→			13.0460-2928.2 602928	TRW 20981 13,8 - WK
2.5 TD	85	10/94→08/98					
2.9 i	110	02/95→08/98					
2.9 i 24V	152	10/94→08/98	←	12/97→		13.0460-7056.2 607056	ATE 21396 17,5 + WK
			←	→ 11/97		13.0460-7165.2 607165	ATE 21358 19,8 - WE / - WK
			→			13.0460-2928.2 602928	TRW 20981 13,8 - WK
 Bremsscheibe							
2.0 i	85	10/94→08/98	←			24.0124-0120.1 424120	Ø 260 24 22,2 V
2.0 i 16V	100	10/94→08/98				24.0324-0120.1 524120	Ø 260 24 22,2 V PD
2.3 i 16V	108	06/96→08/98					
2.5 TD	85	10/94→08/98	→			24.0110-0115.1 410115	Ø 253 10,2 8,9
2.9 i	110	02/95→08/98				24.0310-0115.1 510115	Ø 253 10,2 8,9 PD
2.5 TD	92	09/96→08/98	→			24.0110-0115.1 410115	Ø 253 10,2 8,9
						24.0310-0115.1 510115	Ø 253 10,2 8,9 PD
2.9 i 24V	152	10/94→08/98	←			24.0124-0149.1 424149	Ø 278 24,1 22,2 V
FORD - SCORPIO II Kombi (GNR, GGR) 10/94→08/98							
 Bremsbelagsatz, Scheibenbremse							
2.0 i	85	10/94→08/98	←			13.0460-7057.2 607057	ATE 21394 17,5 - WE / - WK
2.0 i 16V	100	10/94→08/98					
2.3 i 16V	108	06/96→08/98	→			13.0460-2928.2 602928	TRW 20981 13,8 - WK
2.5 TD	85	10/94→08/98					
2.9 i	110	02/95→08/98					
2.9 i 24V	152	10/94→08/98	←	12/97→		13.0460-7056.2 607056	ATE 21396 17,5 + WK
			←	→ 11/97		13.0460-7165.2 607165	ATE 21358 19,8 - WE / - WK
			→			13.0460-2928.2 602928	TRW 20981 13,8 - WK
 Bremsscheibe							
2.0 i	85	10/94→08/98	←			24.0124-0120.1 424120	Ø 260 24 22,2 V
2.0 i 16V	100	10/94→08/98				24.0324-0120.1 524120	Ø 260 24 22,2 V PD
2.3 i 16V	108	06/96→08/98					
2.5 TD	85	10/94→08/98	→			24.0120-0146.1 420146	Ø 253 20 18 V
2.9 i	110	02/95→08/98				24.0320-0146.1 520146	Ø 253 20 18 V PD
2.5 TD	92	09/96→08/98	→			24.0120-0146.1 420146	Ø 253 20 18 V
						24.0320-0146.1 520146	Ø 253 20 18 V PD
2.9 i 24V	152	10/94→08/98	←			24.0124-0149.1 424149	Ø 278 24,1 22,2 V
FORD - S-MAX 01/15→							
 Bremsbelagsatz, Scheibenbremse							
1.5 EcoBoost	118	01/15→	←	02/15→;		13.0460-7313.2 607313	ATE + WK
2.0 EcoBoost	176	01/15→		passend für Felgenreöße [Zoll]: 16			
2.0 TDCi	88	01/15→					
2.0 TDCi	110	01/15→					
2.0 TDCi	132	01/15→					
2.0 TDCi 4x4	110	01/15→					
2.0 TDCi 4x4	132	01/15→					
2.0 TDCi BI-Turbo	154	01/15→					













	kW			 	! #		
FORD - S-MAX (WA6) 05/06→12/14							
 Bremsbelagsatz, Scheibenbremse							
1.6 EcoBoost	118	02/11→12/14	←			13.0460-7228.2 607228	ATE 24123 20,3 - WE / - WK
1.6 TDCi	85	02/11→12/14				13.0470-7228.2 LD7228	ATE 24123 20,3 - WE / - WK
1.8 TDCi	74	01/07→12/10					Ceramic
1.8 TDCi	92	05/06→12/14	→	+ eFSB		13.0460-2722.2 602722	TRW 24496 17,3 - WE / - WK
2.0	107	05/06→12/14					+ Zub
2.0 Flexifuel	107	05/06→12/14				13.0470-2722.2 LD2722	TRW 24496 17,3 - WE / - WK
2.0 TDCi	85	11/07→12/14					+ Zub Ceramic
2.0 TDCi	96	05/06→12/14	→	- eFSB		13.0460-2723.2 602723	TRW 24537 16,1 - WE / - WK
2.0 TDCi	100	05/06→12/14					+ Zub
2.0 TDCi	103	05/06→12/14				13.0470-2723.2 LD2723	TRW 24537 16,1 - WE / - WK
2.0 TDCi	120	03/10→12/14					+ Zub Ceramic
2.2 TDCi	147	07/10→12/14					
2.3	118	07/07→12/14					
2.0 EcoBoost	146	07/10→12/14	←			13.0460-7243.2 607243	ATE 24142 20,6 - WE / - WK
2.0 EcoBoost	149	03/10→12/14				13.0470-7243.2 LD7243	ATE 24142 20,6 - WE / - WK
2.0 EcoBoost	176	07/10→12/14					Ceramic
2.5 ST	162	05/06→12/14	→	+ eFSB		13.0460-2722.2 602722	TRW 24496 17,3 - WE / - WK
							+ Zub
			→	- eFSB		13.0460-2723.2 602723	TRW 24496 17,3 - WE / - WK
						13.0470-2723.2 LD2723	TRW 24496 17,3 - WE / - WK
							+ Zub Ceramic
2.2 TDCi	129	03/08→12/12	←	11/08→		13.0460-7228.2 607228	ATE 24123 20,3 - WE / - WK
						13.0470-7228.2 LD7228	ATE 24123 20,3 - WE / - WK
			←	04/08→ 10/08		13.0460-7243.2 607243	ATE 24142 20,6 - WE / - WK
						13.0470-7243.2 LD7243	ATE 24142 20,6 - WE / - WK
			→	04/08→; + eFSB		13.0460-2722.2 602722	TRW 24496 17,3 - WE / - WK
							+ Zub
						13.0470-2722.2 LD2722	TRW 24496 17,3 - WE / - WK
							+ Zub Ceramic
			→	04/08→; - eFSB		13.0460-2723.2 602723	TRW 24537 16,1 - WE / - WK
						13.0470-2723.2 LD2723	TRW 24537 16,1 - WE / - WK
							+ Zub Ceramic
 Bremsscheibe							
1.6 EcoBoost	118	02/11→12/14	←			24.0128-0154.1 428154	Ø 300 28 26 V + S
1.6 TDCi	85	02/11→12/14				24.0328-0154.1 528154	Ø 300 28 26 V + S PD
1.8 TDCi	74	01/07→12/10					
1.8 TDCi	92	05/06→12/14	→			24.0111-0145.1 411145	Ø 302 10,9 9 + S
2.0	107	05/06→12/14				24.0311-0145.1 511145	Ø 302 10,9 9 PD
2.0 Flexifuel	107	05/06→12/14					
2.0 TDCi	85	11/07→12/14					
2.0 TDCi	96	05/06→12/14					
2.0 TDCi	100	05/06→12/14					
2.0 TDCi	103	05/06→12/14					
2.0 TDCi	120	03/10→12/14					
2.2 TDCi	147	07/10→12/14					
2.3	118	07/07→12/14					
2.0 EcoBoost	146	07/10→12/14	←			24.0128-0162.1 428162	Ø 316 28 26 V + S
2.0 EcoBoost	149	03/10→12/14				24.0328-0162.1 528162	Ø 316 28 26 V + S PD
2.0 EcoBoost	176	07/10→12/14					
2.5 ST	162	05/06→12/14	→			24.0111-0145.1 411145	Ø 302 10,9 9 + S
						24.0311-0145.1 511145	Ø 302 10,9 9 PD
2.2 TDCi	129	03/08→12/12	←	11/08→		24.0128-0154.1 428154	Ø 300 28 26 V + S
						24.0328-0154.1 528154	Ø 300 28 26 V + S PD
			←	04/08→ 10/08		24.0128-0162.1 428162	Ø 316 28 26 V + S
						24.0328-0162.1 528162	Ø 316 28 26 V + S PD
			→	04/08→		24.0111-0145.1 411145	Ø 302 10,9 9 + S
						24.0311-0145.1 511145	Ø 302 10,9 9 PD
FORD - STREET KA (RL2) 03/03→07/05							
 Bremsbelagsatz, Scheibenbremse							
1.6	70	05/03→07/05	←			13.0460-7142.2 607142	ATE 23202 18,3 - WE / - WK
 Bremsscheibe							
1.6	70	05/03→07/05	←			24.0122-0172.1 422172	Ø 258 22 20 V
						24.0322-0172.1 522172	Ø 258 22 20 V PD













	kw			 	! #				
FORD - TOURNEO CONNECT 06/02→12/13									
 Bremsbelagsatz, Scheibenbremse									
1.8 16V	85	06/02→12/13	←	→ 08/13		13.0460-7186.2 607186	ATE 23440 17,6 - WE / - WK		
1.8 TDCi	66	06/02→12/13	→	→ 08/13		13.0460-7160.2 607160	ATE 23482 15,8 - WE / - WK		
1.8 TDCi	81	08/06→12/13					13.0460-7194.2 607194	ATE 23482 16,6 - WE / - WK	
1.8 TDCi /TDDi /DI	55	06/02→12/13					13.0470-7194.2 LD7194	ATE 23482 16,6 - WE / - WK Ceramic	
 Bremsscheibe									
1.8 16V	85	06/02→12/13	←	→ 08/13		24.0124-0179.1 424179	Ø 278 24 22 V		
1.8 TDCi	66	06/02→12/13	→	→ 08/13		24.0111-0154.1 411154	Ø 278 11 9		
1.8 TDCi	81	08/06→12/13							
1.8 TDCi /TDDi /DI	55	06/02→12/13							
FORD - TOURNEO CONNECT / GRAND TOURNEO CONNECT Kombi 09/13→									
 Bremsbelagsatz, Scheibenbremse									
1.0 EcoBoost	74	11/13→	←	kurzer Radstand		13.0460-7193.2 607193	ATE 23723 18,1 - WE / - WK		
1.5 TDCi	55	05/15→					13.0470-7193.2 LD7193	ATE 23723 18,1 - WE / - WK Ceramic	
1.5 TDCi	74	05/15→							
1.5 TDCi	88	05/15→	←	langer Radstand; nicht für erhöhte Nutzlast		13.0460-7193.2 607193	ATE 23723 18,1 - WE / - WK		
1.6 EcoBoost	110	11/13→					13.0470-7193.2 LD7193	ATE 23723 18,1 - WE / - WK Ceramic	
1.6 TDCi	55	09/13→							
1.6 TDCi	70	09/13→							
1.6 TDCi	85	09/13→	→			13.0460-7195.2 607195	ATE 23482 16,6 - WE / - WK		
						13.0470-7195.2 LD7195	ATE 23482 16,6 - WE / - WK Ceramic		
 Bremsscheibe									
1.0 EcoBoost	74	11/13→	←	nicht für Taxifahrzeuge; für Leichtmetallfelgen; nicht für erhöhte Nutzlast		24.0125-0162.1 425162	Ø 300 25 23 V		
1.5 TDCi	55	05/15→					24.0325-0162.1 525162	Ø 300 25 23 V PD	
1.5 TDCi	74	05/15→	←	nicht für Taxifahrzeuge; für Stahlfelgen; nicht für erhöhte Nutzlast		24.0125-0202.1 425202	Ø 300 25 23 V		
1.5 TDCi	88	05/15→							
1.6 EcoBoost	110	11/13→							
1.6 TDCi	55	09/13→	←	nicht für Taxifahrzeuge; für erhöhte Nutzlast		24.0125-0209.1 425209	Ø 320 25 23 V		
1.6 TDCi	70	09/13→							
1.6 TDCi	85	09/13→					24.0111-0172.1 411172	Ø 280 11 9	
			→						
FORD - TOURNEO COURIER Kombi 02/14→									
 Bremsbelagsatz, Scheibenbremse									
1.0 EcoBoost	74	02/14→	←			13.0460-2784.2 602784	TRW 25134 17,2 - WE / - WK + Zub		
1.5 TDCi	55	02/14→							
1.5 TDCi	70	05/15→					13.0470-2784.2 LD2784	TRW 25134 17,2 - WE / - WK + Zub Ceramic	
1.6 TDCi	70	02/14→							
 Bremsscheibe									
1.0 EcoBoost	74	02/14→	←	für Leichtmetallfelgen		24.0123-0122.1 423122	Ø 278 23 21 V		
1.5 TDCi	55	02/14→							
1.5 TDCi	70	05/15→							
1.6 TDCi	70	02/14→							
FORD - TOURNEO CUSTOM Bus 04/12→									
Warnkontakt, Bremsbelagverschleiß									
2.0 TDCi	77	12/15→	←	nicht für Baumuster: 330	1	24.8190-0021.2 620021	L= 478		
2.0 TDCi	96	12/15→		←	Baumuster: 330	1	24.8190-0026.2 620026	L= 312	
2.0 TDCi	125	12/15→			→		2	24.8190-0021.2 620021	L= 478
2.2 TDCi	74	04/12→	←	05/12→; nicht für Baumuster: 330	1	24.8190-0021.2 620021	L= 478		
2.2 TDCi	92	04/12→		←	05/12→; Baumuster: 330	1	24.8190-0026.2 620026	L= 312	
2.2 TDCi	114	04/12→			→	05/12→	2	24.8190-0021.2 620021	L= 478
 Bremsscheibe									
2.0 TDCi	77	12/15→	←	nicht für Baumuster: 290S Sport / 330		24.0133-0101.1 433101	Ø 288 33 30 V + S		
2.0 TDCi	96	12/15→		←	Baumuster: 330		24.0133-0102.1 433102	Ø 308 33 30 V + S	
2.0 TDCi	125	12/15→			→	04/16; Baumuster: 290S Sport		24.0133-0102.1 433102	Ø 308 33 30 V + S
2.2 TDCi	74	04/12→	←	05/12→; nicht für Baumuster: 330 / 290S Sport		24.0133-0101.1 433101	Ø 288 33 30 V + S		
2.2 TDCi	92	04/12→		←	05/12→ 04/16; Baumuster: 290S Sport		24.0133-0102.1 433102	Ø 308 33 30 V + S	
2.2 TDCi	114	04/12→			←	05/12→; Baumuster: 330		24.0133-0102.1 433102	Ø 308 33 30 V + S







	kw			 	! #			
FORD - TRANSIT Bus 04/06→								
 Bremsbelagsatz, Scheibenbremse								
2.2 TDCi	63	04/06→08/14	←	05/06→; Baumuster: 260/280/300; → 04/14		13.0460-3833.2	603833	BOS 24485 19,0 + WK + Zub
2.2 TDCi	81	04/06→08/14						
2.2 TDCi	96	04/06→08/14	←	05/06→; Baumuster: 330/350; → 04/14		13.0460-3834.2	603834	BOS 24484 19,0 + WK + Zub
			→	05/06→ 04/14; für Einfachbereifung		13.0460-3835.2	603835	BOS 24486 17,9 + WK + Zub
2.2 TDCi	74	10/11→08/14	←	Baumuster: 260/280/300; → 04/14		13.0460-3833.2	603833	BOS 24485 19,0 + WK + Zub
2.2 TDCi	85	10/08→08/14	←	Baumuster: 330/350; → 04/14		13.0460-3834.2	603834	BOS 24484 19,0 + WK + Zub
2.2 TDCi	92	10/11→08/14						
2.2 TDCi	103	10/07→08/14	→	→ 04/14; für Einfachbereifung		13.0460-3835.2	603835	BOS 24486 17,9 + WK + Zub
2.2 TDCi [RWD]	74	10/11→08/14	←	→ 04/14		13.0460-3834.2	603834	BOS 24484 19,0 + WK + Zub
2.2 TDCi [RWD]	92	10/11→08/14	→	→ 04/14; für Einfachbereifung		13.0460-3835.2	603835	BOS 24486 17,9 + WK + Zub
2.4 TDCi 4x4	103	11/06→08/14						
3.2 TDCi	147	02/08→08/14						
2.2 TDCi [RWD]	100	09/11→08/14	←	10/11→ 04/14		13.0460-3834.2	603834	BOS 24484 19,0 + WK + Zub
			→	10/11→ 04/14; für Einfachbereifung		13.0460-3835.2	603835	BOS 24486 17,9 + WK + Zub
2.4 TDCi	74	04/06→08/14	←	05/06→ 04/14		13.0460-3834.2	603834	BOS 24484 19,0 + WK + Zub
2.4 TDCi	85	04/06→08/14						
2.4 TDCi	103	04/06→08/14	→	05/06→ 04/14; für Einfachbereifung		13.0460-3835.2	603835	BOS 24486 17,9 + WK + Zub
 Bremsscheibe								
2.2 TDCi	63	04/06→08/14	←	05/06→; Baumuster: 260/280/300; → 04/14		24.0128-0156.1	428156	Ø 280 28 25 V + S
2.2 TDCi	81	04/06→08/14						
2.2 TDCi	96	04/06→08/14	←	05/06→; Baumuster: 330/350; → 04/14		24.0128-0157.1	428157	Ø 300 28 25 V + S
			→	05/06→ 04/14		24.0116-0116.2	416116	Ø 280 16 13 + ABS Ring
2.2 TDCi	74	10/11→08/14	←	Baumuster: 260/280/300; → 04/14		24.0128-0156.1	428156	Ø 280 28 25 V + S
2.2 TDCi	85	10/08→08/14	←	Baumuster: 330/350; → 04/14		24.0128-0157.1	428157	Ø 300 28 25 V + S
2.2 TDCi	92	10/11→08/14						
2.2 TDCi	103	10/07→08/14	→	→ 04/14		24.0116-0116.2	416116	Ø 280 16 13 + ABS Ring
2.2 TDCi [RWD]	74	10/11→08/14	←	→ 04/14; mit Einfachbereifung		24.0128-0157.1	428157	Ø 300 28 25 V + S
2.2 TDCi [RWD]	92	10/11→08/14	←	→ 04/14; mit Doppelbereifung		24.0128-0293.1	428293	Ø 300 28 24 V
2.4 TDCi 4x4	103	11/06→08/14						
3.2 TDCi	147	02/08→08/14	→	→ 04/14		24.0116-0126.1	416126	Ø 280 16 13
2.2 TDCi [RWD]	100	09/11→08/14	←	10/11→ 04/14; mit Einfachbereifung		24.0128-0157.1	428157	Ø 300 28 25 V + S
			←	10/11→ 04/14; mit Doppelbereifung		24.0128-0293.1	428293	Ø 300 28 24 V
			→	10/11→ 04/14		24.0116-0126.1	416126	Ø 280 16 13
2.4 TDCi	74	04/06→08/14	←	05/06→ 04/14; mit Einfachbereifung		24.0128-0157.1	428157	Ø 300 28 25 V + S
2.4 TDCi	85	04/06→08/14	←	05/06→ 04/14; mit Doppelbereifung		24.0128-0293.1	428293	Ø 300 28 24 V
2.4 TDCi	103	04/06→08/14	→	05/06→ 04/14		24.0116-0126.1	416126	Ø 280 16 13
FORD - TRANSIT Bus 08/13→								
Warnkontakt, Bremsbelagverschleiß								
2.0 TDCi	77	03/16→	←		2	24.8190-0026.2	620026	L= 312
2.0 TDCi	96	03/16→						
2.0 TDCi	125	03/16→						
2.2 TDCi	114	12/14→						
2.2 TDCi	74	08/13→	←	05/14→	2	24.8190-0026.2	620026	L= 312
2.2 TDCi	92	08/13→						
2.2 TDCi [RWD]	74	08/13→						
2.2 TDCi [RWD]	92	08/13→						
2.2 TDCi [RWD]	114	08/13→						
2.2 TDCi 4x4	92	08/13→						
 Bremsscheibe								
2.0 TDCi	77	03/16→	←	Baumuster: 10/60/70/80/90/250 / 300; für Einfachbereifung		24.0133-0101.1	433101	Ø 288 33 30 V + S
2.0 TDCi	96	03/16→						
2.0 TDCi	125	03/16→	←	Baumuster: 330/350/390/410/470; für Einfachbereifung		24.0133-0102.1	433102	Ø 308 33 30 V + S
2.2 TDCi	114	12/14→						
2.2 TDCi	74	08/13→	←	05/14→;		24.0133-0101.1	433101	Ø 288 33 30 V + S
2.2 TDCi	92	08/13→		Baumuster: 10/60/70/80/90/250 / 300; für Einfachbereifung				
2.2 TDCi [RWD]	74	08/13→						
2.2 TDCi [RWD]	92	08/13→	←	05/14→;		24.0133-0102.1	433102	Ø 308 33 30 V + S
2.2 TDCi [RWD]	114	08/13→		Baumuster: 330/350/390/410/470; für Einfachbereifung				
2.2 TDCi 4x4	92	08/13→						
FORD - TRANSIT Bus (E _) 06/94→07/00								
 Bremsbelagsatz, Scheibenbremse								
2.0 (EBL, EBS, ECL, EDS, EDL, EGL, ESS, ESL, EUS)	84	09/95→03/00	←	passend für Felgenreife [Zoll]: 15		13.0460-3959.2	603959	BDX 21469 18,0 + WE / - WK
↓			←	passend für Felgenreife [Zoll]: 14		13.0460-3960.2	603960	BDX 21470 18,0 + WE / - WK













	kw			 	! #		
FORD - TRANSIT Bus (E_) 06/94→07/00							
 Bremsbelagsatz, Scheibenbremse							
2.5 DI (EBL, ECL, EDS, EDL)	56	07/94→03/00	←	passend für Felgengröße [Zoll]: 15		13.0460-3959.2 603959	BDX 21469 18,0 + WE / - WK
2.5 DI (EBL, EDL, EDS, ESL, ESS)	85	08/97→03/00	←	passend für Felgengröße [Zoll]: 14		13.0460-3960.2 603960	BDX 21470 18,0 + WE / - WK
2.5 DI (EBL, EDS, ESL, ESS, EUS)	51	08/94→03/00					
2.5 TD (EBL, EDL, EDS, EGL, ESL, ESS, EUS)	63	01/95→03/00					
2.5 TD (ECL, EDL, EDS, ESL, ESS, EUS)	74	07/94→03/00					
2.0 CNG	84	06/94→03/00	←	passend für Felgengröße [Zoll]: 15		13.0460-3959.2 603959	BDX 21469 18,0 + WE / - WK
			←	07/94→; passend für Felgengröße [Zoll]: 15		13.0460-3959.2 603959	BDX 21469 18,0 + WE / - WK
			←	passend für Felgengröße [Zoll]: 14		13.0460-3960.2 603960	BDX 21470 18,0 + WE / - WK
			←	07/94→; passend für Felgengröße [Zoll]: 14		13.0460-3960.2 603960	BDX 21470 18,0 + WE / - WK
2.5 TD (EB_, ED_, ES_)	55	08/94→06/00	←	→ 03/00; passend für Felgengröße [Zoll]: 15		13.0460-3959.2 603959	BDX 21469 18,0 + WE / - WK
			←	→ 03/00; passend für Felgengröße [Zoll]: 14		13.0460-3960.2 603960	BDX 21470 18,0 + WE / - WK
Zubehörsatz, Scheibenbremsbelag							
2.0 (EBL, EBS, ECL, EDS, EDL, EGL, ESS, ESL, EUS)	84	09/95→03/00	←	passend für Felgengröße [Zoll]: 14		13.0460-0427.2 610427	BDX
2.5 DI (EBL, ECL, EDS, EDL)	56	07/94→03/00	←	passend für Felgengröße [Zoll]: 15		13.0460-0427.2 610427	BDX
2.5 DI (EBL, EDL, EDS, ESL, ESS)	85	08/97→03/00					
2.5 DI (EBL, EDS, ESL, ESS, EUS)	51	08/94→03/00					
2.5 TD (EBL, EDL, EDS, EGL, ESL, ESS, EUS)	63	01/95→03/00					
2.5 TD (ECL, EDL, EDS, ESL, ESS, EUS)	74	07/94→03/00					
2.0 CNG	84	06/94→03/00	←	passend für Felgengröße [Zoll]: 15		13.0460-0427.2 610427	BDX
			←	passend für Felgengröße [Zoll]: 14		13.0460-0427.2 610427	BDX
			←	07/94→; passend für Felgengröße [Zoll]: 15		13.0460-0427.2 610427	BDX
			←	07/94→; passend für Felgengröße [Zoll]: 14		13.0460-0427.2 610427	BDX
2.5 TD (EB_, ED_, ES_)	55	08/94→06/00	←	→ 03/00; passend für Felgengröße [Zoll]: 14		13.0460-0427.2 610427	BDX
			←	→ 03/00; passend für Felgengröße [Zoll]: 15		13.0460-0427.2 610427	BDX
 Bremsscheibe							
2.0 (EBL, EBS, ECL, EDS, EDL, EGL, ESS, ESL, EUS)	84	09/95→03/00	←	passend für Felgengröße [Zoll]: 14		24.0124-0131.1 424131	Ø 254 24,2 22,2 V
2.5 DI (EBL, ECL, EDS, EDL)	56	07/94→03/00	←	passend für Felgengröße [Zoll]: 15		24.0124-0132.1 424132	Ø 270 24,2 22,2 V
2.5 DI (EBL, EDL, EDS, ESL, ESS)	85	08/97→03/00					
2.5 DI (EBL, EDS, ESL, ESS, EUS)	51	08/94→03/00					
2.5 TD (EBL, EDL, EDS, EGL, ESL, ESS, EUS)	63	01/95→03/00					
2.5 TD (ECL, EDL, EDS, ESL, ESS, EUS)	74	07/94→03/00					
2.0 CNG	84	06/94→03/00	←	07/94→; passend für Felgengröße [Zoll]: 14		24.0124-0131.1 424131	Ø 254 24,2 22,2 V
			←	passend für Felgengröße [Zoll]: 14		24.0124-0131.1 424131	Ø 254 24,2 22,2 V
			←	07/94→; passend für Felgengröße [Zoll]: 15		24.0124-0132.1 424132	Ø 270 24,2 22,2 V
			←	passend für Felgengröße [Zoll]: 15		24.0124-0132.1 424132	Ø 270 24,2 22,2 V
2.5 TD (EB_, ED_, ES_)	55	08/94→06/00	←	→ 03/00; passend für Felgengröße [Zoll]: 14		24.0124-0131.1 424131	Ø 254 24,2 22,2 V
			←	→ 03/00; passend für Felgengröße [Zoll]: 15		24.0124-0132.1 424132	Ø 270 24,2 22,2 V
FORD - TRANSIT Bus (FD_, FB_, FS_, FZ_, FC_) 01/00→05/06							
 Bremsbelagsatz, Scheibenbremse							
2.0 DI (F_E_, F_F_, F_G_) ↓	55	08/00→05/06	←	→ 04/06; Baumuster: 260/280/300		13.0460-3992.2 603992	BOS 23434 18,7 + WK

	kW					! #		
FORD - TRANSIT Bus (FD_, FB_, FS_, FZ_, FC_) 01/00→05/06								
 Bremsbelagsatz, Scheibenbremse								
2.0 DI (F_E_, F_F_, F_G_) 2.0 DI (F_E_, F_F_, F_G_) 2.0 TDCi (F_F_, F_E_, F_G_)	63 74 92	08/00→05/06 08/00→05/06 08/02→05/06	←	→ 04/06; Baumuster: 330/350			13.0460-3993.2 603993	BOS 23577 18,7 + WK
2.3 16V [RWD] (F_B_, F_C_, F_A_) 2.4 DI (F_B_, F_C_, F_A_) 2.4 DI [RWD] (F_B_, F_C_, F_A_) 2.4 DI [RWD] (F_B_, F_C_) 2.4 TDCi 2.4 TDE 2.4 TD	107 66 88 55 101 85 55	08/00→05/06 01/00→05/06 01/00→05/06 01/00→05/06 03/04→05/06 03/04→05/06 08/00→08/03	←	→ 04/06			13.0460-3993.2 603993	BOS 23577 18,7 + WK
2.4 TDE (F_C_, F_B_, F_A_)	92	07/01→05/06	←	11/01→ 04/06			13.0460-3993.2 603993	BOS 23577 18,7 + WK
 Bremsscheibe								
2.0 DI (F_E_, F_F_, F_G_) 2.0 DI (F_E_, F_F_, F_G_) 2.0 DI (F_E_, F_F_, F_G_) 2.0 TDCi (F_F_, F_E_, F_G_)	55 63 74 92	08/00→05/06 08/00→05/06 08/00→05/06 08/02→05/06	←	→ 04/06; Baumuster: 260/280/300 → 04/06; Baumuster: 330/350			24.0124-0167.1 424167 24.0124-0168.1 424168	Ø 276 24,5 22,1 V Ø 294 24,5 22,1 V
2.3 16V [RWD] (F_B_, F_C_, F_A_) 2.4 DI (F_B_, F_C_, F_A_) 2.4 DI [RWD] (F_B_, F_C_, F_A_) 2.4 DI [RWD] (F_B_, F_C_) 2.4 TDCi 2.4 TDE 2.4 TD	107 66 88 55 101 85 55	08/00→05/06 01/00→05/06 01/00→05/06 01/00→05/06 03/04→05/06 03/04→05/06 08/00→08/03	←	→ 04/06			24.0124-0168.1 424168	Ø 294 24,5 22,1 V
2.4 TDE (F_C_, F_B_, F_A_)	92	07/01→05/06	←	11/01→ 04/06			24.0124-0168.1 424168	Ø 294 24,5 22,1 V
FORD - TRANSIT CONNECT (P65_, P70_, P80_) 06/02→								
 Bremsbelagsatz, Scheibenbremse								
1.8 16V 1.8 16V LPG 1.8 Di 1.8 TDCi 1.8 TDCi	85 85 55 66 81	06/02→12/13 06/02→12/13 06/02→12/13 06/02→12/13 08/06→12/13	← →	→ 08/13 → 08/13			13.0460-7186.2 607186 13.0460-7160.2 607160 13.0460-7194.2 607194 13.0470-7194.2 LD7194	ATE 23440 17,6 - WE / - WK ATE 23482 15,8 - WE / - WK ATE 23482 16,6 - WE / - WK ATE 23482 16,6 - WE / - WK Ceramic
 Bremsscheibe								
1.8 16V 1.8 16V LPG 1.8 Di 1.8 TDCi 1.8 TDCi	85 85 55 66 81	06/02→12/13 06/02→12/13 06/02→12/13 06/02→12/13 08/06→12/13	← →	→ 08/13 → 08/13			24.0124-0179.1 424179 24.0111-0154.1 411154	Ø 278 24 22 V Ø 278 11 9
FORD - TRANSIT CONNECT Kasten 02/13→								
 Bremsbelagsatz, Scheibenbremse								
1.0 EcoBoost 1.6 TDCi 1.6 TDCi 1.6 TDCi	74 55 70 85	02/13→ 02/13→ 02/13→ 02/13→	←	09/13→; kurzer Radstand			13.0460-7193.2 607193 13.0470-7193.2 LD7193	ATE 23723 18,1 - WE / - WK ATE 23723 18,1 - WE / - WK Ceramic
			←	09/13→; langer Radstand; nicht für erhöhte Nutzlast			13.0460-7193.2 607193 13.0470-7193.2 LD7193	ATE 23723 18,1 - WE / - WK ATE 23723 18,1 - WE / - WK Ceramic
			→	09/13→			13.0460-7195.2 607195 13.0470-7195.2 LD7195	ATE 23482 16,6 - WE / - WK ATE 23482 16,6 - WE / - WK Ceramic
1.5 TDCi 1.5 TDCi 1.5 TDCi 1.6 EcoBoost	55 74 88 110	08/15→ 05/15→ 05/15→ 11/13→	←	kurzer Radstand			13.0460-7193.2 607193 13.0470-7193.2 LD7193	ATE 23723 18,1 - WE / - WK ATE 23723 18,1 - WE / - WK Ceramic
			←	langer Radstand; nicht für erhöhte Nutzlast			13.0460-7193.2 607193	ATE 23723 18,1 - WE / - WK











	kW			 	! #			
FORD - TRANSIT CONNECT Kasten 02/13→								
 Bremsbelagsatz, Scheibenbremse								
1.5 TDCi	55	08/15→	←	langer Radstand; nicht für erhöhte Nutzlast	13.0470-7193.2	LD7193	ATE 23723 18,1 - WE / - WK Ceramic	
1.5 TDCi	74	05/15→						
1.5 TDCi	88	05/15→						
1.6 EcoBoost	110	11/13→	→		13.0460-7195.2	607195	ATE 23482 16,6 - WE / - WK Ceramic	
					13.0470-7195.2	LD7195	ATE 23482 16,6 - WE / - WK Ceramic	
 Bremsscheibe								
1.0 EcoBoost	74	02/13→	←	09/13→; nicht für Taxifahrzeuge; für Leichtmetallfelgen; nicht für erhöhte Nutzlast	24.0125-0162.1	425162	Ø 300 25 23 V	
1.6 TDCi	55	02/13→				24.0325-0162.1	525162	Ø 300 25 23 V PD
1.6 TDCi	70	02/13→						
1.6 TDCi	85	02/13→	←	09/13→; nicht für Taxifahrzeuge; für Stahlfelgen; nicht für erhöhte Nutzlast	24.0125-0202.1	425202	Ø 300 25 23 V	
			←	09/13→; nicht für Taxifahrzeuge; für erhöhte Nutzlast	24.0125-0209.1	425209	Ø 320 25 23 V	
			→	09/13→	24.0111-0172.1	411172	Ø 280 11 9	
1.5 TDCi	55	08/15→	←	nicht für Taxifahrzeuge; für Leichtmetallfelgen; nicht für erhöhte Nutzlast	24.0125-0162.1	425162	Ø 300 25 23 V	
1.5 TDCi	74	05/15→				24.0325-0162.1	525162	Ø 300 25 23 V PD
1.5 TDCi	88	05/15→						
1.6 EcoBoost	110	11/13→	←	nicht für Taxifahrzeuge; für Stahlfelgen; nicht für erhöhte Nutzlast	24.0125-0202.1	425202	Ø 300 25 23 V	
			←	nicht für Taxifahrzeuge; für erhöhte Nutzlast	24.0125-0209.1	425209	Ø 320 25 23 V	
			→	09/13→	24.0111-0172.1	411172	Ø 280 11 9	
FORD - TRANSIT CONNECT Kombi 02/13→								
 Bremsbelagsatz, Scheibenbremse								
1.5 TDCi	55	08/15→	←	kurzer Radstand	13.0460-7193.2	607193	ATE 23723 18,1 - WE / - WK Ceramic	
1.5 TDCi	74	05/15→				13.0470-7193.2	LD7193	ATE 23723 18,1 - WE / - WK Ceramic
1.5 TDCi	88	05/15→						
			←	langer Radstand; nicht für erhöhte Nutzlast	13.0460-7193.2	607193	ATE 23723 18,1 - WE / - WK Ceramic	
					13.0470-7193.2	LD7193	ATE 23723 18,1 - WE / - WK Ceramic	
			→		13.0460-7195.2	607195	ATE 23482 16,6 - WE / - WK Ceramic	
					13.0470-7195.2	LD7195	ATE 23482 16,6 - WE / - WK Ceramic	
1.6 EcoBoost	110	02/13→	←	09/13→; kurzer Radstand	13.0460-7193.2	607193	ATE 23723 18,1 - WE / - WK Ceramic	
1.6 TDCi	55	02/13→			13.0470-7193.2	LD7193	ATE 23723 18,1 - WE / - WK Ceramic	
1.6 TDCi	70	02/13→						
1.6 TDCi	85	02/13→	←	09/13→; langer Radstand; nicht für erhöhte Nutzlast	13.0460-7193.2	607193	ATE 23723 18,1 - WE / - WK Ceramic	
					13.0470-7193.2	LD7193	ATE 23723 18,1 - WE / - WK Ceramic	
			→	09/13→	13.0460-7195.2	607195	ATE 23482 16,6 - WE / - WK Ceramic	
					13.0470-7195.2	LD7195	ATE 23482 16,6 - WE / - WK Ceramic	
 Bremsscheibe								
1.5 TDCi	55	08/15→	←	nicht für Taxifahrzeuge; für Leichtmetallfelgen; nicht für erhöhte Nutzlast	24.0125-0162.1	425162	Ø 300 25 23 V	
1.5 TDCi	74	05/15→				24.0325-0162.1	525162	Ø 300 25 23 V PD
1.5 TDCi	88	05/15→						
			←	nicht für Taxifahrzeuge; für Stahlfelgen; nicht für erhöhte Nutzlast	24.0125-0202.1	425202	Ø 300 25 23 V	
			←	nicht für Taxifahrzeuge; für erhöhte Nutzlast	24.0125-0209.1	425209	Ø 320 25 23 V	
			→	09/13→	24.0111-0172.1	411172	Ø 280 11 9	
1.6 EcoBoost	110	02/13→	←	09/13→; nicht für Taxifahrzeuge; für Leichtmetallfelgen; nicht für erhöhte Nutzlast	24.0125-0162.1	425162	Ø 300 25 23 V	
1.6 TDCi	55	02/13→				24.0325-0162.1	525162	Ø 300 25 23 V PD
1.6 TDCi	70	02/13→						
1.6 TDCi	85	02/13→	←	09/13→; nicht für Taxifahrzeuge; für Stahlfelgen; nicht für erhöhte Nutzlast	24.0125-0202.1	425202	Ø 300 25 23 V	
			←	09/13→; nicht für Taxifahrzeuge; für erhöhte Nutzlast	24.0125-0209.1	425209	Ø 320 25 23 V	
			→	09/13→	24.0111-0172.1	411172	Ø 280 11 9	
FORD - TRANSIT COURIER Kasten 02/14→								
 Bremsbelagsatz, Scheibenbremse								
1.0 EcoBoost	74	02/14→	←		13.0460-2784.2	602784	TRW 25134 17,2 - WE / - WK + Zub	
1.5 TDCi	55	02/14→						
1.5 TDCi	70	05/15→						
1.6 TDCi	70	02/14→			13.0470-2784.2	LD2784	TRW 25134 17,2 - WE / - WK + Zub Ceramic	
↓								







	kw					! #		
FORD - TRANSIT COURIER Kasten 02/14→								
 Bremsscheibe								
1.0 EcoBoost 1.5 TDCi 1.5 TDCi 1.6 TDCi	74 55 70 70	02/14→ 02/14→ 05/15→ 02/14→	←	für Leichtmetallfelgen		24.0123-0122.1	423122	∅ 278 23 21 V
FORD - TRANSIT COURIER Kombi 02/14→								
 Bremsbelagsatz, Scheibenbremse								
1.0 EcoBoost 1.5 TDCi 1.5 TDCi 1.6 TDCi	74 55 70 70	02/14→ 02/14→ 05/15→ 02/14→	←			13.0460-2784.2	602784	TRW 25134 17,2 - WE / - WK + Zub
						13.0470-2784.2	LD2784	TRW 25134 17,2 - WE / - WK + Zub Ceramic
 Bremsscheibe								
1.0 EcoBoost 1.5 TDCi 1.5 TDCi 1.6 TDCi	74 55 70 70	02/14→ 02/14→ 05/15→ 02/14→	←	für Leichtmetallfelgen		24.0123-0122.1	423122	∅ 278 23 21 V
FORD - TRANSIT CUSTOM Bus 04/12→								
Warnkontakt, Bremsbelagverschleiß								
2.0 TDCi 2.0 TDCi 2.0 TDCi	77 96 125	12/15→ 12/15→ 12/15→	←	nicht für Baumuster: 330	1	24.8190-0021.2	620021	L= 478
			←	Baumuster: 330	1	24.8190-0026.2	620026	L= 312
			→		2	24.8190-0021.2	620021	L= 478
2.2 TDCi 2.2 TDCi 2.2 TDCi	74 92 114	04/12→ 04/12→ 04/12→	←	05/12→; nicht für Baumuster: 330	1	24.8190-0021.2	620021	L= 478
			←	05/12→; Baumuster: 330	1	24.8190-0026.2	620026	L= 312
			→	05/12→	2	24.8190-0021.2	620021	L= 478
 Bremsscheibe								
2.0 TDCi 2.0 TDCi 2.0 TDCi	77 96 125	12/15→ 12/15→ 12/15→	←	nicht für Baumuster: 290S Sport / 330		24.0133-0101.1	433101	∅ 288 33 30 V + S
			←	Baumuster: 330		24.0133-0102.1	433102	∅ 308 33 30 V + S
			←	Baumuster: 290S Sport; → 04/16		24.0133-0102.1	433102	∅ 308 33 30 V + S
2.2 TDCi 2.2 TDCi 2.2 TDCi	74 92 114	04/12→ 04/12→ 04/12→	←	05/12→; nicht für Baumuster: 330 / 290S Sport		24.0133-0101.1	433101	∅ 288 33 30 V + S
			←	05/12→ 04/16; Baumuster: 290S Sport		24.0133-0102.1	433102	∅ 308 33 30 V + S
			←	05/12→; Baumuster: 330		24.0133-0102.1	433102	∅ 308 33 30 V + S
FORD - TRANSIT CUSTOM Kasten 04/12→								
Warnkontakt, Bremsbelagverschleiß								
2.0 TDCi 2.0 TDCi 2.0 TDCi	77 96 125	12/15→ 12/15→ 12/15→	←	nicht für Baumuster: 330	1	24.8190-0021.2	620021	L= 478
			←	Baumuster: 330	1	24.8190-0026.2	620026	L= 312
			→		2	24.8190-0021.2	620021	L= 478
2.2 TDCi 2.2 TDCi 2.2 TDCi	74 92 114	04/12→ 04/12→ 04/12→	←	05/12→; nicht für Baumuster: 330	1	24.8190-0021.2	620021	L= 478
			←	05/12→; Baumuster: 330	1	24.8190-0026.2	620026	L= 312
			→	05/12→	2	24.8190-0021.2	620021	L= 478
 Bremsscheibe								
2.0 TDCi 2.0 TDCi 2.0 TDCi	77 96 125	12/15→ 12/15→ 12/15→	←	nicht für Baumuster: 290S Sport / 330		24.0133-0101.1	433101	∅ 288 33 30 V + S
			←	Baumuster: 330		24.0133-0102.1	433102	∅ 308 33 30 V + S
			←	→ 04/16; Baumuster: 290S Sport		24.0133-0102.1	433102	∅ 308 33 30 V + S
2.2 TDCi 2.2 TDCi 2.2 TDCi	74 92 114	04/12→ 04/12→ 04/12→	←	05/12→; nicht für Baumuster: 330 / 290S Sport		24.0133-0101.1	433101	∅ 288 33 30 V + S
			←	05/12→ 04/16; Baumuster: 290S Sport		24.0133-0102.1	433102	∅ 308 33 30 V + S
			←	05/12→; Baumuster: 330		24.0133-0102.1	433102	∅ 308 33 30 V + S
FORD - TRANSIT Kasten 04/06→								
 Bremsbelagsatz, Scheibenbremse								
2.2 TDCi 2.2 TDCi 2.2 TDCi	63 81 96	04/06→08/14 04/06→08/14 04/06→08/14	←	05/06→; Baumuster: 260/280/300; → 04/14		13.0460-3833.2	603833	BOS 24485 19,0 + WK + Zub
			←	05/06→; Baumuster: 330/350; → 04/14		13.0460-3834.2	603834	BOS 24484 19,0 + WK + Zub
			→	05/06→ 04/14; für Einfachbereifung		13.0460-3835.2	603835	BOS 24486 17,9 + WK + Zub
2.2 TDCi 2.2 TDCi ↓	74 85	10/11→08/14 10/08→08/14	←	Baumuster: 260/280/300; → 04/14		13.0460-3833.2	603833	BOS 24485 19,0 + WK + Zub













	kw			 	! #		
FORD - TRANSIT Kasten 04/06→							
Bremsbelagsatz, Scheibenbremse							
2.2 TDCi	92	10/11→08/14	←	Baumuster: 330/350; → 04/14		13.0460-3834.2 603834	BOS 24484 19,0 + WK + Zub
2.2 TDCi	103	10/07→08/14	→	→ 04/14; für Einfachbereifung		13.0460-3835.2 603835	BOS 24486 17,9 + WK + Zub
2.2 TDCi [RWD]	74	10/11→08/14	←	→ 04/14		13.0460-3834.2 603834	BOS 24484 19,0 + WK + Zub
2.2 TDCi [RWD]	92	10/11→08/14	→	→ 04/14; für Einfachbereifung		13.0460-3835.2 603835	BOS 24486 17,9 + WK + Zub
2.2 TDCi [RWD]	100	10/11→08/14	→	→ 04/14; für Einfachbereifung		13.0460-3835.2 603835	BOS 24486 17,9 + WK + Zub
2.2 TDCi [RWD]	114	10/11→08/14	→	→ 04/14; für Einfachbereifung		13.0460-3835.2 603835	BOS 24486 17,9 + WK + Zub
2.2 TDCi 4x4	92	10/11→08/14	→	→ 04/14; für Einfachbereifung		13.0460-3835.2 603835	BOS 24486 17,9 + WK + Zub
2.4 TDCi 4x4	103	11/06→08/14	→	→ 04/14; für Einfachbereifung		13.0460-3835.2 603835	BOS 24486 17,9 + WK + Zub
3.2 TDCi [RWD]	147	09/07→08/14	→	→ 04/14; für Einfachbereifung		13.0460-3835.2 603835	BOS 24486 17,9 + WK + Zub
2.3 16V [RWD]	107	04/06→08/14	←	05/06→ 04/14		13.0460-3834.2 603834	BOS 24484 19,0 + WK + Zub
2.3 16V CNG [RWD]	100	04/06→08/14	→	05/06→ 04/14; für Einfachbereifung		13.0460-3835.2 603835	BOS 24486 17,9 + WK + Zub
2.3 16V LPG [RWD]	107	04/06→08/14	→	05/06→ 04/14; für Doppelbereifung		13.0460-4862.2 604862	BRE 29123 20,3 + WK + Zub
2.4 TDCi [RWD]	74	04/06→08/14	←	05/06→ 04/14		13.0460-3834.2 603834	BOS 24484 19,0 + WK + Zub
2.4 TDCi [RWD]	85	04/06→08/14	→	→ 04/14; für Einfachbereifung		13.0460-3835.2 603835	BOS 24486 17,9 + WK + Zub
2.4 TDCi [RWD]	103	04/06→08/14	→	→ 04/14; für Einfachbereifung		13.0460-3835.2 603835	BOS 24486 17,9 + WK + Zub
Bremsscheibe							
2.2 TDCi	63	04/06→08/14	←	05/06→; Baumuster: 260/280/300; → 04/14		24.0128-0156.1 428156	Ø 280 28 25 V + S
2.2 TDCi	81	04/06→08/14	←	05/06→; Baumuster: 330/350; → 04/14		24.0128-0157.1 428157	Ø 300 28 25 V + S
2.2 TDCi	96	04/06→08/14	→	05/06→ 04/14		24.0116-0116.2 416116	Ø 280 16 13 + ABS Ring
2.2 TDCi	74	10/11→08/14	←	Baumuster: 260/280/300; → 04/14		24.0128-0156.1 428156	Ø 280 28 25 V + S
2.2 TDCi	85	10/08→08/14	←	Baumuster: 330/350; → 04/14		24.0128-0157.1 428157	Ø 300 28 25 V + S
2.2 TDCi	92	10/11→08/14	←	Baumuster: 330/350; → 04/14		24.0128-0157.1 428157	Ø 300 28 25 V + S
2.2 TDCi	103	10/07→08/14	→	→ 04/14		24.0116-0116.2 416116	Ø 280 16 13 + ABS Ring
2.2 TDCi [RWD]	74	10/11→08/14	←	→ 04/14; mit Einfachbereifung		24.0128-0157.1 428157	Ø 300 28 25 V + S
2.2 TDCi [RWD]	92	10/11→08/14	←	→ 04/14; mit Einfachbereifung		24.0128-0157.1 428157	Ø 300 28 25 V + S
2.2 TDCi [RWD]	100	10/11→08/14	←	→ 04/14; mit Doppelbereifung		24.0128-0293.1 428293	Ø 300 28 24 V
2.2 TDCi [RWD]	114	10/11→08/14	→	→ 04/14		24.0116-0126.1 416126	Ø 280 16 13
2.2 TDCi 4x4	92	10/11→08/14	→	→ 04/14		24.0116-0126.1 416126	Ø 280 16 13
2.4 TDCi 4x4	103	11/06→08/14	→	→ 04/14		24.0116-0126.1 416126	Ø 280 16 13
3.2 TDCi [RWD]	147	09/07→08/14	→	→ 04/14		24.0116-0126.1 416126	Ø 280 16 13
2.3 16V [RWD]	107	04/06→08/14	←	05/06→ 04/14		24.0128-0293.1 428293	Ø 300 28 24 V
2.3 16V CNG [RWD]	100	04/06→08/14	→	05/06→; mit Einfachbereifung; → 04/14		24.0116-0126.1 416126	Ø 280 16 13
2.3 16V LPG [RWD]	107	04/06→08/14	→	11/07→; mit Doppelbereifung; → 04/14		24.0116-0134.1 416134	Ø 284 16 13
2.4 TDCi [RWD]	74	04/06→08/14	←	05/06→ 04/14; mit Einfachbereifung		24.0128-0157.1 428157	Ø 300 28 25 V + S
2.4 TDCi [RWD]	85	04/06→08/14	←	05/06→ 04/14; mit Einfachbereifung		24.0128-0157.1 428157	Ø 300 28 25 V + S
2.4 TDCi [RWD]	103	04/06→08/14	→	05/06→ 04/14; mit Doppelbereifung		24.0128-0293.1 428293	Ø 300 28 24 V
			→	05/06→ 04/14		24.0116-0126.1 416126	Ø 280 16 13
FORD - TRANSIT Kasten 08/13→							
Warnkontakt, Bremsbelagverschleiß							
2.0 TDCi	77	03/16→	←		2	24.8190-0026.2 620026	L= 312
2.0 TDCi	96	03/16→	←				
2.0 TDCi	125	03/16→	←				
2.0 TDCi [RWD]	77	03/16→	←				
2.0 TDCi [RWD]	96	03/16→	←				
2.0 TDCi [RWD]	125	03/16→	←				
2.0 TDCi 4x4	96	01/17→	←				
2.0 TDCi 4x4	125	01/17→	←				
2.2 TDCi	74	08/13→	←	05/14→	2	24.8190-0026.2 620026	L= 312
2.2 TDCi	92	08/13→	←				
2.2 TDCi	114	08/13→	←				
2.2 TDCi [RWD]	74	08/13→	←				
2.2 TDCi [RWD]	92	08/13→	←				
2.2 TDCi [RWD]	99	08/13→	←				
2.2 TDCi [RWD]	114	08/13→	←				
2.2 TDCi 4x4	92	08/13→	←				
2.2 TDCi 4x4	114	08/13→	←				
Bremsscheibe							
2.0 TDCi	77	03/16→	←	Baumuster: 10/60/70/80/90/250 / 300; für Einfachbereifung		24.0133-0101.1 433101	Ø 288 33 30 V + S
2.0 TDCi	96	03/16→	←	Baumuster: 10/60/70/80/90/250 / 300; für Einfachbereifung		24.0133-0101.1 433101	Ø 288 33 30 V + S
2.0 TDCi	125	03/16→	←	Baumuster: 330/350/390/410/470; für Einfachbereifung		24.0133-0102.1 433102	Ø 308 33 30 V + S
2.0 TDCi [RWD]	77	03/16→	←	Baumuster: 10/60/70/80/90/250 / 300; für Einfachbereifung		24.0133-0101.1 433101	Ø 288 33 30 V + S
2.0 TDCi [RWD]	96	03/16→	←	Baumuster: 10/60/70/80/90/250 / 300; für Einfachbereifung		24.0133-0101.1 433101	Ø 288 33 30 V + S
2.0 TDCi [RWD]	125	03/16→	←	Baumuster: 330/350/390/410/470; für Einfachbereifung		24.0133-0102.1 433102	Ø 308 33 30 V + S
2.0 TDCi 4x4	96	01/17→	←	Baumuster: 10/60/70/80/90/250 / 300; für Einfachbereifung		24.0133-0101.1 433101	Ø 288 33 30 V + S
2.0 TDCi 4x4	125	01/17→	←	Baumuster: 330/350/390/410/470; für Einfachbereifung		24.0133-0102.1 433102	Ø 308 33 30 V + S
2.2 TDCi	74	08/13→	←	05/14→; Baumuster: 10/60/70/80/90/250 / 300; für Einfachbereifung		24.0133-0101.1 433101	Ø 288 33 30 V + S
2.2 TDCi	92	08/13→	←	05/14→; Baumuster: 10/60/70/80/90/250 / 300; für Einfachbereifung		24.0133-0101.1 433101	Ø 288 33 30 V + S
2.2 TDCi	114	08/13→	←	05/14→; Baumuster: 10/60/70/80/90/250 / 300; für Einfachbereifung		24.0133-0101.1 433101	Ø 288 33 30 V + S
2.2 TDCi [RWD]	74	08/13→	←	05/14→; Baumuster: 10/60/70/80/90/250 / 300; für Einfachbereifung		24.0133-0101.1 433101	Ø 288 33 30 V + S











	kw			 	! #			
FORD - TRANSIT Kasten 08/13→								
 Bremsscheibe								
2.2 TDCi [RWD]	92	08/13→	←	05/14→;		24.0133-0102.1	433102	Ø 308 33 30 V + S
2.2 TDCi [RWD]	99	08/13→		Baumuster: 330/350/390/410/470;				
2.2 TDCi [RWD]	114	08/13→		für Einfachbereifung				
2.2 TDCi 4x4	92	08/13→						
2.2 TDCi 4x4	114	08/13→						
FORD - TRANSIT Kasten (E_) 06/94→07/00								
 Bremsbelagsatz, Scheibenbremse								
2.0 (EAL, EAS)	84	06/94→03/00	←	passend für Felgenreöße [Zoll]: 15		13.0460-3959.2	603959	BDX 21469 18,0 + WE / - WK
2.5 DI (EAL, EAS)	51	06/94→03/00						
2.5 DI (EAL, EAS)	56	06/94→03/00	←	passend für Felgenreöße [Zoll]: 14		13.0460-3960.2	603960	BDX 21470 18,0 + WE / - WK
2.5 DI (EAL, EAS)	85	05/99→03/00						
2.5 TD (EAL, EAS)	63	06/94→03/00						
2.5 TD (EAS)	55	10/98→03/00						
2.5 TDI (EAL, EAS)	74	06/94→03/00						
Zubehörsatz, Scheibenbremsbelag								
2.0 (EAL, EAS)	84	06/94→03/00	←	passend für Felgenreöße [Zoll]: 14		13.0460-0427.2	610427	BDX
2.5 DI (EAL, EAS)	51	06/94→03/00						
2.5 DI (EAL, EAS)	56	06/94→03/00	←	passend für Felgenreöße [Zoll]: 15		13.0460-0427.2	610427	BDX
2.5 DI (EAL, EAS)	85	05/99→03/00						
2.5 TD (EAL, EAS)	63	06/94→03/00						
2.5 TD (EAS)	55	10/98→03/00						
2.5 TDI (EAL, EAS)	74	06/94→03/00						
 Bremsscheibe								
2.0 (EAL, EAS)	84	06/94→03/00	←	passend für Felgenreöße [Zoll]: 14		24.0124-0131.1	424131	Ø 254 24,2 22,2 V
2.5 DI (EAL, EAS)	51	06/94→03/00						
2.5 DI (EAL, EAS)	56	06/94→03/00	←	passend für Felgenreöße [Zoll]: 15		24.0124-0132.1	424132	Ø 270 24,2 22,2 V
2.5 DI (EAL, EAS)	85	05/99→03/00						
2.5 TD (EAL, EAS)	63	06/94→03/00						
2.5 TD (EAS)	55	10/98→03/00						
2.5 TDI (EAL, EAS)	74	06/94→03/00						
FORD - TRANSIT Kasten (FA_) 01/00→05/06								
 Bremsbelagsatz, Scheibenbremse								
2.0 DI (FAE_ , FAF_ , FAG_)	55	08/00→05/06	←	→ 04/06; Baumuster: 260/280/300		13.0460-3992.2	603992	BOS 23434 18,7 + WK
2.0 DI (FAE_ , FAF_ , FAG_)	63	08/00→05/06	←	→ 04/06; Baumuster: 330/350		13.0460-3993.2	603993	BOS 23577 18,7 + WK
2.0 DI (FAE_ , FAF_ , FAG_)	74	08/00→05/06						
2.0 TDCi	92	08/02→05/06						
2.3	105	03/01→03/06	←	04/01→; Baumuster: 260/280/300		13.0460-3992.2	603992	BOS 23434 18,7 + WK
2.3	107	03/01→03/06	←	04/01→; Baumuster: 330/350		13.0460-3993.2	603993	BOS 23577 18,7 + WK
2.3 16V [RWD] (FAA_ , FAB_ , FAC_)	107	04/01→05/06	←	→ 04/06		13.0460-3993.2	603993	BOS 23577 18,7 + WK
2.4 DI (FAA_ , FAB_ , FAC_ , FAD_)	66	01/00→05/06						
2.4 DI [RWD] (FAA_ , FAB_ , FAC_ , FAD_)	55	01/00→05/06						
2.4 DI [RWD] (FAA_ , FAB_ , FAC_ , FAD_)	88	01/00→05/06						
2.4 TD Allrad	55	08/00→08/03	←			13.0460-3993.2	603993	BOS 23577 18,7 + WK
2.4 TDCi	101	03/04→05/06	←	→ 04/06; Baumuster: 260/280/300		13.0460-3992.2	603992	BOS 23434 18,7 + WK
2.4 TDE	85	03/04→05/06	←	→ 04/06		13.0460-3993.2	603993	BOS 23577 18,7 + WK
			←	→ 04/06; Baumuster: 330/350		13.0460-3993.2	603993	BOS 23577 18,7 + WK
2.4 Tddi	88	08/00→08/03	←	Baumuster: 260/280/300		13.0460-3992.2	603992	BOS 23434 18,7 + WK
			←	Baumuster: 330/350		13.0460-3993.2	603993	BOS 23577 18,7 + WK
2.4 TDE	92	07/01→05/06	←	11/01→ 04/06; Baumuster: 260/280/300		13.0460-3992.2	603992	BOS 23434 18,7 + WK
			←	11/01→ 04/06		13.0460-3993.2	603993	BOS 23577 18,7 + WK
			←	11/01→ 04/06; Baumuster: 330/350		13.0460-3993.2	603993	BOS 23577 18,7 + WK
 Bremsscheibe								
2.0 DI (FAE_ , FAF_ , FAG_)	55	08/00→05/06	←	→ 04/06; Baumuster: 260/280/300		24.0124-0167.1	424167	Ø 276 24,5 22,1 V
2.0 DI (FAE_ , FAF_ , FAG_)	63	08/00→05/06	←	→ 04/06; Baumuster: 330/350		24.0124-0168.1	424168	Ø 294 24,5 22,1 V
2.0 DI (FAE_ , FAF_ , FAG_)	74	08/00→05/06						
2.0 TDCi	92	08/02→05/06						
2.3	105	03/01→03/06	←	04/01→; Baumuster: 260/280/300		24.0124-0167.1	424167	Ø 276 24,5 22,1 V
2.3	107	03/01→03/06						
↓								



























	kw			 	! #			
FORD - TRANSIT Kasten (FA_) 01/00→05/06								
 Bremsscheibe								
2.3	105	03/01→03/06	←	04/01→; Baumuster: 330/350		24.0124-0168.1	424168	Ø 294 24,5 22,1 V
2.3	107	03/01→03/06	←					
2.3 16V [RWD] (FAA_, FAB_, FAC_)	107	04/01→05/06	←	→ 04/06		24.0124-0168.1	424168	Ø 294 24,5 22,1 V
2.4 DI (FAA_, FAB_, FAC_, FAD_)	66	01/00→05/06						
2.4 DI [RWD] (FAA_, FAB_, FAC_, FAD_)	55	01/00→05/06						
2.4 DI [RWD] (FAA_, FAB_, FAC_, FAD_)	88	01/00→05/06						
2.4 TD Allrad	55	08/00→08/03	←			24.0124-0168.1	424168	Ø 294 24,5 22,1 V
2.4 TDCi	101	03/04→05/06	←	→ 04/06; Baumuster: 260/280/300		24.0124-0167.1	424167	Ø 276 24,5 22,1 V
2.4 TDE	85	03/04→05/06	←	→ 04/06		24.0124-0168.1	424168	Ø 294 24,5 22,1 V
			←	→ 04/06; Baumuster: 330/350		24.0124-0168.1	424168	Ø 294 24,5 22,1 V
2.4 TDi	88	08/00→08/03	←	Baumuster: 260/280/300		24.0124-0167.1	424167	Ø 276 24,5 22,1 V
			←	Baumuster: 330/350		24.0124-0168.1	424168	Ø 294 24,5 22,1 V
2.4 TDE	92	07/01→05/06	←	11/01→ 04/06; Baumuster: 260/280/300		24.0124-0167.1	424167	Ø 276 24,5 22,1 V
			←	11/01→ 04/06		24.0124-0168.1	424168	Ø 294 24,5 22,1 V
			←	11/01→ 04/06; Baumuster: 330/350		24.0124-0168.1	424168	Ø 294 24,5 22,1 V
FORD - TRANSIT Pritsche/Fahrgestell 04/06→08/14								
 Bremsbelagsatz, Scheibenbremse								
2.2 TDCi	63	04/06→08/14	←	05/06→; Baumuster: 260/280/300;		13.0460-3833.2	603833	BOS 24485 19,0 + WK + Zub
2.2 TDCi	81	04/06→08/14		→ 04/14				
2.2 TDCi	96	04/06→08/14	←	05/06→; Baumuster: 330/350; → 04/14		13.0460-3834.2	603834	BOS 24484 19,0 + WK + Zub
			→	05/06→ 04/14; für Einfachbereifung		13.0460-3835.2	603835	BOS 24486 17,9 + WK + Zub
2.2 TDCi	74	10/11→08/14	←	Baumuster: 260/280/300; → 04/14		13.0460-3833.2	603833	BOS 24485 19,0 + WK + Zub
2.2 TDCi	85	10/08→08/14	←	Baumuster: 330/350; → 04/14		13.0460-3834.2	603834	BOS 24484 19,0 + WK + Zub
2.2 TDCi	92	10/11→08/14	→	→ 04/14; für Einfachbereifung		13.0460-3835.2	603835	BOS 24486 17,9 + WK + Zub
2.2 TDCi	103	10/07→09/11	←	Baumuster: 260/280/300		13.0460-3833.2	603833	BOS 24485 19,0 + WK + Zub
			←	Baumuster: 330/350		13.0460-3834.2	603834	BOS 24484 19,0 + WK + Zub
			→	für Einfachbereifung		13.0460-3835.2	603835	BOS 24486 17,9 + WK + Zub
2.2 TDCi [RWD]	74	10/11→08/14	←	→ 04/14		13.0460-3834.2	603834	BOS 24484 19,0 + WK + Zub
2.2 TDCi [RWD]	92	10/11→08/14	→	→ 04/14; für Einfachbereifung		13.0460-3835.2	603835	BOS 24486 17,9 + WK + Zub
2.2 TDCi [RWD]	114	10/11→08/14						
2.2 TDCi 4x4	92	10/11→08/14	→					
2.4 TDCi 4x4	103	11/06→08/14						
3.2 TDCi [RWD]	147	09/07→08/14						
2.3 16V [RWD]	107	04/06→08/14	←	05/06→ 04/14		13.0460-3834.2	603834	BOS 24484 19,0 + WK + Zub
2.3 16V CNG [RWD]	100	04/06→08/14	→	05/06→ 04/14; für Einfachbereifung		13.0460-3835.2	603835	BOS 24486 17,9 + WK + Zub
2.3 16V LPG [RWD]	107	04/06→08/14	→	05/06→ 04/14; für Doppelbereifung		13.0460-4862.2	604862	BRE 29123 20,3 + WK + Zub
2.4 TDCi [RWD]	74	04/06→08/14	←	05/06→ 04/14		13.0460-3834.2	603834	BOS 24484 19,0 + WK + Zub
2.4 TDCi [RWD]	85	04/06→08/14	→	05/06→ 04/14; für Einfachbereifung		13.0460-3835.2	603835	BOS 24486 17,9 + WK + Zub
2.4 TDCi [RWD]	103	04/06→08/14						
 Bremsscheibe								
2.2 TDCi	63	04/06→08/14	←	05/06→; Baumuster: 260/280/300;		24.0128-0156.1	428156	Ø 280 28 25 V + S
2.2 TDCi	81	04/06→08/14		→ 04/14				
2.2 TDCi	96	04/06→08/14	←	05/06→; Baumuster: 330/350; → 04/14		24.0128-0157.1	428157	Ø 300 28 25 V + S
			→	05/06→ 04/14		24.0116-0116.2	416116	Ø 280 16 13 + ABS Ring
2.2 TDCi	74	10/11→08/14	←	Baumuster: 260/280/300; → 04/14		24.0128-0156.1	428156	Ø 280 28 25 V + S
2.2 TDCi	85	10/08→08/14	←	Baumuster: 330/350; → 04/14		24.0128-0157.1	428157	Ø 300 28 25 V + S
2.2 TDCi	92	10/11→08/14	→	→ 04/14		24.0116-0116.2	416116	Ø 280 16 13 + ABS Ring
2.2 TDCi	103	10/07→09/11	←	Baumuster: 260/280/300		24.0128-0156.1	428156	Ø 280 28 25 V + S
			←	Baumuster: 330/350		24.0128-0157.1	428157	Ø 300 28 25 V + S
			→			24.0116-0116.2	416116	Ø 280 16 13 + ABS Ring
2.2 TDCi [RWD]	74	10/11→08/14	←	→ 04/14; mit Einfachbereifung		24.0128-0157.1	428157	Ø 300 28 25 V + S
2.2 TDCi [RWD]	92	10/11→08/14	←	→ 04/14; mit Doppelbereifung		24.0128-0293.1	428293	Ø 300 28 24 V
2.2 TDCi [RWD]	114	10/11→08/14						
2.2 TDCi 4x4	92	10/11→08/14	→	→ 04/14		24.0116-0126.1	416126	Ø 280 16 13
2.4 TDCi 4x4	103	11/06→08/14						
3.2 TDCi [RWD]	147	09/07→08/14						
2.3 16V [RWD]	107	04/06→08/14	←	05/06→ 04/14		24.0128-0293.1	428293	Ø 300 28 24 V
2.3 16V CNG [RWD]	100	04/06→08/14						
↓								















	kw					! #		
FORD - TRANSIT Pritsche/Fahrgestell 04/06→08/14								
Bremsscheibe								
2.3 16V LPG [RWD]	107	04/06→08/14	➔	05/06→; mit Einfachbereifung; → 04/14		24.0116-0126.1	416126	Ø 280 16 13
			➔	11/07→; mit Doppelbereifung; → 04/14		24.0116-0134.1	416134	Ø 284 16 13
2.4 TDCi [RWD]	74	04/06→08/14	➔	05/06→ 04/14; mit Einfachbereifung		24.0128-0157.1	428157	Ø 300 28 25 V + S
2.4 TDCi [RWD]	85	04/06→08/14	➔	05/06→ 04/14; mit Doppelbereifung		24.0128-0293.1	428293	Ø 300 28 24 V
2.4 TDCi [RWD]	103	04/06→08/14	➔	05/06→ 04/14		24.0116-0126.1	416126	Ø 280 16 13
FORD - TRANSIT Pritsche/Fahrgestell 08/13→								
Warnkontakt, Bremsbelagverschleiß								
2.0 TDCi	77	03/16→	➔		2	24.8190-0026.2	620026	L= 312
2.0 TDCi	96	03/16→						
2.0 TDCi	125	03/16→						
2.0 TDCi [RWD]	77	03/16→						
2.0 TDCi [RWD]	96	03/16→						
2.0 TDCi [RWD]	125	03/16→						
2.0 TDCi 4x4	96	01/17→						
2.0 TDCi 4x4	125	01/17→						
2.2 TDCi	74	08/13→	➔	05/14→	2	24.8190-0026.2	620026	L= 312
2.2 TDCi	92	08/13→						
2.2 TDCi	114	08/13→						
2.2 TDCi [RWD]	74	08/13→						
2.2 TDCi [RWD]	92	08/13→						
2.2 TDCi [RWD]	99	08/13→						
2.2 TDCi [RWD]	114	08/13→						
2.2 TDCi 4x4	92	08/13→						
2.2 TDCi 4x4	114	08/13→						
Bremsscheibe								
2.0 TDCi	77	03/16→	➔	Baumuster: 10/60/70/80/90/250 / 300; für Einfachbereifung		24.0133-0101.1	433101	Ø 288 33 30 V + S
2.0 TDCi	96	03/16→						
2.0 TDCi	125	03/16→	➔	Baumuster: 330/350/390/410/470; für Einfachbereifung		24.0133-0102.1	433102	Ø 308 33 30 V + S
2.0 TDCi [RWD]	77	03/16→						
2.0 TDCi [RWD]	96	03/16→						
2.0 TDCi [RWD]	125	03/16→						
2.0 TDCi 4x4	96	01/17→						
2.0 TDCi 4x4	125	01/17→						
2.2 TDCi	74	08/13→	➔	05/14→; Baumuster: 10/60/70/80/90/250 / 300; für Einfachbereifung		24.0133-0101.1	433101	Ø 288 33 30 V + S
2.2 TDCi	92	08/13→						
2.2 TDCi	114	08/13→						
2.2 TDCi [RWD]	74	08/13→	➔	05/14→; Baumuster: 330/350/390/410/470; für Einfachbereifung		24.0133-0102.1	433102	Ø 308 33 30 V + S
2.2 TDCi [RWD]	92	08/13→						
2.2 TDCi [RWD]	99	08/13→						
2.2 TDCi [RWD]	114	08/13→						
2.2 TDCi 4x4	92	08/13→						
2.2 TDCi 4x4	114	08/13→						
FORD - TRANSIT Pritsche/Fahrgestell (E_ _) 08/94→07/00								
Bremsbelagsatz, Scheibenbremse								
2.0 (EME/L/S, ENE/L/S)	84	08/94→03/00	➔	passend für Felgengröße [Zoll]: 15		13.0460-3959.2	603959	BDX 21469 18,0 + WE / - WK
2.5 DI (EME/L/S, ENE/L/S)	56	08/94→03/00	➔	passend für Felgengröße [Zoll]: 14		13.0460-3960.2	603960	BDX 21470 18,0 + WE / - WK
2.5 DI (EML, ENE/L)	85	05/99→03/00						
2.5 DI (EML/S, ENL/S)	51	08/94→03/00						
2.5 TD (EME/L/S, ENE/L/S)	63	08/94→03/00						
2.5 TD (EME/L/S, ENE/L/S)	74	08/94→03/00						
2.5 TD (EME/L/S, ENE/L/S)	55	10/98→07/00	➔	→ 03/00; passend für Felgengröße [Zoll]: 15		13.0460-3959.2	603959	BDX 21469 18,0 + WE / - WK
			➔	→ 03/00; passend für Felgengröße [Zoll]: 14		13.0460-3960.2	603960	BDX 21470 18,0 + WE / - WK
Zubehörsatz, Scheibenbremsbelag								
2.0 (EME/L/S, ENE/L/S)	84	08/94→03/00	➔	passend für Felgengröße [Zoll]: 14		13.0460-0427.2	610427	BDX
2.5 DI (EME/L/S, ENE/L/S)	56	08/94→03/00	➔	passend für Felgengröße [Zoll]: 15		13.0460-0427.2	610427	BDX
2.5 DI (EML, ENE/L)	85	05/99→03/00						
2.5 DI (EML/S, ENL/S)	51	08/94→03/00						
2.5 TD (EME/L/S, ENE/L/S)	63	08/94→03/00						
2.5 TD (EME/L/S, ENE/L/S)	74	08/94→03/00						
2.5 TD (EME/L/S, ENE/L/S)	55	10/98→07/00	➔	→ 03/00; passend für Felgengröße [Zoll]: 14		13.0460-0427.2	610427	BDX
			➔	→ 03/00; passend für Felgengröße [Zoll]: 15		13.0460-0427.2	610427	BDX
↓								

















	kw					! #		
FORD - TRANSIT Pritsche/Fahrgestell (E_ _) 08/94→07/00								
 Bremsscheibe								
2.0 (EME/L/S, ENE/L/S)	84	08/94→03/00	←	passend für Felgenreöße [Zoll]: 14		24.0124-0131.1	424131	Ø 254 24,2 22,2 V
2.5 DI (EME/L/S, ENE/L/S)	56	08/94→03/00	←	passend für Felgenreöße [Zoll]: 15		24.0124-0132.1	424132	Ø 270 24,2 22,2 V
2.5 DI (EML, ENE/L)	85	05/99→03/00						
2.5 DI (EML/S, ENL/S)	51	08/94→03/00						
2.5 TD (EME/L/S, ENE/L/S)	63	08/94→03/00						
2.5 TD (EME/L/S, ENE/L/S)	74	08/94→03/00						
2.5 TD (EME/L/S, ENE/L/S)	55	10/98→07/00	←	→ 03/00; passend für Felgenreöße [Zoll]: 14		24.0124-0131.1	424131	Ø 254 24,2 22,2 V
			←	→ 03/00; passend für Felgenreöße [Zoll]: 15		24.0124-0132.1	424132	Ø 270 24,2 22,2 V
FORD - TRANSIT Pritsche/Fahrgestell (FM_ _, FN_ _) 01/00→05/06								
 Bremsbelagsatz, Scheibenbremse								
2.0 DI (F_E_ _, F_F_ _)	55	08/00→05/06	←	→ 04/06; Baumuster: 260/280/300		13.0460-3992.2	603992	BOS 23434 18,7 + WK
2.0 DI (F_E_ _, F_F_ _)	63	08/00→05/06						
2.0 DI (F_E_ _, F_F_ _)	74	08/00→05/06	←	→ 04/06; Baumuster: 330/350		13.0460-3993.2	603993	BOS 23577 18,7 + WK
2.0 TDCi (F_E_ _, F_F_ _)	92	08/02→05/06						
2.3	105	03/01→03/06	←			13.0460-3993.2	603993	BOS 23577 18,7 + WK
2.3 BiFuel	105	03/01→03/06						
2.3 16V (F_A_ _, F_B_ _, F_C_ _, F_D_ _)	107	04/01→05/06	←	→ 04/06		13.0460-3993.2	603993	BOS 23577 18,7 + WK
2.4 DI (F_A_ _, F_B_ _, F_C_ _, F_D_ _)	55	01/00→05/06						
2.4 DI (F_A_ _, F_B_ _, F_C_ _, F_D_ _)	66	01/00→05/06						
2.4 DI (F_A_ _, F_B_ _, F_C_ _, F_D_ _)	88	01/00→05/06						
2.4 TDCi	101	03/04→05/06						
2.4 TDE	85	03/04→05/06						
2.4 TDE	92	07/01→05/06	←	11/01→ 04/06		13.0460-3993.2	603993	BOS 23577 18,7 + WK
 Bremsscheibe								
2.0 DI (F_E_ _, F_F_ _)	55	08/00→05/06	←	→ 04/06; Baumuster: 260/280/300		24.0124-0167.1	424167	Ø 276 24,5 22,1 V
2.0 DI (F_E_ _, F_F_ _)	63	08/00→05/06						
2.0 DI (F_E_ _, F_F_ _)	74	08/00→05/06	←	→ 04/06; Baumuster: 330/350		24.0124-0168.1	424168	Ø 294 24,5 22,1 V
2.0 TDCi (F_E_ _, F_F_ _)	92	08/02→05/06						
2.3	105	03/01→03/06	←			24.0124-0168.1	424168	Ø 294 24,5 22,1 V
2.3 BiFuel	105	03/01→03/06						
2.3 16V (F_A_ _, F_B_ _, F_C_ _, F_D_ _)	107	04/01→05/06	←	→ 04/06		24.0124-0168.1	424168	Ø 294 24,5 22,1 V
2.4 DI (F_A_ _, F_B_ _, F_C_ _, F_D_ _)	55	01/00→05/06						
2.4 DI (F_A_ _, F_B_ _, F_C_ _, F_D_ _)	66	01/00→05/06						
2.4 DI (F_A_ _, F_B_ _, F_C_ _, F_D_ _)	88	01/00→05/06						
2.4 TDCi	101	03/04→05/06						
2.4 TDE	85	03/04→05/06						
2.4 TDE	92	07/01→05/06	←	11/01→ 04/06		24.0124-0168.1	424168	Ø 294 24,5 22,1 V
FORD - TRANSIT TOURNEO 07/06→08/14								
 Bremsbelagsatz, Scheibenbremse								
2.2 TDCi	81	07/06→08/14	←	Baumuster: 260/280/300; → 04/14		13.0460-3833.2	603833	BOS 24485 19,0 + WK + Zub
2.2 TDCi	85	10/08→08/14						
2.2 TDCi	96	07/06→08/14	←	Baumuster: 330/350; → 04/14		13.0460-3834.2	603834	BOS 24484 19,0 + WK + Zub
2.2 TDCi	103	10/07→08/14	→	→ 04/14; für Einfachbereifung		13.0460-3835.2	603835	BOS 24486 17,9 + WK + Zub
 Bremsscheibe								
2.2 TDCi	81	07/06→08/14	←	Baumuster: 260/280/300; → 04/14		24.0128-0156.1	428156	Ø 280 28 25 V + S
2.2 TDCi	85	10/08→08/14						
2.2 TDCi	96	07/06→08/14	←	Baumuster: 330/350; → 04/14		24.0128-0157.1	428157	Ø 300 28 25 V + S
2.2 TDCi	103	10/07→08/14	→	→ 04/14		24.0116-0116.2	416116	Ø 280 16 13 + ABS Ring
FORD - TRANSIT TOURNEO 08/94→12/00								
 Bremsbelagsatz, Scheibenbremse								
2.0	84	11/94→12/00	←	09/95→ 03/00; passend für Felgenreöße [Zoll]: 15		13.0460-3959.2	603959	BDX 21469 18,0 + WE / - WK
			←	09/95→ 03/00; passend für Felgenreöße [Zoll]: 14		13.0460-3960.2	603960	BDX 21470 18,0 + WE / - WK
2.4 D	55	08/94→06/00	←	→ 03/00; passend für Felgenreöße [Zoll]: 15		13.0460-3959.2	603959	BDX 21469 18,0 + WE / - WK
2.5 DI	51	11/94→12/00						
2.5 DI	56	11/94→12/00						

















	kw				! #		
FORD - TRANSIT TOURNEO 08/94→12/00							
 Bremsbelagsatz, Scheibenbremse							
2.5 TD	74	04/98→12/00	←	→ 03/00; passend für Felgengröße [Zoll]: 14		13.0460-3960.2 603960	BDX 21470 18,0 + WE / - WK
2.5 TD	63	11/94→12/00	←	01/95→ 03/00; passend für Felgengröße [Zoll]: 15		13.0460-3959.2 603959	BDX 21469 18,0 + WE / - WK
			←	01/95→ 03/00; passend für Felgengröße [Zoll]: 14		13.0460-3960.2 603960	BDX 21470 18,0 + WE / - WK
Zubehörsatz, Scheibenbremsbelag							
2.0	84	11/94→12/00	←	09/95→ 03/00; passend für Felgengröße [Zoll]: 14		13.0460-0427.2 610427	BDX
			←	09/95→ 03/00; passend für Felgengröße [Zoll]: 15		13.0460-0427.2 610427	BDX
2.4 D	55	08/94→06/00	←	→ 03/00; passend für Felgengröße [Zoll]: 14		13.0460-0427.2 610427	BDX
2.5 DI	51	11/94→12/00	←	→ 03/00; passend für Felgengröße [Zoll]: 14		13.0460-0427.2 610427	BDX
2.5 DI	56	11/94→12/00	←	→ 03/00; passend für Felgengröße [Zoll]: 15		13.0460-0427.2 610427	BDX
2.5 TD	74	04/98→12/00	←	→ 03/00; passend für Felgengröße [Zoll]: 15		13.0460-0427.2 610427	BDX
2.5 TD	63	11/94→12/00	←	01/95→ 03/00; passend für Felgengröße [Zoll]: 14		13.0460-0427.2 610427	BDX
			←	01/95→ 03/00; passend für Felgengröße [Zoll]: 15		13.0460-0427.2 610427	BDX
 Bremsscheibe							
2.0	84	11/94→12/00	←	09/95→ 03/00; passend für Felgengröße [Zoll]: 14		24.0124-0131.1 424131	Ø 254 24,2 22,2 V
			←	09/95→ 03/00; passend für Felgengröße [Zoll]: 15		24.0124-0132.1 424132	Ø 270 24,2 22,2 V
2.4 D	55	08/94→06/00	←	→ 03/00; passend für Felgengröße [Zoll]: 14		24.0124-0131.1 424131	Ø 254 24,2 22,2 V
2.5 DI	51	11/94→12/00	←	→ 03/00; passend für Felgengröße [Zoll]: 14		24.0124-0131.1 424131	Ø 254 24,2 22,2 V
2.5 DI	56	11/94→12/00	←	→ 03/00; passend für Felgengröße [Zoll]: 15		24.0124-0132.1 424132	Ø 270 24,2 22,2 V
2.5 TD	74	04/98→12/00	←	→ 03/00; passend für Felgengröße [Zoll]: 15		24.0124-0132.1 424132	Ø 270 24,2 22,2 V
2.5 TD	63	11/94→12/00	←	01/95→ 03/00; passend für Felgengröße [Zoll]: 14		24.0124-0131.1 424131	Ø 254 24,2 22,2 V
			←	01/95→ 03/00; passend für Felgengröße [Zoll]: 15		24.0124-0132.1 424132	Ø 270 24,2 22,2 V
FORD USA - PROBE II (ECP) 09/92→03/98							
 Bremsbelagsatz, Scheibenbremse							
2.0 16V	85	10/93→03/98	←	01/94→ 09/97		13.0460-5954.2 605954	SUM 23845 15,8 + WK
			→	01/94→ 09/97		13.0460-5973.2 605973	21766 13,5 - WE / - WK
2.5 V6 24V	119	10/93→03/98	←	→ 09/97		13.0460-5954.2 605954	SUM 23845 15,8 + WK
2.5 V6 24V	120	12/94→03/98	→	→ 09/97		13.0460-5973.2 605973	21766 13,5 - WE / - WK
Zubehörsatz, Scheibenbremsbelag							
2.0 16V	85	10/93→03/98	←	01/94→ 09/97		13.0460-0443.2 610443	SUM
			→	01/94→ 09/97		13.0460-0245.2 610245	
2.5 V6 24V	119	10/93→03/98	←	→ 09/97		13.0460-0443.2 610443	SUM
2.5 V6 24V	120	12/94→03/98	→	→ 09/97		13.0460-0245.2 610245	
 Bremsscheibe							
2.0 16V	85	10/93→03/98	←	01/94→ 09/97		24.0124-0129.1 424129	Ø 258 24 22 V
			→	01/94→ 09/97		24.0110-0234.1 410234	Ø 261 10 8
2.5 V6 24V	119	10/93→03/98	←	→ 09/97		24.0124-0129.1 424129	Ø 258 24 22 V
2.5 V6 24V	120	12/94→03/98	→	→ 09/97		24.0110-0234.1 410234	Ø 261 10 8
HONDA - ACCORD V (CC, CD) 06/92→12/97							
 Bremsbelagsatz, Scheibenbremse							
2.0 i	85	03/93→01/96	←	→ 12/95; Schaltgetriebe		13.0460-5955.2 605955	AKE 21879 18,6 + WK
			←	01/94→		13.0460-5982.2 605982	21651 17,5 + WK
			←	→ 12/95; Vollautomatik		13.0460-5982.2 605982	21651 17,5 + WK
			→	01/94→		13.0460-5929.2 605929	AKE 21719 15,0 + WK
			→	→ 12/95		13.0460-5929.2 605929	AKE 21719 15,0 + WK
2.0 i S	96	03/93→01/96	←	→ 12/95; Schaltgetriebe		13.0460-5955.2 605955	AKE 21879 18,6 + WK
			←	→ 12/95; Vollautomatik		13.0460-5982.2 605982	21651 17,5 + WK
			→	→ 12/95		13.0460-5929.2 605929	AKE 21719 15,0 + WK
↓							











	kw			 	! #		
HONDA - ACCORD V (CC, CD) 06/92→12/97							
 Bremsbelagsatz, Scheibenbremse							
2.3 i SR	116	03/93→01/96	←	→ 12/95		13.0460-5982.2 605982	21651 17,5 + WK
			→	→ 12/95		13.0460-5929.2 605929	AKE 21719 15,0 + WK
Zubehörsatz, Scheibenbremsbelag							
2.0 i	85	03/93→01/96	←	01/94→		13.0460-0075.2 610075	
			←	→ 12/95; Vollautomatik		13.0460-0075.2 610075	
			←	→ 12/95; Schaltgetriebe		13.0460-0453.2 610453	AKE
			→	→ 12/95		13.0460-0287.2 610287	
			→	01/94→		13.0460-0287.2 610287	
2.0 i S	96	03/93→01/96	←	→ 12/95; Vollautomatik		13.0460-0075.2 610075	
			←	→ 12/95; Schaltgetriebe		13.0460-0453.2 610453	AKE
			→	→ 12/95		13.0460-0287.2 610287	
2.3 i SR	116	03/93→01/96	←	→ 12/95		13.0460-0075.2 610075	
			→	→ 12/95		13.0460-0287.2 610287	
 Bremsscheibe							
2.0 i	85	03/93→01/96	←	→ 12/95; Schaltgetriebe		24.0123-0103.1 423103	Ø 260 23 21 V
			←	01/94→		24.0125-0130.1 425130	Ø 282 25 23 V
			→	→ 12/95		24.0110-0233.1 410233	Ø 260 10 8 + S
			→	01/94→		24.0110-0233.1 410233	Ø 260 10 8 + S
2.0 i S	96	03/93→01/96	←	→ 12/95; Schaltgetriebe		24.0123-0103.1 423103	Ø 260 23 21 V
			→	→ 12/95		24.0110-0233.1 410233	Ø 260 10 8 + S
2.3 i SR	116	03/93→01/96	→	→ 12/95		24.0110-0233.1 410233	Ø 260 10 8 + S
HONDA - ACCORD V (CE, CF_) 09/95→10/98							
 Bremsbelagsatz, Scheibenbremse							
1.9 i (CE7) 2.0 i LS (CE8)	85 96	02/96→10/98 02/96→10/98	←	→ 09/98; Schaltgetriebe		13.0460-5955.2 605955	AKE 21879 18,6 + WK
			←	→ 09/98; Vollautomatik		13.0460-5982.2 605982	21651 17,5 + WK
			→	→ 09/98		13.0460-5929.2 605929	AKE 21719 15,0 + WK
2.0 TDi (CF1)	77	04/96→10/98	←	→ 09/98		13.0460-5955.2 605955	AKE 21879 18,6 + WK
			→	→ 09/98		13.0460-5929.2 605929	AKE 21719 15,0 + WK
2.2 2.2 (CE1)	103 107	04/96→12/97 09/95→06/96	←			13.0460-5982.2 605982	21651 17,5 + WK
			→			13.0460-5929.2 605929	AKE 21719 15,0 + WK
2.2 i VTEC (CE9)	110	02/96→10/98	←	→ 09/98		13.0460-5982.2 605982	21651 17,5 + WK
			→	→ 09/98		13.0460-5929.2 605929	AKE 21719 15,0 + WK
Zubehörsatz, Scheibenbremsbelag							
1.9 i (CE7) 2.0 i LS (CE8)	85 96	02/96→10/98 02/96→10/98	←	→ 09/98; Vollautomatik		13.0460-0075.2 610075	
			←	→ 09/98; Schaltgetriebe		13.0460-0453.2 610453	AKE
			→	→ 09/98		13.0460-0287.2 610287	
2.0 TDi (CF1)	77	04/96→10/98	←	→ 09/98		13.0460-0453.2 610453	AKE
			→	→ 09/98		13.0460-0287.2 610287	
2.2 2.2 (CE1)	103 107	04/96→12/97 09/95→06/96	←			13.0460-0075.2 610075	
			→			13.0460-0287.2 610287	
2.2 i VTEC (CE9)	110	02/96→10/98	←	→ 09/98		13.0460-0075.2 610075	
			→	→ 09/98		13.0460-0287.2 610287	
 Bremsscheibe							
1.9 i (CE7) 2.0 i LS (CE8)	85 96	02/96→10/98 02/96→10/98	←	→ 09/98; Schaltgetriebe		24.0123-0103.1 423103	Ø 260 23 21 V
			→	→ 09/98		24.0110-0233.1 410233	Ø 260 10 8 + S
2.0 TDi (CF1)	77	04/96→10/98	←	→ 09/98		24.0123-0103.1 423103	Ø 260 23 21 V
			→	→ 09/98		24.0110-0233.1 410233	Ø 260 10 8 + S
2.2	103	04/96→12/97	→			24.0110-0233.1 410233	Ø 260 10 8 + S
2.2 (CE1)	107	09/95→06/96	←			24.0125-0130.1 425130	Ø 282 25 23 V
			→			24.0110-0233.1 410233	Ø 260 10 8 + S
2.2 i VTEC (CE9)	110	02/96→10/98	→	→ 09/98		24.0110-0233.1 410233	Ø 260 10 8 + S











	kw			 	! #		
HONDA - ACCORD V Aerodeck (CE) 04/93→02/98							
 Bremsbelagsatz, Scheibenbremse							
2.0 i LS 16V (CE2)	100	09/93→02/98	←	01/94→ 01/98		13.0460-5982.2 605982	21651 17,5 + WK
2.2 i ES (CE1)	110	09/93→02/98	→	01/94→ 01/98		13.0460-5929.2 605929	AKE 21719 15,0 + WK
Zubehörsatz, Scheibenbremsbelag							
2.0 i LS 16V (CE2)	100	09/93→02/98	←	01/94→ 01/98		13.0460-0075.2 610075	
2.2 i ES (CE1)	110	09/93→02/98	→	01/94→ 01/98		13.0460-0287.2 610287	
 Bremsscheibe							
2.0 i LS 16V (CE2)	100	09/93→02/98	←	01/94→ 01/98		24.0125-0130.1 425130	Ø 282 25 23 V
2.2 i ES (CE1)	110	09/93→02/98	→	01/94→ 01/98		24.0110-0233.1 410233	Ø 260 10 8 + S
HONDA - ACCORD V Coupe (CD) 04/93→12/98							
 Bremsbelagsatz, Scheibenbremse							
2.0 (CD9)	100	09/93→12/97	←	01/94→		13.0460-5982.2 605982	21651 17,5 + WK
			→	01/94→		13.0460-5929.2 605929	AKE 21719 15,0 + WK
2.2 i ES (CD7)	110	09/93→02/98	←	01/94→ 01/98		13.0460-5982.2 605982	21651 17,5 + WK
			→	01/94→ 01/98		13.0460-5929.2 605929	AKE 21719 15,0 + WK
Zubehörsatz, Scheibenbremsbelag							
2.0 (CD9)	100	09/93→12/97	←	01/94→		13.0460-0075.2 610075	
			→	01/94→		13.0460-0287.2 610287	
2.2 i ES (CD7)	110	09/93→02/98	←	01/94→ 01/98		13.0460-0075.2 610075	
			→	01/94→ 01/98		13.0460-0287.2 610287	
 Bremsscheibe							
2.0 (CD9)	100	09/93→12/97	←	01/94→		24.0125-0130.1 425130	Ø 282 25 23 V
			→	01/94→		24.0110-0233.1 410233	Ø 260 10 8 + S
2.2 i ES (CD7)	110	09/93→02/98	←	01/94→ 01/98		24.0125-0130.1 425130	Ø 282 25 23 V
			→	01/94→ 01/98		24.0110-0233.1 410233	Ø 260 10 8 + S
HONDA - ACCORD VI (CK, CG, CH, CF8) 03/97→12/03							
 Bremsbelagsatz, Scheibenbremse							
1.6 i (CG7)	85	10/98→12/02	←			13.0460-5861.2 605861	23097 17,1 + WK + Zub
1.6 LS (CG7)	79	10/98→12/02					
1.8 i (CG8)	100	10/98→12/02	←			13.0460-5825.2 605825	TRW 23094 16,5 + WK + Zub
2.0 i (CG9)	108	10/98→01/01	→			13.0460-5827.2 605827	TRW 23527 14,5 + WK
2.0 Turbo DI (CH2)	77	02/99→12/02	←	→ 10/00		13.0460-5825.2 605825	TRW 23094 16,5 + WK + Zub
			→	→ 10/00		13.0460-5827.2 605827	TRW 23527 14,5 + WK
2.2 Type-R (CH1)	156	02/99→12/02	→			13.0460-5827.2 605827	TRW 23527 14,5 + WK
2.3	104	07/01→02/03	←	→ 12/02		13.0460-5825.2 605825	TRW 23094 16,5 + WK + Zub
2.3 (CL3)	113	01/01→06/03	→	→ 12/02		13.0460-5827.2 605827	TRW 23527 14,5 + WK
3.0 Vtec (CK1)	147	03/97→12/03	←	02/98→ 06/03		13.0460-5982.2 605982	21651 17,5 + WK
			→	02/98→ 06/03		13.0460-5929.2 605929	AKE 21719 15,0 + WK
 Bremsscheibe							
1.6 i (CG7)	85	10/98→12/02	←	passend für Felgengröße [Zoll]: 14		24.0123-0105.1 423105	Ø 260 23 21 V
1.6 LS (CG7)	79	10/98→12/02					
1.8 i (CG8)	100	10/98→12/02	←	Felge Lochzahl: 4; passend für Felgengröße [Zoll]: 15		24.0125-0146.1 425146	Ø 282 25 23 V
2.0 i (CG9)	108	10/98→01/01	→	Felge Lochzahl: 4		24.0110-0295.1 410295	Ø 260 10 8
2.0 Turbo DI (CH2)	77	02/99→12/02	←	→ 10/00; Felge Lochzahl: 4; passend für Felgengröße [Zoll]: 15		24.0125-0146.1 425146	Ø 282 25 23 V
			→	→ 10/00; Felge Lochzahl: 4		24.0110-0295.1 410295	Ø 260 10 8
2.3	104	07/01→02/03	←	→ 12/02; Felge Lochzahl: 5; passend für Felgengröße [Zoll]: 15		24.0125-0183.1 425183	Ø 282 25 23 V
2.3 (CL3)	113	01/01→06/03					
3.0 Vtec (CK1)	147	03/97→12/03	→	02/98→ 06/03		24.0109-0709.1 409709	Ø 260 9 8











	kw			 	! #		
HONDA - ACCORD VI Aerodeck (CF) 07/97→09/05							
 Bremsbelagsatz, Scheibenbremse							
2.3 i	112	07/97→	←	01/01→		13.0460-5825.2 605825	TRW 23094 16,5 + WK + Zub
			→	01/01→		13.0460-5827.2 605827	TRW 23527 14,5 + WK
 Bremsscheibe							
2.3 i	112	07/97→	←	01/01→; Felge Lochzahl: 5; passend für Felgengröße [Zoll]: 15		24.0125-0183.1 425183	Ø 282 25 23 V
HONDA - ACCORD VI Coupe (CG) 12/97→06/03							
 Bremsbelagsatz, Scheibenbremse							
2.0	107	11/99→10/02	←			13.0460-5982.2 605982	21651 17,5 + WK
2.0 i 16V	108	02/98→06/03					
3.0 V6 24V (CG2)	147	02/98→06/03	→			13.0460-5929.2 605929	AKE 21719 15,0 + WK
3.0 Vtec	152	10/01→06/03					
 Bremsscheibe							
2.0	107	11/99→10/02	→			24.0109-0145.1 409145	Ø 260 9 8
2.0 i 16V	108	02/98→06/03					
3.0 V6 24V (CG2)	147	02/98→06/03	→			24.0109-0709.1 409709	Ø 260 9 8
3.0 Vtec	152	10/01→06/03					
HONDA - ACCORD VI Hatchback (CH, CL) 12/99→12/02							
 Bremsbelagsatz, Scheibenbremse							
1.6 (CH5)	85	12/99→12/02	←			13.0460-5861.2 605861	23097 17,1 + WK + Zub
1.8 i (CH6)	100	12/99→12/02	←			13.0460-5825.2 605825	TRW 23094 16,5 + WK + Zub
2.0 TDi (CH8)	77	12/99→10/00	→			13.0460-5827.2 605827	TRW 23527 14,5 + WK
2.0 (CH7)	108	12/99→12/02	←	→ 01/01		13.0460-5825.2 605825	TRW 23094 16,5 + WK + Zub
			→	→ 01/01		13.0460-5827.2 605827	TRW 23527 14,5 + WK
2.3 (CL4)	113	11/00→12/02	←	01/01→		13.0460-5825.2 605825	TRW 23094 16,5 + WK + Zub
			→	01/01→		13.0460-5827.2 605827	TRW 23527 14,5 + WK
 Bremsscheibe							
1.6 (CH5)	85	12/99→12/02	←	passend für Felgengröße [Zoll]: 14		24.0123-0105.1 423105	Ø 260 23 21 V
1.8 i (CH6)	100	12/99→12/02	←	Felge Lochzahl: 4;		24.0125-0146.1 425146	Ø 282 25 23 V
2.0 TDi (CH8)	77	12/99→10/00	→	passend für Felgengröße [Zoll]: 15			
			→	Felge Lochzahl: 4		24.0110-0295.1 410295	Ø 260 10 8
2.0 (CH7)	108	12/99→12/02	←	→ 01/01; Felge Lochzahl: 4;		24.0125-0146.1 425146	Ø 282 25 23 V
			→	passend für Felgengröße [Zoll]: 15			
			→	→ 01/01; Felge Lochzahl: 4		24.0110-0295.1 410295	Ø 260 10 8
2.3 (CL4)	113	11/00→12/02	←	01/01→; Felge Lochzahl: 5;		24.0125-0183.1 425183	Ø 282 25 23 V
			→	passend für Felgengröße [Zoll]: 15			
HONDA - ACCORD VII (CL, CN) 01/03→09/12							
 Bremsbelagsatz, Scheibenbremse							
2.0 (CL7)	114	02/03→05/08	←			13.0460-5714.2 605714	ATE 23720 17,5 + WK
2.0 Allrad (CL8)	114	02/03→05/08	→			13.0460-5827.2 605827	TRW 23527 14,5 + WK
2.2 i-CTDi (CN1)	103	01/04→05/08					
2.4	113	09/06→05/08					
2.4 Vtec	122	04/06→07/08					
2.4	132	01/08→09/12	→	07/08→		13.0460-5648.2 605648	NIS 24435 14,8 + WK
2.4 (CL9)	140	02/03→05/08	←			13.0460-5714.2 605714	ATE 23720 17,5 + WK
			→			13.0460-5711.2 605711	23652 15,7 + WK
			→			13.0460-5827.2 605827	TRW 23527 14,5 + WK
2.4 i 16V	115	02/03→	←	→ 09/05		13.0460-5714.2 605714	ATE 23720 17,5 + WK
			→	→ 09/05		13.0460-5827.2 605827	TRW 23527 14,5 + WK
 Bremsscheibe							
2.0 (CL7)	114	02/03→05/08	←	passend für Felgengröße [Zoll]: 16		24.0125-0174.1 425174	Ø 300 25 23 V
2.0 Allrad (CL8)	114	02/03→05/08	←				
2.2 i-CTDi (CN1)	103	01/04→05/08	←	passend für Felgengröße [Zoll]: 15		24.0125-0187.1 425187	Ø 280 25 23 V
2.4	113	09/06→05/08	→			24.0110-0321.1 410321	Ø 260 10 8
2.4 (CL9)	140	02/03→05/08					
2.4 Vtec	122	04/06→07/08					
2.4	132	01/08→09/12	←	07/08→		24.0125-0211.1 425211	Ø 296 25 23 V + S
			→			24.0132-0172.1 432172	Ø 320 32 30 V + S
			→	07/08→		24.0109-0169.1 409169	Ø 282 9 8 + S
↓							











	kw			 	! #		
HONDA - ACCORD VII (CL, CN) 01/03→09/12							
 Bremsscheibe							
2.4 i 16V	115	02/03→	←	→ 09/05; passend für Felgengröße [Zoll]: 16		24.0125-0174.1 425174	Ø 300 25 23 V
			←	→ 09/05; passend für Felgengröße [Zoll]: 15		24.0125-0187.1 425187	Ø 280 25 23 V
			→	→ 09/05		24.0110-0321.1 410321	Ø 260 10 8
HONDA - ACCORD VII (CM) 09/02→05/08							
 Bremsbelagsatz, Scheibenbremse							
2.4 Vtec E (CM5)	118	09/02→12/05	←	02/03→ 09/05		13.0460-5714.2 605714	ATE 23720 17,5 + WK
			→	02/03→ 09/05		13.0460-5827.2 605827	TRW 23527 14,5 + WK
 Bremsscheibe							
2.4 Vtec E (CM5)	118	09/02→12/05	←	02/03→ 09/05; passend für Felgengröße [Zoll]: 16		24.0125-0174.1 425174	Ø 300 25 23 V
			←	02/03→ 09/05; passend für Felgengröße [Zoll]: 15		24.0125-0187.1 425187	Ø 280 25 23 V
			→	02/03→ 09/05		24.0110-0321.1 410321	Ø 260 10 8
HONDA - ACCORD VII Tourer (CM, CN) 04/03→05/08							
 Bremsbelagsatz, Scheibenbremse							
2.0 (CM1)	114	04/03→05/08	←			13.0460-5714.2 605714	ATE 23720 17,5 + WK
2.2 i-CTDi (CN2)	103	01/04→05/08	→			13.0460-5711.2 605711	23652 15,7 + WK
2.4 (CM2)	140	04/03→05/08	←			13.0460-5714.2 605714	ATE 23720 17,5 + WK
2.4 Vtec E	118	09/03→09/05	→			13.0460-5827.2 605827	TRW 23527 14,5 + WK
2.4 Vtec T	147	09/03→05/08	→			13.0460-5827.2 605827	TRW 23527 14,5 + WK
 Bremsscheibe							
2.0 (CM1)	114	04/03→05/08	←	passend für Felgengröße [Zoll]: 16		24.0125-0174.1 425174	Ø 300 25 23 V
2.2 i-CTDi (CN2)	103	01/04→05/08	←	passend für Felgengröße [Zoll]: 15		24.0125-0187.1 425187	Ø 280 25 23 V
2.4 (CM2)	140	04/03→05/08	←	passend für Felgengröße [Zoll]: 15		24.0125-0187.1 425187	Ø 280 25 23 V
2.4 Vtec E	118	09/03→09/05	→			24.0109-0161.1 409161	Ø 282 9 7,5
2.4 Vtec T	147	09/03→05/08	→			24.0109-0161.1 409161	Ø 282 9 7,5
HONDA - ACCORD VIII (CP) 09/07→							
 Bremsbelagsatz, Scheibenbremse							
2.4 (CP2)	136	02/08→	→	07/08→ 06/15; Schaltgetriebe		13.0460-5648.2 605648	NIS 24435 14,8 + WK
 Bremsscheibe							
2.4 (CP2)	136	02/08→	←	07/08→ 06/15		24.0125-0211.1 425211	Ø 296 25 23 V + S
			←	07/08→ 06/15; Schaltgetriebe		24.0132-0172.1 432172	Ø 320 32 30 V + S
			→	07/08→ 06/15; Schaltgetriebe		24.0109-0169.1 409169	Ø 282 9 8 + S
HONDA - ACCORD VIII (CU) 06/08→							
 Bremsbelagsatz, Scheibenbremse							
2.0 i (CU1)	115	06/08→06/15	→	07/08→; Schaltgetriebe		13.0460-5648.2 605648	NIS 24435 14,8 + WK
2.2 i-DTEC (CU3)	110	07/08→06/15	→			13.0460-5648.2 605648	NIS 24435 14,8 + WK
2.2 i-DTEC (CU3)	132	07/08→06/15	→			13.0460-5648.2 605648	NIS 24435 14,8 + WK
2.4 i	133	07/08→	→	→ 06/15; Schaltgetriebe		13.0460-5648.2 605648	NIS 24435 14,8 + WK
2.4 i (CU2)	148	07/08→06/15	→	Schaltgetriebe		13.0460-5648.2 605648	NIS 24435 14,8 + WK
 Bremsscheibe							
2.0 i (CU1)	115	06/08→06/15	←	07/08→		24.0125-0211.1 425211	Ø 296 25 23 V + S
			←	07/08→		24.0132-0172.1 432172	Ø 320 32 30 V + S
			→	07/08→; Schaltgetriebe		24.0109-0169.1 409169	Ø 282 9 8 + S
2.2 i-DTEC (CU3)	110	07/08→06/15	←			24.0125-0211.1 425211	Ø 296 25 23 V + S
2.2 i-DTEC (CU3)	132	07/08→06/15	→			24.0109-0169.1 409169	Ø 282 9 8 + S
2.4 i	133	07/08→	←	→ 06/15		24.0125-0211.1 425211	Ø 296 25 23 V + S
			→	→ 06/15; Schaltgetriebe		24.0132-0172.1 432172	Ø 320 32 30 V + S
			→	→ 06/15; Schaltgetriebe		24.0109-0169.1 409169	Ø 282 9 8 + S
2.4 i (CU2)	148	07/08→06/15	←			24.0125-0211.1 425211	Ø 296 25 23 V + S
			←			24.0132-0172.1 432172	Ø 320 32 30 V + S
			→	Schaltgetriebe		24.0109-0169.1 409169	Ø 282 9 8 + S











	kW			 	! #		
HONDA - ACCORD VIII TOURER (CW) 07/08→							
 Bremsbelagsatz, Scheibenbremse							
2.0 i	110	07/08→	➡	→ 06/15		13.0460-5648.2 605648	NIS 24435 14,8 + WK
2.2 i-DTEC (CW3)	132	07/08→					
2.4 i (CW2)	148	07/08→					
2.0 i (CW1)	115	07/08→	➡	→ 06/15; Schaltgetriebe		13.0460-5648.2 605648	NIS 24435 14,8 + WK
2.2 i-DTEC (CW3)	110	07/08→					
 Bremsscheibe							
2.0 i	110	07/08→	⬅	→ 06/15		24.0125-0211.1 425211	Ø 296 25 23 V + S
2.4 i (CW2)	148	07/08→	➡	→ 06/15		24.0109-0169.1 409169	Ø 282 9 8 + S
2.0 i (CW1)	115	07/08→	⬅	→ 06/15		24.0125-0211.1 425211	Ø 296 25 23 V + S
						24.0132-0172.1 432172	Ø 320 32 30 V + S
			➡	→ 06/15; Schaltgetriebe		24.0109-0169.1 409169	Ø 282 9 8 + S
2.2 i-DTEC (CW3)	110	07/08→	⬅	→ 06/15		24.0125-0211.1 425211	Ø 296 25 23 V + S
			➡	→ 06/15; Schaltgetriebe		24.0109-0169.1 409169	Ø 282 9 8 + S
2.2 i-DTEC (CW3)	132	07/08→	⬅	→ 06/15		24.0125-0211.1 425211	Ø 296 25 23 V + S
						24.0132-0172.1 432172	Ø 320 32 30 V + S
			➡	→ 06/15		24.0109-0169.1 409169	Ø 282 9 8 + S
HONDA - ACCORD IX Stufenheck (CR) 09/12→							
 Bremsscheibe							
2.4	132	07/14→	⬅			24.0132-0172.1 432172	Ø 320 32 30 V + S
HONDA - ACCORD Coupe (CM) 07/03→							
 Bremsbelagsatz, Scheibenbremse							
2.4	142	01/09→	➡	07/08→ 06/15; Schaltgetriebe		13.0460-5648.2 605648	NIS 24435 14,8 + WK
 Bremsscheibe							
2.4	142	01/09→	⬅	07/08→ 06/15		24.0125-0211.1 425211	Ø 296 25 23 V + S
						24.0132-0172.1 432172	Ø 320 32 30 V + S
			➡	07/08→ 06/15; Schaltgetriebe		24.0109-0169.1 409169	Ø 282 9 8 + S
HONDA - CITY Stufenheck (GM2, GM3) 09/08→							
 Bremsbelagsatz, Scheibenbremse							
1.4 i-V TEC	73	09/08→	⬅	→ 11/13		13.0460-5943.2 605943	SUM 21697 15,0 + WK
			➡	→ 11/13		13.0460-5731.2 605731	21738 13,5 + WK
 Bremsscheibe							
1.4 i-V TEC	73	09/08→	⬅	→ 11/13		24.0121-0105.1 421105	Ø 262 21 19 V + S
			⬅	→ 11/13		24.0121-0115.1 421115	Ø 258 21 19 V + S
			➡	→ 11/13		24.0109-0168.1 409168	Ø 239 9 8 + S
HONDA - CIVIC II Shuttle (EE) 01/88→02/95							
 Bremsbelagsatz, Scheibenbremse							
1.6 i 16V 4WD (EE4)	81	01/88→02/95	⬅	→ 08/91		13.0460-5920.2 605920	AKE 21322 15,0 + WK
Zubehörsatz, Scheibenbremsbelag							
1.6 i 16V 4WD (EE4)	81	01/88→02/95	⬅	→ 08/91		13.0460-0308.2 610308	AKE
 Bremsscheibe							
1.6 i 16V 4WD (EE4)	81	01/88→02/95	⬅	→ 08/91		24.0119-0106.1 419106	Ø 242 19 17 V
HONDA - CIVIC V Coupe (EJ) 08/93→03/96							
 Bremsbelagsatz, Scheibenbremse							
1.5 i LSi (EJ2)	74	08/93→11/95	⬅	01/94→		13.0460-5943.2 605943	SUM 21697 15,0 + WK
1.6 i (EJ6)	77	01/94→11/95	⬅			13.0460-5943.2 605943	SUM 21697 15,0 + WK
1.6 i Vtec	118	01/94→11/95	⬅			13.0460-5820.2 605820	SUM 21694 16,3 + WK
1.6 i Vtec (EJ1)	92	01/94→03/96	⬅	→ 12/95		13.0460-5820.2 605820	SUM 21694 16,3 + WK
Zubehörsatz, Scheibenbremsbelag							
1.5 i LSi (EJ2)	74	08/93→11/95	⬅	01/94→		13.0460-0073.2 610073	
↓							











	kw			 	! #		
HONDA - CIVIC V Coupe (EJ) 08/93→03/96							
Zubehörsatz, Scheibenbremsbelag							
1.6 i (EJ6)	77	01/94→11/95	←			13.0460-0073.2	610073
1.6 i Vtec	118	01/94→11/95	←				
1.6 i Vtec (EJ1)	92	01/94→03/96	←	→ 12/95		13.0460-0073.2	610073
 Bremsscheibe							
1.5 i LSi (EJ2)	74	08/93→11/95	←	01/94→		24.0121-0104.1	421104 SUM Ø 240 21 19 V + S
1.6 i (EJ6)	77	01/94→11/95	←			24.0121-0104.1	421104 SUM Ø 240 21 19 V + S
1.6 i Vtec	118	01/94→11/95	←			24.0121-0105.1	421105 Ø 262 21 19 V + S
1.6 i Vtec (EJ1)	92	01/94→03/96	←	→ 12/95		24.0121-0105.1	421105 Ø 262 21 19 V + S
HONDA - CIVIC V Hatchback (EG) 10/91→11/95							
 Bremsbelagsatz, Scheibenbremse							
1.3 16V (EG3)	55	10/91→11/95	←	→ 10/95		13.0460-5919.2	605919 AKE 20193 15,0 + WK
						13.0460-5943.2	605943 SUM 21697 15,0 + WK
1.5 i 16V (EG4)	66	10/91→11/95	←	→ 10/95		13.0460-5943.2	605943 SUM 21697 15,0 + WK
1.5 i 16V (EG4)	69	10/91→11/95	←				
1.6 16V Vtec (EG5)	92	10/91→11/95	←	→ 10/95; + ABS		13.0460-5820.2	605820 SUM 21694 16,3 + WK
			←	→ 10/95; - ABS		13.0460-5943.2	605943 SUM 21697 15,0 + WK
			→	→ 10/95		13.0460-5998.2	605998 AKE 21312 12,8 + WK
1.6 Vtec	110	10/91→05/95	←			13.0460-5820.2	605820 SUM 21694 16,3 + WK
			→			13.0460-5998.2	605998 AKE 21312 12,8 + WK
1.6 VTi 16V (EG6)	118	10/91→11/95	←	→ 10/95		13.0460-5820.2	605820 SUM 21694 16,3 + WK
			→	→ 10/95		13.0460-5998.2	605998 AKE 21312 12,8 + WK
Zubehörsatz, Scheibenbremsbelag							
1.6 16V Vtec (EG5)	92	10/91→11/95	→	→ 10/95		13.0460-0430.2	610430 AKE
1.6 VTi 16V (EG6)	118	10/91→11/95	→				
1.6 Vtec	110	10/91→05/95	→			13.0460-0430.2	610430 AKE
 Bremsscheibe							
1.3 16V (EG3)	55	10/91→11/95	←	→ 10/95		24.0117-0101.1	417101 AKE Ø 231 17 15 V
						24.0121-0104.1	421104 SUM Ø 240 21 19 V + S
1.5 i 16V (EG4)	66	10/91→11/95	←	→ 10/95		24.0121-0104.1	421104 SUM Ø 240 21 19 V + S
1.5 i 16V (EG4)	69	10/91→11/95	←				
1.6 16V Vtec (EG5)	92	10/91→11/95	←	→ 10/95; - ABS		24.0121-0104.1	421104 SUM Ø 240 21 19 V + S
			←	→ 10/95; + ABS		24.0121-0105.1	421105 Ø 262 21 19 V + S
			→	→ 10/95		24.0109-0111.1	409111 Ø 239 9 8 + S
1.6 Vtec	110	10/91→05/95	←			24.0121-0105.1	421105 Ø 262 21 19 V + S
			→			24.0109-0111.1	409111 Ø 239 9 8 + S
1.6 VTi 16V (EG6)	118	10/91→11/95	←	→ 10/95		24.0121-0105.1	421105 Ø 262 21 19 V + S
			→	→ 10/95		24.0109-0111.1	409111 Ø 239 9 8 + S
HONDA - CIVIC V Stufenheck (EG, EH) 10/91→12/95							
 Bremsbelagsatz, Scheibenbremse							
1.5	66	10/93→12/95	←	→ 10/95		13.0460-5943.2	605943 SUM 21697 15,0 + WK
1.5	67	10/93→12/95	←				
1.5 (EG8)	74	10/93→12/95	←				
1.5 i 16V (EG8)	69	10/91→11/95	←				
1.6 16V Vtec (EH9)	92	10/91→11/95	←	→ 10/95; + ABS		13.0460-5820.2	605820 SUM 21694 16,3 + WK
			←	→ 10/95; - ABS		13.0460-5943.2	605943 SUM 21697 15,0 + WK
			→	→ 10/95		13.0460-5998.2	605998 AKE 21312 12,8 + WK
1.6 4x4	92	01/92→10/95	←			13.0460-5820.2	605820 SUM 21694 16,3 + WK
1.6 Vtec	110	10/91→05/95	←			13.0460-5820.2	605820 SUM 21694 16,3 + WK
			→			13.0460-5998.2	605998 AKE 21312 12,8 + WK
1.6 VTi (EG9)	118	10/91→11/95	←	→ 10/95		13.0460-5820.2	605820 SUM 21694 16,3 + WK
			→	→ 10/95		13.0460-5998.2	605998 AKE 21312 12,8 + WK
Zubehörsatz, Scheibenbremsbelag							
1.6 16V Vtec (EH9)	92	10/91→11/95	→	→ 10/95		13.0460-0430.2	610430 AKE
1.6 VTi (EG9)	118	10/91→11/95	→				
1.6 Vtec	110	10/91→05/95	→			13.0460-0430.2	610430 AKE











	kw					! #		
HONDA - CIVIC V Stufenheck (EG, EH) 10/91→12/95								
 Bremsscheibe								
1.5	66	10/93→12/95	←	→ 10/95			24.0121-0104.1 421104	SUM Ø 240 21 19 V + S
1.5	67	10/93→12/95						
1.5 (EG8)	74	10/93→12/95						
1.5 i 16V (EG8)	69	10/91→11/95						
1.6 16V Vtec (EH9)	92	10/91→11/95	←	→ 10/95; - ABS			24.0121-0104.1 421104	SUM Ø 240 21 19 V + S
			←	→ 10/95; + ABS			24.0121-0105.1 421105	Ø 262 21 19 V + S
			→	→ 10/95			24.0109-0111.1 409111	Ø 239 9 8 + S
1.6 4x4	92	01/92→10/95	←				24.0121-0105.1 421105	Ø 262 21 19 V + S
1.6 Vtec	110	10/91→05/95	←				24.0121-0105.1 421105	Ø 262 21 19 V + S
			→				24.0109-0111.1 409111	Ø 239 9 8 + S
1.6 VTi (EG9)	118	10/91→11/95	←	→ 10/95			24.0121-0105.1 421105	Ø 262 21 19 V + S
			→	→ 10/95			24.0109-0111.1 409111	Ø 239 9 8 + S
HONDA - CIVIC VI Aerodeck (MB, MC) 04/98→02/01								
 Bremsbelagsatz, Scheibenbremse								
1.4 16V (MB8)	55	04/98→02/01	←				13.0460-2803.2 602803	TRW 21515 17,5 + WK
1.4 16V (MB8)	66	04/98→02/01	→	01/99→; + ABS			13.0460-5929.2 605929	AKE 21719 15,0 + WK
			→	→ 12/98; + ABS			13.0460-5998.2 605998	AKE 21312 12,8 + WK
1.5 16V (MB9)	84	04/98→02/01	←				13.0460-2803.2 602803	TRW 21515 17,5 + WK
			→	+ ABS			13.0460-5929.2 605929	AKE 21719 15,0 + WK
1.6 16V (MC1)	85	04/98→02/01	←				13.0460-2803.2 602803	TRW 21515 17,5 + WK
1.6 16V (MC1)	92	04/98→02/01	→				13.0460-5929.2 605929	AKE 21719 15,0 + WK
1.8 16V (MC2)	124	04/98→02/01	←				13.0460-5982.2 605982	21651 17,5 + WK
			→				13.0460-5929.2 605929	AKE 21719 15,0 + WK
2.0 i D (MC3)	74	04/98→02/01	←				13.0460-2803.2 602803	TRW 21515 17,5 + WK
2.0 i D (MC3)	77	04/98→02/01	→				13.0460-5998.2 605998	AKE 21312 12,8 + WK
Zubehörsatz, Scheibenbremsbelag								
1.4 16V (MB8)	55	04/98→02/01	←				13.0460-0142.2 610142	
1.4 16V (MB8)	66	04/98→02/01						
1.5 16V (MB9)	84	04/98→02/01						
1.6 16V (MC1)	85	04/98→02/01						
1.6 16V (MC1)	92	04/98→02/01						
2.0 i D (MC3)	74	04/98→02/01						
2.0 i D (MC3)	77	04/98→02/01						
 Bremsscheibe								
1.4 16V (MB8)	55	04/98→02/01	←				24.0121-0105.1 421105	Ø 262 21 19 V + S
1.4 16V (MB8)	66	04/98→02/01	→	01/99→; + ABS			24.0109-0143.1 409143	Ø 260 9 8 + S
1.5 16V (MB9)	84	04/98→02/01	→	→ 12/98; + ABS			24.0110-0212.1 410212	Ø 238,5 10 8 + S
1.6 16V (MC1)	85	04/98→02/01	←				24.0121-0105.1 421105	Ø 262 21 19 V + S
1.6 16V (MC1)	92	04/98→02/01	→				24.0109-0143.1 409143	Ø 260 9 8 + S
1.8 16V (MC2)	124	04/98→02/01	←				24.0123-0106.1 423106	Ø 282 23 21 V
			→				24.0110-0233.1 410233	Ø 260 10 8 + S
2.0 i D (MC3)	74	04/98→02/01	←				24.0121-0105.1 421105	Ø 262 21 19 V + S
2.0 i D (MC3)	77	04/98→02/01	→				24.0110-0212.1 410212	Ø 238,5 10 8 + S
HONDA - CIVIC VI Coupe (EJ, EM1) 03/96→12/00								
 Bremsbelagsatz, Scheibenbremse								
1.6	79	05/96→04/99	←	01/98→			13.0460-5820.2 605820	SUM 21694 16,3 + WK
1.6 i	77	03/96→03/00	←	→ 12/97			13.0460-5943.2 605943	SUM 21697 15,0 + WK
1.6 i Vtec	92	03/96→03/00	←				13.0460-5820.2 605820	SUM 21694 16,3 + WK
1.6 i Vtec	118	04/99→12/00	←				13.0460-5820.2 605820	SUM 21694 16,3 + WK
			→				13.0460-5731.2 605731	21738 13,5 + WK
Zubehörsatz, Scheibenbremsbelag								
1.6	79	05/96→04/99	←	→ 12/97			13.0460-0073.2 610073	
1.6 i	77	03/96→03/00	←	01/98→			13.0460-0073.2 610073	
1.6 i Vtec	92	03/96→03/00	←				13.0460-0073.2 610073	
1.6 i Vtec	118	04/99→12/00						











	kw			 	! #		
HONDA - CIVIC VI Coupe (EJ, EM1) 03/96→12/00							
 Bremsscheibe							
1.6	79	05/96→04/99	←	→ 12/97		24.0121-0104.1 421104	SUM Ø 240 21 19 V + S
1.6 i	77	03/96→03/00	←	01/98→		24.0121-0105.1 421105	Ø 262 21 19 V + S
1.6 i Vtec	92	03/96→03/00	←			24.0121-0105.1 421105	Ø 262 21 19 V + S
1.6 i Vtec	118	04/99→12/00	←			24.0121-0105.1 421105	Ø 262 21 19 V + S
			→			24.0109-0111.1 409111	Ø 239 9 8 + S
HONDA - CIVIC VI Fastback (MA, MB) 09/94→02/01							
 Bremsbelagsatz, Scheibenbremse							
1.4 i (MA8, MB2)	55	09/95→02/01	←	01/97→		13.0460-2803.2 602803	TRW 21515 17,5 + WK
			→	01/99→; + ABS		13.0460-5920.2 605920	AKE 21322 15,0 + WK
			→	01/97→ 12/98; + ABS		13.0460-5998.2 605998	AKE 21312 12,8 + WK
1.4 i (MA8, MB2) 1.5 i Vtec-E (MA9)	66 66	09/94→02/01 09/94→01/97	←	→ 12/96		13.0460-2803.2 602803	TRW 21515 17,5 + WK
			→	→ 12/96; + ABS		13.0460-5920.2 605920	AKE 21322 15,0 + WK
			→			13.0460-5998.2 605998	AKE 21312 12,8 + WK
1.5 16V (MB3)	84	01/97→02/01	←			13.0460-2803.2 602803	TRW 21515 17,5 + WK
			→	01/99→; + ABS		13.0460-5920.2 605920	AKE 21322 15,0 + WK
			→	→ 12/98; + ABS		13.0460-5998.2 605998	AKE 21312 12,8 + WK
1.6	92	11/98→10/00	←			13.0460-2803.2 602803	TRW 21515 17,5 + WK
			→			13.0460-5929.2 605929	AKE 21719 15,0 + WK
1.6 16V (MB4) 1.6 VTi 2.0 i TD (MB7) 2.0 TDiC (MB7) 2.0 TDiC (MB7)	85 118 63 74 77	01/97→02/01 01/97→02/01 01/97→02/01 11/98→10/00 11/98→10/00	←			13.0460-2803.2 602803	TRW 21515 17,5 + WK
			→	01/99→		13.0460-5920.2 605920	AKE 21322 15,0 + WK
			→	→ 12/98		13.0460-5929.2 605929	AKE 21719 15,0 + WK
			→			13.0460-5998.2 605998	AKE 21312 12,8 + WK
1.6 i (MB1) 1.6 i Vtec (MB1)	83 93	09/94→01/97 09/94→01/97	←	→ 12/96		13.0460-2803.2 602803	TRW 21515 17,5 + WK
			→	→ 12/96		13.0460-5920.2 605920	AKE 21322 15,0 + WK
			→			13.0460-5998.2 605998	AKE 21312 12,8 + WK
1.8 16V (MB6)	124	01/97→02/01	←			13.0460-5982.2 605982	21651 17,5 + WK
			→			13.0460-5929.2 605929	AKE 21719 15,0 + WK
Zubehörsatz, Scheibenbremsbelag							
1.4 i (MA8, MB2)	55	09/95→02/01	←	01/97→		13.0460-0142.2 610142	
			→	01/97→ 12/98; + ABS		13.0460-0308.2 610308	AKE
			→			13.0460-0430.2 610430	AKE
1.4 i (MA8, MB2) 1.5 i Vtec-E (MA9)	66 66	09/94→02/01 09/94→01/97	←	→ 12/96		13.0460-0142.2 610142	AKE
			→	→ 12/96; + ABS		13.0460-0308.2 610308	AKE
			→			13.0460-0430.2 610430	AKE
1.5 16V (MB3)	84	01/97→02/01	←			13.0460-0142.2 610142	AKE
			→	→ 12/98; + ABS		13.0460-0308.2 610308	AKE
			→			13.0460-0430.2 610430	AKE
1.6	92	11/98→10/00	←			13.0460-0142.2 610142	
1.6 16V (MB4) 1.6 VTi 2.0 i TD (MB7) 2.0 TDiC (MB7) 2.0 TDiC (MB7)	85 118 63 74 77	01/97→02/01 01/97→02/01 01/97→02/01 11/98→10/00 11/98→10/00	←			13.0460-0142.2 610142	AKE
			→	→ 12/98		13.0460-0308.2 610308	AKE
			→			13.0460-0430.2 610430	AKE
1.6 i (MB1) 1.6 i Vtec (MB1)	83 93	09/94→01/97 09/94→01/97	←	→ 12/96		13.0460-0142.2 610142	AKE
			→	→ 12/96		13.0460-0308.2 610308	AKE
			→			13.0460-0430.2 610430	AKE
 Bremsscheibe							
1.4 i (MA8, MB2)	55	09/95→02/01	←	01/97→		24.0121-0105.1 421105	Ø 262 21 19 V + S
			→	01/99→; + ABS		24.0109-0143.1 409143	Ø 260 9 8 + S
			→	01/97→ 12/98; + ABS		24.0110-0212.1 410212	Ø 238,5 10 8 + S
1.4 i (MA8, MB2) 1.5 i Vtec-E (MA9)	66 66	09/94→02/01 09/94→01/97	←	→ 12/96		24.0121-0105.1 421105	Ø 262 21 19 V + S
			→	→ 12/96; + ABS		24.0110-0212.1 410212	Ø 238,5 10 8 + S
1.5 16V (MB3)	84	01/97→02/01	←			24.0121-0105.1 421105	Ø 262 21 19 V + S
↓							



















	kw			 	! #		
HONDA - CIVIC VI Fastback (MA, MB) 09/94→02/01							
 Bremsscheibe							
1.5 16V (MB3)	84	01/97→02/01	➔			24.0109-0143.1 409143	Ø 260 9 8 + S
			➔	+ ABS		24.0110-0212.1 410212	Ø 238,5 10 8 + S
1.6	92	11/98→10/00	➔			24.0121-0105.1 421105	Ø 262 21 19 V + S
			➔			24.0109-0143.1 409143	Ø 260 9 8 + S
1.6 16V (MB4)	85	01/97→02/01	➔			24.0121-0105.1 421105	Ø 262 21 19 V + S
1.6 VTi	118	01/97→02/01	➔				
2.0 i TD (MB7)	63	01/97→02/01	➔			24.0110-0212.1 410212	Ø 238,5 10 8 + S
2.0 TDiC (MB7)	74	11/98→10/00	➔				
2.0 TDiC (MB7)	77	11/98→10/00	➔				
1.6 i (MB1)	83	09/94→01/97	➔	→ 12/96		24.0121-0105.1 421105	Ø 262 21 19 V + S
1.6 i Vtec (MB1)	93	09/94→01/97	➔	→ 12/96		24.0110-0212.1 410212	Ø 238,5 10 8 + S
1.8 16V (MB6)	124	01/97→02/01	➔			24.0123-0106.1 423106	Ø 282 23 21 V
			➔			24.0110-0233.1 410233	Ø 260 10 8 + S
HONDA - CIVIC VI Hatchback (EJ, EK) 10/95→02/01							
 Bremsbelagsatz, Scheibenbremse							
1.4 i (EJ9)	55	11/95→02/01	➔	01/98→ 01/01		13.0460-5820.2 605820	SUM 21694 16,3 + WK
1.4 i S (EJ9)	66	11/95→02/01	➔	→ 12/97		13.0460-5943.2 605943	SUM 21697 15,0 + WK
1.4 LPG	66	01/97→02/01	➔				
1.5	66	11/95→12/96	➔			13.0460-5820.2 605820	SUM 21694 16,3 + WK
1.6 VTEC Type R	136	08/97→09/00	➔			13.0460-5731.2 605731	21738 13,5 + WK
1.5 i (EK3)	84	11/95→02/01	➔	→ 01/01		13.0460-5820.2 605820	SUM 21694 16,3 + WK
1.6 VTi (EK4)	118	11/95→02/01	➔	→ 01/01		13.0460-5731.2 605731	21738 13,5 + WK
1.6	92	11/98→10/00	➔			13.0460-5820.2 605820	SUM 21694 16,3 + WK
1.6	93	10/95→09/00	➔	01/96→		13.0460-5820.2 605820	SUM 21694 16,3 + WK
1.6 i (EK1)	84	11/95→02/01	➔	→ 01/01		13.0460-5820.2 605820	SUM 21694 16,3 + WK
2.0 TDiC	77	11/98→10/00	➔			13.0460-2803.2 602803	TRW 21515 17,5 + WK
			➔			13.0460-5920.2 605920	AKE 21322 15,0 + WK
			➔	01/99→		13.0460-5929.2 605929	AKE 21719 15,0 + WK
			➔	→ 12/98		13.0460-5998.2 605998	AKE 21312 12,8 + WK
Zubehörsatz, Scheibenbremsbelag							
1.4 i (EJ9)	55	11/95→02/01	➔	→ 12/97		13.0460-0073.2 610073	
1.4 i S (EJ9)	66	11/95→02/01	➔				
1.4 LPG	66	01/97→02/01	➔	01/98→ 01/01		13.0460-0073.2 610073	
1.5	66	11/95→12/96	➔			13.0460-0073.2 610073	
1.6 VTEC Type R	136	08/97→09/00	➔			13.0460-0329.2 610329	
1.5 i (EK3)	84	11/95→02/01	➔	→ 01/01		13.0460-0073.2 610073	
1.6 VTi (EK4)	118	11/95→02/01	➔	→ 01/01		13.0460-0329.2 610329	
1.6	92	11/98→10/00	➔			13.0460-0073.2 610073	
1.6	93	10/95→09/00	➔	01/96→		13.0460-0073.2 610073	
1.6 i (EK1)	84	11/95→02/01	➔	→ 01/01		13.0460-0073.2 610073	
2.0 TDiC	77	11/98→10/00	➔			13.0460-0142.2 610142	
			➔			13.0460-0308.2 610308	AKE
			➔	→ 12/98		13.0460-0430.2 610430	AKE
 Bremsscheibe							
1.4 i (EJ9)	55	11/95→02/01	➔	→ 01/01; - ABS		24.0121-0104.1 421104	SUM Ø 240 21 19 V + S
			➔	→ 01/01; + ABS		24.0121-0105.1 421105	Ø 262 21 19 V + S
1.4 i S (EJ9)	66	11/95→02/01	➔	→ 01/01		24.0121-0104.1 421104	SUM Ø 240 21 19 V + S
1.4 LPG	66	01/97→02/01	➔			24.0121-0105.1 421105	Ø 262 21 19 V + S
1.5	66	11/95→12/96	➔	- ABS		24.0121-0104.1 421104	SUM Ø 240 21 19 V + S
			➔	+ ABS		24.0121-0105.1 421105	Ø 262 21 19 V + S
			➔			24.0109-0111.1 409111	Ø 239 9 8 + S
1.5 i (EK3)	84	11/95→02/01	➔	→ 01/01; - ABS		24.0121-0104.1 421104	SUM Ø 240 21 19 V + S
			➔	→ 01/01; + ABS		24.0121-0105.1 421105	Ø 262 21 19 V + S
			➔	→ 01/01		24.0109-0111.1 409111	Ø 239 9 8 + S
1.6	92	11/98→10/00	➔			24.0121-0105.1 421105	Ø 262 21 19 V + S
1.6	93	10/95→09/00	➔	01/96→		24.0121-0105.1 421105	Ø 262 21 19 V + S
↓							















	kw			 	! #		
HONDA - CIVIC VI Hatchback (EJ, EK) 10/95→02/01							
 Bremsscheibe							
1.6 i (EK1)	84	11/95→02/01	← → 01/01		24.0121-0105.1	421105	Ø 262 21 19 V + S
1.6 VTEC Type R	136	08/97→09/00	←		24.0121-0105.1	421105	Ø 262 21 19 V + S
			→		24.0109-0111.1	409111	Ø 239 9 8 + S
1.6 VTi (EK4)	118	11/95→02/01	← → 01/01		24.0121-0105.1	421105	Ø 262 21 19 V + S
			→ 01/01		24.0109-0111.1	409111	Ø 239 9 8 + S
2.0 TDiC	77	11/98→10/00	←		24.0121-0105.1	421105	Ø 262 21 19 V + S
			→		24.0110-0212.1	410212	Ø 238,5 10 8 + S
HONDA - CIVIC VI Stufenheck (EJ, EK) 06/95→03/01							
 Bremsbelagsatz, Scheibenbremse							
1.4	55	11/95→10/98	← 01/98→		13.0460-5820.2	605820	SUM 21694 16,3 + WK
			← → 12/97		13.0460-5943.2	605943	SUM 21697 15,0 + WK
1.4 i (EJ9)	66	11/95→02/01	← 01/98→ 01/01		13.0460-5820.2	605820	SUM 21694 16,3 + WK
			← → 12/97		13.0460-5943.2	605943	SUM 21697 15,0 + WK
1.5 i	66	10/95→03/01	← 11/95→ 01/01		13.0460-5820.2	605820	SUM 21694 16,3 + WK
			→ 11/95→ 01/01		13.0460-5731.2	605731	21738 13,5 + WK
1.5 i (EK3) 1.6 VTi (EK4)	84	11/95→02/01	← → 01/01		13.0460-5820.2	605820	SUM 21694 16,3 + WK
	118	11/95→02/01	→ 01/01		13.0460-5731.2	605731	21738 13,5 + WK
1.6	93	10/95→12/00	← 01/96→		13.0460-5820.2	605820	SUM 21694 16,3 + WK
1.6	118	10/95→09/00	← 11/95→		13.0460-5820.2	605820	SUM 21694 16,3 + WK
			→ 11/95→		13.0460-5731.2	605731	21738 13,5 + WK
1.6 i Vtec	92	11/95→02/01	← → 01/01		13.0460-5820.2	605820	SUM 21694 16,3 + WK
Zubehörsatz, Scheibenbremsbelag							
1.4	55	11/95→10/98	← → 12/97		13.0460-0073.2	610073	
			← 01/98→		13.0460-0073.2	610073	
1.4 i (EJ9)	66	11/95→02/01	← → 12/97		13.0460-0073.2	610073	
			← 01/98→ 01/01		13.0460-0073.2	610073	
1.5 i	66	10/95→03/01	← 11/95→ 01/01		13.0460-0073.2	610073	
			→ 11/95→ 01/01		13.0460-0329.2	610329	
1.5 i (EK3) 1.6 VTi (EK4)	84	11/95→02/01	← → 01/01		13.0460-0073.2	610073	
	118	11/95→02/01	→ 01/01		13.0460-0329.2	610329	
1.6	93	10/95→12/00	← 01/96→		13.0460-0073.2	610073	
1.6	118	10/95→09/00	← 11/95→		13.0460-0073.2	610073	
			→ 11/95→		13.0460-0329.2	610329	
1.6 i Vtec	92	11/95→02/01	← → 01/01		13.0460-0073.2	610073	
 Bremsscheibe							
1.4	55	11/95→10/98	← - ABS		24.0121-0104.1	421104	SUM Ø 240 21 19 V + S
			← + ABS		24.0121-0105.1	421105	Ø 262 21 19 V + S
1.4 i (EJ9)	66	11/95→02/01	← → 01/01		24.0121-0104.1	421104	SUM Ø 240 21 19 V + S
					24.0121-0105.1	421105	Ø 262 21 19 V + S
1.5 i	66	10/95→03/01	← 11/95→ 01/01; - ABS		24.0121-0104.1	421104	SUM Ø 240 21 19 V + S
			← 11/95→ 01/01; + ABS		24.0121-0105.1	421105	Ø 262 21 19 V + S
			→ 11/95→ 01/01		24.0109-0111.1	409111	Ø 239 9 8 + S
1.5 i (EK3)	84	11/95→02/01	← → 01/01; - ABS		24.0121-0104.1	421104	SUM Ø 240 21 19 V + S
			← → 01/01; + ABS		24.0121-0105.1	421105	Ø 262 21 19 V + S
			→ 01/01		24.0109-0111.1	409111	Ø 239 9 8 + S
1.6	93	10/95→12/00	← 01/96→		24.0121-0105.1	421105	Ø 262 21 19 V + S
1.6	118	10/95→09/00	← 11/95→		24.0121-0105.1	421105	Ø 262 21 19 V + S
			→ 11/95→		24.0109-0111.1	409111	Ø 239 9 8 + S
1.6 i Vtec	92	11/95→02/01	← → 01/01		24.0121-0105.1	421105	Ø 262 21 19 V + S
1.6 VTi (EK4)	118	11/95→02/01	← → 01/01		24.0121-0105.1	421105	Ø 262 21 19 V + S
			→ 01/01		24.0109-0111.1	409111	Ø 239 9 8 + S











	kw			 	! #		
HONDA - CIVIC VII Coupe (EM2) 02/01→12/05							
 Bremsbelagsatz, Scheibenbremse							
1.6 i	81	02/01→12/05	←			13.0460-2803.2 602803	TRW 21515 17,5 + WK
			←	für Fahrzeuge mit Sportfahrwerk		13.0460-5755.2 605755	SUM 23178 16,6 + WK
			←	→ 10/04		13.0460-5820.2 605820	SUM 21694 16,3 + WK
			→	→ 10/04		13.0460-5929.2 605929	AKE 21719 15,0 + WK
			→			13.0460-5929.2 605929	AKE 21719 15,0 + WK
1.7 i	88	05/01→12/05	←	→ 10/04		13.0460-5820.2 605820	SUM 21694 16,3 + WK
1.7 i VTEC	92	05/01→12/05	→	→ 10/04		13.0460-5929.2 605929	AKE 21719 15,0 + WK
Zubehörsatz, Scheibenbremsbelag							
1.6 i	81	02/01→12/05	←			13.0460-0142.2 610142	
 Bremsscheibe							
1.6 i	81	02/01→12/05	←	→ 10/04; für Fahrzeuge mit Sportfahrwerk		24.0121-0105.1 421105	Ø 262 21 19 V + S
			←			24.0121-0105.1 421105	Ø 262 21 19 V + S
			←	für Fahrzeuge mit Sportpaket		24.0121-0702.1 421702	Ø 262 21 19 V + S
			←	für Fahrzeuge mit Sportfahrwerk		24.0123-0109.1 423109	Ø 282 23 21 V + S
			←	→ 10/04		24.0123-0109.1 423109	Ø 282 23 21 V + S
			→			24.0109-0143.1 409143	Ø 260 9 8 + S
			→	→ 10/04		24.0109-0143.1 409143	Ø 260 9 8 + S
			→	→ 10/04; für Fahrzeuge mit Sportfahrwerk		24.0110-0279.1 410279	Ø 260 10 8 + S
			→	für Fahrzeuge mit Sportfahrwerk		24.0110-0279.1 410279	Ø 260 10 8 + S
1.7 i	88	05/01→12/05	←	→ 10/04; für Fahrzeuge mit Sportfahrwerk		24.0121-0105.1 421105	Ø 262 21 19 V + S
1.7 i VTEC	92	05/01→12/05	←	→ 10/04		24.0123-0109.1 423109	Ø 282 23 21 V + S
			→	→ 10/04		24.0109-0143.1 409143	Ø 260 9 8 + S
			→	→ 10/04; für Fahrzeuge mit Sportfahrwerk		24.0110-0279.1 410279	Ø 260 10 8 + S
HONDA - CIVIC VII Hatchback (EU, EP, EV) 03/99→02/06							
 Bremsbelagsatz, Scheibenbremse							
1.4 i	55	02/01→09/05	←			13.0460-2803.2 602803	TRW 21515 17,5 + WK
1.6 i	81	02/01→09/05	←			13.0460-5820.2 605820	SUM 21694 16,3 + WK
			→			13.0460-5929.2 605929	AKE 21719 15,0 + WK
1.4 iS (EP1)	66	02/01→09/05	←			13.0460-2803.2 602803	TRW 21515 17,5 + WK
			←	für Fahrzeuge mit Sportfahrwerk		13.0460-5755.2 605755	SUM 23178 16,6 + WK
			→	für Linkslenker		13.0460-5929.2 605929	AKE 21719 15,0 + WK
1.7 CTDi	74	01/02→09/05	←	für Fahrzeuge mit Sportfahrwerk		13.0460-5755.2 605755	SUM 23178 16,6 + WK
			←			13.0460-5878.2 605878	23729 16,9 + WK
			→			13.0460-5861.2 605861	23097 17,1 + WK + Zub
			→			13.0460-5929.2 605929	AKE 21719 15,0 + WK
2.0 i Sport	118	09/01→09/05	←	01/04→		13.0460-5878.2 605878	23729 16,9 + WK
			→	01/04→		13.0460-5929.2 605929	AKE 21719 15,0 + WK
2.0 Type-R	147	09/01→09/05	←			13.0460-5755.2 605755	SUM 23178 16,6 + WK
			→			13.0460-5929.2 605929	AKE 21719 15,0 + WK
Zubehörsatz, Scheibenbremsbelag							
1.4 iS (EP1)	66	02/01→09/05	←			13.0460-0142.2 610142	
1.7 CTDi	74	01/02→09/05	←				
2.0 i Sport	118	09/01→09/05	←	01/04→		13.0460-0142.2 610142	
 Bremsscheibe							
1.4 i	55	02/01→09/05	←			24.0121-0105.1 421105	Ø 262 21 19 V + S
1.6 i	81	02/01→09/05	←	für Fahrzeuge mit Sportfahrwerk		24.0121-0702.1 421702	Ø 262 21 19 V + S
			→			24.0109-0143.1 409143	Ø 260 9 8 + S
			→	für Fahrzeuge mit Sportfahrwerk		24.0110-0279.1 410279	Ø 260 10 8 + S
1.4 iS (EP1)	66	02/01→09/05	←			24.0121-0105.1 421105	Ø 262 21 19 V + S
			←	für Fahrzeuge mit Sportpaket		24.0121-0702.1 421702	Ø 262 21 19 V + S
↓							















	kw					! #		
HONDA - CIVIC VII Hatchback (EU, EP, EV) 03/99→02/06								
 Bremsscheibe								
1.4 iS (EP1)	66	02/01→09/05	←	für Fahrzeuge mit Sportfahrwerk		24.0123-0109.1	423109	Ø 282 23 21 V + S
			→	für Linkslenker		24.0109-0143.1	409143	Ø 260 9 8 + S
			→	für Linkslenker; für Fahrzeuge mit Sportfahrwerk		24.0110-0279.1	410279	Ø 260 10 8 + S
1.7 CTDi	74	01/02→09/05	←	für Fahrzeuge mit Sportfahrwerk		24.0123-0109.1	423109	Ø 282 23 21 V + S
						24.0125-0173.1	425173	Ø 300 25 23 V + S
			←			24.0123-0111.1	423111	Ø 260 23 21 V + S
			→			24.0109-0143.1	409143	Ø 260 9 8 + S
			→	für Fahrzeuge mit Sportfahrwerk		24.0110-0279.1	410279	Ø 260 10 8 + S
2.0 i Sport	118	09/01→09/05	←	01/04→		24.0123-0109.1	423109	Ø 282 23 21 V + S
			→	01/04→		24.0110-0279.1	410279	Ø 260 10 8 + S
2.0 Type-R	147	09/01→09/05	←			24.0125-0173.1	425173	Ø 300 25 23 V + S
			→			24.0110-0279.1	410279	Ø 260 10 8 + S
HONDA - CIVIC VII Stufenheck (ES, ET) 10/00→04/06								
 Bremsbelagsatz, Scheibenbremse								
1.3 IMA (ES9)	61	10/03→09/05	←	01/04→		13.0460-2803.2	602803	TRW 21515 17,5 + WK
						13.0460-5820.2	605820	SUM 21694 16,3 + WK
			→	01/04→		13.0460-5929.2	605929	AKE 21719 15,0 + WK
1.4 (ES4)	66	12/00→09/05	←	02/01→		13.0460-2803.2	602803	TRW 21515 17,5 + WK
						13.0460-5820.2	605820	SUM 21694 16,3 + WK
			←	02/01→; für Fahrzeuge mit Sportfahrwerk		13.0460-5878.2	605878	23729 16,9 + WK
			→	02/01→		13.0460-5929.2	605929	AKE 21719 15,0 + WK
1.6 1.6	81 84	02/01→09/05 02/01→09/05	←			13.0460-2803.2	602803	TRW 21515 17,5 + WK
						13.0460-5820.2	605820	SUM 21694 16,3 + WK
			←	für Fahrzeuge mit Sportfahrwerk		13.0460-5878.2	605878	23729 16,9 + WK
			→			13.0460-5929.2	605929	AKE 21719 15,0 + WK
2.0 (ET1)	118	10/03→09/05	←	01/04→		13.0460-5878.2	605878	23729 16,9 + WK
			→	01/04→		13.0460-5929.2	605929	AKE 21719 15,0 + WK
Zubehörsatz, Scheibenbremsbelag								
1.4 (ES4)	66	12/00→09/05	←	02/01→		13.0460-0142.2	610142	
1.6 1.6	81 84	02/01→09/05 02/01→09/05	←			13.0460-0142.2	610142	
2.0 (ET1)	118	10/03→09/05	←	01/04→		13.0460-0142.2	610142	
 Bremsscheibe								
1.3 IMA (ES9)	61	10/03→09/05	←	01/04→		24.0121-0105.1	421105	Ø 262 21 19 V + S
			←	01/04→; für Fahrzeuge mit Sportfahrwerk		24.0121-0702.1	421702	Ø 262 21 19 V + S
			→	01/04→		24.0109-0143.1	409143	Ø 260 9 8 + S
			→	01/04→; für Fahrzeuge mit Sportfahrwerk		24.0110-0279.1	410279	Ø 260 10 8 + S
1.4 (ES4)	66	12/00→09/05	←	02/01→		24.0121-0105.1	421105	Ø 262 21 19 V + S
			←	02/01→; für Fahrzeuge mit Sportfahrwerk		24.0123-0109.1	423109	Ø 282 23 21 V + S
			→	02/01→		24.0109-0143.1	409143	Ø 260 9 8 + S
			→	02/01→; für Fahrzeuge mit Sportfahrwerk		24.0110-0279.1	410279	Ø 260 10 8 + S
1.6 1.6	81 84	02/01→09/05 02/01→09/05	←			24.0121-0105.1	421105	Ø 262 21 19 V + S
			←	für Fahrzeuge mit Sportfahrwerk		24.0123-0109.1	423109	Ø 282 23 21 V + S
			→	für Rechtslenker		24.0109-0143.1	409143	Ø 260 9 8 + S
			→			24.0109-0143.1	409143	Ø 260 9 8 + S
			→	für Rechtslenker; für Fahrzeuge mit Sportfahrwerk		24.0110-0279.1	410279	Ø 260 10 8 + S
			→	für Fahrzeuge mit Sportfahrwerk		24.0110-0279.1	410279	Ø 260 10 8 + S
2.0 (ET1)	118	10/03→09/05	←	01/04→		24.0123-0109.1	423109	Ø 282 23 21 V + S
			→	01/04→		24.0110-0279.1	410279	Ø 260 10 8 + S

















	kw			 	! #		
HONDA - CIVIC VIII Hatchback (FN, FK) 09/05→							
 Bremsbelagsatz, Scheibenbremse							
1.4 (FK1, FN4)	73	10/08→	← → 12/12			13.0460-5756.2 605756	24087 17,4 + WK + Zub
			→ 12/12			13.0460-5757.2 605757	24086 15,8 + WK + Zub
1.4 (FK1)	61	09/05→	← 01/06→ 01/12			13.0460-5756.2 605756	24087 17,4 + WK + Zub
			→ 01/06→ 01/12			13.0460-5757.2 605757	24086 15,8 + WK + Zub
1.6	84	09/05→	← → 12/12			13.0460-5878.2 605878	23729 16,9 + WK
			→ 12/12			13.0460-5929.2 605929	AKE 21719 15,0 + WK
1.8 (FN1, FK2)	103	09/05→	← 01/06→ 12/12			13.0460-5756.2 605756	24087 17,4 + WK + Zub
2.2 CTDi (FK3)	103	09/05→	→ 01/06→ 12/12			13.0460-5757.2 605757	24086 15,8 + WK + Zub
Type R (FN2)	148	09/06→	← → 12/12			13.0460-5755.2 605755	SUM 23178 16,6 + WK
			→ 12/12			13.0460-5757.2 605757	24086 15,8 + WK + Zub
Zubehörsatz, Scheibenbremsbelag							
1.4 (FK1, FN4)	73	10/08→	← → 12/12			13.0460-0142.2 610142	
1.4 (FK1)	61	09/05→	← 01/06→ 01/12			13.0460-0142.2 610142	
1.8 (FN1, FK2)	103	09/05→	← 01/06→ 12/12			13.0460-0142.2 610142	
2.2 CTDi (FK3)	103	09/05→					
 Bremsscheibe							
1.4 (FK1, FN4)	73	10/08→	← → 12/12			24.0123-0110.1 423110	Ø 282 23 21 V + S
1.6	84	09/05→	→ 12/12			24.0109-0158.1 409158	Ø 260 9 8 + S
1.4 (FK1)	61	09/05→	← 01/06→ 01/12			24.0123-0110.1 423110	Ø 282 23 21 V + S
			→ 01/06→ 01/12			24.0109-0158.1 409158	Ø 260 9 8 + S
1.8 (FN1, FK2)	103	09/05→	← 01/06→ 12/12			24.0123-0110.1 423110	Ø 282 23 21 V + S
2.2 CTDi (FK3)	103	09/05→	→ 01/06→ 12/12			24.0109-0158.1 409158	Ø 260 9 8 + S
Type R (FN2)	148	09/06→	→ 12/12			24.0109-0158.1 409158	Ø 260 9 8 + S
HONDA - CIVIC VIII Stufenheck (FD, FA) 09/05→							
 Bremsbelagsatz, Scheibenbremse							
1.3	85	02/06→	← → 02/12			13.0460-5820.2 605820	SUM 21694 16,3 + WK
1.3 Hybrid (FA3, FD3)	70	01/06→	→ 02/12			13.0460-5929.2 605929	AKE 21719 15,0 + WK
1.3 Hybrid (FD3)	85	01/10→02/12	→			13.0460-5929.2 605929	AKE 21719 15,0 + WK
1.6	84	09/05→	← → 12/12			13.0460-5878.2 605878	23729 16,9 + WK
1.6	92	09/05→	→ 12/12			13.0460-5929.2 605929	AKE 21719 15,0 + WK
1.7	85	09/05→					
1.8	97	01/06→					
1.8 EXS Flex	103	11/06→					
1.6	92	01/12→	← 02/12→			13.0460-7284.2 607284	ATE 25804 17,3 + WK
			→ 02/12→			13.0460-7290.2 607290	ATE 24574 15,0 + WK
1.8 (FD1)	103	09/05→02/12	←			13.0460-5878.2 605878	23729 16,9 + WK
			→			13.0460-5929.2 605929	AKE 21719 15,0 + WK
2.0	114	02/06→02/12	←			13.0460-5755.2 605755	SUM 23178 16,6 + WK
2.0	148	01/07→	→			13.0460-5757.2 605757	24086 15,8 + WK + Zub
Zubehörsatz, Scheibenbremsbelag							
1.6	84	09/05→	← → 12/12			13.0460-0142.2 610142	
1.6	92	09/05→					
1.7	85	09/05→					
1.8	97	01/06→					
1.8 EXS Flex	103	11/06→					
1.8 (FD1)	103	09/05→02/12	←			13.0460-0142.2 610142	
 Bremsscheibe							
1.3	85	02/06→	← → 02/12			24.0121-0702.1 421702	Ø 262 21 19 V + S
1.3 Hybrid (FA3, FD3)	70	01/06→	→ 02/12			24.0109-0158.1 409158	Ø 260 9 8 + S
1.3 Hybrid (FD3)	85	01/10→02/12	←			24.0121-0702.1 421702	Ø 262 21 19 V + S
			→			24.0109-0158.1 409158	Ø 260 9 8 + S
1.6	84	09/05→	← → 12/12			24.0123-0110.1 423110	Ø 282 23 21 V + S
1.6	92	09/05→					
1.7	85	09/05→	→ 12/12			24.0109-0158.1 409158	Ø 260 9 8 + S
1.8	97	01/06→					
1.8 EXS Flex	103	11/06→					
↓							















	kW					! #		
HONDA - CIVIC VIII Stufenheck (FD, FA) 09/05→								
 Bremsscheibe								
1.6	92	01/12→	←	02/12→		24.0125-0201.1	425201	Ø 280 25 22,4 V
			→	02/12→		24.0110-0380.1	410380	Ø 276 10 8
1.8 (FD1)	103	09/05→02/12	←			24.0123-0110.1	423110	Ø 282 23 21 V + S
			→			24.0109-0158.1	409158	Ø 260 9 8 + S
2.0	114	02/06→02/12	→			24.0109-0158.1	409158	Ø 260 9 8 + S
2.0	148	01/07→						
HONDA - CIVIC IX (FK) 02/12→								
 Bremsbelagsatz, Scheibenbremse								
1.4 i-VTEC (FK1)	73	02/12→	←			13.0460-7284.2	607284	ATE 25804 17,3 + WK
1.6 i-DTEC (FK3)	88	02/13→						
1.8 i-VTEC (FK2)	104	02/12→	→			13.0460-7290.2	607290	ATE 24574 15,0 + WK
2.2 i-DTEC (FK3)	110	02/12→						
 Bremsscheibe								
1.4 i-VTEC (FK1)	73	02/12→	←			24.0125-0201.1	425201	Ø 280 25 22,4 V
1.6 i-DTEC (FK3)	88	02/13→						
2.2 i-DTEC (FK3)	110	02/12→	→			24.0110-0380.1	410380	Ø 276 10 8
1.8 i-VTEC (FK2)	104	02/12→	←	passend für Felgenreöße [Zoll]: 15		24.0125-0201.1	425201	Ø 280 25 22,4 V
			→			24.0110-0380.1	410380	Ø 276 10 8
HONDA - CIVIC IX Stufenheck (FB, FG) 09/11→								
 Bremsbelagsatz, Scheibenbremse								
1.8 (FB2)	104	02/12→	←			13.0460-7284.2	607284	ATE 25804 17,3 + WK
2.0	114	06/12→	→			13.0460-7290.2	607290	ATE 24574 15,0 + WK
 Bremsscheibe								
1.8 (FB2)	104	02/12→	←	passend für Felgenreöße [Zoll]: 15		24.0125-0201.1	425201	Ø 280 25 22,4 V
			→			24.0110-0380.1	410380	Ø 276 10 8
2.0	114	06/12→	←			24.0125-0201.1	425201	Ø 280 25 22,4 V
			→			24.0110-0380.1	410380	Ø 276 10 8
HONDA - CIVIC IX Tourer (FK) 01/14→								
 Bremsbelagsatz, Scheibenbremse								
1.6 i-DTEC (FK3)	88	01/14→	←			13.0460-7284.2	607284	ATE 25804 17,3 + WK
1.8 i-VTEC (FK2)	104	01/14→	→			13.0460-7290.2	607290	ATE 24574 15,0 + WK
 Bremsscheibe								
1.6 i-DTEC (FK3)	88	01/14→	←			24.0125-0201.1	425201	Ø 280 25 22,4 V
			→			24.0110-0380.1	410380	Ø 276 10 8
1.8 i-VTEC (FK2)	104	01/14→	←	passend für Felgenreöße [Zoll]: 15		24.0125-0201.1	425201	Ø 280 25 22,4 V
			→			24.0110-0380.1	410380	Ø 276 10 8
HONDA - CIVIC X Schrägheck (FC_, FK) 09/16→								
 Bremsbelagsatz, Scheibenbremse								
1.0 VTEC (FK6)	95	02/17→	←			13.0460-7284.2	607284	ATE 25804 17,3 + WK
1.5 VTEC (FK7)	134	02/17→						
HONDA - CIVIC Coupe 09/05→12/11								
 Bremsbelagsatz, Scheibenbremse								
2.0	148	09/05→12/11	←	09/06→		13.0460-5755.2	605755	SUM 23178 16,6 + WK
			→	09/06→		13.0460-5757.2	605757	24086 15,8 + WK + Zub
 Bremsscheibe								
2.0	148	09/05→12/11	→	09/06→		24.0109-0158.1	409158	Ø 260 9 8 + S
HONDA - CONCERTO (HW, MA) 08/89→10/96								
 Bremsbelagsatz, Scheibenbremse								
1.5 i 16V	66	08/89→03/95	←	01/90→ 01/95		13.0460-2803.2	602803	TRW 21515 17,5 + WK
						13.0460-5920.2	605920	AKE 21322 15,0 + WK
1.6 16V	78	08/89→03/95	←	01/90→ 01/95		13.0460-2803.2	602803	TRW 21515 17,5 + WK
↓								

















	kW			 	! #		
HONDA - CONCERTO (HW, MA) 08/89→10/96							
 Bremsbelagsatz, Scheibenbremse							
1.6 i 16V	82	08/89→03/95	←	01/90→01/95		13.0460-5920.2 605920	AKE 21322 15,0 + WK
1.6 i 16V	90	08/89→03/95	→	01/90→01/95		13.0460-5998.2 605998	AKE 21312 12,8 + WK
Zubehörsatz, Scheibenbremsbelag							
1.5 i 16V	66	08/89→03/95	←	01/90→01/95		13.0460-0142.2 610142 13.0460-0308.2 610308	AKE
1.6 16V	78	08/89→03/95	←	01/90→01/95		13.0460-0142.2 610142	AKE
1.6 i 16V	82	08/89→03/95				13.0460-0308.2 610308	
1.6 i 16V	90	08/89→03/95	→	01/90→01/95		13.0460-0430.2 610430	
 Bremsscheibe							
1.5 i 16V	66	08/89→03/95	←	01/90→01/95		24.0121-0107.1 421107	Ø 262 21 19 V
1.6 16V	78	08/89→03/95	←	01/90→01/95		24.0121-0107.1 421107	Ø 262 21 19 V
1.6 i 16V	82	08/89→03/95				24.0110-0212.1 410212	Ø 238,5 10 8 + S
1.6 i 16V	90	08/89→03/95	→	01/90→01/95			
HONDA - CONCERTO Stufenheck (HWW) 08/89→05/95							
 Bremsbelagsatz, Scheibenbremse							
1.5 i 16V	66	08/89→05/95	←	01/90→01/95		13.0460-2803.2 602803 13.0460-5920.2 605920	TRW 21515 17,5 + WK AKE 21322 15,0 + WK
1.6 16V	78	08/89→03/95	←	01/90→01/95		13.0460-2803.2 602803	TRW 21515 17,5 + WK
1.6 i 16V	82	08/89→03/95				13.0460-5920.2 605920	AKE 21322 15,0 + WK
1.6 i 16V	90	08/89→03/95	→	01/90→01/95		13.0460-5998.2 605998	AKE 21312 12,8 + WK
Zubehörsatz, Scheibenbremsbelag							
1.5 i 16V	66	08/89→05/95	←	01/90→01/95		13.0460-0142.2 610142 13.0460-0308.2 610308	AKE
1.6 16V	78	08/89→03/95	←	01/90→01/95		13.0460-0142.2 610142	AKE
1.6 i 16V	82	08/89→03/95				13.0460-0308.2 610308	
1.6 i 16V	90	08/89→03/95	→	01/90→01/95		13.0460-0430.2 610430	
 Bremsscheibe							
1.5 i 16V	66	08/89→05/95	←	01/90→01/95		24.0121-0107.1 421107	Ø 262 21 19 V
1.6 16V	78	08/89→03/95	←	01/90→01/95		24.0121-0107.1 421107	Ø 262 21 19 V
1.6 i 16V	82	08/89→03/95				24.0110-0212.1 410212	Ø 238,5 10 8 + S
1.6 i 16V	90	08/89→03/95	→	01/90→01/95			
HONDA - CR-V I (RD) 10/95→02/02							
 Bremsbelagsatz, Scheibenbremse							
2.0 (RD1)	98	04/99→02/02	←			13.0460-5982.2 605982	21651 17,5 + WK
2.0 16V 4WD (RD1, RD3)	94	10/95→12/01	←	01/97→04/99		13.0460-5982.2 605982	21651 17,5 + WK
2.0 16V 4WD (RD1, RD3)	108	01/99→02/02	←	04/99→		13.0460-5982.2 605982	21651 17,5 + WK
Zubehörsatz, Scheibenbremsbelag							
2.0 (RD1)	98	04/99→02/02	←			13.0460-0075.2 610075	
2.0 16V 4WD (RD1, RD3)	94	10/95→12/01	←	01/97→04/99		13.0460-0075.2 610075	
2.0 16V 4WD (RD1, RD3)	108	01/99→02/02	←	04/99→		13.0460-0075.2 610075	
 Bremsscheibe							
2.0 (RD1)	98	04/99→02/02	←			24.0123-0104.1 423104	Ø 282 23 21 V + S
2.0 16V 4WD (RD1, RD3)	94	10/95→12/01	←	01/97→04/99		24.0123-0104.1 423104	Ø 282 23 21 V + S
2.0 16V 4WD (RD1, RD3)	108	01/99→02/02	←	04/99→		24.0123-0104.1 423104	Ø 282 23 21 V + S
HONDA - CR-V II (RD_) 09/01→12/06							
 Bremsbelagsatz, Scheibenbremse							
2.0	112	03/02→09/06	←	passend für Felgengröße [Zoll]: 16		13.0460-5753.2 605753	24638 20,0 + WK + Zub
2.2 CTDi (RD9)	103	02/05→09/06	←	passend für Felgengröße [Zoll]: 15		13.0460-5860.2 605860	23868 17,1 + WK + Zub
			→			13.0460-5711.2 605711	23652 15,7 + WK
↓							















	kw			 	! #		
HONDA - CR-V II (RD_) 09/01→12/06							
 Bremsbelagsatz, Scheibenbremse							
2.0 (RD4)	110	09/01→09/06	←	07/02→; passend für Felgengröße [Zoll]: 16	13.0460-5753.2	605753	24638 20,0 + WK + Zub
			←	07/02→; passend für Felgengröße [Zoll]: 15	13.0460-5860.2	605860	23868 17,1 + WK + Zub
			→	07/02→ 12/04	13.0460-5711.2	605711	23652 15,7 + WK
			→	01/05→	13.0460-5754.2	605754	24635 16,6 + WK + Zub
2.4 Vtec 4WD (RD7)	118	09/01→09/06	←	03/02→; passend für Felgengröße [Zoll]: 16	13.0460-5753.2	605753	24638 20,0 + WK + Zub
			←	03/02→; passend für Felgengröße [Zoll]: 15	13.0460-5860.2	605860	23868 17,1 + WK + Zub
			→	03/02→ 12/04	13.0460-5711.2	605711	23652 15,7 + WK
			→	01/05→	13.0460-5754.2	605754	24635 16,6 + WK + Zub
 Bremsscheibe							
2.0	112	03/02→09/06	←	passend für Felgengröße [Zoll]: 15	24.0123-0109.1	423109	Ø 282 23 21 V + S
			←	passend für Felgengröße [Zoll]: 16	24.0125-0182.1	425182	Ø 300 25 23 V + S
			→	→ 12/04	24.0109-0144.1	409144	Ø 282 9 8 + S
			→	01/05→	24.0109-0151.1	409151	Ø 304,5 9 7,5 + S
2.0 (RD4)	110	09/01→09/06	←	07/02→; passend für Felgengröße [Zoll]: 15	24.0123-0109.1	423109	Ø 282 23 21 V + S
			←	07/02→; passend für Felgengröße [Zoll]: 16	24.0125-0182.1	425182	Ø 300 25 23 V + S
			→	07/02→ 12/04	24.0109-0144.1	409144	Ø 282 9 8 + S
			→	01/05→	24.0109-0151.1	409151	Ø 304,5 9 7,5 + S
2.2 CTDi (RD9)	103	02/05→09/06	←	passend für Felgengröße [Zoll]: 15	24.0123-0109.1	423109	Ø 282 23 21 V + S
			←	passend für Felgengröße [Zoll]: 16	24.0125-0182.1	425182	Ø 300 25 23 V + S
			→		24.0109-0151.1	409151	Ø 304,5 9 7,5 + S
2.4 Vtec 4WD (RD7)	118	09/01→09/06	←	03/02→; passend für Felgengröße [Zoll]: 15	24.0123-0109.1	423109	Ø 282 23 21 V + S
			←	03/02→; passend für Felgengröße [Zoll]: 16	24.0125-0182.1	425182	Ø 300 25 23 V + S
			→	03/02→ 12/04	24.0109-0144.1	409144	Ø 282 9 8 + S
			→	01/05→	24.0109-0151.1	409151	Ø 304,5 9 7,5 + S
HONDA - CR-V III (RE_) 06/06→							
 Bremsbelagsatz, Scheibenbremse							
2.0 i	110	01/07→	←	→ 09/12	13.0460-5753.2	605753	24638 20,0 + WK + Zub
2.0 i 4WD (RE5)	110	01/07→	→	→ 09/12	13.0460-5754.2	605754	24635 16,6 + WK + Zub
2.0 i-VTEC	105	11/09→					
2.2 i-CTDi 4WD (RE6)	103	01/07→					
2.2 i-DTEC 4WD (RE6)	110	01/07→					
2.4	125	04/07→					
2.4 i-Vtec 4WD	125	04/07→					
2.4 i-VTEC 4WD (RE7)	122	09/09→					
2.4	134	06/06→06/12	←	01/07→	13.0460-5753.2	605753	24638 20,0 + WK + Zub
			→	01/07→	13.0460-5754.2	605754	24635 16,6 + WK + Zub
2.4 4WD (RE4)	124	09/06→	←	09/07→ 09/12	13.0460-5753.2	605753	24638 20,0 + WK + Zub
			→	09/07→ 09/12	13.0460-5754.2	605754	24635 16,6 + WK + Zub
2.4 i-VTEC	118	10/06→	←	01/07→ 09/12	13.0460-5753.2	605753	24638 20,0 + WK + Zub
2.4 i-VTEC 4WD (RE4)	118	10/06→	→	01/07→ 09/12	13.0460-5754.2	605754	24635 16,6 + WK + Zub
 Bremsscheibe							
2.0 i	110	01/07→	←	→ 09/12	24.0128-0217.1	428217	Ø 293 28 26 V + S
2.0 i 4WD (RE5)	110	01/07→	→	→ 09/12	24.0110-0329.1	410329	Ø 302 10 8 + S
2.0 i-VTEC	105	11/09→					
2.2 i-CTDi 4WD (RE6)	103	01/07→					
2.2 i-DTEC 4WD (RE6)	110	01/07→					
2.4	125	04/07→					
2.4 i-Vtec 4WD	125	04/07→					
2.4 i-VTEC 4WD (RE7)	122	09/09→					
2.4	134	06/06→06/12	←	01/07→	24.0128-0217.1	428217	Ø 293 28 26 V + S
			→	01/07→	24.0110-0329.1	410329	Ø 302 10 8 + S
2.4 4WD (RE4)	124	09/06→	←	09/07→ 09/12	24.0128-0217.1	428217	Ø 293 28 26 V + S
			→	09/07→ 09/12	24.0110-0329.1	410329	Ø 302 10 8 + S
↓							















	kw			 	! #		
HONDA - CR-V III (RE_) 06/06→							
 Bremsscheibe							
2.4 i-VTEC	118	10/06→	←	01/07→ 09/12		24.0128-0217.1 428217	Ø 293 28 26 V + S
2.4 i-VTEC 4WD (RE4)	118	10/06→	→	01/07→ 09/12		24.0110-0329.1 410329	Ø 302 10 8 + S
HONDA - CR-V IV (RM_) 01/12→							
 Bremsbelagsatz, Scheibenbremse							
1.6 i-DTEC (RE6)	88	10/13→	←			13.0460-5753.2 605753	24638 20,0 + WK + Zub
2.0	110	01/12→	→			13.0460-5754.2 605754	24635 16,6 + WK + Zub
2.0 (RE5)	114	10/12→					
2.0 AWD (RE5)	114	10/12→					
2.2 i-DTEC AWD (RE6)	110	10/12→					
1.6 i-DTEC 4WD	118	02/15→	←	Bremssattel(1-Kolben)		13.0460-5753.2 605753	24638 20,0 + WK + Zub
			→			13.0460-5754.2 605754	24635 16,6 + WK + Zub
 Bremsscheibe							
1.6 i-DTEC (RE6)	88	10/13→	←			24.0128-0217.1 428217	Ø 293 28 26 V + S
2.0	110	01/12→	→			24.0110-0329.1 410329	Ø 302 10 8 + S
2.0 (RE5)	114	10/12→					
2.0 AWD (RE5)	114	10/12→					
1.6 i-DTEC 4WD	118	02/15→	←	Bremssattel(1-Kolben)		24.0128-0217.1 428217	Ø 293 28 26 V + S
			→			24.0110-0329.1 410329	Ø 302 10 8 + S
2.2 i-DTEC AWD (RE6)	110	10/12→	→			24.0110-0329.1 410329	Ø 302 10 8 + S
HONDA - CRX III (EH, EG) 03/92→12/98							
 Bremsbelagsatz, Scheibenbremse							
1.6 ESi (EH6)	92	03/92→12/98	←			13.0460-5820.2 605820	SUM 21694 16,3 + WK
			→	+ ABS		13.0460-5998.2 605998	AKE 21312 12,8 + WK
1.6 i VTi (EG2)	118	03/92→12/98	←			13.0460-5820.2 605820	SUM 21694 16,3 + WK
			→			13.0460-5998.2 605998	AKE 21312 12,8 + WK
Zubehörsatz, Scheibenbremsbelag							
1.6 ESi (EH6)	92	03/92→12/98	→	+ ABS		13.0460-0430.2 610430	AKE
1.6 i VTi (EG2)	118	03/92→12/98	→			13.0460-0430.2 610430	AKE
 Bremsscheibe							
1.6 ESi (EH6)	92	03/92→12/98	←			24.0121-0105.1 421105	Ø 262 21 19 V + S
			→	+ ABS		24.0109-0111.1 409111	Ø 239 9 8 + S
1.6 i VTi (EG2)	118	03/92→12/98	←			24.0121-0105.1 421105	Ø 262 21 19 V + S
			→			24.0109-0111.1 409111	Ø 239 9 8 + S
HONDA - FR-V (BE) 08/04→							
 Bremsbelagsatz, Scheibenbremse							
1.7 (BE1)	92	08/04→	←	02/05→ 06/09		13.0460-5878.2 605878	23729 16,9 + WK
			→	02/05→ 06/09		13.0460-5711.2 605711	23652 15,7 + WK
1.8 (BE1)	103	01/07→	←	→ 06/09		13.0460-5878.2 605878	23729 16,9 + WK
2.0 (BE3)	110	02/05→	→	→ 12/09		13.0460-5711.2 605711	23652 15,7 + WK
2.2 i CTDi (BE5)	103	07/05→					
2.0	114	08/04→09/06	←	02/05→		13.0460-5878.2 605878	23729 16,9 + WK
			→	02/05→		13.0460-5711.2 605711	23652 15,7 + WK
 Bremsscheibe							
1.7 (BE1)	92	08/04→	←	02/05→ 06/09		24.0123-0110.1 423110	Ø 282 23 21 V + S
			→	02/05→ 06/09		24.0112-0172.1 412172	Ø 282 12 10 + S
1.8 (BE1)	103	01/07→	←	→ 06/09		24.0123-0110.1 423110	Ø 282 23 21 V + S
2.0 (BE3)	110	02/05→	→	→ 06/09		24.0112-0172.1 412172	Ø 282 12 10 + S
2.0	114	08/04→09/06	←	02/05→		24.0123-0110.1 423110	Ø 282 23 21 V + S
			→	02/05→		24.0112-0172.1 412172	Ø 282 12 10 + S
2.2 i CTDi (BE5)	103	07/05→	←	→ 06/09		24.0125-0189.1 425189	Ø 281,5 25 23 V + S
			→	→ 06/09		24.0112-0172.1 412172	Ø 282 12 10 + S

















	kw			 	! #		
HONDA - HR-V (GH) 03/99 →							
 Bremsbelagsatz, Scheibenbremse							
1.6 16V (GH1, GH3)	77	03/99 →	←	→ 09/05		13.0460-5982.2 605982	21651 17,5 + WK
1.6 16V 4WD (GH2, GH4)	77	03/99 →					
1.6 16V 4WD (GH2, GH4)	91	10/99 →					
 Bremsscheibe							
1.6 16V (GH1, GH3)	77	03/99 →	←	→ 09/05		24.0123-0104.1 423104	Ø 282 23 21 V + S
1.6 16V 4WD (GH2, GH4)	77	03/99 →					
1.6 16V 4WD (GH2, GH4)	91	10/99 →					
HONDA - INSIGHT (ZE_) 04/09 →							
 Bremsbelagsatz, Scheibenbremse							
1.3 Hybrid (ZE2)	65	04/09 →	←	→ 09/13		13.0460-5620.2 605620	AKE 24979 15,9 + WK + Zub
1.3 Hybrid (ZE2)	73	04/09 →	→	→ 09/13		13.0460-5929.2 605929	AKE 21719 15,0 + WK
 Bremsscheibe							
1.3 Hybrid (ZE2)	65	04/09 →	←	→ 09/13		24.0121-0105.1 421105	Ø 262 21 19 V + S
1.3 Hybrid (ZE2)	73	04/09 →	→	→ 09/13		24.0109-0162.1 409162	Ø 260 9 8 + S
HONDA - INSIGHT (ZE) 04/00 → 12/06							
 Bremsscheibe							
1.0 Hybrid (ZE1)	56	04/00 → 12/06	←	08/00 →		24.0117-0101.1 417101	AKE Ø 231 17 15 V
1.0 Vtec	50	04/00 → 10/04					
HONDA - INTEGRA Coupe (DC2, DC4) 07/93 → 11/01							
 Bremsbelagsatz, Scheibenbremse							
1.8	101	07/93 → 11/01	→	11/97 → 10/01		13.0460-5929.2 605929	AKE 21719 15,0 + WK
1.8	107	07/93 → 11/01					
1.8 SiR	132	09/93 → 08/01	→	11/97 →		13.0460-5929.2 605929	AKE 21719 15,0 + WK
1.8 Type-R (DC2)	147	09/93 → 08/01					
1.8 VTiR	125	07/93 → 11/99					
1.8 VTiR	127	07/93 → 11/99					
1.8 Type-R	140	11/97 → 10/01	→			13.0460-5929.2 605929	AKE 21719 15,0 + WK
 Bremsscheibe							
1.8	101	07/93 → 11/01	←	11/97 → 10/01		24.0123-0104.1 423104	Ø 282 23 21 V + S
1.8	107	07/93 → 11/01					
1.8 SiR	132	09/93 → 08/01	←	11/97 →		24.0123-0104.1 423104	Ø 282 23 21 V + S
1.8 Type-R (DC2)	147	09/93 → 08/01					
1.8 VTiR	125	07/93 → 11/99					
1.8 VTiR	127	07/93 → 11/99					
1.8 Type-R	140	11/97 → 10/01	←			24.0123-0104.1 423104	Ø 282 23 21 V + S
HONDA - JAZZ II (GD_, GE3, GE2) 06/01 → 12/08							
 Bremsbelagsatz, Scheibenbremse							
1.2 i-DSi (GD5, GE2)	57	03/02 → 07/08	←			13.0460-5943.2 605943	SUM 21697 15,0 + WK
1.3 (GD1)	61	03/02 → 07/08	→	01/04 →; + ABS		13.0460-5731.2 605731	21738 13,5 + WK
1.3 iDSi	63	03/02 → 09/07	←	10/05 →		13.0460-5943.2 605943	SUM 21697 15,0 + WK
			→	10/05 →		13.0460-5731.2 605731	21738 13,5 + WK
1.4	59	12/06 → 10/08	←			13.0460-5943.2 605943	SUM 21697 15,0 + WK
			→	+ ABS		13.0460-5731.2 605731	21738 13,5 + WK
1.5	81	04/02 → 07/08	←	09/05 →		13.0460-5943.2 605943	SUM 21697 15,0 + WK
1.5 FF	79	03/02 → 09/07	→	09/05 →		13.0460-5731.2 605731	21738 13,5 + WK
1.7	92	10/03 → 09/07	←	01/04 →		13.0460-5943.2 605943	SUM 21697 15,0 + WK
			→	01/04 →		13.0460-5731.2 605731	21738 13,5 + WK
 Bremsscheibe							
1.2 i-DSi (GD5, GE2)	57	03/02 → 07/08	←	→ 12/03		24.0121-0113.1 421113	Ø 240 21 19 V + S
1.3 (GD1)	61	03/02 → 07/08	←	01/04 →		24.0121-0115.1 421115	Ø 258 21 19 V + S
			→	01/04 →; + ABS		24.0109-0111.1 409111	Ø 239 9 8 + S
1.3 iDSi	63	03/02 → 09/07	←	10/05 →		24.0121-0115.1 421115	Ø 258 21 19 V + S
↓							













	kW					! #		
HONDA - JAZZ II (GD_, GE3, GE2) 06/01→12/08								
 Bremsscheibe								
1.3 iDSi	63	03/02→09/07	➔	10/05→		24.0109-0111.1	409111	Ø 239 9 8 + S
1.4	59	12/06→10/08	➔			24.0121-0115.1	421115	Ø 258 21 19 V + S
			➔	+ ABS		24.0109-0111.1	409111	Ø 239 9 8 + S
1.5 1.5 FF	81 79	04/02→07/08 03/02→09/07	➔	09/05→		24.0121-0115.1	421115	Ø 258 21 19 V + S
			➔	09/05→		24.0109-0111.1	409111	Ø 239 9 8 + S
1.7	92	10/03→09/07	➔	01/04→		24.0121-0115.1	421115	Ø 258 21 19 V + S
			➔	01/04→		24.0109-0111.1	409111	Ø 239 9 8 + S
HONDA - JAZZ III (GE_, GG_, GP_) 10/07→								
 Bremsbelagsatz, Scheibenbremse								
1.2 1.3 i	66 73	07/08→ 07/08→	➔	01/09→ 12/15		13.0460-5620.2	605620	AKE 24979 15,9 + WK + Zub
			➔	→ 12/08		13.0460-5943.2	605943	SUM 21697 15,0 + WK
			➔	→ 12/15		13.0460-5731.2	605731	21738 13,5 + WK
1.3 HYBRID (GP1)	65	04/11→	➔	→ 12/15		13.0460-5620.2	605620	AKE 24979 15,9 + WK + Zub
			➔	→ 12/15		13.0460-5929.2	605929	AKE 21719 15,0 + WK
1.4 1.4 LX Flex 1.5 i-VTEC 1.5 i-VTEC	74 74 87 88	11/08→ 11/08→ 09/08→ 07/08→	➔	→ 12/15		13.0460-5620.2	605620	AKE 24979 15,9 + WK + Zub
			➔	→ 12/15		13.0460-5731.2	605731	21738 13,5 + WK
			➔	→ 12/15		13.0460-5620.2	605620	AKE 24979 15,9 + WK + Zub
1.5 Flex	85	10/07→	➔	07/08→		13.0460-5620.2	605620	AKE 24979 15,9 + WK + Zub
			➔	07/08→		13.0460-5731.2	605731	21738 13,5 + WK
1.5 Flexfuel	88	07/08→	➔			13.0460-5620.2	605620	AKE 24979 15,9 + WK + Zub
			➔			13.0460-5731.2	605731	21738 13,5 + WK
 Bremsscheibe								
1.2	66	07/08→	➔	01/09→ 12/15		24.0121-0105.1	421105	Ø 262 21 19 V + S
			➔	→ 12/08		24.0121-0115.1	421115	Ø 258 21 19 V + S
			➔	→ 12/08		24.0109-0111.1	409111	Ø 239 9 8 + S
1.3 HYBRID (GP1)	65	04/11→	➔	→ 12/15		24.0121-0105.1	421105	Ø 262 21 19 V + S
			➔	→ 12/15		24.0109-0162.1	409162	Ø 260 9 8 + S
1.3 i	73	07/08→	➔	→ 12/15		24.0121-0105.1	421105	Ø 262 21 19 V + S
			➔	→ 12/15		24.0109-0178.1	409178	Ø 239 9 8
1.4 1.4 LX Flex	74 74	11/08→ 11/08→	➔	→ 12/15		24.0121-0105.1	421105	Ø 262 21 19 V + S
			➔	07/08→		24.0121-0105.1	421105	Ø 262 21 19 V + S
1.5 Flex	85	10/07→	➔	07/08→		24.0109-0111.1	409111	Ø 239 9 8 + S
			➔	07/08→ 12/08		24.0109-0111.1	409111	Ø 239 9 8 + S
1.5 Flexfuel 1.5 i-VTEC 1.5 i-VTEC	88 87 88	07/08→ 09/08→ 07/08→	➔			24.0121-0105.1	421105	Ø 262 21 19 V + S
			➔	→ 12/08		24.0109-0111.1	409111	Ø 239 9 8 + S
			➔			24.0109-0111.1	409111	Ø 239 9 8 + S
HONDA - JAZZ IV (GK_) 09/13→								
 Bremsscheibe								
1.3	75	09/15→	➔			24.0121-0105.1	421105	Ø 262 21 19 V + S
			➔			24.0109-0178.1	409178	Ø 239 9 8
HONDA - LEGEND II (KA) 01/91→03/96								
 Bremsbelagsatz, Scheibenbremse								
3.2 i 24V (KA7)	151	01/91→02/96	➔	→ 01/96		13.0460-5982.2	605982	21651 17,5 + WK
			➔	→ 01/96		13.0460-5711.2	605711	23652 15,7 + WK
 Bremsscheibe								
3.2 i 24V (KA7)	151	01/91→02/96	➔	→ 01/96		24.0128-0722.1	428722	Ø 282 28 26 V
			➔	→ 01/96		24.0109-0132.1	409132	Ø 282 9 7,5
HONDA - LEGEND II Coupe (KA) 01/91→03/96								
 Bremsbelagsatz, Scheibenbremse								
3.2 i 24V (KA8)	151	01/91→02/96	➔	→ 01/96		13.0460-5982.2	605982	21651 17,5 + WK
			➔	→ 01/96		13.0460-5711.2	605711	23652 15,7 + WK
↓								













	kw			 	! #		
HONDA - LEGEND II Coupe (KA) 01/91→03/96							
 Bremsscheibe							
3.2 i 24V (KA8)	151	01/91→02/96	←	→ 01/96		24.0128-0722.1 428722	Ø 282 28 26 V
			→	→ 01/96		24.0109-0132.1 409132	Ø 282 9 7,5
HONDA - LEGEND III (KA) 02/96→							
 Bremsbelagsatz, Scheibenbremse							
3.5 i 24V (KA9)	151	02/96→10/97	←			13.0460-5982.2 605982	21651 17,5 + WK
			→			13.0460-5711.2 605711	23652 15,7 + WK
3.5 i 24V (KA9)	153	11/97→09/04	←	→ 12/98		13.0460-5982.2 605982	21651 17,5 + WK
			→	01/99→		13.0460-5711.2 605711	23652 15,7 + WK
Zubehörsatz, Scheibenbremsbelag							
3.5 i 24V (KA9)	151	02/96→10/97	→			13.0460-0287.2 610287	
3.5 i 24V (KA9)	153	11/97→09/04	→	01/99→		13.0460-0287.2 610287	
			→	→ 12/98		13.0460-0287.2 610287	
 Bremsscheibe							
3.5 i 24V (KA9)	151	02/96→10/97	←			24.0123-0104.1 423104	Ø 282 23 21 V + S
			→			24.0109-0132.1 409132	Ø 282 9 7,5
3.5 i 24V (KA9)	153	11/97→09/04	←	→ 12/98		24.0123-0104.1 423104	Ø 282 23 21 V + S
			→	→ 12/98		24.0109-0132.1 409132	Ø 282 9 7,5
HONDA - LOGO (GA) 03/99→03/02							
 Bremsbelagsatz, Scheibenbremse							
1.3 (GA3)	48	03/99→03/02	←			13.0460-5943.2 605943	SUM 21697 15,0 + WK
 Bremsscheibe							
1.3 (GA3)	48	03/99→03/02	←			24.0121-0113.1 421113	Ø 240 21 19 V + S
HONDA - NSX Cabriolet (NA) 03/95→09/05							
 Bremsbelagsatz, Scheibenbremse							
3.0 24V Vtec	201	03/95→09/05	←	10/01→; Vollautomatik		13.0460-5982.2 605982	21651 17,5 + WK
3.0 24V Vtec Automatic	188	03/95→09/05					
3.2 24V Vtec	206	01/97→09/05	←	10/01→		13.0460-5982.2 605982	21651 17,5 + WK
HONDA - NSX Coupe (NA) 06/90→09/05							
 Bremsbelagsatz, Scheibenbremse							
3.0 24V Vtec (NA1)	201	06/90→09/05	←	10/01→; Vollautomatik		13.0460-5982.2 605982	21651 17,5 + WK
3.0 24V Vtec Automatic (NA1)	188	06/90→09/05					
3.2 24V Vtec (NA2)	206	01/97→09/05	←	10/01→		13.0460-5982.2 605982	21651 17,5 + WK
HONDA - ODYSSEY (RA_) 10/95→12/99							
 Bremsbelagsatz, Scheibenbremse							
2.3	110	10/97→12/99	←	01/98→		13.0460-5982.2 605982	21651 17,5 + WK
			→	01/98→		13.0460-5711.2 605711	23652 15,7 + WK
Zubehörsatz, Scheibenbremsbelag							
2.3	110	10/97→12/99	←	01/98→		13.0460-0075.2 610075	
			→	01/98→		13.0460-0287.2 610287	
 Bremsscheibe							
2.3	110	10/97→12/99	←	01/98→		24.0123-0104.1 423104	Ø 282 23 21 V + S
			→	01/98→		24.0109-0132.1 409132	Ø 282 9 7,5
HONDA - PRELUDE IV (BB) 12/91→02/97							
 Bremsbelagsatz, Scheibenbremse							
2.0 i 16V (BB3)	98	02/92→09/96	←	passend für Felgengröße [Zoll]: 14		13.0460-5955.2 605955	AKE 21879 18,6 + WK
			→			13.0460-5929.2 605929	AKE 21719 15,0 + WK
2.2 i 16V Vtec (BB1)	136	02/93→09/96	←	passend für Felgengröße [Zoll]: 15		13.0460-5982.2 605982	21651 17,5 + WK
2.3 i 16V (BB2)	118	02/92→09/96					
↓							













	kw					! #		
HONDA - PRELUDE IV (BB) 12/91→02/97								
 Bremsbelagsatz, Scheibenbremse								
2.2 i 16V Vtec (BB1)	136	02/93→09/96	➡				13.0460-5929.2 605929	AKE 21719 15,0 + WK
2.3 i 16V (BB2)	118	02/92→09/96						
Zubehörsatz, Scheibenbremsbelag								
2.0 i 16V (BB3)	98	02/92→09/96	⬅	passend für Felgengröße [Zoll]: 14			13.0460-0453.2 610453	AKE
 Bremsscheibe								
2.0 i 16V (BB3)	98	02/92→09/96	⬅	passend für Felgengröße [Zoll]: 14			24.0123-0105.1 423105	Ø 260 23 21 V
			➡				24.0110-0267.1 410267	Ø 260 10 8
2.2 i 16V Vtec (BB1)	136	02/93→09/96	⬅	passend für Felgengröße [Zoll]: 15			24.0123-0106.1 423106	Ø 282 23 21 V
2.3 i 16V (BB2)	118	02/92→09/96	➡				24.0110-0267.1 410267	Ø 260 10 8
HONDA - PRELUDE V (BB) 10/96→04/01								
 Bremsbelagsatz, Scheibenbremse								
2.0 16V (BB9)	98	10/96→10/00	⬅				13.0460-5955.2 605955	AKE 21879 18,6 + WK
			➡				13.0460-5929.2 605929	AKE 21719 15,0 + WK
2.2 16V	147	10/96→10/00	⬅				13.0460-5982.2 605982	21651 17,5 + WK
2.2 16V (BB6, BB8)	136	10/96→10/00	➡				13.0460-5929.2 605929	AKE 21719 15,0 + WK
2.2 Si (BB5)	118	03/97→07/02	⬅	→ 10/00			13.0460-5982.2 605982	21651 17,5 + WK
			➡	→ 10/00			13.0460-5929.2 605929	AKE 21719 15,0 + WK
Zubehörsatz, Scheibenbremsbelag								
2.0 16V (BB9)	98	10/96→10/00	⬅				13.0460-0075.2 610075	
2.2 16V	147	10/96→10/00	➡				13.0460-0287.2 610287	
2.2 16V (BB6, BB8)	136	10/96→10/00	⬅	→ 10/00			13.0460-0075.2 610075	
2.2 Si (BB5)	118	03/97→07/02	➡	→ 10/00			13.0460-0287.2 610287	
 Bremsscheibe								
2.0 16V (BB9)	98	10/96→10/00	⬅				24.0123-0105.1 423105	Ø 260 23 21 V
			➡				24.0109-0141.1 409141	Ø 260 9 8 + S
2.2 16V	147	10/96→10/00	⬅				24.0123-0104.1 423104	Ø 282 23 21 V + S
2.2 16V (BB6, BB8)	136	10/96→10/00	➡				24.0123-0104.1 423104	Ø 282 23 21 V + S
2.2 Si (BB5)	118	03/97→07/02	⬅	→ 10/00			24.0123-0104.1 423104	Ø 282 23 21 V + S
HONDA - S2000 (AP) 03/99→								
 Bremsbelagsatz, Scheibenbremse								
2.0 (AP1)	177	06/99→	⬅	→ 09/04			13.0460-5755.2 605755	SUM 23178 16,6 + WK
2.0 Vtec (AP1)	184	10/03→	➡	→ 09/04			13.0460-5929.2 605929	AKE 21719 15,0 + WK
 Bremsscheibe								
2.0 (AP1)	177	06/99→	⬅	→ 09/04			24.0125-0706.1 425706	Ø 300 25 23 V
2.0 Vtec (AP1)	184	10/03→	➡	→ 09/04			24.0112-0707.1 412707	Ø 282 12 10
HONDA - SHUTTLE (RA) 06/94→06/04								
 Bremsbelagsatz, Scheibenbremse								
2.2 16V (RA1)	110	10/94→02/98	⬅	01/95→ 12/97			13.0460-5982.2 605982	21651 17,5 + WK
			➡	01/95→ 12/97			13.0460-5711.2 605711	23652 15,7 + WK
2.3 16V (RA3)	110	10/97→06/04	⬅	01/98→ 05/01			13.0460-5982.2 605982	21651 17,5 + WK
3.0	154	10/97→06/04	➡	01/98→ 05/01			13.0460-5711.2 605711	23652 15,7 + WK
Zubehörsatz, Scheibenbremsbelag								
2.2 16V (RA1)	110	10/94→02/98	⬅	01/95→ 12/97			13.0460-0075.2 610075	
			➡	01/95→ 12/97			13.0460-0287.2 610287	
2.3 16V (RA3)	110	10/97→06/04	⬅	01/98→ 05/01			13.0460-0075.2 610075	
3.0	154	10/97→06/04	➡	01/98→ 05/01			13.0460-0287.2 610287	
 Bremsscheibe								
2.2 16V (RA1)	110	10/94→02/98	⬅	01/95→ 12/97			24.0123-0104.1 423104	Ø 282 23 21 V + S
			➡	01/95→ 12/97			24.0109-0132.1 409132	Ø 282 9 7,5
↓								













	kW					! #		
HONDA - SHUTTLE (RA) 06/94→06/04								
 Bremsscheibe								
2.3 16V (RA3) 3.0	110 154	10/97→06/04 10/97→06/04	← →	01/98→ 05/01 01/98→ 05/01		24.0123-0104.1 24.0109-0132.1	423104 409132	∅ 282 23 21 V + S ∅ 282 9 7,5
HONDA - STREAM (RN) 05/01→								
 Bremsbelagsatz, Scheibenbremse								
1.7 16V (RN1) 2.0 16V (RN3)	92 115	05/01→ 05/01→	← →	→ 09/05; passend für Felgenreöße [Zoll]: 15 → 09/05		13.0460-5878.2 13.0460-5711.2	605878 605711	23729 16,9 + WK 23652 15,7 + WK
 Bremsscheibe								
1.7 16V (RN1) 2.0 16V (RN3)	92 115	05/01→ 05/01→	← →	→ 09/05; passend für Felgenreöße [Zoll]: 15 → 09/05		24.0123-0109.1 24.0112-0172.1	423109 412172	∅ 282 23 21 V + S ∅ 282 12 10 + S
HYUNDAI - ACCENT I (X-3) 05/94→01/00								
 Bremsbelagsatz, Scheibenbremse								
1.3	40	09/95→05/98	←			13.0460-5936.2	605936	AKE 21012 15,0 - WE / - WK
1.3 1.3 1.3 i 12V 1.5 16V 1.5 i 12V 1.5 i 16V	44 55 62 76 65 73	10/94→01/00 10/94→01/00 10/94→01/00 10/94→01/00 10/94→01/00 12/95→01/00	←	→ 12/99		13.0460-5936.2	605936	AKE 21012 15,0 - WE / - WK
 Bremsscheibe								
1.3	40	09/95→05/98	←			24.0119-0109.1	419109	∅ 242 19,1 17 V
1.3 1.3 1.3 i 12V 1.5 16V 1.5 i 12V 1.5 i 16V	44 55 62 76 65 73	10/94→01/00 10/94→01/00 10/94→01/00 10/94→01/00 10/94→01/00 12/95→01/00	←	→ 12/99		24.0119-0109.1	419109	∅ 242 19,1 17 V
HYUNDAI - ACCENT II (LC) 09/99→11/05								
 Bremsbelagsatz, Scheibenbremse								
1.3 1.3 1.3 1.3 1.5 1.5 1.5 CRDi 1.6	55 61 62 63 66 75 60 77	01/00→11/05 01/00→11/05 08/02→11/05 01/00→11/05 01/00→11/05 09/00→11/05 04/02→11/05 12/02→11/05	←	→ 09/05		13.0460-5872.2	605872	AKE 21012 15,0 + WK + Zub
1.5 1.5 1.5	65 68 77	09/99→10/02 01/00→10/02 09/99→10/02	←	01/00→ 01/00→ 01/00→ 08/02		13.0460-5872.2	605872	AKE 21012 15,0 + WK + Zub AKE 21012 15,0 + WK + Zub AKE 21012 15,0 + WK + Zub
 Bremsscheibe								
1.3 1.3 1.3 1.3 1.5 1.5 1.5 CRDi 1.6	55 61 62 63 66 75 60 77	01/00→11/05 01/00→11/05 08/02→11/05 01/00→11/05 01/00→11/05 09/00→11/05 04/02→11/05 12/02→11/05	←	→ 09/05		24.0119-0114.1	419114	∅ 241 19 17 V
1.5 1.5 1.5	65 68 77	09/99→10/02 01/00→10/02 09/99→10/02	←	01/00→ 01/00→ 01/00→ 08/02		24.0119-0114.1	419114	∅ 241 19 17 V ∅ 241 19 17 V ∅ 241 19 17 V
HYUNDAI - ACCENT II Stufenheck (LC) 09/99→12/06								
 Bremsbelagsatz, Scheibenbremse								
1.3 1.3 1.5 1.5 1.5 LPG 1.6	55 63 66 69 69 77	01/00→11/05 01/00→11/05 01/00→11/05 01/00→12/06 01/00→ 12/02→11/05	←	→ 09/05		13.0460-5872.2	605872	AKE 21012 15,0 + WK + Zub
1.5 1.5	73 75	09/99→10/02 09/99→10/02	←	09/00→		13.0460-5872.2	605872	AKE 21012 15,0 + WK + Zub











	kw			 	! #		
HYUNDAI - ACCENT II Stufenheck (LC) 09/99→12/06							
 Bremsbelagsatz, Scheibenbremse							
1.5 CRDi	60	01/02→11/05	←	04/02→ 09/05		13.0460-5872.2 605872	AKE 21012 15,0 + WK + Zub
 Bremsscheibe							
1.3	55	01/00→11/05	←	→ 09/05		24.0119-0114.1 419114	Ø 241 19 17 V
1.3	63	01/00→11/05					
1.5	66	01/00→11/05					
1.5	69	01/00→12/06					
1.5 LPG	69	01/00→					
1.6	77	12/02→11/05					
1.5	73	09/99→10/02	←	09/00→		24.0119-0114.1 419114	Ø 241 19 17 V
1.5	75	09/99→10/02					
1.5 CRDi	60	01/02→11/05	←	04/02→ 09/05		24.0119-0114.1 419114	Ø 241 19 17 V
HYUNDAI - ACCENT III (MC) 11/05→11/10							
 Bremsbelagsatz, Scheibenbremse							
1.4 GL	71	11/05→11/10	←			13.0460-5779.2 605779	24317 17,6 + WK + Zub
1.5 CRDi GLS	81	11/05→11/10					
1.6 GLS	82	11/05→11/10	→	+ ABS		13.0460-5780.2 605780	24320 15,3 + WK + Zub
 Bremsscheibe							
1.4 GL	71	11/05→11/10	←			24.0122-0260.1 422260	Ø 256 22 20 V
1.5 CRDi GLS	81	11/05→11/10					
1.6 GLS	82	11/05→11/10	→	+ ABS		24.0110-0312.1 410312	Ø 262 10 8,4
HYUNDAI - ACCENT III Stufenheck (MC) 11/05→11/10							
 Bremsbelagsatz, Scheibenbremse							
1.4 GL	71	11/05→11/10	←			13.0460-5779.2 605779	24317 17,6 + WK + Zub
1.5	70	01/08→11/10					
1.5 CRDi GLS	81	11/05→11/10	→	+ ABS		13.0460-5780.2 605780	24320 15,3 + WK + Zub
1.5 LPG	70	01/08→11/10					
1.6 GLS	82	11/05→11/10					
 Bremsscheibe							
1.4 GL	71	11/05→11/10	←			24.0122-0260.1 422260	Ø 256 22 20 V
1.5 CRDi GLS	81	11/05→11/10					
1.6 GLS	82	11/05→11/10	→	+ ABS		24.0110-0312.1 410312	Ø 262 10 8,4
1.5	70	01/08→11/10	←			24.0122-0260.1 422260	Ø 256 22 20 V
1.5 LPG	70	01/08→11/10					
HYUNDAI - ACCENT IV (RB) 11/10→							
 Bremsbelagsatz, Scheibenbremse							
1.4	74	09/15→	←			13.0460-5646.2 605646	MAN 25348 17,8 + WK + Zub
1.4	79	11/10→					
1.6	90	12/10→					
1.6	91	11/10→					
1.6 CRDi	94	07/11→	←	10/11→		13.0460-5646.2 605646	MAN 25348 17,8 + WK + Zub
 Bremsscheibe							
1.4	74	09/15→	→	+ ABS		24.0110-0398.1 410398	Ø 262 10 8,4
1.4	79	11/10→					
1.6	90	12/10→					
1.6	91	11/10→					
1.6 CRDi	94	07/11→	→	10/11→; + ABS		24.0110-0398.1 410398	Ø 262 10 8,4
HYUNDAI - ACCENT IV Stufenheck (RB) 08/10→							
 Bremsbelagsatz, Scheibenbremse							
1.4	74	11/10→12/16	←			13.0460-5646.2 605646	MAN 25348 17,8 + WK + Zub
1.4	80	11/10→12/14					
1.4 CRDi	66	11/10→					
1.6	90	11/10→					
1.6	91	11/10→					
1.6 CRDi	100	04/11→					
1.6 CRDi	94	11/10→12/15	←	10/11→		13.0460-5646.2 605646	MAN 25348 17,8 + WK + Zub
 Bremsscheibe							
1.4	74	11/10→12/16	→	+ ABS		24.0110-0398.1 410398	Ø 262 10 8,4
1.4	80	11/10→12/14					
1.4 CRDi	66	11/10→					
1.6	90	11/10→					
1.6	91	11/10→					
1.6 CRDi	100	04/11→					
1.6 CRDi	94	11/10→12/15	→	10/11→; + ABS		24.0110-0398.1 410398	Ø 262 10 8,4

	kw				! #		
HYUNDAI - ACCENT Stufenheck (X-3) 05/94→01/00							
 Bremsbelagsatz, Scheibenbremse							
1.3	44	10/94→01/00	←	→ 12/99		13.0460-5936.2	605936 AKE 21012 15,0 - WE / - WK
1.3	55	10/94→01/00					
1.3 i 12V	62	10/94→01/00					
1.5 i 12V	65	10/94→01/00					
1.5 i 16V	73	10/95→01/00					
1.5	63	10/94→07/99	←			13.0460-5936.2	605936 AKE 21012 15,0 - WE / - WK
 Bremsscheibe							
1.3	44	10/94→01/00	←	→ 12/99		24.0119-0109.1	419109 Ø 242 19,1 17 V
1.3	55	10/94→01/00					
1.3 i 12V	62	10/94→01/00					
1.5 i 12V	65	10/94→01/00					
1.5 i 16V	73	10/95→01/00					
1.5	63	10/94→07/99	←			24.0119-0109.1	419109 Ø 242 19,1 17 V
HYUNDAI - ATOS (MX) 01/97→							
 Bremsbelagsatz, Scheibenbremse							
0.8	38	04/99→07/03	←			13.0460-5803.2	605803 23238 16,0 + WK
1.0 i	40	02/98→12/00					
1.0 i	41	02/98→03/02	←	→ 01/01		13.0460-5803.2	605803 23238 16,0 + WK
			←	02/01→		13.0460-5829.2	605829 24277 16,0 + WK + Zub
1.0 i	43	03/01→07/03	←			13.0460-5829.2	605829 24277 16,0 + WK + Zub
1.1	43	08/03→05/05					
1.1	45	06/03→12/10	←	→ 01/07		13.0460-5829.2	605829 24277 16,0 + WK + Zub
1.1	46	01/97→12/08	←	03/04→ 02/08		13.0460-5829.2	605829 24277 16,0 + WK + Zub
 Bremsscheibe							
0.8	38	04/99→07/03	←			24.0111-0125.1	411125 Ø 230 11 8,4
1.0 i	40	02/98→12/00					
1.0 i	41	02/98→03/02	←	→ 01/01		24.0111-0125.1	411125 Ø 230 11 8,4
			←	02/01→		24.0118-0138.1	418138 Ø 234 18 16 V
1.0 i	43	03/01→07/03	←			24.0118-0138.1	418138 Ø 234 18 16 V
1.1	43	08/03→05/05					
1.1	45	06/03→12/10	←	→ 01/07		24.0118-0138.1	418138 Ø 234 18 16 V
1.1	46	01/97→12/08	←	03/04→ 02/08		24.0118-0138.1	418138 Ø 234 18 16 V
HYUNDAI - ATOS PRIME (MX) 08/99→							
 Bremsbelagsatz, Scheibenbremse							
1.0 i	40	08/99→	←	→ 01/01		13.0460-5803.2	605803 23238 16,0 + WK
			←	02/01→ 07/02		13.0460-5829.2	605829 24277 16,0 + WK + Zub
1.0 i	43	03/01→	←	08/01→ 12/05		13.0460-5829.2	605829 24277 16,0 + WK + Zub
1.1	43	06/03→	←	→ 01/07		13.0460-5829.2	605829 24277 16,0 + WK + Zub
1.1	46	09/05→	←	→ 08/08		13.0460-5829.2	605829 24277 16,0 + WK + Zub
 Bremsscheibe							
1.0 i	40	08/99→	←	→ 01/01		24.0111-0125.1	411125 Ø 230 11 8,4
			←	02/01→ 07/02		24.0118-0138.1	418138 Ø 234 18 16 V
1.0 i	43	03/01→	←	08/01→ 12/05		24.0118-0138.1	418138 Ø 234 18 16 V
1.1	43	06/03→	←	→ 01/07		24.0118-0138.1	418138 Ø 234 18 16 V
1.1	46	09/05→	←	→ 08/08		24.0118-0138.1	418138 Ø 234 18 16 V
HYUNDAI - COUPE (GK) 01/01→11/09							
 Bremsbelagsatz, Scheibenbremse							
1.6 16V	77	03/02→08/09	←			13.0460-5873.2	605873 MAN 23891 16,9 + WK
1.6 16V	79	03/02→08/09					
2.0	100	08/01→08/09	→			13.0460-5874.2	605874 SUM 21553 14,0 + WK + Zub
2.0	102	03/02→08/09					
2.0 GLS	105	02/03→08/09					
2.7 V6	123	03/02→08/09					
2.7 V6	121	01/01→08/09	←	01/07→		13.0460-5873.2	605873 MAN 23891 16,9 + WK
			→	01/07→		13.0460-5874.2	605874 SUM 21553 14,0 + WK + Zub
Zubehörsatz, Scheibenbremsbelag							
1.6 16V	77	03/02→08/09	←			13.0460-0139.2	610139 MAN
1.6 16V	79	03/02→08/09					
↓							















	kW			 	! #		
HYUNDAI - COUPE (GK) 01/01→11/09							
Zubehörsatz, Scheibenbremsbelag							
2.0	100	08/01→08/09	←			13.0460-0139.2 610139	MAN
2.0	102	03/02→08/09					
2.0 GLS	105	02/03→08/09					
2.7 V6	123	03/02→08/09					
2.7 V6	121	01/01→08/09	←	01/07→		13.0460-0139.2 610139	MAN
 Bremsscheibe							
1.6 16V	77	03/02→08/09	←			24.0126-0128.1 426128	Ø 280 26 24,4 V
1.6 16V	79	03/02→08/09					
2.0	100	08/01→08/09	→			24.0110-0298.1 410298	Ø 258 10 8
2.0	102	03/02→08/09					
2.0 GLS	105	02/03→08/09					
2.7 V6	123	03/02→08/09					
2.7 V6	121	01/01→08/09	←	01/07→		24.0126-0128.1 426128	Ø 280 26 24,4 V
			→	01/07→		24.0110-0298.1 410298	Ø 258 10 8
HYUNDAI - COUPE (RD) 06/96→04/02							
 Bremsbelagsatz, Scheibenbremse							
1.6 16V	85	03/98→04/02	←			13.0460-5933.2 605933	AKE 21725 16,8 + WK
1.6 i 16V	79	08/00→01/02					
1.6 i 16V	84	12/96→04/02	→	+ ABS		13.0460-5874.2 605874	SUM 21553 14,0 + WK + Zub
1.8 SX	94	07/96→04/02	←	03/01→		13.0460-5933.2 605933	AKE 21725 16,8 + WK
			→	03/01→		13.0460-5874.2 605874	SUM 21553 14,0 + WK + Zub
2.0	101	08/99→01/02	←			13.0460-5933.2 605933	AKE 21725 16,8 + WK
2.0 16V	99	03/01→04/02					
2.0 16V	102	08/96→04/02	→			13.0460-5874.2 605874	SUM 21553 14,0 + WK + Zub
F2 Evolution	115	01/99→05/99					
 Bremsscheibe							
1.6 16V	85	03/98→04/02	←	→ 08/98		24.0122-0170.1 422170	Ø 257 22 20 V
1.6 i 16V	84	12/96→04/02				24.0322-0170.1 522170	Ø 257 22 20 V PD
			←	09/98→		24.0124-0706.1 424706	Ø 257 24 22,4 V
			→	+ ABS		24.0110-0264.1 410264	Ø 258 10 8
1.6 i 16V	79	08/00→01/02	←			24.0124-0706.1 424706	Ø 257 24 22,4 V
			→	+ ABS		24.0110-0264.1 410264	Ø 258 10 8
1.8 SX	94	07/96→04/02	←	03/01→		24.0124-0706.1 424706	Ø 257 24 22,4 V
			→	03/01→		24.0110-0264.1 410264	Ø 258 10 8
2.0	101	08/99→01/02	←			24.0124-0706.1 424706	Ø 257 24 22,4 V
2.0 16V	99	03/01→04/02					
F2 Evolution	115	01/99→05/99	→			24.0110-0264.1 410264	Ø 258 10 8
2.0 16V	102	08/96→04/02	←	→ 08/98		24.0122-0170.1 422170	Ø 257 22 20 V
						24.0322-0170.1 522170	Ø 257 22 20 V PD
			←	09/98→		24.0124-0706.1 424706	Ø 257 24 22,4 V
			→			24.0110-0264.1 410264	Ø 258 10 8
HYUNDAI - CRETA 01/16→							
 Bremsscheibe							
1.6	90	01/16→	→	Made in Russia-made		24.0110-0368.1 410368	Ø 262 10 8,4
2.0	110	01/16→	→			24.0110-0368.1 410368	Ø 262 10 8,4
HYUNDAI - ELANTRA (XD) 03/00→07/06							
 Bremsbelagsatz, Scheibenbremse							
1.6	66	06/00→07/06	←	06/01→ 07/03		13.0460-5875.2 605875	MAN 24031 17,7 + WK
			←	→ 05/01		13.0460-5933.2 605933	AKE 21725 16,8 + WK
			→	→ 05/06; + ABS		13.0460-5874.2 605874	SUM 21553 14,0 + WK + Zub
1.6	77	05/03→07/06	←	08/03→ 05/06		13.0460-5876.2 605876	MAN 24369 17,2 + WK
			→	08/03→ 05/06; + ABS		13.0460-5874.2 605874	SUM 21553 14,0 + WK + Zub
1.6	79	06/00→07/06	←	06/01→ 07/03		13.0460-5875.2 605875	MAN 24031 17,7 + WK
1.8	97	06/00→07/06					
2.0	102	06/00→07/06	←	08/03→ 05/06		13.0460-5876.2 605876	MAN 24369 17,2 + WK
2.0	104	06/00→07/06	←	→ 05/01		13.0460-5933.2 605933	AKE 21725 16,8 + WK
			→	→ 05/06; + ABS		13.0460-5874.2 605874	SUM 21553 14,0 + WK + Zub
1.6	82	09/03→07/06	←	→ 05/06		13.0460-5876.2 605876	MAN 24369 17,2 + WK
2.0	105	10/03→07/06					
↓							













	kw					! #		
HYUNDAI - ELANTRA (XD) 03/00→07/06								
 Bremsbelagsatz, Scheibenbremse								
1.6 2.0	82 105	09/03→07/06 10/03→07/06	➡	→ 05/06; + ABS		13.0460-5874.2	605874	SUM 21553 14,0 + WK + Zub
1.8	79	06/00→07/03	⬅	06/01→		13.0460-5875.2	605875	MAN 24031 17,7 + WK
			⬅	→ 05/01		13.0460-5933.2	605933	AKE 21725 16,8 + WK
			➡	+ ABS		13.0460-5874.2	605874	SUM 21553 14,0 + WK + Zub
2.0 CRDi	83	04/01→07/06	⬅	→ 07/03		13.0460-5875.2	605875	MAN 24031 17,7 + WK
			⬅	08/03→ 05/06		13.0460-5876.2	605876	MAN 24369 17,2 + WK
			➡	→ 05/06; + ABS		13.0460-5874.2	605874	SUM 21553 14,0 + WK + Zub
 Bremsscheibe								
1.6 1.6	66 79	06/00→07/06 06/00→07/06	⬅	→ 07/03		24.0124-0184.1	424184	Ø 257 24 22,1 V
			➡	→ 05/06; + ABS		24.0110-0264.1	410264	Ø 258 10 8
1.6	77	05/03→07/06	⬅	08/03→ 05/06; - ABS		24.0124-0184.1	424184	Ø 257 24 22,1 V
			⬅	08/03→ 05/06; + ABS		24.0126-0129.1	426129	Ø 280 26 24,4 V
			➡	08/03→ 05/06; + ABS		24.0110-0264.1	410264	Ø 258 10 8
1.6	82	09/03→07/06	⬅	→ 05/06; - ABS		24.0124-0184.1	424184	Ø 257 24 22,1 V
			⬅	→ 05/06; + ABS		24.0126-0129.1	426129	Ø 280 26 24,4 V
			➡	→ 05/06; + ABS		24.0110-0264.1	410264	Ø 258 10 8
1.8	79	06/00→07/03	⬅			24.0124-0184.1	424184	Ø 257 24 22,1 V
			➡	+ ABS		24.0110-0264.1	410264	Ø 258 10 8
1.8 2.0 2.0 2.0	97 102 104 105	06/00→07/06 06/00→07/06 06/00→07/06 10/03→07/06	⬅	→ 05/06		24.0124-0184.1	424184	Ø 257 24 22,1 V
			➡	→ 05/06; + ABS		24.0110-0264.1	410264	Ø 258 10 8
2.0 CRDi	83	04/01→07/06	⬅	→ 06/03		24.0124-0184.1	424184	Ø 257 24 22,1 V
			⬅	07/03→ 05/06		24.0126-0129.1	426129	Ø 280 26 24,4 V
			➡	→ 05/06; + ABS		24.0110-0264.1	410264	Ø 258 10 8
HYUNDAI - ELANTRA Stufenheck (HD) 11/05→12/11								
 Bremsbelagsatz, Scheibenbremse								
1.6 CRDi 1.6 CVVT 2.0 CVVT 2.0 CVVT	85 90 103 105	11/05→12/11 06/06→06/11 06/06→05/10 06/06→06/11	⬅			13.0460-5873.2	605873	MAN 23891 16,9 + WK
			➡	+ ABS		13.0460-5833.2	605833	AKE 23543 14,4 + WK + Zub
Zubehörsatz, Scheibenbremsbelag								
1.6 CRDi 1.6 CVVT 2.0 CVVT 2.0 CVVT	85 90 103 105	11/05→12/11 06/06→06/11 06/06→05/10 06/06→06/11	⬅			13.0460-0139.2	610139	MAN
 Bremsscheibe								
1.6 CRDi 1.6 CVVT 2.0 CVVT 2.0 CVVT	85 90 103 105	11/05→12/11 06/06→06/11 06/06→05/10 06/06→06/11	⬅			24.0126-0157.1	426157	Ø 275 26 24 V
			➡	+ ABS		24.0110-0338.1	410338	Ø 262 10 8,4
HYUNDAI - ELANTRA Stufenheck (MD, UD) 09/10→								
 Bremsbelagsatz, Scheibenbremse								
1.6 1.6	94 97	06/11→ 06/11→12/15	⬅	→ 08/15		13.0460-5645.2	605645	25692 17,2 + WK + Zub
1.8	110	09/10→	⬅	02/11→ 12/15		13.0460-5645.2	605645	25692 17,2 + WK + Zub
 Bremsscheibe								
1.6 1.6	94 97	06/11→ 06/11→12/15	⬅	→ 08/15		24.0123-0118.1	423118	Ø 280 23,1 21,4 V
			➡	→ 08/15		24.0110-0368.1	410368	Ø 262 10 8,4
1.6 CRDi 1.6 CRDi 2.0 GDI	94 100 112	02/11→12/15 10/15→ 10/15→	⬅			24.0123-0118.1	423118	Ø 280 23,1 21,4 V
			➡			24.0110-0368.1	410368	Ø 262 10 8,4
1.8	110	09/10→	⬅	02/11→ 12/15		24.0123-0118.1	423118	Ø 280 23,1 21,4 V
			➡	02/11→ 12/15		24.0110-0368.1	410368	Ø 262 10 8,4

















	kw					! #		
HYUNDAI - ELANTRA Stufenheck (XD) 03/00→07/06								
 Bremsbelagsatz, Scheibenbremse								
1.5 16V 1.5 D	75 82	09/00→07/06 06/00→07/06	←	06/01→ 07/03		13.0460-5875.2	605875	MAN 24031 17,7 + WK
			←	08/03→		13.0460-5876.2	605876	MAN 24369 17,2 + WK
			←	→ 05/01		13.0460-5933.2	605933	AKE 21725 16,8 + WK
			→	+ ABS		13.0460-5874.2	605874	SUM 21553 14,0 + WK + Zub
1.6	66	06/00→07/06	←	06/01→ 07/03		13.0460-5875.2	605875	MAN 24031 17,7 + WK
			←	→ 05/01		13.0460-5933.2	605933	AKE 21725 16,8 + WK
			→	→ 05/06; + ABS		13.0460-5874.2	605874	SUM 21553 14,0 + WK + Zub
1.6	77	05/03→07/06	←	08/03→ 05/06		13.0460-5876.2	605876	MAN 24369 17,2 + WK
			→	08/03→ 05/06; + ABS		13.0460-5874.2	605874	SUM 21553 14,0 + WK + Zub
1.6 1.8 2.0 2.0	79 97 102 104	06/00→07/06 06/00→07/06 06/00→07/06 06/00→07/06	←	06/01→ 07/03		13.0460-5875.2	605875	MAN 24031 17,7 + WK
			←	08/03→ 05/06		13.0460-5876.2	605876	MAN 24369 17,2 + WK
			←	→ 05/01		13.0460-5933.2	605933	AKE 21725 16,8 + WK
			→	→ 05/06; + ABS		13.0460-5874.2	605874	SUM 21553 14,0 + WK + Zub
1.8	79	06/00→07/03	←	06/01→		13.0460-5875.2	605875	MAN 24031 17,7 + WK
			←	→ 05/01		13.0460-5933.2	605933	AKE 21725 16,8 + WK
			→	+ ABS		13.0460-5874.2	605874	SUM 21553 14,0 + WK + Zub
1.8 2.0	93 105	06/04→07/06 10/03→07/06	←	→ 05/06		13.0460-5876.2	605876	MAN 24369 17,2 + WK
			→	→ 05/06; + ABS		13.0460-5874.2	605874	SUM 21553 14,0 + WK + Zub
2.0 CRDi	83	04/01→07/06	←	→ 07/03		13.0460-5875.2	605875	MAN 24031 17,7 + WK
			←	08/03→ 05/06		13.0460-5876.2	605876	MAN 24369 17,2 + WK
			→	→ 05/06; + ABS		13.0460-5874.2	605874	SUM 21553 14,0 + WK + Zub
 Bremsscheibe								
1.5 16V 1.5 D 1.8	75 82 79	09/00→07/06 06/00→07/06 06/00→07/03	←			24.0124-0184.1	424184	Ø 257 24 22,1 V
			→	+ ABS		24.0110-0264.1	410264	Ø 258 10 8
1.6 1.6	66 79	06/00→07/06 06/00→07/06	←	→ 07/03		24.0124-0184.1	424184	Ø 257 24 22,1 V
			→	→ 05/06; + ABS		24.0110-0264.1	410264	Ø 258 10 8
1.6	77	05/03→07/06	←	08/03→ 05/06; - ABS		24.0124-0184.1	424184	Ø 257 24 22,1 V
			←	08/03→ 05/06; + ABS		24.0126-0129.1	426129	Ø 280 26 24,4 V
			→	08/03→ 05/06; + ABS		24.0110-0264.1	410264	Ø 258 10 8
1.8 1.8 2.0 2.0 2.0	93 97 102 104 105	06/04→07/06 06/00→07/06 06/00→07/06 06/00→07/06 10/03→07/06	←	→ 05/06		24.0124-0184.1	424184	Ø 257 24 22,1 V
			→	→ 05/06; + ABS		24.0110-0264.1	410264	Ø 258 10 8
2.0 CRDi	83	04/01→07/06	←	→ 06/03		24.0124-0184.1	424184	Ø 257 24 22,1 V
			←	07/03→ 05/06		24.0126-0129.1	426129	Ø 280 26 24,4 V
			→	→ 05/06; + ABS		24.0110-0264.1	410264	Ø 258 10 8
HYUNDAI - EQUUS / CENTENNIAL 03/09→								
 Bremsscheibe								
3.8 GDi	246	03/09→	←	→ 05/13		24.0130-0231.1	430231	Ø 345 30 28 V
5.0 GDi	316	03/09→	←			24.0130-0231.1	430231	Ø 345 30 28 V
HYUNDAI - EQUUS / CENTENNIAL (JS) 10/99→03/09								
 Bremsbelagsatz, Scheibenbremse								
3.5 4.5	155 195	10/99→03/09 10/99→09/03	←			13.0460-5622.2	605622	MAN 23726 16,5 + WK + Zub
HYUNDAI - GALLOPER II (JK-01) 02/97→12/03								
 Bremsbelagsatz, Scheibenbremse								
2.5 TCi D 2.5 TD 2.5 TD intercooler 2.6 TD Allrad 3.0 AWD 3.0 V6 ↓	77 65 73 63 118 104	08/98→12/03 08/98→12/03 08/98→12/03 08/98→06/03 05/99→09/01 08/98→12/03	←			13.0460-5885.2	605885	SUM 23518 17,0 + WK + Zub

















	kw					! #		
HYUNDAI - GALLOPER II (JK-01) 02/97→12/03								
 Bremsscheibe								
2.5 Tci D	77	08/98→12/03	←	+ ABS		24.0122-0237.1	422237	Ø 277 22 20,4 V
2.5 TD	65	08/98→12/03						
2.5 TD intercooler	73	08/98→12/03						
2.6 TD Allrad	63	08/98→06/03						
3.0 AWD	118	05/99→09/01						
3.0 V6	104	08/98→12/03						
HYUNDAI - GENESIS Coupe 01/08→								
 Bremsscheibe								
2.0	191	01/13→12/15	←			24.0130-0231.1	430231	Ø 345 30 28 V
2.0 CVVT	154	06/08→02/14						
2.0 CVVT	184	02/13→02/14						
2.0 T	157	01/08→12/12						
2.0 T	202	11/11→12/14	←	→ 09/13		24.0130-0231.1	430231	Ø 345 30 28 V
2.0 T	204	04/12→02/14						
HYUNDAI - GETZ (TB) 08/02→12/10								
 Bremsbelagsatz, Scheibenbremse								
1.1	46	09/02→09/05	←	→ 07/05		13.0460-5872.2	605872	AKE 21012 15,0 + WK + Zub
1.5 i	73	03/03→09/05						
1.1	49	09/05→06/09	←	→ 02/09		13.0460-5872.2	605872	AKE 21012 15,0 + WK + Zub
1.3	61	09/04→06/09	←	→ 04/05		13.0460-5872.2	605872	AKE 21012 15,0 + WK + Zub
1.3	63	09/03→09/05						
1.3 i	60	09/02→03/04	←			13.0460-5872.2	605872	AKE 21012 15,0 + WK + Zub
1.4 i	71	08/05→12/10	←	→ 02/09		13.0460-5872.2	605872	AKE 21012 15,0 + WK + Zub
1.5 CRDi	65	08/05→06/09	←	→ 02/09; + ABS		13.0460-5833.2	605833	AKE 23543 14,4 + WK + Zub
1.5 CRDi GLS	81	08/05→06/09	→					
1.5 CRDi	60	03/03→09/05	←	→ 04/05		13.0460-5872.2	605872	AKE 21012 15,0 + WK + Zub
			→	→ 04/05; + ABS		13.0460-5833.2	605833	AKE 23543 14,4 + WK + Zub
1.5 CRDi GLS	75	07/04→08/05	←	→ 07/05		13.0460-5872.2	605872	AKE 21012 15,0 + WK + Zub
1.6	77	09/02→09/05	→	→ 07/05; + ABS		13.0460-5833.2	605833	AKE 23543 14,4 + WK + Zub
1.6	78	06/05→12/06	←	08/05→		13.0460-5872.2	605872	AKE 21012 15,0 + WK + Zub
			→	08/05→; + ABS		13.0460-5833.2	605833	AKE 23543 14,4 + WK + Zub
 Bremsscheibe								
1.1	46	09/02→09/05	←	→ 07/05; passend für Felgenreöße [Zoll]: 13		24.0119-0115.1	419115	Ø 241 19 17 V
			←	→ 07/05; passend für Felgenreöße [Zoll]: 14		24.0119-0116.1	419116	Ø 256 19 17 V
1.1	49	09/05→06/09	←	→ 02/09; passend für Felgenreöße [Zoll]: 13		24.0119-0115.1	419115	Ø 241 19 17 V
			←	→ 02/09; passend für Felgenreöße [Zoll]: 14		24.0119-0116.1	419116	Ø 256 19 17 V
1.3	61	09/04→06/09	←	→ 04/05; passend für Felgenreöße [Zoll]: 13		24.0119-0115.1	419115	Ø 241 19 17 V
1.3	63	09/03→09/05	←	→ 04/05; passend für Felgenreöße [Zoll]: 14		24.0119-0116.1	419116	Ø 256 19 17 V
1.3 i	60	09/02→03/04	←	passend für Felgenreöße [Zoll]: 13		24.0119-0115.1	419115	Ø 241 19 17 V
			←	passend für Felgenreöße [Zoll]: 14		24.0119-0116.1	419116	Ø 256 19 17 V
1.4 i	71	08/05→12/10	←	→ 02/09; passend für Felgenreöße [Zoll]: 13		24.0119-0115.1	419115	Ø 241 19 17 V
1.5 CRDi GLS	81	08/05→06/09	←	→ 02/09; passend für Felgenreöße [Zoll]: 14		24.0119-0116.1	419116	Ø 256 19 17 V
			→	→ 02/09; + ABS		24.0110-0312.1	410312	Ø 262 10 8,4
1.5 CRDi	60	03/03→09/05	←	→ 04/05; passend für Felgenreöße [Zoll]: 13		24.0119-0115.1	419115	Ø 241 19 17 V
			←	→ 04/05; passend für Felgenreöße [Zoll]: 14		24.0119-0116.1	419116	Ø 256 19 17 V
			→	→ 04/05; + ABS		24.0110-0312.1	410312	Ø 262 10 8,4
1.5 CRDi	65	08/05→06/09	←	→ 02/09; passend für Felgenreöße [Zoll]: 14		24.0119-0116.1	419116	Ø 256 19 17 V
			→	→ 02/09; + ABS		24.0110-0312.1	410312	Ø 262 10 8,4
1.5 CRDi GLS	75	07/04→08/05	←	→ 07/05; passend für Felgenreöße [Zoll]: 13		24.0119-0115.1	419115	Ø 241 19 17 V
1.6	77	09/02→09/05	←	→ 07/05; passend für Felgenreöße [Zoll]: 14		24.0119-0116.1	419116	Ø 256 19 17 V
			→	→ 07/05; + ABS		24.0110-0312.1	410312	Ø 262 10 8,4
1.5 i	73	03/03→09/05	←	→ 07/05; passend für Felgenreöße [Zoll]: 13		24.0119-0115.1	419115	Ø 241 19 17 V
↓								





























	kw			 	! #		
HYUNDAI - GETZ (TB) 08/02→12/10							
 Bremsscheibe							
1.6	78	06/05→12/06	←	08/05→; passend für Felgenreöße [Zoll]: 13		24.0119-0115.1 419115	Ø 241 19 17 V
			←	08/05→; passend für Felgenreöße [Zoll]: 14		24.0119-0116.1 419116	Ø 256 19 17 V
			→	08/05→; + ABS		24.0110-0312.1 410312	Ø 262 10 8,4
HYUNDAI - GRANDEUR (HG) 01/11→							
 Bremsscheibe							
2.4	132	01/11→	→	- eFSB		24.0110-0388.1 410388	Ø 284 10 8,4
2.4	132	07/11→					
2.4 16V	148	01/11→	→	+ eFSB		24.0110-0400.1 410400	Ø 284 10 8,4
HYUNDAI - GRANDEUR (TG) 06/03→							
 Bremsbelagsatz, Scheibenbremse							
2.2 CRDi	110	06/06→12/11	←	→ 12/10		13.0460-5639.2 605639	24375 17,5 + WK
3.3	191	11/10→12/11					
3.3	198	02/07→	→	→ 12/10		13.0460-5833.2 605833	AKE 23543 14,4 + WK + Zub
3.8	195	06/05→12/11					
2.2 CRDi	114	06/06→10/10	←			13.0460-5639.2 605639	24375 17,5 + WK
3.3	173	04/05→12/10	→			13.0460-5833.2 605833	AKE 23543 14,4 + WK + Zub
2.7	141	05/06→10/10	←	06/06→		13.0460-5639.2 605639	24375 17,5 + WK
			→	06/06→		13.0460-5833.2 605833	AKE 23543 14,4 + WK + Zub
 Bremsscheibe							
2.2 CRDi	110	06/06→12/11	→	→ 05/07		24.0110-0336.1 410336	Ø 284 10 8,4
			→	06/07→ 06/10		24.0110-0336.1 410336	Ø 284 10 8,4
			→	07/10→ 12/10		24.0110-0367.1 410367	Ø 284 10 8,4
2.2 CRDi	114	06/06→10/10	→	→ 05/07		24.0110-0336.1 410336	Ø 284 10 8,4
3.3	173	04/05→12/10	→	06/07→		24.0110-0336.1 410336	Ø 284 10 8,4
2.7	141	05/06→10/10	→	06/07→		24.0110-0336.1 410336	Ø 284 10 8,4
			→	06/06→ 05/07		24.0110-0336.1 410336	Ø 284 10 8,4
3.3	191	11/10→12/11	→	→ 12/10		24.0110-0336.1 410336	Ø 284 10 8,4
3.3	198	02/07→	→	→ 05/07		24.0110-0336.1 410336	Ø 284 10 8,4
3.8	195	06/05→12/11	→	06/07→ 12/10		24.0110-0336.1 410336	Ø 284 10 8,4
HYUNDAI - GRAND SANTA FÉ 01/13→							
 Bremsbelagsatz, Scheibenbremse							
2.2 CRDi Allrad	145	06/13→	←			13.0460-5777.2 605777	24351 16,3 + WK + Zub
3.3	183	01/14→					
3.3 Allrad	199	02/14→	→			13.0460-5633.2 605633	AKE 25520 15,8 + WK + Zub
 Bremsscheibe							
2.2 CRDi Allrad	145	06/13→	←			24.0128-0248.1 428248	Ø 321 28 26,4 V
2.2 CRDi Allrad	147	10/15→					
3.3	183	01/14→	→			24.0111-0170.1 411170	Ø 302 11 9,4
3.3 Allrad	199	02/14→					
HYUNDAI - H-1 / STAREX 06/97→12/07							
 Bremsbelagsatz, Scheibenbremse							
2.4	82	06/97→04/04	←			13.0460-5792.2 605792	23536 17,6 + WK + Zub
2.4	101	02/03→04/04					
2.4 4WD	82	02/98→04/04					
2.4 4WD	99	06/01→04/04					
2.5 CRDi	103	12/02→04/04					
2.5 CRDi	120	12/02→04/04					
2.5 CRDi 4WD	103	12/02→04/04					
2.5 D	57	10/97→04/04					
2.5 Tci	74	05/04→12/07					
2.5 TD	59	06/97→04/04					
2.5 TD 4WD	59	02/98→04/04					
2.5 TD 4WD	73	03/01→04/04					
2.5 TD 4WD	74	11/01→04/04					
2.6 TDiC	63	10/97→04/04					
2.4	107	11/01→04/04	←	02/03→		13.0460-5792.2 605792	23536 17,6 + WK + Zub
2.5 Tci	73	10/97→12/07	←	06/00→ 04/04		13.0460-5792.2 605792	23536 17,6 + WK + Zub
↓							











	kw			 	! #		
HYUNDAI - H-1 / STAREX 06/97→12/07							
 Bremsscheibe							
2.4	82	06/97→04/04	←			24.0124-0220.1 424220	Ø 254 24 22,4 V
2.4	101	02/03→04/04					
2.5 D	57	10/97→04/04					
2.5 TD	59	06/97→04/04					
2.6 TDiC	63	10/97→04/04					
2.4	107	11/01→04/04	←	02/03→		24.0124-0220.1 424220	Ø 254 24 22,4 V
2.4 4WD	99	06/01→04/04	←	07/03→		24.0126-0169.1 426169	Ø 274 26 24,4 V
2.5 CRDi	103	12/02→04/04	←			24.0124-0220.1 424220	Ø 254 24 22,4 V
2.5 CRDi	120	12/02→04/04	←	07/03→		24.0126-0169.1 426169	Ø 274 26 24,4 V
2.5 TCi	73	10/97→12/07	←	06/00→ 04/04		24.0124-0220.1 424220	Ø 254 24 22,4 V
2.5 TCi	74	05/04→12/07	←			24.0126-0169.1 426169	Ø 274 26 24,4 V
2.5 TD 4WD	73	03/01→04/04	←			24.0124-0243.1 424243	Ø 254,5 24 22,4 V
2.5 TD 4WD	74	11/01→04/04	←	→ 09/02		24.0124-0243.1 424243	Ø 254,5 24 22,4 V
			←	10/02→		24.0126-0169.1 426169	Ø 274 26 24,4 V
HYUNDAI - H-1 Cargo (TQ) 02/08→							
 Bremsbelagsatz, Scheibenbremse							
2.4	128	01/10→	←	09/10→		13.0460-5799.2 605799	24597 17,7 + WK + Zub
			→	09/10→		13.0460-5636.2 605636	MAN 24599 14,9 + WK + Zub
2.5 CRDi	81	02/08→	←			13.0460-5799.2 605799	24597 17,7 + WK + Zub
2.5 CRDi	85	08/11→	←	+ ABS		13.0460-5636.2 605636	MAN 24599 14,9 + WK + Zub
2.5 CRDi	100	08/09→	←			13.0460-5799.2 605799	24597 17,7 + WK + Zub
2.5 CRDi	120	02/08→	←			13.0460-5636.2 605636	MAN 24599 14,9 + WK + Zub
2.5 CRDi	125	02/08→	←			13.0460-5636.2 605636	MAN 24599 14,9 + WK + Zub
 Bremsscheibe							
2.4	128	01/10→	←	09/10→		24.0130-0239.1 430239	Ø 300 30 28,4 V
2.5 CRDi	81	02/08→	←			24.0130-0239.1 430239	Ø 300 30 28,4 V
2.5 CRDi	85	08/11→	←				
2.5 CRDi	100	08/09→	←				
2.5 CRDi	120	02/08→	←				
2.5 CRDi	125	02/08→	←				
HYUNDAI - H-1 Kasten 10/97→04/08							
 Bremsbelagsatz, Scheibenbremse							
2.4	82	03/00→04/04	←			13.0460-5792.2 605792	23536 17,6 + WK + Zub
2.5 TD	59	03/00→09/00	←				
2.4	107	11/01→04/04	←	→ 10/02		13.0460-5792.2 605792	23536 17,6 + WK + Zub
			←	11/02→		13.0460-5832.2 605832	23569 16,5 + WK + Zub
			→	+ ABS		13.0460-5637.2 605637	MAN 24488 14,9 + WK + Zub
2.5 CRDi	81	07/01→04/04	←			13.0460-5832.2 605832	23569 16,5 + WK + Zub
			→	+ ABS		13.0460-5637.2 605637	MAN 24488 14,9 + WK + Zub
2.5 CRDi	103	08/03→12/07	←	→ 04/04		13.0460-5832.2 605832	23569 16,5 + WK + Zub
			→	→ 04/04; + ABS		13.0460-5637.2 605637	MAN 24488 14,9 + WK + Zub
2.5 TD	73	03/00→04/04	←	→ 12/01		13.0460-5792.2 605792	23536 17,6 + WK + Zub
			←	01/02→		13.0460-5832.2 605832	23569 16,5 + WK + Zub
2.5 TD	74	10/01→08/07	←	→ 12/01		13.0460-5792.2 605792	23536 17,6 + WK + Zub
			←	01/02→ 04/04		13.0460-5832.2 605832	23569 16,5 + WK + Zub
2.6 CRDi	79	10/97→12/07	←	08/05→		13.0460-5832.2 605832	23569 16,5 + WK + Zub
			→	08/05→; + ABS		13.0460-5637.2 605637	MAN 24488 14,9 + WK + Zub
 Bremsscheibe							
2.4	82	03/00→04/04	←			24.0124-0220.1 424220	Ø 254 24 22,4 V
2.5 TD	59	03/00→09/00	←				
2.4	107	11/01→04/04	←	→ 10/02		24.0124-0243.1 424243	Ø 254,5 24 22,4 V
			←	11/02→		24.0126-0169.1 426169	Ø 274 26 24,4 V
			→	+ ABS		24.0120-0232.1 420232	Ø 303 20 18,4 V
						24.0120-0235.1 420235	Ø 303 20 18,4 V
2.5 CRDi	81	07/01→04/04	←			24.0126-0169.1 426169	Ø 274 26 24,4 V
			→	+ ABS		24.0120-0232.1 420232	Ø 303 20 18,4 V
						24.0120-0235.1 420235	Ø 303 20 18,4 V
↓							











	kW			 	! #		
HYUNDAI - H-1 Kasten 10/97→04/08							
 Bremsscheibe							
2.5 CRDi	103	08/03→12/07	←	→ 04/04		24.0126-0169.1 426169	Ø 274 26 24,4 V
			→	→ 04/04; + ABS		24.0120-0232.1 420232	Ø 303 20 18,4 V
						24.0120-0235.1 420235	Ø 303 20 18,4 V
2.5 TD	73	03/00→04/04	←	→ 10/02		24.0124-0220.1 424220	Ø 254 24 22,4 V
			←	11/02→		24.0124-0243.1 424243	Ø 254,5 24 22,4 V
2.5 TD	74	10/01→08/07	←	→ 10/02		24.0124-0220.1 424220	Ø 254 24 22,4 V
			←	11/02→ 04/04		24.0124-0243.1 424243	Ø 254,5 24 22,4 V
2.6 CRDi	79	10/97→12/07	←	08/05→		24.0126-0169.1 426169	Ø 274 26 24,4 V
			→	08/05→; + ABS		24.0120-0232.1 420232	Ø 303 20 18,4 V
						24.0120-0235.1 420235	Ø 303 20 18,4 V
HYUNDAI - H-1 Pritsche/Fahrgestell 06/00→10/05							
 Bremsbelagsatz, Scheibenbremse							
2.5 CRDi	103	12/02→10/05	←			13.0460-5832.2 605832	23569 16,5 + WK + Zub
			→	+ ABS		13.0460-5637.2 605637	MAN 24488 14,9 + WK + Zub
 Bremsscheibe							
2.5 CRDi	103	12/02→10/05	←			24.0126-0169.1 426169	Ø 274 26 24,4 V
			→	+ ABS		24.0120-0232.1 420232	Ø 303 20 18,4 V
HYUNDAI - H-1 Travel (TQ) 02/08→							
 Bremsbelagsatz, Scheibenbremse							
2.4	101	02/08→	←			13.0460-5799.2 605799	24597 17,7 + WK + Zub
2.4 i	129	02/08→					
2.5 CRDi	81	07/10→	→			13.0460-5636.2 605636	MAN 24599 14,9 + WK + Zub
2.5 CRDi	120	05/08→					
2.5 CRDi	125	05/08→					
2.5 CRDi	100	07/08→					
2.5 CRDi	85	08/11→	←			13.0460-5799.2 605799	24597 17,7 + WK + Zub
			→	+ ABS		13.0460-5636.2 605636	MAN 24599 14,9 + WK + Zub
 Bremsscheibe							
2.4	101	02/08→	←			24.0130-0239.1 430239	Ø 300 30 28,4 V
2.4 i	129	02/08→					
2.5 CRDi	81	07/10→					
2.5 CRDi	85	08/11→					
2.5 CRDi	120	05/08→					
2.5 CRDi	125	05/08→					
2.5 CRDi	100	07/08→					
HYUNDAI - H100 Bus (P) 07/93→10/04							
 Bremsbelagsatz, Scheibenbremse							
2.4	84	01/97→03/00	←			13.0460-5718.2 605718	TRW 23081 18,0 + WK
2.4	90	07/93→03/00					
2.5 D	57	12/94→03/00					
2.5 TD	59	07/93→03/00					
 Bremsscheibe							
2.4	84	01/97→03/00	←			24.0120-0166.1 420166	Ø 253 20 18,4 V
2.4	90	07/93→03/00					
2.5 D	57	12/94→03/00					
2.5 TD	59	07/93→03/00					
HYUNDAI - H100 Kasten 07/93→12/04							
 Bremsbelagsatz, Scheibenbremse							
2.4	84	08/97→10/03	←			13.0460-5792.2 605792	23536 17,6 + WK + Zub
2.4 TD	90	07/93→07/97	←			13.0460-5718.2 605718	TRW 23081 18,0 + WK
2.5 D	57	12/94→03/00					
2.5 TDiC	59	06/98→10/03	←	→ 03/00		13.0460-5718.2 605718	TRW 23081 18,0 + WK
 Bremsscheibe							
2.4	84	08/97→10/03	←			24.0124-0220.1 424220	Ø 254 24 22,4 V
2.4 TD	90	07/93→07/97	←			24.0120-0166.1 420166	Ø 253 20 18,4 V
2.5 D	57	12/94→03/00					
2.5 TDiC	59	06/98→10/03	←	→ 03/00		24.0120-0166.1 420166	Ø 253 20 18,4 V













	kw			 	! #		
HYUNDAI - H100 Pick-up 05/96→10/01							
 Bremsbelagsatz, Scheibenbremse							
2.5 D	57	05/96→10/01	←	→ 03/00		13.0460-5718.2 605718	TRW 23081 18,0 + WK
 Bremsscheibe							
2.5 D	57	05/96→10/01	←	→ 03/00		24.0120-0166.1 420166	Ø 253 20 18,4 V
HYUNDAI - H100 Pritsche/Fahrgestell 07/93→08/98							
 Bremsbelagsatz, Scheibenbremse							
2.5 D	59	05/96→12/97	←			13.0460-5718.2 605718	TRW 23081 18,0 + WK
 Bremsscheibe							
2.5 D	59	05/96→12/97	←			24.0120-0166.1 420166	Ø 253 20 18,4 V
HYUNDAI - HIGHWAY VAN 03/00→03/04							
 Bremsbelagsatz, Scheibenbremse							
2.0 16V	100	03/00→03/04	←			13.0460-5832.2 605832	23569 16,5 + WK + Zub
2.0 CRDi	83	03/01→03/04					
2.0 CVVT	104	11/03→03/04	→			13.0460-5833.2 605833	AKE 23543 14,4 + WK + Zub
2.7 V6 24V	125	03/00→03/04					
 Bremsscheibe							
2.0 16V	100	03/00→03/04	←			24.0126-0126.1 426126	Ø 276 26 24 V
2.0 CRDi	83	03/01→03/04					
2.0 CVVT	104	11/03→03/04	→			24.0110-0286.1 410286	Ø 284 10 8,4
2.7 V6 24V	125	03/00→03/04					
HYUNDAI - i10 (BA, IA) 08/13→							
 Bremsbelagsatz, Scheibenbremse							
1.0	49	08/13→	←	→ 11/13		13.0460-5776.2 605776	AKE 24275 16,5 + WK + Zub
			→	→ 11/13		13.0460-5775.2 605775	24276 14,8 + WK + Zub
 Bremsscheibe							
1.0 LPG	49	02/14→	←			24.0118-0144.1 418144	Ø 252 18 16 V
1.2	64	12/13→	←	nicht für Leichtmetallfelgen; Made in Europa		24.0118-0145.1 418145	Ø 241 18 16 V
			→			24.0110-0394.1 410394	Ø 234 10 8,4
1.0	49	08/13→	←	12/13→		24.0118-0144.1 418144	Ø 252 18 16 V
			←	12/13→; nicht für Leichtmetallfelgen; Made in Europa		24.0118-0145.1 418145	Ø 241 18 16 V
			←	→ 11/13		24.0118-0145.1 418145	Ø 241 18 16 V
			→	→ 11/13		24.0110-0324.1 410324	Ø 234 10 8
			→	12/13→		24.0110-0394.1 410394	Ø 234 10 8,4
HYUNDAI - i10 (PA) 10/07→12/13							
 Bremsbelagsatz, Scheibenbremse							
1.0	51	01/11→12/13	←	→ 11/13		13.0460-5776.2 605776	AKE 24275 16,5 + WK + Zub
1.1	49	01/08→12/13					
1.1	50	11/08→12/13	→	→ 11/13		13.0460-5775.2 605775	24276 14,8 + WK + Zub
1.1	51	04/11→12/13					
1.1 LPG	51	04/11→12/13					
1.2	63	04/11→12/13					
1.1	48	12/07→12/13	←	01/08→ 11/13		13.0460-5776.2 605776	AKE 24275 16,5 + WK + Zub
1.2	59	10/07→	→	01/08→ 11/13		13.0460-5775.2 605775	24276 14,8 + WK + Zub
1.1 CRDi	55	01/08→12/11	←			13.0460-5776.2 605776	AKE 24275 16,5 + WK + Zub
1.2	57	11/08→12/11	→			13.0460-5775.2 605775	24276 14,8 + WK + Zub
 Bremsscheibe							
1.0	51	01/11→12/13	←	→ 11/13		24.0118-0145.1 418145	Ø 241 18 16 V
1.1	49	01/08→12/13					
1.1	50	11/08→12/13	→	→ 11/13		24.0110-0324.1 410324	Ø 234 10 8
1.1	51	04/11→12/13					
1.1 LPG	51	04/11→12/13					
1.2	63	04/11→12/13					
1.1	48	12/07→12/13	←	01/08→ 11/13		24.0118-0145.1 418145	Ø 241 18 16 V
1.2	59	10/07→	→	01/08→ 11/13		24.0110-0324.1 410324	Ø 234 10 8
1.1 CRDi	55	01/08→12/11	←			24.0118-0144.1 418144	Ø 252 18 16 V
↓							













	kw			 	! #		
HYUNDAI - i10 (PA) 10/07→12/13							
 Bremsscheibe							
1.1 CRDi	55	01/08→12/11	➔			24.0110-0324.1 410324	Ø 234 10 8
1.2	57	11/08→12/11	➔			24.0118-0145.1 418145	Ø 241 18 16 V
			➔			24.0110-0324.1 410324	Ø 234 10 8
HYUNDAI - i10 Stufenheck 12/13→							
 Bremsscheibe							
1.2	64	08/15→	➔			24.0118-0144.1 418144	Ø 252 18 16 V
			➔	nicht für Leichtmetallfelgen; Made in Europa		24.0118-0145.1 418145	Ø 241 18 16 V
			➔			24.0110-0394.1 410394	Ø 234 10 8,4
HYUNDAI - i20 (GB) 11/14→							
 Bremsbelagsatz, Scheibenbremse							
1.0 T-GDI	74	01/16→	➔			13.0460-5646.2 605646	MAN 25348 17,8 + WK + Zub
1.0 T-GDI	88	01/16→					
1.2 LPGI	61	11/14→					
1.1 CRDi	55	11/14→	➔	12/14→		13.0460-5646.2 605646	MAN 25348 17,8 + WK + Zub
1.2	55	11/14→					
1.2	62	11/14→					
1.4	74	11/14→					
1.4 CRDi	66	11/14→					
 Bremsscheibe							
1.0 T-GDI	74	01/16→	➔			24.0110-0398.1 410398	Ø 262 10 8,4
1.0 T-GDI	88	01/16→					
1.2 LPGI	61	11/14→					
1.1 CRDi	55	11/14→	➔	12/14→		24.0110-0398.1 410398	Ø 262 10 8,4
1.2	55	11/14→					
1.2	62	11/14→					
1.4	74	11/14→					
1.4 CRDi	66	11/14→					
HYUNDAI - i20 (PB, PBT) 08/08→							
 Bremsbelagsatz, Scheibenbremse							
1.1 CRDi	55	03/12→12/15	➔	→ 12/14		13.0460-5779.2 605779	24317 17,6 + WK + Zub
1.4	74	09/08→12/15	➔	→ 12/14		13.0460-5780.2 605780	24320 15,3 + WK + Zub
1.6	91	12/08→					
1.2	57	09/08→12/12	➔	- ESP		13.0460-5776.2 605776	AKE 24275 16,5 + WK + Zub
			➔	+ ESP		13.0460-5779.2 605779	24317 17,6 + WK + Zub
			➔	+ ESP		13.0460-5780.2 605780	24320 15,3 + WK + Zub
1.2	59	08/08→	➔	09/08→; - ESP		13.0460-5776.2 605776	AKE 24275 16,5 + WK + Zub
			➔	09/08→; + ESP		13.0460-5779.2 605779	24317 17,6 + WK + Zub
			➔	09/08→; + ESP		13.0460-5780.2 605780	24320 15,3 + WK + Zub
1.2	63	03/12→12/15	➔	- ESP; → 12/14		13.0460-5776.2 605776	AKE 24275 16,5 + WK + Zub
			➔	+ ESP; → 12/14		13.0460-5779.2 605779	24317 17,6 + WK + Zub
			➔	→ 12/14; + ESP		13.0460-5780.2 605780	24320 15,3 + WK + Zub
1.4 CRDi	55	09/08→12/12	➔	08/09→		13.0460-5779.2 605779	24317 17,6 + WK + Zub
			➔	08/09→		13.0460-5780.2 605780	24320 15,3 + WK + Zub
1.4 CRDi	66	08/08→12/15	➔	09/08→ 12/14		13.0460-5779.2 605779	24317 17,6 + WK + Zub
			➔	09/08→ 12/14		13.0460-5780.2 605780	24320 15,3 + WK + Zub
1.6	93	09/08→12/12	➔			13.0460-5779.2 605779	24317 17,6 + WK + Zub
1.6 CRDi	85	09/08→12/12					
1.6 CRDi	94	01/09→12/12	➔			13.0460-5780.2 605780	24320 15,3 + WK + Zub
 Bremsscheibe							
1.1 CRDi	55	03/12→12/15	➔	→ 12/14		24.0122-0260.1 422260	Ø 256 22 20 V
1.4	74	09/08→12/15	➔	→ 12/14		24.0110-0312.1 410312	Ø 262 10 8,4
1.6	91	12/08→					
1.2	57	09/08→12/12	➔	- ESP		24.0118-0151.1 418151	Ø 256 18 16 V
			➔	+ ESP		24.0122-0260.1 422260	Ø 256 22 20 V
			➔	+ ESP		24.0110-0312.1 410312	Ø 262 10 8,4
1.2	59	08/08→	➔	09/08→; - ESP		24.0118-0151.1 418151	Ø 256 18 16 V
			➔	09/08→; + ESP		24.0122-0260.1 422260	Ø 256 22 20 V
			➔	09/08→; + ESP		24.0110-0312.1 410312	Ø 262 10 8,4
↓							















	kw			 	! #		
HYUNDAI - i20 (PB, PBT) 08/08→							
 Bremsscheibe							
1.2	63	03/12→12/15	←	- ESP; → 12/14		24.0118-0151.1 418151	Ø 256 18 16 V
			←	+ ESP; → 12/14		24.0122-0260.1 422260	Ø 256 22 20 V
			→	→ 12/14; + ESP		24.0110-0312.1 410312	Ø 262 10 8,4
1.4 CRDi	55	09/08→12/12	←	08/09→		24.0122-0260.1 422260	Ø 256 22 20 V
			→	08/09→		24.0110-0312.1 410312	Ø 262 10 8,4
1.4 CRDi	66	08/08→12/15	←	09/08→ 12/14		24.0122-0260.1 422260	Ø 256 22 20 V
			→	09/08→ 12/14		24.0110-0312.1 410312	Ø 262 10 8,4
1.6	93	09/08→12/12	←			24.0122-0260.1 422260	Ø 256 22 20 V
1.6 CRDi	85	09/08→12/12	←			24.0122-0260.1 422260	Ø 256 22 20 V
1.6 CRDi	94	01/09→12/12	→			24.0110-0312.1 410312	Ø 262 10 8,4
HYUNDAI - i20 ACTIVE (GB) 09/15→							
 Bremsscheibe							
1.0 T-GDI	74	09/15→	→			24.0110-0398.1 410398	Ø 262 10 8,4
1.0 T-GDI	88	09/15→					
1.4	74	09/15→					
1.4 CRDi	66	09/15→					
HYUNDAI - i20 Coupe (GB) 05/15→							
 Bremsbelagsatz, Scheibenbremse							
1.0 T-GDI	74	01/16→	←			13.0460-5646.2 605646	MAN 25348 17,8 + WK + Zub
1.0 T-GDI	88	01/16→					
1.1 CRDi	55	05/15→					
1.2	62	05/15→					
1.4	74	05/15→					
1.4 CRDi	66	05/15→					
 Bremsscheibe							
1.0 T-GDI	74	01/16→	→			24.0110-0398.1 410398	Ø 262 10 8,4
1.0 T-GDI	88	01/16→					
1.1 CRDi	55	05/15→					
1.2	62	05/15→					
1.4	74	05/15→					
1.4 CRDi	66	05/15→					
HYUNDAI - i30 (FD) 10/07→11/11							
 Bremsbelagsatz, Scheibenbremse							
1.4	77	10/07→11/11	←	→ 10/11		13.0460-5742.2 605742	23966 17,7 + WK
1.4	80	10/07→11/11					
1.6	85	10/07→11/11	→	→ 10/11		13.0460-5780.2 605780	24320 15,3 + WK + Zub
1.6	90	10/07→11/11					
1.6	93	02/08→11/11					
1.6 CRDi	66	10/07→11/11					
1.6 CRDi	85	10/07→11/11					
1.6 CRDi	94	01/10→11/11					
2.0	105	10/07→11/11					
2.0 CRDi	103	10/07→11/11					
2.0 CRDi	100	10/07→11/11	←	02/08→ 10/11		13.0460-5742.2 605742	23966 17,7 + WK
			→	02/08→ 10/11		13.0460-5780.2 605780	24320 15,3 + WK + Zub
 Bremsscheibe							
1.4	77	10/07→11/11	←	→ 10/11; 15"		24.0126-0150.1 426150	Ø 280 26 24,4 V
1.4	80	10/07→11/11					
1.6	85	10/07→11/11	←	→ 10/11; 16"		24.0128-0234.1 428234	Ø 300 28 26,4 V
1.6	90	10/07→11/11					
1.6	93	02/08→11/11	→	→ 10/11		24.0110-0332.1 410332	Ø 262 10 8
1.6 CRDi	66	10/07→11/11					
1.6 CRDi	85	10/07→11/11					
1.6 CRDi	94	01/10→11/11					
2.0	105	10/07→11/11					
2.0 CRDi	103	10/07→11/11					
2.0 CRDi	100	10/07→11/11	←	02/08→ 10/11; 15"		24.0126-0150.1 426150	Ø 280 26 24,4 V
			←	02/08→ 10/11; 16"		24.0128-0234.1 428234	Ø 300 28 26,4 V
			→	02/08→ 10/11		24.0110-0332.1 410332	Ø 262 10 8
HYUNDAI - i30 (GD) 06/11→							
 Bremsbelagsatz, Scheibenbremse							
1.4	73	12/11→12/15	←	→ 03/13; passend für Felgenreöße [Zoll]: 15		13.0460-5645.2 605645	25692 17,2 + WK + Zub
↓							













	kw			 	! #		
HYUNDAI - i30 (GD) 06/11→							
 Bremsbelagsatz, Scheibenbremse							
1.4	73	12/11→12/15	←	06/13→; passend für Felgengröße [Zoll]: 15		13.0460-5645.2 605645	25692 17,2 + WK + Zub
1.4 1.6 T-GDI	74 137	12/14→12/16 01/15→	←	passend für Felgengröße [Zoll]: 15		13.0460-5645.2 605645	25692 17,2 + WK + Zub
1.4 CRDi 1.6	66 88	12/11→12/16 01/12→12/16	←	→ 05/13; passend für Felgengröße [Zoll]: 15		13.0460-5645.2 605645	25692 17,2 + WK + Zub
1.6 CRDi 1.6 GDI	94 99	12/11→12/15 12/11→12/16	←	06/13→; passend für Felgengröße [Zoll]: 15		13.0460-5645.2 605645	25692 17,2 + WK + Zub
1.6	95	12/11→12/15	←	→ 05/13; passend für Felgengröße [Zoll]: 15		13.0460-5645.2 605645	25692 17,2 + WK + Zub
1.6 CRDi	81	12/11→12/16	←	06/12→ 05/13; passend für Felgengröße [Zoll]: 15		13.0460-5645.2 605645	25692 17,2 + WK + Zub
			←	06/13→; passend für Felgengröße [Zoll]: 15		13.0460-5645.2 605645	25692 17,2 + WK + Zub
1.6 CRDi	100	11/11→12/16	←	04/13→; passend für Felgengröße [Zoll]: 15		13.0460-5645.2 605645	25692 17,2 + WK + Zub
			←	→ 05/13; passend für Felgengröße [Zoll]: 15		13.0460-5645.2 605645	25692 17,2 + WK + Zub
 Bremsscheibe							
1.4	73	12/11→12/15	←	15		24.0123-0123.1 423123	Ø 280 23,1 21 V
			←	passend für Felgengröße [Zoll]: 16		24.0128-0234.1 428234	Ø 300 28 26,4 V
			→	- eFSB		24.0110-0379.1 410379	Ø 262 10 8,4
			→	+ eFSB		24.0110-0383.1 410383	Ø 284 10 8,4
1.4	74	12/14→12/16	←	15		24.0123-0123.1 423123	Ø 280 23,1 21 V
			←	→ 01/15; passend für Felgengröße [Zoll]: 16		24.0128-0234.1 428234	Ø 300 28 26,4 V
			←	02/15→; passend für Felgengröße [Zoll]: 16		24.0128-0234.1 428234	Ø 300 28 26,4 V
			→	- eFSB		24.0110-0379.1 410379	Ø 262 10 8,4
			→	+ eFSB		24.0110-0383.1 410383	Ø 284 10 8,4
1.4 CRDi 1.6 1.6 1.6 CRDi 1.6 GDI	66 88 95 94 99	12/11→12/16 01/12→12/16 12/11→12/15 12/11→12/15 12/11→12/16	←	15		24.0123-0123.1 423123	Ø 280 23,1 21 V
			←	16		24.0128-0234.1 428234	Ø 300 28 26,4 V
			→	- eFSB		24.0110-0379.1 410379	Ø 262 10 8,4
			→	+ eFSB		24.0110-0383.1 410383	Ø 284 10 8,4
1.6 CRDi	81	12/11→12/16	←	06/12→; 15		24.0123-0123.1 423123	Ø 280 23,1 21 V
			←	06/12→; 16		24.0128-0234.1 428234	Ø 300 28 26,4 V
			→	06/12→; - eFSB		24.0110-0379.1 410379	Ø 262 10 8,4
			→	06/12→; + eFSB		24.0110-0383.1 410383	Ø 284 10 8,4
1.6 CRDi	100	11/11→12/16	←	passend für Felgengröße [Zoll]: 15		24.0123-0123.1 423123	Ø 280 23,1 21 V
			←	16		24.0128-0234.1 428234	Ø 300 28 26,4 V
			→	- eFSB		24.0110-0379.1 410379	Ø 262 10 8,4
			→	+ eFSB		24.0110-0383.1 410383	Ø 284 10 8,4
1.6 T-GDI	137	01/15→	←	passend für Felgengröße [Zoll]: 15		24.0123-0123.1 423123	Ø 280 23,1 21 V
			←	passend für Felgengröße [Zoll]: 16		24.0128-0234.1 428234	Ø 300 28 26,4 V
			→	- eFSB		24.0110-0379.1 410379	Ø 262 10 8,4
			→	+ eFSB		24.0110-0383.1 410383	Ø 284 10 8,4
HYUNDAI - i30 (PDE) 01/17→							
 Bremsscheibe							
1.0 T-GDI 1.4 T-GDI 1.6 CDI 1.6 CDI 1.6 CDI	88 103 100 70 81	01/17→ 01/17→ 01/17→ 01/17→ 01/17→	→	+ eFSB		24.0110-0400.1 410400	Ø 284 10 8,4
1.4 MPI	74	01/17→	←	Felgengröße [Zoll]: 15		24.0123-0123.1 423123	Ø 280 23,1 21 V
			→	+ eFSB		24.0110-0400.1 410400	Ø 284 10 8,4
HYUNDAI - i30 Coupe 05/13→							
 Bremsbelagsatz, Scheibenbremse							
1.4	73	05/13→	←	06/13→; passend für Felgengröße [Zoll]: 15		13.0460-5645.2 605645	25692 17,2 + WK + Zub
1.4 ↓	74	12/14→	←	passend für Felgengröße [Zoll]: 15		13.0460-5645.2 605645	25692 17,2 + WK + Zub

	kw			 	! #			
HYUNDAI - i30 Coupe 05/13→								
 Bremsbelagsatz, Scheibenbremse								
1.6 CRDi 1.6 CRDi 1.6 T-GDi	81 100 137	11/15→ 12/14→ 01/15→	←	passend für Felgenreöße [Zoll]: 15		13.0460-5645.2 605645	25692 17,2 + WK + Zub	
1.4 CRDi	66	05/13→	←			13.0460-5645.2 605645	25692 17,2 + WK + Zub	
1.6 CRDi	94	05/13→	←	Felgenreöße [Zoll]: 15		13.0460-5645.2 605645	25692 17,2 + WK + Zub	
1.6 GDi	99	05/13→	←	06/13→; passend für Felgenreöße [Zoll]: 15		13.0460-5645.2 605645	25692 17,2 + WK + Zub	
			←	→ 05/13; passend für Felgenreöße [Zoll]: 15		13.0460-5645.2 605645	25692 17,2 + WK + Zub	
 Bremsscheibe								
1.4	73	05/13→	←	15		24.0123-0123.1 423123	Ø 280 23,1 21 V	
			←	passend für Felgenreöße [Zoll]: 16		24.0128-0234.1 428234	Ø 300 28 26,4 V	
			→	- eFSB		24.0110-0379.1 410379	Ø 262 10 8,4	
			→	+ eFSB		24.0110-0383.1 410383	Ø 284 10 8,4	
1.4	74	12/14→	←	15		24.0123-0123.1 423123	Ø 280 23,1 21 V	
			←	02/15→; passend für Felgenreöße [Zoll]: 16		24.0128-0234.1 428234	Ø 300 28 26,4 V	
			←	→ 01/15; passend für Felgenreöße [Zoll]: 16		24.0128-0234.1 428234	Ø 300 28 26,4 V	
			→	- eFSB		24.0110-0379.1 410379	Ø 262 10 8,4	
1.4 CRDi 1.6 CRDi 1.6 MPI	66 94 88	05/13→ 05/13→ 11/16→	←	Felgenreöße [Zoll]: 15		24.0123-0123.1 423123	Ø 280 23,1 21 V	
			←	Felgenreöße [Zoll]: 16		24.0128-0234.1 428234	Ø 300 28 26,4 V	
			→	- eFSB		24.0110-0379.1 410379	Ø 262 10 8,4	
			→	+ eFSB		24.0110-0383.1 410383	Ø 284 10 8,4	
1.6 CRDi 1.6 GDi	81 99	11/15→ 05/13→	←	15		24.0123-0123.1 423123	Ø 280 23,1 21 V	
			←	16		24.0128-0234.1 428234	Ø 300 28 26,4 V	
			→	- eFSB		24.0110-0379.1 410379	Ø 262 10 8,4	
			→	+ eFSB		24.0110-0383.1 410383	Ø 284 10 8,4	
1.6 CRDi	100	12/14→	←	passend für Felgenreöße [Zoll]: 15		24.0123-0123.1 423123	Ø 280 23,1 21 V	
			←	16		24.0128-0234.1 428234	Ø 300 28 26,4 V	
			→	- eFSB		24.0110-0379.1 410379	Ø 262 10 8,4	
			→	+ eFSB		24.0110-0383.1 410383	Ø 284 10 8,4	
1.6 T-GDi	137	01/15→	←	passend für Felgenreöße [Zoll]: 15		24.0123-0123.1 423123	Ø 280 23,1 21 V	
			←	passend für Felgenreöße [Zoll]: 16		24.0128-0234.1 428234	Ø 300 28 26,4 V	
			→	- eFSB		24.0110-0379.1 410379	Ø 262 10 8,4	
			→	+ eFSB		24.0110-0383.1 410383	Ø 284 10 8,4	
HYUNDAI - i30 CW 06/17→								
 Bremsscheibe								
1.0 T-GDi 1.4 T-GDi 1.6 CRDi 1.6 CRDi	88 103 81 100	06/17→ 06/17→ 06/17→ 06/17→	→	+ eFSB		24.0110-0400.1 410400	Ø 284 10 8,4	
HYUNDAI - i30 CW (FD) 10/07→06/12								
 Bremsbelagsatz, Scheibenbremse								
1.4	77	10/07→06/12	←	02/08→		13.0460-5742.2 605742	23966 17,7 + WK	
			→	02/08→		13.0460-5780.2 605780	24320 15,3 + WK + Zub	
1.4 1.6 1.6 1.6 1.6 CRDi 1.6 CRDi 1.6 CRDi 2.0 2.0 CRDi	80 85 90 93 66 85 94 105 103	11/09→06/12 02/08→06/12 02/08→06/12 02/08→06/12 02/08→06/12 02/08→06/12 01/10→06/12 02/08→06/12 02/08→06/12	←			13.0460-5742.2 605742	23966 17,7 + WK	
			→			13.0460-5780.2 605780	24320 15,3 + WK + Zub	
			←					
			←					
			←					
			←					
2.0 CRDi	100	10/08→06/12	←	01/10→		13.0460-5742.2 605742	23966 17,7 + WK	
			→	01/10→		13.0460-5780.2 605780	24320 15,3 + WK + Zub	
↓								













	kW			 	! #		
HYUNDAI - i30 CW (FD) 10/07→06/12							
 Bremsscheibe							
1.4	77	10/07→06/12	←	02/08→; 15"		24.0126-0150.1 426150	Ø 280 26 24,4 V
			←	02/08→; 16"		24.0128-0234.1 428234	Ø 300 28 26,4 V
			→	02/08→		24.0110-0332.1 410332	Ø 262 10 8
1.4	80	11/09→06/12	←	15"		24.0126-0150.1 426150	Ø 280 26 24,4 V
1.6	85	02/08→06/12	←	16"		24.0128-0234.1 428234	Ø 300 28 26,4 V
1.6	90	02/08→06/12	←	16"		24.0128-0234.1 428234	Ø 300 28 26,4 V
1.6	93	02/08→06/12	→			24.0110-0332.1 410332	Ø 262 10 8
1.6 CRDi	66	02/08→06/12	→				
1.6 CRDi	85	02/08→06/12	→				
1.6 CRDi	94	01/10→06/12	→				
2.0	105	02/08→06/12	→				
2.0 CRDi	103	02/08→06/12	→				
2.0 CRDi	100	10/08→06/12	←	01/10→; 15"		24.0126-0150.1 426150	Ø 280 26 24,4 V
			←	01/10→; 16"		24.0128-0234.1 428234	Ø 300 28 26,4 V
			→	01/10→		24.0110-0332.1 410332	Ø 262 10 8
HYUNDAI - i30 CW (GD) 06/12→							
 Bremsbelagsatz, Scheibenbremse							
1.4	73	06/12→12/15	←	15"		13.0460-5645.2 605645	25692 17,2 + WK + Zub
1.4	74	01/15→	←	15"			
1.4 CRDi	66	06/12→	←	15"			
1.6	95	06/12→12/15	←	15"			
1.6 CRDi	81	06/12→	←	15"			
1.6 CRDi	94	06/12→12/15	←	15"			
1.6 CRDi	100	01/15→	←	15"			
1.6 GDI	99	06/12→	←	15"			
1.6	88	06/12→	←	15"		13.0460-5645.2 605645	25692 17,2 + WK + Zub
			←	→ 06/12		13.0460-5742.2 605742	23966 17,7 + WK
			→	→ 06/12		13.0460-5780.2 605780	24320 15,3 + WK + Zub
 Bremsscheibe							
1.4	73	06/12→12/15	←	15"		24.0123-0123.1 423123	Ø 280 23,1 21 V
1.4	74	01/15→	←	15"			
1.4 CRDi	66	06/12→	←	16"		24.0128-0234.1 428234	Ø 300 28 26,4 V
1.6	95	06/12→12/15	→	- eFSB		24.0110-0379.1 410379	Ø 262 10 8,4
1.6 CRDi	81	06/12→	→	+ eFSB			
1.6 CRDi	94	06/12→12/15	→	+ eFSB		24.0110-0383.1 410383	Ø 284 10 8,4
1.6 CRDi	100	01/15→	→	+ eFSB			
1.6 GDI	99	06/12→	→	+ eFSB			
1.6	88	06/12→	←	15"		24.0123-0123.1 423123	Ø 280 23,1 21 V
			←	→ 06/12; 15"		24.0126-0150.1 426150	Ø 280 26 24,4 V
			←	16"		24.0128-0234.1 428234	Ø 300 28 26,4 V
			←	→ 06/12; 16"		24.0128-0234.1 428234	Ø 300 28 26,4 V
			→	→ 06/12		24.0110-0332.1 410332	Ø 262 10 8
			→	- eFSB		24.0110-0379.1 410379	Ø 262 10 8,4
			→	+ eFSB		24.0110-0383.1 410383	Ø 284 10 8,4
HYUNDAI - i40 (VF) 03/12→							
 Bremsscheibe							
1.6 GDI	99	03/12→	←	passend für Felgenreöße [Zoll]: 16		24.0128-0256.1 428256	Ø 300 28 26,4 V
1.7 CRDi	85	03/12→	←	passend für Felgenreöße [Zoll]: 17 / 18		24.0128-0258.1 428258	Ø 320 28,1 26,4 V
1.7 CRDi	100	03/12→	←	passend für Felgenreöße [Zoll]: 17 / 18		24.0128-0258.1 428258	Ø 320 28,1 26,4 V
1.7 CRDi	104	01/15→	→	passend für Felgenreöße [Zoll]: 17 / 18		24.0110-0369.1 410369	Ø 300 10 8,4
2.0 CVVT	110	10/12→	→	passend für Felgenreöße [Zoll]: 17 / 18		24.0110-0369.1 410369	Ø 300 10 8,4
2.0 GDi	121	12/14→	→	passend für Felgenreöße [Zoll]: 16		24.0110-0370.1 410370	Ø 284 10 8,4
2.0 GDI	131	03/12→	→	passend für Felgenreöße [Zoll]: 16		24.0110-0370.1 410370	Ø 284 10 8,4
HYUNDAI - i40 CW (VF) 07/11→							
 Bremsscheibe							
1.6 GDI	99	07/11→	←	passend für Felgenreöße [Zoll]: 16		24.0128-0256.1 428256	Ø 300 28 26,4 V
1.7 CRDi	85	07/11→	←	passend für Felgenreöße [Zoll]: 17 / 18		24.0128-0258.1 428258	Ø 320 28,1 26,4 V
1.7 CRDi	100	07/11→	←	passend für Felgenreöße [Zoll]: 17 / 18		24.0128-0258.1 428258	Ø 320 28,1 26,4 V
1.7 CRDi	104	01/15→	→	passend für Felgenreöße [Zoll]: 17 / 18		24.0110-0369.1 410369	Ø 300 10 8,4
2.0 CVVT	110	10/12→	→	passend für Felgenreöße [Zoll]: 17 / 18		24.0110-0369.1 410369	Ø 300 10 8,4
2.0 GDi	121	12/14→	→	passend für Felgenreöße [Zoll]: 16		24.0110-0370.1 410370	Ø 284 10 8,4
2.0 GDI	130	07/11→	→	passend für Felgenreöße [Zoll]: 16		24.0110-0370.1 410370	Ø 284 10 8,4











	kW					! #		
HYUNDAI - IONIQ (AE) 03/16→								
 Bremsscheibe								
1.6 GDI Hybrid	104	03/16→	→			24.0110-0400.1	410400	Ø 284 10 8,4
Electric	88	03/16→						
HYUNDAI - ix20 (JC) 11/10→								
 Bremsbelagsatz, Scheibenbremse								
1.4	66	11/10→	←			13.0460-5641.2	605641	25187 17,8 + WK + Zub
1.4	74	11/10→						
1.4 CRDi	57	06/11→						
1.4 CRDi	66	11/10→						
1.6	92	11/10→						
1.6 CRDI	85	06/11→						
1.6 CRDI	94	06/11→						
 Bremsscheibe								
1.4	66	11/10→	←			24.0126-0150.1	426150	Ø 280 26 24,4 V
1.4	74	11/10→						
1.4 CRDi	57	06/11→	→			24.0110-0357.1	410357	Ø 258 10 8
1.4 CRDi	66	11/10→						
1.6	92	11/10→						
1.6 CRDI	85	06/11→						
1.6 CRDI	94	06/11→						
HYUNDAI - ix35 (LM, EL, ELH) 08/09→								
 Bremsbelagsatz, Scheibenbremse								
1.6	99	11/10→	←	→ 04/13		13.0460-5600.2	605600	SUM 24501 16,7 + WK
1.7 CRDi	85	11/10→						
2.0 CRDi	130	01/12→	→	→ 03/13		13.0460-5780.2	605780	24320 15,3 + WK + Zub
2.0 CRDi	135	01/12→						
2.0	120	01/10→	←	04/10→ 04/13		13.0460-5600.2	605600	SUM 24501 16,7 + WK
			→	08/13→ 12/15; Made in Tschechische Republik		13.0460-5780.2	605780	24320 15,3 + WK + Zub
			→	04/10→ 03/13		13.0460-5780.2	605780	24320 15,3 + WK + Zub
2.0 4WD	120	01/10→	←	04/10→ 04/13		13.0460-5600.2	605600	SUM 24501 16,7 + WK
			→	04/10→ 07/13		13.0460-5780.2	605780	24320 15,3 + WK + Zub
2.0 CRDi	100	01/10→	←	04/10→ 04/13		13.0460-5600.2	605600	SUM 24501 16,7 + WK
			→	04/10→ 03/13		13.0460-5780.2	605780	24320 15,3 + WK + Zub
2.0 CRDi 4WD	100	01/10→	←	04/10→ 12/15		13.0460-5600.2	605600	SUM 24501 16,7 + WK
2.0 CRDi 4WD	135	01/10→	→	04/10→ 12/15		13.0460-5780.2	605780	24320 15,3 + WK + Zub
2.0 CRDi 4WD	130	01/12→	←	→ 12/15		13.0460-5600.2	605600	SUM 24501 16,7 + WK
			→	→ 12/15		13.0460-5780.2	605780	24320 15,3 + WK + Zub
2.0 CVVT	110	08/09→	←	→ 07/13		13.0460-5600.2	605600	SUM 24501 16,7 + WK
2.0 CVVT AWD	110	08/09→	→	→ 07/13		13.0460-5780.2	605780	24320 15,3 + WK + Zub
2.0 GDi	122	08/13→	←	→ 12/15; Made in Tschechische Republik		13.0460-5600.2	605600	SUM 24501 16,7 + WK
2.0 GDi 4WD	122	08/13→	←	→ 12/15; Made in Tschechische Republik		13.0460-5600.2	605600	SUM 24501 16,7 + WK
			→	→ 12/15; Made in Tschechische Republik		13.0460-5780.2	605780	24320 15,3 + WK + Zub
2.4 DCVVT-I 4WD	128	07/10→12/13	←	→ 04/13		13.0460-5600.2	605600	SUM 24501 16,7 + WK
			→			13.0460-5780.2	605780	24320 15,3 + WK + Zub
 Bremsscheibe								
1.6	99	11/10→	←	→ 12/15		24.0128-0256.1	428256	Ø 300 28 26,4 V
1.7 CRDi	85	11/10→						
2.0 CRDi	130	01/12→	→	→ 12/15		24.0110-0332.1	410332	Ø 262 10 8
2.0 CRDi	135	01/12→						
2.0 GDi	122	08/13→						
2.0	120	01/10→	←	04/10→ 07/13		24.0128-0256.1	428256	Ø 300 28 26,4 V
			→	04/10→ 07/13		24.0110-0332.1	410332	Ø 262 10 8
2.0 4WD	120	01/10→	←	04/10→ 07/13		24.0128-0256.1	428256	Ø 300 28 26,4 V
			→	04/10→ 07/13		24.0110-0286.1	410286	Ø 284 10 8,4
2.0 CRDi	100	01/10→	←	04/10→ 12/15		24.0128-0256.1	428256	Ø 300 28 26,4 V
			→	04/10→ 12/15		24.0110-0332.1	410332	Ø 262 10 8
2.0 CRDi 4WD	100	01/10→	←	04/10→ 12/15		24.0128-0256.1	428256	Ø 300 28 26,4 V
2.0 CRDi 4WD	135	01/10→	→	04/10→ 12/15		24.0110-0286.1	410286	Ø 284 10 8,4
2.0 CRDi 4WD	130	01/12→	←	→ 12/15		24.0128-0256.1	428256	Ø 300 28 26,4 V
2.0 GDi 4WD	122	08/13→	→	→ 12/15		24.0110-0286.1	410286	Ø 284 10 8,4
↓								













	kw			 	! #		
HYUNDAI - ix35 (LM, EL, ELH) 08/09→							
 Bremsscheibe							
2.0 CVVT	110	08/09→	←	→ 07/13		24.0128-0256.1 428256	Ø 300 28 26,4 V
2.0 CVVT AWD	110	08/09→	→	→ 07/13		24.0110-0332.1 410332	Ø 262 10 8
2.4 DCVVT-I 4WD	128	07/10→12/13	←			24.0128-0256.1 428256	Ø 300 28 26,4 V
			→			24.0110-0286.1 410286	Ø 284 10 8,4
FCEV Fuel Cell	53	10/12→	←			24.0128-0258.1 428258	Ø 320 28,1 26,4 V
	100	09/14→	→			24.0110-0388.1 410388	Ø 284 10 8,4
HYUNDAI - ix55 09/06→							
 Bremsbelagsatz, Scheibenbremse							
3.0 V6 CRDi 4WD	176	09/08→12/11	←			13.0460-5638.2 605638	AKE 25119 16,9 + WK + Zub
3.0 V6 CRDi 4WD	184	09/11→12/12	→			13.0460-5636.2 605636	MAN 24599 14,9 + WK + Zub
3.8 V6	194	01/11→	←	→ 12/12		13.0460-5638.2 605638	AKE 25119 16,9 + WK + Zub
3.8 V6 4WD	194	01/11→	→	→ 12/12		13.0460-5636.2 605636	MAN 24599 14,9 + WK + Zub
3.8 V6 4WD	199	01/08→	←			13.0460-5638.2 605638	AKE 25119 16,9 + WK + Zub
3.8 V6 4WD	191	01/07→	→	01/08→ 12/12		13.0460-5636.2 605636	MAN 24599 14,9 + WK + Zub
 Bremsscheibe							
3.0 V6 CRDi 4WD	176	09/08→12/11	←			24.0132-0169.1 432169	Ø 321 32 30 V
3.0 V6 CRDi 4WD	184	09/11→12/12	→			24.0118-0154.1 418154	Ø 324 18 16 V
3.8 V6	194	01/11→	←	→ 12/12		24.0132-0169.1 432169	Ø 321 32 30 V
3.8 V6 4WD	194	01/11→	→	→ 12/12		24.0118-0154.1 418154	Ø 324 18 16 V
3.8 V6 4WD	199	01/08→	←			24.0132-0169.1 432169	Ø 321 32 30 V
3.8 V6 4WD	191	01/07→	→	01/08→ 12/12		24.0118-0154.1 418154	Ø 324 18 16 V
HYUNDAI - LANTRA I (J-1) 10/90→11/95							
 Bremsbelagsatz, Scheibenbremse							
1.5 i.e.	63	10/90→11/95	←	12/90→ 04/95		13.0460-5936.2 605936	AKE 21012 15,0 - WE / - WK
1.6 i.e. 16V	78	10/90→11/95	←	12/90→ 04/95		13.0460-5933.2 605933	AKE 21725 16,8 + WK
1.6 i.e. 16V	84	10/90→11/95					
1.8 i.e. 16V	93	10/90→11/95					
Zubehörsatz, Scheibenbremsbelag							
1.5 i.e.	63	10/90→11/95	←	12/90→ 04/95		13.0460-0439.2 610439	AKE
 Bremsscheibe							
1.5 i.e.	63	10/90→11/95	←	12/90→ 04/95		24.0119-0111.1 419111	Ø 242 19,2 17 V
1.6 i.e. 16V	78	10/90→11/95	←	12/90→ 04/95		24.0122-0170.1 422170	Ø 257 22 20 V
1.6 i.e. 16V	84	10/90→11/95				24.0322-0170.1 522170	Ø 257 22 20 V PD
1.8 i.e. 16V	93	10/90→11/95					
HYUNDAI - LANTRA II (J-2) 06/95→10/00							
 Bremsbelagsatz, Scheibenbremse							
1.5 12V	65	12/96→09/00	←	→ 05/00; - ABS		13.0460-5872.2 605872	AKE 21012 15,0 + WK + Zub
			←	→ 05/00; + ABS		13.0460-5933.2 605933	AKE 21725 16,8 + WK
			→	→ 05/00; + ABS		13.0460-5874.2 605874	SUM 21553 14,0 + WK + Zub
1.5 16V	76	11/95→10/00	←			13.0460-5933.2 605933	AKE 21725 16,8 + WK
1.6 16V	76	11/95→10/00	→			13.0460-5874.2 605874	SUM 21553 14,0 + WK + Zub
1.9 D	50	03/98→09/00	←			13.0460-5874.2 605874	SUM 21553 14,0 + WK + Zub
2.0	100	04/97→05/00	→				
1.6 16V	84	11/95→09/00	←	→ 05/00		13.0460-5933.2 605933	AKE 21725 16,8 + WK
1.6 i	66	11/95→09/00	→	→ 05/00		13.0460-5874.2 605874	SUM 21553 14,0 + WK + Zub
1.8 16V	94	11/95→09/00	←				
2.0 16V	102	08/96→09/00	→				
 Bremsscheibe							
1.5 12V	65	12/96→09/00	←	→ 05/00; - ABS		24.0119-0111.1 419111	Ø 242 19,2 17 V
			←	→ 05/00; + ABS		24.0122-0170.1 422170	Ø 257 22 20 V
			→	→ 05/00; + ABS		24.0322-0170.1 522170	Ø 257 22 20 V PD
			→	→ 05/00; + ABS		24.0110-0264.1 410264	Ø 258 10 8
1.5 16V	76	11/95→10/00	←			24.0122-0170.1 422170	Ø 257 22 20 V
1.6 16V	76	11/95→10/00				24.0322-0170.1 522170	Ø 257 22 20 V PD
1.9 D	50	03/98→09/00					
↓							











	kW			 	! #		
HYUNDAI - LANTRA II (J-2) 06/95→10/00							
 Bremsscheibe							
2.0	100	04/97→05/00	➔			24.0110-0264.1 410264	Ø 258 10 8
1.6 16V	84	11/95→09/00	➔	→ 05/00		24.0122-0170.1 422170	Ø 257 22 20 V
1.6 i	66	11/95→09/00				24.0322-0170.1 522170	Ø 257 22 20 V PD
1.8 16V	94	11/95→09/00					
2.0 16V	102	08/96→09/00	➔	→ 05/00		24.0110-0264.1 410264	Ø 258 10 8
HYUNDAI - LANTRA II Wagon (J-2) 02/96→10/00							
 Bremsbelagsatz, Scheibenbremse							
1.5 12V	65	04/97→10/00	➔	→ 05/00; - ABS		13.0460-5872.2 605872	AKE 21012 15,0 + WK + Zub
			➔	→ 05/00; + ABS		13.0460-5933.2 605933	AKE 21725 16,8 + WK
			➔	→ 05/00; + ABS		13.0460-5874.2 605874	SUM 21553 14,0 + WK + Zub
1.6 16V	84	02/96→10/00	➔	→ 05/00		13.0460-5933.2 605933	AKE 21725 16,8 + WK
1.6 i	66	02/96→10/00					
1.8 16V	94	02/96→10/00	➔	→ 05/00		13.0460-5874.2 605874	SUM 21553 14,0 + WK + Zub
2.0 16V	102	12/96→10/00					
1.9 D	50	03/98→10/00	➔	→ 09/00		13.0460-5933.2 605933	AKE 21725 16,8 + WK
			➔	→ 09/00		13.0460-5874.2 605874	SUM 21553 14,0 + WK + Zub
2.0	100	04/97→05/00	➔			13.0460-5933.2 605933	AKE 21725 16,8 + WK
			➔			13.0460-5874.2 605874	SUM 21553 14,0 + WK + Zub
 Bremsscheibe							
1.5 12V	65	04/97→10/00	➔	→ 05/00; - ABS		24.0119-0111.1 419111	Ø 242 19,2 17 V
			➔	→ 05/00; + ABS		24.0122-0170.1 422170	Ø 257 22 20 V
						24.0322-0170.1 522170	Ø 257 22 20 V PD
			➔	→ 05/00; + ABS		24.0110-0264.1 410264	Ø 258 10 8
1.6 16V	84	02/96→10/00	➔	→ 05/00		24.0122-0170.1 422170	Ø 257 22 20 V
1.6 i	66	02/96→10/00					
1.8 16V	94	02/96→10/00	➔	→ 05/00		24.0322-0170.1 522170	Ø 257 22 20 V PD
2.0 16V	102	12/96→10/00	➔	→ 05/00		24.0110-0264.1 410264	Ø 258 10 8
1.9 D	50	03/98→10/00	➔	→ 09/00		24.0122-0170.1 422170	Ø 257 22 20 V
						24.0322-0170.1 522170	Ø 257 22 20 V PD
			➔	→ 09/00		24.0110-0264.1 410264	Ø 258 10 8
2.0	100	04/97→05/00	➔			24.0122-0170.1 422170	Ø 257 22 20 V
						24.0322-0170.1 522170	Ø 257 22 20 V PD
			➔			24.0110-0264.1 410264	Ø 258 10 8
HYUNDAI - MATRIX (FC) 06/01→08/10							
 Bremsbelagsatz, Scheibenbremse							
1.5	75	06/01→08/10	➔	03/02→		13.0460-5875.2 605875	MAN 24031 17,7 + WK
1.5 CRDi	60	10/01→08/10	➔	→ 02/02		13.0460-5933.2 605933	AKE 21725 16,8 + WK
1.6	76	06/01→08/10	➔	+ ABS		13.0460-5833.2 605833	AKE 23543 14,4 + WK + Zub
1.5 CRDi	75	12/04→08/10	➔			13.0460-5875.2 605875	MAN 24031 17,7 + WK
1.5 CRDi VGT	81	08/05→08/10	➔	+ ABS		13.0460-5833.2 605833	AKE 23543 14,4 + WK + Zub
1.6	66	01/02→12/05					
1.8	90	06/01→08/10	➔	03/02→		13.0460-5875.2 605875	MAN 24031 17,7 + WK
			➔	→ 02/02		13.0460-5933.2 605933	AKE 21725 16,8 + WK
			➔			13.0460-5833.2 605833	AKE 23543 14,4 + WK + Zub
 Bremsscheibe							
1.5	75	06/01→08/10	➔			24.0124-0184.1 424184	Ø 257 24 22,1 V
1.5 CRDi	60	10/01→08/10	➔	+ ABS		24.0110-0317.1 410317	Ø 262 10 8,4
1.5 CRDi	75	12/04→08/10					
1.5 CRDi VGT	81	08/05→08/10					
1.6	66	01/02→12/05					
1.6	76	06/01→08/10					
1.8	90	06/01→08/10	➔			24.0124-0184.1 424184	Ø 257 24 22,1 V
			➔			24.0110-0317.1 410317	Ø 262 10 8,4
HYUNDAI - PONY / EXCEL Stufenheck (X-2) 09/89→01/95							
 Bremsbelagsatz, Scheibenbremse							
1.3	49	01/90→01/95	➔	07/94→		13.0460-5936.2 605936	AKE 21012 15,0 - WE / - WK
1.5	53	01/90→01/95					
1.5 i	61	01/90→01/95					
1.5 i	62	01/90→01/95					
↓							



























	kW					! #		
HYUNDAI - PONY / EXCEL Stufenheck (X-2) 09/89→01/95								
 Bremsscheibe								
1.3 1.5 1.5 i 1.5 i	49 53 61 62	01/90→01/95 01/90→01/95 01/90→01/95 01/90→01/95	←	07/94→			24.0119-0109.1 419109	Ø 242 19,1 17 V
HYUNDAI - PONY (X-2) 10/89→01/95								
 Bremsbelagsatz, Scheibenbremse								
1.3 1.3 1.5 1.5 i 1.5 i	43 49 53 61 62	10/89→01/95 10/89→01/95 10/89→01/95 10/89→01/95 10/89→01/95	←	→ 06/94			13.0460-5936.2 605936	AKE 21012 15,0 - WE / - WK
Zubehörsatz, Scheibenbremsbelag								
1.3 1.3 1.5 1.5 i 1.5 i	43 49 53 61 62	10/89→01/95 10/89→01/95 10/89→01/95 10/89→01/95 10/89→01/95	←	→ 06/94			13.0460-0439.2 610439	AKE
 Bremsscheibe								
1.3 1.3 1.5 1.5 i 1.5 i	43 49 53 61 62	10/89→01/95 10/89→01/95 10/89→01/95 10/89→01/95 10/89→01/95	←	→ 06/94			24.0119-0109.1 419109	Ø 242 19,1 17 V
HYUNDAI - SANTA FÉ I (SM) 11/00→03/06								
 Bremsbelagsatz, Scheibenbremse								
2.0 2.0 CRDi 2.0 CRDi 4x4 2.0 CRDi 4x4 2.4 16V 2.4 16V 2.4 16V 4x4 2.4 16V 4x4 2.7 V6 4x4	99 83 83 92 100 107 100 107 107 127	08/01→03/06 08/01→03/06 04/01→03/06 08/03→03/06 02/01→03/06 02/01→03/06 02/01→03/06 02/01→03/06 02/01→03/06	←	→ 02/06			13.0460-5832.2 605832	23569 16,5 + WK + Zub
2.0 CRDi Allrad 2.7 4x4	107 129	11/03→02/06 09/02→12/04	←				13.0460-5832.2 605832	23569 16,5 + WK + Zub
			→	+ ABS			13.0460-5833.2 605833	AKE 23543 14,4 + WK + Zub
2.7	129	08/04→03/06	←	03/06→			13.0460-5777.2 605777	24351 16,3 + WK + Zub
			→	03/06→			13.0460-5782.2 605782	24488 14,9 + WK + Zub
2.7 4x4	132	11/00→03/06	←	02/01→ 02/06			13.0460-5832.2 605832	23569 16,5 + WK + Zub
			→	02/01→ 02/06; + ABS			13.0460-5833.2 605833	AKE 23543 14,4 + WK + Zub
 Bremsscheibe								
2.0 2.0 CRDi 2.0 CRDi 4x4 2.0 CRDi 4x4 2.4 16V 2.4 16V 2.4 16V 4x4 2.4 16V 4x4 2.7 V6 4x4	99 83 83 92 100 107 100 107 107 127	08/01→03/06 08/01→03/06 04/01→03/06 08/03→03/06 02/01→03/06 02/01→03/06 02/01→03/06 02/01→03/06 02/01→03/06	←	→ 02/06; passend für Felgenreöße [Zoll]: 15			24.0126-0126.1 426126	Ø 276 26 24 V
2.0 CRDi Allrad 2.7 4x4	107 129	11/03→02/06 09/02→12/04	←	passend für Felgenreöße [Zoll]: 15			24.0126-0126.1 426126	Ø 276 26 24 V
			←	passend für Felgenreöße [Zoll]: 16			24.0126-0127.1 426127	Ø 294 26 24,4 V
			→	+ ABS			24.0110-0286.1 410286	Ø 284 10 8,4
2.7	129	08/04→03/06	←	03/06→			24.0128-0158.1 428158	Ø 321 28 26,4 V
			→	03/06→			24.0111-0146.1 411146	Ø 302 11 9,4
2.7 4x4	132	11/00→03/06	←	02/01→ 02/06; passend für Felgenreöße [Zoll]: 15			24.0126-0126.1 426126	Ø 276 26 24 V
			←	02/01→ 02/06; passend für Felgenreöße [Zoll]: 16			24.0126-0127.1 426127	Ø 294 26 24,4 V
			→	02/01→ 02/06; + ABS			24.0110-0286.1 410286	Ø 284 10 8,4
HYUNDAI - SANTA FÉ II (CM) 10/05→12/12								
 Bremsbelagsatz, Scheibenbremse								
2.0 CRDi	110	12/10→12/12	←	→ 08/12			13.0460-5777.2 605777	24351 16,3 + WK + Zub
			→	08/12			13.0460-5633.2 605633	AKE 25520 15,8 + WK + Zub
↓								

















	kW			 	! #		
HYUNDAI - SANTA FÉ II (CM) 10/05→12/12							
 Bremsbelagsatz, Scheibenbremse							
2.0 CRDi 4x4	110	12/10→12/12	←			13.0460-5777.2 605777	24351 16,3 + WK + Zub
2.2 CRDi	145	01/09→12/12	→			13.0460-5633.2 605633	AKE 25520 15,8 + WK + Zub
2.2 CRDi	147	01/09→12/10					
2.2 CRDi 4x4	145	01/09→12/12					
2.2 CRDi 4x4	147	01/09→12/12					
2.4	128	11/10→12/12					
2.4 4x4	128	07/10→12/12					
2.2 CRDi	102	03/06→12/12	←	→ 08/07		13.0460-5777.2 605777	24351 16,3 + WK + Zub
2.2 CRDi 4x4	102	03/06→12/12	→	→ 08/07		13.0460-5782.2 605782	24488 14,9 + WK + Zub
2.2 CRDi	114	03/06→12/09	←			13.0460-5777.2 605777	24351 16,3 + WK + Zub
2.2 CRDi 4x4	114	03/06→12/09	→			13.0460-5782.2 605782	24488 14,9 + WK + Zub
2.2 CRDi GLS	110	03/06→12/09					
2.2 CRDi GLS 4x4	110	03/06→12/09					
2.7 V6 GLS	139	03/06→12/09					
2.7 V6 GLS 4x4	139	03/06→12/09					
2.7	125	03/06→12/12	←	→ 12/11		13.0460-5777.2 605777	24351 16,3 + WK + Zub
2.7 4x4	125	03/06→12/12	→	→ 12/11		13.0460-5782.2 605782	24488 14,9 + WK + Zub
2.7 4x4	147	01/07→12/12	←	→ 09/11		13.0460-5777.2 605777	24351 16,3 + WK + Zub
			→	→ 09/11		13.0460-5782.2 605782	24488 14,9 + WK + Zub
 Bremsscheibe							
2.0 CRDi	110	12/10→12/12	←	→ 08/12		24.0128-0248.1 428248	Ø 321 28 26,4 V
			→	→ 08/12		24.0111-0170.1 411170	Ø 302 11 9,4
2.0 CRDi 4x4	110	12/10→12/12	←			24.0128-0248.1 428248	Ø 321 28 26,4 V
2.2 CRDi	145	01/09→12/12	→			24.0111-0170.1 411170	Ø 302 11 9,4
2.2 CRDi	147	01/09→12/10					
2.2 CRDi 4x4	145	01/09→12/12					
2.2 CRDi 4x4	147	01/09→12/12					
2.4	128	11/10→12/12					
2.4 4x4	128	07/10→12/12					
2.2 CRDi	102	03/06→12/12	←	→ 08/07		24.0128-0158.1 428158	Ø 321 28 26,4 V
2.2 CRDi 4x4	102	03/06→12/12	→	→ 08/07		24.0111-0146.1 411146	Ø 302 11 9,4
2.2 CRDi	114	03/06→12/09	←			24.0128-0158.1 428158	Ø 321 28 26,4 V
2.2 CRDi 4x4	114	03/06→12/09	→			24.0111-0146.1 411146	Ø 302 11 9,4
2.2 CRDi GLS	110	03/06→12/09					
2.2 CRDi GLS 4x4	110	03/06→12/09					
2.7 V6 GLS	139	03/06→12/09					
2.7 V6 GLS 4x4	139	03/06→12/09					
2.7	125	03/06→12/12	←	→ 12/11		24.0128-0158.1 428158	Ø 321 28 26,4 V
2.7 4x4	125	03/06→12/12	→	→ 12/11		24.0111-0146.1 411146	Ø 302 11 9,4
2.7 4x4	147	01/07→12/12	←	→ 09/11		24.0128-0158.1 428158	Ø 321 28 26,4 V
			→	→ 09/11		24.0111-0146.1 411146	Ø 302 11 9,4
HYUNDAI - SANTA FÉ III (DM) 09/12→							
 Bremsbelagsatz, Scheibenbremse							
2.0 CRDi	110	09/12→	←			13.0460-5777.2 605777	24351 16,3 + WK + Zub
2.0 CRDi 4WD	110	09/12→	→			13.0460-5633.2 605633	AKE 25520 15,8 + WK + Zub
2.0 CRDi 4WD	135	09/12→					
2.2 CRDi	145	09/12→12/15					
2.2 CRDi 4WD	145	09/12→12/15					
2.4	141	09/12→12/15					
2.4 4WD	141	09/12→12/15					
2.4 CCVT	129	09/12→					
2.4 CCVT AWD	129	09/12→					
 Bremsscheibe							
2.0 CRDi	110	09/12→	←			24.0128-0248.1 428248	Ø 321 28 26,4 V
2.0 CRDi 4WD	110	09/12→	→			24.0111-0170.1 411170	Ø 302 11 9,4
2.0 CRDi 4WD	135	09/12→					
2.2 CRDi	145	09/12→12/15					
2.2 CRDi	147	10/15→					
2.2 CRDi 4WD	145	09/12→12/15					
2.2 CRDi 4WD	147	10/15→					
2.4	141	09/12→12/15					
2.4 4WD	141	09/12→12/15					
2.4 CCVT	129	09/12→					
2.4 CCVT AWD	129	09/12→					
2.4 GDI	138	05/15→					
2.4 GDI 4WD	138	05/15→					



















	kw			 	! #		
HYUNDAI - SANTAMO 10/98→12/02							
 Bremsscheibe							
2.0	77	10/98→10/02	←	- ABS		24.0124-0136.1 424136	Ø 256 24 21,5 V
			←	+ ABS		24.0124-0146.1 424146	Ø 256 24 22,4 V
			→	+ ABS		24.0118-0141.1 418141	Ø 266 18 16,4 V
2.0 16V	102	05/99→12/02	←	→ 10/02; - ABS		24.0124-0136.1 424136	Ø 256 24 21,5 V
2.0 16V 4x4	102	05/99→12/02	←	→ 10/02; + ABS		24.0124-0146.1 424146	Ø 256 24 22,4 V
			→	→ 10/02; + ABS		24.0118-0141.1 418141	Ø 266 18 16,4 V
HYUNDAI - S COUPE (SLC) 02/90→05/96							
 Bremsbelagsatz, Scheibenbremse							
1.5 i	65	04/92→05/96	←	06/92→ 04/96		13.0460-5936.2 605936	AKE 21012 15,0 - WE / - WK
1.5 i Turbo	85	04/91→05/96	←	06/92→		13.0460-5936.2 605936	AKE 21012 15,0 - WE / - WK
Zubehörsatz, Scheibenbremsbelag							
1.5 i	65	04/92→05/96	←	06/92→ 04/96		13.0460-0439.2 610439	AKE
1.5 i Turbo	85	04/91→05/96	←	06/92→		13.0460-0439.2 610439	AKE
 Bremsscheibe							
1.5 i	62	02/90→05/96	←	03/90→ 05/92		24.0119-0109.1 419109	Ø 242 19,1 17 V
1.5 i	65	04/92→05/96	←	06/92→ 04/96		24.0119-0109.1 419109	Ø 242 19,1 17 V
1.5 i Turbo	85	04/91→05/96	←			24.0119-0109.1 419109	Ø 242 19,1 17 V
HYUNDAI - SONATA III (Y-3) 05/93→11/98							
 Bremsbelagsatz, Scheibenbremse							
1.8 i	72	05/93→06/98	←	07/93→ 05/98		13.0460-5933.2 605933	AKE 21725 16,8 + WK
2.0 i 16V	102	05/93→06/98					
3.0 i V6	107	05/93→06/98					
2.0 i	70	08/96→06/98	←	→ 05/98		13.0460-5933.2 605933	AKE 21725 16,8 + WK
2.0 i 16V	92	06/96→06/98					
2.0 i	77	06/94→08/96	←			13.0460-5933.2 605933	AKE 21725 16,8 + WK
 Bremsscheibe							
1.8 i	72	05/93→06/98	←	07/93→ 05/98		24.0122-0169.1 422169	Ø 257 22 20 V
2.0 i 16V	102	05/93→06/98					
3.0 i V6	107	05/93→06/98					
2.0 i	70	08/96→06/98	←	→ 05/98		24.0122-0169.1 422169	Ø 257 22 20 V
2.0 i 16V	92	06/96→06/98					
2.0 i	77	06/94→08/96	←			24.0122-0169.1 422169	Ø 257 22 20 V
HYUNDAI - SONATA IV (EF) 03/98→12/05							
 Bremsbelagsatz, Scheibenbremse							
2.0	100	04/01→11/04	←	10/01→		13.0460-5873.2 605873	MAN 23891 16,9 + WK
			→	10/01→; + ABS		13.0460-5833.2 605833	AKE 23543 14,4 + WK + Zub
2.0 16V	96	10/01→11/04	←			13.0460-5873.2 605873	MAN 23891 16,9 + WK
2.0 16V	106	10/01→11/04	→	+ ABS		13.0460-5833.2 605833	AKE 23543 14,4 + WK + Zub
2.0 16V	100	06/98→10/01	←	→ 09/01		13.0460-5933.2 605933	AKE 21725 16,8 + WK
2.4 16V	105	03/98→10/01	→	→ 09/01; + ABS		13.0460-5833.2 605833	AKE 23543 14,4 + WK + Zub
2.5 V6 24V	118	06/98→10/01					
2.4	104	10/01→05/05	←	→ 12/04		13.0460-5873.2 605873	MAN 23891 16,9 + WK
2.7 i V6	132	10/01→05/05	→	→ 12/04		13.0460-5833.2 605833	AKE 23543 14,4 + WK + Zub
2.5 i V6	127	08/98→09/01	←			13.0460-5933.2 605933	AKE 21725 16,8 + WK
			→			13.0460-5833.2 605833	AKE 23543 14,4 + WK + Zub
2.7 V6	123	10/01→11/04	←			13.0460-5873.2 605873	MAN 23891 16,9 + WK
2.7 V6	127	10/01→11/04					
2.7 V6	129	11/02→11/04	→			13.0460-5833.2 605833	AKE 23543 14,4 + WK + Zub
Zubehörsatz, Scheibenbremsbelag							
2.0	100	04/01→11/04	←	10/01→		13.0460-0139.2 610139	MAN
2.0 16V	96	10/01→11/04	←			13.0460-0139.2 610139	MAN
2.0 16V	106	10/01→11/04					
2.7 V6	123	10/01→11/04					
2.7 V6	127	10/01→11/04					
2.7 V6	129	11/02→11/04					
2.4	104	10/01→05/05	←	→ 12/04		13.0460-0139.2 610139	MAN
2.7 i V6	132	10/01→05/05					
↓							



















	kW			 	! #		
HYUNDAI - SONATA IV (EF) 03/98→12/05							
 Bremsscheibe							
2.0	100	04/01→11/04	←	10/01→		24.0126-0129.1 426129	Ø 280 26 24,4 V
			→	10/01→; + ABS		24.0110-0317.1 410317	Ø 262 10 8,4
2.0 16V	96	10/01→11/04	←			24.0126-0129.1 426129	Ø 280 26 24,4 V
2.0 16V	106	10/01→11/04	→	+ ABS		24.0110-0317.1 410317	Ø 262 10 8,4
2.0 16V	100	06/98→10/01	←	→ 09/01		24.0124-0706.1 424706	Ø 257 24 22,4 V
2.4 16V	105	03/98→10/01	←			24.0124-0706.1 424706	Ø 257 24 22,4 V
2.5 V6 24V	118	06/98→10/01	→	→ 09/01; + ABS		24.0110-0317.1 410317	Ø 262 10 8,4
2.4	104	10/01→05/05	←	→ 12/04		24.0126-0129.1 426129	Ø 280 26 24,4 V
2.7 i V6	132	10/01→05/05	→	→ 12/04		24.0110-0317.1 410317	Ø 262 10 8,4
2.5 i V6	127	08/98→09/01	←			24.0124-0706.1 424706	Ø 257 24 22,4 V
			→			24.0110-0317.1 410317	Ø 262 10 8,4
2.7 V6	123	10/01→11/04	←			24.0126-0129.1 426129	Ø 280 26 24,4 V
2.7 V6	127	10/01→11/04	←			24.0126-0129.1 426129	Ø 280 26 24,4 V
2.7 V6	129	11/02→11/04	→			24.0110-0317.1 410317	Ø 262 10 8,4
HYUNDAI - SONATA V (NF) 01/05→12/10							
 Bremsbelagsatz, Scheibenbremse							
2.0 CRDi	100	02/06→12/10	←			13.0460-5639.2 605639	24375 17,5 + WK
2.0 CRDi	110	03/09→12/10	→			13.0460-5786.2 605786	AKE 24934 15,0 + WK + Zub
						13.0470-5786.2 LD5786	AKE 24934 15,0 + WK + Zub Ceramic
2.0 CRDi	103	02/06→12/10	←			13.0460-5639.2 605639	24375 17,5 + WK
2.0 CRDi	105	02/06→	←			13.0460-5639.2 605639	24375 17,5 + WK
2.0 GLSi	119	07/08→12/10	→			13.0460-5833.2 605833	AKE 23543 14,4 + WK + Zub
2.4	125	06/08→12/09	→			13.0460-5833.2 605833	AKE 23543 14,4 + WK + Zub
2.0 VVTi GLS	106	05/05→12/10	←			13.0460-5639.2 605639	24375 17,5 + WK
2.4	119	01/05→12/10	←			13.0460-5639.2 605639	24375 17,5 + WK
3.3	171	01/05→12/10	→	02/06→		13.0460-5833.2 605833	AKE 23543 14,4 + WK + Zub
3.3	173	06/05→12/10	→			13.0460-5833.2 605833	AKE 23543 14,4 + WK + Zub
2.0 VVTi GLS	121	01/08→12/10	←			13.0460-5639.2 605639	24375 17,5 + WK
			→			13.0460-5780.2 605780	24320 15,3 + WK + Zub
			→	06/08→		13.0460-5833.2 605833	AKE 23543 14,4 + WK + Zub
2.4	128	06/08→12/10	←			13.0460-5639.2 605639	24375 17,5 + WK
3.3	184	01/08→12/10	→			13.0460-5780.2 605780	24320 15,3 + WK + Zub
HYUNDAI - SONATA V (NF) 01/05→12/10							
 Bremsscheibe							
2.0 CRDi	100	02/06→12/10	←	11/07→		24.0128-0256.1 428256	Ø 300 28 26,4 V
2.0 CRDi	103	02/06→12/10	←	→ 10/07		24.0128-0256.1 428256	Ø 300 28 26,4 V
2.0 CRDi	105	02/06→	←			24.0128-0256.1 428256	Ø 300 28 26,4 V
2.0 CRDi	110	03/09→12/10	←			24.0128-0256.1 428256	Ø 300 28 26,4 V
2.0 GLSi	119	07/08→12/10	←			24.0128-0256.1 428256	Ø 300 28 26,4 V
2.0 VVTi GLS	121	01/08→12/10	←			24.0128-0256.1 428256	Ø 300 28 26,4 V
2.4	125	06/08→12/09	←			24.0128-0256.1 428256	Ø 300 28 26,4 V
2.0 VVTi GLS	106	05/05→12/10	←	→ 01/06		24.0126-0128.1 426128	Ø 280 26 24,4 V
			←	11/07→		24.0128-0256.1 428256	Ø 300 28 26,4 V
			←	02/06→ 10/07		24.0128-0256.1 428256	Ø 300 28 26,4 V
			→	→ 01/06		24.0110-0318.1 410318	Ø 262 10 8,4
2.4	119	01/05→12/10	←	→ 01/06		24.0126-0128.1 426128	Ø 280 26 24,4 V
3.3	171	01/05→12/10	←			24.0126-0128.1 426128	Ø 280 26 24,4 V
3.3	173	06/05→12/10	←	11/07→		24.0128-0256.1 428256	Ø 300 28 26,4 V
			←	02/06→ 10/07		24.0128-0256.1 428256	Ø 300 28 26,4 V
			→	→ 01/06		24.0110-0318.1 410318	Ø 262 10 8,4
			→	06/07→		24.0110-0367.1 410367	Ø 284 10 8,4
2.4	128	06/08→12/10	←			24.0128-0256.1 428256	Ø 300 28 26,4 V
3.3	184	01/08→12/10	→			24.0110-0367.1 410367	Ø 284 10 8,4
HYUNDAI - SONATA VI (YF) 01/09→12/15							
 Bremsbelagsatz, Scheibenbremse							
2.0	110	01/09→06/14	←	→ 11/10		13.0460-5641.2 605641	25187 17,8 + WK + Zub
2.4	131	01/09→12/15	←	12/10→		13.0460-5641.2 605641	25187 17,8 + WK + Zub
2.4 GDI	148	01/09→	→			13.0460-5780.2 605780	24320 15,3 + WK + Zub
2.0 Hybrid	110	01/11→06/14	←			13.0460-5641.2 605641	25187 17,8 + WK + Zub
2.0 i	121	01/11→06/14	←			13.0460-5641.2 605641	25187 17,8 + WK + Zub
2.4	128	01/09→11/10	→			13.0460-5780.2 605780	24320 15,3 + WK + Zub
2.4	133	10/12→	→			13.0460-5780.2 605780	24320 15,3 + WK + Zub











	kw				! #		
HYUNDAI - SONATA VII (LF) 09/14→							
 Bremsscheibe							
2.0 Gdi Hybrid 2.0 Hybrid	165 153	09/14→ 09/14→	➔	+ eFSB; für Bremsscheibendurchmesser [Zoll]: 15		24.0110-0400.1 410400	Ø 284 10 8,4
HYUNDAI - TERRACAN (HP) 06/01→03/03							
 Bremsbelagsatz, Scheibenbremse							
2.5 D 2.9 CRDi	74 110	06/01→10/03 11/01→07/03	←			13.0460-5886.2 605886	24059 16,7 + WK + Zub
2.5 TD 3.5 i V6 4WD 3.5 i V6 4WD	74 143 147	12/01→12/06 12/01→12/06 12/01→12/06	←	11/03→ → 10/03		13.0460-5622.2 605622	MAN 23726 16,5 + WK + Zub
2.9 CRDi 4WD 2.9 CRDi 4WD	110 120	12/01→12/06 11/03→12/06	←	→ 07/03		13.0460-5886.2 605886	24059 16,7 + WK + Zub
2.9 CRDi 4WD	120	11/03→12/06	←			13.0460-5622.2 605622	MAN 23726 16,5 + WK + Zub
Zubehörsatz, Scheibenbremsbelag							
2.5 D 2.5 TD 2.9 CRDi 2.9 CRDi 4WD 3.5 i V6 4WD 3.5 i V6 4WD 2.9 CRDi 4WD	74 74 110 120 143 147 110	06/01→10/03 12/01→12/06 11/01→07/03 11/03→12/06 12/01→12/06 12/01→12/06 12/01→12/06	➔			13.0460-0135.2 610135	
2.9 CRDi 4WD	110	12/01→12/06	➔	→ 07/03		13.0460-0135.2 610135	
 Bremsscheibe							
2.5 D 2.9 CRDi	74 110	06/01→10/03 11/01→07/03	←			24.0127-0100.1 427100	Ø 281 27 25,4 V
2.5 TD 3.5 i V6 4WD 3.5 i V6 4WD	74 143 147	12/01→12/06 12/01→12/06 12/01→12/06	←	→ 10/03 11/03→		24.0127-0100.1 427100 24.0128-0224.1 428224	Ø 281 27 25,4 V Ø 303,5 28 26,4 V
2.9 CRDi 4WD 2.9 CRDi 4WD	110 120	12/01→12/06 11/03→12/06	←	→ 07/03		24.0127-0100.1 427100 24.0128-0224.1 428224	Ø 281 27 25,4 V Ø 303,5 28 26,4 V
HYUNDAI - TIBURON Coupe 01/01→12/08							
 Bremsbelagsatz, Scheibenbremse							
1.6 CVVT 2.0 CVVT 2.7	78 105 123	10/06→12/08 10/06→12/08 01/06→12/08	← ➔			13.0460-5873.2 605873 13.0460-5874.2 605874	MAN 23891 16,9 + WK SUM 21553 14,0 + WK + Zub
 Bremsscheibe							
1.6 CVVT 2.0 CVVT 2.7	78 105 123	10/06→12/08 10/06→12/08 01/06→12/08	← ➔			24.0126-0128.1 426128 24.0110-0298.1 410298	Ø 280 26 24,4 V Ø 258 10 8
HYUNDAI - TRAJET (FO) 03/00→07/08							
 Bremsbelagsatz, Scheibenbremse							
2.0	100	03/00→07/08	← ➔	→ 10/03 → 10/03		13.0460-5832.2 605832 13.0460-5833.2 605833	23569 16,5 + WK + Zub AKE 23543 14,4 + WK + Zub
2.0 2.0 2.0 2.0 CRDi 2.0 CRDi 2.7 V6	103 103 104 83 92 127	03/01→10/03 01/04→07/08 11/03→07/08 04/01→07/08 08/05→07/08 09/00→07/08	← ➔			13.0460-5832.2 605832 13.0460-5833.2 605833	23569 16,5 + WK + Zub AKE 23543 14,4 + WK + Zub
 Bremsscheibe							
2.0	100	03/00→07/08	← ➔	→ 10/03 → 10/03		24.0126-0126.1 426126 24.0110-0286.1 410286	Ø 276 26 24 V Ø 284 10 8,4
2.0 2.0 2.0 2.0 CRDi 2.0 CRDi 2.7 V6	103 103 104 83 92 127	03/01→10/03 01/04→07/08 11/03→07/08 04/01→07/08 08/05→07/08 09/00→07/08	← ➔			24.0126-0126.1 426126 24.0110-0286.1 410286	Ø 276 26 24 V Ø 284 10 8,4
HYUNDAI - TUCSON (JM) 08/04→11/10							
 Bremsbelagsatz, Scheibenbremse							
2.0 2.0 Allrad 2.0 CRDi 2.0 CRDi 2.0 CRDi 2.0 CRDi	104 104 83 88 100 103	08/04→03/10 08/04→03/10 08/04→03/10 01/07→03/10 01/06→03/10 01/06→03/10	← ← ➔	01/08→ → 12/07 01/08→		13.0460-5873.2 605873 13.0460-5873.2 605873 13.0460-5786.2 605786	MAN 23891 16,9 + WK MAN 23891 16,9 + WK AKE 24934 15,0 + WK + Zub

	kw			 	! #		
HYUNDAI - TUCSON (JM) 08/04→11/10							
 Bremsbelagsatz, Scheibenbremse							
2.0 CRDi Allrad	83	08/04→03/10	➡	01/08→		13.0470-5786.2 LD5786	AKE 24934 15,0 + WK + Zub Ceramic
2.0 CRDi Allrad	88	01/07→03/10					
2.0 CRDi Allrad	100	01/06→03/10					
2.0 CRDi Allrad	103	01/06→03/10	➡	→ 12/07		13.0460-5833.2 605833	AKE 23543 14,4 + WK + Zub
2.7 Allrad	129	08/04→03/10					
2.0	105	01/10→03/10	⬅			13.0460-5873.2 605873	MAN 23891 16,9 + WK
2.0 CRDi	110	01/09→03/10				13.0460-5786.2 605786	AKE 24934 15,0 + WK + Zub
2.0 CRDi Allrad	110	01/09→03/10	➡			13.0470-5786.2 LD5786	AKE 24934 15,0 + WK + Zub Ceramic
2.0 Allrad	105	07/05→11/10	⬅	01/08→ 03/10		13.0460-5873.2 605873	MAN 23891 16,9 + WK
			⬅	→ 12/07		13.0460-5873.2 605873	MAN 23891 16,9 + WK
			➡	01/08→ 03/10		13.0460-5786.2 605786	AKE 24934 15,0 + WK + Zub
						13.0470-5786.2 LD5786	AKE 24934 15,0 + WK + Zub Ceramic
			➡	→ 12/07		13.0460-5833.2 605833	AKE 23543 14,4 + WK + Zub
Zubehörsatz, Scheibenbremsbelag							
2.0	104	08/04→03/10	⬅	→ 12/07		13.0460-0139.2 610139	MAN
2.0 Allrad	104	08/04→03/10					
2.0 Allrad	105	07/05→11/10					
2.0 CRDi	83	08/04→03/10					
2.0 CRDi	88	01/07→03/10					
2.0 CRDi	100	01/06→03/10					
2.0 CRDi	103	01/06→03/10					
2.0 CRDi Allrad	83	08/04→03/10					
2.0 CRDi Allrad	88	01/07→03/10					
2.0 CRDi Allrad	100	01/06→03/10					
2.0 CRDi Allrad	103	01/06→03/10					
2.7 Allrad	129	08/04→03/10					
Bremsscheibe							
2.0	104	08/04→03/10	⬅	→ 12/07		24.0126-0128.1 426128	Ø 280 26 24,4 V
2.0 CRDi	83	08/04→03/10	⬅			24.0128-0256.1 428256	Ø 300 28 26,4 V
2.0 CRDi	88	01/07→03/10	⬅	01/08→		24.0110-0318.1 410318	Ø 262 10 8,4
2.0 CRDi	100	01/06→03/10	➡			24.0128-0256.1 428256	Ø 300 28 26,4 V
2.0 CRDi	103	01/06→03/10	➡			24.0110-0318.1 410318	Ø 262 10 8,4
2.0	105	01/10→03/10	⬅			24.0128-0256.1 428256	Ø 300 28 26,4 V
2.0 CRDi	110	01/09→03/10	➡			24.0110-0318.1 410318	Ø 262 10 8,4
2.0 Allrad	104	08/04→03/10	⬅	→ 12/07		24.0126-0128.1 426128	Ø 280 26 24,4 V
2.0 CRDi Allrad	83	08/04→03/10	⬅			24.0128-0256.1 428256	Ø 300 28 26,4 V
2.0 CRDi Allrad	88	01/07→03/10	⬅	01/08→		24.0110-0286.1 410286	Ø 284 10 8,4
2.0 CRDi Allrad	100	01/06→03/10	➡			24.0126-0128.1 426128	Ø 280 26 24,4 V
2.0 CRDi Allrad	103	01/06→03/10	➡			24.0128-0256.1 428256	Ø 300 28 26,4 V
2.7 Allrad	129	08/04→03/10	➡			24.0110-0286.1 410286	Ø 284 10 8,4
2.0 Allrad	105	07/05→11/10	⬅	→ 12/07		24.0126-0128.1 426128	Ø 280 26 24,4 V
			⬅	01/08→ 03/10		24.0128-0256.1 428256	Ø 300 28 26,4 V
			➡	→ 03/10		24.0110-0286.1 410286	Ø 284 10 8,4
2.0 CRDi Allrad	110	01/09→03/10	⬅			24.0128-0256.1 428256	Ø 300 28 26,4 V
			➡			24.0110-0286.1 410286	Ø 284 10 8,4
HYUNDAI - TUCSON (TL) 05/15→							
 Bremsbelagsatz, Scheibenbremse							
1.6 GDi	97	06/15→	⬅			13.0460-5600.2 605600	SUM 24501 16,7 + WK
1.6 T-GDi	130	06/15→					
1.6 T-GDi Allrad	130	06/15→					
1.7 CRDi	85	06/15→					
1.7 CRDi	104	06/15→					
2.0 CRDi	100	06/15→	⬅	Made in Tschechische Republik		13.0460-5600.2 605600	SUM 24501 16,7 + WK
2.0 CRDi Allrad	100	06/15→					
2.0 CRDi Allrad	136	06/15→					
HYUNDAI - VELOSTER (FS) 03/11→							
 Bremsbelagsatz, Scheibenbremse							
1.6	95	10/11→	⬅	→ 04/12		13.0460-5645.2 605645	25692 17,2 + WK + Zub
1.6 GDI	103	03/11→	⬅	05/12→		13.0460-5645.2 605645	25692 17,2 + WK + Zub
1.6 MPI	97	04/11→					
Bremsscheibe							
1.6	95	10/11→	➡			24.0110-0368.1 410368	Ø 262 10 8,4
1.6 GDI	103	03/11→					
1.6 MPI	97	04/11→					
↓							

	kw					! #		
HYUNDAI - VELOSTER (FS) 03/11→								
 Bremsscheibe								
1.6 T-GDI	137	10/12→	←			24.0128-0234.1	428234	Ø 300 28 26,4 V
			→			24.0110-0368.1	410368	Ø 262 10 8,4
1.6 T-GDI	150	08/12→	←	10/12→		24.0128-0234.1	428234	Ø 300 28 26,4 V
			→	10/12→		24.0110-0368.1	410368	Ø 262 10 8,4
HYUNDAI - XG (XG) 12/98→12/05								
 Bremsbelagsatz, Scheibenbremse								
250	120	12/98→12/05	→	06/99→ 05/05		13.0460-5833.2	605833	AKE 23543 14,4 + WK + Zub
			→	→ 09/05		13.0460-5833.2	605833	AKE 23543 14,4 + WK + Zub
3.0 300	153 145	10/01→05/05 09/99→09/03	→			13.0460-5833.2	605833	AKE 23543 14,4 + WK + Zub
30	138	12/98→12/05	→	09/99→ 10/02		13.0460-5833.2	605833	AKE 23543 14,4 + WK + Zub
			→	→ 09/05		13.0460-5833.2	605833	AKE 23543 14,4 + WK + Zub
350	145	10/02→12/05	→	04/03→ 09/05		13.0460-5833.2	605833	AKE 23543 14,4 + WK + Zub
			→	→ 05/05		13.0460-5833.2	605833	AKE 23543 14,4 + WK + Zub
 Bremsscheibe								
250	120	12/98→12/05	→	06/99→ 05/05		24.0110-0318.1	410318	Ø 262 10 8,4
			→	→ 09/05		24.0110-0318.1	410318	Ø 262 10 8,4
3.0 300	153 145	10/01→05/05 09/99→09/03	→			24.0110-0318.1	410318	Ø 262 10 8,4
30	138	12/98→12/05	→	09/99→ 10/02		24.0110-0318.1	410318	Ø 262 10 8,4
			→	→ 09/05		24.0110-0318.1	410318	Ø 262 10 8,4
350	145	10/02→12/05	→	04/03→ 09/05		24.0110-0318.1	410318	Ø 262 10 8,4
			→	→ 05/05		24.0110-0318.1	410318	Ø 262 10 8,4
HYUNDAI - XG Stufenheck 09/00→12/05								
 Bremsbelagsatz, Scheibenbremse								
250 300	123 143	10/03→09/05 09/00→12/01	→			13.0460-5833.2	605833	AKE 23543 14,4 + WK + Zub
 Bremsscheibe								
250 300	123 143	10/03→09/05 09/00→12/01	→			24.0110-0318.1	410318	Ø 262 10 8,4
INFINITI - EX 09/07→								
 Bremsbelagsatz, Scheibenbremse								
25 30d	175 175	04/10→ 04/10→	←			13.0460-5778.2	605778	SUM 23698 16,8 + WK
25 AWD	163	09/07→	←	04/10→		13.0460-5778.2	605778	SUM 23698 16,8 + WK
37 37	228 235	10/08→ 09/10→	←			13.0460-5778.2	605778	SUM 23698 16,8 + WK
			←	02/11→; + RUS		13.0460-5778.2	605778	SUM 23698 16,8 + WK
INFINITI - FX 09/02→12/08								
 Bremsscheibe								
35 35 Allrad 45 45 Allrad	206 206 232 232	02/03→12/08 01/03→12/08 02/03→12/08 01/03→12/08	→			24.0116-0122.1	416122	Ø 308 16 14 V
INFINITI - G Cabriolet 09/10→								
 Bremsbelagsatz, Scheibenbremse								
37 37	235 245	09/10→ 09/10→	←	+ RUS; nicht für Felgenreöße [Zoll]: 19		13.0460-5778.2	605778	SUM 23698 16,8 + WK
			←	nicht für Felgenreöße [Zoll]: 19		13.0460-5778.2	605778	SUM 23698 16,8 + WK
INFINITI - G Coupe 09/07→								
 Bremsbelagsatz, Scheibenbremse								
37 37	235 243	09/10→ 09/07→	←	für Fahrzeuge ohne Sportpaket		13.0460-5778.2	605778	SUM 23698 16,8 + WK

	kw			 	! #		
INFINITI - G Stufenheck 01/07→							
 Bremsbelagsatz, Scheibenbremse							
25 37	163 240	01/11→ 01/12→	←	für Fahrzeuge ohne Vierradlenkung	13.0460-5778.2	605778	SUM 23698 16,8 + WK
37 37 37 X	235 243 235	10/08→ 10/08→ 10/08→	←	für Fahrzeuge ohne Vierradlenkung	13.0460-5778.2	605778	SUM 23698 16,8 + WK
			←	11/09→; + RUS; für Fahrzeuge ohne Vierradlenkung	13.0460-5778.2	605778	SUM 23698 16,8 + WK
 Bremsscheibe							
37 37 37 X	235 243 235	10/08→ 10/08→ 10/08→	←	→ 01/10; + RUS	24.0128-0153.1	428153	Ø 320 28 26 V
INFINITI - M (Y51) 03/10→							
 Bremsbelagsatz, Scheibenbremse							
25 30d 37 56 56 X	163 175 235 309 300	07/10→ 03/10→ 03/10→ 01/12→ 03/10→	←	für Fahrzeuge ohne Vierradlenkung	13.0460-5778.2	605778	SUM 23698 16,8 + WK
35h	225	04/11→	←		13.0460-5778.2	605778	SUM 23698 16,8 + WK
37 56	243 300	01/12→ 03/10→	←	01/12→; für Fahrzeuge ohne Vierradlenkung	13.0460-5778.2	605778	SUM 23698 16,8 + WK
 Bremsscheibe							
25 30d 37 56 56 X	163 175 235 309 300	07/10→ 03/10→ 03/10→ 01/12→ 03/10→	→	für Fahrzeuge ohne Vierradlenkung	24.0116-0122.1	416122	Ø 308 16 14 V
35h	225	04/11→	→		24.0116-0122.1	416122	Ø 308 16 14 V
37 56	243 300	01/12→ 03/10→	→	01/12→; für Fahrzeuge ohne Vierradlenkung	24.0116-0122.1	416122	Ø 308 16 14 V
INFINITI - M35 01/05→							
 Bremsbelagsatz, Scheibenbremse							
3.5 h	268	01/10→	←	04/11→	13.0460-5778.2	605778	SUM 23698 16,8 + WK
 Bremsscheibe							
3.5 3.5 X	206 206	01/05→ 01/05→	←	07/06→ 12/13	24.0128-0153.1	428153	Ø 320 28 26 V
3.5 3.5 X	226 226	09/08→12/10 09/08→12/10	←		24.0128-0153.1	428153	Ø 320 28 26 V
3.5 h	268	01/10→	→	04/11→	24.0116-0122.1	416122	Ø 308 16 14 V
INFINITI - M37 01/10→							
 Bremsbelagsatz, Scheibenbremse							
3.7 Allrad	243	01/10→	←	01/12→; für Fahrzeuge ohne Vierradlenkung	13.0460-5778.2	605778	SUM 23698 16,8 + WK
 Bremsscheibe							
3.7 Allrad	243	01/10→	→	01/12→; für Fahrzeuge ohne Vierradlenkung	24.0116-0122.1	416122	Ø 308 16 14 V
INFINITI - M45 01/05→							
 Bremsscheibe							
4.5	250	01/05→	←	07/06→ 12/13	24.0128-0153.1	428153	Ø 320 28 26 V
INFINITI - Q50 04/13→							
 Bremsscheibe							
2.0 T 50 D 50 Hybrid 50 Hybrid AWD	155 125 268 268	04/14→ 04/13→ 04/13→ 04/13→	→		24.0116-0122.1	416122	Ø 308 16 14 V
INFINITI - Q60 Cabriolet 10/13→							
 Bremsbelagsatz, Scheibenbremse							
3.7	235	10/13→	←	+ RUS; nicht für Felgenreöße [Zoll]: 19	13.0460-5778.2	605778	SUM 23698 16,8 + WK
			←	nicht für Felgenreöße [Zoll]: 19	13.0460-5778.2	605778	SUM 23698 16,8 + WK

	kw			 	! #		
INFINITI - Q60 Coupe 09/16→							
 Bremsscheibe							
2.0 T	155	09/16→	➔	für Fahrzeuge ohne Sportpaket	24.0116-0122.1	416122	Ø 308 16 14 V
INFINITI - Q60 Coupe 10/13→							
 Bremsbelagsatz, Scheibenbremse							
3.7	235	10/13→	➔	für Fahrzeuge ohne Sportpaket	13.0460-5778.2	605778	SUM 23698 16,8 + WK
INFINITI - Q70 (Y51) 03/13→							
 Bremsbelagsatz, Scheibenbremse							
2.2 D	125	10/14→	➔	Basis + GT + GT Prem	13.0460-5778.2	605778	SUM 23698 16,8 + WK
3.0	175	03/13→	➔	für Fahrzeuge ohne Vierradlenkung	13.0460-5778.2	605778	SUM 23698 16,8 + WK
3.7	235	03/13→	➔				
5.6 AWD	300	01/15→	➔				
3.5 Hybrid	225	03/13→	➔		13.0460-5778.2	605778	SUM 23698 16,8 + WK
 Bremsscheibe							
2.2 D	125	10/14→	➔	Basis + GT + GT Prem	24.0116-0122.1	416122	Ø 308 16 14 V
3.0	175	03/13→	➔	für Fahrzeuge ohne Vierradlenkung	24.0116-0122.1	416122	Ø 308 16 14 V
3.7	235	03/13→	➔				
5.6 AWD	300	01/15→	➔				
3.5 Hybrid	225	03/13→	➔		24.0116-0122.1	416122	Ø 308 16 14 V
INFINITI - QX50 08/13→							
 Bremsbelagsatz, Scheibenbremse							
2.5 AWD	163	02/14→	➔		13.0460-5778.2	605778	SUM 23698 16,8 + WK
30d AWD	175	08/13→	➔				
37 AWD	235	08/13→	➔		13.0460-5778.2	605778	SUM 23698 16,8 + WK
			➔	+ RUS	13.0460-5778.2	605778	SUM 23698 16,8 + WK
ISUZU - TROOPER II (UB) 08/91→04/00							
 Bremsbelagsatz, Scheibenbremse							
3.1 TD	84	08/91→07/98	➔		13.0460-5926.2	605926	AKE 21845 16,5 + WK
3.2	130	08/91→07/98	➔		13.0460-5927.2	605927	AKE 21875 16,0 + WK
 Bremsscheibe							
3.1 TD	84	08/91→07/98	➔		24.0126-0111.1	426111	Ø 280 26 24,6 V
3.2	130	08/91→07/98	➔		24.0118-0122.1	418122	Ø 313,5 18 16,6 V
ISUZU - TROOPER II Soft Top (UB) 08/91→07/98							
 Bremsbelagsatz, Scheibenbremse							
3.1 TD	84	08/91→07/98	➔		13.0460-5926.2	605926	AKE 21845 16,5 + WK
3.2	130	08/91→07/98	➔		13.0460-5927.2	605927	AKE 21875 16,0 + WK
 Bremsscheibe							
3.1 TD	84	08/91→07/98	➔		24.0126-0111.1	426111	Ø 280 26 24,6 V
3.2	130	08/91→07/98	➔		24.0118-0122.1	418122	Ø 313,5 18 16,6 V
ISUZU - TROOPER III 05/98→08/04							
 Bremsbelagsatz, Scheibenbremse							
3.0 DTI	117	05/98→08/04	➔	08/98→	13.0460-5926.2	605926	AKE 21845 16,5 + WK
			➔	08/98→	13.0460-5927.2	605927	AKE 21875 16,0 + WK
3.5 V6 24V	158	04/00→08/04	➔		13.0460-5926.2	605926	AKE 21845 16,5 + WK
			➔		13.0460-5927.2	605927	AKE 21875 16,0 + WK
 Bremsscheibe							
3.0 DTI	117	05/98→08/04	➔	08/98→	24.0126-0111.1	426111	Ø 280 26 24,6 V
			➔	08/98→	24.0118-0122.1	418122	Ø 313,5 18 16,6 V
3.5 V6 24V	158	04/00→08/04	➔		24.0126-0111.1	426111	Ø 280 26 24,6 V
			➔		24.0118-0122.1	418122	Ø 313,5 18 16,6 V

	kw					! #		
ISUZU - TROOPER III Soft Top 04/00→08/04								
 Bremsbelagsatz, Scheibenbremse								
3.0 DTI	118	04/00→08/04	←				13.0460-5926.2 605926	AKE 21845 16,5 + WK
3.5 V6 24V	158	04/00→08/04	→				13.0460-5927.2 605927	AKE 21875 16,0 + WK
 Bremsscheibe								
3.0 DTI	118	04/00→08/04	←				24.0126-0111.1 426111	Ø 280 26 24,6 V
3.5 V6 24V	158	04/00→08/04	→				24.0118-0122.1 418122	Ø 313,5 18 16,6 V
IVECO - DAILY II Bus 01/89→05/99								
 Bremsbelagsatz, Scheibenbremse								
A 45-10 (94159111, 94159131, 94159211, 94159311...)	76	01/91→04/96	←				13.0460-7903.2 607903	PER 20465 18,0 + WK
A 45-10 (95739111, 95739131, 95739311, 95739317, 95739331)	76	05/96→05/99	←	→ 08/97			13.0460-7903.2 607903	PER 20465 18,0 + WK
IVECO - DAILY II Kasten/Kombi 01/89→05/99								
 Bremsbelagsatz, Scheibenbremse								
30-8 (12914111, 12914112, 12914117, 12914131, 12914137...)	55	01/89→08/98	←	09/97→			13.0460-4918.2 604918	BRE 21048 18,3 + WK
30-8 (12914111, 12914112, 12914117, 12914131, 12914137...)	60	01/89→08/98	←	→ 08/97			13.0460-4955.2 604955	BRE 21048 18,3 + WK
30-8 (14914111, 14914117, 14914211, 14914217, 14915111...)	60	01/89→08/98						
35-8 (12934104, 12934111, 12934112, 12934117, 12934124...)	55	01/91→08/98						
35-8 (12934104, 12934111, 12934112, 12934117, 12934124...)	60	01/91→08/98						
30-8 (14914111, 14914117, 14914211, 14914217, 14915111...)	62	09/98→05/99	←	→ 04/99			13.0460-4918.2 604918	BRE 21048 18,3 + WK
30-8 V (14914111, 14914117, 14914211, 14914217...)	62	09/98→05/99						
35-8 (14934104, 14934111, 14934204, 14934205, 14934211...)	62	09/98→05/99						
35-10 (12974212, 12974217, 12974417)	68	09/96→08/98	←				13.0460-4966.2 604966	BRE 29121 20,3 + WE / - WK
			→				13.0460-4989.2 604989	BRE 29212 17,3 + WE / - WK
							13.0460-4966.2 604966	BRE 29121 20,3 + WE / - WK
35-10 (12974212, 12974217, 13014111, 13014131, 13014204...)	76	01/89→08/98	←	01/96→			13.0460-4966.2 604966	BRE 29121 20,3 + WE / - WK
35-10 (12974212, 12974217, 13014111, 13014131, 13014204...)	80	01/89→08/98	→	01/96→			13.0460-4989.2 604989	BRE 29212 17,3 + WE / - WK
35-12 (13114131, 13114204, 13114211, 13114212, 13114217...)	85	01/90→04/96						
49-12 V (13134124, 13134204, 13134211, 13134212...)	85	06/90→04/96						
35-10 (15034111, 15034204, 15034211, 15034215, 15034217...)	76	01/96→05/99	←	→ 04/99			13.0460-4966.2 604966	BRE 29121 20,3 + WE / - WK
			→	→ 04/99			13.0460-4989.2 604989	BRE 29212 17,3 + WE / - WK
49-12 V (15154204, 15154211, 15154215, 15154217...)	90	05/96→05/99	→	→ 04/99			13.0460-4966.2 604966	BRE 29121 20,3 + WE / - WK
45-10 V (13034204, 13034211, 13034212, 13034224...)	76	01/89→04/96	←				13.0460-7903.2 607903	PER 20465 18,0 + WK
49-10 V (13054204, 13054211, 13054212, 13054215...)	76	01/89→04/96						
59-12 V (13154404, 13154411, 13154412, 13154417...)	85	05/91→04/96	←				13.0460-7906.2 607906	PER 29001 20,0 + WK
59-12 V (15174404, 15174411, 15174415, 15174417)	90	05/96→05/99	←	→ 08/97			13.0460-7906.2 607906	PER 29001 20,0 + WK
			↓					



IVECO - DAILY II Kasten/Kombi 01/89→05/99

Warnkontakt, Bremsbelagverschleiß

35-10 (12974212, 12974217, 12974417)	68	09/96→08/98	←		2	24.8190-1304.2	621304	L= 289
			→		2	24.8190-1304.2	621304	L= 289
35-10 (12974212, 12974217, 13014111, 13014131, 13014204...) 35-10 (12974212, 12974217, 13014111, 13014131, 13014204...) 35-12 (13114131, 13114204, 13114211, 13114212, 13114217...) 49-12 V (13134124, 13134204, 13134211, 13134212...)	76	01/89→08/98	←	01/96→	2	24.8190-1304.2	621304	L= 289
			→	01/96→	2	24.8190-1304.2	621304	L= 289
	80	01/89→08/98						
	85	01/90→04/96						
35-10 (15034111, 15034204, 15034211, 15034215, 15034217...) 49-12 V (15154204, 15154211, 15154215, 15154217...)	76	01/96→05/99	←	→ 04/99	2	24.8190-1304.2	621304	L= 289
			→	→ 04/99	2	24.8190-1304.2	621304	L= 289
90	05/96→05/99							

Zubehörsatz, Scheibenbremsbelag

30-8 (12914111, 12914112, 12914117, 12914131, 12914137...)	55	01/89→08/98	←	→ 08/97		13.0460-0415.2	610415	AP
30-8 (12914111, 12914112, 12914117, 12914131, 12914137...)	60	01/89→08/98						
30-8 (14914111, 14914117, 14914211, 14914217, 14915111...)	60	01/89→08/98						
35-8 (12934104, 12934111, 12934112, 12934117, 12934124...)	55	01/91→08/98						
35-8 (12934104, 12934111, 12934112, 12934117, 12934124...)	60	01/91→08/98						

 **Bremsscheibe**









30-8 (12914111, 12914112, 12914117, 12914131, 12914137...)	55	01/89→08/98	←	→ 05/96		24.0114-0110.2	414110	Ø 267 14,2 12,8 + S
30-8 (12914111, 12914112, 12914117, 12914131, 12914137...)	60	01/89→08/98						
30-8 (14914111, 14914117, 14914211, 14914217, 14915111...)	60	01/89→08/98						
35-8 (12934104, 12934111, 12934112, 12934117, 12934124...)	55	01/91→08/98						
35-8 (12934104, 12934111, 12934112, 12934117, 12934124...)	60	01/91→08/98						

IVECO - DAILY II Kipper 01/89→05/99









 **Bremsbelagsatz, Scheibenbremse**









35-10 K (15030111, 15030211, 15030311, 15031111...) 49-12 K	76	01/97→05/99	←	→ 04/99		13.0460-4966.2	604966	BRE 29121 20,3 + WE / - WK
						13.0460-4989.2	604989	BRE 29212 17,3 + WE / - WK
	90	05/96→05/99	→	→ 04/99		13.0460-4966.2	604966	BRE 29121 20,3 + WE / - WK
35-12 K (15130311, 15130411, 15131111, 15131204...)	90	09/96→08/98	←			13.0460-4966.2	604966	BRE 29121 20,3 + WE / - WK
						13.0460-4989.2	604989	BRE 29212 17,3 + WE / - WK
			→			13.0460-4966.2	604966	BRE 29121 20,3 + WE / - WK
35-8 K (14930304, 14931104, 14931111, 14931115...)	62	09/98→05/99	←	→ 04/99		13.0460-4918.2	604918	BRE 21048 18,3 + WK
45-10 (13031204, 13031211, 13031212, 13031224, 13031231...) 49-10 K (13056212, 13056224, 13056231, 13056237...)	76	01/92→04/96	←			13.0460-7903.2	607903	PER 20465 18,0 + WK
	76	01/89→04/96						
49-10 K (15056204, 15056211, 15056304, 15056311)	76	05/96→05/99	←	→ 08/97		13.0460-7903.2	607903	PER 20465 18,0 + WK







↓								
---	--	--	--	--	--	--	--	--







	kW			 	! #		
IVECO - DAILY II Kipper 01/89→05/99							
 Bremsbelagsatz, Scheibenbremse							
49-12 K (13136204, 13136211, 13136212, 13136224...)	85	06/90→04/96	←	01/96→		13.0460-4966.2 604966	BRE 29121 20,3 + WE / - WK
			→	01/96→		13.0460-4989.2 604989	BRE 29212 17,3 + WE / - WK
59-12 K (13156211, 13156212, 13156231, 13156311...)	85	05/91→04/96	←			13.0460-7906.2 607906	PER 29001 20,0 + WK
			→				
59-12 K (15176211, 15176304, 15176311, 15176315...)	90	05/96→05/99	←	→ 08/97		13.0460-7906.2 607906	PER 29001 20,0 + WK
Warnkontakt, Bremsbelagverschleiß							
35-10 K (15030111, 15030211, 15030311, 15031111...)	76	01/97→05/99	←	→ 04/99	2	24.8190-1304.2 621304	L= 289
			→	→ 04/99	2	24.8190-1304.2 621304	L= 289
49-12 K	90	05/96→05/99					
35-12 K (15130311, 15130411, 15131111, 15131204...)	90	09/96→08/98	←		2	24.8190-1304.2 621304	L= 289
			→		2	24.8190-1304.2 621304	L= 289
49-12 K (13136204, 13136211, 13136212, 13136224...)	85	06/90→04/96	←	01/96→	2	24.8190-1304.2 621304	L= 289
			→	01/96→	2	24.8190-1304.2 621304	L= 289
IVECO - DAILY II Pritsche/Fahrgestell 01/89→05/99							
 Bremsbelagsatz, Scheibenbremse							
35-10 (12971112, 12971212, 12971312, 12971317, 12976112...)	68	01/89→12/96	←	01/96→		13.0460-4966.2 604966	BRE 29121 20,3 + WE / - WK
			→	01/96→		13.0460-4989.2 604989	BRE 29212 17,3 + WE / - WK
35-10 (12971112, 12971212, 12971312, 12971317, 12976112...)	76	01/89→12/96				13.0460-4966.2 604966	BRE 29121 20,3 + WE / - WK
35-12 (13110131, 13110211, 13110231, 13110311, 13110312...)	85	01/90→04/96					
49-12 (13130211, 13130231, 13130304, 13130311, 13130312...)	85	06/90→04/96					
35-10 (15030111, 15030211, 15030311, 15031111, 15031117...)	76	01/96→05/99	←	→ 04/99		13.0460-4966.2 604966	BRE 29121 20,3 + WE / - WK
			→	→ 04/99		13.0460-4989.2 604989	BRE 29212 17,3 + WE / - WK
35-12 (15130311, 15130411, 15131111, 15131204, 15131211...)	90	05/96→05/99	→	→ 04/99		13.0460-4966.2 604966	BRE 29121 20,3 + WE / - WK
49-12 (15150211, 15150311, 15150404, 15150411, 15151204...)	90	05/96→05/99					
35-8 (12931102, 12931104, 12931111, 12931112, 12931117...)	55	01/89→08/98	←	09/97→		13.0460-4918.2 604918	BRE 21048 18,3 + WK
			←	→ 08/97		13.0460-4955.2 604955	BRE 21048 18,3 + WK
35-8 (12931102, 12931104, 12931111, 12931112, 12931117...)	60	01/89→08/98					
35-8 (14930304, 14931104, 14931111, 14931115, 14931204...)	62	09/98→05/99	←	→ 04/99		13.0460-4918.2 604918	BRE 21048 18,3 + WK
45-10 (13031204, 13031211, 13031212, 13031224, 13031231...)	76	01/89→04/96	←			13.0460-7903.2 607903	PER 20465 18,0 + WK
			→				
49-10 (13050211, 13050231, 13050304, 13050311, 13050331...)	76	01/89→04/96					
49-10 (15050304, 15050404, 15050411, 15051204, 15051211...)	76	05/96→05/99	←	→ 08/97		13.0460-7903.2 607903	PER 20465 18,0 + WK
59-12 (13150204, 13150211, 13150231, 13150311, 13150312...)	85	05/91→04/96	←			13.0460-7906.2 607906	PER 29001 20,0 + WK
59-12 (15170211, 15170304, 15170311, 15170504, 15170511...)	90	05/96→05/99	←	→ 08/97		13.0460-7906.2 607906	PER 29001 20,0 + WK
Warnkontakt, Bremsbelagverschleiß							
35-10 (12971112, 12971212, 12971312, 12971317, 12976112...)	68	01/89→12/96	←	01/96→	2	24.8190-1304.2 621304	L= 289
			→	01/96→	2	24.8190-1304.2 621304	L= 289
35-10 (12971112, 12971212, 12971312, 12971317, 12976112...)	76	01/89→12/96					













	kw				! #				
IVECO - DAILY II Pritsche/Fahrgestell 01/89→05/99									
Warnkontakt, Bremsbelagverschleiß									
35-12 (13110131, 13110211, 13110231, 13110311, 13110312...) 49-12 (13130211, 13130231, 13130304, 13130311, 13130312...)	85	01/90→04/96	←	01/96→	2	24.8190-1304.2 621304	L= 289		
			→	01/96→	2		L= 289		
35-10 (15030111, 15030211, 15030311, 15031111, 15031117...) 35-12 (15130311, 15130411, 15131111, 15131204, 15131211...) 49-12 (15150211, 15150311, 15150404, 15150411, 15151204...)	76	01/96→05/99	←	→ 04/99	2	24.8190-1304.2 621304	L= 289		
			→	→ 04/99	2		L= 289		
		90	05/96→05/99						
	90	05/96→05/99							
Zubehörsatz, Scheibenbremsbelag									
35-8 (12931102, 12931104, 12931111, 12931112, 12931117...) 35-8 (12931102, 12931104, 12931111, 12931112, 12931117...)	55	01/89→08/98	←	→ 08/97		13.0460-0415.2 610415	AP		
	60		01/89→08/98						
 Bremsscheibe									
35-8 (12931102, 12931104, 12931111, 12931112, 12931117...) 35-8 (12931102, 12931104, 12931111, 12931112, 12931117...)	55	01/89→08/98	←	→ 05/96		24.0114-0110.2 414110	∅ 267 14,2 12,8 + S		
	60		01/89→08/98						
IVECO - DAILY III Kasten/Kombi 11/97→10/09									
 Bremsbelagsatz, Scheibenbremse									
29 L 10 V (ALJA43A2, ALJA42A2, ALJA41A2) 29 L 11 V 29 L 12 V (ALKA41A2, ALLA52A2, ALKA42A2) 29 L 13 29 L 9 V	70	09/02→07/07	←	→ 04/06		13.0460-4966.2 604966	BRE 29121 20,3 + WE / - WK		
	78		05/99→07/07	→	→ 04/06			13.0460-4996.2 604996	BRE 29123 20,3 + WE / - WK
29 L 14 29 L 9 V	85	09/02→07/07				13.0460-4966.2 604966	BRE 29121 20,3 + WE / - WK		
	92		05/01→07/07					BRE 29121 20,3 + WE / - WK	
29 L 14 29 L 9 V	62	05/99→07/07				13.0460-4966.2 604966	BRE 29123 20,3 + WE / - WK		
	100		01/05→04/06	←				13.0460-4966.2 604966	BRE 29121 20,3 + WE / - WK
35 C 12 V, 35 S 12 V (AGKA43A2, AGKB43A2, AGKB46A2...)	66	11/01→04/06	→			13.0460-4996.2 604996	BRE 29123 20,3 + WE / - WK		
	85		09/02→07/07	←	→ 04/06			13.0460-4966.2 604966	BRE 29121 20,3 + WE / - WK
35 C 14 35 C 14, 35 S 14 35 C 17, 35 S 17		09/02→07/07	→	→ 04/06		13.0460-4989.2 604989	BRE 29212 17,3 + WE / - WK		
	100		09/04→04/06	←				13.0460-4966.2 604966	BRE 29121 20,3 + WE / - WK
	100		01/05→04/06					13.0460-4989.2 604989	BRE 29212 17,3 + WE / - WK
35 S 10 (ANJA41A1, ANJA42A2, ANJA42AB, ANJA43A, ANJAV1A...) 35 S 11 V, 35 C 11 V 35 S 13 V, 35 C 13 V 35 S 15 V, 35 C 15 V (A6HCV3B2, A6HBV4B2, A6HC41B2...) 35 S 9 V, 35 C 9 V	122	01/05→04/06	→			13.0460-4966.2 604966	BRE 29121 20,3 + WE / - WK		
	70		09/02→07/07	←	→ 04/06			13.0460-4966.2 604966	BRE 29121 20,3 + WE / - WK
35 S 9 V	78	05/99→07/07	→	→ 04/06		13.0460-4996.2 604996	BRE 29123 20,3 + WE / - WK		
	92		05/99→07/07						
	107		11/02→07/07						
50 C 11 50 C 13	62	05/99→07/07	←			13.0460-4966.2 604966	BRE 29121 20,3 + WE / - WK		
	66		11/01→04/06	→				13.0460-4989.2 604989	BRE 29212 17,3 + WE / - WK
50 C 14 50 C 15 50 C 17		09/04→04/06	→			13.0460-4996.2 604996	BRE 29123 20,3 + WE / - WK		
	78		05/99→07/07	←	01/01→ 04/06			13.0460-4847.2 604847	BRE 29160 20,3 + WE / - WK + Zub
50 C 14 50 C 15 50 C 17	92	05/99→07/07	→	→ 04/06		13.0460-4996.2 604996	BRE 29123 20,3 + WE / - WK		
	100		09/04→04/06	←				13.0460-4847.2 604847	BRE 29160 20,3 + WE / - WK + Zub
65 C 14 65 C 15 65 C 17	107	01/01→04/06				13.0460-4966.2 604966	BRE 29123 20,3 + WE / - WK		
	122		09/04→04/06	→				13.0460-4996.2 604996	BRE 29123 20,3 + WE / - WK
↓	100	09/04→04/06	←			13.0460-4847.2 604847	BRE 29160 20,3 + WE / - WK + Zub		
	107		11/01→04/06					13.0460-4966.2 604966	BRE 29121 20,3 + WE / - WK
	122	09/04→04/06	→						

	kW			 	! #		
IVECO - DAILY III Kasten/Kombi 11/97→10/09							
Warnkontakt, Bremsbelagverschleiß							
29 L 10 V (ALJA43A2, ALJA42A2, ALJA41A2)	70	09/02→07/07	←	→ 04/06	2	24.8190-1304.2 621304	L= 289
29 L 11 V	78	05/99→07/07					
29 L 12 V (ALKA41A2, ALLA52A2, ALKA42A2)	85	09/02→07/07					
29 L 13	92	05/01→07/07					
29 L 9 V	62	05/99→07/07					
35 S 10 (ANJA41A1, ANJA42A2, ANJA42AB, ANJA43A, ANJAV1A...)	70	09/02→07/07					
35 S 11 V,35 C 11 V	78	05/99→07/07					
35 S 13 V,35 C 13 V	92	05/99→07/07					
35 S 15 V, 35 C 15 V (A6HCV3B2, A6HBV4B2, A6HC41B2...)	107	11/02→07/07					
35 S 9 V,35 C 9 V	62	05/99→07/07					
29 L 14	100	01/05→04/06	←		2	24.8190-1304.2 621304	L= 289
29 L 9 V	66	11/01→04/06					
35 S 9 V	66	11/01→04/06					
35 C 12 V, 35 S 12 V (AGKA43A2, AGKB43A2, AGKB46A2...)	85	09/02→07/07	←	→ 04/06	2	24.8190-1304.2 621304	L= 289
			→	→ 04/06	2	24.8190-1304.2 621304	L= 289
35 C 14	100	09/04→04/06	←		2	24.8190-1304.2 621304	L= 289
35 C 14, 35 S 14	100	01/05→04/06					
35 C 17, 35 S 17	122	01/05→04/06	→		2	24.8190-1304.2 621304	L= 289
65 C 14	100	09/04→04/06	→		2	24.8190-1304.2 621304	L= 289
65 C 15	107	11/01→04/06					
65 C 17	122	09/04→04/06					
 Bremsscheibe							
29 L 10 V (ALJA43A2, ALJA42A2, ALJA41A2)	70	09/02→07/07	←	→ 04/06		24.0122-0262.1 422262	Ø 276 22 19
29 L 11 V	78	05/99→07/07	→	→ 04/06; + ABS		24.0116-0128.1 416128	Ø 276 16 13 + ABS Ring
29 L 12 V (ALKA41A2, ALLA52A2, ALKA42A2)	85	09/02→07/07	→	→ 04/06; - ABS		24.0116-0129.1 416129	Ø 276 16 13
29 L 13	92	05/01→07/07					
29 L 9 V	62	05/99→07/07					
35 C 12 V, 35 S 12 V (AGKA43A2, AGKB43A2, AGKB46A2...)	85	09/02→07/07					
35 S 10 (ANJA41A1, ANJA42A2, ANJA42AB, ANJA43A, ANJAV1A...)	70	09/02→07/07					
35 S 11 V,35 C 11 V	78	05/99→07/07					
35 S 13 V,35 C 13 V	92	05/99→07/07					
35 S 15 V, 35 C 15 V (A6HCV3B2, A6HBV4B2, A6HC41B2...)	107	11/02→07/07					
35 S 9 V,35 C 9 V	62	05/99→07/07					
29 L 14	100	01/05→04/06	←			24.0122-0262.1 422262	Ø 276 22 19
29 L 9 V	66	11/01→04/06					
35 C 14	100	09/04→04/06	→	+ ABS		24.0116-0128.1 416128	Ø 276 16 13 + ABS Ring
35 C 14, 35 S 14	100	01/05→04/06					
35 C 17, 35 S 17	122	01/05→04/06	→	- ABS		24.0116-0129.1 416129	Ø 276 16 13
35 S 9 V	66	11/01→04/06					
IVECO - DAILY III Pritsche/Fahrgestell 03/98→10/09							
 Bremsbelagsatz, Scheibenbremse							
29 L 10 (ALJAV1A1, ALJA41AA, ALJA41A1, AHJA64A1...)	70	09/02→04/06	←			13.0460-4966.2 604966	BRE 29121 20,3 + WE / - WK
			→			13.0460-4996.2 604996	BRE 29123 20,3 + WE / - WK
29 L 11	78	05/99→04/06					
29 L 12 (ALKA41A1, AHKA64A1, ALLA51A1)	85	09/02→04/06					
29 L 13	92	11/01→04/06					
29 L 14 (AHRA11C1B1, AHRA14C1B1, AHRA64C1B1)	100	11/05→04/06					
29 L 9	62	05/99→04/06					
29 L 9	66	11/01→04/06					
35 C 10 V , 35 S 10 V (AMJA14A1, AMJA64A1, AMJA65A1...)	70	09/02→04/06	←			13.0460-4966.2 604966	BRE 29121 20,3 + WE / - WK
			→			13.0460-4989.2 604989	BRE 29212 17,3 + WE / - WK
35 C 12 , 35 S 12 (AEKA14A1, ↓)	85	09/02→04/06				13.0460-4966.2 604966	BRE 29121 20,3 + WE / - WK
						13.0460-4996.2 604996	BRE 29123 20,3 + WE / - WK

	kW				! #		
IVECO - DAILY III Pritsche/Fahrgestell 03/98→10/09							
Bremsbelagsatz, Scheibenbremse							
AEKA14AA, AEKA64A1...)			←			13.0460-4966.2 604966	BRE 29121 20,3 + WE / - WK
35 C 14	100	09/04→04/06				13.0460-4989.2 604989	BRE 29212 17,3 + WE / - WK
35 C 14, 35 S 14	100	01/05→04/06	→			13.0460-4966.2 604966	BRE 29121 20,3 + WE / - WK
35 C 15	107	11/01→04/06				13.0460-4996.2 604996	BRE 29123 20,3 + WE / - WK
35 C 17, 35 S 17	122	01/05→04/06				13.0460-4996.2 604996	BRE 29123 20,3 + WE / - WK
35 C 9, 35 S 9	66	11/01→04/06				13.0460-4996.2 604996	BRE 29123 20,3 + WE / - WK
35 S 11,35 C 11 (A2FC13AA, A6FBU4AB, A2NB14A1, A2ND13A1...)	78	05/99→04/06	←			13.0460-4966.2 604966	BRE 29121 20,3 + WE / - WK
			→			13.0460-4989.2 604989	BRE 29212 17,3 + WE / - WK
35 S 13,35 C 13	92	05/99→04/06				13.0460-4996.2 604996	BRE 29123 20,3 + WE / - WK
35 S 9,35 C 9	62	05/99→04/06				13.0460-4996.2 604996	BRE 29123 20,3 + WE / - WK
50 C 11	78	05/99→04/06	←	01/01→		13.0460-4847.2 604847	BRE 29160 20,3 + WE / - WK + Zub
50 C 13	92	05/99→04/06	→			13.0460-4996.2 604996	BRE 29123 20,3 + WE / - WK
50 C 14	100	09/04→04/06	←			13.0460-4847.2 604847	BRE 29160 20,3 + WE / - WK + Zub
50 C 15	107	01/01→04/06				13.0460-4996.2 604996	BRE 29123 20,3 + WE / - WK
50 C 17	122	09/04→04/06	→			13.0460-4996.2 604996	BRE 29123 20,3 + WE / - WK
65 C 14	100	09/04→04/06	←			13.0460-4847.2 604847	BRE 29160 20,3 + WE / - WK + Zub
65 C 15	107	11/01→04/06				13.0460-4847.2 604847	BRE 29160 20,3 + WE / - WK + Zub
65 C 17	122	09/04→04/06	→			13.0460-4966.2 604966	BRE 29121 20,3 + WE / - WK
Warnkontakt, Bremsbelagverschleiß							
29 L 10 (ALJAV1A1, ALJA41AA, ALJA41A1, AHJA64A1...)	70	09/02→04/06	←		2	24.8190-1304.2 621304	L= 289
29 L 11	78	05/99→04/06					
29 L 12 (ALKA41A1, AHKA64A1, ALLA51A1)	85	09/02→04/06					
29 L 13	92	11/01→04/06					
29 L 14 (AHRA11C1B1, AHRA14C1B1, AHRA64C1B1)	100	11/05→04/06					
29 L 9	62	05/99→04/06					
29 L 9	66	11/01→04/06					
35 S 11,35 C 11 (A2FC13AA, A6FBU4AB, A2NB14A1, A2ND13A1...)	78	05/99→04/06					
35 S 13,35 C 13	92	05/99→04/06					
35 S 9,35 C 9	62	05/99→04/06					
35 C 10 V , 35 S 10 V (AMJA14A1, AMJA64A1, AMJA65A1...)	70	09/02→04/06	←		2	24.8190-1304.2 621304	L= 289
			→		2	24.8190-1304.2 621304	L= 289
35 C 12 , 35 S 12 (AEKA14A1, AEKA14AA, AEKA64A1...)	85	09/02→04/06					
35 C 14	100	09/04→04/06					
35 C 14, 35 S 14	100	01/05→04/06					
35 C 15	107	11/01→04/06					
35 C 17, 35 S 17	122	01/05→04/06					
35 C 9, 35 S 9	66	11/01→04/06					
65 C 14	100	09/04→04/06	→		2	24.8190-1304.2 621304	L= 289
65 C 15	107	11/01→04/06					
65 C 17	122	09/04→04/06					
Bremsscheibe							
29 L 10 (ALJAV1A1, ALJA41AA, ALJA41A1, AHJA64A1...)	70	09/02→04/06	←			24.0122-0262.1 422262	Ø 276 22 19
			→	+ ABS		24.0116-0128.1 416128	Ø 276 16 13 + ABS Ring
29 L 11	78	05/99→04/06	→	- ABS		24.0116-0129.1 416129	Ø 276 16 13
29 L 12 (ALKA41A1, AHKA64A1, ALLA51A1)	85	09/02→04/06					
29 L 13	92	11/01→04/06					
29 L 14 (AHRA11C1B1, AHRA14C1B1, AHRA64C1B1)	100	11/05→04/06					
29 L 9	62	05/99→04/06					
29 L 9	66	11/01→04/06					
35 C 10 V , 35 S 10 V (AMJA14A1, AMJA64A1, AMJA65A1...)	70	09/02→04/06					
35 C 12 , 35 S 12 (AEKA14A1, ↓	85	09/02→04/06					

	kW					! #		
IVECO - DAILY III Pritsche/Fahrgestell 03/98→10/09								
Bremsscheibe								
AEKA14AA, AEKA64A1...)				←			24.0122-0262.1 422262	Ø 276 22 19
35 C 14	100	09/04→04/06		→	+ ABS		24.0116-0128.1 416128	Ø 276 16 13 + ABS Ring
35 C 14, 35 S 14	100	01/05→04/06		→	- ABS		24.0116-0129.1 416129	Ø 276 16 13
35 C 15	107	11/01→04/06						
35 C 17, 35 S 17	122	01/05→04/06						
35 C 9, 35 S 9	66	11/01→04/06						
35 S 11, 35 C 11	78	05/99→04/06						
(A2FC13AA, A6FBU4AB, A2NB14A1, A2ND13A1...)								
35 S 13, 35 C 13	92	05/99→04/06						
35 S 9, 35 C 9	62	05/99→04/06						
IVECO - DAILY IV Bus 05/06→08/11								
Brembelagsatz, Scheibenbremse								
35S14, 35S14 /P	100	05/06→08/11		←			13.0460-4830.2 604830	BRE 29229 20,7 + WE / - WK + Zub
35S14 G	100	07/09→08/11		→			13.0460-4823.2 604823	BRE 29232 21,0 + WE / - WK + Zub
							13.0460-4996.2 604996	BRE 29123 20,3 + WE / - WK
Bremsscheibe								
35S14, 35S14 /P	100	05/06→08/11		←			24.0128-0238.1 428238	Ø 300 28 25 V
35S14 G	100	07/09→08/11		→			24.0128-0239.1 428239	Ø 290 28 25 V
							24.0124-0228.1 424228	Ø 294 24 21 V
IVECO - DAILY IV Kasten/Kombi 05/06→03/12								
Brembelagsatz, Scheibenbremse								
29L10 V	70	05/06→08/11		←			13.0460-4830.2 604830	BRE 29229 20,7 + WE / - WK + Zub
29L12 V, 29L12 V/P	85	05/06→08/11		→			13.0460-4823.2 604823	BRE 29232 21,0 + WE / - WK + Zub
29L14 C, 29L14 C/P, 29L14 V, 29L14 V/P	100	05/06→08/11					13.0460-4996.2 604996	BRE 29123 20,3 + WE / - WK
35C10, 35S10	70	05/06→08/11						
35C11 V, 35S11 V	78	07/07→08/11						
35C12 V, 35C12 V/P, 35S12 V, 35S12 V/P	85	05/06→08/11						
35C13 V, 35C13 V/P, 35S13 V, 35S13 V/P	93	07/07→08/11						
35C14 GV, 35C14 GV/P, 35S14 GV, 35S14 GV/P	100	07/07→08/11						
35C14 V, 35C14 V/P, 35S14 V, 35S14 V/P	103	07/07→08/11						
35C15 V, 35C15 V/P	107	05/06→08/11						
35C17 V, 35C17 V/P, 35S17 V, 35S17 V/P	125	07/07→08/11						
35C18 V, 35C18 V/P, 35S18 V, 35S18 V/P	130	05/06→08/11						
35S14 C, 35S14 C/P, 35S14 V, 35S14 V/P, 35C14 V, 35C14 V/P	100	05/06→08/11						
65C14 V, 65C14 V/P	103	07/07→08/11		←			13.0460-4828.2 604828	BRE 29122 22,1 + WE / - WK
65C15	107	05/06→08/11		→			13.0460-4829.2 604829	BRE 29231 22,7 + WE / - WK + Zub
65C17 V, 65C17 V/P	125	07/07→08/11						
65C18	130	05/06→08/11						
Bremsscheibe								
29L10 V	70	05/06→08/11		←			24.0128-0238.1 428238	Ø 300 28 25 V
29L12 V, 29L12 V/P	85	05/06→08/11		→			24.0128-0239.1 428239	Ø 290 28 25 V
29L14 C, 29L14 C/P, 29L14 V, 29L14 V/P	100	05/06→08/11					24.0124-0228.1 424228	Ø 294 24 21 V
35C10, 35S10	70	05/06→08/11						
35C11 V, 35S11 V	78	07/07→08/11						
35C12 V, 35C12 V/P, 35S12 V, 35S12 V/P	85	05/06→08/11						
35C13 V, 35C13 V/P, 35S13 V, 35S13 V/P	93	07/07→08/11						
35C14 GV, 35C14 GV/P, 35S14 GV, 35S14 GV/P	100	07/07→08/11						
35C14 V, 35C14 V/P, 35S14 V, 35S14 V/P	103	07/07→08/11						
35C15 V, 35C15 V/P	107	05/06→08/11						
35C17 V, 35C17 V/P, 35S17 V, 35S17 V/P	125	07/07→08/11						
35C18 V, 35C18 V/P, 35S18 V, 35S18 V/P	130	05/06→08/11						
↓								

	kw			 	! #		
IVECO - DAILY IV Kasten/Kombi 05/06→03/12							
 Bremsscheibe							
35S14 C, 35S14 C/P, 35S14 V, 35S14 V/P, 35C14 V, 35C14 V/P	100	05/06→08/11	←			24.0128-0238.1 428238	Ø 300 28 25 V
			→			24.0128-0239.1 428239	Ø 290 28 25 V
						24.0124-0228.1 424228	Ø 294 24 21 V
65C14 V, 65C14 V/P 65C15 65C17 V, 65C17 V/P 65C18	103 107 125 130	07/07→08/11 05/06→08/11 07/07→08/11 05/06→08/11	←			24.0128-0238.1 428238	Ø 300 28 25 V
IVECO - DAILY IV Kipper 05/06→08/11							
 Bremsbelagsatz, Scheibenbremse							
35C10 K 35C11 K, 35C11 DK, 35S11 K, 35S11 DK	70 78	05/06→08/11 07/07→08/11	←			13.0460-4830.2 604830	BRE 29229 20,7 + WE / - WK + Zub
35C12 35C13 K, 35C13 DK, 35S13 K, 35S13 DK	85 93	05/06→08/11 07/07→08/11	→			13.0460-4823.2 604823	BRE 29232 21,0 + WE / - WK + Zub
35C14 K, 35C14 DK, 35S14 K, 35S14 DK	103	07/07→08/11				13.0460-4996.2 604996	BRE 29123 20,3 + WE / - WK
35C15 35C17 K, 35C17 DK, 35S17 K, 35S17 DK	107 125	05/06→08/11 07/07→08/11					
35C18 35S14 K, 35S14 DK	130 100	05/06→08/11 07/07→08/11					
65C14 K, 65C14 DK 65C17 K, 65C17 DK, 65C17KK	103 125	07/07→08/11 07/07→08/11	←			13.0460-4828.2 604828	BRE 29122 22,1 + WE / - WK
			→			13.0460-4829.2 604829	BRE 29231 22,7 + WE / - WK + Zub
 Bremsscheibe							
35C10 K 35C11 K, 35C11 DK, 35S11 K, 35S11 DK	70 78	05/06→08/11 07/07→08/11	←			24.0128-0238.1 428238	Ø 300 28 25 V
35C12 35C13 K, 35C13 DK, 35S13 K, 35S13 DK	85 93	05/06→08/11 07/07→08/11	→			24.0128-0239.1 428239	Ø 290 28 25 V
35C14 K, 35C14 DK, 35S14 K, 35S14 DK	103	07/07→08/11				24.0124-0228.1 424228	Ø 294 24 21 V
35C15 35C17 K, 35C17 DK, 35S17 K, 35S17 DK	107 125	05/06→08/11 07/07→08/11					
35C18 35S14 K, 35S14 DK	130 100	05/06→08/11 07/07→08/11					
65C14 K, 65C14 DK 65C17 K, 65C17 DK, 65C17KK	103 125	07/07→08/11 07/07→08/11	←			24.0128-0238.1 428238	Ø 300 28 25 V
IVECO - DAILY IV Pritsche/Fahrgestell 05/06→09/11							
 Bremsbelagsatz, Scheibenbremse							
29L10 29L12 29L14	70 85 100	05/06→08/11 05/06→08/11 05/06→08/11	←			13.0460-4830.2 604830	BRE 29229 20,7 + WE / - WK + Zub
35C10, 35S10 35C11, 35S11, 35S11 D, 35S11 /P	70 78	05/06→08/11 07/07→08/11	→			13.0460-4823.2 604823	BRE 29232 21,0 + WE / - WK + Zub
						13.0460-4996.2 604996	BRE 29123 20,3 + WE / - WK
35C12, 35S12 35C13, 35C13 /P, 35S13 D, 35S13, 35S13 /P	85 93	05/06→08/11 07/07→08/11					
35C14, 35C14 /P, 35S14, 35S14 /P, 35S14 D, 35S14 D/P	103	07/07→08/11					
35C14, 35S14, 35S14 /P 35C14 G, 35C14 G/P, 35S14 G, 35S14 G/P, 35C14 GD, 35S14 GD	100 100	05/06→08/11 07/07→08/11					
35C15 35C17, 35C17 /P, 35S17, 35S17 /P, 35S17 D	107 125	05/06→08/11 07/07→08/11					
35C18, 35S18 35S17 W, 35S17 WD	130 125	05/06→08/11 07/07→08/11					
65C14, 65C14 /P 65C14 G, 65C14 G/P, 65C14 GD, 65C14 GD/P	103 100	07/07→08/11 07/07→08/11	←			13.0460-4828.2 604828	BRE 29122 22,1 + WE / - WK
65C15, 65C15 /P, 65C15 D, 65C15 D/P 65C17, 65C17 /P 65C18	107 125 130	05/06→08/11 07/07→08/11 05/06→08/11	→			13.0460-4829.2 604829	BRE 29231 22,7 + WE / - WK + Zub
↓							

IVECO - DAILY IV Pritsche/Fahrgestell 05/06→09/11

 Bremsscheibe							
29L10	70	05/06→08/11	←		24.0128-0238.1	428238	Ø 300 28 25 V
29L12	85	05/06→08/11			24.0128-0239.1	428239	Ø 290 28 25 V
29L14	100	05/06→08/11					
35C10, 35S10	70	05/06→08/11	→		24.0124-0228.1	424228	Ø 294 24 21 V
35C11, 35S11, 35S11 D, 35S11 /P	78	07/07→08/11					
35C12, 35S12	85	05/06→08/11					
35C13, 35C13 /P, 35S13 D, 35S13, 35S13 /P	93	07/07→08/11					
35C14, 35C14 /P, 35S14, 35S14 /P, 35S14 D, 35S14 D/P	103	07/07→08/11					
35C14, 35S14, 35S14 /P	100	05/06→08/11					
35C14 G, 35C14 G/P, 35S14 G, 35S14 G/P, 35C14 GD, 35S14 GD	100	07/07→08/11					
35C15	107	05/06→08/11					
35C17, 35C17 /P, 35S17, 35S17 /P, 35S17 D	125	07/07→08/11					
35C18, 35S18	130	05/06→08/11					
35S17 W, 35S17 WD	125	07/07→08/11					
65C14, 65C14 /P	103	07/07→08/11	←		24.0128-0238.1	428238	Ø 300 28 25 V
65C14 G, 65C14 G/P, 65C14 GD, 65C14 GD/P	100	07/07→08/11					
65C15, 65C15 /P, 65C15 D, 65C15 D/P	107	05/06→08/11					
65C17, 65C17 /P	125	07/07→08/11					
65C18	130	05/06→08/11					

IVECO - DAILY V Kasten/Kombi 09/11→02/14















 Bremsbelagsatz, Scheibenbremse							
29L11 V, 35C11 V, 35S11 V, 40C11 V	78	09/11→02/14	←		13.0460-4830.2	604830	BRE 29229 20,7 + WE / - WK + Zub
29L13 V, 35C13 V, 35S13 V, 40C13 V, 40S13 V	93	09/11→02/14	→		13.0460-4996.2	604996	BRE 29123 20,3 + WE / - WK
29L15 V, 35C15L V, 40C15L V, 50C15L V	107	09/11→02/14					
35S, 35C Electric	60	09/11→02/14					
35C15 V, 40C15 V	107	09/11→02/14	←		13.0460-4830.2	604830	BRE 29229 20,7 + WE / - WK + Zub
			→		13.0460-4823.2	604823	BRE 29232 21,0 + WE / - WK + Zub
					13.0460-4996.2	604996	BRE 29123 20,3 + WE / - WK
35C17 V, 35S17 V, 40C17 V, 45C17 V, 50C17 V, 60C17 V, 35C21 V, 35S21 V, 40C21 V, 45C21 V, 50C21 V	125	09/11→02/14	←		13.0460-4830.2	604830	BRE 29229 20,7 + WE / - WK + Zub
	150	09/11→02/14	→		13.0460-4823.2	604823	BRE 29232 21,0 + WE / - WK + Zub











 Bremsscheibe							
29L11 V, 35C11 V, 35S11 V, 40C11 V	78	09/11→02/14	←		24.0128-0238.1	428238	Ø 300 28 25 V
29L13 V, 35C13 V, 35S13 V, 40C13 V, 40S13 V	93	09/11→02/14	→		24.0124-0228.1	424228	Ø 294 24 21 V
29L15 V, 35C15L V, 40C15L V, 50C15L V	107	09/11→02/14					
35C15 V, 40C15 V	107	09/11→02/14					
35C17 V, 35S17 V, 40C17 V, 45C17 V, 50C17 V, 60C17 V, 35C21 V, 35S21 V, 40C21 V, 45C21 V, 50C21 V	125	09/11→02/14					
35S, 35C Electric	60	09/11→02/14					













IVECO - DAILY V Kipper 09/11→02/14













 Bremsbelagsatz, Scheibenbremse							
35C11K, 35S11DKP	78	09/11→02/14	←		13.0460-4830.2	604830	BRE 29229 20,7 + WE / - WK + Zub
35C13K, 35C13DKP	93	09/11→02/14					
35C15K, 35S15DKP, 50C15K, 60C15K, 65C15DK, 70C15K	107	09/11→02/14	→		13.0460-4823.2	604823	BRE 29232 21,0 + WE / - WK + Zub
35C17K, 35S17DKP, 50C17K, 65C17DK, 70C17K	125	09/11→02/14					
↓							





























	kw			 	! #		
IVECO - DAILY V Kipper 09/11→02/14							
 Bremsbelagsatz, Scheibenbremse							
35S21DKP	150	09/11→02/14	←			13.0460-4830.2 604830	BRE 29229 20,7 + WE / - WK + Zub
			→			13.0460-4996.2 604996	BRE 29123 20,3 + WE / - WK
 Bremsscheibe							
35C11K, 35S11DKP	78	09/11→02/14	←			24.0128-0238.1 428238	Ø 300 28 25 V
35C13K, 35C13DKP	93	09/11→02/14	→			24.0124-0228.1 424228	Ø 294 24 21 V
35C15K, 35S15DKP, 50C15K, 60C15K, 65C15DK, 70C15K	107	09/11→02/14	←				
35C17K, 35S17DKP, 50C17K, 65C17DK	125	09/11→02/14	→				
70C17K	150	09/11→02/14	←				
35S21DKP	150	09/11→02/14	→				
IVECO - DAILY V Pritsche/Fahrgestell 09/11→02/14							
 Bremsbelagsatz, Scheibenbremse							
26L11, 26L11D, 35C11D, 35S11, 40C11	78	09/11→02/14	←			13.0460-4830.2 604830	BRE 29229 20,7 + WE / - WK + Zub
29L13, 29L13D, 35C13D, 40C13	93	09/11→02/14	→			13.0460-4996.2 604996	BRE 29123 20,3 + WE / - WK
29L15 V, 35C15L V, 40C15L V, 50C15L V	107	09/11→02/14	←			13.0460-4830.2 604830	BRE 29229 20,7 + WE / - WK + Zub
35C15, 35C15D, 35S15, 40C15, 45C15, 50C15, 60C15, 70C15	107	09/11→02/14	→			13.0460-4823.2 604823	BRE 29232 21,0 + WE / - WK + Zub
35C17, 35C17D, 35S17, 40C17, 45C17, 50C17, 60C17, 70C17	125	09/11→02/14	←				
35C21, 35S21, 40C21, 45C21, 50C21, 60C21, 70C21	150	09/11→02/14	→				
 Bremsscheibe							
26L11, 26L11D, 35C11D, 35S11, 40C11	78	09/11→02/14	←			24.0128-0238.1 428238	Ø 300 28 25 V
29L13, 29L13D, 35C13D, 40C13	93	09/11→02/14	→			24.0124-0228.1 424228	Ø 294 24 21 V
29L15 V, 35C15L V, 40C15L V, 50C15L V	107	09/11→02/14	←				
35C15, 35C15D, 35S15, 40C15, 45C15, 50C15, 60C15, 70C15	107	09/11→02/14	→				
35C17, 35C17D, 35S17, 40C17, 45C17, 50C17, 60C17, 70C17	125	09/11→02/14	←				
35C21, 35S21, 40C21, 45C21, 50C21, 60C21, 70C21	150	09/11→02/14	→				
IVECO - MASSIF Pick-up 10/08→02/11							
 Bremsbelagsatz, Scheibenbremse							
3.0 HPI	107	10/08→02/11	←	→ 12/10		13.0460-2750.2 602750	TRW 20741 15,0 - WE / - WK
3.0 HPT	130	10/08→02/11	→	→ 12/10		13.0460-2751.2 602751	TRW 21418 15,5 - WE / - WK
IVECO - MASSIF Single Cab 10/08→02/11							
 Bremsbelagsatz, Scheibenbremse							
3.0 HPI	107	10/08→02/11	←	→ 12/10		13.0460-2750.2 602750	TRW 20741 15,0 - WE / - WK
3.0 HPT	130	10/08→02/11	→	→ 12/10		13.0460-2751.2 602751	TRW 21418 15,5 - WE / - WK
IVECO - MASSIF Station Wagon 10/08→02/11							
 Bremsbelagsatz, Scheibenbremse							
3.0 HPI	107	10/08→02/11	←	→ 12/10		13.0460-2750.2 602750	TRW 20741 15,0 - WE / - WK
3.0 HPT	130	10/08→02/11	→	→ 12/10		13.0460-2751.2 602751	TRW 21418 15,5 - WE / - WK
JAGUAR - S-TYPE (CCX_) 01/99→12/08							
 Bremsbelagsatz, Scheibenbremse							
2.5 V6	147	04/02→10/07	←	→ M45254		13.0460-2729.2 602729	TRW 23423 17,8 - WE / - WK + Zub
3.0 V6	175	01/99→10/07	←				
4.0 V8	203	01/99→04/02	←	M45255→ N52047		13.0460-2898.2 602898	TRW 23908 18,0 + WE / - WK + Zub
4.2 V8	219	04/02→10/07	←				
↓							













	kW			 	! #		
JAGUAR - S-TYPE (CCX_) 01/99→12/08							
 Bremsbelagsatz, Scheibenbremse							
2.5 V6	147	04/02→10/07	←	N52048→		13.0460-7292.2 607292	ATE 24084 19,3 + WE / - WK
3.0 V6	175	01/99→10/07	→			13.0460-2730.2 602730	TRW 23424 17,6 - WE / - WK
4.0 V8	203	01/99→04/02					
4.2 V8	219	04/02→10/07					
2.7 D	152	06/04→10/07	←	→ M45254		13.0460-2729.2 602729	TRW 23423 17,8 - WE / - WK + Zub
			←	M45255→ N52047		13.0460-2898.2 602898	TRW 23908 18,0 + WE / - WK + Zub
			←	N52048→		13.0460-7292.2 607292	ATE 24084 19,3 + WE / - WK
			→	→ N13088		13.0460-2730.2 602730	TRW 23424 17,6 - WE / - WK
			→	N52048→		13.0460-4964.2 604964	BRE 21381 15,0 - WE / - WK
							13.0460-7209.2 607209
4.0 V8	209	09/99→12/02	←	→ M45254		13.0460-2729.2 602729	TRW 23423 17,8 - WE / - WK + Zub
			←	M45255→ N52047		13.0460-2898.2 602898	TRW 23908 18,0 + WE / - WK + Zub
			←	N52048→		13.0460-7292.2 607292	ATE 24084 19,3 + WE / - WK
			→	→ 04/02		13.0460-2730.2 602730	TRW 23424 17,6 - WE / - WK
4.2 Supercharged	298	11/01→12/08	←	→ M45254		13.0460-2729.2 602729	TRW 23423 17,8 - WE / - WK + Zub
			←	M45255→ N52047		13.0460-4841.2 604841	BRE 23489 16,3 - WE
			→			13.0460-4964.2 604964	BRE 21381 15,0 - WE / - WK
R 4,2 V8	291	04/02→10/07	←	→ M45254		13.0460-2729.2 602729	TRW 23423 17,8 - WE / - WK + Zub
			←	M45255→ N52047		13.0460-2898.2 602898	TRW 23908 18,0 + WE / - WK + Zub
			←	N52048→		13.0460-7292.2 607292	ATE 24084 19,3 + WE / - WK
			→			13.0460-4964.2 604964	BRE 21381 15,0 - WE / - WK
						13.0460-7209.2 607209	ATE 23482 16,6 - WE / - WK
 Bremsscheibe							
2.5 V6	147	04/02→10/07	←			24.0130-0182.1 430182	Ø 320 30 28,4 V
4.2 V8	219	04/02→10/07	→			24.0120-0708.1 420708	Ø 288 20 18,5 V
2.7 D	152	06/04→10/07	←			24.0130-0182.1 430182	Ø 320 30 28,4 V
			→	N52048→		24.0120-0238.1 420238	Ø 326 20 18 V
			→	→ N52047		24.0120-0708.1 420708	Ø 288 20 18,5 V
3.0 V6	175	01/99→10/07	←	→ 01/00		24.0130-0120.1 430120	Ø 300 30 28 V
			←	02/00→		24.0130-0182.1 430182	Ø 320 30 28,4 V
			→			24.0120-0708.1 420708	Ø 288 20 18,5 V
4.0 V8	203	01/99→04/02	←			24.0130-0120.1 430120	Ø 300 30 28 V
			→			24.0120-0708.1 420708	Ø 288 20 18,5 V
4.0 V8	209	09/99→12/02	←	→ 04/02		24.0130-0120.1 430120	Ø 300 30 28 V
			→			24.0120-0708.1 420708	Ø 288 20 18,5 V
JAGUAR - XF (CC9_) 03/08→04/15							
 Bremsbelagsatz, Scheibenbremse							
2.0	177	06/12→04/15	←			13.0460-7292.2 607292	ATE 24084 19,3 + WE / - WK
2.2 D	120	04/11→04/15	→			13.0460-7209.2 607209	ATE 23482 16,6 - WE / - WK
2.2 D	140	05/11→04/15					
2.2 D	147	03/12→04/15					
2.7 D	152	03/08→04/15	←			13.0460-7292.2 607292	ATE 24084 19,3 + WE / - WK
			→	→ S20572		13.0460-7209.2 607209	ATE 23482 16,6 - WE / - WK
3.0	175	03/08→04/15					
3.0	179	03/08→04/15					
4.2	219	03/08→04/15					
3.0	250	03/12→04/15	→			13.0460-7209.2 607209	ATE 23482 16,6 - WE / - WK
3.0 AWD	250	10/12→04/15					
3.0 D	155	03/09→04/15	←	für Bremsscheibendurchmesser [mm]:		13.0460-7292.2 607292	ATE 24084 19,3 + WE / - WK
3.0 D	177	03/09→04/15		326			
3.0 D	202	03/09→04/15	→	→ S20572		13.0460-7209.2 607209	ATE 23482 16,6 - WE / - WK
4.2 Kompressor	306	03/08→04/15	→	→ S20572		13.0460-7209.2 607209	ATE 23482 16,6 - WE / - WK
5.0	283	03/09→04/15					
5.0 Kompressor	346	01/09→04/15	→	→ B32752		13.0460-7209.2 607209	ATE 23482 16,6 - WE / - WK
5.0 Kompressor	375	03/09→04/15	→	B32753→		13.0460-7255.2 607255	ATE 25114 15,8 - WE / - WK
↓							













	kw			 	! #		
JAGUAR - XF (CC9_) 03/08→04/15							
 Bremsbelagsatz, Scheibenbremse							
5.0 XFR-S	405	10/12→04/15	➡			13.0460-7255.2 607255	ATE 25114 15,8 - WE / - WK
Warnkontakt, Bremsbelagverschleiß							
2.0	177	06/12→04/15	➡		1	24.8190-0960.2 620960	L= 633
2.2 D	120	04/11→04/15					
2.2 D	140	05/11→04/15					
2.2 D	147	03/12→04/15					
3.0	250	03/12→04/15					
3.0 AWD	250	10/12→04/15					
5.0 XFR-S	405	10/12→04/15					
2.7 D	152	03/08→04/15	➡	S20753→	1	24.8190-0960.2 620960	L= 633
3.0	175	03/08→04/15					
3.0	179	03/08→04/15	➡	→ S20572	1	24.8190-0960.2 620960	L= 633
3.0 D	155	03/09→04/15					
3.0 D	177	03/09→04/15					
3.0 D	202	03/09→04/15					
4.2	219	03/08→04/15					
4.2 Kompressor	306	03/08→04/15					
5.0	283	03/09→04/15					
5.0 Kompressor	346	01/09→04/15	➡	B32753→	1	24.8190-0960.2 620960	L= 633
5.0 Kompressor	375	03/09→04/15	➡	→ B32752	1	24.8190-0960.2 620960	L= 633
 Bremsscheibe							
2.0	177	06/12→04/15	⬅			24.0130-0226.1 430226	Ø 326 30 28 V
2.2 D	120	04/11→04/15					
2.2 D	140	05/11→04/15	➡	→ S49010		24.0120-0238.1 420238	Ø 326 20 18 V
2.2 D	147	03/12→04/15	➡			24.0120-0238.1 420238	Ø 326 20 18 V
3.0 D	155	03/09→04/15	➡	S49011→			
2.7 D	152	03/08→04/15	⬅			24.0130-0226.1 430226	Ø 326 30 28 V
3.0	175	03/08→04/15					
3.0	179	03/08→04/15	➡			24.0120-0238.1 420238	Ø 326 20 18 V
3.0 D	177	03/09→04/15					
3.0 D	202	03/09→04/15					
4.2	219	03/08→04/15					
3.0	250	03/12→04/15	➡	→ S49010		24.0120-0238.1 420238	Ø 326 20 18 V
3.0 AWD	250	10/12→04/15	➡			24.0120-0238.1 420238	Ø 326 20 18 V
			➡	S49011→			
4.2 Kompressor	306	03/08→04/15	➡			24.0120-0238.1 420238	Ø 326 20 18 V
5.0	283	03/09→04/15					
5.0 Kompressor	346	01/09→04/15	⬅			24.0136-0122.1 436122	Ø 380 36 34 V
5.0 Kompressor	375	03/09→04/15					
5.0 XFR-S	405	10/12→04/15	➡			24.0126-0174.1 426174	Ø 376 26 24 V
JAGUAR - XF SPORTBRAKE (CC9_) 09/12→04/14							
 Bremsbelagsatz, Scheibenbremse							
2.2 D	120	09/12→04/14	⬅			13.0460-7292.2 607292	ATE 24084 19,3 + WE / - WK
2.2 D	147	09/12→04/14	➡			13.0460-7209.2 607209	ATE 23482 16,6 - WE / - WK
3.0 D	177	09/12→04/14	⬅	für Bremsscheibendurchmesser [mm]:		13.0460-7292.2 607292	ATE 24084 19,3 + WE / - WK
3.0 D	202	09/12→04/14	➡	326		13.0460-7209.2 607209	ATE 23482 16,6 - WE / - WK
5.0 XFR-S	405	02/13→04/14	➡	02/14→		13.0460-7255.2 607255	ATE 25114 15,8 - WE / - WK
Warnkontakt, Bremsbelagverschleiß							
2.2 D	120	09/12→04/14	➡		1	24.8190-0960.2 620960	L= 633
2.2 D	147	09/12→04/14					
3.0 D	177	09/12→04/14					
3.0 D	202	09/12→04/14					
5.0 XFR-S	405	02/13→04/14	➡	02/14→	1	24.8190-0960.2 620960	L= 633
 Bremsscheibe							
2.2 D	120	09/12→04/14	⬅			24.0130-0226.1 430226	Ø 326 30 28 V
2.2 D	147	09/12→04/14				24.0120-0238.1 420238	Ø 326 20 18 V
3.0 D	177	09/12→04/14	➡	→ S49010			
3.0 D	202	09/12→04/14	➡	S49011→		24.0120-0238.1 420238	Ø 326 20 18 V
5.0 XFR-S	405	02/13→04/14	⬅	02/14→		24.0136-0122.1 436122	Ø 380 36 34 V
			➡	02/14→		24.0126-0174.1 426174	Ø 376 26 24 V
JAGUAR - XJ (NAW_, NBW_, X308_) 09/96→05/03							
 Bremsbelagsatz, Scheibenbremse							
3.2	174	07/97→05/03	⬅	für Fahrzeuge ohne Sportpaket		13.0460-7138.2 607138	ATE 20968 17,5 + WE / - WK
			➡	für Fahrzeuge ohne Sportpaket		13.0460-7246.2 607246	ATE 21275 17,0 + WE / - WK
↓							















	kw					! #		
JAGUAR - XJ (NAW_, NBW_, X308_) 09/96→05/03								
 Bremsbelagsatz, Scheibenbremse								
4.0	209	07/97→05/03	←				13.0460-7138.2 607138	ATE 20968 17,5 + WE / - WK
			→	08/99→			13.0460-7241.2 607241	ATE 20547 16,5 + WE / - WK
			→	→ 07/99			13.0460-7246.2 607246	ATE 21275 17,0 + WE / - WK
4.0	216	10/97→04/03	←				13.0460-7138.2 607138	ATE 20968 17,5 + WE / - WK
			→				13.0460-7246.2 607246	ATE 21275 17,0 + WE / - WK
 Bremsscheibe								
3.2	174	07/97→05/03	←	für Fahrzeuge mit Sportpaket			24.0128-0229.1 428229	Ø 325 28,3 26 V
			←	für Fahrzeuge ohne Sportpaket			24.0129-0100.1 429100	Ø 305 28,5 26 V
			→	für Fahrzeuge ohne Sportpaket			24.0120-0188.1 420188	Ø 305 20 18,5 V
4.0	209	07/97→05/03	←				24.0129-0100.1 429100	Ø 305 28,5 26 V
4.0	216	10/97→04/03	→				24.0120-0188.1 420188	Ø 305 20 18,5 V
4.0	267	07/97→05/03	←				24.0129-0100.1 429100	Ø 305 28,5 26 V
JAGUAR - XJ (X300_, X330_) 09/94→07/97								
 Bremsbelagsatz, Scheibenbremse								
12 6.0	229	11/94→07/97	←				13.0460-7138.2 607138	ATE 20968 17,5 + WE / - WK
6 3.2	155	11/94→07/97						
R Super Charged 4.0	235	11/94→07/97						
6 Sovereign 4.0	177	09/94→07/97	←	11/94→			13.0460-7138.2 607138	ATE 20968 17,5 + WE / - WK
Warnkontakt, Bremsbelagverschleiß								
12 6.0	229	11/94→07/97	←		2	24.8190-1302.2 621302		L= 276
6 3.2	155	11/94→07/97						
R Super Charged 4.0	235	11/94→07/97						
6 Sovereign 4.0	177	09/94→07/97	←	11/94→	2	24.8190-1302.2 621302		L= 276
 Bremsscheibe								
12 6.0	229	11/94→07/97	←				24.0128-0138.1 428138	Ø 291 28,1 26 V
6 3.2	155	11/94→07/97					24.0120-0188.1 420188	Ø 305 20 18,5 V
R Super Charged 4.0	235	11/94→07/97	→					
6 Sovereign 4.0	177	09/94→07/97	←	11/94→			24.0128-0138.1 428138	Ø 291 28,1 26 V
			→	11/94→			24.0120-0188.1 420188	Ø 305 20 18,5 V
JAGUAR - XJ (X350_) 05/03→03/09								
 Bremsbelagsatz, Scheibenbremse								
2,7 D	152	10/05→03/09	←	H32733→			13.0460-2898.2 602898	TRW 23908 18,0 + WE / - WK + Zub
			←	→ H32732			13.0460-7292.2 607292	ATE 24084 19,3 + WE / - WK
			→	→ G27960			13.0460-2730.2 602730	TRW 23424 17,6 - WE / - WK
			→	G27961→ G30744			13.0460-2730.2 602730	TRW 23424 17,6 - WE / - WK
			→	G49701→			13.0460-7209.2 607209	ATE 23482 16,6 - WE / - WK
3.0	175	05/03→03/09	←				13.0460-2898.2 602898	TRW 23908 18,0 + WE / - WK + Zub
3.0	179	04/04→01/07						
3.6	190	05/03→03/09	→				13.0460-2730.2 602730	TRW 23424 17,6 - WE / - WK
4.2	219	05/03→03/09						
R 4.2	291	05/03→03/09	←				13.0460-4841.2 604841	BRE 23489 16,3 - WE
			→				13.0460-4964.2 604964	BRE 21381 15,0 - WE / - WK
Warnkontakt, Bremsbelagverschleiß								
2,7 D	152	10/05→03/09	→	G49701→	1	24.8190-0960.2 620960		L= 633
 Bremsscheibe								
2,7 D	152	10/05→03/09	←	H32733→			24.0130-0182.1 430182	Ø 320 30 28,4 V
			←	→ H32732			24.0130-0226.1 430226	Ø 326 30 28 V
			→	G49701→			24.0120-0238.1 420238	Ø 326 20 18 V
			→	→ G22035			24.0120-0708.1 420708	Ø 288 20 18,5 V
3.0	175	05/03→03/09	←				24.0130-0182.1 430182	Ø 320 30 28,4 V
3.0	179	04/04→01/07						
3.6	190	05/03→03/09	→				24.0120-0708.1 420708	Ø 288 20 18,5 V
4.2	219	05/03→03/09						













	kw			 	! #		
JAGUAR - XJ (X351_) 10/09→							
 Bremsbelagsatz, Scheibenbremse							
2.0	177	05/12→	→			13.0460-7209.2 607209	ATE 23482 16,6 - WE / - WK
3.0	175	01/11→					
3.0	250	03/12→					
3.0 AWD	250	10/12→					
3.0 D	202	10/09→12/15					
5.0 V 8	283	10/09→					
3.0 D	221	04/15→	→	→ V90865		13.0460-7209.2 607209	ATE 23482 16,6 - WE / - WK
5.0 V8	346	10/09→	→			13.0460-7255.2 607255	ATE 25114 15,8 - WE / - WK
5.0 V8	375	10/09→					
5.0 V8	405	06/13→					
Warnkontakt, Bremsbelagverschleiß							
2.0	177	05/12→	→		1	24.8190-0960.2 620960	L= 633
3.0	175	01/11→					
3.0	250	03/12→					
3.0 AWD	250	10/12→					
3.0 D	202	10/09→12/15					
5.0 V 8	283	10/09→					
3.0 D	221	04/15→	→	→ V90865	1	24.8190-0960.2 620960	L= 633
 Bremsscheibe							
2.0	177	05/12→	→	→ V39426		24.0120-0238.1 420238	Ø 326 20 18 V
3.0	175	01/11→					
3.0	250	03/12→	→	V39427→		24.0120-0238.1 420238	Ø 326 20 18 V
3.0 AWD	250	10/12→					
3.0 D	202	10/09→12/15					
5.0 V 8	283	10/09→					
3.0 D	221	04/15→	→	V39427→ V90865		24.0120-0238.1 420238	Ø 326 20 18 V
			→	→ V39426		24.0120-0238.1 420238	Ø 326 20 18 V
5.0 V8	346	10/09→	←			24.0136-0122.1 436122	Ø 380 36 34 V
5.0 V8	375	10/09→					
5.0 V8	405	06/13→	→			24.0126-0174.1 426174	Ø 376 26 24 V
JAGUAR - XJ Coupe 09/73→03/96							
 Bremsbelagsatz, Scheibenbremse							
6.0	222	05/93→03/96	←			13.0460-7138.2 607138	ATE 20968 17,5 + WE / - WK
			→			13.0460-7246.2 607246	ATE 21275 17,0 + WE / - WK
Warnkontakt, Bremsbelagverschleiß							
6.0	222	05/93→03/96	←		2	24.8190-1302.2 621302	L= 276
 Bremsscheibe							
6.0	222	05/93→03/96	←			24.0124-0174.1 424174	Ø 284 24,2 22,9 V
			→			24.0110-0319.1 410319	Ø 295 10 8,8
JAGUAR - XJSC Convertible 07/85→09/97							
 Bremsbelagsatz, Scheibenbremse							
4.0	171	07/94→03/96	←			13.0460-7138.2 607138	ATE 20968 17,5 + WE / - WK
			←	→ 11/94		13.0460-7138.2 607138	ATE 20968 17,5 + WE / - WK
			→	→ 11/94		13.0460-7246.2 607246	ATE 21275 17,0 + WE / - WK
			→			13.0460-7246.2 607246	ATE 21275 17,0 + WE / - WK
Warnkontakt, Bremsbelagverschleiß							
4.0	171	07/94→03/96	←		2	24.8190-1302.2 621302	L= 276
			←	→ 11/94	2	24.8190-1302.2 621302	L= 276
 Bremsscheibe							
4.0	171	07/94→03/96	←	→ 11/94		24.0123-0108.1 423108	Ø 295 22,5 21 V
			←			24.0128-0138.1 428138	Ø 291 28,1 26 V
			←			24.0124-0174.1 424174	Ø 284 24,2 22,9 V
			→			24.0110-0319.1 410319	Ø 295 10 8,8
			→	→ 11/94		24.0110-0319.1 410319	Ø 295 10 8,8
JAGUAR - XK 8 Convertible (X100_, QDV_) 03/96→07/05							
 Bremsbelagsatz, Scheibenbremse							
4.0	209	03/96→07/05	←			13.0460-7138.2 607138	ATE 20968 17,5 + WE / - WK
↓							















	kw			 	! #		
JAGUAR - XK 8 Convertible (X100_, QDV_) 03/96→07/05							
 Bremsbelagsatz, Scheibenbremse							
4.0	267	02/98→07/05	→			13.0460-7241.2 607241	ATE 20547 16,5 + WE / - WK
4.0 XKR	276	05/98→07/05					
4.2	219	08/02→07/05					
R 4,2	291	08/02→07/05					
4.0	216	05/96→07/99	←	für Fahrzeuge ohne Sportpaket		13.0460-7138.2 607138	ATE 20968 17,5 + WE / - WK
			→	für Fahrzeuge ohne Sportpaket		13.0460-7241.2 607241	ATE 20547 16,5 + WE / - WK
Warnkontakt, Bremsbelagverschleiß							
4.0	209	03/96→07/05	←		2	24.8190-1302.2 621302	L= 276
4.0	267	02/98→07/05					
4.0 XKR	276	05/98→07/05					
4.2	219	08/02→07/05					
R 4,2	291	08/02→07/05					
4.0	216	05/96→07/99	←	für Fahrzeuge ohne Sportpaket	2	24.8190-1302.2 621302	L= 276
 Bremsscheibe							
4.0	209	03/96→07/05	←	für Bremsscheibendurchmesser [mm]:		24.0128-0229.1 428229	Ø 325 28,3 26 V
4.0	267	02/98→07/05		325			
4.0 XKR	276	05/98→07/05	←			24.0129-0100.1 429100	Ø 305 28,5 26 V
4.2	219	08/02→07/05					
R 4,2	291	08/02→07/05	→			24.0120-0188.1 420188	Ø 305 20 18,5 V
4.0	216	05/96→07/99	←	für Fahrzeuge ohne Sportpaket;		24.0128-0229.1 428229	Ø 325 28,3 26 V
				für Bremsscheibendurchmesser [mm]:			
				325			
			←	für Fahrzeuge ohne Sportpaket		24.0129-0100.1 429100	Ø 305 28,5 26 V
			→	für Fahrzeuge ohne Sportpaket		24.0120-0188.1 420188	Ø 305 20 18,5 V
JAGUAR - XK 8 Coupe (X100_, QEV_) 03/96→07/05							
 Bremsbelagsatz, Scheibenbremse							
4.0	209	03/96→07/05	←			13.0460-7138.2 607138	ATE 20968 17,5 + WE / - WK
4.0	267	02/98→07/05					
4.0 XKR	276	05/98→07/05	→			13.0460-7241.2 607241	ATE 20547 16,5 + WE / - WK
4.2	219	08/02→07/05					
R 4,2	291	08/02→07/05					
4.0	216	05/96→07/05	←	→ 07/99; für Fahrzeuge ohne Sportpaket		13.0460-7138.2 607138	ATE 20968 17,5 + WE / - WK
			→	→ 07/99; für Fahrzeuge ohne Sportpaket		13.0460-7241.2 607241	ATE 20547 16,5 + WE / - WK
Warnkontakt, Bremsbelagverschleiß							
4.0	209	03/96→07/05	←		2	24.8190-1302.2 621302	L= 276
4.0	267	02/98→07/05					
4.0 XKR	276	05/98→07/05					
4.2	219	08/02→07/05					
R 4,2	291	08/02→07/05					
4.0	216	05/96→07/05	←	→ 07/99; für Fahrzeuge ohne Sportpaket	2	24.8190-1302.2 621302	L= 276
 Bremsscheibe							
4.0	209	03/96→07/05	←	für Bremsscheibendurchmesser [mm]:		24.0128-0229.1 428229	Ø 325 28,3 26 V
4.0	267	02/98→07/05		325			
4.0 XKR	276	05/98→07/05	←			24.0129-0100.1 429100	Ø 305 28,5 26 V
4.2	219	08/02→07/05					
R 4,2	291	08/02→07/05	→			24.0120-0188.1 420188	Ø 305 20 18,5 V
4.0	216	05/96→07/05	←	→ 07/99;		24.0128-0229.1 428229	Ø 325 28,3 26 V
				für Fahrzeuge ohne Sportpaket;			
				für Bremsscheibendurchmesser [mm]:			
				325			
			←	→ 07/99; für Fahrzeuge ohne Sportpaket		24.0129-0100.1 429100	Ø 305 28,5 26 V
			→	→ 07/99; für Fahrzeuge ohne Sportpaket		24.0120-0188.1 420188	Ø 305 20 18,5 V
JAGUAR - XK Cabriolet (QQ6_) 03/06→07/14							
 Bremsbelagsatz, Scheibenbremse							
3.6	190	10/07→07/14	←	→ B00378		13.0460-7292.2 607292	ATE 24084 19,3 + WE / - WK
4.2	291	09/07→12/09					
4.2 XK8	219	03/06→07/14					
4.2 XKR	306	03/06→07/14					
4.2 XKR	313	08/06→07/14					
5.0 V8	218	09/09→12/12					
5.0 V8	283	01/09→07/14					
5.0 XKR	375	01/09→07/14	→	→ B32752		13.0460-7209.2 607209	ATE 23482 16,6 - WE / - WK
			→	B32753→;		13.0460-7255.2 607255	ATE 25114 15,8 - WE / - WK
				nicht für Ausstattungsvariante: Alcon-Bremse			
↓							

















	kw			 	! #		
JAGUAR - XK Cabriolet (QQ6_) 03/06→07/14							
 Bremsbelagsatz, Scheibenbremse							
5.0 XKR-S	405	01/11→07/14	➡	nicht für Ausstattungsvariante: Alcon-Bremse		13.0460-7255.2 607255	ATE 25114 15,8 - WE / - WK
Warnkontakt, Bremsbelagverschleiß							
5.0 XKR	375	01/09→07/14	➡	→ B32752	1	24.8190-0960.2 620960	L= 633
			➡	B32753→	1	24.8190-0960.2 620960	L= 633
5.0 XKR-S	405	01/11→07/14	➡		1	24.8190-0960.2 620960	L= 633
 Bremsscheibe							
5.0 XKR	375	01/09→07/14	⬅			24.0136-0122.1 436122	Ø 380 36 34 V
5.0 XKR-S	405	01/11→07/14	➡			24.0126-0174.1 426174	Ø 376 26 24 V
JAGUAR - XK Coupe (QQ6_) 03/06→07/14							
 Bremsbelagsatz, Scheibenbremse							
3.6	190	07/07→07/14	⬅	→ B00378		13.0460-7292.2 607292	ATE 24084 19,3 + WE / - WK
4.2 XK8	219	03/06→07/14					
4.2 XKR	291	03/06→07/14					
4.2 XKR	306	03/06→07/14					
4.2 XKR	313	08/06→07/14					
5.0 V8	218	09/09→12/12					
5.0 V8	283	01/09→07/14					
5.0 XKR	375	01/09→07/14	➡	→ B32752		13.0460-7209.2 607209	ATE 23482 16,6 - WE / - WK
5.0 XKR	390	09/10→07/14	➡	B32753→; nicht für Ausstattungsvariante: Alcon-Bremse		13.0460-7255.2 607255	ATE 25114 15,8 - WE / - WK
5.0 XKR-S	405	01/11→07/14	➡	nicht für Ausstattungsvariante: Alcon-Bremse		13.0460-7255.2 607255	ATE 25114 15,8 - WE / - WK
Warnkontakt, Bremsbelagverschleiß							
5.0 XKR	375	01/09→07/14	➡	B32753→	1	24.8190-0960.2 620960	L= 633
5.0 XKR	390	09/10→07/14	➡	→ B32752	1	24.8190-0960.2 620960	L= 633
5.0 XKR-S	405	01/11→07/14	➡		1	24.8190-0960.2 620960	L= 633
 Bremsscheibe							
5.0 XKR	375	01/09→07/14	⬅			24.0136-0122.1 436122	Ø 380 36 34 V
5.0 XKR	390	09/10→07/14	➡			24.0126-0174.1 426174	Ø 376 26 24 V
5.0 XKR-S	405	01/11→07/14	➡				
JAGUAR - X-TYPE (CF1_) 06/01→11/09							
 Bremsbelagsatz, Scheibenbremse							
2.0 D	96	07/03→11/09	⬅	→ J04730		13.0460-3987.2 603987	BOS 23279 18,4 - WE / - WK
2.2 D	107	01/07→11/09				13.0470-3987.2 LD3987	BOS 23279 18,4 - WE / - WK
2.2 D	110	10/05→11/09					Ceramic
2.2 D	114	10/05→11/09					
2.5 V6 Allrad	144	06/01→11/09	➡	E73994→		13.0460-3831.2 603831	BOS 24260 17,3 - WE / - WK + Zub
3.0 Allrad	169	09/02→12/08				13.0470-3831.2 LD3831	BOS 24260 17,3 - WE / - WK + Zub Ceramic
3.0 V6 Allrad	169	06/01→11/07					
			➡	→ E73993		13.0460-3988.2 603988	BOS 23557 17,2 - WE / - WK
						13.0470-3988.2 LD3988	BOS 23557 17,2 - WE / - WK Ceramic
2.1 V6	115	03/02→11/09	⬅	→ J04730		13.0460-3987.2 603987	BOS 23279 18,4 - WE / - WK
						13.0470-3987.2 LD3987	BOS 23279 18,4 - WE / - WK Ceramic
			➡	E73994→; → 10/05		13.0460-3831.2 603831	BOS 24260 17,3 - WE / - WK + Zub
						13.0470-3831.2 LD3831	BOS 24260 17,3 - WE / - WK + Zub Ceramic
			➡	→ E73993		13.0460-3988.2 603988	BOS 23557 17,2 - WE / - WK
						13.0470-3988.2 LD3988	BOS 23557 17,2 - WE / - WK Ceramic
 Bremsscheibe							
2.0 D	96	07/03→11/09	⬅	J52301→		24.0124-0161.1 424161	Ø 300 23,9 22 V
2.2 D	107	01/07→11/09				24.0324-0161.1 524161	Ø 300 23,9 22 V PD
2.2 D	110	10/05→11/09					
2.2 D	114	10/05→11/09	⬅	→ J52300		24.0124-0161.1 424161	Ø 300 23,9 22 V
2.5 V6 Allrad	144	06/01→11/09				24.0324-0161.1 524161	Ø 300 23,9 22 V PD
3.0 Allrad	169	09/02→12/08					
3.0 V6 Allrad	169	06/01→11/07	➡	→ J52300		24.0112-0154.1 412154	Ø 280 12 10















	kw			 	! #				
JAGUAR - X-TYPE (CF1_) 06/01→11/09									
 Bremsscheibe									
2.0 D	96	07/03→11/09	➔	→ J52300		24.0312-0154.1 512154	Ø 280 12 10 PD		
2.2 D	107	01/07→11/09	➔	J52301→		24.0112-0154.1 412154	Ø 280 12 10		
2.2 D	110	10/05→11/09				24.0312-0154.1 512154	Ø 280 12 10 PD		
2.2 D	114	10/05→11/09							
2.5 V6 Allrad	144	06/01→11/09							
3.0 Allrad	169	09/02→12/08							
3.0 V6 Allrad	169	06/01→11/07							
2.1 V6	115	03/02→11/09	➔	J52301→; → 10/05		24.0124-0161.1 424161	Ø 300 23,9 22 V		
			➔	→ J52300		24.0324-0161.1 524161	Ø 300 23,9 22 V PD		
			➔	→ J52300		24.0124-0161.1 424161	Ø 300 23,9 22 V		
			➔	→ J52300		24.0324-0161.1 524161	Ø 300 23,9 22 V PD		
			➔	→ J52300		24.0112-0154.1 412154	Ø 280 12 10		
			➔	→ J52300		24.0312-0154.1 512154	Ø 280 12 10 PD		
			➔	J52301→; → 10/05		24.0112-0154.1 412154	Ø 280 12 10		
			➔	→ J52300		24.0312-0154.1 512154	Ø 280 12 10 PD		
JAGUAR - X-TYPE Estate (CF1_) 11/03→12/09									
 Bremsbelagsatz, Scheibenbremse									
2.0 D	96	02/04→12/09	➔	→ J04730		13.0460-3987.2 603987	BOS 23279 18,4 - WE / - WK		
2.1 V6	115	11/03→03/09	➔	E73994→		13.0470-3987.2 LD3987	BOS 23279 18,4 - WE / - WK Ceramic		
2.2 D	107	01/07→12/09							
2.2 D	110	10/05→12/09							
2.2 D	114	10/05→12/09							
2.5	144	02/04→12/09							
3.0	169	02/04→12/09	➔	→ E73993		13.0460-3988.2 603988	BOS 23557 17,2 - WE / - WK		
			➔	→ E73993		13.0470-3988.2 LD3988	BOS 23557 17,2 - WE / - WK Ceramic		
 Bremsscheibe									
2.0 D	96	02/04→12/09	➔	→ J52300		24.0124-0161.1 424161	Ø 300 23,9 22 V		
2.1 V6	115	11/03→03/09	➔	J52301→		24.0324-0161.1 524161	Ø 300 23,9 22 V PD		
2.2 D	107	01/07→12/09							
2.2 D	110	10/05→12/09							
2.2 D	114	10/05→12/09							
2.5	144	02/04→12/09							
3.0	169	02/04→12/09	➔	→ J52301→		24.0112-0154.1 412154	Ø 280 12 10		
			➔	→ J52300		24.0312-0154.1 512154	Ø 280 12 10 PD		
			➔	→ J52300		24.0112-0154.1 412154	Ø 280 12 10		
			➔	→ J52300		24.0312-0154.1 512154	Ø 280 12 10 PD		
JEEP - CHEROKEE (KJ) 09/01→01/08									
 Bremsbelagsatz, Scheibenbremse									
2.4 4x4	108	09/01→01/08	➔			13.0460-2899.2 602899	TRW 23638 17,5 + WK		
2.4 Laredo	108	10/01→09/04	➔						
2.5 CRD 4x4	105	09/01→01/08							
2.8 CRD 4x4	110	11/02→01/08							
2.8 CRD 4x4	120	11/04→01/08							
3.7 4x4	150	08/03→01/08							
3.7 4x4	155	09/01→01/08							
3.7 Laredo	150	10/01→09/04							
3.7 4x4	157	09/01→10/07			➔	10/04→		13.0460-2899.2 602899	TRW 23638 17,5 + WK
 Bremsscheibe									
2.4 4x4	108	09/01→01/08	➔			24.0128-0708.1 428708	Ø 288 28 26 V		
2.4 Laredo	108	10/01→09/04	➔						
2.5 CRD 4x4	105	09/01→01/08							
2.8 CRD 4x4	110	11/02→01/08							
2.8 CRD 4x4	120	11/04→01/08							
3.7 4x4	150	08/03→01/08							
3.7 4x4	155	09/01→01/08							
3.7 Laredo	150	10/01→09/04							
3.7 4x4	157	09/01→10/07	➔	10/04→		24.0128-0708.1 428708	Ø 288 28 26 V		
JEEP - CHEROKEE (KK) 01/08→									
 Bremsbelagsatz, Scheibenbremse									
2.8 CRD 4x4	130	05/08→	➔	→ 12/12;		13.0460-8013.2 608013	BOS 24604 16,5 + WK		
2.8 CRD 4x4	147	01/10→	➔	für Fahrzeuge ohne verstärktes Fahrwerk					
3.7 V6	157	01/08→							
3.7 V6 4x4	151	01/08→							
3.7 V6 4x4	157	01/08→							
↓									
			➔	→ 12/12		13.0460-5629.2 605629	24602 16,0 + WK		













	kW			 	! #		
JEEP - CHEROKEE (KK) 01/08→							
 Bremsscheibe							
2.8 CRD 4x4 3.7 V6	130 157	05/08→ 01/08→	←	01/10→ 12/12; für Fahrzeuge mit verstärktem Fahrwerk		24.0128-0259.1 428259	Ø 332 28 26,4 V
3.7 V6 4x4 3.7 V6 4x4	151 157	01/08→ 01/08→	←	→ 12/12; für Fahrzeuge ohne verstärktes Fahrwerk		24.0128-0270.1 428270	Ø 302 28 26,4 V
2.8 CRD 4x4	147	01/10→	←	→ 12/12; für Fahrzeuge mit verstärktem Fahrwerk		24.0128-0259.1 428259	Ø 332 28 26,4 V
			←	→ 12/12; für Fahrzeuge ohne verstärktes Fahrwerk		24.0128-0270.1 428270	Ø 302 28 26,4 V
JEEP - CHEROKEE (KL) 11/13→							
 Bremsscheibe							
2.0 CRD	103	04/14→	←			24.0128-0191.1 428191	Ø 330 28 26 V + S
2.0 CRD 4x4	103	04/14→	→	BRF		24.0112-0214.1 412214	Ø 278 12 10,4 + S
2.0 CRD 4x4	125	04/14→	→	BRG/BR6		24.0112-0215.1 412215	Ø 320 12 10,4 + S
2.2 CRD 4x4	136	08/15→	→				
2.2 CRD 4x4	147	08/15→	→				
3.2 V6 4x4	200	11/13→	→				
JEEP - CHEROKEE (XJ) 09/83→09/01							
 Bremsscheibe							
2.1 TD	64	10/84→09/01	←	01/94→ 01/99		24.0124-0702.1 424702	Ø 280 24 22,7 V
4.0 i	135	12/91→09/01					
4.0 i	136	01/88→09/01					
2.5	89	10/95→09/01	←	10/96→		24.0124-0702.1 424702	Ø 280 24 22,7 V
2.5 i 4x4	90	12/91→09/01	←	→ 12/93		24.0124-0702.1 424702	Ø 280 24 22,7 V
			←	10/96→		24.0124-0702.1 424702	Ø 280 24 22,7 V
2.5 TD 4x4	85	01/88→09/01	←	→ 12/89		24.0122-0181.1 422181	Ø 280 22,2 20,7 V
			←	01/94→ 01/99		24.0124-0702.1 424702	Ø 280 24 22,7 V
			←	01/90→ 12/93		24.0124-0702.1 424702	Ø 280 24 22,7 V
2.5 Tdi 4x4	85	10/96→09/01	←			24.0124-0702.1 424702	Ø 280 24 22,7 V
4.0 i	127	07/98→09/01					
4.0 i	135	02/99→09/01					
4.0 i 4x4	131	01/95→09/01					
4.0 i	125	10/90→09/01	←	01/95→		24.0124-0702.1 424702	Ø 280 24 22,7 V
JEEP - COMANCHE (MJ) 09/85→09/96							
 Bremsscheibe							
4.0	127	10/90→09/96	←	01/94→		24.0124-0702.1 424702	Ø 280 24 22,7 V
4.0	130	10/90→09/96					
JEEP - COMMANDER (XK, XH) 09/05→12/10							
 Bremsscheibe							
3.0 CRD 4x4	160	04/06→12/10	←			24.0130-0223.1 430223	Ø 328 30 28,5 V
3.7 V6 4x4	157	09/05→12/10	→			24.0114-0118.1 414118	Ø 320 14 12,5
4.7 V8 4x4	170	09/05→12/10	→				
5.7 V8 4x4	240	09/05→12/10	→				
JEEP - COMPASS (MK49) 08/06→							
 Bremsbelagsatz, Scheibenbremse							
2.0	115	05/11→	←			13.0460-5760.2 605760	AKE 23584 16,4 + WK
2.2 CRD	100	05/11→	→	passend für Felgenreöße [Zoll]: 17		13.0460-5735.2 605735	AKE 24014 16,0 + WK
2.2 CRD 4x4	120	12/10→	→	passend für Felgenreöße [Zoll]: 18		13.0460-5855.2 605855	23582 16,0 - WK
2.2 CRD 4x4	100	05/11→	→	passend für Felgenreöße [Zoll]: 17		13.0460-5760.2 605760	AKE 23584 16,4 + WK
2.0 CRD	103	08/06→	←	passend für Felgenreöße [Zoll]: 17		13.0460-5760.2 605760	AKE 23584 16,4 + WK
2.0 CRD 4x4	103	09/06→	→			13.0460-5735.2 605735	AKE 24014 16,0 + WK
2.4 4x4	125	09/06→	→				
2.4	125	08/06→	←	09/06→; passend für Felgenreöße [Zoll]: 17		13.0460-5760.2 605760	AKE 23584 16,4 + WK
			→	09/06→		13.0460-5735.2 605735	AKE 24014 16,0 + WK
 Bremsscheibe							
2.0	115	05/11→	←			24.0126-0170.1 426170	Ø 294 26 24,4 V
2.2 CRD	100	05/11→	→	passend für Felgenreöße [Zoll]: 17		24.0110-0363.1 410363	Ø 262 10 8,4
2.2 CRD 4x4	120	12/10→	→	passend für Felgenreöße [Zoll]: 18		24.0110-0372.1 410372	Ø 302 10 8,4
2.2 CRD 4x4	100	05/11→	→				
2.0 CRD	103	08/06→	←			24.0126-0170.1 426170	Ø 294 26 24,4 V
2.0 CRD 4x4	103	09/06→	→			24.0110-0363.1 410363	Ø 262 10 8,4
2.4 4x4	125	09/06→	→				
2.4	125	08/06→	←	09/06→		24.0126-0170.1 426170	Ø 294 26 24,4 V







	kw				! #		
JEEP - COMPASS (MK49) 08/06→							
 Bremsscheibe							
2.4	125	08/06→	→	09/06→		24.0110-0363.1 410363	Ø 262 10 8,4
JEEP - GRAND CHEROKEE I (ZJ) 09/91→04/99							
 Bremsscheibe							
2.5 TD 4x4 (Z)	85	10/95→04/99	←			24.0124-0702.1 424702	Ø 280 24 22,7 V
2.5 TD Laredo	85	10/96→09/98					
4.0 i 4x4 (Z)	130	10/95→04/99					
4.0 Laredo	131	10/96→09/98					
5.2	164	10/96→09/98					
5.2 4x4	164	10/96→09/98					
5.2 4x4 (Z)	156	10/95→04/99					
5.2 Limited 4x4	136	10/96→09/98					
5.9 i 4x4	177	08/97→04/99					
4.0 i 4x4 (ZJ)	132	09/91→04/99	←	01/94→		24.0124-0702.1 424702	Ø 280 24 22,7 V
4.0 i 4x4 (ZJ)	135	09/91→04/99					
5.2 i 4x4 (ZJ)	155	01/92→04/99	←	01/93→ 12/93		24.0124-0702.1 424702	Ø 280 24 22,7 V
5.2 i 4x4 (ZJ)	158	09/92→04/99					
JEEP - GRAND CHEROKEE II (WJ, WG) 09/98→09/05							
 Bremsbelagsatz, Scheibenbremse							
2.7 CRD 4x4	120	10/01→09/05	←	→ 09/02		13.0460-7206.2 607206	ATE 23631 17,8 + WK
4.0	140	10/98→09/04					
4.0 4x4	140	04/99→09/05					
4.7 V8 4x4	190	10/01→09/05					
3.1 TD 4x4	103	04/99→12/01	←			13.0460-7206.2 607206	ATE 23631 17,8 + WK
4.7 V8 4x4	162	04/99→08/00					
4.7 V8 4x4	164	04/99→09/05	←	08/00→ 09/02		13.0460-7206.2 607206	ATE 23631 17,8 + WK
 Bremsscheibe							
2.7 CRD 4x4	120	10/01→09/05	←			24.0126-0130.1 426130	Ø 305 26 24,5 V
2.7 CRD 4x4	120	10/04→09/05					
2.7 CRD Laredo	120	10/04→09/05	→			24.0110-0299.1 410299	Ø 305 10 8,5
3.1 TD 4x4	103	04/99→12/01					
4.0 4x4	140	04/99→09/05					
4.7 V8 4x4	162	04/99→08/00					
4.7 V8 4x4	167	06/03→09/05					
4.7 V8 4x4	190	10/01→09/05					
4.0	140	10/98→09/04	←	04/99→		24.0126-0130.1 426130	Ø 305 26 24,5 V
			→	04/99→		24.0110-0299.1 410299	Ø 305 10 8,5
4.7 V8	167	10/04→09/05	←			24.0130-0223.1 430223	Ø 328 30 28,5 V
			→			24.0114-0118.1 414118	Ø 320 14 12,5
4.7 V8 4x4	164	04/99→09/05	←	08/00→		24.0126-0130.1 426130	Ø 305 26 24,5 V
			→	08/00→		24.0110-0299.1 410299	Ø 305 10 8,5
JEEP - GRAND CHEROKEE III (WH, WK) 06/05→05/11							
 Bremsscheibe							
3.0 CRD	160	06/05→12/10	←			24.0130-0223.1 430223	Ø 328 30 28,5 V
3.0 CRD 4x4	155	05/06→12/10	←			24.0130-0223.1 430223	Ø 328 30 28,5 V
3.0 CRD 4x4	160	06/05→12/10					
3.7 V6	157	06/05→12/10	→			24.0114-0118.1 414118	Ø 320 14 12,5
3.7 V6 4x4	148	01/08→12/10					
3.7 V6 4x4	157	06/05→12/10					
4.7 FLEX 4x4	228	09/07→12/10					
4.7 V8	228	09/07→12/08					
4.7 V8 4x4	164	06/05→12/10					
4.7 V8 4x4	170	06/05→12/10					
4.7 V8 FLEX	167	10/06→05/10					
5.7 V8 4x4	240	06/05→12/10					
5.7 V8 4x4	259	01/09→12/10					
5.7 V8 4x4	265	01/09→12/10					
4.7 FLEX	228	09/07→12/10	←	→ 12/08		24.0130-0223.1 430223	Ø 328 30 28,5 V
4.7 V8 4x4	223	09/07→02/10	→	→ 12/08		24.0114-0118.1 414118	Ø 320 14 12,5
6.1 SRT8 4x4	313	03/06→12/10	→			24.0128-0255.1 428255	Ø 350 28 26 V
JEEP - GRAND CHEROKEE IV (WK, WK2) 06/10→							
 Bremsbelagsatz, Scheibenbremse							
3.0 CRD V6 4x4	140	02/11→	←			13.0460-7282.2 607282	ATE 25190 21,3 - WK / + WK
3.0 CRD V6 4x4	177	02/11→				13.0470-7282.2 LD7282	ATE 25190 21,3 - WK / + WK
3.0 CRD V6 4x4	184	07/13→					Ceramic
3.6 V6 4x4	210	11/10→					
↓							

	kw					! #		
JEEP - GRAND CHEROKEE IV (WK, WK2) 06/10→								
 Bremsbelagsatz, Scheibenbremse								
5.7 V8 4x4 6.4 SRT8 4x4	259 344	11/10→ 03/11→	←			13.0460-7282.2	607282	ATE 25190 21,3 - WK / + WK
 Bremsscheibe								
3.0 CRD V6 4x4 3.0 CRD V6 4x4 3.0 CRD V6 4x4 3.6 V6 4x4 3.6 V6 FlexFuel 4x4 5.7 V8 4x4 6.4 SRT8 4x4	140 177 184 210 210 259 344	02/11→ 02/11→ 07/13→ 11/10→ 11/10→ 11/10→ 03/11→	← →	passend für Felgenreöße [Zoll]: 17 passend für Felgenreöße [Zoll]: 17		24.0132-0181.1 24.0114-0120.1	432181 414120	Ø 330 32 30,5 V Ø 330 14 12,5
JEEP - PATRIOT (MK74) 02/07→								
 Bremsbelagsatz, Scheibenbremse								
2.0 2.0 CRD 2.0 CRD 4x4 2.4 2.4 4x4 2.4 Eco + 4x4 2.2 CRD 4x4 2.2 CRD 4x4 2.2 CRD 4x4	115 103 103 125 125 125 100 120 120	01/11→ 02/07→ 02/07→ 06/09→ 01/08→ 07/08→ 01/11→ 01/11→ 01/11→	→ → → → → ← → → →	+ ABS + ABS passend für Felgenreöße [Zoll]: 18; + ABS + ABS passend für Felgenreöße [Zoll]: 18; + ABS passend für Felgenreöße [Zoll]: 18; + ABS		13.0460-5855.2 13.0460-5735.2 13.0460-5735.2 13.0460-5855.2 13.0460-5735.2 13.0460-5855.2	605855 605735 605735 605855 605735 605855	23582 16,0 - WK AKE 23584 16,4 + WK AKE 24014 16,0 + WK AKE 24014 16,0 + WK AKE 24014 16,0 + WK 23582 16,0 - WK
 Bremsscheibe								
2.0 2.0 CRD 2.0 CRD 4x4 2.4 2.4 4x4 2.4 Eco + 4x4 2.2 CRD 4x4 2.2 CRD 4x4	115 103 103 125 125 125 100 120	01/11→ 02/07→ 02/07→ 06/09→ 01/08→ 07/08→ 01/11→ 01/11→	← → → → → ← → →	+ ABS + ABS passend für Felgenreöße [Zoll]: 17; + ABS passend für Felgenreöße [Zoll]: 18; + ABS		24.0126-0170.1 24.0110-0372.1 24.0126-0170.1 24.0110-0363.1 24.0110-0372.1	426170 410372 426170 410363 410372	Ø 294 26 24,4 V Ø 302 10 8,4 Ø 294 26 24,4 V Ø 262 10 8,4 Ø 302 10 8,4
JEEP - RENEGADE Geländewagen geschlossen (BU) 07/14→								
 Bremsscheibe								
1.4 1.4 4x4 1.6 2.0 CRD 4x4 2.0 CRD 4x4 1.6 CRD 2.0 CRD 4x4	103 125 81 103 125 88 88	07/14→ 07/14→ 07/14→ 07/14→ 07/14→ 07/14→ 07/14→	← → → ← → ← →			24.0128-0292.1 24.0112-0170.1 24.0126-0168.1 24.0112-0170.1	428292 412170 426168 412170	Ø 305 28 26 V + S Ø 278 12 10 + S Ø 281 26,2 24,2 V + S Ø 278 12 10 + S
JEEP - WRANGLER I (YJ, SJ_) 08/86→08/96								
 Bremsscheibe								
2.5 4.0	89 131	12/91→08/96 12/91→08/96	←			24.0124-0702.1	424702	Ø 280 24 22,7 V
JEEP - WRANGLER II (TJ) 08/96→12/08								
 Bremsbelagsatz, Scheibenbremse								
2.8 CRD [RWD] 3.8	130 153	04/07→02/10 02/06→12/08	← → ← →	→ 04/07; für Fahrzeuge ohne verstärktes Fahrwerk → 04/07 → 04/07 → 04/07		13.0460-8013.2 13.0460-5629.2 13.0460-8013.2 13.0460-5629.2	608013 605629 608013 605629	BOS 24604 16,5 + WK 24602 16,0 + WK BOS 24604 16,5 + WK 24602 16,0 + WK
 Bremsscheibe								
2.5 2.8 CRD [RWD] 3.8	87 130 153	08/96→04/07 04/07→02/10 02/06→12/08	← →	→ 12/98 → 04/07		24.0124-0702.1 24.0112-0193.1	424702 412193	Ø 280 24 22,7 V Ø 316 12 10,4

	kw			 	! #		
JEEP - WRANGLER III (JK) 04/07→							
 Bremsbelagsatz, Scheibenbremse							
2.8 CRD	130	04/07→	←	für Fahrzeuge ohne verstärktes Fahrwerk	13.0460-8013.2	608013	BOS 24604 16,5 + WK
2.8 CRD	147	11/10→	→		13.0460-5629.2	605629	24602 16,0 + WK
3.6 V6	209	10/11→					
3.8	146	04/07→					
3.8	151	01/10→					
 Bremsscheibe							
2.8 CRD	130	04/07→	→		24.0112-0193.1	412193	Ø 316 12 10,4
2.8 CRD	147	11/10→					
3.6 V6	209	10/11→					
3.8	146	04/07→					
3.8	151	01/10→					
KIA - BESTA Bus 07/92→12/03							
 Bremsbelagsatz, Scheibenbremse							
2.2 D	48	07/92→10/97	←	02/96→	13.0460-5806.2	605806	20002 15,0 + WK
KIA - BESTA Kasten 01/93→12/03							
 Bremsbelagsatz, Scheibenbremse							
2.2 D	48	02/96→12/03	←		13.0460-5806.2	605806	20002 15,0 + WK
2.4 D	51	07/93→12/03	←	11/97→	13.0460-5806.2	605806	20002 15,0 + WK
KIA - BONGO Pritsche/Fahrgestell 10/03→							
 Bremsbelagsatz, Scheibenbremse							
2.4 TDCi	69	10/03→	←	→ 12/10	13.0460-5806.2	605806	20002 15,0 + WK
2.9 TDiC	90	10/03→					
2.9 TDiC 4WD	90	10/03→					
KIA - CARENS I (FC) 06/99→10/02							
 Bremsbelagsatz, Scheibenbremse							
1.8 i	81	11/00→07/02	←	→ 06/02	13.0460-5868.2	605868	SUM 23873 15,8 + WK
			→	→ 06/02; + ABS	13.0460-5871.2	605871	SUM 23455 13,7 + WK
1.8 i 16V	81	03/00→05/02	←	11/00→	13.0460-5868.2	605868	SUM 23873 15,8 + WK
			→	11/00→; + ABS	13.0460-5871.2	605871	SUM 23455 13,7 + WK
 Bremsscheibe							
1.8 i	81	11/00→07/02	←	→ 06/02	24.0124-0173.1	424173	Ø 258 24 22 V
			→	→ 06/02; + ABS	24.0110-0308.1	410308	Ø 261 10 8 + S
1.8 i 16V	81	03/00→05/02	←	11/00→	24.0124-0173.1	424173	Ø 258 24 22 V
			→	11/00→; + ABS	24.0110-0308.1	410308	Ø 261 10 8 + S
KIA - CARENS II (FJ) 07/02→							
 Bremsbelagsatz, Scheibenbremse							
1.6	77	07/02→	←	→ 04/06	13.0460-5742.2	605742	23966 17,7 + WK
1.8	93	07/02→	→	→ 04/06; + ABS	13.0460-5871.2	605871	SUM 23455 13,7 + WK
2.0 CRDi	83	07/02→					
2.0 CRDi	103	11/05→					
2.0 CVVT	102	08/04→					
 Bremsscheibe							
1.6	77	07/02→	←	→ 04/06	24.0126-0143.1	426143	Ø 280 26 24 V + S
1.8	93	07/02→	→	→ 04/06; + ABS	24.0110-0308.1	410308	Ø 261 10 8 + S
2.0 CRDi	83	07/02→					
2.0 CRDi	103	11/05→					
2.0 CVVT	102	08/04→					
KIA - CARENS III (UN) 09/06→							
 Bremsbelagsatz, Scheibenbremse							
1.6 CRDi 110	85	10/10→	←	→ 02/13	13.0460-5600.2	605600	SUM 24501 16,7 + WK
1.6 CRDi 128	94	10/10→	→	→ 02/13	13.0460-5601.2	605601	24491 16,0 + WK
1.6 CVVT	93	10/10→					
1.6 CVVT	97	08/09→					
2.0 CRDi 115	85	05/07→					
2.0 CRDi 135	100	08/09→					
2.0 CRDi 140	103	09/06→					
2.0 CVVT	106	09/06→					
↓							

	kw			 	! #		
KIA - CARENS III (UN) 09/06→							
 Bremsscheibe							
1.6 CRDi 110	85	10/10→	←	→ 02/13		24.0126-0171.1 426171	Ø 280 26 24 V
1.6 CRDi 128	94	10/10→	→	→ 02/13		24.0110-0341.1 410341	Ø 275 10 8,4
1.6 CVVT	93	10/10→					
1.6 CVVT	97	08/09→					
2.0 CRDi 115	85	05/07→					
2.0 CRDi 135	100	08/09→					
2.0 CRDi 140	103	09/06→					
2.0 CVVT	106	09/06→					
KIA - CARENS IV 03/13→							
 Bremsscheibe							
1.6 GDi	99	03/13→	←			24.0128-0256.1 428256	Ø 300 28 26,4 V
1.7 CRDi	85	03/13→	→			24.0110-0392.1 410392	Ø 284 10 8,4
1.7 CRDi	100	03/13→					
1.7 CRDi	104	07/15→					
2.0 GDi	122	03/13→					
2.0 GDi	130	03/13→					
KIA - CARNIVAL / GRAND CARNIVAL III (VQ) 09/05→							
 Bremsbelagsatz, Scheibenbremse							
2.2 CRDi	110	01/10→	←	→ 06/15		13.0460-5799.2 605799	24597 17,7 + WK + Zub
2.2 CRDi	143	01/10→	→			13.0460-5771.2 605771	MAN 24599 14,9 + WK + Zub
2.7 V6	139	06/06→	→			13.0460-5771.2 605771	MAN 24599 14,9 + WK + Zub
2.9 CRDi	136	06/06→	→	→ 06/15		13.0460-5771.2 605771	MAN 24599 14,9 + WK + Zub
2.9 CRDi LX	141	09/06→					
3.8	195	09/05→	←	→ 10/06		13.0460-5725.2 605725	23649 17,2 + WK
 Bremsscheibe							
2.2 CRDi	110	01/10→	←	→ 06/15		24.0128-0220.1 428220	Ø 300 28 26 V
2.2 CRDi	143	01/10→	→			24.0112-0185.1 412185	Ø 324 11,9 10,4
2.7 V6	139	06/06→	→			24.0112-0185.1 412185	Ø 324 11,9 10,4
2.9 CRDi	136	06/06→	→	→ 06/15		24.0112-0185.1 412185	Ø 324 11,9 10,4
2.9 CRDi LX	141	09/06→					
3.8	195	09/05→	←	→ 10/06		24.0128-0211.1 428211	Ø 274 28,3 26 V
KIA - CARNIVAL I (UP) 06/98→10/01							
 Bremsbelagsatz, Scheibenbremse							
2.5 i	132	10/00→10/01	←			13.0460-5897.2 605897	21822 17,5 + WK
2.5 V6	121	08/99→10/01	←			13.0460-5897.2 605897	21822 17,5 + WK
2.9 TD	93	08/99→10/01	←	→ 09/01		13.0460-5897.2 605897	21822 17,5 + WK
Zubehörsatz, Scheibenbremsbelag							
2.5 i	132	10/00→10/01	←			13.0460-0107.2 610107	
2.5 V6	121	08/99→10/01	←			13.0460-0107.2 610107	
2.9 TD	93	08/99→10/01	←	→ 09/01		13.0460-0107.2 610107	
 Bremsscheibe							
2.5 i	132	10/00→10/01	←			24.0124-0195.1 424195	Ø 274 24,1 22 V
2.5 V6	121	08/99→10/01	←			24.0124-0195.1 424195	Ø 274 24,1 22 V
2.9 TD	93	08/99→10/01	←	→ 09/01		24.0124-0195.1 424195	Ø 274 24,1 22 V
KIA - CARNIVAL II (GQ) 01/99→09/07							
 Bremsbelagsatz, Scheibenbremse							
2.4	109	12/01→10/06	←	→ 08/06		13.0460-5725.2 605725	23649 17,2 + WK
2.7	124	07/04→10/06	←			13.0460-5725.2 605725	23649 17,2 + WK
2.5 V6	110	10/01→06/06	←			13.0460-5725.2 605725	23649 17,2 + WK
2.5 V6	132	10/01→06/06	←				
2.9 CRDi	106	10/01→06/06	←				
3.5	143	07/02→04/06	←				
2.9 TD	93	01/99→09/07	←	10/01→ 08/06		13.0460-5725.2 605725	23649 17,2 + WK
 Bremsscheibe							
2.4	109	12/01→10/06	←	→ 11/03		24.0126-0135.1 426135	Ø 274 26,2 24 V
			←	12/03→ 08/06		24.0128-0211.1 428211	Ø 274 28,3 26 V
2.5 V6	110	10/01→06/06	←	→ 11/03		24.0126-0135.1 426135	Ø 274 26,2 24 V
2.5 V6	132	10/01→06/06	←	12/03→		24.0128-0211.1 428211	Ø 274 28,3 26 V
2.9 CRDi	106	10/01→06/06	←				
3.5	143	07/02→04/06	←				
↓							

	kw			 	! #		
KIA - CARNIVAL II (GQ) 01/99→09/07							
 Bremsscheibe							
2.7	124	07/04→10/06	←	→ 08/06		24.0128-0211.1 428211	Ø 274 28,3 26 V
2.9 TD	93	01/99→09/07	←	10/01→ 11/03		24.0126-0135.1 426135	Ø 274 26,2 24 V
			←	12/03→ 08/06		24.0128-0211.1 428211	Ø 274 28,3 26 V
KIA - CEE`D Sportswagon (JD) 09/12→							
 Bremsbelagsatz, Scheibenbremse							
1.0 T-GDI	74	07/15→	←	15"		13.0460-5645.2 605645	25692 17,2 + WK + Zub
1.0 T-GDI	88	07/15→	←	16"		24.0128-0234.1 428234	Ø 300 28 26,4 V
1.4 MPI	74	04/15→	→	- eFSB		13.0460-2794.2 602794	TRW 25780 15,0 + WK + Zub
1.6 CRDi 136	100	07/15→	→	+ eFSB		24.0110-0379.1 410379	Ø 262 10 8,4
1.6 CVVT	95	11/14→	→	+ eFSB		24.0110-0383.1 410383	Ø 284 10 8,4
1.4 CRDi 90	66	09/12→	←	05/13→; 15"		13.0460-5645.2 605645	25692 17,2 + WK + Zub
1.4 CVVT	73	09/12→	←	→ 04/13; 15"		13.0460-5645.2 605645	25692 17,2 + WK + Zub
1.6 CRDi 110	81	03/13→	→	- eFSB		24.0110-0379.1 410379	Ø 262 10 8,4
1.6 CRDi 128	94	09/12→	→	+ eFSB		24.0110-0383.1 410383	Ø 284 10 8,4
1.6 GDI	99	09/12→	→	- eFSB		13.0460-2794.2 602794	TRW 25780 15,0 + WK + Zub
 Bremsscheibe							
1.0 T-GDI	74	07/15→	←	15"		24.0123-0123.1 423123	Ø 280 23,1 21 V
1.0 T-GDI	88	07/15→	←	16"		24.0128-0234.1 428234	Ø 300 28 26,4 V
1.4 MPI	74	04/15→	→	- eFSB		24.0110-0379.1 410379	Ø 262 10 8,4
1.6 CRDi 136	100	07/15→	→	+ eFSB		24.0110-0383.1 410383	Ø 284 10 8,4
1.4 CRDi 90	66	09/12→	←	16"		24.0128-0234.1 428234	Ø 300 28 26,4 V
1.4 CVVT	73	09/12→	←	16"		24.0128-0234.1 428234	Ø 300 28 26,4 V
1.6 CRDi 110	81	03/13→	→	- eFSB		24.0110-0379.1 410379	Ø 262 10 8,4
1.6 CRDi 128	94	09/12→	→	+ eFSB		24.0110-0383.1 410383	Ø 284 10 8,4
1.6 CVVT	95	11/14→	←	06/15→; + RUS; 15"		24.0123-0123.1 423123	Ø 280 23,1 21 V
			←	16"		24.0128-0234.1 428234	Ø 300 28 26,4 V
			←	06/15→; + RUS; 16"		24.0128-0234.1 428234	Ø 300 28 26,4 V
			←	17"		24.0128-0258.1 428258	Ø 320 28,1 26,4 V
			→	- eFSB		24.0110-0379.1 410379	Ø 262 10 8,4
			→	+ eFSB		24.0110-0383.1 410383	Ø 284 10 8,4
1.6 GDI	99	09/12→	←	16"		24.0128-0234.1 428234	Ø 300 28 26,4 V
			←	17"		24.0128-0258.1 428258	Ø 320 28,1 26,4 V
			→	- eFSB		24.0110-0379.1 410379	Ø 262 10 8,4
			→	+ eFSB		24.0110-0383.1 410383	Ø 284 10 8,4
KIA - CEE`D (JD) 05/12→							
 Bremsbelagsatz, Scheibenbremse							
1.0 T-GDI	74	07/15→	←	15"		13.0460-5645.2 605645	25692 17,2 + WK + Zub
1.0 T-GDI	88	07/15→	←	16"		24.0128-0234.1 428234	Ø 300 28 26,4 V
1.4 MPI	74	04/15→	→	- eFSB		13.0460-2794.2 602794	TRW 25780 15,0 + WK + Zub
1.6 CRDi 136	100	07/15→	→	+ eFSB		24.0110-0379.1 410379	Ø 262 10 8,4
1.6 CVVT	95	01/13→	→	+ eFSB		24.0110-0383.1 410383	Ø 284 10 8,4
1.6 CVVT	96	11/14→	→	+ eFSB		24.0110-0383.1 410383	Ø 284 10 8,4
1.4 CRDi 90	66	05/12→	←	→ 04/13; 15"		13.0460-5645.2 605645	25692 17,2 + WK + Zub
1.4 CVVT	66	05/12→	←	05/13→; 15"		13.0460-5645.2 605645	25692 17,2 + WK + Zub
1.4 CVVT	73	05/12→	←	05/13→; 15"		13.0460-5645.2 605645	25692 17,2 + WK + Zub
1.6 CRDi 110	81	05/12→	→	- eFSB		13.0460-2794.2 602794	TRW 25780 15,0 + WK + Zub
1.6 CRDi 115	85	05/12→	→	- eFSB		13.0460-2794.2 602794	TRW 25780 15,0 + WK + Zub
1.6 CRDi 128	94	05/12→	→	- eFSB		13.0460-2794.2 602794	TRW 25780 15,0 + WK + Zub
1.6 CVVT	92	05/12→	→	- eFSB		13.0460-2794.2 602794	TRW 25780 15,0 + WK + Zub
1.6 GDI	99	05/12→	→	- eFSB		13.0460-2794.2 602794	TRW 25780 15,0 + WK + Zub
1.6 CRDi 90	66	05/12→	←	→ 04/13; 15"		13.0460-5645.2 605645	25692 17,2 + WK + Zub
			←	15"		13.0460-5645.2 605645	25692 17,2 + WK + Zub
			→	- eFSB		13.0460-2794.2 602794	TRW 25780 15,0 + WK + Zub
1.6 GT	150	06/13→	←	07/13→; 15"		13.0460-5645.2 605645	25692 17,2 + WK + Zub
			→	07/13→; - eFSB		13.0460-2794.2 602794	TRW 25780 15,0 + WK + Zub
 Bremsscheibe							
1.0 T-GDI	74	07/15→	←	15"		24.0123-0123.1 423123	Ø 280 23,1 21 V
1.0 T-GDI	88	07/15→	←	16"		24.0128-0234.1 428234	Ø 300 28 26,4 V
1.4 MPI	74	04/15→	→	- eFSB		24.0110-0379.1 410379	Ø 262 10 8,4
1.6 CRDi 136	100	07/15→	→	+ eFSB		24.0110-0383.1 410383	Ø 284 10 8,4
↓							

	kw			 	! #		
KIA - CEE'D (JD) 05/12→							
Bremsscheibe							
1.4 CRDi 90	66	05/12→	←	16"		24.0128-0234.1 428234	Ø 300 28 26,4 V
1.4 CVVT	66	05/12→	→	- eFSB		24.0110-0379.1 410379	Ø 262 10 8,4
1.4 CVVT	73	05/12→	→	+ eFSB			
1.6 CRDi 110	81	05/12→				24.0110-0383.1 410383	Ø 284 10 8,4
1.6 CRDi 115	85	05/12→					
1.6 CRDi 128	94	05/12→					
1.6 CRDi 90	66	05/12→					
1.6 CVVT	92	05/12→					
1.6 CVVT	95	01/13→	←	06/15→; + RUS; 15"		24.0123-0123.1 423123	Ø 280 23,1 21 V
			←	16"		24.0128-0234.1 428234	Ø 300 28 26,4 V
			←	06/15→; + RUS; 16"		24.0128-0234.1 428234	Ø 300 28 26,4 V
			←	01/14→; 17"		24.0128-0258.1 428258	Ø 320 28,1 26,4 V
			←	17"		24.0128-0258.1 428258	Ø 320 28,1 26,4 V
			→	- eFSB		24.0110-0379.1 410379	Ø 262 10 8,4
			→	+ eFSB		24.0110-0383.1 410383	Ø 284 10 8,4
1.6 CVVT	96	11/14→	←	06/15→; + RUS; 15"		24.0123-0123.1 423123	Ø 280 23,1 21 V
			←	16"		24.0128-0234.1 428234	Ø 300 28 26,4 V
			←	06/15→; + RUS; 16"		24.0128-0234.1 428234	Ø 300 28 26,4 V
			←	17"		24.0128-0258.1 428258	Ø 320 28,1 26,4 V
			→	- eFSB		24.0110-0379.1 410379	Ø 262 10 8,4
			→	+ eFSB		24.0110-0383.1 410383	Ø 284 10 8,4
1.6 GDI	99	05/12→	←	16"		24.0128-0234.1 428234	Ø 300 28 26,4 V
			←	17"		24.0128-0258.1 428258	Ø 320 28,1 26,4 V
			→	- eFSB		24.0110-0379.1 410379	Ø 262 10 8,4
			→	+ eFSB		24.0110-0383.1 410383	Ø 284 10 8,4
1.6 GT	150	06/13→	←	07/13→; 16"		24.0128-0234.1 428234	Ø 300 28 26,4 V
			←	07/13→; 17"		24.0128-0258.1 428258	Ø 320 28,1 26,4 V
			→	07/13→; - eFSB		24.0110-0379.1 410379	Ø 262 10 8,4
			→	07/13→; + eFSB		24.0110-0383.1 410383	Ø 284 10 8,4















KIA - CEE'D Schrägheck (ED) 12/06→12/12

















Bremsbelagsatz, Scheibenbremse















1.4	77	12/06→12/12	←	→ 09/12		13.0460-5742.2 605742	23966 17,7 + WK
1.4	80	12/06→12/12	→	→ 09/12		13.0460-5780.2 605780	24320 15,3 + WK + Zub
1.4 CVVT	66	06/10→12/12					
1.6	85	09/07→12/12					
1.6	90	12/06→12/12					
1.6	93	02/08→12/12					
1.6 CRDi 115	85	12/06→12/12					
1.6 CRDi 128	94	10/10→12/12					
1.6 CRDi 90	66	12/06→12/12					
1.6 CVVT	92	10/10→12/12					
2.0	105	12/06→12/12					
2.0 CRDi 140	103	09/07→12/12					
2.0 CRDi	100	06/07→12/12	←	09/07→ 09/12		13.0460-5742.2 605742	23966 17,7 + WK
			→	09/07→ 09/12		13.0460-5780.2 605780	24320 15,3 + WK + Zub













Bremsscheibe













1.4	77	12/06→12/12	←	→ 09/12		24.0126-0150.1 426150	Ø 280 26 24,4 V
1.4	80	12/06→12/12	→	→ 09/12		24.0110-0332.1 410332	Ø 262 10 8
1.4 CVVT	66	06/10→12/12					
1.6	85	09/07→12/12					
1.6	90	12/06→12/12					
1.6	93	02/08→12/12					
1.6 CRDi 115	85	12/06→12/12					
1.6 CRDi 128	94	10/10→12/12					
1.6 CRDi 90	66	12/06→12/12					
1.6 CVVT	92	10/10→12/12					
2.0	105	12/06→12/12					
2.0 CRDi 140	103	09/07→12/12					
2.0 CRDi	100	06/07→12/12	←	09/07→ 09/12		24.0126-0150.1 426150	Ø 280 26 24,4 V
			→	09/07→ 09/12		24.0110-0332.1 410332	Ø 262 10 8

















	kw			 	! #		
KIA - CEE'D SW (ED) 09/07→12/12							
 Bremsbelagsatz, Scheibenbremse							
1.4	77	10/10→12/12	←			13.0460-5742.2 605742	23966 17,7 + WK
1.4	80	09/07→12/12	→			13.0460-5780.2 605780	24320 15,3 + WK + Zub
1.6	85	09/07→11/12					
1.6	90	09/07→12/12					
1.6	93	09/07→12/12					
1.6 CRDi 115	85	09/07→12/12					
1.6 CRDi 128	94	10/10→12/12					
1.6 CRDi 90	66	09/07→12/12					
1.6 CVVT	92	06/09→12/12					
2.0	105	09/07→12/12					
2.0 CRDi 140	103	09/07→12/12					
1.4 CVVT	66	07/09→12/12	←	10/10→		13.0460-5742.2 605742	23966 17,7 + WK
			→	10/10→		13.0460-5780.2 605780	24320 15,3 + WK + Zub
1.6 LPG	91	01/08→09/12	←	→ 12/11		13.0460-5742.2 605742	23966 17,7 + WK
			→	→ 12/11		13.0460-5780.2 605780	24320 15,3 + WK + Zub
 Bremsscheibe							
1.4	77	10/10→12/12	←			24.0126-0150.1 426150	Ø 280 26 24,4 V
1.4	80	09/07→12/12	→			24.0110-0332.1 410332	Ø 262 10 8
1.6	85	09/07→11/12					
1.6	90	09/07→12/12					
1.6	93	09/07→12/12					
1.6 CRDi 115	85	09/07→12/12					
1.6 CRDi 128	94	10/10→12/12					
1.6 CRDi 90	66	09/07→12/12					
1.6 CVVT	92	06/09→12/12					
2.0	105	09/07→12/12					
2.0 CRDi 140	103	09/07→12/12					
1.4 CVVT	66	07/09→12/12	←	10/10→		24.0126-0150.1 426150	Ø 280 26 24,4 V
			→	10/10→		24.0110-0332.1 410332	Ø 262 10 8
1.6 LPG	91	01/08→09/12	←	→ 12/11		24.0126-0150.1 426150	Ø 280 26 24,4 V
			→	→ 12/11		24.0110-0332.1 410332	Ø 262 10 8
KIA - CERATO (LD) 03/04→							
 Bremsbelagsatz, Scheibenbremse							
1.5 CRDi	75	07/05→	←	→ 06/09		13.0460-5791.2 605791	24218 17,5 + WK + Zub
1.6	77	07/04→	→	→ 06/09		13.0460-5874.2 605874	SUM 21553 14,0 + WK + Zub
1.6	90	05/06→					
1.6 CRDi	85	06/05→					
2.0	105	04/04→					
2.0 CRDi	83	04/04→					
 Bremsscheibe							
1.5 CRDi	75	07/05→	←	→ 06/09		24.0126-0155.1 426155	Ø 275 26 24 V + S
1.6	77	07/04→	→	→ 06/09		24.0110-0334.1 410334	Ø 258 10 8
1.6	90	05/06→					
1.6 CRDi	85	06/05→					
2.0	105	04/04→					
2.0 CRDi	83	04/04→					
KIA - CERATO II (TD) 01/09→							
 Bremsbelagsatz, Scheibenbremse							
1.6	91	02/09→	←	01/10→ 08/10		13.0460-5742.2 605742	23966 17,7 + WK
2.0	115	01/09→	←	03/10→ 08/10		13.0460-5742.2 605742	23966 17,7 + WK
 Bremsscheibe							
1.6	91	02/09→	→	01/10→; + ESP		24.0110-0362.1 410362	Ø 262 10 8,4
2.0	115	01/09→	→	03/10→; + ESP		24.0110-0362.1 410362	Ø 262 10 8,4
KIA - CERATO II Stufenheck (TD) 01/09→							
 Bremsbelagsatz, Scheibenbremse							
1.6	90	01/10→	←	→ 08/10		13.0460-5742.2 605742	23966 17,7 + WK
1.6	93	01/10→				13.0460-5742.2 605742	23966 17,7 + WK
1.6 CVVT	91	02/09→	←	01/10→ 08/10			
2.0	115	01/09→	←	03/10→ 08/10			
 Bremsscheibe							
1.6	90	01/10→	→	+ ESP		24.0110-0362.1 410362	Ø 262 10 8,4
1.6	93	01/10→					
↓							













	kW					! #		
KIA - CERATO II Stufenheck (TD) 01/09→								
 Bremsscheibe								
1.6 CVVT	91	02/09→	➔	01/10→; + ESP		24.0110-0362.1	410362	Ø 262 10 8,4
2.0	115	01/09→	➔	03/10→; + ESP		24.0110-0362.1	410362	Ø 262 10 8,4
KIA - CERATO KOUP 12/13→								
 Bremsbelagsatz, Scheibenbremse								
2.0 MPI	110	12/13→	➔	- ABS		13.0460-5742.2	605742	23966 17,7 + WK
 Bremsscheibe								
2.0 MPI	110	12/13→	➔			24.0110-0362.1	410362	Ø 262 10 8,4
KIA - CERATO KOUP (TD) 01/09→								
 Bremsbelagsatz, Scheibenbremse								
1.6 CVVT	91	10/09→	➔	01/10→; - ABS		13.0460-5742.2	605742	23966 17,7 + WK
1.6 CVVT	93	01/10→06/13	➔	- ABS		13.0460-5742.2	605742	23966 17,7 + WK
2.0	115	01/09→	➔					
 Bremsscheibe								
1.6 CVVT	91	10/09→	➔	01/10→; + ABS		24.0110-0362.1	410362	Ø 262 10 8,4
1.6 CVVT	93	01/10→06/13	➔	+ ABS		24.0110-0362.1	410362	Ø 262 10 8,4
2.0	115	01/09→	➔					
1.6 CVVT	150	09/13→	➔			24.0110-0368.1	410368	Ø 262 10 8,4
KIA - CERATO Stufenheck 01/01→12/04								
 Bremsbelagsatz, Scheibenbremse								
1.8	85	10/01→07/04	➔			13.0460-5868.2	605868	SUM 23873 15,8 + WK
			➔	Brems-/Fahrdyn. Artikelbezug; + ABS		13.0460-5871.2	605871	SUM 23455 13,7 + WK
 Bremsscheibe								
1.8	85	10/01→07/04	➔			24.0124-0185.1	424185	Ø 258 24 22 V
			➔	Brems-/Fahrdyn. Artikelbezug; + ABS		24.0110-0301.1	410301	Ø 261 10 8
KIA - CERATO Stufenheck 09/12→								
 Bremsscheibe								
1.6 MPI	96	06/13→	➔	+ ESP		24.0110-0362.1	410362	Ø 262 10 8,4
2.0 MPI	110	06/13→	➔					
KIA - CERATO Stufenheck (LD) 04/04→12/09								
 Bremsbelagsatz, Scheibenbremse								
1.5 CRDi	66	07/05→12/09	➔	→ 08/06		13.0460-5791.2	605791	24218 17,5 + WK + Zub
			➔	→ 08/06		13.0460-5874.2	605874	SUM 21553 14,0 + WK + Zub
1.5 CRDi	75	07/05→	➔	→ 06/09		13.0460-5791.2	605791	24218 17,5 + WK + Zub
1.6	77	04/04→	➔					
1.6	90	05/06→	➔	→ 06/09		13.0460-5874.2	605874	SUM 21553 14,0 + WK + Zub
1.6 CRDi	85	06/05→	➔					
2.0	105	04/04→	➔					
2.0 CRDi	83	04/04→	➔					
1.6	75	04/04→12/09	➔			13.0460-5868.2	605868	SUM 23873 15,8 + WK
			➔	+ ABS		13.0460-5871.2	605871	SUM 23455 13,7 + WK
 Bremsscheibe								
1.5 CRDi	66	07/05→12/09	➔	→ 08/06		24.0126-0155.1	426155	Ø 275 26 24 V + S
			➔	→ 08/06		24.0110-0334.1	410334	Ø 258 10 8
1.5 CRDi	75	07/05→	➔	→ 06/09		24.0126-0155.1	426155	Ø 275 26 24 V + S
1.6	77	04/04→	➔					
1.6	90	05/06→	➔	→ 06/09		24.0110-0334.1	410334	Ø 258 10 8
1.6 CRDi	85	06/05→	➔					
2.0	105	04/04→	➔					
2.0 CRDi	83	04/04→	➔					
1.6	75	04/04→12/09	➔			24.0124-0185.1	424185	Ø 258 24 22 V
			➔	+ ABS		24.0110-0301.1	410301	Ø 261 10 8

















	kW			 	! #		
KIA - CLARUS (K9A) 07/96→11/01							
 Bremsbelagsatz, Scheibenbremse							
1.8 i 16V	85	07/96→08/01	←			13.0460-5712.2 605712	ATE 23450 17,5 + WK
						13.0460-5868.2 605868	SUM 23873 15,8 + WK
2.0 i 16V	98	07/96→11/01	←	→ 08/01		13.0460-5712.2 605712	ATE 23450 17,5 + WK
			→	→ 08/01; + ABS		13.0460-5868.2 605868	SUM 23873 15,8 + WK
			→	→ 08/01; + ABS		13.0460-5871.2 605871	SUM 23455 13,7 + WK
Zubehörsatz, Scheibenbremsbelag							
2.0 i 16V	98	07/96→11/01	→	→ 08/01; + ABS		13.0460-0296.2 610296	SUM
 Bremsscheibe							
1.8 i 16V	85	07/96→08/01	←			24.0124-0173.1 424173	Ø 258 24 22 V
2.0 i 16V	98	07/96→11/01	←	→ 08/01		24.0124-0173.1 424173	Ø 258 24 22 V
			→	→ 08/01; + ABS		24.0110-0308.1 410308	Ø 261 10 8 + S
KIA - CLARUS Kombi (GC) 05/98→							
 Bremsbelagsatz, Scheibenbremse							
1.8 i 16V	85	05/98→	←	→ 08/01		13.0460-5712.2 605712	ATE 23450 17,5 + WK
						13.0460-5868.2 605868	SUM 23873 15,8 + WK
2.0 i 16V	98	05/98→	←	→ 08/01		13.0460-5712.2 605712	ATE 23450 17,5 + WK
			→	→ 08/01; + ABS		13.0460-5868.2 605868	SUM 23873 15,8 + WK
			→	→ 08/01; + ABS		13.0460-5871.2 605871	SUM 23455 13,7 + WK
Zubehörsatz, Scheibenbremsbelag							
2.0 i 16V	98	05/98→	→	→ 08/01; + ABS		13.0460-0296.2 610296	SUM
 Bremsscheibe							
1.8 i 16V	85	05/98→	←	→ 08/01		24.0124-0173.1 424173	Ø 258 24 22 V
2.0 i 16V	98	05/98→	←	→ 08/01		24.0124-0173.1 424173	Ø 258 24 22 V
			→	→ 08/01; + ABS		24.0110-0308.1 410308	Ø 261 10 8 + S
KIA - JOICE 02/00→							
 Bremsbelagsatz, Scheibenbremse							
2.0	88	09/01→	←	→ 08/03		13.0460-5933.2 605933	AKE 21725 16,8 + WK
2.0	102	02/00→					
 Bremsscheibe							
2.0 2.0	88 102	09/01→ 02/00→	←	→ 08/03; - ABS		24.0124-0136.1 424136	Ø 256 24 21,5 V
			←	→ 08/03; + ABS		24.0124-0146.1 424146	Ø 256 24 22,4 V
			→	→ 08/03; + ABS		24.0118-0141.1 418141	Ø 266 18 16,4 V
KIA - MAGENTIS (GD, MS) 05/01→							
 Bremsbelagsatz, Scheibenbremse							
2.0	100	05/01→09/05	←			13.0460-5873.2 605873	MAN 23891 16,9 + WK
			→	+ ABS		13.0460-5833.2 605833	AKE 23543 14,4 + WK + Zub
2.5 V6	124	05/01→	←	→ 10/05		13.0460-5873.2 605873	MAN 23891 16,9 + WK
			→	→ 10/05; + ABS		13.0460-5833.2 605833	AKE 23543 14,4 + WK + Zub
2.7 V6	132	04/04→	←	11/05→ 12/10		13.0460-5873.2 605873	MAN 23891 16,9 + WK
			→	11/05→ 12/10		13.0460-5833.2 605833	AKE 23543 14,4 + WK + Zub
Zubehörsatz, Scheibenbremsbelag							
2.0	100	05/01→09/05	←			13.0460-0139.2 610139	MAN
2.5 V6	124	05/01→	←	→ 10/05		13.0460-0139.2 610139	MAN
2.7 V6	132	04/04→	←	11/05→ 12/10		13.0460-0139.2 610139	MAN
 Bremsscheibe							
2.0	100	05/01→09/05	←	→ 08/02		24.0125-0177.1 425177	Ø 257 24,5 22,4 V
			←	09/02→		24.0126-0129.1 426129	Ø 280 26 24,4 V
			→	+ ABS		24.0110-0317.1 410317	Ø 262 10 8,4
2.5 V6	124	05/01→	←	→ 08/02		24.0125-0177.1 425177	Ø 257 24,5 22,4 V
↓							















	kw				! #		
KIA - MAGENTIS (GD, MS) 05/01→							
 Bremsscheibe							
2.5 V6	124	05/01→	←	09/02→ 10/05		24.0126-0129.1 426129	Ø 280 26 24,4 V
			→	→ 10/05; + ABS		24.0110-0317.1 410317	Ø 262 10 8,4
2.7 V6	132	04/04→	←	11/05→ 12/10		24.0126-0128.1 426128	Ø 280 26 24,4 V
			→	11/05→ 12/10		24.0110-0318.1 410318	Ø 262 10 8,4
KIA - MAGENTIS (MG) 10/05→							
 Bremsbelagsatz, Scheibenbremse							
2.0	106	11/05→	←	→ 12/10		13.0460-5873.2 605873	MAN 23891 16,9 + WK
2.0	121	07/09→	→	→ 12/10		13.0460-5833.2 605833	AKE 23543 14,4 + WK + Zub
2.0 CRDi	103	04/06→					
2.0 CRDi	110	04/06→					
2.7	138	11/05→					
2.7 V6	142	07/09→					
2.0 CRDi	100	11/05→12/08	←			13.0460-5873.2 605873	MAN 23891 16,9 + WK
			→			13.0460-5833.2 605833	AKE 23543 14,4 + WK + Zub
2.4	119	08/06→12/09	←	07/09→		13.0460-5873.2 605873	MAN 23891 16,9 + WK
			→	07/09→		13.0460-5833.2 605833	AKE 23543 14,4 + WK + Zub
Zubehörsatz, Scheibenbremsbelag							
2.0	106	11/05→	←	→ 12/10		13.0460-0139.2 610139	MAN
2.0	121	07/09→					
2.0 CRDi	103	04/06→					
2.0 CRDi	110	04/06→					
2.7	138	11/05→					
2.7 V6	142	07/09→					
2.0 CRDi	100	11/05→12/08	←			13.0460-0139.2 610139	MAN
2.4	119	08/06→12/09	←	07/09→		13.0460-0139.2 610139	MAN
 Bremsscheibe							
2.0	106	11/05→	←	→ 12/10		24.0126-0128.1 426128	Ø 280 26 24,4 V
2.0	121	07/09→	→	→ 12/10		24.0110-0318.1 410318	Ø 262 10 8,4
2.0 CRDi	103	04/06→					
2.0 CRDi	110	04/06→					
2.7	138	11/05→					
2.7 V6	142	07/09→					
2.0 CRDi	100	11/05→12/08	←			24.0126-0128.1 426128	Ø 280 26 24,4 V
			→			24.0110-0318.1 410318	Ø 262 10 8,4
2.4	119	08/06→12/09	←	07/09→		24.0126-0128.1 426128	Ø 280 26 24,4 V
			→	07/09→		24.0110-0318.1 410318	Ø 262 10 8,4
KIA - OPIRUS (GH) 09/03→							
 Bremsscheibe							
2.7	139	10/06→	→	→ 08/07		24.0110-0336.1 410336	Ø 284 10 8,4
3.3	173	10/06→					
3.8 V6	196	10/06→	→	09/07→ 05/10		24.0110-0336.1 410336	Ø 284 10 8,4
KIA - OPTIMA 09/15→							
 Bremsscheibe							
1.7 CRDi	104	11/15→	←	passend für Felgenreöße [Zoll]: 16 / 17		24.0128-0256.1 428256	Ø 300 28 26,4 V
2.0 CVVL	120	09/15→	←	passend für Felgenreöße [Zoll]: 18		24.0128-0258.1 428258	Ø 320 28,1 26,4 V
2.4 GDI	138	09/15→	→	passend für Felgenreöße [Zoll]: 16 / 17		24.0110-0400.1 410400	Ø 284 10 8,4
2.0 GDI Hybrid	115	09/16→	←	passend für Felgenreöße [Zoll]: 16 / 17		24.0128-0256.1 428256	Ø 300 28 26,4 V
2.0 GDI Hybrid	151	09/16→	→			24.0110-0400.1 410400	Ø 284 10 8,4
KIA - OPTIMA 01/10→							
 Bremsbelagsatz, Scheibenbremse							
1.7 CRDi	100	03/12→	→	→ 12/15; - eFSB		13.0460-5786.2 605786	AKE 24934 15,0 + WK + Zub
2.0	125	03/12→				13.0470-5786.2 LD5786	AKE 24934 15,0 + WK + Zub Ceramic
2.0 CVVL	121	03/12→					
2.0 CVVT Hybrid	110	03/12→					
2.0 CVVT Hybrid	140	12/12→					
2.4	132	03/12→					
2.0	204	09/10→	→	03/12→ 12/15; - eFSB		13.0460-5786.2 605786	AKE 24934 15,0 + WK + Zub
2.4	149	09/10→				13.0470-5786.2 LD5786	AKE 24934 15,0 + WK + Zub Ceramic
2.4	129	06/10→12/15	→	- eFSB		13.0460-5786.2 605786	AKE 24934 15,0 + WK + Zub

















	kw				! #		
KIA - OPTIMA 01/10→							
 Bremssattel, Scheibenbremse							
2.4	129	06/10→12/15	➡	- eFSB		13.0470-5786.2 LD5786	AKE 24934 15,0 + WK + Zub Ceramic
 Bremsscheibe							
1.7 CRDi 2.0 2.0 CVVL 2.4	100 125 121 132	03/12→ 03/12→ 03/12→ 03/12→	← ← ➡ ➡	→ 12/15; Stahlfelge → 12/15; Leichtmetallfelge → 12/15; - eFSB → 12/15; + eFSB		24.0128-0256.1 428256 24.0128-0258.1 428258 24.0110-0388.1 410388 24.0110-0400.1 410400	∅ 300 28 26,4 V ∅ 320 28,1 26,4 V ∅ 284 10 8,4 ∅ 284 10 8,4
2.0 2.4	204 149	09/10→ 09/10→	← ← ➡ ➡	03/12→ 12/15; Stahlfelge 03/12→ 12/15; Leichtmetallfelge 03/12→ 12/15; - eFSB 03/12→ 12/15; + eFSB		24.0128-0256.1 428256 24.0128-0258.1 428258 24.0110-0388.1 410388 24.0110-0400.1 410400	∅ 300 28 26,4 V ∅ 320 28,1 26,4 V ∅ 284 10 8,4 ∅ 284 10 8,4
2.0 CVVT Hybrid 2.0 CVVT Hybrid	110 140	03/12→ 12/12→	← ➡ ➡	→ 12/15; Stahlfelge → 12/15; - eFSB → 12/15; + eFSB		24.0128-0256.1 428256 24.0110-0388.1 410388 24.0110-0400.1 410400	∅ 300 28 26,4 V ∅ 284 10 8,4 ∅ 284 10 8,4
2.4	129	06/10→12/15	← ← ➡ ➡	Stahlfelge Leichtmetallfelge - eFSB + eFSB		24.0128-0256.1 428256 24.0128-0258.1 428258 24.0110-0388.1 410388 24.0110-0400.1 410400	∅ 300 28 26,4 V ∅ 320 28,1 26,4 V ∅ 284 10 8,4 ∅ 284 10 8,4
KIA - OPTIMA Sportswagon 09/16→							
 Bremsscheibe							
1.7 CRDi 2.0 CVVL	104 120	09/16→ 09/16→	← ← ➡	passend für Felgengröße [Zoll]: 16 / 17 passend für Felgengröße [Zoll]: 18 passend für Felgengröße [Zoll]: 16 / 17		24.0128-0256.1 428256 24.0128-0258.1 428258 24.0110-0400.1 410400	∅ 300 28 26,4 V ∅ 320 28,1 26,4 V ∅ 284 10 8,4
KIA - PICANTO (BA) 04/04→							
 Bremssattel, Scheibenbremse							
1.0	45	04/04→	← ➡	05/04→ 04/11 05/04→ 04/11; + ABS		13.0460-5776.2 605776 13.0460-5775.2 605775	AKE 24275 16,5 + WK + Zub 24276 14,8 + WK + Zub
1.0	46	09/07→	← ➡	11/09→ 04/11 11/09→ 04/11; + ABS		13.0460-5776.2 605776 13.0460-5775.2 605775	AKE 24275 16,5 + WK + Zub 24276 14,8 + WK + Zub
1.0	53	04/04→04/11	← ➡	 + ABS		13.0460-5776.2 605776 13.0460-5775.2 605775	AKE 24275 16,5 + WK + Zub 24276 14,8 + WK + Zub
1.1 1.1 CRDi	48 55	04/04→ 11/05→	← ➡	→ 04/11 → 04/11; + ABS		13.0460-5776.2 605776 13.0460-5775.2 605775	AKE 24275 16,5 + WK + Zub 24276 14,8 + WK + Zub
 Bremsscheibe							
1.0	45	04/04→	← ➡	05/04→ 04/11 05/04→ 04/11; + ABS		24.0118-0145.1 418145 24.0110-0324.1 410324	∅ 241 18 16 V ∅ 234 10 8
1.0	46	09/07→	← ➡	11/09→ 04/11 11/09→ 04/11; + ABS		24.0118-0145.1 418145 24.0110-0324.1 410324	∅ 241 18 16 V ∅ 234 10 8
1.0	53	04/04→04/11	← ➡	 + ABS		24.0118-0145.1 418145 24.0110-0324.1 410324	∅ 241 18 16 V ∅ 234 10 8
1.1	48	04/04→	← ➡	→ 04/11 → 04/11; + ABS		24.0118-0145.1 418145 24.0110-0324.1 410324	∅ 241 18 16 V ∅ 234 10 8
1.1 CRDi	55	11/05→	← ➡	→ 04/11 → 04/11; + ABS		24.0118-0144.1 418144 24.0110-0324.1 410324	∅ 252 18 16 V ∅ 234 10 8
KIA - PICANTO (JA) 03/17→							
 Bremsscheibe							
1.0 1.2	49 62	03/17→ 03/17→	➡			24.0110-0324.1 410324	∅ 234 10 8















	kw					! #		
KIA - PICANTO (TA) 05/11→								
 Bremsbelagsatz, Scheibenbremse								
1.0	51	05/11→	←			13.0460-5649.2	605649	MAN 25365 16,0 + WK + Zub
1.0 Bi-Fuel	60	05/11→						
1.0 Flex	59	08/11→						
1.0 LPG	49	08/13→						
1.2	63	09/11→						
 Bremsscheibe								
1.0	49	04/15→	←	Felgenreöße [Zoll]: 14		24.0118-0144.1	418144	Ø 252 18 16 V
			←	Felgenreöße [Zoll]: 13		24.0118-0145.1	418145	Ø 241 18 16 V
			→			24.0110-0324.1	410324	Ø 234 10 8
1.0	51	05/11→	←			24.0118-0145.1	418145	Ø 241 18 16 V
1.0 Bi-Fuel	60	05/11→						
1.0 Flex	59	08/11→	→			24.0110-0324.1	410324	Ø 234 10 8
1.0 LPG	49	08/13→						
1.2	63	09/11→						
KIA - PREGIO Bus 08/95→09/04								
 Bremsbelagsatz, Scheibenbremse								
2.5 D	69	08/95→09/04	←	09/02→		13.0460-5725.2	605725	23649 17,2 + WK
KIA - PREGIO Kasten (TB) 10/97→								
 Bremsbelagsatz, Scheibenbremse								
2.5 Tci D	69	09/02→	←	→ 09/04		13.0460-5725.2	605725	23649 17,2 + WK
2.7 D	60	10/97→	←	01/99→ 12/01		13.0460-5725.2	605725	23649 17,2 + WK
KIA - PRIDE (DA) 01/90→12/11								
 Bremsbelagsatz, Scheibenbremse								
1.1 i	38	01/91→10/00	←	→ 04/94		13.0460-5970.2	605970	SUM 21355 13,5 + WK
1.3 16V	44	01/90→10/00						
1.3 16V	53	01/90→09/01						
1.3 i	51	01/90→05/97						
1.3 16V	47	10/96→05/01	←	→ 10/00		13.0460-5970.2	605970	SUM 21355 13,5 + WK
1.4 LX	71	03/05→12/11	←	→ 08/11		13.0460-5779.2	605779	24317 17,6 + WK + Zub
1.5 CRDi LX	81	03/05→12/11						
1.6 CVVT LX	82	03/05→12/11	→	→ 08/11; + ABS		13.0460-5780.2	605780	24320 15,3 + WK + Zub
Zubehörsatz, Scheibenbremsbelag								
1.1 i	38	01/91→10/00	←	→ 04/94		13.0460-0451.2	610451	SUM
1.3 16V	44	01/90→10/00						
1.3 16V	53	01/90→09/01						
1.3 i	51	01/90→05/97						
1.3 16V	47	10/96→05/01	←	→ 10/00		13.0460-0451.2	610451	SUM
 Bremsscheibe								
1.1 i	38	01/91→10/00	←	→ 04/94		24.0113-0165.1	413165	Ø 219 13 11
1.3 16V	44	01/90→10/00						
1.3 16V	53	01/90→09/01						
1.3 i	51	01/90→05/97						
1.3 16V	47	10/96→05/01	←	→ 10/00		24.0113-0165.1	413165	Ø 219 13 11
1.4 LX	71	03/05→12/11	←	→ 08/11		24.0122-0260.1	422260	Ø 256 22 20 V
1.5 CRDi LX	81	03/05→12/11						
1.6 CVVT LX	82	03/05→12/11	→	→ 08/11; + ABS		24.0110-0312.1	410312	Ø 262 10 8,4
KIA - PRIDE Kombi 08/99→05/01								
 Bremsbelagsatz, Scheibenbremse								
1.3	47	08/99→05/01	←			13.0460-5970.2	605970	SUM 21355 13,5 + WK
Zubehörsatz, Scheibenbremsbelag								
1.3	47	08/99→05/01	←			13.0460-0451.2	610451	SUM
 Bremsscheibe								
1.3	47	08/99→05/01	←			24.0113-0165.1	413165	Ø 219 13 11
KIA - PRIDE Van (DA) 04/92→06/99								
 Bremsbelagsatz, Scheibenbremse								
1.3 16V	44	04/92→10/96	←	→ 04/94		13.0460-5970.2	605970	SUM 21355 13,5 + WK
1.3 16V	47	10/96→06/99	←			13.0460-5970.2	605970	SUM 21355 13,5 + WK
↓								













	kw			 	! #		
KIA - PRIDE Van (DA) 04/92→06/99							
Zubehörsatz, Scheibenbremsbelag							
1.3 16V	44	04/92→10/96	←	→ 04/94		13.0460-0451.2 610451	SUM
1.3 16V	47	10/96→06/99	←			13.0460-0451.2 610451	SUM
 Bremsscheibe							
1.3 16V	44	04/92→10/96	←	→ 04/94		24.0113-0165.1 413165	Ø 219 13 11
1.3 16V	47	10/96→06/99	←			24.0113-0165.1 413165	Ø 219 13 11
KIA - PRO CEE'D (JD) 03/13→							
 Bremsbelagsatz, Scheibenbremse							
1.0 T-GDI	74	07/15→	←	15"		13.0460-5645.2 605645	25692 17,2 + WK + Zub
1.0 T-GDI	88	07/15→	→	- eFSB		13.0460-2794.2 602794	TRW 25780 15,0 + WK + Zub
1.4 CRDi 90	66	03/13→					
1.4 CVVT	73	03/13→					
1.4 MPI	73	07/13→					
1.4 MPI	74	04/15→					
1.6 CRDi 110	81	03/13→					
1.6 CRDi 128	94	03/13→					
1.6 CRDi 136	100	07/15→					
1.6 GDI	99	03/13→					
1.6 GT	150	06/13→					
1.6 CVVT	95	03/13→	←	15"		13.0460-5645.2 605645	25692 17,2 + WK + Zub
			→	07/13→; - eFSB		13.0460-2794.2 602794	TRW 25780 15,0 + WK + Zub
 Bremsscheibe							
1.0 T-GDI	74	07/15→	←	15"		24.0123-0123.1 423123	Ø 280 23,1 21 V
1.0 T-GDI	88	07/15→	←	16"		24.0128-0234.1 428234	Ø 300 28 26,4 V
1.4 MPI	74	04/15→					
1.6 CRDi 136	100	07/15→	→	- eFSB		24.0110-0379.1 410379	Ø 262 10 8,4
			→	+ eFSB		24.0110-0383.1 410383	Ø 284 10 8,4
1.4 CRDi 90	66	03/13→	←	16"		24.0128-0234.1 428234	Ø 300 28 26,4 V
1.4 CVVT	73	03/13→	→	- eFSB		24.0110-0379.1 410379	Ø 262 10 8,4
1.6 CRDi 110	81	03/13→	→	+ eFSB		24.0110-0383.1 410383	Ø 284 10 8,4
1.6 CRDi 128	94	03/13→					
1.6 CVVT	95	03/13→					
1.6 GDI	99	03/13→					
1.6 GT	150	06/13→					
1.4 MPI	73	07/13→	←	06/15→; 15"		24.0123-0123.1 423123	Ø 280 23,1 21 V
			←	16"		24.0128-0234.1 428234	Ø 300 28 26,4 V
			→	- eFSB		24.0110-0379.1 410379	Ø 262 10 8,4
			→	+ eFSB		24.0110-0383.1 410383	Ø 284 10 8,4
KIA - PRO CEE'D (ED) 02/08→02/13							
 Bremsbelagsatz, Scheibenbremse							
1.4	77	02/08→09/12	←			13.0460-5742.2 605742	23966 17,7 + WK
1.4	80	02/08→09/12	→			13.0460-5780.2 605780	24320 15,3 + WK + Zub
1.4 CVVT	66	06/10→09/12					
1.6	90	02/08→09/12					
1.6	93	02/08→09/12					
1.6 CRDi 115	85	02/08→09/12					
1.6 CRDi 128	94	10/10→09/12					
1.6 CRDi 90	66	02/08→09/12					
1.6 CVVT	92	10/10→02/13					
2.0	105	02/08→09/12					
2.0 CRDi 140	103	02/08→09/12					
2.0 LPG	105	01/09→12/09					
 Bremsscheibe							
1.4	77	02/08→09/12	←			24.0126-0150.1 426150	Ø 280 26 24,4 V
1.4	80	02/08→09/12	→			24.0110-0332.1 410332	Ø 262 10 8
1.4 CVVT	66	06/10→09/12					
1.6	90	02/08→09/12					
1.6	93	02/08→09/12					
1.6 CRDi 115	85	02/08→09/12					
1.6 CRDi 128	94	10/10→09/12					
1.6 CRDi 90	66	02/08→09/12					
1.6 CVVT	92	10/10→02/13					
2.0	105	02/08→09/12					
2.0 CRDi 140	103	02/08→09/12					
2.0 LPG	105	01/09→12/09					











	kw			 	! #		
KIA - RETONA (CE) 06/99→							
 Bremsbelagsatz, Scheibenbremse							
2.0 16V 2.0 TD	94 61	05/00→ 06/99→	← →	→ 08/03		13.0460-5896.2 605896	23442 15,3 + WK
KIA - RIO II (JB) 03/05→							
 Bremsbelagsatz, Scheibenbremse							
1.4 16V 1.5 CRDi 1.5 CRDi 1.6 CVVT	71 65 81 82	03/05→ 06/08→ 03/05→ 03/05→	← →	→ 08/11 → 08/11; + ABS		13.0460-5779.2 605779 13.0460-5780.2 605780	24317 17,6 + WK + Zub 24320 15,3 + WK + Zub
 Bremsscheibe							
1.4 16V 1.5 CRDi 1.5 CRDi 1.6 CVVT	71 65 81 82	03/05→ 06/08→ 03/05→ 03/05→	← →	→ 08/11 → 08/11; + ABS		24.0122-0260.1 422260 24.0110-0312.1 410312	Ø 256 22 20 V Ø 262 10 8,4
KIA - RIO II Stufenheck (JB) 03/05→							
 Bremsbelagsatz, Scheibenbremse							
1.4 16V 1.5 CRDi 1.5 CRDi 1.6 16V	71 65 81 82	03/05→ 06/08→ 03/05→ 03/05→	← →	→ 08/11 → 08/11; + ABS		13.0460-5779.2 605779 13.0460-5780.2 605780	24317 17,6 + WK + Zub 24320 15,3 + WK + Zub
 Bremsscheibe							
1.4 16V 1.5 CRDi 1.5 CRDi 1.6 16V	71 65 81 82	03/05→ 06/08→ 03/05→ 03/05→	← →	→ 08/11 → 08/11; + ABS		24.0122-0260.1 422260 24.0110-0312.1 410312	Ø 256 22 20 V Ø 262 10 8,4
KIA - RIO III (UB) 09/11→							
 Bremsbelagsatz, Scheibenbremse							
1.1 CRDi 1.2 1.25 CVVT 1.25 CVVT 1.25 LPG 1.2 CVVT 1.4 CRDi 1.4 CVVT 1.4 CVVT 1.6 CVVT	55 51 63 65 63 62 66 79 80 90	09/11→ 09/11→ 09/11→ 09/11→ 09/11→ 11/14→ 09/11→ 09/11→ 09/11→ 06/12→	← →			13.0460-5646.2 605646	MAN 25348 17,8 + WK + Zub
 Bremsscheibe							
1.1 CRDi 1.4 CRDi 1.4 CVVT 1.4 CVVT 1.2 1.25 CVVT 1.25 CVVT 1.25 LPG 1.6 CVVT 1.2 CVVT	55 66 79 80 51 63 65 63 90 62	09/11→ 09/11→ 09/11→ 09/11→ 09/11→ 09/11→ 09/11→ 09/11→ 06/12→ 11/14→	← →	02/12→; passend für Felgenreöße [Zoll]: 15		24.0122-0260.1 422260 24.0110-0398.1 410398 24.0122-0260.1 422260 24.0110-0398.1 410398 24.0110-0398.1 410398 24.0122-0260.1 422260 24.0110-0398.1 410398	Ø 256 22 20 V Ø 262 10 8,4 Ø 256 22 20 V Ø 262 10 8,4 Ø 262 10 8,4 Ø 256 22 20 V Ø 262 10 8,4
KIA - RIO III Stufenheck (UB) 09/10→							
 Bremsbelagsatz, Scheibenbremse							
1.25 CVVT 1.2 CVVT 1.4 CVVT 1.6 CVVT 1.25 CVVT 1.4 CVVT	63 62 80 90 65 79	10/11→ 11/14→ 10/11→ 06/12→ 06/11→ 06/11→	← →	09/11→		13.0460-5646.2 605646 13.0460-5646.2 605646	MAN 25348 17,8 + WK + Zub MAN 25348 17,8 + WK + Zub
 Bremsscheibe							
1.25 CVVT 1.6 CVVT 1.25 CVVT 1.2 CVVT	63 90 65 62	10/11→ 06/12→ 06/11→ 11/14→	→ →	09/11→ passend für Felgenreöße [Zoll]: 15		24.0110-0398.1 410398 24.0110-0398.1 410398 24.0122-0260.1 422260 24.0110-0398.1 410398	Ø 262 10 8,4 Ø 262 10 8,4 Ø 256 22 20 V Ø 262 10 8,4
↓							













	kw			 	! #		
KIA - RIO III Stufenheck (UB) 09/10→							
 Bremsscheibe							
1.4 CVVT	79	06/11→	←	02/12→; passend für Felgenreöße [Zoll]: 15		24.0122-0260.1 422260	Ø 256 22 20 V
			→	09/11→		24.0110-0398.1 410398	Ø 262 10 8,4
1.4 CVVT	80	10/11→	←	02/12→; passend für Felgenreöße [Zoll]: 15		24.0122-0260.1 422260	Ø 256 22 20 V
			→			24.0110-0398.1 410398	Ø 262 10 8,4
KIA - RIO IV (YB) 01/17→							
 Bremsscheibe							
1.0 T-GDI 100	74	01/17→	→			24.0110-0398.1 410398	Ø 262 10 8,4
1.0 T-GDI 120	88	01/17→					
1.2	62	01/17→					
1.4	73	01/17→					
1.4 CRDi 77	57	01/17→					
1.4 CRDi 90	66	01/17→					
KIA - RIO Kombi (DC) 08/00→02/05							
 Bremsbelagsatz, Scheibenbremse							
1.3	55	08/00→02/05	←	07/02→		13.0460-5868.2 605868	SUM 23873 15,8 + WK
1.3	60	08/00→02/05	←			13.0460-5944.2 605944	SUM 21654 15,0 + WK
1.5 16V	72	08/00→02/05	←	→ 06/02		13.0460-5944.2 605944	SUM 21654 15,0 + WK
1.5 16V	71	09/02→02/05	←			13.0460-5868.2 605868	SUM 23873 15,8 + WK
Zubehörsatz, Scheibenbremsbelag							
1.3	55	08/00→02/05	←	→ 06/02		13.0460-0149.2 610149	SUM
1.3	60	08/00→02/05					
1.5 16V	72	08/00→02/05					
 Bremsscheibe							
1.3	55	08/00→02/05	←	→ 06/02		24.0122-0227.1 422227	Ø 235 22 20 V
1.3	60	08/00→02/05	←			24.0124-0187.1 424187	Ø 254 24 22 V
1.5 16V	72	08/00→02/05	←	07/02→		24.0124-0187.1 424187	Ø 254 24 22 V
1.5 16V	71	09/02→02/05	←			24.0124-0187.1 424187	Ø 254 24 22 V
KIA - RIO Stufenheck (DC_) 09/00→02/05							
 Bremsbelagsatz, Scheibenbremse							
1.3	55	09/00→02/05	←	07/02→		13.0460-5868.2 605868	SUM 23873 15,8 + WK
1.5 16V	72	09/00→02/05	←	→ 06/02		13.0460-5944.2 605944	SUM 21654 15,0 + WK
1.3	60	08/02→02/05	←			13.0460-5868.2 605868	SUM 23873 15,8 + WK
1.5	70	09/02→02/05					
1.5 16V	71	09/02→02/05					
Zubehörsatz, Scheibenbremsbelag							
1.3	55	09/00→02/05	←	→ 06/02		13.0460-0149.2 610149	SUM
1.5 16V	72	09/00→02/05					
 Bremsscheibe							
1.3	55	09/00→02/05	←	→ 06/02		24.0122-0227.1 422227	Ø 235 22 20 V
1.5 16V	72	09/00→02/05	←	07/02→		24.0124-0187.1 424187	Ø 254 24 22 V
1.3	60	08/02→02/05	←			24.0124-0187.1 424187	Ø 254 24 22 V
1.5	70	09/02→02/05					
1.5 16V	71	09/02→02/05					
KIA - SEPHIA (FA) 01/95→10/97							
 Bremsbelagsatz, Scheibenbremse							
1.5 i	59	02/96→10/97	←			13.0460-5923.2 605923	ATE 23384 18,3 + WK
1.8 i 16V	82	01/95→10/97	→	+ ABS		13.0460-5924.2 605924	ATE 21832 14,9 - WE / - WK
1.6 i	59	01/95→10/97	←	→ 06/96		13.0460-5923.2 605923	ATE 23384 18,3 + WK
			→	→ 06/96; + ABS		13.0460-5924.2 605924	ATE 21832 14,9 - WE / - WK
Zubehörsatz, Scheibenbremsbelag							
1.5 i	59	02/96→10/97	→	+ ABS		13.0460-0436.2 610436	ATE
1.8 i 16V	82	01/95→10/97					
1.6 i	59	01/95→10/97	→	→ 06/96; + ABS		13.0460-0436.2 610436	ATE
 Bremsscheibe							
1.5 i	59	02/96→10/97	→	+ ABS		24.0110-0300.1 410300	Ø 270 10 8
1.8 i 16V	82	01/95→10/97					















	kw			 	! #		
KIA - SEPHIA (FA) 01/95→10/97							
 Bremsscheibe							
1.6 i	59	01/95→10/97	➔	→ 06/96; + ABS		24.0110-0300.1 410300	Ø 270 10 8
KIA - SEPHIA Stufenheck (FA) 01/92→09/01							
 Bremsbelagsatz, Scheibenbremse							
1.5 i	59	02/96→10/97	←		13.0460-5923.2 605923	ATE 23384 18,3 + WK	
1.8 i 16V	82	01/95→10/97	➔	+ ABS	13.0460-5924.2 605924	ATE 21832 14,9 - WE / - WK	
1.6 i	59	09/93→10/97	←	10/93→ 06/96	13.0460-5923.2 605923	ATE 23384 18,3 + WK	
			➔	10/93→ 06/96; + ABS	13.0460-5924.2 605924	ATE 21832 14,9 - WE / - WK	
Zubehörsatz, Scheibenbremsbelag							
1.5 i	59	02/96→10/97	➔	+ ABS	13.0460-0436.2 610436	ATE	
1.8 i 16V	82	01/95→10/97					
1.6 i	59	09/93→10/97	➔	10/93→ 06/96; + ABS	13.0460-0436.2 610436	ATE	
 Bremsscheibe							
1.5 i	59	02/96→10/97	➔	+ ABS	24.0110-0300.1 410300	Ø 270 10 8	
1.8 i 16V	82	01/95→10/97					
1.6 i	59	09/93→10/97	➔	10/93→ 06/96; + ABS	24.0110-0300.1 410300	Ø 270 10 8	
KIA - SHUMA (FB) 09/96→12/01							
 Bremsbelagsatz, Scheibenbremse							
1.5 i 16V	65	10/97→03/01	←		13.0460-5923.2 605923	ATE 23384 18,3 + WK	
1.8 i 16V	81	10/97→03/01	➔	+ ABS	13.0460-5871.2 605871	SUM 23455 13,7 + WK	
1.6	75	01/01→12/01	←	05/01→	13.0460-5868.2 605868	SUM 23873 15,8 + WK	
			➔	05/01→; + ABS	13.0460-5871.2 605871	SUM 23455 13,7 + WK	
 Bremsscheibe							
1.5 i 16V	65	10/97→03/01	←		24.0120-0177.1 420177	Ø 242 20 18 V	
1.8 i 16V	81	10/97→03/01	➔	+ ABS	24.0110-0301.1 410301	Ø 261 10 8	
1.6	75	01/01→12/01	←	05/01→	24.0124-0185.1 424185	Ø 258 24 22 V	
			➔	05/01→; + ABS	24.0110-0301.1 410301	Ø 261 10 8	
KIA - SHUMA II (FB) 05/01→08/04							
 Bremsbelagsatz, Scheibenbremse							
1.6	75	05/01→08/04	←		13.0460-5868.2 605868	SUM 23873 15,8 + WK	
1.8	84	04/03→08/04	➔	+ ABS	13.0460-5871.2 605871	SUM 23455 13,7 + WK	
1.8	81	05/01→06/04	←	04/03→	13.0460-5868.2 605868	SUM 23873 15,8 + WK	
			➔	04/03→; + ABS	13.0460-5871.2 605871	SUM 23455 13,7 + WK	
 Bremsscheibe							
1.6	75	05/01→08/04	←		24.0124-0185.1 424185	Ø 258 24 22 V	
1.8	84	04/03→08/04	➔	+ ABS	24.0110-0301.1 410301	Ø 261 10 8	
1.8	81	05/01→06/04	←	04/03→	24.0124-0185.1 424185	Ø 258 24 22 V	
			➔	04/03→; + ABS	24.0110-0301.1 410301	Ø 261 10 8	
KIA - SHUMA II Stufenheck (FB) 05/01→05/04							
 Bremsbelagsatz, Scheibenbremse							
1.6	75	05/01→05/04	←		13.0460-5868.2 605868	SUM 23873 15,8 + WK	
			➔	+ ABS	13.0460-5871.2 605871	SUM 23455 13,7 + WK	
 Bremsscheibe							
1.6	75	05/01→05/04	←		24.0124-0185.1 424185	Ø 258 24 22 V	
			➔	+ ABS	24.0110-0301.1 410301	Ø 261 10 8	
KIA - SHUMA Stufenheck (FB) 03/96→10/01							
 Bremsbelagsatz, Scheibenbremse							
1.5	59	03/96→12/98	←	10/97→	13.0460-5923.2 605923	ATE 23384 18,3 + WK	
			➔	10/97→; + ABS	13.0460-5871.2 605871	SUM 23455 13,7 + WK	
↓							



















	kw			 	! #		
KIA - SHUMA Stufenheck (FB) 03/96→10/01							
 Bremsbelagsatz, Scheibenbremse							
1.5 i 16V	65	10/97→10/01	←	→ 04/01		13.0460-5923.2 605923	ATE 23384 18,3 + WK
			→	→ 04/01; + ABS		13.0460-5871.2 605871	SUM 23455 13,7 + WK
 Bremsscheibe							
1.5	59	03/96→12/98	←	10/97→		24.0120-0177.1 420177	Ø 242 20 18 V
			→	10/97→; + ABS		24.0110-0301.1 410301	Ø 261 10 8
1.5 i 16V	65	10/97→10/01	←	01/98→ 04/01		24.0120-0177.1 420177	Ø 242 20 18 V
			→	→ 04/01; + ABS		24.0110-0301.1 410301	Ø 261 10 8
KIA - SORENTO I (JC) 08/02→							
 Bremsbelagsatz, Scheibenbremse							
2.4	102	08/02→	←	→ 11/06		13.0460-5772.2 605772	24092 17,1 + WK + Zub
2.5 CRDi	103	08/02→	→	→ 11/06		13.0460-5773.2 605773	23993 15,5 + WK + Zub
2.5 CRDi	120	05/06→	←	→ 10/09		13.0460-5772.2 605772	24092 17,1 + WK + Zub
2.5 CRDi	125	12/06→	→	→ 10/09		13.0460-5773.2 605773	23993 15,5 + WK + Zub
3.3 V6	177	12/06→	→	→ 10/09		13.0460-5773.2 605773	23993 15,5 + WK + Zub
3.5 V6 4WD	143	08/02→	→	→ 10/09		13.0460-5773.2 605773	23993 15,5 + WK + Zub
3.3 V6 4WD	182	02/07→	←	11/07→ 10/09		13.0460-5772.2 605772	24092 17,1 + WK + Zub
3.8 4WD	196	09/06→	→	11/07→ 10/09		13.0460-5773.2 605773	23993 15,5 + WK + Zub
 Bremsscheibe							
2.4	102	08/02→	←	→ 11/06		24.0128-0200.1 428200	Ø 302 28 26 V
			→	→ 11/06		24.0120-0202.1 420202	Ø 315 20 18,4 V
2.5 CRDi	103	08/02→	←	→ 11/06		24.0128-0200.1 428200	Ø 302 28 26 V
			→	→ 08/06		24.0120-0202.1 420202	Ø 315 20 18,4 V
			→	09/06→ 11/06		24.0120-0207.1 420207	Ø 315 20 18,4 V
2.5 CRDi	120	05/06→	←	→ 10/09		24.0128-0227.1 428227	Ø 302 28 26,4 V
2.5 CRDi	125	12/06→	→	→ 10/09		24.0120-0207.1 420207	Ø 315 20 18,4 V
3.3 V6	177	12/06→	→	→ 10/09		24.0120-0207.1 420207	Ø 315 20 18,4 V
3.3 V6 4WD	182	02/07→	←	11/07→ 10/09		24.0128-0227.1 428227	Ø 302 28 26,4 V
3.8 4WD	196	09/06→	→	11/07→ 10/09		24.0120-0207.1 420207	Ø 315 20 18,4 V
3.5 V6 4WD	143	08/02→	←	→ 10/09		24.0128-0200.1 428200	Ø 302 28 26 V
			→	→ 10/09		24.0120-0202.1 420202	Ø 315 20 18,4 V
KIA - SORENTO II (XM) 11/09→							
 Bremsbelagsatz, Scheibenbremse							
2.0 CRDi	110	11/10→	←	→ 12/14		13.0460-5777.2 605777	24351 16,3 + WK + Zub
2.0 CRDi 4WD	110	11/10→	→	→ 12/14		13.0460-5633.2 605633	AKE 25520 15,8 + WK + Zub
2.2 CRDi	145	11/09→	→	→ 12/14		13.0460-5633.2 605633	AKE 25520 15,8 + WK + Zub
2.2 CRDi 4WD	145	11/09→	→	→ 12/14		13.0460-5633.2 605633	AKE 25520 15,8 + WK + Zub
2.4 CVVT	128	11/09→	→	→ 12/14		13.0460-5633.2 605633	AKE 25520 15,8 + WK + Zub
2.4 CVVT	141	10/12→	→	→ 12/14		13.0460-5633.2 605633	AKE 25520 15,8 + WK + Zub
2.4 CVVT 4WD	128	11/09→	→	→ 12/14		13.0460-5633.2 605633	AKE 25520 15,8 + WK + Zub
2.4 CVVT 4WD	141	10/12→	→	→ 12/14		13.0460-5633.2 605633	AKE 25520 15,8 + WK + Zub
2.4 GDI	141	10/12→	→	→ 12/14		13.0460-5633.2 605633	AKE 25520 15,8 + WK + Zub
2.4 GDI 4WD	141	10/12→	→	→ 12/14		13.0460-5633.2 605633	AKE 25520 15,8 + WK + Zub
 Bremsscheibe							
2.0 CRDi	110	11/10→	←	→ 12/14		24.0128-0248.1 428248	Ø 321 28 26,4 V
2.0 CRDi 4WD	110	11/10→	→	→ 12/14		24.0111-0170.1 411170	Ø 302 11 9,4
2.2 CRDi	145	11/09→	→	→ 12/14		24.0111-0170.1 411170	Ø 302 11 9,4
2.2 CRDi 4WD	145	11/09→	→	→ 12/14		24.0111-0170.1 411170	Ø 302 11 9,4
2.4 CVVT	128	11/09→	→	→ 12/14		24.0111-0170.1 411170	Ø 302 11 9,4
2.4 CVVT	141	10/12→	→	→ 12/14		24.0111-0170.1 411170	Ø 302 11 9,4
2.4 CVVT 4WD	128	11/09→	→	→ 12/14		24.0111-0170.1 411170	Ø 302 11 9,4
2.4 CVVT 4WD	141	10/12→	→	→ 12/14		24.0111-0170.1 411170	Ø 302 11 9,4
2.4 GDI	141	10/12→	→	→ 12/14		24.0111-0170.1 411170	Ø 302 11 9,4
2.4 GDI 4WD	141	10/12→	→	→ 12/14		24.0111-0170.1 411170	Ø 302 11 9,4
KIA - SORENTO III (UM) 01/15→							
 Bremsbelagsatz, Scheibenbremse							
2.2 CRDi	147	01/15→	→			13.0460-5636.2 605636	MAN 24599 14,9 + WK + Zub
2.2 CRDi 4WD	147	01/15→	→			13.0460-5636.2 605636	MAN 24599 14,9 + WK + Zub
2.2 CRDi 4WD	145	11/16→	→			13.0460-5636.2 605636	MAN 24599 14,9 + WK + Zub
2.4	129	01/15→	→	für Fahrzeuge ohne Sportpaket		13.0460-5636.2 605636	MAN 24599 14,9 + WK + Zub
2.4 4WD	129	01/15→	→	für Fahrzeuge ohne Sportpaket		13.0460-5636.2 605636	MAN 24599 14,9 + WK + Zub
2.4 GDI	138	01/15→	→	für Fahrzeuge ohne Sportpaket		13.0460-5636.2 605636	MAN 24599 14,9 + WK + Zub

















	kw			 	! #		
KIA - SORENTO III (UM) 01/15→							
 Bremsbelagsatz, Scheibenbremse							
2.4 GDI 4WD 3.3	138 199	01/15→ 04/15→	➔	für Fahrzeuge ohne Sportpaket		13.0460-5636.2 605636	MAN 24599 14,9 + WK + Zub
 Bremsscheibe							
2.2 CRDi 2.2 CRDi 4WD 2.2 CRDi 4WD 2.4 2.4 4WD 2.4 GDI 2.4 GDI 4WD 3.3	147 147 145 129 129 138 138 199	01/15→ 01/15→ 11/16→ 01/15→ 01/15→ 01/15→ 01/15→ 04/15→	←			24.0128-0248.1 428248	Ø 321 28 26,4 V
KIA - SOUL (AM) 02/09→							
 Bremsbelagsatz, Scheibenbremse							
1.6 1.6 CRDi 115 1.6 CRDi 128 1.6 CVVT 1.6 CVVT 1.6 CVVT 1.6 Flex 1.6 GDI 1.6 LPG	91 85 94 77 93 95 94 103 92	09/09→12/14 02/09→ 02/09→ 02/09→ 02/09→ 03/12→ 01/11→ 06/11→ 02/09→12/14	← ➔ ← ➔	→ 02/14 → 02/14; + ABS + ABS		13.0460-5873.2 605873 13.0460-5786.2 605786 13.0470-5786.2 LD5786 13.0460-5873.2 605873 13.0460-5786.2 605786 13.0470-5786.2 LD5786	MAN 23891 16,9 + WK AKE 24934 15,0 + WK + Zub AKE 24934 15,0 + WK + Zub Ceramic MAN 23891 16,9 + WK AKE 24934 15,0 + WK + Zub AKE 24934 15,0 + WK + Zub Ceramic
Zubehörsatz, Scheibenbremsbelag							
1.6 1.6 CRDi 115 1.6 CRDi 128 1.6 CVVT 1.6 CVVT 1.6 CVVT 1.6 Flex 1.6 GDI 1.6 LPG	91 85 94 77 93 95 94 103 92	09/09→12/14 02/09→ 02/09→ 02/09→ 02/09→ 03/12→ 01/11→ 06/11→ 02/09→12/14	← ➔ ← ➔	→ 02/14 → 02/14; + ABS + ABS		13.0460-0139.2 610139 13.0460-0139.2 610139	MAN MAN
 Bremsscheibe							
1.6 1.6 CRDi 115 1.6 CRDi 128 1.6 CVVT 1.6 CVVT 1.6 CVVT 1.6 Flex 1.6 GDI 1.6 LPG	91 85 94 77 93 95 94 103 92	09/09→12/14 02/09→ 02/09→ 02/09→ 02/09→ 03/12→ 01/11→ 06/11→ 02/09→12/14	← ➔ ← ➔	→ 02/14 → 02/14; + ABS + ABS		24.0126-0150.1 426150 24.0110-0362.1 410362 24.0126-0150.1 426150 24.0110-0362.1 410362	Ø 280 26 24,4 V Ø 262 10 8,4 Ø 280 26 24,4 V Ø 262 10 8,4
KIA - SOUL II (PS) 02/14→							
 Bremsbelagsatz, Scheibenbremse							
1.6 CRDi 128 1.6 CRDi 136 1.6 CVVT 1.6 GDI 2.0 CVVT	94 100 91 97 113	02/14→ 04/15→ 02/14→ 02/14→ 02/14→	← ← ← ← ←	15" → 02/14 → 02/14; + ABS 15" 04/14→; 15"		13.0460-5641.2 605641 13.0460-5873.2 605873 13.0460-5786.2 605786 13.0470-5786.2 LD5786 13.0460-5641.2 605641 13.0460-5641.2 605641	25187 17,8 + WK + Zub MAN 23891 16,9 + WK AKE 24934 15,0 + WK + Zub AKE 24934 15,0 + WK + Zub Ceramic 25187 17,8 + WK + Zub 25187 17,8 + WK + Zub
Zubehörsatz, Scheibenbremsbelag							
1.6 CRDi 128	94	02/14→	←	→ 02/14		13.0460-0139.2 610139	MAN
 Bremsscheibe							
1.6 CRDi 128	94	02/14→	← ← ←	15" → 02/14 16"		24.0126-0150.1 426150 24.0126-0150.1 426150 24.0128-0234.1 428234	Ø 280 26 24,4 V Ø 280 26 24,4 V Ø 300 28 26,4 V
↓							















	kw			 	! #		
KIA - SOUL II (PS) 02/14→							
 Bremsscheibe							
1.6 CRDi 128	94	02/14→	→	→ 02/14; + ABS		24.0110-0362.1 410362	Ø 262 10 8,4
			→			24.0110-0368.1 410368	Ø 262 10 8,4
1.6 CRDi 136	100	04/15→	←	15"		24.0126-0150.1 426150	Ø 280 26 24,4 V
1.6 CVVT	91	02/14→	←	16"		24.0128-0234.1 428234	Ø 300 28 26,4 V
1.6 GDI	97	02/14→	→			24.0110-0368.1 410368	Ø 262 10 8,4
1.6 TGDI	150	11/16→	←	15"		24.0126-0150.1 426150	Ø 280 26 24,4 V
			←	16"		24.0128-0234.1 428234	Ø 300 28 26,4 V
			←	Felgenreöße [Zoll]: 17		24.0128-0258.1 428258	Ø 320 28,1 26,4 V
			→	Felgenreöße [Zoll]: 15		24.0110-0368.1 410368	Ø 262 10 8,4
2.0 CVVT	113	02/14→	←	04/14→; 15"		24.0126-0150.1 426150	Ø 280 26 24,4 V
			←	04/14→; 16"		24.0128-0234.1 428234	Ø 300 28 26,4 V
			→	04/14→		24.0110-0368.1 410368	Ø 262 10 8,4
EV Electric	25	09/14→	←			24.0128-0234.1 428234	Ø 300 28 26,4 V
EV Electric	26	03/17→	→			24.0110-0400.1 410400	Ø 284 10 8,4
EV Electric	81	09/14→	→				
KIA - SPORTAGE (JE_, KM_) 09/04→							
 Bremsbelagsatz, Scheibenbremse							
2.0 16V 4WD	104	09/04→	←	01/08→ 05/10		13.0460-5600.2 605600	SUM 24501 16,7 + WK
2.0 CRDi	83	02/05→	→				
2.0 CRDi	100	01/06→	←	→ 12/07		13.0460-5873.2 605873	MAN 23891 16,9 + WK
2.0 CRDi	103	01/06→	→	01/07→ 05/10		13.0460-5780.2 605780	24320 15,3 + WK + Zub
2.0 CRDi 4WD	83	09/04→	→				
2.0 CRDi 4WD	100	01/06→	→	→ 12/06		13.0460-5833.2 605833	AKE 23543 14,4 + WK + Zub
2.0 CRDi 4WD	103	01/06→	→				
2.0 i 16V	104	09/04→	→				
2.0 CRDi	110	09/08→	←	→ 05/10		13.0460-5600.2 605600	SUM 24501 16,7 + WK
2.0 CRDi 4WD	110	09/08→	→	→ 05/10		13.0460-5780.2 605780	24320 15,3 + WK + Zub
2.7 V6 4WD	129	09/04→	←	01/08→ 05/10		13.0460-5600.2 605600	SUM 24501 16,7 + WK
			←	→ 12/07		13.0460-5873.2 605873	MAN 23891 16,9 + WK
			→	→ 05/10		13.0460-5833.2 605833	AKE 23543 14,4 + WK + Zub
Zubehörsatz, Scheibenbremsbelag							
2.0 16V 4WD	104	09/04→	←	→ 12/07		13.0460-0139.2 610139	MAN
2.0 CRDi	83	02/05→	→				
2.0 CRDi	100	01/06→	→				
2.0 CRDi	103	01/06→	→				
2.0 CRDi 4WD	83	09/04→	→				
2.0 CRDi 4WD	100	01/06→	→				
2.0 CRDi 4WD	103	01/06→	→				
2.0 i 16V	104	09/04→	→				
2.7 V6 4WD	129	09/04→	→				
 Bremsscheibe							
2.0 16V 4WD	104	09/04→	←	→ 12/07		24.0126-0128.1 426128	Ø 280 26 24,4 V
2.0 CRDi 4WD	83	09/04→	←	01/08→ 05/10		24.0128-0280.1 428280	Ø 300 28 26,4 V
2.0 CRDi 4WD	100	01/06→	→	→ 05/10		24.0110-0286.1 410286	Ø 284 10 8,4
2.0 CRDi 4WD	103	01/06→	→				
2.7 V6 4WD	129	09/04→	→				
2.0 CRDi	83	02/05→	←	→ 12/07		24.0126-0128.1 426128	Ø 280 26 24,4 V
2.0 CRDi	100	01/06→	←	01/08→ 05/10		24.0128-0280.1 428280	Ø 300 28 26,4 V
2.0 CRDi	103	01/06→	→	→ 05/10		24.0110-0318.1 410318	Ø 262 10 8,4
2.0 i 16V	104	09/04→	→				
2.0 CRDi	110	09/08→	←	→ 05/10		24.0128-0280.1 428280	Ø 300 28 26,4 V
			→	→ 05/10		24.0110-0318.1 410318	Ø 262 10 8,4
2.0 CRDi 4WD	110	09/08→	←	→ 05/10		24.0128-0280.1 428280	Ø 300 28 26,4 V
			→	→ 05/10		24.0110-0286.1 410286	Ø 284 10 8,4
KIA - SPORTAGE (K00) 04/94→08/04							
 Bremsbelagsatz, Scheibenbremse							
2.0	87	10/00→08/03	←			13.0460-5896.2 605896	23442 15,3 + WK
2.0 4WD	87	10/00→08/03	→				
2.0 i 16V	94	10/99→08/03	→				
2.0 i 16V 4WD	94	04/94→08/03	←	10/99→		13.0460-5896.2 605896	23442 15,3 + WK
2.0 i 16V 4WD	95	11/98→08/04	←	10/99→ 08/03		13.0460-5896.2 605896	23442 15,3 + WK
2.0 TD 4WD	61	10/97→08/03	←	06/99→		13.0460-5896.2 605896	23442 15,3 + WK









	kw			 	! #		
KIA - SPORTAGE (QL) 09/15→							
 Bremsbelagsatz, Scheibenbremse							
1.6 GDI	97	09/15→	←			13.0460-5600.2 605600	SUM 24501 16,7 + WK
1.6 GDI	130	09/15→					
1.6 GDI AWD	130	09/15→					
1.7 CRDi	85	09/15→					
1.7 CRDi	104	11/16→					
2.0 CRDi	100	09/15→					
2.0 CRDi AWD	100	09/15→	←	Made in Slowakische Republik		13.0460-5600.2 605600	SUM 24501 16,7 + WK
2.0 CRDi AWD	136	09/15→					
KIA - SPORTAGE (SL) 09/09→							
 Bremsbelagsatz, Scheibenbremse							
1.6 GDI	99	02/11→	←	→ 12/15		13.0460-5600.2 605600	SUM 24501 16,7 + WK
1.7 CRDi	85	12/10→					
2.0 CRDi	100	07/10→	→	→ 12/15		13.0460-5780.2 605780	24320 15,3 + WK + Zub
2.0 CRDi	135	08/10→					
2.0 CRDi AWD	100	07/10→					
2.0 CRDi AWD	130	08/12→					
2.0 CRDi AWD	135	08/10→					
2.0 CVVT	120	07/10→					
2.0 CVVT	122	07/10→					
2.0 CVVT AWD	120	07/10→					
2.0 CVVT AWD	122	07/10→					
2.0 GDI	122	02/14→					
2.0 GDI AWD	122	02/14→					
2.0 CVVT	110	06/10→12/13	←			13.0460-5600.2 605600	SUM 24501 16,7 + WK
2.0 CVVT AWD	110	06/10→12/13	→			13.0460-5780.2 605780	24320 15,3 + WK + Zub
 Bremsscheibe							
1.6 GDI	99	02/11→	←	→ 12/15		24.0128-0256.1 428256	Ø 300 28 26,4 V
1.7 CRDi	85	12/10→					
2.0 CRDi	100	07/10→	→	→ 12/15		24.0110-0332.1 410332	Ø 262 10 8
2.0 CRDi	135	08/10→					
2.0 CVVT	120	07/10→					
2.0 CVVT	122	07/10→					
2.0 GDI	122	02/14→					
2.0 CRDi AWD	100	07/10→	←	→ 12/15		24.0128-0256.1 428256	Ø 300 28 26,4 V
2.0 CRDi AWD	130	08/12→					
2.0 CRDi AWD	135	08/10→	→	→ 12/15		24.0110-0286.1 410286	Ø 284 10 8,4
2.0 CVVT AWD	120	07/10→					
2.0 CVVT AWD	122	07/10→					
2.0 GDI AWD	122	02/14→					
2.0 CVVT	110	06/10→12/13	←			24.0128-0256.1 428256	Ø 300 28 26,4 V
			→			24.0110-0332.1 410332	Ø 262 10 8
2.0 CVVT AWD	110	06/10→12/13	←			24.0128-0256.1 428256	Ø 300 28 26,4 V
			→			24.0110-0286.1 410286	Ø 284 10 8,4
KIA - VENGA (YN) 02/10→							
 Bremsbelagsatz, Scheibenbremse							
1.4 CRDi 75	55	02/10→	←			13.0460-2772.2 602772	TRW 25184 19,5 + WK + Zub
1.4 CRDi 75	57	02/10→					
1.4 CRDi 90	66	02/10→	→			13.0460-2868.2 602868	TRW 23417 15,3 + WK + Zub
1.4 CVVT	66	02/10→					
1.4 LPG	66	02/10→				13.0470-2868.2 LD2868	TRW 23417 15,3 + WK + Zub Ceramic
1.6 CRDi 115	85	02/10→					
1.6 CRDi 128	94	02/10→					
1.6 CVVT	92	02/10→					
 Bremsscheibe							
1.4 CRDi 75	55	02/10→	←			24.0126-0150.1 426150	Ø 280 26 24,4 V
1.4 CRDi 75	57	02/10→					
1.4 CRDi 90	66	02/10→	→			24.0110-0357.1 410357	Ø 258 10 8
1.4 CVVT	66	02/10→					
1.4 LPG	66	02/10→					
1.6 CRDi 115	85	02/10→					
1.6 CRDi 128	94	02/10→					
1.6 CVVT	92	02/10→					
LADA - 110 (2110) 01/95→12/12							
 Bremsbelagsatz, Scheibenbremse							
1.5	52	01/95→12/05	←			13.0460-2965.2 602965	TRW 21170 17,3 - WE / - WK
1.5	57	01/95→12/05					
1.5 16V	70	01/95→12/05					
1.6	66	01/00→04/07					
1.6	60	01/00→12/12	←	→ 08/07		13.0460-2965.2 602965	TRW 21170 17,3 - WE / - WK
↓							







	kw			 	! #		
LADA - 110 (2110) 01/95→12/12							
 Bremsscheibe							
1.5	52	01/95→12/05	←	→ 09/00		24.0112-0125.1 412125	Ø 239 12 10,8
1.5	57	01/95→12/05				24.0312-0125.1 512125	Ø 239 12 10,8 PD
1.5 16V	70	01/95→12/05					
1.5	56	10/00→12/05	←	passend für Felgengröße [Zoll]: 13		24.0120-0186.1 420186	Ø 239 19,5 18 V
2.0 i	110	08/96→07/00				24.0120-0187.1 420187	Ø 260 20 18,5 V
Wankel	88	06/97→09/04	←	passend für Felgengröße [Zoll]: 14			
1.5 16V	67	10/00→12/10	←	→ 08/07; passend für Felgengröße [Zoll]: 13		24.0120-0186.1 420186	Ø 239 19,5 18 V
			←	→ 08/07; passend für Felgengröße [Zoll]: 14		24.0120-0187.1 420187	Ø 260 20 18,5 V
1.6	60	01/00→12/12	←	→ 08/07		24.0112-0125.1 412125	Ø 239 12 10,8
						24.0312-0125.1 512125	Ø 239 12 10,8 PD
1.6	66	01/00→04/07	←			24.0112-0125.1 412125	Ø 239 12 10,8
						24.0312-0125.1 512125	Ø 239 12 10,8 PD
LADA - 111 (2111) 01/95→							
 Bremsbelagsatz, Scheibenbremse							
1.5	57	01/96→12/05	←			13.0460-2965.2 602965	TRW 21170 17,3 - WE / - WK
1.5 16V	70	01/95→08/02					
1.6	60	09/04→12/13	←	01/05→ 12/08		13.0460-2965.2 602965	TRW 21170 17,3 - WE / - WK
1.6	66	09/04→	←	03/06→ 12/08		13.0460-2965.2 602965	TRW 21170 17,3 - WE / - WK
 Bremsscheibe							
1.5	56	10/00→12/05	←	passend für Felgengröße [Zoll]: 13		24.0120-0186.1 420186	Ø 239 19,5 18 V
1.5	58	10/00→09/04					
1.5 16V	67	10/00→12/05	←	passend für Felgengröße [Zoll]: 14		24.0120-0187.1 420187	Ø 260 20 18,5 V
1.5	57	01/96→12/05	←	→ 09/00		24.0112-0125.1 412125	Ø 239 12 10,8
1.5 16V	70	01/95→08/02				24.0312-0125.1 512125	Ø 239 12 10,8 PD
1.6	60	09/04→12/13	←	01/05→ 12/08; passend für Felgengröße [Zoll]: 13		24.0120-0186.1 420186	Ø 239 19,5 18 V
			←	01/05→ 12/08; passend für Felgengröße [Zoll]: 14		24.0120-0187.1 420187	Ø 260 20 18,5 V
1.6	66	09/04→	←	03/06→ 12/08; passend für Felgengröße [Zoll]: 13		24.0120-0186.1 420186	Ø 239 19,5 18 V
			←	03/06→ 12/08; passend für Felgengröße [Zoll]: 14		24.0120-0187.1 420187	Ø 260 20 18,5 V
LADA - 112 (2112) 01/95→12/11							
 Bremsbelagsatz, Scheibenbremse							
1.5	54	01/95→10/00	←			13.0460-2965.2 602965	TRW 21170 17,3 - WE / - WK
1.5	57	01/95→09/04					
1.5 16V	70	01/95→09/00					
1.6	66	03/06→12/08					
1.6	60	01/05→12/11	←	→ 12/08		13.0460-2965.2 602965	TRW 21170 17,3 - WE / - WK
 Bremsscheibe							
1.5	54	01/95→10/00	←	→ 09/00		24.0112-0125.1 412125	Ø 239 12 10,8
1.5	57	01/95→09/04				24.0312-0125.1 512125	Ø 239 12 10,8 PD
1.5	56	10/00→12/05	←	passend für Felgengröße [Zoll]: 13		24.0120-0186.1 420186	Ø 239 19,5 18 V
1.5 16V	67	10/00→12/05					
1.6	66	03/06→12/08	←	passend für Felgengröße [Zoll]: 14		24.0120-0187.1 420187	Ø 260 20 18,5 V
1.5 16V	70	01/95→09/00	←			24.0112-0125.1 412125	Ø 239 12 10,8
						24.0312-0125.1 512125	Ø 239 12 10,8 PD
1.6	60	01/05→12/11	←	→ 12/08; passend für Felgengröße [Zoll]: 13		24.0120-0186.1 420186	Ø 239 19,5 18 V
			←	→ 12/08; passend für Felgengröße [Zoll]: 14		24.0120-0187.1 420187	Ø 260 20 18,5 V
LADA - 1200-1600 01/70→12/05							
 Bremsbelagsatz, Scheibenbremse							
1600 N/L (VAZ2106, VAZ2103)	57	03/79→12/05	←	→ 06/85		13.0460-2966.2 602966	TRW 20166 16,0 - WE / - WK
 Bremsscheibe							
1600 N/L (VAZ2106, VAZ2103)	57	03/79→12/05	←	→ 06/85		24.0111-0115.1 411115	Ø 252,5 10 9











	kw			 	! #		
LADA - KALINA Kombi (1117) 10/04→							
 Bremsbelagsatz, Scheibenbremse							
1.4 16V 1.4 16V LPG 1.6 1.6	66 65 60 62	11/08→12/13 11/08→ 10/04→12/13 01/10→	←			13.0460-2965.2 602965	TRW 21170 17,3 - WE / - WK
 Bremsscheibe							
1.4 16V 1.4 16V LPG 1.6 1.6	66 65 60 62	11/08→12/13 11/08→ 10/04→12/13 01/10→	←			24.0120-0187.1 420187	Ø 260 20 18,5 V
LADA - KALINA Kombi (2194) 11/13→							
 Bremsbelagsatz, Scheibenbremse							
1.6 1.6	64 72	11/13→ 11/13→	←			13.0460-2965.2 602965	TRW 21170 17,3 - WE / - WK
 Bremsscheibe							
1.6 1.6	64 72	11/13→ 11/13→	←			24.0120-0187.1 420187	Ø 260 20 18,5 V
LADA - KALINA Schrägheck (1119) 10/04→12/13							
 Bremsbelagsatz, Scheibenbremse							
1.4 16V 1.4 16V LPG 1.6 1.6 1.6	66 65 60 62 66	11/08→12/13 11/08→12/13 10/04→12/13 01/10→12/13 10/04→12/13	←			13.0460-2965.2 602965	TRW 21170 17,3 - WE / - WK
 Bremsscheibe							
1.4 16V 1.4 16V LPG 1.6 1.6 1.6	66 65 60 62 66	11/08→12/13 11/08→12/13 10/04→12/13 01/10→12/13 10/04→12/13	←			24.0120-0187.1 420187	Ø 260 20 18,5 V
LADA - KALINA Schrägheck (2192) 06/13→							
 Bremsbelagsatz, Scheibenbremse							
1.6 1.6	64 72	06/13→ 06/13→	←			13.0460-2965.2 602965	TRW 21170 17,3 - WE / - WK
 Bremsscheibe							
1.6 1.6	64 72	06/13→ 06/13→	←			24.0120-0187.1 420187	Ø 260 20 18,5 V
LADA - KALINA Stufenheck (1118) 10/04→							
 Bremsbelagsatz, Scheibenbremse							
1.4 16V 1.4 16V LPG 1.6 1.6 1.6	66 65 60 62 66	11/08→12/09 11/08→12/13 10/04→12/09 01/10→ 10/04→	←			13.0460-2965.2 602965	TRW 21170 17,3 - WE / - WK
 Bremsscheibe							
1.4 16V 1.4 16V LPG 1.6 1.6 1.6	66 65 60 62 66	11/08→12/09 11/08→12/13 10/04→12/09 01/10→ 10/04→	←			24.0120-0187.1 420187	Ø 260 20 18,5 V
LADA - NIVA (2121) 12/76→							
 Bremsbelagsatz, Scheibenbremse							
1600 4x4 1700 i 1700 i 4x4 1700 i 4x4 1900 Diesel 1900 Diesel	54 59 60 61 55 47	01/87→03/95 06/96→12/06 10/00→12/10 09/10→ 01/99→12/06 01/93→08/99	←			13.0460-8006.2 608006	20660 15,6 - WE / - WK
			←	03/93→		13.0460-8006.2 608006	20660 15,6 - WE / - WK
 Bremsscheibe							
1600 4x4 1700 i 1700 i 4x4 1700 i 4x4 ↓	54 59 60 61	01/87→03/95 06/96→12/06 10/00→12/10 09/10→	←			24.0112-0130.1 412130	Ø 272 11 9,9













	kw			 	! #		
LADA - NIVA (2121) 12/76→							
 Bremsscheibe							
1900 Diesel	55	01/99→12/06	←			24.0112-0130.1 412130	Ø 272 11 9,9
1900 Diesel	47	01/93→08/99	←	03/93→		24.0112-0130.1 412130	Ø 272 11 9,9
LADA - NOVA (2105) 05/81→04/12							
 Bremsbelagsatz, Scheibenbremse							
1200 Junior/L (VAZ, WAS2105)	44	09/81→04/12	←	→ 12/96		13.0460-2966.2 602966	TRW 20166 16,0 - WE / - WK
1300 Spezial/L (VAZ, WAS2105)	48	05/81→04/12					
1500 S (WAS21093)	52	06/89→04/12					
1500 Special (VAZ2105, WAS21053)	55	03/85→04/12					
1600 (WAS21074)	56	01/88→10/01					
1700 i Classic (VAZ2107)	62	06/96→04/12					
 Bremsscheibe							
1200 Junior/L (VAZ, WAS2105)	44	09/81→04/12	←	→ 12/96		24.0111-0115.1 411115	Ø 252,5 10 9
1300 Spezial/L (VAZ, WAS2105)	48	05/81→04/12					
1500 S (WAS21093)	52	06/89→04/12					
1500 Special (VAZ2105, WAS21053)	55	03/85→04/12					
1600 (WAS21074)	56	01/88→10/01					
1700 i Classic (VAZ2107)	62	06/96→04/12					
LADA - NOVA Kombi (2104) 09/81→04/12							
 Bremsbelagsatz, Scheibenbremse							
1500	49	08/94→04/12	←	→ 12/96		13.0460-2966.2 602966	TRW 20166 16,0 - WE / - WK
1700	62	08/94→04/12					
 Bremsscheibe							
1500	49	08/94→04/12	←	→ 12/96		24.0111-0115.1 411115	Ø 252,5 10 9
1700	62	08/94→04/12					
LADA - PRIORA Kombi (2171) 10/09→							
 Bremsbelagsatz, Scheibenbremse							
1.6	60	10/09→	←			13.0460-2965.2 602965	TRW 21170 17,3 - WE / - WK
1.6	72	10/09→					
LADA - PRIORA Schrägheck (2172) 12/08→							
 Bremsbelagsatz, Scheibenbremse							
1.6	60	12/08→	←			13.0460-2965.2 602965	TRW 21170 17,3 - WE / - WK
1.6	72	12/08→					
1.6 LPG	71	12/08→					
LADA - PRIORA Stufenheck (2170) 12/08→							
 Bremsbelagsatz, Scheibenbremse							
1.6	60	12/08→	←			13.0460-2965.2 602965	TRW 21170 17,3 - WE / - WK
1.6	72	12/08→					
1.6 LPG	71	03/09→					
LADA - SAMARA (2108, 2109, 2115, 2113, 2114) 01/86→12/13							
 Bremsbelagsatz, Scheibenbremse							
1.5	56	04/96→12/06	←	→ 12/99		13.0460-2965.2 602965	TRW 21170 17,3 - WE / - WK
1500	52	02/95→12/06					
1100	43	02/96→08/99	←			13.0460-2965.2 602965	TRW 21170 17,3 - WE / - WK
1300	45	09/91→08/99					
1300	46	06/87→12/96					
1300	50	02/96→12/96					
1500	50	09/91→12/96					
1500	53	09/87→12/96					
 Bremsscheibe							
1.5	56	04/96→12/06	←	→ 12/99		24.0112-0125.1 412125	Ø 239 12 10,8
1500	52	02/95→12/06				24.0312-0125.1 512125	Ø 239 12 10,8 PD
1100	43	02/96→08/99	←			24.0112-0125.1 412125	Ø 239 12 10,8
1300	45	09/91→08/99					
1300	46	06/87→12/96					
1300	50	02/96→12/96					
↓							













	kw					! #		
LADA - SAMARA (2108, 2109, 2115, 2113, 2114) 01/86→12/13								
 Bremsscheibe								
1500 1500	50 53	09/91→12/96 09/87→12/96	←			24.0112-0125.1 24.0312-0125.1	412125 512125	Ø 239 12 10,8 Ø 239 12 10,8 PD
LADA - SAMARA FORMA Stufenheck (21099, 2115) 09/87→12/12								
 Bremsbelagsatz, Scheibenbremse								
1100 1300 1300 1300 1500 1500 1500	39 45 46 48 50 52 53	07/91→08/99 07/91→08/99 05/90→08/99 05/89→07/97 07/91→12/96 11/94→12/06 09/91→12/96	←	→ 12/95		13.0460-2965.2	602965	TRW 21170 17,3 - WE / - WK
 Bremsscheibe								
1100 1300 1300 1300 1500 1500 1500	39 45 46 48 50 52 53	07/91→08/99 07/91→08/99 05/90→08/99 05/89→07/97 07/91→12/96 11/94→12/06 09/91→12/96	←	→ 12/95		24.0112-0125.1 24.0312-0125.1	412125 512125	Ø 239 12 10,8 Ø 239 12 10,8 PD
LADA - TAIGA II (2123) 09/02→								
 Bremsbelagsatz, Scheibenbremse								
1.7 1.7 1.7 LPG	59 61 57	09/02→ 08/04→ 09/02→	←			13.0460-8006.2	608006	20660 15,6 - WE / - WK
 Bremsscheibe								
1.7 1.7 1.7 LPG	59 61 57	09/02→ 08/04→ 09/02→	←			24.0112-0130.1	412130	Ø 272 11 9,9
LADA - TOSCANA (2107) 05/82→05/12								
 Bremsbelagsatz, Scheibenbremse								
1300	48	12/85→05/12	←	→ 12/96		13.0460-2966.2	602966	TRW 20166 16,0 - WE / - WK
 Bremsscheibe								
1300	48	12/85→05/12	←	→ 12/96		24.0111-0115.1	411115	Ø 252,5 10 9
LANCIA - DEDRA (835_) 01/89→07/99								
 Bremsbelagsatz, Scheibenbremse								
1.6 16V (835EI) 1.6 LE Cat (835EB)	76 66	01/96→07/99 07/94→07/99	←			13.0460-2949.2 13.0460-7131.2	602949 607131	TRW 20833 17,0 + WK ATE 21193 18,0 + WK
1.6 i.e. (835AN)	55	04/93→07/99	←	→ 10/93		13.0460-2949.2	602949	TRW 20833 17,0 + WK
			←	11/93→		13.0460-2949.2	602949	TRW 20833 17,0 + WK
			→	→ 10/93; + ABS		13.0460-2951.2	602951	TRW 21103 14,2 - WK
1.8 16V LE (835FG) 1.8 i.e. (835FA)	83 74	03/96→07/99 07/94→07/99	←			13.0460-2949.2 13.0460-7131.2	602949 607131	TRW 20833 17,0 + WK ATE 21193 18,0 + WK
			→	ALU		13.0460-2826.2	602826	TRW 23177 14,2 - WK
			→	GG		13.0460-2951.2	602951	TRW 21103 14,2 - WK
1.8 GT 16V (835EH) 2.0 16V (835ED)	96 102	03/96→07/99 07/94→07/99	←			13.0460-7129.2	607129	ATE 20907 18,1 + WK
			→	ALU		13.0460-2826.2	602826	TRW 23177 14,2 - WK
			→	GG		13.0460-2951.2	602951	TRW 21103 14,2 - WK
1.8 i.e. (835AT)	66	08/93→07/99	←	11/93→		13.0460-2949.2 13.0460-7131.2	602949 607131	TRW 20833 17,0 + WK ATE 21193 18,0 + WK
			←	→ 10/93		13.0460-2949.2	602949	TRW 20833 17,0 + WK
			→	11/93→; ALU		13.0460-2826.2	602826	TRW 23177 14,2 - WK
			→	11/93→; GG		13.0460-2951.2	602951	TRW 21103 14,2 - WK
			→	→ 10/93		13.0460-2951.2	602951	TRW 21103 14,2 - WK
1.8 i.e. (835BD, 835AD) 2.0 i.e. (835AL)	77 83	09/89→07/99 09/89→07/99	←	01/90→ 10/93		13.0460-2949.2	602949	TRW 20833 17,0 + WK
			←	11/93→		13.0460-7131.2	607131	ATE 21193 18,0 + WK
↓								











	kw			 	! #		
LANCIA - DEDRA (835_) 01/89→07/99							
 Bremsbelagsatz, Scheibenbremse							
1.8 i.e. (835BD, 835AD) 2.0 i.e. (835AL)	77 83	09/89→07/99 09/89→07/99	➔	11/93→; ALU		13.0460-2826.2 602826	TRW 23177 14,2 - WK
			➔	11/93→; GG		13.0460-2951.2 602951	TRW 21103 14,2 - WK
			➔	01/90→ 10/93		13.0460-2951.2 602951	TRW 21103 14,2 - WK
1.9 TDS (835EE, 835EF)	66	04/89→07/99	➔	01/90→ 10/93		13.0460-2949.2 602949	TRW 20833 17,0 + WK
			➔	11/93→		13.0460-7065.2 607065	ATE 21927 17,9 + WK
			➔	11/93→; ALU		13.0460-2826.2 602826	TRW 23177 14,2 - WK
			➔	11/93→; GG		13.0460-2951.2 602951	TRW 21103 14,2 - WK
			➔	01/90→ 10/93		13.0460-2951.2 602951	TRW 21103 14,2 - WK
2.0 i.e. Turbo (835AR)	119	04/91→07/99	➔	11/93→		13.0460-2949.2 602949	TRW 20833 17,0 + WK
			➔	05/91→ 10/93		13.0460-7131.2 607131	ATE 21193 18,0 + WK
			➔	05/91→ 10/93		13.0460-2979.2 602979	TRW 21147 19,0 + WK
			➔	11/93→; ALU		13.0460-2826.2 602826	TRW 23177 14,2 - WK
			➔	11/93→; GG		13.0460-2951.2 602951	TRW 21103 14,2 - WK
			➔	05/91→ 10/93		13.0460-2951.2 602951	TRW 21103 14,2 - WK
Zubehörsatz, Scheibenbremsbelag							
1.6 i.e. (835AN)	55	04/93→07/99	➔	→ 10/93; + ABS		13.0460-0072.2 610072	TRW
1.8 16V LE (835FG) 1.8 GT 16V (835EH) 1.8 i.e. (835FA) 2.0 16V (835ED)	83 96 74 102	03/96→07/99 03/96→07/99 07/94→07/99 07/94→07/99	➔	GG		13.0460-0072.2 610072	TRW
1.8 i.e. (835AT)	66	08/93→07/99	➔	11/93→; GG		13.0460-0072.2 610072	TRW
			➔	→ 10/93		13.0460-0072.2 610072	TRW
1.8 i.e. (835BD, 835AD) 1.9 TDS (835EE, 835EF) 2.0 i.e. (835AL)	77 66 83	09/89→07/99 04/89→07/99 09/89→07/99	➔	11/93→; GG		13.0460-0072.2 610072	TRW
			➔	01/90→ 10/93		13.0460-0072.2 610072	TRW
2.0 i.e. Turbo (835AR)	119	04/91→07/99	➔	11/93→; GG		13.0460-0072.2 610072	TRW
			➔	05/91→ 10/93		13.0460-0072.2 610072	TRW
 Bremsscheibe							
1.6 16V (835EI)	76	01/96→07/99	➔			24.0112-0127.1 412127	Ø 257,5 12 10,2
			➔			24.0120-0142.1 420142	Ø 257,5 20 18,2 V
			➔			24.0320-0142.1 520142	Ø 257,5 20 18,2 V PD
			➔			24.0111-0119.1 411119	Ø 240,5 11 9,2
1.6 i.e. (835AN)	55	04/93→07/99	➔	11/93→		24.0112-0127.1 412127	Ø 257,5 12 10,2
			➔	→ 10/93		24.0112-0127.1 412127	Ø 257,5 12 10,2
			➔	01/96→		24.0120-0142.1 420142	Ø 257,5 20 18,2 V
			➔			24.0320-0142.1 520142	Ø 257,5 20 18,2 V PD
			➔	01/96→		24.0111-0119.1 411119	Ø 240,5 11 9,2
			➔	→ 10/93; + ABS		24.0111-0119.1 411119	Ø 240,5 11 9,2
1.6 LE Cat (835EB)	66	07/94→07/99	➔			24.0112-0127.1 412127	Ø 257,5 12 10,2
			➔	01/96→		24.0120-0142.1 420142	Ø 257,5 20 18,2 V
			➔			24.0320-0142.1 520142	Ø 257,5 20 18,2 V PD
			➔	01/96→		24.0111-0119.1 411119	Ø 240,5 11 9,2
1.8 16V LE (835FG) 1.8 i.e. (835FA)	83 74	03/96→07/99 07/94→07/99	➔			24.0120-0142.1 420142	Ø 257,5 20 18,2 V
			➔			24.0320-0142.1 520142	Ø 257,5 20 18,2 V PD
			➔			24.0111-0119.1 411119	Ø 240,5 11 9,2
1.8 GT 16V (835EH) 2.0 16V (835ED)	96 102	03/96→07/99 07/94→07/99	➔			24.0122-0197.1 422197	Ø 257,5 22 20,2 V
			➔			24.0322-0197.1 522197	Ø 257,5 22 20,2 V PD
			➔			24.0111-0119.1 411119	Ø 240,5 11 9,2
1.8 i.e. (835AT)	66	08/93→07/99	➔	→ 10/93		24.0112-0127.1 412127	Ø 257,5 12 10,2
			➔	11/93→		24.0120-0142.1 420142	Ø 257,5 20 18,2 V
			➔			24.0320-0142.1 520142	Ø 257,5 20 18,2 V PD
			➔	→ 10/93		24.0111-0119.1 411119	Ø 240,5 11 9,2
			➔	11/93→		24.0111-0119.1 411119	Ø 240,5 11 9,2
1.8 i.e. (835BD, 835AD)	77	09/89→07/99	➔	01/90→ 10/93		24.0112-0127.1 412127	Ø 257,5 12 10,2
			➔	11/93→		24.0120-0142.1 420142	Ø 257,5 20 18,2 V
			➔			24.0320-0142.1 520142	Ø 257,5 20 18,2 V PD
↓							











	kW			 	! #		
LANCIA - DEDRA (835_) 01/89→07/99							
Bremsscheibe							
1.8 i.e. (835BD, 835AD)	77	09/89→07/99	➔	11/93→		24.0111-0119.1 411119	Ø 240,5 11 9,2
			➔	01/90→ 10/93		24.0111-0119.1 411119	Ø 240,5 11 9,2
1.9 TDS (835EE, 835EF)	66	04/89→07/99	←	01/90→ 10/93		24.0112-0127.1 412127	Ø 257,5 12 10,2
			←	11/93→; ohne Katalysator		24.0112-0127.1 412127	Ø 257,5 12 10,2
			←	11/93→; mit geregelttem (3-Wege) Katalysator		24.0122-0147.1 422147	Ø 284 22 20,2 V
			➔	11/93→		24.0111-0119.1 411119	Ø 240,5 11 9,2
			➔	01/90→ 10/93		24.0111-0119.1 411119	Ø 240,5 11 9,2
2.0 i.e. (835AL)	83	09/89→07/99	←	01/90→ 10/93		24.0120-0142.1 420142	Ø 257,5 20 18,2 V
						24.0320-0142.1 520142	Ø 257,5 20 18,2 V PD
			←	11/93→		24.0120-0142.1 420142	Ø 257,5 20 18,2 V
						24.0320-0142.1 520142	Ø 257,5 20 18,2 V PD
			➔	11/93→		24.0111-0119.1 411119	Ø 240,5 11 9,2
			➔	01/90→ 10/93		24.0111-0119.1 411119	Ø 240,5 11 9,2
2.0 i.e. Turbo (835AR)	119	04/91→07/99	←	11/93→		24.0120-0142.1 420142	Ø 257,5 20 18,2 V
						24.0320-0142.1 520142	Ø 257,5 20 18,2 V PD
			←	05/91→ 10/93		24.0122-0107.1 422107	Ø 284 22 20,2 V
			➔	05/91→ 10/93		24.0111-0119.1 411119	Ø 240,5 11 9,2
			➔	11/93→		24.0111-0119.1 411119	Ø 240,5 11 9,2
LANCIA - DEDRA SW (835_) 07/94→07/99							
Bremsbelagsatz, Scheibenbremse							
1.6 (835EB)	66	10/94→07/99	←			13.0460-2949.2 602949	TRW 20833 17,0 + WK
1.6 16V (835EI)	76	01/96→07/99				13.0460-7131.2 607131	ATE 21193 18,0 + WK
1.8 16V LE (835FG)	83	03/96→07/99	←			13.0460-2949.2 602949	TRW 20833 17,0 + WK
1.8 i.e. (835FA)	74	07/94→07/99				13.0460-7131.2 607131	ATE 21193 18,0 + WK
2.0 Integrale (835ED)	102	07/94→07/99	➔	ALU		13.0460-2826.2 602826	TRW 23177 14,2 - WK
			➔	GG		13.0460-2951.2 602951	TRW 21103 14,2 - WK
1.8 GT 16V (835EH)	96	03/96→07/99	←			13.0460-7129.2 607129	ATE 20907 18,1 + WK
			➔	ALU		13.0460-2826.2 602826	TRW 23177 14,2 - WK
			➔	GG		13.0460-2951.2 602951	TRW 21103 14,2 - WK
1.9 TDS (835EE, 835EF)	66	07/94→07/99	←			13.0460-7065.2 607065	ATE 21927 17,9 + WK
			➔	ALU		13.0460-2826.2 602826	TRW 23177 14,2 - WK
			➔	GG		13.0460-2951.2 602951	TRW 21103 14,2 - WK
2.0 16V (835ED)	102	07/94→07/99	←			13.0460-2949.2 602949	TRW 20833 17,0 + WK
						13.0460-7129.2 607129	ATE 20907 18,1 + WK
						13.0460-7131.2 607131	ATE 21193 18,0 + WK
			➔	ALU		13.0460-2826.2 602826	TRW 23177 14,2 - WK
			➔	GG		13.0460-2951.2 602951	TRW 21103 14,2 - WK
Zubehörsatz, Scheibenbremsbelag							
1.8 16V LE (835FG)	83	03/96→07/99	➔	GG		13.0460-0072.2 610072	TRW
1.8 GT 16V (835EH)	96	03/96→07/99					
1.8 i.e. (835FA)	74	07/94→07/99					
1.9 TDS (835EE, 835EF)	66	07/94→07/99					
2.0 16V (835ED)	102	07/94→07/99					
2.0 Integrale (835ED)	102	07/94→07/99					
Bremsscheibe							
1.6 (835EB)	66	10/94→07/99	←			24.0112-0127.1 412127	Ø 257,5 12 10,2
			←	01/96→		24.0120-0142.1 420142	Ø 257,5 20 18,2 V
						24.0320-0142.1 520142	Ø 257,5 20 18,2 V PD
			➔	01/96→		24.0111-0119.1 411119	Ø 240,5 11 9,2
1.6 16V (835EI)	76	01/96→07/99	←			24.0112-0127.1 412127	Ø 257,5 12 10,2
						24.0120-0142.1 420142	Ø 257,5 20 18,2 V
						24.0320-0142.1 520142	Ø 257,5 20 18,2 V PD
			➔			24.0111-0119.1 411119	Ø 240,5 11 9,2
1.8 16V LE (835FG)	83	03/96→07/99	←			24.0120-0142.1 420142	Ø 257,5 20 18,2 V
						24.0320-0142.1 520142	Ø 257,5 20 18,2 V PD
1.8 i.e. (835FA)	74	07/94→07/99	➔			24.0111-0119.1 411119	Ø 240,5 11 9,2
↓							













	kw			 	! #		
LANCIA - DEDRA SW (835_) 07/94→07/99							
 Bremsscheibe							
1.8 GT 16V (835EH)	96	03/96→07/99	←			24.0122-0197.1 422197 24.0322-0197.1 522197	Ø 257,5 22 20,2 V Ø 257,5 22 20,2 V PD
			→			24.0111-0119.1 411119	Ø 240,5 11 9,2
1.9 TDS (835EE, 835EF)	66	07/94→07/99	←	ohne Katalysator		24.0112-0127.1 412127	Ø 257,5 12 10,2
			←	mit geregeltm (3-Wege) Katalysator		24.0122-0147.1 422147	Ø 284 22 20,2 V
			→			24.0111-0119.1 411119	Ø 240,5 11 9,2
2.0 16V (835ED)	102	07/94→07/99	←			24.0120-0142.1 420142 24.0122-0197.1 422197 24.0320-0142.1 520142 24.0322-0197.1 522197	Ø 257,5 20 18,2 V Ø 257,5 22 20,2 V Ø 257,5 20 18,2 V PD Ø 257,5 22 20,2 V PD
			→			24.0111-0119.1 411119	Ø 240,5 11 9,2
2.0 Integrale (835ED)	102	07/94→07/99	←			24.0120-0142.1 420142 24.0122-0107.1 422107 24.0320-0142.1 520142	Ø 257,5 20 18,2 V Ø 284 22 20,2 V Ø 257,5 20 18,2 V PD
			→			24.0111-0119.1 411119	Ø 240,5 11 9,2
LANCIA - DELTA II (836_) 06/93→09/99							
 Bremsbelagsatz, Scheibenbremse							
1.4 i.e. (836AF, 836AH)	51	10/94→08/99	←			13.0460-7064.2 607064	ATE 21930 17,9 + WK
1.6 i.e. (836AD)	55	06/93→08/99	←	11/93→		13.0460-2949.2 602949 13.0460-7064.2 607064 13.0460-7065.2 607065	TRW 20833 17,0 + WK ATE 21930 17,9 + WK ATE 21927 17,9 + WK
			→	→ 10/93		13.0460-3942.2 603942	BDX 20841 12,0 + WE / - WK
1.6 i.e. (836AP)	66	03/96→08/99	←			13.0460-2949.2 602949	TRW 20833 17,0 + WK
1.6 i.e. 16V (836AO)	76	01/96→08/99	←			13.0460-7064.2 607064 13.0460-7065.2 607065	ATE 21930 17,9 + WK ATE 21927 17,9 + WK
1.8 i.e. (836AE)	76	06/93→08/99	←	11/93→		13.0460-2949.2 602949 13.0460-7065.2 607065	TRW 20833 17,0 + WK ATE 21927 17,9 + WK
			→	11/93→; ALU		13.0460-2826.2 602826	TRW 23177 14,2 - WK
			→	11/93→; GG		13.0460-2951.2 602951	TRW 21103 14,2 - WK
1.8 i.e. (836AG, 836AL)	66	07/94→08/99	←			13.0460-2949.2 602949	TRW 20833 17,0 + WK
1.8 i.e. 16V (836AQ)	83	03/96→08/99	←			13.0460-7065.2 607065	ATE 21927 17,9 + WK
1.8 i.e. 16V GT (836AR)	96	03/96→08/99	←			13.0460-2826.2 602826	TRW 23177 14,2 - WK
1.9 TD (836AM, 836AN)	66	10/94→08/99	→	ALU		13.0460-2826.2 602826	TRW 23177 14,2 - WK
			→	GG		13.0460-2951.2 602951	TRW 21103 14,2 - WK
2.0 16V (836AA, 836CA)	102	06/93→08/99	←	11/93→		13.0460-2979.2 602979 13.0460-4958.2 604958	TRW 21147 19,0 + WK BRE 21381 17,3 + WK
			→	11/93→; ALU		13.0460-2826.2 602826	TRW 23177 14,2 - WK
			→	11/93→; GG		13.0460-2951.2 602951	TRW 21103 14,2 - WK
2.0 16V Turbo (836AB)	137	06/93→08/99	←	11/93→		13.0460-2979.2 602979	TRW 21147 19,0 + WK
			→	11/93→; ALU		13.0460-2826.2 602826	TRW 23177 14,2 - WK
			→	11/93→; GG		13.0460-2951.2 602951	TRW 21103 14,2 - WK
2.0 16V Turbo (836AS)	142	07/96→08/99	←			13.0460-2979.2 602979	TRW 21147 19,0 + WK
			→	ALU		13.0460-2826.2 602826	TRW 23177 14,2 - WK
			→	GG		13.0460-2951.2 602951	TRW 21103 14,2 - WK
Zubehörsatz, Scheibenbremsbelag							
1.8 i.e. (836AE)	76	06/93→08/99	→	11/93→		13.0460-0072.2 610072	TRW
2.0 16V (836AA, 836CA)	102	06/93→08/99	→			13.0460-0072.2 610072	TRW
2.0 16V Turbo (836AB)	137	06/93→08/99	→			13.0460-0072.2 610072	TRW
1.8 i.e. (836AG, 836AL)	66	07/94→08/99	→			13.0460-0072.2 610072	TRW
1.8 i.e. 16V (836AQ)	83	03/96→08/99	→			13.0460-0072.2 610072	TRW
1.8 i.e. 16V GT (836AR)	96	03/96→08/99	→			13.0460-0072.2 610072	TRW
1.9 TD (836AM, 836AN)	66	10/94→08/99	→			13.0460-0072.2 610072	TRW
2.0 16V Turbo (836AS)	142	07/96→08/99	→			13.0460-0072.2 610072	TRW
 Bremsscheibe							
1.4 i.e. (836AF, 836AH)	51	10/94→08/99	←			24.0111-0119.1 411119	Ø 240,5 11 9,2
1.6 i.e. (836AD)	55	06/93→08/99	←	→ 10/93		24.0112-0112.1 412112	Ø 257 12 10,8
			←	11/93→		24.0112-0127.1 412127	Ø 257,5 12 10,2
			→	→ 10/93		24.0111-0130.1 411130	Ø 227 10,8 9
↓							















	kw			 	! #		
LANCIA - DELTA II (836_) 06/93→09/99							
 Bremsscheibe							
1.6 i.e. (836AP)	66	03/96→08/99	←			24.0112-0127.1 412127	Ø 257,5 12 10,2
1.6 i.e. 16V (836AO)	76	01/96→08/99					
1.8 i.e. (836AE)	76	06/93→08/99	←	11/93→		24.0112-0127.1 412127	Ø 257,5 12 10,2
			→	11/93→		24.0111-0119.1 411119	Ø 240,5 11 9,2
1.8 i.e. (836AG, 836AL)	66	07/94→08/99	←			24.0112-0127.1 412127	Ø 257,5 12 10,2
1.8 i.e. 16V (836AQ)	83	03/96→08/99	→				
1.8 i.e. 16V GT (836AR)	96	03/96→08/99	→			24.0111-0119.1 411119	Ø 240,5 11 9,2
1.9 TD (836AM, 836AN)	66	10/94→08/99					
2.0 16V (836AA, 836CA)	102	06/93→08/99	←	11/93→		24.0122-0107.1 422107	Ø 284 22 20,2 V
			→	11/93→		24.0126-0114.1 426114	Ø 281 26 24,2 V
						24.0110-0209.1 410209	Ø 251,4 10 9
						24.0111-0119.1 411119	Ø 240,5 11 9,2
2.0 16V Turbo (836AB)	137	06/93→08/99	←	11/93→		24.0122-0147.1 422147	Ø 284 22 20,2 V
			→	11/93→		24.0111-0119.1 411119	Ø 240,5 11 9,2
2.0 16V Turbo (836AS)	142	07/96→08/99	←			24.0122-0147.1 422147	Ø 284 22 20,2 V
			→			24.0111-0119.1 411119	Ø 240,5 11 9,2
LANCIA - DELTA III (844_) 08/08→08/14							
 Bremsbelagsatz, Scheibenbremse							
1.4	88	09/08→08/14	←	→ 10/09		13.0460-3983.2 603983	BOS 23708 19,4 + WK
1.6 D Multijet	85	08/08→08/14				13.0470-3983.2 LD3983	BOS 23708 19,4 + WK Ceramic
1.6 D Multijet	88	09/08→08/14	←	11/09→		13.0460-3984.2 603984	BOS 23711 19,4 + WK
			→			13.0470-3984.2 LD3984	BOS 23711 19,4 + WK Ceramic
			→			13.0460-3861.2 603861	BOS 23714 17,6 + WK + Zub
						13.0460-3991.2 603991	BOS 23714 16,6 - WE / - WK
						13.0470-3812.2 LD3812	BOS 23714 17,6 - WE / - WK Ceramic
1.4	110	09/08→08/14	←			13.0460-3984.2 603984	BOS 23711 19,4 + WK
1.4 16V	103	07/10→08/14				13.0470-3984.2 LD3984	BOS 23711 19,4 + WK Ceramic
1.4 Bifuel	88	07/11→08/14	→				
1.6 D Multijet	77	04/11→08/14	→			13.0460-3861.2 603861	BOS 23714 17,6 + WK + Zub
						13.0460-3991.2 603991	BOS 23714 16,6 - WE / - WK
						13.0470-3812.2 LD3812	BOS 23714 17,6 - WE / - WK Ceramic
1.8	147	01/09→08/14	←			13.0460-7265.2 607265	ATE 24272 20,7 + WK
1.9 D Multijet	140	01/09→08/14					
2.0 D Multijet	120	09/08→08/14	→			13.0460-3861.2 603861	BOS 23714 17,6 + WK + Zub
2.0 D Multijet	121	09/08→08/14	→			13.0460-3991.2 603991	BOS 23714 16,6 - WE / - WK
						13.0470-3812.2 LD3812	BOS 23714 17,6 - WE / - WK Ceramic
 Bremsscheibe							
1.4	88	09/08→08/14	←	→ 10/09		24.0122-0147.1 422147	Ø 284 22 20,2 V
1.6 D Multijet	85	08/08→08/14					
1.6 D Multijet	88	09/08→08/14	←	11/09→; für Leichtmetallfelgen		24.0126-0125.1 426125	Ø 281 26 24,2 V
			→			24.0110-0190.1 410190	Ø 251,5 10 9
1.4	110	09/08→08/14	←	für Leichtmetallfelgen		24.0126-0125.1 426125	Ø 281 26 24,2 V
1.4 16V	103	07/10→08/14					
1.4 Bifuel	88	07/11→08/14	→			24.0110-0190.1 410190	Ø 251,5 10 9
1.6 D Multijet	77	04/11→08/14					
1.8	147	01/09→08/14	→			24.0110-0190.1 410190	Ø 251,5 10 9
1.9 D Multijet	140	01/09→08/14	←			24.0128-0243.1 428243	Ø 305 28 26 V
2.0 D Multijet	120	09/08→08/14					
2.0 D Multijet	121	09/08→08/14	→			24.0110-0190.1 410190	Ø 251,5 10 9
LANCIA - FLAVIA Cabriolet (JS_) 03/12→12/14							
 Bremsbelagsatz, Scheibenbremse							
2.4	125	03/12→12/14	←			13.0460-5760.2 605760	AKE 23584 16,4 + WK
2.4	129	03/12→12/14	→			13.0460-5855.2 605855	23582 16,0 - WK
 Bremsscheibe							
2.4	125	03/12→12/14	→			24.0110-0372.1 410372	Ø 302 10 8,4
2.4	129	03/12→12/14					













	kW			 	! #		
LANCIA - KAPPA (838_) 08/94→10/01							
 Bremsbelagsatz, Scheibenbremse							
2.0 16V Turbo (838AB1AA)	151	02/95→10/01	←	07/95→		13.0460-2987.2 602987	TRW 21147 19,0 + WK
			→	07/95→		13.0460-2827.2 602827	TRW 21606 16,7 - WK
2.0 20V (838AA1AA)	107	10/94→10/01	←	01/95→		13.0460-2987.2 602987	TRW 21147 19,0 + WK
2.4 20V (838AC1AA, 838AC11A)	129	08/94→10/01	→	01/95→		13.0460-2827.2 602827	TRW 21606 16,7 - WK
2.4 T.DS (838AE1AA, 838AH1AA)	91	08/94→10/01					
3.0 24V (838AD1AA, 838AD11A, 838XD1AA, 838ZD1AA)	150	08/94→10/01					
2.0 20V (838AG1AA, 838AG11A)	114	07/96→10/01	←			13.0460-2987.2 602987	TRW 21147 19,0 + WK
2.0 20V Turbo (838AM1AA)	162	06/98→10/01	→			13.0460-2827.2 602827	TRW 21606 16,7 - WK
2.4 JTD (838AL1AA)	100	06/98→10/01					
 Bremsscheibe							
2.0 16V Turbo (838AB1AA)	151	02/95→10/01	←	07/95→		24.0126-0133.1 426133	Ø 281 26 24,2 V
			→	07/95→		24.0110-0290.1 410290	Ø 276 10 9
2.0 20V (838AA1AA)	107	10/94→10/01	←	01/95→		24.0122-0191.1 422191	Ø 281 22 20,2 V
			→	01/95→		24.0110-0290.1 410290	Ø 276 10 9
2.0 20V (838AG1AA, 838AG11A)	114	07/96→10/01	←			24.0122-0191.1 422191	Ø 281 22 20,2 V
			→			24.0110-0290.1 410290	Ø 276 10 9
2.0 20V Turbo (838AM1AA)	162	06/98→10/01	←			24.0126-0133.1 426133	Ø 281 26 24,2 V
2.4 JTD (838AL1AA)	100	06/98→10/01	→			24.0110-0290.1 410290	Ø 276 10 9
2.4 20V (838AC1AA, 838AC11A)	129	08/94→10/01	←	01/95→		24.0126-0133.1 426133	Ø 281 26 24,2 V
2.4 T.DS (838AE1AA, 838AH1AA)	91	08/94→10/01	→	01/95→		24.0110-0290.1 410290	Ø 276 10 9
3.0 24V (838AD1AA, 838AD11A, 838XD1AA, 838ZD1AA)	150	08/94→10/01					
LANCIA - KAPPA Coupe (838_) 07/96→03/01							
 Bremsbelagsatz, Scheibenbremse							
2.0 16V Turbo (838CB)	151	11/96→03/01	←			13.0460-2987.2 602987	TRW 21147 19,0 + WK
2.0 20V Turbo (838CM)	162	06/98→03/01	→			13.0460-2827.2 602827	TRW 21606 16,7 - WK
2.4 20V (838CC)	129	11/96→03/01					
3.0 24V (838CD, 838CD11A)	150	11/96→03/01	←	03/97→		13.0460-4971.2 604971	BRE 23092 16,0 + WK
			→			13.0470-4971.2 LD4971	BRE 23092 16,0 + WK Ceramic
						13.0460-2827.2 602827	TRW 21606 16,7 - WK
 Bremsscheibe							
2.0 16V Turbo (838CB)	151	11/96→03/01	←			24.0126-0133.1 426133	Ø 281 26 24,2 V
2.0 20V Turbo (838CM)	162	06/98→03/01	→			24.0110-0290.1 410290	Ø 276 10 9
2.4 20V (838CC)	129	11/96→03/01					
3.0 24V (838CD, 838CD11A)	150	11/96→03/01					
2.0 20V	114	07/96→03/01	←			24.0122-0191.1 422191	Ø 281 22 20,2 V
			→			24.0110-0290.1 410290	Ø 276 10 9
LANCIA - KAPPA SW (838_) 07/96→10/01							
 Bremsbelagsatz, Scheibenbremse							
2.0 16V Turbo (838BB1AA)	151	07/96→10/01	←			13.0460-2987.2 602987	TRW 21147 19,0 + WK
2.0 20V (838BG1AA)	114	07/96→10/01	→			13.0460-2827.2 602827	TRW 21606 16,7 - WK
2.0 20V Turbo (838BM1AA)	162	06/98→10/01					
2.4 20V (838BC1AA, 838BC11A)	129	07/96→10/01					
2.4 JTD (838BL1AA)	100	06/98→10/01					
2.4 T.DS (838BH1AA)	91	07/96→10/01					
3.0 24V (838BD11A)	150	07/96→10/01					
 Bremsscheibe							
2.0 16V Turbo (838BB1AA)	151	07/96→10/01	←			24.0126-0133.1 426133	Ø 281 26 24,2 V
2.0 20V Turbo (838BM1AA)	162	06/98→10/01	→			24.0110-0290.1 410290	Ø 276 10 9
↓							











	kW			 	! #		
LANCIA - KAPPA SW (838_) 07/96→10/01							
 Bremsscheibe							
2.4 20V (838BC1AA, 838BC11A)	129	07/96→10/01	←			24.0126-0133.1 426133	Ø 281 26 24,2 V
2.4 JTD (838BL1AA)	100	06/98→10/01	→			24.0110-0290.1 410290	Ø 276 10 9
2.4 T.DS (838BH1AA)	91	07/96→10/01					
3.0 24V (838BD11A)	150	07/96→10/01					
2.0 20V (838BG1AA)	114	07/96→10/01	←			24.0122-0191.1 422191	Ø 281 22 20,2 V
			→			24.0110-0290.1 410290	Ø 276 10 9
LANCIA - LYBRA (839_) 07/99→10/05							
 Bremsbelagsatz, Scheibenbremse							
1.6	76	10/00→10/05	←			13.0460-7139.2 607139	ATE 23140 19,4 + WK
			→			13.0470-7139.2 LD7139	ATE 23140 19,4 + WK Ceramic
1.6 16V (839AXA1A)	76	07/99→10/05	←	10/99→ 02/00		13.0460-7105.2 607105	ATE 23140 19,4 + WK
			←	03/00→		13.0460-7139.2 607139	ATE 23140 19,4 + WK
			→	10/99→		13.0470-7139.2 LD7139	ATE 23140 19,4 + WK Ceramic
1.8 16V (839AXB1A, 839AXG1A)	96	07/99→10/05	←	10/99→ 03/00		13.0460-7069.2 607069	ATE 21636 19,3 + WK
1.9 JTD (839AXD1A)	77	07/99→09/00	←	04/00→		13.0460-7140.2 607140	ATE 21637 19,3 + WK
2.0 20V (839AXC11, 839AXC1A)	113	07/99→09/00				13.0470-7140.2 LD7140	ATE 21637 19,3 + WK Ceramic
2.4 JTD (839AXE1A)	99	07/99→02/01	→	10/99→		13.0460-2867.2 602867	TRW 23517 16,6 - WE / - WK
						13.0470-2867.2 LD2867	TRW 23517 16,6 - WE / - WK Ceramic
1.9 JTD	85	05/01→10/05	←			13.0460-7140.2 607140	ATE 21637 19,3 + WK
1.9 JTD (839AXI1A)	81	09/00→05/01				13.0470-7140.2 LD7140	ATE 21637 19,3 + WK Ceramic
2.0 20V (839AXH1A)	110	09/00→10/05					
2.4 20V	125	10/01→10/05	→			13.0460-2867.2 602867	TRW 23517 16,6 - WE / - WK
2.4 JTD	110	05/02→10/05				13.0470-2867.2 LD2867	TRW 23517 16,6 - WE / - WK
2.4 JTD (839AXL1A)	103	09/00→05/02					TRW 23517 16,6 - WE / - WK Ceramic
 Bremsscheibe							
1.6	76	10/00→10/05	←			24.0122-0147.1 422147	Ø 284 22 20,2 V
1.9 JTD	85	05/01→10/05					
1.9 JTD (839AXI1A)	81	09/00→05/01	→			24.0110-0190.1 410190	Ø 251,5 10 9
2.0 20V (839AXH1A)	110	09/00→10/05					
2.4 20V	125	10/01→10/05					
2.4 JTD	110	05/02→10/05					
2.4 JTD (839AXL1A)	103	09/00→05/02					
1.6 16V (839AXA1A)	76	07/99→10/05	←	10/99→		24.0115-0112.1 415112	Ø 281 15 13,2
			→	10/99→		24.0110-0190.1 410190	Ø 251,5 10 9
1.8 16V (839AXB1A, 839AXG1A)	96	07/99→10/05	←	10/99→		24.0122-0147.1 422147	Ø 284 22 20,2 V
1.9 JTD (839AXD1A)	77	07/99→09/00	→	10/99→		24.0110-0190.1 410190	Ø 251,5 10 9
2.0 20V (839AXC11, 839AXC1A)	113	07/99→09/00					
2.4 JTD (839AXE1A)	99	07/99→02/01					
LANCIA - LYBRA SW (839_) 07/99→10/05							
 Bremsbelagsatz, Scheibenbremse							
1.6	76	10/00→10/05	←			13.0460-7139.2 607139	ATE 23140 19,4 + WK
			→			13.0470-7139.2 LD7139	ATE 23140 19,4 + WK Ceramic
1.6 16V (839BXA1A)	76	07/99→10/05	←	10/99→ 02/00		13.0460-7105.2 607105	ATE 23140 19,4 + WK
			←	03/00→		13.0460-7139.2 607139	ATE 23140 19,4 + WK
			→	10/99→		13.0470-7139.2 LD7139	ATE 23140 19,4 + WK Ceramic
1.8 16V (839BXB1A, 839BXG1A)	96	07/99→10/05	←	10/99→ 03/00		13.0460-7069.2 607069	ATE 21636 19,3 + WK
1.9 JTD (839BXD1A)	77	07/99→09/00	←	04/00→		13.0460-7140.2 607140	ATE 21637 19,3 + WK
2.0 20V (839BXC11, 839BXC1A)	113	07/99→09/00				13.0470-7140.2 LD7140	ATE 21637 19,3 + WK Ceramic

	kW			 	! #		
LANCIA - LYBRA SW (839_) 07/99→10/05							
 Bremsbelagsatz, Scheibenbremse							
1.8 16V (839BxB1A, 839BXG1A)	96	07/99→10/05	➔	10/99→		13.0460-2867.2 602867	TRW 23517 16,6 - WE / - WK
1.9 JTD (839BXD1A)	77	07/99→09/00				13.0470-2867.2 LD2867	TRW 23517 16,6 - WE / - WK Ceramic
2.0 20V (839BXC11, 839BXC1A)	113	07/99→09/00					
1.9 JTD (839BXI1A)	85	05/01→10/05	➔			13.0460-7140.2 607140	ATE 21637 19,3 + WK
1.9 JTD (839BXI1A)	81	09/00→05/01				13.0470-7140.2 LD7140	ATE 21637 19,3 + WK Ceramic
2.0 20V (839BXH1A)	110	09/00→10/05					
2.4 JTD (839BXL1A)	110	05/02→10/05	➔			13.0460-2867.2 602867	TRW 23517 16,6 - WE / - WK
2.4 JTD (839BXL1A)	103	09/00→10/05				13.0470-2867.2 LD2867	TRW 23517 16,6 - WE / - WK Ceramic
2.4 JTD (839BXE1A)	99	10/99→09/00	➔	→ 03/00		13.0460-7069.2 607069	ATE 21636 19,3 + WK
			➔	04/00→		13.0460-7140.2 607140	ATE 21637 19,3 + WK
						13.0470-7140.2 LD7140	ATE 21637 19,3 + WK Ceramic
			➔			13.0460-2867.2 602867	TRW 23517 16,6 - WE / - WK
						13.0470-2867.2 LD2867	TRW 23517 16,6 - WE / - WK Ceramic
 Bremsscheibe							
1.6	76	10/00→10/05	➔			24.0122-0147.1 422147	Ø 284 22 20,2 V
1.9 JTD (839BXI1A)	85	05/01→10/05					
1.9 JTD (839BXI1A)	81	09/00→05/01	➔			24.0110-0190.1 410190	Ø 251,5 10 9
2.0 20V (839BXH1A)	110	09/00→10/05					
2.4 JTD (839BXE1A)	110	05/02→10/05					
2.4 JTD (839BXL1A)	99	10/99→09/00					
2.4 JTD (839BXL1A)	103	09/00→10/05					
1.6 16V (839BXA1A)	76	07/99→10/05	➔	10/99→		24.0115-0112.1 415112	Ø 281 15 13,2
			➔	10/99→		24.0110-0190.1 410190	Ø 251,5 10 9
1.8 16V (839BxB1A, 839BXG1A)	96	07/99→10/05	➔	10/99→		24.0122-0147.1 422147	Ø 284 22 20,2 V
1.9 JTD (839BXD1A)	77	07/99→09/00	➔	10/99→		24.0110-0190.1 410190	Ø 251,5 10 9
2.0 20V (839BXC11, 839BXC1A)	113	07/99→09/00					
LANCIA - MUSA (350_) 10/04→09/12							
 Bremsbelagsatz, Scheibenbremse							
1.3 D Multijet	51	10/04→09/12	➔			13.0460-3810.2 603810	BOS 23705 18,1 - WE / - WK
1.4	57	09/05→09/12				13.0460-3818.2 603818	BOS 23706 18,1 + WK
1.4	66	10/07→09/12					
1.4	70	10/04→09/12					
1.4 LPG	57	11/10→09/12					
1.3 D Multijet	66	09/06→09/12	➔			13.0460-3811.2 603811	BOS 23708 19,2 - WE / - WK
1.9 D Multijet	74	10/04→09/12				13.0460-3827.2 603827	BOS 23709 19,6 + WK + Zub
						13.0470-3827.2 LD3827	BOS 23709 19,6 + WK + Zub Ceramic
1.3 D Multijet	70	03/09→09/12	➔	08/09→		13.0460-3811.2 603811	BOS 23708 19,2 - WE / - WK
						13.0460-3827.2 603827	BOS 23709 19,6 + WK + Zub
						13.0470-3827.2 LD3827	BOS 23709 19,6 + WK + Zub Ceramic
1.6 D Multijet	85	07/08→09/12	➔			13.0460-3811.2 603811	BOS 23708 19,2 - WE / - WK
1.6 D Multijet	88	07/08→09/12				13.0460-3827.2 603827	BOS 23709 19,6 + WK + Zub
						13.0470-3827.2 LD3827	BOS 23709 19,6 + WK + Zub Ceramic
			➔			13.0460-2879.2 602879	TRW 23601 13,7 - WE / - WK
						13.0470-2879.2 LD2879	TRW 23601 13,7 - WE / - WK Ceramic
 Bremsscheibe							
1.3 D Multijet	51	10/04→09/12	➔			24.0122-0197.1 422197	Ø 257,5 22 20,2 V
1.4	57	09/05→09/12				24.0322-0197.1 522197	Ø 257,5 22 20,2 V PD
1.4	66	10/07→09/12					
1.4	70	10/04→09/12					
1.4 LPG	57	11/10→09/12					
1.3 D Multijet	66	09/06→09/12	➔			24.0122-0147.1 422147	Ø 284 22 20,2 V
1.9 D Multijet	74	10/04→09/12					
1.3 D Multijet	70	03/09→09/12	➔	08/09→		24.0122-0147.1 422147	Ø 284 22 20,2 V
1.6 D Multijet	85	07/08→09/12	➔			24.0122-0147.1 422147	Ø 284 22 20,2 V
1.6 D Multijet	88	07/08→09/12	➔			24.0111-0119.1 411119	Ø 240,5 11 9,2







	kw			 	! #		
LANCIA - PHEDRA (179_) 09/02→11/10							
 Bremsbelagsatz, Scheibenbremse							
2.0 (179AXA11)	100	09/02→11/10	←	→ 09/10		13.0460-2863.2 602863	TRW 20261 19,0 + WK + Zub
2.0 D Multijet	100	07/06→11/10					
2.0 JTD	79	07/03→11/10	→	→ 09/10		13.0460-2819.2 602819	TRW 20961 17,2 - WK
2.0 JTD	88	06/06→11/10					
2.0 JTD (179AXB1A)	80	09/02→11/10					
2.2 JTD (179AXC1A)	94	09/02→11/10					
2.2 D Multijet	125	03/08→11/10	←	→ 09/10		13.0460-2752.2 602752	TRW 24839 19,4 + WK + Zub
2.2 JTD	120	04/06→11/10	→	→ 09/10		13.0460-2819.2 602819	TRW 20961 17,2 - WK
3.0 V6	150	09/02→11/10	←	→ 09/10		13.0460-4995.2 604995	BRE 23575 15,6 + WK
			→	→ 09/10		13.0460-2819.2 602819	TRW 20961 17,2 - WK
Zubehörsatz, Scheibenbremsbelag							
2.0 (179AXA11)	100	09/02→11/10	→	→ 09/10		13.0460-0072.2 610072	TRW
2.0 D Multijet	100	07/06→11/10					
2.0 JTD	79	07/03→11/10					
2.0 JTD	88	06/06→11/10					
2.0 JTD (179AXB1A)	80	09/02→11/10					
2.2 D Multijet	125	03/08→11/10					
2.2 JTD	120	04/06→11/10					
2.2 JTD (179AXC1A)	94	09/02→11/10					
3.0 V6	150	09/02→11/10					
 Bremsscheibe							
2.0 (179AXA11)	100	09/02→11/10	←	→ 09/10		24.0128-0136.1 428136	Ø 285 28 26 V
2.0 D Multijet	100	07/06→11/10				24.0328-0136.1 528136	Ø 285 28 26 V PD
2.0 JTD	79	07/03→11/10					
2.0 JTD	88	06/06→11/10	→	→ 09/10		24.0112-0156.1 412156	Ø 272 12 10
2.0 JTD (179AXB1A)	80	09/02→11/10					
2.2 JTD (179AXC1A)	94	09/02→11/10					
2.2 D Multijet	125	03/08→11/10	←	→ 09/10		24.0132-0126.1 432126	Ø 310 32 30 V
2.2 JTD	120	04/06→11/10					
3.0 V6	150	09/02→11/10	→	→ 09/10		24.0112-0156.1 412156	Ø 272 12 10
LANCIA - THESIS (841_) 07/02→07/09							
 Bremsbelagsatz, Scheibenbremse							
2.0 Turbo (841AXA1B03)	136	07/02→07/09	←	→ 12/07		13.0460-2704.2 602704	TRW 23761 18,8 + WK
2.4 (841AXB1B00)	125	07/02→07/09	→	→ 12/07; + eFSB		13.0460-2707.2 602707	TRW 23760 17,7 - WE / - WK
2.4 D Multijet	136	04/06→07/09				13.0470-2707.2 LD2707	TRW 23760 17,7 - WE / - WK Ceramic
2.4 JTD	120	09/03→07/09					
2.4 JTD	129	05/03→07/09					
2.4 JTD (841AXD1B02)	110	07/02→07/09					
3.2 V6	169	05/03→07/09					
3.0 V6 (841AXC1101)	158	07/02→07/09	←	→ 12/07; nicht für gepanzerte Fahrzeuge		13.0460-2704.2 602704	TRW 23761 18,8 + WK
			→	→ 12/07; + eFSB		13.0460-2707.2 602707	TRW 23760 17,7 - WE / - WK
						13.0470-2707.2 LD2707	TRW 23760 17,7 - WE / - WK Ceramic
 Bremsscheibe							
2.0 Turbo (841AXA1B03)	136	07/02→07/09	←	→ 12/07		24.0128-0179.1 428179	Ø 305,5 28 26 V
2.4 (841AXB1B00)	125	07/02→07/09	→	→ 12/07; + eFSB		24.0122-0234.1 422234	Ø 281 22 20,2 V
2.4 D Multijet	136	04/06→07/09					
2.4 JTD	120	09/03→07/09					
2.4 JTD	129	05/03→07/09					
2.4 JTD (841AXD1B02)	110	07/02→07/09					
3.2 V6	169	05/03→07/09					
3.0 V6 (841AXC1101)	158	07/02→07/09	←	→ 12/07; nicht für gepanzerte Fahrzeuge		24.0128-0179.1 428179	Ø 305,5 28 26 V
			→	→ 12/07; nicht für gepanzerte Fahrzeuge; + eFSB		24.0122-0234.1 422234	Ø 281 22 20,2 V
LANCIA - Y (840_) 11/95→09/03							
 Bremsbelagsatz, Scheibenbremse							
1.1 (840AE)	40	11/95→09/03	←	05/97→ 12/98		13.0460-3950.2 603950	BDX 21436 17,0 - WK
						13.0460-3951.2 603951	BDX 21436 16,2 + WK
1.2 (840AA, 840AF1A)	44	03/96→09/03	←	10/00→ 07/03; - ABS		13.0460-3950.2 603950	BDX 21436 17,0 - WK
						13.0460-3951.2 603951	BDX 21436 16,2 + WK
			←	→ 09/00		13.0460-3950.2 603950	BDX 21436 17,0 - WK
						13.0460-3951.2 603951	BDX 21436 16,2 + WK
			←	10/00→ 07/03; + ABS		13.0460-7114.2 607114	ATE 21930 17,9 - WE / - WK
1.2 16V (840AD)	63	04/97→09/03	←	05/97→ 09/00		13.0460-7114.2 607114	ATE 21930 17,9 - WE / - WK
↓							











	kw					! #		
LANCIA - Y (840_) 11/95→09/03								
 Bremsbelagsatz, Scheibenbremse								
1.2 16V (840AG1A)	59	10/00→09/03	←	→ 07/03			13.0460-7114.2 607114	ATE 21930 17,9 - WE / - WK
1.4 12V (840AB)	59	10/96→09/03	←	→ 12/98			13.0460-2949.2 602949	TRW 20833 17,0 + WK
1.4 12V (840AC)	55	03/96→09/03	←	01/99→ 07/03			13.0460-7114.2 607114	ATE 21930 17,9 - WE / - WK
 Bremsscheibe								
1.1 (840AE)	40	11/95→09/03	←	05/97→ 12/98			24.0111-0119.1 411119	Ø 240,5 11 9,2
1.2 (840AA, 840AF1A)	44	03/96→09/03	←	10/00→ 07/03; - ABS			24.0111-0119.1 411119	Ø 240,5 11 9,2
				→ 09/00			24.0111-0119.1 411119	Ø 240,5 11 9,2
				10/00→ 07/03; + ABS			24.0112-0127.1 412127	Ø 257,5 12 10,2
1.2 16V (840AD)	63	04/97→09/03	←	05/97→ 09/00			24.0112-0127.1 412127	Ø 257,5 12 10,2
1.2 16V (840AG1A)	59	10/00→09/03	←	→ 07/03			24.0112-0127.1 412127	Ø 257,5 12 10,2
1.4 12V (840AB)	59	10/96→09/03	←	→ 12/98			24.0112-0127.1 412127	Ø 257,5 12 10,2
1.4 12V (840AC)	55	03/96→09/03	←				24.0112-0127.1 412127	Ø 257,5 12 10,2
LANCIA - Y10 (156_) 03/85→12/95								
 Bremsbelagsatz, Scheibenbremse								
1.1 Fire (156AG)	40	01/95→12/95	←				13.0460-3940.2 603940	BDX 20775 18,0 + WK
1.1 Fire Allrad (156AG)	40	01/95→12/95						
1.1 i.e. Fire Allrad (156AG)	37	09/92→12/95						
1.1 i.e. Fire (156AG)	37	07/89→09/95	←	01/90→			13.0460-3940.2 603940	BDX 20775 18,0 + WK
1.3 i.e. (156AF)	53	02/89→12/95	←				13.0460-2941.2 602941	TRW 20838 17,0 + WK
Zubehörsatz, Scheibenbremsbelag								
1.1 Fire (156AG)	40	01/95→12/95	←				13.0460-0410.2 610410	BDX
1.1 Fire Allrad (156AG)	40	01/95→12/95						
1.1 i.e. Fire Allrad (156AG)	37	09/92→12/95						
1.1 i.e. Fire (156AG)	37	07/89→09/95	←	01/90→			13.0460-0410.2 610410	BDX
 Bremsscheibe								
1.1 Fire (156AG)	40	01/95→12/95	←				24.0111-0130.1 411130	Ø 227 10,8 9
1.1 Fire Allrad (156AG)	40	01/95→12/95						
1.1 i.e. Fire Allrad (156AG)	37	09/92→12/95						
1.1 i.e. Fire (156AG)	37	07/89→09/95	←	01/90→			24.0111-0130.1 411130	Ø 227 10,8 9
1.3 i.e. (156AF)	53	02/89→12/95	←				24.0112-0122.1 412122	Ø 240 12 10,8
LANCIA - YPSILON (312_) 05/11→								
 Bremsbelagsatz, Scheibenbremse								
0.9 CNG	63	05/11→	←				13.0460-7289.2 607289	ATE 25323 17,3 + WK
0.9 TwinAir	59	12/13→						
0.9 TwinAir	63	05/11→						
1.2	51	05/11→						
1.2 Bifuel	49	05/11→						
1.3 D Multijet	57	06/16→						
1.3 D Multijet	70	05/11→						
1.2 Bifuel	51	05/11→	←	04/15→			13.0460-7289.2 607289	ATE 25323 17,3 + WK
 Bremsscheibe								
0.9 CNG	63	05/11→	←				24.0122-0197.1 422197	Ø 257,5 22 20,2 V
0.9 TwinAir	59	12/13→					24.0322-0197.1 522197	Ø 257,5 22 20,2 V PD
0.9 TwinAir	63	05/11→						
1.3 D Multijet	57	06/16→						
1.3 D Multijet	70	05/11→						
1.2	51	05/11→	←				24.0112-0127.1 412127	Ø 257,5 12 10,2
1.2 Bifuel	49	05/11→						
1.2 Bifuel	51	05/11→	←	04/15→			24.0112-0127.1 412127	Ø 257,5 12 10,2
LANCIA - YPSILON (843_) 10/03→12/11								
 Bremsbelagsatz, Scheibenbremse								
1.2	44	10/03→12/11	←	08/06→ 06/11			13.0460-2724.2 602724	TRW 24073 16,7 + WK + Zub
1.2	59	10/03→12/11						
1.3 JTD	51	10/03→12/11	←	→ 07/06			13.0460-2878.2 602878	TRW 24073 16,7 - WK
1.4	57	02/06→12/11						
1.4 16V	70	10/03→12/11						
1.2	51	08/10→12/11	←	→ 06/11			13.0460-2724.2 602724	TRW 24073 16,7 + WK + Zub
1.4 LPG	57	11/10→12/11						









	kw			 	! #		
LANCIA - YPSILON (843_) 10/03→12/11							
 Bremsbelagsatz, Scheibenbremse							
1.3 D Multijet	55	09/06→12/11	←	10/06→06/11		13.0460-2724.2 602724	TRW 24073 16,7 + WK + Zub
1.3 D Multijet	66	09/06→12/11					
1.3 D Multijet	77	05/07→12/11	←	07/07→06/11		13.0460-2724.2 602724	TRW 24073 16,7 + WK + Zub
 Bremsscheibe							
1.2	44	10/03→12/11	←	→06/11		24.0112-0127.1 412127	Ø 257,5 12 10,2
1.2	51	08/10→12/11	←	→06/11		24.0122-0197.1 422197	Ø 257,5 22 20,2 V
1.2	59	10/03→12/11				24.0322-0197.1 522197	Ø 257,5 22 20,2 V PD
1.3 JTD	51	10/03→12/11					
1.4	57	02/06→12/11					
1.4 16V	70	10/03→12/11					
1.4 LPG	57	11/10→12/11					
1.3 D Multijet	55	09/06→12/11	←	10/06→06/11		24.0122-0197.1 422197	Ø 257,5 22 20,2 V
1.3 D Multijet	66	09/06→12/11				24.0322-0197.1 522197	Ø 257,5 22 20,2 V PD
1.3 D Multijet	77	05/07→12/11	←	07/07→06/11		24.0122-0197.1 422197	Ø 257,5 22 20,2 V
						24.0322-0197.1 522197	Ø 257,5 22 20,2 V PD
LANCIA - ZETA (22_) 05/95→09/02							
 Bremsbelagsatz, Scheibenbremse							
2.0 16V (220AL5)	97	05/98→07/00	←			13.0460-2978.2 602978	TRW 21801 19,0 + WK
2.0 16V (220AQ5)	100	07/00→09/02					
2.0 JTD	80	04/00→09/02	→	+ ABS		13.0460-7061.2 607061	ATE 21275 17,0 + WK
2.0 JTD 16V (220AN5)	80	09/99→09/02					
2.0 Turbo (220AD5, 220CD5)	108	05/95→09/02	←			13.0460-2978.2 602978	TRW 21801 19,0 + WK
			→			13.0460-7061.2 607061	ATE 21275 17,0 + WK
2.1 TD (220AJ5)	80	05/96→09/99	←	06/96→		13.0460-2978.2 602978	TRW 21801 19,0 + WK
			→	06/96→		13.0460-7061.2 607061	ATE 21275 17,0 + WK
 Bremsscheibe							
2.0 16V (220AL5)	97	05/98→07/00	←			24.0126-0104.1 426104	Ø 281 26 24,2 V
2.0 16V (220AQ5)	100	07/00→09/02					
2.0 JTD	80	04/00→09/02	→	+ ABS		24.0110-0218.1 410218	Ø 295 10 8
2.0 JTD 16V (220AN5)	80	09/99→09/02					
2.0 Turbo (220AD5, 220CD5)	108	05/95→09/02	←			24.0126-0104.1 426104	Ø 281 26 24,2 V
			→			24.0110-0218.1 410218	Ø 295 10 8
2.1 TD (220AJ5)	80	05/96→09/99	←	06/96→		24.0126-0104.1 426104	Ø 281 26 24,2 V
			→	06/96→		24.0110-0218.1 410218	Ø 295 10 8
LAND ROVER - DEFENDER Cabrio (LD_) 09/90→02/16							
 Bremsbelagsatz, Scheibenbremse							
2.2 Td4 4x4 (L317)	90	08/11→02/16	←			13.0460-6925.2 606925	AP 21519 17,8 - WE / - WK + Zub
			→			13.0460-6924.2 606924	AP 23471 17,5 - WE / - WK + Zub
2.4 Td4 4x4 (L317)	90	05/07→02/16	←			13.0460-6925.2 606925	AP 21519 17,8 - WE / - WK + Zub
			→	(V)1A614447; Radstand [mm]: 3.302		13.0460-6923.2 606923	AP 23471 14,5 - WE / - WK
			→	(V)1A614447; Radstand [mm]: 2.794		13.0460-6923.2 606923	AP 23471 14,5 - WE / - WK
			→			13.0460-6924.2 606924	AP 23471 17,5 - WE / - WK + Zub
			→	(V)1A614448→; Radstand [mm]: 3.302		13.0460-6924.2 606924	AP 23471 17,5 - WE / - WK + Zub
			→	(V)1A614448→; Radstand [mm]: 2.794		13.0460-6924.2 606924	AP 23471 17,5 - WE / - WK + Zub
2.5 D 4x4 (L316)	51	09/90→09/01	←			13.0460-6922.2 606922	AP 21459 17,5 - WE / - WK + Zub
2.5 Td5 4x4 (L316)	90	06/98→02/16	←	Radstand [mm]: 2.286; → (V)HA701009		13.0460-6922.2 606922	AP 21459 17,5 - WE / - WK + Zub
2.5 TDI 4x4 (L316)	83	09/90→12/01	←	(V)HA701010→		13.0460-6925.2 606925	AP 21519 17,8 - WE / - WK + Zub
			→	(V)1A614447; Radstand [mm]: 3.302		13.0460-6923.2 606923	AP 23471 14,5 - WE / - WK
			→	(V)1A614447; Radstand [mm]: 2.794		13.0460-6923.2 606923	AP 23471 14,5 - WE / - WK
			→	(V)1A614448→; Radstand [mm]: 2.794		13.0460-6924.2 606924	AP 23471 17,5 - WE / - WK + Zub
			→	(V)1A614448→; Radstand [mm]: 3.302		13.0460-6924.2 606924	AP 23471 17,5 - WE / - WK + Zub











	kw					! #		
LAND ROVER - DEFENDER Cabrio (LD_) 09/90→02/16								
 Bremsbelagsatz, Scheibenbremse								
3.9 4x4	134	04/98→09/00	←	11/98→; Radstand [mm]: 2.286; → (V)HA701009	13.0460-6922.2	606922	AP 21459 17,5 - WE / - WK + Zub	
			←	(V)HA701010→	13.0460-6925.2	606925	AP 21519 17,8 - WE / - WK + Zub	
			→	11/98→; → (V)1A614447; Radstand [mm]: 3.302	13.0460-6923.2	606923	AP 23471 14,5 - WE / - WK	
			→	11/98→; → (V)1A614447; Radstand [mm]: 2.794	13.0460-6923.2	606923	AP 23471 14,5 - WE / - WK	
			→	(V)1A614448→; Radstand [mm]: 3.302	13.0460-6924.2	606924	AP 23471 17,5 - WE / - WK + Zub	
			→	(V)1A614448→; Radstand [mm]: 2.794	13.0460-6924.2	606924	AP 23471 17,5 - WE / - WK + Zub	
Zubehörsatz, Scheibenbremsbelag								
2.5 D 4x4 (L316)	51	09/90→09/01	←		13.0460-0154.2	610154	AP	
2.5 Td5 4x4 (L316)	90	06/98→02/16	←	Radstand [mm]: 2.286; → (V)HA701009	13.0460-0154.2	610154	AP	
2.5 TDI 4x4 (L316)	83	09/90→12/01	←					
3.9 4x4	134	04/98→09/00	←	11/98→; Radstand [mm]: 2.286; → (V)HA701009	13.0460-0154.2	610154	AP	
 Bremsscheibe								
2.2 Td4 4x4 (L317)	90	08/11→02/16	←		24.0114-0108.1	414108	Ø 298,5 14 13	
					24.0124-0143.1	424143	Ø 298,5 24 22 V	
			→		24.0114-0115.1	414115	Ø 298 14 13	
2.4 Td4 4x4 (L317)	90	05/07→02/16	←		24.0114-0108.1	414108	Ø 298,5 14 13	
					24.0124-0143.1	424143	Ø 298,5 24 22 V	
			←	(V)LA930456→	24.0124-0143.1	424143	Ø 298,5 24 22 V	
			→	Radstand [mm]: 2.286	24.0113-0189.1	413189	Ø 290 12,5 11,7	
			→	→ (V)WA159806; - ABS; Radstand [mm]: 2.794	24.0114-0108.1	414108	Ø 298,5 14 13	
			→	→ (V)WA159806; - ABS; Radstand [mm]: 3.302	24.0114-0108.1	414108	Ø 298,5 14 13	
			→		24.0114-0115.1	414115	Ø 298 14 13	
			→	(V)XA159807→; Radstand [mm]: 3.302	24.0114-0115.1	414115	Ø 298 14 13	
→	(V)XA159807→; Radstand [mm]: 2.794	24.0114-0115.1	414115	Ø 298 14 13				
2.5 D 4x4 (L316)	51	09/90→09/01	←		24.0124-0143.1	424143	Ø 298,5 24 22 V	
			→		24.0113-0189.1	413189	Ø 290 12,5 11,7	
			←		24.0114-0108.1	414108	Ø 298,5 14 13	
2.5 Td5 4x4 (L316) 2.5 TDI 4x4 (L316)	90 83	06/98→02/16 09/90→12/01	←		24.0114-0108.1	414108	Ø 298,5 14 13	
			←	(V)LA930456→	24.0124-0143.1	424143	Ø 298,5 24 22 V	
			→	Radstand [mm]: 2.286	24.0113-0189.1	413189	Ø 290 12,5 11,7	
			→	→ (V)WA159806; - ABS; Radstand [mm]: 2.794	24.0114-0108.1	414108	Ø 298,5 14 13	
			→	→ (V)WA159806; - ABS; Radstand [mm]: 3.302	24.0114-0108.1	414108	Ø 298,5 14 13	
			→	(V)XA159807→; Radstand [mm]: 2.794	24.0114-0115.1	414115	Ø 298 14 13	
			→	(V)XA159807→; Radstand [mm]: 3.302	24.0114-0115.1	414115	Ø 298 14 13	
3.9 4x4	134	04/98→09/00	←	11/98→	24.0114-0108.1	414108	Ø 298,5 14 13	
			←	(V)LA930456→	24.0124-0143.1	424143	Ø 298,5 24 22 V	
			→	11/98→; Radstand [mm]: 2.286	24.0113-0189.1	413189	Ø 290 12,5 11,7	
			→	11/98→; → (V)WA159806; - ABS; Radstand [mm]: 2.794	24.0114-0108.1	414108	Ø 298,5 14 13	
			→	11/98→; → (V)WA159806; - ABS; Radstand [mm]: 3.302	24.0114-0108.1	414108	Ø 298,5 14 13	
			→	(V)XA159807→; Radstand [mm]: 2.794	24.0114-0115.1	414115	Ø 298 14 13	
			→	(V)XA159807→; Radstand [mm]: 3.302	24.0114-0115.1	414115	Ø 298 14 13	
LAND ROVER - DEFENDER Pick-up (LD_) 10/95→02/16								
 Bremsbelagsatz, Scheibenbremse								
2.2 Td4 4x4 (L317)	90	08/11→02/16	←		13.0460-6925.2	606925	AP 21519 17,8 - WE / - WK + Zub	
			→		13.0460-6924.2	606924	AP 23471 17,5 - WE / - WK + Zub	
2.4 Td4 4x4 (L317)	90	05/07→02/16	←		13.0460-6925.2	606925	AP 21519 17,8 - WE / - WK + Zub	
↓								





























	kw					! #		
LAND ROVER - DEFENDER Pick-up (LD_) 10/95→02/16								
Bremsbelagsatz, Scheibenbremse								
2.4 Td4 4x4 (L317)	90	05/07→02/16	➔	→ (V)1A614447; Radstand [mm]: 3.302	13.0460-6923.2	606923	AP 23471 14,5 - WE / - WK	
			➔	→ (V)1A614447; Radstand [mm]: 2.794	13.0460-6923.2	606923	AP 23471 14,5 - WE / - WK	
			➔		13.0460-6924.2	606924	AP 23471 17,5 - WE / - WK + Zub	
			➔	(V)1A614448→; Radstand [mm]: 3.302	13.0460-6924.2	606924	AP 23471 17,5 - WE / - WK + Zub	
			➔	(V)1A614448→; Radstand [mm]: 2.794	13.0460-6924.2	606924	AP 23471 17,5 - WE / - WK + Zub	
2.5 Td5 4x4 (L316)	90	06/98→02/16	←	Radstand [mm]: 2.286; → (V)HA701009	13.0460-6922.2	606922	AP 21459 17,5 - WE / - WK + Zub	
			←	(V)HA701010→	13.0460-6925.2	606925	AP 21519 17,8 - WE / - WK + Zub	
			➔	→ (V)1A614447; Radstand [mm]: 3.302	13.0460-6923.2	606923	AP 23471 14,5 - WE / - WK	
			➔	→ (V)1A614447; Radstand [mm]: 2.794	13.0460-6923.2	606923	AP 23471 14,5 - WE / - WK	
			➔	(V)1A614448→; Radstand [mm]: 2.794	13.0460-6924.2	606924	AP 23471 17,5 - WE / - WK + Zub	
			➔	(V)1A614448→; Radstand [mm]: 3.302	13.0460-6924.2	606924	AP 23471 17,5 - WE / - WK + Zub	
4.0 4x4	134	04/98→09/00	←	11/98→; Radstand [mm]: 2.286; → (V)HA701009	13.0460-6922.2	606922	AP 21459 17,5 - WE / - WK + Zub	
			←	(V)HA701010→	13.0460-6925.2	606925	AP 21519 17,8 - WE / - WK + Zub	
			➔	11/98→; → (V)1A614447; Radstand [mm]: 3.302	13.0460-6923.2	606923	AP 23471 14,5 - WE / - WK	
			➔	11/98→; → (V)1A614447; Radstand [mm]: 2.794	13.0460-6923.2	606923	AP 23471 14,5 - WE / - WK	
			➔	(V)1A614448→; Radstand [mm]: 3.302	13.0460-6924.2	606924	AP 23471 17,5 - WE / - WK + Zub	
			➔	(V)1A614448→; Radstand [mm]: 2.794	13.0460-6924.2	606924	AP 23471 17,5 - WE / - WK + Zub	
Zubehörsatz, Scheibenbremsbelag								
2.5 Td5 4x4 (L316)	90	06/98→02/16	←	Radstand [mm]: 2.286; → (V)HA701009	13.0460-0154.2	610154	AP	
4.0 4x4	134	04/98→09/00	←	11/98→; Radstand [mm]: 2.286; → (V)HA701009	13.0460-0154.2	610154	AP	
Bremsscheibe								
2.2 Td4 4x4 (L317)	90	08/11→02/16	←		24.0114-0108.1	414108	Ø 298,5 14 13	
			➔		24.0124-0143.1	424143	Ø 298,5 24 22 V	
2.4 Td4 4x4 (L317)	90	05/07→02/16	➔		24.0114-0115.1	414115	Ø 298 14 13	
			←		24.0114-0108.1	414108	Ø 298,5 14 13	
			←		24.0124-0143.1	424143	Ø 298,5 24 22 V	
			←	(V)LA930456→	24.0124-0143.1	424143	Ø 298,5 24 22 V	
			➔	Radstand [mm]: 2.286	24.0113-0189.1	413189	Ø 290 12,5 11,7	
			➔	→ (V)WA159806; - ABS; Radstand [mm]: 2.794	24.0114-0108.1	414108	Ø 298,5 14 13	
			➔	→ (V)WA159806; - ABS; Radstand [mm]: 3.302	24.0114-0108.1	414108	Ø 298,5 14 13	
			➔		24.0114-0115.1	414115	Ø 298 14 13	
2.5 Td5 4x4 (L316)	90	06/98→02/16	←		24.0114-0108.1	414108	Ø 298,5 14 13	
			←	(V)LA930456→	24.0124-0143.1	424143	Ø 298,5 24 22 V	
			➔	Radstand [mm]: 2.286	24.0113-0189.1	413189	Ø 290 12,5 11,7	
			➔	→ (V)WA159806; - ABS; Radstand [mm]: 2.794	24.0114-0108.1	414108	Ø 298,5 14 13	
			➔	→ (V)WA159806; - ABS; Radstand [mm]: 3.302	24.0114-0108.1	414108	Ø 298,5 14 13	
			➔	(V)XA159807→; Radstand [mm]: 2.794	24.0114-0115.1	414115	Ø 298 14 13	
4.0 4x4	134	04/98→09/00	←	11/98→	24.0114-0108.1	414108	Ø 298,5 14 13	
			←	(V)LA930456→	24.0124-0143.1	424143	Ø 298,5 24 22 V	
			➔	11/98→; Radstand [mm]: 2.286	24.0113-0189.1	413189	Ø 290 12,5 11,7	
↓								

	kw					! #		
LAND ROVER - DEFENDER Pick-up (LD_) 10/95→02/16								
 Bremsscheibe								
4.0 4x4	134	04/98→09/00	➔	11/98→; → (V)WA159806; - ABS; Radstand [mm]: 2.794	24.0114-0108.1	414108	Ø 298,5 14 13	
			➔	11/98→; → (V)WA159806; - ABS; Radstand [mm]: 3.302	24.0114-0108.1	414108	Ø 298,5 14 13	
			➔	(V)XA159807→; Radstand [mm]: 2.794	24.0114-0115.1	414115	Ø 298 14 13	
			➔	(V)XA159807→; Radstand [mm]: 3.302	24.0114-0115.1	414115	Ø 298 14 13	
LAND ROVER - DEFENDER Pritsche/Fahrgestell (LD_) 09/90→02/16								
 Bremsbelagsatz, Scheibenbremse								
2.2 Td4 4x4 (L317)	90	08/11→02/16	←		13.0460-6925.2	606925	AP 21519 17,8 - WE / - WK + Zub	
			➔		13.0460-6924.2	606924	AP 23471 17,5 - WE / - WK + Zub	
 Bremsscheibe								
2.2 Td4 4x4 (L317)	90	08/11→02/16	←		24.0114-0108.1	414108	Ø 298,5 14 13	
					24.0124-0143.1	424143	Ø 298,5 24 22 V	
			➔		24.0114-0115.1	414115	Ø 298 14 13	
LAND ROVER - DEFENDER Station Wagon (LD_) 09/90→02/16								
 Bremsbelagsatz, Scheibenbremse								
2.2 Td4 4x4 (L317)	90	08/11→02/16	←		13.0460-6925.2	606925	AP 21519 17,8 - WE / - WK + Zub	
			➔		13.0460-6917.2	606917	AP 21237 15,5 + WK + Zub	
					13.0460-6924.2	606924	AP 23471 17,5 - WE / - WK + Zub	
2.2 Td4 4x4 (L317)	110	02/15→02/16	←		13.0460-6925.2	606925	AP 21519 17,8 - WE / - WK + Zub	
			➔		13.0460-6924.2	606924	AP 23471 17,5 - WE / - WK + Zub	
2.4 Td4 4x4 (L317)	90	05/07→02/16	←		13.0460-6925.2	606925	AP 21519 17,8 - WE / - WK + Zub	
			➔		13.0460-6917.2	606917	AP 21237 15,5 + WK + Zub	
					13.0460-6924.2	606924	AP 23471 17,5 - WE / - WK + Zub	
			➔	→ (V)1A614447; Radstand [mm]: 3.302	13.0460-6923.2	606923	AP 23471 14,5 - WE / - WK	
			➔	→ (V)1A614447; Radstand [mm]: 2.794	13.0460-6923.2	606923	AP 23471 14,5 - WE / - WK	
			➔	(V)1A614448→; Radstand [mm]: 3.302	13.0460-6924.2	606924	AP 23471 17,5 - WE / - WK + Zub	
2.5 D 4x4 (L316)	51	09/90→09/01	←		13.0460-6922.2	606922	AP 21459 17,5 - WE / - WK + Zub	
			←	Radstand [mm]: 2.286; → (V)HA701009	13.0460-6922.2	606922	AP 21459 17,5 - WE / - WK + Zub	
			➔	(V)HA701010→	13.0460-6925.2	606925	AP 21519 17,8 - WE / - WK + Zub	
			➔	→ (V)1A614447; Radstand [mm]: 3.302	13.0460-6923.2	606923	AP 23471 14,5 - WE / - WK	
			➔	→ (V)1A614447; Radstand [mm]: 2.794	13.0460-6923.2	606923	AP 23471 14,5 - WE / - WK	
			➔	(V)1A614448→; Radstand [mm]: 2.794	13.0460-6924.2	606924	AP 23471 17,5 - WE / - WK + Zub	
2.5 Td5 4x4 (L316) 2.5 TDI 4x4 (L316) 3.9 V8 4x4 (L316)	90 83 136	06/98→02/16 09/90→12/98 11/98→02/16	←	Radstand [mm]: 2.286; → (V)HA701009	13.0460-6922.2	606922	AP 21459 17,5 - WE / - WK + Zub	
			←	(V)HA701010→	13.0460-6925.2	606925	AP 21519 17,8 - WE / - WK + Zub	
			➔	→ (V)1A614447; Radstand [mm]: 3.302	13.0460-6923.2	606923	AP 23471 14,5 - WE / - WK	
			➔	→ (V)1A614447; Radstand [mm]: 2.794	13.0460-6923.2	606923	AP 23471 14,5 - WE / - WK	
			➔	(V)1A614448→; Radstand [mm]: 2.794	13.0460-6924.2	606924	AP 23471 17,5 - WE / - WK + Zub	
			➔	(V)1A614448→; Radstand [mm]: 3.302	13.0460-6924.2	606924	AP 23471 17,5 - WE / - WK + Zub	
3.9 4x4 (L316)	134	01/93→09/00	←	11/98→; Radstand [mm]: 2.286; → (V)HA701009	13.0460-6922.2	606922	AP 21459 17,5 - WE / - WK + Zub	
			←	(V)HA701010→	13.0460-6925.2	606925	AP 21519 17,8 - WE / - WK + Zub	
			➔	11/98→; → (V)1A614447; Radstand [mm]: 3.302	13.0460-6923.2	606923	AP 23471 14,5 - WE / - WK	
			➔	11/98→; → (V)1A614447; Radstand [mm]: 2.794	13.0460-6923.2	606923	AP 23471 14,5 - WE / - WK	
			➔	(V)1A614448→; Radstand [mm]: 3.302	13.0460-6924.2	606924	AP 23471 17,5 - WE / - WK + Zub	
			➔	(V)1A614448→; Radstand [mm]: 2.794	13.0460-6924.2	606924	AP 23471 17,5 - WE / - WK + Zub	













	kw			 	! #		
LAND ROVER - DEFENDER Station Wagon (LD_) 09/90→02/16							
Zubehörsatz, Scheibenbremsbelag							
2.5 D 4x4 (L316)	51	09/90→09/01	←			13.0460-0154.2 610154	AP
2.5 Td5 4x4 (L316)	90	06/98→02/16	←	Radstand [mm]: 2.286; → (V)HA701009		13.0460-0154.2 610154	AP
2.5 TDI 4x4 (L316)	83	09/90→12/98					
3.9 V8 4x4 (L316)	136	11/98→02/16					
3.9 4x4 (L316)	134	01/93→09/00	←	11/98→; Radstand [mm]: 2.286; → (V)HA701009		13.0460-0154.2 610154	AP
 Bremsscheibe							
2.2 Td4 4x4 (L317)	90	08/11→02/16	←			24.0114-0108.1 414108	Ø 298,5 14 13
			→			24.0124-0143.1 424143	Ø 298,5 24 22 V
			→			24.0113-0189.1 413189	Ø 290 12,5 11,7
			→			24.0114-0115.1 414115	Ø 298 14 13
2.2 Td4 4x4 (L317)	110	02/15→02/16	←			24.0114-0108.1 414108	Ø 298,5 14 13
			→			24.0124-0143.1 424143	Ø 298,5 24 22 V
			→			24.0114-0115.1 414115	Ø 298 14 13
			→			24.0114-0115.1 414115	Ø 298 14 13
2.4 Td4 4x4 (L317)	90	05/07→02/16	←			24.0114-0108.1 414108	Ø 298,5 14 13
			→			24.0124-0143.1 424143	Ø 298,5 24 22 V
			←	(V)LA930456→		24.0124-0143.1 424143	Ø 298,5 24 22 V
			→	Radstand [mm]: 2.286		24.0113-0189.1 413189	Ø 290 12,5 11,7
			→			24.0113-0189.1 413189	Ø 290 12,5 11,7
			→			24.0114-0115.1 414115	Ø 298 14 13
			→	→ (V)WA159806; - ABS; Radstand [mm]: 3.302		24.0114-0108.1 414108	Ø 298,5 14 13
			→	→ (V)WA159806; - ABS; Radstand [mm]: 2.794		24.0114-0108.1 414108	Ø 298,5 14 13
			→	(V)XA159807→; Radstand [mm]: 3.302		24.0114-0115.1 414115	Ø 298 14 13
			→	(V)XA159807→; Radstand [mm]: 2.794		24.0114-0115.1 414115	Ø 298 14 13
2.5 D 4x4 (L316)	51	09/90→09/01	←			24.0124-0143.1 424143	Ø 298,5 24 22 V
			→			24.0113-0189.1 413189	Ø 290 12,5 11,7
			←			24.0114-0108.1 414108	Ø 298,5 14 13
			←	(V)LA930456→		24.0124-0143.1 424143	Ø 298,5 24 22 V
2.5 Td5 4x4 (L316) 2.5 TDI 4x4 (L316) 3.9 V8 4x4 (L316)	90 83 136	06/98→02/16 09/90→12/98 11/98→02/16	←			24.0114-0108.1 414108	Ø 298,5 14 13
			←	(V)LA930456→		24.0124-0143.1 424143	Ø 298,5 24 22 V
			→	Radstand [mm]: 2.286		24.0113-0189.1 413189	Ø 290 12,5 11,7
			→	→ (V)WA159806; - ABS; Radstand [mm]: 2.794		24.0114-0108.1 414108	Ø 298,5 14 13
			→	→ (V)WA159806; - ABS; Radstand [mm]: 3.302		24.0114-0108.1 414108	Ø 298,5 14 13
			→	(V)XA159807→; Radstand [mm]: 2.794		24.0114-0115.1 414115	Ø 298 14 13
			→	(V)XA159807→; Radstand [mm]: 3.302		24.0114-0115.1 414115	Ø 298 14 13
3.9 4x4 (L316)	134	01/93→09/00	←	11/98→		24.0114-0108.1 414108	Ø 298,5 14 13
			←	(V)LA930456→		24.0124-0143.1 424143	Ø 298,5 24 22 V
			→	11/98→; Radstand [mm]: 2.286		24.0113-0189.1 413189	Ø 290 12,5 11,7
			→	11/98→; → (V)WA159806; - ABS; Radstand [mm]: 2.794		24.0114-0108.1 414108	Ø 298,5 14 13
			→	11/98→; → (V)WA159806; - ABS; Radstand [mm]: 3.302		24.0114-0108.1 414108	Ø 298,5 14 13
			→	(V)XA159807→; Radstand [mm]: 2.794		24.0114-0115.1 414115	Ø 298 14 13
			→	(V)XA159807→; Radstand [mm]: 3.302		24.0114-0115.1 414115	Ø 298 14 13
LAND ROVER - DISCOVERY I (LJ_) 06/89→10/98							
 Bremsbelagsatz, Scheibenbremse							
2.0 16 V 4x4	99	06/89→10/98	←	MA081992→		13.0460-6916.2 606916	AP 21459 18,5 + WK
			←			13.0460-6922.2 606922	AP 21459 17,5 - WE / - WK + Zub
			←	01/94→		13.0460-6916.2 606916	AP 21459 18,5 + WK
			←			13.0460-6922.2 606922	AP 21459 17,5 - WE / - WK + Zub
			←	09/93→; → KA034313		13.0460-6926.2 606926	AP 20359 19,2 + WK + Zub
2.5 D 4x4	90	06/93→10/98	←			13.0460-6917.2 606917	AP 21237 15,5 + WK + Zub
			←			13.0460-6917.2 606917	AP 21237 15,5 + WK + Zub
			←	01/94→		13.0460-6917.2 606917	AP 21237 15,5 + WK + Zub
↓							
↓							









	kw			 	! #		
LAND ROVER - DISCOVERY I (LJ_) 06/89→10/98							
 Bremsbelagsatz, Scheibenbremse							
2.5 D 4x4	90	06/93→10/98	←	07/94→; → KA034313		13.0460-6926.2 606926	AP 20359 19,2 + WK + Zub
			→	07/94→		13.0460-6917.2 606917	AP 21237 15,5 + WK + Zub
2.5 TDI 4x4	83	10/89→10/98	←	MA081992→		13.0460-6916.2 606916	AP 21459 18,5 + WK
						13.0460-6922.2 606922	AP 21459 17,5 - WE / - WK + Zub
			←	→ KA034313		13.0460-6926.2 606926	AP 20359 19,2 + WK + Zub
			→			13.0460-6917.2 606917	AP 21237 15,5 + WK + Zub
4.0 4x4	134	09/93→10/98	←	MA081992→		13.0460-6916.2 606916	AP 21459 18,5 + WK
						13.0460-6922.2 606922	AP 21459 17,5 - WE / - WK + Zub
			←	07/94→; → KA034313		13.0460-6926.2 606926	AP 20359 19,2 + WK + Zub
			←	→ KA034313		13.0460-6926.2 606926	AP 20359 19,2 + WK + Zub
			→	07/94→		13.0460-6917.2 606917	AP 21237 15,5 + WK + Zub
			→			13.0460-6917.2 606917	AP 21237 15,5 + WK + Zub
Zubehörsatz, Scheibenbremsbelag							
2.0 16 V 4x4	99	06/89→10/98	←	MA081992→		13.0460-0154.2 610154	AP
			←	01/94→		13.0460-0154.2 610154	AP
			→	09/93→		13.0460-0414.2 610414	AP
			→	01/94→		13.0460-0414.2 610414	AP
2.5 D 4x4	90	06/93→10/98	←	MA081992→		13.0460-0154.2 610154	AP
			→	07/94→		13.0460-0414.2 610414	AP
2.5 TDI 4x4	83	10/89→10/98	←	MA081992→		13.0460-0154.2 610154	AP
			→			13.0460-0414.2 610414	AP
4.0 4x4	134	09/93→10/98	←	MA081992→		13.0460-0154.2 610154	AP
			→			13.0460-0414.2 610414	AP
			→	07/94→		13.0460-0414.2 610414	AP
 Bremsscheibe							
2.0 16 V 4x4	99	06/89→10/98	←	05/95→		24.0114-0108.1 414108	Ø 298,5 14 13
			←	09/93→		24.0114-0108.1 414108	Ø 298,5 14 13
						24.0124-0143.1 424143	Ø 298,5 24 22 V
			←	01/94→ 04/95		24.0124-0143.1 424143	Ø 298,5 24 22 V
			→	01/94→		24.0113-0189.1 413189	Ø 290 12,5 11,7
			→	09/93→		24.0113-0189.1 413189	Ø 290 12,5 11,7
2.5 D 4x4	90	06/93→10/98	←	07/94→		24.0114-0108.1 414108	Ø 298,5 14 13
			→	07/94→		24.0124-0143.1 424143	Ø 298,5 24 22 V
			→			24.0113-0189.1 413189	Ø 290 12,5 11,7
2.5 TDI 4x4	83	10/89→10/98	←			24.0114-0108.1 414108	Ø 298,5 14 13
						24.0124-0143.1 424143	Ø 298,5 24 22 V
			→			24.0113-0189.1 413189	Ø 290 12,5 11,7
4.0 4x4	134	09/93→10/98	←	07/94→		24.0114-0108.1 414108	Ø 298,5 14 13
						24.0124-0143.1 424143	Ø 298,5 24 22 V
			←			24.0114-0108.1 414108	Ø 298,5 14 13
						24.0124-0143.1 424143	Ø 298,5 24 22 V
			→			24.0113-0189.1 413189	Ø 290 12,5 11,7
			→	07/94→		24.0113-0189.1 413189	Ø 290 12,5 11,7
LAND ROVER - DISCOVERY II (LT_) 11/98→06/04							
 Bremsbelagsatz, Scheibenbremse							
2.5 Td5 4x4	100	11/98→06/04	←	01/99→		13.0460-2720.2 602720	TRW 23452 19,0 - WE / - WK
			→	01/99→		13.0460-2721.2 602721	TRW 23458 15,6 - WE / - WK
2.5 Td5 4x4 4.0 V8 4x4	102	01/99→06/04	←			13.0460-2720.2 602720	TRW 23452 19,0 - WE / - WK
	136	11/98→06/04	→			13.0460-2721.2 602721	TRW 23458 15,6 - WE / - WK
 Bremsscheibe							
2.5 Td5 4x4	100	11/98→06/04	←	01/99→		24.0125-0176.1 425176	Ø 297,5 25 22 V
↓							













	kw					! #		
LAND ROVER - DISCOVERY II (LT_) 11/98→06/04								
 Bremsscheibe								
2.5 Td5 4x4	100	11/98→06/04	➔	01/99→			24.0113-0197.1 413197	Ø 304,5 12,6 11,7
2.5 Td5 4x4	102	01/99→06/04	➔				24.0125-0176.1 425176	Ø 297,5 25 22 V
4.0 V8 4x4	136	11/98→06/04	➔				24.0113-0197.1 413197	Ø 304,5 12,6 11,7
LAND ROVER - DISCOVERY III (LA_) 07/04→09/09								
 Bremsbelagsatz, Scheibenbremse								
2.7 TD 4x4	140	07/04→09/09	➔	08/06→ 08/09; nicht für gepanzerte Fahrzeuge			13.0460-2728.2 602728	TRW 24191 18,1 + WE / - WK + Zub
4.0 4x4	160	02/05→09/09	➔					
4.0 4x4	161	02/05→09/09	➔	→ 07/06; nicht für gepanzerte Fahrzeuge			13.0460-2728.2 602728	TRW 24191 18,1 + WE / - WK + Zub
4.0 V6 4x4	156	10/04→09/09	➔					
4.0 V6 4x4	160	10/04→09/09	➔	→ 08/09; nicht für gepanzerte Fahrzeuge			13.0460-2719.2 602719	TRW 24192 17,4 + WE / - WK + Zub
4.4 4x4	220	07/04→09/09	➔	08/06→ 08/09; nicht für gepanzerte Fahrzeuge			13.0460-2728.2 602728	TRW 24191 18,1 + WE / - WK + Zub
			➔	→ 07/06; nicht für gepanzerte Fahrzeuge			13.0460-2728.2 602728	TRW 24191 18,1 + WE / - WK + Zub
			➔	→ 08/09; für gepanzerte Fahrzeuge			13.0460-2719.2 602719	TRW 24192 17,4 + WE / - WK + Zub
Warnkontakt, Bremsbelagverschleiß								
2.7 TD 4x4	140	07/04→09/09	➔	08/06→ 08/09; nicht für gepanzerte Fahrzeuge	1		24.8190-0946.2 620946	L= 1.175
4.0 4x4	160	02/05→09/09	➔					
4.0 4x4	161	02/05→09/09	➔	→ 07/06; nicht für gepanzerte Fahrzeuge	1		24.8190-1305.2 621305	L= 1.147
4.0 V6 4x4	156	10/04→09/09	➔					
4.0 V6 4x4	160	10/04→09/09	➔	→ 08/09; nicht für gepanzerte Fahrzeuge	1		24.8190-1306.2 621306	L= 1.156
4.4 4x4	220	07/04→09/09	➔	08/06→ 08/09; nicht für gepanzerte Fahrzeuge	1		24.8190-0946.2 620946	L= 1.175
			➔	→ 07/06; nicht für gepanzerte Fahrzeuge	1		24.8190-1305.2 621305	L= 1.147
			➔	→ 08/09; für gepanzerte Fahrzeuge	1		24.8190-1306.2 621306	L= 1.156
 Bremsscheibe								
2.7 TD 4x4	140	07/04→09/09	➔	→ 08/09; für gepanzerte Fahrzeuge			24.0130-0178.1 430178	Ø 317 30 27 V
4.0 4x4	160	02/05→09/09	➔					
4.0 4x4	161	02/05→09/09	➔	→ 08/09; nicht für gepanzerte Fahrzeuge			24.0120-0210.1 420210	Ø 325 20 17 V
4.0 V6 4x4	156	10/04→09/09	➔					
4.0 V6 4x4	160	10/04→09/09	➔	→ 08/09; nicht für gepanzerte Fahrzeuge			24.0130-0178.1 430178	Ø 317 30 27 V
			➔	→ 08/09; nicht für gepanzerte Fahrzeuge			24.0120-0210.1 420210	Ø 325 20 17 V
4.4 4x4	220	07/04→09/09	➔	→ 08/09; nicht für gepanzerte Fahrzeuge			24.0130-0188.1 430188	Ø 337,5 30 27 V
			➔	→ 08/09; nicht für gepanzerte Fahrzeuge			24.0120-0210.1 420210	Ø 325 20 17 V
LAND ROVER - DISCOVERY IV (LA_) 09/09→								
 Bremsbelagsatz, Scheibenbremse								
2.7 TD 4x4	140	09/09→	➔				13.0460-2728.2 602728	TRW 24191 18,1 + WE / - WK + Zub
3.0 4x4	250	08/13→	➔					
3.0 SDV6 4x4	188	11/09→	➔				13.0460-2762.2 602762	TRW 25021 18,5 + WE / - WK + Zub
3.0 TD 4x4	155	05/10→	➔					
3.0 TD 4x4	180	09/09→	➔	→ AA546302; nicht für gepanzerte Fahrzeuge			13.0460-2731.2 602731	TRW 24192 17,1 + WE / - WK + Zub
3.0 TD 4x4	183	07/12→	➔					
3.0 TD 4x4	200	09/09→	➔					
4.0 4x4	160	09/09→	➔					
5.0 V8 4x4	276	09/09→	➔					
Warnkontakt, Bremsbelagverschleiß								
2.7 TD 4x4	140	09/09→	➔		1		24.8190-1306.2 621306	L= 1.156
3.0 4x4	250	08/13→	➔		1		24.8190-0946.2 620946	L= 1.175
3.0 SDV6 4x4	188	11/09→	➔					
3.0 TD 4x4	155	05/10→	➔					
3.0 TD 4x4	180	09/09→	➔					
3.0 TD 4x4	183	07/12→	➔					
3.0 TD 4x4	200	09/09→	➔					
4.0 4x4	160	09/09→	➔					
5.0 V8 4x4	276	09/09→	➔					
 Bremsscheibe								
2.7 TD 4x4	140	09/09→	➔				24.0130-0178.1 430178	Ø 317 30 27 V
			➔				24.0120-0210.1 420210	Ø 325 20 17 V
3.0 4x4	250	08/13→	➔	→ AA222221			24.0130-0195.1 430195	Ø 360 30 27 V
3.0 SDV6 4x4	188	11/09→	➔					











	kW					! #		
LAND ROVER - DISCOVERY IV (LA_) 09/09→								
 Bremsscheibe								
3.0 TD 4x4	155	05/10→	➔	nicht für gepanzerte Fahrzeuge			24.0120-0201.1 420201	Ø 350 20 17 V
3.0 TD 4x4	180	09/09→						
3.0 TD 4x4	183	07/12→						
3.0 TD 4x4	200	09/09→						
4.0 4x4	160	09/09→						
5.0 V8 4x4	276	09/09→						
LAND ROVER - DISCOVERY V (LR_) 09/16→								
 Bremsbelagsatz, Scheibenbremse								
2.0 D 4x4	132	09/16→	➔				13.0460-2762.2 602762	TRW 25021 18,5 + WE / - WK + Zub
2.0 D 4x4	177	09/16→						
3.0 4x4	250	09/16→						
3.0 D 4x4	155	09/16→						
3.0 D 4x4	183	09/16→						
3.0 D 4x4	190	09/16→						
LAND ROVER - DISCOVERY SPORT (LC_) 12/14→								
 Bremsbelagsatz, Scheibenbremse								
2.0 D	110	08/15→	➔				13.0460-7228.2 607228	ATE 24123 20,3 - WE / - WK
2.0 D 4x4	110	12/14→					13.0470-7228.2 LD7228	ATE 24123 20,3 - WE / - WK Ceramic
2.0 D 4x4	132	06/15→						
 Bremsscheibe								
2.0 D	110	08/15→	➔				24.0128-0154.1 428154	Ø 300 28 26 V + S
							24.0328-0154.1 528154	Ø 300 28 26 V + S PD
LAND ROVER - FREELANDER (LN_) 02/98→10/06								
 Bremsbelagsatz, Scheibenbremse								
1.8 16V 4x4	86	11/00→10/06	➔	1A000001→			13.0460-2718.2 602718	TRW 23615 18,3 - WE / - WK
2.0 Td4 4x4	82	11/00→10/06						
2.5 V6 4x4	130	11/00→10/06	➔	→ YA999999			13.0460-5830.2 605830	TRW 23158 17,5 - WK + Zub
1.8 i 16V 4x4	88	02/98→11/00	➔				13.0460-5830.2 605830	TRW 23158 17,5 - WK + Zub
2.0 DI 4x4	72	02/98→11/00						
2.0 Td4 4x4	80	03/01→10/06	➔	1A000001→			13.0460-2718.2 602718	TRW 23615 18,3 - WE / - WK
			➔	11/01→; → YA999999			13.0460-5830.2 605830	TRW 23158 17,5 - WK + Zub
 Bremsscheibe								
1.8 16V 4x4	86	11/00→10/06	➔	→ YA999999			24.0114-0113.1 414113	Ø 262 14 11
2.0 Td4 4x4	82	11/00→10/06						
2.5 V6 4x4	130	11/00→10/06	➔	1A000001→			24.0121-0114.1 421114	Ø 277 21 18 V
1.8 i 16V 4x4	88	02/98→11/00	➔				24.0114-0113.1 414113	Ø 262 14 11
2.0 DI 4x4	72	02/98→11/00						
2.0 Td4 4x4	80	03/01→10/06	➔	11/01→; → YA999999			24.0114-0113.1 414113	Ø 262 14 11
			➔	1A000001→			24.0121-0114.1 421114	Ø 277 21 18 V
LAND ROVER - FREELANDER 2 (LF_) 10/06→10/14								
 Bremsbelagsatz, Scheibenbremse								
2.0 Si4 4x4	177	10/11→10/14	➔				13.0460-7228.2 607228	ATE 24123 20,3 - WE / - WK
3.2 4x4	171	10/06→10/14					13.0470-7228.2 LD7228	ATE 24123 20,3 - WE / - WK Ceramic
2.2 eD4	110	08/10→10/14	➔				13.0460-7228.2 607228	ATE 24123 20,3 - WE / - WK
2.2 TD4 4x4	110	10/06→10/14						
2.2 TD4 4x4	112	01/07→10/14					13.0470-7228.2 LD7228	ATE 24123 20,3 - WE / - WK Ceramic
2.2 TD4 4x4	115	10/06→10/14	➔					
2.2 TD4 4x4	118	10/06→10/14	➔				13.0460-2737.2 602737	TRW 24537 15,8 - WE / - WK + Zub
2.2 SD4 4x4	140	08/10→10/14	➔				13.0460-7228.2 607228	ATE 24123 20,3 - WE / - WK
			➔	→ CH999999			13.0470-7228.2 LD7228	ATE 24123 20,3 - WE / - WK Ceramic
			➔				13.0460-2737.2 602737	TRW 24537 15,8 - WE / - WK + Zub
 Bremsscheibe								
2.0 Si4 4x4	177	10/11→10/14	➔	→ CH999999			24.0120-0218.1 420218	Ø 302 20 18 V
2.2 eD4	110	08/10→10/14	➔				24.0128-0154.1 428154	Ø 300 28 26 V + S
2.2 TD4 4x4	110	10/06→10/14					24.0328-0154.1 528154	Ø 300 28 26 V + S PD
2.2 TD4 4x4	112	01/07→10/14						
2.2 TD4 4x4	115	10/06→10/14	➔				24.0112-0186.1 412186	Ø 302 12 10
2.2 TD4 4x4	118	10/06→10/14						
2.2 SD4 4x4	140	08/10→10/14	➔				24.0128-0154.1 428154	Ø 300 28 26 V + S

















	kw					! #		
LAND ROVER - FREELANDER 2 (LF_) 10/06→10/14								
 Bremsscheibe								
2.2 SD4 4x4	140	08/10→10/14	←			24.0328-0154.1	528154	Ø 300 28 26 V + S PD
			→	→ CH999999		24.0112-0186.1	412186	Ø 302 12 10
3.2 4x4	171	10/06→10/14	←			24.0128-0162.1	428162	Ø 316 28 26 V + S
			→			24.0328-0162.1	528162	Ø 316 28 26 V + S PD
			→			24.0120-0218.1	420218	Ø 302 20 18 V
LAND ROVER - FREELANDER Soft Top (LN_) 02/98→10/06								
 Bremselagsatz, Scheibenbremse								
1.8 4x4	86	10/00→09/03	←	1A000001→		13.0460-2718.2	602718	TRW 23615 18,3 - WE / - WK
2.0 TD4 4x4	82	10/00→10/06	←	11/00→; → YA999999		13.0460-5830.2	605830	TRW 23158 17,5 - WK + Zub
1.8 i 16V 4x4	88	02/98→10/06	←	→ 11/00		13.0460-5830.2	605830	TRW 23158 17,5 - WK + Zub
2.0 DI 4x4	72	02/98→10/06						
 Bremsscheibe								
1.8 4x4	86	10/00→09/03	←	11/00→; → YA999999		24.0114-0113.1	414113	Ø 262 14 11
2.0 TD4 4x4	82	10/00→10/06	←	1A000001→		24.0121-0114.1	421114	Ø 277 21 18 V
1.8 i 16V 4x4	88	02/98→10/06	←	→ 11/00		24.0114-0113.1	414113	Ø 262 14 11
2.0 DI 4x4	72	02/98→10/06						
LAND ROVER - RANGE ROVER II (LP_) 07/94→03/02								
 Bremselagsatz, Scheibenbremse								
2.5 D 4x4	83	08/94→03/02	←			13.0460-2720.2	602720	TRW 23452 19,0 - WE / - WK
2.5 D 4x4	100	07/94→03/02	→			13.0460-2721.2	602721	TRW 23458 15,6 - WE / - WK
3.9 4x4	140	07/94→03/02						
4.0 4x4	136	06/98→03/02						
4.6 4x4	160	06/98→03/02						
4.6 4x4	165	07/94→03/02						
4.6 4x4	168	09/95→03/02						
 Bremsscheibe								
2.5 D 4x4	83	08/94→03/02	←			24.0125-0164.1	425164	Ø 297 25 22 V
2.5 D 4x4	100	07/94→03/02	→			24.0113-0197.1	413197	Ø 304,5 12,6 11,7
3.9 4x4	140	07/94→03/02						
4.0 4x4	136	06/98→03/02						
4.6 4x4	160	06/98→03/02						
4.6 4x4	165	07/94→03/02						
4.6 4x4	168	09/95→03/02						
LAND ROVER - RANGE ROVER III (LM_) 03/02→08/12								
 Bremselagsatz, Scheibenbremse								
3.0 D 4x4	130	03/02→08/12	←	6A000001→; nicht für gepanzerte Fahrzeuge		13.0460-2728.2	602728	TRW 24191 18,1 + WE / - WK + Zub
4.4 4x4	210	03/02→08/05						
4.4 4x4	220	08/04→08/12	←	→ 5A999999; nicht für gepanzerte Fahrzeuge		13.0460-7224.2	607224	ATE 23397 19,4 + WE / - WK
4.4 4x4	225	05/05→08/12	→	6A000001→; nicht für gepanzerte Fahrzeuge		13.0460-2719.2	602719	TRW 24192 17,4 + WE / - WK + Zub
			→	→ 5A999999; nicht für gepanzerte Fahrzeuge		13.0460-7079.2	607079	ATE 21282 17,3 + WE / - WK
						13.0470-7079.2	LD7079	ATE 21282 17,3 + WE / - WK Ceramic
3.6 D 4x4	200	04/06→08/12	←	BA347977→; nicht für gepanzerte Fahrzeuge		13.0460-2762.2	602762	TRW 25021 18,5 + WE / - WK + Zub
			←	6A000001→ 9A999999; nicht für gepanzerte Fahrzeuge		13.0460-4837.2	604837	BRE 20217 17,1 + WE / - WK
			←	→ 5A999999; nicht für gepanzerte Fahrzeuge		13.0460-7224.2	607224	ATE 23397 19,4 + WE / - WK
			→	6A000001→; nicht für gepanzerte Fahrzeuge		13.0460-2731.2	602731	TRW 24192 17,1 + WE / - WK + Zub
			→	→ 5A999999; nicht für gepanzerte Fahrzeuge		13.0460-7079.2	607079	ATE 21282 17,3 + WE / - WK
						13.0470-7079.2	LD7079	ATE 21282 17,3 + WE / - WK Ceramic
4.2 4x4	291	05/05→08/12	←	6A000001→; nicht für gepanzerte Fahrzeuge		13.0460-4837.2	604837	BRE 20217 17,1 + WE / - WK
			←	→ 5A999999; nicht für gepanzerte Fahrzeuge		13.0460-7224.2	607224	ATE 23397 19,4 + WE / - WK
			→	6A000001→; nicht für gepanzerte Fahrzeuge		13.0460-2719.2	602719	TRW 24192 17,4 + WE / - WK + Zub
			→	→ 5A999999; nicht für gepanzerte Fahrzeuge		13.0460-7079.2	607079	ATE 21282 17,3 + WE / - WK
						13.0470-7079.2	LD7079	ATE 21282 17,3 + WE / - WK Ceramic
↓								















	kw			 	! #		
LAND ROVER - RANGE ROVER III (LM_) 03/02→08/12							
 Bremsbelagsatz, Scheibenbremse							
5.0 4x4	276	09/09→08/12	←	BA347977→; nicht für gepanzerte Fahrzeuge		13.0460-2762.2 602762	TRW 25021 18,5 + WE / - WK + Zub
			→	nicht für gepanzerte Fahrzeuge		13.0460-2731.2 602731	TRW 24192 17,1 + WE / - WK + Zub
Warnkontakt, Bremsbelagverschleiß							
3.0 D 4x4	130	03/02→08/12	←	→ 5A999999; nicht für gepanzerte Fahrzeuge	1	24.8190-0304.2 620304	L= 724
4.4 4x4	220	03/02→08/05					
4.4 4x4	220	08/04→08/12	←	6A000001→; nicht für gepanzerte Fahrzeuge	1	24.8190-0304.2 620304	L= 724
4.4 4x4	225	05/05→08/12	→	6A000001→; nicht für gepanzerte Fahrzeuge	1	24.8190-0305.2 620305	L= 1.158
			→	→ 5A999999; nicht für gepanzerte Fahrzeuge	1	24.8190-1308.2 621308	L= 1.118
3.6 D 4x4	200	04/06→08/12	←	→ 5A999999; nicht für gepanzerte Fahrzeuge	1	24.8190-0304.2 620304	L= 724
			←	6A000001→ 9A999999; nicht für gepanzerte Fahrzeuge	1	24.8190-0944.2 620944	L= 841,5
			→	→ 5A999999; nicht für gepanzerte Fahrzeuge	1	24.8190-1308.2 621308	L= 1.118
4.2 4x4	291	05/05→08/12	←	→ 5A999999; nicht für gepanzerte Fahrzeuge	1	24.8190-0304.2 620304	L= 724
			←	6A000001→; nicht für gepanzerte Fahrzeuge	1	24.8190-0944.2 620944	L= 841,5
			→	6A000001→; nicht für gepanzerte Fahrzeuge	1	24.8190-0305.2 620305	L= 1.158
			→	→ 5A999999; nicht für gepanzerte Fahrzeuge	1	24.8190-1308.2 621308	L= 1.118
 Bremsscheibe							
3.0 D 4x4	130	03/02→08/12	←	→ 5A999999; nicht für gepanzerte Fahrzeuge		24.0130-0184.1 430184	Ø 344 29,9 28,4 V
			←	6A000001→; nicht für gepanzerte Fahrzeuge		24.0130-0196.1 430196	Ø 344 30 27 V
			→	3A129290→ 5A999999; nicht für gepanzerte Fahrzeuge		24.0112-0168.1 412168	Ø 354 11,9 10,4
			→	→ 3A129289; nicht für gepanzerte Fahrzeuge		24.0113-0197.1 413197	Ø 304,5 12,6 11,7
			→	6A000001→; nicht für gepanzerte Fahrzeuge		24.0120-0200.1 420200	Ø 354 20 17 V
3.6 D 4x4	200	04/06→08/12	←	→ 5A999999; nicht für gepanzerte Fahrzeuge		24.0130-0184.1 430184	Ø 344 29,9 28,4 V
			←	6A000001→ 9A999999; nicht für gepanzerte Fahrzeuge		24.0130-0197.1 430197	Ø 360 30 27 V
			→	3A129290→ 9A999999; nicht für gepanzerte Fahrzeuge		24.0112-0168.1 412168	Ø 354 11,9 10,4
			→	→ 3A129289; nicht für gepanzerte Fahrzeuge		24.0113-0197.1 413197	Ø 304,5 12,6 11,7
			→	AA000001→; nicht für gepanzerte Fahrzeuge		24.0120-0200.1 420200	Ø 354 20 17 V
4.2 4x4	291	05/05→08/12	←	→ 5A999999; nicht für gepanzerte Fahrzeuge		24.0130-0184.1 430184	Ø 344 29,9 28,4 V
			←	6A000001→; nicht für gepanzerte Fahrzeuge		24.0130-0197.1 430197	Ø 360 30 27 V
			→	3A129290→ 5A999999; nicht für gepanzerte Fahrzeuge		24.0112-0168.1 412168	Ø 354 11,9 10,4
			→	→ 3A129289; nicht für gepanzerte Fahrzeuge		24.0113-0197.1 413197	Ø 304,5 12,6 11,7
			→	6A000001→; nicht für gepanzerte Fahrzeuge		24.0120-0200.1 420200	Ø 354 20 17 V
4.4 4x4	210	03/02→08/05	←	nicht für gepanzerte Fahrzeuge		24.0130-0184.1 430184	Ø 344 29,9 28,4 V
			→	3A129290→ 5A999999; nicht für gepanzerte Fahrzeuge		24.0112-0168.1 412168	Ø 354 11,9 10,4
			→	→ 3A129289; nicht für gepanzerte Fahrzeuge		24.0113-0197.1 413197	Ø 304,5 12,6 11,7
			→	6A000001→; nicht für gepanzerte Fahrzeuge		24.0120-0200.1 420200	Ø 354 20 17 V
4.4 4x4	220	08/04→08/12	←	→ 5A999999; nicht für gepanzerte Fahrzeuge		24.0130-0184.1 430184	Ø 344 29,9 28,4 V
4.4 4x4	225	05/05→08/12	←	6A000001→; nicht für gepanzerte Fahrzeuge		24.0130-0196.1 430196	Ø 344 30 27 V
			→	→ 5A999999; nicht für gepanzerte Fahrzeuge		24.0112-0168.1 412168	Ø 354 11,9 10,4

	kw					! #		
LAND ROVER - RANGE ROVER III (LM_) 03/02→08/12								
 Bremsscheibe								
4.4 4x4 4.4 4x4	220 225	08/04→08/12 05/05→08/12	➔	6A000001→; nicht für gepanzerte Fahrzeuge		24.0120-0200.1	420200	Ø 354 20 17 V
5.0 4x4	276	09/09→08/12	➔	nicht für gepanzerte Fahrzeuge		24.0130-0197.1	430197	Ø 360 30 27 V
			➔	nicht für gepanzerte Fahrzeuge		24.0120-0200.1	420200	Ø 354 20 17 V
LAND ROVER - RANGE ROVER IV (LG_) 08/12→								
 Bremsbelagsatz, Scheibenbremse								
3.0 4x4	250	10/13→	➔	passend für Felgengröße [Zoll]: 19		13.0460-2762.2	602762	TRW 25021 18,5 + WE / - WK + Zub
			➔	EA000001→		13.0460-2604.2	602604	TRW 25720 17,7 + WE / - WK + Zub
3.0 4x4	280	06/15→	➔	passend für Felgengröße [Zoll]: 19		13.0460-2762.2	602762	TRW 25021 18,5 + WE / - WK + Zub
			➔	passend für Felgengröße [Zoll]: 19		13.0460-2604.2	602604	TRW 25720 17,7 + WE / - WK + Zub
3.0 D 4x4 3.0 D 4x4	155 183	10/13→ 08/12→	➔	EA000001→		13.0460-2762.2	602762	TRW 25021 18,5 + WE / - WK + Zub
			➔	EA000001→		13.0460-2604.2	602604	TRW 25720 17,7 + WE / - WK + Zub
3.0 D 4x4 4.4 D V8 4x4 5.0 4x4 5.0 4x4	190 250 276 375	08/12→ 08/12→ 12/13→ 08/12→	➔			13.0460-2604.2	602604	TRW 25720 17,7 + WE / - WK + Zub
3.0 D Hybrid 4x4	250	10/13→	➔	EA000001→		13.0460-2604.2	602604	TRW 25720 17,7 + WE / - WK + Zub
LAND ROVER - RANGE ROVER EVOQUE (LV_) 06/11→								
 Bremsbelagsatz, Scheibenbremse								
2.0 4x4 2.2 D 2.2 D 4x4 2.2 D 4x4	177 110 110 140	06/11→ 06/11→ 06/11→ 06/11→	➔			13.0460-7228.2	607228	ATE 24123 20,3 - WE / - WK
			➔			13.0470-7228.2	LD7228	ATE 24123 20,3 - WE / - WK Ceramic
			➔			13.0460-2722.2	602722	TRW 24496 17,3 - WE / - WK + Zub
			➔			13.0470-2722.2	LD2722	TRW 24496 17,3 - WE / - WK + Zub Ceramic
2.0 D 2.0 D 4x4 2.0 D 4x4	110 110 132	06/15→ 06/15→ 05/15→	➔	Felgengröße [Zoll]: 16		13.0460-7228.2	607228	ATE 24123 20,3 - WE / - WK
			➔			13.0470-7228.2	LD7228	ATE 24123 20,3 - WE / - WK Ceramic
			➔	→ FH999999		13.0460-2722.2	602722	TRW 24496 17,3 - WE / - WK + Zub
			➔			13.0470-2722.2	LD2722	TRW 24496 17,3 - WE / - WK + Zub Ceramic
 Bremsscheibe								
2.0 4x4 2.2 D 2.2 D 4x4 2.2 D 4x4	177 110 110 140	06/11→ 06/11→ 06/11→ 06/11→	➔			24.0128-0154.1	428154	Ø 300 28 26 V + S
			➔			24.0328-0154.1	528154	Ø 300 28 26 V + S PD
			➔			24.0111-0145.1	411145	Ø 302 10,9 9 + S
			➔			24.0311-0145.1	511145	Ø 302 10,9 9 PD
2.0 D 2.0 D 4x4 2.0 D 4x4	110 110 132	06/15→ 06/15→ 05/15→	➔	Felgengröße [Zoll]: 16		24.0128-0154.1	428154	Ø 300 28 26 V + S
			➔			24.0328-0154.1	528154	Ø 300 28 26 V + S PD
			➔	→ FH999999		24.0111-0145.1	411145	Ø 302 10,9 9 + S
			➔			24.0311-0145.1	511145	Ø 302 10,9 9 PD
LAND ROVER - RANGE ROVER EVOQUE Cabriolet (LV_) 02/16→								
 Bremsbelagsatz, Scheibenbremse								
2.0 4x4 2.0 D 4x4 2.0 D 4x4	177 110 132	02/16→ 02/16→ 02/16→	➔	für Bremsscheibendurchmesser [mm]: 300		13.0460-7228.2	607228	ATE 24123 20,3 - WE / - WK
			➔			13.0470-7228.2	LD7228	ATE 24123 20,3 - WE / - WK Ceramic
			➔	→ FH999999		13.0460-2722.2	602722	TRW 24496 17,3 - WE / - WK + Zub
			➔			13.0470-2722.2	LD2722	TRW 24496 17,3 - WE / - WK + Zub Ceramic
 Bremsscheibe								
2.0 4x4 2.0 D 4x4 2.0 D 4x4	177 110 132	02/16→ 02/16→ 02/16→	➔	→ FH999999		24.0128-0154.1	428154	Ø 300 28 26 V + S
			➔			24.0328-0154.1	528154	Ø 300 28 26 V + S PD
			➔	→ FH999999		24.0111-0145.1	411145	Ø 302 10,9 9 + S



















	kW					! #		
LAND ROVER - RANGE ROVER EVOQUE Cabriolet (LV_) 02/16→								
 Bremsscheibe								
2.0 4x4 2.0 D 4x4 2.0 D 4x4	177 110 132	02/16→ 02/16→ 02/16→	→	→ FH999999			24.0311-0145.1 511145	Ø 302 10,9 9 PD
LAND ROVER - RANGE ROVER SPORT (LS_) 02/05→03/13								
 Bremsbelagsatz, Scheibenbremse								
2.7 D 4x4 4.4 4x4	140 220	02/05→03/13 02/05→03/13	←	→ 6A999999			13.0460-2728.2 602728	TRW 24191 18,1 + WE / - WK + Zub
			←	7A000001→; → 10/09			13.0460-2728.2 602728	TRW 24191 18,1 + WE / - WK + Zub
			←	→ 10/09			13.0460-4837.2 604837	BRE 20217 17,1 + WE / - WK
			→	→ 10/09			13.0460-2719.2 602719	TRW 24192 17,4 + WE / - WK + Zub
3.0 D 4x4 3.0 D 4x4 3.0 D 4x4 3.0 D 4x4 5.0 4x4 5.0 4x4	155 180 183 188 276 372	05/10→03/13 09/09→03/13 08/12→03/13 06/11→03/13 07/09→03/13 04/09→03/13	←				13.0460-2762.2 602762	TRW 25021 18,5 + WE / - WK + Zub
			→				13.0460-2731.2 602731	TRW 24192 17,1 + WE / - WK + Zub
3.6 D 4x4	200	04/06→03/13	←	01/10→			13.0460-2762.2 602762	TRW 25021 18,5 + WE / - WK + Zub
			←	→ 12/09			13.0460-4837.2 604837	BRE 20217 17,1 + WE / - WK
			→				13.0460-2719.2 602719	TRW 24192 17,4 + WE / - WK + Zub
4.2 4x4	287	02/05→03/13	←	→ 6A999999			13.0460-4837.2 604837	BRE 20217 17,1 + WE / - WK
			←	7A000001→; → 10/09			13.0460-4837.2 604837	BRE 20217 17,1 + WE / - WK
			→	→ 10/09			13.0460-2719.2 602719	TRW 24192 17,4 + WE / - WK + Zub
5.0 4x4	375	09/09→03/13	←				13.0460-2762.2 602762	TRW 25021 18,5 + WE / - WK + Zub
Warnkontakt, Bremsbelagverschleiß								
2.7 D 4x4 4.4 4x4	140 220	02/05→03/13 02/05→03/13	←	→ 6A999999	1	24.8190-0945.2 620945	L= 1.227	
			←	7A000001→; → 10/09	1	24.8190-0949.2 620949	L= 1.228	
			←	→ 10/09	1	24.8190-1307.2 621307	L= 1.185	
			→	→ 10/09	1	24.8190-1306.2 621306	L= 1.156	
3.6 D 4x4	200	04/06→03/13	←	→ 12/09	1	24.8190-1307.2 621307	L= 1.185	
			→		1	24.8190-1306.2 621306	L= 1.156	
4.2 4x4	287	02/05→03/13	←	7A000001→; → 10/09	1	24.8190-0948.2 620948	L= 1.212	
			←	→ 6A999999	1	24.8190-1307.2 621307	L= 1.185	
			→	→ 10/09	1	24.8190-1306.2 621306	L= 1.156	
 Bremsscheibe								
2.7 D 4x4	140	02/05→03/13	←	→ 10/09; passend für Felgengröße [Zoll]: 17		24.0130-0178.1 430178	Ø 317 30 27 V	
			←	→ 10/09; passend für Felgengröße [Zoll]: 18 / 19		24.0130-0195.1 430195	Ø 360 30 27 V	
			→	→ 10/09; passend für Felgengröße [Zoll]: 18 / 19		24.0120-0201.1 420201	Ø 350 20 17 V	
			→	→ 10/09; passend für Felgengröße [Zoll]: 17		24.0120-0210.1 420210	Ø 325 20 17 V	
3.0 D 4x4 3.0 D 4x4 3.0 D 4x4 3.0 D 4x4 5.0 4x4 5.0 4x4	155 180 183 188 276 372	05/10→03/13 09/09→03/13 08/12→03/13 06/11→03/13 07/09→03/13 04/09→03/13	←	→ AA215622		24.0130-0195.1 430195	Ø 360 30 27 V	
			→			24.0120-0201.1 420201	Ø 350 20 17 V	
3.6 D 4x4	200	04/06→03/13	←			24.0130-0195.1 430195	Ø 360 30 27 V	
			→			24.0120-0201.1 420201	Ø 350 20 17 V	
4.2 4x4	287	02/05→03/13	←	→ 10/09		24.0130-0195.1 430195	Ø 360 30 27 V	
			→	→ 10/09		24.0120-0201.1 420201	Ø 350 20 17 V	
4.4 4x4	220	02/05→03/13	←	→ 10/09; passend für Felgengröße [Zoll]: 17		24.0130-0188.1 430188	Ø 337,5 30 27 V	
			←	→ 10/09; passend für Felgengröße [Zoll]: 18 / 19		24.0130-0195.1 430195	Ø 360 30 27 V	
			→	→ 10/09		24.0120-0201.1 420201	Ø 350 20 17 V	
5.0 4x4	375	09/09→03/13	←	→ AA215622		24.0130-0195.1 430195	Ø 360 30 27 V	



































	kw			 	! #		
LAND ROVER - RANGE ROVER SPORT (LW_) 04/13→							
 Bremsbelagsatz, Scheibenbremse							
2.0 D 4x4 3.0 4x4 3.0 D 4x4	177 250 225	08/16→ 04/13→ 09/14→	← →			13.0460-2762.2 602762 13.0460-2604.2 602604	TRW 25021 18,5 + WE / - WK + Zub TRW 25720 17,7 + WE / - WK + Zub
3.0 D 4x4 3.0 D 4x4	155 183	04/13→ 04/13→	← ← → →	→ 06/13 passend für Felgengröße [Zoll]: 19 passend für Felgengröße [Zoll]: 19 → 06/13		13.0460-2762.2 602762 13.0460-2762.2 602762 13.0460-2604.2 602604 13.0460-2731.2 602731	TRW 25021 18,5 + WE / - WK + Zub TRW 25021 18,5 + WE / - WK + Zub TRW 25720 17,7 + WE / - WK + Zub TRW 24192 17,1 + WE / - WK + Zub
3.0 D 4x4 3.0 D 4x4	190 215	04/13→ 04/13→	← ← → →	→ 06/13		13.0460-2762.2 602762 13.0460-2762.2 602762 13.0460-2604.2 602604 13.0460-2731.2 602731	TRW 25021 18,5 + WE / - WK + Zub TRW 25021 18,5 + WE / - WK + Zub TRW 25720 17,7 + WE / - WK + Zub TRW 24192 17,1 + WE / - WK + Zub
5.0 4x4	375	04/13→	← →	→ 06/13		13.0460-2762.2 602762 13.0460-2604.2 602604	TRW 25021 18,5 + WE / - WK + Zub TRW 25720 17,7 + WE / - WK + Zub
5.0 4x4	405	09/14→	→			13.0460-2604.2 602604	TRW 25720 17,7 + WE / - WK + Zub
 Bremsscheibe							
3.0 D 4x4 3.0 D 4x4 3.0 D 4x4 3.0 D 4x4 5.0 4x4	155 183 190 215 375	04/13→ 04/13→ 04/13→ 04/13→ 04/13→	← → ←	→ AA215622 → 06/13 → AA215622		24.0130-0195.1 430195 24.0120-0201.1 420201 24.0130-0195.1 430195	∅ 360 30 27 V ∅ 350 20 17 V ∅ 360 30 27 V
LEXUS - CT (ZWA10_) 12/10→							
 Bremsbelagsatz, Scheibenbremse							
200h (ZWA10_)	73	12/10→	← →	03/11→ 03/11→		13.0460-5617.2 605617 13.0460-5769.2 605769	24451 15,6 - WE / - WK 24610 15,0 + WK
 Bremsscheibe							
200h (ZWA10_)	73	12/10→	← →	03/11→ 03/11→		24.0125-0196.1 425196 24.0109-0163.1 409163 24.0110-0364.1 410364	∅ 255 25 22 V ∅ 259 9 7,5 ∅ 279 10 8,5
LEXUS - ES (_V4_) 03/06→06/12							
 Bremsbelagsatz, Scheibenbremse							
3.5 (GSV40_)	204	05/06→06/12	← →			13.0460-5764.2 605764 13.0460-5765.2 605765	AKE 24350 17,3 - WE / - WK + Zub AKE 24338 15,5 - WE / - WK
 Bremsscheibe							
3.5 (GSV40_)	204	05/06→06/12	←			24.0128-0159.1 428159	∅ 296 28 25 V
LEXUS - ES (_V6_) 06/12→							
 Bremsbelagsatz, Scheibenbremse							
250 (AVV60_, ASV60_) 300h (ASV60_, AVV60_)	135 118	06/12→ 06/12→	← →			13.0460-5764.2 605764 13.0460-5765.2 605765	AKE 24350 17,3 - WE / - WK + Zub AKE 24338 15,5 - WE / - WK
350 (GSV60_)	183	06/12→	← →	01/14→ 01/14→		13.0460-5764.2 605764 13.0460-5765.2 605765	AKE 24350 17,3 - WE / - WK + Zub AKE 24338 15,5 - WE / - WK
350 (GSV60_)	204	06/12→	← ← →	→ 06/12 → 06/12		13.0460-5764.2 605764 13.0460-5764.2 605764 13.0460-5765.2 605765	AKE 24350 17,3 - WE / - WK + Zub AKE 24350 17,3 - WE / - WK + Zub AKE 24338 15,5 - WE / - WK
↓							















	kW				! #		
LEXUS - ES (_V6_) 06/12→							
 Bremsbelagsatz, Scheibenbremse							
350 (GSV60_)	204	06/12→	➔			13.0460-5765.2 605765	AKE 24338 15,5 - WE / - WK
 Bremsscheibe							
250 (AVV60_, ASV60_)	135	06/12→	←			24.0128-0159.1 428159	Ø 296 28 25 V
300h (ASV60_, AVV60_)	118	06/12→					
350 (GSV60_)	183	06/12→	←	01/14→		24.0128-0159.1 428159	Ø 296 28 25 V
350 (GSV60_)	204	06/12→	←			24.0128-0159.1 428159	Ø 296 28 25 V
			←	→ 06/12		24.0128-0159.1 428159	Ø 296 28 25 V
LEXUS - ES (MCV_, VZV_) 10/96→06/08							
 Bremsbelagsatz, Scheibenbremse							
3.0 (MCV20_, MCV30_)	157	08/01→10/06	➔			13.0460-5738.2 605738	23702 15,1 - WE / - WK
3.3 (MCV31_)	168	06/03→10/06					
3.0 (MCV20_, MCV30_)	158	10/01→06/08	➔	→ 10/06		13.0460-5738.2 605738	23702 15,1 - WE / - WK
3.0 (MCV30_, MCV20_)	140	10/96→07/01	➔			13.0460-5840.2 605840	AKE 21833 15,0 + WK
 Bremsscheibe							
3.0 (MCV30_, MCV20_)	140	10/96→07/01	←			24.0128-0115.1 428115	Ø 275 28 26 V
LEXUS - GS (_L1_) 09/11→							
 Bremsbelagsatz, Scheibenbremse							
200t	180	09/15→	←			13.0460-5789.2 605789	20325 17,2 + WK
250 (GRL11_)	154	01/12→					
250 (GRL11_)	158	01/12→					
300h (AWL10_, GRL11_)	133	10/13→					
350 (GRL10_, GRL15_, GWL10_)	234	01/12→					
350 AWD (GRL10_)	234	01/12→					
450h (GRL10_, GRL15_, GWL10_)	215	06/12→					
450h (GRL10_, GRL15_, GWL10_)	217	01/12→					
 Bremsscheibe							
200t	180	09/15→	←	☐		24.0130-0201.1 430201	Ø 334 30 27 V
250 (GRL11_)	154	01/12→					
250 (GRL11_)	158	01/12→	←	☐		24.0130-0202.1 430202	Ø 334 30 27 V
LEXUS - GS (GRS19_, UZS19_, URS19_) 01/05→11/11							
 Bremsbelagsatz, Scheibenbremse							
300 (GRS195_, GRS190_)	170	04/05→11/11	←			13.0460-5789.2 605789	20325 17,2 + WK
300 (GRS195_, GRS190_)	183	04/05→11/11	➔			13.0460-5790.2 605790	24323 15,5 + WK
350 (GRS191_)	232	05/08→11/11					
350 (GRS196_, GRS191_)	226	04/08→11/11					
350 AWD (GRS196_, GRS191_)	232	05/08→11/11					
4.3 VVTi (UZS190_)	221	04/05→11/11					
430 (UZS190_)	208	04/05→11/11					
450h (GRS196_, GRS191_, GWS191_)	218	02/06→11/11					
450h (GWS191_, GRS196_, GRS191_)	254	02/06→11/11					
350 AWD (GRS196_)	226	04/05→11/11	←	04/08→		13.0460-5789.2 605789	20325 17,2 + WK
			➔	04/08→		13.0460-5790.2 605790	24323 15,5 + WK
460 (UZS190_, URS190_)	255	01/05→11/11	←	05/08→		13.0460-5789.2 605789	20325 17,2 + WK
 Bremsscheibe							
300 (GRS195_, GRS190_)	170	04/05→11/11	←	☐		24.0130-0201.1 430201	Ø 334 30 27 V
300 (GRS195_, GRS190_)	183	04/05→11/11	←	☐		24.0130-0202.1 430202	Ø 334 30 27 V
4.3 VVTi (UZS190_)	221	04/05→11/11	➔			24.0118-0147.1 418147	Ø 310 18 16,5 V
430 (UZS190_)	208	04/05→11/11					
450h (GRS196_, GRS191_, GWS191_)	218	02/06→11/11					
450h (GWS191_, GRS196_, GRS191_)	254	02/06→11/11					
↓							

























	kw			 	! #			
LEXUS - GS (GRS19_, UZS19_, URS19_) 01/05→11/11								
 Bremsscheibe								
350 (GRS191_) 350 (GRS196_, GRS191_) 350 AWD (GRS196_, GRS191_) 350 AWD (GRS196_) 460 (UZS190_, URS190_)	232 226 232 226 255	05/08→11/11 04/08→11/11 05/08→11/11 04/05→11/11 01/05→11/11	← → ← → ← ← →	→ 09/08 04/08→ 04/08→ 09/08 04/08→ ☐; 05/08→ ☐; 05/08→ 05/08→		24.0130-0201.1 24.0118-0147.1 24.0130-0201.1 24.0118-0147.1 24.0130-0201.1 24.0130-0202.1 24.0118-0147.1	430201 418147 430201 418147 430201 430202 418147	Ø 334 30 27 V Ø 310 18 16,5 V Ø 334 30 27 V Ø 310 18 16,5 V Ø 334 30 27 V Ø 334 30 27 V Ø 310 18 16,5 V
LEXUS - GS (JZS160_, UZS161_, UZS160_) 08/97→12/04								
 Bremsbelagsatz, Scheibenbremse								
300 (JZS160_) 300 (JZS160_) 400 (UZS160_) 430 (UZS161_)	161 163 216 208	10/00→12/04 08/97→10/00 12/97→11/00 11/00→12/04	→			13.0460-5748.2	605748	23429 15,5 + WK
 Bremsscheibe								
300 (JZS160_) 300 (JZS160_) 400 (UZS160_) 430 (UZS161_)	161 163 216 208	10/00→12/04 08/97→10/00 12/97→11/00 11/00→12/04	← → ← →	→ 10/01		24.0132-0701.1 24.0112-0703.1 24.0132-0701.1 24.0112-0703.1	432701 412703 432701 412703	Ø 296 32 30 V Ø 306,6 12 10,5 Ø 296 32 30 V Ø 306,6 12 10,5
LEXUS - GX (_J12_) 11/01→11/09								
 Bremsbelagsatz, Scheibenbremse								
470 470	175 199	11/01→11/09 11/01→11/09	← →			13.0460-5747.2 13.0460-5744.2	605747 605744	24024 17,0 + WK 21947 15,4 - WE / - WK
 Bremsscheibe								
470 470	175 199	11/01→11/09 11/01→11/09	← →			24.0128-0194.1 24.0118-0709.1	428194 418709	Ø 338 28 26 V Ø 312 18 16 V
LEXUS - GX (URJ15_) 11/09→								
 Bremsbelagsatz, Scheibenbremse								
460 4WD 460 4WD	218 225	11/09→ 01/10→	← →			13.0460-5747.2 13.0460-5744.2	605747 605744	24024 17,0 + WK 21947 15,4 - WE / - WK
 Bremsscheibe								
460 4WD 460 4WD	218 225	11/09→ 01/10→	←			24.0132-0174.1	432174	Ø 338 32 29 V
LEXUS - HS (ANF10) 07/09→								
 Bremsbelagsatz, Scheibenbremse								
250h	110	07/09→	← →	09/09→ 09/09→		13.0460-5767.2 13.0460-5765.2	605767 605765	AKE 24336 17,5 - WE / - WK AKE 24338 15,5 - WE / - WK
 Bremsscheibe								
250h	110	07/09→	← →	09/09→ 09/09→		24.0125-0178.1 24.0112-0714.1	425178 412714	Ø 275 25 22 V Ø 281 12 10,5
LEXUS - IS I (JCE1_, GXE1_) 04/99→07/05								
 Bremsbelagsatz, Scheibenbremse								
200 300	114 157	04/99→07/05 09/01→07/05	→			13.0460-5748.2	605748	23429 15,5 + WK
 Bremsscheibe								
200 300	114 157	04/99→07/05 09/01→07/05	← →			24.0132-0701.1 24.0112-0703.1	432701 412703	Ø 296 32 30 V Ø 306,6 12 10,5













	kW					! #		
LEXUS - IS II (GSE2_, ALE2_, USE2_) 10/05→03/13								
 Bremsbelagsatz, Scheibenbremse								
200d	110	07/10→03/13	←				13.0460-5770.2 605770	23983 17,0
220d (ALE20)	130	10/05→03/13						
250	158	11/10→03/13	→				13.0460-5790.2 605790	24323 15,5 + WK
250 (GSE20)	153	10/05→03/13						
250 AWD	153	10/05→03/13						
250 AWD	158	11/10→03/13						
 Bremsscheibe								
200d	110	07/10→03/13	←				24.0128-0740.1 428740	Ø 296 28 26 V
250	158	11/10→03/13						
250 AWD	158	11/10→03/13	→				24.0118-0147.1 418147	Ø 310 18 16,5 V
220d (ALE20)	130	10/05→03/13	←				24.0128-0740.1 428740	Ø 296 28 26 V
250 (GSE20)	153	10/05→03/13						
250 AWD	153	10/05→03/13	→	→ 06/06			24.0110-0335.1 410335	Ø 291 10 8,5
			→	07/06→			24.0118-0147.1 418147	Ø 310 18 16,5 V
LEXUS - IS III (_E3_) 04/13→								
 Bremsbelagsatz, Scheibenbremse								
250 (GSE30_)	153	04/13→	←	F-Sport			13.0460-5770.2 605770	23983 17,0
300h (AVE30_)	133	04/13→	←				13.0460-5770.2 605770	23983 17,0
 Bremsscheibe								
250 (GSE30_)	153	04/13→	←				24.0128-0740.1 428740	Ø 296 28 26 V
300h (AVE30_)	133	04/13→						
LEXUS - IS C (GSE2_) 04/09→								
 Bremsbelagsatz, Scheibenbremse								
250	153	04/09→	←				13.0460-5770.2 605770	23983 17,0
			→				13.0460-5790.2 605790	24323 15,5 + WK
250	157	08/10→	←	11/10→			13.0460-5770.2 605770	23983 17,0
			→	11/10→			13.0460-5790.2 605790	24323 15,5 + WK
 Bremsscheibe								
250	153	04/09→	←				24.0128-0740.1 428740	Ø 296 28 26 V
			→				24.0118-0147.1 418147	Ø 310 18 16,5 V
250	157	08/10→	←	11/10→			24.0128-0740.1 428740	Ø 296 28 26 V
			→	11/10→			24.0118-0147.1 418147	Ø 310 18 16,5 V
LEXUS - IS SportCross 10/01→10/05								
 Bremsbelagsatz, Scheibenbremse								
200	114	10/02→10/05	→	→ 09/05			13.0460-5748.2 605748	23429 15,5 + WK
300	157	10/01→10/05						
 Bremsscheibe								
200	114	10/02→10/05	←	→ 09/05			24.0132-0701.1 432701	Ø 296 32 30 V
300	157	10/01→10/05	→	→ 09/05			24.0112-0703.1 412703	Ø 306,6 12 10,5
LEXUS - LS (_F4_) 04/06→								
 Bremsbelagsatz, Scheibenbremse								
460	255	05/08→	←	→ 08/09			13.0460-5607.2 605607	24245 18,5 + WE / - WK
			→				13.0460-5608.2 605608	24244 18,5 + WE / - WK
460	270	10/09→	→				13.0460-5608.2 605608	24244 18,5 + WE / - WK
460 AWD	272	09/12→						
460 AWD	283	10/09→						
460	283	12/08→	←				13.0460-5607.2 605607	24245 18,5 + WE / - WK
460 (USF40)	280	04/06→						
460 4WD (USF4_)	280	08/06→	→				13.0460-5608.2 605608	24244 18,5 + WE / - WK
460 AWD	270	12/08→						
600h	290	08/07→						
LEXUS - LX (_J2_) 08/07→								
 Bremsbelagsatz, Scheibenbremse								
570	285	08/07→	→				13.0460-5619.2 605619	24653 17,3 - WE / - WK
570 (URJ201_)	270	11/07→						
570 (URJ201_)	282	11/07→						











	kw					! #		
LEXUS - LX (UZJ100) 09/97→03/08								
 Bremsbelagsatz, Scheibenbremse								
470	170	05/98→03/08	←			13.0460-5746.2	605746	23524 17,4 + WK
470	173	09/01→03/08						
470	197	05/98→10/02	→			13.0460-5749.2	605749	23539 17,3 - WE / - WK
470	202	08/02→03/08						
 Bremsscheibe								
470	170	05/98→03/08	←			24.0132-0148.1	432148	Ø 313 32 30 V
470	173	09/01→03/08						
470	197	05/98→10/02	→			24.0118-0143.1	418143	Ø 329,2 18 16 V
470	202	08/02→03/08						
LEXUS - NX (_Z1_) 07/14→								
 Bremsbelagsatz, Scheibenbremse								
200 (AGZ10_)	110	11/14→	←			13.0460-5634.2	605634	ADV 24452 17,5 - WK + Zub
200t (ZGZ10_)	175	07/14→						
200t AWD (ZGZ15_)	175	07/14→				13.0470-5634.2	LD5634	ADV 24452 17,5 - WK + Zub Ceramic
300h (AYZ10_)	114	07/14→						
300h AWD (AYZ15_)	114	07/14→						
LEXUS - RC (_C1_) 08/14→								
 Bremsbelagsatz, Scheibenbremse								
200t	180	08/15→	←	für Fahrzeuge mit Sportpaket		13.0460-5789.2	605789	20325 17,2 + WK
350	234	08/14→	←	09/14→; für Fahrzeuge mit Sportpaket		13.0460-5789.2	605789	20325 17,2 + WK
 Bremsscheibe								
300h (AVC10_)	133	09/14→	←			24.0130-0201.1	430201	Ø 334 30 27 V
			←			24.0130-0202.1	430202	Ø 334 30 27 V
LEXUS - RX (_L1_) 12/08→10/15								
 Bremsbelagsatz, Scheibenbremse								
270 (AGL10_)	138	12/08→10/15	←	01/09→		13.0460-5634.2	605634	ADV 24452 17,5 - WK + Zub
350 (GYL10_)	206	12/08→10/15				13.0470-5634.2	LD5634	ADV 24452 17,5 - WK + Zub Ceramic
350 AWD (GGL15_)	204	12/08→02/12						
450h (GYL10_)	183	12/08→10/15						
450h (GYL10_)	220	12/08→10/15	→	01/09→		13.0460-5635.2	605635	AKE 24918 15,0 - WK
450h AWD (GYL15_)	183	12/08→10/15				13.0470-5635.2	LD5635	AKE 24918 15,0 - WK Ceramic
450h AWD (GYL15_)	220	12/08→10/15						
350 AWD (GGL15_)	206	03/09→02/12	←			13.0460-5634.2	605634	ADV 24452 17,5 - WK + Zub
						13.0470-5634.2	LD5634	ADV 24452 17,5 - WK + Zub Ceramic
			→			13.0460-5635.2	605635	AKE 24918 15,0 - WK
						13.0470-5635.2	LD5635	AKE 24918 15,0 - WK Ceramic
 Bremsscheibe								
350 (GYL10_)	206	12/08→10/15	←	01/09→; Made in Kanada		24.0134-0104.1	434104	Ø 328 34 31 V
350 AWD (GGL15_)	204	12/08→02/12						
450h (GYL10_)	183	12/08→10/15	→	01/09→; Made in Kanada		24.0118-0157.1	418157	Ø 309 18 16,5 V
450h (GYL10_)	220	12/08→10/15						
450h AWD (GYL15_)	183	12/08→10/15						
450h AWD (GYL15_)	220	12/08→10/15						
350 AWD (GGL15_)	206	03/09→02/12	←	Made in Kanada		24.0134-0104.1	434104	Ø 328 34 31 V
			→	Made in Kanada		24.0118-0157.1	418157	Ø 309 18 16,5 V
LEXUS - RX (_U3_) 02/03→12/08								
 Bremsbelagsatz, Scheibenbremse								
300	150	05/03→12/08	←			13.0460-5750.2	605750	23734 16,8 - WK
350 AWD	203	02/06→12/08						
400h	155	09/05→12/08	→			13.0460-5734.2	605734	SUM 23967 15,1
400h AWD	155	09/04→12/08						
330	171	04/03→01/06	←	05/03→		13.0460-5750.2	605750	23734 16,8 - WK
330 AWD	171	04/03→12/08						
			→	05/03→		13.0460-5734.2	605734	SUM 23967 15,1
350	203	01/06→12/08	←	02/06→		13.0460-5750.2	605750	23734 16,8 - WK
			→	02/06→		13.0460-5734.2	605734	SUM 23967 15,1
 Bremsscheibe								
300	150	05/03→12/08	←			24.0128-0753.1	428753	Ø 319 28 26 V
350 AWD	203	02/06→12/08						
400h	155	09/05→12/08	→			24.0110-0316.1	410316	Ø 288 10 8,5
400h AWD	155	09/04→12/08						













	kw			 	! #		
LEXUS - RX (_U3_) 02/03→12/08							
 Bremsscheibe							
330 330 AWD	171 171	04/03→01/06 04/03→12/08	← →	05/03→ 05/03→		24.0128-0753.1 428753 24.0110-0316.1 410316	Ø 319 28 26 V Ø 288 10 8,5
350	203	01/06→12/08	← →	02/06→ 02/06→		24.0128-0753.1 428753 24.0110-0316.1 410316	Ø 319 28 26 V Ø 288 10 8,5
LEXUS - RX (MCU15) 07/00→05/03							
 Bremsbelagsatz, Scheibenbremse							
300 300 AWD	148 148	07/00→03/03 10/00→05/03	← →			13.0460-5882.2 605882 13.0460-5840.2 605840	23703 17,9 + WK AKE 21833 15,0 + WK
300 AWD	164	07/00→05/03	→	10/00→		13.0460-5840.2 605840	AKE 21833 15,0 + WK
 Bremsscheibe							
300 300 AWD	148 148	07/00→03/03 10/00→05/03	← →			24.0128-0186.1 428186 24.0110-0712.1 410712	Ø 296 28 26 V Ø 288 10 8,5
300 AWD	164	07/00→05/03	← →	10/00→ 10/00→		24.0128-0186.1 428186 24.0110-0712.1 410712	Ø 296 28 26 V Ø 288 10 8,5
LEXUS - SC Cabriolet (UZZ40_) 01/01→07/10							
 Bremsbelagsatz, Scheibenbremse							
430 (UZZ40_) 430 (UZZ40_) 430 (UZZ40_)	210 215 244	05/01→07/10 05/01→07/10 05/01→07/10	→			13.0460-5748.2 605748	23429 15,5 + WK
 Bremsscheibe							
430 (UZZ40_) 430 (UZZ40_) 430 (UZZ40_)	210 215 244	05/01→07/10 05/01→07/10 05/01→07/10	← →	→ 10/01		24.0132-0701.1 432701 24.0112-0703.1 412703	Ø 296 32 30 V Ø 306,6 12 10,5
MAYBACH - MAYBACH (240_) 09/02→12/12							
Warnkontakt, Bremsbelagverschleiß							
5.5 V12 5.5 V12 57/62 (240.078, 240.178)	405 405	09/02→12/12 09/02→12/12	← →		2 1	24.8190-0410.2 620410 24.8190-0410.2 620410	L= 97,5 L= 97,5
6.0 Biturbo 6.0 V12 57/62 6.0 V12 57S (240.079)	471 463 450	06/09→12/12 01/11→12/12 09/05→12/12					
MAZDA - 2 (DE) 07/07→06/15							
 Bremsbelagsatz, Scheibenbremse							
1.3 1.3 1.3 MZR 1.4 MZR-CD 1.5 1.5 MZR 1.6 MZ-CD 1.6 MZ-CD	55 63 62 50 76 75 66 70	10/07→06/15 10/07→06/15 01/10→06/15 01/08→06/15 10/07→06/15 06/11→06/15 10/08→06/15 06/11→06/15	←	→ 12/14		13.0460-5794.2 605794	TRW 24283 15,5 + WK + Zub
1.3 BiFuel 1.3 BiFuel	55 62	05/11→11/14 05/11→11/14	←			13.0460-5794.2 605794	TRW 24283 15,5 + WK + Zub
 Bremsscheibe							
1.3 1.3 1.3 MZR 1.4 MZR-CD 1.5 1.5 MZR 1.6 MZ-CD 1.6 MZ-CD	55 63 62 50 76 75 66 70	10/07→06/15 10/07→06/15 01/10→06/15 01/08→06/15 10/07→06/15 06/11→06/15 10/08→06/15 06/11→06/15	←	→ 12/14		24.0123-0112.1 423112	Ø 258 23 21 V
1.3 BiFuel 1.3 BiFuel	55 62	05/11→11/14 05/11→11/14	←			24.0123-0112.1 423112	Ø 258 23 21 V
MAZDA - 2 (DY) 02/03→06/07							
 Bremsbelagsatz, Scheibenbremse							
1.2 1.25 1.3 L 1.4 1.4 ↓	55 55 67 59 59	02/03→06/07 04/03→06/07 04/03→06/07 02/03→06/07 04/03→06/07	←			13.0460-7142.2 607142	ATE 23202 18,3 - WE / - WK











	kW			 	! #		
MAZDA - 2 (DY) 02/03→06/07							
 Bremsbelagsatz, Scheibenbremse							
1.4 CD 1.5 1.6 1.6	50 82 74 74	04/03→06/07 04/03→06/07 02/03→06/07 04/03→06/07	←			13.0460-7142.2 607142	ATE 23202 18,3 - WE / - WK
 Bremsscheibe							
1.2 1.25 1.3 L 1.4 1.4 1.4 CD 1.5 1.6 1.6	55 55 67 59 59 50 82 74 74	02/03→06/07 04/03→06/07 04/03→06/07 02/03→06/07 04/03→06/07 04/03→06/07 04/03→06/07 02/03→06/07 04/03→06/07	←			24.0122-0172.1 422172 24.0322-0172.1 522172	Ø 258 22 20 V Ø 258 22 20 V PD
MAZDA - 2 Stufenheck (DE) 05/10→06/15							
 Bremsbelagsatz, Scheibenbremse							
1.3 1.5 i	63 76	05/10→ 05/10→06/15	← → 12/14			13.0460-5794.2 605794	TRW 24283 15,5 + WK + Zub
 Bremsscheibe							
1.3 1.5 i	63 76	05/10→ 05/10→06/15	← → 12/14			24.0123-0112.1 423112	Ø 258 23 21 V
MAZDA - 3 (BK) 10/03→12/09							
 Bremsbelagsatz, Scheibenbremse							
1.4 1.6 1.6 DI Turbo 1.6 MZ-CD 2.0 2.0 MZR-CD 2.3 MZR Sport	59 77 80 66 110 105 126	02/04→06/09 10/03→06/09 06/04→06/09 06/06→12/09 10/03→06/09 12/06→06/09 10/03→06/09	← → 05/09 → 05/09			13.0460-7193.2 607193 13.0470-7193.2 LD7193 13.0460-7195.2 607195 13.0470-7195.2 LD7195	ATE 23723 18,1 - WE / - WK ATE 23723 18,1 - WE / - WK Ceramic ATE 23482 16,6 - WE / - WK ATE 23482 16,6 - WE / - WK Ceramic
1.4	62	10/03→06/09	← → 03/06 → 03/06			13.0460-7193.2 607193 13.0470-7193.2 LD7193 13.0460-7195.2 607195 13.0470-7195.2 LD7195	ATE 23723 18,1 - WE / - WK ATE 23723 18,1 - WE / - WK Ceramic ATE 23482 16,6 - WE / - WK ATE 23482 16,6 - WE / - WK Ceramic
2.0 2.3 MZR	104 115	04/04→06/06 03/04→03/09	←			13.0460-7193.2 607193 13.0470-7193.2 LD7193 13.0460-7195.2 607195 13.0470-7195.2 LD7195	ATE 23723 18,1 - WE / - WK ATE 23723 18,1 - WE / - WK Ceramic ATE 23482 16,6 - WE / - WK ATE 23482 16,6 - WE / - WK Ceramic
2.3	118	01/04→12/09	← → 09/04 → 09/04			13.0460-7193.2 607193 13.0470-7193.2 LD7193 13.0460-7195.2 607195 13.0470-7195.2 LD7195	ATE 23723 18,1 - WE / - WK ATE 23723 18,1 - WE / - WK Ceramic ATE 23482 16,6 - WE / - WK ATE 23482 16,6 - WE / - WK Ceramic
2.3 DiSi Turbo MPS	184	06/06→06/09	←			13.0460-7204.2 607204 13.0470-7204.2 LD7204 13.0460-7195.2 607195 13.0470-7195.2 LD7195	ATE 23801 18,8 - WE / - WK ATE 23801 18,8 - WE / - WK Ceramic ATE 23482 16,6 - WE / - WK ATE 23482 16,6 - WE / - WK Ceramic
2.3 MPS 2.3 MPS Turbo	196 191	01/07→06/09 12/06→06/09	← → 05/09 → 05/09			13.0460-7204.2 607204 13.0470-7204.2 LD7204 13.0460-7195.2 607195 13.0470-7195.2 LD7195	ATE 23801 18,8 - WE / - WK ATE 23801 18,8 - WE / - WK Ceramic ATE 23482 16,6 - WE / - WK ATE 23482 16,6 - WE / - WK Ceramic
 Bremsscheibe							
1.4 1.6 1.6 DI Turbo 1.6 MZ-CD	59 77 80 66	02/04→06/09 10/03→06/09 06/04→06/09 06/06→12/09	← → 05/09 → 05/09			24.0125-0165.1 425165 24.0111-0164.1 411164	Ø 278 25 23 V Ø 265 11 9
1.4 ↓	62	10/03→06/09	← → 03/06			24.0125-0165.1 425165	Ø 278 25 23 V











	kw			 	! #		
MAZDA - 3 (BK) 10/03→12/09							
 Bremsscheibe							
1.4	62	10/03→06/09	➔	→ 03/06		24.0111-0164.1 411164	Ø 265 11 9
2.0	104	04/04→06/06	➔			24.0125-0170.1 425170	Ø 300 25 23 V
2.3 MZR	115	03/04→03/09	➔			24.0111-0160.1 411160	Ø 280 11 9
2.0	110	10/03→06/09	➔	→ 05/09		24.0125-0170.1 425170	Ø 300 25 23 V
2.0 MZR-CD	105	12/06→06/09	➔	→ 05/09		24.0111-0160.1 411160	Ø 280 11 9
2.3 MZR Sport	126	10/03→06/09	➔	→ 05/09		24.0111-0160.1 411160	Ø 280 11 9
2.3	118	01/04→12/09	➔	→ 09/04		24.0125-0170.1 425170	Ø 300 25 23 V
			➔	→ 09/04		24.0111-0160.1 411160	Ø 280 11 9
2.3 DiSi Turbo MPS	184	06/06→06/09	➔			24.0125-0195.1 425195	Ø 320 25 23 V
			➔			24.0111-0160.1 411160	Ø 280 11 9
2.3 MPS	196	01/07→06/09	➔	→ 05/09		24.0125-0195.1 425195	Ø 320 25 23 V
2.3 MPS Turbo	191	12/06→06/09	➔	→ 05/09		24.0111-0160.1 411160	Ø 280 11 9
MAZDA - 3 (BL) 12/08→09/14							
 Bremsbelagsatz, Scheibenbremse							
1.6 MZR	77	12/08→09/14	➔	06/09→ 11/13		13.0460-7193.2 607193	ATE 23723 18,1 - WE / - WK
2.0 MZR	110	01/09→09/14	➔			13.0470-7193.2 LD7193	ATE 23723 18,1 - WE / - WK Ceramic
2.5	122	03/09→09/14	➔	06/09→ 11/13		13.0460-7195.2 607195	ATE 23482 16,6 - WE / - WK
			➔			13.0470-7195.2 LD7195	ATE 23482 16,6 - WE / - WK Ceramic
1.6 MZR	79	01/10→12/13	➔	→ 11/13		13.0460-7193.2 607193	ATE 23723 18,1 - WE / - WK
2.0 MZR	108	06/10→09/14	➔	→ 11/13		13.0470-7193.2 LD7193	ATE 23723 18,1 - WE / - WK Ceramic
			➔			13.0460-7195.2 607195	ATE 23482 16,6 - WE / - WK
			➔			13.0470-7195.2 LD7195	ATE 23482 16,6 - WE / - WK Ceramic
1.6 MZR CD	80	12/08→05/13	➔	06/09→		13.0460-7193.2 607193	ATE 23723 18,1 - WE / - WK
2.0 MZR DISI	111	12/08→05/13	➔			13.0470-7193.2 LD7193	ATE 23723 18,1 - WE / - WK Ceramic
2.2 MZR CD	110	01/09→05/13	➔			13.0460-7195.2 607195	ATE 23482 16,6 - WE / - WK
2.2 MZR CD	136	01/09→05/13	➔	06/09→		13.0470-7195.2 LD7195	ATE 23482 16,6 - WE / - WK Ceramic
1.6 MZR CD	85	09/10→05/13	➔	11/10→		13.0460-7193.2 607193	ATE 23723 18,1 - WE / - WK
			➔			13.0470-7193.2 LD7193	ATE 23723 18,1 - WE / - WK Ceramic
			➔	11/10→		13.0460-7195.2 607195	ATE 23482 16,6 - WE / - WK
			➔			13.0470-7195.2 LD7195	ATE 23482 16,6 - WE / - WK Ceramic
2.3 MPS Turbo	191	06/09→09/14	➔	→ 11/13		13.0460-7204.2 607204	ATE 23801 18,8 - WE / - WK
			➔			13.0470-7204.2 LD7204	ATE 23801 18,8 - WE / - WK Ceramic
			➔	→ 11/13		13.0460-7195.2 607195	ATE 23482 16,6 - WE / - WK
			➔			13.0470-7195.2 LD7195	ATE 23482 16,6 - WE / - WK Ceramic
 Bremsscheibe							
1.6 MZR	77	12/08→09/14	➔	06/09→ 11/13		24.0125-0165.1 425165	Ø 278 25 23 V
			➔	06/09→ 11/13		24.0111-0164.1 411164	Ø 265 11 9
1.6 MZR	79	01/10→12/13	➔	→ 11/13		24.0125-0165.1 425165	Ø 278 25 23 V
			➔	→ 11/13		24.0111-0164.1 411164	Ø 265 11 9
1.6 MZR CD	80	12/08→05/13	➔	06/09→		24.0125-0165.1 425165	Ø 278 25 23 V
			➔	06/09→		24.0111-0164.1 411164	Ø 265 11 9
1.6 MZR CD	85	09/10→05/13	➔	11/10→		24.0125-0165.1 425165	Ø 278 25 23 V
			➔	11/10→		24.0111-0164.1 411164	Ø 265 11 9
2.0 MZR	108	06/10→09/14	➔	→ 11/13		24.0125-0170.1 425170	Ø 300 25 23 V
			➔	→ 11/13		24.0111-0164.1 411164	Ø 265 11 9
2.0 MZR	110	01/09→09/14	➔	06/09→ 11/13		24.0125-0170.1 425170	Ø 300 25 23 V
2.5	122	03/09→09/14	➔	06/09→ 11/13		24.0111-0164.1 411164	Ø 265 11 9
2.0 MZR DISI	111	12/08→05/13	➔	06/09→		24.0125-0170.1 425170	Ø 300 25 23 V
2.2 MZR CD	110	01/09→05/13	➔			24.0111-0160.1 411160	Ø 280 11 9
2.2 MZR CD	136	01/09→05/13	➔	06/09→		24.0111-0160.1 411160	Ø 280 11 9
↓							













	kW					! #		
MAZDA - 3 (BL) 12/08→09/14								
 Bremsscheibe								
2.3 MPS Turbo	191	06/09→09/14	←	→ 11/13		24.0125-0195.1	425195	Ø 320 25 23 V
			→	→ 11/13		24.0111-0160.1	411160	Ø 280 11 9
MAZDA - 3 (BM) 09/13→								
 Bremsbelagsatz, Scheibenbremse								
1.5	74	09/13→	←			13.0460-5658.2	605658	AKE 25875 15,9 + WK
1.5 D	77	02/16→						
1.6	77	09/13→						
2.0	88	09/13→						
2.0	110	11/13→						
2.0	121	09/13→						
2.2 D	110	09/13→						
1.5	88	10/13→	←			13.0460-5658.2	605658	AKE 25875 15,9 + WK
 Bremsscheibe								
1.5	74	09/13→	→			24.0109-0181.1	409181	Ø 265 9 7
1.5	88	10/13→						
1.6	77	09/13→						
1.5 D	77	02/16→	←			24.0125-0208.1	425208	Ø 295 25 23 V
2.0	88	09/13→						
2.0	110	11/13→	→			24.0109-0181.1	409181	Ø 265 9 7
2.0	121	09/13→						
2.2 D	110	09/13→						
MAZDA - 3 Stufenheck (BK) 09/99→06/09								
 Bremsbelagsatz, Scheibenbremse								
1.6	77	02/04→06/09	←	→ 05/09		13.0460-7193.2	607193	ATE 23723 18,1 - WE / - WK
1.6 DI Turbo	80	06/04→06/09				13.0470-7193.2	LD7193	ATE 23723 18,1 - WE / - WK Ceramic
2.0	110	02/04→06/09						
2.0 MZR-CD	105	12/06→06/09						
2.3	115	01/04→12/09	→	→ 05/09		13.0460-7195.2	607195	ATE 23482 16,6 - WE / - WK
						13.0470-7195.2	LD7195	ATE 23482 16,6 - WE / - WK Ceramic
2.0	104	04/04→06/06	←			13.0460-7193.2	607193	ATE 23723 18,1 - WE / - WK
						13.0470-7193.2	LD7193	ATE 23723 18,1 - WE / - WK Ceramic
			→			13.0460-7195.2	607195	ATE 23482 16,6 - WE / - WK
						13.0470-7195.2	LD7195	ATE 23482 16,6 - WE / - WK Ceramic
2.3	118	03/04→03/09	←	→ 09/04		13.0460-7193.2	607193	ATE 23723 18,1 - WE / - WK
						13.0470-7193.2	LD7193	ATE 23723 18,1 - WE / - WK Ceramic
			→	→ 09/04		13.0460-7195.2	607195	ATE 23482 16,6 - WE / - WK
						13.0470-7195.2	LD7195	ATE 23482 16,6 - WE / - WK Ceramic
2.3 MPS	191	01/04→12/09	←	12/06→ 05/09		13.0460-7204.2	607204	ATE 23801 18,8 - WE / - WK
						13.0470-7204.2	LD7204	ATE 23801 18,8 - WE / - WK Ceramic
			→	12/06→ 05/09		13.0460-7195.2	607195	ATE 23482 16,6 - WE / - WK
						13.0470-7195.2	LD7195	ATE 23482 16,6 - WE / - WK Ceramic
 Bremsscheibe								
1.6	77	02/04→06/09	←	→ 05/09		24.0125-0165.1	425165	Ø 278 25 23 V
1.6 DI Turbo	80	06/04→06/09	→	→ 05/09		24.0111-0164.1	411164	Ø 265 11 9
2.0	104	04/04→06/06	←			24.0125-0170.1	425170	Ø 300 25 23 V
			→			24.0111-0160.1	411160	Ø 280 11 9
2.0	110	02/04→06/09	←	→ 05/09		24.0125-0170.1	425170	Ø 300 25 23 V
2.0 MZR-CD	105	12/06→06/09						
2.3	115	01/04→12/09	→	→ 05/09		24.0111-0160.1	411160	Ø 280 11 9
2.3	118	03/04→03/09	←	→ 09/04		24.0125-0170.1	425170	Ø 300 25 23 V
			→	→ 09/04		24.0111-0160.1	411160	Ø 280 11 9
2.3 MPS	191	01/04→12/09	←	12/06→ 05/09		24.0125-0195.1	425195	Ø 320 25 23 V
			→	12/06→ 05/09		24.0111-0160.1	411160	Ø 280 11 9













	kw			 	! #		
MAZDA - 3 Stufenheck (BL) 12/08→							
 Bremsbelagsatz, Scheibenbremse							
1.6 MZR 2.0 MZR 2.2 MZR CD 2.5	77 110 110 122	02/09→09/14 03/09→09/14 01/09→09/14 05/09→09/14	← →	06/09→ 11/13 06/09→ 11/13		13.0460-7193.2 607193 13.0470-7193.2 LD7193 13.0460-7195.2 607195 13.0470-7195.2 LD7195	ATE 23723 18,1 - WE / - WK ATE 23723 18,1 - WE / - WK Ceramic ATE 23482 16,6 - WE / - WK ATE 23482 16,6 - WE / - WK Ceramic
1.6 MZR CD 2.0 MZR DISI	80 111	12/08→05/13 02/09→05/13	← →	06/09→ 06/09→		13.0460-7193.2 607193 13.0470-7193.2 LD7193 13.0460-7195.2 607195 13.0470-7195.2 LD7195	ATE 23723 18,1 - WE / - WK ATE 23723 18,1 - WE / - WK Ceramic ATE 23482 16,6 - WE / - WK ATE 23482 16,6 - WE / - WK Ceramic
1.6 MZR CD	85	09/10→05/13	← →	11/10→ 11/10→		13.0460-7193.2 607193 13.0470-7193.2 LD7193 13.0460-7195.2 607195 13.0470-7195.2 LD7195	ATE 23723 18,1 - WE / - WK ATE 23723 18,1 - WE / - WK Ceramic ATE 23482 16,6 - WE / - WK ATE 23482 16,6 - WE / - WK Ceramic
2.0 MZR	108	06/10→	← →	→ 11/13 → 11/13		13.0460-7193.2 607193 13.0470-7193.2 LD7193 13.0460-7195.2 607195 13.0470-7195.2 LD7195	ATE 23723 18,1 - WE / - WK ATE 23723 18,1 - WE / - WK Ceramic ATE 23482 16,6 - WE / - WK ATE 23482 16,6 - WE / - WK Ceramic
2.2 MZR CD	136	06/09→05/13	← →			13.0460-7193.2 607193 13.0470-7193.2 LD7193 13.0460-7195.2 607195 13.0470-7195.2 LD7195	ATE 23723 18,1 - WE / - WK ATE 23723 18,1 - WE / - WK Ceramic ATE 23482 16,6 - WE / - WK ATE 23482 16,6 - WE / - WK Ceramic
 Bremsscheibe							
1.6 MZR	77	02/09→09/14	← →	06/09→ 11/13 06/09→ 11/13		24.0125-0165.1 425165 24.0111-0164.1 411164	Ø 278 25 23 V Ø 265 11 9
1.6 MZR CD	80	12/08→05/13	← →	06/09→ 06/09→		24.0125-0165.1 425165 24.0111-0164.1 411164	Ø 278 25 23 V Ø 265 11 9
1.6 MZR CD	85	09/10→05/13	← →	11/10→ 11/10→		24.0125-0165.1 425165 24.0111-0164.1 411164	Ø 278 25 23 V Ø 265 11 9
2.0 MZR	108	06/10→	← →	→ 11/13 → 11/13		24.0125-0170.1 425170 24.0111-0164.1 411164	Ø 300 25 23 V Ø 265 11 9
2.0 MZR 2.5	110 122	03/09→09/14 05/09→09/14	← →	06/09→ 11/13 06/09→ 11/13		24.0125-0170.1 425170 24.0111-0164.1 411164	Ø 300 25 23 V Ø 265 11 9
2.0 MZR DISI	111	02/09→05/13	← →	06/09→ 06/09→		24.0125-0170.1 425170 24.0111-0160.1 411160	Ø 300 25 23 V Ø 280 11 9
2.2 MZR CD	110	01/09→09/14	← →	06/09→ 11/13 06/09→ 11/13		24.0125-0170.1 425170 24.0111-0160.1 411160	Ø 300 25 23 V Ø 280 11 9
2.2 MZR CD	136	06/09→05/13	← →			24.0125-0170.1 425170 24.0111-0160.1 411160	Ø 300 25 23 V Ø 280 11 9
MAZDA - 3 Stufenheck (BM) 09/13→							
 Bremsbelagsatz, Scheibenbremse							
1.5 1.5 D 1.6 2.0 2.0 2.0 2.2 D	74 77 77 88 110 121 110	10/14→ 02/16→ 09/13→ 09/13→ 11/13→ 11/14→ 09/13→	←			13.0460-5658.2 605658	AKE 25875 15,9 + WK
1.5	88	10/13→	←			13.0460-5658.2 605658	AKE 25875 15,9 + WK
 Bremsscheibe							
1.5 1.5 1.6 ↓	74 88 77	10/14→ 10/13→ 09/13→	→			24.0109-0181.1 409181	Ø 265 9 7















	kW			 	! #		
MAZDA - 3 Stufenheck (BM) 09/13→							
 Bremsscheibe							
1.5 D	77	02/16→	←			24.0125-0208.1 425208	Ø 295 25 23 V
2.0	88	09/13→	→				
2.0	110	11/13→				24.0109-0181.1 409181	Ø 265 9 7
2.0	121	11/14→					
2.2 D	110	09/13→					
MAZDA - 5 (CR19) 02/05→12/10							
 Bremsbelagsatz, Scheibenbremse							
1.8	85	02/05→05/10	←	03/05→		13.0460-7193.2 607193	ATE 23723 18,1 - WE / - WK
2.0	107	02/05→05/10				13.0470-7193.2 LD7193	ATE 23723 18,1 - WE / - WK Ceramic
2.0 CD	81	02/05→05/10	→	03/05→		13.0460-7195.2 607195	ATE 23482 16,6 - WE / - WK
						13.0470-7195.2 LD7195	ATE 23482 16,6 - WE / - WK Ceramic
2.0 CD	105	02/05→05/10	←	06/05→		13.0460-7193.2 607193	ATE 23723 18,1 - WE / - WK
						13.0470-7193.2 LD7193	ATE 23723 18,1 - WE / - WK Ceramic
			→	06/05→		13.0460-7195.2 607195	ATE 23482 16,6 - WE / - WK
						13.0470-7195.2 LD7195	ATE 23482 16,6 - WE / - WK Ceramic
 Bremsscheibe							
1.8	85	02/05→05/10	←	03/05→;		24.0125-0165.1 425165	Ø 278 25 23 V
2.0	107	02/05→05/10		passend für Felgenreöße [Zoll]: 15			
2.0 CD	81	02/05→05/10	←	03/05→;		24.0125-0170.1 425170	Ø 300 25 23 V
				passend für Felgenreöße [Zoll]: 16			
			→	03/05→;		24.0111-0160.1 411160	Ø 280 11 9
				passend für Felgenreöße [Zoll]: 15			
			→	03/05→;		24.0111-0165.1 411165	Ø 302 11 9
				passend für Felgenreöße [Zoll]: 16			
2.0 CD	105	02/05→05/10	←	06/05→;		24.0125-0165.1 425165	Ø 278 25 23 V
				passend für Felgenreöße [Zoll]: 15			
			←	06/05→;		24.0125-0170.1 425170	Ø 300 25 23 V
				passend für Felgenreöße [Zoll]: 16			
			→	06/05→;		24.0111-0160.1 411160	Ø 280 11 9
				passend für Felgenreöße [Zoll]: 15			
			→	03/05→;		24.0111-0165.1 411165	Ø 302 11 9
				passend für Felgenreöße [Zoll]: 16			
MAZDA - 5 (CW) 09/10→							
 Bremsbelagsatz, Scheibenbremse							
1.6 CD	85	09/10→	←			13.0460-7193.2 607193	ATE 23723 18,1 - WE / - WK
1.8 MZR	85	09/10→				13.0470-7193.2 LD7193	ATE 23723 18,1 - WE / - WK Ceramic
2.0	106	01/11→					
2.0	108	01/11→	→			13.0460-7195.2 607195	ATE 23482 16,6 - WE / - WK
2.0	110	09/10→				13.0470-7195.2 LD7195	ATE 23482 16,6 - WE / - WK Ceramic
2.0	111	08/14→					
 Bremsscheibe							
1.6 CD	85	09/10→	←	passend für Felgenreöße [Zoll]: 15		24.0125-0165.1 425165	Ø 278 25 23 V
1.8 MZR	85	09/10→					
2.0	106	01/11→	←	passend für Felgenreöße [Zoll]: 16,17		24.0125-0170.1 425170	Ø 300 25 23 V
2.0	108	01/11→	→	passend für Felgenreöße [Zoll]: 15		24.0111-0160.1 411160	Ø 280 11 9
2.0	110	09/10→					
2.0	111	08/14→	→	passend für Felgenreöße [Zoll]: 16		24.0111-0165.1 411165	Ø 302 11 9
MAZDA - 6 Hatchback (GG) 08/02→12/08							
 Bremsbelagsatz, Scheibenbremse							
1.8	88	08/02→08/07	←	→ 07/07		13.0460-5822.2 605822	24246 16,8 + WK
			→	→ 07/07		13.0460-5804.2 605804	AKE 24045 13,7 - WE / - WK
2.0	104	08/02→08/07	←	→ 07/07		13.0460-5821.2 605821	AKE 24046 18,6 + WK
2.0	108	03/05→08/07					
2.0 DI	89	08/02→08/07	→	→ 07/07		13.0460-5804.2 605804	AKE 24045 13,7 - WE / - WK
2.0 DI	100	08/02→08/07					
2.0 DI	105	06/05→08/07					
2.3	122	08/02→08/07					
2.5	125	08/07→12/08	←			13.0460-5610.2 605610	24582 17,4 + WK + Zub
			→			13.0460-5804.2 605804	AKE 24045 13,7 - WE / - WK
↓							











	kW					! #		
MAZDA - 6 Hatchback (GG) 08/02→12/08								
Zubehörsatz, Scheibenbremsbelag								
1.8	88	08/02→08/07	←	→ 07/07			13.0460-0260.2 610260	
			→	→ 07/07			13.0460-0234.2 610234	
2.0	104	08/02→08/07	←	→ 07/07			13.0460-0261.2 610261	
2.0	108	03/05→08/07						
2.0 DI	89	08/02→08/07	→	→ 07/07			13.0460-0234.2 610234	
2.0 DI	100	08/02→08/07						
2.0 DI	105	06/05→08/07						
2.3	122	08/02→08/07						
2.5	125	08/07→12/08	→				13.0460-0234.2 610234	
 Bremsscheibe								
1.8	88	08/02→08/07	←	→ 07/07			24.0124-0175.1 424175	Ø 273,5 24 22 V
			→	→ 07/07			24.0110-0302.1 410302	Ø 280 10 8
2.0	104	08/02→08/07	←	→ 07/07			24.0125-0147.1 425147	Ø 282,5 25 23 V
2.0	108	03/05→08/07						
2.0 DI	89	08/02→08/07	→	→ 07/07			24.0110-0302.1 410302	Ø 280 10 8
2.0 DI	100	08/02→08/07						
2.0 DI	105	06/05→08/07						
2.3	122	08/02→08/07						
2.5	125	08/07→12/08	←				24.0125-0188.1 425188	Ø 299 25 23 V
			→				24.0110-0302.1 410302	Ø 280 10 8
MAZDA - 6 Kombi (GJ, GL) 12/12→								
 Bremsscheibe								
2.0	107	01/13→	←	Kombi			24.0128-0277.1 428277	Ø 297 28 26 V
2.0	114	12/12→						
2.0	121	01/13→	←				24.0128-0279.1 428279	Ø 297 28 26 V
2.2 D	129	12/12→						
2.5	138	12/12→						
2.2 D	110	12/12→	←	01/13→; Kombi			24.0128-0277.1 428277	Ø 297 28 26 V
			←	01/13→			24.0128-0279.1 428279	Ø 297 28 26 V
2.2 D AWD	110	02/15→	←	Kombi			24.0128-0277.1 428277	Ø 297 28 26 V
2.2 D AWD	129	02/15→						
2.5	141	12/12→	←	01/13→			24.0128-0279.1 428279	Ø 297 28 26 V
MAZDA - 6 Sport (GH) 08/07→07/13								
 Bremsbelagsatz, Scheibenbremse								
1.8 MZR	88	08/07→07/13	←	→ 12/12			13.0460-5610.2 605610	24582 17,4 + WK + Zub
2.0 MZR	108	08/07→07/13						
2.5 MZR	125	08/07→03/13	→	→ 12/12			13.0460-5804.2 605804	AKE 24045 13,7 - WE / - WK
2.0 MZR	114	01/10→12/12	←				13.0460-5610.2 605610	24582 17,4 + WK + Zub
2.0 MZR-CD	103	08/07→10/09						
2.2 D	95	01/10→12/12	→				13.0460-5804.2 605804	AKE 24045 13,7 - WE / - WK
2.2 MZR-CD	92	01/09→12/12						
2.2 MZR-CD	120	01/09→12/12						
2.2 MZR-CD	132	01/10→12/12						
2.2 MZR-CD	136	01/09→12/12						
Zubehörsatz, Scheibenbremsbelag								
1.8 MZR	88	08/07→07/13	→	→ 12/12			13.0460-0234.2 610234	
2.0 MZR	108	08/07→07/13						
2.5 MZR	125	08/07→03/13						
2.0 MZR	114	01/10→12/12	→				13.0460-0234.2 610234	
2.0 MZR-CD	103	08/07→10/09						
2.2 D	95	01/10→12/12						
2.2 MZR-CD	92	01/09→12/12						
2.2 MZR-CD	120	01/09→12/12						
2.2 MZR-CD	132	01/10→12/12						
2.2 MZR-CD	136	01/09→12/12						
 Bremsscheibe								
1.8 MZR	88	08/07→07/13	←	→ 12/12			24.0125-0188.1 425188	Ø 299 25 23 V
2.0 MZR	108	08/07→07/13						
2.5 MZR	125	08/07→03/13	→	→ 12/12			24.0110-0302.1 410302	Ø 280 10 8
2.0 MZR	114	01/10→12/12	←				24.0125-0188.1 425188	Ø 299 25 23 V
2.0 MZR-CD	103	08/07→10/09						
2.2 D	95	01/10→12/12	→				24.0110-0302.1 410302	Ø 280 10 8
2.2 MZR-CD	92	01/09→12/12						
2.2 MZR-CD	120	01/09→12/12						
2.2 MZR-CD	132	01/10→12/12						
2.2 MZR-CD	136	01/09→12/12						













	kW			 	! #		
MAZDA - 6 Sport Kombi (GH) 12/07→07/13							
 Bremsbelagsatz, Scheibenbremse							
1.8 MZR	88	02/08→07/13	←	→ 12/12		13.0460-5610.2 605610	24582 17,4 + WK + Zub
2.0 MZR	108	12/07→07/13					
2.0 MZR	114	01/10→07/13	→	→ 12/12		13.0460-5804.2 605804	AKE 24045 13,7 - WE / - WK
2.2 D	95	01/10→07/13					
2.2 MZR-CD	132	01/10→07/13					
2.5 MZR	125	02/08→07/13					
2.0 MZR-CD	103	12/07→12/10	←			13.0460-5610.2 605610	24582 17,4 + WK + Zub
2.2 MZR-CD	92	01/09→12/10	→			13.0460-5804.2 605804	AKE 24045 13,7 - WE / - WK
2.2 MZR-CD	120	08/08→07/13	←	01/09→ 12/12		13.0460-5610.2 605610	24582 17,4 + WK + Zub
			→	01/09→ 12/12		13.0460-5804.2 605804	AKE 24045 13,7 - WE / - WK
2.2 MZR-CD	136	08/08→12/11	←	01/09→		13.0460-5610.2 605610	24582 17,4 + WK + Zub
			→	01/09→		13.0460-5804.2 605804	AKE 24045 13,7 - WE / - WK
Zubehörsatz, Scheibenbremsbelag							
1.8 MZR	88	02/08→07/13	→	→ 12/12		13.0460-0234.2 610234	
2.0 MZR	108	12/07→07/13					
2.0 MZR	114	01/10→07/13					
2.2 D	95	01/10→07/13					
2.2 MZR-CD	132	01/10→07/13					
2.5 MZR	125	02/08→07/13					
2.0 MZR-CD	103	12/07→12/10	→			13.0460-0234.2 610234	
2.2 MZR-CD	92	01/09→12/10					
2.2 MZR-CD	120	08/08→07/13	→	01/09→ 12/12		13.0460-0234.2 610234	
2.2 MZR-CD	136	08/08→12/11	→	01/09→		13.0460-0234.2 610234	
 Bremsscheibe							
1.8 MZR	88	02/08→07/13	←	→ 12/12		24.0125-0188.1 425188	∅ 299 25 23 V
2.0 MZR	108	12/07→07/13					
2.0 MZR	114	01/10→07/13	→	→ 12/12		24.0110-0302.1 410302	∅ 280 10 8
2.2 D	95	01/10→07/13					
2.2 MZR-CD	132	01/10→07/13					
2.5 MZR	125	02/08→07/13					
2.0 MZR-CD	103	12/07→12/10	←			24.0125-0188.1 425188	∅ 299 25 23 V
2.2 MZR-CD	92	01/09→12/10	→			24.0110-0302.1 410302	∅ 280 10 8
2.2 MZR-CD	120	08/08→07/13	←	01/09→ 12/12		24.0125-0188.1 425188	∅ 299 25 23 V
			→	01/09→ 12/12		24.0110-0302.1 410302	∅ 280 10 8
2.2 MZR-CD	136	08/08→12/11	←	01/09→		24.0125-0188.1 425188	∅ 299 25 23 V
			→	01/09→		24.0110-0302.1 410302	∅ 280 10 8
MAZDA - 6 Station Wagon (GY) 08/02→12/07							
 Bremsbelagsatz, Scheibenbremse							
1.8	88	08/02→08/07	←	→ 07/07		13.0460-5821.2 605821	AKE 24046 18,6 + WK
2.0	104	08/02→08/07					
2.0	108	03/05→08/07	→	→ 07/07		13.0460-5804.2 605804	AKE 24045 13,7 - WE / - WK
2.0 DI	89	08/02→08/07					
2.0 DI	105	06/05→08/07					
2.3	122	08/02→08/07					
2.3 AWD	119	11/02→08/07					
2.0 DI	100	08/02→02/05	←			13.0460-5821.2 605821	AKE 24046 18,6 + WK
			→			13.0460-5804.2 605804	AKE 24045 13,7 - WE / - WK
Zubehörsatz, Scheibenbremsbelag							
1.8	88	08/02→08/07	←	→ 07/07		13.0460-0261.2 610261	
2.0	104	08/02→08/07					
2.0	108	03/05→08/07	→	→ 07/07		13.0460-0234.2 610234	
2.0 DI	89	08/02→08/07					
2.0 DI	105	06/05→08/07					
2.3	122	08/02→08/07					
2.3 AWD	119	11/02→08/07					
2.0 DI	100	08/02→02/05	←			13.0460-0261.2 610261	
			→			13.0460-0234.2 610234	
 Bremsscheibe							
1.8	88	08/02→08/07	←	→ 07/07		24.0125-0147.1 425147	∅ 282,5 25 23 V
2.0	104	08/02→08/07					
2.0	108	03/05→08/07	→	→ 07/07		24.0110-0302.1 410302	∅ 280 10 8
2.0 DI	89	08/02→08/07					
2.0 DI	105	06/05→08/07					
2.3	122	08/02→08/07					
2.3 AWD	119	11/02→08/07					











	kW					! #		
MAZDA - 6 Station Wagon (GY) 08/02→12/07								
 Bremsscheibe								
2.0 DI	100	08/02→02/05	←			24.0125-0147.1	425147	∅ 282,5 25 23 V
			→			24.0110-0302.1	410302	∅ 280 10 8
MAZDA - 6 Stufenheck (GG) 06/02→12/08								
 Bremsbelagsatz, Scheibenbremse								
1.8	88	08/02→08/07	←	→ 07/07		13.0460-5822.2	605822	24246 16,8 + WK
			→	→ 07/07		13.0460-5804.2	605804	AKE 24045 13,7 - WE / - WK
2.0	104	06/02→08/07	←	→ 07/07		13.0460-5821.2	605821	AKE 24046 18,6 + WK
2.0 DI	89	08/02→08/07	→	→ 07/07		13.0460-5804.2	605804	AKE 24045 13,7 - WE / - WK
2.0 DI	100	06/02→08/07						
2.0 DI	105	06/05→08/07						
2.3	103	09/06→08/07						
2.3	122	06/02→08/07						
2.3	118	07/03→02/05	←			13.0460-5821.2	605821	AKE 24046 18,6 + WK
2.3	120	03/05→07/07	→			13.0460-5804.2	605804	AKE 24045 13,7 - WE / - WK
Zubehörsatz, Scheibenbremsbelag								
1.8	88	08/02→08/07	←	→ 07/07		13.0460-0260.2	610260	
			→	→ 07/07		13.0460-0234.2	610234	
2.0	104	06/02→08/07	←	→ 07/07		13.0460-0261.2	610261	
2.0 DI	89	08/02→08/07	→	→ 07/07		13.0460-0234.2	610234	
2.0 DI	100	06/02→08/07						
2.0 DI	105	06/05→08/07						
2.3	103	09/06→08/07						
2.3	122	06/02→08/07						
2.3	118	07/03→02/05	←			13.0460-0261.2	610261	
2.3	120	03/05→07/07	→			13.0460-0234.2	610234	
 Bremsscheibe								
1.8	88	08/02→08/07	←	→ 07/07		24.0124-0175.1	424175	∅ 273,5 24 22 V
			→	→ 07/07		24.0110-0302.1	410302	∅ 280 10 8
2.0	104	06/02→08/07	←	→ 07/07		24.0125-0147.1	425147	∅ 282,5 25 23 V
2.0 DI	89	08/02→08/07	→	→ 07/07		24.0110-0302.1	410302	∅ 280 10 8
2.0 DI	100	06/02→08/07						
2.0 DI	105	06/05→08/07						
2.3	103	09/06→08/07						
2.3	122	06/02→08/07						
2.3	118	07/03→02/05	←			24.0125-0147.1	425147	∅ 282,5 25 23 V
2.3	120	03/05→07/07	→			24.0110-0302.1	410302	∅ 280 10 8
MAZDA - 6 Stufenheck (GH) 08/07→12/13								
 Bremsbelagsatz, Scheibenbremse								
1.8 MZR	88	08/07→07/13	←	→ 12/12		13.0460-5610.2	605610	24582 17,4 + WK + Zub
2.2 D	132	01/10→07/13						
2.5 MZR	125	08/07→07/13	→	→ 12/12		13.0460-5804.2	605804	AKE 24045 13,7 - WE / - WK
2.0 MZR	108	08/07→12/12	←			13.0460-5610.2	605610	24582 17,4 + WK + Zub
2.0 MZR	114	01/10→12/12						
2.0 MZR-CD	103	08/07→10/10	→			13.0460-5804.2	605804	AKE 24045 13,7 - WE / - WK
2.2 D	95	01/10→12/12						
2.2 MZR-CD	92	01/09→12/12						
2.2 MZR-CD	120	01/09→12/12						
2.2 MZR-CD	136	01/09→12/12						
Zubehörsatz, Scheibenbremsbelag								
1.8 MZR	88	08/07→07/13	→	→ 12/12		13.0460-0234.2	610234	
2.2 D	132	01/10→07/13						
2.5 MZR	125	08/07→07/13						
2.0 MZR	108	08/07→12/12	→			13.0460-0234.2	610234	
2.0 MZR	114	01/10→12/12						
2.0 MZR-CD	103	08/07→10/10						
2.2 D	95	01/10→12/12						
2.2 MZR-CD	92	01/09→12/12						
2.2 MZR-CD	120	01/09→12/12						
2.2 MZR-CD	136	01/09→12/12						
 Bremsscheibe								
1.8 MZR	88	08/07→07/13	←	→ 12/12		24.0125-0188.1	425188	∅ 299 25 23 V
2.2 D	132	01/10→07/13						
↓								













	kw			 	! #		
MAZDA - 6 Stufenheck (GH) 08/07→12/13							
 Bremsscheibe							
2.5 MZR	125	08/07→07/13	→	→ 12/12		24.0110-0302.1 410302	Ø 280 10 8
2.0 MZR	108	08/07→12/12	←			24.0125-0188.1 425188	Ø 299 25 23 V
2.0 MZR	114	01/10→12/12					
2.0 MZR-CD	103	08/07→10/10	→			24.0110-0302.1 410302	Ø 280 10 8
2.2 D	95	01/10→12/12					
2.2 MZR-CD	92	01/09→12/12					
2.2 MZR-CD	120	01/09→12/12					
2.2 MZR-CD	136	01/09→12/12					
MAZDA - 6 Stufenheck (GJ, GL) 12/12→							
 Bremsscheibe							
2.0	107	01/13→	←	Kombi		24.0128-0277.1 428277	Ø 297 28 26 V
2.0	114	12/12→					
2.0	121	01/13→	←			24.0128-0279.1 428279	Ø 297 28 26 V
2.2 D	110	01/13→					
2.2 D	129	12/12→					
2.5	138	12/12→					
2.0	110	12/12→	←			24.0128-0279.1 428279	Ø 297 28 26 V
2.5	141	01/13→					
MAZDA - 121 II (DB) 11/90→05/97							
 Bremsbelagsatz, Scheibenbremse							
1.3 16V	39	11/90→03/96	←	04/91→ 02/96		13.0460-5944.2 605944	SUM 21654 15,0 + WK
1.3 i 16V	53	11/90→03/96					
Zubehörsatz, Scheibenbremsbelag							
1.3 16V	39	11/90→03/96	←	04/91→ 02/96		13.0460-0339.2 610339	SUM
1.3 i 16V	53	11/90→03/96					
 Bremsscheibe							
1.3 16V	39	11/90→03/96	←	04/91→ 02/96; Vollautomatik		24.0118-0113.1 418113	Ø 235 18 16 V
1.3 i 16V	53	11/90→03/96					
MAZDA - 121 III (JASM, JBSM) 03/96→04/03							
 Bremsbelagsatz, Scheibenbremse							
1.25	55	03/96→04/03	←	→ 01/00; Vollautomatik		13.0460-7071.2 607071	ATE 20640 17,5 - WE / - WK
			←	→ 01/00; Schaltgetriebe		13.0460-7073.2 607073	ATE 21202 16,9 - WE / - WK
			←	02/00→ 03/03; + ABS		13.0460-7142.2 607142	ATE 23202 18,3 - WE / - WK
			←	02/00→ 03/03; - ABS		13.0460-7148.2 607148	ATE 23200 18,0 - WE / - WK
1.3	37	03/96→04/03	←	→ 01/00		13.0460-7073.2 607073	ATE 21202 16,9 - WE / - WK
1.3	44	03/96→04/03	←	02/00→ 03/03; + ABS		13.0460-7142.2 607142	ATE 23202 18,3 - WE / - WK
1.8 D	44	03/96→04/03	←	02/00→ 03/03; - ABS		13.0460-7148.2 607148	ATE 23200 18,0 - WE / - WK
1.4	44	07/96→10/02	←	→ 01/00		13.0460-7073.2 607073	ATE 21202 16,9 - WE / - WK
			←	02/00→; + ABS		13.0460-7142.2 607142	ATE 23202 18,3 - WE / - WK
			←	02/00→; - ABS		13.0460-7148.2 607148	ATE 23200 18,0 - WE / - WK
 Bremsscheibe							
1.25	55	03/96→04/03	←	→ 01/00; Schaltgetriebe		24.0112-0141.1 412141	Ø 239,5 12 10
						24.0312-0141.1 512141	Ø 239,5 12 10 PD
			←	→ 01/00; Vollautomatik		24.0120-0147.1 420147	Ø 239,5 20 18 V
						24.0320-0147.1 520147	Ø 239,5 20 18 V PD
			←	02/00→ 03/03; - ABS		24.0120-0147.1 420147	Ø 239,5 20 18 V
						24.0320-0147.1 520147	Ø 239,5 20 18 V PD
			←	02/00→ 03/03; + ABS		24.0122-0172.1 422172	Ø 258 22 20 V
						24.0322-0172.1 522172	Ø 258 22 20 V PD
1.3	37	03/96→04/03	←	→ 01/00		24.0112-0141.1 412141	Ø 239,5 12 10
1.3	44	03/96→04/03	←	02/00→ 03/03; - ABS		24.0120-0147.1 420147	Ø 239,5 20 18 V
1.8 D	44	03/96→04/03	←	02/00→ 03/03; + ABS		24.0122-0172.1 422172	Ø 258 22 20 V
						24.0322-0172.1 522172	Ø 258 22 20 V PD
1.4	44	07/96→10/02	←	→ 01/00		24.0112-0141.1 412141	Ø 239,5 12 10
						24.0312-0141.1 512141	Ø 239,5 12 10 PD
			←	02/00→; - ABS		24.0120-0147.1 420147	Ø 239,5 20 18 V
						24.0320-0147.1 520147	Ø 239,5 20 18 V PD
↓							













	kW					! #		
MAZDA - 121 III (JASM, JBSM) 03/96→04/03								
 Bremsscheibe								
1.4	44	07/96→10/02	←	02/00→; + ABS		24.0122-0172.1 422172	Ø 258 22 20 V	
						24.0322-0172.1 522172	Ø 258 22 20 V PD	
MAZDA - 323 III Station Wagon (BW) 01/86→10/98								
 Bremsscheibe								
1.6	63	09/86→10/95	←	→ 12/94		24.0118-0101.1 418101	Ø 238 18 16 V	
MAZDA - 323 C IV (BG) 06/89→09/00								
 Bremsbelagsatz, Scheibenbremse								
1.6	66	09/93→09/00	←	→ 12/94		13.0460-5944.2 605944	SUM 21654 15,0 + WK	
			→	→ 12/94		13.0460-5972.2 605972	21559 11,5 - WE / - WK	
Zubehörsatz, Scheibenbremsbelag								
1.6	66	09/93→09/00	←	→ 12/94		13.0460-0339.2 610339	SUM	
 Bremsscheibe								
1.6	66	09/93→09/00	←	→ 12/94; Schaltgetriebe; für Fahrzeuge mit Trommelbremse an der Hinterachse		24.0118-0113.1 418113	Ø 235 18 16 V	
			←	→ 12/94; Vollautomatik		24.0122-0166.1 422166	Ø 235 22 20 V	
			←	→ 12/94; Schaltgetriebe; für Fahrzeuge mit Scheibenbremse an der Hinterachse		24.0122-0166.1 422166	Ø 235 22 20 V	
			→	→ 12/94		24.0109-0127.1 409127	Ø 231 9 8	
MAZDA - 323 C V (BA) 08/94→01/01								
 Bremsbelagsatz, Scheibenbremse								
1.3 16V	54	08/94→09/98	←	→ 08/98		13.0460-5944.2 605944	SUM 21654 15,0 + WK	
1.5 16V	65	08/94→09/98	←					
1.8	92	08/94→09/98	←	→ 08/98; Türenanzahl: 5		13.0460-5944.2 605944	SUM 21654 15,0 + WK	
1.8 16V	84	08/94→09/98	←	→ 08/98; Türenanzahl: 3		13.0460-5974.2 605974	SUM 21539 15,0 + WK	
			←	→ 08/98; Türenanzahl: 4		13.0460-5974.2 605974	SUM 21539 15,0 + WK	
Zubehörsatz, Scheibenbremsbelag								
1.3 16V	54	08/94→09/98	←	→ 08/98		13.0460-0339.2 610339	SUM	
1.5 16V	65	08/94→09/98	←					
1.8	92	08/94→09/98	←	→ 08/98; Türenanzahl: 5		13.0460-0339.2 610339	SUM	
1.8 16V	84	08/94→09/98	←					
 Bremsscheibe								
1.3 16V	54	08/94→09/98	←	→ 08/98		24.0118-0113.1 418113	Ø 235 18 16 V	
1.5 16V	65	08/94→09/98	←	→ 08/98		24.0122-0166.1 422166	Ø 235 22 20 V	
1.8	92	08/94→09/98	←	→ 08/98		24.0122-0165.1 422165	Ø 257 22 20 V	
1.8 16V	84	08/94→09/98	←					
MAZDA - 323 F V (BA) 07/94→09/98								
 Bremsbelagsatz, Scheibenbremse								
1.5 16V	65	07/94→09/98	←	→ 08/98		13.0460-5944.2 605944	SUM 21654 15,0 + WK	
1.8 16V	84	08/94→09/98	←	→ 08/98; Türenanzahl: 5		13.0460-5944.2 605944	SUM 21654 15,0 + WK	
1.8 16V	92	08/94→09/98	←	→ 08/98; Türenanzahl: 3		13.0460-5974.2 605974	SUM 21539 15,0 + WK	
			←	→ 08/98; Türenanzahl: 4		13.0460-5974.2 605974	SUM 21539 15,0 + WK	
Zubehörsatz, Scheibenbremsbelag								
1.5 16V	65	07/94→09/98	←	→ 08/98		13.0460-0339.2 610339	SUM	
1.8 16V	84	08/94→09/98	←	→ 08/98; Türenanzahl: 5		13.0460-0339.2 610339	SUM	
1.8 16V	92	08/94→09/98	←					
 Bremsscheibe								
1.5 16V	65	07/94→09/98	←	→ 08/98		24.0122-0166.1 422166	Ø 235 22 20 V	
1.8 16V	84	08/94→09/98	←	→ 08/98		24.0122-0165.1 422165	Ø 257 22 20 V	
1.8 16V	92	08/94→09/98	←					

















	kw			 	! #		
MAZDA - 323 F VI (BJ) 09/98→05/04							
 Bremsbelagsatz, Scheibenbremse							
1.4	53	01/01→05/04	←	→ 10/03		13.0460-5802.2 605802	23490 15,4 + WK + Zub
1.4 16V	54	09/98→01/01	←	→ 12/00		13.0460-5802.2 605802	23490 15,4 + WK + Zub
1.5 16V	65	09/98→01/01					
1.6	70	01/01→05/04	←	→ 10/03		13.0460-5954.2 605954	SUM 23845 15,8 + WK
1.6	72	01/01→05/04					
2.0 TD	74	01/01→05/04	→	→ 10/03		13.0460-5804.2 605804	AKE 24045 13,7 - WE / - WK
1.9 16V	84	09/98→01/01	←	→ 12/00		13.0460-5954.2 605954	SUM 23845 15,8 + WK
2.0 D	52	09/98→05/04					
2.0 TD	66	09/98→12/01	→	→ 12/00		13.0460-5804.2 605804	AKE 24045 13,7 - WE / - WK
2.0	96	01/01→05/04	←	→ 10/03; für Fahrzeuge mit Sportfahrwerk		13.0460-5831.2 605831	SUM 23777 16,0 + WK + Zub
			←	→ 10/03; für Fahrzeuge ohne Sportfahrwerk		13.0460-5954.2 605954	SUM 23845 15,8 + WK
			→	→ 10/03		13.0460-5804.2 605804	AKE 24045 13,7 - WE / - WK
2.0	98	02/00→09/04	←	01/01→ 10/03; für Fahrzeuge mit Sportfahrwerk		13.0460-5831.2 605831	SUM 23777 16,0 + WK + Zub
			←	01/01→ 10/03; für Fahrzeuge ohne Sportfahrwerk		13.0460-5954.2 605954	SUM 23845 15,8 + WK
			→	01/01→ 10/03		13.0460-5804.2 605804	AKE 24045 13,7 - WE / - WK
Zubehörsatz, Scheibenbremsbelag							
1.6	70	01/01→05/04	→	→ 10/03		13.0460-0234.2 610234	
1.6	72	01/01→05/04					
2.0	96	01/01→05/04					
2.0 TD	74	01/01→05/04					
1.9 16V	84	09/98→01/01	→	→ 12/00		13.0460-0234.2 610234	
2.0 D	52	09/98→05/04					
2.0 TD	66	09/98→12/01					
2.0	98	02/00→09/04	→	01/01→ 10/03		13.0460-0234.2 610234	
 Bremsscheibe							
1.4	53	01/01→05/04	←	→ 10/03		24.0122-0207.1 422207	Ø 235 22 20 V
1.4 16V	54	09/98→01/01	←	→ 12/00		24.0122-0207.1 422207	Ø 235 22 20 V
1.5 16V	65	09/98→01/01					
1.6	70	01/01→05/04	←	→ 10/03		24.0124-0164.1 424164	Ø 258 24 22 V
1.6	72	01/01→05/04					
2.0 TD	74	01/01→05/04	→	→ 10/03		24.0110-0269.1 410269	Ø 261 10 8
1.9 16V	84	09/98→01/01	←	→ 12/00		24.0124-0164.1 424164	Ø 258 24 22 V
2.0 D	52	09/98→05/04					
2.0 TD	66	09/98→12/01	→	→ 12/00		24.0110-0269.1 410269	Ø 261 10 8
2.0	96	01/01→05/04	←	→ 10/03; für Fahrzeuge ohne Sportfahrwerk		24.0124-0164.1 424164	Ø 258 24 22 V
			←	→ 10/03; für Fahrzeuge mit Sportfahrwerk		24.0124-0175.1 424175	Ø 273,5 24 22 V
			→	→ 10/03; für Fahrzeuge ohne Sportfahrwerk		24.0110-0269.1 410269	Ø 261 10 8
			→	→ 10/03; für Fahrzeuge mit Sportfahrwerk		24.0110-0302.1 410302	Ø 280 10 8
2.0	98	02/00→09/04	←	01/01→ 10/03; für Fahrzeuge ohne Sportfahrwerk		24.0124-0164.1 424164	Ø 258 24 22 V
			←	01/01→ 10/03; für Fahrzeuge mit Sportfahrwerk		24.0124-0175.1 424175	Ø 273,5 24 22 V
			→	01/01→ 10/03; für Fahrzeuge ohne Sportfahrwerk		24.0110-0269.1 410269	Ø 261 10 8
			→	01/01→ 10/03; für Fahrzeuge mit Sportfahrwerk		24.0110-0302.1 410302	Ø 280 10 8
MAZDA - 323 P V (BA) 10/96→09/98							
 Bremsbelagsatz, Scheibenbremse							
1.3 16V	54	10/96→09/98	←	→ 08/98		13.0460-5944.2 605944	SUM 21654 15,0 + WK
1.5 16V	65	10/96→09/98					
2.0 D	52	10/96→09/98	←	→ 08/98		13.0460-5974.2 605974	SUM 21539 15,0 + WK
Zubehörsatz, Scheibenbremsbelag							
1.3 16V	54	10/96→09/98	←	→ 08/98		13.0460-0339.2 610339	SUM
1.5 16V	65	10/96→09/98					
 Bremsscheibe							
1.3 16V	54	10/96→09/98	←	→ 08/98		24.0118-0113.1 418113	Ø 235 18 16 V
1.5 16V	65	10/96→09/98	←	→ 08/98		24.0122-0166.1 422166	Ø 235 22 20 V
2.0 D	52	10/96→09/98	←	→ 08/98		24.0122-0165.1 422165	Ø 257 22 20 V













	kw			 	! #		
MAZDA - 323 S IV (BG) 06/89→05/95							
 Bremsbelagsatz, Scheibenbremse							
1.6	77	06/89→	←	09/89→		13.0460-5944.2 605944	SUM 21654 15,0 + WK
			→	09/89→		13.0460-5972.2 605972	21559 11,5 - WE / - WK
Zubehörsatz, Scheibenbremsbelag							
1.6	77	06/89→	←	09/89→		13.0460-0339.2 610339	SUM
 Bremsscheibe							
1.6	77	06/89→	←	09/89→; Schaltgetriebe; für Fahrzeuge mit Trommelbremse an der Hinterachse		24.0118-0113.1 418113	Ø 235 18 16 V
			←	09/89→; Vollautomatik		24.0122-0166.1 422166	Ø 235 22 20 V
			←	09/89→; Schaltgetriebe; für Fahrzeuge mit Scheibenbremse an der Hinterachse		24.0122-0166.1 422166	Ø 235 22 20 V
			→	09/89→		24.0109-0127.1 409127	Ø 231 9 8
MAZDA - 323 S V (BA) 09/92→12/03							
 Bremsbelagsatz, Scheibenbremse							
1.3 16V	54	08/94→09/98	←	→ 08/98		13.0460-5944.2 605944	SUM 21654 15,0 + WK
1.5 16V	65	08/94→09/98					
1.6	66	08/94→09/00					
1.6 TD	60	05/94→09/98	←	→ 08/98		13.0460-5974.2 605974	SUM 21539 15,0 + WK
2.0 D	52	10/96→09/98					
1.8	92	07/94→09/98	←	→ 08/98; Türenanzahl: 5		13.0460-5944.2 605944	SUM 21654 15,0 + WK
1.8 16V	84	08/94→09/98	←	→ 08/98; Türenanzahl: 3		13.0460-5974.2 605974	SUM 21539 15,0 + WK
			←	→ 08/98; Türenanzahl: 4		13.0460-5974.2 605974	SUM 21539 15,0 + WK
Zubehörsatz, Scheibenbremsbelag							
1.3 16V	54	08/94→09/98	←	→ 08/98		13.0460-0339.2 610339	SUM
1.5 16V	65	08/94→09/98					
1.6	66	08/94→09/00					
1.8	92	07/94→09/98	←	→ 08/98; Türenanzahl: 5		13.0460-0339.2 610339	SUM
1.8 16V	84	08/94→09/98					
 Bremsscheibe							
1.3 16V	54	08/94→09/98	←	→ 08/98		24.0118-0113.1 418113	Ø 235 18 16 V
1.5 16V	65	08/94→09/98	←	→ 08/98		24.0122-0166.1 422166	Ø 235 22 20 V
1.6	66	08/94→09/00					
1.6 TD	60	05/94→09/98	←	→ 08/98		24.0122-0165.1 422165	Ø 257 22 20 V
1.8	92	07/94→09/98					
1.8 16V	84	08/94→09/98					
2.0 D	52	10/96→09/98					
MAZDA - 323 S VI (BJ) 05/98→05/04							
 Bremsbelagsatz, Scheibenbremse							
1.4	53	01/01→05/04	←	→ 10/03		13.0460-5802.2 605802	23490 15,4 + WK + Zub
1.4 16V	54	09/98→01/01	←	→ 12/00		13.0460-5802.2 605802	23490 15,4 + WK + Zub
1.5 16V	65	09/98→01/01					
1.6	70	01/01→05/04	←	→ 10/03		13.0460-5954.2 605954	SUM 23845 15,8 + WK
1.6	72	01/01→05/04	→	→ 10/03		13.0460-5804.2 605804	AKE 24045 13,7 - WE / - WK
1.6	80	09/98→02/01	←	01/01→		13.0460-5954.2 605954	SUM 23845 15,8 + WK
2.0 DiTD	74	10/00→10/02	→	01/01→		13.0460-5804.2 605804	AKE 24045 13,7 - WE / - WK
1.9 16V	84	09/98→05/04	←	→ 12/00		13.0460-5954.2 605954	SUM 23845 15,8 + WK
2.0 D	52	09/98→05/04					
2.0 TD	66	09/98→05/04	→	→ 12/00		13.0460-5804.2 605804	AKE 24045 13,7 - WE / - WK
2.0	96	01/01→05/04	←	→ 10/03; für Fahrzeuge mit Sportfahrwerk		13.0460-5831.2 605831	SUM 23777 16,0 + WK + Zub
			←	→ 10/03; für Fahrzeuge ohne Sportfahrwerk		13.0460-5954.2 605954	SUM 23845 15,8 + WK
			→	→ 10/03		13.0460-5804.2 605804	AKE 24045 13,7 - WE / - WK
2.0	98	02/00→05/04	←	01/01→ 10/03; für Fahrzeuge mit Sportfahrwerk		13.0460-5831.2 605831	SUM 23777 16,0 + WK + Zub
			←	01/01→ 10/03; für Fahrzeuge ohne Sportfahrwerk		13.0460-5954.2 605954	SUM 23845 15,8 + WK
			→	01/01→ 10/03		13.0460-5804.2 605804	AKE 24045 13,7 - WE / - WK
↓							

















	kW			 	! #			
MAZDA - 323 S VI (BJ) 05/98→05/04								
Zubehörsatz, Scheibenbremsbelag								
1.6	70	01/01→05/04	➡	→ 10/03		13.0460-0234.2	610234	
1.6	72	01/01→05/04						
2.0	96	01/01→05/04						
1.6	80	09/98→02/01	➡	01/01→		13.0460-0234.2	610234	
2.0 DiTD	74	10/00→10/02						
1.9 16V	84	09/98→05/04	➡	→ 12/00		13.0460-0234.2	610234	
2.0 D	52	09/98→05/04						
2.0 TD	66	09/98→05/04						
2.0	98	02/00→05/04	➡	01/01→ 10/03		13.0460-0234.2	610234	
 Bremsscheibe								
1.4	53	01/01→05/04	⬅	→ 10/03		24.0122-0207.1	422207	Ø 235 22 20 V
1.4 16V	54	09/98→01/01	⬅	→ 12/00		24.0122-0207.1	422207	Ø 235 22 20 V
1.5 16V	65	09/98→01/01						
1.6	70	01/01→05/04	⬅	→ 10/03		24.0124-0164.1	424164	Ø 258 24 22 V
1.6	72	01/01→05/04	➡	→ 10/03		24.0110-0269.1	410269	Ø 261 10 8
1.6	80	09/98→02/01	⬅	01/01→		24.0124-0164.1	424164	Ø 258 24 22 V
2.0 DiTD	74	10/00→10/02	➡	01/01→		24.0110-0269.1	410269	Ø 261 10 8
1.9 16V	84	09/98→05/04	⬅	→ 12/00		24.0124-0164.1	424164	Ø 258 24 22 V
2.0 D	52	09/98→05/04						
2.0 TD	66	09/98→05/04	➡	→ 12/00		24.0110-0269.1	410269	Ø 261 10 8
2.0	96	01/01→05/04	⬅	→ 10/03; für Fahrzeuge ohne Sportfahrwerk		24.0124-0164.1	424164	Ø 258 24 22 V
			⬅	→ 10/03; für Fahrzeuge mit Sportfahrwerk		24.0124-0175.1	424175	Ø 273,5 24 22 V
			➡	→ 10/03; für Fahrzeuge ohne Sportfahrwerk		24.0110-0269.1	410269	Ø 261 10 8
			➡	→ 10/03; für Fahrzeuge mit Sportfahrwerk		24.0110-0302.1	410302	Ø 280 10 8
2.0	98	02/00→05/04	⬅	01/01→ 10/03; für Fahrzeuge ohne Sportfahrwerk		24.0124-0164.1	424164	Ø 258 24 22 V
			⬅	01/01→ 10/03; für Fahrzeuge mit Sportfahrwerk		24.0124-0175.1	424175	Ø 273,5 24 22 V
			➡	01/01→ 10/03; für Fahrzeuge ohne Sportfahrwerk		24.0110-0269.1	410269	Ø 261 10 8
			➡	01/01→ 10/03; für Fahrzeuge mit Sportfahrwerk		24.0110-0302.1	410302	Ø 280 10 8
MAZDA - 626 III Station Wagon (GV) 09/87→10/98								
 Bremsbelagsatz, Scheibenbremse								
2.0	66	10/88→09/97	⬅	04/92→		13.0460-5932.2	605932	AKE 21378 15,0 + WK
			➡	04/92→		13.0460-5995.2	605995	21558 13,0 - WE / - WK
2.0 D	60	11/94→09/97	⬅	→ 04/96		13.0460-5932.2	605932	AKE 21378 15,0 + WK
			➡	→ 04/96		13.0460-5995.2	605995	21558 13,0 - WE / - WK
2.0 D Complex	55	05/93→11/96	⬅			13.0460-5932.2	605932	AKE 21378 15,0 + WK
2.0 GLX	86	04/92→02/95	➡			13.0460-5995.2	605995	21558 13,0 - WE / - WK
2.2 12V	85	03/89→11/96	⬅	→ 10/90		13.0460-5932.2	605932	AKE 21378 15,0 + WK
			⬅	04/92→		13.0460-5932.2	605932	AKE 21378 15,0 + WK
			➡	→ 10/90		13.0460-5995.2	605995	21558 13,0 - WE / - WK
			➡	04/92→		13.0460-5995.2	605995	21558 13,0 - WE / - WK
Zubehörsatz, Scheibenbremsbelag								
2.2 12V	85	03/89→11/96	⬅	→ 10/90		13.0460-0313.2	610313	AKE
 Bremsscheibe								
2.0	66	10/88→09/97	⬅	04/92→		24.0124-0105.1	424105	Ø 264 24 22 V
			➡	04/92→		24.0110-0256.1	410256	Ø 259 10 8
2.0 D	60	11/94→09/97	⬅	→ 04/96		24.0124-0105.1	424105	Ø 264 24 22 V
			➡	→ 04/96		24.0110-0256.1	410256	Ø 259 10 8
2.0 D Complex	55	05/93→11/96	⬅			24.0124-0105.1	424105	Ø 264 24 22 V
2.0 GLX	86	04/92→02/95	➡			24.0110-0256.1	410256	Ø 259 10 8
2.2 12V	85	03/89→11/96	⬅	→ 10/90		24.0124-0105.1	424105	Ø 264 24 22 V
			⬅	04/92→		24.0124-0105.1	424105	Ø 264 24 22 V
			➡	04/92→		24.0110-0256.1	410256	Ø 259 10 8

	kw			 	! #		
MAZDA - 626 III Station Wagon (GV) 09/87→10/98							
 Bremsscheibe							
2.2 12V	85	03/89→11/96	→	→ 10/90		24.0110-0256.1 410256	Ø 259 10 8
MAZDA - 626 IV (GE) 08/91→08/98							
 Bremsbelagsatz, Scheibenbremse							
1.8 i	66	08/94→04/97	←			13.0460-5954.2 605954	SUM 23845 15,8 + WK
1.8 i	77	01/92→04/97	→			13.0460-5973.2 605973	21766 13,5 - WE / - WK
1.8 i	78	05/94→06/97	→				
2.0 D	56	05/94→06/97	→				
2.0 D GLX Complex	55	10/92→04/97	→				
2.0 i	85	01/92→04/97	→				
2.5 24V	121	01/92→04/97	→				
2.0 i 4WD	85	04/92→04/97	←			13.0460-5954.2 605954	SUM 23845 15,8 + WK
Zubehörsatz, Scheibenbremsbelag							
1.8 i	66	08/94→04/97	←			13.0460-0443.2 610443	SUM
1.8 i	77	01/92→04/97	→				
1.8 i	78	05/94→06/97	→			13.0460-0245.2 610245	
2.0 D	56	05/94→06/97	→				
2.0 D GLX Complex	55	10/92→04/97	→				
2.0 i	85	01/92→04/97	→				
2.5 24V	121	01/92→04/97	→				
2.0 i 4WD	85	04/92→04/97	←			13.0460-0443.2 610443	SUM
 Bremsscheibe							
1.8 i	66	08/94→04/97	←			24.0124-0129.1 424129	Ø 258 24 22 V
1.8 i	77	01/92→04/97	→				
1.8 i	78	05/94→06/97	→			24.0110-0234.1 410234	Ø 261 10 8
2.0 D	56	05/94→06/97	→				
2.0 D GLX Complex	55	10/92→04/97	→				
2.0 i	85	01/92→04/97	→				
2.0 i 4WD	85	04/92→04/97	←				
2.5 24V	121	01/92→04/97	→				
MAZDA - 626 IV Hatchback (GE) 08/91→08/98							
 Bremsbelagsatz, Scheibenbremse							
1.8	66	08/94→04/97	←			13.0460-5954.2 605954	SUM 23845 15,8 + WK
1.8	77	08/91→04/97	→			13.0460-5973.2 605973	21766 13,5 - WE / - WK
2.0 D GLX Complex	55	01/93→04/97	→				
2.0 i	85	08/91→04/97	→				
2.5 24V	120	08/94→04/97	→				
2.5 24V	121	01/92→04/97	→				
2.0 i 4WD	85	04/92→04/97	←			13.0460-5932.2 605932	AKE 21378 15,0 + WK
Zubehörsatz, Scheibenbremsbelag							
1.8	66	08/94→04/97	←			13.0460-0443.2 610443	SUM
1.8	77	08/91→04/97	→				
2.0 D GLX Complex	55	01/93→04/97	→			13.0460-0245.2 610245	
2.0 i	85	08/91→04/97	→				
2.5 24V	120	08/94→04/97	→				
2.5 24V	121	01/92→04/97	→				
 Bremsscheibe							
1.8	66	08/94→04/97	←			24.0124-0129.1 424129	Ø 258 24 22 V
1.8	77	08/91→04/97	→				
2.0 D GLX Complex	55	01/93→04/97	→			24.0110-0234.1 410234	Ø 261 10 8
2.0 i	85	08/91→04/97	→				
2.5 24V	120	08/94→04/97	→				
2.5 24V	121	01/92→04/97	→				
2.0 i 4WD	85	04/92→04/97	←			24.0124-0105.1 424105	Ø 264 24 22 V
MAZDA - 626 V (GF) 05/97→12/02							
 Bremsbelagsatz, Scheibenbremse							
1.8	66	05/97→12/99	←	→ 11/99		13.0460-5954.2 605954	SUM 23845 15,8 + WK
1.8	74	12/99→10/02	←			13.0460-5831.2 605831	SUM 23777 16,0 + WK + Zub
2.0	85	05/97→10/02	←	12/99→		13.0460-5831.2 605831	SUM 23777 16,0 + WK + Zub
2.0	93	01/98→10/02	←				
2.0	100	04/98→10/02	←	→ 11/99		13.0460-5954.2 605954	SUM 23845 15,8 + WK
2.0 DI TD	66	04/98→10/02	→			13.0460-5804.2 605804	AKE 24045 13,7 - WE / - WK
2.0 Turbo DI	74	04/98→10/02	→				
2.0 TD	81	10/00→10/02	←			13.0460-5831.2 605831	SUM 23777 16,0 + WK + Zub
↓			→			13.0460-5804.2 605804	AKE 24045 13,7 - WE / - WK













	kW			 	! #		
MAZDA - 626 V (GF) 05/97→12/02							
Zubehörsatz, Scheibenbremsbelag							
2.0	85	05/97→10/02	➔			13.0460-0234.2	610234
2.0	93	01/98→10/02					
2.0	100	04/98→10/02					
2.0 DI TD	66	04/98→10/02					
2.0 TD	81	10/00→10/02					
2.0 Turbo DI	74	04/98→10/02					
 Bremsscheibe							
1.8	66	05/97→12/99	←	→ 11/99		24.0124-0129.1	424129 Ø 258 24 22 V
1.8	74	12/99→10/02	←			24.0124-0129.1	424129 Ø 258 24 22 V
2.0	85	05/97→10/02	←			24.0124-0129.1	424129 Ø 258 24 22 V
2.0	93	01/98→10/02					
2.0	100	04/98→10/02	➔			24.0110-0234.1	410234 Ø 261 10 8
2.0 DI TD	66	04/98→10/02					
2.0 TD	81	10/00→10/02					
2.0 Turbo DI	74	04/98→10/02					
MAZDA - 626 V Hatchback (GF) 05/97→12/02							
 Bremsbelagsatz, Scheibenbremse							
1.8	66	05/97→12/99	←	→ 11/99		13.0460-5954.2	605954 SUM 23845 15,8 + WK
1.8	74	12/99→10/02	←			13.0460-5831.2	605831 SUM 23777 16,0 + WK + Zub
2.0	85	05/97→10/02	←	12/99→		13.0460-5831.2	605831 SUM 23777 16,0 + WK + Zub
2.0	93	01/98→10/02					
2.0 DITD	66	04/98→10/02	←	→ 11/99		13.0460-5954.2	605954 SUM 23845 15,8 + WK
2.0 H.P.	100	02/98→10/02	➔			13.0460-5804.2	605804 AKE 24045 13,7 - WE / - WK
2.0 Turbo DI	74	04/98→10/02	➔				
2.0 TD	81	10/00→10/02	←			13.0460-5831.2	605831 SUM 23777 16,0 + WK + Zub
			➔			13.0460-5804.2	605804 AKE 24045 13,7 - WE / - WK
Zubehörsatz, Scheibenbremsbelag							
2.0	85	05/97→10/02	➔			13.0460-0234.2	610234
2.0	93	01/98→10/02					
2.0 DITD	66	04/98→10/02					
2.0 H.P.	100	02/98→10/02					
2.0 TD	81	10/00→10/02					
2.0 Turbo DI	74	04/98→10/02					
 Bremsscheibe							
1.8	66	05/97→12/99	←	→ 11/99		24.0124-0129.1	424129 Ø 258 24 22 V
1.8	74	12/99→10/02	←			24.0124-0129.1	424129 Ø 258 24 22 V
2.0	85	05/97→10/02	←			24.0124-0129.1	424129 Ø 258 24 22 V
2.0	93	01/98→10/02					
2.0 DITD	66	04/98→10/02	➔			24.0110-0234.1	410234 Ø 261 10 8
2.0 H.P.	100	02/98→10/02					
2.0 TD	81	10/00→10/02					
2.0 Turbo DI	74	04/98→10/02					
MAZDA - 626 V Station Wagon (GW) 01/98→12/02							
 Bremsbelagsatz, Scheibenbremse							
1.8	66	02/98→01/00	←	→ 12/99		13.0460-5954.2	605954 SUM 23845 15,8 + WK
			➔	→ 12/99		13.0460-5804.2	605804 AKE 24045 13,7 - WE / - WK
1.8	74	01/00→10/02	←			13.0460-5831.2	605831 SUM 23777 16,0 + WK + Zub
2.0 DITD	66	09/99→10/02	➔			13.0460-5804.2	605804 AKE 24045 13,7 - WE / - WK
2.0 TD	81	10/00→10/02	➔				
2.0	85	02/98→10/02	←	10/99→		13.0460-5831.2	605831 SUM 23777 16,0 + WK + Zub
2.0	93	01/98→10/02					
2.0 H.P.	100	02/98→10/02	←	→ 09/99		13.0460-5954.2	605954 SUM 23845 15,8 + WK
2.0 Turbo DI	74	04/98→10/02	➔			13.0460-5804.2	605804 AKE 24045 13,7 - WE / - WK
Zubehörsatz, Scheibenbremsbelag							
1.8	66	02/98→01/00	➔	→ 12/99		13.0460-0234.2	610234
1.8	74	01/00→10/02	➔			13.0460-0234.2	610234
2.0	85	02/98→10/02					
2.0	93	01/98→10/02					
2.0 DITD	66	09/99→10/02					
2.0 H.P.	100	02/98→10/02					
2.0 TD	81	10/00→10/02					
2.0 Turbo DI	74	04/98→10/02					
 Bremsscheibe							
1.8	66	02/98→01/00	←	→ 12/99		24.0124-0129.1	424129 Ø 258 24 22 V
↓							















	kw					! #		
MAZDA - 626 V Station Wagon (GW) 01/98→12/02								
 Bremsscheibe								
1.8	66	02/98→01/00	➡	→ 12/99			24.0110-0234.1 410234	Ø 261 10 8
1.8	74	01/00→10/02	⬅				24.0124-0129.1 424129	Ø 258 24 22 V
2.0	85	02/98→10/02						
2.0	93	01/98→10/02	➡				24.0110-0234.1 410234	Ø 261 10 8
2.0 H.P.	100	02/98→10/02						
2.0 DITD	66	09/99→10/02	⬅				24.0124-0175.1 424175	Ø 273,5 24 22 V
2.0 TD	81	10/00→10/02						
2.0 Turbo DI	74	04/98→10/02	➡				24.0110-0302.1 410302	Ø 280 10 8
MAZDA - B-SERIE (UN) 11/98→11/06								
 Bremsbelagsatz, Scheibenbremse								
2.5 D 4WD	62	12/02→11/06	⬅	→ 07/06			13.0460-5795.2 605795	24353 15,4 + WK + Zub
2.5 TD 4WD	80	06/99→07/06	⬅	08/02→			13.0460-5795.2 605795	24353 15,4 + WK + Zub
 Bremsscheibe								
2.5 D 4WD	62	12/02→11/06	⬅	→ 07/06			24.0128-0226.1 428226	Ø 289 28 26 V
2.5 TD 4WD	80	06/99→07/06	⬅	08/02→			24.0128-0226.1 428226	Ø 289 28 26 V
MAZDA - BT-50 Pick-up (CD, UN) 08/06→12/15								
 Bremsbelagsatz, Scheibenbremse								
2.5 MRZ-CD 4x4	105	12/06→12/15	⬅	→ 07/12			13.0460-5795.2 605795	24353 15,4 + WK + Zub
3.0 CDVi 4x4	115	12/06→12/15						
2.5 TDi 4x4	81	08/06→12/15	⬅	12/06→ 07/12			13.0460-5795.2 605795	24353 15,4 + WK + Zub
 Bremsscheibe								
2.5 MRZ-CD 4x4	105	12/06→12/15	⬅	→ 07/12			24.0128-0226.1 428226	Ø 289 28 26 V
3.0 CDVi 4x4	115	12/06→12/15						
2.5 TDi 4x4	81	08/06→12/15	⬅	12/06→ 07/12			24.0128-0226.1 428226	Ø 289 28 26 V
MAZDA - BT-50 Pritsche/Fahrgestell (CD, UN) 08/06→								
 Bremsbelagsatz, Scheibenbremse								
2.5 TDi 4WD	81	08/06→	⬅	12/06→ 07/12			13.0460-5795.2 605795	24353 15,4 + WK + Zub
3.0 CDVi 4x4	115	12/06→	⬅	→ 07/12			13.0460-5795.2 605795	24353 15,4 + WK + Zub
 Bremsscheibe								
2.5 TDi 4WD	81	08/06→	⬅	12/06→ 07/12			24.0128-0226.1 428226	Ø 289 28 26 V
3.0 CDVi 4x4	115	12/06→	⬅	→ 07/12			24.0128-0226.1 428226	Ø 289 28 26 V
MAZDA - CX-3 (DK) 01/15→								
 Bremsbelagsatz, Scheibenbremse								
1.5 D	77	05/15→	⬅				13.0460-5658.2 605658	AKE 25875 15,9 + WK
1.5 D AWD	77	05/15→						
2.0	88	05/15→						
2.0 AWD	109	07/15→						
2.0 AWD	110	05/15→						
 Bremsscheibe								
1.5 D AWD	77	05/15→	⬅				24.0125-0208.1 425208	Ø 295 25 23 V
2.0	88	05/15→						
2.0 AWD	109	07/15→						
2.0 AWD	110	05/15→						
MAZDA - CX-5 (KE, GH) 11/11→								
 Bremsscheibe								
2.0	110	02/12→	⬅	→ 08/15			24.0128-0277.1 428277	Ø 297 28 26 V
2.0	121	11/11→						
2.0 AWD	110	02/12→	➡	→ 02/17			24.0110-0381.1 410381	Ø 303 10 8
2.0 AWD	113	07/12→						
2.0 AWD	114	07/12→						
2.0 AWD	118	11/11→						
2.2 D	110	04/12→						
2.2 D AWD	110	04/12→						
2.2 D AWD	129	04/12→						
2.5 AWD	141	02/15→						
2.0	114	07/12→	⬅	→ 08/15			24.0128-0277.1 428277	Ø 297 28 26 V
			➡				24.0110-0381.1 410381	Ø 303 10 8













	kw			 	! #		
MAZDA - CX-5 (KF) 11/16→							
 Bremsscheibe							
2.0	121	05/17→	→			24.0110-0381.1 410381	Ø 303 10 8
2.0 AWD	118	05/17→					
2.2 D	110	05/17→					
2.2 D AWD	110	05/17→					
2.2 D AWD	129	05/17→					
2.5 AWD	143	05/17→					
MAZDA - CX-7 (ER) 06/06→12/14							
 Bremsbelagsatz, Scheibenbremse							
2.2 MZR-CD AWD	120	01/12→03/13	←			13.0460-5606.2 605606	24544 18,1 + WK + Zub
2.2 MZR-CD AWD	127	07/09→03/13	←	09/09→		13.0460-5606.2 605606	24544 18,1 + WK + Zub
2.3 MZR DISI Turbo	191	06/09→03/13	→	09/09→		13.0460-5605.2 605605	24545 16,9 - WE / - WK + Zub
2.2 MZR-CD AWD	136	09/09→	←			13.0460-5606.2 605606	24544 18,1 + WK + Zub
2.3 MZR DISI Turbo	179	01/07→	→				
2.3 MZR DISI Turbo	190	10/07→08/09	→			13.0460-5605.2 605605	24545 16,9 - WE / - WK + Zub
2.3 MZR DISI Turbo AWD	179	01/07→					
2.3 AWD	182	06/06→12/12	←	01/07→		13.0460-5606.2 605606	24544 18,1 + WK + Zub
			→	01/07→		13.0460-5605.2 605605	24545 16,9 - WE / - WK + Zub
2.3 DISI	182	01/12→12/14	←	→ 09/13		13.0460-5606.2 605606	24544 18,1 + WK + Zub
2.3 DISI AWD	182	01/12→	→	→ 09/13		13.0460-5605.2 605605	24545 16,9 - WE / - WK + Zub
2.3 MZR DISI Turbo AWD	175	06/06→12/14	←	11/06→ 09/13		13.0460-5606.2 605606	24544 18,1 + WK + Zub
			→	11/06→ 09/13		13.0460-5605.2 605605	24545 16,9 - WE / - WK + Zub
2.5 MZR	120	07/09→03/13	←	09/09→		13.0460-5606.2 605606	24544 18,1 + WK + Zub
 Bremsscheibe							
2.2 MZR-CD AWD	120	01/12→03/13	←			24.0128-0233.1 428233	Ø 320 28 26 V
			→			24.0118-0158.1 418158	Ø 324 18 16 V
2.2 MZR-CD AWD	127	07/09→03/13	←	09/09→; Vollautomatik		24.0128-0228.1 428228	Ø 295,6 28 26 V
			←	09/09→; Schaltgetriebe		24.0128-0233.1 428233	Ø 320 28 26 V
			→	09/09→		24.0118-0158.1 418158	Ø 324 18 16 V
2.2 MZR-CD AWD	136	09/09→	←	Vollautomatik		24.0128-0228.1 428228	Ø 295,6 28 26 V
2.3 MZR DISI Turbo	179	01/07→	←	Schaltgetriebe		24.0128-0233.1 428233	Ø 320 28 26 V
2.3 MZR DISI Turbo	190	10/07→08/09	→			24.0118-0150.1 418150	Ø 301,6 18 16 V
2.3 MZR DISI Turbo AWD	179	01/07→	→				
2.3 AWD	182	06/06→12/12	→	01/07→		24.0118-0150.1 418150	Ø 301,6 18 16 V
2.3 DISI	182	01/12→12/14	←	Vollautomatik; → 09/13		24.0128-0228.1 428228	Ø 295,6 28 26 V
2.3 DISI AWD	182	01/12→	←	Schaltgetriebe; → 09/13		24.0128-0233.1 428233	Ø 320 28 26 V
			→	→ 09/13		24.0118-0150.1 418150	Ø 301,6 18 16 V
2.3 MZR DISI Turbo	191	06/09→03/13	←	09/09→; Vollautomatik		24.0128-0228.1 428228	Ø 295,6 28 26 V
			←	09/09→; Schaltgetriebe		24.0128-0233.1 428233	Ø 320 28 26 V
			→	09/09→		24.0118-0150.1 418150	Ø 301,6 18 16 V
2.3 MZR DISI Turbo AWD	175	06/06→12/14	←	11/06→; Vollautomatik; → 09/13		24.0128-0228.1 428228	Ø 295,6 28 26 V
			←	11/06→; Schaltgetriebe; → 09/13		24.0128-0233.1 428233	Ø 320 28 26 V
			→	11/06→ 09/13		24.0118-0150.1 418150	Ø 301,6 18 16 V
2.5 MZR	120	07/09→03/13	←	09/09→		24.0128-0228.1 428228	Ø 295,6 28 26 V
			→	09/09→		24.0118-0150.1 418150	Ø 301,6 18 16 V
MAZDA - CX-9 (TB) 01/07→							
 Bremsbelagsatz, Scheibenbremse							
3.5	193	01/07→	←			13.0460-5606.2 605606	24544 18,1 + WK + Zub
3.5 AWD	193	01/07→	→			13.0460-5605.2 605605	24545 16,9 - WE / - WK + Zub
3.7	204	01/07→					
3.7 AWD	204	01/07→					
 Bremsscheibe							
3.5	193	01/07→	←			24.0128-0233.1 428233	Ø 320 28 26 V
3.5 AWD	193	01/07→	→			24.0118-0158.1 418158	Ø 324 18 16 V
3.7	204	01/07→					
3.7 AWD	204	01/07→					

















	kW			 	! #		
MAZDA - DEMIO (DW) 01/96→07/03							
 Bremsbelagsatz, Scheibenbremse							
1.3 16V	46	08/98→07/03	←	→ 10/02		13.0460-5944.2 605944	SUM 21654 15,0 + WK
1.5 16V	55	04/00→07/03					
1.3 i 16V	53	08/98→04/00	←	→ 03/00		13.0460-5944.2 605944	SUM 21654 15,0 + WK
1.5 i 16V	64	10/96→12/02	←	04/00→ 10/02		13.0460-5944.2 605944	SUM 21654 15,0 + WK
Zubehörsatz, Scheibenbremsbelag							
1.3 16V	46	08/98→07/03	←	→ 10/02		13.0460-0149.2 610149	SUM
1.5 16V	55	04/00→07/03					
1.3 i 16V	53	08/98→04/00	←	→ 03/00		13.0460-0149.2 610149	SUM
1.5 i 16V	64	10/96→12/02	←	04/00→ 10/02		13.0460-0149.2 610149	SUM
 Bremsscheibe							
1.3 16V	46	08/98→07/03	←	→ 10/02		24.0122-0166.1 422166	Ø 235 22 20 V
1.5 16V	55	04/00→07/03					
1.3 i 16V	53	08/98→04/00	←	→ 03/00		24.0122-0166.1 422166	Ø 235 22 20 V
1.5 i 16V	64	10/96→12/02	←	04/00→ 10/02		24.0122-0166.1 422166	Ø 235 22 20 V
MAZDA - E-SERIE Bus 03/91→07/04							
 Bremsbelagsatz, Scheibenbremse							
E2200 D	47	03/91→05/03	←	→ 03/97		13.0460-5806.2 605806	20002 15,0 + WK
MAZDA - E-SERIE Kasten (SR2) 10/83→07/04							
 Bremsbelagsatz, Scheibenbremse							
2200 D 4WD	47	03/91→05/03	←	→ 03/97		13.0460-5806.2 605806	20002 15,0 + WK
E2000	70	06/94→05/03					
E2200 D	47	03/91→05/03					
E2200 D	52	02/97→08/02					
E2200 D 4WD	52	02/97→05/03					
MAZDA - E-SERIE Pritsche/Fahrgestell (SD1) 01/83→07/99							
 Bremsbelagsatz, Scheibenbremse							
E2000	60	10/89→05/95	←			13.0460-5806.2 605806	20002 15,0 + WK
E2200 D	47	11/88→03/97					
MAZDA - MPV I (LV) 09/88→09/99							
 Bremsbelagsatz, Scheibenbremse							
2.5 TD	85	05/96→09/99	→	→ 08/99		13.0460-5627.2 605627	AKE 21569 14,9 + WK
3.0 i V6	109	11/89→09/99	→	05/96→ 08/99		13.0460-5627.2 605627	AKE 21569 14,9 + WK
3.0 i V6 (LV10)	113	03/95→09/99					
MAZDA - MPV II (LW) 08/99→02/06							
 Bremsbelagsatz, Scheibenbremse							
2.0	88	08/00→07/02	←	→ 06/02		13.0460-5884.2 605884	SUM 23515 15,8 + WK + Zub
2.0	90	09/99→08/00	←	→ 07/00		13.0460-5884.2 605884	SUM 23515 15,8 + WK + Zub
2.0 DI	100	07/02→02/06	←	→ 10/05		13.0460-5884.2 605884	SUM 23515 15,8 + WK + Zub
2.3	104	07/02→02/06					
3.0 i V6	147	03/02→02/06	→	09/03→ 10/05		13.0460-5736.2 605736	24215 15,7 + WK + Zub
2.5 V6	125	09/99→03/02	←			13.0460-5884.2 605884	SUM 23515 15,8 + WK + Zub
 Bremsscheibe							
2.0	88	08/00→07/02	←	→ 06/02		24.0128-0175.1 428175	Ø 273,5 28 26 V
2.0	90	09/99→08/00	←	→ 07/00		24.0128-0175.1 428175	Ø 273,5 28 26 V
2.0 DI	100	07/02→02/06	←	→ 10/05		24.0128-0180.1 428180	Ø 296 28 26 V
3.0 i V6	147	03/02→02/06	→	09/03→ 10/05		24.0118-0148.1 418148	Ø 286 18 16 V
2.3	104	07/02→02/06	←	→ 10/05		24.0128-0175.1 428175	Ø 273,5 28 26 V
			→	09/03→ 10/05		24.0118-0148.1 418148	Ø 286 18 16 V
2.5 V6	125	09/99→03/02	←			24.0128-0175.1 428175	Ø 273,5 28 26 V
MAZDA - MX-3 (EC) 07/91→09/98							
 Bremsbelagsatz, Scheibenbremse							
1.6 i	65	07/91→10/97	←			13.0460-5974.2 605974	SUM 21539 15,0 + WK
1.6 i	79	01/94→10/97	→	+ ABS		13.0460-5824.2 605824	AKE 20008 13,0 - WE / - WK
1.8 i V6	95	01/94→10/97	←			13.0460-5974.2 605974	SUM 21539 15,0 + WK









































	kw			 	! #		
MAZDA - MX-3 (EC) 07/91→09/98							
 Bremsbelagsatz, Scheibenbremse							
1.8 i V6	99	01/96→10/97	➔			13.0460-5824.2 605824	AKE 20008 13,0 - WE / - WK
 Bremsscheibe							
1.6 i	65	07/91→10/97	←			24.0122-0165.1 422165	Ø 257 22 20 V
1.6 i	79	01/94→10/97	➔	+ ABS		24.0109-0131.1 409131	Ø 251 9 8
1.8 i V6	95	01/94→10/97	←			24.0122-0165.1 422165	Ø 257 22 20 V
1.8 i V6	99	01/96→10/97	➔			24.0109-0131.1 409131	Ø 251 9 8
MAZDA - MX-5 I (NA) 09/89→04/98							
 Bremsbelagsatz, Scheibenbremse							
1.6	66	01/95→04/98	←			13.0460-5834.2 605834	SUM 23354 13,0 + WK + Zub
			➔	+ ABS		13.0460-5865.2 605865	AKE 23387 12,6 + WK + Zub
			➔	- ABS		13.0460-5972.2 605972	21559 11,5 - WE / - WK
1.8	96	09/93→12/97	←			13.0460-5834.2 605834	SUM 23354 13,0 + WK + Zub
1.8	96	02/94→04/98	➔			13.0460-5865.2 605865	AKE 23387 12,6 + WK + Zub
Zubehörsatz, Scheibenbremsbelag							
1.6	66	01/95→04/98	←			13.0460-0278.2 610278	
1.8	96	09/93→12/97					
1.8	96	02/94→04/98					
 Bremsscheibe							
1.6	66	01/95→04/98	←	- ABS		24.0118-0113.1 418113	Ø 235 18 16 V
			←	+ ABS		24.0120-0169.1 420169	Ø 255 20 18 V
			➔	- ABS		24.0109-0127.1 409127	Ø 231 9 8
			➔	+ ABS		24.0109-0131.1 409131	Ø 251 9 8
1.8	96	09/93→12/97	←			24.0120-0169.1 420169	Ø 255 20 18 V
1.8	96	02/94→04/98	➔			24.0109-0131.1 409131	Ø 251 9 8
MAZDA - MX-5 II (NB) 01/98→10/05							
 Bremsbelagsatz, Scheibenbremse							
1.6 16V	81	05/98→10/05	←	für Fahrzeuge ohne Sportpaket		13.0460-5834.2 605834	SUM 23354 13,0 + WK + Zub
			←	für Fahrzeuge mit Sportpaket		13.0460-5867.2 605867	23863 14,3 + WK + Zub
			➔	08/03→; Sport		13.0460-5732.2 605732	AKE 24029 12,5 + WK + Zub
			➔	→ 07/03		13.0460-5865.2 605865	AKE 23387 12,6 + WK + Zub
1.8	103	01/98→07/02	←	05/98→; für Fahrzeuge ohne Sportpaket		13.0460-5834.2 605834	SUM 23354 13,0 + WK + Zub
			➔	05/98→		13.0460-5865.2 605865	AKE 23387 12,6 + WK + Zub
1.8	107	08/02→10/05	←	für Fahrzeuge mit Sportpaket		13.0460-5867.2 605867	23863 14,3 + WK + Zub
1.8 16V	102	11/00→10/05	➔			13.0460-5732.2 605732	AKE 24029 12,5 + WK + Zub
1.8 16V	107	11/00→10/05					
1.8 i	113	04/02→10/05					
1.8 i Turbo	136	04/02→10/05					
1.8 i Turbo	157	01/02→10/02					
1.8 16V	103	05/98→10/05	←	für Fahrzeuge ohne Sportpaket		13.0460-5834.2 605834	SUM 23354 13,0 + WK + Zub
			➔	08/03→		13.0460-5732.2 605732	AKE 24029 12,5 + WK + Zub
			➔	→ 07/03		13.0460-5865.2 605865	AKE 23387 12,6 + WK + Zub
Zubehörsatz, Scheibenbremsbelag							
1.6 16V	81	05/98→10/05	←	für Fahrzeuge ohne Sportpaket		13.0460-0278.2 610278	
1.8 16V	103	05/98→10/05					
1.8	103	01/98→07/02	←	05/98→; für Fahrzeuge ohne Sportpaket		13.0460-0278.2 610278	
 Bremsscheibe							
1.6 16V	81	05/98→10/05	←	für Fahrzeuge ohne Sportpaket		24.0120-0169.1 420169	Ø 255 20 18 V
			←	für Fahrzeuge mit Sportpaket		24.0122-0235.1 422235	Ø 270 22 20 V
			➔	→ 07/03		24.0109-0131.1 409131	Ø 251 9 8
			➔	08/03→; Sport		24.0110-0307.1 410307	Ø 276 10 8
1.8	103	01/98→07/02	←	05/98→; für Fahrzeuge ohne Sportpaket		24.0120-0169.1 420169	Ø 255 20 18 V
			➔	05/98→		24.0109-0131.1 409131	Ø 251 9 8
1.8	107	08/02→10/05	←	für Fahrzeuge mit Sportpaket		24.0122-0235.1 422235	Ø 270 22 20 V
↓							

	kw			 	! #		
MAZDA - MX-5 II (NB) 01/98→10/05							
 Bremsscheibe							
1.8 16V	107	11/00→10/05	➔			24.0110-0307.1 410307	Ø 276 10 8
1.8 i	113	04/02→10/05					
1.8 i Turbo	136	04/02→10/05					
1.8 i Turbo	157	01/02→10/02					
1.8 16V	102	11/00→10/05	➔	für Fahrzeuge mit Sportpaket		24.0122-0235.1 422235	Ø 270 22 20 V
			➔	08/03→		24.0110-0307.1 410307	Ø 276 10 8
1.8 16V	103	05/98→10/05	➔	für Fahrzeuge ohne Sportpaket		24.0120-0169.1 420169	Ø 255 20 18 V
			➔	→ 07/03		24.0109-0131.1 409131	Ø 251 9 8
MAZDA - MX-5 III (NC) 03/05→12/14							
 Bremsbelagsatz, Scheibenbremse							
1.8	93	03/05→12/14	➔			13.0460-5761.2 605761	24297 14,4 + WK + Zub
2.0	118	09/08→12/14	➔			13.0460-5762.2 605762	24298 14,0 + WK + Zub
 Bremsscheibe							
1.8	93	03/05→12/14	➔			24.0122-0249.1 422249	Ø 290 22 20 V
2.0	118	09/08→12/14	➔			24.0110-0302.1 410302	Ø 280 10 8
MAZDA - MX-5 IV (ND) 04/15→							
 Bremsbelagsatz, Scheibenbremse							
1.5	96	06/15→	➔			13.0460-5762.2 605762	24298 14,0 + WK + Zub
2.0	118	06/15→					
MAZDA - MX-5 RF (ND) 10/16→							
 Bremsbelagsatz, Scheibenbremse							
2.0	118	12/16→	➔			13.0460-5762.2 605762	24298 14,0 + WK + Zub
MAZDA - MX-6 (GE) 07/91→02/97							
 Bremsbelagsatz, Scheibenbremse							
2.0	85	02/92→02/97	➔			13.0460-5954.2 605954	SUM 23845 15,8 + WK
2.5 24V	121	02/92→02/97					
2.5 24V	123	02/93→11/95	➔			13.0460-5973.2 605973	21766 13,5 - WE / - WK
2.5 i 24V	120	08/94→02/97					
Zubehörsatz, Scheibenbremsbelag							
2.0	85	02/92→02/97	➔			13.0460-0443.2 610443	SUM
2.5 24V	121	02/92→02/97					
2.5 24V	123	02/93→11/95	➔			13.0460-0245.2 610245	
2.5 i 24V	120	08/94→02/97					
 Bremsscheibe							
2.0	85	02/92→02/97	➔			24.0124-0129.1 424129	Ø 258 24 22 V
2.5 24V	121	02/92→02/97					
2.5 24V	123	02/93→11/95	➔			24.0110-0234.1 410234	Ø 261 10 8
2.5 i 24V	120	08/94→02/97					
MAZDA - PREMACY (CP) 07/99→03/05							
 Bremsbelagsatz, Scheibenbremse							
1.9	74	07/99→03/05	➔	Anzahl Sitzplätze: 7		13.0460-5831.2 605831	SUM 23777 16,0 + WK + Zub
2.0 TD	74	07/00→03/05	➔	Anzahl Sitzplätze: 5		13.0460-5954.2 605954	SUM 23845 15,8 + WK
			➔	+ ABS		13.0460-5804.2 605804	AKE 24045 13,7 - WE / - WK
1.9	84	07/99→03/05	➔	Anzahl Sitzplätze: 7		13.0460-5831.2 605831	SUM 23777 16,0 + WK + Zub
			➔	Anzahl Sitzplätze: 5		13.0460-5954.2 605954	SUM 23845 15,8 + WK
			➔			13.0460-5804.2 605804	AKE 24045 13,7 - WE / - WK
2.0	96	11/01→03/05	➔	Anzahl Sitzplätze: 7		13.0460-5831.2 605831	SUM 23777 16,0 + WK + Zub
			➔			13.0460-5804.2 605804	AKE 24045 13,7 - WE / - WK
2.0	107	02/05→03/05	➔	03/05→		13.0460-7193.2 607193	ATE 23723 18,1 - WE / - WK
			➔			13.0470-7193.2 LD7193	ATE 23723 18,1 - WE / - WK Ceramic
			➔	03/05→		13.0460-7195.2 607195	ATE 23482 16,6 - WE / - WK
			➔			13.0470-7195.2 LD7195	ATE 23482 16,6 - WE / - WK Ceramic
2.0 TD	66	10/99→07/00	➔	→ 06/00; Anzahl Sitzplätze: 7		13.0460-5831.2 605831	SUM 23777 16,0 + WK + Zub
			➔	→ 06/00; Anzahl Sitzplätze: 5		13.0460-5954.2 605954	SUM 23845 15,8 + WK
↓							







	kw					! #		
MAZDA - PREMACY (CP) 07/99→03/05								
 Bremsbelagsatz, Scheibenbremse								
2.0 TD	66	10/99→07/00	➡	→ 06/00			13.0460-5804.2 605804	AKE 24045 13,7 - WE / - WK
Zubehörsatz, Scheibenbremsbelag								
1.9	74	07/99→03/05	➡	+ ABS			13.0460-0234.2 610234	
2.0 TD	74	07/00→03/05						
1.9	84	07/99→03/05	➡				13.0460-0234.2 610234	
2.0	96	11/01→03/05						
2.0 TD	66	10/99→07/00	➡	→ 06/00			13.0460-0234.2 610234	
 Bremsscheibe								
1.9	74	07/99→03/05	⬅	Anzahl Sitzplätze: 5			24.0124-0129.1 424129	Ø 258 24 22 V
2.0 TD	74	07/00→03/05	⬅	Anzahl Sitzplätze: 7			24.0124-0175.1 424175	Ø 273,5 24 22 V
			➡	+ ABS; Anzahl Sitzplätze: 5			24.0110-0234.1 410234	Ø 261 10 8
			➡	+ ABS; Anzahl Sitzplätze: 7			24.0110-0302.1 410302	Ø 280 10 8
1.9	84	07/99→03/05	⬅	Anzahl Sitzplätze: 5			24.0124-0129.1 424129	Ø 258 24 22 V
			⬅	Anzahl Sitzplätze: 7			24.0124-0175.1 424175	Ø 273,5 24 22 V
			➡	Anzahl Sitzplätze: 5			24.0110-0234.1 410234	Ø 261 10 8
			➡	Anzahl Sitzplätze: 7			24.0110-0302.1 410302	Ø 280 10 8
2.0	96	11/01→03/05	⬅	Anzahl Sitzplätze: 7			24.0124-0175.1 424175	Ø 273,5 24 22 V
			➡	Anzahl Sitzplätze: 5			24.0110-0234.1 410234	Ø 261 10 8
			➡	Anzahl Sitzplätze: 7			24.0110-0302.1 410302	Ø 280 10 8
2.0	107	02/05→03/05	⬅	03/05→; passend für Felgengröße [Zoll]: 15			24.0125-0165.1 425165	Ø 278 25 23 V
			⬅	03/05→; passend für Felgengröße [Zoll]: 16			24.0125-0170.1 425170	Ø 300 25 23 V
			➡	03/05→; passend für Felgengröße [Zoll]: 15			24.0111-0160.1 411160	Ø 280 11 9
			➡	03/05→; passend für Felgengröße [Zoll]: 16			24.0111-0165.1 411165	Ø 302 11 9
2.0 TD	66	10/99→07/00	⬅	→ 06/00; Anzahl Sitzplätze: 5			24.0124-0129.1 424129	Ø 258 24 22 V
			⬅	→ 06/00; Anzahl Sitzplätze: 7			24.0124-0175.1 424175	Ø 273,5 24 22 V
			➡	→ 06/00; Anzahl Sitzplätze: 5			24.0110-0234.1 410234	Ø 261 10 8
			➡	→ 06/00; Anzahl Sitzplätze: 7			24.0110-0302.1 410302	Ø 280 10 8
MAZDA - RX-8 (SE, FE) 10/03→06/12								
 Bremsbelagsatz, Scheibenbremse								
1.3	141	10/03→06/12	⬅				13.0460-5877.2 605877	SUM 24042 16,3 - WE / - WK
1.3	170	10/03→06/12						
1.3	177	11/03→06/12	➡				13.0460-5856.2 605856	24039 14,4 + WK
1.3	158	11/03→06/12						
 Bremsscheibe								
1.3	141	10/03→06/12	⬅	für Fahrzeuge ohne Sportfahrwerk			24.0124-0217.1 424217	Ø 302,5 24 22 V
1.3	170	10/03→06/12	⬅	für Fahrzeuge mit Sportfahrwerk			24.0124-0218.1 424218	Ø 322,6 24 22 V
1.3	177	11/03→06/12						
1.3	158	11/03→06/12	➡	→ 09/05			24.0118-0149.1 418149	Ø 302 18 16 V
MAZDA - TRIBUTE (EP) 03/00→05/08								
 Bremsbelagsatz, Scheibenbremse								
2.0	91	03/00→05/08	⬅	→ 03/04			13.0460-7205.2 607205	ATE 23787 19,0 - WE / - WK
2.0 4WD	91	03/00→05/08						
3.0 V6 24V 4WD	145	03/00→05/08						
2.3 AWD	110	04/04→05/08	⬅	→ 02/05; für Fahrzeuge mit Trommelbremse an der Hinterachse			13.0460-7205.2 607205	ATE 23787 19,0 - WE / - WK
3.0 V6 AWD	149	04/04→05/08	⬅	für Fahrzeuge mit Scheibenbremse an der Hinterachse			13.0460-7234.2 607234	ATE 24438 16,1 - WE / - WK
			➡	+ ABS			13.0460-7235.2 607235	ATE 24670 18,0 - WE / - WK
2.3 GX	110	12/03→10/04	➡				13.0460-7235.2 607235	ATE 24670 18,0 - WE / - WK
 Bremsscheibe								
2.0	91	03/00→05/08	⬅	→ 03/04			24.0124-0735.1 424735	Ø 278 24 22 V
2.0 4WD	91	03/00→05/08						
3.0 V6 24V 4WD	145	03/00→05/08						
2.3 AWD	110	04/04→05/08	➡	+ ABS			24.0112-0181.1 412181	Ø 302 12 11
3.0 V6 AWD	149	04/04→05/08						
↓								







	kW			 	! #		
MAZDA - TRIBUTE (EP) 03/00→05/08							
 Bremsscheibe							
2.3 GX	110	12/03→10/04	←			24.0124-0735.1 424735	Ø 278 24 22 V
MAZDA - XEDOS 6 (CA) 01/92→10/99							
 Bremsbelagsatz, Scheibenbremse							
1.6 16V	79	06/94→10/99	←	→ 09/99		13.0460-5954.2 605954	SUM 23845 15,8 + WK
			→	→ 09/99		13.0460-5973.2 605973	21766 13,5 - WE / - WK
2.0 V6	103	06/94→10/99	←			13.0460-5954.2 605954	SUM 23845 15,8 + WK
			→			13.0460-5973.2 605973	21766 13,5 - WE / - WK
Zubehörsatz, Scheibenbremsbelag							
1.6 16V	79	06/94→10/99	←	→ 09/99		13.0460-0443.2 610443	SUM
			→	→ 09/99		13.0460-0245.2 610245	
2.0 V6	103	06/94→10/99	←			13.0460-0443.2 610443	SUM
			→			13.0460-0245.2 610245	
 Bremsscheibe							
1.6 16V	79	06/94→10/99	←	→ 09/99		24.0124-0129.1 424129	Ø 258 24 22 V
			→	→ 09/99		24.0110-0234.1 410234	Ø 261 10 8
2.0 V6	103	06/94→10/99	←			24.0124-0129.1 424129	Ø 258 24 22 V
			→			24.0110-0234.1 410234	Ø 261 10 8
MAZDA - XEDOS 9 (TA) 07/93→09/02							
 Bremsbelagsatz, Scheibenbremse							
2.0 24V	105	08/93→01/00	→	10/98→		13.0460-5625.2 605625	21319 14,9 + WK
2.3 24V	155	02/95→01/00	→			13.0460-5625.2 605625	21319 14,9 + WK
2.5 V6	120	07/00→09/02	→				
2.5 24V	123	07/93→07/00	→	10/98→06/00		13.0460-5625.2 605625	21319 14,9 + WK
 Bremsscheibe							
2.0 24V	105	08/93→01/00	←			24.0128-0175.1 428175	Ø 273,5 28 26 V
2.3 24V	155	02/95→01/00	←				
2.5 24V	123	07/93→07/00	←	→ 06/00		24.0128-0175.1 428175	Ø 273,5 28 26 V
MERCEDES-BENZ - 100 Bus (631) 02/88→04/96							
 Bremsbelagsatz, Scheibenbremse							
2.0 D	45	09/93→04/96	←	→ 02/96		13.0460-3945.2 603945	BDX 20932 14,0 - WE / - WK
D (631.333, 631.343, 631.334, 631.344)	55	12/90→02/96	←			13.0460-3945.2 603945	BDX 20932 14,0 - WE / - WK
Zubehörsatz, Scheibenbremsbelag							
2.0 D	45	09/93→04/96	←	→ 02/96		13.0460-0918.2 610918	BDX
D (631.333, 631.343, 631.334, 631.344)	55	12/90→02/96	←			13.0460-0918.2 610918	BDX
 Bremsscheibe							
2.0 D	45	09/93→04/96	←	→ 02/96		24.0116-0107.2 416107	Ø 238,5 16 14,5 + S
D (631.333, 631.343, 631.334, 631.344)	55	12/90→02/96	←			24.0116-0107.2 416107	Ø 238,5 16 14,5 + S
MERCEDES-BENZ - 100 Kasten (631) 02/88→04/96							
 Bremsbelagsatz, Scheibenbremse							
2.0 D	45	09/93→04/96	←	→ 02/96		13.0460-3945.2 603945	BDX 20932 14,0 - WE / - WK
D (631.332, 631.342)	55	12/90→02/96	←			13.0460-3945.2 603945	BDX 20932 14,0 - WE / - WK
Zubehörsatz, Scheibenbremsbelag							
2.0 D	45	09/93→04/96	←	→ 02/96		13.0460-0918.2 610918	BDX
D (631.332, 631.342)	55	12/90→02/96	←			13.0460-0918.2 610918	BDX
 Bremsscheibe							
2.0 D	45	09/93→04/96	←	→ 02/96		24.0116-0107.2 416107	Ø 238,5 16 14,5 + S
D (631.332, 631.342)	55	12/90→02/96	←			24.0116-0107.2 416107	Ø 238,5 16 14,5 + S







	kW			 	! #		
MERCEDES-BENZ - 100 Pritsche/Fahrgestell (631) 02/88→02/96							
Zubehörsatz, Scheibenbremsbelag							
D (631.340)	55	12/90→02/96		Baumuster: 631.349		13.0460-0918.2 610918	BDX
MERCEDES-BENZ - A-KLASSE (W168) 07/97→08/04							
 Bremsbelagsatz, Scheibenbremse							
A 140 (168.031, 168.131)	60	07/97→08/04		09/97→; langer Radstand; Baumuster: 168.131		13.0460-2776.2 602776 13.0470-2776.2 LD2776	TRW 23070 17,0 + WE / - WK + Zub TRW 23070 17,0 + WE / - WK + Zub Ceramic
				09/97→; kurzer Radstand; Baumuster: 168.031		13.0460-2833.2 602833 13.0470-2833.2 LD2833	TRW 23070 17,0 + WE / - WK + Zub TRW 23070 17,0 + WE / - WK + Zub Ceramic
A 140 (168.031, 168.131)	60	01/01→08/04		langer Radstand; Baumuster: 168.131		13.0460-2776.2 602776 13.0470-2776.2 LD2776	TRW 23070 17,0 + WE / - WK + Zub TRW 23070 17,0 + WE / - WK + Zub Ceramic
				kurzer Radstand; Baumuster: 168.031		13.0460-2833.2 602833 13.0470-2833.2 LD2833	TRW 23070 17,0 + WE / - WK + Zub TRW 23070 17,0 + WE / - WK + Zub Ceramic
A 160 (168.033, 168.133)	75	07/97→08/04		09/97→		13.0460-2776.2 602776 13.0470-2776.2 LD2776	TRW 23070 17,0 + WE / - WK + Zub TRW 23070 17,0 + WE / - WK + Zub Ceramic
				09/97→; langer Radstand; Baumuster: 168.133		13.0460-2855.2 602855 13.0470-2855.2 LD2855	TRW 23138 14,6 - WE / - WK TRW 23138 14,6 - WE / - WK Ceramic
A 160 CDI (168.006)	55	02/01→08/04				13.0460-2833.2 602833 13.0470-2833.2 LD2833	TRW 23070 17,0 + WE / - WK + Zub TRW 23070 17,0 + WE / - WK + Zub Ceramic
A 160 CDI (168.007)	44	07/98→02/01		08/98→ 01/01		13.0460-2833.2 602833 13.0470-2833.2 LD2833	TRW 23070 17,0 + WE / - WK + Zub TRW 23070 17,0 + WE / - WK + Zub Ceramic
A 170 CDI (168.008)	66	07/98→02/01		→ 01/01		13.0460-2776.2 602776 13.0470-2776.2 LD2776	TRW 23070 17,0 + WE / - WK + Zub TRW 23070 17,0 + WE / - WK + Zub Ceramic
A 170 CDI (168.009, 168.109)	70	02/01→08/04				13.0460-2776.2 602776 13.0470-2776.2 LD2776	TRW 23070 17,0 + WE / - WK + Zub TRW 23070 17,0 + WE / - WK + Zub Ceramic
				langer Radstand; Baumuster: 168.109		13.0460-2855.2 602855 13.0470-2855.2 LD2855	TRW 23138 14,6 - WE / - WK TRW 23138 14,6 - WE / - WK Ceramic
A 190 (168.032, 168.132)	92	03/99→08/04		05/99→		13.0460-2776.2 602776 13.0470-2776.2 LD2776	TRW 23070 17,0 + WE / - WK + Zub TRW 23070 17,0 + WE / - WK + Zub Ceramic
				05/99→		13.0460-2855.2 602855 13.0470-2855.2 LD2855	TRW 23138 14,6 - WE / - WK TRW 23138 14,6 - WE / - WK Ceramic
A 210 (168.035, 168.135)	103	03/02→08/04				13.0460-2855.2 602855 13.0470-2855.2 LD2855	TRW 23138 14,6 - WE / - WK TRW 23138 14,6 - WE / - WK Ceramic
Warnkontakt, Bremsbelagsverschleiß							
A 140 (168.031, 168.131)	60	07/97→08/04		09/97→; langer Radstand; Baumuster: 168.131	1	24.8190-0401.2 620401	L= 95
				09/97→; kurzer Radstand; Baumuster: 168.031	1	24.8190-0401.2 620401	L= 95
A 140 (168.031, 168.131)	60	01/01→08/04		langer Radstand; Baumuster: 168.131	1	24.8190-0401.2 620401	L= 95
				kurzer Radstand; Baumuster: 168.031	1	24.8190-0401.2 620401	L= 95
A 160 (168.033, 168.133)	75	07/97→08/04		09/97→	1	24.8190-0401.2 620401	L= 95
				05/99→	1	24.8190-0401.2 620401	L= 95
A 160 CDI (168.006) A 170 CDI (168.009, 168.109) ↓	55 70	02/01→08/04 02/01→08/04			1	24.8190-0401.2 620401	L= 95







	kW				! #		
MERCEDES-BENZ - A-KLASSE (W168) 07/97→08/04							
Warnkontakt, Bremsbelagverschleiß							
A 210 (168.035, 168.135)	103	03/02→08/04	←		1	24.8190-0401.2 620401	L= 95
A 160 CDI (168.007)	44	07/98→02/01	←	08/98→ 01/01	1	24.8190-0401.2 620401	L= 95
A 170 CDI (168.008)	66	07/98→02/01	←	→ 01/01	1	24.8190-0401.2 620401	L= 95
A 190 (168.032, 168.132)	92	03/99→08/04	←	05/99→	1	24.8190-0401.2 620401	L= 95
Zubehörsatz, Scheibenbremsbelag							
A 140 (168.031, 168.131)	60	07/97→08/04	←	09/97→; langer Radstand; Baumuster: 168.131		13.0460-0024.2 610024	
			←	09/97→; kurzer Radstand; Baumuster: 168.031		13.0460-0163.2 610163	TRW
A 140 (168.031, 168.131)	60	01/01→08/04	←	langer Radstand; Baumuster: 168.131		13.0460-0024.2 610024	
			←	kurzer Radstand; Baumuster: 168.031		13.0460-0163.2 610163	TRW
A 160 (168.033, 168.133)	75	07/97→08/04	←	09/97→		13.0460-0024.2 610024	
			→	09/97→; langer Radstand; Baumuster: 168.133		13.0460-0144.2 610144	TRW
A 160 CDI (168.006)	55	02/01→08/04	←			13.0460-0163.2 610163	TRW
A 160 CDI (168.007)	44	07/98→02/01	←	08/98→ 01/01		13.0460-0163.2 610163	TRW
A 170 CDI (168.008)	66	07/98→02/01	←	→ 01/01		13.0460-0024.2 610024	
A 170 CDI (168.009, 168.109)	70	02/01→08/04	←			13.0460-0024.2 610024	
			→	langer Radstand; Baumuster: 168.109		13.0460-0144.2 610144	TRW
A 190 (168.032, 168.132)	92	03/99→08/04	←	05/99→		13.0460-0024.2 610024	
			→	05/99→		13.0460-0144.2 610144	TRW
A 210 (168.035, 168.135)	103	03/02→08/04	→			13.0460-0144.2 610144	TRW
 Bremsscheibe							
A 140 (168.031, 168.131)	60	07/97→08/04	←	09/97→; kurzer Radstand; Baumuster: 168.031		24.0112-0144.1 412144 24.0312-0144.1 512144	Ø 260 12 10 + S Ø 260 12 10 + S PD
			←	09/97→; langer Radstand; Baumuster: 168.131		24.0122-0168.1 422168 24.0322-0168.1 522168	Ø 260 22 19,4 V + S Ø 260 22 19,4 V + S PD
			←	kurzer Radstand; Baumuster: 168.031		24.0112-0144.1 412144 24.0312-0144.1 512144	Ø 260 12 10 + S Ø 260 12 10 + S PD
A 140 (168.031, 168.131)	60	01/01→08/04	←	langer Radstand; Baumuster: 168.131		24.0122-0168.1 422168 24.0322-0168.1 522168	Ø 260 22 19,4 V + S Ø 260 22 19,4 V + S PD
			←	kurzer Radstand; Baumuster: 168.031		24.0112-0144.1 412144 24.0312-0144.1 512144	Ø 260 12 10 + S Ø 260 12 10 + S PD
A 160 (168.033, 168.133)	75	07/97→08/04	←	09/97→		24.0122-0168.1 422168 24.0322-0168.1 522168	Ø 260 22 19,4 V + S Ø 260 22 19,4 V + S PD
			→	09/97→; langer Radstand; Baumuster: 168.133		24.0108-0111.1 408111 24.0308-0111.1 508111	Ø 258 8 7 Ø 258 8 7 PD
A 160 CDI (168.006)	55	02/01→08/04	←			24.0112-0144.1 412144 24.0312-0144.1 512144	Ø 260 12 10 + S Ø 260 12 10 + S PD
A 160 CDI (168.007)	44	07/98→02/01	←	08/98→ 01/01		24.0112-0144.1 412144 24.0312-0144.1 512144	Ø 260 12 10 + S Ø 260 12 10 + S PD
A 170 CDI (168.008)	66	07/98→02/01	←	→ 01/01		24.0122-0168.1 422168 24.0322-0168.1 522168	Ø 260 22 19,4 V + S Ø 260 22 19,4 V + S PD
A 170 CDI (168.009, 168.109)	70	02/01→08/04	←			24.0122-0168.1 422168 24.0322-0168.1 522168	Ø 260 22 19,4 V + S Ø 260 22 19,4 V + S PD
			→	langer Radstand; Baumuster: 168.109		24.0108-0111.1 408111 24.0308-0111.1 508111	Ø 258 8 7 Ø 258 8 7 PD
A 190 (168.032, 168.132)	92	03/99→08/04	←	05/99→		24.0122-0168.1 422168 24.0122-0208.1 422208 24.0322-0168.1 522168	Ø 260 22 19,4 V + S Ø 276 22 19,4 V Ø 260 22 19,4 V + S PD
			→	05/99→		24.0108-0111.1 408111 24.0308-0111.1 508111	Ø 258 8 7 Ø 258 8 7 PD
			→			24.0108-0111.1 408111 24.0308-0111.1 508111	Ø 258 8 7 Ø 258 8 7 PD
A 210 (168.035, 168.135)	103	03/02→08/04	→			24.0108-0111.1 408111 24.0308-0111.1 508111	Ø 258 8 7 Ø 258 8 7 PD
MERCEDES-BENZ - A-KLASSE (W169) 09/04→06/12							
 Bremsbelagsatz, Scheibenbremse							
A 150 (169.031, 169.331) ↓	70	09/04→06/12	←	→ 05/12		13.0460-2885.2 602885	TRW 24077 19,1 + WE / - WK + Zub



















	kw					! #				
MERCEDES-BENZ - A-KLASSE (W169) 09/04→06/12										
Bremsbelagsatz, Scheibenbremse										
A 160 (169.031, 169.331)	70	04/09→06/12	←	→ 05/12			13.0470-2885.2	LD2885	TRW 24077 19,1 + WE / - WK + Zub Ceramic	
			→	→ 05/12			13.0460-2712.2	602712	TRW 23138 14,6 - WE / - WK + Zub	
							13.0470-2712.2	LD2712	TRW 23138 14,6 - WE / - WK + Zub Ceramic	
A 160 CDI (169.006, 169.306)	60	09/04→06/12	←	J 215301→; → 05/12; nicht für erhöhte Nutzlast			13.0460-2711.2	602711	TRW 24077 19,1 + WE / - WK + Zub	
							13.0470-2711.2	LD2711	TRW 24077 19,1 + WE / - WK + Zub Ceramic	
			←	→ 05/12; für erhöhte Nutzlast			13.0460-2711.2	602711	TRW 24077 19,1 + WE / - WK + Zub	
							13.0470-2711.2	LD2711	TRW 24077 19,1 + WE / - WK + Zub Ceramic	
			←	→ J 215300; nicht für erhöhte Nutzlast			13.0460-2885.2	602885	TRW 24077 19,1 + WE / - WK + Zub	
						13.0470-2885.2	LD2885	TRW 24077 19,1 + WE / - WK + Zub Ceramic		
			→	→ 05/12			13.0460-2712.2	602712	TRW 23138 14,6 - WE / - WK + Zub	
							13.0470-2712.2	LD2712	TRW 23138 14,6 - WE / - WK + Zub Ceramic	
A 170 (169.032, 169.332) A 180 (169.032, 169.332) A 180 CDI (169.007, 169.307) A 200 (169.033, 169.333)	85	09/04→06/12	←	→ 05/12			13.0460-2711.2	602711	TRW 24077 19,1 + WE / - WK + Zub	
	85	04/09→06/12					13.0470-2711.2	LD2711	TRW 24077 19,1 + WE / - WK + Zub Ceramic	
	80	09/04→06/12	→	→ 05/12			13.0460-2712.2	602712	TRW 23138 14,6 - WE / - WK + Zub	
	100	09/04→06/12					13.0470-2712.2	LD2712	TRW 23138 14,6 - WE / - WK + Zub Ceramic	
A 200 CDI (169.008, 169.308) A 200 CDI (169.308) A 200 TURBO (169.034, 169.334)	103	09/04→06/12	←	→ 05/12			13.0460-2708.2	602708	TRW 23881 20,0 + WE / - WK + Zub	
	100	09/04→06/12					13.0470-2708.2	LD2708	TRW 23881 20,0 + WE / - WK + Zub Ceramic	
	142	09/05→06/12	→	→ 05/12			13.0460-2712.2	602712	TRW 23138 14,6 - WE / - WK + Zub	
							13.0470-2712.2	LD2712	TRW 23138 14,6 - WE / - WK + Zub Ceramic	
E-CELL (169.090)	50	12/10→06/12	←	→ 05/12			13.0460-2708.2	602708	TRW 23881 20,0 + WE / - WK + Zub	
							13.0470-2708.2	LD2708	TRW 23881 20,0 + WE / - WK + Zub Ceramic	
			→	→ 05/12			13.0460-2855.2	602855	TRW 23138 14,6 - WE / - WK + Zub	
							13.0470-2855.2	LD2855	TRW 23138 14,6 - WE / - WK + Zub Ceramic	
Warnkontakt, Bremsbelagsverschleiß										
A 150 (169.031, 169.331) A 160 (169.031, 169.331) A 170 (169.032, 169.332) A 180 (169.032, 169.332) A 180 CDI (169.007, 169.307) A 200 (169.033, 169.333) A 200 CDI (169.008, 169.308) A 200 CDI (169.308) A 200 TURBO (169.034, 169.334) E-CELL (169.090)	70	09/04→06/12	←	→ 05/12	1		24.8190-0410.2	620410	L= 97,5	
	70	04/09→06/12								
	85	09/04→06/12								
	85	04/09→06/12								
	80	09/04→06/12								
	100	09/04→06/12								
	103	09/04→06/12								
	100	09/04→06/12								
	142	09/05→06/12								
	50	12/10→06/12								
	A 160 CDI (169.006, 169.306)	60	09/04→06/12	←	J 215301→; → 05/12; nicht für erhöhte Nutzlast	1		24.8190-0410.2	620410	L= 97,5
				←	→ 05/12; für erhöhte Nutzlast	1		24.8190-0410.2	620410	L= 97,5
				←	→ J 215300; nicht für erhöhte Nutzlast	1		24.8190-0410.2	620410	L= 97,5
Zubehörsatz, Scheibenbremsbelag										
E-CELL (169.090) ↓	50	12/10→06/12	→	→ 05/12			13.0460-0144.2	610144	TRW	













	kW			 	! #		
MERCEDES-BENZ - A-KLASSE (W169) 09/04→06/12							
Bremsscheibe							
A 150 (169.031, 169.331)	70	09/04→06/12	←	→ 05/12; nicht für erhöhte Nutzlast		24.0112-0167.1 412167	Ø 276 12 10 + S
A 160 (169.031, 169.331)	70	04/09→06/12	←	→ 05/12; für erhöhte Nutzlast		24.0312-0167.1 512167	Ø 276 12 10 + S PD
A 160 CDI (169.006, 169.306)	60	09/04→06/12	←			24.0122-0232.1 422232	Ø 276 22 19,4 V + S
			→	→ 05/12		24.0322-0232.1 522232	Ø 276 22 19,4 V + S PD
			→			24.0108-0113.1 408113	Ø 258 8 7 + S
			→			24.0308-0113.1 508113	Ø 258 8 7 + S PD
A 170 (169.032, 169.332)	85	09/04→06/12	←	→ 05/12		24.0122-0232.1 422232	Ø 276 22 19,4 V + S
A 180 (169.032, 169.332)	85	04/09→06/12	→	→ 05/12		24.0322-0232.1 522232	Ø 276 22 19,4 V + S PD
A 180 CDI (169.007, 169.307)	80	09/04→06/12	→			24.0108-0113.1 408113	Ø 258 8 7 + S
A 200 (169.033, 169.333)	100	09/04→06/12	→			24.0308-0113.1 508113	Ø 258 8 7 + S PD
A 200 CDI (169.008, 169.308)	103	09/04→06/12	←	→ 05/12		24.0125-0167.1 425167	Ø 288 25 22,4 V + S
A 200 CDI (169.308)	100	09/04→06/12	→			24.0325-0167.1 525167	Ø 288 25 22,4 V + S PD
A 200 TURBO (169.034, 169.334)	142	09/05→06/12	→	→ 05/12		24.0108-0113.1 408113	Ø 258 8 7 + S
E-CELL (169.090)	50	12/10→06/12	→			24.0308-0113.1 508113	Ø 258 8 7 + S PD
MERCEDES-BENZ - A-KLASSE (W176) 06/12→							
Bremsbelagsatz, Scheibenbremse							
A 160 (176.041)	75	07/15→	←			13.0460-2779.2 602779	TRW 24869 19,3 + WE / - WK
A 200 (176.043)	115	06/12→				13.0470-2779.2 LD2779	TRW 24869 19,3 + WE / - WK Ceramic
A 200 CDI / d (176.008)	100	02/14→					
A 200 CDI / d 4-matic (176.002)	100	02/14→	→	+ eFSB		13.0460-2786.2 602786	TRW 24848 18,3 + WE / - WK + Zub
A 220 4-matic (176.047)	135	05/14→				13.0470-2786.2 LD2786	TRW 24848 18,3 + WE / - WK + Zub Ceramic
A 220 CDI (176.003)	120	01/14→					
A 220 CDI (176.003)	125	09/12→					
A 220 CDI 4-matic (176.005)	125	09/12→					
A 220 d (176.003)	130	07/15→					
A 220 d 4-matic (176.005)	130	07/15→					
A 250 (176.044)	155	06/12→06/15					
A 250 (176.050)	160	07/15→					
A 250 4-matic (176.051)	160	07/15→					
A 160 CDI / d (176.011)	66	06/13→	←	für Fahrzeuge ohne Sportpaket / für Fahrzeuge ohne AMG-Sportpaket		13.0460-2778.2 602778	TRW 25326 19,3 + WE / - WK
A 180 CDI / d (176.012)	80	06/12→				13.0470-2778.2 LD2778	TRW 25326 19,3 + WE / - WK Ceramic
A 180 CDI (176.000)	80	06/12→	←	für Fahrzeuge mit Sportpaket / für Fahrzeuge mit AMG-Sportpaket		13.0460-2779.2 602779	TRW 24869 19,3 + WE / - WK Ceramic
			←			13.0470-2779.2 LD2779	TRW 24869 19,3 + WE / - WK Ceramic
			→	+ eFSB		13.0460-2786.2 602786	TRW 24848 18,3 + WE / - WK + Zub
						13.0470-2786.2 LD2786	TRW 24848 18,3 + WE / - WK + Zub Ceramic
A 180 (176.042)	90	06/12→	←	für Stahlfelgen		13.0460-2778.2 602778	TRW 25326 19,3 + WE / - WK
						13.0470-2778.2 LD2778	TRW 25326 19,3 + WE / - WK Ceramic
			←	für Leichtmetallfelgen		13.0460-2779.2 602779	TRW 24869 19,3 + WE / - WK
						13.0470-2779.2 LD2779	TRW 24869 19,3 + WE / - WK Ceramic
			→	+ eFSB		13.0460-2786.2 602786	TRW 24848 18,3 + WE / - WK + Zub
						13.0470-2786.2 LD2786	TRW 24848 18,3 + WE / - WK + Zub Ceramic
A 200 CDI (176.001)	100	06/12→	←	→ 02/14		13.0460-2779.2 602779	TRW 24869 19,3 + WE / - WK
						13.0470-2779.2 LD2779	TRW 24869 19,3 + WE / - WK Ceramic
			→	→ 02/14; + eFSB		13.0460-2786.2 602786	TRW 24848 18,3 + WE / - WK + Zub
						13.0470-2786.2 LD2786	TRW 24848 18,3 + WE / - WK + Zub Ceramic
A 250 4-matic (176.046)	155	06/12→06/15	←	06/13→		13.0460-2779.2 602779	TRW 24869 19,3 + WE / - WK
						13.0470-2779.2 LD2779	TRW 24869 19,3 + WE / - WK Ceramic
			→	06/13→; + eFSB		13.0460-2786.2 602786	TRW 24848 18,3 + WE / - WK + Zub
						13.0470-2786.2 LD2786	TRW 24848 18,3 + WE / - WK + Zub Ceramic









	kw			 	! #		
MERCEDES-BENZ - A-KLASSE (W176) 06/12→							
Warnkontakt, Bremsbelagverschleiß							
A 160 (176.041)	75	07/15→	←		1	24.8190-0067.2 620067	L= 92,5
A 160 CDI / d (176.011)	66	06/13→					
A 180 (176.042)	90	06/12→					
A 180 CDI / d (176.012)	80	06/12→					
A 180 CDI (176.000)	80	06/12→					
A 200 (176.043)	115	06/12→					
A 200 CDI / d (176.008)	100	02/14→					
A 200 CDI / d 4-matic (176.002)	100	02/14→					
A 220 4-matic (176.047)	135	05/14→					
A 220 CDI (176.003)	120	01/14→					
A 220 CDI (176.003)	125	09/12→					
A 220 CDI 4-matic (176.005)	125	09/12→					
A 220 d (176.003)	130	07/15→					
A 220 d 4-matic (176.005)	130	07/15→					
A 250 (176.044)	155	06/12→06/15					
A 250 (176.050)	160	07/15→					
A 250 4-matic (176.051)	160	07/15→					
A 45 AMG 4-matic (176.052)	265	06/13→06/15					
AMG A 45 4-matic (176.052)	280	07/15→					
A 200 CDI (176.001)	100	06/12→	←	→ 02/14	1	24.8190-0067.2 620067	L= 92,5
A 250 4-matic (176.046)	155	06/12→06/15	←	06/13→	1	24.8190-0067.2 620067	L= 92,5
Bremsscheibe							
A 160 (176.041)	75	07/15→	←	für Fahrzeuge mit Sportpaket / für Fahrzeuge mit AMG-Sportpaket		24.0128-0262.1 428262	Ø 295 28 26 V• + S
A 200 (176.043)	115	06/12→	←	für Fahrzeuge ohne Sportpaket / für Fahrzeuge ohne AMG-Sportpaket		24.0128-0276.1 428276	Ø 295 28 25,4 V + S
A 200 CDI / d (176.008)	100	02/14→	→	+ eFSB		24.0109-0173.1 409173	Ø 276 9 7,3 + S
A 160 CDI / d (176.011)	66	06/13→	←	für Fahrzeuge ohne Sportpaket / für Fahrzeuge ohne AMG-Sportpaket		24.0125-0200.1 425200	Ø 280 25 22,4 V + S
A 180 CDI / d (176.012)	80	06/12→	←	für Fahrzeuge mit Sportpaket / für Fahrzeuge mit AMG-Sportpaket		24.0128-0262.1 428262	Ø 295 28 26 V• + S
A 180 CDI (176.000)	80	06/12→	→	+ eFSB		24.0109-0173.1 409173	Ø 276 9 7,3 + S
A 180 (176.042)	90	06/12→	←	für Fahrzeuge ohne Sportpaket / für Fahrzeuge ohne AMG-Sportpaket; mit Stahlfelge		24.0125-0200.1 425200	Ø 280 25 22,4 V + S
			←	für Fahrzeuge mit Sportpaket / für Fahrzeuge mit AMG-Sportpaket		24.0128-0262.1 428262	Ø 295 28 26 V• + S
			←	für Fahrzeuge ohne Sportpaket / für Fahrzeuge ohne AMG-Sportpaket; mit Leichtmetallfelge		24.0128-0276.1 428276	Ø 295 28 25,4 V + S
			→	+ eFSB		24.0109-0173.1 409173	Ø 276 9 7,3 + S
A 200 CDI / d 4-matic (176.002)	100	02/14→	←	für Fahrzeuge mit Sportpaket / für Fahrzeuge mit AMG-Sportpaket		24.0128-0262.1 428262	Ø 295 28 26 V• + S
			←	für Fahrzeuge ohne Sportpaket / für Fahrzeuge ohne AMG-Sportpaket		24.0128-0276.1 428276	Ø 295 28 25,4 V + S
			→	+ eFSB		24.0110-0382.1 410382	Ø 295 10 8,3 + S
A 200 CDI (176.001)	100	06/12→	←	für Fahrzeuge mit Sportpaket / für Fahrzeuge mit AMG-Sportpaket; → 02/14		24.0128-0262.1 428262	Ø 295 28 26 V• + S
			←	für Fahrzeuge ohne Sportpaket / für Fahrzeuge ohne AMG-Sportpaket; → 02/14		24.0128-0276.1 428276	Ø 295 28 25,4 V + S
			→	→ 02/14; + eFSB		24.0109-0173.1 409173	Ø 276 9 7,3 + S
A 220 4-matic (176.047)	135	05/14→	←	für Fahrzeuge ohne Sportpaket / für Fahrzeuge ohne AMG-Sportpaket		24.0128-0275.1 428275	Ø 295 28 25,4 V + S
			←	für Fahrzeuge mit Sportpaket / für Fahrzeuge mit AMG-Sportpaket		24.0130-0238.1 430238	Ø 320 30 28 V• + S
			→	nicht für Ausstattungsvariante: Sport Edition [P84]; + eFSB		24.0110-0382.1 410382	Ø 295 10 8,3 + S
A 220 CDI (176.003)	120	01/14→	←	für Fahrzeuge ohne Sportpaket / für Fahrzeuge ohne AMG-Sportpaket		24.0128-0275.1 428275	Ø 295 28 25,4 V + S
A 220 CDI (176.003)	125	09/12→	←	für Fahrzeuge mit Sportpaket / für Fahrzeuge mit AMG-Sportpaket		24.0130-0238.1 430238	Ø 320 30 28 V• + S
A 220 CDI 4-matic (176.005)	125	09/12→	←	für Fahrzeuge mit Sportpaket / für Fahrzeuge mit AMG-Sportpaket		24.0130-0238.1 430238	Ø 320 30 28 V• + S
A 220 d (176.003)	130	07/15→	→	+ eFSB		24.0110-0382.1 410382	Ø 295 10 8,3 + S
A 220 d 4-matic (176.005)	130	07/15→	→	+ eFSB		24.0110-0382.1 410382	Ø 295 10 8,3 + S
A 250 (176.044)	155	06/12→06/15	←	für Fahrzeuge ohne Sportpaket / für Fahrzeuge ohne AMG-Sportpaket		24.0130-0237.1 430237	Ø 320 30 28 V + S
A 250 (176.050)	160	07/15→	←	für Fahrzeuge mit Sportpaket / für Fahrzeuge mit AMG-Sportpaket		24.0130-0238.1 430238	Ø 320 30 28 V• + S
↓							







	kw				! #		
MERCEDES-BENZ - A-KLASSE (W176) 06/12→							
Bremsscheibe							
A 250 (176.044) A 250 (176.050)	155 160	06/12→06/15 07/15→	➔	+ eFSB		24.0110-0382.1 410382	Ø 295 10 8,3 + S
A 250 4-matic (176.046)	155	06/12→06/15	➔	06/13→; für Fahrzeuge ohne Sportpaket / für Fahrzeuge ohne AMG-Sportpaket		24.0130-0237.1 430237	Ø 320 30 28 V + S
			➔	06/13→; für Fahrzeuge mit Sportpaket / für Fahr- zeuge mit AMG-Sportpaket		24.0130-0238.1 430238	Ø 320 30 28 V• + S
			➔	06/13→; nicht für Ausstattungsvariante: Sport Edition [P84]; + eFSB		24.0110-0382.1 410382	Ø 295 10 8,3 + S
A 250 4-matic (176.051)	160	07/15→	➔	für Fahrzeuge ohne Sportpaket / für Fahrzeuge ohne AMG-Sportpaket		24.0130-0237.1 430237	Ø 320 30 28 V + S
			➔	für Fahrzeuge mit Sportpaket / für Fahr- zeuge mit AMG-Sportpaket		24.0130-0238.1 430238	Ø 320 30 28 V• + S
			➔	nicht für Ausstattungsvariante: Sport Edition [P84]; + eFSB		24.0110-0382.1 410382	Ø 295 10 8,3 + S
A 45 AMG 4-matic (176.052) AMG A 45 4-matic (176.052)	265 280	06/13→06/15 07/15→	➔	+SA 660		24.0128-0262.1 428262	Ø 295 28 26 V• + S
MERCEDES-BENZ - B-KLASSE (W245) 03/05→11/11							
Bremsbelagsatz, Scheibenbremse							
B 150 (245.231) B 160 (245.231) B 170 (245.232) B 180 (245.232)	70 70 85 85	03/05→11/11 04/09→11/11 03/05→11/11 04/09→11/11	➔	→ 04/11		13.0460-2711.2 602711	TRW 24077 19,1 + WE / - WK + Zub
			➔	→ 04/11		13.0470-2711.2 LD2711	TRW 24077 19,1 + WE / - WK + Zub Ceramic
			➔	→ 04/11		13.0460-2712.2 602712	TRW 23138 14,6 - WE / - WK + Zub
			➔	→ 04/11		13.0470-2712.2 LD2712	TRW 23138 14,6 - WE / - WK + Zub Ceramic
B 170 NGT (245.233)	85	04/08→11/11	➔	→ 04/09		13.0460-2708.2 602708	TRW 23881 20,0 + WE / - WK + Zub
			➔	→ 04/09		13.0470-2708.2 LD2708	TRW 23881 20,0 + WE / - WK + Zub Ceramic
			➔	→ 04/09		13.0460-2712.2 602712	TRW 23138 14,6 - WE / - WK + Zub
			➔	→ 04/09		13.0470-2712.2 LD2712	TRW 23138 14,6 - WE / - WK + Zub Ceramic
B 180 CDI (245.207) B 200 (245.233) B 200 CDI (245.208) B 200 CDI (245.208) B 200 TURBO (245.234)	80 100 100 103 142	03/05→11/11 03/05→11/11 03/05→11/11 03/05→11/11 03/05→11/11	➔	→ 04/11		13.0460-2708.2 602708	TRW 23881 20,0 + WE / - WK + Zub
			➔	→ 04/11		13.0470-2708.2 LD2708	TRW 23881 20,0 + WE / - WK + Zub Ceramic
			➔	→ 04/11		13.0460-2712.2 602712	TRW 23138 14,6 - WE / - WK + Zub
			➔	→ 04/11		13.0470-2712.2 LD2712	TRW 23138 14,6 - WE / - WK + Zub Ceramic
B 180 NGT (245.233)	85	04/08→11/11	➔	04/09→ 04/11		13.0460-2708.2 602708	TRW 23881 20,0 + WE / - WK + Zub
			➔	04/09→ 04/11		13.0470-2708.2 LD2708	TRW 23881 20,0 + WE / - WK + Zub Ceramic
			➔	04/09→ 04/11		13.0460-2712.2 602712	TRW 23138 14,6 - WE / - WK + Zub
			➔	04/09→ 04/11		13.0470-2712.2 LD2712	TRW 23138 14,6 - WE / - WK + Zub Ceramic
Warnkontakt, Bremsbelagsverschleiß							
B 150 (245.231) B 160 (245.231) B 170 (245.232) B 180 (245.232) B 180 CDI (245.207) B 200 (245.233) B 200 CDI (245.208) B 200 CDI (245.208) B 200 TURBO (245.234) B 170 NGT (245.233) B 180 NGT (245.233)	70 70 85 85 80 100 100 103 142 85 85	03/05→11/11 04/09→11/11 03/05→11/11 04/09→11/11 03/05→11/11 03/05→11/11 03/05→11/11 03/05→11/11 03/05→11/11 04/08→11/11 04/08→11/11	➔	→ 04/11	1	24.8190-0410.2 620410	L= 97,5
			➔	→ 04/11			
			➔	→ 04/11			
			➔	→ 04/11			
			➔	→ 04/11			
			➔	→ 04/11			
			➔	→ 04/11			
			➔	→ 04/11			
			➔	→ 04/11			
			➔	→ 04/11			
Bremsscheibe							
B 150 (245.231) B 160 (245.231) ↓	70 70	03/05→11/11 04/09→11/11	➔	→ 04/11		24.0122-0232.1 422232	Ø 276 22 19,4 V + S







	kW					! #		
MERCEDES-BENZ - B-KLASSE (W245) 03/05→11/11								
Bremsscheibe								
B 170 (245.232)	85	03/05→11/11	←	→ 04/11		24.0322-0232.1	522232	Ø 276 22 19,4 V + S PD
B 180 (245.232)	85	04/09→11/11	→	→ 04/11		24.0108-0113.1	408113	Ø 258 8 7 + S
						24.0308-0113.1	508113	Ø 258 8 7 + S PD
B 170 NGT (245.233)	85	04/08→11/11	←	→ 04/09		24.0125-0167.1	425167	Ø 288 25 22,4 V + S
			→	→ 04/09		24.0325-0167.1	525167	Ø 288 25 22,4 V + S PD
						24.0108-0113.1	408113	Ø 258 8 7 + S
						24.0308-0113.1	508113	Ø 258 8 7 + S PD
B 180 CDI (245.207)	80	03/05→11/11	←	04/05→ 10/11		24.0125-0167.1	425167	Ø 288 25 22,4 V + S
B 200 (245.233)	100	03/05→11/11				24.0325-0167.1	525167	Ø 288 25 22,4 V + S PD
B 200 CDI (245.208)	100	03/05→11/11	→	→ 04/11		24.0108-0113.1	408113	Ø 258 8 7 + S
B 200 CDI (245.208)	103	03/05→11/11				24.0308-0113.1	508113	Ø 258 8 7 + S PD
B 200 TURBO (245.234)	142	03/05→11/11						
B 180 NGT (245.233)	85	04/08→11/11	←	04/09→ 10/11		24.0125-0167.1	425167	Ø 288 25 22,4 V + S
			→	04/09→ 04/11		24.0325-0167.1	525167	Ø 288 25 22,4 V + S PD
						24.0108-0113.1	408113	Ø 258 8 7 + S
						24.0308-0113.1	508113	Ø 258 8 7 + S PD
MERCEDES-BENZ - B-KLASSE (W246, W242) 10/11→								
Bremsbelagsatz, Scheibenbremse								
B 160 (246.241)	75	07/15→	←	für Fahrzeuge ohne Sportpaket		13.0460-2778.2	602778	TRW 25326 19,3 + WE / - WK
B 160 CDI / d (246.211)	66	05/13→				13.0470-2778.2	LD2778	TRW 25326 19,3 + WE / - WK
B 180 (246.242)	90	11/11→						Ceramic
B 180 CDI / d (246.212)	80	02/13→						
B 180 CDI (246.200)	80	11/11→	←	für Fahrzeuge mit Sportpaket; für Taxifahrzeuge		13.0460-2779.2	602779	TRW 24869 19,3 + WE / - WK
B 200 CDI (246.201)	100	11/11→				13.0470-2779.2	LD2779	TRW 24869 19,3 + WE / - WK
			→	+ eFSB		13.0460-2786.2	602786	TRW 24848 18,3 + WE / - WK
						13.0470-2786.2	LD2786	TRW 24848 18,3 + WE / - WK
								+ Zub Ceramic
B 200 (246.243)	115	11/11→	←			13.0460-2779.2	602779	TRW 24869 19,3 + WE / - WK
B 200 CDI / d (246.208)	100	08/14→				13.0470-2779.2	LD2779	TRW 24869 19,3 + WE / - WK
B 200 CDI / d 4-matic (246.202)	100	08/14→						Ceramic
B 200 Natural Gas Drive / B 200 c (242.848)	115	11/12→	→	+ eFSB		13.0460-2786.2	602786	TRW 24848 18,3 + WE / - WK
B 220 4-matic (246.247)	135	05/13→				13.0470-2786.2	LD2786	TRW 24848 18,3 + WE / - WK
B 220 CDI / d (246.203)	120	06/13→						+ Zub Ceramic
B 220 CDI / d (246.203)	130	09/14→						
B 220 CDI / d 4-matic (246.205)	130	09/14→						
B 250 4-matic (246.246)	155	08/14→						
Electric Drive / B 250 e (242.890)	65	11/14→						
Electric Drive / B 250 e (242.890)	132	11/14→						
B 220 CDI (246.203)	125	11/11→	←	12/12→		13.0460-2779.2	602779	TRW 24869 19,3 + WE / - WK
			→	12/12→; + eFSB		13.0470-2779.2	LD2779	TRW 24869 19,3 + WE / - WK
						13.0460-2786.2	602786	TRW 24848 18,3 + WE / - WK
						13.0470-2786.2	LD2786	TRW 24848 18,3 + WE / - WK
								+ Zub Ceramic
B 250 (246.244)	155	05/12→	←	09/12→		13.0460-2779.2	602779	TRW 24869 19,3 + WE / - WK
			→	09/12→; + eFSB		13.0470-2779.2	LD2779	TRW 24869 19,3 + WE / - WK
						13.0460-2786.2	602786	TRW 24848 18,3 + WE / - WK
						13.0470-2786.2	LD2786	TRW 24848 18,3 + WE / - WK
								+ Zub
								+ Zub Ceramic
Warnkontakt, Bremsbelagverschleiß								
B 160 (246.241)	75	07/15→	←		1	24.8190-0067.2	620067	L= 92,5
B 160 CDI / d (246.211)	66	05/13→						
B 180 (246.242)	90	11/11→						
B 180 CDI / d (246.212)	80	02/13→						
B 180 CDI (246.200)	80	11/11→						
B 200 (246.243)	115	11/11→						
B 200 CDI / d (246.208)	100	08/14→						
B 200 CDI / d 4-matic (246.202)	100	08/14→						
B 200 CDI (246.201)	100	11/11→						
B 200 Natural Gas Drive / B 200 c (242.848)	115	11/12→						









	kw				! #		
MERCEDES-BENZ - B-KLASSE (W246, W242) 10/11→							
Warnkontakt, Bremsbelagverschleiß							
B 220 4-matic (246.247) B 220 CDI / d (246.203) B 220 CDI / d (246.203) B 220 CDI / d 4-matic (246.205) B 250 4-matic (246.246) Electric Drive / B 250 e (242.890) Electric Drive / B 250 e (242.890)	135 120 130 130 155 65 132	05/13→ 06/13→ 09/14→ 09/14→ 08/14→ 11/14→ 11/14→	←		1	24.8190-0067.2 620067	L= 92,5
B 220 CDI (246.203)	125	11/11→	←	12/12→	1	24.8190-0067.2 620067	L= 92,5
B 250 (246.244)	155	05/12→	←	09/12→	1	24.8190-0067.2 620067	L= 92,5
 Bremsscheibe							
B 160 (246.241) B 160 CDI / d (246.211) B 180 (246.242) B 180 CDI / d (246.212) B 180 CDI (246.200)	75 66 90 80 80	07/15→ 05/13→ 11/11→ 02/13→ 11/11→	←	für Fahrzeuge ohne Sportpaket		24.0125-0200.1 425200 24.0128-0276.1 428276	Ø 280 25 22,4 V + S Ø 295 28 25,4 V + S
			←	für Fahrzeuge mit Sportpaket		24.0128-0262.1 428262	Ø 295 28 26 V* + S
			→	+ eFSB; nicht für Taxifahrzeuge		24.0109-0173.1 409173	Ø 276 9 7,3 + S
			→	für Taxifahrzeuge; + eFSB		24.0110-0382.1 410382	Ø 295 10 8,3 + S
B 200 (246.243) B 200 CDI (246.201) B 200 Natural Gas Drive / B 200 c (242.848)	115 100 115	11/11→ 11/11→ 11/12→	←	für Fahrzeuge mit Sportpaket; nicht für Taxifahrzeuge		24.0128-0262.1 428262	Ø 295 28 26 V* + S
			←	für Taxifahrzeuge		24.0128-0275.1 428275	Ø 295 28 25,4 V + S
			←	für Fahrzeuge ohne Sportpaket; nicht für Taxifahrzeuge		24.0128-0276.1 428276	Ø 295 28 25,4 V + S
			→	+ eFSB; nicht für Taxifahrzeuge		24.0109-0173.1 409173	Ø 276 9 7,3 + S
			→	für Taxifahrzeuge; + eFSB		24.0110-0382.1 410382	Ø 295 10 8,3 + S
B 200 CDI / d (246.208) B 200 CDI / d 4-matic (246.202)	100 100	08/14→ 08/14→	←	für Fahrzeuge mit Sportpaket; nicht für Taxifahrzeuge		24.0128-0262.1 428262	Ø 295 28 26 V* + S
			←	für Taxifahrzeuge		24.0128-0275.1 428275	Ø 295 28 25,4 V + S
			←	für Fahrzeuge ohne Sportpaket; nicht für Taxifahrzeuge		24.0128-0276.1 428276	Ø 295 28 25,4 V + S
			→	+ eFSB		24.0110-0382.1 410382	Ø 295 10 8,3 + S
B 220 4-matic (246.247) B 220 CDI / d (246.203) B 220 CDI / d (246.203) B 220 CDI / d 4-matic (246.205)	135 120 130 130	05/13→ 06/13→ 09/14→ 09/14→	←	für Fahrzeuge ohne Sportpaket		24.0128-0275.1 428275	Ø 295 28 25,4 V + S
			←	für Fahrzeuge mit Sportpaket		24.0130-0238.1 430238	Ø 320 30 28 V* + S
			→	+ eFSB		24.0110-0382.1 410382	Ø 295 10 8,3 + S
B 220 CDI (246.203)	125	11/11→	←	12/12→; für Fahrzeuge ohne Sportpaket		24.0128-0275.1 428275	Ø 295 28 25,4 V + S
			←	12/12→; für Fahrzeuge mit Sportpaket		24.0130-0238.1 430238	Ø 320 30 28 V* + S
			→	12/12→; + eFSB		24.0110-0382.1 410382	Ø 295 10 8,3 + S
B 250 (246.244)	155	05/12→	←	09/12→; für Fahrzeuge ohne Sportpaket		24.0130-0237.1 430237	Ø 320 30 28 V + S
			←	09/12→; für Fahrzeuge mit Sportpaket		24.0130-0238.1 430238	Ø 320 30 28 V* + S
			→	09/12→; + eFSB		24.0110-0382.1 410382	Ø 295 10 8,3 + S
B 250 4-matic (246.246)	155	08/14→	←	für Fahrzeuge ohne Sportpaket		24.0130-0237.1 430237	Ø 320 30 28 V + S
			←	für Fahrzeuge mit Sportpaket		24.0130-0238.1 430238	Ø 320 30 28 V* + S
			→	+ eFSB		24.0110-0382.1 410382	Ø 295 10 8,3 + S
Electric Drive / B 250 e (242.890) Electric Drive / B 250 e (242.890)	65 132	11/14→ 11/14→	←	für Fahrzeuge mit Sportpaket		24.0128-0262.1 428262	Ø 295 28 26 V* + S
			←	für Fahrzeuge ohne Sportpaket		24.0128-0275.1 428275	Ø 295 28 25,4 V + S
			→	+ eFSB		24.0110-0382.1 410382	Ø 295 10 8,3 + S
MERCEDES-BENZ - CITAN Kasten (415) 11/12→							
 Bremsbelagsatz, Scheibenbremse							
108 CDI (415.601, 415.603) 109 CDI (415.601, 415.603, 415.605) 111 CDI (415.603, 415.605) 112 (415.603)	55 66 81 84	11/12→ 11/12→ 06/13→ 06/13→	←	passend für Felgengröße [Zoll]: 14		13.0460-2709.2 602709 13.0470-2709.2 LD2709	TRW 23973 17,1 - WE / - WK + Zub TRW 23973 17,1 - WE / - WK + Zub Ceramic
			←	passend für Felgengröße [Zoll]: 15 / 16		13.0460-2742.2 602742	TRW 24693 17,5 - WE / - WK + Zub
			→	passend für Felgengröße [Zoll]: 15 / 16		13.0460-2744.2 602744	TRW 24692 15,9 - WE / - WK + Zub
 Bremsscheibe							
108 CDI (415.601, 415.603)	55	11/12→	←	passend für Felgengröße [Zoll]: 14		24.0122-0270.1 422270	Ø 258 22 19,8 V + S
			←	02/13→; + RUS / + RO / + TR / + SKA; passend für Felgengröße [Zoll]: 15 / 16		24.0124-0222.1 424222	Ø 280 24 21,8 V + S
↓							









	kw				! #		
MERCEDES-BENZ - CITAN Kasten (415) 11/12→							
 Bremsscheibe							
109 CDI (415.601, 415.603, 415.605)	66	11/12→	←	passend für Felgengröße [Zoll]: 15 / 16	24.0124-0222.1	424222	Ø 280 24 21,8 V + S
			←	→ 01/13; + RUS / + RO / + TR / + SKA; passend für Felgengröße [Zoll]: 15 / 16	24.0126-0180.1	426180	Ø 280 26 23,8 V + S
			→	passend für Felgengröße [Zoll]: 15 / 16	24.0111-0182.2	411182	Ø 274 11 9,5 + LG / + ABS Ring
111 CDI (415.603, 415.605) 112 (415.603)	81	06/13→	←	passend für Felgengröße [Zoll]: 14	24.0122-0270.1	422270	Ø 258 22 19,8 V + S
			←	+ RUS / + RO / + TR / + SKA; passend für Felgengröße [Zoll]: 15 / 16	24.0124-0222.1	424222	Ø 280 24 21,8 V + S
	84	06/13→	←	passend für Felgengröße [Zoll]: 15 / 16	24.0124-0222.1	424222	Ø 280 24 21,8 V + S
			→	passend für Felgengröße [Zoll]: 15 / 16	24.0111-0182.2	411182	Ø 274 11 9,5 + LG / + ABS Ring
MERCEDES-BENZ - CITAN Kombi / Tourer (415) 11/12→							
 Bremsbelagsatz, Scheibenbremse							
108 CDI (415.703) 109 CDI (415.703) 111 CDI (415.703) 112 (415.703)	55	11/12→	←	passend für Felgengröße [Zoll]: 14	13.0460-2709.2	602709	TRW 23973 17,1 - WE / - WK + Zub
	66	11/12→			13.0470-2709.2	LD2709	TRW 23973 17,1 - WE / - WK + Zub Ceramic
	81	06/13→	←	passend für Felgengröße [Zoll]: 15 / 16	13.0460-2742.2	602742	TRW 24693 17,5 - WE / - WK + Zub
	84	06/13→			13.0460-2744.2	602744	TRW 24692 15,9 - WE / - WK + Zub
 Bremsscheibe							
108 CDI (415.703) 109 CDI (415.703)	55	11/12→	←	passend für Felgengröße [Zoll]: 14	24.0122-0270.1	422270	Ø 258 22 19,8 V + S
	66	11/12→	←	02/13→; + RUS / + RO / + TR / + SKA; passend für Felgengröße [Zoll]: 15 / 16	24.0124-0222.1	424222	Ø 280 24 21,8 V + S
			←	passend für Felgengröße [Zoll]: 15 / 16	24.0124-0222.1	424222	Ø 280 24 21,8 V + S
			←	→ 01/13; + RUS / + RO / + TR / + SKA; passend für Felgengröße [Zoll]: 15 / 16	24.0126-0180.1	426180	Ø 280 26 23,8 V + S
			→	passend für Felgengröße [Zoll]: 15 / 16	24.0111-0182.2	411182	Ø 274 11 9,5 + LG / + ABS Ring
111 CDI (415.703) 112 (415.703)	81	06/13→	←	passend für Felgengröße [Zoll]: 14	24.0122-0270.1	422270	Ø 258 22 19,8 V + S
			←	+ RUS / + RO / + TR / + SKA; passend für Felgengröße [Zoll]: 15 / 16	24.0124-0222.1	424222	Ø 280 24 21,8 V + S
	84	06/13→	←	passend für Felgengröße [Zoll]: 15 / 16	24.0124-0222.1	424222	Ø 280 24 21,8 V + S
			→	passend für Felgengröße [Zoll]: 15 / 16	24.0111-0182.2	411182	Ø 274 11 9,5 + LG / + ABS Ring
MERCEDES-BENZ - CITAN Mixto (415) 11/12→							
 Bremsbelagsatz, Scheibenbremse							
109 CDI 111 CDI (415.601, 415.603, 415.605)	66	11/12→	←	passend für Felgengröße [Zoll]: 14	13.0460-2709.2	602709	TRW 23973 17,1 - WE / - WK + Zub
	81	06/13→			13.0470-2709.2	LD2709	TRW 23973 17,1 - WE / - WK + Zub Ceramic
				←	passend für Felgengröße [Zoll]: 15 / 16	13.0460-2742.2	602742
			→	passend für Felgengröße [Zoll]: 15 / 16	13.0460-2744.2	602744	TRW 24692 15,9 - WE / - WK + Zub
 Bremsscheibe							
109 CDI	66	11/12→	←	passend für Felgengröße [Zoll]: 14	24.0122-0270.1	422270	Ø 258 22 19,8 V + S
			←	02/13→; + RUS / + RO / + TR / + SKA; passend für Felgengröße [Zoll]: 15 / 16	24.0124-0222.1	424222	Ø 280 24 21,8 V + S
			←	passend für Felgengröße [Zoll]: 15 / 16	24.0124-0222.1	424222	Ø 280 24 21,8 V + S
			←	→ 01/13; + RUS / + RO / + TR / + SKA; passend für Felgengröße [Zoll]: 15 / 16	24.0126-0180.1	426180	Ø 280 26 23,8 V + S
			→	passend für Felgengröße [Zoll]: 15 / 16	24.0111-0182.2	411182	Ø 274 11 9,5 + LG / + ABS Ring
111 CDI (415.601, 415.603, 415.605)	81	06/13→	←	passend für Felgengröße [Zoll]: 14	24.0122-0270.1	422270	Ø 258 22 19,8 V + S
			←	+ RUS / + RO / + TR / + SKA; passend für Felgengröße [Zoll]: 15 / 16	24.0124-0222.1	424222	Ø 280 24 21,8 V + S
			←	passend für Felgengröße [Zoll]: 15 / 16	24.0124-0222.1	424222	Ø 280 24 21,8 V + S
			→	passend für Felgengröße [Zoll]: 15 / 16	24.0111-0182.2	411182	Ø 274 11 9,5 + LG / + ABS Ring
MERCEDES-BENZ - C-KLASSE (W202) 03/93→05/00							
 Bremsbelagsatz, Scheibenbremse							
C 180 (202.018) C 180 (202.018) ↓	89 90	11/94→05/00 03/93→05/00	←		13.0460-2975.2	602975	TRW 21439 20,3 + WE / - WK







	kw			 	! #		
MERCEDES-BENZ - C-KLASSE (W202) 03/93→05/00							
 Bremsbelagsatz, Scheibenbremse							
C 200 (202.020)	100	01/94→05/00	←			13.0470-2975.2	LD2975 TRW 21439 20,3 + WE / - WK Ceramic
C 200 D (202.120)	55	03/93→05/00					
C 200 D (202.122)	65	10/96→05/00					
C 220 D (202.021)	55	07/96→05/00	→	→ A419828 / F443892		13.0460-4034.2	604034 ATE 20687 15,5 - WE / - WK
C 220 D (202.121)	70	08/93→05/00	→	A419829 / F443893→		13.0460-4060.2	604060 ATE 21900 15,0 - WK
C 200 CDI (202.134)	75	03/98→05/00	←			13.0460-2975.2	602975 TRW 21439 20,3 + WE / - WK
C 220 CDI (202.133)	92	09/97→05/00				13.0470-2975.2	LD2975 TRW 21439 20,3 + WE / - WK Ceramic
			→			13.0460-4060.2	604060 ATE 21900 15,0 - WK
C 200 Kompressor (202.025)	132	10/95→05/00	←			13.0460-7086.2	607086 ATE 21664 19,8 + WE / - WK
C 200 Kompressor (202.025)	141	11/96→05/00				13.0470-7086.2	LD7086 ATE 21664 19,8 + WE / - WK Ceramic
C 230 Kompressor (202.024)	142	10/95→05/00	→	→ A487047 / F576240		13.0460-3805.2	603805 ATE 21197 15,0 + WE / - WK
C 240 (202.026)	125	06/97→05/00				13.0470-3805.2	LD3805 ATE 21197 15,0 + WE / - WK Ceramic
C 250 Turbo-D (202.128)	110	10/95→05/00	→	A487048 / F576241→		13.0460-4064.2	604064 ATE 21919 15,3 - WE / - WK + Zub
						13.0470-4064.2	LD4064 ATE 21919 15,3 - WE / - WK + Zub Ceramic
C 220 (202.022)	110	03/93→05/00	←	→ 08/96		13.0460-2975.2	602975 TRW 21439 20,3 + WE / - WK
			→	→ A419828 / F443892		13.0460-4034.2	604034 ATE 20687 15,5 - WE / - WK
			→	A419829 / F443893→; → 08/96		13.0460-4060.2	604060 ATE 21900 15,0 - WK
C 230 (202.023)	110	06/96→06/97	←	07/96→		13.0460-2975.2	602975 TRW 21439 20,3 + WE / - WK
						13.0470-2975.2	LD2975 TRW 21439 20,3 + WE / - WK Ceramic
			→	07/96→		13.0460-4060.2	604060 ATE 21900 15,0 - WK
C 250 D (202.125)	83	05/93→05/00	←	06/93→ 08/95		13.0460-2975.2	602975 TRW 21439 20,3 + WE / - WK
						13.0470-2975.2	LD2975 TRW 21439 20,3 + WE / - WK Ceramic
			→	06/93→; → A419828 / F443892		13.0460-4034.2	604034 ATE 20687 15,5 - WE / - WK
			→	A419829 / F443893→; → 08/95		13.0460-4060.2	604060 ATE 21900 15,0 - WK
C 280 (202.028)	142	05/93→05/00	←	06/93→; → A344660 / F331440		13.0460-2975.2	602975 TRW 21439 20,3 + WE / - WK
						13.0470-2975.2	LD2975 TRW 21439 20,3 + WE / - WK Ceramic
			←	A344661 / F331441→		13.0460-7086.2	607086 ATE 21664 19,8 + WE / - WK
						13.0470-7086.2	LD7086 ATE 21664 19,8 + WE / - WK Ceramic
			→	06/93→ 05/97; + ASR / + ETS		13.0460-3504.2	603504 ATE 21301 15,5 + WE / - WK
			→	A344661 / F331441→; → 05/97; - ASR / - ETS		13.0460-3805.2	603805 ATE 21197 15,0 + WE / - WK
						13.0470-3805.2	LD3805 ATE 21197 15,0 + WE / - WK Ceramic
			→	06/93→; → A344660 / F331440; - ASR / - ETS		13.0460-4034.2	604034 ATE 20687 15,5 - WE / - WK
C 280 (202.029)	145	06/97→05/00	←	→ A344660 / F331440		13.0460-2975.2	602975 TRW 21439 20,3 + WE / - WK
						13.0470-2975.2	LD2975 TRW 21439 20,3 + WE / - WK Ceramic
			←	A344661 / F331441→		13.0460-7086.2	607086 ATE 21664 19,8 + WE / - WK
						13.0470-7086.2	LD7086 ATE 21664 19,8 + WE / - WK Ceramic
			→	→ A487047 / F576240		13.0460-3805.2	603805 ATE 21197 15,0 + WE / - WK
						13.0470-3805.2	LD3805 ATE 21197 15,0 + WE / - WK Ceramic
			→	A487048 / F576241→		13.0460-4064.2	604064 ATE 21919 15,3 - WE / - WK + Zub
						13.0470-4064.2	LD4064 ATE 21919 15,3 - WE / - WK + Zub Ceramic
C 36 AMG (202.028)	206	05/94→05/00	←	→ 08/97		13.0460-4201.2	604201 ATE 21153 17,5 + WE / - WK
			→	→ A344660 / F331440		13.0460-3805.2	603805 ATE 21197 15,0 + WE / - WK
						13.0470-3805.2	LD3805 ATE 21197 15,0 + WE / - WK Ceramic
			→	→ 08/97; A344661 / F331441→		13.0460-4047.2	604047 ATE 21305 15,7 + WE / - WK
						13.0470-4047.2	LD4047 ATE 21305 15,7 + WE / - WK Ceramic
C 43 AMG (202.033)	225	08/97→05/00	←	09/97→		13.0460-7183.2	607183 ATE 21484 20,5 + WE / - WK
↓							







	kW				! #		
MERCEDES-BENZ - C-KLASSE (W202) 03/93→05/00							
Bremsbelagsatz, Scheibenbremse							
C 43 AMG (202.033)	225	08/97→05/00	➡	09/97→		13.0460-4047.2 604047 13.0470-4047.2 LD4047	ATE 21305 15,7 + WE / - WK ATE 21305 15,7 + WE / - WK Ceramic
Warnkontakt, Bremsbelagverschleiß							
C 180 (202.018)	89	11/94→05/00	←		2	24.8190-0401.2 620401	L= 95
C 180 (202.018)	90	03/93→05/00					
C 200 (202.020)	100	01/94→05/00					
C 200 CDI (202.134)	75	03/98→05/00					
C 200 D (202.120)	55	03/93→05/00					
C 200 D (202.122)	65	10/96→05/00					
C 220 CDI (202.133)	92	09/97→05/00					
C 220 D (202.021)	55	07/96→05/00					
C 220 D (202.121)	70	08/93→05/00					
C 200 Kompressor (202.025)	132	10/95→05/00	←		2	24.8190-0401.2 620401	L= 95
C 200 Kompressor (202.025)	141	11/96→05/00	➡	→ A487047 / F576240	1	24.8190-0401.2 620401	L= 95
C 230 Kompressor (202.024)	142	10/95→05/00					
C 240 (202.026)	125	06/97→05/00					
C 250 Turbo-D (202.128)	110	10/95→05/00					
C 220 (202.022)	110	03/93→05/00	←	→ 08/96	2	24.8190-0401.2 620401	L= 95
C 230 (202.023)	110	06/96→06/97	←	07/96→	2	24.8190-0401.2 620401	L= 95
C 250 D (202.125)	83	05/93→05/00	←	06/93→ 08/95	2	24.8190-0401.2 620401	L= 95
C 280 (202.028)	142	05/93→05/00	←	A344661 / F331441→	2	24.8190-0401.2 620401	L= 95
			←	06/93→; → A344660 / F331440	2	24.8190-0401.2 620401	L= 95
			➡	A344661 / F331441→; → 05/97; - ASR / - ETS	1	24.8190-0401.2 620401	L= 95
			➡	06/93→ 05/97; + ASR / + ETS	1	24.8190-0401.2 620401	L= 95
C 280 (202.029)	145	06/97→05/00	←	→ A344660 / F331440	2	24.8190-0401.2 620401	L= 95
			←	A344661 / F331441→	2	24.8190-0401.2 620401	L= 95
			➡	→ A487047 / F576240	1	24.8190-0401.2 620401	L= 95
C 36 AMG (202.028)	206	05/94→05/00	←	→ 08/97	2	24.8190-0401.2 620401	L= 95
			➡	→ 08/97; A344661 / F331441→	1	24.8190-0401.2 620401	L= 95
			➡	→ A344660 / F331440	1	24.8190-0401.2 620401	L= 95
C 43 AMG (202.033)	225	08/97→05/00	←	09/97→	2	24.8190-0419.2 620419	L= 74
			➡	09/97→	1	24.8190-0401.2 620401	L= 95
Zubehörsatz, Scheibenbremsbelag							
C 180 (202.018)	89	11/94→05/00	➡	→ A419828 / F443892		13.0460-0186.2 610186	ATE
C 180 (202.018)	90	03/93→05/00	➡				
C 200 (202.020)	100	01/94→05/00	➡	A419829 / F443893→		13.0460-0229.2 610229	ATE
C 200 D (202.120)	55	03/93→05/00					
C 200 D (202.122)	65	10/96→05/00					
C 220 D (202.021)	55	07/96→05/00					
C 220 D (202.121)	70	08/93→05/00					
C 200 CDI (202.134)	75	03/98→05/00	➡			13.0460-0229.2 610229	ATE
C 220 CDI (202.133)	92	09/97→05/00					
C 200 Kompressor (202.025)	132	10/95→05/00	➡	A487048 / F576241→		13.0460-0229.2 610229	ATE
C 200 Kompressor (202.025)	141	11/96→05/00					
C 230 Kompressor (202.024)	142	10/95→05/00					
C 240 (202.026)	125	06/97→05/00					
C 250 Turbo-D (202.128)	110	10/95→05/00					
C 280 (202.029)	145	06/97→05/00					
C 220 (202.022)	110	03/93→05/00	➡	→ A419828 / F443892		13.0460-0186.2 610186	ATE
			➡	A419829 / F443893→; → 08/96		13.0460-0229.2 610229	ATE
C 230 (202.023)	110	06/96→06/97	➡	07/96→		13.0460-0229.2 610229	ATE
C 250 D (202.125)	83	05/93→05/00	➡	06/93→; → A419828 / F443892		13.0460-0186.2 610186	ATE
			➡	A419829 / F443893→; → 08/95		13.0460-0229.2 610229	ATE
C 280 (202.028)	142	05/93→05/00	➡	06/93→; → A344660 / F331440; - ASR / - ETS		13.0460-0186.2 610186	ATE
C 36 AMG (202.028)	206	05/94→05/00	➡	→ 08/97; A344661 / F331441→		13.0460-0236.2 610236	ATE
C 43 AMG (202.033)	225	08/97→05/00	➡	09/97→		13.0460-0236.2 610236	ATE
↓							

	kW			 	! #			
MERCEDES-BENZ - C-KLASSE (W202) 03/93→05/00								
Bremsscheibe								
C 180 (202.018)	89	11/94→05/00	←			24.0112-0128.1 412128	Ø 284 12 10 + S	
C 180 (202.018)	90	03/93→05/00	→			24.0109-0120.1 409120	Ø 258 9 7,3 + S	
C 200 D (202.120)	55	03/93→05/00				24.0309-0120.1 509120	Ø 258 9 7,3 + S PD	
C 200 D (202.122)	65	10/96→05/00						
C 220 D (202.021)	55	07/96→05/00						
C 220 D (202.121)	70	08/93→05/00						
C 200 (202.020)	100	01/94→05/00	←			24.0122-0132.1 422132	Ø 284 22 19,4 V + S	
C 200 CDI (202.134)	75	03/98→05/00	→			24.0322-0132.1 522132	Ø 284 22 19,4 V + S PD	
C 220 CDI (202.133)	92	09/97→05/00				24.0109-0120.1 409120	Ø 258 9 7,3 + S	
						24.0309-0120.1 509120	Ø 258 9 7,3 + S PD	
C 200 Kompressor (202.025)	132	10/95→05/00	←			24.0125-0110.1 425110	Ø 288 25 22,4 V + S	
C 200 Kompressor (202.025)	141	11/96→05/00	→			24.0325-0110.1 525110	Ø 288 25 22,4 V + S PD	
C 230 Kompressor (202.024)	142	10/95→05/00				24.0109-0114.1 409114	Ø 278 9 7,3 + S	
C 240 (202.026)	125	06/97→05/00				24.0309-0114.1 509114	Ø 278 9 7,3 + S PD	
C 250 Turbo-D (202.128)	110	10/95→05/00						
C 220 (202.022)	110	03/93→05/00	←	→ 08/96		24.0122-0132.1 422132	Ø 284 22 19,4 V + S	
			→	→ 08/96		24.0322-0132.1 522132	Ø 284 22 19,4 V + S PD	
			→	→ 08/96		24.0109-0120.1 409120	Ø 258 9 7,3 + S	
						24.0309-0120.1 509120	Ø 258 9 7,3 + S PD	
C 230 (202.023)	110	06/96→06/97	←	A545906 / F647651→		24.0112-0128.1 412128	Ø 284 12 10 + S	
			←	07/96→; → A545905 / F647650		24.0122-0132.1 422132	Ø 284 22 19,4 V + S	
			→	07/96→		24.0322-0132.1 522132	Ø 284 22 19,4 V + S PD	
			→	07/96→		24.0109-0120.1 409120	Ø 258 9 7,3 + S	
						24.0309-0120.1 509120	Ø 258 9 7,3 + S PD	
C 250 D (202.125)	83	05/93→05/00	←	06/93→ 08/95		24.0112-0128.1 412128	Ø 284 12 10 + S	
			→	06/93→ 08/95		24.0109-0120.1 409120	Ø 258 9 7,3 + S	
						24.0309-0120.1 509120	Ø 258 9 7,3 + S PD	
C 280 (202.028)	142	05/93→05/00	←	06/93→; → A344660 / F331440		24.0122-0132.1 422132	Ø 284 22 19,4 V + S	
			←	A344661 / F331441→		24.0322-0132.1 522132	Ø 284 22 19,4 V + S PD	
			→	A344661 / F331441→; → 05/97		24.0125-0110.1 425110	Ø 288 25 22,4 V + S	
			→	06/93→; → A344660 / F331440		24.0325-0110.1 525110	Ø 288 25 22,4 V + S PD	
			→	06/93→; → A344660 / F331440		24.0109-0114.1 409114	Ø 278 9 7,3 + S	
						24.0309-0114.1 509114	Ø 278 9 7,3 + S PD	
			→	06/93→; → A344660 / F331440		24.0109-0120.1 409120	Ø 258 9 7,3 + S	
						24.0309-0120.1 509120	Ø 258 9 7,3 + S PD	
C 280 (202.029)	145	06/97→05/00	←	→ A344660 / F331440		24.0122-0132.1 422132	Ø 284 22 19,4 V + S	
			←	A344661 / F331441→		24.0322-0132.1 522132	Ø 284 22 19,4 V + S PD	
			→			24.0125-0110.1 425110	Ø 288 25 22,4 V + S	
			→			24.0325-0110.1 525110	Ø 288 25 22,4 V + S PD	
			→			24.0109-0114.1 409114	Ø 278 9 7,3 + S	
						24.0309-0114.1 509114	Ø 278 9 7,3 + S PD	
C 36 AMG (202.028)	206	05/94→05/00	←	→ 08/97; A344661 / F331441→		24.0128-0126.1 428126	Ø 316 28 25,4 V	
			→	→ 08/97; A344661 / F331441→		24.0110-0217.1 410217	Ø 290 10 8,3 + S	
			→	→ A344660 / F331440		24.0310-0217.1 510217	Ø 290 10 8,3 + S PD	
			→	→ A344660 / F331440		24.0124-0188.1 424188	Ø 278 24 21,4 V	
C 43 AMG (202.033)	225	08/97→05/00	→	09/97→		24.0122-0228.1 422228	Ø 300 22 19,4 V	
MERCEDES-BENZ - C-KLASSE (W203) 05/00→08/07								
Bremsbelagsatz, Scheibenbremse								
C 180 (203.035)	95	10/00→05/02	←			13.0460-2726.2 602726	TRW 23144 19,8 + WE / - WK + Zub	
			→				13.0470-2726.2 LD2726	TRW 23144 19,8 + WE / - WK + Zub Ceramic
			→				13.0460-4064.2 604064	ATE 21919 15,3 - WE / - WK + Zub
						13.0470-4064.2 LD4064	ATE 21919 15,3 - WE / - WK + Zub Ceramic	
C 180 Kompressor (203.046)	105	05/02→02/07	←	für Fahrzeuge ohne Sportpaket / für Fahrzeuge ohne AMG-Sportpaket		13.0460-2726.2 602726	TRW 23144 19,8 + WE / - WK + Zub	
C 200 CDI (203.007)	90	04/03→02/07				13.0470-2726.2 LD2726	TRW 23144 19,8 + WE / - WK + Zub Ceramic	
C 200 CGI Kompressor (203.043)	125	07/03→02/07						
C 200 Kompressor (203.042)	120	05/02→02/07						
↓								







	kw			 	! #		
MERCEDES-BENZ - C-KLASSE (W203) 05/00→08/07							
 Bremsbelagsatz, Scheibenbremse							
C 180 Kompressor (203.046)	105	05/02→02/07	←	→ A 660226 / F 565688; für Fahrzeuge mit Sportpaket / für Fahrzeuge mit AMG-Sportpaket		13.0460-4990.2 604990	BRE 23271 17,4 + WE / - WK
C 200 CDI (203.007)	90	04/03→02/07				13.0470-4990.2 LD4990	BRE 23271 17,4 + WE / - WK
C 200 CGI Kompressor (203.043)	125	07/03→02/07					Ceramic
C 200 Kompressor (203.042)	120	05/02→02/07	←	A 660227 / F 565689→; für Fahrzeuge mit Sportpaket / für Fahrzeuge mit AMG-Sportpaket		13.0460-4994.2 604994	BRE 23945 16,5 + WE / - WK
						13.0470-4994.2 LD4994	BRE 23945 16,5 + WE / - WK
			→	für Fahrzeuge ohne Sportpaket / für Fahrzeuge ohne AMG-Sportpaket		13.0460-4064.2 604064	ATE 21919 15,3 - WE / - WK + Zub
						13.0470-4064.2 LD4064	ATE 21919 15,3 - WE / - WK + Zub Ceramic
			→	für Fahrzeuge mit Sportpaket / für Fahrzeuge mit AMG-Sportpaket		13.0460-4065.2 604065	ATE 21899 15,3 + WE / - WK + Zub
						13.0470-4065.2 LD4065	ATE 21899 15,3 + WE / - WK + Zub Ceramic
C 200 CDI (203.004)	75	02/01→02/07	←	für Fahrzeuge ohne Sportpaket / für Fahrzeuge ohne AMG-Sportpaket		13.0460-2726.2 602726	TRW 23144 19,8 + WE / - WK + Zub
C 200 CDI (203.004)	85	09/00→02/07					
C 220 CDI (203.006)	100	05/00→02/07				13.0470-2726.2 LD2726	TRW 23144 19,8 + WE / - WK + Zub Ceramic
C 220 CDI (203.006)	105	05/00→02/07					
			←	für Fahrzeuge mit Sportpaket / für Fahrzeuge mit AMG-Sportpaket		13.0460-4990.2 604990	BRE 23271 17,4 + WE / - WK
						13.0470-4990.2 LD4990	BRE 23271 17,4 + WE / - WK
			→	für Fahrzeuge ohne Sportpaket / für Fahrzeuge ohne AMG-Sportpaket		13.0460-4064.2 604064	ATE 21919 15,3 - WE / - WK + Zub
						13.0470-4064.2 LD4064	ATE 21919 15,3 - WE / - WK + Zub Ceramic
			→	für Fahrzeuge mit Sportpaket / für Fahrzeuge mit AMG-Sportpaket		13.0460-4065.2 604065	ATE 21899 15,3 + WE / - WK + Zub
						13.0470-4065.2 LD4065	ATE 21899 15,3 + WE / - WK + Zub Ceramic
C 200 Kompressor (203.045)	120	05/00→06/02	←	→ 05/02		13.0460-2726.2 602726	TRW 23144 19,8 + WE / - WK + Zub
						13.0470-2726.2 LD2726	TRW 23144 19,8 + WE / - WK + Zub Ceramic
			→	→ 05/02		13.0460-4064.2 604064	ATE 21919 15,3 - WE / - WK + Zub
						13.0470-4064.2 LD4064	ATE 21919 15,3 - WE / - WK + Zub Ceramic
C 220 CDI (203.008)	110	02/03→02/07	←	02/04→; für Fahrzeuge ohne Sportpaket / für Fahrzeuge ohne AMG-Sportpaket		13.0460-2726.2 602726	TRW 23144 19,8 + WE / - WK + Zub
						13.0470-2726.2 LD2726	TRW 23144 19,8 + WE / - WK + Zub Ceramic
			←	02/04→; → A 660226 / F 565688; für Fahrzeuge mit Sportpaket / für Fahrzeuge mit AMG-Sportpaket		13.0460-4990.2 604990	BRE 23271 17,4 + WE / - WK
						13.0470-4990.2 LD4990	BRE 23271 17,4 + WE / - WK
			←	A 660227 / F 565689→; für Fahrzeuge mit Sportpaket / für Fahrzeuge mit AMG-Sportpaket		13.0460-4994.2 604994	BRE 23945 16,5 + WE / - WK
						13.0470-4994.2 LD4994	BRE 23945 16,5 + WE / - WK
			→	02/04→; für Fahrzeuge ohne Sportpaket / für Fahrzeuge ohne AMG-Sportpaket		13.0460-4064.2 604064	ATE 21919 15,3 - WE / - WK + Zub
						13.0470-4064.2 LD4064	ATE 21919 15,3 - WE / - WK + Zub Ceramic
			→	02/04→; für Fahrzeuge mit Sportpaket / für Fahrzeuge mit AMG-Sportpaket		13.0460-4065.2 604065	ATE 21899 15,3 + WE / - WK + Zub
						13.0470-4065.2 LD4065	ATE 21899 15,3 + WE / - WK + Zub Ceramic
C 230 (203.052)	150	01/05→02/07	←	06/05→; für Fahrzeuge ohne Sportpaket / für Fahrzeuge ohne AMG-Sportpaket		13.0460-2727.2 602727	TRW 23144 19,8 + WE / - WK + Zub
C 280 (203.054)	170	01/05→02/07					
C 280 4-matic (203.092)	170	01/05→02/07				13.0470-2727.2 LD2727	TRW 23144 19,8 + WE / - WK + Zub Ceramic
			←	06/05→; für Fahrzeuge mit Sportpaket / für Fahrzeuge mit AMG-Sportpaket		13.0460-4994.2 604994	BRE 23945 16,5 + WE / - WK
						13.0470-4994.2 LD4994	BRE 23945 16,5 + WE / - WK
			→	06/05→		13.0460-4065.2 604065	ATE 21899 15,3 + WE / - WK + Zub
						13.0470-4065.2 LD4065	ATE 21899 15,3 + WE / - WK + Zub Ceramic
C 230 Kompressor (203.040)	141	02/04→02/07	←	für Fahrzeuge ohne Sportpaket / für Fahrzeuge ohne AMG-Sportpaket		13.0460-2727.2 602727	TRW 23144 19,8 + WE / - WK + Zub
C 240 (203.061)	125	05/00→02/07					
C 270 CDI (203.016)	120	12/00→02/07				13.0470-2727.2 LD2727	TRW 23144 19,8 + WE / - WK + Zub Ceramic









	kw			 	! #		
MERCEDES-BENZ - C-KLASSE (W203) 05/00→08/07							
 Bremsbelagsatz, Scheibenbremse							
C 270 CDI (203.016) C 320 (203.064)	125 160	12/00→02/07 05/00→02/07	←	→ A 660226 / F 565688; für Fahrzeuge mit Sportpaket / für Fahr- zeuge mit AMG-Sportpaket		13.0460-4990.2 604990	BRE 23271 17,4 + WE / - WK
			←	A 660227 / F 565689→; für Fahrzeuge mit Sportpaket / für Fahr- zeuge mit AMG-Sportpaket		13.0470-4990.2 LD4990	BRE 23271 17,4 + WE / - WK Ceramic
			→			13.0460-4994.2 604994 13.0470-4994.2 LD4994	BRE 23945 16,5 + WE / - WK Ceramic
			→			13.0460-4065.2 604065 13.0470-4065.2 LD4065	ATE 21899 15,3 + WE / - WK + Zub ATE 21899 15,3 + WE / - WK + Zub Ceramic
C 240 4-matic (203.081) C 320 4-matic (203.084)	125 160	07/02→02/07 07/02→02/07	←			13.0460-2727.2 602727 13.0470-2727.2 LD2727	TRW 23144 19,8 + WE / - WK + Zub TRW 23144 19,8 + WE / - WK + Zub Ceramic
			→			13.0460-4065.2 604065 13.0470-4065.2 LD4065	ATE 21899 15,3 + WE / - WK + Zub ATE 21899 15,3 + WE / - WK + Zub Ceramic
C 30 CDI AMG (203.018)	170	01/03→02/07	←			13.0460-4990.2 604990 13.0470-4990.2 LD4990	BRE 23271 17,4 + WE / - WK Ceramic
			→			13.0460-4047.2 604047 13.0470-4047.2 LD4047	ATE 21305 15,7 + WE / - WK Ceramic
C 320 CDI (203.020)	165	01/05→02/07	←	02/05→; für Fahrzeuge mit Sportpaket / für Fahr- zeuge mit AMG-Sportpaket		13.0460-4990.2 604990 13.0470-4990.2 LD4990	BRE 23271 17,4 + WE / - WK Ceramic
			←	02/05→; für Fahrzeuge ohne Sportpaket / für Fahrzeuge ohne AMG-Sportpaket		13.0460-4994.2 604994 13.0470-4994.2 LD4994	BRE 23945 16,5 + WE / - WK Ceramic
			→	02/05→		13.0460-4065.2 604065 13.0470-4065.2 LD4065	ATE 21899 15,3 + WE / - WK + Zub ATE 21899 15,3 + WE / - WK + Zub Ceramic
C 32 AMG Kompressor (203.065)	260	02/01→02/07	←	03/01→		13.0460-4990.2 604990	BRE 23271 17,4 + WE / - WK
			→	03/01→		13.0460-4047.2 604047 13.0470-4047.2 LD4047	ATE 21305 15,7 + WE / - WK Ceramic
C 350 (203.056)	200	01/05→02/07	←	06/05→; für Fahrzeuge mit Sportpaket / für Fahr- zeuge mit AMG-Sportpaket		13.0460-4990.2 604990 13.0470-4990.2 LD4990	BRE 23271 17,4 + WE / - WK Ceramic
			←	06/05→; für Fahrzeuge ohne Sportpaket / für Fahrzeuge ohne AMG-Sportpaket		13.0460-4994.2 604994 13.0470-4994.2 LD4994	BRE 23945 16,5 + WE / - WK Ceramic
			→	06/05→		13.0460-4065.2 604065 13.0470-4065.2 LD4065	ATE 21899 15,3 + WE / - WK + Zub ATE 21899 15,3 + WE / - WK + Zub Ceramic
C 350 4-matic (203.087)	200	01/05→02/07	←	06/05→		13.0460-4990.2 604990 13.0470-4990.2 LD4990	BRE 23271 17,4 + WE / - WK Ceramic
			→	06/05→		13.0460-4065.2 604065 13.0470-4065.2 LD4065	ATE 21899 15,3 + WE / - WK + Zub ATE 21899 15,3 + WE / - WK + Zub Ceramic
C 55 AMG (203.076)	270	02/04→02/07	←			13.0460-4990.2 604990	BRE 23271 17,4 + WE / - WK
			→			13.0460-4047.2 604047 13.0470-4047.2 LD4047	ATE 21305 15,7 + WE / - WK Ceramic
Warnkontakt, Bremsbelagverschleiß							
C 180 (203.035)	95	10/00→05/02	←		2	24.8190-0410.2 620410	L= 97,5
C 240 4-matic (203.081)	125	07/02→02/07	→		1	24.8190-0410.2 620410	L= 97,5
C 320 4-matic (203.084)	160	07/02→02/07					
C 180 Kompressor (203.046)	105	05/02→02/07	←	A 660227 / F 565689→; für Fahrzeuge mit Sportpaket / für Fahr- zeuge mit AMG-Sportpaket	2	24.8190-0410.2 620410	L= 97,5
C 200 CDI (203.007)	90	04/03→02/07					
C 200 CGI Kompressor (203.043)	125	07/03→02/07					
↓							









	kw			 	! #		
MERCEDES-BENZ - C-KLASSE (W203) 05/00→08/07							
Warnkontakt, Bremsbelagverschleiß							
C 200 Kompressor (203.042)	120	05/02→02/07	←	→ A 660226 / F 565688; für Fahrzeuge mit Sportpaket / für Fahrzeuge mit AMG-Sportpaket	2	24.8190-0410.2 620410	L= 97,5
			←	für Fahrzeuge ohne Sportpaket / für Fahrzeuge ohne AMG-Sportpaket	2	24.8190-0410.2 620410	L= 97,5
			→	für Fahrzeuge mit Sportpaket / für Fahrzeuge mit AMG-Sportpaket	1	24.8190-0410.2 620410	L= 97,5
			→	für Fahrzeuge ohne Sportpaket / für Fahrzeuge ohne AMG-Sportpaket	1	24.8190-0410.2 620410	L= 97,5
C 200 CDI (203.004) C 200 CDI (203.004) C 220 CDI (203.006) C 220 CDI (203.006)	75 85 100 105	02/01→02/07 09/00→02/07 05/00→02/07 05/00→02/07	←	für Fahrzeuge mit Sportpaket / für Fahrzeuge mit AMG-Sportpaket	2	24.8190-0410.2 620410	L= 97,5
			←	für Fahrzeuge ohne Sportpaket / für Fahrzeuge ohne AMG-Sportpaket	2	24.8190-0410.2 620410	L= 97,5
			→	für Fahrzeuge mit Sportpaket / für Fahrzeuge mit AMG-Sportpaket	1	24.8190-0410.2 620410	L= 97,5
			→	für Fahrzeuge ohne Sportpaket / für Fahrzeuge ohne AMG-Sportpaket	1	24.8190-0410.2 620410	L= 97,5
C 200 Kompressor (203.045)	120	05/00→06/02	←	→ 05/02	2	24.8190-0410.2 620410	L= 97,5
			→	→ 05/02	1	24.8190-0410.2 620410	L= 97,5
C 220 CDI (203.008)	110	02/03→02/07	←	02/04→; → A 660226 / F 565688; für Fahrzeuge mit Sportpaket / für Fahrzeuge mit AMG-Sportpaket	2	24.8190-0410.2 620410	L= 97,5
			←	A 660227 / F 565689→; für Fahrzeuge mit Sportpaket / für Fahrzeuge mit AMG-Sportpaket	2	24.8190-0410.2 620410	L= 97,5
			←	02/04→; für Fahrzeuge ohne Sportpaket / für Fahrzeuge ohne AMG-Sportpaket	2	24.8190-0410.2 620410	L= 97,5
			→	02/04→; für Fahrzeuge mit Sportpaket / für Fahrzeuge mit AMG-Sportpaket	1	24.8190-0410.2 620410	L= 97,5
			→	02/04→; für Fahrzeuge ohne Sportpaket / für Fahrzeuge ohne AMG-Sportpaket	1	24.8190-0410.2 620410	L= 97,5
C 230 (203.052) C 280 (203.054) C 280 4-matic (203.092) C 350 (203.056)	150 170 170 200	01/05→02/07 01/05→02/07 01/05→02/07 01/05→02/07	←	06/05→; für Fahrzeuge mit Sportpaket / für Fahrzeuge mit AMG-Sportpaket	2	24.8190-0410.2 620410	L= 97,5
			←	06/05→; für Fahrzeuge ohne Sportpaket / für Fahrzeuge ohne AMG-Sportpaket	2	24.8190-0410.2 620410	L= 97,5
			→	06/05→	1	24.8190-0410.2 620410	L= 97,5
C 230 Kompressor (203.040) C 240 (203.061) C 270 CDI (203.016) C 270 CDI (203.016) C 320 (203.064)	141 125 120 125 160	02/04→02/07 05/00→02/07 12/00→02/07 12/00→02/07 05/00→02/07	←	A 660227 / F 565689→; für Fahrzeuge mit Sportpaket / für Fahrzeuge mit AMG-Sportpaket	2	24.8190-0410.2 620410	L= 97,5
			←	für Fahrzeuge ohne Sportpaket / für Fahrzeuge ohne AMG-Sportpaket	2	24.8190-0410.2 620410	L= 97,5
			←	→ A 660226 / F 565688; für Fahrzeuge mit Sportpaket / für Fahrzeuge mit AMG-Sportpaket	2	24.8190-0410.2 620410	L= 97,5
			→		1	24.8190-0410.2 620410	L= 97,5
C 30 CDI AMG (203.018) C 55 AMG (203.076)	170 270	01/03→02/07 02/04→02/07	←		2	24.8190-0410.2 620410	L= 97,5
			→		2	24.8190-0410.2 620410	L= 97,5
C 320 CDI (203.020)	165	01/05→02/07	←	02/05→; für Fahrzeuge mit Sportpaket / für Fahrzeuge mit AMG-Sportpaket	2	24.8190-0410.2 620410	L= 97,5
			←	02/05→; für Fahrzeuge ohne Sportpaket / für Fahrzeuge ohne AMG-Sportpaket	2	24.8190-0410.2 620410	L= 97,5
			→	02/05→	1	24.8190-0410.2 620410	L= 97,5
C 32 AMG Kompressor (203.065)	260	02/01→02/07	←	03/01→	2	24.8190-0410.2 620410	L= 97,5
			→	03/01→	2	24.8190-0410.2 620410	L= 97,5
C 350 4-matic (203.087)	200	01/05→02/07	←	06/05→	2	24.8190-0410.2 620410	L= 97,5
			→	06/05→	1	24.8190-0410.2 620410	L= 97,5
Zubehörsatz, Scheibenbremsbelag							
C 180 (203.035)	95	10/00→05/02	→			13.0460-0229.2 610229	ATE
C 180 Kompressor (203.046) C 200 CDI (203.007)	105 90	05/02→02/07 04/03→02/07	←	→ A 660226 / F 565688; für Fahrzeuge mit Sportpaket / für Fahrzeuge mit AMG-Sportpaket		13.0460-0275.2 610275	
			→	für Fahrzeuge ohne Sportpaket / für Fahrzeuge ohne AMG-Sportpaket		13.0460-0229.2 610229	ATE
C 200 CGI Kompressor (203.043)	125	07/03→02/07	→				
↓							









	kW			 	! #		
MERCEDES-BENZ - C-KLASSE (W203) 05/00→08/07							
Zubehörsatz, Scheibenbremsbelag							
C 200 Kompressor (203.042)	120	05/02→02/07	➔	für Fahrzeuge mit Sportpaket / für Fahrzeuge mit AMG-Sportpaket		13.0460-0231.2 610231	ATE
C 200 CDI (203.004)	75	02/01→02/07	➔	für Fahrzeuge mit Sportpaket / für Fahrzeuge mit AMG-Sportpaket		13.0460-0275.2 610275	
C 200 CDI (203.004)	85	09/00→02/07	➔	für Fahrzeuge mit AMG-Sportpaket			
C 220 CDI (203.006)	100	05/00→02/07	➔	für Fahrzeuge ohne Sportpaket / für Fahrzeuge ohne AMG-Sportpaket		13.0460-0229.2 610229	ATE
C 220 CDI (203.006)	105	05/00→02/07	➔	für Fahrzeuge mit Sportpaket / für Fahrzeuge mit AMG-Sportpaket		13.0460-0231.2 610231	ATE
C 200 Kompressor (203.045)	120	05/00→06/02	➔	→ 05/02		13.0460-0229.2 610229	ATE
C 220 CDI (203.008)	110	02/03→02/07	➔	02/04→; → A 660226 / F 565688; für Fahrzeuge mit Sportpaket / für Fahrzeuge mit AMG-Sportpaket		13.0460-0275.2 610275	
			➔	02/04→; für Fahrzeuge ohne Sportpaket / für Fahrzeuge ohne AMG-Sportpaket		13.0460-0229.2 610229	ATE
			➔	02/04→; für Fahrzeuge mit Sportpaket / für Fahrzeuge mit AMG-Sportpaket		13.0460-0231.2 610231	ATE
C 230 (203.052)	150	01/05→02/07	➔	06/05→		13.0460-0231.2 610231	ATE
C 280 (203.054)	170	01/05→02/07	➔				
C 280 4-matic (203.092)	170	01/05→02/07	➔				
C 230 Kompressor (203.040)	141	02/04→02/07	➔	→ A 660226 / F 565688; für Fahrzeuge mit Sportpaket / für Fahrzeuge mit AMG-Sportpaket		13.0460-0275.2 610275	
C 240 (203.061)	125	05/00→02/07	➔				
C 270 CDI (203.016)	120	12/00→02/07	➔			13.0460-0231.2 610231	ATE
C 270 CDI (203.016)	125	12/00→02/07	➔				
C 320 (203.064)	160	05/00→02/07	➔				
C 240 4-matic (203.081)	125	07/02→02/07	➔			13.0460-0231.2 610231	ATE
C 320 4-matic (203.084)	160	07/02→02/07	➔				
C 30 CDI AMG (203.018)	170	01/03→02/07	➔			13.0460-0237.2 610237	BRE
C 55 AMG (203.076)	270	02/04→02/07	➔			13.0460-0269.2 610269	
			➔			13.0460-0236.2 610236	ATE
C 320 CDI (203.020)	165	01/05→02/07	➔	02/05→; für Fahrzeuge mit Sportpaket / für Fahrzeuge mit AMG-Sportpaket		13.0460-0237.2 610237	BRE
			➔			13.0460-0269.2 610269	
			➔			13.0460-0231.2 610231	ATE
C 32 AMG Kompressor (203.065)	260	02/01→02/07	➔	03/01→		13.0460-0237.2 610237	BRE
			➔			13.0460-0269.2 610269	
			➔			13.0460-0236.2 610236	ATE
C 350 (203.056)	200	01/05→02/07	➔	06/05→; für Fahrzeuge mit Sportpaket / für Fahrzeuge mit AMG-Sportpaket		13.0460-0237.2 610237	BRE
			➔			13.0460-0269.2 610269	
			➔			13.0460-0231.2 610231	ATE
C 350 4-matic (203.087)	200	01/05→02/07	➔	06/05→		13.0460-0237.2 610237	BRE
			➔			13.0460-0269.2 610269	
			➔			13.0460-0231.2 610231	ATE
Bremsscheibe							
C 180 (203.035)	95	10/00→05/02	➔			24.0125-0110.1 425110	Ø 288 25 22,4 V + S
			➔			24.0325-0110.1 525110	Ø 288 25 22,4 V + S PD
			➔			24.0109-0114.1 409114	Ø 278 9 7,3 + S
			➔			24.0309-0114.1 509114	Ø 278 9 7,3 + S PD
C 180 Kompressor (203.046)	105	05/02→02/07	➔	für Fahrzeuge ohne Sportpaket / für Fahrzeuge ohne AMG-Sportpaket		24.0125-0110.1 425110	Ø 288 25 22,4 V + S
C 200 CDI (203.004)	75	02/01→02/07	➔			24.0325-0110.1 525110	Ø 288 25 22,4 V + S PD
C 200 CDI (203.004)	85	09/00→02/07	➔	für Fahrzeuge mit Sportpaket / für Fahrzeuge mit AMG-Sportpaket		24.0128-0177.1 428177	Ø 330 28 26 V*
C 200 CDI (203.007)	90	04/03→02/07	➔				
C 200 CGI Kompressor (203.043)	125	07/03→02/07	➔	für Fahrzeuge ohne Sportpaket / für Fahrzeuge ohne AMG-Sportpaket		24.0109-0114.1 409114	Ø 278 9 7,3 + S
			➔			24.0309-0114.1 509114	Ø 278 9 7,3 + S PD
C 200 Kompressor (203.042)	120	05/02→02/07	➔	für Fahrzeuge mit Sportpaket / für Fahrzeuge mit AMG-Sportpaket		24.0110-0217.1 410217	Ø 290 10 8,3 + S
C 220 CDI (203.006)	100	05/00→02/07	➔			24.0310-0217.1 510217	Ø 290 10 8,3 + S PD
C 220 CDI (203.006)	105	05/00→02/07	➔				
C 200 Kompressor (203.045)	120	05/00→06/02	➔	→ 05/02		24.0125-0110.1 425110	Ø 288 25 22,4 V + S
			➔			24.0325-0110.1 525110	Ø 288 25 22,4 V + S PD
			➔	→ 05/02		24.0109-0114.1 409114	Ø 278 9 7,3 + S
			➔			24.0309-0114.1 509114	Ø 278 9 7,3 + S PD
C 220 CDI (203.008)	110	02/03→02/07	➔	02/04→; für Fahrzeuge ohne Sportpaket / für Fahrzeuge ohne AMG-Sportpaket		24.0125-0110.1 425110	Ø 288 25 22,4 V + S
			➔			24.0325-0110.1 525110	Ø 288 25 22,4 V + S PD
↓							











	kw			 	! #		
MERCEDES-BENZ - C-KLASSE (W203) 05/00→08/07							
Bremsscheibe							
C 220 CDI (203.008)	110	02/03→02/07	←	02/04→; für Fahrzeuge mit Sportpaket / für Fahrzeuge mit AMG-Sportpaket	24.0128-0177.1	428177	Ø 330 28 26 V•
			→	02/04→; für Fahrzeuge ohne Sportpaket / für Fahrzeuge ohne AMG-Sportpaket	24.0109-0114.1 24.0309-0114.1	409114 509114	Ø 278 9 7,3 + S Ø 278 9 7,3 + S PD
			→	02/04→; für Fahrzeuge mit Sportpaket / für Fahrzeuge mit AMG-Sportpaket	24.0110-0217.1 24.0310-0217.1	410217 510217	Ø 290 10 8,3 + S Ø 290 10 8,3 + S PD
C 230 (203.052)	150	01/05→02/07	←	06/05→; für Fahrzeuge ohne Sportpaket / für Fahrzeuge ohne AMG-Sportpaket	24.0128-0106.1 24.0328-0106.1	428106 528106	Ø 300 28 25,4 V + S Ø 300 28 25,4 V + S PD
			←	06/05→; für Fahrzeuge mit Sportpaket / für Fahrzeuge mit AMG-Sportpaket	24.0128-0177.1	428177	Ø 330 28 26 V•
			→	06/05→; für Fahrzeuge ohne Sportpaket / für Fahrzeuge ohne AMG-Sportpaket	24.0109-0114.1 24.0309-0114.1	409114 509114	Ø 278 9 7,3 + S Ø 278 9 7,3 + S PD
			→	06/05→; für Fahrzeuge mit Sportpaket / für Fahrzeuge mit AMG-Sportpaket	24.0110-0217.1 24.0310-0217.1	410217 510217	Ø 290 10 8,3 + S Ø 290 10 8,3 + S PD
C 230 Kompressor (203.040) C 240 (203.061) C 270 CDI (203.016) C 270 CDI (203.016) C 320 (203.064)	141	02/04→02/07	←	für Fahrzeuge ohne Sportpaket / für Fahrzeuge ohne AMG-Sportpaket	24.0128-0106.1 24.0328-0106.1	428106 528106	Ø 300 28 25,4 V + S Ø 300 28 25,4 V + S PD
	125	05/00→02/07	←	für Fahrzeuge mit Sportpaket / für Fahrzeuge mit AMG-Sportpaket	24.0128-0177.1	428177	Ø 330 28 26 V•
	120	12/00→02/07	→		24.0110-0217.1 24.0310-0217.1	410217 510217	Ø 290 10 8,3 + S Ø 290 10 8,3 + S PD
	125	12/00→02/07	→		24.0110-0217.1 24.0310-0217.1	410217 510217	Ø 290 10 8,3 + S Ø 290 10 8,3 + S PD
C 240 4-matic (203.081) C 320 4-matic (203.084)	125	07/02→02/07	←		24.0128-0106.1 24.0328-0106.1	428106 528106	Ø 300 28 25,4 V + S Ø 300 28 25,4 V + S PD
	160	07/02→02/07	→		24.0110-0217.1 24.0310-0217.1	410217 510217	Ø 290 10 8,3 + S Ø 290 10 8,3 + S PD
C 280 (203.054) C 280 4-matic (203.092)	170	01/05→02/07	←	06/05→; für Fahrzeuge ohne Sportpaket / für Fahrzeuge ohne AMG-Sportpaket	24.0128-0106.1 24.0328-0106.1	428106 528106	Ø 300 28 25,4 V + S Ø 300 28 25,4 V + S PD
			←	06/05→; für Fahrzeuge mit Sportpaket / für Fahrzeuge mit AMG-Sportpaket	24.0128-0177.1	428177	Ø 330 28 26 V•
			→	06/05→	24.0110-0217.1 24.0310-0217.1	410217 510217	Ø 290 10 8,3 + S Ø 290 10 8,3 + S PD
C 30 CDI AMG (203.018) C 55 AMG (203.076)	170	01/03→02/07	←		24.0130-0180.1	430180	Ø 345 30 28 V•
	270	02/04→02/07	→		24.0122-0228.1	422228	Ø 300 22 19,4 V
C 320 CDI (203.020)	165	01/05→02/07	←	02/05→; für Fahrzeuge ohne Sportpaket / für Fahrzeuge ohne AMG-Sportpaket	24.0128-0188.1	428188	Ø 330 28 26 V + S
			←	02/05→; für Fahrzeuge mit Sportpaket / für Fahrzeuge mit AMG-Sportpaket	24.0130-0180.1	430180	Ø 345 30 28 V•
			→	02/05→	24.0110-0217.1 24.0310-0217.1	410217 510217	Ø 290 10 8,3 + S Ø 290 10 8,3 + S PD
C 32 AMG Kompressor (203.065)	260	02/01→02/07	←	03/01→	24.0130-0180.1	430180	Ø 345 30 28 V•
			→	03/01→	24.0122-0228.1	422228	Ø 300 22 19,4 V
C 350 (203.056)	200	01/05→02/07	←	06/05→; für Fahrzeuge ohne Sportpaket / für Fahrzeuge ohne AMG-Sportpaket	24.0128-0188.1	428188	Ø 330 28 26 V + S
			←	06/05→; für Fahrzeuge mit Sportpaket / für Fahrzeuge mit AMG-Sportpaket	24.0130-0180.1	430180	Ø 345 30 28 V•
			→	06/05→	24.0110-0217.1 24.0310-0217.1	410217 510217	Ø 290 10 8,3 + S Ø 290 10 8,3 + S PD
C 350 4-matic (203.087)	200	01/05→02/07	←	06/05→; für Fahrzeuge ohne Sportpaket / für Fahrzeuge ohne AMG-Sportpaket	24.0130-0171.1	430171	Ø 345 30 27,4 V
			←	06/05→; für Fahrzeuge mit Sportpaket / für Fahrzeuge mit AMG-Sportpaket	24.0130-0180.1	430180	Ø 345 30 28 V•
			→	06/05→	24.0110-0217.1 24.0310-0217.1	410217 510217	Ø 290 10 8,3 + S Ø 290 10 8,3 + S PD







	kw			 	! #		
MERCEDES-BENZ - C-KLASSE (W204) 01/07→01/14							
 Bremsbelagsatz, Scheibenbremse							
C 180 CDI (204.000) C 180 Kompressor (204.044, 204.045) C 200 CDI (204.001)	88 115 100	01/11→01/14 01/08→01/14 01/11→01/14	← ← ← →	für Fahrzeuge mit Sportpaket / für Fahrzeuge mit AMG-Sportpaket; - USA für Fahrzeuge ohne Sportpaket / für Fahrzeuge ohne AMG-Sportpaket für Fahrzeuge mit Sportpaket / für Fahrzeuge mit AMG-Sportpaket	13.0460-2732.2 13.0470-2732.2	602732 LD2732 LD2732 LD2732	TRW 24306 20,3 + WE / - WK + Zub TRW 24306 20,3 + WE / - WK + Zub Ceramic TRW 24306 20,3 + WE / - WK + Zub TRW 24306 20,3 + WE / - WK + Zub Ceramic ATE 24253 17,8 + WE / - WK ATE 24253 17,8 + WE / - WK Ceramic
C 180 CGI (204.031) C 180 CGI (204.049)	115 115	01/08→01/14 01/07→01/14	← ← ← →	04/09→; für Fahrzeuge mit Sportpaket / für Fahrzeuge mit AMG-Sportpaket; - USA 04/09→; für Fahrzeuge ohne Sportpaket / für Fahrzeuge ohne AMG-Sportpaket 04/09→; für Fahrzeuge mit Sportpaket / für Fahrzeuge mit AMG-Sportpaket 04/09→	13.0460-2732.2 13.0470-2732.2 13.0460-2733.2 13.0470-2733.2 13.0470-9000.2	602732 LD2732 602733 LD2733 LD9000	TRW 24306 20,3 + WE / - WK + Zub TRW 24306 20,3 + WE / - WK + Zub Ceramic TRW 24306 20,3 + WE / - WK + Zub TRW 24306 20,3 + WE / - WK + Zub Ceramic TRW 24306 20,3 + WE / - WK + Zub Ceramic
C 180 Kompressor (204.046) C 200 CDI (204.007, 204.006)	115 100	01/07→01/14 01/07→12/10	← ← ← →	03/07→; für Fahrzeuge mit Sportpaket / für Fahrzeuge mit AMG-Sportpaket; - USA 03/07→; für Fahrzeuge ohne Sportpaket / für Fahrzeuge ohne AMG-Sportpaket 03/07→; für Fahrzeuge mit Sportpaket / für Fahrzeuge mit AMG-Sportpaket 03/07→	13.0460-2732.2 13.0470-2732.2 13.0460-2733.2 13.0470-2733.2 13.0470-9000.2	602732 LD2732 602733 LD2733 LD9000	TRW 24306 20,3 + WE / - WK + Zub TRW 24306 20,3 + WE / - WK + Zub Ceramic TRW 24306 20,3 + WE / - WK + Zub TRW 24306 20,3 + WE / - WK + Zub Ceramic ATE 24253 17,8 + WE / - WK ATE 24253 17,8 + WE / - WK Ceramic
C 200 (204.048) C 220 CDI (204.002) C 220 CDI (204.002) C 220 CDI 4-matic (204.084) C 230 4-matic (204.085) C 250 CGI (204.047)	137 120 125 125 150 150	05/11→01/14 10/08→01/14 12/08→01/14 02/13→01/14 07/07→01/14 07/09→01/14	← ← ← →	- USA	13.0460-2732.2 13.0470-2732.2	602732 LD2732	TRW 24306 20,3 + WE / - WK + Zub TRW 24306 20,3 + WE / - WK + Zub Ceramic
C 200 CGI (204.048)	135	01/07→01/14	← ← →	04/09→; - USA 04/09→ 04/09→	13.0460-2732.2 13.0470-2732.2 13.0470-9000.2	602732 LD2732 LD9000	TRW 24306 20,3 + WE / - WK + Zub TRW 24306 20,3 + WE / - WK + Zub Ceramic TRW 24306 20,3 + WE / - WK + Zub Ceramic
C 200 Kompressor (204.041) C 220 CDI (204.008) C 220 CDI (204.008) C 230 (204.052)	135 120 125 150	01/07→01/14 01/07→11/08 01/07→11/08 01/07→01/14	← ← →	03/07→; - USA 03/07→ 03/07→	13.0460-2732.2 13.0470-2732.2 13.0470-9000.2	602732 LD2732 LD9000	TRW 24306 20,3 + WE / - WK + Zub TRW 24306 20,3 + WE / - WK + Zub Ceramic TRW 24306 20,3 + WE / - WK + Zub Ceramic
C 250 CDI (204.003)	150	08/08→01/14	←	- USA	13.0460-2732.2	602732	TRW 24306 20,3 + WE / - WK + Zub

	kw			 	! #			
MERCEDES-BENZ - C-KLASSE (W204) 01/07→01/14								
 Bremsbelagsatz, Scheibenbremse								
C 250 CDI (204.003)	150	08/08→01/14	←	- USA		13.0470-2732.2	LD2732	TRW 24306 20,3 + WE / - WK + Zub Ceramic
			←			13.0470-9000.2	LD9000	TRW 24306 20,3 + WE / - WK + Zub Ceramic
			→	ALU		13.0460-7244.2	607244	ATE 24253 17,8 + WE / - WK
			→	GG		13.0470-7244.2	LD7244	ATE 24253 17,8 + WE / - WK Ceramic
C 250 CDI 4-matic (204.082)	150	01/11→01/14	←	für Fahrzeuge ohne Sportpaket / für Fahrzeuge ohne AMG-Sportpaket; - USA		13.0460-2732.2	602732	TRW 24306 20,3 + WE / - WK + Zub
			←			13.0470-2732.2	LD2732	TRW 24306 20,3 + WE / - WK + Zub Ceramic
			→			13.0460-7244.2	607244	ATE 24253 17,8 + WE / - WK
			→			13.0470-7244.2	LD7244	ATE 24253 17,8 + WE / - WK Ceramic
C 280 4-matic (204.081)	170	07/07→01/14	←	für Fahrzeuge mit Sportpaket / für Fahrzeuge mit AMG-Sportpaket		13.0460-2734.2	602734	TRW 24310 19,0 + WE / - WK
			←			13.0470-2734.2	LD2734	TRW 24310 19,0 + WE / - WK Ceramic
			←	für Fahrzeuge ohne Sportpaket / für Fahrzeuge ohne AMG-Sportpaket		13.0470-9000.2	LD9000	TRW 24306 20,3 + WE / - WK + Zub Ceramic
			→			13.0460-7244.2	607244	ATE 24253 17,8 + WE / - WK
C 300 (204.054)	170	07/09→01/14	→			13.0470-7244.2	LD7244	ATE 24253 17,8 + WE / - WK Ceramic
			→			13.0470-7244.2	LD7244	ATE 24253 17,8 + WE / - WK Ceramic
			←			13.0460-2732.2	602732	TRW 24306 20,3 + WE / - WK + Zub
			←			13.0470-2732.2	LD2732	TRW 24306 20,3 + WE / - WK + Zub Ceramic
C 280 (204.054)	170	01/07→01/14	←	03/07→; für Fahrzeuge ohne Sportpaket / für Fahrzeuge ohne AMG-Sportpaket; - USA		13.0460-2732.2	602732	TRW 24306 20,3 + WE / - WK + Zub
			←			13.0470-2732.2	LD2732	TRW 24306 20,3 + WE / - WK + Zub Ceramic
			←	03/07→; für Fahrzeuge mit Sportpaket / für Fahrzeuge mit AMG-Sportpaket		13.0460-2734.2	602734	TRW 24310 19,0 + WE / - WK
			←			13.0470-2734.2	LD2734	TRW 24310 19,0 + WE / - WK Ceramic
C 300 (204.055)	185	02/11→01/14	←			13.0470-9000.2	LD9000	TRW 24306 20,3 + WE / - WK + Zub Ceramic
			←			13.0460-2734.2	602734	TRW 24310 19,0 + WE / - WK
			←			13.0470-2734.2	LD2734	TRW 24310 19,0 + WE / - WK Ceramic
			→			13.0460-7244.2	607244	ATE 24253 17,8 + WE / - WK
C 300 4-matic (204.080)	185	02/11→01/14	→			13.0470-7244.2	LD7244	ATE 24253 17,8 + WE / - WK Ceramic
			→			13.0470-7244.2	LD7244	ATE 24253 17,8 + WE / - WK Ceramic
			←			13.0460-2732.2	602732	TRW 24306 20,3 + WE / - WK + Zub
			←			13.0470-2732.2	LD2732	TRW 24306 20,3 + WE / - WK + Zub Ceramic
C 350 (204.057)	225	01/11→01/14	←			13.0460-2734.2	602734	TRW 24310 19,0 + WE / - WK
			←			13.0470-2734.2	LD2734	TRW 24310 19,0 + WE / - WK Ceramic
			→			13.0460-7244.2	607244	ATE 24253 17,8 + WE / - WK
			→			13.0470-7244.2	LD7244	ATE 24253 17,8 + WE / - WK Ceramic
C 350 4-matic (204.088)	225	01/11→01/14	→			13.0470-7244.2	LD7244	ATE 24253 17,8 + WE / - WK Ceramic
			→			13.0470-7244.2	LD7244	ATE 24253 17,8 + WE / - WK Ceramic
			←			13.0460-2732.2	602732	TRW 24306 20,3 + WE / - WK + Zub
			←			13.0470-2732.2	LD2732	TRW 24306 20,3 + WE / - WK + Zub Ceramic
C 300 4-matic (204.081)	170	07/07→01/14	←	04/09→; für Fahrzeuge ohne Sportpaket / für Fahrzeuge ohne AMG-Sportpaket; - USA		13.0460-2732.2	602732	TRW 24306 20,3 + WE / - WK + Zub
			←			13.0470-2732.2	LD2732	TRW 24306 20,3 + WE / - WK + Zub Ceramic
			←	04/09→; für Fahrzeuge mit Sportpaket / für Fahrzeuge mit AMG-Sportpaket		13.0460-2734.2	602734	TRW 24310 19,0 + WE / - WK
			←			13.0470-2734.2	LD2734	TRW 24310 19,0 + WE / - WK Ceramic
C 300 CDI 4-matic (204.092)	170	01/11→01/14	←			13.0470-9000.2	LD9000	TRW 24306 20,3 + WE / - WK + Zub Ceramic
			←			13.0460-2734.2	602734	TRW 24310 19,0 + WE / - WK
			←			13.0470-2734.2	LD2734	TRW 24310 19,0 + WE / - WK Ceramic
			→			13.0460-7244.2	607244	ATE 24253 17,8 + WE / - WK
C 320 CDI 4-matic (204.089)	165	07/07→01/14	→			13.0470-7244.2	LD7244	ATE 24253 17,8 + WE / - WK Ceramic
			→			13.0470-7244.2	LD7244	ATE 24253 17,8 + WE / - WK Ceramic
			→	ALU		13.0460-7244.2	607244	ATE 24253 17,8 + WE / - WK
			→			13.0470-7244.2	LD7244	ATE 24253 17,8 + WE / - WK Ceramic
C 350 CDI (204.022)	165	07/09→01/14	→			13.0460-7257.2	607257	ATE 24253 18,0 + WE / - WK
			→			13.0470-7257.2	LD7257	ATE 24253 18,0 + WE / - WK Ceramic
			→	GG		13.0460-7257.2	607257	ATE 24253 18,0 + WE / - WK
			→			13.0470-7257.2	LD7257	ATE 24253 18,0 + WE / - WK Ceramic
C 350 CDI (204.023)	195	06/11→01/14	→			13.0460-7257.2	607257	ATE 24253 18,0 + WE / - WK
			→			13.0470-7257.2	LD7257	ATE 24253 18,0 + WE / - WK Ceramic
			→	GG		13.0460-7257.2	607257	ATE 24253 18,0 + WE / - WK
			→			13.0470-7257.2	LD7257	ATE 24253 18,0 + WE / - WK Ceramic
C 350 CDI (204.025)	170	10/09→01/14	→			13.0460-7257.2	607257	ATE 24253 18,0 + WE / - WK
			→			13.0470-7257.2	LD7257	ATE 24253 18,0 + WE / - WK Ceramic
			→	GG		13.0460-7257.2	607257	ATE 24253 18,0 + WE / - WK
			→			13.0470-7257.2	LD7257	ATE 24253 18,0 + WE / - WK Ceramic
C 350 CDI 4-matic (204.089)	165	07/09→01/14	→			13.0460-7257.2	607257	ATE 24253 18,0 + WE / - WK
			→			13.0470-7257.2	LD7257	ATE 24253 18,0 + WE / - WK Ceramic
			→	GG		13.0460-7257.2	607257	ATE 24253 18,0 + WE / - WK
			→			13.0470-7257.2	LD7257	ATE 24253 18,0 + WE / - WK Ceramic
C 350 CDI 4-matic (204.092)	170	10/09→01/14	→			13.0460-7257.2	607257	ATE 24253 18,0 + WE / - WK
			→			13.0470-7257.2	LD7257	ATE 24253 18,0 + WE / - WK Ceramic
			→	GG		13.0460-7257.2	607257	ATE 24253 18,0 + WE / - WK
			→			13.0470-7257.2	LD7257	ATE 24253 18,0 + WE / - WK Ceramic
C 350 CGI (204.065)	215	09/08→01/14	→			13.0460-7257.2	607257	ATE 24253 18,0 + WE / - WK
			→			13.0470-7257.2	LD7257	ATE 24253 18,0 + WE / - WK Ceramic
			→	GG		13.0460-7257.2	607257	ATE 24253 18,0 + WE / - WK
			→			13.0470-7257.2	LD7257	ATE 24253 18,0 + WE / - WK Ceramic
C 320 CDI (204.022)	165	01/07→01/14	←	03/07→		13.0460-2734.2	602734	TRW 24310 19,0 + WE / - WK
			←			13.0470-2734.2	LD2734	TRW 24310 19,0 + WE / - WK Ceramic
			→			13.0460-7244.2	607244	ATE 24253 17,8 + WE / - WK
			→	03/07→; ALU		13.0460-7244.2	607244	ATE 24253 17,8 + WE / - WK
C 350 (204.056)	200	01/07→01/14	←			13.0460-2734.2	602734	TRW 24310 19,0 + WE / - WK
			←			13.0470-2734.2	LD2734	TRW 24310 19,0 + WE / - WK Ceramic
			→			13.0460-7244.2	607244	ATE 24253 17,8 + WE / - WK
			→	03/07→; ALU		13.0460-7244.2	607244	ATE 24253 17,8 + WE / - WK









	kw			 	! #		
MERCEDES-BENZ - C-KLASSE (W204) 01/07→01/14							
 Bremsbelagsatz, Scheibenbremse							
C 320 CDI (204.022) C 350 (204.056)	165 200	01/07→01/14 01/07→01/14	➡	03/07→; ALU		13.0470-7244.2 LD7244	ATE 24253 17,8 + WE / - WK Ceramic
			➡	03/07→; GG		13.0460-7257.2 607257 13.0470-7257.2 LD7257	ATE 24253 18,0 + WE / - WK ATE 24253 18,0 + WE / - WK Ceramic
C 350 4-matic (204.087)	200	07/07→01/14	⬅			13.0460-2734.2 602734 13.0470-2734.2 LD2734	TRW 24310 19,0 + WE / - WK TRW 24310 19,0 + WE / - WK Ceramic
			➡			13.0460-7244.2 607244 13.0470-7244.2 LD7244	ATE 24253 17,8 + WE / - WK ATE 24253 17,8 + WE / - WK Ceramic
			➡	ALU		13.0460-7244.2 607244 13.0470-7244.2 LD7244	ATE 24253 17,8 + WE / - WK ATE 24253 17,8 + WE / - WK Ceramic
			➡	GG		13.0460-7257.2 607257 13.0470-7257.2 LD7257	ATE 24253 18,0 + WE / - WK ATE 24253 18,0 + WE / - WK Ceramic
C 63 AMG C 63 AMG (204.077) C 63 AMG (204.077) C 63 AMG (204.077)	382 336 358 373	07/10→01/14 02/08→01/14 02/08→01/14 02/08→01/14	⬅	nicht für Bremssattelfarbe: rot		13.0460-4839.2 604839	BRE 24455 16,8 + WE / - WK
Warnkontakt, Bremsbelagverschleiß							
C 180 CDI (204.000) C 180 Kompressor (204.044, 204.045) C 200 CDI (204.001) C 250 CDI 4-matic (204.082) C 280 4-matic (204.081) C 300 (204.054)	88 115 100 150 170 170	01/11→01/14 01/08→01/14 01/11→01/14 01/11→01/14 07/07→01/14 07/09→01/14	⬅	für Fahrzeuge mit Sportpaket / für Fahr- zeuge mit AMG-Sportpaket	1	24.8190-0410.2 620410	L= 97,5
			⬅	für Fahrzeuge ohne Sportpaket / für Fahrzeuge ohne AMG-Sportpaket	1	24.8190-0410.2 620410	L= 97,5
			➡		1	24.8190-0410.2 620410	L= 97,5
			⬅	04/09→; für Fahrzeuge mit Sportpaket / für Fahr- zeuge mit AMG-Sportpaket	1	24.8190-0410.2 620410	L= 97,5
			⬅	04/09→; für Fahrzeuge ohne Sportpaket / für Fahrzeuge ohne AMG-Sportpaket	1	24.8190-0410.2 620410	L= 97,5
			➡	04/09→	1	24.8190-0410.2 620410	L= 97,5
C 180 Kompressor (204.046) C 200 CDI (204.007, 204.006) C 280 (204.054)	115 100 170	01/07→01/14 01/07→12/10 01/07→01/14	⬅	03/07→; für Fahrzeuge ohne Sportpaket / für Fahrzeuge ohne AMG-Sportpaket	1	24.8190-0410.2 620410	L= 97,5
			⬅	03/07→; für Fahrzeuge mit Sportpaket / für Fahr- zeuge mit AMG-Sportpaket	1	24.8190-0410.2 620410	L= 97,5
			➡	03/07→	1	24.8190-0410.2 620410	L= 97,5
C 200 (204.048) C 220 CDI (204.002) C 220 CDI (204.002) C 220 CDI 4-matic (204.084) C 230 4-matic (204.085) C 250 CDI (204.003) C 250 CGI (204.047) C 300 (204.055) C 300 4-matic (204.080) C 300 CDI 4-matic (204.092) C 320 CDI 4-matic (204.089) C 350 (204.057) C 350 4-matic (204.087) C 350 4-matic (204.088) C 350 CDI (204.022) C 350 CDI (204.023) C 350 CDI (204.025) C 350 CDI 4-matic (204.089) C 350 CDI 4-matic (204.092) C 350 CGI (204.065)	137 120 125 125 150 150 150 185 185 170 165 225 200 225 165 195 170 165 170 215	05/11→01/14 10/08→01/14 12/08→01/14 02/13→01/14 07/07→01/14 08/08→01/14 07/09→01/14 02/11→01/14 02/11→01/14 01/11→01/14 07/07→01/14 01/11→01/14 07/07→01/14 01/11→01/14 07/09→01/14 06/11→01/14 10/09→01/14 07/09→01/14 10/09→01/14 09/08→01/14	⬅		1	24.8190-0410.2 620410	L= 97,5
			➡		1	24.8190-0410.2 620410	L= 97,5
			⬅	04/09→	1	24.8190-0410.2 620410	L= 97,5
			➡	04/09→	1	24.8190-0410.2 620410	L= 97,5
C 200 Kompressor (204.041) C 220 CDI (204.008) C 220 CDI (204.008)	135 120 125	01/07→01/14 01/07→11/08 01/07→11/08	⬅	03/07→	1	24.8190-0410.2 620410	L= 97,5
			➡	03/07→	1	24.8190-0410.2 620410	L= 97,5







	kw			 	! #		
MERCEDES-BENZ - C-KLASSE (W204) 01/07→01/14							
Warnkontakt, Bremsbelagverschleiß							
C 230 (204.052)	150	01/07→01/14	←	03/07→	1	24.8190-0410.2 620410	L= 97,5
C 320 CDI (204.022)	165	01/07→01/14	→	03/07→	1	24.8190-0410.2 620410	L= 97,5
C 350 (204.056)	200	01/07→01/14					
C 63 AMG	382	07/10→01/14	←		1	24.8190-0420.2 620420	L= 119
C 63 AMG (204.077)	336	02/08→01/14	→		1	24.8190-0420.2 620420	L= 119
C 63 AMG (204.077)	358	02/08→01/14					
C 63 AMG (204.077)	373	02/08→01/14					
 Bremsscheibe							
C 180 CDI (204.000) C 180 Kompressor (204.044, 204.045)	88	01/11→01/14	←	für Fahrzeuge ohne Sportpaket / für Fahrzeuge ohne AMG-Sportpaket		24.0125-0179.1 425179	Ø 288 25 22 V + S
	115	01/08→01/14	←			24.0325-0179.1 525179	Ø 288 25 22 V + S PD
			←			24.0128-0100.1 428100	Ø 295 28 26 V• + S
			→			24.0109-0154.1 409154	Ø 278 9 7,3 + S
			→	24.0309-0154.1 509154	Ø 278 9 7,3 + S PD		
			→	24.0110-0328.1 410328	Ø 300 10 8,3 + S		
			→	24.0310-0328.1 510328	Ø 300 10 8,3 + S PD		
C 180 CGI (204.031) C 180 CGI (204.049)	115	01/08→01/14	←	04/09→; für Fahrzeuge ohne Sportpaket / für Fahrzeuge ohne AMG-Sportpaket		24.0125-0179.1 425179	Ø 288 25 22 V + S
	115	01/07→01/14	←			24.0325-0179.1 525179	Ø 288 25 22 V + S PD
			←			24.0128-0100.1 428100	Ø 295 28 26 V• + S
			→			24.0109-0154.1 409154	Ø 278 9 7,3 + S
			→	24.0309-0154.1 509154	Ø 278 9 7,3 + S PD		
			→	24.0110-0328.1 410328	Ø 300 10 8,3 + S		
			→	24.0310-0328.1 510328	Ø 300 10 8,3 + S PD		
C 180 Kompressor (204.046) C 200 CDI (204.007, 204.006)	115	01/07→01/14	←	03/07→; für Fahrzeuge ohne Sportpaket / für Fahrzeuge ohne AMG-Sportpaket		24.0125-0179.1 425179	Ø 288 25 22 V + S
			←			24.0325-0179.1 525179	Ø 288 25 22 V + S PD
			←			24.0128-0100.1 428100	Ø 295 28 26 V• + S
			→			24.0109-0154.1 409154	Ø 278 9 7,3 + S
			→	24.0309-0154.1 509154	Ø 278 9 7,3 + S PD		
			→	24.0110-0328.1 410328	Ø 300 10 8,3 + S		
			→	24.0310-0328.1 510328	Ø 300 10 8,3 + S PD		
C 200 (204.048) C 220 CDI (204.002) C 220 CDI (204.002) C 220 CDI 4-matic (204.084) C 230 4-matic (204.085) C 250 CGI (204.047)	137	05/11→01/14	←	für Fahrzeuge mit Sportpaket / für Fahr- zeuge mit AMG-Sportpaket		24.0128-0100.1 428100	Ø 295 28 26 V• + S
	120	10/08→01/14	←			24.0128-0155.1 428155	Ø 295 28 25,4 V + S
	125	12/08→01/14	←			24.0328-0155.1 528155	Ø 295 28 25,4 V + S PD
	125	02/13→01/14	→			24.0110-0328.1 410328	Ø 300 10 8,3 + S
			→	24.0310-0328.1 510328	Ø 300 10 8,3 + S PD		
C 200 CDI (204.001)	150	07/07→01/14	→	für Fahrzeuge ohne Sportpaket / für Fahrzeuge ohne AMG-Sportpaket		24.0125-0179.1 425179	Ø 288 25 22 V + S
	150	07/09→01/14	→			24.0325-0179.1 525179	Ø 288 25 22 V + S PD
			←			24.0128-0100.1 428100	Ø 295 28 26 V• + S
			→			24.0109-0154.1 409154	Ø 278 9 7,3 + S
			→			24.0309-0154.1 509154	Ø 278 9 7,3 + S PD
			→			24.0110-0328.1 410328	Ø 300 10 8,3 + S
			→	24.0310-0328.1 510328	Ø 300 10 8,3 + S PD		
			→	24.0110-0328.1 410328	Ø 300 10 8,3 + S		
			→	24.0310-0328.1 510328	Ø 300 10 8,3 + S PD		
C 200 CGI (204.048)	135	01/07→01/14	←	04/09→; für Fahrzeuge mit Sportpaket / für Fahr- zeuge mit AMG-Sportpaket		24.0128-0100.1 428100	Ø 295 28 26 V• + S
			←			24.0128-0155.1 428155	Ø 295 28 25,4 V + S
			←			24.0328-0155.1 528155	Ø 295 28 25,4 V + S PD
			→	24.0110-0328.1 410328	Ø 300 10 8,3 + S		
			→	24.0310-0328.1 510328	Ø 300 10 8,3 + S PD		
C 200 Kompressor (204.041) C 220 CDI (204.008) C 220 CDI (204.008) C 230 (204.052)	135	01/07→01/14	←	03/07→; für Fahrzeuge mit Sportpaket / für Fahr- zeuge mit AMG-Sportpaket		24.0128-0100.1 428100	Ø 295 28 26 V• + S
	120	01/07→11/08	←			24.0128-0155.1 428155	Ø 295 28 25,4 V + S
	125	01/07→11/08	←			24.0328-0155.1 528155	Ø 295 28 25,4 V + S PD
	150	01/07→01/14	←			24.0128-0155.1 428155	Ø 295 28 25,4 V + S PD











	kw			 	! #		
MERCEDES-BENZ - C-KLASSE (W204) 01/07→01/14							
Bremsscheibe							
C 200 Kompressor (204.041)	135	01/07→01/14	➔	03/07→		24.0110-0328.1 410328	Ø 300 10 8,3 + S
C 220 CDI (204.008)	120	01/07→11/08				24.0310-0328.1 510328	Ø 300 10 8,3 + S PD
C 220 CDI (204.008)	125	01/07→11/08					
C 230 (204.052)	150	01/07→01/14					
C 250 CDI (204.003)	150	08/08→01/14	➔	für Fahrzeuge mit Sportpaket / für Fahrzeuge mit AMG-Sportpaket		24.0128-0100.1 428100	Ø 295 28 26 V• + S
			➔	für Fahrzeuge ohne Sportpaket / für Fahrzeuge ohne AMG-Sportpaket		24.0128-0155.1 428155	Ø 295 28 25,4 V + S
			➔	24.0328-0155.1 528155			Ø 295 28 25,4 V + S PD
			➔	10/08→		24.0120-0208.1 420208	Ø 300 22 19,4 V + S
C 250 CDI 4-matic (204.082)	150	01/11→01/14	➔	für Fahrzeuge ohne Sportpaket / für Fahrzeuge ohne AMG-Sportpaket		24.0128-0155.1 428155	Ø 295 28 25,4 V + S
			➔	24.0328-0155.1 528155			Ø 295 28 25,4 V + S PD
			➔	für Fahrzeuge mit Sportpaket / für Fahrzeuge mit AMG-Sportpaket		24.0132-0100.1 432100	Ø 322 32 30 V• + S
			➔	für Fahrzeuge mit Sportpaket / für Fahrzeuge mit AMG-Sportpaket		24.0110-0328.1 410328	Ø 300 10 8,3 + S
			➔	24.0310-0328.1 510328			Ø 300 10 8,3 + S PD
			➔	für Fahrzeuge ohne Sportpaket / für Fahrzeuge ohne AMG-Sportpaket		24.0120-0208.1 420208	Ø 300 22 19,4 V + S
C 280 (204.054)	170	01/07→01/14	➔	03/07→; für Fahrzeuge ohne Sportpaket / für Fahrzeuge ohne AMG-Sportpaket		24.0128-0155.1 428155	Ø 295 28 25,4 V + S
			➔	24.0328-0155.1 528155			Ø 295 28 25,4 V + S PD
			➔	03/07→; für Fahrzeuge mit Sportpaket / für Fahrzeuge mit AMG-Sportpaket		24.0132-0100.1 432100	Ø 322 32 30 V• + S
			➔	03/07→		24.0110-0328.1 410328	Ø 300 10 8,3 + S
			➔	24.0310-0328.1 510328			Ø 300 10 8,3 + S PD
C 280 4-matic (204.081)	170	07/07→01/14	➔	für Fahrzeuge ohne Sportpaket / für Fahrzeuge ohne AMG-Sportpaket		24.0128-0155.1 428155	Ø 295 28 25,4 V + S
C 300 (204.054)	170	07/09→01/14	➔	für Fahrzeuge mit Sportpaket / für Fahrzeuge mit AMG-Sportpaket		24.0328-0155.1 528155	Ø 295 28 25,4 V + S PD
			➔	24.0132-0100.1 432100			Ø 322 32 30 V• + S
			➔			24.0110-0328.1 410328	Ø 300 10 8,3 + S
			➔			24.0310-0328.1 510328	Ø 300 10 8,3 + S PD
C 300 (204.055)	185	02/11→01/14	➔	für Fahrzeuge mit Sportpaket / für Fahrzeuge mit AMG-Sportpaket		24.0132-0100.1 432100	Ø 322 32 30 V• + S
C 300 4-matic (204.080)	185	02/11→01/14	➔	für Fahrzeuge ohne Sportpaket / für Fahrzeuge ohne AMG-Sportpaket		24.0132-0101.1 432101	Ø 322 32 29,4 V + S
C 300 CDI 4-matic (204.092)	170	01/11→01/14	➔			24.0332-0101.1 532101	Ø 322 32 29,4 V + S PD
C 350 (204.057)	225	01/11→01/14	➔			24.0120-0208.1 420208	Ø 300 22 19,4 V + S
C 350 CDI (204.023)	195	06/11→01/14	➔				
C 350 CDI 4-matic (204.092)	170	10/09→01/14	➔				
C 300 4-matic (204.081)	170	07/07→01/14	➔	04/09→; für Fahrzeuge ohne Sportpaket / für Fahrzeuge ohne AMG-Sportpaket		24.0128-0155.1 428155	Ø 295 28 25,4 V + S
			➔	24.0328-0155.1 528155			Ø 295 28 25,4 V + S PD
			➔	04/09→; für Fahrzeuge mit Sportpaket / für Fahrzeuge mit AMG-Sportpaket		24.0132-0100.1 432100	Ø 322 32 30 V• + S
			➔	04/09→		24.0110-0328.1 410328	Ø 300 10 8,3 + S
			➔	24.0310-0328.1 510328			Ø 300 10 8,3 + S PD
C 320 CDI (204.022)	165	01/07→01/14	➔	03/07→; für Fahrzeuge ohne Sportpaket / für Fahrzeuge ohne AMG-Sportpaket		24.0132-0100.1 432100	Ø 322 32 30 V• + S
C 350 (204.056)	200	01/07→01/14	➔			24.0132-0101.1 432101	Ø 322 32 29,4 V + S
			➔	24.0332-0101.1 532101			Ø 322 32 29,4 V + S PD
			➔	03/07→; für Fahrzeuge mit Sportpaket / für Fahrzeuge mit AMG-Sportpaket		24.0132-0100.1 432100	Ø 322 32 30 V• + S
			➔	03/07→		24.0120-0208.1 420208	Ø 300 22 19,4 V + S
C 320 CDI 4-matic (204.089)	165	07/07→01/14	➔	für Fahrzeuge mit Sportpaket / für Fahrzeuge mit AMG-Sportpaket		24.0132-0100.1 432100	Ø 322 32 30 V• + S
C 350 4-matic (204.087)	200	07/07→01/14	➔	für Fahrzeuge ohne Sportpaket / für Fahrzeuge ohne AMG-Sportpaket		24.0132-0100.1 432100	Ø 322 32 30 V• + S
C 350 CDI (204.022)	165	07/09→01/14	➔			24.0132-0101.1 432101	Ø 322 32 29,4 V + S
C 350 CDI 4-matic (204.089)	165	07/09→01/14	➔			24.0332-0101.1 532101	Ø 322 32 29,4 V + S PD
			➔			24.0120-0208.1 420208	Ø 300 22 19,4 V + S
C 350 4-matic (204.088)	225	01/11→01/14	➔	für Fahrzeuge ohne Sportpaket / für Fahrzeuge ohne AMG-Sportpaket		24.0132-0101.1 432101	Ø 322 32 29,4 V + S
C 350 CDI (204.025)	170	10/09→01/14	➔			24.0332-0101.1 532101	Ø 322 32 29,4 V + S PD
C 350 CGI (204.065)	215	09/08→01/14	➔			24.0120-0208.1 420208	Ø 300 22 19,4 V + S
C 63 AMG	382	07/10→01/14	➔	- AMG-Performance P.		24.0136-0108.1 436108	Ø 360 36 34 V• + S
C 63 AMG (204.077)	336	02/08→01/14					
C 63 AMG (204.077)	358	02/08→01/14					
C 63 AMG (204.077)	373	02/08→01/14					





















	kw			 	! #		
MERCEDES-BENZ - C-KLASSE (W205) 07/13→							
 Bremsbelagsatz, Scheibenbremse							
AMG C 43 4-matic (205.064)	270	04/16→	←	für Fahrzeuge mit AMG-Sportpaket		13.0460-4883.2 604883	BRE 22061 18,7 + WE / - WK
C 450 AMG 4-matic (205.064)	270	04/15→04/16	→	für Fahrzeuge mit AMG-Sportpaket / + eFSB		13.0460-7304.2 607304 13.0470-7304.2 LD7304	ATE 25353 16,2 + WE / - WK ATE 25353 16,2 + WE / - WK Ceramic
C 160 (205.044) C 180 (205.040) C 180 BlueTEC / d (205.036)	95 115 85	04/15→ 03/14→ 05/14→	←	für Fahrzeuge ohne AMG-Sportpaket		13.0460-2792.2 602792 13.0470-2792.2 LD2792	TRW 22031 19,6 + WE / - WK TRW 22031 19,6 + WE / - WK Ceramic
C 200 4-matic (205.043) C 200 BlueTEC / d (205.037)	135 100	04/15→ 05/14→	←	für Fahrzeuge mit AMG-Sportpaket		13.0460-4880.2 604880 13.0470-4880.2 LD4880	BRE 25997 18,7 + WE / - WK BRE 25997 18,7 + WE / - WK Ceramic
C 200 d (205.007) C 220 BlueTEC / d (205.003) C 220 d 4-matic (205.005)	100 120 125	10/15→ 03/14→04/16 04/15→	→	+ eFSB		13.0460-7304.2 607304 13.0470-7304.2 LD7304	ATE 25353 16,2 + WE / - WK ATE 25353 16,2 + WE / - WK Ceramic
C 200 (205.042) C 220 BlueTEC / d (205.004)	135 125	12/13→ 12/13→	←	02/14→; für Fahrzeuge ohne AMG-Sportpaket		13.0460-2792.2 602792 13.0470-2792.2 LD2792	TRW 22031 19,6 + WE / - WK TRW 22031 19,6 + WE / - WK Ceramic
			←	02/14→; für Fahrzeuge mit AMG-Sportpaket		13.0460-4880.2 604880 13.0470-4880.2 LD4880	BRE 25997 18,7 + WE / - WK BRE 25997 18,7 + WE / - WK Ceramic
			→	02/14→; + eFSB		13.0460-7304.2 607304 13.0470-7304.2 LD7304	ATE 25353 16,2 + WE / - WK ATE 25353 16,2 + WE / - WK Ceramic
C 250 (205.045) C 250 BlueTEC / d (205.008) C 300 BlueTEC Hybrid / h (205.012)	155 150 150	03/14→ 02/14→ 05/14→	←	für Fahrzeuge ohne AMG-Sportpaket		13.0460-4880.2 604880 13.0470-4880.2 LD4880	BRE 25997 18,7 + WE / - WK BRE 25997 18,7 + WE / - WK Ceramic
			←	für Fahrzeuge mit AMG-Sportpaket		13.0460-4883.2 604883	BRE 22061 18,7 + WE / - WK
			→	+ eFSB		13.0460-7304.2 607304 13.0470-7304.2 LD7304	ATE 25353 16,2 + WE / - WK ATE 25353 16,2 + WE / - WK Ceramic
C 250 BlueTEC / d 4-matic (205.009)	150	02/14→	←	05/14→; für Fahrzeuge ohne AMG-Sportpaket		13.0460-2610.2 602610 13.0470-2610.2 LD2610	TRW 22076 19,6 + WE / - WK TRW 22076 19,6 + WE / - WK Ceramic
			←	für Fahrzeuge mit AMG-Sportpaket		13.0460-4883.2 604883	BRE 22061 18,7 + WE / - WK
			→	+ eFSB		13.0460-7304.2 607304 13.0470-7304.2 LD7304	ATE 25353 16,2 + WE / - WK ATE 25353 16,2 + WE / - WK Ceramic
C 300 (205.048)	180	09/15→	←	für Fahrzeuge ohne AMG-Sportpaket		13.0460-2610.2 602610 13.0470-2610.2 LD2610	TRW 22076 19,6 + WE / - WK TRW 22076 19,6 + WE / - WK Ceramic
			←	für Fahrzeuge mit AMG-Sportpaket		13.0460-4883.2 604883	BRE 22061 18,7 + WE / - WK
			→	+ eFSB		13.0460-7304.2 607304 13.0470-7304.2 LD7304	ATE 25353 16,2 + WE / - WK ATE 25353 16,2 + WE / - WK Ceramic
C 350 e (205.047) C 350 e (205.047)	155 205	02/15→ 02/15→	←			13.0460-4883.2 604883	BRE 22061 18,7 + WE / - WK
			→	+ eFSB		13.0460-7304.2 607304 13.0470-7304.2 LD7304	ATE 25353 16,2 + WE / - WK ATE 25353 16,2 + WE / - WK Ceramic
C 400 4-matic (205.066)	245	10/14→	←			13.0460-4883.2 604883	BRE 22061 18,7 + WE / - WK
			→	+ eFSB		13.0460-7304.2 607304 13.0470-7304.2 LD7304	ATE 25353 16,2 + WE / - WK ATE 25353 16,2 + WE / - WK Ceramic
Warnkontakt, Bremsbelagverschleiß							
AMG C 43 4-matic (205.064) C 450 AMG 4-matic (205.064)	270 270	04/16→ 04/15→04/16	←	für Fahrzeuge ohne AMG-Sportpaket	1	24.8190-0067.2 620067	L= 92,5
			←	für Fahrzeuge mit AMG-Sportpaket	1	24.8190-0067.2 620067	L= 92,5
			→	für Fahrzeuge ohne AMG-Sportpaket	1	24.8190-0067.2 620067	L= 92,5
			→	für Fahrzeuge mit AMG-Sportpaket	1	24.8190-0067.2 620067	L= 92,5
AMG C 63 (205.086) AMG C 63 S (205.087)	350 375	10/14→ 10/14→	→		1	24.8190-0410.2 620410	L= 97,5
C 160 (205.044) C 180 (205.040) C 180 BlueTEC / d (205.036)	95 115 85	04/15→ 03/14→ 05/14→	←	für Fahrzeuge mit AMG-Sportpaket	1	24.8190-0067.2 620067	L= 92,5
			←	für Fahrzeuge ohne AMG-Sportpaket	1	24.8190-0067.2 620067	L= 92,5
C 200 4-matic (205.043) ↓	135	04/15→	→		1	24.8190-0067.2 620067	L= 92,5







	kW			 	! #		
MERCEDES-BENZ - C-KLASSE (W205) 07/13→							
Warnkontakt, Bremsbelagverschleiß							
C 200 BlueTEC / d (205.037)	100	05/14→	←	für Fahrzeuge mit AMG-Sportpaket	1	24.8190-0067.2 620067	L= 92,5
C 200 d (205.007)	100	10/15→	←	für Fahrzeuge ohne AMG-Sportpaket	1	24.8190-0067.2 620067	L= 92,5
C 220 BlueTEC / d (205.003)	120	03/14→04/16	→		1	24.8190-0067.2 620067	L= 92,5
C 220 d 4-matic (205.005)	125	04/15→					
C 250 (205.045)	155	03/14→					
C 250 BlueTEC / d (205.008)	150	02/14→					
C 300 (205.048)	180	09/15→					
C 300 BlueTEC Hybrid / h (205.012)	150	05/14→					
C 200 (205.042)	135	12/13→	←	02/14→; für Fahrzeuge ohne AMG-Sportpaket	1	24.8190-0067.2 620067	L= 92,5
C 220 BlueTEC / d (205.004)	125	12/13→	←	02/14→; für Fahrzeuge mit AMG-Sportpaket	1	24.8190-0067.2 620067	L= 92,5
			→	02/14→	1	24.8190-0067.2 620067	L= 92,5
C 250 BlueTEC / d 4-matic (205.009)	150	02/14→	←	für Fahrzeuge mit AMG-Sportpaket	1	24.8190-0067.2 620067	L= 92,5
			←	05/14→; für Fahrzeuge ohne AMG-Sportpaket	1	24.8190-0067.2 620067	L= 92,5
			→		1	24.8190-0067.2 620067	L= 92,5
C 350 e (205.047)	155	02/15→	←		1	24.8190-0067.2 620067	L= 92,5
C 350 e (205.047)	205	02/15→					
C 400 4-matic (205.066)	245	10/14→	→		1	24.8190-0067.2 620067	L= 92,5
Bremsscheibe							
AMG C 63 (205.086)	350	10/14→	←	nicht für Bremssattelfarbe: rot; für Fahrzeuge ohne Keramikbremse		24.0136-0108.1 436108	Ø 360 36 34 V* + S
AMG C 63 S (205.087)	375	10/14→					
C 200 (205.042)	135	12/13→	←	02/14→; für Fahrzeuge ohne AMG-Sportpaket		24.0128-0300.1 428300	Ø 305 28 25,4 V + S
C 200 4-matic (205.043)	135	04/15→	←	für Fahrzeuge ohne AMG-Sportpaket		24.0128-0300.1 428300	Ø 305 28 25,4 V + S
C 200 d (205.007)	100	10/15→					
C 220 BlueTEC / d (205.003)	120	03/14→04/16					
C 220 d 4-matic (205.005)	125	04/15→					
MERCEDES-BENZ - C-KLASSE Cabriolet (A205) 06/16→							
Bremsbelagsatz, Scheibenbremse							
C 180 (205.440)	115	06/16→	←	für Fahrzeuge ohne AMG-Sportpaket		13.0460-2792.2 602792	TRW 22031 19,6 + WE / - WK
C 200 (205.442)	135	06/16→				13.0470-2792.2 LD2792	TRW 22031 19,6 + WE / - WK Ceramic
C 200 4-matic (205.443)	135	06/16→					
C 220 d (205.404)	120	06/16→					
C 220 d (205.404)	125	06/16→	←	für Fahrzeuge mit AMG-Sportpaket		13.0460-4880.2 604880	BRE 25997 18,7 + WE / - WK Ceramic
C 220 d 4-matic (205.405)	125	06/16→				13.0470-4880.2 LD4880	BRE 25997 18,7 + WE / - WK Ceramic
			→			13.0460-7304.2 607304	ATE 25353 16,2 + WE / - WK Ceramic
						13.0470-7304.2 LD7304	ATE 25353 16,2 + WE / - WK Ceramic
C 250 (205.445)	155	06/16→	←	für Fahrzeuge ohne AMG-Sportpaket		13.0460-2610.2 602610	TRW 22076 19,6 + WE / - WK Ceramic
C 250 d (205.408)	150	06/16→				13.0470-2610.2 LD2610	TRW 22076 19,6 + WE / - WK Ceramic
C 300 (205.448)	180	06/16→					
			←	für Fahrzeuge mit AMG-Sportpaket; - USA		13.0460-4883.2 604883	BRE 22061 18,7 + WE / - WK
			→			13.0460-7304.2 607304	ATE 25353 16,2 + WE / - WK Ceramic
						13.0470-7304.2 LD7304	ATE 25353 16,2 + WE / - WK Ceramic
C 400 4-matic (205.466)	245	06/16→	←	- USA		13.0460-4883.2 604883	BRE 22061 18,7 + WE / - WK
			→			13.0460-7304.2 607304	ATE 25353 16,2 + WE / - WK Ceramic
						13.0470-7304.2 LD7304	ATE 25353 16,2 + WE / - WK Ceramic
Warnkontakt, Bremsbelagverschleiß							
AMG C 43 4-matic (205.464)	270	10/16→	→		1	24.8190-0067.2 620067	L= 92,5
C 180 (205.440)	115	06/16→	←	für Fahrzeuge mit AMG-Sportpaket	1	24.8190-0067.2 620067	L= 92,5
C 200 (205.442)	135	06/16→					
C 200 4-matic (205.443)	135	06/16→	←	für Fahrzeuge ohne AMG-Sportpaket	1	24.8190-0067.2 620067	L= 92,5
C 220 d (205.404)	120	06/16→					
C 220 d (205.404)	125	06/16→	→		1	24.8190-0067.2 620067	L= 92,5
C 220 d 4-matic (205.405)	125	06/16→					
C 250 (205.445)	155	06/16→					
↓							



















	kw			 	! #		
MERCEDES-BENZ - C-KLASSE Cabriolet (A205) 06/16→							
Warnkontakt, Bremsbelagverschleiß							
C 250 d (205.408) C 300 (205.448)	150 180	06/16→ 06/16→	←	für Fahrzeuge mit AMG-Sportpaket	1	24.8190-0067.2 620067	L= 92,5
			←	für Fahrzeuge ohne AMG-Sportpaket	1	24.8190-0067.2 620067	L= 92,5
			→		1	24.8190-0067.2 620067	L= 92,5
C 400 4-matic (205.466)	245	06/16→	←		1	24.8190-0067.2 620067	L= 92,5
			→		1	24.8190-0067.2 620067	L= 92,5
 Bremsscheibe							
C 200 (205.442) C 200 4-matic (205.443) C 220 d (205.404) C 220 d (205.404) C 220 d 4-matic (205.405)	135 135 120 125 125	06/16→ 06/16→ 06/16→ 06/16→ 06/16→	←	für Fahrzeuge ohne AMG-Sportpaket		24.0128-0300.1 428300	Ø 305 28 25,4 V + S
MERCEDES-BENZ - C-KLASSE Coupe (C204) 01/11→							
 Bremsbelagsatz, Scheibenbremse							
C 180 (204.331) C 180 (204.349)	115 115	01/13→ 06/11→	←	für Fahrzeuge mit Sportpaket / für Fahrzeuge mit AMG-Sportpaket		13.0460-2732.2 602732 13.0470-2732.2 LD2732	TRW 24306 20,3 + WE / - WK + Zub TRW 24306 20,3 + WE / - WK + Zub Ceramic
			←	für Fahrzeuge ohne Sportpaket / für Fahrzeuge ohne AMG-Sportpaket		13.0460-2733.2 602733 13.0470-2733.2 LD2733	TRW 24306 20,3 + WE / - WK + Zub TRW 24306 20,3 + WE / - WK + Zub Ceramic
			→			13.0460-7244.2 607244 13.0470-7244.2 LD7244	ATE 24253 17,8 + WE / - WK ATE 24253 17,8 + WE / - WK Ceramic
C 200 CGI (204.348) C 250 (204.347) C 250 CDI (204.303)	135 150 150	06/11→ 06/11→ 06/11→	←	nicht für Ausstattungsvariante: Sport Edition [P84]		13.0460-2732.2 602732 13.0470-2732.2 LD2732	TRW 24306 20,3 + WE / - WK + Zub TRW 24306 20,3 + WE / - WK + Zub Ceramic
			←	Sport Edition [P84]		13.0460-2734.2 602734 13.0470-2734.2 LD2734	TRW 24310 19,0 + WE / - WK TRW 24310 19,0 + WE / - WK Ceramic
			→			13.0460-7244.2 607244 13.0470-7244.2 LD7244	ATE 24253 17,8 + WE / - WK ATE 24253 17,8 + WE / - WK Ceramic
C 220 CDI (204.302) C 220 CDI (204.302)	120 125	06/11→ 06/11→	←			13.0460-2732.2 602732 13.0470-2732.2 LD2732	TRW 24306 20,3 + WE / - WK + Zub TRW 24306 20,3 + WE / - WK + Zub Ceramic
			→			13.0460-7244.2 607244 13.0470-7244.2 LD7244	ATE 24253 17,8 + WE / - WK ATE 24253 17,8 + WE / - WK Ceramic
C 350 (204.357) C 350 4-matic	225 225	06/11→ 09/13→	←			13.0460-2734.2 602734 13.0470-2734.2 LD2734	TRW 24310 19,0 + WE / - WK TRW 24310 19,0 + WE / - WK Ceramic
			→			13.0460-7244.2 607244 13.0470-7244.2 LD7244	ATE 24253 17,8 + WE / - WK ATE 24253 17,8 + WE / - WK Ceramic
C 63 AMG (204.377) C 63 AMG (204.377) C 63 AMG (204.377)	336 358 373	06/11→ 01/12→ 11/12→	←	für Fahrzeuge ohne AMG-Performance Package		13.0460-4839.2 604839	BRE 24455 16,8 + WE / - WK
Warnkontakt, Bremsbelagverschleiß							
C 180 (204.331) C 180 (204.349)	115 115	01/13→ 06/11→	←	für Fahrzeuge mit Sportpaket / für Fahrzeuge mit AMG-Sportpaket	2	24.8190-0410.2 620410	L= 97,5
			←	für Fahrzeuge ohne Sportpaket / für Fahrzeuge ohne AMG-Sportpaket	2	24.8190-0410.2 620410	L= 97,5
			→		2	24.8190-0410.2 620410	L= 97,5
C 200 CGI (204.348) C 250 (204.347) C 250 CDI (204.303)	135 150 150	06/11→ 06/11→ 06/11→	←	nicht für Ausstattungsvariante: Sport Edition [P84]	2	24.8190-0410.2 620410	L= 97,5
			←	Sport Edition [P84]	2	24.8190-0410.2 620410	L= 97,5
			→		2	24.8190-0410.2 620410	L= 97,5
C 220 CDI (204.302) C 220 CDI (204.302) C 350 (204.357) C 350 4-matic	120 125 225 225	06/11→ 06/11→ 06/11→ 09/13→	←		2	24.8190-0410.2 620410	L= 97,5
			→		2	24.8190-0410.2 620410	L= 97,5
↓							









	kw			 	! #			
MERCEDES-BENZ - C-KLASSE Coupe (C204) 01/11→								
Warnkontakt, Bremsbelagverschleiß								
C 63 AMG (204.377)	336	06/11→	←		2	24.8190-0420.2 620420	L= 119	
C 63 AMG (204.377)	358	01/12→	→		2	24.8190-0410.2 620410	L= 97,5	
C 63 AMG (204.377)	373	11/12→						
C 63 AMG (204.377)	380	01/12→	→		2	24.8190-0420.2 620420	L= 119	
 Bremsscheibe								
C 180 (204.331)	115	01/13→	←	für Fahrzeuge ohne Sportpaket / für Fahrzeuge ohne AMG-Sportpaket		24.0125-0179.1 425179	Ø 288 25 22 V + S	
C 180 (204.349)	115	06/11→		für Fahrzeuge mit Sportpaket / für Fahrzeuge mit AMG-Sportpaket		24.0325-0179.1 525179	Ø 288 25 22 V + S PD	
				→	für Fahrzeuge ohne Sportpaket / für Fahrzeuge ohne AMG-Sportpaket		24.0109-0154.1 409154	Ø 278 9 7,3 + S
				→	für Fahrzeuge mit Sportpaket / für Fahrzeuge mit AMG-Sportpaket		24.0309-0154.1 509154	Ø 278 9 7,3 + S PD
C 200 CGI (204.348)	135	06/11→	←	für Fahrzeuge mit Sportpaket / für Fahrzeuge mit AMG-Sportpaket; nicht für Ausstattungsvariante: Sport Edition [P84]		24.0128-0100.1 428100	Ø 295 28 26 V• + S	
C 250 (204.347)	150	06/11→		für Fahrzeuge ohne Sportpaket / für Fahrzeuge ohne AMG-Sportpaket; nicht für Ausstattungsvariante: Sport Edition [P84]		24.0128-0155.1 428155	Ø 295 28 25,4 V + S	
				←	Sport Edition [P84]		24.0328-0155.1 528155	Ø 295 28 25,4 V + S PD
				→			24.0132-0168.1 432168	Ø 344 32 30 V• + S
						24.0110-0328.1 410328	Ø 300 10 8,3 + S	
						24.0310-0328.1 510328	Ø 300 10 8,3 + S PD	
C 220 CDI (204.302)	120	06/11→	←	für Fahrzeuge mit Sportpaket / für Fahrzeuge mit AMG-Sportpaket		24.0128-0100.1 428100	Ø 295 28 26 V• + S	
C 220 CDI (204.302)	125	06/11→		für Fahrzeuge ohne Sportpaket / für Fahrzeuge ohne AMG-Sportpaket		24.0128-0155.1 428155	Ø 295 28 25,4 V + S	
				←			24.0328-0155.1 528155	Ø 295 28 25,4 V + S PD
				→			24.0110-0328.1 410328	Ø 300 10 8,3 + S
						24.0310-0328.1 510328	Ø 300 10 8,3 + S PD	
C 250 CDI (204.303)	150	06/11→	←	für Fahrzeuge mit Sportpaket / für Fahrzeuge mit AMG-Sportpaket; nicht für Ausstattungsvariante: Sport Edition [P84]		24.0128-0100.1 428100	Ø 295 28 26 V• + S	
				für Fahrzeuge ohne Sportpaket / für Fahrzeuge ohne AMG-Sportpaket; nicht für Ausstattungsvariante: Sport Edition [P84]		24.0128-0155.1 428155	Ø 295 28 25,4 V + S	
				←	Sport Edition [P84]		24.0328-0155.1 528155	Ø 295 28 25,4 V + S PD
				→			24.0132-0168.1 432168	Ø 344 32 30 V• + S
						24.0120-0208.1 420208	Ø 300 22 19,4 V + S	
C 350 (204.357)	225	06/11→	←	für Fahrzeuge mit Sportpaket / für Fahrzeuge mit AMG-Sportpaket		24.0132-0100.1 432100	Ø 322 32 30 V• + S	
C 350 4-matic	225	09/13→		für Fahrzeuge ohne Sportpaket / für Fahrzeuge ohne AMG-Sportpaket		24.0132-0101.1 432101	Ø 322 32 29,4 V + S	
				←			24.0332-0101.1 532101	Ø 322 32 29,4 V + S PD
			→			24.0120-0208.1 420208	Ø 300 22 19,4 V + S	
C 63 AMG (204.377)	336	06/11→	←	- AMG-Performance P.		24.0136-0108.1 436108	Ø 360 36 34 V• + S	
C 63 AMG (204.377)	358	01/12→						
C 63 AMG (204.377)	373	11/12→						
MERCEDES-BENZ - C-KLASSE Coupe (C205) 10/15→								
 Bremsbelagsatz, Scheibenbremse								
C 180 (205.340)	115	10/15→	←	für Fahrzeuge ohne AMG-Sportpaket		13.0460-2792.2 602792	TRW 22031 19,6 + WE / - WK	
C 200 (205.342)	135	10/15→					13.0470-2792.2 LD2792	TRW 22031 19,6 + WE / - WK Ceramic
C 200 4-matic (205.343)	135	04/16→	←	für Fahrzeuge mit AMG-Sportpaket		13.0460-4880.2 604880	BRE 25997 18,7 + WE / - WK	
C 220 d (205.304)	120	10/15→					13.0470-4880.2 LD4880	BRE 25997 18,7 + WE / - WK Ceramic
C 220 d (205.304)	125	10/15→		→			13.0460-7304.2 607304	ATE 25353 16,2 + WE / - WK
C 220 d 4-matic (205.305)	125	04/16→					13.0470-7304.2 LD7304	ATE 25353 16,2 + WE / - WK Ceramic
C 250 (205.345)	155	10/15→	←			13.0460-2610.2 602610	TRW 22076 19,6 + WE / - WK	
				→			13.0470-2610.2 LD2610	TRW 22076 19,6 + WE / - WK Ceramic
						13.0460-7304.2 607304	ATE 25353 16,2 + WE / - WK	
						13.0470-7304.2 LD7304	ATE 25353 16,2 + WE / - WK Ceramic	
C 250 d (205.308)	150	10/15→	←	für Fahrzeuge ohne AMG-Sportpaket		13.0460-2610.2 602610	TRW 22076 19,6 + WE / - WK	
↓								

	kW					! #		
MERCEDES-BENZ - C-KLASSE Coupe (C205) 10/15→								
 Bremsbelagsatz, Scheibenbremse								
C 250 d 4-matic (205.309) C 300 (205.348)	150	04/16→	←	für Fahrzeuge ohne AMG-Sportpaket		13.0470-2610.2	LD2610	TRW 22076 19,6 + WE / - WK Ceramic
	180	10/15→	←	für Fahrzeuge mit AMG-Sportpaket		13.0460-4883.2	604883	BRE 22061 18,7 + WE / - WK
			→			13.0460-7304.2	607304	ATE 25353 16,2 + WE / - WK
						13.0470-7304.2	LD7304	ATE 25353 16,2 + WE / - WK Ceramic
C 400 4-matic (205.366)	245	04/16→	←			13.0460-4883.2	604883	BRE 22061 18,7 + WE / - WK
			→			13.0460-7304.2	607304	ATE 25353 16,2 + WE / - WK
						13.0470-7304.2	LD7304	ATE 25353 16,2 + WE / - WK Ceramic
Warnkontakt, Bremsbelagverschleiß								
AMG C 43 4-matic (205.364)	270	04/16→	←		1	24.8190-0067.2	620067	L= 92,5
C 180 (205.340)	115	10/15→	→		1	24.8190-0067.2	620067	L= 92,5
C 200 (205.342)	135	10/15→						
C 200 4-matic (205.343)	135	04/16→						
C 220 d (205.304)	120	10/15→						
C 220 d (205.304)	125	10/15→						
C 220 d 4-matic (205.305)	125	04/16→						
C 250 (205.345)	155	10/15→						
C 400 4-matic (205.366)	245	04/16→						
AMG C 63 (205.386)	350	02/16→	←		1	24.8190-0420.2	620420	L= 119
AMG C 63 S (205.387)	375	02/16→	→		1	24.8190-0410.2	620410	L= 97,5
C 250 d (205.308)	150	10/15→	←	für Fahrzeuge mit AMG-Sportpaket	1	24.8190-0067.2	620067	L= 92,5
C 250 d 4-matic (205.309)	150	04/16→	←	für Fahrzeuge ohne AMG-Sportpaket	1	24.8190-0067.2	620067	L= 92,5
C 300 (205.348)	180	10/15→	→		1	24.8190-0067.2	620067	L= 92,5
 Bremsscheibe								
AMG C 63 S (205.387)	375	02/16→	←	nicht für Bremssattelfarbe: rot; für Fahrzeuge ohne Keramikbremse		24.0136-0108.1	436108	Ø 360 36 34 V• + S
C 200 (205.342)	135	10/15→	←	für Fahrzeuge ohne AMG-Sportpaket		24.0128-0300.1	428300	Ø 305 28 25,4 V + S
C 200 4-matic (205.343)	135	04/16→						
C 220 d (205.304)	120	10/15→						
C 220 d (205.304)	125	10/15→						
C 220 d 4-matic (205.305)	125	04/16→						
MERCEDES-BENZ - C-KLASSE Kombi (S202) 06/96→03/01								
 Bremsbelagsatz, Scheibenbremse								
C 180 T (202.078)	90	06/96→09/00	←			13.0460-2975.2	602975	TRW 21439 20,3 + WE / - WK
C 180 T (202.081)	95	09/00→03/01				13.0470-2975.2	LD2975	TRW 21439 20,3 + WE / - WK Ceramic
C 200 T CDI (202.194)	75	03/98→03/01						
C 200 T D (202.180)	65	10/96→03/01	→	→ F576240		13.0460-3805.2	603805	ATE 21197 15,0 + WE / - WK
C 220 T CDI (202.193)	92	09/97→03/01				13.0470-3805.2	LD3805	ATE 21197 15,0 + WE / - WK Ceramic
C 220 T D (202.182)	55	06/96→03/01						
C 220 T D (202.182)	70	06/96→09/98	→	F576241→		13.0460-4064.2	604064	ATE 21919 15,3 - WE / - WK + Zub
						13.0470-4064.2	LD4064	ATE 21919 15,3 - WE / - WK + Zub Ceramic
C 200 T (202.080)	100	06/96→03/01	←			13.0460-2975.2	602975	TRW 21439 20,3 + WE / - WK
C 200 T Kompressor (202.082)	141	11/96→03/01				13.0460-7086.2	607086	ATE 21664 19,8 + WE / - WK
						13.0470-2975.2	LD2975	TRW 21439 20,3 + WE / - WK Ceramic
						13.0470-7086.2	LD7086	ATE 21664 19,8 + WE / - WK Ceramic
			→	→ F576240		13.0460-3805.2	603805	ATE 21197 15,0 + WE / - WK
						13.0470-3805.2	LD3805	ATE 21197 15,0 + WE / - WK Ceramic
			→	F576241→		13.0460-4064.2	604064	ATE 21919 15,3 - WE / - WK + Zub
						13.0470-4064.2	LD4064	ATE 21919 15,3 - WE / - WK + Zub Ceramic
C 200 T Kompressor (202.087)	120	09/00→03/01	←			13.0460-7086.2	607086	ATE 21664 19,8 + WE / - WK
C 250 T Turbo-D (202.188)	110	06/96→03/01				13.0470-7086.2	LD7086	ATE 21664 19,8 + WE / - WK Ceramic
↓			→	→ F576240		13.0460-3805.2	603805	ATE 21197 15,0 + WE / - WK









	kw			 	! #		
MERCEDES-BENZ - C-KLASSE Kombi (S202) 06/96→03/01							
Bremsbelagsatz, Scheibenbremse							
C 200 T Kompressor (202.087)	120	09/00→03/01	➡	→ F576240		13.0470-3805.2	LD3805 ATE 21197 15,0 + WE / - WK Ceramic
C 250 T Turbo-D (202.188)	110	06/96→03/01	➡	F576241→		13.0460-4064.2	604064 ATE 21919 15,3 - WE / - WK + Zub
						13.0470-4064.2	LD4064 ATE 21919 15,3 - WE / - WK + Zub Ceramic
C 230 T (202.083)	110	06/96→06/98	⬅	→ 06/97		13.0460-2975.2	602975 TRW 21439 20,3 + WE / - WK Ceramic
			➡	→ F576240		13.0460-3805.2	603805 ATE 21197 15,0 + WE / - WK Ceramic
			➡	→ 06/97; F576241→		13.0460-4064.2	604064 ATE 21919 15,3 - WE / - WK + Zub
						13.0470-4064.2	LD4064 ATE 21919 15,3 - WE / - WK + Zub Ceramic
C 230 T Kompressor (202.085)	142	06/97→09/00	⬅			13.0460-7086.2	607086 ATE 21664 19,8 + WE / - WK Ceramic
C 240 T (202.086)	125	06/97→09/00				13.0470-7086.2	LD7086 ATE 21664 19,8 + WE / - WK Ceramic
C 240 T (202.088)	125	09/00→03/01	➡			13.0460-4064.2	604064 ATE 21919 15,3 - WE / - WK + Zub
C 280 T (202.089)	145	06/97→03/01				13.0470-4064.2	LD4064 ATE 21919 15,3 - WE / - WK + Zub Ceramic
C 43 AMG (202.093)	225	08/97→03/01	⬅	09/97→		13.0460-7183.2	607183 ATE 21484 20,5 + WE / - WK
			➡	09/97→		13.0460-4047.2	604047 ATE 21305 15,7 + WE / - WK
						13.0470-4047.2	LD4047 ATE 21305 15,7 + WE / - WK Ceramic
Warnkontakt, Bremsbelagverschleiß							
C 180 T (202.078)	90	06/96→09/00	⬅		2	24.8190-0401.2	620401 L= 95
C 180 T (202.081)	95	09/00→03/01					
C 200 T (202.080)	100	06/96→03/01	➡	→ F576240	1	24.8190-0401.2	620401 L= 95
C 200 T CDI (202.194)	75	03/98→03/01					
C 200 T D (202.180)	65	10/96→03/01					
C 200 T Kompressor (202.082)	141	11/96→03/01					
C 200 T Kompressor (202.087)	120	09/00→03/01					
C 220 T CDI (202.193)	92	09/97→03/01					
C 220 T D (202.182)	55	06/96→03/01					
C 220 T D (202.182)	70	06/96→09/98					
C 250 T Turbo-D (202.188)	110	06/96→03/01					
C 230 T (202.083)	110	06/96→06/98	⬅	→ 06/97	2	24.8190-0401.2	620401 L= 95
			➡	→ F576240	1	24.8190-0401.2	620401 L= 95
C 230 T Kompressor (202.085)	142	06/97→09/00	⬅		2	24.8190-0401.2	620401 L= 95
C 240 T (202.086)	125	06/97→09/00					
C 240 T (202.088)	125	09/00→03/01					
C 280 T (202.089)	145	06/97→03/01					
C 43 AMG (202.093)	225	08/97→03/01	⬅	09/97→	2	24.8190-0419.2	620419 L= 74
			➡	09/97→	1	24.8190-0401.2	620401 L= 95
Zubehörsatz, Scheibenbremsbelag							
C 180 T (202.078)	90	06/96→09/00	➡	F576241→		13.0460-0229.2	610229 ATE
C 180 T (202.081)	95	09/00→03/01					
C 200 T (202.080)	100	06/96→03/01					
C 200 T CDI (202.194)	75	03/98→03/01					
C 200 T D (202.180)	65	10/96→03/01					
C 200 T Kompressor (202.082)	141	11/96→03/01					
C 200 T Kompressor (202.087)	120	09/00→03/01					
C 220 T CDI (202.193)	92	09/97→03/01					
C 220 T D (202.182)	55	06/96→03/01					
C 220 T D (202.182)	70	06/96→09/98					
C 250 T Turbo-D (202.188)	110	06/96→03/01					
C 230 T (202.083)	110	06/96→06/98	➡	→ 06/97; F576241→		13.0460-0229.2	610229 ATE
C 230 T Kompressor (202.085)	142	06/97→09/00	➡			13.0460-0229.2	610229 ATE
C 240 T (202.086)	125	06/97→09/00					
C 240 T (202.088)	125	09/00→03/01					
C 280 T (202.089)	145	06/97→03/01					
↓							

	kw			 	! #		
MERCEDES-BENZ - C-KLASSE Kombi (S202) 06/96→03/01							
Zubehörsatz, Scheibenbremsbelag							
C 43 AMG (202.093)	225	08/97→03/01	➡	09/97→		13.0460-0236.2 610236	ATE
 Bremsscheibe							
C 180 T (202.078)	90	06/96→09/00	←			24.0122-0132.1 422132	Ø 284 22 19,4 V + S
C 180 T (202.081)	95	09/00→03/01				24.0322-0132.1 522132	Ø 284 22 19,4 V + S PD
C 200 T CDI (202.194)	75	03/98→03/01				24.0109-0114.1 409114	Ø 278 9 7,3 + S
C 200 T D (202.180)	65	10/96→03/01	➡			24.0309-0114.1 509114	Ø 278 9 7,3 + S PD
C 220 T CDI (202.193)	92	09/97→03/01					
C 220 T D (202.182)	55	06/96→03/01					
C 220 T D (202.182)	70	06/96→09/98					
C 200 T (202.080)	100	06/96→03/01	←			24.0122-0132.1 422132	Ø 284 22 19,4 V + S
C 200 T Kompressor (202.082)	141	11/96→03/01				24.0125-0110.1 425110	Ø 288 25 22,4 V + S
						24.0322-0132.1 522132	Ø 284 22 19,4 V + S PD
						24.0325-0110.1 525110	Ø 288 25 22,4 V + S PD
			➡			24.0109-0114.1 409114	Ø 278 9 7,3 + S
						24.0309-0114.1 509114	Ø 278 9 7,3 + S PD
C 200 T Kompressor (202.087)	120	09/00→03/01	←			24.0125-0110.1 425110	Ø 288 25 22,4 V + S
C 230 T Kompressor (202.085)	142	06/97→09/00				24.0325-0110.1 525110	Ø 288 25 22,4 V + S PD
C 240 T (202.086)	125	06/97→09/00	➡			24.0109-0114.1 409114	Ø 278 9 7,3 + S
C 240 T (202.088)	125	09/00→03/01				24.0309-0114.1 509114	Ø 278 9 7,3 + S PD
C 250 T Turbo-D (202.188)	110	06/96→03/01					
C 280 T (202.089)	145	06/97→03/01					
C 230 T (202.083)	110	06/96→06/98	←	→ 06/97		24.0122-0132.1 422132	Ø 284 22 19,4 V + S
						24.0322-0132.1 522132	Ø 284 22 19,4 V + S PD
			➡	→ 06/97		24.0109-0114.1 409114	Ø 278 9 7,3 + S
						24.0309-0114.1 509114	Ø 278 9 7,3 + S PD
C 43 AMG (202.093)	225	08/97→03/01	➡	09/97→		24.0122-0228.1 422228	Ø 300 22 19,4 V
MERCEDES-BENZ - C-KLASSE Kombi (S203) 03/01→08/07							
 Bremsbelagsatz, Scheibenbremse							
C 180 (203.235)	95	03/01→05/02	←			13.0460-2726.2 602726	TRW 23144 19,8 + WE / - WK + Zub
						13.0470-2726.2 LD2726	TRW 23144 19,8 + WE / - WK + Zub Ceramic
			➡			13.0460-4065.2 604065	ATE 21899 15,3 + WE / - WK + Zub
						13.0470-4065.2 LD4065	ATE 21899 15,3 + WE / - WK + Zub Ceramic
C 180 Kompressor (203.246)	105	05/02→08/07	←	für Fahrzeuge ohne Sportpaket / für Fahrzeuge ohne AMG-Sportpaket		13.0460-2726.2 602726	TRW 23144 19,8 + WE / - WK + Zub
C 200 CDI (203.207)	90	04/03→08/07				13.0470-2726.2 LD2726	TRW 23144 19,8 + WE / - WK + Zub Ceramic
C 200 CGI Kompressor (203.243)	125	07/03→08/07					
C 200 Kompressor (203.242)	120	05/02→08/07	←	→ A 660226 / F 565688; für Fahrzeuge mit Sportpaket / für Fahrzeuge mit AMG-Sportpaket		13.0460-4990.2 604990	BRE 23271 17,4 + WE / - WK Ceramic
C 220 CDI (203.208)	110	02/04→08/07				13.0470-4990.2 LD4990	BRE 23271 17,4 + WE / - WK Ceramic
			←	A 660227 / F 565689→; für Fahrzeuge mit Sportpaket / für Fahrzeuge mit AMG-Sportpaket		13.0460-4994.2 604994	BRE 23945 16,5 + WE / - WK Ceramic
						13.0470-4994.2 LD4994	BRE 23945 16,5 + WE / - WK Ceramic
			➡			13.0460-4065.2 604065	ATE 21899 15,3 + WE / - WK + Zub
						13.0470-4065.2 LD4065	ATE 21899 15,3 + WE / - WK + Zub Ceramic
C 200 CDI (203.204, 203.207)	75	03/01→08/07	←	für Fahrzeuge ohne Sportpaket / für Fahrzeuge ohne AMG-Sportpaket		13.0460-2726.2 602726	TRW 23144 19,8 + WE / - WK + Zub
C 200 CDI (203.204)	85	03/01→08/07				13.0470-2726.2 LD2726	TRW 23144 19,8 + WE / - WK + Zub Ceramic
C 220 CDI (203.206)	105	03/01→08/07					
C 220 CDI (203.208)	100	08/06→08/07					
			←	für Fahrzeuge mit Sportpaket / für Fahrzeuge mit AMG-Sportpaket		13.0460-4990.2 604990	BRE 23271 17,4 + WE / - WK Ceramic
						13.0470-4990.2 LD4990	BRE 23271 17,4 + WE / - WK Ceramic
			➡			13.0460-4065.2 604065	ATE 21899 15,3 + WE / - WK + Zub
						13.0470-4065.2 LD4065	ATE 21899 15,3 + WE / - WK + Zub Ceramic
C 200 Kompressor (203.245)	120	03/01→05/02	←	→ 04/02		13.0460-2726.2 602726	TRW 23144 19,8 + WE / - WK + Zub
						13.0470-2726.2 LD2726	TRW 23144 19,8 + WE / - WK + Zub Ceramic

	kw			 	! #		
MERCEDES-BENZ - C-KLASSE Kombi (S203) 03/01→08/07							
 Bremsbelagsatz, Scheibenbremse							
C 200 Kompressor (203.245)	120	03/01→05/02	➔	→ 04/02		13.0460-4065.2 604065 13.0470-4065.2 LD4065	ATE 21899 15,3 + WE / - WK + Zub ATE 21899 15,3 + WE / - WK + Zub Ceramic
C 230 (203.252) C 280 (203.254) C 280 4-matic (203.292)	150	01/05→08/07	➔	06/05→; für Fahrzeuge ohne Sportpaket / für Fahrzeuge ohne AMG-Sportpaket		13.0460-2727.2 602727 13.0470-2727.2 LD2727	TRW 23144 19,8 + WE / - WK + Zub TRW 23144 19,8 + WE / - WK + Zub Ceramic
	170	01/05→08/07	➔	06/05→; für Fahrzeuge mit Sportpaket / für Fahrzeuge mit AMG-Sportpaket		13.0460-4994.2 604994 13.0470-4994.2 LD4994	BRE 23945 16,5 + WE / - WK Ceramic BRE 23945 16,5 + WE / - WK Ceramic
	170	01/05→08/07	➔	06/05→		13.0460-4065.2 604065 13.0470-4065.2 LD4065	ATE 21899 15,3 + WE / - WK + Zub ATE 21899 15,3 + WE / - WK + Zub Ceramic
C 230 Kompressor (203.240)	141	02/04→08/07	➔	für Fahrzeuge ohne Sportpaket / für Fahrzeuge ohne AMG-Sportpaket		13.0460-2727.2 602727 13.0470-2727.2 LD2727	TRW 23144 19,8 + WE / - WK + Zub TRW 23144 19,8 + WE / - WK + Zub Ceramic
			➔	für Fahrzeuge mit Sportpaket / für Fahrzeuge mit AMG-Sportpaket		13.0460-4994.2 604994 13.0470-4994.2 LD4994	BRE 23945 16,5 + WE / - WK Ceramic BRE 23945 16,5 + WE / - WK Ceramic
			➔			13.0460-4065.2 604065 13.0470-4065.2 LD4065	ATE 21899 15,3 + WE / - WK + Zub ATE 21899 15,3 + WE / - WK + Zub Ceramic
C 240 (203.261) C 270 CDI (203.216) C 270 CDI (203.216) C 320 (203.264)	125	03/01→08/07	➔	für Fahrzeuge ohne Sportpaket / für Fahrzeuge ohne AMG-Sportpaket		13.0460-2727.2 602727 13.0470-2727.2 LD2727	TRW 23144 19,8 + WE / - WK + Zub TRW 23144 19,8 + WE / - WK + Zub Ceramic
	120	03/01→08/07	➔	→ A 660226 / F 565688; für Fahrzeuge mit Sportpaket / für Fahrzeuge mit AMG-Sportpaket		13.0460-4990.2 604990 13.0470-4990.2 LD4990	BRE 23271 17,4 + WE / - WK Ceramic BRE 23271 17,4 + WE / - WK Ceramic
	125	03/01→08/07	➔	A 660227 / F 565689→; für Fahrzeuge mit Sportpaket / für Fahrzeuge mit AMG-Sportpaket		13.0460-4994.2 604994 13.0470-4994.2 LD4994	BRE 23945 16,5 + WE / - WK Ceramic BRE 23945 16,5 + WE / - WK Ceramic
	160	03/01→08/07	➔			13.0460-4065.2 604065 13.0470-4065.2 LD4065	ATE 21899 15,3 + WE / - WK + Zub ATE 21899 15,3 + WE / - WK + Zub Ceramic
C 240 4-matic (203.281)	125	07/02→08/07	➔	für Fahrzeuge ohne Sportpaket / für Fahrzeuge ohne AMG-Sportpaket		13.0460-2727.2 602727 13.0470-2727.2 LD2727	TRW 23144 19,8 + WE / - WK + Zub TRW 23144 19,8 + WE / - WK + Zub Ceramic
			➔			13.0460-4065.2 604065 13.0470-4065.2 LD4065	ATE 21899 15,3 + WE / - WK + Zub ATE 21899 15,3 + WE / - WK + Zub Ceramic
C 30 CDI AMG (203.218)	170	01/03→08/07	➔			13.0460-4990.2 604990 13.0470-4990.2 LD4990	BRE 23271 17,4 + WE / - WK Ceramic BRE 23271 17,4 + WE / - WK Ceramic
			➔			13.0460-4047.2 604047 13.0470-4047.2 LD4047	ATE 21305 15,7 + WE / - WK Ceramic ATE 21305 15,7 + WE / - WK Ceramic
C 320 4-matic (203.284)	160	07/02→08/07	➔			13.0460-2727.2 602727 13.0470-2727.2 LD2727	TRW 23144 19,8 + WE / - WK + Zub TRW 23144 19,8 + WE / - WK + Zub Ceramic
			➔			13.0460-4065.2 604065 13.0470-4065.2 LD4065	ATE 21899 15,3 + WE / - WK + Zub ATE 21899 15,3 + WE / - WK + Zub Ceramic
C 320 CDI (203.220)	165	06/05→08/07	➔	für Fahrzeuge mit Sportpaket / für Fahrzeuge mit AMG-Sportpaket		13.0460-4990.2 604990 13.0470-4990.2 LD4990	BRE 23271 17,4 + WE / - WK Ceramic BRE 23271 17,4 + WE / - WK Ceramic
			➔	für Fahrzeuge ohne Sportpaket / für Fahrzeuge ohne AMG-Sportpaket		13.0460-4994.2 604994 13.0470-4994.2 LD4994	BRE 23945 16,5 + WE / - WK Ceramic BRE 23945 16,5 + WE / - WK Ceramic
↓							

	kw			 	! #		
MERCEDES-BENZ - C-KLASSE Kombi (S203) 03/01→08/07							
 Bremsbelagsatz, Scheibenbremse							
C 320 CDI (203.220)	165	06/05→08/07	➔			13.0460-4065.2 604065 13.0470-4065.2 LD4065	ATE 21899 15,3 + WE / - WK + Zub ATE 21899 15,3 + WE / - WK + Zub Ceramic
C 32 AMG Kompressor (203.265)	260	03/01→08/07	➔			13.0460-4990.2 604990	BRE 23271 17,4 + WE / - WK
C 55 AMG (203.276)	270	02/04→08/07	➔			13.0460-4047.2 604047 13.0470-4047.2 LD4047	ATE 21305 15,7 + WE / - WK ATE 21305 15,7 + WE / - WK Ceramic
C 350 (203.256)	200	01/05→08/07	➔	06/05→; für Fahrzeuge mit Sportpaket / für Fahrzeuge mit AMG-Sportpaket		13.0460-4990.2 604990 13.0470-4990.2 LD4990	BRE 23271 17,4 + WE / - WK BRE 23271 17,4 + WE / - WK Ceramic
			➔	06/05→; für Fahrzeuge ohne Sportpaket / für Fahrzeuge ohne AMG-Sportpaket		13.0460-4994.2 604994 13.0470-4994.2 LD4994	BRE 23945 16,5 + WE / - WK BRE 23945 16,5 + WE / - WK Ceramic
			➔	06/05→		13.0460-4065.2 604065 13.0470-4065.2 LD4065	ATE 21899 15,3 + WE / - WK + Zub ATE 21899 15,3 + WE / - WK + Zub Ceramic
C 350 4-matic (203.287)	200	01/05→08/07	➔	06/05→		13.0460-4990.2 604990 13.0470-4990.2 LD4990	BRE 23271 17,4 + WE / - WK BRE 23271 17,4 + WE / - WK Ceramic
			➔	06/05→; für Fahrzeuge ohne Sportpaket / für Fahrzeuge ohne AMG-Sportpaket		13.0460-4047.2 604047 13.0470-4047.2 LD4047	ATE 21305 15,7 + WE / - WK ATE 21305 15,7 + WE / - WK Ceramic
			➔	06/05→; für Fahrzeuge mit Sportpaket / für Fahrzeuge mit AMG-Sportpaket		13.0460-4065.2 604065 13.0470-4065.2 LD4065	ATE 21899 15,3 + WE / - WK + Zub ATE 21899 15,3 + WE / - WK + Zub Ceramic
Warnkontakt, Bremsbelagverschleiß							
C 180 (203.235)	95	03/01→05/02	➔		2	24.8190-0410.2 620410	L= 97,5
C 30 CDI AMG (203.218)	170	01/03→08/07	➔		1	24.8190-0410.2 620410	L= 97,5
C 320 4-matic (203.284)	160	07/02→08/07					
C 32 AMG Kompressor (203.265)	260	03/01→08/07					
C 55 AMG (203.276)	270	02/04→08/07					
C 180 Kompressor (203.246)	105	05/02→08/07	➔	A 660227 / F 565689→; für Fahrzeuge mit Sportpaket / für Fahrzeuge mit AMG-Sportpaket	2	24.8190-0410.2 620410	L= 97,5
C 200 CDI (203.207)	90	04/03→08/07	➔	für Fahrzeuge ohne Sportpaket / für Fahrzeuge ohne AMG-Sportpaket	2	24.8190-0410.2 620410	L= 97,5
C 200 CGI Kompressor (203.243)	125	07/03→08/07	➔	für Fahrzeuge ohne Sportpaket / für Fahrzeuge ohne AMG-Sportpaket	2	24.8190-0410.2 620410	L= 97,5
C 200 Kompressor (203.242)	120	05/02→08/07	➔	→ A 660226 / F 565688; für Fahrzeuge mit Sportpaket / für Fahrzeuge mit AMG-Sportpaket	2	24.8190-0410.2 620410	L= 97,5
C 220 CDI (203.208)	110	02/04→08/07					
C 240 (203.261)	125	03/01→08/07					
C 270 CDI (203.216)	120	03/01→08/07	➔		1	24.8190-0410.2 620410	L= 97,5
C 270 CDI (203.216)	125	03/01→08/07					
C 320 (203.264)	160	03/01→08/07					
C 200 CDI (203.204, 203.207)	75	03/01→08/07	➔	für Fahrzeuge mit Sportpaket / für Fahrzeuge mit AMG-Sportpaket	2	24.8190-0410.2 620410	L= 97,5
C 200 CDI (203.204)	85	03/01→08/07	➔	für Fahrzeuge ohne Sportpaket / für Fahrzeuge ohne AMG-Sportpaket	2	24.8190-0410.2 620410	L= 97,5
C 220 CDI (203.206)	105	03/01→08/07					
C 220 CDI (203.208)	100	08/06→08/07	➔		1	24.8190-0410.2 620410	L= 97,5
C 230 Kompressor (203.240)	141	02/04→08/07					
C 320 CDI (203.220)	165	06/05→08/07					
C 200 Kompressor (203.245)	120	03/01→05/02	➔	→ 04/02	2	24.8190-0410.2 620410	L= 97,5
			➔	→ 04/02	1	24.8190-0410.2 620410	L= 97,5
C 230 (203.252)	150	01/05→08/07	➔	06/05→; für Fahrzeuge mit Sportpaket / für Fahrzeuge mit AMG-Sportpaket	2	24.8190-0410.2 620410	L= 97,5
C 280 (203.254)	170	01/05→08/07					
C 280 4-matic (203.292)	170	01/05→08/07	➔	06/05→; für Fahrzeuge ohne Sportpaket / für Fahrzeuge ohne AMG-Sportpaket	2	24.8190-0410.2 620410	L= 97,5
C 350 (203.256)	200	01/05→08/07	➔	06/05→	1	24.8190-0410.2 620410	L= 97,5
C 240 4-matic (203.281)	125	07/02→08/07	➔	für Fahrzeuge ohne Sportpaket / für Fahrzeuge ohne AMG-Sportpaket	2	24.8190-0410.2 620410	L= 97,5
			➔		1	24.8190-0410.2 620410	L= 97,5
C 350 4-matic (203.287)	200	01/05→08/07	➔	06/05→	2	24.8190-0410.2 620410	L= 97,5
			➔	06/05→; für Fahrzeuge mit Sportpaket / für Fahrzeuge mit AMG-Sportpaket	1	24.8190-0410.2 620410	L= 97,5



	kW			 	! #		
MERCEDES-BENZ - C-KLASSE Kombi (S203) 03/01→08/07							
Warnkontakt, Bremsbelagverschleiß							
C 350 4-matic (203.287)	200	01/05→08/07	➔	06/05→; für Fahrzeuge ohne Sportpaket / für Fahrzeuge ohne AMG-Sportpaket	1	24.8190-0410.2 620410	L= 97,5
Zubehörsatz, Scheibenbremsbelag							
C 180 (203.235)	95	03/01→05/02	➔			13.0460-0231.2 610231	ATE
C 230 Kompressor (203.240)	141	02/04→08/07	➔				
C 240 4-matic (203.281)	125	07/02→08/07	➔				
C 320 4-matic (203.284)	160	07/02→08/07	➔				
C 180 Kompressor (203.246)	105	05/02→08/07	➔	→ A 660226 / F 565688; für Fahrzeuge mit Sportpaket / für Fahr- zeuge mit AMG-Sportpaket		13.0460-0275.2 610275	
C 200 CDI (203.207)	90	04/03→08/07	➔				
C 200 CGI Kompressor (203.243)	125	07/03→08/07	➔			13.0460-0231.2 610231	ATE
C 200 Kompressor (203.242)	120	05/02→08/07	➔				
C 220 CDI (203.208)	110	02/04→08/07	➔				
C 240 (203.261)	125	03/01→08/07	➔				
C 270 CDI (203.216)	120	03/01→08/07	➔				
C 270 CDI (203.216)	125	03/01→08/07	➔				
C 320 (203.264)	160	03/01→08/07	➔				
C 200 CDI (203.204, 203.207)	75	03/01→08/07	➔	für Fahrzeuge mit Sportpaket / für Fahr- zeuge mit AMG-Sportpaket		13.0460-0275.2 610275	
C 200 CDI (203.204)	85	03/01→08/07	➔			13.0460-0231.2 610231	ATE
C 220 CDI (203.206)	105	03/01→08/07	➔				
C 220 CDI (203.208)	100	08/06→08/07	➔				
C 200 Kompressor (203.245)	120	03/01→05/02	➔	→ 04/02		13.0460-0231.2 610231	ATE
C 230 (203.252)	150	01/05→08/07	➔	06/05→		13.0460-0231.2 610231	ATE
C 280 (203.254)	170	01/05→08/07	➔				
C 280 4-matic (203.292)	170	01/05→08/07	➔				
C 30 CDI AMG (203.218)	170	01/03→08/07	➔			13.0460-0237.2 610237	BRE
C 32 AMG Kompressor (203.265)	260	03/01→08/07	➔			13.0460-0269.2 610269	ATE
C 55 AMG (203.276)	270	02/04→08/07	➔			13.0460-0236.2 610236	ATE
C 320 CDI (203.220)	165	06/05→08/07	➔	für Fahrzeuge mit Sportpaket / für Fahr- zeuge mit AMG-Sportpaket		13.0460-0237.2 610237	BRE
			➔			13.0460-0269.2 610269	ATE
C 350 (203.256)	200	01/05→08/07	➔	06/05→; für Fahrzeuge mit Sportpaket / für Fahr- zeuge mit AMG-Sportpaket		13.0460-0237.2 610237	BRE
			➔	06/05→		13.0460-0269.2 610269	ATE
C 350 4-matic (203.287)	200	01/05→08/07	➔	06/05→		13.0460-0237.2 610237	BRE
			➔	06/05→; für Fahrzeuge mit Sportpaket / für Fahr- zeuge mit AMG-Sportpaket		13.0460-0269.2 610269	ATE
			➔	06/05→; für Fahrzeuge ohne Sportpaket / für Fahrzeuge ohne AMG-Sportpaket		13.0460-0236.2 610236	ATE
 Bremsscheibe							
C 180 (203.235)	95	03/01→05/02	➔			24.0125-0110.1 425110	Ø 288 25 22,4 V + S
			➔			24.0325-0110.1 525110	Ø 288 25 22,4 V + S PD
			➔			24.0110-0217.1 410217	Ø 290 10 8,3 + S
			➔			24.0310-0217.1 510217	Ø 290 10 8,3 + S PD
C 180 Kompressor (203.246)	105	05/02→08/07	➔	für Fahrzeuge ohne Sportpaket / für Fahrzeuge ohne AMG-Sportpaket		24.0125-0110.1 425110	Ø 288 25 22,4 V + S
C 200 CDI (203.204, 203.207)	75	03/01→08/07	➔			24.0325-0110.1 525110	Ø 288 25 22,4 V + S PD
C 200 CDI (203.204)	85	03/01→08/07	➔	für Fahrzeuge mit Sportpaket / für Fahr- zeuge mit AMG-Sportpaket		24.0128-0177.1 428177	Ø 330 28 26 V*
C 200 CDI (203.207)	90	04/03→08/07	➔			24.0110-0217.1 410217	Ø 290 10 8,3 + S
C 200 CGI Kompressor (203.243)	125	07/03→08/07	➔			24.0310-0217.1 510217	Ø 290 10 8,3 + S PD
C 200 Kompressor (203.242)	120	05/02→08/07	➔				
C 220 CDI (203.206)	105	03/01→08/07	➔				
C 220 CDI (203.208)	100	08/06→08/07	➔				
C 220 CDI (203.208)	110	02/04→08/07	➔				
C 200 Kompressor (203.245)	120	03/01→05/02	➔	→ 04/02		24.0125-0110.1 425110	Ø 288 25 22,4 V + S
			➔	→ 04/02		24.0325-0110.1 525110	Ø 288 25 22,4 V + S PD
			➔			24.0110-0217.1 410217	Ø 290 10 8,3 + S
			➔			24.0310-0217.1 510217	Ø 290 10 8,3 + S PD
↓							

MERCEDES-BENZ - C-KLASSE Kombi (S203) 03/01→08/07









Bremsscheibe







C 230 (203.252) C 280 (203.254) C 280 4-matic (203.292)	150	01/05→08/07	←	06/05→; für Fahrzeuge ohne Sportpaket / für Fahrzeuge ohne AMG-Sportpaket	24.0128-0106.1 428106	Ø 300 28 25,4 V + S
	170	01/05→08/07			24.0328-0106.1 528106	Ø 300 28 25,4 V + S PD
	170	01/05→08/07	←	06/05→; für Fahrzeuge mit Sportpaket / für Fahr- zeuge mit AMG-Sportpaket	24.0128-0177.1 428177	Ø 330 28 26 V•
			→	06/05→	24.0110-0217.1 410217 24.0310-0217.1 510217	Ø 290 10 8,3 + S Ø 290 10 8,3 + S PD
C 230 Kompressor (203.240)	141	02/04→08/07	←	für Fahrzeuge ohne Sportpaket / für Fahrzeuge ohne AMG-Sportpaket	24.0128-0106.1 428106	Ø 300 28 25,4 V + S
C 240 (203.261)	125	03/01→08/07			24.0328-0106.1 528106	Ø 300 28 25,4 V + S PD
C 270 CDI (203.216)	120	03/01→08/07	←	für Fahrzeuge mit Sportpaket / für Fahr- zeuge mit AMG-Sportpaket	24.0128-0177.1 428177	Ø 330 28 26 V•
C 270 CDI (203.216)	125	03/01→08/07				
C 320 (203.264)	160	03/01→08/07	→		24.0110-0217.1 410217 24.0310-0217.1 510217	Ø 290 10 8,3 + S Ø 290 10 8,3 + S PD
C 240 4-matic (203.281)	125	07/02→08/07	←		24.0128-0106.1 428106	Ø 300 28 25,4 V + S
C 320 4-matic (203.284)	160	07/02→08/07			24.0328-0106.1 528106	Ø 300 28 25,4 V + S PD
			→		24.0110-0217.1 410217 24.0310-0217.1 510217	Ø 290 10 8,3 + S Ø 290 10 8,3 + S PD
C 30 CDI AMG (203.218)	170	01/03→08/07	←		24.0130-0180.1 430180	Ø 345 30 28 V•
C 32 AMG Kompressor (203.265)	260	03/01→08/07	→		24.0122-0228.1 422228	Ø 300 22 19,4 V
C 55 AMG (203.276)	270	02/04→08/07				
C 320 CDI (203.220)	165	06/05→08/07	←	für Fahrzeuge ohne Sportpaket / für Fahrzeuge ohne AMG-Sportpaket	24.0128-0188.1 428188	Ø 330 28 26 V + S
			←	für Fahrzeuge mit Sportpaket / für Fahr- zeuge mit AMG-Sportpaket	24.0130-0180.1 430180	Ø 345 30 28 V•
			→		24.0110-0217.1 410217 24.0310-0217.1 510217	Ø 290 10 8,3 + S Ø 290 10 8,3 + S PD
C 350 (203.256)	200	01/05→08/07	←	06/05→; für Fahrzeuge ohne Sportpaket / für Fahrzeuge ohne AMG-Sportpaket	24.0128-0188.1 428188	Ø 330 28 26 V + S
			←	06/05→; für Fahrzeuge mit Sportpaket / für Fahr- zeuge mit AMG-Sportpaket	24.0130-0180.1 430180	Ø 345 30 28 V•
			→	06/05→	24.0110-0217.1 410217 24.0310-0217.1 510217	Ø 290 10 8,3 + S Ø 290 10 8,3 + S PD
C 350 4-matic (203.287)	200	01/05→08/07	←	06/05→; für Fahrzeuge ohne Sportpaket / für Fahrzeuge ohne AMG-Sportpaket	24.0130-0171.1 430171	Ø 345 30 27,4 V
			←	06/05→; für Fahrzeuge mit Sportpaket / für Fahr- zeuge mit AMG-Sportpaket	24.0130-0180.1 430180	Ø 345 30 28 V•
			→	06/05→	24.0122-0228.1 422228	Ø 300 22 19,4 V







MERCEDES-BENZ - C-KLASSE Kombi (S204) 08/07→08/14







Bremsbelagsatz, Scheibenbremse

C 180 (204.231) C 180 CDI (204.200) C 180 CGI (204.249) C 180 Kompressor (204.245) C 200 CDI (204.201)	115	02/12→08/14	←	für Fahrzeuge mit Sportpaket / für Fahr- zeuge mit AMG-Sportpaket	13.0460-2732.2 602732	TRW 24306 20,3 + WE / - WK + Zub
	88	01/11→08/14			13.0470-2732.2 LD2732	TRW 24306 20,3 + WE / - WK + Zub Ceramic
	115	11/09→08/14			13.0470-9000.2 LD9000	TRW 24306 20,3 + WE / - WK + Zub Ceramic
	115	01/08→08/14				
	100	08/10→08/14	←	für Fahrzeuge ohne Sportpaket / für Fahrzeuge ohne AMG-Sportpaket	13.0460-2733.2 602733	TRW 24306 20,3 + WE / - WK + Zub
					13.0470-2733.2 LD2733	TRW 24306 20,3 + WE / - WK + Zub Ceramic
			→		13.0460-7244.2 607244 13.0470-7244.2 LD7244	ATE 24253 17,8 + WE / - WK ATE 24253 17,8 + WE / - WK Ceramic
C 180 Kompressor (204.246) C 200 CDI (204.207)	115	08/07→08/14	←	09/07→; für Fahrzeuge mit Sportpaket / für Fahr- zeuge mit AMG-Sportpaket	13.0460-2732.2 602732	TRW 24306 20,3 + WE / - WK + Zub
	100	08/07→12/11			13.0470-2732.2 LD2732	TRW 24306 20,3 + WE / - WK + Zub Ceramic
					13.0470-9000.2 LD9000	TRW 24306 20,3 + WE / - WK + Zub Ceramic
			←	09/07→; für Fahrzeuge ohne Sportpaket / für Fahrzeuge ohne AMG-Sportpaket	13.0460-2733.2 602733	TRW 24306 20,3 + WE / - WK + Zub
					13.0470-2733.2 LD2733	TRW 24306 20,3 + WE / - WK + Zub Ceramic







	kw			 	! #		
MERCEDES-BENZ - C-KLASSE Kombi (S204) 08/07→08/14							
 Bremsbelagsatz, Scheibenbremse							
C 180 Kompressor (204.246) C 200 CDI (204.207)	115 100	08/07→08/14 08/07→12/11	➡	09/07→		13.0460-7244.2 607244 13.0470-7244.2 LD7244	ATE 24253 17,8 + WE / - WK ATE 24253 17,8 + WE / - WK Ceramic
C 200 CGI (204.248)	135	08/07→08/14	⬅	04/09→		13.0460-2732.2 602732 13.0470-2732.2 LD2732 13.0470-9000.2 LD9000	TRW 24306 20,3 + WE / - WK + Zub TRW 24306 20,3 + WE / - WK + Zub Ceramic TRW 24306 20,3 + WE / - WK + Zub Ceramic
			➡	04/09→		13.0460-7244.2 607244 13.0470-7244.2 LD7244	ATE 24253 17,8 + WE / - WK ATE 24253 17,8 + WE / - WK Ceramic
C 200 Kompressor (204.241) C 220 CDI (204.208) C 230 (204.252)	135 125 150	08/07→08/14 08/07→11/08 08/07→08/14	⬅	09/07→		13.0460-2732.2 602732 13.0470-2732.2 LD2732 13.0470-9000.2 LD9000	TRW 24306 20,3 + WE / - WK + Zub TRW 24306 20,3 + WE / - WK + Zub Ceramic TRW 24306 20,3 + WE / - WK + Zub Ceramic
			➡	09/07→		13.0460-7244.2 607244 13.0470-7244.2 LD7244	ATE 24253 17,8 + WE / - WK ATE 24253 17,8 + WE / - WK Ceramic
C 220 CDI (204.202) C 220 CDI (204.202) C 220 CDI 4-matic (204.284) C 250 CGI (204.247)	120 125 125 150	12/08→08/14 12/08→08/14 02/13→08/14 07/09→08/14	⬅			13.0460-2732.2 602732 13.0470-2732.2 LD2732 13.0470-9000.2 LD9000	TRW 24306 20,3 + WE / - WK + Zub TRW 24306 20,3 + WE / - WK + Zub Ceramic TRW 24306 20,3 + WE / - WK + Zub Ceramic
			➡			13.0460-7244.2 607244 13.0470-7244.2 LD7244	ATE 24253 17,8 + WE / - WK ATE 24253 17,8 + WE / - WK Ceramic
C 220 CDI (204.208)	120	08/07→11/08	⬅			13.0460-2732.2 602732 13.0470-2732.2 LD2732 13.0470-9000.2 LD9000	TRW 24306 20,3 + WE / - WK + Zub TRW 24306 20,3 + WE / - WK + Zub Ceramic TRW 24306 20,3 + WE / - WK + Zub Ceramic
			⬅	09/07→		13.0460-2732.2 602732 13.0470-2732.2 LD2732 13.0470-9000.2 LD9000	TRW 24306 20,3 + WE / - WK + Zub TRW 24306 20,3 + WE / - WK + Zub Ceramic TRW 24306 20,3 + WE / - WK + Zub Ceramic
			➡	09/07→		13.0460-7244.2 607244 13.0470-7244.2 LD7244	ATE 24253 17,8 + WE / - WK ATE 24253 17,8 + WE / - WK Ceramic
			➡			13.0460-7244.2 607244 13.0470-7244.2 LD7244	ATE 24253 17,8 + WE / - WK ATE 24253 17,8 + WE / - WK Ceramic
C 250 CDI (204.203)	150	01/09→08/14	⬅	04/09→		13.0460-2732.2 602732 13.0470-2732.2 LD2732 13.0470-9000.2 LD9000	TRW 24306 20,3 + WE / - WK + Zub TRW 24306 20,3 + WE / - WK + Zub Ceramic TRW 24306 20,3 + WE / - WK + Zub Ceramic
			➡	04/09→; ALU		13.0460-7244.2 607244 13.0470-7244.2 LD7244	ATE 24253 17,8 + WE / - WK ATE 24253 17,8 + WE / - WK Ceramic
			➡	04/09→; GG		13.0460-7257.2 607257 13.0470-7257.2 LD7257	ATE 24253 18,0 + WE / - WK ATE 24253 18,0 + WE / - WK Ceramic
C 250 CDI 4-matic (204.282)	150	04/10→08/14	⬅	für Fahrzeuge ohne Sportpaket / für Fahrzeuge ohne AMG-Sportpaket		13.0460-2732.2 602732 13.0470-2732.2 LD2732 13.0470-9000.2 LD9000	TRW 24306 20,3 + WE / - WK + Zub TRW 24306 20,3 + WE / - WK + Zub Ceramic TRW 24306 20,3 + WE / - WK + Zub Ceramic
			⬅	für Fahrzeuge mit Sportpaket / für Fahrzeuge mit AMG-Sportpaket		13.0460-2734.2 602734 13.0470-2734.2 LD2734	TRW 24310 19,0 + WE / - WK TRW 24310 19,0 + WE / - WK Ceramic
↓							

	kw			 	! #		
MERCEDES-BENZ - C-KLASSE Kombi (S204) 08/07→08/14							
Bremsbelagsatz, Scheibenbremse							
C 250 CDI 4-matic (204.282)	150	04/10→08/14	➔	für Fahrzeuge mit Sportpaket / für Fahrzeuge mit AMG-Sportpaket		13.0460-7244.2 607244 13.0470-7244.2 LD7244	ATE 24253 17,8 + WE / - WK ATE 24253 17,8 + WE / - WK Ceramic
			➔	für Fahrzeuge ohne Sportpaket / für Fahrzeuge ohne AMG-Sportpaket; ALU		13.0460-7244.2 607244 13.0470-7244.2 LD7244	ATE 24253 17,8 + WE / - WK ATE 24253 17,8 + WE / - WK Ceramic
			➔	für Fahrzeuge ohne Sportpaket / für Fahrzeuge ohne AMG-Sportpaket; GG		13.0460-7257.2 607257 13.0470-7257.2 LD7257	ATE 24253 18,0 + WE / - WK ATE 24253 18,0 + WE / - WK Ceramic
C 280 (204.254)	170	08/07→08/14	←	09/07→; für Fahrzeuge ohne Sportpaket / für Fahrzeuge ohne AMG-Sportpaket		13.0460-2732.2 602732 13.0470-2732.2 LD2732 13.0470-9000.2 LD9000	TRW 24306 20,3 + WE / - WK + Zub TRW 24306 20,3 + WE / - WK + Zub Ceramic TRW 24306 20,3 + WE / - WK + Zub Ceramic
			←	09/07→; für Fahrzeuge mit Sportpaket / für Fahrzeuge mit AMG-Sportpaket		13.0460-2734.2 602734 13.0470-2734.2 LD2734	TRW 24310 19,0 + WE / - WK TRW 24310 19,0 + WE / - WK Ceramic
			➔	09/07→		13.0460-7244.2 607244 13.0470-7244.2 LD7244	ATE 24253 17,8 + WE / - WK ATE 24253 17,8 + WE / - WK Ceramic
C 300 (204.254)	170	08/07→08/14	←	für Fahrzeuge ohne Sportpaket / für Fahrzeuge ohne AMG-Sportpaket		13.0460-2732.2 602732 13.0470-2732.2 LD2732 13.0470-9000.2 LD9000	TRW 24306 20,3 + WE / - WK + Zub TRW 24306 20,3 + WE / - WK + Zub Ceramic TRW 24306 20,3 + WE / - WK + Zub Ceramic
			←	für Fahrzeuge mit Sportpaket / für Fahrzeuge mit AMG-Sportpaket		13.0460-2734.2 602734 13.0470-2734.2 LD2734	TRW 24310 19,0 + WE / - WK TRW 24310 19,0 + WE / - WK Ceramic
			➔			13.0460-7244.2 607244 13.0470-7244.2 LD7244	ATE 24253 17,8 + WE / - WK ATE 24253 17,8 + WE / - WK Ceramic
C 320 CDI (204.222) C 320 CDI 4-matic (204.289) C 350 (204.256)	165 165 200	08/07→08/14 08/07→08/14 08/07→08/14	←	09/07→		13.0460-2734.2 602734 13.0470-2734.2 LD2734	TRW 24310 19,0 + WE / - WK TRW 24310 19,0 + WE / - WK Ceramic
			➔	09/07→; ALU		13.0460-7244.2 607244 13.0470-7244.2 LD7244	ATE 24253 17,8 + WE / - WK ATE 24253 17,8 + WE / - WK Ceramic
			➔	09/07→; GG		13.0460-7257.2 607257 13.0470-7257.2 LD7257	ATE 24253 18,0 + WE / - WK ATE 24253 18,0 + WE / - WK Ceramic
C 350 CDI C 350 CDI (204.223) C 350 CDI (204.225) C 350 CDI 4-matic (204.292)	165 195 170 170	08/07→08/14 06/11→08/14 10/09→08/14 10/09→08/14	←			13.0460-2734.2 602734 13.0470-2734.2 LD2734	TRW 24310 19,0 + WE / - WK TRW 24310 19,0 + WE / - WK Ceramic
			➔	ALU		13.0460-7244.2 607244 13.0470-7244.2 LD7244	ATE 24253 17,8 + WE / - WK ATE 24253 17,8 + WE / - WK Ceramic
			➔	GG		13.0460-7257.2 607257 13.0470-7257.2 LD7257	ATE 24253 18,0 + WE / - WK ATE 24253 18,0 + WE / - WK Ceramic
C 350 CGI (204.257)	225	06/11→08/14	←			13.0460-2734.2 602734 13.0470-2734.2 LD2734	TRW 24310 19,0 + WE / - WK TRW 24310 19,0 + WE / - WK Ceramic
			➔			13.0460-7244.2 607244 13.0470-7244.2 LD7244	ATE 24253 17,8 + WE / - WK ATE 24253 17,8 + WE / - WK Ceramic
C 63 AMG C 63 AMG C 63 AMG (204.277) C 63 AMG (204.277)	373 382 336 358	06/13→08/14 07/10→08/14 02/08→08/14 01/12→08/14	←	nicht für Bremssattelfarbe: rot		13.0460-4839.2 604839	BRE 24455 16,8 + WE / - WK
Warnkontakt, Bremsbelagverschleiß							
C 180 (204.231) C 180 CDI (204.200) C 180 CGI (204.249) C 180 Kompressor (204.245) C 200 CDI (204.201) C 300 (204.254)	115 88 115 115 100 170	02/12→08/14 01/11→08/14 11/09→08/14 01/08→08/14 08/10→08/14 08/07→08/14	←	für Fahrzeuge mit Sportpaket / für Fahrzeuge mit AMG-Sportpaket	1	24.8190-0410.2 620410	L= 97,5
			←	für Fahrzeuge ohne Sportpaket / für Fahrzeuge ohne AMG-Sportpaket	1	24.8190-0410.2 620410	L= 97,5
			➔		1	24.8190-0410.2 620410	L= 97,5
↓							











	kW			 	! #		
MERCEDES-BENZ - C-KLASSE Kombi (S204) 08/07→08/14							
Warnkontakt, Bremsbelagverschleiß							
C 180 Kompressor (204.246)	115	08/07→08/14	←	09/07→; für Fahrzeuge mit Sportpaket / für Fahrzeuge mit AMG-Sportpaket	1	24.8190-0410.2 620410	L= 97,5
C 200 CDI (204.207)	100	08/07→12/11					
C 280 (204.254)	170	08/07→08/14	←	09/07→; für Fahrzeuge ohne Sportpaket / für Fahrzeuge ohne AMG-Sportpaket	1	24.8190-0410.2 620410	L= 97,5
			→	09/07→	1	24.8190-0410.2 620410	L= 97,5
C 200 CGI (204.248)	135	08/07→08/14	←	04/09→	1	24.8190-0410.2 620410	L= 97,5
C 250 CDI (204.203)	150	01/09→08/14	→	04/09→	1	24.8190-0410.2 620410	L= 97,5
C 200 Kompressor (204.241)	135	08/07→08/14	←	09/07→	1	24.8190-0410.2 620410	L= 97,5
C 220 CDI (204.208)	125	08/07→11/08	→	09/07→	1	24.8190-0410.2 620410	L= 97,5
C 230 (204.252)	150	08/07→08/14					
C 320 CDI (204.222)	165	08/07→08/14					
C 320 CDI 4-matic (204.289)	165	08/07→08/14					
C 350 (204.256)	200	08/07→08/14					
C 220 CDI (204.202)	120	12/08→08/14	←		1	24.8190-0410.2 620410	L= 97,5
C 220 CDI (204.202)	125	12/08→08/14					
C 220 CDI 4-matic (204.284)	125	02/13→08/14	→		1	24.8190-0410.2 620410	L= 97,5
C 250 CGI (204.247)	150	07/09→08/14					
C 350 CDI	165	08/07→08/14					
C 350 CDI (204.223)	195	06/11→08/14					
C 350 CDI (204.225)	170	10/09→08/14					
C 350 CDI 4-matic (204.292)	170	10/09→08/14					
C 350 CGI (204.257)	225	06/11→08/14					
C 220 CDI (204.208)	120	08/07→11/08	←		1	24.8190-0410.2 620410	L= 97,5
			←	09/07→	1	24.8190-0410.2 620410	L= 97,5
			→		1	24.8190-0410.2 620410	L= 97,5
			→	09/07→	1	24.8190-0410.2 620410	L= 97,5
C 250 CDI 4-matic (204.282)	150	04/10→08/14	←	für Fahrzeuge mit Sportpaket / für Fahrzeuge mit AMG-Sportpaket	1	24.8190-0410.2 620410	L= 97,5
			←	für Fahrzeuge ohne Sportpaket / für Fahrzeuge ohne AMG-Sportpaket	1	24.8190-0410.2 620410	L= 97,5
			→	für Fahrzeuge mit Sportpaket / für Fahrzeuge mit AMG-Sportpaket	1	24.8190-0410.2 620410	L= 97,5
			→	für Fahrzeuge ohne Sportpaket / für Fahrzeuge ohne AMG-Sportpaket	1	24.8190-0410.2 620410	L= 97,5
C 63 AMG	373	06/13→08/14	←		1	24.8190-0420.2 620420	L= 119
C 63 AMG	382	07/10→08/14					
C 63 AMG (204.277)	336	02/08→08/14	→		1	24.8190-0420.2 620420	L= 119
C 63 AMG (204.277)	358	01/12→08/14					
Bremsscheibe							
C 180 (204.231)	115	02/12→08/14	←	für Fahrzeuge ohne Sportpaket / für Fahrzeuge ohne AMG-Sportpaket		24.0125-0179.1 425179	Ø 288 25 22 V + S
C 180 CDI (204.200)	88	01/11→08/14				24.0325-0179.1 525179	Ø 288 25 22 V + S PD
C 180 CGI (204.249)	115	11/09→08/14	←	für Fahrzeuge mit Sportpaket / für Fahrzeuge mit AMG-Sportpaket		24.0128-0100.1 428100	Ø 295 28 26 V• + S
C 180 Kompressor (204.245)	115	01/08→08/14	←	für Fahrzeuge mit Sportpaket / für Fahrzeuge mit AMG-Sportpaket		24.0128-0100.1 428100	Ø 295 28 26 V• + S
C 200 CDI (204.201)	100	08/10→08/14	→	für Fahrzeuge ohne Sportpaket / für Fahrzeuge ohne AMG-Sportpaket		24.0109-0154.1 409154	Ø 278 9 7,3 + S
			→	für Fahrzeuge ohne AMG-Sportpaket		24.0309-0154.1 509154	Ø 278 9 7,3 + S PD
			→	für Fahrzeuge mit Sportpaket / für Fahrzeuge mit AMG-Sportpaket		24.0110-0328.1 410328	Ø 300 10 8,3 + S
			→	für Fahrzeuge mit AMG-Sportpaket		24.0310-0328.1 510328	Ø 300 10 8,3 + S PD
C 180 Kompressor (204.246)	115	08/07→08/14	←	09/07→; für Fahrzeuge ohne Sportpaket / für Fahrzeuge ohne AMG-Sportpaket		24.0125-0179.1 425179	Ø 288 25 22 V + S
						24.0325-0179.1 525179	Ø 288 25 22 V + S PD
			←	09/07→; für Fahrzeuge mit Sportpaket / für Fahrzeuge mit AMG-Sportpaket		24.0128-0100.1 428100	Ø 295 28 26 V• + S
			→	09/07→; für Fahrzeuge ohne Sportpaket / für Fahrzeuge ohne AMG-Sportpaket		24.0109-0154.1 409154	Ø 278 9 7,3 + S
			→	für Fahrzeuge ohne AMG-Sportpaket		24.0309-0154.1 509154	Ø 278 9 7,3 + S PD
			→	09/07→; für Fahrzeuge mit Sportpaket / für Fahrzeuge mit AMG-Sportpaket		24.0110-0328.1 410328	Ø 300 10 8,3 + S
			→	für Fahrzeuge mit AMG-Sportpaket		24.0310-0328.1 510328	Ø 300 10 8,3 + S PD
C 200 CDI (204.207)	100	08/07→12/11	←	09/07→; für Fahrzeuge ohne Sportpaket / für Fahrzeuge ohne AMG-Sportpaket		24.0125-0179.1 425179	Ø 288 25 22 V + S
						24.0128-0155.1 428155	Ø 295 28 25,4 V + S
						24.0325-0179.1 525179	Ø 288 25 22 V + S PD
						24.0328-0155.1 528155	Ø 295 28 25,4 V + S PD
			←	09/07→; für Fahrzeuge mit Sportpaket / für Fahrzeuge mit AMG-Sportpaket		24.0128-0100.1 428100	Ø 295 28 26 V• + S









	kw			 	! #		
MERCEDES-BENZ - C-KLASSE Kombi (S204) 08/07→08/14							
Bremsscheibe							
C 200 CDI (204.207)	100	08/07→12/11	➔	09/07→; für Fahrzeuge ohne Sportpaket / für Fahrzeuge ohne AMG-Sportpaket	24.0109-0154.1 409154 24.0309-0154.1 509154	Ø 278 9 7,3 + S Ø 278 9 7,3 + S PD	
			➔	09/07→; für Fahrzeuge mit Sportpaket / für Fahr- zeuge mit AMG-Sportpaket	24.0110-0328.1 410328 24.0310-0328.1 510328	Ø 300 10 8,3 + S Ø 300 10 8,3 + S PD	
C 200 CGI (204.248)	135	08/07→08/14	←	04/09→; für Fahrzeuge mit Sportpaket / für Fahr- zeuge mit AMG-Sportpaket	24.0128-0100.1 428100	Ø 295 28 26 V• + S	
			←	04/09→; für Fahrzeuge ohne Sportpaket / für Fahrzeuge ohne AMG-Sportpaket	24.0128-0155.1 428155 24.0328-0155.1 528155	Ø 295 28 25,4 V + S Ø 295 28 25,4 V + S PD	
			➔	04/09→	24.0110-0328.1 410328 24.0310-0328.1 510328	Ø 300 10 8,3 + S Ø 300 10 8,3 + S PD	
C 200 Kompressor (204.241)	135	08/07→08/14	←	09/07→; für Fahrzeuge mit Sportpaket / für Fahr- zeuge mit AMG-Sportpaket	24.0128-0100.1 428100	Ø 295 28 26 V• + S	
C 220 CDI (204.208)	125	08/07→11/08	←	09/07→; für Fahrzeuge ohne Sportpaket / für Fahrzeuge ohne AMG-Sportpaket	24.0128-0155.1 428155 24.0328-0155.1 528155	Ø 295 28 25,4 V + S Ø 295 28 25,4 V + S PD	
C 230 (204.252)	150	08/07→08/14					➔
C 220 CDI (204.202)	120	12/08→08/14	←	für Fahrzeuge mit Sportpaket / für Fahr- zeuge mit AMG-Sportpaket	24.0128-0100.1 428100	Ø 295 28 26 V• + S	
C 220 CDI (204.202)	125	12/08→08/14	←	für Fahrzeuge ohne Sportpaket / für Fahrzeuge ohne AMG-Sportpaket	24.0128-0155.1 428155 24.0328-0155.1 528155	Ø 295 28 25,4 V + S Ø 295 28 25,4 V + S PD	
C 220 CDI 4-matic (204.284)	125	02/13→08/14					➔
C 250 CGI (204.247)	150	07/09→08/14	➔				
C 220 CDI (204.208)	120	08/07→11/08	←	für Fahrzeuge mit Sportpaket / für Fahr- zeuge mit AMG-Sportpaket	24.0128-0100.1 428100	Ø 295 28 26 V• + S	
			←	09/07→; für Fahrzeuge mit Sportpaket / für Fahr- zeuge mit AMG-Sportpaket	24.0128-0100.1 428100	Ø 295 28 26 V• + S	
			←	für Fahrzeuge ohne Sportpaket / für Fahrzeuge ohne AMG-Sportpaket	24.0128-0155.1 428155 24.0328-0155.1 528155	Ø 295 28 25,4 V + S Ø 295 28 25,4 V + S PD	
			←	09/07→; für Fahrzeuge ohne Sportpaket / für Fahrzeuge ohne AMG-Sportpaket	24.0128-0155.1 428155 24.0328-0155.1 528155	Ø 295 28 25,4 V + S Ø 295 28 25,4 V + S PD	
			➔	09/07→	24.0110-0328.1 410328 24.0310-0328.1 510328	Ø 300 10 8,3 + S Ø 300 10 8,3 + S PD	
			➔		24.0110-0328.1 410328 24.0310-0328.1 510328	Ø 300 10 8,3 + S Ø 300 10 8,3 + S PD	
C 250 CDI (204.203)	150	01/09→08/14	←	04/09→; für Fahrzeuge mit Sportpaket / für Fahr- zeuge mit AMG-Sportpaket	24.0128-0100.1 428100	Ø 295 28 26 V• + S	
			←	04/09→; für Fahrzeuge ohne Sportpaket / für Fahrzeuge ohne AMG-Sportpaket	24.0128-0155.1 428155 24.0328-0155.1 528155	Ø 295 28 25,4 V + S Ø 295 28 25,4 V + S PD	
			➔	04/09→	24.0120-0208.1 420208	Ø 300 22 19,4 V + S	
C 250 CDI 4-matic (204.282)	150	04/10→08/14	←	für Fahrzeuge ohne Sportpaket / für Fahrzeuge ohne AMG-Sportpaket	24.0128-0155.1 428155 24.0328-0155.1 528155	Ø 295 28 25,4 V + S Ø 295 28 25,4 V + S PD	
			←	für Fahrzeuge mit Sportpaket / für Fahr- zeuge mit AMG-Sportpaket	24.0132-0100.1 432100	Ø 322 32 30 V• + S	
			➔	für Fahrzeuge mit Sportpaket / für Fahr- zeuge mit AMG-Sportpaket	24.0110-0328.1 410328 24.0310-0328.1 510328	Ø 300 10 8,3 + S Ø 300 10 8,3 + S PD	
			➔	für Fahrzeuge ohne Sportpaket / für Fahrzeuge ohne AMG-Sportpaket	24.0120-0208.1 420208	Ø 300 22 19,4 V + S	
C 280 (204.254)	170	08/07→08/14	←	09/07→; für Fahrzeuge ohne Sportpaket / für Fahrzeuge ohne AMG-Sportpaket	24.0128-0155.1 428155 24.0328-0155.1 528155	Ø 295 28 25,4 V + S Ø 295 28 25,4 V + S PD	
			←	09/07→; für Fahrzeuge mit Sportpaket / für Fahr- zeuge mit AMG-Sportpaket	24.0132-0100.1 432100	Ø 322 32 30 V• + S	
			➔	09/07→	24.0110-0328.1 410328 24.0310-0328.1 510328	Ø 300 10 8,3 + S Ø 300 10 8,3 + S PD	
C 300 (204.254)	170	08/07→08/14	←	für Fahrzeuge ohne Sportpaket / für Fahrzeuge ohne AMG-Sportpaket	24.0128-0155.1 428155 24.0328-0155.1 528155	Ø 295 28 25,4 V + S Ø 295 28 25,4 V + S PD	
			←	für Fahrzeuge mit Sportpaket / für Fahr- zeuge mit AMG-Sportpaket	24.0132-0100.1 432100	Ø 322 32 30 V• + S	
			➔		24.0110-0328.1 410328	Ø 300 10 8,3 + S	











	kw				! #		
MERCEDES-BENZ - C-KLASSE Kombi (S204) 08/07→08/14							
Bremsscheibe							
C 300 (204.254)	170	08/07→08/14	➔			24.0310-0328.1 510328	Ø 300 10 8,3 + S PD
C 320 CDI (204.222)	165	08/07→08/14	➔	09/07→; für Fahrzeuge ohne Sportpaket / für Fahrzeuge ohne AMG-Sportpaket		24.0132-0100.1 432100 24.0132-0101.1 432101 24.0332-0101.1 532101	Ø 322 32 30 V• + S Ø 322 32 29,4 V + S Ø 322 32 29,4 V + S PD
			➔	09/07→; für Fahrzeuge mit Sportpaket / für Fahr- zeuge mit AMG-Sportpaket		24.0132-0100.1 432100	Ø 322 32 30 V• + S
			➔	09/07→		24.0120-0208.1 420208	Ø 300 22 19,4 V + S
C 320 CDI 4-matic (204.289) C 350 (204.256)	165 200	08/07→08/14	➔	09/07→; für Fahrzeuge mit Sportpaket / für Fahr- zeuge mit AMG-Sportpaket		24.0132-0100.1 432100	Ø 322 32 30 V• + S
			➔	09/07→; für Fahrzeuge ohne Sportpaket / für Fahrzeuge ohne AMG-Sportpaket		24.0132-0101.1 432101 24.0332-0101.1 532101	Ø 322 32 29,4 V + S Ø 322 32 29,4 V + S PD
			➔	09/07→		24.0120-0208.1 420208	Ø 300 22 19,4 V + S
C 350 CDI C 350 CDI (204.223) C 350 CDI (204.225) C 350 CDI 4-matic (204.292) C 350 CGI (204.257)	165 195 170 170 225	08/07→08/14	➔	für Fahrzeuge mit Sportpaket / für Fahr- zeuge mit AMG-Sportpaket		24.0132-0100.1 432100	Ø 322 32 30 V• + S
			➔	für Fahrzeuge ohne Sportpaket / für Fahrzeuge ohne AMG-Sportpaket		24.0132-0101.1 432101 24.0332-0101.1 532101	Ø 322 32 29,4 V + S Ø 322 32 29,4 V + S PD
			➔	09/07→		24.0120-0208.1 420208	Ø 300 22 19,4 V + S
C 63 AMG C 63 AMG C 63 AMG (204.277) C 63 AMG (204.277)	373 382 336 358	06/13→08/14 07/10→08/14 02/08→08/14 01/12→08/14	➔			24.0136-0108.1 436108	Ø 360 36 34 V• + S
MERCEDES-BENZ - C-KLASSE Kombi (S205) 09/14→							
Bremsbelagsatz, Scheibenbremse							
AMG C 43 4-matic (205.264) C 450 AMG 4-matic (205.264)	270 270	04/16→ 04/15→04/16	➔	für Fahrzeuge mit AMG-Sportpaket / + eFSB		13.0460-7304.2 607304 13.0470-7304.2 LD7304	ATE 25353 16,2 + WE / - WK ATE 25353 16,2 + WE / - WK Ceramic
C 160 (205.244) C 180 (205.240) C 180 BlueTEC / d (205.236) C 200 (205.242) C 200 4-matic (205.243) C 200 BlueTEC / d (205.237) C 200 d (205.207) C 220 BlueTEC / d (205.204) C 220 BlueTEC / d (205.204) C 220 d 4-matic (205.205)	95 115 85	04/15→ 09/14→ 09/14→	➔	für Fahrzeuge ohne AMG-Sportpaket		13.0460-2792.2 602792 13.0470-2792.2 LD2792	TRW 22031 19,6 + WE / - WK TRW 22031 19,6 + WE / - WK Ceramic
			➔	für Fahrzeuge mit AMG-Sportpaket		13.0460-4880.2 604880 13.0470-4880.2 LD4880	BRE 25997 18,7 + WE / - WK BRE 25997 18,7 + WE / - WK Ceramic
			➔	+ eFSB		13.0460-7304.2 607304 13.0470-7304.2 LD7304	ATE 25353 16,2 + WE / - WK ATE 25353 16,2 + WE / - WK Ceramic
C 250 (205.245) C 250 BlueTEC / d (205.208) C 300 BlueTEC Hybrid / h (205.212)	155 150 150	09/14→ 09/14→ 10/14→	➔	für Fahrzeuge ohne AMG-Sportpaket		13.0460-4880.2 604880 13.0470-4880.2 LD4880	BRE 25997 18,7 + WE / - WK BRE 25997 18,7 + WE / - WK Ceramic
			➔	für Fahrzeuge mit AMG-Sportpaket		13.0460-4883.2 604883	BRE 22061 18,7 + WE / - WK
			➔	+ eFSB		13.0460-7304.2 607304 13.0470-7304.2 LD7304	ATE 25353 16,2 + WE / - WK ATE 25353 16,2 + WE / - WK Ceramic
C 250 BlueTEC / d 4- matic (205.209) C 300 (205.248)	150 180	10/14→ 09/15→	➔	für Fahrzeuge ohne AMG-Sportpaket		13.0460-2610.2 602610 13.0470-2610.2 LD2610	TRW 22076 19,6 + WE / - WK TRW 22076 19,6 + WE / - WK Ceramic
			➔	für Fahrzeuge mit AMG-Sportpaket		13.0460-4883.2 604883	BRE 22061 18,7 + WE / - WK
			➔	+ eFSB		13.0460-7304.2 607304 13.0470-7304.2 LD7304	ATE 25353 16,2 + WE / - WK ATE 25353 16,2 + WE / - WK Ceramic
C 350 e (205.247) C 350 e (205.247)	155 205	02/15→ 02/15→	➔			13.0460-4883.2 604883	BRE 22061 18,7 + WE / - WK
			➔	+ eFSB		13.0460-7304.2 607304 13.0470-7304.2 LD7304	ATE 25353 16,2 + WE / - WK ATE 25353 16,2 + WE / - WK Ceramic
C 400 4-matic (205.266)	245	10/14→	➔	für Fahrzeuge ohne AMG-Sportpaket		13.0460-4880.2 604880 13.0470-4880.2 LD4880	BRE 25997 18,7 + WE / - WK BRE 25997 18,7 + WE / - WK Ceramic
			➔	für Fahrzeuge mit AMG-Sportpaket		13.0460-4883.2 604883	BRE 22061 18,7 + WE / - WK
			➔	+ eFSB		13.0460-7304.2 607304	ATE 25353 16,2 + WE / - WK



















	kW			 	! #		
MERCEDES-BENZ - C-KLASSE Kombi (S205) 09/14→							
 Bremsbelagsatz, Scheibenbremse							
C 400 4-matic (205.266)	245	10/14→	➡	+ eFSB		13.0470-7304.2 LD7304	ATE 25353 16,2 + WE / - WK Ceramic
Warnkontakt, Bremsbelagverschleiß							
AMG C 43 4-matic (205.264)	270	04/16→	⬅	für Fahrzeuge ohne AMG-Sportpaket	1	24.8190-0067.2 620067	L= 92,5
C 450 AMG 4-matic (205.264)	270	04/15→04/16	➡	für Fahrzeuge mit AMG-Sportpaket	1	24.8190-0067.2 620067	L= 92,5
			➡	für Fahrzeuge ohne AMG-Sportpaket	1	24.8190-0067.2 620067	L= 92,5
C 160 (205.244)	95	04/15→	⬅	für Fahrzeuge mit AMG-Sportpaket	1	24.8190-0067.2 620067	L= 92,5
C 180 (205.240)	115	09/14→					
C 180 BlueTEC / d (205.236)	85	09/14→	⬅	für Fahrzeuge ohne AMG-Sportpaket	1	24.8190-0067.2 620067	L= 92,5
C 200 (205.242)	135	09/14→	➡		1	24.8190-0067.2 620067	L= 92,5
C 200 4-matic (205.243)	135	04/15→					
C 200 BlueTEC / d (205.237)	100	09/14→					
C 200 d (205.207)	100	10/15→					
C 220 BlueTEC / d (205.204)	120	09/14→					
C 220 BlueTEC / d (205.204)	125	09/14→					
C 220 d 4-matic (205.205)	125	04/15→					
C 250 (205.245)	155	09/14→					
C 250 BlueTEC / d (205.208)	150	09/14→					
C 250 BlueTEC / d 4-matic (205.209)	150	10/14→					
C 300 (205.248)	180	09/15→					
C 300 BlueTEC Hybrid / h (205.212)	150	10/14→					
C 400 4-matic (205.266)	245	10/14→					
C 350 e (205.247)	155	02/15→	⬅		1	24.8190-0067.2 620067	L= 92,5
C 350 e (205.247)	205	02/15→	➡		1	24.8190-0067.2 620067	L= 92,5
 Bremsscheibe							
AMG C 63 (205.286)	350	10/15→	⬅	nicht für Bremssattelfarbe: rot; für Fahrzeuge ohne Keramikbremse		24.0136-0108.1 436108	Ø 360 36 34 V• + S
AMG C 63 S (205.287)	375	10/15→					
C 200 (205.242)	135	09/14→	⬅	für Fahrzeuge ohne AMG-Sportpaket		24.0128-0300.1 428300	Ø 305 28 25,4 V + S
C 200 4-matic (205.243)	135	04/15→					
C 200 d (205.207)	100	10/15→					
C 220 BlueTEC / d (205.204)	120	09/14→					
C 220 BlueTEC / d (205.204)	125	09/14→					
C 220 d 4-matic (205.205)	125	04/15→					
MERCEDES-BENZ - C-KLASSE Sportcoupe (CL203) 03/01→06/11							
 Bremsbelagsatz, Scheibenbremse							
C 160 Kompressor (203.730)	90	05/02→05/08	⬅	04/05→; für Bremsscheibendurchmesser [mm]: 288; für Bremsscheibendicke [mm]: 25		13.0460-2726.2 602726	TRW 23144 19,8 + WE / - WK + Zub
			⬅	04/05→		13.0470-2726.2 LD2726	TRW 23144 19,8 + WE / - WK + Zub Ceramic
			➡	04/05→		13.0460-4064.2 604064	ATE 21919 15,3 - WE / - WK + Zub
						13.0470-4064.2 LD4064	ATE 21919 15,3 - WE / - WK + Zub Ceramic
C 180 (203.735)	95	03/01→05/02	⬅	für Bremsscheibendurchmesser [mm]: 288; für Bremsscheibendicke [mm]: 25		13.0460-2726.2 602726	TRW 23144 19,8 + WE / - WK + Zub
C 180 Kompressor (203.746)	105	05/02→05/08	⬅			13.0470-2726.2 LD2726	TRW 23144 19,8 + WE / - WK + Zub Ceramic
C 200 Kompressor (203.742)	120	05/02→05/08	⬅				
C 200 Kompressor (203.745)	120	03/01→05/02	➡			13.0460-4064.2 604064	ATE 21919 15,3 - WE / - WK + Zub
C 220	120	05/02→05/08				13.0470-4064.2 LD4064	ATE 21919 15,3 - WE / - WK + Zub Ceramic
C 220 CDI	100	03/01→01/04					
C 220 CDI (203.706)	105	03/01→01/04					
C 220 CDI (203.708)	110	02/04→05/08					
C 200 CDI (203.707)	90	03/03→05/08	⬅	07/03→; für Bremsscheibendurchmesser [mm]: 288; für Bremsscheibendicke [mm]: 25		13.0460-2726.2 602726	TRW 23144 19,8 + WE / - WK + Zub
C 200 CGI Kompressor (203.743)	125	03/03→05/08	⬅			13.0470-2726.2 LD2726	TRW 23144 19,8 + WE / - WK + Zub Ceramic
			➡	07/03→		13.0460-4064.2 604064	ATE 21919 15,3 - WE / - WK + Zub









	kw			 	! #		
MERCEDES-BENZ - C-KLASSE Sportcoupe (CL203) 03/01→06/11							
 Bremsbelagsatz, Scheibenbremse							
C 200 CDI (203.707) C 200 CGI Kompressor (203.743)	90 125	03/03→05/08 03/03→05/08	➡	07/03→		13.0470-4064.2 LD4064	ATE 21919 15,3 - WE / - WK + Zub Ceramic
C 230 (203.752)	150	01/05→05/08	⬅	06/05→; für Bremsscheibendurchmesser [mm]: 300; für Bremsscheibendicke [mm]: 28		13.0460-2727.2 602727	TRW 23144 19,8 + WE / - WK + Zub
			⬅	06/05→		13.0470-2727.2 LD2727	TRW 23144 19,8 + WE / - WK + Zub Ceramic
			➡	06/05→		13.0460-4065.2 604065 13.0470-4065.2 LD4065	ATE 21899 15,3 + WE / - WK + Zub ATE 21899 15,3 + WE / - WK + Zub Ceramic
C 230 Kompressor (203.740) C 230 Kompressor (203.747)	141	05/02→05/08	⬅	+ (AUS) (J) (USA)		13.0460-2726.2 602726	TRW 23144 19,8 + WE / - WK + Zub
	145	03/01→05/02	⬅			13.0470-2726.2 LD2726	TRW 23144 19,8 + WE / - WK + Zub Ceramic
			⬅			13.0460-2727.2 602727	TRW 23144 19,8 + WE / - WK + Zub
			➡	+ (AUS) (J) (USA)		13.0460-4064.2 604064 13.0470-4064.2 LD4064	ATE 21919 15,3 - WE / - WK + Zub ATE 21919 15,3 - WE / - WK + Zub Ceramic
			➡			13.0460-4065.2 604065 13.0470-4065.2 LD4065	ATE 21899 15,3 + WE / - WK + Zub ATE 21899 15,3 + WE / - WK + Zub Ceramic
C 30 CDI AMG (203.718)	170	09/02→05/08	⬅			13.0460-4990.2 604990 13.0470-4990.2 LD4990	BRE 23271 17,4 + WE / - WK Ceramic
			➡	A 556573→		13.0460-4047.2 604047 13.0470-4047.2 LD4047	ATE 21305 15,7 + WE / - WK Ceramic
			➡	→ A 556572		13.0460-4065.2 604065 13.0470-4065.2 LD4065	ATE 21899 15,3 + WE / - WK + Zub ATE 21899 15,3 + WE / - WK + Zub Ceramic
C 320 (203.764)	160	09/02→05/08	⬅	für Bremsscheibendurchmesser [mm]: 300; für Bremsscheibendicke [mm]: 28		13.0460-2727.2 602727	TRW 23144 19,8 + WE / - WK + Zub
			⬅			13.0470-2727.2 LD2727	TRW 23144 19,8 + WE / - WK + Zub Ceramic
			➡			13.0460-4065.2 604065 13.0470-4065.2 LD4065	ATE 21899 15,3 + WE / - WK + Zub ATE 21899 15,3 + WE / - WK + Zub Ceramic
C 350 (203.756)	200	01/05→05/08	⬅	06/05→		13.0460-4994.2 604994 13.0470-4994.2 LD4994	BRE 23945 16,5 + WE / - WK Ceramic
			➡	06/05→		13.0460-4065.2 604065 13.0470-4065.2 LD4065	ATE 21899 15,3 + WE / - WK + Zub ATE 21899 15,3 + WE / - WK + Zub Ceramic
Warnkontakt, Bremsbelagverschleiß							
C 160 Kompressor (203.730)	90	05/02→05/08	⬅	04/05→	1	24.8190-0410.2 620410	L= 97,5
			➡	04/05→	1	24.8190-0410.2 620410	L= 97,5
C 180 (203.735) C 180 Kompressor (203.746)	95 105	03/01→05/02 05/02→05/08	⬅		1	24.8190-0410.2 620410	L= 97,5
			➡		1	24.8190-0410.2 620410	L= 97,5
C 200 Kompressor (203.742)	120	05/02→05/08					
C 200 Kompressor (203.745)	120	03/01→05/02					
C 220	120	05/02→05/08					
C 220 CDI	100	03/01→01/04					
C 220 CDI (203.706)	105	03/01→01/04					
C 220 CDI (203.708)	110	02/04→05/08					
C 200 CDI (203.707)	90	03/03→05/08	⬅	07/03→	1	24.8190-0410.2 620410	L= 97,5
C 200 CGI Kompressor (203.743)	125	03/03→05/08	➡	07/03→	1	24.8190-0410.2 620410	L= 97,5
C 230 (203.752)	150	01/05→05/08	⬅	06/05→	2	24.8190-0410.2 620410	L= 97,5
↓							









	kW			 	! #		
MERCEDES-BENZ - C-KLASSE Sportcoupe (CL203) 03/01→06/11							
Warnkontakt, Bremsbelagverschleiß							
C 230 (203.752)	150	01/05→05/08	➡	06/05→	1	24.8190-0410.2 620410	L= 97,5
C 230 Kompressor (203.740)	141	05/02→05/08	←		2	24.8190-0410.2 620410	L= 97,5
C 230 Kompressor (203.747)	145	03/01→05/02	➡		1	24.8190-0410.2 620410	L= 97,5
C 320 (203.764)	160	09/02→05/08					
C 30 CDI AMG (203.718)	170	09/02→05/08	←		1	24.8190-0410.2 620410	L= 97,5
			➡	A 556573→	1	24.8190-0410.2 620410	L= 97,5
			➡	→ A 556572	1	24.8190-0410.2 620410	L= 97,5
C 350 (203.756)	200	01/05→05/08	←	06/05→	1	24.8190-0410.2 620410	L= 97,5
			➡	06/05→	1	24.8190-0410.2 620410	L= 97,5
Zubehörsatz, Scheibenbremsbelag							
C 160 Kompressor (203.730)	90	05/02→05/08	➡	04/05→		13.0460-0229.2 610229	ATE
C 180 (203.735)	95	03/01→05/02	➡			13.0460-0229.2 610229	ATE
C 180 Kompressor (203.746)	105	05/02→05/08					
C 200 Kompressor (203.742)	120	05/02→05/08					
C 200 Kompressor (203.745)	120	03/01→05/02					
C 220	120	05/02→05/08					
C 220 CDI	100	03/01→01/04					
C 220 CDI (203.706)	105	03/01→01/04					
C 220 CDI (203.708)	110	02/04→05/08					
C 200 CDI (203.707)	90	03/03→05/08	➡	07/03→		13.0460-0229.2 610229	ATE
C 200 CGI Kompressor (203.743)	125	03/03→05/08					
C 230 (203.752)	150	01/05→05/08	➡	06/05→		13.0460-0258.2 610258	
C 350 (203.756)	200	01/05→05/08					
C 230 Kompressor (203.740)	141	05/02→05/08	➡	+ (AUS) (J) (USA)		13.0460-0229.2 610229	ATE
C 230 Kompressor (203.747)	145	03/01→05/02	➡			13.0460-0231.2 610231	ATE
C 30 CDI AMG (203.718)	170	09/02→05/08	←			13.0460-0275.2 610275	
			➡	A 556573→		13.0460-0236.2 610236	ATE
			➡	→ A 556572		13.0460-0258.2 610258	
C 320 (203.764)	160	09/02→05/08	➡			13.0460-0258.2 610258	
Bremsscheibe							
C 160 Kompressor (203.730)	90	05/02→05/08	←	04/05→		24.0125-0110.1 425110	Ø 288 25 22,4 V + S
						24.0325-0110.1 525110	Ø 288 25 22,4 V + S PD
			➡	04/05→		24.0109-0114.1 409114	Ø 278 9 7,3 + S
						24.0309-0114.1 509114	Ø 278 9 7,3 + S PD
C 180 (203.735)	95	03/01→05/02	←			24.0125-0110.1 425110	Ø 288 25 22,4 V + S
C 180 Kompressor (203.746)	105	05/02→05/08				24.0325-0110.1 525110	Ø 288 25 22,4 V + S PD
C 200 Kompressor (203.742)	120	05/02→05/08	➡			24.0109-0114.1 409114	Ø 278 9 7,3 + S
C 200 Kompressor (203.745)	120	03/01→05/02				24.0309-0114.1 509114	Ø 278 9 7,3 + S PD
C 220	120	05/02→05/08					
C 220 CDI	100	03/01→01/04					
C 220 CDI (203.706)	105	03/01→01/04					
C 220 CDI (203.708)	110	02/04→05/08					
C 200 CDI (203.707)	90	03/03→05/08	←	07/03→		24.0125-0110.1 425110	Ø 288 25 22,4 V + S
C 200 CGI Kompressor (203.743)	125	03/03→05/08				24.0325-0110.1 525110	Ø 288 25 22,4 V + S PD
			➡	07/03→		24.0109-0114.1 409114	Ø 278 9 7,3 + S
						24.0309-0114.1 509114	Ø 278 9 7,3 + S PD
C 230 (203.752)	150	01/05→05/08	←	06/05→		24.0128-0106.1 428106	Ø 300 28 25,4 V + S
						24.0328-0106.1 528106	Ø 300 28 25,4 V + S PD
			➡	06/05→		24.0110-0217.1 410217	Ø 290 10 8,3 + S
						24.0310-0217.1 510217	Ø 290 10 8,3 + S PD
C 230 Kompressor (203.740)	141	05/02→05/08	←	(AUS) (J) (USA)		24.0125-0110.1 425110	Ø 288 25 22,4 V + S
C 230 Kompressor (203.747)	145	03/01→05/02	←			24.0325-0110.1 525110	Ø 288 25 22,4 V + S PD
			←			24.0128-0106.1 428106	Ø 300 28 25,4 V + S
						24.0328-0106.1 528106	Ø 300 28 25,4 V + S PD
			➡	+ (AUS) (J) (USA)		24.0109-0114.1 409114	Ø 278 9 7,3 + S
						24.0309-0114.1 509114	Ø 278 9 7,3 + S PD

















	kw			 	! #		
MERCEDES-BENZ - C-KLASSE Sportcoupe (CL203) 03/01→06/11							
Bremsscheibe							
C 230 Kompressor (203.740)	141	05/02→05/08	→			24.0110-0217.1 410217	Ø 290 10 8,3 + S
C 230 Kompressor (203.747)	145	03/01→05/02				24.0310-0217.1 510217	Ø 290 10 8,3 + S PD
C 30 CDI AMG (203.718)	170	09/02→05/08	←			24.0130-0180.1 430180	Ø 345 30 28 V*
			→	→ A 556572		24.0110-0217.1 410217	Ø 290 10 8,3 + S
			→	A 556573→		24.0310-0217.1 510217	Ø 290 10 8,3 + S PD
C 320 (203.764)	160	09/02→05/08	←			24.0128-0106.1 428106	Ø 300 28 25,4 V + S
						24.0328-0106.1 528106	Ø 300 28 25,4 V + S PD
			→			24.0110-0217.1 410217	Ø 290 10 8,3 + S
C 350 (203.756)	200	01/05→05/08	←	06/05→		24.0310-0217.1 510217	Ø 290 10 8,3 + S PD
			→	06/05→		24.0128-0188.1 428188	Ø 330 28 26 V + S
						24.0110-0217.1 410217	Ø 290 10 8,3 + S
						24.0310-0217.1 510217	Ø 290 10 8,3 + S PD
MERCEDES-BENZ - CLA Coupe (C117) 01/13→							
Bremsbelagsatz, Scheibenbremse							
AMG CLA 45 4-matic (117.352)	280	07/15→	←	+SA 660		13.0460-2779.2 602779	TRW 24869 19,3 + WE / - WK
CLA 45 AMG 4-matic (117.352)	265	07/13→06/15					
CLA 180 (117.342)	90	01/13→	←			13.0460-2779.2 602779	TRW 24869 19,3 + WE / - WK
CLA 180 CDI / d (117.312)	80	10/13→				13.0470-2779.2 LD2779	TRW 24869 19,3 + WE / - WK Ceramic
CLA 200 (117.343)	115	01/13→	→	+ eFSB		13.0460-2786.2 602786	TRW 24848 18,3 + WE / - WK + Zub
CLA 200 CDI / d (117.308)	100	07/14→				13.0470-2786.2 LD2786	TRW 24848 18,3 + WE / - WK + Zub Ceramic
CLA 200 CDI / d 4-matic (117.302)	100	07/14→					
CLA 200 CDI (117.301)	100	06/13→					
CLA 220 CDI / d (117.303)	120	01/13→					
CLA 220 CDI / d (117.303)	130	09/14→					
CLA 220 CDI / d 4-matic (117.305)	120	08/14→					
CLA 220 CDI / d 4-matic (117.305)	130	09/14→					
CLA 220 CDI (117.303)	125	01/13→					
CLA 220 CDI 4-matic (117.305)	125	07/14→					
CLA 250 (117.344)	155	01/13→					
CLA 250 (117.350)	160	07/15→					
CLA 220 4-matic (117.347)	135	04/16→	←			13.0460-2779.2 602779	TRW 24869 19,3 + WE / - WK
						13.0470-2779.2 LD2779	TRW 24869 19,3 + WE / - WK Ceramic
			→	für Fahrzeuge ohne Sportpaket / für Fahrzeuge ohne AMG-Sportpaket / + eFSB		13.0460-2786.2 602786	TRW 24848 18,3 + WE / - WK + Zub
						13.0470-2786.2 LD2786	TRW 24848 18,3 + WE / - WK + Zub Ceramic
CLA 250 4-matic (117.346)	155	07/13→	←			13.0460-2779.2 602779	TRW 24869 19,3 + WE / - WK
CLA 250 4-matic (117.351)	160	07/15→				13.0470-2779.2 LD2779	TRW 24869 19,3 + WE / - WK Ceramic
Warnkontakt, Bremsbelagverschleiß							
AMG CLA 45 4-matic (117.352)	280	07/15→	←		1	24.8190-0067.2 620067	L= 92,5
CLA 180 (117.342)	90	01/13→					
CLA 180 CDI / d (117.312)	80	10/13→					
CLA 200 (117.343)	115	01/13→					
CLA 200 CDI / d (117.308)	100	07/14→					
CLA 200 CDI / d 4-matic (117.302)	100	07/14→					
CLA 200 CDI (117.301)	100	06/13→					
CLA 220 4-matic (117.347)	135	04/16→					
CLA 220 CDI / d (117.303)	120	01/13→					
CLA 220 CDI / d (117.303)	130	09/14→					
CLA 220 CDI / d 4-matic (117.305)	120	08/14→					









	kW			 	! #		
MERCEDES-BENZ - CLA Coupe (C117) 01/13→							
Warnkontakt, Bremsbelagverschleiß							
CLA 220 CDI / d 4-matic (117.305)	130	09/14→	←		1	24.8190-0067.2 620067	L= 92,5
CLA 220 CDI (117.303)	125	01/13→					
CLA 220 CDI 4-matic (117.305)	125	07/14→					
CLA 250 (117.344)	155	01/13→					
CLA 250 (117.350)	160	07/15→					
CLA 250 4-matic (117.346)	155	07/13→					
CLA 250 4-matic (117.351)	160	07/15→					
CLA 45 AMG 4-matic (117.352)	265	07/13→06/15					
 Brems Scheibe							
AMG CLA 45 4-matic (117.352)	280	07/15→	←	+SA 660		24.0128-0262.1 428262	Ø 295 28 26 V• + S
CLA 45 AMG 4-matic (117.352)	265	07/13→06/15					
CLA 180 (117.342)	90	01/13→	←	für Fahrzeuge mit Sportpaket / für Fahrzeuge mit AMG-Sportpaket		24.0128-0262.1 428262	Ø 295 28 26 V• + S
CLA 180 CDI / d (117.312)	80	10/13→					
CLA 200 (117.343)	115	01/13→	←	für Fahrzeuge ohne Sportpaket / für Fahrzeuge ohne AMG-Sportpaket		24.0128-0276.1 428276	Ø 295 28 25,4 V + S
CLA 200 CDI / d (117.308)	100	07/14→	→			24.0110-0382.1 410382	Ø 295 10 8,3 + S
CLA 200 CDI (117.301)	100	06/13→					
CLA 200 CDI / d 4-matic (117.302)	100	07/14→	←	für Fahrzeuge mit Sportpaket / für Fahrzeuge mit AMG-Sportpaket		24.0128-0262.1 428262	Ø 295 28 26 V• + S
			←	für Fahrzeuge ohne Sportpaket / für Fahrzeuge ohne AMG-Sportpaket		24.0128-0276.1 428276	Ø 295 28 25,4 V + S
			→	→ 07/14		24.0110-0382.1 410382	Ø 295 10 8,3 + S
CLA 220 4-matic (117.347)	135	04/16→	←	für Fahrzeuge ohne Sportpaket / für Fahrzeuge ohne AMG-Sportpaket		24.0128-0276.1 428276	Ø 295 28 25,4 V + S
			←	für Fahrzeuge mit Sportpaket / für Fahrzeuge mit AMG-Sportpaket		24.0130-0238.1 430238	Ø 320 30 28 V• + S
			→	für Fahrzeuge ohne Sportpaket / für Fahrzeuge ohne AMG-Sportpaket		24.0110-0382.1 410382	Ø 295 10 8,3 + S
CLA 220 CDI / d (117.303)	120	01/13→	←	für Fahrzeuge ohne Sportpaket / für Fahrzeuge ohne AMG-Sportpaket		24.0128-0275.1 428275	Ø 295 28 25,4 V + S
CLA 220 CDI / d (117.303)	130	09/14→	←	für Fahrzeuge mit Sportpaket / für Fahrzeuge mit AMG-Sportpaket		24.0130-0238.1 430238	Ø 320 30 28 V• + S
CLA 220 CDI (117.303)	125	01/13→	→			24.0110-0382.1 410382	Ø 295 10 8,3 + S
CLA 220 CDI / d 4-matic (117.305)	120	08/14→	←	für Fahrzeuge ohne Sportpaket / für Fahrzeuge ohne AMG-Sportpaket		24.0128-0275.1 428275	Ø 295 28 25,4 V + S
CLA 220 CDI / d 4-matic (117.305)	130	09/14→	←	für Fahrzeuge mit Sportpaket / für Fahrzeuge mit AMG-Sportpaket		24.0130-0238.1 430238	Ø 320 30 28 V• + S
CLA 220 CDI 4-matic (117.305)	125	07/14→	←	für Fahrzeuge ohne Sportpaket / für Fahrzeuge ohne AMG-Sportpaket		24.0128-0275.1 428275	Ø 295 28 25,4 V + S
			←	für Fahrzeuge mit Sportpaket / für Fahrzeuge mit AMG-Sportpaket		24.0130-0238.1 430238	Ø 320 30 28 V• + S
			→	→ 07/14		24.0110-0382.1 410382	Ø 295 10 8,3 + S
CLA 250 (117.344)	155	01/13→	←	für Fahrzeuge ohne Sportpaket / für Fahrzeuge ohne AMG-Sportpaket		24.0130-0237.1 430237	Ø 320 30 28 V + S
CLA 250 (117.350)	160	07/15→					
CLA 250 4-matic (117.346)	155	07/13→	←	für Fahrzeuge mit Sportpaket / für Fahrzeuge mit AMG-Sportpaket		24.0130-0238.1 430238	Ø 320 30 28 V• + S
			→			24.0110-0382.1 410382	Ø 295 10 8,3 + S
CLA 250 4-matic (117.351)	160	07/15→	←	für Fahrzeuge ohne Sportpaket / für Fahrzeuge ohne AMG-Sportpaket		24.0130-0237.1 430237	Ø 320 30 28 V + S
			←	für Fahrzeuge mit Sportpaket / für Fahrzeuge mit AMG-Sportpaket		24.0130-0238.1 430238	Ø 320 30 28 V• + S
			→	nicht für Ausstattungsvariante: Sport Edition [P84]		24.0110-0382.1 410382	Ø 295 10 8,3 + S
MERCEDES-BENZ - CLA Shooting Brake (X117) 01/15→							
 Bremsbelagsatz, Scheibenbremse							
AMG CLA 45 4-matic (117.952)	280	07/15→	←	+SA 660		13.0460-2779.2 602779	TRW 24869 19,3 + WE / - WK
CLA 45 AMG 4-matic (117.952)	265	01/15→06/15					
CLA 180 (117.942)	90	01/15→	←			13.0460-2779.2 602779	TRW 24869 19,3 + WE / - WK
CLA 180 d (117.912)	80	07/15→					
CLA 200 (117.943)	115	01/15→				13.0470-2779.2 LD2779	TRW 24869 19,3 + WE / - WK Ceramic
CLA 200 CDI / d (117.908)	100	01/15→	→				
CLA 200 CDI / d 4-matic (117.902)	100	01/15→				13.0460-2786.2 602786	TRW 24848 18,3 + WE / - WK + Zub
↓							







	kW			 	! #			
MERCEDES-BENZ - CLA Shooting Brake (X117) 01/15→								
 Bremsbelagsatz, Scheibenbremse								
CLA 220 CDI / d (117.903)	120	01/15→	➔			13.0470-2786.2	LD2786	TRW 24848 18,3 + WE / - WK + Zub Ceramic
CLA 220 CDI / d (117.903)	130	01/15→						
CLA 220 CDI / d 4-matic (117.905)	120	09/15→						
CLA 220 CDI / d 4-matic (117.905)	130	01/15→						
CLA 250 (117.944)	155	01/15→						
CLA 250 4-matic (117.946)	155	01/15→	➔			13.0460-2779.2	602779	TRW 24869 19,3 + WE / - WK
CLA 250 4-matic (117.951)	160	07/15→				13.0470-2779.2	LD2779	TRW 24869 19,3 + WE / - WK Ceramic
Warnkontakt, Bremsbelagverschleiß								
AMG CLA 45 4-matic (117.952)	280	07/15→	➔		1	24.8190-0067.2	620067	L= 92,5
CLA 180 (117.942)	90	01/15→						
CLA 180 d (117.912)	80	07/15→						
CLA 200 (117.943)	115	01/15→						
CLA 200 CDI / d (117.908)	100	01/15→						
CLA 200 CDI / d 4-matic (117.902)	100	01/15→						
CLA 220 CDI / d (117.903)	120	01/15→						
CLA 220 CDI / d (117.903)	130	01/15→						
CLA 220 CDI / d 4-matic (117.905)	120	09/15→						
CLA 220 CDI / d 4-matic (117.905)	130	01/15→						
CLA 250 (117.944)	155	01/15→						
CLA 250 4-matic (117.946)	155	01/15→						
CLA 250 4-matic (117.951)	160	07/15→						
CLA 45 AMG 4-matic (117.952)	265	01/15→06/15						
 Bremsscheibe								
AMG CLA 45 4-matic (117.952)	280	07/15→	➔	+SA 660		24.0128-0262.1	428262	Ø 295 28 26 V• + S
CLA 45 AMG 4-matic (117.952)	265	01/15→06/15						
CLA 180 (117.942)	90	01/15→	➔	für Fahrzeuge mit AMG-Sportpaket		24.0128-0262.1	428262	Ø 295 28 26 V• + S
CLA 180 d (117.912)	80	07/15→	➔	für Fahrzeuge ohne AMG-Sportpaket		24.0128-0276.1	428276	Ø 295 28 25,4 V + S
CLA 200 (117.943)	115	01/15→	➔			24.0110-0382.1	410382	Ø 295 10 8,3 + S
CLA 200 CDI / d (117.908)	100	01/15→	➔					
CLA 200 CDI / d 4-matic (117.902)	100	01/15→	➔	für Fahrzeuge mit AMG-Sportpaket		24.0128-0262.1	428262	Ø 295 28 26 V• + S
			➔	für Fahrzeuge ohne AMG-Sportpaket		24.0128-0276.1	428276	Ø 295 28 25,4 V + S
CLA 220 CDI / d (117.903)	120	01/15→	➔	für Fahrzeuge ohne AMG-Sportpaket		24.0128-0275.1	428275	Ø 295 28 25,4 V + S
CLA 220 CDI / d (117.903)	130	01/15→	➔	für Fahrzeuge mit AMG-Sportpaket		24.0130-0238.1	430238	Ø 320 30 28 V• + S
			➔			24.0110-0382.1	410382	Ø 295 10 8,3 + S
CLA 220 CDI / d 4-matic (117.905)	120	09/15→	➔	für Fahrzeuge ohne AMG-Sportpaket		24.0128-0275.1	428275	Ø 295 28 25,4 V + S
			➔	für Fahrzeuge mit AMG-Sportpaket		24.0130-0238.1	430238	Ø 320 30 28 V• + S
CLA 220 CDI / d 4-matic (117.905)	130	01/15→	➔	für Fahrzeuge ohne AMG-Sportpaket		24.0128-0275.1	428275	Ø 295 28 25,4 V + S
			➔	für Fahrzeuge mit AMG-Sportpaket		24.0130-0238.1	430238	Ø 320 30 28 V• + S
			➔	für Fahrzeuge ohne AMG-Sportpaket		24.0110-0382.1	410382	Ø 295 10 8,3 + S
CLA 250 (117.944)	155	01/15→	➔	für Fahrzeuge ohne AMG-Sportpaket		24.0130-0237.1	430237	Ø 320 30 28 V + S
			➔	für Fahrzeuge mit AMG-Sportpaket		24.0130-0238.1	430238	Ø 320 30 28 V• + S
			➔			24.0110-0382.1	410382	Ø 295 10 8,3 + S
CLA 250 4-matic (117.946)	155	01/15→	➔	für Fahrzeuge ohne AMG-Sportpaket		24.0130-0237.1	430237	Ø 320 30 28 V + S
			➔	für Fahrzeuge mit AMG-Sportpaket		24.0130-0238.1	430238	Ø 320 30 28 V• + S
CLA 250 4-matic (117.951)	160	07/15→	➔	für Fahrzeuge ohne AMG-Sportpaket		24.0130-0237.1	430237	Ø 320 30 28 V + S
			➔	für Fahrzeuge mit AMG-Sportpaket		24.0130-0238.1	430238	Ø 320 30 28 V• + S
			➔	für Fahrzeuge ohne AMG-Sportpaket		24.0110-0382.1	410382	Ø 295 10 8,3 + S









	kw					! #			
MERCEDES-BENZ - CLC-KLASSE (CL203) 05/08→06/11									
 Bremsbelagsatz, Scheibenbremse									
CLC 160 (203.731)	95	02/09→06/11	←	→ 10/10			13.0460-2726.2	602726	TRW 23144 19,8 + WE / - WK + Zub
							13.0470-2726.2	LD2726	TRW 23144 19,8 + WE / - WK + Zub Ceramic
			→	→ 10/10			13.0460-4064.2	604064	ATE 21919 15,3 - WE / - WK + Zub
							13.0470-4064.2	LD4064	ATE 21919 15,3 - WE / - WK + Zub Ceramic
CLC 180 Kompressor (203.746)	105	05/08→06/11	←	→ 10/10; für Bremsscheibendurchmesser [mm]: 288; für Bremsscheibendicke [mm]: 25			13.0460-2726.2	602726	TRW 23144 19,8 + WE / - WK + Zub
CLC 200 CDI (203.707)	90	05/08→06/11	←	→ 10/10			13.0470-2726.2	LD2726	TRW 23144 19,8 + WE / - WK + Zub Ceramic
CLC 220 CDI (203.708)	110	05/08→06/11							
			→	→ 10/10			13.0460-4064.2	604064	ATE 21919 15,3 - WE / - WK + Zub
							13.0470-4064.2	LD4064	ATE 21919 15,3 - WE / - WK + Zub Ceramic
CLC 200 Kompressor (203.741)	135	05/08→06/11	←	→ 10/10; für Bremsscheibendurchmesser [mm]: 300; für Bremsscheibendicke [mm]: 28			13.0460-2727.2	602727	TRW 23144 19,8 + WE / - WK + Zub
CLC 230 (203.752)	150	05/08→06/11	←	→ 10/10			13.0470-2727.2	LD2727	TRW 23144 19,8 + WE / - WK + Zub Ceramic
			→	→ 10/10			13.0460-4065.2	604065	ATE 21899 15,3 + WE / - WK + Zub
							13.0470-4065.2	LD4065	ATE 21899 15,3 + WE / - WK + Zub Ceramic
CLC 350 (203.756)	200	05/08→06/11	←	→ 10/10			13.0460-4994.2	604994	BRE 23945 16,5 + WE / - WK Ceramic
							13.0470-4994.2	LD4994	BRE 23945 16,5 + WE / - WK Ceramic
							13.0460-4065.2	604065	ATE 21899 15,3 + WE / - WK + Zub
			→	→ 10/10			13.0470-4065.2	LD4065	ATE 21899 15,3 + WE / - WK + Zub Ceramic
Warnkontakt, Bremsbelagverschleiß									
CLC 160 (203.731)	95	02/09→06/11	←	→ 10/10	1		24.8190-0410.2	620410	L= 97,5
CLC 180 Kompressor (203.746)	105	05/08→06/11	→	→ 10/10	1		24.8190-0410.2	620410	L= 97,5
CLC 200 CDI (203.707)	90	05/08→06/11							
CLC 200 Kompressor (203.741)	135	05/08→06/11							
CLC 220 CDI (203.708)	110	05/08→06/11							
CLC 230 (203.752)	150	05/08→06/11							
CLC 350 (203.756)	200	05/08→06/11							
Zubehörsatz, Scheibenbremsbelag									
CLC 160 (203.731)	95	02/09→06/11	→	→ 10/10			13.0460-0229.2	610229	ATE
CLC 180 Kompressor (203.746)	105	05/08→06/11							
CLC 200 CDI (203.707)	90	05/08→06/11							
CLC 220 CDI (203.708)	110	05/08→06/11							
CLC 200 Kompressor (203.741)	135	05/08→06/11	→	→ 10/10			13.0460-0231.2	610231	ATE
CLC 230 (203.752)	150	05/08→06/11							
CLC 350 (203.756)	200	05/08→06/11							
 Bremsscheibe									
CLC 160 (203.731)	95	02/09→06/11	←	→ 10/10			24.0125-0110.1	425110	Ø 288 25 22,4 V + S
							24.0325-0110.1	525110	Ø 288 25 22,4 V + S PD
			→	→ 10/10			24.0109-0114.1	409114	Ø 278 9 7,3 + S
CLC 180 Kompressor (203.746)	105	05/08→06/11	←	→ 10/10			24.0125-0110.1	425110	Ø 288 25 22,4 V + S
CLC 200 CDI (203.707)	90	05/08→06/11							Ø 288 25 22,4 V + S PD
CLC 220 CDI (203.708)	110	05/08→06/11							
			→	→ 10/10			24.0109-0114.1	409114	Ø 278 9 7,3 + S
							24.0309-0114.1	509114	Ø 278 9 7,3 + S PD
CLC 200 Kompressor (203.741)	135	05/08→06/11	←	→ 10/10			24.0128-0106.1	428106	Ø 300 28 25,4 V + S
CLC 230 (203.752)	150	05/08→06/11							Ø 300 28 25,4 V + S PD
			→	→ 10/10			24.0110-0217.1	410217	Ø 290 10 8,3 + S
							24.0310-0217.1	510217	Ø 290 10 8,3 + S PD
CLC 350 (203.756)	200	05/08→06/11	←	→ 10/10			24.0128-0188.1	428188	Ø 330 28 26 V + S
							24.0110-0217.1	410217	Ø 290 10 8,3 + S
							24.0310-0217.1	510217	Ø 290 10 8,3 + S PD







	kW			 	! #		
MERCEDES-BENZ - CLK (C208) 06/97→09/02							
 Bremsbelagsatz, Scheibenbremse							
200 (208.335) 200 Kompressor (208.344) 200 Kompressor (208.345) 230 Kompressor (208.347) 230 Kompressor (208.348)	100 120 141 142 145	06/97→06/02 06/00→06/02 06/97→06/00 06/97→06/00 06/00→06/02	← → →	 → F 000850 F 000851 / T 000001→		13.0460-7086.2 607086 13.0470-7086.2 LD7086 13.0460-3805.2 603805 13.0470-3805.2 LD3805 13.0460-4064.2 604064 13.0470-4064.2 LD4064	ATE 21664 19,8 + WE / - WK ATE 21664 19,8 + WE / - WK Ceramic ATE 21197 15,0 + WE / - WK ATE 21197 15,0 + WE / - WK Ceramic ATE 21919 15,3 - WE / - WK + Zub ATE 21919 15,3 - WE / - WK + Zub Ceramic
320 (208.365)	160	06/97→06/02	← → →	 → F 196683 / T 098095 F 196684 / T 098096→		13.0460-7087.2 607087 13.0470-7087.2 LD7087 13.0460-4047.2 604047 13.0470-4047.2 LD4047 13.0460-4065.2 604065 13.0470-4065.2 LD4065	ATE 21670 19,3 + WE / - WK ATE 21670 19,3 + WE / - WK Ceramic ATE 21305 15,7 + WE / - WK ATE 21305 15,7 + WE / - WK Ceramic ATE 21899 15,3 + WE / - WK + Zub ATE 21899 15,3 + WE / - WK + Zub Ceramic
430 (208.370)	205	07/98→06/02	← ← ← →	→ F129678 F129679→		13.0460-4201.2 604201 13.0460-7087.2 607087 13.0470-7087.2 LD7087 13.0460-7183.2 607183 13.0460-4047.2 604047 13.0470-4047.2 LD4047	ATE 21153 17,5 + WE / - WK ATE 21670 19,3 + WE / - WK ATE 21670 19,3 + WE / - WK Ceramic ATE 21484 20,5 + WE / - WK ATE 21305 15,7 + WE / - WK ATE 21305 15,7 + WE / - WK Ceramic
55 AMG (208.374)	255	08/99→06/02	← →			13.0460-7183.2 607183 13.0460-4047.2 604047 13.0470-4047.2 LD4047	ATE 21484 20,5 + WE / - WK ATE 21305 15,7 + WE / - WK ATE 21305 15,7 + WE / - WK Ceramic
Warnkontakt, Bremsbelagsverschleiß							
200 (208.335) 200 Kompressor (208.344) 200 Kompressor (208.345) 230 Kompressor (208.347) 230 Kompressor (208.348)	100 120 141 142 145	06/97→06/02 06/00→06/02 06/97→06/00 06/97→06/00 06/00→06/02	← ←		2	24.8190-0401.2 620401	L= 95
320 (208.365)	160	06/97→06/02	← → →	 → F 196683 / T 098095	2 1	24.8190-0401.2 620401 24.8190-0401.2 620401	L= 95 L= 95
430 (208.370)	205	07/98→06/02	← ← ← →	→ F129678 F129679→	2 2 2 1	24.8190-0401.2 620401 24.8190-0401.2 620401 24.8190-0419.2 620419 24.8190-0401.2 620401	L= 95 L= 95 L= 74 L= 95
55 AMG (208.374)	255	08/99→06/02	← →		2 1	24.8190-0419.2 620419 24.8190-0401.2 620401	L= 74 L= 95
Zubehörsatz, Scheibenbremsbelag							
200 (208.335) 200 Kompressor (208.344) 200 Kompressor (208.345) 230 Kompressor (208.347) 230 Kompressor (208.348)	100 120 141 142 145	06/97→06/02 06/00→06/02 06/97→06/00 06/97→06/00 06/00→06/02	→ → →	→ F 000850 F 000851 / T 000001→		13.0460-0215.2 610215 13.0460-0229.2 610229	ATE ATE
320 (208.365)	160	06/97→06/02	→ →	F 196684 / T 098096→ → F 196683 / T 098095		13.0460-0231.2 610231 13.0460-0236.2 610236	ATE ATE
430 (208.370) 55 AMG (208.374) ↓	205 255	07/98→06/02 08/99→06/02	→			13.0460-0236.2 610236	ATE









	kW			 	! #		
MERCEDES-BENZ - CLK (C208) 06/97→09/02							
Bremsscheibe							
200 (208.335)	100	06/97→06/02	←			24.0125-0110.1 425110	Ø 288 25 22,4 V + S
200 Kompressor (208.344)	120	06/00→06/02				24.0325-0110.1 525110	Ø 288 25 22,4 V + S PD
200 Kompressor (208.345)	141	06/97→06/00	→			24.0109-0114.1 409114	Ø 278 9 7,3 + S
230 Kompressor (208.347)	142	06/97→06/00				24.0309-0114.1 509114	Ø 278 9 7,3 + S PD
230 Kompressor (208.348)	145	06/00→06/02					
320 (208.365)	160	06/97→06/02	←			24.0128-0106.1 428106	Ø 300 28 25,4 V + S
						24.0328-0106.1 528106	Ø 300 28 25,4 V + S PD
			→			24.0110-0217.1 410217	Ø 290 10 8,3 + S
						24.0310-0217.1 510217	Ø 290 10 8,3 + S PD
430 (208.370)	205	07/98→06/02	←	für Australien		24.0128-0106.1 428106	Ø 300 28 25,4 V + S
						24.0328-0106.1 528106	Ø 300 28 25,4 V + S PD
			←	→ F129678		24.0128-0126.1 428126	Ø 316 28 25,4 V
			←	F129679→		24.0132-0159.1 432159	Ø 330 32 29,4 V
			→	→ F 129678		24.0110-0217.1 410217	Ø 290 10 8,3 + S
						24.0310-0217.1 510217	Ø 290 10 8,3 + S PD
			→	F 126679→		24.0122-0228.1 422228	Ø 300 22 19,4 V
55 AMG (208.374)	255	08/99→06/02	→			24.0122-0228.1 422228	Ø 300 22 19,4 V
MERCEDES-BENZ - CLK (C209) 06/02→05/09							
Bremsbelagsatz, Scheibenbremse							
200 CGI (209.343)	125	07/03→05/09	←	→ 04/09; für Fahrzeuge ohne Sportpaket / für Fahrzeuge ohne AMG-Sportpaket		13.0460-2726.2 602726	TRW 23144 19,8 + WE / - WK + Zub
200 Kompressor (209.342)	120	09/02→05/09				13.0470-2726.2 LD2726	TRW 23144 19,8 + WE / - WK + Zub Ceramic
			←	→ 04/09; für Fahrzeuge mit Sportpaket / für Fahr- zeuge mit AMG-Sportpaket		13.0460-4994.2 604994	BRE 23945 16,5 + WE / - WK Ceramic
						13.0470-4994.2 LD4994	BRE 23945 16,5 + WE / - WK Ceramic
			→	→ 04/09; für Fahrzeuge ohne Sportpaket / für Fahrzeuge ohne AMG-Sportpaket		13.0460-4064.2 604064	ATE 21919 15,3 - WE / - WK + Zub
						13.0470-4064.2 LD4064	ATE 21919 15,3 - WE / - WK + Zub Ceramic
			→	→ 04/09; für Fahrzeuge mit Sportpaket / für Fahr- zeuge mit AMG-Sportpaket		13.0460-4065.2 604065	ATE 21899 15,3 + WE / - WK + Zub
						13.0470-4065.2 LD4065	ATE 21899 15,3 + WE / - WK + Zub Ceramic
200 Kompressor (209.341)	135	10/06→05/09	←	→ 04/09; für Fahrzeuge ohne Sportpaket / für Fahrzeuge ohne AMG-Sportpaket		13.0460-2727.2 602727	TRW 23144 19,8 + WE / - WK + Zub
270 CDI (209.316)	125	10/02→05/09				13.0470-2727.2 LD2727	TRW 23144 19,8 + WE / - WK + Zub Ceramic
			←	→ 04/09; für Fahrzeuge mit Sportpaket / für Fahr- zeuge mit AMG-Sportpaket		13.0460-4994.2 604994	BRE 23945 16,5 + WE / - WK Ceramic
						13.0470-4994.2 LD4994	BRE 23945 16,5 + WE / - WK Ceramic
			→	→ 04/09		13.0460-4065.2 604065	ATE 21899 15,3 + WE / - WK + Zub
						13.0470-4065.2 LD4065	ATE 21899 15,3 + WE / - WK + Zub Ceramic
220 CDI (209.308)	100	01/05→05/09	←	05/05→ 04/09; für Fahrzeuge ohne Sportpaket / für Fahrzeuge ohne AMG-Sportpaket		13.0460-2726.2 602726	TRW 23144 19,8 + WE / - WK + Zub
220 CDI (209.308)	110	01/05→05/09				13.0470-2726.2 LD2726	TRW 23144 19,8 + WE / - WK + Zub Ceramic
			←	05/05→ 04/09; für Fahrzeuge mit Sportpaket / für Fahr- zeuge mit AMG-Sportpaket		13.0460-4994.2 604994	BRE 23945 16,5 + WE / - WK Ceramic
						13.0470-4994.2 LD4994	BRE 23945 16,5 + WE / - WK Ceramic
			→	05/05→ 04/09; für Fahrzeuge ohne Sportpaket / für Fahrzeuge ohne AMG-Sportpaket		13.0460-4064.2 604064	ATE 21919 15,3 - WE / - WK + Zub
						13.0470-4064.2 LD4064	ATE 21919 15,3 - WE / - WK + Zub Ceramic
			→	05/05→ 04/09; für Fahrzeuge mit Sportpaket / für Fahr- zeuge mit AMG-Sportpaket		13.0460-4065.2 604065	ATE 21899 15,3 + WE / - WK + Zub
						13.0470-4065.2 LD4065	ATE 21899 15,3 + WE / - WK + Zub Ceramic
240 (209.361)	120	06/02→05/09	←	→ 04/09;		13.0460-2727.2 602727	TRW 23144 19,8 + WE / - WK + Zub
240 (209.361)	125	06/02→05/09		für Bremsscheibendurchmesser [mm]:			
320 (209.365)	160	06/02→05/09		300; für Bremsscheibendicke [mm]: 28			
↓							







	kw			 	! #		
MERCEDES-BENZ - CLK (C209) 06/02→05/09							
 Bremsbelagsatz, Scheibenbremse							
240 (209.361) 240 (209.361) 320 (209.365)	120 125 160	06/02→05/09 06/02→05/09 06/02→05/09	← → 04/09 → → 04/09			13.0470-2727.2 LD2727 13.0460-4065.2 604065 13.0470-4065.2 LD4065	TRW 23144 19,8 + WE / - WK + Zub Ceramic ATE 21899 15,3 + WE / - WK + Zub ATE 21899 15,3 + WE / - WK + Zub Ceramic
270 CDI (209.316)	120	02/03→06/05	← für Fahrzeuge ohne Sportpaket / für Fahrzeuge ohne AMG-Sportpaket			13.0460-2727.2 602727 13.0470-2727.2 LD2727	TRW 23144 19,8 + WE / - WK + Zub TRW 23144 19,8 + WE / - WK + Zub Ceramic
			← für Fahrzeuge mit Sportpaket / für Fahrzeuge mit AMG-Sportpaket			13.0460-4994.2 604994 13.0470-4994.2 LD4994	BRE 23945 16,5 + WE / - WK BRE 23945 16,5 + WE / - WK Ceramic
			→			13.0460-4065.2 604065 13.0470-4065.2 LD4065	ATE 21899 15,3 + WE / - WK + Zub ATE 21899 15,3 + WE / - WK + Zub Ceramic
280 (209.354)	170	01/05→05/09	← 05/05→ 04/09; für Fahrzeuge ohne Sportpaket / für Fahrzeuge ohne AMG-Sportpaket			13.0460-2727.2 602727 13.0470-2727.2 LD2727	TRW 23144 19,8 + WE / - WK + Zub TRW 23144 19,8 + WE / - WK + Zub Ceramic
			← 05/05→ 04/09; für Fahrzeuge mit Sportpaket / für Fahrzeuge mit AMG-Sportpaket			13.0460-4994.2 604994 13.0470-4994.2 LD4994	BRE 23945 16,5 + WE / - WK BRE 23945 16,5 + WE / - WK Ceramic
			→ 05/05→ 04/09			13.0460-4065.2 604065 13.0470-4065.2 LD4065	ATE 21899 15,3 + WE / - WK + Zub ATE 21899 15,3 + WE / - WK + Zub Ceramic
320 CDI (209.320) 350 (209.356)	165 200	01/05→05/09 01/05→05/09	← 05/05→ 04/09; für Fahrzeuge mit Sportpaket / für Fahrzeuge mit AMG-Sportpaket			13.0460-4990.2 604990 13.0470-4990.2 LD4990	BRE 23271 17,4 + WE / - WK BRE 23271 17,4 + WE / - WK Ceramic
			← 05/05→ 04/09; für Fahrzeuge ohne Sportpaket / für Fahrzeuge ohne AMG-Sportpaket			13.0460-4994.2 604994 13.0470-4994.2 LD4994	BRE 23945 16,5 + WE / - WK BRE 23945 16,5 + WE / - WK Ceramic
			→ 05/05→ 04/09			13.0460-4065.2 604065 13.0470-4065.2 LD4065	ATE 21899 15,3 + WE / - WK + Zub ATE 21899 15,3 + WE / - WK + Zub Ceramic
500 (209.372) 500 (209.375)	285 225	06/06→05/09 06/02→05/09	← → 04/09			13.0460-4990.2 604990	BRE 23271 17,4 + WE / - WK
			→ → 04/09			13.0460-4047.2 604047 13.0470-4047.2 LD4047	ATE 21305 15,7 + WE / - WK ATE 21305 15,7 + WE / - WK Ceramic
55 AMG (209.376)	270	09/02→05/09	← F 123375→; → 04/09			13.0460-4806.2 604806	BRE 23955 16,2 + WE / - WK
			← → F 123374			13.0460-4990.2 604990	BRE 23271 17,4 + WE / - WK
			→ → F 123374			13.0460-4047.2 604047 13.0470-4047.2 LD4047	ATE 21305 15,7 + WE / - WK ATE 21305 15,7 + WE / - WK Ceramic
			→ F 123375→; → 04/09			13.0460-4819.2 604819	BRE 23478 14,6 + WE / - WK
63 AMG (209.377) 63 AMG (209.377)	354 373	04/06→05/09 05/07→05/09	← → 04/09			13.0460-4806.2 604806	BRE 23955 16,2 + WE / - WK
			→ → 04/09			13.0460-4819.2 604819	BRE 23478 14,6 + WE / - WK
Warnkontakt, Bremsbelagverschleiß							
200 CGI (209.343) 200 Kompressor (209.342)	125 120	07/03→05/09 09/02→05/09	← → 04/09	1	24.8190-0410.2 620410	L= 97,5	
			→ □; → 04/09		24.8190-0410.2 620410	L= 97,5	
200 Kompressor (209.341) 270 CDI (209.316) 500 (209.372) 500 (209.375)	135 125 285 225	10/06→05/09 10/02→05/09 06/06→05/09 06/02→05/09	← □; → 04/09	1	24.8190-0410.2 620410	L= 97,5	
			→ → 04/09		24.8190-0410.2 620410	L= 97,5	
220 CDI (209.308) 220 CDI (209.308)	100 110	01/05→05/09 01/05→05/09	← 05/05→ 04/09	1	24.8190-0410.2 620410	L= 97,5	
			→ □; 05/05→ 04/09		24.8190-0410.2 620410	L= 97,5	
240 (209.361) 240 (209.361) 320 (209.365)	120 125 160	06/02→05/09 06/02→05/09 06/02→05/09	← → 04/09	2	24.8190-0410.2 620410	L= 97,5	
			→ → 04/09		24.8190-0410.2 620410	L= 97,5	
			→ → 04/09		24.8190-0410.2 620410	L= 97,5	
270 CDI (209.316)	120	02/03→06/05	← □	1	24.8190-0410.2 620410	L= 97,5	
			→		24.8190-0410.2 620410	L= 97,5	
↓							

	kw				! #		
MERCEDES-BENZ - CLK (C209) 06/02→05/09							
Warnkontakt, Bremsbelagverschleiß							
280 (209.354)	170	01/05→05/09	←	☐; 05/05→ 04/09	1	24.8190-0410.2 620410	L= 97,5
320 CDI (209.320)	165	01/05→05/09	→	05/05→ 04/09	1	24.8190-0410.2 620410	L= 97,5
350 (209.356)	200	01/05→05/09	→	05/05→ 04/09	1	24.8190-0410.2 620410	L= 97,5
55 AMG (209.376)	270	09/02→05/09	←	☐; → F 123374	1	24.8190-0410.2 620410	L= 97,5
			←	F 123375→; → 04/09	1	24.8190-0420.2 620420	L= 119
			→	→ F 123374	1	24.8190-0410.2 620410	L= 97,5
			→	F 123375→; → 04/09	1	24.8190-0410.2 620410	L= 97,5
63 AMG (209.377)	354	04/06→05/09	←	→ 04/09	1	24.8190-0420.2 620420	L= 119
63 AMG (209.377)	373	05/07→05/09	→	→ 04/09	1	24.8190-0410.2 620410	L= 97,5
Zubehörsatz, Scheibenbremsbelag							
200 CGI (209.343)	125	07/03→05/09	→	→ 04/09		13.0460-0229.2 610229	ATE
200 Kompressor (209.342)	120	09/02→05/09	→	→ 04/09		13.0460-0229.2 610229	ATE
200 Kompressor (209.341)	135	10/06→05/09	←	→ 04/09; für Fahrzeuge mit Sportpaket / für Fahrzeuge mit AMG-Sportpaket		13.0460-0275.2 610275	
270 CDI (209.316)	125	10/02→05/09	→	→ 04/09		13.0460-0258.2 610258	
220 CDI (209.308)	100	01/05→05/09	→	05/05→ 04/09		13.0460-0229.2 610229	ATE
220 CDI (209.308)	110	01/05→05/09	→	05/05→ 04/09		13.0460-0229.2 610229	ATE
240 (209.361)	120	06/02→05/09	→	→ 04/09		13.0460-0258.2 610258	
240 (209.361)	125	06/02→05/09	→	→ 04/09		13.0460-0258.2 610258	
320 (209.365)	160	06/02→05/09	→	→ 04/09		13.0460-0258.2 610258	
270 CDI (209.316)	120	02/03→06/05	←	für Fahrzeuge mit Sportpaket / für Fahrzeuge mit AMG-Sportpaket		13.0460-0275.2 610275	
			→	→ 04/09		13.0460-0258.2 610258	
280 (209.354)	170	01/05→05/09	←	05/05→ 04/09; für Fahrzeuge mit Sportpaket / für Fahrzeuge mit AMG-Sportpaket		13.0460-0275.2 610275	
			→	05/05→ 04/09		13.0460-0258.2 610258	
320 CDI (209.320)	165	01/05→05/09	←	05/05→ 04/09		13.0460-0275.2 610275	
350 (209.356)	200	01/05→05/09	→	05/05→ 04/09		13.0460-0258.2 610258	
500 (209.372)	285	06/06→05/09	←	→ 04/09		13.0460-0275.2 610275	
500 (209.375)	225	06/02→05/09	→	→ 04/09		13.0460-0236.2 610236	ATE
55 AMG (209.376)	270	09/02→05/09	←	→ F 123374		13.0460-0275.2 610275	
			→	→ F 123374		13.0460-0236.2 610236	ATE
Bremsscheibe							
200 CGI (209.343)	125	07/03→05/09	←	→ 04/09; für Fahrzeuge ohne Sportpaket / für Fahrzeuge ohne AMG-Sportpaket		24.0125-0110.1 425110	Ø 288 25 22,4 V + S
200 Kompressor (209.342)	120	09/02→05/09	←	→ 04/09; für Fahrzeuge mit Sportpaket / für Fahrzeuge mit AMG-Sportpaket		24.0325-0110.1 525110	Ø 288 25 22,4 V + S PD
			←	→ 04/09; für Fahrzeuge mit Sportpaket / für Fahrzeuge mit AMG-Sportpaket		24.0128-0177.1 428177	Ø 330 28 26 V•
			→	→ 04/09; für Fahrzeuge ohne Sportpaket / für Fahrzeuge ohne AMG-Sportpaket		24.0109-0114.1 409114	Ø 278 9 7,3 + S
			→	→ 04/09; für Fahrzeuge ohne Sportpaket / für Fahrzeuge ohne AMG-Sportpaket		24.0309-0114.1 509114	Ø 278 9 7,3 + S PD
			→	→ 04/09; für Fahrzeuge mit Sportpaket / für Fahrzeuge mit AMG-Sportpaket		24.0110-0217.1 410217	Ø 290 10 8,3 + S
			→	→ 04/09; für Fahrzeuge mit Sportpaket / für Fahrzeuge mit AMG-Sportpaket		24.0310-0217.1 510217	Ø 290 10 8,3 + S PD
200 Kompressor (209.341)	135	10/06→05/09	←	→ 04/09; für Fahrzeuge ohne Sportpaket / für Fahrzeuge ohne AMG-Sportpaket		24.0128-0106.1 428106	Ø 300 28 25,4 V + S
270 CDI (209.316)	125	10/02→05/09	←	→ 04/09; für Fahrzeuge ohne Sportpaket / für Fahrzeuge ohne AMG-Sportpaket		24.0328-0106.1 528106	Ø 300 28 25,4 V + S PD
			←	→ 04/09; für Fahrzeuge mit Sportpaket / für Fahrzeuge mit AMG-Sportpaket		24.0128-0177.1 428177	Ø 330 28 26 V•
			→	→ 04/09		24.0110-0217.1 410217	Ø 290 10 8,3 + S
			→	→ 04/09		24.0310-0217.1 510217	Ø 290 10 8,3 + S PD
220 CDI (209.308)	100	01/05→05/09	←	05/05→ 04/09; für Fahrzeuge ohne Sportpaket / für Fahrzeuge ohne AMG-Sportpaket		24.0125-0110.1 425110	Ø 288 25 22,4 V + S
220 CDI (209.308)	110	01/05→05/09	←	05/05→ 04/09; für Fahrzeuge ohne Sportpaket / für Fahrzeuge ohne AMG-Sportpaket		24.0325-0110.1 525110	Ø 288 25 22,4 V + S PD
			←	05/05→ 04/09; für Fahrzeuge mit Sportpaket / für Fahrzeuge mit AMG-Sportpaket		24.0128-0177.1 428177	Ø 330 28 26 V•
			→	05/05→ 04/09; für Fahrzeuge ohne Sportpaket / für Fahrzeuge ohne AMG-Sportpaket		24.0109-0114.1 409114	Ø 278 9 7,3 + S
			→	05/05→ 04/09; für Fahrzeuge ohne Sportpaket / für Fahrzeuge ohne AMG-Sportpaket		24.0309-0114.1 509114	Ø 278 9 7,3 + S PD
			→	05/05→ 04/09; für Fahrzeuge mit Sportpaket / für Fahrzeuge mit AMG-Sportpaket		24.0110-0217.1 410217	Ø 290 10 8,3 + S
			→	05/05→ 04/09; für Fahrzeuge mit Sportpaket / für Fahrzeuge mit AMG-Sportpaket		24.0310-0217.1 510217	Ø 290 10 8,3 + S PD
↓							

	kW			 	! #		
MERCEDES-BENZ - CLK (C209) 06/02→05/09							
 Bremsscheibe							
240 (209.361) 240 (209.361) 320 (209.365)	120 125 160	06/02→05/09 06/02→05/09 06/02→05/09	← →	→ 04/09 → 04/09		24.0128-0106.1 428106 24.0328-0106.1 528106 24.0110-0217.1 410217 24.0310-0217.1 510217	∅ 300 28 25,4 V + S ∅ 300 28 25,4 V + S PD ∅ 290 10 8,3 + S ∅ 290 10 8,3 + S PD
270 CDI (209.316)	120	02/03→06/05	← ← →	für Fahrzeuge ohne Sportpaket / für Fahrzeuge ohne AMG-Sportpaket für Fahrzeuge mit Sportpaket / für Fahrzeuge mit AMG-Sportpaket →		24.0128-0106.1 428106 24.0328-0106.1 528106 24.0128-0177.1 428177 24.0110-0217.1 410217 24.0310-0217.1 510217	∅ 300 28 25,4 V + S ∅ 300 28 25,4 V + S PD ∅ 330 28 26 V* ∅ 290 10 8,3 + S ∅ 290 10 8,3 + S PD
280 (209.354)	170	01/05→05/09	← ← →	05/05→ 04/09; für Fahrzeuge ohne Sportpaket / für Fahrzeuge ohne AMG-Sportpaket 05/05→ 04/09; für Fahrzeuge mit Sportpaket / für Fahrzeuge mit AMG-Sportpaket 05/05→ 04/09		24.0128-0106.1 428106 24.0328-0106.1 528106 24.0128-0177.1 428177 24.0110-0217.1 410217 24.0310-0217.1 510217	∅ 300 28 25,4 V + S ∅ 300 28 25,4 V + S PD ∅ 330 28 26 V* ∅ 290 10 8,3 + S ∅ 290 10 8,3 + S PD
320 CDI (209.320) 350 (209.356)	165 200	01/05→05/09 01/05→05/09	← ← →	05/05→ 04/09; für Fahrzeuge ohne Sportpaket / für Fahrzeuge ohne AMG-Sportpaket 05/05→ 04/09; für Fahrzeuge mit Sportpaket / für Fahrzeuge mit AMG-Sportpaket 05/05→ 04/09		24.0128-0188.1 428188 24.0130-0180.1 430180 24.0110-0217.1 410217 24.0310-0217.1 510217	∅ 330 28 26 V + S ∅ 345 30 28 V* ∅ 290 10 8,3 + S ∅ 290 10 8,3 + S PD
500 (209.372) 500 (209.375)	285 225	06/06→05/09 06/02→05/09	← ← →	→ 04/09; für Fahrzeuge ohne Sportpaket / für Fahrzeuge ohne AMG-Sportpaket → 04/09; für Fahrzeuge mit Sportpaket / für Fahrzeuge mit AMG-Sportpaket → 04/09		24.0130-0171.1 430171 24.0130-0180.1 430180 24.0122-0228.1 422228	∅ 345 30 27,4 V ∅ 345 30 28 V* ∅ 300 22 19,4 V
55 AMG (209.376)	270	09/02→05/09	← →	→ F 123374 → F 123374		24.0130-0180.1 430180 24.0122-0228.1 422228	∅ 345 30 28 V* ∅ 300 22 19,4 V
MERCEDES-BENZ - CLK Cabriolet (A208) 03/98→03/02							
 Bremsbelagsatz, Scheibenbremse							
200 (208.435)	100	03/98→03/02	← →	06/98→ 06/98→		13.0460-7086.2 607086 13.0470-7086.2 LD7086 13.0460-4064.2 604064 13.0470-4064.2 LD4064	ATE 21664 19,8 + WE / - WK ATE 21664 19,8 + WE / - WK Ceramic ATE 21919 15,3 - WE / - WK + Zub ATE 21919 15,3 - WE / - WK + Zub Ceramic
200 Kompressor (208.444) 230 Kompressor (208.448)	120 145	06/00→03/02 06/00→03/02	← → →	 → F 196683 / T 098095 F 196684 / T 098096→		13.0460-7087.2 607087 13.0470-7087.2 LD7087 13.0460-4047.2 604047 13.0470-4047.2 LD4047 13.0460-4065.2 604065 13.0470-4065.2 LD4065	ATE 21670 19,3 + WE / - WK ATE 21670 19,3 + WE / - WK Ceramic ATE 21305 15,7 + WE / - WK ATE 21305 15,7 + WE / - WK Ceramic ATE 21899 15,3 + WE / - WK + Zub ATE 21899 15,3 + WE / - WK + Zub Ceramic
200 Kompressor (208.445) 230 Kompressor (208.447) 320 (208.465)	141 142 160	03/98→06/00 03/98→06/00 03/98→03/02	← → →	06/98→ 06/98→; → F 196683 / T 098095 F 196684 / T 098096→		13.0460-7087.2 607087 13.0470-7087.2 LD7087 13.0460-4047.2 604047 13.0470-4047.2 LD4047 13.0460-4065.2 604065 13.0470-4065.2 LD4065	ATE 21670 19,3 + WE / - WK ATE 21670 19,3 + WE / - WK Ceramic ATE 21305 15,7 + WE / - WK ATE 21305 15,7 + WE / - WK Ceramic ATE 21899 15,3 + WE / - WK + Zub ATE 21899 15,3 + WE / - WK + Zub Ceramic
430 (208.470) ↓	205	09/98→03/02	← →	06/99→ 06/99→; → F 196683 / T 098095		13.0460-7183.2 607183 13.0460-4047.2 604047	ATE 21484 20,5 + WE / - WK ATE 21305 15,7 + WE / - WK

	kW					! #			
MERCEDES-BENZ - CLK Cabriolet (A208) 03/98→03/02									
Bremsbelagsatz, Scheibenbremse									
430 (208.470)	205	09/98→03/02	➡	06/99→; → F 196683 / T 098095			13.0470-4047.2	LD4047	ATE 21305 15,7 + WE / - WK Ceramic
			➡	F 196684 / T 098096→			13.0460-4065.2	604065	ATE 21899 15,3 + WE / - WK + Zub
							13.0470-4065.2	LD4065	ATE 21899 15,3 + WE / - WK + Zub Ceramic
55 AMG (208.474)	255	01/00→03/02	←				13.0460-7183.2	607183	ATE 21484 20,5 + WE / - WK
			➡	→ F 196683 / T 098095			13.0460-4047.2	604047	ATE 21305 15,7 + WE / - WK
			➡	F 196684 / T 098096→			13.0470-4047.2	LD4047	ATE 21305 15,7 + WE / - WK Ceramic
			➡	F 196684 / T 098096→			13.0460-4065.2	604065	ATE 21899 15,3 + WE / - WK + Zub
							13.0470-4065.2	LD4065	ATE 21899 15,3 + WE / - WK + Zub Ceramic
Warnkontakt, Bremsbelagverschleiß									
200 (208.435)	100	03/98→03/02	←	06/98→		2	24.8190-0401.2	620401	L= 95
200 Kompressor (208.444)	120	06/00→03/02	←			2	24.8190-0401.2	620401	L= 95
230 Kompressor (208.448)	145	06/00→03/02	➡	F 196684 / T 098096→		1	24.8190-0401.2	620401	L= 95
			➡	→ F 196683 / T 098095		1	24.8190-0401.2	620401	L= 95
200 Kompressor (208.445)	141	03/98→06/00	←	06/98→		2	24.8190-0401.2	620401	L= 95
230 Kompressor (208.447)	142	03/98→06/00	➡	06/98→; → F 196683 / T 098095		1	24.8190-0401.2	620401	L= 95
320 (208.465)	160	03/98→03/02	➡	F 196684 / T 098096→		1	24.8190-0401.2	620401	L= 95
430 (208.470)	205	09/98→03/02	←	06/99→		2	24.8190-0419.2	620419	L= 74
			➡	06/99→; → F 196683 / T 098095			24.8190-0401.2	620401	L= 95
			➡	F 196684 / T 098096→			24.8190-0401.2	620401	L= 95
55 AMG (208.474)	255	01/00→03/02	←			2	24.8190-0419.2	620419	L= 74
			➡	F 196684 / T 098096→			24.8190-0401.2	620401	L= 95
			➡	→ F 196683 / T 098095			24.8190-0401.2	620401	L= 95
Zubehörsatz, Scheibenbremsbelag									
200 (208.435)	100	03/98→03/02	➡	06/98→			13.0460-0229.2	610229	ATE
200 Kompressor (208.444)	120	06/00→03/02	➡	→ F 196683 / T 098095			13.0460-0236.2	610236	ATE
230 Kompressor (208.448)	145	06/00→03/02							
55 AMG (208.474)	255	01/00→03/02							
200 Kompressor (208.445)	141	03/98→06/00	➡	06/98→; → F 196683 / T 098095			13.0460-0236.2	610236	ATE
230 Kompressor (208.447)	142	03/98→06/00							
320 (208.465)	160	03/98→03/02							
430 (208.470)	205	09/98→03/02	➡	06/99→; → F 196683 / T 098095			13.0460-0236.2	610236	ATE
Bremsscheibe									
200 (208.435)	100	03/98→03/02	←	06/98→			24.0125-0110.1	425110	Ø 288 25 22,4 V + S
							24.0325-0110.1	525110	Ø 288 25 22,4 V + S PD
			➡	06/98→			24.0109-0114.1	409114	Ø 278 9 7,3 + S
							24.0309-0114.1	509114	Ø 278 9 7,3 + S PD
200 Kompressor (208.444)	120	06/00→03/02	←				24.0128-0106.1	428106	Ø 300 28 25,4 V + S
230 Kompressor (208.448)	145	06/00→03/02	➡				24.0328-0106.1	528106	Ø 300 28 25,4 V + S PD
							24.0110-0217.1	410217	Ø 290 10 8,3 + S
							24.0310-0217.1	510217	Ø 290 10 8,3 + S PD
200 Kompressor (208.445)	141	03/98→06/00	←	06/98→			24.0128-0106.1	428106	Ø 300 28 25,4 V + S
230 Kompressor (208.447)	142	03/98→06/00	➡	06/98→			24.0328-0106.1	528106	Ø 300 28 25,4 V + S PD
320 (208.465)	160	03/98→03/02					24.0110-0217.1	410217	Ø 290 10 8,3 + S
							24.0310-0217.1	510217	Ø 290 10 8,3 + S PD
430 (208.470)	205	09/98→03/02	←	06/99→			24.0132-0159.1	432159	Ø 330 32 29,4 V
			➡	06/99→			24.0122-0228.1	422228	Ø 300 22 19,4 V
55 AMG (208.474)	255	01/00→03/02	➡				24.0122-0228.1	422228	Ø 300 22 19,4 V

	kw			 	! #		
MERCEDES-BENZ - CLK Cabriolet (A209) 02/03→03/10							
 Bremsbelagsatz, Scheibenbremse							
CLK 200 CGI (209.443)	125	07/03→03/10	←	→ 12/09		13.0460-2726.2 602726	TRW 23144 19,8 + WE / - WK + Zub
						13.0470-2726.2 LD2726	TRW 23144 19,8 + WE / - WK + Zub Ceramic
			→	→ 12/09		13.0460-4064.2 604064	ATE 21919 15,3 - WE / - WK + Zub
						13.0470-4064.2 LD4064	ATE 21919 15,3 - WE / - WK + Zub Ceramic
CLK 200 Kompressor (209.441)	135	10/06→03/10	←	→ 12/09; für Fahrzeuge ohne Sportpaket / für Fahrzeuge ohne AMG-Sportpaket		13.0460-2727.2 602727	TRW 23144 19,8 + WE / - WK + Zub
						13.0470-2727.2 LD2727	TRW 23144 19,8 + WE / - WK + Zub Ceramic
			←	→ 12/09; für Fahrzeuge mit Sportpaket / für Fahrzeuge mit AMG-Sportpaket		13.0460-4994.2 604994	BRE 23945 16,5 + WE / - WK
						13.0470-4994.2 LD4994	BRE 23945 16,5 + WE / - WK Ceramic
			→	→ 12/09		13.0460-4065.2 604065	ATE 21899 15,3 + WE / - WK + Zub
						13.0470-4065.2 LD4065	ATE 21899 15,3 + WE / - WK + Zub Ceramic
CLK 200 Kompressor (209.442)	120	02/03→03/10	←	05/03→ 12/09; für Fahrzeuge ohne Sportpaket / für Fahrzeuge ohne AMG-Sportpaket		13.0460-2727.2 602727	TRW 23144 19,8 + WE / - WK + Zub
						13.0470-2727.2 LD2727	TRW 23144 19,8 + WE / - WK + Zub Ceramic
			←	05/03→ 12/09; für Fahrzeuge mit Sportpaket / für Fahrzeuge mit AMG-Sportpaket		13.0460-4994.2 604994	BRE 23945 16,5 + WE / - WK
						13.0470-4994.2 LD4994	BRE 23945 16,5 + WE / - WK Ceramic
			→	05/03→ 12/09		13.0460-4065.2 604065	ATE 21899 15,3 + WE / - WK + Zub
						13.0470-4065.2 LD4065	ATE 21899 15,3 + WE / - WK + Zub Ceramic
CLK 240 (209.461) CLK 320 (209.465)	125 160	02/03→03/10 02/03→03/10	←	05/03→ 12/09		13.0460-2727.2 602727	TRW 23144 19,8 + WE / - WK + Zub
						13.0470-2727.2 LD2727	TRW 23144 19,8 + WE / - WK + Zub Ceramic
			→	05/03→ 12/09		13.0460-4065.2 604065	ATE 21899 15,3 + WE / - WK + Zub
						13.0470-4065.2 LD4065	ATE 21899 15,3 + WE / - WK + Zub Ceramic
CLK 280 (209.454)	170	01/05→03/10	←	05/05→ 12/09; für Fahrzeuge ohne Sportpaket / für Fahrzeuge ohne AMG-Sportpaket		13.0460-2727.2 602727	TRW 23144 19,8 + WE / - WK + Zub
						13.0470-2727.2 LD2727	TRW 23144 19,8 + WE / - WK + Zub Ceramic
			←	05/05→ 12/09; für Fahrzeuge mit Sportpaket / für Fahrzeuge mit AMG-Sportpaket		13.0460-4994.2 604994	BRE 23945 16,5 + WE / - WK
						13.0470-4994.2 LD4994	BRE 23945 16,5 + WE / - WK Ceramic
			→	05/05→ 12/09		13.0460-4065.2 604065	ATE 21899 15,3 + WE / - WK + Zub
						13.0470-4065.2 LD4065	ATE 21899 15,3 + WE / - WK + Zub Ceramic
CLK 320 CDI (209.420) CLK 350 (209.456)	165 200	03/05→03/10 01/05→03/10	←	05/05→ 12/09; für Fahrzeuge mit Sportpaket / für Fahrzeuge mit AMG-Sportpaket		13.0460-4990.2 604990	BRE 23271 17,4 + WE / - WK
						13.0470-4990.2 LD4990	BRE 23271 17,4 + WE / - WK Ceramic
			←	05/05→ 12/09; für Fahrzeuge ohne Sportpaket / für Fahrzeuge ohne AMG-Sportpaket		13.0460-4994.2 604994	BRE 23945 16,5 + WE / - WK
						13.0470-4994.2 LD4994	BRE 23945 16,5 + WE / - WK Ceramic
			→	05/05→ 12/09		13.0460-4065.2 604065	ATE 21899 15,3 + WE / - WK + Zub
						13.0470-4065.2 LD4065	ATE 21899 15,3 + WE / - WK + Zub Ceramic
CLK 500 (209.472)	285	06/06→03/10	←	→ 12/09		13.0460-4990.2 604990	BRE 23271 17,4 + WE / - WK
						13.0470-4047.2 604047	ATE 21305 15,7 + WE / - WK
			→	→ 12/09		13.0460-4047.2 604047	ATE 21305 15,7 + WE / - WK Ceramic
						13.0470-4047.2 LD4047	ATE 21305 15,7 + WE / - WK Ceramic
CLK 500 (209.475)	225	02/03→03/10	←	05/03→ 12/09		13.0460-4990.2 604990	BRE 23271 17,4 + WE / - WK
						13.0470-4047.2 604047	ATE 21305 15,7 + WE / - WK
			→	05/03→ 12/09		13.0460-4047.2 604047	ATE 21305 15,7 + WE / - WK Ceramic
						13.0470-4047.2 LD4047	ATE 21305 15,7 + WE / - WK Ceramic
CLK 55 AMG (209.476) ↓	270	02/03→03/10	←	T 023346 / F 103001→; → 12/09		13.0460-4806.2 604806	BRE 23955 16,2 + WE / - WK

	kW			 	! #			
MERCEDES-BENZ - CLK Cabriolet (A209) 02/03→03/10								
Bremsbelagsatz, Scheibenbremse								
CLK 55 AMG (209.476)	270	02/03→03/10	←	05/03→; → T 033979 / F 123374		13.0460-4990.2	604990	BRE 23271 17,4 + WE / - WK
			→	05/03→; → T 033979 / F 123374		13.0460-4047.2	604047	ATE 21305 15,7 + WE / - WK
			→	T 023346 / F 103001→; → 12/09		13.0470-4047.2	LD4047	ATE 21305 15,7 + WE / - WK Ceramic
CLK 63 AMG (209.477)	354	04/06→03/10	←	→ 12/09		13.0460-4806.2	604806	BRE 23478 14,6 + WE / - WK
			→	→ 12/09		13.0460-4819.2	604819	BRE 23478 14,6 + WE / - WK
Warnkontakt, Bremsbelagverschleiß								
CLK 200 CGI (209.443)	125	07/03→03/10	←	→ 12/09	1	24.8190-0410.2	620410	L= 97,5
CLK 200 Kompressor (209.441)	135	10/06→03/10	←	☐; → 12/09	1	24.8190-0410.2	620410	L= 97,5
			→	☐; → 12/09		24.8190-0410.2	620410	L= 97,5
CLK 200 Kompressor (209.442)	120	02/03→03/10	←	☐; 05/03→ 12/09	1	24.8190-0410.2	620410	L= 97,5
			→	☐; 05/03→ 12/09		24.8190-0410.2	620410	L= 97,5
CLK 240 (209.461) CLK 320 (209.465)	125 160	02/03→03/10 02/03→03/10	←	05/03→ 12/09	2	24.8190-0410.2	620410	L= 97,5
			→	☐; 05/03→ 12/09		24.8190-0410.2	620410	L= 97,5
CLK 280 (209.454)	170	01/05→03/10	←	☐; 05/05→ 12/09	1	24.8190-0410.2	620410	L= 97,5
			→	☐; 05/05→ 12/09		24.8190-0410.2	620410	L= 97,5
CLK 320 CDI (209.420) CLK 350 (209.456)	165 200	03/05→03/10 01/05→03/10	←	☐; 05/05→ 12/09	1	24.8190-0410.2	620410	L= 97,5
			←	☐; 05/05→ 12/09	1	24.8190-0416.2	620416	L= 100
			→	☐; 05/05→ 12/09		24.8190-0410.2	620410	L= 97,5
CLK 500 (209.472)	285	06/06→03/10	←	☐; → 12/09	1	24.8190-0410.2	620410	L= 97,5
			→	→ 12/09	1	24.8190-0410.2	620410	L= 97,5
CLK 500 (209.475)	225	02/03→03/10	←	☐; 05/03→ 12/09	1	24.8190-0410.2	620410	L= 97,5
			→	05/03→ 12/09	1	24.8190-0410.2	620410	L= 97,5
CLK 55 AMG (209.476)	270	02/03→03/10	←	☐; 05/03→; → T 033979 / F 123374	1	24.8190-0410.2	620410	L= 97,5
			←	T 023346 / F 103001→; → 12/09	1	24.8190-0420.2	620420	L= 119
			→	05/03→; → T 033979 / F 123374	1	24.8190-0410.2	620410	L= 97,5
			→	T 023346 / F 103001→; → 12/09	1	24.8190-0410.2	620410	L= 97,5
CLK 63 AMG (209.477)	354	04/06→03/10	←	→ 12/09	1	24.8190-0420.2	620420	L= 119
			→	→ 12/09	1	24.8190-0410.2	620410	L= 97,5
Zubehörsatz, Scheibenbremsbelag								
CLK 200 CGI (209.443)	125	07/03→03/10	→	→ 12/09		13.0460-0229.2	610229	ATE
CLK 200 Kompressor (209.441)	135	10/06→03/10	→	→ 12/09		13.0460-0258.2	610258	
CLK 200 Kompressor (209.442)	120	02/03→03/10	→	05/03→ 12/09		13.0460-0258.2	610258	
CLK 240 (209.461)	125	02/03→03/10						
CLK 320 (209.465)	160	02/03→03/10						
CLK 280 (209.454)	170	01/05→03/10	→	05/05→ 12/09		13.0460-0258.2	610258	
CLK 320 CDI (209.420) CLK 350 (209.456)	165 200	03/05→03/10 01/05→03/10	←	05/05→ 12/09		13.0460-0275.2	610275	
			→	05/05→ 12/09		13.0460-0258.2	610258	
CLK 500 (209.472)	285	06/06→03/10	←	→ 12/09		13.0460-0275.2	610275	
			→	→ 12/09		13.0460-0236.2	610236	ATE
CLK 500 (209.475)	225	02/03→03/10	←	05/03→ 12/09		13.0460-0275.2	610275	
			→	05/03→ 12/09		13.0460-0236.2	610236	ATE
CLK 55 AMG (209.476)	270	02/03→03/10	←	05/03→; → T 033979 / F 123374		13.0460-0275.2	610275	
			→	05/03→; → T 033979 / F 123374		13.0460-0236.2	610236	ATE
Bremsscheibe								
CLK 200 CGI (209.443)	125	07/03→03/10	←	→ 12/09		24.0125-0110.1	425110	Ø 288 25 22,4 V + S
						24.0325-0110.1	525110	Ø 288 25 22,4 V + S PD
			→	→ 12/09		24.0109-0114.1	409114	Ø 278 9 7,3 + S
CLK 200 Kompressor (209.441)	135	10/06→03/10	←	→ 12/09; für Fahrzeuge ohne Sportpaket / für Fahrzeuge ohne AMG-Sportpaket		24.0128-0106.1	428106	Ø 300 28 25,4 V + S
						24.0328-0106.1	528106	Ø 300 28 25,4 V + S PD
			↓					

MERCEDES-BENZ - CLK Cabriolet (A209) 02/03→03/10









Bremsscheibe







CLK 200 Kompressor (209.441)	135	10/06→03/10	←	→ 12/09; für Fahrzeuge mit Sportpaket / für Fahrzeuge mit AMG-Sportpaket	24.0128-0177.1	428177	Ø 330 28 26 V•
			→	→ 12/09	24.0110-0217.1	410217	Ø 290 10 8,3 + S
CLK 200 Kompressor (209.442)	120	02/03→03/10	←	05/03→ 12/09; für Fahrzeuge ohne Sportpaket / für Fahrzeuge ohne AMG-Sportpaket	24.0128-0106.1	428106	Ø 300 28 25,4 V + S
			←	05/03→ 12/09; für Fahrzeuge mit Sportpaket / für Fahrzeuge mit AMG-Sportpaket	24.0328-0106.1	528106	Ø 300 28 25,4 V + S PD
			→	05/03→ 12/09	24.0128-0177.1	428177	Ø 330 28 26 V•
CLK 240 (209.461) CLK 320 (209.465)	125 160	02/03→03/10 02/03→03/10	←	05/03→ 12/09	24.0128-0106.1	428106	Ø 300 28 25,4 V + S
			→	05/03→ 12/09	24.0328-0106.1	528106	Ø 300 28 25,4 V + S PD
CLK 280 (209.454)	170	01/05→03/10	←	05/05→ 12/09; für Fahrzeuge ohne Sportpaket / für Fahrzeuge ohne AMG-Sportpaket	24.0128-0106.1	428106	Ø 300 28 25,4 V + S
			←	05/05→ 12/09; für Fahrzeuge mit Sportpaket / für Fahrzeuge mit AMG-Sportpaket	24.0328-0106.1	528106	Ø 300 28 25,4 V + S PD
			→	05/05→ 12/09	24.0128-0177.1	428177	Ø 330 28 26 V•
CLK 320 CDI (209.420) CLK 350 (209.456)	165 200	03/05→03/10 01/05→03/10	←	05/05→ 12/09; für Fahrzeuge ohne Sportpaket / für Fahrzeuge ohne AMG-Sportpaket	24.0110-0217.1	410217	Ø 290 10 8,3 + S
			←	05/05→ 12/09; für Fahrzeuge mit Sportpaket / für Fahrzeuge mit AMG-Sportpaket	24.0310-0217.1	510217	Ø 290 10 8,3 + S PD
			→	05/05→ 12/09	24.0128-0188.1	428188	Ø 330 28 26 V + S
CLK 500 (209.472)	285	06/06→03/10	←	→ 12/09; für Fahrzeuge ohne Sportpaket / für Fahrzeuge ohne AMG-Sportpaket	24.0130-0180.1	430180	Ø 345 30 28 V•
			←	→ 12/09; für Fahrzeuge mit Sportpaket / für Fahrzeuge mit AMG-Sportpaket	24.0130-0171.1	430171	Ø 345 30 27,4 V
			→	→ 12/09	24.0122-0228.1	422228	Ø 300 22 19,4 V
CLK 500 (209.475)	225	02/03→03/10	←	05/03→ 12/09; für Fahrzeuge ohne Sportpaket / für Fahrzeuge ohne AMG-Sportpaket	24.0130-0171.1	430171	Ø 345 30 27,4 V
			←	05/03→ 12/09; für Fahrzeuge mit Sportpaket / für Fahrzeuge mit AMG-Sportpaket	24.0130-0180.1	430180	Ø 345 30 28 V•
			→	05/03→ 12/09	24.0122-0228.1	422228	Ø 300 22 19,4 V
CLK 55 AMG (209.476)	270	02/03→03/10	←	05/03→; → T 033979 / F 123374	24.0130-0180.1	430180	Ø 345 30 28 V•
			→	05/03→; → T 033979 / F 123374	24.0122-0228.1	422228	Ø 300 22 19,4 V

MERCEDES-BENZ - CLS (C218) 01/11→

Bremsbelagsatz, Scheibenbremse

CLS 220 BlueTEC / d (218.301)	120	05/14→	←		13.0460-2734.2	602734	TRW 24310 19,0 + WE / - WK
CLS 220 BlueTEC / d (218.301)	125	05/14→	←		13.0470-2734.2	LD2734	TRW 24310 19,0 + WE / - WK Ceramic
CLS 220 BlueTEC (218.301)	130	05/14→	→		13.0460-7259.2	607259	ATE 24862 16,7 + WE / - WK
CLS 250 BlueTEC / d 4-matic (218.397)	150	05/14→	→		13.0470-7259.2	LD7259	ATE 24862 16,7 + WE / - WK Ceramic
CLS 250 CDI / BlueTEC / d (218.303, 218.304)	150	04/11→	→				
CLS 350 (218.359)	225	01/11→	←	für Fahrzeuge ohne Sportpaket / für Fahrzeuge ohne AMG-Sportpaket	13.0460-2734.2	602734	TRW 24310 19,0 + WE / - WK
CLS 350 BlueTEC / d (218.326)	190	06/14→	←		13.0470-2734.2	LD2734	TRW 24310 19,0 + WE / - WK Ceramic
CLS 350 CDI (218.323)	195	01/11→	←	für Fahrzeuge mit Sportpaket / für Fahrzeuge mit AMG-Sportpaket	13.0460-4863.2	604863	BRE 24976 17,5 + WE / - WK
CLS 350 CDI 4-matic (218.393)	195	09/11→	←				
CLS 350 d 4-matic (218.394)	190	04/15→	→		13.0460-7259.2	607259	ATE 24862 16,7 + WE / - WK
			→		13.0470-7259.2	LD7259	ATE 24862 16,7 + WE / - WK Ceramic
↓							

	kw			 	! #		
MERCEDES-BENZ - CLS (C218) 01/11→							
 Bremsbelagsatz, Scheibenbremse							
CLS 350 BlueTEC (218.326)	185	11/12→	←	01/13→; für Fahrzeuge ohne Sportpaket / für Fahrzeuge ohne AMG-Sportpaket	1	13.0460-2734.2 602734	TRW 24310 19,0 + WE / - WK
CLS 350 BlueTEC 4-matic (218.394)	185	11/12→	←	01/13→; für Fahrzeuge mit Sportpaket / für Fahr- zeuge mit AMG-Sportpaket	1	13.0470-2734.2 LD2734	TRW 24310 19,0 + WE / - WK Ceramic
			→	01/13→	1	13.0460-4863.2 604863	BRE 24976 17,5 + WE / - WK
			→	01/13→	1	13.0460-7259.2 607259	ATE 24862 16,7 + WE / - WK
			→	01/13→	1	13.0470-7259.2 LD7259	ATE 24862 16,7 + WE / - WK Ceramic
CLS 400 (218.361)	245	07/14→	←		1	13.0460-4863.2 604863	BRE 24976 17,5 + WE / - WK
CLS 400 (218.365)	245	05/14→	→		1	13.0460-7259.2 607259	ATE 24862 16,7 + WE / - WK
			→		1	13.0470-7259.2 LD7259	ATE 24862 16,7 + WE / - WK Ceramic
CLS 400 4-matic (218.367)	245	05/14→	→		1	13.0460-7259.2 607259	ATE 24862 16,7 + WE / - WK
CLS 400 4-matic (218.368)	245	07/14→			1	13.0470-7259.2 LD7259	ATE 24862 16,7 + WE / - WK Ceramic
CLS 500 (218.373)	300	02/11→					
CLS 500 4-matic (218.391)	300	09/11→					
Warnkontakt, Bremsbelagverschleiß							
CLS 220 BlueTEC / d (218.301)	120	05/14→	←		1	24.8190-0410.2 620410	L= 97,5
CLS 220 BlueTEC / d (218.301)	125	05/14→	→		1	24.8190-0410.2 620410	L= 97,5
CLS 220 BlueTEC (218.301)	130	05/14→					
CLS 250 BlueTEC / d 4-matic (218.397)	150	05/14→					
CLS 250 CDI / BlueTEC / d (218.303, 218.304)	150	04/11→					
CLS 400 (218.361)	245	07/14→					
CLS 400 (218.365)	245	05/14→					
CLS 400 4-matic (218.367)	245	05/14→					
CLS 400 4-matic (218.368)	245	07/14→					
CLS 500 (218.373)	300	02/11→					
CLS 500 4-matic (218.391)	300	09/11→					
CLS 350 (218.359)	225	01/11→	←	für Fahrzeuge mit Sportpaket / für Fahr- zeuge mit AMG-Sportpaket	1	24.8190-0410.2 620410	L= 97,5
CLS 350 BlueTEC / d (218.326)	190	06/14→	←	für Fahrzeuge ohne Sportpaket / für Fahrzeuge ohne AMG-Sportpaket	1	24.8190-0410.2 620410	L= 97,5
CLS 350 CDI (218.323)	195	01/11→	←		1	24.8190-0410.2 620410	L= 97,5
CLS 350 CDI 4-matic (218.393)	195	09/11→	→		1	24.8190-0410.2 620410	L= 97,5
CLS 350 d 4-matic (218.394)	190	04/15→					
CLS 350 BlueTEC (218.326)	185	11/12→	←	01/13→; für Fahrzeuge ohne Sportpaket / für Fahrzeuge ohne AMG-Sportpaket	1	24.8190-0410.2 620410	L= 97,5
CLS 350 BlueTEC 4-matic (218.394)	185	11/12→	←	01/13→; für Fahrzeuge mit Sportpaket / für Fahr- zeuge mit AMG-Sportpaket	1	24.8190-0410.2 620410	L= 97,5
			→	01/13→	1	24.8190-0410.2 620410	L= 97,5
CLS 63 AMG (218.374)	386	02/11→	←	03/11→	1	24.8190-0420.2 620420	L= 119
			→	03/11→	1	24.8190-0420.2 620420	L= 119
CLS 63 AMG (218.374)	410	01/11→	←		1	24.8190-0420.2 620420	L= 119
			→		1	24.8190-0420.2 620420	L= 119
CLS 63 AMG (218.375)	430	02/13→	←	für Fahrzeuge ohne Keramikbremse	1	24.8190-0420.2 620420	L= 119
CLS 63 AMG 4-matic (218.376)	430	02/13→	→		1	24.8190-0420.2 620420	L= 119
CLS 63 AMG 4-matic (218.392)	410	05/13→					
 Bremsscheibe							
CLS 220 BlueTEC / d (218.301)	120	05/14→	←			24.0132-0170.1 432170	Ø 322 32 30 V+ + S
CLS 220 BlueTEC / d (218.301)	125	05/14→	→			24.0110-0278.1 410278	Ø 300 10 8,3 + S
CLS 220 BlueTEC (218.301)	130	05/14→				24.0310-0278.1 510278	Ø 300 10 8,3 + S PD
CLS 250 BlueTEC / d 4-matic (218.397)	150	05/14→					

	kw			 	! #		
MERCEDES-BENZ - CLS (C218) 01/11→							
Bremsscheibe							
CLS 250 CDI / BlueTEC / d (218.303, 218.304)	150	04/11→	←			24.0132-0170.1 432170	Ø 322 32 30 V• + S
			→			24.0110-0278.1 410278	Ø 300 10 8,3 + S
						24.0310-0278.1 510278	Ø 300 10 8,3 + S PD
CLS 350 (218.359) CLS 350 BlueTEC / d (218.326)	225 190	01/11→ 06/14→	←	für Fahrzeuge ohne Sportpaket / für Fahrzeuge ohne AMG-Sportpaket		24.0132-0170.1 432170	Ø 322 32 30 V• + S
			←	für Fahrzeuge mit Sportpaket / für Fahrzeuge mit AMG-Sportpaket		24.0132-0180.1 432180	Ø 344 32 30 V• + S
CLS 350 CDI (218.323) CLS 350 CDI 4-matic (218.393) CLS 350 d 4-matic (218.394)	195 195	01/11→ 09/11→	←			24.0122-0201.1 422201	Ø 300 22 19,4 V + S
			→				
CLS 350 BlueTEC (218.326) CLS 350 BlueTEC 4-matic (218.394)	185 185	11/12→ 11/12→	←	01/13→; für Fahrzeuge ohne Sportpaket / für Fahrzeuge ohne AMG-Sportpaket		24.0132-0170.1 432170	Ø 322 32 30 V• + S
			←	01/13→; für Fahrzeuge mit Sportpaket / für Fahrzeuge mit AMG-Sportpaket		24.0132-0180.1 432180	Ø 344 32 30 V• + S
			→	01/13→		24.0122-0201.1 422201	Ø 300 22 19,4 V + S
CLS 400 (218.361) CLS 400 (218.365) CLS 400 4-matic (218.367) CLS 400 4-matic (218.368)	245 245 245	07/14→ 05/14→ 05/14→	←			24.0132-0180.1 432180	Ø 344 32 30 V• + S
			→			24.0122-0201.1 422201	Ø 300 22 19,4 V + S
			→				
CLS 500 (218.373) CLS 500 4-matic (218.391)	300 300	02/11→ 09/11→	→			24.0124-0236.1 424236	Ø 320 24 21,1 V + S
MERCEDES-BENZ - CLS (C219) 10/04→02/11							
Bremsbelagsatz, Scheibenbremse							
CLS 280 (219.354) CLS 300 (219.354) CLS 350 (219.356) CLS 350 (219.357)	170 170 200	07/08→12/10 04/09→12/10 10/04→12/10	←	→ 10/10		13.0460-4990.2 604990	BRE 23271 17,4 + WE / - WK
						13.0470-4990.2 LD4990	BRE 23271 17,4 + WE / - WK Ceramic
			→	→ 10/10		13.0460-7171.2 607171	ATE 23334 16,7 + WE / - WK
CLS 350 CDI CLS 350 CDI (219.322) CLS 350 CGI (219.357)	200 165 215	04/09→12/10 04/09→12/10 04/09→12/10	→	→ 10/10		13.0470-7171.2 LD7171	ATE 23334 16,7 + WE / - WK Ceramic
			←	A 038332→; → 10/10		13.0460-4990.2 604990	BRE 23271 17,4 + WE / - WK
			←	05/05→; → A 038331		13.0470-4990.2 LD4990	BRE 23271 17,4 + WE / - WK Ceramic
CLS 320 CDI CLS 320 CDI (219.322)	155 165	01/05→12/10 01/05→12/10	→	05/05→ 10/10		13.0460-7171.2 607171	ATE 23334 16,7 + WE / - WK
			←			13.0470-7171.2 LD7171	ATE 23334 16,7 + WE / - WK Ceramic
			←				
CLS 500 (219.372)	285	04/06→12/10	←	→ A 069799		13.0460-4817.2 604817	BRE 23960 18,3 + WE / - WK
			←	A 069800→; → 10/10		13.0460-4817.2 604817	BRE 23960 18,3 + WE / - WK
			→	→ 10/10		13.0460-7171.2 607171	ATE 23334 16,7 + WE / - WK
CLS 500 (219.375)	225	10/04→12/10	←	→ 10/10		13.0470-7171.2 LD7171	ATE 23334 16,7 + WE / - WK Ceramic
			→	→ 10/10		13.0460-4990.2 604990	BRE 23271 17,4 + WE / - WK
			→	→ 10/10		13.0460-7171.2 607171	ATE 23334 16,7 + WE / - WK
CLS 55 AMG (219.376)	350	01/05→12/10	←	→ 10/10		13.0460-4997.2 604997	BRE 23943 17,5 + WE / - WK
			→	→ 10/10		13.0460-4998.2 604998	BRE 23478 16,5 + WE / - WK
			←	→ 10/10; für Fahrzeuge ohne AMG-Performance Package		13.0460-4839.2 604839	BRE 24455 16,8 + WE / - WK
Warnkontakt, Bremsbelagverschleiß							
CLS 280 (219.354) CLS 300 (219.354) CLS 350 (219.357) CLS 350 CGI (219.357)	170 170 215 215	07/08→12/10 04/09→12/10 04/06→12/10 04/09→12/10	←	→ 10/10	1	24.8190-0410.2 620410	L= 97,5
			→	→ 10/10	1	24.8190-0410.2 620410	L= 97,5
			←	05/05→; → A 038331	2	24.8190-0410.2 620410	L= 97,5
CLS 320 CDI CLS 320 CDI (219.322)	155 165	01/05→12/10 01/05→12/10	←	☐; A 038332→; → 10/10		24.8190-0410.2 620410	L= 97,5
			←	☐; A 038332→; → 10/10		24.8190-0416.2 620416	L= 100
			→	05/05→ 10/10	1	24.8190-0410.2 620410	L= 97,5
↓							

MERCEDES-BENZ - CLS (C219) 10/04→02/11

Warnkontakt, Bremsbelagverschleiß

CLS 350 (219.356) CLS 350 CDI CLS 350 CDI (219.322)	200 200 165	10/04→12/10 04/09→12/10 04/09→12/10	← □; → 10/10 ← □; → 10/10 → 10/10		24.8190-0410.2 620410 24.8190-0416.2 620416 1 24.8190-0410.2 620410	L= 97,5 L= 100 L= 97,5
CLS 500 (219.372)	285	04/06→12/10	← → A 069799 ← A 069800→; → 10/10 → 10/10	1 1 1	24.8190-0410.2 620410 24.8190-0420.2 620420 24.8190-0410.2 620410	L= 97,5 L= 119 L= 97,5
CLS 500 (219.375) CLS 55 AMG (219.376)	225 350	10/04→12/10 01/05→12/10	← □; → 10/10 ← □; → 10/10 → 10/10	1 1 1	24.8190-0410.2 620410 24.8190-0416.2 620416 24.8190-0410.2 620410	L= 97,5 L= 100 L= 97,5
CLS 63 AMG (219.377)	378	04/06→12/10	← → 10/10 → 10/10	1 1	24.8190-0420.2 620420 24.8190-0420.2 620420	L= 119 L= 119

Zubehörsatz, Scheibenbremsbelag

CLS 280 (219.354) CLS 300 (219.354) CLS 350 (219.356) CLS 350 (219.357) CLS 350 CDI CLS 350 CDI (219.322) CLS 350 CGI (219.357)	170 170 200 215 200 165 215	07/08→12/10 04/09→12/10 10/04→12/10 04/06→12/10 04/09→12/10 04/09→12/10 04/09→12/10	← → 10/10		13.0460-0155.2 610155	BRE
CLS 320 CDI CLS 320 CDI (219.322)	155 165	01/05→12/10 01/05→12/10	← A 038332→; → 10/10 ← 05/05→; → A 038331		13.0460-0155.2 610155 13.0460-0275.2 610275	BRE
CLS 500 (219.375)	225	10/04→12/10	← → 10/10		13.0460-0275.2 610275	









Bremsscheibe







CLS 280 (219.354) CLS 300 (219.354) CLS 350 (219.356) CLS 350 (219.357) CLS 350 CGI (219.357) CLS 500 (219.375)	170 170 200 215 215 225	07/08→12/10 04/09→12/10 10/04→12/10 04/06→12/10 04/09→12/10 10/04→12/10	← → 10/10 → 10/10		24.0132-0144.1 432144 24.0332-0144.1 532144 24.0122-0201.1 422201	Ø 330 32 29,4 V + S Ø 330 32 29,4 V + S PD Ø 300 22 19,4 V + S
CLS 320 CDI CLS 320 CDI (219.322)	155 165	01/05→12/10 01/05→12/10	← 05/05→ 10/10 → 05/05→ 10/10		24.0128-0142.1 428142 24.0328-0142.1 528142 24.0122-0201.1 422201	Ø 312 28 25,4 V Ø 312 28 25,4 V PD Ø 300 22 19,4 V + S
CLS 350 CDI CLS 350 CDI (219.322)	200 165	04/09→12/10 04/09→12/10	← → 10/10 → 10/10		24.0128-0142.1 428142 24.0328-0142.1 528142 24.0122-0201.1 422201	Ø 312 28 25,4 V Ø 312 28 25,4 V PD Ø 300 22 19,4 V + S
CLS 500 (219.372)	285	04/06→12/10	← → 10/10 → 10/10		24.0132-0139.1 432139 24.0124-0236.1 424236	Ø 350 32 29,4 V + S Ø 320 24 21,1 V + S
CLS 55 AMG (219.376)	350	01/05→12/10	← → 10/10; für Fahrzeuge ohne AMG-Performance Package → 10/10		24.0136-0102.1 436102 24.0126-0136.1 426136	Ø 360 36 34 V* Ø 330 26 24 V*
CLS 63 AMG (219.377)	378	04/06→12/10	→ 10/10		24.0126-0136.1 426136	Ø 330 26 24 V*









MERCEDES-BENZ - CLS Shooting Brake (X218) 10/12→

Bremsbelagsatz, Scheibenbremse









CLS 220 BlueTEC / d (218.901) CLS 220 BlueTEC / d (218.901) CLS 220 BlueTEC (218.901) CLS 250 BlueTEC / d 4-matic (218.997) CLS 250 CDI / BlueTEC / d (218.903, 218.904)	120 125 130 150 150	05/14→ 05/14→ 05/14→ 05/14→ 10/12→	← →		13.0460-2734.2 602734 13.0470-2734.2 LD2734 13.0460-7259.2 607259 13.0470-7259.2 LD7259	TRW 24310 19,0 + WE / - WK TRW 24310 19,0 + WE / - WK Ceramic ATE 24862 16,7 + WE / - WK ATE 24862 16,7 + WE / - WK Ceramic
CLS 350 (218.959) CLS 350 BlueTEC / d (218.926) CLS 350 BlueTEC 4-matic (218.994) CLS 350 CDI (218.923) CLS 350 CDI 4-matic (218.993) CLS 350 d 4-matic (218.994)	225 190 185 195 195 190	10/12→ 05/14→ 05/14→ 10/12→ 10/12→ 04/15→	← für Fahrzeuge ohne Sportpaket ← für Fahrzeuge mit Sportpaket →		13.0460-2734.2 602734 13.0470-2734.2 LD2734 13.0460-4863.2 604863 13.0460-7259.2 607259 13.0470-7259.2 LD7259	TRW 24310 19,0 + WE / - WK TRW 24310 19,0 + WE / - WK Ceramic BRE 24976 17,5 + WE / - WK ATE 24862 16,7 + WE / - WK ATE 24862 16,7 + WE / - WK Ceramic

	kW			 	! #		
MERCEDES-BENZ - CLS Shooting Brake (X218) 10/12→							
 Bremsbelagsatz, Scheibenbremse							
CLS 400 (218.961) CLS 400 (218.965)	245 245	07/14→ 05/14→	← →			13.0460-4863.2 604863 13.0460-7259.2 607259 13.0470-7259.2 LD7259	BRE 24976 17,5 + WE / - WK ATE 24862 16,7 + WE / - WK ATE 24862 16,7 + WE / - WK Ceramic
CLS 400 4-matic (218.967) CLS 400 4-matic (218.968) CLS 500 (218.973) CLS 500 4-matic (218.991)	245 245 300 300	05/14→ 07/14→ 10/12→ 10/12→	→			13.0460-7259.2 607259 13.0470-7259.2 LD7259	ATE 24862 16,7 + WE / - WK ATE 24862 16,7 + WE / - WK Ceramic
Warnkontakt, Bremsbelagverschleiß							
CLS 220 BlueTEC / d (218.901) CLS 220 BlueTEC / d (218.901) CLS 220 BlueTEC (218.901) CLS 250 BlueTEC / d 4-matic (218.997) CLS 250 CDI / BlueTEC / d (218.903, 218.904) CLS 350 (218.959) CLS 350 BlueTEC / d (218.926) CLS 350 BlueTEC 4-matic (218.994) CLS 350 CDI (218.923) CLS 350 CDI 4-matic (218.993) CLS 350 d 4-matic (218.994) CLS 400 (218.961) CLS 400 (218.965) CLS 400 4-matic (218.967) CLS 400 4-matic (218.968) CLS 500 (218.973) CLS 500 4-matic (218.991)	120 125 130 150 150 225 190 185 195 195 190 245 245 245 245 300 300	05/14→ 05/14→ 05/14→ 05/14→ 10/12→ 10/12→ 05/14→ 10/12→ 10/12→ 10/12→ 04/15→ 07/14→ 05/14→ 05/14→ 07/14→ 10/12→ 10/12→	← →		1 1	24.8190-0410.2 620410 24.8190-0410.2 620410	L= 97,5 L= 97,5
CLS 63 AMG (218.974) CLS 63 AMG (218.974) CLS 63 AMG (218.975) CLS 63 AMG 4-matic (218.976) CLS 63 AMG 4-matic (218.992)	386 410 430 430 410	10/12→ 05/13→ 02/13→ 02/13→ 05/13→	← →	für Fahrzeuge ohne Keramikbremse	1 1	24.8190-0420.2 620420 24.8190-0420.2 620420	L= 119 L= 119
 Bremsscheibe							
CLS 220 BlueTEC / d (218.901) CLS 220 BlueTEC / d (218.901) CLS 220 BlueTEC (218.901) CLS 250 CDI / BlueTEC / d (218.903, 218.904) CLS 250 BlueTEC / d 4-matic (218.997)	120 125 130 150 150	05/14→ 05/14→ 05/14→ 10/12→ 05/14→	← →			24.0132-0170.1 432170 24.0110-0278.1 410278 24.0310-0278.1 510278	Ø 322 32 30 V• + S Ø 300 10 8,3 + S Ø 300 10 8,3 + S PD
CLS 250 BlueTEC / d 4-matic (218.997)	150	05/14→	← →			24.0132-0170.1 432170 24.0110-0278.1 410278 24.0122-0201.1 422201 24.0310-0278.1 510278	Ø 322 32 30 V• + S Ø 300 10 8,3 + S Ø 300 22 19,4 V + S Ø 300 10 8,3 + S PD
CLS 350 (218.959) CLS 350 BlueTEC / d (218.926) CLS 350 BlueTEC 4-matic (218.994) CLS 350 CDI (218.923) CLS 350 CDI 4-matic (218.993) CLS 350 d 4-matic (218.994)	225 190 185 195 195 190	10/12→ 05/14→ 05/14→ 10/12→ 10/12→ 04/15→	← ← →	für Fahrzeuge ohne Sportpaket für Fahrzeuge mit Sportpaket		24.0132-0170.1 432170 24.0132-0180.1 432180 24.0122-0201.1 422201	Ø 322 32 30 V• + S Ø 344 32 30 V• + S Ø 300 22 19,4 V + S
CLS 400 (218.961) CLS 400 (218.965) CLS 400 4-matic (218.967)	245 245 245	07/14→ 05/14→ 05/14→	← ← ←	+SA 802; für Fahrzeuge mit AMG-Sportpaket nicht für SA Code: 802		24.0132-0170.1 432170 24.0132-0180.1 432180	Ø 322 32 30 V• + S Ø 344 32 30 V• + S









	kW					! #		
MERCEDES-BENZ - CLS Shooting Brake (X218) 10/12→								
Bremsscheibe								
CLS 400 4-matic (218.968)	245	07/14→	→			24.0122-0201.1	422201	Ø 300 22 19,4 V + S
CLS 500 (218.973) CLS 500 4-matic (218.991)	300 300	10/12→ 10/12→	→			24.0124-0236.1	424236	Ø 320 24 21,1 V + S
MERCEDES-BENZ - E-KLASSE (W124) 02/93→06/96								
Bremsbelagsatz, Scheibenbremse								
E 200 (124.019) E 200 D (124.120) E 220 (124.022) E 250 D (124.126, 124.129) E 250 Turbo-D (124.128) E 300 4-matic (124.230) E 300 D (124.131) E 300 Turbo-D (124.133) E 300 Turbo-D 4-matic (124.333)	100 55 110 83 93 132 100 108 108	06/93→06/95 06/93→06/95 06/93→06/95 07/93→06/95 06/93→06/95 06/93→06/95 07/93→06/95 06/93→06/95 06/93→06/95	← ← ← → → → → → →			13.0460-2927.2 13.0470-2927.2	602927 LD2927	TRW 20941 19,3 + WE / - WK TRW 20941 19,3 + WE / - WK Ceramic
E 250 D (124.126, 124.129) E 250 Turbo-D (124.128) E 300 4-matic (124.230) E 300 D (124.131) E 300 Turbo-D (124.133) E 300 Turbo-D 4-matic (124.333)	83 93 132 100 108 108	07/93→06/95 06/93→06/95 06/93→06/95 07/93→06/95 06/93→06/95 06/93→06/95	→ → → → → →			13.0460-4034.2	604034	ATE 20687 15,5 - WE / - WK
E 280 (124.028)	145	06/93→06/95	←			13.0460-2927.2 13.0470-2927.2	602927 LD2927	TRW 20941 19,3 + WE / - WK TRW 20941 19,3 + WE / - WK Ceramic
			→	+ ASR		13.0460-3504.2	603504	ATE 21301 15,5 + WE / - WK
			→	- ASR		13.0460-4034.2	604034	ATE 20687 15,5 - WE / - WK
E 280 (124.029) E 320 (124.032)	142 162	06/93→06/95 06/93→06/95	←	→ B 864307		13.0460-4201.2	604201	ATE 21153 17,5 + WE / - WK
			←	B 864308→		13.0460-4202.2	604202	ATE 21153 16,0 + WE / - WK
			→			13.0460-3805.2 13.0470-3805.2	603805 LD3805	ATE 21197 15,0 + WE / - WK ATE 21197 15,0 + WE / - WK Ceramic
E 36 AMG	200	07/94→01/95	←			13.0460-4201.2	604201	ATE 21153 17,5 + WE / - WK
			→			13.0460-3805.2 13.0470-3805.2	603805 LD3805	ATE 21197 15,0 + WE / - WK ATE 21197 15,0 + WE / - WK Ceramic
E 420 (124.034)	205	06/93→06/95	←	B 938569→		13.0460-4201.2	604201	ATE 21153 17,5 + WE / - WK
			←	→ B 938568		13.0460-4202.2	604202	ATE 21153 16,0 + WE / - WK
			→			13.0460-3805.2 13.0470-3805.2	603805 LD3805	ATE 21197 15,0 + WE / - WK ATE 21197 15,0 + WE / - WK Ceramic
E 500 (124.036) E 60 AMG (124.036)	235 280	06/93→06/95 05/94→06/95	←			13.0460-4201.2	604201	ATE 21153 17,5 + WE / - WK
			→	→ B 927760		13.0460-3805.2 13.0470-3805.2	603805 LD3805	ATE 21197 15,0 + WE / - WK ATE 21197 15,0 + WE / - WK Ceramic
			→	B 927761→		13.0460-4047.2 13.0470-4047.2	604047 LD4047	ATE 21305 15,7 + WE / - WK ATE 21305 15,7 + WE / - WK Ceramic
Warnkontakt, Bremsbelagverschleiß								
E 200 (124.019) E 200 D (124.120) E 220 (124.022) E 250 D (124.126, 124.129) E 250 Turbo-D (124.128) E 300 4-matic (124.230) E 300 D (124.131) E 300 Turbo-D (124.133) E 300 Turbo-D 4-matic (124.333)	100 55 110 83 93 132 100 108 108	06/93→06/95 06/93→06/95 06/93→06/95 07/93→06/95 06/93→06/95 06/93→06/95 07/93→06/95 06/93→06/95 06/93→06/95	←		2	24.8190-0402.2	620402	L= 68 L= 150
E 280 (124.028)	145	06/93→06/95	←		2	24.8190-0402.2	620402	L= 68 L= 150
			→	+ ASR	4	24.8190-0401.2	620401	L= 95
E 280 (124.029) E 320 (124.032)	142 162	06/93→06/95 06/93→06/95	←	B 864308→	2	24.8190-0401.2	620401	L= 95
			←	→ B 864307	2	24.8190-0401.2	620401	L= 95
			→		2	24.8190-0401.2	620401	L= 95
E 36 AMG	200	07/94→01/95	←		2	24.8190-0401.2	620401	L= 95
			→		2	24.8190-0401.2	620401	L= 95
E 420 (124.034)	205	06/93→06/95	←	→ B 938568	2	24.8190-0401.2	620401	L= 95
			←	B 938569→	2	24.8190-0401.2	620401	L= 95
↓								









	kW			 	! #		
MERCEDES-BENZ - E-KLASSE (W124) 02/93→06/96							
Warnkontakt, Bremsbelagverschleiß							
E 420 (124.034)	205	06/93→06/95	➔		2	24.8190-0401.2 620401	L= 95
E 500 (124.036)	235	06/93→06/95	➔		2	24.8190-0401.2 620401	L= 95
E 60 AMG (124.036)	280	05/94→06/95	➔	→ B 927760	2	24.8190-0401.2 620401	L= 95
			➔	B 927761→	4	24.8190-0401.2 620401	L= 95
Zubehörsatz, Scheibenbremsbelag							
E 200 (124.019)	100	06/93→06/95	➔			13.0460-0186.2 610186	ATE
E 200 D (124.120)	55	06/93→06/95					
E 220 (124.022)	110	06/93→06/95					
E 250 D (124.126, 124.129)	83	07/93→06/95					
E 250 Turbo-D (124.128)	93	06/93→06/95					
E 300 4-matic (124.230)	132	06/93→06/95					
E 300 D (124.131)	100	07/93→06/95					
E 300 Turbo-D (124.133)	108	06/93→06/95					
E 300 Turbo-D 4-matic (124.333)	108	06/93→06/95					
E 280 (124.028)	145	06/93→06/95	➔	- ASR		13.0460-0186.2 610186	ATE
E 280 (124.029)	142	06/93→06/95	➔	→ B 864307		13.0460-0219.2 610219	ATE
E 320 (124.032)	162	06/93→06/95	➔	B 864308→		13.0460-0268.2 610268	
E 36 AMG	200	07/94→01/95	➔			13.0460-0219.2 610219	ATE
E 420 (124.034)	205	06/93→06/95	➔	B 938569→		13.0460-0219.2 610219	ATE
			➔	→ B 938568		13.0460-0268.2 610268	
E 500 (124.036)	235	06/93→06/95	➔			13.0460-0219.2 610219	ATE
E 60 AMG (124.036)	280	05/94→06/95	➔	B 927761→		13.0460-0236.2 610236	ATE
 Bremsscheibe							
E 200 (124.019)	100	06/93→06/95	➔			24.0122-0123.1 422123	Ø 284 22 19,4 V + S
E 220 (124.022)	110	06/93→06/95				24.0109-0120.1 409120	Ø 258 9 7,3 + S
E 250 Turbo-D (124.128)	93	06/93→06/95	➔			24.0309-0120.1 509120	Ø 258 9 7,3 + S PD
E 280 (124.028)	145	06/93→06/95					
E 300 D (124.131)	100	07/93→06/95					
E 300 Turbo-D (124.133)	108	06/93→06/95					
E 200 D (124.120)	55	06/93→06/95	➔			24.0112-0117.1 412117	Ø 284 12 10 + S
E 250 D (124.126, 124.129)	83	07/93→06/95	➔			24.0109-0120.1 409120	Ø 258 9 7,3 + S
						24.0309-0120.1 509120	Ø 258 9 7,3 + S PD
E 280 (124.029)	142	06/93→06/95	➔	→ B 864307		24.0122-0136.1 422136	Ø 295 22 19,4 V
			➔	B 864308→		24.0125-0107.1 425107	Ø 294 25 22,4 V
			➔			24.0120-0199.1 420199	Ø 278 19,9 17,4 V
E 300 4-matic (124.230)	132	06/93→06/95	➔			24.0122-0134.1 422134	Ø 284 22 19,4 V
E 300 Turbo-D 4-matic (124.333)	108	06/93→06/95	➔			24.0109-0120.1 409120	Ø 258 9 7,3 + S
						24.0309-0120.1 509120	Ø 258 9 7,3 + S PD
E 320 (124.032)	162	06/93→06/95	➔	→ B 864307		24.0122-0136.1 422136	Ø 295 22 19,4 V
			➔	B 864308→		24.0125-0107.1 425107	Ø 294 25 22,4 V
			➔			24.0109-0114.1 409114	Ø 278 9 7,3 + S
						24.0309-0114.1 509114	Ø 278 9 7,3 + S PD
E 36 AMG	200	07/94→01/95	➔	☐		24.0130-0121.1 430121	Ø 320 30 28 V
			➔	☐		24.0130-0122.1 430122	Ø 320 30 28 V
			➔			24.0109-0114.1 409114	Ø 278 9 7,3 + S
						24.0309-0114.1 509114	Ø 278 9 7,3 + S PD
E 420 (124.034)	205	06/93→06/95	➔	→ B 938568		24.0125-0107.1 425107	Ø 294 25 22,4 V
			➔	☐; B 938569→		24.0130-0121.1 430121	Ø 320 30 28 V
			➔	☐; B 938569→		24.0130-0122.1 430122	Ø 320 30 28 V
			➔			24.0124-0188.1 424188	Ø 278 24 21,4 V
E 500 (124.036)	235	06/93→06/95	➔	→ B 927760		24.0128-0103.1 428103	Ø 300 28 25,4 V
			➔	☐; B 927761→		24.0130-0121.1 430121	Ø 320 30 28 V
			➔	☐; B 927761→		24.0130-0122.1 430122	Ø 320 30 28 V
			➔	B 927761→		24.0122-0218.1 422218	Ø 300 22 19,4 V
E 60 AMG (124.036)	280	05/94→06/95	➔	☐		24.0130-0121.1 430121	Ø 320 30 28 V
			➔	☐		24.0130-0122.1 430122	Ø 320 30 28 V
			➔	B 927761→		24.0122-0218.1 422218	Ø 300 22 19,4 V









	kW			 	! #		
MERCEDES-BENZ - E-KLASSE (W210) 06/95→08/03							
 Bremsbelagsatz, Scheibenbremse							
E 200 (210.035) E 230 (210.037) E 290 Turbo-D (210.017) E 300 D (210.020)	100 110 95 100	06/95→08/00 06/95→06/97 03/96→07/99 06/95→06/97	←			13.0460-7086.2 607086 13.0470-7086.2 LD7086	ATE 21664 19,8 + WE / - WK ATE 21664 19,8 + WE / - WK Ceramic
			→	→ A379346		13.0460-3805.2 603805 13.0470-3805.2 LD3805	ATE 21197 15,0 + WE / - WK ATE 21197 15,0 + WE / - WK Ceramic
			→	A379347→		13.0460-4064.2 604064 13.0470-4064.2 LD4064	ATE 21919 15,3 - WE / - WK + Zub ATE 21919 15,3 - WE / - WK + Zub Ceramic
E 200 CDI (210.007) E 220 CDI (210.006)	75 92	06/98→03/02 06/98→07/99	←	07/98→		13.0460-7086.2 607086 13.0470-7086.2 LD7086	ATE 21664 19,8 + WE / - WK ATE 21664 19,8 + WE / - WK Ceramic
			→	07/98→		13.0460-4064.2 604064 13.0470-4064.2 LD4064	ATE 21919 15,3 - WE / - WK + Zub ATE 21919 15,3 - WE / - WK + Zub Ceramic
E 200 CDI (210.007) E 200 Kompressor (210.048) E 220 CDI (210.006) E 220 CDI (210.006)	85 120 100 105	07/99→03/02 08/00→03/02 07/99→03/02 07/99→03/02	←			13.0460-7086.2 607086 13.0470-7086.2 LD7086	ATE 21664 19,8 + WE / - WK ATE 21664 19,8 + WE / - WK Ceramic
			→			13.0460-4064.2 604064 13.0470-4064.2 LD4064	ATE 21919 15,3 - WE / - WK + Zub ATE 21919 15,3 - WE / - WK + Zub Ceramic
E 200 D (210.003)	65	01/96→03/02	←	10/96→		13.0460-7086.2 607086 13.0470-7086.2 LD7086	ATE 21664 19,8 + WE / - WK ATE 21664 19,8 + WE / - WK Ceramic
			→	10/96→; → A379346		13.0460-3805.2 603805 13.0470-3805.2 LD3805	ATE 21197 15,0 + WE / - WK ATE 21197 15,0 + WE / - WK Ceramic
			→	A379347→		13.0460-4064.2 604064 13.0470-4064.2 LD4064	ATE 21919 15,3 - WE / - WK + Zub ATE 21919 15,3 - WE / - WK + Zub Ceramic
E 200 Kompressor (210.045)	137	06/97→03/02	←	09/97→		13.0460-7087.2 607087 13.0470-7087.2 LD7087	ATE 21670 19,3 + WE / - WK ATE 21670 19,3 + WE / - WK Ceramic
			→	09/97→		13.0460-4064.2 604064 13.0460-4065.2 604065 13.0470-4064.2 LD4064 13.0470-4065.2 LD4065	ATE 21919 15,3 - WE / - WK + Zub ATE 21899 15,3 + WE / - WK + Zub ATE 21919 15,3 - WE / - WK + Zub Ceramic ATE 21899 15,3 + WE / - WK + Zub Ceramic
E 220 D E 220 D (210.004)	55 70	05/96→03/02 06/95→07/99	←	→ 06/98		13.0460-7086.2 607086 13.0470-7086.2 LD7086	ATE 21664 19,8 + WE / - WK ATE 21664 19,8 + WE / - WK Ceramic
			→	→ A379346		13.0460-3805.2 603805 13.0470-3805.2 LD3805	ATE 21197 15,0 + WE / - WK ATE 21197 15,0 + WE / - WK Ceramic
			→	→ 06/98; A379347→		13.0460-4064.2 604064 13.0470-4064.2 LD4064	ATE 21919 15,3 - WE / - WK + Zub ATE 21919 15,3 - WE / - WK + Zub Ceramic
E 240 (210.061)	125	06/97→08/00	←	09/97→; - ESP		13.0460-7086.2 607086 13.0470-7086.2 LD7086	ATE 21664 19,8 + WE / - WK ATE 21664 19,8 + WE / - WK Ceramic
			←	09/97→; + ESP		13.0460-7087.2 607087 13.0470-7087.2 LD7087	ATE 21670 19,3 + WE / - WK ATE 21670 19,3 + WE / - WK Ceramic
			→	09/97→; → A379346; - ESP		13.0460-3805.2 603805 13.0470-3805.2 LD3805	ATE 21197 15,0 + WE / - WK ATE 21197 15,0 + WE / - WK Ceramic
			→	09/97→; → A379346; + ESP		13.0460-4047.2 604047 13.0470-4047.2 LD4047	ATE 21305 15,7 + WE / - WK ATE 21305 15,7 + WE / - WK Ceramic
			→	A379347→; - ESP		13.0460-4064.2 604064	ATE 21919 15,3 - WE / - WK + Zub

















	kW			 	! #			
MERCEDES-BENZ - E-KLASSE (W210) 06/95→08/03								
 Bremsbelagsatz, Scheibenbremse								
E 240 (210.061)	125	06/97→08/00	➔	A379347→; - ESP		13.0470-4064.2	LD4064	ATE 21919 15,3 - WE / - WK + Zub Ceramic
			➔	A379347→; + ESP		13.0460-4065.2	604065	ATE 21899 15,3 + WE / - WK + Zub
E 240 (210.062)	125	08/00→03/02	←	- ESP		13.0460-7086.2	607086	ATE 21664 19,8 + WE / - WK
			←	+ ESP		13.0470-7086.2	LD7086	ATE 21664 19,8 + WE / - WK Ceramic
			➔	→ A379346; - ESP		13.0460-7087.2	607087	ATE 21670 19,3 + WE / - WK
			➔	→ A379346; + ESP		13.0470-7087.2	LD7087	ATE 21670 19,3 + WE / - WK Ceramic
			➔	→ A379346; - ESP		13.0460-3805.2	603805	ATE 21197 15,0 + WE / - WK
			➔	→ A379346; + ESP		13.0470-3805.2	LD3805	ATE 21197 15,0 + WE / - WK Ceramic
E 250 D (210.010)	83	06/95→07/99	←			13.0460-4047.2	604047	ATE 21305 15,7 + WE / - WK
			←	für Rechtslenker		13.0470-4047.2	LD4047	ATE 21305 15,7 + WE / - WK Ceramic
			➔	→ A379346		13.0460-4064.2	604064	ATE 21919 15,3 - WE / - WK + Zub
			➔	A379347→		13.0470-4064.2	LD4064	ATE 21919 15,3 - WE / - WK + Zub Ceramic
			➔	→ A379346; - ESP		13.0460-4065.2	604065	ATE 21899 15,3 + WE / - WK + Zub
			➔	→ A379346; + ESP		13.0470-4065.2	LD4065	ATE 21899 15,3 + WE / - WK + Zub Ceramic
E 250 Turbo-D (210.015)	110	06/97→07/99	←	09/97→		13.0460-7086.2	607086	ATE 21664 19,8 + WE / - WK
			➔	09/97→		13.0470-7086.2	LD7086	ATE 21664 19,8 + WE / - WK Ceramic
E 270 CDI (210.016)	120	07/99→03/02	←			13.0460-4064.2	604064	ATE 21919 15,3 - WE / - WK + Zub
			➔			13.0470-4064.2	LD4064	ATE 21919 15,3 - WE / - WK + Zub Ceramic
E 270 CDI (210.016)	125	07/99→03/02	←			13.0460-4065.2	604065	ATE 21899 15,3 + WE / - WK + Zub
			➔			13.0470-4065.2	LD4065	ATE 21899 15,3 + WE / - WK + Zub Ceramic
E 320 CDI (210.026)	145	07/99→03/02	←			13.0460-7087.2	607087	ATE 21670 19,3 + WE / - WK
			➔			13.0470-7087.2	LD7087	ATE 21670 19,3 + WE / - WK Ceramic
E 280 (210.053)	142	01/96→06/97	←			13.0460-4047.2	604047	ATE 21305 15,7 + WE / - WK
			←			13.0470-4047.2	LD4047	ATE 21305 15,7 + WE / - WK Ceramic
			➔	→ A379346		13.0460-4065.2	604065	ATE 21899 15,3 + WE / - WK + Zub
			➔	A379347→		13.0470-4065.2	LD4065	ATE 21899 15,3 + WE / - WK + Zub Ceramic
			➔			13.0460-7087.2	607087	ATE 21670 19,3 + WE / - WK
			➔			13.0470-7087.2	LD7087	ATE 21670 19,3 + WE / - WK Ceramic
E 280 (210.063)	150	12/96→03/02	←			13.0460-4047.2	604047	ATE 21305 15,7 + WE / - WK
			➔			13.0470-4047.2	LD4047	ATE 21305 15,7 + WE / - WK Ceramic
E 280 4-matic (210.081)	150	12/96→03/02	←			13.0460-4047.2	604047	ATE 21305 15,7 + WE / - WK
			➔			13.0470-4047.2	LD4047	ATE 21305 15,7 + WE / - WK Ceramic
E 300 Turbo-D (210.025)	130	12/96→07/99	←			13.0460-4047.2	604047	ATE 21305 15,7 + WE / - WK
			➔			13.0470-4047.2	LD4047	ATE 21305 15,7 + WE / - WK Ceramic
E 320 (210.055)	162	06/95→06/97	←			13.0460-4047.2	604047	ATE 21305 15,7 + WE / - WK
			➔			13.0470-4047.2	LD4047	ATE 21305 15,7 + WE / - WK Ceramic
E 320 (210.065)	165	06/97→03/02	←			13.0460-4047.2	604047	ATE 21305 15,7 + WE / - WK
			➔			13.0470-4047.2	LD4047	ATE 21305 15,7 + WE / - WK Ceramic
E 320 4-matic (210.082)	165	06/97→03/02	←			13.0460-4047.2	604047	ATE 21305 15,7 + WE / - WK
			➔			13.0470-4047.2	LD4047	ATE 21305 15,7 + WE / - WK Ceramic
E 420 (210.072)	205	01/96→06/97	←	→ A 962231 / X 027613		13.0460-4201.2	604201	ATE 21153 17,5 + WE / - WK
			←	A 962232 / X 027614→		13.0460-7183.2	607183	ATE 21484 20,5 + WE / - WK
			➔	→ A379346		13.0460-4047.2	604047	ATE 21305 15,7 + WE / - WK
						13.0470-4047.2	LD4047	ATE 21305 15,7 + WE / - WK Ceramic







	kw			 	! #		
MERCEDES-BENZ - E-KLASSE (W210) 06/95→08/03							
 Bremsbelagsatz, Scheibenbremse							
E 420 (210.072)	205	01/96→06/97	➔	A379347→		13.0460-4065.2 604065 13.0470-4065.2 LD4065	ATE 21899 15,3 + WE / - WK + Zub ATE 21899 15,3 + WE / - WK + Zub Ceramic
E 430 (210.070)	205	06/97→03/02	➔	09/97→; → A 962231 / X 027613		13.0460-4201.2 604201	ATE 21153 17,5 + WE / - WK
			➔	A 962232 / X 027614→		13.0460-7183.2 607183	ATE 21484 20,5 + WE / - WK
			➔	09/97→; → A379346		13.0460-4047.2 604047 13.0470-4047.2 LD4047	ATE 21305 15,7 + WE / - WK ATE 21305 15,7 + WE / - WK Ceramic
			➔	A379347→		13.0460-4065.2 604065 13.0470-4065.2 LD4065	ATE 21899 15,3 + WE / - WK + Zub ATE 21899 15,3 + WE / - WK + Zub Ceramic
E 430 4-matic (210.083) E 55 AMG 4-matic (210.074)	205	05/99→03/02	➔			13.0460-7183.2 607183	ATE 21484 20,5 + WE / - WK
	260	03/01→03/02	➔			13.0460-4047.2 604047 13.0470-4047.2 LD4047	ATE 21305 15,7 + WE / - WK ATE 21305 15,7 + WE / - WK Ceramic
E 50 AMG (210.072)	255	02/96→08/97	➔			13.0460-7183.2 607183	ATE 21484 20,5 + WE / - WK
			➔	Bremssattel mit 2 Haltestiften; nicht für Ausstattungsvariante: AMG Technikpaket		13.0460-4047.2 604047 13.0470-4047.2 LD4047	ATE 21305 15,7 + WE / - WK ATE 21305 15,7 + WE / - WK Ceramic
			➔	Bremssattel mit 1 Haltestift; nicht für Ausstattungsvariante: AMG Technikpaket		13.0460-4065.2 604065 13.0470-4065.2 LD4065	ATE 21899 15,3 + WE / - WK + Zub ATE 21899 15,3 + WE / - WK + Zub Ceramic
E 55 AMG (210.074)	260	08/97→03/02	➔	09/97→		13.0460-7183.2 607183	ATE 21484 20,5 + WE / - WK
			➔	09/97→		13.0460-4047.2 604047 13.0470-4047.2 LD4047	ATE 21305 15,7 + WE / - WK ATE 21305 15,7 + WE / - WK Ceramic
Warnkontakt, Bremsbelagverschleiß							
E 200 (210.035)	100	06/95→08/00	➔		2	24.8190-0401.2 620401	L= 95
E 230 (210.037)	110	06/95→06/97	➔		2	24.8190-0401.2 620401	L= 95
E 290 Turbo-D (210.017)	95	03/96→07/99	➔	→ A379346	2	24.8190-0401.2 620401	L= 95
E 300 D (210.020)	100	06/95→06/97	➔		2	24.8190-0401.2 620401	L= 95
E 200 CDI (210.007)	75	06/98→03/02	➔	07/98→	2	24.8190-0401.2 620401	L= 95
E 220 CDI (210.006)	92	06/98→07/99	➔		2	24.8190-0401.2 620401	L= 95
E 200 CDI (210.007)	85	07/99→03/02	➔		2	24.8190-0401.2 620401	L= 95
E 200 Kompressor (210.048)	120	08/00→03/02	➔		2	24.8190-0401.2 620401	L= 95
E 220 CDI (210.006)	100	07/99→03/02	➔		2	24.8190-0401.2 620401	L= 95
E 220 CDI (210.006)	105	07/99→03/02	➔		2	24.8190-0401.2 620401	L= 95
E 200 D (210.003)	65	01/96→03/02	➔	10/96→	2	24.8190-0401.2 620401	L= 95
			➔	10/96→; → A379346	2	24.8190-0401.2 620401	L= 95
E 200 Kompressor (210.045)	137	06/97→03/02	➔	09/97→	2	24.8190-0401.2 620401	L= 95
			➔	09/97→	2	24.8190-0401.2 620401	L= 95
E 220 D E 220 D (210.004)	55	05/96→03/02	➔	→ 06/98	2	24.8190-0401.2 620401	L= 95
	70	06/95→07/99	➔	→ A379346	2	24.8190-0401.2 620401	L= 95
E 240 (210.061)	125	06/97→08/00	➔	09/97→; + ESP	2	24.8190-0401.2 620401	L= 95
			➔	09/97→; - ESP	2	24.8190-0401.2 620401	L= 95
			➔	09/97→; → A379346; - ESP	2	24.8190-0401.2 620401	L= 95
			➔	A379347→; + ESP	2	24.8190-0401.2 620401	L= 95
			➔	09/97→; → A379346; + ESP	2	24.8190-0401.2 620401	L= 95
E 240 (210.062)	125	08/00→03/02	➔	- ESP	2	24.8190-0401.2 620401	L= 95
			➔	+ ESP	2	24.8190-0401.2 620401	L= 95
			➔	→ A379346; - ESP	2	24.8190-0401.2 620401	L= 95
			➔	→ A379346; + ESP	2	24.8190-0401.2 620401	L= 95
			➔	A379347→; + ESP	2	24.8190-0401.2 620401	L= 95
E 250 D (210.010)	83	06/95→07/99	➔	für Rechtslenker	2	24.8190-0401.2 620401	L= 95
			➔		2	24.8190-0401.2 620401	L= 95
			➔	→ A379346	2	24.8190-0401.2 620401	L= 95
E 250 Turbo-D (210.015)	110	06/97→07/99	➔	09/97→	2	24.8190-0401.2 620401	L= 95
E 270 CDI (210.016)	120	07/99→03/02	➔		2	24.8190-0401.2 620401	L= 95

	kW			 	! #		
MERCEDES-BENZ - E-KLASSE (W210) 06/95→08/03							
Warnkontakt, Bremsbelagverschleiß							
E 270 CDI (210.016)	125	07/99→03/02	➡		2	24.8190-0401.2 620401	L= 95
E 320 CDI (210.026)	145	07/99→03/02					
E 280 (210.053)	142	01/96→06/97	⬅		2	24.8190-0401.2 620401	L= 95
E 280 (210.063)	150	12/96→03/02	➡				
E 280 4-matic (210.081)	150	12/96→03/02	➡	→ A379346	2	24.8190-0401.2 620401	L= 95
E 300 Turbo-D (210.025)	130	12/96→07/99	➡				
E 320 (210.055)	162	06/95→06/97	➡	A379347→	2	24.8190-0401.2 620401	L= 95
E 320 (210.065)	165	06/97→03/02					
E 320 4-matic (210.082)	165	06/97→03/02					
E 420 (210.072)	205	01/96→06/97	⬅	→ A 962231 / X 027613	2	24.8190-0401.2 620401	L= 95
			⬅	A 962232 / X 027614→	2	24.8190-0419.2 620419	L= 74
			➡	A379347→	2	24.8190-0401.2 620401	L= 95
			➡	→ A379346	2	24.8190-0401.2 620401	L= 95
E 430 (210.070)	205	06/97→03/02	⬅	09/97→; → A 962231 / X 027613	2	24.8190-0401.2 620401	L= 95
			⬅	A 962232 / X 027614→	2	24.8190-0419.2 620419	L= 74
			➡	09/97→; → A379346	2	24.8190-0401.2 620401	L= 95
			➡	A379347→	2	24.8190-0401.2 620401	L= 95
E 430 4-matic (210.083)	205	05/99→03/02	⬅		2	24.8190-0419.2 620419	L= 74
E 55 AMG 4-matic (210.074)	260	03/01→03/02	➡		2	24.8190-0401.2 620401	L= 95
E 50 AMG (210.072)	255	02/96→08/97	⬅		2	24.8190-0419.2 620419	L= 74
			➡	Bremssattel mit 2 Haltestiften; nicht für Ausstattungsvariante: AMG Technikpaket	2	24.8190-0401.2 620401	L= 95
			➡	AMG Technikpaket	2	24.8190-0401.2 620401	L= 95
			➡	Bremssattel mit 1 Haltestift; nicht für Ausstattungsvariante: AMG Technikpaket	2	24.8190-0401.2 620401	L= 95
E 55 AMG (210.074)	260	08/97→03/02	⬅	09/97→	2	24.8190-0419.2 620419	L= 74
			➡	09/97→	2	24.8190-0401.2 620401	L= 95
Zubehörsatz, Scheibenbremsbelag							
E 200 (210.035)	100	06/95→08/00	➡	→ A379346		13.0460-0215.2 610215	ATE
E 230 (210.037)	110	06/95→06/97	➡				
E 250 D (210.010)	83	06/95→07/99	➡	A379347→		13.0460-0229.2 610229	ATE
E 290 Turbo-D (210.017)	95	03/96→07/99					
E 300 D (210.020)	100	06/95→06/97					
E 200 CDI (210.007)	75	06/98→03/02	➡	07/98→		13.0460-0229.2 610229	ATE
E 220 CDI (210.006)	92	06/98→07/99					
E 200 CDI (210.007)	85	07/99→03/02	➡			13.0460-0229.2 610229	ATE
E 200 Kompressor (210.048)	120	08/00→03/02					
E 220 CDI (210.006)	100	07/99→03/02					
E 220 CDI (210.006)	105	07/99→03/02					
E 200 D (210.003)	65	01/96→03/02	➡	10/96→; → A379346		13.0460-0215.2 610215	ATE
			➡	A379347→		13.0460-0229.2 610229	ATE
E 200 Kompressor (210.045)	137	06/97→03/02	➡	09/97→		13.0460-0229.2 610229	ATE
						13.0460-0258.2 610258	
E 220 D	55	05/96→03/02	➡	→ A379346		13.0460-0215.2 610215	ATE
E 220 D (210.004)	70	06/95→07/99	➡	→ 06/98; A379347→		13.0460-0229.2 610229	ATE
E 240 (210.061)	125	06/97→08/00	➡	09/97→; → A379346; - ESP		13.0460-0215.2 610215	ATE
			➡	A379347→; - ESP		13.0460-0229.2 610229	ATE
			➡	A379347→; + ESP		13.0460-0258.2 610258	
E 240 (210.062)	125	08/00→03/02	➡	→ A379346; - ESP		13.0460-0215.2 610215	ATE
			➡	A379347→; - ESP		13.0460-0229.2 610229	ATE
			➡	A379347→; + ESP		13.0460-0258.2 610258	
E 250 Turbo-D (210.015)	110	06/97→07/99	➡	09/97→		13.0460-0229.2 610229	ATE
E 270 CDI (210.016)	120	07/99→03/02	➡			13.0460-0258.2 610258	
E 270 CDI (210.016)	125	07/99→03/02					
E 320 CDI (210.026)	145	07/99→03/02					
E 280 (210.053)	142	01/96→06/97	➡	A379347→		13.0460-0258.2 610258	
E 280 (210.063)	150	12/96→03/02					
E 280 4-matic (210.081)	150	12/96→03/02					
E 300 Turbo-D (210.025)	130	12/96→07/99					
E 320 (210.055)	162	06/95→06/97					
E 320 (210.065)	165	06/97→03/02					
E 320 4-matic (210.082)	165	06/97→03/02					
E 420 (210.072)	205	01/96→06/97					

















	kw			 	! #		
MERCEDES-BENZ - E-KLASSE (W210) 06/95→08/03							
Zubehörsatz, Scheibenbremsbelag							
E 430 (210.070)	205	06/97→03/02	➡	A379347→		13.0460-0258.2 610258	
E 430 4-matic (210.083)	205	05/99→03/02	➡			13.0460-0236.2 610236	ATE
E 50 AMG (210.072)	255	02/96→08/97	➡	Bremssattel mit 1 Haltestift; nicht für Ausstattungsvariante: AMG Technikpaket		13.0460-0258.2 610258	
 Bremsscheibe							
E 200 (210.035)	100	06/95→08/00	←			24.0125-0110.1 425110	Ø 288 25 22,4 V + S
E 200 CDI (210.007)	85	07/99→03/02				24.0325-0110.1 525110	Ø 288 25 22,4 V + S PD
E 200 Kompressor (210.048)	120	08/00→03/02	➡			24.0109-0114.1 409114	Ø 278 9 7,3 + S
E 220 CDI (210.006)	100	07/99→03/02				24.0309-0114.1 509114	Ø 278 9 7,3 + S PD
E 220 CDI (210.006)	105	07/99→03/02					
E 230 (210.037)	110	06/95→06/97					
E 290 Turbo-D (210.017)	95	03/96→07/99					
E 300 D (210.020)	100	06/95→06/97					
E 200 CDI (210.007)	75	06/98→03/02	←	07/98→		24.0125-0110.1 425110	Ø 288 25 22,4 V + S
E 220 CDI (210.006)	92	06/98→07/99				24.0325-0110.1 525110	Ø 288 25 22,4 V + S PD
			➡	07/98→		24.0109-0114.1 409114	Ø 278 9 7,3 + S
						24.0309-0114.1 509114	Ø 278 9 7,3 + S PD
E 200 D (210.003)	65	01/96→03/02	←	10/96→; fur Portugal		24.0125-0110.1 425110	Ø 288 25 22,4 V + S
						24.0325-0110.1 525110	Ø 288 25 22,4 V + S PD
			➡	10/96→; fur Portugal		24.0109-0114.1 409114	Ø 278 9 7,3 + S
						24.0309-0114.1 509114	Ø 278 9 7,3 + S PD
E 200 Kompressor (210.045)	137	06/97→03/02	←	09/97→		24.0128-0106.1 428106	Ø 300 28 25,4 V + S
						24.0328-0106.1 528106	Ø 300 28 25,4 V + S PD
			➡	09/97→		24.0110-0217.1 410217	Ø 290 10 8,3 + S
						24.0310-0217.1 510217	Ø 290 10 8,3 + S PD
E 220 D	55	05/96→03/02	←	→ 06/98		24.0125-0110.1 425110	Ø 288 25 22,4 V + S
E 220 D (210.004)	70	06/95→07/99				24.0325-0110.1 525110	Ø 288 25 22,4 V + S PD
			➡	→ 06/98		24.0109-0114.1 409114	Ø 278 9 7,3 + S
						24.0309-0114.1 509114	Ø 278 9 7,3 + S PD
E 240 (210.061)	125	06/97→08/00	←	09/97→; - ESP		24.0125-0110.1 425110	Ø 288 25 22,4 V + S
						24.0325-0110.1 525110	Ø 288 25 22,4 V + S PD
			←	09/97→; + ESP		24.0128-0106.1 428106	Ø 300 28 25,4 V + S
						24.0328-0106.1 528106	Ø 300 28 25,4 V + S PD
			➡	09/97→		24.0109-0114.1 409114	Ø 278 9 7,3 + S
						24.0309-0114.1 509114	Ø 278 9 7,3 + S PD
E 240 (210.062)	125	08/00→03/02	←	- ESP		24.0125-0110.1 425110	Ø 288 25 22,4 V + S
						24.0325-0110.1 525110	Ø 288 25 22,4 V + S PD
			←	+ ESP		24.0128-0106.1 428106	Ø 300 28 25,4 V + S
						24.0328-0106.1 528106	Ø 300 28 25,4 V + S PD
			➡			24.0109-0114.1 409114	Ø 278 9 7,3 + S
						24.0309-0114.1 509114	Ø 278 9 7,3 + S PD
E 250 D (210.010)	83	06/95→07/99	←	fur Italien		24.0125-0110.1 425110	Ø 288 25 22,4 V + S
						24.0325-0110.1 525110	Ø 288 25 22,4 V + S PD
			←	für Rechtslenker		24.0125-0110.1 425110	Ø 288 25 22,4 V + S
						24.0325-0110.1 525110	Ø 288 25 22,4 V + S PD
			➡	für Rechtslenker		24.0109-0114.1 409114	Ø 278 9 7,3 + S
						24.0309-0114.1 509114	Ø 278 9 7,3 + S PD
			➡	fur Italien		24.0109-0114.1 409114	Ø 278 9 7,3 + S
						24.0309-0114.1 509114	Ø 278 9 7,3 + S PD
E 250 Turbo-D (210.015)	110	06/97→07/99	←	09/97→		24.0125-0110.1 425110	Ø 288 25 22,4 V + S
						24.0325-0110.1 525110	Ø 288 25 22,4 V + S PD
			➡	09/97→		24.0109-0114.1 409114	Ø 278 9 7,3 + S
						24.0309-0114.1 509114	Ø 278 9 7,3 + S PD
E 270 CDI (210.016)	120	07/99→03/02	←			24.0128-0106.1 428106	Ø 300 28 25,4 V + S
E 270 CDI (210.016)	125	07/99→03/02				24.0328-0106.1 528106	Ø 300 28 25,4 V + S PD
E 280 (210.053)	142	01/96→06/97					
E 280 (210.063)	150	12/96→03/02	➡			24.0110-0217.1 410217	Ø 290 10 8,3 + S
E 280 4-matic (210.081)	150	12/96→03/02				24.0310-0217.1 510217	Ø 290 10 8,3 + S PD
E 300 Turbo-D (210.025)	130	12/96→07/99					
E 320 (210.055)	162	06/95→06/97					
E 320 (210.065)	165	06/97→03/02					
E 320 4-matic (210.082)	165	06/97→03/02					
E 320 CDI (210.026)	145	07/99→03/02					
E 420 (210.072)	205	01/96→06/97	←	→ A 962231 / X 027613		24.0128-0126.1 428126	Ø 316 28 25,4 V







	kW			 	! #		
MERCEDES-BENZ - E-KLASSE (W210) 06/95→08/03							
Bremsscheibe							
E 420 (210.072)	205	01/96→06/97	←	A 962232 / X 027614→		24.0132-0159.1 432159	Ø 330 32 29,4 V
			→			24.0110-0217.1 410217	Ø 290 10 8,3 + S
						24.0310-0217.1 510217	Ø 290 10 8,3 + S PD
E 430 (210.070)	205	06/97→03/02	←	09/97→; → A 962231 / X 027613		24.0128-0126.1 428126	Ø 316 28 25,4 V
			←	A 962232 / X 027614→		24.0132-0159.1 432159	Ø 330 32 29,4 V
			→	09/97→		24.0110-0217.1 410217	Ø 290 10 8,3 + S
						24.0310-0217.1 510217	Ø 290 10 8,3 + S PD
E 430 4-matic (210.083)	205	05/99→03/02	←			24.0132-0159.1 432159	Ø 330 32 29,4 V
			→			24.0122-0228.1 422228	Ø 300 22 19,4 V
E 50 AMG (210.072)	255	02/96→08/97	→			24.0122-0218.1 422218	Ø 300 22 19,4 V
E 55 AMG (210.074)	260	08/97→03/02	→	09/97→		24.0122-0228.1 422228	Ø 300 22 19,4 V
E 55 AMG 4-matic (210.074)	260	03/01→03/02	→			24.0122-0228.1 422228	Ø 300 22 19,4 V
MERCEDES-BENZ - E-KLASSE (W211) 03/02→03/09							
Bremsbelagsatz, Scheibenbremse							
E 200 CDI (211.004)	75	07/02→12/08	←	für Fahrzeuge ohne Sportpaket / für Fahrzeuge ohne AMG-Sportpaket		13.0460-3999.2 603999	BOS 23743 20,1 + WK + Zub
E 200 CDI (211.004)	90	07/02→12/08				13.0470-3999.2 LD3999	BOS 23743 20,1 + WK + Zub Ceramic
E 200 CDI (211.007)	100	04/06→12/08					
E 200 Kompressor (211.041)	135	04/06→12/08	←	für Fahrzeuge mit Sportpaket / für Fahrzeuge mit AMG-Sportpaket		13.0460-4990.2 604990	BRE 23271 17,4 + WE / - WK
E 200 Kompressor (211.042)	120	11/02→12/08				13.0470-4990.2 LD4990	BRE 23271 17,4 + WE / - WK Ceramic
E 200 NGT (211.041)	120	03/04→12/08	→			13.0460-7171.2 607171	ATE 23334 16,7 + WE / - WK
E 220 CDI	120	03/03→12/08				13.0470-7171.2 LD7171	ATE 23334 16,7 + WE / - WK Ceramic
E 220 CDI (211.006)	100	03/02→12/08					
E 220 CDI (211.006)	110	03/02→12/08					
E 220 CDI (211.008)	125	04/06→12/08					
E 230 (211.052)	150	09/07→12/08					
E 280 CDI (211.020)	140	03/05→12/08					
E 300 BlueTEC (211.024)	155	09/07→12/08					
E 320 CDI (211.022)	165	03/05→12/08					
E 240 (211.061)	130	03/02→12/08	←			13.0460-3999.2 603999	BOS 23743 20,1 + WK + Zub
E 270 CDI (211.016)	120	03/02→12/08				13.0470-3999.2 LD3999	BOS 23743 20,1 + WK + Zub Ceramic
E 270 CDI (211.016)	130	03/02→12/08					
E 280 CDI (211.023)	130	05/04→12/08	→			13.0460-7171.2 607171	ATE 23334 16,7 + WE / - WK
						13.0470-7171.2 LD7171	ATE 23334 16,7 + WE / - WK Ceramic
E 240 4-matic (211.080)	130	03/03→12/08	←			13.0460-7203.2 607203	ATE 21670 19,3 + WE / - WK
E 320 4-matic (211.082)	165	03/03→12/08				13.0470-7203.2 LD7203	ATE 21670 19,3 + WE / - WK Ceramic
			→			13.0460-7171.2 607171	ATE 23334 16,7 + WE / - WK
						13.0470-7171.2 LD7171	ATE 23334 16,7 + WE / - WK Ceramic
E 280 (211.054)	170	03/05→12/08	←	05/05→; für Fahrzeuge ohne Sportpaket / für Fahrzeuge ohne AMG-Sportpaket		13.0460-3999.2 603999	BOS 23743 20,1 + WK + Zub
						13.0470-3999.2 LD3999	BOS 23743 20,1 + WK + Zub Ceramic
			←	05/05→; für Fahrzeuge mit Sportpaket / für Fahrzeuge mit AMG-Sportpaket		13.0460-4990.2 604990	BRE 23271 17,4 + WE / - WK
						13.0470-4990.2 LD4990	BRE 23271 17,4 + WE / - WK Ceramic
			→	05/05→		13.0460-7171.2 607171	ATE 23334 16,7 + WE / - WK
						13.0470-7171.2 LD7171	ATE 23334 16,7 + WE / - WK Ceramic
E 280 4-matic (211.092)	170	01/06→12/08	←	→ A 870950; für Fahrzeuge mit Sportpaket / für Fahrzeuge mit AMG-Sportpaket		13.0460-7183.2 607183	ATE 21484 20,5 + WE / - WK
E 280 CDI 4-matic (211.084)	140	03/05→12/08					
E 320 CDI 4-matic (211.089)	165	03/05→12/08	←	für Fahrzeuge ohne Sportpaket / für Fahrzeuge ohne AMG-Sportpaket		13.0460-7203.2 607203	ATE 21670 19,3 + WE / - WK
E 350 4-matic (211.087)	200	03/05→12/08				13.0470-7203.2 LD7203	ATE 21670 19,3 + WE / - WK Ceramic
			←	A 870951→; für Fahrzeuge mit Sportpaket / für Fahrzeuge mit AMG-Sportpaket		13.0460-7220.2 607220	ATE 23922 21,0 + WE / - WK
						13.0470-7220.2 LD7220	ATE 23922 21,0 + WE / - WK Ceramic
			→			13.0460-7171.2 607171	ATE 23334 16,7 + WE / - WK
						13.0470-7171.2 LD7171	ATE 23334 16,7 + WE / - WK Ceramic
E 320 (211.065)	165	03/02→12/08	←	A 400548→		13.0460-3999.2 603999	BOS 23743 20,1 + WK + Zub
E 320 CDI (211.026)	150	11/02→12/08					
			↓				









	kW			 	! #		
MERCEDES-BENZ - E-KLASSE (W211) 03/02→03/09							
Bremsbelagsatz, Scheibenbremse							
E 320 (211.065) E 320 CDI (211.026)	165 150	03/02→12/08 11/02→12/08	←	A 400548→ → A 400547		13.0470-3999.2 LD3999 13.0460-4990.2 604990 13.0470-4990.2 LD4990	BOS 23743 20,1 + WK + Zub Ceramic BRE 23271 17,4 + WE / - WK Ceramic BRE 23271 17,4 + WE / - WK Ceramic
			→			13.0460-7171.2 607171 13.0470-7171.2 LD7171	ATE 23334 16,7 + WE / - WK Ceramic ATE 23334 16,7 + WE / - WK Ceramic
E 350 (211.056) E 350 CGI (211.057)	200 215	03/05→12/08 09/07→12/08	←			13.0460-4990.2 604990 13.0470-4990.2 LD4990	BRE 23271 17,4 + WE / - WK Ceramic BRE 23271 17,4 + WE / - WK Ceramic
			→			13.0460-7171.2 607171 13.0470-7171.2 LD7171	ATE 23334 16,7 + WE / - WK Ceramic ATE 23334 16,7 + WE / - WK Ceramic
E 400 CDI (211.028)	191	02/03→12/08	←	03/03→		13.0460-4990.2 604990 13.0470-4990.2 LD4990	BRE 23271 17,4 + WE / - WK Ceramic BRE 23271 17,4 + WE / - WK Ceramic
			→	03/03→		13.0460-7171.2 607171 13.0470-7171.2 LD7171	ATE 23334 16,7 + WE / - WK Ceramic ATE 23334 16,7 + WE / - WK Ceramic
E 420 CDI (211.029) E 500 (211.072)	231 285	01/06→12/08 04/06→12/08	←			13.0460-4817.2 604817	BRE 23960 18,3 + WE / - WK
			→			13.0460-7171.2 607171 13.0470-7171.2 LD7171	ATE 23334 16,7 + WE / - WK Ceramic ATE 23334 16,7 + WE / - WK Ceramic
E 500 (211.070)	225	03/02→12/08	←			13.0460-4990.2 604990	BRE 23271 17,4 + WE / - WK
			→			13.0460-7171.2 607171 13.0470-7171.2 LD7171	ATE 23334 16,7 + WE / - WK Ceramic ATE 23334 16,7 + WE / - WK Ceramic
E 500 4-matic (211.083)	225	10/03→12/08	←	→ A 870950		13.0460-7183.2 607183	ATE 21484 20,5 + WE / - WK
			←	A 870951→		13.0460-7220.2 607220	ATE 23922 21,0 + WE / - WK
			→			13.0460-7171.2 607171 13.0470-7171.2 LD7171	ATE 23334 16,7 + WE / - WK Ceramic ATE 23334 16,7 + WE / - WK Ceramic
E 500 4-matic (211.090)	285	04/06→12/08	←			13.0460-7220.2 607220	ATE 23922 21,0 + WE / - WK
			→			13.0460-7171.2 607171 13.0470-7171.2 LD7171	ATE 23334 16,7 + WE / - WK Ceramic ATE 23334 16,7 + WE / - WK Ceramic
E 55 AMG Kompressor (211.076)	350	10/02→12/08	←			13.0460-4997.2 604997	BRE 23943 17,5 + WE / - WK
			→			13.0460-4998.2 604998	BRE 23478 16,5 + WE / - WK
E 63 AMG (211.077, 211.177)	378	03/06→12/08	←			13.0460-4839.2 604839	BRE 24455 16,8 + WE / - WK
Warnkontakt, Bremsbelagverschleiß							
E 200 CDI (211.004) E 200 CDI (211.004) E 200 CDI (211.007) E 200 Kompressor (211.041) E 200 Kompressor (211.042)	75 90 100 135 120	07/02→12/08 07/02→12/08 04/06→12/08 04/06→12/08 11/02→12/08	←	☐; für Fahrzeuge ohne Sportpaket / für Fahrzeuge ohne AMG-Sportpaket		24.8190-0410.2 620410	L= 97,5 L= 97,5
E 200 NGT (211.041) E 220 CDI (211.006) E 220 CDI (211.006) E 220 CDI (211.008) E 230 (211.052) E 280 CDI (211.020) E 300 BlueTEC (211.024) E 320 CDI (211.022)	120 120 100 110 125 150 140 155 165	03/04→12/08 03/03→12/08 03/02→12/08 04/06→12/08 09/07→12/08 03/05→12/08 09/07→12/08 03/05→12/08	←	☐; für Fahrzeuge mit Sportpaket / für Fahr- zeuge mit AMG-Sportpaket		24.8190-0416.2 620416	L= 100
E 240 (211.061) E 240 4-matic (211.080) E 270 CDI (211.016) E 270 CDI (211.016) E 280 CDI (211.023) E 320 4-matic (211.082) E 350 (211.056) E 350 CGI (211.057) E 500 (211.070)	130 130 120 130 130 165 200 215 225	03/02→12/08 03/03→12/08 03/02→12/08 03/02→12/08 05/04→12/08 03/03→12/08 03/05→12/08 09/07→12/08 03/02→12/08	←	☐; für Fahrzeuge ohne Sportpaket / für Fahrzeuge ohne AMG-Sportpaket		24.8190-0410.2 620410	L= 97,5
			←	☐		24.8190-0416.2 620416	L= 100
			→	☐	1	24.8190-0410.2 620410	L= 97,5
			→	☐		24.8190-0410.2 620410	L= 97,5
			→	☐	1	24.8190-0410.2 620410	L= 97,5
			→	☐		24.8190-0410.2 620410	L= 97,5
			→	☐		24.8190-0410.2 620410	L= 97,5
			→	☐		24.8190-0410.2 620410	L= 97,5
			→	☐		24.8190-0410.2 620410	L= 97,5
			→	☐		24.8190-0410.2 620410	L= 97,5
			→	☐		24.8190-0410.2 620410	L= 97,5
			→	☐		24.8190-0410.2 620410	L= 97,5
			→	☐		24.8190-0410.2 620410	L= 97,5
			→	☐		24.8190-0410.2 620410	L= 97,5
			→	☐		24.8190-0410.2 620410	L= 97,5
			→	☐		24.8190-0410.2 620410	L= 97,5
			→	☐		24.8190-0410.2 620410	L= 97,5

















	kw			 	! #			
MERCEDES-BENZ - E-KLASSE (W211) 03/02→03/09								
Warnkontakt, Bremsbelagverschleiß								
E 280 (211.054)	170	03/05→12/08	←	☐; 05/05→; für Fahrzeuge mit Sportpaket / für Fahrzeuge mit AMG-Sportpaket		24.8190-0410.2 620410	L= 97,5	
			←	☐; 05/05→; für Fahrzeuge ohne Sportpaket / für Fahrzeuge ohne AMG-Sportpaket		24.8190-0410.2 620410	L= 97,5	
			←	☐; 05/05→; für Fahrzeuge mit Sportpaket / für Fahrzeuge mit AMG-Sportpaket		24.8190-0416.2 620416	L= 100	
			←	☐; 05/05→; für Fahrzeuge ohne Sportpaket / für Fahrzeuge ohne AMG-Sportpaket		24.8190-0416.2 620416	L= 100	
			→	☐; 05/05→	1	24.8190-0410.2 620410	L= 97,5	
E 280 4-matic (211.092)	170	01/06→12/08	←	☐; für Fahrzeuge ohne Sportpaket / für Fahrzeuge ohne AMG-Sportpaket		24.8190-0410.2 620410	L= 97,5	
E 280 CDI 4-matic (211.084)	140	03/05→12/08	←	☐; für Fahrzeuge ohne Sportpaket / für Fahrzeuge ohne AMG-Sportpaket		24.8190-0416.2 620416	L= 100	
E 320 CDI 4-matic (211.089)	165	03/05→12/08	←	☐; für Fahrzeuge ohne Sportpaket / für Fahrzeuge ohne AMG-Sportpaket		24.8190-0416.2 620416	L= 100	
E 350 4-matic (211.087)	200	03/05→12/08	←	☐; A 870951→; für Fahrzeuge mit Sportpaket / für Fahrzeuge mit AMG-Sportpaket		24.8190-0425.2 620425	L= 98	
			←	☐; → A 870950; für Fahrzeuge mit Sportpaket / für Fahrzeuge mit AMG-Sportpaket		24.8190-0425.2 620425	L= 98	
			→	☐	1	24.8190-0410.2 620410	L= 97,5	
E 320 (211.065)	165	03/02→12/08	←	☐; A 400548→		24.8190-0410.2 620410	L= 97,5	
E 320 CDI (211.026)	150	11/02→12/08	←	☐; → A 400547		24.8190-0410.2 620410	L= 97,5	
			←	☐; A 400548→		24.8190-0416.2 620416	L= 100	
			←	☐; → A 400547		24.8190-0416.2 620416	L= 100	
			→	☐	1	24.8190-0410.2 620410	L= 97,5	
E 400 CDI (211.028)	191	02/03→12/08	←	☐; 03/03→		24.8190-0410.2 620410	L= 97,5	
			←	☐; 03/03→		24.8190-0416.2 620416	L= 100	
			→	☐; 03/03→	1	24.8190-0410.2 620410	L= 97,5	
E 420 CDI (211.029)	231	01/06→12/08	←	☐		24.8190-0420.2 620420	L= 119	
E 500 (211.072)	285	04/06→12/08	→	☐	1	24.8190-0410.2 620410	L= 97,5	
E 500 4-matic (211.083)	225	10/03→12/08	←	☐; A 870951→		24.8190-0425.2 620425	L= 98	
			←	☐; → A 870950		24.8190-0425.2 620425	L= 98	
			←	☐; A 870951→		24.8190-0955.2 620955	L= 100	
			→	☐	1	24.8190-0410.2 620410	L= 97,5	
E 500 4-matic (211.090)	285	04/06→12/08	←	☐		24.8190-0425.2 620425	L= 98	
			→	☐	1	24.8190-0410.2 620410	L= 97,5	
E 55 AMG Kompressor (211.076)	350	10/02→12/08	←	☐		24.8190-0410.2 620410	L= 97,5	
			←	☐		24.8190-0416.2 620416	L= 100	
			→	☐		24.8190-0410.2 620410	L= 97,5	
E 63 AMG (211.077, 211.177)	378	03/06→12/08	←	☐		24.8190-0420.2 620420	L= 119	
			→	☐		24.8190-0420.2 620420	L= 119	
Zubehörsatz, Scheibenbremsbelag								
E 200 CDI (211.004)	75	07/02→12/08	←	für Fahrzeuge mit Sportpaket / für Fahrzeuge mit AMG-Sportpaket		13.0460-0155.2 610155	BRE	
E 200 CDI (211.004)	90	07/02→12/08					13.0460-0275.2 610275	
E 200 CDI (211.007)	100	04/06→12/08						
E 200 Kompressor (211.041)	135	04/06→12/08						
E 200 Kompressor (211.042)	120	11/02→12/08						
E 200 NGT (211.041)	120	03/04→12/08						
E 220 CDI	120	03/03→12/08						
E 220 CDI (211.006)	100	03/02→12/08						
E 220 CDI (211.006)	110	03/02→12/08						
E 220 CDI (211.008)	125	04/06→12/08						
E 230 (211.052)	150	09/07→12/08						
E 280 CDI (211.020)	140	03/05→12/08						
E 300 BlueTEC (211.024)	155	09/07→12/08						
E 320 CDI (211.022)	165	03/05→12/08						
↓								







	kW			 	! #		
MERCEDES-BENZ - E-KLASSE (W211) 03/02→03/09							
Zubehörsatz, Scheibenbremsbelag							
E 280 (211.054)	170	03/05→12/08	←	05/05→; für Fahrzeuge mit Sportpaket / für Fahrzeuge mit AMG-Sportpaket		13.0460-0155.2 610155 13.0460-0275.2 610275	BRE
E 320 (211.065) E 320 CDI (211.026)	165 150	03/02→12/08 11/02→12/08	←	→ A 400547		13.0460-0155.2 610155 13.0460-0275.2 610275	BRE
E 350 (211.056) E 350 CGI (211.057) E 500 (211.070)	200 215 225	03/05→12/08 09/07→12/08 03/02→12/08	←			13.0460-0155.2 610155 13.0460-0275.2 610275	BRE
E 400 CDI (211.028)	191	02/03→12/08	←	03/03→		13.0460-0155.2 610155 13.0460-0275.2 610275	BRE
Bremsscheibe							
E 200 CDI (211.004) E 200 CDI (211.004)	75 90	07/02→12/08 07/02→12/08	←	für Fahrzeuge ohne Sportpaket / für Fahrzeuge ohne AMG-Sportpaket		24.0128-0176.1 428176 24.0328-0176.1 528176	Ø 295 28 25,4 V + S Ø 295 28 25,4 V PD
			←	für Fahrzeuge mit Sportpaket / für Fahrzeuge mit AMG-Sportpaket		24.0132-0153.1 432153	Ø 330 32 30 V• + S
			→	nicht für Taxifahrzeuge; für Fahrzeuge ohne Sportpaket / für Fahrzeuge ohne AMG-Sportpaket		24.0110-0278.1 410278 24.0122-0201.1 422201	Ø 300 10 8,3 + S Ø 300 22 19,4 V + S
			→	für Taxifahrzeuge		24.0310-0278.1 510278	Ø 300 10 8,3 + S PD
			→	für Taxifahrzeuge		24.0122-0201.1 422201	Ø 300 22 19,4 V + S
E 200 CDI (211.007) E 200 Kompressor (211.041)	100 135	04/06→12/08 04/06→12/08	←	für Fahrzeuge ohne Sportpaket / für Fahrzeuge ohne AMG-Sportpaket		24.0128-0176.1 428176 24.0328-0176.1 528176	Ø 295 28 25,4 V + S Ø 295 28 25,4 V PD
E 200 NGT (211.041) E 220 CDI	120 120	03/04→12/08 03/03→12/08	←	für Fahrzeuge mit Sportpaket / für Fahrzeuge mit AMG-Sportpaket		24.0132-0153.1 432153	Ø 330 32 30 V• + S
E 220 CDI (211.006) E 220 CDI (211.006) E 220 CDI (211.008)	100 110 125	03/02→12/08 03/02→12/08 04/06→12/08	→	nicht für Taxifahrzeuge; für Fahrzeuge ohne Sportpaket / für Fahrzeuge ohne AMG-Sportpaket		24.0110-0278.1 410278 24.0310-0278.1 510278	Ø 300 10 8,3 + S Ø 300 10 8,3 + S PD
			→	nicht für Taxifahrzeuge; für Fahrzeuge mit Sportpaket / für Fahrzeuge mit AMG-Sportpaket		24.0122-0201.1 422201	Ø 300 22 19,4 V + S
			→	für Taxifahrzeuge		24.0122-0201.1 422201	Ø 300 22 19,4 V + S
E 200 Kompressor (211.042)	120	11/02→12/08	←	für Fahrzeuge ohne Sportpaket / für Fahrzeuge ohne AMG-Sportpaket		24.0128-0176.1 428176 24.0328-0176.1 528176	Ø 295 28 25,4 V + S Ø 295 28 25,4 V PD
			←			24.0132-0153.1 432153	Ø 330 32 30 V• + S
			→	nicht für Taxifahrzeuge; für Fahrzeuge ohne Sportpaket / für Fahrzeuge ohne AMG-Sportpaket		24.0110-0278.1 410278 24.0310-0278.1 510278	Ø 300 10 8,3 + S Ø 300 10 8,3 + S PD
			→	nicht für Taxifahrzeuge; für Fahrzeuge mit Sportpaket / für Fahrzeuge mit AMG-Sportpaket		24.0122-0201.1 422201	Ø 300 22 19,4 V + S
			→	für Taxifahrzeuge		24.0122-0201.1 422201	Ø 300 22 19,4 V + S
E 230 (211.052) E 280 CDI (211.020)	150 140	09/07→12/08 03/05→12/08	←	für Fahrzeuge ohne Sportpaket / für Fahrzeuge ohne AMG-Sportpaket		24.0128-0176.1 428176 24.0328-0176.1 528176	Ø 295 28 25,4 V + S Ø 295 28 25,4 V PD
			←	für Fahrzeuge mit Sportpaket / für Fahrzeuge mit AMG-Sportpaket		24.0132-0153.1 432153	Ø 330 32 30 V• + S
			→	für Fahrzeuge ohne Sportpaket / für Fahrzeuge ohne AMG-Sportpaket		24.0110-0278.1 410278 24.0310-0278.1 510278	Ø 300 10 8,3 + S Ø 300 10 8,3 + S PD
			→	für Fahrzeuge mit Sportpaket / für Fahrzeuge mit AMG-Sportpaket		24.0122-0201.1 422201	Ø 300 22 19,4 V + S
E 240 (211.061) E 270 CDI (211.016) E 270 CDI (211.016)	130 120 130	03/02→12/08 03/02→12/08 03/02→12/08	←			24.0128-0176.1 428176 24.0328-0176.1 528176	Ø 295 28 25,4 V + S Ø 295 28 25,4 V PD
			→	nicht für Taxifahrzeuge		24.0110-0278.1 410278 24.0310-0278.1 510278	Ø 300 10 8,3 + S Ø 300 10 8,3 + S PD
			→	für Taxifahrzeuge		24.0122-0201.1 422201	Ø 300 22 19,4 V + S
E 240 4-matic (211.080)	130	03/03→12/08	←			24.0130-0179.1 430179	Ø 304 30 27,4 V
			→			24.0110-0278.1 410278 24.0310-0278.1 510278	Ø 300 10 8,3 + S Ø 300 10 8,3 + S PD
E 280 (211.054)	170	03/05→12/08	←	05/05→; für Fahrzeuge ohne Sportpaket / für Fahrzeuge ohne AMG-Sportpaket		24.0128-0176.1 428176 24.0328-0176.1 528176	Ø 295 28 25,4 V + S Ø 295 28 25,4 V PD
			←	05/05→; für Fahrzeuge mit Sportpaket / für Fahrzeuge mit AMG-Sportpaket		24.0132-0153.1 432153	Ø 330 32 30 V• + S
			→	05/05→		24.0122-0201.1 422201	Ø 300 22 19,4 V + S
E 280 4-matic (211.092) E 280 CDI 4-matic (211.084)	170 140	01/06→12/08 03/05→12/08	←	für Fahrzeuge ohne Sportpaket / für Fahrzeuge ohne AMG-Sportpaket		24.0130-0179.1 430179	Ø 304 30 27,4 V
			←	für Fahrzeuge mit Sportpaket / für Fahrzeuge mit AMG-Sportpaket		24.0132-0136.1 432136	Ø 330 32 30 V•











	kw			 	! #		
MERCEDES-BENZ - E-KLASSE (W211) 03/02→03/09							
Bremsscheibe							
E 280 4-matic (211.092) E 280 CDI 4-matic (211.084)	170 140	01/06→12/08 03/05→12/08	➔	für Fahrzeuge ohne Sportpaket / für Fahrzeuge ohne AMG-Sportpaket		24.0110-0278.1 410278 24.0310-0278.1 510278	Ø 300 10 8,3 + S Ø 300 10 8,3 + S PD
			➔	für Fahrzeuge mit Sportpaket / für Fahrzeuge mit AMG-Sportpaket		24.0122-0201.1 422201	Ø 300 22 19,4 V + S
E 280 CDI (211.023)	130	05/04→12/08	➔			24.0128-0176.1 428176 24.0328-0176.1 528176 24.0122-0201.1 422201	Ø 295 28 25,4 V + S Ø 295 28 25,4 V PD Ø 300 22 19,4 V + S
E 300 BlueTEC (211.024) E 320 CDI (211.022)	155 165	09/07→12/08 03/05→12/08	➔	für Fahrzeuge ohne Sportpaket / für Fahrzeuge ohne AMG-Sportpaket		24.0128-0176.1 428176 24.0328-0176.1 528176	Ø 295 28 25,4 V + S Ø 295 28 25,4 V PD
			➔	für Fahrzeuge mit Sportpaket / für Fahrzeuge mit AMG-Sportpaket		24.0132-0153.1 432153	Ø 330 32 30 V• + S
			➔			24.0122-0201.1 422201	Ø 300 22 19,4 V + S
E 320 (211.065) E 320 CDI (211.026)	165 150	03/02→12/08 11/02→12/08	➔	→ A 400547		24.0128-0142.1 428142 24.0328-0142.1 528142	Ø 312 28 25,4 V Ø 312 28 25,4 V PD
			➔	A 400548→		24.0128-0176.1 428176 24.0328-0176.1 528176	Ø 295 28 25,4 V + S Ø 295 28 25,4 V PD
			➔	→ A 400547; nicht für Taxifahrzeuge		24.0110-0278.1 410278 24.0310-0278.1 510278	Ø 300 10 8,3 + S Ø 300 10 8,3 + S PD
			➔	A 400548→; nicht für Taxifahrzeuge		24.0122-0201.1 422201	Ø 300 22 19,4 V + S
			➔	für Taxifahrzeuge		24.0122-0201.1 422201	Ø 300 22 19,4 V + S
E 320 4-matic (211.082)	165	03/03→12/08	➔			24.0130-0179.1 430179	Ø 304 30 27,4 V
			➔	X 122526→		24.0110-0278.1 410278 24.0310-0278.1 510278	Ø 300 10 8,3 + S Ø 300 10 8,3 + S PD
			➔	→ X 122525		24.0122-0201.1 422201	Ø 300 22 19,4 V + S
E 320 CDI 4-matic (211.089) E 350 4-matic (211.087)	165 200	03/05→12/08 03/05→12/08	➔	für Fahrzeuge ohne Sportpaket / für Fahrzeuge ohne AMG-Sportpaket		24.0130-0179.1 430179	Ø 304 30 27,4 V
			➔	für Fahrzeuge mit Sportpaket / für Fahrzeuge mit AMG-Sportpaket		24.0132-0136.1 432136	Ø 330 32 30 V•
			➔			24.0122-0201.1 422201	Ø 300 22 19,4 V + S
E 350 (211.056) E 350 CGI (211.057) E 500 (211.070)	200 215 225	03/05→12/08 09/07→12/08 03/02→12/08	➔	für Fahrzeuge ohne Sportpaket / für Fahrzeuge ohne AMG-Sportpaket		24.0132-0144.1 432144 24.0332-0144.1 532144	Ø 330 32 29,4 V + S Ø 330 32 29,4 V + S PD
			➔	für Fahrzeuge mit Sportpaket / für Fahrzeuge mit AMG-Sportpaket		24.0132-0153.1 432153	Ø 330 32 30 V• + S
			➔			24.0122-0201.1 422201	Ø 300 22 19,4 V + S
E 400 CDI (211.028)	191	02/03→12/08	➔	03/03→		24.0132-0144.1 432144 24.0332-0144.1 532144	Ø 330 32 29,4 V + S Ø 330 32 29,4 V + S PD
			➔	03/03→		24.0122-0201.1 422201	Ø 300 22 19,4 V + S
E 420 CDI (211.029) E 500 (211.072)	231 285	01/06→12/08 04/06→12/08	➔	für Fahrzeuge mit Sportpaket / für Fahrzeuge mit AMG-Sportpaket		24.0132-0138.1 432138	Ø 350 32 30 V• + S
			➔	für Fahrzeuge ohne Sportpaket / für Fahrzeuge ohne AMG-Sportpaket		24.0132-0139.1 432139	Ø 350 32 29,4 V + S
			➔			24.0124-0236.1 424236	Ø 320 24 21,1 V + S
E 500 4-matic (211.083) E 500 4-matic (211.090)	225 285	10/03→12/08 04/06→12/08	➔	für Fahrzeuge mit Sportpaket / für Fahrzeuge mit AMG-Sportpaket		24.0132-0136.1 432136	Ø 330 32 30 V•
			➔	für Fahrzeuge ohne Sportpaket / für Fahrzeuge ohne AMG-Sportpaket		24.0132-0154.1 432154	Ø 330 32 29,4 V
			➔			24.0122-0201.1 422201	Ø 300 22 19,4 V + S
E 55 AMG Kompressor (211.076)	350	10/02→12/08	➔			24.0136-0102.1 436102	Ø 360 36 34 V•
			➔			24.0126-0136.1 426136	Ø 330 26 24 V•
E 63 AMG (211.077, 211.177)	378	03/06→12/08	➔			24.0126-0136.1 426136	Ø 330 26 24 V•
MERCEDES-BENZ - E-KLASSE (W212) 01/09→							
Bremsbelagsatz, Scheibenbremse							
E 200 (212.034) E 200 CGI (212.048, 212.148) E 200 NGT (212.035) E 200 NGT (212.041) E 220 BlueTEC (212.001)	135 135 115 120 130	01/13→ 08/09→ 07/13→ 03/11→ 05/14→	➔	für Fahrzeuge ohne Sportpaket / für Fahrzeuge ohne AMG-Sportpaket		13.0460-2732.2 602732 13.0470-2732.2 LD2732 13.0470-9000.2 LD9000	TRW 24306 20,3 + WE / - WK + Zub TRW 24306 20,3 + WE / - WK + Zub Ceramic TRW 24306 20,3 + WE / - WK + Zub Ceramic
			➔	für Fahrzeuge mit Sportpaket / für Fahrzeuge mit AMG-Sportpaket		13.0460-2734.2 602734 13.0470-2734.2 LD2734	TRW 24310 19,0 + WE / - WK TRW 24310 19,0 + WE / - WK Ceramic
			➔			13.0460-7259.2 607259	ATE 24862 16,7 + WE / - WK











	kW			 	! #		
MERCEDES-BENZ - E-KLASSE (W212) 01/09→							
 Bremsbelagsatz, Scheibenbremse							
E 200 (212.034) E 200 CGI (212.048, 212.148) E 200 NGT (212.035) E 200 NGT (212.041) E 220 BlueTEC (212.001)	135 135 115 120 130	01/13→ 08/09→ 07/13→ 03/11→ 05/14→	→			13.0470-7259.2 LD7259 13.0470-9001.2 LD9001	ATE 24862 16,7 + WE / - WK Ceramic ATE 24862 16,7 + WE / - WK Ceramic
E 200 CDI / BlueTEC (212.005, 212.006) E 220 CDI E 220 CDI / BlueTEC (212.001, 212.002)	100 120 125	01/09→ 01/09→ 01/09→	←	03/09→; für Fahrzeuge ohne Sportpaket / für Fahrzeuge ohne AMG-Sportpaket		13.0460-2732.2 602732 13.0470-2732.2 LD2732 13.0470-9000.2 LD9000	TRW 24306 20,3 + WE / - WK + Zub TRW 24306 20,3 + WE / - WK + Zub Ceramic TRW 24306 20,3 + WE / - WK + Zub Ceramic
			←	03/09→; für Fahrzeuge mit Sportpaket / für Fahrzeuge mit AMG-Sportpaket		13.0460-2734.2 602734 13.0470-2734.2 LD2734	TRW 24310 19,0 + WE / - WK Ceramic TRW 24310 19,0 + WE / - WK Ceramic
			→	03/09→		13.0460-7259.2 607259 13.0470-7259.2 LD7259 13.0470-9001.2 LD9001	ATE 24862 16,7 + WE / - WK Ceramic ATE 24862 16,7 + WE / - WK Ceramic ATE 24862 16,7 + WE / - WK Ceramic
E 220 BlueTEC 4-matic (212.011) E 250 (212.036) E 250 CGI (212.047, 212.147) E 300 (212.055) E 300 4-matic (212.080) E 350 (212.059) E 350 4-matic (212.088) E 350 CDI (212.023) E 350 CDI 4-matic (212.089) E 350 CDI 4-matic (212.093)	125 155 150 185 185 225 225 195 170 195	01/15→ 01/13→ 01/09→ 07/11→ 07/11→ 09/11→ 09/11→ 03/11→ 09/09→ 03/11→	←			13.0460-2734.2 602734 13.0470-2734.2 LD2734	TRW 24310 19,0 + WE / - WK Ceramic TRW 24310 19,0 + WE / - WK Ceramic
			→			13.0460-7259.2 607259 13.0470-7259.2 LD7259 13.0470-9001.2 LD9001	ATE 24862 16,7 + WE / - WK Ceramic ATE 24862 16,7 + WE / - WK Ceramic ATE 24862 16,7 + WE / - WK Ceramic
E 250 CDI / BlueTEC (212.003, 212.004)	150	01/09→	←	03/09→; → A 001284; für Fahrzeuge ohne Sportpaket / für Fahrzeuge ohne AMG-Sportpaket		13.0460-2732.2 602732 13.0470-2732.2 LD2732 13.0470-9000.2 LD9000	TRW 24306 20,3 + WE / - WK + Zub TRW 24306 20,3 + WE / - WK + Zub Ceramic TRW 24306 20,3 + WE / - WK + Zub Ceramic
			←	03/09→; für Fahrzeuge mit Sportpaket / für Fahrzeuge mit AMG-Sportpaket		13.0460-2734.2 602734 13.0470-2734.2 LD2734	TRW 24310 19,0 + WE / - WK Ceramic TRW 24310 19,0 + WE / - WK Ceramic
			←	A 001285→; für Fahrzeuge ohne Sportpaket / für Fahrzeuge ohne AMG-Sportpaket		13.0460-2734.2 602734 13.0470-2734.2 LD2734	TRW 24310 19,0 + WE / - WK Ceramic TRW 24310 19,0 + WE / - WK Ceramic
			→	03/09→		13.0460-7259.2 607259 13.0470-7259.2 LD7259 13.0470-9001.2 LD9001	ATE 24862 16,7 + WE / - WK Ceramic ATE 24862 16,7 + WE / - WK Ceramic ATE 24862 16,7 + WE / - WK Ceramic
E 250 CDI / BlueTEC 4-matic (212.082, 212.097) E 300 (212.054) E 350 (212.056) E 350 4-matic (212.087) E 350 BlueTEC (212.024) E 350 CDI (212.025) E 350 CGI (212.057)	150 170 200 200 155 170 215	01/09→ 01/09→ 01/09→ 01/09→08/11 01/09→ 01/09→ 01/09→08/11	←	03/09→		13.0460-2734.2 602734 13.0470-2734.2 LD2734	TRW 24310 19,0 + WE / - WK Ceramic TRW 24310 19,0 + WE / - WK Ceramic
			→	03/09→		13.0460-7259.2 607259 13.0470-7259.2 LD7259 13.0470-9001.2 LD9001	ATE 24862 16,7 + WE / - WK Ceramic ATE 24862 16,7 + WE / - WK Ceramic ATE 24862 16,7 + WE / - WK Ceramic
E 300 CDI / BlueTEC (212.020, 212.021, 212.027)	170	03/11→	←	04/11→		13.0460-2734.2 602734 13.0470-2734.2 LD2734	TRW 24310 19,0 + WE / - WK Ceramic TRW 24310 19,0 + WE / - WK Ceramic
			→	04/11→		13.0460-7259.2 607259 13.0470-7259.2 LD7259 13.0470-9001.2 LD9001	ATE 24862 16,7 + WE / - WK Ceramic ATE 24862 16,7 + WE / - WK Ceramic ATE 24862 16,7 + WE / - WK Ceramic
E 300 Hybrid / BlueTEC Hybrid (212.098)	150	12/11→	←	06/12→		13.0460-2734.2 602734 13.0470-2734.2 LD2734	TRW 24310 19,0 + WE / - WK Ceramic TRW 24310 19,0 + WE / - WK Ceramic
			→	06/12→		13.0460-7259.2 607259	ATE 24862 16,7 + WE / - WK Ceramic

	kw			 	! #		
MERCEDES-BENZ - E-KLASSE (W212) 01/09→							
 Bremsbelagsatz, Scheibenbremse							
E 300 Hybrid / BlueTEC Hybrid (212.098)	150	12/11→	➔	06/12→		13.0470-7259.2 LD7259 13.0470-9001.2 LD9001	ATE 24862 16,7 + WE / - WK Ceramic ATE 24862 16,7 + WE / - WK Ceramic
E 350 BlueTEC E 350 BlueTEC 4-matic (212.094)	185	11/12→	←	01/13→; für Fahrzeuge ohne Sportpaket / für Fahrzeuge ohne AMG-Sportpaket		13.0460-2734.2 602734 13.0470-2734.2 LD2734	TRW 24310 19,0 + WE / - WK TRW 24310 19,0 + WE / - WK Ceramic
	185	11/12→	←	01/13→; für Fahrzeuge mit Sportpaket / für Fahrzeuge mit AMG-Sportpaket		13.0460-4863.2 604863	BRE 24976 17,5 + WE / - WK
				➔	01/13→		13.0460-7259.2 607259 13.0470-7259.2 LD7259 13.0470-9001.2 LD9001
E 350 BlueTEC (212.026) E 350 BlueTEC 4-matic (212.094)	190	05/14→	←	für Fahrzeuge ohne Sportpaket / für Fahrzeuge ohne AMG-Sportpaket		13.0460-2734.2 602734 13.0470-2734.2 LD2734	TRW 24310 19,0 + WE / - WK TRW 24310 19,0 + WE / - WK Ceramic
	190	05/14→	←	für Fahrzeuge mit Sportpaket / für Fahrzeuge mit AMG-Sportpaket		13.0460-4863.2 604863	BRE 24976 17,5 + WE / - WK
				➔			13.0460-7259.2 607259 13.0470-7259.2 LD7259 13.0470-9001.2 LD9001
E 400 (212.061) E 500 (212.073) E 500 4-matic (212.091)	245	07/14→	➔			13.0460-7259.2 607259 13.0470-7259.2 LD7259 13.0470-9001.2 LD9001	ATE 24862 16,7 + WE / - WK ATE 24862 16,7 + WE / - WK Ceramic ATE 24862 16,7 + WE / - WK Ceramic
	300	09/11→					
	300	09/11→					
E 400 (212.065) E 400 4-matic (212.067) E 400 4-matic (212.099)	245	01/13→	←			13.0460-4863.2 604863	BRE 24976 17,5 + WE / - WK
	245	01/13→	➔			13.0460-7259.2 607259 13.0470-7259.2 LD7259 13.0470-9001.2 LD9001	ATE 24862 16,7 + WE / - WK ATE 24862 16,7 + WE / - WK Ceramic ATE 24862 16,7 + WE / - WK Ceramic
	245	07/14→					
E 500 (212.072) E 500 4-matic (212.090)	285	01/09→	←	03/09→		13.0460-4863.2 604863	BRE 24976 17,5 + WE / - WK
	285	01/09→	➔	03/09→		13.0460-7259.2 607259 13.0470-7259.2 LD7259 13.0470-9001.2 LD9001	ATE 24862 16,7 + WE / - WK ATE 24862 16,7 + WE / - WK Ceramic ATE 24862 16,7 + WE / - WK Ceramic
E 63 AMG (212.077)	386	12/09→	←	für Fahrzeuge ohne Keramikbremse		13.0460-4839.2 604839	BRE 24455 16,8 + WE / - WK
Warnkontakt, Bremsbelagverschleiß							
E 200 (212.034) E 200 CGI (212.048, 212.148) E 200 NGT (212.035) E 200 NGT (212.041) E 220 BlueTEC (212.001) E 350 BlueTEC (212.026) E 350 BlueTEC 4-matic (212.094)	135	01/13→	←	für Fahrzeuge mit Sportpaket / für Fahrzeuge mit AMG-Sportpaket	1	24.8190-0410.2 620410	L= 97,5
	135	08/09→	←	für Fahrzeuge ohne Sportpaket / für Fahrzeuge ohne AMG-Sportpaket	1	24.8190-0410.2 620410	L= 97,5
	115 120 130	07/13→ 03/11→ 05/14→	➔			1	24.8190-0410.2 620410
E 200 CDI / BlueTEC (212.005, 212.006) E 220 CDI (212.001, 212.002)	100	01/09→	←	03/09→; für Fahrzeuge ohne Sportpaket / für Fahrzeuge ohne AMG-Sportpaket	1	24.8190-0410.2 620410	L= 97,5
	120	01/09→	←	03/09→; für Fahrzeuge mit Sportpaket / für Fahrzeuge mit AMG-Sportpaket	1	24.8190-0410.2 620410	L= 97,5
	125	01/09→	➔	03/09→	1	24.8190-0410.2 620410	L= 97,5
E 220 BlueTEC 4-matic (212.011) E 250 (212.036) E 250 CGI (212.047, 212.147) E 300 (212.055) E 300 4-matic (212.080) E 350 (212.059) E 350 4-matic (212.088) ↓	125	01/15→	←		1	24.8190-0410.2 620410	L= 97,5
	155	01/13→	➔		1	24.8190-0410.2 620410	L= 97,5
	150 185 185 225 225	01/09→ 07/11→ 07/11→ 09/11→ 09/11→					









	kw			 	! #		
MERCEDES-BENZ - E-KLASSE (W212) 01/09→							
Warnkontakt, Bremsbelagverschleiß							
E 350 CDI (212.023)	195	03/11→	←		1	24.8190-0410.2 620410	L= 97,5
E 350 CDI 4-matic (212.089)	170	09/09→	→		1	24.8190-0410.2 620410	L= 97,5
E 350 CDI 4-matic (212.093)	195	03/11→					
E 400 (212.061)	245	07/14→					
E 400 (212.065)	245	01/13→					
E 400 4-matic (212.067)	245	01/13→					
E 400 4-matic (212.099)	245	07/14→					
E 500 (212.073)	300	09/11→					
E 500 4-matic (212.091)	300	09/11→					
E 250 CDI / BlueTEC (212.003, 212.004)	150	01/09→	←	03/09→; für Fahrzeuge mit Sportpaket / für Fahrzeuge mit AMG-Sportpaket	1	24.8190-0410.2 620410	L= 97,5
			←	A 001285→; für Fahrzeuge ohne Sportpaket / für Fahrzeuge ohne AMG-Sportpaket	1	24.8190-0410.2 620410	L= 97,5
			←	03/09→; → A 001284; für Fahrzeuge ohne Sportpaket / für Fahrzeuge ohne AMG-Sportpaket	1	24.8190-0410.2 620410	L= 97,5
			→	03/09→	1	24.8190-0410.2 620410	L= 97,5
E 250 CDI / BlueTEC 4-matic (212.082, 212.097)	150	01/09→	←	03/09→	1	24.8190-0410.2 620410	L= 97,5
E 300 (212.054)	170	01/09→	→	03/09→	1	24.8190-0410.2 620410	L= 97,5
E 350 (212.056)	200	01/09→					
E 350 4-matic (212.087)	200	01/09→08/11					
E 350 BlueTEC (212.024)	155	01/09→					
E 350 CDI (212.025)	170	01/09→					
E 350 CGI (212.057)	215	01/09→08/11					
E 500 (212.072)	285	01/09→					
E 500 4-matic (212.090)	285	01/09→					
E 300 CDI / BlueTEC (212.020, 212.021, 212.027)	170	03/11→	←	04/11→	1	24.8190-0410.2 620410	L= 97,5
			→	04/11→	1	24.8190-0410.2 620410	L= 97,5
E 300 Hybrid / BlueTEC Hybrid (212.098)	150	12/11→	←	06/12→	1	24.8190-0410.2 620410	L= 97,5
			→	06/12→	1	24.8190-0410.2 620410	L= 97,5
E 350 BlueTEC	185	11/12→	←	01/13→; für Fahrzeuge ohne Sportpaket / für Fahrzeuge ohne AMG-Sportpaket	1	24.8190-0410.2 620410	L= 97,5
E 350 BlueTEC 4-matic (212.094)	185	11/12→	←	01/13→; für Fahrzeuge mit Sportpaket / für Fahrzeuge mit AMG-Sportpaket	1	24.8190-0410.2 620410	L= 97,5
			→	01/13→	1	24.8190-0410.2 620410	L= 97,5
E 63 AMG (212.074)	386	02/11→	←	für Fahrzeuge ohne Keramikbremse	1	24.8190-0420.2 620420	L= 119
E 63 AMG (212.074)	410	02/11→					
E 63 AMG 4-matic (212.092)	410	02/11→	→		1	24.8190-0420.2 620420	L= 119
E 63 AMG (212.075)	430	02/13→	←	04/13→; für Fahrzeuge ohne Keramikbremse	1	24.8190-0420.2 620420	L= 119
E 63 AMG 4-matic (212.076)	430	02/13→	→	04/13→	1	24.8190-0420.2 620420	L= 119
E 63 AMG (212.077)	386	12/09→	←		1	24.8190-0420.2 620420	L= 119
			→		1	24.8190-0420.2 620420	L= 119
Bremsscheibe							
E 200 (212.034)	135	01/13→	←	für Fahrzeuge ohne Sportpaket / für Fahrzeuge ohne AMG-Sportpaket		24.0128-0155.1 428155	Ø 295 28 25,4 V + S
E 200 CGI (212.048, 212.148)	135	08/09→				24.0328-0155.1 528155	Ø 295 28 25,4 V + S PD
E 200 NGT (212.035)	115	07/13→	←	für Fahrzeuge mit Sportpaket / für Fahrzeuge mit AMG-Sportpaket		24.0132-0100.1 432100	Ø 322 32 30 V• + S
E 200 NGT (212.041)	120	03/11→					
E 220 BlueTEC (212.001)	130	05/14→	→			24.0110-0278.1 410278	Ø 300 10 8,3 + S
						24.0310-0278.1 510278	Ø 300 10 8,3 + S PD
E 200 CDI / BlueTEC (212.005, 212.006)	100	01/09→	←	03/09→; für Fahrzeuge ohne Sportpaket / für Fahrzeuge ohne AMG-Sportpaket		24.0128-0155.1 428155	Ø 295 28 25,4 V + S
E 220 CDI	120	01/09→				24.0328-0155.1 528155	Ø 295 28 25,4 V + S PD
E 220 CDI / BlueTEC (212.001, 212.002)	125	01/09→	←	03/09→; für Fahrzeuge mit Sportpaket / für Fahrzeuge mit AMG-Sportpaket		24.0132-0100.1 432100	Ø 322 32 30 V• + S
			→	03/09→		24.0110-0278.1 410278	Ø 300 10 8,3 + S
						24.0310-0278.1 510278	Ø 300 10 8,3 + S PD
E 220 BlueTEC 4-matic (212.011)	125	01/15→	←	für Fahrzeuge mit Sportpaket / für Fahrzeuge mit AMG-Sportpaket		24.0132-0100.1 432100	Ø 322 32 30 V• + S
E 250 (212.036)	155	01/13→	←	für Fahrzeuge ohne Sportpaket / für Fahrzeuge ohne AMG-Sportpaket		24.0132-0101.1 432101	Ø 322 32 29,4 V + S
E 250 CGI (212.047, 212.147)	150	01/09→				24.0332-0101.1 532101	Ø 322 32 29,4 V + S PD









	kw				! #		
MERCEDES-BENZ - E-KLASSE (W212) 01/09→							
Bremsscheibe							
E 220 BlueTEC 4-matic (212.011)	125	01/15→	➔			24.0110-0278.1 410278	Ø 300 10 8,3 + S
E 250 (212.036)	155	01/13→				24.0310-0278.1 510278	Ø 300 10 8,3 + S PD
E 250 CGI (212.047, 212.147)	150	01/09→					
E 250 CDI / BlueTEC (212.003, 212.004)	150	01/09→	➔	03/09→; → A 001284; für Fahrzeuge ohne Sportpaket / für Fahrzeuge ohne AMG-Sportpaket		24.0128-0155.1 428155 24.0328-0155.1 528155	Ø 295 28 25,4 V + S Ø 295 28 25,4 V + S PD
			➔	03/09→; für Fahrzeuge mit Sportpaket / für Fahrzeuge mit AMG-Sportpaket		24.0132-0100.1 432100	Ø 322 32 30 V• + S
			➔	A 001285→; für Fahrzeuge ohne Sportpaket / für Fahrzeuge ohne AMG-Sportpaket		24.0132-0101.1 432101 24.0332-0101.1 532101	Ø 322 32 29,4 V + S Ø 322 32 29,4 V + S PD
			➔	A 007599→		24.0110-0278.1 410278 24.0310-0278.1 510278	Ø 300 10 8,3 + S Ø 300 10 8,3 + S PD
			➔	03/09→; → A 007598		24.0122-0201.1 422201	Ø 300 22 19,4 V + S
E 250 CDI / BlueTEC 4-matic (212.082, 212.097)	150	01/09→	➔	03/09→; für Fahrzeuge mit Sportpaket / für Fahrzeuge mit AMG-Sportpaket		24.0132-0100.1 432100	Ø 322 32 30 V• + S
			➔	03/09→; für Fahrzeuge ohne Sportpaket / für Fahrzeuge ohne AMG-Sportpaket		24.0132-0101.1 432101 24.0332-0101.1 532101	Ø 322 32 29,4 V + S Ø 322 32 29,4 V + S PD
			➔	03/09→		24.0110-0278.1 410278 24.0310-0278.1 510278	Ø 300 10 8,3 + S Ø 300 10 8,3 + S PD
E 300 (212.054)	170	01/09→	➔	03/09→; für Fahrzeuge mit Sportpaket / für Fahrzeuge mit AMG-Sportpaket		24.0132-0100.1 432100	Ø 322 32 30 V• + S
E 350 (212.056)	200	01/09→					
E 350 4-matic (212.087)	200	01/09→08/11					
E 350 BlueTEC (212.024)	155	01/09→	➔	03/09→; für Fahrzeuge ohne Sportpaket / für Fahrzeuge ohne AMG-Sportpaket		24.0132-0101.1 432101 24.0332-0101.1 532101	Ø 322 32 29,4 V + S Ø 322 32 29,4 V + S PD
E 350 CDI (212.025)	170	01/09→					
E 350 CGI (212.057)	215	01/09→08/11	➔	03/09→		24.0122-0201.1 422201	Ø 300 22 19,4 V + S
E 300 (212.055)	185	07/11→	➔	für Fahrzeuge mit Sportpaket / für Fahrzeuge mit AMG-Sportpaket		24.0132-0100.1 432100	Ø 322 32 30 V• + S
E 300 4-matic (212.080)	185	07/11→					
E 350 (212.059)	225	09/11→	➔	für Fahrzeuge ohne Sportpaket / für Fahrzeuge ohne AMG-Sportpaket		24.0132-0101.1 432101 24.0332-0101.1 532101	Ø 322 32 29,4 V + S Ø 322 32 29,4 V + S PD
E 350 4-matic (212.088)	225	09/11→					
E 350 CDI (212.023)	195	03/11→					
E 350 CDI 4-matic (212.089)	170	09/09→	➔			24.0122-0201.1 422201	Ø 300 22 19,4 V + S
E 350 CDI 4-matic (212.093)	195	03/11→					
E 300 CDI / BlueTEC (212.020, 212.021, 212.027)	170	03/11→	➔	04/11→; für Fahrzeuge mit Sportpaket / für Fahrzeuge mit AMG-Sportpaket		24.0132-0100.1 432100	Ø 322 32 30 V• + S
			➔	04/11→; für Fahrzeuge ohne Sportpaket / für Fahrzeuge ohne AMG-Sportpaket		24.0132-0101.1 432101 24.0332-0101.1 532101	Ø 322 32 29,4 V + S Ø 322 32 29,4 V + S PD
			➔	04/11→		24.0122-0201.1 422201	Ø 300 22 19,4 V + S
E 300 Hybrid / BlueTEC Hybrid (212.098)	150	12/11→	➔	06/12→; für Fahrzeuge mit Sportpaket / für Fahrzeuge mit AMG-Sportpaket		24.0132-0100.1 432100	Ø 322 32 30 V• + S
			➔	06/12→; für Fahrzeuge ohne Sportpaket / für Fahrzeuge ohne AMG-Sportpaket		24.0132-0101.1 432101 24.0332-0101.1 532101	Ø 322 32 29,4 V + S Ø 322 32 29,4 V + S PD
			➔	06/12→		24.0122-0201.1 422201	Ø 300 22 19,4 V + S
E 350 BlueTEC	185	11/12→	➔	01/13→; für Fahrzeuge ohne Sportpaket / für Fahrzeuge ohne AMG-Sportpaket		24.0132-0101.1 432101 24.0332-0101.1 532101	Ø 322 32 29,4 V + S Ø 322 32 29,4 V + S PD
E 350 BlueTEC 4-matic (212.094)	185	11/12→	➔	01/13→; für Fahrzeuge mit Sportpaket / für Fahrzeuge mit AMG-Sportpaket		24.0132-0168.1 432168	Ø 344 32 30 V• + S
			➔	01/13→		24.0122-0201.1 422201	Ø 300 22 19,4 V + S
E 350 BlueTEC (212.026)	190	05/14→	➔	für Fahrzeuge ohne Sportpaket / für Fahrzeuge ohne AMG-Sportpaket		24.0132-0101.1 432101 24.0332-0101.1 532101	Ø 322 32 29,4 V + S Ø 322 32 29,4 V + S PD
			➔	für Fahrzeuge mit Sportpaket / für Fahrzeuge ohne AMG-Sportpaket		24.0132-0168.1 432168	Ø 344 32 30 V• + S
			➔			24.0122-0201.1 422201	Ø 300 22 19,4 V + S
E 350 BlueTEC 4-matic (212.094)	190	05/14→	➔	für Fahrzeuge ohne Sportpaket / für Fahrzeuge ohne AMG-Sportpaket		24.0132-0101.1 432101 24.0332-0101.1 532101	Ø 322 32 29,4 V + S Ø 322 32 29,4 V + S PD
			➔	für Fahrzeuge mit Sportpaket / für Fahrzeuge mit AMG-Sportpaket		24.0132-0168.1 432168	Ø 344 32 30 V• + S
			➔			24.0122-0201.1 422201	Ø 300 22 19,4 V + S
↓							











	kW					! #		
MERCEDES-BENZ - E-KLASSE (W212) 01/09→								
 Bremsscheibe								
E 400 (212.061)	245	07/14→	←			24.0132-0168.1	432168	Ø 344 32 30 V• + S
E 400 (212.065)	245	01/13→	→			24.0122-0201.1	422201	Ø 300 22 19,4 V + S
E 400 4-matic (212.067)	245	01/13→						
E 400 4-matic (212.099)	245	07/14→						
E 500 (212.072)	285	01/09→	←	03/09→		24.0132-0168.1	432168	Ø 344 32 30 V• + S
E 500 4-matic (212.090)	285	01/09→	→	03/09→		24.0124-0236.1	424236	Ø 320 24 21,1 V + S
E 500 (212.073)	300	09/11→	←			24.0136-0108.1	436108	Ø 360 36 34 V• + S
E 500 4-matic (212.091)	300	09/11→	→			24.0124-0236.1	424236	Ø 320 24 21,1 V + S
MERCEDES-BENZ - E-KLASSE (W213) 01/16→								
 Bremsbelagsatz, Scheibenbremse								
E 180 (213.040)	115	01/17→	←	für Fahrzeuge ohne AMG-Sportpaket		13.0460-2792.2	602792	TRW 22031 19,6 + WE / - WK
E 200 (213.042)	135	01/16→				13.0470-2792.2	LD2792	TRW 22031 19,6 + WE / - WK
E 200 d (213.013)	110	07/16→						Ceramic
E 220 d (213.004)	120	01/16→						
E 220 d (213.004)	143	01/16→	←	für Fahrzeuge mit AMG-Sportpaket		13.0460-4883.2	604883	BRE 22061 18,7 + WE / - WK
E 200 4-matic (213.043)	135	07/16→	←	für Fahrzeuge ohne AMG-Sportpaket		13.0460-2610.2	602610	TRW 22076 19,6 + WE / - WK
E 220 d 4-matic (213.005)	120	10/16→				13.0470-2610.2	LD2610	TRW 22076 19,6 + WE / - WK
E 220 d 4-matic (213.005)	143	10/16→						Ceramic
E 250 (213.045)	155	07/16→	←	für Fahrzeuge mit AMG-Sportpaket		13.0460-4883.2	604883	BRE 22061 18,7 + WE / - WK
E 300 (213.048)	180	07/16→	←	für Fahrzeuge ohne AMG-Sportpaket		13.0460-4883.2	604883	BRE 22061 18,7 + WE / - WK
E 350 d (213.033)	190	01/16→						
E 350 e (213.050)	155	07/16→						
E 350 e (213.050)	210	07/16→						
E 400 4-matic (213.071)	245	07/16→						
Warnkontakt, Bremsbelagsverschleiß								
AMG E 43 4-matic (213.064)	295	07/16→	←		1	24.8190-0067.2	620067	L= 92,5
E 180 (213.040)	115	01/17→	→		1	24.8190-0067.2	620067	L= 92,5
E 200 (213.042)	135	01/16→						
E 200 4-matic (213.043)	135	07/16→						
E 200 d (213.013)	110	07/16→						
E 220 d (213.004)	120	01/16→						
E 220 d (213.004)	143	01/16→						
E 220 d 4-matic (213.005)	120	10/16→						
E 220 d 4-matic (213.005)	143	10/16→						
E 250 (213.045)	155	07/16→						
E 300 (213.048)	180	07/16→						
E 350 d (213.033)	190	01/16→						
E 350 e (213.050)	155	07/16→						
E 350 e (213.050)	210	07/16→						
E 400 4-matic (213.071)	245	07/16→						
E 400 4-matic (213.066)	245	06/16→	←	07/16→	1	24.8190-0067.2	620067	L= 92,5
			→	07/16→	1	24.8190-0067.2	620067	L= 92,5
MERCEDES-BENZ - E-KLASSE All-Terrain (S213) 01/17→								
 Bremsbelagsatz, Scheibenbremse								
E 220 d 4-matic (213.217)	143	01/17→	←	für Fahrzeuge ohne AMG-Sportpaket		13.0460-2610.2	602610	TRW 22076 19,6 + WE / - WK
						13.0470-2610.2	LD2610	TRW 22076 19,6 + WE / - WK
			←	für Fahrzeuge mit AMG-Sportpaket		13.0460-4883.2	604883	BRE 22061 18,7 + WE / - WK
Warnkontakt, Bremsbelagsverschleiß								
E 220 d 4-matic (213.217)	143	01/17→	←		1	24.8190-0067.2	620067	L= 92,5
E 350 d 4-matic (213.237)	190	06/17→	→		1	24.8190-0067.2	620067	L= 92,5
MERCEDES-BENZ - E-KLASSE Cabriolet (A124) 05/93→03/98								
 Bremsbelagsatz, Scheibenbremse								
E 200 (124.060)	100	06/93→03/98	←			13.0460-2927.2	602927	TRW 20941 19,3 + WE / - WK
E 220 (124.062)	110	06/93→03/98				13.0470-2927.2	LD2927	TRW 20941 19,3 + WE / - WK
			→			13.0460-3805.2	603805	ATE 21197 15,0 + WE / - WK
						13.0470-3805.2	LD3805	ATE 21197 15,0 + WE / - WK
								Ceramic
E 320 (124.066)	162	06/93→03/98	←	→ B 862121		13.0460-4201.2	604201	ATE 21153 17,5 + WE / - WK
↓								









	kW					! #		
MERCEDES-BENZ - E-KLASSE Cabriolet (A124) 05/93→03/98								
 Bremsbelagsatz, Scheibenbremse								
E 320 (124.066)	162	06/93→03/98	←	B 862122→			13.0460-4202.2 604202	ATE 21153 16,0 + WE / - WK
			→				13.0460-3805.2 603805	ATE 21197 15,0 + WE / - WK
							13.0470-3805.2 LD3805	ATE 21197 15,0 + WE / - WK Ceramic
E 36 AMG (124.066)	200	05/94→03/98	←				13.0460-4201.2 604201	ATE 21153 17,5 + WE / - WK
			→				13.0460-3805.2 603805	ATE 21197 15,0 + WE / - WK
							13.0470-3805.2 LD3805	ATE 21197 15,0 + WE / - WK Ceramic
Warnkontakt, Bremsbelagverschleiß								
E 200 (124.060)	100	06/93→03/98	←		2	24.8190-0402.2 620402	L= 68 L= 150	
E 220 (124.062)	110	06/93→03/98	→		2	24.8190-0401.2 620401	L= 95	
E 320 (124.066)	162	06/93→03/98	←	B 862122→	2	24.8190-0401.2 620401	L= 95	
			←	→ B 862121	2	24.8190-0401.2 620401	L= 95	
			→		2	24.8190-0401.2 620401	L= 95	
E 36 AMG (124.066)	200	05/94→03/98	←		2	24.8190-0401.2 620401	L= 95	
			→		2	24.8190-0401.2 620401	L= 95	
Zubehörsatz, Scheibenbremsbelag								
E 200 (124.060)	100	06/93→03/98	→				13.0460-0186.2 610186	ATE
E 220 (124.062)	110	06/93→03/98						
E 36 AMG (124.066)	200	05/94→03/98						
E 320 (124.066)	162	06/93→03/98	←	B 862122→			13.0460-0268.2 610268	
			→				13.0460-0186.2 610186	ATE
 Bremsscheibe								
E 200 (124.060)	100	06/93→03/98	←				24.0122-0123.1 422123	Ø 284 22 19,4 V + S
E 220 (124.062)	110	06/93→03/98	→				24.0109-0114.1 409114	Ø 278 9 7,3 + S
							24.0309-0114.1 509114	Ø 278 9 7,3 + S PD
E 320 (124.066)	162	06/93→03/98	←	→ B 862121			24.0122-0136.1 422136	Ø 295 22 19,4 V
			←	B 862122→			24.0125-0107.1 425107	Ø 294 25 22,4 V
			→				24.0109-0114.1 409114	Ø 278 9 7,3 + S
							24.0309-0114.1 509114	Ø 278 9 7,3 + S PD
E 36 AMG (124.066)	200	05/94→03/98	←	☐			24.0130-0121.1 430121	Ø 320 30 28 V
			←	☐			24.0130-0122.1 430122	Ø 320 30 28 V
			→				24.0109-0114.1 409114	Ø 278 9 7,3 + S
							24.0309-0114.1 509114	Ø 278 9 7,3 + S PD
MERCEDES-BENZ - E-KLASSE Cabriolet (A207) 01/10→								
 Bremsbelagsatz, Scheibenbremse								
E 200 (207.434)	135	03/13→	←	für Fahrzeuge ohne Sportpaket / für Fahrzeuge ohne AMG-Sportpaket			13.0460-2732.2 602732	TRW 24306 20,3 + WE / - WK + Zub
E 220 BlueTEC (207.401)	130	05/14→					13.0470-2732.2 LD2732	TRW 24306 20,3 + WE / - WK + Zub Ceramic
			←	für Fahrzeuge mit Sportpaket / für Fahrzeuge mit AMG-Sportpaket			13.0460-2734.2 602734	TRW 24310 19,0 + WE / - WK
							13.0470-2734.2 LD2734	TRW 24310 19,0 + WE / - WK Ceramic
			→				13.0460-7244.2 607244	ATE 24253 17,8 + WE / - WK
							13.0470-7244.2 LD7244	ATE 24253 17,8 + WE / - WK Ceramic
E 200 CGI (207.448)	135	01/10→	←	03/10→; für Fahrzeuge ohne Sportpaket / für Fahrzeuge ohne AMG-Sportpaket			13.0460-2732.2 602732	TRW 24306 20,3 + WE / - WK + Zub
E 220 CDI / BlueTEC / d (207.402, 207.401)	125	01/10→					13.0470-2732.2 LD2732	TRW 24306 20,3 + WE / - WK + Zub Ceramic
E 220 CDI (207.402)	120	02/10→						
E 250 CGI (207.447)	150	01/10→	←	03/10→; für Fahrzeuge mit Sportpaket / für Fahrzeuge mit AMG-Sportpaket			13.0460-2734.2 602734	TRW 24310 19,0 + WE / - WK
							13.0470-2734.2 LD2734	TRW 24310 19,0 + WE / - WK Ceramic
			→	03/10→			13.0460-7244.2 607244	ATE 24253 17,8 + WE / - WK
							13.0470-7244.2 LD7244	ATE 24253 17,8 + WE / - WK Ceramic
E 250 (207.436)	155	06/13→	←				13.0460-2734.2 602734	TRW 24310 19,0 + WE / - WK
E 300 (207.455)	185	04/11→					13.0470-2734.2 LD2734	TRW 24310 19,0 + WE / - WK Ceramic
E 320 (207.462)	200	07/14→						
↓								

















	kw			 	! #		
MERCEDES-BENZ - E-KLASSE Cabriolet (A207) 01/10→							
 Bremsbelagsatz, Scheibenbremse							
E 350 BlueTEC/ d (207.426)	190	05/14→	➔			13.0460-7244.2 607244	ATE 24253 17,8 + WE / - WK
E 350 BlueTEC (207.426)	185	06/13→				13.0470-7244.2 LD7244	ATE 24253 17,8 + WE / - WK Ceramic
E 250 CDI / BlueTEC / d (207.403, 207.404)	150	01/10→	➔	03/10→		13.0460-2734.2 602734	TRW 24310 19,0 + WE / - WK Ceramic
			➔	03/10→		13.0460-7244.2 607244	ATE 24253 17,8 + WE / - WK Ceramic
E 350 (207.459) E 350 CDI	225 195	04/11→ 04/11→	➔			13.0460-2734.2 602734	TRW 24310 19,0 + WE / - WK Ceramic
			➔	ALU		13.0460-7244.2 607244	ATE 24253 17,8 + WE / - WK Ceramic
			➔	GG		13.0460-7257.2 607257	ATE 24253 18,0 + WE / - WK Ceramic
E 350 CDI (207.422) E 350 CGI (207.457)	170 215	01/10→ 01/10→	➔	03/10→		13.0460-2734.2 602734	TRW 24310 19,0 + WE / - WK Ceramic
			➔	03/10→; ALU		13.0460-7244.2 607244	ATE 24253 17,8 + WE / - WK Ceramic
			➔	03/10→; GG		13.0460-7257.2 607257	ATE 24253 18,0 + WE / - WK Ceramic
E 400 (207.461) E 400 (207.465)	245 245	07/14→ 06/13→	➔			13.0460-2734.2 602734	TRW 24310 19,0 + WE / - WK
			➔			13.0460-7244.2 607244	ATE 24253 17,8 + WE / - WK Ceramic
E 500 (207.472)	285	01/10→	➔	03/10→		13.0460-2734.2 602734	TRW 24310 19,0 + WE / - WK
			➔	03/10→; ALU		13.0460-7244.2 607244	ATE 24253 17,8 + WE / - WK Ceramic
			➔	03/10→; GG		13.0460-7257.2 607257	ATE 24253 18,0 + WE / - WK Ceramic
E 500 (207.473) E 550	300 299	09/11→ 09/11→	➔	ALU		13.0460-7244.2 607244	ATE 24253 17,8 + WE / - WK Ceramic
			➔	GG		13.0460-7257.2 607257	ATE 24253 18,0 + WE / - WK Ceramic
Warnkontakt, Bremsbelagverschleiß							
E 200 (207.434) E 220 BlueTEC (207.401)	135 130	03/13→ 05/14→	➔	für Fahrzeuge mit Sportpaket / für Fahrzeuge mit AMG-Sportpaket	2	24.8190-0410.2 620410	L= 97,5
			➔	für Fahrzeuge ohne Sportpaket / für Fahrzeuge ohne AMG-Sportpaket	2	24.8190-0410.2 620410	L= 97,5
			➔		1	24.8190-0410.2 620410	L= 97,5
E 200 CGI (207.448) E 220 CDI / BlueTEC / d (207.402, 207.401) E 220 CDI (207.402) E 250 CGI (207.447)	135 125 120 150	01/10→ 01/10→ 02/10→ 01/10→	➔	03/10→; für Fahrzeuge mit Sportpaket / für Fahrzeuge mit AMG-Sportpaket	2	24.8190-0410.2 620410	L= 97,5
			➔	03/10→; für Fahrzeuge ohne Sportpaket / für Fahrzeuge ohne AMG-Sportpaket	2	24.8190-0410.2 620410	L= 97,5
			➔	03/10→	1	24.8190-0410.2 620410	L= 97,5
E 250 (207.436) E 300 (207.455) E 320 (207.462) E 350 (207.459) E 350 BlueTEC/ d (207.426) E 350 BlueTEC (207.426) E 350 CDI E 400 (207.461) E 400 (207.465)	155 185 200 225 190 185 195 245 245	06/13→ 04/11→ 07/14→ 04/11→ 05/14→ 06/13→ 04/11→ 07/14→ 06/13→	➔		2	24.8190-0410.2 620410	L= 97,5
			➔		1	24.8190-0410.2 620410	L= 97,5
			➔				
			➔				
			➔				
			➔				
			➔				
↓							

	kw			 	! #		
MERCEDES-BENZ - E-KLASSE Cabriolet (A207) 01/10→							
Warnkontakt, Bremsbelagverschleiß							
E 250 CDI / BlueTEC / d (207.403, 207.404)	150	01/10→	←	03/10→	2	24.8190-0410.2 620410	L= 97,5
E 350 CDI (207.422)	170	01/10→	→	03/10→	1	24.8190-0410.2 620410	L= 97,5
E 350 CGI (207.457)	215	01/10→					
E 500 (207.472)	285	01/10→					
E 500 (207.473)	300	09/11→	←		1	24.8190-0410.2 620410	L= 97,5
E 550	299	09/11→	→		1	24.8190-0410.2 620410	L= 97,5
 Bremsscheibe							
E 200 (207.434)	135	03/13→	←	für Fahrzeuge mit Sportpaket / für Fahrzeuge mit AMG-Sportpaket		24.0132-0100.1 432100	Ø 322 32 30 V• + S
E 250 (207.436)	155	06/13→	←	für Fahrzeuge ohne Sportpaket / für Fahrzeuge ohne AMG-Sportpaket		24.0132-0101.1 432101	Ø 322 32 29,4 V + S
						24.0332-0101.1 532101	Ø 322 32 29,4 V + S PD
			→			24.0110-0328.1 410328	Ø 300 10 8,3 + S
						24.0310-0328.1 510328	Ø 300 10 8,3 + S PD
E 200 CGI (207.448)	135	01/10→	←	03/10→		24.0128-0155.1 428155	Ø 295 28 25,4 V + S
E 250 CGI (207.447)	150	01/10→				24.0328-0155.1 528155	Ø 295 28 25,4 V + S PD
			→	03/10→		24.0110-0328.1 410328	Ø 300 10 8,3 + S
						24.0310-0328.1 510328	Ø 300 10 8,3 + S PD
E 220 BlueTEC (207.401)	130	05/14→	←	für Fahrzeuge ohne Sportpaket / für Fahrzeuge ohne AMG-Sportpaket		24.0128-0155.1 428155	Ø 295 28 25,4 V + S
			←	für Fahrzeuge mit Sportpaket / für Fahrzeuge mit AMG-Sportpaket		24.0132-0100.1 432100	Ø 322 32 30 V• + S
			→			24.0110-0328.1 410328	Ø 300 10 8,3 + S
						24.0310-0328.1 510328	Ø 300 10 8,3 + S PD
E 220 CDI / BlueTEC / d (207.402, 207.401)	125	01/10→	←	03/10→; für Fahrzeuge ohne Sportpaket / für Fahrzeuge ohne AMG-Sportpaket		24.0128-0155.1 428155	Ø 295 28 25,4 V + S
E 220 CDI (207.402)	120	02/10→	←	03/10→; für Fahrzeuge mit Sportpaket / für Fahrzeuge mit AMG-Sportpaket		24.0132-0100.1 432100	Ø 322 32 30 V• + S
			→	03/10→		24.0110-0328.1 410328	Ø 300 10 8,3 + S
						24.0310-0328.1 510328	Ø 300 10 8,3 + S PD
E 250 CDI / BlueTEC / d (207.403, 207.404)	150	01/10→	←	03/10→; für Fahrzeuge mit Sportpaket / für Fahrzeuge mit AMG-Sportpaket		24.0132-0100.1 432100	Ø 322 32 30 V• + S
			←	03/10→; für Fahrzeuge ohne Sportpaket / für Fahrzeuge ohne AMG-Sportpaket		24.0132-0101.1 432101	Ø 322 32 29,4 V + S
						24.0332-0101.1 532101	Ø 322 32 29,4 V + S PD
			→	03/10→		24.0110-0328.1 410328	Ø 300 10 8,3 + S
						24.0310-0328.1 510328	Ø 300 10 8,3 + S PD
E 300 (207.455)	185	04/11→	←	für Fahrzeuge mit Sportpaket / für Fahrzeuge mit AMG-Sportpaket		24.0132-0100.1 432100	Ø 322 32 30 V• + S
E 350 (207.459)	225	04/11→	←	für Fahrzeuge ohne Sportpaket / für Fahrzeuge ohne AMG-Sportpaket		24.0132-0101.1 432101	Ø 322 32 29,4 V + S
E 350 BlueTEC / d (207.426)	190	05/14→	←	für Fahrzeuge ohne Sportpaket / für Fahrzeuge ohne AMG-Sportpaket		24.0332-0101.1 532101	Ø 322 32 29,4 V + S PD
E 350 BlueTEC (207.426)	185	06/13→	→			24.0120-0208.1 420208	Ø 300 22 19,4 V + S
E 350 CDI	195	04/11→					
E 320 (207.462)	200	07/14→	←	für Fahrzeuge mit Sportpaket / für Fahrzeuge mit AMG-Sportpaket		24.0132-0100.1 432100	Ø 322 32 30 V• + S
			←	für Fahrzeuge ohne Sportpaket / für Fahrzeuge ohne AMG-Sportpaket		24.0132-0168.1 432168	Ø 344 32 30 V• + S
			→			24.0120-0208.1 420208	Ø 300 22 19,4 V + S
E 350 CDI (207.422)	170	01/10→	←	03/10→; für Fahrzeuge mit Sportpaket / für Fahrzeuge mit AMG-Sportpaket		24.0132-0100.1 432100	Ø 322 32 30 V• + S
E 350 CGI (207.457)	215	01/10→	←	03/10→; für Fahrzeuge ohne Sportpaket / für Fahrzeuge ohne AMG-Sportpaket		24.0132-0101.1 432101	Ø 322 32 29,4 V + S
						24.0332-0101.1 532101	Ø 322 32 29,4 V + S PD
			→	03/10→		24.0120-0208.1 420208	Ø 300 22 19,4 V + S
E 400 (207.461)	245	07/14→	←			24.0132-0168.1 432168	Ø 344 32 30 V• + S
E 400 (207.465)	245	06/13→	→			24.0120-0208.1 420208	Ø 300 22 19,4 V + S
E 500 (207.472)	285	01/10→	←	03/10→		24.0132-0168.1 432168	Ø 344 32 30 V• + S
			→	03/10→		24.0120-0208.1 420208	Ø 300 22 19,4 V + S
E 500 (207.473)	300	09/11→	←			24.0136-0108.1 436108	Ø 360 36 34 V• + S
E 550	299	09/11→	→			24.0120-0208.1 420208	Ø 300 22 19,4 V + S









	kw			 	! #		
MERCEDES-BENZ - E-KLASSE Cabriolet (A238) 06/17→							
 Bremsbelagsatz, Scheibenbremse							
E 220 d (238.414) E 220 d (238.414)	120 143	06/17→ 06/17→	←	für Fahrzeuge ohne AMG-Sportpaket; +SA 088		13.0460-2610.2 602610 13.0470-2610.2 LD2610	TRW 22076 19,6 + WE / - WK TRW 22076 19,6 + WE / - WK Ceramic
			←	für Fahrzeuge mit AMG-Sportpaket		13.0460-4883.2 604883	BRE 22061 18,7 + WE / - WK
E 300 (238.448)	180	06/17→	←	für Fahrzeuge ohne AMG-Sportpaket		13.0460-4883.2 604883	BRE 22061 18,7 + WE / - WK
Warnkontakt, Bremsbelagverschleiß							
E 220 d (238.414) E 220 d (238.414)	120 143	06/17→ 06/17→	←		1	24.8190-0067.2 620067	L= 92,5
E 300 (238.448) E 400 4-matic (238.466)	180 245	06/17→ 06/17→	→		1	24.8190-0067.2 620067	L= 92,5
MERCEDES-BENZ - E-KLASSE Coupe (C124) 06/93→06/97							
 Bremsbelagsatz, Scheibenbremse							
E 200 (124.040)	100	06/93→06/97	←			13.0460-2927.2 602927 13.0470-2927.2 LD2927	TRW 20941 19,3 + WE / - WK TRW 20941 19,3 + WE / - WK Ceramic
			←	→ 06/93		13.0460-2927.2 602927 13.0470-2927.2 LD2927	TRW 20941 19,3 + WE / - WK TRW 20941 19,3 + WE / - WK Ceramic
			→	→ 06/93		13.0460-4034.2 604034	ATE 20687 15,5 - WE / - WK
			→			13.0460-4034.2 604034	ATE 20687 15,5 - WE / - WK
E 220 (124.042)	110	06/93→06/97	←			13.0460-2927.2 602927 13.0470-2927.2 LD2927	TRW 20941 19,3 + WE / - WK TRW 20941 19,3 + WE / - WK Ceramic
			→			13.0460-4034.2 604034	ATE 20687 15,5 - WE / - WK
E 320 (124.052)	162	06/93→06/97	←	→ B 862121		13.0460-4201.2 604201	ATE 21153 17,5 + WE / - WK
			←	B 862122→		13.0460-4202.2 604202	ATE 21153 16,0 + WE / - WK
			→			13.0460-3805.2 603805 13.0470-3805.2 LD3805	ATE 21197 15,0 + WE / - WK ATE 21197 15,0 + WE / - WK Ceramic
E 36 AMG (124.052) E 36 AMG (124.052)	195 200	06/93→04/95 05/94→06/97	←			13.0460-4201.2 604201	ATE 21153 17,5 + WE / - WK
			→			13.0460-3805.2 603805 13.0470-3805.2 LD3805	ATE 21197 15,0 + WE / - WK ATE 21197 15,0 + WE / - WK Ceramic
Warnkontakt, Bremsbelagverschleiß							
E 200 (124.040)	100	06/93→06/97	←	→ 06/93	2	24.8190-0402.2 620402	L= 68 L= 150
			←		2	24.8190-0402.2 620402	L= 68 L= 150
E 220 (124.042)	110	06/93→06/97	←		2	24.8190-0402.2 620402	L= 68 L= 150
E 320 (124.052)	162	06/93→06/97	←	→ B 862121	2	24.8190-0401.2 620401	L= 95
			←	B 862122→	2	24.8190-0401.2 620401	L= 95
			→		2	24.8190-0401.2 620401	L= 95
E 36 AMG (124.052) E 36 AMG (124.052)	195 200	06/93→04/95 05/94→06/97	←		2	24.8190-0401.2 620401	L= 95
			→		2	24.8190-0401.2 620401	L= 95
Zubehörsatz, Scheibenbremsbelag							
E 200 (124.040)	100	06/93→06/97	→			13.0460-0186.2 610186	ATE
			→	→ 06/93		13.0460-0186.2 610186	ATE
E 220 (124.042) E 320 (124.052) E 36 AMG (124.052) E 36 AMG (124.052)	110 162 195 200	06/93→06/97 06/93→06/97 06/93→04/95 05/94→06/97	→			13.0460-0186.2 610186	ATE
 Bremsscheibe							
E 200 (124.040)	100	06/93→06/97	←			24.0122-0123.1 422123	Ø 284 22 19,4 V + S
			←	→ 06/93		24.0122-0123.1 422123	Ø 284 22 19,4 V + S
			→			24.0109-0120.1 409120	Ø 258 9 7,3 + S
			→			24.0309-0120.1 509120	Ø 258 9 7,3 + S PD
			→	→ 06/93		24.0109-0120.1 409120	Ø 258 9 7,3 + S
E 220 (124.042)	110	06/93→06/97	←			24.0122-0123.1 422123	Ø 284 22 19,4 V + S
			→			24.0109-0120.1 409120	Ø 258 9 7,3 + S
↓							









	kW			 	! #		
MERCEDES-BENZ - E-KLASSE Coupe (C124) 06/93→06/97							
 Bremsscheibe							
E 220 (124.042)	110	06/93→06/97	➔			24.0309-0120.1 509120	Ø 258 9 7,3 + S PD
E 320 (124.052)	162	06/93→06/97	➔	→ B 862121		24.0122-0136.1 422136	Ø 295 22 19,4 V
			➔	B 862122→		24.0125-0107.1 425107	Ø 294 25 22,4 V
			➔			24.0109-0114.1 409114	Ø 278 9 7,3 + S
			➔			24.0309-0114.1 509114	Ø 278 9 7,3 + S PD
E 36 AMG (124.052)	195	06/93→04/95	➔	☐		24.0130-0121.1 430121	Ø 320 30 28 V
E 36 AMG (124.052)	200	05/94→06/97	➔	☐		24.0130-0122.1 430122	Ø 320 30 28 V
			➔			24.0109-0114.1 409114	Ø 278 9 7,3 + S
			➔			24.0309-0114.1 509114	Ø 278 9 7,3 + S PD
MERCEDES-BENZ - E-KLASSE Coupe (C207) 01/09→							
 Bremsbelagsatz, Scheibenbremse							
E 200 (207.334)	135	06/13→	➔	für Fahrzeuge ohne Sportpaket / für Fahrzeuge ohne AMG-Sportpaket		13.0460-2732.2 602732	TRW 24306 20,3 + WE / - WK + Zub
E 200 CGI (207.348)	135	01/10→				13.0470-2732.2 LD2732	TRW 24306 20,3 + WE / - WK + Zub Ceramic
E 220 BlueTEC (207.301)	130	05/14→					
E 220 CDI	120	07/14→					
E 220 CDI / d (207.302)	125	01/10→	➔	für Fahrzeuge mit Sportpaket / für Fahrzeuge mit AMG-Sportpaket		13.0460-2734.2 602734	TRW 24310 19,0 + WE / - WK Ceramic
						13.0470-2734.2 LD2734	TRW 24310 19,0 + WE / - WK Ceramic
			➔			13.0460-7244.2 607244	ATE 24253 17,8 + WE / - WK Ceramic
						13.0470-7244.2 LD7244	ATE 24253 17,8 + WE / - WK Ceramic
E 250 (207.336)	155	06/13→	➔			13.0460-2734.2 602734	TRW 24310 19,0 + WE / - WK Ceramic
E 320 (207.362)	200	07/14→				13.0470-2734.2 LD2734	TRW 24310 19,0 + WE / - WK Ceramic
E 350 4-matic (207.388)	225	02/13→					
E 350 BlueTEC	185	03/13→					
E 350 BlueTEC / d (207.326)	190	05/14→	➔			13.0460-7244.2 607244	ATE 24253 17,8 + WE / - WK Ceramic
						13.0470-7244.2 LD7244	ATE 24253 17,8 + WE / - WK Ceramic
E 250 CDI / BlueTEC / d (207.303)	150	01/09→	➔	05/09→		13.0460-2734.2 602734	TRW 24310 19,0 + WE / - WK Ceramic
						13.0470-2734.2 LD2734	TRW 24310 19,0 + WE / - WK Ceramic
			➔	05/09→		13.0460-7244.2 607244	ATE 24253 17,8 + WE / - WK Ceramic
						13.0470-7244.2 LD7244	ATE 24253 17,8 + WE / - WK Ceramic
E 250 CGI (207.347)	150	01/09→	➔	05/09→; für Fahrzeuge ohne Sportpaket / für Fahrzeuge ohne AMG-Sportpaket		13.0460-2732.2 602732	TRW 24306 20,3 + WE / - WK + Zub
						13.0470-2732.2 LD2732	TRW 24306 20,3 + WE / - WK + Zub Ceramic
			➔	05/09→; für Fahrzeuge mit Sportpaket / für Fahrzeuge mit AMG-Sportpaket		13.0460-2734.2 602734	TRW 24310 19,0 + WE / - WK Ceramic
						13.0470-2734.2 LD2734	TRW 24310 19,0 + WE / - WK Ceramic
			➔	05/09→		13.0460-7244.2 607244	ATE 24253 17,8 + WE / - WK Ceramic
						13.0470-7244.2 LD7244	ATE 24253 17,8 + WE / - WK Ceramic
E 300 (207.355)	185	04/11→	➔			13.0460-2734.2 602734	TRW 24310 19,0 + WE / - WK Ceramic
E 350 (207.356)	225	04/11→				13.0470-2734.2 LD2734	TRW 24310 19,0 + WE / - WK Ceramic
E 350 CDI	195	04/11→					
			➔	ALU		13.0460-7244.2 607244	ATE 24253 17,8 + WE / - WK Ceramic
						13.0470-7244.2 LD7244	ATE 24253 17,8 + WE / - WK Ceramic
			➔	GG		13.0460-7257.2 607257	ATE 24253 18,0 + WE / - WK Ceramic
						13.0470-7257.2 LD7257	ATE 24253 18,0 + WE / - WK Ceramic
E 350 (207.356)	200	05/11→	➔			13.0460-2734.2 602734	TRW 24310 19,0 + WE / - WK Ceramic
						13.0470-2734.2 LD2734	TRW 24310 19,0 + WE / - WK Ceramic
E 350 CDI (207.322)	170	01/09→	➔	05/09→		13.0460-2734.2 602734	TRW 24310 19,0 + WE / - WK Ceramic
E 350 CGI (207.357)	215	01/09→				13.0470-2734.2 LD2734	TRW 24310 19,0 + WE / - WK Ceramic
			➔	05/09→; ALU		13.0460-7244.2 607244	ATE 24253 17,8 + WE / - WK Ceramic
						13.0470-7244.2 LD7244	ATE 24253 17,8 + WE / - WK Ceramic
			➔	05/09→; GG		13.0460-7257.2 607257	ATE 24253 18,0 + WE / - WK Ceramic
						13.0470-7257.2 LD7257	ATE 24253 18,0 + WE / - WK Ceramic
↓							









	kw			 	! #		
MERCEDES-BENZ - E-KLASSE Coupe (C207) 01/09→							
 Bremsbelagsatz, Scheibenbremse							
E 400 E 400 (207.361)	245 245	06/13→ 07/14→	← →			13.0460-2734.2 602734 13.0460-7244.2 607244 13.0470-7244.2 LD7244	TRW 24310 19,0 + WE / - WK ATE 24253 17,8 + WE / - WK ATE 24253 17,8 + WE / - WK Ceramic
E 500 (207.372)	285	01/09→	← → →	05/09→ 05/09→; ALU 05/09→; GG		13.0460-2734.2 602734 13.0460-7244.2 607244 13.0470-7244.2 LD7244 13.0460-7257.2 607257 13.0470-7257.2 LD7257	TRW 24310 19,0 + WE / - WK ATE 24253 17,8 + WE / - WK ATE 24253 17,8 + WE / - WK Ceramic ATE 24253 18,0 + WE / - WK ATE 24253 18,0 + WE / - WK Ceramic
E 500 (207.373)	300	09/11→	→ →	ALU GG		13.0460-7244.2 607244 13.0470-7244.2 LD7244 13.0460-7257.2 607257 13.0470-7257.2 LD7257	ATE 24253 17,8 + WE / - WK ATE 24253 17,8 + WE / - WK Ceramic ATE 24253 18,0 + WE / - WK ATE 24253 18,0 + WE / - WK Ceramic
Warnkontakt, Bremsbelagverschleiß							
E 200 (207.334) E 200 CGI (207.348) E 220 BlueTEC (207.301) E 220 CDI E 220 CDI / d (207.302)	135 135 130 120 125	06/13→ 01/10→ 05/14→ 07/14→ 01/10→	← ← →	für Fahrzeuge mit Sportpaket / für Fahrzeuge mit AMG-Sportpaket für Fahrzeuge ohne Sportpaket / für Fahrzeuge ohne AMG-Sportpaket	1 1 1	24.8190-0410.2 620410 24.8190-0410.2 620410 24.8190-0410.2 620410	L= 97,5 L= 97,5 L= 97,5
E 250 (207.336) E 300 (207.355) E 320 (207.362) E 350 (207.356) E 350 4-matic (207.388) E 350 BlueTEC E 350 BlueTEC / d (207.326) E 350 CDI E 400 E 400 (207.361) E 500 (207.373)	155 185 200 225 225 185 190 195 245 245 300	06/13→ 04/11→ 07/14→ 04/11→ 02/13→ 03/13→ 05/14→ 04/11→ 06/13→ 07/14→ 09/11→	← →		1 1	24.8190-0410.2 620410 24.8190-0410.2 620410	L= 97,5 L= 97,5
E 250 CDI / BlueTEC / d (207.303) E 350 CDI (207.322) E 350 CGI (207.357) E 500 (207.372)	150 170 215 285	01/09→ 01/09→ 01/09→ 01/09→	← →	05/09→ 05/09→	1 1	24.8190-0410.2 620410 24.8190-0410.2 620410	L= 97,5 L= 97,5
E 250 CGI (207.347)	150	01/09→	← ← →	05/09→; für Fahrzeuge mit Sportpaket / für Fahrzeuge mit AMG-Sportpaket 05/09→; für Fahrzeuge ohne Sportpaket / für Fahrzeuge ohne AMG-Sportpaket 05/09→	1 1 1	24.8190-0410.2 620410 24.8190-0410.2 620410 24.8190-0410.2 620410	L= 97,5 L= 97,5 L= 97,5
E 350 (207.356)	200	05/11→	←		1	24.8190-0410.2 620410	L= 97,5
 Bremsscheibe							
E 200 (207.334) E 250 (207.336)	135 155	06/13→ 06/13→	← ← → →	für Fahrzeuge mit Sportpaket / für Fahrzeuge mit AMG-Sportpaket für Fahrzeuge ohne Sportpaket / für Fahrzeuge ohne AMG-Sportpaket		24.0132-0100.1 432100 24.0132-0101.1 432101 24.0332-0101.1 532101 24.0110-0328.1 410328 24.0310-0328.1 510328	∅ 322 32 30 V• + S ∅ 322 32 29,4 V + S ∅ 322 32 29,4 V + S PD ∅ 300 10 8,3 + S ∅ 300 10 8,3 + S PD
E 200 CGI (207.348)	135	01/10→	← →			24.0128-0155.1 428155 24.0328-0155.1 528155 24.0110-0328.1 410328 24.0310-0328.1 510328	∅ 295 28 25,4 V + S ∅ 295 28 25,4 V + S PD ∅ 300 10 8,3 + S ∅ 300 10 8,3 + S PD
E 220 BlueTEC (207.301) E 220 CDI E 220 CDI / d (207.302)	130 120 125	05/14→ 07/14→ 01/10→	← ← →	für Fahrzeuge ohne Sportpaket / für Fahrzeuge ohne AMG-Sportpaket für Fahrzeuge mit Sportpaket / für Fahrzeuge mit AMG-Sportpaket		24.0128-0155.1 428155 24.0328-0155.1 528155 24.0132-0100.1 432100 24.0110-0328.1 410328 24.0310-0328.1 510328	∅ 295 28 25,4 V + S ∅ 295 28 25,4 V + S PD ∅ 322 32 30 V• + S ∅ 300 10 8,3 + S ∅ 300 10 8,3 + S PD
E 250 CDI / BlueTEC / d (207.303)	150	01/09→	←	05/09→; für Fahrzeuge mit Sportpaket / für Fahrzeuge mit AMG-Sportpaket		24.0132-0100.1 432100	∅ 322 32 30 V• + S







	kw				! #			
MERCEDES-BENZ - E-KLASSE Coupe (C207) 01/09→								
Bremsscheibe								
E 250 CDI / BlueTEC / d (207.303)	150	01/09→	←	05/09→; für Fahrzeuge ohne Sportpaket / für Fahrzeuge ohne AMG-Sportpaket	24.0132-0101.1	432101	Ø 322 32 29,4 V + S	
			→	05/09→	24.0332-0101.1	532101	Ø 322 32 29,4 V + S PD	
E 250 CGI (207.347)	150	01/09→	←	05/09→	24.0110-0328.1	410328	Ø 300 10 8,3 + S	
			→	05/09→	24.0310-0328.1	510328	Ø 300 10 8,3 + S PD	
E 300 (207.355) E 350 (207.356) E 350 (207.356)	185 200 225	04/11→ 05/11→ 04/11→	←	für Fahrzeuge mit Sportpaket / für Fahr- zeuge mit AMG-Sportpaket	24.0132-0100.1	432100	Ø 322 32 30 V• + S	
			←	für Fahrzeuge ohne Sportpaket / für Fahrzeuge ohne AMG-Sportpaket	24.0132-0101.1	432101	Ø 322 32 29,4 V + S	
E 350 4-matic (207.388) E 350 BlueTEC E 350 BlueTEC / d (207.326) E 350 CDI	185 185 190 195	02/13→ 03/13→ 05/14→ 04/11→	←	für Fahrzeuge ohne Sportpaket / für Fahrzeuge ohne AMG-Sportpaket	24.0332-0101.1	532101	Ø 322 32 29,4 V + S PD	
			→		24.0120-0208.1	420208	Ø 300 22 19,4 V + S	
E 320 (207.362) E 400 E 400 (207.361)	200 245 245	07/14→ 06/13→ 07/14→	←		24.0132-0168.1	432168	Ø 344 32 30 V• + S	
			→		24.0120-0208.1	420208	Ø 300 22 19,4 V + S	
E 350 CDI (207.322) E 350 CGI (207.357)	170 215	01/09→ 01/09→	←	05/09→; für Fahrzeuge mit Sportpaket / für Fahr- zeuge mit AMG-Sportpaket	24.0132-0100.1	432100	Ø 322 32 30 V• + S	
			←	05/09→; für Fahrzeuge ohne Sportpaket / für Fahrzeuge ohne AMG-Sportpaket	24.0132-0101.1	432101	Ø 322 32 29,4 V + S	
E 500 (207.372)	285	01/09→	←	05/09→	24.0332-0101.1	532101	Ø 322 32 29,4 V + S PD	
			→	05/09→	24.0120-0208.1	420208	Ø 300 22 19,4 V + S	
E 500 (207.373)	300	09/11→	←		24.0132-0168.1	432168	Ø 344 32 30 V• + S	
			→		24.0120-0208.1	420208	Ø 300 22 19,4 V + S	
E 500 (207.373)	300	09/11→	←		24.0136-0108.1	436108	Ø 360 36 34 V• + S	
			→		24.0120-0208.1	420208	Ø 300 22 19,4 V + S	
MERCEDES-BENZ - E-KLASSE Coupe (C238) 12/16→								
Bremsbelagsatz, Scheibenbremse								
E 200 (238.342) E 220 d (238.314)	135 143	12/16→ 12/16→	←	für Fahrzeuge ohne AMG-Sportpaket; +SA 088	13.0460-2610.2	602610	TRW 22076 19,6 + WE / - WK	
			←	für Fahrzeuge mit AMG-Sportpaket	13.0470-2610.2	LD2610	TRW 22076 19,6 + WE / - WK Ceramic	
E 200 4-matic (238.343)	135	06/17→	←	für Fahrzeuge ohne AMG-Sportpaket	13.0460-4883.2	604883	BRE 22061 18,7 + WE / - WK	
			←	für Fahrzeuge mit AMG-Sportpaket	13.0460-2610.2	602610	TRW 22076 19,6 + WE / - WK Ceramic	
E 300 (238.348)	180	12/16→	←	für Fahrzeuge ohne AMG-Sportpaket	13.0470-2610.2	LD2610	TRW 22076 19,6 + WE / - WK Ceramic	
E 300 (238.348)	180	12/16→	←	für Fahrzeuge mit AMG-Sportpaket	13.0460-4883.2	604883	BRE 22061 18,7 + WE / - WK	
Warnkontakt, Bremsbelagsverschleiß								
E 200 (238.342)	135	12/16→	←		1	24.8190-0067.2	620067	L= 92,5
E 200 4-matic (238.343)	135	06/17→	→		1	24.8190-0067.2	620067	L= 92,5
E 220 d (238.314)	143	12/16→	→					
E 300 (238.348)	180	12/16→	→					
E 400 4-matic (238.366)	245	12/16→	→					
MERCEDES-BENZ - E-KLASSE Kombi (S124) 06/93→06/96								
Bremsbelagsatz, Scheibenbremse								
E 200 T (124.079) E 220 T (124.082)	100 110	06/93→06/96 06/93→06/96	←		13.0460-2927.2	602927	TRW 20941 19,3 + WE / - WK	
			←		13.0470-2927.2	LD2927	TRW 20941 19,3 + WE / - WK Ceramic	
E 250 TD (124.186) E 250 Turbo D	83 93	06/93→06/96 06/93→06/96	←		13.0460-3805.2	603805	ATE 21197 15,0 + WE / - WK	
			→		13.0470-3805.2	LD3805	ATE 21197 15,0 + WE / - WK Ceramic	
E 280 T (124.088) E 280 T (124.088)	145 142	06/93→06/96 06/93→06/96	←					
			←					
E 300 T 4-matic (124.290) E 300 TD (124.191) E 300 T Turbo-D (124.193)	132 100 108	06/93→06/96 06/93→06/96	←					
			←					
E 300 T Turbo-D 4-matic (124.393) E 300 TE-24 AMG (124.091)	108 162	06/93→06/96 06/93→06/96	←		13.0460-4201.2	604201	ATE 21153 17,5 + WE / - WK	
			→		13.0460-3805.2	603805	ATE 21197 15,0 + WE / - WK	
							ATE 21197 15,0 + WE / - WK Ceramic	
↓								

















	kw			 	! #		
MERCEDES-BENZ - E-KLASSE Kombi (S124) 06/93→06/96							
 Bremsbelagsatz, Scheibenbremse							
E 320 T (124.092)	162	06/93→06/96	←	→ F 242721		13.0460-4201.2 604201	ATE 21153 17,5 + WE / - WK
			←	F 242722→		13.0460-4202.2 604202	ATE 21153 16,0 + WE / - WK
			→	→ F 323055		13.0460-3805.2 603805	ATE 21197 15,0 + WE / - WK
			→	→ F 323055		13.0470-3805.2 LD3805	ATE 21197 15,0 + WE / - WK Ceramic
E 320 T (124.092)	162	06/93→06/96	→	F 323056→		13.0460-4047.2 604047	ATE 21305 15,7 + WE / - WK
			→	F 323056→		13.0470-4047.2 LD4047	ATE 21305 15,7 + WE / - WK Ceramic
E 36 T AMG (124.092)	200	05/94→06/96	←			13.0460-4201.2 604201	ATE 21153 17,5 + WE / - WK
			→	→ F 323055		13.0460-3805.2 603805	ATE 21197 15,0 + WE / - WK
			→	→ F 323055		13.0470-3805.2 LD3805	ATE 21197 15,0 + WE / - WK Ceramic
E 36 T AMG (124.092)	200	05/94→06/96	→	F 323056→		13.0460-4047.2 604047	ATE 21305 15,7 + WE / - WK
			→	F 323056→		13.0470-4047.2 LD4047	ATE 21305 15,7 + WE / - WK Ceramic
Warnkontakt, Bremsbelagverschleiß							
E 200 T (124.079)	100	06/93→06/96	←		2	24.8190-0402.2 620402	L= 68 L= 150
E 220 T (124.082)	110	06/93→06/96	→		2	24.8190-0401.2 620401	L= 95
E 250 TD (124.186)	83	06/93→06/96	→		2	24.8190-0401.2 620401	L= 95
E 250 Turbo D	93	06/93→06/96	→		2	24.8190-0401.2 620401	L= 95
E 280 T (124.088)	145	06/93→06/96	→		2	24.8190-0401.2 620401	L= 95
E 280 T (124.088)	142	06/93→06/96	→		2	24.8190-0401.2 620401	L= 95
E 300 T 4-matic (124.290)	132	06/93→06/96	→		2	24.8190-0401.2 620401	L= 95
E 300 TD (124.191)	100	06/93→06/96	→		2	24.8190-0401.2 620401	L= 95
E 300 T Turbo-D (124.193)	108	06/93→06/96	→		2	24.8190-0401.2 620401	L= 95
E 300 T Turbo-D 4-matic (124.393)	108	06/93→06/96	→		2	24.8190-0401.2 620401	L= 95
E 300 TE-24 AMG (124.091)	162	06/93→06/96	←		2	24.8190-0401.2 620401	L= 95
			→		2	24.8190-0401.2 620401	L= 95
E 320 T (124.092)	162	06/93→06/96	←	F 242722→	2	24.8190-0401.2 620401	L= 95
			←	→ F 242721	2	24.8190-0401.2 620401	L= 95
			→	F 323056→	2	24.8190-0401.2 620401	L= 95
			→	→ F 323055	2	24.8190-0401.2 620401	L= 95
E 36 T AMG (124.092)	200	05/94→06/96	←		2	24.8190-0401.2 620401	L= 95
			→	F 323056→	2	24.8190-0401.2 620401	L= 95
			→	→ F 323055	2	24.8190-0401.2 620401	L= 95
Zubehörsatz, Scheibenbremsbelag							
E 200 T (124.079)	100	06/93→06/96	→			13.0460-0186.2 610186	ATE
E 220 T (124.082)	110	06/93→06/96	→			13.0460-0186.2 610186	ATE
E 250 TD (124.186)	83	06/93→06/96	→			13.0460-0186.2 610186	ATE
E 250 Turbo D	93	06/93→06/96	→			13.0460-0186.2 610186	ATE
E 280 T (124.088)	145	06/93→06/96	→			13.0460-0186.2 610186	ATE
E 280 T (124.088)	142	06/93→06/96	→			13.0460-0186.2 610186	ATE
E 300 T 4-matic (124.290)	132	06/93→06/96	→			13.0460-0186.2 610186	ATE
E 300 TD (124.191)	100	06/93→06/96	→			13.0460-0186.2 610186	ATE
E 300 TE-24 AMG (124.091)	162	06/93→06/96	→			13.0460-0186.2 610186	ATE
E 300 T Turbo-D (124.193)	108	06/93→06/96	→			13.0460-0186.2 610186	ATE
E 300 T Turbo-D 4-matic (124.393)	108	06/93→06/96	→			13.0460-0186.2 610186	ATE
E 320 T (124.092)	162	06/93→06/96	←	F 242722→		13.0460-0268.2 610268	
			→	→ F 323055		13.0460-0186.2 610186	ATE
			→	F 323056→		13.0460-0236.2 610236	ATE
E 36 T AMG (124.092)	200	05/94→06/96	→	→ F 323055		13.0460-0186.2 610186	ATE
			→	F 323056→		13.0460-0236.2 610236	ATE
 Bremsscheibe							
E 200 T (124.079)	100	06/93→06/96	←			24.0122-0123.1 422123	Ø 284 22 19,4 V + S
E 220 T (124.082)	110	06/93→06/96	→			24.0109-0114.1 409114	Ø 278 9 7,3 + S
E 250 Turbo D	93	06/93→06/96	→			24.0309-0114.1 509114	Ø 278 9 7,3 + S PD
E 280 T (124.088)	145	06/93→06/96	→			24.0309-0114.1 509114	Ø 278 9 7,3 + S PD
E 280 T (124.088)	142	06/93→06/96	→			24.0309-0114.1 509114	Ø 278 9 7,3 + S PD
E 300 TD (124.191)	100	06/93→06/96	↓				













	kw			 	! #		
MERCEDES-BENZ - E-KLASSE Kombi (S124) 06/93→06/96							
 Bremsscheibe							
E 300 T Turbo-D (124.193)	108	06/93→06/96	←			24.0122-0123.1 422123	Ø 284 22 19,4 V + S
			→			24.0109-0114.1 409114	Ø 278 9 7,3 + S
						24.0309-0114.1 509114	Ø 278 9 7,3 + S PD
E 250 TD (124.186)	83	06/93→06/96	←			24.0112-0117.1 412117	Ø 284 12 10 + S
			→			24.0109-0114.1 409114	Ø 278 9 7,3 + S
						24.0309-0114.1 509114	Ø 278 9 7,3 + S PD
E 300 T 4-matic (124.290)	132	06/93→06/96	←			24.0122-0134.1 422134	Ø 284 22 19,4 V
			→			24.0109-0114.1 409114	Ø 278 9 7,3 + S
E 300 T Turbo-D 4-matic (124.393)	108	06/93→06/96	→			24.0309-0114.1 509114	Ø 278 9 7,3 + S PD
E 300 TE-24 AMG (124.091)	162	06/93→06/96	←			24.0122-0136.1 422136	Ø 295 22 19,4 V
			→			24.0120-0199.1 420199	Ø 278 19,9 17,4 V
E 320 T (124.092)	162	06/93→06/96	←	→ F 242721		24.0122-0136.1 422136	Ø 295 22 19,4 V
			←	F 242722→		24.0125-0107.1 425107	Ø 294 25 22,4 V
			→	→ F 323055		24.0120-0199.1 420199	Ø 278 19,9 17,4 V
E 36 T AMG (124.092)	200	05/94→06/96	←	<input type="checkbox"/>		24.0130-0121.1 430121	Ø 320 30 28 V
			←	<input type="checkbox"/>		24.0130-0122.1 430122	Ø 320 30 28 V
			→	→ F 323055		24.0120-0199.1 420199	Ø 278 19,9 17,4 V
MERCEDES-BENZ - E-KLASSE Kombi (S210) 06/96→03/03							
 Bremsbelagsatz, Scheibenbremse							
E 200 T (210.235)	100	06/96→08/00	←			13.0460-7086.2 607086	ATE 21664 19,8 + WE / - WK
			←			13.0470-7086.2 LD7086	ATE 21664 19,8 + WE / - WK Ceramic
			→			13.0460-4047.2 604047	ATE 21305 15,7 + WE / - WK Ceramic
E 200 T Kompressor (210.248)	120	08/00→03/03	→			13.0470-4047.2 LD4047	ATE 21305 15,7 + WE / - WK Ceramic
E 230 T (210.237)	110	06/96→06/97	→			13.0470-4047.2 LD4047	ATE 21305 15,7 + WE / - WK Ceramic
E 200 T Kompressor (210.245)	137	06/97→03/03	←	09/97→		13.0460-7087.2 607087	ATE 21670 19,3 + WE / - WK Ceramic
			←			13.0470-7087.2 LD7087	ATE 21670 19,3 + WE / - WK Ceramic
			→	09/97→		13.0460-4047.2 604047	ATE 21305 15,7 + WE / - WK Ceramic
E 220 T Kompressor (210.245)	137	06/97→03/03	→	09/97→		13.0470-4047.2 LD4047	ATE 21305 15,7 + WE / - WK Ceramic
E 220 T CDI (210.206)	100	05/99→03/03	←	Radstand [mm]: 2.833		13.0460-7086.2 607086	ATE 21664 19,8 + WE / - WK Ceramic
			←			13.0470-7086.2 LD7086	ATE 21664 19,8 + WE / - WK Ceramic
			→			13.0460-4047.2 604047	ATE 21305 15,7 + WE / - WK Ceramic
E 220 T CDI (210.206)	105	07/99→03/03	←	Radstand [mm]: 3.570		13.0470-7087.2 LD7087	ATE 21670 19,3 + WE / - WK Ceramic
E 290 T Turbo-D (210.217)	95	06/96→07/99	→			13.0470-7087.2 LD7087	ATE 21670 19,3 + WE / - WK Ceramic
E 220 T CDI (210.206)	92	06/98→07/99	←	07/98→; Radstand [mm]: 2.833		13.0460-7086.2 607086	ATE 21664 19,8 + WE / - WK Ceramic
			←			13.0470-7086.2 LD7086	ATE 21664 19,8 + WE / - WK Ceramic
			→	07/98→		13.0460-4047.2 604047	ATE 21305 15,7 + WE / - WK Ceramic
E 220 T CDI (210.206)	92	06/98→07/99	←	07/98→; Radstand [mm]: 3.570		13.0470-7087.2 LD7087	ATE 21670 19,3 + WE / - WK Ceramic
E 240 T (210.261)	125	06/97→03/03	←	09/97→; - ESP		13.0460-7086.2 607086	ATE 21664 19,8 + WE / - WK Ceramic
			←			13.0470-7086.2 LD7086	ATE 21664 19,8 + WE / - WK Ceramic
			→	09/97→		13.0460-4047.2 604047	ATE 21305 15,7 + WE / - WK Ceramic
E 240 T (210.261)	125	06/97→03/03	←	09/97→; + ESP		13.0470-7087.2 LD7087	ATE 21670 19,3 + WE / - WK Ceramic
E 240 T (210.262)	125	08/00→03/03	←	- ESP		13.0460-7086.2 607086	ATE 21664 19,8 + WE / - WK Ceramic
			←	+ ESP		13.0470-7086.2 LD7086	ATE 21664 19,8 + WE / - WK Ceramic
↓			←			13.0460-7087.2 607087	ATE 21670 19,3 + WE / - WK Ceramic







	kw			 	! #			
MERCEDES-BENZ - E-KLASSE Kombi (S210) 06/96→03/03								
 Bremsbelagsatz, Scheibenbremse								
E 240 T (210.262)	125	08/00→03/03	← + ESP			13.0470-7087.2	LD7087	ATE 21670 19,3 + WE / - WK Ceramic
			→			13.0460-4047.2	604047	ATE 21305 15,7 + WE / - WK
E 250 T D (210.210)	83	06/96→07/99	← Radstand [mm]: 2.833			13.0460-7086.2	607086	ATE 21664 19,8 + WE / - WK
			← für Rechtslenker; Radstand [mm]: 2.833			13.0470-7086.2	LD7086	ATE 21664 19,8 + WE / - WK Ceramic
			← Radstand [mm]: 3.570			13.0460-7087.2	607087	ATE 21664 19,8 + WE / - WK
			← Radstand [mm]: 3.570			13.0470-7087.2	LD7087	ATE 21670 19,3 + WE / - WK Ceramic
			→ Radstand [mm]: 3.570			13.0460-4047.2	604047	ATE 21305 15,7 + WE / - WK
			→ für Rechtslenker; Radstand [mm]: 2.833			13.0470-4047.2	LD4047	ATE 21305 15,7 + WE / - WK Ceramic
E 250 T Turbo-D (210.215)	110	06/97→07/99	← 09/97→			13.0460-7086.2	607086	ATE 21664 19,8 + WE / - WK
			→ 09/97→			13.0470-7086.2	LD7086	ATE 21664 19,8 + WE / - WK Ceramic
E 270 T CDI E 270 T CDI (210.216)	120 125	02/00→03/03 07/99→03/03	←			13.0460-7087.2	607087	ATE 21670 19,3 + WE / - WK
			←			13.0470-7087.2	LD7087	ATE 21670 19,3 + WE / - WK Ceramic
E 280 T 4-matic (210.281)	150	12/96→03/03	→			13.0460-4047.2	604047	ATE 21305 15,7 + WE / - WK
			→			13.0470-4047.2	LD4047	ATE 21305 15,7 + WE / - WK Ceramic
E 300 T Turbo-D (210.225)	130	12/96→07/99	→			13.0460-4047.2	604047	ATE 21305 15,7 + WE / - WK
			→			13.0470-4047.2	LD4047	ATE 21305 15,7 + WE / - WK Ceramic
E 320 T (210.265)	165	12/96→03/03	→			13.0460-4047.2	604047	ATE 21305 15,7 + WE / - WK
			→			13.0470-4047.2	LD4047	ATE 21305 15,7 + WE / - WK Ceramic
E 320 T CDI (210.226)	145	07/99→03/03	→			13.0460-4047.2	604047	ATE 21305 15,7 + WE / - WK
			→			13.0470-4047.2	LD4047	ATE 21305 15,7 + WE / - WK Ceramic
E 280 T (210.263)	150	12/96→03/03	← Radstand [mm]: 3.570			13.0460-7087.2	607087	ATE 21670 19,3 + WE / - WK
			→ Radstand [mm]: 3.570			13.0470-7087.2	LD7087	ATE 21670 19,3 + WE / - WK Ceramic
E 320 T 4-matic (210.282)	165	12/96→03/03	← 06/97→			13.0460-7087.2	607087	ATE 21670 19,3 + WE / - WK
			→ 06/97→			13.0470-7087.2	LD7087	ATE 21670 19,3 + WE / - WK Ceramic
E 420 T (210.272)	205	06/96→06/97	← → A 962231 / X 027613			13.0460-4201.2	604201	ATE 21153 17,5 + WE / - WK
			← A 962232 / X 027614→			13.0460-7183.2	607183	ATE 21484 20,5 + WE / - WK
E 430 T (210.270)	205	06/97→03/03	← 09/97→; → A 962231 / X 027613			13.0460-4201.2	604201	ATE 21153 17,5 + WE / - WK
			← A 962232 / X 027614→			13.0460-7183.2	607183	ATE 21484 20,5 + WE / - WK
E 430 T 4-matic (210.283)	205	05/99→03/03	←			13.0460-4047.2	604047	ATE 21305 15,7 + WE / - WK
			→			13.0470-4047.2	LD4047	ATE 21305 15,7 + WE / - WK Ceramic
E 55 T AMG 4-matic (210.274)	260	03/01→03/03	→			13.0460-4047.2	604047	ATE 21305 15,7 + WE / - WK
			→			13.0470-4047.2	LD4047	ATE 21305 15,7 + WE / - WK Ceramic
E 55 T AMG (210.274)	260	08/97→03/03	← 09/97→			13.0460-7183.2	607183	ATE 21484 20,5 + WE / - WK
			→ 09/97→			13.0460-4047.2	604047	ATE 21305 15,7 + WE / - WK
			→			13.0470-4047.2	LD4047	ATE 21305 15,7 + WE / - WK Ceramic
			→			13.0470-4047.2	LD4047	ATE 21305 15,7 + WE / - WK Ceramic









	kW			 	! #		
MERCEDES-BENZ - E-KLASSE Kombi (S210) 06/96→03/03							
Warnkontakt, Bremsbelagverschleiß							
E 200 T (210.235)	100	06/96→08/00	←		2	24.8190-0401.2 620401	L= 95
E 200 T Kompressor (210.248)	120	08/00→03/03	→		2	24.8190-0401.2 620401	L= 95
E 230 T (210.237)	110	06/96→06/97					
E 270 T CDI	120	02/00→03/03					
E 270 T CDI (210.216)	125	07/99→03/03					
E 280 T 4-matic (210.281)	150	12/96→03/03					
E 300 T Turbo-D (210.225)	130	12/96→07/99					
E 320 T (210.265)	165	12/96→03/03					
E 320 T CDI (210.226)	145	07/99→03/03					
E 200 T Kompressor (210.245)	137	06/97→03/03	←	09/97→	2	24.8190-0401.2 620401	L= 95
E 250 T Turbo-D (210.215)	110	06/97→07/99	→	09/97→	2	24.8190-0401.2 620401	L= 95
E 220 T CDI (210.206)	100	05/99→03/03	←	Radstand [mm]: 3.570	2	24.8190-0401.2 620401	L= 95
E 220 T CDI (210.206)	105	07/99→03/03	←	Radstand [mm]: 2.833	2	24.8190-0401.2 620401	L= 95
E 290 T Turbo-D (210.217)	95	06/96→07/99	→		2	24.8190-0401.2 620401	L= 95
E 220 T CDI (210.206)	92	06/98→07/99	←	07/98→; Radstand [mm]: 3.570	2	24.8190-0401.2 620401	L= 95
			←	07/98→; Radstand [mm]: 2.833	2	24.8190-0401.2 620401	L= 95
			→	07/98→	2	24.8190-0401.2 620401	L= 95
E 240 T (210.261)	125	06/97→03/03	←	09/97→; + ESP	2	24.8190-0401.2 620401	L= 95
			←	09/97→; - ESP	2	24.8190-0401.2 620401	L= 95
			→	09/97→	2	24.8190-0401.2 620401	L= 95
E 240 T (210.262)	125	08/00→03/03	←	- ESP	2	24.8190-0401.2 620401	L= 95
			←	+ ESP	2	24.8190-0401.2 620401	L= 95
			→		2	24.8190-0401.2 620401	L= 95
E 250 T D (210.210)	83	06/96→07/99	←	für Rechtslenker; Radstand [mm]: 2.833	2	24.8190-0401.2 620401	L= 95
			←	Radstand [mm]: 3.570	2	24.8190-0401.2 620401	L= 95
			←	Radstand [mm]: 2.833	2	24.8190-0401.2 620401	L= 95
			→	für Rechtslenker; Radstand [mm]: 2.833	2	24.8190-0401.2 620401	L= 95
			→	Radstand [mm]: 2.833	2	24.8190-0401.2 620401	L= 95
			→	Radstand [mm]: 3.570	2	24.8190-0401.2 620401	L= 95
E 280 T (210.263)	150	12/96→03/03	←	Radstand [mm]: 3.570	2	24.8190-0401.2 620401	L= 95
			→	Radstand [mm]: 3.570	2	24.8190-0401.2 620401	L= 95
E 320 T 4-matic (210.282)	165	12/96→03/03	←	06/97→	2	24.8190-0401.2 620401	L= 95
			→	06/97→	2	24.8190-0401.2 620401	L= 95
E 420 T (210.272)	205	06/96→06/97	←	→ A 962231 / X 027613	2	24.8190-0401.2 620401	L= 95
			←	A 962232 / X 027614→	2	24.8190-0419.2 620419	L= 74
			→		2	24.8190-0401.2 620401	L= 95
E 430 T (210.270)	205	06/97→03/03	←	09/97→; → A 962231 / X 027613	2	24.8190-0401.2 620401	L= 95
			←	A 962232 / X 027614→	2	24.8190-0419.2 620419	L= 74
			→	09/97→	2	24.8190-0401.2 620401	L= 95
E 430 T 4-matic (210.283)	205	05/99→03/03	←		2	24.8190-0419.2 620419	L= 74
E 55 T AMG 4-matic (210.274)	260	03/01→03/03	→		2	24.8190-0401.2 620401	L= 95
E 55 T AMG (210.274)	260	08/97→03/03	←	09/97→	2	24.8190-0419.2 620419	L= 74
			→	09/97→	2	24.8190-0401.2 620401	L= 95
Zubehörsatz, Scheibenbremsbelag							
E 200 T (210.235)	100	06/96→08/00	→			13.0460-0239.2 610239	ATE
E 200 T Kompressor (210.248)	120	08/00→03/03					
E 220 T CDI (210.206)	100	05/99→03/03					
E 220 T CDI (210.206)	105	07/99→03/03					
E 230 T (210.237)	110	06/96→06/97					
E 240 T (210.262)	125	08/00→03/03					
E 270 T CDI	120	02/00→03/03					
E 270 T CDI (210.216)	125	07/99→03/03					
E 280 T 4-matic (210.281)	150	12/96→03/03					
E 290 T Turbo-D (210.217)	95	06/96→07/99					
↓							









	kW			 	! #				
MERCEDES-BENZ - E-KLASSE Kombi (S210) 06/96→03/03									
Zubehörsatz, Scheibenbremsbelag									
E 300 T Turbo-D (210.225)	130	12/96→07/99	➔			13.0460-0239.2 610239	ATE		
E 320 T (210.265)	165	12/96→03/03							
E 320 T CDI (210.226)	145	07/99→03/03							
E 420 T (210.272)	205	06/96→06/97							
E 200 T Kompressor (210.245)	137	06/97→03/03	➔	09/97→		13.0460-0239.2 610239	ATE		
E 240 T (210.261)	125	06/97→03/03							
E 250 T Turbo-D (210.215)	110	06/97→07/99							
E 430 T (210.270)	205	06/97→03/03							
E 220 T CDI (210.206)	92	06/98→07/99	➔	07/98→		13.0460-0239.2 610239	ATE		
E 250 T D (210.210)	83	06/96→07/99	➔	für Rechtslenker; Radstand [mm]: 2.833		13.0460-0239.2 610239	ATE		
			➔	Radstand [mm]: 3.570		13.0460-0239.2 610239	ATE		
			➔	Radstand [mm]: 2.833		13.0460-0239.2 610239	ATE		
E 280 T (210.263)	150	12/96→03/03	➔	Radstand [mm]: 3.570		13.0460-0239.2 610239	ATE		
E 320 T 4-matic (210.282)	165	12/96→03/03	➔	06/97→		13.0460-0239.2 610239	ATE		
E 430 T 4-matic (210.283)	205	05/99→03/03	➔			13.0460-0236.2 610236	ATE		
E 55 T AMG 4-matic (210.274)	260	03/01→03/03							
E 55 T AMG (210.274)	260	08/97→03/03	➔	09/97→		13.0460-0236.2 610236	ATE		
Bremsscheibe									
E 200 T (210.235)	100	06/96→08/00	←			24.0125-0110.1 425110	Ø 288 25 22,4 V + S		
E 200 T Kompressor (210.248)	120	08/00→03/03				24.0325-0110.1 525110	Ø 288 25 22,4 V + S PD		
E 230 T (210.237)	110	06/96→06/97	➔			24.0112-0149.1 412149	Ø 290 12 10,3		
E 200 T Kompressor (210.245)	137	06/97→03/03	←	09/97→		24.0128-0106.1 428106	Ø 300 28 25,4 V + S		
						24.0328-0106.1 528106	Ø 300 28 25,4 V + S PD		
			➔	09/97→		24.0112-0149.1 412149	Ø 290 12 10,3		
E 220 T CDI (210.206)	100	05/99→03/03	←	Radstand [mm]: 2.833		24.0125-0110.1 425110	Ø 288 25 22,4 V + S		
						24.0325-0110.1 525110	Ø 288 25 22,4 V + S PD		
			←	Radstand [mm]: 3.570		24.0128-0106.1 428106	Ø 300 28 25,4 V + S		
						24.0328-0106.1 528106	Ø 300 28 25,4 V + S PD		
E 220 T CDI (210.206)	105	07/99→03/03				24.0112-0149.1 412149	Ø 290 12 10,3		
			95	06/96→07/99	←	07/98→; Radstand [mm]: 2.833		24.0125-0110.1 425110	Ø 288 25 22,4 V + S
								24.0325-0110.1 525110	Ø 288 25 22,4 V + S PD
					←	07/98→; Radstand [mm]: 3.570		24.0128-0106.1 428106	Ø 300 28 25,4 V + S
			24.0328-0106.1 528106	Ø 300 28 25,4 V + S PD					
E 220 T CDI (210.206)	92	06/98→07/99	➔	07/98→		24.0112-0149.1 412149	Ø 290 12 10,3		
			←	07/98→; Radstand [mm]: 2.833		24.0125-0110.1 425110	Ø 288 25 22,4 V + S		
						24.0325-0110.1 525110	Ø 288 25 22,4 V + S PD		
			←	07/98→; Radstand [mm]: 3.570		24.0128-0106.1 428106	Ø 300 28 25,4 V + S		
			24.0328-0106.1 528106	Ø 300 28 25,4 V + S PD					
E 240 T (210.261)	125	06/97→03/03	←	09/97→; - ESP		24.0125-0110.1 425110	Ø 288 25 22,4 V + S		
						24.0325-0110.1 525110	Ø 288 25 22,4 V + S PD		
			←	09/97→; + ESP		24.0128-0106.1 428106	Ø 300 28 25,4 V + S		
						24.0328-0106.1 528106	Ø 300 28 25,4 V + S PD		
E 240 T (210.262)	125	08/00→03/03	➔	09/97→		24.0112-0149.1 412149	Ø 290 12 10,3		
			←	- ESP		24.0125-0110.1 425110	Ø 288 25 22,4 V + S		
						24.0325-0110.1 525110	Ø 288 25 22,4 V + S PD		
			←	+ ESP		24.0128-0106.1 428106	Ø 300 28 25,4 V + S		
			24.0328-0106.1 528106	Ø 300 28 25,4 V + S PD					
E 250 T D (210.210)	83	06/96→07/99	←	Radstand [mm]: 2.833; für Italien		24.0125-0110.1 425110	Ø 288 25 22,4 V + S		
						24.0325-0110.1 525110	Ø 288 25 22,4 V + S PD		
			←	für Rechtslenker; Radstand [mm]: 2.833		24.0125-0110.1 425110	Ø 288 25 22,4 V + S		
						24.0325-0110.1 525110	Ø 288 25 22,4 V + S PD		
			←	Radstand [mm]: 3.570		24.0128-0106.1 428106	Ø 300 28 25,4 V + S		
						24.0328-0106.1 528106	Ø 300 28 25,4 V + S PD		
			➔	Radstand [mm]: 3.570		24.0112-0149.1 412149	Ø 290 12 10,3		
E 250 T Turbo-D (210.215)	110	06/97→07/99	➔	für Rechtslenker; Radstand [mm]: 2.833		24.0112-0149.1 412149	Ø 290 12 10,3		
			←	09/97→		24.0125-0110.1 425110	Ø 288 25 22,4 V + S		
						24.0325-0110.1 525110	Ø 288 25 22,4 V + S PD		
			➔	09/97→		24.0112-0149.1 412149	Ø 290 12 10,3		









	kW			 	! #		
MERCEDES-BENZ - E-KLASSE Kombi (S210) 06/96→03/03							
Bremsscheibe							
E 270 T CDI	120	02/00→03/03	←			24.0128-0106.1 428106	Ø 300 28 25,4 V + S
E 270 T CDI (210.216)	125	07/99→03/03				24.0328-0106.1 528106	Ø 300 28 25,4 V + S PD
E 280 T 4-matic (210.281)	150	12/96→03/03	→			24.0112-0149.1 412149	Ø 290 12 10,3
E 300 T Turbo-D (210.225)	130	12/96→07/99					
E 320 T (210.265)	165	12/96→03/03					
E 320 T CDI (210.226)	145	07/99→03/03					
E 280 T (210.263)	150	12/96→03/03	←	Radstand [mm]: 3.570		24.0128-0106.1 428106	Ø 300 28 25,4 V + S
			→	Radstand [mm]: 3.570		24.0328-0106.1 528106	Ø 300 28 25,4 V + S PD
			→			24.0112-0149.1 412149	Ø 290 12 10,3
E 320 T 4-matic (210.282)	165	12/96→03/03	←	06/97→		24.0128-0106.1 428106	Ø 300 28 25,4 V + S
			→	06/97→		24.0328-0106.1 528106	Ø 300 28 25,4 V + S PD
			→			24.0112-0149.1 412149	Ø 290 12 10,3
E 420 T (210.272)	205	06/96→06/97	←	→ A 962231 / X 027613		24.0128-0126.1 428126	Ø 316 28 25,4 V
			←	A 962232 / X 027614→		24.0132-0159.1 432159	Ø 330 32 29,4 V
			→			24.0112-0149.1 412149	Ø 290 12 10,3
E 430 T (210.270)	205	06/97→03/03	←	09/97→; → A 962231 / X 027613		24.0128-0126.1 428126	Ø 316 28 25,4 V
			←	A 962232 / X 027614→		24.0132-0159.1 432159	Ø 330 32 29,4 V
			→	09/97→		24.0112-0149.1 412149	Ø 290 12 10,3
E 430 T 4-matic (210.283)	205	05/99→03/03	←			24.0132-0159.1 432159	Ø 330 32 29,4 V
MERCEDES-BENZ - E-KLASSE Kombi (S211) 03/03→07/09							
Bremsbelagsatz, Scheibenbremse							
350 CGI (211.257)	215	05/06→07/09	←			13.0460-4990.2 604990	BRE 23271 17,4 + WE / - WK
E 230 T (211.252)	150	05/07→07/09				13.0470-4990.2 LD4990	BRE 23271 17,4 + WE / - WK Ceramic
E 280 T CDI (211.223)	130	05/04→07/09					
E 320 T (211.265)	165	03/03→07/09					
E 320 T CDI (211.222)	165	03/05→07/09	→			13.0460-7171.2 607171	ATE 23334 16,7 + WE / - WK
E 320 T CDI (211.226)	150	03/03→07/09				13.0470-7171.2 LD7171	ATE 23334 16,7 + WE / - WK Ceramic
E 350 T (211.256)	200	03/05→07/09					
E 200 CDI (211.207)	100	04/06→07/09	←	für Fahrzeuge ohne Sportpaket / für Fahrzeuge ohne AMG-Sportpaket		13.0460-3999.2 603999	BOS 23743 20,1 + WK + Zub
E 200 Kompressor (211.241)	135	04/06→07/09				13.0470-3999.2 LD3999	BOS 23743 20,1 + WK + Zub Ceramic
E 200 T Kompressor (211.242)	120	03/03→07/09	←	für Fahrzeuge mit Sportpaket / für Fahrzeuge mit AMG-Sportpaket		13.0460-4990.2 604990	BRE 23271 17,4 + WE / - WK
E 220 CDI (211.206)	100	03/03→07/09				13.0470-4990.2 LD4990	BRE 23271 17,4 + WE / - WK Ceramic
E 220 T CDI	120	03/03→07/09					
E 220 T CDI (211.206)	110	03/03→07/09	→			13.0460-7171.2 607171	ATE 23334 16,7 + WE / - WK
E 220 T CDI (211.208)	125	04/06→07/09				13.0470-7171.2 LD7171	ATE 23334 16,7 + WE / - WK Ceramic
E 280 T CDI (211.220)	140	03/05→07/09					
E 240 T (211.261)	130	03/03→07/09	←			13.0460-3999.2 603999	BOS 23743 20,1 + WK + Zub
E 270 T CDI (211.216)	120	03/03→07/09				13.0470-3999.2 LD3999	BOS 23743 20,1 + WK + Zub Ceramic
E 270 T CDI (211.216)	130	03/03→07/09	→			13.0460-7171.2 607171	ATE 23334 16,7 + WE / - WK
			→			13.0470-7171.2 LD7171	ATE 23334 16,7 + WE / - WK Ceramic
E 240 T 4-matic (211.280)	130	07/03→07/09	←			13.0460-7203.2 607203	ATE 21670 19,3 + WE / - WK
E 320 T 4-matic (211.282)	165	07/03→07/09				13.0470-7203.2 LD7203	ATE 21670 19,3 + WE / - WK Ceramic
			→			13.0460-7171.2 607171	ATE 23334 16,7 + WE / - WK
			→			13.0470-7171.2 LD7171	ATE 23334 16,7 + WE / - WK Ceramic
E 280 T (211.254)	170	03/05→07/09	←	05/05→		13.0460-4990.2 604990	BRE 23271 17,4 + WE / - WK
			→	05/05→		13.0470-4990.2 LD4990	BRE 23271 17,4 + WE / - WK Ceramic
			→			13.0460-7171.2 607171	ATE 23334 16,7 + WE / - WK
			→			13.0470-7171.2 LD7171	ATE 23334 16,7 + WE / - WK Ceramic
E 280 T 4-matic (211.292)	170	03/05→07/09	←	05/05→; → A 870950; für Fahrzeuge mit Sportpaket / für Fahrzeuge mit AMG-Sportpaket		13.0460-7183.2 607183	ATE 21484 20,5 + WE / - WK
E 280 T CDI 4-matic (211.284)	140	03/05→07/09	←	05/05→; für Fahrzeuge ohne Sportpaket / für Fahrzeuge ohne AMG-Sportpaket		13.0460-7203.2 607203	ATE 21670 19,3 + WE / - WK
E 320 T CDI 4-matic (211.289)	165	03/05→07/09	←	05/05→; für Fahrzeuge ohne Sportpaket / für Fahrzeuge ohne AMG-Sportpaket		13.0470-7203.2 LD7203	ATE 21670 19,3 + WE / - WK Ceramic
			←	A 870951→; für Fahrzeuge mit Sportpaket / für Fahrzeuge mit AMG-Sportpaket		13.0460-7220.2 607220	ATE 23922 21,0 + WE / - WK

	kw			 	! #			
MERCEDES-BENZ - E-KLASSE Kombi (S211) 03/03→07/09								
Bremsbelagsatz, Scheibenbremse								
E 280 T 4-matic (211.292)	170	03/05→07/09	←	A 870951→;		13.0470-7220.2	LD7220	ATE 23922 21,0 + WE / - WK Ceramic
E 280 T CDI 4-matic (211.284)	140	03/05→07/09	→	für Fahrzeuge mit Sportpaket / für Fahrzeuge mit AMG-Sportpaket		13.0460-7171.2	607171	ATE 23334 16,7 + WE / - WK
E 320 T CDI 4-matic (211.289)	165	03/05→07/09	→	05/05→		13.0470-7171.2	LD7171	ATE 23334 16,7 + WE / - WK Ceramic
E 350 T 4-matic (211.287)	200	03/05→07/09	←	→ A 870950;		13.0460-7183.2	607183	ATE 21484 20,5 + WE / - WK
			←	für Fahrzeuge mit Sportpaket / für Fahrzeuge mit AMG-Sportpaket		13.0460-7203.2	607203	ATE 21670 19,3 + WE / - WK
			←	für Fahrzeuge ohne Sportpaket / für Fahrzeuge ohne AMG-Sportpaket		13.0470-7203.2	LD7203	ATE 21670 19,3 + WE / - WK Ceramic
			←	A 870951→;		13.0460-7220.2	607220	ATE 23922 21,0 + WE / - WK
			←	für Fahrzeuge mit Sportpaket / für Fahrzeuge mit AMG-Sportpaket		13.0470-7220.2	LD7220	ATE 23922 21,0 + WE / - WK Ceramic
			→			13.0460-7171.2	607171	ATE 23334 16,7 + WE / - WK
			→			13.0470-7171.2	LD7171	ATE 23334 16,7 + WE / - WK Ceramic
E 500 T (211.270)	225	10/03→07/09	←			13.0460-4990.2	604990	BRE 23271 17,4 + WE / - WK
			→			13.0460-7171.2	607171	ATE 23334 16,7 + WE / - WK
			→			13.0470-7171.2	LD7171	ATE 23334 16,7 + WE / - WK Ceramic
E 500 T (211.272)	285	04/06→07/09	←			13.0460-4817.2	604817	BRE 23960 18,3 + WE / - WK
			→			13.0460-7171.2	607171	ATE 23334 16,7 + WE / - WK
			→			13.0470-7171.2	LD7171	ATE 23334 16,7 + WE / - WK Ceramic
E 500 T 4-matic (211.283)	225	10/03→07/09	←			13.0460-4990.2	604990	BRE 23271 17,4 + WE / - WK
			←	→ A 870950		13.0460-7183.2	607183	ATE 21484 20,5 + WE / - WK
			←	A 870951→		13.0460-7220.2	607220	ATE 23922 21,0 + WE / - WK
			→			13.0460-7171.2	607171	ATE 23334 16,7 + WE / - WK
			→			13.0470-7171.2	LD7171	ATE 23334 16,7 + WE / - WK Ceramic
E 500 T 4-matic (211.290)	285	04/06→07/09	←			13.0460-7220.2	607220	ATE 23922 21,0 + WE / - WK
			→			13.0460-7171.2	607171	ATE 23334 16,7 + WE / - WK
			→			13.0470-7171.2	LD7171	ATE 23334 16,7 + WE / - WK Ceramic
E 55 T AMG Kompressor (211.276)	350	07/03→07/09	←			13.0460-4997.2	604997	BRE 23943 17,5 + WE / - WK
			→			13.0460-4998.2	604998	BRE 23478 16,5 + WE / - WK
E 63 AMG (211.277)	378	03/06→07/09	←			13.0460-4839.2	604839	BRE 24455 16,8 + WE / - WK
Warnkontakt, Bremsbelagverschleiß								
350 CGI (211.257)	215	05/06→07/09	←		1	24.8190-0410.2	620410	L= 97,5
E 230 T (211.252)	150	05/07→07/09	←		1	24.8190-0416.2	620416	L= 100
E 240 T (211.261)	130	03/03→07/09	←					
E 240 T 4-matic (211.280)	130	07/03→07/09	→		1	24.8190-0410.2	620410	L= 97,5
E 270 T CDI (211.216)	120	03/03→07/09	←					
E 270 T CDI (211.216)	130	03/03→07/09	←					
E 320 T 4-matic (211.282)	165	07/03→07/09	←					
E 500 T (211.270)	225	10/03→07/09	←					
E 200 CDI (211.207)	100	04/06→07/09	←		1	24.8190-0410.2	620410	L= 97,5
E 200 Kompressor (211.241)	135	04/06→07/09	←	für Fahrzeuge mit Sportpaket / für Fahrzeuge mit AMG-Sportpaket				
E 200 T Kompressor (211.242)	120	03/03→07/09	←		1	24.8190-0410.2	620410	L= 97,5
E 220 CDI (211.206)	100	03/03→07/09	←	für Fahrzeuge ohne Sportpaket / für Fahrzeuge ohne AMG-Sportpaket				
E 220 T CDI	120	03/03→07/09	←					
E 220 T CDI (211.206)	110	03/03→07/09	←		1	24.8190-0416.2	620416	L= 100
E 220 T CDI (211.208)	125	04/06→07/09	←	für Fahrzeuge ohne Sportpaket / für Fahrzeuge ohne AMG-Sportpaket				
E 280 T CDI (211.220)	140	03/05→07/09	←		1	24.8190-0416.2	620416	L= 100
			→					
			→		1	24.8190-0410.2	620410	L= 97,5
E 280 T (211.254)	170	03/05→07/09	←	05/05→	1	24.8190-0410.2	620410	L= 97,5
			→			24.8190-0416.2	620416	L= 100
			→	05/05→	1	24.8190-0410.2	620410	L= 97,5
↓								









	kw			 	! #		
MERCEDES-BENZ - E-KLASSE Kombi (S211) 03/03→07/09							
Warnkontakt, Bremsbelagverschleiß							
E 280 T 4-matic (211.292)	170	03/05→07/09	←	☐; 05/05→; → A 870950; für Fahrzeuge mit Sportpaket / für Fahrzeuge mit AMG-Sportpaket	1	24.8190-0410.2 620410	L= 97,5
E 280 T CDI 4-matic (211.284)	140	03/05→07/09	←	☐; A 870951→; für Fahrzeuge mit Sportpaket / für Fahrzeuge mit AMG-Sportpaket	1	24.8190-0410.2 620410	L= 97,5
E 320 T CDI 4-matic (211.289)	165	03/05→07/09	←	☐; 05/05→; für Fahrzeuge ohne Sportpaket / für Fahrzeuge ohne AMG-Sportpaket	1	24.8190-0410.2 620410	L= 97,5
			←	☐; A 870951→; für Fahrzeuge mit Sportpaket / für Fahrzeuge mit AMG-Sportpaket	1	24.8190-0416.2 620416	L= 100
			←	☐; 05/05→; für Fahrzeuge ohne Sportpaket / für Fahrzeuge ohne AMG-Sportpaket	1	24.8190-0416.2 620416	L= 100
			←	☐; 05/05→; → A 870950; für Fahrzeuge mit Sportpaket / für Fahrzeuge mit AMG-Sportpaket	1	24.8190-0416.2 620416	L= 100
			→	05/05→	1	24.8190-0410.2 620410	L= 97,5
E 280 T CDI (211.223)	130	05/04→07/09	←		1	24.8190-0410.2 620410	L= 97,5
E 320 T (211.265)	165	03/03→07/09	→		1	24.8190-0416.2 620416	L= 100
E 320 T CDI (211.222)	165	03/05→07/09	→		1	24.8190-0410.2 620410	L= 97,5
E 320 T CDI (211.226)	150	03/03→07/09	→		1	24.8190-0410.2 620410	L= 97,5
E 350 T (211.256)	200	03/05→07/09	→		1	24.8190-0410.2 620410	L= 97,5
E 350 T 4-matic (211.287)	200	03/05→07/09	←	☐; für Fahrzeuge ohne Sportpaket / für Fahrzeuge ohne AMG-Sportpaket	1	24.8190-0410.2 620410	L= 97,5
			←	☐; → A 870950; für Fahrzeuge mit Sportpaket / für Fahrzeuge mit AMG-Sportpaket	1	24.8190-0410.2 620410	L= 97,5
			←	☐; A 870951→; für Fahrzeuge mit Sportpaket / für Fahrzeuge mit AMG-Sportpaket	1	24.8190-0410.2 620410	L= 97,5
			←	☐; A 870951→; für Fahrzeuge mit Sportpaket / für Fahrzeuge mit AMG-Sportpaket	1	24.8190-0416.2 620416	L= 100
			←	☐; → A 870950; für Fahrzeuge mit Sportpaket / für Fahrzeuge mit AMG-Sportpaket	1	24.8190-0416.2 620416	L= 100
			←	☐; für Fahrzeuge ohne Sportpaket / für Fahrzeuge ohne AMG-Sportpaket	1	24.8190-0416.2 620416	L= 100
			→		1	24.8190-0410.2 620410	L= 97,5
E 500 T (211.272)	285	04/06→07/09	←	☐		24.8190-0420.2 620420	L= 119
			→		1	24.8190-0410.2 620410	L= 97,5
E 500 T 4-matic (211.283)	225	10/03→07/09	←	☐	1	24.8190-0410.2 620410	L= 97,5
			←	☐	1	24.8190-0416.2 620416	L= 100
			←	☐; A 870951→		24.8190-0425.2 620425	L= 98
			←	☐; → A 870950		24.8190-0425.2 620425	L= 98
			←	☐; → A 870950		24.8190-0955.2 620955	L= 100
			→		1	24.8190-0410.2 620410	L= 97,5
E 500 T 4-matic (211.290)	285	04/06→07/09	←	☐		24.8190-0425.2 620425	L= 98
			→		1	24.8190-0410.2 620410	L= 97,5
E 55 T AMG Kompressor (211.276)	350	07/03→07/09	←	☐		24.8190-0410.2 620410	L= 97,5
			←	☐		24.8190-0416.2 620416	L= 100
			→		1	24.8190-0410.2 620410	L= 97,5
E 63 AMG (211.277)	378	03/06→07/09	←		1	24.8190-0420.2 620420	L= 119
			→		1	24.8190-0420.2 620420	L= 119
Zubehörsatz, Scheibenbremsbelag							
350 CGI (211.257)	215	05/06→07/09	←			13.0460-0155.2 610155	BRE
E 230 T (211.252)	150	05/07→07/09	←			13.0460-0155.2 610155	BRE
E 200 CDI (211.207)	100	04/06→07/09	←	für Fahrzeuge mit Sportpaket / für Fahrzeuge mit AMG-Sportpaket		13.0460-0155.2 610155	BRE
E 200 Kompressor (211.241)	135	04/06→07/09	←			13.0460-0155.2 610155	BRE
E 200 T Kompressor (211.242)	120	03/03→07/09	←			13.0460-0155.2 610155	BRE
E 220 CDI (211.206)	100	03/03→07/09	←			13.0460-0155.2 610155	BRE
E 220 T CDI	120	03/03→07/09	←			13.0460-0155.2 610155	BRE
E 220 T CDI (211.206)	110	03/03→07/09	←			13.0460-0155.2 610155	BRE









	kw			 	! #		
MERCEDES-BENZ - E-KLASSE Kombi (S211) 03/03→07/09							
Zubehörsatz, Scheibenbremsbelag							
E 220 T CDI (211.208)	125	04/06→07/09	←	für Fahrzeuge mit Sportpaket / für Fahrzeuge mit AMG-Sportpaket		13.0460-0155.2 610155	BRE
E 280 T CDI (211.220)	140	03/05→07/09					
E 280 T (211.254)	170	03/05→07/09	←	05/05→		13.0460-0155.2 610155 13.0460-0275.2 610275	BRE
E 280 T CDI (211.223)	130	05/04→07/09	←			13.0460-0155.2 610155	BRE
E 320 T (211.265)	165	03/03→07/09				13.0460-0275.2 610275	
E 320 T CDI (211.222)	165	03/05→07/09					
E 320 T CDI (211.226)	150	03/03→07/09					
E 350 T (211.256)	200	03/05→07/09					
E 500 T (211.270)	225	10/03→07/09					
E 500 T 4-matic (211.283)	225	10/03→07/09					
 Bremsscheibe							
350 CGI (211.257)	215	05/06→07/09	←	für Fahrzeuge ohne Sportpaket / für Fahrzeuge ohne AMG-Sportpaket		24.0132-0144.1 432144	Ø 330 32 29,4 V + S
E 350 T (211.256)	200	03/05→07/09				24.0332-0144.1 532144	Ø 330 32 29,4 V + S PD
E 500 T (211.270)	225	10/03→07/09	←	für Fahrzeuge mit Sportpaket / für Fahrzeuge mit AMG-Sportpaket		24.0132-0153.1 432153	Ø 330 32 30 V• + S
			→			24.0122-0201.1 422201	Ø 300 22 19,4 V + S
E 200 CDI (211.207)	100	04/06→07/09	←	für Fahrzeuge ohne Sportpaket / für Fahrzeuge ohne AMG-Sportpaket		24.0128-0176.1 428176	Ø 295 28 25,4 V + S
E 200 Kompressor (211.241)	135	04/06→07/09				24.0328-0176.1 528176	Ø 295 28 25,4 V PD
E 220 CDI (211.206)	100	03/03→07/09	←	für Fahrzeuge mit Sportpaket / für Fahrzeuge mit AMG-Sportpaket		24.0132-0153.1 432153	Ø 330 32 30 V• + S
E 220 T CDI	120	03/03→07/09					
E 220 T CDI (211.206)	110	03/03→07/09	→	nicht für Taxifahrzeuge;		24.0110-0278.1 410278	Ø 300 10 8,3 + S
E 220 T CDI (211.208)	125	04/06→07/09	→	für Fahrzeuge ohne Sportpaket / für Fahrzeuge ohne AMG-Sportpaket		24.0310-0278.1 510278	Ø 300 10 8,3 + S PD
			→	nicht für Taxifahrzeuge;		24.0122-0201.1 422201	Ø 300 22 19,4 V + S
			→	für Fahrzeuge mit Sportpaket / für Fahrzeuge mit AMG-Sportpaket			
			→	für Taxifahrzeuge		24.0122-0201.1 422201	Ø 300 22 19,4 V + S
E 200 T Kompressor (211.242)	120	03/03→07/09	←	für Fahrzeuge ohne Sportpaket / für Fahrzeuge ohne AMG-Sportpaket		24.0128-0176.1 428176	Ø 295 28 25,4 V + S
						24.0328-0176.1 528176	Ø 295 28 25,4 V PD
			←	für Fahrzeuge mit Sportpaket / für Fahrzeuge mit AMG-Sportpaket		24.0132-0153.1 432153	Ø 330 32 30 V• + S
			→	nicht für Taxifahrzeuge		24.0110-0278.1 410278	Ø 300 10 8,3 + S
			→			24.0310-0278.1 510278	Ø 300 10 8,3 + S PD
			→	nicht für Taxifahrzeuge;		24.0122-0201.1 422201	Ø 300 22 19,4 V + S
			→	für Fahrzeuge mit Sportpaket / für Fahrzeuge mit AMG-Sportpaket			
			→	für Taxifahrzeuge		24.0122-0201.1 422201	Ø 300 22 19,4 V + S
E 230 T (211.252)	150	05/07→07/09	←	für Fahrzeuge ohne Sportpaket / für Fahrzeuge ohne AMG-Sportpaket		24.0128-0142.1 428142	Ø 312 28 25,4 V
						24.0328-0142.1 528142	Ø 312 28 25,4 V PD
			←	für Fahrzeuge mit Sportpaket / für Fahrzeuge mit AMG-Sportpaket		24.0132-0153.1 432153	Ø 330 32 30 V• + S
			→			24.0122-0201.1 422201	Ø 300 22 19,4 V + S
E 240 T (211.261)	130	03/03→07/09	←			24.0128-0176.1 428176	Ø 295 28 25,4 V + S
						24.0328-0176.1 528176	Ø 295 28 25,4 V PD
			→	nicht für Taxifahrzeuge		24.0110-0278.1 410278	Ø 300 10 8,3 + S
			→			24.0310-0278.1 510278	Ø 300 10 8,3 + S PD
			→	für Taxifahrzeuge		24.0122-0201.1 422201	Ø 300 22 19,4 V + S
E 240 T 4-matic (211.280)	130	07/03→07/09	←			24.0130-0179.1 430179	Ø 304 30 27,4 V
			→			24.0110-0278.1 410278	Ø 300 10 8,3 + S
						24.0310-0278.1 510278	Ø 300 10 8,3 + S PD
E 270 T CDI (211.216)	120	03/03→07/09	←			24.0128-0176.1 428176	Ø 295 28 25,4 V + S
E 270 T CDI (211.216)	130	03/03→07/09				24.0328-0176.1 528176	Ø 295 28 25,4 V PD
			→			24.0122-0201.1 422201	Ø 300 22 19,4 V + S
E 280 T (211.254)	170	03/05→07/09	←	05/05→;		24.0128-0142.1 428142	Ø 312 28 25,4 V
				für Fahrzeuge ohne Sportpaket / für Fahrzeuge ohne AMG-Sportpaket		24.0328-0142.1 528142	Ø 312 28 25,4 V PD
			←	05/05→;		24.0132-0153.1 432153	Ø 330 32 30 V• + S
				für Fahrzeuge mit Sportpaket / für Fahrzeuge mit AMG-Sportpaket			
			→	05/05→		24.0122-0201.1 422201	Ø 300 22 19,4 V + S
E 280 T 4-matic (211.292)	170	03/05→07/09	←	05/05→;		24.0130-0179.1 430179	Ø 304 30 27,4 V
E 280 T CDI 4-matic (211.284)	140	03/05→07/09		für Fahrzeuge ohne Sportpaket / für Fahrzeuge ohne AMG-Sportpaket			
E 320 T CDI 4-matic (211.289)	165	03/05→07/09	←	05/05→;		24.0132-0136.1 432136	Ø 330 32 30 V•
				für Fahrzeuge mit Sportpaket / für Fahrzeuge mit AMG-Sportpaket			







	kW			 	! #				
MERCEDES-BENZ - E-KLASSE Kombi (S211) 03/03→07/09									
 Bremsscheibe									
E 280 T 4-matic (211.292)	170	03/05→07/09	➔	05/05→		24.0122-0201.1 422201	Ø 300 22 19,4 V + S		
E 280 T CDI 4-matic (211.284)	140	03/05→07/09							
E 320 T CDI 4-matic (211.289)	165	03/05→07/09							
E 280 T CDI (211.220)	140	03/05→07/09	⬅	für Fahrzeuge ohne Sportpaket / für Fahrzeuge ohne AMG-Sportpaket	24.0128-0176.1 428176	Ø 295 28 25,4 V + S			
			⬅	für Fahrzeuge mit Sportpaket / für Fahrzeuge mit AMG-Sportpaket	24.0328-0176.1 528176	Ø 295 28 25,4 V PD			
			➔		24.0122-0201.1 422201	Ø 300 22 19,4 V + S			
E 280 T CDI (211.223)	130	05/04→07/09	⬅		24.0128-0142.1 428142	Ø 312 28 25,4 V			
E 320 T (211.265)	165	03/03→07/09			24.0328-0142.1 528142	Ø 312 28 25,4 V PD			
E 320 T CDI (211.222)	165	03/05→07/09							
E 320 T CDI (211.226)	150	03/03→07/09	➔		24.0122-0201.1 422201	Ø 300 22 19,4 V + S			
E 320 T 4-matic (211.282)	165	07/03→07/09	⬅		24.0130-0179.1 430179	Ø 304 30 27,4 V			
			➔		24.0122-0201.1 422201	Ø 300 22 19,4 V + S			
E 350 T 4-matic (211.287)	200	03/05→07/09	⬅	für Fahrzeuge ohne Sportpaket / für Fahrzeuge ohne AMG-Sportpaket	24.0130-0179.1 430179	Ø 304 30 27,4 V			
			⬅	für Fahrzeuge mit Sportpaket / für Fahrzeuge mit AMG-Sportpaket	24.0132-0136.1 432136	Ø 330 32 30 V•			
			➔		24.0122-0201.1 422201	Ø 300 22 19,4 V + S			
E 500 T (211.272)	285	04/06→07/09	⬅	für Fahrzeuge mit Sportpaket / für Fahrzeuge mit AMG-Sportpaket	24.0132-0138.1 432138	Ø 350 32 30 V• + S			
			⬅	für Fahrzeuge ohne Sportpaket / für Fahrzeuge ohne AMG-Sportpaket	24.0132-0139.1 432139	Ø 350 32 29,4 V + S			
			➔		24.0124-0236.1 424236	Ø 320 24 21,1 V + S			
E 500 T 4-matic (211.283)	225	10/03→07/09	⬅	für Fahrzeuge mit Sportpaket / für Fahrzeuge mit AMG-Sportpaket	24.0132-0136.1 432136	Ø 330 32 30 V•			
E 500 T 4-matic (211.290)	285	04/06→07/09	⬅	für Fahrzeuge ohne Sportpaket / für Fahrzeuge ohne AMG-Sportpaket	24.0132-0154.1 432154	Ø 330 32 29,4 V			
			➔		24.0122-0201.1 422201	Ø 300 22 19,4 V + S			
E 55 T AMG Kompressor (211.276)	350	07/03→07/09	⬅		24.0136-0102.1 436102	Ø 360 36 34 V•			
			➔		24.0126-0136.1 426136	Ø 330 26 24 V•			
E 63 AMG (211.277)	378	03/06→07/09	➔		24.0126-0136.1 426136	Ø 330 26 24 V•			
MERCEDES-BENZ - E-KLASSE Kombi (S212) 08/09→									
 Bremsbelagsatz, Scheibenbremse									
E 200 (212.234)	135	11/12→	⬅	03/13→; für Fahrzeuge ohne Sportpaket / für Fahrzeuge ohne AMG-Sportpaket	13.0460-2732.2 602732	TRW 24306 20,3 + WE / - WK + Zub			
					13.0470-2732.2 LD2732	TRW 24306 20,3 + WE / - WK + Zub Ceramic			
					13.0470-9000.2 LD9000	TRW 24306 20,3 + WE / - WK + Zub Ceramic			
		⬅	03/13→; für Fahrzeuge mit Sportpaket / für Fahrzeuge mit AMG-Sportpaket	13.0460-2734.2 602734	TRW 24310 19,0 + WE / - WK	TRW 24310 19,0 + WE / - WK Ceramic			
		➔	03/13→	13.0460-7259.2 607259	ATE 24862 16,7 + WE / - WK	ATE 24862 16,7 + WE / - WK Ceramic			
				13.0470-7259.2 LD7259	ATE 24862 16,7 + WE / - WK Ceramic				
				13.0470-9001.2 LD9001	ATE 24862 16,7 + WE / - WK Ceramic				
E 200 CDI / BlueTEC (212.205, 212.206)	100	11/09→	⬅	für Fahrzeuge ohne Sportpaket / für Fahrzeuge ohne AMG-Sportpaket	13.0460-2732.2 602732	TRW 24306 20,3 + WE / - WK + Zub			
			E 200 CGI (212.248)	135	11/09→		13.0470-2732.2 LD2732	TRW 24306 20,3 + WE / - WK + Zub Ceramic	
				130	05/15→				
				125	11/09→		13.0470-9000.2 LD9000	TRW 24306 20,3 + WE / - WK + Zub Ceramic	
			E 220 BlueTEC	130	05/15→				
E 220 CDI / BlueTEC (212.202, 212.201)	125	11/09→	⬅	für Fahrzeuge mit Sportpaket / für Fahrzeuge mit AMG-Sportpaket	13.0460-2734.2 602734	TRW 24310 19,0 + WE / - WK			
			➔		13.0460-7259.2 607259	ATE 24862 16,7 + WE / - WK			
					13.0470-7259.2 LD7259	ATE 24862 16,7 + WE / - WK Ceramic			
					13.0470-9001.2 LD9001	ATE 24862 16,7 + WE / - WK Ceramic			
E 220 BlueTEC 4-matic (212.211)	125	12/14→	⬅		13.0460-2734.2 602734	TRW 24310 19,0 + WE / - WK			











	kw			 	! #		
MERCEDES-BENZ - E-KLASSE Kombi (S212) 08/09 →							
 Bremsbelagsatz, Scheibenbremse							
E 250 CDI / BlueTEC (212.203, 212.204)	150	11/09 →	←			13.0470-2734.2 LD2734	TRW 24310 19,0 + WE / - WK Ceramic
E 250 CDI / BlueTEC 4-matic (212.282, 212.297)	150	07/10 →	→			13.0460-7259.2 607259	ATE 24862 16,7 + WE / - WK
E 250 CGI (212.247)	150	11/09 →				13.0470-7259.2 LD7259	ATE 24862 16,7 + WE / - WK Ceramic
E 300 (212.254)	170	11/09 →					
E 300 (212.255)	185	07/11 →				13.0470-9001.2 LD9001	ATE 24862 16,7 + WE / - WK Ceramic
E 300 4-matic (212.280)	185	07/11 →					
E 300 CDI / BlueTEC (212.227, 212.221)	170	11/09 →					
E 350 (212.259)	225	09/11 →					
E 350 4-matic (212.287)	200	11/09 →					
E 350 4-matic (212.288, 212.287)	225	09/11 →					
E 350 BlueTEC (212.224)	155	11/09 →					
E 350 CDI (212.223)	195	07/11 →					
E 350 CDI (212.225)	170	11/09 →					
E 350 CDI 4-matic (212.289)	170	11/09 →					
E 350 CDI 4-matic (212.293)	195	07/11 →					
E 350 CGI (212.257)	215	11/09 →					
E 220 CDI (212.202)	120	08/09 →	←	11/09 →; für Fahrzeuge ohne Sportpaket / für Fahrzeuge ohne AMG-Sportpaket		13.0460-2732.2 602732	TRW 24306 20,3 + WE / - WK + Zub
						13.0470-2732.2 LD2732	TRW 24306 20,3 + WE / - WK + Zub Ceramic
						13.0470-9000.2 LD9000	TRW 24306 20,3 + WE / - WK + Zub Ceramic
			←	11/09 →; für Fahrzeuge mit Sportpaket / für Fahr- zeuge mit AMG-Sportpaket		13.0460-2734.2 602734	TRW 24310 19,0 + WE / - WK
						13.0470-2734.2 LD2734	TRW 24310 19,0 + WE / - WK Ceramic
			→	11/09 →		13.0460-7259.2 607259	ATE 24862 16,7 + WE / - WK
						13.0470-7259.2 LD7259	ATE 24862 16,7 + WE / - WK Ceramic
						13.0470-9001.2 LD9001	ATE 24862 16,7 + WE / - WK Ceramic
E 250 (212.236)	155	11/12 →	←	03/13 →		13.0460-2734.2 602734	TRW 24310 19,0 + WE / - WK
						13.0470-2734.2 LD2734	TRW 24310 19,0 + WE / - WK Ceramic
			→	03/13 →		13.0460-7259.2 607259	ATE 24862 16,7 + WE / - WK
						13.0470-7259.2 LD7259	ATE 24862 16,7 + WE / - WK Ceramic
						13.0470-9001.2 LD9001	ATE 24862 16,7 + WE / - WK Ceramic
E 300 CDI (212.220)	150	12/09 → 12/10	←			13.0460-2734.2 602734	TRW 24310 19,0 + WE / - WK
						13.0470-2734.2 LD2734	TRW 24310 19,0 + WE / - WK Ceramic
E 300 Hybrid / BlueTEC Hybrid (212.298)	150	12/11 →	←	06/12 →		13.0460-2734.2 602734	TRW 24310 19,0 + WE / - WK
						13.0470-2734.2 LD2734	TRW 24310 19,0 + WE / - WK Ceramic
			→	06/12 →		13.0460-7259.2 607259	ATE 24862 16,7 + WE / - WK
						13.0470-7259.2 LD7259	ATE 24862 16,7 + WE / - WK Ceramic
						13.0470-9001.2 LD9001	ATE 24862 16,7 + WE / - WK Ceramic
E 350 (212.256)	200	08/09 →	←	11/09 →		13.0460-2734.2 602734	TRW 24310 19,0 + WE / - WK
						13.0470-2734.2 LD2734	TRW 24310 19,0 + WE / - WK Ceramic
			→	11/09 →		13.0460-7259.2 607259	ATE 24862 16,7 + WE / - WK
						13.0470-7259.2 LD7259	ATE 24862 16,7 + WE / - WK Ceramic
						13.0470-9001.2 LD9001	ATE 24862 16,7 + WE / - WK Ceramic
E 350 BlueTEC	185	11/12 →	←	01/13 →; für Fahrzeuge ohne Sportpaket / für Fahrzeuge ohne AMG-Sportpaket		13.0460-2734.2 602734	TRW 24310 19,0 + WE / - WK
E 350 BlueTEC 4-matic	185	11/12 →				13.0470-2734.2 LD2734	TRW 24310 19,0 + WE / - WK Ceramic
			←	01/13 →; für Fahrzeuge mit Sportpaket / für Fahr- zeuge mit AMG-Sportpaket		13.0460-4863.2 604863	BRE 24976 17,5 + WE / - WK
			→	01/13 →		13.0460-7259.2 607259	ATE 24862 16,7 + WE / - WK
						13.0470-7259.2 LD7259	ATE 24862 16,7 + WE / - WK Ceramic



















	kw			 	! #		
MERCEDES-BENZ - E-KLASSE Kombi (S212) 08/09 →							
 Bremsbelagsatz, Scheibenbremse							
E 350 BlueTEC E 350 BlueTEC 4-matic	185 185	11/12 → 11/12 →	➡	01/13 →		13.0470-9001.2 LD9001	ATE 24862 16,7 + WE / - WK Ceramic
E 350 BlueTEC (212.226) E 350 BlueTEC 4-matic (212.294)	190 190	07/14 → 07/14 →	←	für Fahrzeuge ohne Sportpaket / für Fahrzeuge ohne AMG-Sportpaket		13.0460-2734.2 602734 13.0470-2734.2 LD2734	TRW 24310 19,0 + WE / - WK Ceramic
			←	für Fahrzeuge mit Sportpaket / für Fahrzeuge mit AMG-Sportpaket		13.0460-4863.2 604863	BRE 24976 17,5 + WE / - WK
			➡			13.0460-7259.2 607259 13.0470-7259.2 LD7259 13.0470-9001.2 LD9001	ATE 24862 16,7 + WE / - WK Ceramic ATE 24862 16,7 + WE / - WK Ceramic ATE 24862 16,7 + WE / - WK Ceramic
E 400 E 400 4-matic E 400 4-matic (212.299) E 500 (212.272)	245 245 245 285	01/13 → 01/13 → 07/14 → 11/09 →	←			13.0460-4863.2 604863	BRE 24976 17,5 + WE / - WK
			➡			13.0460-7259.2 607259 13.0470-7259.2 LD7259 13.0470-9001.2 LD9001	ATE 24862 16,7 + WE / - WK Ceramic ATE 24862 16,7 + WE / - WK Ceramic ATE 24862 16,7 + WE / - WK Ceramic
E 400 (212.261) E 500 (212.273) E 500 4-matic (212.291)	245 300 300	07/14 → 09/11 → 09/11 →	➡			13.0460-7259.2 607259 13.0470-7259.2 LD7259 13.0470-9001.2 LD9001	ATE 24862 16,7 + WE / - WK Ceramic ATE 24862 16,7 + WE / - WK Ceramic ATE 24862 16,7 + WE / - WK Ceramic
Warnkontakt, Bremsbelagverschleiß							
E 200 (212.234)	135	11/12 →	←	03/13 →; für Fahrzeuge mit Sportpaket / für Fahrzeuge mit AMG-Sportpaket	1	24.8190-0410.2 620410	L= 97,5
			←	03/13 →; für Fahrzeuge ohne Sportpaket / für Fahrzeuge ohne AMG-Sportpaket	1	24.8190-0410.2 620410	L= 97,5
			➡	03/13 →	1	24.8190-0410.2 620410	L= 97,5
E 200 CDI / BlueTEC (212.205, 212.206) E 200 CGI (212.248) E 220 BlueTEC E 220 CDI / BlueTEC (212.202, 212.201)	100 135 130 125	11/09 → 11/09 → 05/15 → 11/09 →	←	für Fahrzeuge mit Sportpaket / für Fahrzeuge mit AMG-Sportpaket	1	24.8190-0410.2 620410	L= 97,5
			←	für Fahrzeuge ohne Sportpaket / für Fahrzeuge ohne AMG-Sportpaket	1	24.8190-0410.2 620410	L= 97,5
			➡		1	24.8190-0410.2 620410	L= 97,5
E 220 BlueTEC 4-matic (212.211) E 250 CDI / BlueTEC (212.203, 212.204) E 250 CDI / BlueTEC 4-matic (212.282, 212.297) E 250 CGI (212.247) E 300 (212.254) E 300 (212.255) E 300 4-matic (212.280) E 300 CDI / BlueTEC (212.227, 212.221) E 350 (212.259) E 350 4-matic (212.287) E 350 4-matic (212.288, 212.287) E 350 BlueTEC (212.224) E 350 CDI (212.223) E 350 CDI (212.225) E 350 CDI 4-matic (212.289) E 350 CDI 4-matic (212.293) E 350 CGI (212.257) E 500 (212.273) E 500 4-matic (212.291)	125 150 150 150 170 185 185 170 225 200 225 155 195 170 170 195 215 300 300	12/14 → 11/09 → 07/10 → 11/09 → 11/09 → 07/11 → 07/11 → 11/09 → 09/11 → 11/09 → 09/11 → 11/09 → 07/11 → 11/09 → 11/09 → 07/11 → 11/09 → 09/11 → 09/11 →	←		1	24.8190-0410.2 620410	L= 97,5
			➡		1	24.8190-0410.2 620410	L= 97,5
E 220 CDI (212.202)	120	08/09 →	←	11/09 →; für Fahrzeuge mit Sportpaket / für Fahrzeuge mit AMG-Sportpaket	1	24.8190-0410.2 620410	L= 97,5
			←	11/09 →; für Fahrzeuge ohne Sportpaket / für Fahrzeuge ohne AMG-Sportpaket	1	24.8190-0410.2 620410	L= 97,5
			➡	11/09 →	1	24.8190-0410.2 620410	L= 97,5
E 250 (212.236)	155	11/12 →	←	03/13 →	1	24.8190-0410.2 620410	L= 97,5
			➡	03/13 →	1	24.8190-0410.2 620410	L= 97,5
↓							











	kw			 	! #		
MERCEDES-BENZ - E-KLASSE Kombi (S212) 08/09 →							
Warnkontakt, Bremsbelagverschleiß							
E 300 CDI (212.220)	150	12/09 → 12/10	←		1	24.8190-0410.2 620410	L= 97,5
E 300 Hybrid / BlueTEC Hybrid (212.298)	150	12/11 →	←	06/12 →	1	24.8190-0410.2 620410	L= 97,5
			→	06/12 →	1	24.8190-0410.2 620410	L= 97,5
E 350 (212.256)	200	08/09 →	←	11/09 →	1	24.8190-0410.2 620410	L= 97,5
			→	11/09 →	1	24.8190-0410.2 620410	L= 97,5
E 350 BlueTEC E 350 BlueTEC 4-matic	185	11/12 →	←	01/13 →; für Fahrzeuge ohne Sportpaket / für Fahrzeuge ohne AMG-Sportpaket	1	24.8190-0410.2 620410	L= 97,5
	185	11/12 →	←	01/13 →; für Fahrzeuge mit Sportpaket / für Fahr- zeuge mit AMG-Sportpaket	2	24.8190-0410.2 620410	L= 97,5
			→	01/13 →	1	24.8190-0410.2 620410	L= 97,5
E 350 BlueTEC (212.226) E 350 BlueTEC 4-matic (212.294)	190	07/14 →	←	für Fahrzeuge mit Sportpaket / für Fahr- zeuge mit AMG-Sportpaket	2	24.8190-0410.2 620410	L= 97,5
	190	07/14 →	←	für Fahrzeuge ohne Sportpaket / für Fahrzeuge ohne AMG-Sportpaket	1	24.8190-0410.2 620410	L= 97,5
			→		1	24.8190-0410.2 620410	L= 97,5
E 400 E 400 (212.261) E 400 4-matic E 400 4-matic (212.299) E 500 (212.272)	245	01/13 →	←		2	24.8190-0410.2 620410	L= 97,5
	245	07/14 →	→		1	24.8190-0410.2 620410	L= 97,5
	245	01/13 →	→				
	245	07/14 →	→				
	285	11/09 →	→				
E 63 AMG (212.274) E 63 AMG (212.274) E 63 AMG 4-matic (212.292)	386	02/11 →	←	für Fahrzeuge ohne Keramikbremse	2	24.8190-0420.2 620420	L= 119
	410	02/11 →	→		1	24.8190-0420.2 620420	L= 119
	410	02/11 →	→				
E 63 AMG (212.275) E 63 AMG 4-matic (212.276)	430	02/13 →	←	04/13 →; für Fahrzeuge ohne Keramikbremse	2	24.8190-0420.2 620420	L= 119
	430	02/13 →	→	04/13 →	1	24.8190-0420.2 620420	L= 119
E 63 AMG (212.277)	386	08/09 →	←	11/09 →	1	24.8190-0420.2 620420	L= 119
			→	11/09 →	1	24.8190-0420.2 620420	L= 119
 Bremsscheibe							
E 200 (212.234)	135	11/12 →	←	03/13 →; für Fahrzeuge ohne Sportpaket / für Fahrzeuge ohne AMG-Sportpaket		24.0128-0155.1 428155 24.0328-0155.1 528155	Ø 295 28 25,4 V + S Ø 295 28 25,4 V + S PD
			←	03/13 →; für Fahrzeuge mit Sportpaket / für Fahr- zeuge mit AMG-Sportpaket		24.0132-0100.1 432100	Ø 322 32 30 V• + S
			→	03/13 →		24.0110-0278.1 410278 24.0310-0278.1 510278	Ø 300 10 8,3 + S Ø 300 10 8,3 + S PD
E 200 CDI / BlueTEC (212.205, 212.206) E 200 CGI (212.248) E 220 BlueTEC E 220 CDI / BlueTEC (212.202, 212.201)	100	11/09 →	←	für Fahrzeuge ohne Sportpaket / für Fahrzeuge ohne AMG-Sportpaket		24.0128-0155.1 428155 24.0328-0155.1 528155	Ø 295 28 25,4 V + S Ø 295 28 25,4 V + S PD
	135	11/09 →	←	für Fahrzeuge mit Sportpaket / für Fahr- zeuge mit AMG-Sportpaket		24.0132-0100.1 432100	Ø 322 32 30 V• + S
	130	05/15 →	←	für Fahrzeuge mit Sportpaket / für Fahr- zeuge mit AMG-Sportpaket		24.0110-0278.1 410278 24.0310-0278.1 510278	Ø 300 10 8,3 + S Ø 300 10 8,3 + S PD
	125	11/09 →	→			24.0110-0278.1 410278 24.0310-0278.1 510278	Ø 300 10 8,3 + S Ø 300 10 8,3 + S PD
				→			24.0110-0278.1 410278 24.0310-0278.1 510278
E 220 BlueTEC 4-matic (212.211) E 250 CDI / BlueTEC (212.203, 212.204) E 250 CDI / BlueTEC 4- matic (212.282, 212.297) E 250 CGI (212.247)	125	12/14 →	←	für Fahrzeuge mit Sportpaket / für Fahr- zeuge mit AMG-Sportpaket		24.0132-0100.1 432100	Ø 322 32 30 V• + S
	150	11/09 →	←	für Fahrzeuge ohne Sportpaket / für Fahrzeuge ohne AMG-Sportpaket		24.0132-0101.1 432101 24.0332-0101.1 532101	Ø 322 32 29,4 V + S Ø 322 32 29,4 V + S PD
	150	07/10 →	→			24.0110-0278.1 410278 24.0310-0278.1 510278	Ø 300 10 8,3 + S Ø 300 10 8,3 + S PD
	150	11/09 →	→			24.0110-0278.1 410278 24.0310-0278.1 510278	Ø 300 10 8,3 + S Ø 300 10 8,3 + S PD
				→			24.0110-0278.1 410278 24.0310-0278.1 510278
E 220 CDI (212.202)	120	08/09 →	←	11/09 →; für Fahrzeuge ohne Sportpaket / für Fahrzeuge ohne AMG-Sportpaket		24.0128-0155.1 428155 24.0328-0155.1 528155	Ø 295 28 25,4 V + S Ø 295 28 25,4 V + S PD
			←	11/09 →; für Fahrzeuge mit Sportpaket / für Fahr- zeuge mit AMG-Sportpaket		24.0132-0100.1 432100	Ø 322 32 30 V• + S
			→	11/09 →		24.0110-0278.1 410278 24.0310-0278.1 510278	Ø 300 10 8,3 + S Ø 300 10 8,3 + S PD
E 250 (212.236)	155	11/12 →	←	03/13 →; für Fahrzeuge mit Sportpaket / für Fahr- zeuge mit AMG-Sportpaket		24.0132-0100.1 432100	Ø 322 32 30 V• + S
			←	03/13 →; für Fahrzeuge ohne Sportpaket / für Fahrzeuge ohne AMG-Sportpaket		24.0132-0101.1 432101 24.0332-0101.1 532101	Ø 322 32 29,4 V + S Ø 322 32 29,4 V + S PD
			→	03/13 →		24.0110-0278.1 410278 24.0310-0278.1 510278	Ø 300 10 8,3 + S Ø 300 10 8,3 + S PD
↓							

	kw			 	! #		
MERCEDES-BENZ - E-KLASSE Kombi (S212) 08/09→							
Bremsscheibe							
E 300 (212.254)	170	11/09→	←	für Fahrzeuge mit Sportpaket / für Fahrzeuge mit AMG-Sportpaket		24.0132-0100.1 432100	Ø 322 32 30 V• + S
E 300 (212.255)	185	07/11→					
E 300 4-matic (212.280)	185	07/11→	←	für Fahrzeuge ohne Sportpaket / für Fahrzeuge ohne AMG-Sportpaket		24.0132-0101.1 432101	Ø 322 32 29,4 V + S
E 300 CDI / BlueTEC (212.227, 212.221)	170	11/09→				24.0332-0101.1 532101	Ø 322 32 29,4 V + S PD
E 350 (212.259)	225	09/11→	→			24.0122-0201.1 422201	Ø 300 22 19,4 V + S
E 350 4-matic (212.287)	200	11/09→					
E 350 4-matic (212.288, 212.287)	225	09/11→					
E 350 BlueTEC (212.224)	155	11/09→					
E 350 CDI (212.223)	195	07/11→					
E 350 CDI (212.225)	170	11/09→					
E 350 CDI 4-matic (212.289)	170	11/09→					
E 350 CDI 4-matic (212.293)	195	07/11→					
E 350 CGI (212.257)	215	11/09→					
E 300 Hybrid / BlueTEC Hybrid (212.298)	150	12/11→	←	06/12→; für Fahrzeuge mit Sportpaket / für Fahrzeuge mit AMG-Sportpaket		24.0132-0100.1 432100	Ø 322 32 30 V• + S
			←	06/12→; für Fahrzeuge ohne Sportpaket / für Fahrzeuge ohne AMG-Sportpaket		24.0132-0101.1 432101	Ø 322 32 29,4 V + S
						24.0332-0101.1 532101	Ø 322 32 29,4 V + S PD
			→	06/12→		24.0122-0201.1 422201	Ø 300 22 19,4 V + S
E 350 (212.256)	200	08/09→	←	11/09→; für Fahrzeuge mit Sportpaket / für Fahrzeuge mit AMG-Sportpaket		24.0132-0100.1 432100	Ø 322 32 30 V• + S
			←	11/09→; für Fahrzeuge ohne Sportpaket / für Fahrzeuge ohne AMG-Sportpaket		24.0132-0101.1 432101	Ø 322 32 29,4 V + S
						24.0332-0101.1 532101	Ø 322 32 29,4 V + S PD
			→	11/09→		24.0122-0201.1 422201	Ø 300 22 19,4 V + S
E 350 BlueTEC	185	11/12→	←	01/13→; für Fahrzeuge ohne Sportpaket / für Fahrzeuge ohne AMG-Sportpaket		24.0132-0101.1 432101	Ø 322 32 29,4 V + S
E 350 BlueTEC 4-matic	185	11/12→				24.0332-0101.1 532101	Ø 322 32 29,4 V + S PD
			←	01/13→; für Fahrzeuge mit Sportpaket / für Fahrzeuge mit AMG-Sportpaket		24.0132-0168.1 432168	Ø 344 32 30 V• + S
			→	01/13→		24.0122-0201.1 422201	Ø 300 22 19,4 V + S
E 350 BlueTEC (212.226)	190	07/14→	←	für Fahrzeuge ohne Sportpaket / für Fahrzeuge ohne AMG-Sportpaket		24.0132-0101.1 432101	Ø 322 32 29,4 V + S
E 350 BlueTEC 4-matic (212.294)	190	07/14→	←	für Fahrzeuge mit Sportpaket / für Fahrzeuge mit AMG-Sportpaket		24.0332-0101.1 532101	Ø 322 32 29,4 V + S PD
						24.0132-0168.1 432168	Ø 344 32 30 V• + S
			→			24.0122-0201.1 422201	Ø 300 22 19,4 V + S
E 400	245	01/13→	←			24.0132-0168.1 432168	Ø 344 32 30 V• + S
E 400 (212.261)	245	07/14→	→			24.0122-0201.1 422201	Ø 300 22 19,4 V + S
E 400 4-matic	245	01/13→	→				
E 400 4-matic (212.299)	245	07/14→					
E 500 (212.272)	285	11/09→	←			24.0132-0168.1 432168	Ø 344 32 30 V• + S
			→			24.0124-0236.1 424236	Ø 320 24 21,1 V + S
E 500 (212.273)	300	09/11→	←			24.0136-0108.1 436108	Ø 360 36 34 V• + S
E 500 4-matic (212.291)	300	09/11→	→			24.0124-0236.1 424236	Ø 320 24 21,1 V + S
MERCEDES-BENZ - E-KLASSE Kombi (S213) 07/16→							
Bremsbelagsatz, Scheibenbremse							
E 200 (213.242)	135	07/16→	←	für Fahrzeuge ohne AMG-Sportpaket		13.0460-2792.2 602792	TRW 22031 19,6 + WE / - WK
E 200 d (213.213)	110	10/16→				13.0470-2792.2 LD2792	TRW 22031 19,6 + WE / - WK Ceramic
E 220 d (213.204)	120	07/16→					
E 220 d (213.204)	143	07/16→	←	für Fahrzeuge mit AMG-Sportpaket		13.0460-4883.2 604883	BRE 22061 18,7 + WE / - WK
E 200 4-matic (213.243)	135	01/17→	←	für Fahrzeuge ohne AMG-Sportpaket		13.0460-2610.2 602610	TRW 22076 19,6 + WE / - WK
E 220 d 4-matic (213.205)	143	01/17→				13.0470-2610.2 LD2610	TRW 22076 19,6 + WE / - WK Ceramic
E 250 (213.245)	155	07/16→	←	für Fahrzeuge mit AMG-Sportpaket		13.0460-4883.2 604883	BRE 22061 18,7 + WE / - WK
E 350 d (213.233)	190	10/16→	←	für Fahrzeuge ohne AMG-Sportpaket		13.0460-4883.2 604883	BRE 22061 18,7 + WE / - WK
Warnkontakt, Bremsbelagverschleiß							
AMG E 43 4-matic (213.264)	295	10/16→	←		1	24.8190-0067.2 620067	L= 92,5
E 200 (213.242)	135	07/16→	→		1	24.8190-0067.2 620067	L= 92,5
E 200 4-matic (213.243)	135	01/17→					
E 200 d (213.213)	110	10/16→					
E 220 d (213.204)	120	07/16→					











	kW					! #		
MERCEDES-BENZ - E-KLASSE Kombi (S213) 07/16→								
Warnkontakt, Bremsbelagverschleiß								
E 220 d (213.204)	143	07/16→	←			1	24.8190-0067.2 620067	L= 92,5
E 220 d 4-matic (213.205)	143	01/17→	→			1	24.8190-0067.2 620067	L= 92,5
E 250 (213.245)	155	07/16→						
E 350 d (213.233)	190	10/16→						
E 350 d 4-matic (213.234)	190	06/17→						
E 400 4-matic (213.271)	245	10/16→						
MERCEDES-BENZ - G-KLASSE (W461) 09/89→								
 Bremsbelagsatz, Scheibenbremse								
230 GE (461.238, 461.239)	90	09/89→07/96	←	02/93→			13.0460-4401.2 604401	ATE 20784 18,0 + WE / - WK
230 GE (461)	92	06/93→07/00	←				13.0460-4401.2 604401	ATE 20784 18,0 + WE / - WK
290 GD/G 290 D (461.337, 461.338)	70	06/93→07/00						
G 300 CDI	135	04/10→						
G 270 CDI	115	01/03→	←				13.0460-4401.2 604401	ATE 20784 18,0 + WE / - WK
G 280 CDI (461.304, 461.346, 461.370, 461.334, 461.339...)	135	04/09→	→				13.0460-3990.2 603990	BOS 23021 18,9 + WE / - WK
G 290 TD (461.335, 461.336)	88	07/97→						
Warnkontakt, Bremsbelagverschleiß								
230 GE (461.238, 461.239)	90	09/89→07/96	←	02/93→		2	24.8190-0406.2 620406	L= 261
230 GE (461)	92	06/93→07/00	←			2	24.8190-0406.2 620406	L= 261
290 GD/G 290 D (461.337, 461.338)	70	06/93→07/00						
G 300 CDI	135	04/10→						
G 270 CDI	115	01/03→	←			2	24.8190-0406.2 620406	L= 261
G 280 CDI (461.304, 461.346, 461.370, 461.334, 461.339...)	135	04/09→	→			2	24.8190-0407.2 620407	L= 84 L= 185
G 290 TD (461.335, 461.336)	88	07/97→						
Zubehörsatz, Scheibenbremsbelag								
230 GE (461.238, 461.239)	90	09/89→07/96	←	02/93→			13.0460-0158.2 610158	ATE
230 GE (461)	92	06/93→07/00	←				13.0460-0158.2 610158	ATE
290 GD/G 290 D (461.337, 461.338)	70	06/93→07/00						
G 270 CDI	115	01/03→						
G 290 TD (461.335, 461.336)	88	07/97→						
 Bremsscheibe								
230 GE (461.238, 461.239)	90	09/89→07/96	←	02/93→			24.0116-0133.1 416133	Ø 303 16 13 + S
230 GE (461)	92	06/93→07/00	←				24.0116-0133.1 416133	Ø 303 16 13 + S
290 GD/G 290 D (461.337, 461.338)	70	06/93→07/00						
G 270 CDI	115	01/03→	←				24.0116-0133.1 416133	Ø 303 16 13 + S
G 290 TD (461.335, 461.336)	88	07/97→	→				24.0116-0110.1 416110	Ø 272 16 14 + S
G 280 CDI (461.304, 461.346, 461.370, 461.334, 461.339...)	135	04/09→	←				24.0116-0133.1 416133	Ø 303 16 13 + S
			→				24.0130-0217.1 430217	Ø 315 30 27,4 V + S
							24.0116-0110.1 416110	Ø 272 16 14 + S
G 300 CDI	135	04/10→	←				24.0116-0133.1 416133	Ø 303 16 13 + S
							24.0130-0217.1 430217	Ø 315 30 27,4 V + S
MERCEDES-BENZ - G-KLASSE (W463) 09/89→								
 Bremsbelagsatz, Scheibenbremse								
300 GE (463.227, 463.228)	128	06/90→08/97	←				13.0460-4401.2 604401	ATE 20784 18,0 + WE / - WK
350 Turbo GD (463.320, 463.321)	100	09/91→08/96						
G 36 AMG (463.230)	200	01/95→07/98						
G 270 CDI (463.322, 463.323)	115	10/01→	←				13.0460-4401.2 604401	ATE 20784 18,0 + WE / - WK
G 300 TD (463.330, 463.331)	130	08/96→07/00	→				13.0460-3990.2 603990	BOS 23021 18,9 + WE / - WK
G 320 (463.230, 463.231)	155	09/94→12/97						
↓								







	kW			 	! #		
MERCEDES-BENZ - G-KLASSE (W463) 09/89→							
 Bremsbelagsatz, Scheibenbremse							
G 320 (463.232, 463.233, 463.244, 463.245)	158	07/97→	←			13.0460-4401.2 604401	ATE 20784 18,0 + WE / - WK
			→			13.0460-3990.2 603990	BOS 23021 18,9 + WE / - WK
G 320 CDI (463.340, 463.341, 463.343)	165	09/06→					
G 350 CDI	155	07/11→					
G 350 d (463.348)	180	06/15→					
G 400 CDI (463.332, 463.333)	184	12/00→					
G 500 (463.202)	285	05/08→					
G 500 (463.247, 463.248, 463.249, 463.240, 463.241)	218	04/98→					
G 55 AMG (463.243, 463.246)	260	04/99→	←			13.0460-4401.2 604401	ATE 20784 18,0 + WE / - WK
G 55 AMG (463.270, 463.271)	350	06/04→	→	Achsnummer: 741.144		13.0460-3990.2 603990	BOS 23021 18,9 + WE / - WK
G 55 AMG (463.270, 463.271)	368	08/06→	→	Achsnummer: 742.606		13.0460-7219.2 607219	ATE 23923 17,6 + WE / - WK
G 55 AMG (463.270, 463.271)	373	08/08→					
G 63 AMG (463.273)	400	05/12→	→	06/12→		13.0460-7219.2 607219	ATE 23923 17,6 + WE / - WK
G 65 AMG	450	05/12→					
Warnkontakt, Bremsbelagsverschleiß							
300 GE (463.227, 463.228)	128	06/90→08/97	←		2	24.8190-0406.2 620406	L= 261
350 Turbo GD (463.320, 463.321)	100	09/91→08/96	←	V	2	24.8190-0411.2 620411	L= 72
G 36 AMG (463.230)	200	01/95→07/98					
G 270 CDI (463.322, 463.323)	115	10/01→	←		2	24.8190-0406.2 620406	L= 261
G 300 TD (463.330, 463.331)	130	08/96→07/00	←	V	2	24.8190-0411.2 620411	L= 72
G 320 (463.230, 463.231)	155	09/94→12/97	→		2	24.8190-0407.2 620407	L= 84 L= 185
G 320 (463.232, 463.233, 463.244, 463.245)	158	07/97→					
G 400 CDI (463.332, 463.333)	184	12/00→					
G 500 (463.247, 463.248, 463.249, 463.240, 463.241)	218	04/98→					
G 320 CDI (463.340, 463.341, 463.343)	165	09/06→	←		2	24.8190-0406.2 620406	L= 261
G 350 CDI	155	07/11→	→		2	24.8190-0407.2 620407	L= 84 L= 185
G 350 d (463.348)	180	06/15→					
G 500 (463.202)	285	05/08→					
G 55 AMG (463.243, 463.246)	260	04/99→	←		2	24.8190-0406.2 620406	L= 261
G 55 AMG (463.270, 463.271)	350	06/04→	←	V	2	24.8190-0411.2 620411	L= 72
G 55 AMG (463.270, 463.271)	368	08/06→	→	Achsnummer: 741.144	2	24.8190-0407.2 620407	L= 84 L= 185
G 55 AMG (463.270, 463.271)	373	08/08→	→	Achsnummer: 742.606	2	24.8190-0425.2 620425	L= 98
G 63 AMG (463.273)	400	05/12→	→	06/12→	2	24.8190-0425.2 620425	L= 98
G 65 AMG	450	05/12→					
Zubehörsatz, Scheibenbremsbelag							
300 GE (463.227, 463.228)	128	06/90→08/97	←			13.0460-0158.2 610158	ATE
350 Turbo GD (463.320, 463.321)	100	09/91→08/96					
G 270 CDI (463.322, 463.323)	115	10/01→					
G 300 TD (463.330, 463.331)	130	08/96→07/00					
G 320 (463.230, 463.231)	155	09/94→12/97					
G 320 (463.232, 463.233, 463.244, 463.245)	158	07/97→					
G 36 AMG (463.230)	200	01/95→07/98					
G 400 CDI (463.332, 463.333)	184	12/00→					
G 500 (463.247, 463.248, 463.249, 463.240, 463.241)	218	04/98→					
G 55 AMG (463.243, 463.246)	260	04/99→					
↓							











	kW			 	! #		
MERCEDES-BENZ - G-KLASSE (W463) 09/89→							
Zubehörsatz, Scheibenbremsbelag							
G 55 AMG (463.270, 463.271)	350	06/04→	←			13.0460-0158.2 610158	ATE
G 55 AMG (463.270, 463.271)	368	08/06→					
G 55 AMG (463.270, 463.271)	373	08/08→					
 Bremsscheibe							
300 GE (463.227, 463.228)	128	06/90→08/97	←			24.0116-0133.1 416133	Ø 303 16 13 + S
350 Turbo GD (463.320, 463.321)	100	09/91→08/96				24.0130-0217.1 430217	Ø 315 30 27,4 V + S
G 36 AMG (463.230)	200	01/95→07/98					
G 270 CDI (463.322, 463.323)	115	10/01→	←			24.0116-0133.1 416133	Ø 303 16 13 + S
G 300 TD (463.330, 463.331)	130	08/96→07/00	→			24.0130-0217.1 430217	Ø 315 30 27,4 V + S
G 320 (463.230, 463.231)	155	09/94→12/97				24.0116-0110.1 416110	Ø 272 16 14 + S
G 320 (463.232, 463.233, 463.244, 463.245)	158	07/97→					
G 320 CDI (463.340, 463.341, 463.343)	165	09/06→					
G 350 CDI	155	07/11→					
G 350 d (463.348)	180	06/15→					
G 400 CDI (463.332, 463.333)	184	12/00→					
G 500 (463.202)	285	05/08→					
G 500 (463.247, 463.248, 463.249, 463.240, 463.241)	218	04/98→					
G 55 AMG (463.243, 463.246)	260	04/99→	←			24.0116-0133.1 416133	Ø 303 16 13 + S
G 55 AMG (463.270, 463.271)	350	06/04→	→	Achsnnummer: 741.144		24.0130-0217.1 430217	Ø 315 30 27,4 V + S
G 55 AMG (463.270, 463.271)	368	08/06→				24.0116-0110.1 416110	Ø 272 16 14 + S
G 55 AMG (463.270, 463.271)	373	08/08→					
MERCEDES-BENZ - G-KLASSE Geländewagen offen (W463) 09/89→							
 Bremsbelagsatz, Scheibenbremse							
300 GD (463.307)	83	12/90→09/97	←			13.0460-4401.2 604401	ATE 20784 18,0 + WE / - WK
300 GE (463.207)	125	09/89→09/97					
320 GE (463.208)	155	09/94→11/97					
350 G Turbo-D (463.300)	100	09/91→09/97					
G 500	285	12/09→					
G 500 (463)	218	04/98→					
G 300 TD (463.308)	130	09/96→07/00	←			13.0460-4401.2 604401	ATE 20784 18,0 + WE / - WK
G 320 (463.209)	158	11/97→				13.0460-3990.2 603990	BOS 23021 18,9 + WE / - WK
G 350 CDI	155	07/11→	→				
G 400 CDI (463.309)	184	12/00→					
G 320 CDI (463.303)	165	09/06→	←	06/10→		13.0460-4401.2 604401	ATE 20784 18,0 + WE / - WK
			→			13.0460-3990.2 603990	BOS 23021 18,9 + WE / - WK
Warnkontakt, Bremsbelagverschleiß							
300 GD (463.307)	83	12/90→09/97	←		2	24.8190-0406.2 620406	L= 261
300 GE (463.207)	125	09/89→09/97					
320 GE (463.208)	155	09/94→11/97					
350 G Turbo-D (463.300)	100	09/91→09/97					
G 500	285	12/09→					
G 500 (463)	218	04/98→					
G 300 TD (463.308)	130	09/96→07/00	←		2	24.8190-0406.2 620406	L= 261
G 320 (463.209)	158	11/97→					
G 400 CDI (463.309)	184	12/00→	→		2	24.8190-0407.2 620407	L= 84 L= 185
G 320 CDI (463.303)	165	09/06→	←	06/10→	2	24.8190-0406.2 620406	L= 261
			→		2	24.8190-0407.2 620407	L= 84 L= 185
G 350 CDI	155	07/11→	←		2	24.8190-0406.2 620406	L= 261
			→		2	24.8190-0407.2 620407	L= 84 L= 185
Zubehörsatz, Scheibenbremsbelag							
300 GD (463.307)	83	12/90→09/97	←			13.0460-0158.2 610158	ATE
300 GE (463.207)	125	09/89→09/97					
320 GE (463.208)	155	09/94→11/97					
↓							











	kW					! #		
MERCEDES-BENZ - G-KLASSE Geländewagen offen (W463) 09/89→								
Zubehörsatz, Scheibenbremsbelag								
350 G Turbo-D (463.300)	100	09/91→09/97	←				13.0460-0158.2 610158	ATE
G 300 TD (463.308)	130	09/96→07/00						
G 320 (463.209)	158	11/97→						
G 400 CDI (463.309)	184	12/00→						
G 500	285	12/09→						
G 500 (463)	218	04/98→						
 Bremsscheibe								
300 GD (463.307)	83	12/90→09/97	←				24.0116-0133.1 416133	Ø 303 16 13 + S
300 GE (463.207)	125	09/89→09/97					24.0130-0217.1 430217	Ø 315 30 27,4 V + S
320 GE (463.208)	155	09/94→11/97						
350 G Turbo-D (463.300)	100	09/91→09/97						
G 500	285	12/09→						
G 500 (463)	218	04/98→						
G 300 TD (463.308)	130	09/96→07/00	←				24.0116-0133.1 416133	Ø 303 16 13 + S
G 320 (463.209)	158	11/97→					24.0130-0217.1 430217	Ø 315 30 27,4 V + S
G 320 CDI (463.303)	165	09/06→						
G 350 CDI	155	07/11→	→				24.0116-0110.1 416110	Ø 272 16 14 + S
G 400 CDI (463.309)	184	12/00→						
MERCEDES-BENZ - GLA-KLASSE (X156) 12/13→								
 Bremsbelagsatz, Scheibenbremse								
GLA 180 (156.942)	90	02/15→	←				13.0460-2779.2 602779	TRW 24869 19,3 + WE / - WK
GLA 180 CDI / d (156.912)	80	07/14→					13.0470-2779.2 LD2779	TRW 24869 19,3 + WE / - WK Ceramic
GLA 200 (156.943)	115	12/13→						
GLA 200 CDI / d (156.908)	100	12/13→	→	+ eFSB			13.0460-2786.2 602786	TRW 24848 18,3 + WE / - WK + Zub
GLA 200 CDI 4-matic (156.902)	100	12/13→					13.0470-2786.2 LD2786	TRW 24848 18,3 + WE / - WK + Zub Ceramic
GLA 220 CDI / d (156.903)	120	12/13→						
GLA 220 CDI / d 4-matic (156.905)	120	12/13→						
GLA 220 CDI (156.903)	125	12/13→						
GLA 220 CDI 4-matic (156.905)	125	12/13→						
GLA 220 d (156.903)	130	07/15→						
GLA 220 d 4-matic (156.905)	130	07/15→						
GLA 250 (156.944)	155	12/13→						
GLA 250 4-matic (156.946)	155	12/13→	←				13.0460-2779.2 602779	TRW 24869 19,3 + WE / - WK
							13.0470-2779.2 LD2779	TRW 24869 19,3 + WE / - WK Ceramic
Warnkontakt, Bremsbelagverschleiß								
AMG GLA 45 4-matic (156.952)	280	07/15→	←		1		24.8190-0067.2 620067	L= 92,5
GLA 180 (156.942)	90	02/15→						
GLA 180 CDI / d (156.912)	80	07/14→						
GLA 200 (156.943)	115	12/13→						
GLA 200 CDI / d (156.908)	100	12/13→						
GLA 200 CDI 4-matic (156.902)	100	12/13→						
GLA 220 CDI / d (156.903)	120	12/13→						
GLA 220 CDI / d 4-matic (156.905)	120	12/13→						
GLA 220 CDI (156.903)	125	12/13→						
GLA 220 CDI 4-matic (156.905)	125	12/13→						
GLA 220 d (156.903)	130	07/15→						
GLA 220 d 4-matic (156.905)	130	07/15→						
GLA 250 (156.944)	155	12/13→						
GLA 250 4-matic (156.946)	155	12/13→						
GLA 45 AMG 4-matic (156.952)	265	05/14→06/15						
 Bremsscheibe								
GLA 180 (156.942)	90	02/15→	←	für Fahrzeuge mit AMG-Sportpaket			24.0128-0262.1 428262	Ø 295 28 26 V• + S
GLA 180 CDI / d (156.912)	80	07/14→	←	für Fahrzeuge ohne AMG-Sportpaket			24.0128-0276.1 428276	Ø 295 28 25,4 V + S
			→				24.0110-0382.1 410382	Ø 295 10 8,3 + S
↓								





















	kW			 	! #		
MERCEDES-BENZ - GLA-KLASSE (X156) 12/13→							
 Bremsscheibe							
GLA 200 (156.943)	115	12/13→	←	für Fahrzeuge mit Sportpaket		24.0128-0262.1 428262	Ø 295 28 26 V• + S
			←	für Fahrzeuge ohne AMG-Sportpaket		24.0128-0276.1 428276	Ø 295 28 25,4 V + S
			→			24.0110-0382.1 410382	Ø 295 10 8,3 + S
GLA 200 CDI / d (156.908)	100	12/13→	←	für Fahrzeuge mit AMG-Sportpaket		24.0128-0262.1 428262	Ø 295 28 26 V• + S
			←	für Fahrzeuge ohne AMG-Sportpaket		24.0128-0275.1 428275	Ø 295 28 25,4 V + S
GLA 200 CDI 4-matic (156.902)	100	12/13→	→			24.0110-0382.1 410382	Ø 295 10 8,3 + S
GLA 220 CDI / d (156.903)	120	12/13→	←	für Fahrzeuge ohne AMG-Sportpaket		24.0128-0275.1 428275	Ø 295 28 25,4 V + S
GLA 220 CDI / d 4-matic (156.905)	120	12/13→	←	für Fahrzeuge mit AMG-Sportpaket		24.0130-0238.1 430238	Ø 320 30 28 V• + S
GLA 220 CDI (156.903)	125	12/13→	→			24.0110-0382.1 410382	Ø 295 10 8,3 + S
GLA 220 CDI 4-matic (156.905)	125	12/13→					
GLA 220 d (156.903)	130	07/15→					
GLA 220 d 4-matic (156.905)	130	07/15→					
GLA 250 (156.944)	155	12/13→	←	für Fahrzeuge ohne AMG-Sportpaket		24.0130-0237.1 430237	Ø 320 30 28 V + S
			←	für Fahrzeuge mit AMG-Sportpaket		24.0130-0238.1 430238	Ø 320 30 28 V• + S
			→			24.0110-0382.1 410382	Ø 295 10 8,3 + S
GLA 250 4-matic (156.946)	155	12/13→	←			24.0130-0238.1 430238	Ø 320 30 28 V• + S
			→	+ USA; Made in China-made		24.0110-0382.1 410382	Ø 295 10 8,3 + S
MERCEDES-BENZ - GLC (X253) 06/15→							
 Bremsbelagsatz, Scheibenbremse							
220 d 4-matic (253.905)	120	06/15→	←	für Fahrzeuge ohne AMG-Sportpaket		13.0460-4883.2 604883	BRE 22061 18,7 + WE / - WK
220 d 4-matic (253.905)	125	06/15→					
250 4-matic (253.946)	155	06/15→					
250 d 4-matic (253.909)	150	06/15→					
300 4-matic (253.949)	180	07/15→					
350 d 4-matic (253.925)	190	10/16→					
Warnkontakt, Bremsbelagverschleiß							
220 d 4-matic (253.905)	120	06/15→	←		1	24.8190-0067.2 620067	L= 92,5
220 d 4-matic (253.905)	125	06/15→	→		1	24.8190-0067.2 620067	L= 92,5
250 4-matic (253.946)	155	06/15→					
250 d 4-matic (253.909)	150	06/15→					
300 4-matic (253.949)	180	07/15→					
350 d 4-matic (253.925)	190	10/16→					
350 e 4-matic (253.954)	155	01/16→					
350 e 4-matic (253.954)	235	01/16→					
AMG 43 4-matic (253.964)	270	04/16→					
MERCEDES-BENZ - GLC Coupe (C253) 06/16→							
 Bremsbelagsatz, Scheibenbremse							
220 d 4-matic (253.303, 253.305)	120	06/16→	←	für Fahrzeuge ohne AMG-Sportpaket; - USA		13.0460-4883.2 604883	BRE 22061 18,7 + WE / - WK
220 d 4-matic (253.303, 253.305)	125	06/16→					
250 4-matic (253.346)	155	06/16→					
250 d 4-matic (253.309)	150	06/16→					
300 4-matic (253.349)	180	10/16→					
350 d 4-matic (253.325)	190	10/16→					
Warnkontakt, Bremsbelagverschleiß							
220 d 4-matic (253.303, 253.305)	120	06/16→	←	für Fahrzeuge mit AMG-Sportpaket	1	24.8190-0067.2 620067	L= 92,5
220 d 4-matic (253.303, 253.305)	125	06/16→	←	für Fahrzeuge ohne AMG-Sportpaket	1	24.8190-0067.2 620067	L= 92,5
250 4-matic (253.346)	155	06/16→	→		1	24.8190-0067.2 620067	L= 92,5
250 d 4-matic (253.309)	150	06/16→					
300 4-matic (253.349)	180	10/16→					
350 d 4-matic (253.325)	190	10/16→					
350 e 4-matic (253.354)	155	10/16→	→		1	24.8190-0067.2 620067	L= 92,5
350 e 4-matic (253.354)	235	10/16→					
AMG 43 4-matic (253.364)	270	10/16→	←		1	24.8190-0067.2 620067	L= 92,5
			→		1	24.8190-0067.2 620067	L= 92,5
MERCEDES-BENZ - GLE (W166) 04/15→							
 Bremsbelagsatz, Scheibenbremse							
250 d (166.006)	150	04/15→	←			13.0460-7282.2 607282	ATE 25190 21,3 - WK / + WK
↓							









	kW			 	! #		
MERCEDES-BENZ - GLE (W166) 04/15→							
Bremsbelagsatz, Scheibenbremse							
250 d 4-matic (166.004) 350 d 4-matic (166.024)	150 190	04/15→ 04/15→	←			13.0470-7282.2 LD7282	ATE 25190 21,3 - WK / + WK Ceramic
			→	für Fahrzeuge ohne AMG-Sportpaket; - USA		13.0460-2781.2 602781 13.0470-2781.2 LD2781	TRW 25215 18,6 + WE / - WK + Zub TRW 25215 18,6 + WE / - WK + Zub Ceramic
			→	für Fahrzeuge mit AMG-Sportpaket; - USA		13.0460-2782.2 602782 13.0470-2782.2 LD2782	TRW + WE / - WK + Zub TRW + WE / - WK + Zub Ceramic
320 4-matic (166.062)	200	10/15→	←	für Fahrzeuge ohne AMG-Sportpaket		13.0460-7282.2 607282 13.0470-7282.2 LD7282	ATE 25190 21,3 - WK / + WK Ceramic ATE 25190 21,3 - WK / + WK Ceramic
			←	für Fahrzeuge mit AMG-Sportpaket		13.0460-7283.2 607283	ATE 25531 19,3 + WE / - WK
			→			13.0460-2782.2 602782 13.0470-2782.2 LD2782	TRW + WE / - WK + Zub TRW + WE / - WK + Zub Ceramic
400 4-matic (166.056)	245	04/15→	←	für Fahrzeuge ohne AMG-Sportpaket		13.0460-7282.2 607282	ATE 25190 21,3 - WK / + WK
			←	für Fahrzeuge mit AMG-Sportpaket		13.0460-7283.2 607283	ATE 25531 19,3 + WE / - WK
			→			13.0460-2782.2 602782 13.0470-2782.2 LD2782	TRW + WE / - WK + Zub TRW + WE / - WK + Zub Ceramic
450 AMG 4-matic (166.064) AMG 43 4-matic (166.064)	270 270	10/15→04/16 05/16→	←	für Fahrzeuge ohne Sportpaket		13.0460-7283.2 607283	ATE 25531 19,3 + WE / - WK
			→	für Fahrzeuge ohne Sportpaket		13.0460-2782.2 602782 13.0470-2782.2 LD2782	TRW + WE / - WK + Zub TRW + WE / - WK + Zub Ceramic
500 4-matic (166.073) 500 e 4-matic (166.063) 500 e 4-matic (166.063)	320 245 325	04/15→ 04/15→ 04/15→	←			13.0460-7283.2 607283	ATE 25531 19,3 + WE / - WK
			→			13.0460-2782.2 602782 13.0470-2782.2 LD2782	TRW + WE / - WK + Zub TRW + WE / - WK + Zub Ceramic
AMG 63 4-matic (166.074) AMG 63 4-matic (166.074)	386 410	04/15→05/17 04/15→	←			13.0460-4839.2 604839	BRE 24455 16,8 + WE / - WK
Warnkontakt, Bremsbelagverschleiß							
250 d (166.006) 250 d 4-matic (166.004) 320 4-matic (166.062) 350 d 4-matic (166.024) 400 4-matic (166.056) 500 4-matic (166.073) 500 e 4-matic (166.063) 500 e 4-matic (166.063)	150 150 200 190 245 320 245 325	04/15→ 04/15→ 10/15→ 04/15→ 04/15→ 04/15→ 04/15→ 04/15→	←	<input type="checkbox"/>	1	24.8190-0425.2 620425	L= 98
			→		1	24.8190-0410.2 620410	L= 97,5
450 AMG 4-matic (166.064) AMG 43 4-matic (166.064)	270 270	10/15→04/16 05/16→	←	für Fahrzeuge mit Sportpaket	1	24.8190-0420.2 620420	L= 119
			←	für Fahrzeuge ohne Sportpaket	1	24.8190-0425.2 620425	L= 98
			→	für Fahrzeuge ohne Sportpaket	1	24.8190-0410.2 620410	L= 97,5
			→	für Fahrzeuge mit Sportpaket	1	24.8190-0410.2 620410	L= 97,5
AMG 63 4-matic (166.074) AMG 63 4-matic (166.074) AMG 63 S 4-matic (166.075)	386 410 430	04/15→05/17 04/15→ 04/15→	←		1	24.8190-0420.2 620420	L= 119
			→		1	24.8190-0410.2 620410	L= 97,5
Bremsscheibe							
250 d (166.006) 250 d 4-matic (166.004) 350 d 4-matic (166.024)	150 150 190	04/15→ 04/15→ 04/15→	←	für Fahrzeuge ohne AMG-Sportpaket		24.0132-0178.1 432178	Ø 330 32 29,4 V + S
			←	für Fahrzeuge mit AMG-Sportpaket		24.0132-0179.1 432179	Ø 350 32 29,4 V• + S
			→	für Fahrzeuge ohne AMG-Sportpaket		24.0114-0119.1 414119	Ø 325 14 11,4 + S
			→	für Fahrzeuge mit AMG-Sportpaket		24.0122-0288.1 422288	Ø 330 22 19,4 V + S
320 4-matic (166.062) 400 4-matic (166.056)	200 245	10/15→ 04/15→	←	+ USA; für Fahrzeuge ohne AMG-Sportpaket		24.0132-0178.1 432178	Ø 330 32 29,4 V + S
			←	+ USA; für Fahrzeuge mit AMG-Sportpaket		24.0132-0179.1 432179	Ø 350 32 29,4 V• + S
			←	- USA; für Fahrzeuge ohne AMG-Sportpaket		24.0132-0184.1 432184	Ø 350 32 29,4 V + S
			→	für Fahrzeuge ohne AMG-Sportpaket		24.0122-0288.1 422288	Ø 330 22 19,4 V + S
			→	für Fahrzeuge mit AMG-Sportpaket		24.0122-0296.1 422296	Ø 345 22 19,4 V + S
450 AMG 4-matic (166.064) AMG 43 4-matic (166.064)	270 270	10/15→04/16 05/16→	→	für Fahrzeuge ohne Sportpaket		24.0122-0296.1 422296	Ø 345 22 19,4 V + S
500 4-matic (166.073)	320	04/15→	→			24.0122-0296.1 422296	Ø 345 22 19,4 V + S

	kw			 	! #		
MERCEDES-BENZ - GLE (W166) 04/15→							
 Bremsscheibe							
500 e 4-matic (166.063)	245	04/15→	➔			24.0122-0296.1 422296	Ø 345 22 19,4 V + S
500 e 4-matic (166.063)	325	04/15→					
MERCEDES-BENZ - GLE Coupe (C292) 03/15→							
 Bremsbelagsatz, Scheibenbremse							
350 d 4-matic (292.323, 292.324)	190	03/15→	←			13.0460-7282.2 607282	ATE 25190 21,3 - WK / + WK
			←			13.0470-7282.2 LD7282	ATE 25190 21,3 - WK / + WK Ceramic
			➔	für Fahrzeuge ohne AMG-Sportpaket		13.0460-2781.2 602781	TRW 25215 18,6 + WE / - WK + Zub
			➔			13.0470-2781.2 LD2781	TRW 25215 18,6 + WE / - WK + Zub Ceramic
			➔	für Fahrzeuge mit AMG-Sportpaket		13.0460-2782.2 602782	TRW + WE / - WK + Zub
			➔			13.0470-2782.2 LD2782	TRW + WE / - WK + Zub Ceramic
400 4-matic (292.356)	245	03/15→	←	für Fahrzeuge ohne AMG-Sportpaket		13.0460-7282.2 607282	ATE 25190 21,3 - WK / + WK
			←	für Fahrzeuge mit AMG-Sportpaket		13.0460-7283.2 607283	ATE 25531 19,3 + WE / - WK
			➔			13.0460-2782.2 602782	TRW + WE / - WK + Zub
			➔			13.0470-2782.2 LD2782	TRW + WE / - WK + Zub Ceramic
450 AMG 4-matic (292.364)	270	03/15→04/16	←			13.0460-7283.2 607283	ATE 25531 19,3 + WE / - WK
AMG 43 4-matic (292.364)	270	05/16→	➔			13.0460-2782.2 602782	TRW + WE / - WK + Zub
			➔			13.0470-2782.2 LD2782	TRW + WE / - WK + Zub Ceramic
500 4-matic (292.373)	335	10/15→	←			13.0460-7283.2 607283	ATE 25531 19,3 + WE / - WK
			➔	für Fahrzeuge ohne Sportpaket		13.0460-2782.2 602782	TRW + WE / - WK + Zub
			➔			13.0470-2782.2 LD2782	TRW + WE / - WK + Zub Ceramic
Warnkontakt, Bremsbelagverschleiß							
350 d 4-matic (292.323, 292.324)	190	03/15→	←	<input type="checkbox"/>		24.8190-0425.2 620425	L= 98
			➔		für Fahrzeuge mit AMG-Sportpaket	1 24.8190-0410.2 620410	L= 97,5
			➔		für Fahrzeuge ohne AMG-Sportpaket	1 24.8190-0410.2 620410	L= 97,5
400 4-matic (292.356)	245	03/15→	←	<input type="checkbox"/>		24.8190-0425.2 620425	L= 98
450 AMG 4-matic (292.364)	270	03/15→04/16	➔			1 24.8190-0410.2 620410	L= 97,5
AMG 43 4-matic (292.364)	270	05/16→					
500 4-matic (292.373)	335	10/15→	←	<input type="checkbox"/>		24.8190-0425.2 620425	L= 98
			➔		für Fahrzeuge ohne Sportpaket	1 24.8190-0410.2 620410	L= 97,5
			➔		für Fahrzeuge mit Sportpaket	1 24.8190-0410.2 620410	L= 97,5
AMG 63 4-matic (292.374)	410	03/15→	←	<input type="checkbox"/>		24.8190-0420.2 620420	L= 119
AMG 63 S 4-matic (292.375)	430	03/15→	➔			1 24.8190-0410.2 620410	L= 97,5
 Bremsscheibe							
350 d 4-matic (292.323, 292.324)	190	03/15→	←	für Fahrzeuge ohne AMG-Sportpaket		24.0132-0178.1 432178	Ø 330 32 29,4 V + S
			←	für Fahrzeuge mit AMG-Sportpaket		24.0132-0179.1 432179	Ø 350 32 29,4 V + S
			➔	für Fahrzeuge ohne AMG-Sportpaket		24.0114-0119.1 414119	Ø 325 14 11,4 + S
			➔	für Fahrzeuge mit AMG-Sportpaket		24.0122-0288.1 422288	Ø 330 22 19,4 V + S
400 4-matic (292.356)	245	03/15→	←	für Fahrzeuge ohne AMG-Sportpaket		24.0132-0184.1 432184	Ø 350 32 29,4 V + S
			➔	für Fahrzeuge ohne AMG-Sportpaket		24.0122-0288.1 422288	Ø 330 22 19,4 V + S
			➔	für Fahrzeuge mit AMG-Sportpaket		24.0122-0296.1 422296	Ø 345 22 19,4 V + S
450 AMG 4-matic (292.364)	270	03/15→04/16	➔			24.0122-0296.1 422296	Ø 345 22 19,4 V + S
AMG 43 4-matic (292.364)	270	05/16→					
500 4-matic (292.373)	335	10/15→	➔	für Fahrzeuge ohne Sportpaket		24.0122-0296.1 422296	Ø 345 22 19,4 V + S
MERCEDES-BENZ - GLK-KLASSE (X204) 06/08→							
 Bremsbelagsatz, Scheibenbremse							
200 (204.934)	135	08/13→06/15	←			13.0460-3852.2 603852	BOS 24867 20,7 + WE / - WK + Zub
200 CDI (204.901)	100	12/13→06/15					
200 CDI (204.901)	105	07/10→06/15					
250 (204.936)	155	08/13→06/15					13.0470-3852.2 LD3852
250 4-matic (204.937)	155	08/13→06/15	➔				
250 CDI 4-matic (204.982, 204.904)	150	09/09→06/15					13.0460-7257.2 607257









	kW					! #		
MERCEDES-BENZ - GLK-KLASSE (X204) 06/08→								
 Bremsbelagsatz, Scheibenbremse								
300 4-matic	185	09/09→06/15	➔				13.0470-7257.2 LD7257	ATE 24253 18,0 + WE / - WK Ceramic
300 4-matic (204.981)	170	07/09→04/11						
350 (204.956)	200	04/09→06/15						
350 CDI 4-matic (204.992)	165	07/09→01/10						
350 CDI 4-matic (204.992)	170	02/10→05/10						
350 CDI 4-matic (204.993)	195	07/12→06/15						
220 CDI (204.902)	120	12/08→06/15	➔	04/09→			13.0460-3852.2 603852	BOS 24867 20,7 + WE / - WK + Zub
220 CDI (204.902)	125	12/08→06/15						
220 CDI 4-matic (204.984, 204.997)	125	12/08→06/15					13.0470-3852.2 LD3852	BOS 24867 20,7 + WE / - WK + Zub Ceramic
220 CDI 4-matic (204.984)	120	12/08→06/15	➔	04/09→			13.0460-7257.2 607257	ATE 24253 18,0 + WE / - WK Ceramic
							13.0470-7257.2 LD7257	ATE 24253 18,0 + WE / - WK Ceramic
280 4-matic (204.981)	170	06/08→06/09	➔	09/08→			13.0460-3852.2 603852	BOS 24867 20,7 + WE / - WK + Zub
320 CDI 4-matic (204.983)	165	06/08→06/15						
350 4-matic (204.987)	200	06/08→04/11					13.0470-3852.2 LD3852	BOS 24867 20,7 + WE / - WK + Zub Ceramic
350 4-matic (204.988)	225	06/08→06/15	➔	09/08→			13.0460-7257.2 607257	ATE 24253 18,0 + WE / - WK Ceramic
							13.0470-7257.2 LD7257	ATE 24253 18,0 + WE / - WK Ceramic
 Warnkontakt, Bremsbelagverschleiß								
200 (204.934)	135	08/13→06/15	➔			1	24.8190-0410.2 620410	L= 97,5
200 CDI (204.901)	100	12/13→06/15						
200 CDI (204.901)	105	07/10→06/15	➔			1	24.8190-0410.2 620410	L= 97,5
250 (204.936)	155	08/13→06/15						
250 4-matic (204.937)	155	08/13→06/15						
250 CDI 4-matic (204.982, 204.904)	150	09/09→06/15						
300 4-matic	185	09/09→06/15						
300 4-matic (204.981)	170	07/09→04/11						
350 (204.956)	200	04/09→06/15						
350 CDI 4-matic (204.992)	165	07/09→01/10						
350 CDI 4-matic (204.992)	170	02/10→05/10						
350 CDI 4-matic (204.993)	195	07/12→06/15						
220 CDI (204.902)	120	12/08→06/15	➔	04/09→		1	24.8190-0410.2 620410	L= 97,5
220 CDI (204.902)	125	12/08→06/15						
220 CDI 4-matic (204.984, 204.997)	125	12/08→06/15	➔	04/09→		1	24.8190-0410.2 620410	L= 97,5
220 CDI 4-matic (204.984)	120	12/08→06/15						
280 4-matic (204.981)	170	06/08→06/09	➔	09/08→		1	24.8190-0410.2 620410	L= 97,5
320 CDI 4-matic (204.983)	165	06/08→06/15	➔	09/08→		1	24.8190-0410.2 620410	L= 97,5
350 4-matic (204.987)	200	06/08→04/11						
350 4-matic (204.988)	225	06/08→06/15						
 Bremsscheibe								
200 (204.934)	135	08/13→06/15	➔				24.0132-0144.1 432144	Ø 330 32 29,4 V + S
200 CDI (204.901)	100	12/13→06/15					24.0332-0144.1 532144	Ø 330 32 29,4 V + S PD
200 CDI (204.901)	105	07/10→06/15	➔				24.0122-0201.1 422201	Ø 300 22 19,4 V + S
250 (204.936)	155	08/13→06/15						
250 4-matic (204.937)	155	08/13→06/15						
250 CDI 4-matic (204.982, 204.904)	150	09/09→06/15						
300 4-matic	185	09/09→06/15						
300 4-matic (204.981)	170	07/09→04/11						
350 (204.956)	200	04/09→06/15						
350 CDI 4-matic (204.992)	165	07/09→01/10						
350 CDI 4-matic (204.992)	170	02/10→05/10						
350 CDI 4-matic (204.993)	195	07/12→06/15						
220 CDI (204.902)	120	12/08→06/15	➔	04/09→			24.0132-0144.1 432144	Ø 330 32 29,4 V + S
220 CDI (204.902)	125	12/08→06/15					24.0332-0144.1 532144	Ø 330 32 29,4 V + S PD
220 CDI 4-matic (204.984, 204.997)	125	12/08→06/15	➔	04/09→			24.0122-0201.1 422201	Ø 300 22 19,4 V + S
220 CDI 4-matic (204.984)	120	12/08→06/15						
280 4-matic (204.981)	170	06/08→06/09	➔	09/08→			24.0132-0144.1 432144	Ø 330 32 29,4 V + S
320 CDI 4-matic (204.983)	165	06/08→06/15					24.0332-0144.1 532144	Ø 330 32 29,4 V + S PD
↓								







	kW					! #		
MERCEDES-BENZ - GLK-KLASSE (X204) 06/08 →								
Bremsscheibe								
350 4-matic (204.987)	200	06/08→04/11	➔	09/08→			24.0122-0201.1 422201	Ø 300 22 19,4 V + S
350 4-matic (204.988)	225	06/08→06/15						
MERCEDES-BENZ - GL-KLASSE (X164) 09/06 →								
Bremsbelagsatz, Scheibenbremse								
GL 320 CDI / 350 BlueTEC 4-matic (164.824, 164.825)	155	12/09→	←	→ 06/12; nicht für Fahrzeuge mit verstärkter Bremse			13.0460-7220.2 607220	ATE 23922 21,0 + WE / - WK
GL 350 CDI 4-matic (164.822)	165	05/09→	←	→ 06/12; für Fahrzeuge mit verstärkter Bremse			13.0460-7271.2 607271	ATE 24151 21,0 + WE / - WK
GL 350 CDI 4-matic (164.823)	195	10/10→	➔	→ 06/12			13.0460-7219.2 607219 13.0470-7219.2 LD7219	ATE 23923 17,6 + WE / - WK ATE 23923 17,6 + WE / - WK Ceramic
GL 320 CDI 4-matic (164.822)	165	09/06→05/09	←	nicht für Fahrzeuge mit verstärkter Bremse			13.0460-7220.2 607220	ATE 23922 21,0 + WE / - WK
			←	für Fahrzeuge mit verstärkter Bremse			13.0460-7271.2 607271	ATE 24151 21,0 + WE / - WK
			➔				13.0460-7219.2 607219 13.0470-7219.2 LD7219	ATE 23923 17,6 + WE / - WK ATE 23923 17,6 + WE / - WK Ceramic
GL 420 CDI 4-matic (164.828)	225	09/06→05/09	←				13.0460-7271.2 607271	ATE 24151 21,0 + WE / - WK
			➔				13.0460-7219.2 607219 13.0470-7219.2 LD7219	ATE 23923 17,6 + WE / - WK ATE 23923 17,6 + WE / - WK Ceramic
GL 450 4-matic (164.871)	250	09/06→	←	→ 06/12			13.0460-7271.2 607271	ATE 24151 21,0 + WE / - WK
GL 450 CDI 4-matic (164.828)	225	05/09→	➔	→ 06/12			13.0460-7219.2 607219 13.0470-7219.2 LD7219	ATE 23923 17,6 + WE / - WK ATE 23923 17,6 + WE / - WK Ceramic
GL 500 4-matic (164.886)	285	09/06→						
Warnkontakt, Bremsbelagverschleiß								
GL 320 CDI / 350 BlueTEC 4-matic (164.824, 164.825)	155	12/09→	←	→ 06/12	1	24.8190-0425.2 620425		L= 98
GL 350 CDI 4-matic (164.822)	165	05/09→	➔	→ 06/12	1	24.8190-0425.2 620425		L= 98
GL 350 CDI 4-matic (164.823)	195	10/10→						
GL 450 4-matic (164.871)	250	09/06→						
GL 450 CDI 4-matic (164.828)	225	05/09→						
GL 500 4-matic (164.886)	285	09/06→						
GL 320 CDI 4-matic (164.822)	165	09/06→05/09	←		1	24.8190-0425.2 620425		L= 98
GL 420 CDI 4-matic (164.828)	225	09/06→05/09	➔		1	24.8190-0425.2 620425		L= 98
Bremsscheibe								
GL 320 CDI / 350 BlueTEC 4-matic (164.824, 164.825)	155	12/09→	←	→ 06/12; nicht für Fahrzeuge mit verstärkter Bremse			24.0132-0157.1 432157	Ø 350 32 29,4 V + S
GL 350 CDI 4-matic (164.822)	165	05/09→	←	→ 06/12; für Fahrzeuge mit verstärkter Bremse			24.0132-0167.1 432167	Ø 375 32 29,4 V + S
GL 350 CDI 4-matic (164.823)	195	10/10→	➔	→ 06/12			24.0122-0226.1 422226	Ø 330 22 19,4 V + S
GL 320 CDI 4-matic (164.822)	165	09/06→05/09	←	nicht für Fahrzeuge mit verstärkter Bremse			24.0132-0157.1 432157	Ø 350 32 29,4 V + S
			←	für Fahrzeuge mit verstärkter Bremse			24.0132-0167.1 432167	Ø 375 32 29,4 V + S
			➔				24.0122-0226.1 422226	Ø 330 22 19,4 V + S
GL 420 CDI 4-matic (164.828)	225	09/06→05/09	←				24.0132-0167.1 432167	Ø 375 32 29,4 V + S
			➔				24.0122-0226.1 422226	Ø 330 22 19,4 V + S
GL 450 4-matic (164.871)	250	09/06→	←	→ 06/12			24.0132-0167.1 432167	Ø 375 32 29,4 V + S
GL 450 CDI 4-matic (164.828)	225	05/09→	➔	→ 06/12			24.0122-0226.1 422226	Ø 330 22 19,4 V + S
GL 500 4-matic (164.886)	285	09/06→						







	kw			 	! #			
MERCEDES-BENZ - GL-KLASSE (X166) 07/12→								
 Bremsbelagsatz, Scheibenbremse								
GL 350 CDI / BlueTec 4-matic (166.823, 166.824)	190	07/12→	←	für Fahrzeuge ohne AMG-Sportpaket	13.0460-7282.2	607282	ATE 25190 21,3 - WK / + WK	
			←	für Fahrzeuge mit AMG-Sportpaket	13.0470-7282.2	LD2782	ATE 25190 21,3 - WK / + WK Ceramic	
			→		13.0460-2782.2	602782	TRW + WE / - WK + Zub	
			→		13.0470-2782.2	LD2782	TRW + WE / - WK + Zub Ceramic	
GL 400 4-matic (166.856)	245	08/13→	←	für Fahrzeuge ohne AMG-Sportpaket	13.0460-7282.2	607282	ATE 25190 21,3 - WK / + WK	
			←	für Fahrzeuge mit AMG-Sportpaket	13.0460-7283.2	607283	ATE 25531 19,3 + WE / - WK	
			→		13.0460-2782.2	602782	TRW + WE / - WK + Zub	
			→		13.0470-2782.2	LD2782	TRW + WE / - WK + Zub Ceramic	
GL 500 4-matic (166.873)	320	07/12→	←		13.0460-7283.2	607283	ATE 25531 19,3 + WE / - WK	
			→		13.0460-2782.2	602782	TRW + WE / - WK + Zub	
			→		13.0470-2782.2	LD2782	TRW + WE / - WK + Zub Ceramic	
GL 63 AMG 4-matic (166.874)	410	07/12→	←		13.0460-4839.2	604839	BRE 24455 16,8 + WE / - WK	
Warnkontakt, Bremsbelagverschleiß								
GL 350 CDI / BlueTec 4-matic (166.823, 166.824)	190	07/12→	←	<input type="checkbox"/>	1	24.8190-0425.2	620425	L= 98
	245	08/13→	→		1	24.8190-0410.2	620410	L= 97,5
GL 400 4-matic (166.856)	245	08/13→	→					
GL 500 4-matic (166.873)	320	07/12→	→					
GL 63 AMG 4-matic (166.874)	410	07/12→	←	<input type="checkbox"/>	1	24.8190-0420.2	620420	L= 119
			→		1	24.8190-0410.2	620410	L= 97,5
 Bremsscheibe								
GL 350 CDI / BlueTec 4-matic (166.823, 166.824)	190	07/12→	←	für Fahrzeuge ohne AMG-Sportpaket	24.0132-0184.1	432184	∅ 350 32 29,4 V + S	
	245	08/13→	→	für Fahrzeuge ohne AMG-Sportpaket	24.0122-0296.1	422296	∅ 345 22 19,4 V + S	
GL 400 4-matic (166.856)	245	08/13→	→					
MERCEDES-BENZ - GLS (X166) 11/15→								
 Bremsbelagsatz, Scheibenbremse								
350 d 4-matic (166.824)	190	11/15→	←	für Fahrzeuge ohne AMG-Sportpaket	13.0460-7282.2	607282	ATE 25190 21,3 - WK / + WK	
			←	für Fahrzeuge mit AMG-Sportpaket	13.0470-7282.2	LD2782	ATE 25190 21,3 - WK / + WK Ceramic	
			→		13.0460-2782.2	602782	TRW + WE / - WK + Zub	
			→		13.0470-2782.2	LD2782	TRW + WE / - WK + Zub Ceramic	
400 4-matic (166.856)	245	11/15→	←	für Fahrzeuge ohne AMG-Sportpaket	13.0460-7282.2	607282	ATE 25190 21,3 - WK / + WK	
			←	für Fahrzeuge mit AMG-Sportpaket	13.0460-7283.2	607283	ATE 25531 19,3 + WE / - WK	
			→		13.0460-2782.2	602782	TRW + WE / - WK + Zub	
			→		13.0470-2782.2	LD2782	TRW + WE / - WK + Zub Ceramic	
500 4-matic (166.873)	335	11/15→	←		13.0460-7283.2	607283	ATE 25531 19,3 + WE / - WK	
			→		13.0460-2782.2	602782	TRW + WE / - WK + Zub	
			→		13.0470-2782.2	LD2782	TRW + WE / - WK + Zub Ceramic	
Warnkontakt, Bremsbelagverschleiß								
350 d 4-matic (166.824)	190	11/15→	←	<input type="checkbox"/>	1	24.8190-0425.2	620425	L= 98
	245	11/15→	→		1	24.8190-0410.2	620410	L= 97,5
400 4-matic (166.856)	245	11/15→	→					
500 4-matic (166.873)	335	11/15→	→					
AMG 63 4-matic (166.875, 166.874)	430	11/15→	←	<input type="checkbox"/>	1	24.8190-0420.2	620420	L= 119
			→		1	24.8190-0410.2	620410	L= 97,5
 Bremsscheibe								
350 d 4-matic (166.824)	190	11/15→	←	für Fahrzeuge ohne AMG-Sportpaket	24.0132-0184.1	432184	∅ 350 32 29,4 V + S	
	245	11/15→	→	für Fahrzeuge ohne AMG-Sportpaket	24.0122-0296.1	422296	∅ 345 22 19,4 V + S	
400 4-matic (166.856)	245	11/15→	→					
MERCEDES-BENZ - M-KLASSE (W163) 02/98→06/05								
 Bremsbelagsatz, Scheibenbremse								
ML 230 (163.136)	110	02/98→06/05	←	03/98→	13.0460-8004.2	608004	23193 16,4 + WK + Zub	
			→	03/98→ 11/98	13.0460-8005.2	608005	23189 16,7 + WK + Zub	
			→	12/98→	13.0460-8007.2	608007	23189 16,7 + WK	
↓								

	kw			 	! #		
MERCEDES-BENZ - M-KLASSE (W163) 02/98→06/05							
 Bremsbelagsatz, Scheibenbremse							
ML 270 CDI (163.113)	120	12/99→06/05	←	X754620→		13.0460-4984.2 604984	BRE 23271 17,4 + WE / - WK
						13.0470-4984.2 LD4984	BRE 23271 17,4 + WE / - WK Ceramic
			←	A289560→		13.0460-4984.2 604984	BRE 23271 17,4 + WE / - WK
						13.0470-4984.2 LD4984	BRE 23271 17,4 + WE / - WK Ceramic
			←	→ A289559		13.0460-8004.2 608004	23193 16,4 + WK + Zub
			←	→ X754619		13.0460-8004.2 608004	23193 16,4 + WK + Zub
			→	X754620→		13.0460-4977.2 604977	BRE 23157 15,8 + WE / - WK + Zub
						13.0470-4977.2 LD4977	BRE 23157 15,8 + WE / - WK + Zub Ceramic
ML 320 (163.154)	160	02/98→08/02	←	X754620→		13.0460-4984.2 604984	BRE 23271 17,4 + WE / - WK
						13.0470-4984.2 LD4984	BRE 23271 17,4 + WE / - WK Ceramic
			←	A289560→		13.0460-4984.2 604984	BRE 23271 17,4 + WE / - WK
						13.0470-4984.2 LD4984	BRE 23271 17,4 + WE / - WK Ceramic
			←	03/98→; → X754619		13.0460-8004.2 608004	23193 16,4 + WK + Zub
			←	03/98→; → A289559		13.0460-8004.2 608004	23193 16,4 + WK + Zub
			→	X754620→		13.0460-4977.2 604977	BRE 23157 15,8 + WE / - WK + Zub
						13.0470-4977.2 LD4977	BRE 23157 15,8 + WE / - WK + Zub Ceramic
ML 350	173	02/03→06/05	←			13.0460-4984.2 604984	BRE 23271 17,4 + WE / - WK
						13.0470-4984.2 LD4984	BRE 23271 17,4 + WE / - WK Ceramic
			→			13.0460-4977.2 604977	BRE 23157 15,8 + WE / - WK + Zub
						13.0470-4977.2 LD4977	BRE 23157 15,8 + WE / - WK + Zub Ceramic
			←			13.0460-4984.2 604984	BRE 23271 17,4 + WE / - WK
						13.0470-4984.2 LD4984	BRE 23271 17,4 + WE / - WK Ceramic
			→			13.0460-4977.2 604977	BRE 23157 15,8 + WE / - WK + Zub
						13.0470-4977.2 LD4977	BRE 23157 15,8 + WE / - WK + Zub Ceramic
ML 350 (163.157)	180	08/02→06/05	←	09/02→		13.0460-4984.2 604984	BRE 23271 17,4 + WE / - WK
						13.0470-4984.2 LD4984	BRE 23271 17,4 + WE / - WK Ceramic
			→	09/02→		13.0460-4977.2 604977	BRE 23157 15,8 + WE / - WK + Zub
						13.0470-4977.2 LD4977	BRE 23157 15,8 + WE / - WK + Zub Ceramic
ML 400 CDI (163.128) ML 500 (163.175) ML 55 AMG (163.174)	184 215 255	09/01→06/05 09/01→06/05 02/00→06/05	←			13.0460-4984.2 604984	BRE 23271 17,4 + WE / - WK
						13.0470-4984.2 LD4984	BRE 23271 17,4 + WE / - WK Ceramic
			→			13.0460-4977.2 604977	BRE 23157 15,8 + WE / - WK + Zub
						13.0470-4977.2 LD4977	BRE 23157 15,8 + WE / - WK + Zub Ceramic
ML 430 (163.172)	200	02/98→06/05	←	A145273→		13.0460-4984.2 604984	BRE 23271 17,4 + WE / - WK
						13.0470-4984.2 LD4984	BRE 23271 17,4 + WE / - WK Ceramic
			←	X707756→		13.0460-4984.2 604984	BRE 23271 17,4 + WE / - WK
						13.0470-4984.2 LD4984	BRE 23271 17,4 + WE / - WK Ceramic
			←	09/98→; → X707755		13.0460-8004.2 608004	23193 16,4 + WK + Zub
			←	09/98→; → A145272		13.0460-8004.2 608004	23193 16,4 + WK + Zub
			→	X707756→		13.0460-4977.2 604977	BRE 23157 15,8 + WE / - WK + Zub
						13.0470-4977.2 LD4977	BRE 23157 15,8 + WE / - WK + Zub Ceramic









↓









	kw				! #		
MERCEDES-BENZ - M-KLASSE (W163) 02/98→06/05							
 Bremsbelagsatz, Scheibenbremse							
ML 430 (163.172)	200	02/98→06/05	➔	A145273→		13.0460-4977.2 604977	BRE 23157 15,8 + WE / - WK + Zub
						13.0470-4977.2 LD4977	BRE 23157 15,8 + WE / - WK + Zub Ceramic
			➔	09/98→ 11/98		13.0460-8005.2 608005	23189 16,7 + WK + Zub
			➔	12/98→; → A145272		13.0460-8007.2 608007	23189 16,7 + WK
			➔	12/98→; → X707755		13.0460-8007.2 608007	23189 16,7 + WK
Warnkontakt, Bremsbelagverschleiß							
ML 270 CDI (163.113)	120	12/99→06/05	←	A289560→	2	24.8190-0412.2 620412	L= 114
ML 320 (163.154)	160	02/98→08/02	←	X754620→	2	24.8190-0412.2 620412	L= 114
			➔	A289560→	2	24.8190-0411.2 620411	L= 72
			➔	X754620→	2	24.8190-0411.2 620411	L= 72
ML 350	173	02/03→06/05	←		2	24.8190-0412.2 620412	L= 114
ML 400 CDI (163.128)	184	09/01→06/05	➔		2	24.8190-0411.2 620411	L= 72
ML 500 (163.175)	215	09/01→06/05					
ML 55 AMG (163.174)	255	02/00→06/05					
ML 350 (163.157)	180	08/02→06/05	←	09/02→	2	24.8190-0412.2 620412	L= 114
			➔	09/02→	2	24.8190-0411.2 620411	L= 72
ML 430 (163.172)	200	02/98→06/05	←	A145273→	2	24.8190-0412.2 620412	L= 114
			←	X707756→	2	24.8190-0412.2 620412	L= 114
			➔	A145273→	2	24.8190-0411.2 620411	L= 72
			➔	X707756→	2	24.8190-0411.2 620411	L= 72
Zubehörsatz, Scheibenbremsbelag							
ML 270 CDI (163.113)	120	12/99→06/05	←	X754620→		13.0460-0269.2 610269	
ML 320 (163.154)	160	02/98→08/02	←	A289560→		13.0460-0269.2 610269	
ML 350	173	02/03→06/05	←			13.0460-0269.2 610269	
ML 400 CDI (163.128)	184	09/01→06/05					
ML 500 (163.175)	215	09/01→06/05					
ML 55 AMG (163.174)	255	02/00→06/05					
ML 350 (163.157)	180	08/02→06/05	←	09/02→		13.0460-0269.2 610269	
ML 430 (163.172)	200	02/98→06/05	←	A145273→		13.0460-0269.2 610269	
			←	X707756→		13.0460-0269.2 610269	
 Bremsscheibe							
ML 230 (163.136)	110	02/98→06/05	←	03/98→		24.0126-0116.1 426116	Ø 303 26 23 V
			➔	03/98→		24.0115-0111.1 415111	Ø 285 15 13
ML 270 CDI (163.113)	120	12/99→06/05	←	→ A289559		24.0126-0116.1 426116	Ø 303 26 23 V
			←	→ X754619		24.0126-0116.1 426116	Ø 303 26 23 V
			←	A289560→		24.0132-0114.1 432114	Ø 345 31,9 30 V
			←	X754620→		24.0132-0114.1 432114	Ø 345 31,9 30 V
			➔	X754620→		24.0114-0111.1 414111	Ø 331 13,9 12,3
			➔	A289560→		24.0114-0111.1 414111	Ø 331 13,9 12,3
			➔	→ A289559		24.0115-0111.1 415111	Ø 285 15 13
			➔	→ X754619		24.0115-0111.1 415111	Ø 285 15 13
ML 320 (163.154)	160	02/98→08/02	←	03/98→; → A289559		24.0126-0116.1 426116	Ø 303 26 23 V
			←	03/98→; → X754619		24.0126-0116.1 426116	Ø 303 26 23 V
			←	A289560→		24.0132-0114.1 432114	Ø 345 31,9 30 V
			←	X754620→		24.0132-0114.1 432114	Ø 345 31,9 30 V
			➔	X754620→		24.0114-0111.1 414111	Ø 331 13,9 12,3
			➔	A289560→		24.0114-0111.1 414111	Ø 331 13,9 12,3
			➔	03/98→; → X754619		24.0115-0111.1 415111	Ø 285 15 13
			➔	03/98→; → A289559		24.0115-0111.1 415111	Ø 285 15 13
ML 350	173	02/03→06/05	←			24.0132-0114.1 432114	Ø 345 31,9 30 V
ML 400 CDI (163.128)	184	09/01→06/05	➔			24.0114-0111.1 414111	Ø 331 13,9 12,3
ML 500 (163.175)	215	09/01→06/05					
ML 55 AMG (163.174)	255	02/00→06/05					
ML 350 (163.157)	180	08/02→06/05	←	09/02→		24.0132-0114.1 432114	Ø 345 31,9 30 V
↓							







	kw			 	! #		
MERCEDES-BENZ - M-KLASSE (W163) 02/98→06/05							
Bremsscheibe							
ML 350 (163.157)	180	08/02→06/05	➔	09/02→		24.0114-0111.1 414111	Ø 331 13,9 12,3
ML 430 (163.172)	200	02/98→06/05	➔	09/98→; → X707755		24.0126-0116.1 426116	Ø 303 26 23 V
			➔	09/98→; → A145272		24.0126-0116.1 426116	Ø 303 26 23 V
			➔	A145273→		24.0132-0114.1 432114	Ø 345 31,9 30 V
			➔	X707756→		24.0132-0114.1 432114	Ø 345 31,9 30 V
			➔	A145273→		24.0114-0111.1 414111	Ø 331 13,9 12,3
			➔	X707756→		24.0114-0111.1 414111	Ø 331 13,9 12,3
			➔	09/98→; → A145272		24.0115-0111.1 415111	Ø 285 15 13
			➔	09/98→; → X707755		24.0115-0111.1 415111	Ø 285 15 13
MERCEDES-BENZ - M-KLASSE (W164) 07/05→12/11							
Bremsbelagsatz, Scheibenbremse							
ML 280 CDI 4-matic (164.120)	140	07/05→07/09	➔			13.0460-7220.2 607220	ATE 23922 21,0 + WE / - WK
ML 320 CDI 4-matic (164.122)	165	07/05→07/09	➔			13.0470-7220.2 LD7220	ATE 23922 21,0 + WE / - WK Ceramic
			➔			13.0460-7219.2 607219	ATE 23923 17,6 + WE / - WK Ceramic
			➔			13.0470-7219.2 LD7219	ATE 23923 17,6 + WE / - WK Ceramic
ML 300 4-matic (164.182)	170	03/10→	➔	→ 05/11		13.0460-7220.2 607220	ATE 23922 21,0 + WE / - WK
ML 300 CDI 4-matic (164.120)	140	07/09→12/11	➔			13.0470-7220.2 LD7220	ATE 23922 21,0 + WE / - WK Ceramic
ML 300 CDI 4-matic (164.121)	150	02/10→12/11	➔	→ 05/11		13.0460-7219.2 607219	ATE 23923 17,6 + WE / - WK
ML 350 4-matic (164.186)	200	07/05→12/11	➔			13.0470-7219.2 LD7219	ATE 23923 17,6 + WE / - WK Ceramic
ML 350 CDI 4-matic (164.122)	165	07/09→12/11	➔				
ML 350 CDI 4-matic (164.125)	155	09/09→12/11	➔				
ML 350 CDI 4-matic (164.125)	170	02/10→12/11	➔				
ML 420 CDI 4-matic (164.128)	225	02/06→09/09	➔	04/06→		13.0460-7220.2 607220	ATE 23922 21,0 + WE / - WK
			➔	04/06→		13.0460-7219.2 607219	ATE 23923 17,6 + WE / - WK
						13.0470-7219.2 LD7219	ATE 23923 17,6 + WE / - WK Ceramic
ML 450 CDI 4-matic (164.128)	225	09/09→12/11	➔	→ 05/11		13.0460-7220.2 607220	ATE 23922 21,0 + WE / - WK
ML 500 4-matic (164.172)	285	12/07→12/11	➔	→ 05/11		13.0460-7219.2 607219	ATE 23923 17,6 + WE / - WK
ML 500 4-matic (164.175)	225	07/05→12/11	➔			13.0470-7219.2 LD7219	ATE 23923 17,6 + WE / - WK Ceramic
Warnkontakt, Bremsbelagverschleiß							
ML 280 CDI 4-matic (164.120)	140	07/05→07/09	➔		1	24.8190-0425.2 620425	L= 98
ML 320 CDI 4-matic (164.122)	165	07/05→07/09	➔		1	24.8190-0425.2 620425	L= 98
ML 300 4-matic (164.182)	170	03/10→	➔	→ 05/11	1	24.8190-0425.2 620425	L= 98
ML 300 CDI 4-matic (164.120)	140	07/09→12/11	➔	→ 05/11	1	24.8190-0425.2 620425	L= 98
ML 300 CDI 4-matic (164.121)	150	02/10→12/11	➔				
ML 350 4-matic (164.186)	200	07/05→12/11	➔				
ML 350 CDI 4-matic (164.122)	165	07/09→12/11	➔				
ML 350 CDI 4-matic (164.125)	155	09/09→12/11	➔				
ML 350 CDI 4-matic (164.125)	170	02/10→12/11	➔				
ML 450 CDI 4-matic (164.128)	225	09/09→12/11	➔				
ML 500 4-matic (164.172)	285	12/07→12/11	➔				
ML 500 4-matic (164.175)	225	07/05→12/11	➔				
ML 63 AMG 4-matic (164.177)	375	01/06→12/11	➔				
ML 420 CDI 4-matic (164.128)	225	02/06→09/09	➔	04/06→	1	24.8190-0425.2 620425	L= 98
			➔	04/06→	1	24.8190-0425.2 620425	L= 98









	kw				! #		
MERCEDES-BENZ - M-KLASSE (W164) 07/05→12/11							
Bremsscheibe							
ML 280 CDI 4-matic (164.120)	140	07/05→07/09	←	passend für Felgengröße [Zoll]: 18		24.0132-0157.1 432157	Ø 350 32 29,4 V + S
ML 320 CDI 4-matic (164.122)	165	07/05→07/09	←	nicht für Felgengröße [Zoll]: 18		24.0132-0158.1 432158	Ø 330 32 29,4 V + S
						24.0332-0158.1 532158	Ø 330 32 29,4 V + S PD
			→	nicht für Felgengröße [Zoll]: 18		24.0114-0114.1 414114	Ø 330 14 11,4 + S
			→	passend für Felgengröße [Zoll]: 18		24.0122-0226.1 422226	Ø 330 22 19,4 V + S
ML 300 4-matic (164.182)	170	03/10→	←	→ 05/11; passend für Felgengröße [Zoll]: 18		24.0132-0157.1 432157	Ø 350 32 29,4 V + S
ML 300 CDI 4-matic (164.120)	140	07/09→12/11	←	→ 05/11; nicht für Felgengröße [Zoll]: 18		24.0132-0158.1 432158	Ø 330 32 29,4 V + S
ML 300 CDI 4-matic (164.121)	150	02/10→12/11				24.0332-0158.1 532158	Ø 330 32 29,4 V + S PD
ML 350 4-matic (164.186)	200	07/05→12/11	→	→ 05/11; nicht für Felgengröße [Zoll]: 18		24.0114-0114.1 414114	Ø 330 14 11,4 + S
ML 350 CDI 4-matic (164.122)	165	07/09→12/11	→	→ 05/11; passend für Felgengröße [Zoll]: 18		24.0122-0226.1 422226	Ø 330 22 19,4 V + S
ML 350 CDI 4-matic (164.125)	155	09/09→12/11					
ML 350 CDI 4-matic (164.125)	170	02/10→12/11					
ML 450 CDI 4-matic (164.128)	225	09/09→12/11					
ML 500 4-matic (164.172)	285	12/07→12/11					
ML 500 4-matic (164.175)	225	07/05→12/11					
ML 420 CDI 4-matic (164.128)	225	02/06→09/09	←	04/06→; passend für Felgengröße [Zoll]: 18		24.0132-0157.1 432157	Ø 350 32 29,4 V + S
			←	04/06→; nicht für Felgengröße [Zoll]: 18		24.0132-0158.1 432158	Ø 330 32 29,4 V + S
						24.0332-0158.1 532158	Ø 330 32 29,4 V + S PD
			→	04/06→; nicht für Felgengröße [Zoll]: 18		24.0114-0114.1 414114	Ø 330 14 11,4 + S
			→	04/06→; passend für Felgengröße [Zoll]: 18		24.0122-0226.1 422226	Ø 330 22 19,4 V + S
MERCEDES-BENZ - M-KLASSE (W166) 06/11→							
Bremsbelagsatz, Scheibenbremse							
ML 250 CDI / BlueTEC 4-matic (166.004, 166.003)	150	06/11→	←			13.0460-7282.2 607282	ATE 25190 21,3 - WK / + WK
ML 300 4-matic (166.055)	185	04/14→	→	für Fahrzeuge ohne AMG-Sportpaket; - USA		13.0470-7282.2 LD7282	ATE 25190 21,3 - WK / + WK Ceramic
ML 350 BlueTEC 4-matic (166.024)	190	06/11→				13.0460-2781.2 602781	TRW 25215 18,6 + WE / - WK + Zub
ML 350 CDI 4-matic (166.023)	170	06/11→	→	für Fahrzeuge mit AMG-Sportpaket; - USA		13.0470-2781.2 LD2781	TRW 25215 18,6 + WE / - WK + Zub Ceramic
			→			13.0460-2782.2 602782	TRW + WE / - WK + Zub
						13.0470-2782.2 LD2782	TRW + WE / - WK + Zub Ceramic
ML 350 4-matic (166.057)	225	06/11→	←	für Fahrzeuge ohne AMG-Sportpaket		13.0460-7282.2 607282	ATE 25190 21,3 - WK / + WK
			←	für Fahrzeuge mit AMG-Sportpaket		13.0470-7282.2 LD7282	ATE 25190 21,3 - WK / + WK Ceramic
			→			13.0460-2782.2 602782	TRW + WE / - WK + Zub
						13.0470-2782.2 LD2782	TRW + WE / - WK + Zub Ceramic
ML 400 4-matic (166.056)	245	08/13→	←	für Fahrzeuge ohne AMG-Sportpaket		13.0460-7282.2 607282	ATE 25190 21,3 - WK / + WK
			←	für Fahrzeuge mit AMG-Sportpaket		13.0460-7283.2 607283	ATE 25531 19,3 + WE / - WK
			→			13.0460-2782.2 602782	TRW + WE / - WK + Zub
						13.0470-2782.2 LD2782	TRW + WE / - WK + Zub Ceramic
ML 500 4-matic (166.073)	300	02/12→	←			13.0460-7283.2 607283	ATE 25531 19,3 + WE / - WK
			→			13.0460-2782.2 602782	TRW + WE / - WK + Zub
						13.0470-2782.2 LD2782	TRW + WE / - WK + Zub Ceramic
ML 63 AMG 4-matic (166.074)	386	11/11→	←	04/12→		13.0460-4839.2 604839	BRE 24455 16,8 + WE / - WK
ML 63 AMG 4-matic (166.074)	410	11/11→					
Warnkontakt, Bremsbelagverschleiß							
ML 250 CDI / BlueTEC 4-matic (166.004, 166.003)	150	06/11→	←		1	24.8190-0425.2 620425	L= 98
ML 300 4-matic (166.055)	185	04/14→	→		1	24.8190-0410.2 620410	L= 97,5
ML 350 4-matic (166.057)	225	06/11→					
↓							



















	kw			 	! #		
MERCEDES-BENZ - M-KLASSE (W166) 06/11→							
Warnkontakt, Bremsbelagverschleiß							
ML 350 BlueTEC 4-matic (166.024)	190	06/11→	←	☐	1	24.8190-0425.2 620425	L= 98
ML 350 CDI 4-matic (166.023)	170	06/11→	→		1	24.8190-0410.2 620410	L= 97,5
ML 400 4-matic (166.056)	245	08/13→					
ML 500 4-matic (166.073)	300	02/12→					
ML 63 AMG 4-matic (166.074)	386	11/11→	←	04/12→	1	24.8190-0420.2 620420	L= 119
ML 63 AMG 4-matic (166.074)	410	11/11→	→	04/12→	1	24.8190-0410.2 620410	L= 97,5
 Brems Scheibe							
ML 250 CDI / BlueTEC 4-matic (166.004, 166.003)	150	06/11→	←	für Fahrzeuge ohne AMG-Sportpaket		24.0132-0178.1 432178	Ø 330 32 29,4 V + S
			←	für Fahrzeuge mit AMG-Sportpaket		24.0132-0179.1 432179	Ø 350 32 29,4 V• + S
ML 350 BlueTEC 4-matic (166.024)	190	06/11→	→	→ L 174198; für Fahrzeuge ohne AMG-Sportpaket		24.0114-0119.1 414119	Ø 325 14 11,4 + S
ML 350 CDI 4-matic (166.023)	170	06/11→	→	L 174199→; für Fahrzeuge ohne AMG-Sportpaket		24.0114-0119.1 414119	Ø 325 14 11,4 + S
			→	→ L 174198; für Fahrzeuge mit AMG-Sportpaket		24.0122-0287.1 422287	Ø 330 22 19,4 V• + S
			→	L 174199→; für Fahrzeuge mit AMG-Sportpaket		24.0122-0288.1 422288	Ø 330 22 19,4 V + S
ML 300 4-matic (166.055)	185	04/14→	←	für Fahrzeuge ohne AMG-Sportpaket		24.0132-0178.1 432178	Ø 330 32 29,4 V + S
			←	für Fahrzeuge mit AMG-Sportpaket		24.0132-0179.1 432179	Ø 350 32 29,4 V• + S
			→	für Fahrzeuge ohne AMG-Sportpaket		24.0114-0119.1 414119	Ø 325 14 11,4 + S
			→	für Fahrzeuge mit AMG-Sportpaket		24.0122-0288.1 422288	Ø 330 22 19,4 V + S
ML 350 4-matic (166.057)	225	06/11→	←	+ USA; für Fahrzeuge ohne AMG-Sportpaket		24.0132-0178.1 432178	Ø 330 32 29,4 V + S
			←	+ USA; für Fahrzeuge mit AMG-Sportpaket		24.0132-0179.1 432179	Ø 350 32 29,4 V• + S
			←	- USA; für Fahrzeuge ohne AMG-Sportpaket		24.0132-0184.1 432184	Ø 350 32 29,4 V + S
			→	→ A 174198; für Fahrzeuge ohne AMG-Sportpaket		24.0122-0288.1 422288	Ø 330 22 19,4 V + S
			→	A 174199→; für Fahrzeuge ohne AMG-Sportpaket		24.0122-0288.1 422288	Ø 330 22 19,4 V + S
			→	A 174199→; für Fahrzeuge mit AMG-Sportpaket		24.0122-0296.1 422296	Ø 345 22 19,4 V + S
ML 400 4-matic (166.056)	245	08/13→	←	+ USA; für Fahrzeuge ohne AMG-Sportpaket		24.0132-0178.1 432178	Ø 330 32 29,4 V + S
			←	+ USA; für Fahrzeuge mit AMG-Sportpaket		24.0132-0179.1 432179	Ø 350 32 29,4 V• + S
			←	- USA; für Fahrzeuge ohne AMG-Sportpaket		24.0132-0184.1 432184	Ø 350 32 29,4 V + S
			→	für Fahrzeuge ohne AMG-Sportpaket		24.0122-0288.1 422288	Ø 330 22 19,4 V + S
			→	für Fahrzeuge mit AMG-Sportpaket		24.0122-0296.1 422296	Ø 345 22 19,4 V + S
ML 500 4-matic (166.073)	300	02/12→	→	L 174199→		24.0122-0296.1 422296	Ø 345 22 19,4 V + S
MERCEDES-BENZ - R-KLASSE (W251, V251) 01/05→							
 Bremsbelagsatz, Scheibenbremse							
R 280 (251.054, 251.154)	170	01/07→	←			13.0460-7220.2 607220	ATE 23922 21,0 + WE / - WK
R 280 4-matic (251.062)	170	05/07→				13.0470-7220.2 LD7220	ATE 23922 21,0 + WE / - WK Ceramic
R 280 CDI (251.121, 251.026, 251.126)	140	05/06→	→			13.0460-7219.2 607219	ATE 23923 17,6 + WE / - WK
R 280 CDI 4-matic (251.020)	140	05/06→				13.0470-7219.2 LD7219	ATE 23923 17,6 + WE / - WK Ceramic
R 300 (251.054, 251.154)	170	07/09→					
R 300 CDI (251.021, 251.121, 251.026, 251.126)	140	07/09→					
R 300 CDI 4-matic (251.020)	140	07/09→					
R 320 CDI 4-matic (251.022, 251.122)	165	01/06→					
R 320 CDI 4-matic (251.125)	155	01/06→					
R 350 (251.056, 251.156)	200	01/07→					
↓							

	kW			 	! #		
MERCEDES-BENZ - R-KLASSE (W251, V251) 01/05→							
 Bremsbelagsatz, Scheibenbremse							
R 350 CDI 4-matic (251.022, 251.122) R 350 CDI 4-matic (251.023, 251.123)	165 195	07/09→ 08/10→	← →			13.0460-7220.2 607220 13.0470-7220.2 LD7220	ATE 23922 21,0 + WE / - WK ATE 23922 21,0 + WE / - WK Ceramic
R 350 4-matic (251.065, 251.165) R 350 CGI 4-matic (251.057, 251.157) R 500 4-matic (251.072, 251.172) R 500 4-matic (251.075, 251.175)	200 225 285 225	01/06→ 01/06→ 01/07→ 01/06→	← →			13.0460-7219.2 607219 13.0470-7219.2 LD7219	ATE 23923 17,6 + WE / - WK ATE 23923 17,6 + WE / - WK Ceramic
R 350 CDI 4-matic (251.124, 251.125)	155	01/06→	← →	05/09→ 05/09→		13.0460-7220.2 607220 13.0470-7220.2 LD7220 13.0460-7219.2 607219 13.0470-7219.2 LD7219	ATE 23922 21,0 + WE / - WK ATE 23922 21,0 + WE / - WK Ceramic ATE 23923 17,6 + WE / - WK ATE 23923 17,6 + WE / - WK Ceramic
Warnkontakt, Bremsbelagverschleiß							
R 280 (251.054, 251.154) R 280 4-matic (251.062) R 280 CDI (251.121, 251.026, 251.126) R 280 CDI 4-matic (251.020) R 300 (251.054, 251.154) R 300 CDI (251.021, 251.121, 251.026, 251.126) R 300 CDI 4-matic (251.020) R 320 CDI 4-matic (251.022, 251.122) R 320 CDI 4-matic (251.125) R 350 (251.056, 251.156) R 350 4-matic (251.065, 251.165) R 350 CDI 4-matic (251.022, 251.122) R 350 CDI 4-matic (251.023, 251.123) R 350 CGI 4-matic (251.057, 251.157) R 500 4-matic (251.072, 251.172) R 500 4-matic (251.075, 251.175) R 63 AMG 4-matic (251.077, 251.177)	170 170 140 140 170 140 140 165 155 200 200 165 195 225 285 225 375	01/07→ 05/07→ 05/06→ 05/06→ 07/09→ 07/09→ 07/09→ 01/06→ 01/06→ 01/07→ 01/06→ 07/09→ 08/10→ 01/06→ 01/07→ 01/06→ 02/06→	← →		1 1	24.8190-0425.2 620425 24.8190-0425.2 620425	L= 98 L= 98
R 350 CDI 4-matic (251.124, 251.125)	155	01/06→	← →	05/09→ 05/09→	1 1	24.8190-0425.2 620425 24.8190-0425.2 620425	L= 98 L= 98
 Bremsscheibe							
R 280 (251.054, 251.154) R 280 4-matic (251.062) R 280 CDI 4-matic (251.020) R 300 (251.054, 251.154) R 300 CDI (251.021, 251.121, 251.026, 251.126) R 300 CDI 4-matic (251.020) R 320 CDI 4-matic (251.022, 251.122) R 320 CDI 4-matic (251.125) R 350 (251.056, 251.156)	170 170 140 170 140 140 165 155 200	01/07→ 05/07→ 05/06→ 07/09→ 07/09→ 07/09→ 01/06→ 01/06→ 01/07→	← →			24.0132-0158.1 432158 24.0332-0158.1 532158 24.0114-0114.1 414114 24.0122-0226.1 422226	∅ 330 32 29,4 V + S ∅ 330 32 29,4 V + S PD ∅ 330 14 11,4 + S ∅ 330 22 19,4 V + S























	kw			 	! #		
MERCEDES-BENZ - R-KLASSE (W251, V251) 01/05→							
Bremsscheibe							
R 350 4-matic (251.065, 251.165)	200	01/06→	←			24.0132-0158.1 432158	Ø 330 32 29,4 V + S
R 350 CDI 4-matic (251.022, 251.122)	165	07/09→	→			24.0332-0158.1 532158	Ø 330 32 29,4 V + S PD
R 350 CDI 4-matic (251.023, 251.123)	195	08/10→	→			24.0114-0114.1 414114	Ø 330 14 11,4 + S
						24.0122-0226.1 422226	Ø 330 22 19,4 V + S
R 280 CDI (251.121, 251.026, 251.126)	140	05/06→	←	passend für Felgengröße [Zoll]: 18		24.0132-0157.1 432157	Ø 350 32 29,4 V + S
			←	nicht für Felgengröße [Zoll]: 18		24.0132-0158.1 432158	Ø 330 32 29,4 V + S
						24.0332-0158.1 532158	Ø 330 32 29,4 V + S PD
			→			24.0114-0114.1 414114	Ø 330 14 11,4 + S
						24.0122-0226.1 422226	Ø 330 22 19,4 V + S
R 350 CDI 4-matic (251.124, 251.125)	155	01/06→	←	05/09→; passend für Felgengröße [Zoll]: 18		24.0132-0157.1 432157	Ø 350 32 29,4 V + S
			←	05/09→; nicht für Felgengröße [Zoll]: 18		24.0132-0158.1 432158	Ø 330 32 29,4 V + S
						24.0332-0158.1 532158	Ø 330 32 29,4 V + S PD
			→	05/09→		24.0114-0114.1 414114	Ø 330 14 11,4 + S
						24.0122-0226.1 422226	Ø 330 22 19,4 V + S
R 350 CGI 4-matic (251.057, 251.157)	225	01/06→	←			24.0132-0157.1 432157	Ø 350 32 29,4 V + S
R 500 4-matic (251.072, 251.172)	285	01/07→	→			24.0114-0114.1 414114	Ø 330 14 11,4 + S
R 500 4-matic (251.075, 251.175)	225	01/06→	→			24.0122-0226.1 422226	Ø 330 22 19,4 V + S
R 63 AMG 4-matic (251.077, 251.177)	375	02/06→	←			24.0132-0157.1 432157	Ø 350 32 29,4 V + S
MERCEDES-BENZ - S-KLASSE (W140) 02/91→10/98							
Brembelagsatz, Scheibenbremse							
300 SE, SEL/S320 (140.032, 140.033)	170	03/91→10/98	←	04/91→; → A023718; ohne Leichtmetallfelge		13.0460-6036.2 606036	ATE 21304 18,5 + WE / - WK
			←	04/91→; → A050547; mit Leichtmetallfelge		13.0460-6036.2 606036	ATE 21304 18,5 + WE / - WK
			←	→ 06/93; A050548→; mit Leichtmetallfelge		13.0460-9033.2 609033	ATE 21303 18,9 + WE / - WK
			←	07/93→		13.0460-9033.2 609033	ATE 21303 18,9 + WE / - WK
			←	→ 06/93; A023719→; ohne Leichtmetallfelge		13.0460-9033.2 609033	ATE 21303 18,9 + WE / - WK
			→	04/91→ 06/93		13.0460-4047.2 604047	ATE 21305 15,7 + WE / - WK
						13.0470-4047.2 LD4047	ATE 21305 15,7 + WE / - WK Ceramic
			→	07/93→		13.0460-4047.2 604047	ATE 21305 15,7 + WE / - WK
						13.0470-4047.2 LD4047	ATE 21305 15,7 + WE / - WK Ceramic
300 SE 2.8 (140.028)	145	01/93→10/98	←	07/93→		13.0460-9033.2 609033	ATE 21303 18,9 + WE / - WK
S 280 (140.028)	142	02/93→10/98	←	→ 06/93		13.0460-9033.2 609033	ATE 21303 18,9 + WE / - WK
			→	→ 06/93		13.0460-4047.2 604047	ATE 21305 15,7 + WE / - WK
						13.0470-4047.2 LD4047	ATE 21305 15,7 + WE / - WK Ceramic
			→	07/93→		13.0460-4047.2 604047	ATE 21305 15,7 + WE / - WK
						13.0470-4047.2 LD4047	ATE 21305 15,7 + WE / - WK Ceramic
400 SE, SEL/S420 (140.042, 140.043)	210	02/91→10/98	←	04/91→ 06/93		13.0460-9033.2 609033	ATE 21303 18,9 + WE / - WK
500 SE, SEL (140.050, 140.051)	240	02/91→10/98	←	07/93→		13.0460-9033.2 609033	ATE 21303 18,9 + WE / - WK
			→	04/91→ 06/93		13.0460-4047.2 604047	ATE 21305 15,7 + WE / - WK
						13.0470-4047.2 LD4047	ATE 21305 15,7 + WE / - WK Ceramic
			→	07/93→		13.0460-4047.2 604047	ATE 21305 15,7 + WE / - WK
						13.0470-4047.2 LD4047	ATE 21305 15,7 + WE / - WK Ceramic
S 300 Turbo-D (140.135)	130	05/96→10/98	←			13.0460-9033.2 609033	ATE 21303 18,9 + WE / - WK
			→			13.0460-4047.2 604047	ATE 21305 15,7 + WE / - WK
						13.0470-4047.2 LD4047	ATE 21305 15,7 + WE / - WK Ceramic
S 350 Turbo-D (140.134)	110	01/93→10/98	←	07/93→ 06/96		13.0460-9033.2 609033	ATE 21303 18,9 + WE / - WK
			←	03/93→ 06/93		13.0460-9033.2 609033	ATE 21303 18,9 + WE / - WK
			→	07/93→ 06/96		13.0460-4047.2 604047	ATE 21305 15,7 + WE / - WK









	kW			 	! #			
MERCEDES-BENZ - S-KLASSE (W140) 02/91→10/98								
 Bremsbelagsatz, Scheibenbremse								
S 350 Turbo-D (140.134)	110	01/93→10/98	➡	07/93→ 06/96		13.0470-4047.2	LD4047	ATE 21305 15,7 + WE / - WK Ceramic
			➡	03/93→ 06/93		13.0460-4047.2	604047	ATE 21305 15,7 + WE / - WK
S 420 (140.042)	205	01/93→10/98	⬅	07/93→		13.0460-9033.2	609033	ATE 21303 18,9 + WE / - WK
			➡	07/93→		13.0470-4047.2	LD4047	ATE 21305 15,7 + WE / - WK Ceramic
S 500 (140.050, 140.051)	235	01/93→10/98						
S 600 (140.056, 140.057)	290	01/93→10/98						
Warnkontakt, Bremsbelagverschleiß								
300 SE, SEL/S320 (140.032, 140.033)	170	03/91→10/98	⬅	→ 06/93; A050548→; mit Leichtmetallfelge	4	24.8190-0401.2	620401	L= 95
			⬅	07/93→	4	24.8190-0401.2	620401	L= 95
			⬅	→ 06/93; A023719→; ohne Leichtmetallfelge	4	24.8190-0401.2	620401	L= 95
			⬅	04/91→; → A050547; mit Leichtmetallfelge	4	24.8190-0401.2	620401	L= 95
			⬅	04/91→; → A023718; ohne Leichtmetallfelge	4	24.8190-0401.2	620401	L= 95
			➡	07/93→; + ASR	4	24.8190-0401.2	620401	L= 95
			➡	04/91→ 06/93; + ASR	4	24.8190-0401.2	620401	L= 95
300 SE 2.8 (140.028) S 280 (140.028)	145 142	01/93→10/98 02/93→10/98	⬅	07/93→	4	24.8190-0401.2	620401	L= 95
			⬅	→ 06/93	4	24.8190-0401.2	620401	L= 95
			➡	07/93→; + ASR	4	24.8190-0401.2	620401	L= 95
			➡	→ 06/93; + ASR	4	24.8190-0401.2	620401	L= 95
400 SE, SEL/S420 (140.042, 140.043) 500 SE, SEL (140.050, 140.051)	210	02/91→10/98	⬅	07/93→	4	24.8190-0401.2	620401	L= 95
			⬅	04/91→ 06/93	4	24.8190-0401.2	620401	L= 95
	240	02/91→10/98	➡	07/93→; + ASR	4	24.8190-0401.2	620401	L= 95
			➡	04/91→ 06/93; + ASR	4	24.8190-0401.2	620401	L= 95
S 300 Turbo-D (140.135)	130	05/96→10/98	⬅		4	24.8190-0401.2	620401	L= 95
			➡	+ ASR	4	24.8190-0401.2	620401	L= 95
S 350 Turbo-D (140.134)	110	01/93→10/98	⬅	03/93→ 06/93	4	24.8190-0401.2	620401	L= 95
			⬅	07/93→ 06/96	4	24.8190-0401.2	620401	L= 95
			➡	07/93→ 06/96; + ASR	4	24.8190-0401.2	620401	L= 95
			➡	03/93→ 06/93; + ASR	4	24.8190-0401.2	620401	L= 95
S 420 (140.042) S 500 (140.050, 140.051) S 600 (140.056, 140.057)	205 235	01/93→10/98 01/93→10/98	⬅	07/93→	4	24.8190-0401.2	620401	L= 95
			➡	07/93→; + ASR	4	24.8190-0401.2	620401	L= 95
S 600 (140.056, 140.057)	290	01/93→10/98						
Zubehörsatz, Scheibenbremsbelag								
300 SE, SEL/S320 (140.032, 140.033)	170	03/91→10/98	⬅	07/93→		13.0460-0263.2	610263	
			⬅	→ 06/93; A050548→; mit Leichtmetallfelge		13.0460-0263.2	610263	
			⬅	→ 06/93; A023719→; ohne Leichtmetallfelge		13.0460-0263.2	610263	
			➡	07/93→		13.0460-0236.2	610236	ATE
			➡	04/91→ 06/93		13.0460-0239.2	610239	ATE
300 SE 2.8 (140.028) S 280 (140.028)	145 142	01/93→10/98 02/93→10/98	⬅	→ 06/93		13.0460-0263.2	610263	
			⬅	07/93→		13.0460-0263.2	610263	
			➡	07/93→		13.0460-0236.2	610236	ATE
			➡	→ 06/93		13.0460-0239.2	610239	ATE
400 SE, SEL/S420 (140.042, 140.043) 500 SE, SEL (140.050, 140.051)	210	02/91→10/98	⬅	04/91→ 06/93		13.0460-0263.2	610263	
			⬅	07/93→		13.0460-0263.2	610263	
	240	02/91→10/98	➡	04/91→ 06/93		13.0460-0236.2	610236	ATE
➡			07/93→		13.0460-0236.2	610236	ATE	
S 300 Turbo-D (140.135)	130	05/96→10/98	⬅			13.0460-0239.2	610239	ATE
			⬅			13.0460-0263.2	610263	
↓								









	kw					! #		
MERCEDES-BENZ - S-KLASSE (W140) 02/91→10/98								
Zubehörsatz, Scheibenbremsbelag								
S 300 Turbo-D (140.135)	130	05/96→10/98	➔				13.0460-0236.2 610236 13.0460-0239.2 610239	ATE ATE
S 350 Turbo-D (140.134)	110	01/93→10/98	➔	07/93→ 06/96			13.0460-0263.2 610263	
			➔	03/93→ 06/93			13.0460-0263.2 610263	
			➔	07/93→ 06/96			13.0460-0236.2 610236 13.0460-0239.2 610239	ATE ATE
			➔	03/93→ 06/93			13.0460-0239.2 610239	ATE
S 420 (140.042)	205	01/93→10/98	➔	07/93→			13.0460-0263.2 610263	
S 500 (140.050, 140.051)	235	01/93→10/98	➔	07/93→			13.0460-0236.2 610236	ATE
S 600 (140.056, 140.057)	290	01/93→10/98	➔				13.0460-0239.2 610239	ATE
 Bremsscheibe								
300 SE, SEL/S320 (140.032, 140.033)	170	03/91→10/98	➔	04/91→; → A023718; ohne Leichtmetallfelge			24.0128-0127.1 428127	Ø 310 28 25,4 V
			➔	04/91→; → A050547; mit Leichtmetallfelge			24.0128-0127.1 428127	Ø 310 28 25,4 V
			➔	→ 06/93; A050548→; mit Leichtmetallfelge			24.0130-0100.1 430100	Ø 320 30 27,4 V
			➔	07/93→			24.0130-0100.1 430100	Ø 320 30 27,4 V
			➔	→ 06/93; A023719→; ohne Leichtmetallfelge			24.0130-0100.1 430100	Ø 320 30 27,4 V
			➔	04/91→ 06/93			24.0112-0129.1 412129	Ø 290 12 9,8
			➔	07/93→			24.0112-0129.1 412129	Ø 290 12 9,8
300 SE 2.8 (140.028) S 280 (140.028)	145 142	01/93→10/98 02/93→10/98	➔	→ 06/93			24.0130-0100.1 430100	Ø 320 30 27,4 V
			➔	07/93→			24.0130-0100.1 430100	Ø 320 30 27,4 V
			➔	07/93→			24.0112-0129.1 412129	Ø 290 12 9,8
			➔	→ 06/93			24.0112-0129.1 412129	Ø 290 12 9,8
400 SE, SEL/S420 (140.042, 140.043)	210	02/91→10/98	➔	04/91→ 06/93			24.0130-0100.1 430100	Ø 320 30 27,4 V
			➔	07/93→			24.0130-0100.1 430100	Ø 320 30 27,4 V
500 SE, SEL (140.050, 140.051)	240	02/91→10/98	➔	04/91→ 06/93			24.0122-0133.1 422133	Ø 300 22 19,4 V
			➔	07/93→			24.0122-0133.1 422133	Ø 300 22 19,4 V
S 300 Turbo-D (140.135)	130	05/96→10/98	➔				24.0130-0100.1 430100	Ø 320 30 27,4 V
			➔				24.0112-0129.1 412129	Ø 290 12 9,8
S 350 Turbo-D (140.134)	110	01/93→10/98	➔	07/93→ 06/96			24.0130-0100.1 430100	Ø 320 30 27,4 V
			➔	03/93→ 06/93			24.0130-0100.1 430100	Ø 320 30 27,4 V
			➔	07/93→ 06/96			24.0112-0129.1 412129	Ø 290 12 9,8
			➔	03/93→ 06/93			24.0112-0129.1 412129	Ø 290 12 9,8
S 420 (140.042)	205	01/93→10/98	➔	07/93→			24.0130-0100.1 430100	Ø 320 30 27,4 V
			➔	07/93→			24.0122-0133.1 422133	Ø 300 22 19,4 V
S 500 (140.050, 140.051)	235	01/93→10/98	➔					
			➔					
S 600 (140.056, 140.057)	290	01/93→10/98	➔					
			➔					
MERCEDES-BENZ - S-KLASSE (W220) 10/98→08/05								
 Bremsbelagsatz, Scheibenbremse								
S 280 (220.063, 220.163) S 320 (220.065, 220.165)	150	10/98→08/05	➔	11/98→ 08/02			13.0460-4984.2 604984 13.0470-4984.2 LD4984	BRE 23271 17,4 + WE / - WK BRE 23271 17,4 + WE / - WK Ceramic
			➔	09/02→			13.0460-4984.2 604984 13.0460-4990.2 604990 13.0470-4984.2 LD4984 13.0470-4990.2 LD4990	BRE 23271 17,4 + WE / - WK BRE 23271 17,4 + WE / - WK BRE 23271 17,4 + WE / - WK Ceramic BRE 23271 17,4 + WE / - WK Ceramic
	165	10/98→08/05	➔					
			➔	11/98→			13.0460-4069.2 604069	ATE 23078 15,9 + WE / - WK
S 320 CDI (220.025, 220.125) S 350 (220.067, 220.167) S 400 CDI (220.028, 220.128)	150	09/02→08/05	➔				13.0460-4984.2 604984 13.0460-4990.2 604990	BRE 23271 17,4 + WE / - WK BRE 23271 17,4 + WE / - WK
	180	09/02→08/05					13.0470-4984.2 LD4984	BRE 23271 17,4 + WE / - WK Ceramic
	191	06/03→08/05					13.0470-4990.2 LD4990	BRE 23271 17,4 + WE / - WK Ceramic
↓								









	kw			 	! #		
MERCEDES-BENZ - S-KLASSE (W220) 10/98→08/05							
 Bremsbelagsatz, Scheibenbremse							
S 320 CDI (220.025, 220.125)	150	09/02→08/05	➡			13.0460-7171.2 607171	ATE 23334 16,7 + WE / - WK
S 350 (220.067, 220.167)	180	09/02→08/05				13.0470-7171.2 LD7171	ATE 23334 16,7 + WE / - WK Ceramic
S 400 CDI (220.028, 220.128)	191	06/03→08/05					
S 320 CDI (220.026, 220.126)	145	08/99→09/02	⬅	09/02→		13.0460-4984.2 604984	BRE 23271 17,4 + WE / - WK
						13.0460-4990.2 604990	BRE 23271 17,4 + WE / - WK
						13.0470-4984.2 LD4984	BRE 23271 17,4 + WE / - WK Ceramic
						13.0470-4990.2 LD4990	BRE 23271 17,4 + WE / - WK Ceramic
			⬅	→ 08/02		13.0460-4984.2 604984	BRE 23271 17,4 + WE / - WK
						13.0470-4984.2 LD4984	BRE 23271 17,4 + WE / - WK Ceramic
			➡			13.0460-4069.2 604069	ATE 23078 15,9 + WE / - WK
S 350 4-matic (220.087, 220.187)	180	06/03→08/05	⬅			13.0460-7203.2 607203	ATE 21670 19,3 + WE / - WK
			➡			13.0460-7171.2 607171	ATE 23334 16,7 + WE / - WK
						13.0470-7171.2 LD7171	ATE 23334 16,7 + WE / - WK Ceramic
S 400 CDI (220.028, 220.128)	184	06/00→08/05	⬅	08/00→ 08/02		13.0460-4984.2 604984	BRE 23271 17,4 + WE / - WK
			⬅	09/02→		13.0460-4984.2 604984	BRE 23271 17,4 + WE / - WK
						13.0460-4990.2 604990	BRE 23271 17,4 + WE / - WK
						13.0470-4984.2 LD4984	BRE 23271 17,4 + WE / - WK Ceramic
						13.0470-4990.2 LD4990	BRE 23271 17,4 + WE / - WK Ceramic
			➡	08/00→ 09/02		13.0460-4069.2 604069	ATE 23078 15,9 + WE / - WK
			➡	10/02→		13.0460-7171.2 607171	ATE 23334 16,7 + WE / - WK
						13.0470-7171.2 LD7171	ATE 23334 16,7 + WE / - WK Ceramic
S 430 (220.070, 220.170)	205	10/98→08/05	⬅	11/98→ 08/02		13.0460-4984.2 604984	BRE 23271 17,4 + WE / - WK
			⬅	09/02→		13.0460-4984.2 604984	BRE 23271 17,4 + WE / - WK
						13.0460-4990.2 604990	BRE 23271 17,4 + WE / - WK
						13.0470-4984.2 LD4984	BRE 23271 17,4 + WE / - WK Ceramic
						13.0470-4990.2 LD4990	BRE 23271 17,4 + WE / - WK Ceramic
			➡	11/98→ 09/02		13.0460-4069.2 604069	ATE 23078 15,9 + WE / - WK
			➡	10/02→		13.0460-7171.2 607171	ATE 23334 16,7 + WE / - WK
						13.0470-7171.2 LD7171	ATE 23334 16,7 + WE / - WK Ceramic
S 430 4-matic (220.083, 220.183)	205	09/02→08/05	⬅			13.0460-7183.2 607183	ATE 21484 20,5 + WE / - WK
S 500 4-matic (220.084, 220.184)	225	09/02→08/05	➡			13.0460-7171.2 607171	ATE 23334 16,7 + WE / - WK
						13.0470-7171.2 LD7171	ATE 23334 16,7 + WE / - WK Ceramic
S 500 (220.075, 220.175, 220.875)	225	10/98→08/05	⬅	09/02→; nicht für gepanzerte Fahrzeuge		13.0460-4984.2 604984	BRE 23271 17,4 + WE / - WK
						13.0460-4990.2 604990	BRE 23271 17,4 + WE / - WK
			⬅	11/98→ 08/02; nicht für gepanzerte Fahrzeuge		13.0460-4984.2 604984	BRE 23271 17,4 + WE / - WK
			➡	11/98→; für gepanzerte Fahrzeuge		13.0460-4047.2 604047	ATE 21305 15,7 + WE / - WK
						13.0470-4047.2 LD4047	ATE 21305 15,7 + WE / - WK Ceramic
			➡	11/98→ 09/02; nicht für gepanzerte Fahrzeuge		13.0460-4069.2 604069	ATE 23078 15,9 + WE / - WK
			➡	10/02→; nicht für gepanzerte Fahrzeuge		13.0460-7171.2 607171	ATE 23334 16,7 + WE / - WK
						13.0470-7171.2 LD7171	ATE 23334 16,7 + WE / - WK Ceramic
S 55 AMG (220.073, 220.173)	265	04/99→08/05	⬅	→ 08/02		13.0460-4984.2 604984	BRE 23271 17,4 + WE / - WK
			⬅	09/02→		13.0460-4984.2 604984	BRE 23271 17,4 + WE / - WK
						13.0460-4990.2 604990	BRE 23271 17,4 + WE / - WK
			➡	→ 09/02		13.0460-4069.2 604069	ATE 23078 15,9 + WE / - WK
S 55 AMG Kompressor (220.074, 220.174)	368	06/02→08/05	⬅			13.0460-4997.2 604997	BRE 23943 17,5 + WE / - WK
			➡			13.0460-4998.2 604998	BRE 23478 16,5 + WE / - WK
S 600 (220.176)	368	09/02→08/05	⬅	nicht für gepanzerte Fahrzeuge		13.0460-4984.2 604984	BRE 23271 17,4 + WE / - WK
↓							









	kw			 	! #		
MERCEDES-BENZ - S-KLASSE (W220) 10/98→08/05							
 Bremsbelagsatz, Scheibenbremse							
S 600 (220.878, 220.178)	270	01/00→08/05	←	nicht für gepanzerte Fahrzeuge		13.0460-4990.2 604990	BRE 23271 17,4 + WE / - WK
			→	für gepanzerte Fahrzeuge		13.0460-4047.2 604047	ATE 21305 15,7 + WE / - WK
			→	nicht für gepanzerte Fahrzeuge		13.0470-4047.2 LD4047	ATE 21305 15,7 + WE / - WK Ceramic
S 63 AMG S 65 AMG (220.179)	326	09/01→08/05	←			13.0460-4997.2 604997	BRE 23943 17,5 + WE / - WK
	450	03/04→08/05	→			13.0460-4819.2 604819	BRE 23478 14,6 + WE / - WK
Warnkontakt, Bremsbelagsverschleiß							
S 280 (220.063, 220.163) S 320 (220.065, 220.165)	150	10/98→08/05	←	 ; 09/02→	1	24.8190-0410.2 620410	L= 97,5
	165	10/98→08/05	←	11/98→ 08/02	2	24.8190-0410.2 620410	L= 97,5
			←	 ; 09/02→	1	24.8190-0416.2 620416	L= 100
			→	11/98→	1	24.8190-0410.2 620410	L= 97,5
S 320 CDI (220.025, 220.125) S 350 (220.067, 220.167) S 350 4-matic (220.087, 220.187) S 400 CDI (220.028, 220.128)	150	09/02→08/05	←		1	24.8190-0410.2 620410	L= 97,5
	180	09/02→08/05	←		1	24.8190-0416.2 620416	L= 100
	180	06/03→08/05	→		1	24.8190-0410.2 620410	L= 97,5
	191	06/03→08/05	→				
S 320 CDI (220.026, 220.126)	145	08/99→09/02	←	 ; 09/02→	1	24.8190-0410.2 620410	L= 97,5
			←	→ 08/02	2	24.8190-0410.2 620410	L= 97,5
			←	 ; 09/02→	1	24.8190-0416.2 620416	L= 100
			→		1	24.8190-0410.2 620410	L= 97,5
S 400 CDI (220.028, 220.128)	184	06/00→08/05	←	 ; 09/02→	1	24.8190-0410.2 620410	L= 97,5
			←	08/00→ 08/02	2	24.8190-0410.2 620410	L= 97,5
			←	 ; 09/02→	1	24.8190-0416.2 620416	L= 100
			→	10/02→	1	24.8190-0410.2 620410	L= 97,5
			→	08/00→ 09/02	1	24.8190-0410.2 620410	L= 97,5
S 430 (220.070, 220.170)	205	10/98→08/05	←	 ; 09/02→	1	24.8190-0410.2 620410	L= 97,5
			←	11/98→ 08/02	2	24.8190-0410.2 620410	L= 97,5
			←	 ; 09/02→	1	24.8190-0416.2 620416	L= 100
			→	10/02→	1	24.8190-0410.2 620410	L= 97,5
			→	11/98→ 09/02	1	24.8190-0410.2 620410	L= 97,5
S 430 4-matic (220.083, 220.183) S 500 4-matic (220.084, 220.184)	205	09/02→08/05	←		1	24.8190-0425.2 620425	L= 98
	225	09/02→08/05	→		1	24.8190-0410.2 620410	L= 97,5
S 500 (220.075, 220.175, 220.875)	225	10/98→08/05	←	11/98→; für gepanzerte Fahrzeuge	2	24.8190-0410.2 620410	L= 97,5
			←	11/98→ 08/02; nicht für gepanzerte Fahrzeuge	2	24.8190-0410.2 620410	L= 97,5
			←	 ; 09/02→; nicht für gepanzerte Fahrzeuge	1	24.8190-0410.2 620410	L= 97,5
			←	 ; 09/02→; nicht für gepanzerte Fahrzeuge	1	24.8190-0416.2 620416	L= 100
			→	11/98→ 09/02; nicht für gepanzerte Fahrzeuge	1	24.8190-0410.2 620410	L= 97,5
			→	10/02→; nicht für gepanzerte Fahrzeuge	1	24.8190-0410.2 620410	L= 97,5
S 55 AMG (220.073, 220.173)	265	04/99→08/05	←	 ; 09/02→	1	24.8190-0410.2 620410	L= 97,5
			←	→ 08/02	2	24.8190-0410.2 620410	L= 97,5
			←	 ; 09/02→	1	24.8190-0416.2 620416	L= 100
			→	→ 09/02	1	24.8190-0410.2 620410	L= 97,5
S 55 AMG Kompressor (220.074, 220.174) S 63 AMG S 65 AMG (220.179)	368	06/02→08/05	←		2	24.8190-0410.2 620410	L= 97,5
	326 450	09/01→08/05 03/04→08/05	→		1	24.8190-0410.2 620410	L= 97,5
S 600 (220.176) S 600 (220.878, 220.178) ↓	368	09/02→08/05	←	für gepanzerte Fahrzeuge	2	24.8190-0410.2 620410	L= 97,5
	270	01/00→08/05	←	 ; nicht für gepanzerte Fahrzeuge	1	24.8190-0410.2 620410	L= 97,5









	kW			 	! #		
MERCEDES-BENZ - S-KLASSE (W220) 10/98→08/05							
Warnkontakt, Bremsbelagverschleiß							
S 600 (220.176)	368	09/02→08/05	←	☐; nicht für gepanzerte Fahrzeuge	1	24.8190-0416.2 620416	L= 100
S 600 (220.878, 220.178)	270	01/00→08/05	→	nicht für gepanzerte Fahrzeuge	1	24.8190-0410.2 620410	L= 97,5
			→	für gepanzerte Fahrzeuge	1	24.8190-0410.2 620410	L= 97,5
Zubehörsatz, Scheibenbremsbelag							
S 280 (220.063, 220.163)	150	10/98→08/05	←	11/98→ 08/02		13.0460-0275.2 610275	
S 320 (220.065, 220.165)	165	10/98→08/05	←	09/02→		13.0460-0275.2 610275	
S 320 CDI (220.025, 220.125)	150	09/02→08/05	←			13.0460-0275.2 610275	
S 350 (220.067, 220.167)	180	09/02→08/05					
S 400 CDI (220.028, 220.128)	191	06/03→08/05					
S 320 CDI (220.026, 220.126)	145	08/99→09/02	←	09/02→		13.0460-0275.2 610275	
			←	→ 08/02		13.0460-0275.2 610275	
S 400 CDI (220.028, 220.128)	184	06/00→08/05	←	08/00→ 08/02		13.0460-0269.2 610269	
			←	09/02→		13.0460-0275.2 610275	
S 430 (220.070, 220.170)	205	10/98→08/05	←	11/98→ 08/02		13.0460-0269.2 610269	
			←	09/02→		13.0460-0275.2 610275	
S 500 (220.075, 220.175, 220.875)	225	10/98→08/05	←	11/98→ 08/02; nicht für gepanzerte Fahrzeuge		13.0460-0269.2 610269	
			←	09/02→; nicht für gepanzerte Fahrzeuge		13.0460-0275.2 610275	
			→	11/98→; für gepanzerte Fahrzeuge		13.0460-0236.2 610236	ATE
S 55 AMG (220.073, 220.173)	265	04/99→08/05	←	→ 08/02		13.0460-0269.2 610269	
			←	09/02→		13.0460-0275.2 610275	
S 600 (220.176)	368	09/02→08/05	←	nicht für gepanzerte Fahrzeuge		13.0460-0275.2 610275	
S 600 (220.878, 220.178)	270	01/00→08/05	→	für gepanzerte Fahrzeuge		13.0460-0236.2 610236	ATE
 Bremsscheibe							
S 280 (220.063, 220.163)	150	10/98→08/05	←	11/98→		24.0128-0125.1 428125	Ø 312 28 26 V•
S 320 (220.065, 220.165)	165	10/98→08/05	→	11/98→		24.0111-0153.1 411153	Ø 300 11 9,3
S 320 CDI (220.025, 220.125)	150	09/02→08/05	←			24.0132-0115.1 432115	Ø 330 32 30 V•
S 320 CDI (220.026, 220.126)	145	08/99→09/02	→			24.0111-0153.1 411153	Ø 300 11 9,3
S 350 (220.067, 220.167)	180	09/02→08/05	←			24.0128-0125.1 428125	Ø 312 28 26 V•
			→			24.0111-0153.1 411153	Ø 300 11 9,3
S 350 4-matic (220.087, 220.187)	180	06/03→08/05	←			24.0130-0172.1 430172	Ø 304 30 27,4 V•
			→			24.0122-0192.1 422192	Ø 300 22 19,4 V
S 400 CDI (220.028, 220.128)	184	06/00→08/05	←	08/00→		24.0132-0115.1 432115	Ø 330 32 30 V•
			→	08/00→		24.0122-0192.1 422192	Ø 300 22 19,4 V
S 400 CDI (220.028, 220.128)	191	06/03→08/05	←			24.0132-0115.1 432115	Ø 330 32 30 V•
			→			24.0122-0192.1 422192	Ø 300 22 19,4 V
S 430 (220.070, 220.170)	205	10/98→08/05	←	11/98→		24.0132-0115.1 432115	Ø 330 32 30 V•
			→	10/02→		24.0111-0153.1 411153	Ø 300 11 9,3
			→	11/98→ 09/02		24.0122-0192.1 422192	Ø 300 22 19,4 V
S 430 4-matic (220.083, 220.183)	205	09/02→08/05	←			24.0132-0136.1 432136	Ø 330 32 30 V•
S 500 4-matic (220.084, 220.184)	225	09/02→08/05	→			24.0122-0192.1 422192	Ø 300 22 19,4 V
S 500 (220.075, 220.175, 220.875)	225	10/98→08/05	←	11/98→; nicht für gepanzerte Fahrzeuge		24.0132-0115.1 432115	Ø 330 32 30 V•
			→	11/98→; nicht für gepanzerte Fahrzeuge		24.0122-0192.1 422192	Ø 300 22 19,4 V
S 55 AMG (220.073, 220.173)	265	04/99→08/05	←			24.0132-0125.1 432125	Ø 345 32 30 V•
			→			24.0122-0213.1 422213	Ø 315 22 19,4 V
S 55 AMG Kompressor (220.074, 220.174)	368	06/02→08/05	←			24.0136-0105.1 436105	Ø 360 36 34 V•
			→			24.0126-0137.1 426137	Ø 330 26 24 V•
S 600 (220.176)	368	09/02→08/05	←	nicht für gepanzerte Fahrzeuge		24.0132-0125.1 432125	Ø 345 32 30 V•
S 600 (220.878, 220.178)	270	01/00→08/05	→	nicht für gepanzerte Fahrzeuge		24.0122-0213.1 422213	Ø 315 22 19,4 V









	kW			 	! #		
MERCEDES-BENZ - S-KLASSE (W221) 09/05→12/13							
 Bremsbelagsatz, Scheibenbremse							
S 250 CDI (221.003, 221.103)	150	01/11→12/13	←	→ 05/13		13.0460-4817.2 604817	BRE 23960 18,3 + WE / - WK
S 280 (221.054) S 300 (221.054)	170	08/06→12/13	←	→ 05/13		13.0460-4817.2 604817	BRE 23960 18,3 + WE / - WK
	170	08/06→12/13	→	→ 05/13		13.0460-7171.2 607171 13.0470-7171.2 LD7171	ATE 23334 16,7 + WE / - WK ATE 23334 16,7 + WE / - WK Ceramic
S 320 CDI S 320 CDI 4-matic (221.080, 221.180) S 350 (221.056, 221.156) S 500 (221.071, 221.171)	155	10/05→12/13	←	12/05→ 05/13		13.0460-4817.2 604817	BRE 23960 18,3 + WE / - WK
	155	10/05→12/13	→	12/05→; → A 289058		13.0460-7171.2 607171 13.0470-7171.2 LD7171	ATE 23334 16,7 + WE / - WK ATE 23334 16,7 + WE / - WK Ceramic
	200	10/05→12/13					
	285	10/05→12/13					
S 320 CDI (221.022, 221.122)	173	12/05→06/09	←			13.0460-4817.2 604817	BRE 23960 18,3 + WE / - WK
			→	→ A 289058		13.0460-7171.2 607171 13.0470-7171.2 LD7171	ATE 23334 16,7 + WE / - WK ATE 23334 16,7 + WE / - WK Ceramic
S 320 CDI 4-matic (221.080, 221.180) S 350 4-matic (221.087, 221.187) S 350 CDI	173	10/06→12/13	←	→ 05/13		13.0460-4817.2 604817	BRE 23960 18,3 + WE / - WK
	200	02/08→12/13	→	→ A 289058		13.0460-7171.2 607171 13.0470-7171.2 LD7171	ATE 23334 16,7 + WE / - WK ATE 23334 16,7 + WE / - WK Ceramic
	173	06/09→12/13					
S 350 BlueTec (221.026, 221.126) S 350 BlueTEC 4-matic (221.083, 221.183) S 350 CGI (221.057, 221.157) S 350 CGI 4-matic (221.082, 221.182)	190	04/11→12/13	←	→ 05/13		13.0460-4817.2 604817	BRE 23960 18,3 + WE / - WK
	190	04/11→12/13	→	für Fahrzeuge ohne AMG-Sportpaket; → 05/13		13.0460-7171.2 607171 13.0470-7171.2 LD7171	ATE 23334 16,7 + WE / - WK ATE 23334 16,7 + WE / - WK Ceramic
	225	04/11→12/13					
	225	04/11→12/13					
S 400 Hybrid (221.095, 221.195)	205	01/09→12/13	←	06/09→ 05/13		13.0460-4817.2 604817	BRE 23960 18,3 + WE / - WK
			→	06/09→; → A 289058		13.0460-7171.2 607171 13.0470-7171.2 LD7171	ATE 23334 16,7 + WE / - WK ATE 23334 16,7 + WE / - WK Ceramic
S 420 CDI / S 450 CDI (221.028, 221.128)	235	10/06→12/13	←	→ 05/13		13.0460-4817.2 604817	BRE 23960 18,3 + WE / - WK
			←	→ 05/13; für gepanzerte Fahrzeuge	2	13.0460-4984.2 604984	BRE 23271 17,4 + WE / - WK
			→	→ 05/13		13.0460-7171.2 607171 13.0470-7171.2 LD7171	ATE 23334 16,7 + WE / - WK ATE 23334 16,7 + WE / - WK Ceramic
S 450 (221.070, 221.170) S 450 4-matic (221.084, 221.184) S 500 4-matic (221.086, 221.186)	250	12/05→12/13	←	04/06→ 05/13		13.0460-4817.2 604817	BRE 23960 18,3 + WE / - WK
	250	12/05→12/13	→	04/06→; → A 289058		13.0460-7171.2 607171 13.0470-7171.2 LD7171	ATE 23334 16,7 + WE / - WK ATE 23334 16,7 + WE / - WK Ceramic
	285	10/05→12/13					
S 600 (221.176)	380	12/05→12/13	←	A 000101→; → 05/13		13.0460-4839.2 604839	BRE 24455 16,8 + WE / - WK
			←	→ A 000100; für Fahrzeuge mit AMG-Sportpaket		13.0460-4839.2 604839	BRE 24455 16,8 + WE / - WK
			←	A 000101→; → 05/13; für gepanzerte Fahrzeuge	2	13.0460-4984.2 604984	BRE 23271 17,4 + WE / - WK
			←	→ A 000100; für gepanzerte Fahrzeuge	2	13.0460-4984.2 604984	BRE 23271 17,4 + WE / - WK
			←	→ A 000100; für Fahrzeuge ohne AMG-Sportpaket		13.0460-4997.2 604997	BRE 23943 17,5 + WE / - WK
			→	→ 05/13; nicht für gepanzerte Fahrzeuge		13.0460-4998.2 604998	BRE 23478 16,5 + WE / - WK
Warnkontakt, Bremsbelagsverschleiß							
S 250 CDI (221.003, 221.103)	150	01/11→12/13	←	→ 05/13	1	24.8190-0420.2 620420	L= 119
S 280 (221.054) S 300 (221.054)	170	08/06→12/13	→	→ 05/13	1	24.8190-0410.2 620410	L= 97,5
	170	08/06→12/13					
S 320 CDI S 320 CDI 4-matic (221.080, 221.180) S 350 (221.056, 221.156) S 500 (221.071, 221.171)	155	10/05→12/13	←	12/05→ 05/13	1	24.8190-0420.2 620420	L= 119
	155	10/05→12/13	→	A 289059→; → 05/13	1	24.8190-0410.2 620410	L= 97,5
	200	10/05→12/13	→	12/05→; → A 289058	1	24.8190-0410.2 620410	L= 97,5
S 320 CDI (221.022, 221.122)	173	12/05→06/09	←		1	24.8190-0420.2 620420	L= 119
			→	→ A 289058	1	24.8190-0410.2 620410	L= 97,5
			→	A 289059→	1	24.8190-0410.2 620410	L= 97,5
S 320 CDI 4-matic (221.080, 221.180) ↓	173	10/06→12/13	←	→ 05/13	1	24.8190-0420.2 620420	L= 119











	kW			 	! #		
MERCEDES-BENZ - S-KLASSE (W221) 09/05→12/13							
Warnkontakt, Bremsbelagverschleiß							
S 350 4-matic (221.087, 221.187) S 350 CDI	200 173	02/08→12/13 06/09→12/13	➡ ➡	A 289059→; → 05/13 → A 289058	1 1	24.8190-0410.2 620410	L= 97,5 L= 97,5
S 350 BlueTec (221.026, 221.126) S 350 BlueTEC 4-matic (221.083, 221.183) S 350 CGI (221.057, 221.157) S 350 CGI 4-matic (221.082, 221.182)	190 190 225 225	04/11→12/13 04/11→12/13 04/11→12/13 04/11→12/13	← ➡ ➡ ➡	→ 05/13 für Fahrzeuge mit AMG-Sportpaket; → 05/13 für Fahrzeuge ohne AMG-Sportpaket; → 05/13	1 1 1 1	24.8190-0420.2 620420	L= 119 L= 97,5 L= 97,5 L= 97,5
S 400 Hybrid (221.095, 221.195)	205	01/09→12/13	← ➡ ➡	06/09→ 05/13 06/09→; → A 289058 A 289059→; → 05/13	1 1 1	24.8190-0420.2 620420	L= 119 L= 97,5 L= 97,5
S 420 CDI / S 450 CDI (221.028, 221.128)	235	10/06→12/13	← ← ➡	→ 05/13; für gepanzerte Fahrzeuge → 05/13 → 05/13	1 1 1	24.8190-0410.2 620410	L= 97,5 L= 119 L= 97,5
S 450 (221.070, 221.170) S 450 4-matic (221.084, 221.184) S 500 4-matic (221.086, 221.186)	250 250 285	12/05→12/13 12/05→12/13 10/05→12/13	← ➡ ➡	04/06→ 05/13 A 289059→; → 05/13 04/06→; → A 289058	1 1 1	24.8190-0410.2 620410	L= 119 L= 97,5 L= 97,5
S 500 CGI (221.073, 221.173) S 500 CGI 4-matic (221.094, 221.194)	320 320	04/11→12/13 03/11→12/13	➡ ➡	→ 05/13 → 05/13	1 1	24.8190-0410.2 620410	L= 97,5 L= 97,5
S 600 (221.176)	380	12/05→12/13	← ← ← ➡	→ A 000100 A 000101→; → 05/13; für gepanzerte Fahrzeuge A 000101→; → 05/13 → 05/13	1 1 1 1	24.8190-0410.2 620410	L= 97,5 L= 97,5 L= 119 L= 97,5
S 63 AMG (221.074, 221.174) S 63 AMG (221.074, 221.174) S 65 AMG (221.179)	400 420 463	03/11→12/13 02/12→12/13 04/11→12/13	← ➡ ➡	→ 05/13 → 05/13 → 05/13	1 1 1	24.8190-0420.2 620420	L= 119 L= 119 L= 119
S 63 AMG (221.077, 221.177)	386	10/06→12/13	← ➡	01/07→ 05/13 01/07→ 05/13	1 1	24.8190-0420.2 620420	L= 119 L= 119
S 65 AMG (221.179)	450	12/05→12/13	← ➡	04/06→ 05/13 04/06→ 05/13	1 1	24.8190-0420.2 620420	L= 119 L= 119
 Bremsscheibe							
S 250 CDI (221.003, 221.103)	150	01/11→12/13	← ← ➡ ➡	für Fahrzeuge ohne AMG-Sportpaket; → 05/13 für Fahrzeuge mit AMG-Sportpaket; → 05/13 für Fahrzeuge ohne AMG-Sportpaket; → 05/13 für Fahrzeuge mit AMG-Sportpaket; → 05/13		24.0132-0137.1 432137	Ø 335 32 30 V• + S
						24.0132-0138.1 432138	Ø 350 32 30 V• + S
						24.0112-0183.1 412183	Ø 300 12 10 + S
						24.0124-0212.1 424212	Ø 320 24 21,4 V + S
S 280 (221.054) S 300 (221.054) S 350 4-matic (221.087, 221.187) S 350 CDI	170 170 200 173	08/06→12/13 08/06→12/13 02/08→12/13 06/09→12/13	← ← ← ➡ ➡ ➡ ➡	für Fahrzeuge ohne AMG-Sportpaket; → 05/13 für Fahrzeuge mit AMG-Sportpaket; → 05/13 → A 265575 A 265576→; → 05/13; für Fahrzeuge ohne AMG-Sportpaket A 265576→; → 05/13; für Fahrzeuge mit AMG-Sportpaket		24.0132-0137.1 432137	Ø 335 32 30 V• + S
						24.0132-0138.1 432138	Ø 350 32 30 V• + S
						24.0112-0183.1 412183	Ø 300 12 10 + S
						24.0122-0229.1 422229	Ø 300 22 19,4 V
						24.0124-0212.1 424212	Ø 320 24 21,4 V + S
S 320 CDI S 350 (221.056, 221.156)	155 200	10/05→12/13 10/05→12/13	← ← ➡ ➡ ➡ ➡	12/05→; für Fahrzeuge ohne AMG-Sportpaket; → 05/13 12/05→; für Fahrzeuge mit AMG-Sportpaket; → 05/13 12/05→; → A 265575 A 265576→; → 05/13; für Fahrzeuge ohne AMG-Sportpaket A 265576→; → 05/13; für Fahrzeuge mit AMG-Sportpaket		24.0132-0137.1 432137	Ø 335 32 30 V• + S
						24.0132-0138.1 432138	Ø 350 32 30 V• + S
						24.0112-0183.1 412183	Ø 300 12 10 + S
						24.0122-0229.1 422229	Ø 300 22 19,4 V
						24.0124-0212.1 424212	Ø 320 24 21,4 V + S
↓							



















	kw			 	! #		
MERCEDES-BENZ - S-KLASSE (W221) 09/05→12/13							
Bremsscheibe							
S 320 CDI (221.022, 221.122)	173	12/05→06/09	←	für Fahrzeuge ohne AMG-Sportpaket	24.0132-0137.1	432137	Ø 335 32 30 V• + S
			←	für Fahrzeuge mit AMG-Sportpaket	24.0132-0138.1	432138	Ø 350 32 30 V• + S
			→	→ A 265575	24.0112-0183.1	412183	Ø 300 12 10 + S
			→	A 265576→; für Fahrzeuge ohne AMG-Sportpaket	24.0122-0229.1	422229	Ø 300 22 19,4 V
			→	A 265576→; für Fahrzeuge mit AMG-Sportpaket	24.0124-0212.1	424212	Ø 320 24 21,4 V + S
S 320 CDI 4-matic (221.080, 221.180)	155	10/05→12/13	←	12/05→ 05/13	24.0132-0138.1	432138	Ø 350 32 30 V• + S
			→	12/05→; → A 265575	24.0112-0183.1	412183	Ø 300 12 10 + S
			→	A 265576→; → 05/13; für Fahrzeuge ohne AMG-Sportpaket	24.0122-0229.1	422229	Ø 300 22 19,4 V
			→	A 265576→; → 05/13; für Fahrzeuge mit AMG-Sportpaket	24.0124-0212.1	424212	Ø 320 24 21,4 V + S
			→	→ 05/13	24.0132-0138.1	432138	Ø 350 32 30 V• + S
S 320 CDI 4-matic (221.080, 221.180)	173	10/06→12/13	→	→ A 265575	24.0112-0183.1	412183	Ø 300 12 10 + S
			→	A 265576→; → 05/13; für Fahrzeuge ohne AMG-Sportpaket	24.0122-0229.1	422229	Ø 300 22 19,4 V
			→	A 265576→; → 05/13; für Fahrzeuge mit AMG-Sportpaket	24.0124-0212.1	424212	Ø 320 24 21,4 V + S
			←	für Fahrzeuge ohne AMG-Sportpaket; → 05/13	24.0132-0137.1	432137	Ø 335 32 30 V• + S
			←	für Fahrzeuge mit AMG-Sportpaket; → 05/13	24.0132-0138.1	432138	Ø 350 32 30 V• + S
S 350 BlueTec (221.026, 221.126) S 350 CGI (221.057, 221.157) S 350 CGI 4-matic (221.082, 221.182)	190	04/11→12/13	→	→ 05/13; für Fahrzeuge ohne AMG-Sportpaket	24.0122-0229.1	422229	Ø 300 22 19,4 V
	225	04/11→12/13	→	→ 05/13; für Fahrzeuge mit AMG-Sportpaket; → 05/13	24.0124-0212.1	424212	Ø 320 24 21,4 V + S
	225	04/11→12/13	←	→ 05/13	24.0132-0138.1	432138	Ø 350 32 30 V• + S
S 350 BlueTEC 4-matic (221.083, 221.183)	190	04/11→12/13	←	→ 05/13	24.0132-0138.1	432138	Ø 350 32 30 V• + S
			→	→ 05/13; für Fahrzeuge ohne AMG-Sportpaket	24.0122-0229.1	422229	Ø 300 22 19,4 V
			→	für Fahrzeuge mit AMG-Sportpaket; → 05/13	24.0124-0212.1	424212	Ø 320 24 21,4 V + S
S 400 Hybrid (221.095, 221.195)	205	01/09→12/13	←	06/09→; für Fahrzeuge ohne AMG-Sportpaket; → 05/13	24.0132-0137.1	432137	Ø 335 32 30 V• + S
			←	06/09→; für Fahrzeuge mit AMG-Sportpaket; → 05/13	24.0132-0138.1	432138	Ø 350 32 30 V• + S
			→	06/09→; für Fahrzeuge ohne AMG-Sportpaket; → 05/13	24.0112-0183.1	412183	Ø 300 12 10 + S
			→	06/09→; für Fahrzeuge mit AMG-Sportpaket; → 05/13	24.0124-0212.1	424212	Ø 320 24 21,4 V + S
			→	→ 05/13	24.0132-0138.1	432138	Ø 350 32 30 V• + S
S 420 CDI / S 450 CDI (221.028, 221.128)	235	10/06→12/13	→	→ 05/13	24.0124-0212.1	424212	Ø 320 24 21,4 V + S
			←	→ 05/13	24.0132-0138.1	432138	Ø 350 32 30 V• + S
S 450 (221.070, 221.170) S 450 4-matic (221.084, 221.184) S 500 4-matic (221.086, 221.186)	250	12/05→12/13	←	04/06→ 05/13	24.0132-0138.1	432138	Ø 350 32 30 V• + S
	250	12/05→12/13	→	04/06→ 05/13	24.0124-0212.1	424212	Ø 320 24 21,4 V + S
	285	10/05→12/13	←	12/05→; für Fahrzeuge ohne AMG-Sportpaket; → 05/13	24.0132-0137.1	432137	Ø 335 32 30 V• + S
S 500 (221.071, 221.171)	285	10/05→12/13	←	12/05→; für Fahrzeuge mit AMG-Sportpaket; → 05/13	24.0132-0138.1	432138	Ø 350 32 30 V• + S
			→	12/05→ 05/13	24.0124-0212.1	424212	Ø 320 24 21,4 V + S
			←	→ 05/13	24.0136-0102.1	436102	Ø 360 36 34 V•
S 500 CGI (221.073, 221.173) S 500 CGI 4-matic (221.094, 221.194)	320	04/11→12/13	→	→ 05/13	24.0124-0212.1	424212	Ø 320 24 21,4 V + S
	320	03/11→12/13	←	→ 05/13	24.0136-0108.1	436108	Ø 360 36 34 V• + S
S 600 (221.176)	380	12/05→12/13	←	→ 05/13	24.0126-0149.1	426149	Ø 330 26 23,4 V + S
			→	→ 05/13	24.0136-0108.1	436108	Ø 360 36 34 V• + S
MERCEDES-BENZ - S-KLASSE (W222, V222, X222) 05/13→							
Bremsbelagsatz, Scheibenbremse							
S 300 BlueTEC Hybrid / h (222.004, 222.104) ↓	150	02/14→	←	für Fahrzeuge mit AMG-Sportpaket	13.0460-4870.2	604870	BRE 25179 17,8 + WE / - WK









	kW				! #		
MERCEDES-BENZ - S-KLASSE (W222, V222, X222) 05/13→							
 Bremsbelagsatz, Scheibenbremse							
S 300 BlueTEC Hybrid / h (222.104)	170	02/14→	➔			13.0460-2780.2 602780	TRW 25071 18,8 + WE / - WK + Zub
S 320 (222.162) S 350 BlueTEC / d (222.132, 222.032, 222.123)	200	05/14→	➔	für Fahrzeuge ohne AMG-Sportpaket		13.0460-4869.2 604869	BRE 25183 17,9 + WE / - WK
	190	05/13→	➔	für Fahrzeuge mit AMG-Sportpaket		13.0460-4870.2 604870	BRE 25179 17,8 + WE / - WK
S 350 BlueTEC / d 4-matic (222.033, 222.133)	190	02/14→	➔			13.0460-2780.2 602780	TRW 25071 18,8 + WE / - WK + Zub
S 350 BlueTEC 4-matic (222.133)	185	02/14→					
S 400 Hybrid / h (222.057, 222.157)	225	05/13→					
S 400 (222.165)	245	03/14→	➔			13.0460-4870.2 604870	BRE 25179 17,8 + WE / - WK
S 400 4-matic (222.067)	245	11/14→					
S 500 (222.082, 222.182)	335	05/13→	➔			13.0460-2780.2 602780	TRW 25071 18,8 + WE / - WK + Zub
S 500 Hybrid / e (222.163)	245	07/14→					
S 500 4-matic (222.085, 222.185)	335	05/13→	➔	09/13→		13.0460-4870.2 604870	BRE 25179 17,8 + WE / - WK
			➔	09/13→		13.0460-2780.2 602780	TRW 25071 18,8 + WE / - WK + Zub
S 500 Maybach (222.982)	335	12/14→	➔	nicht für gepanzerte Fahrzeuge		13.0460-4870.2 604870	BRE 25179 17,8 + WE / - WK
			➔	nicht für gepanzerte Fahrzeuge		13.0460-2780.2 602780	TRW 25071 18,8 + WE / - WK + Zub
S 63 AMG (222.077, 222.177)	430	05/13→	➔	09/13→; für Fahrzeuge ohne Keramikbremse		13.0460-4839.2 604839	BRE 24455 16,8 + WE / - WK
S 63 AMG 4-matic (222.178)	430	05/13→					
S 65 AMG (222.179)	463	02/14→	➔	03/14→; für Fahrzeuge ohne Keramikbremse		13.0460-4839.2 604839	BRE 24455 16,8 + WE / - WK
Warnkontakt, Bremsbelagverschleiß							
S 300 BlueTEC Hybrid / h (222.004, 222.104)	150	02/14→	➔		2	24.8190-0959.2 620959	L= 102
S 300 BlueTEC Hybrid / h (222.104)	170	02/14→	➔		2	24.8190-0410.2 620410	L= 97,5
S 320 (222.162)	200	05/14→					
S 350 BlueTEC / d (222.132, 222.032, 222.123)	190	05/13→					
S 350 BlueTEC / d 4-matic (222.033, 222.133)	190	02/14→					
S 350 BlueTEC 4-matic (222.133)	185	02/14→					
S 400 (222.165)	245	03/14→					
S 400 4-matic (222.067)	245	11/14→					
S 400 Hybrid / h (222.057, 222.157)	225	05/13→					
S 500 (222.082, 222.182)	335	05/13→					
S 500 Hybrid / e (222.163)	245	07/14→					
S 500 4-matic (222.085, 222.185)	335	05/13→	➔	09/13→	2	24.8190-0959.2 620959	L= 102
			➔	09/13→	2	24.8190-0410.2 620410	L= 97,5
S 500 Maybach (222.982)	335	12/14→	➔	nicht für gepanzerte Fahrzeuge	2	24.8190-0959.2 620959	L= 102
			➔	nicht für gepanzerte Fahrzeuge	2	24.8190-0410.2 620410	L= 97,5
S 600 (222.176)	390	02/14→	➔	04/14→	1	24.8190-0420.2 620420	L= 119
			➔	04/14→	1	24.8190-0410.2 620410	L= 97,5
S 600 Maybach (222.976)	390	12/14→	➔	nicht für gepanzerte Fahrzeuge	1	24.8190-0420.2 620420	L= 119
			➔	nicht für gepanzerte Fahrzeuge	1	24.8190-0410.2 620410	L= 97,5
S 63 AMG (222.077, 222.177)	430	05/13→	➔	09/13→; für Fahrzeuge ohne Keramikbremse	1	24.8190-0420.2 620420	L= 119
S 63 AMG 4-matic (222.178)	430	05/13→	➔	09/13→	1	24.8190-0410.2 620410	L= 97,5
S 65 AMG (222.179)	463	02/14→	➔	03/14→; für Fahrzeuge ohne Keramikbremse	1	24.8190-0420.2 620420	L= 119
			➔	03/14→	1	24.8190-0410.2 620410	L= 97,5
MERCEDES-BENZ - S-KLASSE Cabriolet (A217) 12/15→							
 Bremsbelagsatz, Scheibenbremse							
S 500 (217.482)	335	12/15→	➔			13.0460-4870.2 604870	BRE 25179 17,8 + WE / - WK
			➔			13.0460-2780.2 602780	TRW 25071 18,8 + WE / - WK + Zub
↓							









	kw			 	! #		
MERCEDES-BENZ - S-KLASSE Cabriolet (A217) 12/15→							
Warnkontakt, Bremsbelagverschleiß							
AMG S 63 4-matic (217.478)	430	12/15→	←	☐; für Fahrzeuge ohne Keramikbremse		24.8190-0420.2 620420	L= 119
AMG S 65	463	04/16→	→	☐		24.8190-0410.2 620410	L= 97,5
S 500 (217.482)	335	12/15→	←	☐		24.8190-0959.2 620959	L= 102
			→	☐		24.8190-0410.2 620410	L= 97,5
MERCEDES-BENZ - S-KLASSE Coupe (C140) 07/92→02/99							
 Bremsbelagsatz, Scheibenbremse							
CL 500	225	09/96→12/97	←			13.0460-9033.2 609033	ATE 21303 18,9 + WE / - WK
			→			13.0460-4047.2 604047	ATE 21305 15,7 + WE / - WK
						13.0470-4047.2 LD4047	ATE 21305 15,7 + WE / - WK Ceramic
SEC/CL 420 (140.063)	205	10/94→02/99	←	06/96→		13.0460-9033.2 609033	ATE 21303 18,9 + WE / - WK
			←	→ 05/96		13.0460-9033.2 609033	ATE 21303 18,9 + WE / - WK
			→	06/96→		13.0460-4047.2 604047	ATE 21305 15,7 + WE / - WK
						13.0470-4047.2 LD4047	ATE 21305 15,7 + WE / - WK Ceramic
			→	→ 05/96		13.0460-4047.2 604047	ATE 21305 15,7 + WE / - WK
						13.0470-4047.2 LD4047	ATE 21305 15,7 + WE / - WK Ceramic
SEC/CL 500 (140.070) SEC/CL 600 (140.076)	235 290	10/92→02/99 09/92→02/99	←	06/96→		13.0460-9033.2 609033	ATE 21303 18,9 + WE / - WK
			←	07/93→ 05/96		13.0460-9033.2 609033	ATE 21303 18,9 + WE / - WK
			←	→ 06/93		13.0460-9033.2 609033	ATE 21303 18,9 + WE / - WK
			→	07/93→ 05/96		13.0460-4047.2 604047	ATE 21305 15,7 + WE / - WK
						13.0470-4047.2 LD4047	ATE 21305 15,7 + WE / - WK Ceramic
			→	06/96→		13.0460-4047.2 604047	ATE 21305 15,7 + WE / - WK
						13.0470-4047.2 LD4047	ATE 21305 15,7 + WE / - WK Ceramic
			→	→ 06/93		13.0460-4047.2 604047	ATE 21305 15,7 + WE / - WK
						13.0470-4047.2 LD4047	ATE 21305 15,7 + WE / - WK Ceramic
Warnkontakt, Bremsbelagverschleiß							
CL 500	225	09/96→12/97	←		4	24.8190-0401.2 620401	L= 95
			→	+ ASR	4	24.8190-0401.2 620401	L= 95
SEC/CL 420 (140.063)	205	10/94→02/99	←	06/96→	4	24.8190-0401.2 620401	L= 95
			←	→ 05/96	4	24.8190-0401.2 620401	L= 95
			→	06/96→; + ASR	4	24.8190-0401.2 620401	L= 95
			→	→ 05/96; + ASR	4	24.8190-0401.2 620401	L= 95
SEC/CL 500 (140.070) SEC/CL 600 (140.076)	235 290	10/92→02/99 09/92→02/99	←	07/93→ 05/96	4	24.8190-0401.2 620401	L= 95
			←	→ 06/93	4	24.8190-0401.2 620401	L= 95
			←	06/96→	4	24.8190-0401.2 620401	L= 95
			→	→ 06/93; + ASR	4	24.8190-0401.2 620401	L= 95
			→	06/96→; + ASR	4	24.8190-0401.2 620401	L= 95
			→	07/93→ 05/96; + ASR	4	24.8190-0401.2 620401	L= 95
Zubehörsatz, Scheibenbremsbelag							
CL 500	225	09/96→12/97	←			13.0460-0263.2 610263	
			→			13.0460-0236.2 610236	ATE
SEC/CL 420 (140.063)	205	10/94→02/99	←	06/96→		13.0460-0263.2 610263	
			←	→ 05/96		13.0460-0263.2 610263	
			→	→ 05/96		13.0460-0236.2 610236	ATE
						13.0460-0239.2 610239	ATE
			→	06/96→		13.0460-0236.2 610236	ATE
SEC/CL 500 (140.070) SEC/CL 600 (140.076)	235 290	10/92→02/99 09/92→02/99	←	06/96→		13.0460-0263.2 610263	
			←	07/93→ 05/96		13.0460-0263.2 610263	
			←	→ 06/93		13.0460-0263.2 610263	
			→	07/93→ 05/96		13.0460-0236.2 610236	ATE
						13.0460-0239.2 610239	ATE











	kW					! #		
MERCEDES-BENZ - S-KLASSE Coupe (C140) 07/92→02/99								
Zubehörsatz, Scheibenbremsbelag								
SEC/CL 500 (140.070)	235	10/92→02/99	➡	06/96→			13.0460-0236.2 610236	ATE
SEC/CL 600 (140.076)	290	09/92→02/99	➡	→ 06/93			13.0460-0236.2 610236	ATE
 Bremsscheibe								
CL 500	225	09/96→12/97	←				24.0130-0100.1 430100	Ø 320 30 27,4 V
			➡				24.0122-0133.1 422133	Ø 300 22 19,4 V
SEC/CL 420 (140.063)	205	10/94→02/99	←	06/96→			24.0130-0100.1 430100	Ø 320 30 27,4 V
			←	→ 05/96			24.0130-0100.1 430100	Ø 320 30 27,4 V
			➡	→ 05/96			24.0122-0133.1 422133	Ø 300 22 19,4 V
			➡	06/96→			24.0122-0133.1 422133	Ø 300 22 19,4 V
SEC/CL 500 (140.070)	235	10/92→02/99	←	06/96→			24.0130-0100.1 430100	Ø 320 30 27,4 V
SEC/CL 600 (140.076)	290	09/92→02/99	←	07/93→ 05/96			24.0130-0100.1 430100	Ø 320 30 27,4 V
			←	→ 06/93			24.0130-0100.1 430100	Ø 320 30 27,4 V
			➡	07/93→ 05/96			24.0122-0133.1 422133	Ø 300 22 19,4 V
			➡	06/96→			24.0122-0133.1 422133	Ø 300 22 19,4 V
			➡	→ 06/93			24.0122-0133.1 422133	Ø 300 22 19,4 V
MERCEDES-BENZ - S-KLASSE Coupe (C215) 03/99→08/06								
 Bremsbelagsatz, Scheibenbremse								
CL 500 (215.375)	225	03/99→03/06	←				13.0460-4984.2 604984	BRE 23271 17,4 + WE / - WK
CL 55 AMG (215.373)	265	10/99→03/06	➡				13.0460-4069.2 604069	ATE 23078 15,9 + WE / - WK
CL 600 (215.376)	368	09/02→03/06						
CL 600 (215.378)	270	03/99→03/06						
CL 55 AMG Kompressor (215.374)	368	06/02→03/06	←				13.0460-4997.2 604997	BRE 23943 17,5 + WE / - WK
			➡				13.0460-4998.2 604998	BRE 23478 16,5 + WE / - WK
CL 65 AMG (215.379)	450	09/03→03/06	←				13.0460-4997.2 604997	BRE 23943 17,5 + WE / - WK
			➡				13.0460-4819.2 604819	BRE 23478 14,6 + WE / - WK
Warnkontakt, Bremsbelagsverschleiß								
CL 500 (215.375)	225	03/99→03/06	←		2	24.8190-0410.2 620410		L= 97,5
CL 55 AMG (215.373)	265	10/99→03/06	➡					
CL 55 AMG Kompressor (215.374)	368	06/02→03/06			1	24.8190-0410.2 620410		L= 97,5
CL 600 (215.376)	368	09/02→03/06						
CL 600 (215.378)	270	03/99→03/06						
CL 65 AMG (215.379)	450	09/03→03/06						
Zubehörsatz, Scheibenbremsbelag								
CL 500 (215.375)	225	03/99→03/06	←				13.0460-0269.2 610269	
CL 55 AMG (215.373)	265	10/99→03/06						
CL 600 (215.376)	368	09/02→03/06						
CL 600 (215.378)	270	03/99→03/06						
 Bremsscheibe								
CL 500 (215.375)	225	03/99→03/06	←				24.0132-0115.1 432115	Ø 330 32 30 V•
			➡				24.0122-0192.1 422192	Ø 300 22 19,4 V
CL 55 AMG (215.373)	265	10/99→03/06	←				24.0132-0125.1 432125	Ø 345 32 30 V•
CL 600 (215.376)	368	09/02→03/06	➡				24.0122-0213.1 422213	Ø 315 22 19,4 V
CL 600 (215.378)	270	03/99→03/06						
CL 55 AMG Kompressor (215.374)	368	06/02→03/06	←				24.0136-0105.1 436105	Ø 360 36 34 V•
			➡				24.0126-0137.1 426137	Ø 330 26 24 V•
MERCEDES-BENZ - S-KLASSE Coupe (C216) 05/06→12/13								
 Bremsbelagsatz, Scheibenbremse								
CL 500 (216.371)	285	06/06→12/13	←	07/06→			13.0460-4817.2 604817	BRE 23960 18,3 + WE / - WK
			➡	07/06→			13.0460-7171.2 607171	ATE 23334 16,7 + WE / - WK
							13.0470-7171.2 LD7171	ATE 23334 16,7 + WE / - WK Ceramic
CL 500 4-matic (216.386)	285	02/08→12/13	←	03/08→			13.0460-4817.2 604817	BRE 23960 18,3 + WE / - WK
			➡	03/08→			13.0460-7171.2 607171	ATE 23334 16,7 + WE / - WK
							13.0470-7171.2 LD7171	ATE 23334 16,7 + WE / - WK Ceramic
CL 600 (216.376)	380	05/06→12/13	←	07/06→			13.0460-4839.2 604839	BRE 24455 16,8 + WE / - WK
↓								











	kw					! #		
MERCEDES-BENZ - S-KLASSE Coupe (C216) 05/06→12/13								
 Bremsbelagsatz, Scheibenbremse								
CL 600 (216.376)	380	05/06→12/13	➡	07/06→			13.0460-4998.2 604998	BRE 23478 16,5 + WE / - WK
Warnkontakt, Bremsbelagverschleiß								
CL 500 (216.371)	285	06/06→12/13	←	07/06→	1	24.8190-0420.2 620420		L= 119
CL 600 (216.376)	380	05/06→12/13	➡	07/06→	1	24.8190-0410.2 620410		L= 97,5
CL 500 (216.373)	320	02/11→12/13	←		1	24.8190-0410.2 620410		L= 97,5
CL 500 4-matic (216.394)	320	02/11→12/13	➡		1	24.8190-0410.2 620410		L= 97,5
CL 500 4-matic (216.386)	285	02/08→12/13	←	03/08→	1	24.8190-0420.2 620420		L= 119
			➡	03/08→	1	24.8190-0410.2 620410		L= 97,5
CL 63 AMG (216.374)	400	02/11→12/13	←		1	24.8190-0420.2 620420		L= 119
CL 63 AMG (216.374)	420	01/10→12/13						
CL 65 AMG (216.379)	463	02/11→12/13	➡		1	24.8190-0420.2 620420		L= 119
CL 63 AMG (216.377)	386	10/06→12/13	←	01/07→	1	24.8190-0420.2 620420		L= 119
CL 65 AMG (216.379)	450	10/06→12/10	➡	01/07→	1	24.8190-0420.2 620420		L= 119
 Bremsscheibe								
CL 500 (216.371)	285	06/06→12/13	←	07/06→		24.0132-0138.1 432138		Ø 350 32 30 V• + S
			➡	07/06→		24.0124-0212.1 424212		Ø 320 24 21,4 V + S
CL 500 (216.373)	320	02/11→12/13	←			24.0136-0102.1 436102		Ø 360 36 34 V•
CL 500 4-matic (216.394)	320	02/11→12/13	➡			24.0124-0212.1 424212		Ø 320 24 21,4 V + S
CL 500 4-matic (216.386)	285	02/08→12/13	←	03/08→		24.0132-0138.1 432138		Ø 350 32 30 V• + S
			➡	03/08→		24.0124-0212.1 424212		Ø 320 24 21,4 V + S
CL 600 (216.376)	380	05/06→12/13	←	07/06→		24.0136-0108.1 436108		Ø 360 36 34 V• + S
			➡	07/06→		24.0126-0149.1 426149		Ø 330 26 23,4 V + S
MERCEDES-BENZ - S-KLASSE Coupe (C217) 04/14→								
 Bremsbelagsatz, Scheibenbremse								
S 400 4-matic (217.364)	270	10/15→	←	für Fahrzeuge ohne AMG-Sportpaket		13.0460-4870.2 604870		BRE 25179 17,8 + WE / - WK
S 500 (217.382)	335	11/14→						
S 500 4-matic (217.385)	335	04/14→	➡	nicht für Fahrzeuge mit verstärkter Bremse		13.0460-2780.2 602780		TRW 25071 18,8 + WE / - WK + Zub
S 63 AMG 4-matic (217.378)	430	04/14→	➡	für Fahrzeuge ohne Keramikbremse		13.0460-2780.2 602780		TRW 25071 18,8 + WE / - WK + Zub
Warnkontakt, Bremsbelagverschleiß								
S 400 4-matic (217.364)	270	10/15→	←	☐	1	24.8190-0959.2 620959		L= 102
S 500 (217.382)	335	11/14→						
S 500 4-matic (217.385)	335	04/14→	➡	☐	1	24.8190-0410.2 620410		L= 97,5
S 63 AMG (217.377)	430	07/14→	←	☐; für Fahrzeuge ohne Keramikbremse	1	24.8190-0420.2 620420		L= 119
S 65 AMG (217.379)	463	07/14→	➡		1	24.8190-0410.2 620410		L= 97,5
S 63 AMG 4-matic (217.378)	430	04/14→	←	☐; für Fahrzeuge ohne Keramikbremse	1	24.8190-0420.2 620420		L= 119
			➡	☐	1	24.8190-0410.2 620410		L= 97,5
MERCEDES-BENZ - SL (R129) 03/89→12/01								
 Bremsbelagsatz, Scheibenbremse								
280 (129.058)	142	08/93→10/01	←	→ 09/01		13.0460-4201.2 604201		ATE 21153 17,5 + WE / - WK
320 (129.063)	170	09/93→10/01	➡	→ F 125157		13.0460-3805.2 603805		ATE 21197 15,0 + WE / - WK
						13.0470-3805.2 LD3805		ATE 21197 15,0 + WE / - WK Ceramic
			➡	F 125158→; → 09/01		13.0460-4047.2 604047		ATE 21305 15,7 + WE / - WK
						13.0470-4047.2 LD4047		ATE 21305 15,7 + WE / - WK Ceramic
280 (129.059)	150	05/98→10/01	←	→ F 187941; - ESP		13.0460-4201.2 604201		ATE 21153 17,5 + WE / - WK
320 (129.064)	165	05/98→10/01	←	F 187942→; → 09/01		13.0460-4984.2 604984		BRE 23271 17,4 + WE / - WK
						13.0470-4984.2 LD4984		BRE 23271 17,4 + WE / - WK Ceramic
			←	→ F 187941; + ESP		13.0460-4984.2 604984		BRE 23271 17,4 + WE / - WK
						13.0470-4984.2 LD4984		BRE 23271 17,4 + WE / - WK Ceramic
			➡	→ 09/01		13.0460-4047.2 604047		ATE 21305 15,7 + WE / - WK
						13.0470-4047.2 LD4047		ATE 21305 15,7 + WE / - WK Ceramic
↓								









	kW			 	! #		
MERCEDES-BENZ - SL (R129) 03/89→12/01							
 Bremsbelagsatz, Scheibenbremse							
500 (129.067)	235	09/92→10/01	←	08/93→ 09/01		13.0460-4201.2 604201	ATE 21153 17,5 + WE / - WK
			→	08/93→; → F 125157		13.0460-3805.2 603805	ATE 21197 15,0 + WE / - WK
			→	F 125158→; → 09/01		13.0460-4047.2 604047	ATE 21305 15,7 + WE / - WK
500 (129.068) 55 AMG	225 260	05/98→10/01 03/00→10/01	←	→ 09/01		13.0460-4984.2 604984	BRE 23271 17,4 + WE / - WK
			→	→ 09/01		13.0460-4047.2 604047	ATE 21305 15,7 + WE / - WK
600 (129.076)	290	07/92→10/01	←	08/93→ 09/01; - ESP		13.0460-4201.2 604201	ATE 21153 17,5 + WE / - WK
			←	→ 07/93		13.0460-4201.2 604201	ATE 21153 17,5 + WE / - WK
			←	08/93→ 09/01; + ESP		13.0460-4984.2 604984	BRE 23271 17,4 + WE / - WK
			→	08/93→ 09/01		13.0460-4047.2 604047	ATE 21305 15,7 + WE / - WK
			→	→ 07/93		13.0460-4047.2 604047 13.0470-4047.2 LD4047	ATE 21305 15,7 + WE / - WK Ceramic
60 AMG (129.067)	280	05/97→10/01	←	→ 09/01		13.0460-4201.2 604201	ATE 21153 17,5 + WE / - WK
			→	→ F 125157		13.0460-3805.2 603805	ATE 21197 15,0 + WE / - WK
			→	F 125158→; → 09/01		13.0460-4047.2 604047	ATE 21305 15,7 + WE / - WK
SL 73 AMG (129.076)	385	01/99→12/01	←	→ 09/01; - ESP		13.0460-4201.2 604201	ATE 21153 17,5 + WE / - WK
			←	→ 09/01; + ESP		13.0460-4984.2 604984	BRE 23271 17,4 + WE / - WK
			→	→ 09/01		13.0460-4047.2 604047	ATE 21305 15,7 + WE / - WK
Warnkontakt, Bremsbelagsverschleiß							
280 (129.058) 320 (129.063) 60 AMG (129.067)	142 170 280	08/93→10/01 09/93→10/01 05/97→10/01	←	→ 09/01	2	24.8190-0401.2 620401	L= 95
			→	→ F 125157; + ASR	4	24.8190-0401.2 620401	L= 95
			→	F 125158→; → 09/01	1	24.8190-0401.2 620401	L= 95
280 (129.059) 320 (129.064)	150 165	05/98→10/01 05/98→10/01	←	F 187942→; → 09/01	2	24.8190-0401.2 620401	L= 95
			←	→ F 187941	2	24.8190-0401.2 620401	L= 95
			→	→ 09/01	1	24.8190-0401.2 620401	L= 95
500 (129.067)	235	09/92→10/01	←	08/93→ 09/01	2	24.8190-0401.2 620401	L= 95
			→	08/93→; → F 125157; + ASR	4	24.8190-0401.2 620401	L= 95
			→	F 125158→; → 09/01	1	24.8190-0401.2 620401	L= 95
500 (129.068) 55 AMG SL 73 AMG (129.076)	225 260 385	05/98→10/01 03/00→10/01 01/99→12/01	←	→ 09/01	2	24.8190-0401.2 620401	L= 95
			→	→ 09/01	1	24.8190-0401.2 620401	L= 95
			←	→ 07/93	4	24.8190-0401.2 620401	L= 95
600 (129.076)	290	07/92→10/01	←	08/93→ 09/01	2	24.8190-0401.2 620401	L= 95
			→	→ 07/93; + ASR	4	24.8190-0401.2 620401	L= 95
			→	08/93→ 09/01	1	24.8190-0401.2 620401	L= 95
Zubehörsatz, Scheibenbremsbelag							
280 (129.058) 320 (129.063) 60 AMG (129.067)	142 170 280	08/93→10/01 09/93→10/01 05/97→10/01	←	→ 09/01		13.0460-0219.2 610219	ATE
			→	→ F 125157		13.0460-0215.2 610215	ATE
			→	F 125158→; → 09/01		13.0460-0236.2 610236	ATE
280 (129.059) 320 (129.064)	150 165	05/98→10/01 05/98→10/01	←	→ F 187941		13.0460-0219.2 610219	ATE
			←	F 187942→; → 09/01		13.0460-0269.2 610269	
			←	→ F 187941; + ESP		13.0460-0269.2 610269	
			→	→ 09/01		13.0460-0236.2 610236	ATE
500 (129.067)	235	09/92→10/01	←	08/93→ 09/01		13.0460-0219.2 610219	ATE
			→	08/93→; → F 125157		13.0460-0215.2 610215	ATE
			→	F 125158→; → 09/01		13.0460-0236.2 610236	ATE
500 (129.068) 55 AMG	225 260	05/98→10/01 03/00→10/01	←	→ 09/01		13.0460-0269.2 610269	
			→	→ 09/01		13.0460-0236.2 610236	ATE
600 (129.076)	290	07/92→10/01	←	08/93→ 09/01		13.0460-0219.2 610219	ATE
			←	→ 07/93		13.0460-0219.2 610219	ATE
			←	08/93→ 09/01; + ESP		13.0460-0269.2 610269	
			→	→ 07/93		13.0460-0236.2 610236	ATE
			→	08/93→ 09/01		13.0460-0236.2 610236	ATE
↓							







	kW			 	! #		
MERCEDES-BENZ - SL (R129) 03/89→12/01							
Zubehörsatz, Scheibenbremsbelag							
SL 73 AMG (129.076)	385	01/99→12/01	←	→ 09/01		13.0460-0219.2 610219	ATE
			←	→ 09/01; + ESP		13.0460-0269.2 610269	
			→	→ 09/01		13.0460-0236.2 610236	ATE
 Bremsscheibe							
280 (129.058) 320 (129.063)	142 170	08/93→10/01 09/93→10/01	←	→ 09/01; - ESP		24.0128-0103.1 428103	Ø 300 28 25,4 V
			←	☐; → 09/01; + ESP		24.0130-0121.1 430121	Ø 320 30 28 V
			←	☐; → 09/01; + ESP		24.0130-0122.1 430122	Ø 320 30 28 V
			→	→ F 125157		24.0109-0103.1 409103	Ø 278 9 7,3
			→	F 125158→; → 09/01; - ESP		24.0110-0293.1 410293	Ø 290 10 8,3
			→	F 125158→; → 09/01; + ESP		24.0122-0218.1 422218	Ø 300 22 19,4 V
280 (129.059) 320 (129.064)	150 165	05/98→10/01 05/98→10/01	←	→ F 187941; - ESP		24.0128-0103.1 428103	Ø 300 28 25,4 V
			←	F 187942→; → 09/01; + SL Edition		24.0132-0147.1 432147	Ø 334 32 30 V*
			→	→ F 187941; - ESP		24.0110-0293.1 410293	Ø 290 10 8,3
			→	F 187942→; → 09/01; + ESP; - SL Edition		24.0122-0218.1 422218	Ø 300 22 19,4 V
			→	→ F 187941; + ESP		24.0122-0218.1 422218	Ø 300 22 19,4 V
500 (129.067)	235	09/92→10/01	←	08/93→; → F103936; - AMG Technikpaket		24.0128-0103.1 428103	Ø 300 28 25,4 V
			←	☐; 08/93→ 09/01; + AMG Technikpaket		24.0130-0121.1 430121	Ø 320 30 28 V
			←	☐; F103937→; → 09/01; - AMG Technikpaket		24.0130-0121.1 430121	Ø 320 30 28 V
			←	☐; F103937→; → 09/01; - AMG Technikpaket		24.0130-0122.1 430122	Ø 320 30 28 V
			←	☐; 08/93→ 09/01; + AMG Technikpaket		24.0130-0122.1 430122	Ø 320 30 28 V
			→	08/93→; → F 103936		24.0109-0103.1 409103	Ø 278 9 7,3
			→	F 125158→; → 09/01; - ESP		24.0110-0293.1 410293	Ø 290 10 8,3
			→	F 125158→; → 09/01; + ESP		24.0122-0218.1 422218	Ø 300 22 19,4 V
500 (129.068) 55 AMG	225 260	05/98→10/01 03/00→10/01	←	→ 09/01; + SL Edition		24.0132-0147.1 432147	Ø 334 32 30 V*
			→	→ 09/01; + ESP; - SL Edition		24.0122-0218.1 422218	Ø 300 22 19,4 V
600 (129.076)	290	07/92→10/01	←	☐; 08/93→ 09/01		24.0130-0121.1 430121	Ø 320 30 28 V
			←	☐; → 07/93		24.0130-0121.1 430121	Ø 320 30 28 V
			←	☐; 08/93→ 09/01		24.0130-0122.1 430122	Ø 320 30 28 V
			←	☐; → 07/93		24.0130-0122.1 430122	Ø 320 30 28 V
			→	08/93→ 09/01		24.0122-0218.1 422218	Ø 300 22 19,4 V
			→	→ 07/93		24.0122-0218.1 422218	Ø 300 22 19,4 V
60 AMG (129.067)	280	05/97→10/01	←	→ F103936		24.0128-0103.1 428103	Ø 300 28 25,4 V
			←	☐; F103937→; → 09/01		24.0130-0121.1 430121	Ø 320 30 28 V
			←	☐; F103937→; → 09/01		24.0130-0122.1 430122	Ø 320 30 28 V
			→	→ F 103936		24.0109-0103.1 409103	Ø 278 9 7,3
			→	F 125158→; → 09/01; - ESP		24.0110-0293.1 410293	Ø 290 10 8,3
			→	F 125158→; → 09/01; + ESP		24.0122-0218.1 422218	Ø 300 22 19,4 V
SL 73 AMG (129.076)	385	01/99→12/01	←	☐; → 09/01		24.0130-0121.1 430121	Ø 320 30 28 V
			←	☐; → 09/01		24.0130-0122.1 430122	Ø 320 30 28 V
			→	→ 09/01		24.0122-0218.1 422218	Ø 300 22 19,4 V
MERCEDES-BENZ - SL (R230) 10/01→01/12							
 Bremsbelagsatz, Scheibenbremse							
280 (230.454) 300 (230.454) 350 (230.456)	170 170 200	03/08→01/12 04/09→01/12 03/06→01/12	←	→ 11/11; für Fahrzeuge mit Sportpaket		13.0460-4817.2 604817	BRE 23960 18,3 + WE / - WK
			←	→ 11/11; für Fahrzeuge ohne Sportpaket		13.0460-4990.2 604990 13.0470-4990.2 LD4990	BRE 23271 17,4 + WE / - WK BRE 23271 17,4 + WE / - WK Ceramic
			→	→ 11/11		13.0460-7171.2 607171 13.0470-7171.2 LD7171	ATE 23334 16,7 + WE / - WK ATE 23334 16,7 + WE / - WK Ceramic
350 (230.458)	232	04/08→01/12	←	→ 11/11; für Fahrzeuge mit Sportpaket		13.0460-4817.2 604817	BRE 23960 18,3 + WE / - WK
			←	→ 11/11; für Fahrzeuge ohne Sportpaket		13.0460-4990.2 604990	BRE 23271 17,4 + WE / - WK
↓							









	kw			 	! #		
MERCEDES-BENZ - SL (R230) 10/01—01/12							
 Bremsbelagsatz, Scheibenbremse							
350 (230.458)	232	04/08→01/12	➡	→ 11/11		13.0460-7171.2 607171 13.0470-7171.2 LD7171	ATE 23334 16,7 + WE / - WK ATE 23334 16,7 + WE / - WK Ceramic
350 (230.467)	180	03/03→01/12	⬅	→ 11/11		13.0460-4990.2 604990 13.0470-4990.2 LD4990	BRE 23271 17,4 + WE / - WK BRE 23271 17,4 + WE / - WK Ceramic
			➡	→ 11/11		13.0460-7171.2 607171 13.0470-7171.2 LD7171	ATE 23334 16,7 + WE / - WK ATE 23334 16,7 + WE / - WK Ceramic
500 (230.471)	285	03/06→01/12	⬅	→ 11/11		13.0460-4817.2 604817	BRE 23960 18,3 + WE / - WK
			➡	→ 11/11		13.0460-7171.2 607171 13.0470-7171.2 LD7171	ATE 23334 16,7 + WE / - WK ATE 23334 16,7 + WE / - WK Ceramic
500 (230.475)	225	10/01→01/12	⬅	→ 11/11; für Fahrzeuge mit Sportpaket		13.0460-4990.2 604990	BRE 23271 17,4 + WE / - WK
			⬅	→ 11/11; für Fahrzeuge ohne Sportpaket		13.0460-4990.2 604990	BRE 23271 17,4 + WE / - WK
			➡	→ 11/11		13.0460-7171.2 607171 13.0470-7171.2 LD7171	ATE 23334 16,7 + WE / - WK ATE 23334 16,7 + WE / - WK Ceramic
55 AMG (230.472)	380	03/06→01/12	⬅	→ 11/11; für Fahrzeuge ohne AMG-Performance Package		13.0460-4839.2 604839	BRE 24455 16,8 + WE / - WK
55 AMG (230.474)	350	10/01→06/02	⬅			13.0460-4997.2 604997	BRE 23943 17,5 + WE / - WK
			➡			13.0460-4998.2 604998	BRE 23478 16,5 + WE / - WK
55 AMG Kompressor (230.474)	368	06/02→01/12	⬅	→ 11/11		13.0460-4997.2 604997	BRE 23943 17,5 + WE / - WK
			➡	→ 11/11		13.0460-4998.2 604998	BRE 23478 16,5 + WE / - WK
600 (230.476) 600 (230.477)	368 380	04/03→01/12 03/06→01/12	⬅	→ F 134504		13.0460-4997.2 604997	BRE 23943 17,5 + WE / - WK
			➡	→ 11/11		13.0460-4998.2 604998	BRE 23478 16,5 + WE / - WK
63 AMG (230.470) 65 AMG Black Series (230.479)	386 493	03/08→01/12 07/08→01/12	⬅	→ 11/11		13.0460-4839.2 604839	BRE 24455 16,8 + WE / - WK
65 AMG (230.479)	450	03/04→01/12	⬅	→ F 122820		13.0460-4997.2 604997	BRE 23943 17,5 + WE / - WK
			➡	→ F 122820		13.0460-4819.2 604819	BRE 23478 14,6 + WE / - WK
Warnkontakt, Bremsbelagverschleiß							
280 (230.454)	170	03/08→01/12	⬅	→ 11/11; für Fahrzeuge ohne Sportpaket	2	24.8190-0410.2 620410	L= 97,5
300 (230.454)	170	04/09→01/12	⬅	→ 11/11; für Fahrzeuge mit Sportpaket	2	24.8190-0420.2 620420	L= 119
350 (230.456)	200	03/06→01/12	⬅				
350 (230.458)	232	04/08→01/12	➡	→ 11/11	1	24.8190-0410.2 620410	L= 97,5
500 (230.475)	225	10/01→01/12	➡				
350 (230.467) 55 AMG Kompressor (230.474)	180 368	03/03→01/12 06/02→01/12	⬅	→ 11/11	2	24.8190-0410.2 620410	L= 97,5
			➡	→ 11/11	1	24.8190-0410.2 620410	L= 97,5
500 (230.471)	285	03/06→01/12	⬅	→ 11/11	2	24.8190-0420.2 620420	L= 119
			➡	→ 11/11	1	24.8190-0410.2 620410	L= 97,5
55 AMG (230.472) 63 AMG (230.470) 65 AMG Black Series (230.479)	380 386 493	03/06→01/12 03/08→01/12 07/08→01/12	⬅	→ 11/11	2	24.8190-0420.2 620420	L= 119
			➡	→ 11/11	1	24.8190-0420.2 620420	L= 119
55 AMG (230.474)	350	10/01→06/02	⬅		2	24.8190-0410.2 620410	L= 97,5
			➡		1	24.8190-0410.2 620410	L= 97,5
600 (230.476) 600 (230.477)	368 380	04/03→01/12 03/06→01/12	⬅	→ F 134504	2	24.8190-0410.2 620410	L= 97,5
			⬅	F 134505→; → 11/11	2	24.8190-0420.2 620420	L= 119
			➡	→ 11/11	1	24.8190-0410.2 620410	L= 97,5
65 AMG (230.479)	450	03/04→01/12	⬅	→ F 122820	2	24.8190-0410.2 620410	L= 97,5
			⬅	F 122821→; → 11/11	2	24.8190-0420.2 620420	L= 119
			➡	→ F 122820	1	24.8190-0410.2 620410	L= 97,5
			➡	F 122821→; → 11/11	1	24.8190-0420.2 620420	L= 119
Zubehörsatz, Scheibenbremsbelag							
280 (230.454)	170	03/08→01/12	⬅	→ 11/11; für Fahrzeuge ohne Sportpaket		13.0460-0275.2 610275	
300 (230.454)	170	04/09→01/12					
350 (230.456)	200	03/06→01/12					
350 (230.458)	232	04/08→01/12					
350 (230.467)	180	03/03→01/12	⬅	→ 11/11		13.0460-0275.2 610275	
↓							







	kw			 	! #		
MERCEDES-BENZ - SL (R230) 10/01—01/12							
Zubehörsatz, Scheibenbremsbelag							
500 (230.475)	225	10/01→01/12	←	→ 11/11; für Fahrzeuge mit Sportpaket		13.0460-0275.2 610275	
			←	→ 11/11; für Fahrzeuge ohne Sportpaket		13.0460-0275.2 610275	
 Bremsscheibe							
280 (230.454)	170	03/08→01/12	←	→ 11/11; für Fahrzeuge mit Sportpaket		24.0132-0138.1 432138	Ø 350 32 30 V• + S
300 (230.454)	170	04/09→01/12	←	→ 11/11; für Fahrzeuge ohne Sportpaket		24.0132-0153.1 432153	Ø 330 32 30 V• + S
350 (230.456)	200	03/06→01/12	←	→ 11/11; für Fahrzeuge ohne Sportpaket		24.0112-0183.1 412183	Ø 300 12 10 + S
350 (230.458)	232	04/08→01/12	→	→ 11/11; für Fahrzeuge ohne Sportpaket		24.0124-0226.1 424226	Ø 320 24 22 V• + S
			→	→ 11/11; für Fahrzeuge mit Sportpaket			
350 (230.467)	180	03/03→01/12	←	→ 11/11		24.0128-0163.1 428163	Ø 312 28 26 V•
			→	→ 11/11		24.0110-0351.1 410351	Ø 300 10 8,3 + S
500 (230.471)	285	03/06→01/12	←	→ 11/11		24.0132-0138.1 432138	Ø 350 32 30 V• + S
			→	→ 11/11; für Fahrzeuge ohne Sportpaket		24.0124-0212.1 424212	Ø 320 24 21,4 V + S
			→	→ 11/11; für Fahrzeuge mit Sportpaket		24.0124-0226.1 424226	Ø 320 24 22 V• + S
500 (230.475)	225	10/01→01/12	←	→ 11/11		24.0132-0153.1 432153	Ø 330 32 30 V• + S
			→	→ 11/11		24.0122-0229.1 422229	Ø 300 22 19,4 V
55 AMG (230.474)	350	10/01→06/02	←	für Fahrzeuge ohne AMG-Performance Package		24.0136-0102.1 436102	Ø 360 36 34 V•
55 AMG Kompressor (230.474)	368	06/02→01/12	←	→ 11/11; für Fahrzeuge ohne AMG-Performance Package		24.0136-0102.1 436102	Ø 360 36 34 V•
600 (230.476)	368	04/03→01/12	←	→ 11/11		24.0136-0102.1 436102	Ø 360 36 34 V•
600 (230.477)	380	03/06→01/12	→	→ 11/11		24.0126-0149.1 426149	Ø 330 26 23,4 V + S
MERCEDES-BENZ - SL (R231) 01/12→							
 Bremsbelagsatz, Scheibenbremse							
350 (231.457)	225	02/12→	←	03/12→ 11/12; für Fahrzeuge ohne AMG-Sportpaket		13.0460-4869.2 604869	BRE 25183 17,9 + WE / - WK
500 (231.473)	320	01/12→	←	03/12→ 11/12; für Fahrzeuge mit AMG-Sportpaket; für Fahrzeuge mit verstärkter Bremse		13.0460-4870.2 604870	BRE 25179 17,8 + WE / - WK
			←	12/12→; für Fahrzeuge mit AMG-Sportpaket; für Fahrzeuge mit verstärkter Bremse		13.0460-4870.2 604870	BRE 25179 17,8 + WE / - WK
			→	03/12→		13.0460-2780.2 602780	TRW 25071 18,8 + WE / - WK + Zub
400 (231.465)	245	04/14→	←	für Fahrzeuge mit AMG-Sportpaket; für Fahrzeuge mit verstärkter Bremse		13.0460-4870.2 604870	BRE 25179 17,8 + WE / - WK
400 (231.466)	270	01/16→	→			13.0460-2780.2 602780	TRW 25071 18,8 + WE / - WK + Zub
500 (231.473)	335	04/15→	→				
Warnkontakt, Bremsbelagverschleiß							
350 (231.457)	225	02/12→	←	☐; 12/12→	1	24.8190-0959.2 620959	L= 102
500 (231.473)	320	01/12→	←	☐; 03/12→ 11/12	1	24.8190-0959.2 620959	L= 102
			→	03/12→	1	24.8190-0410.2 620410	L= 97,5
400 (231.465)	245	04/14→	←	☐	1	24.8190-0959.2 620959	L= 102
400 (231.466)	270	01/16→	→		1	24.8190-0410.2 620410	L= 97,5
500 (231.473)	335	04/15→	→		1	24.8190-0410.2 620410	L= 97,5
63 AMG (231.474)	395	01/12→	←	☐; 03/12→	1	24.8190-0420.2 620420	L= 119
63 AMG (231.474)	415	01/12→	→	03/12→	1	24.8190-0410.2 620410	L= 97,5
63 AMG (231.474)	430	04/14→	←	☐	1	24.8190-0420.2 620420	L= 119
65 AMG (231.479)	463	05/12→	→		1	24.8190-0410.2 620410	L= 97,5
MERCEDES-BENZ - SLC (R172) 01/16→							
 Bremsbelagsatz, Scheibenbremse							
180 (172.431)	115	01/16→	←	für Fahrzeuge ohne Sportpaket / für Fahrzeuge ohne AMG-Sportpaket		13.0460-2732.2 602732	TRW 24306 20,3 + WE / - WK + Zub
						13.0470-2732.2 LD2732	TRW 24306 20,3 + WE / - WK + Zub Ceramic
			←	für Fahrzeuge mit Sportpaket / für Fahrzeuge mit AMG-Sportpaket		13.0460-2734.2 602734	TRW 24310 19,0 + WE / - WK
						13.0470-2734.2 LD2734	TRW 24310 19,0 + WE / - WK Ceramic
			→			13.0460-2786.2 602786	TRW 24848 18,3 + WE / - WK + Zub
↓							

	kW			 	! #		
MERCEDES-BENZ - SLC (R172) 01/16→							
 Bremsbelagsatz, Scheibenbremse							
180 (172.431)	115	01/16→	→			13.0470-2786.2 LD2786	TRW 24848 18,3 + WE / - WK + Zub Ceramic
200 (172.434) 250 d (172.404) 300 (172.438)	135 150 180	01/16→ 01/16→ 01/16→	←			13.0460-2734.2 602734 13.0470-2734.2 LD2734	TRW 24310 19,0 + WE / - WK TRW 24310 19,0 + WE / - WK Ceramic
			→			13.0460-2786.2 602786 13.0470-2786.2 LD2786	TRW 24848 18,3 + WE / - WK + Zub TRW 24848 18,3 + WE / - WK + Zub Ceramic
Warnkontakt, Bremsbelagverschleiß							
180 (172.431)	115	01/16→	←	<input type="checkbox"/>	1	24.8190-0410.2 620410	L= 97,5
			→		1	24.8190-0410.2 620410	L= 97,5
200 (172.434) 250 d (172.404) 300 (172.438)	135 150 180	01/16→ 01/16→ 01/16→	←		1	24.8190-0410.2 620410	L= 97,5
			→		1	24.8190-0410.2 620410	L= 97,5
 Bremsscheibe							
180 (172.431)	115	01/16→	←	für Fahrzeuge ohne Sportpaket / für Fahrzeuge ohne AMG-Sportpaket		24.0128-0155.1 428155 24.0328-0155.1 528155	Ø 295 28 25,4 V + S Ø 295 28 25,4 V + S PD
			←	für Fahrzeuge mit Sportpaket / für Fahrzeuge mit AMG-Sportpaket		24.0132-0175.1 432175	Ø 344 32 30 V• + S
			→			24.0110-0391.1 410391	Ø 300 10 8,3 + S
200 (172.434) 250 d (172.404) 300 (172.438)	135 150 180	01/16→ 01/16→ 01/16→	←	für Fahrzeuge ohne Sportpaket / für Fahrzeuge ohne AMG-Sportpaket		24.0132-0101.1 432101 24.0332-0101.1 532101	Ø 322 32 29,4 V + S Ø 322 32 29,4 V + S PD
			←	für Fahrzeuge mit Sportpaket / für Fahrzeuge mit AMG-Sportpaket		24.0132-0175.1 432175	Ø 344 32 30 V• + S
			→			24.0110-0391.1 410391	Ø 300 10 8,3 + S
MERCEDES-BENZ - SLK (R170) 04/96→04/04							
 Bremsbelagsatz, Scheibenbremse							
200 (170.435) 200 Kompressor (170.445) 230 Kompressor (170.447)	100 141 142	09/96→03/00 10/96→03/00 09/96→03/00	←			13.0460-7086.2 607086 13.0470-7086.2 LD7086	ATE 21664 19,8 + WE / - WK ATE 21664 19,8 + WE / - WK Ceramic
			→	→ F017687		13.0460-3805.2 603805 13.0470-3805.2 LD3805	ATE 21197 15,0 + WE / - WK ATE 21197 15,0 + WE / - WK Ceramic
			→	F017688→		13.0460-4064.2 604064 13.0470-4064.2 LD4064	ATE 21919 15,3 - WE / - WK + Zub ATE 21919 15,3 - WE / - WK + Zub Ceramic
200 Kompressor (170.444) 230 Kompressor (170.449)	120 145	03/00→04/04 03/00→04/04	←	→ 03/04		13.0460-7086.2 607086 13.0470-7086.2 LD7086	ATE 21664 19,8 + WE / - WK ATE 21664 19,8 + WE / - WK Ceramic
			→	→ 03/04		13.0460-4064.2 604064 13.0470-4064.2 LD4064	ATE 21919 15,3 - WE / - WK + Zub ATE 21919 15,3 - WE / - WK + Zub Ceramic
320 (170.465)	160	03/00→04/04	←	04/00→ 03/04		13.0460-7087.2 607087 13.0470-7087.2 LD7087	ATE 21670 19,3 + WE / - WK ATE 21670 19,3 + WE / - WK Ceramic
			→	04/00→ 03/04		13.0460-4064.2 604064 13.0470-4064.2 LD4064	ATE 21919 15,3 - WE / - WK + Zub ATE 21919 15,3 - WE / - WK + Zub Ceramic
32 AMG Kompressor (170.466)	260	03/01→04/04	←	→ 03/04		13.0460-7183.2 607183	ATE 21484 20,5 + WE / - WK
			→	→ 03/04		13.0460-4047.2 604047	ATE 21305 15,7 + WE / - WK
Warnkontakt, Bremsbelagverschleiß							
200 (170.435) 200 Kompressor (170.445) 230 Kompressor (170.447)	100 141 142	09/96→03/00 10/96→03/00 09/96→03/00	←		2	24.8190-0401.2 620401	L= 95
			→	→ F017687	2	24.8190-0401.2 620401	L= 95
200 Kompressor (170.444) 230 Kompressor (170.449)	120 145	03/00→04/04 03/00→04/04	←	→ 03/04	2	24.8190-0401.2 620401	L= 95
↓							

	kw			 	! #		
MERCEDES-BENZ - SLK (R170) 04/96→04/04							
Warnkontakt, Bremsbelagverschleiß							
320 (170.465)	160	03/00→04/04	←	04/00→ 03/04	2	24.8190-0401.2 620401	L= 95
32 AMG Kompressor (170.466)	260	03/01→04/04	←	→ 03/04	2	24.8190-0419.2 620419	L= 74
Zubehörsatz, Scheibenbremsbelag							
200 (170.435)	100	09/96→03/00	→	F017688→		13.0460-0229.2 610229	ATE
200 Kompressor (170.445)	141	10/96→03/00					
230 Kompressor (170.447)	142	09/96→03/00					
200 Kompressor (170.444)	120	03/00→04/04	→	→ 03/04		13.0460-0229.2 610229	ATE
230 Kompressor (170.449)	145	03/00→04/04					
320 (170.465)	160	03/00→04/04	→	04/00→ 03/04		13.0460-0229.2 610229	ATE
32 AMG Kompressor (170.466)	260	03/01→04/04	→	→ 03/04		13.0460-0236.2 610236	ATE
 Brems Scheibe							
200 (170.435)	100	09/96→03/00	←			24.0125-0110.1 425110	Ø 288 25 22,4 V + S
200 Kompressor (170.445)	141	10/96→03/00				24.0325-0110.1 525110	Ø 288 25 22,4 V + S PD
230 Kompressor (170.447)	142	09/96→03/00	→			24.0109-0114.1 409114	Ø 278 9 7,3 + S
						24.0309-0114.1 509114	Ø 278 9 7,3 + S PD
200 Kompressor (170.444)	120	03/00→04/04	←	→ 03/04		24.0125-0110.1 425110	Ø 288 25 22,4 V + S
230 Kompressor (170.449)	145	03/00→04/04	→	→ 03/04		24.0325-0110.1 525110	Ø 288 25 22,4 V + S PD
						24.0109-0114.1 409114	Ø 278 9 7,3 + S
						24.0309-0114.1 509114	Ø 278 9 7,3 + S PD
320 (170.465)	160	03/00→04/04	←	04/00→ 03/04		24.0128-0106.1 428106	Ø 300 28 25,4 V + S
						24.0328-0106.1 528106	Ø 300 28 25,4 V + S PD
			→	04/00→ 03/04		24.0109-0114.1 409114	Ø 278 9 7,3 + S
						24.0309-0114.1 509114	Ø 278 9 7,3 + S PD
32 AMG Kompressor (170.466)	260	03/01→04/04	←	→ 03/04		24.0132-0159.1 432159	Ø 330 32 29,4 V
			→	→ 03/04		24.0122-0228.1 422228	Ø 300 22 19,4 V
MERCEDES-BENZ - SLK (R171) 03/04→02/11							
 Bremsbelagsatz, Scheibenbremse							
200 Kompressor (171.442)	120	03/04→02/11	←	→ 01/11; für Fahrzeuge ohne Sportpaket		13.0460-2726.2 602726	TRW 23144 19,8 + WE / - WK + Zub
						13.0470-2726.2 LD2726	TRW 23144 19,8 + WE / - WK + Zub Ceramic
			←	→ 01/11; für Fahrzeuge mit Sportpaket		13.0460-4994.2 604994	BRE 23945 16,5 + WE / - WK Ceramic
						13.0470-4994.2 LD4994	BRE 23945 16,5 + WE / - WK Ceramic
			→	→ 01/11; für Fahrzeuge ohne Sportpaket		13.0460-4064.2 604064	ATE 21919 15,3 - WE / - WK + Zub
						13.0470-4064.2 LD4064	ATE 21919 15,3 - WE / - WK + Zub Ceramic
			→	→ 01/11; für Fahrzeuge mit Sportpaket		13.0460-4065.2 604065	ATE 21899 15,3 + WE / - WK + Zub
						13.0470-4065.2 LD4065	ATE 21899 15,3 + WE / - WK + Zub Ceramic
200 Kompressor (171.445)	135	01/08→02/11	←	→ 01/11; für Fahrzeuge ohne Sportpaket		13.0460-2727.2 602727	TRW 23144 19,8 + WE / - WK + Zub
300 (171.454)	170	04/09→02/11				13.0470-2727.2 LD2727	TRW 23144 19,8 + WE / - WK + Zub Ceramic
			←	→ 01/11; für Fahrzeuge mit Sportpaket		13.0460-4994.2 604994	BRE 23945 16,5 + WE / - WK Ceramic
						13.0470-4994.2 LD4994	BRE 23945 16,5 + WE / - WK Ceramic
			→	→ 01/11; für Fahrzeuge ohne Sportpaket		13.0460-4064.2 604064	ATE 21919 15,3 - WE / - WK + Zub
						13.0470-4064.2 LD4064	ATE 21919 15,3 - WE / - WK + Zub Ceramic
			→	→ 01/11; für Fahrzeuge mit Sportpaket		13.0460-4065.2 604065	ATE 21899 15,3 + WE / - WK + Zub
						13.0470-4065.2 LD4065	ATE 21899 15,3 + WE / - WK + Zub Ceramic
280 (171.454)	170	01/05→02/11	←	04/05→ 01/11; für Fahrzeuge ohne Sportpaket		13.0460-2727.2 602727	TRW 23144 19,8 + WE / - WK + Zub
↓							

	kw			 	! #		
MERCEDES-BENZ - SLK (R171) 03/04→02/11							
Bremsbelagsatz, Scheibenbremse							
280 (171.454)	170	01/05→02/11	←	04/05→ 01/11; für Fahrzeuge ohne Sportpaket		13.0470-2727.2 LD2727	TRW 23144 19,8 + WE / - WK + Zub Ceramic
			←	04/05→ 01/11; für Fahrzeuge mit Sportpaket		13.0460-4994.2 604994 13.0470-4994.2 LD4994	BRE 23945 16,5 + WE / - WK BRE 23945 16,5 + WE / - WK Ceramic
			→	04/05→ 01/11; für Fahrzeuge ohne Sportpaket		13.0460-4064.2 604064 13.0470-4064.2 LD4064	ATE 21919 15,3 - WE / - WK + Zub ATE 21919 15,3 - WE / - WK + Zub Ceramic
			→	04/05→ 01/11; für Fahrzeuge mit Sportpaket		13.0460-4065.2 604065 13.0470-4065.2 LD4065	ATE 21899 15,3 + WE / - WK + Zub ATE 21899 15,3 + WE / - WK + Zub Ceramic
350 (171.456)	200	06/04→02/11	←	→ F 117328		13.0460-4990.2 604990 13.0470-4990.2 LD4990	BRE 23271 17,4 + WE / - WK BRE 23271 17,4 + WE / - WK Ceramic
			←	F 117329→; → 01/11		13.0460-4994.2 604994 13.0470-4994.2 LD4994	BRE 23945 16,5 + WE / - WK BRE 23945 16,5 + WE / - WK Ceramic
			→	→ 01/11		13.0460-4065.2 604065 13.0470-4065.2 LD4065	ATE 21899 15,3 + WE / - WK + Zub ATE 21899 15,3 + WE / - WK + Zub Ceramic
350 (171.458)	224	01/08→02/11	←	→ 01/11		13.0460-4994.2 604994 13.0470-4994.2 LD4994	BRE 23945 16,5 + WE / - WK BRE 23945 16,5 + WE / - WK Ceramic
			→	→ 01/11		13.0460-4065.2 604065 13.0470-4065.2 LD4065	ATE 21899 15,3 + WE / - WK + Zub ATE 21899 15,3 + WE / - WK + Zub Ceramic
55 AMG (171.473) 55 AMG (171.473)	265 294	06/04→02/11 06/06→02/11	←	→ F 197201		13.0460-4806.2 604806	BRE 23955 16,2 + WE / - WK
			←	F 197202→; → 01/11		13.0460-4990.2 604990	BRE 23271 17,4 + WE / - WK
			→	→ 01/11		13.0460-4819.2 604819	BRE 23478 14,6 + WE / - WK
Warnkontakt, Bremsbelagverschleiß							
200 Kompressor (171.442)	120	03/04→02/11	←	→ 01/11; für Fahrzeuge mit Sportpaket	1	24.8190-0410.2 620410	L= 97,5
			←	→ 01/11; für Fahrzeuge ohne Sportpaket	1	24.8190-0410.2 620410	L= 97,5
			→	→ 01/11; für Fahrzeuge mit Sportpaket	1	24.8190-0410.2 620410	L= 97,5
200 Kompressor (171.445) 300 (171.454)	135 170	01/08→02/11 04/09→02/11	←	→ 01/11; für Fahrzeuge ohne Sportpaket	2	24.8190-0410.2 620410	L= 97,5
			→	→ 01/11; für Fahrzeuge mit Sportpaket	1	24.8190-0410.2 620410	L= 97,5
280 (171.454)	170	01/05→02/11	←	04/05→ 01/11; für Fahrzeuge mit Sportpaket	1	24.8190-0410.2 620410	L= 97,5
			←	04/05→ 01/11; für Fahrzeuge ohne Sportpaket	2	24.8190-0410.2 620410	L= 97,5
			→	04/05→ 01/11; für Fahrzeuge mit Sportpaket	1	24.8190-0410.2 620410	L= 97,5
350 (171.456)	200	06/04→02/11	←	F 117329→; → 01/11	1	24.8190-0410.2 620410	L= 97,5
			←	☐; → F 117328	1	24.8190-0410.2 620410	L= 97,5
			→	→ 01/11	1	24.8190-0410.2 620410	L= 97,5
350 (171.458)	224	01/08→02/11	←	→ 01/11	1	24.8190-0410.2 620410	L= 97,5
			→	→ 01/11	1	24.8190-0410.2 620410	L= 97,5
55 AMG (171.473) 55 AMG (171.473)	265 294	06/04→02/11 06/06→02/11	←	→ F 197201	1	24.8190-0420.2 620420	L= 119
			←	F 197202→; → 01/11	1	24.8190-0420.2 620420	L= 119
			→	→ 01/11	1	24.8190-0410.2 620410	L= 97,5
Zubehörsatz, Scheibenbremsbelag							
200 Kompressor (171.442)	120	03/04→02/11	←	→ 01/11; für Fahrzeuge mit Sportpaket		13.0460-0155.2 610155	BRE
200 Kompressor (171.445) 300 (171.454)	135 170	01/08→02/11 04/09→02/11	→	→ 01/11; für Fahrzeuge ohne Sportpaket → 01/11; für Fahrzeuge mit Sportpaket		13.0460-0229.2 610229 13.0460-0258.2 610258	ATE
280 (171.454)	170	01/05→02/11	←	04/05→ 01/11; für Fahrzeuge mit Sportpaket		13.0460-0155.2 610155	BRE
			→	04/05→ 01/11; für Fahrzeuge ohne Sportpaket		13.0460-0229.2 610229	ATE
↓							

	kw			 	! #		
MERCEDES-BENZ - SLK (R171) 03/04→02/11							
Zubehörsatz, Scheibenbremsbelag							
280 (171.454)	170	01/05→02/11	➡	04/05→ 01/11; für Fahrzeuge mit Sportpaket		13.0460-0258.2 610258	
350 (171.456)	200	06/04→02/11	←	F 117329→; → 01/11		13.0460-0155.2 610155	BRE
			←	→ F 117328		13.0460-0275.2 610275	
			➡	→ 01/11		13.0460-0258.2 610258	
350 (171.458)	224	01/08→02/11	←	→ 01/11		13.0460-0155.2 610155	BRE
			➡	→ 01/11		13.0460-0258.2 610258	
 Bremsscheibe							
200 Kompressor (171.442)	120	03/04→02/11	←	→ 01/11; für Fahrzeuge ohne Sportpaket		24.0125-0110.1 425110	Ø 288 25 22,4 V + S
						24.0325-0110.1 525110	Ø 288 25 22,4 V + S PD
			←	→ 01/11; für Fahrzeuge mit Sportpaket		24.0128-0177.1 428177	Ø 330 28 26 V•
			➡	→ 01/11; für Fahrzeuge ohne Sportpaket		24.0109-0114.1 409114	Ø 278 9 7,3 + S
						24.0309-0114.1 509114	Ø 278 9 7,3 + S PD
200 Kompressor (171.445) 300 (171.454)	135	01/08→02/11	←	→ 01/11; für Fahrzeuge ohne Sportpaket		24.0128-0106.1 428106	Ø 300 28 25,4 V + S
	170	04/09→02/11	←	→ 01/11; für Fahrzeuge mit Sportpaket		24.0128-0177.1 428177	Ø 330 28 26 V•
			➡	→ 01/11; für Fahrzeuge ohne Sportpaket		24.0109-0114.1 409114	Ø 278 9 7,3 + S
						24.0309-0114.1 509114	Ø 278 9 7,3 + S PD
			➡	→ 01/11; für Fahrzeuge mit Sportpaket		24.0110-0217.1 410217	Ø 290 10 8,3 + S
			24.0310-0217.1 510217	Ø 290 10 8,3 + S PD			
280 (171.454)	170	01/05→02/11	←	04/05→ 01/11; für Fahrzeuge ohne Sportpaket		24.0128-0106.1 428106	Ø 300 28 25,4 V + S
						24.0328-0106.1 528106	Ø 300 28 25,4 V + S PD
			←	04/05→ 01/11; für Fahrzeuge mit Sportpaket		24.0128-0177.1 428177	Ø 330 28 26 V•
			➡	04/05→ 01/11; für Fahrzeuge ohne Sportpaket		24.0109-0114.1 409114	Ø 278 9 7,3 + S
						24.0309-0114.1 509114	Ø 278 9 7,3 + S PD
350 (171.456) 350 (171.458)	200	06/04→02/11	←	→ 01/11		24.0128-0177.1 428177	Ø 330 28 26 V•
	224	01/08→02/11	➡	→ 01/11		24.0110-0217.1 410217	Ø 290 10 8,3 + S
						24.0310-0217.1 510217	Ø 290 10 8,3 + S PD
			←	→ 01/11		24.0130-0180.1 430180	Ø 345 30 28 V•
			➡	→ 01/11		24.0122-0228.1 422228	Ø 300 22 19,4 V
MERCEDES-BENZ - SLK (R172) 02/11→							
 Bremsbelagsatz, Scheibenbremse							
200 (172.434) 250 CDI / d (172.403) 300 (172.438) 350 (172.457)	135	04/15→	←			13.0460-2734.2 602734	TRW 24310 19,0 + WE / - WK
	150	01/12→				13.0470-2734.2 LD2734	TRW 24310 19,0 + WE / - WK
	180	07/15→	➡			13.0460-2786.2 602786	TRW 24848 18,3 + WE / - WK + Zub
	225	02/11→				13.0470-2786.2 LD2786	TRW 24848 18,3 + WE / - WK + Zub Ceramic
200 (172.448) 250 (172.447)	135	02/11→	←	für Fahrzeuge ohne Sportpaket / für Fahrzeuge ohne AMG-Sportpaket		13.0460-2732.2 602732	TRW 24306 20,3 + WE / - WK + Zub
	150	02/11→					
			←	für Fahrzeuge mit Sportpaket / für Fahrzeuge mit AMG-Sportpaket		13.0460-2734.2 602734	TRW 24310 19,0 + WE / - WK
						13.0470-2734.2 LD2734	TRW 24310 19,0 + WE / - WK Ceramic
			➡			13.0460-2786.2 602786	TRW 24848 18,3 + WE / - WK + Zub
						13.0470-2786.2 LD2786	TRW 24848 18,3 + WE / - WK + Zub Ceramic
Warnkontakt, Bremsbelagsverschleiß							
200 (172.434) 250 CDI / d (172.403) 300 (172.438) 350 (172.457) 55 AMG (172.475)	135	04/15→	←		1	24.8190-0410.2 620410	L= 97,5
	150	01/12→					
	180	07/15→	➡		1	24.8190-0410.2 620410	L= 97,5
	225	02/11→					
	310	01/12→					
↓							

	kw					! #		
MERCEDES-BENZ - SLK (R172) 02/11→								
Warnkontakt, Bremsbelagverschleiß								
200 (172.448)	135	02/11→	←	☐		1	24.8190-0410.2 620410	L= 97,5
250 (172.447)	150	02/11→	→			1	24.8190-0410.2 620410	L= 97,5
Bremsscheibe								
200 (172.434)	135	04/15→	←		für Fahrzeuge ohne Sportpaket / für Fahrzeuge ohne AMG-Sportpaket		24.0132-0101.1 432101	Ø 322 32 29,4 V + S
200 (172.448)	135	02/11→					24.0332-0101.1 532101	Ø 322 32 29,4 V + S PD
250 (172.447)	150	02/11→						
250 CDI / d (172.403)	150	01/12→	←		für Fahrzeuge mit Sportpaket / für Fahrzeuge mit AMG-Sportpaket		24.0132-0175.1 432175	Ø 344 32 30 V• + S
300 (172.438)	180	07/15→	→				24.0110-0391.1 410391	Ø 300 10 8,3 + S
350 (172.457)	225	02/11→	←				24.0132-0175.1 432175	Ø 344 32 30 V• + S
			→				24.0110-0391.1 410391	Ø 300 10 8,3 + S
55 AMG (172.475)	310	01/12→	←		für Fahrzeuge ohne AMG-Performance Package		24.0136-0102.1 436102	Ø 360 36 34 V•
MERCEDES-BENZ - SLR (R199) 04/04→								
Warnkontakt, Bremsbelagverschleiß								
5.4 (199.376)	460	04/04→	←		→ 12/09	2	24.8190-0410.2 620410	L= 97,5
MERCEDES-BENZ - SLR Roadster (R199) 10/06→								
Warnkontakt, Bremsbelagverschleiß								
5.4	460	04/07→	←		→ 12/09	2	24.8190-0410.2 620410	L= 97,5
MERCEDES-BENZ - SLS AMG (C197) 03/10→								
Warnkontakt, Bremsbelagverschleiß								
6.2 (197.377)	420	03/10→	←		→ 04/14; für Fahrzeuge ohne Keramikbremse	1	24.8190-0420.2 620420	L= 119
6.2 GT	435	06/13→	→		→ 04/14	1	24.8190-0420.2 620420	L= 119
MERCEDES-BENZ - SLS AMG Roadster (R197) 06/11→								
Warnkontakt, Bremsbelagverschleiß								
6.2 (197.477)	420	06/11→	←		→ 04/14; für Fahrzeuge ohne Keramikbremse	1	24.8190-0420.2 620420	L= 119
6.2 GT (197.478)	435	06/13→	→		→ 04/14	1	24.8190-0420.2 620420	L= 119
MERCEDES-BENZ - SPRINTER 2-t Bus (901, 902) 01/95→05/06								
Bremsbelagsatz, Scheibenbremse								
208 CDI	60	04/00→05/06	←				13.0460-7196.2 607196	ATE 21576 20,7 + WE / - WK
208 D	58	02/95→04/00					13.0460-7909.2 607909	PER 29153 20,0 + WE / - WK + Zub
210 D	75	03/97→04/00						
211 CDI	80	04/00→05/06	→				13.0460-3990.2 603990	BOS 23021 18,9 + WE / - WK
212 D	90	02/95→04/00					13.0460-7083.2 607083	ATE 21621 17,3 + WE / - WK
213 CDI	95	04/00→05/06					13.0460-7084.2 607084	ATE 21592 18,8 + WE / - WK
214 (902.071, 902.072, 902.671, 902.672)	105	02/95→05/06						
214 NGT	92	04/00→05/06						
216 CDI	115	04/00→05/06						
Warnkontakt, Bremsbelagverschleiß								
208 CDI	60	04/00→05/06	←		nur in Verbindung mit: 13.0460-7196.2	2	24.8190-0417.2 620417	L= 99 L= 167
208 D	58	02/95→04/00	←			2	24.8190-0417.2 620417	L= 99 L= 167
210 D	75	03/97→04/00	→			2	24.8190-0407.2 620407	L= 84 L= 185
211 CDI	80	04/00→05/06						
212 D	90	02/95→04/00						
213 CDI	95	04/00→05/06						
214 (902.071, 902.072, 902.671, 902.672)	105	02/95→05/06						
214 NGT	92	04/00→05/06						
216 CDI	115	04/00→05/06						
Zubehörsatz, Scheibenbremsbelag								
208 CDI	60	04/00→05/06	←		nur in Verbindung mit: Vornr. 13.0460-7904.2		13.0460-0281.2 610281	PER
208 D	58	02/95→04/00	→				13.0460-0250.2 610250	BOS
210 D	75	03/97→04/00						
211 CDI	80	04/00→05/06						
212 D	90	02/95→04/00						
213 CDI	95	04/00→05/06						
214 (902.071, 902.072, 902.671, 902.672)	105	02/95→05/06						
214 NGT	92	04/00→05/06						
216 CDI	115	04/00→05/06						

MERCEDES-BENZ - SPRINTER 2-t Bus (901, 902) 01/95→05/06

Bremsscheibe

208 CDI	60	04/00→05/06	←			24.0122-0161.1	422161	∅ 276 22 19 V + S
208 D	58	02/95→04/00				24.0322-0161.1	522161	∅ 276 22 19 V + S PD
210 D	75	03/97→04/00						
211 CDI	80	04/00→05/06	→			24.0112-0142.1	412142	∅ 258 12 10 + S
212 D	90	02/95→04/00				24.0116-0110.1	416110	∅ 272 16 14 + S
213 CDI	95	04/00→05/06						
214 (902.071, 902.072, 902.671, 902.672)	105	02/95→05/06						
214 NGT	92	04/00→05/06						
216 CDI	115	04/00→05/06						

MERCEDES-BENZ - SPRINTER 2-t Kasten (901, 902) 01/95→05/06

Bremsbelagsatz, Scheibenbremse

208 CDI	60	04/00→05/06	←			13.0460-7196.2	607196	ATE 21576 20,7 + WE / - WK
208 D	58	02/95→04/00				13.0460-7909.2	607909	PER 29153 20,0 + WE / - WK + Zub
208 D	60	10/96→04/00						
210 D	75	01/97→04/00						
211 CDI	80	04/00→05/06	→			13.0460-3990.2	603990	BOS 23021 18,9 + WE / - WK
212 D	90	02/95→04/00				13.0460-7083.2	607083	ATE 21621 17,3 + WE / - WK
213 CDI	95	04/00→05/06				13.0460-7084.2	607084	ATE 21592 18,8 + WE / - WK
214	105	02/95→05/06						
214 NGT	92	04/00→05/06						
216 CDI	115	04/00→05/06						

Warnkontakt, Bremsbelagverschleiß

208 CDI	60	04/00→05/06	←	nur in Verbindung mit: 13.0460-7196.2	2	24.8190-0417.2	620417	L= 99 L= 167
208 D	58	02/95→04/00						
208 D	60	10/96→04/00	←		2	24.8190-0417.2	620417	L= 99 L= 167
210 D	75	01/97→04/00						
211 CDI	80	04/00→05/06	→		2	24.8190-0407.2	620407	L= 84 L= 185
212 D	90	02/95→04/00						
213 CDI	95	04/00→05/06						
214	105	02/95→05/06						
214 NGT	92	04/00→05/06						
216 CDI	115	04/00→05/06						

Zubehörsatz, Scheibenbremsbelag

208 CDI	60	04/00→05/06	←	nur in Verbindung mit: Vorrn. 13.0460-7904.2		13.0460-0281.2	610281	PER
208 D	58	02/95→04/00						
208 D	60	10/96→04/00	→			13.0460-0250.2	610250	BOS
210 D	75	01/97→04/00						
211 CDI	80	04/00→05/06						
212 D	90	02/95→04/00						
213 CDI	95	04/00→05/06						
214	105	02/95→05/06						
214 NGT	92	04/00→05/06						
216 CDI	115	04/00→05/06						

Bremsscheibe







208 CDI	60	04/00→05/06	←			24.0122-0161.1	422161	∅ 276 22 19 V + S
208 D	58	02/95→04/00				24.0322-0161.1	522161	∅ 276 22 19 V + S PD
208 D	60	10/96→04/00						
210 D	75	01/97→04/00	→			24.0112-0142.1	412142	∅ 258 12 10 + S
211 CDI	80	04/00→05/06				24.0116-0110.1	416110	∅ 272 16 14 + S
212 D	90	02/95→04/00						
213 CDI	95	04/00→05/06						
214	105	02/95→05/06						
214 NGT	92	04/00→05/06						
216 CDI	115	04/00→05/06						

MERCEDES-BENZ - SPRINTER 2-t Pritsche/Fahrgestell (901, 902) 01/95→05/06









Bremsbelagsatz, Scheibenbremse







208 CDI	60	04/00→05/06	←			13.0460-7196.2	607196	ATE 21576 20,7 + WE / - WK
208 D	60	09/96→04/00				13.0460-7909.2	607909	PER 29153 20,0 + WE / - WK + Zub
210 D	75	01/97→04/00						
211 CDI	80	04/00→05/06	→			13.0460-3990.2	603990	BOS 23021 18,9 + WE / - WK
212 D	90	02/95→04/00				13.0460-7083.2	607083	ATE 21621 17,3 + WE / - WK
213 CDI	95	04/00→05/06				13.0460-7084.2	607084	ATE 21592 18,8 + WE / - WK
214 (902.011, 902.012, 902.611, 902.612)	105	02/95→05/06						
214 NGT	92	04/00→05/06						
216 CDI	115	04/00→05/06						
208 D	58	01/95→04/00	←	02/95→		13.0460-7196.2	607196	ATE 21576 20,7 + WE / - WK
						13.0460-7909.2	607909	PER 29153 20,0 + WE / - WK + Zub
			→	02/95→		13.0460-3990.2	603990	BOS 23021 18,9 + WE / - WK
						13.0460-7083.2	607083	ATE 21621 17,3 + WE / - WK
						13.0460-7084.2	607084	ATE 21592 18,8 + WE / - WK

↓

	kW			 	! #		
MERCEDES-BENZ - SPRINTER 2-t Pritsche/Fahrgestell (901, 902) 01/95—05/06							
Warnkontakt, Bremsbelagverschleiß							
208 CDI	60	04/00→05/06	←	nur in Verbindung mit: 13.0460-7196.2	2	24.8190-0417.2 620417	L= 99 L= 167
208 D	60	09/96→04/00	←		2	24.8190-0417.2 620417	L= 99 L= 167
210 D	75	01/97→04/00	←		2	24.8190-0417.2 620417	L= 99 L= 167
211 CDI	80	04/00→05/06	→		2	24.8190-0407.2 620407	L= 84 L= 185
212 D	90	02/95→04/00	→				
213 CDI	95	04/00→05/06	→				
214 (902.011, 902.012, 902.611, 902.612)	105	02/95→05/06	→				
214 NGT	92	04/00→05/06	→				
216 CDI	115	04/00→05/06	→				
208 D	58	01/95→04/00	←	02/95→	2	24.8190-0417.2 620417	L= 99 L= 167
			←	02/95→; nur in Verbindung mit: 13.0460-7196.2	2	24.8190-0417.2 620417	L= 99 L= 167
			→	02/95→	2	24.8190-0407.2 620407	L= 84 L= 185
Zubehörsatz, Scheibenbremsbelag							
208 CDI	60	04/00→05/06	←	nur in Verbindung mit: Vorrn. 13.0460-7904.2		13.0460-0281.2 610281	PER
208 D	60	09/96→04/00	←				
210 D	75	01/97→04/00	→			13.0460-0250.2 610250	BOS
211 CDI	80	04/00→05/06	→				
212 D	90	02/95→04/00	→				
213 CDI	95	04/00→05/06	→				
214 (902.011, 902.012, 902.611, 902.612)	105	02/95→05/06	→				
214 NGT	92	04/00→05/06	→				
216 CDI	115	04/00→05/06	→				
208 D	58	01/95→04/00	←	02/95→; nur in Verbindung mit: Vorrn. 13.0460-7904.2		13.0460-0281.2 610281	PER
			→	02/95→		13.0460-0250.2 610250	BOS
Bremsscheibe							
208 CDI	60	04/00→05/06	←			24.0122-0161.1 422161	Ø 276 22 19 V + S
208 D	60	09/96→04/00	←			24.0322-0161.1 522161	Ø 276 22 19 V + S PD
210 D	75	01/97→04/00	→				
211 CDI	80	04/00→05/06	→			24.0112-0142.1 412142	Ø 258 12 10 + S
213 CDI	95	04/00→05/06	→			24.0116-0110.1 416110	Ø 272 16 14 + S
214 (902.011, 902.012, 902.611, 902.612)	105	02/95→05/06	→				
214 NGT	92	04/00→05/06	→				
216 CDI	115	04/00→05/06	→				
208 D	58	01/95→04/00	←	02/95→		24.0122-0161.1 422161	Ø 276 22 19 V + S
			←			24.0322-0161.1 522161	Ø 276 22 19 V + S PD
			→	02/95→		24.0112-0142.1 412142	Ø 258 12 10 + S
			→			24.0116-0110.1 416110	Ø 272 16 14 + S
212 D	90	02/95→04/00	←			24.0122-0161.1 422161	Ø 276 22 19 V + S
			←			24.0322-0161.1 522161	Ø 276 22 19 V + S PD
			→			24.0112-0142.1 412142	Ø 258 12 10 + S
MERCEDES-BENZ - SPRINTER 3,5-t Bus (906) 06/06→							
Bremsbelagsatz, Scheibenbremse							
310 CDI (906.731, 906.733, 906.735)	70	03/09→12/13	←			13.0460-4826.2 604826	BRE 29192 20,7 + WE / - WK + Zub
311 CDI (906.731, 906.733, 906.735)	80	06/06→12/09	←			13.0460-4877.2 604877	BRE 29192 20,3 + WE / - WK + Zub
311 CDI (906.731, 906.733, 906.735)	84	05/16→	→			13.0460-3837.2 603837	BOS 29190 20,2 + WK + Zub
311 CDI 4x4 (906.731, 906.733, 906.735)	80	02/08→12/09	→				
313 CDI (906.731, 906.733, 906.735)	95	08/11→05/16	→				
313 CDI 4x4 (906.731, 906.733, 906.735)	95	08/11→05/16	→				
314 CDI (906.731, 906.733, 906.735)	105	05/16→	→				
314 CDI 4x4 (906.731, 906.733, 906.735)	105	05/16→	→				
315 CDI (906.731, 906.733, 906.735)	110	06/06→12/09	→				
315 CDI 4x4 (906.731, 906.733, 906.735)	110	02/08→12/09	→				
316 (906.733, 906.735)	115	09/08→	→				
316 CDI (906.731, 906.733, 906.735)	120	08/11→	→				
316 CDI 4x4 (906.731, 906.733, 906.735)	120	08/11→	→				
316 LGT	115	09/08→	→				



	kW			 	! #		
MERCEDES-BENZ - SPRINTER 3,5-t Bus (906) 06/06→							
 Bremsbelagsatz, Scheibenbremse							
316 NGT (906.733, 906.735)	115	09/08→	←			13.0460-4826.2 604826	BRE 29192 20,7 + WE / - WK + Zub
318 CDI (906.731, 906.733, 906.735)	135	02/08→12/09				13.0460-4877.2 604877	BRE 29192 20,3 + WE / - WK + Zub
318 CDI 4x4 (906.731, 906.733, 906.735)	135	02/08→12/09					
319 CDI / BlueTEC (906.731, 906.733, 906.735)	140	03/09→	→			13.0460-3837.2 603837	BOS 29190 20,2 + WK + Zub
319 CDI / BlueTEC 4x4 (906.731, 906.733, 906.735)	140	03/09→					
324 (906.733, 906.735)	190	06/06→12/13					
Warnkontakt, Bremsbelagverschleiß							
310 CDI (906.731, 906.733, 906.735)	70	03/09→12/13	←		2	24.8190-0424.2 620424	L= 103,2
311 CDI (906.731, 906.733, 906.735)	80	06/06→12/09	→	nur in Verbindung mit: 13.0460-3837.2	2	24.8190-0418.2 620418	L= 95
311 CDI (906.731, 906.733, 906.735)	84	05/16→					
311 CDI 4x4 (906.731, 906.733, 906.735)	80	02/08→12/09					
313 CDI (906.731, 906.733, 906.735)	95	08/11→05/16					
313 CDI 4x4 (906.731, 906.733, 906.735)	95	08/11→05/16					
314 CDI (906.731, 906.733, 906.735)	105	05/16→					
314 CDI 4x4 (906.731, 906.733, 906.735)	105	05/16→					
315 CDI (906.731, 906.733, 906.735)	110	06/06→12/09					
315 CDI 4x4 (906.731, 906.733, 906.735)	110	02/08→12/09					
316 (906.733, 906.735)	115	09/08→					
316 CDI (906.731, 906.733, 906.735)	120	08/11→					
316 CDI 4x4 (906.731, 906.733, 906.735)	120	08/11→					
316 LGT	115	09/08→					
316 NGT (906.733, 906.735)	115	09/08→					
318 CDI (906.731, 906.733, 906.735)	135	02/08→12/09					
318 CDI 4x4 (906.731, 906.733, 906.735)	135	02/08→12/09					
319 CDI / BlueTEC (906.731, 906.733, 906.735)	140	03/09→					
319 CDI / BlueTEC 4x4 (906.731, 906.733, 906.735)	140	03/09→					
324 (906.733, 906.735)	190	06/06→12/13					
 Bremsscheibe							
310 CDI (906.731, 906.733, 906.735)	70	03/09→12/13	←			24.0128-0203.1 428203	Ø 300 28 25 V + S
311 CDI (906.731, 906.733, 906.735)	80	06/06→12/09	→			24.0116-0121.1 416121	Ø 298 16 14 + S
311 CDI (906.731, 906.733, 906.735)	84	05/16→					
311 CDI 4x4 (906.731, 906.733, 906.735)	80	02/08→12/09					
313 CDI (906.731, 906.733, 906.735)	95	08/11→05/16					
313 CDI 4x4 (906.731, 906.733, 906.735)	95	08/11→05/16					
314 CDI (906.731, 906.733, 906.735)	105	05/16→					
314 CDI 4x4 (906.731, 906.733, 906.735)	105	05/16→					
315 CDI (906.731, 906.733, 906.735)	110	06/06→12/09					
315 CDI 4x4 (906.731, 906.733, 906.735)	110	02/08→12/09					
316 (906.733, 906.735)	115	09/08→					
316 CDI (906.731, 906.733, 906.735)	120	08/11→					
316 CDI 4x4 (906.731, 906.733, 906.735)	120	08/11→					
316 LGT	115	09/08→					
↓							

	kW			 	! #		
MERCEDES-BENZ - SPRINTER 3,5-t Bus (906) 06/06→							
Bremsscheibe							
316 NGT (906.733, 906.735)	115	09/08→	←			24.0128-0203.1 428203	Ø 300 28 25 V + S
318 CDI (906.731, 906.733, 906.735)	135	02/08→12/09	→			24.0116-0121.1 416121	Ø 298 16 14 + S
318 CDI 4x4 (906.731, 906.733, 906.735)	135	02/08→12/09					
319 CDI / BlueTEC (906.731, 906.733, 906.735)	140	03/09→					
319 CDI / BlueTEC 4x4 (906.731, 906.733, 906.735)	140	03/09→					
324 (906.733, 906.735)	190	06/06→12/13					
MERCEDES-BENZ - SPRINTER 3,5-t Kasten (906) 06/06→							
Bremsbelagsatz, Scheibenbremse							
309 CDI (906.631, 906.633, 906.635, 906.637)	65	06/06→12/09	←			13.0460-4826.2 604826	BRE 29192 20,7 + WE / - WK + Zub
310 CDI (906.631, 906.633, 906.635, 906.637)	70	03/09→				13.0460-4877.2 604877	BRE 29192 20,3 + WE / - WK + Zub
311 CDI (906.631, 906.633, 906.635, 906.637)	80	06/06→12/09	→			13.0460-3837.2 603837	BOS 29190 20,2 + WK + Zub
311 CDI (906.631, 906.633, 906.635, 906.637)	84	05/16→					
311 CDI 4x4 (906.631, 906.633, 906.635, 906.637)	80	02/08→12/09					
313 CDI (906.631, 906.633, 906.635, 906.637)	95	06/06→					
313 CDI (906.631, 906.633, 906.635, 906.637)	95	05/09→					
313 CDI 4x4 (906.631, 906.633, 906.635, 906.637)	95	05/09→					
314 CDI (906.631, 906.633, 906.635, 906.637)	105	05/16→					
314 CDI 4x4 (906.631, 906.633, 906.635, 906.637)	105	05/16→					
315 CDI (906.631, 906.633, 906.635, 906.637)	110	06/06→12/09					
315 CDI 4x4 (906.631, 906.633, 906.635, 906.637)	110	02/08→12/09					
316 (906.635, 906.633)	115	09/08→					
316 CDI (906.631, 906.633, 906.635, 906.637)	120	03/09→					
316 CDI 4x4 (906.631, 906.633, 906.635, 906.637)	120	03/09→					
316 LGT (906.633, 906.635)	115	09/08→					
316 NGT (906.633, 906.635)	115	09/08→					
318 CDI (906.631, 906.633, 906.635, 906.637)	135	06/06→12/09					
318 CDI 4x4 (906.631, 906.633, 906.635, 906.637)	135	02/08→12/09					
319 CDI / BlueTEC (906.631, 906.633, 906.635, 906.637)	140	03/09→					
319 CDI / BlueTEC 4x4 (906.631, 906.633, 906.635, 906.637)	140	03/09→					
324 (906.633, 906.635, 906.637)	190	06/06→12/13					
Warnkontakt, Bremsbelagverschleiß							
309 CDI (906.631, 906.633, 906.635, 906.637)	65	06/06→12/09	←		2	24.8190-0424.2 620424	L= 103,2
			→	nur in Verbindung mit: 13.0460-3837.2	2	24.8190-0418.2 620418	L= 95
↓							

MERCEDES-BENZ - SPRINTER 3,5-t Kasten (906) 06/06→

Warnkontakt, Bremsbelagverschleiß

310 CDI (906.631, 906.633, 906.635, 906.637)	70	03/09→	←		2	24.8190-0424.2	620424	L= 103,2
			→	nur in Verbindung mit: 13.0460-3837.2	2	24.8190-0418.2	620418	L= 95
311 CDI (906.631, 906.633, 906.635, 906.637)	80	06/06→12/09						
311 CDI (906.631, 906.633, 906.635, 906.637)	84	05/16→						
311 CDI 4x4 (906.631, 906.633, 906.635, 906.637)	80	02/08→12/09						
313 CDI (906.631, 906.633, 906.635, 906.637)	95	06/06→						
313 CDI (906.631, 906.633, 906.635, 906.637)	95	05/09→						
313 CDI 4x4 (906.631, 906.633, 906.635, 906.637)	95	05/09→						
314 CDI (906.631, 906.633, 906.635, 906.637)	105	05/16→						
314 CDI 4x4 (906.631, 906.633, 906.635, 906.637)	105	05/16→						
315 CDI (906.631, 906.633, 906.635, 906.637)	110	06/06→12/09						
315 CDI 4x4 (906.631, 906.633, 906.635, 906.637)	110	02/08→12/09						
316 (906.635, 906.633)	115	09/08→						
316 CDI (906.631, 906.633, 906.635, 906.637)	120	03/09→						
316 CDI 4x4 (906.631, 906.633, 906.635, 906.637)	120	03/09→						
316 LGT (906.633, 906.635)	115	09/08→						
316 NGT (906.633, 906.635)	115	09/08→						
318 CDI (906.631, 906.633, 906.635, 906.637)	135	06/06→12/09						
318 CDI 4x4 (906.631, 906.633, 906.635, 906.637)	135	02/08→12/09						
319 CDI / BlueTEC (906.631, 906.633, 906.635, 906.637)	140	03/09→						
319 CDI / BlueTEC 4x4 (906.631, 906.633, 906.635, 906.637)	140	03/09→						
324 (906.633, 906.635, 906.637)	190	06/06→12/13						

Bremsscheibe

309 CDI (906.631, 906.633, 906.635, 906.637)	65	06/06→12/09	←			24.0128-0203.1	428203	Ø 300 28 25 V + S
			→			24.0116-0121.1	416121	Ø 298 16 14 + S
310 CDI (906.631, 906.633, 906.635, 906.637)	70	03/09→						
311 CDI (906.631, 906.633, 906.635, 906.637)	80	06/06→12/09						
311 CDI (906.631, 906.633, 906.635, 906.637)	84	05/16→						
311 CDI 4x4 (906.631, 906.633, 906.635, 906.637)	80	02/08→12/09						
313 CDI (906.631, 906.633, 906.635, 906.637)	95	06/06→						
313 CDI (906.631, 906.633, 906.635, 906.637)	95	05/09→						
↓								

MERCEDES-BENZ - SPRINTER 3,5-t Kasten (906) 06/06→









 **Bremsscheibe**









313 CDI 4x4 (906.631, 906.633, 906.635, 906.637)	95	05/09→	←		24.0128-0203.1	428203	Ø 300 28 25 V + S
			→		24.0116-0121.1	416121	Ø 298 16 14 + S
314 CDI (906.631, 906.633, 906.635, 906.637)	105	05/16→					
314 CDI 4x4 (906.631, 906.633, 906.635, 906.637)	105	05/16→					
315 CDI (906.631, 906.633, 906.635, 906.637)	110	06/06→12/09					
315 CDI 4x4 (906.631, 906.633, 906.635, 906.637)	110	02/08→12/09					
316 (906.635, 906.633)	115	09/08→					
316 CDI (906.631, 906.633, 906.635, 906.637)	120	03/09→					
316 CDI 4x4 (906.631, 906.633, 906.635, 906.637)	120	03/09→					
316 LGT (906.633, 906.635)	115	09/08→					
316 NGT (906.633, 906.635)	115	09/08→					
318 CDI (906.631, 906.633, 906.635, 906.637)	135	06/06→12/09					
318 CDI 4x4 (906.631, 906.633, 906.635, 906.637)	135	02/08→12/09					
319 CDI / BlueTEC (906.631, 906.633, 906.635, 906.637)	140	03/09→					
319 CDI / BlueTEC 4x4 (906.631, 906.633, 906.635, 906.637)	140	03/09→					
324 (906.633, 906.635, 906.637)	190	06/06→12/13					











MERCEDES-BENZ - SPRINTER 3,5-t Pritsche/Fahrgestell (906) 06/06→











 **Bremsbelagsatz, Scheibenbremse**







309 CDI (906.131, 906.133, 906.135, 906.231, 906.233...)	65	06/06→12/09	←		13.0460-4826.2	604826	BRE 29192 20,7 + WE / - WK + Zub
					13.0460-4877.2	604877	BRE 29192 20,3 + WE / - WK + Zub
310 CDI (906.131, 906.133, 906.135, 906.231, 906.233...)	70	03/09→05/16	→				
311 CDI (906.131, 906.133, 906.135, 906.231, 906.233...)	80	06/06→12/09					
311 CDI (906.131, 906.133, 906.135, 906.231, 906.233...)	84	05/16→					
311 CDI 4x4 (906.131, 906.133, 906.135, 906.231...)	80	02/08→12/09					
313 CDI (906.131, 906.133, 906.135, 906.231, 906.233...)	95	06/06→05/16					
313 CDI 4x4 (906.131, 906.133, 906.135, 906.231...)	95	06/06→05/16					
314 CDI (906.131, 906.133, 906.135, 906.231, 906.233...)	105	05/16→					
314 CDI 4x4 (906.131, 906.133, 906.135, 906.231...)	105	05/16→					
315 CDI (906.131, 906.133, 906.135, 906.231, 906.233...)	110	06/06→12/09					
315 CDI 4x4 (906.131, 906.133, 906.135, 906.231...)	110	02/08→12/09					
316 (906.133, 906.135, 906.233, 906.235)	115	09/08→					
316 CDI (906.131, 906.133, 906.135, 906.231, 906.233...)	120	03/09→					
↓							







	kW			 	! #		
MERCEDES-BENZ - SPRINTER 3,5-t Pritsche/Fahrgestell (906) 06/06→							
 Bremsbelagsatz, Scheibenbremse							
316 CDI 4x4 (906.131, 906.133, 906.135, 906.231...)	120	03/09→	←			13.0460-4826.2 604826	BRE 29192 20,7 + WE / - WK + Zub
316 LGT (906.133, 906.135, 906.233, 906.235)	115	09/08→				13.0460-4877.2 604877	BRE 29192 20,3 + WE / - WK + Zub
316 NGT (906.133, 906.135, 906.233, 906.235)	115	09/08→	→			13.0460-3837.2 603837	BOS 29190 20,2 + WK + Zub
318 CDI (906.131, 906.133, 906.135, 906.231, 906.233...)	135	06/06→12/09					
318 CDI 4x4 (906.131, 906.133, 906.135, 906.231...)	135	02/08→12/09					
319 CDI / BlueTEC (906.131, 906.133, 906.135, 906.231...)	140	03/09→					
319 CDI / BlueTEC 4x4 (906.131, 906.133, 906.135...)	140	05/11→					
324 (906.133, 906.135, 906.233, 906.235)	190	06/06→12/13					
Warnkontakt, Bremsbelagverschleiß							
309 CDI (906.131, 906.133, 906.135, 906.231, 906.233...)	65	06/06→12/09	←		2	24.8190-0424.2 620424	L= 103,2
310 CDI (906.131, 906.133, 906.135, 906.231, 906.233...)	70	03/09→05/16	→	nur in Verbindung mit: 13.0460-3837.2	2	24.8190-0418.2 620418	L= 95
311 CDI (906.131, 906.133, 906.135, 906.231, 906.233...)	80	06/06→12/09					
311 CDI (906.131, 906.133, 906.135, 906.231, 906.233...)	84	05/16→					
311 CDI 4x4 (906.131, 906.133, 906.135, 906.231...)	80	02/08→12/09					
313 CDI (906.131, 906.133, 906.135, 906.231, 906.233...)	95	06/06→05/16					
313 CDI 4x4 (906.131, 906.133, 906.135, 906.231...)	95	06/06→05/16					
314 CDI (906.131, 906.133, 906.135, 906.231, 906.233...)	105	05/16→					
314 CDI 4x4 (906.131, 906.133, 906.135, 906.231...)	105	05/16→					
315 CDI (906.131, 906.133, 906.135, 906.231, 906.233...)	110	06/06→12/09					
315 CDI 4x4 (906.131, 906.133, 906.135, 906.231...)	110	02/08→12/09					
316 (906.133, 906.135, 906.233, 906.235)	115	09/08→					
316 CDI (906.131, 906.133, 906.135, 906.231, 906.233...)	120	03/09→					
316 CDI 4x4 (906.131, 906.133, 906.135, 906.231...)	120	03/09→					
316 LGT (906.133, 906.135, 906.233, 906.235)	115	09/08→					
316 NGT (906.133, 906.135, 906.233, 906.235)	115	09/08→					
318 CDI (906.131, 906.133, 906.135, 906.231, 906.233...)	135	06/06→12/09					
318 CDI 4x4 (906.131, 906.133, 906.135, 906.231...)	135	02/08→12/09					
319 CDI / BlueTEC (906.131, 906.133, 906.135, 906.231...)	140	03/09→					
↓							

	kW			 	! #		
MERCEDES-BENZ - SPRINTER 3,5-t Pritsche/Fahrgestell (906) 06/06→							
Warnkontakt, Bremsbelagverschleiß							
319 CDI / BlueTEC 4x4 (906.131, 906.133, 906.135...)	140	05/11→	←		2	24.8190-0424.2 620424	L= 103,2
324 (906.133, 906.135, 906.233, 906.235)	190	06/06→12/13	→	nur in Verbindung mit: 13.0460-3837.2	2	24.8190-0418.2 620418	L= 95
 Bremsscheibe							
309 CDI (906.131, 906.133, 906.135, 906.231, 906.233...)	65	06/06→12/09	←			24.0128-0203.1 428203	Ø 300 28 25 V + S
310 CDI (906.131, 906.133, 906.135, 906.231, 906.233...)	70	03/09→05/16	→			24.0116-0121.1 416121	Ø 298 16 14 + S
311 CDI (906.131, 906.133, 906.135, 906.231, 906.233...)	80	06/06→12/09					
311 CDI (906.131, 906.133, 906.135, 906.231, 906.233...)	84	05/16→					
311 CDI 4x4 (906.131, 906.133, 906.135, 906.231...)	80	02/08→12/09					
313 CDI (906.131, 906.133, 906.135, 906.231, 906.233...)	95	06/06→05/16					
313 CDI 4x4 (906.131, 906.133, 906.135, 906.231...)	95	06/06→05/16					
314 CDI (906.131, 906.133, 906.135, 906.231, 906.233...)	105	05/16→					
314 CDI 4x4 (906.131, 906.133, 906.135, 906.231...)	105	05/16→					
315 CDI (906.131, 906.133, 906.135, 906.231, 906.233...)	110	06/06→12/09					
315 CDI 4x4 (906.131, 906.133, 906.135, 906.231...)	110	02/08→12/09					
316 (906.133, 906.135, 906.233, 906.235)	115	09/08→					
316 CDI (906.131, 906.133, 906.135, 906.231, 906.233...)	120	03/09→					
316 CDI 4x4 (906.131, 906.133, 906.135, 906.231...)	120	03/09→					
316 LGT (906.133, 906.135, 906.233, 906.235)	115	09/08→					
316 NGT (906.133, 906.135, 906.233, 906.235)	115	09/08→					
318 CDI (906.131, 906.133, 906.135, 906.231, 906.233...)	135	06/06→12/09					
318 CDI 4x4 (906.131, 906.133, 906.135, 906.231...)	135	02/08→12/09					
319 CDI / BlueTEC (906.131, 906.133, 906.135, 906.231...)	140	03/09→					
319 CDI / BlueTEC 4x4 (906.131, 906.133, 906.135...)	140	05/11→					
324 (906.133, 906.135, 906.233, 906.235)	190	06/06→12/13					
MERCEDES-BENZ - SPRINTER 3-t Bus (903) 01/95→05/06							
 Bremsbelagsatz, Scheibenbremse							
308 CDI	60	04/00→05/06	←			13.0460-7196.2 607196	ATE 21576 20,7 + WE / - WK
308 D	58	02/95→04/00				13.0460-7909.2 607909	PER 29153 20,0 + WE / - WK + Zub
308 D (903.371, 903.372, 903.373)	60	03/97→04/00					
310 D (903.371, 903.372, 903.373)	75	01/97→12/99	→			13.0460-3990.2 603990	BOS 23021 18,9 + WE / - WK
310 D 4x4	75	05/97→08/02				13.0460-7084.2 607084	ATE 21592 18,8 + WE / - WK
311 CDI	80	04/00→05/06					
311 CDI 4x4	80	08/02→05/06					
312 D 2.9	90	02/95→04/00					
312 D 2.9 4x4	90	05/97→08/02					
↓							

	kW					! #			
MERCEDES-BENZ - SPRINTER 3-t Bus (903) 01/95→05/06									
 Bremsbelagsatz, Scheibenbremse									
313 CDI	95	04/00→05/06	←				13.0460-7196.2	607196	ATE 21576 20,7 + WE / - WK
313 CDI 4x4	95	08/02→05/06					13.0460-7909.2	607909	PER 29153 20,0 + WE / - WK + Zub
314 (903.071, 903.072, 903.073, 903.671, 903.672, 903.673)	105	02/95→05/06							
314 4x4	105	08/02→05/06	→				13.0460-3990.2	603990	BOS 23021 18,9 + WE / - WK
314 NGT	92	04/00→05/06					13.0460-7084.2	607084	ATE 21592 18,8 + WE / - WK
316 CDI	115	04/00→05/06							
316 CDI 4x4	115	08/02→05/06							
Warnkontakt, Bremsbelagsverschleiß									
308 CDI	60	04/00→05/06	←			2	24.8190-0417.2	620417	L= 99 L= 167
308 D	58	02/95→04/00							
308 D (903.371, 903.372, 903.373)	60	03/97→04/00	→			2	24.8190-0407.2	620407	L= 84 L= 185
310 D (903.371, 903.372, 903.373)	75	01/97→12/99							
310 D 4x4	75	05/97→08/02							
311 CDI	80	04/00→05/06							
311 CDI 4x4	80	08/02→05/06							
312 D 2.9	90	02/95→04/00							
312 D 2.9 4x4	90	05/97→08/02							
313 CDI	95	04/00→05/06							
313 CDI 4x4	95	08/02→05/06							
314 (903.071, 903.072, 903.073, 903.671, 903.672, 903.673)	105	02/95→05/06							
314 4x4	105	08/02→05/06							
314 NGT	92	04/00→05/06							
316 CDI	115	04/00→05/06							
316 CDI 4x4	115	08/02→05/06							
Zubehörsatz, Scheibenbremsbelag									
308 CDI	60	04/00→05/06	←	nur in Verbindung mit: Vornr. 13.0460-7904.2			13.0460-0281.2	610281	PER
308 D	58	02/95→04/00							
308 D (903.371, 903.372, 903.373)	60	03/97→04/00	→				13.0460-0250.2	610250	BOS
310 D (903.371, 903.372, 903.373)	75	01/97→12/99							
310 D 4x4	75	05/97→08/02							
311 CDI	80	04/00→05/06							
311 CDI 4x4	80	08/02→05/06							
312 D 2.9	90	02/95→04/00							
312 D 2.9 4x4	90	05/97→08/02							
313 CDI	95	04/00→05/06							
313 CDI 4x4	95	08/02→05/06							
314 (903.071, 903.072, 903.073, 903.671, 903.672, 903.673)	105	02/95→05/06							
314 4x4	105	08/02→05/06							
314 NGT	92	04/00→05/06							
316 CDI	115	04/00→05/06							
316 CDI 4x4	115	08/02→05/06							
 Bremsscheibe									
308 CDI	60	04/00→05/06	←	für Bremsscheibendurchmesser [mm]: 276			24.0122-0161.1	422161	Ø 276 22 19 V + S
308 D	58	02/95→04/00					24.0322-0161.1	522161	Ø 276 22 19 V + S PD
308 D (903.371, 903.372, 903.373)	60	03/97→04/00							
310 D (903.371, 903.372, 903.373)	75	01/97→12/99	←	für Bremsscheibendurchmesser [mm]: 285			24.0122-0245.1	422245	Ø 285 22 19 V
310 D 4x4	75	05/97→08/02	→				24.0116-0110.1	416110	Ø 272 16 14 + S
311 CDI	80	04/00→05/06							
311 CDI 4x4	80	08/02→05/06							
312 D 2.9	90	02/95→04/00							
312 D 2.9 4x4	90	05/97→08/02							
313 CDI	95	04/00→05/06							
313 CDI 4x4	95	08/02→05/06							
314 (903.071, 903.072, 903.073, 903.671, 903.672, 903.673)	105	02/95→05/06							
314 4x4	105	08/02→05/06							
314 NGT	92	04/00→05/06							
316 CDI	115	04/00→05/06							
316 CDI 4x4	115	08/02→05/06							
MERCEDES-BENZ - SPRINTER 3-t Bus (906) 06/06→									
 Bremsbelagsatz, Scheibenbremse									
210 CDI (906.711, 906.713)	70	03/09→12/13	←				13.0460-4826.2	604826	BRE 29192 20,7 + WE / - WK + Zub
↓									

	kW			 	! #		
MERCEDES-BENZ - SPRINTER 3-t Bus (906) 06/06→							
 Bremsbelagsatz, Scheibenbremse							
211 CDI (906.711, 906.713)	80	06/06→12/09	←			13.0460-4877.2 604877	BRE 29192 20,3 + WE / - WK + Zub
211 CDI (906.711, 906.713)	84	04/16→	→			13.0460-3837.2 603837	BOS 29190 20,2 + WK + Zub
213 CDI (906.711, 906.713)	95	06/06→05/16					
214 CDI (906.711, 906.713)	105	04/16→					
215 CDI (906.711, 906.713)	110	06/06→12/09					
216 (906.713)	115	09/08→					
224 (906.713)	190	06/06→12/13					
216 CDI (906.711, 906.713)	120	06/06→	←	03/09→		13.0460-4826.2 604826	BRE 29192 20,7 + WE / - WK + Zub
						13.0460-4877.2 604877	BRE 29192 20,3 + WE / - WK + Zub
			→	03/09→		13.0460-3837.2 603837	BOS 29190 20,2 + WK + Zub
Warnkontakt, Bremsbelagverschleiß							
210 CDI (906.711, 906.713)	70	03/09→12/13	←		2	24.8190-0424.2 620424	L= 103,2
211 CDI (906.711, 906.713)	80	06/06→12/09	→	nur in Verbindung mit: 13.0460-3837.2	2	24.8190-0418.2 620418	L= 95
211 CDI (906.711, 906.713)	84	04/16→					
213 CDI (906.711, 906.713)	95	06/06→05/16					
214 CDI (906.711, 906.713)	105	04/16→					
215 CDI (906.711, 906.713)	110	06/06→12/09					
216 (906.713)	115	09/08→					
224 (906.713)	190	06/06→12/13					
216 CDI (906.711, 906.713)	120	06/06→	←	03/09→	2	24.8190-0424.2 620424	L= 103,2
			→	03/09→; nur in Verbindung mit: 13.0460-3837.2	2	24.8190-0418.2 620418	L= 95
 Bremsscheibe							
210 CDI (906.711, 906.713)	70	03/09→12/13	←			24.0128-0203.1 428203	Ø 300 28 25 V + S
211 CDI (906.711, 906.713)	80	06/06→12/09	→			24.0116-0121.1 416121	Ø 298 16 14 + S
211 CDI (906.711, 906.713)	84	04/16→					
213 CDI (906.711, 906.713)	95	06/06→05/16					
214 CDI (906.711, 906.713)	105	04/16→					
215 CDI (906.711, 906.713)	110	06/06→12/09					
216 (906.713)	115	09/08→					
224 (906.713)	190	06/06→12/13					
216 CDI (906.711, 906.713)	120	06/06→	←	03/09→		24.0128-0203.1 428203	Ø 300 28 25 V + S
			→	03/09→		24.0116-0121.1 416121	Ø 298 16 14 + S
MERCEDES-BENZ - SPRINTER 3-t Kasten (903) 01/95→05/06							
 Bremsbelagsatz, Scheibenbremse							
308 CDI	60	04/00→05/06	←			13.0460-7196.2 607196	ATE 21576 20,7 + WE / - WK
308 D 2.3	58	02/95→04/00				13.0460-7909.2 607909	PER 29153 20,0 + WE / - WK + Zub
308 D 2.3	60	02/95→04/00					
310 D 2.9	75	02/95→04/00					
311 CDI	80	04/00→05/06	→			13.0460-3990.2 603990	BOS 23021 18,9 + WE / - WK
311 CDI 4x4	80	08/02→05/06				13.0460-7084.2 607084	ATE 21592 18,8 + WE / - WK
312 D 2.9	90	02/95→04/00					
312 D 2.9 4x4	90	05/97→08/02					
313 CDI	95	04/00→05/06					
313 CDI 4x4	95	08/02→05/06					
314	105	02/95→05/06					
314 4x4	105	08/02→05/06					
314 NGT (903.661)	92	04/00→05/06					
316 CDI	115	04/00→05/06					
316 CDI 4x4	115	08/02→05/06					
Warnkontakt, Bremsbelagverschleiß							
308 CDI	60	04/00→05/06	←		2	24.8190-0417.2 620417	L= 99 L= 167
308 D 2.3	58	02/95→04/00	→		2	24.8190-0407.2 620407	L= 84 L= 185
308 D 2.3	60	02/95→04/00					
310 D 2.9	75	02/95→04/00					
↓							

	kW			 	! #		
MERCEDES-BENZ - SPRINTER 3-t Kasten (903) 01/95→05/06							
Warnkontakt, Bremsbelagverschleiß							
311 CDI	80	04/00→05/06	←		2	24.8190-0417.2 620417	L= 99 L= 167
311 CDI 4x4	80	08/02→05/06					
312 D 2.9	90	02/95→04/00	→		2	24.8190-0407.2 620407	L= 84 L= 185
312 D 2.9 4x4	90	05/97→08/02					
313 CDI	95	04/00→05/06					
313 CDI 4x4	95	08/02→05/06					
314	105	02/95→05/06					
314 4x4	105	08/02→05/06					
314 NGT (903.661)	92	04/00→05/06					
316 CDI	115	04/00→05/06					
316 CDI 4x4	115	08/02→05/06					
Zubehörsatz, Scheibenbremsbelag							
308 CDI	60	04/00→05/06	←	nur in Verbindung mit: Vorrn. 13.0460-7904.2		13.0460-0281.2 610281	PER
308 D 2.3	58	02/95→04/00					
308 D 2.3	60	02/95→04/00	→			13.0460-0250.2 610250	BOS
310 D 2.9	75	02/95→04/00					
311 CDI	80	04/00→05/06					
311 CDI 4x4	80	08/02→05/06					
312 D 2.9	90	02/95→04/00					
312 D 2.9 4x4	90	05/97→08/02					
313 CDI	95	04/00→05/06					
313 CDI 4x4	95	08/02→05/06					
314	105	02/95→05/06					
314 4x4	105	08/02→05/06					
314 NGT (903.661)	92	04/00→05/06					
316 CDI	115	04/00→05/06					
316 CDI 4x4	115	08/02→05/06					
Bremsscheibe							
308 CDI	60	04/00→05/06	←	für Bremsscheibendurchmesser [mm]: 276		24.0122-0161.1 422161	Ø 276 22 19 V + S
308 D 2.3	58	02/95→04/00				24.0322-0161.1 522161	Ø 276 22 19 V + S PD
308 D 2.3	60	02/95→04/00	→				
310 D 2.9	75	02/95→04/00	←	für Bremsscheibendurchmesser [mm]: 285		24.0122-0245.1 422245	Ø 285 22 19 V
311 CDI	80	04/00→05/06					
311 CDI 4x4	80	08/02→05/06	→			24.0116-0110.1 416110	Ø 272 16 14 + S
312 D 2.9	90	02/95→04/00					
312 D 2.9 4x4	90	05/97→08/02					
313 CDI	95	04/00→05/06					
313 CDI 4x4	95	08/02→05/06					
314	105	02/95→05/06					
314 4x4	105	08/02→05/06					
314 NGT (903.661)	92	04/00→05/06					
316 CDI	115	04/00→05/06					
316 CDI 4x4	115	08/02→05/06					
MERCEDES-BENZ - SPRINTER 3-t Kasten (906) 06/06→							
Bremsbelagsatz, Scheibenbremse							
209 CDI (906.611, 906.613)	65	06/06→12/09	←			13.0460-4826.2 604826	BRE 29192 20,7 + WE / - WK + Zub
210 CDI (906.611, 906.613)	70	03/09→				13.0460-4877.2 604877	BRE 29192 20,3 + WE / - WK + Zub
211 CDI (906.611, 906.613)	80	06/06→12/09	→			13.0460-3837.2 603837	BOS 29190 20,2 + WK + Zub
211 CDI (906.611, 906.613)	84	04/16→					
213 CDI (906.611, 906.613)	95	06/06→					
213 CDI (906.611, 906.613)	95	06/06→12/09					
214 CDI (906.611, 906.613)	105	04/16→					
215 CDI (906.611, 906.613)	110	06/06→12/09					
216 (906.613)	115	09/08→					
216 CDI (906.611, 906.613)	120	03/09→					
218 CDI (906.611, 906.613)	135	06/06→12/09					
219 CDI / BlueTEC (906.611, 906.613)	140	03/09→					
224 (906.613)	190	06/06→					
Warnkontakt, Bremsbelagverschleiß							
209 CDI (906.611, 906.613)	65	06/06→12/09	←		2	24.8190-0424.2 620424	L= 103,2
210 CDI (906.611, 906.613)	70	03/09→	→	nur in Verbindung mit: 13.0460-3837.2	2	24.8190-0418.2 620418	L= 95
211 CDI (906.611, 906.613)	80	06/06→12/09					
↓							

	kW			 	! #		
MERCEDES-BENZ - SPRINTER 3-t Kasten (906) 06/06→							
Warnkontakt, Bremsbelagverschleiß							
211 CDI (906.611, 906.613)	84	04/16→	←		2	24.8190-0424.2 620424	L= 103,2
213 CDI (906.611, 906.613)	95	06/06→	→	nur in Verbindung mit: 13.0460-3837.2	2	24.8190-0418.2 620418	L= 95
213 CDI (906.611, 906.613)	95	06/06→12/09					
214 CDI (906.611, 906.613)	105	04/16→					
215 CDI (906.611, 906.613)	110	06/06→12/09					
216 (906.613)	115	09/08→					
216 CDI (906.611, 906.613)	120	03/09→					
218 CDI (906.611, 906.613)	135	06/06→12/09					
219 CDI / BlueTEC (906.611, 906.613)	140	03/09→					
224 (906.613)	190	06/06→					
Bremsscheibe							
209 CDI (906.611, 906.613)	65	06/06→12/09	←			24.0128-0203.1 428203	Ø 300 28 25 V + S
210 CDI (906.611, 906.613)	70	03/09→	→			24.0116-0121.1 416121	Ø 298 16 14 + S
211 CDI (906.611, 906.613)	80	06/06→12/09					
211 CDI (906.611, 906.613)	84	04/16→					
213 CDI (906.611, 906.613)	95	06/06→					
213 CDI (906.611, 906.613)	95	06/06→12/09					
214 CDI (906.611, 906.613)	105	04/16→					
215 CDI (906.611, 906.613)	110	06/06→12/09					
216 (906.613)	115	09/08→					
216 CDI (906.611, 906.613)	120	03/09→					
218 CDI (906.611, 906.613)	135	06/06→12/09					
219 CDI / BlueTEC (906.611, 906.613)	140	03/09→					
224 (906.613)	190	06/06→					
MERCEDES-BENZ - SPRINTER 3-t Pritsche/Fahrgestell (903) 01/95→05/06							
Brembelagsatz, Scheibenbremse							
308 CDI	60	04/00→05/06	←			13.0460-7196.2 607196	ATE 21576 20,7 + WE / - WK
308 D 2.3	58	02/95→04/00				13.0460-7909.2 607909	PER 29153 20,0 + WE / - WK + Zub
308 D 2.3	60	11/96→04/00	→				
310 D 2.9	75	01/97→04/00					
311 CDI	80	04/00→05/06				13.0460-3990.2 603990	BOS 23021 18,9 + WE / - WK
311 CDI 4x4	80	08/02→05/06				13.0460-7084.2 607084	ATE 21592 18,8 + WE / - WK
312 D 2.9	90	02/95→04/00					
312 D 2.9 (903.411, 903.412, 903.413, 903.421, 903.422...)	85	12/98→09/01					
313 CDI	95	04/00→05/06					
313 CDI 4x4	95	08/02→05/06					
314 (903.011, 903.012, 903.013, 903.022, 903.611...)	105	02/95→05/06					
314 4x4	105	08/02→05/06					
314 NGT (903.611, 903.612)	92	04/00→05/06					
316 CDI	115	04/00→05/06					
316 CDI 4x4	115	08/02→05/06					
Warnkontakt, Bremsbelagverschleiß							
308 CDI	60	04/00→05/06	←		2	24.8190-0417.2 620417	L= 99 L= 167
308 D 2.3	58	02/95→04/00					
308 D 2.3	60	11/96→04/00	→		2	24.8190-0407.2 620407	L= 84 L= 185
310 D 2.9	75	01/97→04/00					
311 CDI	80	04/00→05/06					
311 CDI 4x4	80	08/02→05/06					
312 D 2.9	90	02/95→04/00					
312 D 2.9 (903.411, 903.412, 903.413, 903.421, 903.422...)	85	12/98→09/01					
313 CDI	95	04/00→05/06					
313 CDI 4x4	95	08/02→05/06					
↓							

MERCEDES-BENZ - SPRINTER 3-t Pritsche/Fahrgestell (903) 01/95→05/06

Warnkontakt, Bremsbelagverschleiß

314 (903.011, 903.012, 903.013, 903.022, 903.611...)	105	02/95→05/06	←		2	24.8190-0417.2	620417	L= 99 L= 167
			→		2	24.8190-0407.2	620407	L= 84 L= 185
314 4x4	105	08/02→05/06						
314 NGT (903.611, 903.612)	92	04/00→05/06						
316 CDI	115	04/00→05/06						
316 CDI 4x4	115	08/02→05/06						

Zubehörsatz, Scheibenbremsbelag

308 CDI	60	04/00→05/06	←	nur in Verbindung mit: Vornr. 13.0460-7904.2		13.0460-0281.2	610281	PER
			→			13.0460-0250.2	610250	BOS
308 D 2.3	58	02/95→04/00						
308 D 2.3	60	11/96→04/00						
310 D 2.9	75	01/97→04/00						
311 CDI	80	04/00→05/06						
311 CDI 4x4	80	08/02→05/06						
312 D 2.9	90	02/95→04/00						
312 D 2.9 (903.411, 903.412, 903.413, 903.421, 903.422...)	85	12/98→09/01						
313 CDI	95	04/00→05/06						
313 CDI 4x4	95	08/02→05/06						
314 (903.011, 903.012, 903.013, 903.022, 903.611...)	105	02/95→05/06						
314 4x4	105	08/02→05/06						
314 NGT (903.611, 903.612)	92	04/00→05/06						
316 CDI	115	04/00→05/06						
316 CDI 4x4	115	08/02→05/06						









 **Bremsscheibe**











308 CDI	60	04/00→05/06	←	für Bremsscheibendurchmesser [mm]: 276		24.0122-0161.1	422161	Ø 276 22 19 V + S
			→			24.0322-0161.1	522161	Ø 276 22 19 V + S PD
308 D 2.3	58	02/95→04/00						
308 D 2.3	60	11/96→04/00						
310 D 2.9	75	01/97→04/00	←	für Bremsscheibendurchmesser [mm]: 285		24.0122-0245.1	422245	Ø 285 22 19 V
311 CDI	80	04/00→05/06						
311 CDI 4x4	80	08/02→05/06	→			24.0116-0110.1	416110	Ø 272 16 14 + S
312 D 2.9	90	02/95→04/00						
312 D 2.9 (903.411, 903.412, 903.413, 903.421, 903.422...)	85	12/98→09/01						
313 CDI	95	04/00→05/06						
313 CDI 4x4	95	08/02→05/06						
314 (903.011, 903.012, 903.013, 903.022, 903.611...)	105	02/95→05/06						
314 4x4	105	08/02→05/06						
314 NGT (903.611, 903.612)	92	04/00→05/06						
316 CDI	115	04/00→05/06						
316 CDI 4x4	115	08/02→05/06						











MERCEDES-BENZ - SPRINTER 3-t Pritsche/Fahrgestell (906) 06/06→









 **Bremsbelagsatz, Scheibenbremse**







209 CDI (906.111, 906.113, 906.211, 906.213)	65	06/06→12/09	←			13.0460-4826.2	604826	BRE 29192 20,7 + WE / - WK + Zub
			→			13.0460-4877.2	604877	BRE 29192 20,3 + WE / - WK + Zub
210 CDI (906.111, 906.113, 906.211, 906.213)	70	03/09→05/16						
211 CDI (906.111, 906.113, 906.211, 906.213)	80	06/06→12/09						
211 CDI (906.111, 906.113, 906.211, 906.213)	84	04/16→						
213 CDI (906.111, 906.113, 906.211, 906.213)	95	06/06→12/09						
213 CDI (906.111, 906.113, 906.211, 906.213)	95	03/09→05/16						
214 CDI (906.111, 906.113, 906.211, 906.213)	105	04/16→						
215 CDI (906.111, 906.113, 906.211, 906.213)	110	06/06→12/09						
216 (906.113, 906.213)	115	09/08→05/16						











	kW					! #		
MERCEDES-BENZ - SPRINTER 3-t Pritsche/Fahrgestell (906) 06/06 →								
 Bremsbelagsatz, Scheibenbremse								
216 CDI (906.111, 906.113, 906.211, 906.213)	120	03/09 →	←				13.0460-4826.2 604826	BRE 29192 20,7 + WE / - WK + Zub
218 CDI (906.111, 906.113, 906.211, 906.213)	135	06/06 → 12/09					13.0460-4877.2 604877	BRE 29192 20,3 + WE / - WK + Zub
219 CDI / BlueTEC (906.111, 906.113, 906.211, 906.213)	140	03/09 → 05/16	→				13.0460-3837.2 603837	BOS 29190 20,2 + WK + Zub
224 (906.113, 906.213)	190	06/06 → 12/13						
Warnkontakt, Bremsbelagverschleiß								
209 CDI (906.111, 906.113, 906.211, 906.213)	65	06/06 → 12/09	←			2	24.8190-0424.2 620424	L= 103,2
210 CDI (906.111, 906.113, 906.211, 906.213)	70	03/09 → 05/16	→	nur in Verbindung mit: 13.0460-3837.2		2	24.8190-0418.2 620418	L= 95
211 CDI (906.111, 906.113, 906.211, 906.213)	80	06/06 → 12/09						
211 CDI (906.111, 906.113, 906.211, 906.213)	84	04/16 →						
213 CDI (906.111, 906.113, 906.211, 906.213)	95	06/06 → 12/09						
213 CDI (906.111, 906.113, 906.211, 906.213)	95	03/09 → 05/16						
214 CDI (906.111, 906.113, 906.211, 906.213)	105	04/16 →						
215 CDI (906.111, 906.113, 906.211, 906.213)	110	06/06 → 12/09						
216 (906.113, 906.213)	115	09/08 → 05/16						
216 CDI (906.111, 906.113, 906.211, 906.213)	120	03/09 →						
218 CDI (906.111, 906.113, 906.211, 906.213)	135	06/06 → 12/09						
219 CDI / BlueTEC (906.111, 906.113, 906.211, 906.213)	140	03/09 → 05/16						
224 (906.113, 906.213)	190	06/06 → 12/13						
 Bremsscheibe								
209 CDI (906.111, 906.113, 906.211, 906.213)	65	06/06 → 12/09	←				24.0128-0203.1 428203	Ø 300 28 25 V + S
210 CDI (906.111, 906.113, 906.211, 906.213)	70	03/09 → 05/16	→				24.0116-0121.1 416121	Ø 298 16 14 + S
211 CDI (906.111, 906.113, 906.211, 906.213)	80	06/06 → 12/09						
211 CDI (906.111, 906.113, 906.211, 906.213)	84	04/16 →						
213 CDI (906.111, 906.113, 906.211, 906.213)	95	06/06 → 12/09						
213 CDI (906.111, 906.113, 906.211, 906.213)	95	03/09 → 05/16						
214 CDI (906.111, 906.113, 906.211, 906.213)	105	04/16 →						
215 CDI (906.111, 906.113, 906.211, 906.213)	110	06/06 → 12/09						
216 (906.113, 906.213)	115	09/08 → 05/16						
216 CDI (906.111, 906.113, 906.211, 906.213)	120	03/09 →						
218 CDI (906.111, 906.113, 906.211, 906.213)	135	06/06 → 12/09						
219 CDI / BlueTEC (906.111, 906.113, 906.211, 906.213)	140	03/09 → 05/16						
↓								









	kW					! #		
MERCEDES-BENZ - SPRINTER 3-t Pritsche/Fahrgestell (906) 06/06 →								
 Bremsscheibe								
224 (906.113, 906.213)	190	06/06 → 12/13	←			24.0128-0203.1	428203	Ø 300 28 25 V + S
			→			24.0116-0121.1	416121	Ø 298 16 14 + S
MERCEDES-BENZ - SPRINTER 4,6-t Kasten (906) 06/06 →								
 Bremsbelagsatz, Scheibenbremse								
411 CDI (906.653, 906.655, 906.657)	80	06/09 → 12/09	←			13.0460-4827.2	604827	BRE 29200 21,0 + WE / - WK + Zub
413 CDI (906.653, 906.655, 906.657)	95	06/06 → 05/16	→			13.0460-3842.2	603842	BOS 29217 20,5 + WE / - WK
414 CDI	105	05/16 →						
415 CDI (906.653, 906.655, 906.657)	110	06/09 → 12/09						
416 CDI (906.653, 906.655, 906.657)	120	03/09 →						
418 CDI (906.653, 906.655, 906.657)	135	06/09 → 05/16						
419 CDI (906.653, 906.655, 906.657)	140	03/09 →						
424 (906.655, 906.657, 906.653)	190	06/06 → 12/13						
Warnkontakt, Bremsbelagsverschleiß								
411 CDI (906.653, 906.655, 906.657)	80	06/09 → 12/09	←		2	24.8190-0424.2	620424	L= 103,2
413 CDI (906.653, 906.655, 906.657)	95	06/06 → 05/16	→		2	24.8190-0005.2	620005	L= 84
414 CDI	105	05/16 →						
415 CDI (906.653, 906.655, 906.657)	110	06/09 → 12/09						
416 CDI (906.653, 906.655, 906.657)	120	03/09 →						
418 CDI (906.653, 906.655, 906.657)	135	06/09 → 05/16						
419 CDI (906.653, 906.655, 906.657)	140	03/09 →						
424 (906.655, 906.657, 906.653)	190	06/06 → 12/13						
 Bremsscheibe								
411 CDI (906.653, 906.655, 906.657)	80	06/09 → 12/09	←			24.0128-0203.1	428203	Ø 300 28 25 V + S
413 CDI (906.653, 906.655, 906.657)	95	06/06 → 05/16	→			24.0128-0202.1	428202	Ø 303 28 25 V
414 CDI	105	05/16 →						
415 CDI (906.653, 906.655, 906.657)	110	06/09 → 12/09						
416 CDI (906.653, 906.655, 906.657)	120	03/09 →						
418 CDI (906.653, 906.655, 906.657)	135	06/09 → 05/16						
419 CDI (906.653, 906.655, 906.657)	140	03/09 →						
424 (906.655, 906.657, 906.653)	190	06/06 → 12/13						
MERCEDES-BENZ - SPRINTER 4,6-t Pritsche/Fahrgestell (906) 06/06 →								
 Bremsbelagsatz, Scheibenbremse								
411 CDI (906.153, 906.155, 906.253, 906.255)	80	06/09 → 12/09	←			13.0460-4827.2	604827	BRE 29200 21,0 + WE / - WK + Zub
413 CDI (906.153, 906.155, 906.253, 906.255)	95	06/06 → 05/16	→			13.0460-3842.2	603842	BOS 29217 20,5 + WE / - WK
414 CDI	105	05/16 →						
415 CDI (906.153, 906.155, 906.253, 906.255)	110	06/06 → 12/09						
416 CDI (906.153, 906.155, 906.253, 906.255)	120	03/09 →						
418 CDI (906.153, 906.155, 906.253, 906.255)	135	06/06 → 12/09						
419 CDI (906.153, 906.155, 906.253, 906.255)	140	03/09 →						
424 (906.153, 906.155, 906.253, 906.255)	190	06/06 → 12/13						











	kW			 	! #		
MERCEDES-BENZ - SPRINTER 4,6-t Pritsche/Fahrgestell (906) 06/06→							
Warnkontakt, Bremsbelagverschleiß							
411 CDI (906.153, 906.155, 906.253, 906.255)	80	06/09→12/09	←		2	24.8190-0424.2 620424	L= 103,2
			→		2	24.8190-0005.2 620005	L= 84
413 CDI (906.153, 906.155, 906.253, 906.255)	95	06/06→05/16					
414 CDI	105	05/16→					
415 CDI (906.153, 906.155, 906.253, 906.255)	110	06/06→12/09					
416 CDI (906.153, 906.155, 906.253, 906.255)	120	03/09→					
418 CDI (906.153, 906.155, 906.253, 906.255)	135	06/06→12/09					
419 CDI (906.153, 906.155, 906.253, 906.255)	140	03/09→					
424 (906.153, 906.155, 906.253, 906.255)	190	06/06→12/13					
 Bremsscheibe							
411 CDI (906.153, 906.155, 906.253, 906.255)	80	06/09→12/09	←			24.0128-0203.1 428203	Ø 300 28 25 V + S
			→			24.0128-0202.1 428202	Ø 303 28 25 V
413 CDI (906.153, 906.155, 906.253, 906.255)	95	06/06→05/16					
414 CDI	105	05/16→					
415 CDI (906.153, 906.155, 906.253, 906.255)	110	06/06→12/09					
416 CDI (906.153, 906.155, 906.253, 906.255)	120	03/09→					
418 CDI (906.153, 906.155, 906.253, 906.255)	135	06/06→12/09					
419 CDI (906.153, 906.155, 906.253, 906.255)	140	03/09→					
424 (906.153, 906.155, 906.253, 906.255)	190	06/06→12/13					
MERCEDES-BENZ - SPRINTER 4-t Bus (904) 02/96→05/06							
 Bremsbelagsatz, Scheibenbremse							
408 CDI	60	04/00→05/06	←			13.0460-7196.2 607196	ATE 21576 20,7 + WE / - WK
411 CDI	80	04/00→05/06				13.0460-7909.2 607909	PER 29153 20,0 + WE / - WK + Zub
413 CDI	95	04/00→05/06					
414	105	02/96→05/06					
416 CDI	115	04/00→05/06	→			13.0460-7909.2 607909	PER 29153 20,0 + WE / - WK + Zub
Warnkontakt, Bremsbelagverschleiß							
408 CDI	60	04/00→05/06	←		2	24.8190-0417.2 620417	L= 99 L= 167
411 CDI	80	04/00→05/06					
413 CDI	95	04/00→05/06	→		2	24.8190-0417.2 620417	L= 99 L= 167
414	105	02/96→05/06					
416 CDI	115	04/00→05/06					
Zubehörsatz, Scheibenbremsbelag							
408 CDI	60	04/00→05/06	←	nur in Verbindung mit: Vornr. 13.0460-7904.2		13.0460-0281.2 610281	PER
411 CDI	80	04/00→05/06					
413 CDI	95	04/00→05/06	→	nur in Verbindung mit: Vornr. 13.0460-7904.2		13.0460-0281.2 610281	PER
414	105	02/96→05/06					
416 CDI	115	04/00→05/06					
 Bremsscheibe							
408 CDI	60	04/00→05/06	←	für Bremsscheibendurchmesser [mm]: 276		24.0122-0161.1 422161	Ø 276 22 19 V + S
411 CDI	80	04/00→05/06				24.0322-0161.1 522161	Ø 276 22 19 V + S PD
413 CDI	95	04/00→05/06	←	für Bremsscheibendurchmesser [mm]: 285		24.0122-0245.1 422245	Ø 285 22 19 V
414	105	02/96→05/06					
416 CDI	115	04/00→05/06	→			24.0122-0196.1 422196	Ø 285 21,9 19 V
MERCEDES-BENZ - SPRINTER 4-t Kasten (904) 02/96→05/06							
 Bremsbelagsatz, Scheibenbremse							
408 CDI	60	04/00→05/06	←			13.0460-7196.2 607196	ATE 21576 20,7 + WE / - WK









	kW			 	! #		
MERCEDES-BENZ - SPRINTER 4-t Kasten (904) 02/96→05/06							
 Bremsbelagsatz, Scheibenbremse							
408 D	58	02/96→05/06	←			13.0460-7909.2 607909	PER 29153 20,0 + WE / - WK + Zub
410 D 4x4	75	05/97→05/06					
411 CDI	80	04/00→05/06	→			13.0460-7909.2 607909	PER 29153 20,0 + WE / - WK + Zub
411 CDI 4x4	80	04/00→05/06					
412 D	85	02/96→05/06					
412 D	90	02/96→05/06					
412 D 4x4	85	05/97→05/06					
412 D 4x4	90	05/97→05/06					
413 CDI	95	04/00→05/06					
413 CDI 4x4	95	04/00→05/06					
414 (904.062, 904.063, 904.662, 904.663)	105	02/96→05/06					
414 4x4 (904.062, 904.063, 904.662, 904.663)	105	05/97→05/06					
416 CDI	115	04/00→05/06					
416 CDI 4x4	115	04/00→05/06					
410 D	75	02/96→05/06	←	09/96→		13.0460-7196.2 607196	ATE 21576 20,7 + WE / - WK
						13.0460-7909.2 607909	PER 29153 20,0 + WE / - WK + Zub
			→	09/96→		13.0460-7909.2 607909	PER 29153 20,0 + WE / - WK + Zub
Warnkontakt, Bremsbelagsverschleiß							
408 CDI	60	04/00→05/06	←		2	24.8190-0417.2 620417	L= 99 L= 167
408 D	58	02/96→05/06					
410 D 4x4	75	05/97→05/06	→		2	24.8190-0417.2 620417	L= 99 L= 167
411 CDI	80	04/00→05/06					
411 CDI 4x4	80	04/00→05/06					
412 D	85	02/96→05/06					
412 D	90	02/96→05/06					
412 D 4x4	85	05/97→05/06					
412 D 4x4	90	05/97→05/06					
413 CDI	95	04/00→05/06					
413 CDI 4x4	95	04/00→05/06					
414 (904.062, 904.063, 904.662, 904.663)	105	02/96→05/06					
414 4x4 (904.062, 904.063, 904.662, 904.663)	105	05/97→05/06					
416 CDI	115	04/00→05/06					
416 CDI 4x4	115	04/00→05/06					
410 D	75	02/96→05/06	←	09/96→	2	24.8190-0417.2 620417	L= 99 L= 167
			→	09/96→	2	24.8190-0417.2 620417	L= 99 L= 167
Zubehörsatz, Scheibenbremsbelag							
408 CDI	60	04/00→05/06	←	nur in Verbindung mit: Vornr. 13.0460-7904.2		13.0460-0281.2 610281	PER
408 D	58	02/96→05/06					
410 D 4x4	75	05/97→05/06	→	nur in Verbindung mit: Vornr. 13.0460-7904.2		13.0460-0281.2 610281	PER
411 CDI	80	04/00→05/06					
411 CDI 4x4	80	04/00→05/06					
412 D	85	02/96→05/06					
412 D	90	02/96→05/06					
412 D 4x4	85	05/97→05/06					
412 D 4x4	90	05/97→05/06					
413 CDI	95	04/00→05/06					
413 CDI 4x4	95	04/00→05/06					
414 (904.062, 904.063, 904.662, 904.663)	105	02/96→05/06					
414 4x4 (904.062, 904.063, 904.662, 904.663)	105	05/97→05/06					
416 CDI	115	04/00→05/06					
416 CDI 4x4	115	04/00→05/06					
410 D	75	02/96→05/06	←	09/96→; nur in Verbindung mit: Vornr. 13.0460-7904.2		13.0460-0281.2 610281	PER
			→	09/96→; nur in Verbindung mit: Vornr. 13.0460-7904.2		13.0460-0281.2 610281	PER
 Bremsscheibe							
408 CDI	60	04/00→05/06	←	für Bremsscheibendurchmesser [mm]: 276		24.0122-0161.1 422161	Ø 276 22 19 V + S
408 D	58	02/96→05/06				24.0322-0161.1 522161	Ø 276 22 19 V + S PD
410 D 4x4	75	05/97→05/06	←	für Bremsscheibendurchmesser [mm]: 285		24.0122-0245.1 422245	Ø 285 22 19 V
411 CDI	80	04/00→05/06					
411 CDI 4x4	80	04/00→05/06					
412 D	85	02/96→05/06	→			24.0122-0196.1 422196	Ø 285 21,9 19 V
412 D	90	02/96→05/06					
412 D 4x4	85	05/97→05/06					
↓							









	kw					! #		
MERCEDES-BENZ - SPRINTER 4-t Kasten (904) 02/96→05/06								
Bremsscheibe								
412 D 4x4	90	05/97→05/06	←	für Bremsscheibendurchmesser [mm]:		24.0122-0161.1	422161	Ø 276 22 19 V + S
413 CDI	95	04/00→05/06		276		24.0322-0161.1	522161	Ø 276 22 19 V + S PD
413 CDI 4x4	95	04/00→05/06						
414 (904.062, 904.063, 904.662, 904.663)	105	02/96→05/06	←	für Bremsscheibendurchmesser [mm]:		24.0122-0245.1	422245	Ø 285 22 19 V
414 4x4 (904.062, 904.063, 904.662, 904.663)	105	05/97→05/06	→			24.0122-0196.1	422196	Ø 285 21,9 19 V
416 CDI	115	04/00→05/06						
416 CDI 4x4	115	04/00→05/06						
410 D	75	02/96→05/06	←	09/96→;		24.0122-0161.1	422161	Ø 276 22 19 V + S
				für Bremsscheibendurchmesser [mm]:		24.0322-0161.1	522161	Ø 276 22 19 V + S PD
			←	09/96→;		24.0122-0245.1	422245	Ø 285 22 19 V
				für Bremsscheibendurchmesser [mm]:				
			→	09/96→		24.0122-0196.1	422196	Ø 285 21,9 19 V
MERCEDES-BENZ - SPRINTER 4-t Pritsche/Fahrgestell (904) 02/96→05/06								
Bremsbelagsatz, Scheibenbremse								
408 CDI	60	04/00→05/06	←			13.0460-7196.2	607196	ATE 21576 20,7 + WE / - WK
408 D	58	02/96→05/06				13.0460-7909.2	607909	PER 29153 20,0 + WE / - WK + Zub
410 D 4x4	75	05/97→05/06						
411 CDI	80	04/00→05/06	→			13.0460-7909.2	607909	PER 29153 20,0 + WE / - WK + Zub
411 CDI 4x4	80	04/00→05/06						
412 D	85	02/96→05/06						
412 D	90	02/96→05/06						
412 D 4x4	85	05/97→05/06						
412 D 4x4	90	05/97→05/06						
413 CDI	95	04/00→05/06						
413 CDI 4x4	95	04/00→05/06						
414 (904.012, 904.013, 904.612, 904.613)	105	02/96→05/06						
414 4x4 (904.012, 904.013, 904.612, 904.613)	105	05/97→05/06						
416 CDI	115	04/00→05/06						
416 CDI 4x4	115	04/00→05/06						
410 D	75	02/96→05/06	←	09/96→		13.0460-7196.2	607196	ATE 21576 20,7 + WE / - WK
						13.0460-7909.2	607909	PER 29153 20,0 + WE / - WK + Zub
			→	09/96→		13.0460-7909.2	607909	PER 29153 20,0 + WE / - WK + Zub
Warnkontakt, Bremsbelagsverschleiß								
408 CDI	60	04/00→05/06	←		2	24.8190-0417.2	620417	L= 99 L= 167
408 D	58	02/96→05/06	→		2	24.8190-0417.2	620417	L= 99 L= 167
410 D 4x4	75	05/97→05/06						
411 CDI	80	04/00→05/06						
411 CDI 4x4	80	04/00→05/06						
412 D	85	02/96→05/06						
412 D	90	02/96→05/06						
412 D 4x4	85	05/97→05/06						
412 D 4x4	90	05/97→05/06						
413 CDI	95	04/00→05/06						
413 CDI 4x4	95	04/00→05/06						
414 (904.012, 904.013, 904.612, 904.613)	105	02/96→05/06						
414 4x4 (904.012, 904.013, 904.612, 904.613)	105	05/97→05/06						
416 CDI	115	04/00→05/06						
416 CDI 4x4	115	04/00→05/06						
410 D	75	02/96→05/06	←	09/96→	2	24.8190-0417.2	620417	L= 99 L= 167
			→	09/96→	2	24.8190-0417.2	620417	L= 99 L= 167
Zubehörsatz, Scheibenbremsbelag								
408 CDI	60	04/00→05/06	←	nur in Verbindung mit: Vornr.		13.0460-0281.2	610281	PER
408 D	58	02/96→05/06		13.0460-7904.2				
410 D 4x4	75	05/97→05/06	→	nur in Verbindung mit: Vornr.		13.0460-0281.2	610281	PER
411 CDI	80	04/00→05/06		13.0460-7904.2				
411 CDI 4x4	80	04/00→05/06						
412 D	85	02/96→05/06						
412 D	90	02/96→05/06						
412 D 4x4	85	05/97→05/06						
412 D 4x4	90	05/97→05/06						
413 CDI	95	04/00→05/06						
413 CDI 4x4	95	04/00→05/06						
↓								













	kW					! #		
MERCEDES-BENZ - SPRINTER 4-t Pritsche/Fahrgestell (904) 02/96→05/06								
Zubehörsatz, Scheibenbremsbelag								
414 (904.012, 904.013, 904.612, 904.613)	105	02/96→05/06	←	nur in Verbindung mit: Vornr. 13.0460-7904.2			13.0460-0281.2 610281	PER
414 4x4 (904.012, 904.013, 904.612, 904.613)	105	05/97→05/06	→	nur in Verbindung mit: Vornr. 13.0460-7904.2			13.0460-0281.2 610281	PER
416 CDI	115	04/00→05/06						
416 CDI 4x4	115	04/00→05/06						
410 D	75	02/96→05/06	←	09/96→; nur in Verbindung mit: Vornr. 13.0460-7904.2			13.0460-0281.2 610281	PER
			→	09/96→; nur in Verbindung mit: Vornr. 13.0460-7904.2			13.0460-0281.2 610281	PER
 Bremsscheibe								
408 CDI	60	04/00→05/06	←	für Bremsscheibendurchmesser [mm]: 276			24.0122-0161.1 422161	Ø 276 22 19 V + S
408 D	58	02/96→05/06					24.0322-0161.1 522161	Ø 276 22 19 V + S PD
410 D 4x4	75	05/97→05/06						
411 CDI	80	04/00→05/06	←	für Bremsscheibendurchmesser [mm]: 285			24.0122-0245.1 422245	Ø 285 22 19 V
411 CDI 4x4	80	04/00→05/06						
412 D	85	02/96→05/06	→				24.0122-0196.1 422196	Ø 285 21,9 19 V
412 D	90	02/96→05/06						
412 D 4x4	85	05/97→05/06						
412 D 4x4	90	05/97→05/06						
413 CDI	95	04/00→05/06						
413 CDI 4x4	95	04/00→05/06						
414 (904.012, 904.013, 904.612, 904.613)	105	02/96→05/06						
414 4x4 (904.012, 904.013, 904.612, 904.613)	105	05/97→05/06						
416 CDI	115	04/00→05/06						
416 CDI 4x4	115	04/00→05/06						
410 D	75	02/96→05/06	←	09/96→; für Bremsscheibendurchmesser [mm]: 276			24.0122-0161.1 422161	Ø 276 22 19 V + S
							24.0322-0161.1 522161	Ø 276 22 19 V + S PD
			←	09/96→; für Bremsscheibendurchmesser [mm]: 285			24.0122-0245.1 422245	Ø 285 22 19 V
			→	09/96→			24.0122-0196.1 422196	Ø 285 21,9 19 V
MERCEDES-BENZ - SPRINTER 5-t Bus 06/06→								
 Bremsbelagsatz, Scheibenbremse								
513 CDI (906.653, 906.655, 906.657)	95	06/06→	←	03/09→			13.0460-4827.2 604827	BRE 29200 21,0 + WE / - WK + Zub
			→	03/09→			13.0460-3842.2 603842	BOS 29217 20,5 + WE / - WK
516 CDI	120	03/09→	←				13.0460-4827.2 604827	BRE 29200 21,0 + WE / - WK + Zub
519 CDI / BlueTEC	140	03/09→	→				13.0460-3842.2 603842	BOS 29217 20,5 + WE / - WK
Warnkontakt, Bremsbelagverschleiß								
513 CDI (906.653, 906.655, 906.657)	95	06/06→	←	03/09→	2	24.8190-0424.2 620424		L= 103,2
			→	03/09→	2	24.8190-0005.2 620005		L= 84
516 CDI	120	03/09→	←		2	24.8190-0424.2 620424		L= 103,2
519 CDI / BlueTEC	140	03/09→	→		2	24.8190-0005.2 620005		L= 84
 Bremsscheibe								
513 CDI (906.653, 906.655, 906.657)	95	06/06→	←	03/09→			24.0128-0203.1 428203	Ø 300 28 25 V + S
			→	03/09→			24.0128-0202.1 428202	Ø 303 28 25 V
516 CDI	120	03/09→	←				24.0128-0203.1 428203	Ø 300 28 25 V + S
519 CDI / BlueTEC	140	03/09→	→				24.0128-0202.1 428202	Ø 303 28 25 V
MERCEDES-BENZ - SPRINTER 5-t Kasten (906) 06/06→								
 Bremsbelagsatz, Scheibenbremse								
509 CDI (906.653, 906.655, 906.657)	65	06/06→12/09	←				13.0460-4827.2 604827	BRE 29200 21,0 + WE / - WK + Zub
510 CDI (906.653, 906.655, 906.657)	70	03/09→05/16	→				13.0460-3842.2 603842	BOS 29217 20,5 + WE / - WK
511 CDI (906.653, 906.655, 906.657)	80	06/06→12/09						
511 CDI (906.653, 906.655, 906.657)	84	05/16→						

	kW			 	! #		
MERCEDES-BENZ - SPRINTER 5-t Kasten (906) 06/06→							
 Bremsbelagsatz, Scheibenbremse							
511 CDI 4x4 (906.653, 906.655, 906.657)	80	06/06→12/09	←			13.0460-4827.2 604827	BRE 29200 21,0 + WE / - WK + Zub
513 CDI 4x4 (906.653, 906.655, 906.657)	95	06/06→	→			13.0460-3842.2 603842	BOS 29217 20,5 + WE / - WK
514 CDI (906.653, 906.655, 906.657)	105	05/16→					
514 CDI 4x4 (906.653, 906.655, 906.657)	105	05/16→					
515 CDI (906.653, 906.655, 906.657)	110	06/06→12/09					
515 CDI 4x4 (906.653, 906.655, 906.657)	110	06/06→12/09					
516 CDI (906.653, 906.655, 906.657)	120	03/09→					
516 CDI 4x4 (906.653, 906.655, 906.657)	120	06/06→					
518 CDI (906.653, 906.655, 906.657)	135	06/06→12/09					
518 CDI 4x4 (906.653, 906.655, 906.657)	135	06/06→12/09					
519 CDI / BlueTEC (906.653, 906.655, 906.657)	140	03/09→					
519 CDI / BlueTEC 4x4 (906.653, 906.655, 906.657)	140	03/09→					
524 (906.653, 906.655, 906.657)	190	06/06→12/13					
513 CDI (906.653, 906.655, 906.657)	95	06/06→	←	03/09→		13.0460-4827.2 604827	BRE 29200 21,0 + WE / - WK + Zub
			→	03/09→		13.0460-3842.2 603842	BOS 29217 20,5 + WE / - WK
Warnkontakt, Bremsbelagsverschleiß							
509 CDI (906.653, 906.655, 906.657)	65	06/06→12/09	←		2	24.8190-0424.2 620424	L= 103,2
510 CDI (906.653, 906.655, 906.657)	70	03/09→05/16	→		2	24.8190-0005.2 620005	L= 84
511 CDI (906.653, 906.655, 906.657)	80	06/06→12/09					
511 CDI (906.653, 906.655, 906.657)	84	05/16→					
511 CDI 4x4 (906.653, 906.655, 906.657)	80	06/06→12/09					
513 CDI 4x4 (906.653, 906.655, 906.657)	95	06/06→					
514 CDI (906.653, 906.655, 906.657)	105	05/16→					
514 CDI 4x4 (906.653, 906.655, 906.657)	105	05/16→					
515 CDI (906.653, 906.655, 906.657)	110	06/06→12/09					
515 CDI 4x4 (906.653, 906.655, 906.657)	110	06/06→12/09					
516 CDI (906.653, 906.655, 906.657)	120	03/09→					
516 CDI 4x4 (906.653, 906.655, 906.657)	120	06/06→					
518 CDI (906.653, 906.655, 906.657)	135	06/06→12/09					
518 CDI 4x4 (906.653, 906.655, 906.657)	135	06/06→12/09					
519 CDI / BlueTEC (906.653, 906.655, 906.657)	140	03/09→					
519 CDI / BlueTEC 4x4 (906.653, 906.655, 906.657)	140	03/09→					
524 (906.653, 906.655, 906.657)	190	06/06→12/13					
513 CDI (906.653, 906.655, 906.657)	95	06/06→	←	03/09→	2	24.8190-0424.2 620424	L= 103,2
			→	03/09→	2	24.8190-0005.2 620005	L= 84
 Bremsscheibe							
509 CDI (906.653, 906.655, 906.657)	65	06/06→12/09	←			24.0128-0203.1 428203	Ø 300 28 25 V + S
510 CDI (906.653, 906.655, 906.657)	70	03/09→05/16	→			24.0128-0202.1 428202	Ø 303 28 25 V
511 CDI (906.653, 906.655, 906.657)	80	06/06→12/09					
511 CDI (906.653, 906.655, 906.657)	84	05/16→					
↓							











	kW					! #		
MERCEDES-BENZ - SPRINTER 5-t Kasten (906) 06/06→								
 Bremsscheibe								
511 CDI 4x4 (906.653, 906.655, 906.657)	80	06/06→12/09	←				24.0128-0203.1 428203	Ø 300 28 25 V + S
513 CDI 4x4 (906.653, 906.655, 906.657)	95	06/06→	→				24.0128-0202.1 428202	Ø 303 28 25 V
514 CDI (906.653, 906.655, 906.657)	105	05/16→						
514 CDI 4x4 (906.653, 906.655, 906.657)	105	05/16→						
515 CDI (906.653, 906.655, 906.657)	110	06/06→12/09						
515 CDI 4x4 (906.653, 906.655, 906.657)	110	06/06→12/09						
516 CDI (906.653, 906.655, 906.657)	120	03/09→						
516 CDI 4x4 (906.653, 906.655, 906.657)	120	06/06→						
518 CDI (906.653, 906.655, 906.657)	135	06/06→12/09						
518 CDI 4x4 (906.653, 906.655, 906.657)	135	06/06→12/09						
519 CDI / BlueTEC (906.653, 906.655, 906.657)	140	03/09→						
519 CDI / BlueTEC 4x4 (906.653, 906.655, 906.657)	140	03/09→						
524 (906.653, 906.655, 906.657)	190	06/06→12/13						
513 CDI (906.653, 906.655, 906.657)	95	06/06→	←	03/09→			24.0128-0203.1 428203	Ø 300 28 25 V + S
			→	03/09→			24.0128-0202.1 428202	Ø 303 28 25 V
MERCEDES-BENZ - SPRINTER 5-t Pritsche/Fahrgestell (905) 04/01→05/06								
 Bremsbelagsatz, Scheibenbremse								
616 CDI (905.612, 905.613, 905.622, 905.623)	115	04/01→05/06	←				13.0460-4975.2 604975	BRE 29160 20,8 + WE / - WK
			→				13.0460-7909.2 607909	PER 29153 20,0 + WE / - WK + Zub
							13.0460-6015.2 606015	ATE 29835 22,0 + WE / - WK
Warnkontakt, Bremsbelagsverschleiß								
616 CDI (905.612, 905.613, 905.622, 905.623)	115	04/01→05/06	←	nur in Verbindung mit: 13.0460-4975.2	2	24.8190-0415.2 620415		L= 238 L2= 148
			←		2	24.8190-0417.2 620417		L= 99 L= 167
			→	nur in Verbindung mit: 13.0460-6015.2	2	24.8190-0423.2 620423		L= 199 L2= 144
Zubehörsatz, Scheibenbremsbelag								
616 CDI (905.612, 905.613, 905.622, 905.623)	115	04/01→05/06	←	nur in Verbindung mit: Vornr. 13.0460-7904.2		13.0460-0281.2 610281		PER
 Bremsscheibe								
616 CDI (905.612, 905.613, 905.622, 905.623)	115	04/01→05/06	←				24.0122-0161.1 422161	Ø 276 22 19 V + S
							24.0126-0144.1 426144	Ø 290 26 23 V
							24.0322-0161.1 522161	Ø 276 22 19 V + S PD
MERCEDES-BENZ - SPRINTER 5-t Pritsche/Fahrgestell (906) 06/06→								
 Bremsbelagsatz, Scheibenbremse								
509 CDI (906.153, 906.155, 906.253, 906.255)	65	06/06→12/09	←				13.0460-4827.2 604827	BRE 29200 21,0 + WE / - WK + Zub
510 CDI (906.153, 906.155, 906.253, 906.255)	70	03/09→	→				13.0460-3842.2 603842	BOS 29217 20,5 + WE / - WK
511 CDI (906.153, 906.155, 906.253, 906.255)	80	06/06→12/09						
511 CDI (906.153, 906.155, 906.253, 906.255)	84	05/16→						
511 CDI 4x4 (906.153, 906.253, 906.255)	80	06/06→12/09						
513 CDI 4x4 (906.153, 906.253, 906.255)	95	05/11→05/16						
514 CDI (906.153, 906.155, 906.253, 906.255)	105	05/16→						
↓								













	kW			 	! #		
MERCEDES-BENZ - SPRINTER 5-t Pritsche/Fahrgestell (906) 06/06 →							
 Bremsbelagsatz, Scheibenbremse							
514 CDI 4x4 (906.153, 906.155, 906.253, 906.255)	105	05/16 →	←			13.0460-4827.2 604827	BRE 29200 21,0 + WE / - WK + Zub
515 CDI (906.153, 906.155, 906.253, 906.255)	110	06/06 → 12/09	→			13.0460-3842.2 603842	BOS 29217 20,5 + WE / - WK
515 CDI 4x4 (906.153, 906.155, 906.253, 906.255)	110	06/06 → 12/09					
516 (906.153, 906.155, 906.253, 906.255)	115	09/08 →					
516 CDI (906.153, 906.155, 906.253, 906.255)	120	03/09 →					
516 CDI 4x4 (906.153, 906.155, 906.255)	120	05/11 →					
516 NGT (906.153, 906.155, 906.253, 906.255)	115	09/08 →					
518 CDI (906.153, 906.155, 906.253, 906.255)	135	06/06 → 12/09					
518 CDI 4x4 (906.153, 906.155, 906.253, 906.255)	135	06/06 → 12/09					
519 CDI / BlueTEC (906.153, 906.155, 906.253, 906.255)	140	03/09 →					
519 CDI / BlueTEC 4x4 (906.153, 906.155, 906.253, 906.255)	140	03/09 →					
524 (906.153, 906.155, 906.253, 906.255)	190	06/06 → 12/13					
513 CDI (906.155, 906.253, 906.255)	95	06/06 → 05/16	←	03/09 →		13.0460-4827.2 604827	BRE 29200 21,0 + WE / - WK + Zub
			→	03/09 →		13.0460-3842.2 603842	BOS 29217 20,5 + WE / - WK
Warnkontakt, Bremsbelagverschleiß							
509 CDI (906.153, 906.155, 906.253, 906.255)	65	06/06 → 12/09	←		2	24.8190-0424.2 620424	L= 103,2
510 CDI (906.153, 906.155, 906.253, 906.255)	70	03/09 →	→		2	24.8190-0005.2 620005	L= 84
511 CDI (906.153, 906.155, 906.253, 906.255)	80	06/06 → 12/09					
511 CDI (906.153, 906.155, 906.253, 906.255)	84	05/16 →					
511 CDI 4x4 (906.155, 906.253, 906.255)	80	06/06 → 12/09					
513 CDI 4x4 (906.155, 906.253, 906.255)	95	05/11 → 05/16					
514 CDI (906.153, 906.155, 906.253, 906.255)	105	05/16 →					
514 CDI 4x4 (906.153, 906.155, 906.253, 906.255)	105	05/16 →					
515 CDI (906.153, 906.155, 906.253, 906.255)	110	06/06 → 12/09					
515 CDI 4x4 (906.153, 906.155, 906.253, 906.255)	110	06/06 → 12/09					
516 (906.153, 906.155, 906.253, 906.255)	115	09/08 →					
516 CDI (906.153, 906.155, 906.253, 906.255)	120	03/09 →					
516 CDI 4x4 (906.153, 906.155, 906.255)	120	05/11 →					
516 NGT (906.153, 906.155, 906.253, 906.255)	115	09/08 →					
518 CDI (906.153, 906.155, 906.253, 906.255)	135	06/06 → 12/09					
518 CDI 4x4 (906.153, 906.155, 906.253, 906.255)	135	06/06 → 12/09					
↓							













	kW					! #		
MERCEDES-BENZ - SPRINTER 5-t Pritsche/Fahrgestell (906) 06/06 →								
Warnkontakt, Bremsbelagverschleiß								
519 CDI / BlueTEC (906.153, 906.155, 906.253, 906.255)	140	03/09 →	←		2	24.8190-0424.2	620424	L= 103,2
			→		2	24.8190-0005.2	620005	L= 84
519 CDI / BlueTEC 4x4 (906.153, 906.155, 906.253, 906.255)	140	03/09 →						
524 (906.153, 906.155, 906.253, 906.255)	190	06/06 → 12/13						
513 CDI (906.155, 906.253, 906.255)	95	06/06 → 05/16	←	03/09 →	2	24.8190-0424.2	620424	L= 103,2
			→	03/09 →	2	24.8190-0005.2	620005	L= 84
 Bremsscheibe								
509 CDI (906.153, 906.155, 906.253, 906.255)	65	06/06 → 12/09	←			24.0128-0203.1	428203	Ø 300 28 25 V + S
			→			24.0128-0202.1	428202	Ø 303 28 25 V
510 CDI (906.153, 906.155, 906.253, 906.255)	70	03/09 →						
511 CDI (906.153, 906.155, 906.253, 906.255)	80	06/06 → 12/09						
511 CDI (906.153, 906.155, 906.253, 906.255)	84	05/16 →						
511 CDI 4x4 (906.153, 906.253, 906.255)	80	06/06 → 12/09						
513 CDI 4x4 (906.153, 906.253, 906.255)	95	05/11 → 05/16						
514 CDI (906.153, 906.155, 906.253, 906.255)	105	05/16 →						
514 CDI 4x4 (906.153, 906.155, 906.253, 906.255)	105	05/16 →						
515 CDI (906.153, 906.155, 906.253, 906.255)	110	06/06 → 12/09						
515 CDI 4x4 (906.153, 906.155, 906.253, 906.255)	110	06/06 → 12/09						
516 (906.153, 906.155, 906.253, 906.255)	115	09/08 →						
516 CDI (906.153, 906.155, 906.253, 906.255)	120	03/09 →						
516 CDI 4x4 (906.153, 906.155, 906.255)	120	05/11 →						
516 NGT (906.153, 906.155, 906.253, 906.255)	115	09/08 →						
518 CDI (906.153, 906.155, 906.253, 906.255)	135	06/06 → 12/09						
518 CDI 4x4 (906.153, 906.155, 906.253, 906.255)	135	06/06 → 12/09						
519 CDI / BlueTEC (906.153, 906.155, 906.253, 906.255)	140	03/09 →						
519 CDI / BlueTEC 4x4 (906.153, 906.155, 906.253, 906.255)	140	03/09 →						
524 (906.153, 906.155, 906.253, 906.255)	190	06/06 → 12/13						
513 CDI (906.155, 906.253, 906.255)	95	06/06 → 05/16	←	03/09 →		24.0128-0203.1	428203	Ø 300 28 25 V + S
			→	03/09 →		24.0128-0202.1	428202	Ø 303 28 25 V
MERCEDES-BENZ - SPRINTER CLASSIC 3,5-t Kasten (909) 09/13 →								
 Bremsbelagsatz, Scheibenbremse								
311 CDI (909.632, 909.633)	80	09/13 →	←			13.0460-4826.2	604826	BRE 29192 20,7 + WE / - WK + Zub
			→			13.0460-4877.2	604877	BRE 29192 20,3 + WE / - WK + Zub
						13.0460-3837.2	603837	BOS 29190 20,2 + WK + Zub
Warnkontakt, Bremsbelagverschleiß								
311 CDI (909.632, 909.633) ↓	80	09/13 →	←		2	24.8190-0424.2	620424	L= 103,2











	kW			 	! #		
MERCEDES-BENZ - SPRINTER CLASSIC 3,5-t Kasten (909) 09/13→							
Warnkontakt, Bremsbelagverschleiß							
311 CDI (909.632, 909.633)	80	09/13→	→	nur in Verbindung mit: 13.0460-3837.2	2	24.8190-0418.2 620418	L= 95
 Brems Scheibe							
311 CDI (909.632, 909.633)	80	09/13→	←			24.0128-0203.1 428203	∅ 300 28 25 V + S
			→			24.0116-0121.1 416121	∅ 298 16 14 + S
MERCEDES-BENZ - SPRINTER CLASSIC 4,6-t Bus (909) 09/13→							
 Bremsbelagsatz, Scheibenbremse							
411 CDI (909.843)	80	09/13→	←			13.0460-4827.2 604827	BRE 29200 21,0 + WE / - WK + Zub
			→			13.0460-3842.2 603842	BOS 29217 20,5 + WE / - WK
Warnkontakt, Bremsbelagverschleiß							
411 CDI (909.843)	80	09/13→	←		2	24.8190-0424.2 620424	L= 103,2
			→		2	24.8190-0005.2 620005	L= 84
 Brems Scheibe							
411 CDI (909.843)	80	09/13→	←			24.0128-0203.1 428203	∅ 300 28 25 V + S
			→			24.0128-0202.1 428202	∅ 303 28 25 V
MERCEDES-BENZ - SPRINTER Kipper (905) 04/01→							
 Bremsbelagsatz, Scheibenbremse							
616 CDI (905.612, 905.622, 905.623)	115	04/01→	←	→ 05/06		13.0460-4975.2 604975	BRE 29160 20,8 + WE / - WK + Zub
			→	→ 05/06		13.0460-7909.2 607909	PER 29153 20,0 + WE / - WK + Zub
Warnkontakt, Bremsbelagverschleiß							
616 CDI (905.612, 905.622, 905.623)	115	04/01→	←	→ 05/06; nur in Verbindung mit: 13.0460-4975.2	2	24.8190-0415.2 620415	L= 238 L2= 148
			←	→ 05/06	2	24.8190-0417.2 620417	L= 99 L= 167
			→	→ 05/06; nur in Verbindung mit: 13.0460-6015.2	2	24.8190-0423.2 620423	L= 199 L2= 144
Zubehörsatz, Scheibenbremsbelag							
616 CDI (905.612, 905.622, 905.623)	115	04/01→	←	→ 05/06; nur in Verbindung mit: Vornr. 13.0460-7904.2		13.0460-0281.2 610281	PER
 Brems Scheibe							
616 CDI (905.612, 905.622, 905.623)	115	04/01→	←	→ 05/06		24.0122-0161.1 422161	∅ 276 22 19 V + S
						24.0126-0144.1 426144	∅ 290 26 23 V
						24.0322-0161.1 522161	∅ 276 22 19 V + S PD
MERCEDES-BENZ - T1/TN Kasten/Kombi 07/81→06/95							
 Bremsbelagsatz, Scheibenbremse							
408 D (611.367, 611.368)	58	11/88→06/95	←			13.0460-4401.2 604401	ATE 20784 18,0 + WE / - WK
408 D (611.367, 611.368)	60	11/88→06/95					
410 (611.067, 611.068)	70	08/82→06/95					
410 (611.067, 611.068)	77	08/82→06/95					
410 D (611.467, 611.468)	70	11/88→06/95					
410 D (611.467, 611.468)	72	11/88→06/95					
Warnkontakt, Bremsbelagverschleiß							
408 D (611.367, 611.368)	58	11/88→06/95	←		4	24.8190-0401.2 620401	L= 95
408 D (611.367, 611.368)	60	11/88→06/95					
410 (611.067, 611.068)	70	08/82→06/95					
410 (611.067, 611.068)	77	08/82→06/95					
410 D (611.467, 611.468)	70	11/88→06/95					
410 D (611.467, 611.468)	72	11/88→06/95					
↓							









	kw			 	! #		
MERCEDES-BENZ - T1/TN Kasten/Kombi 07/81→06/95							
Zubehörsatz, Scheibenbremsbelag							
408 D (611.367, 611.368)	58	11/88→06/95	←			13.0460-0158.2 610158	ATE
408 D (611.367, 611.368)	60	11/88→06/95				13.0460-0160.2 610160	ATE
410 (611.067, 611.068)	70	08/82→06/95					
410 (611.067, 611.068)	77	08/82→06/95					
410 D (611.467, 611.468)	70	11/88→06/95					
410 D (611.467, 611.468)	72	11/88→06/95					
 Bremsscheibe							
408 D (611.367, 611.368)	58	11/88→06/95	←	→ VA:A025460		24.0116-0100.1 416100	Ø 280 16 13
408 D (611.367, 611.368)	60	11/88→06/95	←	VA:A025461→		24.0122-0140.1 422140	Ø 280 22 19
410 (611.067, 611.068)	70	08/82→06/95					
410 (611.067, 611.068)	77	08/82→06/95					
410 D (611.467, 611.468)	70	11/88→06/95					
410 D (611.467, 611.468)	72	11/88→06/95					
MERCEDES-BENZ - T1/TN Pritsche/Fahrgestell 07/81→06/95							
 Bremsbelagsatz, Scheibenbremse							
408 D (611.317, 611.318)	58	11/88→06/95	←			13.0460-4401.2 604401	ATE 20784 18,0 + WE / - WK
408 D (611.317, 611.318)	60	11/88→06/95					
410 (611.017, 611.018)	70	08/82→06/95					
410 (611.017, 611.018)	77	08/82→06/95					
410 D (611.417, 611.418)	70	11/88→06/95					
410 D (611.417, 611.418)	72	11/88→06/95					
Warnkontakt, Bremsbelagverschleiß							
408 D (611.317, 611.318)	58	11/88→06/95	←		4	24.8190-0401.2 620401	L= 95
408 D (611.317, 611.318)	60	11/88→06/95					
410 (611.017, 611.018)	70	08/82→06/95					
410 (611.017, 611.018)	77	08/82→06/95					
410 D (611.417, 611.418)	70	11/88→06/95					
410 D (611.417, 611.418)	72	11/88→06/95					
Zubehörsatz, Scheibenbremsbelag							
408 D (611.317, 611.318)	58	11/88→06/95	←			13.0460-0158.2 610158	ATE
408 D (611.317, 611.318)	60	11/88→06/95				13.0460-0160.2 610160	ATE
410 (611.017, 611.018)	70	08/82→06/95					
410 (611.017, 611.018)	77	08/82→06/95					
410 D (611.417, 611.418)	70	11/88→06/95					
410 D (611.417, 611.418)	72	11/88→06/95					
 Bremsscheibe							
408 D (611.317, 611.318)	58	11/88→06/95	←	→ VA:A025460		24.0116-0100.1 416100	Ø 280 16 13
408 D (611.317, 611.318)	60	11/88→06/95	←	VA:A025461→		24.0122-0140.1 422140	Ø 280 22 19
410 (611.017, 611.018)	70	08/82→06/95					
410 (611.017, 611.018)	77	08/82→06/95					
410 D (611.417, 611.418)	70	11/88→06/95					
410 D (611.417, 611.418)	72	11/88→06/95					
MERCEDES-BENZ - T1 Bus (601) 05/77→02/96							
 Bremsbelagsatz, Scheibenbremse							
208 D 2.3	60	10/88→02/96	←			13.0460-4401.2 604401	ATE 20784 18,0 + WE / - WK
208 D 2.3 (601.371, 601.372, 601.376, 601.377)	58	10/88→02/96					
210 2.3	77	05/89→02/96					
↓							









	kw			 	! #		
MERCEDES-BENZ - T1 Bus (601) 05/77→02/96							
 Bremsbelagsatz, Scheibenbremse							
210 D 2.8	70	11/88→02/96	←			13.0460-4401.2 604401	ATE 20784 18,0 + WE / - WK
210 D 2.8	72	11/88→02/96					
Warnkontakt, Bremsbelagverschleiß							
208 D 2.3	60	10/88→02/96	←		4	24.8190-0401.2 620401	L= 95
208 D 2.3 (601.371, 601.372, 601.376, 601.377)	58	10/88→02/96					
210 2.3	77	05/89→02/96					
210 D 2.8	70	11/88→02/96					
210 D 2.8	72	11/88→02/96					
Zubehörsatz, Scheibenbremsbelag							
208 D 2.3	60	10/88→02/96	←			13.0460-0158.2 610158	ATE
208 D 2.3 (601.371, 601.372, 601.376, 601.377)	58	10/88→02/96					
210 2.3	77	05/89→02/96					
210 D 2.8	70	11/88→02/96					
210 D 2.8	72	11/88→02/96					
 Bremsscheibe							
208 D 2.3	60	10/88→02/96	←			24.0116-0100.1 416100	Ø 280 16 13
208 D 2.3 (601.371, 601.372, 601.376, 601.377)	58	10/88→02/96					
210 2.3	77	05/89→02/96					
210 D 2.8	70	11/88→02/96					
210 D 2.8	72	11/88→02/96					
MERCEDES-BENZ - T1 Bus (602) 04/77→02/96							
 Bremsbelagsatz, Scheibenbremse							
308 D 2.3	58	05/90→02/96	←			13.0460-4401.2 604401	ATE 20784 18,0 + WE / - WK
308 D 2.3	60	06/89→02/96					
310 D 2.9	70	06/89→02/96					
310 D 2.9	72	06/90→02/96					
Warnkontakt, Bremsbelagverschleiß							
308 D 2.3	58	05/90→02/96	←		4	24.8190-0401.2 620401	L= 95
308 D 2.3	60	06/89→02/96					
310 D 2.9	70	06/89→02/96					
310 D 2.9	72	06/90→02/96					
Zubehörsatz, Scheibenbremsbelag							
308 D 2.3	58	05/90→02/96	←			13.0460-0158.2 610158	ATE
308 D 2.3	60	06/89→02/96				13.0460-0160.2 610160	ATE
310 D 2.9	70	06/89→02/96					
310 D 2.9	72	06/90→02/96					
 Bremsscheibe							
308 D 2.3	58	05/90→02/96	←	→ VA:A025460		24.0116-0100.1 416100	Ø 280 16 13
308 D 2.3	60	06/89→02/96	←				
310 D 2.9	70	06/89→02/96	←	VA:A025461→		24.0122-0140.1 422140	Ø 280 22 19
310 D 2.9	72	06/90→02/96					
MERCEDES-BENZ - T1 Kasten (601, 611) 05/77→02/96							
 Bremsbelagsatz, Scheibenbremse							
208 D 2.3	58	11/88→02/96	←			13.0460-4401.2 604401	ATE 20784 18,0 + WE / - WK
208 D 2.3	60	10/88→02/96					
210 2.3	70	07/82→02/96					
210 2.3	77	05/89→02/96					
210 D 2.8	70	10/88→02/96					
210 D 2.8	72	10/88→02/96					
Warnkontakt, Bremsbelagverschleiß							
208 D 2.3	58	11/88→02/96	←		4	24.8190-0401.2 620401	L= 95
208 D 2.3	60	10/88→02/96					
210 2.3	70	07/82→02/96					
210 2.3	77	05/89→02/96					
210 D 2.8	70	10/88→02/96					
210 D 2.8	72	10/88→02/96					
Zubehörsatz, Scheibenbremsbelag							
208 D 2.3	58	11/88→02/96	←			13.0460-0158.2 610158	ATE
208 D 2.3	60	10/88→02/96					
210 2.3	70	07/82→02/96					
210 2.3	77	05/89→02/96					
210 D 2.8	70	10/88→02/96					
↓							

	kW			 	! #		
MERCEDES-BENZ - T1 Kasten (601, 611) 05/77→02/96							
Zubehörsatz, Scheibenbremsbelag							
210 D 2.8	72	10/88→02/96	←			13.0460-0158.2 610158	ATE
 Bremsscheibe							
208 D 2.3	58	11/88→02/96	←			24.0116-0100.1 416100	Ø 280 16 13
208 D 2.3	60	10/88→02/96					
210 2.3	70	07/82→02/96					
210 2.3	77	05/89→02/96					
210 D 2.8	70	10/88→02/96					
210 D 2.8	72	10/88→02/96					
MERCEDES-BENZ - T1 Kasten (602) 10/82→02/96							
 Bremsbelagsatz, Scheibenbremse							
308 D 2.3	58	11/88→02/96	←			13.0460-4401.2 604401	ATE 20784 18,0 + WE / - WK
308 D 2.3	60	06/89→02/96					
310 2.3	70	06/89→02/96					
310 2.3	77	01/89→12/95					
310 D 2.9	70	06/89→02/96					
310 D 2.9	72	06/89→02/96					
Warnkontakt, Bremsbelagverschleiß							
308 D 2.3	58	11/88→02/96	←		4	24.8190-0401.2 620401	L= 95
308 D 2.3	60	06/89→02/96					
310 2.3	70	06/89→02/96					
310 2.3	77	01/89→12/95					
310 D 2.9	70	06/89→02/96					
310 D 2.9	72	06/89→02/96					
Zubehörsatz, Scheibenbremsbelag							
308 D 2.3	58	11/88→02/96	←			13.0460-0158.2 610158	ATE
308 D 2.3	60	06/89→02/96				13.0460-0160.2 610160	ATE
310 2.3	70	06/89→02/96					
310 2.3	77	01/89→12/95					
310 D 2.9	70	06/89→02/96					
310 D 2.9	72	06/89→02/96					
 Bremsscheibe							
308 D 2.3	58	11/88→02/96	←	→ VA:A025460		24.0116-0100.1 416100	Ø 280 16 13
308 D 2.3	60	06/89→02/96	←	VA:A025461→		24.0122-0140.1 422140	Ø 280 22 19
310 2.3	70	06/89→02/96					
310 2.3	77	01/89→12/95					
310 D 2.9	70	06/89→02/96					
310 D 2.9	72	06/89→02/96					
MERCEDES-BENZ - T1 Pritsche/Fahrgestell (601) 01/77→02/96							
 Bremsbelagsatz, Scheibenbremse							
208 D 2.3	58	11/88→02/96	←			13.0460-4401.2 604401	ATE 20784 18,0 + WE / - WK
208 D 2.3	60	06/89→02/96					
210 D 2.8	72	11/88→02/96					
210 D 2.9	70	11/88→02/96					
Warnkontakt, Bremsbelagverschleiß							
208 D 2.3	58	11/88→02/96	←		4	24.8190-0401.2 620401	L= 95
208 D 2.3	60	06/89→02/96					
210 D 2.8	72	11/88→02/96					
210 D 2.9	70	11/88→02/96					
Zubehörsatz, Scheibenbremsbelag							
208 D 2.3	58	11/88→02/96	←			13.0460-0158.2 610158	ATE
208 D 2.3	60	06/89→02/96					
210 D 2.8	72	11/88→02/96					
210 D 2.9	70	11/88→02/96					
 Bremsscheibe							
208 D 2.3	58	11/88→02/96	←			24.0116-0100.1 416100	Ø 280 16 13
208 D 2.3	60	06/89→02/96					
210 D 2.8	72	11/88→02/96					
210 D 2.9	70	11/88→02/96					
MERCEDES-BENZ - T1 Pritsche/Fahrgestell (602) 01/77→02/96							
 Bremsbelagsatz, Scheibenbremse							
308 D 2.3	58	06/89→02/96	←			13.0460-4401.2 604401	ATE 20784 18,0 + WE / - WK
308 D 2.3	60	06/89→02/96					
310 D 2.9	70	06/89→02/96					
310 D 2.9	72	06/89→02/96					
↓							







	kw					! #		
MERCEDES-BENZ - T1 Pritsche/Fahrgestell (602) 01/77→02/96								
Warnkontakt, Bremsbelagverschleiß								
308 D 2.3	58	06/89→02/96	←			4	24.8190-0401.2 620401	L= 95
308 D 2.3	60	06/89→02/96						
310 D 2.9	70	06/89→02/96						
310 D 2.9	72	06/89→02/96						
Zubehörsatz, Scheibenbremsbelag								
308 D 2.3	58	06/89→02/96	←				13.0460-0158.2 610158	ATE
308 D 2.3	60	06/89→02/96					13.0460-0160.2 610160	ATE
310 D 2.9	70	06/89→02/96						
310 D 2.9	72	06/89→02/96						
 Bremsscheibe								
308 D 2.3	58	06/89→02/96	←	→ VA:A025460			24.0116-0100.1 416100	Ø 280 16 13
308 D 2.3	60	06/89→02/96						
310 D 2.9	70	06/89→02/96	←	VA:A025461→			24.0122-0140.1 422140	Ø 280 22 19
310 D 2.9	72	06/89→02/96						
MERCEDES-BENZ - Vaneo (414) 02/02→07/05								
 Bremsbelagsatz, Scheibenbremse								
1.6 (414.700)	60	02/02→07/05	←				13.0460-2828.2 602828	TRW 23070 19,5 + WE / - WK
1.6 (414.700)	75	02/02→07/05						
1.7 CDI (414.700)	55	02/02→07/05	→				13.0460-2855.2 602855	TRW 23138 14,6 - WE / - WK
1.7 CDI (414.700)	67	02/02→07/05					13.0470-2855.2 LD2855	TRW 23138 14,6 - WE / - WK Ceramic
1.9 (414.700)	92	02/02→07/05						
Warnkontakt, Bremsbelagverschleiß								
1.6 (414.700)	60	02/02→07/05	←			1	24.8190-0410.2 620410	L= 97,5
1.6 (414.700)	75	02/02→07/05						
1.7 CDI (414.700)	55	02/02→07/05						
1.7 CDI (414.700)	67	02/02→07/05						
1.9 (414.700)	92	02/02→07/05						
Zubehörsatz, Scheibenbremsbelag								
1.6 (414.700)	60	02/02→07/05	←				13.0460-0257.2 610257	
1.6 (414.700)	75	02/02→07/05						
1.7 CDI (414.700)	55	02/02→07/05	→				13.0460-0144.2 610144	TRW
1.7 CDI (414.700)	67	02/02→07/05						
1.9 (414.700)	92	02/02→07/05						
 Bremsscheibe								
1.6 (414.700)	60	02/02→07/05	←				24.0122-0199.1 422199	Ø 270 22 19,4 V
1.6 (414.700)	75	02/02→07/05					24.0322-0199.1 522199	Ø 270 22 19,4 V PD
1.7 CDI (414.700)	55	02/02→07/05						
1.7 CDI (414.700)	67	02/02→07/05	→				24.0108-0111.1 408111	Ø 258 8 7
1.9 (414.700)	92	02/02→07/05					24.0308-0111.1 508111	Ø 258 8 7 PD
MERCEDES-BENZ - Vario Bus 09/96→								
 Bremsbelagsatz, Scheibenbremse								
O 810 (670.373, 670.374)	75	09/96→12/10	←				13.0460-6015.2 606015	ATE 29835 22,0 + WE / - WK
O 812 (670.373, 670.674)	90	09/96→12/10	→	Achsnummer: 742.501/742.505			13.0460-6015.2 606015	ATE 29835 22,0 + WE / - WK
O 814 (670.373, 670.374)	100	09/96→12/10	→	Achsnummer: 741.130/741.131			13.0460-7909.2 607909	PER 29153 20,0 + WE / - WK + Zub
O 815 (670.373, 670.374)	112	09/96→12/10						
O 813 (670.373, 670.374)	95	01/06→	←	→ 12/13			13.0460-6015.2 606015	ATE 29835 22,0 + WE / - WK
O 816 D (670.373, 670.374)	115	01/06→	→	→ 12/13; Achsnummer: 742.501/742.505			13.0460-6015.2 606015	ATE 29835 22,0 + WE / - WK
O 818 D (670.373, 670.374)	130	09/06→	→	→ 12/13; Achsnummer: 741.130/741.131			13.0460-7909.2 607909	PER 29153 20,0 + WE / - WK + Zub
Warnkontakt, Bremsbelagverschleiß								
O 810 (670.373, 670.374)	75	09/96→12/10	←			2	24.8190-0415.2 620415	L= 238 L2= 148
O 812 (670.373, 670.674)	90	09/96→12/10						
O 814 (670.373, 670.374)	100	09/96→12/10						
O 815 (670.373, 670.374)	112	09/96→12/10						
O 813 (670.373, 670.374)	95	01/06→	←	→ 12/13		2	24.8190-0415.2 620415	L= 238 L2= 148
O 816 D (670.373, 670.374)	115	01/06→						
O 818 D (670.373, 670.374)	130	09/06→						











	kw			 	! #		
MERCEDES-BENZ - VARIO Bus 09/96→							
Bremsscheibe							
O 810 (670.373, 670.374)	75	09/96→12/10	←			24.0130-0103.1 430103	Ø 324 30 26 V
O 812 (670.373, 670.674)	90	09/96→12/10	→	Achsnummer: 741.130/741.131		24.0130-0198.1 430198	Ø 304 30 26 V
			→	Achsnummer: 742.501		24.0122-0196.1 422196	Ø 285 21,9 19 V
			→	Achsnummer: 742.501		24.0130-0190.1 430190	Ø 304 29,9 26 V
O 813 (670.373, 670.374)	95	01/06→	←	→ 12/13		24.0130-0103.1 430103	Ø 324 30 26 V
O 816 D (670.373, 670.374)	115	01/06→	→	→ 12/13; Achsnummer: 741.130/741.131		24.0130-0198.1 430198	Ø 304 30 26 V
O 818 D (670.373, 670.374)	130	09/06→	→	→ 12/13; Achsnummer: 742.501		24.0122-0196.1 422196	Ø 285 21,9 19 V
O 814 (670.373, 670.374)	100	09/96→12/10	←			24.0130-0103.1 430103	Ø 324 30 26 V
O 815 (670.373, 670.374)	112	09/96→12/10	→	Achsnummer: 741.130/741.131		24.0130-0198.1 430198	Ø 304 30 26 V
			→	Achsnummer: 742.501		24.0122-0196.1 422196	Ø 285 21,9 19 V
			→	Achsnummer: 742.501		24.0130-0191.1 430191	Ø 324 29,9 26 V
MERCEDES-BENZ - VARIO Kasten/Kombi 09/96→							
Bremsbelagsatz, Scheibenbremse							
512 D (667.351, 667.352, 667.353)	90	09/96→12/10	←			13.0460-6015.2 606015	ATE 29835 22,0 + WE / - WK
612 D (668.351, 668.352, 668.353)	90	09/96→12/10	→	Achsnummer: 742.501/742.505		13.0460-6015.2 606015	ATE 29835 22,0 + WE / - WK
613 D, 614 D (668.351, 668.352, 668.353)	95	09/96→12/13	→	Achsnummer: 741.130/741.131		13.0460-7909.2 607909	PER 29153 20,0 + WE / - WK + Zub
613 D, 614 D (668.351, 668.352, 668.353)	100	09/96→12/11					
812 D (670.351, 670.352, 670.353)	90	09/96→12/10					
813 D, 814 D (670.351, 670.352, 670.353)	95	09/96→12/13					
813 D, 814 D (670.351, 670.352, 670.353)	100	09/96→12/13					
813 DA, 814 DA 4x4 (669.599, 670.451, 670.452, 670.453)	95	09/96→12/13					
815 D, 816 D (670.351, 670.352, 670.353)	112	09/96→12/10					
815 D, 816 D (670.351, 670.352, 670.353)	115	09/96→12/13					
815 DA, 816 DA 4x4 (669.599, 670.451, 670.452, 670.453)	112	09/96→12/10					
815 DA, 816 DA 4x4 (669.599, 670.451, 670.452, 670.453)	115	09/96→12/13					
615 D, 616 D (668.351, 668.352, 668.353)	112	09/98→	←	→ 12/13		13.0460-6015.2 606015	ATE 29835 22,0 + WE / - WK
615 D, 616 D (668.351, 668.352, 668.353)	115	09/98→	→	→ 12/13; Achsnummer: 742.501/742.505		13.0460-6015.2 606015	ATE 29835 22,0 + WE / - WK
618 D	130	09/06→	→	→ 12/13; Achsnummer: 741.130/741.131		13.0460-7909.2 607909	PER 29153 20,0 + WE / - WK + Zub
813 DA, 814 DA 4x4 (669.599, 670.451, 670.452, 670.453)	100	09/96→					
818 D (670.351, 670.352, 670.353)	130	09/06→					
Warnkontakt, Bremsbelagverschleiß							
512 D (667.351, 667.352, 667.353)	90	09/96→12/10	←		2	24.8190-0415.2 620415	L= 238 L2= 148
612 D (668.351, 668.352, 668.353)	90	09/96→12/10					
613 D, 614 D (668.351, 668.352, 668.353)	95	09/96→12/13					
613 D, 614 D (668.351, 668.352, 668.353)	100	09/96→12/11					
812 D (670.351, 670.352, 670.353)	90	09/96→12/10					
813 D, 814 D (670.351, 670.352, 670.353)	95	09/96→12/13					
813 D, 814 D (670.351, 670.352, 670.353)	100	09/96→12/13					
813 DA, 814 DA 4x4 (669.599, 670.451, 670.452, 670.453)	95	09/96→12/13					
815 D, 816 D (670.351, 670.352, 670.353)	112	09/96→12/10					
815 D, 816 D (670.351, 670.352, 670.353)	115	09/96→12/13					
↓							

	kW			 	! #		
MERCEDES-BENZ - VARIO Kasten/Kombi 09/96→							
Warnkontakt, Bremsbelagverschleiß							
815 DA, 816 DA 4x4 (669.599, 670.451, 670.452, 670.453)	112	09/96→12/10	←		2	24.8190-0415.2 620415	L= 238 L2= 148
815 DA, 816 DA 4x4 (669.599, 670.451, 670.452, 670.453)	115	09/96→12/13					
615 D, 616 D (668.351, 668.352, 668.353)	112	09/98→	←	→ 12/13	2	24.8190-0415.2 620415	L= 238 L2= 148
615 D, 616 D (668.351, 668.352, 668.353)	115	09/98→					
618 D	130	09/06→					
813 DA, 814 DA 4x4 (669.599, 670.451, 670.452, 670.453)	100	09/96→					
818 D (670.351, 670.352, 670.353)	130	09/06→					
 Brems Scheibe							
512 D (667.351, 667.352, 667.353)	90	09/96→12/10	←			24.0130-0103.1 430103	Ø 324 30 26 V
612 D (668.351, 668.352, 668.353)	90	09/96→12/10				24.0130-0198.1 430198	Ø 304 30 26 V
812 D (670.351, 670.352, 670.353)	90	09/96→12/10	→	Achsnummer: 741.130/741.131		24.0122-0196.1 422196	Ø 285 21,9 19 V
	90	09/96→12/10	→	Achsnummer: 742.501		24.0130-0190.1 430190	Ø 304 29,9 26 V
613 D, 614 D (668.351, 668.352, 668.353)	95	09/96→12/13	←			24.0130-0103.1 430103	Ø 324 30 26 V
613 D, 614 D (668.351, 668.352, 668.353)	100	09/96→12/11				24.0130-0198.1 430198	Ø 304 30 26 V
813 D, 814 D (670.351, 670.352, 670.353)	95	09/96→12/13	→	Achsnummer: 741.130/741.131		24.0122-0196.1 422196	Ø 285 21,9 19 V
813 D, 814 D (670.351, 670.352, 670.353)	100	09/96→12/13	→	Achsnummer: 742.501		24.0130-0191.1 430191	Ø 324 29,9 26 V
813 DA, 814 DA 4x4 (669.599, 670.451, 670.452, 670.453)	95	09/96→12/13					
815 D, 816 D (670.351, 670.352, 670.353)	112	09/96→12/10					
815 D, 816 D (670.351, 670.352, 670.353)	115	09/96→12/13					
815 DA, 816 DA 4x4 (669.599, 670.451, 670.452, 670.453)	112	09/96→12/10					
815 DA, 816 DA 4x4 (669.599, 670.451, 670.452, 670.453)	115	09/96→12/13					
615 D, 616 D (668.351, 668.352, 668.353)	112	09/98→	←	→ 12/13		24.0130-0103.1 430103	Ø 324 30 26 V
615 D, 616 D (668.351, 668.352, 668.353)	115	09/98→				24.0130-0198.1 430198	Ø 304 30 26 V
618 D	130	09/06→	→	→ 12/13; Achsnummer: 741.130/741.131		24.0122-0196.1 422196	Ø 285 21,9 19 V
813 DA, 814 DA 4x4 (669.599, 670.451, 670.452, 670.453)	100	09/96→	→	→ 12/13; Achsnummer: 742.501		24.0130-0191.1 430191	Ø 324 29,9 26 V
818 D (670.351, 670.352, 670.353)	130	09/06→					
MERCEDES-BENZ - VARIO Kipper 09/96→							
 Bremsbelagsatz, Scheibenbremse							
612 D (668.331, 668.332)	90	09/96→12/10	←			13.0460-6015.2 606015	ATE 29835 22,0 + WE / - WK
613 D, 614 D (668.331, 668.332)	95	09/96→12/13	→	Achsnummer: 742.501/742.505		13.0460-6015.2 606015	ATE 29835 22,0 + WE / - WK
613 D, 614 D (668.331, 668.332)	100	09/96→11/12	→	Achsnummer: 741.130/741.131		13.0460-7909.2 607909	PER 29153 20,0 + WE / - WK + Zub
812 D (670.331, 670.332)	90	09/96→12/10					
813 D, 814 D (670.331, 670.332)	95	09/96→12/13					
813 D, 814 D (670.331, 670.332)	100	09/96→12/13					
813 DA, 814 DA 4x4 (670.431, 670.432)	95	09/96→12/13					
813 DA, 814 DA 4x4 (670.431, 670.432)	100	09/96→12/13					
815 D, 816 D (670.331, 670.332)	115	09/96→12/13					
815 DA, 816 DA 4x4 (670.431, 670.432)	112	09/96→12/10					
815 DA, 816 DA 4x4 (670.431, 670.432)	115	09/96→12/13					
615 D, 616 D (668.331, 668.332)	112	09/98→	←	→ 12/13		13.0460-6015.2 606015	ATE 29835 22,0 + WE / - WK



	kW			 	! #		
MERCEDES-BENZ - VARIO Kipper 09/96→							
Bremsbelagsatz, Scheibenbremse							
615 D, 616 D (668.331, 668.332)	115	09/98→	→	→ 12/13; Achsnummer: 742.501/742.505		13.0460-6015.2 606015	ATE 29835 22,0 + WE / - WK
618 D	130	09/06→	→	→ 12/13; Achsnummer: 741.130/741.131		13.0460-7909.2 607909	PER 29153 20,0 + WE / - WK + Zub
815 D, 816 D (670.331, 670.332)	112	09/96→					
818 D (670.321, 670.322)	130	09/06→					
818 DA 4x4	130	09/06→					
Warnkontakt, Bremsbelagverschleiß							
612 D (668.331, 668.332)	90	09/96→12/10	←		2	24.8190-0415.2 620415	L= 238 L2= 148
613 D, 614 D (668.331, 668.332)	95	09/96→12/13					
613 D, 614 D (668.331, 668.332)	100	09/96→11/12					
812 D (670.331, 670.332)	90	09/96→12/10					
813 D, 814 D (670.331, 670.332)	95	09/96→12/13					
813 D, 814 D (670.331, 670.332)	100	09/96→12/13					
813 DA, 814 DA 4x4 (670.431, 670.432)	95	09/96→12/13					
813 DA, 814 DA 4x4 (670.431, 670.432)	100	09/96→12/13					
815 D, 816 D (670.331, 670.332)	115	09/96→12/13					
815 DA, 816 DA 4x4 (670.431, 670.432)	112	09/96→12/10					
815 DA, 816 DA 4x4 (670.431, 670.432)	115	09/96→12/13					
615 D, 616 D (668.331, 668.332)	112	09/98→	←	→ 12/13	2	24.8190-0415.2 620415	L= 238 L2= 148
615 D, 616 D (668.331, 668.332)	115	09/98→					
618 D	130	09/06→					
815 D, 816 D (670.331, 670.332)	112	09/96→					
818 D (670.321, 670.322)	130	09/06→					
818 DA 4x4	130	09/06→					
Bremsscheibe							
612 D (668.331, 668.332)	90	09/96→12/10	←			24.0130-0103.1 430103	Ø 324 30 26 V
812 D (670.331, 670.332)	90	09/96→12/10	→	Achsnummer: 741.130/741.131		24.0130-0198.1 430198	Ø 304 30 26 V
			→	Achsnummer: 742.501		24.0122-0196.1 422196	Ø 285 21,9 19 V
			→	Achsnummer: 742.501		24.0130-0190.1 430190	Ø 304 29,9 26 V
613 D, 614 D (668.331, 668.332)	95	09/96→12/13	←			24.0130-0103.1 430103	Ø 324 30 26 V
613 D, 614 D (668.331, 668.332)	100	09/96→11/12				24.0130-0198.1 430198	Ø 304 30 26 V
813 D, 814 D (670.331, 670.332)	95	09/96→12/13	→	Achsnummer: 741.130/741.131		24.0122-0196.1 422196	Ø 285 21,9 19 V
813 D, 814 D (670.331, 670.332)	95	09/96→12/13	→	Achsnummer: 742.501		24.0130-0191.1 430191	Ø 324 29,9 26 V
813 D, 814 D (670.331, 670.332)	100	09/96→12/13					
813 DA, 814 DA 4x4 (670.431, 670.432)	95	09/96→12/13					
813 DA, 814 DA 4x4 (670.431, 670.432)	100	09/96→12/13					
815 D, 816 D (670.331, 670.332)	115	09/96→12/13					
815 DA, 816 DA 4x4 (670.431, 670.432)	112	09/96→12/10					
815 DA, 816 DA 4x4 (670.431, 670.432)	115	09/96→12/13					
615 D, 616 D (668.331, 668.332)	112	09/98→	←	→ 12/13		24.0130-0103.1 430103	Ø 324 30 26 V
615 D, 616 D (668.331, 668.332)	115	09/98→	→	→ 12/13; Achsnummer: 741.130/741.131		24.0130-0198.1 430198	Ø 304 30 26 V
618 D	130	09/06→	→	→ 12/13; Achsnummer: 742.501		24.0122-0196.1 422196	Ø 285 21,9 19 V
815 D, 816 D (670.331, 670.332)	112	09/96→	→	→ 12/13; Achsnummer: 742.501		24.0130-0191.1 430191	Ø 324 29,9 26 V
818 D (670.321, 670.322)	130	09/06→					
818 DA 4x4	130	09/06→					

	kW			 	! #		
MERCEDES-BENZ - VARIO Pritsche/Fahrgestell 09/96 →							
 Bremsbelagsatz, Scheibenbremse							
512 D (667.321, 667.322, 667.323)	90	09/96 → 12/10	←			13.0460-6015.2 606015	ATE 29835 22,0 + WE / - WK
612 D (668.321, 668.322, 668.323)	90	09/96 → 12/10	→	Achsnummer: 742.501/742.505		13.0460-6015.2 606015	ATE 29835 22,0 + WE / - WK
613 D, 614 D (668.321, 668.322, 668.323)	100	09/96 → 12/11	→	Achsnummer: 741.130/741.131		13.0460-7909.2 607909	PER 29153 20,0 + WE / - WK + Zub
812 D (670.321, 670.322, 670.323, 670.324)	90	09/96 → 12/10					
813 D, 814 D (670.321, 670.322, 670.323, 670.324)	95	09/96 → 12/13					
813 D, 814 D (670.321, 670.322, 670.323, 670.324)	100	09/96 → 12/13					
813 DA, 814 DA 4x4 (670.421, 670.422, 670.423)	95	09/96 → 12/13					
813 DA, 814 DA 4x4 (670.421, 670.422, 670.423)	100	09/96 → 12/13					
815 D, 816 D (670.321, 670.322, 670.323, 670.324)	112	09/96 → 12/10					
815 D, 816 D (670.321, 670.322, 670.323, 670.324)	115	09/96 → 12/13					
815 DA, 816 DA 4x4 (670.421, 670.422, 670.423)	112	09/96 → 12/10					
815 DA, 816 DA 4x4 (670.421, 670.422, 670.423)	115	09/96 → 12/13					
613 D, 614 D (668.321, 668.322, 668.323)	95	09/96 →	←	→ 12/13		13.0460-6015.2 606015	ATE 29835 22,0 + WE / - WK
615 D, 616 D (668.321, 668.322, 668.323)	112	09/98 →	→	→ 12/13; Achsnummer: 742.501/742.505		13.0460-6015.2 606015	ATE 29835 22,0 + WE / - WK
615 D, 616 D (668.321, 668.322, 668.323)	115	09/98 →	→	→ 12/13; Achsnummer: 741.130/741.131		13.0460-7909.2 607909	PER 29153 20,0 + WE / - WK + Zub
618 D (668.321, 668.322, 668.323)	130	09/06 →					
818 D (670.321, 670.322, 670.323, 670.324)	130	09/06 →					
818 DA 4x4	130	09/06 →					
Warnkontakt, Bremsbelagverschleiß							
512 D (667.321, 667.322, 667.323)	90	09/96 → 12/10	←		2	24.8190-0415.2 620415	L= 238 L2= 148
612 D (668.321, 668.322, 668.323)	90	09/96 → 12/10					
613 D, 614 D (668.321, 668.322, 668.323)	100	09/96 → 12/11					
812 D (670.321, 670.322, 670.323, 670.324)	90	09/96 → 12/10					
813 D, 814 D (670.321, 670.322, 670.323, 670.324)	95	09/96 → 12/13					
813 D, 814 D (670.321, 670.322, 670.323, 670.324)	100	09/96 → 12/13					
813 DA, 814 DA 4x4 (670.421, 670.422, 670.423)	95	09/96 → 12/13					
813 DA, 814 DA 4x4 (670.421, 670.422, 670.423)	100	09/96 → 12/13					
815 D, 816 D (670.321, 670.322, 670.323, 670.324)	112	09/96 → 12/10					
815 D, 816 D (670.321, 670.322, 670.323, 670.324)	115	09/96 → 12/13					
815 DA, 816 DA 4x4 (670.421, 670.422, 670.423)	112	09/96 → 12/10					
815 DA, 816 DA 4x4 (670.421, 670.422, 670.423)	115	09/96 → 12/13					
613 D, 614 D (668.321, 668.322, 668.323)	95	09/96 →	←	→ 12/13	2	24.8190-0415.2 620415	L= 238 L2= 148
↓							

MERCEDES-BENZ - VARIO Pritsche/Fahrgestell 09/96 →

Warnkontakt, Bremsbelagverschleiß

615 D, 616 D (668.321, 668.322, 668.323)	112	09/98 →	←	→ 12/13	2	24.8190-0415.2	620415	L= 238 L2= 148
615 D, 616 D (668.321, 668.322, 668.323)	115	09/98 →						
618 D (668.321, 668.322, 668.323)	130	09/06 →						
818 D (670.321, 670.322, 670.323, 670.324)	130	09/06 →						
818 DA 4x4	130	09/06 →						

Bremsscheibe

512 D (667.321, 667.322, 667.323)	90	09/96 → 12/10	←			24.0130-0103.1	430103	Ø 324 30 26 V
612 D (668.321, 668.322, 668.323)	90	09/96 → 12/10				24.0130-0198.1	430198	Ø 304 30 26 V
812 D (670.321, 670.322, 670.323, 670.324)	90	09/96 → 12/10	→	Achsnummer: 741.130/741.131		24.0122-0196.1	422196	Ø 285 21,9 19 V
			→	Achsnummer: 742.501		24.0130-0190.1	430190	Ø 304 29,9 26 V
613 D, 614 D (668.321, 668.322, 668.323)	95	09/96 →	←	→ 12/13		24.0130-0103.1	430103	Ø 324 30 26 V
615 D, 616 D (668.321, 668.322, 668.323)	112	09/98 →				24.0130-0198.1	430198	Ø 304 30 26 V
615 D, 616 D (668.321, 668.322, 668.323)	115	09/98 →	→	→ 12/13; Achsnummer: 741.130/741.131		24.0122-0196.1	422196	Ø 285 21,9 19 V
618 D (668.321, 668.322, 668.323)	130	09/06 →	→	→ 12/13; Achsnummer: 742.501		24.0130-0191.1	430191	Ø 324 29,9 26 V
818 D (670.321, 670.322, 670.323, 670.324)	130	09/06 →						
818 DA 4x4	130	09/06 →						
613 D, 614 D (668.321, 668.322, 668.323)	100	09/96 → 12/11	←			24.0130-0103.1	430103	Ø 324 30 26 V
813 D, 814 D (670.321, 670.322, 670.323, 670.324)	95	09/96 → 12/13				24.0130-0198.1	430198	Ø 304 30 26 V
			→	Achsnummer: 741.130/741.131		24.0122-0196.1	422196	Ø 285 21,9 19 V
813 D, 814 D (670.321, 670.322, 670.323, 670.324)	100	09/96 → 12/13	→	Achsnummer: 742.501		24.0130-0191.1	430191	Ø 324 29,9 26 V
813 DA, 814 DA 4x4 (670.421, 670.422, 670.423)	95	09/96 → 12/13						
813 DA, 814 DA 4x4 (670.421, 670.422, 670.423)	100	09/96 → 12/13						
815 D, 816 D (670.321, 670.322, 670.323, 670.324)	112	09/96 → 12/10						
815 D, 816 D (670.321, 670.322, 670.323, 670.324)	115	09/96 → 12/13						
815 DA, 816 DA 4x4 (670.421, 670.422, 670.423)	112	09/96 → 12/10						
815 DA, 816 DA 4x4 (670.421, 670.422, 670.423)	115	09/96 → 12/13						











MERCEDES-BENZ - VARIO Triebkopf 09/96 →







Bremsbelagsatz, Scheibenbremse







613 D, 614 D (669.599, 669.899)	95	01/06 →	←	→ 12/13		13.0460-6015.2	606015	ATE 29835 22,0 + WE / - WK
615 D, 616 D (669.599, 669.899)	115	01/06 →	→	→ 12/13; Achsnummer: 742.501/742.505		13.0460-6015.2	606015	ATE 29835 22,0 + WE / - WK
618 D (669.599, 669.899)	130	09/06 →	→	→ 12/13; Achsnummer: 741.130/741.131		13.0460-7909.2	607909	PER 29153 20,0 + WE / - WK + Zub
814 DT (670.398)	100	09/96 →						
816 DT (670.398)	112	09/96 →						
810 DT (670.398)	75	09/96 → 12/10	←			13.0460-6015.2	606015	ATE 29835 22,0 + WE / - WK
812 DT	90	09/96 → 12/10				13.0460-6015.2	606015	ATE 29835 22,0 + WE / - WK
			→	Achsnummer: 742.501/742.505		13.0460-6015.2	606015	ATE 29835 22,0 + WE / - WK
			→	Achsnummer: 741.130/741.131		13.0460-7909.2	607909	PER 29153 20,0 + WE / - WK + Zub









Warnkontakt, Bremsbelagverschleiß







613 D, 614 D (669.599, 669.899)	95	01/06 →	←	→ 12/13	2	24.8190-0415.2	620415	L= 238 L2= 148
615 D, 616 D (669.599, 669.899)	115	01/06 →						
618 D (669.599, 669.899)	130	09/06 →						











	kW			 	! #		
MERCEDES-BENZ - VARIO Triebkopf 09/96→							
Warnkontakt, Bremsbelagverschleiß							
814 DT (670.398) 816 DT (670.398)	100 112	09/96→ 09/96→	←	→ 12/13	2	24.8190-0415.2 620415	L= 238 L2= 148
810 DT (670.398) 812 DT	75 90	09/96→12/10 09/96→12/10	←		2	24.8190-0415.2 620415	L= 238 L2= 148
 Bremsscheibe							
613 D, 614 D (669.599, 669.899)	95	01/06→	←	→ 12/13		24.0130-0103.1 430103	Ø 324 30 26 V
615 D, 616 D (669.599, 669.899)	115	01/06→	→	→ 12/13; Achsnummer: 741.130/741.131		24.0130-0198.1 430198	Ø 304 30 26 V
618 D (669.599, 669.899)	130	09/06→	→	→ 12/13; Achsnummer: 742.501		24.0122-0196.1 422196	Ø 285 21,9 19 V
810 DT (670.398) 812 DT	75 90	09/96→12/10 09/96→12/10	←			24.0130-0103.1 430103	Ø 324 30 26 V
			→	Achsnummer: 741.130/741.131		24.0122-0196.1 422196	Ø 285 21,9 19 V
			→	Achsnummer: 742.501		24.0130-0190.1 430190	Ø 304 29,9 26 V
814 DT (670.398) 816 DT (670.398)	100 112	09/96→ 09/96→	←	→ 12/13		24.0130-0103.1 430103	Ø 324 30 26 V
			→	→ 12/13; Achsnummer: 741.130/741.131		24.0122-0196.1 422196	Ø 285 21,9 19 V
			→	→ 12/13; Achsnummer: 742.501		24.0130-0190.1 430190	Ø 304 29,9 26 V
MERCEDES-BENZ - VIANO (W639) 09/03→							
 Bremsbelagsatz, Scheibenbremse							
3,0 3,2 3,5 3,7 CDI 2.0 CDI 2.0 CDI 2.0 CDI 2.2 CDI 2.2 CDI 3.0 CDI 3.0	140 160 190 170 80 85 100 110 120 150 165	09/03→ 09/03→ 09/07→ 06/04→ 09/03→ 08/05→ 07/10→ 09/03→ 07/10→ 03/06→ 07/10→	←	→ 342257		13.0460-3819.2 603819	BOS 24007 20,8 + WK
			←	342258→; → 02/14		13.0460-4826.2 604826	BRE 29192 20,7 + WE / - WK + Zub
			→	→ 02/14		13.0460-4877.2 604877	BRE 29192 20,3 + WE / - WK + Zub
			→	→ 02/14		13.0460-3821.2 603821	BOS 24008 18,3 + WK
CDI 2.0 4-matic CDI 2.2 4-matic	80 110	07/05→ 07/05→	←	07/10→; → 407625		13.0460-3819.2 603819	BOS 24007 20,8 + WK
			←	407626→; → 02/14		13.0460-4826.2 604826	BRE 29192 20,7 + WE / - WK + Zub
			→	07/10→ 02/14		13.0460-4877.2 604877	BRE 29192 20,3 + WE / - WK + Zub
			→	07/10→ 02/14		13.0460-3821.2 603821	BOS 24008 18,3 + WK
CDI 2.0 4-matic CDI 2.2 4-matic	100 120	07/10→ 07/10→	←	→ 407625		13.0460-3819.2 603819	BOS 24007 20,8 + WK
			←	407626→; → 02/14		13.0460-4826.2 604826	BRE 29192 20,7 + WE / - WK + Zub
			→	→ 02/14		13.0460-4877.2 604877	BRE 29192 20,3 + WE / - WK + Zub
			→	→ 02/14		13.0460-3821.2 603821	BOS 24008 18,3 + WK
Warnkontakt, Bremsbelagverschleiß							
3,0 3,2 3,5 3,7 CDI 2.0 CDI 2.0 CDI 2.0 CDI 2.2 CDI 2.2 CDI 3.0 CDI 3.0	140 160 190 170 80 85 100 110 120 150 165	09/03→ 09/03→ 09/07→ 06/04→ 09/03→ 08/05→ 07/10→ 09/03→ 07/10→ 03/06→ 07/10→	←	→ 342257	2	24.8190-0418.2 620418	L= 95
			←	342258→; → 02/14	2	24.8190-0424.2 620424	L= 103,2
			→	→ 02/14	2	24.8190-0418.2 620418	L= 95
CDI 2.0 4-matic CDI 2.2 4-matic	80 110	07/05→ 07/05→	←	07/10→; → 407625	2	24.8190-0418.2 620418	L= 95
			←	407626→; → 02/14	2	24.8190-0424.2 620424	L= 103,2
			→	07/10→ 02/14	2	24.8190-0418.2 620418	L= 95
CDI 2.0 4-matic CDI 2.2 4-matic	100 120	07/10→ 07/10→	←	→ 407625	2	24.8190-0418.2 620418	L= 95
			←	407626→; → 02/14	2	24.8190-0424.2 620424	L= 103,2
			→	→ 02/14	2	24.8190-0418.2 620418	L= 95
 Bremsscheibe							
3,0 3,2 3,5 ↓	140 160 190	09/03→ 09/03→ 09/07→	←	→ 02/14		24.0128-0145.1 428145	Ø 300 28 25 V + S
			→	→ 02/14		24.0110-0280.1 410280	Ø 296 10 8 + S











	kW				! #		
MERCEDES-BENZ - VIANO (W639) 09/03→							
Bremsscheibe							
3.7 CDI 2.0	170 80	06/04→ 09/03→	←	→ 02/14		24.0128-0145.1 428145	Ø 300 28 25 V + S
CDI 2.0 CDI 2.0 CDI 2.0 CDI 2.0 4-matic CDI 2.2 CDI 2.2 CDI 2.2 4-matic CDI 3.0 CDI 3.0	85 100 100 110 120 120 150 165	08/05→ 07/10→ 07/10→ 09/03→ 07/10→ 07/10→ 03/06→ 07/10→	→	→ 02/14		24.0110-0280.1 410280	Ø 296 10 8 + S
CDI 2.0 4-matic CDI 2.2 4-matic	80 110	07/05→ 07/05→	←	07/10→ 02/14		24.0128-0145.1 428145	Ø 300 28 25 V + S
			→	07/10→ 02/14		24.0110-0280.1 410280	Ø 296 10 8 + S
MERCEDES-BENZ - VITO / MIXTO Kasten (W639) 09/03→							
Bremsbelagsatz, Scheibenbremse							
109 CDI 109 CDI 110 CDI 111 CDI 111 CDI 113 CDI 115 CDI 116 CDI 119 122 122 CDI 126	65 70 70 80 85 100 110 120 140 160 165 190	09/03→ 08/06→ 09/10→ 09/03→ 09/07→ 09/10→ 09/03→ 09/10→ 09/03→ 09/03→ 09/10→ 09/07→	←	→ 342257		13.0460-3819.2 603819	BOS 24007 20,8 + WK
			←	342258→; → 02/14		13.0460-4826.2 604826	BRE 29192 20,7 + WE / - WK + Zub
			→	→ 02/14		13.0460-3821.2 603821	BOS 24008 18,3 + WK
			←	→ 407625		13.0460-3819.2 603819	BOS 24007 20,8 + WK
			←	407626→; → 02/14		13.0460-4826.2 604826	BRE 29192 20,7 + WE / - WK + Zub
			→	→ 02/14		13.0460-4877.2 604877	BRE 29192 20,3 + WE / - WK + Zub
			→	→ 02/14		13.0460-3821.2 603821	BOS 24008 18,3 + WK
111 CDI 4x4 113 CDI 4x4 116 CDI 4x4	80 100 120	09/07→ 09/10→ 09/10→	←	→ 407625		13.0460-3819.2 603819	BOS 24007 20,8 + WK
			←	407626→; → 02/14		13.0460-4826.2 604826	BRE 29192 20,7 + WE / - WK + Zub
			→	→ 02/14		13.0460-4877.2 604877	BRE 29192 20,3 + WE / - WK + Zub
			→	→ 02/14		13.0460-3821.2 603821	BOS 24008 18,3 + WK
115 CDI 4x4	110	07/06→	←	09/07→; → 407625		13.0460-3819.2 603819	BOS 24007 20,8 + WK
			←	407626→; → 02/14		13.0460-4826.2 604826	BRE 29192 20,7 + WE / - WK + Zub
			→	09/07→ 02/14		13.0460-4877.2 604877	BRE 29192 20,3 + WE / - WK + Zub
			→	09/07→ 02/14		13.0460-3821.2 603821	BOS 24008 18,3 + WK
120 CDI	150	07/06→	←	09/07→; → 342257		13.0460-3819.2 603819	BOS 24007 20,8 + WK
			←	342258→; → 02/14		13.0460-4826.2 604826	BRE 29192 20,7 + WE / - WK + Zub
			→	09/07→ 02/14		13.0460-4877.2 604877	BRE 29192 20,3 + WE / - WK + Zub
			→	09/07→ 02/14		13.0460-3821.2 603821	BOS 24008 18,3 + WK
123 123 (639.603)	165 170	06/04→07/08 06/04→07/08	←	→ 342257		13.0460-3819.2 603819	BOS 24007 20,8 + WK
			←	342258→		13.0460-4826.2 604826	BRE 29192 20,7 + WE / - WK + Zub
			→			13.0460-4877.2 604877	BRE 29192 20,3 + WE / - WK + Zub
			→			13.0460-3821.2 603821	BOS 24008 18,3 + WK
E-CELL	60	03/12→	←	→ 02/14		13.0460-3819.2 603819	BOS 24007 20,8 + WK
			←			13.0460-4826.2 604826	BRE 29192 20,7 + WE / - WK + Zub
			→			13.0460-4877.2 604877	BRE 29192 20,3 + WE / - WK + Zub
			→	→ 02/14		13.0460-3821.2 603821	BOS 24008 18,3 + WK
Warnkontakt, Bremsbelagsverschleiß							
109 CDI 109 CDI 110 CDI 111 CDI 111 CDI 113 CDI 115 CDI 116 CDI 119 122 122 CDI 126	65 70 70 80 85 100 110 120 140 160 165 190	09/03→ 08/06→ 09/10→ 09/03→ 09/07→ 09/10→ 09/03→ 09/10→ 09/03→ 09/03→ 09/10→ 09/07→	←	→ 342257	2	24.8190-0418.2 620418	L= 95
			←	342258→; → 02/14	2	24.8190-0424.2 620424	L= 103,2
			→	→ 02/14	2	24.8190-0418.2 620418	L= 95
↓							









	kw					! #		
MERCEDES-BENZ - VITO / MIXTO Kasten (W639) 09/03→								
Warnkontakt, Bremsbelagverschleiß								
111 CDI 4x4 113 CDI 4x4 116 CDI 4x4	80 100 120	09/07→ 09/10→ 09/10→	← ← →	→ 407625 407626→; → 02/14 → 02/14	2 2 2	24.8190-0418.2 24.8190-0424.2 24.8190-0418.2	620418 620424 620418	L= 95 L= 103,2 L= 95
115 CDI 4x4	110	07/06→	← ← →	09/07→; → 407625 407626→; → 02/14 09/07→ 02/14	2 2 2	24.8190-0418.2 24.8190-0424.2 24.8190-0418.2	620418 620424 620418	L= 95 L= 103,2 L= 95
120 CDI	150	07/06→	← ← →	09/07→; → 342257 342258→; → 02/14 09/07→ 02/14	2 2 2	24.8190-0418.2 24.8190-0424.2 24.8190-0418.2	620418 620424 620418	L= 95 L= 103,2 L= 95
123 123 (639.603)	165 170	06/04→07/08 06/04→07/08	← ← →	→ 342257 342258→ →	2 2 2	24.8190-0418.2 24.8190-0424.2 24.8190-0418.2	620418 620424 620418	L= 95 L= 103,2 L= 95
E-CELL	60	03/12→	← →	→ 02/14 → 02/14	2 2	24.8190-0418.2 24.8190-0424.2 24.8190-0418.2	620418 620424 620418	L= 95 L= 103,2 L= 95
Bremsscheibe								
109 CDI 109 CDI 110 CDI 111 CDI 111 CDI 111 CDI 4x4 113 CDI 113 CDI 4x4 115 CDI 116 CDI 116 CDI 4x4 119 122 E-CELL	65 70 70 80 85 80 100 100 110 120 120 140 160 60	09/03→ 08/06→ 09/10→ 09/03→ 09/07→ 09/07→ 09/10→ 09/10→ 09/03→ 09/10→ 09/10→ 09/03→ 09/03→ 03/12→	← →	→ 02/14 → 02/14		24.0128-0145.1 24.0110-0280.1	428145 410280	∅ 300 28 25 V + S ∅ 296 10 8 + S
115 CDI 4x4 120 CDI	110 150	07/06→ 07/06→	← →	09/07→ 02/14 09/07→ 02/14		24.0128-0145.1 24.0110-0280.1	428145 410280	∅ 300 28 25 V + S ∅ 296 10 8 + S
122 CDI 126	165 190	09/10→ 09/07→	← ← →	444280→; → 02/14 → 444279 → 02/14		24.0128-0145.1 24.0128-0145.1 24.0110-0280.1	428145 428145 410280	∅ 300 28 25 V + S ∅ 300 28 25 V + S ∅ 296 10 8 + S
123 123 (639.603)	165 170	06/04→07/08 06/04→07/08	← →			24.0128-0145.1 24.0110-0280.1	428145 410280	∅ 300 28 25 V + S ∅ 296 10 8 + S
MERCEDES-BENZ - VITO Bus (638) 02/96→07/03								
Bremsbelagsatz, Scheibenbremse								
108 CDI 2.2 (638.194) 110 CDI 2.2 (638.194) 112 CDI 2.2 (638.194) 114 2.3 (638.134, 638.194)	60 75 90 105	03/99→07/03 03/99→07/03 03/99→07/03 12/96→07/03	← →			13.0460-3980.2 13.0460-7196.2 13.0460-3985.2 13.0460-7085.2	603980 607196 603985 607085	BOS 23022 20,9 + WE / - WK ATE 21576 20,7 + WE / - WK BOS 23020 17,9 - WK ATE 21278 16,9 + WK
108 D 2.3 (638.164) 110 TD 2.3 (638.174) 113 2.0 (638.114, 638.194)	58 72 95	02/96→07/03 02/96→07/03 02/96→07/03	← →	03/96→ 03/96→		13.0460-3980.2 13.0460-7196.2 13.0460-3985.2 13.0460-7085.2	603980 607196 603985 607085	BOS 23022 20,9 + WE / - WK ATE 21576 20,7 + WE / - WK BOS 23020 17,9 - WK ATE 21278 16,9 + WK
Warnkontakt, Bremsbelagverschleiß								
108 CDI 2.2 (638.194) 110 CDI 2.2 (638.194) 112 CDI 2.2 (638.194) 114 2.3 (638.134, 638.194)	60 75 90 105	03/99→07/03 03/99→07/03 03/99→07/03 12/96→07/03	←		2	24.8190-0407.2 24.8190-0417.2	620407 620417	L= 84 L= 185 L= 99 L= 167
108 D 2.3 (638.164) 110 TD 2.3 (638.174) 113 2.0 (638.114, 638.194)	58 72 95	02/96→07/03 02/96→07/03 02/96→07/03	←	03/96→	2	24.8190-0407.2 24.8190-0417.2	620407 620417	L= 84 L= 185 L= 99 L= 167
Zubehörsatz, Scheibenbremsbelag								
108 CDI 2.2 (638.194) 110 CDI 2.2 (638.194) 112 CDI 2.2 (638.194) ↓	60 75 90	03/99→07/03 03/99→07/03 03/99→07/03	← →			13.0460-0250.2 13.0460-0288.2	610250 610288	BOS BOS











	kW					! #		
MERCEDES-BENZ - VITO Bus (638) 02/96→07/03								
Zubehörsatz, Scheibenbremsbelag								
114 2.3 (638.134, 638.194)	105	12/96→07/03	←				13.0460-0250.2 610250	BOS
			→				13.0460-0288.2 610288	BOS
108 D 2.3 (638.164)	58	02/96→07/03	←	03/96→			13.0460-0250.2 610250	BOS
110 TD 2.3 (638.174)	72	02/96→07/03						
113 2.0 (638.114, 638.194)	95	02/96→07/03	→	03/96→			13.0460-0288.2 610288	BOS
 Bremsscheibe								
108 CDI 2.2 (638.194)	60	03/99→07/03	←				24.0122-0162.1 422162	Ø 276 22 19 V + S
110 CDI 2.2 (638.194)	75	03/99→07/03					24.0322-0162.1 522162	Ø 276 22 19 V + S PD
112 CDI 2.2 (638.194)	90	03/99→07/03						
114 2.3 (638.134, 638.194)	105	12/96→07/03	→				24.0110-0228.1 410228	Ø 280 10 8 + S
108 D 2.3 (638.164)	58	02/96→07/03	←	03/96→			24.0122-0162.1 422162	Ø 276 22 19 V + S
110 TD 2.3 (638.174)	72	02/96→07/03					24.0322-0162.1 522162	Ø 276 22 19 V + S PD
113 2.0 (638.114, 638.194)	95	02/96→07/03	→	03/96→			24.0110-0228.1 410228	Ø 280 10 8 + S
MERCEDES-BENZ - VITO Bus (W639) 09/03→								
 Bremsbelagsatz, Scheibenbremse								
109 CDI	65	09/03→	←	→ 342257			13.0460-3819.2 603819	BOS 24007 20,8 + WK
109 CDI	70	09/06→						
110 CDI	70	09/10→	←	342258→; → 02/14			13.0460-4826.2 604826	BRE 29192 20,7 + WE / - WK + Zub
111 CDI	80	09/03→						
111 CDI (639.701)	85	09/07→					13.0460-4877.2 604877	BRE 29192 20,3 + WE / - WK + Zub
113 CDI	100	09/10→						
115 CDI	110	09/03→						
116 CDI	120	09/10→	→	→ 02/14			13.0460-3821.2 603821	BOS 24008 18,3 + WK
119	140	09/03→						
122	160	09/03→						
122 CDI	165	09/10→						
123	170	06/04→						
126	190	09/07→						
109 CDI 4x4	70	09/07→	←	→ 407625			13.0460-3819.2 603819	BOS 24007 20,8 + WK
111 CDI 4x4	80	09/07→						
113 CDI 4x4	100	09/10→	←	407626→; → 02/14			13.0460-4826.2 604826	BRE 29192 20,7 + WE / - WK + Zub
115 CDI 4x4	110	09/07→					13.0460-4877.2 604877	BRE 29192 20,3 + WE / - WK + Zub
116 CDI 4x4	120	09/10→						
			→	→ 02/14			13.0460-3821.2 603821	BOS 24008 18,3 + WK
120 CDI	150	07/06→	←	09/07→; → 342257			13.0460-3819.2 603819	BOS 24007 20,8 + WK
			←	342258→; → 02/14			13.0460-4826.2 604826	BRE 29192 20,7 + WE / - WK + Zub
							13.0460-4877.2 604877	BRE 29192 20,3 + WE / - WK + Zub
			→	09/07→ 02/14			13.0460-3821.2 603821	BOS 24008 18,3 + WK
123	165	06/04→07/08	←	→ 342257			13.0460-3819.2 603819	BOS 24007 20,8 + WK
			←	342258→			13.0460-4826.2 604826	BRE 29192 20,7 + WE / - WK + Zub
							13.0460-4877.2 604877	BRE 29192 20,3 + WE / - WK + Zub
			→				13.0460-3821.2 603821	BOS 24008 18,3 + WK
E-CELL	60	03/12→	←	→ 02/14			13.0460-3819.2 603819	BOS 24007 20,8 + WK
							13.0460-4826.2 604826	BRE 29192 20,7 + WE / - WK + Zub
							13.0460-4877.2 604877	BRE 29192 20,3 + WE / - WK + Zub
			→	→ 02/14			13.0460-3821.2 603821	BOS 24008 18,3 + WK
Warnkontakt, Bremsbelagsverschleiß								
109 CDI	65	09/03→	←	→ 342257	2	24.8190-0418.2 620418		L= 95
109 CDI	70	09/06→						
110 CDI	70	09/10→	←	342258→; → 02/14	2	24.8190-0424.2 620424		L= 103,2
111 CDI	80	09/03→						
111 CDI (639.701)	85	09/07→	→	→ 02/14	2	24.8190-0418.2 620418		L= 95
113 CDI	100	09/10→						
115 CDI	110	09/03→						
116 CDI	120	09/10→						
119	140	09/03→						
122	160	09/03→						
122 CDI	165	09/10→						
123	170	06/04→						
126	190	09/07→						
↓								















	kW				! #		
MERCEDES-BENZ - VITO Bus (W639) 09/03→							
Warnkontakt, Bremsbelagverschleiß							
109 CDI 4x4	70	09/07→	←	→ 407625	2	24.8190-0418.2 620418	L= 95
111 CDI 4x4	80	09/07→	←	407626→; → 02/14	2	24.8190-0424.2 620424	L= 103,2
113 CDI 4x4	100	09/10→					
115 CDI 4x4	110	09/07→	→	→ 02/14	2	24.8190-0418.2 620418	L= 95
116 CDI 4x4	120	09/10→					
120 CDI	150	07/06→	←	09/07→; → 342257	2	24.8190-0418.2 620418	L= 95
			←	342258→; → 02/14	2	24.8190-0424.2 620424	L= 103,2
			→	09/07→ 02/14	2	24.8190-0418.2 620418	L= 95
123	165	06/04→07/08	←	→ 342257	2	24.8190-0418.2 620418	L= 95
			←	342258→	2	24.8190-0424.2 620424	L= 103,2
			→		2	24.8190-0418.2 620418	L= 95
E-CELL	60	03/12→	←	→ 02/14	2	24.8190-0418.2 620418	L= 95
						24.8190-0424.2 620424	L= 103,2
			→	→ 02/14	2	24.8190-0418.2 620418	L= 95
Bremsscheibe							
109 CDI	65	09/03→	←	→ 02/14		24.0128-0145.1 428145	∅ 300 28 25 V + S
109 CDI	70	09/06→	→	→ 02/14		24.0110-0280.1 410280	∅ 296 10 8 + S
109 CDI 4x4	70	09/07→					
110 CDI	70	09/10→					
111 CDI	80	09/03→					
111 CDI (639.701)	85	09/07→					
111 CDI 4x4	80	09/07→					
113 CDI	100	09/10→					
113 CDI 4x4	100	09/10→					
115 CDI	110	09/03→					
115 CDI 4x4	110	09/07→					
116 CDI	120	09/10→					
116 CDI 4x4	120	09/10→					
119	140	09/03→					
122	160	09/03→					
123	170	06/04→					
E-CELL	60	03/12→					
120 CDI	150	07/06→	←	09/07→ 02/14		24.0128-0145.1 428145	∅ 300 28 25 V + S
			→	09/07→ 02/14		24.0110-0280.1 410280	∅ 296 10 8 + S
122 CDI 126	165 190	09/10→ 09/07→	←	444280→; → 02/14		24.0128-0145.1 428145	∅ 300 28 25 V + S
			←	→ 444279		24.0128-0145.1 428145	∅ 300 28 25 V + S
			→	→ 02/14		24.0110-0280.1 410280	∅ 296 10 8 + S
123	165	06/04→07/08	←			24.0128-0145.1 428145	∅ 300 28 25 V + S
			→			24.0110-0280.1 410280	∅ 296 10 8 + S
MERCEDES-BENZ - VITO Kasten (638) 03/97→07/03							
Bremsbelagsatz, Scheibenbremse							
108 CDI 2.2 (638.094)	60	03/99→07/03	←			13.0460-3980.2 603980	BOS 23022 20,9 + WE / - WK
108 D 2.3 (638.064)	58	03/97→07/03	→			13.0460-7196.2 607196	ATE 21576 20,7 + WE / - WK
110 CDI 2.2 (638.094)	75	03/99→07/03					
110 D 2.3 (638.074)	72	03/97→07/03				13.0460-3985.2 603985	BOS 23020 17,9 - WK
112 CDI 2.2 (638.094)	90	03/99→07/03				13.0460-7085.2 607085	ATE 21278 16,9 + WK
113 2.0 (638.014, 638.094)	95	03/97→07/03					
114 2.3 (638.034, 638.094)	105	03/97→07/03					
Warnkontakt, Bremsbelagverschleiß							
108 CDI 2.2 (638.094)	60	03/99→07/03	←		2	24.8190-0407.2 620407	L= 84 L= 185
108 D 2.3 (638.064)	58	03/97→07/03					
110 CDI 2.2 (638.094)	75	03/99→07/03					
110 D 2.3 (638.074)	72	03/97→07/03					
112 CDI 2.2 (638.094)	90	03/99→07/03					
113 2.0 (638.014, 638.094)	95	03/97→07/03					
114 2.3 (638.034, 638.094)	105	03/97→07/03					
Zubehörsatz, Scheibenbremsbelag							
108 CDI 2.2 (638.094)	60	03/99→07/03	←			13.0460-0250.2 610250	BOS
108 D 2.3 (638.064)	58	03/97→07/03	→			13.0460-0288.2 610288	BOS
110 CDI 2.2 (638.094)	75	03/99→07/03					
110 D 2.3 (638.074)	72	03/97→07/03					
112 CDI 2.2 (638.094)	90	03/99→07/03					
113 2.0 (638.014, 638.094)	95	03/97→07/03					
↓							















	kW					! #		
MERCEDES-BENZ - VITO Kasten (638) 03/97→07/03								
Zubehörsatz, Scheibenbremsbelag								
114 2.3 (638.034, 638.094)	105	03/97→07/03	←			13.0460-0250.2	610250	BOS
			→			13.0460-0288.2	610288	BOS
 Bremsscheibe								
108 CDI 2.2 (638.094)	60	03/99→07/03	←			24.0122-0162.1	422162	Ø 276 22 19 V + S
108 D 2.3 (638.064)	58	03/97→07/03				24.0322-0162.1	522162	Ø 276 22 19 V + S PD
110 CDI 2.2 (638.094)	75	03/99→07/03						
110 D 2.3 (638.074)	72	03/97→07/03	→			24.0110-0228.1	410228	Ø 280 10 8 + S
112 CDI 2.2 (638.094)	90	03/99→07/03						
113 2.0 (638.014, 638.094)	95	03/97→07/03						
114 2.3 (638.034, 638.094)	105	03/97→07/03						
MERCEDES-BENZ - VITO Kasten (W447) 10/14→								
 Bremsbelagsatz, Scheibenbremse								
109 CDI (447.601, 447.603, 447.605)	65	10/14→	←			13.0460-4826.2	604826	BRE 29192 20,7 + WE / - WK + Zub
111 CDI (447.601, 447.603, 447.605)	84	10/14→				13.0460-4877.2	604877	BRE 29192 20,3 + WE / - WK + Zub
			→			13.0460-4882.2	604882	BRE 22102 18,2 + WE / - WK
						13.0470-4882.2	LD4882	BRE 22102 18,2 + WE / - WK Ceramic
114 CDI (447.601, 447.603, 447.605)	100	10/14→	←			13.0460-4884.2	604884	BRE 22062 20,7 + WE / - WK
114 CDI 4x4 (447.601, 447.603, 447.605)	100	07/15→				13.0470-4884.2	LD4884	BRE 22062 20,7 + WE / - WK Ceramic
119 CDI / BlueTEC (447.601, 447.603, 447.605)	140	10/14→	→			13.0460-4882.2	604882	BRE 22102 18,2 + WE / - WK
119 CDI / BlueTEC 4x4 (447.601, 447.603, 447.605)	140	07/15→				13.0470-4882.2	LD4882	BRE 22102 18,2 + WE / - WK Ceramic
116 CDI (447.601, 447.603, 447.605)	120	10/14→	←			13.0460-4826.2	604826	BRE 29192 20,7 + WE / - WK + Zub
116 CDI 4x4 (447.601, 447.603, 447.605)	120	07/15→				13.0460-4877.2	604877	BRE 29192 20,3 + WE / - WK + Zub
						13.0460-4884.2	604884	BRE 22062 20,7 + WE / - WK
						13.0470-4884.2	LD4884	BRE 22062 20,7 + WE / - WK Ceramic
			→			13.0460-4882.2	604882	BRE 22102 18,2 + WE / - WK
						13.0470-4882.2	LD4882	BRE 22102 18,2 + WE / - WK Ceramic
Warnkontakt, Bremsbelagverschleiß								
109 CDI (447.601, 447.603, 447.605)	65	10/14→	←		1	24.8190-0424.2	620424	L= 103,2
111 CDI (447.601, 447.603, 447.605)	84	10/14→	→		1	24.8190-0424.2	620424	L= 103,2
114 CDI (447.601, 447.603, 447.605)	100	10/14→						
114 CDI 4x4 (447.601, 447.603, 447.605)	100	07/15→						
116 CDI (447.601, 447.603, 447.605)	120	10/14→						
116 CDI 4x4 (447.601, 447.603, 447.605)	120	07/15→						
119 CDI / BlueTEC (447.601, 447.603, 447.605)	140	10/14→						
119 CDI / BlueTEC 4x4 (447.601, 447.603, 447.605)	140	07/15→						
 Bremsscheibe								
109 CDI (447.601, 447.603, 447.605)	65	10/14→	←	für Stahlfelgen		24.0128-0145.1	428145	Ø 300 28 25 V + S
111 CDI (447.601, 447.603, 447.605)	84	10/14→	→	für Leichtmetallfelgen		24.0112-0213.1	412213	Ø 300 12 9 + S
114 CDI (447.601, 447.603, 447.605)	100	10/14→	←			24.0128-0145.1	428145	Ø 300 28 25 V + S
114 CDI 4x4 (447.601, 447.603, 447.605)	100	07/15→	→	für Leichtmetallfelgen		24.0112-0213.1	412213	Ø 300 12 9 + S
116 CDI (447.601, 447.603, 447.605)	120	10/14→						
↓								











	kW			 	! #			
MERCEDES-BENZ - VITO Kasten (W447) 10/14→								
 Bremsscheibe								
116 CDI 4x4 (447.601, 447.603, 447.605) 119 CDI / BlueTEC (447.601, 447.603, 447.605)	120	07/15→	←			24.0128-0145.1	428145	Ø 300 28 25 V + S
	140	10/14→	→	für Leichtmetallfelgen		24.0112-0213.1	412213	Ø 300 12 9 + S
119 CDI / BlueTEC 4x4 (447.601, 447.603, 447.605)	140	07/15→						
MERCEDES-BENZ - VITO Mixto (W447) 10/14→								
 Bremsbelagsatz, Scheibenbremse								
109 CDI (447.701, 447.703, 447.705) 111 CDI (447.701, 447.703, 447.705)	65	10/14→	←			13.0460-4826.2	604826	BRE 29192 20,7 + WE / - WK + Zub
	84	10/14→	→			13.0460-4877.2	604877	BRE 29192 20,3 + WE / - WK + Zub
			→			13.0460-4882.2	604882	BRE 22102 18,2 + WE / - WK
						13.0470-4882.2	LD4882	BRE 22102 18,2 + WE / - WK Ceramic
114 CDI (447.701, 447.703, 447.705) 114 CDI 4x4 (447.701, 447.703, 447.705) 119 BlueTEC (447.701, 447.703, 447.705) 119 BlueTEC 4x4 (447.701, 447.703, 447.705)	100	10/14→	←			13.0460-4884.2	604884	BRE 22062 20,7 + WE / - WK
	100	07/15→				13.0470-4884.2	LD4884	BRE 22062 20,7 + WE / - WK Ceramic
	140	10/14→	→			13.0460-4882.2	604882	BRE 22102 18,2 + WE / - WK
	140	12/14→				13.0470-4882.2	LD4882	BRE 22102 18,2 + WE / - WK Ceramic
116 CDI (447.701, 447.703, 447.705) 116 CDI 4x4 (447.701, 447.703, 447.705)	120	10/14→	←			13.0460-4826.2	604826	BRE 29192 20,7 + WE / - WK + Zub
	120	07/15→				13.0460-4877.2	604877	BRE 29192 20,3 + WE / - WK + Zub
						13.0460-4884.2	604884	BRE 22062 20,7 + WE / - WK
						13.0470-4884.2	LD4884	BRE 22062 20,7 + WE / - WK Ceramic
			→			13.0460-4882.2	604882	BRE 22102 18,2 + WE / - WK
						13.0470-4882.2	LD4882	BRE 22102 18,2 + WE / - WK Ceramic
Warnkontakt, Bremsbelagsverschleiß								
109 CDI (447.701, 447.703, 447.705) 111 CDI (447.701, 447.703, 447.705)	65	10/14→	←		1	24.8190-0424.2	620424	L= 103,2
	84	10/14→	→		1	24.8190-0424.2	620424	L= 103,2
114 CDI (447.701, 447.703, 447.705) 114 CDI 4x4 (447.701, 447.703, 447.705) 116 CDI (447.701, 447.703, 447.705) 116 CDI 4x4 (447.701, 447.703, 447.705) 119 BlueTEC (447.701, 447.703, 447.705) 119 BlueTEC 4x4 (447.701, 447.703, 447.705)	100	10/14→						
	100	07/15→						
	120	10/14→						
	120	07/15→						
	140	10/14→						
	140	12/14→						
 Bremsscheibe								
109 CDI (447.701, 447.703, 447.705) 111 CDI (447.701, 447.703, 447.705)	65	10/14→	←	für Stahlfelgen		24.0128-0145.1	428145	Ø 300 28 25 V + S
	84	10/14→	→	für Leichtmetallfelgen		24.0112-0213.1	412213	Ø 300 12 9 + S
114 CDI (447.701, 447.703, 447.705) 114 CDI 4x4 (447.701, 447.703, 447.705) 116 CDI (447.701, 447.703, 447.705) 116 CDI 4x4 (447.701, 447.703, 447.705) 119 BlueTEC (447.701, 447.703, 447.705) 119 BlueTEC 4x4 (447.701, 447.703, 447.705)	100	10/14→	←			24.0128-0145.1	428145	Ø 300 28 25 V + S
	100	07/15→	→	für Leichtmetallfelgen		24.0112-0213.1	412213	Ø 300 12 9 + S
	120	10/14→						
	120	07/15→						
	140	10/14→						
	140	12/14→						











	kW			 	! #		
MERCEDES-BENZ - VITO Tourer (W447) 10/14→							
 Bremsbelagsatz, Scheibenbremse							
109 CDI / 109 BlueTEC (447.701, 447.703, 447.705)	65	10/14→	←			13.0460-4826.2 604826	BRE 29192 20,7 + WE / - WK + Zub
111 CDI / 111 BlueTEC (447.701, 447.703, 447.705)	84	10/14→	→			13.0460-4877.2 604877	BRE 29192 20,3 + WE / - WK + Zub
114 CDI / 114 BlueTEC (447.701, 447.703, 447.705)	100	10/14→	←			13.0460-4884.2 604884	BRE 22062 20,7 + WE / - WK Ceramic
114 CDI / 114 BlueTEC 4x4 (447.701, 447.703, 447.705)	100	07/15→	→			13.0460-4882.2 604882	BRE 22102 18,2 + WE / - WK Ceramic
119 BlueTEC (447.701, 447.703, 447.705)	140	10/14→				13.0470-4882.2 LD4882	BRE 22102 18,2 + WE / - WK Ceramic
119 CDI / 119 BlueTEC 4x4 (447.701, 447.703, 447.705)	140	12/14→					
116 CDI / 116 BlueTEC (447.701, 447.703, 447.705)	120	10/14→	←			13.0460-4826.2 604826	BRE 29192 20,7 + WE / - WK + Zub
116 CDI / 116 BlueTEC 4x4 (447.701, 447.703, 447.705)	120	07/15→				13.0460-4877.2 604877	BRE 29192 20,3 + WE / - WK + Zub
						13.0460-4884.2 604884	BRE 22062 20,7 + WE / - WK Ceramic
						13.0470-4884.2 LD4884	BRE 22062 20,7 + WE / - WK Ceramic
			→			13.0460-4882.2 604882	BRE 22102 18,2 + WE / - WK Ceramic
						13.0470-4882.2 LD4882	BRE 22102 18,2 + WE / - WK Ceramic
Warnkontakt, Bremsbelagsverschleiß							
109 CDI / 109 BlueTEC (447.701, 447.703, 447.705)	65	10/14→	←		1	24.8190-0424.2 620424	L= 103,2
111 CDI / 111 BlueTEC (447.701, 447.703, 447.705)	84	10/14→	→		1	24.8190-0424.2 620424	L= 103,2
114 CDI / 114 BlueTEC (447.701, 447.703, 447.705)	100	10/14→					
114 CDI / 114 BlueTEC 4x4 (447.701, 447.703, 447.705)	100	07/15→					
116 CDI / 116 BlueTEC (447.701, 447.703, 447.705)	120	10/14→					
116 CDI / 116 BlueTEC 4x4 (447.701, 447.703, 447.705)	120	07/15→					
119 BlueTEC (447.701, 447.703, 447.705)	140	10/14→					
119 CDI / 119 BlueTEC 4x4 (447.701, 447.703, 447.705)	140	12/14→					
 Bremsscheibe							
109 CDI / 109 BlueTEC (447.701, 447.703, 447.705)	65	10/14→	←	für Stahlfelgen		24.0128-0145.1 428145	Ø 300 28 25 V + S
111 CDI / 111 BlueTEC (447.701, 447.703, 447.705)	84	10/14→	→	für Leichtmetallfelgen		24.0112-0213.1 412213	Ø 300 12 9 + S
114 CDI / 114 BlueTEC (447.701, 447.703, 447.705)	100	10/14→	←			24.0128-0145.1 428145	Ø 300 28 25 V + S
114 CDI / 114 BlueTEC 4x4 (447.701, 447.703, 447.705)	100	07/15→	→	für Leichtmetallfelgen		24.0112-0213.1 412213	Ø 300 12 9 + S
116 CDI / 116 BlueTEC (447.701, 447.703, 447.705)	120	10/14→					
116 CDI / 116 BlueTEC 4x4 (447.701, 447.703, 447.705)	120	07/15→					
119 BlueTEC (447.701, 447.703, 447.705)	140	10/14→					
119 CDI / 119 BlueTEC 4x4 (447.701, 447.703, 447.705)	140	12/14→					









	kW					! #		
MERCEDES-BENZ - V-KLASSE (638/2) 02/96→07/03								
 Bremsbelagsatz, Scheibenbremse								
V 200 (638.214, 638.294)	95	02/97→07/03	←				13.0460-3980.2 603980	BOS 23022 20,9 + WE / - WK
V 200 CDI (638.294)	75	03/99→07/03	→				13.0460-7196.2 607196	ATE 21576 20,7 + WE / - WK
V 220 CDI (638.294)	90	03/99→07/03					13.0460-3985.2 603985	BOS 23020 17,9 - WK
V 230 (638.234, 638.294)	105	10/96→07/03					13.0460-7085.2 607085	ATE 21278 16,9 + WK
V 230 TD (638.274)	72	09/96→07/03						
V 280 (638.244, 638.294)	128	08/97→07/03	←	09/97→			13.0460-3980.2 603980	BOS 23022 20,9 + WE / - WK
			→	09/97→			13.0460-7196.2 607196	ATE 21576 20,7 + WE / - WK
			→	09/97→			13.0460-3985.2 603985	BOS 23020 17,9 - WK
			→	09/97→			13.0460-7085.2 607085	ATE 21278 16,9 + WK
Warnkontakt, Bremsbelagverschleiß								
V 200 (638.214, 638.294)	95	02/97→07/03	←	für Bosch System	2	24.8190-0407.2 620407	L= 84 L= 185	
V 200 CDI (638.294)	75	03/99→07/03	←	für ATE System	2	24.8190-0417.2 620417	L= 99 L= 167	
V 220 CDI (638.294)	90	03/99→07/03						
V 230 (638.234, 638.294)	105	10/96→07/03						
V 230 TD (638.274)	72	09/96→07/03						
V 280 (638.244, 638.294)	128	08/97→07/03	←	09/97→; für Bosch System	2	24.8190-0407.2 620407	L= 84 L= 185	
			←	09/97→; für ATE System	2	24.8190-0417.2 620417	L= 99 L= 167	
Zubehörsatz, Scheibenbremsbelag								
V 200 (638.214, 638.294)	95	02/97→07/03	←				13.0460-0250.2 610250	BOS
V 200 CDI (638.294)	75	03/99→07/03	→				13.0460-0288.2 610288	BOS
V 220 CDI (638.294)	90	03/99→07/03						
V 230 (638.234, 638.294)	105	10/96→07/03						
V 230 TD (638.274)	72	09/96→07/03						
V 280 (638.244, 638.294)	128	08/97→07/03	←	09/97→			13.0460-0250.2 610250	BOS
			→	09/97→			13.0460-0288.2 610288	BOS
 Bremsscheibe								
V 200 (638.214, 638.294)	95	02/97→07/03	←				24.0122-0162.1 422162	Ø 276 22 19 V + S
V 200 CDI (638.294)	75	03/99→07/03	→				24.0322-0162.1 522162	Ø 276 22 19 V + S PD
V 220 CDI (638.294)	90	03/99→07/03					24.0110-0228.1 410228	Ø 280 10 8 + S
V 230 (638.234, 638.294)	105	10/96→07/03						
V 230 TD (638.274)	72	09/96→07/03						
V 280 (638.244, 638.294)	128	08/97→07/03	←	09/97→			24.0122-0162.1 422162	Ø 276 22 19 V + S
			→	09/97→			24.0322-0162.1 522162	Ø 276 22 19 V + S PD
			→	09/97→			24.0110-0228.1 410228	Ø 280 10 8 + S
MERCEDES-BENZ - V-KLASSE (W447) 03/14→								
 Bremsbelagsatz, Scheibenbremse								
V 200 CDI / d (447.811, 447.813, 447.815)	100	03/14→	←				13.0460-4826.2 604826	BRE 29192 20,7 + WE / - WK + Zub
			→				13.0460-4877.2 604877	BRE 29192 20,3 + WE / - WK + Zub
							13.0460-4884.2 604884	BRE 22062 20,7 + WE / - WK
							13.0470-4884.2 LD4884	BRE 22062 20,7 + WE / - WK Ceramic
							13.0460-4882.2 604882	BRE 22102 18,2 + WE / - WK
						13.0470-4882.2 LD4882	BRE 22102 18,2 + WE / - WK Ceramic	
V 200 CDI / d 4-matic	100	04/15→	←				13.0460-4884.2 604884	BRE 22062 20,7 + WE / - WK
V 220 CDI / d (447.811, 447.813, 447.815)	120	03/14→					13.0470-4884.2 LD4884	BRE 22062 20,7 + WE / - WK Ceramic
V 220 CDI / d 4-matic	120	04/15→	→				13.0460-4882.2 604882	BRE 22102 18,2 + WE / - WK
V 250 BlueTEC / d (447.811, 447.813, 447.815)	140	03/14→					13.0470-4882.2 LD4882	BRE 22102 18,2 + WE / - WK Ceramic
V 250 BlueTEC / d 4-matic	140	12/14→						
Warnkontakt, Bremsbelagverschleiß								
V 200 CDI / d (447.811, 447.813, 447.815)	100	03/14→	←		1	24.8190-0424.2 620424	L= 103,2	
V 200 CDI / d 4-matic ↓	100	04/15→						









	kw			 	! #		
MERCEDES-BENZ - V-KLASSE (W447) 03/14→							
Warnkontakt, Bremsbelagverschleiß							
V 220 CDI / d (447.811, 447.813, 447.815)	120	03/14→	←		1	24.8190-0424.2 620424	L= 103,2
V 220 CDI / d 4-matic	120	04/15→					
V 250 BlueTEC / d (447.811, 447.813, 447.815)	140	03/14→					
V 250 BlueTEC / d 4-matic	140	12/14→					
 Brems Scheibe							
V 200 CDI / d (447.811, 447.813, 447.815)	100	03/14→	←	für Stahlfelgen		24.0128-0145.1 428145	Ø 300 28 25 V + S
V 200 CDI / d 4-matic	100	04/15→	→	für Leichtmetallfelgen		24.0112-0213.1 412213	Ø 300 12 9 + S
V 220 CDI / d (447.811, 447.813, 447.815)	120	03/14→					
V 220 CDI / d 4-matic	120	04/15→					
V 250 BlueTEC / d (447.811, 447.813, 447.815)	140	03/14→					
V 250 BlueTEC / d 4-matic	140	12/14→					
MG - EXPRESS Kasten 03/03→05/05							
 Bremsbelagsatz, Scheibenbremse							
1.4	76	03/03→05/05	←			13.0460-2803.2 602803	TRW 21515 17,5 + WK
1.8	86	03/03→05/05	→			13.0460-5998.2 605998	AKE 21312 12,8 + WK
2.0 TD	74	03/03→05/05					
2.0 TD	83	03/03→05/05					
160	118	03/03→05/05	←			13.0460-5825.2 605825	TRW 23094 16,5 + WK + Zub
			→			13.0460-5929.2 605929	AKE 21719 15,0 + WK
Zubehörsatz, Scheibenbremsbelag							
1.4	76	03/03→05/05	←			13.0460-0142.2 610142	
1.8	86	03/03→05/05					
2.0 TD	74	03/03→05/05					
2.0 TD	83	03/03→05/05					
 Brems Scheibe							
1.4	76	03/03→05/05	←			24.0113-0198.1 413198	Ø 262 13 11
1.8	86	03/03→05/05				24.0121-0105.1 421105	Ø 262 21 19 V + S
2.0 TD	74	03/03→05/05	→			24.0110-0212.1 410212	Ø 238,5 10 8 + S
2.0 TD	83	03/03→05/05					
160	118	03/03→05/05	←			24.0125-0161.1 425161	Ø 282 25 23 V
			→			24.0110-0326.1 410326	Ø 260 10 8
MG - MGF (RD) 03/95→03/02							
 Bremsbelagsatz, Scheibenbremse							
1.6	82	02/00→03/02	←			13.0460-2804.2 602804	TRW 21518 17,0 - WK
1.8 i 16V	88	03/95→03/02					
1.8 i VVC	107	03/95→03/02					
 Brems Scheibe							
1.6	82	02/00→03/02	←			24.0122-0177.1 422177	Ø 240,5 22 20 V
1.8 i 16V	88	03/95→03/02					
1.8 i VVC	107	03/95→03/02					
MG - MG TF 03/02→12/09							
 Bremsbelagsatz, Scheibenbremse							
115	85	03/02→12/09	←	→ 12/05		13.0460-2804.2 602804	TRW 21518 17,0 - WK
120	88	03/02→12/09					
135	100	03/02→12/09					
 Brems Scheibe							
115	85	03/02→12/09	←	→ 12/05		24.0122-0177.1 422177	Ø 240,5 22 20 V
120	88	03/02→12/09					
135	100	03/02→12/09					
MG - MG ZR 06/01→04/05							
 Bremsbelagsatz, Scheibenbremse							
105	76	06/01→04/05	←			13.0460-2803.2 602803	TRW 21515 17,5 + WK
120	86	06/01→04/05	→			13.0460-5998.2 605998	AKE 21312 12,8 + WK
2.0 TD	74	06/01→04/05					
160	118	06/01→04/05	←			13.0460-5825.2 605825	TRW 23094 16,5 + WK + Zub
↓							









	kW					! #		
MG - MG ZR 06/01→04/05								
 Bremsbelagsatz, Scheibenbremse								
160	118	06/01→04/05	➔			13.0460-5929.2	605929	AKE 21719 15,0 + WK
Zubehörsatz, Scheibenbremsbelag								
105	76	06/01→04/05	➔			13.0460-0142.2	610142	
120	86	06/01→04/05						
2.0 TD	74	06/01→04/05						
 Bremsscheibe								
105	76	06/01→04/05	➔			24.0113-0198.1	413198	Ø 262 13 11
120	86	06/01→04/05				24.0121-0105.1	421105	Ø 262 21 19 V + S
2.0 TD	74	06/01→04/05	➔			24.0110-0212.1	410212	Ø 238,5 10 8 + S
160	118	06/01→04/05	➔			24.0125-0161.1	425161	Ø 282 25 23 V
			➔			24.0110-0326.1	410326	Ø 260 10 8
MG - MG ZS 07/01→04/05								
 Bremsbelagsatz, Scheibenbremse								
120	86	07/01→04/05	➔			13.0460-5825.2	605825	TRW 23094 16,5 + WK + Zub
180	130	07/01→04/05						
2.0 TD	74	01/04→04/05						
2.0 TD	83	01/04→04/05						
 Bremsscheibe								
120	86	07/01→04/05	➔			24.0125-0161.1	425161	Ø 282 25 23 V
180	130	07/01→04/05						
2.0 TD	74	01/04→04/05	➔			24.0110-0326.1	410326	Ø 260 10 8
2.0 TD	83	01/04→04/05						
MG - MG ZS Hatchback 07/01→10/05								
 Bremsbelagsatz, Scheibenbremse								
120	86	07/01→10/05	➔			13.0460-5825.2	605825	TRW 23094 16,5 + WK + Zub
180	130	07/01→10/05						
2.0 TD	74	01/04→10/05						
2.0 TD	83	01/04→10/05						
 Bremsscheibe								
120	86	07/01→10/05	➔			24.0125-0161.1	425161	Ø 282 25 23 V
180	130	07/01→10/05						
2.0 TD	74	01/04→10/05	➔			24.0110-0326.1	410326	Ø 260 10 8
2.0 TD	83	01/04→10/05						
MG - MG ZT 06/01→07/05								
 Bremsbelagsatz, Scheibenbremse								
1.8 T 16V	118	01/03→07/05	➔	für Bremsscheibendurchmesser [mm]:		13.0460-7144.2	607144	ATE 23112 19,1 + WE / - WK
160	118	06/01→07/05		284				
180	130	01/03→07/05	➔			13.0460-3605.2	603605	ATE 20180 17,3 + WE / - WK
2.0 CDTi	85	06/02→09/03				13.0470-3605.2	LD3605	ATE 20180 17,3 + WE / - WK
2.0 CDTi	96	11/02→07/05						Ceramic
190	140	06/01→07/05	➔	für Bremsscheibendurchmesser [mm]:		13.0460-7155.2	607155	ATE 21676 20,3 + WE / - WK
				325		13.0470-7155.2	LD7155	ATE 21676 20,3 + WE / - WK
			➔			13.0460-3605.2	603605	ATE 20180 17,3 + WE / - WK
						13.0470-3605.2	LD3605	ATE 20180 17,3 + WE / - WK
								Ceramic
260	191	10/03→07/05	➔	für Bremsscheibendurchmesser [mm]:		13.0460-7155.2	607155	ATE 21676 20,3 + WE / - WK
				325		13.0470-7155.2	LD7155	ATE 21676 20,3 + WE / - WK
								Ceramic
Warnkontakt, Bremsbelagverschleiß								
1.8 T 16V	118	01/03→07/05	➔	für Bremsscheibendurchmesser [mm]:	1	24.8190-2801.2	622801	L= 1.103
160	118	06/01→07/05		284				
180	130	01/03→07/05	➔		1	24.8190-2802.2	622802	L= 846
2.0 CDTi	85	06/02→09/03						
2.0 CDTi	96	11/02→07/05						
190	140	06/01→07/05	➔	für Bremsscheibendurchmesser [mm]:	1	24.8190-2801.2	622801	L= 1.103
260	191	10/03→07/05		325				
			➔		1	24.8190-2802.2	622802	L= 846
 Bremsscheibe								
1.8 T 16V	118	01/03→07/05	➔			24.0122-0206.1	422206	Ø 284 22 19 V
160	118	06/01→07/05						
↓								









	kw			 	! #		
MG - MG ZT 06/01→07/05							
 Bremsscheibe							
180 2.0 CDTi 2.0 CDTi	130 85 96	01/03→07/05 06/02→09/03 11/02→07/05	➔			24.0110-0270.1 410270	Ø 280 10 8
190	140	06/01→07/05	➔			24.0110-0270.1 410270	Ø 280 10 8
MG - MG ZT- T 10/01→07/05							
 Bremsbelagsatz, Scheibenbremse							
1.8 T 16V 160 180 2.0 CDTi	118 118 130 96	01/03→07/05 10/01→07/05 01/03→07/05 11/02→07/05	←	für Bremsscheibendurchmesser [mm]: 284		13.0460-7144.2 607144	ATE 23112 19,1 + WE / - WK
			➔			13.0460-3605.2 603605 13.0470-3605.2 LD3605	ATE 20180 17,3 + WE / - WK ATE 20180 17,3 + WE / - WK Ceramic
190	140	10/01→07/05	←	für Bremsscheibendurchmesser [mm]: 325		13.0460-7155.2 607155 13.0470-7155.2 LD7155	ATE 21676 20,3 + WE / - WK ATE 21676 20,3 + WE / - WK Ceramic
			➔			13.0460-3605.2 603605 13.0470-3605.2 LD3605	ATE 20180 17,3 + WE / - WK ATE 20180 17,3 + WE / - WK Ceramic
2.0 CDTi	85	06/02→07/05	←	→ 09/03; für Bremsscheibendurchmesser [mm]: 284		13.0460-7144.2 607144	ATE 23112 19,1 + WE / - WK
			➔	→ 09/03		13.0460-3605.2 603605 13.0470-3605.2 LD3605	ATE 20180 17,3 + WE / - WK ATE 20180 17,3 + WE / - WK Ceramic
260	191	10/03→07/05	←	für Bremsscheibendurchmesser [mm]: 325		13.0460-7155.2 607155 13.0470-7155.2 LD7155	ATE 21676 20,3 + WE / - WK ATE 21676 20,3 + WE / - WK Ceramic
Warnkontakt, Bremsbelagverschleiß							
1.8 T 16V 160 180 2.0 CDTi	118 118 130 96	01/03→07/05 10/01→07/05 01/03→07/05 11/02→07/05	←	für Bremsscheibendurchmesser [mm]: 284	1	24.8190-2801.2 622801	L= 1.103
			➔		1	24.8190-2802.2 622802	L= 846
190 260	140 191	10/01→07/05 10/03→07/05	←	für Bremsscheibendurchmesser [mm]: 325	1	24.8190-2801.2 622801	L= 1.103
			➔		1	24.8190-2802.2 622802	L= 846
2.0 CDTi	85	06/02→07/05	←	→ 09/03; für Bremsscheibendurchmesser [mm]: 284	1	24.8190-2801.2 622801	L= 1.103
			➔	→ 09/03	1	24.8190-2802.2 622802	L= 846
 Bremsscheibe							
1.8 T 16V 160 180 2.0 CDTi	118 118 130 96	01/03→07/05 10/01→07/05 01/03→07/05 11/02→07/05	←	für Bremsscheibendurchmesser [mm]: 284		24.0122-0206.1 422206	Ø 284 22 19 V
			➔			24.0110-0270.1 410270	Ø 280 10 8
190	140	10/01→07/05	➔			24.0110-0270.1 410270	Ø 280 10 8
2.0 CDTi	85	06/02→07/05	←	→ 09/03; für Bremsscheibendurchmesser [mm]: 284		24.0122-0206.1 422206	Ø 284 22 19 V
			➔	→ 09/03		24.0110-0270.1 410270	Ø 280 10 8
MINI - MINI (F55) 09/13→							
 Bremsbelagsatz, Scheibenbremse							
Cooper Cooper D One One D	100 85 75 70	09/13→ 10/13→ 02/14→ 02/14→	←	10/14→		13.0460-2795.2 602795 13.0470-2795.2 LD2795	TRW 23915 17,6 + WE / - WK + Zub TRW + WE / - WK + Zub Ceramic
			➔	10/14→		13.0460-2797.2 602797 13.0470-2797.2 LD2797	MAN 25980 16,8 + WE / - WK + Zub MAN 25980 16,8 + WE / - WK + Zub Ceramic
Cooper S Cooper S Cooper SD Cooper SD	120 141 120 125	09/13→ 09/13→ 09/13→ 09/13→	➔	10/14→		13.0460-2797.2 602797 13.0470-2797.2 LD2797	MAN 25980 16,8 + WE / - WK + Zub MAN 25980 16,8 + WE / - WK + Zub Ceramic
One First	55	06/14→	←	03/15→		13.0460-2795.2 602795 13.0470-2795.2 LD2795	TRW 23915 17,6 + WE / - WK + Zub TRW + WE / - WK + Zub Ceramic
↓							











	kw			 	! #		
MINI - MINI (F55) 09/13→							
 Bremsbelagsatz, Scheibenbremse							
One First	55	06/14→	➡	03/15→		13.0460-2797.2 602797 13.0470-2797.2 LD2797	MAN 25980 16,8 + WE / - WK + Zub MAN 25980 16,8 + WE / - WK + Zub Ceramic
Warnkontakt, Bremsbelagsverschleiß							
Cooper	100	09/13→	⬅	☐; 10/14→	1	24.8190-0941.2 620941	L= 648
Cooper D	85	10/13→	➡	10/14→	1	24.8190-0942.2 620942	L= 641
Cooper S	120	09/13→					
Cooper S	141	09/13→					
Cooper SD	120	09/13→					
Cooper SD	125	09/13→					
One	75	02/14→					
One D	70	02/14→					
One First	55	06/14→	⬅	☐; 03/15→	1	24.8190-0941.2 620941	L= 648
			➡	03/15→	1	24.8190-0942.2 620942	L= 641
 Bremsscheibe							
Cooper	100	09/13→	⬅	10/14→		24.0122-0292.1 422292	Ø 280 22 20,4 V + S
Cooper D	85	10/13→	➡	10/14→		24.0110-0396.1 410396	Ø 259 10 8,4 + S
One	75	02/14→					
One D	70	02/14→					
Cooper S	120	09/13→	➡	10/14→		24.0110-0396.1 410396	Ø 259 10 8,4 + S
Cooper S	141	09/13→					
Cooper SD	120	09/13→					
Cooper SD	125	09/13→					
One First	55	06/14→	⬅	03/15→		24.0122-0292.1 422292	Ø 280 22 20,4 V + S
			➡	03/15→		24.0110-0396.1 410396	Ø 259 10 8,4 + S
MINI - MINI (F56) 04/13→							
 Bremsbelagsatz, Scheibenbremse							
Cooper	100	04/13→	⬅	11/13→		13.0460-2795.2 602795	TRW 23915 17,6 + WE / - WK + Zub
One	75	06/13→				13.0470-2795.2 LD2795	TRW + WE / - WK + Zub Ceramic
One D	70	07/13→	➡	11/13→		13.0460-2797.2 602797 13.0470-2797.2 LD2797	MAN 25980 16,8 + WE / - WK + Zub MAN 25980 16,8 + WE / - WK + Zub Ceramic
Cooper D	85	12/13→	⬅			13.0460-2795.2 602795 13.0470-2795.2 LD2795	TRW 23915 17,6 + WE / - WK + Zub TRW + WE / - WK + Zub Ceramic
			➡			13.0460-2797.2 602797 13.0470-2797.2 LD2797	MAN 25980 16,8 + WE / - WK + Zub MAN 25980 16,8 + WE / - WK + Zub Ceramic
Cooper S	120	04/13→	➡	11/14→		13.0460-2797.2 602797 13.0470-2797.2 LD2797	MAN 25980 16,8 + WE / - WK + Zub MAN 25980 16,8 + WE / - WK + Zub Ceramic
Cooper S	141	04/13→	➡	11/13→		13.0460-2797.2 602797 13.0470-2797.2 LD2797	MAN 25980 16,8 + WE / - WK + Zub MAN 25980 16,8 + WE / - WK + Zub Ceramic
Cooper SD	120	10/13→	➡	06/14→		13.0460-2797.2 602797 13.0470-2797.2 LD2797	MAN 25980 16,8 + WE / - WK + Zub MAN 25980 16,8 + WE / - WK + Zub Ceramic
Cooper SD	125	10/13→					
John Cooper Works	170	06/14→	➡	03/15→		13.0460-2797.2 602797 13.0470-2797.2 LD2797	MAN 25980 16,8 + WE / - WK + Zub MAN 25980 16,8 + WE / - WK + Zub Ceramic
One First	55	11/13→	⬅	06/14→		13.0460-2795.2 602795 13.0470-2795.2 LD2795	TRW 23915 17,6 + WE / - WK + Zub TRW + WE / - WK + Zub Ceramic
			➡	06/14→		13.0460-2797.2 602797 13.0470-2797.2 LD2797	MAN 25980 16,8 + WE / - WK + Zub MAN 25980 16,8 + WE / - WK + Zub Ceramic
↓							









	kW			 	! #		
MINI - MINI (F56) 04/13→							
Warnkontakt, Bremsbelagverschleiß							
Cooper	100	04/13→	←	☐; 11/13→	1	24.8190-0941.2 620941	L= 648
Cooper S	141	04/13→	→	11/13→	1	24.8190-0942.2 620942	L= 641
One	75	06/13→					
One D	70	07/13→					
Cooper D	85	12/13→	←	☐	1	24.8190-0941.2 620941	L= 648
			→		1	24.8190-0942.2 620942	L= 641
Cooper S	120	04/13→	←	☐; 11/14→	1	24.8190-0941.2 620941	L= 648
			→	11/14→	1	24.8190-0942.2 620942	L= 641
Cooper SD	120	10/13→	←	☐; 06/14→	1	24.8190-0941.2 620941	L= 648
Cooper SD	125	10/13→	→	06/14→	1	24.8190-0942.2 620942	L= 641
One First	55	11/13→					
John Cooper Works	170	06/14→	←	☐; 03/15→	1	24.8190-0941.2 620941	L= 648
			→	03/15→	1	24.8190-0942.2 620942	L= 641
 Bremsscheibe							
Cooper	100	04/13→	←	11/13→		24.0122-0292.1 422292	∅ 280 22 20,4 V + S
			→	11/13→		24.0110-0396.1 410396	∅ 259 10 8,4 + S
One	75	06/13→	→	11/13→		24.0110-0396.1 410396	∅ 259 10 8,4 + S
One D	70	07/13→					
Cooper D	85	12/13→	←			24.0122-0292.1 422292	∅ 280 22 20,4 V + S
			→			24.0110-0396.1 410396	∅ 259 10 8,4 + S
Cooper S	120	04/13→	→	11/14→		24.0110-0396.1 410396	∅ 259 10 8,4 + S
Cooper S	141	04/13→	→	11/13→		24.0110-0396.1 410396	∅ 259 10 8,4 + S
Cooper SD	120	10/13→	→	06/14→		24.0110-0396.1 410396	∅ 259 10 8,4 + S
Cooper SD	125	10/13→					
John Cooper Works	170	06/14→	→	03/15→		24.0110-0396.1 410396	∅ 259 10 8,4 + S
One First	55	11/13→	←	06/14→		24.0122-0292.1 422292	∅ 280 22 20,4 V + S
			→	06/14→		24.0110-0396.1 410396	∅ 259 10 8,4 + S
MINI - MINI (R50, R53) 06/01→09/06							
 Bremsbelagsatz, Scheibenbremse							
Cooper	85	06/01→09/06	←			13.0460-7161.2 607161	ATE 23281 18,3 + WE / - WK
Cooper S	125	07/04→09/06	→			13.0470-7161.2 LD7161	ATE 23281 18,3 + WE / - WK
One	55	04/03→09/06					
One	66	06/01→09/06	→			13.0460-7162.2 607162	ATE 23716 15,8 + WE / - WK
One D	55	06/03→09/06					
One D	65	06/03→09/06				13.0470-7162.2 LD7162	ATE 23716 15,8 + WE / - WK Ceramic
Cooper S	120	03/02→09/06	←	07/02→		13.0460-7161.2 607161	ATE 23281 18,3 + WE / - WK
			→	07/02→		13.0470-7161.2 LD7161	ATE 23281 18,3 + WE / - WK Ceramic
S Works	149	11/03→06/05	←			13.0460-2725.2 602725	TRW 23984 17,8 + WE / - WK + Zub
			→			13.0470-2725.2 LD2725	TRW 23984 17,8 + WE / - WK + Zub Ceramic
Works	155	11/03→09/06	←	03/06→		13.0460-7162.2 607162	ATE 23716 15,8 + WE / - WK
			→			13.0470-7162.2 LD7162	ATE 23716 15,8 + WE / - WK Ceramic
Works	155	11/03→09/06	←	→ 02/06		13.0460-2725.2 602725	TRW 23984 17,8 + WE / - WK + Zub
			→			13.0470-2725.2 LD2725	TRW 23984 17,8 + WE / - WK + Zub Ceramic
Works	155	11/03→09/06	←			13.0460-7162.2 607162	ATE 23716 15,8 + WE / - WK
			→			13.0470-7162.2 LD7162	ATE 23716 15,8 + WE / - WK Ceramic
Warnkontakt, Bremsbelagverschleiß							
Cooper	85	06/01→09/06	←		1	24.8190-0235.2 620235	L= 883
Cooper S	125	07/04→09/06	→		1	24.8190-0236.2 620236	L= 1.130
One	55	04/03→09/06					
One	66	06/01→09/06					
One D	55	06/03→09/06					
↓							









	kW			 	! #		
MINI - MINI (R50, R53) 06/01→09/06							
Warnkontakt, Bremsbelagverschleiß							
One D S Works	65 149	06/03→09/06 11/03→06/05	← →		1	24.8190-0235.2 620235	L= 883
					1	24.8190-0236.2 620236	L= 1.130
Cooper S	120	03/02→09/06	← →	07/02→ 07/02→	1	24.8190-0235.2 620235	L= 883
					1	24.8190-0236.2 620236	L= 1.130
Works	155	11/03→09/06	← ← →	03/06→ → 02/06	1	24.8190-0235.2 620235	L= 883
					1	24.8190-0236.2 620236	L= 1.130
 Bremsscheibe							
Cooper Cooper S One One One D One D	85 125 55 66 55 65	06/01→09/06 07/04→09/06 04/03→09/06 06/01→09/06 06/03→09/06 06/03→09/06	← →			24.0122-0204.1 422204 24.0322-0204.1 522204 24.0110-0271.1 410271 24.0310-0271.1 510271	Ø 276 22 20,4 V Ø 276 22 19,6 V PD Ø 259 10 8,4 Ø 259 10 7,6 PD
Cooper S	120	03/02→09/06	← →	07/02→ 07/02→		24.0122-0204.1 422204 24.0322-0204.1 522204 24.0110-0271.1 410271 24.0310-0271.1 510271	Ø 276 22 20,4 V Ø 276 22 19,6 V PD Ø 259 10 8,4 Ø 259 10 7,6 PD
S Works Works	149 155	11/03→06/05 11/03→09/06	← →			24.0122-0244.1 422244 24.0110-0271.1 410271 24.0310-0271.1 510271	Ø 294 22 20,4 V Ø 259 10 8,4 Ø 259 10 7,6 PD
MINI - MINI (R56) 11/05→11/13							
 Bremsbelagsatz, Scheibenbremse							
Cooper Cooper D One One One D	85 82 55 72 66	03/10→11/13 06/10→11/13 03/10→11/13 03/10→11/13 07/10→11/13	← →			13.0460-2710.2 602710 13.0470-2710.2 LD2710	TRW 23915 17,6 + WE / - WK + Zub TRW 23915 17,6 + WE / - WK + Zub Ceramic
				09/10→		13.0460-2714.2 602714 13.0470-2714.2 LD2714	TRW 24289 16,9 + WE / - WK + Zub TRW 24289 16,9 + WE / - WK + Zub Ceramic
				→ 08/10		13.0460-2714.2 602714 13.0470-2714.2 LD2714	TRW 24289 16,9 + WE / - WK + Zub TRW 24289 16,9 + WE / - WK + Zub Ceramic
Cooper	88	10/06→02/12	← →	11/06→ 11/06→ 08/10		13.0460-2710.2 602710 13.0470-2710.2 LD2710 13.0460-2714.2 602714 13.0470-2714.2 LD2714	TRW 23915 17,6 + WE / - WK + Zub TRW 23915 17,6 + WE / - WK + Zub Ceramic TRW 24289 16,9 + WE / - WK + Zub TRW 24289 16,9 + WE / - WK + Zub Ceramic
				09/10→		13.0460-2714.2 602714 13.0470-2714.2 LD2714	TRW 24289 16,9 + WE / - WK + Zub TRW 24289 16,9 + WE / - WK + Zub Ceramic
Cooper	90	09/09→11/13	← →	03/10→ 09/10→		13.0460-2710.2 602710 13.0470-2710.2 LD2710 13.0460-2714.2 602714 13.0470-2714.2 LD2714	TRW 23915 17,6 + WE / - WK + Zub TRW 23915 17,6 + WE / - WK + Zub Ceramic TRW 24289 16,9 + WE / - WK + Zub TRW 24289 16,9 + WE / - WK + Zub Ceramic
				03/10→ 08/10		13.0460-2714.2 602714 13.0470-2714.2 LD2714	TRW 24289 16,9 + WE / - WK + Zub TRW 24289 16,9 + WE / - WK + Zub Ceramic
Cooper D	80	11/06→09/10	← →	04/07→ 04/07→ 08/10		13.0460-2710.2 602710 13.0470-2710.2 LD2710 13.0460-2714.2 602714	TRW 23915 17,6 + WE / - WK + Zub TRW 23915 17,6 + WE / - WK + Zub Ceramic TRW 24289 16,9 + WE / - WK + Zub
↓							









	kW			 	! #		
MINI - MINI (R56) 11/05→11/13							
 Bremsbelagsatz, Scheibenbremse							
Cooper D	80	11/06→09/10	➡	04/07→ 08/10		13.0470-2714.2 LD2714	TRW 24289 16,9 + WE / - WK + Zub Ceramic
			➡	09/10→		13.0460-2714.2 602714	TRW 24289 16,9 + WE / - WK + Zub
Cooper D Cooper SD Cooper SD One	82 100 105 55	02/11→11/13 02/11→11/13 02/11→11/13 03/09→03/10	←			13.0460-2710.2 602710	TRW 23915 17,6 + WE / - WK + Zub
			➡			13.0470-2710.2 LD2710	TRW 23915 17,6 + WE / - WK + Zub Ceramic
Cooper D Cooper SD Cooper SD One	82 100 105 55	02/11→11/13 02/11→11/13 02/11→11/13 03/09→03/10	➡			13.0460-2714.2 602714	TRW 24289 16,9 + WE / - WK + Zub
			➡			13.0470-2714.2 LD2714	TRW 24289 16,9 + WE / - WK + Zub Ceramic
Cooper S Cooper S	120 135	03/10→11/13 03/10→11/13	←			13.0460-2725.2 602725	TRW 23984 17,8 + WE / - WK + Zub
			➡	09/10→		13.0460-2714.2 602714	TRW 24289 16,9 + WE / - WK + Zub
			➡	→ 08/10		13.0470-2714.2 LD2714	TRW 24289 16,9 + WE / - WK + Zub Ceramic
Cooper S Cooper S	120 135	03/10→11/13 03/10→11/13	←			13.0460-2725.2 602725	TRW 23984 17,8 + WE / - WK + Zub
			➡	09/10→		13.0460-2714.2 602714	TRW 24289 16,9 + WE / - WK + Zub
			➡	→ 08/10		13.0470-2714.2 LD2714	TRW 24289 16,9 + WE / - WK + Zub Ceramic
Cooper S	128	10/06→01/11	←	11/06→		13.0460-2725.2 602725	TRW 23984 17,8 + WE / - WK + Zub
			➡	11/06→ 08/10		13.0460-2714.2 602714	TRW 24289 16,9 + WE / - WK + Zub
			➡	09/10→		13.0470-2714.2 LD2714	TRW 24289 16,9 + WE / - WK + Zub Ceramic
Cooper S	128	10/06→01/11	←			13.0460-2725.2 602725	TRW 23984 17,8 + WE / - WK + Zub
			➡			13.0460-2714.2 602714	TRW 24289 16,9 + WE / - WK + Zub
			➡			13.0470-2714.2 LD2714	TRW 24289 16,9 + WE / - WK + Zub Ceramic
John Cooper Works John Cooper Works	141 155	11/06→12/11 11/07→11/13	➡	03/08→ 08/10		13.0460-2714.2 602714	TRW 24289 16,9 + WE / - WK + Zub
			➡	09/10→		13.0460-2714.2 602714	TRW 24289 16,9 + WE / - WK + Zub
John Cooper Works John Cooper Works	141 155	11/06→12/11 11/07→11/13	➡			13.0470-2714.2 LD2714	TRW 24289 16,9 + WE / - WK + Zub Ceramic
			➡			13.0470-2714.2 LD2714	TRW 24289 16,9 + WE / - WK + Zub Ceramic
John Cooper Works GP	160	09/12→11/13	➡			13.0460-2714.2 602714	TRW 24289 16,9 + WE / - WK + Zub
John Cooper Works GP	160	09/12→11/13	➡			13.0470-2714.2 LD2714	TRW 24289 16,9 + WE / - WK + Zub Ceramic
One	70	11/06→03/10	←	04/07→		13.0460-2710.2 602710	TRW 23915 17,6 + WE / - WK + Zub
			➡	04/07→		13.0460-2714.2 602714	TRW 24289 16,9 + WE / - WK + Zub
One One	70	11/06→03/10	➡			13.0470-2710.2 LD2710	TRW 23915 17,6 + WE / - WK + Zub Ceramic
			➡			13.0470-2714.2 LD2714	TRW 24289 16,9 + WE / - WK + Zub Ceramic
One D	66	06/09→07/10	←	03/10→		13.0460-2710.2 602710	TRW 23915 17,6 + WE / - WK + Zub
			➡			13.0470-2710.2 LD2710	TRW 23915 17,6 + WE / - WK + Zub Ceramic
↓							

	kw			 	! #		
MINI - MINI (R56) 11/05→11/13							
 Bremsbelagsatz, Scheibenbremse							
One D	66	06/09→07/10	➡	03/10→		13.0460-2714.2 602714 13.0470-2714.2 LD2714	TRW 24289 16,9 + WE / - WK + Zub TRW 24289 16,9 + WE / - WK + Zub Ceramic
Warnkontakt, Bremsbelagverschleiß							
Cooper	85	03/10→11/13	←		1	24.8190-0277.2 620277	L= 802
Cooper D	82	06/10→11/13	➡	09/10→	1	24.8190-0010.2 620010	L= 1.141
Cooper S	120	03/10→11/13	➡	→ 08/10	1	24.8190-0278.2 620278	L= 1.130
Cooper S	135	03/10→11/13	➡				
One	55	03/10→11/13	➡				
One	72	03/10→11/13	➡				
One D	66	07/10→11/13	➡				
Cooper	88	10/06→02/12	←	11/06→	1	24.8190-0277.2 620277	L= 802
Cooper S	128	10/06→01/11	➡	09/10→	1	24.8190-0010.2 620010	L= 1.141
			➡	11/06→ 08/10	1	24.8190-0278.2 620278	L= 1.130
Cooper	90	09/09→11/13	←	03/10→	1	24.8190-0277.2 620277	L= 802
			➡	09/10→	1	24.8190-0010.2 620010	L= 1.141
			➡	03/10→ 08/10	1	24.8190-0278.2 620278	L= 1.130
Cooper D	80	11/06→09/10	←	04/07→	1	24.8190-0277.2 620277	L= 802
			➡	09/10→	1	24.8190-0010.2 620010	L= 1.141
			➡	04/07→ 08/10	1	24.8190-0278.2 620278	L= 1.130
Cooper D	82	02/11→11/13	←		1	24.8190-0277.2 620277	L= 802
Cooper S	147	01/12→11/13	➡		1	24.8190-0010.2 620010	L= 1.141
Cooper SD	100	02/11→11/13	➡				
Cooper SD	105	02/11→11/13	➡				
John Cooper Works GP	160	09/12→11/13	➡				
John Cooper Works	141	11/06→12/11	←	03/08→	1	24.8190-0277.2 620277	L= 802
John Cooper Works	155	11/07→11/13	➡	09/10→	1	24.8190-0010.2 620010	L= 1.141
			➡	03/08→ 08/10	1	24.8190-0278.2 620278	L= 1.130
One	55	03/09→03/10	←		1	24.8190-0277.2 620277	L= 802
			➡		1	24.8190-0278.2 620278	L= 1.130
One	70	11/06→03/10	←	04/07→	1	24.8190-0277.2 620277	L= 802
			➡	04/07→	1	24.8190-0278.2 620278	L= 1.130
One D	66	06/09→07/10	←	03/10→	1	24.8190-0277.2 620277	L= 802
			➡	03/10→	1	24.8190-0278.2 620278	L= 1.130
 Bremsscheibe							
Cooper	85	03/10→11/13	←			24.0122-0248.1 422248	Ø 280 22 20,4 V
Cooper D	82	06/10→11/13	➡			24.0322-0248.1 522248	Ø 280 22 19,6 V PD
Cooper D	82	02/11→11/13	➡			24.0110-0271.1 410271	Ø 259 10 8,4
Cooper SD	100	02/11→11/13	➡				
Cooper SD	105	02/11→11/13	➡				
One	55	03/09→03/10	➡				
One	55	03/10→11/13	➡				
One	72	03/10→11/13	➡				
One D	66	07/10→11/13	➡				
Cooper	88	10/06→02/12	←	11/06→		24.0122-0248.1 422248	Ø 280 22 20,4 V
			➡	11/06→		24.0322-0248.1 522248	Ø 280 22 19,6 V PD
			➡	11/06→		24.0110-0271.1 410271	Ø 259 10 8,4
Cooper	90	09/09→11/13	←	03/10→		24.0122-0248.1 422248	Ø 280 22 20,4 V
One D	66	06/09→07/10	➡	03/10→		24.0322-0248.1 522248	Ø 280 22 19,6 V PD
			➡	03/10→		24.0110-0271.1 410271	Ø 259 10 8,4
Cooper D	80	11/06→09/10	←	04/07→		24.0122-0248.1 422248	Ø 280 22 20,4 V
One	70	11/06→03/10	➡	04/07→		24.0322-0248.1 522248	Ø 280 22 19,6 V PD
			➡	04/07→		24.0110-0271.1 410271	Ø 259 10 8,4
Cooper S	120	03/10→11/13	←			24.0122-0247.1 422247	Ø 294 22 20,4 V
Cooper S	135	03/10→11/13	➡			24.0322-0247.1 522247	Ø 294 22 19,6 V PD
Cooper S	147	01/12→11/13	➡			24.0110-0271.1 410271	Ø 259 10 8,4
Cooper S	128	10/06→01/11	←	11/06→		24.0122-0247.1 422247	Ø 294 22 20,4 V
			➡	11/06→		24.0322-0247.1 522247	Ø 294 22 19,6 V PD
			➡	11/06→		24.0110-0271.1 410271	Ø 259 10 8,4

	kW			 	! #		
MINI - MINI Cabriolet (F57) 11/14→							
 Bremsbelagsatz, Scheibenbremse							
Cooper Cooper D	100 85	11/14→ 12/14→	←	11/15→		13.0460-2795.2 602795	TRW 23915 17,6 + WE / - WK + Zub
			→	11/15→		13.0470-2795.2 LD2795	TRW + WE / - WK + Zub Ceramic
Cooper S Cooper S	120 141	11/14→ 11/14→	→	11/15→		13.0460-2797.2 602797	MAN 25980 16,8 + WE / - WK + Zub
						13.0470-2797.2 LD2797	MAN 25980 16,8 + WE / - WK + Zub Ceramic
Cooper SD Cooper SD John Cooper Works	120 125 170	05/15→ 05/15→ 05/15→	→	03/16→		13.0460-2797.2 602797	MAN 25980 16,8 + WE / - WK + Zub
						13.0470-2797.2 LD2797	MAN 25980 16,8 + WE / - WK + Zub Ceramic
One	75	06/15→	←	03/16→		13.0460-2795.2 602795	TRW 23915 17,6 + WE / - WK + Zub
			→	03/16→		13.0470-2795.2 LD2795	TRW + WE / - WK + Zub Ceramic
						13.0460-2797.2 602797	MAN 25980 16,8 + WE / - WK + Zub
						13.0470-2797.2 LD2797	MAN 25980 16,8 + WE / - WK + Zub Ceramic
Warnkontakt, Bremsbelagverschleiß							
Cooper Cooper D	100 85	11/14→ 12/14→	→	11/15→	1	24.8190-0942.2 620942	L= 641
Cooper S Cooper S	120 141	11/14→ 11/14→					
Cooper SD Cooper SD One	120 125 75	05/15→ 05/15→ 06/15→	→	03/16→	1	24.8190-0942.2 620942	L= 641
John Cooper Works	170	05/15→	←	☐; 03/16→	1	24.8190-0941.2 620941	L= 648
			→	03/16→	1	24.8190-0942.2 620942	L= 641
 Bremsscheibe							
Cooper Cooper D	100 85	11/14→ 12/14→	←	11/15→		24.0122-0292.1 422292	Ø 280 22 20,4 V + S
			→	11/15→		24.0110-0396.1 410396	Ø 259 10 8,4 + S
Cooper S Cooper S	120 141	11/14→ 11/14→	→	11/15→		24.0110-0396.1 410396	Ø 259 10 8,4 + S
Cooper SD Cooper SD John Cooper Works	120 125 170	05/15→ 05/15→ 05/15→	→	03/16→		24.0110-0396.1 410396	Ø 259 10 8,4 + S
One	75	06/15→	←	03/16→		24.0122-0292.1 422292	Ø 280 22 20,4 V + S
			→	03/16→		24.0110-0396.1 410396	Ø 259 10 8,4 + S
MINI - MINI Cabriolet (R52) 07/04→11/07							
 Bremsbelagsatz, Scheibenbremse							
Cooper Cooper S Cooper S One	85 120 125 66	07/04→11/07 07/04→11/07 07/04→11/07 07/04→11/07	←			13.0460-7161.2 607161	ATE 23281 18,3 + WE / - WK
			→			13.0470-7161.2 LD7161	ATE 23281 18,3 + WE / - WK Ceramic
John Cooper Works	155	07/04→11/07	→			13.0460-7162.2 607162	ATE 23716 15,8 + WE / - WK
						13.0470-7162.2 LD7162	ATE 23716 15,8 + WE / - WK Ceramic
John Cooper Works	155	07/04→11/07	←	06/06→		13.0460-2725.2 602725	TRW 23984 17,8 + WE / - WK + Zub
						13.0470-2725.2 LD2725	TRW 23984 17,8 + WE / - WK + Zub Ceramic
			←	→ 05/06		13.0460-2725.2 602725	TRW 23984 17,8 + WE / - WK + Zub
						13.0470-2725.2 LD2725	TRW 23984 17,8 + WE / - WK + Zub Ceramic
John Cooper Works	155	07/04→11/07	→			13.0460-7162.2 607162	ATE 23716 15,8 + WE / - WK
						13.0470-7162.2 LD7162	ATE 23716 15,8 + WE / - WK Ceramic
Warnkontakt, Bremsbelagverschleiß							
Cooper Cooper S Cooper S ↓	85 120 125	07/04→11/07 07/04→11/07 07/04→11/07	←		1	24.8190-0235.2 620235	L= 883
			→		1	24.8190-0236.2 620236	L= 1.130

	kW			 	! #		
MINI - MINI Cabriolet (R52) 07/04→11/07							
Warnkontakt, Bremsbelagverschleiß							
One	66	07/04→11/07	←		1	24.8190-0235.2 620235	L= 883
			→		1	24.8190-0236.2 620236	L= 1.130
John Cooper Works	155	07/04→11/07	←	06/06→	1	24.8190-0235.2 620235	L= 883
			←	→ 05/06	1	24.8190-0235.2 620235	L= 883
			→		1	24.8190-0236.2 620236	L= 1.130
 Brems Scheibe							
Cooper	85	07/04→11/07	←			24.0122-0204.1 422204	Ø 276 22 20,4 V
Cooper S	120	07/04→11/07				24.0322-0204.1 522204	Ø 276 22 19,6 V PD
Cooper S	125	07/04→11/07				24.0110-0271.1 410271	Ø 259 10 8,4
One	66	07/04→11/07	→			24.0310-0271.1 510271	Ø 259 10 7,6 PD
John Cooper Works	155	07/04→11/07	←			24.0122-0244.1 422244	Ø 294 22 20,4 V
			→			24.0110-0271.1 410271	Ø 259 10 8,4
						24.0310-0271.1 510271	Ø 259 10 7,6 PD
MINI - MINI Cabriolet (R57) 10/07→06/15							
 Bremsbelagsatz, Scheibenbremse							
Cooper	85	10/07→06/10	←	01/09→		13.0460-2710.2 602710	TRW 23915 17,6 + WE / - WK + Zub
						13.0470-2710.2 LD2710	TRW 23915 17,6 + WE / - WK + Zub Ceramic
			→	01/09→		13.0460-2714.2 602714	TRW 24289 16,9 + WE / - WK + Zub
						13.0470-2714.2 LD2714	TRW 24289 16,9 + WE / - WK + Zub Ceramic
Cooper	88	10/07→06/15	←	01/09→ 06/14		13.0460-2710.2 602710	TRW 23915 17,6 + WE / - WK + Zub
						13.0470-2710.2 LD2710	TRW 23915 17,6 + WE / - WK + Zub Ceramic
			→	09/10→ 06/14		13.0460-2714.2 602714	TRW 24289 16,9 + WE / - WK + Zub
						13.0470-2714.2 LD2714	TRW 24289 16,9 + WE / - WK + Zub Ceramic
			→	01/09→ 08/10		13.0460-2714.2 602714	TRW 24289 16,9 + WE / - WK + Zub
						13.0470-2714.2 LD2714	TRW 24289 16,9 + WE / - WK + Zub Ceramic
Cooper One	90 72	09/09→06/15 09/09→06/15	←	03/10→ 06/14		13.0460-2710.2 602710	TRW 23915 17,6 + WE / - WK + Zub
						13.0470-2710.2 LD2710	TRW 23915 17,6 + WE / - WK + Zub Ceramic
			→	09/10→ 06/14		13.0460-2714.2 602714	TRW 24289 16,9 + WE / - WK + Zub
						13.0470-2714.2 LD2714	TRW 24289 16,9 + WE / - WK + Zub Ceramic
			→	03/10→ 08/10		13.0460-2714.2 602714	TRW 24289 16,9 + WE / - WK + Zub
						13.0470-2714.2 LD2714	TRW 24289 16,9 + WE / - WK + Zub Ceramic
Cooper D	82	05/09→11/13	←	06/10→		13.0460-2710.2 602710	TRW 23915 17,6 + WE / - WK + Zub
						13.0470-2710.2 LD2710	TRW 23915 17,6 + WE / - WK + Zub Ceramic
			→	06/10→ 08/10		13.0460-2714.2 602714	TRW 24289 16,9 + WE / - WK + Zub
						13.0470-2714.2 LD2714	TRW 24289 16,9 + WE / - WK + Zub Ceramic
			→	09/10→		13.0460-2714.2 602714	TRW 24289 16,9 + WE / - WK + Zub
						13.0470-2714.2 LD2714	TRW 24289 16,9 + WE / - WK + Zub Ceramic
Cooper D	82	02/11→05/15	←	→ 06/14		13.0460-2710.2 602710	TRW 23915 17,6 + WE / - WK + Zub
						13.0470-2710.2 LD2710	TRW 23915 17,6 + WE / - WK + Zub Ceramic
			→	→ 06/14		13.0460-2714.2 602714	TRW 24289 16,9 + WE / - WK + Zub

	kw			 	! #		
MINI - MINI Cabriolet (R57) 10/07→06/15							
 Bremsbelagsatz, Scheibenbremse							
Cooper D	82	02/11→05/15	➡	→ 06/14		13.0470-2714.2 LD2714	TRW 24289 16,9 + WE / - WK + Zub Ceramic
Cooper S	120	10/07→06/15	⬅	01/09→ 06/14		13.0460-2725.2 602725	TRW 23984 17,8 + WE / - WK + Zub
						13.0470-2725.2 LD2725	TRW 23984 17,8 + WE / - WK + Zub Ceramic
			➡	09/10→ 06/14		13.0460-2714.2 602714	TRW 24289 16,9 + WE / - WK + Zub
						13.0470-2714.2 LD2714	TRW 24289 16,9 + WE / - WK + Zub Ceramic
			➡	01/09→ 08/10		13.0460-2714.2 602714	TRW 24289 16,9 + WE / - WK + Zub
						13.0470-2714.2 LD2714	TRW 24289 16,9 + WE / - WK + Zub Ceramic
Cooper S	128	11/07→07/10	⬅	01/09→		13.0460-2725.2 602725	TRW 23984 17,8 + WE / - WK + Zub
						13.0470-2725.2 LD2725	TRW 23984 17,8 + WE / - WK + Zub Ceramic
			➡	01/09→		13.0460-2714.2 602714	TRW 24289 16,9 + WE / - WK + Zub
						13.0470-2714.2 LD2714	TRW 24289 16,9 + WE / - WK + Zub Ceramic
Cooper S Cooper S	135 147	06/09→06/15 06/09→06/15	⬅	03/10→ 06/14		13.0460-2725.2 602725	TRW 23984 17,8 + WE / - WK + Zub
						13.0470-2725.2 LD2725	TRW 23984 17,8 + WE / - WK + Zub Ceramic
			➡	09/10→ 06/14		13.0460-2714.2 602714	TRW 24289 16,9 + WE / - WK + Zub
						13.0470-2714.2 LD2714	TRW 24289 16,9 + WE / - WK + Zub Ceramic
			➡	03/10→ 08/10		13.0460-2714.2 602714	TRW 24289 16,9 + WE / - WK + Zub
						13.0470-2714.2 LD2714	TRW 24289 16,9 + WE / - WK + Zub Ceramic
Cooper SD	105	06/09→05/15	⬅	02/11→ 06/14		13.0460-2710.2 602710	TRW 23915 17,6 + WE / - WK + Zub
						13.0470-2710.2 LD2710	TRW 23915 17,6 + WE / - WK + Zub Ceramic
			➡	02/11→ 06/14		13.0460-2714.2 602714	TRW 24289 16,9 + WE / - WK + Zub
						13.0470-2714.2 LD2714	TRW 24289 16,9 + WE / - WK + Zub Ceramic
John Cooper Works	155	08/08→05/15	➡	09/10→ 06/14		13.0460-2714.2 602714	TRW 24289 16,9 + WE / - WK + Zub
						13.0470-2714.2 LD2714	TRW 24289 16,9 + WE / - WK + Zub Ceramic
			➡	03/09→ 08/10		13.0460-2714.2 602714	TRW 24289 16,9 + WE / - WK + Zub
						13.0470-2714.2 LD2714	TRW 24289 16,9 + WE / - WK + Zub Ceramic
Warnkontakt, Bremsbelagsverschleiß							
Cooper Cooper S	85 128	10/07→06/10 11/07→07/10	⬅	01/09→	1	24.8190-0277.2 620277	L= 802
			➡	01/09→	1	24.8190-0278.2 620278	L= 1.130
Cooper Cooper S	88 120	10/07→06/15 10/07→06/15	⬅	01/09→ 06/14	1	24.8190-0277.2 620277	L= 802
			➡	09/10→ 06/14	1	24.8190-0010.2 620010	L= 1.141
			➡	01/09→ 08/10	1	24.8190-0278.2 620278	L= 1.130
Cooper Cooper S Cooper S One	90 135 147 72	09/09→06/15 06/09→06/15 06/09→06/15 09/09→06/15	⬅	03/10→ 06/14	1	24.8190-0277.2 620277	L= 802
			➡	09/10→ 06/14	1	24.8190-0010.2 620010	L= 1.141
			➡	03/10→ 08/10	1	24.8190-0278.2 620278	L= 1.130
Cooper D	82	05/09→11/13	⬅	06/10→	1	24.8190-0277.2 620277	L= 802
			➡	09/10→	1	24.8190-0010.2 620010	L= 1.141
			➡	06/10→ 08/10	1	24.8190-0278.2 620278	L= 1.130
Cooper D	82	02/11→05/15	⬅	→ 06/14	1	24.8190-0277.2 620277	L= 802
			➡	→ 06/14	1	24.8190-0010.2 620010	L= 1.141
Cooper SD ↓	105	06/09→05/15	⬅	02/11→ 06/14	1	24.8190-0277.2 620277	L= 802

	kw			 	! #		
MINI - MINI Cabriolet (R57) 10/07→06/15							
Warnkontakt, Bremsbelagverschleiß							
Cooper SD	105	06/09→05/15	➡	02/11→ 06/14	1	24.8190-0010.2 620010	L= 1.141
John Cooper Works	155	08/08→05/15	⬅	03/09→ 06/14	1	24.8190-0277.2 620277	L= 802
			➡	09/10→ 06/14	1	24.8190-0010.2 620010	L= 1.141
			➡	03/09→ 08/10	1	24.8190-0278.2 620278	L= 1.130
 Bremsscheibe							
Cooper	85	10/07→06/10	⬅	01/09→		24.0122-0248.1 422248	Ø 280 22 20,4 V
			➡	01/09→		24.0322-0248.1 522248	Ø 280 22 19,6 V PD
Cooper	88	10/07→06/15	⬅	01/09→ 06/14		24.0122-0248.1 422248	Ø 280 22 20,4 V
			➡	01/09→ 06/14		24.0322-0248.1 522248	Ø 280 22 19,6 V PD
Cooper One	90 72	09/09→06/15 09/09→06/15	⬅	03/10→ 06/14		24.0122-0248.1 422248	Ø 280 22 20,4 V
			➡	03/10→ 06/14		24.0322-0248.1 522248	Ø 280 22 19,6 V PD
Cooper D	82	05/09→11/13	⬅	06/10→		24.0122-0248.1 422248	Ø 280 22 20,4 V
			➡	06/10→		24.0322-0248.1 522248	Ø 280 22 19,6 V PD
Cooper D	82	02/11→05/15	⬅	→ 06/14		24.0122-0248.1 422248	Ø 280 22 20,4 V
			➡	→ 06/14		24.0322-0248.1 522248	Ø 280 22 19,6 V PD
Cooper S	120	10/07→06/15	⬅	01/09→ 06/14		24.0122-0247.1 422247	Ø 294 22 20,4 V
			➡	01/09→ 06/14		24.0322-0247.1 522247	Ø 294 22 19,6 V PD
Cooper S	128	11/07→07/10	⬅	01/09→		24.0122-0247.1 422247	Ø 294 22 20,4 V
			➡	01/09→		24.0322-0247.1 522247	Ø 294 22 19,6 V PD
Cooper S Cooper S	135 147	06/09→06/15 06/09→06/15	⬅	03/10→ 06/14		24.0122-0247.1 422247	Ø 294 22 20,4 V
			➡	03/10→ 06/14		24.0322-0247.1 522247	Ø 294 22 19,6 V PD
Cooper SD	105	06/09→05/15	⬅	02/11→ 06/14		24.0122-0248.1 422248	Ø 280 22 20,4 V
			➡	02/11→ 06/14		24.0322-0248.1 522248	Ø 280 22 19,6 V PD
MINI - MINI CLUBMAN (F54) 11/14→							
 Bremsbelagsatz, Scheibenbremse							
Cooper	100	12/14→	➡	07/15→; + eFSB		13.0460-7315.2 607315	ATE 25331 16,2 + WE / - WK
Cooper D	100	12/14→				13.0470-7315.2 LD7315	ATE 25331 16,2 + WE / - WK
Cooper D	110	12/14→					Ceramic
Cooper S	120	11/14→					
Cooper S	141	11/14→					
Cooper S ALL4	120	04/15→	➡	01/16→; + eFSB		13.0460-7315.2 607315	ATE 25331 16,2 + WE / - WK
Cooper S ALL4	141	04/15→				13.0470-7315.2 LD7315	ATE 25331 16,2 + WE / - WK
Cooper SD ALL4	120	04/15→					Ceramic
Cooper SD ALL4	140	04/15→					
Cooper SD	120	02/15→	➡	11/15→; + eFSB		13.0460-7315.2 607315	ATE 25331 16,2 + WE / - WK
Cooper SD	140	02/15→				13.0470-7315.2 LD7315	ATE 25331 16,2 + WE / - WK
							Ceramic
John Cooper Works	170	11/15→	➡	+ eFSB		13.0460-7315.2 607315	ATE 25331 16,2 + WE / - WK
						13.0470-7315.2 LD7315	ATE 25331 16,2 + WE / - WK
							Ceramic
One	75	02/15→	⬅	11/15→		13.0460-2795.2 602795	TRW 23915 17,6 + WE / - WK
One D	85	02/15→					+ Zub
						13.0470-2795.2 LD2795	TRW + WE / - WK + Zub Ceramic
						13.0460-7315.2 607315	ATE 25331 16,2 + WE / - WK
						13.0470-7315.2 LD7315	ATE 25331 16,2 + WE / - WK
							Ceramic
Warnkontakt, Bremsbelagverschleiß							
Cooper	100	12/14→	➡	07/15→	1	24.8190-0942.2 620942	L= 641
Cooper D	100	12/14→					
Cooper D	110	12/14→					
Cooper S	120	11/14→					
Cooper S	141	11/14→					
↓							

MINI - MINI CLUBMAN (F54) 11/14→

Warnkontakt, Bremsbelagverschleiß

Cooper S ALL4	120	04/15→	➡	01/16→	1	24.8190-0942.2	620942	L= 641
Cooper S ALL4	141	04/15→						
Cooper SD ALL4	120	04/15→						
Cooper SD ALL4	140	04/15→						
Cooper SD	120	02/15→	➡	11/15→	1	24.8190-0942.2	620942	L= 641
Cooper SD	140	02/15→						
One	75	02/15→						
One D	85	02/15→						
John Cooper Works	170	11/15→	➡		1	24.8190-0942.2	620942	L= 641











Bremsscheibe

Cooper	100	12/14→	➡	07/15→		24.0110-0401.1	410401	Ø 280 10 8,4 + S
Cooper D	100	12/14→						
Cooper D	110	12/14→						
Cooper S	120	11/14→	⬅	07/15→		24.0124-0260.1	424260	Ø 307 24 22,4 V + S
Cooper S	141	11/14→	➡	07/15→		24.0110-0401.1	410401	Ø 280 10 8,4 + S
Cooper S ALL4	120	04/15→	⬅	01/16→		24.0124-0260.1	424260	Ø 307 24 22,4 V + S
Cooper S ALL4	141	04/15→	➡	01/16→		24.0110-0401.1	410401	Ø 280 10 8,4 + S
Cooper SD ALL4	120	04/15→						
Cooper SD ALL4	140	04/15→						
Cooper SD	120	02/15→	⬅	11/15→		24.0124-0260.1	424260	Ø 307 24 22,4 V + S
Cooper SD	140	02/15→	➡	11/15→		24.0110-0401.1	410401	Ø 280 10 8,4 + S
One	75	02/15→	⬅	07/15→		24.0122-0292.1	422292	Ø 280 22 20,4 V + S
			➡	11/15→		24.0110-0401.1	410401	Ø 280 10 8,4 + S
One D	85	02/15→	⬅	11/15→		24.0122-0292.1	422292	Ø 280 22 20,4 V + S
			➡	11/15→		24.0110-0401.1	410401	Ø 280 10 8,4 + S

MINI - MINI CLUBMAN (R55) 10/06→06/14

Bremsbelagsatz, Scheibenbremse

Cooper	85	03/10→06/14	⬅			13.0460-2710.2	602710	TRW 23915 17,6 + WE / - WK + Zub
Cooper	88	10/07→12/13						
Cooper	90	03/10→06/14				13.0470-2710.2	LD2710	TRW 23915 17,6 + WE / - WK + Zub Ceramic
Cooper D	82	03/10→06/14						
One	72	03/10→06/14						
One D	66	03/10→06/14	➡	09/10→		13.0460-2714.2	602714	TRW 24289 16,9 + WE / - WK + Zub
						13.0470-2714.2	LD2714	TRW 24289 16,9 + WE / - WK + Zub Ceramic
			➡	→ 08/10		13.0460-2714.2	602714	TRW 24289 16,9 + WE / - WK + Zub
						13.0470-2714.2	LD2714	TRW 24289 16,9 + WE / - WK + Zub Ceramic
Cooper D	80	10/07→02/10	⬅			13.0460-2710.2	602710	TRW 23915 17,6 + WE / - WK + Zub
Cooper D	82	02/11→06/14						
Cooper SD	100	02/11→06/14				13.0470-2710.2	LD2710	TRW 23915 17,6 + WE / - WK + Zub Ceramic
Cooper SD	105	02/11→06/14	➡			13.0460-2714.2	602714	TRW 24289 16,9 + WE / - WK + Zub
						13.0470-2714.2	LD2714	TRW 24289 16,9 + WE / - WK + Zub Ceramic
Cooper S	120	10/07→02/10	⬅			13.0460-2725.2	602725	TRW 23984 17,8 + WE / - WK + Zub
Cooper S	128	10/07→02/10	➡			13.0470-2725.2	LD2725	TRW 23984 17,8 + WE / - WK + Zub Ceramic
			➡			13.0460-2714.2	602714	TRW 24289 16,9 + WE / - WK + Zub
						13.0470-2714.2	LD2714	TRW 24289 16,9 + WE / - WK + Zub Ceramic
Cooper S	135	03/10→06/14	⬅			13.0460-2725.2	602725	TRW 23984 17,8 + WE / - WK + Zub
Cooper S	147	03/10→06/14	➡	→ 08/10		13.0460-2714.2	602714	TRW 24289 16,9 + WE / - WK + Zub
						13.0470-2714.2	LD2714	TRW 24289 16,9 + WE / - WK + Zub Ceramic
			➡	09/10→		13.0460-2714.2	602714	TRW 24289 16,9 + WE / - WK + Zub
						13.0470-2714.2	LD2714	TRW 24289 16,9 + WE / - WK + Zub Ceramic

	kW					! #		
MINI - MINI CLUBMAN (R55) 10/06→06/14								
 Bremsbelagsatz, Scheibenbremse								
John Cooper Works	141	10/08→02/10	➔				13.0460-2714.2 602714	TRW 24289 16,9 + WE / - WK + Zub
							13.0470-2714.2 LD2714	TRW 24289 16,9 + WE / - WK + Zub Ceramic
John Cooper Works	155	11/07→06/14	➔	03/08→08/10			13.0460-2714.2 602714	TRW 24289 16,9 + WE / - WK + Zub
							13.0470-2714.2 LD2714	TRW 24289 16,9 + WE / - WK + Zub Ceramic
			➔	09/10→			13.0460-2714.2 602714	TRW 24289 16,9 + WE / - WK + Zub
							13.0470-2714.2 LD2714	TRW 24289 16,9 + WE / - WK + Zub Ceramic
Warnkontakt, Bremsbelagverschleiß								
Cooper	85	03/10→06/14	➔			1	24.8190-0277.2 620277	L= 802
Cooper	88	10/07→12/13						
Cooper	90	03/10→06/14	➔	09/10→		1	24.8190-0010.2 620010	L= 1.141
Cooper D	82	03/10→06/14	➔	→ 08/10		1	24.8190-0278.2 620278	L= 1.130
Cooper S	135	03/10→06/14						
Cooper S	147	03/10→06/14						
One	72	03/10→06/14						
One D	66	03/10→06/14						
Cooper D	80	10/07→02/10	➔			1	24.8190-0277.2 620277	L= 802
Cooper S	120	10/07→02/10						
Cooper S	128	10/07→02/10	➔			1	24.8190-0278.2 620278	L= 1.130
John Cooper Works	141	10/08→02/10						
Cooper D	82	02/11→06/14	➔			1	24.8190-0277.2 620277	L= 802
Cooper SD	100	02/11→06/14						
Cooper SD	105	02/11→06/14	➔			1	24.8190-0010.2 620010	L= 1.141
John Cooper Works	155	11/07→06/14	➔	03/08→		1	24.8190-0277.2 620277	L= 802
			➔	09/10→		1	24.8190-0010.2 620010	L= 1.141
			➔	03/08→08/10		1	24.8190-0278.2 620278	L= 1.130
 Bremsscheibe								
Cooper	85	03/10→06/14	➔				24.0122-0248.1 422248	Ø 280 22 20,4 V
Cooper	88	10/07→12/13					24.0322-0248.1 522248	Ø 280 22 19,6 V PD
Cooper	90	03/10→06/14	➔					
Cooper D	80	10/07→02/10	➔				24.0110-0271.1 410271	Ø 259 10 8,4
Cooper D	82	03/10→06/14					24.0310-0271.1 510271	Ø 259 10 7,6 PD
Cooper D	82	02/11→06/14						
Cooper SD	100	02/11→06/14						
Cooper SD	105	02/11→06/14						
One	72	03/10→06/14						
One D	66	03/10→06/14						
Cooper S	120	10/07→02/10	➔				24.0122-0247.1 422247	Ø 294 22 20,4 V
Cooper S	128	10/07→02/10					24.0322-0247.1 522247	Ø 294 22 19,6 V PD
Cooper S	135	03/10→06/14						
Cooper S	147	03/10→06/14	➔				24.0110-0271.1 410271	Ø 259 10 8,4
							24.0310-0271.1 510271	Ø 259 10 7,6 PD
MINI - MINI CLUBVAN (R55) 12/12→06/14								
 Bremsbelagsatz, Scheibenbremse								
Cooper	90	12/12→06/14	➔				13.0460-2710.2 602710	TRW 23915 17,6 + WE / - WK + Zub
Cooper D	82	12/12→06/14					13.0470-2710.2 LD2710	TRW 23915 17,6 + WE / - WK + Zub Ceramic
One	72	12/12→06/14						
			➔				13.0460-2714.2 602714	TRW 24289 16,9 + WE / - WK + Zub
							13.0470-2714.2 LD2714	TRW 24289 16,9 + WE / - WK + Zub Ceramic
Warnkontakt, Bremsbelagverschleiß								
Cooper	90	12/12→06/14	➔			1	24.8190-0009.2 620009	L= 808
Cooper D	82	12/12→06/14						
One	72	12/12→06/14	➔			1	24.8190-0010.2 620010	L= 1.141
 Bremsscheibe								
Cooper	90	12/12→06/14	➔				24.0122-0248.1 422248	Ø 280 22 20,4 V
Cooper D	82	12/12→06/14					24.0322-0248.1 522248	Ø 280 22 19,6 V PD
One	72	12/12→06/14	➔				24.0110-0271.1 410271	Ø 259 10 8,4

MINI - MINI COUNTRYMAN (F60) 10/16→

Bremsbelagsatz, Scheibenbremse

Cooper	100	10/16→	→			13.0460-7315.2	607315	ATE 25331 16,2 + WE / - WK
Cooper ALL4	100	10/16→				13.0470-7315.2	LD7315	ATE 25331 16,2 + WE / - WK
Cooper D	100	10/16→						Ceramic
Cooper D	110	10/16→						
Cooper D ALL4	100	10/16→						
Cooper D ALL4	110	10/16→						
Cooper S	120	10/16→						
Cooper S	141	10/16→						
Cooper S ALL4	120	10/16→						
Cooper S ALL4	141	10/16→						
Cooper SD	120	10/16→						
Cooper SD	140	10/16→						
Cooper SD ALL4	120	10/16→						
Cooper SD ALL4	140	10/16→						
Cooper SE ALL4	100	01/17→						
Cooper SE ALL4	165	01/17→						
John Cooper Works ALL4	170	01/17→						

Warnkontakt, Bremsbelagverschleiß

Cooper	100	10/16→	→		1	24.8190-0942.2	620942	L= 641
Cooper ALL4	100	10/16→						
Cooper D	100	10/16→						
Cooper D	110	10/16→						
Cooper D ALL4	100	10/16→						
Cooper D ALL4	110	10/16→						
Cooper S	120	10/16→						
Cooper S	141	10/16→						
Cooper S ALL4	120	10/16→						
Cooper S ALL4	141	10/16→						
Cooper SD	120	10/16→						
Cooper SD	140	10/16→						
Cooper SD ALL4	120	10/16→						
Cooper SD ALL4	140	10/16→						
Cooper SE ALL4	100	01/17→						
Cooper SE ALL4	165	01/17→						
John Cooper Works ALL4	170	01/17→						









Bremsscheibe











Cooper	100	10/16→	←			24.0124-0260.1	424260	Ø 307 24 22,4 V + S
Cooper ALL4	100	10/16→						
Cooper D	100	10/16→	→			24.0110-0401.1	410401	Ø 280 10 8,4 + S
Cooper D	110	10/16→						
Cooper D ALL4	100	10/16→						
Cooper D ALL4	110	10/16→						
Cooper S	120	10/16→	←			24.0124-0259.1	424259	Ø 330 24 22,4 V + S
Cooper S	141	10/16→						
Cooper S ALL4	120	10/16→	→			24.0110-0401.1	410401	Ø 280 10 8,4 + S
Cooper S ALL4	141	10/16→						
Cooper SD	120	10/16→						
Cooper SD	140	10/16→						
Cooper SD ALL4	120	10/16→						
Cooper SD ALL4	140	10/16→						
Cooper SE ALL4	100	01/17→	←			24.0124-0259.1	424259	Ø 330 24 22,4 V + S
Cooper SE ALL4	165	01/17→						











MINI - MINI COUNTRYMAN (R60) 01/10→10/16











Bremsbelagsatz, Scheibenbremse









Cooper	85	01/10→10/16	←	09/10→		13.0460-2725.2	602725	TRW 23984 17,8 + WE / - WK + Zub
Cooper	88	01/10→10/16						
Cooper	90	01/10→10/16				13.0470-2725.2	LD2725	TRW 23984 17,8 + WE / - WK + Zub Ceramic
Cooper D	82	01/10→10/16						
Cooper D ALL4	82	01/10→09/16						
Cooper D ALL4	82	07/10→09/16	→	09/10→		13.0460-2713.2	602713	TRW 23623 17,4 + WE / - WK + Zub
Cooper S	135	01/10→10/16						
Cooper S	140	01/10→10/16				13.0470-2713.2	LD2713	TRW 23623 17,4 + WE / - WK + Zub Ceramic
Cooper S ALL4	120	01/10→10/16						
Cooper S ALL4	135	01/10→10/16						
Cooper S ALL4	140	01/10→10/16						
One	72	01/10→09/16						
One D	66	01/10→10/16						
Cooper ALL4	90	11/12→09/16	←	11/14→		13.0460-2725.2	602725	TRW 23984 17,8 + WE / - WK + Zub
Cooper ALL4	90	11/12→10/16				13.0470-2725.2	LD2725	TRW 23984 17,8 + WE / - WK + Zub Ceramic
			→	11/14→		13.0460-2713.2	602713	TRW 23623 17,4 + WE / - WK + Zub
						13.0470-2713.2	LD2713	TRW 23623 17,4 + WE / - WK + Zub Ceramic









	kw			 	! #		
MINI - MINI COUNTRYMAN (R60) 01/10→10/16							
 Bremsbelagsatz, Scheibenbremse							
Cooper S	147	01/10→10/16	←	02/12→		13.0460-2725.2 602725	TRW 23984 17,8 + WE / - WK + Zub
						13.0470-2725.2 LD2725	TRW 23984 17,8 + WE / - WK + Zub Ceramic
			→	02/12→		13.0460-2713.2 602713	TRW 23623 17,4 + WE / - WK + Zub
						13.0470-2713.2 LD2713	TRW 23623 17,4 + WE / - WK + Zub Ceramic
Cooper SD	100	01/10→10/16	←	02/11→		13.0460-2725.2 602725	TRW 23984 17,8 + WE / - WK + Zub
Cooper SD	105	01/10→10/16					
Cooper SD ALL4	100	01/10→09/16				13.0470-2725.2 LD2725	TRW 23984 17,8 + WE / - WK + Zub Ceramic
Cooper SD ALL4	105	01/10→09/16					
			→	02/11→		13.0460-2713.2 602713	TRW 23623 17,4 + WE / - WK + Zub
						13.0470-2713.2 LD2713	TRW 23623 17,4 + WE / - WK + Zub Ceramic
John Cooper Works ALL4	160	04/11→10/16	←	09/12→		13.0460-2725.2 602725	TRW 23984 17,8 + WE / - WK + Zub
						13.0470-2725.2 LD2725	TRW 23984 17,8 + WE / - WK + Zub Ceramic
			→	09/12→		13.0460-2713.2 602713	TRW 23623 17,4 + WE / - WK + Zub
						13.0470-2713.2 LD2713	TRW 23623 17,4 + WE / - WK + Zub Ceramic
Warnkontakt, Bremsbelagverschleiß							
Cooper	85	01/10→10/16	←	09/10→	1	24.8190-0306.2 620306	L= 908
Cooper	88	01/10→10/16					
Cooper	90	01/10→10/16	→	09/10→	1	24.8190-0307.2 620307	L= 957
Cooper D	82	01/10→10/16					
Cooper D ALL4	82	01/10→09/16					
Cooper D ALL4	82	07/10→09/16					
Cooper S	135	01/10→10/16					
Cooper S	140	01/10→10/16					
Cooper S ALL4	120	01/10→10/16					
Cooper S ALL4	135	01/10→10/16					
Cooper S ALL4	140	01/10→10/16					
One	72	01/10→09/16					
One D	66	01/10→10/16					
Cooper ALL4	90	11/12→09/16	←	11/14→	1	24.8190-0306.2 620306	L= 908
Cooper ALL4	90	11/12→10/16					
			→	11/14→	1	24.8190-0307.2 620307	L= 957
Cooper S	147	01/10→10/16	←	02/12→	1	24.8190-0306.2 620306	L= 908
			→	02/12→	1	24.8190-0307.2 620307	L= 957
Cooper SD	100	01/10→10/16	←	02/11→	1	24.8190-0306.2 620306	L= 908
Cooper SD	105	01/10→10/16					
Cooper SD ALL4	100	01/10→09/16	→	02/11→	1	24.8190-0307.2 620307	L= 957
Cooper SD ALL4	105	01/10→09/16					
John Cooper Works ALL4	160	04/11→10/16	←	09/12→	1	24.8190-0306.2 620306	L= 908
			→	09/12→	1	24.8190-0307.2 620307	L= 957
 Bremsscheibe							
Cooper	85	01/10→10/16	←	09/10→		24.0122-0271.1 422271	Ø 294 22 20,4 V + S
Cooper	88	01/10→10/16					
Cooper	90	01/10→10/16	→	09/10→		24.0110-0358.1 410358	Ø 280 10 8,4 + S
Cooper D	82	01/10→10/16					
Cooper D ALL4	82	01/10→09/16					
Cooper D ALL4	82	07/10→09/16					
One	72	01/10→09/16					
One D	66	01/10→10/16					
Cooper ALL4	90	11/12→09/16	←	11/14→		24.0122-0271.1 422271	Ø 294 22 20,4 V + S
Cooper ALL4	90	11/12→10/16					
			→	11/14→		24.0110-0358.1 410358	Ø 280 10 8,4 + S
Cooper S	135	01/10→10/16	←	09/10→		24.0124-0240.1 424240	Ø 307 24 22,4 V + S
Cooper S	140	01/10→10/16					
Cooper S ALL4	120	01/10→10/16	→	09/10→		24.0110-0358.1 410358	Ø 280 10 8,4 + S
Cooper S ALL4	135	01/10→10/16					
Cooper S ALL4	140	01/10→10/16					
Cooper S	147	01/10→10/16	←	02/12→		24.0124-0240.1 424240	Ø 307 24 22,4 V + S
			→	02/12→		24.0110-0358.1 410358	Ø 280 10 8,4 + S
Cooper SD	100	01/10→10/16	←	02/11→		24.0122-0271.1 422271	Ø 294 22 20,4 V + S
Cooper SD	105	01/10→10/16					
Cooper SD ALL4	100	01/10→09/16	→	02/11→		24.0110-0358.1 410358	Ø 280 10 8,4 + S
Cooper SD ALL4	105	01/10→09/16					
↓							













	kW			 	! #		
MINI - MINI COUNTRYMAN (R60) 01/10→10/16							
 Bremsscheibe							
John Cooper Works ALL4	160	04/11→10/16	←	09/12→		24.0124-0240.1 424240	Ø 307 24 22,4 V + S
MINI - MINI Coupe (R58) 12/10→05/15							
 Bremsbelagsatz, Scheibenbremse							
Cooper	85	12/10→04/15	←	10/11→		13.0460-2710.2 602710	TRW 23915 17,6 + WE / - WK + Zub
Cooper	90	12/10→04/15					
Cooper SD	100	12/10→05/15				13.0470-2710.2 LD2710	TRW 23915 17,6 + WE / - WK + Zub Ceramic
Cooper SD	105	12/10→05/15					
			→	10/11→		13.0460-2714.2 602714	TRW 24289 16,9 + WE / - WK + Zub
						13.0470-2714.2 LD2714	TRW 24289 16,9 + WE / - WK + Zub Ceramic
Cooper S	120	12/10→04/15	←	10/11→		13.0460-2725.2 602725	TRW 23984 17,8 + WE / - WK + Zub
Cooper S	135	12/10→04/15					
Cooper S	147	12/10→04/15				13.0470-2725.2 LD2725	TRW 23984 17,8 + WE / - WK + Zub Ceramic
			→	10/11→		13.0460-2714.2 602714	TRW 24289 16,9 + WE / - WK + Zub
						13.0470-2714.2 LD2714	TRW 24289 16,9 + WE / - WK + Zub Ceramic
John Cooper Works	155	12/10→05/15	→	10/11→		13.0460-2714.2 602714	TRW 24289 16,9 + WE / - WK + Zub
						13.0470-2714.2 LD2714	TRW 24289 16,9 + WE / - WK + Zub Ceramic
Warnkontakt, Bremsbelagverschleiß							
Cooper	85	12/10→04/15	←	10/11→	1	24.8190-0009.2 620009	L= 808
Cooper	90	12/10→04/15					
Cooper S	120	12/10→04/15	→	10/11→	1	24.8190-0010.2 620010	L= 1.141
Cooper S	135	12/10→04/15					
Cooper S	147	12/10→04/15					
Cooper SD	100	12/10→05/15					
Cooper SD	105	12/10→05/15					
John Cooper Works	155	12/10→05/15					
 Bremsscheibe							
Cooper	85	12/10→04/15	←	10/11→		24.0122-0248.1 422248	Ø 280 22 20,4 V
Cooper	90	12/10→04/15				24.0322-0248.1 522248	Ø 280 22 19,6 V PD
Cooper SD	100	12/10→05/15					
Cooper SD	105	12/10→05/15	→	10/11→		24.0110-0271.1 410271	Ø 259 10 8,4
						24.0310-0271.1 510271	Ø 259 10 7,6 PD
Cooper S	120	12/10→04/15	←	10/11→		24.0122-0247.1 422247	Ø 294 22 20,4 V
Cooper S	135	12/10→04/15				24.0322-0247.1 522247	Ø 294 22 19,6 V PD
Cooper S	147	12/10→04/15					
			→	10/11→		24.0110-0271.1 410271	Ø 259 10 8,4
						24.0310-0271.1 510271	Ø 259 10 7,6 PD
MINI - MINI PACEMAN (R61) 03/12→09/16							
 Bremsbelagsatz, Scheibenbremse							
Cooper	88	04/12→09/16	←	11/12→		13.0460-2725.2 602725	TRW 23984 17,8 + WE / - WK + Zub
Cooper	90	04/12→09/16					
Cooper D	82	04/12→09/16				13.0470-2725.2 LD2725	TRW 23984 17,8 + WE / - WK + Zub Ceramic
Cooper D	82	07/12→09/16					
Cooper D ALL4	82	04/12→09/16					
Cooper D ALL4	82	03/12→09/16	→	11/12→		13.0460-2713.2 602713	TRW 23623 17,4 + WE / - WK + Zub
Cooper S	135	04/12→09/16					
Cooper S	140	04/12→09/16				13.0470-2713.2 LD2713	TRW 23623 17,4 + WE / - WK + Zub Ceramic
Cooper S ALL4	120	03/12→09/16					
Cooper S ALL4	135	03/12→09/16					
Cooper S ALL4	140	03/12→09/16					
Cooper SD	105	03/12→09/16					
Cooper SD ALL4	100	04/12→09/16					
Cooper SD ALL4	105	04/12→09/16					
John Cooper Works	160	09/12→09/16					
Cooper ALL4	90	11/12→09/16	←	07/14→		13.0460-2725.2 602725	TRW 23984 17,8 + WE / - WK + Zub
Cooper ALL4	90	02/13→09/16				13.0470-2725.2 LD2725	TRW 23984 17,8 + WE / - WK + Zub Ceramic
			→	07/14→		13.0460-2713.2 602713	TRW 23623 17,4 + WE / - WK + Zub
						13.0470-2713.2 LD2713	TRW 23623 17,4 + WE / - WK + Zub Ceramic

















	kW					! #								
MINI - MINI PACEMAN (R61) 03/12→09/16														
Warnkontakt, Bremsbelagverschleiß														
Cooper	88	04/12→09/16	←	11/12→		1	24.8190-0306.2 620306	L= 908						
Cooper	90	04/12→09/16	→	11/12→		2	24.8190-0307.2 620307	L= 957						
Cooper D	82	04/12→09/16												
Cooper D	82	07/12→09/16												
Cooper D ALL4	82	04/12→09/16												
Cooper D ALL4	82	03/12→09/16												
Cooper S	135	04/12→09/16												
Cooper S	140	04/12→09/16												
Cooper S ALL4	120	03/12→09/16												
Cooper S ALL4	135	03/12→09/16												
Cooper S ALL4	140	03/12→09/16												
Cooper SD	105	03/12→09/16												
Cooper SD ALL4	100	04/12→09/16												
Cooper SD ALL4	105	04/12→09/16												
John Cooper Works	160	09/12→09/16												
Cooper ALL4	90	11/12→09/16	←	07/14→		1	24.8190-0306.2 620306	L= 908						
Cooper ALL4	90	02/13→09/16	→	07/14→		2	24.8190-0307.2 620307	L= 957						
 Bremsscheibe														
Cooper	88	04/12→09/16	←	11/12→			24.0122-0271.1 422271	∅ 294 22 20,4 V + S						
Cooper	90	04/12→09/16	→	11/12→			24.0110-0358.1 410358	∅ 280 10 8,4 + S						
Cooper D	82	04/12→09/16												
Cooper D	82	07/12→09/16												
Cooper D ALL4	82	04/12→09/16												
Cooper D ALL4	82	03/12→09/16												
Cooper SD	105	03/12→09/16												
Cooper SD ALL4	100	04/12→09/16												
Cooper SD ALL4	105	04/12→09/16												
Cooper ALL4	90	11/12→09/16							←	07/14→		24.0122-0271.1 422271	∅ 294 22 20,4 V + S	
Cooper ALL4	90	02/13→09/16							→	07/14→		24.0110-0358.1 410358	∅ 280 10 8,4 + S	
Cooper S	135	04/12→09/16							←	11/12→		24.0124-0240.1 424240	∅ 307 24 22,4 V + S	
Cooper S	140	04/12→09/16							→	11/12→			24.0110-0358.1 410358	∅ 280 10 8,4 + S
Cooper S ALL4	120	03/12→09/16												
Cooper S ALL4	135	03/12→09/16												
Cooper S ALL4	140	03/12→09/16												
John Cooper Works	160	09/12→09/16	←	11/12→		24.0124-0240.1 424240	∅ 307 24 22,4 V + S							
MINI - MINI Roadster (R59) 01/11→04/15														
 Bremsbelagsatz, Scheibenbremse														
Cooper	85	01/11→04/15	←	02/12→			13.0460-2710.2 602710	TRW 23915 17,6 + WE / - WK + Zub						
Cooper	90	01/11→04/15	→	02/12→			13.0470-2710.2 LD2710	TRW 23915 17,6 + WE / - WK + Zub Ceramic						
Cooper SD	100	01/11→04/15												
Cooper SD	105	01/11→04/15												
Cooper S	120	01/11→04/15							←	02/12→		13.0460-2714.2 602714	TRW 24289 16,9 + WE / - WK + Zub	
Cooper S	135	01/11→04/15							→	02/12→		13.0470-2714.2 LD2714	TRW 24289 16,9 + WE / - WK + Zub Ceramic	
Cooper S	147	01/11→04/15												
Cooper S	147	01/11→04/15												
Cooper S	147	01/11→04/15												
John Cooper Works	155	05/11→04/15							→	02/12→		13.0460-2714.2 602714	TRW 24289 16,9 + WE / - WK + Zub	
													13.0470-2714.2 LD2714	TRW 24289 16,9 + WE / - WK + Zub Ceramic
Warnkontakt, Bremsbelagverschleiß														
Cooper	85	01/11→04/15							←	02/12→		1	24.8190-0009.2 620009	L= 808
Cooper	90	01/11→04/15							→	02/12→		1	24.8190-0010.2 620010	L= 1.141
Cooper S	120	01/11→04/15												
Cooper S	135	01/11→04/15												
Cooper S	147	01/11→04/15												
Cooper SD	100	01/11→04/15												
Cooper SD	105	01/11→04/15												
John Cooper Works	155	05/11→04/15												
John Cooper Works	155	05/11→04/15												
 Bremsscheibe														
Cooper	85	01/11→04/15	←	02/12→			24.0122-0248.1 422248	∅ 280 22 20,4 V						
Cooper	90	01/11→04/15	→				24.0322-0248.1 522248	∅ 280 22 19,6 V PD						
Cooper SD	100	01/11→04/15												
↓														















	kw			 	! #		
MINI - MINI Roadster (R59) 01/11→04/15							
 Bremsscheibe							
Cooper SD	105	01/11→04/15	➔	02/12→		24.0110-0271.1 410271 24.0310-0271.1 510271	Ø 259 10 8,4 Ø 259 10 7,6 PD
Cooper S	120	01/11→04/15	➔	02/12→		24.0122-0247.1 422247	Ø 294 22 20,4 V
Cooper S	135	01/11→04/15				24.0322-0247.1 522247	Ø 294 22 19,6 V PD
Cooper S	147	01/11→04/15	➔	02/12→		24.0110-0271.1 410271 24.0310-0271.1 510271	Ø 259 10 8,4 Ø 259 10 7,6 PD
MITSUBISHI - ASX (GA_W_) 01/10→							
 Bremsbelagsatz, Scheibenbremse							
1.6 DI-D	84	07/15→	➔			13.0460-5760.2 605760	AKE 23584 16,4 + WK
1.6 DI-D 4WD	84	07/15→					
2.2 Di-D 4WD	110	04/13→	➔			13.0460-5654.2 605654	MAN 25688 14,4 + WK
1.6 MIVEC	85	05/10→	➔	06/10→		13.0460-5760.2 605760	AKE 23584 16,4 + WK
			➔	07/12→		13.0460-5654.2 605654	MAN 25688 14,4 + WK
			➔	06/10→ 06/12		13.0460-5855.2 605855	23582 16,0 - WK
1.6 MIVEC 1.8 1.8 4WD 1.8 DI-D 1.8 DI-D 1.8 DI-D 4WD 2.0 i 2.0 i 2.0 i 4WD 2.0 i 4WD	86 102 102 85 110 85 110 110 118 110 118	06/10→ 02/10→ 02/10→ 06/10→ 06/10→ 06/10→ 06/10→ 06/10→ 06/10→ 06/10→	➔			13.0460-5760.2 605760	AKE 23584 16,4 + WK
			➔	07/12→		13.0460-5654.2 605654	MAN 25688 14,4 + WK
			➔	→ 06/12		13.0460-5855.2 605855	23582 16,0 - WK
			➔				
			➔				
			➔				
			➔				
			➔				
			➔				
			➔				
Bremsscheibe							
1.6 DI-D	84	07/15→	➔			24.0110-0395.1 410395	Ø 302 10 8,4
1.6 DI-D 4WD	84	07/15→					
2.2 Di-D 4WD	110	04/13→					
1.6 MIVEC	85	05/10→	➔	06/10→		24.0126-0170.1 426170	Ø 294 26 24,4 V
			➔	06/10→ 06/12		24.0110-0360.1 410360	Ø 302 10 8,4
			➔	07/12→		24.0110-0395.1 410395	Ø 302 10 8,4
1.6 MIVEC 1.8 1.8 4WD 1.8 DI-D 1.8 DI-D 1.8 DI-D 4WD 2.0 i 2.0 i 2.0 i 4WD 2.0 i 4WD	86 102 102 85 110 85 110 110 118 110 118	06/10→ 02/10→ 02/10→ 06/10→ 06/10→ 06/10→ 06/10→ 06/10→ 06/10→ 06/10→	➔			24.0126-0170.1 426170	Ø 294 26 24,4 V
			➔	→ 06/12		24.0110-0360.1 410360	Ø 302 10 8,4
			➔	07/12→		24.0110-0395.1 410395	Ø 302 10 8,4
			➔				
			➔				
			➔				
			➔				
			➔				
			➔				
			➔				
MITSUBISHI - ASX Van (GA_W_) 06/10→							
 Bremsbelagsatz, Scheibenbremse							
1.8 DI-D 4WD	110	06/10→	➔			13.0460-5760.2 605760	AKE 23584 16,4 + WK
			➔	07/12→		13.0460-5654.2 605654	MAN 25688 14,4 + WK
			➔	→ 06/12		13.0460-5855.2 605855	23582 16,0 - WK
Bremsscheibe							
1.8 DI-D 4WD	110	06/10→	➔			24.0126-0170.1 426170	Ø 294 26 24,4 V
			➔	→ 06/12		24.0110-0360.1 410360	Ø 302 10 8,4
			➔	07/12→		24.0110-0395.1 410395	Ø 302 10 8,4
MITSUBISHI - CARISMA (DA_) 07/95→06/06							
 Bremsbelagsatz, Scheibenbremse							
1.6 (DA1A)	66	07/95→06/06	➔	03/99→ 06/00; für Bremsscheibendurchmesser [mm]: 256		13.0460-2830.2 602830	TRW 21920 14,6 + WK + Zub
			➔	07/00→; für Bremsscheibendurchmesser [mm]: 281		13.0460-2853.2 602853	TRW 21983 17,2 + WK
			➔	→ 02/99; für Bremsscheibendurchmesser [mm]: 236		13.0460-5987.2 605987	TRW 23080 15,0 - WK
↓							











	kw			 	! #		
MITSUBISHI - CARISMA (DA_) 07/95→06/06							
 Bremsbelagsatz, Scheibenbremse							
1.6 (DA1A)	66	07/95→06/06	➔	06/99→; + ABS		13.0460-2831.2 602831	TRW 21861 15,2 + WK
			➔	→ 05/99; + ABS		13.0460-5826.2 605826	AKE 21872 14,5 + WK
1.6 (DA1A)	70	12/98→06/06	➔	für Bremsscheibendurchmesser [mm]: 236		13.0460-5987.2 605987	TRW 23080 15,0 - WK
1.6 (DA1A)	73	05/97→06/06	➔	+ ABS		13.0460-5826.2 605826	AKE 21872 14,5 + WK
1.6 (DA1A)	76	09/00→06/06	➔	für Bremsscheibendurchmesser [mm]: 281		13.0460-2853.2 602853	TRW 21983 17,2 + WK
1.8 GDI (DA2A)	90	10/00→06/06	➔	+ ABS		13.0460-2831.2 602831	TRW 21861 15,2 + WK
1.8 (DA2A)	85	07/95→07/97	➔	für Bremsscheibendurchmesser [mm]: 256		13.0460-2830.2 602830	TRW 21920 14,6 + WK + Zub
1.8 MSX - 16V (DA2A)	103	07/95→07/97	➔	+ ABS		13.0460-5826.2 605826	AKE 21872 14,5 + WK
1.8 16V GDI (DA2A)	92	09/97→06/06	➔	→ 08/00; für Bremsscheibendurchmesser [mm]: 256		13.0460-2830.2 602830	TRW 21920 14,6 + WK + Zub
			➔	09/00→; für Bremsscheibendurchmesser [mm]: 281		13.0460-2853.2 602853	TRW 21983 17,2 + WK
			➔	06/99→; + ABS		13.0460-2831.2 602831	TRW 21861 15,2 + WK
			➔	→ 05/99; + ABS		13.0460-5826.2 605826	AKE 21872 14,5 + WK
1.9 DI-D	85	09/00→06/06	➔	für Bremsscheibendurchmesser [mm]: 281		13.0460-2853.2 602853	TRW 21983 17,2 + WK
1.9 DI-D (DA5A)	75	09/00→06/06	➔			13.0460-2831.2 602831	TRW 21861 15,2 + WK
1.9 TD (DA4A)	66	10/96→09/00	➔	03/99→; für Bremsscheibendurchmesser [mm]: 256		13.0460-2830.2 602830	TRW 21920 14,6 + WK + Zub
			➔	→ 02/99; für Bremsscheibendurchmesser [mm]: 236		13.0460-5987.2 605987	TRW 23080 15,0 - WK
			➔	+ ABS		13.0460-5826.2 605826	AKE 21872 14,5 + WK
Zubehörsatz, Scheibenbremsbelag							
1.6 (DA1A)	66	07/95→06/06	➔	→ 05/99; + ABS		13.0460-0116.2 610116	
1.8 16V GDI (DA2A)	92	09/97→06/06	➔				
1.6 (DA1A)	70	12/98→06/06	➔	+ ABS		13.0460-0116.2 610116	
1.6 (DA1A)	73	05/97→06/06					
1.8 (DA2A)	85	07/95→07/97					
1.8 MSX - 16V (DA2A)	103	07/95→07/97					
1.9 TD (DA4A)	66	10/96→09/00					
 Bremsscheibe							
1.6 (DA1A)	66	07/95→06/06	➔	→ 02/99		24.0118-0120.1 418120	Ø 236 18 16,4 V
			➔	03/99→ 06/00		24.0124-0136.1 424136	Ø 256 24 21,5 V
			➔	07/00→		24.0124-0159.1 424159	Ø 281 23,9 21,5 V
			➔			24.0324-0159.1 524159	Ø 281 23,9 21,5 V PD
			➔	06/99→; + ABS		24.0110-0229.1 410229	Ø 260 10 8,4
			➔	→ 05/99; + ABS		24.0110-0266.1 410266	Ø 236 10 8,4
1.6 (DA1A)	70	12/98→06/06	➔			24.0118-0120.1 418120	Ø 236 18 16,4 V
1.6 (DA1A)	73	05/97→06/06	➔	+ ABS		24.0110-0266.1 410266	Ø 236 10 8,4
1.6 (DA1A)	76	09/00→06/06	➔			24.0124-0159.1 424159	Ø 281 23,9 21,5 V
1.8 GDI (DA2A)	90	10/00→06/06	➔			24.0324-0159.1 524159	Ø 281 23,9 21,5 V PD
			➔	+ ABS		24.0110-0229.1 410229	Ø 260 10 8,4
1.8 (DA2A)	85	07/95→07/97	➔			24.0124-0136.1 424136	Ø 256 24 21,5 V
1.8 MSX - 16V (DA2A)	103	07/95→07/97	➔	+ ABS		24.0110-0229.1 410229	Ø 260 10 8,4
1.8 16V GDI (DA2A)	92	09/97→06/06	➔	→ 08/00		24.0124-0136.1 424136	Ø 256 24 21,5 V
			➔	09/00→		24.0124-0159.1 424159	Ø 281 23,9 21,5 V
			➔			24.0324-0159.1 524159	Ø 281 23,9 21,5 V PD
			➔	+ ABS		24.0110-0229.1 410229	Ø 260 10 8,4
1.9 DI-D	85	09/00→06/06	➔			24.0124-0159.1 424159	Ø 281 23,9 21,5 V
1.9 DI-D (DA5A)	75	09/00→06/06	➔			24.0324-0159.1 524159	Ø 281 23,9 21,5 V PD
			➔			24.0110-0229.1 410229	Ø 260 10 8,4
1.9 TD (DA4A)	66	10/96→09/00	➔	→ 02/99		24.0118-0120.1 418120	Ø 236 18 16,4 V
			➔	03/99→		24.0124-0136.1 424136	Ø 256 24 21,5 V
			➔	+ ABS		24.0110-0266.1 410266	Ø 236 10 8,4











	kw			 	! #		
MITSUBISHI - CARISMA Stufenheck (DA_) 09/96→06/06							
 Bremsbelagsatz, Scheibenbremse							
1.3 16V 1.9 DI-D 1.9 DI-D (DA5A)	60 85 75	09/00→10/04 09/00→06/06 09/00→06/06	← →	für Bremsscheibendurchmesser [mm]: 281		13.0460-2853.2 602853	TRW 21983 17,2 + WK
						13.0460-2831.2 602831	TRW 21861 15,2 + WK
1.6 (DA1A)	66	09/96→06/06	←	03/99→ 06/00; für Bremsscheibendurchmesser [mm]: 256		13.0460-2830.2 602830	TRW 21920 14,6 + WK + Zub
			←	07/00→; für Bremsscheibendurchmesser [mm]: 281		13.0460-2853.2 602853	TRW 21983 17,2 + WK
			←	→ 02/99; für Bremsscheibendurchmesser [mm]: 236		13.0460-5987.2 605987	TRW 23080 15,0 - WK
			→	06/99→; + ABS		13.0460-2831.2 602831	TRW 21861 15,2 + WK
			→	→ 05/99; + ABS		13.0460-5826.2 605826	AKE 21872 14,5 + WK
1.6 (DA1A) 1.6 (DA1A)	70 73	12/98→06/06 05/97→06/06	←	für Bremsscheibendurchmesser [mm]: 236		13.0460-5987.2 605987	TRW 23080 15,0 - WK
			→	+ ABS		13.0460-5826.2 605826	AKE 21872 14,5 + WK
1.6 (DA1A) 1.8 GDI (DA2A)	76 90	09/00→06/06 10/00→06/06	←	für Bremsscheibendurchmesser [mm]: 281		13.0460-2853.2 602853	TRW 21983 17,2 + WK
			→	+ ABS		13.0460-2831.2 602831	TRW 21861 15,2 + WK
1.8 (DA2A)	85	09/96→09/97	←	für Bremsscheibendurchmesser [mm]: 256		13.0460-2830.2 602830	TRW 21920 14,6 + WK + Zub
			→	+ ABS		13.0460-5826.2 605826	AKE 21872 14,5 + WK
1.8 16V GDI (DA2A)	92	09/97→06/06	←	→ 08/00; für Bremsscheibendurchmesser [mm]: 256		13.0460-2830.2 602830	TRW 21920 14,6 + WK + Zub
			←	09/00→; für Bremsscheibendurchmesser [mm]: 281		13.0460-2853.2 602853	TRW 21983 17,2 + WK
			→	06/99→; + ABS		13.0460-2831.2 602831	TRW 21861 15,2 + WK
			→	→ 05/99; + ABS		13.0460-5826.2 605826	AKE 21872 14,5 + WK
1.9 TD (DA4A)	66	10/96→09/00	←	03/99→; für Bremsscheibendurchmesser [mm]: 256		13.0460-2830.2 602830	TRW 21920 14,6 + WK + Zub
			←	→ 02/99; für Bremsscheibendurchmesser [mm]: 236		13.0460-5987.2 605987	TRW 23080 15,0 - WK
			→	+ ABS		13.0460-5826.2 605826	AKE 21872 14,5 + WK
2.0 16V GT EVO VI/VII	206	11/99→06/06	←	→ 08/03		13.0460-4973.2 604973	BRE 23092 16,0 + WK
			→	→ 08/03		13.0460-4974.2 604974	BRE 21580 14,6 + WK
Zubehörsatz, Scheibenbremsbelag							
1.6 (DA1A) 1.8 16V GDI (DA2A)	66 92	09/96→06/06 09/97→06/06	→	→ 05/99; + ABS		13.0460-0116.2 610116	
1.6 (DA1A) 1.6 (DA1A) 1.8 (DA2A) 1.9 TD (DA4A)	70 73 85 66	12/98→06/06 05/97→06/06 09/96→09/97 10/96→09/00	→	+ ABS		13.0460-0116.2 610116	
 Bremsscheibe							
1.3 16V 1.9 DI-D 1.9 DI-D (DA5A)	60 85 75	09/00→10/04 09/00→06/06 09/00→06/06	← →			24.0124-0159.1 424159 24.0324-0159.1 524159 24.0110-0229.1 410229	∅ 281 23,9 21,5 V ∅ 281 23,9 21,5 V PD ∅ 260 10 8,4
1.6 (DA1A)	66	09/96→06/06	←	→ 02/99		24.0118-0120.1 418120	∅ 236 18 16,4 V
			←	03/99→ 06/00		24.0124-0136.1 424136	∅ 256 24 21,5 V
			←	07/00→		24.0124-0159.1 424159 24.0324-0159.1 524159	∅ 281 23,9 21,5 V ∅ 281 23,9 21,5 V PD
			→	06/99→; + ABS		24.0110-0229.1 410229	∅ 260 10 8,4
			→	→ 05/99; + ABS		24.0110-0266.1 410266	∅ 236 10 8,4
1.6 (DA1A) 1.6 (DA1A)	70 73	12/98→06/06 05/97→06/06	← →			24.0118-0120.1 418120 24.0110-0266.1 410266	∅ 236 18 16,4 V ∅ 236 10 8,4
1.6 (DA1A) 1.8 GDI (DA2A)	76 90	09/00→06/06 10/00→06/06	← →			24.0124-0159.1 424159 24.0324-0159.1 524159 24.0110-0229.1 410229	∅ 281 23,9 21,5 V ∅ 281 23,9 21,5 V PD ∅ 260 10 8,4
1.8 (DA2A)	85	09/96→09/97	← →			24.0124-0136.1 424136 24.0110-0229.1 410229	∅ 256 24 21,5 V ∅ 260 10 8,4
↓							

	kW					! #		
MITSUBISHI - CARISMA Stufenheck (DA_) 09/96→06/06								
 Bremsscheibe								
1.8 16V GDI (DA2A)	92	09/97→06/06	←	→ 08/00		24.0124-0136.1	424136	Ø 256 24 21,5 V
			←	09/00→		24.0124-0159.1	424159	Ø 281 23,9 21,5 V
						24.0324-0159.1	524159	Ø 281 23,9 21,5 V PD
			→	+ ABS		24.0110-0229.1	410229	Ø 260 10 8,4
1.9 TD (DA4A)	66	10/96→09/00	←	→ 02/99		24.0118-0120.1	418120	Ø 236 18 16,4 V
			←	03/99→		24.0124-0136.1	424136	Ø 256 24 21,5 V
			→	+ ABS		24.0110-0266.1	410266	Ø 236 10 8,4
MITSUBISHI - COLT IV (CA_A) 03/92→04/96								
 Bremsbelagsatz, Scheibenbremse								
1.3 GLi 12V (CA1A)	55	04/92→04/96	←			13.0460-5953.2	605953	SUM 21650 15,0 - WE / - WK
1.6 (CA4A)	66	02/94→04/96	←			13.0460-5953.2	605953	SUM 21650 15,0 - WE / - WK
1.6 4WD (CC4A)	84	08/93→08/95	←					
1.6 GLXi 16V (CA4A)	83	04/92→04/96	→			13.0460-5826.2	605826	AKE 21872 14,5 + WK
1.8 GTi 16V (CA5A)	103	04/92→04/96	←			13.0460-5952.2	605952	SUM 21647 16,0 + WK
			→			13.0460-5826.2	605826	AKE 21872 14,5 + WK
Zubehörsatz, Scheibenbremsbelag								
1.3 GLi 12V (CA1A)	55	04/92→04/96	←			13.0460-0233.2	610233	SUM
1.6 (CA4A)	66	02/94→04/96	←					
1.6 4WD (CC4A)	84	08/93→08/95	←					
1.6 GLXi 16V (CA4A)	83	04/92→04/96	←					
1.8 GTi 16V (CA5A)	103	04/92→04/96	←			13.0460-0442.2	610442	SUM
 Bremsscheibe								
1.3 GLi 12V (CA1A)	55	04/92→04/96	←			24.0113-0186.1	413186	Ø 234 13 11,4
			←	→ 11/93		24.0118-0120.1	418120	Ø 236 18 16,4 V
1.6 (CA4A)	66	02/94→04/96	←			24.0118-0120.1	418120	Ø 236 18 16,4 V
1.6 4WD (CC4A)	84	08/93→08/95	←					
1.6 GLXi 16V (CA4A)	83	04/92→04/96	→			24.0110-0266.1	410266	Ø 236 10 8,4
MITSUBISHI - COLT V (CJ_, CP_) 09/95→09/03								
 Bremsbelagsatz, Scheibenbremse								
1.5 16V (CJ2A)	69	10/99→09/03	←	→ 08/00		13.0460-5889.2	605889	SUM 21650 15,0 + WK
1600 GLX (CJ4A)	66	05/96→09/00	←					
1300 (CJ1A)	60	06/00→09/03	←	09/00→ 06/03		13.0460-5889.2	605889	SUM 21650 15,0 + WK
1300 GL, GLX (CJ1A)	55	05/96→06/00	←			13.0460-5889.2	605889	SUM 21650 15,0 + WK
1600	76	09/00→09/03	←	→ 06/03		13.0460-5889.2	605889	SUM 21650 15,0 + WK
Zubehörsatz, Scheibenbremsbelag								
1.5 16V (CJ2A)	69	10/99→09/03	←	→ 08/00		13.0460-0233.2	610233	SUM
1600 GLX (CJ4A)	66	05/96→09/00	←					
1300 (CJ1A)	60	06/00→09/03	←	09/00→ 06/03		13.0460-0233.2	610233	SUM
1300 GL, GLX (CJ1A)	55	05/96→06/00	←			13.0460-0233.2	610233	SUM
1600	76	09/00→09/03	←	→ 06/03		13.0460-0233.2	610233	SUM
 Bremsscheibe								
1.5 16V (CJ2A)	69	10/99→09/03	←	→ 08/00		24.0118-0120.1	418120	Ø 236 18 16,4 V
1600 GLX (CJ4A)	66	05/96→09/00	←					
1300 (CJ1A)	60	06/00→09/03	←	09/00→ 06/03		24.0118-0120.1	418120	Ø 236 18 16,4 V
1300 GL, GLX (CJ1A)	55	05/96→06/00	←			24.0118-0120.1	418120	Ø 236 18 16,4 V
1600	76	09/00→09/03	←	→ 06/03		24.0118-0120.1	418120	Ø 236 18 16,4 V
MITSUBISHI - COLT VI (Z3_A, Z2_A) 10/02→12/12								
 Bremsbelagsatz, Scheibenbremse								
1.1	55	10/04→06/12	←			13.0460-2896.2	602896	TRW 21920 16,6 + WK + Zub
1.1 LPG	55	10/04→06/12	→			13.0460-2831.2	602831	TRW 21861 15,2 + WK
1.3	68	10/04→06/12	←			13.0460-2896.2	602896	TRW 21920 16,6 + WK + Zub
1.3	70	06/04→06/12	←					
1.3 LPG	70	06/04→06/12	→			13.0460-2897.2	602897	TRW 21861 15,2 + WK
1.5	80	06/04→06/12	←					
1.5 (Z27)	72	09/04→02/06	←					
1.5 DI-D	50	08/04→06/12	←					
1.5 DI-D	70	08/04→06/12	←					
↓								

















	kw					! #		
MITSUBISHI - COLT VI (Z3_A, Z2_A) 10/02→12/12								
 Bremsbelagsatz, Scheibenbremse								
1.5 CZT	110	03/05→06/12	→			13.0460-2897.2	602897	TRW 21861 15,2 + WK
1.5 Ralliart R	120	02/10→06/12						
1.5 Ralliart R	132	02/10→06/12						
1.5 Turbo (Z23)	113	09/06→06/12	→	05/07→		13.0460-2897.2	602897	TRW 21861 15,2 + WK
 Bremsscheibe								
1.1	55	10/04→06/12	←			24.0124-0192.1	424192	Ø 256 24 21,5 V
1.1 LPG	55	10/04→06/12						
1.3	68	10/04→06/12	→			24.0110-0304.1	410304	Ø 250 10 8
1.3	70	06/04→06/12						
1.3 LPG	70	06/04→06/12						
1.5	80	06/04→06/12						
1.5 (Z27)	72	09/04→02/06						
1.5 DI-D	50	08/04→06/12						
1.5 DI-D	70	08/04→06/12						
1.5 CZT	110	03/05→06/12	→			24.0110-0304.1	410304	Ø 250 10 8
1.5 Ralliart R	120	02/10→06/12						
1.5 Ralliart R	132	02/10→06/12						
1.5 Turbo (Z23)	113	09/06→06/12	→	05/07→		24.0110-0304.1	410304	Ø 250 10 8
MITSUBISHI - COLT CZC Cabriolet (RG) 05/06→07/09								
 Bremsbelagsatz, Scheibenbremse								
1.5	80	05/06→07/09	←			13.0460-2896.2	602896	TRW 21920 16,6 + WK + Zub
			→			13.0460-2831.2	602831	TRW 21861 15,2 + WK
1.5 Turbo	110	05/06→07/09	→			13.0460-2831.2	602831	TRW 21861 15,2 + WK
 Bremsscheibe								
1.5	80	05/06→07/09	←			24.0124-0192.1	424192	Ø 256 24 21,5 V
			→			24.0110-0304.1	410304	Ø 250 10 8
1.5 Turbo	110	05/06→07/09	→			24.0110-0304.1	410304	Ø 250 10 8
MITSUBISHI - COLT PLUS VI (Z2_W) 08/04→								
 Bremsbelagsatz, Scheibenbremse								
1.3	68	08/04→	←	10/04→ 06/12		13.0460-2896.2	602896	TRW 21920 16,6 + WK + Zub
			→	10/04→ 06/12		13.0460-2897.2	602897	TRW 21861 15,2 + WK
1.5	77	08/04→	←	→ 06/12		13.0460-2896.2	602896	TRW 21920 16,6 + WK + Zub
			→	→ 06/12		13.0460-2897.2	602897	TRW 21861 15,2 + WK
 Bremsscheibe								
1.3	68	08/04→	←	10/04→ 06/12		24.0124-0192.1	424192	Ø 256 24 21,5 V
			→	10/04→ 06/12		24.0110-0304.1	410304	Ø 250 10 8
1.5	77	08/04→	←	→ 06/12		24.0124-0192.1	424192	Ø 256 24 21,5 V
			→	→ 06/12		24.0110-0304.1	410304	Ø 250 10 8
MITSUBISHI - DELICA / SPACE GEAR 01/94→01/07								
 Bremsbelagsatz, Scheibenbremse								
2.0	83	09/95→10/02	←	08/96→ 05/00		13.0460-5890.2	605890	AKE 23290 15,5 + WK
2.4	97	05/95→05/00	←			13.0460-5890.2	605890	AKE 23290 15,5 + WK
MITSUBISHI - ECLIPSE I (D2_A) 12/89→12/95								
 Bremsbelagsatz, Scheibenbremse								
2.0 i 16V (D22A, D27A)	110	04/91→11/95	←			13.0460-5952.2	605952	SUM 21647 16,0 + WK
Zubehörsatz, Scheibenbremsbelag								
2.0 i 16V (D22A, D27A)	110	04/91→11/95	←			13.0460-0442.2	610442	SUM
2.0 i 16V 4WD (D22A, D27A)	110	04/91→11/95	←			13.0460-0235.2	610235	
 Bremsscheibe								
2.0 i 16V (D22A, D27A)	110	04/91→11/95	←	- ABS		24.0124-0142.1	424142	Ø 256 24 22,4 V
			→			24.0110-0243.1	410243	Ø 265 10 8,4
2.0 i 16V 4WD (D22A, D27A)	110	04/91→11/95	←			24.0124-0144.1	424144	Ø 276 24 22,4 V
			→			24.0110-0243.1	410243	Ø 265 10 8,4















	kw			 	! #		
MITSUBISHI - ECLIPSE II (D3_A) 04/94→04/99							
 Bremsbelagsatz, Scheibenbremse							
2000 GS 16V (D32A)	107	12/95→04/99	←			13.0460-5952.2 605952	SUM 21647 16,0 + WK
2000 GT 16V	157	12/95→04/99					
2400 GS 16V	105	09/98→04/99	→			13.0460-5980.2 605980	21706 15,5 + WK
Zubehörsatz, Scheibenbremsbelag							
2000 GS 16V (D32A)	107	12/95→04/99	→			13.0460-0150.2 610150	AKE
2000 GT 16V	157	12/95→04/99					
2400 GS 16V	105	09/98→04/99					
 Bremsscheibe							
2000 GS 16V (D32A)	107	12/95→04/99	←			24.0124-0142.1 424142	Ø 256 24 22,4 V
2000 GT 16V	157	12/95→04/99					
2400 GS 16V	105	09/98→04/99	→			24.0110-0704.1 410704	Ø 262 10 8,4
MITSUBISHI - FTO Coupe (DE_A) 09/94→07/01							
 Bremsbelagsatz, Scheibenbremse							
2.0 (DE3A)	127	09/94→07/01	←			13.0460-5952.2 605952	SUM 21647 16,0 + WK
			→			13.0460-5980.2 605980	21706 15,5 + WK
 Bremsscheibe							
2.0 (DE3A)	127	09/94→07/01	←			24.0124-0136.1 424136	Ø 256 24 21,5 V
			→			24.0110-0240.1 410240	Ø 262 10 8,4
MITSUBISHI - GALANT V (E5_A, E7_A, E8_A) 11/92→10/96							
 Bremsbelagsatz, Scheibenbremse							
1.8 (E52A)	85	02/94→08/96	←			13.0460-5952.2 605952	SUM 21647 16,0 + WK
1.8 GLSI (E52A)	93	11/92→08/96	→			13.0460-5980.2 605980	21706 15,5 + WK
					+ ABS; passend für Felgenreöße [Zoll]: 14		
2.0 (E55A)	90	04/93→03/95	←			13.0460-5952.2 605952	SUM 21647 16,0 + WK
2.0 GLSI (E55A)	101	11/92→08/96	→			13.0460-5980.2 605980	21706 15,5 + WK
2.0 GLSI 4WD (E75A)	101	11/92→08/96			passend für Felgenreöße [Zoll]: 14		
2.0 GLSTD (E57A)	66	11/92→08/96					
2.0 V6-24 (E64A, E54A)	110	11/92→08/96					
Zubehörsatz, Scheibenbremsbelag							
1.8 (E52A)	85	02/94→08/96	←			13.0460-0442.2 610442	SUM
1.8 GLSI (E52A)	93	11/92→08/96	→			13.0460-0150.2 610150	AKE
					+ ABS		
2.0 (E55A)	90	04/93→03/95	←			13.0460-0442.2 610442	SUM
2.0 GLSI (E55A)	101	11/92→08/96	→			13.0460-0150.2 610150	AKE
2.0 GLSI 4WD (E75A)	101	11/92→08/96					
2.0 GLSTD (E57A)	66	11/92→08/96					
2.0 V6-24 (E64A, E54A)	110	11/92→08/96					
2.5 (E88A)	125	11/92→09/96	←			13.0460-0235.2 610235	
2.5 V6-24 4WD (E88A)	125	11/92→08/96					
 Bremsscheibe							
1.8 (E52A)	85	02/94→08/96	←			24.0124-0136.1 424136	Ø 256 24 21,5 V
1.8 GLSI (E52A)	93	11/92→08/96	→			24.0110-0240.1 410240	Ø 262 10 8,4
					+ ABS		
2.0 (E55A)	90	04/93→03/95	←			24.0124-0136.1 424136	Ø 256 24 21,5 V
2.0 GLSI (E55A)	101	11/92→08/96	→			24.0110-0240.1 410240	Ø 262 10 8,4
2.0 GLSI 4WD (E75A)	101	11/92→08/96					
2.0 GLSTD (E57A)	66	11/92→08/96					
2.0 V6-24 (E64A, E54A)	110	11/92→08/96					
MITSUBISHI - GALANT V Stufenheck (E5_A, E7_A, E8_A) 11/92→12/98							
 Bremsbelagsatz, Scheibenbremse							
1.8 (E52A)	85	02/94→08/96	←			13.0460-5952.2 605952	SUM 21647 16,0 + WK
1.8 GLSI (E52A)	93	11/92→08/96	→			13.0460-5980.2 605980	21706 15,5 + WK
					+ ABS; passend für Felgenreöße [Zoll]: 14		
2.0 GLSI (E55A)	101	11/92→08/96	←			13.0460-5952.2 605952	SUM 21647 16,0 + WK
2.0 GLSI 4WD (E75A)	101	11/92→08/96	→			13.0460-5980.2 605980	21706 15,5 + WK
2.0 GLSTD (E57A)	66	11/92→08/96			passend für Felgenreöße [Zoll]: 14		
2.0 V6-24 (E64A, E54A)	110	11/92→08/96					
Zubehörsatz, Scheibenbremsbelag							
1.8 (E52A)	85	02/94→08/96	←			13.0460-0442.2 610442	SUM
1.8 GLSI (E52A)	93	11/92→08/96	→			13.0460-0150.2 610150	AKE
					+ ABS		
2.0 GLSI (E55A)	101	11/92→08/96	←			13.0460-0442.2 610442	SUM
2.0 GLSI 4WD (E75A)	101	11/92→08/96					
↓							











	kW			 	! #		
MITSUBISHI - GALANT V Stufenheck (E5_A, E7_A, E8_A) 11/92→12/98							
Zubehörsatz, Scheibenbremsbelag							
2.0 GLSTD (E57A)	66	11/92→08/96	➔			13.0460-0150.2	610150 AKE
2.0 V6-24 (E64A, E54A)	110	11/92→08/96					
2.5 V6-24 4WD (E88A)	125	11/92→08/96	➔			13.0460-0235.2	610235
 Bremsscheibe							
1.8 (E52A)	85	02/94→08/96	➔			24.0124-0136.1	424136 Ø 256 24 21,5 V
1.8 GLSI (E52A)	93	11/92→08/96	➔	+ ABS		24.0110-0240.1	410240 Ø 262 10 8,4
2.0 GLSI (E55A)	101	11/92→08/96	➔			24.0124-0136.1	424136 Ø 256 24 21,5 V
2.0 GLSI 4WD (E75A)	101	11/92→08/96					
2.0 GLSTD (E57A)	66	11/92→08/96	➔			24.0110-0240.1	410240 Ø 262 10 8,4
2.0 V6-24 (E64A, E54A)	110	11/92→08/96					
MITSUBISHI - GALANT VI (EA_) 06/94→10/04							
 Bremsbelagsatz, Scheibenbremse							
2.0 (EA2A)	98	09/00→10/04	➔	→ 10/03		13.0460-5760.2	605760 AKE 23584 16,4 + WK
2.4 GDI (EA3A)	106	09/00→10/04	➔	→ 10/03		13.0460-5980.2	605980 21706 15,5 + WK
2.0 (EA2A)	100	09/96→09/00	➔	04/00→		13.0460-5760.2	605760 AKE 23584 16,4 + WK
			➔	10/96→ 11/97		13.0460-5952.2	605952 SUM 21647 16,0 + WK
			➔	12/97→ 03/00		13.0460-5958.2	605958 AKE 21363 15,8 + WK
			➔	10/96→		13.0460-5980.2	605980 21706 15,5 + WK
2.0 GDI	107	10/99→10/04	➔	03/00→ 05/03		13.0460-5760.2	605760 AKE 23584 16,4 + WK
			➔	→ 02/00		13.0460-5952.2	605952 SUM 21647 16,0 + WK
			➔	→ 05/03		13.0460-5980.2	605980 21706 15,5 + WK
2.0 TDI (EA6A)	66	09/96→10/04	➔	10/96→ 07/01		13.0460-5952.2	605952 SUM 21647 16,0 + WK
2.4 GDI (EA3A)	110	02/99→09/00	➔	04/00→		13.0460-5760.2	605760 AKE 23584 16,4 + WK
			➔	03/99→ 03/00		13.0460-5958.2	605958 AKE 21363 15,8 + WK
			➔	03/99→		13.0460-5980.2	605980 21706 15,5 + WK
2.5 Type S	151	10/99→10/04	➔	04/00→ 05/03		13.0460-5760.2	605760 AKE 23584 16,4 + WK
			➔	→ 03/00		13.0460-5958.2	605958 AKE 21363 15,8 + WK
			➔	→ 05/03		13.0460-5980.2	605980 21706 15,5 + WK
2.5 V6 24V 2.5 V6 24V (EA5A)	206 120	09/96→10/02 09/96→09/00	➔	04/00→		13.0460-5760.2	605760 AKE 23584 16,4 + WK
			➔	10/96→ 11/97		13.0460-5952.2	605952 SUM 21647 16,0 + WK
			➔	12/97→ 03/00		13.0460-5958.2	605958 AKE 21363 15,8 + WK
			➔	04/00→		13.0460-5980.2	605980 21706 15,5 + WK
2.5 V6 24V (EA5A)	118	09/00→10/04	➔	→ 10/03		13.0460-5760.2	605760 AKE 23584 16,4 + WK
Zubehörsatz, Scheibenbremsbelag							
2.0 (EA2A)	98	09/00→10/04	➔	→ 10/03		13.0460-0235.2	610235
2.4 GDI (EA3A)	106	09/00→10/04					
2.5 V6 24V (EA5A)	118	09/00→10/04					
2.0 (EA2A)	100	09/96→09/00	➔	12/97→ 03/00		13.0460-0235.2	610235
2.5 V6 24V	206	09/96→10/02					
2.5 V6 24V (EA5A)	120	09/96→09/00	➔	04/00→		13.0460-0235.2	610235
2.0 GDI	107	10/99→10/04	➔	03/00→ 05/03		13.0460-0235.2	610235
2.4 GDI (EA3A)	110	02/99→09/00	➔	03/99→ 03/00		13.0460-0235.2	610235
			➔	04/00→		13.0460-0235.2	610235
2.5 Type S	151	10/99→10/04	➔	04/00→ 05/03		13.0460-0235.2	610235
			➔	→ 03/00		13.0460-0235.2	610235
 Bremsscheibe							
2.0 (EA2A)	98	09/00→10/04	➔	→ 10/03		24.0126-0131.1	426131 Ø 276 26 24,4 V
2.4 GDI (EA3A)	106	09/00→10/04	➔	→ 10/03		24.0110-0240.1	410240 Ø 262 10 8,4
2.5 V6 24V (EA5A)	118	09/00→10/04					
2.0 (EA2A)	100	09/96→09/00	➔	10/96→ 11/97		24.0124-0136.1	424136 Ø 256 24 21,5 V
2.5 V6 24V	206	09/96→10/02					
2.5 V6 24V (EA5A)	120	09/96→09/00	➔	12/97→ 03/00		24.0124-0170.1	424170 Ø 276 24 22,4 V
2.0 GDI	107	10/99→10/04	➔	04/00→		24.0126-0131.1	426131 Ø 276 26 24,4 V
			➔	10/96→		24.0110-0240.1	410240 Ø 262 10 8,4
2.0 GDI	107	10/99→10/04	➔	→ 02/00		24.0124-0136.1	424136 Ø 256 24 21,5 V
			➔	03/00→ 05/03		24.0126-0131.1	426131 Ø 276 26 24,4 V











	kw			 	! #		
MITSUBISHI - GALANT VI (EA_) 06/94→10/04							
 Bremsscheibe							
2.0 GDI	107	10/99→10/04	➔	→ 05/03		24.0110-0240.1 410240	Ø 262 10 8,4
2.0 TDI (EA6A)	66	09/96→10/04	➔	10/96→ 07/01		24.0124-0136.1 424136	Ø 256 24 21,5 V
2.4 GDI (EA3A)	110	02/99→09/00	➔	03/99→ 03/00		24.0124-0170.1 424170	Ø 276 24 22,4 V
			➔	04/00→		24.0126-0131.1 426131	Ø 276 26 24,4 V
			➔	03/99→		24.0110-0240.1 410240	Ø 262 10 8,4
2.5 Type S	151	10/99→10/04	➔	→ 03/00		24.0124-0170.1 424170	Ø 276 24 22,4 V
			➔	04/00→ 05/03		24.0126-0131.1 426131	Ø 276 26 24,4 V
MITSUBISHI - GALANT VI Station Wagon (EA_) 09/96→10/03							
 Bremsbelagsatz, Scheibenbremse							
2.0 (EA2W)	98	09/00→10/03	➔			13.0460-5760.2 605760	AKE 23584 16,4 + WK
2.4 GDI (EA3W)	106	09/00→10/03	➔			13.0460-5980.2 605980	21706 15,5 + WK
2.0 (EA2W)	100	09/96→09/00	➔	04/00→		13.0460-5760.2 605760	AKE 23584 16,4 + WK
			➔	10/96→ 11/97		13.0460-5952.2 605952	SUM 21647 16,0 + WK
			➔	12/97→ 03/00		13.0460-5958.2 605958	AKE 21363 15,8 + WK
			➔	10/96→		13.0460-5980.2 605980	21706 15,5 + WK
			➔	10/96→ 07/01		13.0460-5952.2 605952	SUM 21647 16,0 + WK
2.0 TDI (EA6W)	66	09/96→10/03	➔	10/96→ 07/01		13.0460-5952.2 605952	SUM 21647 16,0 + WK
2.4 GDI (EA3W)	110	02/99→10/03	➔	04/00→		13.0460-5760.2 605760	AKE 23584 16,4 + WK
			➔	03/99→ 03/00		13.0460-5958.2 605958	AKE 21363 15,8 + WK
			➔	03/99→		13.0460-5980.2 605980	21706 15,5 + WK
2.5 V6 24V 2.5 V6 24V (EA5W)	206 120	09/96→10/02 09/96→09/00	➔	04/00→		13.0460-5760.2 605760	AKE 23584 16,4 + WK
			➔	10/96→ 11/97		13.0460-5952.2 605952	SUM 21647 16,0 + WK
			➔	12/97→ 03/00		13.0460-5958.2 605958	AKE 21363 15,8 + WK
			➔	04/00→		13.0460-5980.2 605980	21706 15,5 + WK
			➔	10/96→		13.0460-5980.2 605980	21706 15,5 + WK
2.5 V6 24V (EA5W)	118	09/00→10/03	➔			13.0460-5760.2 605760	AKE 23584 16,4 + WK
2.8 TD	92	10/96→07/01	➔	04/00→		13.0460-5760.2 605760	AKE 23584 16,4 + WK
			➔	→ 11/97		13.0460-5952.2 605952	SUM 21647 16,0 + WK
			➔	12/97→ 03/00		13.0460-5958.2 605958	AKE 21363 15,8 + WK
			➔			13.0460-5980.2 605980	21706 15,5 + WK
			➔	04/00→		13.0460-5980.2 605980	21706 15,5 + WK
Zubehörsatz, Scheibenbremsbelag							
2.0 (EA2W)	98	09/00→10/03	➔			13.0460-0235.2 610235	
2.4 GDI (EA3W)	106	09/00→10/03	➔			13.0460-0235.2 610235	
2.5 V6 24V (EA5W)	118	09/00→10/03	➔			13.0460-0235.2 610235	
2.0 (EA2W)	100	09/96→09/00	➔	12/97→ 03/00		13.0460-0235.2 610235	
2.5 V6 24V	206	09/96→10/02	➔	04/00→		13.0460-0235.2 610235	
2.5 V6 24V (EA5W)	120	09/96→09/00	➔			13.0460-0235.2 610235	
2.8 TD	92	10/96→07/01	➔			13.0460-0235.2 610235	
2.4 GDI (EA3W)	110	02/99→10/03	➔	03/99→ 03/00		13.0460-0235.2 610235	
			➔	04/00→		13.0460-0235.2 610235	
 Bremsscheibe							
2.0 (EA2W)	98	09/00→10/03	➔			24.0126-0131.1 426131	Ø 276 26 24,4 V
2.4 GDI (EA3W)	106	09/00→10/03	➔			24.0110-0240.1 410240	Ø 262 10 8,4
2.5 V6 24V (EA5W)	118	09/00→10/03	➔			24.0110-0240.1 410240	Ø 262 10 8,4
2.0 (EA2W)	100	09/96→09/00	➔	10/96→ 11/97		24.0124-0136.1 424136	Ø 256 24 21,5 V
			➔	12/97→ 03/00		24.0124-0170.1 424170	Ø 276 24 22,4 V
2.5 V6 24V	206	09/96→10/02	➔			24.0124-0170.1 424170	Ø 276 24 22,4 V
2.5 V6 24V (EA5W)	120	09/96→09/00	➔	04/00→		24.0126-0131.1 426131	Ø 276 26 24,4 V
			➔	10/96→		24.0110-0240.1 410240	Ø 262 10 8,4
2.0 TDI (EA6W)	66	09/96→10/03	➔	10/96→ 07/01		24.0124-0136.1 424136	Ø 256 24 21,5 V
2.4 GDI (EA3W)	110	02/99→10/03	➔	03/99→ 03/00		24.0124-0170.1 424170	Ø 276 24 22,4 V
			➔	04/00→		24.0126-0131.1 426131	Ø 276 26 24,4 V
			➔	03/99→		24.0110-0240.1 410240	Ø 262 10 8,4
2.8 TD	92	10/96→07/01	➔	→ 11/97		24.0124-0136.1 424136	Ø 256 24 21,5 V
			➔	12/97→ 03/00		24.0124-0170.1 424170	Ø 276 24 22,4 V
↓							

























	kw					! #		
MITSUBISHI - GALANT VI Station Wagon (EA_) 09/96→10/03								
 Bremsscheibe								
2.8 TD	92	10/96→07/01	←	04/00→		24.0126-0131.1	426131	Ø 276 26 24,4 V
			→			24.0110-0240.1	410240	Ø 262 10 8,4
MITSUBISHI - GALANT Stufenheck (DJ_, ED_, EF_) 10/03→								
 Bremsbelagsatz, Scheibenbremse								
2.4	116	10/03→	←			13.0460-5760.2	605760	AKE 23584 16,4 + WK
2.4	118	12/04→						
MITSUBISHI - GALLOPER (JK-01) 09/98→12/03								
 Bremsbelagsatz, Scheibenbremse								
2.5 TD	65	09/98→12/03	←	01/99→		13.0460-5885.2	605885	SUM 23518 17,0 + WK + Zub
2.5 TD intercooler	73	09/98→12/03						
3.0 V6	104	09/98→12/03						
 Bremsscheibe								
2.5 TD	65	09/98→12/03	←	01/99→; + ABS		24.0122-0237.1	422237	Ø 277 22 20,4 V
2.5 TD intercooler	73	09/98→12/03						
3.0 V6	104	09/98→12/03						
MITSUBISHI - GRANDIS (NA_W) 03/03→12/11								
 Bremsbelagsatz, Scheibenbremse								
2.0 DI-D (NA8W)	100	09/05→03/10	←			13.0460-5853.2	605853	SUM 23488 15,4 + WK
2.0 DI-D (NA8W)	103	02/07→03/10	→			13.0460-5855.2	605855	23582 16,0 - WK
2.4 MIVEC (NA4W)	121	04/04→12/11	←	→ 08/10		13.0460-5853.2	605853	SUM 23488 15,4 + WK
2.4 MIVEC (NA4W)	130	04/04→12/11	→	→ 08/10		13.0460-5855.2	605855	23582 16,0 - WK
Zubehörsatz, Scheibenbremsbelag								
2.0 DI-D (NA8W)	100	09/05→03/10	←			13.0460-0222.2	610222	SUM
2.0 DI-D (NA8W)	103	02/07→03/10	→			13.0460-0137.2	610137	
2.4 MIVEC (NA4W)	121	04/04→12/11	←	→ 08/10		13.0460-0222.2	610222	SUM
2.4 MIVEC (NA4W)	130	04/04→12/11	→	→ 08/10		13.0460-0137.2	610137	
 Bremsscheibe								
2.0 DI-D (NA8W)	100	09/05→03/10	←			24.0126-0162.1	426162	Ø 290 26 24,4 V
2.0 DI-D (NA8W)	103	02/07→03/10	→			24.0110-0344.1	410344	Ø 302 10 8,4
2.4 MIVEC (NA4W)	121	04/04→12/11	←	→ 08/10		24.0126-0162.1	426162	Ø 290 26 24,4 V
2.4 MIVEC (NA4W)	130	04/04→12/11	→	→ 08/10		24.0110-0344.1	410344	Ø 302 10 8,4
MITSUBISHI - i (HA_) 01/06→								
 Bremsbelagsatz, Scheibenbremse								
0.7	38	01/10→	←	für Rechtslenker		13.0460-5621.2	605621	24423 14,6 + WK
0.7	47	08/10→						
MiEV (HA4W)	35	07/09→	←			13.0460-5621.2	605621	24423 14,6 + WK
MiEV (HA4W)	47	07/09→						
MiEV (HA4W)	49	02/11→	←	→ 04/14		13.0460-5621.2	605621	24423 14,6 + WK
 Bremsscheibe								
MiEV (HA4W)	35	07/09→	←			24.0117-0110.1	417110	Ø 257 17 15 V
MiEV (HA4W)	47	07/09→						
MiEV (HA4W)	49	02/11→	←	→ 04/14		24.0117-0110.1	417110	Ø 257 17 15 V
MITSUBISHI - L100 / MINICAB Bus (U6_V) 03/99→								
 Bremsbelagsatz, Scheibenbremse								
0.7	35	03/99→	←	01/10→; für Rechtslenker		13.0460-5621.2	605621	24423 14,6 + WK
0.7 4WD	35	03/99→	←	08/10→; für Rechtslenker		13.0460-5621.2	605621	24423 14,6 + WK
MiEV	25	10/11→	←	→ 04/14		13.0460-5621.2	605621	24423 14,6 + WK
 Bremsscheibe								
MiEV	25	10/11→	←	→ 04/14		24.0117-0110.1	417110	Ø 257 17 15 V











	kw			 	! #		
MITSUBISHI - L100 / MINICAB Pritsche/Fahrgestell (U6_T) 03/99→							
 Bremsbelagsatz, Scheibenbremse							
0.7	35	03/99→	←	01/10→; für Rechtslenker	13.0460-5621.2	605621	24423 14,6 + WK
0.7 4WD	35	03/99→	←	08/10→; für Rechtslenker	13.0460-5621.2	605621	24423 14,6 + WK
MIeV	30	10/11→	←	→ 04/14	13.0460-5621.2	605621	24423 14,6 + WK
 Bremsscheibe							
MIeV	30	10/11→	←	→ 04/14	24.0117-0110.1	417110	Ø 257 17 15 V
MITSUBISHI - L200 (KJ_, KK_, KL_) 11/14→							
 Bremsbelagsatz, Scheibenbremse							
2.4 DI-D (KJ0T)	113	09/15→	←		13.0460-5631.2	605631	24529 16,0 + WK
2.4 DI-D 4WD (KJ0T)	113	09/15→	←		13.0460-5631.2	605631	24529 16,0 + WK
2.4 DI-D 4WD	133	11/14→	←	09/15→	13.0460-5631.2	605631	24529 16,0 + WK
MITSUBISHI - L 200 / TRITON (KA_T, KB_T) 01/04→12/15							
 Bremsbelagsatz, Scheibenbremse							
2.5 DI-D (16V) 4WD	98	04/07→12/15	←		13.0460-5631.2	605631	24529 16,0 + WK
2.5 DI-D (KA4T)	94	04/10→12/15	←		13.0460-5631.2	605631	24529 16,0 + WK
2.5 DI-D (KA4T)	103	04/10→12/15	←		13.0460-5631.2	605631	24529 16,0 + WK
2.5 DI-D (KA4T)	123	08/07→12/15	←		13.0460-5631.2	605631	24529 16,0 + WK
2.5 DI-D 4WD (KB4T)	103	04/10→12/15	←		13.0460-5631.2	605631	24529 16,0 + WK
2.5 DI-D 4WD (KB4T)	123	10/07→12/15	←		13.0460-5631.2	605631	24529 16,0 + WK
2.5 DI-D 4WD (KB4T)	131	04/10→12/15	←		13.0460-5631.2	605631	24529 16,0 + WK
2.5 DiD (KA4T)	100	11/05→12/15	←	01/06→	13.0460-5631.2	605631	24529 16,0 + WK
2.5 DI-D 4WD (KB4T)	100	11/05→12/15	←		13.0460-5631.2	605631	24529 16,0 + WK
2.5 DI-D (KA4T)	131	01/10→12/15	←	03/13→	13.0460-5631.2	605631	24529 16,0 + WK
3.2 DI-D 4WD (KB8T)	121	01/07→12/15	←	04/10→	13.0460-5631.2	605631	24529 16,0 + WK
3.5 4WD (KB9T)	147	05/07→12/15	←		13.0460-5631.2	605631	24529 16,0 + WK
3.5 Flex 4WD (KB9T)	147	09/09→12/15	←		13.0460-5631.2	605631	24529 16,0 + WK
MITSUBISHI - L 200 / TRITON Pritsche/Fahrgestell (KA_T, KB_T) 03/06→12/15							
 Bremsbelagsatz, Scheibenbremse							
2.4 (KA5T)	94	01/09→12/15	←	04/10→	13.0460-5631.2	605631	24529 16,0 + WK
2.5 DI-D 4WD (KB4T)	131	09/09→12/15	←		13.0460-5631.2	605631	24529 16,0 + WK
MITSUBISHI - L 200 (K3_T, K2_T, K1_T, K0_T) 01/86→10/96							
 Bremsbelagsatz, Scheibenbremse							
1.6 (K11T)	60	04/87→10/96	←	→ 05/92	13.0460-5940.2	605940	SUM 21373 16,0 + WK
2.0 4WD (K32T, K22T)	75	11/86→08/96	←		13.0460-5940.2	605940	SUM 21373 16,0 + WK
2.0 (K12T, K32T)	75	11/86→08/96	←		13.0460-5940.2	605940	SUM 21373 16,0 + WK
2.5 D (K14T)	51	11/86→10/96	←	→ 08/96	13.0460-5940.2	605940	SUM 21373 16,0 + WK
2.5 TD 4WD (K34T)	64	11/92→08/96	←	→ 04/93	13.0460-5940.2	605940	SUM 21373 16,0 + WK
			←	05/93→; für Fahrzeuge ohne Servolenkung	13.0460-5940.2	605940	SUM 21373 16,0 + WK
			←	05/93→; für Fahrzeuge mit Servolenkung	13.0460-5958.2	605958	AKE 21363 15,8 + WK
Zubehörsatz, Scheibenbremsbelag							
1.6 (K11T)	60	04/87→10/96	←	→ 05/92	13.0460-0335.2	610335	SUM
2.0 4WD (K32T, K22T)	75	11/86→08/96	←		13.0460-0335.2	610335	SUM
2.0 (K12T, K32T)	75	11/86→08/96	←		13.0460-0335.2	610335	SUM
2.5 D (K14T)	51	11/86→10/96	←	→ 08/96	13.0460-0335.2	610335	SUM
2.5 TD 4WD (K34T)	64	11/92→08/96	←	05/93→; für Fahrzeuge mit Servolenkung	13.0460-0235.2	610235	
			←	→ 04/93	13.0460-0335.2	610335	SUM
			←	05/93→; für Fahrzeuge ohne Servolenkung	13.0460-0335.2	610335	SUM
 Bremsscheibe							
2.5 TD 4WD (K34T)	64	11/92→08/96	←	05/93→; für Fahrzeuge mit Servolenkung	24.0124-0140.1	424140	Ø 276 24 22,4 V
MITSUBISHI - L 200 (K7_T, K6_T) 01/96→12/07							
 Bremsbelagsatz, Scheibenbremse							
2.0 (K62T)	90	06/96→12/07	←	→ 05/00	13.0460-5890.2	605890	AKE 23290 15,5 + WK
2.4 4WD (K75T)	97	06/96→12/07	←	→ 05/00; - ABS	13.0460-5890.2	605890	AKE 23290 15,5 + WK
2.4 i	97	10/96→12/06	←	01/99→ 07/01; + ABS	13.0460-5958.2	605958	AKE 21363 15,8 + WK
2.5 D (K64T)	55	06/96→12/07	←	→ 05/00; - ABS	13.0460-5890.2	605890	AKE 23290 15,5 + WK
↓							













	kw			 	! #		
MITSUBISHI - L 200 (K7_T, K6_T) 01/96→12/07							
 Bremsbelagsatz, Scheibenbremse							
2.5 D (K64T)	55	06/96→12/07	←	06/00→ 07/01; + ABS		13.0460-5958.2 605958	AKE 21363 15,8 + WK
2.5 TD 4WD (K74T)	73	06/96→12/07	←	→ 05/00; - ABS		13.0460-5890.2 605890	AKE 23290 15,5 + WK
2.8 D 4WD	71	10/96→03/03	←	→ 07/01; + ABS		13.0460-5958.2 605958	AKE 21363 15,8 + WK
2.8 D	71	10/96→09/00	←	→ 05/00; - ABS		13.0460-5890.2 605890	AKE 23290 15,5 + WK
			←	+ ABS		13.0460-5958.2 605958	AKE 21363 15,8 + WK
Zubehörsatz, Scheibenbremsbelag							
2.0 (K62T)	90	06/96→12/07	←	→ 05/00		13.0460-0235.2 610235	
2.4 4WD (K75T) 2.4 i	97	06/96→12/07	←	01/99→ 07/01; + ABS		13.0460-0235.2 610235	
	97	10/96→12/06	←	→ 05/00; - ABS		13.0460-0235.2 610235	
2.5 D (K64T)	55	06/96→12/07	←	06/00→ 07/01; + ABS		13.0460-0235.2 610235	
			←	→ 05/00; - ABS		13.0460-0235.2 610235	
2.5 TD 4WD (K74T) 2.8 D 4WD	73	06/96→12/07	←	→ 07/01; + ABS		13.0460-0235.2 610235	
	71	10/96→03/03	←	→ 05/00; - ABS		13.0460-0235.2 610235	
2.8 D	71	10/96→09/00	←	+ ABS		13.0460-0235.2 610235	
			←	→ 05/00; - ABS		13.0460-0235.2 610235	
Bremsscheibe							
2.0 (K62T)	90	06/96→12/07	←	→ 07/01		24.0124-0207.1 424207	∅ 254 24 22,4 V
2.5 D (K64T)	55	06/96→12/07	←	→ 07/01		24.0124-0140.1 424140	∅ 276 24 22,4 V
2.4 4WD (K75T) 2.4 i	97	06/96→12/07	←	→ 07/01		24.0124-0140.1 424140	∅ 276 24 22,4 V
	97	10/96→12/06	←	→ 07/01		24.0124-0140.1 424140	∅ 276 24 22,4 V
2.5 TD 4WD (K74T)	73	06/96→12/07	←	→ 07/01		24.0124-0140.1 424140	∅ 276 24 22,4 V
2.8 D 4WD	71	10/96→03/03	←	→ 07/01		24.0124-0140.1 424140	∅ 276 24 22,4 V
2.5 TD 4WD (K74T) 2.5 TD 4WD (K74T)	85	09/01→12/07	←	→ 04/06; passend für Felgenreöße [Zoll]: 15		24.0124-0140.1 424140	∅ 276 24 22,4 V
	98	08/01→12/07	←	→ 04/06; passend für Felgenreöße [Zoll]: 16		24.0124-0724.1 424724	∅ 314 24 22,4 V
2.8 D	71	10/96→09/00	←	→ 07/01		24.0124-0140.1 424140	∅ 276 24 22,4 V
3.0 3.0 4WD	133	08/00→10/06	←	08/01→ 04/06; passend für Felgenreöße [Zoll]: 15		24.0124-0140.1 424140	∅ 276 24 22,4 V
	133	10/96→10/06	←	08/01→ 04/06; passend für Felgenreöße [Zoll]: 16		24.0124-0724.1 424724	∅ 314 24 22,4 V
MITSUBISHI - L 200 Pritsche/Fahrgestell (K3_T, K0_T, K1_T, K2_T) 01/86→10/96							
 Bremsbelagsatz, Scheibenbremse							
2.5 D (K14T)	55	10/86→10/96	←	11/86→ 08/96		13.0460-5940.2 605940	SUM 21373 16,0 + WK
2.5 D 4WD (K24T)	55	12/86→10/96	←	12/87→ 05/93		13.0460-5940.2 605940	SUM 21373 16,0 + WK
Zubehörsatz, Scheibenbremsbelag							
2.5 D (K14T)	55	10/86→10/96	←	11/86→ 08/96		13.0460-0335.2 610335	SUM
2.5 D 4WD (K24T)	55	12/86→10/96	←	12/87→ 05/93		13.0460-0335.2 610335	SUM
MITSUBISHI - L 200 Pritsche/Fahrgestell (K6_T, K7_T) 01/96→12/06							
 Bremsbelagsatz, Scheibenbremse							
2.4 i	97	10/96→12/06	←	→ 05/00; - ABS		13.0460-5890.2 605890	AKE 23290 15,5 + WK
			←	01/99→ 07/01; + ABS		13.0460-5958.2 605958	AKE 21363 15,8 + WK
Zubehörsatz, Scheibenbremsbelag							
2.4 i	97	10/96→12/06	←	01/99→ 07/01; + ABS		13.0460-0235.2 610235	
			←	→ 05/00; - ABS		13.0460-0235.2 610235	
Bremsscheibe							
2.4 i	97	10/96→12/06	←	→ 07/01		24.0124-0140.1 424140	∅ 276 24 22,4 V
MITSUBISHI - L 300 III Bus (P0_W, P1_W, P2_W) 11/86→12/06							
 Bremsbelagsatz, Scheibenbremse							
1.6 (P02W, P12W)	51	11/86→05/04	←	11/88→ 05/94		13.0460-5940.2 605940	SUM 21373 16,0 + WK
2.0	82	06/94→05/03	←	→ 04/00		13.0460-5940.2 605940	SUM 21373 16,0 + WK
2.0 (P03W, P13W) 2.0 (P03W, P13W) 2.4 (P04W, P14W) ↓	64	11/86→05/04	←	→ 05/94		13.0460-5940.2 605940	SUM 21373 16,0 + WK
	66	11/86→05/04	←	→ 05/94		13.0460-5940.2 605940	SUM 21373 16,0 + WK
	82	11/90→05/04	←	→ 05/94		13.0460-5940.2 605940	SUM 21373 16,0 + WK

	kw					! #		
MITSUBISHI - L 300 III Bus (P0_W, P1_W, P2_W) 11/86→12/06								
 Bremsbelagsatz, Scheibenbremse								
2.4 4WD (P24W)	82	11/90→05/04	←	→ 05/94			13.0460-5940.2 605940	SUM 21373 16,0 + WK
2.5 D (P05W, P15W, P25W)	51	11/86→05/04						
2.5 TD 4WD (P25W)	64	11/88→05/04						
2.0 4WD (P23W, P03W, P13W)	65	12/86→05/04	←	07/88→ 10/92			13.0460-5940.2 605940	SUM 21373 16,0 + WK
2.0 4WD (P23W, P03W, P13W)	66	11/86→05/04	←	→ 10/92			13.0460-5940.2 605940	SUM 21373 16,0 + WK
2.0 i (P00W, P03W, P13W)	83	06/94→10/98	←				13.0460-5940.2 605940	SUM 21373 16,0 + WK
2.4 i	97	09/94→05/04	←	→ 05/99			13.0460-5940.2 605940	SUM 21373 16,0 + WK
2.4 i 4WD	97	09/94→02/01						
2.5 TD	73	09/94→05/04						
3.0	136	06/94→05/03						
2.5 D (P05W, P15W)	55	09/91→09/03	←	06/94→ 05/99			13.0460-5940.2 605940	SUM 21373 16,0 + WK
Zubehörsatz, Scheibenbremsbelag								
1.6 (P02W, P12W)	51	11/86→05/04	←	11/88→ 05/94			13.0460-0335.2 610335	SUM
2.0 (P03W, P13W)	64	11/86→05/04	←	→ 05/94			13.0460-0335.2 610335	SUM
2.0 (P03W, P13W)	66	11/86→05/04						
2.4 (P04W, P14W)	82	11/90→05/04						
2.4 4WD (P24W)	82	11/90→05/04						
2.5 D (P05W, P15W, P25W)	51	11/86→05/04						
2.5 TD 4WD (P25W)	64	11/88→05/04						
2.0 4WD (P23W, P03W, P13W)	65	12/86→05/04	←	07/88→ 10/92			13.0460-0335.2 610335	SUM
2.0 4WD (P23W, P03W, P13W)	66	11/86→05/04	←	→ 10/92			13.0460-0335.2 610335	SUM
 Bremsscheibe								
1.6 (P02W, P12W)	51	11/86→05/04	←	11/88→ 05/94			24.0122-0155.1 422155	Ø 258 22 20,4 V
2.0	82	06/94→05/03	←	→ 04/00; Abmessungen beachten			24.0122-0155.1 422155	Ø 258 22 20,4 V
2.0 (P03W, P13W)	64	11/86→05/04	←	→ 05/94			24.0122-0155.1 422155	Ø 258 22 20,4 V
2.0 (P03W, P13W)	66	11/86→05/04						
2.4 (P04W, P14W)	82	11/90→05/04						
2.5 D (P05W, P15W, P25W)	51	11/86→05/04						
2.0 i (P00W, P03W, P13W)	83	06/94→10/98	←	Abmessungen beachten			24.0122-0155.1 422155	Ø 258 22 20,4 V
2.4 i	97	09/94→05/04	←	→ 05/99; Abmessungen beachten			24.0122-0155.1 422155	Ø 258 22 20,4 V
2.4 i 4WD	97	09/94→02/01						
2.5 TD	73	09/94→05/04						
3.0	136	06/94→05/03						
2.5 D (P05W, P15W)	55	09/91→09/03	←	06/94→ 05/99; Abmessungen beachten			24.0122-0155.1 422155	Ø 258 22 20,4 V
MITSUBISHI - L 300 III Kasten (P0_V, P1_V, P_2V) 11/86→09/13								
 Bremsbelagsatz, Scheibenbremse								
2.0 (P03V, P13V)	64	11/86→05/96	←	→ 05/94			13.0460-5940.2 605940	SUM 21373 16,0 + WK
2.5 D (P05V, P05W, P15V)	51	11/86→02/06						
2.0 (P23W, P23V)	82	06/94→05/02	←	→ 04/00			13.0460-5940.2 605940	SUM 21373 16,0 + WK
2.4 i	97	09/94→02/06	←	→ 05/99			13.0460-5940.2 605940	SUM 21373 16,0 + WK
2.5 D	55	09/91→09/03	←	06/94→ 05/99			13.0460-5940.2 605940	SUM 21373 16,0 + WK
2.5 TD 4WD	64	11/91→05/03						
Zubehörsatz, Scheibenbremsbelag								
2.0 (P03V, P13V)	64	11/86→05/96	←	→ 05/94			13.0460-0335.2 610335	SUM
2.5 D (P05V, P05W, P15V)	51	11/86→02/06						
 Bremsscheibe								
2.0 (P03V, P13V)	64	11/86→05/96	←	→ 05/94			24.0122-0155.1 422155	Ø 258 22 20,4 V
2.5 D (P05V, P05W, P15V)	51	11/86→02/06						
2.0 (P23W, P23V)	82	06/94→05/02	←	→ 04/00; Abmessungen beachten			24.0122-0155.1 422155	Ø 258 22 20,4 V
2.4 i	97	09/94→02/06	←	→ 05/99; Abmessungen beachten			24.0122-0155.1 422155	Ø 258 22 20,4 V
2.5 D	55	09/91→09/03	←	06/94→ 05/99; Abmessungen beachten			24.0122-0155.1 422155	Ø 258 22 20,4 V
2.5 TD 4WD	64	11/91→05/03						















	kw					! #		
MITSUBISHI - L 300 III Pritsche/Fahrgestell (P1_T) 04/94→04/00								
 Bremsbelagsatz, Scheibenbremse								
2.0 (P13T)	85	07/94→04/00	←				13.0460-5940.2 605940	SUM 21373 16,0 + WK
2.5 TD (P15T)	64	11/94→04/00	←	→ 05/99			13.0460-5940.2 605940	SUM 21373 16,0 + WK
 Bremsscheibe								
2.0 (P13T)	85	07/94→04/00	←	Abmessungen beachten			24.0122-0155.1 422155	Ø 258 22 20,4 V
2.5 TD (P15T)	64	11/94→04/00	←	→ 05/99; Abmessungen beachten			24.0122-0155.1 422155	Ø 258 22 20,4 V
MITSUBISHI - L 400 Bus (PD_W, PC_W, PA_V, PB_V, PA_W) 06/94→04/07								
 Bremsbelagsatz, Scheibenbremse								
2.0 (PA3W)	83	09/95→10/02	←	08/96→			13.0460-5890.2 605890	AKE 23290 15,5 + WK
			←	06/96→			13.0460-5890.2 605890	AKE 23290 15,5 + WK
2.0 16V (PA3V/W, PB3V, PA3W)	85	05/95→05/00	←				13.0460-5890.2 605890	AKE 23290 15,5 + WK
2.5 TD (PA5V/W, PB5V)	73	05/95→05/00	←					
2.4	94	09/96→06/05	←				13.0460-5958.2 605958	AKE 21363 15,8 + WK
2.4 4WD	94	09/96→06/05	←					
2.4	97	05/95→10/02	←				13.0460-5890.2 605890	AKE 23290 15,5 + WK
			←	06/96→			13.0460-5958.2 605958	AKE 21363 15,8 + WK
2.4 i 4WD (PD4V/W)	97	05/95→05/00	←				13.0460-5958.2 605958	AKE 21363 15,8 + WK
2.5 TD 4WD (PD5V/W)	73	05/95→05/00	→				13.0460-5980.2 605980	21706 15,5 + WK
2500 TD	64	05/95→06/05	←	06/96→ 05/99; - ABS			13.0460-5890.2 605890	AKE 23290 15,5 + WK
			←	06/99→; + ABS			13.0460-5958.2 605958	AKE 21363 15,8 + WK
Zubehörsatz, Scheibenbremsbelag								
2.0 (PA3W)	83	09/95→10/02	←	08/96→			13.0460-0235.2 610235	
			←	06/96→			13.0460-0235.2 610235	
2.0 16V (PA3V/W, PB3V, PA3W)	85	05/95→05/00	←				13.0460-0235.2 610235	
2.4	94	09/96→06/05	←					
2.4 4WD	94	09/96→06/05	←					
2.4 i 4WD (PD4V/W)	97	05/95→05/00	←					
2.5 TD (PA5V/W, PB5V)	73	05/95→05/00	←					
2.5 TD 4WD (PD5V/W)	73	05/95→05/00	←					
2.4	97	05/95→10/02	←				13.0460-0235.2 610235	
			←	06/96→			13.0460-0235.2 610235	
2500 TD	64	05/95→06/05	←	06/96→ 05/99; - ABS			13.0460-0235.2 610235	
			←	06/99→; + ABS			13.0460-0235.2 610235	
 Bremsscheibe								
2.4	94	09/96→06/05	←				24.0124-0202.1 424202	Ø 276 24 22,4 V
2.4	97	05/95→10/02	←	06/96→			24.0124-0202.1 424202	Ø 276 24 22,4 V
2.4 4WD	94	09/96→06/05	←				24.0124-0202.1 424202	Ø 276 24 22,4 V
2.4 i 4WD (PD4V/W)	97	05/95→05/00	→					
2.5 TD 4WD (PD5V/W)	73	05/95→05/00	→				24.0118-0140.1 418140	Ø 315 18 16,4
MITSUBISHI - L 400 Kasten (PD_W, PC_W, PB_V, PA_W, PA_V) 12/94→04/07								
 Bremsbelagsatz, Scheibenbremse								
2.0 (PA3W)	83	12/94→10/02	←	06/96→			13.0460-5890.2 605890	AKE 23290 15,5 + WK
2.4	97	06/96→10/02	←				13.0460-5958.2 605958	AKE 21363 15,8 + WK
2500 TD (PD5W, PD5V, PA5W, PA5V)	64	09/96→06/05	←	→ 05/99; - ABS			13.0460-5890.2 605890	AKE 23290 15,5 + WK
2500 TD 4WD (PD5W, PD5V, PA5W, PA5V)	64	09/96→06/05	←	06/99→; + ABS			13.0460-5958.2 605958	AKE 21363 15,8 + WK
Zubehörsatz, Scheibenbremsbelag								
2.0 (PA3W)	83	12/94→10/02	←	06/96→			13.0460-0235.2 610235	
2.4	97	06/96→10/02	←				13.0460-0235.2 610235	
2500 TD (PD5W, PD5V, PA5W, PA5V)	64	09/96→06/05	←	06/99→; + ABS			13.0460-0235.2 610235	
2500 TD 4WD (PD5W, PD5V, PA5W, PA5V)	64	09/96→06/05	←	→ 05/99; - ABS			13.0460-0235.2 610235	
 Bremsscheibe								
2.4	97	06/96→10/02	←				24.0124-0202.1 424202	Ø 276 24 22,4 V











	kw			 	! #		
MITSUBISHI - LANCER V (CB_A, CD_A, CE_A) 09/91→12/96							
 Bremsbelagsatz, Scheibenbremse							
1.3 (CB1A)	55	06/92→12/96	←	→ 04/96		13.0460-5953.2 605953	SUM 21650 15,0 - WE / - WK
1.6 (CB4A)	66	02/94→12/96	←	→ 04/96		13.0460-5953.2 605953	SUM 21650 15,0 - WE / - WK
1.6 16V (CB4A)	83	06/92→12/96	→	→ 04/96		13.0460-5826.2 605826	AKE 21872 14,5 + WK
2.0 Diesel (CB8A)	50	06/92→12/96	→	→ 04/96		13.0460-5826.2 605826	AKE 21872 14,5 + WK
1.6 16V 4WD (CD4A)	83	06/92→12/96	←	→ 04/96		13.0460-5953.2 605953	SUM 21650 15,0 - WE / - WK
			→	→ 11/93		13.0460-5826.2 605826	AKE 21872 14,5 + WK
EVO III (CE9A)	198	08/95→07/96	←			13.0460-5958.2 605958	AKE 21363 15,8 + WK
Zubehörsatz, Scheibenbremsbelag							
1.3 (CB1A)	55	06/92→12/96	←	→ 04/96		13.0460-0233.2 610233	SUM
1.6 (CB4A)	66	02/94→12/96					
1.6 16V (CB4A)	83	06/92→12/96					
1.6 16V 4WD (CD4A)	83	06/92→12/96					
2.0 Diesel (CB8A)	50	06/92→12/96					
Bremsscheibe							
1.3 (CB1A)	55	06/92→12/96	←	→ 04/96		24.0113-0186.1 413186	Ø 234 13 11,4
			←	→ 04/96		24.0118-0120.1 418120	Ø 236 18 16,4 V
1.6 (CB4A)	66	02/94→12/96	←	→ 04/96		24.0118-0120.1 418120	Ø 236 18 16,4 V
1.6 16V (CB4A)	83	06/92→12/96	→	→ 04/96		24.0110-0266.1 410266	Ø 236 10 8,4
2.0 Diesel (CB8A)	50	06/92→12/96	→	→ 04/96		24.0110-0266.1 410266	Ø 236 10 8,4
1.6 16V 4WD (CD4A)	83	06/92→12/96	←	→ 04/96		24.0118-0120.1 418120	Ø 236 18 16,4 V
			→	→ 11/93		24.0110-0266.1 410266	Ø 236 10 8,4
MITSUBISHI - LANCER V Station Wagon (CB_W, CD_W) 09/92→10/03							
 Bremsbelagsatz, Scheibenbremse							
1.6 16V (CB4W)	83	12/92→10/03	←	→ 09/96		13.0460-5953.2 605953	SUM 21650 15,0 - WE / - WK
2.0 D	65	03/95→10/03	→	→ 09/96; + ABS		13.0460-5826.2 605826	AKE 21872 14,5 + WK
2.0 D (CB8W)	50	12/92→10/03	→	→ 09/96; + ABS		13.0460-5826.2 605826	AKE 21872 14,5 + WK
1.6 16V 4WD (CD4W)	83	12/92→10/03	←	→ 02/95		13.0460-5952.2 605952	SUM 21647 16,0 + WK
1.8 i	88	03/95→10/03	←	→ 04/96		13.0460-5952.2 605952	SUM 21647 16,0 + WK
1.8 i (CB5)	86	09/92→10/03	→	→ 04/96		13.0460-5826.2 605826	AKE 21872 14,5 + WK
Zubehörsatz, Scheibenbremsbelag							
1.6 16V (CB4W)	83	12/92→10/03	←	→ 09/96		13.0460-0233.2 610233	SUM
2.0 D	65	03/95→10/03					
2.0 D (CB8W)	50	12/92→10/03					
1.6 16V 4WD (CD4W)	83	12/92→10/03	←	→ 02/95		13.0460-0442.2 610442	SUM
1.8 i	88	03/95→10/03	←	→ 04/96		13.0460-0442.2 610442	SUM
1.8 i (CB5)	86	09/92→10/03					
Bremsscheibe							
1.6 16V (CB4W)	83	12/92→10/03	←	→ 09/96		24.0118-0120.1 418120	Ø 236 18 16,4 V
2.0 D	65	03/95→10/03	→	→ 09/96; + ABS		24.0110-0266.1 410266	Ø 236 10 8,4
2.0 D (CB8W)	50	12/92→10/03	→	→ 09/96; + ABS		24.0110-0266.1 410266	Ø 236 10 8,4
1.6 16V 4WD (CD4W)	83	12/92→10/03	←	→ 02/95		24.0124-0136.1 424136	Ø 256 24 21,5 V
MITSUBISHI - LANCER VI (CJ-CP_) 09/95→08/03							
 Bremsbelagsatz, Scheibenbremse							
1.3 12V (CK1A)	55	12/95→08/03	←	05/96→ 07/01		13.0460-5889.2 605889	SUM 21650 15,0 + WK
1.6 16V (CK4A)	66	12/95→08/03					
1.5 16V (CK2A)	69	10/99→08/03	←	→ 08/00		13.0460-5889.2 605889	SUM 21650 15,0 + WK
EVO VI (CP9A)	207	01/99→02/01	←			13.0460-4973.2 604973	BRE 23092 16,0 + WK
			→			13.0460-4974.2 604974	BRE 21580 14,6 + WK
Zubehörsatz, Scheibenbremsbelag							
1.3 12V (CK1A)	55	12/95→08/03	←	05/96→ 07/01		13.0460-0233.2 610233	SUM
1.6 16V (CK4A)	66	12/95→08/03					
1.5 16V (CK2A)	69	10/99→08/03	←	→ 08/00		13.0460-0233.2 610233	SUM
Bremsscheibe							
1.3 12V (CK1A)	55	12/95→08/03	←	05/96→ 07/01		24.0118-0120.1 418120	Ø 236 18 16,4 V
1.6 16V (CK4A)	66	12/95→08/03					
1.5 16V (CK2A)	69	10/99→08/03	←	→ 08/00		24.0118-0120.1 418120	Ø 236 18 16,4 V

	kw					! #		
MITSUBISHI - LANCER VI Coupe (CJ_A, CE) 07/96→09/04								
 Bremsbelagsatz, Scheibenbremse								
1.5 16V	63	07/96→09/04	←	→ 08/00			13.0460-5889.2 605889	SUM 21650 15,0 + WK
Zubehörsatz, Scheibenbremsbelag								
1.5 16V	63	07/96→09/04	←	→ 08/00			13.0460-0233.2 610233	SUM
 Bremsscheibe								
1.5 16V	63	07/96→09/04	←	→ 08/00			24.0118-0120.1 418120	Ø 236 18 16,4 V
MITSUBISHI - LANCER VII (CS_A, CT_A) 03/00→08/13								
 Bremsbelagsatz, Scheibenbremse								
1.3	60	09/03→	←	→ 03/07			13.0460-5760.2 605760	AKE 23584 16,4 + WK
1.5	63	05/06→						
1.5 LPG	63	05/06→	→	→ 03/07			13.0460-5735.2 605735	AKE 24014 16,0 + WK
1.6 (CS3A)	72	09/03→						
2.0	92	08/05→						
2.0 (CS9A)	99	12/03→						
2.4 iVRX	115	08/05→						
2.0	85	08/03→04/06	←	12/03→			13.0460-5760.2 605760	AKE 23584 16,4 + WK
2.0 CNG	85	08/03→04/06	→	12/03→			13.0460-5735.2 605735	AKE 24014 16,0 + WK
2.0 GDi	92	09/03→	←	12/03→ 03/07			13.0460-5760.2 605760	AKE 23584 16,4 + WK
			→	12/03→ 03/07			13.0460-5735.2 605735	AKE 24014 16,0 + WK
2.0 i	113	10/07→	←				13.0460-5760.2 605760	AKE 23584 16,4 + WK
			←	+ RUS			13.0460-5958.2 605958	AKE 21363 15,8 + WK
			→				13.0460-5735.2 605735	AKE 24014 16,0 + WK
EVO IX (CT9A)	206	01/05→09/07	←	01/06→ 08/07			13.0460-5760.2 605760	AKE 23584 16,4 + WK
			→	01/06→ 08/07			13.0460-5735.2 605735	AKE 24014 16,0 + WK
EVO IX (CT9A)	213	08/05→09/06	←				13.0460-5760.2 605760	AKE 23584 16,4 + WK
			→				13.0460-5735.2 605735	AKE 24014 16,0 + WK
EVO IX - FQ-300 (CT9A)	227	06/05→12/06	←				13.0460-4973.2 604973	BRE 23092 16,0 + WK
EVO IX - FQ-340 (CT9A)	257	06/05→12/07						
EVO VIII - FQ-320 (CT9A)	243	04/04→03/05						
EVO VIII - FQ-400 (CT9A)	302	10/04→03/05						
EVO VIII - 260 (CT9A)	195	03/04→07/05	←				13.0460-5958.2 605958	AKE 21363 15,8 + WK
EVO VIII - FQ-330 (CT9A)	246	10/03→04/05	←	12/03→			13.0460-4973.2 604973	BRE 23092 16,0 + WK
Zubehörsatz, Scheibenbremsbelag								
EVO VIII - 260 (CT9A)	195	03/04→07/05	←				13.0460-0235.2 610235	
 Bremsscheibe								
1.3	60	09/03→	←	→ 03/07			24.0126-0131.1 426131	Ø 276 26 24,4 V
1.5	63	05/06→					24.0126-0134.1 426134	Ø 276 26 24,4 V
1.5 LPG	63	05/06→	→	→ 03/07			24.0110-0240.1 410240	Ø 262 10 8,4
1.6 (CS3A)	72	09/03→					24.0110-0704.1 410704	Ø 262 10 8,4
2.0	92	08/05→						
2.0 (CS9A)	99	12/03→						
2.4 iVRX	115	08/05→						
2.0	85	08/03→04/06	←	12/03→			24.0126-0131.1 426131	Ø 276 26 24,4 V
2.0 CNG	85	08/03→04/06	→	12/03→			24.0126-0134.1 426134	Ø 276 26 24,4 V
			→	12/03→			24.0110-0240.1 410240	Ø 262 10 8,4
							24.0110-0704.1 410704	Ø 262 10 8,4
2.0 GDi	92	09/03→	←	12/03→ 03/07			24.0126-0131.1 426131	Ø 276 26 24,4 V
			→	12/03→ 03/07			24.0126-0134.1 426134	Ø 276 26 24,4 V
			→	12/03→ 03/07			24.0110-0240.1 410240	Ø 262 10 8,4
							24.0110-0704.1 410704	Ø 262 10 8,4
2.0 i	113	10/07→	←				24.0126-0164.1 426164	Ø 276 26 24,4 V
			→				24.0110-0345.1 410345	Ø 262 10 8,4
EVO IX (CT9A)	206	01/05→09/07	→	01/06→ 08/07			24.0110-0704.1 410704	Ø 262 10 8,4
EVO IX (CT9A)	213	08/05→09/06	←				24.0126-0131.1 426131	Ø 276 26 24,4 V
			→				24.0126-0134.1 426134	Ø 276 26 24,4 V
			→				24.0110-0240.1 410240	Ø 262 10 8,4
							24.0110-0704.1 410704	Ø 262 10 8,4











	kw			 	! #							
MITSUBISHI - LANCER VII Kombi (CS_W, CT_W) 09/03→10/08												
 Bremsbelagsatz, Scheibenbremse												
1.6	72	09/03→10/08	←	→ 03/07		13.0460-5760.2 605760	AKE 23584 16,4 + WK					
2.0	92	08/05→10/08	→	→ 03/07		13.0460-5735.2 605735	AKE 24014 16,0 + WK					
2.0	99	09/03→12/07										
2.4 GDI	98	09/03→10/08										
 Bremsscheibe												
1.6	72	09/03→10/08	←	→ 03/07		24.0126-0131.1 426131	Ø 276 26 24,4 V					
2.0	92	08/05→10/08	→	→ 03/07		24.0126-0134.1 426134	Ø 276 26 24,4 V					
2.0	99	09/03→12/07										
2.4 GDI	98	09/03→10/08										
MITSUBISHI - LANCER VIII (CY_A, CZ_A) 03/07→												
 Bremsbelagsatz, Scheibenbremse												
1.5	80	06/08→	←			13.0460-5760.2 605760	AKE 23584 16,4 + WK					
1.5 Bifuel	80	02/10→	→			13.0460-5735.2 605735	AKE 24014 16,0 + WK					
1.6 MIVEC	86	05/10→										
1.8	103	05/10→										
1.8	105	02/08→										
1.8 Bifuel	105	01/10→										
1.8 DI-D	85	05/10→										
1.8 DI-D (CY9A)	110	06/10→										
1.8 Flexfuel	103	03/09→										
1.8 Flexfuel (CY3A)	105	01/10→										
2.0	108	01/09→										
2.0 DI-D	103	01/08→										
2.0	115	04/08→						←			13.0460-5760.2 605760	AKE 23584 16,4 + WK
2.0 i	113	01/09→						←	+ RUS		13.0460-5958.2 605958	AKE 21363 15,8 + WK
2.0 i	118	10/09→	→			13.0460-5735.2 605735	AKE 24014 16,0 + WK					
2.0 i 4WD	113	03/07→	←	10/07→		13.0460-5760.2 605760	AKE 23584 16,4 + WK					
			←	10/07→; + RUS		13.0460-5958.2 605958	AKE 21363 15,8 + WK					
			→	10/07→		13.0460-5735.2 605735	AKE 24014 16,0 + WK					
2.0 i Ralliart 4WD (CY4A)	177	10/08→	←	10/11→		13.0460-5760.2 605760	AKE 23584 16,4 + WK					
			←	→ 09/11		13.0460-5958.2 605958	AKE 21363 15,8 + WK					
			→			13.0460-5735.2 605735	AKE 24014 16,0 + WK					
 Bremsscheibe												
1.5	80	06/08→	←			24.0126-0164.1 426164	Ø 276 26 24,4 V					
1.5 Bifuel	80	02/10→	→			24.0110-0345.1 410345	Ø 262 10 8,4					
1.6 MIVEC	86	05/10→										
1.8	103	05/10→										
1.8 Bifuel	105	01/10→										
1.8 DI-D	85	05/10→										
1.8 DI-D (CY9A)	110	06/10→										
1.8 Flexfuel	103	03/09→										
1.8 Flexfuel (CY3A)	105	01/10→										
2.0	108	01/09→										
2.0	115	04/08→										
2.0 DI-D	103	01/08→										
2.0 i	113	01/09→										
2.0 i	118	10/09→										
1.8	105	02/08→						←	04/09→		24.0126-0164.1 426164	Ø 276 26 24,4 V
								→			24.0110-0345.1 410345	Ø 262 10 8,4
2.0 i 4WD	113	03/07→						←	10/07→		24.0126-0164.1 426164	Ø 276 26 24,4 V
								→	10/07→		24.0110-0345.1 410345	Ø 262 10 8,4
2.0 i Ralliart 4WD (CY4A)	177	10/08→	←	→ 03/09		24.0124-0215.1 424215	Ø 294 24 22,4 V					
			←	10/11→		24.0126-0164.1 426164	Ø 276 26 24,4 V					
			→			24.0110-0345.1 410345	Ø 262 10 8,4					
MITSUBISHI - LANCER VIII Sportback (CX_A) 10/07→												
 Bremsbelagsatz, Scheibenbremse												
1.5	80	06/08→	←			13.0460-5760.2 605760	AKE 23584 16,4 + WK					
1.5 Bifuel	80	03/10→	→			13.0460-5735.2 605735	AKE 24014 16,0 + WK					
1.6 MIVEC	86	05/10→										
1.8 (CX3A)	105	06/08→										
1.8 Bifuel	105	02/10→										
1.8 DI-D	85	05/10→										
1.8 DI-D (CX9A)	110	06/10→										
1.8 Flex	103	03/09→										
1.8 MIVEC	103	03/09→										
↓												

























	kw					! #		
MITSUBISHI - LANCER VIII Sportback (CX_A) 10/07→								
 Bremsbelagsatz, Scheibenbremse								
2.0 DI-D	103	06/08→	←			13.0460-5760.2	605760	AKE 23584 16,4 + WK
			→			13.0460-5735.2	605735	AKE 24014 16,0 + WK
2.0 Ralliart	184	08/11→	→			13.0460-5855.2	605855	23582 16,0 - WK
2.0 Ralliart 4WD (CX4A)	177	10/08→						
Zubehörsatz, Scheibenbremsbelag								
2.0 Ralliart	184	08/11→	→			13.0460-0137.2	610137	
2.0 Ralliart 4WD (CX4A)	177	10/08→						
 Bremsscheibe								
1.5	80	06/08→	←			24.0126-0164.1	426164	Ø 276 26 24,4 V
1.5 Bifuel	80	03/10→						
1.6 MIVEC	86	05/10→	→			24.0110-0345.1	410345	Ø 262 10 8,4
1.8 (CX3A)	105	06/08→						
1.8 Bifuel	105	02/10→						
1.8 DI-D	85	05/10→						
1.8 DI-D (CX9A)	110	06/10→						
1.8 Flex	103	03/09→						
1.8 MIVEC	103	03/09→						
2.0 DI-D	103	06/08→						
2.0 Ralliart	184	08/11→	←			24.0124-0215.1	424215	Ø 294 24 22,4 V
2.0 Ralliart 4WD (CX4A)	177	10/08→	→			24.0110-0330.1	410330	Ø 302 10 8
MITSUBISHI - MIRAGE Schrägheck (CJ_A, CL_A) 12/91→07/03								
 Bremsbelagsatz, Scheibenbremse								
1.3	58	12/91→08/95	←			13.0460-5953.2	605953	SUM 21650 15,0 - WE / - WK
1.6 4WD	88	12/91→08/95	←			13.0460-5953.2	605953	SUM 21650 15,0 - WE / - WK
			→			13.0460-5826.2	605826	AKE 21872 14,5 + WK
Zubehörsatz, Scheibenbremsbelag								
1.3	58	12/91→08/95	←			13.0460-0233.2	610233	SUM
1.6 4WD	88	12/91→08/95						
 Bremsscheibe								
1.3	58	12/91→08/95	←			24.0113-0186.1	413186	Ø 234 13 11,4
			←	→ 11/93		24.0118-0120.1	418120	Ø 236 18 16,4 V
1.6 4WD	88	12/91→08/95	←			24.0118-0120.1	418120	Ø 236 18 16,4 V
			→			24.0110-0266.1	410266	Ø 236 10 8,4
MITSUBISHI - MIRAGE Schrägheck (CJ_A) 09/95→07/03								
 Bremsbelagsatz, Scheibenbremse								
1.3	55	09/95→07/03	←	05/96→ 08/00		13.0460-5889.2	605889	SUM 21650 15,0 + WK
1.6	84	09/99→07/03	←	09/00→ 06/03		13.0460-5889.2	605889	SUM 21650 15,0 + WK
1.6	128	09/95→08/99	←	05/96→		13.0460-5889.2	605889	SUM 21650 15,0 + WK
Zubehörsatz, Scheibenbremsbelag								
1.3	55	09/95→07/03	←	05/96→ 08/00		13.0460-0233.2	610233	SUM
1.6	84	09/99→07/03	←	09/00→ 06/03		13.0460-0233.2	610233	SUM
1.6	128	09/95→08/99	←	05/96→		13.0460-0233.2	610233	SUM
 Bremsscheibe								
1.3	55	09/95→07/03	←	05/96→ 08/00		24.0118-0120.1	418120	Ø 236 18 16,4 V
1.6	84	09/99→07/03	←	09/00→ 06/03		24.0118-0120.1	418120	Ø 236 18 16,4 V
1.6	128	09/95→08/99	←	05/96→		24.0118-0120.1	418120	Ø 236 18 16,4 V
MITSUBISHI - MIRAGE Stufenheck (A1_A) 07/13→								
 Bremsbelagsatz, Scheibenbremse								
1.2	59	07/13→	←	10/13→		13.0460-5709.2	605709	AKE 24230 15,3 + WK + Zub
MITSUBISHI - MIRAGE Stufenheck (CK_A) 09/95→07/03								
 Bremsbelagsatz, Scheibenbremse								
1.5 (CK2A)	81	09/95→08/99	←	05/96→		13.0460-5889.2	605889	SUM 21650 15,0 + WK
↓								











	kw					! #		
MITSUBISHI - MIRAGE Stufenheck (CK_A) 09/95→07/03								
Zubehörsatz, Scheibenbremsbelag								
1.5 (CK2A)	81	09/95→08/99	←	05/96→			13.0460-0233.2 610233	SUM
 Bremsscheibe								
1.5 (CK2A)	81	09/95→08/99	←	05/96→			24.0118-0120.1 418120	Ø 236 18 16,4 V
MITSUBISHI - OUTLANDER I (CU_W) 03/01→12/06								
 Bremsbelagsatz, Scheibenbremse								
2.0 (CU2W)	100	05/03→10/06	←				13.0460-5958.2 605958	AKE 21363 15,8 + WK
2.0 4WD (CU2W)	93	05/03→10/06						
2.0 4WD (CU2W)	100	05/03→10/06	→				13.0460-5735.2 605735	AKE 24014 16,0 + WK
2.0 Turbo 4WD (CU2W)	148	04/04→10/06						
2.4 4WD	102	05/03→10/06						
2.4 4WD (CU5W)	118	11/03→10/06						
2.4 4WD (CU5W)	119	05/03→10/06						
2.0 Turbo-R 4WD	177	01/02→10/06	←	05/03→			13.0460-5958.2 605958	AKE 21363 15,8 + WK
			→	05/03→			13.0460-5735.2 605735	AKE 24014 16,0 + WK
2.4 4WD	121	10/05→12/06	←	→ 10/06			13.0460-5958.2 605958	AKE 21363 15,8 + WK
2.4 GDI 4WD	121	01/05→12/06	→	→ 10/06			13.0460-5735.2 605735	AKE 24014 16,0 + WK
2.4 HDD Mivec (CU5W)	118	03/01→12/06	←	07/03→ 10/06			13.0460-5958.2 605958	AKE 21363 15,8 + WK
			→	07/03→ 10/06			13.0460-5735.2 605735	AKE 24014 16,0 + WK
Zubehörsatz, Scheibenbremsbelag								
2.0 (CU2W)	100	05/03→10/06	←				13.0460-0235.2 610235	
2.0 4WD (CU2W)	93	05/03→10/06						
2.0 4WD (CU2W)	100	05/03→10/06	→					
2.0 Turbo 4WD (CU2W)	148	04/04→10/06						
2.4 4WD	102	05/03→10/06						
2.4 4WD (CU5W)	118	11/03→10/06						
2.4 4WD (CU5W)	119	05/03→10/06						
2.0 Turbo-R 4WD	177	01/02→10/06	←	05/03→			13.0460-0235.2 610235	
2.4 4WD	121	10/05→12/06	←	→ 10/06			13.0460-0235.2 610235	
2.4 GDI 4WD	121	01/05→12/06	→	→ 10/06				
2.4 HDD Mivec (CU5W)	118	03/01→12/06	←	07/03→ 10/06			13.0460-0235.2 610235	
 Bremsscheibe								
2.0 (CU2W)	100	05/03→10/06	←				24.0124-0215.1 424215	Ø 294 24 22,4 V
2.0 4WD (CU2W)	93	05/03→10/06						
2.0 4WD (CU2W)	100	05/03→10/06	→				24.0110-0704.1 410704	Ø 262 10 8,4
2.0 Turbo 4WD (CU2W)	148	04/04→10/06						
2.4 4WD	102	05/03→10/06						
2.4 4WD (CU5W)	118	11/03→10/06						
2.4 4WD (CU5W)	119	05/03→10/06						
2.0 Turbo-R 4WD	177	01/02→10/06	←	05/03→			24.0124-0215.1 424215	Ø 294 24 22,4 V
			→	05/03→			24.0110-0704.1 410704	Ø 262 10 8,4
2.4 4WD	121	10/05→12/06	←	→ 10/06			24.0124-0215.1 424215	Ø 294 24 22,4 V
2.4 GDI 4WD	121	01/05→12/06	→	→ 10/06			24.0110-0704.1 410704	Ø 262 10 8,4
2.4 HDD Mivec (CU5W)	118	03/01→12/06	←	07/03→ 10/06			24.0124-0215.1 424215	Ø 294 24 22,4 V
			→	07/03→ 10/06			24.0110-0704.1 410704	Ø 262 10 8,4
MITSUBISHI - OUTLANDER II (CW_W) 11/06→12/12								
 Bremsbelagsatz, Scheibenbremse								
2.0	108	11/06→11/12	←				13.0460-5958.2 605958	AKE 21363 15,8 + WK
			→				13.0460-5735.2 605735	AKE 24014 16,0 + WK
2.0 4WD	108	11/06→11/12	←				13.0460-5958.2 605958	AKE 21363 15,8 + WK
2.0 DI-D	103	02/07→11/12						
2.2 DI-D	130	11/06→11/12	→				13.0460-5855.2 605855	23582 16,0 - WK
2.2 DI-D 4WD	115	08/07→11/12						
2.2 DI-D 4WD	130	11/06→11/12						
2.2 DI-D 4WD	103	09/10→11/12	→				13.0460-5855.2 605855	23582 16,0 - WK
3.0 4WD	177	10/09→11/12						
3.0 FWD	162	11/06→11/12						
2.4	125	11/06→11/12	←				13.0460-5760.2 605760	AKE 23584 16,4 + WK
2.4 4WD	125	09/07→11/12					13.0460-5958.2 605958	AKE 21363 15,8 + WK
2.4 Flex 4WD	125	09/07→11/12						
3.0 4WD	162	11/06→11/12	→				13.0460-5855.2 605855	23582 16,0 - WK
Zubehörsatz, Scheibenbremsbelag								
2.0 4WD	108	11/06→11/12	→				13.0460-0137.2 610137	
↓								













	kw			 	! #			
MITSUBISHI - OUTLANDER II (CW_W) 11/06→12/12								
Zubehörsatz, Scheibenbremsbelag								
2.0 DI-D	103	02/07→11/12	➔			13.0460-0137.2	610137	
2.2 DI-D	130	11/06→11/12						
2.2 DI-D 4WD	103	09/10→11/12						
2.2 DI-D 4WD	115	08/07→11/12						
2.2 DI-D 4WD	130	11/06→11/12						
2.4	125	11/06→11/12						
2.4 4WD	125	09/07→11/12						
2.4 Flex 4WD	125	09/07→11/12						
3.0 4WD	162	11/06→11/12						
3.0 4WD	177	10/09→11/12						
3.0 FWD	162	11/06→11/12						
 Bremsscheibe								
2.0	108	11/06→11/12	←			24.0124-0215.1	424215	Ø 294 24 22,4 V
			➔			24.0110-0360.1	410360	Ø 302 10 8,4
						24.0110-0704.1	410704	Ø 262 10 8,4
2.0 4WD	108	11/06→11/12	←			24.0124-0215.1	424215	Ø 294 24 22,4 V
2.2 DI-D	130	11/06→11/12						
2.2 DI-D 4WD	103	09/10→11/12	➔			24.0110-0360.1	410360	Ø 302 10 8,4
2.2 DI-D 4WD	130	11/06→11/12						
2.0 DI-D	103	02/07→11/12	←			24.0124-0215.1	424215	Ø 294 24 22,4 V
			➔	für Fahrzeuge mit 3. Sitzreihe		24.0110-0330.1	410330	Ø 302 10 8
			➔			24.0110-0360.1	410360	Ø 302 10 8,4
2.2 DI-D 4WD	115	08/07→11/12	←			24.0124-0215.1	424215	Ø 294 24 22,4 V
3.0 4WD	162	11/06→11/12						
3.0 4WD	177	10/09→11/12	➔			24.0110-0330.1	410330	Ø 302 10 8
3.0 FWD	162	11/06→11/12						
2.4	125	11/06→11/12	←			24.0124-0215.1	424215	Ø 294 24 22,4 V
			➔	→ 08/09		24.0110-0330.1	410330	Ø 302 10 8
			➔	09/09→		24.0110-0360.1	410360	Ø 302 10 8,4
			➔			24.0110-0704.1	410704	Ø 262 10 8,4
2.4 4WD	125	09/07→11/12	←			24.0124-0215.1	424215	Ø 294 24 22,4 V
			➔			24.0110-0330.1	410330	Ø 302 10 8
						24.0110-0360.1	410360	Ø 302 10 8,4
						24.0110-0704.1	410704	Ø 262 10 8,4
2.4 Flex 4WD	125	09/07→11/12	←			24.0124-0215.1	424215	Ø 294 24 22,4 V
			➔	CVT-Automatikgetriebe (Stufenlos)		24.0110-0330.1	410330	Ø 302 10 8
			➔	Schaltgetriebe		24.0110-0360.1	410360	Ø 302 10 8,4
MITSUBISHI - OUTLANDER III (GG_W, GF_W, ZJ) 08/12→								
 Bremsbelagsatz, Scheibenbremse								
2.0 (GF2W)	107	10/12→	←			13.0460-5958.2	605958	AKE 21363 15,8 + WK
2.0 (GF7W)	110	08/12→						
2.0 4WD (GF2W)	107	10/12→						
2.0 4WD (GF7W)	110	08/12→						
2.0 Hybrid 4WD (GG2W)	87	01/14→						
2.0 Hybrid 4WD (GG2W)	89	12/12→						
2.0 Hybrid 4WD (GG2W)	139	12/12→						
2.2 Di-D (GF6W)	110	08/12→						
2.2 Di-D 4WD (GF6W)	110	08/12→						
2.4 4WD	123	10/12→	←			13.0460-5760.2	605760	AKE 23584 16,4 + WK
2.4 4WD (GF3W)	124	10/12→						
3.0 4WD	169	03/14→						
Zubehörsatz, Scheibenbremsbelag								
2.0 (GF2W)	107	10/12→	←			13.0460-0235.2	610235	
2.0 (GF7W)	110	08/12→						
2.0 4WD (GF2W)	107	10/12→	➔					
2.0 4WD (GF7W)	110	08/12→						
2.0 Hybrid 4WD (GG2W)	87	01/14→						
2.0 Hybrid 4WD (GG2W)	89	12/12→						
2.0 Hybrid 4WD (GG2W)	139	12/12→						
2.2 Di-D (GF6W)	110	08/12→						
2.2 Di-D 4WD (GF6W)	110	08/12→						
 Bremsscheibe								
2.0 (GF2W)	107	10/12→	←			24.0124-0215.1	424215	Ø 294 24 22,4 V
2.0 (GF7W)	110	08/12→	➔			24.0110-0395.1	410395	Ø 302 10 8,4
2.0 4WD (GF2W)	107	10/12→						
2.0 4WD (GF7W)	110	08/12→						
2.2 Di-D (GF6W)	110	08/12→						
2.2 Di-D 4WD (GF6W)	110	08/12→						
↓								













	kW					! #		
MITSUBISHI - OUTLANDER III (GG_W, GF_W, ZJ) 08/12→								
 Bremsscheibe								
2.0 Hybrid 4WD (GG2W)	87	01/14→	→			24.0110-0395.1	410395	Ø 302 10 8,4
2.0 Hybrid 4WD (GG2W)	89	12/12→						
2.0 Hybrid 4WD (GG2W)	139	12/12→						
3.0 4WD	169	03/14→						
2.4 4WD	123	10/12→	←			24.0126-0170.1	426170	Ø 294 26 24,4 V
2.4 4WD (GF3W)	124	10/12→	→			24.0110-0395.1	410395	Ø 302 10 8,4
MITSUBISHI - PAJERO II (V3_W, V2_W, V4_W) 12/90→10/99								
 Bremsbelagsatz, Scheibenbremse								
2.4 (V21W, V21C)	82	04/91→10/99	←			13.0460-5958.2	605958	AKE 21363 15,8 + WK
2.5 TD 4WD (V24C, V24W)	73	12/90→10/99	→			13.0460-5981.2	605981	21840 14,4 + WK
2.5 TDiC (V44W, V24W)	73	03/91→08/99						
2.8 D 4WD (V46W, V26W)	71	11/93→07/97						
2.8 TD (V46W, V26W)	92	06/94→10/99						
3.0 V6 24V (V43W, V23W)	130	06/97→10/99						
3.0 V6 24V (V43W, V23W)	133	06/94→05/97						
3.0 V6 4WD (V23W, V43W, V23C)	110	12/90→12/95						
3.5 V6 24V (V25W, V45W)	153	06/94→10/99						
3.5 V6 24V (V45W, V25W)	143	07/97→10/99						
Zubehörsatz, Scheibenbremsbelag								
2.4 (V21W, V21C)	82	04/91→10/99	←			13.0460-0235.2	610235	
2.5 TD 4WD (V24C, V24W)	73	12/90→10/99						
2.5 TDiC (V44W, V24W)	73	03/91→08/99						
2.8 D 4WD (V46W, V26W)	71	11/93→07/97						
2.8 TD (V46W, V26W)	92	06/94→10/99						
3.0 V6 24V (V43W, V23W)	130	06/97→10/99						
3.0 V6 24V (V43W, V23W)	133	06/94→05/97						
3.0 V6 4WD (V23W, V43W, V23C)	110	12/90→12/95						
3.5 V6 24V (V25W, V45W)	153	06/94→10/99						
3.5 V6 24V (V45W, V25W)	143	07/97→10/99						
 Bremsscheibe								
2.4 (V21W, V21C)	82	04/91→10/99	←			24.0124-0140.1	424140	Ø 276 24 22,4 V
2.5 TD 4WD (V24C, V24W)	73	12/90→10/99	→			24.0118-0140.1	418140	Ø 315 18 16,4
2.5 TDiC (V44W, V24W)	73	03/91→08/99						
2.8 D 4WD (V46W, V26W)	71	11/93→07/97						
2.8 TD (V46W, V26W)	92	06/94→10/99						
3.0 V6 24V (V43W, V23W)	130	06/97→10/99						
3.0 V6 24V (V43W, V23W)	133	06/94→05/97						
3.0 V6 4WD (V23W, V43W, V23C)	110	12/90→12/95						
3.5 V6 24V (V25W, V45W)	153	06/94→10/99	←	- ABS		24.0127-0101.1	427101	Ø 276 27 25,4 V
3.5 V6 24V (V45W, V25W)	143	07/97→10/99	→			24.0118-0140.1	418140	Ø 315 18 16,4
MITSUBISHI - PAJERO II (V3_W) 04/00→09/07								
 Bremsbelagsatz, Scheibenbremse								
3.2 DiD 4WD	121	04/00→09/07	←			13.0460-5853.2	605853	SUM 23488 15,4 + WK
			←	→ 09/01		13.0460-5958.2	605958	AKE 21363 15,8 + WK
			→			13.0460-5855.2	605855	23582 16,0 - WK
Zubehörsatz, Scheibenbremsbelag								
3.2 DiD 4WD	121	04/00→09/07	←	→ 09/01		13.0460-0235.2	610235	
↓			→			13.0460-0137.2	610137	

	kW			 	! #		
MITSUBISHI - PAJERO II (V3_W) 04/00→09/07							
 Bremsscheibe							
3.2 DiD 4WD	121	04/00→09/07	←	→ 09/01; passend für Felgenreöße [Zoll]: 15	24.0124-0140.1	424140	Ø 276 24 22,4 V
			←	passend für Felgenreöße [Zoll]: 16	24.0126-0145.1	426145	Ø 290 26 24,4 V
			→		24.0122-0724.1	422724	Ø 300 22 20,4 V
MITSUBISHI - PAJERO II Canvas Top (V2_W, V4_W) 12/90→04/00							
 Bremsbelagsatz, Scheibenbremse							
1.8 GDI	96	06/98→04/00	←	10/99→	13.0460-5854.2	605854	SUM 23487 15,5 - WE / - WK
			→	10/99→	13.0460-5980.2	605980	21706 15,5 + WK
2.4 (V41W, V21W, V21C)	82	04/91→04/00	←	→ 03/00	13.0460-5958.2	605958	AKE 21363 15,8 + WK
			→	→ 03/00	13.0460-5981.2	605981	21840 14,4 + WK
2.5 TD 4WD (V24C, V24W)	73	12/90→04/00	←				
			→				
3.0 V6 24V (V23C)	130	06/94→04/00	←				
			→				
3.0 V6 24V (V23W, V23C)	133	06/94→04/00	←				
			→				
3.0 V6 (V23W, v43W, V23C)	110	12/90→12/95	←		13.0460-5958.2	605958	AKE 21363 15,8 + WK
			→		13.0460-5981.2	605981	21840 14,4 + WK
Zubehörsatz, Scheibenbremsbelag							
1.8 GDI	96	06/98→04/00	→	10/99→	13.0460-0150.2	610150	AKE
2.4 (V41W, V21W, V21C)	82	04/91→04/00	←	→ 03/00	13.0460-0235.2	610235	
			→				
2.5 TD 4WD (V24C, V24W)	73	12/90→04/00	←				
			→				
3.0 V6 24V (V23C)	130	06/94→04/00	←				
			→				
3.0 V6 24V (V23W, V23C)	133	06/94→04/00	←				
			→				
3.0 V6 (V23W, v43W, V23C)	110	12/90→12/95	←		13.0460-0235.2	610235	
			→				
 Bremsscheibe							
1.8 GDI	96	06/98→04/00	←	10/99→	24.0122-0230.1	422230	Ø 285 22 20,4 V
			→	10/99→	24.0110-0281.1	410281	Ø 262 9,5 8,4
2.4 (V41W, V21W, V21C)	82	04/91→04/00	←	→ 03/00	24.0124-0140.1	424140	Ø 276 24 22,4 V
			→	→ 03/00	24.0118-0140.1	418140	Ø 315 18 16,4
2.5 TD 4WD (V24C, V24W)	73	12/90→04/00	←				
			→				
3.0 V6 24V (V23C)	130	06/94→04/00	←				
			→				
3.0 V6 24V (V23W, V23C)	133	06/94→04/00	←				
			→				
3.0 V6 (V23W, v43W, V23C)	110	12/90→12/95	←		24.0124-0140.1	424140	Ø 276 24 22,4 V
			→		24.0118-0140.1	418140	Ø 315 18 16,4
MITSUBISHI - PAJERO III (V7_W, V6_W) 01/99→01/07							
 Bremsbelagsatz, Scheibenbremse							
2.5 TDi	73	04/00→12/06	←		13.0460-5853.2	605853	SUM 23488 15,4 + WK
			→		13.0460-5958.2	605958	AKE 21363 15,8 + WK
2.5 TDi	85	09/01→12/06	←				
			→		13.0460-5855.2	605855	23582 16,0 - WK
3.2 Di-D	121	04/00→10/01	←		13.0460-5853.2	605853	SUM 23488 15,4 + WK
			←	→ 09/01	13.0460-5958.2	605958	AKE 21363 15,8 + WK
			→		13.0460-5855.2	605855	23582 16,0 - WK
3.2 Di-D (V68W)	118	04/00→12/06	←	10/01→ 08/06	13.0460-5853.2	605853	SUM 23488 15,4 + WK
			←		13.0460-5958.2	605958	AKE 21363 15,8 + WK
			→	10/01→ 08/06	13.0460-5855.2	605855	23582 16,0 - WK
3.5	149	04/00→01/07	←	→ 08/06	13.0460-5853.2	605853	SUM 23488 15,4 + WK
			←		13.0460-5958.2	605958	AKE 21363 15,8 + WK
			→	→ 08/06	13.0460-5855.2	605855	23582 16,0 - WK
3.8 (V67W)	184	03/03→01/07	←				
			←				
			→				
Zubehörsatz, Scheibenbremsbelag							
2.5 TDi	73	04/00→12/06	←		13.0460-0235.2	610235	
			→		13.0460-0137.2	610137	
2.5 TDi	85	09/01→12/06	←				
			→				
3.2 Di-D	121	04/00→10/01	←	→ 09/01	13.0460-0235.2	610235	
			→		13.0460-0137.2	610137	
3.2 Di-D (V68W)	118	04/00→12/06	←	10/01→ 08/06	13.0460-0235.2	610235	
			→				













	kw					! #		
MITSUBISHI - PAJERO III (V7_W, V6_W) 01/99→01/07								
Zubehörsatz, Scheibenbremsbelag								
3.2 Di-D (V68W)	118	04/00→12/06	➡	10/01→08/06			13.0460-0137.2 610137	
3.5	149	04/00→01/07	➡	→08/06			13.0460-0235.2 610235	
3.8 (V67W)	184	03/03→01/07	➡	→08/06			13.0460-0137.2 610137	
 Bremsscheibe								
2.5 TDi	73	04/00→12/06	➡	passend für Felgengröße [Zoll]: 15			24.0124-0140.1 424140	Ø 276 24 22,4 V
			➡	passend für Felgengröße [Zoll]: 16			24.0126-0145.1 426145	Ø 290 26 24,4 V
			➡				24.0122-0724.1 422724	Ø 300 22 20,4 V
2.5 TDi	85	09/01→12/06	➡	passend für Felgengröße [Zoll]: 15			24.0124-0140.1 424140	Ø 276 24 22,4 V
			➡	passend für Felgengröße [Zoll]: 16			24.0126-0145.1 426145	Ø 290 26 24,4 V
			➡				24.0118-0140.1 418140	Ø 315 18 16,4
3.2 Di-D	121	04/00→10/01	➡	→09/01; passend für Felgengröße [Zoll]: 15			24.0124-0140.1 424140	Ø 276 24 22,4 V
			➡	passend für Felgengröße [Zoll]: 16			24.0126-0145.1 426145	Ø 290 26 24,4 V
			➡				24.0122-0724.1 422724	Ø 300 22 20,4 V
3.2 Di-D (V68W)	118	04/00→12/06	➡	10/01→08/06; passend für Felgengröße [Zoll]: 15			24.0124-0140.1 424140	Ø 276 24 22,4 V
			➡	10/01→08/06; passend für Felgengröße [Zoll]: 16			24.0126-0145.1 426145	Ø 290 26 24,4 V
			➡	10/01→08/06			24.0122-0724.1 422724	Ø 300 22 20,4 V
3.5	149	04/00→01/07	➡	→08/06; passend für Felgengröße [Zoll]: 15			24.0124-0140.1 424140	Ø 276 24 22,4 V
3.8 (V67W)	184	03/03→01/07	➡	→08/06; passend für Felgengröße [Zoll]: 16			24.0126-0145.1 426145	Ø 290 26 24,4 V
			➡	→08/06			24.0122-0724.1 422724	Ø 300 22 20,4 V
MITSUBISHI - PAJERO III Geländewagen offen (V6_W, V7_W) 04/00→12/06								
 Bremsbelagsatz, Scheibenbremse								
2.5 TDi (V64W, V74W)	73	04/00→12/06	➡				13.0460-5853.2 605853	SUM 23488 15,4 + WK
2.5 TDi (V64W, V74W)	85	09/01→12/06	➡				13.0460-5958.2 605958	AKE 21363 15,8 + WK
2.8 TD 4WD	92	05/00→07/02	➡					
3.5 i 4WD	140	05/00→04/04	➡				13.0460-5855.2 605855	23582 16,0 - WK
3.2 Di-D (V68W, V78W)	118	10/01→12/06	➡	→08/06			13.0460-5853.2 605853	SUM 23488 15,4 + WK
3.5 GDi 4WD (V75W)	125	10/01→12/06	➡				13.0460-5958.2 605958	AKE 21363 15,8 + WK
3.5 i	160	09/03→10/06	➡					
3.5 V6 GDI (V65W, V75W)	149	04/00→12/06	➡	→08/06			13.0460-5855.2 605855	23582 16,0 - WK
3.8 i 4WD	149	09/03→10/06	➡					
3.2 Di-D (V68W, V78W)	121	04/00→12/06	➡				13.0460-5853.2 605853	SUM 23488 15,4 + WK
			➡	→09/01			13.0460-5958.2 605958	AKE 21363 15,8 + WK
			➡				13.0460-5855.2 605855	23582 16,0 - WK
Zubehörsatz, Scheibenbremsbelag								
2.5 TDi (V64W, V74W)	73	04/00→12/06	➡				13.0460-0235.2 610235	
2.5 TDi (V64W, V74W)	85	09/01→12/06	➡					
2.8 TD 4WD	92	05/00→07/02	➡				13.0460-0137.2 610137	
3.5 i 4WD	140	05/00→04/04	➡					
3.2 Di-D (V68W, V78W)	118	10/01→12/06	➡	→08/06			13.0460-0235.2 610235	
3.5 GDi 4WD (V75W)	125	10/01→12/06	➡					
3.5 i	160	09/03→10/06	➡	→08/06			13.0460-0137.2 610137	
3.5 V6 GDI (V65W, V75W)	149	04/00→12/06	➡					
3.8 i 4WD	149	09/03→10/06	➡					
3.2 Di-D (V68W, V78W)	121	04/00→12/06	➡	→09/01			13.0460-0235.2 610235	
			➡				13.0460-0137.2 610137	
 Bremsscheibe								
2.5 TDi (V64W, V74W)	73	04/00→12/06	➡	passend für Felgengröße [Zoll]: 15			24.0124-0140.1 424140	Ø 276 24 22,4 V
3.5 i 4WD	140	05/00→04/04	➡	passend für Felgengröße [Zoll]: 16			24.0126-0145.1 426145	Ø 290 26 24,4 V
			➡				24.0122-0724.1 422724	Ø 300 22 20,4 V
2.5 TDi (V64W, V74W)	85	09/01→12/06	➡	passend für Felgengröße [Zoll]: 15			24.0124-0140.1 424140	Ø 276 24 22,4 V
2.8 TD 4WD	92	05/00→07/02	➡	passend für Felgengröße [Zoll]: 16			24.0126-0145.1 426145	Ø 290 26 24,4 V
			➡				24.0118-0140.1 418140	Ø 315 18 16,4
3.2 Di-D (V68W, V78W)	118	10/01→12/06	➡	→08/06;			24.0124-0140.1 424140	Ø 276 24 22,4 V
3.5 GDi 4WD (V75W)	125	10/01→12/06	➡	passend für Felgengröße [Zoll]: 15				
3.5 i	160	09/03→10/06	➡					































	kw					! #		
MITSUBISHI - PAJERO III Geländewagen offen (V6_W, V7_W) 04/00→12/06								
 Bremsscheibe								
3.5 V6 GDI (V65W, V75W)	149	04/00→12/06	←	→ 08/06; passend für Felgenreöße [Zoll]: 16		24.0126-0145.1	426145	Ø 290 26 24,4 V
3.8 i 4WD	149	09/03→10/06	→	→ 08/06		24.0122-0724.1	422724	Ø 300 22 20,4 V
3.2 DI-D (V68W, V78W)	121	04/00→12/06	←	→ 09/01; passend für Felgenreöße [Zoll]: 15		24.0124-0140.1	424140	Ø 276 24 22,4 V
			←	passend für Felgenreöße [Zoll]: 16		24.0126-0145.1	426145	Ø 290 26 24,4 V
			→			24.0122-0724.1	422724	Ø 300 22 20,4 V
			→					
MITSUBISHI - PAJERO IV (V8_W, V9_W) 11/06→								
 Bremsbelagsatz, Scheibenbremse								
3.0 4WD	131	02/07→	←			13.0460-5747.2	605747	24024 17,0 + WK
			→			13.0460-5744.2	605744	21947 15,4 - WE / - WK
3.2 DI-D	121	01/10→	←	Baumuster: V88W		13.0460-5853.2	605853	SUM 23488 15,4 + WK
			→	Baumuster: V88W		13.0460-5855.2	605855	23582 16,0 - WK
3.2 DI-D (V88W, V98W)	118	02/07→	←	Baumuster: V98W		13.0460-5747.2	605747	24024 17,0 + WK
			←	Baumuster: V88W		13.0460-5853.2	605853	SUM 23488 15,4 + WK
			→	Baumuster: V98W		13.0460-5744.2	605744	21947 15,4 - WE / - WK
			→	Baumuster: V88W		13.0460-5855.2	605855	23582 16,0 - WK
3.2 DI-D 4WD (V98W)	140	02/07→	←	01/09→; Baumuster: V98W		13.0460-5747.2	605747	24024 17,0 + WK
			←			13.0460-5853.2	605853	SUM 23488 15,4 + WK
			←	01/09→; Baumuster: V88W		13.0460-5853.2	605853	SUM 23488 15,4 + WK
			→	01/09→; Baumuster: V98W		13.0460-5744.2	605744	21947 15,4 - WE / - WK
			→			13.0460-5855.2	605855	23582 16,0 - WK
3.8 V6	182	02/10→	←	Baumuster: V97W		13.0460-5747.2	605747	24024 17,0 + WK
			←	Baumuster: V87W		13.0460-5853.2	605853	SUM 23488 15,4 + WK
			→	Baumuster: V97W		13.0460-5744.2	605744	21947 15,4 - WE / - WK
			→	Baumuster: V87W		13.0460-5855.2	605855	23582 16,0 - WK
3.8 V6 (V87W, V97W)	184	02/07→	←	Baumuster: V97W		13.0460-5747.2	605747	24024 17,0 + WK
			←	Baumuster: V87W		13.0460-5853.2	605853	SUM 23488 15,4 + WK
			→	Baumuster: V97W		13.0460-5744.2	605744	21947 15,4 - WE / - WK
			→	Baumuster: V87W		13.0460-5855.2	605855	23582 16,0 - WK
Zubehörsatz, Scheibenbremsbelag								
3.2 DI-D	121	01/10→	→	Baumuster: V88W		13.0460-0137.2	610137	
			→					
			→					
			→					
			→					
3.2 DI-D (V88W, V98W)	118	02/07→	→					
			→					
3.2 DI-D 4WD	149	01/12→	→					
			→					
3.2 DI-D 4WD (V98W, V88W)	147	01/09→	→					
			→					
			→					
			→					
3.2 DI-D 4WD (V98W)	140	02/07→	→			13.0460-0137.2	610137	
			→	01/09→; Baumuster: V88W		13.0460-0137.2	610137	
3.8 V6	182	02/10→	→	Baumuster: V87W		13.0460-0137.2	610137	
			→					
3.8 V6 (V87W, V97W)	184	02/07→	→					
			→					
 Bremsscheibe								
3.0 4WD	131	02/07→	←			24.0128-0215.1	428215	Ø 332 28 26 V
			→			24.0118-0146.1	418146	Ø 332 18 16 V
3.2 DI-D	121	01/10→	←	Baumuster: V88W		24.0126-0145.1	426145	Ø 290 26 24,4 V
			→	Baumuster: V88W		24.0122-0724.1	422724	Ø 300 22 20,4 V
3.2 DI-D (V88W, V98W)	118	02/07→	←	Baumuster: V88W		24.0126-0145.1	426145	Ø 290 26 24,4 V
			←	Baumuster: V98W		24.0128-0215.1	428215	Ø 332 28 26 V
			→	Baumuster: V98W		24.0118-0146.1	418146	Ø 332 18 16 V
			→	Baumuster: V88W		24.0122-0724.1	422724	Ø 300 22 20,4 V
3.2 DI-D 4WD (V98W)	140	02/07→	←			24.0126-0145.1	426145	Ø 290 26 24,4 V
			←	01/09→; Baumuster: V88W		24.0126-0145.1	426145	Ø 290 26 24,4 V
			←	01/09→; Baumuster: V98W		24.0128-0215.1	428215	Ø 332 28 26 V
			→	01/09→; Baumuster: V98W		24.0118-0146.1	418146	Ø 332 18 16 V
			→			24.0122-0724.1	422724	Ø 300 22 20,4 V
3.8 V6	182	02/10→	←	Baumuster: V87W		24.0126-0145.1	426145	Ø 290 26 24,4 V
			←	Baumuster: V97W		24.0128-0215.1	428215	Ø 332 28 26 V
3.8 V6 (V87W, V97W)	184	02/07→	←					













	kw					! #		
MITSUBISHI - PAJERO IV (V8_W, V9_W) 11/06→								
 Bremsscheibe								
3.8 V6	182	02/10→	➡	Baumuster: V97W		24.0118-0146.1	418146	Ø 332 18 16 V
3.8 V6 (V87W, V97W)	184	02/07→	➡	Baumuster: V87W		24.0122-0724.1	422724	Ø 300 22 20,4 V
MITSUBISHI - PAJERO IV Van (V90, V80, V8_V) 11/06→								
 Bremsbelagsatz, Scheibenbremse								
3.2 DI-D	118	11/06→	⬅	02/07→; Baumuster: V98W		13.0460-5747.2	605747	24024 17,0 + WK
			⬅	02/07→; Baumuster: V88W		13.0460-5853.2	605853	SUM 23488 15,4 + WK
			➡	02/07→; Baumuster: V98W		13.0460-5744.2	605744	21947 15,4 - WE / - WK
			➡	02/07→; Baumuster: V88W		13.0460-5855.2	605855	23582 16,0 - WK
3.2 DI-D 4WD	140	02/07→	⬅			13.0460-5853.2	605853	SUM 23488 15,4 + WK
			➡			13.0460-5855.2	605855	23582 16,0 - WK
3.2 TD 4WD	147	01/10→	⬅	Baumuster: V98W		13.0460-5747.2	605747	24024 17,0 + WK
			⬅	Baumuster: V88W		13.0460-5853.2	605853	SUM 23488 15,4 + WK
			➡	Baumuster: V98W		13.0460-5744.2	605744	21947 15,4 - WE / - WK
			➡	Baumuster: V88W		13.0460-5855.2	605855	23582 16,0 - WK
Zubehörsatz, Scheibenbremsbelag								
3.2 DI-D	118	11/06→	➡	02/07→; Baumuster: V88W		13.0460-0137.2	610137	
3.2 DI-D 4WD	140	02/07→	➡			13.0460-0137.2	610137	
3.2 TD 4WD	147	01/10→	➡	Baumuster: V88W		13.0460-0137.2	610137	
 Bremsscheibe								
3.2 DI-D	118	11/06→	⬅	02/07→; Baumuster: V88W		24.0126-0145.1	426145	Ø 290 26 24,4 V
			⬅	02/07→; Baumuster: V98W		24.0128-0215.1	428215	Ø 332 28 26 V
			➡	02/07→; Baumuster: V98W		24.0118-0146.1	418146	Ø 332 18 16 V
			➡	02/07→; Baumuster: V88W		24.0122-0724.1	422724	Ø 300 22 20,4 V
3.2 DI-D 4WD	140	02/07→	⬅			24.0126-0145.1	426145	Ø 290 26 24,4 V
			➡			24.0122-0724.1	422724	Ø 300 22 20,4 V
3.2 TD 4WD	147	01/10→	⬅	Baumuster: V88W		24.0126-0145.1	426145	Ø 290 26 24,4 V
			⬅	Baumuster: V98W		24.0128-0215.1	428215	Ø 332 28 26 V
			➡	Baumuster: V98W		24.0118-0146.1	418146	Ø 332 18 16 V
			➡	Baumuster: V88W		24.0122-0724.1	422724	Ø 300 22 20,4 V
MITSUBISHI - PAJERO CLASSIC (V2_W) 06/02→								
 Bremsbelagsatz, Scheibenbremse								
2.5 TD	85	07/02→	⬅	→ 01/07		13.0460-5853.2	605853	SUM 23488 15,4 + WK
			➡	→ 01/07		13.0460-5958.2	605958	AKE 21363 15,8 + WK
3.0	131	09/06→	⬅	02/07→		13.0460-5747.2	605747	24024 17,0 + WK
			➡	02/07→		13.0460-5744.2	605744	21947 15,4 - WE / - WK
3.2 DiD	125	09/06→	⬅	02/07→; Baumuster: V98W		13.0460-5747.2	605747	24024 17,0 + WK
			⬅	02/07→; Baumuster: V88W		13.0460-5853.2	605853	SUM 23488 15,4 + WK
			➡	02/07→; Baumuster: V98W		13.0460-5744.2	605744	21947 15,4 - WE / - WK
			➡	02/07→; Baumuster: V88W		13.0460-5855.2	605855	23582 16,0 - WK
3.8 Allrad	184	09/06→	⬅	02/07→; Baumuster: V97W		13.0460-5747.2	605747	24024 17,0 + WK
			➡	02/07→; Baumuster: V97W		13.0460-5744.2	605744	21947 15,4 - WE / - WK
Zubehörsatz, Scheibenbremsbelag								
2.5 TD	85	07/02→	⬅	→ 01/07		13.0460-0235.2	610235	
			➡	→ 01/07		13.0460-0137.2	610137	
3.2 DiD	125	09/06→	➡	02/07→; Baumuster: V88W		13.0460-0137.2	610137	
 Bremsscheibe								
2.5 TD	85	07/02→	⬅	→ 01/07; passend für Felgengröße [Zoll]: 15		24.0124-0140.1	424140	Ø 276 24 22,4 V
			⬅	→ 01/07; passend für Felgengröße [Zoll]: 16		24.0126-0145.1	426145	Ø 290 26 24,4 V
↓								



























	kw					! #		
MITSUBISHI - PAJERO CLASSIC (V2_W) 06/02→								
 Bremsscheibe								
2.5 TD	85	07/02→	➡	→ 01/07		24.0118-0140.1	418140	Ø 315 18 16,4
3.0	131	09/06→	⬅	02/07→		24.0128-0215.1	428215	Ø 332 28 26 V
			➡	02/07→		24.0118-0146.1	418146	Ø 332 18 16 V
3.2 DiD	125	09/06→	⬅	02/07→; Baumuster: V88W		24.0126-0145.1	426145	Ø 290 26 24,4 V
			⬅	02/07→; Baumuster: V98W		24.0128-0215.1	428215	Ø 332 28 26 V
			➡	02/07→; Baumuster: V98W		24.0118-0146.1	418146	Ø 332 18 16 V
			➡	02/07→; Baumuster: V88W		24.0122-0724.1	422724	Ø 300 22 20,4 V
3.8 Allrad	184	09/06→	⬅	02/07→; Baumuster: V97W		24.0128-0215.1	428215	Ø 332 28 26 V
			➡	02/07→; Baumuster: V97W		24.0118-0146.1	418146	Ø 332 18 16 V
MITSUBISHI - PAJERO PININ (H6_W, H7_W) 03/99→06/07								
 Bremsbelagsatz, Scheibenbremse								
1.8 (H76W, H66W)	84	11/01→06/07	⬅	→ 02/05		13.0460-5854.2	605854	SUM 23487 15,5 - WE / - WK
2.0 GDI (H67W, H77W)	95	10/00→06/07	➡	→ 02/05		13.0460-5980.2	605980	21706 15,5 + WK
1.8 GDI (H66W)	88	10/99→10/01	⬅			13.0460-5854.2	605854	SUM 23487 15,5 - WE / - WK
			➡			13.0460-5980.2	605980	21706 15,5 + WK
Zubehörsatz, Scheibenbremsbelag								
1.8 (H76W, H66W)	84	11/01→06/07	➡	→ 02/05		13.0460-0150.2	610150	AKE
2.0 GDI (H67W, H77W)	95	10/00→06/07	➡			13.0460-0150.2	610150	AKE
1.8 GDI (H66W)	88	10/99→10/01	➡			13.0460-0150.2	610150	AKE
 Bremsscheibe								
1.8 (H76W, H66W)	84	11/01→06/07	⬅	→ 02/05		24.0122-0230.1	422230	Ø 285 22 20,4 V
2.0 GDI (H67W, H77W)	95	10/00→06/07	➡	→ 02/05		24.0110-0281.1	410281	Ø 262 9,5 8,4
1.8 GDI (H66W)	88	10/99→10/01	⬅			24.0122-0230.1	422230	Ø 285 22 20,4 V
			➡			24.0110-0281.1	410281	Ø 262 9,5 8,4
MITSUBISHI - PAJERO SPORT I (K7_, K9_) 07/96→								
 Bremsbelagsatz, Scheibenbremse								
1.8 4WD	84	03/01→02/05	⬅	11/01→		13.0460-5854.2	605854	SUM 23487 15,5 - WE / - WK
			➡	11/01→		13.0460-5980.2	605980	21706 15,5 + WK
2.5 TD (K94W)	73	11/98→	⬅	→ 02/09		13.0460-5958.2	605958	AKE 21363 15,8 + WK
2.5 TD (K94W)	85	07/02→						
2.5 TD (K94W)	98	08/03→						
2.8 TDi	87	11/98→						
3.0 V6 (K96W)	123	03/03→						
3.0 V6 (K96W)	125	06/00→						
2.8 TDi	92	11/98→10/03	⬅			13.0460-5958.2	605958	AKE 21363 15,8 + WK
3.0 4WD	129	09/96→12/01	⬅	08/98→		13.0460-5958.2	605958	AKE 21363 15,8 + WK
3.0 V6 (K96W)	130	11/98→	⬅	→ 09/01		13.0460-5958.2	605958	AKE 21363 15,8 + WK
Zubehörsatz, Scheibenbremsbelag								
1.8 4WD	84	03/01→02/05	➡	11/01→		13.0460-0150.2	610150	AKE
2.5 TD (K94W)	73	11/98→	⬅	→ 02/09		13.0460-0235.2	610235	
2.5 TD (K94W)	85	07/02→						
2.5 TD (K94W)	98	08/03→						
2.8 TDi	87	11/98→						
3.0 V6 (K96W)	123	03/03→						
3.0 V6 (K96W)	125	06/00→						
2.8 TDi	92	11/98→10/03	⬅			13.0460-0235.2	610235	
3.0 4WD	129	09/96→12/01	⬅	08/98→		13.0460-0235.2	610235	
3.0 V6 (K96W)	130	11/98→	⬅	→ 09/01		13.0460-0235.2	610235	
 Bremsscheibe								
1.8 4WD	84	03/01→02/05	⬅	11/01→		24.0122-0230.1	422230	Ø 285 22 20,4 V
			➡	11/01→		24.0110-0281.1	410281	Ø 262 9,5 8,4
2.5 TD (K94W)	73	11/98→	⬅	→ 02/09		24.0124-0140.1	424140	Ø 276 24 22,4 V
2.5 TD (K94W)	85	07/02→						
2.5 TD (K94W)	98	08/03→	➡	→ 02/09		24.0118-0140.1	418140	Ø 315 18 16,4
2.8 TDi	87	11/98→						
2.8 TDi	92	11/98→10/03	⬅			24.0124-0140.1	424140	Ø 276 24 22,4 V
↓								











	kw					! #		
MITSUBISHI - PAJERO SPORT I (K7_, K9_) 07/96→								
 Bremsscheibe								
2.8 TDi	92	11/98→10/03	➡				24.0118-0140.1 418140	Ø 315 18 16,4
3.0 4WD	129	09/96→12/01	⬅	08/98→			24.0124-0724.1 424724	Ø 314 24 22,4 V
			➡	08/98→			24.0118-0140.1 418140	Ø 315 18 16,4
3.0 V6 (K96W)	123	03/03→	⬅	→ 02/09			24.0124-0724.1 424724	Ø 314 24 22,4 V
	125	06/00→	➡	→ 02/09			24.0118-0140.1 418140	Ø 315 18 16,4
3.0 V6 (K96W)	130	11/98→	⬅	→ 09/01			24.0124-0724.1 424724	Ø 314 24 22,4 V
			➡	→ 09/01			24.0118-0140.1 418140	Ø 315 18 16,4
MITSUBISHI - PAJERO SPORT II (KH_, KG_) 07/08→								
 Bremsbelagsatz, Scheibenbremse								
2.4	94	07/08→	⬅	11/09→			13.0460-5631.2 605631	24529 16,0 + WK
2.5 DI-D	131	07/08→						
2.5 DI-D 4WD (KH4W)	131	07/08→						
3.0 4WD	162	09/08→						
3.2 DI-D	121	07/08→						
3.2 DI-D 4WD	118	07/08→						
2.5 TD	98	09/08→	⬅	→ 02/09			13.0460-5958.2 605958	AKE 21363 15,8 + WK
3.5 V6 24V	153	09/08→	⬅				13.0460-5631.2 605631	24529 16,0 + WK
Zubehörsatz, Scheibenbremsbelag								
2.5 TD	98	09/08→	⬅	→ 02/09			13.0460-0235.2 610235	
 Bremsscheibe								
2.5 TD	98	09/08→	⬅	→ 02/09			24.0124-0140.1 424140	Ø 276 24 22,4 V
			➡	→ 02/09			24.0118-0140.1 418140	Ø 315 18 16,4
MITSUBISHI - PAJERO SPORT VAN I (K90) 12/99→01/08								
 Bremsbelagsatz, Scheibenbremse								
2.5 TD	85	12/99→01/08	⬅	07/02→			13.0460-5958.2 605958	AKE 21363 15,8 + WK
3.0 V6	125	12/99→01/08	⬅	06/00→			13.0460-5958.2 605958	AKE 21363 15,8 + WK
Zubehörsatz, Scheibenbremsbelag								
2.5 TD	85	12/99→01/08	⬅	07/02→			13.0460-0235.2 610235	
3.0 V6	125	12/99→01/08	⬅	06/00→			13.0460-0235.2 610235	
 Bremsscheibe								
2.5 TD	85	12/99→01/08	⬅	07/02→			24.0124-0140.1 424140	Ø 276 24 22,4 V
			➡	07/02→			24.0118-0140.1 418140	Ø 315 18 16,4
3.0 V6	125	12/99→01/08	⬅	06/00→			24.0124-0724.1 424724	Ø 314 24 22,4 V
			➡	06/00→			24.0118-0140.1 418140	Ø 315 18 16,4
MITSUBISHI - SANTAMO 03/99→12/04								
 Bremsbelagsatz, Scheibenbremse								
2.0 16V	102	05/99→12/04	⬅				13.0460-5952.2 605952	SUM 21647 16,0 + WK
2.0 16V 4WD	102	05/99→12/04	➡	+ ABS			13.0460-5980.2 605980	21706 15,5 + WK
 Bremsscheibe								
2.0 16V 2.0 16V 4WD	102	05/99→12/04 05/99→12/04	⬅	- ABS			24.0124-0136.1 424136	Ø 256 24 21,5 V
			⬅	+ ABS			24.0124-0146.1 424146	Ø 256 24 22,4 V
			➡	+ ABS			24.0110-0240.1 410240	Ø 262 10 8,4
MITSUBISHI - SIGMA (F2_A, F1_A) 10/90→07/96								
 Bremsbelagsatz, Scheibenbremse								
3.0 V6	130	12/90→07/96	➡				13.0460-5980.2 605980	21706 15,5 + WK
3.0 V6	151	12/90→07/96						
Zubehörsatz, Scheibenbremsbelag								
3.0 V6	130	12/90→07/96	⬅				13.0460-0235.2 610235	
3.0 V6 ↓	151	12/90→07/96						

	kw					! #		
MITSUBISHI - SIGMA (F2_A, F1_A) 10/90→07/96								
 Bremsscheibe								
3.0 V6 3.0 V6	130 151	12/90→07/96 12/90→07/96	← →	→ 07/91			24.0124-0144.1 424144	Ø 276 24 22,4 V
MITSUBISHI - SIGMA Station Wagon (F0_W) 06/92→10/96								
 Bremsbelagsatz, Scheibenbremse								
3.0	125	06/92→10/96	→	01/93→ 07/96			13.0460-5980.2 605980	21706 15,5 + WK
Zubehörsatz, Scheibenbremsbelag								
3.0	125	06/92→10/96	←	01/93→ 07/96			13.0460-0235.2 610235	
MITSUBISHI - SPACE RUNNER (N1_W, N2_W) 10/91→08/99								
 Bremsbelagsatz, Scheibenbremse								
1.8 (N11W) 1.8 (N11W) 1.8 4WD (N21W) 1.8 4WD (N21W)	85 90 85 90	06/96→08/99 10/91→08/99 06/96→08/99 10/91→08/99	← → → ←				13.0460-5952.2 605952 13.0460-5980.2 605980 13.0460-5952.2 605952	SUM 21647 16,0 + WK 21706 15,5 + WK SUM 21647 16,0 + WK
2.0 TD (N18W)	60	10/92→08/99	←				13.0460-5952.2 605952	SUM 21647 16,0 + WK
Zubehörsatz, Scheibenbremsbelag								
1.8 (N11W) 1.8 (N11W) 1.8 4WD (N21W) 1.8 4WD (N21W) 2.0 TD (N18W)	85 90 85 90 60	06/96→08/99 10/91→08/99 06/96→08/99 10/91→08/99 10/92→08/99	← ← ← ← ←				13.0460-0442.2 610442	SUM
 Bremsscheibe								
1.8 (N11W) 1.8 (N11W) 1.8 4WD (N21W) 1.8 4WD (N21W)	85 90 85 90	06/96→08/99 10/91→08/99 06/96→08/99 10/91→08/99	← ← ← ←	- ABS; für Fahrzeuge mit Trommelbremse an der Hinterachse			24.0124-0136.1 424136	Ø 256 24 21,5 V
1.8 4WD (N21W) 1.8 4WD (N21W)	85 90	06/96→08/99 10/91→08/99	← ←	+ ABS; für Fahrzeuge mit Scheibenbremse an der Hinterachse			24.0124-0146.1 424146	Ø 256 24 22,4 V
			→				24.0110-0240.1 410240	Ø 262 10 8,4
2.0 TD (N18W)	60	10/92→08/99	←	- ABS			24.0124-0136.1 424136	Ø 256 24 21,5 V
MITSUBISHI - SPACE RUNNER (N6_W) 08/99→01/03								
 Bremsbelagsatz, Scheibenbremse								
2.0	98	05/00→08/02	← →				13.0460-5760.2 605760 13.0460-5980.2 605980	AKE 23584 16,4 + WK 21706 15,5 + WK
2.0 (N63W) 2.4 GDI 2.4 GDI	100 108 110	08/99→08/02 08/99→08/02 08/99→01/03	← ← ←	05/00→ 09/99→ 04/00			13.0460-5760.2 605760 13.0460-5958.2 605958	AKE 23584 16,4 + WK AKE 21363 15,8 + WK
			→	09/99→			13.0460-5980.2 605980	21706 15,5 + WK
Zubehörsatz, Scheibenbremsbelag								
2.0	98	05/00→08/02	← →				13.0460-0235.2 610235 13.0460-0150.2 610150	 AKE
2.0 (N63W) 2.4 GDI 2.4 GDI	100 108 110	08/99→08/02 08/99→08/02 08/99→01/03	← ← ←	05/00→ 09/99→ 04/00			13.0460-0235.2 610235 13.0460-0235.2 610235	
			→	09/99→			13.0460-0150.2 610150	AKE
 Bremsscheibe								
2.0	98	05/00→08/02	← →				24.0126-0134.1 426134 24.0110-0704.1 410704	Ø 276 26 24,4 V Ø 262 10 8,4
2.0 (N63W) 2.4 GDI 2.4 GDI	100 108 110	08/99→08/02 08/99→08/02 08/99→01/03	← ← ←	09/99→ 04/00 05/00→			24.0124-0182.1 424182 24.0126-0134.1 426134	Ø 276 24 22,4 V Ø 276 26 24,4 V
			→	09/99→			24.0110-0704.1 410704	Ø 262 10 8,4
MITSUBISHI - SPACE STAR Großraumlimousine (DG_A) 06/98→12/04								
 Bremsbelagsatz, Scheibenbremse								
1.3 16V (DG1A) 1.3 16V (DG1A) 1.8 GDI (DG5A) 1.8 GDI (DG5A) 1.8 MPI	60 61 87 90 82	09/00→12/04 12/98→12/04 06/98→12/04 06/98→12/04 10/02→12/04	← → → → →	+ ABS			13.0460-2830.2 602830 13.0460-2831.2 602831	TRW 21920 14,6 + WK + Zub TRW 21861 15,2 + WK
↓								









	kw			 	! #		
MITSUBISHI - SPACE STAR Großraumlimousine (DG_A) 06/98→12/04							
 Bremsbelagsatz, Scheibenbremse							
1.3 16V (DG1A)	63	06/98→12/04	←	→ 07/00		13.0460-2830.2 602830	TRW 21920 14,6 + WK + Zub
			→	→ 07/00; + ABS		13.0460-2831.2 602831	TRW 21861 15,2 + WK
1.6	72	04/01→12/04	←	09/01→		13.0460-2830.2 602830	TRW 21920 14,6 + WK + Zub
1.6 16V (DG3A)	72	01/01→12/04	→	09/01→		13.0460-2831.2 602831	TRW 21861 15,2 + WK
1.9 DI-D	85	10/02→12/04	←			13.0460-2830.2 602830	TRW 21920 14,6 + WK + Zub
1.9 DI-D (DG4A)	75	02/01→12/04	→			13.0460-2831.2 602831	TRW 21861 15,2 + WK
 Bremsscheibe							
1.3 16V (DG1A)	60	09/00→12/04	←			24.0124-0136.1 424136	Ø 256 24 21,5 V
1.3 16V (DG1A)	61	12/98→12/04	→	+ ABS		24.0110-0229.1 410229	Ø 260 10 8,4
1.8 GDI (DG5A)	87	06/98→12/04	→				
1.8 GDI (DG5A)	90	06/98→12/04	→				
1.8 MPI	82	10/02→12/04	→				
1.3 16V (DG1A)	63	06/98→12/04	←	→ 07/00		24.0124-0136.1 424136	Ø 256 24 21,5 V
			→	→ 07/00; + ABS		24.0110-0229.1 410229	Ø 260 10 8,4
1.6	72	04/01→12/04	←	09/01→		24.0124-0136.1 424136	Ø 256 24 21,5 V
1.6 16V (DG3A)	72	01/01→12/04	→	09/01→		24.0110-0229.1 410229	Ø 260 10 8,4
1.9 DI-D	85	10/02→12/04	←			24.0124-0136.1 424136	Ø 256 24 21,5 V
1.9 DI-D (DG4A)	75	02/01→12/04	→			24.0110-0229.1 410229	Ø 260 10 8,4
MITSUBISHI - SPACE STAR Schrägheck (A0_A) 05/12→							
 Bremsbelagsatz, Scheibenbremse							
1.0 (A05A)	52	05/12→	←			13.0460-5709.2 605709	AKE 24230 15,3 + WK + Zub
1.2 (A03A)	59	10/12→	←				
MITSUBISHI - SPACE STAR Schrägheck (A0_A) 01/12→							
 Bremsbelagsatz, Scheibenbremse							
1.2 (A03A)	57	01/12→	←	05/12→		13.0460-5709.2 605709	AKE 24230 15,3 + WK + Zub
MITSUBISHI - SPACE WAGON (N3_W, N4_W) 05/91→11/98							
 Bremsbelagsatz, Scheibenbremse							
1.8 (N31W)	90	10/91→10/98	←	→ 05/92		13.0460-5952.2 605952	SUM 21647 16,0 + WK
1.8 4WD (N41W)	90	10/91→10/98	→	→ 05/92		13.0460-5980.2 605980	21706 15,5 + WK
1.8 TD (N35W)	55	10/91→10/98	→				
2.0 (N33W)	77	05/91→10/97	←	06/92→		13.0460-5952.2 605952	SUM 21647 16,0 + WK
			→	06/92→		13.0460-5980.2 605980	21706 15,5 + WK
2.0 (N33W)	98	10/92→10/98	←			13.0460-5952.2 605952	SUM 21647 16,0 + WK
2.0 4WD (N43W)	98	10/92→10/98	→			13.0460-5980.2 605980	21706 15,5 + WK
2.0 TD (N38W)	60	10/92→10/98	→				
2.4	88	10/91→10/97	←	06/92→ 05/96		13.0460-5952.2 605952	SUM 21647 16,0 + WK
			→	06/92→ 05/96		13.0460-5980.2 605980	21706 15,5 + WK
2.4 i (N34W)	102	10/92→10/98	←	→ 05/96		13.0460-5952.2 605952	SUM 21647 16,0 + WK
			→	→ 05/96		13.0460-5980.2 605980	21706 15,5 + WK
Zubehörsatz, Scheibenbremsbelag							
1.8 (N31W)	90	10/91→10/98	←	→ 05/92		13.0460-0442.2 610442	SUM
1.8 4WD (N41W)	90	10/91→10/98	→				
1.8 TD (N35W)	55	10/91→10/98	→				
2.0 (N33W)	77	05/91→10/97	←	06/92→		13.0460-0442.2 610442	SUM
2.0 (N33W)	98	10/92→10/98	←			13.0460-0442.2 610442	SUM
2.0 4WD (N43W)	98	10/92→10/98	→				
2.0 TD (N38W)	60	10/92→10/98	→				
2.4	88	10/91→10/97	←	06/92→ 05/96		13.0460-0442.2 610442	SUM
2.4 i (N34W)	102	10/92→10/98	←	→ 05/96		13.0460-0442.2 610442	SUM
 Bremsscheibe							
1.8 (N31W)	90	10/91→10/98	←	→ 05/92; für Fahrzeuge mit Trommelbremse an der Hinterachse		24.0124-0136.1 424136	Ø 256 24 21,5 V
1.8 4WD (N41W)	90	10/91→10/98	←	→ 05/92; für Fahrzeuge mit Scheibenbremse an der Hinterachse		24.0124-0146.1 424146	Ø 256 24 22,4 V
1.8 TD (N35W)	55	10/91→10/98	→	→ 05/92		24.0110-0240.1 410240	Ø 262 10 8,4
↓							













	kW					! #		
MITSUBISHI - SPACE WAGON (N3_W, N4_W) 05/91→11/98								
 Bremsscheibe								
2.0 (N33W)	77	05/91→10/97	←	06/92→; für Fahrzeuge mit Trommelbremse an der Hinterachse	24.0124-0136.1	424136	Ø 256 24 21,5 V	
			←	06/92→; für Fahrzeuge mit Scheibenbremse an der Hinterachse	24.0124-0146.1	424146	Ø 256 24 22,4 V	
			→	06/92→	24.0110-0240.1	410240	Ø 262 10 8,4	
2.0 (N33W) 2.0 4WD (N43W) 2.0 TD (N38W)	98	10/92→10/98	←	für Fahrzeuge mit Trommelbremse an der Hinterachse	24.0124-0136.1	424136	Ø 256 24 21,5 V	
	98	10/92→10/98	←	für Fahrzeuge mit Scheibenbremse an der Hinterachse	24.0124-0146.1	424146	Ø 256 24 22,4 V	
	60	10/92→10/98	→		24.0110-0240.1	410240	Ø 262 10 8,4	
2.4	88	10/91→10/97	←	06/92→ 05/96; für Fahrzeuge mit Trommelbremse an der Hinterachse	24.0124-0136.1	424136	Ø 256 24 21,5 V	
			←	06/92→ 05/96; für Fahrzeuge mit Scheibenbremse an der Hinterachse	24.0124-0146.1	424146	Ø 256 24 22,4 V	
			→	06/92→ 05/96	24.0110-0240.1	410240	Ø 262 10 8,4	
2.4 i (N34W)	102	10/92→10/98	←	→ 05/96; für Fahrzeuge mit Trommelbremse an der Hinterachse	24.0124-0136.1	424136	Ø 256 24 21,5 V	
			←	→ 05/96; für Fahrzeuge mit Scheibenbremse an der Hinterachse	24.0124-0146.1	424146	Ø 256 24 22,4 V	
			→	→ 05/96	24.0110-0240.1	410240	Ø 262 10 8,4	
MITSUBISHI - SPACE WAGON (N9_W, N8_W) 10/98→12/04								
 Bremsbelagsatz, Scheibenbremse								
2.0	98	10/98→12/04	←	05/02→	13.0460-5958.2	605958	AKE 21363 15,8 + WK	
2.0 (N83W)	80	12/98→06/02	←	→ 04/02	13.0460-5958.2	605958	AKE 21363 15,8 + WK	
2.4	96	11/98→04/04	←	→ 08/03	13.0460-5958.2	605958	AKE 21363 15,8 + WK	
2.4 GDI	108	09/00→12/04						
2.4 GDI	110	10/98→12/04						
2.4 GDI 4WD	108	09/00→12/04						
2.4 GDI 4WD	110	10/98→12/04						
Zubehörsatz, Scheibenbremsbelag								
2.0	98	10/98→12/04	←	05/02→	13.0460-0235.2	610235		
2.0 (N83W)	80	12/98→06/02	←	→ 04/02	13.0460-0235.2	610235		
2.4	96	11/98→04/04	←	→ 08/03	13.0460-0235.2	610235		
2.4 GDI	108	09/00→12/04						
2.4 GDI	110	10/98→12/04						
2.4 GDI 4WD	108	09/00→12/04						
2.4 GDI 4WD	110	10/98→12/04						
 Bremsscheibe								
2.0	98	10/98→12/04	←	05/02→	24.0124-0182.1	424182	Ø 276 24 22,4 V	
2.0 (N83W)	80	12/98→06/02	←	→ 04/02	24.0124-0182.1	424182	Ø 276 24 22,4 V	
2.4	96	11/98→04/04	←	→ 08/03	24.0124-0182.1	424182	Ø 276 24 22,4 V	
2.4 GDI	108	09/00→12/04						
2.4 GDI	110	10/98→12/04						
2.4 GDI 4WD	108	09/00→12/04						
2.4 GDI 4WD	110	10/98→12/04						
NISSAN - 200 SX (S14) 10/93→12/99								
 Bremsscheibe								
2.0 i 16V	118	10/93→12/99	→	04/94→	24.0109-0147.1	409147	Ø 258 9 8	
2.0 i 16V Turbo	147	10/93→12/99						
NISSAN - 350 Z Coupe (Z33) 09/02→								
 Bremsbelagsatz, Scheibenbremse								
3.5	206	10/03→	←	→ 05/09	13.0460-4818.2	604818	BRE 23142 15,1 + WK + Zub	
3.5	221	09/02→						
3.5	230	09/05→	→	→ 05/09	13.0460-4974.2	604974	BRE 21580 14,6 + WK	
3.5	214	11/04→01/07	←		13.0460-4818.2	604818	BRE 23142 15,1 + WK + Zub	
			→		13.0460-4974.2	604974	BRE 21580 14,6 + WK	
↓								

	kw			 	! #		
NISSAN - 350 Z Coupe (Z33) 09/02→							
 Bremsscheibe							
3.5	206	10/03→	←	→ 05/09		24.0130-0215.1 430215	Ø 324 30 28,4 V
3.5	221	09/02→	→	→ 05/09		24.0122-0268.1 422268	Ø 322 22 20,2 V
3.5	230	09/05→	→	→ 05/09		24.0130-0215.1 430215	Ø 324 30 28,4 V
3.5	214	11/04→01/07	←			24.0122-0268.1 422268	Ø 322 22 20,2 V
			→				
NISSAN - 350 Z Roadster (Z33) 10/03→							
 Bremsbelagsatz, Scheibenbremse							
3.5	206	03/05→	←	→ 05/09		13.0460-4818.2 604818	BRE 23142 15,1 + WK + Zub
3.5	221	04/06→	→	→ 05/09		13.0460-4974.2 604974	BRE 21580 14,6 + WK
3.5	230	09/05→	→	→ 05/09			
 Bremsscheibe							
3.5	206	03/05→	←	→ 05/09		24.0130-0215.1 430215	Ø 324 30 28,4 V
3.5	221	04/06→	→	→ 05/09		24.0122-0268.1 422268	Ø 322 22 20,2 V
3.5	230	09/05→	→	→ 05/09			
NISSAN - ALMERA I (N15) 07/95→07/00							
 Bremsbelagsatz, Scheibenbremse							
1.4	64	09/95→07/00	←	→ 04/00; + ABS		13.0460-5717.2 605717	23502 16,0 + WK
1.4 GX,LX	55	09/95→07/00	←	→ 04/00; - ABS		13.0460-5988.2 605988	AKE 23004 15,9 + WK
2.0 D	55	11/95→07/00	→	→ 12/97; + ABS		13.0460-5841.2 605841	SUM 23023 14,8 + WK
			→	01/98→ 04/00; + ABS		13.0460-5983.2 605983	21713 16,5 - WE / - WK
1.6	73	09/95→07/00	←	→ 04/00; + ABS		13.0460-5717.2 605717	23502 16,0 + WK
1.6 SLX	66	09/95→07/00	←	01/98→ 04/00; - ABS		13.0460-5717.2 605717	23502 16,0 + WK
			←	→ 12/97; - ABS		13.0460-5988.2 605988	AKE 23004 15,9 + WK
			→	→ 12/97; + ABS		13.0460-5841.2 605841	SUM 23023 14,8 + WK
			→	01/98→ 04/00; + ABS		13.0460-5983.2 605983	21713 16,5 - WE / - WK
1.6	75	07/95→03/00	←	01/98→; - ABS		13.0460-5717.2 605717	23502 16,0 + WK
			←	+ ABS		13.0460-5717.2 605717	23502 16,0 + WK
			←	→ 12/97; - ABS		13.0460-5988.2 605988	AKE 23004 15,9 + WK
			→	→ 12/97; + ABS		13.0460-5841.2 605841	SUM 23023 14,8 + WK
			→	01/98→; + ABS		13.0460-5983.2 605983	21713 16,5 - WE / - WK
Zubehörsatz, Scheibenbremsbelag							
1.4	64	09/95→07/00	←	→ 04/00; - ABS		13.0460-0283.2 610283	
1.4 GX,LX	55	09/95→07/00	←	→ 04/00; + ABS		13.0460-0285.2 610285	
2.0 D	55	11/95→07/00	→	→ 12/97; + ABS		13.0460-0284.2 610284	
			→	01/98→ 04/00; + ABS		13.0460-0332.2 610332	
1.6	73	09/95→07/00	←	→ 12/97; - ABS		13.0460-0283.2 610283	
1.6 SLX	66	09/95→07/00	←	→ 04/00; + ABS		13.0460-0285.2 610285	
			←	01/98→ 04/00; - ABS		13.0460-0285.2 610285	
			→	→ 12/97; + ABS		13.0460-0284.2 610284	
			→	01/98→ 04/00; + ABS		13.0460-0332.2 610332	
1.6	75	07/95→03/00	←	→ 12/97; - ABS		13.0460-0283.2 610283	
			←	01/98→; - ABS		13.0460-0285.2 610285	
			←	+ ABS		13.0460-0285.2 610285	
			→	→ 12/97; + ABS		13.0460-0284.2 610284	
			→	01/98→; + ABS		13.0460-0332.2 610332	
 Bremsscheibe							
1.4	64	09/95→07/00	←	01/98→ 04/00; - ABS		24.0118-0117.1 418117	Ø 247 18 16 V
1.4 GX,LX	55	09/95→07/00	←	→ 12/97; - ABS		24.0118-0118.1 418118	Ø 232 18 16 V
			←	→ 04/00; + ABS		24.0120-0203.1 420203	Ø 252 20 18 V
			→	→ 12/97; + ABS		24.0107-0108.1 407108	Ø 234 7 6
1.6	73	09/95→07/00	←	→ 04/00; - ABS		24.0118-0117.1 418117	Ø 247 18 16 V
1.6 SLX	66	09/95→07/00	←	→ 04/00; + ABS		24.0120-0203.1 420203	Ø 252 20 18 V
2.0 D	55	11/95→07/00	→	→ 12/97; + ABS		24.0107-0108.1 407108	Ø 234 7 6
↓							













	kw			 	! #		
NISSAN - ALMERA I (N15) 07/95→07/00							
 Bremsscheibe							
1.6	75	07/95→03/00	←	- ABS	24.0118-0117.1	418117	Ø 247 18 16 V
			←	+ ABS	24.0120-0203.1	420203	Ø 252 20 18 V
			→	→ 12/97; + ABS	24.0107-0108.1	407108	Ø 234 7 6
NISSAN - ALMERA I Hatchback (N15) 07/95→07/00							
 Bremsbelagsatz, Scheibenbremse							
1.4 1.4 S,GX,LX 2.0 D	64 55 55	09/95→03/00 09/95→03/00 11/95→03/00	←	+ ABS	13.0460-5717.2	605717	23502 16,0 + WK
			←	- ABS	13.0460-5988.2	605988	AKE 23004 15,9 + WK
			→	→ 12/97; + ABS	13.0460-5841.2	605841	SUM 23023 14,8 + WK
			→	01/98→; + ABS	13.0460-5983.2	605983	21713 16,5 - WE / - WK
1.6 1.6 1.6 SR,SLX	73 75 66	09/95→03/00 07/95→03/00 09/95→03/00	←	01/98→; - ABS	13.0460-5717.2	605717	23502 16,0 + WK
			←	+ ABS	13.0460-5717.2	605717	23502 16,0 + WK
			←	→ 12/97; - ABS	13.0460-5988.2	605988	AKE 23004 15,9 + WK
			→	→ 12/97; + ABS	13.0460-5841.2	605841	SUM 23023 14,8 + WK
			→	01/98→; + ABS	13.0460-5983.2	605983	21713 16,5 - WE / - WK
1.6	86	09/95→07/00	←	→ 04/00; + ABS	13.0460-5717.2	605717	23502 16,0 + WK
			←	01/98→ 04/00; - ABS	13.0460-5717.2	605717	23502 16,0 + WK
			←	→ 12/97; - ABS	13.0460-5988.2	605988	AKE 23004 15,9 + WK
			→	→ 12/97; + ABS	13.0460-5841.2	605841	SUM 23023 14,8 + WK
			→	01/98→ 04/00; + ABS	13.0460-5983.2	605983	21713 16,5 - WE / - WK
2.0 GTi	105	07/96→03/00	→		13.0460-5983.2	605983	21713 16,5 - WE / - WK
Zubehörsatz, Scheibenbremsbelag							
1.4 1.4 S,GX,LX 2.0 D	64 55 55	09/95→03/00 09/95→03/00 11/95→03/00	←	- ABS	13.0460-0283.2	610283	
			←	+ ABS	13.0460-0285.2	610285	
			→	→ 12/97; + ABS	13.0460-0284.2	610284	
			→	01/98→; + ABS	13.0460-0332.2	610332	
1.6 1.6 1.6 SR,SLX	73 75 66	09/95→03/00 07/95→03/00 09/95→03/00	←	→ 12/97; - ABS	13.0460-0283.2	610283	
			←	01/98→; - ABS	13.0460-0285.2	610285	
			←	+ ABS	13.0460-0285.2	610285	
			→	→ 12/97; + ABS	13.0460-0284.2	610284	
			→	01/98→; + ABS	13.0460-0332.2	610332	
1.6	86	09/95→07/00	←	→ 12/97; - ABS	13.0460-0283.2	610283	
			←	→ 04/00; + ABS	13.0460-0285.2	610285	
			←	01/98→ 04/00; - ABS	13.0460-0285.2	610285	
			→	→ 12/97; + ABS	13.0460-0284.2	610284	
			→	01/98→ 04/00; + ABS	13.0460-0332.2	610332	
2.0 GTi	105	07/96→03/00	→		13.0460-0332.2	610332	
 Bremsscheibe							
1.4 1.4 S,GX,LX	64 55	09/95→03/00 09/95→03/00	←	01/98→; - ABS	24.0118-0117.1	418117	Ø 247 18 16 V
			←	→ 12/97; - ABS	24.0118-0118.1	418118	Ø 232 18 16 V
			←	+ ABS	24.0120-0203.1	420203	Ø 252 20 18 V
			→	→ 12/97; + ABS	24.0107-0108.1	407108	Ø 234 7 6
1.6 1.6 1.6 SR,SLX 2.0 D	73 75 66 55	09/95→03/00 07/95→03/00 09/95→03/00 11/95→03/00	←	- ABS	24.0118-0117.1	418117	Ø 247 18 16 V
			←	+ ABS	24.0120-0203.1	420203	Ø 252 20 18 V
			→	→ 12/97; + ABS	24.0107-0108.1	407108	Ø 234 7 6
1.6	86	09/95→07/00	←	→ 04/00; - ABS	24.0118-0117.1	418117	Ø 247 18 16 V
			←	→ 04/00; + ABS	24.0120-0203.1	420203	Ø 252 20 18 V
			→	→ 12/97; + ABS	24.0107-0108.1	407108	Ø 234 7 6
2.0 GTi	105	07/96→03/00	←		24.0126-0112.1	426112	Ø 257 26 24 V













	kw			 	! #		
NISSAN - ALMERA II (N16) 06/00→							
 Bremsbelagsatz, Scheibenbremse							
1.5	66	07/00→	←	→ 11/06; + ABS	13.0460-5807.2	605807	TRW 23093 16,6 - WK
			←	→ 03/01; + ABS; Made in Japan	13.0460-5807.2	605807	TRW 23093 16,6 - WK
			←	→ 11/06; - ABS	13.0460-5950.2	605950	TRW 21546 16,7 - WK
			←	→ 03/01; - ABS; Made in Japan	13.0460-5950.2	605950	TRW 21546 16,7 - WK
			→	→ 03/01; + ABS; Made in Japan	13.0460-5983.2	605983	21713 16,5 - WE / - WK
			→	→ 11/06; + ABS	13.0460-5986.2	605986	TRW 21545 14,9 - WK
1.5 1.5 dCi	72 60	10/02→ 01/03→	←	→ 11/06; + ABS	13.0460-5807.2	605807	TRW 23093 16,6 - WK
			←	→ 11/06; - ABS	13.0460-5950.2	605950	TRW 21546 16,7 - WK
			→	→ 11/06; + ABS	13.0460-5986.2	605986	TRW 21545 14,9 - WK
1.8 2.2 Di	84 81	07/00→ 07/00→	←	→ 03/01; Made in Japan	13.0460-5807.2	605807	TRW 23093 16,6 - WK
			←	→ 11/06	13.0460-5807.2	605807	TRW 23093 16,6 - WK
			→	→ 03/01; Made in Japan	13.0460-5983.2	605983	21713 16,5 - WE / - WK
			→	→ 11/06	13.0460-5986.2	605986	TRW 21545 14,9 - WK
1.8 2.2 dCi 2.2 dCi	85 82 100	10/02→ 09/03→ 09/03→	←	→ 11/06	13.0460-5807.2	605807	TRW 23093 16,6 - WK
			→	→ 11/06	13.0460-5986.2	605986	TRW 21545 14,9 - WK
			←	10/02→ 11/06	13.0460-5807.2	605807	TRW 23093 16,6 - WK
1.8	94	01/02→	→	10/02→ 11/06	13.0460-5986.2	605986	TRW 21545 14,9 - WK
			←	10/02→ 11/06	13.0460-5807.2	605807	TRW 23093 16,6 - WK
Zubehörsatz, Scheibenbremsbelag							
1.5	66	07/00→	←	→ 03/01; + ABS; Made in Japan	13.0460-0148.2	610148	TRW
			←	→ 11/06; + ABS	13.0460-0148.2	610148	TRW
1.5 1.5 dCi	72 60	10/02→ 01/03→	←	→ 11/06; + ABS	13.0460-0148.2	610148	TRW
			←	→ 03/01; Made in Japan	13.0460-0148.2	610148	TRW
1.8 2.2 Di	84 81	07/00→ 07/00→	←	→ 11/06	13.0460-0148.2	610148	TRW
			←	→ 11/06	13.0460-0148.2	610148	TRW
1.8 2.2 dCi 2.2 dCi	85 82 100	10/02→ 09/03→ 09/03→	←	→ 11/06	13.0460-0148.2	610148	TRW
			←	10/02→ 11/06	13.0460-0148.2	610148	TRW
			←	10/02→ 11/06	13.0460-0148.2	610148	TRW
Bremsscheibe							
1.5	66	07/00→	←	→ 11/06; - ABS	24.0122-0146.1	422146	Ø 257 22 20 V
			←	→ 03/01; - ABS; Made in Japan	24.0122-0146.1	422146	Ø 257 22 20 V
			←	→ 03/01; + ABS; Made in Japan	24.0122-0179.1	422179	Ø 280 22 20 V
			←	→ 11/06; + ABS	24.0122-0179.1	422179	Ø 280 22 20 V
			→	→ 11/06; + ABS	24.0110-0215.1	410215	Ø 258 10 9
			→	→ 03/01; + ABS; Made in Japan	24.0110-0215.1	410215	Ø 258 10 9
1.5 1.5 dCi	72 60	10/02→ 01/03→	←	→ 11/06; - ABS	24.0122-0146.1	422146	Ø 257 22 20 V
			←	→ 11/06; + ABS	24.0122-0179.1	422179	Ø 280 22 20 V
			→	→ 11/06; + ABS	24.0110-0215.1	410215	Ø 258 10 9
1.8 2.2 Di	84 81	07/00→ 07/00→	←	→ 03/01; Made in Japan	24.0122-0179.1	422179	Ø 280 22 20 V
			←	→ 11/06	24.0122-0179.1	422179	Ø 280 22 20 V
			→	→ 03/01; Made in Japan	24.0110-0215.1	410215	Ø 258 10 9
			→	→ 11/06	24.0110-0215.1	410215	Ø 258 10 9
1.8 2.2 dCi 2.2 dCi	85 82 100	10/02→ 09/03→ 09/03→	←	→ 11/06	24.0122-0179.1	422179	Ø 280 22 20 V
			→	→ 11/06	24.0110-0215.1	410215	Ø 258 10 9
			←	10/02→ 11/06	24.0122-0179.1	422179	Ø 280 22 20 V
1.8	94	01/02→	→	10/02→ 11/06	24.0110-0215.1	410215	Ø 258 10 9
			←	10/02→ 11/06	24.0110-0215.1	410215	Ø 258 10 9
NISSAN - ALMERA II Hatchback (N16) 01/00→							
 Bremsbelagsatz, Scheibenbremse							
1.5	66	03/00→	←	→ 11/06; + ABS	13.0460-5807.2	605807	TRW 23093 16,6 - WK
			←	→ 03/01; + ABS; Made in Japan	13.0460-5807.2	605807	TRW 23093 16,6 - WK
			←	→ 11/06; - ABS	13.0460-5950.2	605950	TRW 21546 16,7 - WK
			←	→ 03/01; - ABS; Made in Japan	13.0460-5950.2	605950	TRW 21546 16,7 - WK
			→	→ 03/01; + ABS; Made in Japan	13.0460-5983.2	605983	21713 16,5 - WE / - WK
↓							

	kw			 	! #		
NISSAN - ALMERA II Hatchback (N16) 01/00→							
 Bremsbelagsatz, Scheibenbremse							
1.5	66	03/00→	➡	→ 11/06; + ABS		13.0460-5986.2 605986	TRW 21545 14,9 - WK
1.5 1.5 dCi	72 60	10/02→ 01/03→	⬅	→ 11/06; + ABS		13.0460-5807.2 605807	TRW 23093 16,6 - WK
			⬅	→ 11/06; - ABS		13.0460-5950.2 605950	TRW 21546 16,7 - WK
			➡	→ 11/06; + ABS		13.0460-5986.2 605986	TRW 21545 14,9 - WK
1.8	84	01/00→	⬅	02/00→ 11/06		13.0460-5807.2 605807	TRW 23093 16,6 - WK
			⬅	03/00→ 03/01; Made in Japan		13.0460-5807.2 605807	TRW 23093 16,6 - WK
			➡	03/00→ 03/01; Made in Japan		13.0460-5983.2 605983	21713 16,5 - WE / - WK
			➡	02/00→ 11/06		13.0460-5986.2 605986	TRW 21545 14,9 - WK
1.8 2.2 dCi 2.2 dCi	85 82 100	10/02→ 09/03→ 09/03→	⬅	→ 11/06		13.0460-5807.2 605807	TRW 23093 16,6 - WK
			➡	→ 11/06		13.0460-5986.2 605986	TRW 21545 14,9 - WK
			➡	→ 11/06		13.0460-5986.2 605986	TRW 21545 14,9 - WK
1.8	94	08/02→	⬅	10/02→ 11/06		13.0460-5807.2 605807	TRW 23093 16,6 - WK
			➡	10/02→ 11/06		13.0460-5986.2 605986	TRW 21545 14,9 - WK
2.2 Di	81	03/00→	⬅	→ 03/01; Made in Japan		13.0460-5807.2 605807	TRW 23093 16,6 - WK
			⬅	→ 11/06		13.0460-5807.2 605807	TRW 23093 16,6 - WK
			➡	→ 03/01; Made in Japan		13.0460-5983.2 605983	21713 16,5 - WE / - WK
			➡	→ 11/06		13.0460-5986.2 605986	TRW 21545 14,9 - WK
Zubehörsatz, Scheibenbremsbelag							
1.5	66	03/00→	⬅	→ 03/01; + ABS; Made in Japan		13.0460-0148.2 610148	TRW
			⬅	→ 11/06; + ABS		13.0460-0148.2 610148	TRW
1.5 1.5 dCi	72 60	10/02→ 01/03→	⬅	→ 11/06; + ABS		13.0460-0148.2 610148	TRW
1.8	84	01/00→	⬅	02/00→ 11/06		13.0460-0148.2 610148	TRW
			⬅	03/00→ 03/01; Made in Japan		13.0460-0148.2 610148	TRW
1.8 2.2 dCi 2.2 dCi	85 82 100	10/02→ 09/03→ 09/03→	⬅	→ 11/06		13.0460-0148.2 610148	TRW
1.8	94	08/02→	⬅	10/02→ 11/06		13.0460-0148.2 610148	TRW
2.2 Di	81	03/00→	⬅	→ 03/01; Made in Japan		13.0460-0148.2 610148	TRW
			⬅	→ 11/06		13.0460-0148.2 610148	TRW
 Bremsscheibe							
1.5	66	03/00→	⬅	→ 11/06; - ABS		24.0122-0146.1 422146	Ø 257 22 20 V
			⬅	→ 03/01; - ABS; Made in Japan		24.0122-0146.1 422146	Ø 257 22 20 V
			⬅	→ 03/01; + ABS; Made in Japan		24.0122-0179.1 422179	Ø 280 22 20 V
			⬅	→ 11/06; + ABS		24.0122-0179.1 422179	Ø 280 22 20 V
			➡	→ 11/06; + ABS		24.0110-0215.1 410215	Ø 258 10 9
			➡	→ 03/01; + ABS; Made in Japan		24.0110-0215.1 410215	Ø 258 10 9
1.5 1.5 dCi	72 60	10/02→ 01/03→	⬅	→ 11/06; - ABS		24.0122-0146.1 422146	Ø 257 22 20 V
			⬅	→ 11/06; + ABS		24.0122-0179.1 422179	Ø 280 22 20 V
			➡	→ 11/06; + ABS		24.0110-0215.1 410215	Ø 258 10 9
1.8	84	01/00→	⬅	02/00→ 11/06		24.0122-0179.1 422179	Ø 280 22 20 V
			⬅	03/00→ 03/01; Made in Japan		24.0122-0179.1 422179	Ø 280 22 20 V
			➡	03/00→ 03/01; Made in Japan		24.0110-0215.1 410215	Ø 258 10 9
			➡	02/00→ 11/06		24.0110-0215.1 410215	Ø 258 10 9
1.8 2.2 dCi 2.2 dCi	85 82 100	10/02→ 09/03→ 09/03→	⬅	→ 11/06		24.0122-0179.1 422179	Ø 280 22 20 V
			➡	→ 11/06		24.0110-0215.1 410215	Ø 258 10 9
			➡	→ 11/06		24.0110-0215.1 410215	Ø 258 10 9
1.8	94	08/02→	⬅	10/02→ 11/06		24.0122-0179.1 422179	Ø 280 22 20 V
			➡	10/02→ 11/06		24.0110-0215.1 410215	Ø 258 10 9
2.2 Di	81	03/00→	⬅	→ 03/01; Made in Japan		24.0122-0179.1 422179	Ø 280 22 20 V
			⬅	→ 11/06		24.0122-0179.1 422179	Ø 280 22 20 V
			➡	→ 03/01; Made in Japan		24.0110-0215.1 410215	Ø 258 10 9
			➡	→ 11/06		24.0110-0215.1 410215	Ø 258 10 9











	kW			 	! #		
NISSAN - ALMERA TINO (V10) 12/98→02/06							
 Bremsbelagsatz, Scheibenbremse							
1.8	84	08/00→02/06	←	→ 01/03		13.0460-5825.2 605825	TRW 23094 16,5 + WK + Zub
			←	02/03→ 11/05		13.0460-5825.2 605825	TRW 23094 16,5 + WK + Zub
			→	→ 11/05		13.0460-5986.2 605986	TRW 21545 14,9 - WK
1.8	85	12/02→02/06	←	→ 11/05		13.0460-5825.2 605825	TRW 23094 16,5 + WK + Zub
2.2 dCi	82	09/03→02/06	←	→ 11/05		13.0460-5825.2 605825	TRW 23094 16,5 + WK + Zub
2.2 dCi	100	09/03→02/06	→	→ 11/05		13.0460-5986.2 605986	TRW 21545 14,9 - WK
2.0	100	08/00→01/03	←			13.0460-5825.2 605825	TRW 23094 16,5 + WK + Zub
			→			13.0460-5986.2 605986	TRW 21545 14,9 - WK
2.2 dCi	84	08/00→02/06	←	02/03→ 08/03		13.0460-5825.2 605825	TRW 23094 16,5 + WK + Zub
			←	→ 01/03		13.0460-5825.2 605825	TRW 23094 16,5 + WK + Zub
			→	→ 08/03		13.0460-5986.2 605986	TRW 21545 14,9 - WK
Zubehörsatz, Scheibenbremsbelag							
1.8	84	08/00→02/06	←	→ 01/03		13.0460-0282.2 610282	
			←	02/03→ 11/05		13.0460-0282.2 610282	
1.8	85	12/02→02/06	←	→ 11/05		13.0460-0282.2 610282	
2.2 dCi	82	09/03→02/06	←	→ 11/05		13.0460-0282.2 610282	
2.2 dCi	100	09/03→02/06	→	→ 11/05		13.0460-0282.2 610282	
2.0	100	08/00→01/03	←			13.0460-0282.2 610282	
2.2 dCi	84	08/00→02/06	←	02/03→ 08/03		13.0460-0282.2 610282	
			←	→ 01/03		13.0460-0282.2 610282	
 Bremsscheibe							
1.8	84	08/00→02/06	←	→ 11/05		24.0128-0140.1 428140	∅ 280 28 26 V
1.8	85	12/02→02/06	←	→ 11/05		24.0110-0285.1 410285	∅ 278 10 9
2.2 dCi	82	09/03→02/06	→	→ 11/05		24.0110-0285.1 410285	∅ 278 10 9
2.2 dCi	100	09/03→02/06	→	→ 11/05		24.0110-0285.1 410285	∅ 278 10 9
2.0	100	08/00→01/03	←			24.0128-0140.1 428140	∅ 280 28 26 V
			→			24.0110-0285.1 410285	∅ 278 10 9
2.2 dCi	84	08/00→02/06	←	→ 08/03		24.0128-0140.1 428140	∅ 280 28 26 V
			→	→ 08/03		24.0110-0285.1 410285	∅ 278 10 9
NISSAN - CABSTAR (F23, H41, H42) 07/92→09/11							
 Bremsbelagsatz, Scheibenbremse							
2.5 D	55	07/92→12/00	←			13.0460-3856.2 603856	BOS 23434 18,0 + WK
2.7 D	66	10/00→04/04	←			13.0460-3856.2 603856	BOS 23434 18,0 + WK
3.0 110.35 (TL0)	81	10/00→04/04	←			13.0460-3856.2 603856	BOS 23434 18,0 + WK
35 DI 3.0	92	01/04→12/06	←			13.0460-3856.2 603856	BOS 23434 18,0 + WK
2.5 dCi	96	10/06→09/11	←			13.0460-4866.2 604866	BRE 29229 20,7 + WK
			→			13.0460-4859.2 604859	BRE 23921 20,1 + WK + Zub
 Bremsscheibe							
2.5 D	55	07/92→12/00	←			24.0124-0229.1 424229	∅ 263 24 22 V
2.7 D	66	10/00→04/04	←			24.0124-0229.1 424229	∅ 263 24 22 V
35 DI 3.0	92	01/04→12/06	←			24.0124-0229.1 424229	∅ 263 24 22 V
2.5 dCi	96	10/06→09/11	←			24.0128-0244.1 428244	∅ 276 28 26 V
			→	Brems-/Fahrdyn. Artikelbezug: + ABS		24.0116-0131.1 416131	∅ 280 16 13 + ABS Ring
			→	Brems-/Fahrdyn. Artikelbezug: - ABS		24.0116-0132.1 416132	∅ 280 16 13
NISSAN - CABSTAR (F24M, F24W) 09/06→12/13							
 Bremsbelagsatz, Scheibenbremse							
28.11 DCI, 32.11 DCI, 35.11 DCI 2.5 (F24M)	81	09/06→12/13	←	→ 11/09		13.0460-4866.2 604866	BRE 29229 20,7 + WK
			→	→ 09/11		13.0460-4859.2 604859	BRE 23921 20,1 + WK + Zub
28.12 DCI, 32.12 DCI, 34.12 DCI, 35.12 DCI 2.5 (F24M)	90	09/06→12/13	←	10/11→		13.0460-4866.2 604866	BRE 29229 20,7 + WK
			→	10/11→		13.0460-4859.2 604859	BRE 23921 20,1 + WK + Zub
35.13 DCI, 45.13 DCI 2.5 (F24M)	96	09/06→12/12	←	10/06→ 09/11; zul. Gesamtgewicht [kg]: 4.500		13.0460-4866.2 604866	BRE 29160 20,3 + WK + Zub
			←	10/06→ 11/09; zul. Gesamtgewicht [kg]: 3.500		13.0460-4866.2 604866	BRE 29229 20,7 + WK
			→	10/06→ 09/11		13.0460-4859.2 604859	BRE 23921 20,1 + WK + Zub
			→	10/06→ 09/11; zul. Gesamtgewicht [kg]: 4.500		13.0460-4861.2 604861	BRE 29121 20,3 + WK + Zub
↓							















	kw			 	! #		
NISSAN - CABSTAR (F24M, F24W) 09/06→12/13							
 Bremsbelagsatz, Scheibenbremse							
35.14 DCI, 45.14 DCI 2.5 (F24M)	100	09/06→12/13	←	10/11→; zul. Gesamtgewicht [kg]: 4.500	13.0460-4865.2	604865	BRE 29160 20,3 + WK + Zub
			←	10/11→	13.0460-4866.2	604866	BRE 29229 20,7 + WK
			→	10/11→	13.0460-4859.2	604859	BRE 23921 20,1 + WK + Zub
			→	10/11→; zul. Gesamtgewicht [kg]: 4.500	13.0460-4861.2	604861	BRE 29121 20,3 + WK + Zub
35.15 DCI, 45.15 DCI 3.0 (F24M)	110	09/06→12/13	←	10/06→; zul. Gesamtgewicht [kg]: 4.500	13.0460-4865.2	604865	BRE 29160 20,3 + WK + Zub
			←	10/06→; zul. Gesamtgewicht [kg]: 3.500	13.0460-4866.2	604866	BRE 29229 20,7 + WK
			→	10/06→; zul. Gesamtgewicht [kg]: 3.500	13.0460-4859.2	604859	BRE 23921 20,1 + WK + Zub
			→	10/06→; zul. Gesamtgewicht [kg]: 4.500	13.0460-4861.2	604861	BRE 29121 20,3 + WK + Zub
 Bremsscheibe							
28.11 DCI, 32.11 DCI, 35.11 DCI 2.5 (F24M)	81	09/06→12/13	←	→ 09/11	24.0128-0244.1	428244	Ø 276 28 26 V
			→	→ 09/11; Brems-/Fahrdyn. Artikelbezug: + ABS	24.0116-0131.1	416131	Ø 280 16 13 + ABS Ring
			→	→ 09/11; Brems-/Fahrdyn. Artikelbezug: - ABS	24.0116-0132.1	416132	Ø 280 16 13
28.12 DCI, 32.12 DCI, 34.12 DCI, 35.12 DCI 2.5 (F24M)	90	09/06→12/13	←	10/11→	24.0128-0244.1	428244	Ø 276 28 26 V
			→	10/11→; Brems-/Fahrdyn. Artikelbezug: + ABS	24.0116-0131.1	416131	Ø 280 16 13 + ABS Ring
			→	10/11→; Brems-/Fahrdyn. Artikelbezug: - ABS	24.0116-0132.1	416132	Ø 280 16 13
35.13 DCI, 45.13 DCI 2.5 (F24M)	96	09/06→12/12	←	10/06→ 09/11; zul. Gesamtgewicht [kg]: 4.500	24.0126-0163.1	426163	Ø 290 26 23 V
			←	10/06→ 09/11	24.0128-0244.1	428244	Ø 276 28 26 V
			→	10/06→ 09/11; Brems-/Fahrdyn. Artikelbezug: + ABS	24.0116-0131.1	416131	Ø 280 16 13 + ABS Ring
			→	10/06→ 09/11; Brems-/Fahrdyn. Artikelbezug: - ABS	24.0116-0132.1	416132	Ø 280 16 13
			→	10/06→ 09/11; zul. Gesamtgewicht [kg]: 4.500	24.0122-0264.1	422264	Ø 290 22 19 V
35.14 DCI, 45.14 DCI 2.5 (F24M)	100	09/06→12/13	←	10/11→; zul. Gesamtgewicht [kg]: 4.500	24.0126-0163.1	426163	Ø 290 26 23 V
			←	10/11→	24.0128-0244.1	428244	Ø 276 28 26 V
			→	10/11→; Brems-/Fahrdyn. Artikelbezug: + ABS	24.0116-0131.1	416131	Ø 280 16 13 + ABS Ring
			→	10/11→; Brems-/Fahrdyn. Artikelbezug: - ABS	24.0116-0132.1	416132	Ø 280 16 13
			→	10/11→; zul. Gesamtgewicht [kg]: 4.500	24.0122-0264.1	422264	Ø 290 22 19 V
35.15 DCI, 45.15 DCI 3.0 (F24M)	110	09/06→12/13	←	10/06→; zul. Gesamtgewicht [kg]: 4.500	24.0126-0163.1	426163	Ø 290 26 23 V
			←	10/06→	24.0128-0244.1	428244	Ø 276 28 26 V
			→	10/06→; zul. Gesamtgewicht [kg]: 3.500; Brems-/Fahrdyn. Artikelbezug: + ABS	24.0116-0131.1	416131	Ø 280 16 13 + ABS Ring
			→	10/06→; zul. Gesamtgewicht [kg]: 3.500; Brems-/Fahrdyn. Artikelbezug: - ABS	24.0116-0132.1	416132	Ø 280 16 13
			→	10/06→; zul. Gesamtgewicht [kg]: 4.500	24.0122-0264.1	422264	Ø 290 22 19 V
→	10/06→; zul. Gesamtgewicht [kg]: 4.500; Schaltgetriebe 5 Gang	24.0122-0264.1	422264	Ø 290 22 19 V			
NISSAN - CABSTAR E (TL_, VL_) 07/92→10/06							
 Bremsbelagsatz, Scheibenbremse							
105.35, 110.35, 110.45 (TL0)	78	10/98→10/06	←	09/01→ 12/03	13.0460-3856.2	603856	BOS 23434 18,0 + WK
120.35, 120.45 (TL0)	88	10/98→10/06					
75.28 (TL0)	55	10/98→10/06					
90.32 (TL0)	66	10/98→10/06					
NISSAN - CEFIRO III Stufenheck (A33) 01/00→09/03							
 Bremsbelagsatz, Scheibenbremse							
2.0	103	01/00→09/03	←	→ 08/03	13.0460-5880.2	605880	23184 14,8 + WK
3.0	147	01/00→09/03	→	→ 08/03	13.0460-5626.2	605626	AKE 21713 16,0 + WK
 Bremsscheibe							
2.0	103	01/00→09/03	←	→ 08/03	24.0128-0140.1	428140	Ø 280 28 26 V
3.0	147	01/00→09/03					















	kw			 	! #		
NISSAN - CUBE (Z12) 09/07→							
 Bremsbelagsatz, Scheibenbremse							
1.5 dCi 1.5 dCi 1.6 16V	78 81 81	03/10→ 03/10→ 03/10→	← ← ←	→ 03/11		13.0460-5716.2 605716	21561 17,0 + WK
Zubehörsatz, Scheibenbremsbelag							
1.5 dCi 1.5 dCi 1.6 16V	78 81 81	03/10→ 03/10→ 03/10→	← ← ←	→ 03/11		13.0460-0170.2 610170	
 Bremsscheibe							
1.5 dCi 1.5 dCi 1.6 16V	78 81 81	03/10→ 03/10→ 03/10→	← ← →	→ 03/11		24.0124-0238.1 424238	Ø 280 24 22 V
				→ 03/11		24.0109-0166.1 409166	Ø 292 9 8
NISSAN - EVALIA Bus 07/10→							
 Bremsbelagsatz, Scheibenbremse							
e- (ME0)	80	07/14→	←			13.0460-5783.2 605783	TOK 24227 16,7 + WK
 Bremsscheibe							
1.5 dci (M20, M20M) 1.5 dci (M20, M20M) 1.5 dci (M20, M20M) 1.6 16V (M20, M20M)	63 66 81 81	07/10→ 04/11→ 04/11→ 07/10→	← ← ← ←			24.0126-0175.1 426175	Ø 257 26 24 V
e- (ME0)	80	07/14→	← →			24.0128-0268.1 428268	Ø 283 28 26 V
						24.0109-0157.1 409157	Ø 291,5 9 8
NISSAN - INTERSTAR Bus (X70) 04/02→							
 Bremsbelagsatz, Scheibenbremse							
dCi 100 dCi 100 dCi 120 dCi 150	73 74 88 107	11/03→ 04/06→ 09/06→ 09/06→	← ← → →	→ 06/10 → 06/10		13.0460-3800.2 603800 13.0460-3806.2 603806	BOS 23613 17,7 - WE / - WK BOS 23669 16,8 - WE / - WK
dCi 120	84	07/02→08/06	← →			13.0460-3800.2 603800 13.0460-3806.2 603806	BOS 23613 17,7 - WE / - WK BOS 23669 16,8 - WE / - WK
dCi 140 dCi 90	100 66	11/03→ 07/02→	← →	→ 08/06 → 08/06		13.0460-3800.2 603800 13.0460-3806.2 603806	BOS 23613 17,7 - WE / - WK BOS 23669 16,8 - WE / - WK
dCi 80	60	04/02→08/06	← →	07/02→ 07/02→		13.0460-3800.2 603800 13.0460-3806.2 603806	BOS 23613 17,7 - WE / - WK BOS 23669 16,8 - WE / - WK
Zubehörsatz, Scheibenbremsbelag							
dCi 100 dCi 100 dCi 120 dCi 150	73 74 88 107	11/03→ 04/06→ 09/06→ 09/06→	← ← → →	→ 06/10 → 06/10		13.0460-0344.2 610344	
dCi 120	84	07/02→08/06	← →			13.0460-0344.2 610344	
dCi 140 dCi 90	100 66	11/03→ 07/02→	← →	→ 08/06 → 08/06		13.0460-0344.2 610344	
dCi 80	60	04/02→08/06	← →	07/02→ 07/02→		13.0460-0344.2 610344	
 Bremsscheibe							
dCi 100 dCi 100 dCi 120 dCi 150	73 74 88 107	11/03→ 04/06→ 09/06→ 09/06→	← ← → →	→ 06/10 → 06/10		24.0128-0129.1 428129 24.0328-0129.1 528129 24.0112-0155.1 412155	Ø 305,5 28 25 V + S Ø 305,5 28 25 V + S PD Ø 305 12 10,5 + S
dCi 120	84	07/02→08/06	← →			24.0128-0129.1 428129 24.0328-0129.1 528129 24.0112-0155.1 412155	Ø 305,5 28 25 V + S Ø 305,5 28 25 V + S PD Ø 305 12 10,5 + S
dCi 140 dCi 90	100 66	11/03→ 07/02→	← →	→ 08/06 → 08/06		24.0128-0129.1 428129 24.0328-0129.1 528129 24.0112-0155.1 412155	Ø 305,5 28 25 V + S Ø 305,5 28 25 V + S PD Ø 305 12 10,5 + S
dCi 80	60	04/02→08/06	← →	07/02→ 07/02→		24.0128-0129.1 428129 24.0328-0129.1 528129 24.0112-0155.1 412155	Ø 305,5 28 25 V + S Ø 305,5 28 25 V + S PD Ø 305 12 10,5 + S































	kw			 	! #		
NISSAN - INTERSTAR Kasten (X70) 04/02→							
 Bremsbelagsatz, Scheibenbremse							
dCi 100	73	11/03→	←	→ 06/10		13.0460-3800.2 603800	BOS 23613 17,7 - WE / - WK
dCi 100	74	04/06→	→	→ 06/10		13.0460-3806.2 603806	BOS 23669 16,8 - WE / - WK
dCi 120	88	09/06→					
dCi 150	107	09/06→	→	→ 06/10			
dCi 120	84	07/02→	←	→ 08/06		13.0460-3800.2 603800	BOS 23613 17,7 - WE / - WK
dCi 140	100	11/03→	→	→ 08/06		13.0460-3806.2 603806	BOS 23669 16,8 - WE / - WK
dCi 90	66	07/02→					
dCi 80	60	04/02→08/06	←	07/02→		13.0460-3800.2 603800	BOS 23613 17,7 - WE / - WK
			→	07/02→		13.0460-3806.2 603806	BOS 23669 16,8 - WE / - WK
Zubehörsatz, Scheibenbremsbelag							
dCi 100	73	11/03→	←	→ 06/10		13.0460-0344.2 610344	
dCi 100	74	04/06→					
dCi 120	88	09/06→					
dCi 150	107	09/06→					
dCi 120	84	07/02→	←	→ 08/06		13.0460-0344.2 610344	
dCi 140	100	11/03→					
dCi 90	66	07/02→					
dCi 80	60	04/02→08/06	←	07/02→		13.0460-0344.2 610344	
Bremsscheibe							
dCi 100	73	11/03→	←	→ 06/10		24.0128-0129.1 428129	Ø 305,5 28 25 V + S
dCi 100	74	04/06→				24.0328-0129.1 528129	Ø 305,5 28 25 V + S PD
dCi 120	88	09/06→	→	→ 06/10		24.0112-0155.1 412155	Ø 305 12 10,5 + S
dCi 150	107	09/06→					
dCi 120	84	07/02→	←	→ 08/06		24.0128-0129.1 428129	Ø 305,5 28 25 V + S
dCi 140	100	11/03→				24.0328-0129.1 528129	Ø 305,5 28 25 V + S PD
dCi 90	66	07/02→	→	→ 08/06		24.0112-0155.1 412155	Ø 305 12 10,5 + S
dCi 80	60	04/02→08/06	←	07/02→		24.0128-0129.1 428129	Ø 305,5 28 25 V + S
						24.0328-0129.1 528129	Ø 305,5 28 25 V + S PD
			→	07/02→		24.0112-0155.1 412155	Ø 305 12 10,5 + S
NISSAN - INTERSTAR Pritsche/Fahrgestell 08/03→							
 Bremsbelagsatz, Scheibenbremse							
dCi 100	73	02/04→	←	→ 06/10		13.0460-3800.2 603800	BOS 23613 17,7 - WE / - WK
			→	→ 06/10		13.0460-3806.2 603806	BOS 23669 16,8 - WE / - WK
dCi 120	84	08/03→	←	→ 08/06		13.0460-3800.2 603800	BOS 23613 17,7 - WE / - WK
dCi 140	100	11/03→	→	→ 08/06		13.0460-3806.2 603806	BOS 23669 16,8 - WE / - WK
dCi 120	88	08/06→	←	09/06→ 06/10		13.0460-3800.2 603800	BOS 23613 17,7 - WE / - WK
dCi 150	107	08/06→	→	09/06→ 06/10		13.0460-3806.2 603806	BOS 23669 16,8 - WE / - WK
Zubehörsatz, Scheibenbremsbelag							
dCi 100	73	02/04→	←	→ 06/10		13.0460-0344.2 610344	
dCi 120	84	08/03→	←	→ 08/06		13.0460-0344.2 610344	
dCi 140	100	11/03→					
dCi 120	88	08/06→	←	09/06→ 06/10		13.0460-0344.2 610344	
dCi 150	107	08/06→					
Bremsscheibe							
dCi 100	73	02/04→	←	→ 06/10		24.0128-0129.1 428129	Ø 305,5 28 25 V + S
						24.0328-0129.1 528129	Ø 305,5 28 25 V + S PD
			→	→ 06/10		24.0112-0155.1 412155	Ø 305 12 10,5 + S
dCi 120	84	08/03→	←	→ 08/06		24.0128-0129.1 428129	Ø 305,5 28 25 V + S
dCi 140	100	11/03→				24.0328-0129.1 528129	Ø 305,5 28 25 V + S PD
			→	→ 08/06		24.0112-0155.1 412155	Ø 305 12 10,5 + S
dCi 120	88	08/06→	←	09/06→ 06/10		24.0128-0129.1 428129	Ø 305,5 28 25 V + S
dCi 150	107	08/06→				24.0328-0129.1 528129	Ø 305,5 28 25 V + S PD
			→	09/06→ 06/10		24.0112-0155.1 412155	Ø 305 12 10,5 + S
NISSAN - JUKE (F15) 06/10→							
 Bremsbelagsatz, Scheibenbremse							
1.2 DIG-T	85	05/14→	←			13.0460-5716.2 605716	21561 17,0 + WK
1.5 dCi	81	06/10→					
1.6	69	01/13→					
1.6	86	06/10→					
1.6 DIG-T	140	06/10→					
↓							













	kw			 	! #		
NISSAN - JUKE (F15) 06/10→							
 Bremsbelagsatz, Scheibenbremse							
1.6 DIG-T 4x4 1.6 DIG-T NISMO 1.6 DIG-T NISMO 4x4 1.6 DIG-T NISMO RS 1.6 DIG-T NISMO RS 4x4 1.6 LPG	140 147 147 160 157 85	06/10→ 03/13→07/14 02/13→07/14 08/14→ 08/14→ 01/12→	←			13.0460-5716.2 605716	21561 17,0 + WK
Zubehörsatz, Scheibenbremsbelag							
1.2 DIG-T 1.5 dCi 1.6 1.6 1.6 LPG	85 81 69 86 85	05/14→ 06/10→ 01/13→ 06/10→ 01/12→	←			13.0460-0170.2 610170	
 Bremsscheibe							
1.2 DIG-T 1.5 dCi 1.6 1.6	85 81 69 86	05/14→ 06/10→ 01/13→ 06/10→	← →			24.0124-0247.1 424247 24.0109-0157.1 409157	Ø 280 24 22 V Ø 291,5 9 8
1.6 DIG-T 1.6 DIG-T 4x4	140 140	06/10→ 06/10→	← →	Made in Großbritannien		24.0126-0177.1 426177 24.0109-0157.1 409157	Ø 296 26 24 V Ø 291,5 9 8
1.6 DIG-T NISMO 1.6 DIG-T NISMO RS	147 160	03/13→07/14 08/14→	← →			24.0126-0177.1 426177 24.0109-0157.1 409157	Ø 296 26 24 V Ø 291,5 9 8
1.6 DIG-T NISMO 4x4 1.6 DIG-T NISMO RS 4x4	147 157	02/13→07/14 08/14→	←			24.0126-0177.1 426177	Ø 296 26 24 V
1.6 LPG	85	01/12→	←			24.0124-0247.1 424247	Ø 280 24 22 V
NISSAN - KUBISTAR (X76) 08/03→10/09							
 Bremsbelagsatz, Scheibenbremse							
1.2 1.5 dCi 1.5 dCi 1.5 dCi	44 42 48 60	08/03→10/09 08/03→10/09 08/03→10/09 08/03→10/09	←	→ 08/05		13.0460-3977.2 603977	BOS 21980 18,0 + WE / - WK
1.2 16V 1.4 1.5 dCi 70 1.5 dCi 85 1.6 16V	55 55 50 62 70	04/06→10/09 08/03→10/09 04/06→10/09 04/06→10/09 08/03→10/09	←			13.0460-3977.2 603977	BOS 21980 18,0 + WE / - WK
1.5 dCi	45	08/05→10/09	←	09/05→		13.0460-3977.2 603977	BOS 21980 18,0 + WE / - WK
 Bremsscheibe							
1.2 1.5 dCi 1.5 dCi 1.5 dCi	44 42 48 60	08/03→10/09 08/03→10/09 08/03→10/09 08/03→10/09	←	→ 08/05; - ABS → 08/05; + ABS		24.0120-0125.1 420125 24.0121-0106.1 421106	Ø 238 20,1 17,7 V + S Ø 259 20,7 17,7 V + S
1.2 16V 1.4 1.5 dCi 70 1.5 dCi 85 1.6 16V	55 55 50 62 70	04/06→10/09 08/03→10/09 04/06→10/09 04/06→10/09 08/03→10/09	←	- ABS + ABS		24.0120-0125.1 420125 24.0121-0106.1 421106	Ø 238 20,1 17,7 V + S Ø 259 20,7 17,7 V + S
1.5 dCi	45	08/05→10/09	←	09/05→; - ABS 09/05→; + ABS		24.0120-0125.1 420125 24.0121-0106.1 421106	Ø 238 20,1 17,7 V + S Ø 259 20,7 17,7 V + S
NISSAN - KUBISTAR Kasten (X80) 08/03→							
 Bremsbelagsatz, Scheibenbremse							
1.2 1.5 dCi 1.5 dCi	44 48 60	08/03→ 08/03→ 08/03→	←	→ 08/05		13.0460-3977.2 603977	BOS 21980 18,0 + WE / - WK
1.2 16V 1.5 dCi 70 1.6 16V	55 50 70	04/06→ 04/06→03/10 08/03→	←	→ 10/09		13.0460-3977.2 603977	BOS 21980 18,0 + WE / - WK
1.5 dCi	45	08/05→	←	09/05→ 10/09		13.0460-3977.2 603977	BOS 21980 18,0 + WE / - WK
 Bremsscheibe							
1.2 1.5 dCi 1.5 dCi	44 48 60	08/03→ 08/03→ 08/03→	←	→ 08/05; - ABS → 08/05; + ABS		24.0120-0125.1 420125 24.0121-0106.1 421106	Ø 238 20,1 17,7 V + S Ø 259 20,7 17,7 V + S
1.2 16V 1.5 dCi 70 1.6 16V	55 50 70	04/06→ 04/06→03/10 08/03→	←	→ 10/09; - ABS → 10/09; + ABS		24.0120-0125.1 420125 24.0121-0106.1 421106	Ø 238 20,1 17,7 V + S Ø 259 20,7 17,7 V + S
↓							































	kw					! #		
NISSAN - KUBISTAR Kasten (X80) 08/03→								
 Bremsscheibe								
1.5 dCi	45	08/05→	←	09/05→ 10/09; - ABS		24.0120-0125.1	420125	Ø 238 20,1 17,7 V + S
			→	09/05→ 10/09; + ABS		24.0121-0106.1	421106	Ø 259 20,7 17,7 V + S
NISSAN - LEAF (ZE0) 11/10→								
 Bremsbelagsatz, Scheibenbremse								
Electric	80	11/10→	←			13.0460-5783.2	605783	TOK 24227 16,7 + WK
 Bremsscheibe								
Electric	80	11/10→	←			24.0128-0268.1	428268	Ø 283 28 26 V
			→			24.0116-0119.1	416119	Ø 292 16 14 V
NISSAN - MAXIMA / MAXIMA QX V (A33) 04/99→11/03								
 Bremsbelagsatz, Scheibenbremse								
2.0 V6 24V	103	03/00→11/03	←			13.0460-5880.2	605880	23184 14,8 + WK
2.5 V6 24V	154	03/00→11/03	→			13.0460-5626.2	605626	AKE 21713 16,0 + WK
3.0 V6 24V	147	03/00→11/03	→					
3.0 V6 24V	157	12/99→11/03	←	03/00→		13.0460-5880.2	605880	23184 14,8 + WK
			→	03/00→		13.0460-5626.2	605626	AKE 21713 16,0 + WK
Zubehörsatz, Scheibenbremsbelag								
2.0 V6 24V	103	03/00→11/03	←			13.0460-0112.2	610112	
2.5 V6 24V	154	03/00→11/03	→			13.0460-0295.2	610295	
3.0 V6 24V	147	03/00→11/03	→					
3.0 V6 24V	157	12/99→11/03	←	03/00→		13.0460-0112.2	610112	
			→	03/00→		13.0460-0295.2	610295	
 Bremsscheibe								
2.0 V6 24V	103	03/00→11/03	←			24.0128-0140.1	428140	Ø 280 28 26 V
2.5 V6 24V	154	03/00→11/03	→					
3.0 V6 24V	147	03/00→11/03	→					
3.0 V6 24V	157	12/99→11/03	←	03/00→		24.0128-0140.1	428140	Ø 280 28 26 V
NISSAN - MICRA II (K11) 01/92→12/07								
 Bremsbelagsatz, Scheibenbremse								
1.0 i 16V	40	08/92→09/00	←	→ 07/00		13.0460-5956.2	605956	AKE 21626 15,0 - WE / - WK
1.3 i 16V	55	08/92→09/00	→	→ 08/00; + ABS		13.0460-5989.2	605989	AKE 23454 14,9 - WE / - WK
1.0 i 16V	44	09/00→02/03	←	→ 12/02		13.0460-5956.2	605956	AKE 21626 15,0 - WE / - WK
1.4 i 16V	60	09/00→02/03	→	→ 12/02; + ABS		13.0460-5989.2	605989	AKE 23454 14,9 - WE / - WK
1.5 D	42	02/98→02/03	←	→ 12/02		13.0460-5956.2	605956	AKE 21626 15,0 - WE / - WK
Zubehörsatz, Scheibenbremsbelag								
1.0 i 16V	40	08/92→09/00	←	→ 07/00; - ABS		13.0460-0452.2	610452	AKE
1.3 i 16V	55	08/92→09/00	→	→ 08/00; + ABS		13.0460-0248.2	610248	AKE
1.0 i 16V	44	09/00→02/03	←	→ 12/02; - ABS		13.0460-0452.2	610452	AKE
1.4 i 16V	60	09/00→02/03	→	→ 12/02; + ABS		13.0460-0248.2	610248	AKE
1.5 D	42	02/98→02/03	←	→ 12/02; - ABS		13.0460-0452.2	610452	AKE
 Bremsscheibe								
1.0 i 16V	40	08/92→09/00	←	→ 07/00; - ABS		24.0112-0137.1	412137	Ø 234 12 10
1.3 i 16V	55	08/92→09/00	→	→ 08/00; + ABS		24.0107-0109.1	407109	Ø 240 7 6
1.0 i 16V	44	09/00→02/03	←	→ 12/02; - ABS		24.0112-0137.1	412137	Ø 234 12 10
1.4 i 16V	60	09/00→02/03	→	→ 12/02; + ABS		24.0118-0139.1	418139	Ø 238 18 16 V
			→	→ 12/02; + ABS		24.0107-0109.1	407109	Ø 240 7 6
1.5 D	42	02/98→02/03	←	→ 12/02; - ABS		24.0112-0137.1	412137	Ø 234 12 10
			←	08/00→ 12/02; + ABS		24.0118-0139.1	418139	Ø 238 18 16 V
NISSAN - MICRA III (K12) 03/02→06/10								
 Bremsbelagsatz, Scheibenbremse								
1.0 16V	48	01/03→06/10	←			13.0460-5801.2	605801	TRW 23973 17,1 - WE / - WK
1.2 16V	48	01/03→06/10	←					
1.2 16V	59	01/03→06/10	←					















	kW			 	! #		
NISSAN - MICRA III (K12) 03/02→06/10							
 Bremsbelagsatz, Scheibenbremse							
1.2 LPG	59	06/05→06/10	←			13.0460-5801.2 605801	TRW 23973 17,1 - WE / - WK
1.3	60	08/04→					
1.4 16V	65	01/03→06/10					
1.5 dCi	48	01/03→06/10					
1.5 dCi	50	06/05→06/10					
1.5 dCi	60	09/03→06/10					
1.5 dCi	63	06/05→06/10					
160 SR	81	05/05→06/10					
Zubehörsatz, Scheibenbremsbelag							
1.0 16V	48	01/03→06/10	←			13.0460-0291.2 610291	
1.2 16V	48	01/03→06/10					
1.2 16V	59	01/03→06/10					
1.2 LPG	59	06/05→06/10					
1.3	60	08/04→					
1.4 16V	65	01/03→06/10					
1.5 dCi	48	01/03→06/10					
1.5 dCi	50	06/05→06/10					
1.5 dCi	60	09/03→06/10					
1.5 dCi	63	06/05→06/10					
160 SR	81	05/05→06/10					
 Bremsscheibe							
1.0 16V	48	01/03→06/10	←			24.0122-0216.1 422216	Ø 260 22 19,8 V + S
1.2 16V	48	01/03→06/10					
1.2 16V	59	01/03→06/10					
1.2 LPG	59	06/05→06/10					
1.3	60	08/04→					
1.4 16V	65	01/03→06/10					
1.5 dCi	48	01/03→06/10					
1.5 dCi	50	06/05→06/10					
1.5 dCi	60	09/03→06/10					
1.5 dCi	63	06/05→06/10					
160 SR	81	05/05→06/10					
NISSAN - MICRA IV (K13) 05/10→							
 Bremsbelagsatz, Scheibenbremse							
1.2	56	05/10→	←	→ 09/15		13.0460-2774.2 602774	TRW 23973 17,4 + WK
1.2	59	05/10→	←			13.0460-2774.2 602774	TRW 23973 17,4 + WK
1.2 DIG-S	72	04/11→					
 Bremsscheibe							
1.2	56	05/10→	←	→ 09/15		24.0122-0277.1 422277	Ø 260 22 20 V
1.2	59	05/10→	←			24.0122-0277.1 422277	Ø 260 22 20 V
1.2 DIG-S	72	04/11→					
NISSAN - MICRA V (K14) 12/16→							
 Bremsscheibe							
0.9 IG-T	66	12/16→	←	03/17→		24.0122-0216.1 422216	Ø 260 22 19,8 V + S
1.0	54	12/16→					
1.5 DCI	66	12/16→					
1.0	52	12/16→	←			24.0122-0216.1 422216	Ø 260 22 19,8 V + S
NISSAN - MICRA C+C III (K12) 08/05→							
 Bremsbelagsatz, Scheibenbremse							
1.4 16V	65	08/05→	←	→ 12/10		13.0460-5801.2 605801	TRW 23973 17,1 - WE / - WK
1.6 160 SR	81	08/05→					
Zubehörsatz, Scheibenbremsbelag							
1.4 16V	65	08/05→	←	→ 12/10		13.0460-0291.2 610291	
1.6 160 SR	81	08/05→					
 Bremsscheibe							
1.4 16V	65	08/05→	←	→ 12/10		24.0122-0216.1 422216	Ø 260 22 19,8 V + S
1.6 160 SR	81	08/05→					
NISSAN - MURANO I (Z50) 08/03→09/08							
 Bremsbelagsatz, Scheibenbremse							
3.5	172	08/03→10/07	←			13.0460-5778.2 605778	SUM 23698 16,8 + WK
3.5	180	08/03→10/07					
3.5 4x4	180	11/04→06/08	→	→ 07/05		13.0460-5843.2 605843	AKE 23871 14,3 + WK
3.5	198	09/06→	←	→ 06/08		13.0460-5778.2 605778	SUM 23698 16,8 + WK
3.5 4x4	170	01/06→09/08					
3.5 4x4	198	09/06→					
↓							













	kw			 	! #		
NISSAN - MURANO I (Z50) 08/03→09/08							
 Bremsbelagsatz, Scheibenbremse							
3.5 4x4	172	08/03→09/08	←	→ 06/08		13.0460-5778.2 605778	SUM 23698 16,8 + WK
			→	→ 07/05		13.0460-5843.2 605843	AKE 23871 14,3 + WK
Zubehörsatz, Scheibenbremsbelag							
3.5	172	08/03→10/07	←			13.0460-0017.2 610017	
3.5	180	08/03→10/07					
3.5 4x4	180	11/04→06/08	→	→ 07/05		13.0460-0341.2 610341	
3.5	198	09/06→	←	→ 06/08		13.0460-0017.2 610017	
3.5 4x4	170	01/06→09/08					
3.5 4x4	198	09/06→					
3.5 4x4	172	08/03→09/08	←	→ 06/08		13.0460-0017.2 610017	
			→	→ 07/05		13.0460-0341.2 610341	
 Bremsscheibe							
3.5	172	08/03→10/07	←			24.0128-0153.1 428153	Ø 320 28 26 V
3.5	180	08/03→10/07					
3.5 4x4	180	11/04→06/08	→			24.0116-0122.1 416122	Ø 308 16 14 V
3.5	198	09/06→	←	→ 06/08		24.0128-0153.1 428153	Ø 320 28 26 V
3.5 4x4	170	01/06→09/08					
3.5 4x4	172	08/03→09/08	→	→ 06/08		24.0116-0122.1 416122	Ø 308 16 14 V
3.5 4x4	198	09/06→					
NISSAN - MURANO II (Z51) 10/07→09/14							
 Bremsbelagsatz, Scheibenbremse							
2.5 dCi 4x4	140	01/10→09/14	←			13.0460-5778.2 605778	SUM 23698 16,8 + WK
3.5	172	11/07→					
3.5	191	01/11→09/14					
3.5	195	11/07→09/14					
3.5 4x4	183	12/10→09/14					
3.5 4x4	188	10/08→09/14					
3.5 4x4	195	11/07→09/14					
3.5 4x4	191	12/09→09/14	←	01/11→		13.0460-5778.2 605778	SUM 23698 16,8 + WK
 Bremsscheibe							
2.5 dCi 4x4	140	01/10→09/14	←			24.0128-0153.1 428153	Ø 320 28 26 V
3.5	172	11/07→					
3.5	191	01/11→09/14	→			24.0116-0122.1 416122	Ø 308 16 14 V
3.5	195	11/07→09/14					
3.5 4x4	183	12/10→09/14					
3.5 4x4	188	10/08→09/14					
3.5 4x4	195	11/07→09/14					
3.5 4x4	191	12/09→09/14	←	01/11→		24.0128-0153.1 428153	Ø 320 28 26 V
			→	01/11→		24.0116-0122.1 416122	Ø 308 16 14 V
NISSAN - NAVARA (D21) 11/85→03/08							
 Bremsbelagsatz, Scheibenbremse							
2.4 4x4	74	01/86→12/96	←	03/86→		13.0460-5937.2 605937	AKE 21119 17,0 + WK
2.4 4x4	79	01/92→12/96	←			13.0460-5937.2 605937	AKE 21119 17,0 + WK
2.4 4x4	80	01/92→12/97					
2.4 4x4	91	06/92→02/97					
2.5 D 4x4	59	01/86→03/08	←	→ 02/98		13.0460-5937.2 605937	AKE 21119 17,0 + WK
Zubehörsatz, Scheibenbremsbelag							
2.4 4x4	74	01/86→12/96	←	03/86→		13.0460-0322.2 610322	AKE
2.4 4x4	79	01/92→12/96	←			13.0460-0322.2 610322	AKE
2.4 4x4	80	01/92→12/97					
2.4 4x4	91	06/92→02/97					
2.5 D 4x4	59	01/86→03/08	←	→ 02/98		13.0460-0322.2 610322	AKE
 Bremsscheibe							
2.4 4x4	74	01/86→12/96	←	03/86→		24.0122-0180.1 422180	Ø 267 22 20 V
2.4 4x4	79	01/92→12/96	←			24.0122-0180.1 422180	Ø 267 22 20 V
2.4 4x4	80	01/92→12/97					
2.4 4x4	91	06/92→02/97					
2.5 D 4x4	59	01/86→03/08	←	→ 02/98		24.0122-0180.1 422180	Ø 267 22 20 V
NISSAN - NAVARA (D22_) 01/97→							
 Bremsbelagsatz, Scheibenbremse							
2.4 ↓	93	01/97→09/02	←	02/98→ 10/01		13.0460-5957.2 605957	AKE 21348 17,0 + WK

	kw					! #		
NISSAN - NAVARA (D22_) 01/97→								
 Bremsbelagsatz, Scheibenbremse								
2.4 4x4	93	01/97→09/02	←	02/98→ 10/01		13.0460-5957.2	605957	AKE 21348 17,0 + WK
2.5 D	98	01/08→	←			13.0460-5957.2	605957	AKE 21348 17,0 + WK
2.5 D 4x4	96	01/08→	←			13.0460-5632.2	605632	23970 16,8 + WK
3.3 4x4	125	11/01→04/07						
2.5 D 4x4	98	11/01→	←	→ 04/05		13.0460-5632.2	605632	23970 16,8 + WK
3.2 D 4x4	76	01/98→10/01	←	10/98→		13.0460-5957.2	605957	AKE 21348 17,0 + WK
Zubehörsatz, Scheibenbremsbelag								
2.4	93	01/97→09/02	←	02/98→ 10/01		13.0460-0289.2	610289	
2.4 4x4	93	01/97→09/02	←					
2.5 D	98	01/08→	←			13.0460-0289.2	610289	
3.2 D 4x4	76	01/98→10/01	←	10/98→		13.0460-0289.2	610289	
 Bremsscheibe								
2.4 4x4	93	01/97→09/02	←	02/98→ 03/01		24.0126-0109.1	426109	Ø 277 26 24 V
2.5 D 4x4	96	01/08→	←			24.0128-0166.1	428166	Ø 300 28 26 V
3.3 4x4	125	11/01→04/07						
2.5 D 4x4	98	11/01→	←	→ 04/05		24.0128-0166.1	428166	Ø 300 28 26 V
NISSAN - NAVARA Pritsche/Fahrgestell (D22) 03/97→								
 Bremsbelagsatz, Scheibenbremse								
2.4	110	08/99→12/05	←	01/03→		13.0460-5957.2	605957	AKE 21348 17,0 + WK
2.4 4WD	110	08/99→12/05	←	11/01→ 04/05		13.0460-5632.2	605632	23970 16,8 + WK
2.4 i	93	03/97→08/99	←	02/98→		13.0460-5957.2	605957	AKE 21348 17,0 + WK
2.4 i 4WD	93	03/97→08/99	←					
2.5 Di	98	02/02→	←	→ 04/05		13.0460-5957.2	605957	AKE 21348 17,0 + WK
2.5 Di 4WD	98	02/02→	←	→ 04/05		13.0460-5632.2	605632	23970 16,8 + WK
3.0 TD 4WD	110	12/01→01/08						
2.7 TD	73	03/97→12/01	←	02/98→ 10/01		13.0460-5957.2	605957	AKE 21348 17,0 + WK
3.0	120	06/00→04/04	←	11/01→		13.0460-5632.2	605632	23970 16,8 + WK
			←	→ 10/01		13.0460-5957.2	605957	AKE 21348 17,0 + WK
3.2 D 4WD	76	04/98→12/01	←	11/01→		13.0460-5632.2	605632	23970 16,8 + WK
			←	10/98→ 10/01		13.0460-5957.2	605957	AKE 21348 17,0 + WK
Zubehörsatz, Scheibenbremsbelag								
2.4	110	08/99→12/05	←	01/03→		13.0460-0289.2	610289	
2.4 i	93	03/97→08/99	←	02/98→		13.0460-0289.2	610289	
2.4 i 4WD	93	03/97→08/99	←					
2.5 Di	98	02/02→	←	→ 04/05		13.0460-0289.2	610289	
2.7 TD	73	03/97→12/01	←	02/98→ 10/01		13.0460-0289.2	610289	
3.0	120	06/00→04/04	←	→ 10/01		13.0460-0289.2	610289	
3.2 D 4WD	76	04/98→12/01	←	10/98→ 10/01		13.0460-0289.2	610289	
 Bremsscheibe								
2.4 4WD	110	08/99→12/05	←	11/01→ 04/05		24.0128-0166.1	428166	Ø 300 28 26 V
2.4 i 4WD	93	03/97→08/99	←	02/98→		24.0126-0109.1	426109	Ø 277 26 24 V
2.5 Di 4WD	98	02/02→	←	→ 04/05		24.0128-0166.1	428166	Ø 300 28 26 V
3.0 TD 4WD	110	12/01→01/08						
3.0	120	06/00→04/04	←	11/01→		24.0128-0166.1	428166	Ø 300 28 26 V
3.2 D 4WD	76	04/98→12/01	←					
NISSAN - NOTE (E11, NE11) 01/05→06/12								
 Bremsbelagsatz, Scheibenbremse								
1.4	65	03/06→06/12	←			13.0460-2709.2	602709	TRW 23973 17,1 - WE / - WK + Zub
1.5 dCi	50	03/06→06/12						
1.5 dCi	63	03/06→06/12				13.0470-2709.2	LD2709	TRW 23973 17,1 - WE / - WK + Zub Ceramic
1.5 dCi	66	09/10→06/12						
1.5 dCi	76	07/08→06/12						
1.6	81	03/06→06/12						
 Bremsscheibe								
1.4	65	03/06→06/12	←			24.0122-0216.1	422216	Ø 260 22 19,8 V + S
1.5 dCi	50	03/06→06/12						
1.5 dCi	63	03/06→06/12						
1.5 dCi	66	09/10→06/12						















	kw					! #		
NISSAN - NOTE (E11, NE11) 01/05→06/12								
 Bremsscheibe								
1.5 dCi 1.6	76 81	07/08→06/12 03/06→06/12	←			24.0122-0216.1	422216	Ø 260 22 19,8 V + S
NISSAN - NOTE (E12) 06/13→								
 Bremsbelagsatz, Scheibenbremse								
1.2 1.2 DIG-S 1.2 LPG 1.5 dCi	59 72 56 66	06/13→ 06/13→ 03/15→ 06/13→	←			13.0460-2774.2	602774	TRW 23973 17,4 + WK
 Bremsscheibe								
1.2 1.2 DIG-S 1.2 LPG 1.5 dCi	59 72 56 66	06/13→ 06/13→ 03/15→ 06/13→	←			24.0122-0277.1	422277	Ø 260 22 20 V
NISSAN - NP300 NAVARA (D40) 10/04→								
 Bremsbelagsatz, Scheibenbremse								
2.5 dCi 2.5 dCi 2.5 dCi 2.5 dCi 4WD 2.5 dCi 4WD 2.5 dCi 4WD 2.5 dCi 4WD 3.0 dCi 4WD 4.0 4WD	106 120 128 106 126 128 140 170 198	07/05→ 10/06→ 12/05→ 10/08→ 10/06→ 07/05→ 12/09→ 02/10→ 12/05→	← ← ← ← ← ← ← ← ←	passend für Felgengröße [Zoll]: 17 passend für Felgengröße [Zoll]: 16 02/10→		13.0460-5778.2 13.0460-5783.2 13.0460-5778.2 13.0460-5778.2	605778 605783 605778 605778	SUM 23698 16,8 + WK TOK 24227 16,7 + WK SUM 23698 16,8 + WK SUM 23698 16,8 + WK
Zubehörsatz, Scheibenbremsbelag								
2.5 dCi 2.5 dCi 2.5 dCi 2.5 dCi 4WD 2.5 dCi 4WD 2.5 dCi 4WD 2.5 dCi 4WD	106 120 128 106 126 128 140	07/05→ 10/06→ 12/05→ 10/08→ 10/06→ 07/05→ 12/09→	← ← ← ← ← ← ←	passend für Felgengröße [Zoll]: 16 		13.0460-0017.2	610017	
 Bremsscheibe								
2.5 dCi 2.5 dCi 2.5 dCi 2.5 dCi 4WD 2.5 dCi 4WD 2.5 dCi 4WD 2.5 dCi 4WD 3.0 dCi 4WD 4.0 4WD	106 120 128 106 126 128 140 170 198	07/05→ 10/06→ 12/05→ 10/08→ 10/06→ 07/05→ 12/09→ 02/10→ 12/05→	← ← ← ← ← ← ← ← ←	passend für Felgengröße [Zoll]: 17 passend für Felgengröße [Zoll]: 16 02/10→		24.0128-0240.1 24.0128-0241.1 24.0128-0240.1 24.0128-0240.1	428240 428241 428240 428240	Ø 320 28 26 V Ø 296 28 26 V Ø 320 28 26 V Ø 320 28 26 V
NISSAN - NP300 NAVARA Pritsche/Fahrgestell (D40) 08/08→								
 Bremsbelagsatz, Scheibenbremse								
2.5 dCi 2.5 dCi 4WD 2.5 dCi 4WD 3.0 dCi	140 126 106 170	03/10→ 08/08→ 08/08→ 03/10→	← ← ← ← ←	passend für Felgengröße [Zoll]: 17 passend für Felgengröße [Zoll]: 16 10/08→; passend für Felgengröße [Zoll]: 17 10/08→; passend für Felgengröße [Zoll]: 16		13.0460-5778.2 13.0460-5783.2 13.0460-5778.2 13.0460-5783.2	605778 605783 605778 605783	SUM 23698 16,8 + WK TOK 24227 16,7 + WK SUM 23698 16,8 + WK TOK 24227 16,7 + WK SUM 23698 16,8 + WK
Zubehörsatz, Scheibenbremsbelag								
2.5 dCi 2.5 dCi 4WD 2.5 dCi 4WD	140 126 106	03/10→ 08/08→ 08/08→	← ← ←	passend für Felgengröße [Zoll]: 16 10/08→; passend für Felgengröße [Zoll]: 16		13.0460-0017.2	610017	
 Bremsscheibe								
2.5 dCi 2.5 dCi 4WD 2.5 dCi 4WD 3.0 dCi	140 126 106 170	03/10→ 08/08→ 08/08→ 03/10→	← ← ← ← ←	passend für Felgengröße [Zoll]: 17 passend für Felgengröße [Zoll]: 16 10/08→; passend für Felgengröße [Zoll]: 17 10/08→; passend für Felgengröße [Zoll]: 16		24.0128-0240.1 24.0128-0241.1 24.0128-0240.1 24.0128-0241.1	428240 428241 428240 428241	Ø 320 28 26 V Ø 296 28 26 V Ø 320 28 26 V Ø 296 28 26 V Ø 320 28 26 V











	kw			 	! #		
NISSAN - NP300 PICKUP (D22) 04/08→							
 Bremsbelagsatz, Scheibenbremse							
2.5 dCi 2.5 dCi 4x4	98 98	04/08→ 04/08→	←			13.0460-5783.2 605783	TOK 24227 16,7 + WK
 Bremsscheibe							
2.5 dCi 2.5 dCi 4x4	98 98	04/08→ 04/08→	←			24.0128-0241.1 428241	Ø 296 28 26 V
NISSAN - NT400 CABSTAR (F24F) 08/09→							
 Bremsbelagsatz, Scheibenbremse							
28.12, 32.12, 35.12 (F91AN)	90	01/14→	←	02/14→		13.0460-4866.2 604866	BRE 29229 20,7 + WK
			→	02/14→		13.0460-4859.2 604859	BRE 23921 20,1 + WK + Zub
35.14, 45.14	100	01/14→	←	02/14→		13.0460-4865.2 604865	BRE 29160 20,3 + WK + Zub
			←	02/14→; zul. Gesamtgewicht [kg]: 3.500		13.0460-4866.2 604866	BRE 29229 20,7 + WK
			→	02/14→; zul. Gesamtgewicht [kg]: 3.500		13.0460-4859.2 604859	BRE 23921 20,1 + WK + Zub
			→	02/14→; zul. Gesamtgewicht [kg]: 4.500		13.0460-4861.2 604861	BRE 29121 20,3 + WK + Zub
35.15, 45.15	107	01/14→	←	02/14→; zul. Gesamtgewicht [kg]: 4.500		13.0460-4865.2 604865	BRE 29160 20,3 + WK + Zub
			←	02/14→; zul. Gesamtgewicht [kg]: 3.500		13.0460-4866.2 604866	BRE 29229 20,7 + WK
			→	02/14→; zul. Gesamtgewicht [kg]: 3.500		13.0460-4859.2 604859	BRE 23921 20,1 + WK + Zub
			→	02/14→; zul. Gesamtgewicht [kg]: 4.500		13.0460-4861.2 604861	BRE 29121 20,3 + WK + Zub
 Bremsscheibe							
28.12, 32.12, 35.12 (F91AN)	90	01/14→	←	02/14→		24.0128-0244.1 428244	Ø 276 28 26 V
			→	02/14→; Brems-/Fahr dyn. Artikelbezug: + ABS		24.0116-0131.1 416131	Ø 280 16 13 + ABS Ring
			→	02/14→; Brems-/Fahr dyn. Artikelbezug: - ABS		24.0116-0132.1 416132	Ø 280 16 13
35.14, 45.14	100	01/14→	←	02/14→; zul. Gesamtgewicht [kg]: 4.500		24.0126-0163.1 426163	Ø 290 26 23 V
			←	02/14→; zul. Gesamtgewicht [kg]: 3.500		24.0128-0244.1 428244	Ø 276 28 26 V
			→	02/14→; zul. Gesamtgewicht [kg]: 3.500; Brems-/Fahr dyn. Artikelbezug: + ABS		24.0116-0131.1 416131	Ø 280 16 13 + ABS Ring
			→	02/14→; zul. Gesamtgewicht [kg]: 3.500; Brems-/Fahr dyn. Artikelbezug: - ABS		24.0116-0132.1 416132	Ø 280 16 13
			→	02/14→; zul. Gesamtgewicht [kg]: 4.500		24.0122-0264.1 422264	Ø 290 22 19 V
35.15, 45.15	107	01/14→	←	02/14→; zul. Gesamtgewicht [kg]: 4.500		24.0126-0163.1 426163	Ø 290 26 23 V
			←	02/14→; zul. Gesamtgewicht [kg]: 3.500		24.0128-0244.1 428244	Ø 276 28 26 V
			→	02/14→; Brems-/Fahr dyn. Artikelbezug: + ABS		24.0116-0131.1 416131	Ø 280 16 13 + ABS Ring
			→	02/14→; Brems-/Fahr dyn. Artikelbezug: - ABS		24.0116-0132.1 416132	Ø 280 16 13
			→	02/14→; zul. Gesamtgewicht [kg]: 4.500		24.0122-0264.1 422264	Ø 290 22 19 V
NISSAN - NV200 Kasten/Kombi 02/10→							
 Bremsbelagsatz, Scheibenbremse							
e-NV (ME0)	80	05/14→	←			13.0460-5783.2 605783	TOK 24227 16,7 + WK
 Bremsscheibe							
1.5 dci (M20, M20M)	63	02/10→	←			24.0126-0175.1 426175	Ø 257 26 24 V
1.5 dci (M20, M20M)	66	04/11→					
1.5 dci (M20, M20M)	81	04/11→					
1.6 16V (M20, M20M)	81	02/10→					
e-NV (ME0)	80	05/14→	←			24.0128-0268.1 428268	Ø 283 28 26 V
			→			24.0109-0157.1 409157	Ø 291,5 9 8
NISSAN - NV400 Bus 11/11→							
 Bremsbelagsatz, Scheibenbremse							
dCi 100 dCi 110 dCi 125 dCi 140 dCi 145 dCi 150 dCi 160 ↓	74 81 92 100 107 110 120	11/11→06/14 06/14→09/16 11/11→09/16 06/14→09/16 11/11→02/14 02/14→09/16 06/14→09/16	→			13.0460-4858.2 604858	BRE 25112 18,4 + WK













	kw			 	! #		
NISSAN - NV400 Bus 11/11→							
 Bremsscheibe							
dCi 100	74	11/11→06/14	←			24.0128-0252.1 428252	Ø 302 28 24,5 V + S
dCi 110	81	06/14→09/16	→			24.0112-0191.1 412191	Ø 305 12 10 + S
dCi 125	92	11/11→09/16					
dCi 140	100	06/14→09/16					
dCi 145	107	11/11→02/14					
dCi 150	110	02/14→09/16					
dCi 160	120	06/14→09/16					
NISSAN - NV400 Kasten 11/11→							
 Bremsbelagsatz, Scheibenbremse							
2.3 dCi 150	110	02/14→09/16	→			13.0460-4858.2 604858	BRE 25112 18,4 + WK
2.3 dCi 165	120	06/14→09/16					
dCi 100	74	11/11→05/14					
dCi 110	81	06/14→					
dCi 125	92	11/11→09/16					
dCi 145	107	11/11→02/14					
 Bremsscheibe							
2.3 dCi 145 [RWD]	107	11/11→02/14	←			24.0128-0252.1 428252	Ø 302 28 24,5 V + S
dCi 125 [RWD]	92	11/11→09/16	→	mit Einfachbereifung		24.0112-0190.1 412190	Ø 305 12 10 + S
dCi 140 [RWD]	100	06/14→09/16					
dCi 150 [RWD]	110	02/14→09/16	→	mit Doppelbereifung		24.0118-0153.1 418153	Ø 302 18 15
dCi 165 [RWD]	120	06/14→09/16					
2.3 dCi 150	110	02/14→09/16	←			24.0128-0252.1 428252	Ø 302 28 24,5 V + S
2.3 dCi 165	120	06/14→09/16					
dCi 100	74	11/11→05/14	→			24.0112-0191.1 412191	Ø 305 12 10 + S
dCi 110	81	06/14→					
dCi 125	92	11/11→09/16					
dCi 145	107	11/11→02/14					
NISSAN - NV400 Pritsche/Fahrgestell 11/11→							
 Bremsbelagsatz, Scheibenbremse							
dCi 100	74	11/11→06/14	→			13.0460-4858.2 604858	BRE 25112 18,4 + WK
dCi 110	81	06/14→06/16					
dCi 125	92	11/11→06/16					
dCi 125 [RWD]	92	11/11→06/16					
dCi 140	100	06/14→06/16					
dCi 140 [RWD]	100	06/14→06/16					
dCi 145	107	11/11→06/16					
dCi 145 [RWD]	107	11/11→06/16					
dCi 150	110	08/14→06/16					
dCi 150 [RWD]	110	08/14→06/16					
dCi 165	120	06/14→06/16					
dCi 165 [RWD]	120	06/14→					
 Bremsscheibe							
dCi 100	74	11/11→06/14	←			24.0128-0252.1 428252	Ø 302 28 24,5 V + S
dCi 110	81	06/14→06/16	→			24.0112-0191.1 412191	Ø 305 12 10 + S
dCi 125	92	11/11→06/16					
dCi 140	100	06/14→06/16					
dCi 145	107	11/11→06/16					
dCi 150	110	08/14→06/16					
dCi 165	120	06/14→06/16					
dCi 125 [RWD]	92	11/11→06/16	←			24.0128-0252.1 428252	Ø 302 28 24,5 V + S
dCi 140 [RWD]	100	06/14→06/16	→	mit Einfachbereifung		24.0112-0190.1 412190	Ø 305 12 10 + S
dCi 145 [RWD]	107	11/11→06/16					
dCi 150 [RWD]	110	08/14→06/16	→	mit Doppelbereifung		24.0118-0153.1 418153	Ø 302 18 15
dCi 165 [RWD]	120	06/14→					
NISSAN - PATHFINDER II (R50) 09/95→12/04							
 Bremsscheibe							
2.7 TD 4WD	96	09/97→12/04	←	03/98→10/00		24.0128-0166.1 428166	Ø 300 28 26 V
3.2 TD 4WD	110	09/97→12/04					
3.3 V6 4WD	110	03/98→10/00	←			24.0128-0166.1 428166	Ø 300 28 26 V
3.3 V6 4WD	125	09/97→12/04					
3.5 V6 4WD	162	11/00→12/04					
NISSAN - PATHFINDER III (R51) 01/05→							
 Bremsbelagsatz, Scheibenbremse							
2.5 dCi	128	01/05→	←	passend für Felgengröße [Zoll]: 17		13.0460-5778.2 605778	SUM 23698 16,8 + WK
2.5 dCi 4WD	120	01/05→	←	passend für Felgengröße [Zoll]: 16		13.0460-5783.2 605783	TOK 24227 16,7 + WK
2.5 dCi 4WD	126	10/06→					
2.5 dCi 4WD	128	03/05→	→			13.0460-5784.2 605784	24240 16,6 + WK
2.5 dCi 4WD	140	08/10→					
3.0 dCi	170	08/10→	←	passend für Felgengröße [Zoll]: 17		13.0460-5778.2 605778	SUM 23698 16,8 + WK
4.0	198	01/05→	→			13.0460-5784.2 605784	24240 16,6 + WK
4.0 4WD	198	09/05→					
↓							











	kw			 	! #		
NISSAN - PATHFINDER III (R51) 01/05→							
Zubehörsatz, Scheibenbremsbelag							
2.5 dCi	128	01/05→	←	passend für Felgengröße [Zoll]: 16		13.0460-0017.2	610017
2.5 dCi 4WD	120	01/05→					
2.5 dCi 4WD	126	10/06→					
2.5 dCi 4WD	128	03/05→					
2.5 dCi 4WD	140	08/10→					
 Bremsscheibe							
2.5 dCi	128	01/05→	←	passend für Felgengröße [Zoll]: 17		24.0128-0240.1	428240 Ø 320 28 26 V
2.5 dCi 4WD	120	01/05→	←	passend für Felgengröße [Zoll]: 16		24.0128-0241.1	428241 Ø 296 28 26 V
2.5 dCi 4WD	126	10/06→					
2.5 dCi 4WD	128	03/05→	→			24.0118-0724.1	418724 Ø 308 18 16 V
2.5 dCi 4WD	140	08/10→					
3.0 dCi	170	08/10→	←			24.0128-0240.1	428240 Ø 320 28 26 V
			→			24.0118-0724.1	418724 Ø 308 18 16 V
4.0	198	01/05→	←	passend für Felgengröße [Zoll]: 17		24.0128-0240.1	428240 Ø 320 28 26 V
4.0 4WD	198	09/05→	→			24.0118-0724.1	418724 Ø 308 18 16 V
NISSAN - PATROL GR IV (Y60, GR) 08/87→02/98							
 Bremsbelagsatz, Scheibenbremse							
2.8 TD (Y60A)	85	09/88→06/97	←			13.0460-5960.2	605960 SUM 20863 16,5 - WE / - WK
4.2 Cat	121	11/88→02/98	←	10/91→ 06/97		13.0460-5960.2	605960 SUM 20863 16,5 - WE / - WK
Zubehörsatz, Scheibenbremsbelag							
2.8 TD (Y60A)	85	09/88→06/97	←			13.0460-0448.2	610448 SUM
4.2 Cat	121	11/88→02/98	←	10/91→ 06/97		13.0460-0448.2	610448 SUM
 Bremsscheibe							
2.8 TD (Y60A)	85	09/88→06/97	←			24.0120-0119.1	420119 Ø 295 20 18 V
			→	10/91→		24.0118-0136.1	418136 Ø 316 18 16 V
4.2 Cat	121	11/88→02/98	←	10/91→ 06/97		24.0120-0119.1	420119 Ø 295 20 18 V
			→	10/91→ 06/97		24.0118-0136.1	418136 Ø 316 18 16 V
NISSAN - PATROL GR V Pritsche/Fahrgestell (Y61) 05/98→							
 Bremsbelagsatz, Scheibenbremse							
3.0 D 4x4	118	09/07→	←	→ 03/10		13.0460-5879.2	605879 AKE 23611 18,8 + WK
			→	→ 03/10		13.0460-5751.2	605751 23502 16,0 + WK
 Bremsscheibe							
3.0 D 4x4	118	09/07→	→	→ 03/10		24.0118-0136.1	418136 Ø 316 18 16 V
NISSAN - PATROL GR V Wagon (Y61) 06/97→							
 Bremsbelagsatz, Scheibenbremse							
2.7 TD	73	05/98→06/01	←			13.0460-5960.2	605960 SUM 20863 16,5 - WE / - WK
2.8 TD	95	06/97→05/00	←	→ 04/00		13.0460-5879.2	605879 AKE 23611 18,8 + WK
			→	→ 04/00		13.0460-5751.2	605751 23502 16,0 + WK
2.8 TDiC	96	10/97→02/00	←			13.0460-5879.2	605879 AKE 23611 18,8 + WK
			→			13.0460-5751.2	605751 23502 16,0 + WK
3.0 DTi	116	05/00→	←	→ 08/04		13.0460-5879.2	605879 AKE 23611 18,8 + WK
			→	→ 08/04		13.0460-5751.2	605751 23502 16,0 + WK
3.0 DTi	118	05/00→	←	→ 03/10		13.0460-5879.2	605879 AKE 23611 18,8 + WK
			→	→ 03/10		13.0460-5751.2	605751 23502 16,0 + WK
3.2 D	70	05/98→06/01	←	→ 04/01		13.0460-5960.2	605960 SUM 20863 16,5 - WE / - WK
4.8	180	03/00→	←	05/00→ 03/10		13.0460-5879.2	605879 AKE 23611 18,8 + WK
4.8	185	10/01→12/07	←			13.0460-5879.2	605879 AKE 23611 18,8 + WK
Zubehörsatz, Scheibenbremsbelag							
4.8	180	03/00→	←	05/00→ 03/10		13.0460-0117.2	610117
			→	05/00→ 03/10		13.0460-0203.2	610203
4.8	185	10/01→12/07	←			13.0460-0117.2	610117
			→			13.0460-0203.2	610203
↓							























	kW					! #		
NISSAN - PATROL GR V Wagon (Y61) 06/97→								
 Bremsscheibe								
2.7 TD	73	05/98→06/01	←				24.0120-0119.1 420119	Ø 295 20 18 V
2.8 TD	95	06/97→05/00	→	→ 04/00			24.0118-0136.1 418136	Ø 316 18 16 V
2.8 TDiC	96	10/97→02/00	→				24.0118-0136.1 418136	Ø 316 18 16 V
3.0 DTi	116	05/00→	→	→ 08/04			24.0118-0136.1 418136	Ø 316 18 16 V
3.0 DTi	118	05/00→	→	→ 03/10			24.0118-0136.1 418136	Ø 316 18 16 V
3.2 D	70	05/98→06/01	←	→ 04/01			24.0120-0119.1 420119	Ø 295 20 18 V
NISSAN - PATROL III/2 Hardtop (K260) 10/84→04/98								
 Bremsbelagsatz, Scheibenbremse								
2.8 D	66	03/89→03/96	←	04/89→ 11/95			13.0460-5960.2 605960	SUM 20863 16,5 - WE / - WK
2.8 D	76	03/89→04/98						
Zubehörsatz, Scheibenbremsbelag								
2.8 D	66	03/89→03/96	←	04/89→ 11/95			13.0460-0448.2 610448	SUM
2.8 D	76	03/89→04/98						
 Bremsscheibe								
2.8 D	66	03/89→03/96	←	04/89→ 11/95			24.0120-0119.1 420119	Ø 295 20 18 V
2.8 D	76	03/89→04/98						
NISSAN - PATROL III/2 Station Wagon (W260) 08/88→04/98								
 Bremsbelagsatz, Scheibenbremse								
2.8 D 4x4	66	03/89→03/96	←	04/89→ 11/95			13.0460-5960.2 605960	SUM 20863 16,5 - WE / - WK
2.8 D 4x4	76	03/89→04/98						
2.8 TD	85	06/89→11/95	←				13.0460-5960.2 605960	SUM 20863 16,5 - WE / - WK
Zubehörsatz, Scheibenbremsbelag								
2.8 D 4x4	66	03/89→03/96	←	04/89→ 11/95			13.0460-0448.2 610448	SUM
2.8 D 4x4	76	03/89→04/98						
2.8 TD	85	06/89→11/95	←				13.0460-0448.2 610448	SUM
 Bremsscheibe								
2.8 D 4x4	66	03/89→03/96	←	04/89→ 11/95			24.0120-0119.1 420119	Ø 295 20 18 V
2.8 D 4x4	76	03/89→04/98						
2.8 TD	85	06/89→11/95	←				24.0120-0119.1 420119	Ø 295 20 18 V
NISSAN - PICK UP (D21) 09/85→02/98								
 Bremsbelagsatz, Scheibenbremse								
2.4 4WD	80	01/92→12/97	←				13.0460-5937.2 605937	AKE 21119 17,0 + WK
2.4 i 12V 4WD	93	04/92→02/98						
2.5 D	55	09/87→02/98						
2.5 D	59	09/94→08/96						
2.5 D	61	08/92→02/98						
2.5 D 4WD	59	08/87→02/98						
2.5 D 4WD	61	03/96→02/98						
2.5 D	53	01/86→02/98	←	09/87→			13.0460-5937.2 605937	AKE 21119 17,0 + WK
Zubehörsatz, Scheibenbremsbelag								
2.4 4WD	80	01/92→12/97	←				13.0460-0322.2 610322	AKE
2.4 i 12V 4WD	93	04/92→02/98						
2.5 D	55	09/87→02/98						
2.5 D	59	09/94→08/96						
2.5 D	61	08/92→02/98						
2.5 D 4WD	59	08/87→02/98						
2.5 D 4WD	61	03/96→02/98						
2.5 D	53	01/86→02/98	←	09/87→			13.0460-0322.2 610322	AKE
 Bremsscheibe								
2.4 4WD	80	01/92→12/97	←				24.0122-0180.1 422180	Ø 267 22 20 V
2.4 i 12V 4WD	93	04/92→02/98						
2.5 D 4WD	59	08/87→02/98						
2.5 D 4WD	61	03/96→02/98						
NISSAN - PICK UP (D22) 01/97→								
 Bremsbelagsatz, Scheibenbremse								
2.4	87	02/98→10/01	←				13.0460-5957.2 605957	AKE 21348 17,0 + WK
2.4	98	11/01→04/05						
2.4	110	01/03→04/05						
2.5 Di	98	03/02→04/05						
↓								











	kW			 	! #		
NISSAN - PICK UP (D22) 01/97→							
 Bremsbelagsatz, Scheibenbremse							
2.4 2.4 i 4WD	93 93	03/97→08/99 03/97→08/99	←	02/98→		13.0460-5957.2 605957	AKE 21348 17,0 + WK
2.4	116	02/98→	←	01/03→		13.0460-5957.2 605957	AKE 21348 17,0 + WK
2.4 4WD 2.4 i 4WD 2.5 Di 4WD	110 98 98	11/01→04/05 03/02→04/05 03/02→04/05	←			13.0460-5632.2 605632	23970 16,8 + WK
2.4 i 2.4 i 4WD 2.5 D 2.5 TD 4WD	88 88 61 76	02/98→04/05 02/98→04/05 02/98→04/05 05/98→04/05	←	→ 10/01		13.0460-5957.2 605957	AKE 21348 17,0 + WK
2.5 D 4WD	61	02/98→04/05	←	05/98→ 10/01		13.0460-5957.2 605957	AKE 21348 17,0 + WK
2.5 D 4WD	96	01/97→04/05	←	11/01→		13.0460-5632.2 605632	23970 16,8 + WK
3.2 D 4WD	76	12/98→04/05	←	11/01→		13.0460-5632.2 605632	23970 16,8 + WK
			←	→ 10/01		13.0460-5957.2 605957	AKE 21348 17,0 + WK
Zubehörsatz, Scheibenbremsbelag							
2.4 2.4 2.4 2.5 Di	87 98 110 98	02/98→10/01 11/01→04/05 01/03→04/05 03/02→04/05	←			13.0460-0289.2 610289	
2.4 2.4 i 4WD	93 93	03/97→08/99 03/97→08/99	←	02/98→		13.0460-0289.2 610289	
2.4	116	02/98→	←	01/03→		13.0460-0289.2 610289	
2.4 i 2.4 i 4WD 2.5 D 2.5 TD 4WD 3.2 D 4WD 2.5 D 4WD	88 88 61 76 76 61	02/98→04/05 02/98→04/05 02/98→04/05 05/98→04/05 12/98→04/05 02/98→04/05	←	→ 10/01 05/98→ 10/01		13.0460-0289.2 610289	
Bremsscheibe							
2.4 4WD 2.4 i 4WD 2.5 Di 4WD	110 98 98	11/01→04/05 03/02→04/05 03/02→04/05	←			24.0128-0166.1 428166	Ø 300 28 26 V
2.4 i 4WD 2.5 TD 4WD	88 76	02/98→04/05 05/98→04/05	←	→ 03/01		24.0126-0109.1 426109	Ø 277 26 24 V
2.4 i 4WD	93	03/97→08/99	←	02/98→		24.0126-0109.1 426109	Ø 277 26 24 V
2.5 D 4WD	61	02/98→04/05	←	05/98→ 03/01		24.0126-0109.1 426109	Ø 277 26 24 V
2.5 D 4WD 3.2 D 4WD	96 76	01/97→04/05 12/98→04/05	←	11/01→		24.0128-0166.1 428166	Ø 300 28 26 V
NISSAN - PIXO (UA0) 03/09→							
 Bremsbelagsatz, Scheibenbremse							
1.0	50	06/09→	←	→ 04/13		13.0460-5887.2 605887	SUM 23507 15,2 + WK
Bremsscheibe							
1.0	50	06/09→	←	→ 04/13		24.0120-0225.1 420225	Ø 231 20 18 V
NISSAN - PRIMASTAR Bus (X83) 03/01→							
 Bremsbelagsatz, Scheibenbremse							
2.0 2.0 dCi 115 dCi 120 dCi 150 dCi 90	86 88 84 84 107 66	04/06→ 03/01→ 09/08→ 09/06→ 09/06→ 09/06→	← → → → → →			13.0460-2870.2 602870 13.0460-2840.2 602840	TRW 23099 18,4 - WK TRW 23980 16,5 + WE / - WK
dCi 100 dCi 140 dCi 80	74 99 60	03/01→ 07/03→ 03/01→	← → →	→ 08/06 → 08/06		13.0460-2870.2 602870 13.0460-2840.2 602840	TRW 23099 18,4 - WK TRW 23980 16,5 + WE / - WK
Bremsscheibe							
2.0 2.0 dCi 115 dCi 120 dCi 150 dCi 90	86 88 84 84 107 66	04/06→ 03/01→ 09/08→ 09/06→ 09/06→ 09/06→	← → → → → →			24.0128-0132.1 428132 24.0112-0177.2 412177	Ø 305 28 24 V + S Ø 280 12 10 + LG / + ABS Ring
dCi 100 dCi 140 dCi 80	74 99 60	03/01→ 07/03→ 03/01→	← → →	→ 08/06 → 08/06		24.0128-0132.1 428132 24.0112-0177.2 412177	Ø 305 28 24 V + S Ø 280 12 10 + LG / + ABS Ring











	kW					! #		
NISSAN - PRIMASTAR Kasten (X83) 09/02→								
 Bremsbelagsatz, Scheibenbremse								
1.9 dCi 100	74	09/02→	←	→ 08/06		13.0460-2870.2	602870	TRW 23099 18,4 - WK
1.9 dCi 80	60	09/02→	←	→ 08/06		13.0460-2840.2	602840	TRW 23980 16,5 + WE / - WK
2.5 dCi 140	99	07/03→	→					
2.0	88	02/03→	←			13.0460-2870.2	602870	TRW 23099 18,4 - WK
2.0 dCi 115	84	09/06→	←			13.0460-2840.2	602840	TRW 23980 16,5 + WE / - WK
2.0 dCi 90	66	09/06→	→					
2.5 dCi 115	84	09/08→	←					
2.5 dCi 150	107	09/06→	→					
 Bremsscheibe								
1.9 dCi 100	74	09/02→	←	→ 08/06		24.0128-0132.1	428132	Ø 305 28 24 V + S
1.9 dCi 80	60	09/02→	←	→ 08/06		24.0112-0177.2	412177	Ø 280 12 10 + LG / + ABS Ring
2.5 dCi 140	99	07/03→	→					
2.0	88	02/03→	←			24.0128-0132.1	428132	Ø 305 28 24 V + S
2.0 dCi 115	84	09/06→	←			24.0112-0177.2	412177	Ø 280 12 10 + LG / + ABS Ring
2.0 dCi 90	66	09/06→	→					
2.5 dCi 115	84	09/08→	←					
2.5 dCi 150	107	09/06→	→					
NISSAN - PRIMASTAR Pritsche/Fahrgestell (X83) 07/02→08/06								
 Bremsbelagsatz, Scheibenbremse								
1.9 dCi 100	74	07/02→08/06	←			13.0460-2870.2	602870	TRW 23099 18,4 - WK
1.9 dCi 80	60	07/02→08/06	←			13.0460-2840.2	602840	TRW 23980 16,5 + WE / - WK
2.5 dCi 140	99	07/02→08/06	→					
2.5 dCi 150	107	04/06→	←	09/06→		13.0460-2870.2	602870	TRW 23099 18,4 - WK
			→	09/06→		13.0460-2840.2	602840	TRW 23980 16,5 + WE / - WK
 Bremsscheibe								
1.9 dCi 100	74	07/02→08/06	←			24.0128-0132.1	428132	Ø 305 28 24 V + S
1.9 dCi 80	60	07/02→08/06	←			24.0112-0177.2	412177	Ø 280 12 10 + LG / + ABS Ring
2.5 dCi 140	99	07/02→08/06	→					
2.5 dCi 150	107	04/06→	←	09/06→		24.0128-0132.1	428132	Ø 305 28 24 V + S
			→	09/06→		24.0112-0177.2	412177	Ø 280 12 10 + LG / + ABS Ring
NISSAN - PRIMERA (P10) 06/90→06/96								
 Bremsbelagsatz, Scheibenbremse								
1.6	66	06/90→01/96	←	- ABS		13.0460-5949.2	605949	AKE 21280 16,0 - WE / - WK
1.6	71	06/90→01/96	←	05/93→; + ABS		13.0460-5950.2	605950	TRW 21546 16,7 - WK
			→	05/93→; + ABS		13.0460-5986.2	605986	TRW 21545 14,9 - WK
1.6	75	06/93→01/96	←	- ABS		13.0460-5949.2	605949	AKE 21280 16,0 - WE / - WK
			←	+ ABS		13.0460-5950.2	605950	TRW 21546 16,7 - WK
			→	+ ABS		13.0460-5986.2	605986	TRW 21545 14,9 - WK
2.0	96	06/90→05/96	←	→ 01/96		13.0460-5950.2	605950	TRW 21546 16,7 - WK
2.0 i	92	01/95→06/96	→	→ 01/96		13.0460-5986.2	605986	TRW 21545 14,9 - WK
2.0 16V	85	06/90→01/96	←			13.0460-5950.2	605950	TRW 21546 16,7 - WK
2.0 16V 4x4	85	04/91→06/96	←			13.0460-5986.2	605986	TRW 21545 14,9 - WK
2.0 GT	110	06/90→01/96	→					
2.0 D	55	01/91→01/96	←	→ 04/93		13.0460-5949.2	605949	AKE 21280 16,0 - WE / - WK
			←	05/93→		13.0460-5950.2	605950	TRW 21546 16,7 - WK
			→	05/93→		13.0460-5986.2	605986	TRW 21545 14,9 - WK
Zubehörsatz, Scheibenbremsbelag								
1.6	66	06/90→01/96	←	- ABS		13.0460-0440.2	610440	AKE
1.6	71	06/90→01/96	←					
1.6	75	06/93→01/96	←					
2.0 D	55	01/91→01/96	←	→ 04/93		13.0460-0440.2	610440	AKE
 Bremsscheibe								
1.6	66	06/90→01/96	←	- ABS		24.0120-0152.1	420152	Ø 242 20 18 V
1.6	71	06/90→01/96	←	05/93→; + ABS		24.0122-0146.1	422146	Ø 257 22 20 V
			→	05/93→; + ABS		24.0110-0215.1	410215	Ø 258 10 9
1.6	75	06/93→01/96	←	- ABS		24.0120-0152.1	420152	Ø 242 20 18 V
			←	+ ABS		24.0122-0146.1	422146	Ø 257 22 20 V
			→	+ ABS		24.0110-0215.1	410215	Ø 258 10 9
2.0	96	06/90→05/96	←	→ 01/96		24.0122-0146.1	422146	Ø 257 22 20 V
↓								













	kw			 	! #		
NISSAN - PRIMERA (P10) 06/90→06/96							
 Bremsscheibe							
2.0 i	92	01/95→06/96	➔	→ 01/96		24.0110-0215.1 410215	Ø 258 10 9
2.0 16V	85	06/90→01/96	➔			24.0122-0146.1 422146	Ø 257 22 20 V
2.0 16V 4x4	85	04/91→06/96	➔			24.0110-0215.1 410215	Ø 258 10 9
2.0 GT	110	06/90→01/96	➔			24.0110-0215.1 410215	Ø 258 10 9
2.0 D	55	01/91→01/96	➔	→ 04/93		24.0120-0152.1 420152	Ø 242 20 18 V
			➔	05/93→		24.0122-0146.1 422146	Ø 257 22 20 V
			➔	05/93→		24.0110-0215.1 410215	Ø 258 10 9
NISSAN - PRIMERA (P11) 06/96→12/01							
 Bremsbelagsatz, Scheibenbremse							
1.6 16V	66	09/96→12/01	➔	04/98→		13.0460-5807.2 605807	TRW 23093 16,6 - WK
1.6 16V	73	09/96→10/00	➔			13.0460-5950.2 605950	TRW 21546 16,7 - WK
1.6 16V	78	06/96→12/01	➔	→ 03/98		13.0460-5950.2 605950	TRW 21546 16,7 - WK
2.0 TD	66	09/96→12/01	➔			13.0460-5986.2 605986	TRW 21545 14,9 - WK
1.8 16V	84	08/99→12/01	➔			13.0460-5807.2 605807	TRW 23093 16,6 - WK
			➔	+ ABS		13.0460-5986.2 605986	TRW 21545 14,9 - WK
2.0 16V	85	09/96→12/01	➔	04/98→		13.0460-5807.2 605807	TRW 23093 16,6 - WK
2.0 16V	96	09/96→12/01	➔	→ 03/98		13.0460-5950.2 605950	TRW 21546 16,7 - WK
			➔			13.0460-5986.2 605986	TRW 21545 14,9 - WK
2.0 16V	103	08/99→12/01	➔			13.0460-5727.2 605727	ATE 23160 17,3 - WE / - WK
2.0 16V	110	09/96→12/01	➔			13.0460-5807.2 605807	TRW 23093 16,6 - WK
			➔			13.0460-5986.2 605986	TRW 21545 14,9 - WK
Zubehörsatz, Scheibenbremsbelag							
1.6 16V	66	09/96→12/01	➔	04/98→		13.0460-0148.2 610148	TRW
1.6 16V	73	09/96→10/00	➔			13.0460-0148.2 610148	TRW
1.6 16V	78	06/96→12/01	➔			13.0460-0148.2 610148	TRW
2.0 16V	85	09/96→12/01	➔			13.0460-0148.2 610148	TRW
2.0 16V	96	09/96→12/01	➔			13.0460-0148.2 610148	TRW
2.0 TD	66	09/96→12/01	➔			13.0460-0148.2 610148	TRW
1.8 16V	84	08/99→12/01	➔			13.0460-0148.2 610148	TRW
2.0 16V	103	08/99→12/01	➔			13.0460-0148.2 610148	TRW
2.0 16V	110	09/96→12/01	➔			13.0460-0148.2 610148	TRW
 Bremsscheibe							
1.6 16V	66	09/96→12/01	➔	→ 05/99		24.0122-0146.1 422146	Ø 257 22 20 V
1.6 16V	73	09/96→10/00	➔			24.0122-0179.1 422179	Ø 280 22 20 V
1.6 16V	78	06/96→12/01	➔	06/99→		24.0122-0179.1 422179	Ø 280 22 20 V
2.0 TD	66	09/96→12/01	➔			24.0122-0179.1 422179	Ø 280 22 20 V
1.8 16V	84	08/99→12/01	➔			24.0122-0179.1 422179	Ø 280 22 20 V
			➔	+ ABS		24.0110-0310.1 410310	Ø 278 10 9
2.0 16V	85	09/96→12/01	➔	→ 05/99		24.0122-0146.1 422146	Ø 257 22 20 V
2.0 16V	96	09/96→12/01	➔	06/99→		24.0122-0179.1 422179	Ø 280 22 20 V
			➔	→ 05/99		24.0110-0215.1 410215	Ø 258 10 9
			➔	06/99→		24.0110-0310.1 410310	Ø 278 10 9
2.0 16V	103	08/99→12/01	➔			24.0122-0179.1 422179	Ø 280 22 20 V
			➔			24.0110-0215.1 410215	Ø 258 10 9
2.0 16V	110	09/96→12/01	➔			24.0110-0310.1 410310	Ø 278 10 9
			➔	→ 05/99		24.0122-0179.1 422179	Ø 280 22 20 V
2.0 16V	110	09/96→12/01	➔	06/99→		24.0110-0215.1 410215	Ø 258 10 9
			➔			24.0110-0310.1 410310	Ø 278 10 9
NISSAN - PRIMERA (P12) 01/02→							
 Bremsbelagsatz, Scheibenbremse							
1.6	78	03/02→	➔	→ 10/08		13.0460-5825.2 605825	TRW 23094 16,5 + WK + Zub
1.8	85	03/02→	➔			13.0460-7137.2 607137	ATE 23482 15,8 - WE / - WK
2.0	103	03/02→	➔	→ 10/08		13.0470-7137.2 LD7137	ATE 23482 15,8 - WE / - WK Ceramic
1.6	80	01/02→	➔	03/02→ 04/06		13.0460-5825.2 605825	TRW 23094 16,5 + WK + Zub
			➔	03/02→ 04/06		13.0460-7137.2 607137	ATE 23482 15,8 - WE / - WK
2.5	125	01/02→	➔	03/02→ 04/06		13.0470-7137.2 LD7137	ATE 23482 15,8 - WE / - WK Ceramic
			➔			13.0470-7137.2 LD7137	ATE 23482 15,8 - WE / - WK Ceramic
1.9 dCi	85	08/02→	➔	04/03→ 10/07		13.0460-5825.2 605825	TRW 23094 16,5 + WK + Zub
↓							









	kw					! #		
NISSAN - PRIMERA (P12) 01/02→								
 Bremsbelagsatz, Scheibenbremse								
1.9 dCi	85	08/02→	➡	04/03→ 10/07			13.0460-7137.2 607137 13.0470-7137.2 LD7137	ATE 23482 15,8 - WE / - WK ATE 23482 15,8 - WE / - WK Ceramic
1.9 dCi	88	04/03→	←	→ 10/07			13.0460-5825.2 605825	TRW 23094 16,5 + WK + Zub
2.2 dCi	102	04/03→	➡	→ 10/07			13.0460-7137.2 607137 13.0470-7137.2 LD7137	ATE 23482 15,8 - WE / - WK ATE 23482 15,8 - WE / - WK Ceramic
2.2 Di	93	03/02→	←	→ 04/03			13.0460-5825.2 605825	TRW 23094 16,5 + WK + Zub
			➡	→ 04/03			13.0460-7137.2 607137 13.0470-7137.2 LD7137	ATE 23482 15,8 - WE / - WK ATE 23482 15,8 - WE / - WK Ceramic
Zubehörsatz, Scheibenbremsbelag								
1.6	78	03/02→	←	→ 10/08			13.0460-0282.2 610282	
1.8	85	03/02→						
2.0	103	03/02→						
1.6	80	01/02→	←	03/02→ 04/06			13.0460-0282.2 610282	
2.5	125	01/02→						
1.9 dCi	85	08/02→	←	04/03→ 10/07			13.0460-0282.2 610282	
1.9 dCi	88	04/03→	←	→ 10/07			13.0460-0282.2 610282	
2.2 dCi	102	04/03→						
2.2 Di	93	03/02→	←	→ 04/03			13.0460-0282.2 610282	
 Bremsscheibe								
1.6	78	03/02→	←	→ 10/08			24.0128-0140.1 428140	Ø 280 28 26 V
1.8	85	03/02→						
2.0	103	03/02→	➡	→ 10/08			24.0110-0285.1 410285	Ø 278 10 9
1.6	80	01/02→	←	03/02→ 04/06			24.0128-0140.1 428140	Ø 280 28 26 V
2.5	125	01/02→	➡	03/02→ 04/06			24.0110-0285.1 410285	Ø 278 10 9
1.9 dCi	85	08/02→	←	04/03→ 10/07			24.0128-0140.1 428140	Ø 280 28 26 V
			➡	04/03→ 10/07			24.0110-0285.1 410285	Ø 278 10 9
1.9 dCi	88	04/03→	←	→ 10/07			24.0128-0140.1 428140	Ø 280 28 26 V
2.2 dCi	102	04/03→	➡	→ 10/07			24.0110-0285.1 410285	Ø 278 10 9
2.2 Di	93	03/02→	←	→ 04/03			24.0128-0140.1 428140	Ø 280 28 26 V
			➡	→ 04/03			24.0110-0285.1 410285	Ø 278 10 9
NISSAN - PRIMERA Hatchback (P10) 06/90→06/96								
 Bremsbelagsatz, Scheibenbremse								
1.6	66	06/90→01/96	←	- ABS			13.0460-5949.2 605949	AKE 21280 16,0 - WE / - WK
			←	05/93→; + ABS			13.0460-5950.2 605950	TRW 21546 16,7 - WK
			➡	05/93→; + ABS			13.0460-5986.2 605986	TRW 21545 14,9 - WK
1.6	75	06/93→01/96	←	- ABS			13.0460-5949.2 605949	AKE 21280 16,0 - WE / - WK
			←	+ ABS			13.0460-5950.2 605950	TRW 21546 16,7 - WK
			➡	+ ABS			13.0460-5986.2 605986	TRW 21545 14,9 - WK
2.0	110	06/90→01/96	←				13.0460-5950.2 605950	TRW 21546 16,7 - WK
2.0	112	09/90→01/96						
2.0 16V	85	06/90→01/96	➡				13.0460-5986.2 605986	TRW 21545 14,9 - WK
2.0 16V 4x4	85	04/91→06/96						
2.0 D	55	01/91→01/96	←	→ 04/93			13.0460-5949.2 605949	AKE 21280 16,0 - WE / - WK
			←	05/93→			13.0460-5950.2 605950	TRW 21546 16,7 - WK
			➡	05/93→			13.0460-5986.2 605986	TRW 21545 14,9 - WK
2.0 i	92	01/95→06/96	←	→ 01/96			13.0460-5950.2 605950	TRW 21546 16,7 - WK
			➡	→ 01/96			13.0460-5986.2 605986	TRW 21545 14,9 - WK
Zubehörsatz, Scheibenbremsbelag								
1.6	66	06/90→01/96	←	- ABS			13.0460-0440.2 610440	AKE
1.6	75	06/93→01/96						
2.0 D	55	01/91→01/96	←	→ 04/93			13.0460-0440.2 610440	AKE
 Bremsscheibe								
1.6	66	06/90→01/96	←	- ABS			24.0120-0152.1 420152	Ø 242 20 18 V
			←	05/93→; + ABS			24.0122-0146.1 422146	Ø 257 22 20 V
↓								

	kW				! #		
NISSAN - PRIMERA Hatchback (P10) 06/90→06/96							
 Bremsscheibe							
1.6	66	06/90→01/96	➡	05/93→; + ABS		24.0110-0215.1 410215	Ø 258 10 9
1.6	75	06/93→01/96	←	- ABS		24.0120-0152.1 420152	Ø 242 20 18 V
			←	+ ABS		24.0122-0146.1 422146	Ø 257 22 20 V
			➡	+ ABS		24.0110-0215.1 410215	Ø 258 10 9
2.0	110	06/90→01/96	←			24.0122-0146.1 422146	Ø 257 22 20 V
			➡			24.0110-0215.1 410215	Ø 258 10 9
2.0 16V	85	06/90→01/96	➡			24.0110-0215.1 410215	Ø 258 10 9
2.0 16V 4x4	85	04/91→06/96	➡			24.0110-0215.1 410215	Ø 258 10 9
2.0 D	55	01/91→01/96	←	→ 04/93		24.0120-0152.1 420152	Ø 242 20 18 V
			←	05/93→		24.0122-0146.1 422146	Ø 257 22 20 V
			➡	05/93→		24.0110-0215.1 410215	Ø 258 10 9
2.0 i	92	01/95→06/96	←	→ 01/96		24.0122-0146.1 422146	Ø 257 22 20 V
			➡	→ 01/96		24.0110-0215.1 410215	Ø 258 10 9
NISSAN - PRIMERA Hatchback (P11) 06/96→07/02							
 Bremsbelagsatz, Scheibenbremse							
1.6 16V	66	09/96→07/02	←	04/98→ 02/02		13.0460-5807.2 605807	TRW 23093 16,6 - WK
1.6 16V	73	09/96→07/02	←	→ 03/98		13.0460-5950.2 605950	TRW 21546 16,7 - WK
2.0 TD	66	09/96→07/02	←	→ 03/98		13.0460-5950.2 605950	TRW 21546 16,7 - WK
1.6 16V	78	09/00→07/02	←	→ 02/02		13.0460-5807.2 605807	TRW 23093 16,6 - WK
1.8 16V	84	08/99→07/02	←	→ 02/02		13.0460-5807.2 605807	TRW 23093 16,6 - WK
			➡	→ 02/02; + ABS		13.0460-5986.2 605986	TRW 21545 14,9 - WK
2.0 16V	85	09/96→07/02	←	04/98→ 02/02		13.0460-5807.2 605807	TRW 23093 16,6 - WK
2.0 16V	96	09/96→07/02	←	→ 03/98		13.0460-5950.2 605950	TRW 21546 16,7 - WK
			➡	→ 02/02		13.0460-5986.2 605986	TRW 21545 14,9 - WK
2.0 16V	103	08/99→07/02	←	→ 02/02		13.0460-5727.2 605727	ATE 23160 17,3 - WE / - WK
2.0 16V	110	09/96→07/02	←	→ 02/02		13.0460-5807.2 605807	TRW 23093 16,6 - WK
			➡	→ 02/02		13.0460-5986.2 605986	TRW 21545 14,9 - WK
Zubehörsatz, Scheibenbremsbelag							
1.6 16V	66	09/96→07/02	←	04/98→ 02/02		13.0460-0148.2 610148	TRW
1.6 16V	73	09/96→07/02	←	04/98→ 02/02		13.0460-0148.2 610148	TRW
2.0 16V	85	09/96→07/02	←	04/98→ 02/02		13.0460-0148.2 610148	TRW
2.0 16V	96	09/96→07/02	←	04/98→ 02/02		13.0460-0148.2 610148	TRW
2.0 TD	66	09/96→07/02	←	04/98→ 02/02		13.0460-0148.2 610148	TRW
1.6 16V	78	09/00→07/02	←	→ 02/02		13.0460-0148.2 610148	TRW
1.8 16V	84	08/99→07/02	←	→ 02/02		13.0460-0148.2 610148	TRW
2.0 16V	103	08/99→07/02	←	→ 02/02		13.0460-0148.2 610148	TRW
2.0 16V	110	09/96→07/02	←	→ 02/02		13.0460-0148.2 610148	TRW
 Bremsscheibe							
1.6 16V	66	09/96→07/02	←	→ 05/99		24.0122-0146.1 422146	Ø 257 22 20 V
1.6 16V	73	09/96→07/02	←	→ 05/99		24.0122-0146.1 422146	Ø 257 22 20 V
2.0 TD	66	09/96→07/02	←	06/99→ 02/02		24.0122-0179.1 422179	Ø 280 22 20 V
1.6 16V	78	09/00→07/02	←	→ 02/02		24.0122-0179.1 422179	Ø 280 22 20 V
1.8 16V	84	08/99→07/02	←	→ 02/02		24.0122-0179.1 422179	Ø 280 22 20 V
			➡	→ 02/02; + ABS		24.0110-0310.1 410310	Ø 278 10 9
2.0 16V	85	09/96→07/02	←	→ 05/99		24.0122-0146.1 422146	Ø 257 22 20 V
2.0 16V	96	09/96→07/02	←	06/99→ 02/02		24.0122-0179.1 422179	Ø 280 22 20 V
			➡	→ 05/99		24.0110-0215.1 410215	Ø 258 10 9
			➡	06/99→ 02/02		24.0110-0310.1 410310	Ø 278 10 9
2.0 16V	103	08/99→07/02	←	→ 02/02		24.0122-0179.1 422179	Ø 280 22 20 V
			➡	→ 02/02		24.0110-0215.1 410215	Ø 258 10 9
2.0 16V	110	09/96→07/02	←	→ 02/02		24.0122-0179.1 422179	Ø 280 22 20 V
			➡	→ 05/99		24.0110-0215.1 410215	Ø 258 10 9
2.0 16V	110	09/96→07/02	←	→ 02/02		24.0122-0179.1 422179	Ø 280 22 20 V
			➡	06/99→ 02/02		24.0110-0310.1 410310	Ø 278 10 9
NISSAN - PRIMERA Hatchback (P12) 01/02→							
 Bremsbelagsatz, Scheibenbremse							
1.6	78	07/02→	←	→ 10/08		13.0460-5825.2 605825	TRW 23094 16,5 + WK + Zub
1.8	85	07/02→	←	→ 10/08		13.0460-5825.2 605825	TRW 23094 16,5 + WK + Zub
2.0	103	07/02→	➡	→ 10/08		13.0460-7137.2 607137	ATE 23482 15,8 - WE / - WK













	kw			 	! #		
NISSAN - PRIMERA Hatchback (P12) 01/02→							
 Bremsbelagsatz, Scheibenbremse							
1.6 1.8 2.0	78 85 103	07/02→ 07/02→ 07/02→	→	→ 10/08		13.0470-7137.2 LD7137	ATE 23482 15,8 - WE / - WK Ceramic
1.6	80	07/02→	←	→ 04/06		13.0460-5825.2 605825	TRW 23094 16,5 + WK + Zub
			→	→ 04/06		13.0460-7137.2 607137 13.0470-7137.2 LD7137	ATE 23482 15,8 - WE / - WK ATE 23482 15,8 - WE / - WK Ceramic
1.9 dCi	85	08/02→	←	04/03→ 10/07		13.0460-5825.2 605825	TRW 23094 16,5 + WK + Zub
			→	04/03→ 10/07		13.0460-7137.2 607137 13.0470-7137.2 LD7137	ATE 23482 15,8 - WE / - WK ATE 23482 15,8 - WE / - WK Ceramic
1.9 dCi 2.2 dCi	88 102	04/03→ 04/03→	←	→ 10/07		13.0460-5825.2 605825	TRW 23094 16,5 + WK + Zub
			→	→ 10/07		13.0460-7137.2 607137 13.0470-7137.2 LD7137	ATE 23482 15,8 - WE / - WK ATE 23482 15,8 - WE / - WK Ceramic
2.2 Di	93	07/02→	←	→ 04/03		13.0460-5825.2 605825	TRW 23094 16,5 + WK + Zub
			→	→ 04/03		13.0460-7137.2 607137 13.0470-7137.2 LD7137	ATE 23482 15,8 - WE / - WK ATE 23482 15,8 - WE / - WK Ceramic
2.5	125	01/02→	←	03/02→ 04/06		13.0460-5825.2 605825	TRW 23094 16,5 + WK + Zub
			→	03/02→ 04/06		13.0460-7137.2 607137 13.0470-7137.2 LD7137	ATE 23482 15,8 - WE / - WK ATE 23482 15,8 - WE / - WK Ceramic
Zubehörsatz, Scheibenbremsbelag							
1.6 1.8 2.0	78 85 103	07/02→ 07/02→ 07/02→	←	→ 10/08		13.0460-0282.2 610282	
1.6	80	07/02→	←	→ 04/06		13.0460-0282.2 610282	
1.9 dCi	85	08/02→	←	04/03→ 10/07		13.0460-0282.2 610282	
1.9 dCi 2.2 dCi	88 102	04/03→ 04/03→	←	→ 10/07		13.0460-0282.2 610282	
2.2 Di	93	07/02→	←	→ 04/03		13.0460-0282.2 610282	
2.5	125	01/02→	←	03/02→ 04/06		13.0460-0282.2 610282	
 Bremsscheibe							
1.6 1.8 2.0	78 85 103	07/02→ 07/02→ 07/02→	←	→ 10/08		24.0128-0140.1 428140	Ø 280 28 26 V
1.6	80	07/02→	←	→ 04/06		24.0128-0140.1 428140	Ø 280 28 26 V
			→	→ 04/06		24.0110-0285.1 410285	Ø 278 10 9
1.9 dCi	85	08/02→	←	04/03→ 10/07		24.0128-0140.1 428140	Ø 280 28 26 V
			→	04/03→ 10/07		24.0110-0285.1 410285	Ø 278 10 9
1.9 dCi 2.2 dCi	88 102	04/03→ 04/03→	←	→ 10/07		24.0128-0140.1 428140	Ø 280 28 26 V
2.2 Di	93	07/02→	←	→ 04/03		24.0128-0140.1 428140	Ø 280 28 26 V
			→	→ 04/03		24.0110-0285.1 410285	Ø 278 10 9
2.5	125	01/02→	←	03/02→ 04/06		24.0128-0140.1 428140	Ø 280 28 26 V
			→	03/02→ 04/06		24.0110-0285.1 410285	Ø 278 10 9
NISSAN - PRIMERA Traveller (W10) 07/90→03/98							
 Bremsbelagsatz, Scheibenbremse							
1.6 i 1.6 i 2.0 D	66 75 55	07/90→03/98 02/91→03/98 07/90→12/95	←			13.0460-5933.2 605933	AKE 21725 16,8 + WK
2.0 i	85	07/90→03/98	→	+ ABS		13.0460-5983.2 605983	21713 16,5 - WE / - WK
			←	→ 12/95		13.0460-5933.2 605933	AKE 21725 16,8 + WK
			→	→ 12/95		13.0460-5983.2 605983	21713 16,5 - WE / - WK
 Bremsscheibe							
1.6 i 1.6 i 2.0 D	66 75 55	07/90→03/98 02/91→03/98 07/90→12/95	←			24.0122-0146.1 422146	Ø 257 22 20 V
2.0 i	85	07/90→03/98	→	+ ABS		24.0109-0129.1 409129	Ø 258 9 8
			←	→ 12/95		24.0122-0146.1 422146	Ø 257 22 20 V
			→	→ 12/95		24.0109-0129.1 409129	Ø 258 9 8













	kW			 	! #		
NISSAN - PRIMERA Traveller (WP11) 06/96→01/02							
 Bremsbelagsatz, Scheibenbremse							
1.6 16V	66	04/98→12/01	←			13.0460-5807.2 605807	TRW 23093 16,6 - WK
1.6 16V	73	04/98→12/01					
1.6 16V	81	04/98→01/02	→			13.0460-5986.2 605986	TRW 21545 14,9 - WK
1.8 16V	84	08/99→12/01					
2.0 TD	66	04/98→12/01					
2.0 16V	85	06/96→12/01	←	07/99→		13.0460-5727.2 605727	ATE 23160 17,3 - WE / - WK
			←	04/98→06/99		13.0460-5807.2 605807	TRW 23093 16,6 - WK
			→	04/98→		13.0460-5986.2 605986	TRW 21545 14,9 - WK
2.0 16V	96	04/98→12/01	←	07/99→		13.0460-5727.2 605727	ATE 23160 17,3 - WE / - WK
			←	→06/99		13.0460-5807.2 605807	TRW 23093 16,6 - WK
			→			13.0460-5986.2 605986	TRW 21545 14,9 - WK
2.0 16V	103	08/99→12/01	←			13.0460-5727.2 605727	ATE 23160 17,3 - WE / - WK
			→			13.0460-5986.2 605986	TRW 21545 14,9 - WK
Zubehörsatz, Scheibenbremsbelag							
1.6 16V	66	04/98→12/01	←			13.0460-0148.2 610148	TRW
1.6 16V	73	04/98→12/01					
1.6 16V	81	04/98→01/02					
1.8 16V	84	08/99→12/01					
2.0 TD	66	04/98→12/01					
2.0 16V	85	06/96→12/01	←	04/98→06/99		13.0460-0148.2 610148	TRW
2.0 16V	96	04/98→12/01	←	→06/99		13.0460-0148.2 610148	TRW
 Bremsscheibe							
1.6 16V	66	04/98→12/01	←			24.0122-0179.1 422179	Ø 280 22 20 V
1.6 16V	73	04/98→12/01					
1.8 16V	84	08/99→12/01	→	04/01→		24.0110-0215.1 410215	Ø 258 10 9
2.0 16V	96	04/98→12/01	→	→03/01		24.0110-0310.1 410310	Ø 278 10 9
2.0 16V	103	08/99→12/01					
2.0 TD	66	04/98→12/01					
1.6 16V	81	04/98→01/02	←	→05/99		24.0122-0146.1 422146	Ø 257 22 20 V
			←			24.0122-0179.1 422179	Ø 280 22 20 V
			←	06/99→		24.0122-0179.1 422179	Ø 280 22 20 V
			→	04/01→		24.0110-0215.1 410215	Ø 258 10 9
			→	→03/01		24.0110-0310.1 410310	Ø 278 10 9
2.0 16V	85	06/96→12/01	←	04/98→		24.0122-0179.1 422179	Ø 280 22 20 V
			→	04/01→		24.0110-0215.1 410215	Ø 258 10 9
			→	04/98→03/01		24.0110-0310.1 410310	Ø 278 10 9
NISSAN - PRIMERA Traveller (WP12) 01/02→							
 Bremsbelagsatz, Scheibenbremse							
1.6 Visia	80	01/02→	←	03/02→04/06		13.0460-5825.2 605825	TRW 23094 16,5 + WK + Zub
2.5	125	01/02→	→	03/02→04/06		13.0460-7137.2 607137	ATE 23482 15,8 - WE / - WK
						13.0470-7137.2 LD7137	ATE 23482 15,8 - WE / - WK Ceramic
1.8	85	03/02→	←	→10/08		13.0460-5825.2 605825	TRW 23094 16,5 + WK + Zub
2.0	103	03/02→	→	→10/08		13.0460-7137.2 607137	ATE 23482 15,8 - WE / - WK
						13.0470-7137.2 LD7137	ATE 23482 15,8 - WE / - WK Ceramic
1.9 dCi	85	08/02→	←	04/03→10/07		13.0460-5825.2 605825	TRW 23094 16,5 + WK + Zub
			→	04/03→10/07		13.0460-7137.2 607137	ATE 23482 15,8 - WE / - WK
						13.0470-7137.2 LD7137	ATE 23482 15,8 - WE / - WK Ceramic
1.9 dCi	88	04/03→	←	→10/07		13.0460-5825.2 605825	TRW 23094 16,5 + WK + Zub
2.2 dCi	102	04/03→	→	→10/07		13.0460-7137.2 607137	ATE 23482 15,8 - WE / - WK
						13.0470-7137.2 LD7137	ATE 23482 15,8 - WE / - WK Ceramic
2.2 Di	93	03/02→	←	→04/03		13.0460-5825.2 605825	TRW 23094 16,5 + WK + Zub
			→	→04/03		13.0460-7137.2 607137	ATE 23482 15,8 - WE / - WK
						13.0470-7137.2 LD7137	ATE 23482 15,8 - WE / - WK Ceramic
↓							

















	kW			 	! #		
NISSAN - PRIMERA Traveller (WP12) 01/02→							
Zubehörsatz, Scheibenbremsbelag							
1.6 Visia 2.5	80 125	01/02→ 01/02→	←	03/02→ 04/06		13.0460-0282.2 610282	
1.8 2.0	85 103	03/02→ 03/02→	←	→ 10/08		13.0460-0282.2 610282	
1.9 dCi	85	08/02→	←	04/03→ 10/07		13.0460-0282.2 610282	
1.9 dCi 2.2 dCi	88 102	04/03→ 04/03→	←	→ 10/07		13.0460-0282.2 610282	
2.2 Di	93	03/02→	←	→ 04/03		13.0460-0282.2 610282	
 Bremsscheibe							
1.6 Visia 2.5	80 125	01/02→ 01/02→	←	03/02→ 04/06		24.0128-0140.1 428140	Ø 280 28 26 V
			→	03/02→ 04/06		24.0110-0285.1 410285	Ø 278 10 9
1.8 2.0	85 103	03/02→ 03/02→	←	→ 10/08		24.0128-0140.1 428140	Ø 280 28 26 V
			→	→ 10/08		24.0110-0285.1 410285	Ø 278 10 9
1.9 dCi	85	08/02→	←	04/03→ 10/07		24.0128-0140.1 428140	Ø 280 28 26 V
			→	04/03→ 10/07		24.0110-0285.1 410285	Ø 278 10 9
1.9 dCi 2.2 dCi	88 102	04/03→ 04/03→	←	→ 10/07		24.0128-0140.1 428140	Ø 280 28 26 V
			→	→ 10/07		24.0110-0285.1 410285	Ø 278 10 9
2.2 Di	93	03/02→	←	→ 04/03		24.0128-0140.1 428140	Ø 280 28 26 V
			→	→ 04/03		24.0110-0285.1 410285	Ø 278 10 9
NISSAN - PULSAR I Stufenheck (N15) 07/95→07/00							
 Bremsbelagsatz, Scheibenbremse							
1.6	86	09/95→07/00	←	→ 04/00; + ABS		13.0460-5717.2 605717	23502 16,0 + WK
			←	01/98→ 04/00; - ABS		13.0460-5717.2 605717	23502 16,0 + WK
			←	→ 12/97; - ABS		13.0460-5988.2 605988	AKE 23004 15,9 + WK
			→	→ 12/97; + ABS		13.0460-5841.2 605841	SUM 23023 14,8 + WK
			→	01/98→ 04/00; + ABS		13.0460-5983.2 605983	21713 16,5 - WE / - WK
Zubehörsatz, Scheibenbremsbelag							
1.6	86	09/95→07/00	←	→ 12/97; - ABS		13.0460-0283.2 610283	
			←	→ 04/00; + ABS		13.0460-0285.2 610285	
			←	01/98→ 04/00; - ABS		13.0460-0285.2 610285	
			→	→ 12/97; + ABS		13.0460-0284.2 610284	
			→	01/98→ 04/00; + ABS		13.0460-0332.2 610332	
 Bremsscheibe							
1.6	86	09/95→07/00	←	→ 04/00; - ABS		24.0118-0117.1 418117	Ø 247 18 16 V
			←	→ 04/00; + ABS		24.0120-0203.1 420203	Ø 252 20 18 V
			→	→ 12/97; + ABS		24.0107-0108.1 407108	Ø 234 7 6
NISSAN - PULSAR Schrägheck (C13) 08/12→							
 Bremsbelagsatz, Scheibenbremse							
1.2 DIG-T 1.5 dCi 1.6 DIG-T	85 81 140	10/14→ 10/14→ 02/15→	←			13.0460-5716.2 605716	21561 17,0 + WK
 Bremsscheibe							
1.2 DIG-T 1.5 dCi	85 81	10/14→ 10/14→	←			24.0124-0247.1 424247	Ø 280 24 22 V
			→			24.0109-0157.1 409157	Ø 291,5 9 8
1.6 DIG-T	140	02/15→	←			24.0126-0177.1 426177	Ø 296 26 24 V
			→			24.0109-0157.1 409157	Ø 291,5 9 8
NISSAN - QASHQAI / QASHQAI +2 I (J10, JJ10) 12/06→12/13							
 Bremsbelagsatz, Scheibenbremse							
1.5 dCi 1.5 dCi 1.6 1.6	76 78 81 84	07/08→12/13 02/07→12/13 02/07→ 02/07→12/13	←	kurzer Radstand		13.0460-5752.2 605752	24632 17,0 - WK
						13.0470-5752.2 LD5752	24632 17,0 - WK Ceramic
1.5 dCi ↓	81	01/10→12/13	←	11/10→; kurzer Radstand		13.0460-5752.2 605752	24632 17,0 - WK

















	kw				! #		
NISSAN - QASHQAI / QASHQAI +2 I (J10, JJ10) 12/06→12/13							
 Bremsbelagsatz, Scheibenbremse							
1.5 dCi	81	01/10→12/13	←	11/10→; kurzer Radstand		13.0470-5752.2 LD5752	24632 17,0 - WK Ceramic
1.6	86	11/10→12/13	←	kurzer Radstand		13.0460-5752.2 605752	24632 17,0 - WK
1.6 dCi	96	10/11→12/13				13.0470-5752.2 LD5752	24632 17,0 - WK Ceramic
1.6 dCi Allrad	96	10/11→12/13	←	langer Radstand		13.0460-5778.2 605778	SUM 23698 16,8 + WK
2.0	102	02/07→12/13	←	kurzer Radstand		13.0460-5752.2 605752	24632 17,0 - WK
2.0	104	02/07→12/13				13.0470-5752.2 LD5752	24632 17,0 - WK Ceramic
2.0 Allrad	102	02/07→12/13	←	08/08→; langer Radstand		13.0460-5778.2 605778	SUM 23698 16,8 + WK
2.0 Allrad	104	02/07→12/13					
2.0 dCi	110	02/07→12/13					
2.0 dCi Allrad	110	02/07→12/13					
2.0 (J11E)	106	06/14→	←			13.0460-5652.2 605652	AKE 22065 17,7 + WK
			→			13.0460-2600.2 602600	TRW 25965 15,0 + WK
Zubehörsatz, Scheibenbremsbelag							
1.5 dCi	76	07/08→12/13	←	kurzer Radstand		13.0460-0212.2 610212	ATE
1.5 dCi	78	02/07→12/13					
1.6	81	02/07→	→			13.0460-0213.2 610213	ATE
1.6	84	02/07→12/13					
1.6	86	11/10→12/13					
1.6 dCi	96	10/11→12/13					
1.6 dCi Allrad	96	10/11→12/13					
2.0	102	02/07→12/13					
2.0	104	02/07→12/13					
2.0 Allrad	102	02/07→12/13					
2.0 Allrad	104	02/07→12/13					
2.0 dCi	110	02/07→12/13					
2.0 dCi Allrad	110	02/07→12/13					
1.5 dCi	81	01/10→12/13	←	11/10→; kurzer Radstand		13.0460-0212.2 610212	ATE
			→	11/10→		13.0460-0213.2 610213	ATE
 Bremsscheibe							
1.5 dCi	76	07/08→12/13	←	kurzer Radstand		24.0126-0154.1 426154	Ø 295,5 26 24 V
1.5 dCi	78	02/07→12/13	→	kurzer Radstand		24.0109-0157.1 409157	Ø 291,5 9 8
1.6	81	02/07→	→				
1.6	84	02/07→12/13	→	08/08→; langer Radstand		24.0116-0119.1 416119	Ø 292 16 14 V
1.5 dCi	81	01/10→12/13	←	11/10→; kurzer Radstand		24.0126-0154.1 426154	Ø 295,5 26 24 V
			→	11/10→; kurzer Radstand		24.0109-0157.1 409157	Ø 291,5 9 8
			→	02/10→; langer Radstand		24.0116-0119.1 416119	Ø 292 16 14 V
1.6	86	11/10→12/13	←	kurzer Radstand		24.0126-0154.1 426154	Ø 295,5 26 24 V
1.6 dCi	96	10/11→12/13	←	langer Radstand		24.0128-0242.1 428242	Ø 320 28 26 V
1.6 dCi Allrad	96	10/11→12/13	→	kurzer Radstand		24.0109-0157.1 409157	Ø 291,5 9 8
			→	langer Radstand		24.0116-0119.1 416119	Ø 292 16 14 V
2.0	102	02/07→12/13	←	kurzer Radstand		24.0126-0154.1 426154	Ø 295,5 26 24 V
2.0 Allrad	102	02/07→12/13	←	08/08→; langer Radstand		24.0128-0242.1 428242	Ø 320 28 26 V
			→	kurzer Radstand		24.0109-0157.1 409157	Ø 291,5 9 8
2.0	104	02/07→12/13	←	kurzer Radstand		24.0126-0154.1 426154	Ø 295,5 26 24 V
2.0 Allrad	104	02/07→12/13					
2.0 dCi	110	02/07→12/13	←	08/08→; langer Radstand		24.0128-0242.1 428242	Ø 320 28 26 V
2.0 dCi Allrad	110	02/07→12/13	→	kurzer Radstand		24.0109-0157.1 409157	Ø 291,5 9 8
			→	08/08→; langer Radstand		24.0116-0119.1 416119	Ø 292 16 14 V
2.0 (J11E)	106	06/14→	←			24.0126-0185.1 426185	Ø 296 26 24 V
			→			24.0113-0200.1 413200	Ø 290 13 11
NISSAN - QASHQAI II (J11, J11_) 11/13→							
 Bremsbelagsatz, Scheibenbremse							
1.2 DIG-T	85	11/13→	←	02/14→		13.0460-5652.2 605652	AKE 22065 17,7 + WK
1.6 dCi	96	11/13→					
1.6 dCi ALL MODE 4x4-i	96	11/13→	→	02/14→		13.0460-2600.2 602600	TRW 25965 15,0 + WK
1.5 dCi	81	11/13→	←	02/14→		13.0460-5652.2 605652	AKE 22065 17,7 + WK
			←	→ 01/14; kurzer Radstand		13.0460-5752.2 605752	24632 17,0 - WK
						13.0470-5752.2 LD5752	24632 17,0 - WK Ceramic
			→	02/14→		13.0460-2600.2 602600	TRW 25965 15,0 + WK
1.6 DIG-T	120	10/14→	←			13.0460-5652.2 605652	AKE 22065 17,7 + WK
2.0 ALL MODE 4x4-i (J11R)	106	10/15→	→			13.0460-2600.2 602600	TRW 25965 15,0 + WK
↓							































	kw			 	! #		
NISSAN - QASHQAI II (J11, J11_) 11/13→							
Zubehörsatz, Scheibenbremsbelag							
1.5 dCi	81	11/13→	←	→ 01/14; kurzer Radstand		13.0460-0212.2 610212	ATE
			→	→ 01/14		13.0460-0213.2 610213	ATE
 Bremsscheibe							
1.2 DIG-T	85	11/13→	←	02/14→		24.0126-0185.1 426185	Ø 296 26 24 V
1.6 dCi	96	11/13→	→	02/14→		24.0113-0200.1 413200	Ø 290 13 11
1.6 dCi ALL MODE 4x4-i	96	11/13→					
1.5 dCi	81	11/13→	←	→ 01/14; kurzer Radstand		24.0126-0154.1 426154	Ø 295,5 26 24 V
			←	02/14→		24.0126-0185.1 426185	Ø 296 26 24 V
			→	→ 01/14; kurzer Radstand		24.0109-0157.1 409157	Ø 291,5 9 8
			→	02/14→		24.0113-0200.1 413200	Ø 290 13 11
			→	→ 01/14; langer Radstand		24.0116-0119.1 416119	Ø 292 16 14 V
1.6 DIG-T	120	10/14→	←			24.0126-0185.1 426185	Ø 296 26 24 V
2.0 ALL MODE 4x4-i (J11R)	106	10/15→	→			24.0113-0200.1 413200	Ø 290 13 11
NISSAN - SENTRA VII (B17) 08/12→							
 Bremsbelagsatz, Scheibenbremse							
1.6	86	08/14→	←			13.0460-5716.2 605716	21561 17,0 + WK
 Bremsscheibe							
1.6	86	08/14→	←			24.0124-0247.1 424247	Ø 280 24 22 V
			→			24.0109-0157.1 409157	Ø 291,5 9 8
NISSAN - SERENA (C23) 06/91→09/01							
 Bremsbelagsatz, Scheibenbremse							
1.6	71	02/93→09/01	←	Bremssattel(1-Kolben)		13.0460-5881.2 605881	21099 17,0 - WE / - WK
2.3 D	55	01/95→09/01	←	Bremssattel(2-Kolben)		13.0460-5959.2 605959	TRW 21481 15,5 - WK
2.0	93	11/92→09/01	←			13.0460-5959.2 605959	TRW 21481 15,5 - WK
2.0 D	49	11/92→09/01	←	→ 08/94; Bremssattel(1-Kolben)		13.0460-5881.2 605881	21099 17,0 - WE / - WK
			←	→ 08/94; Bremssattel(2-Kolben)		13.0460-5959.2 605959	TRW 21481 15,5 - WK
Zubehörsatz, Scheibenbremsbelag							
1.6	71	02/93→09/01	←	Bremssattel(1-Kolben)		13.0460-0322.2 610322	AKE
2.3 D	55	01/95→09/01	←				
2.0 D	49	11/92→09/01	←	→ 08/94; Bremssattel(1-Kolben)		13.0460-0322.2 610322	AKE
 Bremsscheibe							
1.6	71	02/93→09/01	←	Bremssattel(1-Kolben)		24.0122-0193.1 422193	Ø 250 22 20 V
			←	Bremssattel(2-Kolben)		24.0126-0108.1 426108	Ø 257 26 24 V
2.0	93	11/92→09/01	←			24.0126-0108.1 426108	Ø 257 26 24 V
2.0 D	49	11/92→09/01	←	→ 08/94; Bremssattel(1-Kolben)		24.0122-0193.1 422193	Ø 250 22 20 V
			←	→ 08/94; Bremssattel(2-Kolben)		24.0126-0108.1 426108	Ø 257 26 24 V
NISSAN - SUNNY III (N14) 05/90→12/96							
 Bremsbelagsatz, Scheibenbremse							
1.4	60	10/90→06/95	←	→ 05/95		13.0460-5941.2 605941	SUM 21657 16,4 + WK
1.4 i 16V	64	10/90→06/95					
1.6	60	10/90→06/95					
1.6 16V	78	01/93→12/95					
1.4 i	55	10/90→05/95	←			13.0460-5941.2 605941	SUM 21657 16,4 + WK
1.6 i	66	10/90→05/95					
1.6 i 16V	75	10/92→05/95					
1.6 i 16V 4WD	66	10/90→05/95					
2.0 D	55	10/90→05/95					
2.0	104	08/90→12/96	→	10/90→ 05/95		13.0460-5983.2 605983	21713 16,5 - WE / - WK
Zubehörsatz, Scheibenbremsbelag							
1.4	60	10/90→06/95	←	→ 05/95		13.0460-0336.2 610336	SUM
1.4 i 16V	64	10/90→06/95					
1.6	60	10/90→06/95	→	→ 05/95; + ABS		13.0460-0295.2 610295	
1.6 16V	78	01/93→12/95					
1.4 i	55	10/90→05/95	←			13.0460-0336.2 610336	SUM
1.6 i	66	10/90→05/95					
1.6 i 16V	75	10/92→05/95	→	+ ABS		13.0460-0295.2 610295	











	kW			 	! #		
NISSAN - SUNNY III (N14) 05/90→12/96							
Zubehörsatz, Scheibenbremsbelag							
1.6 i 16V 4WD 2.0 D	66 55	10/90→05/95 10/90→05/95	← →			13.0460-0336.2 610336 13.0460-0295.2 610295	SUM
2.0	104	08/90→12/96	→	10/90→ 05/95		13.0460-0295.2 610295	
 Bremsscheibe							
1.4 1.4 i 16V 1.6 1.6 16V	60 64 60 78	10/90→06/95 10/90→06/95 10/90→06/95 01/93→12/95	← →	→ 05/95 → 05/95; + ABS		24.0118-0107.1 418107 24.0107-0108.1 407108	Ø 240 18 16 V Ø 234 7 6
1.4 i 1.6 i 1.6 i 16V 1.6 i 16V 4WD 2.0 D	55 66 75 66 55	10/90→05/95 10/90→05/95 10/92→05/95 10/90→05/95 10/90→05/95	← →	+ ABS		24.0118-0107.1 418107 24.0107-0108.1 407108	Ø 240 18 16 V Ø 234 7 6
2.0	104	08/90→12/96	←	10/90→ 05/95		24.0126-0112.1 426112	Ø 257 26 24 V
NISSAN - SUNNY III Hatchback (N14) 10/90→07/95							
 Bremsbelagsatz, Scheibenbremse							
1.4	60	10/90→06/95	←	→ 05/95		13.0460-5941.2 605941	SUM 21657 16,4 + WK
1.4 i 1.4 i 16V 1.6 i 1.6 i 1.6 i 16V 1.6 i 16V 4x4 2.0 D	55 64 66 82 75 75 55	10/90→05/95 10/90→05/95 10/90→05/95 10/90→05/95 10/92→05/95 10/92→05/95 10/90→05/95	←			13.0460-5941.2 605941	SUM 21657 16,4 + WK
2.0 GTI 16V 2.0 GTI-R 4x4	105 162	10/90→05/95 10/90→05/95	→			13.0460-5983.2 605983	21713 16,5 - WE / - WK
Zubehörsatz, Scheibenbremsbelag							
1.4	60	10/90→06/95	← →	→ 05/95 → 05/95; + ABS		13.0460-0336.2 610336 13.0460-0295.2 610295	SUM
1.4 i 1.4 i 16V 1.6 i 1.6 i 1.6 i 16V 1.6 i 16V 4x4 2.0 D	55 64 66 82 75 75 55	10/90→05/95 10/90→05/95 10/90→05/95 10/90→05/95 10/92→05/95 10/92→05/95 10/90→05/95	← →	+ ABS		13.0460-0336.2 610336 13.0460-0295.2 610295	SUM
2.0 GTI 16V 2.0 GTI-R 4x4	105 162	10/90→05/95 10/90→05/95	→			13.0460-0295.2 610295	
 Bremsscheibe							
1.4	60	10/90→06/95	← →	→ 05/95 → 05/95; + ABS		24.0118-0107.1 418107 24.0107-0108.1 407108	Ø 240 18 16 V Ø 234 7 6
1.4 i 1.4 i 16V 1.6 i 1.6 i 1.6 i 16V 1.6 i 16V 4x4 2.0 D	55 64 66 82 75 75 55	10/90→05/95 10/90→05/95 10/90→05/95 10/90→05/95 10/92→05/95 10/92→05/95 10/90→05/95	← →	+ ABS		24.0118-0107.1 418107 24.0107-0108.1 407108	Ø 240 18 16 V Ø 234 7 6
2.0 GTI 16V 2.0 GTI-R 4x4	105 162	10/90→05/95 10/90→05/95	←			24.0126-0112.1 426112	Ø 257 26 24 V
NISSAN - SUNNY III Kasten (Y10) 11/90→03/00							
 Bremsbelagsatz, Scheibenbremse							
1.6 i 16V 1.7 D	66 40	10/92→03/00 11/90→03/00	←			13.0460-5808.2 605808	21716 16,0 + WK
 Bremsscheibe							
1.6 i 16V 1.7 D	66 40	10/92→03/00 11/90→03/00	←			24.0118-0107.1 418107	Ø 240 18 16 V
NISSAN - SUNNY III Liftback (N14) 10/90→10/95							
 Bremsbelagsatz, Scheibenbremse							
1.4 i 1.6 i 1.6 i 16V 2.0 D	55 66 75 55	10/90→05/95 10/90→05/95 10/92→05/95 10/90→05/95	←			13.0460-5941.2 605941	SUM 21657 16,4 + WK
1.4 i 16V 1.6	64 82	10/90→06/95 10/91→10/95	←	→ 05/95		13.0460-5941.2 605941	SUM 21657 16,4 + WK
↓							











	kw			 	! #		
NISSAN - SUNNY III Liftback (N14) 10/90→10/95							
 Bremsbelagsatz, Scheibenbremse							
2.0 i 16V	105	10/90→05/95	➡			13.0460-5983.2 605983	21713 16,5 - WE / - WK
Zubehörsatz, Scheibenbremsbelag							
1.4 i	55	10/90→05/95	←			13.0460-0336.2 610336	SUM
1.6 i	66	10/90→05/95	←				
1.6 i 16V	75	10/92→05/95	➡	+ ABS		13.0460-0295.2 610295	
2.0 D	55	10/90→05/95	←				
1.4 i 16V	64	10/90→06/95	←	→ 05/95		13.0460-0336.2 610336	SUM
1.6	82	10/91→10/95	➡	→ 05/95; + ABS		13.0460-0295.2 610295	
2.0 i 16V	105	10/90→05/95	➡			13.0460-0295.2 610295	
 Bremsscheibe							
1.4 i	55	10/90→05/95	←			24.0118-0107.1 418107	Ø 240 18 16 V
1.6 i	66	10/90→05/95	←				
1.6 i 16V	75	10/92→05/95	➡	+ ABS		24.0107-0108.1 407108	Ø 234 7 6
2.0 D	55	10/90→05/95	←				
1.4 i 16V	64	10/90→06/95	←	→ 05/95		24.0118-0107.1 418107	Ø 240 18 16 V
1.6	82	10/91→10/95	➡	→ 05/95; + ABS		24.0107-0108.1 407108	Ø 234 7 6
2.0 i 16V	105	10/90→05/95	←			24.0126-0112.1 426112	Ø 257 26 24 V
NISSAN - SUNNY III Traveller (Y10) 11/90→03/00							
 Bremsbelagsatz, Scheibenbremse							
1.6	75	07/95→03/00	←			13.0460-5808.2 605808	21716 16,0 + WK
1.6 16V 4x4	66	11/90→05/95	←				
1.6 i	66	06/91→03/00	←				
1.6 i 16V 4x4	75	10/92→03/00	➡				
2.0 D	55	06/91→03/00	←				
 Bremsscheibe							
1.6	75	07/95→03/00	←			24.0118-0107.1 418107	Ø 240 18 16 V
1.6 16V 4x4	66	11/90→05/95	←				
1.6 i	66	06/91→03/00	←				
1.6 i 16V 4x4	75	10/92→03/00	➡				
2.0 D	55	06/91→03/00	←				
NISSAN - TEANA I (J31) 02/03→09/08							
 Bremsbelagsatz, Scheibenbremse							
2.0	103	10/03→06/08	←			13.0460-5716.2 605716	21561 17,0 + WK
2.3	127	10/03→06/08	←				
3.5	170	10/03→06/08	➡			13.0460-5843.2 605843	AKE 23871 14,3 + WK
NISSAN - TERRANO (D10) 09/13→							
 Bremsscheibe							
1.6	75	03/14→	←	+ ESP		24.0124-0221.1 424221	Ø 280 24 21,8 V + S
2.0	98	03/14→	←				
NISSAN - TERRANO I (WD21) 07/86→02/96							
 Bremsbelagsatz, Scheibenbremse							
2.7 TD 4WD	73	02/89→02/96	←	→ 10/93		13.0460-5957.2 605957	AKE 21348 17,0 + WK
3.0 i 4WD	109	01/90→12/95	←			13.0460-5957.2 605957	AKE 21348 17,0 + WK
Zubehörsatz, Scheibenbremsbelag							
2.7 TD 4WD	73	02/89→02/96	←	→ 10/93		13.0460-0289.2 610289	
3.0 i 4WD	109	01/90→12/95	←			13.0460-0289.2 610289	
 Bremsscheibe							
2.7 TD 4WD	73	02/89→02/96	←	→ 10/93		24.0126-0109.1 426109	Ø 277 26 24 V
3.0 i 4WD	109	01/90→12/95	←			24.0126-0109.1 426109	Ø 277 26 24 V
NISSAN - TERRANO II (R20) 10/92→09/07							
 Bremsbelagsatz, Scheibenbremse							
2.4 4WD	85	05/96→01/02	←			13.0460-5959.2 605959	TRW 21481 15,5 - WK
2.7 TD 4WD	74	02/93→01/02	←				
2.4 4WD	87	05/96→09/07	←	→ 11/05		13.0460-5959.2 605959	TRW 21481 15,5 - WK
2.7 TDi 4WD	92	05/96→09/07	←				
2.4 i 12V 4WD	91	02/93→12/97	←	→ 04/96		13.0460-5959.2 605959	TRW 21481 15,5 - WK
↓							

	kw					! #		
NISSAN - TERRANO II (R20) 10/92→09/07								
 Bremsbelagsatz, Scheibenbremse								
3.0 Di 4WD	113	05/02→09/07	←	→ 04/06		13.0460-5959.2	605959	TRW 21481 15,5 - WK
 Bremsscheibe								
2.4 4WD	85	05/96→01/02	←			24.0126-0109.1	426109	Ø 277 26 24 V
2.7 TD 4WD	74	02/93→01/02	←					
2.4 4WD	87	05/96→09/07	←	→ 11/05		24.0126-0109.1	426109	Ø 277 26 24 V
2.7 TDi 4WD	92	05/96→09/07	←					
2.4 i 12V 4WD	91	02/93→12/97	←	→ 04/96		24.0126-0109.1	426109	Ø 277 26 24 V
3.0 Di 4WD	113	05/02→09/07	←	→ 04/06		24.0126-0109.1	426109	Ø 277 26 24 V
NISSAN - TERRANO II Van (R20) 06/98→09/07								
 Bremsbelagsatz, Scheibenbremse								
2.7 TDi 4WD	92	06/98→09/07	←	→ 11/05		13.0460-5959.2	605959	TRW 21481 15,5 - WK
3.0 Di 4WD	113	04/03→09/07	←	→ 04/06		13.0460-5959.2	605959	TRW 21481 15,5 - WK
 Bremsscheibe								
2.7 TDi 4WD	92	06/98→09/07	←	→ 11/05		24.0126-0109.1	426109	Ø 277 26 24 V
3.0 Di 4WD	113	04/03→09/07	←	→ 04/06		24.0126-0109.1	426109	Ø 277 26 24 V
NISSAN - TIIDA Schrägheck (C11) 02/06→12/11								
 Bremsbelagsatz, Scheibenbremse								
1.5 dCi	78	09/07→12/11	←	→ 04/11		13.0460-5716.2	605716	21561 17,0 + WK
1.6	81	09/07→12/11	→	06/10→ 04/11		13.0460-5843.2	605843	AKE 23871 14,3 + WK
1.8	93	09/07→12/11	→					
1.8 Flex	92	05/09→12/11	→					
Zubehörsatz, Scheibenbremsbelag								
1.5 dCi	78	09/07→12/11	←	→ 04/11		13.0460-0170.2	610170	
1.6	81	09/07→12/11	→	→ 05/10		13.0460-0213.2	610213	ATE
1.8	93	09/07→12/11	→					
1.8 Flex	92	05/09→12/11	→					
 Bremsscheibe								
1.5 dCi	78	09/07→12/11	←	→ 04/11		24.0124-0238.1	424238	Ø 280 24 22 V
1.6	81	09/07→12/11	→	→ 04/11		24.0109-0166.1	409166	Ø 292 9 8
1.8	93	09/07→12/11	→					
1.8 Flex	92	05/09→12/11	→					
NISSAN - TIIDA Schrägheck (C11) 05/04→06/13								
 Bremsbelagsatz, Scheibenbremse								
1.8	78	01/07→06/11	←	09/07→ 04/11		13.0460-5716.2	605716	21561 17,0 + WK
1.8 4x4	95	08/06→06/11	→	06/10→ 04/11		13.0460-5843.2	605843	AKE 23871 14,3 + WK
1.8 Flex 4x4	78	05/09→06/11	←	→ 04/11		13.0460-5716.2	605716	21561 17,0 + WK
			→	06/10→ 04/11		13.0460-5843.2	605843	AKE 23871 14,3 + WK
Zubehörsatz, Scheibenbremsbelag								
1.8	78	01/07→06/11	←	09/07→ 04/11		13.0460-0170.2	610170	
1.8 4x4	95	08/06→06/11	→	09/07→ 05/10		13.0460-0213.2	610213	ATE
1.8 Flex 4x4	78	05/09→06/11	←	→ 04/11		13.0460-0170.2	610170	
			→	→ 05/10		13.0460-0213.2	610213	ATE
 Bremsscheibe								
1.8	78	01/07→06/11	←	09/07→ 04/11		24.0124-0238.1	424238	Ø 280 24 22 V
1.8 4x4	95	08/06→06/11	→	09/07→ 04/11		24.0109-0166.1	409166	Ø 292 9 8
1.8 Flex 4x4	78	05/09→06/11	←	→ 04/11		24.0124-0238.1	424238	Ø 280 24 22 V
			→	→ 04/11		24.0109-0166.1	409166	Ø 292 9 8
NISSAN - TIIDA Stufenheck (SC11) 05/04→06/13								
 Bremsbelagsatz, Scheibenbremse								
1.5 dCi	76	01/07→12/12	←	→ 04/11		13.0460-5716.2	605716	21561 17,0 + WK
1.5 dCi	78	09/07→12/12	←					
1.6	81	09/07→12/12	←					
1.8	78	01/07→06/11	←					
1.8	93	09/07→12/12	←					
↓								















	kW				! #		
NISSAN - TIIDA Stufenheck (SC11) 05/04→06/13							
 Bremsbelagsatz, Scheibenbremse							
1.8	95	08/06→	←	01/07→04/11		13.0460-5716.2 605716	21561 17,0 + WK
Zubehörsatz, Scheibenbremsbelag							
1.5 dCi	76	01/07→12/12	←	→ 04/11		13.0460-0170.2 610170	
1.5 dCi	78	09/07→12/12					
1.6	81	09/07→12/12	→	→ 05/10		13.0460-0213.2 610213	ATE
1.8	78	01/07→06/11					
1.8	93	09/07→12/12					
1.8	95	08/06→	←	01/07→04/11		13.0460-0170.2 610170	
			→	01/07→05/10		13.0460-0213.2 610213	ATE
 Bremsscheibe							
1.5 dCi	76	01/07→12/12	←	→ 04/11		24.0124-0238.1 424238	Ø 280 24 22 V
1.5 dCi	78	09/07→12/12					
1.6	81	09/07→12/12	→	→ 04/11		24.0109-0166.1 409166	Ø 292 9 8
1.8	78	01/07→06/11					
1.8	93	09/07→12/12					
1.8	95	08/06→	←	01/07→04/11		24.0124-0238.1 424238	Ø 280 24 22 V
			→	01/07→04/11		24.0109-0166.1 409166	Ø 292 9 8
NISSAN - TRADE Pritsche/Fahrgestell 11/98→09/04							
 Bremsscheibe							
2.7 TD	73	11/98→09/04	←			24.0124-0229.1 424229	Ø 263 24 22 V
3.0 TD	81	11/98→09/04					
NISSAN - URVAN Bus (E24) 06/86→05/97							
 Bremsbelagsatz, Scheibenbremse							
2.5 D	59	05/89→10/96	←			13.0460-5957.2 605957	AKE 21348 17,0 + WK
NISSAN - URVAN Kasten (E24) 06/86→05/97							
 Bremsbelagsatz, Scheibenbremse							
2.0	64	05/87→05/97	←			13.0460-5957.2 605957	AKE 21348 17,0 + WK
2.4	72	10/93→05/97					
2.4	74	02/92→04/97					
2.3 D	51	01/88→05/97	←	→ 12/88		13.0460-5957.2 605957	AKE 21348 17,0 + WK
2.5 D	59	12/88→05/97	←	01/89→		13.0460-5957.2 605957	AKE 21348 17,0 + WK
NISSAN - VANETTE Bus (C22) 10/86→12/11							
 Bremsbelagsatz, Scheibenbremse							
1.5	51	10/86→12/95	←	04/87→01/95		13.0460-5937.2 605937	AKE 21119 17,0 + WK
2.0 D (ULC22)	47	10/86→12/95					
2.4 i (SLC22)	74	10/86→12/95	←	→ 05/87		13.0460-5957.2 605957	AKE 21348 17,0 + WK
2.4 i (SLC22)	77	10/86→12/95					
Zubehörsatz, Scheibenbremsbelag							
1.5	51	10/86→12/95	←	04/87→01/95		13.0460-0322.2 610322	AKE
2.0 D (ULC22)	47	10/86→12/95					
 Bremsscheibe							
1.5	51	10/86→12/95	←	04/87→01/95		24.0122-0167.1 422167	Ø 250 22 20 V
2.0 D (ULC22)	47	10/86→12/95					
NISSAN - VANETTE CARGO Bus (HC 23) 09/94→05/01							
 Bremsbelagsatz, Scheibenbremse							
1.6 i	72	01/96→05/01	←	Bremssattel(1-Kolben)		13.0460-5881.2 605881	21099 17,0 - WE / - WK
2.3 D	55	09/94→05/01	←	Bremssattel(2-Kolben)		13.0460-5959.2 605959	TRW 21481 15,5 - WK
Zubehörsatz, Scheibenbremsbelag							
1.6 i	72	01/96→05/01	←	Bremssattel(1-Kolben)		13.0460-0322.2 610322	AKE
2.3 D	55	09/94→05/01					
 Bremsscheibe							
1.6 i	72	01/96→05/01	←	Bremssattel(1-Kolben)		24.0122-0193.1 422193	Ø 250 22 20 V
2.3 D	55	09/94→05/01	←	Bremssattel(2-Kolben)		24.0126-0108.1 426108	Ø 257 26 24 V















	kW					! #		
NISSAN - VANETTE CARGO Kasten (HC 23) 09/94→05/02								
 Bremsbelagsatz, Scheibenbremse								
1.6 i	71	09/94→05/01	←	Bremssattel(1-Kolben)		13.0460-5881.2	605881	21099 17,0 - WE / - WK
			←	Bremssattel(2-Kolben)		13.0460-5959.2	605959	TRW 21481 15,5 - WK
2.3 D	55	09/94→05/02	←	→ 11/01; Bremssattel(1-Kolben)		13.0460-5881.2	605881	21099 17,0 - WE / - WK
			←	→ 11/01; Bremssattel(2-Kolben)		13.0460-5959.2	605959	TRW 21481 15,5 - WK
Zubehörsatz, Scheibenbremsbelag								
1.6 i	71	09/94→05/01	←	Bremssattel(1-Kolben)		13.0460-0322.2	610322	AKE
2.3 D	55	09/94→05/02	←	→ 11/01; Bremssattel(1-Kolben)		13.0460-0322.2	610322	AKE
 Bremsscheibe								
1.6 i	71	09/94→05/01	←	Bremssattel(1-Kolben)		24.0122-0193.1	422193	Ø 250 22 20 V
			←	Bremssattel(2-Kolben)		24.0126-0108.1	426108	Ø 257 26 24 V
2.3 D	55	09/94→05/02	←	→ 11/01; Bremssattel(1-Kolben)		24.0122-0193.1	422193	Ø 250 22 20 V
			←	→ 11/01; Bremssattel(2-Kolben)		24.0126-0108.1	426108	Ø 257 26 24 V
NISSAN - VANETTE Kasten (C22) 10/86→12/11								
 Bremsbelagsatz, Scheibenbremse								
1.5	51	10/86→12/95	←	07/87→ 01/95		13.0460-5937.2	605937	AKE 21119 17,0 + WK
2.0 D	49	07/91→01/95	←			13.0460-5937.2	605937	AKE 21119 17,0 + WK
Zubehörsatz, Scheibenbremsbelag								
1.5	51	10/86→12/95	←	07/87→ 01/95		13.0460-0322.2	610322	AKE
2.0 D	49	07/91→01/95	←			13.0460-0322.2	610322	AKE
 Bremsscheibe								
1.5	51	10/86→12/95	←	07/87→ 01/95		24.0122-0167.1	422167	Ø 250 22 20 V
2.0 D	49	07/91→01/95	←			24.0122-0167.1	422167	Ø 250 22 20 V
NISSAN - VERSA I 08/06→								
 Bremsbelagsatz, Scheibenbremse								
1.6 Flex	82	01/11→	←	→ 04/11		13.0460-5716.2	605716	21561 17,0 + WK
1.8 Flex	93	07/10→						
Zubehörsatz, Scheibenbremsbelag								
1.6 Flex	82	01/11→	←	→ 04/11		13.0460-0170.2	610170	
1.8 Flex	93	07/10→						
 Bremsscheibe								
1.6 Flex	82	01/11→	←	→ 04/11		24.0124-0238.1	424238	Ø 280 24 22 V
1.8 Flex	93	07/10→	→	→ 04/11		24.0109-0166.1	409166	Ø 292 9 8
NISSAN - X-TRAIL (T30) 06/01→01/13								
 Bremsbelagsatz, Scheibenbremse								
2.0	103	07/01→01/13	←	→ 02/07		13.0460-5842.2	605842	23420 16,5 - WE / - WK
2.0	110	09/01→01/13						
2.0 4x4	103	07/01→01/13	→	→ 02/07		13.0460-5843.2	605843	AKE 23871 14,3 + WK
2.0 4x4	110	09/01→01/13						
2.0 4x4	206	06/01→01/13						
2.2 dCi	100	12/03→01/13						
2.2 DCi	84	10/04→01/13						
2.2 dCi 4x4	100	12/03→01/13						
2.5 4x4	132	11/02→01/13						
2.2 DCi FWD	84	06/01→09/03	←	07/01→		13.0460-5842.2	605842	23420 16,5 - WE / - WK
			→	07/01→		13.0460-5843.2	605843	AKE 23871 14,3 + WK
2.2 Di 4x4	84	07/01→10/05	←	→ 09/03		13.0460-5842.2	605842	23420 16,5 - WE / - WK
			→	→ 09/03		13.0460-5843.2	605843	AKE 23871 14,3 + WK
2.5 4x4	121	09/02→01/13	←	01/03→ 02/07		13.0460-5842.2	605842	23420 16,5 - WE / - WK
			→	01/03→ 02/07		13.0460-5843.2	605843	AKE 23871 14,3 + WK
2.5 4x4	134	09/01→02/07	←			13.0460-5842.2	605842	23420 16,5 - WE / - WK
			→			13.0460-5843.2	605843	AKE 23871 14,3 + WK
2.5 FWD	131	06/01→12/07	←	11/02→ 02/07		13.0460-5842.2	605842	23420 16,5 - WE / - WK
↓								













	kw			 	! #		
NISSAN - X-TRAIL (T30) 06/01→01/13							
 Bremsbelagsatz, Scheibenbremse							
2.5 FWD	131	06/01→12/07	➡	11/02→02/07		13.0460-5843.2 605843	AKE 23871 14,3 + WK
Zubehörsatz, Scheibenbremsbelag							
2.0	103	07/01→01/13	←	→ 02/07		13.0460-0340.2 610340	
2.0	110	09/01→01/13	➡	→ 02/07		13.0460-0341.2 610341	
2.0 4x4	103	07/01→01/13	➡	→ 02/07			
2.0 4x4	110	09/01→01/13					
2.0 4x4	206	06/01→01/13					
2.2 dCi	100	12/03→01/13					
2.2 DCi	84	10/04→01/13					
2.2 dCi 4x4	100	12/03→01/13					
2.5 4x4	132	11/02→01/13					
2.2 DCi FWD	84	06/01→09/03	←	07/01→		13.0460-0340.2 610340	
			➡	07/01→		13.0460-0341.2 610341	
2.2 Di 4x4	84	07/01→10/05	←	→ 09/03		13.0460-0340.2 610340	
			➡	→ 09/03		13.0460-0341.2 610341	
2.5 4x4	121	09/02→01/13	←	01/03→02/07		13.0460-0340.2 610340	
			➡	01/03→02/07		13.0460-0341.2 610341	
2.5 4x4	134	09/01→02/07	←			13.0460-0340.2 610340	
			➡			13.0460-0341.2 610341	
2.5 FWD	131	06/01→12/07	←	11/02→02/07		13.0460-0340.2 610340	
			➡	11/02→02/07		13.0460-0341.2 610341	
 Bremsscheibe							
2.0	103	07/01→01/13	←	→ 02/07		24.0128-0140.1 428140	Ø 280 28 26 V
2.0	110	09/01→01/13	➡	→ 02/07		24.0116-0119.1 416119	Ø 292 16 14 V
2.0 4x4	103	07/01→01/13	➡	→ 02/07			
2.0 4x4	110	09/01→01/13					
2.0 4x4	206	06/01→01/13					
2.2 dCi	100	12/03→01/13					
2.2 DCi	84	10/04→01/13					
2.2 dCi 4x4	100	12/03→01/13					
2.5 4x4	132	11/02→01/13					
2.2 DCi FWD	84	06/01→09/03	←	07/01→		24.0128-0140.1 428140	Ø 280 28 26 V
			➡	07/01→		24.0116-0119.1 416119	Ø 292 16 14 V
2.2 Di 4x4	84	07/01→10/05	←	→ 09/03		24.0128-0140.1 428140	Ø 280 28 26 V
			➡	→ 09/03		24.0116-0119.1 416119	Ø 292 16 14 V
2.5 4x4	121	09/02→01/13	←	01/03→02/07		24.0128-0140.1 428140	Ø 280 28 26 V
			➡	01/03→02/07		24.0116-0119.1 416119	Ø 292 16 14 V
2.5 4x4	134	09/01→02/07	←			24.0128-0140.1 428140	Ø 280 28 26 V
			➡			24.0116-0119.1 416119	Ø 292 16 14 V
2.5 FWD	131	06/01→12/07	←	11/02→02/07		24.0128-0140.1 428140	Ø 280 28 26 V
			➡	11/02→02/07		24.0116-0119.1 416119	Ø 292 16 14 V
NISSAN - X-TRAIL (T31) 03/07→07/14							
 Bremsbelagsatz, Scheibenbremse							
2.0	101	06/07→11/13	←			13.0460-5752.2 605752	24632 17,0 - WK
2.0	103	06/08→11/13				13.0470-5752.2 LD5752	24632 17,0 - WK Ceramic
2.0	104	06/07→11/13					
2.0 dCi	110	06/07→11/13					
2.0 dCi	127	06/07→11/13					
2.0 dCi 4x4	130	10/09→11/13					
2.0 dCi FWD	110	06/07→11/13					
2.0 FWD	103	06/08→11/13					
2.0 FWD	104	03/07→11/13					
2.5 4x4	124	06/07→11/13					
2.5 4x4	122	01/12→	←	01/12→		13.0460-5752.2 605752	24632 17,0 - WK
						13.0470-5752.2 LD5752	24632 17,0 - WK Ceramic
Zubehörsatz, Scheibenbremsbelag							
2.0	101	06/07→11/13	←			13.0460-0212.2 610212	ATE
2.0	103	06/08→11/13	➡			13.0460-0213.2 610213	ATE
2.0	104	06/07→11/13					
2.0 dCi	110	06/07→11/13					
2.0 dCi	127	06/07→11/13					
2.0 dCi 4x4	130	10/09→11/13					
2.0 dCi FWD	110	06/07→11/13					
2.0 FWD	103	06/08→11/13					
↓							









	kW				! #		
NISSAN - X-TRAIL (T31) 03/07→07/14							
Zubehörsatz, Scheibenbremsbelag							
2.0 FWD	104	03/07→11/13	←			13.0460-0212.2 610212	ATE
2.5 4x4	124	06/07→11/13	→			13.0460-0213.2 610213	ATE
2.5 4x4	122	01/12→	←	01/12→		13.0460-0212.2 610212	ATE
			→	01/12→		13.0460-0213.2 610213	ATE
 Bremsscheibe							
2.0	101	06/07→11/13	←	→ 12/10		24.0126-0154.1 426154	Ø 295,5 26 24 V
2.0	103	06/08→11/13	←			24.0126-0177.1 426177	Ø 296 26 24 V
2.0	104	06/07→11/13	←	01/11→			
2.0 dCi	110	06/07→11/13	→			24.0116-0119.1 416119	Ø 292 16 14 V
2.0 dCi	127	06/07→11/13	→				
2.0 dCi 4x4	130	10/09→11/13	→				
2.0 dCi FWD	110	06/07→11/13	→				
2.0 FWD	103	06/08→11/13	→				
2.0 FWD	104	03/07→11/13	→				
2.5 4x4	124	06/07→11/13	→				
2.5 4x4	122	01/12→	←	01/12→		24.0126-0177.1 426177	Ø 296 26 24 V
			→	01/12→		24.0116-0119.1 416119	Ø 292 16 14 V
NISSAN - X-TRAIL (T32_) 10/13→							
 Bremsscheibe							
1.6 dCi (T32)	96	12/13→	←	für Fahrzeuge ohne 3. Sitzreihe		24.0126-0185.1 426185	Ø 296 26 24 V
1.6 dCi ALL MODE 4x4-i (NT32)	96	12/13→	←	für Fahrzeuge mit 3. Sitzreihe		24.0128-0291.1 428291	Ø 320 28 26 V
1.6 DIG-T (T32)	120	06/15→					
2.0 (T32)	106	09/14→					
2.0 ALL MODE 4x4-i (NT32)	106	09/14→					
2.0 dCi (T32)	130	10/16→					
2.0 dCi ALL MODE 4x4-i (NT32)	130	10/16→					
2.5 ALL MODE 4x4-i (NT32)	126	12/13→	←	12/14→; für Fahrzeuge ohne 3. Sitzreihe		24.0126-0185.1 426185	Ø 296 26 24 V
			←	12/14→; für Fahrzeuge mit 3. Sitzreihe		24.0128-0291.1 428291	Ø 320 28 26 V
OPEL - ADAM 10/12→							
 Bremsbelagsatz, Scheibenbremse							
1.0	66	07/14→	←	für Bremsscheibendurchmesser [mm]: 257		13.0460-3839.2 603839	BOS 23707 17,9 + WK + Zub
1.0	85	07/14→				13.0470-3839.2 LD3839	BOS 23982 18,1 + WK + Zub
1.2	69	07/13→					Ceramic
1.4 LPG	64	07/13→	←	für Bremsscheibendurchmesser [mm]: 308		13.0460-7179.2 607179	ATE 23832 20,2 - WK / + WK
1.4 S	110	11/14→				13.0470-7179.2 LD7179	ATE 23832 20,2 - WK / + WK
							Ceramic
			←	für Bremsscheibendurchmesser [mm]: 284		13.0460-7308.2 607308	ATE 22123 18,2 + WK + Zub
			→			13.0460-2793.2 602793	TRW 25973 17,2 + WK + Zub
1.2	51	10/12→	←	01/13→; für Bremsscheibendurchmesser [mm]: 257		13.0460-3839.2 603839	BOS 23707 17,9 + WK + Zub
1.4	64	10/12→				13.0470-3839.2 LD3839	BOS 23982 18,1 + WK + Zub
1.4	74	10/12→	←	01/13→; für Bremsscheibendurchmesser [mm]: 308		13.0460-7179.2 607179	ATE 23832 20,2 - WK / + WK
						13.0470-7179.2 LD7179	ATE 23832 20,2 - WK / + WK
							Ceramic
			←	01/13→; für Bremsscheibendurchmesser [mm]: 284		13.0460-7308.2 607308	ATE 22123 18,2 + WK + Zub
			→	01/13→		13.0460-2793.2 602793	TRW 25973 17,2 + WK + Zub
 Bremsscheibe							
1.0	66	07/14→	←			24.0122-0231.1 422231	Ø 257 22 20 V + S
1.0	85	07/14→				24.0122-0241.1 422241	Ø 284 22 20 V + S
1.2	69	07/13→				24.0125-0142.1 425142	Ø 308 25 22 V + S
1.4 LPG	64	07/13→				24.0322-0231.1 522231	Ø 257 22 20 V + S PD
1.4 S	110	11/14→				24.0325-0142.1 525142	Ø 308 25 23 V + S PD
			→			24.0110-0323.1 410323	Ø 264 10 8
						24.0110-0347.1 410347	Ø 264 10 8
1.2	51	10/12→	←	01/13→		24.0122-0231.1 422231	Ø 257 22 20 V + S
1.4	64	10/12→				24.0122-0241.1 422241	Ø 284 22 20 V + S
1.4	74	10/12→				24.0125-0142.1 425142	Ø 308 25 22 V + S
↓							











	kW			 	! #		
OPEL - ADAM 10/12→							
 Bremsscheibe							
1.2	51	10/12→	←	01/13→		24.0322-0231.1 522231	Ø 257 22 20 V + S PD
1.4	64	10/12→				24.0325-0142.1 525142	Ø 308 25 23 V + S PD
1.4	74	10/12→	→	01/13→		24.0110-0323.1 410323	Ø 264 10 8
						24.0110-0347.1 410347	Ø 264 10 8
OPEL - AGILA (A) (H00) 09/00→12/07							
 Bremsbelagsatz, Scheibenbremse							
1.0	44	08/03→12/07	←	→ 07/07		13.0460-3995.2 603995	BOS 23605 15,7 + WK + Zub
1.0 12V	43	09/00→12/07					
1.2 16V	55	09/00→12/07					
1.2 16V Twinport	59	07/04→12/07					
1.3 CDTI	51	08/03→12/07					
 Bremsscheibe							
1.0	44	08/03→12/07	←	→ 3G002367		24.0112-0153.1 412153	Ø 247 12 10,5
1.0 12V	43	09/00→12/07					
1.2 16V	55	09/00→12/07	←	3G002368→; → 07/07		24.0117-0106.1 417106	Ø 253 17 15 V
1.2 16V Twinport	59	07/04→12/07					
1.3 CDTI	51	08/03→12/07					
OPEL - AGILA (B) (H08) 04/08→							
 Bremsbelagsatz, Scheibenbremse							
1.0	48	04/08→	←			13.0460-5700.2 605700	TRW 23973 17,0 + WK
1.0	50	07/11→					
1.0 LPG	48	01/10→					
1.2	63	04/08→					
1.2	69	11/10→					
1.2 LPG	63	04/08→					
1.3 CDTI	55	04/08→					
 Bremsscheibe							
1.0	48	04/08→	←			24.0120-0211.1 420211	Ø 252 20 18 V + S
1.0	50	07/11→					
1.0 LPG	48	01/10→					
1.2	63	04/08→					
1.2	69	11/10→					
1.2 LPG	63	04/08→					
1.3 CDTI	55	04/08→					
OPEL - AMPERA 11/11→							
 Bremsbelagsatz, Scheibenbremse							
EV 150	111	11/11→	←			13.0460-7263.2 607263	24034 19,1 + WK + Zub
			→	+ eFSB		13.0460-7264.2 607264	ATE 25096 17,0 + WK + Zub
						13.0470-7264.2 LD7264	ATE 25096 17,0 + WK + Zub Ceramic
 Bremsscheibe							
EV 150	111	11/11→	←			24.0126-0166.1 426166	Ø 300 26 23 V + S
						24.0326-0166.1 526166	Ø 300 26 23 V + S PD
			→	+ eFSB		24.0112-0189.1 412189	Ø 292 12 10 + S
						24.0312-0189.1 512189	Ø 292 12 10 + S PD
OPEL - ANTARA 05/06→							
 Bremsbelagsatz, Scheibenbremse							
2.0 CDTI	93	03/07→	←			13.0460-5785.2 605785	24510 17,0 + WK
2.0 CDTI	93	09/08→					
2.0 CDTI	125	01/16→	→			13.0460-5788.2 605788	24498 14,7 + WK
2.0 CDTI 4x4	125	01/16→					
2.2 CDTi	120	12/10→					
2.2 CDTi 4x4	120	12/10→					
2.2 CDTi 4x4	135	12/10→					
2.4	103	09/08→					
2.4	123	12/10→					
2.4 4x4	103	01/07→					
2.4 4x4	123	12/10→					
2.4 LPG	103	10/08→					
2.4 LPG 4x4	103	10/08→					
3.2 V6	167	03/07→					
2.0 CDTI	110	05/06→	←	08/06→		13.0460-5785.2 605785	24510 17,0 + WK
			→	08/06→		13.0460-5788.2 605788	24498 14,7 + WK
2.0 CDTI 4x4	110	05/06→	←	07/06→		13.0460-5785.2 605785	24510 17,0 + WK
2.4	104	05/06→					
↓							









	kW			 	! #		
OPEL - ANTARA 05/06→							
 Bremsbelagsatz, Scheibenbremse							
2.0 CDTi 4x4 2.4	110 104	05/06→ 05/06→	➔	07/06→		13.0460-5788.2 605788	24498 14,7 + WK
3.0	190	11/10→	➔	12/10→		13.0460-5785.2 605785	24510 17,0 + WK
			➔	12/10→		13.0460-5788.2 605788	24498 14,7 + WK
Zubehörsatz, Scheibenbremsbelag							
2.0 CDTi	93	03/07→	➔			13.0460-0135.2 610135	
2.0 CDTi	93	09/08→					
2.0 CDTi	125	01/16→					
2.0 CDTi 4x4	125	01/16→					
2.2 CDTi	120	12/10→					
2.2 CDTi 4x4	120	12/10→					
2.2 CDTi 4x4	135	12/10→					
2.4	103	09/08→					
2.4	123	12/10→					
2.4 4x4	103	01/07→					
2.4 4x4	123	12/10→					
2.4 LPG	103	10/08→					
2.4 LPG 4x4	103	10/08→					
3.2 V6	167	03/07→					
2.0 CDTi	110	05/06→	➔	08/06→		13.0460-0135.2 610135	
2.0 CDTi 4x4 2.4	110 104	05/06→ 05/06→	➔	07/06→		13.0460-0135.2 610135	
3.0	190	11/10→	➔	12/10→		13.0460-0135.2 610135	
 Bremsscheibe							
2.0 CDTi	93	03/07→	➔			24.0129-0101.1 429101	Ø 296 29 27,5 V
2.0 CDTi	93	09/08→					
2.0 CDTi	125	01/16→	➔			24.0120-0209.1 420209	Ø 303 20 18,4 V
2.0 CDTi 4x4	125	01/16→					
2.2 CDTi	120	12/10→					
2.2 CDTi 4x4	120	12/10→					
2.2 CDTi 4x4	135	12/10→					
2.4	103	09/08→					
2.4	123	12/10→					
2.4 4x4	103	01/07→					
2.4 4x4	123	12/10→					
2.4 LPG	103	10/08→					
2.4 LPG 4x4	103	10/08→					
3.2 V6	167	03/07→					
2.0 CDTi	110	05/06→	➔	08/06→		24.0129-0101.1 429101	Ø 296 29 27,5 V
			➔	08/06→		24.0120-0209.1 420209	Ø 303 20 18,4 V
2.0 CDTi 4x4 2.4	110 104	05/06→ 05/06→	➔	07/06→		24.0129-0101.1 429101	Ø 296 29 27,5 V
			➔	07/06→		24.0120-0209.1 420209	Ø 303 20 18,4 V
3.0	190	11/10→	➔	12/10→		24.0129-0101.1 429101	Ø 296 29 27,5 V
			➔	12/10→		24.0120-0209.1 420209	Ø 303 20 18,4 V
OPEL - ARENA Bus 01/97→12/01							
 Bremsbelagsatz, Scheibenbremse							
1.9 D 2.5 D	44 55	01/97→12/01 01/97→12/01	➔	03/98→ 09/01		13.0460-3969.2 603969	BDX 20926 18,5 + WK
 Bremsscheibe							
1.9 D 2.5 D	44 55	01/97→12/01 01/97→12/01	➔	03/98→ 09/01		24.0124-0103.1 424103	Ø 252,5 24 22 V
OPEL - ARENA Combi (THB) 03/98→08/01							
 Bremsbelagsatz, Scheibenbremse							
1.9 D 2.5 D	44 55	03/98→08/01 03/98→08/01	➔			13.0460-3969.2 603969	BDX 20926 18,5 + WK
 Bremsscheibe							
1.9 D 2.5 D	44 55	03/98→08/01 03/98→08/01	➔			24.0124-0103.1 424103	Ø 252,5 24 22 V
OPEL - ARENA Kasten 01/97→12/01							
 Bremsbelagsatz, Scheibenbremse							
1.9 D 2.5 D ↓	44 55	01/97→12/01 01/97→12/01	➔	03/98→ 09/01		13.0460-3969.2 603969	BDX 20926 18,5 + WK









	kw					! #		
OPEL - ARENA Kasten 01/97→12/01								
 Bremsscheibe								
1.9 D 2.5 D	44 55	01/97→12/01 01/97→12/01	←	03/98→09/01			24.0124-0103.1 424103	Ø 252,5 24 22 V
OPEL - ARENA Kasten (TB, TF) 03/98→08/01								
 Bremsbelagsatz, Scheibenbremse								
1.9 D 2.5 D	44 55	03/98→08/01 03/98→08/01	←				13.0460-3969.2 603969	BDX 20926 18,5 + WK
 Bremsscheibe								
1.9 D 2.5 D	44 55	03/98→08/01 03/98→08/01	←				24.0124-0103.1 424103	Ø 252,5 24 22 V
OPEL - ASTRA CLASSIC (L48) 01/09→								
 Bremsbelagsatz, Scheibenbremse								
1.3 CDTI 1.6	66 85	01/09→ 01/09→	←	→ 11/10			13.0460-7179.2 607179 13.0470-7179.2 LD7179	ATE 23832 20,2 - WK / + WK ATE 23832 20,2 - WK / + WK Ceramic
			→	→ 11/10			13.0460-2868.2 602868 13.0470-2868.2 LD2868	TRW 23417 15,3 + WK + Zub TRW 23417 15,3 + WK + Zub Ceramic
Warnkontakt, Bremsbelagverschleiß								
1.3 CDTI 1.6	66 85	01/09→ 01/09→	←	→ 11/10	1		24.8190-0720.2 620720	L= 287
 Bremsscheibe								
1.3 CDTI 1.6	66 85	01/09→ 01/09→	←	→ 11/10; Felge Lochzahl: 5			24.0125-0131.1 425131 24.0325-0131.1 525131	Ø 280 24,8 22 V + S Ø 280 24,8 22 V + S PD
			←	→ 11/10; Felge Lochzahl: 4			24.0125-0198.1 425198 24.0325-0198.1 525198	Ø 280 25 22 V + S Ø 280 25 22 V + S PD
			→	→ 11/10; Felge Lochzahl: 5			24.0110-0250.1 410250 24.0310-0250.1 510250	Ø 264 9,8 8 + S Ø 264 9,8 8 + S PD
			→	→ 11/10; Felge Lochzahl: 4			24.0110-0251.1 410251 24.0310-0251.1 510251	Ø 240 9,8 8 + S Ø 240 9,8 8 + S PD
OPEL - ASTRA F (56_, 57_) 09/91→09/98								
 Bremsbelagsatz, Scheibenbremse								
1.4 1.4 i 16V 1.4 Si 1.7 D 1.7 TD 1.7 TDS	60 66 60 44 50 60	09/92→09/98 02/96→09/98 03/92→09/98 07/92→09/98 11/94→09/98 03/92→09/98	←	nicht für Fahrzeuge mit verstärkter Bremse für Fahrzeuge mit verstärkter Bremse			13.0460-7051.2 607051 13.0460-7052.2 607052	ATE 20547 16,5 + WE / - WK ATE 21190 17,5 + WE / - WK
1.4 i	44	09/91→09/98	←	10/91→			13.0460-7051.2 607051	ATE 20547 16,5 + WE / - WK
1.6 1.6 i 1.6 i	55 52 55	09/95→09/98 05/93→07/96 03/92→09/98	←	Motorcode: C16NZ / X16SZR nicht für Motorcode: C16NZ / X16SZR			13.0460-7051.2 607051 13.0460-7052.2 607052	ATE 20547 16,5 + WE / - WK ATE 21190 17,5 + WE / - WK
1.6 i 16V 2.0 i	74 85	08/94→09/98 03/92→09/98	←				13.0460-7052.2 607052	ATE 21190 17,5 + WE / - WK
1.8 i	66	03/92→09/98	←				13.0460-7051.2 607051	ATE 20547 16,5 + WE / - WK
1.8 i 16V 1.8 i 16V 1.8 i 16V 2.0 i 16V	82 85 85 100	09/95→09/96 11/94→09/98 09/95→08/97 02/95→09/98	← ← →				13.0460-7052.2 607052 13.0460-4043.2 604043	ATE 21190 17,5 + WE / - WK ATE 21140 15,0 - WE / - WK
Warnkontakt, Bremsbelagverschleiß								
1.4 1.4 i 16V 1.4 Si 1.7 D 1.7 TD 1.7 TDS	60 66 60 44 50 60	09/92→09/98 02/96→09/98 03/92→09/98 07/92→09/98 11/94→09/98 03/92→09/98	←	für Fahrzeuge mit verstärkter Bremse nicht für Fahrzeuge mit verstärkter Bremse	2		24.8190-0705.2 620705 24.8190-0707.2 620707	L= 670 L= 685
1.4 i	44	09/91→09/98	←	10/91→	2		24.8190-0707.2 620707	L= 685
1.6 1.6 i 1.6 i	55 52 55	09/95→09/98 05/93→07/96 03/92→09/98	←	nicht für Motorcode: C16NZ / X16SZR Motorcode: C16NZ / X16SZR	2		24.8190-0705.2 620705 24.8190-0707.2 620707	L= 670 L= 685
1.6 i 16V 1.8 i 16V 1.8 i 16V 1.8 i 16V 2.0 i ↓	74 82 85 85 85	08/94→09/98 09/95→09/96 11/94→09/98 09/95→08/97 03/92→09/98	←		2		24.8190-0705.2 620705	L= 670

	kw					! #		
OPEL - ASTRA F (56_, 57_) 09/91→09/98								
Warnkontakt, Bremsbelagverschleiß								
2.0 i 16V	100	02/95→09/98	←			2	24.8190-0705.2 620705	L= 670
1.8 i	66	03/92→09/98	←			2	24.8190-0707.2 620707	L= 685
Zubehörsatz, Scheibenbremsbelag								
1.8 i 16V	82	09/95→09/96	→				13.0460-0217.2 610217	ATE
1.8 i 16V	85	11/94→09/98						
1.8 i 16V	85	09/95→08/97						
2.0 i 16V	100	02/95→09/98						
 Bremsscheibe								
1.4	60	09/92→09/98	←				24.0120-0115.1 420115	Ø 236 20 17 V + S
1.6 i 16V	74	08/94→09/98					24.0124-0115.1 424115	Ø 256 24 21 V + S
							24.0320-0115.1 520115	Ø 236 20 17 V + S PD
							24.0324-0115.1 524115	Ø 256 24 21 V + S PD
1.4 i	44	09/91→09/98	←	10/91→			24.0113-0161.1 413161	Ø 236 12,7 9,7 + S
							24.0313-0161.1 513161	Ø 236 12,7 9,7 + S PD
1.4 i 16V	66	02/96→09/98	←	Schaltgetriebe;			24.0113-0161.1 413161	Ø 236 12,7 9,7 + S
1.4 Si	60	03/92→09/98		nicht für Fahrzeuge mit verstärkter Bremse			24.0313-0161.1 513161	Ø 236 12,7 9,7 + S PD
			←	Vollautomatik;			24.0120-0115.1 420115	Ø 236 20 17 V + S
				nicht für Fahrzeuge mit verstärkter Bremse			24.0320-0115.1 520115	Ø 236 20 17 V + S PD
			←	für Fahrzeuge mit verstärkter Bremse			24.0124-0115.1 424115	Ø 256 24 21 V + S
							24.0324-0115.1 524115	Ø 256 24 21 V + S PD
1.6	55	09/95→09/98	←	→ T5000073; Schaltgetriebe			24.0113-0161.1 413161	Ø 236 12,7 9,7 + S
1.6 i	52	05/93→07/96					24.0313-0161.1 513161	Ø 236 12,7 9,7 + S PD
1.6 i	55	03/92→09/98	←	Vollautomatik			24.0120-0115.1 420115	Ø 236 20 17 V + S
							24.0320-0115.1 520115	Ø 236 20 17 V + S PD
			←	T5000074→; Schaltgetriebe			24.0120-0115.1 420115	Ø 236 20 17 V + S
							24.0320-0115.1 520115	Ø 236 20 17 V + S PD
			←				24.0124-0115.1 424115	Ø 256 24 21 V + S
							24.0324-0115.1 524115	Ø 256 24 21 V + S PD
1.7 D	44	07/92→09/98	←	nicht für Fahrzeuge mit verstärkter Bremse			24.0120-0115.1 420115	Ø 236 20 17 V + S
1.7 TD	50	11/94→09/98					24.0320-0115.1 520115	Ø 236 20 17 V + S PD
1.7 TDS	60	03/92→09/98	←	für Fahrzeuge mit verstärkter Bremse			24.0124-0115.1 424115	Ø 256 24 21 V + S
							24.0324-0115.1 524115	Ø 256 24 21 V + S PD
1.8 i	66	03/92→09/98	←				24.0120-0140.1 420140	Ø 256 20 17 V + S
1.8 i 16V	82	09/95→09/96	←				24.0124-0115.1 424115	Ø 256 24 21 V + S
1.8 i 16V	85	11/94→09/98					24.0324-0115.1 524115	Ø 256 24 21 V + S PD
1.8 i 16V	85	09/95→08/97						
2.0 i 16V	100	02/95→09/98	→				24.0110-0204.1 410204	Ø 260 10 8
2.0 i	85	03/92→09/98	←				24.0124-0115.1 424115	Ø 256 24 21 V + S
							24.0324-0115.1 524115	Ø 256 24 21 V + S PD
OPEL - ASTRA F Cabriolet (53_B) 03/93→03/01								
 Bremsbelagsatz, Scheibenbremse								
1.4 i 16V	66	01/96→03/01	←				13.0460-7051.2 607051	ATE 20547 16,5 + WE / - WK
1.4 Si	60	05/93→03/01	←	→ 09/98;			13.0460-7051.2 607051	ATE 20547 16,5 + WE / - WK
				nicht für Fahrzeuge mit verstärkter Bremse				
			←	→ 09/98;			13.0460-7052.2 607052	ATE 21190 17,5 + WE / - WK
				für Fahrzeuge mit verstärkter Bremse				
1.6 i	52	03/93→08/96	←				13.0460-7051.2 607051	ATE 20547 16,5 + WE / - WK
			←	Motorcode: C16NZ / X16SZR			13.0460-7051.2 607051	ATE 20547 16,5 + WE / - WK
1.6 i	55	01/96→03/01	←				13.0460-7051.2 607051	ATE 20547 16,5 + WE / - WK
			←	→ 09/98; Motorcode: C16NZ / X16SZR			13.0460-7051.2 607051	ATE 20547 16,5 + WE / - WK
			←	→ 09/98;			13.0460-7052.2 607052	ATE 21190 17,5 + WE / - WK
				nicht für Motorcode: C16NZ / X16SZR				
1.8 i 16V	85	11/94→03/01	←				13.0460-7052.2 607052	ATE 21190 17,5 + WE / - WK
			←	→ 09/98			13.0460-7052.2 607052	ATE 21190 17,5 + WE / - WK
			→	→ 09/98			13.0460-4043.2 604043	ATE 21140 15,0 - WE / - WK
Warnkontakt, Bremsbelagverschleiß								
1.4 i 16V	66	01/96→03/01	←	→ 09/98;		2	24.8190-0705.2 620705	L= 670
1.4 Si	60	05/93→03/01		für Fahrzeuge mit verstärkter Bremse				
↓								



























	kw			 	! #		
OPEL - ASTRA F Cabriolet (53_B) 03/93→03/01							
Warnkontakt, Bremsbelagverschleiß							
1.4 i 16V 1.4 Si	66 60	01/96→03/01 05/93→03/01	←	→ 09/98; nicht für Fahrzeuge mit verstärkter Bremsen	2	24.8190-0707.2 620707	L= 685
			←		2	24.8190-0707.2 620707	L= 685
1.6 i	52	03/93→08/96	←		2	24.8190-0707.2 620707	L= 685
			←	Motorcode: C16NZ / X16SZR	2	24.8190-0707.2 620707	L= 685
1.6 i	55	01/96→03/01	←	→ 09/98; nicht für Motorcode: C16NZ / X16SZR	2	24.8190-0705.2 620705	L= 670
			←	→ 09/98; Motorcode: C16NZ / X16SZR	2	24.8190-0707.2 620707	L= 685
			←		2	24.8190-0707.2 620707	L= 685
1.8 i 16V	85	11/94→03/01	←		2	24.8190-0705.2 620705	L= 670
			←	→ 09/98	2	24.8190-0705.2 620705	L= 670
Zubehörsatz, Scheibenbremsbelag							
1.8 i 16V	85	11/94→03/01	→	→ 09/98		13.0460-0217.2 610217	ATE
 Bremsscheibe							
1.4 i 16V 1.4 Si	66 60	01/96→03/01 05/93→03/01	←	→ 09/98; Schaltgetriebe; nicht für Fahrzeuge mit verstärkter Bremsen		24.0113-0161.1 413161 24.0313-0161.1 513161	Ø 236 12,7 9,7 + S Ø 236 12,7 9,7 + S PD
			←			24.0120-0115.1 420115 24.0320-0115.1 520115	Ø 236 20 17 V + S Ø 236 20 17 V + S PD
			←	→ 09/98; Vollautomatik; nicht für Fahrzeuge mit verstärkter Bremsen		24.0120-0115.1 420115 24.0320-0115.1 520115	Ø 236 20 17 V + S Ø 236 20 17 V + S PD
			←	→ 09/98; für Fahrzeuge mit verstärkter Bremsen		24.0124-0115.1 424115 24.0324-0115.1 524115	Ø 256 24 21 V + S Ø 256 24 21 V + S PD
1.6 i	52	03/93→08/96	←			24.0120-0115.1 420115 24.0320-0115.1 520115	Ø 236 20 17 V + S Ø 236 20 17 V + S PD
1.6 i	55	01/96→03/01	←			24.0120-0115.1 420115 24.0320-0115.1 520115	Ø 236 20 17 V + S Ø 236 20 17 V + S PD
			←	→ 09/98		24.0124-0115.1 424115 24.0324-0115.1 524115	Ø 256 24 21 V + S Ø 256 24 21 V + S PD
1.8 i 16V	85	11/94→03/01	←			24.0124-0115.1 424115 24.0324-0115.1 524115	Ø 256 24 21 V + S Ø 256 24 21 V + S PD
			←	→ 09/98		24.0124-0115.1 424115 24.0324-0115.1 524115	Ø 256 24 21 V + S Ø 256 24 21 V + S PD
			→	→ 09/98		24.0110-0204.1 410204	Ø 260 10 8
OPEL - ASTRA F Caravan (51_, 52_) 09/91→01/98							
 Bremsbelagsatz, Scheibenbremse							
1.4 1.4 i 16V 1.4 Si	60 66 60	09/92→01/98 02/96→01/98 03/92→01/98	←	nicht für Fahrzeuge mit verstärkter Bremsen		13.0460-7051.2 607051	ATE 20547 16,5 + WE / - WK
1.7 D 1.7 TD 1.7 TDS	44 50 60	07/92→01/98 11/94→01/98 12/91→01/98	←	für Fahrzeuge mit verstärkter Bremsen		13.0460-7052.2 607052	ATE 21190 17,5 + WE / - WK
1.4 i 1.8 i	44 66	09/91→01/98 09/91→01/98	←	10/91→		13.0460-7051.2 607051	ATE 20547 16,5 + WE / - WK
1.6	55	09/95→01/98	←			13.0460-7051.2 607051	ATE 20547 16,5 + WE / - WK
			←	Motorcode: C16NZ / X16SZR		13.0460-7051.2 607051	ATE 20547 16,5 + WE / - WK
			←	nicht für Motorcode: C16NZ / X16SZR		13.0460-7052.2 607052	ATE 21190 17,5 + WE / - WK
1.6 i	52	05/93→07/96	←			13.0460-7051.2 607051	ATE 20547 16,5 + WE / - WK
1.6 i	55	09/91→01/98	←	10/91→; Motorcode: C16NZ / X16SZR		13.0460-7051.2 607051	ATE 20547 16,5 + WE / - WK
			←	10/91→		13.0460-7051.2 607051	ATE 20547 16,5 + WE / - WK
			←	10/91→; nicht für Motorcode: C16NZ / X16SZR		13.0460-7052.2 607052	ATE 21190 17,5 + WE / - WK
1.6 i 16V 2.0 i 16V 2.0 i 16V	74 100 110	08/94→01/98 02/95→01/98 03/93→01/98	←			13.0460-7052.2 607052	ATE 21190 17,5 + WE / - WK
1.8 i 16V 1.8 i 16V	85 92	07/94→01/98 06/93→01/98	←			13.0460-7052.2 607052	ATE 21190 17,5 + WE / - WK
			→			13.0460-4043.2 604043	ATE 21140 15,0 - WE / - WK
Warnkontakt, Bremsbelagverschleiß							
1.4 ↓	60	09/92→01/98	←	für Fahrzeuge mit verstärkter Bremsen	2	24.8190-0705.2 620705	L= 670











	kw			 	! #		
OPEL - ASTRA F Caravan (51_, 52_) 09/91→01/98							
Warnkontakt, Bremsbelagverschleiß							
1.4 i 16V 1.4 Si 1.7 D 1.7 TD 1.7 TDS	66 60 44 50 60	02/96→01/98 03/92→01/98 07/92→01/98 11/94→01/98 12/91→01/98	←	nicht für Fahrzeuge mit verstärkter Bremse	2	24.8190-0707.2 620707	L= 685
1.4 i 1.8 i	44 66	09/91→01/98 09/91→01/98	←	10/91→	2	24.8190-0707.2 620707	L= 685
1.6	55	09/95→01/98	←	nicht für Motorcode: C16NZ / X16SZR	2	24.8190-0705.2 620705	L= 670
			←		2	24.8190-0707.2 620707	L= 685
			←	Motorcode: C16NZ / X16SZR	2	24.8190-0707.2 620707	L= 685
1.6 i	52	05/93→07/96	←		2	24.8190-0707.2 620707	L= 685
1.6 i	55	09/91→01/98	←	10/91→; nicht für Motorcode: C16NZ / X16SZR	2	24.8190-0705.2 620705	L= 670
			←	10/91→; Motorcode: C16NZ / X16SZR	2	24.8190-0707.2 620707	L= 685
			←	10/91→	2	24.8190-0707.2 620707	L= 685
1.6 i 16V 1.8 i 16V 1.8 i 16V 2.0 i 16V 2.0 i 16V	74 85 92 100 110	08/94→01/98 07/94→01/98 06/93→01/98 02/95→01/98 03/93→01/98	←		2	24.8190-0705.2 620705	L= 670
Zubehörsatz, Scheibenbremsbelag							
1.8 i 16V 1.8 i 16V	85 92	07/94→01/98 06/93→01/98	→			13.0460-0217.2 610217	ATE
 Bremsscheibe							
1.4 1.6	60 55	09/92→01/98 09/95→01/98	←			24.0120-0115.1 420115	Ø 236 20 17 V + S
						24.0124-0115.1 424115	Ø 256 24 21 V + S
						24.0320-0115.1 520115	Ø 236 20 17 V + S PD
						24.0324-0115.1 524115	Ø 256 24 21 V + S PD
1.4 i	44	09/91→01/98	←	10/91→		24.0113-0161.1 413161	Ø 236 12,7 9,7 + S
						24.0313-0161.1 513161	Ø 236 12,7 9,7 + S PD
1.4 i 16V 1.4 Si	66 60	02/96→01/98 03/92→01/98	←	Schaltgetriebe; nicht für Fahrzeuge mit verstärkter Bremse		24.0113-0161.1 413161	Ø 236 12,7 9,7 + S
			←	Vollautomatik; nicht für Fahrzeuge mit verstärkter Bremse		24.0313-0161.1 513161	Ø 236 12,7 9,7 + S PD
			←	für Fahrzeuge mit verstärkter Bremse		24.0120-0115.1 420115	Ø 236 20 17 V + S
						24.0320-0115.1 520115	Ø 236 20 17 V + S PD
24.0124-0115.1 424115	Ø 256 24 21 V + S						
24.0324-0115.1 524115	Ø 256 24 21 V + S PD						
1.6 i	52	05/93→07/96	←			24.0120-0115.1 420115	Ø 236 20 17 V + S
						24.0320-0115.1 520115	Ø 236 20 17 V + S PD
1.6 i	55	09/91→01/98	←	10/91→		24.0120-0115.1 420115	Ø 236 20 17 V + S
						24.0124-0115.1 424115	Ø 256 24 21 V + S
						24.0320-0115.1 520115	Ø 236 20 17 V + S PD
						24.0324-0115.1 524115	Ø 256 24 21 V + S PD
1.6 i 16V 2.0 i 16V 2.0 i 16V	74 100 110	08/94→01/98 02/95→01/98 03/93→01/98	←			24.0124-0115.1 424115	Ø 256 24 21 V + S
						24.0324-0115.1 524115	Ø 256 24 21 V + S PD
1.7 D 1.7 TD 1.7 TDS	44 50 60	07/92→01/98 11/94→01/98 12/91→01/98	←	nicht für Fahrzeuge mit verstärkter Bremse		24.0120-0115.1 420115	Ø 236 20 17 V + S
						24.0320-0115.1 520115	Ø 236 20 17 V + S PD
			←	für Fahrzeuge mit verstärkter Bremse		24.0124-0115.1 424115	Ø 256 24 21 V + S
						24.0324-0115.1 524115	Ø 256 24 21 V + S PD
1.8 i	66	09/91→01/98	←	10/91→		24.0120-0140.1 420140	Ø 256 20 17 V + S
1.8 i 16V 1.8 i 16V	85 92	07/94→01/98 06/93→01/98	←			24.0124-0115.1 424115	Ø 256 24 21 V + S
			←			24.0324-0115.1 524115	Ø 256 24 21 V + S PD
			→			24.0110-0204.1 410204	Ø 260 10 8
OPEL - ASTRA F CC (53_, 54_, 58_, 59_) 09/91→01/98							
 Bremsbelagsatz, Scheibenbremse							
1.4 1.4 i 16V 1.4 Si 1.7 D 1.7 TD 1.7 TDS	60 66 60 44 50 60	09/92→01/98 01/96→01/98 03/92→01/98 07/92→01/98 11/94→01/98 12/91→01/98	←	nicht für Fahrzeuge mit verstärkter Bremse		13.0460-7051.2 607051	ATE 20547 16,5 + WE / - WK
			←	für Fahrzeuge mit verstärkter Bremse		13.0460-7052.2 607052	ATE 21190 17,5 + WE / - WK
1.4 i	44	03/92→01/98	←			13.0460-7051.2 607051	ATE 20547 16,5 + WE / - WK
1.6	55	09/95→01/98	←	Motorcode: C16NZ / X16SZR		13.0460-7051.2 607051	ATE 20547 16,5 + WE / - WK
↓							









	kw					! #			
OPEL - ASTRA F CC (53_, 54_, 58_, 59_) 09/91→01/98									
 Bremsbelagsatz, Scheibenbremse									
1.6 i	52	05/93→07/96	←	nicht für Motorcode: C16NZ / X16SZR			13.0460-7052.2 607052	ATE 21190 17,5 + WE / - WK	
1.6 i	55	09/91→01/98	←	10/91→; Motorcode: C16NZ / X16SZR			13.0460-7051.2 607051	ATE 20547 16,5 + WE / - WK	
			←	10/91→; nicht für Motorcode: C16NZ / X16SZR			13.0460-7052.2 607052	ATE 21190 17,5 + WE / - WK	
1.6 i 16V	74	08/94→01/98	←				13.0460-7052.2 607052	ATE 21190 17,5 + WE / - WK	
1.8 i	66	09/91→01/98	←	10/91→			13.0460-7051.2 607051	ATE 20547 16,5 + WE / - WK	
1.8 i 16V 2.0 i 16V	85	09/94→01/98	←				13.0460-7052.2 607052	ATE 21190 17,5 + WE / - WK	
	100	02/95→01/98	→				13.0460-4043.2 604043	ATE 21140 15,0 - WE / - WK	
2.0 GSI 16V	110	09/91→01/98	←	10/91→			13.0460-7052.2 607052	ATE 21190 17,5 + WE / - WK	
			→	10/91→			13.0460-4043.2 604043	ATE 21140 15,0 - WE / - WK	
2.0 i	85	09/91→01/98	←	10/91→			13.0460-7052.2 607052	ATE 21190 17,5 + WE / - WK	
Warnkontakt, Bremsbelagverschleiß									
1.4	60	09/92→01/98	←	für Fahrzeuge mit verstärkter Bremse		2	24.8190-0705.2 620705	L= 670	
1.4 i 16V	66	01/96→01/98	←	nicht für Fahrzeuge mit verstärkter Bremse		2	24.8190-0707.2 620707	L= 685	
1.4 Si	60	03/92→01/98							
1.7 D	44	07/92→01/98							
1.7 TD	50	11/94→01/98							
1.7 TDS	60	12/91→01/98							
1.4 i	44	03/92→01/98	←			2	24.8190-0707.2 620707	L= 685	
1.6	55	09/95→01/98	←	nicht für Motorcode: C16NZ / X16SZR		2	24.8190-0705.2 620705	L= 670	
	52	05/93→07/96	←	Motorcode: C16NZ / X16SZR		2	24.8190-0707.2 620707	L= 685	
1.6 i	55	09/91→01/98	←	10/91→; nicht für Motorcode: C16NZ / X16SZR		2	24.8190-0705.2 620705	L= 670	
			←	10/91→; Motorcode: C16NZ / X16SZR		2	24.8190-0707.2 620707	L= 685	
1.6 i 16V	74	08/94→01/98	←			2	24.8190-0705.2 620705	L= 670	
1.8 i 16V	85	09/94→01/98							
2.0 i 16V	100	02/95→01/98							
1.8 i	66	09/91→01/98	←	10/91→		2	24.8190-0707.2 620707	L= 685	
2.0 GSI 16V	110	09/91→01/98	←	10/91→		2	24.8190-0705.2 620705	L= 670	
2.0 i	85	09/91→01/98							
Zubehörsatz, Scheibenbremsbelag									
1.8 i 16V	85	09/94→01/98	→				13.0460-0217.2 610217	ATE	
2.0 i 16V	100	02/95→01/98							
2.0 GSI 16V	110	09/91→01/98	→	10/91→			13.0460-0217.2 610217	ATE	
 Bremsscheibe									
1.4	60	09/92→01/98	←				24.0120-0115.1 420115	Ø 236 20 17 V + S	
1.6 i 16V	74	08/94→01/98						24.0124-0115.1 424115	Ø 256 24 21 V + S
							24.0320-0115.1 520115	Ø 236 20 17 V + S PD	
							24.0324-0115.1 524115	Ø 256 24 21 V + S PD	
1.4 i	44	03/92→01/98	←				24.0113-0161.1 413161	Ø 236 12,7 9,7 + S	
							24.0313-0161.1 513161	Ø 236 12,7 9,7 + S PD	
1.4 i 16V	66	01/96→01/98	←	Schaltgetriebe; nicht für Fahrzeuge mit verstärkter Bremse			24.0113-0161.1 413161	Ø 236 12,7 9,7 + S	
				60	03/92→01/98	←	Vollautomatik; nicht für Fahrzeuge mit verstärkter Bremse		
←	für Fahrzeuge mit verstärkter Bremse						24.0320-0115.1 520115	Ø 236 20 17 V + S PD	
	1.6	55	09/95→01/98	←	→ T5000073; Schaltgetriebe			24.0124-0115.1 424115	Ø 256 24 21 V + S
52					05/93→07/96	←	Vollautomatik		
	←	T5000074→; Schaltgetriebe					24.0120-0115.1 420115	Ø 236 20 17 V + S	
←					24.0320-0115.1 520115	Ø 236 20 17 V + S PD			
	←				24.0124-0115.1 424115	Ø 256 24 21 V + S			
←					24.0324-0115.1 524115	Ø 256 24 21 V + S PD			
	1.6 i	55	09/91→01/98	←	10/91→; → T5000073; Schaltgetriebe			24.0113-0161.1 413161	Ø 236 12,7 9,7 + S
←					10/91→; Vollautomatik			24.0313-0161.1 513161	Ø 236 12,7 9,7 + S PD
					←	T5000074→; Schaltgetriebe			24.0120-0115.1 420115
←				24.0320-0115.1 520115		Ø 236 20 17 V + S PD			











	kW					! #		
OPEL - ASTRA F CC (53_, 54_, 58_, 59_) 09/91→01/98								
 Bremsscheibe								
1.6 i	55	09/91→01/98	←	T5000074→; Schaltgetriebe			24.0320-0115.1 520115	Ø 236 20 17 V + S PD
			←	10/91→			24.0124-0115.1 424115	Ø 256 24 21 V + S
							24.0324-0115.1 524115	Ø 256 24 21 V + S PD
1.7 D 1.7 TD 1.7 TDS	44 50 60	07/92→01/98 11/94→01/98 12/91→01/98	←	nicht für Fahrzeuge mit verstärkter Bremse			24.0120-0115.1 420115	Ø 236 20 17 V + S
			←	für Fahrzeuge mit verstärkter Bremse			24.0320-0115.1 520115	Ø 236 20 17 V + S PD
							24.0124-0115.1 424115	Ø 256 24 21 V + S
							24.0324-0115.1 524115	Ø 256 24 21 V + S PD
1.8 i	66	09/91→01/98	←	10/91→			24.0120-0140.1 420140	Ø 256 20 17 V + S
1.8 i 16V 2.0 i 16V	85 100	09/94→01/98 02/95→01/98	←				24.0124-0115.1 424115	Ø 256 24 21 V + S
			→				24.0324-0115.1 524115	Ø 256 24 21 V + S PD
							24.0110-0204.1 410204	Ø 260 10 8
2.0 GSI 16V	110	09/91→01/98	←	10/91→			24.0124-0115.1 424115	Ø 256 24 21 V + S
			→				24.0324-0115.1 524115	Ø 256 24 21 V + S PD
							24.0110-0204.1 410204	Ø 260 10 8
2.0 i	85	09/91→01/98	←	10/91→			24.0124-0115.1 424115	Ø 256 24 21 V + S
							24.0324-0115.1 524115	Ø 256 24 21 V + S PD
OPEL - ASTRA F CLASSIC Caravan 01/98→01/05								
 Bremsbelagsatz, Scheibenbremse								
1.4 i 1.6 i	44 55	01/98→01/05	←				13.0460-7051.2 607051	ATE 20547 16,5 + WE / - WK
1.6 i 16V	74	01/98→01/05	←				13.0460-7052.2 607052	ATE 21190 17,5 + WE / - WK
 Bremsscheibe								
1.4 i	44	01/98→01/05	←				24.0113-0161.1 413161	Ø 236 12,7 9,7 + S
1.6 i	55	01/98→01/05	←				24.0120-0115.1 420115	Ø 236 20 17 V + S
1.6 i 16V	74	01/98→01/05	←				24.0124-0115.1 424115	Ø 256 24 21 V + S
OPEL - ASTRA F CLASSIC CC 01/98→08/02								
 Bremsbelagsatz, Scheibenbremse								
1.4 i 1.6 i	44 55	01/98→08/02	←				13.0460-7051.2 607051	ATE 20547 16,5 + WE / - WK
1.6 i 16V	74	01/98→08/02	←				13.0460-7052.2 607052	ATE 21190 17,5 + WE / - WK
Warnkontakt, Bremsbelagverschleiß								
1.4 i 1.6 i 1.6 i 16V	44 55 74	01/98→08/02 01/98→08/02 01/98→08/02	←		2	24.8190-0707.2 620707		L= 685
 Bremsscheibe								
1.4 i	44	01/98→08/02	←				24.0113-0161.1 413161	Ø 236 12,7 9,7 + S
							24.0313-0161.1 513161	Ø 236 12,7 9,7 + S PD
1.6 i	55	01/98→08/02	←				24.0120-0115.1 420115	Ø 236 20 17 V + S
							24.0320-0115.1 520115	Ø 236 20 17 V + S PD
1.6 i 16V	74	01/98→08/02	←				24.0124-0115.1 424115	Ø 256 24 21 V + S
							24.0324-0115.1 524115	Ø 256 24 21 V + S PD
OPEL - ASTRA F CLASSIC Stufenheck 01/98→08/02								
 Bremsbelagsatz, Scheibenbremse								
1.4 i 1.6 i	44 55	01/98→08/02	←				13.0460-7051.2 607051	ATE 20547 16,5 + WE / - WK
1.6 i 16V	74	01/98→08/02	←				13.0460-7052.2 607052	ATE 21190 17,5 + WE / - WK
Warnkontakt, Bremsbelagverschleiß								
1.4 i 1.6 i 1.6 i 16V	44 55 74	01/98→08/02 01/98→08/02 01/98→08/02	←		2	24.8190-0707.2 620707		L= 685
 Bremsscheibe								
1.4 i	44	01/98→08/02	←				24.0113-0161.1 413161	Ø 236 12,7 9,7 + S
							24.0313-0161.1 513161	Ø 236 12,7 9,7 + S PD
1.6 i	55	01/98→08/02	←				24.0120-0115.1 420115	Ø 236 20 17 V + S
							24.0320-0115.1 520115	Ø 236 20 17 V + S PD
1.6 i 16V	74	01/98→08/02	←				24.0124-0115.1 424115	Ø 256 24 21 V + S
↓								







	kw			 	! #		
OPEL - ASTRA F CLASSIC Stufenheck 01/98→08/02							
 Bremsscheibe							
1.6 i 16V	74	01/98→08/02	←			24.0324-0115.1 524115	Ø 256 24 21 V + S PD
OPEL - ASTRA F Van (55_) 10/91→01/99							
 Bremsbelagsatz, Scheibenbremse							
1.4 i	44	10/91→01/99	←	→ 09/98		13.0460-7051.2 607051	ATE 20547 16,5 + WE / - WK
1.6 i	52	02/93→07/96	←			13.0460-7051.2 607051	ATE 20547 16,5 + WE / - WK
			←	Motorcode: C16NZ / X16SZR		13.0460-7051.2 607051	ATE 20547 16,5 + WE / - WK
			←	nicht für Motorcode: C16NZ / X16SZR		13.0460-7052.2 607052	ATE 21190 17,5 + WE / - WK
1.6 i 16V	74	08/94→03/98	←			13.0460-7052.2 607052	ATE 21190 17,5 + WE / - WK
1.7 D 1.7 TD	44 50	07/92→01/99 08/94→01/99	←	→ 09/98; nicht für Fahrzeuge mit verstärkter Bremsen		13.0460-7051.2 607051	ATE 20547 16,5 + WE / - WK
			←	→ 09/98; für Fahrzeuge mit verstärkter Bremsen		13.0460-7052.2 607052	ATE 21190 17,5 + WE / - WK
1.7 TD	60	03/95→02/98	←	nicht für Fahrzeuge mit verstärkter Bremsen		13.0460-7051.2 607051	ATE 20547 16,5 + WE / - WK
			←	für Fahrzeuge mit verstärkter Bremsen		13.0460-7052.2 607052	ATE 21190 17,5 + WE / - WK
Warnkontakt, Bremsbelagverschleiß							
1.4 i	44	10/91→01/99	←	→ 09/98	2	24.8190-0707.2 620707	L= 685
1.6 i	52	02/93→07/96	←	nicht für Motorcode: C16NZ / X16SZR	2	24.8190-0705.2 620705	L= 670
			←		2	24.8190-0707.2 620707	L= 685
			←	Motorcode: C16NZ / X16SZR	2	24.8190-0707.2 620707	L= 685
1.6 i 16V	74	08/94→03/98	←		2	24.8190-0705.2 620705	L= 670
1.7 D 1.7 TD	44 50	07/92→01/99 08/94→01/99	←	→ 09/98; für Fahrzeuge mit verstärkter Bremsen	2	24.8190-0705.2 620705	L= 670
			←	→ 09/98; nicht für Fahrzeuge mit verstärkter Bremsen	2	24.8190-0707.2 620707	L= 685
1.7 TD	60	03/95→02/98	←	für Fahrzeuge mit verstärkter Bremsen	2	24.8190-0705.2 620705	L= 670
			←	nicht für Fahrzeuge mit verstärkter Bremsen	2	24.8190-0707.2 620707	L= 685
 Bremsscheibe							
1.4 i	44	10/91→01/99	←	→ 09/98		24.0113-0161.1 413161	Ø 236 12,7 9,7 + S
						24.0313-0161.1 513161	Ø 236 12,7 9,7 + S PD
1.6 i	52	02/93→07/96	←			24.0120-0115.1 420115	Ø 236 20 17 V + S
						24.0124-0115.1 424115	Ø 256 24 21 V + S
						24.0320-0115.1 520115	Ø 236 20 17 V + S PD
						24.0324-0115.1 524115	Ø 256 24 21 V + S PD
1.6 i 16V	74	08/94→03/98	←			24.0124-0115.1 424115	Ø 256 24 21 V + S
						24.0324-0115.1 524115	Ø 256 24 21 V + S PD
1.7 D 1.7 TD	44 50	07/92→01/99 08/94→01/99	←	→ 09/98; nicht für Fahrzeuge mit verstärkter Bremsen		24.0120-0115.1 420115	Ø 236 20 17 V + S
						24.0320-0115.1 520115	Ø 236 20 17 V + S PD
1.7 TD	60	03/95→02/98	←	→ 09/98; für Fahrzeuge mit verstärkter Bremsen		24.0124-0115.1 424115	Ø 256 24 21 V + S
						24.0324-0115.1 524115	Ø 256 24 21 V + S PD
						24.0120-0115.1 420115	Ø 236 20 17 V + S
			←	für Fahrzeuge mit verstärkter Bremsen		24.0320-0115.1 520115	Ø 236 20 17 V + S PD
			←	für Fahrzeuge mit verstärkter Bremsen		24.0124-0115.1 424115	Ø 256 24 21 V + S
						24.0324-0115.1 524115	Ø 256 24 21 V + S PD
OPEL - ASTRA G Cabriolet (F67) 03/01→10/05							
 Bremsbelagsatz, Scheibenbremse							
1.6 1.6 16V	76 74	01/03→10/05 03/01→10/05	←			13.0460-7115.2 607115	ATE 23063 17,5 ohne integrierten Verschleiß- sensor / + WK
					13.0470-7115.2 LD7115	ATE 23063 17,5 - WK / + WK Ceramic	
						13.0460-2868.2 602868	TRW 23417 15,3 + WK + Zub
						13.0460-3976.2 603976	BOS 23258 16,5 + WK + Zub
						13.0470-2868.2 LD2868	TRW 23417 15,3 + WK + Zub Ceramic
↓							









	kw			 	! #				
OPEL - ASTRA G Cabriolet (F67) 03/01→10/05									
 Bremsbelagsatz, Scheibenbremse									
1.8 16V	92	03/01→10/05	←	- ABS		13.0460-7115.2 607115	ATE 23063 17,5 ohne integrierten Verschleißsensor / + WK		
						13.0470-7115.2 LD7115	ATE 23063 17,5 - WK / + WK Ceramic		
			←	+ ABS		13.0460-7116.2 607116	ATE 23057 20,2 - WK / + WK		
						13.0470-7116.2 LD7116	ATE 23057 20,2 - WK / + WK Ceramic		
			→			13.0460-2868.2 602868	TRW 23417 15,3 + WK + Zub		
						13.0460-3976.2 603976	BOS 23258 16,5 + WK + Zub		
						13.0470-2868.2 LD2868	TRW 23417 15,3 + WK + Zub Ceramic		
2.0 16V Turbo 2.0 OPC	147 141	11/02→10/05 03/02→10/05	←			13.0460-7173.2 607173	ATE 21829 20,3 - WK / + WK		
			→			13.0460-2868.2 602868	TRW 23417 15,3 + WK + Zub		
						13.0460-3976.2 603976	BOS 23258 16,5 + WK + Zub		
						13.0470-2868.2 LD2868	TRW 23417 15,3 + WK + Zub Ceramic		
2.2 16V 2.2 DTI	108 92	03/01→10/05 09/02→10/05	←			13.0460-7116.2 607116	ATE 23057 20,2 - WK / + WK		
						13.0470-7116.2 LD7116	ATE 23057 20,2 - WK / + WK Ceramic		
			→			13.0460-2868.2 602868	TRW 23417 15,3 + WK + Zub		
						13.0460-3976.2 603976	BOS 23258 16,5 + WK + Zub		
						13.0470-2868.2 LD2868	TRW 23417 15,3 + WK + Zub Ceramic		
Warnkontakt, Bremsbelagverschleiß									
1.6 1.6 16V	76 74	01/03→10/05 03/01→10/05	←	42187759→	2	24.8190-0018.2 620018	L= 755		
2.0 16V Turbo 2.0 OPC	147 141	11/02→10/05 03/02→10/05	←	→ 42187758	2	24.8190-0718.2 620718	L= 720		
2.2 16V	108	03/01→10/05							
2.2 DTI	92	09/02→10/05							
1.8 16V	92	03/01→10/05	←	+ ABS; 42187759→	2	24.8190-0018.2 620018	L= 755		
			←	- ABS; 42187759→	2	24.8190-0018.2 620018	L= 755		
			←	- ABS; → 42187758	2	24.8190-0718.2 620718	L= 720		
			←	+ ABS; → 42187758	2	24.8190-0718.2 620718	L= 720		
 Bremsscheibe									
1.6 1.6 16V	76 74	01/03→10/05 03/01→10/05	←	Felge Lochzahl: 4		24.0124-0152.1 424152	Ø 256 23,8 21 V + S		
						24.0324-0152.1 524152	Ø 256 23,8 21 V + S PD		
			→	Felge Lochzahl: 4		24.0110-0251.1 410251	Ø 240 9,8 8 + S		
						24.0310-0251.1 510251	Ø 240 9,8 8 + S PD		
1.8 16V	92	03/01→10/05	←	- ABS; Felge Lochzahl: 4		24.0124-0152.1 424152	Ø 256 23,8 21 V + S		
						24.0324-0152.1 524152	Ø 256 23,8 21 V + S PD		
			←	+ ABS; Felge Lochzahl: 5		24.0125-0131.1 425131	Ø 280 24,8 22 V + S		
						24.0325-0131.1 525131	Ø 280 24,8 22 V + S PD		
			→	+ ABS; Felge Lochzahl: 5		24.0110-0250.1 410250	Ø 264 9,8 8 + S		
						24.0310-0250.1 510250	Ø 264 9,8 8 + S PD		
			→	- ABS; Felge Lochzahl: 4		24.0110-0251.1 410251	Ø 240 9,8 8 + S		
						24.0310-0251.1 510251	Ø 240 9,8 8 + S PD		
2.0 16V Turbo 2.0 OPC	147 141	11/02→10/05 03/02→10/05	←			24.0125-0142.1 425142	Ø 308 25 22 V + S		
						24.0325-0142.1 525142	Ø 308 25 23 V + S PD		
			→	Felge Lochzahl: 5		24.0110-0250.1 410250	Ø 264 9,8 8 + S		
						24.0310-0250.1 510250	Ø 264 9,8 8 + S PD		
2.2 16V 2.2 DTI	108 92	03/01→10/05 09/02→10/05	←	Felge Lochzahl: 5		24.0125-0131.1 425131	Ø 280 24,8 22 V + S		
						24.0325-0131.1 525131	Ø 280 24,8 22 V + S PD		
			→	Felge Lochzahl: 5		24.0110-0250.1 410250	Ø 264 9,8 8 + S		
						24.0310-0250.1 510250	Ø 264 9,8 8 + S PD		
OPEL - ASTRA G Caravan (F35_) 02/98→12/09									
 Bremsbelagsatz, Scheibenbremse									
1.2 16V 1.6 1.6 16V 1.7 TD ↓	48 55 74 50	02/98→09/00 02/98→09/00 02/98→07/04 02/98→08/00	←	04/98→		13.0460-7115.2 607115	ATE 23063 17,5 ohne integrierten Verschleißsensor / + WK		









	kw			 	! #		
OPEL - ASTRA G Caravan (F35_) 02/98→12/09							
 Bremsbelagsatz, Scheibenbremse							
1.2 16V 1.6 1.6 16V 1.7 TD	48 55 74 50	02/98→09/00 02/98→09/00 02/98→07/04 02/98→08/00	← ← → →	04/98→ 04/98→ 		13.0470-7115.2 LD7115 13.0460-2868.2 602868 13.0460-3976.2 603976 13.0470-2868.2 LD2868	ATE 23063 17,5 - WK / + WK Ceramic TRW 23417 15,3 + WK + Zub BOS 23258 16,5 + WK + Zub TRW 23417 15,3 + WK + Zub Ceramic
1.2 16V 1.4 16V 1.6 1.6 1.7 CDTI 1.7 DTI 16V	55 66 62 76 59 55	09/00→07/04 06/98→07/04 09/00→07/04 12/02→07/09 04/03→07/09 02/00→07/04	← ← ← ← → →	 		13.0460-7115.2 607115 13.0470-7115.2 LD7115 13.0460-2868.2 602868 13.0460-3976.2 603976 13.0470-2868.2 LD2868	ATE 23063 17,5 ohne integrierten Verschleißsensor / + WK ATE 23063 17,5 - WK / + WK Ceramic TRW 23417 15,3 + WK + Zub BOS 23258 16,5 + WK + Zub TRW 23417 15,3 + WK + Zub Ceramic
1.4	66	10/04→12/09	← →	09/07→ 09/07→		13.0460-7115.2 607115 13.0470-7115.2 LD7115 13.0460-2868.2 602868 13.0460-3976.2 603976 13.0470-2868.2 LD2868	ATE 23063 17,5 ohne integrierten Verschleißsensor / + WK ATE 23063 17,5 - WK / + WK Ceramic TRW 23417 15,3 + WK + Zub BOS 23258 16,5 + WK + Zub TRW 23417 15,3 + WK + Zub Ceramic
1.6 CNG 2.0 DTI 16V 2.2 16V 2.2 DTI 2.2 DTI	71 74 108 86 92	03/03→07/04 08/99→07/04 03/01→07/04 09/02→07/04 09/02→07/04	← ← ← → →	 		13.0460-7116.2 607116 13.0470-7116.2 LD7116 13.0460-2868.2 602868 13.0460-3976.2 603976 13.0470-2868.2 LD2868	ATE 23057 20,2 - WK / + WK ATE 23057 20,2 - WK / + WK Ceramic TRW 23417 15,3 + WK + Zub BOS 23258 16,5 + WK + Zub TRW 23417 15,3 + WK + Zub Ceramic
1.8 16V	85	02/98→09/00	← ← →	04/98→; - ABS 04/98→; + ABS 04/98→		13.0460-7115.2 607115 13.0470-7115.2 LD7115 13.0460-7116.2 607116 13.0470-7116.2 LD7116 13.0460-2868.2 602868 13.0460-3976.2 603976 13.0470-2868.2 LD2868	ATE 23063 17,5 ohne integrierten Verschleißsensor / + WK ATE 23063 17,5 - WK / + WK Ceramic ATE 23057 20,2 - WK / + WK ATE 23057 20,2 - WK / + WK Ceramic TRW 23417 15,3 + WK + Zub BOS 23258 16,5 + WK + Zub TRW 23417 15,3 + WK + Zub Ceramic
1.8 16V	92	09/00→07/04	← ← →	- ABS + ABS 		13.0460-7115.2 607115 13.0470-7115.2 LD7115 13.0460-7116.2 607116 13.0470-7116.2 LD7116 13.0460-2868.2 602868 13.0460-3976.2 603976 13.0470-2868.2 LD2868	ATE 23063 17,5 ohne integrierten Verschleißsensor / + WK ATE 23063 17,5 - WK / + WK Ceramic ATE 23057 20,2 - WK / + WK ATE 23057 20,2 - WK / + WK Ceramic TRW 23417 15,3 + WK + Zub BOS 23258 16,5 + WK + Zub TRW 23417 15,3 + WK + Zub Ceramic
2.0 16V	100	02/98→07/04	← →	04/98→ 04/98→		13.0460-7116.2 607116 13.0470-7116.2 LD7116 13.0460-2868.2 602868 13.0460-3976.2 603976 13.0470-2868.2 LD2868	ATE 23057 20,2 - WK / + WK ATE 23057 20,2 - WK / + WK Ceramic TRW 23417 15,3 + WK + Zub BOS 23258 16,5 + WK + Zub TRW 23417 15,3 + WK + Zub Ceramic
2.0 DI	60	02/98→07/04	← ←	04/98→ 04/98→; + ABS		13.0460-7115.2 607115 13.0470-7115.2 LD7115 13.0460-7116.2 607116	ATE 23063 17,5 ohne integrierten Verschleißsensor / + WK ATE 23063 17,5 - WK / + WK Ceramic ATE 23057 20,2 - WK / + WK
↓							







	kw			 	! #		
OPEL - ASTRA G Caravan (F35_) 02/98→12/09							
 Bremsbelagsatz, Scheibenbremse							
2.0 DI	60	02/98→07/04	←	04/98→; + ABS		13.0470-7116.2 LD7116	ATE 23057 20,2 - WK / + WK Ceramic
			→	04/98→		13.0460-2868.2 602868	TRW 23417 15,3 + WK + Zub
						13.0460-3976.2 603976	BOS 23258 16,5 + WK + Zub
						13.0470-2868.2 LD2868	TRW 23417 15,3 + WK + Zub Ceramic
2.0 OPC	141	09/02→07/04	←			13.0460-7173.2 607173	ATE 21829 20,3 - WK / + WK
2.0 OPC	147	11/02→07/04	→			13.0460-2868.2 602868	TRW 23417 15,3 + WK + Zub
						13.0460-3976.2 603976	BOS 23258 16,5 + WK + Zub
						13.0470-2868.2 LD2868	TRW 23417 15,3 + WK + Zub Ceramic
Warnkontakt, Bremsbelagverschleiß							
1.2 16V	48	02/98→09/00	←	04/98→; 42187759→	2	24.8190-0018.2 620018	L= 755
1.6	55	02/98→09/00					
1.6 16V	74	02/98→07/04	←	04/98→; → 42187758	2	24.8190-0718.2 620718	L= 720
1.7 TD	50	02/98→08/00					
2.0 16V	100	02/98→07/04					
1.2 16V	55	09/00→07/04	←	42187759→	2	24.8190-0018.2 620018	L= 755
1.4 16V	66	06/98→07/04					
1.6	62	09/00→07/04	←	→ 42187758	2	24.8190-0718.2 620718	L= 720
1.6	76	12/02→07/09					
1.6 CNG	71	03/03→07/04					
1.7 CDTI	59	04/03→07/09					
1.7 DTI 16V	55	02/00→07/04					
2.0 DTI 16V	74	08/99→07/04					
2.0 OPC	141	09/02→07/04					
2.0 OPC	147	11/02→07/04					
2.2 16V	108	03/01→07/04					
2.2 DTI	86	09/02→07/04					
2.2 DTI	92	09/02→07/04					
1.4	66	10/04→12/09	←	09/07→; 42187759→	2	24.8190-0018.2 620018	L= 755
			←	09/07→; → 42187758	2	24.8190-0718.2 620718	L= 720
1.8 16V	85	02/98→09/00	←	04/98→; - ABS; 42187759→	2	24.8190-0018.2 620018	L= 755
			←	04/98→; + ABS; 42187759→	2	24.8190-0018.2 620018	L= 755
			←	04/98→; + ABS; → 42187758	2	24.8190-0718.2 620718	L= 720
			←	04/98→; - ABS; → 42187758	2	24.8190-0718.2 620718	L= 720
1.8 16V	92	09/00→07/04	←	+ ABS; 42187759→	2	24.8190-0018.2 620018	L= 755
			←	- ABS; 42187759→	2	24.8190-0018.2 620018	L= 755
			←	- ABS; → 42187758	2	24.8190-0718.2 620718	L= 720
			←	+ ABS; → 42187758	2	24.8190-0718.2 620718	L= 720
2.0 DI	60	02/98→07/04	←	04/98→; 42187759→	2	24.8190-0018.2 620018	L= 755
			←	04/98→; + ABS; 42187759→	2	24.8190-0018.2 620018	L= 755
			←	04/98→; + ABS; → 42187758	2	24.8190-0718.2 620718	L= 720
			←	04/98→; → 42187758	2	24.8190-0718.2 620718	L= 720
 Bremsscheibe							
1.2 16V	48	02/98→09/00	←	04/98→; → 18999999; für Fahrzeuge mit Trommelbremse an der Hinterachse		24.0111-0141.1 411141	Ø 256 10,8 8
			←	04/98→; → 18999999; für Fahrzeuge mit Scheibenbremse an der Hinterachse; Felge Lochzahl: 4		24.0311-0141.1 511141	Ø 256 10,8 8 PD
			←	22000001→; Felge Lochzahl: 4		24.0124-0152.1 424152	Ø 256 23,8 21 V + S
			←			24.0324-0152.1 524152	Ø 256 23,8 21 V + S PD
			→	04/98→; Felge Lochzahl: 4		24.0124-0152.1 424152	Ø 256 23,8 21 V + S
						24.0324-0152.1 524152	Ø 256 23,8 21 V + S PD
						24.0110-0251.1 410251	Ø 240 9,8 8 + S
						24.0310-0251.1 510251	Ø 240 9,8 8 + S PD
1.2 16V	55	09/00→07/04	←	→ 18999999; für Fahrzeuge mit Trommelbremse an der Hinterachse		24.0111-0141.1 411141	Ø 256 10,8 8
			←	22000001→; Felge Lochzahl: 4		24.0311-0141.1 511141	Ø 256 10,8 8 PD
			←			24.0124-0152.1 424152	Ø 256 23,8 21 V + S
			←			24.0324-0152.1 524152	Ø 256 23,8 21 V + S PD
			←	→ 18999999; für Fahrzeuge mit Scheibenbremse an der Hinterachse; Felge Lochzahl: 4		24.0124-0152.1 424152	Ø 256 23,8 21 V + S
			←			24.0324-0152.1 524152	Ø 256 23,8 21 V + S PD
			→	Felge Lochzahl: 4		24.0110-0251.1 410251	Ø 240 9,8 8 + S
						24.0310-0251.1 510251	Ø 240 9,8 8 + S PD
↓							













	kw			 	! #		
OPEL - ASTRA G Caravan (F35_) 02/98→12/09							
Bremsscheibe							
1.4	66	10/04→12/09	←	09/07→; Felge Lochzahl: 4	24.0124-0152.1	424152	Ø 256 23,8 21 V + S
			→	09/07→; Felge Lochzahl: 4	24.0324-0152.1	524152	Ø 256 23,8 21 V + S PD
1.4 16V 1.7 CDTI 1.7 DTI 16V	66 59 55	06/98→07/04 04/03→07/09 02/00→07/04	←	Felge Lochzahl: 4	24.0124-0152.1	424152	Ø 256 23,8 21 V + S
			→	Felge Lochzahl: 4	24.0324-0152.1	524152	Ø 256 23,8 21 V + S PD
1.6	55	02/98→09/00	←	04/98→; Felge Lochzahl: 4	24.0124-0152.1	424152	Ø 256 23,8 21 V + S
			←	04/98→; Felge Lochzahl: 5	24.0125-0131.1	425131	Ø 280 24,8 22 V + S
			→	04/98→; Felge Lochzahl: 4	24.0325-0131.1	525131	Ø 280 24,8 22 V + S PD
1.6 1.6	62 76	09/00→07/04 12/02→07/09	←	Felge Lochzahl: 4	24.0110-0251.1	410251	Ø 240 9,8 8 + S
			←	Felge Lochzahl: 5	24.0310-0251.1	510251	Ø 240 9,8 8 + S PD
			→	Felge Lochzahl: 4	24.0124-0152.1	424152	Ø 256 23,8 21 V + S
1.6 16V	74	02/98→07/04	←	04/98→; Felge Lochzahl: 4	24.0324-0152.1	524152	Ø 256 23,8 21 V + S PD
			←	04/98→; Felge Lochzahl: 5	24.0125-0131.1	425131	Ø 280 24,8 22 V + S
			→	04/98→; Felge Lochzahl: 5	24.0325-0131.1	525131	Ø 280 24,8 22 V + S PD
1.6 CNG 2.0 DTI 16V 2.2 16V 2.2 DTI 2.2 DTI	71 74 108 86 92	03/03→07/04 08/99→07/04 03/01→07/04 09/02→07/04 09/02→07/04	←	Felge Lochzahl: 5	24.0110-0250.1	410250	Ø 264 9,8 8 + S
			←	Felge Lochzahl: 5	24.0310-0250.1	510250	Ø 264 9,8 8 + S PD
			→	Felge Lochzahl: 5	24.0124-0152.1	424152	Ø 256 23,8 21 V + S
1.7 TD	50	02/98→08/00	←	04/98→; Felge Lochzahl: 4	24.0324-0152.1	524152	Ø 256 23,8 21 V + S PD
			→	04/98→; Felge Lochzahl: 4	24.0110-0251.1	410251	Ø 240 9,8 8 + S
1.8 16V 2.0 DI	85 60	02/98→09/00 02/98→07/04	←	04/98→; - ABS; Felge Lochzahl: 4	24.0310-0251.1	510251	Ø 240 9,8 8 + S PD
			←	04/98→; + ABS; Felge Lochzahl: 5	24.0124-0152.1	424152	Ø 256 23,8 21 V + S
			→	04/98→; + ABS; Felge Lochzahl: 5	24.0324-0152.1	524152	Ø 256 23,8 21 V + S PD
1.8 16V	92	09/00→07/04	←	- ABS; Felge Lochzahl: 4	24.0125-0131.1	425131	Ø 280 24,8 22 V + S
			←	+ ABS; Felge Lochzahl: 5	24.0325-0131.1	525131	Ø 280 24,8 22 V + S PD
			→	+ ABS; Felge Lochzahl: 5	24.0110-0250.1	410250	Ø 264 9,8 8 + S
2.0 16V	100	02/98→07/04	←	04/98→; Felge Lochzahl: 5	24.0310-0250.1	510250	Ø 264 9,8 8 + S PD
			←	04/98→; - ABS; Felge Lochzahl: 4	24.0110-0251.1	410251	Ø 240 9,8 8 + S
			→	04/98→; - ABS; Felge Lochzahl: 4	24.0310-0251.1	510251	Ø 240 9,8 8 + S PD
2.0 OPC 2.0 OPC	141 147	09/02→07/04 11/02→07/04	←	Felge Lochzahl: 5	24.0125-0142.1	425142	Ø 308 25 22 V + S
			→	Felge Lochzahl: 5	24.0325-0142.1	525142	Ø 308 25 23 V + S PD
			→	Felge Lochzahl: 5	24.0110-0250.1	410250	Ø 264 9,8 8 + S
					24.0310-0250.1	510250	Ø 264 9,8 8 + S PD











	kw			 	! #		
OPEL - ASTRA G CC (F48_, F08_) 02/98→12/09							
 Bremsbelagsatz, Scheibenbremse							
1.2 16V 1.4 16V 1.6 1.6 16V 1.7 TD	48 66 55 74 50	02/98→09/00 02/98→01/05 02/98→09/00 02/98→01/05 02/98→08/00	← →	04/98→ 04/98→		13.0460-7115.2 607115 13.0470-7115.2 LD7115	ATE 23063 17,5 ohne integrierten Verschleiß- sensor / + WK ATE 23063 17,5 - WK / + WK Ceramic
1.2 16V 1.4 1.6 1.6 1.7 CDTI 1.7 DTI 16V	55 66 62 76 59 55	09/00→01/05 09/07→12/09 09/00→01/05 12/02→12/09 04/03→12/09 02/00→01/05	← →			13.0460-7115.2 607115 13.0470-7115.2 LD7115 13.0460-2868.2 602868 13.0460-3976.2 603976 13.0470-2868.2 LD2868	ATE 23063 17,5 ohne integrierten Verschleiß- sensor / + WK ATE 23063 17,5 - WK / + WK Ceramic TRW 23417 15,3 + WK + Zub BOS 23258 16,5 + WK + Zub TRW 23417 15,3 + WK + Zub Ceramic
1.8 16V	85	02/98→09/00	← ← →	04/98→; - ABS 04/98→; + ABS 04/98→		13.0460-7115.2 607115 13.0470-7115.2 LD7115 13.0460-7116.2 607116 13.0470-7116.2 LD7116 13.0460-2868.2 602868 13.0460-3976.2 603976 13.0470-2868.2 LD2868	ATE 23063 17,5 ohne integrierten Verschleiß- sensor / + WK ATE 23063 17,5 - WK / + WK Ceramic ATE 23057 20,2 - WK / + WK ATE 23057 20,2 - WK / + WK Ceramic TRW 23417 15,3 + WK + Zub BOS 23258 16,5 + WK + Zub TRW 23417 15,3 + WK + Zub Ceramic
1.8 16V	92	09/00→01/05	← ← →	- ABS + ABS		13.0460-7115.2 607115 13.0470-7115.2 LD7115 13.0460-7116.2 607116 13.0470-7116.2 LD7116 13.0460-2868.2 602868 13.0460-3976.2 603976 13.0470-2868.2 LD2868	ATE 23063 17,5 ohne integrierten Verschleiß- sensor / + WK ATE 23063 17,5 - WK / + WK Ceramic ATE 23057 20,2 - WK / + WK ATE 23057 20,2 - WK / + WK Ceramic TRW 23417 15,3 + WK + Zub BOS 23258 16,5 + WK + Zub TRW 23417 15,3 + WK + Zub Ceramic
2.0 16V	100	02/98→01/05	← →	04/98→ 04/98→		13.0460-7116.2 607116 13.0470-7116.2 LD7116 13.0460-2868.2 602868 13.0460-3976.2 603976 13.0470-2868.2 LD2868	ATE 23057 20,2 - WK / + WK ATE 23057 20,2 - WK / + WK Ceramic TRW 23417 15,3 + WK + Zub BOS 23258 16,5 + WK + Zub TRW 23417 15,3 + WK + Zub Ceramic
2.0 16V OPC 2.0 OPC 2.0 OPC	118 141 147	11/99→09/02 09/02→01/05 11/02→01/05	← →			13.0460-7173.2 607173 13.0460-2868.2 602868 13.0460-3976.2 603976 13.0470-2868.2 LD2868	ATE 21829 20,3 - WK / + WK TRW 23417 15,3 + WK + Zub BOS 23258 16,5 + WK + Zub TRW 23417 15,3 + WK + Zub Ceramic
2.0 DI	60	02/98→01/05	← ← →	04/98→ 04/98→; + ABS 04/98→		13.0460-7115.2 607115 13.0470-7115.2 LD7115 13.0460-7116.2 607116 13.0470-7116.2 LD7116 13.0460-2868.2 602868 13.0460-3976.2 603976 13.0470-2868.2 LD2868	ATE 23063 17,5 ohne integrierten Verschleiß- sensor / + WK ATE 23063 17,5 - WK / + WK Ceramic ATE 23057 20,2 - WK / + WK ATE 23057 20,2 - WK / + WK Ceramic TRW 23417 15,3 + WK + Zub BOS 23258 16,5 + WK + Zub TRW 23417 15,3 + WK + Zub Ceramic
2.0 DTI 16V 2.2 DTI 2.2 DTI ↓	74 86 92	08/99→01/05 09/02→01/05 09/02→01/05	←			13.0460-7116.2 607116	ATE 23057 20,2 - WK / + WK







	kw			 	! #		
OPEL - ASTRA G CC (F48_, F08_) 02/98→12/09							
 Bremsbelagsatz, Scheibenbremse							
2.0 DTI 16V	74	08/99→01/05	←			13.0470-7116.2 LD7116	ATE 23057 20,2 - WK / + WK Ceramic
2.2 DTI	86	09/02→01/05					
2.2 DTI	92	09/02→01/05	→			13.0460-2868.2 602868	TRW 23417 15,3 + WK + Zub
						13.0460-3976.2 603976	BOS 23258 16,5 + WK + Zub
						13.0470-2868.2 LD2868	TRW 23417 15,3 + WK + Zub Ceramic
2.2 16V	108	06/00→01/05	←	09/00→		13.0460-7116.2 607116	ATE 23057 20,2 - WK / + WK Ceramic
						13.0470-7116.2 LD7116	ATE 23057 20,2 - WK / + WK Ceramic
			→	09/00→		13.0460-2868.2 602868	TRW 23417 15,3 + WK + Zub
						13.0460-3976.2 603976	BOS 23258 16,5 + WK + Zub
						13.0470-2868.2 LD2868	TRW 23417 15,3 + WK + Zub Ceramic
Warnkontakt, Bremsbelagverschleiß							
1.2 16V	48	02/98→09/00	←	04/98→; 42187759→	2	24.8190-0018.2 620018	L= 755
1.4 16V	66	02/98→01/05					
1.6	55	02/98→09/00	←	04/98→; → 42187758	2	24.8190-0718.2 620718	L= 720
1.6 16V	74	02/98→01/05					
1.7 TD	50	02/98→08/00					
2.0 16V	100	02/98→01/05					
1.2 16V	55	09/00→01/05	←	42187759→	2	24.8190-0018.2 620018	L= 755
1.4	66	09/07→12/09					
1.6	62	09/00→01/05	←	→ 42187758	2	24.8190-0718.2 620718	L= 720
1.6	76	12/02→12/09					
1.7 CDTI	59	04/03→12/09					
1.7 DTI 16V	55	02/00→01/05					
2.0 16V OPC	118	11/99→09/02					
2.0 DTI 16V	74	08/99→01/05					
2.0 OPC	141	09/02→01/05					
2.0 OPC	147	11/02→01/05					
2.2 DTI	86	09/02→01/05					
2.2 DTI	92	09/02→01/05					
1.8 16V	85	02/98→09/00	←	04/98→; - ABS; 42187759→	2	24.8190-0018.2 620018	L= 755
			←	04/98→; + ABS; 42187759→	2	24.8190-0018.2 620018	L= 755
			←	04/98→; + ABS; → 42187758	2	24.8190-0718.2 620718	L= 720
			←	04/98→; - ABS; → 42187758	2	24.8190-0718.2 620718	L= 720
1.8 16V	92	09/00→01/05	←	+ ABS; 42187759→	2	24.8190-0018.2 620018	L= 755
			←	- ABS; 42187759→	2	24.8190-0018.2 620018	L= 755
			←	- ABS; → 42187758	2	24.8190-0718.2 620718	L= 720
			←	+ ABS; → 42187758	2	24.8190-0718.2 620718	L= 720
2.0 DI	60	02/98→01/05	←	04/98→; 42187759→	2	24.8190-0018.2 620018	L= 755
			←	04/98→; + ABS; 42187759→	2	24.8190-0018.2 620018	L= 755
			←	04/98→; + ABS; → 42187758	2	24.8190-0718.2 620718	L= 720
			←	04/98→; → 42187758	2	24.8190-0718.2 620718	L= 720
2.2 16V	108	06/00→01/05	←	09/00→; 42187759→	2	24.8190-0018.2 620018	L= 755
			←	09/00→; → 42187758	2	24.8190-0718.2 620718	L= 720
 Bremsscheibe							
1.2 16V	48	02/98→09/00	←	04/98→; → 18999999; für Fahrzeuge mit Trommelbremse an der Hinterachse		24.0111-0141.1 411141	Ø 256 10,8 8
						24.0311-0141.1 511141	Ø 256 10,8 8 PD
			←	04/98→; → 18999999; für Fahrzeuge mit Scheibenbremse an der Hinterachse; Felge Lochzahl: 4		24.0124-0152.1 424152	Ø 256 23,8 21 V + S
						24.0324-0152.1 524152	Ø 256 23,8 21 V + S PD
			←	22000001→; Felge Lochzahl: 4		24.0124-0152.1 424152	Ø 256 23,8 21 V + S
						24.0324-0152.1 524152	Ø 256 23,8 21 V + S PD
			→	04/98→; Felge Lochzahl: 4		24.0110-0251.1 410251	Ø 240 9,8 8 + S
						24.0310-0251.1 510251	Ø 240 9,8 8 + S PD
1.2 16V	55	09/00→01/05	←	→ 18999999; für Fahrzeuge mit Trommelbremse an der Hinterachse		24.0111-0141.1 411141	Ø 256 10,8 8
						24.0311-0141.1 511141	Ø 256 10,8 8 PD
			←	22000001→; Felge Lochzahl: 4		24.0124-0152.1 424152	Ø 256 23,8 21 V + S
						24.0324-0152.1 524152	Ø 256 23,8 21 V + S PD
			←	→ 18999999; für Fahrzeuge mit Scheibenbremse an der Hinterachse; Felge Lochzahl: 4		24.0124-0152.1 424152	Ø 256 23,8 21 V + S
						24.0324-0152.1 524152	Ø 256 23,8 21 V + S PD
			→	Felge Lochzahl: 4		24.0110-0251.1 410251	Ø 240 9,8 8 + S







	kw			 	! #		
OPEL - ASTRA G CC (F48_, F08_) 02/98→12/09							
Bremsscheibe							
1.2 16V	55	09/00→01/05	➔	Felge Lochzahl: 4		24.0310-0251.1 510251	Ø 240 9,8 8 + S PD
1.4 1.7 CDTI 1.7 DTI 16V	66	09/07→12/09	➔	Felge Lochzahl: 4		24.0124-0152.1 424152	Ø 256 23,8 21 V + S
	59	04/03→12/09				24.0324-0152.1 524152	Ø 256 23,8 21 V + S PD
	55	02/00→01/05	➔	Felge Lochzahl: 4		24.0110-0251.1 410251	Ø 240 9,8 8 + S
						24.0310-0251.1 510251	Ø 240 9,8 8 + S PD
1.4 16V 1.7 TD	66	02/98→01/05	➔	04/98→; Felge Lochzahl: 4		24.0124-0152.1 424152	Ø 256 23,8 21 V + S
	50	02/98→08/00				24.0324-0152.1 524152	Ø 256 23,8 21 V + S PD
			➔	04/98→; Felge Lochzahl: 4		24.0110-0251.1 410251	Ø 240 9,8 8 + S
						24.0310-0251.1 510251	Ø 240 9,8 8 + S PD
1.6	55	02/98→09/00	➔	04/98→; Felge Lochzahl: 4		24.0124-0152.1 424152	Ø 256 23,8 21 V + S
						24.0324-0152.1 524152	Ø 256 23,8 21 V + S PD
			➔	04/98→; Felge Lochzahl: 5		24.0125-0131.1 425131	Ø 280 24,8 22 V + S
					24.0325-0131.1 525131	Ø 280 24,8 22 V + S PD	
			➔	04/98→; Felge Lochzahl: 4		24.0110-0251.1 410251	Ø 240 9,8 8 + S
						24.0310-0251.1 510251	Ø 240 9,8 8 + S PD
1.6 1.6	62 76	09/00→01/05 12/02→12/09	➔	Felge Lochzahl: 4		24.0124-0152.1 424152	Ø 256 23,8 21 V + S
						24.0324-0152.1 524152	Ø 256 23,8 21 V + S PD
			➔	Felge Lochzahl: 5		24.0125-0131.1 425131	Ø 280 24,8 22 V + S
					24.0325-0131.1 525131	Ø 280 24,8 22 V + S PD	
			➔	Felge Lochzahl: 4		24.0110-0251.1 410251	Ø 240 9,8 8 + S
						24.0310-0251.1 510251	Ø 240 9,8 8 + S PD
1.6 16V	74	02/98→01/05	➔	04/98→; Felge Lochzahl: 4		24.0124-0152.1 424152	Ø 256 23,8 21 V + S
						24.0324-0152.1 524152	Ø 256 23,8 21 V + S PD
			➔	04/98→; Felge Lochzahl: 5		24.0125-0131.1 425131	Ø 280 24,8 22 V + S
						24.0325-0131.1 525131	Ø 280 24,8 22 V + S PD
			➔	04/98→; Felge Lochzahl: 5		24.0110-0250.1 410250	Ø 264 9,8 8 + S
					24.0310-0250.1 510250	Ø 264 9,8 8 + S PD	
			➔	04/98→; Felge Lochzahl: 4		24.0110-0251.1 410251	Ø 240 9,8 8 + S
						24.0310-0251.1 510251	Ø 240 9,8 8 + S PD
1.8 16V 2.0 DI	85 60	02/98→09/00 02/98→01/05	➔	04/98→; - ABS; Felge Lochzahl: 4		24.0124-0152.1 424152	Ø 256 23,8 21 V + S
						24.0324-0152.1 524152	Ø 256 23,8 21 V + S PD
			➔	04/98→; + ABS; Felge Lochzahl: 5		24.0125-0131.1 425131	Ø 280 24,8 22 V + S
						24.0325-0131.1 525131	Ø 280 24,8 22 V + S PD
			➔	04/98→; + ABS; Felge Lochzahl: 5		24.0110-0250.1 410250	Ø 264 9,8 8 + S
						24.0310-0250.1 510250	Ø 264 9,8 8 + S PD
			➔	04/98→; - ABS; Felge Lochzahl: 4		24.0110-0251.1 410251	Ø 240 9,8 8 + S
						24.0310-0251.1 510251	Ø 240 9,8 8 + S PD
1.8 16V	92	09/00→01/05	➔	- ABS; Felge Lochzahl: 4		24.0124-0152.1 424152	Ø 256 23,8 21 V + S
						24.0324-0152.1 524152	Ø 256 23,8 21 V + S PD
			➔	+ ABS; Felge Lochzahl: 5		24.0125-0131.1 425131	Ø 280 24,8 22 V + S
						24.0325-0131.1 525131	Ø 280 24,8 22 V + S PD
			➔	+ ABS; Felge Lochzahl: 5		24.0110-0250.1 410250	Ø 264 9,8 8 + S
						24.0310-0250.1 510250	Ø 264 9,8 8 + S PD
			➔	- ABS; Felge Lochzahl: 4		24.0110-0251.1 410251	Ø 240 9,8 8 + S
						24.0310-0251.1 510251	Ø 240 9,8 8 + S PD
2.0 16V	100	02/98→01/05	➔	04/98→; Felge Lochzahl: 5		24.0125-0131.1 425131	Ø 280 24,8 22 V + S
						24.0325-0131.1 525131	Ø 280 24,8 22 V + S PD
			➔	04/98→; Felge Lochzahl: 5		24.0110-0250.1 410250	Ø 264 9,8 8 + S
						24.0310-0250.1 510250	Ø 264 9,8 8 + S PD
2.0 16V OPC 2.0 OPC 2.0 OPC	118 141 147	11/99→09/02 09/02→01/05 11/02→01/05	➔			24.0125-0142.1 425142	Ø 308 25 22 V + S
						24.0325-0142.1 525142	Ø 308 25 23 V + S PD
			➔	Felge Lochzahl: 5		24.0110-0250.1 410250	Ø 264 9,8 8 + S
						24.0310-0250.1 510250	Ø 264 9,8 8 + S PD
2.0 DTI 16V 2.2 DTI 2.2 DTI	74 86 92	08/99→01/05 09/02→01/05 09/02→01/05	➔	Felge Lochzahl: 5		24.0125-0131.1 425131	Ø 280 24,8 22 V + S
						24.0325-0131.1 525131	Ø 280 24,8 22 V + S PD
			➔	Felge Lochzahl: 5		24.0110-0250.1 410250	Ø 264 9,8 8 + S
						24.0310-0250.1 510250	Ø 264 9,8 8 + S PD
2.2 16V	108	06/00→01/05	➔	09/00→; Felge Lochzahl: 5		24.0125-0131.1 425131	Ø 280 24,8 22 V + S
						24.0325-0131.1 525131	Ø 280 24,8 22 V + S PD
			➔	09/00→; Felge Lochzahl: 5		24.0110-0250.1 410250	Ø 264 9,8 8 + S
						24.0310-0250.1 510250	Ø 264 9,8 8 + S PD



	kw					! #		
OPEL - ASTRA G Coupe (F07_) 03/00→05/05								
 Bremsbelagsatz, Scheibenbremse								
1.6 16V 1.6 16V	74 76	03/00→05/05 03/00→05/05	←				13.0460-7115.2 607115 13.0470-7115.2 LD7115	ATE 23063 17,5 ohne integrierten Verschleiß- sensor / + WK ATE 23063 17,5 - WK / + WK Ceramic
			→				13.0460-2868.2 602868 13.0460-3976.2 603976 13.0470-2868.2 LD2868	TRW 23417 15,3 + WK + Zub BOS 23258 16,5 + WK + Zub TRW 23417 15,3 + WK + Zub Ceramic
1.8 16V 1.8 16V 2.2 16V 2.2 DTI	85 92 108 92	03/00→10/00 09/00→05/05 09/00→05/05 09/02→05/05	←				13.0460-7116.2 607116 13.0470-7116.2 LD7116	ATE 23057 20,2 - WK / + WK ATE 23057 20,2 - WK / + WK Ceramic
			→				13.0460-2868.2 602868 13.0460-3976.2 603976 13.0470-2868.2 LD2868	TRW 23417 15,3 + WK + Zub BOS 23258 16,5 + WK + Zub TRW 23417 15,3 + WK + Zub Ceramic
2.0 16V Turbo 2.0 16V Turbo 2.0 16V Turbo	140 141 147	09/00→08/01 08/01→05/05 11/02→05/05	←				13.0460-7173.2 607173	ATE 21829 20,3 - WK / + WK
			→				13.0460-2868.2 602868 13.0460-3976.2 603976 13.0470-2868.2 LD2868	TRW 23417 15,3 + WK + Zub BOS 23258 16,5 + WK + Zub TRW 23417 15,3 + WK + Zub Ceramic
Warnkontakt, Bremsbelagsverschleiß								
1.6 16V 1.6 16V 1.8 16V 1.8 16V 2.0 16V Turbo 2.0 16V Turbo 2.0 16V Turbo 2.2 16V 2.2 DTI	74 76 85 92 140 141 147 108 92	03/00→05/05 03/00→05/05 03/00→10/00 09/00→05/05 09/00→08/01 08/01→05/05 11/02→05/05 09/00→05/05 09/02→05/05	←	42187759→		2	24.8190-0018.2 620018	L= 755
			←	→ 42187758		2	24.8190-0718.2 620718	L= 720
 Bremsscheibe								
1.6 16V 1.6 16V	74 76	03/00→05/05 03/00→05/05	←	Felge Lochzahl: 4			24.0124-0152.1 424152 24.0324-0152.1 524152	Ø 256 23,8 21 V + S Ø 256 23,8 21 V + S PD
			←	Felge Lochzahl: 5			24.0125-0131.1 425131 24.0325-0131.1 525131	Ø 280 24,8 22 V + S Ø 280 24,8 22 V + S PD
			→	Felge Lochzahl: 5			24.0110-0250.1 410250 24.0310-0250.1 510250	Ø 264 9,8 8 + S Ø 264 9,8 8 + S PD
			→	Felge Lochzahl: 4			24.0110-0251.1 410251 24.0310-0251.1 510251	Ø 240 9,8 8 + S Ø 240 9,8 8 + S PD
1.8 16V 1.8 16V 2.2 16V 2.2 DTI	85 92 108 92	03/00→10/00 09/00→05/05 09/00→05/05 09/02→05/05	←	Felge Lochzahl: 5			24.0125-0131.1 425131 24.0325-0131.1 525131	Ø 280 24,8 22 V + S Ø 280 24,8 22 V + S PD
			→	Felge Lochzahl: 5			24.0110-0250.1 410250 24.0310-0250.1 510250	Ø 264 9,8 8 + S Ø 264 9,8 8 + S PD
2.0 16V Turbo 2.0 16V Turbo 2.0 16V Turbo	140 141 147	09/00→08/01 08/01→05/05 11/02→05/05	←				24.0125-0142.1 425142 24.0325-0142.1 525142	Ø 308 25 22 V + S Ø 308 25 23 V + S PD
			→	Felge Lochzahl: 5			24.0110-0250.1 410250 24.0310-0250.1 510250	Ø 264 9,8 8 + S Ø 264 9,8 8 + S PD
OPEL - ASTRA G Kasten (F70) 01/99→04/05								
 Bremsbelagsatz, Scheibenbremse								
1.6 1.6 1.6 1.7 DTI 16V 1.7 TD	55 62 76 55 50	01/99→09/00 09/00→04/05 10/04→04/05 02/00→04/05 01/99→04/05	←				13.0460-7115.2 607115 13.0470-7115.2 LD7115	ATE 23063 17,5 ohne integrierten Verschleiß- sensor / + WK ATE 23063 17,5 - WK / + WK Ceramic
			→				13.0460-2868.2 602868 13.0460-3976.2 603976 13.0470-2868.2 LD2868	TRW 23417 15,3 + WK + Zub BOS 23258 16,5 + WK + Zub TRW 23417 15,3 + WK + Zub Ceramic
2.0 DI	60	01/99→04/05	←				13.0460-7115.2 607115 13.0470-7115.2 LD7115	ATE 23063 17,5 ohne integrierten Verschleiß- sensor / + WK ATE 23063 17,5 - WK / + WK Ceramic
			←	+ ABS			13.0460-7116.2 607116	ATE 23057 20,2 - WK / + WK

	kw			 	! #		
OPEL - ASTRA G Kasten (F70) 01/99→04/05							
 Bremsbelagsatz, Scheibenbremse							
2.0 DI	60	01/99→04/05	← + ABS			13.0470-7116.2 LD7116	ATE 23057 20,2 - WK / + WK Ceramic
			→			13.0460-2868.2 602868	TRW 23417 15,3 + WK + Zub
						13.0460-3976.2 603976	BOS 23258 16,5 + WK + Zub
						13.0470-2868.2 LD2868	TRW 23417 15,3 + WK + Zub Ceramic
Warnkontakt, Bremsbelagverschleiß							
1.6	55	01/99→09/00	← 42187759→	2	24.8190-0018.2 620018		L= 755
1.6	62	09/00→04/05	← → 42187758	2	24.8190-0718.2 620718		L= 720
1.6	76	10/04→04/05					
1.7 DTI 16V	55	02/00→04/05					
1.7 TD	50	01/99→04/05					
2.0 DI	60	01/99→04/05	← + ABS; 42187759→	2	24.8190-0018.2 620018		L= 755
			← 42187759→	2	24.8190-0018.2 620018		L= 755
			← → 42187758	2	24.8190-0718.2 620718		L= 720
			← + ABS; → 42187758	2	24.8190-0718.2 620718		L= 720
 Bremsscheibe							
1.6	55	01/99→09/00	← Felge Lochzahl: 4		24.0124-0152.1 424152	424152	Ø 256 23,8 21 V + S
1.6	62	09/00→04/05	← Felge Lochzahl: 5		24.0324-0152.1 524152	524152	Ø 256 23,8 21 V + S PD
			← Felge Lochzahl: 5		24.0125-0131.1 425131	425131	Ø 280 24,8 22 V + S
			← Felge Lochzahl: 5		24.0325-0131.1 525131	525131	Ø 280 24,8 22 V + S PD
			→ Felge Lochzahl: 4		24.0110-0251.1 410251	410251	Ø 240 9,8 8 + S
					24.0310-0251.1 510251	510251	Ø 240 9,8 8 + S PD
1.6	76	10/04→04/05	← Felge Lochzahl: 4		24.0124-0152.1 424152	424152	Ø 256 23,8 21 V + S
			← Felge Lochzahl: 5		24.0324-0152.1 524152	524152	Ø 256 23,8 21 V + S PD
			← Felge Lochzahl: 5		24.0125-0131.1 425131	425131	Ø 280 24,8 22 V + S
			← Felge Lochzahl: 5		24.0325-0131.1 525131	525131	Ø 280 24,8 22 V + S PD
			→ Felge Lochzahl: 5		24.0110-0250.1 410250	410250	Ø 264 9,8 8 + S
			→ Felge Lochzahl: 5		24.0310-0250.1 510250	510250	Ø 264 9,8 8 + S PD
			→ Felge Lochzahl: 4		24.0110-0251.1 410251	410251	Ø 240 9,8 8 + S
			→ Felge Lochzahl: 4		24.0310-0251.1 510251	510251	Ø 240 9,8 8 + S PD
1.7 DTI 16V	55	02/00→04/05	← Felge Lochzahl: 4		24.0124-0152.1 424152	424152	Ø 256 23,8 21 V + S
1.7 TD	50	01/99→04/05	← Felge Lochzahl: 4		24.0324-0152.1 524152	524152	Ø 256 23,8 21 V + S PD
			→ Felge Lochzahl: 4		24.0110-0251.1 410251	410251	Ø 240 9,8 8 + S
					24.0310-0251.1 510251	510251	Ø 240 9,8 8 + S PD
2.0 DI	60	01/99→04/05	← - ABS; Felge Lochzahl: 4		24.0124-0152.1 424152	424152	Ø 256 23,8 21 V + S
			← + ABS; Felge Lochzahl: 5		24.0324-0152.1 524152	524152	Ø 256 23,8 21 V + S PD
			← + ABS; Felge Lochzahl: 5		24.0125-0131.1 425131	425131	Ø 280 24,8 22 V + S
			→ + ABS; Felge Lochzahl: 5		24.0325-0131.1 525131	525131	Ø 280 24,8 22 V + S PD
			→ + ABS; Felge Lochzahl: 5		24.0110-0250.1 410250	410250	Ø 264 9,8 8 + S
			→ + ABS; Felge Lochzahl: 5		24.0310-0250.1 510250	510250	Ø 264 9,8 8 + S PD
			→ - ABS; Felge Lochzahl: 4		24.0110-0251.1 410251	410251	Ø 240 9,8 8 + S
					24.0310-0251.1 510251	510251	Ø 240 9,8 8 + S PD
OPEL - ASTRA G Stufenheck (F69_) 09/98→12/09							
 Bremsbelagsatz, Scheibenbremse							
1.2 16V	48	09/98→09/00	←		13.0460-7115.2 607115	607115	ATE 23063 17,5 ohne integrierten Verschleißsensor / + WK
1.2 16V	55	09/00→01/05					
1.4	66	09/07→12/09					
1.4 16V	66	09/98→01/05			13.0470-7115.2 LD7115	LD7115	ATE 23063 17,5 - WK / + WK Ceramic
1.6	55	09/98→09/00					
1.6	62	09/00→01/05					
1.6	76	12/02→12/09	→		13.0460-2868.2 602868	602868	TRW 23417 15,3 + WK + Zub
1.6 16V	74	09/98→01/05			13.0460-3976.2 603976	603976	BOS 23258 16,5 + WK + Zub
1.7 CDTI	59	04/03→12/09			13.0470-2868.2 LD2868	LD2868	TRW 23417 15,3 + WK + Zub Ceramic
1.7 DTI 16V	55	02/00→01/05					
1.7 TD	50	09/98→08/00					
1.8 16V	85	09/98→09/00	← - ABS		13.0460-7115.2 607115	607115	ATE 23063 17,5 ohne integrierten Verschleißsensor / + WK
1.8 16V	92	06/00→01/05			13.0470-7115.2 LD7115	LD7115	ATE 23063 17,5 - WK / + WK Ceramic
			← + ABS		13.0460-7116.2 607116	607116	ATE 23057 20,2 - WK / + WK
					13.0470-7116.2 LD7116	LD7116	ATE 23057 20,2 - WK / + WK Ceramic

	kW					! #		
OPEL - ASTRA G Stufenheck (F69_) 09/98→12/09								
Bremsbelagsatz, Scheibenbremse								
1.8 16V 1.8 16V	85 92	09/98→09/00 06/00→01/05	➔				13.0460-2868.2 602868 13.0460-3976.2 603976 13.0470-2868.2 LD2868	TRW 23417 15,3 + WK + Zub BOS 23258 16,5 + WK + Zub TRW 23417 15,3 + WK + Zub Ceramic
2.0 16V 2.0 DTI 16V 2.2 16V 2.2 DTI 2.2 DTI	100 74 108 86 92	09/98→01/05 08/99→01/05 03/01→01/05 09/02→01/05 09/02→01/05	➔ ➔ ➔ ➔ ➔				13.0460-7116.2 607116 13.0470-7116.2 LD7116 13.0460-2868.2 602868 13.0460-3976.2 603976 13.0470-2868.2 LD2868	ATE 23057 20,2 - WK / + WK ATE 23057 20,2 - WK / + WK Ceramic TRW 23417 15,3 + WK + Zub BOS 23258 16,5 + WK + Zub TRW 23417 15,3 + WK + Zub Ceramic
2.0 DI	60	09/98→01/05	➔				13.0460-7115.2 607115 13.0470-7115.2 LD7115	ATE 23063 17,5 ohne integrierten Verschleißsensor / + WK ATE 23063 17,5 - WK / + WK Ceramic
			➔ + ABS				13.0460-7116.2 607116 13.0470-7116.2 LD7116	ATE 23057 20,2 - WK / + WK ATE 23057 20,2 - WK / + WK Ceramic
			➔				13.0460-2868.2 602868 13.0460-3976.2 603976 13.0470-2868.2 LD2868	TRW 23417 15,3 + WK + Zub BOS 23258 16,5 + WK + Zub TRW 23417 15,3 + WK + Zub Ceramic
Warnkontakt, Bremsbelagverschleiß								
1.2 16V 1.2 16V 1.4 1.4 16V 1.6 1.6 1.6 1.6 16V 1.7 CDTI 1.7 DTI 16V 1.7 TD 2.0 16V 2.0 DTI 16V 2.2 16V 2.2 DTI 2.2 DTI	48 55 66 66 55 62 76 74 59 55 50 100 74 108 86 92	09/98→09/00 09/00→01/05 09/07→12/09 09/98→01/05 09/98→09/00 09/00→01/05 12/02→12/09 09/98→01/05 04/03→12/09 02/00→01/05 09/98→08/00 09/98→01/05 08/99→01/05 03/01→01/05 09/02→01/05 09/02→01/05	➔ ➔ ➔ ➔ ➔ ➔ ➔ ➔ ➔ ➔ ➔ ➔ ➔ ➔ ➔ ➔	42187759→ → 42187758	2 2	24.8190-0018.2 620018 24.8190-0718.2 620718	L= 755 L= 720	
1.8 16V 1.8 16V	85 92	09/98→09/00 06/00→01/05	➔ ➔ ➔ ➔	+ ABS; 42187759→ - ABS; 42187759→ - ABS; → 42187758 + ABS; → 42187758	2 2 2 2	24.8190-0018.2 620018 24.8190-0018.2 620018 24.8190-0718.2 620718 24.8190-0718.2 620718	L= 755 L= 755 L= 720 L= 720	
2.0 DI	60	09/98→01/05	➔ ➔ ➔ ➔	+ ABS; 42187759→ 42187759→ → 42187758 + ABS; → 42187758	2 2 2 2	24.8190-0018.2 620018 24.8190-0018.2 620018 24.8190-0718.2 620718 24.8190-0718.2 620718	L= 755 L= 755 L= 720 L= 720	
Bremsscheibe								
1.2 16V 1.2 16V	48 55	09/98→09/00 09/00→01/05	➔ ➔ ➔ ➔ ➔ ➔	→ 18999999; für Fahrzeuge mit Trommelbremse an der Hinterachse 22000001→; Felge Lochzahl: 4 → 18999999; für Fahrzeuge mit Scheibenbremse an der Hinterachse; Felge Lochzahl: 4 Felge Lochzahl: 4		24.0111-0141.1 411141 24.0311-0141.1 511141 24.0124-0152.1 424152 24.0324-0152.1 524152 24.0124-0152.1 424152 24.0324-0152.1 524152 24.0110-0251.1 410251 24.0310-0251.1 510251	∅ 256 10,8 8 ∅ 256 10,8 8 PD ∅ 256 23,8 21 V + S ∅ 256 23,8 21 V + S PD ∅ 256 23,8 21 V + S ∅ 256 23,8 21 V + S PD ∅ 240 9,8 8 + S ∅ 240 9,8 8 + S PD	
1.4 1.4 16V 1.7 CDTI 1.7 DTI 16V 1.7 TD	66 66 59 55 50	09/07→12/09 09/98→01/05 04/03→12/09 02/00→01/05 09/98→08/00	➔ ➔ ➔ ➔ ➔	Felge Lochzahl: 4 Felge Lochzahl: 4		24.0124-0152.1 424152 24.0324-0152.1 524152 24.0110-0251.1 410251 24.0310-0251.1 510251	∅ 256 23,8 21 V + S ∅ 256 23,8 21 V + S PD ∅ 240 9,8 8 + S ∅ 240 9,8 8 + S PD	
1.6 1.6 1.6	55 62 76	09/98→09/00 09/00→01/05 12/02→12/09	➔ ➔ ➔	Felge Lochzahl: 4 Felge Lochzahl: 5		24.0124-0152.1 424152 24.0324-0152.1 524152 24.0125-0131.1 425131	∅ 256 23,8 21 V + S ∅ 256 23,8 21 V + S PD ∅ 280 24,8 22 V + S	

	kw			 	! #		
OPEL - ASTRA G Stufenheck (F69_) 09/98→12/09							
Bremsscheibe							
1.6	55	09/98→09/00	←	Felge Lochzahl: 5		24.0325-0131.1 525131	Ø 280 24,8 22 V + S PD
1.6	62	09/00→01/05	→	Felge Lochzahl: 4		24.0110-0251.1 410251	Ø 240 9,8 8 + S
1.6	76	12/02→12/09	→			24.0310-0251.1 510251	Ø 240 9,8 8 + S PD
1.6 16V	74	09/98→01/05	←	Felge Lochzahl: 4		24.0124-0152.1 424152	Ø 256 23,8 21 V + S
			←	Felge Lochzahl: 5		24.0324-0152.1 524152	Ø 256 23,8 21 V + S PD
			→	Felge Lochzahl: 5		24.0125-0131.1 425131	Ø 280 24,8 22 V + S
			→	Felge Lochzahl: 5		24.0325-0131.1 525131	Ø 280 24,8 22 V + S PD
			→	Felge Lochzahl: 5		24.0110-0250.1 410250	Ø 264 9,8 8 + S
			→	Felge Lochzahl: 5		24.0310-0250.1 510250	Ø 264 9,8 8 + S PD
			→	Felge Lochzahl: 4		24.0110-0251.1 410251	Ø 240 9,8 8 + S
			→	Felge Lochzahl: 4		24.0310-0251.1 510251	Ø 240 9,8 8 + S PD
1.8 16V	85	09/98→09/00	←	- ABS; Felge Lochzahl: 4		24.0124-0152.1 424152	Ø 256 23,8 21 V + S
1.8 16V	92	06/00→01/05	←			24.0324-0152.1 524152	Ø 256 23,8 21 V + S PD
2.0 DI	60	09/98→01/05	←	+ ABS; Felge Lochzahl: 5		24.0125-0131.1 425131	Ø 280 24,8 22 V + S
			→	+ ABS; Felge Lochzahl: 5		24.0325-0131.1 525131	Ø 280 24,8 22 V + S PD
			→	+ ABS; Felge Lochzahl: 5		24.0110-0250.1 410250	Ø 264 9,8 8 + S
			→	+ ABS; Felge Lochzahl: 5		24.0310-0250.1 510250	Ø 264 9,8 8 + S PD
			→	- ABS; Felge Lochzahl: 4		24.0110-0251.1 410251	Ø 240 9,8 8 + S
			→	- ABS; Felge Lochzahl: 4		24.0310-0251.1 510251	Ø 240 9,8 8 + S PD
2.0 16V	100	09/98→01/05	←	Felge Lochzahl: 5		24.0125-0131.1 425131	Ø 280 24,8 22 V + S
2.0 DTI 16V	74	08/99→01/05	←			24.0325-0131.1 525131	Ø 280 24,8 22 V + S PD
2.2 16V	108	03/01→01/05	→	Felge Lochzahl: 5		24.0110-0250.1 410250	Ø 264 9,8 8 + S
2.2 DTI	86	09/02→01/05	→			24.0310-0250.1 510250	Ø 264 9,8 8 + S PD
2.2 DTI	92	09/02→01/05	→			24.0310-0250.1 510250	Ø 264 9,8 8 + S PD
OPEL - ASTRA H (L48) 01/04→05/14							
Bremsbelagsatz, Scheibenbremse							
1.2	59	08/05→10/10	←			13.0460-7179.2 607179	ATE 23832 20,2 - WK / + WK
1.3 CDTI	66	08/05→10/10	←			13.0470-7179.2 LD7179	ATE 23832 20,2 - WK / + WK Ceramic
1.4	55	04/04→10/04	→			13.0460-2868.2 602868	TRW 23417 15,3 + WK + Zub
1.4 LPG	66	03/04→10/10	→			13.0470-2868.2 LD2868	TRW 23417 15,3 + WK + Zub Ceramic
1.4 LPG	66	08/09→10/10	→				
1.6	77	03/04→10/10	→				
1.6 Turbo	132	02/07→10/10	→				
1.7 CDTI	59	03/04→10/10	→				
1.7 CDTI	74	03/04→10/10	→				
1.8	92	01/04→10/10	→				
1.8	103	01/06→10/10	→				
1.9 CDTI	74	09/05→10/10	→				
1.9 CDTI	110	09/04→10/10	→				
2.0 Turbo	125	03/04→10/10	→				
2.0 Turbo	147	09/04→10/10	→				
1.6	85	12/06→05/14	←	01/07→ 11/10		13.0460-7179.2 607179	ATE 23832 20,2 - WK / + WK
			→	01/07→ 11/10		13.0470-7179.2 LD7179	ATE 23832 20,2 - WK / + WK Ceramic
			→	01/07→ 11/10		13.0460-2868.2 602868	TRW 23417 15,3 + WK + Zub
			→	01/07→ 11/10		13.0470-2868.2 LD2868	TRW 23417 15,3 + WK + Zub Ceramic
1.7 CDTI	81	02/07→05/14	←	04/07→ 11/10		13.0460-7179.2 607179	ATE 23832 20,2 - WK / + WK
1.7 CDTI	92	02/07→05/14	←			13.0470-7179.2 LD7179	ATE 23832 20,2 - WK / + WK Ceramic
			→	04/07→ 11/10		13.0460-2868.2 602868	TRW 23417 15,3 + WK + Zub
			→	04/07→ 11/10		13.0470-2868.2 LD2868	TRW 23417 15,3 + WK + Zub Ceramic
1.9 CDTI	88	06/04→10/10	←	09/04→		13.0460-7179.2 607179	ATE 23832 20,2 - WK / + WK
1.9 CDTI 16V	88	04/04→10/10	←			13.0470-7179.2 LD7179	ATE 23832 20,2 - WK / + WK Ceramic
			→	09/04→		13.0460-2868.2 602868	TRW 23417 15,3 + WK + Zub
			→			13.0470-2868.2 LD2868	TRW 23417 15,3 + WK + Zub Ceramic
2.0 Turbo	177	03/05→10/10	←	für Bremssattel mit Kunststoffkolben		13.0460-7172.2 607172	ATE 23378 20,1 + WE / - WK
			←	für Bremssattel mit Stahlkolben		13.0470-7172.2 LD7172	ATE 23378 20,1 + WE / - WK Ceramic
			→			13.0460-2868.2 602868	TRW 23417 15,3 + WK + Zub
			→			13.0470-2868.2 LD2868	TRW 23417 15,3 + WK + Zub Ceramic













OPEL - ASTRA H (L48) 01/04 → 05/14

Warnkontakt, Bremsbelagverschleiß

1.2	59	08/05 → 10/10	←		1	24.8190-0720.2	620720	L= 287
1.3 CDTI	66	08/05 → 10/10						
1.4	55	04/04 → 10/04						
1.4	66	03/04 → 10/10						
1.4 LPG	66	08/09 → 10/10						
1.6	77	03/04 → 10/10						
1.6 Turbo	132	02/07 → 10/10						
1.7 CDTI	59	03/04 → 10/10						
1.7 CDTI	74	03/04 → 10/10						
1.8	92	01/04 → 10/10						
1.8	103	01/06 → 10/10						
1.9 CDTI	74	09/05 → 10/10						
1.9 CDTI	110	09/04 → 10/10						
2.0 Turbo	125	03/04 → 10/10						
2.0 Turbo	147	09/04 → 10/10						
2.0 Turbo	177	03/05 → 10/10						
1.6	85	12/06 → 05/14	←	01/07 → 11/10	1	24.8190-0720.2	620720	L= 287
1.7 CDTI	81	02/07 → 05/14	←	04/07 → 11/10	1	24.8190-0720.2	620720	L= 287
1.7 CDTI	92	02/07 → 05/14						
1.9 CDTI	88	06/04 → 10/10	←	09/04 →	1	24.8190-0720.2	620720	L= 287
1.9 CDTI 16V	88	04/04 → 10/10						

Bremsscheibe

1.2	59	08/05 → 10/10	←	Felge Lochzahl: 5		24.0125-0131.1	425131	∅ 280 24,8 22 V + S
1.3 CDTI	66	08/05 → 10/10				24.0325-0131.1	525131	∅ 280 24,8 22 V + S PD
1.4	55	04/04 → 10/04						
1.4	66	03/04 → 10/10	←	Felge Lochzahl: 4		24.0125-0198.1	425198	∅ 280 25 22 V + S
1.4 LPG	66	08/09 → 10/10				24.0325-0198.1	525198	∅ 280 25 22 V + S PD
1.6	77	03/04 → 10/10	→	Felge Lochzahl: 5		24.0110-0250.1	410250	∅ 264 9,8 8 + S
1.7 CDTI	59	03/04 → 10/10				24.0310-0250.1	510250	∅ 264 9,8 8 + S PD
1.7 CDTI	74	03/04 → 10/10						
1.8	92	01/04 → 10/10	→	Felge Lochzahl: 4		24.0110-0251.1	410251	∅ 240 9,8 8 + S
1.8	103	01/06 → 10/10				24.0310-0251.1	510251	∅ 240 9,8 8 + S PD
1.6	85	12/06 → 05/14	←	01/07 → 11/10; Felge Lochzahl: 5		24.0125-0131.1	425131	∅ 280 24,8 22 V + S
						24.0325-0131.1	525131	∅ 280 24,8 22 V + S PD
			←	01/07 → 11/10; Felge Lochzahl: 4		24.0125-0198.1	425198	∅ 280 25 22 V + S
						24.0325-0198.1	525198	∅ 280 25 22 V + S PD
			→	01/07 → 11/10; Felge Lochzahl: 5		24.0110-0250.1	410250	∅ 264 9,8 8 + S
						24.0310-0250.1	510250	∅ 264 9,8 8 + S PD
			→	01/07 → 11/10; Felge Lochzahl: 4		24.0110-0251.1	410251	∅ 240 9,8 8 + S
						24.0310-0251.1	510251	∅ 240 9,8 8 + S PD
1.6 Turbo	132	02/07 → 10/10	←	Felge Lochzahl: 5		24.0125-0142.1	425142	∅ 308 25 22 V + S
1.9 CDTI	74	09/05 → 10/10				24.0325-0142.1	525142	∅ 308 25 23 V + S PD
1.9 CDTI	110	09/04 → 10/10						
2.0 Turbo	125	03/04 → 10/10	←	Felge Lochzahl: 4		24.0125-0198.1	425198	∅ 280 25 22 V + S
2.0 Turbo	147	09/04 → 10/10				24.0325-0198.1	525198	∅ 280 25 22 V + S PD
			→	Felge Lochzahl: 5		24.0110-0250.1	410250	∅ 264 9,8 8 + S
						24.0310-0250.1	510250	∅ 264 9,8 8 + S PD
			→	Felge Lochzahl: 4		24.0110-0251.1	410251	∅ 240 9,8 8 + S
						24.0310-0251.1	510251	∅ 240 9,8 8 + S PD
1.7 CDTI	81	02/07 → 05/14	←	04/07 → 11/10; Felge Lochzahl: 5		24.0125-0131.1	425131	∅ 280 24,8 22 V + S
						24.0325-0131.1	525131	∅ 280 24,8 22 V + S PD
			←	04/07 → 11/10; Felge Lochzahl: 4		24.0125-0198.1	425198	∅ 280 25 22 V + S
						24.0325-0198.1	525198	∅ 280 25 22 V + S PD
			→	04/07 → 11/10; Felge Lochzahl: 5		24.0110-0250.1	410250	∅ 264 9,8 8 + S
						24.0310-0250.1	510250	∅ 264 9,8 8 + S PD
			→	04/07 → 11/10; Felge Lochzahl: 4		24.0110-0251.1	410251	∅ 240 9,8 8 + S
						24.0310-0251.1	510251	∅ 240 9,8 8 + S PD
1.7 CDTI	92	02/07 → 05/14	←	04/07 → 11/10; Felge Lochzahl: 5		24.0125-0142.1	425142	∅ 308 25 22 V + S
						24.0325-0142.1	525142	∅ 308 25 23 V + S PD
			←	04/07 → 11/10; Felge Lochzahl: 4		24.0125-0198.1	425198	∅ 280 25 22 V + S
						24.0325-0198.1	525198	∅ 280 25 22 V + S PD
			→	04/07 → 11/10; Felge Lochzahl: 5		24.0110-0250.1	410250	∅ 264 9,8 8 + S
						24.0310-0250.1	510250	∅ 264 9,8 8 + S PD
			→	04/07 → 11/10; Felge Lochzahl: 4		24.0110-0251.1	410251	∅ 240 9,8 8 + S
						24.0310-0251.1	510251	∅ 240 9,8 8 + S PD
1.9 CDTI	88	06/04 → 10/10	←	09/04 →; Felge Lochzahl: 5		24.0125-0142.1	425142	∅ 308 25 22 V + S
1.9 CDTI 16V	88	04/04 → 10/10				24.0325-0142.1	525142	∅ 308 25 23 V + S PD
			←	09/04 →; Felge Lochzahl: 4		24.0125-0198.1	425198	∅ 280 25 22 V + S

	kW			 	! #		
OPEL - ASTRA H (L48) 01/04→05/14							
 Bremsscheibe							
1.9 CDTI 1.9 CDTI 16V	88 88	06/04→10/10 04/04→10/10	← →	09/04→; Felge Lochzahl: 4 09/04→; Felge Lochzahl: 5 09/04→; Felge Lochzahl: 4		24.0325-0198.1 525198 24.0110-0250.1 410250 24.0310-0250.1 510250 24.0110-0251.1 410251 24.0310-0251.1 510251	Ø 280 25 22 V + S PD Ø 264 9,8 8 + S Ø 264 9,8 8 + S PD Ø 240 9,8 8 + S Ø 240 9,8 8 + S PD
2.0 Turbo	177	03/05→10/10	← →	Felge Lochzahl: 5		24.0128-0201.1 428201 24.0110-0339.1 410339	Ø 321 28 25 V Ø 278 10 8 + S
OPEL - ASTRA H Caravan (L35) 08/04→05/14							
 Bremsbelagsatz, Scheibenbremse							
1.3 CDTI 1.4 1.4 1.4 LPG 1.6 1.6 LPG 1.6 Turbo 1.7 CDTI 1.7 CDTI 1.8 1.9 CDTI 1.9 CDTI 1.9 CDTI 1.9 CDTI 16V 2.0 Turbo 2.0 Turbo	66 55 66 66 77 85 132 59 74 103 74 88 110 88 125 147	08/05→10/10 08/04→10/10 08/04→10/10 08/09→10/10 08/04→10/10 08/09→10/10 02/07→10/10 08/04→10/10 08/04→10/10 08/05→10/10 09/05→10/10 09/05→10/10 09/04→10/10 08/04→10/10 08/04→10/10 09/04→10/10	← →			13.0460-7179.2 607179 13.0470-7179.2 LD7179 13.0460-2868.2 602868 13.0470-2868.2 LD2868	ATE 23832 20,2 - WK / + WK ATE 23832 20,2 - WK / + WK Ceramic TRW 23417 15,3 + WK + Zub TRW 23417 15,3 + WK + Zub Ceramic
1.6	85	12/06→05/14	← →	01/07→ 11/10 01/07→ 11/10		13.0460-7179.2 607179 13.0470-7179.2 LD7179 13.0460-2868.2 602868 13.0470-2868.2 LD2868	ATE 23832 20,2 - WK / + WK ATE 23832 20,2 - WK / + WK Ceramic TRW 23417 15,3 + WK + Zub TRW 23417 15,3 + WK + Zub Ceramic
1.7 CDTI 1.7 CDTI	81 92	02/07→05/14 02/07→05/14	← →	04/07→ 11/10 04/07→ 11/10		13.0460-7179.2 607179 13.0470-7179.2 LD7179 13.0460-2868.2 602868 13.0470-2868.2 LD2868	ATE 23832 20,2 - WK / + WK ATE 23832 20,2 - WK / + WK Ceramic TRW 23417 15,3 + WK + Zub TRW 23417 15,3 + WK + Zub Ceramic
1.8	92	08/04→10/10	← →	09/04→ 09/04→		13.0460-7179.2 607179 13.0470-7179.2 LD7179 13.0460-2868.2 602868 13.0470-2868.2 LD2868	ATE 23832 20,2 - WK / + WK ATE 23832 20,2 - WK / + WK Ceramic TRW 23417 15,3 + WK + Zub TRW 23417 15,3 + WK + Zub Ceramic
Warnkontakt, Bremsbelagverschleiß							
1.3 CDTI 1.4 1.4 1.4 LPG 1.6 1.6 LPG 1.6 Turbo 1.7 CDTI 1.7 CDTI 1.8 1.9 CDTI 1.9 CDTI 1.9 CDTI 1.9 CDTI 16V 2.0 Turbo 2.0 Turbo	66 55 66 66 77 85 132 59 74 103 74 88 110 88 125 147	08/05→10/10 08/04→10/10 08/04→10/10 08/09→10/10 08/04→10/10 08/09→10/10 02/07→10/10 08/04→10/10 08/04→10/10 08/05→10/10 09/05→10/10 09/05→10/10 09/04→10/10 08/04→10/10 08/04→10/10 09/04→10/10	←		1	24.8190-0720.2 620720	L= 287
1.6	85	12/06→05/14	←	01/07→ 11/10	1	24.8190-0720.2 620720	L= 287
1.7 CDTI 1.7 CDTI	81 92	02/07→05/14 02/07→05/14	←	04/07→ 11/10	1	24.8190-0720.2 620720	L= 287
1.8	92	08/04→10/10	←	09/04→	1	24.8190-0720.2 620720	L= 287
 Bremsscheibe							
1.3 CDTI 1.4 1.4 1.4 LPG 1.6	66 55 66 66 77	08/05→10/10 08/04→10/10 08/04→10/10 08/09→10/10 08/04→10/10	← ←	Felge Lochzahl: 5 Felge Lochzahl: 4		24.0125-0131.1 425131 24.0125-0198.1 425198 24.0325-0198.1 525198	Ø 280 24,8 22 V + S Ø 280 25 22 V + S Ø 280 25 22 V + S PD

OPEL - ASTRA H Caravan (L35) 08/04→05/14









Bremsscheibe











1.6 LPG 1.7 CDTI 1.7 CDTI 1.8	85	08/09→10/10	➔	Felge Lochzahl: 5	24.0110-0250.1	410250	Ø 264 9,8 8 + S
	59	08/04→10/10			24.0310-0250.1	510250	Ø 264 9,8 8 + S PD
	74	08/04→10/10					
	103	08/05→10/10	➔	Felge Lochzahl: 4	24.0110-0251.1	410251	Ø 240 9,8 8 + S
1.6	85	12/06→05/14	➔	01/07→ 11/10; Felge Lochzahl: 5	24.0125-0131.1	425131	Ø 280 24,8 22 V + S
			➔	01/07→ 11/10; Felge Lochzahl: 4	24.0125-0198.1	425198	Ø 280 25 22 V + S
					24.0325-0198.1	525198	Ø 280 25 22 V + S PD
			➔	01/07→ 11/10; Felge Lochzahl: 5	24.0110-0250.1	410250	Ø 264 9,8 8 + S
					24.0310-0250.1	510250	Ø 264 9,8 8 + S PD
1.6 Turbo 1.9 CDTI 1.9 CDTI 1.9 CDTI 16V 2.0 Turbo 2.0 Turbo	132 74 88 110 88 125 147	02/07→10/10 09/05→10/10 09/05→10/10 09/04→10/10 08/04→10/10 08/04→10/10 09/04→10/10	➔	Felge Lochzahl: 5	24.0125-0142.1	425142	Ø 308 25 22 V + S
					24.0325-0142.1	525142	Ø 308 25 23 V + S PD
			➔	Felge Lochzahl: 4	24.0125-0198.1	425198	Ø 280 25 22 V + S
					24.0325-0198.1	525198	Ø 280 25 22 V + S PD
			➔	Felge Lochzahl: 5	24.0110-0250.1	410250	Ø 264 9,8 8 + S
					24.0310-0250.1	510250	Ø 264 9,8 8 + S PD
1.7 CDTI	81	02/07→05/14	➔	04/07→ 11/10; Felge Lochzahl: 5	24.0125-0131.1	425131	Ø 280 24,8 22 V + S
			➔	04/07→ 11/10; Felge Lochzahl: 4	24.0125-0198.1	425198	Ø 280 25 22 V + S
					24.0325-0198.1	525198	Ø 280 25 22 V + S PD
			➔	04/07→ 11/10; Felge Lochzahl: 5	24.0110-0250.1	410250	Ø 264 9,8 8 + S
					24.0310-0250.1	510250	Ø 264 9,8 8 + S PD
1.7 CDTI	92	02/07→05/14	➔	04/07→ 11/10; Felge Lochzahl: 5	24.0125-0142.1	425142	Ø 308 25 22 V + S
					24.0325-0142.1	525142	Ø 308 25 23 V + S PD
			➔	04/07→ 11/10; Felge Lochzahl: 4	24.0125-0198.1	425198	Ø 280 25 22 V + S
					24.0325-0198.1	525198	Ø 280 25 22 V + S PD
			➔	04/07→ 11/10; Felge Lochzahl: 5	24.0110-0250.1	410250	Ø 264 9,8 8 + S
1.8	92	08/04→10/10	➔	09/04→; Felge Lochzahl: 5	24.0125-0131.1	425131	Ø 280 24,8 22 V + S
					24.0325-0131.1	525131	Ø 280 24,8 22 V + S PD
			➔	09/04→; Felge Lochzahl: 4	24.0125-0198.1	425198	Ø 280 25 22 V + S
					24.0325-0198.1	525198	Ø 280 25 22 V + S PD
			➔	09/04→; Felge Lochzahl: 5	24.0110-0250.1	410250	Ø 264 9,8 8 + S
		24.0310-0250.1	510250	Ø 264 9,8 8 + S PD			
			➔	09/04→; Felge Lochzahl: 4	24.0110-0251.1	410251	Ø 240 9,8 8 + S
				24.0310-0251.1	510251	Ø 240 9,8 8 + S PD	











OPEL - ASTRA H GTC (L08) 03/05→10/10











Bremsbelagsatz, Scheibenbremse











1.2 1.4 1.4 1.6 1.6 Turbo 1.7 CDTi 1.7 CDTI 1.8 1.8 1.9 CDTi 1.9 CDTI 1.9 CDTI 1.9 CDTi 16V 2.0 Turbo 2.0 Turbo	59 55 66 77 132 74 59 92 103 110 74 88 88 125 147	08/05→10/10 03/05→10/10 03/05→10/10 03/05→10/10 02/07→10/10 03/05→10/10 03/05→10/10 03/05→10/10 01/06→10/10 03/05→10/10 01/06→10/10 09/05→10/10 03/05→10/10 03/05→10/10 03/05→10/10	➔		13.0460-7179.2	607179	ATE 23832 20,2 - WK / + WK
					13.0470-7179.2	LD7179	ATE 23832 20,2 - WK / + WK Ceramic
1.3 CDTI	66	04/05→10/10	➔	08/05→	13.0460-7179.2	607179	ATE 23832 20,2 - WK / + WK
					13.0470-7179.2	LD7179	ATE 23832 20,2 - WK / + WK Ceramic
			➔	08/05→	13.0460-2868.2	602868	TRW 23417 15,3 + WK + Zub
					13.0470-2868.2	LD2868	TRW 23417 15,3 + WK + Zub Ceramic

	kw			 	! #		
OPEL - ASTRA H GTC (L08) 03/05→10/10							
 Bremsbelagsatz, Scheibenbremse							
1.3 CDTI	66	04/05→10/10	➡	08/05→		13.0470-2868.2 LD2868	TRW 23417 15,3 + WK + Zub Ceramic
1.6	85	12/06→10/10	←	01/07→		13.0460-7179.2 607179 13.0470-7179.2 LD7179	ATE 23832 20,2 - WK / + WK ATE 23832 20,2 - WK / + WK Ceramic
			➡	01/07→		13.0460-2868.2 602868 13.0470-2868.2 LD2868	TRW 23417 15,3 + WK + Zub TRW 23417 15,3 + WK + Zub Ceramic
1.7 CDTI 1.7 CDTI	81 92	02/07→10/10 02/07→10/10	←	04/07→		13.0460-7179.2 607179 13.0470-7179.2 LD7179	ATE 23832 20,2 - WK / + WK ATE 23832 20,2 - WK / + WK Ceramic
			➡	04/07→		13.0460-2868.2 602868 13.0470-2868.2 LD2868	TRW 23417 15,3 + WK + Zub TRW 23417 15,3 + WK + Zub Ceramic
2.0 Turbo	177	08/05→10/10	←	für Bremssattel mit Kunststoffkolben		13.0460-7172.2 607172 13.0470-7172.2 LD7172	ATE 23378 20,1 + WE / - WK ATE 23378 20,1 + WE / - WK Ceramic
			←	für Bremssattel mit Stahlkolben		13.0460-7212.2 607212	ATE 23738 20,1 + WE / - WK
			➡			13.0460-2868.2 602868 13.0470-2868.2 LD2868	TRW 23417 15,3 + WK + Zub TRW 23417 15,3 + WK + Zub Ceramic
Warnkontakt, Bremsbelagverschleiß							
1.2 1.4 1.4 1.6 1.6 Turbo 1.7 CDTi 1.7 CDTI 1.8 1.8 1.9 CDTi 1.9 CDTI 1.9 CDTI 1.9 CDTI 16V 2.0 Turbo 2.0 Turbo 2.0 Turbo	59 55 66 77 132 74 59 92 103 110 74 88 88 125 147 177	08/05→10/10 03/05→10/10 03/05→10/10 03/05→10/10 02/07→10/10 03/05→10/10 03/05→10/10 03/05→10/10 01/06→10/10 03/05→10/10 01/06→10/10 09/05→10/10 03/05→10/10 03/05→10/10 03/05→10/10 08/05→10/10	←		1	24.8190-0720.2 620720	L= 287
1.3 CDTI	66	04/05→10/10	←	08/05→	1	24.8190-0720.2 620720	L= 287
1.6	85	12/06→10/10	←	01/07→	1	24.8190-0720.2 620720	L= 287
1.7 CDTI 1.7 CDTI	81 92	02/07→10/10 02/07→10/10	←	04/07→	1	24.8190-0720.2 620720	L= 287
 Bremsscheibe							
1.2 1.4 1.4 1.6 1.7 CDTi 1.7 CDTI 1.8 1.8	59 55 66 77 74 59 92 103	08/05→10/10 03/05→10/10 03/05→10/10 03/05→10/10 03/05→10/10 03/05→10/10 03/05→10/10 01/06→10/10	←	Felge Lochzahl: 5		24.0125-0131.1 425131 24.0325-0131.1 525131	Ø 280 24,8 22 V + S Ø 280 24,8 22 V + S PD
1.6	77	03/05→10/10	←	Felge Lochzahl: 4		24.0125-0198.1 425198 24.0325-0198.1 525198	Ø 280 25 22 V + S Ø 280 25 22 V + S PD
			➡	Felge Lochzahl: 5		24.0110-0250.1 410250 24.0310-0250.1 510250	Ø 264 9,8 8 + S Ø 264 9,8 8 + S PD
1.3 CDTI	66	04/05→10/10	←	08/05→; Felge Lochzahl: 5		24.0125-0131.1 425131 24.0325-0131.1 525131	Ø 280 24,8 22 V + S Ø 280 24,8 22 V + S PD
			←	08/05→; Felge Lochzahl: 4		24.0125-0198.1 425198 24.0325-0198.1 525198	Ø 280 25 22 V + S Ø 280 25 22 V + S PD
			➡	08/05→; Felge Lochzahl: 5		24.0110-0250.1 410250 24.0310-0250.1 510250	Ø 264 9,8 8 + S Ø 264 9,8 8 + S PD
			➡	08/05→; Felge Lochzahl: 4		24.0110-0251.1 410251 24.0310-0251.1 510251	Ø 240 9,8 8 + S Ø 240 9,8 8 + S PD
1.6	85	12/06→10/10	←	01/07→; Felge Lochzahl: 5		24.0125-0131.1 425131 24.0325-0131.1 525131	Ø 280 24,8 22 V + S Ø 280 24,8 22 V + S PD
			←	01/07→; Felge Lochzahl: 4		24.0125-0198.1 425198 24.0325-0198.1 525198	Ø 280 25 22 V + S Ø 280 25 22 V + S PD
			➡	01/07→; Felge Lochzahl: 5		24.0110-0250.1 410250 24.0310-0250.1 510250	Ø 264 9,8 8 + S Ø 264 9,8 8 + S PD
			➡	01/07→; Felge Lochzahl: 4		24.0110-0251.1 410251	Ø 240 9,8 8 + S











	kW			 	! #		
OPEL - ASTRA H GTC (L08) 03/05→10/10							
 Bremsscheibe							
1.6	85	12/06→10/10	➔	01/07→; Felge Lochzahl: 4		24.0310-0251.1 510251	Ø 240 9,8 8 + S PD
1.6 Turbo	132	02/07→10/10	➔	Felge Lochzahl: 5		24.0125-0142.1 425142	Ø 308 25 22 V + S
1.9 CDTi	110	03/05→10/10				24.0325-0142.1 525142	Ø 308 25 23 V + S PD
1.9 CDTi	74	01/06→10/10					
1.9 CDTi	88	09/05→10/10	➔	Felge Lochzahl: 4		24.0125-0198.1 425198	Ø 280 25 22 V + S
1.9 CDTi 16V	88	03/05→10/10				24.0325-0198.1 525198	Ø 280 25 22 V + S PD
2.0 Turbo	125	03/05→10/10	➔	Felge Lochzahl: 5		24.0110-0250.1 410250	Ø 264 9,8 8 + S
2.0 Turbo	147	03/05→10/10	➔	Felge Lochzahl: 5		24.0310-0250.1 510250	Ø 264 9,8 8 + S PD
			➔	Felge Lochzahl: 4		24.0110-0251.1 410251	Ø 240 9,8 8 + S
			➔	Felge Lochzahl: 4		24.0310-0251.1 510251	Ø 240 9,8 8 + S PD
1.7 CDTI	81	02/07→10/10	➔	04/07→; Felge Lochzahl: 5		24.0125-0131.1 425131	Ø 280 24,8 22 V + S
			➔	04/07→; Felge Lochzahl: 5		24.0325-0131.1 525131	Ø 280 24,8 22 V + S PD
			➔	04/07→; Felge Lochzahl: 4		24.0125-0198.1 425198	Ø 280 25 22 V + S
			➔	04/07→; Felge Lochzahl: 4		24.0325-0198.1 525198	Ø 280 25 22 V + S PD
			➔	04/07→; Felge Lochzahl: 5		24.0110-0250.1 410250	Ø 264 9,8 8 + S
			➔	04/07→; Felge Lochzahl: 5		24.0310-0250.1 510250	Ø 264 9,8 8 + S PD
			➔	04/07→; Felge Lochzahl: 4		24.0110-0251.1 410251	Ø 240 9,8 8 + S
			➔	04/07→; Felge Lochzahl: 4		24.0310-0251.1 510251	Ø 240 9,8 8 + S PD
1.7 CDTI	92	02/07→10/10	➔	04/07→; Felge Lochzahl: 5		24.0125-0142.1 425142	Ø 308 25 22 V + S
			➔	04/07→; Felge Lochzahl: 4		24.0325-0142.1 525142	Ø 308 25 23 V + S PD
			➔	04/07→; Felge Lochzahl: 4		24.0125-0198.1 425198	Ø 280 25 22 V + S
			➔	04/07→; Felge Lochzahl: 4		24.0325-0198.1 525198	Ø 280 25 22 V + S PD
			➔	04/07→; Felge Lochzahl: 5		24.0110-0250.1 410250	Ø 264 9,8 8 + S
			➔	04/07→; Felge Lochzahl: 5		24.0310-0250.1 510250	Ø 264 9,8 8 + S PD
			➔	04/07→; Felge Lochzahl: 4		24.0110-0251.1 410251	Ø 240 9,8 8 + S
			➔	04/07→; Felge Lochzahl: 4		24.0310-0251.1 510251	Ø 240 9,8 8 + S PD
2.0 Turbo	177	08/05→10/10	➔	Felge Lochzahl: 5		24.0128-0201.1 428201	Ø 321 28 25 V
			➔			24.0110-0339.1 410339	Ø 278 10 8 + S
OPEL - ASTRA H Kasten (L70) 02/04→12/13							
 Bremsbelagsatz, Scheibenbremse							
1.3 CDTi	66	08/05→10/10	➔			13.0460-7179.2 607179	ATE 23832 20,2 - WK / + WK
1.9 CDTi	88	09/05→10/10				13.0470-7179.2 LD7179	ATE 23832 20,2 - WK / + WK
1.9 CDTi	110	09/04→10/10					Ceramic
1.9 CDTi 16V	88	08/04→10/10	➔			13.0460-2868.2 602868	TRW 23417 15,3 + WK + Zub
			➔			13.0470-2868.2 LD2868	TRW 23417 15,3 + WK + Zub
							Ceramic
1.7 CDTi	74	03/04→10/10	➔	08/04→		13.0460-7179.2 607179	ATE 23832 20,2 - WK / + WK
			➔	08/04→		13.0470-7179.2 LD7179	ATE 23832 20,2 - WK / + WK
							Ceramic
			➔	08/04→		13.0460-2868.2 602868	TRW 23417 15,3 + WK + Zub
			➔	08/04→		13.0470-2868.2 LD2868	TRW 23417 15,3 + WK + Zub
							Ceramic
1.7 CDTi	81	02/07→10/10	➔	04/07→		13.0460-7179.2 607179	ATE 23832 20,2 - WK / + WK
1.7 CDTi	92	02/07→10/10				13.0470-7179.2 LD7179	ATE 23832 20,2 - WK / + WK
							Ceramic
			➔	04/07→		13.0460-2868.2 602868	TRW 23417 15,3 + WK + Zub
			➔	04/07→		13.0470-2868.2 LD2868	TRW 23417 15,3 + WK + Zub
							Ceramic
Warnkontakt, Bremsbelagverschleiß							
1.3 CDTi	66	08/05→10/10	➔		1	24.8190-0720.2 620720	L= 287
1.9 CDTi	88	09/05→10/10					
1.9 CDTi	110	09/04→10/10					
1.9 CDTi 16V	88	08/04→10/10					
1.7 CDTi	74	03/04→10/10	➔	08/04→	1	24.8190-0720.2 620720	L= 287
1.7 CDTi	81	02/07→10/10	➔	04/07→	1	24.8190-0720.2 620720	L= 287
1.7 CDTi	92	02/07→10/10					
 Bremsscheibe							
1.3 CDTi	66	08/05→10/10	➔	Felge Lochzahl: 5		24.0125-0131.1 425131	Ø 280 24,8 22 V + S
			➔	Felge Lochzahl: 4		24.0125-0198.1 425198	Ø 280 25 22 V + S
						24.0325-0198.1 525198	Ø 280 25 22 V + S PD
			➔	Felge Lochzahl: 5		24.0110-0250.1 410250	Ø 264 9,8 8 + S
						24.0310-0250.1 510250	Ø 264 9,8 8 + S PD
↓							













	kW			 	! #		
OPEL - ASTRA H Kasten (L70) 02/04→12/13							
 Bremsscheibe							
1.3 CDTi	66	08/05→10/10	➔	Felge Lochzahl: 4		24.0110-0251.1 410251 24.0310-0251.1 510251	Ø 240 9,8 8 + S Ø 240 9,8 8 + S PD
1.7 CDTi	74	03/04→10/10	➔	08/04→; Felge Lochzahl: 5		24.0125-0131.1 425131	Ø 280 24,8 22 V + S
			➔	08/04→; Felge Lochzahl: 4		24.0125-0198.1 425198 24.0325-0198.1 525198	Ø 280 25 22 V + S Ø 280 25 22 V + S PD
			➔	08/04→; Felge Lochzahl: 5		24.0110-0250.1 410250 24.0310-0250.1 510250	Ø 264 9,8 8 + S Ø 264 9,8 8 + S PD
			➔	08/04→; Felge Lochzahl: 4		24.0110-0251.1 410251 24.0310-0251.1 510251	Ø 240 9,8 8 + S Ø 240 9,8 8 + S PD
1.7 CDTi	81	02/07→10/10	➔	04/07→; Felge Lochzahl: 5		24.0125-0131.1 425131	Ø 280 24,8 22 V + S
			➔	04/07→; Felge Lochzahl: 4		24.0125-0198.1 425198 24.0325-0198.1 525198	Ø 280 25 22 V + S Ø 280 25 22 V + S PD
			➔	04/07→; Felge Lochzahl: 5		24.0110-0250.1 410250 24.0310-0250.1 510250	Ø 264 9,8 8 + S Ø 264 9,8 8 + S PD
			➔	04/07→; Felge Lochzahl: 4		24.0110-0251.1 410251 24.0310-0251.1 510251	Ø 240 9,8 8 + S Ø 240 9,8 8 + S PD
1.7 CDTi	92	02/07→10/10	➔	04/07→; Felge Lochzahl: 5		24.0125-0142.1 425142 24.0325-0142.1 525142	Ø 308 25 22 V + S Ø 308 25 23 V + S PD
			➔	04/07→; Felge Lochzahl: 4		24.0125-0198.1 425198 24.0325-0198.1 525198	Ø 280 25 22 V + S Ø 280 25 22 V + S PD
			➔	04/07→; Felge Lochzahl: 5		24.0110-0250.1 410250 24.0310-0250.1 510250	Ø 264 9,8 8 + S Ø 264 9,8 8 + S PD
			➔	04/07→; Felge Lochzahl: 4		24.0110-0251.1 410251 24.0310-0251.1 510251	Ø 240 9,8 8 + S Ø 240 9,8 8 + S PD
1.9 CDTi 1.9 CDTi 1.9 CDTi 16V	88 110 88	09/05→10/10 09/04→10/10 08/04→10/10	➔	Felge Lochzahl: 5		24.0125-0142.1 425142 24.0325-0142.1 525142	Ø 308 25 22 V + S Ø 308 25 23 V + S PD
			➔	Felge Lochzahl: 4		24.0125-0198.1 425198 24.0325-0198.1 525198	Ø 280 25 22 V + S Ø 280 25 22 V + S PD
			➔	Felge Lochzahl: 5		24.0110-0250.1 410250 24.0310-0250.1 510250	Ø 264 9,8 8 + S Ø 264 9,8 8 + S PD
			➔	Felge Lochzahl: 4		24.0110-0251.1 410251 24.0310-0251.1 510251	Ø 240 9,8 8 + S Ø 240 9,8 8 + S PD
OPEL - ASTRA H Stufenheck (L69) 02/07→05/14							
 Bremsbelagsatz, Scheibenbremse							
1.3 CDTi 1.7 CDTi 1.8	66 74 103	02/07→10/10 02/07→10/10 02/07→10/10	➔			13.0460-7179.2 607179 13.0470-7179.2 LD7179	ATE 23832 20,2 - WK / + WK ATE 23832 20,2 - WK / + WK Ceramic
			➔			13.0460-2868.2 602868 13.0470-2868.2 LD2868	TRW 23417 15,3 + WK + Zub TRW 23417 15,3 + WK + Zub Ceramic
1.6	85	02/07→05/14	➔	→ 11/10		13.0460-7179.2 607179 13.0470-7179.2 LD7179	ATE 23832 20,2 - WK / + WK ATE 23832 20,2 - WK / + WK Ceramic
			➔	→ 11/10		13.0460-2868.2 602868 13.0470-2868.2 LD2868	TRW 23417 15,3 + WK + Zub TRW 23417 15,3 + WK + Zub Ceramic
1.7 CDTi 1.7 CDTi	81 92	02/07→05/14 02/07→05/14	➔	04/07→ 11/10		13.0460-7179.2 607179 13.0470-7179.2 LD7179	ATE 23832 20,2 - WK / + WK ATE 23832 20,2 - WK / + WK Ceramic
			➔	04/07→ 11/10		13.0460-2868.2 602868 13.0470-2868.2 LD2868	TRW 23417 15,3 + WK + Zub TRW 23417 15,3 + WK + Zub Ceramic
Warnkontakt, Bremsbelagsverschleiß							
1.3 CDTi 1.7 CDTi 1.8	66 74 103	02/07→10/10 02/07→10/10 02/07→10/10	➔		1	24.8190-0720.2 620720	L= 287
1.6	85	02/07→05/14	➔	→ 11/10	1	24.8190-0720.2 620720	L= 287
1.7 CDTi 1.7 CDTi	81 92	02/07→05/14 02/07→05/14	➔	04/07→ 11/10	1	24.8190-0720.2 620720	L= 287
 Bremsscheibe							
1.3 CDTi ↓	66	02/07→10/10	➔	Felge Lochzahl: 5		24.0125-0131.1 425131	Ø 280 24,8 22 V + S











	kW			 	! #				
OPEL - ASTRA H Stufenheck (L69) 02/07→05/14									
 Bremsscheibe									
1.7 CDTi 1.8	74 103	02/07→10/10 02/07→10/10	←	Felge Lochzahl: 5		24.0325-0131.1 525131	Ø 280 24,8 22 V + S PD		
			←	Felge Lochzahl: 4		24.0125-0198.1 425198	Ø 280 25 22 V + S		
						24.0325-0198.1 525198	Ø 280 25 22 V + S PD		
			→	Felge Lochzahl: 5		24.0110-0250.1 410250	Ø 264 9,8 8 + S		
			→	Felge Lochzahl: 4		24.0310-0250.1 510250	Ø 264 9,8 8 + S PD		
			→	Felge Lochzahl: 5		24.0110-0251.1 410251	Ø 240 9,8 8 + S		
			→	Felge Lochzahl: 4		24.0310-0251.1 510251	Ø 240 9,8 8 + S PD		
1.6	85	02/07→05/14	←	→ 11/10; Felge Lochzahl: 5		24.0125-0131.1 425131	Ø 280 24,8 22 V + S		
						24.0325-0131.1 525131	Ø 280 24,8 22 V + S PD		
			←	→ 11/10; Felge Lochzahl: 4		24.0125-0198.1 425198	Ø 280 25 22 V + S		
						24.0325-0198.1 525198	Ø 280 25 22 V + S PD		
			→	→ 11/10; Felge Lochzahl: 5		24.0110-0250.1 410250	Ø 264 9,8 8 + S		
			→	Felge Lochzahl: 5		24.0310-0250.1 510250	Ø 264 9,8 8 + S PD		
			→	→ 11/10; Felge Lochzahl: 4		24.0110-0251.1 410251	Ø 240 9,8 8 + S		
			→	Felge Lochzahl: 4		24.0310-0251.1 510251	Ø 240 9,8 8 + S PD		
1.7 CDTi	81	02/07→05/14	←	04/07→ 11/10; Felge Lochzahl: 5		24.0125-0131.1 425131	Ø 280 24,8 22 V + S		
						24.0325-0131.1 525131	Ø 280 24,8 22 V + S PD		
			←	04/07→ 11/10; Felge Lochzahl: 4		24.0125-0198.1 425198	Ø 280 25 22 V + S		
						24.0325-0198.1 525198	Ø 280 25 22 V + S PD		
			→	04/07→ 11/10; Felge Lochzahl: 5		24.0110-0250.1 410250	Ø 264 9,8 8 + S		
			→	Felge Lochzahl: 5		24.0310-0250.1 510250	Ø 264 9,8 8 + S PD		
			→	04/07→ 11/10; Felge Lochzahl: 4		24.0110-0251.1 410251	Ø 240 9,8 8 + S		
			→	Felge Lochzahl: 4		24.0310-0251.1 510251	Ø 240 9,8 8 + S PD		
1.7 CDTi	92	02/07→05/14	←	04/07→ 11/10; Felge Lochzahl: 5		24.0125-0142.1 425142	Ø 308 25 22 V + S		
						24.0325-0142.1 525142	Ø 308 25 23 V + S PD		
			←	04/07→ 11/10; Felge Lochzahl: 4		24.0125-0198.1 425198	Ø 280 25 22 V + S		
						24.0325-0198.1 525198	Ø 280 25 22 V + S PD		
			→	04/07→ 11/10; Felge Lochzahl: 5		24.0110-0250.1 410250	Ø 264 9,8 8 + S		
			→	Felge Lochzahl: 5		24.0310-0250.1 510250	Ø 264 9,8 8 + S PD		
			→	04/07→ 11/10; Felge Lochzahl: 4		24.0110-0251.1 410251	Ø 240 9,8 8 + S		
			→	Felge Lochzahl: 4		24.0310-0251.1 510251	Ø 240 9,8 8 + S PD		
OPEL - ASTRA H TwinTop (L67) 09/05→10/10									
 Bremsbelagsatz, Scheibenbremse									
1.6 1.8 1.8 1.9 CDTi 2.0 Turbo 2.0 Turbo	77 92 103 110 125 147	09/05→10/10 09/05→10/10 09/05→10/10 09/05→10/10 09/05→10/10 09/05→10/10	←	03/06→		13.0460-7179.2 607179	ATE 23832 20,2 - WK / + WK		
						13.0470-7179.2 LD7179	ATE 23832 20,2 - WK / + WK Ceramic		
			→	03/06→		13.0460-2868.2 602868	TRW 23417 15,3 + WK + Zub		
						13.0470-2868.2 LD2868	TRW 23417 15,3 + WK + Zub Ceramic		
			←					13.0460-7179.2 607179	ATE 23832 20,2 - WK / + WK
1.6 1.6 Turbo	85 132	12/06→10/10 02/07→10/10	←			13.0470-7179.2 LD7179	ATE 23832 20,2 - WK / + WK Ceramic		
			→			13.0460-2868.2 602868	TRW 23417 15,3 + WK + Zub		
						13.0470-2868.2 LD2868	TRW 23417 15,3 + WK + Zub Ceramic		
Warnkontakt, Bremsbelagverschleiß									
1.6 1.8 1.8 1.9 CDTi 2.0 Turbo 2.0 Turbo	77 92 103 110 125 147	09/05→10/10 09/05→10/10 09/05→10/10 09/05→10/10 09/05→10/10 09/05→10/10	←	03/06→	1	24.8190-0720.2 620720	L= 287		
1.6 1.6 Turbo	85 132	12/06→10/10 02/07→10/10	←		1	24.8190-0720.2 620720	L= 287		
 Bremsscheibe									
1.6 1.8 1.8	77 92 103	09/05→10/10 09/05→10/10 09/05→10/10	←	03/06→; Felge Lochzahl: 5		24.0125-0131.1 425131	Ø 280 24,8 22 V + S		
						24.0325-0131.1 525131	Ø 280 24,8 22 V + S PD		
			←	03/06→; Felge Lochzahl: 4		24.0125-0198.1 425198	Ø 280 25 22 V + S		
						24.0325-0198.1 525198	Ø 280 25 22 V + S PD		
			→	03/06→; Felge Lochzahl: 5		24.0110-0250.1 410250	Ø 264 9,8 8 + S		
			→	03/06→; Felge Lochzahl: 4		24.0110-0291.1 410291	Ø 264 10 8 + S		
						24.0310-0291.1 510291	Ø 264 10 8 + S PD		
↓									







	kW			 	! #				
OPEL - ASTRA H TwinTop (L67) 09/05→10/10									
 Bremsscheibe									
1.6	85	12/06→10/10	←	Felge Lochzahl: 5	24.0125-0131.1 425131	Ø 280 24,8 22 V + S			
					24.0325-0131.1 525131	Ø 280 24,8 22 V + S PD			
			←	Felge Lochzahl: 4	24.0125-0198.1 425198	Ø 280 25 22 V + S			
					24.0325-0198.1 525198	Ø 280 25 22 V + S PD			
			→	Felge Lochzahl: 5	24.0110-0250.1 410250	Ø 264 9,8 8 + S			
					24.0110-0291.1 410291	Ø 264 10 8 + S			
			→	Felge Lochzahl: 4	24.0310-0291.1 510291	Ø 264 10 8 + S PD			
1.6 Turbo	132	02/07→10/10	←	Felge Lochzahl: 5	24.0125-0142.1 425142	Ø 308 25 22 V + S			
					24.0125-0198.1 425198	Ø 280 25 22 V + S			
					24.0325-0198.1 525198	Ø 280 25 22 V + S PD			
			←		24.0325-0142.1 525142	Ø 308 25 23 V + S PD			
			→	Felge Lochzahl: 5	24.0110-0250.1 410250	Ø 264 9,8 8 + S			
					24.0110-0291.1 410291	Ø 264 10 8 + S			
1.9 CDTi 2.0 Turbo 2.0 Turbo	110 125 147	09/05→10/10 09/05→10/10 09/05→10/10	←	03/06→; Felge Lochzahl: 5	24.0125-0142.1 425142	Ø 308 25 22 V + S			
					24.0125-0198.1 425198	Ø 280 25 22 V + S			
					24.0325-0198.1 525198	Ø 280 25 22 V + S PD			
			←	03/06→; Felge Lochzahl: 4	24.0325-0142.1 525142	Ø 308 25 23 V + S PD			
			→	03/06→	24.0110-0250.1 410250	Ø 264 9,8 8 + S			
					24.0110-0291.1 410291	Ø 264 10 8 + S			
			→	03/06→; Felge Lochzahl: 5	24.0310-0291.1 510291	Ø 264 10 8 + S PD			
			→	03/06→; Felge Lochzahl: 4	24.0310-0291.1 510291	Ø 264 10 8 + S PD			
			→						
OPEL - ASTRA J 12/09→									
 Bremsbelagsatz, Scheibenbremse									
1.3 CDTi 1.4 1.4 1.4 LPG 1.4 Turbo 1.6 1.6 CDTi 1.6 CDTi 1.6 SIDI 1.6 Turbo 1.7 CDTi 1.7 CDTi 1.7 CDTi 1.7 CDTi 2.0 BiTurbo CDTi 2.0 CDTi 2.0 CDTi	70 64 74 103 103 85 81 100 125 132 74 81 92 96 143 118 121	12/09→ 12/09→ 12/09→ 01/12→ 12/09→ 12/09→ 02/14→ 01/14→ 12/12→ 12/09→ 10/10→ 12/09→ 12/09→ 12/09→ 12/12→ 12/09→ 06/11→	←	für Bremsscheibendurchmesser [mm]: 321	13.0460-5612.2 605612	MAN 24412 19,0 + WK + Zub			
					13.0470-5612.2 LD5612	MAN 24412 19,0 + WK + Zub Ceramic			
			←	für Bremsscheibendurchmesser [mm]: 276	13.0460-7262.2 607262	25031 19,1 + WK + Zub			
					13.0470-7262.2 LD7262	25031 19,1 + WK + Zub Ceramic			
			←	für Bremsscheibendurchmesser [mm]: 300	13.0460-7263.2 607263	24034 19,1 + WK + Zub			
					13.0470-7263.2 LD7263	24034 19,1 + WK + Zub Ceramic			
			→		13.0460-7264.2 607264	ATE 25096 17,0 + WK + Zub			
					13.0470-7264.2 LD7264	ATE 25096 17,0 + WK + Zub Ceramic			
			1.4 Turbo	88	10/10→	←	11/10→; für Bremsscheibendurchmesser [mm]: 321	13.0460-5612.2 605612	MAN 24412 19,0 + WK + Zub
								13.0470-5612.2 LD5612	MAN 24412 19,0 + WK + Zub Ceramic
						←	11/10→; für Bremsscheibendurchmesser [mm]: 276	13.0460-7262.2 607262	25031 19,1 + WK + Zub
								13.0470-7262.2 LD7262	25031 19,1 + WK + Zub Ceramic
					←	11/10→; für Bremsscheibendurchmesser [mm]: 300	13.0460-7263.2 607263	24034 19,1 + WK + Zub	
							13.0470-7263.2 LD7263	24034 19,1 + WK + Zub Ceramic	
					→	11/10→	13.0460-7264.2 607264	ATE 25096 17,0 + WK + Zub	
							13.0470-7264.2 LD7264	ATE 25096 17,0 + WK + Zub Ceramic	
 Bremsscheibe									
1.3 CDTi 1.4 1.4 1.4 LPG 1.4 Turbo 1.6 1.6 CDTi 1.6 CDTi 1.6 SIDI 1.6 Turbo 1.7 CDTi 1.7 CDTi 1.7 CDTi 2.0 BiTurbo CDTi 2.0 CDTi	70 64 74 103 103 85 81 100 125 132 74 81 92 96 143 118	12/09→ 12/09→ 12/09→ 01/12→ 12/09→ 12/09→ 02/14→ 01/14→ 12/12→ 12/09→ 10/10→ 12/09→ 12/09→ 12/09→ 12/12→ 12/09→	←		24.0126-0165.1 426165	Ø 276 26 23 V + S			
					24.0126-0166.1 426166	Ø 300 26 23 V + S			
					24.0130-0224.1 430224	Ø 321 30 27 V + S			
					24.0326-0165.1 526165	Ø 276 26 23 V + S PD			
					24.0326-0166.1 526166	Ø 300 26 23 V + S PD			
			→		24.0112-0188.1 412188	Ø 268 12 10 + S			
					24.0112-0189.1 412189	Ø 292 12 10 + S			
					24.0312-0188.1 512188	Ø 268 12 10 + S PD			
					24.0312-0189.1 512189	Ø 292 12 10 + S PD			
			2.0 CDTi	118	12/09→	↓			















	kw			 	! #		
OPEL - ASTRA J 12/09→							
 Bremsscheibe							
2.0 CDTI	121	06/11→	←		24.0126-0165.1	426165	Ø 276 26 23 V + S
			→		24.0126-0166.1	426166	Ø 300 26 23 V + S
			←	11/10→	24.0130-0224.1	430224	Ø 321 30 27 V + S
			→		24.0326-0165.1	526165	Ø 276 26 23 V + S PD
			←		24.0326-0166.1	526166	Ø 300 26 23 V + S PD
			→		24.0112-0188.1	412188	Ø 268 12 10 + S
			→		24.0112-0189.1	412189	Ø 292 12 10 + S
			→		24.0312-0188.1	512188	Ø 268 12 10 + S PD
			→		24.0312-0189.1	512189	Ø 292 12 10 + S PD
			→				
OPEL - ASTRA J GTC 10/11→							
 Bremsbelagsatz, Scheibenbremse							
1.4	74	10/11→	←	für Bremsscheibendurchmesser [mm]: 321	13.0460-5612.2	605612	MAN 24412 19,0 + WK + Zub
1.4	88	10/11→			13.0470-5612.2	LD5612	MAN 24412 19,0 + WK + Zub Ceramic
1.4	103	10/11→					
1.6	132	10/11→					
1.6 CDTI	81	07/14→	←	für Bremsscheibendurchmesser [mm]: 276	13.0460-7262.2	607262	25031 19,1 + WK + Zub
1.6 CDTI	100	07/14→			13.0470-7262.2	LD7262	25031 19,1 + WK + Zub Ceramic
1.6 SIDI	125	12/12→					
1.6 SIDI	147	07/13→	←	für Bremsscheibendurchmesser [mm]: 300	13.0460-7263.2	607263	24034 19,1 + WK + Zub
1.7 CDTI	81	10/11→			13.0470-7263.2	LD7263	24034 19,1 + WK + Zub Ceramic
1.7 CDTI	96	10/11→	→		13.0460-7264.2	607264	ATE 25096 17,0 + WK + Zub
1.8	103	10/11→			13.0470-7264.2	LD7264	ATE 25096 17,0 + WK + Zub Ceramic
2.0 CDTI	121	10/11→					
2.0	206	04/12→	←	06/12→	13.0460-4855.2	604855	BRE 23325 16,4 + WK
			→	F0000001→	13.0460-7309.2	607309	ATE 25096 16,7 + WK + Zub
					13.0470-7309.2	LD7309	ATE 25096 16,7 + WK + Zub Ceramic
2.0 BiTurbo CDTI	143	10/12→	←	12/12→; für Bremsscheibendurchmesser [mm]: 321	13.0460-5612.2	605612	MAN 24412 19,0 + WK + Zub
					13.0470-5612.2	LD5612	MAN 24412 19,0 + WK + Zub Ceramic
			←	12/12→; für Bremsscheibendurchmesser [mm]: 276	13.0460-7262.2	607262	25031 19,1 + WK + Zub
					13.0470-7262.2	LD7262	25031 19,1 + WK + Zub Ceramic
			←	12/12→; für Bremsscheibendurchmesser [mm]: 300	13.0460-7263.2	607263	24034 19,1 + WK + Zub
					13.0470-7263.2	LD7263	24034 19,1 + WK + Zub Ceramic
			→	12/12→	13.0460-7264.2	607264	ATE 25096 17,0 + WK + Zub
					13.0470-7264.2	LD7264	ATE 25096 17,0 + WK + Zub Ceramic
 Bremsscheibe							
1.4	74	10/11→	←		24.0126-0165.1	426165	Ø 276 26 23 V + S
			→		24.0126-0166.1	426166	Ø 300 26 23 V + S
1.4	88	10/11→			24.0130-0224.1	430224	Ø 321 30 27 V + S
					24.0326-0165.1	526165	Ø 276 26 23 V + S PD
1.4	103	10/11→			24.0326-0166.1	526166	Ø 300 26 23 V + S PD
1.6	132	10/11→			24.0112-0188.1	412188	Ø 268 12 10 + S
					24.0112-0189.1	412189	Ø 292 12 10 + S
1.6 CDTI	81	07/14→	→		24.0312-0188.1	512188	Ø 268 12 10 + S PD
					24.0312-0189.1	512189	Ø 292 12 10 + S PD
1.6 CDTI	100	07/14→					
1.6 SIDI	125	12/12→					
1.6 SIDI	147	07/13→					
1.7 CDTI	81	10/11→					
1.7 CDTI	96	10/11→					
1.8	103	10/11→					
2.0 CDTI	121	10/11→					
2.0 BiTurbo CDTI	143	10/12→	←	12/12→	24.0126-0165.1	426165	Ø 276 26 23 V + S
					24.0126-0166.1	426166	Ø 300 26 23 V + S
					24.0130-0224.1	430224	Ø 321 30 27 V + S
					24.0326-0165.1	526165	Ø 276 26 23 V + S PD
					24.0326-0166.1	526166	Ø 300 26 23 V + S PD
			→	12/12→	24.0112-0188.1	412188	Ø 268 12 10 + S













	kw			 	! #		
OPEL - ASTRA J GTC 10/11→							
 Bremsscheibe							
2.0 BiTurbo CDTI	143	10/12→	→	12/12→		24.0112-0189.1 412189 24.0312-0188.1 512188 24.0312-0189.1 512189	∅ 292 12 10 + S ∅ 268 12 10 + S PD ∅ 292 12 10 + S PD
OPEL - ASTRA J Sports Tourer 10/10→							
 Bremsbelagsatz, Scheibenbremse							
1.3 CDTI	70	10/10→	←	11/10→; für Bremsscheibendurchmesser [mm]: 321	13.0460-5612.2 605612 13.0470-5612.2 LD5612	MAN 24412 19,0 + WK + Zub MAN 24412 19,0 + WK + Zub Ceramic	
1.4	64	10/10→10/15					
1.4	74	10/10→					
1.4 Turbo	88	10/10→					
1.4 Turbo	103	10/10→	←	11/10→; für Bremsscheibendurchmesser [mm]: 276	13.0460-7262.2 607262 13.0470-7262.2 LD7262	25031 19,1 + WK + Zub 25031 19,1 + WK + Zub Ceramic	
1.6	85	10/10→					
1.6 Turbo	132	10/10→					
1.7 CDTI	74	10/10→	←	11/10→; für Bremsscheibendurchmesser [mm]: 300	13.0460-7263.2 607263 13.0470-7263.2 LD7263	24034 19,1 + WK + Zub 24034 19,1 + WK + Zub Ceramic	
1.7 CDTI	81	10/10→					
1.7 CDTI	92	10/10→					
1.7 CDTI	96	10/10→	→	11/10→	13.0460-7264.2 607264 13.0470-7264.2 LD7264	ATE 25096 17,0 + WK + Zub ATE 25096 17,0 + WK + Zub Ceramic	
2.0 CDTI	96	10/10→					
2.0 CDTI	118	10/10→					
1.4 LPG	103	01/12→	←	für Bremsscheibendurchmesser [mm]: 321	13.0460-5612.2 605612 13.0470-5612.2 LD5612	MAN 24412 19,0 + WK + Zub MAN 24412 19,0 + WK + Zub Ceramic	
1.6 CDTi	81	02/14→					
1.6 CDTi	100	01/14→					
1.6 LPG	84	10/12→					
1.6 SIDI	125	12/12→	←	für Bremsscheibendurchmesser [mm]: 276	13.0460-7262.2 607262 13.0470-7262.2 LD7262	25031 19,1 + WK + Zub 25031 19,1 + WK + Zub Ceramic	
2.0 BiTurbo CDTI	143	12/12→					
2.0 CDTI	121	08/11→	←	für Bremsscheibendurchmesser [mm]: 300	13.0460-7263.2 607263 13.0470-7263.2 LD7263	24034 19,1 + WK + Zub 24034 19,1 + WK + Zub Ceramic	
			→		13.0460-7264.2 607264 13.0470-7264.2 LD7264	ATE 25096 17,0 + WK + Zub ATE 25096 17,0 + WK + Zub Ceramic	
 Bremsscheibe							
1.3 CDTI	70	10/10→	←	11/10→	24.0126-0165.1 426165 24.0126-0166.1 426166 24.0130-0224.1 430224	∅ 276 26 23 V + S ∅ 300 26 23 V + S ∅ 321 30 27 V + S	
1.4	64	10/10→10/15					
1.4	74	10/10→					
1.4 Turbo	88	10/10→					
1.4 Turbo	103	10/10→					
1.6	85	10/10→					
1.6 Turbo	132	10/10→					
1.7 CDTI	74	10/10→	→	11/10→	24.0112-0188.1 412188 24.0112-0189.1 412189 24.0312-0188.1 512188 24.0312-0189.1 512189	∅ 268 12 10 + S ∅ 292 12 10 + S ∅ 268 12 10 + S PD ∅ 292 12 10 + S PD	
1.7 CDTI	81	10/10→					
1.7 CDTI	92	10/10→					
1.7 CDTI	96	10/10→					
2.0 CDTI	96	10/10→					
2.0 CDTI	118	10/10→					
1.4 LPG	103	01/12→	←		24.0126-0165.1 426165 24.0126-0166.1 426166 24.0130-0224.1 430224	∅ 276 26 23 V + S ∅ 300 26 23 V + S ∅ 321 30 27 V + S	
1.6 CDTi	81	02/14→					
1.6 CDTi	100	01/14→					
1.6 LPG	84	10/12→					
1.6 SIDI	125	12/12→					
2.0 BiTurbo CDTI	143	12/12→					
2.0 CDTI	121	08/11→	→		24.0112-0188.1 412188 24.0112-0189.1 412189 24.0312-0188.1 512188 24.0312-0189.1 512189	∅ 268 12 10 + S ∅ 292 12 10 + S ∅ 268 12 10 + S PD ∅ 292 12 10 + S PD	
OPEL - ASTRA J Stufenheck 06/12→							
 Bremsbelagsatz, Scheibenbremse							
1.3 CDTI	70	06/12→	←	für Bremsscheibendurchmesser [mm]: 321	13.0460-5612.2 605612 13.0470-5612.2 LD5612	MAN 24412 19,0 + WK + Zub MAN 24412 19,0 + WK + Zub Ceramic	
1.4	74	06/12→					
1.4 LPG	103	07/14→					
1.4 Turbo	88	06/12→					
1.4 Turbo	103	06/12→	←	für Bremsscheibendurchmesser [mm]: 276	13.0460-7262.2 607262 13.0470-7262.2 LD7262	25031 19,1 + WK + Zub 25031 19,1 + WK + Zub Ceramic	
1.6	85	06/12→					
1.6 CDTi	81	04/14→					
1.6 CDTi	100	01/14→	←	für Bremsscheibendurchmesser [mm]: 300	13.0460-7263.2 607263 13.0470-7263.2 LD7263	24034 19,1 + WK + Zub 24034 19,1 + WK + Zub Ceramic	
1.6 SIDI	125	12/12→					
1.6 Turbo	132	06/12→					
1.7 CDTI	81	06/12→	→		13.0460-7264.2 607264 13.0470-7264.2 LD7264	ATE 25096 17,0 + WK + Zub ATE 25096 17,0 + WK + Zub Ceramic	
1.7 CDTI	96	06/12→					
 Bremsscheibe							
1.3 CDTI	70	06/12→	←		24.0126-0165.1 426165	∅ 276 26 23 V + S	
↓							

	kw			 	! #		
OPEL - ASTRA J Stufenheck 06/12→							
 Bremsscheibe							
1.4	74	06/12→	←			24.0126-0166.1 426166	Ø 300 26 23 V + S
1.4 LPG	103	07/14→				24.0130-0224.1 430224	Ø 321 30 27 V + S
1.4 Turbo	88	06/12→				24.0326-0165.1 526165	Ø 276 26 23 V + S PD
1.4 Turbo	103	06/12→				24.0326-0166.1 526166	Ø 300 26 23 V + S PD
1.6	85	06/12→				24.0112-0188.1 412188	Ø 268 12 10 + S
1.6 CDTi	81	04/14→	→			24.0112-0189.1 412189	Ø 292 12 10 + S
1.6 CDTi	100	01/14→				24.0312-0188.1 512188	Ø 268 12 10 + S PD
1.6 SIDI	125	12/12→				24.0312-0189.1 512189	Ø 292 12 10 + S PD
1.6 Turbo	132	06/12→					
1.7 CDTi	81	06/12→					
1.7 CDTi	96	06/12→					
OPEL - CALIBRA A (85_) 06/90→07/97							
 Bremsbelagsatz, Scheibenbremse							
2.0 i	85	06/90→07/97	←			13.0460-7052.2 607052	ATE 21190 17,5 + WE / - WK
2.0 i 16V	100	02/94→07/97				13.0460-4043.2 604043	ATE 21140 15,0 - WE / - WK
2.0 i 16V 4x4	100	02/94→07/97	→				
2.0 i 4x4	85	06/90→07/97					
2.0 i Turbo 4x4	150	03/92→07/97	←	→ S9999999		13.0460-7080.2 607080	ATE 21411 17,5 - WK
			←	T1000001→		13.0460-7091.2 607091	ATE 21829 20,3 + WE / - WK
			→			13.0460-4043.2 604043	ATE 21140 15,0 - WE / - WK
2.5 i V6	125	04/93→07/97	←	→ S9999999		13.0460-7080.2 607080	ATE 21411 17,5 - WK
			←	T1000001→		13.0460-7091.2 607091	ATE 21829 20,3 + WE / - WK
			→	T1000001→		13.0460-4040.2 604040	ATE 21050 15,8 - WE / - WK
			→	→ S9999999		13.0460-4043.2 604043	ATE 21140 15,0 - WE / - WK
Warnkontakt, Bremsbelagsverschleiß							
2.0 i	85	06/90→07/97	←		2	24.8190-0705.2 620705	L= 670
2.0 i 16V	100	02/94→07/97					
2.0 i 16V 4x4	100	02/94→07/97					
2.0 i 4x4	85	06/90→07/97					
2.0 i Turbo 4x4	150	03/92→07/97	←	→ S9999999	2	24.8190-0707.2 620707	L= 685
2.5 i V6	125	04/93→07/97	←	T1000001→	2	24.8190-0713.2 620713	L= 685
Zubehörsatz, Scheibenbremsbelag							
2.0 i	85	06/90→07/97	→			13.0460-0217.2 610217	ATE
2.0 i 16V	100	02/94→07/97					
2.0 i 16V 4x4	100	02/94→07/97					
2.0 i 4x4	85	06/90→07/97					
2.0 i Turbo 4x4	150	03/92→07/97					
2.5 i V6	125	04/93→07/97	→	→ S9999999		13.0460-0217.2 610217	ATE
			→	T1000001→		13.0460-0347.2 610347	
 Bremsscheibe							
2.0 i	85	06/90→07/97	←			24.0124-0115.1 424115	Ø 256 24 21 V + S
2.0 i 16V	100	02/94→07/97				24.0324-0115.1 524115	Ø 256 24 21 V + S PD
2.0 i 16V 4x4	100	02/94→07/97				24.0110-0205.1 410205	Ø 270 9,9 8
2.0 i 4x4	85	06/90→07/97	→				
2.0 i Turbo 4x4	150	03/92→07/97	←	→ S9999999		24.0124-0133.1 424133	Ø 284 24 21 V
2.5 i V6	125	04/93→07/97	←	T1000001→		24.0125-0119.1 425119	Ø 288 25 22 V + S
			→			24.0325-0119.1 525119	Ø 288 25 22 V + S PD
			→			24.0110-0253.1 410253	Ø 270 10 8
OPEL - CAMPO (TF_) 08/87→06/02							
 Bremsbelagsatz, Scheibenbremse							
2.2 D (TFR52)	39	08/91→09/96	←	01/92→ 08/96		13.0460-5942.2 605942	AKE 21543 16,5 + WK
2.2 D 4x4 (TFS52)	39	08/91→09/96	←	→ 08/96		13.0460-5942.2 605942	AKE 21543 16,5 + WK
2.3 (TFR16)	72	08/94→09/96					
2.3 4x4 (TFS16)	72	08/94→09/96					
2.5 TD (TFR54)	56	07/94→06/01					
2.5 TD 4x4 (TFS54)	56	07/94→06/01					
2.5 DTI	74	07/01→12/01	←			13.0460-5942.2 605942	AKE 21543 16,5 + WK
2.5 DTI 4x4	74	07/01→12/01					
3.1 TD (TFR69)	80	12/92→06/01	←	→ 08/96		13.0460-5942.2 605942	AKE 21543 16,5 + WK
3.1 TD 4x4 (TFS69)	80	12/92→06/01	←	09/96→		13.0460-5942.2 605942	AKE 21543 16,5 + WK
Zubehörsatz, Scheibenbremsbelag							
2.2 D (TFR52)	39	08/91→09/96	←	01/92→ 08/96		13.0460-0337.2 610337	AKE
↓							











	kW			 	! #		
OPEL - CAMPO (TF_) 08/87→06/02							
Zubehörsatz, Scheibenbremsbelag							
2.2 D 4x4 (TFS52)	39	08/91→09/96	←	→ 08/96		13.0460-0337.2 610337	AKE
2.3 (TFR16)	72	08/94→09/96					
2.3 4x4 (TFS16)	72	08/94→09/96					
2.5 TD (TFR54)	56	07/94→06/01					
2.5 TD 4x4 (TFS54)	56	07/94→06/01					
2.5 DTI	74	07/01→12/01	←			13.0460-0337.2 610337	AKE
2.5 DTI 4x4	74	07/01→12/01					
3.1 TD (TFR69)	80	12/92→06/01	←	→ 08/96		13.0460-0337.2 610337	AKE
3.1 TD 4x4 (TFS69)	80	12/92→06/01	←	09/96→		13.0460-0337.2 610337	AKE
Bremsscheibe							
2.2 D (TFR52)	39	08/91→09/96	←	01/92→ 08/96		24.0122-0156.1 422156	Ø 257 22 20,6 V
2.2 D 4x4 (TFS52)	39	08/91→09/96	←	→ 08/96		24.0122-0156.1 422156	Ø 257 22 20,6 V
2.3 (TFR16)	72	08/94→09/96					
2.3 4x4 (TFS16)	72	08/94→09/96					
2.5 TD (TFR54)	56	07/94→06/01					
2.5 TD 4x4 (TFS54)	56	07/94→06/01					
2.5 DTI	74	07/01→12/01	←			24.0122-0156.1 422156	Ø 257 22 20,6 V
2.5 DTI 4x4	74	07/01→12/01					
3.1 TD (TFR69)	80	12/92→06/01	←	→ 08/96		24.0122-0156.1 422156	Ø 257 22 20,6 V
3.1 TD 4x4 (TFS69)	80	12/92→06/01	←	09/96→		24.0122-0156.1 422156	Ø 257 22 20,6 V
OPEL - CASCADA (W13) 03/13→							
Bremsbelagsatz, Scheibenbremse							
1.4	88	03/13→	←			13.0460-5612.2 605612	MAN 24412 19,0 + WK + Zub
1.4 Turbo	103	03/13→				13.0470-5612.2 LD5612	MAN 24412 19,0 + WK + Zub
1.6	147	11/13→					Ceramic
1.6 SIDI	125	03/13→					
2.0 CDTI	121	03/13→	→			13.0460-7264.2 607264	ATE 25096 17,0 + WK + Zub
2.0 CDTI	125	07/15→				13.0470-7264.2 LD7264	ATE 25096 17,0 + WK + Zub
2.0 CDTI	143	03/13→					Ceramic
Bremsscheibe							
1.4	88	03/13→	←			24.0130-0224.1 430224	Ø 321 30 27 V + S
1.4 Turbo	103	03/13→	→				
1.6	147	11/13→				24.0112-0189.1 412189	Ø 292 12 10 + S
1.6 SIDI	125	03/13→				24.0312-0189.1 512189	Ø 292 12 10 + S PD
2.0 CDTI	121	03/13→					
2.0 CDTI	125	07/15→					
2.0 CDTI	143	03/13→					
OPEL - COMBO (71_) 07/94→10/01							
Bremsbelagsatz, Scheibenbremse							
1.2	33	07/94→10/01	←	→ 09/00		13.0460-7051.2 607051	ATE 20547 16,5 + WE / - WK
1.4	44	07/94→10/01					
1.4	60	07/94→10/01					
1.7 D	44	07/94→10/01					
1.4 16V	66	08/99→10/01	←	10/01→; → 43033898, 53000000; für erhöhte Nutzlast		13.0460-2857.2 602857 13.0470-2857.2 LD2857	TRW 23225 17,0 + WK + Zub Ceramic
			←	10/01→; nicht für erhöhte Nutzlast		13.0460-2857.2 602857 13.0470-2857.2 LD2857	TRW 23225 17,0 + WK + Zub Ceramic
			←	43033899, 53000001→; für erhöhte Nutzlast		13.0460-7179.2 607179 13.0470-7179.2 LD7179	ATE 23832 20,2 - WK / + WK Ceramic
			→	10/01→		13.0460-2868.2 602868 13.0470-2868.2 LD2868	TRW 23417 15,3 + WK + Zub Ceramic
Bremsscheibe							
1.2	33	07/94→10/01	←	→ 09/00		24.0120-0115.1 420115	Ø 236 20 17 V + S
1.4	44	07/94→10/01				24.0320-0115.1 520115	Ø 236 20 17 V + S PD
1.4	60	07/94→10/01					
1.7 D	44	07/94→10/01					
1.4 16V	66	08/99→10/01	←	10/01→; → 43033898, 53000000; für erhöhte Nutzlast		24.0124-0166.1 424166 24.0324-0166.1 524166	Ø 260 24 21 V + S Ø 260 24 21 V PD
			←	10/01→; nicht für erhöhte Nutzlast		24.0124-0166.1 424166 24.0324-0166.1 524166	Ø 260 24 21 V + S Ø 260 24 21 V PD
			←	43033899, 53000001→; für erhöhte Nutzlast		24.0125-0148.1 425148 24.0325-0148.1 525148	Ø 280 25 22 V + S Ø 280 25 22 V + S PD



























	kW					! #		
OPEL - COMBO (71_) 07/94 → 10/01								
 Bremsscheibe								
1.4 16V	66	08/99 → 10/01	➔	10/01 →		24.0110-0291.1 410291	Ø 264 10 8 + S	
						24.0310-0291.1 510291	Ø 264 10 8 + S PD	
OPEL - COMBO Kasten/Kombi 10/01 →								
 Bremsbelagsatz, Scheibenbremse								
1.3 CDTI 16V	51	08/05 →	➔	→ 43033898, 53000000; für erhöhte Nutzlast		13.0460-2857.2 602857	TRW 23225 17,0 + WK + Zub	
1.3 CDTI 16V	55	10/05 →				13.0470-2857.2 LD2857	TRW 23225 17,0 + WK + Zub Ceramic	
1.4 16V	66	08/05 →						
1.6	64	10/01 →	➔	→ 10/11; nicht für erhöhte Nutzlast		13.0460-2857.2 602857	TRW 23225 17,0 + WK + Zub	
1.7 DI 16V	48	10/01 →				13.0470-2857.2 LD2857	TRW 23225 17,0 + WK + Zub Ceramic	
1.7 DTI 16V	55	10/01 →	➔	43033899, 53000001 →; → 10/11; für erhöhte Nutzlast		13.0460-7179.2 607179	ATE 23832 20,2 - WK / + WK	
						13.0470-7179.2 LD7179	ATE 23832 20,2 - WK / + WK Ceramic	
			➔	→ 10/11		13.0460-2868.2 602868	TRW 23417 15,3 + WK + Zub	
						13.0470-2868.2 LD2868	TRW 23417 15,3 + WK + Zub Ceramic	
1.6 CNG 16V	69	06/06 →	➔	→ 10/11		13.0460-7179.2 607179	ATE 23832 20,2 - WK / + WK	
1.6 CNG 16V	71	04/05 →				13.0470-7179.2 LD7179	ATE 23832 20,2 - WK / + WK Ceramic	
1.7 CDTI 16V	74	12/04 →	➔	→ 10/11		13.0460-2868.2 602868	TRW 23417 15,3 + WK + Zub	
						13.0470-2868.2 LD2868	TRW 23417 15,3 + WK + Zub Ceramic	
 Bremsscheibe								
1.3 CDTI 16V	51	08/05 →	➔	→ 10/11; nicht für erhöhte Nutzlast		24.0124-0166.1 424166	Ø 260 24 21 V + S	
1.3 CDTI 16V	55	10/05 →				24.0324-0166.1 524166	Ø 260 24 21 V PD	
1.4 16V	66	08/05 →						
1.6	64	10/01 →	➔	→ 43033898, 53000000; für erhöhte Nutzlast		24.0124-0166.1 424166	Ø 260 24 21 V + S	
1.7 DI 16V	48	10/01 →				24.0324-0166.1 524166	Ø 260 24 21 V PD	
1.7 DTI 16V	55	10/01 →	➔	43033899, 53000001 →; → 10/11; für erhöhte Nutzlast		24.0125-0148.1 425148	Ø 280 25 22 V + S	
						24.0325-0148.1 525148	Ø 280 25 22 V + S PD	
			➔	→ 10/11		24.0110-0291.1 410291	Ø 264 10 8 + S	
						24.0310-0291.1 510291	Ø 264 10 8 + S PD	
1.6 CNG 16V	69	06/06 →	➔	→ 10/11		24.0125-0148.1 425148	Ø 280 25 22 V + S	
1.6 CNG 16V	71	04/05 →				24.0325-0148.1 525148	Ø 280 25 22 V + S PD	
			➔	→ 10/11		24.0110-0291.1 410291	Ø 264 10 8 + S	
						24.0310-0291.1 510291	Ø 264 10 8 + S PD	
1.7 CDTI 16V	74	12/04 →	➔	→ 10/11		24.0125-0131.1 425131	Ø 280 24,8 22 V + S	
						24.0325-0131.1 525131	Ø 280 24,8 22 V + S PD	
			➔	→ 10/11		24.0110-0250.1 410250	Ø 264 9,8 8 + S	
OPEL - COMBO Kasten/Kombi (X12) 02/12 →								
 Bremsbelagsatz, Scheibenbremse								
1.3 CDTI	55	02/12 →	➔	03/15 →; für Bremsscheibendurchmesser [mm]: 284		13.0460-3827.2 603827	BOS 23709 19,6 + WK + Zub	
						13.0470-3827.2 LD3827	BOS 23709 19,6 + WK + Zub Ceramic	
			➔	03/15 →; für Bremsscheibendurchmesser [mm]: 305		13.0460-7265.2 607265	ATE 24727 20,7 + WK	
1.3 CDTI	66	02/12 →	➔	für Bremsscheibendurchmesser [mm]: 284		13.0460-3827.2 603827	BOS 23709 19,6 + WK + Zub	
1.3 CDTI	70	03/16 →				13.0470-3827.2 LD3827	BOS 23709 19,6 + WK + Zub Ceramic	
1.4	70	02/12 →						
1.4	88	02/12 →	➔	für Bremsscheibendurchmesser [mm]: 305		13.0460-7265.2 607265	ATE 24727 20,7 + WK	
1.4 CNG	88	02/12 →						
1.6 CDTI	66	02/12 →						
1.6 CDTI	70	04/15 →						
1.6 CDTI	74	02/12 →						
1.6 CDTI	77	02/12 →						
1.6 CDTI	88	04/15 →						
2.0 CDTI	99	02/12 →						
 Bremsscheibe								
1.3 CDTI	55	02/12 →	➔	03/15 →		24.0122-0145.1 422145	Ø 284 22 20,2 V	
						24.0128-0253.1 428253	Ø 305 28 26 V	
1.3 CDTI	66	02/12 →	➔			24.0122-0145.1 422145	Ø 284 22 20,2 V	
1.3 CDTI	70	03/16 →				24.0128-0253.1 428253	Ø 305 28 26 V	
1.4	70	02/12 →						
1.4	88	02/12 →						









	kW			 	! #		
OPEL - COMBO Kasten/Kombi (X12) 02/12→							
 Bremsscheibe							
1.4 CNG	88	02/12→	←			24.0122-0145.1 422145	Ø 284 22 20,2 V
1.6 CDTI	66	02/12→				24.0128-0253.1 428253	Ø 305 28 26 V
1.6 CDTI	70	04/15→					
1.6 CDTI	74	02/12→					
1.6 CDTI	77	02/12→					
1.6 CDTI	88	04/15→					
2.0 CDTI	99	02/12→					
OPEL - COMBO Pritsche/Fahrgestell (X12) 08/12→							
 Bremsbelagsatz, Scheibenbremse							
1.3 CDTI	55	08/12→	←	03/15→; für Bremsscheibendurchmesser [mm]: 284	13.0460-3827.2 603827	BOS 23709 19,6 + WK + Zub	
			←	03/15→; für Bremsscheibendurchmesser [mm]: 305	13.0470-3827.2 LD3827	BOS 23709 19,6 + WK + Zub Ceramic	
2.0 CDTI	99	08/12→	←	für Bremsscheibendurchmesser [mm]: 284	13.0460-3827.2 603827	BOS 23709 19,6 + WK + Zub	
			←	für Bremsscheibendurchmesser [mm]: 305	13.0470-3827.2 LD3827	BOS 23709 19,6 + WK + Zub Ceramic	
					13.0460-7265.2 607265	ATE 24727 20,7 + WK	
 Bremsscheibe							
1.3 CDTI	55	08/12→	←	03/15→		24.0122-0145.1 422145	Ø 284 22 20,2 V
						24.0128-0253.1 428253	Ø 305 28 26 V
2.0 CDTI	99	08/12→	←			24.0122-0145.1 422145	Ø 284 22 20,2 V
						24.0128-0253.1 428253	Ø 305 28 26 V
OPEL - COMBO Tour 10/01→							
 Bremsbelagsatz, Scheibenbremse							
1.3 CDTI 16V	51	10/04→	←	→ 43033898, 53000000; für erhöhte Nutzlast	13.0460-2857.2 602857	TRW 23225 17,0 + WK + Zub	
			←		13.0470-2857.2 LD2857	TRW 23225 17,0 + WK + Zub Ceramic	
1.3 CDTI 16V	55	10/05→					
1.4	66	10/04→					
1.6	64	10/01→					
1.7 DI 16V	48	10/01→	←	→ 10/11; nicht für erhöhte Nutzlast	13.0460-2857.2 602857	TRW 23225 17,0 + WK + Zub	
1.7 DTI 16V	55	10/01→	←		13.0470-2857.2 LD2857	TRW 23225 17,0 + WK + Zub Ceramic	
			←	43033899, 53000001→; → 10/11; für erhöhte Nutzlast	13.0460-7179.2 607179	ATE 23832 20,2 - WK / + WK	
			←		13.0470-7179.2 LD7179	ATE 23832 20,2 - WK / + WK Ceramic	
			→	→ 10/11	13.0460-2868.2 602868	TRW 23417 15,3 + WK + Zub	
			→		13.0470-2868.2 LD2868	TRW 23417 15,3 + WK + Zub Ceramic	
1.6 CNG	69	06/06→	←	→ 10/11	13.0460-7179.2 607179	ATE 23832 20,2 - WK / + WK	
			←		13.0470-7179.2 LD7179	ATE 23832 20,2 - WK / + WK Ceramic	
1.6 CNG	71	04/05→					
1.7 CDTI 16V	74	12/04→	→	→ 10/11	13.0460-2868.2 602868	TRW 23417 15,3 + WK + Zub	
			→		13.0470-2868.2 LD2868	TRW 23417 15,3 + WK + Zub Ceramic	
 Bremsscheibe							
1.3 CDTI 16V	51	10/04→	←	→ 10/11; nicht für erhöhte Nutzlast	24.0124-0166.1 424166	Ø 260 24 21 V + S	
			←		24.0324-0166.1 524166	Ø 260 24 21 V PD	
1.3 CDTI 16V	55	10/05→					
1.4	66	10/04→					
1.6	64	10/01→					
1.7 DI 16V	48	10/01→	←	→ 43033898, 53000000; für erhöhte Nutzlast	24.0124-0166.1 424166	Ø 260 24 21 V + S	
1.7 DTI 16V	55	10/01→	←		24.0324-0166.1 524166	Ø 260 24 21 V PD	
			←	43033899, 53000001→; → 10/11; für erhöhte Nutzlast	24.0125-0148.1 425148	Ø 280 25 22 V + S	
			←		24.0325-0148.1 525148	Ø 280 25 22 V + S PD	
			→	→ 10/11	24.0110-0291.1 410291	Ø 264 10 8 + S	
			→		24.0310-0291.1 510291	Ø 264 10 8 + S PD	
1.6 CNG	69	06/06→	←	→ 10/11	24.0125-0148.1 425148	Ø 280 25 22 V + S	
			←		24.0325-0148.1 525148	Ø 280 25 22 V + S PD	
1.6 CNG	71	04/05→					
			→	→ 10/11	24.0110-0291.1 410291	Ø 264 10 8 + S	
			→		24.0310-0291.1 510291	Ø 264 10 8 + S PD	
1.7 CDTI 16V	74	12/04→	←	→ 10/11	24.0125-0131.1 425131	Ø 280 24,8 22 V + S	
			←		24.0325-0131.1 525131	Ø 280 24,8 22 V + S PD	
			→	→ 10/11	24.0110-0250.1 410250	Ø 264 9,8 8 + S	

























	kW			 	! #		
OPEL - COMBO Tour (X12) 02/12→							
 Bremsbelagsatz, Scheibenbremse							
1.3 CDTI 1.4 1.4 CNG 1.6 CDTI 1.6 CDTI 1.6 CDTI 1.6 CDTI 2.0 CDTI	66 70 88 88 66 70 74 77 88 99	02/12→ 02/12→ 02/12→ 02/12→ 02/12→ 03/15→ 02/12→ 02/12→ 03/15→ 02/12→	← ←	für Bremsscheibendurchmesser [mm]: 284 für Bremsscheibendurchmesser [mm]: 305		13.0460-3827.2 603827 13.0470-3827.2 LD3827 13.0460-7265.2 607265	BOS 23709 19,6 + WK + Zub BOS 23709 19,6 + WK + Zub Ceramic ATE 24727 20,7 + WK
 Bremsscheibe							
1.3 CDTI 1.4 1.4 CNG 1.6 CDTI 1.6 CDTI 1.6 CDTI 1.6 CDTI 1.6 CDTI 2.0 CDTI	66 70 88 88 66 70 74 77 88 99	02/12→ 02/12→ 02/12→ 02/12→ 02/12→ 03/15→ 02/12→ 02/12→ 03/15→ 02/12→	←			24.0122-0145.1 422145 24.0128-0253.1 428253	Ø 284 22 20,2 V Ø 305 28 26 V
OPEL - CORSA B (73_, 78_, 79_) 03/93→12/02							
 Bremsbelagsatz, Scheibenbremse							
1.0 i 12V 1.2 i 1.4 i 1.4 i 1.4 i 16V 1.4 i 16V 1.4 i 16V 1.4 Si 1.5 D 1.5 TD 1.6 i 16V 1.6 i 16V 1.7 D	40 33 40 44 63 66 67 60 37 49 74 78 44	11/96→09/00 03/93→09/00 03/93→09/00 03/93→09/00 08/97→09/00 09/94→09/00 09/94→09/00 03/93→09/00 03/93→09/00 03/93→09/00 08/97→09/00 09/94→09/00 02/96→09/00	←			13.0460-7051.2 607051	ATE 20547 16,5 + WE / - WK
1.2 i 16V 1.6 GSI 16V	48 80	03/98→09/00 03/93→09/00	←	04/98→ 09/93→		13.0460-7051.2 607051 13.0460-7051.2 607051	ATE 20547 16,5 + WE / - WK ATE 20547 16,5 + WE / - WK
 Bremsscheibe							
1.0 i 12V 1.2 i 1.5 D 1.5 TD 1.7 D	40 33 37 49 44	11/96→09/00 03/93→09/00 03/93→09/00 03/93→09/00 02/96→09/00	←			24.0113-0161.1 413161 24.0313-0161.1 513161	Ø 236 12,7 9,7 + S Ø 236 12,7 9,7 + S PD
1.2 i 16V	48	03/98→09/00	←	04/98→; für Schaltgetriebe		24.0113-0161.1 413161 24.0313-0161.1 513161	Ø 236 12,7 9,7 + S Ø 236 12,7 9,7 + S PD
			←	04/98→; für Fahrzeuge ohne Klimaanlage; für Automatikgetriebe		24.0113-0161.1 413161 24.0313-0161.1 513161	Ø 236 12,7 9,7 + S Ø 236 12,7 9,7 + S PD
			←	04/98→; für Fahrzeuge mit Klimaanlage; für Automatikgetriebe		24.0120-0115.1 420115 24.0320-0115.1 520115	Ø 236 20 17 V + S Ø 236 20 17 V + S PD
			←	04/98→		24.0120-0115.1 420115 24.0320-0115.1 520115	Ø 236 20 17 V + S Ø 236 20 17 V + S PD
1.4 i 1.4 i 1.4 i 16V	40 44 63	03/93→09/00 03/93→09/00 08/97→09/00	←	für Automatikgetriebe; für Fahrzeuge ohne Klimaanlage		24.0113-0161.1 413161 24.0313-0161.1 513161	Ø 236 12,7 9,7 + S Ø 236 12,7 9,7 + S PD
			←	für Schaltgetriebe		24.0113-0161.1 413161 24.0313-0161.1 513161	Ø 236 12,7 9,7 + S Ø 236 12,7 9,7 + S PD
			←			24.0120-0115.1 420115 24.0320-0115.1 520115	Ø 236 20 17 V + S Ø 236 20 17 V + S PD
			←	für Fahrzeuge mit Klimaanlage; für Automatikgetriebe		24.0120-0115.1 420115 24.0320-0115.1 520115	Ø 236 20 17 V + S Ø 236 20 17 V + S PD
1.4 i 16V 1.4 i 16V 1.4 Si	66 67 60	09/94→09/00 09/94→09/00 03/93→09/00	←			24.0120-0115.1 420115 24.0320-0115.1 520115	Ø 236 20 17 V + S Ø 236 20 17 V + S PD
1.6 GSI 16V	80	03/93→09/00	←	09/93→		24.0120-0140.1 420140	Ø 256 20 17 V + S
1.6 i 16V 1.6 i 16V	74 78	08/97→09/00 09/94→09/00	←			24.0120-0140.1 420140	Ø 256 20 17 V + S















	kw			 	! #		
OPEL - CORSA B Kasten (73_) 08/99→09/00							
 Bremsbelagsatz, Scheibenbremse							
1.4 i 1.7 D	44 44	08/99→09/00 08/99→09/00	←			13.0460-7051.2 607051	ATE 20547 16,5 + WE / - WK
 Bremsscheibe							
1.4 i	44	08/99→09/00	←			24.0120-0115.1 420115 24.0320-0115.1 520115	Ø 236 20 17 V + S Ø 236 20 17 V + S PD
1.7 D	44	08/99→09/00	←			24.0113-0161.1 413161 24.0313-0161.1 513161	Ø 236 12,7 9,7 + S Ø 236 12,7 9,7 + S PD
OPEL - CORSA B Kombi (F35) 01/99→12/02							
 Bremsbelagsatz, Scheibenbremse							
1.4 i 16V 1.7 D	66 44	01/99→12/02 01/99→12/02	←	→ 09/00		13.0460-7051.2 607051	ATE 20547 16,5 + WE / - WK
 Bremsscheibe							
1.4 i 16V	66	01/99→12/02	←	→ 09/00		24.0120-0115.1 420115 24.0320-0115.1 520115	Ø 236 20 17 V + S Ø 236 20 17 V + S PD
1.7 D	44	01/99→12/02	←	→ 09/00		24.0113-0161.1 413161 24.0313-0161.1 513161	Ø 236 12,7 9,7 + S Ø 236 12,7 9,7 + S PD
OPEL - CORSA C (F08, F68) 09/00→12/09							
 Bremsbelagsatz, Scheibenbremse							
1.0	43	09/00→06/03	←			13.0460-2857.2 602857 13.0470-2857.2 LD2857	TRW 23225 17,0 + WK + Zub TRW 23225 17,0 + WK + Zub Ceramic
1.0 1.2 1.2 Twinport	44 55 59	06/03→12/09 09/00→12/09 07/04→12/09	←	→ 09/06		13.0460-2857.2 602857 13.0470-2857.2 LD2857	TRW 23225 17,0 + WK + Zub TRW 23225 17,0 + WK + Zub Ceramic
1.3 CDTI 1.4 1.4 Twinport 1.7 DI 1.7 DTI 1.8	51 66 66 48 55 92	06/03→12/09 09/00→12/09 06/03→12/09 09/00→12/09 09/00→12/09 09/00→12/09	←	→ 09/06		13.0460-2857.2 602857 13.0470-2857.2 LD2857	TRW 23225 17,0 + WK + Zub TRW 23225 17,0 + WK + Zub Ceramic
1.7 CDTI	74	06/03→12/09	←	→ 09/06		13.0460-2858.2 602858 13.0470-2858.2 LD2858	TRW 23284 14,0 + WK TRW 23284 14,0 + WK Ceramic
			→	→ 09/06		13.0460-7179.2 607179 13.0470-7179.2 LD7179	ATE 23832 20,2 - WK / + WK ATE 23832 20,2 - WK / + WK Ceramic
			→	→ 09/06		13.0460-2858.2 602858 13.0470-2858.2 LD2858	TRW 23284 14,0 + WK TRW 23284 14,0 + WK Ceramic
 Bremsscheibe							
1.0	43	09/00→06/03	←	- ABS		24.0111-0152.1 411152	Ø 240 11 8
			←	+ ABS		24.0120-0174.1 420174	Ø 240 20 17 V + S
1.0 1.2 1.2 Twinport	44 55 59	06/03→12/09 09/00→12/09 07/04→12/09	←	- ABS; → 09/06		24.0111-0152.1 411152	Ø 240 11 8
			←	+ ABS; → 09/06		24.0120-0174.1 420174	Ø 240 20 17 V + S
1.3 CDTI 1.4 1.4 Twinport 1.7 DTI 1.8	51 66 66 55 92	06/03→12/09 09/00→12/09 06/03→12/09 09/00→12/09 09/00→12/09	←	→ 09/06		24.0124-0166.1 424166 24.0324-0166.1 524166	Ø 260 24 21 V + S Ø 260 24 21 V PD
			→	→ 09/06		24.0110-0268.1 410268 24.0110-0291.1 410291 24.0310-0291.1 510291	Ø 240 10,2 8,2 Ø 264 10 8 + S Ø 264 10 8 + S PD
1.7 CDTI	74	06/03→12/09	←	→ 09/06		24.0125-0131.1 425131 24.0325-0131.1 525131	Ø 280 24,8 22 V + S Ø 280 24,8 22 V + S PD
			→	→ 09/06		24.0110-0250.1 410250 24.0310-0250.1 510250	Ø 264 9,8 8 + S Ø 264 9,8 8 + S PD
1.7 DI	48	09/00→12/09	←	→ 09/06		24.0120-0174.1 420174	Ø 240 20 17 V + S
			→	→ 09/06		24.0110-0268.1 410268 24.0110-0291.1 410291 24.0310-0291.1 510291	Ø 240 10,2 8,2 Ø 264 10 8 + S Ø 264 10 8 + S PD
OPEL - CORSA C Kasten (F08, W5L) 09/00→							
 Bremsbelagsatz, Scheibenbremse							
1.2 1.2 16V 1.6	59 55 71	07/05→ 09/00→ 08/05→	←	→ 09/06		13.0460-2857.2 602857 13.0470-2857.2 LD2857	TRW 23225 17,0 + WK + Zub TRW 23225 17,0 + WK + Zub Ceramic
↓							











	kW			 	! #		
OPEL - CORSA C Kasten (F08, W5L) 09/00→							
 Bremsbelagsatz, Scheibenbremse							
1.3 CDTi 16V 1.4 1.7 DI 16V 1.7 DTi 16V	51 66 48 55	08/05→ 08/03→ 09/00→ 09/00→	← ← → →	→ 09/06 → 09/06 → 09/06 → 09/06		13.0460-2857.2 602857 13.0470-2857.2 LD2857 13.0460-2858.2 602858 13.0470-2858.2 LD2858	TRW 23225 17,0 + WK + Zub TRW 23225 17,0 + WK + Zub Ceramic TRW 23284 14,0 + WK TRW 23284 14,0 + WK Ceramic
1.7 CDTi	74	08/03→	← →	→ 09/06 → 09/06		13.0460-7179.2 607179 13.0470-7179.2 LD7179 13.0460-2858.2 602858 13.0470-2858.2 LD2858	ATE 23832 20,2 - WK / + WK ATE 23832 20,2 - WK / + WK Ceramic TRW 23284 14,0 + WK TRW 23284 14,0 + WK Ceramic
 Bremsscheibe							
1.2 1.2 16V	59 55	07/05→ 09/00→	← ←	- ABS; → 09/06 + ABS; → 09/06		24.0111-0152.1 411152 24.0120-0174.1 420174	Ø 240 11 8 Ø 240 20 17 V + S
1.3 CDTi 16V 1.4 1.7 DTi 16V	51 66 55	08/05→ 08/03→ 09/00→	← ← →	→ 09/06 → 09/06 → 09/06		24.0124-0166.1 424166 24.0324-0166.1 524166 24.0110-0268.1 410268 24.0110-0291.1 410291 24.0310-0291.1 510291	Ø 260 24 21 V + S Ø 260 24 21 V PD Ø 240 10,2 8,2 Ø 264 10 8 + S Ø 264 10 8 + S PD
1.6	71	08/05→	←	→ 09/06		24.0124-0166.1 424166 24.0324-0166.1 524166	Ø 260 24 21 V + S Ø 260 24 21 V PD
1.7 CDTi	74	08/03→	← →	→ 09/06 → 09/06		24.0125-0131.1 425131 24.0325-0131.1 525131 24.0110-0250.1 410250 24.0310-0250.1 510250	Ø 280 24,8 22 V + S Ø 280 24,8 22 V + S PD Ø 264 9,8 8 + S Ø 264 9,8 8 + S PD
1.7 DI 16V	48	09/00→	← →	→ 09/06 → 09/06		24.0120-0174.1 420174 24.0110-0268.1 410268 24.0110-0291.1 410291 24.0310-0291.1 510291	Ø 240 20 17 V + S Ø 240 10,2 8,2 Ø 264 10 8 + S Ø 264 10 8 + S PD
OPEL - CORSA D 07/06→							
 Bremsbelagsatz, Scheibenbremse							
1.0	44	07/06→	← ←	10/06→; V 10/06→		13.0460-3839.2 603839 13.0470-3839.2 LD3839 13.0460-3839.2 603839 13.0470-3839.2 LD3839	BOS 23707 17,9 + WK + Zub BOS 23982 18,1 + WK + Zub Ceramic BOS 23707 17,9 + WK + Zub BOS 23982 18,1 + WK + Zub Ceramic
1.0	48	01/10→	← ←	V V		13.0460-3839.2 603839 13.0470-3839.2 LD3839 13.0460-3839.2 603839 13.0470-3839.2 LD3839	BOS 23707 17,9 + WK + Zub BOS 23982 18,1 + WK + Zub Ceramic BOS 23707 17,9 + WK + Zub BOS 23982 18,1 + WK + Zub Ceramic
1.2 1.2 1.2 LPG 1.2 LPG 1.2 LPG 1.2 LPG 1.4 1.4 1.4 LPG	51 63 55 59 61 63 64 74 64	06/10→ 06/10→ 09/09→ 09/09→ 06/11→ 08/11→ 09/09→ 06/10→ 09/09→	← ← ← ← ← ← ← ← ←			13.0460-3839.2 603839 13.0470-3839.2 LD3839 13.0460-3839.2 603839 13.0470-3839.2 LD3839	BOS 23707 17,9 + WK + Zub BOS 23982 18,1 + WK + Zub Ceramic
1.2 1.4 1.4 LPG	59 66 66	07/06→ 07/06→ 07/06→	← ← ←	10/06→ 10/06→ 10/06→		13.0460-3839.2 603839 13.0470-3839.2 LD3839	BOS 23707 17,9 + WK + Zub BOS 23982 18,1 + WK + Zub Ceramic
1.3 CDTi	55	07/06→	← ←	10/06→; für Bremsscheibendurchmesser [mm]: 257 10/06→; für Bremsscheibendurchmesser [mm]: 284		13.0460-3839.2 603839 13.0470-3839.2 LD3839 13.0460-3840.2 603840 13.0470-3840.2 LD3840	BOS 23707 17,9 + WK + Zub BOS 23982 18,1 + WK + Zub Ceramic BOS 23981 19,6 + WK + Zub BOS 23981 19,6 + WK + Zub Ceramic
1.3 CDTi	66	07/06→	←	10/06→		13.0460-3840.2 603840 13.0470-3840.2 LD3840	BOS 23981 19,6 + WK + Zub BOS 23981 19,6 + WK + Zub Ceramic
↓							

	kw			 	! #		
OPEL - CORSA D 07/06→							
 Bremsbelagsatz, Scheibenbremse							
1.3 CDTI	70	06/10→	←	für Bremsscheibendurchmesser [mm]: 257		13.0460-3839.2 603839 13.0470-3839.2 LD3839	BOS 23707 17,9 + WK + Zub BOS 23982 18,1 + WK + Zub Ceramic
			←	für Bremsscheibendurchmesser [mm]: 284		13.0460-3840.2 603840 13.0470-3840.2 LD3840	BOS 23981 19,6 + WK + Zub BOS 23981 19,6 + WK + Zub Ceramic
1.4 1.7 CDTI	88 96	07/12→ 06/10→	←			13.0460-3841.2 603841	BOS 24550 19,5 + WK + Zub
			→			13.0460-3848.2 603848	BOS 24349 17,6 - WE / - WK + Zub
1.6 Turbo	110	02/07→	←	06/07→		13.0460-7179.2 607179 13.0470-7179.2 LD7179	ATE 23832 20,2 - WK / + WK ATE 23832 20,2 - WK / + WK Ceramic
			→	06/07→		13.0460-3848.2 603848	BOS 24349 17,6 - WE / - WK + Zub
1.6 Turbo	141	02/07→	←	03/07→		13.0460-7179.2 607179 13.0470-7179.2 LD7179	ATE 23832 20,2 - WK / + WK ATE 23832 20,2 - WK / + WK Ceramic
			→	03/07→		13.0460-3848.2 603848	BOS 24349 17,6 - WE / - WK + Zub
1.6 Turbo	155	06/11→	←			13.0460-7179.2 607179 13.0470-7179.2 LD7179	ATE 23832 20,2 - WK / + WK ATE 23832 20,2 - WK / + WK Ceramic
			→			13.0460-3848.2 603848	BOS 24349 17,6 - WE / - WK + Zub
1.7 CDTI	92	07/06→	←	10/06→		13.0460-3841.2 603841	BOS 24550 19,5 + WK + Zub
			→	10/06→		13.0460-3848.2 603848	BOS 24349 17,6 - WE / - WK + Zub
 Bremsscheibe							
1.0	44	07/06→	←	10/06→		24.0112-0184.1 412184 24.0122-0231.1 422231 24.0322-0231.1 522231	Ø 257 12 10 + S Ø 257 22 20 V + S Ø 257 22 20 V + S PD
1.0	48	01/10→	←			24.0112-0184.1 412184 24.0122-0231.1 422231 24.0322-0231.1 522231	Ø 257 12 10 + S Ø 257 22 20 V + S Ø 257 22 20 V + S PD
1.2 1.2 1.2 LPG 1.2 LPG 1.2 LPG 1.4 1.4 LPG	51 63 55 59 61 63 64 64	06/10→ 06/10→ 09/09→ 09/09→ 06/11→ 08/11→ 09/09→ 09/09→	←			24.0122-0231.1 422231 24.0322-0231.1 522231	Ø 257 22 20 V + S Ø 257 22 20 V + S PD
1.2 1.4 1.4 LPG	59 66 66	07/06→ 07/06→ 07/06→	←	10/06→		24.0122-0231.1 422231 24.0322-0231.1 522231	Ø 257 22 20 V + S Ø 257 22 20 V + S PD
1.3 CDTI	55	07/06→	←	10/06→; für Bremsscheibendurchmesser [mm]: 257		24.0122-0231.1 422231 24.0322-0231.1 522231	Ø 257 22 20 V + S Ø 257 22 20 V + S PD
			←	10/06→; für Bremsscheibendurchmesser [mm]: 284		24.0122-0241.1 422241	Ø 284 22 20 V + S
1.3 CDTI	66	07/06→	←	10/06→		24.0122-0241.1 422241	Ø 284 22 20 V + S
1.3 CDTI	70	06/10→	←	für Bremsscheibendurchmesser [mm]: 257		24.0122-0231.1 422231 24.0322-0231.1 522231	Ø 257 22 20 V + S Ø 257 22 20 V + S PD
			←	für Bremsscheibendurchmesser [mm]: 284		24.0122-0241.1 422241	Ø 284 22 20 V + S
1.4	74	06/10→	←	für Bremsscheibendurchmesser [mm]: 257		24.0122-0231.1 422231 24.0322-0231.1 522231	Ø 257 22 20 V + S Ø 257 22 20 V + S PD
1.4 1.7 CDTI	88 96	07/12→ 06/10→	←			24.0126-0146.1 426146	Ø 278 26 23 V
			→			24.0110-0347.1 410347	Ø 264 10 8
1.6 Turbo	110	02/07→	←	06/07→		24.0125-0142.1 425142 24.0325-0142.1 525142	Ø 308 25 22 V + S Ø 308 25 23 V + S PD
			→	06/07→		24.0110-0347.1 410347	Ø 264 10 8
1.6 Turbo	141	02/07→	←	03/07→; nicht für Ausstattungsvariante: Nuerburg- ring Edit.		24.0125-0142.1 425142 24.0325-0142.1 525142	Ø 308 25 22 V + S Ø 308 25 23 V + S PD
			→	03/07→		24.0110-0347.1 410347	Ø 264 10 8
↓							









	kw			 	! #		
OPEL - CORSA D 07/06→							
 Bremsscheibe							
1.6 Turbo	155	06/11→	←	nicht für Ausstattungsvariante: Nuerburg-ring Edit.	24.0125-0142.1	425142	Ø 308 25 22 V + S
			→		24.0325-0142.1	525142	Ø 308 25 23 V + S PD
1.7 CDTI	92	07/06→	←	10/06→	24.0126-0146.1	426146	Ø 278 26 23 V
			→	10/06→	24.0110-0347.1	410347	Ø 264 10 8
OPEL - CORSA D Van 07/06→							
 Bremsbelagsatz, Scheibenbremse							
1.0	44	07/06→	←	10/06→; V	13.0460-3839.2	603839	BOS 23707 17,9 + WK + Zub
			←	10/06→	13.0470-3839.2	LD3839	BOS 23982 18,1 + WK + Zub Ceramic
1.0	48	01/10→	←	V	13.0460-3839.2	603839	BOS 23707 17,9 + WK + Zub
			←		13.0470-3839.2	LD3839	BOS 23982 18,1 + WK + Zub Ceramic
1.2 1.2 1.2	51 59 63	06/10→ 07/09→ 06/10→	←		13.0460-3839.2	603839	BOS 23707 17,9 + WK + Zub
			←		13.0470-3839.2	LD3839	BOS 23982 18,1 + WK + Zub Ceramic
1.3 CDTI	55	07/06→	←	10/06→; für Bremsscheibendurchmesser [mm]: 257	13.0460-3839.2	603839	BOS 23707 17,9 + WK + Zub
			←	10/06→; für Bremsscheibendurchmesser [mm]: 284	13.0470-3839.2	LD3839	BOS 23982 18,1 + WK + Zub Ceramic
1.3 CDTI	66	07/06→	←	10/06→	13.0460-3840.2	603840	BOS 23981 19,6 + WK + Zub
			←		13.0470-3840.2	LD3840	BOS 23981 19,6 + WK + Zub Ceramic
1.3 CDTI	70	06/10→	←	für Bremsscheibendurchmesser [mm]: 257	13.0460-3839.2	603839	BOS 23707 17,9 + WK + Zub
			←	für Bremsscheibendurchmesser [mm]: 284	13.0470-3839.2	LD3839	BOS 23982 18,1 + WK + Zub Ceramic
			←	für Bremsscheibendurchmesser [mm]: 257	13.0460-3840.2	603840	BOS 23981 19,6 + WK + Zub
			←	für Bremsscheibendurchmesser [mm]: 284	13.0470-3840.2	LD3840	BOS 23981 19,6 + WK + Zub Ceramic
 Bremsscheibe							
1.0	44	07/06→	←	10/06→	24.0112-0184.1	412184	Ø 257 12 10 + S
			←		24.0122-0231.1	422231	Ø 257 22 20 V + S
			←		24.0322-0231.1	522231	Ø 257 22 20 V + S PD
1.0	48	01/10→	←		24.0112-0184.1	412184	Ø 257 12 10 + S
			←		24.0122-0231.1	422231	Ø 257 22 20 V + S
			←		24.0322-0231.1	522231	Ø 257 22 20 V + S PD
1.2 1.2 1.2	51 59 63	06/10→ 07/09→ 06/10→	←		24.0122-0231.1	422231	Ø 257 22 20 V + S
			←		24.0322-0231.1	522231	Ø 257 22 20 V + S PD
			←				
1.3 CDTI	55	07/06→	←	10/06→; für Bremsscheibendurchmesser [mm]: 257	24.0122-0231.1	422231	Ø 257 22 20 V + S
			←	10/06→; für Bremsscheibendurchmesser [mm]: 284	24.0322-0231.1	522231	Ø 257 22 20 V + S PD
1.3 CDTI	66	07/06→	←	10/06→	24.0122-0241.1	422241	Ø 284 22 20 V + S
			←				
1.3 CDTI	70	06/10→	←	für Bremsscheibendurchmesser [mm]: 257	24.0122-0231.1	422231	Ø 257 22 20 V + S
			←	für Bremsscheibendurchmesser [mm]: 284	24.0322-0231.1	522231	Ø 257 22 20 V + S PD
			←	für Bremsscheibendurchmesser [mm]: 257	24.0122-0241.1	422241	Ø 284 22 20 V + S
			←	für Bremsscheibendurchmesser [mm]: 284	24.0322-0231.1	522231	Ø 257 22 20 V + S PD
OPEL - CORSA E 09/14→							
 Bremsbelagsatz, Scheibenbremse							
1.0	66	09/14→	←	11/14→; für Bremsscheibendurchmesser [mm]: 308	13.0460-7179.2	607179	ATE 23832 20,2 - WK / + WK
1.0	85	09/14→	←		13.0470-7179.2	LD7179	ATE 23832 20,2 - WK / + WK Ceramic
1.2	51	09/14→	←				
1.3 CDTI	55	09/14→	←				
↓							











	kW			 	! #		
OPEL - CORSA E 09/14→							
 Bremsbelagsatz, Scheibenbremse							
1.3 CDTI 1.4 1.4 Turbo	70 55 66 74	09/14→ 09/14→ 09/14→	←	11/14→; für Bremsscheibendurchmesser [mm]: 284		13.0460-7308.2 607308	ATE 22123 18,2 + WK + Zub
			←	11/14→; für Bremsscheibendurchmesser [mm]: 257		13.0460-7310.2 607310	ATE 22143 17,5 + WK + Zub
			→	11/14→		13.0460-2793.2 602793	TRW 25973 17,2 + WK + Zub
1.4 LPG 1.4 LPG 1.4 Turbo	64 66 110	11/15→ 03/15→ 03/15→	←	für Bremsscheibendurchmesser [mm]: 308		13.0460-7179.2 607179 13.0470-7179.2 LD7179	ATE 23832 20,2 - WK / + WK ATE 23832 20,2 - WK / + WK Ceramic
			←	für Bremsscheibendurchmesser [mm]: 284		13.0460-7308.2 607308	ATE 22123 18,2 + WK + Zub
			←	für Bremsscheibendurchmesser [mm]: 257		13.0460-7310.2 607310	ATE 22143 17,5 + WK + Zub
			→			13.0460-2793.2 602793	TRW 25973 17,2 + WK + Zub
1.6 Turbo	152	03/15→	→			13.0460-2793.2 602793	TRW 25973 17,2 + WK + Zub
 Bremsscheibe							
1.0 1.0 1.2 1.3 CDTI 1.3 CDTI 1.4 1.4 1.4 Turbo	66 85 51 55 70 55 66 74	09/14→ 09/14→ 09/14→ 09/14→ 09/14→ 09/14→ 09/14→	←	11/14→		24.0122-0231.1 422231 24.0122-0241.1 422241 24.0125-0142.1 425142 24.0322-0231.1 522231 24.0325-0142.1 525142	Ø 257 22 20 V + S Ø 284 22 20 V + S Ø 308 25 22 V + S Ø 257 22 20 V + S PD Ø 308 25 23 V + S PD
			→	11/14→; +POC J67		24.0110-0323.1 410323	Ø 264 10 8
			→	11/14→; +POC J7A		24.0110-0347.1 410347	Ø 264 10 8
1.4 LPG 1.4 LPG 1.4 Turbo	64 66 110	11/15→ 03/15→ 03/15→	←			24.0122-0231.1 422231 24.0122-0241.1 422241 24.0125-0142.1 425142 24.0322-0231.1 522231 24.0325-0142.1 525142	Ø 257 22 20 V + S Ø 284 22 20 V + S Ø 308 25 22 V + S Ø 257 22 20 V + S PD Ø 308 25 23 V + S PD
			→	+POC J67		24.0110-0323.1 410323	Ø 264 10 8
			→	+POC J7A		24.0110-0347.1 410347	Ø 264 10 8
1.6 Turbo	152	03/15→	→			24.0110-0347.1 410347	Ø 264 10 8
OPEL - CORSA E Van 09/14→							
 Bremsbelagsatz, Scheibenbremse							
1.2 1.3 CDTI	51 55	01/15→ 01/15→	←	für Bremsscheibendurchmesser [mm]: 308		13.0460-7179.2 607179 13.0470-7179.2 LD7179	ATE 23832 20,2 - WK / + WK ATE 23832 20,2 - WK / + WK Ceramic
			←	für Bremsscheibendurchmesser [mm]: 284		13.0460-7308.2 607308	ATE 22123 18,2 + WK + Zub
			←	für Bremsscheibendurchmesser [mm]: 257		13.0460-7310.2 607310	ATE 22143 17,5 + WK + Zub
			→			13.0460-2793.2 602793	TRW 25973 17,2 + WK + Zub
1.3 CDTI 1.4 1.4	70 55 66	09/14→ 09/14→ 09/14→	←	11/14→; für Bremsscheibendurchmesser [mm]: 308		13.0460-7179.2 607179 13.0470-7179.2 LD7179	ATE 23832 20,2 - WK / + WK ATE 23832 20,2 - WK / + WK Ceramic
			←	11/14→; für Bremsscheibendurchmesser [mm]: 284		13.0460-7308.2 607308	ATE 22123 18,2 + WK + Zub
			←	11/14→; für Bremsscheibendurchmesser [mm]: 257		13.0460-7310.2 607310	ATE 22143 17,5 + WK + Zub
			→	11/14→		13.0460-2793.2 602793	TRW 25973 17,2 + WK + Zub
 Bremsscheibe							
1.2 1.3 CDTI	51 55	01/15→ 01/15→	←			24.0122-0231.1 422231 24.0122-0241.1 422241 24.0125-0142.1 425142 24.0322-0231.1 522231 24.0325-0142.1 525142	Ø 257 22 20 V + S Ø 284 22 20 V + S Ø 308 25 22 V + S Ø 257 22 20 V + S PD Ø 308 25 23 V + S PD
			→	+POC J67		24.0110-0323.1 410323	Ø 264 10 8
			→	+POC J7A		24.0110-0347.1 410347	Ø 264 10 8
1.3 CDTI 1.4	70 55	09/14→ 09/14→	←	11/14→		24.0122-0231.1 422231 24.0122-0241.1 422241	Ø 257 22 20 V + S Ø 284 22 20 V + S









	kw					! #		
OPEL - CORSA E Van 09/14→								
 Bremsscheibe								
1.4	66	09/14→	←	11/14→		24.0125-0142.1	425142	Ø 308 25 22 V + S
						24.0322-0231.1	522231	Ø 257 22 20 V + S PD
						24.0325-0142.1	525142	Ø 308 25 23 V + S PD
			→	11/14→; +POC J67		24.0110-0323.1	410323	Ø 264 10 8
			→	11/14→; +POC J7A		24.0110-0347.1	410347	Ø 264 10 8
OPEL - FRONTERA A (5_MWL4) 03/92→10/98								
 Bremsbelagsatz, Scheibenbremse								
2.2 i (54MWL4)	100	03/95→10/98	←	SV720103→		13.0460-5926.2	605926	AKE 21845 16,5 + WK
2.3 TD (5JMWL4)	74	03/92→10/98	←	→ SV720102		13.0460-5942.2	605942	AKE 21543 16,5 + WK
2.4 i (53MWL4)	92	03/92→10/98	←	→ SV720102		13.0460-5942.2	605942	AKE 21543 16,5 + WK
2.5 TDS	85	09/96→10/98	→	SV720103→		13.0460-5927.2	605927	AKE 21875 16,0 + WK
2.8 TD (5BMW4)	83	03/95→10/98	→	SV720103→		13.0460-5927.2	605927	AKE 21875 16,0 + WK
Zubehörsatz, Scheibenbremsbelag								
2.2 i (54MWL4)	100	03/95→10/98	←	→ SV720102		13.0460-0337.2	610337	AKE
2.3 TD (5JMWL4)	74	03/92→10/98	←	→ SV720102		13.0460-0337.2	610337	AKE
2.4 i (53MWL4)	92	03/92→10/98	←	SV720103→		13.0460-0446.2	610446	AKE
2.5 TDS	85	09/96→10/98	→	SV720103→		13.0460-0447.2	610447	AKE
2.8 TD (5BMW4)	83	03/95→10/98	→	SV720103→		13.0460-0447.2	610447	AKE
 Bremsscheibe								
2.2 i (54MWL4)	100	03/95→10/98	←	→ SV720102		24.0122-0156.1	422156	Ø 257 22 20,6 V
2.3 TD (5JMWL4)	74	03/92→10/98	←	SV720103→; - ABS		24.0126-0111.1	426111	Ø 280 26 24,6 V
2.4 i (53MWL4)	92	03/92→10/98	←	SV720103→; - ABS		24.0126-0111.1	426111	Ø 280 26 24,6 V
2.5 TDS	85	09/96→10/98	←	SV720103→; + ABS		24.0126-0111.1	426111	Ø 280 26 24,6 V
2.8 TD (5BMW4)	83	03/95→10/98	→	SV720103→		24.0118-0122.1	418122	Ø 313,5 18 16,6 V
OPEL - FRONTERA A Sport (5_SUD2) 03/92→10/98								
 Bremsbelagsatz, Scheibenbremse								
2.0 i (52SUD2, 55SUD2)	85	03/92→10/98	←	SV720103→		13.0460-5926.2	605926	AKE 21845 16,5 + WK
2.5 TDS	85	09/96→10/98	←	→ SV720102		13.0460-5942.2	605942	AKE 21543 16,5 + WK
2.8 TD (53SUD2)	83	03/95→08/96	←	→ SV720102		13.0460-5942.2	605942	AKE 21543 16,5 + WK
			→	SV720103→		13.0460-5927.2	605927	AKE 21875 16,0 + WK
Zubehörsatz, Scheibenbremsbelag								
2.0 i (52SUD2, 55SUD2)	85	03/92→10/98	←	→ SV720102		13.0460-0337.2	610337	AKE
2.5 TDS	85	09/96→10/98	←	→ SV720102		13.0460-0446.2	610446	AKE
2.8 TD (53SUD2)	83	03/95→08/96	←	→ SV720102		13.0460-0446.2	610446	AKE
			→	SV720103→		13.0460-0447.2	610447	AKE
 Bremsscheibe								
2.0 i (52SUD2, 55SUD2)	85	03/92→10/98	←	→ SV720102		24.0122-0156.1	422156	Ø 257 22 20,6 V
2.5 TDS	85	09/96→10/98	←	SV720103→; - ABS		24.0126-0111.1	426111	Ø 280 26 24,6 V
2.8 TD (53SUD2)	83	03/95→08/96	←	SV720103→; - ABS		24.0126-0111.1	426111	Ø 280 26 24,6 V
			←	SV720103→; + ABS		24.0126-0111.1	426111	Ø 280 26 24,6 V
			→	SV720103→		24.0118-0122.1	418122	Ø 313,5 18 16,6 V
OPEL - FRONTERA B (6B_) 10/98→09/02								
 Bremsbelagsatz, Scheibenbremse								
2.2 DTI	88	09/02→	←	→ 02/04;		13.0460-5926.2	605926	AKE 21845 16,5 + WK
2.2 i (6B_ZC, 6B_VF, 6B_66, 6B_76)	100	10/98→	←	für Fahrzeuge ohne Bordcomputer		13.0460-5926.2	605926	AKE 21845 16,5 + WK
3.2 i (6B1VF, 6B1_6)	151	10/98→	→	→ 02/04		13.0460-5927.2	605927	AKE 21875 16,0 + WK
2.2 DTI (6B_ZC, 6B_VF, 6B_66, 6B_76)	85	10/98→09/02	←	für Fahrzeuge ohne Bordcomputer		13.0460-5926.2	605926	AKE 21845 16,5 + WK
			→			13.0460-5927.2	605927	AKE 21875 16,0 + WK
Zubehörsatz, Scheibenbremsbelag								
2.2 DTI	88	09/02→	→	→ 02/04		13.0460-0447.2	610447	AKE
2.2 i (6B_ZC, 6B_VF, 6B_66, 6B_76)	100	10/98→	→			13.0460-0447.2	610447	AKE
3.2 i (6B1VF, 6B1_6)	151	10/98→	→			13.0460-0447.2	610447	AKE
2.2 DTI (6B_ZC, 6B_VF, 6B_66, 6B_76)	85	10/98→09/02	→			13.0460-0447.2	610447	AKE
 Bremsscheibe								
2.2 DTI	88	09/02→	←	→ 02/04		24.0126-0111.1	426111	Ø 280 26 24,6 V
2.2 i (6B_ZC, 6B_VF, 6B_66, 6B_76)	100	10/98→	→	→ 02/04		24.0118-0122.1	418122	Ø 313,5 18 16,6 V
3.2 i (6B1VF, 6B1_6)	151	10/98→	→					











	kw			 	! #		
OPEL - FRONTERA B (6B_) 10/98→09/02							
 Bremsscheibe							
2.2 DTI (6B_ZC, 6B_VF, 6B_66, 6B_76)	85	10/98→09/02	←			24.0126-0111.1 426111	∅ 280 26 24,6 V
			→			24.0118-0122.1 418122	∅ 313,5 18 16,6 V
OPEL - GT Cabriolet 06/07→							
 Bremsbelagsatz, Scheibenbremse							
2.0	194	06/07→	→	→ 07/09		13.0460-7195.2 607195 13.0470-7195.2 LD7195	ATE 23482 16,6 - WE / - WK ATE 23482 16,6 - WE / - WK Ceramic
OPEL - INSIGNIA 07/08→							
 Bremsbelagsatz, Scheibenbremse							
1.4	103	04/11→	←	06/11→; für Bremsscheibendurchmesser [mm]: 337		13.0460-2754.2 602754	TRW 24418 17,0 + WK + Zub
			←	06/11→; für Bremsscheibendurchmesser [mm]: 296		13.0460-5611.2 605611 13.0470-5611.2 LD5611	MAN 24415 19,1 + WK + Zub MAN 24415 19,1 + WK + Zub Ceramic
			←	06/11→; für Bremsscheibendurchmesser [mm]: 321		13.0460-5612.2 605612 13.0470-5612.2 LD5612	MAN 24412 19,0 + WK + Zub MAN 24412 19,0 + WK + Zub Ceramic
			→	06/11→; für Bremsscheibendurchmesser [mm]: 315		13.0460-2755.2 602755 13.0470-2755.2 LD2755	TRW 24421 17,2 + WK + Zub TRW 24421 17,2 + WK + Zub Ceramic
			→	06/11→; für Bremsscheibendurchmesser [mm]: 292		13.0460-2758.2 602758 13.0470-2758.2 LD2758	TRW 24421 17,2 + WK + Zub TRW 24421 17,2 + WK + Zub Ceramic
1.4 LPG	103	07/12→	←	für Bremsscheibendurchmesser [mm]: 337		13.0460-2754.2 602754	TRW 24418 17,0 + WK + Zub
1.6	85	07/08→	←	für Bremsscheibendurchmesser [mm]: 296		13.0460-5611.2 605611 13.0470-5611.2 LD5611	MAN 24415 19,1 + WK + Zub MAN 24415 19,1 + WK + Zub Ceramic
1.6 CDTi	88	07/15→	←	für Bremsscheibendurchmesser [mm]: 321		13.0460-5612.2 605612 13.0470-5612.2 LD5612	MAN 24412 19,0 + WK + Zub MAN 24412 19,0 + WK + Zub Ceramic
1.6 CDTi	100	07/15→	←	für Bremsscheibendurchmesser [mm]: 315		13.0460-2755.2 602755 13.0470-2755.2 LD2755	TRW 24421 17,2 + WK + Zub TRW 24421 17,2 + WK + Zub Ceramic
1.6 SIDI	125	03/13→	←	für Bremsscheibendurchmesser [mm]: 292		13.0460-2758.2 602758 13.0470-2758.2 LD2758	TRW 24421 17,2 + WK + Zub TRW 24421 17,2 + WK + Zub Ceramic
1.8	103	07/08→	←	für Bremsscheibendurchmesser [mm]: 337		13.0460-2754.2 602754	TRW 24418 17,0 + WK + Zub
2.0 Biturbo CDTi	140	07/08→	←	für Bremsscheibendurchmesser [mm]: 296		13.0460-5611.2 605611 13.0470-5611.2 LD5611	MAN 24415 19,1 + WK + Zub MAN 24415 19,1 + WK + Zub Ceramic
2.0 Biturbo CDTi	143	01/12→	←	für Bremsscheibendurchmesser [mm]: 321		13.0460-5612.2 605612 13.0470-5612.2 LD5612	MAN 24412 19,0 + WK + Zub MAN 24412 19,0 + WK + Zub Ceramic
2.0 Biturbo CDTi 4x4	140	05/09→	←	für Bremsscheibendurchmesser [mm]: 315		13.0460-2755.2 602755 13.0470-2755.2 LD2755	TRW 24421 17,2 + WK + Zub TRW 24421 17,2 + WK + Zub Ceramic
2.0 Biturbo CDTi 4x4	143	01/12→	←	für Bremsscheibendurchmesser [mm]: 292		13.0460-2758.2 602758 13.0470-2758.2 LD2758	TRW 24421 17,2 + WK + Zub TRW 24421 17,2 + WK + Zub Ceramic
2.0 CDTi	81	07/08→	→	für Bremsscheibendurchmesser [mm]: 315		13.0460-2755.2 602755 13.0470-2755.2 LD2755	TRW 24421 17,2 + WK + Zub TRW 24421 17,2 + WK + Zub Ceramic
2.0 CDTi	96	07/08→	→	für Bremsscheibendurchmesser [mm]: 292		13.0460-2758.2 602758 13.0470-2758.2 LD2758	TRW 24421 17,2 + WK + Zub TRW 24421 17,2 + WK + Zub Ceramic
2.0 CDTi	103	07/13→	→	für Bremsscheibendurchmesser [mm]: 337		13.0460-2754.2 602754	TRW 24418 17,0 + WK + Zub
2.0 CDTi	118	07/08→	→	für Bremsscheibendurchmesser [mm]: 296		13.0460-5611.2 605611 13.0470-5611.2 LD5611	MAN 24415 19,1 + WK + Zub MAN 24415 19,1 + WK + Zub Ceramic
2.0 CDTi	120	07/13→	→	für Bremsscheibendurchmesser [mm]: 321		13.0460-5612.2 605612 13.0470-5612.2 LD5612	MAN 24412 19,0 + WK + Zub MAN 24412 19,0 + WK + Zub Ceramic
2.0 CDTi	125	11/14→	→	für Bremsscheibendurchmesser [mm]: 315		13.0460-2755.2 602755 13.0470-2755.2 LD2755	TRW 24421 17,2 + WK + Zub TRW 24421 17,2 + WK + Zub Ceramic
2.0 CDTi 4x4	118	06/10→	→	für Bremsscheibendurchmesser [mm]: 292		13.0460-2758.2 602758 13.0470-2758.2 LD2758	TRW 24421 17,2 + WK + Zub TRW 24421 17,2 + WK + Zub Ceramic
2.0 CDTi 4x4	120	07/13→	→	für Bremsscheibendurchmesser [mm]: 337		13.0460-2754.2 602754	TRW 24418 17,0 + WK + Zub
2.0 CDTi 4x4	125	11/14→	→	für Bremsscheibendurchmesser [mm]: 296		13.0460-5611.2 605611 13.0470-5611.2 LD5611	MAN 24415 19,1 + WK + Zub MAN 24415 19,1 + WK + Zub Ceramic
2.0 E85 Turbo	162	09/10→	→	für Bremsscheibendurchmesser [mm]: 321		13.0460-5612.2 605612 13.0470-5612.2 LD5612	MAN 24412 19,0 + WK + Zub MAN 24412 19,0 + WK + Zub Ceramic
2.0 Turbo	162	07/08→	→	für Bremsscheibendurchmesser [mm]: 315		13.0460-2755.2 602755 13.0470-2755.2 LD2755	TRW 24421 17,2 + WK + Zub TRW 24421 17,2 + WK + Zub Ceramic
2.0 Turbo	184	04/14→	→	für Bremsscheibendurchmesser [mm]: 292		13.0460-2758.2 602758 13.0470-2758.2 LD2758	TRW 24421 17,2 + WK + Zub TRW 24421 17,2 + WK + Zub Ceramic
2.0 Turbo 4x4	162	07/08→	→	für Bremsscheibendurchmesser [mm]: 337		13.0460-2754.2 602754	TRW 24418 17,0 + WK + Zub
2.0 Turbo 4x4	184	09/11→	→	für Bremsscheibendurchmesser [mm]: 296		13.0460-5611.2 605611 13.0470-5611.2 LD5611	MAN 24415 19,1 + WK + Zub MAN 24415 19,1 + WK + Zub Ceramic
1.6 Turbo	132	07/08→	←	10/08→; für Bremsscheibendurchmesser [mm]: 337		13.0460-2754.2 602754	TRW 24418 17,0 + WK + Zub
			←	10/08→; für Bremsscheibendurchmesser [mm]: 296		13.0460-5611.2 605611 13.0470-5611.2 LD5611	MAN 24415 19,1 + WK + Zub MAN 24415 19,1 + WK + Zub Ceramic
			←	10/08→; für Bremsscheibendurchmesser [mm]: 321		13.0460-5612.2 605612 13.0470-5612.2 LD5612	MAN 24412 19,0 + WK + Zub MAN 24412 19,0 + WK + Zub Ceramic
			→	10/08→; für Bremsscheibendurchmesser [mm]: 315		13.0460-2755.2 602755 13.0470-2755.2 LD2755	TRW 24421 17,2 + WK + Zub TRW 24421 17,2 + WK + Zub Ceramic
			→	10/08→; für Bremsscheibendurchmesser [mm]: 292		13.0460-2758.2 602758 13.0470-2758.2 LD2758	TRW 24421 17,2 + WK + Zub TRW 24421 17,2 + WK + Zub Ceramic
2.0 CDTi	88	03/12→	←	03/13→; für Bremsscheibendurchmesser [mm]: 337		13.0460-2754.2 602754	TRW 24418 17,0 + WK + Zub
			←	03/13→; für Bremsscheibendurchmesser [mm]: 296		13.0460-5611.2 605611 13.0470-5611.2 LD5611	MAN 24415 19,1 + WK + Zub MAN 24415 19,1 + WK + Zub Ceramic
↓							

















	kW			 	! #							
OPEL - INSIGNIA 07/08→												
 Bremsbelagsatz, Scheibenbremse												
2.0 CDTI	88	03/12→	←	03/13→; für Bremsscheibendurchmesser [mm]: 321	13.0460-5612.2 605612	MAN 24412 19,0 + WK + Zub						
					13.0470-5612.2 LD5612	MAN 24412 19,0 + WK + Zub Ceramic						
			→	03/13→; für Bremsscheibendurchmesser [mm]: 315	13.0460-2755.2 602755	TRW 24421 17,2 + WK + Zub						
				13.0470-2755.2 LD2755	TRW 24421 17,2 + WK + Zub Ceramic							
			→	03/13→; für Bremsscheibendurchmesser [mm]: 292	13.0460-2758.2 602758	TRW 24421 17,2 + WK + Zub						
				13.0470-2758.2 LD2758	TRW 24421 17,2 + WK + Zub Ceramic							
2.8 V6 Turbo 4x4	191	07/08→	←	für Bremsscheibendurchmesser [mm]: 337	13.0460-2754.2 602754	TRW 24418 17,0 + WK + Zub						
			→		13.0460-2755.2 602755	TRW 24421 17,2 + WK + Zub						
2.8 V6 Turbo OPC 4x4	239	07/09→	←		13.0460-4855.2 604855	BRE 23325 16,4 + WK						
			→		13.0460-2755.2 602755	TRW 24421 17,2 + WK + Zub						
 Bremsscheibe												
1.4	103	04/11→	←	06/11→	24.0130-0207.1 430207	∅ 296 30 27 V + S						
					24.0130-0208.1 430208	∅ 337 30 27 V + S						
					24.0130-0209.1 430209	∅ 321 30 27 V + S						
					24.0330-0207.1 530207	∅ 296 30 27 V + S PD						
					24.0330-0209.1 530209	∅ 321 30 27 V + S PD						
			→	06/11→	24.0112-0187.1 412187	∅ 292 12 10,5 + S						
					24.0123-0114.1 423114	∅ 315 22,9 21,5 V + S						
					24.0312-0187.1 512187	∅ 292 12 10,5 + S PD						
					24.0323-0114.1 523114	∅ 315 22,9 21,5 V + S PD						
1.4 LPG 1.6 1.6 CDTi 1.6 CDTi 1.6 SIDI 1.8 2.0 Biturbo CDTI 2.0 Biturbo CDTI 2.0 Biturbo CDTI 4x4 2.0 Biturbo CDTI 4x4 2.0 CDTI 2.0 CDTI 2.0 CDTI 2.0 CDTI 2.0 CDTI 2.0 CDTI 2.0 CDTI 2.0 CDTI 2.0 CDTI 2.0 CDTI 2.0 CDTI 2.0 CDTI 2.0 CDTI 2.0 CDTI 2.0 E85 Turbo 2.0 Turbo 2.0 Turbo 2.0 Turbo 4x4 2.0 Turbo 4x4	103 85 88 100 125 103 140 143 140 143 81 96 103 118 120 125 118 120 125 118 120 125 162 162 184 162 184	07/12→ 07/08→ 07/15→ 07/15→ 03/13→ 07/08→ 07/08→ 01/12→ 05/09→ 01/12→ 07/08→ 07/08→ 07/13→ 07/08→ 07/13→ 11/14→ 06/10→ 07/13→ 11/14→ 09/10→ 07/08→ 04/14→ 07/08→ 09/11→	←		24.0130-0207.1 430207	∅ 296 30 27 V + S						
					24.0130-0208.1 430208	∅ 337 30 27 V + S						
					24.0130-0209.1 430209	∅ 321 30 27 V + S						
					24.0330-0207.1 530207	∅ 296 30 27 V + S PD						
					24.0330-0209.1 530209	∅ 321 30 27 V + S PD						
								→		24.0112-0187.1 412187	∅ 292 12 10,5 + S	
										24.0123-0114.1 423114	∅ 315 22,9 21,5 V + S	
										24.0312-0187.1 512187	∅ 292 12 10,5 + S PD	
										24.0323-0114.1 523114	∅ 315 22,9 21,5 V + S PD	
					1.6 Turbo	132	07/08→	←	10/08→	24.0130-0207.1 430207	∅ 296 30 27 V + S	
										24.0130-0208.1 430208	∅ 337 30 27 V + S	
										24.0130-0209.1 430209	∅ 321 30 27 V + S	
										24.0330-0207.1 530207	∅ 296 30 27 V + S PD	
										24.0330-0209.1 530209	∅ 321 30 27 V + S PD	
								→	10/08→	24.0112-0187.1 412187	∅ 292 12 10,5 + S	
										24.0123-0114.1 423114	∅ 315 22,9 21,5 V + S	
										24.0312-0187.1 512187	∅ 292 12 10,5 + S PD	
										24.0323-0114.1 523114	∅ 315 22,9 21,5 V + S PD	
					2.0 CDTI	88	03/12→	←	03/13→	24.0130-0207.1 430207	∅ 296 30 27 V + S	
										24.0130-0208.1 430208	∅ 337 30 27 V + S	
24.0130-0209.1 430209	∅ 321 30 27 V + S											
24.0330-0207.1 530207	∅ 296 30 27 V + S PD											
24.0330-0209.1 530209	∅ 321 30 27 V + S PD											
			→	03/13→	24.0112-0187.1 412187	∅ 292 12 10,5 + S						
					24.0123-0114.1 423114	∅ 315 22,9 21,5 V + S						
					24.0312-0187.1 512187	∅ 292 12 10,5 + S PD						
					24.0323-0114.1 523114	∅ 315 22,9 21,5 V + S PD						
2.8 V6 Turbo 4x4 ↓	191	07/08→	←		24.0130-0208.1 430208	∅ 337 30 27 V + S						







	kw			 	! #		
OPEL - INSIGNIA 07/08→							
 Bremsscheibe							
2.8 V6 Turbo 4x4	191	07/08→	→			24.0123-0114.1 423114 24.0323-0114.1 523114	Ø 315 22,9 21,5 V + S Ø 315 22,9 21,5 V + S PD
2.8 V6 Turbo OPC 4x4	239	07/09→	→			24.0123-0114.1 423114 24.0323-0114.1 523114	Ø 315 22,9 21,5 V + S Ø 315 22,9 21,5 V + S PD
OPEL - INSIGNIA Caravan 07/08→							
 Bremsbelagsatz, Scheibenbremse							
1.4	103	09/11→	←	für Bremsscheibendurchmesser [mm]: 337		13.0460-2754.2 602754	TRW 24418 17,0 + WK + Zub
1.4 LPG	103	07/12→					
1.6	85	07/08→	←	für Bremsscheibendurchmesser [mm]: 296		13.0460-5611.2 605611 13.0470-5611.2 LD5611	MAN 24415 19,1 + WK + Zub MAN 24415 19,1 + WK + Zub Ceramic
1.6 CDTi	88	07/15→					
1.6 CDTi	100	07/15→					
1.6 SIDI	125	03/13→					
1.6 Turbo	132	01/09→	←	für Bremsscheibendurchmesser [mm]: 321		13.0460-5612.2 605612 13.0470-5612.2 LD5612	MAN 24412 19,0 + WK + Zub MAN 24412 19,0 + WK + Zub Ceramic
1.8	103	07/08→					
2.0 Biturbo CDTI	140	07/08→					
2.0 Biturbo CDTI	143	01/12→					
2.0 Biturbo CDTI 4x4	140	07/08→	→	für Bremsscheibendurchmesser [mm]: 315		13.0460-2755.2 602755 13.0470-2755.2 LD2755	TRW 24421 17,2 + WK + Zub TRW 24421 17,2 + WK + Zub Ceramic
2.0 Biturbo CDTI 4x4	143	01/12→					
2.0 CDTI	81	07/08→					
2.0 CDTI	96	07/08→	→	für Bremsscheibendurchmesser [mm]: 292		13.0460-2758.2 602758 13.0470-2758.2 LD2758	TRW 24421 17,2 + WK + Zub TRW 24421 17,2 + WK + Zub Ceramic
2.0 CDTI	103	07/13→					
2.0 CDTI	118	07/08→					
2.0 CDTI	120	07/13→					
2.0 CDTI	125	11/14→					
2.0 CDTI 4x4	118	06/10→					
2.0 CDTI 4x4	120	07/13→					
2.0 CDTI 4x4	125	11/14→					
2.0 E85 Turbo	162	09/10→					
2.0 Turbo	162	07/08→					
2.0 Turbo	184	04/14→					
2.0 Turbo 4x4	162	07/08→					
2.0 Turbo 4x4	184	09/11→					
2.0 CDTI	88	03/12→	←	03/13→; für Bremsscheibendurchmesser [mm]: 337		13.0460-2754.2 602754	TRW 24418 17,0 + WK + Zub
			←	03/13→; für Bremsscheibendurchmesser [mm]: 296		13.0460-5611.2 605611 13.0470-5611.2 LD5611	MAN 24415 19,1 + WK + Zub MAN 24415 19,1 + WK + Zub Ceramic
			←	03/13→; für Bremsscheibendurchmesser [mm]: 321		13.0460-5612.2 605612 13.0470-5612.2 LD5612	MAN 24412 19,0 + WK + Zub MAN 24412 19,0 + WK + Zub Ceramic
			→	03/13→; für Bremsscheibendurchmesser [mm]: 315		13.0460-2755.2 602755 13.0470-2755.2 LD2755	TRW 24421 17,2 + WK + Zub TRW 24421 17,2 + WK + Zub Ceramic
			→	03/13→; für Bremsscheibendurchmesser [mm]: 292		13.0460-2758.2 602758 13.0470-2758.2 LD2758	TRW 24421 17,2 + WK + Zub TRW 24421 17,2 + WK + Zub Ceramic
2.8 V6 Turbo 4x4	191	10/08→	←	für Bremsscheibendurchmesser [mm]: 337		13.0460-2754.2 602754	TRW 24418 17,0 + WK + Zub
			→			13.0460-2755.2 602755 13.0470-2755.2 LD2755	TRW 24421 17,2 + WK + Zub TRW 24421 17,2 + WK + Zub Ceramic
2.8 V6 Turbo OPC 4x4	239	07/09→	←			13.0460-4855.2 604855	BRE 23325 16,4 + WK
			→			13.0460-2755.2 602755 13.0470-2755.2 LD2755	TRW 24421 17,2 + WK + Zub TRW 24421 17,2 + WK + Zub Ceramic
 Bremsscheibe							
1.4	103	09/11→	←			24.0130-0207.1 430207	Ø 296 30 27 V + S
1.4 LPG	103	07/12→				24.0130-0208.1 430208	Ø 337 30 27 V + S
1.6	85	07/08→				24.0130-0209.1 430209	Ø 321 30 27 V + S
1.6 CDTi	88	07/15→				24.0330-0207.1 530207	Ø 296 30 27 V + S PD
1.6 CDTi	100	07/15→				24.0330-0209.1 530209	Ø 321 30 27 V + S PD
1.6 SIDI	125	03/13→					
1.6 Turbo	132	01/09→	→			24.0112-0187.1 412187	Ø 292 12 10,5 + S
1.8	103	07/08→				24.0123-0114.1 423114	Ø 315 22,9 21,5 V + S
2.0 Biturbo CDTI	140	07/08→				24.0312-0187.1 512187	Ø 292 12 10,5 + S PD
2.0 Biturbo CDTI	143	01/12→				24.0323-0114.1 523114	Ø 315 22,9 21,5 V + S PD
2.0 Biturbo CDTI 4x4	140	07/08→					
2.0 Biturbo CDTI 4x4	143	01/12→					
2.0 CDTI	81	07/08→					
2.0 CDTI	96	07/08→					
2.0 CDTI	103	07/13→					
2.0 CDTI	118	07/08→					











	kw			 	! #				
OPEL - INSIGNIA Caravan 07/08 →									
 Bremsscheibe									
2.0 CDTI	120	07/13 →	←		24.0130-0207.1	430207	Ø 296 30 27 V + S		
2.0 CDTI	125	11/14 →			24.0130-0208.1	430208	Ø 337 30 27 V + S		
2.0 CDTI 4x4	118	06/10 →			24.0130-0209.1	430209	Ø 321 30 27 V + S		
2.0 CDTI 4x4	120	07/13 →			24.0330-0207.1	530207	Ø 296 30 27 V + S PD		
2.0 CDTI 4x4	125	11/14 →			24.0330-0209.1	530209	Ø 321 30 27 V + S PD		
2.0 E85 Turbo	162	09/10 →			→		24.0112-0187.1	412187	Ø 292 12 10,5 + S
2.0 Turbo	162	07/08 →					24.0123-0114.1	423114	Ø 315 22,9 21,5 V + S
2.0 Turbo	184	04/14 →					24.0312-0187.1	512187	Ø 292 12 10,5 + S PD
2.0 Turbo 4x4	162	07/08 →					24.0323-0114.1	523114	Ø 315 22,9 21,5 V + S PD
2.0 Turbo 4x4	184	09/11 →							
2.0 CDTI	88	03/12 →	←	03/13 →	24.0130-0207.1	430207	Ø 296 30 27 V + S		
				24.0130-0208.1	430208	Ø 337 30 27 V + S			
				24.0130-0209.1	430209	Ø 321 30 27 V + S			
				24.0330-0207.1	530207	Ø 296 30 27 V + S PD			
				24.0330-0209.1	530209	Ø 321 30 27 V + S PD			
			→	03/13 →	24.0112-0187.1	412187	Ø 292 12 10,5 + S		
					24.0123-0114.1	423114	Ø 315 22,9 21,5 V + S		
					24.0312-0187.1	512187	Ø 292 12 10,5 + S PD		
					24.0323-0114.1	523114	Ø 315 22,9 21,5 V + S PD		
2.8 V6 Turbo 4x4	191	10/08 →	←		24.0130-0208.1	430208	Ø 337 30 27 V + S		
					24.0123-0114.1	423114	Ø 315 22,9 21,5 V + S		
					24.0323-0114.1	523114	Ø 315 22,9 21,5 V + S PD		
			→		24.0123-0114.1	423114	Ø 315 22,9 21,5 V + S		
					24.0323-0114.1	523114	Ø 315 22,9 21,5 V + S PD		
2.8 V6 Turbo OPC 4x4	239	07/09 →	→		24.0123-0114.1	423114	Ø 315 22,9 21,5 V + S		
					24.0323-0114.1	523114	Ø 315 22,9 21,5 V + S PD		
OPEL - INSIGNIA Stufenheck 07/08 →									
 Bremsbelagsatz, Scheibenbremse									
1.4	103	04/11 →	←	06/11 →; für Bremsscheibendurchmesser [mm]: 337	13.0460-2754.2	602754	TRW 24418 17,0 + WK + Zub		
				←	06/11 →; für Bremsscheibendurchmesser [mm]: 296	13.0460-5611.2	605611	MAN 24415 19,1 + WK + Zub	
				←	06/11 →; für Bremsscheibendurchmesser [mm]: 321	13.0460-5612.2	605612	MAN 24412 19,0 + WK + Zub	
				→	06/11 →; für Bremsscheibendurchmesser [mm]: 315	13.0460-2755.2	602755	TRW 24421 17,2 + WK + Zub	
				→	06/11 →; für Bremsscheibendurchmesser [mm]: 292	13.0460-2758.2	602758	TRW 24421 17,2 + WK + Zub	
					13.0470-5611.2	LD5611	MAN 24415 19,1 + WK + Zub Ceramic		
1.4 LPG	103	07/12 →	←	für Bremsscheibendurchmesser [mm]: 337	13.0460-2754.2	602754	TRW 24418 17,0 + WK + Zub		
1.6	85	07/08 →							
1.6 CDTi	88	07/15 →	←	für Bremsscheibendurchmesser [mm]: 296	13.0460-5611.2	605611	MAN 24415 19,1 + WK + Zub		
1.6 CDTi	100	07/15 →							
1.6 SIDI	125	03/13 →			13.0470-5611.2	LD5611	MAN 24415 19,1 + WK + Zub Ceramic		
1.6 Turbo	132	01/09 →	←	für Bremsscheibendurchmesser [mm]: 321	13.0460-5612.2	605612	MAN 24412 19,0 + WK + Zub		
1.8	103	07/08 →				13.0470-5612.2	LD5612	MAN 24412 19,0 + WK + Zub Ceramic	
2.0 Biturbo CDTI	140	07/08 →	→	für Bremsscheibendurchmesser [mm]: 315	13.0460-2755.2	602755	TRW 24421 17,2 + WK + Zub		
2.0 Biturbo CDTI	143	01/12 →				13.0470-2755.2	LD2755	TRW 24421 17,2 + WK + Zub Ceramic	
2.0 Biturbo CDTI 4x4	140	07/08 →	→	für Bremsscheibendurchmesser [mm]: 292	13.0460-2758.2	602758	TRW 24421 17,2 + WK + Zub		
2.0 Biturbo CDTI 4x4	143	01/12 →				13.0470-2758.2	LD2758	TRW 24421 17,2 + WK + Zub Ceramic	
2.0 CDTI	81	07/08 →	→	für Bremsscheibendurchmesser [mm]: 315	13.0460-2755.2	602755	TRW 24421 17,2 + WK + Zub		
2.0 CDTI	96	07/08 →				13.0470-2755.2	LD2755	TRW 24421 17,2 + WK + Zub Ceramic	
2.0 CDTI	103	07/13 →							
2.0 CDTI	118	07/08 →							
2.0 CDTI	120	07/13 →							
2.0 CDTI	125	11/14 →							
2.0 CDTI 4x4	118	06/10 →							
2.0 CDTI 4x4	120	07/13 →							
2.0 CDTI 4x4	125	11/14 →							
2.0 Turbo	162	07/08 →							
2.0 Turbo	184	04/14 →							
2.0 Turbo 4x4	162	07/08 →							
2.0 Turbo 4x4	184	09/11 →							
2.0 Turbo E85	162	07/08 →							
2.0 CDTI	88	03/12 →	←	03/13 →; für Bremsscheibendurchmesser [mm]: 337	13.0460-2754.2	602754	TRW 24418 17,0 + WK + Zub		
↓									

	kW			 	! #		
OPEL - MERIVA 05/03→05/10							
 Bremsbelagsatz, Scheibenbremse							
1.3 CDTI	51	04/05→05/10	←			13.0460-7179.2 607179	ATE 23832 20,2 - WK / + WK
1.3 CDTI	55	09/03→05/10				13.0470-7179.2 LD7179	ATE 23832 20,2 - WK / + WK Ceramic
1.6	77	01/06→05/10					
1.6 16V	74	05/03→01/06					
1.6 Turbo	132	09/05→05/10	→			13.0460-2868.2 602868	TRW 23417 15,3 + WK + Zub
1.7 CDTI	74	09/03→05/10				13.0470-2868.2 LD2868	TRW 23417 15,3 + WK + Zub Ceramic
1.7 CDTI	92	09/06→05/10					
1.7 DTI	55	09/03→05/10					
1.8	92	05/03→05/10					
1.4 16V Twinport	66	07/04→05/10	←	Felge Lochzahl: 4		13.0460-2857.2 602857	TRW 23225 17,0 + WK + Zub
1.4 16V Twinport LPG	66	07/04→05/10				13.0470-2857.2 LD2857	TRW 23225 17,0 + WK + Zub Ceramic
			←	Felge Lochzahl: 5		13.0460-7179.2 607179	ATE 23832 20,2 - WK / + WK
						13.0470-7179.2 LD7179	ATE 23832 20,2 - WK / + WK Ceramic
			→			13.0460-2868.2 602868	TRW 23417 15,3 + WK + Zub
						13.0470-2868.2 LD2868	TRW 23417 15,3 + WK + Zub Ceramic
1.6	64	05/03→05/10	←			13.0460-2857.2 602857	TRW 23225 17,0 + WK + Zub
						13.0470-2857.2 LD2857	TRW 23225 17,0 + WK + Zub Ceramic
			→			13.0460-2868.2 602868	TRW 23417 15,3 + WK + Zub
						13.0470-2868.2 LD2868	TRW 23417 15,3 + WK + Zub Ceramic
 Bremsscheibe							
1.3 CDTI	51	04/05→05/10	←	Felge Lochzahl: 5		24.0125-0131.1 425131	Ø 280 24,8 22 V + S
1.3 CDTI	55	09/03→05/10				24.0325-0131.1 525131	Ø 280 24,8 22 V + S PD
1.6	77	01/06→05/10					
1.6 16V	74	05/03→01/06	←	Felge Lochzahl: 4		24.0125-0148.1 425148	Ø 280 25 22 V + S
1.7 DTI	55	09/03→05/10				24.0325-0148.1 525148	Ø 280 25 22 V + S PD
1.8	92	05/03→05/10	→	Felge Lochzahl: 5		24.0110-0250.1 410250	Ø 264 9,8 8 + S
						24.0310-0250.1 510250	Ø 264 9,8 8 + S PD
			→	Felge Lochzahl: 4		24.0110-0291.1 410291	Ø 264 10 8 + S
						24.0310-0291.1 510291	Ø 264 10 8 + S PD
1.4 16V Twinport	66	07/04→05/10	←	Felge Lochzahl: 4		24.0124-0166.1 424166	Ø 260 24 21 V + S
1.4 16V Twinport LPG	66	07/04→05/10				24.0324-0166.1 524166	Ø 260 24 21 V PD
1.6	64	05/03→05/10	←	Felge Lochzahl: 5		24.0125-0131.1 425131	Ø 280 24,8 22 V + S
						24.0325-0131.1 525131	Ø 280 24,8 22 V + S PD
			→	Felge Lochzahl: 5		24.0110-0250.1 410250	Ø 264 9,8 8 + S
						24.0310-0250.1 510250	Ø 264 9,8 8 + S PD
			→	Felge Lochzahl: 4		24.0110-0251.1 410251	Ø 240 9,8 8 + S
						24.0310-0251.1 510251	Ø 240 9,8 8 + S PD
1.6 Turbo	132	09/05→05/10	←			24.0125-0142.1 425142	Ø 308 25 22 V + S
						24.0325-0142.1 525142	Ø 308 25 23 V + S PD
			→	Felge Lochzahl: 5		24.0110-0250.1 410250	Ø 264 9,8 8 + S
						24.0310-0250.1 510250	Ø 264 9,8 8 + S PD
1.7 CDTI	74	09/03→05/10	←	Felge Lochzahl: 5		24.0125-0131.1 425131	Ø 280 24,8 22 V + S
1.7 CDTI	92	09/06→05/10				24.0325-0131.1 525131	Ø 280 24,8 22 V + S PD
			→	Felge Lochzahl: 5		24.0110-0250.1 410250	Ø 264 9,8 8 + S
						24.0310-0250.1 510250	Ø 264 9,8 8 + S PD
OPEL - MERIVA B 06/10→							
 Bremsbelagsatz, Scheibenbremse							
1.3 CDTI	55	06/10→	←			13.0460-7179.2 607179	ATE 23832 20,2 - WK / + WK
1.3 CDTI	70	06/10→				13.0470-7179.2 LD7179	ATE 23832 20,2 - WK / + WK Ceramic
1.4	74	06/10→					
1.4	88	06/10→					
1.4	103	06/10→	→			13.0460-2868.2 602868	TRW 23417 15,3 + WK + Zub
1.4 LPG	88	06/11→				13.0470-2868.2 LD2868	TRW 23417 15,3 + WK + Zub Ceramic
1.6 CDTi	100	08/13→					
1.6 CDTI	81	03/14→					
1.7 CDTI	74	06/10→					
1.7 CDTI	81	06/10→					
1.7 CDTI	96	06/10→					
1.6 CDTI	70	01/14→	←	03/14→		13.0460-7179.2 607179	ATE 23832 20,2 - WK / + WK
						13.0470-7179.2 LD7179	ATE 23832 20,2 - WK / + WK Ceramic
			→	03/14→		13.0460-2868.2 602868	TRW 23417 15,3 + WK + Zub
↓							











	kw			 	! #		
OPEL - MERIVA B 06/10→							
 Bremsbelagsatz, Scheibenbremse							
1.6 CDTI	70	01/14→	→	03/14→		13.0470-2868.2 LD2868	TRW 23417 15,3 + WK + Zub Ceramic
 Bremsscheibe							
1.3 CDTI	55	06/10→	←			24.0125-0131.1 425131	Ø 280 24,8 22 V + S
1.3 CDTI	70	06/10→				24.0325-0131.1 525131	Ø 280 24,8 22 V + S PD
1.4	74	06/10→	→			24.0110-0250.1 410250	Ø 264 9,8 8 + S
						24.0310-0250.1 510250	Ø 264 9,8 8 + S PD
1.4	88	06/10→	←			24.0125-0131.1 425131	Ø 280 24,8 22 V + S
1.4 LPG	88	06/11→				24.0125-0142.1 425142	Ø 308 25 22 V + S
1.7 CDTI	74	06/10→				24.0325-0131.1 525131	Ø 280 24,8 22 V + S PD
1.7 CDTI	81	06/10→					
1.7 CDTI	96	06/10→	→			24.0110-0250.1 410250	Ø 264 9,8 8 + S
						24.0310-0250.1 510250	Ø 264 9,8 8 + S PD
1.4	103	06/10→	←			24.0125-0142.1 425142	Ø 308 25 22 V + S
1.6 CDTI	100	08/13→				24.0110-0250.1 410250	Ø 264 9,8 8 + S
1.6 CDTI	81	03/14→	→			24.0310-0250.1 510250	Ø 264 9,8 8 + S PD
1.6 CDTI	70	01/14→	←	03/14→		24.0125-0142.1 425142	Ø 308 25 22 V + S
			→	03/14→		24.0110-0250.1 410250	Ø 264 9,8 8 + S
						24.0310-0250.1 510250	Ø 264 9,8 8 + S PD
OPEL - MOKKA / MOKKA X 06/12→							
 Bremsbelagsatz, Scheibenbremse							
1.4	103	04/13→	←			13.0460-7263.2 607263	24034 19,1 + WK + Zub
1.4 4x4	103	06/12→				13.0470-7263.2 LD7263	24034 19,1 + WK + Zub Ceramic
1.4 4x4	112	06/16→	→				
1.4 LPG	103	04/13→				13.0460-7264.2 607264	ATE 25096 17,0 + WK + Zub
1.6	85	06/12→				13.0470-7264.2 LD7264	ATE 25096 17,0 + WK + Zub Ceramic
1.6 CDTI	81	06/15→					
1.6 CDTI	100	01/15→					
1.6 CDTI 4x4	100	01/15→					
1.7 CDTI	96	06/12→					
1.7 CDTI 4x4	96	06/12→					
1.8	103	01/13→					
1.8 4x4	103	01/13→					
 Bremsscheibe							
1.4	103	04/13→	←			24.0126-0182.1 426182	Ø 300 26 23 V + S
1.4 4x4	103	06/12→					
1.4 4x4	112	06/16→	→			24.0112-0188.1 412188	Ø 268 12 10 + S
1.4 LPG	103	04/13→				24.0312-0188.1 512188	Ø 268 12 10 + S PD
1.6	85	06/12→					
1.6 CDTI	81	06/15→					
1.6 CDTI	100	01/15→					
1.6 CDTI 4x4	100	01/15→					
1.7 CDTI	96	06/12→					
1.7 CDTI 4x4	96	06/12→					
1.8	103	01/13→					
1.8 4x4	103	01/13→					
OPEL - MONTEREY A (UBS_) 09/91→07/98							
 Bremsbelagsatz, Scheibenbremse							
3.1 TD (UBS69_)	84	09/91→07/98	←			13.0460-5926.2 605926	AKE 21845 16,5 + WK
3.2 (UBS25_)	130	06/92→07/98	→			13.0460-5927.2 605927	AKE 21875 16,0 + WK
Zubehörsatz, Scheibenbremsbelag							
3.1 TD (UBS69_)	84	09/91→07/98	←			13.0460-0446.2 610446	AKE
3.2 (UBS25_)	130	06/92→07/98	→			13.0460-0447.2 610447	AKE
 Bremsscheibe							
3.1 TD (UBS69_)	84	09/91→07/98	←	+ ABS		24.0126-0111.1 426111	Ø 280 26 24,6 V
3.2 (UBS25_)	130	06/92→07/98	←	- ABS		24.0126-0111.1 426111	Ø 280 26 24,6 V
			→			24.0118-0122.1 418122	Ø 313,5 18 16,6 V
OPEL - MONTEREY B 07/98→08/99							
 Bremsbelagsatz, Scheibenbremse							
3.0 DTI	117	07/98→08/99	←			13.0460-5926.2 605926	AKE 21845 16,5 + WK
3.5 V6 24V	158	07/98→08/99	→			13.0460-5927.2 605927	AKE 21875 16,0 + WK
↓							













	kw			 	! #		
OPEL - MONTEREY B 07/98→08/99							
Zubehörsatz, Scheibenbremsbelag							
3.0 DTI	117	07/98→08/99	←			13.0460-0446.2 610446	AKE
3.5 V6 24V	158	07/98→08/99	→			13.0460-0447.2 610447	AKE
Bremsscheibe							
3.0 DTI	117	07/98→08/99	←	+ ABS		24.0126-0111.1 426111	Ø 280 26 24,6 V
3.5 V6 24V	158	07/98→08/99	←	- ABS		24.0126-0111.1 426111	Ø 280 26 24,6 V
			→			24.0118-0122.1 418122	Ø 313,5 18 16,6 V
OPEL - MOVANO B Bus 12/10→							
Bremsbelagsatz, Scheibenbremse							
2.3 CDTI	74	12/10→	←			13.0460-4856.2 604856	BRE 25147 18,4 + WK
2.3 CDTI	81	05/14→	→	für Doppelbereifung		13.0460-4857.2 604857	BRE 25172 18,4 + WK
2.3 CDTI	92	12/10→	→	für Einfachbereifung		13.0460-4858.2 604858	BRE 25112 18,4 + WK
2.3 CDTI	100	05/14→					
2.3 CDTI	107	12/10→					
2.3 CDTI	110	01/13→					
2.3 CDTI	120	05/14→					
2.3 CDTI	125	07/15→					
Bremsscheibe							
2.3 CDTI	74	12/10→	←			24.0128-0252.1 428252	Ø 302 28 24,5 V + S
2.3 CDTI	81	05/14→	→			24.0112-0191.1 412191	Ø 305 12 10 + S
2.3 CDTI	92	12/10→					
2.3 CDTI	100	05/14→					
2.3 CDTI	107	12/10→					
2.3 CDTI	110	01/13→					
2.3 CDTI	120	05/14→					
2.3 CDTI	125	07/15→					
OPEL - MOVANO B Kasten 05/10→							
Bremsbelagsatz, Scheibenbremse							
2.3 CDTI [RWD]	74	05/10→	←			13.0460-4856.2 604856	BRE 25147 18,4 + WK
2.3 CDTI [RWD]	92	05/10→	→	für Doppelbereifung		13.0460-4857.2 604857	BRE 25172 18,4 + WK
2.3 CDTI [RWD]	96	11/16→	→	für Einfachbereifung		13.0460-4858.2 604858	BRE 25112 18,4 + WK
2.3 CDTI [RWD]	100	05/14→					
2.3 CDTI [RWD]	107	05/10→					
2.3 CDTI [RWD]	110	01/13→					
2.3 CDTI [RWD]	120	05/14→					
2.3 CDTI FWD	74	05/10→					
2.3 CDTI FWD	92	05/10→					
2.3 CDTI FWD	96	11/16→					
2.3 CDTI FWD	100	05/14→					
2.3 CDTI FWD	107	05/10→					
2.3 CDTI FWD	110	01/13→					
2.3 CDTI FWD	120	05/14→					
2.3 CDTI FWD	125	11/16→					
2.3 CDTI FWD	81	02/12→	←	05/14→		13.0460-4856.2 604856	BRE 25147 18,4 + WK
			→	05/14→; für Doppelbereifung		13.0460-4857.2 604857	BRE 25172 18,4 + WK
			→	05/14→; für Einfachbereifung		13.0460-4858.2 604858	BRE 25112 18,4 + WK
Bremsscheibe							
2.3 CDTI [RWD]	74	05/10→	←			24.0128-0252.1 428252	Ø 302 28 24,5 V + S
2.3 CDTI [RWD]	92	05/10→	→	für Einfachbereifung		24.0112-0190.1 412190	Ø 305 12 10 + S
2.3 CDTI [RWD]	96	11/16→	→	für Doppelbereifung		24.0118-0153.1 418153	Ø 302 18 15
2.3 CDTI [RWD]	100	05/14→					
2.3 CDTI [RWD]	107	05/10→					
2.3 CDTI [RWD]	110	01/13→					
2.3 CDTI [RWD]	120	05/14→					
2.3 CDTI FWD	74	05/10→	←			24.0128-0252.1 428252	Ø 302 28 24,5 V + S
2.3 CDTI FWD	92	05/10→	→			24.0112-0191.1 412191	Ø 305 12 10 + S
2.3 CDTI FWD	96	11/16→					
2.3 CDTI FWD	100	05/14→					
2.3 CDTI FWD	107	05/10→					
2.3 CDTI FWD	110	01/13→					
2.3 CDTI FWD	120	05/14→					
2.3 CDTI FWD	125	11/16→					
2.3 CDTI FWD	81	02/12→	←	05/14→		24.0128-0252.1 428252	Ø 302 28 24,5 V + S
			→	05/14→		24.0112-0191.1 412191	Ø 305 12 10 + S
OPEL - MOVANO B Pritsche/Fahrgestell 05/10→							
Bremsbelagsatz, Scheibenbremse							
2.3 CDTI [RWD]	74	05/10→	←			13.0460-4856.2 604856	BRE 25147 18,4 + WK
2.3 CDTI [RWD]	92	05/10→					







	kw				! #							
OPEL - MOVANO B Pritsche/Fahrgestell 05/10→												
 Bremsbelagsatz, Scheibenbremse												
2.3 CDTI [RWD]	96	11/16→	➔	für Doppelbereifung		13.0460-4857.2 604857	BRE 25172 18,4 + WK					
2.3 CDTI [RWD]	100	05/14→	➔	für Einfachbereifung		13.0460-4858.2 604858	BRE 25112 18,4 + WK					
2.3 CDTI [RWD]	107	05/10→										
2.3 CDTI [RWD]	110	01/13→										
2.3 CDTI [RWD]	120	05/14→										
2.3 CDTI FWD	74	05/10→										
2.3 CDTI FWD	81	05/14→										
2.3 CDTI FWD	92	05/10→										
2.3 CDTI FWD	96	11/16→										
2.3 CDTI FWD	100	05/14→										
2.3 CDTI FWD	107	05/10→										
2.3 CDTI FWD	110	01/13→										
2.3 CDTI FWD	120	05/14→										
2.3 CDTI FWD	125	11/16→										
 Bremsscheibe												
2.3 CDTI [RWD]	74	05/10→	←			24.0128-0252.1 428252	Ø 302 28 24,5 V + S					
2.3 CDTI [RWD]	92	05/10→	➔	für Einfachbereifung		24.0112-0190.1 412190	Ø 305 12 10 + S					
2.3 CDTI [RWD]	96	11/16→										
2.3 CDTI [RWD]	100	05/14→										
2.3 CDTI [RWD]	107	05/10→										
2.3 CDTI [RWD]	110	01/13→										
2.3 CDTI [RWD]	120	05/14→										
2.3 CDTI FWD	74	05/10→						←			24.0128-0252.1 428252	Ø 302 28 24,5 V + S
2.3 CDTI FWD	81	05/14→						➔			24.0112-0191.1 412191	Ø 305 12 10 + S
2.3 CDTI FWD	92	05/10→										
2.3 CDTI FWD	96	11/16→										
2.3 CDTI FWD	100	05/14→										
2.3 CDTI FWD	107	05/10→										
2.3 CDTI FWD	110	01/13→										
2.3 CDTI FWD	120	05/14→										
2.3 CDTI FWD	125	11/16→										
OPEL - MOVANO Combi (J9) 07/98→												
 Bremsbelagsatz, Scheibenbremse												
1.9 DTI	59	09/00→10/01	←	passend für Felgenreöße [Zoll]: 16		13.0460-3800.2 603800	BOS 23613 17,7 - WE / - WK					
2.5 D	59	07/98→09/00	←	passend für Felgenreöße [Zoll]: 15		13.0460-3946.2 603946	BDX 23302 18,0 + WE / - WK					
2.8 DTI	84	07/98→10/01										
			➔			13.0460-3806.2 603806	BOS 23669 16,8 - WE / - WK					
1.9 DTI	60	10/01→	←	→ 01/10; passend für Felgenreöße [Zoll]: 16		13.0460-3800.2 603800	BOS 23613 17,7 - WE / - WK					
2.2 DTI	66	09/00→										
2.5 CDTI	74	09/07→										
2.5 DTI	84	10/01→										
3.0 DTI	100	10/03→										
								➔	→ 01/10		13.0460-3806.2 603806	BOS 23669 16,8 - WE / - WK
2.5 CDTI	73	10/03→12/06						←	09/06→; passend für Felgenreöße [Zoll]: 16		13.0460-3800.2 603800	BOS 23613 17,7 - WE / - WK
								←	09/06→; passend für Felgenreöße [Zoll]: 15		13.0460-3946.2 603946	BDX 23302 18,0 + WE / - WK
								➔	09/06→		13.0460-3806.2 603806	BOS 23669 16,8 - WE / - WK
2.5 CDTI	88	08/06→						←	09/06→ 01/10; passend für Felgenreöße [Zoll]: 16		13.0460-3800.2 603800	BOS 23613 17,7 - WE / - WK
2.5 CDTI	107	08/06→										
			←	09/06→ 01/10; passend für Felgenreöße [Zoll]: 15		13.0460-3946.2 603946	BDX 23302 18,0 + WE / - WK					
			➔	09/06→ 01/10		13.0460-3806.2 603806	BOS 23669 16,8 - WE / - WK					
Zubehörsatz, Scheibenbremsbelag												
1.9 DTI	59	09/00→10/01	←	passend für Felgenreöße [Zoll]: 16		13.0460-0344.2 610344						
2.5 D	59	07/98→09/00										
2.8 DTI	84	07/98→10/01										
1.9 DTI	60	10/01→	←	→ 01/10; passend für Felgenreöße [Zoll]: 16		13.0460-0344.2 610344						
2.2 DTI	66	09/00→										
2.5 CDTI	74	09/07→										
2.5 DTI	84	10/01→										
3.0 DTI	100	10/03→										
2.5 CDTI	73	10/03→12/06	←	09/06→; passend für Felgenreöße [Zoll]: 16		13.0460-0344.2 610344						
2.5 CDTI	88	08/06→	←	09/06→ 01/10; passend für Felgenreöße [Zoll]: 16		13.0460-0344.2 610344						
2.5 CDTI	107	08/06→										
 Bremsscheibe												
1.9 DTI	59	09/00→10/01	←	passend für Felgenreöße [Zoll]: 15		24.0124-0162.1 424162	Ø 280 24 21 V					
2.5 D	59	07/98→09/00										
2.8 DTI	84	07/98→10/01										
			←	passend für Felgenreöße [Zoll]: 16		24.0128-0129.1 428129	Ø 305,5 28 25 V + S					
								➔			24.0328-0129.1 528129	Ø 305,5 28 25 V + S PD
↓												



	kw			 	! #		
OPEL - MOVANO Combi (J9) 07/98→							
 Bremsscheibe							
1.9 DTI 2.2 DTI 2.5 CDTI 2.5 DTI 3.0 DTI	60 66 74 84 100	10/01→ 09/00→ 09/07→ 10/01→ 10/03→	← ← ← →	→ 01/10; passend für Felgengröße [Zoll]: 15 → 01/10; passend für Felgengröße [Zoll]: 16 → 01/10	24.0124-0162.1 24.0128-0129.1 24.0328-0129.1 24.0112-0155.1	424162 428129 528129 412155	Ø 280 24 21 V Ø 305,5 28 25 V + S Ø 305,5 28 25 V + S PD Ø 305 12 10,5 + S
2.5 CDTI	73	10/03→12/06	← ← →	09/06→; passend für Felgengröße [Zoll]: 15 09/06→; passend für Felgengröße [Zoll]: 16 09/06→	24.0124-0162.1 24.0128-0129.1 24.0328-0129.1 24.0112-0155.1	424162 428129 528129 412155	Ø 280 24 21 V Ø 305,5 28 25 V + S Ø 305,5 28 25 V + S PD Ø 305 12 10,5 + S
2.5 CDTI 2.5 CDTI	88 107	08/06→ 08/06→	← ← →	09/06→ 01/10; passend für Felgengröße [Zoll]: 15 09/06→ 01/10; passend für Felgengröße [Zoll]: 16 09/06→ 01/10	24.0124-0162.1 24.0128-0129.1 24.0328-0129.1 24.0112-0155.1	424162 428129 528129 412155	Ø 280 24 21 V Ø 305,5 28 25 V + S Ø 305,5 28 25 V + S PD Ø 305 12 10,5 + S
OPEL - MOVANO Kasten (F9) 01/99→							
 Bremsbelagsatz, Scheibenbremse							
1.9 DTI 2.5 D 2.8 DTI	59 59 84	09/00→10/01 01/99→09/00 01/99→10/01	← ← →	passend für Felgengröße [Zoll]: 16 passend für Felgengröße [Zoll]: 15	13.0460-3800.2 13.0460-3946.2	603800 603946	BOS 23613 17,7 - WE / - WK BDX 23302 18,0 + WE / - WK BOS 23669 16,8 - WE / - WK
1.9 DTI 2.2 DTI 2.5 DTI 2.5 DTI 3.0 DTI	60 66 73 84 100	10/01→ 09/00→ 10/03→ 10/01→ 10/03→	← ← ← →	→ 01/10; passend für Felgengröße [Zoll]: 16 → 01/10; passend für Felgengröße [Zoll]: 15 → 01/10	13.0460-3800.2 13.0460-3946.2 13.0460-3806.2	603800 603946 603806	BOS 23613 17,7 - WE / - WK BDX 23302 18,0 + WE / - WK BOS 23669 16,8 - WE / - WK
2.5 CDTI 2.5 CDTI 2.5 CDTI	74 88 107	10/03→ 10/03→ 10/03→	← ← →	09/06→ 01/10; passend für Felgengröße [Zoll]: 16 09/06→ 01/10; passend für Felgengröße [Zoll]: 15 09/06→ 01/10	13.0460-3800.2 13.0460-3946.2 13.0460-3806.2	603800 603946 603806	BOS 23613 17,7 - WE / - WK BDX 23302 18,0 + WE / - WK BOS 23669 16,8 - WE / - WK
Zubehörsatz, Scheibenbremsbelag							
1.9 DTI 2.5 D 2.8 DTI	59 59 84	09/00→10/01 01/99→09/00 01/99→10/01	←	passend für Felgengröße [Zoll]: 16	13.0460-0344.2	610344	
1.9 DTI 2.2 DTI 2.5 DTI 2.5 DTI 3.0 DTI	60 66 73 84 100	10/01→ 09/00→ 10/03→ 10/01→ 10/03→	←	→ 01/10; passend für Felgengröße [Zoll]: 16	13.0460-0344.2	610344	
2.5 CDTI 2.5 CDTI 2.5 CDTI	74 88 107	10/03→ 10/03→ 10/03→	←	09/06→ 01/10; passend für Felgengröße [Zoll]: 16	13.0460-0344.2	610344	
 Bremsscheibe							
1.9 DTI 2.5 D 2.8 DTI	59 59 84	09/00→10/01 01/99→09/00 01/99→10/01	← ← →	passend für Felgengröße [Zoll]: 15 passend für Felgengröße [Zoll]: 16	24.0124-0162.1 24.0128-0129.1 24.0328-0129.1 24.0112-0155.1	424162 428129 528129 412155	Ø 280 24 21 V Ø 305,5 28 25 V + S Ø 305,5 28 25 V + S PD Ø 305 12 10,5 + S
1.9 DTI 2.2 DTI 2.5 DTI 2.5 DTI 3.0 DTI	60 66 73 84 100	10/01→ 09/00→ 10/03→ 10/01→ 10/03→	← ← ← →	→ 01/10; passend für Felgengröße [Zoll]: 15 → 01/10; passend für Felgengröße [Zoll]: 16 → 01/10	24.0124-0162.1 24.0128-0129.1 24.0328-0129.1 24.0112-0155.1	424162 428129 528129 412155	Ø 280 24 21 V Ø 305,5 28 25 V + S Ø 305,5 28 25 V + S PD Ø 305 12 10,5 + S
2.5 CDTI 2.5 CDTI 2.5 CDTI	74 88 107	10/03→ 10/03→ 10/03→	← ← →	09/06→ 01/10; passend für Felgengröße [Zoll]: 15 09/06→ 01/10; passend für Felgengröße [Zoll]: 16 09/06→ 01/10	24.0124-0162.1 24.0128-0129.1 24.0328-0129.1 24.0112-0155.1	424162 428129 528129 412155	Ø 280 24 21 V Ø 305,5 28 25 V + S Ø 305,5 28 25 V + S PD Ø 305 12 10,5 + S
OPEL - MOVANO Kipper (H9) 01/99→							
 Bremsbelagsatz, Scheibenbremse							
2.2 DTI 2.5 DTI 2.5 DTI 3.0 DTI	66 73 84 100	09/00→ 10/03→ 10/01→ 10/03→	←	→ 01/10; passend für Felgengröße [Zoll]: 16	13.0460-3800.2	603800	BOS 23613 17,7 - WE / - WK

	kw			 	! #			
OPEL - MOVANO Kipper (H9) 01/99→								
 Bremsbelagsatz, Scheibenbremse								
2.2 DTI	66	09/00→	←	→ 01/10;		13.0460-3946.2	603946	BDX 23302 18,0 + WE / - WK
2.5 DTI	73	10/03→		passend für Felgengröße [Zoll]: 15				
2.5 DTI	84	10/01→	→	→ 01/10		13.0460-3806.2	603806	BOS 23669 16,8 - WE / - WK
3.0 DTI	100	10/03→						
2.5 CDTI	74	08/06→	←	09/06→ 01/10;		13.0460-3800.2	603800	BOS 23613 17,7 - WE / - WK
2.5 CDTI	88	08/06→		passend für Felgengröße [Zoll]: 16				
2.5 CDTI	107	08/06→	←	09/06→ 01/10;		13.0460-3946.2	603946	BDX 23302 18,0 + WE / - WK
				passend für Felgengröße [Zoll]: 15				
			→	09/06→ 01/10		13.0460-3806.2	603806	BOS 23669 16,8 - WE / - WK
2.5 D	59	01/99→09/00	←	passend für Felgengröße [Zoll]: 16		13.0460-3800.2	603800	BOS 23613 17,7 - WE / - WK
2.8 DTI	84	01/99→10/01	←	passend für Felgengröße [Zoll]: 15		13.0460-3946.2	603946	BDX 23302 18,0 + WE / - WK
			→			13.0460-3806.2	603806	BOS 23669 16,8 - WE / - WK
Zubehörsatz, Scheibenbremsbelag								
2.2 DTI	66	09/00→	←	→ 01/10;		13.0460-0344.2	610344	
2.5 DTI	73	10/03→		passend für Felgengröße [Zoll]: 16				
2.5 DTI	84	10/01→						
3.0 DTI	100	10/03→						
2.5 CDTI	74	08/06→	←	09/06→ 01/10;		13.0460-0344.2	610344	
2.5 CDTI	88	08/06→		passend für Felgengröße [Zoll]: 16				
2.5 CDTI	107	08/06→						
2.5 D	59	01/99→09/00	←	passend für Felgengröße [Zoll]: 16		13.0460-0344.2	610344	
2.8 DTI	84	01/99→10/01						
 Bremsscheibe								
2.2 DTI	66	09/00→	←	→ 01/10;		24.0124-0162.1	424162	Ø 280 24 21 V
2.5 DTI	73	10/03→		passend für Felgengröße [Zoll]: 15				
2.5 DTI	84	10/01→	←	→ 01/10;		24.0128-0129.1	428129	Ø 305,5 28 25 V + S
3.0 DTI	100	10/03→		passend für Felgengröße [Zoll]: 16		24.0328-0129.1	528129	Ø 305,5 28 25 V + S PD
			→	→ 01/10		24.0112-0155.1	412155	Ø 305 12 10,5 + S
2.5 CDTI	74	08/06→	←	09/06→ 01/10;		24.0124-0162.1	424162	Ø 280 24 21 V
2.5 CDTI	88	08/06→		passend für Felgengröße [Zoll]: 15				
2.5 CDTI	107	08/06→	←	09/06→ 01/10;		24.0128-0129.1	428129	Ø 305,5 28 25 V + S
				passend für Felgengröße [Zoll]: 16		24.0328-0129.1	528129	Ø 305,5 28 25 V + S PD
			→	09/06→ 01/10		24.0112-0155.1	412155	Ø 305 12 10,5 + S
2.5 D	59	01/99→09/00	←	passend für Felgengröße [Zoll]: 15		24.0124-0162.1	424162	Ø 280 24 21 V
2.8 DTI	84	01/99→10/01	←	passend für Felgengröße [Zoll]: 16		24.0128-0129.1	428129	Ø 305,5 28 25 V + S
						24.0328-0129.1	528129	Ø 305,5 28 25 V + S PD
			→			24.0112-0155.1	412155	Ø 305 12 10,5 + S
OPEL - MOVANO Pritsche/Fahrgestell (U9, E9) 07/98→								
 Bremsbelagsatz, Scheibenbremse								
2.2 DTI	66	09/00→	←	→ 01/10;		13.0460-3800.2	603800	BOS 23613 17,7 - WE / - WK
2.5 DTI	73	10/03→		passend für Felgengröße [Zoll]: 16				
2.5 DTI	84	10/01→	←	→ 01/10;		13.0460-3946.2	603946	BDX 23302 18,0 + WE / - WK
3.0 DTI	100	10/03→		passend für Felgengröße [Zoll]: 15				
			→	→ 01/10		13.0460-3806.2	603806	BOS 23669 16,8 - WE / - WK
2.5 CDTI	74	08/06→	←	09/06→ 01/10;		13.0460-3800.2	603800	BOS 23613 17,7 - WE / - WK
2.5 CDTI	88	08/06→		passend für Felgengröße [Zoll]: 16				
2.5 CDTI	107	08/06→	←	09/06→ 01/10;		13.0460-3946.2	603946	BDX 23302 18,0 + WE / - WK
				passend für Felgengröße [Zoll]: 15				
			→	09/06→ 01/10		13.0460-3806.2	603806	BOS 23669 16,8 - WE / - WK
2.5 D	59	07/98→09/00	←	passend für Felgengröße [Zoll]: 16		13.0460-3800.2	603800	BOS 23613 17,7 - WE / - WK
2.8 DTI	84	07/98→10/01	←	passend für Felgengröße [Zoll]: 15		13.0460-3946.2	603946	BDX 23302 18,0 + WE / - WK
			→			13.0460-3806.2	603806	BOS 23669 16,8 - WE / - WK
Zubehörsatz, Scheibenbremsbelag								
2.2 DTI	66	09/00→	←	→ 01/10;		13.0460-0344.2	610344	
2.5 DTI	73	10/03→		passend für Felgengröße [Zoll]: 16				
2.5 DTI	84	10/01→						
3.0 DTI	100	10/03→						
2.5 CDTI	74	08/06→	←	09/06→ 01/10;		13.0460-0344.2	610344	
2.5 CDTI	88	08/06→		passend für Felgengröße [Zoll]: 16				
2.5 CDTI	107	08/06→						
2.5 D	59	07/98→09/00	←	passend für Felgengröße [Zoll]: 16		13.0460-0344.2	610344	
2.8 DTI	84	07/98→10/01						



	kw					! #			
OPEL - MOVANO Pritsche/Fahrgestell (U9, E9) 07/98→									
Bremsscheibe									
2.2 DTI	66	09/00→	←	→ 01/10;			24.0124-0162.1	424162	Ø 280 24 21 V
2.5 DTI	73	10/03→		passend für Felgengröße [Zoll]: 15					
2.5 DTI	84	10/01→	←	→ 01/10;			24.0128-0129.1	428129	Ø 305,5 28 25 V + S
3.0 DTI	100	10/03→		passend für Felgengröße [Zoll]: 16			24.0328-0129.1	528129	Ø 305,5 28 25 V + S PD
			→	→ 01/10			24.0112-0155.1	412155	Ø 305 12 10,5 + S
2.5 CDTI	74	08/06→	←	09/06→ 01/10;			24.0124-0162.1	424162	Ø 280 24 21 V
2.5 CDTI	88	08/06→		passend für Felgengröße [Zoll]: 15					
2.5 CDTI	107	08/06→	←	09/06→ 01/10;			24.0128-0129.1	428129	Ø 305,5 28 25 V + S
				passend für Felgengröße [Zoll]: 16			24.0328-0129.1	528129	Ø 305,5 28 25 V + S PD
			→	09/06→ 01/10			24.0112-0155.1	412155	Ø 305 12 10,5 + S
2.5 D	59	07/98→09/00	←	passend für Felgengröße [Zoll]: 15			24.0124-0162.1	424162	Ø 280 24 21 V
2.8 DTI	84	07/98→10/01	←	passend für Felgengröße [Zoll]: 16			24.0128-0129.1	428129	Ø 305,5 28 25 V + S
							24.0328-0129.1	528129	Ø 305,5 28 25 V + S PD
			→				24.0112-0155.1	412155	Ø 305 12 10,5 + S
OPEL - OMEGA B (25_, 26_, 27_) 03/94→07/03									
Bremsbelagsatz, Scheibenbremse									
2.0	85	03/94→09/99	←	W1000001→			13.0460-2815.2	602815	TRW 21368 18,3 - WK
2.0	90	05/94→05/99	←	→ V1999999;			13.0460-7080.2	607080	ATE 21411 17,5 - WK
2.0 16V	100	03/94→09/99		nicht für Sonderfahrzeuge / nicht für Polizei-fahrzeuge					
			→				13.0460-4040.2	604040	ATE 21050 15,8 - WE / - WK
2.0	85	03/94→12/00	←	W1000001→; → 09/99			13.0460-2815.2	602815	TRW 21368 18,3 - WK
			←	→ V1999999;			13.0460-7080.2	607080	ATE 21411 17,5 - WK
				nicht für Sonderfahrzeuge / nicht für Polizei-fahrzeuge					
			→	→ 09/99			13.0460-4040.2	604040	ATE 21050 15,8 - WE / - WK
2.0 DTI 16V	74	09/97→09/00	←	→ 08/00			13.0460-2815.2	602815	TRW 21368 18,3 - WK
			→	→ 08/00			13.0460-4040.2	604040	ATE 21050 15,8 - WE / - WK
2.2 16V	106	09/99→07/03	←	10/99→			13.0460-2815.2	602815	TRW 21368 18,3 - WK
			→	10/99→			13.0460-4040.2	604040	ATE 21050 15,8 - WE / - WK
2.2 DTI 16V	81	09/00→07/03	←				13.0460-2815.2	602815	TRW 21368 18,3 - WK
2.2 DTI 16V	86	01/01→07/03							
2.2 DTI 16V	88	09/00→07/03	→				13.0460-4040.2	604040	ATE 21050 15,8 - WE / - WK
2.5 D	96	05/94→05/99							
2.5 DTI	110	09/01→07/03							
2.5 TD	96	04/94→07/03							
2.5 V6	125	03/94→09/00							
2.6 V6	132	09/00→07/03							
3.2 V6	160	02/01→07/03							
3.0 V6	155	04/94→02/01	←	→ 01/01			13.0460-2815.2	602815	TRW 21368 18,3 - WK
			→	→ 01/01			13.0460-4040.2	604040	ATE 21050 15,8 - WE / - WK
Warnkontakt, Bremsbelagverschleiß									
2.0	85	03/94→09/99	←	→ V1999999;	2	24.8190-0710.2	620710	L= 730	
2.0	90	05/94→05/99		nicht für Sonderfahrzeuge / nicht für Polizei-fahrzeuge					
2.0 16V	100	03/94→09/99	←	W1000001→	2	24.8190-0711.2	620711	L= 730	
2.0	85	03/94→12/00	←	→ V1999999;	2	24.8190-0710.2	620710	L= 730	
				nicht für Sonderfahrzeuge / nicht für Polizei-fahrzeuge					
			←	W1000001→; → 09/99	2	24.8190-0711.2	620711	L= 730	
2.0 DTI 16V	74	09/97→09/00	←	→ 08/00	2	24.8190-0711.2	620711	L= 730	
2.2 16V	106	09/99→07/03	←	10/99→	2	24.8190-0711.2	620711	L= 730	
2.2 DTI 16V	81	09/00→07/03	←		2	24.8190-0711.2	620711	L= 730	
2.2 DTI 16V	86	01/01→07/03							
2.2 DTI 16V	88	09/00→07/03							
2.5 D	96	05/94→05/99							
2.5 DTI	110	09/01→07/03							
2.5 TD	96	04/94→07/03							
2.5 V6	125	03/94→09/00							
2.6 V6	132	09/00→07/03							
3.2 V6	160	02/01→07/03							
3.0 V6	155	04/94→02/01	←	→ 01/01	2	24.8190-0711.2	620711	L= 730	
Zubehörsatz, Scheibenbremsbelag									
2.0	85	03/94→09/99	→				13.0460-0246.2	610246	

OPEL - OMEGA B (25_, 26_, 27_) 03/94→07/03

Zubehörsatz, Scheibenbremsbelag

2.0	90	05/94→05/99	➡			13.0460-0246.2	610246	
2.0 16V	100	03/94→09/99						
2.2 DTI 16V	81	09/00→07/03						
2.2 DTI 16V	86	01/01→07/03						
2.2 DTI 16V	88	09/00→07/03						
2.5 D	96	05/94→05/99						
2.5 DTI	110	09/01→07/03						
2.5 TD	96	04/94→07/03						
2.5 V6	125	03/94→09/00						
2.6 V6	132	09/00→07/03						
3.2 V6	160	02/01→07/03						
2.0	85	03/94→12/00	➡	→ 09/99		13.0460-0246.2	610246	
2.0 DTI 16V	74	09/97→09/00	➡	→ 08/00		13.0460-0246.2	610246	
2.2 16V	106	09/99→07/03	➡	10/99→		13.0460-0246.2	610246	
3.0 V6	155	04/94→02/01	➡	→ 01/01		13.0460-0246.2	610246	







Bremsscheibe







2.0	85	03/94→09/99	←	→ V1999999; nicht für Sonderfahrzeuge / nicht für Polizei- fahrzeuge		24.0124-0119.1	424119	Ø 286 24 21 V
2.0	90	05/94→05/99						
2.0 16V	100	03/94→09/99	←	W1000001→		24.0128-0104.1	428104	Ø 296 28 25 V + S
			➡			24.0112-0131.1	412131	Ø 286 12 10
						24.0120-0171.1	420171	Ø 286 20 18 V
2.0	85	03/94→12/00	←	→ V1999999; nicht für Sonderfahrzeuge / nicht für Polizei- fahrzeuge		24.0124-0119.1	424119	Ø 286 24 21 V
			←	W1000001→; → 09/99		24.0128-0104.1	428104	Ø 296 28 25 V + S
			➡	→ 09/99		24.0112-0131.1	412131	Ø 286 12 10
						24.0120-0171.1	420171	Ø 286 20 18 V
2.0 DTI 16V	74	09/97→09/00	←	→ 08/00		24.0128-0104.1	428104	Ø 296 28 25 V + S
			➡	→ 08/00		24.0112-0131.1	412131	Ø 286 12 10
						24.0120-0171.1	420171	Ø 286 20 18 V
2.2 16V	106	09/99→07/03	←	10/99→		24.0128-0104.1	428104	Ø 296 28 25 V + S
			➡	10/99→		24.0112-0131.1	412131	Ø 286 12 10
						24.0120-0171.1	420171	Ø 286 20 18 V
2.2 DTI 16V	81	09/00→07/03	←			24.0128-0104.1	428104	Ø 296 28 25 V + S
2.2 DTI 16V	86	01/01→07/03						
2.2 DTI 16V	88	09/00→07/03	➡			24.0112-0131.1	412131	Ø 286 12 10
2.5 D	96	05/94→05/99				24.0120-0171.1	420171	Ø 286 20 18 V
2.5 DTI	110	09/01→07/03						
2.5 TD	96	04/94→07/03						
2.5 V6	125	03/94→09/00						
2.6 V6	132	09/00→07/03						
3.2 V6	160	02/01→07/03						
3.0 V6	155	04/94→02/01	←	→ 01/01		24.0128-0104.1	428104	Ø 296 28 25 V + S
			➡	→ 01/01		24.0112-0131.1	412131	Ø 286 12 10
						24.0120-0171.1	420171	Ø 286 20 18 V

OPEL - OMEGA B Caravan (21_, 22_, 23_) 03/94→07/03











Bremsbelagsatz, Scheibenbremse













2.0	85	03/94→09/99	←	W1000001→		13.0460-2815.2	602815	TRW 21368 18,3 - WK
2.0	90	05/94→05/99						
2.0 16V	100	03/94→09/99	←	→ V1999999; nicht für Sonderfahrzeuge / nicht für Polizei- fahrzeuge		13.0460-7080.2	607080	ATE 21411 17,5 - WK
			➡			13.0460-4040.2	604040	ATE 21050 15,8 - WE / - WK
2.0 DTI 16V	74	09/97→09/00	←	→ 08/00		13.0460-2815.2	602815	TRW 21368 18,3 - WK
			➡	→ 08/00		13.0460-4040.2	604040	ATE 21050 15,8 - WE / - WK
2.2 16V	106	09/99→07/03	←	10/99→		13.0460-2815.2	602815	TRW 21368 18,3 - WK
			➡	10/99→		13.0460-4040.2	604040	ATE 21050 15,8 - WE / - WK
2.2 DTI 16V	81	09/00→07/03	←			13.0460-2815.2	602815	TRW 21368 18,3 - WK
2.2 DTI 16V	88	09/00→07/03						
2.5 DTI	110	09/01→07/03	➡			13.0460-4040.2	604040	ATE 21050 15,8 - WE / - WK
2.5 TD	96	04/94→07/01						
2.5 V6	125	03/94→09/00						
2.6 V6	132	09/00→07/03						
3.2 V6	160	02/01→07/03						
3.0 V6	155	04/94→02/01	←	→ 01/01		13.0460-2815.2	602815	TRW 21368 18,3 - WK
			➡	→ 01/01		13.0460-4040.2	604040	ATE 21050 15,8 - WE / - WK







	kw					! #		
OPEL - OMEGA B Caravan (21_, 22_, 23_) 03/94→07/03								
Warnkontakt, Bremsbelagverschleiß								
2.0 2.0 2.0 16V	85 90 100	03/94→09/99 05/94→05/99 03/94→09/99	←	→ V1999999; nicht für Sonderfahrzeuge / nicht für Polizei- fahrzeuge		2	24.8190-0710.2 620710	L= 730
			←	W1000001→		2	24.8190-0711.2 620711	L= 730
2.0 DTI 16V	74	09/97→09/00	←	→ 08/00		2	24.8190-0711.2 620711	L= 730
2.2 16V	106	09/99→07/03	←	10/99→		2	24.8190-0711.2 620711	L= 730
2.2 DTI 16V 2.2 DTI 16V 2.5 DTI 2.5 TD 2.5 V6 2.6 V6 3.2 V6 3.0 V6	81 88 110 96 125 132 160 155	09/00→07/03 09/00→07/03 09/01→07/03 04/94→07/01 03/94→09/00 09/00→07/03 02/01→07/03 04/94→02/01	←			2	24.8190-0711.2 620711	L= 730
Zubehörsatz, Scheibenbremsbelag								
2.0 2.0 2.0 16V 2.2 DTI 16V 2.2 DTI 16V 2.5 DTI 2.5 TD 2.5 V6 2.6 V6 3.2 V6 2.0 DTI 16V 2.2 16V 3.0 V6	85 90 100 81 88 110 96 125 132 160 74 106 155	03/94→09/99 05/94→05/99 03/94→09/99 09/00→07/03 09/00→07/03 09/01→07/03 04/94→07/01 03/94→09/00 09/00→07/03 02/01→07/03 09/97→09/00 09/99→07/03 04/94→02/01	→				13.0460-0246.2 610246	
			→	→ 08/00			13.0460-0246.2 610246	
			→	10/99→			13.0460-0246.2 610246	
			→	→ 01/01			13.0460-0246.2 610246	
Bremsscheibe								
2.0 2.0 2.0 16V	85 90 100	03/94→09/99 05/94→05/99 03/94→09/99	←	→ V1999999; nicht für Sonderfahrzeuge / nicht für Polizei- fahrzeuge			24.0124-0119.1 424119	Ø 286 24 21 V
			←	W1000001→			24.0128-0104.1 428104	Ø 296 28 25 V + S
			→				24.0112-0131.1 412131	Ø 286 12 10
			→				24.0120-0171.1 420171	Ø 286 20 18 V
2.0 DTI 16V	74	09/97→09/00	←	→ 08/00			24.0128-0104.1 428104	Ø 296 28 25 V + S
			→	→ 08/00			24.0112-0131.1 412131	Ø 286 12 10
			→				24.0120-0171.1 420171	Ø 286 20 18 V
2.2 16V	106	09/99→07/03	←	10/99→			24.0128-0104.1 428104	Ø 296 28 25 V + S
			→	10/99→			24.0112-0131.1 412131	Ø 286 12 10
			→				24.0120-0171.1 420171	Ø 286 20 18 V
2.2 DTI 16V 2.2 DTI 16V 2.5 DTI 2.5 TD 2.5 V6 2.6 V6 3.2 V6 3.0 V6	81 88 110 96 125 132 160 155	09/00→07/03 09/00→07/03 09/01→07/03 04/94→07/01 03/94→09/00 09/00→07/03 02/01→07/03 04/94→02/01	←				24.0128-0104.1 428104	Ø 296 28 25 V + S
			→				24.0112-0131.1 412131	Ø 286 12 10
			→				24.0120-0171.1 420171	Ø 286 20 18 V
			←	→ 01/01			24.0128-0104.1 428104	Ø 296 28 25 V + S
			→	→ 01/01			24.0112-0131.1 412131	Ø 286 12 10
			→				24.0120-0171.1 420171	Ø 286 20 18 V
OPEL - SIGNUM 05/03→								
Brembelagsatz, Scheibenbremse								
1.8 1.9 CDTI 1.9 CDTI 2.0 DTI 2.0 Turbo 2.2 direct 2.2 DTI 2.2 DTI 16V	90 88 110 74 129 114 92 86	05/03→ 04/04→ 04/04→ 05/03→ 05/03→ 05/03→ 05/03→ 05/03→06/08	←	→ 05/08; für Bremssattel mit Kunststoffkolben			13.0460-7172.2 607172 13.0470-7172.2 LD7172	ATE 23378 20,1 + WE / - WK ATE 23378 20,1 + WE / - WK Ceramic
			←	→ 05/08; für Bremssattel mit Stahlkolben			13.0460-7212.2 607212	ATE 23738 20,1 + WE / - WK
			→	41096249 / 48091179→; → 05/08			13.0460-7194.2 607194 13.0460-7195.2 607195 13.0470-7194.2 LD7194 13.0470-7195.2 LD7195	ATE 23482 16,6 - WE / - WK ATE 23482 16,6 - WE / - WK ATE 23482 16,6 - WE / - WK Ceramic ATE 23482 16,6 - WE / - WK Ceramic
			→	→ 41096248 / 48091178			13.0460-7194.2 607194	ATE 23482 16,6 - WE / - WK







	kW			 	! #		
OPEL - SIGNUM 05/03→							
Bremsbelagsatz, Scheibenbremse							
1.8 1.9 CDTI 1.9 CDTI 2.0 DTI 2.0 Turbo 2.2 direct 2.2 DTI 2.2 DTI 16V	90 88 110 74 129 114 92 86	05/03→ 04/04→ 04/04→ 05/03→ 05/03→ 05/03→ 05/03→ 05/03→06/08	➔	→ 41096248 / 48091178		13.0470-7194.2 LD7194	ATE 23482 16,6 - WE / - WK Ceramic
1.8 1.9 CDTI	103 74	09/05→ 08/05→	➔	→ 05/08; für Bremssattel mit Kunststoffkolben		13.0460-7172.2 607172 13.0470-7172.2 LD7172	ATE 23378 20,1 + WE / - WK Ceramic
			➔	→ 05/08; für Bremssattel mit Stahlkolben		13.0460-7212.2 607212	ATE 23738 20,1 + WE / - WK
			➔	→ 05/08		13.0460-7194.2 607194 13.0460-7195.2 607195 13.0470-7194.2 LD7194 13.0470-7195.2 LD7195	ATE 23482 16,6 - WE / - WK ATE 23482 16,6 - WE / - WK ATE 23482 16,6 - WE / - WK Ceramic ATE 23482 16,6 - WE / - WK Ceramic
2.8 V6 Turbo 3.0 V6 CDTI	169 135	09/05→ 09/05→	➔	61000001→; → 05/08		13.0460-7199.2 607199	ATE 23404 20,6 + WE / - WK
			➔	→ 05/08		13.0460-7194.2 607194 13.0460-7195.2 607195 13.0470-7194.2 LD7194 13.0470-7195.2 LD7195	ATE 23482 16,6 - WE / - WK ATE 23482 16,6 - WE / - WK ATE 23482 16,6 - WE / - WK Ceramic ATE 23482 16,6 - WE / - WK Ceramic
2.8 V6 Turbo	184	01/06→	➔	03/06→ 05/08		13.0460-7199.2 607199	ATE 23404 20,6 + WE / - WK
			➔	03/06→ 05/08		13.0460-7194.2 607194 13.0460-7195.2 607195 13.0470-7194.2 LD7194 13.0470-7195.2 LD7195	ATE 23482 16,6 - WE / - WK ATE 23482 16,6 - WE / - WK ATE 23482 16,6 - WE / - WK Ceramic ATE 23482 16,6 - WE / - WK Ceramic
3.0 V6 CDTI 3.2 V6	130 155	05/03→ 05/03→	➔	→ 31068238; für Bremssattel mit Kunststoffkolben		13.0460-7172.2 607172 13.0470-7172.2 LD7172	ATE 23378 20,1 + WE / - WK Ceramic
			➔	31068239→; → 05/08		13.0460-7199.2 607199	ATE 23404 20,6 + WE / - WK
			➔	→ 31068238; für Bremssattel mit Stahlkolben		13.0460-7212.2 607212	ATE 23738 20,1 + WE / - WK
			➔	→ 41096248 / 48091178		13.0460-7194.2 607194 13.0470-7194.2 LD7194	ATE 23482 16,6 - WE / - WK ATE 23482 16,6 - WE / - WK Ceramic
			➔	41096249 / 48091179→; → 05/08		13.0460-7194.2 607194 13.0460-7195.2 607195 13.0470-7194.2 LD7194 13.0470-7195.2 LD7195	ATE 23482 16,6 - WE / - WK ATE 23482 16,6 - WE / - WK ATE 23482 16,6 - WE / - WK Ceramic ATE 23482 16,6 - WE / - WK Ceramic
Warnkontakt, Bremsbelagsverschleiß							
1.8 1.8 1.9 CDTI 1.9 CDTI 1.9 CDTI 2.0 DTI 2.0 Turbo 2.2 direct 2.2 DTI 2.2 DTI 16V	90 103 74 88 110 74 129 114 92 86	05/03→ 09/05→ 08/05→ 04/04→ 04/04→ 05/03→ 05/03→ 05/03→ 05/03→ 05/03→06/08	➔	→ 05/08; bis Bj. 08.2004	1	24.8190-0719.2 620719	L= 685,5
			➔	→ 05/08; ab Bj. 09.2004	1	24.8190-0720.2 620720	L= 287
2.8 V6 Turbo 3.0 V6 CDTI	169 135	09/05→ 09/05→	➔	61000001→; → 05/08; bis ChNr. 41048790	1	24.8190-0721.2 620721	L= 700
			➔	61000001→; → 05/08; ab ChNr. 41048791	1	24.8190-0722.2 620722	L= 302
2.8 V6 Turbo	184	01/06→	➔	03/06→ 05/08; bis ChNr. 41048790	1	24.8190-0721.2 620721	L= 700
			➔	03/06→ 05/08; ab ChNr. 41048791	1	24.8190-0722.2 620722	L= 302
3.0 V6 CDTI 3.2 V6	130 155	05/03→ 05/03→	➔	→ 31068238; bis Bj. 08.2004	1	24.8190-0719.2 620719	L= 685,5
			➔	→ 31068238; ab Bj. 09.2004	1	24.8190-0720.2 620720	L= 287
			➔	31068239→; → 05/08; bis ChNr. 41048790	1	24.8190-0721.2 620721	L= 700
↓							

















	kw			 	! #		
OPEL - SIGNUM 05/03→							
Warnkontakt, Bremsbelagverschleiß							
3.0 V6 CDTI 3.2 V6	130 155	05/03→ 05/03→	←	31068239→; → 05/08; ab ChNr. 41048791	1	24.8190-0722.2 620722	L= 302
 Bremsscheibe							
1.8 1.9 CDTI 1.9 CDTI 2.0 DTI 2.2 direct 2.2 DTI 2.2 DTI 16V	90 88 110 74 114 92 86	05/03→ 04/04→ 04/04→ 05/03→ 05/03→ 05/03→ 05/03→06/08	←	für Fahrzeuge ohne Sportfahrwerk; → 05/08		24.0125-0141.1 425141 24.0325-0141.1 525141	Ø 285 24,9 22 V + S Ø 285 24,9 22 V + S PD
			←	für Fahrzeuge mit Sportfahrwerk; → 05/08		24.0128-0137.1 428137 24.0328-0137.1 528137	Ø 302 28 25 V + S Ø 302 28 25 V + S PD
			→	→ 05/08		24.0112-0157.1 412157 24.0120-0173.1 420173 24.0312-0157.1 512157 24.0320-0173.1 520173	Ø 278 11,9 10 + S Ø 292 19,9 18 V + S Ø 278 11,9 10 + S PD Ø 292 19,9 18 V + S PD
1.8	103	09/05→	←	→ 05/08; nicht für Polizeifahrzeuge; für Fahrzeuge mit Sportfahrwerk		24.0125-0141.1 425141 24.0325-0141.1 525141	Ø 285 24,9 22 V + S Ø 285 24,9 22 V + S PD
			←	→ 05/08; für Polizeifahrzeuge; für Fahrzeuge mit Sportfahrwerk		24.0128-0137.1 428137 24.0328-0137.1 528137	Ø 302 28 25 V + S Ø 302 28 25 V + S PD
			→	→ 05/08		24.0112-0157.1 412157 24.0120-0173.1 420173 24.0312-0157.1 512157 24.0320-0173.1 520173	Ø 278 11,9 10 + S Ø 292 19,9 18 V + S Ø 278 11,9 10 + S PD Ø 292 19,9 18 V + S PD
1.9 CDTI	74	08/05→	←	→ 05/08; nicht für Polizeifahrzeuge		24.0125-0141.1 425141 24.0325-0141.1 525141	Ø 285 24,9 22 V + S Ø 285 24,9 22 V + S PD
			←	→ 05/08; für Polizeifahrzeuge		24.0128-0137.1 428137 24.0328-0137.1 528137	Ø 302 28 25 V + S Ø 302 28 25 V + S PD
			→	→ 05/08		24.0112-0157.1 412157 24.0120-0173.1 420173 24.0312-0157.1 512157 24.0320-0173.1 520173	Ø 278 11,9 10 + S Ø 292 19,9 18 V + S Ø 278 11,9 10 + S PD Ø 292 19,9 18 V + S PD
2.0 Turbo	129	05/03→	←	→ 05/08		24.0128-0137.1 428137 24.0328-0137.1 528137	Ø 302 28 25 V + S Ø 302 28 25 V + S PD
			→	→ 05/08		24.0120-0173.1 420173 24.0320-0173.1 520173	Ø 292 19,9 18 V + S Ø 292 19,9 18 V + S PD
2.8 V6 Turbo 3.0 V6 CDTI	169 135	09/05→ 09/05→	←	61000001→; → 05/08		24.0128-0164.1 428164	Ø 314 28 25 V + S
			→	→ 05/08		24.0112-0157.1 412157 24.0120-0173.1 420173 24.0312-0157.1 512157 24.0320-0173.1 520173	Ø 278 11,9 10 + S Ø 292 19,9 18 V + S Ø 278 11,9 10 + S PD Ø 292 19,9 18 V + S PD
2.8 V6 Turbo	184	01/06→	←	03/06→ 05/08		24.0128-0164.1 428164	Ø 314 28 25 V + S
			→	03/06→ 05/08		24.0112-0157.1 412157 24.0120-0173.1 420173 24.0312-0157.1 512157 24.0320-0173.1 520173	Ø 278 11,9 10 + S Ø 292 19,9 18 V + S Ø 278 11,9 10 + S PD Ø 292 19,9 18 V + S PD
3.0 V6 CDTI 3.2 V6	130 155	05/03→ 05/03→	←	→ 31068238		24.0128-0137.1 428137 24.0328-0137.1 528137	Ø 302 28 25 V + S Ø 302 28 25 V + S PD
			←	31068239→; → 05/08		24.0128-0164.1 428164	Ø 314 28 25 V + S
			→	→ 05/08		24.0120-0173.1 420173 24.0320-0173.1 520173	Ø 292 19,9 18 V + S Ø 292 19,9 18 V + S PD
OPEL - SINTRA 11/96→04/99							
 Bremsbelagsatz, Scheibenbremse							
2.2 DTI 2.2 i 16V 3.0 i 24V	85 104 148	07/97→04/99 11/96→04/99 11/96→04/99	←			13.0460-8002.2 608002	23358 18,0 + WK
			→			13.0460-8011.2 608011	23361 14,8 + WK
 Bremsscheibe							
2.2 DTI 2.2 i 16V 3.0 i 24V	85 104 148	07/97→04/99 11/96→04/99 11/96→04/99	←			24.0132-0110.1 432110	Ø 278 32,2 30,7 V
			→			24.0111-0133.1 411133	Ø 278 11 9
OPEL - SPEEDSTER 09/00→							
 Bremsscheibe							
2.0 Turbo 2.2 ↓	147 108	04/03→ 09/00→	←	→ 09/05		24.0125-0119.1 425119 24.0325-0119.1 525119	Ø 288 25 22 V + S Ø 288 25 22 V + S PD

	kw					! #		
OPEL - SPEEDSTER 09/00→								
 Bremsscheibe								
2.0 Turbo 2.2	147 108	04/03→ 09/00→	→	→ 09/05		24.0125-0119.1 24.0325-0119.1	425119 525119	∅ 288 25 22 V + S ∅ 288 25 22 V + S PD
OPEL - TIGRA (75_) 07/94→12/00								
 Bremsbelagsatz, Scheibenbremse								
1.4 16V 1.4 16V 1.6 16V 1.6 16V	63 66 74 78	08/97→12/00 07/94→12/00 08/97→08/98 07/94→08/98	←			13.0460-7051.2	607051	ATE 20547 16,5 + WE / - WK
 Bremsscheibe								
1.4 16V 1.4 16V 1.6 16V 1.6 16V	63 66 74 78	08/97→12/00 07/94→12/00 08/97→08/98 07/94→08/98	←			24.0120-0140.1	420140	∅ 256 20 17 V + S
OPEL - TIGRA TwinTop 06/04→								
 Bremsbelagsatz, Scheibenbremse								
1.3 CDTI 1.4 1.8	51 66 92	06/04→ 06/04→ 06/04→	←	→ 08/09		13.0460-2857.2 13.0470-2857.2	602857 LD2857	TRW 23225 17,0 + WK + Zub TRW 23225 17,0 + WK + Zub Ceramic
			→	→ Orga 6E999999		13.0460-2858.2 13.0470-2858.2	602858 LD2858	TRW 23284 14,0 + WK TRW 23284 14,0 + WK Ceramic
			→	Orga 7E000001→; → 08/09		13.0460-2858.2 13.0470-2858.2	602858 LD2858	TRW 23284 14,0 + WK TRW 23284 14,0 + WK Ceramic
 Bremsscheibe								
1.3 CDTI 1.4 1.8	51 66 92	06/04→ 06/04→ 06/04→	←	→ 08/09		24.0124-0166.1 24.0324-0166.1	424166 524166	∅ 260 24 21 V + S ∅ 260 24 21 V PD
			→	→ 08/09		24.0110-0268.1	410268	∅ 240 10,2 8,2
OPEL - VECTRA A (86_, 87_) 08/88→12/95								
 Bremsbelagsatz, Scheibenbremse								
1.6 i 1.6 i 1.6 i	52 55 55	09/93→11/95 09/88→11/95 09/93→11/95	←	→ M5999999		13.0460-7048.2	607048	DEL 20939 15,8 + WE / - WK
			←	→ N1038529		13.0460-7048.2	607048	DEL 20939 15,8 + WE / - WK
			←	N5000001→; → 08/95		13.0460-7051.2	607051	ATE 20547 16,5 + WE / - WK
			←	N1038530→; → 08/95		13.0460-7051.2	607051	ATE 20547 16,5 + WE / - WK
1.7 D 1.7 TD 1.8 i Cat	44 60 66	07/92→11/95 03/90→11/95 03/90→11/95	←	→ M5999999		13.0460-7048.2	607048	DEL 20939 15,8 + WE / - WK
			←	→ N1038529		13.0460-7048.2	607048	DEL 20939 15,8 + WE / - WK
			←	N5000001→ R5999999		13.0460-7051.2	607051	ATE 20547 16,5 + WE / - WK
			←	N1038530→ R1999999		13.0460-7051.2	607051	ATE 20547 16,5 + WE / - WK
			←	S1000001→; → 08/95		13.0460-7052.2	607052	ATE 21190 17,5 + WE / - WK
			←	S5000001→; → 08/95		13.0460-7052.2	607052	ATE 21190 17,5 + WE / - WK
2.0 i 16V 2.0 i 16V 4x4 2.0 i Cat 2.0 i Cat 4x4 2000/GT 16V Cat 2000/GT 16V Cat 4x4	100 100 85 85 110 110	06/94→11/95 06/94→11/95 09/88→11/95 01/89→11/95 02/90→11/95 02/90→11/95	←	→ 08/95		13.0460-7052.2	607052	ATE 21190 17,5 + WE / - WK
			→	→ 08/95		13.0460-4043.2	604043	ATE 21140 15,0 - WE / - WK
2.0 i Turbo 4x4 2.5 V6	150 125	06/94→11/95 02/93→11/95	←	→ 08/95		13.0460-7080.2	607080	ATE 21411 17,5 - WK
			→	→ 08/95		13.0460-4043.2	604043	ATE 21140 15,0 - WE / - WK
Warnkontakt, Bremsbelagverschleiß								
1.6 i 1.6 i 1.6 i	52 55 55	09/93→11/95 09/88→11/95 09/93→11/95	←	→ M5999999	2	24.8190-0704.2	620704	L= 660
			←	→ N1038529	2	24.8190-0704.2	620704	L= 660
			←	N1038530→; → 08/95	2	24.8190-0707.2	620707	L= 685
			←	N5000001→; → 08/95	2	24.8190-0707.2	620707	L= 685
1.7 D 1.7 TD 1.8 i Cat	44 60 66	07/92→11/95 03/90→11/95 03/90→11/95	←	→ M5999999	2	24.8190-0704.2	620704	L= 660
			←	→ N1038529	2	24.8190-0704.2	620704	L= 660
			←	S5000001→; → 08/95	2	24.8190-0705.2	620705	L= 670
			←	S1000001→; → 08/95	2	24.8190-0705.2	620705	L= 670
			←	N5000001→ R5999999	2	24.8190-0707.2	620707	L= 685







	kW			 	! #		
OPEL - VECTRA A (86_, 87_) 08/88→12/95							
Warnkontakt, Bremsbelagverschleiß							
1.7 D 1.7 TD 1.8 i Cat	44 60 66	07/92→11/95 03/90→11/95 03/90→11/95	←	N1038530→ R1999999	2	24.8190-0707.2 620707	L= 685
2.0 i 16V 2.0 i 16V 4x4 2.0 i Cat 2.0 i Cat 4x4 2000/GT 16V Cat 2000/GT 16V Cat 4x4	100 100 85 85 110 110	06/94→11/95 06/94→11/95 09/88→11/95 01/89→11/95 02/90→11/95 02/90→11/95	←	→ 08/95	2	24.8190-0705.2 620705	L= 670
2.0 i Turbo 4x4 2.5 V6	150 125	06/94→11/95 02/93→11/95	←	→ 08/95	2	24.8190-0707.2 620707	L= 685
Zubehörsatz, Scheibenbremsbelag							
1.6 i 1.6 i 1.6 i 1.7 D 1.7 TD 1.8 i Cat	52 55 55 44 60 66	09/93→11/95 09/88→11/95 09/93→11/95 07/92→11/95 03/90→11/95 03/90→11/95	←	→ M5999999 → N1038529		13.0460-0127.2 610127	DEL DEL
2.0 i 16V 2.0 i 16V 4x4 2.0 i Cat 2.0 i Cat 4x4 2.0 i Turbo 4x4 2.5 V6 2000/GT 16V Cat 2000/GT 16V Cat 4x4	100 100 85 85 150 125 110 110	06/94→11/95 06/94→11/95 09/88→11/95 01/89→11/95 06/94→11/95 02/93→11/95 02/90→11/95 02/90→11/95	→	→ 08/95		13.0460-0217.2 610217	ATE
Bremsscheibe							
1.6 i 1.6 i 1.6 i	52 55 55	09/93→11/95 09/88→11/95 09/93→11/95	←	→ M5999999 → N1038529		24.0113-0161.1 413161 24.0313-0161.1 513161	Ø 236 12,7 9,7 + S Ø 236 12,7 9,7 + S PD
			←	→ N1038529		24.0113-0161.1 413161 24.0313-0161.1 513161	Ø 236 12,7 9,7 + S Ø 236 12,7 9,7 + S PD
			←	N5000001→; → 08/95		24.0120-0115.1 420115 24.0320-0115.1 520115	Ø 236 20 17 V + S Ø 236 20 17 V + S PD
			←	N1038530→; → 08/95		24.0120-0115.1 420115 24.0320-0115.1 520115	Ø 236 20 17 V + S Ø 236 20 17 V + S PD
1.7 D 1.7 TD 1.8 i Cat	44 60 66	07/92→11/95 03/90→11/95 03/90→11/95	←	→ M5999999 → N1038529		24.0113-0161.1 413161 24.0313-0161.1 513161	Ø 236 12,7 9,7 + S Ø 236 12,7 9,7 + S PD
			←	N1038530→ R1999999		24.0113-0161.1 413161 24.0313-0161.1 513161	Ø 236 12,7 9,7 + S Ø 236 12,7 9,7 + S PD
			←	N5000001→ R5999999		24.0120-0140.1 420140	Ø 256 20 17 V + S
			←	S1000001→; → 08/95		24.0124-0115.1 424115 24.0324-0115.1 524115	Ø 256 24 21 V + S Ø 256 24 21 V + S PD
			←	S5000001→; → 08/95		24.0124-0115.1 424115 24.0324-0115.1 524115	Ø 256 24 21 V + S Ø 256 24 21 V + S PD
2.0 i 16V 2000/GT 16V Cat	100 110	06/94→11/95 02/90→11/95	←	→ 08/95		24.0124-0115.1 424115 24.0324-0115.1 524115	Ø 256 24 21 V + S Ø 256 24 21 V + S PD
			→	P1000001→; → 08/95		24.0110-0204.1 410204	Ø 260 10 8
			→	→ N1299999		24.0110-0205.1 410205	Ø 270 9,9 8
			→	→ N5299999		24.0110-0205.1 410205	Ø 270 9,9 8
			→	→ NV299999		24.0110-0205.1 410205	Ø 270 9,9 8
2.0 i 16V 4x4	100	06/94→11/95	←	→ 08/95		24.0124-0115.1 424115 24.0324-0115.1 524115	Ø 256 24 21 V + S Ø 256 24 21 V + S PD
			→	P1000001→; → 08/95		24.0110-0204.1 410204	Ø 260 10 8
			→	→ N5299999		24.0110-0205.1 410205	Ø 270 9,9 8
			→	→ 08/95		24.0110-0205.1 410205	Ø 270 9,9 8
			→	→ N1299999		24.0110-0205.1 410205	Ø 270 9,9 8
			→	→ NV299999		24.0110-0205.1 410205	Ø 270 9,9 8
2.0 i Cat	85	09/88→11/95	←	→ 08/95		24.0124-0115.1 424115 24.0324-0115.1 524115	Ø 256 24 21 V + S Ø 256 24 21 V + S PD
			→	→ N1299999		24.0110-0144.1 410144	Ø 261 9,9 8
			→	→ N5299999		24.0110-0144.1 410144	Ø 261 9,9 8
			→	→ NV299999		24.0110-0144.1 410144	Ø 261 9,9 8
			→	P1000001→; → 08/95		24.0110-0204.1 410204	Ø 260 10 8
↓							









	kW			 	! #		
OPEL - VECTRA A (86_, 87_) 08/88→12/95							
Bremsscheibe							
2.0 i Cat 4x4 2000/GT 16V Cat 4x4	85	01/89→11/95	←	→ 08/95		24.0124-0115.1 424115	Ø 256 24 21 V + S
	110	02/90→11/95	→	→ 08/95		24.0324-0115.1 524115	Ø 256 24 21 V + S PD
2.0 i Turbo 4x4	150	06/94→11/95	←	→ 08/95		24.0110-0205.1 410205	Ø 270 9,9 8
			→	→ 08/95		24.0124-0133.1 424133	Ø 284 24 21 V
2.5 V6	125	02/93→11/95	←	→ 08/95		24.0110-0253.1 410253	Ø 270 10 8
			→	→ 08/95		24.0124-0133.1 424133	Ø 284 24 21 V
			→	→ 08/95		24.0110-0249.1 410249	Ø 260 10 8
OPEL - VECTRA A CC (88_, 89_) 04/88→12/95							
Bremsbelagsatz, Scheibenbremse							
1.6 i 1.6 i 1.6 i Cat	52	09/93→11/95	←	→ M5999999		13.0460-7048.2 607048	DEL 20939 15,8 + WE / - WK
	55	09/93→11/95	←	→ N1038529		13.0460-7048.2 607048	DEL 20939 15,8 + WE / - WK
	55	09/88→11/95	←	N5000001→; → 08/95		13.0460-7051.2 607051	ATE 20547 16,5 + WE / - WK
			←	N1038530→; → 08/95		13.0460-7051.2 607051	ATE 20547 16,5 + WE / - WK
1.7 D 1.7 TD 1.8 i Cat	44	07/92→11/95	←	→ M5999999		13.0460-7048.2 607048	DEL 20939 15,8 + WE / - WK
	60	03/90→11/95	←	→ N1038529		13.0460-7048.2 607048	DEL 20939 15,8 + WE / - WK
	66	03/90→11/95	←	N5000001→ R5999999		13.0460-7051.2 607051	ATE 20547 16,5 + WE / - WK
			←	N1038530→ R1999999		13.0460-7051.2 607051	ATE 20547 16,5 + WE / - WK
			←	S1000001→; → 08/95		13.0460-7052.2 607052	ATE 21190 17,5 + WE / - WK
			←	S5000001→; → 08/95		13.0460-7052.2 607052	ATE 21190 17,5 + WE / - WK
2.0 i 16V 2.0 i 16V Cat	100	06/94→11/95	←	→ 08/95		13.0460-7052.2 607052	ATE 21190 17,5 + WE / - WK
	110	02/90→11/95	→	→ 08/95		13.0460-4043.2 604043	ATE 21140 15,0 - WE / - WK
2.0 i Cat 2.0 i GT	85	09/88→11/95	→	→ 08/95			
	95	09/88→11/95	→	→ 08/95			
2.5 V6	125	02/93→11/95	←	→ 08/95		13.0460-7080.2 607080	ATE 21411 17,5 - WK
			→	→ 08/95		13.0460-4043.2 604043	ATE 21140 15,0 - WE / - WK
Warnkontakt, Bremsbelagverschleiß							
1.6 i 1.6 i 1.6 i Cat	52	09/93→11/95	←	→ M5999999	2	24.8190-0704.2 620704	L= 660
	55	09/93→11/95	←	→ N1038529	2	24.8190-0704.2 620704	L= 660
	55	09/88→11/95	←	N1038530→; → 08/95	2	24.8190-0707.2 620707	L= 685
			←	N5000001→; → 08/95	2	24.8190-0707.2 620707	L= 685
1.7 D 1.7 TD 1.8 i Cat	44	07/92→11/95	←	→ M5999999	2	24.8190-0704.2 620704	L= 660
	60	03/90→11/95	←	→ N1038529	2	24.8190-0704.2 620704	L= 660
	66	03/90→11/95	←	S5000001→; → 08/95	2	24.8190-0705.2 620705	L= 670
			←	S1000001→; → 08/95	2	24.8190-0705.2 620705	L= 670
			←	N5000001→ R5999999	2	24.8190-0707.2 620707	L= 685
			←	N1038530→ R1999999	2	24.8190-0707.2 620707	L= 685
2.0 i 16V 2.0 i 16V Cat	100	06/94→11/95	←	→ 08/95	2	24.8190-0705.2 620705	L= 670
	110	02/90→11/95					
	85	09/88→11/95					
	95	09/88→11/95					
2.5 V6	125	02/93→11/95	←	→ 08/95	2	24.8190-0707.2 620707	L= 685
Zubehörsatz, Scheibenbremsbelag							
1.6 i 1.6 i 1.6 i Cat	52	09/93→11/95	←	→ M5999999		13.0460-0127.2 610127	DEL
	55	09/93→11/95	←	→ N1038529		13.0460-0127.2 610127	DEL
	55	09/88→11/95					
	55	09/88→11/95					
1.7 D 1.7 TD 1.8 i Cat	44	07/92→11/95					
	60	03/90→11/95					
	66	03/90→11/95					
	66	03/90→11/95					
2.0 i 16V 2.0 i 16V Cat 2.0 i Cat 2.0 i GT 2.5 V6	100	06/94→11/95	→	→ 08/95		13.0460-0217.2 610217	ATE
	110	02/90→11/95					
	85	09/88→11/95					
	95	09/88→11/95					
	125	02/93→11/95					
Bremsscheibe							
1.6 i 1.6 i 1.6 i Cat	52	09/93→11/95	←	→ M5999999		24.0113-0161.1 413161	Ø 236 12,7 9,7 + S
	55	09/93→11/95				24.0313-0161.1 513161	Ø 236 12,7 9,7 + S PD
	55	09/88→11/95	←	→ N1038529		24.0113-0161.1 413161	Ø 236 12,7 9,7 + S
						24.0313-0161.1 513161	Ø 236 12,7 9,7 + S PD
↓							

	kW				! #		
OPEL - VECTRA A CC (88_, 89_) 04/88→12/95							
Bremsscheibe							
1.6 i	52	09/93→11/95	←	N5000001→; → 08/95		24.0120-0115.1 420115	Ø 236 20 17 V + S
1.6 i	55	09/93→11/95				24.0320-0115.1 520115	Ø 236 20 17 V + S PD
1.6 i Cat	55	09/88→11/95	←	N1038530→; → 08/95		24.0120-0115.1 420115	Ø 236 20 17 V + S
						24.0320-0115.1 520115	Ø 236 20 17 V + S PD
1.7 D	44	07/92→11/95	←	→ M5999999		24.0113-0161.1 413161	Ø 236 12,7 9,7 + S
1.7 TD	60	03/90→11/95				24.0313-0161.1 513161	Ø 236 12,7 9,7 + S PD
1.8 i Cat	66	03/90→11/95	←	→ N1038529		24.0113-0161.1 413161	Ø 236 12,7 9,7 + S
						24.0313-0161.1 513161	Ø 236 12,7 9,7 + S PD
			←	N1038530→ R1999999		24.0120-0140.1 420140	Ø 256 20 17 V + S
			←	N5000001→ R5999999		24.0120-0140.1 420140	Ø 256 20 17 V + S
			←	S1000001→; → 08/95		24.0124-0115.1 424115	Ø 256 24 21 V + S
						24.0324-0115.1 524115	Ø 256 24 21 V + S PD
			←	S5000001→; → 08/95		24.0124-0115.1 424115	Ø 256 24 21 V + S
						24.0324-0115.1 524115	Ø 256 24 21 V + S PD
2.0 i 16V	100	06/94→11/95	←	→ 08/95		24.0124-0115.1 424115	Ø 256 24 21 V + S
2.0 i 16V Cat	110	02/90→11/95				24.0324-0115.1 524115	Ø 256 24 21 V + S PD
			→	P1000001→; → 08/95		24.0110-0204.1 410204	Ø 260 10 8
			→	→ N1299999		24.0110-0205.1 410205	Ø 270 9,9 8
			→	→ N5299999		24.0110-0205.1 410205	Ø 270 9,9 8
			→	→ NV299999		24.0110-0205.1 410205	Ø 270 9,9 8
2.0 i Cat	85	09/88→11/95	←	→ 08/95		24.0124-0115.1 424115	Ø 256 24 21 V + S
2.0 i GT	95	09/88→11/95				24.0324-0115.1 524115	Ø 256 24 21 V + S PD
			→	→ N1299999		24.0110-0144.1 410144	Ø 261 9,9 8
			→	→ N5299999		24.0110-0144.1 410144	Ø 261 9,9 8
			→	→ NV299999		24.0110-0144.1 410144	Ø 261 9,9 8
			→	P1000001→; → 08/95		24.0110-0204.1 410204	Ø 260 10 8
2.5 V6	125	02/93→11/95	←	→ 08/95		24.0124-0133.1 424133	Ø 284 24 21 V
			→	→ 08/95		24.0110-0249.1 410249	Ø 260 10 8
OPEL - VECTRA B (36_) 09/95→04/02							
Bremsbelagsatz, Scheibenbremse							
1.6 i	55	10/95→04/02	←	→ W7999999		13.0460-7052.2 607052	ATE 21190 17,5 + WE / - WK
2.0 DI 16V	60	11/96→04/02	←	X1000001→		13.0460-7091.2 607091	ATE 21829 20,3 + WE / - WK
1.6 i 16V	74	10/95→04/02	←	→ W7999999		13.0460-7052.2 607052	ATE 21190 17,5 + WE / - WK
1.8 i 16V	85	10/95→09/00					
1.8 i 16V	92	09/00→04/02	←	X1000001→		13.0460-7091.2 607091	ATE 21829 20,3 + WE / - WK
2.0 DTI 16V	74	06/97→04/02	→			13.0460-4040.2 604040	ATE 21050 15,8 - WE / - WK
1.7 TD	60	10/95→12/98	←	→ 11/96		13.0460-7052.2 607052	ATE 21190 17,5 + WE / - WK
			→	→ 11/96		13.0460-4040.2 604040	ATE 21050 15,8 - WE / - WK
2.0 i	82	10/95→04/02	←			13.0460-7091.2 607091	ATE 21829 20,3 + WE / - WK
2.0 i 16V	100	10/95→09/00					
2.2 DTI 16V	88	09/00→04/02	→			13.0460-4040.2 604040	ATE 21050 15,8 - WE / - WK
2.2 DTI 16V	92	09/00→04/02					
2.2 i 16V	108	09/00→04/02					
2.5 i V6	125	10/95→09/00					
2.6 i V6	125	09/00→04/02					
i 500 2.5	143	05/98→09/00					
Warnkontakt, Bremsbelagverschleiß							
1.6 i	55	10/95→04/02	←	X1000001→	2	24.8190-0714.2 620714	L= 660
1.6 i 16V	74	10/95→04/02					
1.8 i 16V	85	10/95→09/00	←	→ W7999999	2	24.8190-0715.2 620715	L= 660
1.8 i 16V	92	09/00→04/02					
2.0 DI 16V	60	11/96→04/02					
2.0 DTI 16V	74	06/97→04/02					
1.7 TD	60	10/95→12/98	←	→ 11/96	2	24.8190-0715.2 620715	L= 660
2.0 i	82	10/95→04/02	←		2	24.8190-0714.2 620714	L= 660
2.0 i 16V	100	10/95→09/00					
2.2 DTI 16V	88	09/00→04/02					
2.2 DTI 16V	92	09/00→04/02					
2.2 i 16V	108	09/00→04/02					
2.5 i V6	125	10/95→09/00					
2.6 i V6	125	09/00→04/02					
↓							







	kw			 	! #		
OPEL - VECTRA B (36_) 09/95→04/02							
Zubehörsatz, Scheibenbremsbelag							
1.6 i 16V	74	10/95→04/02	➔			13.0460-0347.2 610347	
1.8 i 16V	85	10/95→09/00					
1.8 i 16V	92	09/00→04/02					
2.0 DTI 16V	74	06/97→04/02					
2.0 i	82	10/95→04/02					
2.0 i 16V	100	10/95→09/00					
2.2 DTI 16V	88	09/00→04/02					
2.2 DTI 16V	92	09/00→04/02					
2.2 i 16V	108	09/00→04/02					
2.5 i V6	125	10/95→09/00					
2.6 i V6	125	09/00→04/02					
i 500 2.5	143	05/98→09/00					
1.7 TD	60	10/95→12/98	➔	→ 11/96		13.0460-0347.2 610347	
 Bremsscheibe							
1.6 i	55	10/95→04/02	←	→ W7999999		24.0124-0115.1 424115	Ø 256 24 21 V + S
2.0 DI 16V	60	11/96→04/02				24.0324-0115.1 524115	Ø 256 24 21 V + S PD
			←	X1000001→		24.0125-0119.1 425119	Ø 288 25 22 V + S
						24.0325-0119.1 525119	Ø 288 25 22 V + S PD
1.6 i 16V	74	10/95→04/02	←	→ W7999999		24.0124-0115.1 424115	Ø 256 24 21 V + S
1.8 i 16V	85	10/95→09/00				24.0324-0115.1 524115	Ø 256 24 21 V + S PD
1.8 i 16V	92	09/00→04/02					
2.0 DTI 16V	74	06/97→04/02	←	X1000001→		24.0125-0119.1 425119	Ø 288 25 22 V + S
						24.0325-0119.1 525119	Ø 288 25 22 V + S PD
			➔	→ W7999999		24.0110-0225.1 410225	Ø 270 10 8 + S
			➔	X1000001→		24.0310-0225.1 510225	Ø 270 10 8 + S PD
			➔	X1000001→		24.0110-0226.1 410226	Ø 286 10 8 + S
						24.0310-0226.1 510226	Ø 286 10 8 + S PD
1.7 TD	60	10/95→12/98	←	→ 11/96		24.0124-0115.1 424115	Ø 256 24 21 V + S
						24.0324-0115.1 524115	Ø 256 24 21 V + S PD
			➔	→ 11/96		24.0110-0225.1 410225	Ø 270 10 8 + S
						24.0310-0225.1 510225	Ø 270 10 8 + S PD
2.0 i	82	10/95→04/02	←			24.0125-0119.1 425119	Ø 288 25 22 V + S
2.0 i 16V	100	10/95→09/00				24.0325-0119.1 525119	Ø 288 25 22 V + S PD
2.2 DTI 16V	88	09/00→04/02					
2.2 DTI 16V	92	09/00→04/02	➔			24.0110-0226.1 410226	Ø 286 10 8 + S
2.2 i 16V	108	09/00→04/02				24.0310-0226.1 510226	Ø 286 10 8 + S PD
2.5 i V6	125	10/95→09/00					
2.6 i V6	125	09/00→04/02					
i 500 2.5	143	05/98→09/00	←			24.0125-0142.1 425142	Ø 308 25 22 V + S
						24.0325-0142.1 525142	Ø 308 25 23 V + S PD
			➔			24.0110-0226.1 410226	Ø 286 10 8 + S
						24.0310-0226.1 510226	Ø 286 10 8 + S PD
OPEL - VECTRA B Caravan (31_) 11/96→07/03							
 Bremsbelagsatz, Scheibenbremse							
1.6 i	55	11/96→06/00	←	→ W7999999		13.0460-7052.2 607052	ATE 21190 17,5 + WE / - WK
			←	X1000001→		13.0460-7091.2 607091	ATE 21829 20,3 + WE / - WK
1.6 i 16V	74	11/96→07/02	←	→ W7999999		13.0460-7052.2 607052	ATE 21190 17,5 + WE / - WK
1.8 i 16V	92	09/00→07/03					
2.0 DTI 16V	74	06/97→07/03	←	X1000001→; → 04/02		13.0460-7091.2 607091	ATE 21829 20,3 + WE / - WK
			➔	→ 04/02		13.0460-4040.2 604040	ATE 21050 15,8 - WE / - WK
1.7 TD	60	11/96→12/97	←	→ 11/96		13.0460-7052.2 607052	ATE 21190 17,5 + WE / - WK
			➔	→ 11/96		13.0460-4040.2 604040	ATE 21050 15,8 - WE / - WK
1.8 i 16V	85	11/96→09/00	←	→ W7999999		13.0460-7052.2 607052	ATE 21190 17,5 + WE / - WK
2.0 DI 16V	60	11/96→06/00	←	X1000001→		13.0460-7091.2 607091	ATE 21829 20,3 + WE / - WK
			➔			13.0460-4040.2 604040	ATE 21050 15,8 - WE / - WK
2.0 i	82	11/96→02/02	←			13.0460-7091.2 607091	ATE 21829 20,3 + WE / - WK
2.0 i 16V	100	11/96→09/00					
2.2 DTI 16V	88	09/00→04/02	➔			13.0460-4040.2 604040	ATE 21050 15,8 - WE / - WK
2.5 i V6	125	11/96→09/00					
i 500 2.5	143	05/98→09/00					
2.2 DTI 16V	92	09/00→07/03	←	→ 04/02		13.0460-7091.2 607091	ATE 21829 20,3 + WE / - WK
2.2 i 16V	108	09/00→07/03					
2.6 i V6	125	09/00→07/03	➔	→ 04/02		13.0460-4040.2 604040	ATE 21050 15,8 - WE / - WK
Warnkontakt, Bremsbelagverschleiß							
1.6 i	55	11/96→06/00	←	X1000001→	2	24.8190-0714.2 620714	L= 660
1.8 i 16V	85	11/96→09/00					
2.0 DI 16V	60	11/96→06/00	←	→ W7999999	2	24.8190-0715.2 620715	L= 660
↓							









	kW			 	! #		
OPEL - VECTRA B Caravan (31_) 11/96→07/03							
Warnkontakt, Bremsbelagverschleiß							
1.6 i 16V	74	11/96→07/02	←	X1000001→; → 04/02	2	24.8190-0714.2 620714	L= 660
1.8 i 16V	92	09/00→07/03	←	→ W7999999	2	24.8190-0715.2 620715	L= 660
2.0 DTI 16V	74	06/97→07/03	←				
1.7 TD	60	11/96→12/97	←	→ 11/96	2	24.8190-0715.2 620715	L= 660
2.0 i	82	11/96→02/02	←		2	24.8190-0714.2 620714	L= 660
2.0 i 16V	100	11/96→09/00	←				
2.2 DTI 16V	88	09/00→04/02	←				
2.5 i V6	125	11/96→09/00	←				
2.2 DTI 16V	92	09/00→07/03	←	→ 04/02	2	24.8190-0714.2 620714	L= 660
2.2 i 16V	108	09/00→07/03	←				
2.6 i V6	125	09/00→07/03	←				
Zubehörsatz, Scheibenbremsbelag							
1.6 i 16V	74	11/96→07/02	→	→ 04/02		13.0460-0347.2 610347	
1.8 i 16V	92	09/00→07/03	→				
2.0 DTI 16V	74	06/97→07/03	→				
2.2 DTI 16V	92	09/00→07/03	→				
2.2 i 16V	108	09/00→07/03	→				
2.6 i V6	125	09/00→07/03	→				
1.7 TD	60	11/96→12/97	→	→ 11/96		13.0460-0347.2 610347	
1.8 i 16V	85	11/96→09/00	→			13.0460-0347.2 610347	
2.0 DI 16V	60	11/96→06/00	→				
2.0 i	82	11/96→02/02	→				
2.0 i 16V	100	11/96→09/00	→				
2.2 DTI 16V	88	09/00→04/02	→				
2.5 i V6	125	11/96→09/00	→				
i 500 2.5	143	05/98→09/00	→				
Bremsscheibe							
1.6 i	55	11/96→06/00	←	→ W7999999		24.0124-0115.1 424115	Ø 256 24 21 V + S
			←	X1000001→		24.0324-0115.1 524115	Ø 256 24 21 V + S PD
			←	X1000001→		24.0125-0119.1 425119	Ø 288 25 22 V + S
			←	X1000001→		24.0325-0119.1 525119	Ø 288 25 22 V + S PD
1.6 i 16V 1.8 i 16V 2.0 DTI 16V	74 92 74	11/96→07/02 09/00→07/03 06/97→07/03	←	→ W7999999		24.0124-0115.1 424115	Ø 256 24 21 V + S
			←	X1000001→		24.0324-0115.1 524115	Ø 256 24 21 V + S PD
			←	X1000001→; → 04/02		24.0125-0119.1 425119	Ø 288 25 22 V + S
			←	X1000001→; → 04/02		24.0325-0119.1 525119	Ø 288 25 22 V + S PD
			→	→ W7999999		24.0110-0225.1 410225	Ø 270 10 8 + S
			→	X1000001→; → 04/02		24.0310-0225.1 510225	Ø 270 10 8 + S PD
1.7 TD	60	11/96→12/97	←	→ 11/96		24.0124-0115.1 424115	Ø 256 24 21 V + S
			←	→ 11/96		24.0324-0115.1 524115	Ø 256 24 21 V + S PD
			→	→ 11/96		24.0110-0225.1 410225	Ø 270 10 8 + S
			→	→ 11/96		24.0310-0225.1 510225	Ø 270 10 8 + S PD
1.8 i 16V 2.0 DI 16V	85 60	11/96→09/00 11/96→06/00	←	→ W7999999		24.0124-0115.1 424115	Ø 256 24 21 V + S
			←	X1000001→		24.0324-0115.1 524115	Ø 256 24 21 V + S PD
			←	X1000001→		24.0125-0119.1 425119	Ø 288 25 22 V + S
			←	X1000001→		24.0325-0119.1 525119	Ø 288 25 22 V + S PD
			→	→ W7999999		24.0110-0225.1 410225	Ø 270 10 8 + S
			→	X1000001→		24.0310-0225.1 510225	Ø 270 10 8 + S PD
2.0 i 2.0 i 16V 2.2 DTI 16V 2.5 i V6	82 100 88 125	11/96→02/02 11/96→09/00 09/00→04/02 11/96→09/00	←			24.0125-0119.1 425119	Ø 288 25 22 V + S
			←			24.0325-0119.1 525119	Ø 288 25 22 V + S PD
			→			24.0110-0226.1 410226	Ø 286 10 8 + S
			→			24.0310-0226.1 510226	Ø 286 10 8 + S PD
2.2 DTI 16V 2.2 i 16V 2.6 i V6	92 108 125	09/00→07/03 09/00→07/03 09/00→07/03	←	→ 04/02		24.0125-0119.1 425119	Ø 288 25 22 V + S
			←	→ 04/02		24.0325-0119.1 525119	Ø 288 25 22 V + S PD
			→	→ 04/02		24.0110-0226.1 410226	Ø 286 10 8 + S
			→	→ 04/02		24.0310-0226.1 510226	Ø 286 10 8 + S PD
i 500 2.5	143	05/98→09/00	←			24.0125-0142.1 425142	Ø 308 25 22 V + S
			←			24.0325-0142.1 525142	Ø 308 25 23 V + S PD
			→			24.0110-0226.1 410226	Ø 286 10 8 + S
			→			24.0310-0226.1 510226	Ø 286 10 8 + S PD







	kW			 	! #		
OPEL - VECTRA B CC (38_) 10/95→07/03							
 Bremsbelagsatz, Scheibenbremse							
1.6 i	55	10/95→07/03	←	→ W7999999		13.0460-7052.2 607052	ATE 21190 17,5 + WE / - WK
			←	X1000001→; → 04/02		13.0460-7091.2 607091	ATE 21829 20,3 + WE / - WK
1.6 i 16V	74	10/95→07/02	←	→ W7999999		13.0460-7052.2 607052	ATE 21190 17,5 + WE / - WK
1.8 i 16V	92	09/00→07/03	←	→ W7999999		13.0460-7052.2 607052	ATE 21190 17,5 + WE / - WK
2.0 DTI 16V	74	06/97→07/03	←	X1000001→; → 04/02		13.0460-7091.2 607091	ATE 21829 20,3 + WE / - WK
			→	→ 04/02		13.0460-4040.2 604040	ATE 21050 15,8 - WE / - WK
1.7 TD	60	10/95→12/98	←	→ 11/96		13.0460-7052.2 607052	ATE 21190 17,5 + WE / - WK
			→	→ 11/96		13.0460-4040.2 604040	ATE 21050 15,8 - WE / - WK
1.8 i 16V	85	10/95→09/00	←	→ W7999999		13.0460-7052.2 607052	ATE 21190 17,5 + WE / - WK
			←	X1000001→		13.0460-7091.2 607091	ATE 21829 20,3 + WE / - WK
			→			13.0460-4040.2 604040	ATE 21050 15,8 - WE / - WK
2.0 DI 16V	60	11/96→06/00	←	→ W7999999		13.0460-7052.2 607052	ATE 21190 17,5 + WE / - WK
			←	X1000001→		13.0460-7091.2 607091	ATE 21829 20,3 + WE / - WK
2.0 i	82	10/95→02/02	←			13.0460-7091.2 607091	ATE 21829 20,3 + WE / - WK
2.0 i 16V	100	10/95→09/00	→			13.0460-4040.2 604040	ATE 21050 15,8 - WE / - WK
2.2 DTI 16V	88	09/00→04/02	→			13.0460-4040.2 604040	ATE 21050 15,8 - WE / - WK
2.5	144	10/99→06/00					
2.5 i V6	125	10/95→09/00					
2.2 DTI 16V	92	09/00→07/03	←	→ 04/02		13.0460-7091.2 607091	ATE 21829 20,3 + WE / - WK
2.2 i 16V	108	09/00→07/03	→	→ 04/02		13.0460-4040.2 604040	ATE 21050 15,8 - WE / - WK
2.6 i V6	125	09/00→07/03	→	→ 04/02		13.0460-4040.2 604040	ATE 21050 15,8 - WE / - WK
Warnkontakt, Bremsbelagsverschleiß							
1.6 i	55	10/95→07/03	←	X1000001→; → 04/02	2	24.8190-0714.2 620714	L= 660
1.6 i 16V	74	10/95→07/02	←	→ W7999999	2	24.8190-0715.2 620715	L= 660
1.8 i 16V	92	09/00→07/03	←	→ W7999999	2	24.8190-0715.2 620715	L= 660
2.0 DTI 16V	74	06/97→07/03	←	→ W7999999	2	24.8190-0715.2 620715	L= 660
1.7 TD	60	10/95→12/98	←	→ 11/96	2	24.8190-0715.2 620715	L= 660
1.8 i 16V	85	10/95→09/00	←	X1000001→	2	24.8190-0714.2 620714	L= 660
2.0 DI 16V	60	11/96→06/00	←	→ W7999999	2	24.8190-0715.2 620715	L= 660
2.0 i	82	10/95→02/02	←		2	24.8190-0714.2 620714	L= 660
2.0 i 16V	100	10/95→09/00	→		2	24.8190-0714.2 620714	L= 660
2.2 DTI 16V	88	09/00→04/02	→		2	24.8190-0714.2 620714	L= 660
2.5	144	10/99→06/00			2	24.8190-0714.2 620714	L= 660
2.5 i V6	125	10/95→09/00			2	24.8190-0714.2 620714	L= 660
2.2 DTI 16V	92	09/00→07/03	←	→ 04/02	2	24.8190-0714.2 620714	L= 660
2.2 i 16V	108	09/00→07/03	→	→ 04/02	2	24.8190-0714.2 620714	L= 660
2.6 i V6	125	09/00→07/03	→	→ 04/02	2	24.8190-0714.2 620714	L= 660
Zubehörsatz, Scheibenbremsbelag							
1.6 i 16V	74	10/95→07/02	→	→ 04/02		13.0460-0347.2 610347	
1.8 i 16V	92	09/00→07/03	→	→ 04/02		13.0460-0347.2 610347	
2.0 DTI 16V	74	06/97→07/03	→	→ 04/02		13.0460-0347.2 610347	
2.2 DTI 16V	92	09/00→07/03	→	→ 04/02		13.0460-0347.2 610347	
2.2 i 16V	108	09/00→07/03	→	→ 04/02		13.0460-0347.2 610347	
2.6 i V6	125	09/00→07/03	→	→ 04/02		13.0460-0347.2 610347	
1.7 TD	60	10/95→12/98	→	→ 11/96		13.0460-0347.2 610347	
1.8 i 16V	85	10/95→09/00	→	→ 04/02		13.0460-0347.2 610347	
2.0 i	82	10/95→02/02	→	→ 04/02		13.0460-0347.2 610347	
2.0 i 16V	100	10/95→09/00	→	→ 04/02		13.0460-0347.2 610347	
2.2 DTI 16V	88	09/00→04/02	→	→ 04/02		13.0460-0347.2 610347	
2.5	144	10/99→06/00	→	→ 04/02		13.0460-0347.2 610347	
2.5 i V6	125	10/95→09/00	→	→ 04/02		13.0460-0347.2 610347	
 Bremsscheibe							
1.6 i	55	10/95→07/03	←	→ W7999999		24.0124-0115.1 424115	Ø 256 24 21 V + S
			←	X1000001→; → 04/02		24.0324-0115.1 524115	Ø 256 24 21 V + S PD
			←	X1000001→; → 04/02		24.0125-0119.1 425119	Ø 288 25 22 V + S
			←	X1000001→; → 04/02		24.0325-0119.1 525119	Ø 288 25 22 V + S PD
1.6 i 16V	74	10/95→07/02	←	→ W7999999		24.0124-0115.1 424115	Ø 256 24 21 V + S
1.8 i 16V	92	09/00→07/03	←	→ W7999999		24.0124-0115.1 424115	Ø 256 24 21 V + S
2.0 DTI 16V	74	06/97→07/03	←	X1000001→; → 04/02		24.0324-0115.1 524115	Ø 256 24 21 V + S PD
			←	X1000001→; → 04/02		24.0125-0119.1 425119	Ø 288 25 22 V + S
			←	X1000001→; → 04/02		24.0325-0119.1 525119	Ø 288 25 22 V + S PD
			→	→ W7999999		24.0110-0225.1 410225	Ø 270 10 8 + S
			→	→ W7999999		24.0310-0225.1 510225	Ø 270 10 8 + S PD
			→	→ W7999999		24.0110-0226.1 410226	Ø 286 10 8 + S
			→	→ W7999999		24.0310-0226.1 510226	Ø 286 10 8 + S PD
1.7 TD	60	10/95→12/98	←	→ 11/96		24.0124-0115.1 424115	Ø 256 24 21 V + S
↓							











	kW			 	! #		
OPEL - VECTRA B CC (38_) 10/95→07/03							
Bremsscheibe							
1.7 TD	60	10/95→12/98	←	→ 11/96		24.0324-0115.1 524115	Ø 256 24 21 V + S PD
			→	→ 11/96		24.0110-0225.1 410225	Ø 270 10 8 + S
						24.0310-0225.1 510225	Ø 270 10 8 + S PD
1.8 i 16V	85	10/95→09/00	←	→ W7999999		24.0124-0115.1 424115	Ø 256 24 21 V + S
			←	X1000001→		24.0324-0115.1 524115	Ø 256 24 21 V + S PD
			←	X1000001→		24.0125-0119.1 425119	Ø 288 25 22 V + S
						24.0325-0119.1 525119	Ø 288 25 22 V + S PD
			→	→ W7999999		24.0110-0225.1 410225	Ø 270 10 8 + S
						24.0310-0225.1 510225	Ø 270 10 8 + S PD
			→	X1000001→		24.0110-0226.1 410226	Ø 286 10 8 + S
						24.0310-0226.1 510226	Ø 286 10 8 + S PD
2.0 DI 16V	60	11/96→06/00	←	→ W7999999		24.0124-0115.1 424115	Ø 256 24 21 V + S
			←	X1000001→		24.0324-0115.1 524115	Ø 256 24 21 V + S PD
			←	X1000001→		24.0125-0119.1 425119	Ø 288 25 22 V + S
						24.0325-0119.1 525119	Ø 288 25 22 V + S PD
2.0 i	82	10/95→02/02	←			24.0125-0119.1 425119	Ø 288 25 22 V + S
2.0 i 16V	100	10/95→09/00				24.0325-0119.1 525119	Ø 288 25 22 V + S PD
2.2 DTI 16V	88	09/00→04/02	→			24.0110-0226.1 410226	Ø 286 10 8 + S
2.5	144	10/99→06/00				24.0310-0226.1 510226	Ø 286 10 8 + S PD
2.5 i V6	125	10/95→09/00					
2.2 DTI 16V	92	09/00→07/03	←	→ 04/02		24.0125-0119.1 425119	Ø 288 25 22 V + S
2.2 i 16V	108	09/00→07/03				24.0325-0119.1 525119	Ø 288 25 22 V + S PD
2.6 i V6	125	09/00→07/03	→	→ 04/02		24.0110-0226.1 410226	Ø 286 10 8 + S
						24.0310-0226.1 510226	Ø 286 10 8 + S PD
OPEL - VECTRA C 04/02→							
Bremsbelagsatz, Scheibenbremse							
1.6	77	01/06→	←	→ 10/08;		13.0460-7172.2 607172	ATE 23378 20,1 + WE / - WK
1.8	103	01/06→		für Bremssattel mit Kunststoffkolben		13.0470-7172.2 LD7172	ATE 23378 20,1 + WE / - WK Ceramic
1.9 CDTI	74	10/05→	←	→ 10/08; für Bremssattel mit Stahlkolben		13.0460-7212.2 607212	ATE 23738 20,1 + WE / - WK
			→	→ 10/08		13.0460-7194.2 607194	ATE 23482 16,6 - WE / - WK
						13.0460-7195.2 607195	ATE 23482 16,6 - WE / - WK
						13.0470-7194.2 LD7194	ATE 23482 16,6 - WE / - WK Ceramic
						13.0470-7195.2 LD7195	ATE 23482 16,6 - WE / - WK Ceramic
1.6 16V	74	06/04→	←	→ 10/08;		13.0460-7172.2 607172	ATE 23378 20,1 + WE / - WK
1.8	81	04/02→		für Bremssattel mit Kunststoffkolben		13.0470-7172.2 LD7172	ATE 23378 20,1 + WE / - WK Ceramic
1.8 16V	90	04/02→					
1.9 CDTI	88	04/04→01/09	←	→ 10/08; für Bremssattel mit Stahlkolben		13.0460-7212.2 607212	ATE 23738 20,1 + WE / - WK
1.9 CDTI	110	04/04→	→	→ 41096248 / 48091178		13.0460-7194.2 607194	ATE 23482 16,6 - WE / - WK
2.0 16V Turbo	129	03/03→				13.0470-7194.2 LD7194	ATE 23482 16,6 - WE / - WK Ceramic
2.0 DTI 16V	74	04/02→					
2.2 16V	108	04/02→					
2.2 direct	114	10/03→					
2.2 DTI 16V	92	04/02→	→	41096249 / 48091179→; → 10/08		13.0460-7194.2 607194	ATE 23482 16,6 - WE / - WK
						13.0460-7195.2 607195	ATE 23482 16,6 - WE / - WK
						13.0470-7194.2 LD7194	ATE 23482 16,6 - WE / - WK Ceramic
						13.0470-7195.2 LD7195	ATE 23482 16,6 - WE / - WK Ceramic
2.2 DTI 16V	86	04/02→12/04	←	für Bremssattel mit Kunststoffkolben		13.0460-7172.2 607172	ATE 23378 20,1 + WE / - WK
			←	für Bremssattel mit Stahlkolben		13.0470-7172.2 LD7172	ATE 23378 20,1 + WE / - WK Ceramic
			→	41096249 / 48091179→		13.0460-7194.2 607194	ATE 23482 16,6 - WE / - WK
						13.0460-7195.2 607195	ATE 23482 16,6 - WE / - WK
						13.0470-7194.2 LD7194	ATE 23482 16,6 - WE / - WK Ceramic
						13.0470-7195.2 LD7195	ATE 23482 16,6 - WE / - WK Ceramic
			→	→ 41096248 / 48091178		13.0460-7194.2 607194	ATE 23482 16,6 - WE / - WK
						13.0470-7194.2 LD7194	ATE 23482 16,6 - WE / - WK Ceramic
2.8 V6 Turbo	169	08/05→	←	→ 10/08		13.0460-7199.2 607199	ATE 23404 20,6 + WE / - WK
2.8 V6 Turbo	184	08/06→					
↓							







	kw			 	! #		
OPEL - VECTRA C 04/02→							
Bremsbelagsatz, Scheibenbremse							
3.0 CDTi	135	08/05→	➡	→ 10/08		13.0460-7194.2 607194 ATE 23482 16,6 - WE / - WK 13.0460-7195.2 607195 ATE 23482 16,6 - WE / - WK 13.0470-7194.2 LD7194 ATE 23482 16,6 - WE / - WK Ceramic 13.0470-7195.2 LD7195 ATE 23482 16,6 - WE / - WK Ceramic	
2.8 V6 Turbo	188	08/05→	➡	→ 10/08		13.0460-7194.2 607194 ATE 23482 16,6 - WE / - WK 13.0460-7195.2 607195 ATE 23482 16,6 - WE / - WK 13.0470-7194.2 LD7194 ATE 23482 16,6 - WE / - WK Ceramic 13.0470-7195.2 LD7195 ATE 23482 16,6 - WE / - WK Ceramic	
2.8 V6 Turbo OPC	206	09/06→09/08	➡			13.0460-7194.2 607194 ATE 23482 16,6 - WE / - WK 13.0460-7195.2 607195 ATE 23482 16,6 - WE / - WK 13.0470-7194.2 LD7194 ATE 23482 16,6 - WE / - WK Ceramic 13.0470-7195.2 LD7195 ATE 23482 16,6 - WE / - WK Ceramic	
3.0 CDTI	130	06/03→	⬅	→ 10/08		13.0460-7199.2 607199 ATE 23404 20,6 + WE / - WK	
			➡	→ 41096248 / 48091178		13.0460-7194.2 607194 ATE 23482 16,6 - WE / - WK 13.0470-7194.2 LD7194 ATE 23482 16,6 - WE / - WK Ceramic	
			➡	41096249 / 48091179→; → 10/08		13.0460-7194.2 607194 ATE 23482 16,6 - WE / - WK 13.0460-7195.2 607195 ATE 23482 16,6 - WE / - WK 13.0470-7194.2 LD7194 ATE 23482 16,6 - WE / - WK Ceramic 13.0470-7195.2 LD7195 ATE 23482 16,6 - WE / - WK Ceramic	
3.2 V6	155	08/02→	⬅	→ 31070293 / 38047797; für Bremssattel mit Kunststoffkolben		13.0460-7172.2 607172 ATE 23378 20,1 + WE / - WK 13.0470-7172.2 LD7172 ATE 23378 20,1 + WE / - WK Ceramic	
			⬅	48045598→; → 10/08		13.0460-7199.2 607199 ATE 23404 20,6 + WE / - WK	
			⬅	31070294 / 38047798→ 48045597		13.0460-7199.2 607199 ATE 23404 20,6 + WE / - WK	
			⬅	→ 31070293 / 38047797; für Bremssattel mit Stahlkolben		13.0460-7212.2 607212 ATE 23738 20,1 + WE / - WK	
			➡	→ 41096248 / 48091178		13.0460-7194.2 607194 ATE 23482 16,6 - WE / - WK 13.0470-7194.2 LD7194 ATE 23482 16,6 - WE / - WK Ceramic	
			➡	41096249 / 48091179→; → 10/08		13.0460-7194.2 607194 ATE 23482 16,6 - WE / - WK 13.0460-7195.2 607195 ATE 23482 16,6 - WE / - WK 13.0470-7194.2 LD7194 ATE 23482 16,6 - WE / - WK Ceramic 13.0470-7195.2 LD7195 ATE 23482 16,6 - WE / - WK Ceramic	
Warnkontakt, Bremsbelagverschleiß							
1.6	77	01/06→	⬅	→ 10/08; → 48045597	1	24.8190-0719.2 620719	L= 685,5
1.6 16V	74	06/04→	⬅	→ 10/08; 48045598→	1	24.8190-0720.2 620720	L= 287
1.8	81	04/02→	⬅				
1.8	103	01/06→					
1.8 16V	90	04/02→					
1.9 CDTI	74	10/05→					
1.9 CDTI	88	04/04→01/09					
1.9 CDTI	110	04/04→					
2.0 16V Turbo	129	03/03→					
2.0 DTI 16V	74	04/02→					
2.2 16V	108	04/02→					
2.2 direct	114	10/03→					
2.2 DTI 16V	92	04/02→					
2.2 DTI 16V	86	04/02→12/04	⬅	→ 48045597	1	24.8190-0719.2 620719	L= 685,5
			⬅	48045598→	1	24.8190-0720.2 620720	L= 287
2.8 V6 Turbo	169	08/05→	⬅	→ 10/08; → 48045597	1	24.8190-0721.2 620721	L= 700
2.8 V6 Turbo	184	08/06→	⬅	→ 10/08; 48045598→	1	24.8190-0722.2 620722	L= 302
3.0 CDTi	135	08/05→					
3.0 CDTI	130	06/03→					
2.8 V6 Turbo	188	08/05→	⬅	→ 10/08	1	24.8190-0722.2 620722	L= 302
2.8 V6 Turbo OPC	206	09/06→09/08	⬅		1	24.8190-0722.2 620722	L= 302
3.2 V6	155	08/02→	⬅	→ 31070293 / 38047797	1	24.8190-0719.2 620719	L= 685,5
↓							



	kW			 	! #		
OPEL - VECTRA C 04/02→							
Warnkontakt, Bremsbelagverschleiß							
3.2 V6	155	08/02→	←	31070294 / 38047798 → 48045597	1	24.8190-0721.2 620721	L= 700
			←	→ 10/08; 48045598→	1	24.8190-0722.2 620722	L= 302
Bremsscheibe							
1.6 1.6 16V 1.9 CDTi 1.9 CDTi 2.0 DTi 16V	77 74 88 110 74	01/06→ 06/04→ 04/04→01/09 04/04→ 04/02→	←	→ 10/08		24.0125-0141.1 425141 24.0325-0141.1 525141	Ø 285 24,9 22 V + S Ø 285 24,9 22 V + S PD
			→	→ 10/08		24.0112-0157.1 412157 24.0120-0173.1 420173 24.0312-0157.1 512157 24.0320-0173.1 520173	Ø 278 11,9 10 + S Ø 292 19,9 18 V + S Ø 278 11,9 10 + S PD Ø 292 19,9 18 V + S PD
1.8 1.8 16V 2.2 16V 2.2 direct 2.2 DTi 16V	81 90 108 114 92	04/02→ 04/02→ 04/02→ 10/03→ 04/02→	←	für Fahrzeuge ohne Sportfahrwerk; → 10/08		24.0125-0141.1 425141 24.0325-0141.1 525141	Ø 285 24,9 22 V + S Ø 285 24,9 22 V + S PD
			←	für Fahrzeuge mit Sportfahrwerk; → 10/08		24.0128-0137.1 428137 24.0328-0137.1 528137	Ø 302 28 25 V + S Ø 302 28 25 V + S PD
			→	→ 10/08		24.0112-0157.1 412157 24.0120-0173.1 420173 24.0312-0157.1 512157 24.0320-0173.1 520173	Ø 278 11,9 10 + S Ø 292 19,9 18 V + S Ø 278 11,9 10 + S PD Ø 292 19,9 18 V + S PD
1.8	103	01/06→	←	→ 10/08; für Fahrzeuge mit Sportfahrwerk; nicht für Polizeifahrzeuge		24.0125-0141.1 425141 24.0325-0141.1 525141	Ø 285 24,9 22 V + S Ø 285 24,9 22 V + S PD
			←	→ 10/08; für Fahrzeuge mit Sportfahrwerk; für Polizeifahrzeuge		24.0128-0137.1 428137 24.0328-0137.1 528137	Ø 302 28 25 V + S Ø 302 28 25 V + S PD
			→	→ 10/08		24.0112-0157.1 412157 24.0120-0173.1 420173 24.0312-0157.1 512157 24.0320-0173.1 520173	Ø 278 11,9 10 + S Ø 292 19,9 18 V + S Ø 278 11,9 10 + S PD Ø 292 19,9 18 V + S PD
1.9 CDTi	74	10/05→	←	→ 10/08; nicht für Polizeifahrzeuge		24.0125-0141.1 425141 24.0325-0141.1 525141	Ø 285 24,9 22 V + S Ø 285 24,9 22 V + S PD
			←	→ 10/08; für Polizeifahrzeuge		24.0128-0137.1 428137 24.0328-0137.1 528137	Ø 302 28 25 V + S Ø 302 28 25 V + S PD
			→	→ 10/08		24.0112-0157.1 412157 24.0120-0173.1 420173 24.0312-0157.1 512157 24.0320-0173.1 520173	Ø 278 11,9 10 + S Ø 292 19,9 18 V + S Ø 278 11,9 10 + S PD Ø 292 19,9 18 V + S PD
2.0 16V Turbo	129	03/03→	←	→ 10/08		24.0128-0137.1 428137 24.0328-0137.1 528137	Ø 302 28 25 V + S Ø 302 28 25 V + S PD
			→	→ 10/08		24.0112-0157.1 412157 24.0120-0173.1 420173 24.0312-0157.1 512157 24.0320-0173.1 520173	Ø 278 11,9 10 + S Ø 292 19,9 18 V + S Ø 278 11,9 10 + S PD Ø 292 19,9 18 V + S PD
2.2 DTi 16V	86	04/02→12/04	←	für Fahrzeuge ohne Sportfahrwerk		24.0125-0141.1 425141 24.0325-0141.1 525141	Ø 285 24,9 22 V + S Ø 285 24,9 22 V + S PD
			←	für Fahrzeuge mit Sportfahrwerk		24.0128-0137.1 428137 24.0328-0137.1 528137	Ø 302 28 25 V + S Ø 302 28 25 V + S PD
			→			24.0112-0157.1 412157 24.0120-0173.1 420173 24.0312-0157.1 512157 24.0320-0173.1 520173	Ø 278 11,9 10 + S Ø 292 19,9 18 V + S Ø 278 11,9 10 + S PD Ø 292 19,9 18 V + S PD
2.8 V6 Turbo 3.0 CDTi	169 135	08/05→ 08/05→	←	61000001→; → 10/08		24.0128-0164.1 428164	Ø 314 28 25 V + S
			→	→ 10/08		24.0112-0157.1 412157 24.0120-0173.1 420173 24.0312-0157.1 512157 24.0320-0173.1 520173	Ø 278 11,9 10 + S Ø 292 19,9 18 V + S Ø 278 11,9 10 + S PD Ø 292 19,9 18 V + S PD
2.8 V6 Turbo	184	08/06→	←	→ 10/08		24.0128-0164.1 428164	Ø 314 28 25 V + S
			→	→ 10/08		24.0112-0157.1 412157 24.0120-0173.1 420173 24.0312-0157.1 512157 24.0320-0173.1 520173	Ø 278 11,9 10 + S Ø 292 19,9 18 V + S Ø 278 11,9 10 + S PD Ø 292 19,9 18 V + S PD
2.8 V6 Turbo	188	08/05→	←	61000001→; → 10/08		24.0130-0189.1 430189	Ø 345 29,9 27,5 V
			→	→ 10/08		24.0112-0157.1 412157	Ø 278 11,9 10 + S

	kW			 	! #		
OPEL - VECTRA C 04/02→							
 Bremsscheibe							
2.8 V6 Turbo	188	08/05→	➔	→ 10/08		24.0120-0173.1 420173 24.0312-0157.1 512157 24.0320-0173.1 520173	Ø 292 19,9 18 V + S Ø 278 11,9 10 + S PD Ø 292 19,9 18 V + S PD
2.8 V6 Turbo OPC	206	09/06→09/08	➔	61000001→		24.0130-0189.1 430189	Ø 345 29,9 27,5 V
			➔			24.0112-0157.1 412157	Ø 278 11,9 10 + S
			➔			24.0120-0173.1 420173	Ø 292 19,9 18 V + S
			➔			24.0312-0157.1 512157	Ø 278 11,9 10 + S PD
3.0 CDTI 3.2 V6	130 155	06/03→ 08/02→	➔	→ 31070293		24.0128-0137.1 428137 24.0328-0137.1 528137	Ø 302 28 25 V + S Ø 302 28 25 V + S PD
			➔	31070294→; → 10/08		24.0128-0164.1 428164	Ø 314 28 25 V + S
			➔	→ 10/08		24.0112-0157.1 412157	Ø 278 11,9 10 + S
			➔			24.0120-0173.1 420173	Ø 292 19,9 18 V + S
			➔			24.0312-0157.1 512157	Ø 278 11,9 10 + S PD
			➔			24.0320-0173.1 520173	Ø 292 19,9 18 V + S PD
OPEL - VECTRA C Caravan 10/03→							
 Bremsbelagsatz, Scheibenbremse							
1.6	77	01/06→	➔	06/06→ 10/08; für Bremssattel mit Kunststoffkolben		13.0460-7172.2 607172 13.0470-7172.2 LD7172	ATE 23378 20,1 + WE / - WK ATE 23378 20,1 + WE / - WK Ceramic
			➔	06/06→ 10/08; für Bremssattel mit Stahlkolben		13.0460-7212.2 607212	ATE 23738 20,1 + WE / - WK
			➔	06/06→; → 41096248 / 48091178		13.0460-7194.2 607194 13.0470-7194.2 LD7194	ATE 23482 16,6 - WE / - WK ATE 23482 16,6 - WE / - WK Ceramic
			➔	41096249 / 48091179→; → 10/08		13.0460-7195.2 607195 13.0470-7195.2 LD7195	ATE 23482 16,6 - WE / - WK ATE 23482 16,6 - WE / - WK Ceramic
1.6 16V 1.8 1.8 1.8 1.9 CDTI 1.9 CDTI 1.9 CDTI 2.0 DTI 2.0 Turbo 2.2 direct 2.2 DTI	74 90 103 74 88 110 74 129 114 92	06/04→ 10/03→ 01/06→ 10/05→ 04/04→01/09 04/04→ 10/03→ 10/03→ 10/03→ 10/03→	➔	→ 10/08; für Bremssattel mit Kunststoffkolben		13.0460-7172.2 607172 13.0470-7172.2 LD7172	ATE 23378 20,1 + WE / - WK ATE 23378 20,1 + WE / - WK Ceramic
			➔	→ 10/08; für Bremssattel mit Stahlkolben		13.0460-7212.2 607212	ATE 23738 20,1 + WE / - WK
			➔	→ 41096248 / 48091178		13.0460-7194.2 607194 13.0470-7194.2 LD7194	ATE 23482 16,6 - WE / - WK ATE 23482 16,6 - WE / - WK Ceramic
			➔	41096249 / 48091179→; → 10/08		13.0460-7195.2 607195 13.0470-7195.2 LD7195	ATE 23482 16,6 - WE / - WK ATE 23482 16,6 - WE / - WK Ceramic
			➔			13.0460-7172.2 607172 13.0470-7172.2 LD7172	ATE 23378 20,1 + WE / - WK ATE 23378 20,1 + WE / - WK Ceramic
			➔			13.0460-7212.2 607212	ATE 23738 20,1 + WE / - WK
2.2 DTI	86	10/03→06/08	➔	für Bremssattel mit Kunststoffkolben		13.0460-7172.2 607172 13.0470-7172.2 LD7172	ATE 23378 20,1 + WE / - WK ATE 23378 20,1 + WE / - WK Ceramic
			➔	für Bremssattel mit Stahlkolben		13.0460-7212.2 607212	ATE 23738 20,1 + WE / - WK
			➔	→ 41096248 / 48091178		13.0460-7194.2 607194 13.0470-7194.2 LD7194	ATE 23482 16,6 - WE / - WK ATE 23482 16,6 - WE / - WK Ceramic
			➔	41096249 / 48091179→		13.0460-7195.2 607195 13.0470-7195.2 LD7195	ATE 23482 16,6 - WE / - WK ATE 23482 16,6 - WE / - WK Ceramic
2.8 V6 Turbo 2.8 V6 Turbo 3.0 V6 CDTI 3.0 V6 CDTI 3.2 V6	169 184 130 135 155	08/05→ 01/07→ 10/03→ 08/05→ 10/03→	➔	→ 10/08		13.0460-7199.2 607199	ATE 23404 20,6 + WE / - WK
			➔	→ 41096248 / 48091178		13.0460-7194.2 607194 13.0470-7194.2 LD7194	ATE 23482 16,6 - WE / - WK ATE 23482 16,6 - WE / - WK Ceramic
			➔	41096249 / 48091179→; → 10/08		13.0460-7195.2 607195 13.0470-7195.2 LD7195	ATE 23482 16,6 - WE / - WK ATE 23482 16,6 - WE / - WK Ceramic
			➔			13.0460-7194.2 607194 13.0470-7194.2 LD7194	ATE 23482 16,6 - WE / - WK ATE 23482 16,6 - WE / - WK Ceramic
2.8 V6 Turbo 2.8 V6 Turbo	188 206	08/05→ 01/07→	➔	→ 41096248 / 48091178		13.0460-7194.2 607194 13.0470-7194.2 LD7194	ATE 23482 16,6 - WE / - WK ATE 23482 16,6 - WE / - WK Ceramic
			➔	41096249 / 48091179→; → 10/08		13.0460-7195.2 607195 13.0470-7195.2 LD7195	ATE 23482 16,6 - WE / - WK ATE 23482 16,6 - WE / - WK Ceramic
↓							



	kW			 	! #		
OPEL - VECTRA C Caravan 10/03→							
Warnkontakt, Bremsbelagverschleiß							
1.6	77	01/06→	←	06/06→ 10/08; → 48045597	1	24.8190-0719.2 620719	L= 685,5
			←	06/06→ 10/08; 48045598→	1	24.8190-0720.2 620720	L= 287
1.6 16V	74	06/04→	←	→ 10/08; → 48045597	1	24.8190-0719.2 620719	L= 685,5
1.8	90	10/03→	←	→ 10/08; 48045598→	1	24.8190-0720.2 620720	L= 287
1.8	103	01/06→	←				
1.9 CDTI	74	10/05→					
1.9 CDTI	88	04/04→01/09					
1.9 CDTI	110	04/04→					
2.0 DTI	74	10/03→					
2.0 Turbo	129	10/03→					
2.2 direct	114	10/03→					
2.2 DTI	92	10/03→					
2.2 DTI	86	10/03→06/08	←	→ 48045597	1	24.8190-0719.2 620719	L= 685,5
			←	48045598→	1	24.8190-0720.2 620720	L= 287
2.8 V6 Turbo	169	08/05→	←	→ 10/08; → 48045597	1	24.8190-0721.2 620721	L= 700
2.8 V6 Turbo	184	01/07→	←	→ 10/08; 48045598→	1	24.8190-0722.2 620722	L= 302
3.0 V6 CDTI	130	10/03→	←				
3.0 V6 CDTI	135	08/05→					
3.2 V6	155	10/03→					
2.8 V6 Turbo	188	08/05→	←	→ 10/08	1	24.8190-0722.2 620722	L= 302
2.8 V6 Turbo	206	01/07→					
Bremsscheibe							
1.6	77	01/06→	←	06/06→ 10/08		24.0125-0141.1 425141 24.0325-0141.1 525141	Ø 285 24,9 22 V + S Ø 285 24,9 22 V + S PD
			→	06/06→ 10/08		24.0112-0157.1 412157 24.0120-0173.1 420173 24.0312-0157.1 512157 24.0320-0173.1 520173	Ø 278 11,9 10 + S Ø 292 19,9 18 V + S Ø 278 11,9 10 + S PD Ø 292 19,9 18 V + S PD
1.6 16V	74	06/04→	←	→ 10/08		24.0125-0141.1 425141 24.0325-0141.1 525141	Ø 285 24,9 22 V + S Ø 285 24,9 22 V + S PD
2.0 DTI	74	10/03→	→	→ 10/08		24.0112-0157.1 412157 24.0120-0173.1 420173 24.0312-0157.1 512157 24.0320-0173.1 520173	Ø 278 11,9 10 + S Ø 292 19,9 18 V + S Ø 278 11,9 10 + S PD Ø 292 19,9 18 V + S PD
1.8	90	10/03→	←	für Fahrzeuge ohne Sportfahrwerk; → 10/08		24.0125-0141.1 425141 24.0325-0141.1 525141	Ø 285 24,9 22 V + S Ø 285 24,9 22 V + S PD
1.9 CDTI	110	04/04→	←	für Fahrzeuge mit Sportfahrwerk; → 10/08		24.0128-0137.1 428137 24.0328-0137.1 528137	Ø 302 28 25 V + S Ø 302 28 25 V + S PD
2.2 direct	114	10/03→	→	→ 10/08		24.0112-0157.1 412157 24.0120-0173.1 420173 24.0312-0157.1 512157 24.0320-0173.1 520173	Ø 278 11,9 10 + S Ø 292 19,9 18 V + S Ø 278 11,9 10 + S PD Ø 292 19,9 18 V + S PD
2.2 DTI	92	10/03→	→	→ 10/08		24.0112-0157.1 412157 24.0120-0173.1 420173 24.0312-0157.1 512157 24.0320-0173.1 520173	Ø 278 11,9 10 + S Ø 292 19,9 18 V + S Ø 278 11,9 10 + S PD Ø 292 19,9 18 V + S PD
1.8	103	01/06→	←	→ 10/08; für Fahrzeuge mit Sportfahrwerk; nicht für Polizeifahrzeuge		24.0125-0141.1 425141 24.0325-0141.1 525141	Ø 285 24,9 22 V + S Ø 285 24,9 22 V + S PD
			←	→ 10/08; für Fahrzeuge mit Sportfahrwerk; für Polizeifahrzeuge		24.0128-0137.1 428137 24.0328-0137.1 528137	Ø 302 28 25 V + S Ø 302 28 25 V + S PD
			→	→ 10/08		24.0112-0157.1 412157 24.0120-0173.1 420173 24.0312-0157.1 512157 24.0320-0173.1 520173	Ø 278 11,9 10 + S Ø 292 19,9 18 V + S Ø 278 11,9 10 + S PD Ø 292 19,9 18 V + S PD
1.9 CDTI	74	10/05→	←	→ 10/08; für Fahrzeuge ohne Sportfahrwerk; nicht für Polizeifahrzeuge		24.0125-0141.1 425141 24.0325-0141.1 525141	Ø 285 24,9 22 V + S Ø 285 24,9 22 V + S PD
1.9 CDTI	88	04/04→01/09	←	→ 10/08; für Fahrzeuge mit Sportfahrwerk; für Polizeifahrzeuge		24.0128-0137.1 428137 24.0328-0137.1 528137	Ø 302 28 25 V + S Ø 302 28 25 V + S PD
			→	→ 10/08		24.0112-0157.1 412157 24.0120-0173.1 420173 24.0312-0157.1 512157 24.0320-0173.1 520173	Ø 278 11,9 10 + S Ø 292 19,9 18 V + S Ø 278 11,9 10 + S PD Ø 292 19,9 18 V + S PD
2.0 Turbo	129	10/03→	←	→ 10/08		24.0128-0137.1 428137 24.0328-0137.1 528137	Ø 302 28 25 V + S Ø 302 28 25 V + S PD
			→	→ 10/08		24.0112-0157.1 412157 24.0120-0173.1 420173 24.0312-0157.1 512157	Ø 278 11,9 10 + S Ø 292 19,9 18 V + S Ø 278 11,9 10 + S PD



OPEL - VECTRA C Caravan 10/03→







Bremsscheibe







2.0 Turbo	129	10/03→	➔	→ 10/08	24.0320-0173.1 520173	Ø 292 19,9 18 V + S PD
2.2 DTI	86	10/03→06/08	←	für Fahrzeuge ohne Sportfahrwerk	24.0125-0141.1 425141	Ø 285 24,9 22 V + S
				24.0325-0141.1 525141	Ø 285 24,9 22 V + S PD	
			←	für Fahrzeuge mit Sportfahrwerk	24.0128-0137.1 428137	Ø 302 28 25 V + S
				24.0328-0137.1 528137	Ø 302 28 25 V + S PD	
2.8 V6 Turbo	169	08/05→	←	61000001→; → 10/08	24.0128-0164.1 428164	Ø 314 28 25 V + S
				➔	→ 10/08	24.0112-0157.1 412157
			➔		24.0120-0173.1 420173	Ø 292 19,9 18 V + S
					24.0312-0157.1 512157	Ø 278 11,9 10 + S PD
2.8 V6 Turbo 3.0 V6 CDTI	184 135	01/07→ 08/05→	←	→ 10/08	24.0128-0164.1 428164	Ø 314 28 25 V + S
				➔	→ 10/08	24.0112-0157.1 412157
			➔		24.0120-0173.1 420173	Ø 292 19,9 18 V + S
					24.0312-0157.1 512157	Ø 278 11,9 10 + S PD
2.8 V6 Turbo	188	08/05→	←	61000001→; → 10/08	24.0130-0189.1 430189	Ø 345 29,9 27,5 V
				➔	→ 10/08	24.0112-0157.1 412157
			➔		24.0120-0173.1 420173	Ø 292 19,9 18 V + S
					24.0312-0157.1 512157	Ø 278 11,9 10 + S PD
2.8 V6 Turbo	206	01/07→	←	→ 10/08	24.0130-0189.1 430189	Ø 345 29,9 27,5 V
				➔	→ 10/08	24.0112-0157.1 412157
			➔		24.0120-0173.1 420173	Ø 292 19,9 18 V + S
					24.0312-0157.1 512157	Ø 278 11,9 10 + S PD
3.0 V6 CDTI 3.2 V6	130 155	10/03→ 10/03→	←	→ 31070293	24.0128-0137.1 428137	Ø 302 28 25 V + S
				24.0328-0137.1 528137	Ø 302 28 25 V + S PD	
			←	31070294→; → 10/08	24.0128-0164.1 428164	Ø 314 28 25 V + S
				➔	→ 10/08	24.0112-0157.1 412157
		24.0120-0173.1 420173	Ø 292 19,9 18 V + S			
		24.0312-0157.1 512157	Ø 278 11,9 10 + S PD			
		24.0320-0173.1 520173	Ø 292 19,9 18 V + S PD			

OPEL - VECTRA C GTS 08/02→













Bremsbelagsatz, Scheibenbremse















1.6 1.6 1.8 1.9 CDTI	74 77 103 74	08/05→ 01/06→ 01/06→ 10/05→	←	→ 10/08; für Bremssattel mit Kunststoffkolben	13.0460-7172.2 607172	ATE 23378 20,1 + WE / - WK
				13.0470-7172.2 LD7172	ATE 23378 20,1 + WE / - WK Ceramic	
			←	→ 10/08; für Bremssattel mit Stahlkolben	13.0460-7212.2 607212	ATE 23738 20,1 + WE / - WK
				➔	→ 10/08	13.0460-7194.2 607194
				13.0460-7195.2 607195	ATE 23482 16,6 - WE / - WK	
				13.0470-7194.2 LD7194	ATE 23482 16,6 - WE / - WK Ceramic	
				13.0470-7195.2 LD7195	ATE 23482 16,6 - WE / - WK Ceramic	
1.8 16V 2.2 DTI 16V	81 86	08/02→12/06 08/02→06/08	←	für Bremssattel mit Kunststoffkolben	13.0460-7172.2 607172	ATE 23378 20,1 + WE / - WK
				13.0470-7172.2 LD7172	ATE 23378 20,1 + WE / - WK Ceramic	
			←	für Bremssattel mit Stahlkolben	13.0460-7212.2 607212	ATE 23738 20,1 + WE / - WK
				➔	41096249 / 48091179→	13.0460-7194.2 607194
				13.0460-7195.2 607195	ATE 23482 16,6 - WE / - WK	
				13.0470-7194.2 LD7194	ATE 23482 16,6 - WE / - WK Ceramic	
				13.0470-7195.2 LD7195	ATE 23482 16,6 - WE / - WK Ceramic	
			➔	→ 41096248 / 48091178	13.0460-7194.2 607194	ATE 23482 16,6 - WE / - WK
					13.0470-7194.2 LD7194	ATE 23482 16,6 - WE / - WK Ceramic

	kW			 	! #		
OPEL - VECTRA C GTS 08/02→							
Bremsbelagsatz, Scheibenbremse							
1.8 16V 1.9 CDTi 1.9 CDTi 2.0 16V Turbo 2.0 DTI 16V 2.2 16V 2.2 direct 2.2 DTI 16V	90 88 110 129 74 108 114 92	08/02→ 04/04→01/09 04/04→ 03/03→ 08/02→ 08/02→ 10/03→ 08/02→	← ← → →	→ 10/08; für Bremssattel mit Kunststoffkolben → 10/08; für Bremssattel mit Stahlkolben → 41096248 / 48091178 41096249 / 48091179→; → 10/08		13.0460-7172.2 607172 13.0470-7172.2 LD7172 13.0460-7212.2 607212 13.0460-7194.2 607194 13.0470-7194.2 LD7194 13.0460-7194.2 607194 13.0460-7195.2 607195 13.0470-7194.2 LD7194 13.0470-7195.2 LD7195	ATE 23378 20,1 + WE / - WK ATE 23378 20,1 + WE / - WK Ceramic ATE 23738 20,1 + WE / - WK ATE 23482 16,6 - WE / - WK ATE 23482 16,6 - WE / - WK Ceramic ATE 23482 16,6 - WE / - WK ATE 23482 16,6 - WE / - WK Ceramic ATE 23482 16,6 - WE / - WK Ceramic
2.8 V6 Turbo 2.8 V6 Turbo 3.0 CDTi	169 184 135	08/05→ 08/06→ 08/05→	← →	→ 10/08 → 10/08		13.0460-7199.2 607199 13.0460-7194.2 607194 13.0460-7195.2 607195 13.0470-7194.2 LD7194 13.0470-7195.2 LD7195	ATE 23404 20,6 + WE / - WK ATE 23482 16,6 - WE / - WK ATE 23482 16,6 - WE / - WK ATE 23482 16,6 - WE / - WK Ceramic ATE 23482 16,6 - WE / - WK Ceramic
2.8 V6 Turbo 2.8 V6 Turbo	188 206	08/05→ 08/06→	→	→ 10/08		13.0460-7194.2 607194 13.0460-7195.2 607195 13.0470-7194.2 LD7194 13.0470-7195.2 LD7195	ATE 23482 16,6 - WE / - WK ATE 23482 16,6 - WE / - WK ATE 23482 16,6 - WE / - WK Ceramic ATE 23482 16,6 - WE / - WK Ceramic
3.0 CDTi	130	06/03→	← → →	→ 10/08 → 41096248 / 48091178 41096249 / 48091179→; → 10/08		13.0460-7199.2 607199 13.0460-7194.2 607194 13.0470-7194.2 LD7194 13.0460-7194.2 607194 13.0460-7195.2 607195 13.0470-7194.2 LD7194 13.0470-7195.2 LD7195	ATE 23404 20,6 + WE / - WK ATE 23482 16,6 - WE / - WK ATE 23482 16,6 - WE / - WK Ceramic ATE 23482 16,6 - WE / - WK ATE 23482 16,6 - WE / - WK Ceramic ATE 23482 16,6 - WE / - WK Ceramic
3.2 V6	155	08/02→	← ← ← ← → →	→ 31070293 / 38047797; für Bremssattel mit Kunststoffkolben 48045598→; → 10/08 31070294 / 38047798→ 48045597 → 31070293 / 38047797; für Bremssattel mit Stahlkolben → 41096248 / 48091178 41096249 / 48091179→; → 10/08		13.0460-7172.2 607172 13.0470-7172.2 LD7172 13.0460-7199.2 607199 13.0460-7199.2 607199 13.0460-7212.2 607212 13.0460-7194.2 607194 13.0470-7194.2 LD7194 13.0460-7194.2 607194 13.0460-7195.2 607195 13.0470-7194.2 LD7194 13.0470-7195.2 LD7195	ATE 23378 20,1 + WE / - WK ATE 23378 20,1 + WE / - WK Ceramic ATE 23404 20,6 + WE / - WK ATE 23404 20,6 + WE / - WK ATE 23738 20,1 + WE / - WK ATE 23482 16,6 - WE / - WK ATE 23482 16,6 - WE / - WK Ceramic ATE 23482 16,6 - WE / - WK ATE 23482 16,6 - WE / - WK Ceramic ATE 23482 16,6 - WE / - WK Ceramic
Warnkontakt, Bremsbelagverschleiß							
1.6 1.6 1.8 1.8 16V 1.9 CDTi 1.9 CDTi 1.9 CDTi 2.0 16V Turbo 2.0 DTI 16V 2.2 16V 2.2 direct 2.2 DTI 16V	74 77 103 90 74 88 110 129 74 108 114 92	08/05→ 01/06→ 01/06→ 08/02→ 10/05→ 04/04→01/09 04/04→ 03/03→ 08/02→ 08/02→ 10/03→ 08/02→	← ← ← ← → →	→ 10/08; → 48045597 → 10/08; 48045598→ → 48045597 48045598→	1 1	24.8190-0719.2 620719 24.8190-0720.2 620720	L= 685,5 L= 287
1.8 16V 2.2 DTI 16V	81 86	08/02→12/06 08/02→06/08	← ←	→ 48045597 48045598→	1 1	24.8190-0719.2 620719 24.8190-0720.2 620720	L= 685,5 L= 287
↓							











	kW			 	! #		
OPEL - VECTRA C GTS 08/02→							
Warnkontakt, Bremsbelagverschleiß							
2.8 V6 Turbo	169	08/05→	←	→ 10/08; → 48045597	1	24.8190-0721.2 620721	L= 700
2.8 V6 Turbo	184	08/06→	←	→ 10/08; 48045598→	1	24.8190-0722.2 620722	L= 302
3.0 CDTi	135	08/05→					
3.0 CDTi	130	06/03→					
2.8 V6 Turbo	188	08/05→	←	→ 10/08	1	24.8190-0722.2 620722	L= 302
2.8 V6 Turbo	206	08/06→					
3.2 V6	155	08/02→	←	→ 31070293 / 38047797	1	24.8190-0719.2 620719	L= 685,5
			←	31070294 / 38047798→ 48045597	1	24.8190-0721.2 620721	L= 700
			←	→ 10/08; 48045598→	1	24.8190-0722.2 620722	L= 302
Bremsscheibe							
1.6	74	08/05→	←	→ 10/08		24.0125-0141.1 425141	Ø 285 24,9 22 V + S
1.6	77	01/06→				24.0325-0141.1 525141	Ø 285 24,9 22 V + S PD
1.9 CDTi	88	04/04→01/09	→	→ 10/08		24.0112-0157.1 412157	Ø 278 11,9 10 + S
1.9 CDTi	110	04/04→				24.0120-0173.1 420173	Ø 292 19,9 18 V + S
2.0 DTI 16V	74	08/02→				24.0312-0157.1 512157	Ø 278 11,9 10 + S PD
						24.0320-0173.1 520173	Ø 292 19,9 18 V + S PD
1.8	103	01/06→	←	→ 10/08; für Fahrzeuge mit Sportfahrwerk; nicht für Polizeifahrzeuge	24.0125-0141.1 425141	Ø 285 24,9 22 V + S	
			←	→ 10/08; für Fahrzeuge mit Sportfahrwerk; für Polizeifahrzeuge	24.0128-0137.1 428137	Ø 302 28 25 V + S	
					24.0328-0137.1 528137	Ø 302 28 25 V + S PD	
			→	→ 10/08	24.0112-0157.1 412157	Ø 278 11,9 10 + S	
						24.0120-0173.1 420173	Ø 292 19,9 18 V + S
						24.0312-0157.1 512157	Ø 278 11,9 10 + S PD
						24.0320-0173.1 520173	Ø 292 19,9 18 V + S PD
1.8 16V 2.2 DTI 16V	81 86	08/02→12/06 08/02→06/08	←	für Fahrzeuge ohne Sportfahrwerk	24.0125-0141.1 425141	Ø 285 24,9 22 V + S	
			←	für Fahrzeuge mit Sportfahrwerk	24.0128-0137.1 428137	Ø 302 28 25 V + S	
					24.0328-0137.1 528137	Ø 302 28 25 V + S PD	
			→		24.0112-0157.1 412157	Ø 278 11,9 10 + S	
						24.0120-0173.1 420173	Ø 292 19,9 18 V + S
						24.0312-0157.1 512157	Ø 278 11,9 10 + S PD
						24.0320-0173.1 520173	Ø 292 19,9 18 V + S PD
1.8 16V 2.2 16V 2.2 direct 2.2 DTI 16V	90 108 114 92	08/02→ 08/02→ 10/03→ 08/02→	←	für Fahrzeuge ohne Sportfahrwerk; → 10/08	24.0125-0141.1 425141	Ø 285 24,9 22 V + S	
			←	für Fahrzeuge mit Sportfahrwerk; → 10/08	24.0325-0141.1 525141	Ø 285 24,9 22 V + S PD	
					24.0128-0137.1 428137	Ø 302 28 25 V + S	
			→	→ 10/08	24.0328-0137.1 528137	Ø 302 28 25 V + S PD	
						24.0112-0157.1 412157	Ø 278 11,9 10 + S
						24.0120-0173.1 420173	Ø 292 19,9 18 V + S
						24.0312-0157.1 512157	Ø 278 11,9 10 + S PD
						24.0320-0173.1 520173	Ø 292 19,9 18 V + S PD
1.9 CDTi	74	10/05→	←	→ 10/08; nicht für Polizeifahrzeuge	24.0125-0141.1 425141	Ø 285 24,9 22 V + S	
			←	→ 10/08; für Polizeifahrzeuge	24.0325-0141.1 525141	Ø 285 24,9 22 V + S PD	
					24.0128-0137.1 428137	Ø 302 28 25 V + S	
			→	→ 10/08	24.0328-0137.1 528137	Ø 302 28 25 V + S PD	
						24.0112-0157.1 412157	Ø 278 11,9 10 + S
						24.0120-0173.1 420173	Ø 292 19,9 18 V + S
						24.0312-0157.1 512157	Ø 278 11,9 10 + S PD
						24.0320-0173.1 520173	Ø 292 19,9 18 V + S PD
2.0 16V Turbo	129	03/03→	←	→ 10/08	24.0128-0137.1 428137	Ø 302 28 25 V + S	
			→	→ 10/08	24.0328-0137.1 528137	Ø 302 28 25 V + S PD	
						24.0112-0157.1 412157	Ø 278 11,9 10 + S
						24.0120-0173.1 420173	Ø 292 19,9 18 V + S
						24.0312-0157.1 512157	Ø 278 11,9 10 + S PD
						24.0320-0173.1 520173	Ø 292 19,9 18 V + S PD
2.8 V6 Turbo 3.0 CDTi	169 135	08/05→ 08/05→	←	61000001→; → 10/08	24.0128-0164.1 428164	Ø 314 28 25 V + S	
			→	→ 10/08	24.0112-0157.1 412157	Ø 278 11,9 10 + S	
						24.0120-0173.1 420173	Ø 292 19,9 18 V + S
						24.0312-0157.1 512157	Ø 278 11,9 10 + S PD
						24.0320-0173.1 520173	Ø 292 19,9 18 V + S PD
2.8 V6 Turbo	184	08/06→	←	→ 10/08	24.0128-0164.1 428164	Ø 314 28 25 V + S	
			→	→ 10/08	24.0112-0157.1 412157	Ø 278 11,9 10 + S	























	kW			 	! #		
OPEL - VECTRA C GTS 08/02→							
 Bremsscheibe							
2.8 V6 Turbo	184	08/06→	→	→ 10/08		24.0120-0173.1 420173 24.0312-0157.1 512157 24.0320-0173.1 520173	Ø 292 19,9 18 V + S Ø 278 11,9 10 + S PD Ø 292 19,9 18 V + S PD
2.8 V6 Turbo	188	08/05→	←	61000001→; → 10/08		24.0130-0189.1 430189	Ø 345 29,9 27,5 V
2.8 V6 Turbo	206	08/06→	→	→ 10/08		24.0112-0157.1 412157 24.0120-0173.1 420173 24.0312-0157.1 512157 24.0320-0173.1 520173	Ø 278 11,9 10 + S Ø 292 19,9 18 V + S Ø 278 11,9 10 + S PD Ø 292 19,9 18 V + S PD
3.0 CDTI	130	06/03→	←	→ 31070293		24.0128-0137.1 428137 24.0328-0137.1 528137	Ø 302 28 25 V + S Ø 302 28 25 V + S PD
3.2 V6	155	08/02→	←	31070294→; → 10/08		24.0128-0164.1 428164	Ø 314 28 25 V + S
			→	→ 10/08		24.0112-0157.1 412157 24.0120-0173.1 420173 24.0312-0157.1 512157 24.0320-0173.1 520173	Ø 278 11,9 10 + S Ø 292 19,9 18 V + S Ø 278 11,9 10 + S PD Ø 292 19,9 18 V + S PD
OPEL - VIVARO Combi 06/14→							
 Bremsbelagsatz, Scheibenbremse							
1.6 CDTI	66	06/14→	→	07/14→		13.0460-2840.2 602840	TRW 23980 16,5 + WE / - WK
1.6 CDTI	85	06/14→					
1.6 CDTI	88	06/14→					
1.6 CDTI	103	06/14→					
1.6 CDTI	70	04/15→	→			13.0460-2840.2 602840	TRW 23980 16,5 + WE / - WK
1.6 CDTI	92	04/15→					
1.6 CDTI	107	04/15→					
 Bremsscheibe							
1.6 CDTI	66	06/14→	←	07/14→		24.0128-0287.1 428287	Ø 296 28 23,4 V + S
1.6 CDTI	85	06/14→					
1.6 CDTI	88	06/14→					
1.6 CDTI	103	06/14→					
1.6 CDTI	70	04/15→	←			24.0128-0287.1 428287	Ø 296 28 23,4 V + S
1.6 CDTI	92	04/15→					
1.6 CDTI	107	04/15→					
OPEL - VIVARO Combi (J7) 08/01→							
 Bremsbelagsatz, Scheibenbremse							
1.9 DI	60	08/01→	←	→ 06/14		13.0460-2870.2 602870	TRW 23099 18,4 - WK
1.9 DTI	74	08/01→	→	→ 06/14		13.0460-2840.2 602840	TRW 23980 16,5 + WE / - WK
2.0 16V	88	08/01→					
2.0 CDTI	66	08/06→					
2.0 CDTI	84	08/06→					
2.0 ECOTEC	86	08/06→					
2.5 CDTI	84	08/06→					
2.5 CDTI	107	08/06→					
2.5 DTI	99	05/03→					
Zubehörsatz, Scheibenbremsbelag							
1.9 DI	60	08/01→	→	→ 06/14		13.0460-0072.2 610072	TRW
1.9 DTI	74	08/01→					
2.0 16V	88	08/01→					
2.0 CDTI	66	08/06→					
2.0 CDTI	84	08/06→					
2.0 ECOTEC	86	08/06→					
2.5 CDTI	84	08/06→					
2.5 CDTI	107	08/06→					
2.5 DTI	99	05/03→					
 Bremsscheibe							
1.9 DI	60	08/01→	←	→ 06/14		24.0128-0132.1 428132	Ø 305 28 24 V + S
1.9 DTI	74	08/01→	→	→ 06/14		24.0112-0177.2 412177	Ø 280 12 10 + LG / + ABS Ring
2.0 16V	88	08/01→					
2.0 CDTI	66	08/06→					
2.0 CDTI	84	08/06→					
2.0 ECOTEC	86	08/06→					
2.5 CDTI	84	08/06→					
2.5 CDTI	107	08/06→					
2.5 DTI	99	05/03→					
OPEL - VIVARO Kasten 06/14→							
 Bremsbelagsatz, Scheibenbremse							
1.6 CDTI	66	06/14→	→	07/14→		13.0460-2840.2 602840	TRW 23980 16,5 + WE / - WK







	kw			 	! #		
OPEL - VIVARO Kasten 06/14→							
 Bremsbelagsatz, Scheibenbremse							
1.6 CDTI	85	06/14→	➔	07/14→		13.0460-2840.2 602840	TRW 23980 16,5 + WE / - WK
1.6 CDTI	88	06/14→					
1.6 CDTI	103	06/14→					
1.6 CDTI	70	08/16→	➔			13.0460-2840.2 602840	TRW 23980 16,5 + WE / - WK
1.6 CDTI	92	03/16→					
1.6 CDTI	107	03/16→					
 Bremsscheibe							
1.6 CDTI	66	06/14→	➔	07/14→		24.0128-0287.1 428287	Ø 296 28 23,4 V + S
1.6 CDTI	85	06/14→					
1.6 CDTI	88	06/14→					
1.6 CDTI	103	06/14→					
1.6 CDTI	70	08/16→	➔			24.0128-0287.1 428287	Ø 296 28 23,4 V + S
1.6 CDTI	92	03/16→					
1.6 CDTI	107	03/16→					
OPEL - VIVARO Kasten (F7) 08/01→							
 Bremsbelagsatz, Scheibenbremse							
1.9 DI	60	08/01→	➔	→ 06/14		13.0460-2870.2 602870	TRW 23099 18,4 - WK
1.9 DTI	74	08/01→					
2.0 16V	88	08/01→	➔	→ 06/14		13.0460-2840.2 602840	TRW 23980 16,5 + WE / - WK
2.0 CDTI	66	08/06→					
2.0 CDTI	84	08/06→					
2.0 ECOTEC	86	08/06→					
2.5 CDTI	84	08/06→					
2.5 CDTI	107	08/06→					
2.5 DTI	99	05/03→					
Zubehörsatz, Scheibenbremsbelag							
1.9 DI	60	08/01→	➔	→ 06/14		13.0460-0072.2 610072	TRW
1.9 DTI	74	08/01→					
2.0 16V	88	08/01→					
2.0 CDTI	66	08/06→					
2.0 CDTI	84	08/06→					
2.0 ECOTEC	86	08/06→					
2.5 CDTI	84	08/06→					
2.5 CDTI	107	08/06→					
2.5 DTI	99	05/03→					
 Bremsscheibe							
1.9 DI	60	08/01→	➔	→ 06/14		24.0128-0132.1 428132	Ø 305 28 24 V + S
1.9 DTI	74	08/01→					
2.0 16V	88	08/01→	➔	→ 06/14		24.0112-0177.2 412177	Ø 280 12 10 + LG / + ABS Ring
2.0 CDTI	66	08/06→					
2.0 CDTI	84	08/06→					
2.0 ECOTEC	86	08/06→					
2.5 CDTI	84	08/06→					
2.5 CDTI	107	08/06→					
2.5 DTI	99	05/03→					
OPEL - VIVARO Pritsche/Fahrgestell 06/14→							
 Bremsbelagsatz, Scheibenbremse							
1.6 CDTI	66	06/14→	➔	07/14→		13.0460-2840.2 602840	TRW 23980 16,5 + WE / - WK
1.6 CDTI	85	06/14→					
1.6 CDTI	88	08/15→	➔			13.0460-2840.2 602840	TRW 23980 16,5 + WE / - WK
1.6 CDTI	92	11/16→					
1.6 CDTI	103	08/15→					
1.6 CDTI	107	11/16→					
 Bremsscheibe							
1.6 CDTI	66	06/14→	➔	07/14→		24.0128-0287.1 428287	Ø 296 28 23,4 V + S
1.6 CDTI	85	06/14→					
1.6 CDTI	88	08/15→	➔			24.0128-0287.1 428287	Ø 296 28 23,4 V + S
1.6 CDTI	92	11/16→					
1.6 CDTI	103	08/15→					
1.6 CDTI	107	11/16→					
OPEL - VIVARO Pritsche/Fahrgestell (E7) 08/01→							
 Bremsbelagsatz, Scheibenbremse							
1.9 Di	60	08/01→	➔	08/06→ 06/14		13.0460-2870.2 602870	TRW 23099 18,4 - WK
2.0 CDTI	66	01/06→					
2.5 DTI	99	08/03→	➔	08/06→ 06/14		13.0460-2840.2 602840	TRW 23980 16,5 + WE / - WK
1.9 DTI	74	08/06→	➔	→ 06/14		13.0460-2870.2 602870	TRW 23099 18,4 - WK
2.0 16V	88	08/03→					
2.0 CDTI	84	08/06→	➔	→ 06/14		13.0460-2840.2 602840	TRW 23980 16,5 + WE / - WK
2.0 ECOTEC	86	08/06→					
2.5 CDTI	84	08/06→					













	kW			 	! #		
OPEL - VIVARO Pritsche/Fahrgestell (E7) 08/01→							
 Bremsbelagsatz, Scheibenbremse							
2.5 CDTI	107	08/06→	←	→ 06/14		13.0460-2870.2 602870	TRW 23099 18,4 - WK
			→	→ 06/14		13.0460-2840.2 602840	TRW 23980 16,5 + WE / - WK
Zubehörsatz, Scheibenbremsbelag							
1.9 Di	60	08/01→	→	08/06→ 06/14		13.0460-0072.2 610072	TRW
2.0 CDTI	66	01/06→					
2.5 DTi	99	08/03→					
1.9 DTI	74	08/06→	→	→ 06/14		13.0460-0072.2 610072	TRW
2.0 16V	88	08/03→					
2.0 CDTI	84	08/06→					
2.0 ECOTEC	86	08/06→					
2.5 CDTI	84	08/06→					
2.5 CDTI	107	08/06→					
 Bremsscheibe							
1.9 Di	60	08/01→	←	08/06→ 06/14		24.0128-0132.1 428132	Ø 305 28 24 V + S
2.0 CDTI	66	01/06→	→	08/06→ 06/14		24.0112-0177.2 412177	Ø 280 12 10 + LG / + ABS Ring
2.5 DTi	99	08/03→					
1.9 DTI	74	08/06→	←	→ 06/14		24.0128-0132.1 428132	Ø 305 28 24 V + S
2.0 16V	88	08/03→	→	→ 06/14		24.0112-0177.2 412177	Ø 280 12 10 + LG / + ABS Ring
2.0 CDTI	84	08/06→					
2.0 ECOTEC	86	08/06→					
2.5 CDTI	84	08/06→					
2.5 CDTI	107	08/06→					
OPEL - ZAFIRA A (F75_) 04/99→06/05							
 Bremsbelagsatz, Scheibenbremse							
1.6	76	10/03→06/05	←	- ABS		13.0460-7115.2 607115	ATE 23063 17,5 ohne integrierten Verschleißsensor / + WK
1.6 16V	74	04/99→06/05					
1.6 CNG	71	09/01→06/05					
1.8 16V	85	04/99→09/00				13.0470-7115.2 LD7115	ATE 23063 17,5 - WK / + WK Ceramic
1.8 16V	92	09/00→06/05					
2.0 DTI 16V	74	09/00→06/05	←	+ ABS		13.0460-7116.2 607116	ATE 23057 20,2 - WK / + WK Ceramic
			→			13.0470-7116.2 LD7116	ATE 23057 20,2 - WK / + WK Ceramic
			→			13.0460-2868.2 602868	TRW 23417 15,3 + WK + Zub
						13.0460-3976.2 603976	BOS 23258 16,5 + WK + Zub
						13.0470-2868.2 LD2868	TRW 23417 15,3 + WK + Zub Ceramic
2.0 DI	63	07/99→06/00	←	06/00→; - ABS		13.0460-7115.2 607115	ATE 23063 17,5 ohne integrierten Verschleißsensor / + WK
						13.0470-7115.2 LD7115	ATE 23063 17,5 - WK / + WK Ceramic
			←	06/00→; + ABS		13.0460-7116.2 607116	ATE 23057 20,2 - WK / + WK Ceramic
						13.0470-7116.2 LD7116	ATE 23057 20,2 - WK / + WK Ceramic
			→	06/00→		13.0460-2868.2 602868	TRW 23417 15,3 + WK + Zub
						13.0460-3976.2 603976	BOS 23258 16,5 + WK + Zub
						13.0470-2868.2 LD2868	TRW 23417 15,3 + WK + Zub Ceramic
2.0 DI 16V	60	07/99→06/05	←	10/99→; - ABS		13.0460-7115.2 607115	ATE 23063 17,5 ohne integrierten Verschleißsensor / + WK
						13.0470-7115.2 LD7115	ATE 23063 17,5 - WK / + WK Ceramic
			←	10/99→; + ABS		13.0460-7116.2 607116	ATE 23057 20,2 - WK / + WK Ceramic
						13.0470-7116.2 LD7116	ATE 23057 20,2 - WK / + WK Ceramic
			→	10/99→		13.0460-2868.2 602868	TRW 23417 15,3 + WK + Zub
						13.0460-3976.2 603976	BOS 23258 16,5 + WK + Zub
						13.0470-2868.2 LD2868	TRW 23417 15,3 + WK + Zub Ceramic
2.0 OPC	141	09/01→06/05	←			13.0460-7173.2 607173	ATE 21829 20,3 - WK / + WK
2.0 OPC	147	11/02→06/05	→			13.0460-2868.2 602868	TRW 23417 15,3 + WK + Zub
						13.0460-3976.2 603976	BOS 23258 16,5 + WK + Zub
						13.0470-2868.2 LD2868	TRW 23417 15,3 + WK + Zub Ceramic
2.2 16V	108	09/00→06/05	←			13.0460-7116.2 607116	ATE 23057 20,2 - WK / + WK
2.2 DTI 16V	86	01/02→06/05					
2.2 DTI 16V	92	01/02→06/05					













	kw			 	! #		
OPEL - ZAFIRA A (F75_) 04/99→06/05							
 Bremsbelagsatz, Scheibenbremse							
2.2 16V	108	09/00→06/05	←			13.0470-7116.2 LD7116	ATE 23057 20,2 - WK / + WK Ceramic
2.2 DTI 16V	86	01/02→06/05					
2.2 DTI 16V	92	01/02→06/05	→			13.0460-2868.2 602868	TRW 23417 15,3 + WK + Zub
						13.0460-3976.2 603976	BOS 23258 16,5 + WK + Zub
						13.0470-2868.2 LD2868	TRW 23417 15,3 + WK + Zub Ceramic
Warnkontakt, Bremsbelagverschleiß							
1.6	76	10/03→06/05	←	42187759→	2	24.8190-0018.2 620018	L= 755
1.6 16V	74	04/99→06/05					
1.6 CNG	71	09/01→06/05	←	→ 42187758	2	24.8190-0718.2 620718	L= 720
1.8 16V	85	04/99→09/00					
1.8 16V	92	09/00→06/05					
2.0 DTI 16V	74	09/00→06/05					
2.0 OPC	141	09/01→06/05					
2.0 OPC	147	11/02→06/05					
2.0 DI	63	07/99→06/00	←	06/00→; 42187759→	2	24.8190-0018.2 620018	L= 755
			←	06/00→; → 42187758	2	24.8190-0718.2 620718	L= 720
2.0 DI 16V	60	07/99→06/05	←	10/99→; 42187759→	2	24.8190-0018.2 620018	L= 755
			←	10/99→; → 42187758	2	24.8190-0718.2 620718	L= 720
2.2 16V	108	09/00→06/05	←		2	24.8190-0718.2 620718	L= 720
2.2 DTI 16V	86	01/02→06/05					
2.2 DTI 16V	92	01/02→06/05					
 Bremsscheibe							
1.6	76	10/03→06/05	←			24.0125-0131.1 425131	Ø 280 24,8 22 V + S
1.6 16V	74	04/99→06/05				24.0325-0131.1 525131	Ø 280 24,8 22 V + S PD
1.6 CNG	71	09/01→06/05					
1.8 16V	85	04/99→09/00	→			24.0110-0250.1 410250	Ø 264 9,8 8 + S
1.8 16V	92	09/00→06/05				24.0310-0250.1 510250	Ø 264 9,8 8 + S PD
2.0 DTI 16V	74	09/00→06/05					
2.2 16V	108	09/00→06/05					
2.2 DTI 16V	86	01/02→06/05					
2.2 DTI 16V	92	01/02→06/05					
2.0 DI	63	07/99→06/00	←	06/00→		24.0125-0131.1 425131	Ø 280 24,8 22 V + S
						24.0325-0131.1 525131	Ø 280 24,8 22 V + S PD
			→	06/00→		24.0110-0250.1 410250	Ø 264 9,8 8 + S
						24.0310-0250.1 510250	Ø 264 9,8 8 + S PD
2.0 DI 16V	60	07/99→06/05	←	10/99→		24.0125-0131.1 425131	Ø 280 24,8 22 V + S
						24.0325-0131.1 525131	Ø 280 24,8 22 V + S PD
			→	10/99→		24.0110-0250.1 410250	Ø 264 9,8 8 + S
						24.0310-0250.1 510250	Ø 264 9,8 8 + S PD
2.0 OPC	141	09/01→06/05	←			24.0125-0142.1 425142	Ø 308 25 22 V + S
2.0 OPC	147	11/02→06/05				24.0325-0142.1 525142	Ø 308 25 23 V + S PD
			→			24.0110-0250.1 410250	Ø 264 9,8 8 + S
						24.0310-0250.1 510250	Ø 264 9,8 8 + S PD
OPEL - ZAFIRA B (A05) 07/05→							
 Bremsbelagsatz, Scheibenbremse							
1.6	77	07/05→	←			13.0460-7179.2 607179	ATE 23832 20,2 - WK / + WK
1.6	85	01/08→				13.0470-7179.2 LD7179	ATE 23832 20,2 - WK / + WK Ceramic
1.6 CNG	69	01/06→					
1.6 CNG Turbo	110	02/09→					
1.7 CDTI	81	01/08→	→			13.0460-2868.2 602868	TRW 23417 15,3 + WK + Zub
1.7 CDTI	92	01/08→				13.0470-2868.2 LD2868	TRW 23417 15,3 + WK + Zub Ceramic
1.8	88	06/13→					
1.8	103	07/05→					
1.9 CDTI	74	07/05→					
1.9 CDTI	88	07/05→					
1.9 CDTI	110	07/05→					
2.0	147	07/05→					
2.2	110	07/05→					
2.0	177	01/06→	←	für Bremssattel mit Kunststoffkolben		13.0460-7172.2 607172	ATE 23378 20,1 + WE / - WK
						13.0470-7172.2 LD7172	ATE 23378 20,1 + WE / - WK Ceramic
			←	für Bremssattel mit Stahlkolben		13.0460-7212.2 607212	ATE 23738 20,1 + WE / - WK
			→			13.0460-2868.2 602868	TRW 23417 15,3 + WK + Zub
						13.0470-2868.2 LD2868	TRW 23417 15,3 + WK + Zub Ceramic
↓							









	kw			 	! #		
OPEL - ZAFIRA B (A05) 07/05→							
Warnkontakt, Bremsbelagverschleiß							
1.6	77	07/05→	←		1	24.8190-0720.2 620720	L= 287
1.6	85	01/08→					
1.6 CNG	69	01/06→					
1.6 CNG Turbo	110	02/09→					
1.7 CDTI	81	01/08→					
1.7 CDTI	92	01/08→					
1.8	88	06/13→					
1.8	103	07/05→					
1.9 CDTI	74	07/05→					
1.9 CDTI	88	07/05→					
1.9 CDTI	110	07/05→					
2.0	147	07/05→					
2.0	177	01/06→					
2.2	110	07/05→					
 Bremsscheibe							
1.6	77	07/05→	←			24.0125-0131.1 425131	Ø 280 24,8 22 V + S
1.6	85	01/08→				24.0325-0131.1 525131	Ø 280 24,8 22 V + S PD
			→			24.0110-0250.1 410250	Ø 264 9,8 8 + S
						24.0310-0250.1 510250	Ø 264 9,8 8 + S PD
1.6 CNG	69	01/06→	←			24.0125-0142.1 425142	Ø 308 25 22 V + S
1.6 CNG Turbo	110	02/09→				24.0325-0142.1 525142	Ø 308 25 23 V + S PD
1.7 CDTI	81	01/08→	←			24.0125-0131.1 425131	Ø 280 24,8 22 V + S
1.7 CDTI	92	01/08→				24.0125-0142.1 425142	Ø 308 25 22 V + S
1.8	88	06/13→				24.0325-0131.1 525131	Ø 280 24,8 22 V + S PD
1.8	103	07/05→				24.0325-0142.1 525142	Ø 308 25 23 V + S PD
			→	nicht für Fahrzeuge mit verstärkter Bremse		24.0110-0250.1 410250	Ø 264 9,8 8 + S
			→	für Fahrzeuge mit verstärkter Bremse		24.0310-0250.1 510250	Ø 264 9,8 8 + S PD
			→			24.0110-0339.1 410339	Ø 278 10 8 + S
1.9 CDTI	74	07/05→	←			24.0125-0142.1 425142	Ø 308 25 22 V + S
1.9 CDTI	88	07/05→				24.0325-0142.1 525142	Ø 308 25 23 V + S PD
1.9 CDTI	110	07/05→				24.0110-0250.1 410250	Ø 264 9,8 8 + S
2.2	110	07/05→				24.0310-0250.1 510250	Ø 264 9,8 8 + S PD
			→			24.0110-0339.1 410339	Ø 278 10 8 + S
2.0	147	07/05→	←			24.0125-0142.1 425142	Ø 308 25 22 V + S
						24.0325-0142.1 525142	Ø 308 25 23 V + S PD
			→	→ 52999999		24.0110-0250.1 410250	Ø 264 9,8 8 + S
			→			24.0310-0250.1 510250	Ø 264 9,8 8 + S PD
			→	62000001→		24.0110-0339.1 410339	Ø 278 10 8 + S
2.0	177	01/06→	←			24.0128-0201.1 428201	Ø 321 28 25 V
			→			24.0110-0339.1 410339	Ø 278 10 8 + S
OPEL - ZAFIRA B Van 07/05→							
 Bremsbelagsatz, Scheibenbremse							
1.6 CNG Turbo	110	02/09→	←			13.0460-7179.2 607179	ATE 23832 20,2 - WK / + WK
1.7 CDTI	81	01/08→				13.0470-7179.2 LD7179	ATE 23832 20,2 - WK / + WK Ceramic
1.7 CDTI	92	01/08→					
1.8	103	07/05→					
			→			13.0460-2868.2 602868	TRW 23417 15,3 + WK + Zub
						13.0470-2868.2 LD2868	TRW 23417 15,3 + WK + Zub Ceramic
Warnkontakt, Bremsbelagverschleiß							
1.6 CNG Turbo	110	02/09→	←		1	24.8190-0720.2 620720	L= 287
1.7 CDTI	81	01/08→					
1.7 CDTI	92	01/08→					
1.8	103	07/05→					
 Bremsscheibe							
1.6 CNG Turbo	110	02/09→	←			24.0125-0142.1 425142	Ø 308 25 22 V + S
						24.0325-0142.1 525142	Ø 308 25 23 V + S PD
1.7 CDTI	81	01/08→	←			24.0125-0131.1 425131	Ø 280 24,8 22 V + S
1.7 CDTI	92	01/08→				24.0125-0142.1 425142	Ø 308 25 22 V + S
1.8	103	07/05→				24.0325-0131.1 525131	Ø 280 24,8 22 V + S PD
						24.0325-0142.1 525142	Ø 308 25 23 V + S PD
			→	nicht für Fahrzeuge mit verstärkter Bremse		24.0110-0250.1 410250	Ø 264 9,8 8 + S
			→			24.0310-0250.1 510250	Ø 264 9,8 8 + S PD
			→	für Fahrzeuge mit verstärkter Bremse		24.0110-0339.1 410339	Ø 278 10 8 + S











	kw					! #		
OPEL - ZAFIRA TOURER C (P12) 10/11→								
Bremsscheibe								
1.6 SIDI	125	12/12→	←			24.0130-0224.1	430224	Ø 321 30 27 V + S
1.6 SIDI	147	07/13→				24.0326-0166.1	526166	Ø 300 26 23 V + S PD
2.0 BiTurbo CDTI	143	01/13→				24.0112-0189.1	412189	Ø 292 12 10 + S
2.0 CDTi	125	01/15→	→			24.0123-0116.1	423116	Ø 315 23 20 V + S
						24.0312-0189.1	512189	Ø 292 12 10 + S PD
1.6 CDTI	100	02/13→	←	03/13→		24.0126-0166.1	426166	Ø 300 26 23 V + S
						24.0130-0224.1	430224	Ø 321 30 27 V + S
						24.0326-0166.1	526166	Ø 300 26 23 V + S PD
			→	03/13→		24.0112-0189.1	412189	Ø 292 12 10 + S
						24.0123-0116.1	423116	Ø 315 23 20 V + S
						24.0312-0189.1	512189	Ø 292 12 10 + S PD
PEUGEOT - 106 I (1A, 1C) 08/91→04/96								
Bremsbelagsatz, Scheibenbremse								
1.0	33	09/91→04/96	←	→ S 50994342; - ABS; Felge Lochzahl: 4		13.0460-3943.2	603943	BDX 20905 18,0 + WK
1.0	37	09/91→04/96	←	+ ABS		13.0460-3943.2	603943	BDX 20905 18,0 + WK
1.1	44	09/91→04/96	←	S 50994343→; - ABS; Felge Lochzahl: 4		13.0460-3962.2	603962	BDX 20905 18,0 + WE / - WK
			←	→ S 50994342; - ABS; Felge Lochzahl: 3		13.0460-4042.2	604042	ATE 21191 16,8 + WK
			←	S 50994343→; - ABS; Felge Lochzahl: 3		13.0460-4066.2	604066	ATE 21857 17,7 - WE / - WK
1.3	72	10/93→04/96	←	→ S 51132346		13.0460-3943.2	603943	BDX 20905 18,0 + WK
1.6	76	01/94→04/96	←	S 51132347→		13.0460-7088.2	607088	ATE 21430 17,3 - WE / - WK
1.4	51	08/91→03/96	←	→ S 51132346; + ABS		13.0460-3943.2	603943	BDX 20905 18,0 + WK
1.4	55	09/91→04/96	←	→ S 50994342; - ABS		13.0460-3943.2	603943	BDX 20905 18,0 + WK
1.4 D	37	09/92→04/96	←	S 50994343→; - ABS		13.0460-3962.2	603962	BDX 20905 18,0 + WE / - WK
1.5 D	40	06/94→04/96	←	→ S 51132346; + ABS		13.0460-4066.2	604066	ATE 21857 17,7 - WE / - WK
1.5 D	43	06/94→04/96	←	S 50994343→; - ABS		13.0460-3962.2	603962	BDX 20905 18,0 + WE / - WK
1.6	65	06/93→04/96	←	S 51132347→; + ABS		13.0460-7088.2	607088	ATE 21430 17,3 - WE / - WK
1.4	69	09/91→04/96	←			13.0460-3943.2	603943	BDX 20905 18,0 + WK
1.4	72	08/91→03/96	←			13.0460-3943.2	603943	BDX 20905 18,0 + WK
Zubehörsatz, Scheibenbremsbelag								
1.0	33	09/91→04/96	←	→ S 50994342; - ABS; Felge Lochzahl: 4		13.0460-0403.2	610403	BDX
1.0	37	09/91→04/96	←	S 50994343→; - ABS; Felge Lochzahl: 4		13.0460-0403.2	610403	BDX
1.1	44	09/91→04/96	←	+ ABS		13.0460-0406.2	610406	BDX
			←	→ S 50994342; - ABS; Felge Lochzahl: 3		13.0460-0424.2	610424	ATE
			←	S 50994343→; - ABS; Felge Lochzahl: 3		13.0460-0424.2	610424	ATE
1.3	72	10/93→04/96	←	→ S 51132346		13.0460-0406.2	610406	BDX
1.6	76	01/94→04/96	←			13.0460-0406.2	610406	BDX
1.4	51	08/91→03/96	←	→ S 50994342; - ABS		13.0460-0403.2	610403	BDX
1.4	55	09/91→04/96	←	S 50994343→; - ABS		13.0460-0403.2	610403	BDX
1.4 D	37	09/92→04/96	←	→ S 51132346; + ABS		13.0460-0406.2	610406	BDX
1.5 D	40	06/94→04/96	←			13.0460-0406.2	610406	BDX
1.5 D	43	06/94→04/96	←			13.0460-0406.2	610406	BDX
1.6	65	06/93→04/96	←			13.0460-0406.2	610406	BDX
1.4	69	09/91→04/96	←			13.0460-0406.2	610406	BDX
1.4	72	08/91→03/96	←			13.0460-0406.2	610406	BDX
Bremsscheibe								
1.0	33	09/91→04/96	←	- ABS; Felge Lochzahl: 3		24.0108-0107.1	408107	Ø 238 8 6 + S
1.0	37	09/91→04/96	←	- ABS; Felge Lochzahl: 4		24.0110-0187.1	410187	Ø 247 10 9 + S
1.1	44	09/91→04/96	←	+ ABS		24.0120-0132.1	420132	Ø 247 20,4 18,5 V + S
						24.0320-0132.1	520132	Ø 247 20,4 18,5 V + S PD
1.3	72	10/93→04/96	←			24.0120-0132.1	420132	Ø 247 20,4 18,5 V + S
1.4	69	09/91→04/96	←			24.0320-0132.1	520132	Ø 247 20,4 18,5 V + S PD
1.4	72	08/91→03/96	←			24.0120-0132.1	420132	Ø 247 20,4 18,5 V + S
1.4	51	08/91→03/96	←	- ABS		24.0110-0187.1	410187	Ø 247 10 9 + S
1.4	55	09/91→04/96	←	+ ABS		24.0120-0132.1	420132	Ø 247 20,4 18,5 V + S
1.4 D	37	09/92→04/96	←			24.0320-0132.1	520132	Ø 247 20,4 18,5 V + S PD
1.5 D	40	06/94→04/96	←			24.0320-0132.1	520132	Ø 247 20,4 18,5 V + S PD
1.5 D	43	06/94→04/96	←			24.0320-0132.1	520132	Ø 247 20,4 18,5 V + S PD
1.6	65	06/93→04/96	←	- ABS		24.0110-0187.1	410187	Ø 247 10 9 + S
			←	07/94→; + ABS		24.0120-0132.1	420132	Ø 247 20,4 18,5 V + S
						24.0320-0132.1	520132	Ø 247 20,4 18,5 V + S PD
1.6	76	01/94→04/96	←	07/94→		24.0120-0132.1	420132	Ø 247 20,4 18,5 V + S
						24.0320-0132.1	520132	Ø 247 20,4 18,5 V + S PD







	kW			 	! #		
PEUGEOT - 106 II (1) 04/96→07/04							
 Bremsbelagsatz, Scheibenbremse							
1.0 i 1.1 LPG	33 42	05/96→10/99 09/00→10/02	←	Felge Lochzahl: 4		13.0460-3943.2 603943 13.0460-3962.2 603962	BDX 20905 18,0 + WK BDX 20905 18,0 + WE / - WK
			←	Felge Lochzahl: 3		13.0460-4042.2 604042 13.0460-4066.2 604066	ATE 21191 16,8 + WK ATE 21857 17,7 - WE / - WK
1.0 i 1.1 i 1.1 i	37 40 44	01/97→ 01/97→ 05/96→07/04	←	→ 03/04; Felge Lochzahl: 4		13.0460-3943.2 603943 13.0460-3962.2 603962	BDX 20905 18,0 + WK BDX 20905 18,0 + WE / - WK
			←	→ 03/04; Felge Lochzahl: 3		13.0460-4042.2 604042 13.0460-4066.2 604066	ATE 21191 16,8 + WK ATE 21857 17,7 - WE / - WK
1.4 i	55	05/96→07/04	←	→ 03/04		13.0460-3943.2 603943 13.0460-3962.2 603962	BDX 20905 18,0 + WK BDX 20905 18,0 + WE / - WK
1.5 D 1.6 i	40 65	05/96→03/01 05/96→10/99	←			13.0460-3943.2 603943 13.0460-3962.2 603962	BDX 20905 18,0 + WK BDX 20905 18,0 + WE / - WK
1.5 D	42	04/98→	←	10/00→ 03/04		13.0460-3943.2 603943 13.0460-3962.2 603962	BDX 20905 18,0 + WK BDX 20905 18,0 + WE / - WK
1.6 i 1.6 S16	74 88	05/96→01/01 04/98→09/01	←			13.0460-7088.2 607088	ATE 21430 17,3 - WE / - WK
			→			13.0460-3954.2 603954	BDX 20973 11,0 - WK
1.6 S16	87	05/96→07/04	←	→ 03/04		13.0460-7088.2 607088	ATE 21430 17,3 - WE / - WK
			→	→ 03/04		13.0460-3954.2 603954	BDX 20973 11,0 - WK
Zubehörsatz, Scheibenbremsbelag							
1.0 i 1.1 LPG	33 42	05/96→10/99 09/00→10/02	←	Felge Lochzahl: 4		13.0460-0406.2 610406	BDX
			←	Felge Lochzahl: 3		13.0460-0424.2 610424	ATE
1.0 i 1.1 i 1.1 i	37 40 44	01/97→ 01/97→ 05/96→07/04	←	→ 03/04; Felge Lochzahl: 4		13.0460-0406.2 610406	BDX
			←	→ 03/04; Felge Lochzahl: 3		13.0460-0424.2 610424	ATE
1.4 i	55	05/96→07/04	←	→ 03/04		13.0460-0403.2 610403	BDX
1.5 D 1.6 i	40 65	05/96→03/01 05/96→10/99	←			13.0460-0403.2 610403	BDX
1.5 D	42	04/98→	←	10/00→ 03/04		13.0460-0403.2 610403	BDX
1.6 i 1.6 S16	74 88	05/96→01/01 04/98→09/01	→			13.0460-0435.2 610435	BDX
1.6 S16	87	05/96→07/04	→	→ 03/04		13.0460-0435.2 610435	BDX
 Bremsscheibe							
1.0 i 1.1 LPG	33 42	05/96→10/99 09/00→10/02	←	Felge Lochzahl: 3		24.0108-0107.1 408107	Ø 238 8 6 + S
			←	Felge Lochzahl: 4		24.0110-0187.1 410187	Ø 247 10 9 + S
1.0 i 1.1 i 1.1 i	37 40 44	01/97→ 01/97→ 05/96→07/04	←	→ 03/04; Felge Lochzahl: 3		24.0108-0107.1 408107	Ø 238 8 6 + S
			←	→ 03/04; Felge Lochzahl: 4		24.0110-0187.1 410187	Ø 247 10 9 + S
1.4 i	55	05/96→07/04	←	→ 03/04		24.0110-0187.1 410187	Ø 247 10 9 + S
1.5 D 1.6 i Electric	40 65 20	05/96→03/01 05/96→10/99 04/96→07/04	←			24.0110-0187.1 410187	Ø 247 10 9 + S
1.5 D	42	04/98→	←	10/00→ 03/04		24.0110-0187.1 410187	Ø 247 10 9 + S
1.6 i 1.6 S16	74 88	05/96→01/01 04/98→09/01	←			24.0120-0132.1 420132 24.0320-0132.1 520132	Ø 247 20,4 18,5 V + S Ø 247 20,4 18,5 V + S PD
			→			24.0108-0106.1 408106	Ø 247 8 6 + S
1.6 S16	87	05/96→07/04	←	→ 03/04		24.0120-0132.1 420132 24.0320-0132.1 520132	Ø 247 20,4 18,5 V + S Ø 247 20,4 18,5 V + S PD
			→	→ 03/04		24.0108-0106.1 408106	Ø 247 8 6 + S
PEUGEOT - 106 Van (1_) 08/91→03/01							
 Bremsbelagsatz, Scheibenbremse							
1.0	33	09/91→03/01	←	05/96→; Felge Lochzahl: 4		13.0460-3943.2 603943 13.0460-3962.2 603962	BDX 20905 18,0 + WK BDX 20905 18,0 + WE / - WK
			←	05/96→; Felge Lochzahl: 3		13.0460-4042.2 604042 13.0460-4066.2 604066	ATE 21191 16,8 + WK ATE 21857 17,7 - WE / - WK
1.5 D 1.5 D	40 42	05/96→03/01 10/00→03/01	←			13.0460-3943.2 603943 13.0460-3962.2 603962	BDX 20905 18,0 + WK BDX 20905 18,0 + WE / - WK
Zubehörsatz, Scheibenbremsbelag							
1.0 ↓	33	09/91→03/01	←	05/96→; Felge Lochzahl: 4		13.0460-0406.2 610406	BDX





















	kw			 	! #		
PEUGEOT - 106 Van (1_) 08/91→03/01							
Zubehörsatz, Scheibenbremsbelag							
1.0	33	09/91→03/01	←	05/96→; Felge Lochzahl: 3		13.0460-0424.2 610424	ATE
1.5 D	40	05/96→03/01	←			13.0460-0403.2 610403	BDX
1.5 D	42	10/00→03/01					
 Bremsscheibe							
1.0	33	09/91→03/01	←	05/96→; Felge Lochzahl: 3		24.0108-0107.1 408107	Ø 238 8 6 + S
			←	05/96→; Felge Lochzahl: 4		24.0110-0187.1 410187	Ø 247 10 9 + S
1.5 D	40	05/96→03/01	←			24.0110-0187.1 410187	Ø 247 10 9 + S
1.5 D	42	10/00→03/01					
Electric	20	04/96→03/01					
PEUGEOT - 107 06/05→							
 Bremsbelagsatz, Scheibenbremse							
1.0	50	06/05→	←	→ 05/14		13.0460-3829.2 603829	BOS 23959 17,0 - WE / - WK + Zub
1.4 HDi	40	06/05→					
 Bremsscheibe							
1.0	50	06/05→	←	→ 05/14		24.0120-0180.1 420180	Ø 247 20 18 V + S
1.4 HDi	40	06/05→					
PEUGEOT - 108 05/14→							
 Bremsbelagsatz, Scheibenbremse							
1.0 VTi	51	05/14→	←			13.0460-3829.2 603829	BOS 23959 17,0 - WE / - WK + Zub
1.2	60	05/14→					
 Bremsscheibe							
1.0 VTi	51	05/14→	←			24.0120-0180.1 420180	Ø 247 20 18 V + S
1.2	60	05/14→					
PEUGEOT - 205 II (20A/C) 01/87→09/98							
 Bremsbelagsatz, Scheibenbremse							
1.0	33	10/87→09/98	←	09/90→		13.0460-2956.2 602956	TRW 20989 17,7 + WK
1.4	55	08/90→07/98				13.0460-3911.2 603911	BDX 20905 18,0 + WK
1.0	37	08/92→05/97	←			13.0460-2956.2 602956	TRW 20989 17,7 + WK
						13.0460-3911.2 603911	BDX 20905 18,0 + WK
1.1	44	07/89→09/98	←	09/90→		13.0460-2956.2 602956	TRW 20989 17,7 + WK
			←	09/89→ 08/90		13.0460-2956.2 602956	TRW 20989 17,7 + WK
						13.0460-3911.2 603911	BDX 20905 18,0 + WK
1.4	55	07/88→09/98	←	09/90→		13.0460-2956.2 602956	TRW 20989 17,7 + WK
1.9 Diesel	47	10/87→09/98				13.0460-3911.2 603911	BDX 20905 18,0 + WK
			←	09/88→ 08/90		13.0460-2956.2 602956	TRW 20989 17,7 + WK
						13.0460-3911.2 603911	BDX 20905 18,0 + WK
1.6	53	10/87→09/98	←	→ 08/90		13.0460-2956.2 602956	TRW 20989 17,7 + WK
1.6	55	10/87→09/98				13.0460-3911.2 603911	BDX 20905 18,0 + WK
			←	09/90→		13.0460-2956.2 602956	TRW 20989 17,7 + WK
						13.0460-3911.2 603911	BDX 20905 18,0 + WK
1.6 Aut.	58	10/87→09/98	←	09/90→		13.0460-2956.2 602956	TRW 20989 17,7 + WK
1.6 Aut.	65	05/90→09/98				13.0460-3911.2 603911	BDX 20905 18,0 + WK
			←	→ 08/90; Automatikgetriebe		13.0460-2956.2 602956	TRW 20989 17,7 + WK
						13.0460-3911.2 603911	BDX 20905 18,0 + WK
1.7 Diesel	44	07/87→09/98	←	03/94→		13.0460-2956.2 602956	TRW 20989 17,7 + WK
						13.0460-3911.2 603911	BDX 20905 18,0 + WK
			←	→ 08/90		13.0460-2956.2 602956	TRW 20989 17,7 + WK
						13.0460-3911.2 603911	BDX 20905 18,0 + WK
1.8 TD	57	01/90→09/98	←	09/90→		13.0460-3911.2 603911	BDX 20905 18,0 + WK
						13.0460-7058.2 607058	ATE 21430 17,3 + WK
1.9	77	08/92→05/97	←	→ 07/94		13.0460-2956.2 602956	TRW 20989 17,7 + WK
						13.0460-3911.2 603911	BDX 20905 18,0 + WK
1.9	89	08/90→05/97	←	09/90→ 10/94		13.0460-2955.2 602955	TRW 20772 18,0 + WK
						13.0460-7058.2 607058	ATE 21430 17,3 + WK
			→	09/90→ 10/94		13.0460-3954.2 603954	BDX 20973 11,0 - WK
1.9 GTI	94	10/87→09/98	←	09/90→		13.0460-2955.2 602955	TRW 20772 18,0 + WK
						13.0460-7058.2 607058	ATE 21430 17,3 + WK
↓							

	kW			 	! #		
PEUGEOT - 205 II (20A/C) 01/87→09/98							
 Bremsbelagsatz, Scheibenbremse							
1.9 GTI	94	10/87→09/98	←	→ 08/88		13.0460-2955.2 602955	TRW 20772 18,0 + WK
			→	09/90→		13.0460-3954.2 603954	BDX 20973 11,0 - WK
			→	→ 08/88		13.0460-3954.2 603954	BDX 20973 11,0 - WK
Zubehörsatz, Scheibenbremsbelag							
1.0	33	10/87→09/98	←	09/90→		13.0460-0060.2 610060 13.0460-0402.2 610402	TRW BDX
1.0	37	08/92→05/97	←			13.0460-0060.2 610060 13.0460-0402.2 610402	TRW BDX
1.1	44	07/89→09/98	←	09/90→		13.0460-0060.2 610060 13.0460-0404.2 610404	TRW BDX
			←	09/89→ 08/90		13.0460-0060.2 610060 13.0460-0404.2 610404	TRW BDX
1.4	55	07/88→09/98	←	09/90→		13.0460-0060.2 610060 13.0460-0404.2 610404	TRW BDX
			←	09/88→ 08/90		13.0460-0060.2 610060 13.0460-0404.2 610404	TRW BDX
1.4	55	08/90→07/98	←	09/90→		13.0460-0060.2 610060 13.0460-0404.2 610404	TRW BDX
1.6 1.6	53 55	10/87→09/98 10/87→09/98	←	09/90→		13.0460-0060.2 610060 13.0460-0402.2 610402	TRW BDX
			←	→ 08/90		13.0460-0060.2 610060 13.0460-0402.2 610402	TRW BDX
1.6 Aut.	58	10/87→09/98	←	09/90→		13.0460-0060.2 610060 13.0460-0402.2 610402	TRW BDX
			←	→ 08/90; Automatikgetriebe		13.0460-0060.2 610060 13.0460-0402.2 610402	TRW BDX
1.6 Aut.	65	05/90→09/98	←	09/90→		13.0460-0060.2 610060 13.0460-0404.2 610404	TRW BDX
			←	→ 08/90; Automatikgetriebe		13.0460-0060.2 610060 13.0460-0402.2 610402	TRW BDX
1.7 Diesel	44	07/87→09/98	←	03/94→		13.0460-0060.2 610060 13.0460-0402.2 610402	TRW BDX
			←	→ 08/90		13.0460-0060.2 610060 13.0460-0402.2 610402	TRW BDX
1.8 TD	57	01/90→09/98	←	09/90→		13.0460-0402.2 610402	BDX
1.9	77	08/92→05/97	←	→ 07/94		13.0460-0060.2 610060 13.0460-0404.2 610404	TRW BDX
1.9	89	08/90→05/97	→	09/90→ 10/94		13.0460-0435.2 610435	BDX
1.9 Diesel	47	10/87→09/98	←	09/90→		13.0460-0060.2 610060 13.0460-0402.2 610402	TRW BDX
			←	09/88→ 08/90		13.0460-0060.2 610060 13.0460-0402.2 610402	TRW BDX
1.9 GTI	94	10/87→09/98	→	→ 08/88		13.0460-0435.2 610435	BDX
			→	09/90→		13.0460-0435.2 610435	BDX
 Bremsscheibe							
1.0	33	10/87→09/98	←	09/90→		24.0110-0187.1 410187	Ø 247 10 9 + S
1.0	37	08/92→05/97	←			24.0110-0187.1 410187	Ø 247 10 9 + S
1.1	44	07/89→09/98	←	09/90→		24.0110-0187.1 410187 24.0120-0131.1 420131	Ø 247 10 9 + S Ø 247 20,4 18,5 V
			←	→ 08/90		24.0110-0187.1 410187	Ø 247 10 9 + S
1.4	55	07/88→09/98	←	→ 08/90		24.0110-0187.1 410187	Ø 247 10 9 + S
			←	09/90→		24.0120-0131.1 420131	Ø 247 20,4 18,5 V
1.4	55	08/90→07/98	←	09/90→		24.0120-0131.1 420131	Ø 247 20,4 18,5 V
1.6 1.6	53 55	10/87→09/98 10/87→09/98	←	→ 08/90		24.0120-0131.1 420131	Ø 247 20,4 18,5 V
			←	09/90→		24.0120-0131.1 420131	Ø 247 20,4 18,5 V
1.6 Aut. 1.6 Aut.	58 65	10/87→09/98 05/90→09/98	←	09/90→		24.0120-0131.1 420131	Ø 247 20,4 18,5 V
			←	→ 08/90; Automatikgetriebe		24.0120-0131.1 420131	Ø 247 20,4 18,5 V
↓							













	kw			 	! #		
PEUGEOT - 205 II (20A/C) 01/87→09/98							
 Bremsscheibe							
1.7 Diesel	44	07/87→09/98	←	09/90→		24.0110-0187.1 410187	Ø 247 10 9 + S
			←	→ 08/90		24.0110-0187.1 410187	Ø 247 10 9 + S
1.8 TD	57	01/90→09/98	←	09/90→		24.0110-0187.1 410187	Ø 247 10 9 + S
			←	01/91→		24.0120-0132.1 420132	Ø 247 20,4 18,5 V + S
1.8 XDT	58	08/90→05/97	←			24.0320-0132.1 520132	Ø 247 20,4 18,5 V + S PD
			←			24.0120-0132.1 420132	Ø 247 20,4 18,5 V + S
1.9	77	08/92→05/97	←	→ 07/94		24.0120-0131.1 420131	Ø 247 20,4 18,5 V
1.9	89	08/90→05/97	←	09/90→ 10/94		24.0120-0132.1 420132	Ø 247 20,4 18,5 V + S
			←	09/90→ 10/94		24.0320-0132.1 520132	Ø 247 20,4 18,5 V + S PD
1.9 Diesel	47	10/87→09/98	←	09/90→		24.0108-0105.1 408105	Ø 247,5 8 6,5
			←	09/88→ 08/90		24.0110-0187.1 410187	Ø 247 10 9 + S
1.9 GTI	94	10/87→09/98	←	→ 08/88		24.0110-0187.1 410187	Ø 247 10 9 + S
			←	→ 08/88		24.0120-0132.1 420132	Ø 247 20,4 18,5 V + S
			←	09/90→		24.0320-0132.1 520132	Ø 247 20,4 18,5 V + S PD
			←	09/90→		24.0120-0132.1 420132	Ø 247 20,4 18,5 V + S
			→	→ 08/88		24.0320-0132.1 520132	Ø 247 20,4 18,5 V + S PD
			→	→ 08/88		24.0108-0105.1 408105	Ø 247,5 8 6,5
			→	09/90→		24.0108-0105.1 408105	Ø 247,5 8 6,5
PEUGEOT - 205 Kasten 03/94→05/97							
 Bremsbelagsatz, Scheibenbremse							
1.7 Diesel	44	03/94→05/97	←			13.0460-2956.2 602956	TRW 20989 17,7 + WK
			←			13.0460-3911.2 603911	BDX 20905 18,0 + WK
Zubehörsatz, Scheibenbremsbelag							
1.7 Diesel	44	03/94→05/97	←			13.0460-0060.2 610060	TRW
			←			13.0460-0402.2 610402	BDX
 Bremsscheibe							
1.7 Diesel	44	03/94→05/97	←			24.0110-0187.1 410187	Ø 247 10 9 + S
PEUGEOT - 206 CC (2D) 09/00→							
 Bremsbelagsatz, Scheibenbremse							
1.6 1.6 16V	81 80	09/01→12/08 09/00→	←	Orga 10950→; → 01/07		13.0460-2862.2 602862	TRW 23346 19,0 - WK
			←	→Orga 09078		13.0460-3978.2 603978	BOS 23332 18,0 - WK + Zub
			←	Orga 09079→ Orga 10949		13.0460-3994.2 603994	BOS 23599 19,0 - WE / - WK + Zub
			←	→ 01/07		13.0470-3994.2 LD3994	BOS 23599 19,0 - WE / - WK + Zub Ceramic
1.6 HDi 110	80	04/05→	←	→ 01/07		13.0460-3823.2 603823	BOS 20974 11,0 - WK
			←	→ 01/07		13.0460-3994.2 603994	BOS 23599 19,0 - WE / - WK + Zub
2.0 S16	100	09/00→	←	→Orga 09078		13.0470-3994.2 LD3994	BOS 23599 19,0 - WE / - WK + Zub Ceramic
			←	Orga 09079→; → 01/07		13.0460-3978.2 603978	BOS 23332 18,0 - WK + Zub
			←	→ 01/07		13.0460-3994.2 603994	BOS 23599 19,0 - WE / - WK + Zub
			←	→ 01/07		13.0470-3994.2 LD3994	BOS 23599 19,0 - WE / - WK + Zub Ceramic
			→	→ 01/07		13.0460-3823.2 603823	BOS 20974 11,0 - WK
Zubehörsatz, Scheibenbremsbelag							
1.6 1.6 16V	81 80	09/01→12/08 09/00→	←	Orga 09079→ Orga 10949		13.0460-0454.2 610454	BOS
			→	→ 01/07		13.0460-0435.2 610435	BDX
1.6 HDi 110	80	04/05→	←	→ 01/07		13.0460-0454.2 610454	BOS
			→	→ 01/07		13.0460-0435.2 610435	BDX
2.0 S16	100	09/00→	←	Orga 09079→; → 01/07		13.0460-0454.2 610454	BOS
			→	→ 01/07		13.0460-0435.2 610435	BDX
↓							









	kW			 	! #		
PEUGEOT - 206 CC (2D) 09/00→							
Bremsscheibe							
1.6 1.6 16V 2.0 S16	81 80 100	09/01→12/08 09/00→ 09/00→	←	→Orga 09078		24.0120-0133.1 420133 24.0320-0133.1 520133	∅ 266 20,5 18,5 V + S ∅ 266 20,5 18,5 V + S PD
			←	Orga 09079→; → 01/07		24.0122-0194.1 422194	∅ 266 22 20 V + S
			→	→ 01/07		24.0108-0106.1 408106	∅ 247 8 6 + S
1.6 HDi 110	80	04/05→	←	→ 01/07		24.0122-0194.1 422194	∅ 266 22 20 V + S
			→	→ 01/07		24.0108-0106.1 408106	∅ 247 8 6 + S
PEUGEOT - 206 Schrägheck (2A/C) 08/98→							
Bremsbelagsatz, Scheibenbremse							
1.1	40	08/98→07/00	←	09/98→		13.0460-3975.2 603975	BOS 23597 18,0 - WK
1.1 i 1.4 HDi eco 70 1.4 i	44 50 55	09/98→ 09/01→ 09/98→	←	→ 02/09		13.0460-3975.2 603975	BOS 23597 18,0 - WK
1.4 16V 1.6 HDi 110	65 80	10/03→ 05/04→	←	→ 02/09		13.0460-3994.2 603994 13.0470-3994.2 LD3994	BOS 23599 19,0 - WE / - WK + Zub BOS 23599 19,0 - WE / - WK + Zub Ceramic
			→	→ 02/09		13.0460-3823.2 603823	BOS 20974 11,0 - WK
1.4 CNG 1.4 HDi 1.4 LPG 1.6 i 1.9 D	55 51 55 65 51	05/06→09/07 09/02→02/07 05/06→09/07 09/98→12/00 09/98→11/01	←			13.0460-3975.2 603975	BOS 23597 18,0 - WK
1.6 1.6 16V	81 79	05/05→07/08 06/01→04/05	←	Orga 10950→		13.0460-2862.2 602862	TRW 23346 19,0 - WK
			←	→Orga 09078		13.0460-3978.2 603978	BOS 23332 18,0 - WK + Zub
			←	Orga 09079→		13.0460-3994.2 603994 13.0470-3994.2 LD3994	BOS 23599 19,0 - WE / - WK + Zub BOS 23599 19,0 - WE / - WK + Zub Ceramic
			→			13.0460-3823.2 603823	BOS 20974 11,0 - WK
1.6 16V	80	12/00→	←	Orga 10950→; → 02/09		13.0460-2862.2 602862	TRW 23346 19,0 - WK
			←	→Orga 09078		13.0460-3978.2 603978	BOS 23332 18,0 - WK + Zub
			←	Orga 09079→; → 02/09		13.0460-3994.2 603994 13.0470-3994.2 LD3994	BOS 23599 19,0 - WE / - WK + Zub BOS 23599 19,0 - WE / - WK + Zub Ceramic
			→	→ 02/09		13.0460-3823.2 603823	BOS 20974 11,0 - WK
1.6 8V	66	05/99→10/03	←	→ 12/00		13.0460-3975.2 603975	BOS 23597 18,0 - WK
2.0 HDI 90	66	12/99→	←	Orga 10892→; → 02/09		13.0460-2862.2 602862	TRW 23346 19,0 - WK
			←	→Orga 09078		13.0460-3978.2 603978	BOS 23332 18,0 - WK + Zub
			←	Orga 09079→; → 02/09		13.0460-3994.2 603994 13.0470-3994.2 LD3994	BOS 23599 19,0 - WE / - WK + Zub BOS 23599 19,0 - WE / - WK + Zub Ceramic
2.0 RC	130	07/03→	←	→ 02/09		13.0460-3966.2 603966 13.0470-3966.2 LD3966	BOS 23600 19,4 - WE / - WK + Zub BOS 23600 19,4 - WE / - WK + Zub Ceramic
			→	→ 02/09		13.0460-3823.2 603823	BOS 20974 11,0 - WK
2.0 S16	99	04/99→10/00	←			13.0460-3978.2 603978	BOS 23332 18,0 - WK + Zub
			→			13.0460-3823.2 603823	BOS 20974 11,0 - WK
2.0 S16	100	06/99→	←	10/00→; →Orga 09078		13.0460-3978.2 603978	BOS 23332 18,0 - WK + Zub
			←	Orga 09079→; → 02/09		13.0460-3994.2 603994 13.0470-3994.2 LD3994	BOS 23599 19,0 - WE / - WK + Zub BOS 23599 19,0 - WE / - WK + Zub Ceramic
			→	10/00→ 02/09		13.0460-3823.2 603823	BOS 20974 11,0 - WK
Zubehörsatz, Scheibenbremsbelag							
1.4 16V 1.6 HDi 110	65 80	10/03→ 05/04→	←	→ 02/09		13.0460-0454.2 610454	BOS
			→	→ 02/09		13.0460-0435.2 610435	BDX
1.6 1.6 16V	81 79	05/05→07/08 06/01→04/05	←	Orga 09079→		13.0460-0454.2 610454	BOS
			→			13.0460-0435.2 610435	BDX
↓							













	kW			 	! #		
PEUGEOT - 206 Schrägheck (2A/C) 08/98→							
Zubehörsatz, Scheibenbremsbelag							
1.6 16V	80	12/00→	←	Orga 09079→; → 02/09		13.0460-0454.2 610454	BOS
			→	→ 02/09		13.0460-0435.2 610435	BDX
2.0 HDI 90	66	12/99→	←	Orga 09079→; → 02/09		13.0460-0454.2 610454	BOS
2.0 RC	130	07/03→	→	→ 02/09		13.0460-0435.2 610435	BDX
2.0 S16	99	04/99→10/00	→			13.0460-0435.2 610435	BDX
2.0 S16	100	06/99→	←	Orga 09079→; → 02/09		13.0460-0454.2 610454	BOS
			→	10/00→ 02/09		13.0460-0435.2 610435	BDX
 Bremsscheibe							
1.1	40	08/98→07/00	←	09/98→; →Orga 08988; - D; - ABS		24.0110-0187.1 410187	Ø 247 10 9 + S
			←	Orga 08989→ Orga 09974; - D; - ABS		24.0113-0185.1 413185	Ø 247,5 13 11 + S
						24.0313-0185.1 513185	Ø 247,5 13 11 + S PD
			←	09/98→		24.0113-0185.1 413185	Ø 247,5 13 11 + S
						24.0313-0185.1 513185	Ø 247,5 13 11 + S PD
			←	Orga 09975→		24.0120-0132.1 420132	Ø 247 20,4 18,5 V + S
						24.0320-0132.1 520132	Ø 247 20,4 18,5 V + S PD
1.1 i	44	09/98→	←	→Orga 08988; - D; - ABS		24.0110-0187.1 410187	Ø 247 10 9 + S
			←	Orga 08989→ Orga 09974; - D; - ABS		24.0113-0185.1 413185	Ø 247,5 13 11 + S
						24.0313-0185.1 513185	Ø 247,5 13 11 + S PD
			←	→ 02/09		24.0113-0185.1 413185	Ø 247,5 13 11 + S
						24.0313-0185.1 513185	Ø 247,5 13 11 + S PD
			←	Orga 09975→; → 02/09		24.0120-0132.1 420132	Ø 247 20,4 18,5 V + S
						24.0320-0132.1 520132	Ø 247 20,4 18,5 V + S PD
1.4 16V 1.6 HDi 110	65 80	10/03→ 05/04→	←	→ 02/09		24.0122-0194.1 422194	Ø 266 22 20 V + S
			→	→ 02/09		24.0108-0106.1 408106	Ø 247 8 6 + S
1.4 CNG 1.4 LPG	55 55	05/06→09/07 05/06→09/07	←	- Roland Garros		24.0113-0185.1 413185	Ø 247,5 13 11 + S
						24.0313-0185.1 513185	Ø 247,5 13 11 + S PD
						24.0120-0132.1 420132	Ø 247 20,4 18,5 V + S
						24.0320-0132.1 520132	Ø 247 20,4 18,5 V + S PD
1.4 HDi	51	09/02→02/07	←			24.0113-0185.1 413185	Ø 247,5 13 11 + S
						24.0120-0132.1 420132	Ø 247 20,4 18,5 V + S
						24.0313-0185.1 513185	Ø 247,5 13 11 + S PD
						24.0320-0132.1 520132	Ø 247 20,4 18,5 V + S PD
1.4 HDi eco 70	50	09/01→	←	→ 02/09		24.0113-0185.1 413185	Ø 247,5 13 11 + S
						24.0120-0132.1 420132	Ø 247 20,4 18,5 V + S
						24.0313-0185.1 513185	Ø 247,5 13 11 + S PD
						24.0320-0132.1 520132	Ø 247 20,4 18,5 V + S PD
1.4 i	55	09/98→	←	→ 02/09; - Roland Garros		24.0113-0185.1 413185	Ø 247,5 13 11 + S
						24.0313-0185.1 513185	Ø 247,5 13 11 + S PD
			←	→ 02/09		24.0120-0132.1 420132	Ø 247 20,4 18,5 V + S
						24.0320-0132.1 520132	Ø 247 20,4 18,5 V + S PD
1.6 1.6 16V	81 79	05/05→07/08 06/01→04/05	←	→Orga 09078		24.0120-0133.1 420133	Ø 266 20,5 18,5 V + S
						24.0320-0133.1 520133	Ø 266 20,5 18,5 V + S PD
			←	Orga 09079→		24.0122-0194.1 422194	Ø 266 22 20 V + S
			→			24.0108-0106.1 408106	Ø 247 8 6 + S
1.6 16V	80	12/00→	←	→Orga 09078		24.0120-0133.1 420133	Ø 266 20,5 18,5 V + S
						24.0320-0133.1 520133	Ø 266 20,5 18,5 V + S PD
			←	Orga 09079→; → 02/09		24.0122-0194.1 422194	Ø 266 22 20 V + S
			→	→ 02/09		24.0108-0106.1 408106	Ø 247 8 6 + S
1.6 8V	66	05/99→10/03	←	→ 12/00		24.0120-0132.1 420132	Ø 247 20,4 18,5 V + S
						24.0320-0132.1 520132	Ø 247 20,4 18,5 V + S PD
1.6 i 1.9 D	65 51	09/98→12/00 09/98→11/01	←			24.0120-0132.1 420132	Ø 247 20,4 18,5 V + S
						24.0320-0132.1 520132	Ø 247 20,4 18,5 V + S PD
2.0 HDI 90	66	12/99→	←	→Orga 09078		24.0120-0133.1 420133	Ø 266 20,5 18,5 V + S
						24.0320-0133.1 520133	Ø 266 20,5 18,5 V + S PD
			←	Orga 09079→; → 02/09		24.0122-0194.1 422194	Ø 266 22 20 V + S
2.0 RC	130	07/03→	←	→ 02/09		24.0126-0120.1 426120	Ø 283 26 24 V + S
						24.0326-0120.1 526120	Ø 283 26 24 V + S PD
			→	→ 02/09		24.0108-0106.1 408106	Ø 247 8 6 + S
↓							









	kW					! #		
PEUGEOT - 206 Schrägheck (2A/C) 08/98→								
 Bremsscheibe								
2.0 S16	99	04/99→10/00	←			24.0120-0133.1 420133	Ø 266 20,5 18,5 V + S	
			→			24.0320-0133.1 520133	Ø 266 20,5 18,5 V + S PD	
			←			24.0108-0106.1 408106	Ø 247 8 6 + S	
2.0 S16	100	06/99→	←	10/00→; →Orga 09078		24.0120-0133.1 420133	Ø 266 20,5 18,5 V + S	
			←	Orga 09079→; → 02/09		24.0320-0133.1 520133	Ø 266 20,5 18,5 V + S PD	
			←	Orga 09079→; → 02/09		24.0122-0194.1 422194	Ø 266 22 20 V + S	
			→	10/00→ 02/09		24.0108-0106.1 408106	Ø 247 8 6 + S	
PEUGEOT - 206 Stufenheck 03/07→								
 Bremsbelagsatz, Scheibenbremse								
1.4	55	03/07→	←	→ 02/09		13.0460-3975.2 603975	BOS 23597 18,0 - WK	
1.4 HDi eco 70	50	09/08→						
1.6 16V	80	03/07→	←	Orga 10950→; → 02/09		13.0460-2862.2 602862	TRW 23346 19,0 - WK	
			←	→Orga 09078		13.0460-3978.2 603978	BOS 23332 18,0 - WK + Zub	
			←	Orga 09079→; → 02/09		13.0460-3994.2 603994	BOS 23599 19,0 - WE / - WK + Zub	
						13.0470-3994.2 LD3994	BOS 23599 19,0 - WE / - WK + Zub Ceramic	
			→	→ 02/09		13.0460-3823.2 603823	BOS 20974 11,0 - WK	
Zubehörsatz, Scheibenbremsbelag								
1.6 16V	80	03/07→	←	Orga 09079→; → 02/09		13.0460-0454.2 610454	BOS	
			→	→ 02/09		13.0460-0435.2 610435	BDX	
 Bremsscheibe								
1.4	55	03/07→	←	→ 02/09; - Roland Garros		24.0113-0185.1 413185	Ø 247,5 13 11 + S	
			←	→ 02/09		24.0313-0185.1 513185	Ø 247,5 13 11 + S PD	
			←	→ 02/09		24.0120-0132.1 420132	Ø 247 20,4 18,5 V + S	
						24.0320-0132.1 520132	Ø 247 20,4 18,5 V + S PD	
1.4 HDi eco 70	50	09/08→	←	→ 02/09		24.0113-0185.1 413185	Ø 247,5 13 11 + S	
						24.0120-0132.1 420132	Ø 247 20,4 18,5 V + S	
						24.0313-0185.1 513185	Ø 247,5 13 11 + S PD	
						24.0320-0132.1 520132	Ø 247 20,4 18,5 V + S PD	
1.6 16V	80	03/07→	←	→Orga 09078		24.0120-0133.1 420133	Ø 266 20,5 18,5 V + S	
			←	Orga 09079→; → 02/09		24.0320-0133.1 520133	Ø 266 20,5 18,5 V + S PD	
			←	Orga 09079→; → 02/09		24.0122-0194.1 422194	Ø 266 22 20 V + S	
			→	→ 02/09		24.0108-0106.1 408106	Ø 247 8 6 + S	
PEUGEOT - 206 SW (2E/K) 07/02→								
 Bremsbelagsatz, Scheibenbremse								
1.1	44	07/02→	←	→ 05/07		13.0460-3975.2 603975	BOS 23597 18,0 - WK	
1.4	55	07/02→						
1.4 HDi	50	07/02→						
1.4 16V	65	10/03→	←	→ 05/07		13.0460-3994.2 603994	BOS 23599 19,0 - WE / - WK + Zub	
1.6 HDi 110	80	05/04→						
2.0 16V	100	07/02→				13.0470-3994.2 LD3994	BOS 23599 19,0 - WE / - WK + Zub Ceramic	
			→	→ 05/07		13.0460-3823.2 603823	BOS 20974 11,0 - WK	
1.6	81	05/05→07/08	←	Orga 10809→; → 05/07		13.0460-2862.2 602862	TRW 23346 19,0 - WK	
1.6 16V	80	07/02→	←	→Orga 10808		13.0460-3994.2 603994	BOS 23599 19,0 - WE / - WK + Zub	
						13.0470-3994.2 LD3994	BOS 23599 19,0 - WE / - WK + Zub Ceramic	
			→	→ 05/07		13.0460-3823.2 603823	BOS 20974 11,0 - WK	
2.0 HDi	66	07/02→	←	Orga 10809→; → 05/07		13.0460-2862.2 602862	TRW 23346 19,0 - WK	
			←	→Orga 10808		13.0460-3994.2 603994	BOS 23599 19,0 - WE / - WK + Zub	
						13.0470-3994.2 LD3994	BOS 23599 19,0 - WE / - WK + Zub Ceramic	
Zubehörsatz, Scheibenbremsbelag								
1.4 16V	65	10/03→	←	→ 05/07		13.0460-0454.2 610454	BOS	
1.6 HDi 110	80	05/04→						
2.0 16V	100	07/02→	→	→ 05/07		13.0460-0435.2 610435	BDX	
↓								



























	kw			 	! #		
PEUGEOT - 206 SW (2E/K) 07/02→							
Zubehörsatz, Scheibenbremsbelag							
1.6 1.6 16V	81 80	05/05→07/08 07/02→	←	→Orga 10808		13.0460-0454.2 610454	BOS
			→	→ 05/07		13.0460-0435.2 610435	BDX
2.0 HDi	66	07/02→	←	→Orga 10808		13.0460-0454.2 610454	BOS
 Bremsscheibe							
1.1	44	07/02→	←	→ 05/07		24.0113-0185.1 413185	Ø 247,5 13 11 + S
						24.0313-0185.1 513185	Ø 247,5 13 11 + S PD
1.4 1.4 HDi	55 50	07/02→ 07/02→	←	→ 05/07		24.0113-0185.1 413185	Ø 247,5 13 11 + S
						24.0120-0132.1 420132	Ø 247 20,4 18,5 V + S
						24.0313-0185.1 513185	Ø 247,5 13 11 + S PD
1.4 16V 1.6 1.6 16V 1.6 HDi 110 2.0 16V 2.0 HDi	65 81 80 80 100 66	10/03→ 05/05→07/08 07/02→ 05/04→ 07/02→ 07/02→	← →	→ 05/07		24.0122-0194.1 422194	Ø 266 22 20 V + S
						24.0108-0106.1 408106	Ø 247 8 6 + S
			←	→ 05/07		24.0122-0194.1 422194	Ø 266 22 20 V + S
PEUGEOT - 206 Van 04/99→03/09							
 Bremsbelagsatz, Scheibenbremse							
1.4 HDi	50	09/01→03/09	←	→ 02/09		13.0460-3975.2 603975	BOS 23597 18,0 - WK
1.9 D	51	04/99→05/07	←			13.0460-3975.2 603975	BOS 23597 18,0 - WK
 Bremsscheibe							
1.4 HDi	50	09/01→03/09	←	→ 02/09		24.0113-0185.1 413185	Ø 247,5 13 11 + S
						24.0120-0132.1 420132	Ø 247 20,4 18,5 V + S
						24.0313-0185.1 513185	Ø 247,5 13 11 + S PD
						24.0320-0132.1 520132	Ø 247 20,4 18,5 V + S PD
1.9 D	51	04/99→05/07	←			24.0120-0132.1 420132	Ø 247 20,4 18,5 V + S
						24.0320-0132.1 520132	Ø 247 20,4 18,5 V + S PD
PEUGEOT - 206+ (T3E) 01/09→							
 Bremsbelagsatz, Scheibenbremse							
1.1 1.4 HDi eco 70 1.4 i 1.4 i	44 50 54 55	01/09→ 01/09→ 09/10→ 01/09→	←	+ D; → 05/13		13.0460-3975.2 603975	BOS 23597 18,0 - WK
1.6 16V	80	07/10→	←	→ 05/13		13.0460-3994.2 603994	BOS 23599 19,0 - WE / - WK + Zub
						13.0470-3994.2 LD3994	BOS 23599 19,0 - WE / - WK + Zub Ceramic
 Bremsscheibe							
1.1 1.4 HDi eco 70 1.4 i 1.4 i	44 50 54 55	01/09→ 01/09→ 09/10→ 01/09→	←	- D; → 05/13		24.0113-0185.1 413185	Ø 247,5 13 11 + S
						24.0313-0185.1 513185	Ø 247,5 13 11 + S PD
			←	+ D; → 05/13		24.0120-0132.1 420132	Ø 247 20,4 18,5 V + S
						24.0320-0132.1 520132	Ø 247 20,4 18,5 V + S PD
1.6 16V	80	07/10→	←	→ 05/13		24.0122-0194.1 422194	Ø 266 22 20 V + S
PEUGEOT - 207 (WA_, WC_) 02/06→							
 Bremsbelagsatz, Scheibenbremse							
1.4 1.4 1.4 1.4 16V 1.4 Bioflex 1.4 HDi 1.4 HDi 1.6 HDi	53 54 55 65 60 50 52 68	02/06→ 12/07→ 08/08→ 02/06→ 08/08→ 02/06→ 02/11→ 11/09→	←	→ 06/12		13.0460-3994.2 603994	BOS 23599 19,0 - WE / - WK + Zub
						13.0470-3994.2 LD3994	BOS 23599 19,0 - WE / - WK + Zub Ceramic
1.4 16V	70	06/07→	←	08/07→ 06/12		13.0460-3966.2 603966	BOS 23600 19,4 - WE / - WK + Zub
						13.0470-3966.2 LD3966	BOS 23600 19,4 - WE / - WK + Zub Ceramic
1.4 16V	72	10/09→	←	→ 06/12		13.0460-3966.2 603966	BOS 23600 19,4 - WE / - WK + Zub
						13.0470-3966.2 LD3966	BOS 23600 19,4 - WE / - WK + Zub Ceramic
↓							

	kW			 	! #		
PEUGEOT - 207 (WA_, WC_) 02/06→							
 Bremsbelagsatz, Scheibenbremse							
1.6 1.6 1.6 16V 1.6 16V Turbo 1.6 16V VTI 1.6 HDi 1.6 HDi 110	81 90 80 110 88 80 82	08/08→ 09/07→12/13 02/06→ 02/06→ 02/07→ 02/06→ 08/09→	← → →	→ 06/12 Orga 11635→; → 06/12 →Orga 11634		13.0460-3966.2 603966 13.0470-3966.2 LD3966 13.0460-2740.2 602740 13.0470-2740.2 LD2740 13.0460-3813.2 603813 13.0460-3851.2 603851 13.0470-3813.2 LD3813	BOS 23600 19,4 - WE / - WK + Zub BOS 23600 19,4 - WE / - WK + Zub Ceramic TRW 23554 17,0 - WE / - WK + Zub TRW 23554 17,0 - WE / - WK + Zub Ceramic BOS 24150 17,6 - WE / - WK + Zub BOS 24150 17,6 - WE / - WK + Zub BOS 24150 17,6 - WE / - WK + Zub Ceramic
1.6 16V RC	128	02/07→	← → →	→ 06/12 Orga 11628→; → 06/12 →Orga 11627		13.0460-7202.2 607202 13.0470-7202.2 LD7202 13.0460-2740.2 602740 13.0470-2740.2 LD2740 13.0460-3851.2 603851	ATE 23589 19,1 - WE / - WK Ceramic ATE 23589 19,1 - WE / - WK Ceramic TRW 23554 17,0 - WE / - WK + Zub TRW 23554 17,0 - WE / - WK + Zub Ceramic BOS 24150 17,6 - WE / - WK + Zub
1.6 16V Turbo	115	10/09→	← → →	01/10→ 06/12 Orga 11635→; → 06/12 →Orga 11634		13.0460-3966.2 603966 13.0470-3966.2 LD3966 13.0460-2740.2 602740 13.0470-2740.2 LD2740 13.0460-3813.2 603813 13.0460-3851.2 603851 13.0470-3813.2 LD3813	BOS 23600 19,4 - WE / - WK + Zub BOS 23600 19,4 - WE / - WK + Zub Ceramic TRW 23554 17,0 - WE / - WK + Zub TRW 23554 17,0 - WE / - WK + Zub Ceramic BOS 24150 17,6 - WE / - WK + Zub BOS 24150 17,6 - WE / - WK + Zub BOS 24150 17,6 - WE / - WK + Zub Ceramic
1.6 HDi	66	02/06→	← ← → →	für Bremsscheibendurchmesser [mm]: 283; → 06/12 für Bremsscheibendurchmesser [mm]: 266; → 06/12 Orga 11635→; → 06/12 →Orga 11634		13.0460-3966.2 603966 13.0470-3966.2 LD3966 13.0460-3994.2 603994 13.0470-3994.2 LD3994 13.0460-2740.2 602740 13.0470-2740.2 LD2740 13.0460-3813.2 603813 13.0460-3851.2 603851 13.0470-3813.2 LD3813	BOS 23600 19,4 - WE / - WK + Zub BOS 23600 19,4 - WE / - WK + Zub Ceramic BOS 23599 19,0 - WE / - WK + Zub BOS 23599 19,0 - WE / - WK + Zub Ceramic TRW 23554 17,0 - WE / - WK + Zub TRW 23554 17,0 - WE / - WK + Zub Ceramic BOS 24150 17,6 - WE / - WK + Zub BOS 24150 17,6 - WE / - WK + Zub BOS 24150 17,6 - WE / - WK + Zub Ceramic
 Bremsscheibe							
1.4 1.4 1.4 1.4 16V 1.4 Bioflex 1.4 HDi 1.4 HDi 1.6 HDi	53 54 55 65 60 50 52 68	02/06→ 12/07→ 08/08→ 02/06→ 08/08→ 02/06→ 02/11→ 11/09→	←	→ 06/12		24.0122-0194.1 422194	Ø 266 22 20 V + S
1.4 16V	70	06/07→	←	08/07→ 06/12		24.0126-0120.1 426120 24.0326-0120.1 526120	Ø 283 26 24 V + S Ø 283 26 24 V + S PD
1.4 16V	72	10/09→	←	→ 06/12		24.0126-0120.1 426120 24.0326-0120.1 526120	Ø 283 26 24 V + S Ø 283 26 24 V + S PD
1.6 1.6	81 90	08/08→ 09/07→12/13	←	→ 06/12		24.0126-0120.1 426120 24.0326-0120.1 526120	Ø 283 26 24 V + S Ø 283 26 24 V + S PD
↓							









	kW			 	! #		
PEUGEOT - 207 (WA_, WC_) 02/06→							
 Bremsscheibe							
1.6 16V	80	02/06→	→	→ 06/12		24.0109-0100.2 409100	Ø 249 9 7 + LG / + ABS Ring
1.6 16V Turbo	110	02/06→					
1.6 16V VTi	88	02/07→					
1.6 HDi	80	02/06→					
1.6 HDi 110	82	08/09→					
1.6 16V RC	128	02/07→	←	→ 06/12		24.0126-0140.1 426140	Ø 302 26 24 V + S
			→	→ 06/12		24.0109-0100.2 409100	Ø 249 9 7 + LG / + ABS Ring
1.6 16V Turbo	115	10/09→	←	01/10→ 06/12		24.0126-0120.1 426120	Ø 283 26 24 V + S
			→	→ 06/12		24.0326-0120.1 526120	Ø 283 26 24 V + S PD
			→	→ 06/12		24.0109-0100.2 409100	Ø 249 9 7 + LG / + ABS Ring
1.6 HDi	66	02/06→	←	→ 06/12		24.0122-0194.1 422194	Ø 266 22 20 V + S
						24.0126-0120.1 426120	Ø 283 26 24 V + S
						24.0326-0120.1 526120	Ø 283 26 24 V + S PD
			→	→ 06/12		24.0109-0100.2 409100	Ø 249 9 7 + LG / + ABS Ring
PEUGEOT - 207 CC (WD_) 02/07→							
 Bremsbelagsatz, Scheibenbremse							
1.6	90	09/10→12/11	←			13.0460-3966.2 603966	BOS 23600 19,4 - WE / - WK + Zub
1.6 16V	88	02/07→				13.0470-3966.2 LD3966	BOS 23600 19,4 - WE / - WK + Zub Ceramic
			→	Orga 1164282→		13.0460-2740.2 602740	TRW 23554 17,0 - WE / - WK + Zub
						13.0470-2740.2 LD2740	TRW 23554 17,0 - WE / - WK + Zub Ceramic
			→	→Orga 1164182		13.0460-3851.2 603851	BOS 24150 17,6 - WE / - WK + Zub
1.6 16V Turbo	110	02/07→	←			13.0460-3966.2 603966	BOS 23600 19,4 - WE / - WK + Zub
1.6 16V Turbo	115	10/09→				13.0470-3966.2 LD3966	BOS 23600 19,4 - WE / - WK + Zub Ceramic
1.6 HDi	80	02/07→					
			→	Orga 1163582→		13.0460-2740.2 602740	TRW 23554 17,0 - WE / - WK + Zub
						13.0470-2740.2 LD2740	TRW 23554 17,0 - WE / - WK + Zub Ceramic
			→	→Orga 1163482		13.0460-3851.2 603851	BOS 24150 17,6 - WE / - WK + Zub
1.6 HDi	82	08/09→	←			13.0460-3966.2 603966	BOS 23600 19,4 - WE / - WK + Zub
						13.0470-3966.2 LD3966	BOS 23600 19,4 - WE / - WK + Zub Ceramic
			→			13.0460-2740.2 602740	TRW 23554 17,0 - WE / - WK + Zub
						13.0470-2740.2 LD2740	TRW 23554 17,0 - WE / - WK + Zub Ceramic
 Bremsscheibe							
1.6	90	09/10→12/11	←			24.0126-0120.1 426120	Ø 283 26 24 V + S
1.6 16V	88	02/07→				24.0326-0120.1 526120	Ø 283 26 24 V + S PD
1.6 16V Turbo	110	02/07→					
1.6 16V Turbo	115	10/09→	→			24.0109-0100.2 409100	Ø 249 9 7 + LG / + ABS Ring
1.6 HDi	80	02/07→					
1.6 HDi	82	08/09→					
PEUGEOT - 207 Stufenheck 12/07→							
 Bremsbelagsatz, Scheibenbremse							
1.4	54	12/07→	←	→ 06/12		13.0460-3994.2 603994	BOS 23599 19,0 - WE / - WK + Zub
						13.0470-3994.2 LD3994	BOS 23599 19,0 - WE / - WK + Zub Ceramic
 Bremsscheibe							
1.4	54	12/07→	←	→ 06/12		24.0122-0194.1 422194	Ø 266 22 20 V + S
PEUGEOT - 207 SW (WK_) 02/07→							
 Bremsbelagsatz, Scheibenbremse							
1.4	54	06/07→	←	→ 07/13		13.0460-3994.2 603994	BOS 23599 19,0 - WE / - WK + Zub
↓							









	kW			 	! #		
PEUGEOT - 207 SW (WK_) 02/07→							
 Bremsbelagsatz, Scheibenbremse							
1.4	54	06/07→	←	→ 07/13		13.0470-3994.2 LD3994	BOS 23599 19,0 - WE / - WK + Zub Ceramic
1.4 16V 1.4 16V	70 72	06/07→ 11/09→	←	→ 07/13		13.0460-3966.2 603966 13.0470-3966.2 LD3966	BOS 23600 19,4 - WE / - WK + Zub BOS 23600 19,4 - WE / - WK + Zub Ceramic
1.6 16V 1.6 16V Turbo	88 110	06/07→ 02/07→	←	→ 07/13		13.0460-3966.2 603966 13.0470-3966.2 LD3966	BOS 23600 19,4 - WE / - WK + Zub BOS 23600 19,4 - WE / - WK + Zub Ceramic
			→	Orga 11628→; → 07/13		13.0460-2740.2 602740 13.0470-2740.2 LD2740	TRW 23554 17,0 - WE / - WK + Zub TRW 23554 17,0 - WE / - WK + Zub Ceramic
			→	→Orga 11627		13.0460-3851.2 603851	BOS 24150 17,6 - WE / - WK + Zub
1.6 16V RC	128	02/07→	←	11/07→ 07/13		13.0460-7202.2 607202 13.0470-7202.2 LD7202	ATE 23589 19,1 - WE / - WK ATE 23589 19,1 - WE / - WK Ceramic
			→	Orga 11628→; → 07/13		13.0460-2740.2 602740 13.0470-2740.2 LD2740	TRW 23554 17,0 - WE / - WK + Zub TRW 23554 17,0 - WE / - WK + Zub Ceramic
			→	11/07→; →Orga 11627		13.0460-3851.2 603851	BOS 24150 17,6 - WE / - WK + Zub
1.6 HDi	66	06/07→	←	→ 07/13		13.0460-3966.2 603966 13.0470-3966.2 LD3966	BOS 23600 19,4 - WE / - WK + Zub BOS 23600 19,4 - WE / - WK + Zub Ceramic
			→	Orga 11634→; → 07/13		13.0460-2740.2 602740 13.0470-2740.2 LD2740	TRW 23554 17,0 - WE / - WK + Zub TRW 23554 17,0 - WE / - WK + Zub Ceramic
			→	→Orga 11634		13.0460-3851.2 603851	BOS 24150 17,6 - WE / - WK + Zub
1.6 HDi	68	11/09→	←	→ 07/13		13.0460-3966.2 603966 13.0470-3966.2 LD3966	BOS 23600 19,4 - WE / - WK + Zub BOS 23600 19,4 - WE / - WK + Zub Ceramic
			→	→ 07/13		13.0460-2740.2 602740 13.0470-2740.2 LD2740	TRW 23554 17,0 - WE / - WK + Zub TRW 23554 17,0 - WE / - WK + Zub Ceramic
1.6 HDi	80	06/07→	←	→ 07/13		13.0460-3966.2 603966 13.0470-3966.2 LD3966	BOS 23600 19,4 - WE / - WK + Zub BOS 23600 19,4 - WE / - WK + Zub Ceramic
			→	Orga 11635→; → 07/13		13.0460-2740.2 602740 13.0470-2740.2 LD2740	TRW 23554 17,0 - WE / - WK + Zub TRW 23554 17,0 - WE / - WK + Zub Ceramic
			→	→Orga 11634		13.0460-3851.2 603851	BOS 24150 17,6 - WE / - WK + Zub
1.6 HDi	82	08/09→	←	→ 07/13		13.0460-3966.2 603966 13.0470-3966.2 LD3966	BOS 23600 19,4 - WE / - WK + Zub BOS 23600 19,4 - WE / - WK + Zub Ceramic
			→	→ 07/13; Orga 11631→		13.0460-2740.2 602740 13.0470-2740.2 LD2740	TRW 23554 17,0 - WE / - WK + Zub TRW 23554 17,0 - WE / - WK + Zub Ceramic
			→	→Orga 11631		13.0460-3851.2 603851	BOS 24150 17,6 - WE / - WK + Zub
 Bremsscheibe							
1.4	54	06/07→	←	→ 07/13		24.0122-0194.1 422194	Ø 266 22 20 V + S
1.4 16V 1.4 16V	70 72	06/07→ 11/09→	←	→ 07/13		24.0126-0120.1 426120 24.0326-0120.1 526120	Ø 283 26 24 V + S Ø 283 26 24 V + S PD
1.6 16V 1.6 16V Turbo ↓	88 110	06/07→ 02/07→	←	→ 07/13		24.0126-0120.1 426120	Ø 283 26 24 V + S

	kw			 	! #		
PEUGEOT - 207 SW (WK_) 02/07→							
 Bremsscheibe							
1.6 HDi	66	06/07→	←	→ 07/13		24.0326-0120.1 526120	Ø 283 26 24 V + S PD
1.6 HDi	68	11/09→	→	→ 07/13		24.0109-0100.2 409100	Ø 249 9 7 + LG / + ABS Ring
1.6 HDi	80	06/07→					
1.6 HDi	82	08/09→					
1.6 16V RC	128	02/07→	←	11/07→ 07/13		24.0126-0140.1 426140	Ø 302 26 24 V + S
			→	06/07→ 07/13		24.0109-0100.2 409100	Ø 249 9 7 + LG / + ABS Ring
PEUGEOT - 207 Van 04/07→							
 Bremsbelagsatz, Scheibenbremse							
1.4	54	06/07→10/08	←			13.0460-3994.2 603994	BOS 23599 19,0 - WE / - WK + Zub
						13.0470-3994.2 LD3994	BOS 23599 19,0 - WE / - WK + Zub Ceramic
1.4 HDi	50	04/07→	←	→ 06/12		13.0460-3994.2 603994	BOS 23599 19,0 - WE / - WK + Zub
						13.0470-3994.2 LD3994	BOS 23599 19,0 - WE / - WK + Zub Ceramic
1.6 HDi	66	04/07→	←	für Bremsscheibendurchmesser [mm]: 283; → 06/12		13.0460-3966.2 603966	BOS 23600 19,4 - WE / - WK + Zub
1.6 HDi	68	11/09→	←	für Bremsscheibendurchmesser [mm]: 266; → 06/12		13.0470-3966.2 LD3966	BOS 23600 19,4 - WE / - WK + Zub Ceramic
			→	Orga 11635→; → 06/12		13.0460-2740.2 602740	TRW 23554 17,0 - WE / - WK + Zub
						13.0470-2740.2 LD2740	TRW 23554 17,0 - WE / - WK + Zub Ceramic
			→	→Orga 11634		13.0460-3813.2 603813	BOS 24150 17,6 - WE / - WK + Zub
						13.0460-3851.2 603851	BOS 24150 17,6 - WE / - WK + Zub
						13.0470-3813.2 LD3813	BOS 24150 17,6 - WE / - WK + Zub Ceramic
 Bremsscheibe							
1.4	54	06/07→10/08	←			24.0122-0194.1 422194	Ø 266 22 20 V + S
1.4 HDi	50	04/07→	←	→ 06/12		24.0122-0194.1 422194	Ø 266 22 20 V + S
1.6 HDi	66	04/07→	←	→ 06/12		24.0122-0194.1 422194	Ø 266 22 20 V + S
1.6 HDi	68	11/09→	←	→ 06/12		24.0126-0120.1 426120	Ø 283 26 24 V + S
			→	→ 06/12		24.0326-0120.1 526120	Ø 283 26 24 V + S PD
						24.0109-0100.2 409100	Ø 249 9 7 + LG / + ABS Ring
PEUGEOT - 208 03/12→							
 Bremsbelagsatz, Scheibenbremse							
1.0	50	03/12→	←	für Bremsscheibendurchmesser [mm]: 266		13.0460-3994.2 603994	BOS 23599 19,0 - WE / - WK + Zub
1.2	60	03/12→					
1.2 GPL	60	06/15→				13.0470-3994.2 LD3994	BOS 23599 19,0 - WE / - WK + Zub Ceramic
1.2 THP	81	01/13→					
1.4 GPL	70	10/13→					
1.4 HDi	50	03/12→	←	für Bremsscheibendurchmesser [mm]: 302		13.0460-7202.2 607202	ATE 23589 19,1 - WE / - WK
1.4 VTi	70	03/12→				13.0470-7202.2 LD7202	ATE 23589 19,1 - WE / - WK Ceramic
1.6	88	03/12→					
1.6	115	03/12→	→			13.0460-2740.2 602740	TRW 23554 17,0 - WE / - WK + Zub
1.6 BlueHDi 100	73	01/15→					
1.6 BlueHDi 120	88	11/13→					
1.6 HDi	68	03/12→				13.0470-2740.2 LD2740	TRW 23554 17,0 - WE / - WK + Zub Ceramic
1.6 HDi	69	09/16→					
1.6 HDi	84	03/12→					
1.6 HDi	85	04/14→					
1.6 HDi / BlueHDi 75	55	01/13→					
1.6 THP 165	121	03/15→					
1.6 GTi	147	08/12→	→	03/13→		13.0460-2740.2 602740	TRW 23554 17,0 - WE / - WK + Zub
						13.0470-2740.2 LD2740	TRW 23554 17,0 - WE / - WK + Zub Ceramic
1.6 GTi	153	10/14→	→			13.0460-2740.2 602740	TRW 23554 17,0 - WE / - WK + Zub
						13.0470-2740.2 LD2740	TRW 23554 17,0 - WE / - WK + Zub Ceramic

	kw			 	! #		
PEUGEOT - 208 03/12→							
 Bremsscheibe							
1.0	50	03/12→	←			24.0122-0194.1 422194	Ø 266 22 20 V + S
1.2	60	03/12→				24.0126-0159.1 426159	Ø 302 26 24 V + S
1.2 GPL	60	06/15→					
1.2 THP	81	01/13→	→			24.0109-0100.2 409100	Ø 249 9 7 + LG / + ABS Ring
1.4 GPL	70	10/13→					
1.4 HDi	50	03/12→					
1.4 VTi	70	03/12→					
1.6	88	03/12→					
1.6	115	03/12→					
1.6 BlueHDi 100	73	01/15→					
1.6 BlueHDi 120	88	11/13→					
1.6 HDi	68	03/12→					
1.6 HDi	69	09/16→					
1.6 HDi	84	03/12→					
1.6 HDi	85	04/14→					
1.6 HDi / BlueHDi 75	55	01/13→					
1.6 THP 165	121	03/15→					
1.6 GTi	147	08/12→	←	03/13→		24.0126-0159.1 426159	Ø 302 26 24 V + S
			→	03/13→		24.0109-0100.2 409100	Ø 249 9 7 + LG / + ABS Ring
1.6 GTi	153	10/14→	→			24.0109-0100.2 409100	Ø 249 9 7 + LG / + ABS Ring
PEUGEOT - 208 Kasten 10/12→							
 Bremsbelagsatz, Scheibenbremse							
1.4 HDi	50	10/12→	←	für Bremsscheibendurchmesser [mm]: 266		13.0460-3994.2 603994	BOS 23599 19,0 - WE / - WK + Zub
1.6 BlueHDi 75	55	04/15→				13.0470-3994.2 LD3994	BOS 23599 19,0 - WE / - WK + Zub Ceramic
1.6 HDi	68	03/14→					
			←	für Bremsscheibendurchmesser [mm]: 302		13.0460-7202.2 607202	ATE 23589 19,1 - WE / - WK
						13.0470-7202.2 LD7202	ATE 23589 19,1 - WE / - WK Ceramic
			→			13.0460-2740.2 602740	TRW 23554 17,0 - WE / - WK + Zub
						13.0470-2740.2 LD2740	TRW 23554 17,0 - WE / - WK + Zub Ceramic
 Bremsscheibe							
1.4 HDi	50	10/12→	←			24.0122-0194.1 422194	Ø 266 22 20 V + S
1.6 BlueHDi 75	55	04/15→				24.0126-0159.1 426159	Ø 302 26 24 V + S
1.6 HDi	68	03/14→	→			24.0109-0100.2 409100	Ø 249 9 7 + LG / + ABS Ring
PEUGEOT - 301 11/12→							
 Bremsbelagsatz, Scheibenbremse							
1.2 VTi 72	53	11/12→	←			13.0460-3867.2 603867	MAN 25250 18,9 - WE / - WK + Zub
1.2 VTi 82	60	12/14→					
1.6 BlueHDi 100	73	04/14→	←	V		13.0460-3994.2 603994	BOS 23599 19,0 - WE / - WK + Zub
1.6 HDi 90	68	11/12→				13.0470-3994.2 LD3994	BOS 23599 19,0 - WE / - WK + Zub Ceramic
1.6 HDi 90	69	09/16→					
1.6 VTi 115	85	11/12→					
1.6 VTi 115	86	09/16→					
 Bremsscheibe							
1.2 VTi 72	53	11/12→	←			24.0113-0184.1 413184	Ø 266 13 11 + S
1.2 VTi 82	60	12/14→				24.0122-0194.1 422194	Ø 266 22 20 V + S
1.6 BlueHDi 100	73	04/14→				24.0313-0184.1 513184	Ø 266 13 11 + S PD
1.6 HDi 90	68	11/12→					
1.6 HDi 90	69	09/16→					
1.6 VTi 115	85	11/12→					
1.6 VTi 115	86	09/16→					
PEUGEOT - 306 (7B, N3, N5) 04/93→10/03							
 Bremsbelagsatz, Scheibenbremse							
1.1	44	06/94→05/01	←	→ 04/97; - ABS		13.0460-3952.2 603952	BDX 20905 18,0 + WK
			←	→ 04/97; + ABS		13.0460-7058.2 607058	ATE 21430 17,3 + WK
						13.0460-7088.2 607088	ATE 21430 17,3 - WE / - WK
1.4 SL	55	06/94→05/01	←	Orga 08576→; + ABS		13.0460-2829.2 602829	TRW 23124 19,0 + WK
			←	10/94→ 04/97; - ABS		13.0460-3978.2 603978	BOS 23332 18,0 - WK + Zub
			←	10/94→; - ABS		13.0460-3952.2 603952	BDX 20905 18,0 + WK
			←	05/97→; - ABS		13.0460-3975.2 603975	BOS 23597 18,0 - WK
			←	10/94→; →Orga 08575; + ABS		13.0460-7058.2 607058	ATE 21430 17,3 + WK
						13.0460-7088.2 607088	ATE 21430 17,3 - WE / - WK
↓							



	kw			 	! #		
PEUGEOT - 306 (7B, N3, N5) 04/93→10/03							
 Bremsbelagsatz, Scheibenbremse							
1.6	72	10/00→05/01	← + ABS			13.0460-2829.2 602829	TRW 23124 19,0 + WK
			← - ABS			13.0460-3978.2 603978	BOS 23332 18,0 - WK + Zub
1.6 SR	65	06/94→10/00	← Orga 08576→; + ABS			13.0460-2829.2 602829	TRW 23124 19,0 + WK
			← 10/94→; →Orga 08575			13.0460-3978.2 603978	BOS 23332 18,0 - WK + Zub
			← Orga 08576→; - ABS			13.0460-7058.2 607058	ATE 21430 17,3 + WK
1.8	74	10/95→04/97	← Orga 08576→; - ABS			13.0460-7088.2 607088	ATE 21430 17,3 - WE / - WK
			← Orga 08576→; + ABS			13.0460-2829.2 602829	TRW 23124 19,0 + WK
			← →Orga 08575			13.0460-3978.2 603978	BOS 23332 18,0 - WK + Zub
1.8 16V 2.0 2.0 HDI 90	81 99 66	03/97→05/01 05/97→06/00 06/99→05/01	←			13.0460-2829.2 602829	TRW 23124 19,0 + WK
			→			13.0460-3978.2 603978	BOS 23332 18,0 - WK + Zub
			→			13.0460-3823.2 603823	BOS 20974 11,0 - WK
1.8 16V	82	03/97→07/01	← → 05/01			13.0460-3954.2 603954	BDX 20973 11,0 - WK
			→ 05/01			13.0460-2829.2 602829	TRW 23124 19,0 + WK
			→			13.0460-3978.2 603978	BOS 23332 18,0 - WK + Zub
1.8 ST	74	06/94→05/01	← Orga 08576→; - ABS			13.0460-3823.2 603823	BOS 20974 11,0 - WK
			← →Orga 08575			13.0460-3954.2 603954	BDX 20973 11,0 - WK
			←			13.0460-2829.2 602829	TRW 23124 19,0 + WK
1.9 D 1.9 STD	51 51	09/98→05/01 02/94→10/95	← Orga 08576→; + ABS			13.0460-3978.2 603978	BOS 23332 18,0 - WK + Zub
			← Orga 08576→; - ABS			13.0460-7058.2 607058	ATE 21430 17,3 + WK
			← →Orga 08575			13.0460-7088.2 607088	ATE 21430 17,3 - WE / - WK
1.9 D	55	03/98→05/01	←			13.0460-7058.2 607058	ATE 21430 17,3 + WK
			←			13.0460-7088.2 607088	ATE 21430 17,3 - WE / - WK
1.9 D	69	02/94→04/97	←			13.0460-7058.2 607058	ATE 21430 17,3 + WK
			← 10/94→			13.0460-7088.2 607088	ATE 21430 17,3 - WE / - WK
			←			13.0460-7058.2 607058	ATE 21430 17,3 + WK
1.9 SLD 1.9 SLD 1.9 SRDT	47 50 66	06/94→05/01 06/94→05/01 06/94→05/01	← 10/94→			13.0460-7088.2 607088	ATE 21430 17,3 - WE / - WK
			←			13.0460-7058.2 607058	ATE 21430 17,3 + WK
			←			13.0460-7088.2 607088	ATE 21430 17,3 - WE / - WK
2.0	97	03/97→05/01	←			13.0460-2829.2 602829	TRW 23124 19,0 + WK
			← → 04/97			13.0460-3978.2 603978	BOS 23332 18,0 - WK + Zub
			→			13.0460-2869.2 602869	TRW 23169 19,4 + WK
2.0 S16 2.0 ST	110 89	06/94→05/01 07/94→05/01	← 05/97→			13.0460-3823.2 603823	BOS 20974 11,0 - WK
			← → 04/97			13.0460-3954.2 603954	BDX 20973 11,0 - WK
			→			13.0460-2829.2 602829	TRW 23124 19,0 + WK
2.0 S16	112	06/94→05/01	← 05/97→			13.0460-3978.2 603978	BOS 23332 18,0 - WK + Zub
			← 07/94→ 04/97			13.0460-2869.2 602869	TRW 23169 19,4 + WK
			→ 07/94→			13.0460-3823.2 603823	BOS 20974 11,0 - WK
↓							

	kw			 	! #		
PEUGEOT - 306 (7B, N3, N5) 04/93→10/03							
 Bremsbelagsatz, Scheibenbremse							
2.0 S16	112	06/94→05/01	➡	07/94→		13.0460-3954.2 603954	BDX 20973 11,0 - WK
Zubehörsatz, Scheibenbremsbelag							
1.1	44	06/94→05/01	←	→ 04/97; - ABS		13.0460-0403.2 610403	BDX
1.4 SL	55	06/94→05/01	←	10/94→ 04/97; - ABS		13.0460-0403.2 610403	BDX
1.8 16V 2.0 2.0 HDI 90 2.0 S16 2.0 ST	81 97 99 66 110 89	03/97→05/01 03/97→05/01 05/97→06/00 06/99→05/01 06/94→05/01 07/94→05/01	➡			13.0460-0435.2 610435	BDX
1.8 16V	82	03/97→07/01	➡	→ 05/01		13.0460-0435.2 610435	BDX
2.0 S16	112	06/94→05/01	➡	07/94→		13.0460-0435.2 610435	BDX
 Bremsscheibe							
1.1	44	06/94→05/01	←	→ 04/97; - ABS		24.0110-0187.1 410187	Ø 247 10 9 + S
			←	→ 04/97; + ABS		24.0120-0132.1 420132	Ø 247 20,4 18,5 V + S
						24.0320-0132.1 520132	Ø 247 20,4 18,5 V + S PD
1.4 SL	55	06/94→05/01	←	10/94→ 04/97; - ABS		24.0110-0187.1 410187	Ø 247 10 9 + S
			←	05/97→; - ABS		24.0113-0185.1 413185	Ø 247,5 13 11 + S
						24.0313-0185.1 513185	Ø 247,5 13 11 + S PD
			←	10/94→; →Orga 08575; + ABS		24.0120-0132.1 420132	Ø 247 20,4 18,5 V + S
						24.0320-0132.1 520132	Ø 247 20,4 18,5 V + S PD
			←	05/00→; + ABS		24.0120-0133.1 420133	Ø 266 20,5 18,5 V + S
						24.0320-0133.1 520133	Ø 266 20,5 18,5 V + S PD
1.6	72	10/00→05/01	←	- ABS		24.0120-0132.1 420132	Ø 247 20,4 18,5 V + S
			←	+ ABS		24.0120-0133.1 420133	Ø 266 20,5 18,5 V + S
						24.0320-0133.1 520133	Ø 266 20,5 18,5 V + S PD
1.6 SR	65	06/94→10/00	←	10/94→ 05/00		24.0120-0132.1 420132	Ø 247 20,4 18,5 V + S
						24.0320-0132.1 520132	Ø 247 20,4 18,5 V + S PD
			←	Orga 08576→; - ABS		24.0120-0132.1 420132	Ø 247 20,4 18,5 V + S
						24.0320-0132.1 520132	Ø 247 20,4 18,5 V + S PD
			←	05/00→; + ABS		24.0120-0133.1 420133	Ø 266 20,5 18,5 V + S
						24.0320-0133.1 520133	Ø 266 20,5 18,5 V + S PD
1.8	74	10/95→04/97	←	Orga 08576→; - ABS		24.0120-0132.1 420132	Ø 247 20,4 18,5 V + S
						24.0320-0132.1 520132	Ø 247 20,4 18,5 V + S PD
			←	→Orga 08575		24.0120-0132.1 420132	Ø 247 20,4 18,5 V + S
						24.0320-0132.1 520132	Ø 247 20,4 18,5 V + S PD
			←	Orga 08576→; + ABS		24.0120-0133.1 420133	Ø 266 20,5 18,5 V + S
						24.0320-0133.1 520133	Ø 266 20,5 18,5 V + S PD
1.8 16V 2.0 2.0 HDI 90 2.0 ST	81 97 99 66 89	03/97→05/01 03/97→05/01 05/97→06/00 06/99→05/01 07/94→05/01	←			24.0120-0133.1 420133	Ø 266 20,5 18,5 V + S
						24.0320-0133.1 520133	Ø 266 20,5 18,5 V + S PD
			➡			24.0108-0106.1 408106	Ø 247 8 6 + S
1.8 16V	82	03/97→07/01	←	→ 05/01		24.0120-0133.1 420133	Ø 266 20,5 18,5 V + S
						24.0320-0133.1 520133	Ø 266 20,5 18,5 V + S PD
			➡	→ 05/01		24.0108-0106.1 408106	Ø 247 8 6 + S
1.8 ST 1.9 D	74 51	06/94→05/01 09/98→05/01	←	Orga 08576→; - ABS		24.0120-0132.1 420132	Ø 247 20,4 18,5 V + S
						24.0320-0132.1 520132	Ø 247 20,4 18,5 V + S PD
			←	→Orga 08575		24.0120-0132.1 420132	Ø 247 20,4 18,5 V + S
						24.0320-0132.1 520132	Ø 247 20,4 18,5 V + S PD
			←	05/00→; + ABS		24.0120-0133.1 420133	Ø 266 20,5 18,5 V + S
						24.0320-0133.1 520133	Ø 266 20,5 18,5 V + S PD
1.9 D	55	03/98→05/01	←			24.0120-0132.1 420132	Ø 247 20,4 18,5 V + S
						24.0320-0132.1 520132	Ø 247 20,4 18,5 V + S PD
1.9 D	69	02/94→04/97	←			24.0120-0132.1 420132	Ø 247 20,4 18,5 V + S
						24.0320-0132.1 520132	Ø 247 20,4 18,5 V + S PD
			←	10/94→		24.0120-0132.1 420132	Ø 247 20,4 18,5 V + S
						24.0320-0132.1 520132	Ø 247 20,4 18,5 V + S PD
1.9 SLD 1.9 SLD 1.9 SRDT	47 50 66	06/94→05/01 06/94→05/01 06/94→05/01	←	10/94→		24.0120-0132.1 420132	Ø 247 20,4 18,5 V + S
						24.0320-0132.1 520132	Ø 247 20,4 18,5 V + S PD
↓							

PEUGEOT - 306 (7B, N3, N5) 04/93→10/03

Bremsscheibe

1.9 STD	51	02/94→10/95	←	Orga 08576→; - ABS	24.0120-0132.1 420132	Ø 247 20,4 18,5 V + S
					24.0320-0132.1 520132	Ø 247 20,4 18,5 V + S PD
			←	Orga 08576→; + ABS	24.0120-0133.1 420133	Ø 266 20,5 18,5 V + S
					24.0320-0133.1 520133	Ø 266 20,5 18,5 V + S PD
2.0 S16	110	06/94→05/01	←	05/97→	24.0120-0133.1 420133	Ø 266 20,5 18,5 V + S
					24.0320-0133.1 520133	Ø 266 20,5 18,5 V + S PD
			←	→ 04/97	24.0122-0142.1 422142	Ø 283 22 20 V
			→		24.0108-0106.1 408106	Ø 247 8 6 + S
2.0 S16	112	06/94→05/01	←	05/97→	24.0120-0133.1 420133	Ø 266 20,5 18,5 V + S
					24.0320-0133.1 520133	Ø 266 20,5 18,5 V + S PD
			←	07/94→ 04/97	24.0122-0142.1 422142	Ø 283 22 20 V
			→	07/94→	24.0108-0106.1 408106	Ø 247 8 6 + S

PEUGEOT - 306 Break (7E, N3, N5) 06/94→04/02

Bremsbelagsatz, Scheibenbremse







1.4	55	03/97→04/02	←	→ 03/02; + ABS	13.0460-2829.2 602829	TRW 23124 19,0 + WK
					13.0460-3978.2 603978	BOS 23332 18,0 - WK + Zub
1.6	72	10/00→04/02				
1.9 D	50	03/97→04/02				
1.9 D	51	09/98→04/02	←	→ 03/02; - ABS	13.0460-7088.2 607088	ATE 21430 17,3 - WE / - WK
1.9 D	55	03/98→04/02				
1.6	65	03/97→10/00	←	+ ABS	13.0460-2829.2 602829	TRW 23124 19,0 + WK
					13.0460-3978.2 603978	BOS 23332 18,0 - WK + Zub
1.9 D	51	05/97→05/99	←	- ABS	13.0460-7088.2 607088	ATE 21430 17,3 - WE / - WK
1.8	74	03/97→04/02	←	→ 03/02	13.0460-2829.2 602829	TRW 23124 19,0 + WK
					13.0460-3978.2 603978	BOS 23332 18,0 - WK + Zub
1.8 16V	81	03/97→04/02	←	→ 03/02	13.0460-2829.2 602829	TRW 23124 19,0 + WK
					13.0460-3978.2 603978	BOS 23332 18,0 - WK + Zub
2.0	97	03/97→04/02				
2.0 16V	99	03/97→04/02				
2.0 HDI 90	66	06/99→04/02	→	→ 03/02	13.0460-3823.2 603823	BOS 20974 11,0 - WK
					13.0460-3954.2 603954	BDX 20973 11,0 - WK
1.8 16V	82	03/97→07/01	←		13.0460-2829.2 602829	TRW 23124 19,0 + WK
					13.0460-3978.2 603978	BOS 23332 18,0 - WK + Zub
			→		13.0460-3823.2 603823	BOS 20974 11,0 - WK
					13.0460-3954.2 603954	BDX 20973 11,0 - WK
1.9 Td	52	07/95→08/00	←	03/97→	13.0460-2829.2 602829	TRW 23124 19,0 + WK
					13.0460-3978.2 603978	BOS 23332 18,0 - WK + Zub
1.9 TD	66	02/97→04/02	←	03/97→ 03/02	13.0460-2829.2 602829	TRW 23124 19,0 + WK
					13.0460-3978.2 603978	BOS 23332 18,0 - WK + Zub

Zubehörsatz, Scheibenbremsbelag











1.8 16V	81	03/97→04/02	→	→ 03/02	13.0460-0435.2 610435	BDX
2.0	97	03/97→04/02				
2.0 16V	99	03/97→04/02				
2.0 HDI 90	66	06/99→04/02				
1.8 16V	82	03/97→07/01	→		13.0460-0435.2 610435	BDX



















































Bremsscheibe









1.4	55	03/97→04/02	←	→ 03/02; - ABS	24.0120-0132.1 420132	Ø 247 20,4 18,5 V + S
					24.0320-0132.1 520132	Ø 247 20,4 18,5 V + S PD
1.6	72	10/00→04/02				
1.9 D	50	03/97→04/02				
1.9 D	51	09/98→04/02	←	→ 03/02; + ABS	24.0120-0133.1 420133	Ø 266 20,5 18,5 V + S
1.9 D	55	03/98→04/02			24.0320-0133.1 520133	Ø 266 20,5 18,5 V + S PD
1.6	65	03/97→10/00	←	- ABS	24.0120-0132.1 420132	Ø 247 20,4 18,5 V + S
					24.0320-0132.1 520132	Ø 247 20,4 18,5 V + S PD
1.9 D	51	05/97→05/99	←	+ ABS	24.0120-0133.1 420133	Ø 266 20,5 18,5 V + S
					24.0320-0133.1 520133	Ø 266 20,5 18,5 V + S PD
1.8	74	03/97→04/02	←	→ 03/02	24.0120-0133.1 420133	Ø 266 20,5 18,5 V + S
					24.0320-0133.1 520133	Ø 266 20,5 18,5 V + S PD
1.8 16V	81	03/97→04/02	←	→ 03/02	24.0120-0133.1 420133	Ø 266 20,5 18,5 V + S
					24.0320-0133.1 520133	Ø 266 20,5 18,5 V + S PD
2.0	97	03/97→04/02				
2.0 16V	99	03/97→04/02				
2.0 HDI 90	66	06/99→04/02	→	→ 03/02	24.0108-0106.1 408106	Ø 247 8 6 + S
1.8 16V	82	03/97→07/01	←		24.0120-0133.1 420133	Ø 266 20,5 18,5 V + S
					24.0320-0133.1 520133	Ø 266 20,5 18,5 V + S PD
			→		24.0108-0106.1 408106	Ø 247 8 6 + S
1.9 Td	52	07/95→08/00	←	03/97→	24.0120-0133.1 420133	Ø 266 20,5 18,5 V + S









	kw			 	! #		
PEUGEOT - 306 Break (7E, N3, N5) 06/94→04/02							
Bremsscheibe							
1.9 Td	52	07/95→08/00	←	03/97→		24.0320-0133.1 520133	Ø 266 20,5 18,5 V + S PD
1.9 TD	66	02/97→04/02	←	03/97→ 03/02		24.0120-0133.1 420133	Ø 266 20,5 18,5 V + S
						24.0320-0133.1 520133	Ø 266 20,5 18,5 V + S PD
PEUGEOT - 306 Cabriolet (7D, N3, N5) 03/94→04/02							
Bremsbelagsatz, Scheibenbremse							
1.6	65	04/96→10/00	←	Orga 08576→; + ABS		13.0460-2829.2 602829	TRW 23124 19,0 + WK
			←	05/00→; - ABS		13.0460-3978.2 603978	BOS 23332 18,0 - WK + Zub
			←	→Orga 08575		13.0460-7058.2 607058	ATE 21430 17,3 + WK
			←			13.0460-7088.2 607088	ATE 21430 17,3 - WE / - WK
			←			13.0460-7058.2 607058	ATE 21430 17,3 + WK
			←			13.0460-7088.2 607088	ATE 21430 17,3 - WE / - WK
1.6	72	10/00→04/02	←			13.0460-2829.2 602829	TRW 23124 19,0 + WK
			←			13.0460-3978.2 603978	BOS 23332 18,0 - WK + Zub
1.8	74	03/94→04/02	←	Orga 08576→; → 10/00; + ABS		13.0460-2829.2 602829	TRW 23124 19,0 + WK
			←	05/00→ 10/00; - ABS		13.0460-3978.2 603978	BOS 23332 18,0 - WK + Zub
			←	→Orga 08575		13.0460-7058.2 607058	ATE 21430 17,3 + WK
			←			13.0460-7088.2 607088	ATE 21430 17,3 - WE / - WK
			←			13.0460-7058.2 607058	ATE 21430 17,3 + WK
			←			13.0460-7088.2 607088	ATE 21430 17,3 - WE / - WK
1.8	74	05/97→04/99	←	Orga 08576→; + ABS		13.0460-2829.2 602829	TRW 23124 19,0 + WK
			←	→Orga 08575		13.0460-3978.2 603978	BOS 23332 18,0 - WK + Zub
			←			13.0460-7058.2 607058	ATE 21430 17,3 + WK
			←			13.0460-7088.2 607088	ATE 21430 17,3 - WE / - WK
1.8 16V	81	07/00→04/02	←			13.0460-2829.2 602829	TRW 23124 19,0 + WK
			←			13.0460-3978.2 603978	BOS 23332 18,0 - WK + Zub
			←			13.0460-3823.2 603823	BOS 20974 11,0 - WK
			←	- ABS		13.0460-7058.2 607058	ATE 21430 17,3 + WK
			←			13.0460-7088.2 607088	ATE 21430 17,3 - WE / - WK
			←	→Orga 08575		13.0460-7058.2 607058	ATE 21430 17,3 + WK
			←			13.0460-7088.2 607088	ATE 21430 17,3 - WE / - WK
			→			13.0460-3954.2 603954	BDX 20973 11,0 - WK
2.0	89	03/94→04/02	←	→ 04/97		13.0460-2829.2 602829	TRW 23124 19,0 + WK
2.0	90	02/95→11/97	←			13.0460-3978.2 603978	BOS 23332 18,0 - WK + Zub
			←	→ 04/97		13.0460-3823.2 603823	BOS 20974 11,0 - WK
			→	→ 04/97		13.0460-3954.2 603954	BDX 20973 11,0 - WK
2.0 16V	97	03/97→04/02	←	→ 10/00		13.0460-2829.2 602829	TRW 23124 19,0 + WK
			←			13.0460-3978.2 603978	BOS 23332 18,0 - WK + Zub
			←	→ 10/00		13.0460-3823.2 603823	BOS 20974 11,0 - WK
			→	→ 10/00		13.0460-3954.2 603954	BDX 20973 11,0 - WK
2.0 16V	99	03/97→04/02	←			13.0460-2829.2 602829	TRW 23124 19,0 + WK
			←			13.0460-3978.2 603978	BOS 23332 18,0 - WK + Zub
			←			13.0460-3823.2 603823	BOS 20974 11,0 - WK
			→			13.0460-3954.2 603954	BDX 20973 11,0 - WK
Zubehörsatz, Scheibenbremsbelag							
1.8 16V	81	07/00→04/02				13.0460-0435.2 610435	BDX
2.0 16V	99	03/97→04/02					
2.0	89	03/94→04/02		→ 04/97		13.0460-0435.2 610435	BDX
2.0	90	02/95→11/97					
2.0 16V	97	03/97→04/02		→ 10/00		13.0460-0435.2 610435	BDX
Bremsscheibe							
1.6	65	04/96→10/00	←	Orga 08576→; - ABS		24.0120-0132.1 420132	Ø 247 20,4 18,5 V + S
1.8	74	05/97→04/99	←			24.0320-0132.1 520132	Ø 247 20,4 18,5 V + S PD
			←	→Orga 08575		24.0120-0132.1 420132	Ø 247 20,4 18,5 V + S
			←			24.0320-0132.1 520132	Ø 247 20,4 18,5 V + S PD
			←	Orga 08576→; + ABS		24.0120-0133.1 420133	Ø 266 20,5 18,5 V + S
			←			24.0320-0133.1 520133	Ø 266 20,5 18,5 V + S PD
1.6	72	10/00→04/02	←			24.0120-0133.1 420133	Ø 266 20,5 18,5 V + S
			←			24.0320-0133.1 520133	Ø 266 20,5 18,5 V + S PD
1.8	74	03/94→04/02	←	Orga 08576→; → 10/00; - ABS		24.0120-0132.1 420132	Ø 247 20,4 18,5 V + S
↓							









	kw			 	! #		
PEUGEOT - 306 Cabriolet (7D, N3, N5) 03/94→04/02							
 Bremsscheibe							
1.8	74	03/94→04/02	←	Orga 08576→; → 10/00; - ABS	24.0320-0132.1	520132	Ø 247 20,4 18,5 V + S PD
			←	→Orga 08575	24.0120-0132.1	420132	Ø 247 20,4 18,5 V + S
					24.0320-0132.1	520132	Ø 247 20,4 18,5 V + S PD
			←	Orga 08576→; → 10/00; + ABS	24.0120-0133.1	420133	Ø 266 20,5 18,5 V + S
				24.0320-0133.1	520133	Ø 266 20,5 18,5 V + S PD	
1.8 16V 2.0 16V	81 99	07/00→04/02 03/97→04/02	←		24.0120-0133.1	420133	Ø 266 20,5 18,5 V + S
			→		24.0320-0133.1	520133	Ø 266 20,5 18,5 V + S PD
2.0 2.0	89 90	03/94→04/02 02/95→11/97	←	→ 04/97	24.0120-0133.1	420133	Ø 266 20,5 18,5 V + S
			→		24.0320-0133.1	520133	Ø 266 20,5 18,5 V + S PD
			→	→ 04/97	24.0108-0106.1	408106	Ø 247 8 6 + S
2.0 16V	97	03/97→04/02	←	→ 10/00	24.0120-0133.1	420133	Ø 266 20,5 18,5 V + S
			→		24.0320-0133.1	520133	Ø 266 20,5 18,5 V + S PD
			→	→ 10/00	24.0108-0106.1	408106	Ø 247 8 6 + S
PEUGEOT - 306 Kasten/Kombi (N_, 7_) 07/93→08/02							
 Bremsbelagsatz, Scheibenbremse							
1.4	55	03/96→07/01	←	Orga 08576→; → 05/01; + ABS	13.0460-2829.2	602829	TRW 23124 19,0 + WK
					13.0460-3978.2	603978	BOS 23332 18,0 - WK + Zub
			←	→ 04/97; - ABS	13.0460-3952.2	603952	BDX 20905 18,0 + WK
			←	05/97→ 05/01	13.0460-3975.2	603975	BOS 23597 18,0 - WK
			←	→Orga 08575; + ABS	13.0460-7058.2	607058	ATE 21430 17,3 + WK
					13.0460-7088.2	607088	ATE 21430 17,3 - WE / - WK
1.9 D	51	02/99→08/02	←	→ 03/02; + ABS	13.0460-2829.2	602829	TRW 23124 19,0 + WK
					13.0460-3978.2	603978	BOS 23332 18,0 - WK + Zub
			←	→ 03/02; - ABS	13.0460-7088.2	607088	ATE 21430 17,3 - WE / - WK
1.9 D	69	02/94→04/99	←		13.0460-7058.2	607058	ATE 21430 17,3 + WK
					13.0460-7088.2	607088	ATE 21430 17,3 - WE / - WK
1.9 STD	51	02/94→05/99	←	Orga 08576→; - ABS	13.0460-7058.2	607058	ATE 21430 17,3 + WK
					13.0460-7088.2	607088	ATE 21430 17,3 - WE / - WK
			←	→Orga 08575	13.0460-7058.2	607058	ATE 21430 17,3 + WK
					13.0460-7088.2	607088	ATE 21430 17,3 - WE / - WK
Zubehörsatz, Scheibenbremsbelag							
1.4	55	03/96→07/01	←	→ 04/97; - ABS	13.0460-0403.2	610403	BDX
 Bremsscheibe							
1.4	55	03/96→07/01	←	→ 04/97; - ABS	24.0110-0187.1	410187	Ø 247 10 9 + S
			←	05/97→ 05/01; - ABS	24.0113-0185.1	413185	Ø 247,5 13 11 + S
					24.0313-0185.1	513185	Ø 247,5 13 11 + S PD
			←	→Orga 08575; + ABS	24.0120-0132.1	420132	Ø 247 20,4 18,5 V + S
				24.0320-0132.1	520132	Ø 247 20,4 18,5 V + S PD	
			←	Orga 08576→; → 05/01; + ABS	24.0120-0133.1	420133	Ø 266 20,5 18,5 V + S
					24.0320-0133.1	520133	Ø 266 20,5 18,5 V + S PD
1.9 D	51	02/99→08/02	←	→ 03/02; - ABS	24.0120-0132.1	420132	Ø 247 20,4 18,5 V + S
					24.0320-0132.1	520132	Ø 247 20,4 18,5 V + S PD
			←	→ 03/02; + ABS	24.0120-0133.1	420133	Ø 266 20,5 18,5 V + S
					24.0320-0133.1	520133	Ø 266 20,5 18,5 V + S PD
1.9 D	69	02/94→04/99	←		24.0120-0132.1	420132	Ø 247 20,4 18,5 V + S
					24.0320-0132.1	520132	Ø 247 20,4 18,5 V + S PD
1.9 STD	51	02/94→05/99	←	09/98→; + ABS	24.0120-0132.1	420132	Ø 247 20,4 18,5 V + S
					24.0320-0132.1	520132	Ø 247 20,4 18,5 V + S PD
			←	09/98→; →Orga 08575	24.0120-0132.1	420132	Ø 247 20,4 18,5 V + S
					24.0320-0132.1	520132	Ø 247 20,4 18,5 V + S PD
			←	Orga 08576→; - ABS	24.0120-0132.1	420132	Ø 247 20,4 18,5 V + S
					24.0320-0132.1	520132	Ø 247 20,4 18,5 V + S PD
			←	Orga 08576→; + ABS	24.0120-0133.1	420133	Ø 266 20,5 18,5 V + S
					24.0320-0133.1	520133	Ø 266 20,5 18,5 V + S PD









	kw			 	! #		
PEUGEOT - 306 Kasten/Schrägheck 04/93→08/01							
 Bremsbelagsatz, Scheibenbremse							
1.4	55	03/96→07/01		Orga 08576→; → 05/01; + ABS	13.0460-2829.2	602829	TRW 23124 19,0 + WK
				→ 04/97; - ABS	13.0460-3978.2	603978	BOS 23332 18,0 - WK + Zub
				05/97→ 05/01	13.0460-3952.2	603952	BDX 20905 18,0 + WK
				→Orga 08575; + ABS	13.0460-3975.2	603975	BOS 23597 18,0 - WK
1.8 D 1.9 D 1.9 D	44 50 69	04/93→05/99 05/97→05/99 02/94→04/99			13.0460-7058.2	607058	ATE 21430 17,3 + WK
					13.0460-7088.2	607088	ATE 21430 17,3 - WE / - WK
1.9 D	51	02/99→08/01		05/00→ 05/01; + ABS	13.0460-2829.2	602829	TRW 23124 19,0 + WK
				Orga 08576→; → 05/01; - ABS	13.0460-3978.2	603978	BOS 23332 18,0 - WK + Zub
				→Orga 08575	13.0460-7058.2	607058	ATE 21430 17,3 + WK
1.9 STD	51	02/94→10/95		06/94→	13.0460-7058.2	607058	ATE 21430 17,3 + WK
					13.0460-7088.2	607088	ATE 21430 17,3 - WE / - WK
Zubehörsatz, Scheibenbremsbelag							
1.4	55	03/96→07/01		→ 04/97; - ABS	13.0460-0403.2	610403	BDX
 Bremsscheibe							
1.4	55	03/96→07/01		→ 04/97; - ABS	24.0110-0187.1	410187	Ø 247 10 9 + S
				05/97→ 05/01; - ABS	24.0113-0185.1	413185	Ø 247,5 13 11 + S
				→Orga 08575; + ABS	24.0313-0185.1	513185	Ø 247,5 13 11 + S PD
				→Orga 08575; + ABS	24.0120-0132.1	420132	Ø 247 20,4 18,5 V + S
1.8 D 1.9 D 1.9 D	44 50 69	04/93→05/99 05/97→05/99 02/94→04/99			24.0320-0132.1	520132	Ø 247 20,4 18,5 V + S PD
					24.0120-0133.1	420133	Ø 266 20,5 18,5 V + S
1.9 D	51	02/99→08/01		→ 10/00; + ABS	24.0120-0133.1	420133	Ø 266 20,5 18,5 V + S PD
				Orga 08576→; → 05/01; + ABS	24.0120-0132.1	420132	Ø 247 20,4 18,5 V + S
				Orga 08576→; → 05/01; - ABS	24.0320-0132.1	520132	Ø 247 20,4 18,5 V + S PD
				→Orga 08575	24.0120-0132.1	420132	Ø 247 20,4 18,5 V + S
1.9 STD	51	02/94→10/95			24.0320-0132.1	520132	Ø 247 20,4 18,5 V + S PD
				Orga 08576→; → 05/01; + ABS	24.0120-0133.1	420133	Ø 266 20,5 18,5 V + S
				06/94→	24.0320-0133.1	520133	Ø 266 20,5 18,5 V + S PD
					24.0120-0132.1	420132	Ø 247 20,4 18,5 V + S
					24.0320-0132.1	520132	Ø 247 20,4 18,5 V + S PD
PEUGEOT - 306 Schrägheck (7A, 7C, N3, N5) 01/93→10/03							
 Bremsbelagsatz, Scheibenbremse							
1.1	44	05/93→05/01		03/94→ 04/97; - ABS	13.0460-3952.2	603952	BDX 20905 18,0 + WK
				03/94→ 04/97; + ABS	13.0460-7058.2	607058	ATE 21430 17,3 + WK
1.4	55	05/93→05/01		Orga 08576→; + ABS	13.0460-7088.2	607088	ATE 21430 17,3 - WE / - WK
				→ 04/97; - ABS	13.0460-2829.2	602829	TRW 23124 19,0 + WK
				05/97→	13.0460-3978.2	603978	BOS 23332 18,0 - WK + Zub
					13.0460-3952.2	603952	BDX 20905 18,0 + WK
					13.0460-3975.2	603975	BOS 23597 18,0 - WK
					13.0460-7058.2	607058	ATE 21430 17,3 + WK
1.6	65	05/93→10/00		→Orga 08575; + ABS	13.0460-7088.2	607088	ATE 21430 17,3 - WE / - WK
				→Orga 08575	13.0460-7058.2	607058	ATE 21430 17,3 + WK
				→Orga 08575	13.0460-7088.2	607088	ATE 21430 17,3 - WE / - WK
				05/00→; - ABS	13.0460-7058.2	607058	ATE 21430 17,3 + WK
					13.0460-7088.2	607088	ATE 21430 17,3 - WE / - WK
↓							







	kw			 	! #		
PEUGEOT - 306 Schrägheck (7A, 7C, N3, N5) 01/93→10/03							
 Bremsbelagsatz, Scheibenbremse							
1.6	72	10/00→05/01	←	+ ABS		13.0460-2829.2 602829	TRW 23124 19,0 + WK
			←	- ABS		13.0460-3978.2 603978	BOS 23332 18,0 - WK + Zub
1.8	74	05/93→05/01	←	Orga 08576→; + ABS		13.0460-2829.2 602829	TRW 23124 19,0 + WK
			←	Orga 08576→; - ABS		13.0460-3978.2 603978	BOS 23332 18,0 - WK + Zub
			←	→Orga 08575		13.0460-7058.2 607058	ATE 21430 17,3 + WK
1.8	74	05/97→04/99	←	Orga 08576→; - ABS		13.0460-7088.2 607088	ATE 21430 17,3 - WE / - WK
			←	Orga 08576→; + ABS		13.0460-2829.2 602829	TRW 23124 19,0 + WK
			←	→Orga 08575		13.0460-3978.2 603978	BOS 23332 18,0 - WK + Zub
1.8 16V 2.0 16V 2.0 HDI 90	81 97 66	03/97→05/01 03/97→05/01 06/99→05/01	←			13.0460-2829.2 602829	TRW 23124 19,0 + WK
			→			13.0460-3978.2 603978	BOS 23332 18,0 - WK + Zub
			→			13.0460-3823.2 603823	BOS 20974 11,0 - WK
1.8 16V	82	03/97→10/03	←	→ 05/01		13.0460-3954.2 603954	BDX 20973 11,0 - WK
			→	→ 05/01		13.0460-2829.2 602829	TRW 23124 19,0 + WK
			→	→ 05/01		13.0460-3978.2 603978	BOS 23332 18,0 - WK + Zub
1.8 D 1.8 D 1.9 Td	43 44 52	05/93→05/01 04/93→05/99 07/95→08/00	←			13.0460-3823.2 603823	BOS 20974 11,0 - WK
			←			13.0460-7058.2 607058	ATE 21430 17,3 + WK
			←			13.0460-7088.2 607088	ATE 21430 17,3 - WE / - WK
1.9 D 1.9 D 1.9 D	47 50 55	05/93→05/01 06/94→05/01 03/98→05/01	←	10/00→; + ABS		13.0460-3954.2 603954	BDX 20973 11,0 - WK
			←			13.0460-2829.2 602829	TRW 23124 19,0 + WK
			←			13.0460-3978.2 603978	BOS 23332 18,0 - WK + Zub
			←	09/98→ 10/00; + ABS		13.0460-7058.2 607058	ATE 21430 17,3 + WK
1.9 D	51	04/93→05/99	←	09/98→ 10/00; + ABS		13.0460-7088.2 607088	ATE 21430 17,3 - WE / - WK
			←	Orga 08576→; + ABS		13.0460-2829.2 602829	TRW 23124 19,0 + WK
			←	09/98→; →Orga 08575		13.0460-3978.2 603978	BOS 23332 18,0 - WK + Zub
			←	Orga 08576→; - ABS		13.0460-7058.2 607058	ATE 21430 17,3 + WK
1.9 D	51	09/98→05/01	←	→Orga 08575		13.0460-7088.2 607088	ATE 21430 17,3 - WE / - WK
			←	10/00→; + ABS		13.0460-2829.2 602829	TRW 23124 19,0 + WK
			←	05/00→; + ABS		13.0460-3978.2 603978	BOS 23332 18,0 - WK + Zub
			←	→ 10/00; + ABS		13.0460-7058.2 607058	ATE 21430 17,3 + WK
			←	→Orga 08575		13.0460-7088.2 607088	ATE 21430 17,3 - WE / - WK
			←	Orga 08576→; - ABS		13.0460-7058.2 607058	ATE 21430 17,3 + WK
1.9 D	52	01/99→08/03	←	ATE 21430 17,3 - WE / - WK		13.0460-7088.2 607088	ATE 21430 17,3 - WE / - WK
			←	05/00→ 05/01; + ABS		13.0460-2829.2 602829	TRW 23124 19,0 + WK
			←	Orga 08576→; → 05/01; - ABS		13.0460-3978.2 603978	BOS 23332 18,0 - WK + Zub
			←	→Orga 08575		13.0460-7058.2 607058	ATE 21430 17,3 + WK
1.9 D	69	04/93→04/97	←	ATE 21430 17,3 + WK		13.0460-7088.2 607088	ATE 21430 17,3 - WE / - WK
			←	10/94→		13.0460-2829.2 602829	TRW 23124 19,0 + WK
			←	10/93→		13.0460-7058.2 607058	ATE 21430 17,3 + WK









	kw			 	! #		
PEUGEOT - 306 Schrägheck (7A, 7C, N3, N5) 01/93→10/03							
 Bremsbelagsatz, Scheibenbremse							
1.9 D	69	04/93→04/97	←	10/93→		13.0460-7088.2 607088	ATE 21430 17,3 - WE / - WK
1.9 DT	66	05/93→05/01	←	10/93→		13.0460-7058.2 607058 13.0460-7088.2 607088	ATE 21430 17,3 + WK ATE 21430 17,3 - WE / - WK
2.0 16V	99	03/97→06/00	←			13.0460-2829.2 602829 13.0460-3978.2 603978	TRW 23124 19,0 + WK BOS 23332 18,0 - WK + Zub
			←	→ 04/97		13.0460-2869.2 602869	TRW 23169 19,4 + WK
			→			13.0460-3823.2 603823 13.0460-3954.2 603954	BOS 20974 11,0 - WK BDX 20973 11,0 - WK
2.0 S16	110	06/94→05/01	←	→ 04/97		13.0460-2817.2 602817	TRW 21674 19,0 + WK
			←	05/97→		13.0460-2829.2 602829 13.0460-3978.2 603978	TRW 23124 19,0 + WK BOS 23332 18,0 - WK + Zub
			→			13.0460-3823.2 603823 13.0460-3954.2 603954	BOS 20974 11,0 - WK BDX 20973 11,0 - WK
2.0 S16	112	05/93→05/01	←	07/94→ 04/97		13.0460-2817.2 602817	TRW 21674 19,0 + WK
			←	05/97→		13.0460-2829.2 602829 13.0460-3978.2 603978	TRW 23124 19,0 + WK BOS 23332 18,0 - WK + Zub
			→	07/94→		13.0460-3823.2 603823 13.0460-3954.2 603954	BOS 20974 11,0 - WK BDX 20973 11,0 - WK
2.0 S16	120	03/96→05/01	←			13.0460-2817.2 602817	TRW 21674 19,0 + WK
			→			13.0460-3823.2 603823 13.0460-3954.2 603954	BOS 20974 11,0 - WK BDX 20973 11,0 - WK
						13.0460-2817.2 602817	TRW 21674 19,0 + WK
2.0 XSi	89	05/93→05/01	←	05/97→		13.0460-2829.2 602829 13.0460-3978.2 603978	TRW 23124 19,0 + WK BOS 23332 18,0 - WK + Zub
			←	03/94→ 04/97		13.0460-2869.2 602869	TRW 23169 19,4 + WK
			→	03/94→		13.0460-3823.2 603823 13.0460-3954.2 603954	BOS 20974 11,0 - WK BDX 20973 11,0 - WK
Zubehörsatz, Scheibenbremsbelag							
1.1	44	05/93→05/01	←	03/94→ 04/97; - ABS		13.0460-0403.2 610403	BDX
1.4	55	05/93→05/01	←	→ 04/97; - ABS		13.0460-0403.2 610403	BDX
1.8 16V 2.0 16V 2.0 16V 2.0 HDI 90 2.0 S16 2.0 S16	81 97 99 66 110 120	03/97→05/01 03/97→05/01 03/97→06/00 06/99→05/01 06/94→05/01 03/96→05/01	→			13.0460-0435.2 610435	BDX
1.8 16V	82	03/97→10/03	→	→ 05/01		13.0460-0435.2 610435	BDX
2.0 S16	112	05/93→05/01	→	07/94→		13.0460-0435.2 610435	BDX
2.0 XSi	89	05/93→05/01	→	03/94→		13.0460-0435.2 610435	BDX
 Bremsscheibe							
1.1	44	05/93→05/01	←	03/94→ 04/97; - ABS		24.0110-0187.1 410187	Ø 247 10 9 + S
			←	03/94→ 04/97; + ABS		24.0120-0132.1 420132 24.0320-0132.1 520132	Ø 247 20,4 18,5 V + S Ø 247 20,4 18,5 V + S PD
						24.0110-0187.1 410187	Ø 247 10 9 + S
1.4	55	05/93→05/01	←	→ 04/97; - ABS		24.0110-0187.1 410187	Ø 247 10 9 + S
			←	05/97→; - ABS		24.0113-0185.1 413185 24.0313-0185.1 513185	Ø 247,5 13 11 + S Ø 247,5 13 11 + S PD
			←			24.0120-0132.1 420132 24.0320-0132.1 520132	Ø 247 20,4 18,5 V + S Ø 247 20,4 18,5 V + S PD
			←	→Orga 08575; + ABS		24.0120-0132.1 420132 24.0320-0132.1 520132	Ø 247 20,4 18,5 V + S Ø 247 20,4 18,5 V + S PD
			←	Orga 08576→; + ABS		24.0120-0133.1 420133 24.0320-0133.1 520133	Ø 266 20,5 18,5 V + S Ø 266 20,5 18,5 V + S PD
						24.0120-0132.1 420132 24.0320-0132.1 520132	Ø 247 20,4 18,5 V + S Ø 247 20,4 18,5 V + S PD
1.6 1.8 1.8	65 74 74	05/93→10/00 05/93→05/01 05/97→04/99	←	Orga 08576→; - ABS		24.0120-0132.1 420132 24.0320-0132.1 520132	Ø 247 20,4 18,5 V + S Ø 247 20,4 18,5 V + S PD
			←	→Orga 08575		24.0120-0132.1 420132 24.0320-0132.1 520132	Ø 247 20,4 18,5 V + S Ø 247 20,4 18,5 V + S PD
			←	Orga 08576→; + ABS		24.0120-0133.1 420133 24.0320-0133.1 520133	Ø 266 20,5 18,5 V + S Ø 266 20,5 18,5 V + S PD
1.6	72	10/00→05/01	←	- ABS		24.0120-0132.1 420132 24.0320-0132.1 520132	Ø 247 20,4 18,5 V + S Ø 247 20,4 18,5 V + S PD
↓							



















	kw			 	! #		
PEUGEOT - 306 Schrägheck (7A, 7C, N3, N5) 01/93→10/03							
Bremsscheibe							
1.6	72	10/00→05/01	←	+ ABS		24.0120-0133.1 420133 24.0320-0133.1 520133	Ø 266 20,5 18,5 V + S Ø 266 20,5 18,5 V + S PD
1.8 16V	81	03/97→05/01	←			24.0120-0133.1 420133 24.0320-0133.1 520133	Ø 266 20,5 18,5 V + S Ø 266 20,5 18,5 V + S PD
2.0 16V	97	03/97→05/01				24.0120-0133.1 420133 24.0320-0133.1 520133	Ø 266 20,5 18,5 V + S Ø 266 20,5 18,5 V + S PD
2.0 16V	99	03/97→06/00					
2.0 HDI 90	66	06/99→05/01	→			24.0108-0106.1 408106	Ø 247 8 6 + S
1.8 16V	82	03/97→10/03	←	→ 05/01		24.0120-0133.1 420133 24.0320-0133.1 520133	Ø 266 20,5 18,5 V + S Ø 266 20,5 18,5 V + S PD
			→	→ 05/01		24.0108-0106.1 408106	Ø 247 8 6 + S
1.8 D	43	05/93→05/01	←			24.0120-0132.1 420132 24.0320-0132.1 520132	Ø 247 20,4 18,5 V + S Ø 247 20,4 18,5 V + S PD
1.8 D	44	04/93→05/99					
1.9 Td	52	07/95→08/00					
1.9 D	47	05/93→05/01	←			24.0120-0132.1 420132 24.0320-0132.1 520132	Ø 247 20,4 18,5 V + S Ø 247 20,4 18,5 V + S PD
1.9 D	50	06/94→05/01					
1.9 D	55	03/98→05/01	←	10/00→; + ABS		24.0120-0133.1 420133 24.0320-0133.1 520133	Ø 266 20,5 18,5 V + S Ø 266 20,5 18,5 V + S PD
1.9 D	51	04/93→05/99	←	09/98→; + ABS		24.0120-0132.1 420132 24.0320-0132.1 520132	Ø 247 20,4 18,5 V + S Ø 247 20,4 18,5 V + S PD
			←	09/98→; →Orga 08575		24.0120-0132.1 420132 24.0320-0132.1 520132	Ø 247 20,4 18,5 V + S Ø 247 20,4 18,5 V + S PD
			←	Orga 08576→; - ABS		24.0120-0132.1 420132 24.0320-0132.1 520132	Ø 247 20,4 18,5 V + S Ø 247 20,4 18,5 V + S PD
			←	Orga 08576→; + ABS		24.0120-0133.1 420133 24.0320-0133.1 520133	Ø 266 20,5 18,5 V + S Ø 266 20,5 18,5 V + S PD
1.9 D	51	09/98→05/01	←	Orga 08576→; - ABS		24.0120-0132.1 420132 24.0320-0132.1 520132	Ø 247 20,4 18,5 V + S Ø 247 20,4 18,5 V + S PD
			←	→ 10/00; + ABS		24.0120-0132.1 420132 24.0320-0132.1 520132	Ø 247 20,4 18,5 V + S Ø 247 20,4 18,5 V + S PD
			←	→Orga 08575		24.0120-0132.1 420132 24.0320-0132.1 520132	Ø 247 20,4 18,5 V + S Ø 247 20,4 18,5 V + S PD
			←	Orga 08576→; + ABS		24.0120-0133.1 420133 24.0320-0133.1 520133	Ø 266 20,5 18,5 V + S Ø 266 20,5 18,5 V + S PD
			←	10/00→; + ABS		24.0120-0133.1 420133 24.0320-0133.1 520133	Ø 266 20,5 18,5 V + S Ø 266 20,5 18,5 V + S PD
1.9 D	52	01/99→08/03	←	→ 10/00; + ABS		24.0120-0132.1 420132 24.0320-0132.1 520132	Ø 247 20,4 18,5 V + S Ø 247 20,4 18,5 V + S PD
			←	Orga 08576→; → 05/01; - ABS		24.0120-0132.1 420132 24.0320-0132.1 520132	Ø 247 20,4 18,5 V + S Ø 247 20,4 18,5 V + S PD
			←	→Orga 08575		24.0120-0132.1 420132 24.0320-0132.1 520132	Ø 247 20,4 18,5 V + S Ø 247 20,4 18,5 V + S PD
			←	Orga 08576→; → 05/01; + ABS		24.0120-0133.1 420133 24.0320-0133.1 520133	Ø 266 20,5 18,5 V + S Ø 266 20,5 18,5 V + S PD
1.9 D	69	04/93→04/97	←	10/94→		24.0120-0132.1 420132 24.0320-0132.1 520132	Ø 247 20,4 18,5 V + S Ø 247 20,4 18,5 V + S PD
			←	10/93→		24.0120-0132.1 420132 24.0320-0132.1 520132	Ø 247 20,4 18,5 V + S Ø 247 20,4 18,5 V + S PD
1.9 DT	66	05/93→05/01	←	10/93→		24.0120-0132.1 420132 24.0320-0132.1 520132	Ø 247 20,4 18,5 V + S Ø 247 20,4 18,5 V + S PD
2.0 S16	110	06/94→05/01	←	05/97→		24.0120-0133.1 420133 24.0320-0133.1 520133	Ø 266 20,5 18,5 V + S Ø 266 20,5 18,5 V + S PD
			←	→ 04/97		24.0122-0142.1 422142	Ø 283 22 20 V
			→			24.0108-0106.1 408106	Ø 247 8 6 + S
2.0 S16	112	05/93→05/01	←	05/97→		24.0120-0133.1 420133 24.0320-0133.1 520133	Ø 266 20,5 18,5 V + S Ø 266 20,5 18,5 V + S PD
			←	07/94→ 04/97		24.0122-0142.1 422142	Ø 283 22 20 V
			→	07/94→		24.0108-0106.1 408106	Ø 247 8 6 + S
2.0 S16	120	03/96→05/01	←			24.0122-0142.1 422142	Ø 283 22 20 V
			→			24.0108-0106.1 408106	Ø 247 8 6 + S
2.0 XSi	89	05/93→05/01	←	03/94→		24.0120-0133.1 420133 24.0320-0133.1 520133	Ø 266 20,5 18,5 V + S Ø 266 20,5 18,5 V + S PD
			→	03/94→		24.0108-0106.1 408106	Ø 247 8 6 + S







	kw			 	! #		
PEUGEOT - 307 (3A/C) 08/00→							
 Bremsbelagsatz, Scheibenbremse							
1.4 1.4 HDi	55 50	08/00→ 10/01→	←	→ 07/07	13.0460-3994.2	603994	BOS 23599 19,0 - WE / - WK + Zub
					13.0470-3994.2	LD3994	BOS 23599 19,0 - WE / - WK + Zub Ceramic
			→	→ 07/07	13.0460-2820.2	602820	TRW 20961 17,2 - WK
			→	→Orga 10656	13.0470-2823.2	LD2823	TRW 23554 17,2 - WK Ceramic
			→	→Orga 10656	13.0460-3813.2	603813	BOS 24150 17,6 - WE / - WK + Zub
					13.0470-3813.2	LD3813	BOS 24150 17,6 - WE / - WK + Zub Ceramic
1.4 16V 1.6 HDi	65 66	11/03→ 04/05→	←	→Orga 10550; + ESP	13.0460-3966.2	603966	BOS 23600 19,4 - WE / - WK + Zub
					13.0470-3966.2	LD3966	BOS 23600 19,4 - WE / - WK + Zub Ceramic
			←	Orga 10551→; → 07/07; + ESP	13.0460-3994.2	603994	BOS 23599 19,0 - WE / - WK + Zub
					13.0470-3994.2	LD3994	BOS 23599 19,0 - WE / - WK + Zub Ceramic
			←	→ 07/07; - ESP	13.0460-3994.2	603994	BOS 23599 19,0 - WE / - WK + Zub
					13.0470-3994.2	LD3994	BOS 23599 19,0 - WE / - WK + Zub Ceramic
			→	→ 07/07	13.0460-2820.2	602820	TRW 20961 17,2 - WK
			→	→Orga 10656	13.0470-2823.2	LD2823	TRW 23554 17,2 - WK Ceramic
			→	→Orga 10656	13.0460-3813.2	603813	BOS 24150 17,6 - WE / - WK + Zub
					13.0470-3813.2	LD3813	BOS 24150 17,6 - WE / - WK + Zub Ceramic
1.6	81	07/06→	←	→ 07/07; Vollautomatik	13.0460-3966.2	603966	BOS 23600 19,4 - WE / - WK + Zub
					13.0470-3966.2	LD3966	BOS 23600 19,4 - WE / - WK + Zub Ceramic
			←	→ 07/07; + ESP; Schaltgetriebe	13.0460-3994.2	603994	BOS 23599 19,0 - WE / - WK + Zub
					13.0470-3994.2	LD3994	BOS 23599 19,0 - WE / - WK + Zub Ceramic
			→	→ 07/07	13.0460-2820.2	602820	TRW 20961 17,2 - WK
			→	→Orga 10656	13.0470-2823.2	LD2823	TRW 23554 17,2 - WK Ceramic
1.6	85	08/05→12/09	←	07/06→ 07/07; Vollautomatik	13.0460-3966.2	603966	BOS 23600 19,4 - WE / - WK + Zub
					13.0470-3966.2	LD3966	BOS 23600 19,4 - WE / - WK + Zub Ceramic
			←	07/06→ 07/07; + ESP; Schaltgetriebe	13.0460-3994.2	603994	BOS 23599 19,0 - WE / - WK + Zub
					13.0470-3994.2	LD3994	BOS 23599 19,0 - WE / - WK + Zub Ceramic
			→	07/06→ 07/07	13.0460-2820.2	602820	TRW 20961 17,2 - WK
					13.0470-2823.2	LD2823	TRW 23554 17,2 - WK Ceramic
1.6 16V	80	08/00→	←	→ 07/07; Vollautomatik	13.0460-3966.2	603966	BOS 23600 19,4 - WE / - WK + Zub
					13.0470-3966.2	LD3966	BOS 23600 19,4 - WE / - WK + Zub Ceramic
			←	→Orga 10550; + ESP; Schaltgetriebe	13.0460-3966.2	603966	BOS 23600 19,4 - WE / - WK + Zub
					13.0470-3966.2	LD3966	BOS 23600 19,4 - WE / - WK + Zub Ceramic
			←	Orga 10551→; → 07/07; + ESP; Schaltgetriebe	13.0460-3994.2	603994	BOS 23599 19,0 - WE / - WK + Zub
					13.0470-3994.2	LD3994	BOS 23599 19,0 - WE / - WK + Zub Ceramic
			←	→ 07/07; Schaltgetriebe; - ESP	13.0460-3994.2	603994	BOS 23599 19,0 - WE / - WK + Zub
				13.0470-3994.2	LD3994	BOS 23599 19,0 - WE / - WK + Zub Ceramic	
			→	→ 07/07	13.0460-2820.2	602820	TRW 20961 17,2 - WK
			→	→Orga 10656	13.0470-2823.2	LD2823	TRW 23554 17,2 - WK Ceramic
			→	→Orga 10656	13.0460-3813.2	603813	BOS 24150 17,6 - WE / - WK + Zub









	kw			 	! #		
PEUGEOT - 307 (3A/C) 08/00→							
Bremsbelagsatz, Scheibenbremse							
1.6 16V	80	08/00→	➔	→Orga 10656		13.0470-3813.2 LD3813	BOS 24150 17,6 - WE / - WK + Zub Ceramic
1.6 BioFlex	80	09/07→	➔			13.0460-3966.2 603966 13.0470-3966.2 LD3966	BOS 23600 19,4 - WE / - WK + Zub BOS 23600 19,4 - WE / - WK + Zub Ceramic
1.6 HDi 110 2.0 16V 2.0 16V 2.0 HDi 110	80 100 103 79	02/04→ 08/00→ 03/05→ 08/00→	➔	→ 07/07		13.0460-3966.2 603966 13.0470-3966.2 LD3966	BOS 23600 19,4 - WE / - WK + Zub BOS 23600 19,4 - WE / - WK + Zub Ceramic
			➔	→ 07/07		13.0460-2820.2 602820 13.0470-2823.2 LD2823	TRW 20961 17,2 - WK TRW 23554 17,2 - WK Ceramic
			➔	→Orga 10656		13.0460-3813.2 603813 13.0470-3813.2 LD3813	BOS 24150 17,6 - WE / - WK + Zub BOS 24150 17,6 - WE / - WK + Zub Ceramic
2.0	105	08/08→	➔	→Orga 10656		13.0460-3813.2 603813 13.0470-3813.2 LD3813	BOS 24150 17,6 - WE / - WK + Zub BOS 24150 17,6 - WE / - WK + Zub Ceramic
2.0 16V 2.0 HDi 135	130 100	06/05→ 10/03→	➔	→ 07/07		13.0460-7202.2 607202 13.0470-7202.2 LD7202	ATE 23589 19,1 - WE / - WK ATE 23589 19,1 - WE / - WK Ceramic
			➔	→ 07/07		13.0460-2820.2 602820 13.0470-2823.2 LD2823	TRW 20961 17,2 - WK TRW 23554 17,2 - WK Ceramic
			➔	→Orga 10656		13.0460-3813.2 603813 13.0470-3813.2 LD3813	BOS 24150 17,6 - WE / - WK + Zub BOS 24150 17,6 - WE / - WK + Zub Ceramic
2.0 HDi 90	66	08/00→	➔	→Orga 09519		13.0460-3966.2 603966 13.0470-3966.2 LD3966	BOS 23600 19,4 - WE / - WK + Zub BOS 23600 19,4 - WE / - WK + Zub Ceramic
			➔	Orga 09520→; + ESP; → 07/07		13.0460-3966.2 603966 13.0470-3966.2 LD3966	BOS 23600 19,4 - WE / - WK + Zub BOS 23600 19,4 - WE / - WK + Zub Ceramic
			➔	Orga 09520→; → 07/07; - ESP		13.0460-3994.2 603994 13.0470-3994.2 LD3994	BOS 23599 19,0 - WE / - WK + Zub BOS 23599 19,0 - WE / - WK + Zub Ceramic
			➔	→ 07/07		13.0460-2820.2 602820 13.0470-2823.2 LD2823	TRW 20961 17,2 - WK TRW 23554 17,2 - WK Ceramic
			➔	→Orga 10656		13.0460-3813.2 603813 13.0470-3813.2 LD3813	BOS 24150 17,6 - WE / - WK + Zub BOS 24150 17,6 - WE / - WK + Zub Ceramic
Zubehörsatz, Scheibenbremsbelag							
1.4 1.4 HDi 2.0 16V 2.0 HDi 135	55 50 130 100	08/00→ 10/01→ 06/05→ 10/03→	➔	→ 07/07		13.0460-0072.2 610072	TRW
1.4 16V 1.6 HDi	65 66	11/03→ 04/05→	➔	→Orga 10550; + ESP		13.0460-0454.2 610454	BOS
			➔	→ 07/07		13.0460-0072.2 610072	TRW
1.6	81	07/06→	➔	→ 07/07; Vollautomatik		13.0460-0454.2 610454	BOS
			➔	→ 07/07		13.0460-0072.2 610072	TRW
1.6	85	08/05→12/09	➔	07/06→ 07/07; Vollautomatik		13.0460-0454.2 610454	BOS
			➔	07/06→ 07/07		13.0460-0072.2 610072	TRW
1.6 16V	80	08/00→	➔	→Orga 10550; + ESP; Schaltgetriebe		13.0460-0454.2 610454	BOS
			➔	→ 07/07; Vollautomatik		13.0460-0454.2 610454	BOS
			➔	→ 07/07		13.0460-0072.2 610072	TRW
1.6 BioFlex	80	09/07→	➔			13.0460-0454.2 610454	BOS
1.6 HDi 110 2.0 16V 2.0 16V 2.0 HDi 110	80 100 103 79	02/04→ 08/00→ 03/05→ 08/00→	➔	→ 07/07		13.0460-0454.2 610454	BOS
			➔	→ 07/07		13.0460-0072.2 610072	TRW
↓							







	kW			 	! #		
PEUGEOT - 307 (3A/C) 08/00→							
Zubehörsatz, Scheibenbremsbelag							
2.0 HDi 90	66	08/00→	←	Orga 09520→; + ESP; → 07/07		13.0460-0454.2 610454	BOS
			←	→Orga 09519		13.0460-0454.2 610454	BOS
			→	→ 07/07		13.0460-0072.2 610072	TRW
 Bremsscheibe							
1.4 1.4 HDi	55 50	08/00→ 10/01→	←	→ 07/07		24.0122-0194.1 422194	Ø 266 22 20 V + S
			→	Orga 10898→; → 07/07		24.0109-0100.2 409100	Ø 249 9 7 + LG / + ABS Ring
			→	→ 07/07		24.0109-0137.1 409137	Ø 247 9 8 + S
			→	→Orga 10897		24.0109-0150.2 409150	Ø 249 9 8 + LG / + ABS Ring
1.4 16V 1.6 HDi	65 66	11/03→ 04/05→	←	Orga 10551→; → 07/07; + ESP		24.0122-0194.1 422194	Ø 266 22 20 V + S
			←	→ 07/07; - ESP		24.0122-0194.1 422194	Ø 266 22 20 V + S
			←	→Orga 10550; + ESP		24.0126-0120.1 426120	Ø 283 26 24 V + S
						24.0326-0120.1 526120	Ø 283 26 24 V + S PD
			→	Orga 10898→; → 07/07		24.0109-0100.2 409100	Ø 249 9 7 + LG / + ABS Ring
			→	→ 07/07		24.0109-0137.1 409137	Ø 247 9 8 + S
			→	→Orga 10897		24.0109-0150.2 409150	Ø 249 9 8 + LG / + ABS Ring
1.6	81	07/06→	←	→ 07/07; + ESP; Schaltgetriebe		24.0122-0194.1 422194	Ø 266 22 20 V + S
			←	→ 07/07; Vollautomatik		24.0126-0120.1 426120	Ø 283 26 24 V + S
						24.0326-0120.1 526120	Ø 283 26 24 V + S PD
			→	Orga 10898→; → 07/07		24.0109-0100.2 409100	Ø 249 9 7 + LG / + ABS Ring
			→	→ 07/07		24.0109-0137.1 409137	Ø 247 9 8 + S
			→	→Orga 10897		24.0109-0150.2 409150	Ø 249 9 8 + LG / + ABS Ring
1.6	85	08/05→12/09	←	07/06→ 07/07; + ESP; Schaltgetriebe		24.0122-0194.1 422194	Ø 266 22 20 V + S
			←	07/06→ 07/07; Vollautomatik		24.0126-0120.1 426120	Ø 283 26 24 V + S
						24.0326-0120.1 526120	Ø 283 26 24 V + S PD
			→	Orga 10898→; → 07/07		24.0109-0100.2 409100	Ø 249 9 7 + LG / + ABS Ring
			→	07/06→ 07/07		24.0109-0137.1 409137	Ø 247 9 8 + S
			→	07/06→; →Orga 10897		24.0109-0150.2 409150	Ø 249 9 8 + LG / + ABS Ring
1.6 16V	80	08/00→	←	Orga 10551→; + ESP; → 07/07; Schaltgetriebe		24.0122-0194.1 422194	Ø 266 22 20 V + S
			←	→ 07/07; Schaltgetriebe; - ESP		24.0122-0194.1 422194	Ø 266 22 20 V + S
			←	+ ESP; → 07/07; Schaltgetriebe		24.0126-0120.1 426120	Ø 283 26 24 V + S
						24.0326-0120.1 526120	Ø 283 26 24 V + S PD
			←	→ 07/07; Vollautomatik		24.0126-0120.1 426120	Ø 283 26 24 V + S
						24.0326-0120.1 526120	Ø 283 26 24 V + S PD
			→	Orga 10898→; → 07/07		24.0109-0100.2 409100	Ø 249 9 7 + LG / + ABS Ring
			→	→ 07/07		24.0109-0137.1 409137	Ø 247 9 8 + S
			→	→Orga 10897		24.0109-0150.2 409150	Ø 249 9 8 + LG / + ABS Ring
1.6 BioFlex	80	09/07→	←			24.0126-0120.1 426120	Ø 283 26 24 V + S
						24.0326-0120.1 526120	Ø 283 26 24 V + S PD
1.6 HDi 110 2.0 16V 2.0 16V 2.0 HDi 110	80 100 103 79	02/04→ 08/00→ 03/05→ 08/00→	←	→ 07/07		24.0126-0120.1 426120	Ø 283 26 24 V + S
						24.0326-0120.1 526120	Ø 283 26 24 V + S PD
			→	Orga 10898→; → 07/07		24.0109-0100.2 409100	Ø 249 9 7 + LG / + ABS Ring
			→	→ 07/07		24.0109-0137.1 409137	Ø 247 9 8 + S
			→	→Orga 10897		24.0109-0150.2 409150	Ø 249 9 8 + LG / + ABS Ring
2.0	105	08/08→	→	→Orga 10897		24.0109-0150.2 409150	Ø 249 9 8 + LG / + ABS Ring
2.0 16V	130	06/05→	←	→ 07/07		24.0126-0140.1 426140	Ø 302 26 24 V + S
			→	→ 07/07		24.0109-0137.1 409137	Ø 247 9 8 + S
2.0 HDi 135	100	10/03→	←	→ 07/07		24.0126-0140.1 426140	Ø 302 26 24 V + S
			→	Orga 10898→; → 07/07		24.0109-0100.2 409100	Ø 249 9 7 + LG / + ABS Ring
			→	→ 07/07		24.0109-0137.1 409137	Ø 247 9 8 + S
			→	→Orga 10897		24.0109-0150.2 409150	Ø 249 9 8 + LG / + ABS Ring
2.0 HDi 90	66	08/00→	←	Orga 09520→; → 07/07; - ESP		24.0122-0194.1 422194	Ø 266 22 20 V + S
			←	→Orga 09519		24.0126-0120.1 426120	Ø 283 26 24 V + S
						24.0326-0120.1 526120	Ø 283 26 24 V + S PD
			←	Orga 09520→; → 07/07; + ESP		24.0126-0120.1 426120	Ø 283 26 24 V + S









	kw			 	! #			
PEUGEOT - 307 (3A/C) 08/00→								
 Bremsscheibe								
2.0 HDi 90	66	08/00→	←	Orga 09520→; → 07/07; + ESP	24.0326-0120.1	526120	∅ 283 26 24 V + S PD	
			→	Orga 10898→; → 07/07	24.0109-0100.2	409100	∅ 249 9 7 + LG / + ABS Ring	
			→	→ 07/07	24.0109-0137.1	409137	∅ 247 9 8 + S	
			→	→Orga 10897	24.0109-0150.2	409150	∅ 249 9 8 + LG / + ABS Ring	
PEUGEOT - 307 Break (3E) 03/02→								
 Bremsbelagsatz, Scheibenbremse								
1.4	55	04/02→09/03	←	→Orga 10550; + ESP	13.0460-3966.2	603966	BOS 23600 19,4 - WE / - WK + Zub	
					13.0470-3966.2	LD3966	BOS 23600 19,4 - WE / - WK + Zub Ceramic	
			←	Orga 10551→	13.0460-3994.2	603994	BOS 23599 19,0 - WE / - WK + Zub	
					13.0470-3994.2	LD3994	BOS 23599 19,0 - WE / - WK + Zub Ceramic	
			←	- ESP	13.0460-3994.2	603994	BOS 23599 19,0 - WE / - WK + Zub	
					13.0470-3994.2	LD3994	BOS 23599 19,0 - WE / - WK + Zub Ceramic	
			→	→Orga 12056	13.0460-2820.2	602820	TRW 20961 17,2 - WK	
		13.0470-2823.2	LD2823	TRW 23554 17,2 - WK Ceramic				
		→	Orga 12057→	13.0460-3813.2	603813	BOS 24150 17,6 - WE / - WK + Zub		
				13.0470-3813.2	LD3813	BOS 24150 17,6 - WE / - WK + Zub Ceramic		
		→	→Orga 10656	13.0460-3813.2	603813	BOS 24150 17,6 - WE / - WK + Zub		
				13.0470-3813.2	LD3813	BOS 24150 17,6 - WE / - WK + Zub Ceramic		
1.4 16V	65	11/03→	←	→Orga 10550; + ESP	13.0460-3966.2	603966	BOS 23600 19,4 - WE / - WK + Zub	
					13.0470-3966.2	LD3966	BOS 23600 19,4 - WE / - WK + Zub Ceramic	
			←	→ 04/08; - ESP	13.0460-3994.2	603994	BOS 23599 19,0 - WE / - WK + Zub	
					13.0470-3994.2	LD3994	BOS 23599 19,0 - WE / - WK + Zub Ceramic	
			←	Orga 10551→; → 04/08; + ESP	13.0460-3994.2	603994	BOS 23599 19,0 - WE / - WK + Zub	
					13.0470-3994.2	LD3994	BOS 23599 19,0 - WE / - WK + Zub Ceramic	
			→	→Orga 12056	13.0460-2820.2	602820	TRW 20961 17,2 - WK	
		13.0470-2823.2	LD2823	TRW 23554 17,2 - WK Ceramic				
		→	→Orga 10656	13.0460-3813.2	603813	BOS 24150 17,6 - WE / - WK + Zub		
				13.0470-3813.2	LD3813	BOS 24150 17,6 - WE / - WK + Zub Ceramic		
		→	Orga 12057→; → 04/08	13.0460-3813.2	603813	BOS 24150 17,6 - WE / - WK + Zub		
				13.0470-3813.2	LD3813	BOS 24150 17,6 - WE / - WK + Zub Ceramic		
1.4 HDi	50	03/02→	←	→ 04/08	13.0460-3994.2	603994	BOS 23599 19,0 - WE / - WK + Zub	
					13.0470-3994.2	LD3994	BOS 23599 19,0 - WE / - WK + Zub Ceramic	
			→	→Orga 12056	13.0460-2820.2	602820	TRW 20961 17,2 - WK	
					13.0470-2823.2	LD2823	TRW 23554 17,2 - WK Ceramic	
			→	Orga 12057→; → 04/08	13.0460-3813.2	603813	BOS 24150 17,6 - WE / - WK + Zub	
				13.0470-3813.2	LD3813	BOS 24150 17,6 - WE / - WK + Zub Ceramic		
		→	→Orga 10656	13.0460-3813.2	603813	BOS 24150 17,6 - WE / - WK + Zub		
				13.0470-3813.2	LD3813	BOS 24150 17,6 - WE / - WK + Zub Ceramic		
1.6 16V 1.6 HDi 1.6 HDi 110 2.0 ↓	80 66 80 100	03/02→ 04/05→ 02/04→ 03/02→	←	→ 04/08	13.0460-3966.2	603966	BOS 23600 19,4 - WE / - WK + Zub	











	kw			 	! #			
PEUGEOT - 307 Break (3E) 03/02→								
 Bremsbelagsatz, Scheibenbremse								
2.0 16V 2.0 HDi 110 2.0 HDi 90	103 79 66	03/05→ 03/02→ 03/02→	←	→ 04/08		13.0470-3966.2	LD3966	BOS 23600 19,4 - WE / - WK + Zub Ceramic
			→	→Orga 12056		13.0460-2820.2	602820	TRW 20961 17,2 - WK
			→	Orga 12057→; → 04/08		13.0470-2823.2	LD2823	TRW 23554 17,2 - WK Ceramic
			→	→Orga 10656		13.0460-3813.2	603813	BOS 24150 17,6 - WE / - WK + Zub
						13.0470-3813.2	LD3813	BOS 24150 17,6 - WE / - WK + Zub Ceramic
			→	→Orga 10656		13.0460-3813.2	603813	BOS 24150 17,6 - WE / - WK + Zub
						13.0470-3813.2	LD3813	BOS 24150 17,6 - WE / - WK + Zub Ceramic
1.6 BioFlex	80	09/07→	←	→ 04/08		13.0460-3966.2	603966	BOS 23600 19,4 - WE / - WK + Zub
			→	→Orga 12056		13.0470-3966.2	LD3966	BOS 23600 19,4 - WE / - WK + Zub Ceramic
			→	→Orga 12056		13.0460-2820.2	602820	TRW 20961 17,2 - WK
			→	Orga 12057→; → 04/08		13.0470-2823.2	LD2823	TRW 23554 17,2 - WK Ceramic
			→	→Orga 10656		13.0460-3813.2	603813	BOS 24150 17,6 - WE / - WK + Zub
						13.0470-3813.2	LD3813	BOS 24150 17,6 - WE / - WK + Zub Ceramic
2.0 16V 2.0 HDi 135	130 100	06/05→ 02/04→	←	→ 04/08		13.0460-7202.2	607202	ATE 23589 19,1 - WE / - WK Ceramic
			→	→Orga 12056		13.0470-7202.2	LD7202	ATE 23589 19,1 - WE / - WK Ceramic
			→	Orga 12057→; → 04/08		13.0460-2820.2	602820	TRW 20961 17,2 - WK
			→	→Orga 10656		13.0470-2823.2	LD2823	TRW 23554 17,2 - WK Ceramic
			→	→Orga 10656		13.0460-3813.2	603813	BOS 24150 17,6 - WE / - WK + Zub
						13.0470-3813.2	LD3813	BOS 24150 17,6 - WE / - WK + Zub Ceramic
Zubehörsatz, Scheibenbremsbelag								
1.4 1.4 16V	55 65	04/02→09/03 11/03→	←	→Orga 10550; + ESP		13.0460-0454.2	610454	BOS
			→	→Orga 12056		13.0460-0072.2	610072	TRW
1.4 HDi 2.0 16V 2.0 HDi 135	50 130 100	03/02→ 06/05→ 02/04→	→	→Orga 12056		13.0460-0072.2	610072	TRW
			←	→ 04/08		13.0460-0454.2	610454	BOS
1.6 16V 1.6 BioFlex 1.6 HDi 1.6 HDi 110 2.0 2.0 16V 2.0 HDi 110 2.0 HDi 90	80 80 66 80 100 103 79 66	03/02→ 09/07→ 04/05→ 02/04→ 03/02→ 03/05→ 03/02→ 03/02→	→	→Orga 12056		13.0460-0072.2	610072	TRW
			←	→ 04/08		13.0460-0454.2	610454	BOS
			→	→Orga 10897		24.0109-0150.2	409150	Ø 249 9 8 + LG / + ABS Ring
			→	→Orga 10897		24.0109-0137.1	409137	Ø 247 9 8 + S
1.4 16V	65	11/03→	←	→ 04/08; - ESP		24.0122-0194.1	422194	Ø 266 22 20 V + S
			←	Orga 10551→; → 04/08; + ESP		24.0122-0194.1	422194	Ø 266 22 20 V + S
			←	→Orga 10550; + ESP		24.0126-0120.1	426120	Ø 283 26 24 V + S
			←	→Orga 10550; + ESP		24.0326-0120.1	526120	Ø 283 26 24 V + S PD
			→	Orga 10898→; → 04/08		24.0109-0100.2	409100	Ø 249 9 7 + LG / + ABS Ring
			→	→ 04/08		24.0109-0137.1	409137	Ø 247 9 8 + S
1.4 HDi	50	03/02→	→	→Orga 10897		24.0109-0150.2	409150	Ø 249 9 8 + LG / + ABS Ring
			←	→ 04/08		24.0122-0194.1	422194	Ø 266 22 20 V + S
			→	→Orga 10898→; → 04/08		24.0109-0100.2	409100	Ø 249 9 7 + LG / + ABS Ring
			→	→ 04/08		24.0109-0137.1	409137	Ø 247 9 8 + S











	kw			 	! #		
PEUGEOT - 307 Break (3E) 03/02→							
Bremsscheibe							
1.4 HDi	50	03/02→	→	→Orga 10897		24.0109-0150.2 409150	Ø 249 9 8 + LG / + ABS Ring
1.6 16V	80	03/02→	←	→ 04/08		24.0126-0120.1 426120	Ø 283 26 24 V + S
1.6 BioFlex	80	09/07→				24.0326-0120.1 526120	Ø 283 26 24 V + S PD
1.6 HDi	66	04/05→					
1.6 HDi 110	80	02/04→	→	Orga 10898→; → 04/08		24.0109-0100.2 409100	Ø 249 9 7 + LG / + ABS Ring
2.0	100	03/02→	→	→ 04/08		24.0109-0137.1 409137	Ø 247 9 8 + S
2.0 16V	103	03/05→					
2.0 HDi 110	79	03/02→	→	→Orga 10897		24.0109-0150.2 409150	Ø 249 9 8 + LG / + ABS Ring
2.0 HDi 90	66	03/02→					
2.0 16V	130	06/05→	←	→ 04/08		24.0126-0140.1 426140	Ø 302 26 24 V + S
			→	→ 04/08		24.0109-0137.1 409137	Ø 247 9 8 + S
2.0 HDi 135	100	02/04→	←	→ 04/08		24.0126-0140.1 426140	Ø 302 26 24 V + S
			→	Orga 10898→; → 04/08		24.0109-0100.2 409100	Ø 249 9 7 + LG / + ABS Ring
			→	→ 04/08		24.0109-0137.1 409137	Ø 247 9 8 + S
			→	→Orga 10897		24.0109-0150.2 409150	Ø 249 9 8 + LG / + ABS Ring
PEUGEOT - 307 CC (3B) 10/03→							
Bremsbelagsatz, Scheibenbremse							
1.6 16V	80	02/05→	←	03/05→ 02/09		13.0460-3966.2 603966	BOS 23600 19,4 - WE / - WK + Zub
			→	03/05→; →Orga 12056		13.0470-3966.2 LD3966	BOS 23600 19,4 - WE / - WK + Zub Ceramic
			→	03/05→; →Orga 10656		13.0460-2820.2 602820	TRW 20961 17,2 - WK
			→	03/05→; →Orga 10656		13.0470-2823.2 LD2823	TRW 23554 17,2 - WK Ceramic
			→	03/05→; →Orga 10656		13.0460-3813.2 603813	BOS 24150 17,6 - WE / - WK + Zub
			→	03/05→; →Orga 10656		13.0470-3813.2 LD3813	BOS 24150 17,6 - WE / - WK + Zub Ceramic
			→	Orga 12057→; → 02/09		13.0460-3813.2 603813	BOS 24150 17,6 - WE / - WK + Zub
			→	Orga 12057→; → 02/09		13.0470-3813.2 LD3813	BOS 24150 17,6 - WE / - WK + Zub Ceramic
2.0 16V	100	10/03→	←	→ 02/09		13.0460-3966.2 603966	BOS 23600 19,4 - WE / - WK + Zub
2.0 16V	103	03/05→				13.0470-3966.2 LD3966	BOS 23600 19,4 - WE / - WK + Zub Ceramic
			→	→Orga 12056		13.0460-2820.2 602820	TRW 20961 17,2 - WK
			→	→Orga 10656		13.0470-2823.2 LD2823	TRW 23554 17,2 - WK Ceramic
			→	→Orga 10656		13.0460-3813.2 603813	BOS 24150 17,6 - WE / - WK + Zub
			→	→Orga 10656		13.0470-3813.2 LD3813	BOS 24150 17,6 - WE / - WK + Zub Ceramic
			→	Orga 12057→; → 02/09		13.0460-3813.2 603813	BOS 24150 17,6 - WE / - WK + Zub
			→	Orga 12057→; → 02/09		13.0470-3813.2 LD3813	BOS 24150 17,6 - WE / - WK + Zub Ceramic
2.0 16V	130	10/03→	←	→ 02/09		13.0460-7202.2 607202	ATE 23589 19,1 - WE / - WK
2.0 HDi 135	100	06/05→				13.0470-7202.2 LD7202	ATE 23589 19,1 - WE / - WK Ceramic
			→	→Orga 12056		13.0460-2820.2 602820	TRW 20961 17,2 - WK
			→	→Orga 10656		13.0470-2823.2 LD2823	TRW 23554 17,2 - WK Ceramic
			→	→Orga 10656		13.0460-3813.2 603813	BOS 24150 17,6 - WE / - WK + Zub
			→	→Orga 10656		13.0470-3813.2 LD3813	BOS 24150 17,6 - WE / - WK + Zub Ceramic
			→	Orga 12057→; → 02/09		13.0460-3813.2 603813	BOS 24150 17,6 - WE / - WK + Zub
			→	Orga 12057→; → 02/09		13.0470-3813.2 LD3813	BOS 24150 17,6 - WE / - WK + Zub Ceramic
Zubehörsatz, Scheibenbremsbelag							
1.6 16V	80	02/05→	←	03/05→ 02/09		13.0460-0454.2 610454	BOS
			→	03/05→; →Orga 12056		13.0460-0072.2 610072	TRW
2.0 16V	100	10/03→	←	→ 02/09		13.0460-0454.2 610454	BOS
2.0 16V	103	03/05→	→	→Orga 12056		13.0460-0072.2 610072	TRW
2.0 16V	130	10/03→	→	→Orga 12056		13.0460-0072.2 610072	TRW
2.0 HDi 135	100	06/05→					
↓							

	kW			 	! #		
PEUGEOT - 307 CC (3B) 10/03→							
 Bremsscheibe							
1.6 16V	80	02/05→	←	03/05→ 02/09	24.0126-0120.1	426120	Ø 283 26 24 V + S
					24.0326-0120.1	526120	Ø 283 26 24 V + S PD
			→	Orga 10898→; → 02/09	24.0109-0100.2	409100	Ø 249 9 7 + LG / + ABS Ring
			→	03/05→ 02/09	24.0109-0137.1	409137	Ø 247 9 8 + S
2.0 16V 2.0 16V	100 103	10/03→ 03/05→	←	→ 02/09	24.0126-0120.1	426120	Ø 283 26 24 V + S
					24.0326-0120.1	526120	Ø 283 26 24 V + S PD
			→	Orga 10898→; → 02/09	24.0109-0100.2	409100	Ø 249 9 7 + LG / + ABS Ring
			→	→ 02/09	24.0109-0137.1	409137	Ø 247 9 8 + S
2.0 16V	130	10/03→	←	→ 02/09	24.0126-0140.1	426140	Ø 302 26 24 V + S
			→	→ 02/09	24.0109-0137.1	409137	Ø 247 9 8 + S
2.0 HDi 135	100	06/05→	←	→ 02/09	24.0126-0140.1	426140	Ø 302 26 24 V + S
			→	Orga 10898→; → 02/09	24.0109-0100.2	409100	Ø 249 9 7 + LG / + ABS Ring
			→	→ 02/09	24.0109-0137.1	409137	Ø 247 9 8 + S
			→	→Orga 10897	24.0109-0150.2	409150	Ø 249 9 8 + LG / + ABS Ring
PEUGEOT - 307 SW (3H) 03/02→							
 Brembelagsatz, Scheibenbremse							
1.4	55	04/02→09/03	←	→Orga 10550; + ESP	13.0460-3966.2	603966	BOS 23600 19,4 - WE / - WK + Zub
					13.0470-3966.2	LD3966	BOS 23600 19,4 - WE / - WK + Zub Ceramic
			←	+ ESP; Orga 10551→	13.0460-3994.2	603994	BOS 23599 19,0 - WE / - WK + Zub
					13.0470-3994.2	LD3994	BOS 23599 19,0 - WE / - WK + Zub Ceramic
			←	- ESP	13.0460-3994.2	603994	BOS 23599 19,0 - WE / - WK + Zub
					13.0470-3994.2	LD3994	BOS 23599 19,0 - WE / - WK + Zub Ceramic
1.4 16V	65	11/03→	←	→Orga 10550; + ESP	13.0460-3966.2	603966	BOS 23600 19,4 - WE / - WK + Zub
					13.0470-3966.2	LD3966	BOS 23600 19,4 - WE / - WK + Zub Ceramic
			←	→ 04/08; - ESP	13.0460-3994.2	603994	BOS 23599 19,0 - WE / - WK + Zub
					13.0470-3994.2	LD3994	BOS 23599 19,0 - WE / - WK + Zub Ceramic
			←	Orga 10551→; → 04/08; + ESP	13.0460-3994.2	603994	BOS 23599 19,0 - WE / - WK + Zub
					13.0470-3994.2	LD3994	BOS 23599 19,0 - WE / - WK + Zub Ceramic
1.4 HDi 70	50	03/02→01/05	←		13.0460-3994.2	603994	BOS 23599 19,0 - WE / - WK + Zub
					13.0470-3994.2	LD3994	BOS 23599 19,0 - WE / - WK + Zub Ceramic
			→		13.0460-2820.2	602820	TRW 20961 17,2 - WK
					13.0470-2823.2	LD2823	TRW 23554 17,2 - WK Ceramic
			→	Orga 12057→; → 04/08	13.0460-3813.2	603813	BOS 24150 17,6 - WE / - WK + Zub
					13.0470-3813.2	LD3813	BOS 24150 17,6 - WE / - WK + Zub Ceramic









	kW			 	! #		
PEUGEOT - 307 SW (3H) 03/02→							
Bremsbelagsatz, Scheibenbremse							
1.4 HDi 70	50	03/02→01/05	→			13.0460-3813.2 603813 13.0470-2823.2 LD2823 13.0470-3813.2 LD3813	BOS 24150 17,6 - WE / - WK + Zub TRW 23554 17,2 - WK Ceramic BOS 24150 17,6 - WE / - WK + Zub Ceramic
1.6 16V 1.6 BioFlex 1.6 HDi 110 1.6 HDi 90 2.0 16V 2.0 16V 2.0 HDi 110 2.0 HDi 90	80 80 80 66 100 103 79 66	03/02→ 09/07→ 02/04→ 12/06→ 03/02→ 03/05→ 03/02→ 03/02→	← → → →	→ 04/08 → Orga 12056 Orga 12057→; → 04/08 → Orga 10656		13.0460-3966.2 603966 13.0470-3966.2 LD3966 13.0460-2820.2 602820 13.0470-2823.2 LD2823 13.0460-3813.2 603813 13.0470-3813.2 LD3813 13.0460-3813.2 603813 13.0470-3813.2 LD3813	BOS 23600 19,4 - WE / - WK + Zub BOS 23600 19,4 - WE / - WK + Zub Ceramic TRW 20961 17,2 - WK TRW 23554 17,2 - WK Ceramic BOS 24150 17,6 - WE / - WK + Zub BOS 24150 17,6 - WE / - WK + Zub Ceramic BOS 24150 17,6 - WE / - WK + Zub BOS 24150 17,6 - WE / - WK + Zub Ceramic
2.0 HDi 135	100	02/04→	← → → →	→ 04/08 → Orga 12056 Orga 12057→; → 04/08 → Orga 10656		13.0460-7202.2 607202 13.0470-7202.2 LD7202 13.0460-2820.2 602820 13.0470-2823.2 LD2823 13.0460-3813.2 603813 13.0470-3813.2 LD3813 13.0460-3813.2 603813 13.0470-3813.2 LD3813	ATE 23589 19,1 - WE / - WK Ceramic ATE 23589 19,1 - WE / - WK Ceramic TRW 20961 17,2 - WK TRW 23554 17,2 - WK Ceramic BOS 24150 17,6 - WE / - WK + Zub BOS 24150 17,6 - WE / - WK + Zub Ceramic BOS 24150 17,6 - WE / - WK + Zub BOS 24150 17,6 - WE / - WK + Zub Ceramic
Zubehörsatz, Scheibenbremsbelag							
1.4 1.4 16V	55 65	04/02→09/03 11/03→	← →	→ Orga 10550; + ESP → Orga 12056		13.0460-0454.2 610454 13.0460-0072.2 610072	BOS TRW
1.4 HDi 70	50	03/02→01/05	→			13.0460-0072.2 610072	TRW
1.6 16V 1.6 BioFlex 1.6 HDi 110 1.6 HDi 90 2.0 16V 2.0 16V 2.0 HDi 110 2.0 HDi 90	80 80 80 66 100 103 79 66	03/02→ 09/07→ 02/04→ 12/06→ 03/02→ 03/05→ 03/02→ 03/02→	← → → →	→ 04/08 → Orga 12056		13.0460-0454.2 610454 13.0460-0072.2 610072	BOS TRW
2.0 HDi 135	100	02/04→	→	→ Orga 12056		13.0460-0072.2 610072	TRW
Bremsscheibe							
1.4	55	04/02→09/03	← ← ← → → →	+ ESP; Orga 10551→ - ESP → Orga 10550; + ESP Orga 10898→ → Orga 10897		24.0122-0194.1 422194 24.0122-0194.1 422194 24.0126-0120.1 426120 24.0326-0120.1 526120 24.0109-0100.2 409100 24.0109-0137.1 409137 24.0109-0150.2 409150	Ø 266 22 20 V + S Ø 266 22 20 V + S Ø 283 26 24 V + S Ø 283 26 24 V + S PD Ø 249 9 7 + LG / + ABS Ring Ø 247 9 8 + S Ø 249 9 8 + LG / + ABS Ring
1.4 16V	65	11/03→	← ← ← → → →	→ 04/08; - ESP Orga 10551→; → 04/08; + ESP → Orga 10550; + ESP Orga 10898→; → 04/08 → 04/08 → Orga 10897		24.0122-0194.1 422194 24.0122-0194.1 422194 24.0126-0120.1 426120 24.0326-0120.1 526120 24.0109-0100.2 409100 24.0109-0137.1 409137 24.0109-0150.2 409150	Ø 266 22 20 V + S Ø 266 22 20 V + S Ø 283 26 24 V + S Ø 283 26 24 V + S PD Ø 249 9 7 + LG / + ABS Ring Ø 247 9 8 + S Ø 249 9 8 + LG / + ABS Ring
1.4 HDi 70	50	03/02→01/05	← →			24.0122-0194.1 422194 24.0109-0100.2 409100	Ø 266 22 20 V + S Ø 249 9 7 + LG / + ABS Ring
↓							







	kw			 	! #		
PEUGEOT - 307 SW (3H) 03/02→							
 Bremsscheibe							
1.4 HDi 70	50	03/02→01/05	➔			24.0109-0137.1 409137	Ø 247 9 8 + S
			➔	→ Orga 10897		24.0109-0150.2 409150	Ø 249 9 8 + LG / + ABS Ring
1.6 16V	80	03/02→	➔	→ 04/08		24.0126-0120.1 426120	Ø 283 26 24 V + S
1.6 HDi 110	80	02/04→				24.0326-0120.1 526120	Ø 283 26 24 V + S PD
1.6 HDi 90	66	12/06→					
2.0 16V	100	03/02→	➔	Orga 10898→; → 04/08		24.0109-0100.2 409100	Ø 249 9 7 + LG / + ABS Ring
2.0 16V	103	03/05→	➔	→ 04/08		24.0109-0137.1 409137	Ø 247 9 8 + S
2.0 HDi 110	79	03/02→	➔	→ Orga 10897		24.0109-0150.2 409150	Ø 249 9 8 + LG / + ABS Ring
2.0 HDi 90	66	03/02→	➔	→ Orga 10897			
1.6 BioFlex	80	09/07→	➔	→ 04/08		24.0126-0120.1 426120	Ø 283 26 24 V + S
			➔	→ 04/08		24.0326-0120.1 526120	Ø 283 26 24 V + S PD
			➔	→ 04/08		24.0109-0137.1 409137	Ø 247 9 8 + S
2.0 HDi 135	100	02/04→	➔	→ 04/08		24.0126-0140.1 426140	Ø 302 26 24 V + S
			➔	Orga 10898→; → 04/08		24.0109-0100.2 409100	Ø 249 9 7 + LG / + ABS Ring
			➔	→ 04/08		24.0109-0137.1 409137	Ø 247 9 8 + S
			➔	→ Orga 10897		24.0109-0150.2 409150	Ø 249 9 8 + LG / + ABS Ring
PEUGEOT - 308 (4A_, 4C_) 09/07→							
 Bremsbelagsatz, Scheibenbremse							
1.4 16V	70	09/07→	➔	→ 07/13		13.0460-3847.2 603847	BOS 24660 17,8 - WE / - WK + Zub
1.4 16V	72	12/09→					
1.6 16V	88	09/07→				13.0470-3847.2 LD3847	BOS 24660 17,8 - WE / - WK + Zub Ceramic
1.6 16V	103	09/07→					
1.6 16V	110	09/07→					
1.6 BioFlex	80	04/08→	➔	→ 07/13		13.0460-2740.2 602740	TRW 23554 17,0 - WE / - WK + Zub
1.6 HDi	66	09/07→				13.0470-2740.2 LD2740	TRW 23554 17,0 - WE / - WK + Zub Ceramic
1.6 HDi	68	11/09→					
1.6 HDi	80	09/07→					
1.6 HDi	82	12/09→					
1.6 HDi	84	03/13→					
2.0 HDi	103	07/10→					
1.6	120	01/12→	➔	→ 07/13		13.0460-2740.2 602740	TRW 23554 17,0 - WE / - WK + Zub
2.0 HDi	110	10/11→				13.0470-2740.2 LD2740	TRW 23554 17,0 - WE / - WK + Zub Ceramic
1.6 16V	115	10/09→	➔	→ 07/13		13.0460-3847.2 603847	BOS 24660 17,8 - WE / - WK + Zub
						13.0460-7202.2 607202	ATE 23589 19,1 - WE / - WK
						13.0470-3847.2 LD3847	BOS 24660 17,8 - WE / - WK + Zub Ceramic
						13.0470-7202.2 LD7202	ATE 23589 19,1 - WE / - WK Ceramic
			➔	→ 07/13		13.0460-2740.2 602740	TRW 23554 17,0 - WE / - WK + Zub
						13.0470-2740.2 LD2740	TRW 23554 17,0 - WE / - WK + Zub Ceramic
1.6 16V	128	03/08→	➔	→ 07/13		13.0460-7202.2 607202	ATE 23589 19,1 - WE / - WK
2.0 HDi	120	04/12→				13.0470-7202.2 LD7202	ATE 23589 19,1 - WE / - WK Ceramic
			➔	→ 07/13		13.0460-2740.2 602740	TRW 23554 17,0 - WE / - WK + Zub
						13.0470-2740.2 LD2740	TRW 23554 17,0 - WE / - WK + Zub Ceramic
1.6 GTi	147	07/10→	➔	→ 07/13		13.0460-7279.2 607279	ATE 25069 17,3 + WK
			➔	→ 07/13		13.0460-2761.2 602761	TRW 24922 17,5 - WK + Zub
2.0 Bioflex	103	01/08→01/12	➔			13.0460-3847.2 603847	BOS 24660 17,8 - WE / - WK + Zub
						13.0470-3847.2 LD3847	BOS 24660 17,8 - WE / - WK + Zub Ceramic
			➔			13.0460-2740.2 602740	TRW 23554 17,0 - WE / - WK + Zub
						13.0470-2740.2 LD2740	TRW 23554 17,0 - WE / - WK + Zub Ceramic
2.0 HDi	100	09/07→	➔	Orga 11678→; → 07/13		13.0460-3847.2 603847	BOS 24660 17,8 - WE / - WK + Zub
						13.0470-3847.2 LD3847	BOS 24660 17,8 - WE / - WK + Zub Ceramic
			➔	→ Orga 11678		13.0460-7202.2 607202	ATE 23589 19,1 - WE / - WK

	kw			 	! #		
PEUGEOT - 308 (4A_, 4C_) 09/07→							
 Bremsbelagsatz, Scheibenbremse							
2.0 HDi	100	09/07→	←	→Orga 11678		13.0470-7202.2 LD7202	ATE 23589 19,1 - WE / - WK Ceramic
			→	→ 07/13		13.0460-2740.2 602740	TRW 23554 17,0 - WE / - WK + Zub
						13.0470-2740.2 LD2740	TRW 23554 17,0 - WE / - WK + Zub Ceramic
 Bremsscheibe							
1.4 16V	70	09/07→	←	→ 07/13		24.0126-0120.1 426120	Ø 283 26 24 V + S
1.4 16V	72	12/09→				24.0326-0120.1 526120	Ø 283 26 24 V + S PD
1.6 16V	88	09/07→	→	→ 07/13		24.0109-0171.2 409171	Ø 249 9 8 + LG / + ABS Ring
1.6 16V	103	09/07→					
1.6 16V	110	09/07→					
1.6 BioFlex	80	04/08→					
1.6 HDi	66	09/07→					
1.6 HDi	68	11/09→					
1.6 HDi	80	09/07→					
1.6 HDi	82	12/09→					
1.6 HDi	84	03/13→					
2.0 HDi	103	07/10→					
1.6	120	01/12→	→	→ 07/13		24.0109-0171.2 409171	Ø 249 9 8 + LG / + ABS Ring
2.0 HDi	110	10/11→					
1.6 16V	115	10/09→	←	→ 07/13		24.0126-0159.1 426159	Ø 302 26 24 V + S
1.6 16V	128	03/08→					
2.0 HDi	120	04/12→	→	→ 07/13		24.0109-0171.2 409171	Ø 249 9 8 + LG / + ABS Ring
1.6 GTi	147	07/10→	←	→ 07/13		24.0130-0230.1 430230	Ø 340 30 28 V + S
			→	→ 07/13		24.0112-0198.1 412198	Ø 290 12 10 + S
2.0 Bioflex	103	01/08→01/12	←			24.0126-0120.1 426120	Ø 283 26 24 V + S
			→			24.0326-0120.1 526120	Ø 283 26 24 V + S PD
						24.0109-0171.2 409171	Ø 249 9 8 + LG / + ABS Ring
2.0 HDi	100	09/07→	←	→ 07/13		24.0126-0120.1 426120	Ø 283 26 24 V + S
						24.0326-0120.1 526120	Ø 283 26 24 V + S PD
			←	Orga 11678→; → 07/13		24.0126-0120.1 426120	Ø 283 26 24 V + S
						24.0326-0120.1 526120	Ø 283 26 24 V + S PD
			←	→Orga 11678		24.0126-0159.1 426159	Ø 302 26 24 V + S
			→	→ 07/13		24.0109-0171.2 409171	Ø 249 9 8 + LG / + ABS Ring
PEUGEOT - 308 II 09/13→							
 Bremsbelagsatz, Scheibenbremse							
1.2 THP 110	81	11/13→	←	für Bremsscheibendurchmesser [mm]: 266		13.0460-3869.2 603869	MAN - WE / - WK + Zub
1.2 THP 130	96	11/13→					
1.2 VTi 72	60	09/13→	←	für Bremsscheibendurchmesser [mm]: 283		13.0460-3870.2 603870	BOS 25895 18,5 - WE / - WK + Zub
1.6	115	09/13→					
1.6 BlueHDi 120	88	11/13→				13.0470-3870.2 LD3870	BOS 25895 18,5 - WE / - WK + Zub Ceramic
1.6 GT 205	151	06/14→					
1.6 GTi	184	08/15→					
1.6 GTi	200	06/15→	←	für Bremsscheibendurchmesser [mm]: 304		13.0460-7300.2 607300	ATE 25833 17,3 + WE / - WK
1.6 HDi	68	09/13→				13.0470-7300.2 LD7300	ATE 25833 17,3 + WE / - WK Ceramic
1.6 HDi / BlueHDi 115	85	09/13→					
1.6 HDi 100	73	04/14→					
1.6 THP 125	92	09/13→	→	für Bremsscheibendurchmesser [mm]: 268; + eFSB		13.0460-3871.2 603871	BOS 25839 17,8 - WE / - WK + Zub
1.6 THP 150	110	03/14→					
1.6 THP 163	120	06/14→				13.0470-3871.2 LD3871	BOS 25839 17,8 - WE / - WK + Zub Ceramic
1.6 VTi	85	03/14→					
2.0 BlueHDi 150	110	11/13→	→	für Bremsscheibendurchmesser [mm]: 290		13.0460-3872.2 603872	BOS 25827 17,7 - WE / - WK + Zub
2.0 GT HDi 180	133	06/14→				13.0470-3872.2 LD3872	BOS 25827 17,7 - WE / - WK + Zub Ceramic
			→	für Bremsscheibendurchmesser [mm]: 268; - eFSB		13.0460-7295.2 607295	ATE 25968 16,1 - WE / - WK
						13.0470-7295.2 LD7295	ATE 25968 16,1 - WE / - WK Ceramic
			→	für Bremsscheibendurchmesser [mm]: 249; - eFSB		13.0460-7301.2 607301	ATE 25841 16,1 - WE / - WK
			→	für Bremsscheibendurchmesser [mm]: 249		13.0470-7301.2 LD7301	ATE 25841 16,1 - WE / - WK Ceramic
 Bremsscheibe							
1.2 THP 110	81	11/13→	←	für Bremsscheibendurchmesser [mm]: 266		24.0122-0291.1 422291	Ø 266 22 20 V + S
1.2 THP 130	96	11/13→					
1.2 VTi 72	60	09/13→	←	für Bremsscheibendurchmesser [mm]: 283		24.0126-0183.1 426183	Ø 283 26 24 V + S
1.6	115	09/13→					
1.6 BlueHDi 120	88	11/13→					
↓							







	kw			 	! #		
PEUGEOT - 308 II 09/13→							
 Bremsscheibe							
1.6 GT 205	151	06/14→	←	für Bremsscheibendurchmesser [mm]: 304		24.0128-0269.1 428269	Ø 304 28 26 V + S
1.6 GTi	184	08/15→					
1.6 HDi	68	09/13→	←	für Bremsscheibendurchmesser [mm]: 330		24.0130-0241.1 430241	Ø 330 30 28 V + S
1.6 HDi / BlueHDi 115	85	09/13→					
1.6 HDi 100	73	04/14→					
1.6 THP 125	92	09/13→	→	für Bremsscheibendurchmesser [mm]: 268		24.0112-0211.1 412211	Ø 268 12 10 + S
1.6 THP 150	110	03/14→					
1.6 THP 163	120	06/14→	→	für Bremsscheibendurchmesser [mm]: 290		24.0112-0212.1 412212	Ø 290 12 10 + S
1.6 VTi	85	03/14→					
2.0 BlueHDi 150	110	11/13→					
2.0 GT HDi 180	133	06/14→					
1.6 GTi	200	06/15→	←	für Bremsscheibendurchmesser [mm]: 266		24.0122-0291.1 422291	Ø 266 22 20 V + S
			←	+PR 283		24.0126-0183.1 426183	Ø 283 26 24 V + S
			←	für Bremsscheibendurchmesser [mm]: 304		24.0128-0269.1 428269	Ø 304 28 26 V + S
			←	für Bremsscheibendurchmesser [mm]: 330		24.0130-0241.1 430241	Ø 330 30 28 V + S
			→	für Bremsscheibendurchmesser [mm]: 268		24.0112-0211.1 412211	Ø 268 12 10 + S
			→	für Bremsscheibendurchmesser [mm]: 290		24.0112-0212.1 412212	Ø 290 12 10 + S
PEUGEOT - 308 CC 04/09→							
 Bremsbelagsatz, Scheibenbremse							
1.6 16V	88	06/09→	←			13.0460-3847.2 603847	BOS 24660 17,8 - WE / - WK + Zub
1.6 HDi	82	06/09→					
1.6 HDi	84	03/13→				13.0470-3847.2 LD3847	BOS 24660 17,8 - WE / - WK + Zub Ceramic
			→			13.0460-2740.2 602740	TRW 23554 17,0 - WE / - WK + Zub
						13.0470-2740.2 LD2740	TRW 23554 17,0 - WE / - WK + Zub Ceramic
1.6 16V	103	06/09→	←			13.0460-7202.2 607202	ATE 23589 19,1 - WE / - WK
1.6 16V	110	06/09→				13.0470-7202.2 LD7202	ATE 23589 19,1 - WE / - WK Ceramic
2.0 CVVT	103	07/09→11/14					
2.0 HDi	100	04/09→					
2.0 HDi	103	04/09→	→			13.0460-2740.2 602740	TRW 23554 17,0 - WE / - WK + Zub
2.0 HDi	120	06/09→				13.0470-2740.2 LD2740	TRW 23554 17,0 - WE / - WK + Zub Ceramic
1.6 16V	115	06/09→	←	09/09→		13.0460-7202.2 607202	ATE 23589 19,1 - WE / - WK
						13.0470-7202.2 LD7202	ATE 23589 19,1 - WE / - WK Ceramic
			→	09/09→		13.0460-2740.2 602740	TRW 23554 17,0 - WE / - WK + Zub
						13.0470-2740.2 LD2740	TRW 23554 17,0 - WE / - WK + Zub Ceramic
1.6 THP	147	10/10→	←			13.0460-7279.2 607279	ATE 25069 17,3 + WK
			→			13.0460-2761.2 602761	TRW 24922 17,5 - WK + Zub
 Bremsscheibe							
1.6 16V	88	06/09→	←			24.0126-0120.1 426120	Ø 283 26 24 V + S
1.6 HDi	82	06/09→				24.0326-0120.1 526120	Ø 283 26 24 V + S PD
1.6 HDi	84	03/13→				24.0109-0171.2 409171	Ø 249 9 8 + LG / + ABS Ring
			→				
1.6 16V	103	06/09→	←			24.0126-0159.1 426159	Ø 302 26 24 V + S
1.6 16V	110	06/09→					
2.0 CVVT	103	07/09→11/14	→			24.0109-0171.2 409171	Ø 249 9 8 + LG / + ABS Ring
2.0 HDi	100	04/09→					
2.0 HDi	103	04/09→					
2.0 HDi	120	06/09→					
1.6 16V	115	06/09→	←	09/09→		24.0126-0159.1 426159	Ø 302 26 24 V + S
			→	09/09→		24.0109-0171.2 409171	Ø 249 9 8 + LG / + ABS Ring
1.6 THP	147	10/10→	←			24.0130-0230.1 430230	Ø 340 30 28 V + S
			→			24.0112-0198.1 412198	Ø 290 12 10 + S
PEUGEOT - 308 SW 09/07→							
 Bremsbelagsatz, Scheibenbremse							
1.4 16V	70	09/07→	←	05/08→ 04/14		13.0460-3847.2 603847	BOS 24660 17,8 - WE / - WK + Zub
1.6 16V	88	09/07→					
1.6 HDi	66	09/07→					



















	kw			 	! #			
PEUGEOT - 308 SW 09/07→								
 Bremsbelagsatz, Scheibenbremse								
1.6 HDi	80	09/07→	←	05/08→ 04/14		13.0470-3847.2	LD3847	BOS 24660 17,8 - WE / - WK + Zub Ceramic
			→	05/08→; - Break Loisirs; → 04/14		13.0460-2740.2	602740	TRW 23554 17,0 - WE / - WK + Zub
			→	05/08→; + Break Loisirs; → 04/14		13.0470-2740.2	LD2740	TRW 23554 17,0 - WE / - WK + Zub Ceramic
1.4 16V 1.6 Bioflex 1.6 HDi 1.6 HDi 1.6 HDi	72 82 68 82 84	12/09→ 03/09→ 11/09→ 12/09→ 03/13→	←	→ 04/14		13.0460-3847.2	603847	BOS 24660 17,8 - WE / - WK + Zub
			→	- Break Loisirs; → 04/14		13.0460-2740.2	602740	TRW 23554 17,0 - WE / - WK + Zub
			→	+ Break Loisirs; → 04/14		13.0470-2740.2	LD2740	TRW 23554 17,0 - WE / - WK + Zub Ceramic
1.6 16V 1.6 16V 1.6 16V 2.0 HDi	103 110 128 100	09/07→ 09/07→ 03/08→ 09/07→	←	05/08→ 04/14		13.0460-7202.2	607202	ATE 23589 19,1 - WE / - WK
			→	05/08→; - Break Loisirs; → 04/14		13.0470-7202.2	LD7202	ATE 23589 19,1 - WE / - WK Ceramic
			→	05/08→; + Break Loisirs; → 04/14		13.0460-2740.2	602740	TRW 23554 17,0 - WE / - WK + Zub
1.6 16V 2.0 HDi 2.0 HDi	115 110 120	10/09→ 04/11→ 06/09→	←	→ 04/14		13.0460-7202.2	607202	ATE 23589 19,1 - WE / - WK
			→	- Break Loisirs; → 04/14		13.0470-7202.2	LD7202	ATE 23589 19,1 - WE / - WK Ceramic
			→	+ Break Loisirs; → 04/14		13.0460-2740.2	602740	TRW 23554 17,0 - WE / - WK + Zub
2.0 Bioflex	103	01/08→	←	Orga 11679→; → 04/14		13.0460-3847.2	603847	BOS 24660 17,8 - WE / - WK + Zub
			←	05/08→; →Orga 11678		13.0470-3847.2	LD3847	BOS 24660 17,8 - WE / - WK + Zub Ceramic
			→	05/08→; - Break Loisirs; → 04/14		13.0460-7202.2	607202	ATE 23589 19,1 - WE / - WK
			→	05/08→; + Break Loisirs; → 04/14		13.0470-7202.2	LD7202	ATE 23589 19,1 - WE / - WK Ceramic
2.0 HDi	103	09/07→	←	12/08→ 04/14		13.0460-2740.2	602740	TRW 23554 17,0 - WE / - WK + Zub
			→	12/08→; - Break Loisirs; → 04/14		13.0470-2740.2	LD2740	TRW 23554 17,0 - WE / - WK + Zub Ceramic
			→	12/08→; + Break Loisirs; → 04/14		13.0460-7202.2	607202	ATE 23589 19,1 - WE / - WK Ceramic
 Bremsscheibe								
1.4 16V 1.6 16V 1.6 HDi 1.6 HDi	70 88 66 80	09/07→ 09/07→ 09/07→ 09/07→	←	05/08→ 04/14		24.0126-0120.1	426120	Ø 283 26 24 V + S
			→	05/08→; - Break Loisirs; → 04/14		24.0326-0120.1	526120	Ø 283 26 24 V + S PD
			→	05/08→ 04/14; + Break Loisirs		24.0109-0171.2	409171	Ø 249 9 8 + LG / + ABS Ring
1.4 16V 1.6 Bioflex	72 82	12/09→ 03/09→	←	→ 04/14		24.0112-0194.2	412194	Ø 268 12 10 + LG / + ABS Ring
			→	au?er Break Loisirs; → 04/14		24.0126-0120.1	426120	Ø 283 26 24 V + S
			→	+ Break Loisirs; → 04/14		24.0326-0120.1	526120	Ø 283 26 24 V + S PD
↓								

	kw			 	! #		
PEUGEOT - 308 SW 09/07 →							
Bremsscheibe							
1.6 16V	103	09/07 →	←	05/08 → 04/14		24.0126-0159.1 426159	Ø 302 26 24 V + S
1.6 16V	110	09/07 →	→	05/08 →; - Break Loisirs; → 04/14		24.0109-0171.2 409171	Ø 249 9 8 + LG / + ABS Ring
1.6 16V	128	03/08 →	→	05/08 → 04/14; + Break Loisirs		24.0112-0194.2 412194	Ø 268 12 10 + LG / + ABS Ring
2.0 HDi	100	09/07 →	→	05/08 → 04/14; + Break Loisirs		24.0112-0194.2 412194	Ø 268 12 10 + LG / + ABS Ring
1.6 16V	115	10/09 →	←	→ 04/14		24.0126-0159.1 426159	Ø 302 26 24 V + S
2.0 HDi	110	04/11 →	→	- Break Loisirs; → 04/14		24.0109-0171.2 409171	Ø 249 9 8 + LG / + ABS Ring
			→	+ Break Loisirs; → 04/14		24.0112-0194.2 412194	Ø 268 12 10 + LG / + ABS Ring
1.6 HDi	68	11/09 →	←	→ 04/14		24.0126-0120.1 426120	Ø 283 26 24 V + S
1.6 HDi	82	12/09 →	→	- Break Loisirs; → 04/14		24.0326-0120.1 526120	Ø 283 26 24 V + S PD
1.6 HDi	84	03/13 →	→	- Break Loisirs; → 04/14		24.0109-0171.2 409171	Ø 249 9 8 + LG / + ABS Ring
			→	+ Break Loisirs; → 04/14		24.0112-0194.2 412194	Ø 268 12 10 + LG / + ABS Ring
2.0 Bioflex	103	01/08 →	←	Orga 11679 →; → 04/14		24.0126-0120.1 426120	Ø 283 26 24 V + S
			→	05/08 →; → Orga 11678		24.0326-0120.1 526120	Ø 283 26 24 V + S PD
			→	05/08 →; → Orga 11678		24.0126-0159.1 426159	Ø 302 26 24 V + S
			→	05/08 →; - Break Loisirs; → 04/14		24.0109-0171.2 409171	Ø 249 9 8 + LG / + ABS Ring
			→	05/08 → 04/14; + Break Loisirs		24.0112-0194.2 412194	Ø 268 12 10 + LG / + ABS Ring
2.0 HDi	103	09/07 →	←	12/08 → 04/14		24.0126-0159.1 426159	Ø 302 26 24 V + S
			→	12/08 →; - Break Loisirs; → 04/14		24.0109-0171.2 409171	Ø 249 9 8 + LG / + ABS Ring
			→	12/08 →; + Break Loisirs; → 04/14		24.0112-0194.2 412194	Ø 268 12 10 + LG / + ABS Ring
2.0 HDi	120	06/09 →	←	→ 04/14		24.0126-0159.1 426159	Ø 302 26 24 V + S
			→	au?er Break Loisirs; → 04/14		24.0109-0171.2 409171	Ø 249 9 8 + LG / + ABS Ring
			→	+ Break Loisirs; → 04/14		24.0112-0194.2 412194	Ø 268 12 10 + LG / + ABS Ring
PEUGEOT - 308 SW II 03/14 →							
Brembelagsatz, Scheibenbremse							
1.2 THP 110	81	03/14 →	←	08/14 →; für Bremsscheibendurchmesser [mm]: 266		13.0460-3869.2 603869	MAN - WE / - WK + Zub
			←	08/14 →; für Bremsscheibendurchmesser [mm]: 283		13.0460-3870.2 603870	BOS 25895 18,5 - WE / - WK + Zub
						13.0470-3870.2 LD3870	BOS 25895 18,5 - WE / - WK + Zub Ceramic
			←	08/14 →; für Bremsscheibendurchmesser [mm]: 304		13.0460-7300.2 607300	ATE 25833 17,3 + WE / - WK Ceramic
						13.0470-7300.2 LD7300	ATE 25833 17,3 + WE / - WK Ceramic
			→	08/14 →; für Bremsscheibendurchmesser [mm]: 268; + eFSB		13.0460-3871.2 603871	BOS 25839 17,8 - WE / - WK + Zub
						13.0470-3871.2 LD3871	BOS 25839 17,8 - WE / - WK + Zub Ceramic
			→	08/14 →; für Bremsscheibendurchmesser [mm]: 290		13.0460-3872.2 603872	BOS 25827 17,7 - WE / - WK + Zub
						13.0470-3872.2 LD3872	BOS 25827 17,7 - WE / - WK + Zub Ceramic
			→	08/14 →; für Bremsscheibendurchmesser [mm]: 268; - eFSB		13.0460-7295.2 607295	ATE 25968 16,1 - WE / - WK Ceramic
						13.0470-7295.2 LD7295	ATE 25968 16,1 - WE / - WK Ceramic
			→	08/14 →; für Bremsscheibendurchmesser [mm]: 249		13.0460-7301.2 607301	ATE 25841 16,1 - WE / - WK Ceramic
						13.0470-7301.2 LD7301	ATE 25841 16,1 - WE / - WK Ceramic
1.2 THP 130	96	03/14 →	←	für Bremsscheibendurchmesser [mm]: 266		13.0460-3869.2 603869	MAN - WE / - WK + Zub
1.6 BlueHDi 100	73	04/14 →	←	für Bremsscheibendurchmesser [mm]: 283		13.0460-3870.2 603870	BOS 25895 18,5 - WE / - WK + Zub
1.6 BlueHDi 120	88	03/14 →				13.0470-3870.2 LD3870	BOS 25895 18,5 - WE / - WK + Zub Ceramic
1.6 GT 205	151	06/14 →					
1.6 HDi / BlueHDi 115	85	03/14 →	←	für Bremsscheibendurchmesser [mm]: 304		13.0460-7300.2 607300	ATE 25833 17,3 + WE / - WK Ceramic
1.6 HDi 92	68	03/14 →				13.0470-7300.2 LD7300	ATE 25833 17,3 + WE / - WK Ceramic
1.6 THP 125	92	03/14 →	→	für Bremsscheibendurchmesser [mm]: 268; + eFSB		13.0460-3871.2 603871	BOS 25839 17,8 - WE / - WK + Zub
1.6 THP 150	110	03/14 →				13.0470-3871.2 LD3871	BOS 25839 17,8 - WE / - WK + Zub Ceramic
1.6 THP 155	115	03/14 →					
1.6 THP 163	120	06/14 →					
1.6 VTi	85	03/14 →	→	für Bremsscheibendurchmesser [mm]: 290		13.0460-3872.2 603872	BOS 25827 17,7 - WE / - WK + Zub
2.0 BlueHDi 150	110	03/14 →					
2.0 BlueHDi 180	132	06/14 →					



















	kW			 	! #		
PEUGEOT - 308 SW II 03/14 →							
 Bremsscheibe							
2.0 GT BlueHDi 180	133	06/14 →	→	09/14 →; für Bremsscheibendurchmesser [mm]: 268		24.0112-0211.1 412211	Ø 268 12 10 + S
			→	für Bremsscheibendurchmesser [mm]: 290		24.0112-0212.1 412212	Ø 290 12 10 + S
PEUGEOT - 405 II (4B) 01/92 → 11/99							
 Bremsbelagsatz, Scheibenbremse							
1.4	55	08/92 → 10/95	←	09/92 →		13.0460-3911.2 603911	BDX 20905 18,0 + WK
1.6	65	08/92 → 10/95	←	09/92 →		13.0460-2971.2 602971	TRW 21209 18,5 + WK
						13.0460-3911.2 603911	BDX 20905 18,0 + WK
1.6	66	08/92 → 05/97	←	09/92 → 10/95		13.0460-2971.2 602971	TRW 21209 18,5 + WK
						13.0460-3911.2 603911	BDX 20905 18,0 + WK
1.8 1.9 D	74 47	08/92 → 10/95 08/92 → 10/95	←	09/92 →		13.0460-2971.2 602971	TRW 21209 18,5 + WK
1.9	90	01/92 → 11/97	←	09/92 → 12/93		13.0460-2971.2 602971	TRW 21209 18,5 + WK
			→	09/92 → 12/93		13.0460-2842.2 602842	TRW 20961 15,2 - WK
1.9 D	50	06/94 → 10/95	←			13.0460-2971.2 602971	TRW 21209 18,5 + WK
1.9 TD	66	08/92 → 10/95	←	09/92 →		13.0460-2971.2 602971	TRW 21209 18,5 + WK
			→	09/92 →; + ABS		13.0460-2842.2 602842	TRW 20961 15,2 - WK
1.9 TD	69	08/92 → 05/97	←	09/92 → 10/95		13.0460-2971.2 602971	TRW 21209 18,5 + WK
			→	09/92 → 10/95; + ABS		13.0460-2842.2 602842	TRW 20961 15,2 - WK
2.0 2.0 MI-16	89 112	08/92 → 10/95 08/92 → 10/95	←	09/92 →		13.0460-2971.2 602971	TRW 21209 18,5 + WK
			→	09/92 →		13.0460-2842.2 602842	TRW 20961 15,2 - WK
2.0 16V	110	06/94 → 10/95	←			13.0460-2971.2 602971	TRW 21209 18,5 + WK
			→			13.0460-2842.2 602842	TRW 20961 15,2 - WK
2.0 T 16 X4	144	08/92 → 10/95	→	07/93 →		13.0460-2937.2 602937	TRW 20961 15,2 - WK + Zub
2.0 X4	89	08/92 → 10/95	←	09/92 →		13.0460-2971.2 602971	TRW 21209 18,5 + WK
			→	09/92 →		13.0460-2937.2 602937	TRW 20961 15,2 - WK + Zub
Zubehörsatz, Scheibenbremsbelag							
1.4 1.6	55 65	08/92 → 10/95 08/92 → 10/95	←	09/92 →		13.0460-0403.2 610403	BDX
1.6	66	08/92 → 05/97	←	09/92 → 10/95		13.0460-0403.2 610403	BDX
1.9	90	01/92 → 11/97	→	09/92 → 12/93		13.0460-0072.2 610072	TRW
1.9 TD	66	08/92 → 10/95	→	09/92 →; + ABS		13.0460-0072.2 610072	TRW
1.9 TD	69	08/92 → 05/97	→	09/92 → 10/95; + ABS		13.0460-0072.2 610072	TRW
2.0 2.0 MI-16	89 112	08/92 → 10/95 08/92 → 10/95	→	09/92 →		13.0460-0072.2 610072	TRW
2.0 16V	110	06/94 → 10/95	→			13.0460-0072.2 610072	TRW
2.0 T 16 X4	144	08/92 → 10/95	→	07/93 →		13.0460-0419.2 610419	TRW
2.0 X4	89	08/92 → 10/95	→	09/92 →		13.0460-0419.2 610419	TRW
 Bremsscheibe							
1.4 1.6	55 65	08/92 → 10/95 08/92 → 10/95	←	09/92 →		24.0110-0183.1 410183	Ø 266 10 8
1.6	66	08/92 → 05/97	←	09/92 → 10/95		24.0110-0183.1 410183	Ø 266 10 8
1.8 1.9 D	74 47	08/92 → 10/95 08/92 → 10/95	←	09/92 →		24.0120-0133.1 420133	Ø 266 20,5 18,5 V + S
						24.0320-0133.1 520133	Ø 266 20,5 18,5 V + S PD
1.9	90	01/92 → 11/97	←	09/92 → 12/93		24.0120-0133.1 420133	Ø 266 20,5 18,5 V + S
			→	09/92 → 12/93		24.0320-0133.1 520133	Ø 266 20,5 18,5 V + S PD
			→	09/92 → 12/93		24.0110-0199.1 410199	Ø 247 10 8
1.9 D	50	06/94 → 10/95	←			24.0120-0133.1 420133	Ø 266 20,5 18,5 V + S
						24.0320-0133.1 520133	Ø 266 20,5 18,5 V + S PD
1.9 TD	66	08/92 → 10/95	←	09/92 →		24.0120-0133.1 420133	Ø 266 20,5 18,5 V + S
			→	09/92 →; + ABS		24.0320-0133.1 520133	Ø 266 20,5 18,5 V + S PD
			→	09/92 →; + ABS		24.0110-0199.1 410199	Ø 247 10 8
1.9 TD	69	08/92 → 05/97	←	09/92 → 10/95		24.0120-0133.1 420133	Ø 266 20,5 18,5 V + S
			→	09/92 → 10/95; + ABS		24.0320-0133.1 520133	Ø 266 20,5 18,5 V + S PD
			→	09/92 → 10/95; + ABS		24.0110-0199.1 410199	Ø 247 10 8
↓							

	kw			 	! #		
PEUGEOT - 405 II (4B) 01/92→11/99							
 Bremsscheibe							
2.0 2.0 MI-16	89 112	08/92→10/95 08/92→10/95	←	09/92→		24.0120-0133.1 420133 24.0320-0133.1 520133	Ø 266 20,5 18,5 V + S Ø 266 20,5 18,5 V + S PD
			→	09/92→		24.0110-0199.1 410199	Ø 247 10 8
2.0 16V	110	06/94→10/95	←			24.0120-0133.1 420133 24.0320-0133.1 520133	Ø 266 20,5 18,5 V + S Ø 266 20,5 18,5 V + S PD
			→			24.0110-0199.1 410199	Ø 247 10 8
2.0 T 16 X4	144	08/92→10/95	←	07/93→		24.0122-0142.1 422142	Ø 283 22 20 V
			→	07/93→		24.0110-0187.1 410187	Ø 247 10 9 + S
2.0 X4	89	08/92→10/95	←	09/92→		24.0120-0133.1 420133 24.0320-0133.1 520133	Ø 266 20,5 18,5 V + S Ø 266 20,5 18,5 V + S PD
			→	09/92→		24.0110-0187.1 410187	Ø 247 10 9 + S
PEUGEOT - 405 II Break (4E) 08/92→10/98							
 Bremsbelagsatz, Scheibenbremse							
1.4	55	08/92→10/96	←	09/92→ 10/95		13.0460-3911.2 603911	BDX 20905 18,0 + WK
1.6 1.6	65 80	08/92→10/96 08/92→10/96	←	09/92→ 10/95		13.0460-2971.2 602971 13.0460-3911.2 603911	TRW 21209 18,5 + WK BDX 20905 18,0 + WK
1.8 1.9 D 1.9 D	74 47 52	08/92→10/96 08/92→10/96 08/92→10/98	←	09/92→ 10/95		13.0460-2971.2 602971	TRW 21209 18,5 + WK
1.9 D	50	06/94→10/96	←	→ 10/95		13.0460-2971.2 602971	TRW 21209 18,5 + WK
1.9 TD 1.9 TD	66 69	08/92→10/96 08/92→10/96	←	09/92→ 10/95		13.0460-2971.2 602971	TRW 21209 18,5 + WK
			→	09/92→ 10/95; + ABS		13.0460-2842.2 602842	TRW 20961 15,2 - WK
2.0 2.0 4x4	89 144	08/92→10/96 08/92→12/95	←	09/92→ 10/95		13.0460-2971.2 602971	TRW 21209 18,5 + WK
			→	09/92→ 10/95		13.0460-2842.2 602842	TRW 20961 15,2 - WK
2.0 4x4	89	08/92→10/96	←	09/92→ 10/95		13.0460-2971.2 602971	TRW 21209 18,5 + WK
			→	09/92→ 10/95		13.0460-2937.2 602937	TRW 20961 15,2 - WK + Zub
Zubehörsatz, Scheibenbremsbelag							
1.4 1.6 1.6	55 65 80	08/92→10/96 08/92→10/96 08/92→10/96	←	09/92→ 10/95		13.0460-0403.2 610403	BDX
1.9 TD 1.9 TD	66 69	08/92→10/96 08/92→10/96	→	09/92→ 10/95; + ABS		13.0460-0072.2 610072	TRW
2.0 2.0 4x4	89 144	08/92→10/96 08/92→12/95	→	09/92→ 10/95		13.0460-0072.2 610072	TRW
2.0 4x4	89	08/92→10/96	→	09/92→ 10/95		13.0460-0419.2 610419	TRW
 Bremsscheibe							
1.4 1.6 1.6	55 65 80	08/92→10/96 08/92→10/96 08/92→10/96	←	09/92→ 10/95		24.0110-0183.1 410183	Ø 266 10 8
1.8 1.9 D 1.9 D	74 47 52	08/92→10/96 08/92→10/96 08/92→10/98	←	09/92→ 10/95		24.0120-0133.1 420133 24.0320-0133.1 520133	Ø 266 20,5 18,5 V + S Ø 266 20,5 18,5 V + S PD
1.9 D	50	06/94→10/96	←	→ 10/95		24.0120-0133.1 420133 24.0320-0133.1 520133	Ø 266 20,5 18,5 V + S Ø 266 20,5 18,5 V + S PD
1.9 TD 1.9 TD	66 69	08/92→10/96 08/92→10/96	←	09/92→ 10/95		24.0120-0133.1 420133 24.0320-0133.1 520133	Ø 266 20,5 18,5 V + S Ø 266 20,5 18,5 V + S PD
			→	09/92→ 10/95; + ABS		24.0110-0199.1 410199	Ø 247 10 8
2.0 2.0 4x4	89 144	08/92→10/96 08/92→12/95	←	09/92→ 10/95		24.0120-0133.1 420133 24.0320-0133.1 520133	Ø 266 20,5 18,5 V + S Ø 266 20,5 18,5 V + S PD
			→	09/92→ 10/95		24.0110-0199.1 410199	Ø 247 10 8
2.0 4x4	89	08/92→10/96	←	09/92→ 10/95		24.0120-0133.1 420133 24.0320-0133.1 520133	Ø 266 20,5 18,5 V + S Ø 266 20,5 18,5 V + S PD
			→	09/92→ 10/95		24.0110-0187.1 410187	Ø 247 10 9 + S
PEUGEOT - 406 (8B) 10/95→01/05							
 Bremsbelagsatz, Scheibenbremse							
1.6 1.8 1.9 D	65 66 55	11/95→05/04 05/97→05/04 10/96→05/04	←	→ 04/04		13.0460-2816.2 602816	TRW 21724 19,3 + WK
1.8 1.8 16V	74 81	10/96→03/99 11/95→10/00	←			13.0460-2816.2 602816	TRW 21724 19,3 + WK
↓							







	kW			 	! #		
PEUGEOT - 406 (8B) 10/95→01/05							
 Bremsbelagsatz, Scheibenbremse							
1.8 16V	85	10/00→05/04	←	→ 04/04		13.0460-2816.2 602816	TRW 21724 19,3 + WK
			→	→ S 80012040		13.0460-4059.2 604059	ATE 21278 16,4 + WK
			→	S 80012041→; → 04/04		13.0460-7134.2 607134	ATE 21278 16,4 - WE / - WK
1.8 Bifuel	81	04/99→05/03	←	→ 10/00		13.0460-2816.2 602816	TRW 21724 19,3 + WK
1.9 TD	66	01/96→05/04	←	→ 04/04		13.0460-2817.2 602817	TRW 21674 19,0 + WK
1.9 TD	68	01/96→05/04					
1.9 TD	69	10/95→10/97	←	01/96→		13.0460-2817.2 602817	TRW 21674 19,0 + WK
2.0	104	11/96→03/99	←			13.0460-2817.2 602817	TRW 21674 19,0 + WK
3.0 24V	143	01/98→06/99	→	→ S 80012040		13.0460-4059.2 604059	ATE 21278 16,4 + WK
			→	S 80012041→		13.0460-7134.2 607134	ATE 21278 16,4 - WE / - WK
2.0 16V	97	11/95→05/04	←	→ 04/04		13.0460-2817.2 602817	TRW 21674 19,0 + WK
2.0 16V	100	08/00→06/04	→	→ S 80012040		13.0460-4059.2 604059	ATE 21278 16,4 + WK
2.0 16V HPi	103	05/01→05/04	→	→ S 80012041→; → 04/04		13.0460-7134.2 607134	ATE 21278 16,4 - WE / - WK
2.0 HDi 110	79	08/01→05/04	→				
2.0 HDi 90	66	02/99→05/04					
2.0 Turbo	108	04/96→05/04					
2.1 TD 12V	80	01/96→05/04					
2.2	116	07/00→05/04					
2.2 HDi	98	03/00→05/04					
3.0 24V	140	10/96→05/04					
3.0 V6	152	03/00→05/04					
2.0 16V	99	01/99→08/00	←			13.0460-2817.2 602817	TRW 21674 19,0 + WK
			→			13.0460-4059.2 604059	ATE 21278 16,4 + WK
2.0 HDi 110	80	06/98→08/01	←	02/99→		13.0460-2817.2 602817	TRW 21674 19,0 + WK
			→	02/99→		13.0460-4059.2 604059	ATE 21278 16,4 + WK
3.0 V6	154	03/99→12/01	←	03/00→		13.0460-2817.2 602817	TRW 21674 19,0 + WK
			→	03/00→; → S 80012040		13.0460-4059.2 604059	ATE 21278 16,4 + WK
			→	S 80012041→		13.0460-7134.2 607134	ATE 21278 16,4 - WE / - WK
Zubehörsatz, Scheibenbremsbelag							
1.8 16V	85	10/00→05/04	→	→ S 80012040		13.0460-0409.2 610409	ATE
2.0	104	11/96→03/99					
2.0 16V	97	11/95→05/04					
2.0 16V	100	08/00→06/04					
2.0 16V HPi	103	05/01→05/04					
2.0 HDi 110	79	08/01→05/04					
2.0 HDi 90	66	02/99→05/04					
2.0 Turbo	108	04/96→05/04					
2.1 TD 12V	80	01/96→05/04					
2.2	116	07/00→05/04					
2.2 HDi	98	03/00→05/04					
3.0 24V	140	10/96→05/04					
3.0 24V	143	01/98→06/99					
3.0 V6	152	03/00→05/04					
2.0 16V	99	01/99→08/00	→			13.0460-0409.2 610409	ATE
2.0 HDi 110	80	06/98→08/01	→	02/99→		13.0460-0409.2 610409	ATE
3.0 V6	154	03/99→12/01	→	03/00→; → S 80012040		13.0460-0409.2 610409	ATE
 Bremsscheibe							
1.6	65	11/95→05/04	←	→ 04/04		24.0124-0139.1 424139	Ø 260 24 22 V + S
1.8	66	05/97→05/04					
1.9 D	55	10/96→05/04					
1.8	74	10/96→03/99	←			24.0124-0139.1 424139	Ø 260 24 22 V + S
1.8 16V	81	11/95→10/00					
1.8 16V	85	10/00→05/04	←	→ 04/04		24.0124-0139.1 424139	Ø 260 24 22 V + S
			→	→ 04/04		24.0110-0230.1 410230	Ø 290,5 10 8
1.8 Bifuel	81	04/99→05/03	←	→ 10/00		24.0124-0139.1 424139	Ø 260 24 22 V + S
1.9 TD	66	01/96→05/04	←	→ 04/04		24.0126-0106.1 426106	Ø 283 26 24,2 V + S
1.9 TD	68	01/96→05/04				24.0326-0106.1 526106	Ø 283 26 24,2 V + S PD
1.9 TD	69	10/95→10/97	←	01/96→		24.0126-0106.1 426106	Ø 283 26 24,2 V + S
						24.0326-0106.1 526106	Ø 283 26 24,2 V + S PD
2.0	104	11/96→03/99	←			24.0126-0106.1 426106	Ø 283 26 24,2 V + S
2.0 16V	99	01/99→08/00				24.0326-0106.1 526106	Ø 283 26 24,2 V + S PD
3.0 24V	143	01/98→06/99	→			24.0110-0230.1 410230	Ø 290,5 10 8
2.0 16V	97	11/95→05/04	←	→ 04/04		24.0126-0106.1 426106	Ø 283 26 24,2 V + S
2.0 16V	100	08/00→06/04				24.0326-0106.1 526106	Ø 283 26 24,2 V + S PD
2.0 16V HPi	103	05/01→05/04					
↓							























	kW			 	! #		
PEUGEOT - 406 (8B) 10/95→01/05							
 Bremsscheibe							
2.0 HDi 110 2.0 HDi 90 2.0 Turbo 2.1 TD 12V 2.2 2.2 HDi 3.0 24V 3.0 V6	79 66 108 80 116 98 140 152	08/01→05/04 02/99→05/04 04/96→05/04 01/96→05/04 07/00→05/04 03/00→05/04 10/96→05/04 03/00→05/04	➔	→ 04/04		24.0110-0230.1 410230	Ø 290,5 10 8
2.0 HDi 110	80	06/98→08/01	➔	02/99→		24.0126-0106.1 426106	Ø 283 26 24,2 V + S
			➔	02/99→		24.0326-0106.1 526106	Ø 283 26 24,2 V + S PD
3.0 V6	154	03/99→12/01	➔	02/99→		24.0110-0230.1 410230	Ø 290,5 10 8
			➔	03/00→		24.0126-0106.1 426106	Ø 283 26 24,2 V + S
			➔	03/00→		24.0326-0106.1 526106	Ø 283 26 24,2 V + S PD
			➔	03/00→		24.0110-0230.1 410230	Ø 290,5 10 8
PEUGEOT - 406 Break (8E/F) 10/96→10/04							
 Bremsbelagsatz, Scheibenbremse							
1.8 1.9 D	66 55	05/97→10/04 10/96→10/04	➔	→ 04/04		13.0460-2816.2 602816	TRW 21724 19,3 + WK
1.8 16V	81	10/96→10/00	➔			13.0460-2816.2 602816	TRW 21724 19,3 + WK
1.8 16V	85	10/00→10/04	➔	→ 04/04		13.0460-2816.2 602816	TRW 21724 19,3 + WK
			➔	→ S 80012040		13.0460-4059.2 604059	ATE 21278 16,4 + WK
			➔	S 80012041→; → 04/04		13.0460-7134.2 607134	ATE 21278 16,4 - WE / - WK
1.9 TD	66	10/96→10/04	➔	→ 04/04		13.0460-2817.2 602817	TRW 21674 19,0 + WK
2.0	104	11/96→03/99	➔			13.0460-2817.2 602817	TRW 21674 19,0 + WK
			➔	→ S 80012040		13.0460-4059.2 604059	ATE 21278 16,4 + WK
			➔	S 80012041→		13.0460-7134.2 607134	ATE 21278 16,4 - WE / - WK
2.0 16V 2.0 16V 2.0 16V HPi 2.0 HDi 110 2.0 HDi 90 2.0 Turbo 2.1 TD 12V 2.2 2.2 HDi 3.0 24V 3.0 V6	97	10/96→10/04	➔	→ 04/04		13.0460-2817.2 602817	TRW 21674 19,0 + WK
	100	10/00→10/04	➔			13.0460-4059.2 604059	ATE 21278 16,4 + WK
	103	05/01→10/04	➔	→ S 80012040		13.0460-4059.2 604059	ATE 21278 16,4 + WK
	79	08/01→10/04	➔	S 80012041→; → 04/04		13.0460-7134.2 607134	ATE 21278 16,4 - WE / - WK
	66	02/99→10/04	➔				
	108	10/96→10/04	➔				
	80	10/96→10/04	➔				
	116	07/00→10/04	➔				
	98	03/00→10/04	➔				
	140	10/96→10/04	➔				
	152	03/00→10/04	➔				
2.0 16V	99	01/99→10/00	➔			13.0460-2817.2 602817	TRW 21674 19,0 + WK
			➔			13.0460-4059.2 604059	ATE 21278 16,4 + WK
2.0 HDi 110	80	02/99→04/04	➔	→ 08/01		13.0460-2817.2 602817	TRW 21674 19,0 + WK
			➔	→ 08/01		13.0460-4059.2 604059	ATE 21278 16,4 + WK
Zubehörsatz, Scheibenbremsbelag							
1.8 16V 2.0 2.0 16V 2.0 16V 2.0 16V HPi 2.0 HDi 110 2.0 HDi 90 2.0 Turbo 2.1 TD 12V 2.2 2.2 HDi 3.0 24V 3.0 V6	85 104 97 100 103 79 66 108 80 116 98 140 152	10/00→10/04 11/96→03/99 10/96→10/04 10/00→10/04 05/01→10/04 08/01→10/04 02/99→10/04 10/96→10/04 10/96→10/04 07/00→10/04 03/00→10/04 10/96→10/04 03/00→10/04	➔	→ S 80012040		13.0460-0409.2 610409	ATE
2.0 16V	99	01/99→10/00	➔			13.0460-0409.2 610409	ATE
2.0 HDi 110	80	02/99→04/04	➔	→ 08/01		13.0460-0409.2 610409	ATE
 Bremsscheibe							
1.8 1.9 D	66 55	05/97→10/04 10/96→10/04	➔	→ 04/04		24.0124-0139.1 424139	Ø 260 24 22 V + S
1.8 16V	81	10/96→10/00	➔			24.0124-0139.1 424139	Ø 260 24 22 V + S
1.8 16V	85	10/00→10/04	➔	→ 04/04		24.0124-0139.1 424139	Ø 260 24 22 V + S
			➔	→ 04/04		24.0110-0230.1 410230	Ø 290,5 10 8
1.9 TD	66	10/96→10/04	➔	→ 04/04		24.0126-0106.1 426106	Ø 283 26 24,2 V + S
			➔			24.0326-0106.1 526106	Ø 283 26 24,2 V + S PD
↓							











	kW					! #		
PEUGEOT - 406 Break (8E/F) 10/96→10/04								
Bremsscheibe								
2.0 2.0 16V	104 99	11/96→03/99 01/99→10/00	←				24.0126-0106.1 426106 24.0326-0106.1 526106	Ø 283 26 24,2 V + S Ø 283 26 24,2 V + S PD
			→				24.0110-0230.1 410230	Ø 290,5 10 8
2.0 16V 2.0 16V 2.0 16V HPI 2.0 HDi 110 2.0 HDi 90 2.0 Turbo 2.1 TD 12V 2.2 2.2 HDi 3.0 24V 3.0 V6	97 100 103 79 66 108 80 116 98 140 152	10/96→10/04 10/00→10/04 05/01→10/04 08/01→10/04 02/99→10/04 10/96→10/04 10/96→10/04 07/00→10/04 03/00→10/04 10/96→10/04 03/00→10/04	←	→ 04/04			24.0126-0106.1 426106 24.0326-0106.1 526106	Ø 283 26 24,2 V + S Ø 283 26 24,2 V + S PD
			→	→ 04/04			24.0110-0230.1 410230	Ø 290,5 10 8
2.0 HDi 110	80	02/99→04/04	←	→ 08/01			24.0126-0106.1 426106 24.0326-0106.1 526106	Ø 283 26 24,2 V + S Ø 283 26 24,2 V + S PD
			→	→ 08/01			24.0110-0230.1 410230	Ø 290,5 10 8
PEUGEOT - 406 Coupe (8C) 03/97→12/04								
Bremsbelagsatz, Scheibenbremse								
2.0 16V 2.0 16V 2.2	97 100 116	03/97→12/04 10/00→12/04 03/02→12/04	←				13.0460-2817.2 602817	TRW 21674 19,0 + WK
			→	→ S 80012040			13.0460-4059.2 604059	ATE 21278 16,4 + WK
			→	S 80012041→			13.0460-7134.2 607134	ATE 21278 16,4 - WE / - WK
2.0 16V	99	01/99→10/00	←				13.0460-2817.2 602817	TRW 21674 19,0 + WK
			→				13.0460-4059.2 604059	ATE 21278 16,4 + WK
2.0 16V	99	04/99→09/04	←	→ 10/00			13.0460-2817.2 602817	TRW 21674 19,0 + WK
			→	→ 10/00			13.0460-4059.2 604059	ATE 21278 16,4 + WK
2.2 HDi	98	03/00→12/04	←	06/02→			13.0460-2817.2 602817	TRW 21674 19,0 + WK
			←	→ 06/02			13.0460-4969.2 604969	BRE 23753 18,0 + WK
			→	→ S 80012040			13.0460-4059.2 604059	ATE 21278 16,4 + WK
			→	S 80012041→			13.0460-7134.2 607134	ATE 21278 16,4 - WE / - WK
3.0 24V 3.0 V6 3.0 V6 24V	143 152 140	05/97→06/99 03/00→12/04 03/97→12/04	←				13.0460-4969.2 604969	BRE 23753 18,0 + WK
			→	→ S 80012040			13.0460-4059.2 604059	ATE 21278 16,4 + WK
			→	S 80012041→			13.0460-7134.2 607134	ATE 21278 16,4 - WE / - WK
3.0 V6	154	03/99→06/01	←	03/00→			13.0460-4969.2 604969	BRE 23753 18,0 + WK
			→	03/00→; → S 80012040			13.0460-4059.2 604059	ATE 21278 16,4 + WK
			→	S 80012041→			13.0460-7134.2 607134	ATE 21278 16,4 - WE / - WK
Zubehörsatz, Scheibenbremsbelag								
2.0 16V 2.0 16V 2.2 2.2 HDi 3.0 24V 3.0 V6 3.0 V6 24V	97 100 116 98 143 152 140	03/97→12/04 10/00→12/04 03/02→12/04 03/00→12/04 05/97→06/99 03/00→12/04 03/97→12/04	→	→ S 80012040			13.0460-0409.2 610409	ATE
2.0 16V	99	01/99→10/00	→				13.0460-0409.2 610409	ATE
2.0 16V	99	04/99→09/04	→	→ 10/00			13.0460-0409.2 610409	ATE
3.0 V6	154	03/99→06/01	→	03/00→; → S 80012040			13.0460-0409.2 610409	ATE
Bremsscheibe								
2.0 16V 2.0 16V 2.0 16V 2.2	97 99 100 116	03/97→12/04 01/99→10/00 10/00→12/04 03/02→12/04	←				24.0126-0106.1 426106 24.0326-0106.1 526106	Ø 283 26 24,2 V + S Ø 283 26 24,2 V + S PD
			→				24.0110-0230.1 410230	Ø 290,5 10 8
2.0 16V	99	04/99→09/04	←	→ 10/00			24.0126-0106.1 426106 24.0326-0106.1 526106	Ø 283 26 24,2 V + S Ø 283 26 24,2 V + S PD
			→	→ 10/00			24.0110-0230.1 410230	Ø 290,5 10 8
2.2 HDi	98	03/00→12/04	←	06/02→			24.0126-0106.1 426106 24.0326-0106.1 526106	Ø 283 26 24,2 V + S Ø 283 26 24,2 V + S PD
			←	→ 06/02			24.0128-0143.1 428143	Ø 305 28 26 V
			→				24.0110-0230.1 410230	Ø 290,5 10 8
3.0 24V ↓	143	05/97→06/99	←				24.0128-0143.1 428143	Ø 305 28 26 V





















	kw			 	! #		
PEUGEOT - 406 Coupe (8C) 03/97→12/04							
Bremsscheibe							
3.0 V6	152	03/00→12/04	→			24.0110-0230.1 410230	Ø 290,5 10 8
3.0 V6 24V	140	03/97→12/04					
3.0 V6	154	03/99→06/01	←	03/00→		24.0128-0143.1 428143	Ø 305 28 26 V
			→	03/00→		24.0110-0230.1 410230	Ø 290,5 10 8
PEUGEOT - 407 (6D_) 05/04→							
Bremsbelagsatz, Scheibenbremse							
1.6 HDi 110	80	05/04→	←	→ 02/11		13.0460-2891.2 602891	TRW 24134 19,6 + WK
1.8	85	05/04→				13.0470-2891.2 LD2891	TRW 24134 19,6 + WK Ceramic
1.8 16V	92	09/05→					
2.0	100	05/04→	→	→ 02/11		13.0460-2893.2 602893	TRW 24135 17,7 - WK
2.0 16V	103	09/05→				13.0470-2893.2 LD2893	TRW 24135 17,7 - WK Ceramic
2.0 Bioflex	103	09/07→					
2.0 16V	105	08/08→12/09	←			13.0460-2891.2 602891	TRW 24134 19,6 + WK
			→			13.0470-2891.2 LD2891	TRW 24134 19,6 + WK Ceramic
						13.0460-2893.2 602893	TRW 24135 17,7 - WK
						13.0470-2893.2 LD2893	TRW 24135 17,7 - WK Ceramic
2.0 HDi	103	08/08→	←	→ 02/11		13.0460-7252.2 607252	ATE 24084 19,3 + WK
2.0 HDi	120	07/09→				13.0470-7252.2 LD7252	ATE 24084 19,3 + WK Ceramic
			→	→ 02/11		13.0460-2893.2 602893	TRW 24135 17,7 - WK
						13.0470-2893.2 LD2893	TRW 24135 17,7 - WK Ceramic
2.0 HDi	110	02/10→	←	10/10→ 02/11		13.0460-7252.2 607252	ATE 24084 19,3 + WK
			→	→ 02/11		13.0470-7252.2 LD7252	ATE 24084 19,3 + WK Ceramic
						13.0460-2893.2 602893	TRW 24135 17,7 - WK
						13.0470-2893.2 LD2893	TRW 24135 17,7 - WK Ceramic
2.0 HDi 135	100	05/04→	←	→Orga 11682		13.0460-2891.2 602891	TRW 24134 19,6 + WK
			←	Orga 11683→; → 02/11		13.0460-7252.2 607252	ATE 24084 19,3 + WK
						13.0470-7252.2 LD7252	ATE 24084 19,3 + WK Ceramic
			→	→ 02/11		13.0460-2893.2 602893	TRW 24135 17,7 - WK
						13.0470-2893.2 LD2893	TRW 24135 17,7 - WK Ceramic
2.2	116	05/04→	←	→ 02/11		13.0460-2892.2 602892	TRW 24133 18,6 + WK + Zub
2.2 16V	120	09/05→				13.0470-2892.2 LD2892	TRW 24133 18,6 + WK + Zub
2.2 HDi	120	06/08→					Ceramic
2.2 HDi 170	125	05/06→					
2.7 HDi	150	10/05→	→	→ 02/11		13.0460-2893.2 602893	TRW 24135 17,7 - WK
						13.0470-2893.2 LD2893	TRW 24135 17,7 - WK Ceramic
3.0	155	05/04→	←	→Orga 12410		13.0460-2892.2 602892	TRW 24133 18,6 + WK + Zub
			←	Orga 12411→; → 02/11		13.0470-2892.2 LD2892	TRW 24133 18,6 + WK + Zub
						13.0460-7279.2 607279	ATE 25069 17,3 + WK
			→	→ 02/11		13.0460-2893.2 602893	TRW 24135 17,7 - WK
						13.0470-2893.2 LD2893	TRW 24135 17,7 - WK Ceramic
Bremsscheibe							
1.6 HDi 110	80	05/04→	←	→ 02/11		24.0126-0121.1 426121	Ø 283 26 24 V + S
1.8	85	05/04→					
1.8 16V	92	09/05→	→	→ 02/11		24.0112-0162.1 412162	Ø 290 12 10 + S
2.0	100	05/04→					
2.0 16V	103	09/05→					
2.0 Bioflex	103	09/07→					
2.0 16V	105	08/08→12/09	←			24.0126-0121.1 426121	Ø 283 26 24 V + S
			→			24.0112-0162.1 412162	Ø 290 12 10 + S
2.0 HDi	103	08/08→	←	→ 02/11		24.0128-0216.1 428216	Ø 304 28 26 V + S
			→	→ 02/11		24.0112-0162.1 412162	Ø 290 12 10 + S
2.0 HDi	110	02/10→	←	10/10→ 02/11		24.0128-0216.1 428216	Ø 304 28 26 V + S
			→	→ 02/11		24.0112-0162.1 412162	Ø 290 12 10 + S
2.0 HDi	120	07/09→	←	→ 02/11		24.0128-0269.1 428269	Ø 304 28 26 V + S
			→	→ 02/11		24.0112-0162.1 412162	Ø 290 12 10 + S
2.0 HDi 135	100	05/04→	←	→Orga 11682		24.0126-0121.1 426121	Ø 283 26 24 V + S
			←	Orga 11683→; → 02/11		24.0128-0216.1 428216	Ø 304 28 26 V + S
			→	→ 02/11		24.0112-0162.1 412162	Ø 290 12 10 + S
2.2	116	05/04→	←	→Orga 11193		24.0130-0181.1 430181	Ø 330 30 28 V + S
2.2 16V	120	09/05→					
2.2 HDi	120	06/08→	←	Orga 11194→; → 02/11		24.0130-0206.1 430206	Ø 330 30 28 V + S
↓							











	kW			 	! #		
PEUGEOT - 407 (6D_) 05/04→							
 Bremsscheibe							
2.2 HDi 170	125	05/06→	→	→ 02/11		24.0112-0162.1 412162	Ø 290 12 10 + S
2.7 HDi	150	10/05→					
3.0	155	05/04→	←	→Orga 11193		24.0130-0181.1 430181	Ø 330 30 28 V + S
			←	Orga 11194→ Orga 12410		24.0130-0206.1 430206	Ø 330 30 28 V + S
			←	Orga 12411→; → 02/11		24.0130-0227.1 430227	Ø 340 30 28 V + S
			→	→ 02/11		24.0112-0162.1 412162	Ø 290 12 10 + S
PEUGEOT - 407 Coupe (6C_) 10/05→							
 Bremsbelagsatz, Scheibenbremse							
2.0 HDi	100	10/05→	←	07/07→ 12/11		13.0460-2892.2 602892	TRW 24133 18,6 + WK + Zub
			→	07/07→ 12/11		13.0470-2892.2 LD2892	TRW 24133 18,6 + WK + Zub Ceramic
2.0 HDi	103	09/08→12/09	←			13.0460-2893.2 602893	TRW 24135 17,7 - WK
			→			13.0470-2893.2 LD2893	TRW 24135 17,7 - WK Ceramic
2.0 HDi	110	02/10→	←	→ 12/11		13.0460-2892.2 602892	TRW 24133 18,6 + WK + Zub
			→	→ 12/11		13.0470-2892.2 LD2892	TRW 24133 18,6 + WK + Zub Ceramic
2.0 HDi	120	06/09→	←	→ 12/11		13.0460-7252.2 607252	ATE 24084 19,3 + WK
			→	→ 12/11		13.0470-7252.2 LD7252	ATE 24084 19,3 + WK Ceramic
2.0 HDi	120	10/05→	←	→ 12/11		13.0460-2893.2 602893	TRW 24135 17,7 - WK
			→	→ 12/11		13.0470-2893.2 LD2893	TRW 24135 17,7 - WK Ceramic
2.2 16V	120	10/05→	←	→ 12/11		13.0460-2892.2 602892	TRW 24133 18,6 + WK + Zub
			→	→ 12/11		13.0470-2892.2 LD2892	TRW 24133 18,6 + WK + Zub Ceramic
2.7 HDi	150	10/05→	←	→ 12/11		13.0460-2893.2 602893	TRW 24135 17,7 - WK
			→	→ 12/11		13.0470-2893.2 LD2893	TRW 24135 17,7 - WK Ceramic
3.0 HDi	177	06/09→	←	→ 12/11		13.0460-7279.2 607279	ATE 25069 17,3 + WK
			→	→ 12/11		13.0460-2893.2 602893	TRW 24135 17,7 - WK
3.0 HDi	177	06/09→	←	→ 12/11		13.0470-2893.2 LD2893	TRW 24135 17,7 - WK Ceramic
			→	→ 12/11			
3.0 V6	155	10/05→	←	→Orga 12410		13.0460-2892.2 602892	TRW 24133 18,6 + WK + Zub
			←	Orga 12411→; → 12/11		13.0470-2892.2 LD2892	TRW 24133 18,6 + WK + Zub Ceramic
			→	→ 12/11		13.0460-7279.2 607279	ATE 25069 17,3 + WK
3.0 V6	155	10/05→	←	→ 12/11		13.0460-2893.2 602893	TRW 24135 17,7 - WK
			→	→ 12/11		13.0470-2893.2 LD2893	TRW 24135 17,7 - WK Ceramic
 Bremsscheibe							
2.0 HDi	100	10/05→	←	07/07→ 12/11		24.0130-0206.1 430206	Ø 330 30 28 V + S
			→	07/07→ 12/11		24.0112-0162.1 412162	Ø 290 12 10 + S
2.0 HDi	103	09/08→12/09	←			24.0112-0174.1 412174	Ø 290 12 10
			→			24.0130-0206.1 430206	Ø 330 30 28 V + S
2.0 HDi	110	02/10→	←	→ 12/11		24.0112-0162.1 412162	Ø 290 12 10 + S
			→	→ 12/11		24.0112-0174.1 412174	Ø 290 12 10
2.0 HDi	120	06/09→	←	→ 12/11		24.0128-0216.1 428216	Ø 304 28 26 V + S
			→	→ 12/11		24.0112-0162.1 412162	Ø 290 12 10 + S
2.0 HDi	120	06/09→	←	→ 12/11		24.0112-0174.1 412174	Ø 290 12 10
			→	→ 12/11		24.0112-0174.1 412174	Ø 290 12 10
2.2 16V	120	10/05→	←	→Orga 11193		24.0128-0216.1 428216	Ø 304 28 26 V + S
			→	→ 12/11		24.0112-0162.1 412162	Ø 290 12 10 + S
2.7 HDi	150	10/05→	←	→Orga 11194→; → 12/11		24.0112-0174.1 412174	Ø 290 12 10
			→	→ 12/11		24.0130-0181.1 430181	Ø 330 30 28 V + S
3.0 HDi	177	06/09→	←	→ 12/11		24.0130-0206.1 430206	Ø 330 30 28 V + S
			→	→ 12/11		24.0112-0174.1 412174	Ø 290 12 10
3.0 HDi	177	06/09→	←	→ 12/11		24.0112-0162.1 412162	Ø 290 12 10 + S
			→	→ 12/11		24.0112-0174.1 412174	Ø 290 12 10
3.0 V6	155	10/05→	←	→Orga 11193		24.0130-0227.1 430227	Ø 340 30 28 V + S
			←	Orga 11194→ Orga 12410		24.0112-0162.1 412162	Ø 290 12 10 + S
			←	Orga 12411→; → 12/11		24.0112-0174.1 412174	Ø 290 12 10
			→	→ 12/11		24.0130-0181.1 430181	Ø 330 30 28 V + S
3.0 V6	155	10/05→	←	→Orga 11194→ Orga 12410		24.0130-0206.1 430206	Ø 330 30 28 V + S
			←	Orga 12411→; → 12/11		24.0130-0227.1 430227	Ø 340 30 28 V + S
3.0 V6	155	10/05→	←	→ 12/11		24.0112-0174.1 412174	Ø 290 12 10
			→	→ 12/11			







	kw			 	! #		
PEUGEOT - 407 SW (6E_) 05/04 →							
 Bremsbelagsatz, Scheibenbremse							
1.6 HDi 110	80	05/04 →	←	→ 02/11		13.0460-2891.2 602891	TRW 24134 19,6 + WK
1.8	85	05/04 →				13.0470-2891.2 LD2891	TRW 24134 19,6 + WK Ceramic
1.8 16V	92	09/05 →	→	→ 02/11		13.0460-2893.2 602893	TRW 24135 17,7 - WK
2.0	100	05/04 →				13.0470-2893.2 LD2893	TRW 24135 17,7 - WK Ceramic
2.0 16V	103	09/05 →					
2.0 Bioflex	103	01/08 →					
2.0 HDi	93	11/04 →	←	→ Orga 11682		13.0460-2891.2 602891	TRW 24134 19,6 + WK
2.0 HDi 135	100	05/04 →	←	Orga 11683 →; → 02/11		13.0470-2891.2 LD2891	TRW 24134 19,6 + WK Ceramic
			→	→ 02/11		13.0460-7252.2 607252	ATE 24084 19,3 + WK
						13.0470-7252.2 LD7252	ATE 24084 19,3 + WK Ceramic
			→	→ 02/11		13.0460-2893.2 602893	TRW 24135 17,7 - WK
						13.0470-2893.2 LD2893	TRW 24135 17,7 - WK Ceramic
2.0 HDi	103	08/08 →	←	→ 02/11		13.0460-7252.2 607252	ATE 24084 19,3 + WK
2.0 HDi	120	07/09 →				13.0470-7252.2 LD7252	ATE 24084 19,3 + WK Ceramic
			→	→ 02/11		13.0460-2893.2 602893	TRW 24135 17,7 - WK
						13.0470-2893.2 LD2893	TRW 24135 17,7 - WK Ceramic
2.0 HDi	110	02/10 →	←	10/10 → 02/11		13.0460-7252.2 607252	ATE 24084 19,3 + WK
						13.0470-7252.2 LD7252	ATE 24084 19,3 + WK Ceramic
			→	→ 02/11		13.0460-2893.2 602893	TRW 24135 17,7 - WK
						13.0470-2893.2 LD2893	TRW 24135 17,7 - WK Ceramic
2.2	116	05/04 →	←	→ 02/11		13.0460-2892.2 602892	TRW 24133 18,6 + WK + Zub
2.2 16V	120	09/05 →				13.0470-2892.2 LD2892	TRW 24133 18,6 + WK + Zub Ceramic
2.2 HDi	120	06/08 →					
2.2 HDi 170	125	05/06 →	→	→ 02/11		13.0460-2893.2 602893	TRW 24135 17,7 - WK
2.7 HDi	150	10/05 →				13.0470-2893.2 LD2893	TRW 24135 17,7 - WK Ceramic
3.0	155	05/04 →	←	→ Orga 12410		13.0460-2892.2 602892	TRW 24133 18,6 + WK + Zub
						13.0470-2892.2 LD2892	TRW 24133 18,6 + WK + Zub Ceramic
			←	Orga 12411 →; → 02/11		13.0460-7279.2 607279	ATE 25069 17,3 + WK
			→	→ 02/11		13.0460-2893.2 602893	TRW 24135 17,7 - WK
						13.0470-2893.2 LD2893	TRW 24135 17,7 - WK Ceramic
 Bremsscheibe							
1.6 HDi 110	80	05/04 →	←	→ 02/11		24.0126-0121.1 426121	Ø 283 26 24 V + S
1.8	85	05/04 →					
1.8 16V	92	09/05 →	→	→ 02/11		24.0112-0162.1 412162	Ø 290 12 10 + S
2.0	100	05/04 →					
2.0 16V	103	09/05 →					
2.0 Bioflex	103	01/08 →					
2.0 HDi	93	11/04 →	←	→ Orga 11682		24.0126-0121.1 426121	Ø 283 26 24 V + S
2.0 HDi 135	100	05/04 →	←	Orga 11683 →; → 02/11		24.0128-0216.1 428216	Ø 304 28 26 V + S
			→	→ 02/11		24.0112-0162.1 412162	Ø 290 12 10 + S
2.0 HDi	103	08/08 →	←	→ 02/11		24.0128-0216.1 428216	Ø 304 28 26 V + S
			→	→ 02/11		24.0112-0162.1 412162	Ø 290 12 10 + S
2.0 HDi	110	02/10 →	←	10/10 → 02/11		24.0128-0216.1 428216	Ø 304 28 26 V + S
			→	→ 02/11		24.0112-0162.1 412162	Ø 290 12 10 + S
2.0 HDi	120	07/09 →	←	→ 02/11		24.0128-0269.1 428269	Ø 304 28 26 V + S
			→	→ 02/11		24.0112-0162.1 412162	Ø 290 12 10 + S
2.2	116	05/04 →	←	→ Orga 11193		24.0130-0181.1 430181	Ø 330 30 28 V + S
2.2 16V	120	09/05 →					
2.2 HDi	120	06/08 →	←	Orga 11194 →; → 02/11		24.0130-0206.1 430206	Ø 330 30 28 V + S
2.2 HDi 170	125	05/06 →	→	→ 02/11		24.0112-0162.1 412162	Ø 290 12 10 + S
2.7 HDi	150	10/05 →					
3.0	155	05/04 →	←	→ Orga 11193		24.0130-0181.1 430181	Ø 330 30 28 V + S
			←	Orga 11194 → Orga 12410		24.0130-0206.1 430206	Ø 330 30 28 V + S
			←	Orga 12411 →; → 02/11		24.0130-0227.1 430227	Ø 340 30 28 V + S
			→	→ 02/11		24.0112-0162.1 412162	Ø 290 12 10 + S
PEUGEOT - 505 (551A) 05/79 → 10/96							
 Bremsscheibe							
2.0	72	09/85 → 09/95	←	→ 11/87		24.0113-0128.1 413128	Ø 273 13 10,7











	kW					! #		
PEUGEOT - 508 11/10→								
 Bremsbelagsatz, Scheibenbremse								
1.6	120	01/12→	←	für Bremsscheidendurchmesser [mm]: 283; für Bremsscheibendicke [mm]: 26	13.0460-7276.2	607276	ATE 25222 17,3 + WK	
1.6	121	09/11→						
1.6 BlueHDi 120	88	03/14→	←	für Bremsscheidendurchmesser [mm]: 304; für Bremsscheibendicke [mm]: 28	13.0460-7277.2	607277	ATE 24084 19,3 + WK	
1.6 HDi	82	11/10→						
1.6 HDi	84	02/12→	←	für Bremsscheidendurchmesser [mm]: 340; für Bremsscheibendicke [mm]: 30	13.0460-7279.2	607279	ATE 25069 17,3 + WK	
1.6 HDi	85	09/14→						
1.6 THP	110	11/10→	→		13.0460-7278.2	607278	ATE 23482 16,6 - WE / - WK	
1.6 THP	115	11/10→						
1.6 VTi	85	11/10→						
1.6 VTi	88	11/10→						
2.0 BlueHDi 150	110	04/14→						
2.0 BlueHDi 180	133	04/14→						
2.0 HDi	100	11/10→						
2.0 HDi	103	11/10→						
2.0 HDi	120	11/10→						
2.2 HDi	150	11/10→						
2.0 HDi Hybrid4 AWC	120	11/10→	←	für Bremsscheidendurchmesser [mm]: 283; für Bremsscheibendicke [mm]: 26	13.0460-7276.2	607276	ATE 25222 17,3 + WK	
			←	für Bremsscheidendurchmesser [mm]: 304; für Bremsscheibendicke [mm]: 28	13.0460-7277.2	607277	ATE 24084 19,3 + WK	
			←	für Bremsscheidendurchmesser [mm]: 340; für Bremsscheibendicke [mm]: 30	13.0460-7279.2	607279	ATE 25069 17,3 + WK	
			→		13.0460-2761.2	602761	TRW 24922 17,5 - WK + Zub	
2.0 HDi Hybrid4 AWC	147	11/10→	←	06/12→; für Bremsscheidendurchmesser [mm]: 283; für Bremsscheibendicke [mm]: 26	13.0460-7276.2	607276	ATE 25222 17,3 + WK	
			←	06/12→; für Bremsscheidendurchmesser [mm]: 304; für Bremsscheibendicke [mm]: 28	13.0460-7277.2	607277	ATE 24084 19,3 + WK	
			←	06/12→; für Bremsscheidendurchmesser [mm]: 340; für Bremsscheibendicke [mm]: 30	13.0460-7279.2	607279	ATE 25069 17,3 + WK	
			→	06/12→	13.0460-2761.2	602761	TRW 24922 17,5 - WK + Zub	
 Bremsscheibe								
1.6	120	01/12→	←		24.0126-0121.1	426121	Ø 283 26 24 V + S	
1.6	121	09/11→			24.0128-0269.1	428269	Ø 304 28 26 V + S	
1.6 BlueHDi 120	88	03/14→			24.0130-0227.1	430227	Ø 340 30 28 V + S	
1.6 HDi	82	11/10→						
1.6 HDi	84	02/12→	→		24.0112-0197.1	412197	Ø 290 12 10 + S	
1.6 HDi	85	09/14→						
1.6 THP	110	11/10→						
1.6 THP	115	11/10→						
1.6 VTi	85	11/10→						
1.6 VTi	88	11/10→						
2.0 BlueHDi 150	110	04/14→						
2.0 BlueHDi 180	133	04/14→						
2.0 HDi	100	11/10→						
2.0 HDi	103	11/10→						
2.0 HDi	120	11/10→						
2.0 HDi Hybrid4 AWC	120	11/10→	←		24.0126-0121.1	426121	Ø 283 26 24 V + S	
2.2 HDi	150	11/10→			24.0128-0269.1	428269	Ø 304 28 26 V + S	
					24.0130-0227.1	430227	Ø 340 30 28 V + S	
			→	+ eFSB	24.0112-0162.1	412162	Ø 290 12 10 + S	
			→	- eFSB	24.0112-0197.1	412197	Ø 290 12 10 + S	
2.0 HDi Hybrid4 AWC	147	11/10→	←	06/12→	24.0126-0121.1	426121	Ø 283 26 24 V + S	
					24.0128-0269.1	428269	Ø 304 28 26 V + S	
					24.0130-0227.1	430227	Ø 340 30 28 V + S	
			→	06/12→; + eFSB	24.0112-0162.1	412162	Ø 290 12 10 + S	
			→	06/12→; - eFSB	24.0112-0197.1	412197	Ø 290 12 10 + S	
PEUGEOT - 508 SW 11/10→								
 Bremsbelagsatz, Scheibenbremse								
1.6	121	02/12→	←	Orga 12775→; für Bremsscheidendurchmesser [mm]: 283; für Bremsscheibendicke [mm]: 26	13.0460-7276.2	607276	ATE 25222 17,3 + WK	
1.6 HDi	82	11/10→						
1.6 HDi	84	02/12→						
1.6 HDi	85	09/14→	←	→Orga 12774; für Bremsscheidendurchmesser [mm]: 283; für Bremsscheibendicke [mm]: 26	13.0460-7276.2	607276	ATE 25222 17,3 + WK	
1.6 THP	110	11/10→						
1.6 THP	115	11/10→						
1.6 VTi	85	11/10→	←	Orga 12775→; für Bremsscheidendurchmesser [mm]: 304; für Bremsscheibendicke [mm]: 28	13.0460-7277.2	607277	ATE 24084 19,3 + WK	
1.6 VTi	88	11/10→						
2.0 HDi	100	11/10→						
2.0 HDi	103	11/10→						
2.0 HDi	120	11/10→						
2.2 HDi	150	11/10→						
↓								













	kW			 	! #		
PEUGEOT - 508 SW 11/10→							
 Bremsbelagsatz, Scheibenbremse							
1.6	121	02/12→	←	→Orga 12774; für Bremsscheibendurchmesser [mm]: 304; für Bremsscheibendicke [mm]: 28		13.0460-7277.2 607277	ATE 24084 19,3 + WK
1.6 HDi	82	11/10→					
1.6 HDi	84	02/12→	←	für Bremsscheibendurchmesser [mm]: 340; für Bremsscheibendicke [mm]: 30		13.0460-7279.2 607279	ATE 25069 17,3 + WK
1.6 HDi	85	09/14→					
1.6 THP	110	11/10→	→			13.0460-7278.2 607278	ATE 23482 16,6 - WE / - WK
1.6 THP	115	11/10→					
1.6 VTi	85	11/10→					
1.6 VTi	88	11/10→					
2.0 HDi	100	11/10→					
2.0 HDi	103	11/10→					
2.0 HDi	120	11/10→					
2.2 HDi	150	11/10→					
1.6 BlueHDi 120	88	03/14→	←	für Bremsscheibendurchmesser [mm]: 283; für Bremsscheibendicke [mm]: 26		13.0460-7276.2 607276	ATE 25222 17,3 + WK
2.0 BlueHDi 150	110	04/14→	←	für Bremsscheibendurchmesser [mm]: 304; für Bremsscheibendicke [mm]: 28		13.0460-7277.2 607277	ATE 24084 19,3 + WK
2.0 BlueHDi 180	133	04/14→	←	für Bremsscheibendurchmesser [mm]: 340; für Bremsscheibendicke [mm]: 30		13.0460-7279.2 607279	ATE 25069 17,3 + WK
			→			13.0460-7278.2 607278	ATE 23482 16,6 - WE / - WK
2.0 HDi 180 RXH	133	10/14→	←	für Bremsscheibendurchmesser [mm]: 283; für Bremsscheibendicke [mm]: 26		13.0460-7276.2 607276	ATE 25222 17,3 + WK
			←			13.0460-7277.2 607277	ATE 24084 19,3 + WK
			←	für Bremsscheibendurchmesser [mm]: 340; für Bremsscheibendicke [mm]: 30		13.0460-7279.2 607279	ATE 25069 17,3 + WK
			→	+ eFSB		13.0460-2761.2 602761	TRW 24922 17,5 - WK + Zub
2.0 HDi RXH Hybrid4	120	11/10→	←	→Orga 12774; für Bremsscheibendurchmesser [mm]: 283; für Bremsscheibendicke [mm]: 26		13.0460-7276.2 607276	ATE 25222 17,3 + WK
			←	Orga 12775→; für Bremsscheibendurchmesser [mm]: 283; für Bremsscheibendicke [mm]: 26		13.0460-7276.2 607276	ATE 25222 17,3 + WK
			←	→Orga 12774; für Bremsscheibendurchmesser [mm]: 304; für Bremsscheibendicke [mm]: 28		13.0460-7277.2 607277	ATE 24084 19,3 + WK
			←	Orga 12775→; für Bremsscheibendurchmesser [mm]: 304; für Bremsscheibendicke [mm]: 28		13.0460-7277.2 607277	ATE 24084 19,3 + WK
			←	für Bremsscheibendurchmesser [mm]: 340; für Bremsscheibendicke [mm]: 30		13.0460-7279.2 607279	ATE 25069 17,3 + WK
			→	+ eFSB		13.0460-2761.2 602761	TRW 24922 17,5 - WK + Zub
 Bremsscheibe							
1.6	121	02/12→	←			24.0126-0121.1 426121	Ø 283 26 24 V + S
1.6 BlueHDi 120	88	03/14→				24.0128-0269.1 428269	Ø 304 28 26 V + S
1.6 HDi	82	11/10→				24.0130-0227.1 430227	Ø 340 30 28 V + S
1.6 HDi	84	02/12→					
1.6 HDi	85	09/14→	→			24.0112-0197.1 412197	Ø 290 12 10 + S
1.6 THP	110	11/10→					
1.6 THP	115	11/10→					
1.6 VTi	85	11/10→					
1.6 VTi	88	11/10→					
2.0 BlueHDi 150	110	04/14→					
2.0 HDi	100	11/10→					
2.0 HDi	103	11/10→					
2.0 HDi	120	11/10→					
2.0 BlueHDi 180	133	04/14→	←			24.0126-0121.1 426121	Ø 283 26 24 V + S
						24.0128-0269.1 428269	Ø 304 28 26 V + S
						24.0130-0227.1 430227	Ø 340 30 28 V + S
			→			24.0112-0216.1 412216	Ø 290 12 10 + S
2.0 HDi 180 RXH	133	10/14→	←			24.0126-0121.1 426121	Ø 283 26 24 V + S
2.0 HDi RXH Hybrid4	120	11/10→				24.0128-0269.1 428269	Ø 304 28 26 V + S
						24.0130-0227.1 430227	Ø 340 30 28 V + S
			→	+ eFSB		24.0112-0162.1 412162	Ø 290 12 10 + S
2.2 HDi	150	11/10→	←			24.0126-0121.1 426121	Ø 283 26 24 V + S
						24.0128-0269.1 428269	Ø 304 28 26 V + S
						24.0130-0227.1 430227	Ø 340 30 28 V + S
			→	+ eFSB		24.0112-0162.1 412162	Ø 290 12 10 + S
			→	- eFSB		24.0112-0197.1 412197	Ø 290 12 10 + S













	kW			 	! #		
PEUGEOT - 605 (6B) 06/89→09/99							
 Bremsbelagsatz, Scheibenbremse							
2.0	79	02/90→09/99	←	04/90→; → S 90807683		13.0460-3902.2 603902	BDX 20035 17,0 + WK
2.0	84	06/89→09/99	←	S 90807684→		13.0460-3948.2 603948	BDX 21508 17,0 + WK
2.0	89	06/89→09/99	→	04/90→; → S 91036112		13.0460-4014.2 604014	ATE 21278 16,4 + WK
3.0	123	10/89→09/99	→	S 91036113→		13.0460-7107.2 607107	ATE 21278 16,4 - WE / - WK
2.0 16V	97	07/94→09/99	←	09/94→		13.0460-3948.2 603948	BDX 21508 17,0 + WK
2.0 Turbo	108	07/91→09/99	→	09/94→; → S 91036112		13.0460-4014.2 604014	ATE 21278 16,4 + WK
2.5 Turbo Diesel	95	07/94→09/99	→	S 91036113→		13.0460-7107.2 607107	ATE 21278 16,4 - WE / - WK
2.0 Turbo	104	07/92→09/99	←	12/92→; → S 90807683		13.0460-3902.2 603902	BDX 20035 17,0 + WK
			←	→ 08/94; S 90807684→		13.0460-3948.2 603948	BDX 21508 17,0 + WK
			→	12/92→ 08/94		13.0460-4014.2 604014	ATE 21278 16,4 + WK
2.1 D	60	06/89→07/95	←	04/90→; → S 90807683		13.0460-3902.2 603902	BDX 20035 17,0 + WK
			←	→ 08/94; S 90807684→		13.0460-3948.2 603948	BDX 21508 17,0 + WK
			→	04/90→ 08/94		13.0460-4014.2 604014	ATE 21278 16,4 + WK
2.1 TD 12V	80	08/94→09/99	←	→ S 90807863		13.0460-3902.2 603902	BDX 20035 17,0 + WK
			←	S 90807684→		13.0460-3948.2 603948	BDX 21508 17,0 + WK
			→	→ S 91036112		13.0460-4014.2 604014	ATE 21278 16,4 + WK
			→	S 91036113→		13.0460-7107.2 607107	ATE 21278 16,4 - WE / - WK
2.1 Turbo Diesel	80	06/89→09/99	←	10/90→; → S 90807863		13.0460-3902.2 603902	BDX 20035 17,0 + WK
			←	S 90807684→		13.0460-3948.2 603948	BDX 21508 17,0 + WK
			→	10/90→; → S 91036112		13.0460-4014.2 604014	ATE 21278 16,4 + WK
			→	S 91036113→		13.0460-7107.2 607107	ATE 21278 16,4 - WE / - WK
3.0 SV 24	147	08/89→09/99	←	04/90→; → S 90807683		13.0460-3902.2 603902	BDX 20035 17,0 + WK
			→	04/90→; → S 91036112		13.0460-4014.2 604014	ATE 21278 16,4 + WK
			→	S 91036113→		13.0460-7107.2 607107	ATE 21278 16,4 - WE / - WK
3.0 V6	140	04/97→09/99	→			13.0460-7107.2 607107	ATE 21278 16,4 - WE / - WK
Zubehörsatz, Scheibenbremsbelag							
2.0	79	02/90→09/99	←	04/90→; → S 90807683		13.0460-0206.2 610206	BDX
2.0	84	06/89→09/99	→	04/90→; → S 91036112		13.0460-0409.2 610409	ATE
2.0	89	06/89→09/99	→				
3.0	123	10/89→09/99					
3.0 SV 24	147	08/89→09/99					
2.0 16V	97	07/94→09/99	→	09/94→; → S 91036112		13.0460-0409.2 610409	ATE
2.0 Turbo	108	07/91→09/99					
2.5 Turbo Diesel	95	07/94→09/99					
2.0 Turbo	104	07/92→09/99	←	12/92→; → S 90807683		13.0460-0206.2 610206	BDX
			→	12/92→ 08/94		13.0460-0409.2 610409	ATE
2.1 D	60	06/89→07/95	←	04/90→; → S 90807683		13.0460-0206.2 610206	BDX
			→	04/90→ 08/94		13.0460-0409.2 610409	ATE
2.1 TD 12V	80	08/94→09/99	←	→ S 90807863		13.0460-0206.2 610206	BDX
			→	→ S 91036112		13.0460-0409.2 610409	ATE
2.1 Turbo Diesel	80	06/89→09/99	←	10/90→; → S 90807863		13.0460-0206.2 610206	BDX
			→	10/90→; → S 91036112		13.0460-0409.2 610409	ATE
 Bremsscheibe							
2.0	79	02/90→09/99	←	04/90→; → S 90807683		24.0122-0141.1 422141	Ø 276 22 20 V
2.0	84	06/89→09/99	←	S 90807684→		24.0126-0100.1 426100	Ø 283 26 24 V
2.0	89	06/89→09/99	→	04/90→		24.0110-0231.1 410231	Ø 290 10 8
3.0	123	10/89→09/99					
2.0 16V	97	07/94→09/99	←	09/94→		24.0126-0100.1 426100	Ø 283 26 24 V
2.0 Turbo	108	07/91→09/99	→	09/94→		24.0110-0231.1 410231	Ø 290 10 8
2.5 Turbo Diesel	95	07/94→09/99					
2.0 Turbo	104	07/92→09/99	←	12/92→; → S 90807683		24.0122-0141.1 422141	Ø 276 22 20 V
			←	→ 08/94; S 90807684→		24.0126-0100.1 426100	Ø 283 26 24 V
			→	12/92→ 08/94		24.0110-0231.1 410231	Ø 290 10 8
2.1 D	60	06/89→07/95	←	04/90→; → S 90807683		24.0122-0141.1 422141	Ø 276 22 20 V
			←	→ 08/94; S 90807684→		24.0126-0100.1 426100	Ø 283 26 24 V
			→	04/90→ 08/94		24.0110-0231.1 410231	Ø 290 10 8
↓							















	kW			 	! #		
PEUGEOT - 605 (6B) 06/89→09/99							
 Bremsscheibe							
2.1 TD 12V	80	08/94→09/99	←	→ S 90807863		24.0122-0141.1 422141	Ø 276 22 20 V
			←	S 90807684 →		24.0126-0100.1 426100	Ø 283 26 24 V
			→			24.0110-0231.1 410231	Ø 290 10 8
2.1 Turbo Diesel	80	06/89→09/99	←	10/90→; → S 90807863		24.0122-0141.1 422141	Ø 276 22 20 V
			←	S 90807684 →		24.0126-0100.1 426100	Ø 283 26 24 V
			→	10/90→		24.0110-0231.1 410231	Ø 290 10 8
3.0 SV 24	147	08/89→09/99	←	04/90→; → S 90807683		24.0122-0141.1 422141	Ø 276 22 20 V
			←	S 90807684 →		24.0128-0195.1 428195	Ø 295 28 26 V
			→	04/90→		24.0110-0231.1 410231	Ø 290 10 8
3.0 V6	140	04/97→09/99	←			24.0126-0100.1 426100	Ø 283 26 24 V
			→			24.0110-0231.1 410231	Ø 290 10 8
PEUGEOT - 607 (9D, 9U) 01/00→							
 Bremsbelagsatz, Scheibenbremse							
2.0 2.0 HDI 2.2 16V 2.2 HDI	100	02/00→	←	→ 11/04		13.0460-2844.2 602844	TRW 21674 19,4 + WK + Zub
	80	05/00→	←	12/04→ 12/10		13.0460-2892.2 602892	TRW 24133 18,6 + WK + Zub
	116	02/00→				13.0470-2892.2 LD2892	TRW 24133 18,6 + WK + Zub Ceramic
	98	02/00→	→	12/04→ 12/10		13.0460-2893.2 602893	TRW 24135 17,7 - WK
				→	11/04		13.0470-2893.2 LD2893
2.0 HDi	79	03/01→07/04	←			13.0460-2844.2 602844	TRW 21674 19,4 + WK + Zub
			→			13.0460-7134.2 607134	ATE 21278 16,4 - WE / - WK
2.0 HDI 2.2 16V 2.2 HDi 2.7 HDi 24V 3.0 V6 24V	100	09/05→	←	→ 12/10		13.0460-2892.2 602892	TRW 24133 18,6 + WK + Zub
	120	09/05→				13.0470-2892.2 LD2892	TRW 24133 18,6 + WK + Zub Ceramic
	125	05/06→				13.0460-2893.2 602893	TRW 24135 17,7 - WK
	150	12/04→	→	12/10		13.0470-2893.2 LD2893	TRW 24135 17,7 - WK Ceramic
	155	03/04→	→	12/10		13.0460-2893.2 602893	TRW 24135 17,7 - WK
3.0 V6 24V	152	02/00→	←	→ 11/04		13.0460-4972.2 604972	BRE 23575 16,0 + WK + Zub
			→	→ 11/04		13.0460-7134.2 607134	ATE 21278 16,4 - WE / - WK
Zubehörsatz, Scheibenbremsbelag							
2.0 2.0 HDI 2.2 16V 2.2 HDI 3.0 V6 24V	100	02/00→	→	→ 11/04		13.0460-0409.2 610409	ATE
	80	05/00→					
	116	02/00→					
	98	02/00→					
	152	02/00→					
2.0 HDi	79	03/01→07/04	→			13.0460-0409.2 610409	ATE
 Bremsscheibe							
2.0 2.0 HDI 2.2 16V 2.2 HDI	100	02/00→	←	→ 11/04		24.0126-0121.1 426121	Ø 283 26 24 V + S
	80	05/00→	←	12/04→ 12/10		24.0130-0181.1 430181	Ø 330 30 28 V + S
	116	02/00→	→	→ 11/04		24.0110-0272.1 410272	Ø 290 10 8
	98	02/00→	→	12/04→ 12/10		24.0112-0162.1 412162	Ø 290 12 10 + S
2.0 HDi	79	03/01→07/04	←			24.0126-0121.1 426121	Ø 283 26 24 V + S
			→			24.0110-0272.1 410272	Ø 290 10 8
2.0 HDI 2.2 16V 2.2 HDi 2.7 HDi 24V 3.0 V6 24V	100	09/05→	←	→ 12/10		24.0130-0181.1 430181	Ø 330 30 28 V + S
	120	09/05→				24.0112-0162.1 412162	Ø 290 12 10 + S
	125	05/06→	→	→ 12/10			
	150	12/04→					
3.0 V6 24V	155	03/04→	←	→ 11/04		24.0132-0152.1 432152	Ø 309 32 30 V
			→	→ 11/04		24.0110-0272.1 410272	Ø 290 10 8
PEUGEOT - 806 (221) 06/94→08/02							
 Bremsbelagsatz, Scheibenbremse							
1.8	73	07/95→08/02	←	10/96→ 06/02		13.0460-3957.2 603957	BDX 23042 19,0 + WK + Zub
			→	10/96→ 06/02; + ABS		13.0460-7061.2 607061	ATE 21275 17,0 + WK
1.9 TD 1.9 TD	66	07/95→08/02	←	→ 06/02		13.0460-2978.2 602978	TRW 21801 19,0 + WK
	68	05/97→08/02					
2.0 HDI	80	08/99→08/02	→	→ 06/02; + ABS		13.0460-7061.2 607061	ATE 21275 17,0 + WK







	kW			 	! #		
PEUGEOT - 806 (221) 06/94 → 08/02							
 Bremsbelagsatz, Scheibenbremse							
2.0 HDI 16V	80	08/99 → 08/02	←	→ 06/02		13.0460-2978.2 602978	TRW 21801 19,0 + WK
			→	→ 06/02; + ABS		13.0460-7061.2 607061	ATE 21275 17,0 + WK
2.0	89	06/94 → 08/02	←	08/94 → 06/02		13.0460-2978.2 602978	TRW 21801 19,0 + WK
			→	08/94 → 06/02; + ABS		13.0460-7061.2 607061	ATE 21275 17,0 + WK
2.0 16V	97	05/98 → 09/00	←	10/98 →		13.0460-2978.2 602978	TRW 21801 19,0 + WK
			→	10/98 →		13.0460-7061.2 607061	ATE 21275 17,0 + WK
2.0 16V	100	09/00 → 08/02	←	→ 06/02		13.0460-2978.2 602978	TRW 21801 19,0 + WK
			→	→ 06/02		13.0460-7061.2 607061	ATE 21275 17,0 + WK
2.0 Turbo	108	06/94 → 08/02	←	08/94 → 06/02		13.0460-2978.2 602978	TRW 21801 19,0 + WK
			→	08/94 → 06/02		13.0460-7061.2 607061	ATE 21275 17,0 + WK
2.1 td 12V	80	06/96 → 08/99	←			13.0460-2978.2 602978	TRW 21801 19,0 + WK
			→			13.0460-7061.2 607061	ATE 21275 17,0 + WK
 Bremsscheibe							
1.8	73	07/95 → 08/02	←	10/96 → 06/02		24.0120-0155.1 420155	∅ 257,5 20 18,2 V
			→	10/96 → 06/02; + ABS		24.0110-0218.1 410218	∅ 295 10 8
1.9 TD	66	07/95 → 08/02	←	→ 06/02		24.0126-0104.1 426104	∅ 281 26 24,2 V
1.9 TD	68	05/97 → 08/02	→	→ 06/02; + ABS		24.0110-0218.1 410218	∅ 295 10 8
2.0 HDI	80	08/99 → 08/02	←				
2.0 HDI 16V	80	08/99 → 08/02	→				
2.0	89	06/94 → 08/02	←	08/94 → 06/02		24.0126-0104.1 426104	∅ 281 26 24,2 V
			→	08/94 → 06/02; + ABS		24.0110-0218.1 410218	∅ 295 10 8
2.0 16V	97	05/98 → 09/00	←	10/98 →		24.0126-0104.1 426104	∅ 281 26 24,2 V
			→	10/98 →		24.0110-0218.1 410218	∅ 295 10 8
2.0 16V	100	09/00 → 08/02	←	→ 06/02		24.0126-0104.1 426104	∅ 281 26 24,2 V
			→	→ 06/02		24.0110-0218.1 410218	∅ 295 10 8
2.0 Turbo	108	06/94 → 08/02	←	08/94 → 06/02		24.0126-0104.1 426104	∅ 281 26 24,2 V
			→	08/94 → 06/02		24.0110-0218.1 410218	∅ 295 10 8
2.1 td 12V	80	06/96 → 08/99	←			24.0126-0104.1 426104	∅ 281 26 24,2 V
			→			24.0110-0218.1 410218	∅ 295 10 8
PEUGEOT - 807 (E) 06/02 →							
 Bremsbelagsatz, Scheibenbremse							
2.0	100	06/02 →	←	→ 06/14		13.0460-2863.2 602863	TRW 20261 19,0 + WK + Zub
2.0 16V	103	09/05 →	→	→ 06/14		13.0460-2819.2 602819	TRW 20961 17,2 - WK
2.0 HDi	79	06/02 →					
2.0 HDi	100	06/06 →					
2.2	116	06/02 →					
2.2 HDi	94	06/02 →					
2.2 HDi	100	04/04 →					
2.0 HDi	80	04/04 → 05/06	←	→ 05/06		13.0460-2863.2 602863	TRW 20261 19,0 + WK + Zub
			→	→ 05/06		13.0460-2819.2 602819	TRW 20961 17,2 - WK
2.0 HDi	88	02/06 →	←	11/06 → 06/14		13.0460-2863.2 602863	TRW 20261 19,0 + WK + Zub
			→	11/06 → 06/14		13.0460-2819.2 602819	TRW 20961 17,2 - WK
2.0 HDi	120	06/09 →	←	→ 06/14		13.0460-2752.2 602752	TRW 24839 19,4 + WK + Zub
			→	→ 06/14		13.0460-2819.2 602819	TRW 20961 17,2 - WK
2.2 HDi	120	06/06 →	←	01/07 → 06/14		13.0460-2752.2 602752	TRW 24839 19,4 + WK + Zub
2.2 HDi	125	06/06 →	→	10/07 → 06/14		13.0460-2819.2 602819	TRW 20961 17,2 - WK
3.0 V6	150	06/02 →	←	→ 06/14		13.0460-4995.2 604995	BRE 23575 15,6 + WK
			→	→ 06/14		13.0460-2819.2 602819	TRW 20961 17,2 - WK
Zubehörsatz, Scheibenbremsbelag							
2.0	100	06/02 →	→	→ 06/14		13.0460-0072.2 610072	TRW
2.0 16V	103	09/05 →					
2.0 HDi	79	06/02 →					
2.0 HDi	120	06/09 →					
2.0 HDi	100	06/06 →					
2.2	116	06/02 →					
2.2 HDi	94	06/02 →					
2.2 HDi	100	04/04 →					
3.0 V6	150	06/02 →					
↓							

	kW			 	! #		
PEUGEOT - 807 (E) 06/02→							
Zubehörsatz, Scheibenbremsbelag							
2.0 HDi	80	04/04→05/06	➡	→ 05/06		13.0460-0072.2 610072	TRW
2.0 HDi	88	02/06→	➡	11/06→ 06/14		13.0460-0072.2 610072	TRW
2.2 HDi	120	06/06→	➡	10/07→ 06/14		13.0460-0072.2 610072	TRW
2.2 HDi	125	06/06→					
 Bremsscheibe							
2.0	100	06/02→	←	→ 06/14		24.0128-0136.1 428136	Ø 285 28 26 V
2.0 16V	103	09/05→				24.0328-0136.1 528136	Ø 285 28 26 V PD
2.0 HDi	79	06/02→					
2.0 HDi	120	06/09→	➡	→ 06/14		24.0112-0156.1 412156	Ø 272 12 10
2.0 HDi	100	06/06→					
2.2	116	06/02→					
2.2 HDi	94	06/02→					
2.2 HDi	100	04/04→					
2.0 HDi	80	04/04→05/06	←	→ 05/06		24.0128-0136.1 428136	Ø 285 28 26 V
						24.0328-0136.1 528136	Ø 285 28 26 V PD
			➡	→ 05/06		24.0112-0156.1 412156	Ø 272 12 10
2.0 HDi	88	02/06→	←	11/06→ 06/14		24.0128-0136.1 428136	Ø 285 28 26 V
						24.0328-0136.1 528136	Ø 285 28 26 V PD
			➡	11/06→ 06/14		24.0112-0156.1 412156	Ø 272 12 10
2.2 HDi	120	06/06→	←	10/07→ 06/14		24.0132-0126.1 432126	Ø 310 32 30 V
2.2 HDi	125	06/06→	➡	10/07→ 06/14		24.0112-0156.1 412156	Ø 272 12 10
3.0 V6	150	06/02→	←	→ 06/14		24.0132-0126.1 432126	Ø 310 32 30 V
			➡	→ 06/14		24.0112-0156.1 412156	Ø 272 12 10
PEUGEOT - 1007 (KM_) 04/05→							
 Bremsbelagsatz, Scheibenbremse							
1.4	54	04/05→	←	→ 02/11		13.0460-3994.2 603994	BOS 23599 19,0 - WE / - WK + Zub
1.4 16V	65	10/05→					
1.4 HDi	50	04/05→				13.0470-3994.2 LD3994	BOS 23599 19,0 - WE / - WK + Zub Ceramic
1.6 16V	80	04/05→	←	→ 02/11		13.0460-3994.2 603994	BOS 23599 19,0 - WE / - WK + Zub
						13.0470-3994.2 LD3994	BOS 23599 19,0 - WE / - WK + Zub Ceramic
			➡	→ 02/11		13.0460-2820.2 602820	TRW 20961 17,2 - WK
						13.0470-2823.2 LD2823	TRW 23554 17,2 - WK Ceramic
1.6 HDi	80	06/07→	←	→ 02/11		13.0460-3966.2 603966	BOS 23600 19,4 - WE / - WK + Zub
						13.0470-3966.2 LD3966	BOS 23600 19,4 - WE / - WK + Zub Ceramic
			➡	→ 02/11		13.0460-2820.2 602820	TRW 20961 17,2 - WK
						13.0470-2823.2 LD2823	TRW 23554 17,2 - WK Ceramic
 Bremsscheibe							
1.4	54	04/05→	←	→ 02/11		24.0122-0194.1 422194	Ø 266 22 20 V + S
1.4 16V	65	10/05→					
1.4 HDi	50	04/05→					
1.6 16V	80	04/05→	←	→ 02/11		24.0122-0194.1 422194	Ø 266 22 20 V + S
			➡	→ 02/11		24.0109-0137.1 409137	Ø 247 9 8 + S
1.6 HDi	80	06/07→	←	→ 02/11		24.0126-0120.1 426120	Ø 283 26 24 V + S
						24.0326-0120.1 526120	Ø 283 26 24 V + S PD
			➡	→ 02/11		24.0109-0137.1 409137	Ø 247 9 8 + S
PEUGEOT - 2008 03/13→							
 Bremsbelagsatz, Scheibenbremse							
1.2 THP 110	81	01/15→	←	für Bremsscheibendurchmesser [mm]: 283		13.0460-3855.2 603855	BOS 24883 18,0 - WE / - WK + Zub
1.2 THP 130	96	01/15→					
1.2 VTi	60	03/13→	←	für Bremsscheibendurchmesser [mm]: 266		13.0460-3994.2 603994	BOS 23599 19,0 - WE / - WK + Zub
1.4 HDi	50	06/13→					
1.6 BlueHDi 100	73	01/15→				13.0470-3994.2 LD3994	BOS 23599 19,0 - WE / - WK + Zub Ceramic
1.6 BlueHDi 120	88	07/14→					
1.6 BlueHDi 75	55	01/15→					
1.6 HDi	68	03/13→	➡			13.0460-2740.2 602740	TRW 23554 17,0 - WE / - WK + Zub
1.6 HDi	84	03/13→					
1.6 HDi	85	07/14→					
1.6 VTi	88	03/13→				13.0470-2740.2 LD2740	TRW 23554 17,0 - WE / - WK + Zub Ceramic
↓							







	kw					! #		
PEUGEOT - 2008 03/13→								
 Bremsscheibe								
1.2 THP 110	81	01/15→	←			24.0122-0194.1	422194	Ø 266 22 20 V + S
1.2 THP 130	96	01/15→				24.0126-0120.1	426120	Ø 283 26 24 V + S
1.2 VTi	60	03/13→				24.0326-0120.1	526120	Ø 283 26 24 V + S PD
1.4 HDi	50	06/13→						
1.6 BlueHDi 100	73	01/15→	→			24.0109-0100.2	409100	Ø 249 9 7 + LG / + ABS Ring
1.6 BlueHDi 120	88	07/14→						
1.6 BlueHDi 75	55	01/15→						
1.6 HDi	68	03/13→						
1.6 HDi	84	03/13→						
1.6 HDi	85	07/14→						
1.6 VTi	88	03/13→						
PEUGEOT - 3008 06/09→								
 Bremsbelagsatz, Scheibenbremse								
1.2	96	01/15→	←			13.0460-3847.2	603847	BOS 24660 17,8 - WE / - WK + Zub
1.6 BlueHDi 120	88	05/14→						
1.6 HDi	80	06/09→				13.0470-3847.2	LD3847	BOS 24660 17,8 - WE / - WK + Zub Ceramic
1.6 HDi	82	08/10→						
1.6 HDi	84	03/13→						
1.6 HDi 115 / BlueHDi 115	85	02/13→	→			13.0460-2761.2	602761	TRW 24922 17,5 - WK + Zub
1.6 VTi	88	06/09→						
1.6 THP	110	06/09→	←			13.0460-7202.2	607202	ATE 23589 19,1 - WE / - WK
1.6 THP	115	06/09→				13.0470-7202.2	LD7202	ATE 23589 19,1 - WE / - WK Ceramic
1.6 Turbo	121	05/14→						
2.0 HDi	100	09/11→						
2.0 HDi	120	06/09→	→			13.0460-2761.2	602761	TRW 24922 17,5 - WK + Zub
2.0 HDi 150 / BlueHDi 150	110	06/09→						
2.0 HDi Hybrid4	120	02/11→	←			13.0460-7230.2	607230	ATE 24557 19,4 - WE / - WK
2.0 HDi Hybrid4	147	11/11→				13.0470-7230.2	LD7230	ATE 24557 19,4 - WE / - WK Ceramic
			→			13.0460-2761.2	602761	TRW 24922 17,5 - WK + Zub
 Bremsscheibe								
1.2	96	01/15→	←			24.0126-0120.1	426120	Ø 283 26 24 V + S
1.6 BlueHDi 120	88	05/14→				24.0326-0120.1	526120	Ø 283 26 24 V + S PD
1.6 HDi	80	06/09→						
1.6 HDi	82	08/10→	→			24.0112-0194.2	412194	Ø 268 12 10 + LG / + ABS Ring
1.6 HDi	84	03/13→						
1.6 HDi 115 / BlueHDi 115	85	02/13→						
1.6 VTi	88	06/09→						
1.6 THP	110	06/09→	←			24.0126-0159.1	426159	Ø 302 26 24 V + S
1.6 THP	115	06/09→						
2.0 HDi	100	09/11→	→			24.0112-0194.2	412194	Ø 268 12 10 + LG / + ABS Ring
2.0 HDi	120	06/09→						
2.0 HDi 150 / BlueHDi 150	110	06/09→						
1.6 Turbo	121	05/14→	←			24.0126-0140.1	426140	Ø 302 26 24 V + S
			→			24.0112-0194.2	412194	Ø 268 12 10 + LG / + ABS Ring
2.0 HDi Hybrid4	120	02/11→	←			24.0126-0159.1	426159	Ø 302 26 24 V + S
2.0 HDi Hybrid4	147	11/11→	→			24.0112-0198.1	412198	Ø 290 12 10 + S
PEUGEOT - 3008 SUV 05/16→								
 Bremsbelagsatz, Scheibenbremse								
1.2	96	05/16→	→	für Bremsscheibendurchmesser [mm]: 268		13.0460-3871.2	603871	BOS 25839 17,8 - WE / - WK + Zub
1.6 BlueHDi 100	73	11/16→						
1.6 BlueHDi 115	85	11/16→				13.0470-3871.2	LD3871	BOS 25839 17,8 - WE / - WK + Zub Ceramic
1.6 BlueHDi 120	88	05/16→						
1.6 THP 165	121	05/16→						
2.0 BlueHDi 136	100	11/16→	→	für Bremsscheibendurchmesser [mm]: 290		13.0460-3872.2	603872	BOS 25827 17,7 - WE / - WK + Zub
2.0 BlueHDi 150	110	05/16→						
2.0 BlueHDi 180	133	05/16→				13.0470-3872.2	LD3872	BOS 25827 17,7 - WE / - WK + Zub Ceramic
 Bremsscheibe								
1.2	96	05/16→	←			24.0128-0269.1	428269	Ø 304 28 26 V + S
1.6 BlueHDi 100	73	11/16→						
1.6 BlueHDi 115	85	11/16→	→			24.0112-0211.1	412211	Ø 268 12 10 + S
1.6 BlueHDi 120	88	05/16→				24.0112-0212.1	412212	Ø 290 12 10 + S
1.6 THP 165	121	05/16→						
2.0 BlueHDi 136	100	11/16→						
2.0 BlueHDi 150	110	05/16→						
2.0 BlueHDi 180	133	05/16→						

	kw			 	! #		
PEUGEOT - 4007 (GP_) 02/07→							
 Bremsbelagsatz, Scheibenbremse							
2.0	108	11/10→	←	→ 11/12		13.0460-5958.2	605958 AKE 21363 15,8 + WK
2.0 4x4	108	11/10→	→	→ 11/12		13.0460-5855.2	605855 23582 16,0 - WK
2.2 HDi	115	02/07→					
2.4 16V	125	01/08→					
Zubehörsatz, Scheibenbremsbelag							
2.0	108	11/10→	←	→ 11/12		13.0460-0235.2	610235
2.0 4x4	108	11/10→	→	→ 11/12		13.0460-0137.2	610137
2.2 HDi	115	02/07→					
2.4 16V	125	01/08→					
 Bremsscheibe							
2.0	108	11/10→	←	→ 11/12		24.0124-0215.1	424215 Ø 294 24 22,4 V
2.0 4x4	108	11/10→	→	→ 11/12		24.0110-0360.1	410360 Ø 302 10 8,4
2.2 HDi	115	02/07→	←	→ 11/12		24.0124-0215.1	424215 Ø 294 24 22,4 V
2.4 16V	125	01/08→	→	→ 11/12		24.0110-0330.1	410330 Ø 302 10 8
PEUGEOT - 4008 05/12→							
 Bremsbelagsatz, Scheibenbremse							
1.6	86	05/12→	←			13.0460-5760.2	605760 AKE 23584 16,4 + WK
1.6 HDi	84	05/12→	→	Orga 13115→		13.0460-5654.2	605654 MAN 25688 14,4 + WK
1.6 HDi AWC	84	05/12→	→	→ Orga 13114		13.0460-5855.2	605855 23582 16,0 - WK
1.8 HDi	110	05/12→					
1.8 HDi AWC	110	05/12→					
2.0 AWC	110	05/12→					
 Bremsscheibe							
1.6	86	05/12→	←			24.0126-0170.1	426170 Ø 294 26 24,4 V
1.6 HDi	84	05/12→	→	→ Orga 13114		24.0110-0360.1	410360 Ø 302 10 8,4
1.6 HDi AWC	84	05/12→	→	→ Orga 13115→		24.0110-0395.1	410395 Ø 302 10 8,4
1.8 HDi	110	05/12→					
1.8 HDi AWC	110	05/12→					
2.0 AWC	110	05/12→					
PEUGEOT - 5008 06/09→							
 Bremsbelagsatz, Scheibenbremse							
1.2	96	01/15→	←			13.0460-7230.2	607230 ATE 24557 19,4 - WE / - WK
1.6 16V	115	09/09→	→			13.0470-7230.2	LD7230 ATE 24557 19,4 - WE / - WK Ceramic
1.6 BlueHDi 120	88	05/14→					
1.6 THP 150	110	02/12→					
1.6 THP 163	120	02/12→				13.0460-2761.2	602761 TRW 24922 17,5 - WK + Zub
1.6 THP 165	121	02/12→					
2.0 HDi	120	09/09→					
2.0 HDi 136 / BlueHDi 136	100	02/12→					
1.6 16V	88	09/09→	←			13.0460-7229.2	607229 ATE 24538 18,5 - WE / - WK
1.6 HDi	80	09/09→	→			13.0470-7229.2	LD7229 ATE 24538 18,5 - WE / - WK Ceramic
1.6 HDi	82	08/10→					
1.6 HDi	84	03/13→				13.0460-2761.2	602761 TRW 24922 17,5 - WK + Zub
2.0 HDi 150 / BlueHDi 150	110	06/09→	←	09/09→		13.0460-7230.2	607230 ATE 24557 19,4 - WE / - WK
			→	09/09→		13.0470-7230.2	LD7230 ATE 24557 19,4 - WE / - WK Ceramic
			→	09/09→		13.0460-2761.2	602761 TRW 24922 17,5 - WK + Zub
 Bremsscheibe							
1.2	96	01/15→	←			24.0126-0159.1	426159 Ø 302 26 24 V + S
1.6 16V	115	09/09→	→			24.0112-0194.2	412194 Ø 268 12 10 + LG / + ABS Ring
1.6 BlueHDi 120	88	05/14→					
1.6 THP 150	110	02/12→					
1.6 THP 163	120	02/12→					
1.6 THP 165	121	02/12→					
2.0 HDi	120	09/09→					
2.0 HDi 136 / BlueHDi 136	100	02/12→					
1.6 16V	88	09/09→	←			24.0126-0120.1	426120 Ø 283 26 24 V + S
1.6 HDi	80	09/09→	→			24.0326-0120.1	526120 Ø 283 26 24 V + S PD
1.6 HDi	82	08/10→				24.0112-0194.2	412194 Ø 268 12 10 + LG / + ABS Ring
1.6 HDi	84	03/13→					
2.0 HDi 150 / BlueHDi 150	110	06/09→	←	09/09→		24.0126-0159.1	426159 Ø 302 26 24 V + S
			→	09/09→		24.0112-0194.2	412194 Ø 268 12 10 + LG / + ABS Ring

	kw			 	! #		
PEUGEOT - 5008 II 12/16→							
 Bremsbelagsatz, Scheibenbremse							
1.2	96	12/16→	➔	für Bremsscheidendurchmesser [mm]: 290	13.0460-3872.2	603872	BOS 25827 17,7 - WE / - WK + Zub
1.6 BlueHDi 100	73	12/16→					
1.6 BlueHDi 115	85	12/16→			13.0470-3872.2	LD3872	BOS 25827 17,7 - WE / - WK + Zub Ceramic
1.6 BlueHDi 120	88	12/16→					
1.6 THP 165	121	12/16→					
2.0 BlueHDi 136	100	12/16→					
2.0 BlueHDi 150	110	12/16→					
2.0 BlueHDi 180	133	12/16→					
 Bremsscheibe							
1.2	96	12/16→	←		24.0128-0269.1	428269	Ø 304 28 26 V + S
1.6 BlueHDi 100	73	12/16→					
1.6 BlueHDi 115	85	12/16→	➔	für Bremsscheidendurchmesser [mm]: 290	24.0112-0212.1	412212	Ø 290 12 10 + S
1.6 BlueHDi 120	88	12/16→					
1.6 THP 165	121	12/16→					
2.0 BlueHDi 136	100	12/16→					
2.0 BlueHDi 150	110	12/16→					
2.0 BlueHDi 180	133	12/16→					
PEUGEOT - BIPPER (AA_) 02/08→							
 Bremsbelagsatz, Scheibenbremse							
1.3 HDi 75	55	10/10→	←		13.0460-3863.2	603863	BOS 23706 18,0 + WK + Zub
1.4	54	02/08→	←		13.0460-3818.2	603818	BOS 23706 18,1 + WK
1.4 HDi	50	02/08→					
 Bremsscheibe							
1.3 HDi 75	55	10/10→	←		24.0122-0197.1	422197	Ø 257,5 22 20,2 V
1.4	54	02/08→			24.0322-0197.1	522197	Ø 257,5 22 20,2 V PD
1.4 HDi	50	02/08→	←	Schaltgetriebe, automatisch betätigt	24.0122-0147.1	422147	Ø 284 22 20,2 V
			←	Schaltgetriebe	24.0122-0197.1	422197	Ø 257,5 22 20,2 V
					24.0322-0197.1	522197	Ø 257,5 22 20,2 V PD
PEUGEOT - BIPPER Tepee 04/08→							
 Bremsbelagsatz, Scheibenbremse							
1.3 HDi 75	55	10/10→	←		13.0460-3863.2	603863	BOS 23706 18,0 + WK + Zub
1.3 HDi 80	59	12/15→					
1.4	54	04/08→	←		13.0460-3818.2	603818	BOS 23706 18,1 + WK
1.4 HDi	50	04/08→					
 Bremsscheibe							
1.3 HDi 75	55	10/10→	←		24.0122-0197.1	422197	Ø 257,5 22 20,2 V
1.3 HDi 80	59	12/15→			24.0322-0197.1	522197	Ø 257,5 22 20,2 V PD
1.4	54	04/08→					
1.4 HDi	50	04/08→	←	Schaltgetriebe, automatisch betätigt	24.0122-0147.1	422147	Ø 284 22 20,2 V
			←	Schaltgetriebe	24.0122-0197.1	422197	Ø 257,5 22 20,2 V
					24.0322-0197.1	522197	Ø 257,5 22 20,2 V PD
PEUGEOT - BOXER Bus 04/06→							
 Bremsbelagsatz, Scheibenbremse							
2.0 BlueHDi 110	81	07/15→	←	Nutzlast 12Q/14Q; Nutzlast ab [kg] 1.200	13.0460-4807.2	604807	BRE 24468 19,1 + WK + Zub
2.0 BlueHDi 130	96	07/15→		Nutzlast bis [kg] 1.400			
2.0 BlueHDi 160	120	07/15→	←	Nutzlast leicht 16Q; Nutzlast [kg]: 1.600; nicht für erhöhte Nutzlast	13.0460-4809.2	604809	BRE 24468 19,1 + WK + Zub
			←	Nutzlast 20Q; Nutzlast [kg]: 2.000	13.0460-4811.2	604811	BRE 24466 19,1 + WK + Zub
			←	Nutzlast schwer 16Q; Nutzlast [kg]: 1.600; für erhöhte Nutzlast	13.0460-4811.2	604811	BRE 24466 19,1 + WK + Zub
2.2 HDi 100	74	04/06→	←	Nutzlast 12Q/14Q; Nutzlast ab [kg] 1.200	13.0460-4807.2	604807	BRE 24468 19,1 + WK + Zub
2.2 HDi 110	81	03/11→		Nutzlast bis [kg] 1.400			
2.2 HDi 120	88	04/06→	←	Nutzlast leicht 16Q; Nutzlast [kg]: 1.600; nicht für erhöhte Nutzlast	13.0460-4809.2	604809	BRE 24468 19,1 + WK + Zub
2.2 HDi 130	96	03/11→					
2.2 HDi 150	110	03/11→	←	Nutzlast schwer 16Q; Nutzlast [kg]: 1.600; für erhöhte Nutzlast	13.0460-4810.2	604810	BRE 24466 19,1 + WK + Zub
3.0 HDi 145	107	04/10→					
3.0 HDi 160	116	04/06→	←	Nutzlast 20Q; Nutzlast [kg]: 2.000	13.0460-4811.2	604811	BRE 24466 19,1 + WK + Zub
3.0 HDi 175	130	03/11→	➔		13.0460-4812.2	604812	BOS 24465 19,2 - WE / - WK + Zub
 Bremsscheibe							
2.0 BlueHDi 110	81	07/15→	←	Nutzlast leicht 12Q; Nutzlast ab [kg] 1.200	24.0124-0127.1	424127	Ø 280 24 21,9 V
2.0 BlueHDi 130	96	07/15→		Nutzlast bis [kg] 1.400			
2.0 BlueHDi 160	120	07/15→					
↓							

	kw			 	! #		
PEUGEOT - BOXER Bus 04/06→							
Bremsscheibe							
2.0 BlueHDi 110 2.0 BlueHDi 130 2.0 BlueHDi 160	81 96 120	07/15→ 07/15→ 07/15→	➡	Nutzlast 12Q/14Q + / leicht 16Q; Nutzlast ab [kg] 1.200 Nutzlast bis [kg] 1.600; nicht für erhöhte Nutzlast		24.0116-0124.1 416124	Ø 280 16 14,2
			➡	Nutzlast schwer 16Q; Nutzlast [kg]: 1.600; für erhöhte Nutzlast		24.0116-0125.1 416125	Ø 280 16 14,2
2.2 HdI 100 2.2 HdI 110 2.2 HdI 120 2.2 HdI 130 2.2 HdI 150 3.0 HdI 145 3.0 HdI 160 3.0 HdI 175	74 81 88 96 110 107 116 130	04/06→ 03/11→ 04/06→ 03/11→ 03/11→ 04/10→ 04/06→ 03/11→	⬅	Nutzlast 12Q/14Q; Nutzlast ab [kg] 1.200 Nutzlast bis [kg] 1.400		24.0124-0127.1 424127	Ø 280 24 21,9 V
			⬅	Nutzlast schwer 16Q; Nutzlast [kg]: 1.600; für erhöhte Nutzlast		24.0124-0138.1 424138	Ø 300 24 21,9 V
			⬅	Nutzlast leicht 16Q; Nutzlast [kg]: 1.600; nicht für erhöhte Nutzlast		24.0128-0213.1 428213	Ø 280 28 25,9 V
			⬅	Nutzlast 20Q; Nutzlast [kg]: 2.000		24.0132-0131.1 432131	Ø 300 32 29,9 V
			➡	Nutzlast 20Q; Nutzlast [kg]: 2.000		24.0116-0123.1 416123	Ø 300 16 14,2
			➡	Nutzlast 12Q/14Q + / leicht 16Q; Nutzlast ab [kg] 1.200 Nutzlast bis [kg] 1.600; nicht für erhöhte Nutzlast		24.0116-0124.1 416124	Ø 280 16 14,2
			➡	Nutzlast schwer 16Q; Nutzlast [kg]: 1.600; für erhöhte Nutzlast		24.0116-0125.1 416125	Ø 280 16 14,2
PEUGEOT - BOXER Bus (230P) 03/94→04/02							
Bremsbelagsatz, Scheibenbremse							
1.9 D	51	03/94→04/02	⬅	01/00→ 10/01; Nutzlast [kg]: 1.000		13.0460-2850.2 602850	TRW 21797 19,7 + WK
			⬅	→ 12/99; Nutzlast [kg]: 1.000		13.0460-2976.2 602976	TRW 21797 19,7 + WK
			⬅	11/01→ 03/02; Nutzlast [kg]: 1.000		13.0460-4978.2 604978	BRE 23917 19,3 + WK + Zub
			➡	11/01→ 03/02; Nutzlast [kg]: 1.000		13.0460-4980.2 604980	BRE 23921 20,3 - WE / - WK + Zub
1.9 TD 1.9 TD 1.9 TD 4x4	66 68 68	08/94→04/02 03/94→04/02 07/96→04/02	⬅	01/00→ 10/01; Nutzlast ab [kg] 1.000 Nutzlast bis [kg] 1.400		13.0460-2850.2 602850	TRW 21797 19,7 + WK
			⬅	→ 12/99; Nutzlast ab [kg] 1.000 Nutzlast bis [kg] 1.400		13.0460-2976.2 602976	TRW 21797 19,7 + WK
			⬅	11/01→ 03/02; Nutzlast ab [kg] 1.000 Nutzlast bis [kg] 1.400		13.0460-4978.2 604978	BRE 23917 19,3 + WK + Zub
			➡	11/01→ 03/02; Nutzlast ab [kg] 1.000 Nutzlast bis [kg] 1.400		13.0460-4980.2 604980	BRE 23921 20,3 - WE / - WK + Zub
2.0 i 2.0 i 4x4	80 80	03/94→04/02 08/96→04/02	⬅	01/00→ 10/01; Nutzlast ab [kg] 1.000 Nutzlast bis [kg] 1.400		13.0460-2850.2 602850	TRW 21797 19,7 + WK
			⬅	01/00→ 10/01; Nutzlast [kg]: 1.800		13.0460-2852.2 602852	TRW 21799 19,7 + WK
			⬅	→ 12/99; Nutzlast ab [kg] 1.000 Nutzlast bis [kg] 1.400		13.0460-2976.2 602976	TRW 21797 19,7 + WK
			⬅	→ 12/99; Nutzlast [kg]: 1.800		13.0460-2977.2 602977	TRW 21799 19,7 + WK
			⬅	11/01→ 03/02; Nutzlast ab [kg] 1.000 Nutzlast bis [kg] 1.400		13.0460-4978.2 604978	BRE 23917 19,3 + WK + Zub
			⬅	11/01→ 03/02; Nutzlast [kg]: 1.800		13.0460-4979.2 604979	BRE 23919 19,3 + WK + Zub
			➡	11/01→ 03/02; Nutzlast ab [kg] 1.000 Nutzlast bis [kg] 1.800		13.0460-4980.2 604980	BRE 23921 20,3 - WE / - WK + Zub
2.5 D 2.5 D 4x4 2.5 TD 4x4 2.5 TDI 2.5 TDI 4x4	63 63 76 79 79	08/94→04/02 07/96→04/02 07/96→04/02 01/97→04/02 01/97→04/02	⬅	01/00→ 10/01; Nutzlast [kg]: 1.400		13.0460-2850.2 602850	TRW 21797 19,7 + WK
			⬅	01/00→ 10/01; Nutzlast [kg]: 1.800		13.0460-2852.2 602852	TRW 21799 19,7 + WK
			⬅	→ 12/99; Nutzlast [kg]: 1.400		13.0460-2976.2 602976	TRW 21797 19,7 + WK
			⬅	→ 12/99; Nutzlast [kg]: 1.800		13.0460-2977.2 602977	TRW 21799 19,7 + WK
			⬅	11/01→ 03/02; Nutzlast [kg]: 1.400		13.0460-4978.2 604978	BRE 23917 19,3 + WK + Zub
			⬅	11/01→ 03/02; Nutzlast [kg]: 1.800		13.0460-4979.2 604979	BRE 23919 19,3 + WK + Zub
			➡	11/01→ 03/02; Nutzlast ab [kg] 1.400 Nutzlast bis [kg] 1.800		13.0460-4980.2 604980	BRE 23921 20,3 - WE / - WK + Zub
2.5 DT	62	10/97→11/01	⬅	01/00→ 10/01; Nutzlast [kg]: 1.400		13.0460-2850.2 602850	TRW 21797 19,7 + WK
			⬅	01/00→ 10/01; Nutzlast [kg]: 1.800		13.0460-2852.2 602852	TRW 21799 19,7 + WK
			⬅	→ 12/99; Nutzlast [kg]: 1.400		13.0460-2976.2 602976	TRW 21797 19,7 + WK
			⬅	→ 12/99; Nutzlast [kg]: 1.800		13.0460-2977.2 602977	TRW 21799 19,7 + WK
			⬅	11/01→; Nutzlast [kg]: 1.400		13.0460-4978.2 604978	BRE 23917 19,3 + WK + Zub
			⬅	11/01→; Nutzlast [kg]: 1.800		13.0460-4979.2 604979	BRE 23919 19,3 + WK + Zub
			➡	11/01→; Nutzlast ab [kg] 1.400 Nutzlast bis [kg] 1.800		13.0460-4980.2 604980	BRE 23921 20,3 - WE / - WK + Zub
2.5 TD	76	07/94→04/02	⬅	01/00→ 10/01; Nutzlast [kg]: 1.400		13.0460-2850.2 602850	TRW 21797 19,7 + WK
			⬅	01/00→ 10/01; Nutzlast [kg]: 1.800		13.0460-2852.2 602852	TRW 21799 19,7 + WK
			⬅	08/94→ 12/99; Nutzlast [kg]: 1.400		13.0460-2976.2 602976	TRW 21797 19,7 + WK



	kw			 	! #		
PEUGEOT - BOXER Bus (230P) 03/94→04/02							
Bremsbelagsatz, Scheibenbremse							
2.5 TD	76	07/94→04/02	←	08/94→ 12/99; Nutzlast [kg]: 1.800	13.0460-2977.2	602977	TRW 21799 19,7 + WK
			←	11/01→ 03/02; Nutzlast [kg]: 1.400	13.0460-4978.2	604978	BRE 23917 19,3 + WK + Zub
			←	11/01→ 03/02; Nutzlast [kg]: 1.800	13.0460-4979.2	604979	BRE 23919 19,3 + WK + Zub
			→	11/01→ 03/02; Nutzlast ab [kg] 1.400 Nutzlast bis [kg] 1.800	13.0460-4980.2	604980	BRE 23921 20,3 - WE / - WK + Zub
2.8 D	64	01/99→02/02	←	→ S 16206253; Nutzlast [kg]: 1.400	13.0460-2850.2	602850	TRW 21797 19,7 + WK
					13.0460-2976.2	602976	TRW 21797 19,7 + WK
			←	→ S 16205352; Nutzlast [kg]: 1.800	13.0460-2977.2	602977	TRW 21799 19,7 + WK
			←	S 16204256→; Nutzlast [kg]: 1.400	13.0460-4978.2	604978	BRE 23917 19,3 + WK + Zub
			←	S 16194400→; Nutzlast [kg]: 1.800	13.0460-4979.2	604979	BRE 23919 19,3 + WK + Zub
2.8 HDi	93	10/00→11/01	→	S 16194400→; Nutzlast ab [kg] 1.400 Nutzlast bis [kg] 1.800	13.0460-4980.2	604980	BRE 23921 20,3 - WE / - WK + Zub
			→	S 16206253; Nutzlast ab [kg] 1.000 Nutzlast bis [kg] 1.400	13.0460-2850.2	602850	TRW 21797 19,7 + WK
2.8 HDi	94	11/00→04/02	←	→ 10/01; Nutzlast [kg]: 1.400	13.0460-2852.2	602852	TRW 21799 19,7 + WK
			←	→ 10/01; Nutzlast [kg]: 1.800	13.0460-2852.2	602852	TRW 21799 19,7 + WK
			←	11/01→ 03/02; Nutzlast [kg]: 1.400	13.0460-4978.2	604978	BRE 23917 19,3 + WK + Zub
			←	11/01→ 03/02; Nutzlast [kg]: 1.800	13.0460-4979.2	604979	BRE 23919 19,3 + WK + Zub
			→	11/01→ 03/02; Nutzlast ab [kg] 1.400 Nutzlast bis [kg] 1.800	13.0460-4980.2	604980	BRE 23921 20,3 - WE / - WK + Zub
2.8 HDi 4x4	94	10/00→04/02	←	→ S 16206253; Nutzlast ab [kg] 1.000 Nutzlast bis [kg] 1.400	13.0460-2850.2	602850	TRW 21797 19,7 + WK
					13.0460-2976.2	602976	TRW 21797 19,7 + WK
			←	→ S 16205352; Nutzlast [kg]: 1.800	13.0460-2852.2	602852	TRW 21799 19,7 + WK
					13.0460-2977.2	602977	TRW 21799 19,7 + WK
			←	S 16204256→; → 03/02; Nutzlast ab [kg] 1.000 Nutzlast bis [kg] 1.400	13.0460-4978.2	604978	BRE 23917 19,3 + WK + Zub
			←	S 16194400→; → 03/02; Nutzlast [kg]: 1.800	13.0460-4979.2	604979	BRE 23919 19,3 + WK + Zub
2.8 HDi Allrad	93	10/00→11/01	→	S 16194400→; → 03/02; Nutzlast ab [kg] 1.000 Nutzlast bis [kg] 1.400	13.0460-4980.2	604980	BRE 23921 20,3 - WE / - WK + Zub
			→	S 16194400→; → 03/02; Nutzlast [kg]: 1.800	13.0460-4980.2	604980	BRE 23921 20,3 - WE / - WK + Zub
			←	→ S 16206253; Nutzlast ab [kg] 1.000 Nutzlast bis [kg] 1.400	13.0460-2850.2	602850	TRW 21797 19,7 + WK
					13.0460-2976.2	602976	TRW 21797 19,7 + WK
			←	→ S 16205352; Nutzlast [kg]: 1.800	13.0460-2852.2	602852	TRW 21799 19,7 + WK
					13.0460-2977.2	602977	TRW 21799 19,7 + WK
Bremsscheibe							
1.9 D	51	03/94→04/02	←	→ 03/02; Nutzlast [kg]: 1.000	24.0118-0108.1	418108	Ø 280 18 15,9
			→	11/01→ 03/02; Nutzlast [kg]: 1.000	24.0116-0124.1	416124	Ø 280 16 14,2
1.9 TD	66	08/94→04/02	←	→ 03/02; Nutzlast ab [kg] 1.000 Nutzlast bis [kg] 1.400	24.0118-0108.1	418108	Ø 280 18 15,9
1.9 TD	68	03/94→04/02	→	11/01→ 03/02; Nutzlast ab [kg] 1.000 Nutzlast bis [kg] 1.400	24.0116-0124.1	416124	Ø 280 16 14,2
1.9 TD 4x4	68	07/96→04/02					
2.0 i	80	03/94→04/02	←	→ 03/02; Nutzlast ab [kg] 1.000 Nutzlast bis [kg] 1.400	24.0118-0108.1	418108	Ø 280 18 15,9
			←	→ 03/02; Nutzlast [kg]: 1.800	24.0124-0138.1	424138	Ø 300 24 21,9 V
			→	11/01→ 03/02; Nutzlast ab [kg] 1.000 Nutzlast bis [kg] 1.400	24.0116-0124.1	416124	Ø 280 16 14,2
			→	11/01→ 03/02; Nutzlast [kg]: 1.800	24.0116-0125.1	416125	Ø 280 16 14,2
2.5 D	63	08/94→04/02	←	→ 03/02; Nutzlast [kg]: 1.400	24.0118-0108.1	418108	Ø 280 18 15,9
			←	→ 03/02; Nutzlast [kg]: 1.800	24.0124-0138.1	424138	Ø 300 24 21,9 V
			→	11/01→ 03/02; Nutzlast [kg]: 1.400	24.0116-0124.1	416124	Ø 280 16 14,2
			→	11/01→ 03/02; Nutzlast [kg]: 1.800	24.0116-0125.1	416125	Ø 280 16 14,2
2.5 D 4x4	63	07/96→04/02	←	Nutzlast [kg]: 1.400	24.0118-0108.1	418108	Ø 280 18 15,9
↓	62	10/97→11/01					









PEUGEOT - BOXER Bus (230P) 03/94→04/02









Bremsscheibe							
2.5 DT	62	10/97→11/01	←	Nutzlast [kg]: 1.800	24.0124-0138.1	424138	Ø 300 24 21,9 V
			→	11/01→; Nutzlast [kg]: 1.400	24.0116-0124.1	416124	Ø 280 16 14,2
			→	11/01→; Nutzlast [kg]: 1.800	24.0116-0125.1	416125	Ø 280 16 14,2
2.5 TD	76	07/94→04/02	←	08/94→ 03/02; Nutzlast [kg]: 1.400	24.0124-0127.1	424127	Ø 280 24 21,9 V
			←	08/94→ 03/02; Nutzlast [kg]: 1.800	24.0124-0138.1	424138	Ø 300 24 21,9 V
			→	11/01→ 03/02; Nutzlast [kg]: 1.400	24.0116-0124.1	416124	Ø 280 16 14,2
			→	11/01→ 03/02; Nutzlast [kg]: 1.800	24.0116-0125.1	416125	Ø 280 16 14,2
2.5 TD 4x4 2.5 TDI 2.5 TDI 4x4	76	07/96→04/02	←	→ 03/02; Nutzlast [kg]: 1.400	24.0124-0127.1	424127	Ø 280 24 21,9 V
			79	01/97→04/02	←	→ 03/02; Nutzlast [kg]: 1.800	24.0124-0138.1
	79	01/97→04/02			→	11/01→ 03/02; Nutzlast [kg]: 1.400	24.0116-0124.1
			→	11/01→ 03/02; Nutzlast [kg]: 1.800	24.0116-0125.1	416125	Ø 280 16 14,2
2.8 D	64	01/99→02/02	←	→ S 16206253; Nutzlast [kg]: 1.400	24.0118-0108.1	418108	Ø 280 18 15,9
			←	S 16204256→; Nutzlast [kg]: 1.400	24.0124-0127.1	424127	Ø 280 24 21,9 V
			←	Nutzlast [kg]: 1.800	24.0124-0138.1	424138	Ø 300 24 21,9 V
			→	S 16194400→; Nutzlast [kg]: 1.400	24.0116-0124.1	416124	Ø 280 16 14,2
			→	S 16194400→; Nutzlast [kg]: 1.800	24.0116-0125.1	416125	Ø 280 16 14,2
2.8 HDI	94	11/00→04/02	←	→ 03/02; Nutzlast [kg]: 1.400	24.0124-0127.1	424127	Ø 280 24 21,9 V
			→	11/01→ 03/02; Nutzlast [kg]: 1.400	24.0116-0124.1	416124	Ø 280 16 14,2
			→	11/01→ 03/02; Nutzlast [kg]: 1.800	24.0116-0125.1	416125	Ø 280 16 14,2
2.8 HDi 4x4	94	10/00→04/02	←	→ S 16206253; Nutzlast ab [kg] 1.000 Nutzlast bis [kg] 1.400	24.0118-0108.1	418108	Ø 280 18 15,9
			←	S 16204256→; → 03/02; Nutzlast ab [kg] 1.000 Nutzlast bis [kg] 1.400	24.0124-0127.1	424127	Ø 280 24 21,9 V
			←	→ 03/02; Nutzlast [kg]: 1.800	24.0124-0138.1	424138	Ø 300 24 21,9 V
			→	S 16194400→; → 03/02; Nutzlast ab [kg] 1.000 Nutzlast bis [kg] 1.400	24.0116-0124.1	416124	Ø 280 16 14,2
			→	S 16194400→; → 03/02; Nutzlast [kg]: 1.800	24.0116-0125.1	416125	Ø 280 16 14,2
2.8 HDi Allrad	93	10/00→11/01	←	→ S 16206253; Nutzlast ab [kg] 1.000 Nutzlast bis [kg] 1.400	24.0118-0108.1	418108	Ø 280 18 15,9
			←	S 16204256→; Nutzlast ab [kg] 1.000 Nutzlast bis [kg] 1.400	24.0124-0127.1	424127	Ø 280 24 21,9 V
			←	Nutzlast [kg]: 1.800	24.0124-0138.1	424138	Ø 300 24 21,9 V
			→	S 16194400→; Nutzlast ab [kg] 1.000 Nutzlast bis [kg] 1.400	24.0116-0124.1	416124	Ø 280 16 14,2
			→	S 16194400→; Nutzlast [kg]: 1.800	24.0116-0125.1	416125	Ø 280 16 14,2

PEUGEOT - BOXER Bus (244, Z_) 12/01→

Bremsbelagsatz, Scheibenbremse							
2.0	81	04/02→	←	→ 03/06; Nutzlast ab [kg] 1.000 Nutzlast bis [kg] 1.400	13.0460-4978.2	604978	BRE 23917 19,3 + WK + Zub
			→	→ 03/06; Nutzlast [kg]: 1.800	13.0460-4979.2	604979	BRE 23919 19,3 + WK + Zub
2.0 HDi	62	04/02→	←	→ 03/06; Nutzlast [kg]: 1.800	13.0460-4979.2	604979	BRE 23919 19,3 + WK + Zub
2.2 HDi	74	04/02→	←	→ 03/06; Nutzlast [kg]: 1.800	13.0460-4979.2	604979	BRE 23919 19,3 + WK + Zub
2.8 HDi	94	04/02→	←	→ 03/06; Nutzlast [kg]: 1.800	13.0460-4979.2	604979	BRE 23919 19,3 + WK + Zub
2.8 HDi	107	04/04→	→	→ 03/06; Nutzlast ab [kg] 1.000 Nutzlast bis [kg] 1.800	13.0460-4980.2	604980	BRE 23921 20,3 - WE / - WK + Zub
2.8 HDi 4x4	94	04/02→	→	→ 03/06; Nutzlast ab [kg] 1.000 Nutzlast bis [kg] 1.800	13.0460-4980.2	604980	BRE 23921 20,3 - WE / - WK + Zub
2.0 BiFuel	81	12/01→06/06	←	04/02→ 03/06; Nutzlast ab [kg] 1.000 Nutzlast bis [kg] 1.400	13.0460-4978.2	604978	BRE 23917 19,3 + WK + Zub
			←	04/02→ 03/06; Nutzlast [kg]: 1.800	13.0460-4979.2	604979	BRE 23919 19,3 + WK + Zub
			→	04/02→ 03/06; Nutzlast ab [kg] 1.000 Nutzlast bis [kg] 1.800	13.0460-4980.2	604980	BRE 23921 20,3 - WE / - WK + Zub

Bremsscheibe							
2.0	81	04/02→	←	→ 03/06; Nutzlast ab [kg] 1.000 Nutzlast bis [kg] 1.400	24.0124-0127.1	424127	Ø 280 24 21,9 V
2.0 HDi	62	04/02→	←	→ 03/06; Nutzlast [kg]: 1.800	24.0124-0138.1	424138	Ø 300 24 21,9 V
2.2 HDi	74	04/02→	←	→ 03/06; Nutzlast [kg]: 1.800	24.0124-0138.1	424138	Ø 300 24 21,9 V
2.8 HDi	94	04/02→	←	→ 03/06; Nutzlast [kg]: 1.800	24.0124-0138.1	424138	Ø 300 24 21,9 V
2.8 HDi	107	04/04→	→	→ 03/06; Nutzlast ab [kg] 1.000 Nutzlast bis [kg] 1.400	24.0116-0124.1	416124	Ø 280 16 14,2
2.8 HDi 4x4	94	04/02→	→	→ 03/06; Nutzlast [kg]: 1.800	24.0116-0125.1	416125	Ø 280 16 14,2
2.0 BiFuel	81	12/01→06/06	←	04/02→ 03/06; Nutzlast ab [kg] 1.000 Nutzlast bis [kg] 1.400	24.0124-0127.1	424127	Ø 280 24 21,9 V
			→	04/02→ 03/06; Nutzlast ab [kg] 1.000 Nutzlast bis [kg] 1.400	24.0116-0124.1	416124	Ø 280 16 14,2
			→	04/02→ 03/06; Nutzlast [kg]: 1.800	24.0116-0125.1	416125	Ø 280 16 14,2

	kw				! #		
PEUGEOT - BOXER Kasten 04/06→							
 Bremsbelagsatz, Scheibenbremse							
2.0 BlueHDI 110 2.0 BlueHDI 130 2.0 BlueHDI 160	81 96 120	07/15→ 07/15→ 07/15→	←	Nutzlast 12Q/14Q; Nutzlast ab [kg] 1.200 Nutzlast bis [kg] 1.400	13.0460-4807.2	604807	BRE 24468 19,1 + WK + Zub
			←	Nutzlast leicht 16Q; Nutzlast [kg]: 1.600; nicht für erhöhte Nutzlast	13.0460-4809.2	604809	BRE 24468 19,1 + WK + Zub
			←	Nutzlast 20Q; Nutzlast [kg]: 2.000	13.0460-4811.2	604811	BRE 24466 19,1 + WK + Zub
			←	Nutzlast schwer 16Q; Nutzlast [kg]: 1.600; für erhöhte Nutzlast	13.0460-4811.2	604811	BRE 24466 19,1 + WK + Zub
2.2 HDi 100 2.2 HDi 110 2.2 HDi 120 2.2 HDi 130 2.2 HDi 150 3.0 D 3.0 HDi 3.0 HDi 145 3.0 HDi 160 3.0 HDi 175	74 81 88 96 110 116 115 107 116 130	04/06→ 03/11→ 04/06→ 03/11→ 03/11→ 09/08→12/09 07/06→ 04/10→ 04/06→ 03/11→	←	Nutzlast 12Q/14Q; Nutzlast ab [kg] 1.200 Nutzlast bis [kg] 1.400	13.0460-4807.2	604807	BRE 24468 19,1 + WK + Zub
			←	Nutzlast leicht 16Q; Nutzlast [kg]: 1.600; nicht für erhöhte Nutzlast	13.0460-4809.2	604809	BRE 24468 19,1 + WK + Zub
			←	Nutzlast schwer 16Q; Nutzlast [kg]: 1.600; für erhöhte Nutzlast	13.0460-4810.2	604810	BRE 24466 19,1 + WK + Zub
			←	Nutzlast 20Q; Nutzlast [kg]: 2.000	13.0460-4811.2	604811	BRE 24466 19,1 + WK + Zub
			→		13.0460-4812.2	604812	BOS 24465 19,2 - WE / - WK + Zub
 Bremsscheibe							
2.0 BlueHDI 110 2.0 BlueHDI 130 2.0 BlueHDI 160	81 96 120	07/15→ 07/15→ 07/15→	←	Nutzlast leicht 12Q; Nutzlast ab [kg] 1.200 Nutzlast bis [kg] 1.400	24.0124-0127.1	424127	Ø 280 24 21,9 V
			→	Nutzlast 12Q/14Q + / leicht 16Q; Nutzlast ab [kg] 1.200 Nutzlast bis [kg] 1.600; nicht für erhöhte Nutzlast	24.0116-0124.1	416124	Ø 280 16 14,2
			→	Nutzlast schwer 16Q; Nutzlast [kg]: 1.600; für erhöhte Nutzlast	24.0116-0125.1	416125	Ø 280 16 14,2
2.2 HDi 100 2.2 HDi 110 2.2 HDi 120 2.2 HDi 130 2.2 HDi 150 3.0 D 3.0 HDi 3.0 HDi 145 3.0 HDi 160 3.0 HDi 175	74 81 88 96 110 116 115 107 116 130	04/06→ 03/11→ 04/06→ 03/11→ 03/11→ 09/08→12/09 07/06→ 04/10→ 04/06→ 03/11→	←	Nutzlast 12Q/14Q; Nutzlast ab [kg] 1.200 Nutzlast bis [kg] 1.400	24.0124-0127.1	424127	Ø 280 24 21,9 V
			←	Nutzlast schwer 16Q; Nutzlast [kg]: 1.600; für erhöhte Nutzlast	24.0124-0138.1	424138	Ø 300 24 21,9 V
			←	Nutzlast leicht 16Q; Nutzlast [kg]: 1.600; nicht für erhöhte Nutzlast	24.0128-0213.1	428213	Ø 280 28 25,9 V
			←	Nutzlast 20Q; Nutzlast [kg]: 2.000	24.0132-0131.1	432131	Ø 300 32 29,9 V
			→	Nutzlast 20Q; Nutzlast [kg]: 2.000	24.0116-0123.1	416123	Ø 300 16 14,2
			→	Nutzlast 12Q/14Q + / leicht 16Q; Nutzlast ab [kg] 1.200 Nutzlast bis [kg] 1.600; nicht für erhöhte Nutzlast	24.0116-0124.1	416124	Ø 280 16 14,2
			→	Nutzlast schwer 16Q; Nutzlast [kg]: 1.600; für erhöhte Nutzlast	24.0116-0125.1	416125	Ø 280 16 14,2
PEUGEOT - BOXER Kasten (230L) 03/94→06/03							
 Bremsbelagsatz, Scheibenbremse							
1.9 D 1.9 D	50 51	07/99→04/02 03/94→04/02	←	01/00→ 10/01; Nutzlast [kg]: 1.000	13.0460-2850.2	602850	TRW 21797 19,7 + WK
			←	→ 12/99; Nutzlast [kg]: 1.000	13.0460-2976.2	602976	TRW 21797 19,7 + WK
			←	11/01→ 03/02; Nutzlast [kg]: 1.000	13.0460-4978.2	604978	BRE 23917 19,3 + WK + Zub
			→	11/01→ 03/02; Nutzlast [kg]: 1.000	13.0460-4980.2	604980	BRE 23921 20,3 - WE / - WK + Zub
1.9 DT 4x4	66	03/96→09/98	←	Nutzlast ab [kg] 1.000 Nutzlast bis [kg] 1.400	13.0460-2976.2	602976	TRW 21797 19,7 + WK
1.9 TD 1.9 TD	66 68	07/99→04/02 03/94→04/02	←	01/00→ 10/01; Nutzlast ab [kg] 1.000 Nutzlast bis [kg] 1.400	13.0460-2850.2	602850	TRW 21797 19,7 + WK
			←	→ 12/99; Nutzlast ab [kg] 1.000 Nutzlast bis [kg] 1.400	13.0460-2976.2	602976	TRW 21797 19,7 + WK
			←	11/01→ 03/02; Nutzlast ab [kg] 1.000 Nutzlast bis [kg] 1.400	13.0460-4978.2	604978	BRE 23917 19,3 + WK + Zub
			→	11/01→ 03/02; Nutzlast ab [kg] 1.000 Nutzlast bis [kg] 1.400	13.0460-4980.2	604980	BRE 23921 20,3 - WE / - WK + Zub
2.0 4x4	80	03/96→09/98	←	Nutzlast ab [kg] 1.000 Nutzlast bis [kg] 1.400	13.0460-2976.2	602976	TRW 21797 19,7 + WK
			←	Nutzlast [kg]: 1.800	13.0460-2977.2	602977	TRW 21799 19,7 + WK
2.0 HDI	62	08/01→04/02	←	→ 10/01; Nutzlast ab [kg] 1.000 Nutzlast bis [kg] 1.400	13.0460-2850.2	602850	TRW 21797 19,7 + WK
			←	11/01→ 03/02; Nutzlast ab [kg] 1.000 Nutzlast bis [kg] 1.400	13.0460-4978.2	604978	BRE 23917 19,3 + WK + Zub
			→	11/01→ 03/02; Nutzlast ab [kg] 1.000 Nutzlast bis [kg] 1.800	13.0460-4980.2	604980	BRE 23921 20,3 - WE / - WK + Zub
2.0 i	80	06/94→04/02	←	01/00→ 10/01; Nutzlast ab [kg] 1.000 Nutzlast bis [kg] 1.400	13.0460-2850.2	602850	TRW 21797 19,7 + WK
			←	01/00→ 10/01; Nutzlast [kg]: 1.800	13.0460-2852.2	602852	TRW 21799 19,7 + WK
			←	→ 12/99; Nutzlast ab [kg] 1.000 Nutzlast bis [kg] 1.400	13.0460-2976.2	602976	TRW 21797 19,7 + WK

	kw			 	! #		
PEUGEOT - BOXER Kasten (230L) 03/94→06/03							
 Bremsbelagsatz, Scheibenbremse							
2.0 i	80	06/94→04/02	←	→ 12/99; Nutzlast [kg]: 1.800	13.0460-2977.2	602977	TRW 21799 19,7 + WK
			←	11/01→ 03/02; Nutzlast ab [kg] 1.000 Nutzlast bis [kg] 1.400	13.0460-4978.2	604978	BRE 23917 19,3 + WK + Zub
			←	11/01→ 03/02; Nutzlast [kg]: 1.800	13.0460-4979.2	604979	BRE 23919 19,3 + WK + Zub
			→	11/01→ 03/02; Nutzlast ab [kg] 1.000 Nutzlast bis [kg] 1.800	13.0460-4980.2	604980	BRE 23921 20,3 - WE / - WK + Zub
2.5 D 2.5 D 4x4 2.5 TDI 2.5 TDI 4x4	63	03/94→04/02	←	01/00→ 10/01; Nutzlast [kg]: 1.400	13.0460-2850.2	602850	TRW 21797 19,7 + WK
	63	07/99→04/02	←	01/00→ 10/01; Nutzlast [kg]: 1.800	13.0460-2852.2	602852	TRW 21799 19,7 + WK
	79	01/97→04/02	←	→ 12/99; Nutzlast [kg]: 1.400	13.0460-2976.2	602976	TRW 21797 19,7 + WK
	79	07/99→04/02	←	→ 12/99; Nutzlast [kg]: 1.800	13.0460-2977.2	602977	TRW 21799 19,7 + WK
			←	11/01→ 03/02; Nutzlast [kg]: 1.400	13.0460-4978.2	604978	BRE 23917 19,3 + WK + Zub
			←	11/01→ 03/02; Nutzlast [kg]: 1.800	13.0460-4979.2	604979	BRE 23919 19,3 + WK + Zub
			→	11/01→ 03/02; Nutzlast ab [kg] 1.400 Nutzlast bis [kg] 1.800	13.0460-4980.2	604980	BRE 23921 20,3 - WE / - WK + Zub
2.5 DT	62	10/97→11/01	←	01/00→ 10/01; Nutzlast [kg]: 1.400	13.0460-2850.2	602850	TRW 21797 19,7 + WK
			←	01/00→ 10/01; Nutzlast [kg]: 1.800	13.0460-2852.2	602852	TRW 21799 19,7 + WK
			←	→ 12/99; Nutzlast [kg]: 1.400	13.0460-2976.2	602976	TRW 21797 19,7 + WK
			←	→ 12/99; Nutzlast [kg]: 1.800	13.0460-2977.2	602977	TRW 21799 19,7 + WK
			←	11/01→; Nutzlast [kg]: 1.400	13.0460-4978.2	604978	BRE 23917 19,3 + WK + Zub
			←	11/01→; Nutzlast [kg]: 1.800	13.0460-4979.2	604979	BRE 23919 19,3 + WK + Zub
			→	11/01→; Nutzlast ab [kg] 1.400 Nutzlast bis [kg] 1.800	13.0460-4980.2	604980	BRE 23921 20,3 - WE / - WK + Zub
2.5 TD	76	03/94→04/02	←	01/00→ 10/01; Nutzlast [kg]: 1.400	13.0460-2850.2	602850	TRW 21797 19,7 + WK
			←	01/00→ 10/01; Nutzlast [kg]: 1.800	13.0460-2852.2	602852	TRW 21799 19,7 + WK
			←	→ 12/99; Nutzlast [kg]: 1.400	13.0460-2976.2	602976	TRW 21797 19,7 + WK
			←	→ 12/99; Nutzlast [kg]: 1.800	13.0460-2977.2	602977	TRW 21799 19,7 + WK
			←	11/01→ 03/02; Nutzlast [kg]: 1.400	13.0460-4978.2	604978	BRE 23917 19,3 + WK + Zub
			←	11/01→ 03/02; Nutzlast [kg]: 1.800	13.0460-4979.2	604979	BRE 23919 19,3 + WK + Zub
2.8 D	64	01/99→02/02	←	→ S 16206253; Nutzlast [kg]: 1.400	13.0460-2850.2	602850	TRW 21797 19,7 + WK
			←	→ S 16206253; Nutzlast [kg]: 1.800	13.0460-2976.2	602976	TRW 21797 19,7 + WK
			←	→ S 16205352; Nutzlast [kg]: 1.800	13.0460-2852.2	602852	TRW 21799 19,7 + WK
			←	→ S 16205352; Nutzlast [kg]: 1.800	13.0460-2977.2	602977	TRW 21799 19,7 + WK
			←	S 16204256→; Nutzlast [kg]: 1.400	13.0460-4978.2	604978	BRE 23917 19,3 + WK + Zub
			←	S 16194400→; Nutzlast [kg]: 1.800	13.0460-4979.2	604979	BRE 23919 19,3 + WK + Zub
			→	S 16194400→; Nutzlast ab [kg] 1.400 Nutzlast bis [kg] 1.800	13.0460-4980.2	604980	BRE 23921 20,3 - WE / - WK + Zub
2.8 HDi	93	10/00→11/01	→	11/01→; Nutzlast ab [kg] 1.400 Nutzlast bis [kg] 1.800	13.0460-4980.2	604980	BRE 23921 20,3 - WE / - WK + Zub
2.8 HDI	94	11/00→04/02	←	→ 10/01; Nutzlast [kg]: 1.400	13.0460-2850.2	602850	TRW 21797 19,7 + WK
			←	→ 10/01; Nutzlast [kg]: 1.800	13.0460-2852.2	602852	TRW 21799 19,7 + WK
			←	11/01→ 03/02; Nutzlast [kg]: 1.400	13.0460-4978.2	604978	BRE 23917 19,3 + WK + Zub
			←	11/01→ 03/02; Nutzlast [kg]: 1.800	13.0460-4979.2	604979	BRE 23919 19,3 + WK + Zub
			→	11/01→ 03/02; Nutzlast ab [kg] 1.400 Nutzlast bis [kg] 1.800	13.0460-4980.2	604980	BRE 23921 20,3 - WE / - WK + Zub
2.8 HDi 4x4	93	10/00→11/01	←	→ 10/01; Nutzlast [kg]: 1.400	13.0460-2850.2	602850	TRW 21797 19,7 + WK
			←	→ 10/01; Nutzlast [kg]: 1.800	13.0460-2852.2	602852	TRW 21799 19,7 + WK
			←	11/01→; Nutzlast [kg]: 1.800	13.0460-4979.2	604979	BRE 23919 19,3 + WK + Zub
			→	11/01→; Nutzlast ab [kg] 1.400 Nutzlast bis [kg] 1.800	13.0460-4980.2	604980	BRE 23921 20,3 - WE / - WK + Zub
2.8 HDi 4x4	94	10/00→04/02	←	→ 10/01; Nutzlast [kg]: 1.400	13.0460-2850.2	602850	TRW 21797 19,7 + WK
			←	→ 10/01; Nutzlast [kg]: 1.800	13.0460-2852.2	602852	TRW 21799 19,7 + WK
			←	11/01→ 03/02; Nutzlast [kg]: 1.800	13.0460-4979.2	604979	BRE 23919 19,3 + WK + Zub
			→	11/01→ 03/02; Nutzlast ab [kg] 1.400 Nutzlast bis [kg] 1.800	13.0460-4980.2	604980	BRE 23921 20,3 - WE / - WK + Zub
 Bremsscheibe							
1.9 D 1.9 D	50	07/99→04/02	←	→ 03/02; Nutzlast [kg]: 1.000	24.0118-0108.1	418108	Ø 280 18 15,9
	51	03/94→04/02	→	11/01→ 03/02; Nutzlast [kg]: 1.000	24.0116-0124.1	416124	Ø 280 16 14,2
↓							

PEUGEOT - BOXER Kasten (230L) 03/94→06/03

Bremsscheibe							
1.9 DT 4x4	66	03/96→09/98	←	Nutzlast ab [kg] 1.000 Nutzlast bis [kg] 1.400	24.0118-0108.1	418108	Ø 280 18 15,9
1.9 TD 1.9 TD	66	07/99→04/02	←	→ 03/02; Nutzlast ab [kg] 1.000 Nutzlast bis [kg] 1.400	24.0118-0108.1	418108	Ø 280 18 15,9
	68	03/94→04/02	→	11/01→ 03/02; Nutzlast ab [kg] 1.000 Nutzlast bis [kg] 1.400	24.0116-0124.1	416124	Ø 280 16 14,2
2.0 4x4	80	03/96→09/98	←	Nutzlast ab [kg] 1.000 Nutzlast bis [kg] 1.400	24.0118-0108.1	418108	Ø 280 18 15,9
			←	Nutzlast [kg]: 1.800	24.0124-0138.1	424138	Ø 300 24 21,9 V
2.0 HDI	62	08/01→04/02	←	→ 03/02; Nutzlast [kg]: 1.800	24.0124-0138.1	424138	Ø 300 24 21,9 V
			→	11/01→ 03/02; Nutzlast ab [kg] 1.000 Nutzlast bis [kg] 1.400	24.0116-0124.1	416124	Ø 280 16 14,2
2.0 i	80	06/94→04/02	←	→ 03/02; Nutzlast ab [kg] 1.000 Nutzlast bis [kg] 1.400	24.0118-0108.1	418108	Ø 280 18 15,9
			←	→ 03/02; Nutzlast [kg]: 1.800	24.0124-0138.1	424138	Ø 300 24 21,9 V
			→	11/01→ 03/02; Nutzlast ab [kg] 1.000 Nutzlast bis [kg] 1.400	24.0116-0124.1	416124	Ø 280 16 14,2
			→	11/01→ 03/02; Nutzlast [kg]: 1.800	24.0116-0125.1	416125	Ø 280 16 14,2
2.5 D 2.5 D 4x4	63	03/94→04/02 07/99→04/02	←	→ 03/02; Nutzlast [kg]: 1.400	24.0118-0108.1	418108	Ø 280 18 15,9
	63		←	→ 03/02; Nutzlast [kg]: 1.800	24.0124-0138.1	424138	Ø 300 24 21,9 V
			→	11/01→ 03/02; Nutzlast [kg]: 1.400	24.0116-0124.1	416124	Ø 280 16 14,2
			→	11/01→ 03/02; Nutzlast [kg]: 1.800	24.0116-0125.1	416125	Ø 280 16 14,2
2.5 DT	62	10/97→11/01	←	Nutzlast [kg]: 1.400	24.0118-0108.1	418108	Ø 280 18 15,9
			←	Nutzlast [kg]: 1.800	24.0124-0138.1	424138	Ø 300 24 21,9 V
			→	11/01→; Nutzlast [kg]: 1.400	24.0116-0124.1	416124	Ø 280 16 14,2
			→	11/01→; Nutzlast [kg]: 1.800	24.0116-0125.1	416125	Ø 280 16 14,2
2.5 TD 2.5 TDi 2.5 TDi 4x4 2.8 HDi 2.8 HDi 4x4	76	03/94→04/02 01/97→04/02 07/99→04/02 11/00→04/02 10/00→04/02	←	→ 03/02; Nutzlast [kg]: 1.400	24.0124-0127.1	424127	Ø 280 24 21,9 V
	79		←	→ 03/02; Nutzlast [kg]: 1.800	24.0124-0138.1	424138	Ø 300 24 21,9 V
	79		→	11/01→ 03/02; Nutzlast [kg]: 1.400	24.0116-0124.1	416124	Ø 280 16 14,2
	94		→	11/01→ 03/02; Nutzlast [kg]: 1.800	24.0116-0125.1	416125	Ø 280 16 14,2
2.8 D	64	01/99→02/02	←	→ S 16206253; Nutzlast [kg]: 1.400	24.0118-0108.1	418108	Ø 280 18 15,9
			←	S 16204256→; Nutzlast [kg]: 1.400	24.0124-0127.1	424127	Ø 280 24 21,9 V
			←	Nutzlast [kg]: 1.800	24.0124-0138.1	424138	Ø 300 24 21,9 V
			→	S 16194400→; Nutzlast [kg]: 1.400	24.0116-0124.1	416124	Ø 280 16 14,2
			→	S 16194400→; Nutzlast [kg]: 1.800	24.0116-0125.1	416125	Ø 280 16 14,2
2.8 HDi 4x4	93	10/00→11/01	←	Nutzlast [kg]: 1.400	24.0124-0127.1	424127	Ø 280 24 21,9 V
			←	Nutzlast [kg]: 1.800	24.0124-0138.1	424138	Ø 300 24 21,9 V
			→	11/01→; Nutzlast [kg]: 1.400	24.0116-0124.1	416124	Ø 280 16 14,2
			→	11/01→; Nutzlast [kg]: 1.800	24.0116-0125.1	416125	Ø 280 16 14,2













PEUGEOT - BOXER Kasten (244) 12/01→









Bremsbelagsatz, Scheibenbremse							
2.0	81	04/02→	←	→ 03/06; Nutzlast ab [kg] 1.000 Nutzlast bis [kg] 1.400	13.0460-4978.2	604978	BRE 23917 19,3 + WK + Zub
2.0 HDi	62	04/02→	←	→ 03/06; Nutzlast [kg]: 1.800	13.0460-4979.2	604979	BRE 23919 19,3 + WK + Zub
2.2 HDi	74	04/02→	←	→ 03/06; Nutzlast [kg]: 1.800	13.0460-4979.2	604979	BRE 23919 19,3 + WK + Zub
2.8 HDi	93	09/05→09/09	→	→ 03/06; Nutzlast ab [kg] 1.000 Nutzlast bis [kg] 1.800	13.0460-4980.2	604980	BRE 23921 20,3 - WE / - WK + Zub
2.8 HDi	94	04/02→	→	→ 03/06; Nutzlast ab [kg] 1.000 Nutzlast bis [kg] 1.800	13.0460-4980.2	604980	BRE 23921 20,3 - WE / - WK + Zub
2.8 HDi	107	04/04→	→	→ 03/06; Nutzlast ab [kg] 1.000 Nutzlast bis [kg] 1.800	13.0460-4980.2	604980	BRE 23921 20,3 - WE / - WK + Zub
2.8 HDi 4x4	94	04/02→	→	→ 03/06; Nutzlast [kg]: 1.800	24.0116-0125.1	416125	Ø 280 16 14,2
2.0 BiFuel	81	12/01→06/06	←	04/02→ 03/06; Nutzlast ab [kg] 1.000 Nutzlast bis [kg] 1.400	13.0460-4978.2	604978	BRE 23917 19,3 + WK + Zub
			←	04/02→ 03/06; Nutzlast [kg]: 1.800	13.0460-4979.2	604979	BRE 23919 19,3 + WK + Zub
			→	04/02→ 03/06; Nutzlast ab [kg] 1.000 Nutzlast bis [kg] 1.800	13.0460-4980.2	604980	BRE 23921 20,3 - WE / - WK + Zub











Bremsscheibe							
2.0	81	04/02→	←	→ 03/06; Nutzlast ab [kg] 1.000 Nutzlast bis [kg] 1.400	24.0124-0127.1	424127	Ø 280 24 21,9 V
2.0 HDi	62	04/02→	←	→ 03/06; Nutzlast [kg]: 1.800	24.0124-0138.1	424138	Ø 300 24 21,9 V
2.2 HDi	74	04/02→	←	→ 03/06; Nutzlast [kg]: 1.800	24.0124-0138.1	424138	Ø 300 24 21,9 V
2.8 HDi	93	09/05→09/09	→	→ 03/06; Nutzlast ab [kg] 1.000 Nutzlast bis [kg] 1.400	24.0116-0124.1	416124	Ø 280 16 14,2
2.8 HDi	94	04/02→	→	→ 03/06; Nutzlast ab [kg] 1.000 Nutzlast bis [kg] 1.400	24.0116-0124.1	416124	Ø 280 16 14,2
2.8 HDi	107	04/04→	→	→ 03/06; Nutzlast ab [kg] 1.000 Nutzlast bis [kg] 1.400	24.0116-0124.1	416124	Ø 280 16 14,2
2.8 HDi 4x4	94	04/02→	→	→ 03/06; Nutzlast [kg]: 1.800	24.0116-0125.1	416125	Ø 280 16 14,2













↓

















	kw			 	! #		
PEUGEOT - BOXER Kasten (244) 12/01→							
 Bremsscheibe							
2.0 BiFuel	81	12/01→06/06	←	04/02→ 03/06; Nutzlast ab [kg] 1.000 Nutzlast bis [kg] 1.400	24.0124-0127.1	424127	Ø 280 24 21,9 V
			→	04/02→ 03/06; Nutzlast ab [kg] 1.000 Nutzlast bis [kg] 1.400	24.0116-0124.1	416124	Ø 280 16 14,2
			→	04/02→ 03/06; Nutzlast [kg]: 1.800	24.0116-0125.1	416125	Ø 280 16 14,2
PEUGEOT - BOXER Pritsche/Fahrgestell 04/06→							
 Bremsbelagsatz, Scheibenbremse							
2.0 BlueHDi 110	81	07/15→	←	Nutzlast 12Q/14Q; Nutzlast ab [kg] 1.200 Nutzlast bis [kg] 1.400	13.0460-4807.2	604807	BRE 24468 19,1 + WK + Zub
2.0 BlueHDi 130	96	07/15→	←	Nutzlast leicht 16Q; Nutzlast [kg]: 1.600; nicht für erhöhte Nutzlast	13.0460-4809.2	604809	BRE 24468 19,1 + WK + Zub
2.0 BlueHDi 160	120	07/15→	←	Nutzlast 20Q; Nutzlast [kg]: 2.000	13.0460-4811.2	604811	BRE 24466 19,1 + WK + Zub
			←	Nutzlast schwer 16Q; Nutzlast [kg]: 1.600; für erhöhte Nutzlast	13.0460-4811.2	604811	BRE 24466 19,1 + WK + Zub
2.2 HDi 100	74	04/06→	←	Nutzlast 12Q/14Q; Nutzlast ab [kg] 1.200 Nutzlast bis [kg] 1.400	13.0460-4807.2	604807	BRE 24468 19,1 + WK + Zub
2.2 HDi 110	81	03/11→	←	Nutzlast leicht 16Q; Nutzlast [kg]: 1.600; nicht für erhöhte Nutzlast	13.0460-4809.2	604809	BRE 24468 19,1 + WK + Zub
2.2 HDi 120	88	04/06→	←	Nutzlast schwer 16Q; Nutzlast [kg]: 1.600; für erhöhte Nutzlast	13.0460-4810.2	604810	BRE 24466 19,1 + WK + Zub
2.2 HDi 130	96	03/11→	←	Nutzlast 20Q; Nutzlast [kg]: 2.000	13.0460-4811.2	604811	BRE 24466 19,1 + WK + Zub
2.2 HDi 150	110	03/11→	←	Nutzlast 20Q; Nutzlast [kg]: 2.000	13.0460-4812.2	604812	BOS 24465 19,2 - WE / - WK + Zub
3.0 HDi	115	02/07→	←	Nutzlast leicht 16Q; Nutzlast [kg]: 1.600; nicht für erhöhte Nutzlast	13.0460-4809.2	604809	BRE 24468 19,1 + WK + Zub
3.0 HDi 145	107	04/10→	←	Nutzlast schwer 16Q; Nutzlast [kg]: 1.600; für erhöhte Nutzlast	13.0460-4810.2	604810	BRE 24466 19,1 + WK + Zub
3.0 HDi 160	116	04/06→	←	Nutzlast 20Q; Nutzlast [kg]: 2.000	13.0460-4811.2	604811	BRE 24466 19,1 + WK + Zub
3.0 HDi 175	130	03/11→	→		13.0460-4812.2	604812	BOS 24465 19,2 - WE / - WK + Zub
 Bremsscheibe							
2.0 BlueHDi 110	81	07/15→	←	Nutzlast leicht 12Q; Nutzlast ab [kg] 1.200 Nutzlast bis [kg] 1.400	24.0124-0127.1	424127	Ø 280 24 21,9 V
2.0 BlueHDi 130	96	07/15→	→	Nutzlast 12Q/14Q + / leicht 16Q; Nutzlast ab [kg] 1.200 Nutzlast bis [kg] 1.600; nicht für erhöhte Nutzlast	24.0116-0124.1	416124	Ø 280 16 14,2
2.0 BlueHDi 160	120	07/15→	→	Nutzlast schwer 16Q; Nutzlast [kg]: 1.600; für erhöhte Nutzlast	24.0116-0125.1	416125	Ø 280 16 14,2
2.2 HDi 100	74	04/06→	←	Nutzlast 12Q/14Q; Nutzlast ab [kg] 1.200 Nutzlast bis [kg] 1.400	24.0124-0127.1	424127	Ø 280 24 21,9 V
2.2 HDi 110	81	03/11→	←	Nutzlast schwer 16Q; Nutzlast [kg]: 1.600; für erhöhte Nutzlast	24.0124-0138.1	424138	Ø 300 24 21,9 V
2.2 HDi 120	88	04/06→	←	Nutzlast leicht 16Q; Nutzlast [kg]: 1.600; nicht für erhöhte Nutzlast	24.0128-0213.1	428213	Ø 280 28 25,9 V
2.2 HDi 130	96	03/11→	←	Nutzlast 20Q; Nutzlast [kg]: 2.000	24.0132-0131.1	432131	Ø 300 32 29,9 V
2.2 HDi 150	110	03/11→	→	Nutzlast 20Q; Nutzlast [kg]: 2.000	24.0116-0123.1	416123	Ø 300 16 14,2
3.0 HDi	115	02/07→	→	Nutzlast 12Q/14Q + / leicht 16Q; Nutzlast ab [kg] 1.200 Nutzlast bis [kg] 1.600; nicht für erhöhte Nutzlast	24.0116-0124.1	416124	Ø 280 16 14,2
3.0 HDi 145	107	04/10→	→	Nutzlast schwer 16Q; Nutzlast [kg]: 1.600; für erhöhte Nutzlast	24.0116-0125.1	416125	Ø 280 16 14,2
3.0 HDi 160	116	04/06→	→				
3.0 HDi 175	130	03/11→	→				
PEUGEOT - BOXER Pritsche/Fahrgestell (244) 12/01→							
 Bremsbelagsatz, Scheibenbremse							
2.0 BiFuel	81	12/01→06/06	←	04/02→ 03/06; Nutzlast ab [kg] 1.000 Nutzlast bis [kg] 1.400	13.0460-4978.2	604978	BRE 23917 19,3 + WK + Zub
			←	04/02→ 03/06; Nutzlast [kg]: 1.800	13.0460-4979.2	604979	BRE 23919 19,3 + WK + Zub
			→	04/02→ 03/06; Nutzlast ab [kg] 1.000 Nutzlast bis [kg] 1.800	13.0460-4980.2	604980	BRE 23921 20,3 - WE / - WK + Zub
2.0 HDi	62	04/02→	←	→ 03/06; Nutzlast ab [kg] 1.000 Nutzlast bis [kg] 1.400	13.0460-4978.2	604978	BRE 23917 19,3 + WK + Zub
2.2 HDi	74	04/02→	←	→ 03/06; Nutzlast [kg]: 1.800	13.0460-4979.2	604979	BRE 23919 19,3 + WK + Zub
2.8 HDi	94	04/02→	←	→ 03/06; Nutzlast ab [kg] 1.000 Nutzlast bis [kg] 1.800	13.0460-4980.2	604980	BRE 23921 20,3 - WE / - WK + Zub
2.8 HDi	107	04/04→	←	→ 03/06; Nutzlast ab [kg] 1.000 Nutzlast bis [kg] 1.800	13.0460-4980.2	604980	BRE 23921 20,3 - WE / - WK + Zub
2.8 HDi 4x4	94	04/02→	→				
 Bremsscheibe							
2.0 BiFuel	81	12/01→06/06	←	04/02→ 03/06; Nutzlast ab [kg] 1.000 Nutzlast bis [kg] 1.400	24.0124-0127.1	424127	Ø 280 24 21,9 V
			→	04/02→ 03/06; Nutzlast ab [kg] 1.000 Nutzlast bis [kg] 1.400	24.0116-0124.1	416124	Ø 280 16 14,2
			→	04/02→ 03/06; Nutzlast [kg]: 1.800	24.0116-0125.1	416125	Ø 280 16 14,2
2.0 HDi	62	04/02→	←	→ 03/06; Nutzlast ab [kg] 1.000 Nutzlast bis [kg] 1.400	24.0124-0127.1	424127	Ø 280 24 21,9 V
2.2 HDi	74	04/02→	←	→ 03/06; Nutzlast [kg]: 1.800	24.0124-0138.1	424138	Ø 300 24 21,9 V
2.8 HDi	94	04/02→	←	→ 03/06; Nutzlast ab [kg] 1.000 Nutzlast bis [kg] 1.400	24.0124-0127.1	424127	Ø 280 24 21,9 V
2.8 HDi	107	04/04→	←	→ 03/06; Nutzlast [kg]: 1.800	24.0124-0138.1	424138	Ø 300 24 21,9 V
↓							













	kw			 	! #		
PEUGEOT - BOXER Pritsche/Fahrgestell (244) 12/01→							
 Bremsscheibe							
2.8 HDi 4x4	94	04/02→	➔	→ 03/06; Nutzlast ab [kg] 1.000 Nutzlast bis [kg] 1.400	24.0116-0124.1	416124	Ø 280 16 14,2
			➔	→ 03/06; Nutzlast [kg]: 1.800	24.0116-0125.1	416125	Ø 280 16 14,2
PEUGEOT - BOXER Pritsche/Fahrgestell (ZCT_) 03/94→04/02							
 Bremsbelagsatz, Scheibenbremse							
1.9 D	51	03/94→04/02	←	→ S 16206253; Nutzlast ab [kg] 1.000 Nutzlast bis [kg] 1.400	13.0460-2850.2	602850	TRW 21797 19,7 + WK
			←	S 16204256→; Nutzlast ab [kg] 1.000 Nutzlast bis [kg] 1.400	13.0460-2976.2	602976	TRW 21797 19,7 + WK
			➔	S 16194400→; Nutzlast ab [kg] 1.000 Nutzlast bis [kg] 1.400	13.0460-4978.2	604978	BRE 23917 19,3 + WK + Zub
			➔	S 16194400→; Nutzlast ab [kg] 1.000 Nutzlast bis [kg] 1.400	13.0460-4980.2	604980	BRE 23921 20,3 - WE / - WK + Zub
1.9 TD	66	06/94→04/02	←	01/00→ 10/01; Nutzlast ab [kg] 1.000 Nutzlast bis [kg] 1.400	13.0460-2850.2	602850	TRW 21797 19,7 + WK
			←	12/98→ 12/99; Nutzlast ab [kg] 1.000 Nutzlast bis [kg] 1.400	13.0460-2976.2	602976	TRW 21797 19,7 + WK
			←	11/01→ 03/02; Nutzlast ab [kg] 1.000 Nutzlast bis [kg] 1.400	13.0460-4978.2	604978	BRE 23917 19,3 + WK + Zub
			➔	11/01→ 03/02; Nutzlast ab [kg] 1.000 Nutzlast bis [kg] 1.400	13.0460-4980.2	604980	BRE 23921 20,3 - WE / - WK + Zub
1.9 TD	68	07/94→04/02	←	01/00→ 10/01; Nutzlast ab [kg] 1.000 Nutzlast bis [kg] 1.400	13.0460-2850.2	602850	TRW 21797 19,7 + WK
			←	07/96→ 12/99; Nutzlast ab [kg] 1.000 Nutzlast bis [kg] 1.400	13.0460-2976.2	602976	TRW 21797 19,7 + WK
			←	11/01→ 03/02; Nutzlast ab [kg] 1.000 Nutzlast bis [kg] 1.400	13.0460-4978.2	604978	BRE 23917 19,3 + WK + Zub
			➔	11/01→ 03/02; Nutzlast ab [kg] 1.000 Nutzlast bis [kg] 1.400	13.0460-4980.2	604980	BRE 23921 20,3 - WE / - WK + Zub
2.0	81	12/01→04/02	←	→ 03/02; Nutzlast ab [kg] 1.000 Nutzlast bis [kg] 1.400	13.0460-4978.2	604978	BRE 23917 19,3 + WK + Zub
			←	→ 03/02; Nutzlast [kg]: 1.800	13.0460-4979.2	604979	BRE 23919 19,3 + WK + Zub
			➔	→ 03/02; Nutzlast ab [kg] 1.000 Nutzlast bis [kg] 1.800	13.0460-4980.2	604980	BRE 23921 20,3 - WE / - WK + Zub
2.0 i	80	06/94→04/02	←	01/00→ 10/01; Nutzlast ab [kg] 1.000 Nutzlast bis [kg] 1.400	13.0460-2850.2	602850	TRW 21797 19,7 + WK
			←	01/00→ 10/01; Nutzlast [kg]: 1.800	13.0460-2852.2	602852	TRW 21799 19,7 + WK
			←	→ 12/99; Nutzlast ab [kg] 1.000 Nutzlast bis [kg] 1.400	13.0460-2976.2	602976	TRW 21797 19,7 + WK
			←	→ 12/99; Nutzlast [kg]: 1.800	13.0460-2977.2	602977	TRW 21799 19,7 + WK
			←	11/01→ 03/02; Nutzlast ab [kg] 1.000 Nutzlast bis [kg] 1.400	13.0460-4978.2	604978	BRE 23917 19,3 + WK + Zub
			←	11/01→ 03/02; Nutzlast [kg]: 1.800	13.0460-4979.2	604979	BRE 23919 19,3 + WK + Zub
			➔	11/01→ 03/02; Nutzlast ab [kg] 1.000 Nutzlast bis [kg] 1.800	13.0460-4980.2	604980	BRE 23921 20,3 - WE / - WK + Zub
2.5 D 2.5 D 4x4 2.5 TD 2.5 TDI 2.5 TDI 4x4	63 63 76 79 79	03/94→04/02 07/99→04/02 03/94→04/02 01/97→04/02 07/99→04/02	←	01/00→ 10/01; Nutzlast [kg]: 1.400	13.0460-2850.2	602850	TRW 21797 19,7 + WK
			←	01/00→ 10/01; Nutzlast [kg]: 1.800	13.0460-2852.2	602852	TRW 21799 19,7 + WK
			←	→ 12/99; Nutzlast [kg]: 1.400	13.0460-2976.2	602976	TRW 21797 19,7 + WK
			←	→ 12/99; Nutzlast [kg]: 1.800	13.0460-2977.2	602977	TRW 21799 19,7 + WK
			←	11/01→ 03/02; Nutzlast [kg]: 1.400	13.0460-4978.2	604978	BRE 23917 19,3 + WK + Zub
			←	11/01→ 03/02; Nutzlast [kg]: 1.800	13.0460-4979.2	604979	BRE 23919 19,3 + WK + Zub
			➔	11/01→ 03/02; Nutzlast ab [kg] 1.400 Nutzlast bis [kg] 1.800	13.0460-4980.2	604980	BRE 23921 20,3 - WE / - WK + Zub
2.8 D	64	01/99→02/02	←	→ S 16206253; Nutzlast [kg]: 1.400	13.0460-2850.2	602850	TRW 21797 19,7 + WK
			←	→ S 16205352; Nutzlast [kg]: 1.800	13.0460-2976.2	602976	TRW 21797 19,7 + WK
			←	→ S 16205352; Nutzlast [kg]: 1.800	13.0460-2977.2	602977	TRW 21799 19,7 + WK
			←	S 16204256→; Nutzlast [kg]: 1.400	13.0460-4978.2	604978	BRE 23917 19,3 + WK + Zub
			←	S 16194400→; Nutzlast [kg]: 1.800	13.0460-4979.2	604979	BRE 23919 19,3 + WK + Zub
			➔	S 16194400→; Nutzlast ab [kg] 1.400 Nutzlast bis [kg] 1.800	13.0460-4980.2	604980	BRE 23921 20,3 - WE / - WK + Zub
2.8 HDi	93	10/00→11/01	➔	11/01→; Nutzlast ab [kg] 1.400 Nutzlast bis [kg] 1.800	13.0460-4980.2	604980	BRE 23921 20,3 - WE / - WK + Zub
2.8 HDi	94	11/00→04/02	←	→ 10/01; Nutzlast [kg]: 1.400	13.0460-2850.2	602850	TRW 21797 19,7 + WK
			←	→ 10/01; Nutzlast [kg]: 1.800	13.0460-2852.2	602852	TRW 21799 19,7 + WK
			←	11/01→ 03/02; Nutzlast [kg]: 1.400	13.0460-4978.2	604978	BRE 23917 19,3 + WK + Zub
			←	11/01→ 03/02; Nutzlast [kg]: 1.800	13.0460-4979.2	604979	BRE 23919 19,3 + WK + Zub









	kw					! #		
PEUGEOT - BOXER Pritsche/Fahrgestell (ZCT_) 03/94→04/02								
 Bremsbelagsatz, Scheibenbremse								
2.8 HDI	94	11/00→04/02	➔	11/01→ 03/02; Nutzlast ab [kg] 1.400 Nutzlast bis [kg] 1.800		13.0460-4980.2	604980	BRE 23921 20,3 - WE / - WK + Zub
2.8 HDi Allrad	93	10/00→11/01	➔	→ 10/01; Nutzlast [kg]: 1.400		13.0460-2850.2	602850	TRW 21797 19,7 + WK
			➔	→ 10/01; Nutzlast [kg]: 1.800		13.0460-2852.2	602852	TRW 21799 19,7 + WK
			➔	11/01→; Nutzlast [kg]: 1.400		13.0460-4978.2	604978	BRE 23917 19,3 + WK + Zub
			➔	11/01→; Nutzlast [kg]: 1.800		13.0460-4979.2	604979	BRE 23919 19,3 + WK + Zub
			➔	11/01→; Nutzlast ab [kg] 1.400 Nutzlast bis [kg] 1.800		13.0460-4980.2	604980	BRE 23921 20,3 - WE / - WK + Zub
 Bremsscheibe								
1.9 D	51	03/94→04/02	➔	→ S 16206253; Nutzlast ab [kg] 1.000 Nutzlast bis [kg] 1.400		24.0118-0108.1	418108	Ø 280 18 15,9
			➔	S 16204256→; Nutzlast ab [kg] 1.000 Nutzlast bis [kg] 1.400		24.0124-0127.1	424127	Ø 280 24 21,9 V
			➔	S 16194400→; Nutzlast ab [kg] 1.000 Nutzlast bis [kg] 1.400		24.0116-0124.1	416124	Ø 280 16 14,2
1.9 TD	66	06/94→04/02	➔	12/98→ 12/99; Nutzlast ab [kg] 1.000 Nutzlast bis [kg] 1.400		24.0118-0108.1	418108	Ø 280 18 15,9
			➔	11/01→ 03/02; Nutzlast ab [kg] 1.000 Nutzlast bis [kg] 1.400		24.0116-0124.1	416124	Ø 280 16 14,2
1.9 TD	68	07/94→04/02	➔	07/96→ 12/99; Nutzlast ab [kg] 1.000 Nutzlast bis [kg] 1.400		24.0118-0108.1	418108	Ø 280 18 15,9
			➔	11/01→ 03/02; Nutzlast ab [kg] 1.000 Nutzlast bis [kg] 1.400		24.0116-0124.1	416124	Ø 280 16 14,2
2.0	81	12/01→04/02	➔	→ 03/02; Nutzlast [kg]: 1.800		24.0124-0138.1	424138	Ø 300 24 21,9 V
			➔	→ 03/02; Nutzlast ab [kg] 1.000 Nutzlast bis [kg] 1.400		24.0116-0124.1	416124	Ø 280 16 14,2
			➔	→ 03/02; Nutzlast [kg]: 1.800		24.0116-0125.1	416125	Ø 280 16 14,2
2.0 i	80	06/94→04/02	➔	→ 12/99; Nutzlast ab [kg] 1.000 Nutzlast bis [kg] 1.400		24.0118-0108.1	418108	Ø 280 18 15,9
			➔	→ 03/02; Nutzlast [kg]: 1.800		24.0124-0138.1	424138	Ø 300 24 21,9 V
			➔	11/01→ 03/02; Nutzlast ab [kg] 1.000 Nutzlast bis [kg] 1.400		24.0116-0124.1	416124	Ø 280 16 14,2
			➔	11/01→ 03/02; Nutzlast [kg]: 1.800		24.0116-0125.1	416125	Ø 280 16 14,2
2.5 D 2.5 D 4x4	63 63	03/94→04/02 07/99→04/02	➔	→ 12/99; Nutzlast [kg]: 1.400		24.0118-0108.1	418108	Ø 280 18 15,9
			➔	→ 03/02; Nutzlast [kg]: 1.800		24.0124-0138.1	424138	Ø 300 24 21,9 V
			➔	11/01→ 03/02; Nutzlast [kg]: 1.400		24.0116-0124.1	416124	Ø 280 16 14,2
			➔	11/01→ 03/02; Nutzlast [kg]: 1.800		24.0116-0125.1	416125	Ø 280 16 14,2
2.5 TD 2.5 TDI 2.5 TDI 4x4 2.8 HDI	76 79 79 94	03/94→04/02 01/97→04/02 07/99→04/02 11/00→04/02	➔	→ 03/02; Nutzlast [kg]: 1.400		24.0124-0127.1	424127	Ø 280 24 21,9 V
			➔	→ 03/02; Nutzlast [kg]: 1.800		24.0124-0138.1	424138	Ø 300 24 21,9 V
			➔	11/01→ 03/02; Nutzlast [kg]: 1.400		24.0116-0124.1	416124	Ø 280 16 14,2
			➔	11/01→ 03/02; Nutzlast [kg]: 1.800		24.0116-0125.1	416125	Ø 280 16 14,2
2.8 D	64	01/99→02/02	➔	→ S 16206253; Nutzlast [kg]: 1.400		24.0118-0108.1	418108	Ø 280 18 15,9
			➔	S 16204256→; Nutzlast [kg]: 1.400		24.0124-0127.1	424127	Ø 280 24 21,9 V
			➔	Nutzlast [kg]: 1.800		24.0124-0138.1	424138	Ø 300 24 21,9 V
			➔	S 16194400→; Nutzlast [kg]: 1.400		24.0116-0124.1	416124	Ø 280 16 14,2
			➔	S 16194400→; Nutzlast [kg]: 1.800		24.0116-0125.1	416125	Ø 280 16 14,2
2.8 HDi Allrad	93	10/00→11/01	➔	Nutzlast [kg]: 1.400		24.0124-0127.1	424127	Ø 280 24 21,9 V
			➔	Nutzlast [kg]: 1.800		24.0124-0138.1	424138	Ø 300 24 21,9 V
			➔	11/01→; Nutzlast [kg]: 1.400		24.0116-0124.1	416124	Ø 280 16 14,2
PEUGEOT - EXPERT (224) 10/95→12/06								
 Bremsbelagsatz, Scheibenbremse								
1.6	58	02/96→09/00	➔	Orga 09793→		13.0460-2863.2	602863	TRW 20261 19,0 + WK + Zub
			➔	→Orga 09792		13.0460-2978.2	602978	TRW 21801 19,0 + WK
			➔	→Orga 09155		13.0460-3957.2	603957	BDX 23042 19,0 + WK + Zub
1.8	74	10/96→09/00	➔	Orga 09793→		13.0460-2863.2	602863	TRW 20261 19,0 + WK + Zub
1.9 TD	66	02/96→09/00						
2.0 HDi	69	10/00→10/06	➔	→Orga 09792		13.0460-2978.2	602978	TRW 21801 19,0 + WK
2.0 HDI	80	07/00→12/06						
2.0 HDI 16V	80	07/00→12/06						
1.9 D	51	02/96→12/98	➔	→Orga 09155		13.0460-2978.2	602978	TRW 21801 19,0 + WK
1.9 D	51	12/03→12/06						
↓								







	kw			 	! #		
PEUGEOT - EXPERT (224) 10/95→12/06							
 Bremsbelagsatz, Scheibenbremse							
1.9 D	51	02/96→12/98	←	Orga 09156→		13.0460-3957.2 603957	BDX 23042 19,0 + WK + Zub
1.9 D	51	12/03→12/06					
1.9 TD	68	02/96→05/98	←	Orga 09793→		13.0460-2863.2 602863	TRW 20261 19,0 + WK + Zub
			←	04/96→; →Orga 09792		13.0460-2978.2 602978	TRW 21801 19,0 + WK
2.0	100	07/00→12/06	←	Orga 09793→		13.0460-2863.2 602863	TRW 20261 19,0 + WK + Zub
			←	Orga 09156→ Orga 09792		13.0460-2978.2 602978	TRW 21801 19,0 + WK
			←	→Orga 09155		13.0460-3957.2 603957	BDX 23042 19,0 + WK + Zub
 Bremsscheibe							
1.6	58	02/96→09/00	←	→Orga 09155		24.0120-0155.1 420155	Ø 257,5 20 18,2 V
1.8	74	10/96→09/00					
1.9 D	51	02/96→12/98	←	→Orga 09792		24.0126-0104.1 426104	Ø 281 26 24,2 V
1.9 D	51	12/03→12/06	←	Orga 09793→		24.0128-0136.1 428136	Ø 285 28 26 V
1.9 TD	66	02/96→09/00					
2.0	100	07/00→12/06				24.0328-0136.1 528136	Ø 285 28 26 V PD
2.0 HDi	69	10/00→10/06					
2.0 HDi	80	07/00→12/06					
2.0 HDi 16V	80	07/00→12/06					
1.9 TD	68	02/96→05/98	←	04/96→; →Orga 09155		24.0120-0155.1 420155	Ø 257,5 20 18,2 V
			←	04/96→; →Orga 09792		24.0126-0104.1 426104	Ø 281 26 24,2 V
			←	Orga 09793→		24.0128-0136.1 428136	Ø 285 28 26 V
						24.0328-0136.1 528136	Ø 285 28 26 V PD
PEUGEOT - EXPERT Kasten 04/16→							
 Bremsscheibe							
1.6 BlueHDi 115	85	04/16→	→			24.0112-0212.1 412212	Ø 290 12 10 + S
1.6 BlueHDi 95	70	04/16→					
2.0 BlueHDi 120	90	04/16→					
2.0 BlueHDi 150	110	04/16→					
2.0 BlueHDi 180	130	04/16→					
PEUGEOT - EXPERT Kasten (222) 07/95→12/06							
 Bremsbelagsatz, Scheibenbremse							
1.6	58	02/96→09/00	←	Orga 09793→; Nutzlast [kg]: 800 / 900		13.0460-2863.2 602863	TRW 20261 19,0 + WK + Zub
1.8	74	10/96→09/00					
1.9 D	51	02/96→12/98	←	→Orga 09792; Nutzlast [kg]: 900		13.0460-2978.2 602978	TRW 21801 19,0 + WK
1.9 D 70	51	12/98→12/06	←	Orga 09156→ Orga 09792;		13.0460-2978.2 602978	TRW 21801 19,0 + WK
1.9 TD	66	02/96→09/00		Nutzlast [kg]: 800			
2.0	100	09/02→12/06	←	→Orga 09155; Nutzlast [kg]: 800		13.0460-3957.2 603957	BDX 23042 19,0 + WK + Zub
2.0 HDi	69	07/00→12/06					
2.0 HDi	80	07/00→12/06					
1.9 TD	68	02/96→05/98	←	Orga 09793→; Nutzlast [kg]: 800 / 900		13.0460-2863.2 602863	TRW 20261 19,0 + WK + Zub
			←	04/96→; →Orga 09792;		13.0460-2978.2 602978	TRW 21801 19,0 + WK
			←	Nutzlast [kg]: 900			
			←	Orga 09156→ Orga 09792;		13.0460-2978.2 602978	TRW 21801 19,0 + WK
			←	Nutzlast [kg]: 800			
			←	04/96→; →Orga 09155;		13.0460-3957.2 603957	BDX 23042 19,0 + WK + Zub
				Nutzlast [kg]: 800			
 Bremsscheibe							
1.6	58	02/96→09/00	←	→Orga 09155; Nutzlast [kg]: 800		24.0120-0155.1 420155	Ø 257,5 20 18,2 V
1.8	74	10/96→09/00					
1.9 D	51	02/96→12/98	←	→Orga 09792; Nutzlast [kg]: 900		24.0126-0104.1 426104	Ø 281 26 24,2 V
1.9 D 70	51	12/98→12/06	←	Orga 09156→ Orga 09792;		24.0126-0104.1 426104	Ø 281 26 24,2 V
1.9 TD	66	02/96→09/00		Nutzlast [kg]: 800			
2.0	100	09/02→12/06	←	Orga 09793→; Nutzlast [kg]: 800		24.0128-0136.1 428136	Ø 285 28 26 V
2.0 HDi	69	07/00→12/06				24.0328-0136.1 528136	Ø 285 28 26 V PD
2.0 HDi	80	07/00→12/06					
1.9 TD	68	02/96→05/98	←	Orga 09793→; Nutzlast [kg]: 900		24.0128-0136.1 428136	Ø 285 28 26 V
			←			24.0328-0136.1 528136	Ø 285 28 26 V PD
			←	04/96→; →Orga 09155;		24.0120-0155.1 420155	Ø 257,5 20 18,2 V
			←	Nutzlast [kg]: 800			
			←	04/96→; →Orga 09792;		24.0126-0104.1 426104	Ø 281 26 24,2 V
			←	Nutzlast [kg]: 900			
			←	Orga 09156→ Orga 09792;		24.0126-0104.1 426104	Ø 281 26 24,2 V
			←	Nutzlast [kg]: 800			
			←	Orga 09793→; Nutzlast [kg]: 900		24.0128-0136.1 428136	Ø 285 28 26 V
			←			24.0328-0136.1 528136	Ø 285 28 26 V PD
			←	Orga 09793→; Nutzlast [kg]: 800		24.0128-0136.1 428136	Ø 285 28 26 V
						24.0328-0136.1 528136	Ø 285 28 26 V PD





















	kW					! #		
PEUGEOT - EXPERT Kasten (VF3A_, VF3U_, VF3X_) 01/07→								
 Bremsbelagsatz, Scheibenbremse								
1.6 HDi 90 16V	66	01/07→	←			13.0460-2738.2	602738	TRW 24608 18,5 + WK + Zub
1.6 HDi 90 8V	66	01/07→	→			13.0460-2739.2	602739	TRW 24578 16,5 - WE / - WK + Zub
2.0 HDi 100	72	03/11→	←					
2.0 HDi 120	88	01/07→	→					
2.0 HDi 120 4x4	88	01/10→	←					
2.0 HDi 130	94	03/11→	→					
2.0 HDi 130 4x4	94	01/12→	←					
2.0 HDi 140	100	01/07→	→					
2.0 HDi 165	120	09/09→	←					
2.0 16V	103	01/07→	←			13.0460-2738.2	602738	TRW 24608 18,5 + WK + Zub
			→	langer Radstand		13.0460-2739.2	602739	TRW 24578 16,5 - WE / - WK + Zub
 Bremsscheibe								
1.6 HDi 90 16V	66	01/07→	←	für Fahrzeuge mit Trommelbremse an der Hinterachse		24.0128-0214.1	428214	Ø 280 28 26 V + S
1.6 HDi 90 8V	66	01/07→	←	für Fahrzeuge mit Scheibenbremse an der Hinterachse		24.0128-0216.1	428216	Ø 304 28 26 V + S
			→			24.0114-0116.1	414116	Ø 290 14 12 + S
2.0 16V	103	01/07→	←			24.0128-0216.1	428216	Ø 304 28 26 V + S
			→	langer Radstand		24.0114-0116.1	414116	Ø 290 14 12 + S
2.0 HDi 100	72	03/11→	←			24.0128-0216.1	428216	Ø 304 28 26 V + S
2.0 HDi 120	88	01/07→	→			24.0114-0116.1	414116	Ø 290 14 12 + S
2.0 HDi 120 4x4	88	01/10→	←					
2.0 HDi 130	94	03/11→	→					
2.0 HDi 130 4x4	94	01/12→	←					
2.0 HDi 140	100	01/07→	→					
2.0 HDi 165	120	09/09→	←					
PEUGEOT - EXPERT Pritsche/Fahrgestell 01/07→								
 Bremsbelagsatz, Scheibenbremse								
1.6 HDi 90 16V	66	01/07→	←			13.0460-2738.2	602738	TRW 24608 18,5 + WK + Zub
1.6 HDi 90 8V	66	01/07→	→			13.0460-2739.2	602739	TRW 24578 16,5 - WE / - WK + Zub
2.0 HDi 120	88	01/07→	←					
2.0 HDi 130	94	03/11→	→					
2.0 HDi 140	100	01/07→	←					
2.0 HDi 165	120	09/09→	→					
 Bremsscheibe								
1.6 HDi 90 16V	66	01/07→	←	für Fahrzeuge mit Trommelbremse an der Hinterachse		24.0128-0214.1	428214	Ø 280 28 26 V + S
1.6 HDi 90 8V	66	01/07→	←	für Fahrzeuge mit Scheibenbremse an der Hinterachse		24.0128-0216.1	428216	Ø 304 28 26 V + S
			→			24.0114-0116.1	414116	Ø 290 14 12 + S
2.0 HDi 120	88	01/07→	←			24.0128-0216.1	428216	Ø 304 28 26 V + S
2.0 HDi 130	94	03/11→	→			24.0114-0116.1	414116	Ø 290 14 12 + S
2.0 HDi 140	100	01/07→	←					
2.0 HDi 165	120	09/09→	→					
PEUGEOT - EXPERT Pritsche/Fahrgestell 09/16→								
 Bremsscheibe								
1.6 BlueHDi 95	70	09/16→	→			24.0112-0212.1	412212	Ø 290 12 10 + S
2.0 BlueHDi 120	90	09/16→	←					
2.0 BlueHDi 150	110	09/16→	→					
PEUGEOT - EXPERT Pritsche/Fahrgestell (223) 12/95→12/06								
 Bremsbelagsatz, Scheibenbremse								
1.6	58	02/96→09/00	←	Orga 09793→		13.0460-2863.2	602863	TRW 20261 19,0 + WK + Zub
1.9 D	51	02/96→12/98	←	→Orga 09792		13.0460-2978.2	602978	TRW 21801 19,0 + WK
1.9 D	51	06/98→09/01	←					
1.9 TD	66	02/96→09/00	←					
2.0 HDi	69	10/00→10/06	←					
2.0 HDi	80	10/00→10/06	←					
1.9 TD	68	02/96→05/98	←	Orga 09793→		13.0460-2863.2	602863	TRW 20261 19,0 + WK + Zub
			←	04/96→; →Orga 09792		13.0460-2978.2	602978	TRW 21801 19,0 + WK
 Bremsscheibe								
1.6	58	02/96→09/00	←	→Orga 09792		24.0126-0104.1	426104	Ø 281 26 24,2 V
1.9 D	51	02/96→12/98	←			24.0128-0136.1	428136	Ø 285 28 26 V
1.9 D	51	06/98→09/01	←	Orga 09793→		24.0328-0136.1	528136	Ø 285 28 26 V PD
1.9 TD	66	02/96→09/00	←					
2.0 HDi	69	10/00→10/06	←					
2.0 HDi	80	10/00→10/06	←					













	kW					! #		
PEUGEOT - EXPERT Pritsche/Fahrgestell (223) 12/95→12/06								
 Bremsscheibe								
1.9 TD	68	02/96→05/98	←	04/96→; →Orga 09792		24.0126-0104.1	426104	Ø 281 26 24,2 V
			←	Orga 09793→		24.0128-0136.1	428136	Ø 285 28 26 V
						24.0328-0136.1	528136	Ø 285 28 26 V PD
PEUGEOT - EXPERT Tepee (VF3V_) 01/07→								
 Bremsbelagsatz, Scheibenbremse								
1.6 HDi 90 16V	66	01/07→	←			13.0460-2738.2	602738	TRW 24608 18,5 + WK + Zub
1.6 HDi 90 8V	66	01/07→	→			13.0460-2739.2	602739	TRW 24578 16,5 - WE / - WK + Zub
2.0 HDi 100	72	03/11→						
2.0 HDi 120	88	01/07→						
2.0 HDi 120 4x4	88	01/07→						
2.0 HDi 130	94	03/11→						
2.0 HDi 130 4x4	94	03/11→						
2.0 HDi 140	100	01/07→						
2.0 HDi 165	120	09/09→						
2.0 16V	103	01/07→	←			13.0460-2738.2	602738	TRW 24608 18,5 + WK + Zub
			→	langer Radstand		13.0460-2739.2	602739	TRW 24578 16,5 - WE / - WK + Zub
 Bremsscheibe								
1.6 HDi 90 16V	66	01/07→	←	für Fahrzeuge mit Trommelbremse an der Hinterachse		24.0128-0214.1	428214	Ø 280 28 26 V + S
1.6 HDi 90 8V	66	01/07→	←	für Fahrzeuge mit Scheibenbremse an der Hinterachse		24.0128-0216.1	428216	Ø 304 28 26 V + S
			→			24.0114-0116.1	414116	Ø 290 14 12 + S
2.0 16V	103	01/07→	←			24.0128-0216.1	428216	Ø 304 28 26 V + S
			→	langer Radstand		24.0114-0116.1	414116	Ø 290 14 12 + S
2.0 HDi 100	72	03/11→	←			24.0128-0216.1	428216	Ø 304 28 26 V + S
2.0 HDi 120	88	01/07→	→			24.0114-0116.1	414116	Ø 290 14 12 + S
2.0 HDi 120 4x4	88	01/07→						
2.0 HDi 130	94	03/11→						
2.0 HDi 130 4x4	94	03/11→						
2.0 HDi 140	100	01/07→						
2.0 HDi 165	120	09/09→						
PEUGEOT - ION 11/10→								
 Bremsbelagsatz, Scheibenbremse								
Electric	35	11/10→	←			13.0460-5621.2	605621	24423 14,6 + WK
Electric	47	11/10→						
Electric	49	10/14→						
 Bremsscheibe								
Electric	35	11/10→	←			24.0117-0110.1	417110	Ø 257 17 15 V
Electric	47	11/10→						
Electric	49	10/14→						
PEUGEOT - PARTNER Combispace (5F) 05/96→12/15								
 Bremsbelagsatz, Scheibenbremse								
1.1	44	06/96→10/02	←	07/96→ 09/02		13.0460-2829.2	602829	TRW 23124 19,0 + WK
			←	10/02→		13.0460-3994.2	603994	BOS 23599 19,0 - WE / - WK + Zub
						13.0470-3994.2	LD3994	BOS 23599 19,0 - WE / - WK + Zub Ceramic
1.4	54	11/02→10/06	←			13.0460-2829.2	602829	TRW 23124 19,0 + WK
						13.0460-3994.2	603994	BOS 23599 19,0 - WE / - WK + Zub
						13.0470-3994.2	LD3994	BOS 23599 19,0 - WE / - WK + Zub Ceramic
1.4	55	06/96→12/15	←	07/96→ 09/02		13.0460-2829.2	602829	TRW 23124 19,0 + WK
			←	10/02→ 03/08		13.0460-3994.2	603994	BOS 23599 19,0 - WE / - WK + Zub
						13.0470-3994.2	LD3994	BOS 23599 19,0 - WE / - WK + Zub Ceramic
1.6 16V	80	07/01→03/08	←	→Orga 09127		13.0460-2829.2	602829	TRW 23124 19,0 + WK
2.0 HDi 4x4	66	04/04→08/05	←	Orga 09128→; + ESP		13.0460-3811.2	603811	BOS 23708 19,2 - WE / - WK + Zub
			←	Orga 09128→; - ESP		13.0460-3994.2	603994	BOS 23599 19,0 - WE / - WK + Zub
						13.0470-3994.2	LD3994	BOS 23599 19,0 - WE / - WK + Zub Ceramic













	kw			 	! #		
PEUGEOT - PARTNER Combispace (5F) 05/96→12/15							
 Bremsbelagsatz, Scheibenbremse							
1.6 16V 2.0 HDi 4x4	80 66	07/01→03/08 04/04→08/05	➡	+ ESP		13.0460-2820.2 602820 13.0470-2823.2 LD2823	TRW 20961 17,2 - WK TRW 23554 17,2 - WK Ceramic
1.6 Flexfuel	80	09/00→10/02	⬅	07/01→; →Orga 09127		13.0460-2829.2 602829	TRW 23124 19,0 + WK
			⬅	Orga 09128→; + ESP		13.0460-3811.2 603811	BOS 23708 19,2 - WE / - WK
			⬅	Orga 09128→; - ESP		13.0460-3994.2 603994 13.0470-3994.2 LD3994	BOS 23599 19,0 - WE / - WK + Zub BOS 23599 19,0 - WE / - WK + Zub Ceramic
			➡	07/01→; + ESP		13.0460-2820.2 602820 13.0470-2823.2 LD2823	TRW 20961 17,2 - WK TRW 23554 17,2 - WK Ceramic
1.6 HDi 75	55	02/06→12/13	⬅	→ 03/08; + ESP		13.0460-3811.2 603811	BOS 23708 19,2 - WE / - WK
			⬅	→ 03/08; - ESP		13.0460-3994.2 603994 13.0470-3994.2 LD3994	BOS 23599 19,0 - WE / - WK + Zub BOS 23599 19,0 - WE / - WK + Zub Ceramic
			➡	→ 03/08; + ESP		13.0460-2820.2 602820 13.0470-2823.2 LD2823	TRW 20961 17,2 - WK TRW 23554 17,2 - WK Ceramic
1.6 HDi 90	66	10/05→12/15	⬅	02/06→ 03/08; + ESP		13.0460-3811.2 603811	BOS 23708 19,2 - WE / - WK
			⬅	02/06→ 03/08; - ESP		13.0460-3994.2 603994 13.0470-3994.2 LD3994	BOS 23599 19,0 - WE / - WK + Zub BOS 23599 19,0 - WE / - WK + Zub Ceramic
			➡	02/06→ 03/08; + ESP		13.0460-2820.2 602820 13.0470-2823.2 LD2823	TRW 20961 17,2 - WK TRW 23554 17,2 - WK Ceramic
1.8	66	05/97→12/03	⬅	→Orga 09127		13.0460-2829.2 602829	TRW 23124 19,0 + WK
			⬅	Orga 09128→		13.0460-3994.2 603994 13.0470-3994.2 LD3994	BOS 23599 19,0 - WE / - WK + Zub BOS 23599 19,0 - WE / - WK + Zub Ceramic
1.9 D	50	06/96→12/02	⬅	07/96→; →Orga 09127		13.0460-2829.2 602829	TRW 23124 19,0 + WK
			⬅	Orga 09128→		13.0460-3994.2 603994 13.0470-3994.2 LD3994	BOS 23599 19,0 - WE / - WK + Zub BOS 23599 19,0 - WE / - WK + Zub Ceramic
1.9 D	51	05/96→12/98	⬅	12/98→; →Orga 09127		13.0460-2829.2 602829	TRW 23124 19,0 + WK
			⬅	Orga 09128→		13.0460-3994.2 603994 13.0470-3994.2 LD3994	BOS 23599 19,0 - WE / - WK + Zub BOS 23599 19,0 - WE / - WK + Zub Ceramic
1.9 D	51	12/98→07/08	⬅	→Orga 09127		13.0460-2829.2 602829	TRW 23124 19,0 + WK
			⬅	Orga 09128→; → 03/08		13.0460-3994.2 603994 13.0470-3994.2 LD3994	BOS 23599 19,0 - WE / - WK + Zub BOS 23599 19,0 - WE / - WK + Zub Ceramic
1.9 D 4x4	51	04/04→08/05	⬅			13.0460-3994.2 603994 13.0470-3994.2 LD3994	BOS 23599 19,0 - WE / - WK + Zub BOS 23599 19,0 - WE / - WK + Zub Ceramic
2.0 HDI	66	02/00→07/08	⬅	→Orga 09127		13.0460-2829.2 602829	TRW 23124 19,0 + WK
			⬅	Orga 09128→; → 03/08; + ESP		13.0460-3811.2 603811	BOS 23708 19,2 - WE / - WK
			⬅	Orga 09128→; → 03/08; - ESP		13.0460-3994.2 603994 13.0470-3994.2 LD3994	BOS 23599 19,0 - WE / - WK + Zub BOS 23599 19,0 - WE / - WK + Zub Ceramic
			➡	→ 03/08; + ESP		13.0460-2820.2 602820 13.0470-2823.2 LD2823	TRW 20961 17,2 - WK TRW 23554 17,2 - WK Ceramic
Electric	28	01/98→12/01	⬅			13.0460-2829.2 602829	TRW 23124 19,0 + WK
 Bremsscheibe							
1.1	44	06/96→10/02	⬅	07/96→ 09/02		24.0113-0184.1 413184 24.0313-0184.1 513184	Ø 266 13 11 + S Ø 266 13 11 + S PD
			⬅	10/02→		24.0122-0194.1 422194	Ø 266 22 20 V + S
1.4 1.9 D 4x4	54 51	11/02→10/06 04/04→08/05	⬅			24.0122-0194.1 422194	Ø 266 22 20 V + S
↓							













	kw			 	! #		
PEUGEOT - PARTNER Combispace (5F) 05/96→12/15							
Bremsscheibe							
1.4	55	06/96→12/15	←	07/96→09/02		24.0113-0184.1 413184	Ø 266 13 11 + S
						24.0313-0184.1 513184	Ø 266 13 11 + S PD
			←	10/02→; →Orga 09127		24.0120-0133.1 420133	Ø 266 20,5 18,5 V + S
						24.0320-0133.1 520133	Ø 266 20,5 18,5 V + S PD
1.6 16V	80	07/01→03/08	←	→Orga 09127		24.0120-0133.1 420133	Ø 266 20,5 18,5 V + S
						24.0320-0133.1 520133	Ø 266 20,5 18,5 V + S PD
			←	Orga 09128→; - ESP		24.0122-0194.1 422194	Ø 266 22 20 V + S
			←	Orga 09128→; + ESP		24.0126-0120.1 426120	Ø 283 26 24 V + S
			24.0326-0120.1 526120	Ø 283 26 24 V + S PD			
			→ + ESP		24.0109-0137.1 409137	Ø 247 9 8 + S	
1.6 Flexfuel	80	09/00→10/02	←	07/01→; →Orga 09127		24.0120-0133.1 420133	Ø 266 20,5 18,5 V + S
						24.0320-0133.1 520133	Ø 266 20,5 18,5 V + S PD
			←	Orga 09128→; - ESP		24.0122-0194.1 422194	Ø 266 22 20 V + S
			←	Orga 09128→; + ESP		24.0126-0120.1 426120	Ø 283 26 24 V + S
			→ + ESP		24.0326-0120.1 526120	Ø 283 26 24 V + S PD	
					24.0109-0137.1 409137	Ø 247 9 8 + S	
1.6 HDi 75	55	02/06→12/13	←	→ 03/08; - ESP		24.0122-0194.1 422194	Ø 266 22 20 V + S
			←	→ 03/08; + ESP		24.0126-0120.1 426120	Ø 283 26 24 V + S
						24.0326-0120.1 526120	Ø 283 26 24 V + S PD
			→	→ 03/08; + ESP		24.0109-0137.1 409137	Ø 247 9 8 + S
1.6 HDi 90	66	10/05→12/15	←	02/06→03/08; - ESP		24.0122-0194.1 422194	Ø 266 22 20 V + S
			←	02/06→03/08; + ESP		24.0126-0120.1 426120	Ø 283 26 24 V + S
						24.0326-0120.1 526120	Ø 283 26 24 V + S PD
			→	02/06→03/08; + ESP		24.0109-0137.1 409137	Ø 247 9 8 + S
1.8	66	05/97→12/03	←	→Orga 09127		24.0120-0133.1 420133	Ø 266 20,5 18,5 V + S
						24.0320-0133.1 520133	Ø 266 20,5 18,5 V + S PD
			←	Orga 09128→		24.0122-0194.1 422194	Ø 266 22 20 V + S
1.9 D	50	06/96→12/02	←	07/96→; →Orga 09127		24.0120-0133.1 420133	Ø 266 20,5 18,5 V + S
						24.0320-0133.1 520133	Ø 266 20,5 18,5 V + S PD
			←	Orga 09128→		24.0122-0194.1 422194	Ø 266 22 20 V + S
1.9 D	51	05/96→12/98	←	12/98→; →Orga 09127		24.0120-0133.1 420133	Ø 266 20,5 18,5 V + S
						24.0320-0133.1 520133	Ø 266 20,5 18,5 V + S PD
			←	Orga 09128→		24.0122-0194.1 422194	Ø 266 22 20 V + S
1.9 D	51	12/98→07/08	←	→Orga 09127		24.0120-0133.1 420133	Ø 266 20,5 18,5 V + S
						24.0320-0133.1 520133	Ø 266 20,5 18,5 V + S PD
			←	Orga 09128→; → 03/08		24.0122-0194.1 422194	Ø 266 22 20 V + S
2.0 HDi	66	02/00→07/08	←			24.0113-0184.1 413184	Ø 266 13 11 + S
						24.0313-0184.1 513184	Ø 266 13 11 + S PD
			←	→Orga 09127		24.0120-0133.1 420133	Ø 266 20,5 18,5 V + S
						24.0320-0133.1 520133	Ø 266 20,5 18,5 V + S PD
			←	Orga 09128→; → 03/08; - ESP		24.0122-0194.1 422194	Ø 266 22 20 V + S
			←	Orga 09128→; → 03/08; + ESP		24.0126-0120.1 426120	Ø 283 26 24 V + S
			→ + ESP		24.0326-0120.1 526120	Ø 283 26 24 V + S PD	
					24.0109-0137.1 409137	Ø 247 9 8 + S	
2.0 HDi 4x4	66	04/04→08/05	←			24.0113-0184.1 413184	Ø 266 13 11 + S
						24.0313-0184.1 513184	Ø 266 13 11 + S PD
			←	→Orga 09127		24.0120-0133.1 420133	Ø 266 20,5 18,5 V + S
						24.0320-0133.1 520133	Ø 266 20,5 18,5 V + S PD
			←	Orga 09128→; - ESP		24.0122-0194.1 422194	Ø 266 22 20 V + S
			←	Orga 09128→; + ESP		24.0126-0120.1 426120	Ø 283 26 24 V + S
			→ + ESP		24.0326-0120.1 526120	Ø 283 26 24 V + S PD	
					24.0109-0137.1 409137	Ø 247 9 8 + S	
Electric	28	01/98→12/01	←			24.0120-0133.1 420133	Ø 266 20,5 18,5 V + S
						24.0320-0133.1 520133	Ø 266 20,5 18,5 V + S PD











	kW			 	! #		
PEUGEOT - PARTNER Kasten 04/08→							
 Bremsbelagsatz, Scheibenbremse							
1.6	66	04/08→	←			13.0460-7229.2 607229	ATE 24538 18,5 - WE / - WK
1.6	72	11/10→				13.0470-7229.2 LD7229	ATE 24538 18,5 - WE / - WK
1.6	80	04/08→					Ceramic
1.6	88	04/10→	→			13.0460-2745.2 602745	TRW 24765 16,5 - WE / - WK
1.6 BlueHDi 100	73	04/15→					+ Zub
1.6 BlueHDi 120	88	04/15→					
1.6 Flex	81	09/08→					
1.6 HDi	55	04/08→					
1.6 HDi	66	03/13→					
1.6 HDi	67	09/09→12/12					
1.6 HDi	80	04/08→					
1.6 HDi	82	08/10→					
1.6 HDi	84	03/13→					
1.6 HDi 16V	66	04/08→					
1.6 HDi 16V 4x4	66	04/12→					
1.6 HDi 90	68	04/10→					
Électrique	49	06/13→					
1.6 HDi / BlueHDi 75	55	01/14→	←	01/15→		13.0460-7229.2 607229	ATE 24538 18,5 - WE / - WK
						13.0470-7229.2 LD7229	ATE 24538 18,5 - WE / - WK
			→	01/15→		13.0460-2745.2 602745	TRW 24765 16,5 - WE / - WK
							+ Zub
 Bremsscheibe							
1.6	66	04/08→	←			24.0126-0120.1 426120	Ø 283 26 24 V + S
1.6	72	11/10→				24.0326-0120.1 526120	Ø 283 26 24 V + S PD
1.6	80	04/08→					
1.6	88	04/10→	→			24.0112-0194.2 412194	Ø 268 12 10 + LG / + ABS Ring
1.6 BlueHDi 100	73	04/15→					
1.6 BlueHDi 120	88	04/15→					
1.6 Flex	81	09/08→					
1.6 HDi	55	04/08→					
1.6 HDi	66	03/13→					
1.6 HDi	67	09/09→12/12					
1.6 HDi	80	04/08→					
1.6 HDi	82	08/10→					
1.6 HDi	84	03/13→					
1.6 HDi 16V	66	04/08→					
1.6 HDi 16V 4x4	66	04/12→					
1.6 HDi 90	68	04/10→					
Électrique	49	06/13→					
1.6 HDi / BlueHDi 75	55	01/14→	←	01/15→		24.0126-0120.1 426120	Ø 283 26 24 V + S
						24.0326-0120.1 526120	Ø 283 26 24 V + S PD
			→	01/15→		24.0112-0194.2 412194	Ø 268 12 10 + LG / + ABS Ring
PEUGEOT - PARTNER Kasten (5) 04/96→12/15							
 Bremsbelagsatz, Scheibenbremse							
1.1	44	06/96→09/05	←	07/96→ 09/02		13.0460-2829.2 602829	TRW 23124 19,0 + WK
			←	10/02→		13.0460-3994.2 603994	BOS 23599 19,0 - WE / - WK
						13.0470-3994.2 LD3994	BOS 23599 19,0 - WE / - WK
							+ Zub Ceramic
1.4	54	11/02→10/06	←			13.0460-3994.2 603994	BOS 23599 19,0 - WE / - WK
1.4 BiFuel	55	04/03→10/06					+ Zub
1.6	80	09/00→10/02				13.0470-3994.2 LD3994	BOS 23599 19,0 - WE / - WK
1.6 Bioflex	80	09/00→10/02					+ Zub Ceramic
1.4	55	06/96→12/15	←	07/96→ 09/02		13.0460-2829.2 602829	TRW 23124 19,0 + WK
			←	10/02→ 03/08		13.0460-3994.2 603994	BOS 23599 19,0 - WE / - WK
						13.0470-3994.2 LD3994	BOS 23599 19,0 - WE / - WK
							+ Zub Ceramic
1.6 HDi 75	55	02/06→07/08	←	→ 03/08		13.0460-3994.2 603994	BOS 23599 19,0 - WE / - WK
1.6 HDi 90	66	02/06→12/15				13.0470-3994.2 LD3994	BOS 23599 19,0 - WE / - WK
							+ Zub Ceramic
1.8	66	03/97→08/00	←			13.0460-2829.2 602829	TRW 23124 19,0 + WK
1.8 D	43	06/96→12/02	←	07/96→; →Orga 09127		13.0460-2829.2 602829	TRW 23124 19,0 + WK
1.9 D	51	06/96→12/02	←	Orga 09128→		13.0460-3994.2 603994	BOS 23599 19,0 - WE / - WK
						13.0470-3994.2 LD3994	BOS 23599 19,0 - WE / - WK
							+ Zub Ceramic
1.8 D	44	11/96→02/98	←	→Orga 09127		13.0460-2829.2 602829	TRW 23124 19,0 + WK
1.9 D	50	05/96→12/98					
↓							

	kw			 	! #		
PEUGEOT - PARTNER Kasten (5) 04/96→12/15							
 Bremsbelagsatz, Scheibenbremse							
1.9 D 4x4	51	04/04→11/07	←	Orga 09128→		13.0460-3994.2 603994 13.0470-3994.2 LD3994	BOS 23599 19,0 - WE / - WK + Zub BOS 23599 19,0 - WE / - WK + Zub Ceramic
1.9 D	51	06/96→12/15	←	07/96→; →Orga 09127		13.0460-2829.2 602829	TRW 23124 19,0 + WK
			←	Orga 09128→; → 03/08		13.0460-3994.2 603994 13.0470-3994.2 LD3994	BOS 23599 19,0 - WE / - WK + Zub BOS 23599 19,0 - WE / - WK + Zub Ceramic
2.0 HDi	66	04/00→07/08	←	→Orga 09127		13.0460-2829.2 602829	TRW 23124 19,0 + WK
			←	Orga 09128→; → 03/08; + ESP		13.0460-3811.2 603811	BOS 23708 19,2 - WE / - WK
			←	Orga 09128→; → 03/08; - ESP		13.0460-3994.2 603994 13.0470-3994.2 LD3994	BOS 23599 19,0 - WE / - WK + Zub BOS 23599 19,0 - WE / - WK + Zub Ceramic
			→	→ 03/08; + ESP		13.0460-2820.2 602820 13.0470-2823.2 LD2823	TRW 20961 17,2 - WK TRW 23554 17,2 - WK Ceramic
2.0 HDi 4x4	66	04/04→08/05	←	→Orga 09127		13.0460-2829.2 602829	TRW 23124 19,0 + WK
			←	Orga 09128→; + ESP		13.0460-3811.2 603811	BOS 23708 19,2 - WE / - WK
			←	Orga 09128→; - ESP		13.0460-3994.2 603994 13.0470-3994.2 LD3994	BOS 23599 19,0 - WE / - WK + Zub BOS 23599 19,0 - WE / - WK + Zub Ceramic
			→	+ ESP		13.0460-2820.2 602820 13.0470-2823.2 LD2823	TRW 20961 17,2 - WK TRW 23554 17,2 - WK Ceramic
Electric	25	04/96→12/02	←	01/98→		13.0460-3994.2 603994 13.0470-3994.2 LD3994	BOS 23599 19,0 - WE / - WK + Zub BOS 23599 19,0 - WE / - WK + Zub Ceramic
 Bremsscheibe							
1.1	44	06/96→09/05	←	07/96→ 09/02		24.0113-0184.1 413184 24.0313-0184.1 513184	Ø 266 13 11 + S Ø 266 13 11 + S PD
			←	10/02→		24.0122-0194.1 422194	Ø 266 22 20 V + S
1.4 1.4 BiFuel 1.6 1.6 Bioflex	54 55 80 80	11/02→10/06 04/03→10/06 09/00→10/02 09/00→10/02	←			24.0122-0194.1 422194	Ø 266 22 20 V + S
1.4	55	06/96→12/15	←	07/96→ 09/02		24.0113-0184.1 413184 24.0313-0184.1 513184	Ø 266 13 11 + S Ø 266 13 11 + S PD
			←	10/02→ 03/08		24.0122-0194.1 422194	Ø 266 22 20 V + S
1.6 HDi 75 1.6 HDi 90	55 66	02/06→07/08 02/06→12/15	←	→ 03/08		24.0122-0194.1 422194	Ø 266 22 20 V + S
1.8	66	03/97→08/00	←			24.0113-0184.1 413184 24.0120-0133.1 420133 24.0313-0184.1 513184 24.0320-0133.1 520133	Ø 266 13 11 + S Ø 266 20,5 18,5 V + S Ø 266 13 11 + S PD Ø 266 20,5 18,5 V + S PD
			←	07/96→; →Orga 09127		24.0120-0133.1 420133 24.0320-0133.1 520133	Ø 266 20,5 18,5 V + S Ø 266 20,5 18,5 V + S PD
			←	Orga 09128→		24.0122-0194.1 422194	Ø 266 22 20 V + S
			←	→Orga 09127		24.0120-0133.1 420133 24.0320-0133.1 520133	Ø 266 20,5 18,5 V + S Ø 266 20,5 18,5 V + S PD
1.8 D 1.9 D 1.9 D 4x4	44 50 51	11/96→02/98 05/96→12/98 04/04→11/07	←	→Orga 09127		24.0120-0133.1 420133 24.0320-0133.1 520133	Ø 266 20,5 18,5 V + S Ø 266 20,5 18,5 V + S PD
1.9 D	51	06/96→12/15	←	Orga 09128→		24.0122-0194.1 422194	Ø 266 22 20 V + S
			←	07/96→; →Orga 09127		24.0120-0133.1 420133 24.0320-0133.1 520133	Ø 266 20,5 18,5 V + S Ø 266 20,5 18,5 V + S PD
2.0 HDi	66	04/00→07/08	←	Orga 09128→; → 03/08		24.0122-0194.1 422194	Ø 266 22 20 V + S
			←	→Orga 09127		24.0120-0133.1 420133 24.0320-0133.1 520133	Ø 266 20,5 18,5 V + S Ø 266 20,5 18,5 V + S PD
			←	Orga 09128→; → 03/08; - ESP		24.0122-0194.1 422194	Ø 266 22 20 V + S
			←	Orga 09128→; → 03/08; + ESP		24.0126-0120.1 426120 24.0326-0120.1 526120	Ø 283 26 24 V + S Ø 283 26 24 V + S PD
→	→ 03/08; + ESP		24.0109-0137.1 409137	Ø 247 9 8 + S			
2.0 HDi 4x4 ↓	66	04/04→08/05	←	→Orga 09127		24.0120-0133.1 420133	Ø 266 20,5 18,5 V + S









	kw			 	! #		
PEUGEOT - PARTNER Kasten (5) 04/96→12/15							
 Bremsscheibe							
2.0 HDi 4x4	66	04/04→08/05	←	→Orga 09127	24.0320-0133.1	520133	Ø 266 20,5 18,5 V + S PD
			←	Orga 09128→; - ESP	24.0122-0194.1	422194	Ø 266 22 20 V + S
			←	Orga 09128→; + ESP	24.0126-0120.1	426120	Ø 283 26 24 V + S
			→	+ ESP	24.0326-0120.1	526120	Ø 283 26 24 V + S PD
Electric	25	04/96→12/02	←	01/98→	24.0109-0137.1	409137	Ø 247 9 8 + S
PEUGEOT - PARTNER Pritsche/Fahrgestell 01/99→07/08							
 Bremsbelagsatz, Scheibenbremse							
1.9 D	51	01/99→07/08	←	→Orga 09127	13.0460-2829.2	602829	TRW 23124 19,0 + WK
			←	Orga 09128→; → 03/08	13.0460-3994.2	603994	BOS 23599 19,0 - WE / - WK + Zub
2.0 HDi	66	11/02→07/08	←	→Orga 09127	13.0470-3994.2	LD3994	BOS 23599 19,0 - WE / - WK + Zub Ceramic
			←	→Orga 09127	13.0460-2829.2	602829	TRW 23124 19,0 + WK
			←	Orga 09128→; → 03/08; + ESP	13.0460-3811.2	603811	BOS 23708 19,2 - WE / - WK
			←	Orga 09128→; → 03/08; - ESP	13.0460-3994.2	603994	BOS 23599 19,0 - WE / - WK + Zub
			→	→ 03/08; + ESP	13.0470-3994.2	LD3994	BOS 23599 19,0 - WE / - WK + Zub Ceramic
			→	→ 03/08; + ESP	13.0460-2820.2	602820	TRW 20961 17,2 - WK
					13.0470-2823.2	LD2823	TRW 23554 17,2 - WK Ceramic
 Bremsscheibe							
1.9 D	51	01/99→07/08	←	→Orga 09127	24.0120-0133.1	420133	Ø 266 20,5 18,5 V + S
			←	Orga 09128→; → 03/08	24.0320-0133.1	520133	Ø 266 20,5 18,5 V + S PD
2.0 HDi	66	11/02→07/08	←	→Orga 09127	24.0122-0194.1	422194	Ø 266 22 20 V + S
			←	→Orga 09127	24.0120-0133.1	420133	Ø 266 20,5 18,5 V + S
			←	Orga 09128→; → 03/08; - ESP	24.0320-0133.1	520133	Ø 266 20,5 18,5 V + S PD
			←	Orga 09128→; → 03/08; + ESP	24.0122-0194.1	422194	Ø 266 22 20 V + S
			→	→ 03/08; + ESP	24.0126-0120.1	426120	Ø 283 26 24 V + S
					24.0326-0120.1	526120	Ø 283 26 24 V + S PD
					24.0109-0137.1	409137	Ø 247 9 8 + S
PEUGEOT - PARTNER Pritsche/Fahrgestell 01/09→							
 Bremsbelagsatz, Scheibenbremse							
1.6 HDi	55	01/09→	←		13.0460-7229.2	607229	ATE 24538 18,5 - WE / - WK
1.6 HDi	66	03/13→			13.0470-7229.2	LD7229	ATE 24538 18,5 - WE / - WK Ceramic
1.6 HDi 16V	66	01/09→	→		13.0460-2745.2	602745	TRW 24765 16,5 - WE / - WK + Zub
 Bremsscheibe							
1.6 HDi	55	01/09→	←		24.0126-0120.1	426120	Ø 283 26 24 V + S
1.6 HDi	66	03/13→			24.0326-0120.1	526120	Ø 283 26 24 V + S PD
1.6 HDi 16V	66	01/09→	→		24.0112-0194.2	412194	Ø 268 12 10 + LG / + ABS Ring
PEUGEOT - PARTNER Tepee 04/08→							
 Bremsbelagsatz, Scheibenbremse							
1.2 THP	81	02/16→	←		13.0460-7229.2	607229	ATE 24538 18,5 - WE / - WK
1.6	66	04/08→			13.0470-7229.2	LD7229	ATE 24538 18,5 - WE / - WK Ceramic
1.6	72	08/10→					
1.6	80	04/08→	→		13.0460-2745.2	602745	TRW 24765 16,5 - WE / - WK + Zub
1.6	88	04/10→					
1.6 BlueHDi 100	73	12/14→					
1.6 BlueHDi 100 4x4	73	04/15→					
1.6 BlueHDi 120	88	12/14→					
1.6 BlueHDi 75	55	01/15→					
1.6 Flex	81	09/08→					
1.6 HDi	55	04/08→					
1.6 HDi	66	03/13→					
1.6 HDi	80	04/08→					
1.6 HDi	82	08/10→					
1.6 HDi	84	03/13→					
1.6 HDi 16V	66	04/08→					
1.6 HDi 90	68	04/10→					





















	kw			 	! #		
PEUGEOT - PARTNER Tepee 04/08→							
 Bremsbelagsatz, Scheibenbremse							
1.6	81	09/08→	←	04/10→		13.0460-7229.2 607229 13.0470-7229.2 LD7229	ATE 24538 18,5 - WE / - WK ATE 24538 18,5 - WE / - WK Ceramic
			→	04/10→		13.0460-2745.2 602745	TRW 24765 16,5 - WE / - WK + Zub
 Bremsscheibe							
1.2 THP	81	02/16→	←			24.0126-0120.1 426120	Ø 283 26 24 V + S
1.6	66	04/08→				24.0326-0120.1 526120	Ø 283 26 24 V + S PD
1.6	72	08/10→					
1.6	80	04/08→	→			24.0112-0194.2 412194	Ø 268 12 10 + LG / + ABS Ring
1.6	88	04/10→					
1.6 BlueHDi 100	73	12/14→					
1.6 BlueHDi 100 4x4	73	04/15→					
1.6 BlueHDi 120	88	12/14→					
1.6 BlueHDi 75	55	01/15→					
1.6 Flex	81	09/08→					
1.6 HDi	55	04/08→					
1.6 HDi	66	03/13→					
1.6 HDi	80	04/08→					
1.6 HDi	82	08/10→					
1.6 HDi	84	03/13→					
1.6 HDi 16V	66	04/08→					
1.6 HDi 90	68	04/10→					
1.6	81	09/08→	←	04/10→		24.0126-0120.1 426120 24.0326-0120.1 526120	Ø 283 26 24 V + S Ø 283 26 24 V + S PD
			→	04/10→		24.0112-0194.2 412194	Ø 268 12 10 + LG / + ABS Ring
PEUGEOT - RCZ 03/10→							
 Bremsbelagsatz, Scheibenbremse							
1.6 16V	115	03/10→	←			13.0460-7202.2 607202 13.0470-7202.2 LD7202	ATE 23589 19,1 - WE / - WK ATE 23589 19,1 - WE / - WK Ceramic
1.6 THP 150	110	03/11→					
			→			13.0460-2761.2 602761	TRW 24922 17,5 - WK + Zub
1.6 16V	147	06/10→	←			13.0460-7279.2 607279	ATE 25069 17,3 + WK
			→			13.0460-2761.2 602761	TRW 24922 17,5 - WK + Zub
1.6 THP 270	199	06/13→	→	10/13→		13.0460-2761.2 602761	TRW 24922 17,5 - WK + Zub
2.0 HDi	120	03/10→	←	Raddurchmesser [Zoll]: 18		13.0460-7202.2 607202 13.0470-7202.2 LD7202	ATE 23589 19,1 - WE / - WK ATE 23589 19,1 - WE / - WK Ceramic
			←	Raddurchmesser [Zoll]: 19		13.0460-7279.2 607279	ATE 25069 17,3 + WK
			→			13.0460-2761.2 602761	TRW 24922 17,5 - WK + Zub
 Bremsscheibe							
1.6 16V	115	03/10→	←			24.0126-0176.1 426176	Ø 302 26 24 V + S
1.6 THP 150	110	03/11→				24.0112-0162.1 412162	Ø 290 12 10 + S
			→				
1.6 16V	147	06/10→	←			24.0130-0229.1 430229	Ø 340 30 28 V + S
			→			24.0112-0162.1 412162	Ø 290 12 10 + S
1.6 THP 270	199	06/13→	→	10/13→		24.0112-0162.1 412162	Ø 290 12 10 + S
2.0 HDi	120	03/10→	←	Raddurchmesser [Zoll]: 18		24.0126-0176.1 426176	Ø 302 26 24 V + S
			←	Raddurchmesser [Zoll]: 19		24.0130-0229.1 430229	Ø 340 30 28 V + S
			→			24.0112-0162.1 412162	Ø 290 12 10 + S
PEUGEOT - TRAVELLER 04/16→							
 Bremsscheibe							
1.6 BlueHDi 115	85	04/16→	→			24.0112-0212.1 412212	Ø 290 12 10 + S
1.6 BlueHDi 95	70	04/16→					
2.0 BlueHDi 150	110	04/16→					
2.0 BlueHDi 180	130	04/16→					
PONTIAC - TRANS SPORT 03/97→12/99							
 Bremsbelagsatz, Scheibenbremse							
3.4	134	03/97→09/98	←			13.0460-8002.2 608002	23358 18,0 + WK
3.4	137	09/98→12/99					
↓							







	kw					! #		
PONTIAC - TRANS SPORT 03/97→12/99								
 Bremsscheibe								
3.4	134	03/97→09/98	←			24.0132-0110.1	432110	Ø 278 32,2 30,7 V
3.4	137	09/98→12/99	→			24.0111-0133.1	411133	Ø 278 11 9
PORSCHE - 718 BOXSTER (982) 04/16→								
 Bremsbelagsatz, Scheibenbremse								
2.0	220	04/16→	→	für Fahrzeuge ohne Keramikbremse		13.0460-4816.2	604816	BRE 24541 15,5 + WE / - WK
S 2.5	257	04/16→						
Warnkontakt, Bremsbelagverschleiß								
2.0	220	04/16→	←	für Fahrzeuge mit Keramikbremse		2	24.8190-0952.2	620952 L= 300
S 2.5	257	04/16→	→	für Fahrzeuge mit Keramikbremse		2	24.8190-0070.2	620070 L= 268
			→	für Fahrzeuge ohne Keramikbremse		2	24.8190-0070.2	620070 L= 268
 Bremsscheibe								
2.0	220	04/16→	←	☐; für Fahrzeuge ohne Keramikbremse		24.0128-0246.1	428246	Ø 330 28 26 V•
			←	☐; für Fahrzeuge ohne Keramikbremse		24.0128-0247.1	428247	Ø 330 28 26 V•
			→	für Fahrzeuge ohne Keramikbremse		24.0120-0212.1	420212	Ø 299 20 18 V•
S 2.5	257	04/16→	→	für Fahrzeuge ohne Keramikbremse		24.0120-0212.1	420212	Ø 299 20 18 V•
PORSCHE - 718 CAYMAN (982) 04/16→								
 Bremsbelagsatz, Scheibenbremse								
2.0	220	04/16→	→	für Fahrzeuge ohne Keramikbremse		13.0460-4816.2	604816	BRE 24541 15,5 + WE / - WK
S 2.5	257	04/16→						
Warnkontakt, Bremsbelagverschleiß								
2.0	220	04/16→	←	für Fahrzeuge mit Keramikbremse		2	24.8190-0952.2	620952 L= 300
S 2.5	257	04/16→	→	für Fahrzeuge mit Keramikbremse		2	24.8190-0070.2	620070 L= 268
			→	für Fahrzeuge ohne Keramikbremse		2	24.8190-0070.2	620070 L= 268
 Bremsscheibe								
2.0	220	04/16→	←	☐; für Fahrzeuge ohne Keramikbremse		24.0128-0246.1	428246	Ø 330 28 26 V•
			←	☐; für Fahrzeuge ohne Keramikbremse		24.0128-0247.1	428247	Ø 330 28 26 V•
			→	für Fahrzeuge ohne Keramikbremse		24.0120-0212.1	420212	Ø 299 20 18 V•
S 2.5	257	04/16→	→	für Fahrzeuge ohne Keramikbremse		24.0120-0212.1	420212	Ø 299 20 18 V•
PORSCHE - 911 (991) 12/11→								
Warnkontakt, Bremsbelagverschleiß								
3.0 Carrera	272	11/15→	←	für Fahrzeuge mit Keramikbremse		2	24.8190-0952.2	620952 L= 300
3.0 Carrera 4	272	11/15→						
3.0 Carrera 4S	309	11/15→	→			2	24.8190-0953.2	620953 L= 215
3.0 Carrera S	309	11/15→						
3.4 Carrera 4	257	11/12→						
3.8 Carrera 4S	294	11/12→						
3.8 Carrera 4S / 4 GTS	316	11/12→						
3.8 Carrera S	294	12/11→						
3.8 Carrera S / GTS	316	07/12→						
3.4 Carrera	257	12/11→	←	für Fahrzeuge ohne Keramikbremse		2	24.8190-0069.2	620069 L= 248
			←	für Fahrzeuge mit Keramikbremse		2	24.8190-0952.2	620952 L= 300
			→			2	24.8190-0953.2	620953 L= 215
3.8 GT3	350	08/13→	←	für Fahrzeuge mit Keramikbremse		2	24.8190-0952.2	620952 L= 300
4.0 GT3 RS / R	368	04/15→	→	für Fahrzeuge ohne Keramikbremse		2	24.8190-0953.2	620953 L= 215
3.8 Turbo	383	09/13→	←			2	24.8190-0952.2	620952 L= 300
3.8 Turbo	397	01/16→						
3.8 Turbo S	412	09/13→	→	für Fahrzeuge mit Keramikbremse		2	24.8190-0953.2	620953 L= 215
3.8 Turbo S	427	01/16→						
 Bremsscheibe								
3.0 Carrera	272	11/15→	→	☐; für Fahrzeuge ohne Keramikbremse		24.0128-0196.1	428196	Ø 330 28 26 V•
3.0 Carrera 4	272	11/15→						
3.0 Carrera 4S	309	11/15→	→	☐; für Fahrzeuge ohne Keramikbremse		24.0128-0197.1	428197	Ø 330 28 26 V•
3.0 Carrera S	309	11/15→						
3.4 Carrera 4	257	11/12→						
3.8 Carrera 4S	294	11/12→						
3.8 Carrera 4S / 4 GTS	316	11/12→						
3.8 Carrera S	294	12/11→						
3.8 Carrera S / GTS	316	07/12→						

	kw			 	! #		
PORSCHE - 911 (991) 12/11→							
 Bremsscheibe							
3.4 Carrera	257	12/11→	←	☐; für Fahrzeuge ohne Keramikbremse	24.0128-0246.1	428246	Ø 330 28 26 V•
			←	☐; für Fahrzeuge ohne Keramikbremse	24.0128-0247.1	428247	Ø 330 28 26 V•
PORSCHE - 911 (993) 10/93→09/97							
 Bremsbelagsatz, Scheibenbremse							
3.6 Turbo 4	300	03/95→09/97	←		13.0460-4056.2	604056	BRE 21402 17,5 + WE / - WK
3.6 Turbo GT2	316	03/95→09/97					
3.6 Turbo GT2 4	316	08/95→09/97					
3.6 Turbo GT2 4	331	06/97→09/97					
3.8 Carrera 4	221	08/95→09/97					
3.8 Carrera RS	221	06/95→09/97					
Warnkontakt, Bremsbelagsverschleiß							
3.6 Carrera	200	10/93→08/95	←		2	24.8190-0917.2	620917 L= 518
3.6 Carrera	210	08/95→09/97					
3.6 Carrera 4	200	07/94→08/95	→		2	24.8190-0920.2	620920 L= 698
3.6 Carrera 4	210	08/95→09/97					
3.8 Carrera	210	06/95→09/97					
3.8 Carrera	221	08/95→09/97					
3.8 Carrera 4	210	06/95→09/97					
3.6 Turbo 4	300	03/95→09/97	←		2	24.8190-0926.2	620926 L= 475
3.6 Turbo GT2	316	03/95→09/97					
3.6 Turbo GT2 4	316	08/95→09/97	→		2	24.8190-0920.2	620920 L= 698
3.6 Turbo GT2 4	331	06/97→09/97					
3.8 Carrera 4	221	08/95→09/97					
3.8 Carrera RS	221	06/95→09/97					
 Bremsscheibe							
3.6 Carrera	200	10/93→08/95	←	☐	24.0132-0142.1	432142	Ø 304 32 30 V•
3.6 Carrera	210	08/95→09/97					
3.6 Carrera 4	200	07/94→08/95	←	☐	24.0132-0143.1	432143	Ø 304 32 30 V•
3.6 Carrera 4	210	08/95→09/97	→		24.0124-0183.1	424183	Ø 299 24 22 V•
3.8 Carrera	210	06/95→09/97					
3.8 Carrera	221	08/95→09/97					
3.8 Carrera 4	210	06/95→09/97					
3.6 Turbo 4	300	03/95→09/97	←	☐	24.0132-0163.2	432163	Ø 322 32 30 V•
3.6 Turbo GT2	316	03/95→09/97					Bremsscheibe zweiteilig
3.6 Turbo GT2 4	316	08/95→09/97			24.0132-0164.2	432164	Ø 322 32 30 V•
3.6 Turbo GT2 4	331	06/97→09/97	←	☐			Bremsscheibe zweiteilig
PORSCHE - 911 (996) 09/97→08/05							
 Bremsbelagsatz, Scheibenbremse							
3.4 Carrera	221	09/97→09/01	←		13.0460-4987.2	604987	BRE 23329 17,0 + WE / - WK
3.4 Carrera 4	221	09/97→09/01	→		13.0460-4988.2	604988	BRE 21792 15,2 + WE / - WK
3.4 Carrera	235	05/01→08/05	←	→ 09/01	13.0460-4987.2	604987	BRE 23329 17,0 + WE / - WK
3.4 Carrera 4	235	05/01→08/05	→	→ 09/01	13.0460-4988.2	604988	BRE 21792 15,2 + WE / - WK
3.6 Carrera	235	10/01→08/05	←		13.0460-4987.2	604987	BRE 23329 17,0 + WE / - WK
3.6 Carrera S	254	02/03→08/05	→	für Fahrzeuge ohne Keramikbremse	13.0460-4987.2	604987	BRE 23329 17,0 + WE / - WK
3.6 Carrera 4	235	10/01→08/05	←	für Fahrzeuge ohne Keramikbremse	13.0460-4999.2	604999	BRE 23330 17,0 + WE / - WK
			→	01/02→; für Fahrzeuge ohne Keramikbremse	13.0460-4987.2	604987	BRE 23329 17,0 + WE / - WK
			→		13.0460-4988.2	604988	BRE 21792 15,2 + WE / - WK
3.6 Carrera 4S	254	02/03→08/05	←	für Fahrzeuge ohne Keramikbremse	13.0460-4999.2	604999	BRE 23330 17,0 + WE / - WK
			→	für Fahrzeuge ohne Keramikbremse	13.0460-4987.2	604987	BRE 23329 17,0 + WE / - WK
			→		13.0460-4988.2	604988	BRE 21792 15,2 + WE / - WK
3.6 GT3	265	03/99→08/05	→	für Fahrzeuge ohne Keramikbremse	13.0460-4987.2	604987	BRE 23329 17,0 + WE / - WK
3.6 GT3	280	03/03→08/05					
3.6 S	331	08/04→08/05	←	für Fahrzeuge ohne Keramikbremse	13.0460-4999.2	604999	BRE 23330 17,0 + WE / - WK
3.6 Turbo 4S	331	02/03→08/05	→	für Fahrzeuge ohne Keramikbremse	13.0460-4987.2	604987	BRE 23329 17,0 + WE / - WK
3.6 Turbo 4	309	06/00→08/05	←	für Fahrzeuge ohne Keramikbremse	13.0460-4999.2	604999	BRE 23330 17,0 + WE / - WK
			→	01/02→; für Fahrzeuge ohne Keramikbremse	13.0460-4987.2	604987	BRE 23329 17,0 + WE / - WK
Warnkontakt, Bremsbelagsverschleiß							
3.4 Carrera	221	09/97→09/01	←		2	24.8190-0921.2	620921 L= 440
3.4 Carrera 4	221	09/97→09/01	→		2	24.8190-0921.2	620921 L= 440
3.4 Carrera	235	05/01→08/05	←	→ 09/01	2	24.8190-0921.2	620921 L= 440
3.4 Carrera 4	235	05/01→08/05					



	kW			 	! #		
PORSCHE - 911 (996) 09/97→08/05							
Warnkontakt, Bremsbelagverschleiß							
3.4 Carrera 3.4 Carrera 4	235 235	05/01→08/05 05/01→08/05	➡	→ 09/01	2	24.8190-0921.2 620921	L= 440
3.6 Carrera 3.6 Carrera S	235 254	10/01→08/05 02/03→08/05	➡		2	24.8190-0921.2 620921	L= 440
			➡	für Fahrzeuge ohne Keramikbremse	2	24.8190-0921.2 620921	L= 440
3.6 Carrera 4	235	10/01→08/05	➡	für Fahrzeuge ohne Keramikbremse	2	24.8190-0921.2 620921	L= 440
			➡		2	24.8190-0921.2 620921	L= 440
			➡	01/02→; für Fahrzeuge ohne Keramikbremse	2	24.8190-0921.2 620921	L= 440
3.6 Carrera 4S	254	02/03→08/05	➡	für Fahrzeuge ohne Keramikbremse	2	24.8190-0921.2 620921	L= 440
			➡	für Fahrzeuge ohne Keramikbremse	2	24.8190-0921.2 620921	L= 440
			➡		2	24.8190-0921.2 620921	L= 440
3.6 GT3	265	03/99→08/05	➡	01/03→; für Fahrzeuge ohne Keramikbremse	2	24.8190-0921.2 620921	L= 440
			➡	→ 12/02; für Fahrzeuge ohne Keramikbremse	2	24.8190-0921.2 620921	L= 440
			➡	für Fahrzeuge ohne Keramikbremse	2	24.8190-0921.2 620921	L= 440
3.6 GT3 3.6 S 3.6 Turbo 4S	280 331 331	03/03→08/05 08/04→08/05 02/03→08/05	➡	für Fahrzeuge ohne Keramikbremse	2	24.8190-0921.2 620921	L= 440
			➡	für Fahrzeuge ohne Keramikbremse	2	24.8190-0921.2 620921	L= 440
3.6 Turbo 4	309	06/00→08/05	➡	für Fahrzeuge ohne Keramikbremse	2	24.8190-0921.2 620921	L= 440
			➡	01/02→; für Fahrzeuge ohne Keramikbremse	2	24.8190-0921.2 620921	L= 440
 Bremsscheibe							
3.4 Carrera 3.4 Carrera 4	221 221	09/97→09/01 09/97→09/01	➡			24.0128-0130.1 428130	Ø 318 28 26 V•
			➡			24.0128-0131.1 428131	Ø 318 28 26 V•
			➡			24.0124-0176.1 424176	Ø 299 24 22 V•
3.4 Carrera 3.4 Carrera 4	235 235	05/01→08/05 05/01→08/05	➡	➡ 09/01		24.0128-0130.1 428130	Ø 318 28 26 V•
			➡	➡ 09/01		24.0128-0131.1 428131	Ø 318 28 26 V•
			➡	→ 09/01		24.0124-0176.1 424176	Ø 299 24 22 V•
3.6 Carrera 3.6 Carrera 4	235 235	10/01→08/05 10/01→08/05	➡			24.0128-0130.1 428130	Ø 318 28 26 V•
			➡			24.0128-0131.1 428131	Ø 318 28 26 V•
			➡	01/02→; für Fahrzeuge ohne Keramikbremse		24.0134-0101.1 434101	Ø 330 34 32 V•
			➡	01/02→; für Fahrzeuge ohne Keramikbremse		24.0134-0102.1 434102	Ø 330 34 32 V•
			➡			24.0124-0176.1 424176	Ø 299 24 22 V•
			➡	01/02→; für Fahrzeuge ohne Keramikbremse		24.0128-0196.1 428196	Ø 330 28 26 V•
			➡	01/02→; für Fahrzeuge ohne Keramikbremse		24.0128-0197.1 428197	Ø 330 28 26 V•
3.6 Carrera 4S 3.6 Carrera S	254 254	02/03→08/05 02/03→08/05	➡			24.0128-0130.1 428130	Ø 318 28 26 V•
			➡			24.0128-0131.1 428131	Ø 318 28 26 V•
			➡	für Fahrzeuge ohne Keramikbremse		24.0134-0101.1 434101	Ø 330 34 32 V•
			➡	für Fahrzeuge ohne Keramikbremse		24.0134-0102.1 434102	Ø 330 34 32 V•
			➡			24.0124-0176.1 424176	Ø 299 24 22 V•
			➡	für Fahrzeuge ohne Keramikbremse		24.0128-0196.1 428196	Ø 330 28 26 V•
			➡	für Fahrzeuge ohne Keramikbremse		24.0128-0197.1 428197	Ø 330 28 26 V•
3.6 GT2 3.6 GT2 3.6 GT3 3.6 GT3 3.6 S	340 355 265 280 331	04/01→08/05 10/03→08/05 03/99→08/05 03/03→08/05 08/04→08/05	➡	für Fahrzeuge ohne Keramikbremse		24.0128-0196.1 428196	Ø 330 28 26 V•
			➡	für Fahrzeuge ohne Keramikbremse		24.0128-0197.1 428197	Ø 330 28 26 V•
3.6 Turbo 4 3.6 Turbo 4S	309 331	06/00→08/05 02/03→08/05	➡	für Fahrzeuge ohne Keramikbremse		24.0134-0101.1 434101	Ø 330 34 32 V•
			➡	für Fahrzeuge ohne Keramikbremse		24.0134-0102.1 434102	Ø 330 34 32 V•
			➡	für Fahrzeuge ohne Keramikbremse		24.0128-0196.1 428196	Ø 330 28 26 V•
			➡	für Fahrzeuge ohne Keramikbremse		24.0128-0197.1 428197	Ø 330 28 26 V•
PORSCHE - 911 (997) 07/04→12/12							
 Bremsbelagsatz, Scheibenbremse							
3.6 Carrera 3.6 Carrera 3.6 Carrera	235 239 242	08/04→07/05 07/04→12/08 07/04→12/08	➡	für Fahrzeuge ohne Keramikbremse		13.0460-4842.2 604842	BRE 24049 17,0 + WE / - WK
			↓				

	kW			 	! #		
PORSCHE - 911 (997) 07/04→12/12							
 Bremsbelagsatz, Scheibenbremse							
3.6 Carrera 4	239	07/04→12/08	➔	für Fahrzeuge ohne Keramikbremse		13.0460-4988.2 604988	BRE 21792 15,2 + WE / - WK
3.8 Carrera 4 GTS	300	06/09→12/12	➔	für Fahrzeuge ohne Keramikbremse		13.0460-4999.2 604999	BRE 23330 17,0 + WE / - WK
3.8 Carrera 4S	261	07/04→12/08	➔	für Fahrzeuge ohne Keramikbremse		13.0460-4999.2 604999	BRE 23330 17,0 + WE / - WK
3.8 Carrera 4S	280	08/05→12/08	➔	für Fahrzeuge ohne Keramikbremse		13.0460-4842.2 604842	BRE 24049 17,0 + WE / - WK
3.8 Carrera S	261	07/04→12/08	➔	für Fahrzeuge ohne Keramikbremse		13.0460-4842.2 604842	BRE 24049 17,0 + WE / - WK
3.8 Carrera S	264	07/04→12/08	➔	für Fahrzeuge ohne Keramikbremse		13.0460-4842.2 604842	BRE 24049 17,0 + WE / - WK
3.8 Carrera S	280	08/05→12/08	➔	für Fahrzeuge ohne Keramikbremse		13.0460-4842.2 604842	BRE 24049 17,0 + WE / - WK
3.8 Carrera GTS	300	06/09→12/11	➔	für Fahrzeuge ohne Keramikbremse		13.0460-4842.2 604842	BRE 24049 17,0 + WE / - WK
						13.0460-4999.2 604999	BRE 23330 17,0 + WE / - WK
Warnkontakt, Bremsbelagsverschleiß							
3.6 Carrera	235	08/04→07/05	➔	 für Fahrzeuge ohne Keramikbremse		24.8190-0024.2 620024	L= 369,6
3.6 Carrera	239	07/04→12/08	➔	 für Fahrzeuge ohne Keramikbremse		24.8190-0025.2 620025	L= 349,6
3.6 Carrera	242	07/04→12/08	➔	 für Fahrzeuge mit Keramikbremse		24.8190-0956.2 620956	L= 454,6
			➔	 für Fahrzeuge mit Keramikbremse		24.8190-0957.2 620957	L= 394,6
			➔	für Fahrzeuge ohne Keramikbremse	2	24.8190-0921.2 620921	L= 440
			➔	für Fahrzeuge mit Keramikbremse	2	24.8190-0943.2 620943	L= 504,6
3.6 Carrera	254	06/08→12/11	➔	für Fahrzeuge ohne Keramikbremse	2	24.8190-0016.2 620016	L= 359,6
			➔	 für Fahrzeuge mit Keramikbremse		24.8190-0956.2 620956	L= 454,6
			➔	 für Fahrzeuge mit Keramikbremse		24.8190-0957.2 620957	L= 394,6
			➔	für Fahrzeuge ohne Keramikbremse	2	24.8190-0023.2 620023	L= 484,6
			➔	für Fahrzeuge mit Keramikbremse	2	24.8190-0943.2 620943	L= 504,6
3.6 Carrera 4	239	07/04→12/08	➔	für Fahrzeuge ohne Keramikbremse	2	24.8190-0938.2 620938	L= 495
			➔	für Fahrzeuge mit Keramikbremse	2	24.8190-0938.2 620938	L= 495
			➔	für Fahrzeuge ohne Keramikbremse	2	24.8190-0921.2 620921	L= 440
			➔	für Fahrzeuge mit Keramikbremse	2	24.8190-0943.2 620943	L= 504,6
3.6 Carrera 4	254	06/08→12/12	➔	für Fahrzeuge ohne Keramikbremse	2	24.8190-0938.2 620938	L= 495
			➔	für Fahrzeuge mit Keramikbremse	2	24.8190-0938.2 620938	L= 495
			➔	für Fahrzeuge ohne Keramikbremse	2	24.8190-0023.2 620023	L= 484,6
			➔	für Fahrzeuge mit Keramikbremse	2	24.8190-0943.2 620943	L= 504,6
3.6 GT 2	390	09/07→12/12	➔		2	24.8190-0938.2 620938	L= 495
			➔		2	24.8190-0023.2 620023	L= 484,6
3.6 GT2 RS	456	05/10→12/12	➔		2	24.8190-0951.2 620951	L= 500
			➔		2	24.8190-0023.2 620023	L= 484,6
3.6 GT3	305	03/06→12/09	➔	für Fahrzeuge ohne Keramikbremse; → 12/08	2	24.8190-0951.2 620951	L= 500
			➔	für Fahrzeuge mit Keramikbremse	2	24.8190-0023.2 620023	L= 484,6
			➔	01/07→ 12/07; für Fahrzeuge ohne Keramikbremse	2	24.8190-0023.2 620023	L= 484,6
			➔	für Fahrzeuge ohne Keramikbremse; → 12/06	2	24.8190-0023.2 620023	L= 484,6
3.6 Turbo	353	03/06→12/09	➔	für Fahrzeuge mit Keramikbremse	2	24.8190-0938.2 620938	L= 495
			➔	für Fahrzeuge ohne Keramikbremse	2	24.8190-0938.2 620938	L= 495
			➔	für Fahrzeuge ohne Keramikbremse	2	24.8190-0023.2 620023	L= 484,6
			➔	für Fahrzeuge mit Keramikbremse	2	24.8190-0023.2 620023	L= 484,6
3.8 Carrera 4 GTS	300	06/09→12/12	➔	 für Fahrzeuge ohne Keramikbremse	1	24.8190-0931.2 620931	L= 336
			➔	 für Fahrzeuge ohne Keramikbremse	1	24.8190-0933.2 620933	L= 305
			➔	für Fahrzeuge ohne Keramikbremse	2	24.8190-0950.2 620950	L= 525
			➔	 für Fahrzeuge mit Keramikbremse		24.8190-0956.2 620956	L= 454,6
			➔	 für Fahrzeuge mit Keramikbremse		24.8190-0957.2 620957	L= 394,6
			➔	für Fahrzeuge ohne Keramikbremse	2	24.8190-0943.2 620943	L= 504,6
3.8 Carrera 4S	261	07/04→12/08	➔	für Fahrzeuge mit Keramikbremse	2	24.8190-0938.2 620938	L= 495
3.8 Carrera 4S	280	08/05→12/08	➔	für Fahrzeuge ohne Keramikbremse	2	24.8190-0950.2 620950	L= 525
3.8 Carrera 4S	283	06/08→12/12	➔	für Fahrzeuge ohne Keramikbremse	2	24.8190-0943.2 620943	L= 504,6
			➔	für Fahrzeuge mit Keramikbremse	2	24.8190-0943.2 620943	L= 504,6
3.8 Carrera GTS	300	06/09→12/11	➔	 für Fahrzeuge ohne Keramikbremse		24.8190-0931.2 620931	L= 336
			➔	 für Fahrzeuge ohne Keramikbremse	1	24.8190-0931.2 620931	L= 336

	kw			 	! #		
PORSCHE - 911 (997) 07/04 → 12/12							
Warnkontakt, Bremsbelagverschleiß							
3.8 Carrera GTS	300	06/09 → 12/11	←	☐; für Fahrzeuge ohne Keramikbremse	1	24.8190-0933.2 620933	L= 305
			←	☐; für Fahrzeuge ohne Keramikbremse		24.8190-0933.2 620933	L= 305
			←	für Fahrzeuge ohne Keramikbremse	2	24.8190-0938.2 620938	L= 495
			←	☐; für Fahrzeuge mit Keramikbremse		24.8190-0956.2 620956	L= 454,6
			←	☐; für Fahrzeuge mit Keramikbremse		24.8190-0957.2 620957	L= 394,6
			→		2	24.8190-0943.2 620943	L= 504,6
			→	für Fahrzeuge ohne Keramikbremse	2	24.8190-0943.2 620943	L= 504,6
3.8 Carrera S 3.8 Carrera S 3.8 Carrera S 3.8 Carrera S	261 264 280 283	07/04 → 12/08 07/04 → 12/08 08/05 → 12/08 06/08 → 12/11	←	☐; für Fahrzeuge ohne Keramikbremse		24.8190-0931.2 620931	L= 336
			←	☐; für Fahrzeuge ohne Keramikbremse		24.8190-0933.2 620933	L= 305
			←	☐; für Fahrzeuge mit Keramikbremse		24.8190-0956.2 620956	L= 454,6
			←	☐; für Fahrzeuge mit Keramikbremse		24.8190-0957.2 620957	L= 394,6
			→	für Fahrzeuge mit Keramikbremse	2	24.8190-0943.2 620943	L= 504,6
			→	für Fahrzeuge ohne Keramikbremse	2	24.8190-0943.2 620943	L= 504,6
3.8 GT3	320	05/09 → 12/11	←	für Fahrzeuge mit Keramikbremse	2	24.8190-0938.2 620938	L= 495
			←	für Fahrzeuge ohne Keramikbremse	2	24.8190-0951.2 620951	L= 500
			→	für Fahrzeuge ohne Keramikbremse	2	24.8190-0023.2 620023	L= 484,6
			→	für Fahrzeuge mit Keramikbremse	2	24.8190-0023.2 620023	L= 484,6
3.8 GT3 RS 4.0 GT3 RS	331 368	08/09 → 12/11 07/11 → 12/12	←	für Fahrzeuge mit Keramikbremse	2	24.8190-0951.2 620951	L= 500
			←	für Fahrzeuge ohne Keramikbremse	2	24.8190-0951.2 620951	L= 500
			→	für Fahrzeuge ohne Keramikbremse	2	24.8190-0023.2 620023	L= 484,6
			→	für Fahrzeuge mit Keramikbremse	2	24.8190-0023.2 620023	L= 484,6
3.8 Turbo	368	09/09 → 12/12	←	für Fahrzeuge mit Keramikbremse; → 12/10	2	24.8190-0938.2 620938	L= 495
			←	01/11 →; für Fahrzeuge ohne Keramikbremse	2	24.8190-0938.2 620938	L= 495
			←	für Fahrzeuge ohne Motorbremse	2	24.8190-0938.2 620938	L= 495
			→	für Fahrzeuge ohne Keramikbremse	2	24.8190-0023.2 620023	L= 484,6
			→	für Fahrzeuge mit Keramikbremse	2	24.8190-0023.2 620023	L= 484,6
3.8 Turbo S	390	02/10 → 12/12	←	01/11 →; für Fahrzeuge mit Keramikbremse	2	24.8190-0938.2 620938	L= 495
			←	für Fahrzeuge mit Keramikbremse; → 12/10	2	24.8190-0938.2 620938	L= 495
			→	für Fahrzeuge ohne Keramikbremse	2	24.8190-0023.2 620023	L= 484,6
			→	für Fahrzeuge mit Keramikbremse	2	24.8190-0023.2 620023	L= 484,6
Bremsscheibe							
3.6 Carrera 3.6 Carrera 3.6 Carrera 3.6 Carrera 4	235 239 242 239	08/04 → 07/05 07/04 → 12/08 07/04 → 12/08 07/04 → 12/08	←	☐; für Fahrzeuge ohne Keramikbremse		24.0128-0130.1 428130	Ø 318 28 26 V•
			←	☐; für Fahrzeuge ohne Keramikbremse		24.0128-0131.1 428131	Ø 318 28 26 V•
			→	für Fahrzeuge ohne Keramikbremse		24.0124-0176.1 424176	Ø 299 24 22 V•
			→				
3.6 Carrera 3.6 Carrera 4	254 254	06/08 → 12/11 06/08 → 12/12	←	☐; für Fahrzeuge ohne Keramikbremse		24.0128-0246.1 428246	Ø 330 28 26 V•
			←	☐; für Fahrzeuge ohne Keramikbremse		24.0128-0247.1 428247	Ø 330 28 26 V•
			→	☐; → 12/10; für Fahrzeuge ohne Keramikbremse		24.0128-0196.1 428196	Ø 330 28 26 V•
			→	☐; 01/11 →; für Fahrzeuge ohne Keramikbremse		24.0128-0196.1 428196	Ø 330 28 26 V•
			→	☐; 01/11 →; für Fahrzeuge ohne Keramikbremse		24.0128-0197.1 428197	Ø 330 28 26 V•
			→	☐; → 12/10; für Fahrzeuge ohne Keramikbremse		24.0128-0197.1 428197	Ø 330 28 26 V•
3.6 GT3	305	03/06 → 12/09	←	☐; für Fahrzeuge ohne Keramikbremse		24.0134-0105.1 434105	Ø 350 34 32 V•
			←	☐; für Fahrzeuge ohne Keramikbremse		24.0134-0106.1 434106	Ø 350 34 32 V•
			→	☐; für Fahrzeuge ohne Keramikbremse		24.0128-0264.1 428264	Ø 350 28 26 V•
			→	☐; für Fahrzeuge ohne Keramikbremse		24.0128-0265.1 428265	Ø 350 28 26 V•
3.6 Turbo 3.8 Turbo 3.8 Turbo S	353 368 390	03/06 → 12/09 09/09 → 12/12 02/10 → 12/12	→	☐; für Fahrzeuge ohne Keramikbremse		24.0128-0264.1 428264	Ø 350 28 26 V•
			→	☐; für Fahrzeuge ohne Keramikbremse		24.0128-0265.1 428265	Ø 350 28 26 V•
			→				
3.8 Carrera 4 GTS 3.8 Carrera 4S 3.8 Carrera 4S 3.8 Carrera GTS	300 261 280 300	06/09 → 12/12 07/04 → 12/08 08/05 → 12/08 06/09 → 12/11	←	☐; für Fahrzeuge ohne Keramikbremse		24.0134-0101.1 434101	Ø 330 34 32 V•
			←	☐; für Fahrzeuge ohne Keramikbremse		24.0134-0102.1 434102	Ø 330 34 32 V•
			→	☐; für Fahrzeuge ohne Keramikbremse		24.0128-0196.1 428196	Ø 330 28 26 V•
			→				

PORSCHE - 911 (997) 07/04 → 12/12

Bremsscheibe

3.8 Carrera S	261	07/04 → 12/08	➔	☐; für Fahrzeuge ohne Keramikbremse	24.0128-0197.1	428197	Ø 330 28 26 V•
3.8 Carrera S	264	07/04 → 12/08					
3.8 Carrera 4S	283	06/08 → 12/12	➔	☐; 01/11→;	24.0134-0101.1	434101	Ø 330 34 32 V•
3.8 Carrera S	283	06/08 → 12/11		für Fahrzeuge ohne Keramikbremse			
			➔	☐; für Fahrzeuge ohne Keramikbremse;	24.0134-0101.1	434101	Ø 330 34 32 V•
				→ 12/10			
			➔	☐; 01/11→;	24.0134-0102.1	434102	Ø 330 34 32 V•
				für Fahrzeuge ohne Keramikbremse			
			➔	☐; für Fahrzeuge ohne Keramikbremse;	24.0134-0102.1	434102	Ø 330 34 32 V•
				→ 12/10			
			➔	☐; 01/11→;	24.0128-0196.1	428196	Ø 330 28 26 V•
				für Fahrzeuge ohne Keramikbremse			
			➔	☐; → 12/10;	24.0128-0196.1	428196	Ø 330 28 26 V•
				für Fahrzeuge ohne Keramikbremse			
			➔	☐; 01/11→;	24.0128-0197.1	428197	Ø 330 28 26 V•
				für Fahrzeuge ohne Keramikbremse			
			➔	☐; → 12/10;	24.0128-0197.1	428197	Ø 330 28 26 V•
				für Fahrzeuge ohne Keramikbremse			
3.8 Carrera S	280	08/05 → 12/08	➔	☐	24.0134-0101.1	434101	Ø 330 34 32 V•
			➔	☐	24.0134-0102.1	434102	Ø 330 34 32 V•
			➔	☐; für Fahrzeuge ohne Keramikbremse	24.0128-0196.1	428196	Ø 330 28 26 V•
			➔	☐; für Fahrzeuge ohne Keramikbremse	24.0128-0197.1	428197	Ø 330 28 26 V•

PORSCHE - 911 Cabriolet (991) 03/12 →

Warnkontakt, Bremsbelagverschleiß

3.0 Carrera	272	11/15 →	➔	für Fahrzeuge mit Keramikbremse	2	24.8190-0952.2	620952	L= 300
3.0 Carrera 4	272	11/15 →						
3.0 Carrera 4S	309	11/15 →	➔		2	24.8190-0953.2	620953	L= 215
3.0 Carrera S	309	11/15 →						
3.8 Carrera S	294	03/12 →						
3.8 Carrera S / GTS	316	07/12 →						
3.4 Carrera	257	03/12 →	➔	für Fahrzeuge ohne Keramikbremse	2	24.8190-0069.2	620069	L= 248
3.8 Turbo	383	12/13 →						
3.8 Turbo	397	01/16 →	➔	für Fahrzeuge mit Keramikbremse	2	24.8190-0952.2	620952	L= 300
			➔		2	24.8190-0953.2	620953	L= 215
3.4 Carrera 4	257	11/12 →	➔		2	24.8190-0953.2	620953	L= 215
3.8 Carrera 4S	294	11/12 →						
3.8 Carrera 4S / 4 GTS	316	11/12 →						
3.8 Turbo S	412	12/13 →						
3.8 Turbo S	427	01/16 →						

Bremsscheibe

3.0 Carrera	272	11/15 →	➔	☐; für Fahrzeuge ohne Keramikbremse	24.0128-0196.1	428196	Ø 330 28 26 V•
3.0 Carrera 4	272	11/15 →					
3.0 Carrera 4S	309	11/15 →	➔	☐; für Fahrzeuge ohne Keramikbremse	24.0128-0197.1	428197	Ø 330 28 26 V•
3.0 Carrera S	309	11/15 →					
3.4 Carrera	257	03/12 →	➔	☐; für Fahrzeuge ohne Keramikbremse	24.0128-0246.1	428246	Ø 330 28 26 V•
3.8 Turbo	383	12/13 →					
3.8 Turbo	397	01/16 →	➔	☐; für Fahrzeuge ohne Keramikbremse	24.0128-0247.1	428247	Ø 330 28 26 V•
3.4 Carrera 4	257	11/12 →	➔	☐; für Fahrzeuge ohne Keramikbremse	24.0128-0196.1	428196	Ø 330 28 26 V•
3.8 Carrera 4S	294	11/12 →					
3.8 Carrera 4S / 4 GTS	316	11/12 →	➔	☐; für Fahrzeuge ohne Keramikbremse	24.0128-0197.1	428197	Ø 330 28 26 V•
3.8 Carrera S	294	03/12 →					
3.8 Carrera S / GTS	316	07/12 →					
3.8 Turbo S	412	12/13 →					
3.8 Turbo S	427	01/16 →					

PORSCHE - 911 Cabriolet (993) 07/94 → 09/97











Bremsbelagsatz, Scheibenbremse







3.8 Carrera	221	08/95 → 09/97	➔		13.0460-4056.2	604056	BRE 21402 17,5 + WE / - WK
3.8 Carrera 4	221	08/95 → 09/97					

Warnkontakt, Bremsbelagverschleiß











3.6 Carrera	200	07/94 → 08/95	➔		2	24.8190-0917.2	620917	L= 518
3.6 Carrera	210	08/95 → 09/97						
3.6 Carrera 4	200	07/94 → 08/95	➔		2	24.8190-0920.2	620920	L= 698
3.6 Carrera 4	210	08/95 → 09/97						
3.8 Carrera	210	06/95 → 09/97						
3.8 Carrera 4	210	06/95 → 09/97						
3.8 Carrera	221	08/95 → 09/97	➔		2	24.8190-0926.2	620926	L= 475
3.8 Carrera 4	221	08/95 → 09/97						
			➔		2	24.8190-0920.2	620920	L= 698























↓

















	kw			 	! #		
PORSCHE - 911 Cabriolet (993) 07/94→09/97							
 Bremsscheibe							
3.6 Carrera	200	07/94→08/95	←	<input type="checkbox"/>		24.0132-0142.1 432142	Ø 304 32 30 V•
3.6 Carrera	210	08/95→09/97	←	<input type="checkbox"/>		24.0132-0143.1 432143	Ø 304 32 30 V•
3.6 Carrera 4	200	07/94→08/95	←	<input type="checkbox"/>		24.0132-0143.1 432143	Ø 304 32 30 V•
3.6 Carrera 4	210	08/95→09/97	→			24.0124-0183.1 424183	Ø 299 24 22 V•
3.8 Carrera	210	06/95→09/97	→			24.0124-0183.1 424183	Ø 299 24 22 V•
3.8 Carrera 4	210	06/95→09/97	→			24.0124-0183.1 424183	Ø 299 24 22 V•
PORSCHE - 911 Cabriolet (996) 02/98→08/05							
 Bremsbelagsatz, Scheibenbremse							
3.4 Carrera	221	02/98→09/01	←			13.0460-4987.2 604987	BRE 23329 17,0 + WE / - WK
3.4 Carrera 4	221	02/98→09/01	→		für Fahrzeuge ohne Keramikbremse	13.0460-4987.2 604987	BRE 23329 17,0 + WE / - WK
			→			13.0460-4988.2 604988	BRE 21792 15,2 + WE / - WK
3.4 Carrera	235	05/01→08/05	←		→ 09/01	13.0460-4987.2 604987	BRE 23329 17,0 + WE / - WK
3.4 Carrera 4	235	05/01→08/05	→		→ 09/01; für Fahrzeuge ohne Keramikbremse	13.0460-4987.2 604987	BRE 23329 17,0 + WE / - WK
			→		→ 09/01	13.0460-4988.2 604988	BRE 21792 15,2 + WE / - WK
3.6 Carrera	235	10/01→08/05	←			13.0460-4987.2 604987	BRE 23329 17,0 + WE / - WK
3.6 Carrera 4	235	10/01→08/05	←		01/02→; für Fahrzeuge ohne Keramikbremse	13.0460-4999.2 604999	BRE 23330 17,0 + WE / - WK
			→		für Fahrzeuge ohne Keramikbremse	13.0460-4987.2 604987	BRE 23329 17,0 + WE / - WK
			→			13.0460-4988.2 604988	BRE 21792 15,2 + WE / - WK
3.6 Carrera 4S	254	06/02→08/05	←			13.0460-4987.2 604987	BRE 23329 17,0 + WE / - WK
3.6 Carrera S	254	06/02→08/05	←		für Fahrzeuge ohne Keramikbremse	13.0460-4999.2 604999	BRE 23330 17,0 + WE / - WK
			→		für Fahrzeuge ohne Keramikbremse	13.0460-4987.2 604987	BRE 23329 17,0 + WE / - WK
			→			13.0460-4988.2 604988	BRE 21792 15,2 + WE / - WK
3.6 Turbo 4	309	10/03→08/05	←		für Fahrzeuge ohne Keramikbremse	13.0460-4999.2 604999	BRE 23330 17,0 + WE / - WK
3.6 Turbo 4S	331	10/03→08/05	→		für Fahrzeuge ohne Keramikbremse	13.0460-4987.2 604987	BRE 23329 17,0 + WE / - WK
Warnkontakt, Bremsbelagverschleiß							
3.4 Carrera	221	02/98→09/01	←			2 24.8190-0921.2 620921	L= 440
3.4 Carrera 4	221	02/98→09/01	→		für Fahrzeuge ohne Keramikbremse	2 24.8190-0921.2 620921	L= 440
			→			2 24.8190-0921.2 620921	L= 440
3.4 Carrera	235	05/01→08/05	←		→ 09/01	2 24.8190-0921.2 620921	L= 440
3.4 Carrera 4	235	05/01→08/05	→		→ 09/01	2 24.8190-0921.2 620921	L= 440
			→		→ 09/01; für Fahrzeuge ohne Keramikbremse	2 24.8190-0921.2 620921	L= 440
3.6 Carrera	235	10/01→08/05	←		01/02→; für Fahrzeuge ohne Keramikbremse	2 24.8190-0921.2 620921	L= 440
3.6 Carrera 4	235	10/01→08/05	←			2 24.8190-0921.2 620921	L= 440
			→		für Fahrzeuge ohne Keramikbremse	2 24.8190-0921.2 620921	L= 440
			→			2 24.8190-0921.2 620921	L= 440
3.6 Carrera 4S	254	06/02→08/05	←		für Fahrzeuge ohne Keramikbremse	2 24.8190-0921.2 620921	L= 440
3.6 Carrera S	254	06/02→08/05	←			2 24.8190-0921.2 620921	L= 440
			→		für Fahrzeuge ohne Keramikbremse	2 24.8190-0921.2 620921	L= 440
			→			2 24.8190-0921.2 620921	L= 440
3.6 Turbo 4	309	10/03→08/05	←		für Fahrzeuge ohne Keramikbremse	2 24.8190-0921.2 620921	L= 440
3.6 Turbo 4S	331	10/03→08/05	→		für Fahrzeuge ohne Keramikbremse	2 24.8190-0921.2 620921	L= 440
 Bremsscheibe							
3.4 Carrera	221	02/98→09/01	←	<input type="checkbox"/>		24.0128-0130.1 428130	Ø 318 28 26 V•
3.4 Carrera 4	221	02/98→09/01	←	<input type="checkbox"/>		24.0128-0131.1 428131	Ø 318 28 26 V•
			→			24.0124-0176.1 424176	Ø 299 24 22 V•
3.4 Carrera	235	05/01→08/05	←	<input type="checkbox"/>	→ 09/01	24.0128-0130.1 428130	Ø 318 28 26 V•
3.4 Carrera 4	235	05/01→08/05	←	<input type="checkbox"/>	→ 09/01	24.0128-0131.1 428131	Ø 318 28 26 V•
			→		→ 09/01	24.0124-0176.1 424176	Ø 299 24 22 V•
3.6 Carrera	235	10/01→08/05	←	<input type="checkbox"/>		24.0128-0130.1 428130	Ø 318 28 26 V•
3.6 Carrera 4	235	10/01→08/05	←	<input type="checkbox"/>		24.0128-0131.1 428131	Ø 318 28 26 V•
			←	<input type="checkbox"/>	01/02→; für Fahrzeuge ohne Keramikbremse	24.0134-0101.1 434101	Ø 330 34 32 V•
↓							







	kW			 	! #		
PORSCHE - 911 Cabriolet (996) 02/98→08/05							
Bremsscheibe							
3.6 Carrera 3.6 Carrera 4	235 235	10/01→08/05 10/01→08/05	← → → →	☐; 01/02→; für Fahrzeuge ohne Keramikbremse ☐; 01/02→; für Fahrzeuge ohne Keramikbremse ☐; 01/02→; für Fahrzeuge ohne Keramikbremse		24.0134-0102.1 434102 24.0124-0176.1 424176 24.0128-0196.1 428196 24.0128-0197.1 428197	Ø 330 34 32 V• Ø 299 24 22 V• Ø 330 28 26 V• Ø 330 28 26 V•
3.6 Carrera 4S 3.6 Carrera S	254 254	06/02→08/05 06/02→08/05	← ← ← ← → → →	☐ ☐ ☐; für Fahrzeuge ohne Keramikbremse ☐; für Fahrzeuge ohne Keramikbremse ☐; für Fahrzeuge ohne Keramikbremse ☐; für Fahrzeuge ohne Keramikbremse		24.0128-0130.1 428130 24.0128-0131.1 428131 24.0134-0101.1 434101 24.0134-0102.1 434102 24.0124-0176.1 424176 24.0128-0196.1 428196 24.0128-0197.1 428197	Ø 318 28 26 V• Ø 318 28 26 V• Ø 330 34 32 V• Ø 330 34 32 V• Ø 299 24 22 V• Ø 330 28 26 V• Ø 330 28 26 V•
3.6 Turbo 4 3.6 Turbo 4S	309 331	10/03→08/05 10/03→08/05	← ← → →	☐; für Fahrzeuge ohne Keramikbremse ☐; für Fahrzeuge ohne Keramikbremse ☐; für Fahrzeuge ohne Keramikbremse ☐; für Fahrzeuge ohne Keramikbremse		24.0134-0101.1 434101 24.0134-0102.1 434102 24.0128-0196.1 428196 24.0128-0197.1 428197	Ø 330 34 32 V• Ø 330 34 32 V• Ø 330 28 26 V• Ø 330 28 26 V•
PORSCHE - 911 Cabriolet (997) 04/05→12/12							
Bremsbelagsatz, Scheibenbremse							
3.6 Carrera 3.6 Carrera 3.6 Carrera	235 239 242	04/05→07/05 04/05→12/08 04/05→12/08	← ← → →	für Fahrzeuge ohne Keramikbremse; für Fahrzeuge mit Sportpaket für Fahrzeuge ohne Keramikbremse; für Fahrzeuge ohne Sportpaket für Fahrzeuge ohne Keramikbremse; für Fahrzeuge mit Sportpaket für Fahrzeuge ohne Keramikbremse; für Fahrzeuge ohne Sportpaket		13.0460-4842.2 604842 13.0460-4987.2 604987 13.0460-4843.2 604843 13.0460-4988.2 604988	BRE 24049 17,0 + WE / - WK BRE 23329 17,0 + WE / - WK BRE XXXXX 15,5 + WE / - WK BRE 21792 15,2 + WE / - WK
3.6 Carrera 4 3.6 Carrera 4	239 242	04/05→12/08 04/05→12/08	← →	für Fahrzeuge ohne Keramikbremse für Fahrzeuge ohne Keramikbremse		13.0460-4842.2 604842 13.0460-4988.2 604988	BRE 24049 17,0 + WE / - WK BRE 21792 15,2 + WE / - WK
3.6 Carrera 4 3.6 Turbo 3.8 Carrera GTS 3.8 Turbo 3.8 Turbo S	254 353 300 368 390	06/08→12/12 09/07→12/09 06/09→12/11 09/09→12/12 02/10→12/12	←	für Fahrzeuge ohne Keramikbremse		13.0460-4842.2 604842	BRE 24049 17,0 + WE / - WK
3.8 Carrera 4 GTS 3.8 Carrera 4S 3.8 Carrera 4S 3.8 Carrera S 3.8 Carrera S	300 280 283 280 283	06/09→12/12 08/05→12/08 06/08→12/12 08/05→12/08 06/08→12/11	←	für Fahrzeuge ohne Keramikbremse		13.0460-4999.2 604999	BRE 23330 17,0 + WE / - WK
3.8 Carrera 4S 3.8 Carrera 4S 3.8 Carrera S 3.8 Carrera S	261 264 261 264	04/05→12/08 04/05→12/10 04/05→12/08 04/05→12/08	← →	für Fahrzeuge ohne Keramikbremse für Fahrzeuge ohne Keramikbremse		13.0460-4999.2 604999 13.0460-4842.2 604842	BRE 23330 17,0 + WE / - WK BRE 24049 17,0 + WE / - WK
Warnkontakt, Bremsbelagverschleiß							
3.6 Carrera 3.6 Carrera 3.6 Carrera	235 239 242	04/05→07/05 04/05→12/08 04/05→12/08	← →		2	24.8190-0931.2 620931 24.8190-0921.2 620921	L= 336 L= 440
3.6 Carrera	254	06/08→12/11	← →	für Fahrzeuge ohne Keramikbremse für Fahrzeuge ohne Keramikbremse	2	24.8190-0016.2 620016 24.8190-0023.2 620023	L= 359,6 L= 484,6
3.6 Carrera 4 3.6 Carrera 4	239 242	04/05→12/08 04/05→12/08	← →	für Fahrzeuge ohne Keramikbremse für Fahrzeuge ohne Keramikbremse	2	24.8190-0938.2 620938 24.8190-0921.2 620921	L= 495 L= 440
3.6 Carrera 4	254	06/08→12/12	← →	für Fahrzeuge ohne Keramikbremse für Fahrzeuge ohne Keramikbremse	2	24.8190-0938.2 620938 24.8190-0023.2 620023	L= 495 L= 484,6
3.6 Turbo 3.8 Carrera GTS 3.8 Turbo 3.8 Turbo S	353 300 368 390	09/07→12/09 06/09→12/11 09/09→12/12 02/10→12/12	← →	für Fahrzeuge ohne Keramikbremse	2	24.8190-0938.2 620938 24.8190-0943.2 620943	L= 495 L= 504,6
3.8 Carrera 4 GTS	300	06/09→12/12	← ←	☐; für Fahrzeuge ohne Keramikbremse ☐; für Fahrzeuge ohne Keramikbremse	1	24.8190-0931.2 620931 24.8190-0933.2 620933	L= 336 L= 305
3.8 Carrera 4S 3.8 Carrera 4S 3.8 Carrera 4S 3.8 Carrera 4S	261 264 280 283	04/05→12/08 04/05→12/10 08/05→12/08 06/08→12/12	← →	für Fahrzeuge ohne Keramikbremse	2	24.8190-0950.2 620950 24.8190-0943.2 620943	L= 525 L= 504,6
↓							











	kw			 	! #		
PORSCHE - 911 Cabriolet (997) 04/05→12/12							
Warnkontakt, Bremsbelagverschleiß							
3.8 Carrera S	261	04/05→12/08	←	☐; für Fahrzeuge ohne Keramikbremse	1	24.8190-0931.2 620931	L= 336
3.8 Carrera S	264	04/05→12/08	←	☐; für Fahrzeuge ohne Keramikbremse	1	24.8190-0933.2 620933	L= 305
3.8 Carrera S	280	08/05→12/08	←				
3.8 Carrera S	283	06/08→12/11	→		2	24.8190-0943.2 620943	L= 504,6
 Bremsscheibe							
3.6 Carrera	235	04/05→07/05	←	☐; für Fahrzeuge ohne Keramikbremse		24.0128-0130.1 428130	Ø 318 28 26 V•
3.6 Carrera	239	04/05→12/08	←	☐; für Fahrzeuge ohne Keramikbremse		24.0128-0131.1 428131	Ø 318 28 26 V•
3.6 Carrera	242	04/05→12/08	←	☐; für Fahrzeuge ohne Keramikbremse			
3.6 Carrera 4	239	04/05→12/08	→	für Fahrzeuge ohne Keramikbremse		24.0124-0176.1 424176	Ø 299 24 22 V•
3.6 Carrera 4	242	04/05→12/08	→				
3.6 Carrera	254	06/08→12/11	←	☐		24.0128-0246.1 428246	Ø 330 28 26 V•
3.6 Carrera 4	254	06/08→12/12	←	☐		24.0128-0247.1 428247	Ø 330 28 26 V•
			→	☐; für Fahrzeuge ohne Keramikbremse		24.0128-0196.1 428196	Ø 330 28 26 V•
			→	☐; für Fahrzeuge ohne Keramikbremse		24.0128-0197.1 428197	Ø 330 28 26 V•
3.6 Turbo	353	09/07→12/09	←	☐; für Fahrzeuge ohne Keramikbremse		24.0134-0101.1 434101	Ø 330 34 32 V•
			←	☐; für Fahrzeuge ohne Keramikbremse		24.0134-0102.1 434102	Ø 330 34 32 V•
			→	☐; für Fahrzeuge ohne Keramikbremse		24.0128-0264.1 428264	Ø 350 28 26 V•
			→	☐; für Fahrzeuge ohne Keramikbremse		24.0128-0265.1 428265	Ø 350 28 26 V•
3.8 Carrera 4 GTS	300	06/09→12/12	←	☐; für Fahrzeuge ohne Keramikbremse		24.0134-0101.1 434101	Ø 330 34 32 V•
3.8 Carrera 4S	261	04/05→12/08	←	☐; für Fahrzeuge ohne Keramikbremse		24.0134-0102.1 434102	Ø 330 34 32 V•
3.8 Carrera 4S	264	04/05→12/10	←				
3.8 Carrera 4S	280	08/05→12/08	→	☐; für Fahrzeuge ohne Keramikbremse		24.0128-0196.1 428196	Ø 330 28 26 V•
3.8 Carrera 4S	283	06/08→12/12	→				
3.8 Carrera GTS	300	06/09→12/11	→	☐; für Fahrzeuge ohne Keramikbremse		24.0128-0197.1 428197	Ø 330 28 26 V•
3.8 Carrera S	261	04/05→12/08					
3.8 Carrera S	264	04/05→12/08					
3.8 Carrera S	280	08/05→12/08					
3.8 Carrera S	283	06/08→12/11					
3.8 Turbo	368	09/09→12/12					
3.8 Turbo S	390	02/10→12/12					
PORSCHE - 911 Targa (991) 05/14→							
Warnkontakt, Bremsbelagverschleiß							
3.0 Carrera 4	272	11/15→	←	für Fahrzeuge mit Keramikbremse	2	24.8190-0952.2 620952	L= 300
3.0 Carrera 4S	309	11/15→	←				
3.8 Carrera 4S	294	05/14→	→		2	24.8190-0953.2 620953	L= 215
3.8 Carrera 4S / 4 GTS	316	05/14→	→				
3.4 Carrera 4	257	05/14→	←	für Fahrzeuge ohne Keramikbremse	2	24.8190-0069.2 620069	L= 248
			←	für Fahrzeuge mit Keramikbremse	2	24.8190-0952.2 620952	L= 300
			→		2	24.8190-0953.2 620953	L= 215
 Bremsscheibe							
3.0 Carrera 4	272	11/15→	→	☐; für Fahrzeuge ohne Keramikbremse		24.0128-0196.1 428196	Ø 330 28 26 V•
3.0 Carrera 4S	309	11/15→	→				
3.8 Carrera 4S	294	05/14→	→	☐; für Fahrzeuge ohne Keramikbremse		24.0128-0197.1 428197	Ø 330 28 26 V•
3.8 Carrera 4S / 4 GTS	316	05/14→	→				
3.4 Carrera 4	257	05/14→	←	☐; für Fahrzeuge ohne Keramikbremse		24.0128-0246.1 428246	Ø 330 28 26 V•
			←	☐; für Fahrzeuge ohne Keramikbremse		24.0128-0247.1 428247	Ø 330 28 26 V•
PORSCHE - 911 Targa (993) 01/94→09/97							
Warnkontakt, Bremsbelagverschleiß							
3.6 Carrera	210	08/95→09/97	←		2	24.8190-0917.2 620917	L= 518
			→		2	24.8190-0920.2 620920	L= 698
 Bremsscheibe							
3.6 Carrera	210	08/95→09/97	←	☐		24.0132-0142.1 432142	Ø 304 32 30 V•
			←	☐		24.0132-0143.1 432143	Ø 304 32 30 V•
			→			24.0124-0183.1 424183	Ø 299 24 22 V•
PORSCHE - 911 Targa (996) 12/01→08/05							
 Bremsbelagsatz, Scheibenbremse							
3.6	235	12/01→08/05	←			13.0460-4987.2 604987	BRE 23329 17,0 + WE / - WK
↓			→			13.0460-4988.2 604988	BRE 21792 15,2 + WE / - WK







	kW					! #		
PORSCHE - 911 Targa (996) 12/01→08/05								
Warnkontakt, Bremsbelagverschleiß								
3.6	235	12/01→08/05	←			2	24.8190-0921.2 620921	L= 440
			→			2	24.8190-0921.2 620921	L= 440
 Bremsscheibe								
3.6	235	12/01→08/05	←				24.0128-0130.1 428130	Ø 318 28 26 V•
			←				24.0128-0131.1 428131	Ø 318 28 26 V•
			→				24.0124-0176.1 424176	Ø 299 24 22 V•
PORSCHE - 911 Targa (997) 07/06→12/12								
Warnkontakt, Bremsbelagverschleiß								
3.6 Carrera 4	239	07/06→12/08	←	11/06→;	für Fahrzeuge ohne Keramikbremse	2	24.8190-0027.2 620027	L= 514,6
3.8 Carrera 4S	261	07/06→12/08	→	11/06→;	für Fahrzeuge ohne Keramikbremse	2	24.8190-0023.2 620023	L= 484,6
3.6 Carrera 4	254	10/08→12/12	←		für Fahrzeuge ohne Keramikbremse	2	24.8190-0027.2 620027	L= 514,6
			→		für Fahrzeuge ohne Keramikbremse	2	24.8190-0023.2 620023	L= 484,6
3.8 Carrera 4S	283	10/08→12/12	←		für Fahrzeuge ohne Keramikbremse	2	24.8190-0950.2 620950	L= 525
			→		für Fahrzeuge ohne Keramikbremse	2	24.8190-0023.2 620023	L= 484,6
 Bremsscheibe								
3.6 Carrera 4	239	07/06→12/08	←		11/06→;		24.0128-0246.1 428246	Ø 330 28 26 V•
3.8 Carrera 4S	261	07/06→12/08	←		11/06→;		24.0128-0247.1 428247	Ø 330 28 26 V•
			→		11/06→;		24.0124-0176.1 424176	Ø 299 24 22 V•
3.6 Carrera 4	254	10/08→12/12	←		für Fahrzeuge ohne Keramikbremse		24.0128-0246.1 428246	Ø 330 28 26 V•
			←		für Fahrzeuge ohne Keramikbremse		24.0128-0247.1 428247	Ø 330 28 26 V•
			→		für Fahrzeuge ohne Keramikbremse		24.0124-0176.1 424176	Ø 299 24 22 V•
3.8 Carrera 4S	283	10/08→12/12	←		für Fahrzeuge ohne Keramikbremse		24.0134-0101.1 434101	Ø 330 34 32 V•
			←		für Fahrzeuge ohne Keramikbremse		24.0134-0102.1 434102	Ø 330 34 32 V•
			→		für Fahrzeuge ohne Keramikbremse		24.0128-0196.1 428196	Ø 330 28 26 V•
			→		für Fahrzeuge ohne Keramikbremse		24.0128-0197.1 428197	Ø 330 28 26 V•
PORSCHE - 928 09/77→11/95								
 Bremsbelagsatz, Scheibenbremse								
5.4 GTS	257	08/91→11/95	←				13.0460-4056.2 604056	BRE 21402 17,5 + WE / - WK
Warnkontakt, Bremsbelagverschleiß								
5.4 GTS	257	08/91→11/95	←			2	24.8190-0925.2 620925	L= 265
			→			2	24.8190-0910.2 620910	L= 515
							24.8190-0919.2 620919	L= 638
 Bremsscheibe								
5.4 GTS	257	08/91→11/95	→				24.0124-0116.1 424116	Ø 299 24 22 V
PORSCHE - 968 06/91→11/95								
Warnkontakt, Bremsbelagverschleiß								
3.0	176	06/91→11/95	←		für Fahrzeuge ohne Sportfahrwerk	2	24.8190-0916.2 620916	L= 395
3.0 Turbo S	224	03/93→11/95	←		für Fahrzeuge mit Sportfahrwerk	2	24.8190-0916.2 620916	L= 395
			→			2	24.8190-0916.2 620916	L= 395
 Bremsscheibe								
3.0	176	06/91→11/95	←		für Fahrzeuge ohne Sportfahrwerk		24.0128-0167.1 428167	Ø 298 28 26 V
3.0 Turbo S	224	03/93→11/95	→		für Fahrzeuge ohne Sportfahrwerk		24.0124-0117.1 424117	Ø 299 24 22 V
PORSCHE - 968 Cabriolet 06/91→11/95								
Warnkontakt, Bremsbelagverschleiß								
3.0	176	06/91→11/95	←		für Fahrzeuge ohne Sportfahrwerk	2	24.8190-0916.2 620916	L= 395
↓			←		für Fahrzeuge mit Sportfahrwerk	2	24.8190-0916.2 620916	L= 395

	kw			 	! #		
PORSCHE - 968 Cabriolet 06/91→11/95							
Warnkontakt, Bremsbelagverschleiß							
3.0	176	06/91→11/95	➔		2	24.8190-0916.2 620916	L= 395
 Bremsscheibe							
3.0	176	06/91→11/95	⬅	für Fahrzeuge ohne Sportfahrwerk		24.0128-0167.1 428167	Ø 298 28 26 V
			➔	für Fahrzeuge ohne Sportfahrwerk		24.0124-0117.1 424117	Ø 299 24 22 V
PORSCHE - BOXSTER (981) 04/12→							
 Bremsbelagsatz, Scheibenbremse							
2.7 GTS 3.4 S 3.4	195 243 232	04/12→ 02/14→ 04/12→	➔	für Fahrzeuge ohne Keramikbremse		13.0460-4816.2 604816	BRE 24541 15,5 + WE / - WK
Warnkontakt, Bremsbelagverschleiß							
2.7 GTS 3.4 S 3.4	195 243 232	04/12→ 02/14→ 04/12→	⬅	für Fahrzeuge ohne Keramikbremse	2	24.8190-0069.2 620069	L= 248
			⬅	für Fahrzeuge mit Keramikbremse	2	24.8190-0952.2 620952	L= 300
			➔	für Fahrzeuge mit Keramikbremse	2	24.8190-0070.2 620070	L= 268
 Bremsscheibe							
2.7	195	04/12→	⬅	 für Fahrzeuge ohne Keramikbremse		24.0128-0260.1 428260	Ø 315 28 26 V•
			⬅	 für Fahrzeuge ohne Keramikbremse		24.0128-0273.1 428273	Ø 315 28 26 V•
			➔	für Fahrzeuge ohne Keramikbremse		24.0120-0212.1 420212	Ø 299 20 18 V•
GTS 3.4 S 3.4	243 232	02/14→ 04/12→	⬅	 für Fahrzeuge ohne Keramikbremse		24.0128-0246.1 428246	Ø 330 28 26 V•
			⬅	 für Fahrzeuge ohne Keramikbremse		24.0128-0247.1 428247	Ø 330 28 26 V•
PORSCHE - BOXSTER (986) 09/96→12/04							
 Bremsbelagsatz, Scheibenbremse							
2.5	150	09/96→08/99	⬅	→ 07/99		13.0460-4814.2 604814	BRE 21937 15,5 + WE / - WK
			➔	→ 07/99		13.0470-4814.2 LD4814	BRE 21937 15,5 + WE / - WK Ceramic
2.7	155	06/99→12/02	⬅	08/99→ 06/02		13.0460-4814.2 604814	BRE 21937 15,5 + WE / - WK
			➔	08/99→ 06/02		13.0470-4814.2 LD4814	BRE 21937 15,5 + WE / - WK Ceramic
2.7	162	08/99→07/02	⬅	→ 06/02		13.0460-4814.2 604814	BRE 21937 15,5 + WE / - WK
			➔	→ 06/02		13.0470-4814.2 LD4814	BRE 21937 15,5 + WE / - WK Ceramic
2.7	168	07/02→12/04	⬅			13.0460-4814.2 604814	BRE 21937 15,5 + WE / - WK
			➔			13.0470-4814.2 LD4814	BRE 21937 15,5 + WE / - WK Ceramic
S 3.2 S 3.2	191 196	07/02→12/04 01/04→12/04	⬅			13.0460-4988.2 604988	BRE 21792 15,2 + WE / - WK
			➔			13.0460-4988.2 604988	BRE 21792 15,2 + WE / - WK
S 3.2	185	08/99→07/02	⬅	→ 06/02		13.0460-4987.2 604987	BRE 23329 17,0 + WE / - WK
			➔	→ 06/02		13.0460-4988.2 604988	BRE 21792 15,2 + WE / - WK
Warnkontakt, Bremsbelagverschleiß							
2.5	150	09/96→08/99	⬅	→ 07/99	2	24.8190-0921.2 620921	L= 440
			➔	→ 07/99	2	24.8190-0922.2 620922	L= 440
2.7	155	06/99→12/02	⬅	08/99→ 06/02	2	24.8190-0921.2 620921	L= 440
			➔	08/99→ 06/02	2	24.8190-0922.2 620922	L= 440
2.7 S 3.2	162 185	08/99→07/02 08/99→07/02	⬅	→ 06/02	2	24.8190-0921.2 620921	L= 440
			➔	→ 06/02	2	24.8190-0922.2 620922	L= 440
2.7 S 3.2 S 3.2	168 191 196	07/02→12/04 07/02→12/04 01/04→12/04	⬅		2	24.8190-0921.2 620921	L= 440
			➔		2	24.8190-0922.2 620922	L= 440
 Bremsscheibe							
2.5	150	09/96→08/99	⬅	→ 07/99		24.0124-0165.1 424165	Ø 298 24 22 V
			➔	→ 07/99		24.0120-0176.1 420176	Ø 292 20 18 V
↓							









	kW			 	! #		
PORSCHE - BOXSTER (986) 09/96→12/04							
Bremsscheibe							
2.7	155	06/99→12/02	←	08/99→06/02		24.0124-0165.1 424165	Ø 298 24 22 V
			→	08/99→06/02		24.0120-0176.1 420176	Ø 292 20 18 V
2.7	162	08/99→07/02	←	→06/02		24.0124-0165.1 424165	Ø 298 24 22 V
			→	→06/02		24.0120-0176.1 420176	Ø 292 20 18 V
2.7	168	07/02→12/04	←			24.0124-0165.1 424165	Ø 298 24 22 V
			→			24.0120-0176.1 420176	Ø 292 20 18 V
S 3.2	191	07/02→12/04	←	☐		24.0128-0130.1 428130	Ø 318 28 26 V•
S 3.2	196	01/04→12/04	←	☐		24.0128-0131.1 428131	Ø 318 28 26 V•
			→			24.0124-0194.1 424194	Ø 299 24 22 V•
S 3.2	185	08/99→07/02	←	☐; →06/02		24.0128-0130.1 428130	Ø 318 28 26 V•
			←	☐; →06/02		24.0128-0131.1 428131	Ø 318 28 26 V•
			→	→06/02		24.0124-0194.1 424194	Ø 299 24 22 V•
PORSCHE - BOXSTER (987) 11/04→12/11							
Bremsbelagsatz, Scheibenbremse							
2.7	176	11/04→12/06	←	→07/06		13.0460-4815.2 604815	BRE 21937 15,5 + WE / - WK
			→	→07/06		13.0470-4814.2 LD4814	BRE 21937 15,5 + WE / - WK Ceramic
			→	→07/06		13.0460-4816.2 604816	BRE 24541 15,5 + WE / - WK
2.7	180	07/06→12/09	←			13.0460-4815.2 604815	BRE 21937 15,5 + WE / - WK
			→			13.0470-4814.2 LD4814	BRE 21937 15,5 + WE / - WK Ceramic
			→			13.0460-4816.2 604816	BRE 24541 15,5 + WE / - WK
2.9	188	06/09→12/11	→	→09/11		13.0460-4816.2 604816	BRE 24541 15,5 + WE / - WK
S 3.2	206	11/04→12/06	→	→07/06; für Fahrzeuge ohne Keramikbremse		13.0460-4988.2 604988	BRE 21792 15,2 + WE / - WK
S 3.4	217	07/06→12/09	→	für Fahrzeuge ohne Keramikbremse		13.0460-4988.2 604988	BRE 21792 15,2 + WE / - WK
S 3.4	223	08/08→12/09	→	06/09→; für Fahrzeuge ohne Keramikbremse		13.0460-4988.2 604988	BRE 21792 15,2 + WE / - WK
S 3.4	228	06/09→12/11	→	→09/11; für Fahrzeuge ohne Keramikbremse		13.0460-4988.2 604988	BRE 21792 15,2 + WE / - WK
Warnkontakt, Bremsbelagsverschleiß							
2.7	176	11/04→12/06	←	☐; →07/06	1	24.8190-0933.2 620933	L= 305
			←	☐; →07/06	1	24.8190-0934.2 620934	L= 295
			→	→07/06	2	24.8190-0932.2 620932	L= 461
2.7	180	07/06→12/09	←	☐	1	24.8190-0933.2 620933	L= 305
			←	☐	1	24.8190-0934.2 620934	L= 295
			→		2	24.8190-0932.2 620932	L= 461
2.9	188	06/09→12/11	←	☐; →09/11; für Fahrzeuge ohne Keramikbremse	1	24.8190-0024.2 620024	L= 369,6
			←	☐; →09/11; für Fahrzeuge ohne Keramikbremse	1	24.8190-0025.2 620025	L= 349,6
			→	→09/11	2	24.8190-0932.2 620932	L= 461
3.4	231	09/09→12/11	←	☐; 06/10→09/11; für Fahrzeuge ohne Keramikbremse	1	24.8190-0024.2 620024	L= 369,6
			←	☐; 06/10→09/11; für Fahrzeuge ohne Keramikbremse	1	24.8190-0025.2 620025	L= 349,6
3.4	235	06/10→12/11	←	☐; →09/11; für Fahrzeuge ohne Keramikbremse	1	24.8190-0024.2 620024	L= 369,6
			←	☐; →09/11; für Fahrzeuge ohne Keramikbremse	1	24.8190-0025.2 620025	L= 349,6
S 3.2	206	11/04→12/06	←	☐; →07/06; für Fahrzeuge ohne Keramikbremse	1	24.8190-0024.2 620024	L= 369,6
			←	☐; →07/06; für Fahrzeuge ohne Keramikbremse	1	24.8190-0025.2 620025	L= 349,6
			→	→07/06; für Fahrzeuge ohne Keramikbremse	2	24.8190-0922.2 620922	L= 440
S 3.4	217	07/06→12/09	←	☐; für Fahrzeuge ohne Keramikbremse	1	24.8190-0024.2 620024	L= 369,6
			←	☐; für Fahrzeuge ohne Keramikbremse	1	24.8190-0025.2 620025	L= 349,6
			→	für Fahrzeuge ohne Keramikbremse	2	24.8190-0922.2 620922	L= 440
↓							









	kw			 	! #		
PORSCHE - BOXSTER (987) 11/04→12/11							
Warnkontakt, Bremsbelagverschleiß							
S 3.4	223	08/08→12/09	←	☐; 06/09→; für Fahrzeuge ohne Keramikbremse	1	24.8190-0024.2 620024	L= 369,6
			←	☐; 06/09→; für Fahrzeuge ohne Keramikbremse	1	24.8190-0025.2 620025	L= 349,6
			→	06/09→; für Fahrzeuge ohne Keramikbremse	2	24.8190-0922.2 620922	L= 440
S 3.4	228	06/09→12/11	←	☐; → 09/11; für Fahrzeuge ohne Keramikbremse	1	24.8190-0024.2 620024	L= 369,6
			←	☐; → 09/11; für Fahrzeuge ohne Keramikbremse	1	24.8190-0025.2 620025	L= 349,6
			→	→ 09/11; für Fahrzeuge ohne Keramikbremse	2	24.8190-0922.2 620922	L= 440
 Brems Scheibe							
2.7	176	11/04→12/06	←	☐; → 07/06		24.0124-0210.1 424210	Ø 298 24 22 V•
			←	☐; → 07/06		24.0124-0211.1 424211	Ø 298 24 22 V•
			→	→ 07/06		24.0120-0212.1 420212	Ø 299 20 18 V•
2.7	180	07/06→12/09	←	☐		24.0124-0210.1 424210	Ø 298 24 22 V•
			←	☐		24.0124-0211.1 424211	Ø 298 24 22 V•
			→			24.0120-0212.1 420212	Ø 299 20 18 V•
2.9	188	06/09→12/11	←	☐; → 09/11; für Fahrzeuge ohne Keramikbremse		24.0128-0130.1 428130	Ø 318 28 26 V•
			←	☐; → 09/11; für Fahrzeuge ohne Keramikbremse		24.0128-0131.1 428131	Ø 318 28 26 V•
			→	→ 09/11		24.0120-0212.1 420212	Ø 299 20 18 V•
S 3.2	206	11/04→12/06	←	☐; → 07/06; für Fahrzeuge ohne Keramikbremse		24.0128-0130.1 428130	Ø 318 28 26 V•
			←	☐; → 07/06; für Fahrzeuge ohne Keramikbremse		24.0128-0131.1 428131	Ø 318 28 26 V•
			→	→ 07/06; für Fahrzeuge ohne Keramikbremse		24.0124-0194.1 424194	Ø 299 24 22 V•
S 3.4	217	07/06→12/09	←	☐; für Fahrzeuge ohne Keramikbremse		24.0128-0130.1 428130	Ø 318 28 26 V•
			←	☐; für Fahrzeuge ohne Keramikbremse		24.0128-0131.1 428131	Ø 318 28 26 V•
			→	für Fahrzeuge ohne Keramikbremse		24.0124-0194.1 424194	Ø 299 24 22 V•
S 3.4	223	08/08→12/09	←	☐; 06/09→; für Fahrzeuge ohne Keramikbremse		24.0128-0130.1 428130	Ø 318 28 26 V•
			←	☐; 06/09→; für Fahrzeuge ohne Keramikbremse		24.0128-0131.1 428131	Ø 318 28 26 V•
			→	06/09→; für Fahrzeuge ohne Keramikbremse		24.0124-0194.1 424194	Ø 299 24 22 V•
S 3.4	228	06/09→12/11	←	☐; → 09/11; für Fahrzeuge ohne Keramikbremse		24.0128-0130.1 428130	Ø 318 28 26 V•
			←	☐; → 09/11; für Fahrzeuge ohne Keramikbremse		24.0128-0131.1 428131	Ø 318 28 26 V•
			→	→ 09/11; für Fahrzeuge ohne Keramikbremse		24.0124-0194.1 424194	Ø 299 24 22 V•
PORSCHE - BOXSTER Spyder (981) 07/15→							
Warnkontakt, Bremsbelagverschleiß							
3.8	276	07/15→	←	für Fahrzeuge ohne Keramikbremse	2	24.8190-0952.2 620952	L= 300
			→	für Fahrzeuge mit Keramikbremse	2	24.8190-0952.2 620952	L= 300
			→	für Fahrzeuge ohne Keramikbremse	2	24.8190-0953.2 620953	L= 215
PORSCHE - BOXSTER Spyder (987) 09/07→12/11							
 Bremsbelagsatz, Scheibenbremse							
3.4 RS 60	223	09/07→12/08	→	08/08→; für Fahrzeuge ohne Keramikbremse		13.0460-4988.2 604988	BRE 21792 15,2 + WE / - WK
Warnkontakt, Bremsbelagverschleiß							
3.4 RS 60	223	09/07→12/08	←	☐; 08/08→; für Fahrzeuge ohne Keramikbremse	1	24.8190-0024.2 620024	L= 369,6
			←	☐; 08/08→; für Fahrzeuge ohne Keramikbremse	1	24.8190-0025.2 620025	L= 349,6
			→	08/08→; für Fahrzeuge ohne Keramikbremse	2	24.8190-0922.2 620922	L= 440
↓							







	kw					! #		
PORSCHE - BOXSTER Spyder (987) 09/07→12/11								
Bremsscheibe								
3.4 RS 60	223	09/07→12/08	←	☐; 08/08→; für Fahrzeuge ohne Keramikbremse	24.0128-0130.1	428130	Ø 318 28 26 V•	
			←	☐; 08/08→; für Fahrzeuge ohne Keramikbremse	24.0128-0131.1	428131	Ø 318 28 26 V•	
			→	08/08→; für Fahrzeuge ohne Keramikbremse	24.0124-0194.1	424194	Ø 299 24 22 V•	
PORSCHE - CARRERA GT (980) 07/03→12/06								
Warnkontakt, Bremsbelagverschleiß								
5.7	450	07/03→12/06	→		2	24.8190-0938.2	620938	L= 495
PORSCHE - CAYENNE (9PA) 09/02→09/10								
Bremsbelagsatz, Scheibenbremse								
3.0 TDI	176	02/09→09/10	←	→ 04/10; passend für Felgengröße [Zoll]: 19; Brems sattelfarbe: rot	13.0460-4840.2	604840	BRE 23961 16,8 + WE / - WK	
			←	→ 04/10; passend für Felgengröße [Zoll]: 18; Brems sattelfarbe: rot	13.0460-4852.2	604852	BRE 24553 15,8 + WE / - WK + Zub	
					13.0460-4993.2	604993	BRE 23693 16,6 + WE / - WK	
			←	→ 04/10; passend für Felgengröße [Zoll]: 17; Brems sattelfarbe: schwarz	13.0460-4992.2	604992	BRE 23692 16,6 + WE / - WK	
					13.0470-4992.2	LD4992	BRE 23692 16,6 + WE / - WK Ceramic	
			←	→ 04/10; passend für Felgengröße [Zoll]: 18; Brems sattelfarbe: silber	13.0460-4993.2	604993	BRE 23693 16,6 + WE / - WK	
		13.0470-4993.2	LD4993	BRE 23693 16,6 + WE / - WK Ceramic				
		→ 12/09; passend für Felgengröße [Zoll]: 18		13.0460-4850.2	604850	BRE 24296 15,5 + WE / - WK		
				13.0470-4850.2	LD4850	BRE 24296 15,5 + WE / - WK Ceramic		
		→ 12/09; passend für Felgengröße [Zoll]: 17		13.0460-4976.2	604976	BRE 23694 16,7 + WE / - WK		
				13.0470-4976.2	LD4976	BRE 23694 16,4 + WE / - WK Ceramic		
3.2	177	08/03→09/07	←	01/05→ 12/06; passend für Felgengröße [Zoll]: 19	13.0460-4840.2	604840	BRE 23961 16,8 + WE / - WK	
			←	10/03→ 12/06; passend für Felgengröße [Zoll]: 18; Brems sattelfarbe: rot	13.0460-4852.2	604852	BRE 24553 15,8 + WE / - WK + Zub	
					13.0460-4993.2	604993	BRE 23693 16,6 + WE / - WK	
			←	10/03→ 12/06; passend für Felgengröße [Zoll]: 17; Brems sattelfarbe: schwarz	13.0460-4992.2	604992	BRE 23692 16,6 + WE / - WK	
					13.0470-4992.2	LD4992	BRE 23692 16,6 + WE / - WK Ceramic	
			←	10/03→ 12/06; passend für Felgengröße [Zoll]: 18; Brems sattelfarbe: silber	13.0460-4993.2	604993	BRE 23693 16,6 + WE / - WK	
		13.0470-4993.2	LD4993	BRE 23693 16,6 + WE / - WK Ceramic				
		→ 01/05→ 12/06; passend für Felgengröße [Zoll]: 18		13.0460-4976.2	604976	BRE 23694 16,7 + WE / - WK		
				13.0470-4976.2	LD4976	BRE 23694 16,4 + WE / - WK Ceramic		
		→ 10/03→ 12/06; passend für Felgengröße [Zoll]: 17		13.0460-4976.2	604976	BRE 23694 16,7 + WE / - WK		
				13.0470-4976.2	LD4976	BRE 23694 16,4 + WE / - WK Ceramic		
3.2	184	10/03→09/07	←	01/05→ 12/06; passend für Felgengröße [Zoll]: 19	13.0460-4840.2	604840	BRE 23961 16,8 + WE / - WK	
			←	→ 12/06; passend für Felgengröße [Zoll]: 18; Brems sattelfarbe: rot	13.0460-4852.2	604852	BRE 24553 15,8 + WE / - WK + Zub	
					13.0460-4993.2	604993	BRE 23693 16,6 + WE / - WK	
			←	→ 12/06; passend für Felgengröße [Zoll]: 17; Brems sattelfarbe: schwarz	13.0460-4992.2	604992	BRE 23692 16,6 + WE / - WK	
					13.0470-4992.2	LD4992	BRE 23692 16,6 + WE / - WK Ceramic	
			←	→ 12/06; passend für Felgengröße [Zoll]: 18; Brems sattelfarbe: silber	13.0460-4993.2	604993	BRE 23693 16,6 + WE / - WK	
		13.0470-4993.2	LD4993	BRE 23693 16,6 + WE / - WK Ceramic				
		→ 12/06; passend für Felgengröße [Zoll]: 17		13.0460-4976.2	604976	BRE 23694 16,7 + WE / - WK		
				13.0470-4976.2	LD4976	BRE 23694 16,4 + WE / - WK Ceramic		
		→ 01/05→ 12/06; passend für Felgengröße [Zoll]: 18		13.0460-4976.2	604976	BRE 23694 16,7 + WE / - WK		
				13.0470-4976.2	LD4976	BRE 23694 16,4 + WE / - WK Ceramic		
3.6	213	02/07→09/10	←	→ 04/10; passend für Felgengröße [Zoll]: 19	13.0460-4840.2	604840	BRE 23961 16,8 + WE / - WK	
↓								

















	kw			 	! #		
PORSCHE - CAYENNE (9PA) 09/02→09/10							
 Bremsbelagsatz, Scheibenbremse							
3.6	213	02/07→09/10	←	→ 04/10; passend für Felgengröße [Zoll]: 18; Bremsattelfarbe: rot	13.0460-4852.2	604852	BRE 24553 15,8 + WE / - WK + Zub
			←	→ 04/10; passend für Felgengröße [Zoll]: 17; Bremsattelfarbe: schwarz	13.0460-4992.2	604992	BRE 23692 16,6 + WE / - WK
			←	→ 04/10; passend für Felgengröße [Zoll]: 18; Bremsattelfarbe: silber	13.0470-4992.2	LD4992	BRE 23692 16,6 + WE / - WK Ceramic
			→	→ 04/10; passend für Felgengröße [Zoll]: 18; Bremsattelfarbe: silber	13.0460-4993.2	604993	BRE 23693 16,6 + WE / - WK
			→	→ 12/09; passend für Felgengröße [Zoll]: 18	13.0470-4993.2	LD4993	BRE 23693 16,6 + WE / - WK Ceramic
GTS 4.8	298	10/07→09/10	←	→ 12/09; passend für Felgengröße [Zoll]: 18	13.0460-4850.2	604850	BRE 24296 15,5 + WE / - WK
			←	→ 12/09; passend für Felgengröße [Zoll]: 17	13.0470-4850.2	LD4850	BRE 24296 15,5 + WE / - WK Ceramic
			←	→ 12/09; passend für Felgengröße [Zoll]: 18	13.0460-4976.2	604976	BRE 23694 16,7 + WE / - WK
			←	→ 12/09; passend für Felgengröße [Zoll]: 17	13.0470-4976.2	LD4976	BRE 23694 16,4 + WE / - WK Ceramic
			→	→ 12/09; passend für Felgengröße [Zoll]: 17	13.0460-4976.2	604976	BRE 23694 16,7 + WE / - WK
S 4.5	250	09/02→09/07	→	→ 12/09; passend für Felgengröße [Zoll]: 17	13.0470-4976.2	LD4976	BRE 23694 16,4 + WE / - WK Ceramic
			→	→ 12/09; passend für Felgengröße [Zoll]: 18	13.0460-4976.2	604976	BRE 23694 16,7 + WE / - WK
			→	→ 12/09; passend für Felgengröße [Zoll]: 17	13.0470-4976.2	LD4976	BRE 23694 16,4 + WE / - WK Ceramic
			→	→ 12/09; passend für Felgengröße [Zoll]: 18	13.0460-4976.2	604976	BRE 23694 16,7 + WE / - WK
			→	→ 12/09; passend für Felgengröße [Zoll]: 17	13.0470-4976.2	LD4976	BRE 23694 16,4 + WE / - WK Ceramic
S 4.8 Turbo S 4.8	283 368	02/07→09/10 02/07→09/10	←	01/05→ 12/06; passend für Felgengröße [Zoll]: 19; Bremsattelfarbe: rot	13.0460-4840.2	604840	BRE 23961 16,8 + WE / - WK
			←	→ 04/10; passend für Felgengröße [Zoll]: 19; Bremsattelfarbe: rot	13.0460-4840.2	604840	BRE 23961 16,8 + WE / - WK
			←	→ 04/10; passend für Felgengröße [Zoll]: 18; Bremsattelfarbe: rot	13.0460-4852.2	604852	BRE 24553 15,8 + WE / - WK + Zub
			←	→ 04/10; passend für Felgengröße [Zoll]: 17; Bremsattelfarbe: schwarz	13.0460-4992.2	604992	BRE 23692 16,6 + WE / - WK
			←	→ 04/10; passend für Felgengröße [Zoll]: 18; Bremsattelfarbe: silber	13.0460-4993.2	604993	BRE 23693 16,6 + WE / - WK
			→	→ 12/09; passend für Felgengröße [Zoll]: 18	13.0460-4850.2	604850	BRE 24296 15,5 + WE / - WK
Turbo 4.5	331	09/02→09/07	→	→ 12/09; passend für Felgengröße [Zoll]: 18	13.0470-4850.2	LD4850	BRE 24296 15,5 + WE / - WK Ceramic
			→	→ 12/09; passend für Felgengröße [Zoll]: 17	13.0460-4976.2	604976	BRE 23694 16,7 + WE / - WK
			→	→ 12/09; passend für Felgengröße [Zoll]: 17	13.0470-4976.2	LD4976	BRE 23694 16,4 + WE / - WK Ceramic
			←	01/05→ 12/06; passend für Felgengröße [Zoll]: 19	13.0460-4840.2	604840	BRE 23961 16,8 + WE / - WK
			←	→ 12/06; passend für Felgengröße [Zoll]: 18; Bremsattelfarbe: rot	13.0460-4852.2	604852	BRE 24553 15,8 + WE / - WK + Zub









	kw			 	! #		
PORSCHE - CAYENNE (9PA) 09/02→09/10							
Bremsbelagsatz, Scheibenbremse							
Turbo 4.5	331	09/02→09/07	←	→ 12/06; passend für Felgengröße [Zoll]: 18; Bremsstättelfarbe: rot		13.0460-4993.2 604993	BRE 23693 16,6 + WE / - WK
			←	→ 12/06; passend für Felgengröße [Zoll]: 17; Bremsstättelfarbe: schwarz		13.0460-4992.2 604992	BRE 23692 16,6 + WE / - WK
			←	→ 12/06; passend für Felgengröße [Zoll]: 18		13.0460-4993.2 604993	BRE 23693 16,6 + WE / - WK
			→	→ 12/06; passend für Felgengröße [Zoll]: 17		13.0460-4976.2 604976 13.0470-4976.2 LD4976	BRE 23694 16,7 + WE / - WK BRE 23694 16,4 + WE / - WK Ceramic
			→	01/05→ 12/06; passend für Felgengröße [Zoll]: 18		13.0460-4976.2 604976 13.0470-4976.2 LD4976	BRE 23694 16,7 + WE / - WK BRE 23694 16,4 + WE / - WK Ceramic
Turbo S 4.5	368	01/04→09/07	←	passend für Felgengröße [Zoll]: 19; Bremsstättelfarbe: rot		13.0460-4840.2 604840	BRE 23961 16,8 + WE / - WK
			←	passend für Felgengröße [Zoll]: 18; Bremsstättelfarbe: rot		13.0460-4852.2 604852	BRE 24553 15,8 + WE / - WK + Zub
			←	passend für Felgengröße [Zoll]: 17; Bremsstättelfarbe: schwarz		13.0460-4993.2 604993	BRE 23693 16,6 + WE / - WK
			←	passend für Felgengröße [Zoll]: 18; Bremsstättelfarbe: silber		13.0460-4993.2 604993	BRE 23693 16,6 + WE / - WK
Turbo S 4.5	383	03/06→09/07	←	passend für Felgengröße [Zoll]: 19; Bremsstättelfarbe: rot		13.0460-4840.2 604840 13.0460-4852.2 604852 13.0460-4993.2 604993	BRE 23961 16,8 + WE / - WK BRE 24553 15,8 + WE / - WK + Zub BRE 23693 16,6 + WE / - WK
			←	passend für Felgengröße [Zoll]: 17; Bremsstättelfarbe: schwarz		13.0460-4992.2 604992	BRE 23692 16,6 + WE / - WK
			←	passend für Felgengröße [Zoll]: 18; Bremsstättelfarbe: silber		13.0460-4993.2 604993	BRE 23693 16,6 + WE / - WK
Turbo S 4.8	397	02/07→09/10	←	→ 04/10; passend für Felgengröße [Zoll]: 19; Bremsstättelfarbe: rot		13.0460-4840.2 604840	BRE 23961 16,8 + WE / - WK
			←	→ 04/10; passend für Felgengröße [Zoll]: 18; Bremsstättelfarbe: rot		13.0460-4852.2 604852 13.0460-4993.2 604993	BRE 24553 15,8 + WE / - WK + Zub BRE 23693 16,6 + WE / - WK
			←	→ 12/09; passend für Felgengröße [Zoll]: 17; Bremsstättelfarbe: schwarz		13.0460-4992.2 604992	BRE 23692 16,6 + WE / - WK
			←	→ 04/10; passend für Felgengröße [Zoll]: 18; Bremsstättelfarbe: silber		13.0460-4993.2 604993	BRE 23693 16,6 + WE / - WK
			←	→ 04/10; passend für Felgengröße [Zoll]: 19; Bremsstättelfarbe: rot		13.0460-4840.2 604840	BRE 23961 16,8 + WE / - WK
Turbo S 4.8	404	08/08→09/10	←	→ 04/10; passend für Felgengröße [Zoll]: 18; Bremsstättelfarbe: rot		13.0460-4852.2 604852 13.0460-4993.2 604993	BRE 24553 15,8 + WE / - WK + Zub BRE 23693 16,6 + WE / - WK
			←	→ 04/10; passend für Felgengröße [Zoll]: 17; Bremsstättelfarbe: schwarz		13.0460-4992.2 604992	BRE 23692 16,6 + WE / - WK
			←	→ 04/10; passend für Felgengröße [Zoll]: 18; Bremsstättelfarbe: silber		13.0460-4993.2 604993	BRE 23693 16,6 + WE / - WK
			←	→ 04/10; passend für Felgengröße [Zoll]: 19; Bremsstättelfarbe: rot		13.0460-4840.2 604840	BRE 23961 16,8 + WE / - WK
Warnkontakt, Bremsbelagverschleiß							
3.0 TDI	176	02/09→09/10	←	→ 04/10; passend für Felgengröße [Zoll]: 19; Bremsstättelfarbe: rot	2	24.8190-0066.2 620066	L= 397,4
			←	→ 04/10; passend für Felgengröße [Zoll]: 18; Bremsstättelfarbe: rot	2	24.8190-0929.2 620929 24.8190-0936.2 620936	L= 417,4 L= 367,4
			←	→ 04/10; passend für Felgengröße [Zoll]: 17; Bremsstättelfarbe: schwarz	2	24.8190-0929.2 620929	L= 417,4
			←	→ 04/10; passend für Felgengröße [Zoll]: 18; Bremsstättelfarbe: silber	2	24.8190-0929.2 620929	L= 417,4
			←	→ 04/10; Bremsstättelfarbe: gelb; passend für Felgengröße [Zoll]: 20	2	24.8190-0954.2 620954	L= 365
			→	01/10→; passend für Felgengröße [Zoll]: 17; → 04/10	2	24.8190-0930.2 620930	L= 252,4
			↓				







	kw			 	! #			
PORSCHE - CAYENNE (9PA) 09/02→09/10								
Warnkontakt, Bremsbelagverschleiß								
3.0 TDI	176	02/09→09/10	➡	→ 12/09; passend für Felgengröße [Zoll]: 17	2	24.8190-0930.2 620930	L= 252,4	
			➡	01/10→; passend für Felgengröße [Zoll]: 18; → 04/10	2	24.8190-0937.2 620937	L= 247,4	
			➡	→ 12/09; passend für Felgengröße [Zoll]: 18	2	24.8190-0937.2 620937	L= 247,4	
			➡	→ 04/10; passend für Felgengröße [Zoll]: 19; Bremsattelfarbe: gelb	2	24.8190-0937.2 620937	L= 247,4	
3.2	177	08/03→09/07	⬅	01/05→ 12/06; passend für Felgengröße [Zoll]: 19	2	24.8190-0066.2 620066	L= 397,4	
			⬅	10/03→ 12/06; passend für Felgengröße [Zoll]: 18; Bremsattelfarbe: rot	2	24.8190-0929.2 620929 24.8190-0936.2 620936	L= 417,4 L= 367,4	
			⬅	10/03→ 12/06; passend für Felgengröße [Zoll]: 17; Bremsattelfarbe: schwarz	2	24.8190-0929.2 620929	L= 417,4	
			⬅	10/03→ 12/06; passend für Felgengröße [Zoll]: 18; Bremsattelfarbe: silber	2	24.8190-0929.2 620929	L= 417,4	
			⬅	01/05→; passend für Felgengröße [Zoll]: 20; Bremsattelfarbe: gelb; → 12/06	2	24.8190-0954.2 620954	L= 365	
			➡	01/05→ 12/06; passend für Felgengröße [Zoll]: 18	2	24.8190-0930.2 620930	L= 252,4	
			➡	10/03→ 12/06; passend für Felgengröße [Zoll]: 17	2	24.8190-0930.2 620930	L= 252,4	
			➡	01/05→ 12/06; passend für Felgengröße [Zoll]: 19; Bremsattelfarbe: gelb	2	24.8190-0937.2 620937	L= 247,4	
			3.2	184	10/03→09/07	⬅	01/05→ 12/06; passend für Felgengröße [Zoll]: 19	2
⬅	→ 12/06; passend für Felgengröße [Zoll]: 18; Bremsattelfarbe: rot	2				24.8190-0929.2 620929 24.8190-0936.2 620936	L= 417,4 L= 367,4	
⬅	→ 12/06; passend für Felgengröße [Zoll]: 17; Bremsattelfarbe: schwarz	2				24.8190-0929.2 620929	L= 417,4	
⬅	→ 12/06; passend für Felgengröße [Zoll]: 18; Bremsattelfarbe: silber	2				24.8190-0929.2 620929	L= 417,4	
⬅	01/05→; passend für Felgengröße [Zoll]: 20; Bremsattelfarbe: gelb; → 12/06	2				24.8190-0954.2 620954	L= 365	
➡	01/05→ 12/06; passend für Felgengröße [Zoll]: 18	2				24.8190-0930.2 620930	L= 252,4	
➡	→ 12/06; passend für Felgengröße [Zoll]: 17	2				24.8190-0930.2 620930	L= 252,4	
➡	01/05→ 12/06; passend für Felgengröße [Zoll]: 19; Bremsattelfarbe: gelb	2				24.8190-0937.2 620937	L= 247,4	
3.6	213	02/07→09/10				⬅	→ 04/10; passend für Felgengröße [Zoll]: 19	2
			⬅	→ 04/10; passend für Felgengröße [Zoll]: 17; Bremsattelfarbe: schwarz	2	24.8190-0929.2 620929	L= 417,4	
			⬅	→ 04/10; passend für Felgengröße [Zoll]: 18; Bremsattelfarbe: silber	2	24.8190-0929.2 620929	L= 417,4	
			⬅	→ 04/10; passend für Felgengröße [Zoll]: 18; Bremsattelfarbe: rot	2	24.8190-0936.2 620936	L= 367,4	
			⬅	→ 04/10; Bremsattelfarbe: gelb; passend für Felgengröße [Zoll]: 20	2	24.8190-0954.2 620954	L= 365	
			➡	01/10→; passend für Felgengröße [Zoll]: 17; → 04/10	2	24.8190-0930.2 620930	L= 252,4	
			➡	→ 12/09; passend für Felgengröße [Zoll]: 17	2	24.8190-0930.2 620930	L= 252,4	
			➡	01/10→; passend für Felgengröße [Zoll]: 18; → 04/10	2	24.8190-0937.2 620937	L= 247,4	
			➡	→ 12/09; passend für Felgengröße [Zoll]: 18	2	24.8190-0937.2 620937	L= 247,4	
			↓					

	kw			 	! #		
PORSCHE - CAYENNE (9PA) 09/02→09/10							
Warnkontakt, Bremsbelagverschleiß							
3.6	213	02/07→09/10	➡	→ 04/10; passend für Felgengröße [Zoll]: 19; Brems sattelfarbe: gelb	2	24.8190-0937.2 620937	L= 247,4
GTS 4.8	298	10/07→09/10	←	→ 04/10; passend für Felgengröße [Zoll]: 19; Brems sattelfarbe: rot	2	24.8190-0066.2 620066	L= 397,4
			←	→ 04/10; passend für Felgengröße [Zoll]: 18; Brems sattelfarbe: rot	2	24.8190-0929.2 620929 24.8190-0936.2 620936	L= 417,4 L= 367,4
			←	→ 04/10; passend für Felgengröße [Zoll]: 17; Brems sattelfarbe: schwarz	2	24.8190-0929.2 620929	L= 417,4
			←	→ 04/10; passend für Felgengröße [Zoll]: 18; Brems sattelfarbe: silber	2	24.8190-0929.2 620929	L= 417,4
			←	→ 04/10; Brems sattelfarbe: gelb; passend für Felgengröße [Zoll]: 20	2	24.8190-0954.2 620954	L= 365
			➡	01/10→; Version: 17; Brems sattelfarbe: rot; → 04/10	2	24.8190-0930.2 620930	L= 252,4
			➡	→ 12/09; passend für Felgengröße [Zoll]: 17; Brems sattelfarbe: rot	2	24.8190-0930.2 620930	L= 252,4
			➡	→ 04/10; passend für Felgengröße [Zoll]: 19; Brems sattelfarbe: gelb	2	24.8190-0937.2 620937	L= 247,4
S 4.5	250	09/02→09/07	←	01/05→ 12/06; passend für Felgengröße [Zoll]: 19; Brems sattelfarbe: rot	2	24.8190-0066.2 620066	L= 397,4
			←	→ 12/06; passend für Felgengröße [Zoll]: 18; Brems sattelfarbe: silber	2	24.8190-0929.2 620929	L= 417,4
			←	→ 12/06; passend für Felgengröße [Zoll]: 17; Brems sattelfarbe: schwarz	2	24.8190-0929.2 620929	L= 417,4
			←	passend für Felgengröße [Zoll]: 18; Brems sattelfarbe: rot	2	24.8190-0929.2 620929	L= 417,4
			←	→ 12/06; passend für Felgengröße [Zoll]: 18; Brems sattelfarbe: rot	2	24.8190-0936.2 620936	L= 367,4
			←	01/05→; passend für Felgengröße [Zoll]: 20; Brems sattelfarbe: gelb; → 12/06	2	24.8190-0954.2 620954	L= 365
			➡	01/05→ 12/06; passend für Felgengröße [Zoll]: 18	2	24.8190-0930.2 620930	L= 252,4
			➡	→ 12/06; passend für Felgengröße [Zoll]: 17	2	24.8190-0930.2 620930	L= 252,4
			➡	01/05→ 12/06; passend für Felgengröße [Zoll]: 19; Brems sattelfarbe: gelb	2	24.8190-0937.2 620937	L= 247,4
			S 4.8 Turbo S 4.8	283 368	02/07→09/10 02/07→09/10	←	→ 04/10; passend für Felgengröße [Zoll]: 19; Brems sattelfarbe: rot
←	→ 04/10; passend für Felgengröße [Zoll]: 17; Brems sattelfarbe: schwarz	2				24.8190-0929.2 620929	L= 417,4
←	→ 04/10; passend für Felgengröße [Zoll]: 18; Brems sattelfarbe: silber	2				24.8190-0929.2 620929	L= 417,4
←	→ 04/10; passend für Felgengröße [Zoll]: 18; Brems sattelfarbe: rot	2				24.8190-0936.2 620936	L= 367,4
←	→ 04/10; Brems sattelfarbe: gelb; passend für Felgengröße [Zoll]: 20	2				24.8190-0954.2 620954	L= 365
➡	01/10→; passend für Felgengröße [Zoll]: 17; → 04/10	2				24.8190-0930.2 620930	L= 252,4
➡	→ 12/09; passend für Felgengröße [Zoll]: 17	2				24.8190-0930.2 620930	L= 252,4
➡	01/10→; passend für Felgengröße [Zoll]: 18; → 04/10	2				24.8190-0937.2 620937	L= 247,4
➡	→ 12/09; passend für Felgengröße [Zoll]: 18	2				24.8190-0937.2 620937	L= 247,4
➡	→ 04/10; passend für Felgengröße [Zoll]: 19; Brems sattelfarbe: gelb	2				24.8190-0937.2 620937	L= 247,4
↓							

	kw			 	! #			
PORSCHE - CAYENNE (9PA) 09/02→09/10								
Warnkontakt, Bremsbelagverschleiß								
Turbo 4.5	331	09/02→09/07	←	01/05→ 12/06; passend für Felgengröße [Zoll]: 19	2	24.8190-0066.2	620066	L= 397,4
			←	→ 12/06; passend für Felgengröße [Zoll]: 18; Bremsattelfarbe: rot	2	24.8190-0929.2	620929	L= 417,4
						24.8190-0936.2	620936	L= 367,4
			←	→ 12/06; passend für Felgengröße [Zoll]: 18	2	24.8190-0929.2	620929	L= 417,4
			←	→ 12/06; passend für Felgengröße [Zoll]: 17; Bremsattelfarbe: schwarz	2	24.8190-0929.2	620929	L= 417,4
			←	01/05→; passend für Felgengröße [Zoll]: 20; Bremsattelfarbe: gelb; → 12/06	2	24.8190-0954.2	620954	L= 365
			→	01/05→ 12/06; passend für Felgengröße [Zoll]: 18	2	24.8190-0930.2	620930	L= 252,4
			→	→ 12/06; passend für Felgengröße [Zoll]: 17	2	24.8190-0930.2	620930	L= 252,4
			01/05→ 12/06; passend für Felgengröße [Zoll]: 19; Bremsattelfarbe: gelb	2	24.8190-0937.2	620937	L= 247,4	
Turbo S 4.5	368	01/04→09/07	←	passend für Felgengröße [Zoll]: 19; Bremsattelfarbe: rot	2	24.8190-0066.2	620066	L= 397,4
			←	passend für Felgengröße [Zoll]: 17; Bremsattelfarbe: schwarz	2	24.8190-0929.2	620929	L= 417,4
			←	passend für Felgengröße [Zoll]: 18; Bremsattelfarbe: silber	2	24.8190-0929.2	620929	L= 417,4
			←	passend für Felgengröße [Zoll]: 18; Bremsattelfarbe: rot	2	24.8190-0929.2	620929	L= 417,4
						24.8190-0936.2	620936	L= 367,4
			←	Bremsattelfarbe: gelb; passend für Felgengröße [Zoll]: 20	2	24.8190-0954.2	620954	L= 365
			passend für Felgengröße [Zoll]: 19; Bremsattelfarbe: gelb	2	24.8190-0937.2	620937	L= 247,4	
Turbo S 4.5	383	03/06→09/07	←	passend für Felgengröße [Zoll]: 19; Bremsattelfarbe: rot	2	24.8190-0066.2	620066	L= 397,4
						24.8190-0929.2	620929	L= 417,4
						24.8190-0936.2	620936	L= 367,4
			←	passend für Felgengröße [Zoll]: 18; Bremsattelfarbe: silber	2	24.8190-0929.2	620929	L= 417,4
			←	passend für Felgengröße [Zoll]: 17; Bremsattelfarbe: schwarz	2	24.8190-0929.2	620929	L= 417,4
			Bremsattelfarbe: gelb; passend für Felgengröße [Zoll]: 20	2	24.8190-0954.2	620954	L= 365	
			passend für Felgengröße [Zoll]: 19; Bremsattelfarbe: gelb	2	24.8190-0937.2	620937	L= 247,4	
Turbo S 4.8	397	02/07→09/10	←	→ 04/10; passend für Felgengröße [Zoll]: 19; Bremsattelfarbe: rot	2	24.8190-0066.2	620066	L= 397,4
			←	→ 12/09; passend für Felgengröße [Zoll]: 17; Bremsattelfarbe: schwarz	2	24.8190-0929.2	620929	L= 417,4
			←	→ 04/10; passend für Felgengröße [Zoll]: 18; Bremsattelfarbe: rot	2	24.8190-0929.2	620929	L= 417,4
						24.8190-0936.2	620936	L= 367,4
			←	→ 04/10; passend für Felgengröße [Zoll]: 18; Bremsattelfarbe: silber	2	24.8190-0929.2	620929	L= 417,4
			←	→ 04/10; Bremsattelfarbe: gelb; passend für Felgengröße [Zoll]: 20	2	24.8190-0954.2	620954	L= 365
			→ 04/10; passend für Felgengröße [Zoll]: 19; Bremsattelfarbe: gelb	2	24.8190-0937.2	620937	L= 247,4	
Turbo S 4.8	404	08/08→09/10	←	→ 04/10; passend für Felgengröße [Zoll]: 19; Bremsattelfarbe: rot	2	24.8190-0066.2	620066	L= 397,4
			←	→ 04/10; passend für Felgengröße [Zoll]: 17; Bremsattelfarbe: schwarz	2	24.8190-0929.2	620929	L= 417,4
			←	→ 04/10; passend für Felgengröße [Zoll]: 18; Bremsattelfarbe: rot	2	24.8190-0929.2	620929	L= 417,4
						24.8190-0936.2	620936	L= 367,4
			←	→ 04/10; passend für Felgengröße [Zoll]: 18; Bremsattelfarbe: silber	2	24.8190-0929.2	620929	L= 417,4
			→ 04/10; Bremsattelfarbe: gelb; passend für Felgengröße [Zoll]: 20	2	24.8190-0954.2	620954	L= 365	

↓

	kw			 	! #		
PORSCHE - CAYENNE (9PA) 09/02→09/10							
Warnkontakt, Bremsbelagverschleiß							
Turbo S 4.8	404	08/08→09/10	➡	→ 04/10; passend für Felgengröße [Zoll]: 19; Bremsattelfarbe: gelb	2	24.8190-0937.2 620937	L= 247,4
Zubehörsatz, Scheibenbremsbelag							
3.0 TDI 3.6 S 4.8	176 213 283	02/09→09/10 02/07→09/10 02/07→09/10	←	→ 04/10; passend für Felgengröße [Zoll]: 17; Bremsattelfarbe: schwarz		13.0460-0279.2 610279	
			←	→ 04/10; passend für Felgengröße [Zoll]: 18; Bremsattelfarbe: silber		13.0460-0279.2 610279	
			➡	→ 12/09; passend für Felgengröße [Zoll]: 17		13.0460-0280.2 610280	
3.2	177	08/03→09/07	←	10/03→ 12/06; passend für Felgengröße [Zoll]: 17; Bremsattelfarbe: schwarz		13.0460-0279.2 610279	
			←	10/03→ 12/06; passend für Felgengröße [Zoll]: 18; Bremsattelfarbe: silber		13.0460-0279.2 610279	
			➡	10/03→ 12/06; passend für Felgengröße [Zoll]: 17		13.0460-0280.2 610280	
3.2 S 4.5	184 250	10/03→09/07 09/02→09/07	←	→ 12/06; passend für Felgengröße [Zoll]: 18; Bremsattelfarbe: silber		13.0460-0279.2 610279	
			←	→ 12/06; passend für Felgengröße [Zoll]: 17; Bremsattelfarbe: schwarz		13.0460-0279.2 610279	
			➡	→ 12/06; passend für Felgengröße [Zoll]: 17		13.0460-0280.2 610280	
GTS 4.8	298	10/07→09/10	←	→ 04/10; passend für Felgengröße [Zoll]: 17; Bremsattelfarbe: schwarz		13.0460-0279.2 610279	
			←	→ 04/10; passend für Felgengröße [Zoll]: 18; Bremsattelfarbe: silber		13.0460-0279.2 610279	
			➡	→ 12/09; passend für Felgengröße [Zoll]: 17; Bremsattelfarbe: rot		13.0460-0280.2 610280	
Turbo 4.5	331	09/02→09/07	←	→ 12/06; passend für Felgengröße [Zoll]: 17; Bremsattelfarbe: schwarz		13.0460-0279.2 610279	
			←	→ 12/06; passend für Felgengröße [Zoll]: 18		13.0460-0279.2 610279	
			➡	→ 12/06; passend für Felgengröße [Zoll]: 17		13.0460-0280.2 610280	
Turbo S 4.5 Turbo S 4.5	368 383	01/04→09/07 03/06→09/07	←	passend für Felgengröße [Zoll]: 17; Bremsattelfarbe: schwarz		13.0460-0279.2 610279	
			←	passend für Felgengröße [Zoll]: 18; Bremsattelfarbe: silber		13.0460-0279.2 610279	
Turbo S 4.8	368	02/07→09/10	←	→ 04/10; passend für Felgengröße [Zoll]: 17; Bremsattelfarbe: schwarz		13.0460-0279.2 610279	
			➡	→ 12/09; passend für Felgengröße [Zoll]: 17		13.0460-0280.2 610280	
Turbo S 4.8	397	02/07→09/10	←	→ 12/09; passend für Felgengröße [Zoll]: 17; Bremsattelfarbe: schwarz		13.0460-0279.2 610279	
			←	→ 04/10; passend für Felgengröße [Zoll]: 18; Bremsattelfarbe: silber		13.0460-0279.2 610279	
Turbo S 4.8	404	08/08→09/10	←	→ 04/10; passend für Felgengröße [Zoll]: 17; Bremsattelfarbe: schwarz		13.0460-0279.2 610279	
			←	→ 04/10; passend für Felgengröße [Zoll]: 18; Bremsattelfarbe: silber		13.0460-0279.2 610279	
Bremsscheibe							
3.0 TDI 3.6 S 4.8 Turbo S 4.8	176 213 283 368	02/09→09/10 02/07→09/10 02/07→09/10 02/07→09/10	←	☐; → 04/10; passend für Felgengröße [Zoll]: 17		24.0132-0117.1 432117	Ø 330 32 30 V + S
			←	☐; → 04/10; passend für Felgengröße [Zoll]: 17		24.0132-0118.1 432118	Ø 330 32 30 V + S
			←	☐; → 04/10; passend für Felgengröße [Zoll]: 18		24.0134-0123.1 434123	Ø 350 34 32 V
			←	☐; → 04/10; passend für Felgengröße [Zoll]: 18		24.0134-0124.1 434124	Ø 350 34 32 V
↓							

	kw			 	! #		
PORSCHE - CAYENNE (9PA) 09/02→09/10							
Bremsscheibe							
3.0 TDI 3.6 S 4.8 Turbo S 4.8	176 213 283 368	02/09→09/10 02/07→09/10 02/07→09/10 02/07→09/10	← → → →	→ 04/10; passend für Felgengröße [Zoll]: 18; Bremssattelfarbe: rot → 04/10 → 04/10; passend für Felgengröße [Zoll]: 18		24.0136-0111.1 436111 24.0128-0149.1 428149 24.0128-0169.1 428169	∅ 368 36 34 V ∅ 330 28 26 V + S ∅ 358 28 26 V
3.2	177	08/03→09/07	← ← ← ← →	☐; 10/03→; passend für Felgengröße [Zoll]: 17 ☐; 10/03→; passend für Felgengröße [Zoll]: 17 ☐; 10/03→; passend für Felgengröße [Zoll]: 18 ☐; 10/03→; passend für Felgengröße [Zoll]: 18 01/05→ 12/06		24.0132-0117.1 432117 24.0132-0118.1 432118 24.0134-0123.1 434123 24.0134-0124.1 434124 24.0128-0149.1 428149 24.0128-0169.1 428169	∅ 330 32 30 V + S ∅ 330 32 30 V + S ∅ 350 34 32 V ∅ 350 34 32 V ∅ 330 28 26 V + S ∅ 358 28 26 V
3.2 S 4.5 Turbo 4.5	184 250 331	10/03→09/07 09/02→09/07 09/02→09/07	← ← ← ← →	☐; passend für Felgengröße [Zoll]: 17 ☐; passend für Felgengröße [Zoll]: 17 ☐; passend für Felgengröße [Zoll]: 18 ☐; passend für Felgengröße [Zoll]: 18 01/05→ 12/06		24.0132-0117.1 432117 24.0132-0118.1 432118 24.0134-0123.1 434123 24.0134-0124.1 434124 24.0128-0149.1 428149 24.0128-0169.1 428169	∅ 330 32 30 V + S ∅ 330 32 30 V + S ∅ 350 34 32 V ∅ 350 34 32 V ∅ 330 28 26 V + S ∅ 358 28 26 V
GTS 4.8	298	10/07→09/10	← ← → →	☐; → 04/10; passend für Felgengröße [Zoll]: 18 ☐; → 04/10; passend für Felgengröße [Zoll]: 18 → 04/10 → 04/10; passend für Felgengröße [Zoll]: 18		24.0134-0123.1 434123 24.0134-0124.1 434124 24.0128-0149.1 428149 24.0128-0169.1 428169	∅ 350 34 32 V ∅ 350 34 32 V ∅ 330 28 26 V + S ∅ 358 28 26 V
Turbo S 4.5 Turbo S 4.5	368 383	01/04→09/07 03/06→09/07	→ →	passend für Felgengröße [Zoll]: 18		24.0128-0149.1 428149 24.0128-0169.1 428169	∅ 330 28 26 V + S ∅ 358 28 26 V
Turbo S 4.8	397	02/07→09/10	→ →	→ 04/10 → 04/10; passend für Felgengröße [Zoll]: 18		24.0128-0149.1 428149 24.0128-0169.1 428169	∅ 330 28 26 V + S ∅ 358 28 26 V
Turbo S 4.8	404	08/08→09/10	→	→ 04/10		24.0128-0149.1 428149 24.0128-0169.1 428169	∅ 330 28 26 V + S ∅ 358 28 26 V
PORSCHE - CAYENNE (92A) 06/10→							
Warnkontakt, Bremsbelagverschleiß							
3.0 Diesel 3.0 Diesel 3.0 Diesel 3.0 S E-Hybrid 4.2 S Diesel 4.8 GTS 4.8 S	155 176 180 245 281 309 294	06/10→ 06/10→ 06/11→ 06/10→ 10/12→ 06/12→ 06/10→	← ← ← ← → → →	passend für Felgengröße [Zoll]: 18 / 19; Bremssattelfarbe: silber / rot passend für Felgengröße [Zoll]: 18; Bremssattelfarbe: schwarz passend für Felgengröße [Zoll]: 18; Bremssattelfarbe: grün passend für Felgengröße [Zoll]: 19 / 20; Bremssattelfarbe: gelb passend für Felgengröße [Zoll]: 17 / 18; Bremssattelfarbe: silber / rot + 18" plus Rad; Bremssattelfarbe: rot Bremssattelfarbe: gelb; passend für Felgengröße [Zoll]: 19	2 2 2 2 2 2 2	24.8190-0014.2 620014 24.8190-0014.2 620014 24.8190-0014.2 620014 24.8190-0939.2 620939 24.8190-0015.2 620015 24.8190-0015.2 620015 24.8190-0940.2 620940	L= 296 L= 296 L= 296 L= 296 L= 372,4 L= 138 L= 138 L= 227,4
3.0 Diesel	184	08/14→	← →	10/14→ 10/14→	2 2	24.8190-0014.2 620014 24.8190-0939.2 620939 24.8190-0015.2 620015 24.8190-0940.2 620940	L= 296 L= 372,4 L= 138 L= 227,4
3.0 Diesel 3.0 S E-Hybrid 3.6 GTS 3.6 S 4.2 S Diesel 4.8 Turbo	193 306 324 309 283 382	10/14→ 10/14→ 02/15→ 10/14→ 10/14→ 10/14→	← →		2 2	24.8190-0014.2 620014 24.8190-0939.2 620939 24.8190-0015.2 620015 24.8190-0940.2 620940	L= 296 L= 372,4 L= 138 L= 227,4
3.6	220	06/10→	← ← ←	passend für Felgengröße [Zoll]: 18 / 19; Bremssattelfarbe: silber / rot Bremssattelfarbe: schwarz passend für Felgengröße [Zoll]: 18; Bremssattelfarbe: grün	2 2 2	24.8190-0014.2 620014 24.8190-0014.2 620014 24.8190-0014.2 620014	L= 296 L= 296 L= 296
↓							































PORSCHE - CAYENNE (92A) 06/10→











Warnkontakt, Bremsbelagverschleiß











3.6	220	06/10→	←	passend für Felgengröße [Zoll]: 19 / 20; Bremsattelfarbe: gelb	2	24.8190-0939.2	620939	L= 372,4
			→	+ 18" plus Rad; Bremsattelfarbe: rot	2	24.8190-0015.2	620015	L= 138
			←	passend für Felgengröße [Zoll]: 17 / 18; Bremsattelfarbe: silber / rot	2	24.8190-0015.2	620015	L= 138
			→	Bremsattelfarbe: gelb	2	24.8190-0940.2	620940	L= 227,4
4.8 Turbo 4.8 Turbo	368 397	06/10→ 06/10→	←	passend für Felgengröße [Zoll]: 19 / 18; Bremsattelfarbe: silber / rot	2	24.8190-0014.2	620014	L= 296
			←	passend für Felgengröße [Zoll]: 18; Bremsattelfarbe: schwarz	2	24.8190-0014.2	620014	L= 296
			←	passend für Felgengröße [Zoll]: 18; Bremsattelfarbe: grün	2	24.8190-0014.2	620014	L= 296
			←	passend für Felgengröße [Zoll]: 19 / 20; Bremsattelfarbe: gelb	2	24.8190-0939.2	620939	L= 372,4
			→	passend für Felgengröße [Zoll]: 17 / 18; Bremsattelfarbe: silber / rot	2	24.8190-0015.2	620015	L= 138
			→	+ 18" plus Rad; Bremsattelfarbe: rot	2	24.8190-0015.2	620015	L= 138
			→	Bremsattelfarbe: gelb; passend für Felgengröße [Zoll]: 19	2	24.8190-0940.2	620940	L= 227,4
4.8 Turbo S	405	10/12→	←	passend für Felgengröße [Zoll]: 18 / 19; Bremsattelfarbe: rot / silber	2	24.8190-0014.2	620014	L= 296
			←	passend für Felgengröße [Zoll]: 18; Bremsattelfarbe: schwarz	2	24.8190-0014.2	620014	L= 296
			←	passend für Felgengröße [Zoll]: 18; Bremsattelfarbe: grün	2	24.8190-0014.2	620014	L= 296
			←	passend für Felgengröße [Zoll]: 19 / 20; Bremsattelfarbe: gelb	2	24.8190-0939.2	620939	L= 372,4
			→	Bremsattelfarbe: rot / silber; passend für Felgengröße [Zoll]: 17 / 18	2	24.8190-0015.2	620015	L= 138
			→	+ 18" plus Rad; Bremsattelfarbe: rot	2	24.8190-0015.2	620015	L= 138
			→	Bremsattelfarbe: gelb; passend für Felgengröße [Zoll]: 19	2	24.8190-0940.2	620940	L= 227,4
4.8 Turbo S	419	01/15→	←	Bremsattelfarbe: rot; passend für Felgengröße [Zoll]: 19	2	24.8190-0014.2	620014	L= 296
			←	passend für Felgengröße [Zoll]: 18; Bremsattelfarbe: schwarz	2	24.8190-0014.2	620014	L= 296
			←	passend für Felgengröße [Zoll]: 18; Bremsattelfarbe: grün	2	24.8190-0014.2	620014	L= 296
			←	passend für Felgengröße [Zoll]: 19 / 20; Bremsattelfarbe: gelb	2	24.8190-0939.2	620939	L= 372,4
			→	passend für Felgengröße [Zoll]: 18	2	24.8190-0015.2	620015	L= 138
			→	+ 18" plus Rad; Bremsattelfarbe: rot	2	24.8190-0015.2	620015	L= 138
			→	Bremsattelfarbe: gelb; passend für Felgengröße [Zoll]: 19	2	24.8190-0940.2	620940	L= 227,4







Bremsscheibe

3.0 Diesel 3.0 Diesel 3.0 Diesel 3.6 4.2 S Diesel 4.8 GTS 4.8 Turbo 4.8 Turbo 4.8 Turbo S	155 176 180 220 281 309 368 397 405	06/10→ 06/10→ 06/11→ 06/10→ 10/12→ 06/12→ 06/10→ 06/10→ 10/12→	←	☐; passend für Felgengröße [Zoll]: 18; Bremsattelfarbe: schwarz	24.0134-0123.1	434123	Ø 350 34 32 V			
			←	☐; passend für Felgengröße [Zoll]: 18; Bremsattelfarbe: schwarz	24.0134-0124.1	434124	Ø 350 34 32 V			
			←	☐; passend für Felgengröße [Zoll]: 18; Bremsattelfarbe: grün	24.0136-0123.1	436123	Ø 360 36 34 V + S			
			←	☐; Bremsattelfarbe: silber; passend für Felgengröße [Zoll]: 18	24.0136-0123.1	436123	Ø 360 36 34 V + S			
			←	☐; Bremsattelfarbe: silber; passend für Felgengröße [Zoll]: 18	24.0136-0124.1	436124	Ø 360 36 34 V + S			
			←	☐; passend für Felgengröße [Zoll]: 18; Bremsattelfarbe: grün	24.0136-0124.1	436124	Ø 360 36 34 V + S			
			→	Bremsattelfarbe: silber / rot; passend für Felgengröße [Zoll]: 17 / 18	24.0128-0149.1	428149	Ø 330 28 26 V + S			
			→	18" plus Rad; Bremsattelfarbe: rot	24.0128-0169.1	428169	Ø 358 28 26 V			
			3.0 Diesel	184	08/14→	←	☐; 10/14→	24.0134-0123.1	434123	Ø 350 34 32 V
						←	☐; 10/14→	24.0136-0123.1	436123	Ø 360 36 34 V + S
						←	☐; 10/14→	24.0134-0124.1	434124	Ø 350 34 32 V
						←	☐; 10/14→	24.0136-0124.1	436124	Ø 360 36 34 V + S
→	10/14→; Bremsattelfarbe: silber / rot; passend für Felgengröße [Zoll]: 17 / 18	24.0128-0149.1				428149	Ø 330 28 26 V + S			
→	10/14→; Bremsattelfarbe: rot; 18" plus Rad	24.0128-0169.1	428169	Ø 358 28 26 V						
3.0 Diesel 3.0 S E-Hybrid ↓	193 306	10/14→ 10/14→	←	☐	24.0134-0123.1	434123	Ø 350 34 32 V			















	kw			 	! #		
PORSCHE - CAYENNE (92A) 06/10→							
Bremsscheibe							
3.6 S 4.2 S Diesel	309 283	10/14→ 10/14→	←			24.0136-0123.1 436123	Ø 360 36 34 V + S
			←			24.0134-0124.1 434124	Ø 350 34 32 V
			→		Bremssattelfarbe: silber / rot; passend für Felgengröße [Zoll]: 17 / 18	24.0136-0124.1 436124	Ø 360 36 34 V + S
			→		18" plus Rad; Bremssattelfarbe: rot	24.0128-0149.1 428149	Ø 330 28 26 V + S
3.0 S E-Hybrid	245	06/10→	←		; passend für Felgengröße [Zoll]: 18; Bremssattelfarbe: schwarz	24.0128-0169.1 428169	Ø 358 28 26 V
			←		; passend für Felgengröße [Zoll]: 18; Bremssattelfarbe: schwarz	24.0134-0123.1 434123	Ø 350 34 32 V
			←		; 10/14→	24.0134-0124.1 434124	Ø 350 34 32 V
			←		; passend für Felgengröße [Zoll]: 18; Bremssattelfarbe: grün	24.0136-0123.1 436123	Ø 360 36 34 V + S
			←		; Bremssattelfarbe: silber; passend für Felgengröße [Zoll]: 18	24.0136-0123.1 436123	Ø 360 36 34 V + S
			←		; 10/14→	24.0136-0124.1 436124	Ø 360 36 34 V + S
			←		; Bremssattelfarbe: silber; passend für Felgengröße [Zoll]: 18	24.0136-0124.1 436124	Ø 360 36 34 V + S
			←		; passend für Felgengröße [Zoll]: 18; Bremssattelfarbe: grün	24.0136-0124.1 436124	Ø 360 36 34 V + S
			→		Bremssattelfarbe: silber / rot; passend für Felgengröße [Zoll]: 17 / 18	24.0128-0149.1 428149	Ø 330 28 26 V + S
			→		18" plus Rad; Bremssattelfarbe: rot	24.0128-0169.1 428169	Ø 358 28 26 V
3.6 GTS 4.8 Turbo	324 382	02/15→ 10/14→	←			24.0134-0123.1 434123	Ø 350 34 32 V
			←			24.0136-0123.1 436123	Ø 360 36 34 V + S
			→		Bremssattelfarbe: rot / silber; passend für Felgengröße [Zoll]: 17 / 18	24.0134-0124.1 434124	Ø 350 34 32 V
			→		18" plus Rad; Bremssattelfarbe: rot	24.0136-0124.1 436124	Ø 360 36 34 V + S
4.8 S	294	06/10→	←		; passend für Felgengröße [Zoll]: 18; Bremssattelfarbe: schwarz	24.0128-0149.1 428149	Ø 330 28 26 V + S
			←		; passend für Felgengröße [Zoll]: 18; Bremssattelfarbe: schwarz	24.0128-0169.1 428169	Ø 358 28 26 V
			←		; passend für Felgengröße [Zoll]: 18; Bremssattelfarbe: grün	24.0134-0123.1 434123	Ø 350 34 32 V
			←		; Bremssattelfarbe: silber; passend für Felgengröße [Zoll]: 18	24.0134-0124.1 434124	Ø 350 34 32 V
			←		; Bremssattelfarbe: silber; passend für Felgengröße [Zoll]: 18	24.0136-0123.1 436123	Ø 360 36 34 V + S
			←		; passend für Felgengröße [Zoll]: 18; Bremssattelfarbe: grün	24.0136-0124.1 436124	Ø 360 36 34 V + S
			→		Bremssattelfarbe: schwarz / rot; passend für Felgengröße [Zoll]: 17 / 18	24.0136-0124.1 436124	Ø 360 36 34 V + S
			→		18" plus Rad; Bremssattelfarbe: rot	24.0128-0149.1 428149	Ø 330 28 26 V + S
4.8 Turbo S	419	01/15→	←		; passend für Felgengröße [Zoll]: 18; Bremssattelfarbe: schwarz	24.0128-0169.1 428169	Ø 358 28 26 V
			←		; passend für Felgengröße [Zoll]: 18; Bremssattelfarbe: schwarz	24.0134-0123.1 434123	Ø 350 34 32 V
			←		; passend für Felgengröße [Zoll]: 18; Bremssattelfarbe: grün	24.0134-0124.1 434124	Ø 350 34 32 V
			←		; passend für Felgengröße [Zoll]: 18; Bremssattelfarbe: grün	24.0136-0123.1 436123	Ø 360 36 34 V + S
			←		; passend für Felgengröße [Zoll]: 18; Bremssattelfarbe: grün	24.0136-0124.1 436124	Ø 360 36 34 V + S
			→		passend für Felgengröße [Zoll]: 18	24.0128-0149.1 428149	Ø 330 28 26 V + S
PORSCHE - CAYMAN (981) 03/13→							
Bremsbelagsatz, Scheibenbremse							
2.7 GTS 3.4 S 3.4	202 250 239	03/13→ 02/14→ 03/13→	→		für Fahrzeuge ohne Keramikbremse	13.0460-4816.2 604816	BRE 24541 15,5 + WE / - WK
Warnkontakt, Bremsbelagverschleiß							
2.7 GTS 3.4 S 3.4	202 250 239	03/13→ 02/14→ 03/13→	←		für Fahrzeuge ohne Keramikbremse	2 24.8190-0069.2 620069	L= 248
			←		für Fahrzeuge mit Keramikbremse	2 24.8190-0952.2 620952	L= 300
			→			2 24.8190-0070.2 620070	L= 268
3.8 GT4 ↓	283	01/15→	←			2 24.8190-0952.2 620952	L= 300

















	kw			 	! #		
PORSCHE - CAYMAN (981) 03/13→							
Warnkontakt, Bremsbelagverschleiß							
3.8 GT4	283	01/15→	➡		2	24.8190-0952.2 620952	L= 300
 Bremsscheibe							
2.7 GTS 3.4 S 3.4	202	03/13→	←	☐; für Fahrzeuge ohne Keramikbremse		24.0128-0260.1 428260	Ø 315 28 26 V•
	250	02/14→	←	☐; für Fahrzeuge ohne Keramikbremse		24.0128-0273.1 428273	Ø 315 28 26 V•
	239	03/13→	➡	für Fahrzeuge ohne Keramikbremse		24.0120-0212.1 420212	Ø 299 20 18 V•
PORSCHE - CAYMAN (987) 11/05→12/13							
 Bremsbelagsatz, Scheibenbremse							
2.7	180	07/06→12/09	←			13.0460-4815.2 604815	BRE 21937 15,5 + WE / - WK
			➡			13.0470-4814.2 LD4814	BRE 21937 15,5 + WE / - WK Ceramic
2.9 S 3.4 Sport S 3.4	195 223 235	02/09→12/12 08/08→12/12 02/09→06/13	➡	→ 05/12		13.0460-4816.2 604816	BRE 24541 15,5 + WE / - WK
R 3.4	243	11/10→12/12	➡	→ 05/12; für Fahrzeuge ohne Keramikbremse		13.0460-4816.2 604816	BRE 24541 15,5 + WE / - WK
S 3.4	217	11/05→12/09	➡	für Fahrzeuge ohne Keramikbremse		13.0460-4988.2 604988	BRE 21792 15,2 + WE / - WK
Warnkontakt, Bremsbelagverschleiß							
2.7	180	07/06→12/09	←	☐	1	24.8190-0933.2 620933	L= 305
			←	☐	1	24.8190-0934.2 620934	L= 295
			➡		2	24.8190-0932.2 620932	L= 461
2.9	195	02/09→12/12	←	☐; → 05/12	1	24.8190-0024.2 620024	L= 369,6
			←	☐; → 05/12	1	24.8190-0025.2 620025	L= 349,6
			➡	→ 05/12	2	24.8190-0932.2 620932	L= 461
R 3.4	243	11/10→12/12	←	☐; → 05/12; für Fahrzeuge ohne Keramikbremse	1	24.8190-0024.2 620024	L= 369,6
						24.8190-0935.2 620935	L= 315
			←	☐; → 05/12; für Fahrzeuge ohne Keramikbremse	1	24.8190-0025.2 620025	L= 349,6
			←	☐; → 05/12; für Fahrzeuge mit Keramikbremse	1	24.8190-0956.2 620956	L= 454,6
			←	☐; → 05/12; für Fahrzeuge mit Keramikbremse	1	24.8190-0957.2 620957	L= 394,6
			➡	→ 05/12	2	24.8190-0922.2 620922	L= 440
S 3.4 Sport S 3.4	223 235	08/08→12/12 02/09→06/13	←	☐; → 05/12; für Fahrzeuge ohne Keramikbremse	1	24.8190-0024.2 620024	L= 369,6
						24.8190-0935.2 620935	L= 315
			←	☐; → 05/12; für Fahrzeuge ohne Keramikbremse	1	24.8190-0025.2 620025	L= 349,6
			←	☐; → 05/12; für Fahrzeuge mit Keramikbremse	1	24.8190-0956.2 620956	L= 454,6
			←	☐; → 05/12; für Fahrzeuge mit Keramikbremse	1	24.8190-0957.2 620957	L= 394,6
			➡	→ 05/12	2	24.8190-0932.2 620932	L= 461
S 3.4	217	11/05→12/09	←	☐; für Fahrzeuge ohne Keramikbremse	1	24.8190-0024.2 620024	L= 369,6
						24.8190-0935.2 620935	L= 315
			←	☐; für Fahrzeuge ohne Keramikbremse	1	24.8190-0025.2 620025	L= 349,6
			➡	für Fahrzeuge ohne Keramikbremse	2	24.8190-0922.2 620922	L= 440
 Bremsscheibe							
2.7	180	07/06→12/09	←	☐		24.0124-0210.1 424210	Ø 298 24 22 V•
			←	☐		24.0124-0211.1 424211	Ø 298 24 22 V•
			➡			24.0120-0212.1 420212	Ø 299 20 18 V•
2.9	195	02/09→12/12	←	☐; → 05/12; für Fahrzeuge ohne Keramikbremse		24.0128-0130.1 428130	Ø 318 28 26 V•
			←	☐; → 05/12; für Fahrzeuge ohne Keramikbremse		24.0128-0131.1 428131	Ø 318 28 26 V•
			➡	→ 05/12		24.0120-0212.1 420212	Ø 299 20 18 V•
R 3.4 S 3.4 Sport S 3.4	243 223 235	11/10→12/12 08/08→12/12 02/09→06/13	←	☐; → 05/12; für Fahrzeuge ohne Keramikbremse		24.0128-0130.1 428130	Ø 318 28 26 V•
			←	☐; → 05/12; für Fahrzeuge ohne Keramikbremse		24.0128-0131.1 428131	Ø 318 28 26 V•
↓							









	kw			 	! #			
PORSCHE - CAYMAN (987) 11/05→12/13								
 Bremsscheibe								
S 3.4	217	11/05→12/09	←	☐; für Fahrzeuge ohne Keramikbremse	24.0128-0130.1	428130	Ø 318 28 26 V•	
			←	☐; für Fahrzeuge ohne Keramikbremse	24.0128-0131.1	428131	Ø 318 28 26 V•	
			→	für Fahrzeuge ohne Keramikbremse	24.0124-0194.1	424194	Ø 299 24 22 V•	
PORSCHE - MACAN (95B) 02/14→								
 Bremsbelagsatz, Scheibenbremse								
2.0	174	07/14→	←	für Bremsscheibendurchmesser [mm]: 396	13.0460-4852.2	604852	BRE 24553 15,8 + WE / - WK + Zub	
2.0	185	10/15→						
3.0 GTS	265	10/15→	←	für Bremsscheibendurchmesser [mm]: 360	13.0460-4852.2	604852	BRE 24553 15,8 + WE / - WK + Zub	
3.0 S	250	02/14→						
3.0 S Diesel	155	02/14→						
3.0 S Diesel	184	02/14→	←	für Bremsscheibendurchmesser [mm]: 345	13.0460-4879.2	604879	BRE 25643 16,8 + WE / - WK	
3.0 S Diesel	190	02/14→			13.0470-4879.2	LD4879	BRE 25643 17,0 + WE / - WK Ceramic	
3.6 Turbo	294	02/14→						
3.6 Turbo	324	09/16→	→	für Bremsscheibendurchmesser [mm]: 330	13.0460-2770.2	602770	TRW 24606 17,4 + WK + Zub	
					13.0470-2770.2	LD2770	TRW 24606 17,4 + WK + Zub Ceramic	
Warnkontakt, Bremsbelagverschleiß								
2.0	174	07/14→	→	für Bremsscheibendurchmesser [mm]: 330	2	24.8190-0313.2	620313	L= 217
2.0	185	10/15→						
3.0 GTS	265	10/15→	→	für Bremsscheibendurchmesser [mm]: 356	2	24.8190-0313.2	620313	L= 217
3.0 S	250	02/14→						
3.0 S Diesel	155	02/14→						
3.0 S Diesel	184	02/14→						
3.0 S Diesel	190	02/14→						
3.6 Turbo	294	02/14→						
3.6 Turbo	324	09/16→						
 Bremsscheibe								
2.0	174	07/14→	←	für Bremsscheibendurchmesser [mm]: 345	24.0130-0222.1	430222	Ø 345 30 28 V + S	
2.0	185	10/15→						
3.0 GTS	265	10/15→	→	für Bremsscheibendurchmesser [mm]: 330	24.0122-0272.1	422272	Ø 330 21,9 20 V + S	
3.0 S	250	02/14→						
3.0 S Diesel	155	02/14→						
3.0 S Diesel	184	02/14→	→	für Bremsscheibendurchmesser [mm]: 356	24.0128-0289.1	428289	Ø 356 28 26 V + S	
3.0 S Diesel	190	02/14→						
3.6 Turbo	294	02/14→						
3.6 Turbo	324	09/16→						
PORSCHE - PANAMERA (970) 09/09→10/16								
 Bremsbelagsatz, Scheibenbremse								
4.8 4S	294	09/09→07/13	←	für Fahrzeuge ohne Keramikbremse	13.0460-4852.2	604852	BRE 24553 15,8 + WE / - WK + Zub	
4.8 S	294	09/09→07/13						
4.8 Turbo	368	09/09→07/13						
4.8 Turbo	382	07/13→10/16						
4.8 Turbo	397	08/10→07/13						
4.8 Turbo S	404	05/11→07/13						
4.8 GTS	316	01/12→07/13	←	- Sondermodell; für Fahrzeuge ohne Keramikbremse	13.0460-4852.2	604852	BRE 24553 15,8 + WE / - WK + Zub	
4.8 GTS	324	07/13→10/16						
4.8 Turbo S	419	07/13→10/16	←	01/14→; für Fahrzeuge ohne Keramikbremse	13.0460-4852.2	604852	BRE 24553 15,8 + WE / - WK + Zub	
Warnkontakt, Bremsbelagverschleiß								
3.0 4S	309	07/13→10/16	←	für Fahrzeuge ohne Keramikbremse	2	24.8190-0014.2	620014	L= 296
3.0 D	155	08/11→07/13						
3.0 D	184	08/11→07/13	←	für Fahrzeuge mit Keramikbremse	2	24.8190-0939.2	620939	L= 372,4
3.0 S	309	07/13→10/16			2	24.8190-0940.2	620940	L= 227,4
3.0 S E-Hybrid	245	03/11→07/13						
3.0 S E-Hybrid	279	03/11→07/13	→		2	24.8190-0015.2	620015	L= 138
3.0 S E-Hybrid	306	07/13→10/16						
3.6	220	05/10→07/13						
3.6	228	07/13→10/16						
3.6 4	220	05/10→07/13						
3.6 4	228	07/13→10/16						
3.0 D	221	07/13→10/16	←	01/14→; für Fahrzeuge ohne Keramikbremse	2	24.8190-0014.2	620014	L= 296
			←	01/14→; für Fahrzeuge mit Keramikbremse	2	24.8190-0939.2	620939	L= 372,4
				01/14→	2	24.8190-0940.2	620940	L= 227,4
			→	01/14→	2	24.8190-0015.2	620015	L= 138
4.8 4S	294	09/09→07/13	←	für Fahrzeuge ohne Keramikbremse	2	24.8190-0939.2	620939	L= 372,4
4.8 S	294	09/09→07/13	←	für Fahrzeuge mit Keramikbremse	2	24.8190-0939.2	620939	L= 372,4
↓								











	kw			 	! #		
PORSCHE - PANAMERA (970) 09/09→10/16							
Warnkontakt, Bremsbelagverschleiß							
4.8 4S 4.8 S	294 294	09/09→07/13 09/09→07/13			2	24.8190-0940.2 620940	L= 227,4
4.8 GTS 4.8 GTS	316 324	01/12→07/13 07/13→10/16	←	+ Sondermodell; für Fahrzeuge ohne Keramikbremse	2	24.8190-0014.2 620014	L= 296
			←	- Sondermodell; für Fahrzeuge ohne Keramikbremse	2	24.8190-0939.2 620939	L= 372,4
			←	für Fahrzeuge mit Keramikbremse	2	24.8190-0939.2 620939	L= 372,4
					2	24.8190-0940.2 620940	L= 227,4
				- Sondermodell	2	24.8190-0940.2 620940	L= 227,4
			→	+ Sondermodell	2	24.8190-0015.2 620015	L= 138
4.8 Turbo 4.8 Turbo 4.8 Turbo 4.8 Turbo S	368 382 397 404	09/09→07/13 07/13→10/16 08/10→07/13 05/11→07/13	←	für Fahrzeuge ohne Keramikbremse	2	24.8190-0939.2 620939	L= 372,4
			←	für Fahrzeuge mit Keramikbremse	2	24.8190-0939.2 620939	L= 372,4
					2	24.8190-0940.2 620940	L= 227,4
			→		2	24.8190-0940.2 620940	L= 227,4
4.8 Turbo S	419	07/13→10/16	←	01/14→; für Fahrzeuge mit Keramikbremse	2	24.8190-0939.2 620939	L= 372,4
			←	01/14→; für Fahrzeuge ohne Keramikbremse	2	24.8190-0939.2 620939	L= 372,4
				01/14→	2	24.8190-0940.2 620940	L= 227,4
			→	01/14→	2	24.8190-0940.2 620940	L= 227,4
Bremsscheibe							
3.0 4S 3.0 D 3.0 D 3.0 S 3.0 S E-Hybrid 3.0 S E-Hybrid 3.0 S E-Hybrid 3.6 3.6 3.6 4 3.6 4 4.8 4S 4.8 S	309 155 184 309 245 279 306 220 228 220 228 294 294	07/13→10/16 08/11→07/13 08/11→07/13 07/13→10/16 03/11→07/13 03/11→07/13 07/13→10/16 05/10→07/13 07/13→10/16 05/10→07/13 07/13→10/16 09/09→07/13 09/09→07/13	←	☐; für Fahrzeuge ohne Keramikbremse		24.0136-0127.1 436127	Ø 360 36 34 V/ + S
			←	☐; für Fahrzeuge ohne Keramikbremse		24.0136-0128.1 436128	Ø 360 36 34 V/ + S
			→	☐; für Fahrzeuge ohne Keramikbremse		24.0128-0282.1 428282	Ø 330 28 26 V/ + S
			→	☐; für Fahrzeuge ohne Keramikbremse		24.0128-0283.1 428283	Ø 330 28 26 V/ + S
3.0 D	221	07/13→10/16	←	☐; 01/14→; für Fahrzeuge ohne Keramikbremse		24.0136-0127.1 436127	Ø 360 36 34 V/ + S
			←	☐; 01/14→; für Fahrzeuge ohne Keramikbremse		24.0136-0128.1 436128	Ø 360 36 34 V/ + S
			→	☐; 01/14→; für Fahrzeuge ohne Keramikbremse		24.0128-0282.1 428282	Ø 330 28 26 V/ + S
			→	☐; 01/14→; für Fahrzeuge ohne Keramikbremse		24.0128-0283.1 428283	Ø 330 28 26 V/ + S
4.8 GTS 4.8 GTS	316 324	01/12→07/13 07/13→10/16	←	☐; für Fahrzeuge ohne Keramikbremse		24.0136-0127.1 436127	Ø 360 36 34 V/ + S
			←	☐; für Fahrzeuge ohne Keramikbremse		24.0136-0128.1 436128	Ø 360 36 34 V/ + S
			→	☐; - Sondermodell; für Fahrzeuge ohne Keramikbremse		24.0128-0282.1 428282	Ø 330 28 26 V/ + S
			→	☐; - Sondermodell; für Fahrzeuge ohne Keramikbremse		24.0128-0283.1 428283	Ø 330 28 26 V/ + S
PROTON - JUMBUCK Pick-up 02/02→							
Bremsscheibe							
1.5	64	05/02→	←			24.0118-0120.1 418120	Ø 236 18 16,4 V
PROTON - PERSONA 300 (C9_M) 03/96→07/04							
Bremsbelagsatz, Scheibenbremse							
313i 315 GLSi	55 64	03/96→01/00 09/96→07/00	←			13.0460-5953.2 605953	SUM 21650 15,0 - WE / - WK
315 GLi/GLSi	66	03/96→07/00	←	07/00→		13.0460-5953.2 605953	SUM 21650 15,0 - WE / - WK
			←			13.0460-5953.2 605953	SUM 21650 15,0 - WE / - WK
316	70	03/96→07/04	←	→ 07/00		13.0460-5952.2 605952	SUM 21647 16,0 + WK
			→	→ 07/00		13.0460-5826.2 605826	AKE 21872 14,5 + WK
316 GLXi	83	03/96→07/00	←			13.0460-5952.2 605952	SUM 21647 16,0 + WK
			←	07/00→		13.0460-5953.2 605953	SUM 21650 15,0 - WE / - WK
			→			13.0460-5826.2 605826	AKE 21872 14,5 + WK
318 16V GTI ↓	99	03/96→07/00	←	05/96→		13.0460-5952.2 605952	SUM 21647 16,0 + WK

















	kW			 	! #		
PROTON - PERSONA 300 (C9_M) 03/96→07/04							
 Bremsbelagsatz, Scheibenbremse							
318 16V GTI	99	03/96→07/00	➡	05/96→		13.0460-5826.2 605826	AKE 21872 14,5 + WK
Zubehörsatz, Scheibenbremsbelag							
313i	55	03/96→01/00	←			13.0460-0233.2 610233	SUM
315 GLSi	64	09/96→07/00					
315 GLi/GLSi	66	03/96→07/00	←			13.0460-0233.2 610233	SUM
			←	07/00→		13.0460-0233.2 610233	SUM
316 GLXi	83	03/96→07/00	←	07/00→		13.0460-0233.2 610233	SUM
 Bremsscheibe							
313i	55	03/96→01/00	←			24.0118-0120.1 418120	Ø 236 18 16,4 V
315 GLSi	64	09/96→07/00					
315 GLi/GLSi	66	03/96→07/00	←			24.0118-0120.1 418120	Ø 236 18 16,4 V
			←	07/00→		24.0118-0120.1 418120	Ø 236 18 16,4 V
316 GLXi	83	03/96→07/00	←	07/00→		24.0118-0120.1 418120	Ø 236 18 16,4 V
PROTON - PERSONA 400 (C9_S) 01/94→02/08							
 Bremsbelagsatz, Scheibenbremse							
413	55	01/94→06/03	←	→ 07/00		13.0460-5953.2 605953	SUM 21650 15,0 - WE / - WK
415 GLi/GLSi	66	01/94→07/00	←			13.0460-5953.2 605953	SUM 21650 15,0 - WE / - WK
420 TD	60	09/96→07/00					
416 GLXi	83	01/94→07/00	←			13.0460-5952.2 605952	SUM 21647 16,0 + WK
418	85	05/96→07/00	➡			13.0460-5826.2 605826	AKE 21872 14,5 + WK
420 GLS D	48	05/96→04/99	←	09/96→		13.0460-5953.2 605953	SUM 21650 15,0 - WE / - WK
Zubehörsatz, Scheibenbremsbelag							
413	55	01/94→06/03	←	→ 07/00		13.0460-0233.2 610233	SUM
415 GLi/GLSi	66	01/94→07/00	←			13.0460-0233.2 610233	SUM
420 TD	60	09/96→07/00					
420 GLS D	48	05/96→04/99	←	09/96→		13.0460-0233.2 610233	SUM
 Bremsscheibe							
413	55	01/94→06/03	←	→ 07/00		24.0118-0120.1 418120	Ø 236 18 16,4 V
415 GLi/GLSi	66	01/94→07/00	←			24.0118-0120.1 418120	Ø 236 18 16,4 V
420 TD	60	09/96→07/00					
420 GLS D	48	05/96→04/99	←	09/96→		24.0118-0120.1 418120	Ø 236 18 16,4 V
PROTON - PERSONA 400 Hatchback (C9_C, C9_S) 01/94→02/08							
 Bremsbelagsatz, Scheibenbremse							
413 GLSi	55	01/94→01/00	←			13.0460-5953.2 605953	SUM 21650 15,0 - WE / - WK
415 GLi/GLSi	66	01/94→07/00					
420 D	60	09/96→07/00					
416 GLXi	83	01/94→07/00	←			13.0460-5952.2 605952	SUM 21647 16,0 + WK
416 i	70	12/95→07/00					
418 GLXi	85	05/96→07/00	➡			13.0460-5826.2 605826	AKE 21872 14,5 + WK
420 GLS D	48	05/96→04/99	←	09/96→		13.0460-5953.2 605953	SUM 21650 15,0 - WE / - WK
Zubehörsatz, Scheibenbremsbelag							
413 GLSi	55	01/94→01/00	←			13.0460-0233.2 610233	SUM
415 GLi/GLSi	66	01/94→07/00					
420 D	60	09/96→07/00					
420 GLS D	48	05/96→04/99	←	09/96→		13.0460-0233.2 610233	SUM
 Bremsscheibe							
413 GLSi	55	01/94→01/00	←			24.0118-0120.1 418120	Ø 236 18 16,4 V
415 GLi/GLSi	66	01/94→07/00					
420 D	60	09/96→07/00					
420 GLS D	48	05/96→04/99	←	09/96→		24.0118-0120.1 418120	Ø 236 18 16,4 V
PROTON - SATRIA (C9_M) 04/96→05/06							
 Bremsbelagsatz, Scheibenbremse							
1.3	55	07/96→05/06	←	08/00→		13.0460-5953.2 605953	SUM 21650 15,0 - WE / - WK
1.3	55	08/00→05/06	←			13.0460-5953.2 605953	SUM 21650 15,0 - WE / - WK
1.5	64	07/00→05/06					
1.6	70	07/97→07/00	←	07/00→		13.0460-5953.2 605953	SUM 21650 15,0 - WE / - WK
1.6	83	07/97→05/06					
↓							















	kW			 	! #		
PROTON - SATRIA (C9_M) 04/96→05/06							
 Bremsbelagsatz, Scheibenbremse							
1.8 GTi	103	08/00→05/06	←			13.0460-5952.2 605952	SUM 21647 16,0 + WK
			→			13.0460-5826.2 605826	AKE 21872 14,5 + WK
Zubehörsatz, Scheibenbremsbelag							
1.3	55	07/96→05/06	←	08/00→		13.0460-0233.2 610233	SUM
1.3	55	08/00→05/06	←			13.0460-0233.2 610233	SUM
1.5	64	07/00→05/06	←				
1.6	70	07/97→07/00	←	07/00→		13.0460-0233.2 610233	SUM
1.6	83	07/97→05/06	←				
 Bremsscheibe							
1.3	55	07/96→05/06	←	08/00→		24.0113-0186.1 413186	Ø 234 13 11,4
1.3	55	08/00→05/06	←			24.0113-0186.1 413186	Ø 234 13 11,4
1.5	64	07/00→05/06	←			24.0118-0120.1 418120	Ø 236 18 16,4 V
1.6	70	07/97→07/00	←	07/00→		24.0118-0120.1 418120	Ø 236 18 16,4 V
1.6	83	07/97→05/06	←				
PROTON - SATRIA NEO 02/07→							
 Bremsbelagsatz, Scheibenbremse							
1.3	70	02/07→09/08	←			13.0460-5953.2 605953	SUM 21650 15,0 - WE / - WK
1.6	81	02/07→	←				
Zubehörsatz, Scheibenbremsbelag							
1.3	70	02/07→09/08	←			13.0460-0233.2 610233	SUM
1.6	81	02/07→	←				
 Bremsscheibe							
1.3	70	02/07→09/08	←			24.0113-0186.1 413186	Ø 234 13 11,4
1.6	81	02/07→	←			24.0118-0120.1 418120	Ø 236 18 16,4 V
PROTON - WIRA 05/95→							
 Bremsbelagsatz, Scheibenbremse							
1.3	55	08/00→	←	→ 09/05		13.0460-5953.2 605953	SUM 21650 15,0 - WE / - WK
1.5	64	08/00→	←				
Zubehörsatz, Scheibenbremsbelag							
1.3	55	08/00→	←	→ 09/05		13.0460-0233.2 610233	SUM
1.5	64	08/00→	←				
 Bremsscheibe							
1.3	55	08/00→	←	→ 09/05		24.0113-0186.1 413186	Ø 234 13 11,4
1.5	64	08/00→	←	→ 09/05		24.0118-0120.1 418120	Ø 236 18 16,4 V
PROTON - WIRA Hatchback 01/00→							
 Bremsbelagsatz, Scheibenbremse							
1.3	55	08/00→	←	→ 09/05		13.0460-5953.2 605953	SUM 21650 15,0 - WE / - WK
1.5	64	08/00→	←				
Zubehörsatz, Scheibenbremsbelag							
1.3	55	08/00→	←	→ 09/05		13.0460-0233.2 610233	SUM
1.5	64	08/00→	←				
 Bremsscheibe							
1.3	55	08/00→	←	→ 09/05		24.0113-0186.1 413186	Ø 234 13 11,4
1.5	64	08/00→	←	→ 09/05		24.0118-0120.1 418120	Ø 236 18 16,4 V
RENAULT - 19 II (B/C53_) 01/91→06/01							
 Bremsbelagsatz, Scheibenbremse							
1.2	40	04/92→12/95	←			13.0460-2834.2 602834	TRW 21463 18,0 + WK
1.4 (B/C532)	43	04/92→12/95	←			13.0460-3911.2 603911	BDX 20905 18,0 + WK
1.4	59	01/92→12/95	←	01/95→; Vollautomatik; + ABS		13.0460-2834.2 602834	TRW 21463 18,0 + WK
			←	→ 12/94; Vollautomatik; + ABS		13.0460-2834.2 602834	TRW 21463 18,0 + WK
			←	- ABS		13.0460-2834.2 602834	TRW 21463 18,0 + WK
			←	Schaltgetriebe		13.0460-2834.2 602834	TRW 21463 18,0 + WK
			←			13.0460-3911.2 603911	BDX 20905 18,0 + WK
↓							













	kw			 	! #		
RENAULT - 19 II (B/C53_) 01/91→06/01							
 Bremsbelagsatz, Scheibenbremse							
1.4 (B/C535)	55	01/92→12/95	←	09/94→		13.0460-2834.2 602834	TRW 21463 18,0 + WK
			→	09/94→; + ABS		13.0460-3911.2 603911	BDX 20905 18,0 + WK
			→	09/94→; + ABS		13.0460-3822.2 603822	BDX 21597 11,0 - WE / - WK
1.7 (B/C53B)	54	04/92→12/95	←	→ 12/94; Vollautomatik; + ABS		13.0460-2834.2 602834	TRW 21463 18,0 + WK
			←			13.0460-2834.2 602834	TRW 21463 18,0 + WK
			←			13.0460-3911.2 603911	BDX 20905 18,0 + WK
			←	Schaltgetriebe		13.0460-2834.2 602834	TRW 21463 18,0 + WK
			←	- ABS		13.0460-2834.2 602834	TRW 21463 18,0 + WK
			←	01/95→; Vollautomatik; + ABS		13.0460-2834.2 602834	TRW 21463 18,0 + WK
			→	+ ABS		13.0460-3822.2 603822	BDX 21597 11,0 - WE / - WK
1.7 (B/C53C)	66	04/92→12/95	→	+ ABS		13.0460-3822.2 603822	BDX 21597 11,0 - WE / - WK
1.8 (5/353A)	66	04/92→12/95	←	09/94→		13.0460-2834.2 602834	TRW 21463 18,0 + WK
			→	09/94→; + ABS		13.0460-3822.2 603822	BDX 21597 11,0 - WE / - WK
1.8 (5/353F, B/C538)	79	05/94→12/95	←			13.0460-2834.2 602834	TRW 21463 18,0 + WK
			→	09/94→; + ABS		13.0460-3822.2 603822	BDX 21597 11,0 - WE / - WK
1.8 (B/C53Y)	65	04/92→12/95	←	05/92→		13.0460-2834.2 602834	TRW 21463 18,0 + WK
			→	05/92→; + ABS		13.0460-3822.2 603822	BDX 21597 11,0 - WE / - WK
1.8 16V (B/C53D)	99	04/92→12/95	←			13.0460-2834.2 602834	TRW 21463 18,0 + WK
			→			13.0460-3822.2 603822	BDX 21597 11,0 - WE / - WK
1.9 D (B/C53J)	47	04/92→12/95	←	05/92→		13.0460-2834.2 602834	TRW 21463 18,0 + WK
			←			13.0460-3911.2 603911	BDX 20905 18,0 + WK
			←			13.0460-2834.2 602834	TRW 21463 18,0 + WK
			←	- ABS		13.0460-2834.2 602834	TRW 21463 18,0 + WK
			←			13.0460-3911.2 603911	BDX 20905 18,0 + WK
			←	+ ABS		13.0460-2834.2 602834	TRW 21463 18,0 + WK
			←			13.0460-3911.2 603911	BDX 20905 18,0 + WK
			→	+ ABS		13.0460-3822.2 603822	BDX 21597 11,0 - WE / - WK
1.9 dT (B/C53T)	66	04/92→12/95	←			13.0460-2834.2 602834	TRW 21463 18,0 + WK
			←	05/92→		13.0460-2834.2 602834	TRW 21463 18,0 + WK
			→	+ ABS		13.0460-3822.2 603822	BDX 21597 11,0 - WE / - WK
Zubehörsatz, Scheibenbremsbelag							
1.2	40	04/92→12/95	←			13.0460-0411.2 610411	BDX
1.4	59	01/92→12/95	←				
1.4 (B/C532)	43	04/92→12/95	←				
1.7 (B/C53B)	54	04/92→12/95	←				
1.4 (B/C535)	55	01/92→12/95	←	09/94→		13.0460-0411.2 610411	BDX
1.9 D (B/C53J)	47	04/92→12/95	←	05/92→		13.0460-0411.2 610411	BDX
			←			13.0460-0411.2 610411	BDX
			←	- ABS		13.0460-0411.2 610411	BDX
			←	+ ABS		13.0460-0411.2 610411	BDX
 Bremsscheibe							
1.2	40	04/92→12/95	←			24.0112-0116.1 412116	Ø 238 12 10,5 + S
1.4 (B/C532)	43	04/92→12/95	←				
1.4	59	01/92→12/95	←	Schaltgetriebe		24.0112-0116.1 412116	Ø 238 12 10,5 + S
			←	→ 12/94; Vollautomatik; + ABS		24.0112-0116.1 412116	Ø 238 12 10,5 + S
			←	Vollautomatik; - ABS		24.0112-0116.1 412116	Ø 238 12 10,5 + S
			←	01/95→; Vollautomatik; + ABS		24.0121-0106.1 421106	Ø 259 20,7 17,7 V + S
1.4 (B/C535)	55	01/92→12/95	←	09/94→		24.0112-0116.1 412116	Ø 238 12 10,5 + S
			→	09/94→; + ABS		24.0108-0108.1 408108	Ø 238 8 7 - ABS Ring
1.7 (B/C53B)	54	04/92→12/95	←	Schaltgetriebe; + ABS		24.0112-0116.1 412116	Ø 238 12 10,5 + S
			←			24.0112-0116.1 412116	Ø 238 12 10,5 + S
			←			24.0120-0125.1 420125	Ø 238 20,1 17,7 V + S
			←	→ 12/94; Vollautomatik; + ABS		24.0112-0116.1 412116	Ø 238 12 10,5 + S
			←			24.0120-0125.1 420125	Ø 238 20,1 17,7 V + S
			←	Vollautomatik; - ABS		24.0112-0116.1 412116	Ø 238 12 10,5 + S









	kw			 	! #		
RENAULT - 19 II (B/C53_) 01/91→06/01							
 Bremsscheibe							
1.7 (B/C53B)	54	04/92→12/95	←	Vollautomatik; - ABS	24.0120-0125.1	420125	Ø 238 20,1 17,7 V + S
			←	Schaltgetriebe	24.0120-0125.1	420125	Ø 238 20,1 17,7 V + S
			←	01/95→; Vollautomatik; + ABS	24.0121-0106.1	421106	Ø 259 20,7 17,7 V + S
			→	+ ABS	24.0108-0108.1	408108	Ø 238 8 7 - ABS Ring
1.7 (B/C53C)	66	04/92→12/95	←	Schaltgetriebe	24.0120-0125.1	420125	Ø 238 20,1 17,7 V + S
			←	→ 12/94; Vollautomatik; + ABS	24.0120-0125.1	420125	Ø 238 20,1 17,7 V + S
			←	Vollautomatik; - ABS	24.0120-0125.1	420125	Ø 238 20,1 17,7 V + S
			←	01/95→; Vollautomatik; + ABS	24.0121-0106.1	421106	Ø 259 20,7 17,7 V + S
1.8 (5/353A)	66	04/92→12/95	←	09/94→; - ABS	24.0120-0125.1	420125	Ø 238 20,1 17,7 V + S
			←	09/94→ 12/94; + ABS	24.0120-0125.1	420125	Ø 238 20,1 17,7 V + S
			←	01/95→; + ABS	24.0121-0106.1	421106	Ø 259 20,7 17,7 V + S
			←	09/94→	24.0121-0106.1	421106	Ø 259 20,7 17,7 V + S
			→	09/94→; + ABS	24.0108-0108.1	408108	Ø 238 8 7 - ABS Ring
1.8 (5/353F, B/C538)	79	05/94→12/95	←	09/94→ 12/94; + ABS	24.0120-0125.1	420125	Ø 238 20,1 17,7 V + S
			←	09/94→; - ABS	24.0120-0125.1	420125	Ø 238 20,1 17,7 V + S
			←	01/95→; + ABS	24.0121-0106.1	421106	Ø 259 20,7 17,7 V + S
			←		24.0121-0106.1	421106	Ø 259 20,7 17,7 V + S
			→	11/94→; + ABS	24.0108-0108.1	408108	Ø 238 8 7 - ABS Ring
			→	09/94→; + ABS	24.0108-0108.1	408108	Ø 238 8 7 - ABS Ring
1.8 (B/C53Y)	65	04/92→12/95	←	05/92→; Schaltgetriebe	24.0120-0125.1	420125	Ø 238 20,1 17,7 V + S
			←	05/92→ 12/94; + ABS	24.0120-0125.1	420125	Ø 238 20,1 17,7 V + S
			←	05/92→; - ABS	24.0120-0125.1	420125	Ø 238 20,1 17,7 V + S
			←	01/95→; + ABS	24.0121-0106.1	421106	Ø 259 20,7 17,7 V + S
			→	05/92→; + ABS	24.0108-0108.1	408108	Ø 238 8 7 - ABS Ring
1.8 16V (B/C53D)	99	04/92→12/95	←		24.0121-0106.1	421106	Ø 259 20,7 17,7 V + S
			→		24.0108-0108.1	408108	Ø 238 8 7 - ABS Ring
			→	05/93→; für Fahrzeuge mit Klimaanlage	24.0108-0108.1	408108	Ø 238 8 7 - ABS Ring
1.9 D (B/C53J)	47	04/92→12/95	←		24.0112-0116.1	412116	Ø 238 12 10,5 + S
			←	05/92→	24.0112-0116.1	412116	Ø 238 12 10,5 + S
			←	- ABS	24.0112-0116.1	412116	Ø 238 12 10,5 + S
			←	+ ABS	24.0112-0116.1	412116	Ø 238 12 10,5 + S
			→	+ ABS	24.0108-0108.1	408108	Ø 238 8 7 - ABS Ring
1.9 dT (B/C53T)	66	04/92→12/95	←		24.0120-0125.1	420125	Ø 238 20,1 17,7 V + S
			←	05/92→ 12/94; + ABS	24.0120-0125.1	420125	Ø 238 20,1 17,7 V + S
			←	05/92→; - ABS	24.0120-0125.1	420125	Ø 238 20,1 17,7 V + S
			←	01/95→; + ABS	24.0121-0106.1	421106	Ø 259 20,7 17,7 V + S
			→	05/92→; + ABS	24.0108-0108.1	408108	Ø 238 8 7 - ABS Ring
RENAULT - 19 II Cabriolet (D53_, 853_) 04/92→06/01							
 Bremsbelagsatz, Scheibenbremse							
1.8 1.8 16V (D53D)	86	01/95→06/01	←	→ 03/95	13.0460-2834.2	602834	TRW 21463 18,0 + WK
	99	04/92→06/96	→	→ 03/95	13.0460-3822.2	603822	BDX 21597 11,0 - WE / - WK
1.8 (853A)	66	09/93→06/96	←	→ 12/94	13.0460-2834.2	602834	TRW 21463 18,0 + WK
			→	+ ABS	13.0460-3822.2	603822	BDX 21597 11,0 - WE / - WK
1.8 (D53V, 853F, D53C)	79	07/94→06/96	←	09/94→	13.0460-2834.2	602834	TRW 21463 18,0 + WK
			→	09/94→ 12/95; + ABS	13.0460-3822.2	603822	BDX 21597 11,0 - WE / - WK
			→	09/94→; + ABS	13.0460-3822.2	603822	BDX 21597 11,0 - WE / - WK
1.8 (D53Y)	65	04/92→06/96	←	→ 12/94	13.0460-2834.2	602834	TRW 21463 18,0 + WK
			→	→ 12/95; + ABS	13.0460-3822.2	603822	BDX 21597 11,0 - WE / - WK
 Bremsscheibe							
1.8 1.8 16V (D53D)	86	01/95→06/01	←	→ 03/95	24.0121-0106.1	421106	Ø 259 20,7 17,7 V + S
	99	04/92→06/96	→	→ 03/95	24.0108-0108.1	408108	Ø 238 8 7 - ABS Ring
↓							











	kw			 	! #		
RENAULT - 19 II Cabriolet (D53_, 853_) 04/92→06/01							
Bremsscheibe							
1.8 (853A)	66	09/93→06/96	←	- ABS	24.0120-0125.1	420125	∅ 238 20,1 17,7 V + S
			←	+ ABS	24.0121-0106.1	421106	∅ 259 20,7 17,7 V + S
			→	+ ABS	24.0108-0108.1	408108	∅ 238 8 7 - ABS Ring
1.8 (D53V, 853F, D53C)	79	07/94→06/96	←	09/94→	24.0121-0106.1	421106	∅ 259 20,7 17,7 V + S
			→	09/94→ 12/95; + ABS	24.0108-0108.1	408108	∅ 238 8 7 - ABS Ring
			→	09/94→; + ABS	24.0108-0108.1	408108	∅ 238 8 7 - ABS Ring
1.8 (D53Y)	65	04/92→06/96	←	→ 12/94; Vollautomatik; + ABS	24.0120-0125.1	420125	∅ 238 20,1 17,7 V + S
			←	→ 12/94; Schaltgetriebe	24.0120-0125.1	420125	∅ 238 20,1 17,7 V + S
			←	→ 12/94; Vollautomatik; - ABS	24.0120-0125.1	420125	∅ 238 20,1 17,7 V + S
			→	→ 12/94; + ABS	24.0108-0108.1	408108	∅ 238 8 7 - ABS Ring
RENAULT - 19 II Chamade (L53_) 04/92→08/03							
Bremsbelagsatz, Scheibenbremse							
1.4 1.4	57 59	10/94→11/95 10/94→11/95	←		13.0460-2834.2	602834	TRW 21463 18,0 + WK
					13.0460-3911.2	603911	BDX 20905 18,0 + WK
1.4 (532)	43	04/92→12/95	←	Vollautomatik; + ABS	13.0460-2834.2	602834	TRW 21463 18,0 + WK
			←		13.0460-2834.2	602834	TRW 21463 18,0 + WK
					13.0460-3911.2	603911	BDX 20905 18,0 + WK
			←	- ABS	13.0460-2834.2	602834	TRW 21463 18,0 + WK
1.4 (L535)	55	11/93→12/95	←	Schaltgetriebe	13.0460-2834.2	602834	TRW 21463 18,0 + WK
			←	Vollautomatik; + ABS	13.0460-2834.2	602834	TRW 21463 18,0 + WK
			←		13.0460-2834.2	602834	TRW 21463 18,0 + WK
					13.0460-3911.2	603911	BDX 20905 18,0 + WK
			←	Schaltgetriebe	13.0460-2834.2	602834	TRW 21463 18,0 + WK
			←	- ABS	13.0460-2834.2	602834	TRW 21463 18,0 + WK
1.7	55	05/92→11/95	←	09/94→	13.0460-2834.2	602834	TRW 21463 18,0 + WK
			←	Vollautomatik; + ABS	13.0460-2834.2	602834	TRW 21463 18,0 + WK
			←	Schaltgetriebe	13.0460-2834.2	602834	TRW 21463 18,0 + WK
			←	- ABS	13.0460-2834.2	602834	TRW 21463 18,0 + WK
			←		13.0460-3911.2	603911	BDX 20905 18,0 + WK
1.7 (L533)	68	01/93→08/95	→	+ ABS	13.0460-3822.2	603822	BDX 21597 11,0 - WE / - WK
			→	+ ABS	13.0460-3822.2	603822	BDX 21597 11,0 - WE / - WK
1.7 (L53B)	54	04/92→12/95	←		13.0460-2834.2	602834	TRW 21463 18,0 + WK
					13.0460-3911.2	603911	BDX 20905 18,0 + WK
			←	Vollautomatik; + ABS	13.0460-2834.2	602834	TRW 21463 18,0 + WK
			←	- ABS	13.0460-2834.2	602834	TRW 21463 18,0 + WK
			←	Schaltgetriebe	13.0460-2834.2	602834	TRW 21463 18,0 + WK
1.7 (L53C) 1.8 1.8 (L53V, L538) 1.9 dT (L53T)	66 79 79 66	04/92→12/95 05/92→11/95 05/94→12/95 04/92→12/95	←		13.0460-2834.2	602834	TRW 21463 18,0 + WK
			→	+ ABS	13.0460-3822.2	603822	BDX 21597 11,0 - WE / - WK
			←	11/94→	13.0460-2834.2	602834	TRW 21463 18,0 + WK
1.8 (453A/F)	66	04/92→12/95	→	09/94→; + ABS	13.0460-3822.2	603822	BDX 21597 11,0 - WE / - WK
			←	05/92→	13.0460-2834.2	602834	TRW 21463 18,0 + WK
1.8 (L53Y)	65	04/92→12/95	→	+ ABS	13.0460-3822.2	603822	BDX 21597 11,0 - WE / - WK
			←		13.0460-2834.2	602834	TRW 21463 18,0 + WK
1.8 16V (L53D)	99	04/92→12/95	←		13.0460-2834.2	602834	TRW 21463 18,0 + WK
			→		13.0460-3822.2	603822	BDX 21597 11,0 - WE / - WK
1.9 D (L53J)	47	04/92→12/95	←	05/92→	13.0460-2834.2	602834	TRW 21463 18,0 + WK
					13.0460-3911.2	603911	BDX 20905 18,0 + WK
			←	+ ABS	13.0460-2834.2	602834	TRW 21463 18,0 + WK
					13.0460-3911.2	603911	BDX 20905 18,0 + WK
			←	- ABS	13.0460-2834.2	602834	TRW 21463 18,0 + WK
				13.0460-3911.2	603911	BDX 20905 18,0 + WK	
			→	+ ABS	13.0460-3822.2	603822	BDX 21597 11,0 - WE / - WK

	kw			 	! #		
RENAULT - 19 II Chamade (L53_) 04/92→08/03							
Zubehörsatz, Scheibenbremsbelag							
1.4	57	10/94→11/95	←			13.0460-0411.2 610411	BDX
1.4	59	10/94→11/95	←				
1.4 (532)	43	04/92→12/95	←				
1.7	55	05/92→11/95	←				
1.7 (L53B)	54	04/92→12/95	←				
1.4 (L535)	55	11/93→12/95	←			13.0460-0411.2 610411	BDX
			←	09/94→		13.0460-0411.2 610411	BDX
1.9 D (L53J)	47	04/92→12/95	←	05/92→		13.0460-0411.2 610411	BDX
			←	+ ABS		13.0460-0411.2 610411	BDX
			←	- ABS		13.0460-0411.2 610411	BDX
 Bremsscheibe							
1.4 (532)	43	04/92→12/95	←	→ 12/94; Vollautomatik; + ABS		24.0112-0116.1 412116	Ø 238 12 10,5 + S
			←			24.0112-0116.1 412116	Ø 238 12 10,5 + S
			←	Schaltgetriebe		24.0112-0116.1 412116	Ø 238 12 10,5 + S
			←	Vollautomatik; - ABS		24.0112-0116.1 412116	Ø 238 12 10,5 + S
			←	01/95→; Vollautomatik; + ABS		24.0121-0106.1 421106	Ø 259 20,7 17,7 V + S
1.4 (L535)	55	11/93→12/95	←	09/94→		24.0112-0116.1 412116	Ø 238 12 10,5 + S
			←	→ 12/94; Vollautomatik; + ABS		24.0112-0116.1 412116	Ø 238 12 10,5 + S
			←	Vollautomatik; - ABS		24.0112-0116.1 412116	Ø 238 12 10,5 + S
			←	Schaltgetriebe		24.0112-0116.1 412116	Ø 238 12 10,5 + S
			←	01/95→; Vollautomatik; + ABS		24.0121-0106.1 421106	Ø 259 20,7 17,7 V + S
			➔	+ ABS		24.0108-0108.1 408108	Ø 238 8 7 - ABS Ring
1.7	55	05/92→11/95	←	→ 12/94; Vollautomatik; + ABS		24.0112-0116.1 412116	Ø 238 12 10,5 + S
			←	Vollautomatik; - ABS		24.0112-0116.1 412116	Ø 238 12 10,5 + S
			←	Schaltgetriebe		24.0112-0116.1 412116	Ø 238 12 10,5 + S
			➔	+ ABS		24.0108-0108.1 408108	Ø 238 8 7 - ABS Ring
1.7 (L53B)	54	04/92→12/95	←	→ 12/94; Vollautomatik; + ABS		24.0112-0116.1 412116	Ø 238 12 10,5 + S
			←			24.0120-0125.1 420125	Ø 238 20,1 17,7 V + S
			←			24.0112-0116.1 412116	Ø 238 12 10,5 + S
			←	Vollautomatik; - ABS		24.0112-0116.1 412116	Ø 238 12 10,5 + S
			←			24.0120-0125.1 420125	Ø 238 20,1 17,7 V + S
			←	Schaltgetriebe		24.0112-0116.1 412116	Ø 238 12 10,5 + S
			←			24.0120-0125.1 420125	Ø 238 20,1 17,7 V + S
			←	01/95→; Vollautomatik; + ABS		24.0121-0106.1 421106	Ø 259 20,7 17,7 V + S
			➔	+ ABS		24.0108-0108.1 408108	Ø 238 8 7 - ABS Ring
1.7 (L53C)	66	04/92→12/95	←	→ 12/94; Vollautomatik; + ABS		24.0120-0125.1 420125	Ø 238 20,1 17,7 V + S
			←	Schaltgetriebe		24.0120-0125.1 420125	Ø 238 20,1 17,7 V + S
			←	Vollautomatik; - ABS		24.0120-0125.1 420125	Ø 238 20,1 17,7 V + S
			←	01/95→; Vollautomatik; + ABS		24.0121-0106.1 421106	Ø 259 20,7 17,7 V + S
			➔	+ ABS		24.0108-0108.1 408108	Ø 238 8 7 - ABS Ring
1.8	79	05/92→11/95	←			24.0121-0106.1 421106	Ø 259 20,7 17,7 V + S
1.8 (L53V, L538)	79	05/94→12/95	➔	+ ABS		24.0108-0108.1 408108	Ø 238 8 7 - ABS Ring
1.8 (453A/F)	66	04/92→12/95	←	09/94→; - ABS		24.0120-0125.1 420125	Ø 238 20,1 17,7 V + S
			←	09/94→ 12/94; + ABS		24.0120-0125.1 420125	Ø 238 20,1 17,7 V + S
			←	01/95→; + ABS		24.0121-0106.1 421106	Ø 259 20,7 17,7 V + S
			←	09/94→		24.0121-0106.1 421106	Ø 259 20,7 17,7 V + S
			➔	09/94→; + ABS		24.0108-0108.1 408108	Ø 238 8 7 - ABS Ring
1.8 (L53Y)	65	04/92→12/95	←	05/92→; Schaltgetriebe		24.0120-0125.1 420125	Ø 238 20,1 17,7 V + S
			←	05/92→; Vollautomatik; - ABS		24.0120-0125.1 420125	Ø 238 20,1 17,7 V + S
			←	05/92→ 12/94; Vollautomatik; + ABS		24.0120-0125.1 420125	Ø 238 20,1 17,7 V + S
			←	01/95→; Vollautomatik; + ABS		24.0121-0106.1 421106	Ø 259 20,7 17,7 V + S
			➔	05/92→; + ABS		24.0108-0108.1 408108	Ø 238 8 7 - ABS Ring
1.8 16V (L53D)	99	04/92→12/95	←			24.0121-0106.1 421106	Ø 259 20,7 17,7 V + S
			➔			24.0108-0108.1 408108	Ø 238 8 7 - ABS Ring
1.9 D (L53J)	47	04/92→12/95	←	05/92→		24.0112-0116.1 412116	Ø 238 12 10,5 + S
↓							











	kw			 	! #		
RENAULT - 19 II Chamade (L53_) 04/92→08/03							
 Bremsscheibe							
1.9 D (L53J)	47	04/92→12/95	←	+ ABS	24.0112-0116.1	412116	Ø 238 12 10,5 + S
			←	- ABS	24.0112-0116.1	412116	Ø 238 12 10,5 + S
			←	05/92→ 12/94; + ABS	24.0120-0125.1	420125	Ø 238 20,1 17,7 V + S
			←	05/92→; - ABS	24.0120-0125.1	420125	Ø 238 20,1 17,7 V + S
			←	01/95→; + ABS	24.0121-0106.1	421106	Ø 259 20,7 17,7 V + S
			→	05/92→; + ABS	24.0108-0108.1	408108	Ø 238 8 7 - ABS Ring
			→	+ ABS	24.0108-0108.1	408108	Ø 238 8 7 - ABS Ring
1.9 dT (L53T)	66	04/92→12/95	←	→ 12/94; + ABS	24.0120-0125.1	420125	Ø 238 20,1 17,7 V + S
			←	- ABS	24.0120-0125.1	420125	Ø 238 20,1 17,7 V + S
			←	01/95→; + ABS	24.0121-0106.1	421106	Ø 259 20,7 17,7 V + S
			→	+ ABS	24.0108-0108.1	408108	Ø 238 8 7 - ABS Ring
RENAULT - 19 II Kasten (S53_) 03/92→12/95							
 Bremsbelagsatz, Scheibenbremse							
1.2	40	03/92→12/95	←		13.0460-2834.2	602834	TRW 21463 18,0 + WK
					13.0460-3911.2	603911	BDX 20905 18,0 + WK
1.9 D	48	03/92→12/95	→	+ ABS	13.0460-3822.2	603822	BDX 21597 11,0 - WE / - WK
1.9 dT	68	03/92→12/95	←		13.0460-2834.2	602834	TRW 21463 18,0 + WK
			→	+ ABS	13.0460-3822.2	603822	BDX 21597 11,0 - WE / - WK
Zubehörsatz, Scheibenbremsbelag							
1.2	40	03/92→12/95	←		13.0460-0411.2	610411	BDX
 Bremsscheibe							
1.2	40	03/92→12/95	←		24.0112-0116.1	412116	Ø 238 12 10,5 + S
1.9 dT	68	03/92→12/95	←		24.0120-0125.1	420125	Ø 238 20,1 17,7 V + S
			←	- ABS	24.0120-0125.1	420125	Ø 238 20,1 17,7 V + S
			←	→ 12/94; + ABS	24.0120-0125.1	420125	Ø 238 20,1 17,7 V + S
			←	01/95→; + ABS	24.0121-0106.1	421106	Ø 259 20,7 17,7 V + S
			→	+ ABS	24.0108-0108.1	408108	Ø 238 8 7 - ABS Ring
RENAULT - 21 Kasten (S48_) 06/86→04/95							
 Bremsbelagsatz, Scheibenbremse							
1.7	65	06/86→04/95	←	07/86→	13.0460-2834.2	602834	TRW 21463 18,0 + WK
 Bremsscheibe							
1.7	65	06/86→04/95	←	07/86→	24.0120-0125.1	420125	Ø 238 20,1 17,7 V + S
RENAULT - 21 Kombi (K48_) 03/86→07/97							
 Bremsbelagsatz, Scheibenbremse							
2.1 D (K480)	51	02/92→09/95	←	04/92→	13.0460-3933.2	603933	BDX 21016 17,0 + WK
			→	04/92→; + ABS	13.0460-3961.2	603961	BDX 20336 14,0 + WK
					13.0460-4957.2	604957	BRE 20410 15,0 - WE / - WK
Zubehörsatz, Scheibenbremsbelag							
2.1 D (K480)	51	02/92→09/95	→	04/92→; + ABS	13.0460-0438.2	610438	BRE
 Bremsscheibe							
2.1 D (K480)	51	02/92→09/95	←	04/92→; + ABS	24.0120-0134.1	420134	Ø 265 20,5 17,7 V
			←	04/92→; - ABS	24.0120-0135.1	420135	Ø 244 20,5 17,7 V
			→	04/92→; + ABS	24.0111-0122.1	411122	Ø 255 10,5 9,5
RENAULT - AVANTIME (DE0_) 09/01→05/03							
 Bremsbelagsatz, Scheibenbremse							
2.0 16V Turbo (DE0U, DE0V)	120	11/01→05/03	←		13.0460-2870.2	602870	TRW 23099 18,4 - WK
3.0 V6 (DE04, DE0T)	152	09/01→05/03	→		13.0460-2845.2	602845	TRW 23554 16,4 - WK + Zub
					13.0470-2845.2	LD2845	TRW 23554 16,4 - WK + Zub Ceramic
↓							







	kW					! #		
RENAULT - AVANTIME (DE0_) 09/01→05/03								
 Bremsbelagsatz, Scheibenbremse								
2.2 dCi (DE01)	110	05/02→05/03	←	für OE-Nummer: 60 25 371 662			13.0460-2870.2 602870	TRW 23099 18,4 - WK
			→				13.0460-2845.2 602845	TRW 23554 16,4 - WK + Zub
							13.0470-2845.2 LD2845	TRW 23554 16,4 - WK + Zub Ceramic
Zubehörsatz, Scheibenbremsbelag								
2.0 16V Turbo (DE0U, DE0V)	120	11/01→05/03	→				13.0460-0077.2 610077	TRW
2.2 dCi (DE01)	110	05/02→05/03						
3.0 V6 (DE04, DE0T)	152	09/01→05/03						
 Bremsscheibe								
2.0 16V Turbo (DE0U, DE0V)	120	11/01→05/03	←				24.0128-0134.1 428134	Ø 305 28 26 V
2.2 dCi (DE01)	110	05/02→05/03	→				24.0111-0151.1 411151	Ø 265 10,5 9,5
3.0 V6 (DE04, DE0T)	152	09/01→05/03						
RENAULT - CAPTUR (J5_) 06/13→								
 Bremsbelagsatz, Scheibenbremse								
0.9 TCe 90	66	06/13→	←				13.0460-2709.2 602709	TRW 23973 17,1 - WE / - WK + Zub
							13.0470-2709.2 LD2709	TRW 23973 17,1 - WE / - WK + Zub Ceramic
1.2 TCe 120	87	01/16→	←				13.0460-7266.2 607266	ATE 24538 17,9 - WE / - WK
1.2 TCe 120	88	06/13→						
1.5 dCi 110	81	01/15→					13.0470-7266.2 LD7266	ATE 24538 17,9 - WE / - WK Ceramic
1.5 dCi 90	66	06/13→						
 Bremsscheibe								
0.9 TCe 90	66	06/13→	←				24.0122-0270.1 422270	Ø 258 22 19,8 V + S
1.2 TCe 120	87	01/16→	←				24.0124-0253.1 424253	Ø 280 24 21,8 V + S
1.2 TCe 120	88	06/13→						
1.5 dCi 110	81	01/15→						
1.5 dCi 90	66	06/13→						
RENAULT - CLIO I (B/C57_, 5/357_) 05/90→09/98								
 Bremsbelagsatz, Scheibenbremse								
1.1	34	01/91→09/98	←	05/92→			13.0460-2834.2 602834	TRW 21463 18,0 + WK
			←	→ 04/92			13.0460-3911.2 603911	BDX 20905 18,0 + WK
							13.0460-2834.2 602834	TRW 21463 18,0 + WK
							13.0460-3955.2 603955	BDX 20634 15,0 + WK
1.2 (5/357Y, 5/357K)	40	01/96→09/98	←				13.0460-2834.2 602834	TRW 21463 18,0 + WK
1.2 (5/357Y, 5/357K)	43	01/96→09/98					13.0460-3911.2 603911	BDX 20905 18,0 + WK
1.2 (B/C/S572)	44	05/90→03/96						
1.2 (B/C/S577)	40	01/96→12/96	→	+ ABS			13.0460-3822.2 603822	BDX 21597 11,0 - WE / - WK
1.4	59	01/91→09/98						
1.4 (B/C57T, B/C57Y)	58	01/91→09/98						
1.4 (B57J, C57J)	55	01/91→09/98						
1.8 (B/C578)	66	08/94→09/98						
1.9 D	40	01/97→09/98						
1.9 D	48	05/96→02/98						
1.9 D (B/C/S576, B/C/S57L)	47	01/91→09/98						
1.2 (B/C/S57A, B/C57S, 5/357F, 5/357J, 5/357L, 5/357R)	43	05/90→09/98	←				13.0460-2834.2 602834	TRW 21463 18,0 + WK
			←	10/94→			13.0460-2834.2 602834	TRW 21463 18,0 + WK
			→	+ ABS			13.0460-3911.2 603911	BDX 20905 18,0 + WK
			→	10/94→; + ABS			13.0460-3822.2 603822	BDX 21597 11,0 - WE / - WK
1.2 (B/C57R)	40	01/91→06/96	←	→ 01/96			13.0460-2834.2 602834	TRW 21463 18,0 + WK
			→	→ 01/96; + ABS			13.0460-3911.2 603911	BDX 20905 18,0 + WK
							13.0460-3822.2 603822	BDX 21597 11,0 - WE / - WK
1.4	57	05/90→02/98	←	01/91→			13.0460-2834.2 602834	TRW 21463 18,0 + WK
			→	01/91→; + ABS			13.0460-3911.2 603911	BDX 20905 18,0 + WK
							13.0460-3822.2 603822	BDX 21597 11,0 - WE / - WK
1.8	66	08/90→04/96	←	08/94→			13.0460-2834.2 602834	TRW 21463 18,0 + WK
			→	08/94→; + ABS			13.0460-3911.2 603911	BDX 20905 18,0 + WK
							13.0460-3822.2 603822	BDX 21597 11,0 - WE / - WK
1.8	70	01/91→09/98	←				13.0460-2834.2 602834	TRW 21463 18,0 + WK











	kw			 	! #		
RENAULT - CLIO I (B/C57_, 5/357_) 05/90→09/98							
 Bremsbelagsatz, Scheibenbremse							
1.8	70	01/91→09/98	←			13.0460-3911.2 603911	BDX 20905 18,0 + WK
			→	08/94→; + ABS		13.0460-3822.2 603822	BDX 21597 11,0 - WE / - WK
			→	10/94→ 04/96; + ABS		13.0460-3822.2 603822	BDX 21597 11,0 - WE / - WK
			→	10/94→; + ABS		13.0460-3822.2 603822	BDX 21597 11,0 - WE / - WK
			→	09/96→; + ABS		13.0460-3822.2 603822	BDX 21597 11,0 - WE / - WK
			→	08/94→ 04/96; + ABS		13.0460-3822.2 603822	BDX 21597 11,0 - WE / - WK
			→	10/94→ 04/96		13.0460-3822.2 603822	BDX 21597 11,0 - WE / - WK
1.8 (B/C57C, B/C57U)	65	01/91→09/98	←			13.0460-2834.2 602834	TRW 21463 18,0 + WK
			→	12/93→; + ABS		13.0460-3911.2 603911	BDX 20905 18,0 + WK
1.8 16V (C57D)	99	01/91→03/96	←	08/91→ 06/94		13.0460-2834.2 602834	TRW 21463 18,0 + WK
			→	08/91→ 06/94		13.0460-3911.2 603911	BDX 20905 18,0 + WK
1.8 Rsi (B/C579) 1.8 Rsi (B/C57H) Williams (B/C57M)	80 79 108	01/93→08/95 08/95→09/98 01/94→09/98	←			13.0460-2834.2 602834	TRW 21463 18,0 + WK
			→			13.0460-3911.2 603911	BDX 20905 18,0 + WK
Electric	21	05/96→02/98	←			13.0460-2834.2 602834	TRW 21463 18,0 + WK
			→			13.0460-3911.2 603911	BDX 20905 18,0 + WK
Zubehörsatz, Scheibenbremsbelag							
1.1	34	01/91→09/98	←	05/92→		13.0460-0411.2 610411	BDX
			←	→ 04/92		13.0460-0423.2 610423	BDX
1.2 (5/357Y, 5/357K)	40	01/96→09/98	←			13.0460-0411.2 610411	BDX
1.2 (5/357Y, 5/357K)	43	01/96→09/98	←			13.0460-0411.2 610411	BDX
1.2 (B/C/S572)	44	05/90→03/96	←			13.0460-0411.2 610411	BDX
1.2 (B/C/S577)	40	01/96→12/96	←			13.0460-0411.2 610411	BDX
1.4	59	01/91→09/98	←			13.0460-0411.2 610411	BDX
1.4 (B/C57T, B/C57Y)	58	01/91→09/98	←			13.0460-0411.2 610411	BDX
1.4 (B57J, C57J)	55	01/91→09/98	←			13.0460-0411.2 610411	BDX
1.8	70	01/91→09/98	←			13.0460-0411.2 610411	BDX
1.8 (B/C578)	66	08/94→09/98	←			13.0460-0411.2 610411	BDX
1.8 (B/C57C, B/C57U)	65	01/91→09/98	←			13.0460-0411.2 610411	BDX
1.8 Rsi (B/C579)	80	01/93→08/95	←			13.0460-0411.2 610411	BDX
1.8 Rsi (B/C57H)	79	08/95→09/98	←			13.0460-0411.2 610411	BDX
1.9 D	40	01/97→09/98	←			13.0460-0411.2 610411	BDX
1.9 D	48	05/96→02/98	←			13.0460-0411.2 610411	BDX
1.9 D (B/C/S576, B/C/S57L)	47	01/91→09/98	←			13.0460-0411.2 610411	BDX
Electric	21	05/96→02/98	←			13.0460-0411.2 610411	BDX
Williams (B/C57M)	108	01/94→09/98	←			13.0460-0411.2 610411	BDX
1.2 (B/C/S57A, B/C57S, 5/357F, 5/357J, 5/357L, 5/357R)	43	05/90→09/98	←			13.0460-0411.2 610411	BDX
			←	10/94→		13.0460-0411.2 610411	BDX
1.2 (B/C57R)	40	01/91→06/96	←	→ 01/96		13.0460-0411.2 610411	BDX
1.4	57	05/90→02/98	←	01/91→		13.0460-0411.2 610411	BDX
1.8	66	08/90→04/96	←	08/94→		13.0460-0411.2 610411	BDX
1.8 16V (C57D)	99	01/91→03/96	←	08/91→ 06/94		13.0460-0411.2 610411	BDX
 Bremsscheibe							
1.1	34	01/91→09/98	←	→ 04/92		24.0108-0104.1 408104	Ø 238 8,2 7 + S
			←	05/92→		24.0112-0116.1 412116	Ø 238 12 10,5 + S
1.2 (5/357Y, 5/357K)	40	01/96→09/98	←			24.0112-0116.1 412116	Ø 238 12 10,5 + S
1.2 (5/357Y, 5/357K)	43	01/96→09/98	←			24.0112-0116.1 412116	Ø 238 12 10,5 + S
1.2 (B/C/S572)	44	05/90→03/96	→	+ ABS		24.0108-0109.1 408109	Ø 238 8 7
1.2 (B/C/S577)	40	01/96→12/96	←			24.0112-0116.1 412116	Ø 238 12 10,5 + S
1.2 (B/C/S57A, B/C57S, 5/357F, 5/357J, 5/357L, 5/357R)	43	05/90→09/98	←			24.0112-0116.1 412116	Ø 238 12 10,5 + S
			←	10/94→		24.0112-0116.1 412116	Ø 238 12 10,5 + S
			→	+ ABS		24.0108-0109.1 408109	Ø 238 8 7
			→	10/94→; + ABS		24.0108-0109.1 408109	Ø 238 8 7
1.2 (B/C57R)	40	01/91→06/96	←	→ 01/96		24.0112-0116.1 412116	Ø 238 12 10,5 + S
			→	→ 01/96; + ABS		24.0108-0109.1 408109	Ø 238 8 7
1.4	57	05/90→02/98	←	01/91→ 03/96; Automatikgetriebe		24.0112-0116.1 412116	Ø 238 12 10,5 + S
			←	01/91→; Schaltgetriebe		24.0112-0116.1 412116	Ø 238 12 10,5 + S
			←	04/96→; Automatikgetriebe		24.0120-0125.1 420125	Ø 238 20,1 17,7 V + S









	kw			 	! #		
RENAULT - CLIO I (B/C57_, 5/357_) 05/90→09/98							
 Bremsscheibe							
1.4	57	05/90→02/98	➔	01/91→; + ABS		24.0108-0109.1 408109	Ø 238 8 7
1.4	59	01/91→09/98	➔	→ 03/96; Automatikgetriebe		24.0112-0116.1 412116	Ø 238 12 10,5 + S
1.4 (B/C57T, B/C57Y)	58	01/91→09/98	➔	Schaltgetriebe		24.0112-0116.1 412116	Ø 238 12 10,5 + S
1.4 (B57J, C57J)	55	01/91→09/98	➔			24.0120-0125.1 420125	Ø 238 20,1 17,7 V + S
			➔	04/96→; Automatikgetriebe		24.0120-0125.1 420125	Ø 238 20,1 17,7 V + S
			➔	+ ABS		24.0108-0109.1 408109	Ø 238 8 7
1.8	66	08/90→04/96	➔	08/94→		24.0120-0125.1 420125	Ø 238 20,1 17,7 V + S
			➔	08/94→; + ABS		24.0108-0109.1 408109	Ø 238 8 7
1.8	70	01/91→09/98	➔			24.0120-0125.1 420125	Ø 238 20,1 17,7 V + S
			➔	10/94→; + ABS		24.0108-0109.1 408109	Ø 238 8 7
			➔	08/94→; + ABS		24.0108-0109.1 408109	Ø 238 8 7
			➔	10/94→ 04/96; + ABS		24.0108-0109.1 408109	Ø 238 8 7
			➔	09/96→; + ABS		24.0108-0109.1 408109	Ø 238 8 7
			➔	10/94→ 04/96		24.0108-0109.1 408109	Ø 238 8 7
			➔	08/94→ 04/96; + ABS		24.0108-0109.1 408109	Ø 238 8 7
1.8 (B/C578)	66	08/94→09/98	➔			24.0120-0125.1 420125	Ø 238 20,1 17,7 V + S
1.9 D	40	01/97→09/98	➔				
1.9 D	48	05/96→02/98	➔	+ ABS		24.0108-0109.1 408109	Ø 238 8 7
1.8 (B/C57C, B/C57U)	65	01/91→09/98	➔			24.0120-0125.1 420125	Ø 238 20,1 17,7 V + S
			➔	12/93→; + ABS		24.0108-0109.1 408109	Ø 238 8 7
1.8 16V (C57D)	99	01/91→03/96	➔	08/91→ 06/94		24.0121-0106.1 421106	Ø 259 20,7 17,7 V + S
			➔	08/91→ 06/94		24.0108-0109.1 408109	Ø 238 8 7
1.8 Rsi (B/C579)	80	01/93→08/95	➔			24.0120-0125.1 420125	Ø 238 20,1 17,7 V + S
1.8 Rsi (B/C57H)	79	08/95→09/98	➔			24.0108-0109.1 408109	Ø 238 8 7
1.9 D (B/C/S576, B/C/S57L)	47	01/91→09/98	➔	→ 01/94		24.0112-0116.1 412116	Ø 238 12 10,5 + S
			➔	02/94→		24.0120-0125.1 420125	Ø 238 20,1 17,7 V + S
			➔	+ ABS		24.0108-0109.1 408109	Ø 238 8 7
Electric	21	05/96→02/98	➔			24.0112-0116.1 412116	Ø 238 12 10,5 + S
Williams (B/C57M)	108	01/94→09/98	➔			24.0121-0106.1 421106	Ø 259 20,7 17,7 V + S
			➔			24.0108-0109.1 408109	Ø 238 8 7
RENAULT - CLIO I Kasten (S57_) 01/91→09/98							
 Bremsbelagsatz, Scheibenbremse							
1.1	34	01/91→09/98	➔	05/92→		13.0460-2834.2 602834	TRW 21463 18,0 + WK
			➔	→ 04/92		13.0460-3911.2 603911	BDX 20905 18,0 + WK
			➔			13.0460-2834.2 602834	TRW 21463 18,0 + WK
			➔			13.0460-3955.2 603955	BDX 20634 15,0 + WK
1.2	40	01/91→09/98	➔			13.0460-2834.2 602834	TRW 21463 18,0 + WK
1.2	40	06/94→02/98	➔			13.0460-3911.2 603911	BDX 20905 18,0 + WK
1.2	44	01/91→09/98	➔				
1.9 D	48	01/91→09/98	➔	+ ABS		13.0460-3822.2 603822	BDX 21597 11,0 - WE / - WK
1.9 RND	40	04/96→02/98	➔				
Zubehörsatz, Scheibenbremsbelag							
1.1	34	01/91→09/98	➔	05/92→		13.0460-0411.2 610411	BDX
			➔	→ 04/92		13.0460-0423.2 610423	BDX
1.2	40	01/91→09/98	➔			13.0460-0411.2 610411	BDX
1.2	40	06/94→02/98	➔				
1.2	44	01/91→09/98	➔				
1.9 D	48	01/91→09/98	➔				
1.9 RND	40	04/96→02/98	➔				
 Bremsscheibe							
1.1	34	01/91→09/98	➔	→ 04/92		24.0108-0104.1 408104	Ø 238 8,2 7 + S
			➔	05/92→		24.0112-0116.1 412116	Ø 238 12 10,5 + S
1.2	40	01/91→09/98	➔			24.0112-0116.1 412116	Ø 238 12 10,5 + S
1.2	40	06/94→02/98	➔				
1.2	44	01/91→09/98	➔	+ ABS		24.0108-0109.1 408109	Ø 238 8 7
1.9 D	48	01/91→09/98	➔	→ 01/94		24.0112-0116.1 412116	Ø 238 12 10,5 + S
			➔	02/94→		24.0120-0125.1 420125	Ø 238 20,1 17,7 V + S
↓							





























	kW			 	! #		
RENAULT - CLIO I Kasten (S57_) 01/91→09/98							
 Bremsscheibe							
1.9 D	48	01/91→09/98	➔	+ ABS		24.0108-0109.1 408109	Ø 238 8 7
1.9 RND	40	04/96→02/98	➔			24.0120-0125.1 420125	Ø 238 20,1 17,7 V + S
			➔	+ ABS		24.0108-0109.1 408109	Ø 238 8 7
RENAULT - CLIO II (BB0/1/2_, CB0/1/2_) 09/98→							
 Bremsbelagsatz, Scheibenbremse							
1.0	40	02/00→05/01	➔			13.0460-2834.2 602834	TRW 21463 18,0 + WK
1.2 (BB0A, CB0A)	44	03/99→05/01	➔				
1.4 (B/CB0C)	55	09/98→05/05	➔				
1.6	81	11/04→02/09	➔				
1.6 (B/CB0D)	66	09/98→05/05	➔				
1.6 16V	82	10/01→12/08	➔				
1.6 Flex	81	05/00→12/06	➔				
1.6 Hi-Flex (CB0H)	86	01/05→02/10	➔				
1.9 D (B/CB0E)	47	09/98→05/05	➔				
1.9 D (B/CB0J)	48	02/00→05/01	➔				
1.2 (BB0A, BB0F, BB10, BB1K, BB28, BB2D, BB2H, CB0A...)	43	09/98→	➔	→ 12/12		13.0460-2834.2 602834	TRW 21463 18,0 + WK
			➔	+ ABS; → 12/12		13.0460-3926.2 603926	BDX 20974 10,8 - WE / - WK
1.2 16V	54	06/06→	➔				
1.2 16V (BB05, BB0W, BB11, BB27, BB2T, BB2U, BB2V, CB05...)	55	06/01→	➔				
1.4 16V (B/CB0P)	72	08/00→	➔				
1.5 dCi	74	01/04→	➔				
1.5 dCi (B/C2J)	50	08/04→	➔				
1.5 dCi (B/CB07)	48	06/01→	➔				
1.5 dCi (B/CB08)	60	06/01→	➔				
1.5 dCi (B/CB3N)	62	02/07→	➔				
1.2 LPG	43	09/98→06/09	➔			13.0460-2834.2 602834	TRW 21463 18,0 + WK
1.5 dCi	42	06/01→12/06	➔				
1.5 dCi (B/CB03)	59	06/01→10/03	➔	+ ABS		13.0460-3926.2 603926	BDX 20974 10,8 - WE / - WK
1.4 16V (B/CB0L)	70	10/99→09/04	➔	→ 07/00		13.0460-2834.2 602834	TRW 21463 18,0 + WK
1.5 dCi (B/CB3M)	47	06/05→	➔	→ 12/12		13.0460-2834.2 602834	TRW 21463 18,0 + WK
1.6 16V (BB01, BB0H, BB0T, BB14, BB1D, BB1R, BB2KL...)	79	09/98→	➔				
1.9 dTi (B/CB0U)	59	12/99→05/05	➔	02/00→		13.0460-2834.2 602834	TRW 21463 18,0 + WK
2.0 16V Sport	132	01/04→	➔	→ 12/12		13.0460-2895.2 602895	TRW 23172 18,0 - WK
2.0 16V Sport (CB0M)	124	02/00→	➔	→ 12/12		13.0460-3926.2 603926	BDX 20974 10,8 - WE / - WK
Zubehörsatz, Scheibenbremsbelag							
1.2 (BB0A, BB0F, BB10, BB1K, BB28, BB2D, BB2H, CB0A...)	43	09/98→	➔	+ ABS; → 12/12		13.0460-0435.2 610435	BDX
			➔				
1.2 16V	54	06/06→	➔				
1.2 16V (BB05, BB0W, BB11, BB27, BB2T, BB2U, BB2V, CB05...)	55	06/01→	➔				
1.4 16V (B/CB0P)	72	08/00→	➔				
1.5 dCi	74	01/04→	➔				
1.5 dCi (B/C2J)	50	08/04→	➔				
1.5 dCi (B/CB07)	48	06/01→	➔				
1.5 dCi (B/CB08)	60	06/01→	➔				
1.5 dCi (B/CB3N)	62	02/07→	➔				
1.2 LPG	43	09/98→06/09	➔	+ ABS		13.0460-0435.2 610435	BDX
1.5 dCi	42	06/01→12/06	➔				
1.5 dCi (B/CB03)	59	06/01→10/03	➔				
2.0 16V Sport	132	01/04→	➔	→ 12/12		13.0460-0262.2 610262	TRW
2.0 16V Sport (CB0M)	124	02/00→	➔	→ 12/12		13.0460-0435.2 610435	BDX
 Bremsscheibe							
1.0	40	02/00→05/01	➔	- ABS		24.0112-0116.1 412116	Ø 238 12 10,5 + S
			➔	+ ABS		24.0120-0125.1 420125	Ø 238 20,1 17,7 V + S
			➔			24.0121-0106.1 421106	Ø 259 20,7 17,7 V + S
1.2 (BB0A, BB0F, BB10, BB1K, BB28, BB2D, BB2H, CB0A...)	43	09/98→	➔	→ 05/01; - ABS		24.0112-0116.1 412116	Ø 238 12 10,5 + S
			➔	→ 05/01; + ABS		24.0120-0125.1 420125	Ø 238 20,1 17,7 V + S
			➔	06/01→ 12/12		24.0121-0106.1 421106	Ø 259 20,7 17,7 V + S
			➔	+ ABS; → 12/12		24.0108-0117.2 408117	Ø 238 8 7 + LG / + ABS Ring
1.2 (BB0A, CB0A)	44	03/99→05/01	➔	- ABS		24.0112-0116.1 412116	Ø 238 12 10,5 + S
↓							













	kw			 	! #				
RENAULT - CLIO II (BB0/1/2_, CB0/1/2_) 09/98→									
Bremsscheibe									
1.2 (BB0A, CB0A)	44	03/99→05/01	←	+ ABS		24.0120-0125.1 420125	Ø 238 20,1 17,7 V + S		
1.2 16V 1.2 16V (BB05, BB0W, BB11, BB27, BB2T, BB2U, BB2V, CB05...)	54	06/06→	←	- ABS; → 02/10		24.0112-0116.1 412116	Ø 238 12 10,5 + S		
	55	06/01→	←	+ ABS; → 12/12		24.0120-0125.1 420125	Ø 238 20,1 17,7 V + S		
			→	+ ABS; → 12/12		24.0121-0106.1 421106	Ø 259 20,7 17,7 V + S		
			→	+ ABS; → 12/12		24.0108-0117.2 408117	Ø 238 8 7 + LG / + ABS Ring		
1.2 LPG	43	09/98→06/09	←	→ 05/01; - ABS		24.0112-0116.1 412116	Ø 238 12 10,5 + S		
			←	- ABS		24.0112-0116.1 412116	Ø 238 12 10,5 + S		
			←	→ 05/01; + ABS		24.0120-0125.1 420125	Ø 238 20,1 17,7 V + S		
			←	+ ABS		24.0120-0125.1 420125	Ø 238 20,1 17,7 V + S		
					←	06/01→		24.0121-0106.1 421106	Ø 259 20,7 17,7 V + S
					→	+ ABS		24.0108-0117.2 408117	Ø 238 8 7 + LG / + ABS Ring
1.4 (B/CB0C)	55	09/98→05/05	←	- ABS; Schaltgetriebe		24.0112-0116.1 412116	Ø 238 12 10,5 + S		
			←	- ABS		24.0112-0116.1 412116	Ø 238 12 10,5 + S		
			←	- ABS; Automatikgetriebe		24.0120-0125.1 420125	Ø 238 20,1 17,7 V + S		
			←	+ ABS		24.0120-0125.1 420125	Ø 238 20,1 17,7 V + S		
			←	+ ABS; Schaltgetriebe		24.0120-0125.1 420125	Ø 238 20,1 17,7 V + S		
			←	+ ABS; Automatikgetriebe		24.0121-0106.1 421106	Ø 259 20,7 17,7 V + S		
1.4 16V (B/CB0L)	70	10/99→09/04	←	→ 07/00; - ABS		24.0120-0125.1 420125	Ø 238 20,1 17,7 V + S		
			←	→ 07/00; + ABS		24.0121-0106.1 421106	Ø 259 20,7 17,7 V + S		
1.4 16V (B/CB0P)	72	08/00→	←	- ABS; → 12/12		24.0120-0125.1 420125	Ø 238 20,1 17,7 V + S		
			←	+ ABS; → 12/12		24.0121-0106.1 421106	Ø 259 20,7 17,7 V + S		
			→	12/02→ 12/12; + ESP		24.0108-0108.1 408108	Ø 238 8 7 - ABS Ring		
			→	→ 11/02; + ABS		24.0108-0117.2 408117	Ø 238 8 7 + LG / + ABS Ring		
1.5 dCi	42	06/01→12/06	←			24.0121-0106.1 421106	Ø 259 20,7 17,7 V + S		
			→	+ ABS		24.0108-0117.2 408117	Ø 238 8 7 + LG / + ABS Ring		
1.5 dCi 1.5 dCi (B/C2J) 1.5 dCi (B/CB07) 1.5 dCi (B/CB08)	74	01/04→	←	→ 12/12		24.0121-0106.1 421106	Ø 259 20,7 17,7 V + S		
	50	08/04→	→	+ ABS; → 12/12		24.0108-0117.2 408117	Ø 238 8 7 + LG / + ABS Ring		
	48	06/01→	→	+ ABS; → 12/12		24.0108-0117.2 408117	Ø 238 8 7 + LG / + ABS Ring		
	60	06/01→	→	+ ABS; → 12/12		24.0108-0117.2 408117	Ø 238 8 7 + LG / + ABS Ring		
1.5 dCi (B/CB03)	59	06/01→10/03	←			24.0121-0106.1 421106	Ø 259 20,7 17,7 V + S		
			→	12/02→; + ESP		24.0108-0108.1 408108	Ø 238 8 7 - ABS Ring		
			→	→ 11/02; + ABS		24.0108-0117.2 408117	Ø 238 8 7 + LG / + ABS Ring		
1.5 dCi (B/CB3M)	47	06/05→	←	- ABS; → 02/08		24.0112-0116.1 412116	Ø 238 12 10,5 + S		
			←	+ ABS; → 02/08		24.0120-0125.1 420125	Ø 238 20,1 17,7 V + S		
1.5 dCi (B/CB3N)	62	02/07→	←	- ABS; → 12/12		24.0112-0116.1 412116	Ø 238 12 10,5 + S		
			←	+ ABS; → 12/12		24.0120-0125.1 420125	Ø 238 20,1 17,7 V + S		
			→	+ ABS; → 12/12		24.0108-0117.2 408117	Ø 238 8 7 + LG / + ABS Ring		
1.6 1.6 16V 1.6 Flex 1.6 Hi-Flex (CB0H)	81	11/04→02/09	←			24.0121-0106.1 421106	Ø 259 20,7 17,7 V + S		
	82	10/01→12/08	←			24.0121-0106.1 421106	Ø 259 20,7 17,7 V + S		
	81	05/00→12/06	←			24.0121-0106.1 421106	Ø 259 20,7 17,7 V + S		
	86	01/05→02/10	←			24.0121-0106.1 421106	Ø 259 20,7 17,7 V + S		
1.6 (B/CB0D)	66	09/98→05/05	←	- ABS		24.0120-0125.1 420125	Ø 238 20,1 17,7 V + S		
			←	+ ABS		24.0121-0106.1 421106	Ø 259 20,7 17,7 V + S		
1.6 16V (BB01, BB0H, BB0T, BB14, BB1D, BB1R, BB2KL...)	79	09/98→	←	→ 12/12		24.0121-0106.1 421106	Ø 259 20,7 17,7 V + S		
1.9 D (B/CB0E) 1.9 D (B/CB0J)	47	09/98→05/05	←	- ABS; für Fahrzeuge ohne Klimaanlage		24.0112-0116.1 412116	Ø 238 12 10,5 + S		
	48	02/00→05/01	←	+ ABS; für Fahrzeuge ohne Klimaanlage		24.0120-0125.1 420125	Ø 238 20,1 17,7 V + S		
			←	+ ABS; für Fahrzeuge mit Klimaanlage		24.0121-0106.1 421106	Ø 259 20,7 17,7 V + S		
1.9 dTi (B/CB0U)	59	12/99→05/05	←	02/00→		24.0121-0106.1 421106	Ø 259 20,7 17,7 V + S		
2.0 16V Sport 2.0 16V Sport (CB0M)	132	01/04→	←	→ 12/12		24.0124-0158.1 424158	Ø 280 24 21,8 V + S		
	124	02/00→	←	→ 12/12		24.0324-0158.1 524158	Ø 280 24 21,8 V + S PD		
			→	→ 12/12		24.0108-0108.1 408108	Ø 238 8 7 - ABS Ring		
RENAULT - CLIO II Kasten (SB0/1/2_) 09/98→									
Bremsbelagsatz, Scheibenbremse									
1.2 (SB0A, SB0F, SB10)	44	03/99→10/03	←			13.0460-2834.2 602834	TRW 21463 18,0 + WK		











	kw			 	! #		
RENAULT - CLIO II Kasten (SB0/1/2_) 09/98→							
 Bremsbelagsatz, Scheibenbremse							
1.5 dCi	59	06/01→10/04	←			13.0460-2834.2 602834	TRW 21463 18,0 + WK
1.9 D (SB0J)	48	02/00→05/01					
1.9 D (SB0R)	40	03/99→01/00					
1.9 DTi (SB0U)	59	02/00→05/01					
1.2 (SB0A, SB0F, SB1K, SB2D)	43	09/98→	←	→ 12/12		13.0460-2834.2 602834	TRW 21463 18,0 + WK
1.5 dCi	50	04/04→					
1.5 dCi	60	11/03→					
1.5 dCi (SB07)	48	06/01→					
1.9 D (SB0E)	47	09/98→					
1.6 (SB0H)	79	11/03→	←	→ 04/05		13.0460-2834.2 602834	TRW 21463 18,0 + WK
 Bremsscheibe							
1.2 (SB0A, SB0F, SB10)	44	03/99→10/03	←	- ABS		24.0112-0116.1 412116	Ø 238 12 10,5 + S
1.2 (SB0A, SB0F, SB1K, SB2D)	43	09/98→	←	- ABS; → 12/12		24.0112-0116.1 412116	Ø 238 12 10,5 + S
			←	+ ABS; → 12/12		24.0120-0125.1 420125	Ø 238 20,1 17,7 V + S
1.5 dCi	50	04/04→	←	→ 12/12		24.0121-0106.1 421106	Ø 259 20,7 17,7 V + S
1.5 dCi	60	11/03→					
1.5 dCi (SB07)	48	06/01→					
1.5 dCi	59	06/01→10/04	←			24.0121-0106.1 421106	Ø 259 20,7 17,7 V + S
1.9 DTi (SB0U)	59	02/00→05/01					
1.6 (SB0H)	79	11/03→	←	→ 04/05		24.0121-0106.1 421106	Ø 259 20,7 17,7 V + S
1.9 D (SB0E)	47	09/98→	←	→ 12/12		24.0120-0125.1 420125	Ø 238 20,1 17,7 V + S
1.9 D (SB0J)	48	02/00→05/01	←	- ABS		24.0120-0125.1 420125	Ø 238 20,1 17,7 V + S
			←	+ ABS		24.0121-0106.1 421106	Ø 259 20,7 17,7 V + S
1.9 D (SB0R)	40	03/99→01/00	←			24.0120-0125.1 420125	Ø 238 20,1 17,7 V + S
RENAULT - CLIO III (BR0/1, CR0/1) 01/05→							
 Bremsbelagsatz, Scheibenbremse							
1.2	43	05/05→06/09	←	06/06→		13.0460-2709.2 602709	TRW 23973 17,1 - WE / - WK + Zub
			→	06/06→		13.0470-2709.2 LD2709	TRW 23973 17,1 - WE / - WK + Zub Ceramic
1.2 (BR01, BR03, BR0E, CR0E)	57	10/05→	←	→ 12/12		13.0460-2709.2 602709	TRW 23973 17,1 - WE / - WK + Zub
			→	→ 12/12		13.0470-2709.2 LD2709	TRW 23973 17,1 - WE / - WK + Zub Ceramic
1.2 16V	58	06/05→					
1.2 16V	76	09/10→					
1.2 16V (BR02, BR0J, BR11, CR02, CR0J, CR11)	55	06/05→					
1.2 16V (BR0P, CR0P)	74	05/07→					
1.2 16V (BR0R, BR1D, BR1L, CR0R)	48	06/05→					
1.2 16V Hi-Flex (BR1U, CR1U)	55	07/08→					
1.2 Ethanol	55	07/08→					
1.4 16V	72	06/05→					
1.5 dCi	55	08/10→					
1.5 dCi	60	11/07→					
1.5 dCi	65	08/10→					
1.5 dCi (BR0H, CR0H)	78	06/05→					
1.5 dCi (BR17, CR17)	63	06/05→					
1.5 dCi (BR1C, CR1C)	76	06/05→					
1.5 dCi (C/BR0G, C/BR1G)	50	06/05→					
1.6 16V (BR05, BR0B, BR0Y, BR15, BR1J, BR1M, BR1Y, CR0B...)	82	06/05→					
1.6 16V (BR09, BR0T, CR09, CR0T)	65	06/05→					
1.6 16V GT (BR10, CR10)	94	06/09→					
1.2 16V	43	06/06→08/10	←			13.0460-2709.2 602709	TRW 23973 17,1 - WE / - WK + Zub
1.6 Hi-Flex	86	05/05→02/10	←			13.0470-2709.2 LD2709	TRW 23973 17,1 - WE / - WK + Zub Ceramic
			→			13.0460-2845.2 602845	TRW 23554 16,4 - WK + Zub
						13.0470-2845.2 LD2845	TRW 23554 16,4 - WK + Zub Ceramic
↓							















	kw			 	! #		
RENAULT - CLIO III (BR0/1, CR0/1) 01/05→							
 Bremsbelagsatz, Scheibenbremse							
1.5 dCi	47	06/05→	←	→ 12/12		13.0460-2709.2 602709 13.0470-2709.2 LD2709	TRW 23973 17,1 - WE / - WK + Zub TRW 23973 17,1 - WE / - WK + Zub Ceramic
1.5 dCi	48	05/05→	←	→ 10/06		13.0460-2709.2 602709 13.0470-2709.2 LD2709	TRW 23973 17,1 - WE / - WK + Zub TRW 23973 17,1 - WE / - WK + Zub Ceramic
			→	→ 10/06		13.0460-2845.2 602845 13.0470-2845.2 LD2845	TRW 23554 16,4 - WK + Zub TRW 23554 16,4 - WK + Zub Ceramic
2.0 16V (BR0C, BR0K, CR0C, CR0K)	102	09/06→	←	→ 12/12		13.0460-7221.2 607221 13.0470-7221.2 LD7221	ATE 23215 18,3 - WE / - WK ATE 23215 18,3 - WE / - WK Ceramic
			→	→ 12/12		13.0460-2845.2 602845 13.0470-2845.2 LD2845	TRW 23554 16,4 - WK + Zub TRW 23554 16,4 - WK + Zub Ceramic
2.0 16V Sport	145	02/06→	←	→ 12/12		13.0460-4805.2 604805	BRE 24162 15,2 - WE / - WK
2.0 16V Sport	148	09/08→	←	04/09→ 12/12		13.0460-4805.2 604805	BRE 24162 15,2 - WE / - WK
 Bremsscheibe							
1.2	43	05/05→06/09	←	06/06→		24.0122-0216.1 422216	Ø 260 22 19,8 V + S
			→	06/06→		24.0108-0114.2 408114	Ø 240 8 7 + LG / + ABS Ring
1.2 (BR01, BR03, BR0E, CR0E)	57	10/05→	←	→ 12/12		24.0122-0216.1 422216	Ø 260 22 19,8 V + S
1.2 16V	58	06/05→	→	→ 12/12		24.0108-0114.2 408114	Ø 240 8 7 + LG / + ABS Ring
1.2 16V	76	09/10→					
1.2 16V (BR02, BR0J, BR11, CR02, CR0J, CR11)	55	06/05→					
1.2 16V (BR0P, CR0P)	74	05/07→					
1.2 16V Hi-Flex (BR1U, CR1U)	55	07/08→					
1.2 Ethanol	55	07/08→					
1.4 16V	72	06/05→					
1.5 dCi	55	08/10→					
1.5 dCi	60	11/07→					
1.5 dCi	65	08/10→					
1.5 dCi (BR0H, CR0H)	78	06/05→					
1.5 dCi (BR17, CR17)	63	06/05→					
1.5 dCi (BR1C, CR1C)	76	06/05→					
1.5 dCi (C/BR0G, C/BR1G)	50	06/05→					
1.6 16V (BR05, BR0B, BR0Y, BR15, BR1J, BR1M, BR1Y, CR0B...)	82	06/05→					
1.6 16V (BR09, BR0T, CR09, CR0T)	65	06/05→					
1.6 16V GT (BR10, CR10)	94	06/09→					
1.2 16V	43	06/06→08/10	←			24.0122-0216.1 422216	Ø 260 22 19,8 V + S
1.6 Hi-Flex	86	05/05→02/10	→			24.0108-0114.2 408114	Ø 240 8 7 + LG / + ABS Ring
1.2 16V (BR0R, BR1D, BR1L, CR0R)	48	06/05→	←	→ 12/12		24.0122-0216.1 422216	Ø 260 22 19,8 V + S
			→	→ 12/12; Achszapfendurchmesser [mm]: 25		24.0108-0114.2 408114	Ø 240 8 7 + LG / + ABS Ring
1.5 dCi	47	06/05→	←	→ 12/12		24.0122-0216.1 422216	Ø 260 22 19,8 V + S
1.5 dCi	48	05/05→	←	→ 10/06		24.0122-0216.1 422216	Ø 260 22 19,8 V + S
			→	→ 10/06		24.0108-0114.2 408114	Ø 240 8 7 + LG / + ABS Ring
2.0 16V (BR0C, BR0K, CR0C, CR0K)	102	09/06→	←	→ 12/12		24.0124-0158.1 424158 24.0324-0158.1 524158	Ø 280 24 21,8 V + S Ø 280 24 21,8 V + S PD
			→	→ 12/12		24.0108-0114.2 408114	Ø 240 8 7 + LG / + ABS Ring
2.0 16V Sport	145	02/06→	←	→ 12/12		24.0128-0223.1 428223	Ø 312,5 28 26 V + S
			→	→ 12/12		24.0111-0183.2 411183	Ø 300 11 9,5 + LG / + ABS Ring
2.0 16V Sport	148	09/08→	←	04/09→ 12/12		24.0128-0223.1 428223	Ø 312,5 28 26 V + S
			→	04/09→ 12/12		24.0111-0183.2 411183	Ø 300 11 9,5 + LG / + ABS Ring











	kw			 	! #		
RENAULT - CLIO III Kasten (SB_, SR_) 06/05→							
 Bremsbelagsatz, Scheibenbremse							
1.2 (SR0J) 1.5 dCi (SR1H)	55 65	11/05→12/14 08/10→12/14	←	→ 12/12		13.0460-2709.2 602709 13.0470-2709.2 LD2709	TRW 23973 17,1 - WE / - WK + Zub TRW 23973 17,1 - WE / - WK + Zub Ceramic
			→	→ 12/12		13.0460-2845.2 602845 13.0470-2845.2 LD2845	TRW 23554 16,4 - WK + Zub TRW 23554 16,4 - WK + Zub Ceramic
1.2 (SR0P) 1.5 dCi 1.5 dCi 1.5 dCi	74 50 63 78	11/07→12/11 10/05→07/10 06/05→07/10 10/05→10/07	←			13.0460-2709.2 602709 13.0470-2709.2 LD2709	TRW 23973 17,1 - WE / - WK + Zub TRW 23973 17,1 - WE / - WK + Zub Ceramic
			→			13.0460-2845.2 602845 13.0470-2845.2 LD2845	TRW 23554 16,4 - WK + Zub TRW 23554 16,4 - WK + Zub Ceramic
 Bremsscheibe							
1.2 (SR0J) 1.5 dCi (SR1H)	55 65	11/05→12/14 08/10→12/14	←	→ 12/12		24.0122-0216.1 422216	Ø 260 22 19,8 V + S
			→	→ 12/12		24.0108-0114.2 408114	Ø 240 8 7 + LG / + ABS Ring
1.2 (SR0P) 1.5 dCi 1.5 dCi 1.5 dCi	74 50 63 78	11/07→12/11 10/05→07/10 06/05→07/10 10/05→10/07	←			24.0122-0216.1 422216	Ø 260 22 19,8 V + S
			→			24.0108-0114.2 408114	Ø 240 8 7 + LG / + ABS Ring
RENAULT - CLIO IV (BH_) 11/12→							
 Bremsbelagsatz, Scheibenbremse							
0.9 TCe 90 1.2 16V 1.2 LPG 16V 1.2 TCe 120 1.5 dCi 75 1.5 dCi 90	66 54 54 88 55 66	11/12→ 11/12→ 11/12→ 03/13→ 11/12→ 11/12→	←	→ 03/15		13.0460-2709.2 602709 13.0460-7298.2 607298 13.0470-2709.2 LD2709	TRW 23973 17,1 - WE / - WK + Zub ATE 25702 18,2 - WE / - WK TRW 23973 17,1 - WE / - WK + Zub Ceramic
1.6 RS 1.6 RS Trophy	147 162	03/13→ 03/15→	←			13.0460-7249.2 607249 13.0470-7249.2 LD7249	ATE 24709 18,6 - WE / - WK ATE 24709 18,6 - WE / - WK Ceramic
			→			13.0460-2740.2 602740 13.0470-2740.2 LD2740	TRW 23554 17,0 - WE / - WK + Zub TRW 23554 17,0 - WE / - WK + Zub Ceramic
 Bremsscheibe							
0.9 TCe 90 0.9 TCe 90 LPG 1.2 16V 1.2 LPG 16V 1.5 dCi 75	66 66 54 54 55	11/12→ 06/16→ 11/12→ 11/12→ 11/12→	←			24.0122-0289.1 422289	Ø 258 22 19,8 V + S
1.2 TCe 120 1.2 TCe 120	87 88	01/16→ 03/13→	←			24.0122-0270.1 422270	Ø 258 22 19,8 V + S
1.5 dCi 110 1.5 dCi 90	81 66	06/16→ 11/12→	←	Automatikgetriebe		24.0122-0270.1 422270	Ø 258 22 19,8 V + S
			←	Schaltgetriebe		24.0122-0289.1 422289	Ø 258 22 19,8 V + S
1.6 RS 1.6 RS Trophy	147 162	03/13→ 03/15→	←			24.0128-0245.1 428245	Ø 320 28 25,4 V + S
			→			24.0108-0118.2 408118	Ø 260 8 7 + LG / + ABS Ring
RENAULT - CLIO IV Grandtour (KH_) 01/13→							
 Bremsbelagsatz, Scheibenbremse							
0.9 TCe 90 1.2 16V 1.2 TCe 120 1.2 TCe 120 1.5 dCi 110 1.5 dCi 75 1.5 dCi 90	66 54 87 88 81 55 66	01/13→ 01/13→ 01/16→ 03/13→ 06/16→ 01/13→ 01/13→	←			13.0460-2709.2 602709 13.0470-2709.2 LD2709	TRW 23973 17,1 - WE / - WK + Zub TRW 23973 17,1 - WE / - WK + Zub Ceramic
 Bremsscheibe							
0.9 TCe 90 1.2 16V 1.2 TCe 120 1.2 TCe 120 1.5 dCi 110 1.5 dCi 75 1.5 dCi 90	66 54 87 88 81 55 66	01/13→ 01/13→ 01/16→ 03/13→ 06/16→ 01/13→ 01/13→	←			24.0122-0270.1 422270	Ø 258 22 19,8 V + S

	kW			 	! #		
RENAULT - CLIO IV Kasten 01/14→							
 Bremsbelagsatz, Scheibenbremse							
0.9 TCe 90 1.2 16V 1.5 dCi 75 1.5 dCi 90	66 55 55 66	01/14→ 01/14→ 01/14→ 01/14→	←	→ 03/15		13.0460-2709.2 602709 13.0460-7298.2 607298 13.0470-2709.2 LD2709	TRW 23973 17,1 - WE / - WK + Zub ATE 25702 18,2 - WE / - WK TRW 23973 17,1 - WE / - WK + Zub Ceramic
 Bremsscheibe							
0.9 TCe 90 1.2 16V 1.5 dCi 75	66 55 55	01/14→ 01/14→ 01/14→	←			24.0122-0289.1 422289	∅ 258 22 19,8 V + S
1.5 dCi 90	66	01/14→	←	Automatikgetriebe		24.0122-0270.1 422270	∅ 258 22 19,8 V + S
			←	Schaltgetriebe		24.0122-0289.1 422289	∅ 258 22 19,8 V + S
RENAULT - CLIO Grandtour (KR0/1_) 02/08→							
 Bremsbelagsatz, Scheibenbremse							
1.2 16V 1.2 16V (KR02, KR0J) 1.2 16V (KR0E) 1.2 16V (KR0P) 1.2 16V Hi-Flex (KR0S) 1.4 16V 1.5 dCi 1.5 dCi 1.5 dCi 1.5 dCi (KR0F) 1.5 dCi (KR0G) 1.5 dCi (KR0H) 1.5 dCi (KR1C, KR1N) 1.6 16V 1.6 16V (KR0B) 1.6 16V (KR10)	76 55 58 74 55 72 48 55 65 63 50 78 76 80 82 94	09/10→ 02/08→ 02/08→ 02/08→ 07/08→ 02/10→ 02/10→ 08/10→ 08/10→ 02/08→ 02/08→ 02/08→ 02/08→ 02/08→ 02/08→ 11/08→	←	→ 12/12		13.0460-2709.2 602709 13.0470-2709.2 LD2709 13.0460-2845.2 602845 13.0470-2845.2 LD2845	TRW 23973 17,1 - WE / - WK + Zub TRW 23973 17,1 - WE / - WK + Zub Ceramic TRW 23554 16,4 - WK + Zub TRW 23554 16,4 - WK + Zub Ceramic
			→	+ ESP; → 12/12			
 Bremsscheibe							
1.2 16V 1.2 16V (KR02, KR0J) 1.2 16V (KR0E) 1.2 16V (KR0P) 1.2 16V Hi-Flex (KR0S) 1.4 16V 1.5 dCi 1.5 dCi 1.5 dCi 1.5 dCi (KR0F) 1.5 dCi (KR0G) 1.5 dCi (KR0H) 1.5 dCi (KR1C, KR1N) 1.6 16V 1.6 16V (KR0B) 1.6 16V (KR10)	76 55 58 74 55 72 48 55 65 63 50 78 76 80 82 94	09/10→ 02/08→ 02/08→ 02/08→ 07/08→ 02/10→ 02/10→ 08/10→ 08/10→ 02/08→ 02/08→ 02/08→ 02/08→ 02/08→ 11/08→	←	→ 12/12		24.0122-0216.1 422216	∅ 260 22 19,8 V + S
			→	+ ESP; → 12/12		24.0108-0114.2 408114	∅ 240 8 7 + LG / + ABS Ring
RENAULT - DOKKER 12/13→							
 Bremsbelagsatz, Scheibenbremse							
1.5 dCi 1.6 1.6	66 62 63	12/13→ 12/13→ 12/13→	←	- ESP		13.0460-2709.2 602709 13.0470-2709.2 LD2709	TRW 23973 17,1 - WE / - WK + Zub TRW 23973 17,1 - WE / - WK + Zub Ceramic
			←	+ ESP		13.0460-7266.2 607266 13.0470-7266.2 LD7266	ATE 24538 17,9 - WE / - WK ATE 24538 17,9 - WE / - WK Ceramic
 Bremsscheibe							
1.5 dCi 1.6 1.6	66 62 63	12/13→ 12/13→ 12/13→	←	- ESP; nicht für erhöhte Nutzlast		24.0122-0270.1 422270	∅ 258 22 19,8 V + S
			←	- ESP; für erhöhte Nutzlast		24.0124-0253.1 424253	∅ 280 24 21,8 V + S
			←	+ ESP		24.0124-0253.1 424253	∅ 280 24 21,8 V + S
RENAULT - DUSTER (HS_) 01/11→							
 Bremsbelagsatz, Scheibenbremse							
1.5 dCi 2.0	66 98	06/11→ 02/12→	←	- ABS		13.0460-2709.2 602709 13.0470-2709.2 LD2709	TRW 23973 17,1 - WE / - WK + Zub TRW 23973 17,1 - WE / - WK + Zub Ceramic
			←	+ ABS		13.0460-7266.2 607266	ATE 24538 17,9 - WE / - WK









	kw			 	! #		
RENAULT - DUSTER (HS_) 01/11→							
 Bremsbelagsatz, Scheibenbremse							
1.5 dCi 2.0	66 98	06/11→ 02/12→	←	+ ABS		13.0470-7266.2 LD7266	ATE 24538 17,9 - WE / - WK Ceramic
1.5 dCi 4x4 2.0 4x4	66 99	06/11→ 02/12→	←			13.0460-7266.2 607266 13.0470-7266.2 LD7266	ATE 24538 17,9 - WE / - WK ATE 24538 17,9 - WE / - WK Ceramic
1.6 16V 1.6 16V (HSAT) 1.6 16V 4x4 1.6 16V 4x4	84 75 75 84	06/15→ 02/12→ 06/11→05/15 06/15→	←	- ESP		13.0460-2709.2 602709 13.0470-2709.2 LD2709	TRW 23973 17,1 - WE / - WK + Zub TRW 23973 17,1 - WE / - WK + Zub Ceramic
			←	+ ESP		13.0460-7266.2 607266 13.0470-7266.2 LD7266	ATE 24538 17,9 - WE / - WK ATE 24538 17,9 - WE / - WK Ceramic
 Bremsscheibe							
1.5 dCi 2.0	66 98	06/11→ 02/12→	←	- ABS		24.0123-0119.1 423119	Ø 269 22,5 19,8 V + S
			←	+ ABS		24.0124-0221.1 424221	Ø 280 24 21,8 V + S
1.5 dCi 4x4 2.0 4x4	66 99	06/11→ 02/12→	←			24.0124-0221.1 424221	Ø 280 24 21,8 V + S
1.6 16V 1.6 16V (HSAT) 1.6 16V 4x4 1.6 16V 4x4	84 75 75 84	06/15→ 02/12→ 06/11→05/15 06/15→	←	- ESP		24.0123-0119.1 423119	Ø 269 22,5 19,8 V + S
			←	+ ESP		24.0124-0221.1 424221	Ø 280 24 21,8 V + S
RENAULT - ESPACE II (J/S63_) 01/91→10/97							
 Bremsbelagsatz, Scheibenbremse							
2.0 (J636)	76	01/91→10/96	←			13.0460-2810.2 602810	TRW 20236 18,0 + WK
			→	+ ABS; für Fahrzeuge mit Niveauregulierung		13.0460-3961.2 603961	BDX 20336 14,0 + WK
2.1 TD (J633, J634, J/S635, J/S63D) 2.1 TD (J63E)	65 66	01/91→10/96 11/94→10/96	←			13.0460-2810.2 602810 13.0460-3961.2 603961	TRW 20236 18,0 + WK BDX 20336 14,0 + WK
2.2 (J/S637, J63G) 2.2 4x4 (J/S637, J63G)	79 79	01/91→10/96 03/91→12/96	←			13.0460-2810.2 602810 13.0460-3961.2 603961	TRW 20236 18,0 + WK BDX 20336 14,0 + WK
2.8 V6 (J638, J63J)	110	01/91→10/96	←			13.0460-2983.2 602983 13.0460-3961.2 603961	TRW 20919 18,0 + WK BDX 20336 14,0 + WK
 Bremsscheibe							
2.0 (J636) 2.2 (J/S637, J63G)	76 79	01/91→10/96 01/91→10/96	←			24.0120-0126.1 420126 24.0112-0134.1 412134	Ø 259 20,2 17,7 V Ø 253,8 12 10,5
			→	+ ABS; für Fahrzeuge mit Niveauregulierung			
2.1 TD (J633, J634, J/S635, J/S63D) 2.1 TD (J63E)	65 66	01/91→10/96 11/94→10/96	←			24.0120-0126.1 420126 24.0112-0134.1 412134	Ø 259 20,2 17,7 V Ø 253,8 12 10,5
2.2 4x4 (J/S637, J63G)	79	03/91→12/96	←			24.0120-0126.1 420126 24.0111-0150.1 411150 24.0112-0134.1 412134	Ø 259 20,2 17,7 V Ø 257 10,5 9,5 Ø 253,8 12 10,5
			→	→ 10/96			
			→	05/93→; + ABS; für Fahrzeuge mit Niveauregulierung			
2.8 V6 (J638, J63J)	110	01/91→10/96	←			24.0122-0143.1 422143 24.0112-0133.1 412133	Ø 280 22 20 V Ø 253,8 12 10,5
			→				
RENAULT - ESPACE III (JE0_) 11/96→10/02							
 Bremsbelagsatz, Scheibenbremse							
1.9 dTi (JE0M) 2.0 (JE0A) 2.2 12V TD (JE0E, JE0H, JE0P) 2.2 D	72 84 83 84	02/99→10/02 11/96→10/00 11/96→10/00 11/97→01/00	←			13.0460-2832.2 602832	TRW 21888 18,1 + WK
2.0	102	09/01→10/02	←			13.0460-2832.2 602832	TRW 21888 18,1 + WK
			→			13.0460-2845.2 602845 13.0470-2845.2 LD2845	TRW 23554 16,4 - WK + Zub TRW 23554 16,4 - WK + Zub Ceramic
2.0 16V (JE0N, JE0L, JE02)	103	10/98→10/02	←			13.0460-2832.2 602832	TRW 21888 18,1 + WK
			→	07/00→		13.0460-2845.2 602845 13.0470-2845.2 LD2845	TRW 23554 16,4 - WK + Zub TRW 23554 16,4 - WK + Zub Ceramic
			→	→ 06/00		13.0460-4957.2 604957	BRE 20410 15,0 - WE / - WK
↓							















	kW			 	! #		
RENAULT - ESPACE III (JE0_) 11/96→10/02							
 Bremsbelagsatz, Scheibenbremse							
2.2 dCi (JE0K)	95	10/00→10/02	←			13.0460-2735.2 602735	TRW 23099 18,4 + WK + Zub
			→			13.0460-2870.2 602870	TRW 23099 18,4 - WK
			←			13.0460-2845.2 602845	TRW 23554 16,4 - WK + Zub
			→			13.0470-2845.2 LD2845	TRW 23554 16,4 - WK + Zub Ceramic
2.2 dCi (JE0S)	85	07/00→10/02	←			13.0460-2870.2 602870	TRW 23099 18,4 - WK
3.0 (JE0D)	123	11/96→10/98	←			13.0460-2832.2 602832	TRW 21888 18,1 + WK
			→			13.0460-4957.2 604957	BRE 20410 15,0 - WE / - WK
3.0 V6 24V (JE0G, JE0R)	140	10/98→10/02	←	→ 06/00		13.0460-2735.2 602735	TRW 23099 18,4 + WK + Zub
			←	07/00→		13.0460-2870.2 602870	TRW 23099 18,4 - WK
			→	07/00→		13.0460-2845.2 602845	TRW 23554 16,4 - WK + Zub
			→			13.0470-2845.2 LD2845	TRW 23554 16,4 - WK + Zub Ceramic
			→	→ 06/00		13.0460-4957.2 604957	BRE 20410 15,0 - WE / - WK
Zubehörsatz, Scheibenbremsbelag							
2.0 16V (JE0N, JE0L, JE02)	103	10/98→10/02	→	→ 06/00		13.0460-0438.2 610438	BRE
3.0 V6 24V (JE0G, JE0R)	140	10/98→10/02					
3.0 (JE0D)	123	11/96→10/98	→			13.0460-0438.2 610438	BRE
 Bremsscheibe							
1.9 dTi (JE0M)	72	02/99→10/02	←			24.0124-0171.1 424171	Ø 280 24 21,8 V + S
2.0 (JE0A)	84	11/96→10/00				24.0324-0171.1 524171	Ø 280 24 21,8 V + S PD
2.2 12V TD (JE0E, JE0H, JE0P)	83	11/96→10/00					
2.2 D	84	11/97→01/00					
2.0	102	09/01→10/02	←			24.0124-0171.1 424171	Ø 280 24 21,8 V + S
2.0 16V (JE0N, JE0L, JE02)	103	10/98→10/02				24.0324-0171.1 524171	Ø 280 24 21,8 V + S PD
3.0 (JE0D)	123	11/96→10/98	→			24.0111-0151.1 411151	Ø 265 10,5 9,5
2.2 dCi (JE0K)	95	10/00→10/02	←			24.0128-0134.1 428134	Ø 305 28 26 V
			→			24.0111-0151.1 411151	Ø 265 10,5 9,5
2.2 dCi (JE0S)	85	07/00→10/02	←			24.0128-0134.1 428134	Ø 305 28 26 V
3.0 V6 24V (JE0G, JE0R)	140	10/98→10/02	←	07/00→		24.0128-0134.1 428134	Ø 305 28 26 V
			→			24.0111-0151.1 411151	Ø 265 10,5 9,5
RENAULT - ESPACE IV (JK0/1_) 11/02→							
 Bremsbelagsatz, Scheibenbremse							
1.9 dCi (JK0U, JK0G)	88	11/02→	←			13.0460-7159.2 607159	ATE 23245 18,3 - WE / - WK
1.9 dCi (JK0U)	85	04/03→02/05				13.0470-7159.2 LD7159	ATE 23245 18,3 - WE / - WK Ceramic
2.0 (JK09)	100	11/02→					
2.0 (JK0A, JK1D, JK0N)	125	04/05→					
2.0 (JK0K)	98	11/02→02/05	→			13.0460-7137.2 607137	ATE 23482 15,8 - WE / - WK
2.0 dCi (JK01, JK02, JK1J, JK1K)	110	01/06→				13.0470-7137.2 LD7137	ATE 23482 15,8 - WE / - WK Ceramic
2.0 dCi (JK02, JK03)	96	01/06→					
2.0 dCi (JK03, JK04)	127	01/06→					
2.0 Turbo (JK0A, JK0B, JK0N)	120	11/02→					
2.2 dCi (JK07)	102	02/06→					
2.2 dCi (JK0H)	110	11/02→					
3.0 dCi (JK0E, JK0Y)	133	01/06→					
3.0 dCi (JK0J, JK0V)	130	11/02→					
3.5 V6 (JK00, JK0F, JK0P, JK0S, JK0W)	177	11/02→					
3.0 dCi	120	09/05→	←	09/09→		13.0460-7159.2 607159	ATE 23245 18,3 - WE / - WK
			→			13.0470-7159.2 LD7159	ATE 23245 18,3 - WE / - WK Ceramic
			←			13.0460-7137.2 607137	ATE 23482 15,8 - WE / - WK
			→			13.0470-7137.2 LD7137	ATE 23482 15,8 - WE / - WK Ceramic
 Bremsscheibe							
1.9 dCi (JK0U, JK0G)	88	11/02→	←	→ 09/03; für Leichtmetallfelgen		24.0128-0133.1 428133	Ø 324 28 25,4 V
2.0 (JK09)	100	11/02→	←	für Stahlfelgen		24.0128-0135.1 428135	Ø 308 28 25,8 V
			←	10/03→; für Leichtmetallfelgen		24.0128-0135.1 428135	Ø 308 28 25,8 V
↓							

	kW					! #		
RENAULT - ESPACE IV (JK0/1_) 11/02→								
 Bremsscheibe								
1.9 dCi (JK0U, JK0G) 2.0 (JK09)	88 100	11/02→ 11/02→	➔	Achszapfendurchmesser [mm]: 30		24.0111-0100.2	411100	Ø 300 11 9,5 + LG / + ABS Ring
1.9 dCi (JK0U) 2.0 (JK0A, JK1D, JK0N) 2.0 dCi (JK02, JK03)	85 125 96	04/03→02/05 04/05→ 01/06→	➔	Achszapfendurchmesser [mm]: 30		24.0128-0135.1	428135	Ø 308 28 25,8 V
2.0 (JK0K)	98	11/02→02/05	➔	für Leichtmetallfelgen		24.0128-0133.1	428133	Ø 324 28 25,4 V
			➔	für Stahlfelgen		24.0128-0135.1	428135	Ø 308 28 25,8 V
			➔	Achszapfendurchmesser [mm]: 30		24.0111-0100.2	411100	Ø 300 11 9,5 + LG / + ABS Ring
2.0 dCi (JK01, JK02, JK1J, JK1K) 2.0 dCi (JK03, JK04) 2.2 dCi (JK07) 2.2 dCi (JK0H) 3.0 dCi 3.0 dCi (JK0E, JK0Y) 3.0 dCi (JK0J, JK0V) 3.5 V6 (JK00, JK0F, JK0P, JK0S, JK0W)	110 127 102 110 120 133 130 177	01/06→ 01/06→ 02/06→ 11/02→ 09/05→ 01/06→ 11/02→ 11/02→	➔	Achszapfendurchmesser [mm]: 30		24.0111-0100.2	411100	Ø 300 11 9,5 + LG / + ABS Ring
2.0 Turbo (JK0A, JK0B, JK0N)	120	11/02→	➔	für Leichtmetallfelgen; Raddurchmesser [Zoll]: 18		24.0128-0133.1	428133	Ø 324 28 25,4 V
			➔	→ 09/03; für Leichtmetallfelgen; Raddurchmesser [Zoll]: 17		24.0128-0133.1	428133	Ø 324 28 25,4 V
			➔	→ 09/03; für Stahlfelgen		24.0128-0133.1	428133	Ø 324 28 25,4 V
			➔	10/03→; für Stahlfelgen		24.0128-0135.1	428135	Ø 308 28 25,8 V
			➔	10/03→; für Leichtmetallfelgen; Raddurchmesser [Zoll]: 17		24.0128-0135.1	428135	Ø 308 28 25,8 V
			➔	Achszapfendurchmesser [mm]: 30		24.0111-0100.2	411100	Ø 300 11 9,5 + LG / + ABS Ring
RENAULT - ESPACE V (JR_) 02/15→								
 Bremsscheibe								
1.6 dCi 130 1.6 dCi 160 1.6 TCe 200	96 118 147	06/15→ 06/15→ 02/15→	➔			24.0128-0245.1	428245	Ø 320 28 25,4 V + S
RENAULT - EXPRESS Kasten/Kombi 07/95→03/98								
 Bremsbelagsatz, Scheibenbremse								
1.9 D	47	07/95→03/98	➔			13.0460-3911.2	603911	BDX 20905 18,0 + WK
Zubehörsatz, Scheibenbremsbelag								
1.9 D	47	07/95→03/98	➔			13.0460-0411.2	610411	BDX
 Bremsscheibe								
1.9 D	47	07/95→03/98	➔			24.0112-0116.1	412116	Ø 238 12 10,5 + S
RENAULT - EXPRESS Pick-up 07/95→10/99								
 Bremsbelagsatz, Scheibenbremse								
1.9 D	40	07/95→10/97	➔	09/95→		13.0460-3911.2	603911	BDX 20905 18,0 + WK
1.9 D	47	07/95→10/99	➔	→ 03/98		13.0460-3911.2	603911	BDX 20905 18,0 + WK
Zubehörsatz, Scheibenbremsbelag								
1.9 D	40	07/95→10/97	➔	09/95→		13.0460-0411.2	610411	BDX
1.9 D	47	07/95→10/99	➔	→ 03/98		13.0460-0411.2	610411	BDX
 Bremsscheibe								
1.9 D	40	07/95→10/97	➔	09/95→		24.0112-0116.1	412116	Ø 238 12 10,5 + S
1.9 D	47	07/95→10/99	➔	→ 03/98		24.0112-0116.1	412116	Ø 238 12 10,5 + S
RENAULT - FLUENCE (L30_) 02/10→								
 Bremsbelagsatz, Scheibenbremse								
1.5 dCi 1.5 dCi (L30A) 1.5 dCi (L30B) 1.5 dCi (L30D, L30L) 1.5 dCi (L30S) 1.6 16V 1.6 16V (L301, L30F, L30P, L30R)	70 63 78 81 66 78 81	07/14→ 02/10→ 02/10→ 02/10→ 02/10→ 02/10→ 02/10→	➔			13.0460-7266.2 13.0470-7266.2	607266 LD7266	ATE 24538 17,9 - WE / - WK ATE 24538 17,9 - WE / - WK Ceramic
			➔	- eFSB		13.0460-2740.2	602740	TRW 23554 17,0 - WE / - WK + Zub
			➔			13.0470-2740.2	LD2740	TRW 23554 17,0 - WE / - WK + Zub Ceramic







	kW			 	! #		
RENAULT - FLUENCE (L30_) 02/10→							
 Bremsbelagsatz, Scheibenbremse							
1.6 16V (L304, L305, L30H)	82	02/10→	➔	+ eFSB		13.0460-2756.2 602756	TRW 24820 16,1 - WE / - WK + Zub
1.6 dCi	96	07/14→					
1.6 LPG 16V	81	01/12→					
2.0 16V	101	05/11→					
2.0 16V (L30C, L30G, L30T, L30V)	103	02/10→					
1.6	86	01/13→	➔			13.0460-7266.2 607266 13.0470-7266.2 LD7266	ATE 24538 17,9 - WE / - WK ATE 24538 17,9 - WE / - WK Ceramic
			➔	- eFSB		13.0460-2740.2 602740 13.0470-2740.2 LD2740	TRW 23554 17,0 - WE / - WK + Zub TRW 23554 17,0 - WE / - WK + Zub Ceramic
Z.E.	70	02/12→	➔			13.0460-7266.2 607266 13.0470-7266.2 LD7266	ATE 24538 17,9 - WE / - WK ATE 24538 17,9 - WE / - WK Ceramic
 Bremsscheibe							
1.5 dCi	70	07/14→	➔			24.0124-0221.1 424221	Ø 280 24 21,8 V + S
1.5 dCi (L30A)	63	02/10→	➔			24.0108-0116.2 408116	Ø 260 8 7 + LG / + ABS Ring
1.5 dCi (L30B)	78	02/10→	➔				
1.5 dCi (L30D, L30L)	81	02/10→					
1.5 dCi (L30S)	66	02/10→					
1.6	86	01/13→					
1.6 16V	78	02/10→					
1.6 16V (L301, L30F, L30P, L30R)	81	02/10→					
1.6 16V (L304, L305, L30H)	82	02/10→					
1.6 dCi	96	07/14→					
1.6 LPG 16V	81	01/12→					
2.0 16V	101	05/11→					
2.0 16V (L30C, L30G, L30T, L30V)	103	02/10→					
Z.E.	70	02/12→	➔			24.0124-0221.1 424221	Ø 280 24 21,8 V + S
			➔			24.0111-0180.2 411180	Ø 274 11 9,5 + LG / + ABS Ring
RENAULT - GRAND SCÉNIC II (JM0/1_) 04/04→							
 Bremsbelagsatz, Scheibenbremse							
1.5 dCi	60	04/04→	➔	→ 09/05		13.0460-3815.2 603815	BOS 23930 18,2 - WK + Zub
1.5 dCi (JM02, JM13)	74	04/04→				13.0470-3815.2 LD3815	BOS 23930 18,2 - WK + Zub Ceramic
1.6	83	04/04→					
1.9 dCi (JM0G, JM12, JM1G, JM2C)	88	04/04→	➔	10/05→ 03/09		13.0460-7222.2 607222	ATE 23245 18,3 - WE / - WK
1.9 dCi (JM14)	96	05/05→	➔	→ 03/09		13.0460-2845.2 602845	TRW 23554 16,4 - WK + Zub
1.9 dCi (JM15)	81	05/05→				13.0470-2845.2 LD2845	TRW 23554 16,4 - WK + Zub Ceramic
2.0	99	04/04→					
2.0	120	04/04→					
2.0 dCi (JM1K)	110	09/05→					
1.5 dCi	76	06/06→11/08	➔			13.0460-7222.2 607222	ATE 23245 18,3 - WE / - WK
1.6	82	06/06→11/08	➔			13.0460-2845.2 602845	TRW 23554 16,4 - WK + Zub
1.6 Flex	82	06/06→11/08	➔			13.0470-2845.2 LD2845	TRW 23554 16,4 - WK + Zub Ceramic
1.5 dCi (JM1E)	78	05/05→	➔	06/06→ 03/09		13.0460-7222.2 607222	ATE 23245 18,3 - WE / - WK
			➔	06/06→ 03/09		13.0460-2845.2 602845 13.0470-2845.2 LD2845	TRW 23554 16,4 - WK + Zub TRW 23554 16,4 - WK + Zub Ceramic
1.6	77	06/06→	➔	→ 03/09		13.0460-7222.2 607222	ATE 23245 18,3 - WE / - WK
			➔	→ 03/09		13.0460-2845.2 602845 13.0470-2845.2 LD2845	TRW 23554 16,4 - WK + Zub TRW 23554 16,4 - WK + Zub Ceramic
1.9 dCi	85	05/05→01/09	➔	→ 09/05		13.0460-3815.2 603815 13.0470-3815.2 LD3815	BOS 23930 18,2 - WK + Zub BOS 23930 18,2 - WK + Zub Ceramic
			➔	10/05→		13.0460-7222.2 607222	ATE 23245 18,3 - WE / - WK
			➔			13.0460-2845.2 602845 13.0470-2845.2 LD2845	TRW 23554 16,4 - WK + Zub TRW 23554 16,4 - WK + Zub Ceramic
Zubehörsatz, Scheibenbremsbelag							
1.5 dCi	60	04/04→	➔	→ 03/09		13.0460-0072.2 610072	TRW

























	kW			 	! #		
RENAULT - GRAND SCÉNIC II (JM0/1_) 04/04→							
Zubehörsatz, Scheibenbremsbelag							
1.5 dCi (JM02, JM13)	74	04/04→	➡	→ 03/09		13.0460-0072.2 610072	TRW
1.6	77	06/06→					
1.6	83	04/04→					
1.9 dCi (JM0G, JM12, JM1G, JM2C)	88	04/04→					
1.9 dCi (JM14)	96	05/05→					
1.9 dCi (JM15)	81	05/05→					
2.0	99	04/04→					
2.0	120	04/04→					
2.0 dCi (JM1K)	110	09/05→					
1.5 dCi	76	06/06→11/08	➡			13.0460-0072.2 610072	TRW
1.6	82	06/06→11/08					
1.6 Flex	82	06/06→11/08					
1.9 dCi	85	05/05→01/09					
1.5 dCi (JM1E)	78	05/05→	➡	06/06→ 03/09		13.0460-0072.2 610072	TRW
 Bremsscheibe							
1.5 dCi	60	04/04→	⬅	→ 03/09		24.0124-0191.1 424191	Ø 300 24 21,8 V + S
1.5 dCi (JM02, JM13)	74	04/04→					
1.6	77	06/06→	➡	→ 03/09;		24.0111-0148.2 411148	Ø 274 10,9 9,5
1.6	83	04/04→		Achszapfendurchmesser [mm]: 30			+ LG / + ABS Ring
1.9 dCi (JM0G, JM12, JM1G, JM2C)	88	04/04→					
1.9 dCi (JM14)	96	05/05→					
1.9 dCi (JM15)	81	05/05→					
1.5 dCi	76	06/06→11/08	⬅			24.0124-0191.1 424191	Ø 300 24 21,8 V + S
1.6	82	06/06→11/08					
1.6 Flex	82	06/06→11/08	➡	Achszapfendurchmesser [mm]: 30		24.0111-0148.2 411148	Ø 274 10,9 9,5
1.9 dCi	85	05/05→01/09					+ LG / + ABS Ring
1.5 dCi (JM1E)	78	05/05→	⬅	06/06→ 03/09		24.0124-0191.1 424191	Ø 300 24 21,8 V + S
			➡	06/06→ 03/09;		24.0111-0148.2 411148	Ø 274 10,9 9,5
				Achszapfendurchmesser [mm]: 30			+ LG / + ABS Ring
2.0	99	04/04→	⬅	→ 03/09		24.0124-0191.1 424191	Ø 300 24 21,8 V + S
			➡	→ 06/09; Baumuster: JM2T/JM1M		24.0110-0325.2 410325	Ø 270 10 9 + LG / + ABS Ring
			➡	→ 03/09;		24.0111-0148.2 411148	Ø 274 10,9 9,5
				Achszapfendurchmesser [mm]: 30			+ LG / + ABS Ring
2.0	120	04/04→	⬅	→ 03/09		24.0128-0223.1 428223	Ø 312,5 28 26 V + S
			➡	→ 03/09;		24.0111-0148.2 411148	Ø 274 10,9 9,5
				Achszapfendurchmesser [mm]: 30			+ LG / + ABS Ring
2.0 dCi (JM1K)	110	09/05→	⬅	→ 03/09		24.0124-0224.1 424224	Ø 300 24 21,8 V + S
			➡	→ 03/09;		24.0111-0101.2 411101	Ø 274 10,9 9,5
				Achszapfendurchmesser [mm]: 30			+ LG / + ABS Ring
RENAULT - GRAND SCÉNIC III (JZ0/1_) 02/09→							
 Bremsbelagsatz, Scheibenbremse							
1.2 TCe	85	04/12→	⬅			13.0460-7249.2 607249	ATE 24709 18,6 - WE / - WK
1.4 16V (JZ0F)	96	02/09→				13.0470-7249.2 LD7249	ATE 24709 18,6 - WE / - WK
1.5 dCi	70	11/10→					Ceramic
1.5 dCi	78	02/09→					
1.5 dCi	81	04/09→	➡	- eFSB		13.0460-2753.2 602753	TRW 23554 16,0 - WK + Zub
1.6 16V (JZ0U)	81	02/09→	➡	+ eFSB		13.0460-2757.2 602757	TRW 24820 16,1 - WE / - WK
1.6 16V Bifuel	79	04/12→					+ Zub
1.6 16V Bifuel	81	02/09→					
1.6 dCi (JZ00, JZ12)	96	04/11→					
1.6 E85	81	02/09→					
1.9 dCi	96	02/09→					
2.0 16V (JZ0G)	103	02/09→					
1.2 TCe (JZ16)	97	01/13→	⬅	03/13→		13.0460-7249.2 607249	ATE 24709 18,6 - WE / - WK
						13.0470-7249.2 LD7249	ATE 24709 18,6 - WE / - WK
			➡	03/13→; - eFSB		13.0460-2753.2 602753	TRW 23554 16,0 - WK + Zub
			➡	03/13→; + eFSB		13.0460-2757.2 602757	TRW 24820 16,1 - WE / - WK
							+ Zub
1.5 dCi	63	04/09→	⬅			13.0460-7266.2 607266	ATE 24538 17,9 - WE / - WK
						13.0470-7266.2 LD7266	ATE 24538 17,9 - WE / - WK
			➡	+ eFSB		13.0460-2757.2 602757	TRW 24820 16,1 - WE / - WK
							+ Zub
2.0 dCi (JZ0L)	118	04/09→	⬅			13.0460-7250.2 607250	ATE 24709 17,5 - WE / - WK
2.0 dCi (JZ0Y)	110	02/09→	➡	- eFSB		13.0460-2753.2 602753	TRW 23554 16,0 - WK + Zub
			➡	+ eFSB		13.0460-2757.2 602757	TRW 24820 16,1 - WE / - WK
							+ Zub













	kw			 	! #		
RENAULT - GRAND SCÉNIC III (JZ0/1_) 02/09→							
 Bremsscheibe							
1.2 TCe	85	04/12→	←			24.0126-0158.1 426158	Ø 296 26 23,4 V + S
1.4 16V (JZ0F)	96	02/09→	→				
1.5 dCi	70	11/10→				24.0111-0180.2 411180	Ø 274 11 9,5 + LG / + ABS Ring
1.5 dCi	78	02/09→					
1.5 dCi	81	04/09→					
1.6 16V (JZ0U)	81	02/09→					
1.6 16V Bifuel	79	04/12→					
1.6 16V Bifuel	81	02/09→					
1.6 dCi (JZ00, JZ12)	96	04/11→					
1.6 E85	81	02/09→					
1.9 dCi	96	02/09→					
2.0 16V (JZ0G)	103	02/09→					
1.2 TCe (JZ16)	97	01/13→	←	03/13→		24.0126-0158.1 426158	Ø 296 26 23,4 V + S
			→	03/13→		24.0111-0180.2 411180	Ø 274 11 9,5 + LG / + ABS Ring
1.5 dCi	63	04/09→	←			24.0124-0221.1 424221	Ø 280 24 21,8 V + S
			→			24.0108-0118.2 408118	Ø 260 8 7 + LG / + ABS Ring
2.0 dCi (JZ0L)	118	04/09→	←			24.0128-0245.1 428245	Ø 320 28 25,4 V + S
			→			24.0111-0184.2 411184	Ø 290 11 9,5 + LG / + ABS Ring
2.0 dCi (JZ0Y)	110	02/09→	←	langer Radstand		24.0128-0245.1 428245	Ø 320 28 25,4 V + S
			→			24.0111-0184.2 411184	Ø 290 11 9,5 + LG / + ABS Ring
RENAULT - GRAND SCÉNIC IV (R9_) 09/16→							
 Bremsbelagsatz, Scheibenbremse							
1.2 TCe 115	85	09/16→	→	- eFSB		13.0460-2740.2 602740	TRW 23554 17,0 - WE / - WK + Zub
1.2 TCe 130	96	09/16→					
1.5 dCi 110	81	09/16→				13.0470-2740.2 LD2740	TRW 23554 17,0 - WE / - WK + Zub Ceramic
 Bremsscheibe							
1.2 TCe 115	85	09/16→	←			24.0128-0245.1 428245	Ø 320 28 25,4 V + S
1.2 TCe 130	96	09/16→					
1.5 dCi 110	81	09/16→					
1.6 dCi 130	96	09/16→					
1.6 dCi 160	118	09/16→					
RENAULT - KADJAR (HA_, HL_) 06/15→							
 Bremsbelagsatz, Scheibenbremse							
1.2 TCe 130	96	06/15→	←			13.0460-5652.2 605652	AKE 22065 17,7 + WK
1.5 dCi 110	81	06/15→	→				
1.6 dCi 130	96	06/15→				13.0460-2600.2 602600	TRW 25965 15,0 + WK
1.6 dCi 130 4x4	96	06/15→					
1.6 TCe 165	120	11/16→					
 Bremsscheibe							
1.2 TCe 130	96	06/15→	←			24.0126-0185.1 426185	Ø 296 26 24 V
1.5 dCi 110	81	06/15→	→				
1.6 dCi 130	96	06/15→				24.0113-0200.1 413200	Ø 290 13 11
1.6 dCi 130 4x4	96	06/15→					
1.6 TCe 165	120	11/16→					
RENAULT - KANGOO / GRAND KANGOO (KW0/1_) 02/08→							
 Bremsbelagsatz, Scheibenbremse							
1.2 TCe 115	84	07/13→	←			13.0460-2741.2 602741	TRW 24693 18,5 - WE / - WK + Zub
1.5 dCi	48	01/09→					
1.5 dCi	55	11/12→	→			13.0460-2742.2 602742	TRW 24693 17,5 - WE / - WK + Zub
1.5 dCi	66	11/12→					
1.5 dCi	78	02/08→					
1.5 dCi (KW0A)	50	02/08→				13.0460-2743.2 602743	TRW 24693 17,5 + WK
1.5 dCi (KW0B)	63	02/08→	→			13.0460-2744.2 602744	TRW 24692 15,9 - WE / - WK + Zub
1.5 dCi (KW0C, KW0F)	76	02/08→					
1.5 dCi 110	80	09/10→					
1.5 dCi 110	81	03/13→					
1.6 (KW00, KW0Y)	64	02/08→					
1.6 16V (KW0D)	78	02/08→					
1.6 16V Hi-Flex	78	02/08→					
Z.E.	44	10/11→					
 Bremsscheibe							
1.2 TCe 115	84	07/13→	←			24.0124-0222.1 424222	Ø 280 24 21,8 V + S
1.5 dCi	55	11/12→				24.0126-0186.1 426186	Ø 280 26 23,8 V + S
1.5 dCi	66	11/12→	→				
1.5 dCi 110	81	03/13→				24.0111-0182.2 411182	Ø 274 11 9,5 + LG / + ABS Ring
↓							











	kw					! #		
RENAULT - KANGOO / GRAND KANGOO (KW0/1_) 02/08→								
Bremsscheibe								
1.5 dCi	48	01/09→	←			24.0124-0222.1	424222	Ø 280 24 21,8 V + S
1.5 dCi	78	02/08→				24.0126-0186.1	426186	Ø 280 26 23,8 V + S
1.5 dCi (KW0A)	50	02/08→						
1.5 dCi (KW0B)	63	02/08→	→	→ 10/11		24.0111-0174.2	411174	Ø 274 11 9,5 + LG / + ABS Ring
1.5 dCi (KW0C, KW0F)	76	02/08→	→	11/11→		24.0111-0182.2	411182	Ø 274 11 9,5 + LG / + ABS Ring
1.5 dCi 110	80	09/10→						
1.6 (KW00, KW0Y)	64	02/08→						
1.6 16V (KW0D)	78	02/08→						
1.6 16V Hi-Flex	78	02/08→						
Z.E.	44	10/11→	←			24.0124-0222.1	424222	Ø 280 24 21,8 V + S
						24.0126-0186.1	426186	Ø 280 26 23,8 V + S
			→	11/11→		24.0111-0182.2	411182	Ø 274 11 9,5 + LG / + ABS Ring
RENAULT - KANGOO (KC0/1_) 08/97→								
Bremsbelagsatz, Scheibenbremse								
1.2 (KC0A, KC0K, KC0F, KC01)	43	08/97→	←	03/98→ 12/07; nicht für Postfahrzeuge		13.0460-3977.2	603977	BOS 21980 18,0 + WE / - WK
1.4 (KC0C, KC0H, KC0B, KC0M)	55	08/97→						
D 55 1.9 (KC0D)	40	08/97→						
D 65 1.9 (KC0E, KC02, KC0J, KC0N)	47	08/97→						
1.2 16V (KC05, KC06, KC03, KC0T, KC0W, KC1D)	55	06/01→	←	→ 12/07; nicht für Postfahrzeuge		13.0460-3977.2	603977	BOS 21980 18,0 + WE / - WK
1.5 dCi	42	07/03→						
1.5 dCi	45	04/05→06/10						
1.5 dCi	50	06/05→						
1.5 dCi	62	06/05→						
1.5 dCi (KC07)	48	12/01→						
1.5 dCi (KC08, KC09)	60	07/02→						
1.6 16V bivalent	60	06/05→						
1.9 dTi (KC0U)	59	02/00→						
1.6	66	09/99→06/01	←	nicht für Postfahrzeuge		13.0460-3977.2	603977	BOS 21980 18,0 + WE / - WK
1.9 RXED	48	09/99→06/01						
Elect'road RE	22	01/02→12/04						
1.6 16V	70	06/01→	←	→ 12/07; Frontantrieb; nicht für Postfahrzeuge		13.0460-3977.2	603977	BOS 21980 18,0 + WE / - WK
1.6 16V 4x4 (KC0P, KC0S, KC0L)	70	10/01→	←	→ 12/07		13.0460-3815.2	603815	BOS 23930 18,2 - WK + Zub
1.9 dCi 4x4	62	10/03→				13.0470-3815.2	LD3815	BOS 23930 18,2 - WK + Zub Ceramic
1.9 dCi 4x4 (KC0V)	59	10/01→	→	→ 12/07		13.0460-3988.2	603988	BOS 23557 17,2 - WE / - WK
						13.0470-3988.2	LD3988	BOS 23557 17,2 - WE / - WK Ceramic
Bremsscheibe								
1.2 (KC0A, KC0K, KC0F, KC01)	43	08/97→	←	03/98→ 12/07; - ABS		24.0120-0125.1	420125	Ø 238 20,1 17,7 V + S
D 55 1.9 (KC0D)	40	08/97→	←	03/98→ 12/07; + ABS		24.0121-0106.1	421106	Ø 259 20,7 17,7 V + S
D 65 1.9 (KC0E, KC02, KC0J, KC0N)	47	08/97→						
1.2 16V (KC05, KC06, KC03, KC0T, KC0W, KC1D)	55	06/01→	←	→ 12/07; - ABS; für Fahrzeuge ohne verstärktes Fahrwerk		24.0120-0125.1	420125	Ø 238 20,1 17,7 V + S
			←	→ 12/07; + ABS; für Fahrzeuge mit verstärktem Fahrwerk		24.0121-0106.1	421106	Ø 259 20,7 17,7 V + S
1.4 (KC0C, KC0H, KC0B, KC0M)	55	08/97→	←	03/98→ 12/07; - ABS; für Fahrzeuge ohne verstärktes Fahrwerk		24.0120-0125.1	420125	Ø 238 20,1 17,7 V + S
			←	03/98→ 12/07; + ABS; für Fahrzeuge mit verstärktem Fahrwerk		24.0121-0106.1	421106	Ø 259 20,7 17,7 V + S
1.5 dCi	42	07/03→	←	→ 12/07		24.0121-0106.1	421106	Ø 259 20,7 17,7 V + S
1.5 dCi	50	06/05→						
1.5 dCi	62	06/05→						
1.5 dCi (KC07)	48	12/01→						
1.5 dCi (KC08, KC09)	60	07/02→						
1.6 16V bivalent	60	06/05→						
1.5 dCi	45	04/05→06/10	←	→ 12/07; - ABS		24.0120-0125.1	420125	Ø 238 20,1 17,7 V + S
1.9 dTi (KC0U)	59	02/00→	←	→ 12/07; + ABS		24.0121-0106.1	421106	Ø 259 20,7 17,7 V + S
1.6	66	09/99→06/01	←			24.0121-0106.1	421106	Ø 259 20,7 17,7 V + S
1.6 16V	70	06/01→	←	→ 12/07; Frontantrieb		24.0121-0106.1	421106	Ø 259 20,7 17,7 V + S
1.6 16V 4x4 (KC0P, KC0S, KC0L)	70	10/01→	←	→ 12/07		24.0124-0158.1	424158	Ø 280 24 21,8 V + S
1.9 dCi 4x4	62	10/03→				24.0324-0158.1	524158	Ø 280 24 21,8 V + S PD
1.9 dCi 4x4 (KC0V)	59	10/01→	→	→ 12/07		24.0112-0160.1	412160	Ø 280,5 12 11
1.9 RXED	48	09/99→06/01	←	- ABS		24.0120-0125.1	420125	Ø 238 20,1 17,7 V + S
↓								









	kw					! #		
RENAULT - KANGOO (KC0/1_) 08/97→								
 Bremsscheibe								
1.9 RXED	48	09/99→06/01	←	+ ABS		24.0121-0106.1	421106	Ø 259 20,7 17,7 V + S
Elect'road RE	22	01/02→12/04	←			24.0120-0125.1	420125	Ø 238 20,1 17,7 V + S
RENAULT - KANGOO BE BOP (KW0/1_) 02/09→								
 Bremsbelagsatz, Scheibenbremse								
1.5 dCi	80	06/09→	←	passend für Felgenreöße [Zoll]: 14; → 12/10	13.0460-2709.2	602709	TRW 23973 17,1 - WE / - WK + Zub	
1.5 dCi (KW0F)	76	02/09→						
1.5 dCi (KW0G)	66	06/09→	←	passend für Felgenreöße [Zoll]: 15 / 16; → 12/10	13.0460-2741.2	602741	TRW 24693 18,5 - WE / - WK + Zub	
1.5 dCi 75	55	09/10→						
1.6 (KW0D)	78	02/09→						
			→	passend für Felgenreöße [Zoll]: 15 / 16; → 12/10	13.0460-2742.2	602742	TRW 24693 17,5 - WE / - WK + Zub	
					13.0460-2743.2	602743	TRW 24693 17,5 + WK	
					13.0460-2744.2	602744	TRW 24692 15,9 - WE / - WK + Zub	
 Bremsscheibe								
1.5 dCi	80	06/09→	←	passend für Felgenreöße [Zoll]: 14; → 12/10	24.0122-0270.1	422270	Ø 258 22 19,8 V + S	
1.5 dCi (KW0F)	76	02/09→						
1.5 dCi (KW0G)	66	06/09→	←	passend für Felgenreöße [Zoll]: 15 / 16; → 12/10	24.0124-0222.1	424222	Ø 280 24 21,8 V + S	
1.5 dCi 75	55	09/10→						
1.6 (KW0D)	78	02/09→						
			→	passend für Felgenreöße [Zoll]: 15 / 16; → 12/10	24.0126-0186.1	426186	Ø 280 26 23,8 V + S	
					24.0111-0174.2	411174	Ø 274 11 9,5 + LG / + ABS Ring	
RENAULT - KANGOO Express (FW0/1_) 02/08→								
 Bremsbelagsatz, Scheibenbremse								
1.2 TCe 115	84	07/13→	←	passend für Felgenreöße [Zoll]: 14	13.0460-2709.2	602709	TRW 23973 17,1 - WE / - WK + Zub	
1.5 dCi	50	02/08→						
1.5 dCi (FW0F)	76	02/08→	←	passend für Felgenreöße [Zoll]: 15 / 16	13.0470-2709.2	LD2709	TRW 23973 17,1 - WE / - WK + Zub Ceramic	
1.5 dCi 110	80	09/10→						
1.5 dCi 75	55	09/10→						
1.5 dCi 85 (FW0A, FW0B)	63	02/08→	←	passend für Felgenreöße [Zoll]: 15 / 16	13.0460-2741.2	602741	TRW 24693 18,5 - WE / - WK + Zub	
1.5 dCi 90 (FW0G)	66	06/09→						
1.6	64	02/08→						
1.6 16V	78	02/08→						
1.6 16V LPG	72	02/08→	→	passend für Felgenreöße [Zoll]: 15 / 16	13.0460-2743.2	602743	TRW 24693 17,5 + WK	
					13.0460-2744.2	602744	TRW 24692 15,9 - WE / - WK + Zub	
1.5 dCi 110	81	09/13→	←	passend für Felgenreöße [Zoll]: 14	13.0460-2709.2	602709	TRW 23973 17,1 - WE / - WK + Zub	
			←	passend für Felgenreöße [Zoll]: 15 / 16	13.0470-2709.2	LD2709	TRW 23973 17,1 - WE / - WK + Zub Ceramic	
			→		13.0460-2742.2	602742	TRW 24693 18,5 - WE / - WK + Zub	
					13.0460-2743.2	602743	TRW 24693 17,5 - WE / - WK + Zub	
					13.0460-2744.2	602744	TRW 24692 15,9 - WE / - WK + Zub	
Z.E.	44	10/11→	←	passend für Felgenreöße [Zoll]: 14	13.0460-2709.2	602709	TRW 23973 17,1 - WE / - WK + Zub	
			←	passend für Felgenreöße [Zoll]: 15 / 16	13.0470-2709.2	LD2709	TRW 23973 17,1 - WE / - WK + Zub Ceramic	
			→	passend für Felgenreöße [Zoll]: 15 / 16	13.0460-2744.2	602744	TRW 24692 15,9 - WE / - WK + Zub	
 Bremsscheibe								
1.2 TCe 115	84	07/13→	←	passend für Felgenreöße [Zoll]: 14	24.0122-0270.1	422270	Ø 258 22 19,8 V + S	
			←	passend für Felgenreöße [Zoll]: 15 / 16	24.0124-0222.1	424222	Ø 280 24 21,8 V + S	
			→	passend für Felgenreöße [Zoll]: 15 / 16	24.0126-0186.1	426186	Ø 280 26 23,8 V + S	
					24.0111-0182.2	411182	Ø 274 11 9,5 + LG / + ABS Ring	
1.5 dCi	50	02/08→	←	passend für Felgenreöße [Zoll]: 14	24.0122-0270.1	422270	Ø 258 22 19,8 V + S	
1.5 dCi (FW0F)	76	02/08→						
1.5 dCi 110	80	09/10→	←	passend für Felgenreöße [Zoll]: 15 / 16	24.0124-0222.1	424222	Ø 280 24 21,8 V + S	
1.5 dCi 75	55	09/10→						
1.5 dCi 85 (FW0A, FW0B)	63	02/08→						
1.5 dCi 90 (FW0G)	66	06/09→	→	passend für Felgenreöße [Zoll]: 15 / 16; → 10/11	24.0126-0186.1	426186	Ø 280 26 23,8 V + S	
					24.0111-0174.2	411174	Ø 274 11 9,5 + LG / + ABS Ring	







	kw			 	! #		
RENAULT - KANGOO Express (FW0/1_) 02/08→							
 Bremsscheibe							
1.6 1.6 16V 1.6 16V LPG	64 78 72	02/08→ 02/08→ 02/08→	➔	11/11→; passend für Felgengröße [Zoll]: 15 / 16		24.0111-0182.2 411182	Ø 274 11 9,5 + LG / + ABS Ring
1.5 dCi 110	81	09/13→	➔	passend für Felgengröße [Zoll]: 14		24.0122-0270.1 422270	Ø 258 22 19,8 V + S
			➔	passend für Felgengröße [Zoll]: 15 / 16		24.0124-0222.1 424222	Ø 280 24 21,8 V + S
			➔			24.0126-0186.1 426186	Ø 280 26 23,8 V + S
			➔			24.0111-0182.2 411182	Ø 274 11 9,5 + LG / + ABS Ring
Z.E.	44	10/11→	➔	passend für Felgengröße [Zoll]: 14		24.0122-0270.1 422270	Ø 258 22 19,8 V + S
			➔	passend für Felgengröße [Zoll]: 15 / 16		24.0111-0182.2 411182	Ø 274 11 9,5 + LG / + ABS Ring
RENAULT - KANGOO Rapid (FC0/1_) 08/97→							
 Bremsbelagsatz, Scheibenbremse							
1.0 1.2 16V (FC05) 1.5 dCi 1.5 dCi (FC07, FC1R) 1.5 dCi (FC08, FC09) 1.5 dCi (FC1E) 1.5 dCi (FC1G) 1.5 dCi (FC1R) 1.6 16V 1.6 16V bivalent 1.9 dCi (FC0V) 1.9 dTi (FC0U)	40 55 45 48 60 50 62 42 70 60 62 59	07/03→ 10/01→ 10/05→ 12/01→ 04/03→ 06/05→ 06/05→ 12/02→ 10/01→ 06/05→ 07/03→ 02/00→	➔	→ 12/07		13.0460-3977.2 603977	BOS 21980 18,0 + WE / - WK
1.0	50	01/02→01/07	➔	07/03→		13.0460-3977.2 603977	BOS 21980 18,0 + WE / - WK
1.2 (FC01, FC0A, FC0F) 1.4 (FC0C, FC0B, FC0H, FC0M) D 55 1.9 (FC0D) D 65 1.9 (FC0E, FC02, FC0J, FC0N)	43 55 40 47	08/97→ 08/97→ 08/97→ 08/97→	➔	03/98→ 12/07		13.0460-3977.2 603977	BOS 21980 18,0 + WE / - WK
1.2 (FC1A) 1.2 BiFuel 1.6 1.9 D (FC0J)	44 43 66 48	07/98→07/01 07/98→07/01 09/99→06/01 09/99→06/03	➔			13.0460-3977.2 603977	BOS 21980 18,0 + WE / - WK
1.6 16V 4x4 (FC0L, FC0P, FC0S) 1.9 dCi 4x4 (FC0V) 1.9 dCi 4x4 (FC0V)	70 59 62	10/01→ 10/01→ 07/03→	➔	→ 12/07		13.0460-3815.2 603815 13.0470-3815.2 LD3815	BOS 23930 18,2 - WK + Zub BOS 23930 18,2 - WK + Zub Ceramic
			➔	→ 12/07		13.0460-3988.2 603988 13.0470-3988.2 LD3988	BOS 23557 17,2 - WE / - WK BOS 23557 17,2 - WE / - WK Ceramic
 Bremsscheibe							
1.0 1.5 dCi 1.5 dCi (FC07, FC1R) 1.5 dCi (FC1E)	40 45 48 50	07/03→ 10/05→ 12/01→ 06/05→	➔	→ 12/07; - ABS		24.0120-0125.1 420125	Ø 238 20,1 17,7 V + S
			➔	→ 12/07		24.0121-0106.1 421106	Ø 259 20,7 17,7 V + S
1.0	50	01/02→01/07	➔	07/03→; - ABS		24.0120-0125.1 420125	Ø 238 20,1 17,7 V + S
			➔	07/03→		24.0121-0106.1 421106	Ø 259 20,7 17,7 V + S
1.2 (FC01, FC0A, FC0F) D 55 1.9 (FC0D) D 65 1.9 (FC0E, FC02, FC0J, FC0N)	43 40 47	08/97→ 08/97→ 08/97→	➔	03/98→ 12/07; - ABS		24.0120-0125.1 420125	Ø 238 20,1 17,7 V + S
			➔	03/98→ 12/07; + ABS		24.0121-0106.1 421106	Ø 259 20,7 17,7 V + S
1.2 (FC1A)	44	07/98→07/01	➔	- ABS		24.0120-0125.1 420125	Ø 238 20,1 17,7 V + S
			➔			24.0121-0106.1 421106	Ø 259 20,7 17,7 V + S
1.2 16V (FC05) 1.5 dCi (FC08, FC09) 1.6 16V 1.6 16V bivalent 1.9 dCi (FC0V)	55 60 70 60 62	10/01→ 04/03→ 10/01→ 06/05→ 07/03→	➔	→ 12/07		24.0121-0106.1 421106	Ø 259 20,7 17,7 V + S
1.2 BiFuel	43	07/98→07/01	➔	- ABS		24.0120-0125.1 420125	Ø 238 20,1 17,7 V + S
			➔	+ ABS		24.0121-0106.1 421106	Ø 259 20,7 17,7 V + S
1.4 (FC0C, FC0B, FC0H, FC0M)	55	08/97→	➔	03/98→ 12/07; - ABS; für Fahrzeuge ohne verstärktes Fahrwerk		24.0120-0125.1 420125	Ø 238 20,1 17,7 V + S
			➔	03/98→ 12/07; + ABS; für Fahrzeuge mit verstärktem Fahrwerk		24.0121-0106.1 421106	Ø 259 20,7 17,7 V + S
1.5 dCi (FC1G)	62	06/05→	➔	→ 12/07; + ABS		24.0121-0106.1 421106	Ø 259 20,7 17,7 V + S
1.5 dCi (FC1R) 1.9 dTi (FC0U)	42 59	12/02→ 02/00→	➔	→ 12/07; - ABS		24.0120-0125.1 420125	Ø 238 20,1 17,7 V + S
			➔	→ 12/07; + ABS		24.0121-0106.1 421106	Ø 259 20,7 17,7 V + S
1.6	66	09/99→06/01	➔			24.0121-0106.1 421106	Ø 259 20,7 17,7 V + S
↓							









	kW					! #		
RENAULT - KANGOO Rapid (FC0/1_) 08/97→								
 Bremsscheibe								
1.6 16V 4x4 (FC0L, FC0P, FC0S)	70	10/01→	←	→ 12/07		24.0124-0158.1	424158	Ø 280 24 21,8 V + S
			→	→ 12/07		24.0324-0158.1	524158	Ø 280 24 21,8 V + S PD
1.9 D (FC0J)	48	09/99→06/03	←	+ ABS		24.0112-0160.1	412160	Ø 280,5 12 11
1.9 dCi 4x4 (FC0V) 1.9 dCi 4x4 (FC0V)	59 62	10/01→ 07/03→	←	→ 12/07		24.0121-0106.1	421106	Ø 259 20,7 17,7 V + S
			→	→ 12/07		24.0124-0158.1	424158	Ø 280 24 21,8 V + S
			→	→ 12/07		24.0324-0158.1	524158	Ø 280 24 21,8 V + S PD
			→	→ 12/07		24.0112-0160.1	412160	Ø 280,5 12 11
RENAULT - KOLEOS I (HY_) 09/08→								
 Bremsbelagsatz, Scheibenbremse								
2.0 dCi (HY0K)	110	09/08→	←			13.0460-5778.2	605778	SUM 23698 16,8 + WK
2.0 dCi 4x4 (HY0B)	127	09/08→						
2.0 dCi 4x4 (HY0K)	110	09/08→						
2.5 (HY0C, HY0N)	126	09/08→						
2.5 4x4 (HY0C, HY0N)	126	09/08→						
 Bremsscheibe								
2.0 dCi (HY0K)	110	09/08→	←			24.0128-0242.1	428242	Ø 320 28 26 V
2.0 dCi 4x4 (HY0B)	127	09/08→						
2.0 dCi 4x4 (HY0K)	110	09/08→	→			24.0116-0119.1	416119	Ø 292 16 14 V
2.5 (HY0C, HY0N)	126	09/08→						
2.5 4x4 (HY0C, HY0N)	126	09/08→						
RENAULT - KOLEOS II 08/16→								
 Bremsscheibe								
2.0 dCi 175 4WD	130	08/16→	←			24.0128-0291.1	428291	Ø 320 28 26 V
RENAULT - LAGUNA I (B56_, 556_) 11/93→08/02								
 Bremsbelagsatz, Scheibenbremse								
1.6 16V (B568, B561)	79	11/97→03/01	←	04/99→ 02/01		13.0460-2895.2	602895	TRW 23172 18,0 - WK
			←	→ 03/99		13.0460-2983.2	602983	TRW 20919 18,0 + WK
1.8 1.8	69 70	06/95→02/01 06/95→06/98	←			13.0460-2983.2	602983	TRW 20919 18,0 + WK
			→	→ 06/95; + ABS		13.0460-4957.2	604957	BRE 20410 15,0 - WE / - WK
1.8 (B56A/B)	66	11/93→03/01	←	→ 09/94; - ABS		13.0460-2836.2	602836	TRW 21595 18,3 + WK
			←	→ 02/01; + ABS		13.0460-2983.2	602983	TRW 20919 18,0 + WK
			→	→ 02/01; + ABS		13.0460-4957.2	604957	BRE 20410 15,0 - WE / - WK
1.8 (B56S/T/0)	66	08/95→03/01	←	→ 02/01		13.0460-2983.2	602983	TRW 20919 18,0 + WK
			→	→ 02/01; + ABS		13.0460-4957.2	604957	BRE 20410 15,0 - WE / - WK
1.8 (B56Z)	69	08/95→03/01	←	→ 02/01		13.0460-2983.2	602983	TRW 20919 18,0 + WK
1.8 16V (B563, B564)	88	04/98→03/01	←	04/99→ 02/01		13.0460-2895.2	602895	TRW 23172 18,0 - WK
			←	→ 03/99		13.0460-2983.2	602983	TRW 20919 18,0 + WK
			→	→ 02/01		13.0460-4986.2	604986	BRE 21965 15,0 - WE / - WK
1.9 dCi (B56W) 2.0 16V (556A/B)	79 103	09/99→03/01 09/99→03/01	←	→ 02/01		13.0460-2895.2	602895	TRW 23172 18,0 - WK
			→	→ 02/01		13.0460-4986.2	604986	BRE 21965 15,0 - WE / - WK
1.9 dTi (B56J)	72	10/97→03/01	←	04/99→ 02/01		13.0460-2895.2	602895	TRW 23172 18,0 - WK
			←	→ 03/99		13.0460-2983.2	602983	TRW 20919 18,0 + WK
			→	→ 02/01		13.0460-4986.2	604986	BRE 21965 15,0 - WE / - WK
2.0	70	11/93→03/01	←	04/99→ 02/01		13.0460-2895.2	602895	TRW 23172 18,0 - WK
			←	06/95→ 03/99		13.0460-2983.2	602983	TRW 20919 18,0 + WK
			→	06/95→ 02/01		13.0460-4957.2	604957	BRE 20410 15,0 - WE / - WK
			→	06/95→ 01/97		13.0460-4957.2	604957	BRE 20410 15,0 - WE / - WK
			→	02/97→ 02/01		13.0460-4986.2	604986	BRE 21965 15,0 - WE / - WK
			→	06/95→ 02/01		13.0460-4986.2	604986	BRE 21965 15,0 - WE / - WK
2.0	80	03/99→03/01	←	04/99→ 02/01		13.0460-2895.2	602895	TRW 23172 18,0 - WK
			→	→ 02/01		13.0460-4986.2	604986	BRE 21965 15,0 - WE / - WK
2.0	84	06/95→02/01	←	04/99→		13.0460-2895.2	602895	TRW 23172 18,0 - WK
			←	→ 03/99		13.0460-2983.2	602983	TRW 20919 18,0 + WK
↓								









	kw			 	! #		
RENAULT - LAGUNA I (B56_, 556_) 11/93→08/02							
 Bremsbelagsatz, Scheibenbremse							
2.0	84	06/95→02/01	➔	Baccara		13.0460-4957.2 604957	BRE 20410 15,0 - WE / - WK
			➔	→ 01/97; Initiale		13.0460-4957.2 604957	BRE 20410 15,0 - WE / - WK
			➔	nicht für Ausstattungsvariante: Baccara/Initiale		13.0460-4986.2 604986	BRE 21965 15,0 - WE / - WK
			➔	02/97→; Initiale		13.0460-4986.2 604986	BRE 21965 15,0 - WE / - WK
2.0 (556A)	102	09/99→02/01	➔			13.0460-2983.2 602983	TRW 20919 18,0 + WK
			➔			13.0460-4986.2 604986	BRE 21965 15,0 - WE / - WK
2.0 (B56C/H/N)	83	11/93→03/01	➔	→ 02/01		13.0460-2983.2 602983	TRW 20919 18,0 + WK
			➔	→ 06/95; + ABS		13.0460-4957.2 604957	BRE 20410 15,0 - WE / - WK
			➔	→ 02/01		13.0460-4957.2 604957	BRE 20410 15,0 - WE / - WK
2.0 16V (B56D/M)	102	06/95→03/01	➔	09/99→ 02/01		13.0460-2983.2 602983	TRW 20919 18,0 + WK
			➔	→ 02/01		13.0460-2983.2 602983	TRW 20919 18,0 + WK
			➔	→ 01/97; + ABS		13.0460-4957.2 604957	BRE 20410 15,0 - WE / - WK
			➔	→ 12/97; - ABS		13.0460-4957.2 604957	BRE 20410 15,0 - WE / - WK
			➔	01/98→ 02/01; - ABS		13.0460-4986.2 604986	BRE 21965 15,0 - WE / - WK
			➔	09/99→ 02/01		13.0460-4986.2 604986	BRE 21965 15,0 - WE / - WK
			➔	02/97→ 02/01; + ABS		13.0460-4986.2 604986	BRE 21965 15,0 - WE / - WK
2.2 D (B56F/2)	61	11/93→03/01	➔	→ 02/94; - ABS		13.0460-2836.2 602836	TRW 21595 18,3 + WK
			➔	→ 02/01; + ABS		13.0460-2983.2 602983	TRW 20919 18,0 + WK
			➔	→ 06/95; + ABS		13.0460-4957.2 604957	BRE 20410 15,0 - WE / - WK
2.2 dT (B569)	83	03/96→03/01	➔	09/99→ 02/01		13.0460-2895.2 602895	TRW 23172 18,0 - WK
			➔	→ 08/99		13.0460-2983.2 602983	TRW 20919 18,0 + WK
			➔	→ 12/97; - ABS		13.0460-4957.2 604957	BRE 20410 15,0 - WE / - WK
			➔	→ 01/97; + ABS		13.0460-4957.2 604957	BRE 20410 15,0 - WE / - WK
			➔	02/97→ 02/01; + ABS		13.0460-4986.2 604986	BRE 21965 15,0 - WE / - WK
			➔	01/98→ 02/01; - ABS		13.0460-4986.2 604986	BRE 21965 15,0 - WE / - WK
3.0 (B56E/R, B565)	123	11/93→03/01	➔	→ 02/01		13.0460-2983.2 602983	TRW 20919 18,0 + WK
			➔	→ 01/97		13.0460-4957.2 604957	BRE 20410 15,0 - WE / - WK
			➔	02/97→ 02/01		13.0460-4986.2 604986	BRE 21965 15,0 - WE / - WK
3.0 24V (B56V)	140	03/97→03/01	➔	09/99→ 02/01		13.0460-2895.2 602895	TRW 23172 18,0 - WK
			➔	→ 08/99		13.0460-2983.2 602983	TRW 20919 18,0 + WK
			➔	→ 02/01		13.0460-4986.2 604986	BRE 21965 15,0 - WE / - WK
Zubehörsatz, Scheibenbremsbelag							
1.6 16V (B568, B561)	79	11/97→03/01	➔	04/99→ 02/01		13.0460-0262.2 610262	TRW
1.8	69	06/95→02/01	➔	→ 06/95; + ABS		13.0460-0438.2 610438	BRE
1.8	70	06/95→06/98					
2.2 D (B56F/2)	61	11/93→03/01					
1.8 (B56A/B)	66	11/93→03/01	➔	→ 02/01; + ABS		13.0460-0438.2 610438	BRE
1.8 (B56S/T/O)	66	08/95→03/01					
1.8 16V (B563, B564)	88	04/98→03/01	➔	04/99→ 02/01		13.0460-0262.2 610262	TRW
			➔	→ 02/01		13.0460-0438.2 610438	BRE
1.9 dCi (B56W)	79	09/99→03/01	➔	→ 02/01		13.0460-0262.2 610262	TRW
2.0 16V (556A/B)	103	09/99→03/01	➔	→ 02/01		13.0460-0438.2 610438	BRE
1.9 dTi (B56J)	72	10/97→03/01	➔	04/99→ 02/01		13.0460-0262.2 610262	TRW
			➔	→ 02/01		13.0460-0438.2 610438	BRE
2.0	70	11/93→03/01	➔	04/99→ 02/01		13.0460-0262.2 610262	TRW
			➔	06/95→ 02/01		13.0460-0438.2 610438	BRE
			➔	06/95→ 01/97		13.0460-0438.2 610438	BRE
			➔	02/97→ 02/01		13.0460-0438.2 610438	BRE
			➔	06/95→ 02/01		13.0460-0438.2 610438	BRE
2.0	80	03/99→03/01	➔	04/99→ 02/01		13.0460-0262.2 610262	TRW
			➔	→ 02/01		13.0460-0438.2 610438	BRE
2.0	84	06/95→02/01	➔	04/99→		13.0460-0262.2 610262	TRW
			➔	nicht für Ausstattungsvariante: Baccara/Initiale		13.0460-0438.2 610438	BRE
↓							









	kw			 	! #		
RENAULT - LAGUNA I (B56_, 556_) 11/93→08/02							
Zubehörsatz, Scheibenbremsbelag							
2.0	84	06/95→02/01	➡	Baccara		13.0460-0438.2 610438	BRE
			➡	→ 01/97; Initiale		13.0460-0438.2 610438	BRE
			➡	02/97→; Initiale		13.0460-0438.2 610438	BRE
2.0 (556A)	102	09/99→02/01	➡			13.0460-0438.2 610438	BRE
2.0 (B56C/H/N)	83	11/93→03/01	➡	→ 06/95; + ABS		13.0460-0438.2 610438	BRE
			➡	→ 02/01		13.0460-0438.2 610438	BRE
2.0 16V (B56D/M)	102	06/95→03/01	➡	02/97→ 02/01; + ABS		13.0460-0438.2 610438	BRE
			➡	09/99→ 02/01		13.0460-0438.2 610438	BRE
			➡	→ 12/97; - ABS		13.0460-0438.2 610438	BRE
			➡	01/98→ 02/01; - ABS		13.0460-0438.2 610438	BRE
			➡	→ 01/97; + ABS		13.0460-0438.2 610438	BRE
2.2 dT (B569)	83	03/96→03/01	⬅	09/99→ 02/01		13.0460-0262.2 610262	TRW
			➡	02/97→ 02/01; + ABS		13.0460-0438.2 610438	BRE
			➡	→ 12/97; - ABS		13.0460-0438.2 610438	BRE
			➡	→ 01/97; + ABS		13.0460-0438.2 610438	BRE
			➡	01/98→ 02/01; - ABS		13.0460-0438.2 610438	BRE
3.0 (B56E/R, B565)	123	11/93→03/01	➡	02/97→ 02/01		13.0460-0438.2 610438	BRE
			➡	→ 01/97		13.0460-0438.2 610438	BRE
3.0 24V (B56V)	140	03/97→03/01	⬅	09/99→ 02/01		13.0460-0262.2 610262	TRW
			➡	→ 02/01		13.0460-0438.2 610438	BRE
 Bremsscheibe							
1.6 16V (B568, B561)	79	11/97→03/01	⬅	→ 02/01; Felge Lochzahl: 4		24.0124-0158.1 424158	Ø 280 24 21,8 V + S
						24.0324-0158.1 524158	Ø 280 24 21,8 V + S PD
1.8	69	06/95→02/01	⬅	Felge Lochzahl: 4		24.0122-0148.1 422148	Ø 262 22 19,8 V + S
1.8	70	06/95→06/98	➡	→ 06/95; + ABS; Felge Lochzahl: 4		24.0110-0219.1 410219	Ø 265 10,5 9,5
1.8 (B56A/B)	66	11/93→03/01	⬅	→ 02/01; Felge Lochzahl: 4		24.0122-0148.1 422148	Ø 262 22 19,8 V + S
			➡	→ 02/01; + ABS; Felge Lochzahl: 4		24.0110-0219.1 410219	Ø 265 10,5 9,5
1.8 (B56S/T/0)	66	08/95→03/01	⬅	→ 04/98; Felge Lochzahl: 4		24.0122-0148.1 422148	Ø 262 22 19,8 V + S
			⬅	05/98→ 02/01; Felge Lochzahl: 4		24.0124-0158.1 424158	Ø 280 24 21,8 V + S
						24.0324-0158.1 524158	Ø 280 24 21,8 V + S PD
			➡	→ 02/01; + ABS; Felge Lochzahl: 4		24.0110-0219.1 410219	Ø 265 10,5 9,5
1.8 (B56Z)	69	08/95→03/01	⬅	→ 02/01; Felge Lochzahl: 4		24.0122-0148.1 422148	Ø 262 22 19,8 V + S
1.8 16V (B563, B564)	88	04/98→03/01	⬅	09/99→ 02/01; Felge Lochzahl: 4		24.0124-0158.1 424158	Ø 280 24 21,8 V + S
						24.0324-0158.1 524158	Ø 280 24 21,8 V + S PD
			⬅	→ 08/99; Felge Lochzahl: 5		24.0124-0171.1 424171	Ø 280 24 21,8 V + S
						24.0324-0171.1 524171	Ø 280 24 21,8 V + S PD
			➡	→ 08/99; Felge Lochzahl: 4		24.0110-0219.1 410219	Ø 265 10,5 9,5
			➡	09/99→ 02/01; Felge Lochzahl: 5		24.0110-0220.1 410220	Ø 265 10,5 9,5
1.9 dCi (B56W)	79	09/99→03/01	⬅	→ 02/01; Felge Lochzahl: 4		24.0124-0158.1 424158	Ø 280 24 21,8 V + S
2.0 16V (556A/B)	103	09/99→03/01				24.0324-0158.1 524158	Ø 280 24 21,8 V + S PD
			➡	→ 02/01; Felge Lochzahl: 4		24.0110-0219.1 410219	Ø 265 10,5 9,5
1.9 dTi (B56J)	72	10/97→03/01	⬅	→ 02/01; Felge Lochzahl: 4		24.0124-0158.1 424158	Ø 280 24 21,8 V + S
						24.0324-0158.1 524158	Ø 280 24 21,8 V + S PD
			⬅	→ 02/01; Felge Lochzahl: 5		24.0124-0171.1 424171	Ø 280 24 21,8 V + S
						24.0324-0171.1 524171	Ø 280 24 21,8 V + S PD
			➡	→ 02/01; Felge Lochzahl: 5		24.0110-0220.1 410220	Ø 265 10,5 9,5
2.0	70	11/93→03/01	⬅	06/95→ 04/98; Felge Lochzahl: 4		24.0122-0148.1 422148	Ø 262 22 19,8 V + S
			⬅	06/95→ 02/01; Felge Lochzahl: 4		24.0122-0148.1 422148	Ø 262 22 19,8 V + S
			⬅	06/95→ 04/98; Felge Lochzahl: 5		24.0122-0149.1 422149	Ø 262 22 19,8 V
			⬅	06/95→ 02/01; Felge Lochzahl: 5		24.0122-0149.1 422149	Ø 262 22 19,8 V
			⬅	05/98→ 02/01; Felge Lochzahl: 4		24.0124-0158.1 424158	Ø 280 24 21,8 V + S
						24.0324-0158.1 524158	Ø 280 24 21,8 V + S PD
			⬅	05/98→ 08/99; Felge Lochzahl: 5		24.0124-0171.1 424171	Ø 280 24 21,8 V + S
						24.0324-0171.1 524171	Ø 280 24 21,8 V + S PD
			➡	09/99→ 02/01; Felge Lochzahl: 4		24.0110-0219.1 410219	Ø 265 10,5 9,5







	kw			 	! #		
RENAULT - LAGUNA I (B56_, 556_) 11/93→08/02							
Bremsscheibe							
2.0	70	11/93→03/01	➔	06/95→ 02/01; Felge Lochzahl: 5	24.0110-0220.1	410220	Ø 265 10,5 9,5
			➔	06/95→ 08/99; Felge Lochzahl: 5	24.0110-0220.1	410220	Ø 265 10,5 9,5
2.0	80	03/99→03/01	←	→ 02/01; Felge Lochzahl: 4	24.0124-0158.1	424158	Ø 280 24 21,8 V + S
					24.0324-0158.1	524158	Ø 280 24 21,8 V + S PD
			←	→ 02/01; Felge Lochzahl: 5	24.0124-0171.1	424171	Ø 280 24 21,8 V + S
					24.0324-0171.1	524171	Ø 280 24 21,8 V + S PD
			➔	→ 02/01; Felge Lochzahl: 5	24.0110-0220.1	410220	Ø 265 10,5 9,5
2.0	84	06/95→02/01	←	→ 04/98; Felge Lochzahl: 4	24.0122-0148.1	422148	Ø 262 22 19,8 V + S
			←	Felge Lochzahl: 5	24.0122-0149.1	422149	Ø 262 22 19,8 V
			←	→ 04/98; Felge Lochzahl: 5	24.0122-0149.1	422149	Ø 262 22 19,8 V
			←	05/98→; Felge Lochzahl: 4	24.0124-0158.1	424158	Ø 280 24 21,8 V + S
					24.0324-0158.1	524158	Ø 280 24 21,8 V + S PD
			←	05/98→; Felge Lochzahl: 5	24.0124-0171.1	424171	Ø 280 24 21,8 V + S
					24.0324-0171.1	524171	Ø 280 24 21,8 V + S PD
			➔	09/99→; Initiale; Felge Lochzahl: 4	24.0110-0219.1	410219	Ø 265 10,5 9,5
			➔	Baccara; Felge Lochzahl: 5	24.0110-0220.1	410220	Ø 265 10,5 9,5
						➔	→ 08/99; Initiale; Felge Lochzahl: 5
2.0	103	06/95→02/01	←	Felge Lochzahl: 5	24.0124-0171.1	424171	Ø 280 24 21,8 V + S
					24.0324-0171.1	524171	Ø 280 24 21,8 V + S PD
2.0 (556A)	102	09/99→02/01	←	Felge Lochzahl: 4	24.0124-0158.1	424158	Ø 280 24 21,8 V + S
					24.0324-0158.1	524158	Ø 280 24 21,8 V + S PD
			←	Felge Lochzahl: 5	24.0124-0171.1	424171	Ø 280 24 21,8 V + S
					24.0324-0171.1	524171	Ø 280 24 21,8 V + S PD
			➔	Felge Lochzahl: 4	24.0110-0219.1	410219	Ø 265 10,5 9,5
			➔	Felge Lochzahl: 5	24.0110-0220.1	410220	Ø 265 10,5 9,5
2.0 (B56C/H/N)	83	11/93→03/01	←	→ 02/01; Felge Lochzahl: 4	24.0122-0148.1	422148	Ø 262 22 19,8 V + S
			←	→ 02/01; Felge Lochzahl: 5	24.0122-0149.1	422149	Ø 262 22 19,8 V
			➔	→ 06/95; + ABS; Felge Lochzahl: 4	24.0110-0219.1	410219	Ø 265 10,5 9,5
			➔	→ 02/01; Felge Lochzahl: 5	24.0110-0220.1	410220	Ø 265 10,5 9,5
2.0 16V (B56D/M)	102	06/95→03/01	←	→ 02/01; Felge Lochzahl: 4	24.0124-0158.1	424158	Ø 280 24 21,8 V + S
					24.0324-0158.1	524158	Ø 280 24 21,8 V + S PD
			←	09/99→ 02/01; Felge Lochzahl: 4	24.0124-0158.1	424158	Ø 280 24 21,8 V + S
					24.0324-0158.1	524158	Ø 280 24 21,8 V + S PD
			←	09/99→ 02/01; Felge Lochzahl: 5	24.0124-0171.1	424171	Ø 280 24 21,8 V + S
					24.0324-0171.1	524171	Ø 280 24 21,8 V + S PD
			←	→ 02/01; Felge Lochzahl: 5	24.0124-0171.1	424171	Ø 280 24 21,8 V + S
					24.0324-0171.1	524171	Ø 280 24 21,8 V + S PD
			➔	09/99→ 02/01; Felge Lochzahl: 4	24.0110-0219.1	410219	Ø 265 10,5 9,5
			➔	→ 02/01; Felge Lochzahl: 4	24.0110-0219.1	410219	Ø 265 10,5 9,5
➔	→ 02/01; Felge Lochzahl: 5	24.0110-0220.1	410220	Ø 265 10,5 9,5			
➔	09/99→ 02/01; Felge Lochzahl: 5	24.0110-0220.1	410220	Ø 265 10,5 9,5			
2.2 D (B56F/2)	61	11/93→03/01	←	→ 02/01; Felge Lochzahl: 4	24.0122-0148.1	422148	Ø 262 22 19,8 V + S
			➔	→ 06/95; + ABS; Felge Lochzahl: 4	24.0110-0219.1	410219	Ø 265 10,5 9,5
2.2 dT (B569) 3.0 24V (B56V)	83	03/96→03/01	←	09/99→ 02/01; Felge Lochzahl: 4	24.0124-0158.1	424158	Ø 280 24 21,8 V + S
					24.0324-0158.1	524158	Ø 280 24 21,8 V + S PD
	140	03/97→03/01	←	→ 08/99; Felge Lochzahl: 5	24.0124-0171.1	424171	Ø 280 24 21,8 V + S
					24.0324-0171.1	524171	Ø 280 24 21,8 V + S PD
			➔	09/99→ 02/01; Felge Lochzahl: 4	24.0110-0219.1	410219	Ø 265 10,5 9,5
			➔	→ 08/99; Felge Lochzahl: 5	24.0110-0220.1	410220	Ø 265 10,5 9,5
3.0 (B56E/R, B565)	123	11/93→03/01	←	→ 02/01; Felge Lochzahl: 5	24.0124-0171.1	424171	Ø 280 24 21,8 V + S
					24.0324-0171.1	524171	Ø 280 24 21,8 V + S PD
			➔	→ 02/01; Felge Lochzahl: 5	24.0110-0220.1	410220	Ø 265 10,5 9,5
RENAULT - LAGUNA I Grandtour (K56_) 09/95→08/02							
Bremsbelagsatz, Scheibenbremse							
1.6 16V (K568)	79	11/97→03/01	←	02/99→ 02/01	13.0460-2895.2	602895	TRW 23172 18,0 - WK
			←	→ 02/01	13.0460-2983.2	602983	TRW 20919 18,0 + WK
↓							









	kw			 	! #					
RENAULT - LAGUNA I Grandtour (K56_) 09/95→08/02										
 Bremsbelagsatz, Scheibenbremse										
1.8 (K56S/T/0)	66	09/95→03/01	←	→ 02/01		13.0460-2983.2 602983	TRW 20919 18,0 + WK			
1.8 (K56Z)	69	09/95→03/01	→	→ 05/96; + ABS		13.0460-4957.2 604957	BRE 20410 15,0 - WE / - WK			
2.2 D (K56F/2, S56F)	61	09/95→03/01	→	→ 05/96; + ABS		13.0460-4957.2 604957	BRE 20410 15,0 - WE / - WK			
1.8 16V (K563, K564)	88	04/98→03/01	←	05/99→ 02/01		13.0460-2895.2 602895	TRW 23172 18,0 - WK			
			←	→ 02/01		13.0460-2983.2 602983	TRW 20919 18,0 + WK			
			←	02/99→ 02/01		13.0460-2983.2 602983	TRW 20919 18,0 + WK			
			→	→ 02/01		13.0460-4986.2 604986	BRE 21965 15,0 - WE / - WK			
1.9 dCi (K56W)	79	09/99→03/01	←	→ 02/01		13.0460-2895.2 602895	TRW 23172 18,0 - WK			
			2.0 16V (A56A/B)	103	09/99→03/01	→	→ 02/01		13.0460-4986.2 604986	BRE 21965 15,0 - WE / - WK
1.9 dTi (K56J)	72	10/97→03/01	←	→ 02/01		13.0460-2983.2 602983	TRW 20919 18,0 + WK			
			→	→ 02/01		13.0460-4986.2 604986	BRE 21965 15,0 - WE / - WK			
2.0	84	10/98→01/01	←			13.0460-2983.2 602983	TRW 20919 18,0 + WK			
			→	+ ABS		13.0460-4957.2 604957	BRE 20410 15,0 - WE / - WK			
2.0 (K56C/H)	83	09/95→03/01	←	11/95→ 02/01		13.0460-2983.2 602983	TRW 20919 18,0 + WK			
			←	→ 02/01		13.0460-2983.2 602983	TRW 20919 18,0 + WK			
			→	→ 05/96; + ABS		13.0460-4957.2 604957	BRE 20410 15,0 - WE / - WK			
			→	11/95→ 05/96; + ABS		13.0460-4957.2 604957	BRE 20410 15,0 - WE / - WK			
2.0 16V (K56D/M)	102	09/95→03/01	←	09/99→ 02/01		13.0460-2895.2 602895	TRW 23172 18,0 - WK			
			←	→ 02/01		13.0460-2983.2 602983	TRW 20919 18,0 + WK			
			→	→ 02/01		13.0460-4957.2 604957	BRE 20410 15,0 - WE / - WK			
			→	→ 01/97		13.0460-4957.2 604957	BRE 20410 15,0 - WE / - WK			
			→	09/99→ 02/01		13.0460-4986.2 604986	BRE 21965 15,0 - WE / - WK			
			→	02/97→ 02/01		13.0460-4986.2 604986	BRE 21965 15,0 - WE / - WK			
2.2 dT (K569)	83	03/96→03/01	←	→ 02/01		13.0460-2983.2 602983	TRW 20919 18,0 + WK			
			→	→ 01/97		13.0460-4957.2 604957	BRE 20410 15,0 - WE / - WK			
			→	02/97→ 02/01		13.0460-4986.2 604986	BRE 21965 15,0 - WE / - WK			
3.0 (K56R, K565)	123	02/96→03/01	←	→ 02/01		13.0460-2983.2 602983	TRW 20919 18,0 + WK			
			→	→ 02/01		13.0460-4957.2 604957	BRE 20410 15,0 - WE / - WK			
			→	03/96→ 02/01		13.0460-4957.2 604957	BRE 20410 15,0 - WE / - WK			
3.0 24V (K56V)	140	03/97→03/01	←	→ 02/01		13.0460-2983.2 602983	TRW 20919 18,0 + WK			
			→	→ 02/01		13.0460-4986.2 604986	BRE 21965 15,0 - WE / - WK			
Zubehörsatz, Scheibenbremsbelag										
1.6 16V (K568)	79	11/97→03/01	←	02/99→ 02/01		13.0460-0262.2 610262	TRW			
1.8 (K56S/T/0)	66	09/95→03/01	→	→ 05/96; + ABS		13.0460-0438.2 610438	BRE			
			1.8 (K56Z)	69	09/95→03/01	→	→ 05/96; + ABS		13.0460-0438.2 610438	BRE
			2.2 D (K56F/2, S56F)	61	09/95→03/01	→	→ 05/96; + ABS		13.0460-0438.2 610438	BRE
1.8 16V (K563, K564)	88	04/98→03/01	←	05/99→ 02/01		13.0460-0262.2 610262	TRW			
			→	→ 02/01		13.0460-0438.2 610438	BRE			
1.9 dCi (K56W)	79	09/99→03/01	←	→ 02/01		13.0460-0262.2 610262	TRW			
			2.0 16V (A56A/B)	103	09/99→03/01	→	→ 02/01		13.0460-0438.2 610438	BRE
1.9 dTi (K56J)	72	10/97→03/01	→	→ 02/01		13.0460-0438.2 610438	BRE			
2.0	84	10/98→01/01	→	+ ABS		13.0460-0438.2 610438	BRE			
2.0 (K56C/H)	83	09/95→03/01	→	11/95→ 05/96; + ABS		13.0460-0438.2 610438	BRE			
			→	→ 05/96; + ABS		13.0460-0438.2 610438	BRE			
			←	09/99→ 02/01		13.0460-0262.2 610262	TRW			
2.0 16V (K56D/M)	102	09/95→03/01	→	→ 02/01		13.0460-0438.2 610438	BRE			
			→	02/97→ 02/01		13.0460-0438.2 610438	BRE			
			→	→ 01/97		13.0460-0438.2 610438	BRE			
			→	09/99→ 02/01		13.0460-0438.2 610438	BRE			
2.2 dT (K569)	83	03/96→03/01	→	02/97→ 02/01		13.0460-0438.2 610438	BRE			
			→	→ 01/97		13.0460-0438.2 610438	BRE			
3.0 (K56R, K565)	123	02/96→03/01	→	→ 02/01		13.0460-0438.2 610438	BRE			
			→	03/96→ 02/01		13.0460-0438.2 610438	BRE			
3.0 24V (K56V)	140	03/97→03/01	→	→ 02/01		13.0460-0438.2 610438	BRE			
↓										























	kw			 	! #		
RENAULT - LAGUNA I Grandtour (K56_) 09/95→08/02							
Bremsscheibe							
1.6 16V (K568) 1.9 dCi (K56W)	79 79	11/97→03/01 09/99→03/01	←	→ 02/01; Felge Lochzahl: 4		24.0124-0158.1 424158 24.0324-0158.1 524158	Ø 280 24 21,8 V + S Ø 280 24 21,8 V + S PD
1.8 (K56S/T/0)	66	09/95→03/01	←	→ 02/01; Felge Lochzahl: 4		24.0122-0148.1 422148	Ø 262 22 19,8 V + S
			←	→ 04/98; Felge Lochzahl: 4		24.0122-0148.1 422148	Ø 262 22 19,8 V + S
			←	05/98→ 02/01; Felge Lochzahl: 4		24.0124-0158.1 424158 24.0324-0158.1 524158	Ø 280 24 21,8 V + S Ø 280 24 21,8 V + S PD
			➔	→ 05/96; + ABS; Felge Lochzahl: 4		24.0110-0219.1 410219	Ø 265 10,5 9,5
1.8 (K56Z) 2.2 D (K56F/2, S56F)	69 61	09/95→03/01 09/95→03/01	←	→ 02/01; Felge Lochzahl: 4		24.0122-0148.1 422148	Ø 262 22 19,8 V + S
			➔	→ 05/96; + ABS; Felge Lochzahl: 4		24.0110-0219.1 410219	Ø 265 10,5 9,5
1.8 16V (K563, K564)	88	04/98→03/01	←	05/99→ 02/01; Felge Lochzahl: 4		24.0124-0158.1 424158 24.0324-0158.1 524158	Ø 280 24 21,8 V + S Ø 280 24 21,8 V + S PD
			←	02/99→ 02/01; Felge Lochzahl: 4		24.0124-0158.1 424158 24.0324-0158.1 524158	Ø 280 24 21,8 V + S Ø 280 24 21,8 V + S PD
			←	→ 02/01; Felge Lochzahl: 4		24.0124-0158.1 424158	Ø 280 24 21,8 V + S
			←	→ 02/01; Felge Lochzahl: 5		24.0124-0171.1 424171 24.0324-0171.1 524171	Ø 280 24 21,8 V + S Ø 280 24 21,8 V + S PD
			←	→ 02/01; Felge Lochzahl: 4		24.0324-0158.1 524158	Ø 280 24 21,8 V + S PD
			➔	→ 02/01; Felge Lochzahl: 5		24.0110-0220.1 410220	Ø 265 10,5 9,5
			➔	→ 02/01; Felge Lochzahl: 5		24.0110-0220.1 410220	Ø 265 10,5 9,5
1.9 dTi (K56J)	72	10/97→03/01	←	→ 02/01; Felge Lochzahl: 4		24.0124-0158.1 424158 24.0324-0158.1 524158	Ø 280 24 21,8 V + S Ø 280 24 21,8 V + S PD
			➔	→ 02/01; Felge Lochzahl: 5		24.0110-0220.1 410220	Ø 265 10,5 9,5
2.0	84	10/98→01/01	←	Felge Lochzahl: 4		24.0122-0148.1 422148	Ø 262 22 19,8 V + S
			➔	+ ABS; Felge Lochzahl: 4		24.0110-0219.1 410219	Ø 265 10,5 9,5
2.0 (K56C/H)	83	09/95→03/01	←	11/95→ 04/98; Felge Lochzahl: 4		24.0122-0148.1 422148	Ø 262 22 19,8 V + S
			←	→ 02/01; Felge Lochzahl: 4		24.0122-0148.1 422148	Ø 262 22 19,8 V + S
			←	05/98→ 02/01; Felge Lochzahl: 4		24.0124-0158.1 424158 24.0324-0158.1 524158	Ø 280 24 21,8 V + S Ø 280 24 21,8 V + S PD
			➔	→ 05/96; + ABS; Felge Lochzahl: 4		24.0110-0219.1 410219	Ø 265 10,5 9,5
			➔	11/95→ 05/96; + ABS; Felge Lochzahl: 4		24.0110-0219.1 410219	Ø 265 10,5 9,5
2.0 16V (A56A/B)	103	09/99→03/01	←	→ 02/01; Felge Lochzahl: 4		24.0124-0158.1 424158 24.0324-0158.1 524158	Ø 280 24 21,8 V + S Ø 280 24 21,8 V + S PD
			←	→ 02/01; Felge Lochzahl: 5		24.0124-0171.1 424171 24.0324-0171.1 524171	Ø 280 24 21,8 V + S Ø 280 24 21,8 V + S PD
			➔	→ 02/01; Felge Lochzahl: 5		24.0110-0220.1 410220	Ø 265 10,5 9,5
2.0 16V (K56D/M)	102	09/95→03/01	←	09/99→ 02/01; Felge Lochzahl: 4		24.0124-0158.1 424158 24.0324-0158.1 524158	Ø 280 24 21,8 V + S Ø 280 24 21,8 V + S PD
			←	→ 02/01; Felge Lochzahl: 5		24.0124-0171.1 424171 24.0324-0171.1 524171	Ø 280 24 21,8 V + S Ø 280 24 21,8 V + S PD
			➔	09/99→ 02/01; Felge Lochzahl: 4		24.0110-0219.1 410219	Ø 265 10,5 9,5
			➔	→ 02/01; Felge Lochzahl: 4		24.0110-0219.1 410219	Ø 265 10,5 9,5
			➔	→ 02/01; Felge Lochzahl: 5		24.0110-0220.1 410220	Ø 265 10,5 9,5
2.2 dT (K569)	83	03/96→03/01	←	→ 02/01; Felge Lochzahl: 4		24.0124-0158.1 424158 24.0324-0158.1 524158	Ø 280 24 21,8 V + S Ø 280 24 21,8 V + S PD
			←	→ 02/01; Felge Lochzahl: 5		24.0124-0171.1 424171 24.0324-0171.1 524171	Ø 280 24 21,8 V + S Ø 280 24 21,8 V + S PD
			➔	→ 02/01; Felge Lochzahl: 4		24.0110-0219.1 410219	Ø 265 10,5 9,5
			➔	→ 02/01; Felge Lochzahl: 5		24.0110-0220.1 410220	Ø 265 10,5 9,5
3.0 (K56R, K565)	123	02/96→03/01	←	→ 02/01; Felge Lochzahl: 5		24.0124-0171.1 424171 24.0324-0171.1 524171	Ø 280 24 21,8 V + S Ø 280 24 21,8 V + S PD
			➔	→ 02/01; Felge Lochzahl: 4		24.0110-0219.1 410219	Ø 265 10,5 9,5
			➔	03/96→ 02/01; Felge Lochzahl: 4		24.0110-0219.1 410219	Ø 265 10,5 9,5
3.0 24V (K56V)	140	03/97→03/01	←	09/99→ 02/01; Felge Lochzahl: 4		24.0124-0158.1 424158 24.0324-0158.1 524158	Ø 280 24 21,8 V + S Ø 280 24 21,8 V + S PD
			←	→ 08/99; Felge Lochzahl: 5		24.0124-0171.1 424171 24.0324-0171.1 524171	Ø 280 24 21,8 V + S Ø 280 24 21,8 V + S PD
			➔	→ 02/01; Felge Lochzahl: 5		24.0110-0220.1 410220	Ø 265 10,5 9,5













	kW			 	! #		
RENAULT - LAGUNA II (BG0/1_) 03/01→							
 Bremsbelagsatz, Scheibenbremse							
1.6 1.6 LPG 1.6 LPG	76 76 79	03/01→05/05 03/01→05/05 03/01→05/05	←	für Bremsscheibendurchmesser [mm]: 280		13.0460-7157.2 607157 13.0470-7157.2 LD7157	ATE 23215 18,3 - WE / - WK ATE 23215 18,3 - WE / - WK Ceramic
			←	für Bremsscheibendurchmesser [mm]: 300		13.0460-7158.2 607158 13.0470-7158.2 LD7158	ATE 23245 18,3 - WE / - WK ATE 23245 18,3 - WE / - WK Ceramic
			→			13.0460-7137.2 607137 13.0470-7137.2 LD7137	ATE 23482 15,8 - WE / - WK ATE 23482 15,8 - WE / - WK Ceramic
1.6 16V (BG0A, BG0L) 1.6 16V (BG1G, BG1H) 1.8 16V (BG04, BG0B, BG0C, BG0V) 1.8 16V (BG06, BG0J, BG0M) 1.8 16V (BG0B, BG0C, BG0J, BG0M, BG0V) 1.8 16V (BG0B, BG0M) 1.9 dCi 1.9 dCi 1.9 dCi 1.9 dCi (BG05) 1.9 dCi (BG08, BG0G) 1.9 dCi (BG0E) 1.9 dCi (BG0R) 1.9 dCi (BG1A, BG1V) 1.9 dCi (BG1A, BG1W) 2.0 16V 2.0 16V (BG00, BG0K, BG0P, BG0W) 2.0 16V IDE (BG0N)	79 82 86 85 89 88 79 85 92 68 88 77 74 96 81 98 99 103	03/01→ 02/05→ 03/01→ 03/01→ 03/01→ 03/01→ 03/01→ 03/01→ 09/05→ 09/05→ 03/04→ 03/01→ 06/01→ 10/01→ 05/05→ 01/05→ 08/02→ 04/01→	←	→ 06/07; für Bremsscheibendurchmesser [mm]: 280		13.0460-7157.2 607157 13.0470-7157.2 LD7157	ATE 23215 18,3 - WE / - WK ATE 23215 18,3 - WE / - WK Ceramic
			←	→ 06/07; für Bremsscheibendurchmesser [mm]: 300		13.0460-7158.2 607158 13.0470-7158.2 LD7158	ATE 23245 18,3 - WE / - WK ATE 23245 18,3 - WE / - WK Ceramic
			→	→ 06/07		13.0460-7137.2 607137 13.0470-7137.2 LD7137	ATE 23482 15,8 - WE / - WK ATE 23482 15,8 - WE / - WK Ceramic
2.0 16V 2.0 16V 2.0 16V Turbo (BG0S, BG0Z, BG1L, BG1M) 2.0 dCi (BG14, BG1S) 2.0 dCi (BG1T) 3.0 V6 24V (BG01, BG02, BG0D, BG0Y)	125 150 120 127 110 152	01/05→ 01/05→ 01/03→ 01/06→ 08/05→ 03/01→	←	→ 06/07		13.0460-7159.2 607159 13.0470-7159.2 LD7159	ATE 23245 18,3 - WE / - WK ATE 23245 18,3 - WE / - WK Ceramic
			→	→ 06/07		13.0460-7137.2 607137 13.0470-7137.2 LD7137	ATE 23482 15,8 - WE / - WK ATE 23482 15,8 - WE / - WK Ceramic
2.2 dCi	102	05/05→	←	→ 06/07		13.0460-7158.2 607158 13.0470-7158.2 LD7158	ATE 23245 18,3 - WE / - WK ATE 23245 18,3 - WE / - WK Ceramic
			→	→ 06/07		13.0460-7137.2 607137 13.0470-7137.2 LD7137	ATE 23482 15,8 - WE / - WK ATE 23482 15,8 - WE / - WK Ceramic
2.2 dCi (BG09)	85	04/04→10/05	←			13.0460-7158.2 607158 13.0460-7159.2 607159 13.0470-7158.2 LD7158 13.0470-7159.2 LD7159	ATE 23245 18,3 - WE / - WK ATE 23245 18,3 - WE / - WK ATE 23245 18,3 - WE / - WK Ceramic ATE 23245 18,3 - WE / - WK Ceramic
			→			13.0460-7137.2 607137 13.0470-7137.2 LD7137	ATE 23482 15,8 - WE / - WK ATE 23482 15,8 - WE / - WK Ceramic
2.2 dCi (BG0F)	110	10/01→	←	→ 11/01		13.0460-7158.2 607158 13.0470-7158.2 LD7158	ATE 23245 18,3 - WE / - WK ATE 23245 18,3 - WE / - WK Ceramic
			←	05/05→ 06/07		13.0460-7158.2 607158 13.0470-7158.2 LD7158	ATE 23245 18,3 - WE / - WK ATE 23245 18,3 - WE / - WK Ceramic
			←	12/01→ 04/05		13.0460-7159.2 607159 13.0470-7159.2 LD7159	ATE 23245 18,3 - WE / - WK ATE 23245 18,3 - WE / - WK Ceramic
			→	→ 06/07		13.0460-7137.2 607137 13.0470-7137.2 LD7137	ATE 23482 15,8 - WE / - WK ATE 23482 15,8 - WE / - WK Ceramic
2.9 V6 24V 2.9 V6 24V	155 157	03/01→08/07 09/02→12/05	←			13.0460-7159.2 607159 13.0470-7159.2 LD7159	ATE 23245 18,3 - WE / - WK ATE 23245 18,3 - WE / - WK Ceramic
			→			13.0460-7137.2 607137 13.0470-7137.2 LD7137	ATE 23482 15,8 - WE / - WK ATE 23482 15,8 - WE / - WK Ceramic
↓							













	kw			 	! #		
RENAULT - LAGUNA II (BG0/1_) 03/01→							
Bremsscheibe							
1.6 1.6 LPG 1.6 LPG	76 76 79	03/01→05/05 03/01→05/05 03/01→05/05	← →			24.0124-0169.1 424169 24.0126-0123.1 426123 24.0326-0123.1 526123	Ø 280 24 21,8 V Ø 300 26 22,8 V Ø 300 26 22,8 V PD
						24.0111-0101.2 411101	Ø 274 10,9 9,5 + LG / + ABS Ring
1.6 16V (BG0A, BG0L) 1.6 16V (BG1G, BG1H) 1.8 16V (BG04, BG0B, BG0C, BG0V) 1.8 16V (BG06, BG0J, BG0M) 1.8 16V (BG0B, BG0C, BG0J, BG0M, BG0V) 1.8 16V (BG0B, BG0M) 1.9 dCi 1.9 dCi 1.9 dCi 1.9 dCi (BG05) 1.9 dCi (BG08, BG0G) 1.9 dCi (BG0E) 1.9 dCi (BG0R) 1.9 dCi (BG1A, BG1V) 1.9 dCi (BG1A, BG1W) 2.0 16V 2.0 16V (BG00, BG0K, BG0P, BG0W) 2.0 16V IDE (BG0N)	79 82 86 85 89 88 79 85 92 68 88 77 74 96 81 98 99 103	03/01→ 02/05→ 03/01→ 03/01→ 03/01→ 03/01→ 03/01→ 03/01→ 09/05→ 09/05→ 03/04→ 03/01→ 06/01→ 10/01→ 05/05→ 01/05→ 08/02→ 08/02→ 04/01→	← → 06/07 → 06/07			24.0124-0169.1 424169 24.0126-0123.1 426123 24.0326-0123.1 526123	Ø 280 24 21,8 V Ø 300 26 22,8 V Ø 300 26 22,8 V PD
						24.0111-0101.2 411101	Ø 274 10,9 9,5 + LG / + ABS Ring
2.0 16V 2.0 16V 2.0 16V Turbo (BG0S, BG0Z, BG1L, BG1M) 2.0 dCi (BG14, BG1S) 2.0 dCi (BG1T)	125 150 120 127 110	01/05→ 01/05→ 01/03→ 01/06→ 08/05→	← → 06/07 → 06/07			24.0128-0182.1 428182 24.0111-0101.2 411101	Ø 308 28 25,4 V Ø 274 10,9 9,5 + LG / + ABS Ring
2.2 dCi	102	05/05→	← → 06/07 → 06/07			24.0126-0123.1 426123 24.0326-0123.1 526123 24.0111-0101.2 411101	Ø 300 26 22,8 V Ø 300 26 22,8 V PD Ø 274 10,9 9,5 + LG / + ABS Ring
2.2 dCi (BG09)	85	04/04→10/05	← 05/05→ ← → 04/05 →			24.0126-0123.1 426123 24.0326-0123.1 526123 24.0128-0182.1 428182 24.0111-0101.2 411101	Ø 300 26 22,8 V Ø 300 26 22,8 V PD Ø 308 28 25,4 V Ø 274 10,9 9,5 + LG / + ABS Ring
2.2 dCi (BG0F)	110	10/01→	← → 11/01 ← 05/05→ 06/07 ← 12/01→ 10/02 ← 11/02→ 04/05 → → 06/07			24.0126-0123.1 426123 24.0326-0123.1 526123 24.0326-0123.1 526123 24.0128-0135.1 428135 24.0128-0182.1 428182 24.0111-0101.2 411101	Ø 300 26 22,8 V Ø 300 26 22,8 V PD Ø 300 26 22,8 V PD Ø 308 28 25,8 V Ø 308 28 25,4 V Ø 274 10,9 9,5 + LG / + ABS Ring
2.9 V6 24V	155	03/01→08/07	← →			24.0128-0182.1 428182 24.0111-0101.2 411101	Ø 308 28 25,4 V Ø 274 10,9 9,5 + LG / + ABS Ring
2.9 V6 24V	157	09/02→12/05	← →			24.0128-0135.1 428135 24.0111-0101.2 411101	Ø 308 28 25,8 V Ø 274 10,9 9,5 + LG / + ABS Ring
3.0 V6 24V (BG01, BG02, BG0D, BG0Y)	152	03/01→	← 07/01→ 06/07 ← → 06/01 → → 06/07			24.0128-0135.1 428135 24.0128-0182.1 428182 24.0111-0101.2 411101	Ø 308 28 25,8 V Ø 308 28 25,4 V Ø 274 10,9 9,5 + LG / + ABS Ring
RENAULT - LAGUNA II Grandtour (KG0/1_) 03/01→							
Bremsbelagsatz, Scheibenbremse							
1.6 1.6 FlexFuel 2.0 Flex 2.0 Flex	76 76 95 97	03/01→10/05 06/01→10/03 09/02→05/05 09/02→05/05	← für Bremsscheibendurchmesser [mm]: 280 ← für Bremsscheibendurchmesser [mm]: 300 →			13.0460-7157.2 607157 13.0470-7157.2 LD7157 13.0460-7158.2 607158 13.0470-7158.2 LD7158 13.0460-7137.2 607137	ATE 23215 18,3 - WE / - WK ATE 23215 18,3 - WE / - WK Ceramic ATE 23245 18,3 - WE / - WK ATE 23245 18,3 - WE / - WK Ceramic ATE 23482 15,8 - WE / - WK

















	kW			 	! #		
RENAULT - LAGUNA II Grandtour (KG0/1_) 03/01→							
 Bremsbelagsatz, Scheibenbremse							
1.6	76	03/01→10/05	➔			13.0470-7137.2 LD7137	ATE 23482 15,8 - WE / - WK Ceramic
1.6 FlexFuel	76	06/01→10/03					
2.0 Flex	95	09/02→05/05					
2.0 Flex	97	09/02→05/05					
1.6 16V	82	02/05→	➔	→ 06/07;		13.0460-7157.2 607157	ATE 23215 18,3 - WE / - WK Ceramic
1.6 16V (KG0A, KG0L)	79	03/01→		für Bremsscheibendurchmesser [mm]:		13.0470-7157.2 LD7157	ATE 23215 18,3 - WE / - WK Ceramic
1.6 Bifuel	79	06/05→12/07		280			
1.8 16V	86	03/01→	➔	→ 06/07;		13.0460-7158.2 607158	ATE 23245 18,3 - WE / - WK Ceramic
1.8 16V	89	03/01→		für Bremsscheibendurchmesser [mm]:		13.0470-7158.2 LD7158	ATE 23245 18,3 - WE / - WK Ceramic
1.8 16V (KG0B, KG0M)	88	03/01→		300			
1.8 16V (KG0J)	85	03/01→					
1.9 dCi	79	03/01→	➔	→ 06/07		13.0460-7137.2 607137	ATE 23482 15,8 - WE / - WK Ceramic
1.9 dCi	92	09/05→				13.0470-7137.2 LD7137	ATE 23482 15,8 - WE / - WK Ceramic
1.9 dCi (KG05)	68	03/04→					
1.9 dCi (KG0E, KG0R)	74	10/01→					
1.9 dCi (KG0E)	77	06/01→					
1.9 dCi (KG0G)	88	03/01→					
1.9 dCi (KG12)	85	08/05→09/07					
1.9 dCi (KG1A, KG1W)	81	01/05→					
1.9 dCi (KG1V)	96	05/05→					
2.0 16V	98	10/04→09/07					
2.0 16V (KG00, KG0K, KG0W)	99	08/02→					
2.0 16V IDE (KG0N)	103	04/01→					
1.9 dCi	66	08/03→09/07	➔	03/04→ 06/07;		13.0460-7157.2 607157	ATE 23215 18,3 - WE / - WK Ceramic
				für Bremsscheibendurchmesser [mm]:		13.0470-7157.2 LD7157	ATE 23215 18,3 - WE / - WK Ceramic
				280			
			➔	03/04→ 06/07;		13.0460-7158.2 607158	ATE 23245 18,3 - WE / - WK Ceramic
				für Bremsscheibendurchmesser [mm]:		13.0470-7158.2 LD7158	ATE 23245 18,3 - WE / - WK Ceramic
				300			
			➔	03/04→ 06/07		13.0460-7137.2 607137	ATE 23482 15,8 - WE / - WK Ceramic
						13.0470-7137.2 LD7137	ATE 23482 15,8 - WE / - WK Ceramic
2.0 16V	125	01/05→	➔	→ 06/07		13.0460-7159.2 607159	ATE 23245 18,3 - WE / - WK Ceramic
2.0 16V	150	01/05→				13.0470-7159.2 LD7159	ATE 23245 18,3 - WE / - WK Ceramic
2.0 16V Turbo (KG0S, KG0Z, KG1L, KG1M)	120	01/03→					
2.0 dCi (KG1S)	127	01/06→	➔	→ 06/07		13.0460-7137.2 607137	ATE 23482 15,8 - WE / - WK Ceramic
3.0 V6 24V (KG0D)	152	03/01→				13.0470-7137.2 LD7137	ATE 23482 15,8 - WE / - WK Ceramic
2.0 dCi (KG1T)	110	08/05→	➔	→ 06/07;		13.0460-7158.2 607158	ATE 23245 18,3 - WE / - WK Ceramic
				passend für Felgengröße [Zoll]: 16		13.0470-7158.2 LD7158	ATE 23245 18,3 - WE / - WK Ceramic
			➔	→ 06/07;		13.0460-7159.2 607159	ATE 23245 18,3 - WE / - WK Ceramic
				passend für Felgengröße [Zoll]: 17		13.0470-7159.2 LD7159	ATE 23245 18,3 - WE / - WK Ceramic
			➔	→ 06/07		13.0460-7137.2 607137	ATE 23482 15,8 - WE / - WK Ceramic
						13.0470-7137.2 LD7137	ATE 23482 15,8 - WE / - WK Ceramic
2.2 dCi	102	05/05→	➔	→ 06/07		13.0460-7158.2 607158	ATE 23245 18,3 - WE / - WK Ceramic
						13.0470-7158.2 LD7158	ATE 23245 18,3 - WE / - WK Ceramic
			➔	→ 06/07		13.0460-7137.2 607137	ATE 23482 15,8 - WE / - WK Ceramic
						13.0470-7137.2 LD7137	ATE 23482 15,8 - WE / - WK Ceramic
2.2 dCi (KG09)	85	04/04→10/05	➔			13.0460-7158.2 607158	ATE 23245 18,3 - WE / - WK Ceramic
						13.0470-7158.2 LD7158	ATE 23245 18,3 - WE / - WK Ceramic
			➔			13.0460-7137.2 607137	ATE 23482 15,8 - WE / - WK Ceramic
						13.0470-7137.2 LD7137	ATE 23482 15,8 - WE / - WK Ceramic
2.2 dCi (KG0F)	110	10/01→	➔	→ 11/01		13.0460-7158.2 607158	ATE 23245 18,3 - WE / - WK Ceramic
						13.0470-7158.2 LD7158	ATE 23245 18,3 - WE / - WK Ceramic
			➔	05/05→ 06/07		13.0460-7158.2 607158	ATE 23245 18,3 - WE / - WK Ceramic
						13.0470-7158.2 LD7158	ATE 23245 18,3 - WE / - WK Ceramic
			➔	12/01→ 04/05		13.0460-7159.2 607159	ATE 23245 18,3 - WE / - WK Ceramic
						13.0470-7159.2 LD7159	ATE 23245 18,3 - WE / - WK Ceramic
			➔	→ 06/07		13.0460-7137.2 607137	ATE 23482 15,8 - WE / - WK Ceramic
						13.0470-7137.2 LD7137	ATE 23482 15,8 - WE / - WK Ceramic
↓							













	kw					! #		
RENAULT - LAGUNA II Grandtour (KG0/1_) 03/01→								
 Bremsbelagsatz, Scheibenbremse								
2.9 V6 24V	157	09/02→12/05	←				13.0460-7159.2 607159 13.0470-7159.2 LD7159	ATE 23245 18,3 - WE / - WK ATE 23245 18,3 - WE / - WK Ceramic
			→				13.0460-7137.2 607137 13.0470-7137.2 LD7137	ATE 23482 15,8 - WE / - WK ATE 23482 15,8 - WE / - WK Ceramic
 Bremsscheibe								
1.6	76	03/01→10/05	←				24.0124-0169.1 424169	Ø 280 24 21,8 V
1.6 FlexFuel	76	06/01→10/03					24.0126-0123.1 426123	Ø 300 26 22,8 V
2.0 Flex	95	09/02→05/05					24.0326-0123.1 526123	Ø 300 26 22,8 V PD
2.0 Flex	97	09/02→05/05	→				24.0111-0101.2 411101	Ø 274 10,9 9,5 + LG / + ABS Ring
1.6 16V	82	02/05→	←	→ 06/07			24.0124-0169.1 424169	Ø 280 24 21,8 V
1.6 16V (KG0A, KG0L)	79	03/01→					24.0126-0123.1 426123	Ø 300 26 22,8 V
1.6 Bifuel	79	06/05→12/07					24.0326-0123.1 526123	Ø 300 26 22,8 V PD
1.8 16V	86	03/01→	→	→ 06/07			24.0111-0101.2 411101	Ø 274 10,9 9,5 + LG / + ABS Ring
1.8 16V	89	03/01→						
1.8 16V (KG0B, KG0M)	88	03/01→						
1.8 16V (KG0J)	85	03/01→						
1.9 dCi	79	03/01→						
1.9 dCi	92	09/05→						
1.9 dCi (KG05)	68	03/04→						
1.9 dCi (KG0E, KG0R)	74	10/01→						
1.9 dCi (KG0E)	77	06/01→						
1.9 dCi (KG0G)	88	03/01→						
1.9 dCi (KG12)	85	08/05→09/07						
1.9 dCi (KG1A, KG1W)	81	01/05→						
1.9 dCi (KG1V)	96	05/05→						
2.0 16V	98	10/04→09/07						
2.0 16V (KG00, KG0K, KG0W)	99	08/02→						
2.0 16V IDE (KG0N)	103	04/01→						
1.9 dCi	66	08/03→09/07	←	03/04→ 06/07			24.0124-0169.1 424169 24.0126-0123.1 426123 24.0326-0123.1 526123	Ø 280 24 21,8 V Ø 300 26 22,8 V Ø 300 26 22,8 V PD
			→	03/04→ 06/07			24.0111-0101.2 411101	Ø 274 10,9 9,5 + LG / + ABS Ring
2.0 16V	125	01/05→	←	→ 06/07			24.0128-0182.1 428182	Ø 308 28 25,4 V
2.0 16V	150	01/05→	→	→ 06/07			24.0111-0101.2 411101	Ø 274 10,9 9,5 + LG / + ABS Ring
2.0 16V Turbo (KG0S, KG0Z, KG1L, KG1M)	120	01/03→						
2.0 dCi (KG1S)	127	01/06→						
2.0 dCi (KG1T)	110	08/05→	←	→ 06/07; passend für Felgenreöße [Zoll]: 16			24.0126-0123.1 426123 24.0326-0123.1 526123	Ø 300 26 22,8 V Ø 300 26 22,8 V PD
			←	→ 06/07; passend für Felgenreöße [Zoll]: 17			24.0128-0182.1 428182	Ø 308 28 25,4 V
			→	→ 06/07			24.0111-0101.2 411101	Ø 274 10,9 9,5 + LG / + ABS Ring
2.2 dCi	102	05/05→	←	→ 06/07			24.0126-0123.1 426123 24.0326-0123.1 526123	Ø 300 26 22,8 V Ø 300 26 22,8 V PD
			→	→ 06/07			24.0111-0101.2 411101	Ø 274 10,9 9,5 + LG / + ABS Ring
2.2 dCi (KG09)	85	04/04→10/05	←				24.0126-0123.1 426123 24.0326-0123.1 526123	Ø 300 26 22,8 V Ø 300 26 22,8 V PD
			→				24.0111-0101.2 411101	Ø 274 10,9 9,5 + LG / + ABS Ring
2.2 dCi (KG0F)	110	10/01→	←	→ 11/01			24.0126-0123.1 426123 24.0326-0123.1 526123	Ø 300 26 22,8 V Ø 300 26 22,8 V PD
			←	05/05→ 06/07			24.0126-0123.1 426123 24.0326-0123.1 526123	Ø 300 26 22,8 V Ø 300 26 22,8 V PD
			←	12/01→ 10/02			24.0128-0135.1 428135	Ø 308 28 25,8 V
			←	11/02→ 04/05			24.0128-0182.1 428182	Ø 308 28 25,4 V
			→	→ 06/07			24.0111-0101.2 411101	Ø 274 10,9 9,5 + LG / + ABS Ring
2.9 V6 24V	157	09/02→12/05	←				24.0128-0135.1 428135	Ø 308 28 25,8 V
			→				24.0111-0101.2 411101	Ø 274 10,9 9,5 + LG / + ABS Ring
3.0 V6 24V (KG0D)	152	03/01→	←	07/01→ 06/07			24.0128-0135.1 428135	Ø 308 28 25,8 V
			←	→ 06/01			24.0128-0182.1 428182	Ø 308 28 25,4 V
↓								











	kw			 	! #		
RENAULT - LAGUNA II Grandtour (KG0/1_) 03/01→							
 Bremsscheibe							
3.0 V6 24V (KG0D)	152	03/01→	→	→ 06/07		24.0111-0101.2 411101	Ø 274 10,9 9,5 + LG / + ABS Ring
RENAULT - LAGUNA III (BT0/1) 10/07→							
 Bremsbelagsatz, Scheibenbremse							
1.5 dCi (BT00, BT0A, BT0T, BT1J)	81	10/07→	←			13.0460-7248.2 607248	ATE 23215 17,5 - WE / - WK
1.6 16V (BT04, BT0D, BT0U)	81	10/07→	→			13.0460-7251.2 607251 13.0470-7251.2 LD7251	ATE 23482 15,8 - WE / - WK ATE 23482 15,8 - WE / - WK Ceramic
2.0 16V (BT05, BT0F, BT0W)	103	10/07→	←			13.0460-7249.2 607249	ATE 24709 18,6 - WE / - WK
2.0 16V Hi-Flex (BT1H)	103	10/07→	→			13.0470-7249.2 LD7249	ATE 24709 18,6 - WE / - WK Ceramic
2.0 16V Turbo	125	10/07→	→			13.0460-7251.2 607251 13.0470-7251.2 LD7251	ATE 23482 15,8 - WE / - WK ATE 23482 15,8 - WE / - WK Ceramic
2.0 dCi (BT01, BT09, BT12, BT1S)	110	10/07→	←	für Fahrzeuge ohne Vierradlenkung		13.0460-7249.2 607249	ATE 24709 18,6 - WE / - WK
2.0 dCi (BT08, BT0K, BT0J, BT14, BT1A, BT1D)	96	10/07→	←	für Fahrzeuge mit Vierradlenkung		13.0470-7249.2 LD7249	ATE 24709 18,6 - WE / - WK Ceramic
2.0 dCi (BT0M, BT0N, BT19)	127	01/08→	→			13.0460-7251.2 607251	ATE 23482 15,8 - WE / - WK
2.0 dCi GT (BT1E, BT1N)	131	03/08→	→			13.0470-7251.2 LD7251	ATE 23482 15,8 - WE / - WK Ceramic
2.0 GT	150	03/08→	←			13.0460-7250.2 607250	ATE 24709 17,5 - WE / - WK
3.0 dCi (BT03, BT13)	173	09/08→	→			13.0460-7251.2 607251	ATE 23482 15,8 - WE / - WK
3.5 V6 (BT0C, BT0P)	175	04/08→	→			13.0470-7251.2 LD7251	ATE 23482 15,8 - WE / - WK Ceramic
 Bremsscheibe							
1.5 dCi (BT00, BT0A, BT0T, BT1J)	81	10/07→	←			24.0124-0221.1 424221	Ø 280 24 21,8 V + S
1.6 16V (BT04, BT0D, BT0U)	81	10/07→	→			24.0111-0173.2 411173	Ø 300 11 9,5 + LG / + ABS Ring
2.0 16V (BT05, BT0F, BT0W)	103	10/07→	←			24.0126-0158.1 426158	Ø 296 26 23,4 V + S
2.0 16V Hi-Flex (BT1H)	103	10/07→	→			24.0111-0173.2 411173	Ø 300 11 9,5 + LG / + ABS Ring
2.0 16V Turbo	125	10/07→	→				
2.0 dCi (BT01, BT09, BT12, BT1S)	110	10/07→	←	für Fahrzeuge ohne Vierradlenkung		24.0126-0158.1 426158	Ø 296 26 23,4 V + S
2.0 dCi (BT08, BT0K, BT0J, BT14, BT1A, BT1D)	96	10/07→	←	für Fahrzeuge mit Vierradlenkung		24.0128-0245.1 428245	Ø 320 28 25,4 V + S
2.0 dCi (BT0M, BT0N, BT19)	127	01/08→	→			24.0111-0173.2 411173	Ø 300 11 9,5 + LG / + ABS Ring
2.0 dCi GT (BT1E, BT1N)	131	03/08→	→				
2.0 GT	150	03/08→	←			24.0128-0245.1 428245	Ø 320 28 25,4 V + S
3.0 dCi (BT03, BT13)	173	09/08→	→			24.0111-0173.2 411173	Ø 300 11 9,5 + LG / + ABS Ring
3.5 V6 (BT0C, BT0P)	175	04/08→	→				
RENAULT - LAGUNA III Grandtour (KT0/1) 10/07→							
 Bremsbelagsatz, Scheibenbremse							
1.5 dCi (KT0A)	81	10/07→	←			13.0460-7248.2 607248	ATE 23215 17,5 - WE / - WK
1.6 16V (KT0D)	81	10/07→	→			13.0460-7251.2 607251 13.0470-7251.2 LD7251	ATE 23482 15,8 - WE / - WK ATE 23482 15,8 - WE / - WK Ceramic
2.0 16V (KT0F, KT0W)	103	10/07→	←			13.0460-7249.2 607249	ATE 24709 18,6 - WE / - WK
2.0 16V Hi-Flex (KT1H)	103	10/07→	→			13.0470-7249.2 LD7249	ATE 24709 18,6 - WE / - WK Ceramic
2.0 16V Turbo	125	10/07→	→			13.0460-7251.2 607251 13.0470-7251.2 LD7251	ATE 23482 15,8 - WE / - WK ATE 23482 15,8 - WE / - WK Ceramic
2.0 dCi (KT01, KT08, KT0K, KT0J, KT1A, KT1D)	96	10/07→	←	für Fahrzeuge ohne Vierradlenkung		13.0460-7249.2 607249	ATE 24709 18,6 - WE / - WK
2.0 dCi (KT01, KT09, KT12, KT1S)	110	10/07→	←	für Fahrzeuge mit Vierradlenkung		13.0470-7249.2 LD7249	ATE 24709 18,6 - WE / - WK Ceramic
2.0 dCi (KT0M, KT0N, KT19)	127	01/08→	→			13.0460-7251.2 607251	ATE 23482 15,8 - WE / - WK
2.0 dCi GT (KT11, KT1E, KT1N)	131	03/08→	→			13.0470-7251.2 LD7251	ATE 23482 15,8 - WE / - WK Ceramic
↓							













	kw					! #		
RENAULT - LAGUNA III Grandtour (KT0/1) 10/07→								
 Bremsbelagsatz, Scheibenbremse								
2.0 GT	150	03/08→	←			13.0460-7250.2	607250	ATE 24709 17,5 - WE / - WK
3.0 dCi (KT03, KT13)	173	09/08→	→			13.0460-7251.2	607251	ATE 23482 15,8 - WE / - WK
3.5 V6 (KT0C, KT0P)	175	04/08→				13.0470-7251.2	LD7251	ATE 23482 15,8 - WE / - WK Ceramic
 Bremsscheibe								
1.5 dCi (KT0A)	81	10/07→	←			24.0124-0221.1	424221	Ø 280 24 21,8 V + S
1.6 16V (KT0D)	81	10/07→	→			24.0111-0173.2	411173	Ø 300 11 9,5 + LG / + ABS Ring
2.0 16V (KT0F, KT0W)	103	10/07→	←			24.0126-0158.1	426158	Ø 296 26 23,4 V + S
2.0 16V Hi-Flex (KT1H)	103	10/07→				24.0111-0173.2	411173	Ø 300 11 9,5 + LG / + ABS Ring
2.0 16V Turbo	125	10/07→	→					
2.0 dCi (KT01, KT08, KT0K, KT0J, KT1A, KT1D)	96	10/07→	←	für Fahrzeuge ohne Vierradlenkung		24.0126-0158.1	426158	Ø 296 26 23,4 V + S
			←	für Fahrzeuge mit Vierradlenkung		24.0128-0245.1	428245	Ø 320 28 25,4 V + S
2.0 dCi (KT01, KT09, KT12, KT1S)	110	10/07→	→			24.0111-0173.2	411173	Ø 300 11 9,5 + LG / + ABS Ring
2.0 dCi (KT0M, KT0N, KT19)	127	01/08→						
2.0 dCi GT (KT11, KT1E, KT1N)	131	03/08→						
2.0 GT	150	03/08→	←			24.0128-0245.1	428245	Ø 320 28 25,4 V + S
3.0 dCi (KT03, KT13)	173	09/08→	→			24.0111-0173.2	411173	Ø 300 11 9,5 + LG / + ABS Ring
3.5 V6 (KT0C, KT0P)	175	04/08→						
RENAULT - LAGUNA Coupe (DT0/1) 09/08→								
 Bremsbelagsatz, Scheibenbremse								
1.5 dCi	81	03/12→	←			13.0460-7248.2	607248	ATE 23215 17,5 - WE / - WK
			→			13.0460-7251.2	607251	ATE 23482 15,8 - WE / - WK
						13.0470-7251.2	LD7251	ATE 23482 15,8 - WE / - WK Ceramic
2.0 16V Turbo	125	09/08→	←			13.0460-7249.2	607249	ATE 24709 18,6 - WE / - WK
			→			13.0470-7249.2	LD7249	ATE 24709 18,6 - WE / - WK Ceramic
						13.0460-7251.2	607251	ATE 23482 15,8 - WE / - WK
						13.0470-7251.2	LD7251	ATE 23482 15,8 - WE / - WK Ceramic
2.0 dCi	127	09/08→	←	für Fahrzeuge ohne Vierradlenkung		13.0460-7249.2	607249	ATE 24709 18,6 - WE / - WK
2.0 dCi (DT01, DT09, DT12, DT1D)	110	09/08→				13.0470-7249.2	LD7249	ATE 24709 18,6 - WE / - WK Ceramic
2.0 dCi GT (DT11, DT1E, DT1N)	131	09/08→	←	für Fahrzeuge mit Vierradlenkung		13.0460-7250.2	607250	ATE 24709 17,5 - WE / - WK
			→			13.0460-7251.2	607251	ATE 23482 15,8 - WE / - WK
						13.0470-7251.2	LD7251	ATE 23482 15,8 - WE / - WK Ceramic
2.0 GT	150	09/08→	←			13.0460-7250.2	607250	ATE 24709 17,5 - WE / - WK
3.0 dCi	177	01/12→	→					
3.0 dCi (DT03)	173	09/08→				13.0460-7251.2	607251	ATE 23482 15,8 - WE / - WK
3.5 V6 (DT0P)	175	09/08→				13.0470-7251.2	LD7251	ATE 23482 15,8 - WE / - WK Ceramic
 Bremsscheibe								
1.5 dCi	81	03/12→	←			24.0124-0221.1	424221	Ø 280 24 21,8 V + S
			→			24.0111-0181.2	411181	Ø 300 11 9,5 + LG / + ABS Ring
2.0 16V Turbo	125	09/08→	←			24.0126-0158.1	426158	Ø 296 26 23,4 V + S
			→			24.0111-0181.2	411181	Ø 300 11 9,5 + LG / + ABS Ring
2.0 dCi	127	09/08→	←	für Fahrzeuge ohne Vierradlenkung		24.0126-0158.1	426158	Ø 296 26 23,4 V + S
2.0 dCi (DT01, DT09, DT12, DT1D)	110	09/08→	←	für Fahrzeuge mit Vierradlenkung		24.0128-0245.1	428245	Ø 320 28 25,4 V + S
2.0 dCi GT (DT11, DT1E, DT1N)	131	09/08→	→			24.0111-0181.2	411181	Ø 300 11 9,5 + LG / + ABS Ring
2.0 GT	150	09/08→	←			24.0128-0245.1	428245	Ø 320 28 25,4 V + S
3.0 dCi	177	01/12→	→					
3.0 dCi (DT03)	173	09/08→				24.0111-0181.2	411181	Ø 300 11 9,5 + LG / + ABS Ring
3.5 V6 (DT0P)	175	09/08→						
RENAULT - LATITUDE (L70_) 07/10→								
 Bremsbelagsatz, Scheibenbremse								
1.5 dCi (L70R)	81	07/10→	←	02/11→ 06/13		13.0460-7249.2	607249	ATE 24709 18,6 - WE / - WK
						13.0470-7249.2	LD7249	ATE 24709 18,6 - WE / - WK Ceramic
↓								

	kW			 	! #		
RENAULT - LATITUDE (L70_) 07/10→							
 Bremsbelagsatz, Scheibenbremse							
1.5 dCi (L70R)	81	07/10→	➔	02/11→ 06/13		13.0460-7287.2 607287	ATE 25265 16,6 + WE / - WK
2.0 16V	102	02/11→	➔	→ 06/13		13.0460-7249.2 607249	ATE 24709 18,6 - WE / - WK
2.0 16V (L70B)	103	02/11→				13.0470-7249.2 LD7249	ATE 24709 18,6 - WE / - WK
2.0 16V eco2 Flexfuel (L70B)	103	02/11→					Ceramic
2.0 dCi 150 (L70H)	110	02/11→	➔	→ 06/13		13.0460-7287.2 607287	ATE 25265 16,6 + WE / - WK
2.5 dCi	133	05/11→					
2.5 V6 (L702, L703, L704, L707)	130	05/11→					
2.0 dCi	130	02/11→	➔	→ 06/13		13.0460-5716.2 605716	21561 17,0 + WK
2.0 dCi 175 (L70Y)	127	05/11→	➔	→ 06/13		13.0460-7287.2 607287	ATE 25265 16,6 + WE / - WK
2.0 dCi 130	96	12/13→	➔			13.0460-7249.2 607249	ATE 24709 18,6 - WE / - WK
						13.0470-7249.2 LD7249	ATE 24709 18,6 - WE / - WK
						13.0460-7287.2 607287	ATE 25265 16,6 + WE / - WK
3.0 dCi 240 (L70G)	177	02/11→	➔	→ 06/13		13.0460-7250.2 607250	ATE 24709 17,5 - WE / - WK
			➔	→ 06/13		13.0460-7287.2 607287	ATE 25265 16,6 + WE / - WK
 Bremsscheibe							
1.5 dCi (L70R)	81	07/10→	➔	02/11→ 06/13		24.0126-0158.1 426158	Ø 296 26 23,4 V + S
			➔	02/11→ 06/13		24.0111-0173.2 411173	Ø 300 11 9,5 + LG / + ABS Ring
2.0 16V	102	02/11→	➔	→ 06/13		24.0126-0158.1 426158	Ø 296 26 23,4 V + S
2.0 16V (L70B)	103	02/11→				24.0111-0173.2 411173	Ø 300 11 9,5 + LG / + ABS Ring
2.0 16V eco2 Flexfuel (L70B)	103	02/11→					
2.0 dCi	130	02/11→					
2.0 dCi 150 (L70H)	110	02/11→					
2.0 dCi 175 (L70Y)	127	05/11→					
2.5 dCi	133	05/11→					
2.5 V6 (L702, L703, L704, L707)	130	05/11→					
2.0 dCi 130	96	12/13→	➔			24.0126-0158.1 426158	Ø 296 26 23,4 V + S
			➔			24.0111-0173.2 411173	Ø 300 11 9,5 + LG / + ABS Ring
3.0 dCi 240 (L70G)	177	02/11→	➔	→ 06/13		24.0111-0173.2 411173	Ø 300 11 9,5 + LG / + ABS Ring
RENAULT - LOGAN I (LS_) 09/04→							
 Bremsbelagsatz, Scheibenbremse							
1.2	55	11/13→	➔			13.0460-7298.2 607298	ATE 25702 18,2 - WE / - WK
1.4	55	09/04→	➔	→ 04/13		13.0460-2834.2 602834	TRW 21463 18,0 + WK
1.5 dCi	48	06/11→					
1.5 dCi	50	04/07→					
1.5 dCi	63	02/08→					
1.6	64	09/04→					
1.6	66	05/08→					
1.6	77	04/07→					
1.6 Flex	68	11/07→					
1.6	80	02/07→	➔	04/07→		13.0460-2834.2 602834	TRW 21463 18,0 + WK
 Bremsscheibe							
1.2	55	11/13→	➔			24.0112-0171.1 412171	Ø 259 12 10,6 + S
1.4	55	09/04→	➔	→ 04/13; - ABS		24.0112-0116.1 412116	Ø 238 12 10,5 + S
1.6	64	09/04→	➔	→ 04/13; + ABS		24.0112-0171.1 412171	Ø 259 12 10,6 + S
1.6	66	05/08→					
1.5 dCi	48	06/11→	➔	→ 04/13		24.0121-0106.1 421106	Ø 259 20,7 17,7 V + S
1.5 dCi	50	04/07→					
1.5 dCi	63	02/08→					
1.6	77	04/07→					
1.6 Flex	68	11/07→					
1.6	80	02/07→	➔	04/07→		24.0121-0106.1 421106	Ø 259 20,7 17,7 V + S
RENAULT - LOGAN I Kombi (KS_) 04/07→							
 Bremsbelagsatz, Scheibenbremse							
1.4	55	10/07→	➔	→ 04/13		13.0460-2834.2 602834	TRW 21463 18,0 + WK
1.5 dCi	48	06/11→					
1.5 dCi	50	04/07→					
1.5 dCi	63	02/08→					
1.5 dCi	66	06/11→					
1.6	64	04/07→					
1.6	77	04/07→					
↓							

	kw					! #		
RENAULT - LOGAN I Kombi (KS_) 04/07→								
 Bremsscheibe								
1.4	55	10/07→	←	→ 04/13; - ABS		24.0112-0116.1	412116	Ø 238 12 10,5 + S
1.6	64	04/07→	←	→ 04/13; + ABS		24.0112-0171.1	412171	Ø 259 12 10,6 + S
1.5 dCi	48	06/11→	←	→ 04/13		24.0121-0106.1	421106	Ø 259 20,7 17,7 V + S
1.5 dCi	50	04/07→						
1.5 dCi	63	02/08→						
1.5 dCi	66	06/11→						
1.6	77	04/07→						
RENAULT - LOGAN II (B8_) 10/13→								
 Bremsbelagsatz, Scheibenbremse								
1.2 16V LPG	53	11/13→	←			13.0460-7298.2	607298	ATE 25702 18,2 - WE / - WK
1.5 dCi	62	12/13→						
1.5 dCi	66	12/13→						
1.6	60	04/14→						
1.6	75	04/14→						
 Bremsscheibe								
1.2 16V LPG	53	11/13→	←			24.0112-0171.1	412171	Ø 259 12 10,6 + S
1.6	60	04/14→						
1.5 dCi	62	12/13→	←			24.0122-0289.1	422289	Ø 258 22 19,8 V + S
1.5 dCi	66	12/13→						
1.6	75	04/14→						
RENAULT - LOGAN II Kombi (K8_) 12/13→								
 Bremsbelagsatz, Scheibenbremse								
1.2 16V	54	12/13→	←			13.0460-7298.2	607298	ATE 25702 18,2 - WE / - WK
1.2 16V LPG	53	12/13→						
1.5 dCi	62	12/13→						
1.5 dCi	66	12/13→						
1.6	59	12/13→						
 Bremsscheibe								
1.2 16V	54	12/13→	←			24.0122-0289.1	422289	Ø 258 22 19,8 V + S
1.2 16V LPG	53	12/13→						
1.5 dCi	62	12/13→						
1.5 dCi	66	12/13→						
1.6	59	12/13→						
RENAULT - LOGAN EXPRESS (US_) 04/07→								
 Bremsbelagsatz, Scheibenbremse								
1.5 dCi	50	04/07→	←	→ 04/13		13.0460-2709.2	602709	TRW 23973 17,1 - WE / - WK + Zub
1.6	64	04/07→				13.0460-7270.2	607270	ATE 24673 18,0 - WE / - WK
						13.0470-2709.2	LD2709	TRW 23973 17,1 - WE / - WK + Zub Ceramic
 Bremsscheibe								
1.5 dCi	50	04/07→	←	→ 04/13		24.0122-0216.1	422216	Ø 260 22 19,8 V + S
1.6	64	04/07→						
RENAULT - MASTER I Bus (T_) 08/80→07/98								
 Bremsbelagsatz, Scheibenbremse								
28-35 2,5 TD	72	08/89→07/98	←			13.0460-2824.2	602824	TRW 20380 15,6 + WK
28-35 2.0	58	10/86→07/98						
28-35 2.1 D	44	08/80→07/98						
28-35 2.5 D	55	08/89→07/98						
30 2,2	67	08/80→07/98						
35 2,5 TD	69	08/89→07/98						
 Bremsscheibe								
28-35 2,5 TD	72	08/89→07/98	←			24.0124-0137.1	424137	Ø 278 24 22 V
28-35 2.0	58	10/86→07/98						
28-35 2.1 D	44	08/80→07/98						
28-35 2.5 D	55	08/89→07/98						
30 2,2	67	08/80→07/98						
35 2,5 TD	69	08/89→07/98						
RENAULT - MASTER I Kasten (T_) 07/80→07/98								
 Bremsbelagsatz, Scheibenbremse								
28-35 2,5 D	55	08/89→07/98	←			13.0460-2824.2	602824	TRW 20380 15,6 + WK
28-35 2,5 TD	72	08/89→07/98						
28-35 2.0	58	10/86→07/98						
28-35 2.1 D	44	08/80→07/98						
↓								

	kW				! #		
RENAULT - MASTER I Kasten (T_) 07/80→07/98							
 Bremsbelagsatz, Scheibenbremse							
30 2,2 35 2,5 TD	67 69	08/80→07/98 08/89→07/98	←			13.0460-2824.2 602824	TRW 20380 15,6 + WK
 Bremsscheibe							
28-35 2,5 D 28-35 2,5 TD 28-35 2.0 28-35 2.1 D 30 2,2 35 2,5 TD	55 72 58 44 67 69	08/89→07/98 08/89→07/98 10/86→07/98 08/80→07/98 08/80→07/98 08/89→07/98	←			24.0124-0137.1 424137	Ø 278 24 22 V
RENAULT - MASTER I Pritsche/Fahrgestell (P_) 07/80→07/98							
 Bremsbelagsatz, Scheibenbremse							
28-35 2.0	58	10/86→07/98	←			13.0460-2824.2 602824	TRW 20380 15,6 + WK
28-35 2.5 D	52	09/80→07/98	←	08/89→		13.0460-2824.2 602824	TRW 20380 15,6 + WK
 Bremsscheibe							
28-35 2.0	58	10/86→07/98	←			24.0124-0137.1 424137	Ø 278 24 22 V
28-35 2.5 D	52	09/80→07/98	←	08/89→		24.0124-0137.1 424137	Ø 278 24 22 V
RENAULT - MASTER II Bus (JD) 03/98→							
 Bremsbelagsatz, Scheibenbremse							
1.9 dCi 80 1.9 dTi 2.2 dCi 90 2.5 dCi 100 (JDCV) 2.5 dCi 120 3.0 dCi 140 (JD0T)	60 59 66 73 84 100	11/01→ 09/00→ 09/00→ 10/03→ 10/01→ 10/03→	← →	→ 08/06 → 08/06		13.0460-3800.2 603800 13.0460-3806.2 603806	BOS 23613 17,7 - WE / - WK BOS 23669 16,8 - WE / - WK
2.5 D 2.8 dTi	59 84	07/98→01/01 07/98→10/01	← ← →	08/00→ → 07/00		13.0460-3800.2 603800 13.0460-3946.2 603946 13.0460-3806.2 603806	BOS 23613 17,7 - WE / - WK BDX 23302 18,0 + WE / - WK BOS 23669 16,8 - WE / - WK
2.5 dCi 2.5 dCi 2.5 dCi	74 88 107	08/06→ 08/06→ 08/06→	← →	→ 12/10 → 12/10		13.0460-3800.2 603800 13.0460-3806.2 603806	BOS 23613 17,7 - WE / - WK BOS 23669 16,8 - WE / - WK
Zubehörsatz, Scheibenbremsbelag							
2.5 dCi 2.5 dCi 2.5 dCi	74 88 107	08/06→ 08/06→ 08/06→	←	→ 12/10		13.0460-0344.2 610344	
 Bremsscheibe							
1.9 dCi 80 1.9 dTi 2.2 dCi 90 2.5 dCi 100 (JDCV) 2.5 dCi 120	60 59 66 73 84	11/01→ 09/00→ 09/00→ 10/03→ 10/01→	← →	→ 08/06; passend für Felgenreöße [Zoll]: 16 → 08/06		24.0128-0129.1 428129 24.0328-0129.1 528129 24.0112-0155.1 412155	Ø 305,5 28 25 V + S Ø 305,5 28 25 V + S PD Ø 305 12 10,5 + S
2.5 D 2.8 dTi	59 84	07/98→01/01 07/98→10/01	← ← →	→ 07/00; passend für Felgenreöße [Zoll]: 15 08/00→; passend für Felgenreöße [Zoll]: 16		24.0124-0162.1 424162 24.0128-0129.1 428129 24.0328-0129.1 528129 24.0112-0155.1 412155	Ø 280 24 21 V Ø 305,5 28 25 V + S Ø 305,5 28 25 V + S PD Ø 305 12 10,5 + S
2.5 dCi 2.5 dCi 2.5 dCi	74 88 107	08/06→ 08/06→ 08/06→	← →	→ 12/10 → 12/10		24.0128-0129.1 428129 24.0328-0129.1 528129 24.0112-0155.1 412155	Ø 305,5 28 25 V + S Ø 305,5 28 25 V + S PD Ø 305 12 10,5 + S
3.0 dCi 140 (JD0T)	100	10/03→	← →	→ 08/06 → 08/06		24.0128-0129.1 428129 24.0328-0129.1 528129 24.0112-0155.1 412155	Ø 305,5 28 25 V + S Ø 305,5 28 25 V + S PD Ø 305 12 10,5 + S
RENAULT - MASTER II Kasten (FD) 07/98→							
 Bremsbelagsatz, Scheibenbremse							
1.9 dCi 80 2.5 dCi 100 (FD0U, FD0V) 2.5 dCi 120 3.0 dCi 120 3.0 dCi 140 (HD0S, FD0S, HD1S) 3.0 dCi 160	60 73 84 85 100 115	11/01→ 10/03→ 10/01→ 06/05→ 10/03→ 06/05→	← →	→ 08/06 → 08/06		13.0460-3800.2 603800 13.0460-3806.2 603806	BOS 23613 17,7 - WE / - WK BOS 23669 16,8 - WE / - WK
1.9 dTi	59	09/00→	←	11/01→ 08/06		13.0460-3800.2 603800	BOS 23613 17,7 - WE / - WK
↓							

	kW			 	! #		
RENAULT - MASTER II Kasten (FD) 07/98→							
 Bremsbelagsatz, Scheibenbremse							
2.2 dCi 90	66	09/00→	→	→ 08/06		13.0460-3806.2 603806	BOS 23669 16,8 - WE / - WK
2.5 D 2.8 dTi	59 84	07/98→01/01 07/98→10/01	←	08/00→		13.0460-3800.2 603800	BOS 23613 17,7 - WE / - WK
			←	→ 07/00		13.0460-3946.2 603946	BDX 23302 18,0 + WE / - WK
			→	08/00→		13.0460-3806.2 603806	BOS 23669 16,8 - WE / - WK
2.5 dCi	74	08/06→	←	→ 12/10		13.0460-3800.2 603800	BOS 23613 17,7 - WE / - WK
2.5 dCi	88	08/06→	←	→ 12/10		13.0460-3806.2 603806	BOS 23669 16,8 - WE / - WK
2.5 dCi	107	08/06→	→	→ 12/10		13.0460-3806.2 603806	BOS 23669 16,8 - WE / - WK
Zubehörsatz, Scheibenbremsbelag							
2.5 dCi	74	08/06→	←	→ 12/10		13.0460-0344.2 610344	
2.5 dCi	88	08/06→	←	→ 12/10			
2.5 dCi	107	08/06→	←	→ 12/10			
 Bremsscheibe							
1.9 dCi 80	60	11/01→	←	→ 08/06		24.0128-0129.1 428129	Ø 305,5 28 25 V + S
1.9 dTi	59	09/00→	←	→ 08/06		24.0328-0129.1 528129	Ø 305,5 28 25 V + S PD
2.2 dCi 90	66	09/00→	→	→ 08/06		24.0112-0155.1 412155	Ø 305 12 10,5 + S
2.5 dCi 100 (FD0U, FD0V)	73	10/03→	→	→ 08/06			
2.5 dCi 120	84	10/01→	→	→ 08/06			
3.0 dCi 120	85	06/05→	→	→ 08/06			
3.0 dCi 140 (HD0S, FD0S, HD1S)	100	10/03→	→	→ 08/06			
3.0 dCi 160	115	06/05→	→	→ 08/06			
2.5 D	59	07/98→01/01	←	→ 07/00		24.0124-0162.1 424162	Ø 280 24 21 V
2.8 dTi	84	07/98→10/01	←	08/00→		24.0128-0129.1 428129	Ø 305,5 28 25 V + S
			←	→ 07/00		24.0328-0129.1 528129	Ø 305,5 28 25 V + S PD
			→	08/00→		24.0112-0155.1 412155	Ø 305 12 10,5 + S
2.5 dCi	74	08/06→	←	→ 12/10		24.0128-0129.1 428129	Ø 305,5 28 25 V + S
2.5 dCi	88	08/06→	←	→ 12/10		24.0328-0129.1 528129	Ø 305,5 28 25 V + S PD
2.5 dCi	107	08/06→	→	→ 12/10		24.0112-0155.1 412155	Ø 305 12 10,5 + S
RENAULT - MASTER II Pritsche/Fahrgestell (ED/HD/UD) 07/98→							
 Bremsbelagsatz, Scheibenbremse							
2.2 dCi 90	66	09/00→	←	11/01→ 08/06		13.0460-3800.2 603800	BOS 23613 17,7 - WE / - WK
			←	→ 10/01		13.0460-3946.2 603946	BDX 23302 18,0 + WE / - WK
			→	→ 08/06		13.0460-3806.2 603806	BOS 23669 16,8 - WE / - WK
2.5 D	59	07/98→01/01	←	→ 08/00→		13.0460-3946.2 603946	BDX 23302 18,0 + WE / - WK
2.8 dTi	84	07/98→10/01	→	→ 08/00→		13.0460-3806.2 603806	BOS 23669 16,8 - WE / - WK
2.5 dCi	74	08/06→	←	→ 12/10		13.0460-3800.2 603800	BOS 23613 17,7 - WE / - WK
2.5 dCi	88	08/06→	←	→ 12/10		13.0460-3806.2 603806	BOS 23669 16,8 - WE / - WK
2.5 dCi	107	08/06→	→	→ 12/10		13.0460-3806.2 603806	BOS 23669 16,8 - WE / - WK
2.5 dCi 100 (ED4V, ED8V)	73	10/03→	←	→ 08/06		13.0460-3800.2 603800	BOS 23613 17,7 - WE / - WK
2.5 dCi 120	84	10/01→	→	→ 08/06		13.0460-3806.2 603806	BOS 23669 16,8 - WE / - WK
3.0 dCi 120	85	06/05→	→	→ 08/06			
3.0 dCi 140 (ED0S, UD0S)	100	10/03→	→	→ 08/06			
3.0 dCi 160	115	06/05→	→	→ 08/06			
Zubehörsatz, Scheibenbremsbelag							
2.5 dCi	74	08/06→	←	→ 12/10		13.0460-0344.2 610344	
2.5 dCi	88	08/06→	←	→ 12/10			
2.5 dCi	107	08/06→	←	→ 12/10			
 Bremsscheibe							
2.2 dCi 90	66	09/00→	←	→ 10/01		24.0124-0162.1 424162	Ø 280 24 21 V
			←	11/01→ 08/06		24.0128-0129.1 428129	Ø 305,5 28 25 V + S
			→	→ 08/06		24.0328-0129.1 528129	Ø 305,5 28 25 V + S PD
2.5 D	59	07/98→01/01	→	→ 08/06		24.0112-0155.1 412155	Ø 305 12 10,5 + S
2.5 D	59	07/98→01/01	←	→ 08/00→		24.0124-0162.1 424162	Ø 280 24 21 V
			→	→ 08/00→		24.0112-0155.1 412155	Ø 305 12 10,5 + S
2.5 dCi	74	08/06→	←	→ 12/10		24.0128-0129.1 428129	Ø 305,5 28 25 V + S
2.5 dCi	88	08/06→	←	→ 12/10		24.0328-0129.1 528129	Ø 305,5 28 25 V + S PD
2.5 dCi	107	08/06→	→	→ 12/10		24.0112-0155.1 412155	Ø 305 12 10,5 + S
2.5 dCi 100 (ED4V, ED8V)	73	10/03→	←	→ 08/06		24.0128-0129.1 428129	Ø 305,5 28 25 V + S
						24.0328-0129.1 528129	Ø 305,5 28 25 V + S PD

	kw					! #		
RENAULT - MASTER II Pritsche/Fahrgestell (ED/HD/UD) 07/98→								
 Bremsscheibe								
2.5 dCi 120	84	10/01→	➔	→ 08/06			24.0112-0155.1 412155	Ø 305 12 10,5 + S
3.0 dCi 120	85	06/05→						
3.0 dCi 140 (ED0S, UD0S)	100	10/03→						
3.0 dCi 160	115	06/05→						
2.8 dTi	84	07/98→10/01	➔	→ 07/00			24.0124-0162.1 424162	Ø 280 24 21 V
			➔	08/00→ 08/01			24.0128-0129.1 428129	Ø 305,5 28 25 V + S
			➔	08/00→			24.0328-0129.1 528129	Ø 305,5 28 25 V + S PD
			➔	08/00→			24.0112-0155.1 412155	Ø 305 12 10,5 + S
RENAULT - MASTER III Bus (JV) 02/11→								
 Bremsbelagsatz, Scheibenbremse								
2.3 dCi 100 FWD (JV0A, JV0B)	74	02/11→	➔				13.0460-4856.2 604856	BRE 25147 18,4 + WK
2.3 dCi 110 FWD	81	09/14→	➔	mit Doppelbereifung			13.0460-4857.2 604857	BRE 25172 18,4 + WK
2.3 dCi 125 FWD (JV0C, JV0D, JV0H)	92	02/11→	➔	mit Einfachbereifung			13.0460-4858.2 604858	BRE 25112 18,4 + WK
2.3 dCi 135 FWD	100	07/14→						
2.3 dCi 145 FWD (JV0F, JV0H)	107	02/11→						
2.3 dCi 165 FWD	120	07/14→						
2.3 dCi 170 FWD	125	07/15→						
2.3 dCi 150 FWD	110	10/12→	➔	01/13→			13.0460-4856.2 604856	BRE 25147 18,4 + WK
			➔	01/13→; mit Doppelbereifung			13.0460-4857.2 604857	BRE 25172 18,4 + WK
			➔	01/13→; mit Einfachbereifung			13.0460-4858.2 604858	BRE 25112 18,4 + WK
 Bremsscheibe								
2.3 dCi 100 FWD (JV0A, JV0B)	74	02/11→	➔				24.0128-0252.1 428252	Ø 302 28 24,5 V + S
2.3 dCi 110 FWD	81	09/14→	➔				24.0112-0191.1 412191	Ø 305 12 10 + S
2.3 dCi 125 FWD (JV0C, JV0D, JV0H)	92	02/11→						
2.3 dCi 145 FWD (JV0F, JV0H)	107	02/11→						
2.3 dCi 170 FWD	125	07/15→						
2.3 dCi 135 FWD	100	07/14→	➔				24.0128-0252.1 428252	Ø 302 28 24,5 V + S
2.3 dCi 165 FWD	120	07/14→	➔	mit Einfachbereifung			24.0112-0190.1 412190	Ø 305 12 10 + S
			➔	mit Doppelbereifung			24.0118-0153.1 418153	Ø 302 18 15
2.3 dCi 150 FWD	110	10/12→	➔	01/13→			24.0128-0252.1 428252	Ø 302 28 24,5 V + S
			➔	01/13→			24.0112-0191.1 412191	Ø 305 12 10 + S
RENAULT - MASTER III Kasten (FV) 02/10→								
 Bremsbelagsatz, Scheibenbremse								
2.3 dCi 100 [RWD] (FV0B, FV0C, FV0D)	74	02/10→	➔				13.0460-4856.2 604856	BRE 25147 18,4 + WK
2.3 dCi 100 FWD (FV0A, FV0B, FV0G, FV0K)	74	02/10→	➔	mit Doppelbereifung			13.0460-4857.2 604857	BRE 25172 18,4 + WK
2.3 dCi 110 FWD	81	09/14→	➔	mit Einfachbereifung			13.0460-4858.2 604858	BRE 25112 18,4 + WK
2.3 dCi 125 [RWD] (FV0C, FV0D, FV0H, FV0J)	92	02/10→						
2.3 dCi 125 FWD (FV0C, FV0D)	92	02/10→						
2.3 dCi 130 [RWD]	96	03/12→						
2.3 dCi 130 FWD	96	06/16→						
2.3 dCi 135 [RWD]	100	07/14→						
2.3 dCi 135 FWD	100	07/14→						
2.3 dCi 145 [RWD] (FV0E, FV0F, FV0J)	107	02/10→						
2.3 dCi 145 FWD (FV0E, FV0F, FV0H, FV0J)	107	02/10→						
2.3 dCi 150 [RWD]	110	03/13→						
2.3 dCi 150 FWD	110	03/13→						
2.3 dCi 165 [RWD]	120	07/14→						
2.3 dCi 165 FWD	120	07/14→						
2.3 dCi 170 FWD	125	07/15→						
 Bremsscheibe								
2.3 dCi 100 [RWD] (FV0B, FV0C, FV0D)	74	02/10→	➔				24.0128-0252.1 428252	Ø 302 28 24,5 V + S
2.3 dCi 125 [RWD] (FV0C, FV0D, FV0H, FV0J)	92	02/10→	➔	mit Einfachbereifung			24.0112-0190.1 412190	Ø 305 12 10 + S
↓			➔	mit Doppelbereifung			24.0118-0153.1 418153	Ø 302 18 15



RENAULT - MASTER III Kasten (FV) 02/10→

Bremsscheibe

2.3 dCi 130 [RWD]	96	03/12→	←		24.0128-0252.1	428252	Ø 302 28 24,5 V + S
2.3 dCi 135 [RWD]	100	07/14→					
2.3 dCi 145 [RWD]	107	02/10→	→	mit Einfachbereifung	24.0112-0190.1	412190	Ø 305 12 10 + S
(FV0E, FV0F, FV0J)							
2.3 dCi 150 [RWD]	110	03/13→	→	mit Doppelbereifung	24.0118-0153.1	418153	Ø 302 18 15
2.3 dCi 165 [RWD]	120	07/14→					
2.3 dCi 100 FWD (FV0A, FV0B, FV0G, FV0K)	74	02/10→	←		24.0128-0252.1	428252	Ø 302 28 24,5 V + S
2.3 dCi 110 FWD	81	09/14→	→		24.0112-0191.1	412191	Ø 305 12 10 + S
2.3 dCi 125 FWD (FV0C, FV0D)	92	02/10→					
2.3 dCi 130 FWD	96	06/16→					
2.3 dCi 135 FWD	100	07/14→					
2.3 dCi 145 FWD (FV0E, FV0F, FV0H, FV0J)	107	02/10→					
2.3 dCi 150 FWD	110	03/13→					
2.3 dCi 165 FWD	120	07/14→					
2.3 dCi 170 FWD	125	07/15→					









RENAULT - MASTER III Pritsche/Fahrgestell (EV, HV, UV) 02/10→

Bremsbelagsatz, Scheibenbremse







2.3 dCi 100 [RWD] (UV0C, UV0D, HV0C, HV0D)	74	02/10→	←		13.0460-4856.2	604856	BRE 25147 18,4 + WK
			→	mit Doppelbereifung	13.0460-4857.2	604857	BRE 25172 18,4 + WK
2.3 dCi 100 FWD (EV0A, EV0B, HV0A, HV0B, HV0G, UV0A...)	74	02/10→	→	mit Einfachbereifung	13.0460-4858.2	604858	BRE 25112 18,4 + WK
2.3 dCi 110 FWD	81	09/14→					
2.3 dCi 125 [RWD] (HV0C, HV0D, UV0C, UV0D, UV0H, UV0J)	92	02/10→					
2.3 dCi 125 FWD (EV0C, EV0D, EV0J, HV0C, HV0D, HV0H...)	92	02/10→					
2.3 dCi 130 [RWD]	96	07/16→					
2.3 dCi 130 FWD	96	03/12→					
2.3 dCi 135 [RWD]	100	07/14→					
2.3 dCi 145 [RWD] (UV0F, UV0E)	107	02/10→					
2.3 dCi 145 FWD (EV0E, EV0F, HV0E, HV0F, UV0E, UV0F)	107	02/10→					
2.3 dCi 150 [RWD]	110	03/13→					
2.3 dCi 150 FWD	110	03/13→					
2.3 dCi 165 [RWD]	120	07/14→					
2.3 dCi 165 FWD	120	07/14→					
2.3 dCi 170 FWD	125	06/16→					
2.3 dCi 135 FWD	100	07/14→	→	mit Doppelbereifung	13.0460-4857.2	604857	BRE 25172 18,4 + WK
			→	mit Einfachbereifung	13.0460-4858.2	604858	BRE 25112 18,4 + WK











Bremsscheibe









2.3 dCi 100 [RWD] (UV0C, UV0D, HV0C, HV0D)	74	02/10→	←		24.0128-0252.1	428252	Ø 302 28 24,5 V + S
			→	für Einfachbereifung	24.0112-0190.1	412190	Ø 305 12 10 + S
2.3 dCi 125 [RWD] (HV0C, HV0D, UV0C, UV0D, UV0H, UV0J)	92	02/10→	→	für Doppelbereifung	24.0118-0153.1	418153	Ø 302 18 15
2.3 dCi 130 [RWD]	96	07/16→					
2.3 dCi 135 [RWD]	100	07/14→					
2.3 dCi 145 [RWD] (UV0F, UV0E)	107	02/10→					
2.3 dCi 150 [RWD]	110	03/13→					
2.3 dCi 165 [RWD]	120	07/14→					
2.3 dCi 100 FWD (EV0A, EV0B, HV0A, HV0B, HV0G, UV0A...)	74	02/10→	←		24.0128-0252.1	428252	Ø 302 28 24,5 V + S
2.3 dCi 110 FWD	81	09/14→	→		24.0112-0191.1	412191	Ø 305 12 10 + S
2.3 dCi 125 FWD (EV0C, EV0D, EV0J, HV0C, HV0D, HV0H...)	92	02/10→					
2.3 dCi 130 FWD	96	03/12→					
2.3 dCi 135 FWD	100	07/14→					
2.3 dCi 145 FWD (EV0E, EV0F, HV0E, HV0F, UV0E, UV0F)	107	02/10→					
2.3 dCi 150 FWD	110	03/13→					
2.3 dCi 165 FWD	120	07/14→					
2.3 dCi 170 FWD	125	06/16→					









	kw			 	! #		
RENAULT - MEGANE I (BA0/1_) 08/95→12/04							
 Bremsbelagsatz, Scheibenbremse							
1.4 16V (BA0D, BA1H, BA0W, BA10)	70	03/99→08/03	←	→ 12/02		13.0460-2834.2 602834	TRW 21463 18,0 + WK
			→	→ 12/02; + ASR		13.0460-3954.2 603954	BDX 20973 11,0 - WK
1.4 e (BA0E, BA0V)	55	01/96→08/03	←	→ 12/02		13.0460-2834.2 602834	TRW 21463 18,0 + WK
1.9 dT (B/SA0K, B/SA0Y)	66	01/96→08/03					
1.9 TDI	69	09/96→08/03					
2.0 i	80	03/99→08/03					
2.0 i (BA0G)	84	01/96→08/03					
1.4 Eco (BA0T)	52	01/96→03/99	←			13.0460-2834.2 602834	TRW 21463 18,0 + WK
1.6 e (BA0F, BA0S)	66	01/96→03/99					
1.6 i (BA0L)	55	01/96→03/99					
1.9 dT	76	08/98→10/99					
2.0	85	05/98→05/01					
1.6 16V	81	11/01→12/04	←	→ 12/02; für Fahrzeuge mit verstärktem Fahrwerk		13.0460-2834.2 602834	TRW 21463 18,0 + WK
1.6 16V (BA11, BA04, BA0B, BA1J)	79	03/99→08/03	←	→ 12/02		13.0460-2895.2 602895	TRW 23172 18,0 - WK
			←	→ 12/02; für Fahrzeuge ohne verstärktes Fahrwerk		13.0460-2895.2 602895	TRW 23172 18,0 - WK
			→	→ 12/02; + ASR		13.0460-3954.2 603954	BDX 20973 11,0 - WK
1.6 LPG	66	08/95→03/99	←	01/96→		13.0460-2834.2 602834	TRW 21463 18,0 + WK
1.6 LPG	80	10/00→08/02	←	für Fahrzeuge mit verstärktem Fahrwerk		13.0460-2834.2 602834	TRW 21463 18,0 + WK
			←			13.0460-2895.2 602895	TRW 23172 18,0 - WK
			←	für Fahrzeuge ohne verstärktes Fahrwerk		13.0460-2895.2 602895	TRW 23172 18,0 - WK
			→	+ ASR		13.0460-3954.2 603954	BDX 20973 11,0 - WK
1.8 16V (BA06, BA12, BA1A, BA1M, BA1R)	85	01/01→08/03	←	→ 12/02		13.0460-2895.2 602895	TRW 23172 18,0 - WK
			→	→ 12/02		13.0460-3954.2 603954	BDX 20973 11,0 - WK
			→	→ 12/02; + ASR		13.0460-3954.2 603954	BDX 20973 11,0 - WK
1.9 D	69	04/96→02/01	←	09/96→		13.0460-2834.2 602834	TRW 21463 18,0 + WK
1.9 DCi	77	03/99→08/03	←	→ 12/02		13.0460-2895.2 602895	TRW 23172 18,0 - WK
1.9 dTi (BA1U)	59	02/01→08/03					
1.9 dCi (BA05, BA1F)	75	02/01→08/03	←	→ 12/02		13.0460-2895.2 602895	TRW 23172 18,0 - WK
			→	→ 12/02; + ASR		13.0460-3954.2 603954	BDX 20973 11,0 - WK
1.9 D Eco (B/SA0U, BA0A)	47	01/96→08/03	←	→ 12/02		13.0460-2834.2 602834	TRW 21463 18,0 + WK
			←	06/98→ 12/02		13.0460-2834.2 602834	TRW 21463 18,0 + WK
1.9 dTi (BA08, BA0N)	72	03/97→02/01	←			13.0460-2834.2 602834	TRW 21463 18,0 + WK
			←	→ 03/99		13.0460-2834.2 602834	TRW 21463 18,0 + WK
			←	04/99→		13.0460-2895.2 602895	TRW 23172 18,0 - WK
2.0 16V (BA0H)	108	07/96→08/03	←	→ 12/02		13.0460-2983.2 602983	TRW 20919 18,0 + WK
			→	→ 12/02		13.0460-3954.2 603954	BDX 20973 11,0 - WK
Zubehörsatz, Scheibenbremsbelag							
1.4 16V (BA0D, BA1H, BA0W, BA10)	70	03/99→08/03	→	→ 12/02; + ASR		13.0460-0435.2 610435	BDX
1.6 16V	81	11/01→12/04	←	→ 12/02		13.0460-0262.2 610262	TRW
1.6 16V (BA11, BA04, BA0B, BA1J)	79	03/99→08/03	←	→ 12/02; für Fahrzeuge ohne verstärktes Fahrwerk		13.0460-0262.2 610262	TRW
			→	→ 12/02; + ASR		13.0460-0435.2 610435	BDX
1.6 LPG	80	10/00→08/02	←			13.0460-0262.2 610262	TRW
			←	für Fahrzeuge ohne verstärktes Fahrwerk		13.0460-0262.2 610262	TRW
			→	+ ASR		13.0460-0435.2 610435	BDX
1.8 16V (BA06, BA12, BA1A, BA1M, BA1R)	85	01/01→08/03	←	→ 12/02		13.0460-0262.2 610262	TRW
			→	→ 12/02		13.0460-0435.2 610435	BDX
			→	→ 12/02; + ASR		13.0460-0435.2 610435	BDX
1.9 DCi	77	03/99→08/03	←	→ 12/02		13.0460-0262.2 610262	TRW
1.9 dTi (BA1U)	59	02/01→08/03					
1.9 dCi (BA05, BA1F)	75	02/01→08/03	←	→ 12/02		13.0460-0262.2 610262	TRW
			→	→ 12/02; + ASR		13.0460-0435.2 610435	BDX
1.9 dTi (BA08, BA0N)	72	03/97→02/01	←	04/99→		13.0460-0262.2 610262	TRW
2.0 16V (BA0H)	108	07/96→08/03	→	→ 12/02		13.0460-0435.2 610435	BDX
↓							







	kw				! #		
RENAULT - MEGANE I (BA0/1_) 08/95→12/04							
Bremsscheibe							
1.4 16V (BA0D, BA1H, BA0W, BA10)	70	03/99→08/03	←	→ 12/02		24.0121-0106.1 421106	Ø 259 20,7 17,7 V + S
			→	→ 12/02; + ASR		24.0108-0108.1 408108	Ø 238 8 7 - ABS Ring
1.4 e (BA0E, BA0V)	55	01/96→08/03	←	→ 10/97		24.0112-0116.1 412116	Ø 238 12 10,5 + S
			←	11/97→ 09/98		24.0120-0125.1 420125	Ø 238 20,1 17,7 V + S
			←	06/98→ 12/02		24.0121-0106.1 421106	Ø 259 20,7 17,7 V + S
			←	10/98→ 12/02		24.0121-0106.1 421106	Ø 259 20,7 17,7 V + S
1.4 Eco (BA0T)	52	01/96→03/99	←	→ 10/97		24.0112-0116.1 412116	Ø 238 12 10,5 + S
			←	11/97→		24.0120-0125.1 420125	Ø 238 20,1 17,7 V + S
1.6 16V (BA11, BA04, BA0B, BA1J) 1.9 dCi (BA05, BA1F)	81	11/01→12/04	←	→ 12/02		24.0124-0158.1 424158	Ø 280 24 21,8 V + S
	79	03/99→08/03				24.0324-0158.1 524158	Ø 280 24 21,8 V + S PD
	75	02/01→08/03	→	→ 12/02; + ASR		24.0108-0108.1 408108	Ø 238 8 7 - ABS Ring
1.6 e (BA0F, BA0S)	66	01/96→03/99	←	→ 09/98		24.0120-0125.1 420125	Ø 238 20,1 17,7 V + S
			←	10/98→		24.0121-0106.1 421106	Ø 259 20,7 17,7 V + S
1.6 i (BA0L)	55	01/96→03/99	←	→ 10/97		24.0112-0116.1 412116	Ø 238 12 10,5 + S
			←	11/97→ 09/98		24.0120-0125.1 420125	Ø 238 20,1 17,7 V + S
			←	10/98→		24.0121-0106.1 421106	Ø 259 20,7 17,7 V + S
1.6 LPG	66	08/95→03/99	←	01/96→ 09/98		24.0120-0125.1 420125	Ø 238 20,1 17,7 V + S
			←	10/98→		24.0121-0106.1 421106	Ø 259 20,7 17,7 V + S
1.6 LPG	80	10/00→08/02	←			24.0124-0158.1 424158	Ø 280 24 21,8 V + S
						24.0324-0158.1 524158	Ø 280 24 21,8 V + S PD
			→	+ ASR		24.0108-0108.1 408108	Ø 238 8 7 - ABS Ring
1.8 16V (BA06, BA12, BA1A, BA1M, BA1R)	85	01/01→08/03	←	→ 12/02		24.0124-0158.1 424158	Ø 280 24 21,8 V + S
						24.0324-0158.1 524158	Ø 280 24 21,8 V + S PD
			→	→ 12/02		24.0108-0108.1 408108	Ø 238 8 7 - ABS Ring
1.9 D	69	04/96→02/01	←	09/96→		24.0121-0106.1 421106	Ø 259 20,7 17,7 V + S
1.9 DCi 1.9 dTi (BA1U)	77	03/99→08/03	←	→ 12/02		24.0124-0158.1 424158	Ø 280 24 21,8 V + S
	59	02/01→08/03				24.0324-0158.1 524158	Ø 280 24 21,8 V + S PD
1.9 D Eco (B/SA0U, BA0A)	47	01/96→08/03	←	→ 10/97		24.0112-0116.1 412116	Ø 238 12 10,5 + S
			←	11/97→ 09/98		24.0120-0125.1 420125	Ø 238 20,1 17,7 V + S
			←	11/97→ 12/02		24.0120-0125.1 420125	Ø 238 20,1 17,7 V + S
			←	06/98→ 12/02		24.0121-0106.1 421106	Ø 259 20,7 17,7 V + S
			←	→ 12/02		24.0121-0106.1 421106	Ø 259 20,7 17,7 V + S
			←	10/98→ 12/02		24.0121-0106.1 421106	Ø 259 20,7 17,7 V + S
1.9 dT 2.0	76	08/98→10/99	←			24.0121-0106.1 421106	Ø 259 20,7 17,7 V + S
	85	05/98→05/01					
1.9 dT (B/SA0K, B/SA0Y) 1.9 TDI 2.0 i 2.0 i (BA0G)	66	01/96→08/03	←	→ 12/02		24.0121-0106.1 421106	Ø 259 20,7 17,7 V + S
	69	09/96→08/03					
	80	03/99→08/03					
	84	01/96→08/03					
1.9 dTi (BA08, BA0N)	72	03/97→02/01	←			24.0121-0106.1 421106	Ø 259 20,7 17,7 V + S
			←	→ 02/99		24.0121-0106.1 421106	Ø 259 20,7 17,7 V + S
			←	03/99→		24.0124-0158.1 424158	Ø 280 24 21,8 V + S
2.0 16V (BA0H)	108	07/96→08/03	←	→ 09/98		24.0122-0148.1 422148	Ø 262 22 19,8 V + S
			←	10/98→ 12/02		24.0124-0158.1 424158	Ø 280 24 21,8 V + S
						24.0324-0158.1 524158	Ø 280 24 21,8 V + S PD
			→	→ 12/02		24.0108-0108.1 408108	Ø 238 8 7 - ABS Ring
RENAULT - MEGANE I Cabriolet (EA0/1_) 10/96→08/03							
Bremsbelagsatz, Scheibenbremse							
1.4 16V (EA0D, EA1H, EA0W, EA10)	70	03/99→08/03	←			13.0460-2834.2 602834	TRW 21463 18,0 + WK
			←	10/00→		13.0460-2895.2 602895	TRW 23172 18,0 - WK
			→	10/00→; + ASR		13.0460-3954.2 603954	BDX 20973 11,0 - WK
1.6 16V (EA0B, EA04, EA11)	79	03/99→08/03	←			13.0460-2895.2 602895	TRW 23172 18,0 - WK
			→	10/00→; + ASR		13.0460-3954.2 603954	BDX 20973 11,0 - WK
↓							







	kw			 	! #		
RENAULT - MEGANE I Cabriolet (EA0/1_) 10/96→08/03							
 Bremsbelagsatz, Scheibenbremse							
1.6 e (EA0F) 2.0 (EA0G) 2.0 i (EA0G)	66 84 80	10/96→03/99 04/97→08/03 03/99→08/03	←			13.0460-2834.2 602834	TRW 21463 18,0 + WK
2.0 16V	102	01/02→08/03	←			13.0460-2895.2 602895	TRW 23172 18,0 - WK
			→			13.0460-3954.2 603954	BDX 20973 11,0 - WK
2.0 16V (EA0H)	108	10/96→11/99	←			13.0460-2983.2 602983	TRW 20919 18,0 + WK
			→			13.0460-3954.2 603954	BDX 20973 11,0 - WK
2.0 16V IDE (EA03, EA0P, EA14)	103	11/99→08/03	←			13.0460-2895.2 602895	TRW 23172 18,0 - WK
			←	10/00→		13.0460-2895.2 602895	TRW 23172 18,0 - WK
			→			13.0460-3954.2 603954	BDX 20973 11,0 - WK
			→	10/00→		13.0460-3954.2 603954	BDX 20973 11,0 - WK
Zubehörsatz, Scheibenbremsbelag							
1.4 16V (EA0D, EA1H, EA0W, EA10)	70	03/99→08/03	←	10/00→		13.0460-0262.2 610262	TRW
			→	10/00→; + ASR		13.0460-0435.2 610435	BDX
1.6 16V (EA0B, EA04, EA11)	79	03/99→08/03	←			13.0460-0262.2 610262	TRW
			→	10/00→; + ASR		13.0460-0435.2 610435	BDX
2.0 16V	102	01/02→08/03	←			13.0460-0262.2 610262	TRW
			→			13.0460-0435.2 610435	BDX
2.0 16V (EA0H)	108	10/96→11/99	→			13.0460-0435.2 610435	BDX
2.0 16V IDE (EA03, EA0P, EA14)	103	11/99→08/03	←			13.0460-0262.2 610262	TRW
			←	10/00→		13.0460-0262.2 610262	TRW
			→			13.0460-0435.2 610435	BDX
			→	10/00→		13.0460-0435.2 610435	BDX
 Bremsscheibe							
1.4 16V (EA0D, EA1H, EA0W, EA10)	70	03/99→08/03	←			24.0121-0106.1 421106	Ø 259 20,7 17,7 V + S
			←	10/00→		24.0121-0106.1 421106	Ø 259 20,7 17,7 V + S
			→	10/00→; + ASR		24.0108-0108.1 408108	Ø 238 8 7 - ABS Ring
1.6 16V (EA0B, EA04, EA11)	79	03/99→08/03	←			24.0124-0158.1 424158	Ø 280 24 21,8 V + S
			→	10/00→; + ASR		24.0324-0158.1 524158	Ø 280 24 21,8 V + S PD
			→	10/00→; + ASR		24.0108-0108.1 408108	Ø 238 8 7 - ABS Ring
1.6 e (EA0F)	66	10/96→03/99	←	→ 10/97		24.0120-0125.1 420125	Ø 238 20,1 17,7 V + S
			←	11/97→		24.0121-0106.1 421106	Ø 259 20,7 17,7 V + S
2.0 (EA0G) 2.0 i (EA0G)	84 80	04/97→08/03 03/99→08/03	←			24.0121-0106.1 421106	Ø 259 20,7 17,7 V + S
2.0 16V	102	01/02→08/03	←			24.0124-0158.1 424158	Ø 280 24 21,8 V + S
			→			24.0324-0158.1 524158	Ø 280 24 21,8 V + S PD
			→			24.0108-0108.1 408108	Ø 238 8 7 - ABS Ring
2.0 16V (EA0H)	108	10/96→11/99	←	→ 08/98; für Linkslenker		24.0122-0148.1 422148	Ø 262 22 19,8 V + S
			←	für Rechtslenker		24.0124-0158.1 424158	Ø 280 24 21,8 V + S
			→			24.0324-0158.1 524158	Ø 280 24 21,8 V + S PD
			←	09/98→; für Linkslenker		24.0124-0158.1 424158	Ø 280 24 21,8 V + S
			→			24.0324-0158.1 524158	Ø 280 24 21,8 V + S PD
			→			24.0108-0108.1 408108	Ø 238 8 7 - ABS Ring
2.0 16V IDE (EA03, EA0P, EA14)	103	11/99→08/03	←	10/00→		24.0124-0158.1 424158	Ø 280 24 21,8 V + S
			←			24.0324-0158.1 524158	Ø 280 24 21,8 V + S PD
			←			24.0124-0158.1 424158	Ø 280 24 21,8 V + S
			→			24.0324-0158.1 524158	Ø 280 24 21,8 V + S PD
			→			24.0108-0108.1 408108	Ø 238 8 7 - ABS Ring
			→	10/00→		24.0108-0108.1 408108	Ø 238 8 7 - ABS Ring
RENAULT - MEGANE I Classic (LA0/1_) 09/96→08/08							
 Bremsbelagsatz, Scheibenbremse							
1.4 (LA0E, LA0V)	55	09/96→08/03	←	04/98→ 12/02		13.0460-2834.2 602834	TRW 21463 18,0 + WK
			←	→ 12/02		13.0460-2834.2 602834	TRW 21463 18,0 + WK
1.4 16V (LA0D, LA1H, IA0W, LA10)	70	03/99→08/03	←	→ 12/02		13.0460-2834.2 602834	TRW 21463 18,0 + WK
			→			13.0460-2895.2 602895	TRW 23172 18,0 - WK
↓							

	kw			 	! #		
RENAULT - MEGANE I Classic (LA0/1) 09/96→08/08							
 Bremsbelagsatz, Scheibenbremse							
1.4 16V (LA0D, LA1H, IA0W, LA10)	70	03/99→08/03	➔	→ 12/02; + ASR		13.0460-3954.2 603954	BDX 20973 11,0 - WK
1.6 1.6 e (LA0F, LA0S) 1.6 i (LA0L) 1.9 dT 2.0 RT	64 66 55 76 112	02/00→09/00 09/96→03/99 09/96→03/99 08/98→10/99 10/96→02/99	➔			13.0460-2834.2 602834	TRW 21463 18,0 + WK
1.6 16V	81	09/99→12/01	➔			13.0460-2834.2 602834	TRW 21463 18,0 + WK
			➔	für Fahrzeuge mit verstärktem Fahrwerk		13.0460-2895.2 602895	TRW 23172 18,0 - WK
			➔	für Fahrzeuge ohne verstärktes Fahrwerk		13.0460-2895.2 602895	TRW 23172 18,0 - WK
			➔			13.0460-3954.2 603954	BDX 20973 11,0 - WK
1.6 16V (La04, LA11, LA0B, LA1C, LA1J)	79	03/99→08/03	➔	→ 12/02; für Fahrzeuge mit verstärktem Fahrwerk		13.0460-2834.2 602834	TRW 21463 18,0 + WK
			➔	09/99→ 12/02		13.0460-2834.2 602834	TRW 21463 18,0 + WK
			➔	→ 12/02		13.0460-2895.2 602895	TRW 23172 18,0 - WK
			➔	→ 12/02; für Fahrzeuge ohne verstärktes Fahrwerk		13.0460-2895.2 602895	TRW 23172 18,0 - WK
			➔	→ 12/02		13.0460-3954.2 603954	BDX 20973 11,0 - WK
1.8 16V (LA06, LA12, LA1A, LA1M, LA1R)	85	01/01→08/03	➔	→ 12/02		13.0460-2895.2 602895	TRW 23172 18,0 - WK
			➔	→ 12/02		13.0460-3954.2 603954	BDX 20973 11,0 - WK
			➔	→ 12/02; + ASR		13.0460-3954.2 603954	BDX 20973 11,0 - WK
1.9 D (LA0A, LA0U)	47	09/96→08/03	➔	→ 12/02		13.0460-2834.2 602834	TRW 21463 18,0 + WK
			➔	09/98→ 12/02		13.0460-2834.2 602834	TRW 21463 18,0 + WK
1.9 dCi	77	03/99→09/00	➔			13.0460-2895.2 602895	TRW 23172 18,0 - WK
1.9 dCi (LA05, LA1F)	75	02/01→08/03	➔	→ 12/02		13.0460-2895.2 602895	TRW 23172 18,0 - WK
			➔	→ 12/02		13.0460-3954.2 603954	BDX 20973 11,0 - WK
1.9 dT (LA0K, LA0Y) 1.9 TDI	66 69	09/96→08/03 09/96→08/03	➔	→ 12/02		13.0460-2834.2 602834	TRW 21463 18,0 + WK
1.9 dTi (LA08, LA0N)	72	03/97→02/01	➔			13.0460-2834.2 602834	TRW 21463 18,0 + WK
			➔	→ 02/99		13.0460-2834.2 602834	TRW 21463 18,0 + WK
			➔			13.0460-2983.2 602983	TRW 20919 18,0 + WK
			➔	03/99→		13.0460-2895.2 602895	TRW 23172 18,0 - WK
1.9 dTi (LA1U)	59	02/01→08/03	➔	→ 12/02		13.0460-2834.2 602834	TRW 21463 18,0 + WK
			➔			13.0460-2895.2 602895	TRW 23172 18,0 - WK
2.0 i (LA07, LA0G)	84	09/96→08/03	➔	→ 12/02		13.0460-2834.2 602834	TRW 21463 18,0 + WK
			➔	→ 02/99		13.0460-2834.2 602834	TRW 21463 18,0 + WK
			➔	03/99→ 12/02		13.0460-2895.2 602895	TRW 23172 18,0 - WK
2.0 i (LA0G)	80	03/99→08/03	➔	→ 12/02		13.0460-2895.2 602895	TRW 23172 18,0 - WK
2.0 RT	103	03/01→08/03	➔	→ 02/03		13.0460-2895.2 602895	TRW 23172 18,0 - WK
			➔	→ 02/03		13.0460-3954.2 603954	BDX 20973 11,0 - WK
Zubehörsatz, Scheibenbremsbelag							
1.4 16V (LA0D, LA1H, IA0W, LA10)	70	03/99→08/03	➔	→ 12/02		13.0460-0262.2 610262	TRW
			➔	→ 12/02; + ASR		13.0460-0435.2 610435	BDX
1.6 16V	81	09/99→12/01	➔			13.0460-0262.2 610262	TRW
			➔	für Fahrzeuge ohne verstärktes Fahrwerk		13.0460-0262.2 610262	TRW
			➔			13.0460-0435.2 610435	BDX
1.6 16V (La04, LA11, LA0B, LA1C, LA1J)	79	03/99→08/03	➔	→ 12/02		13.0460-0262.2 610262	TRW
			➔	→ 12/02; für Fahrzeuge ohne verstärktes Fahrwerk		13.0460-0262.2 610262	TRW
			➔	→ 12/02		13.0460-0435.2 610435	BDX
1.8 16V (LA06, LA12, LA1A, LA1M, LA1R)	85	01/01→08/03	➔	→ 12/02		13.0460-0262.2 610262	TRW
			➔	→ 12/02		13.0460-0435.2 610435	BDX
			➔	→ 12/02; + ASR		13.0460-0435.2 610435	BDX
1.9 dCi	77	03/99→09/00	➔			13.0460-0262.2 610262	TRW
1.9 dCi (LA05, LA1F)	75	02/01→08/03	➔	→ 12/02		13.0460-0262.2 610262	TRW
			➔	→ 12/02		13.0460-0435.2 610435	BDX
1.9 dTi (LA08, LA0N)	72	03/97→02/01	➔	03/99→		13.0460-0262.2 610262	TRW
↓							







	kw			 	! #		
RENAULT - MEGANE I Classic (LA0/1) 09/96→08/08							
Zubehörsatz, Scheibenbremsbelag							
1.9 dTi (LA1U) 2.0 i (LA0G)	59 80	02/01→08/03 03/99→08/03	← → 12/02			13.0460-0262.2 610262	TRW
2.0 i (LA07, LA0G)	84	09/96→08/03	← 03/99→ 12/02			13.0460-0262.2 610262	TRW
2.0 RT	103	03/01→08/03	← → 02/03			13.0460-0262.2 610262	TRW
			→ 02/03			13.0460-0435.2 610435	BDX
 Bremsscheibe							
1.4 (LA0E, LA0V)	55	09/96→08/03	← → 10/97			24.0112-0116.1 412116	∅ 238 12 10,5 + S
			← 11/97→ 09/98			24.0120-0125.1 420125	∅ 238 20,1 17,7 V + S
			← 04/98→ 12/02			24.0121-0106.1 421106	∅ 259 20,7 17,7 V + S
			← 10/98→ 12/02			24.0121-0106.1 421106	∅ 259 20,7 17,7 V + S
1.4 16V (LA0D, LA1H, IA0W, LA10)	70	03/99→08/03	← → 12/02			24.0121-0106.1 421106	∅ 259 20,7 17,7 V + S
			→ 12/02; + ASR			24.0108-0108.1 408108	∅ 238 8 7 - ABS Ring
1.6 1.9 dT 2.0 RT	64 76 112	02/00→09/00 08/98→10/99 10/96→02/99	←			24.0121-0106.1 421106	∅ 259 20,7 17,7 V + S
			←			24.0124-0158.1 424158	∅ 280 24 21,8 V + S
			←			24.0324-0158.1 524158	∅ 280 24 21,8 V + S PD
1.6 16V	81	09/99→12/01	←			24.0108-0108.1 408108	∅ 238 8 7 - ABS Ring
1.6 16V (La04, LA11, LA0B, LA1C, LA1J)	79	03/99→08/03	← 09/99→ 12/02			24.0121-0106.1 421106	∅ 259 20,7 17,7 V + S
			← → 12/02			24.0124-0158.1 424158	∅ 280 24 21,8 V + S
			←			24.0324-0158.1 524158	∅ 280 24 21,8 V + S PD
			→ 12/02			24.0108-0108.1 408108	∅ 238 8 7 - ABS Ring
1.6 e (LA0F, LA0S)	66	09/96→03/99	← → 10/97			24.0120-0125.1 420125	∅ 238 20,1 17,7 V + S
			← 11/97→			24.0121-0106.1 421106	∅ 259 20,7 17,7 V + S
1.6 i (LA0L)	55	09/96→03/99	← → 10/97			24.0112-0116.1 412116	∅ 238 12 10,5 + S
			← 11/97→ 09/98			24.0120-0125.1 420125	∅ 238 20,1 17,7 V + S
			← 10/98→			24.0121-0106.1 421106	∅ 259 20,7 17,7 V + S
1.8 16V (LA06, LA12, LA1A, LA1M, LA1R)	85	01/01→08/03	← → 12/02			24.0124-0158.1 424158	∅ 280 24 21,8 V + S
			←			24.0324-0158.1 524158	∅ 280 24 21,8 V + S PD
			→ 12/02			24.0108-0108.1 408108	∅ 238 8 7 - ABS Ring
			→ 12/02; + ASR			24.0108-0108.1 408108	∅ 238 8 7 - ABS Ring
1.9 D (LA0A, LA0U)	47	09/96→08/03	← → 10/97			24.0112-0116.1 412116	∅ 238 12 10,5 + S
			← 11/97→ 12/02			24.0120-0125.1 420125	∅ 238 20,1 17,7 V + S
			← 11/97→ 09/98			24.0120-0125.1 420125	∅ 238 20,1 17,7 V + S
			← 09/98→ 12/02			24.0121-0106.1 421106	∅ 259 20,7 17,7 V + S
			← 10/98→ 12/02			24.0121-0106.1 421106	∅ 259 20,7 17,7 V + S
1.9 dCi	77	03/99→09/00	←			24.0124-0158.1 424158	∅ 280 24 21,8 V + S
						24.0324-0158.1 524158	∅ 280 24 21,8 V + S PD
1.9 dCi (LA05, LA1F)	75	02/01→08/03	← → 12/02			24.0124-0158.1 424158	∅ 280 24 21,8 V + S
			←			24.0324-0158.1 524158	∅ 280 24 21,8 V + S PD
			→ 12/02			24.0108-0108.1 408108	∅ 238 8 7 - ABS Ring
1.9 dT (LA0K, LA0Y) 1.9 TDI	66 69	09/96→08/03 09/96→08/03	← → 12/02			24.0121-0106.1 421106	∅ 259 20,7 17,7 V + S
			←				
1.9 dTi (LA08, LA0N)	72	03/97→02/01	←			24.0121-0106.1 421106	∅ 259 20,7 17,7 V + S
			← → 02/99			24.0121-0106.1 421106	∅ 259 20,7 17,7 V + S
			← 03/99→			24.0124-0158.1 424158	∅ 280 24 21,8 V + S
						24.0324-0158.1 524158	∅ 280 24 21,8 V + S PD
1.9 dTi (LA1U) 2.0 i (LA0G)	59 80	02/01→08/03 03/99→08/03	← → 12/02			24.0124-0158.1 424158	∅ 280 24 21,8 V + S
			←			24.0324-0158.1 524158	∅ 280 24 21,8 V + S PD
2.0 i (LA07, LA0G)	84	09/96→08/03	← → 12/02			24.0121-0106.1 421106	∅ 259 20,7 17,7 V + S
			← → 02/99			24.0121-0106.1 421106	∅ 259 20,7 17,7 V + S
			← 03/99→ 12/02			24.0124-0158.1 424158	∅ 280 24 21,8 V + S
						24.0324-0158.1 524158	∅ 280 24 21,8 V + S PD
2.0 RT	103	03/01→08/03	← → 02/03			24.0124-0158.1 424158	∅ 280 24 21,8 V + S
			←			24.0324-0158.1 524158	∅ 280 24 21,8 V + S PD
			→ 02/03			24.0108-0108.1 408108	∅ 238 8 7 - ABS Ring











	kW			 	! #		
RENAULT - MEGANE I Coach (DA0/1_) 03/96→08/03							
 Bremsbelagsatz, Scheibenbremse							
1.4 16V (DA0D, DA1H, DA0W, DA10)	70	03/99→08/03	←	→ 02/03		13.0460-2834.2 602834	TRW 21463 18,0 + WK
			←	10/00→ 02/03		13.0460-2895.2 602895	TRW 23172 18,0 - WK
			→	10/00→ 02/03; + ASR		13.0460-3954.2 603954	BDX 20973 11,0 - WK
1.6 16V (DA0B, DA04, DA11)	79	03/99→08/03	←	→ 02/03		13.0460-2895.2 602895	TRW 23172 18,0 - WK
			←	→ 04/99		13.0460-2983.2 602983	TRW 20919 18,0 + WK
			→	10/00→ 02/03; + ASR		13.0460-3954.2 603954	BDX 20973 11,0 - WK
1.6 e (DA0F)	66	03/96→03/99	←			13.0460-2834.2 602834	TRW 21463 18,0 + WK
1.9 dCi (DA05, DA1F)	75	02/01→08/03	←	→ 02/03		13.0460-2895.2 602895	TRW 23172 18,0 - WK
			→	→ 02/03; + ASR		13.0460-3954.2 603954	BDX 20973 11,0 - WK
1.9 dTi (DA0N)	72	03/97→02/01	←	05/97→ 02/99		13.0460-2834.2 602834	TRW 21463 18,0 + WK
			←	03/99→		13.0460-2895.2 602895	TRW 23172 18,0 - WK
			←	03/99→ 04/99		13.0460-2983.2 602983	TRW 20919 18,0 + WK
2.0 16V	102	01/02→08/03	←	→ 02/03		13.0460-2895.2 602895	TRW 23172 18,0 - WK
			→	→ 02/03		13.0460-3954.2 603954	BDX 20973 11,0 - WK
2.0 16V (DA0H)	108	03/96→11/99	←	09/98→		13.0460-2895.2 602895	TRW 23172 18,0 - WK
			←	→ 08/98		13.0460-2983.2 602983	TRW 20919 18,0 + WK
			→			13.0460-3954.2 603954	BDX 20973 11,0 - WK
2.0 16V IDE (DA03, DA0P, DA14)	103	11/99→08/03	←	→ 02/03		13.0460-2895.2 602895	TRW 23172 18,0 - WK
			←	10/00→ 02/03		13.0460-2895.2 602895	TRW 23172 18,0 - WK
			→	10/00→ 02/03		13.0460-3954.2 603954	BDX 20973 11,0 - WK
			→	→ 02/03		13.0460-3954.2 603954	BDX 20973 11,0 - WK
2.0 i	80	03/99→08/03	←	→ 02/03		13.0460-2834.2 602834	TRW 21463 18,0 + WK
2.0 i (DA0G)	84	03/96→08/03					
Zubehörsatz, Scheibenbremsbelag							
1.4 16V (DA0D, DA1H, DA0W, DA10)	70	03/99→08/03	←	10/00→ 02/03		13.0460-0262.2 610262	TRW
			→	10/00→ 02/03; + ASR		13.0460-0435.2 610435	BDX
1.6 16V (DA0B, DA04, DA11)	79	03/99→08/03	←	→ 02/03		13.0460-0262.2 610262	TRW
			→	10/00→ 02/03; + ASR		13.0460-0435.2 610435	BDX
1.9 dCi (DA05, DA1F)	75	02/01→08/03	←	→ 02/03		13.0460-0262.2 610262	TRW
			→	→ 02/03; + ASR		13.0460-0435.2 610435	BDX
1.9 dTi (DA0N)	72	03/97→02/01	←	03/99→		13.0460-0262.2 610262	TRW
2.0 16V	102	01/02→08/03	←	→ 02/03		13.0460-0262.2 610262	TRW
			→	→ 02/03		13.0460-0435.2 610435	BDX
2.0 16V (DA0H)	108	03/96→11/99	←	09/98→		13.0460-0262.2 610262	TRW
			→			13.0460-0435.2 610435	BDX
2.0 16V IDE (DA03, DA0P, DA14)	103	11/99→08/03	←	→ 02/03		13.0460-0262.2 610262	TRW
			←	10/00→ 02/03		13.0460-0262.2 610262	TRW
			→	10/00→ 02/03		13.0460-0435.2 610435	BDX
			→	→ 02/03		13.0460-0435.2 610435	BDX
 Bremsscheibe							
1.4 16V (DA0D, DA1H, DA0W, DA10)	70	03/99→08/03	←	→ 02/03		24.0121-0106.1 421106	∅ 259 20,7 17,7 V + S
			←	10/00→ 02/03		24.0121-0106.1 421106	∅ 259 20,7 17,7 V + S
			→	10/00→ 02/03; + ASR		24.0108-0108.1 408108	∅ 238 8 7 - ABS Ring
1.6 16V (DA0B, DA04, DA11)	79	03/99→08/03	←	→ 02/03		24.0124-0158.1 424158	∅ 280 24 21,8 V + S
			→	10/00→ 02/03; + ASR		24.0324-0158.1 524158	∅ 280 24 21,8 V + S PD
			→			24.0108-0108.1 408108	∅ 238 8 7 - ABS Ring
1.6 e (DA0F)	66	03/96→03/99	←	→ 10/97		24.0120-0125.1 420125	∅ 238 20,1 17,7 V + S
			←	11/97→		24.0121-0106.1 421106	∅ 259 20,7 17,7 V + S
1.9 dCi (DA05, DA1F)	75	02/01→08/03	←	→ 02/03		24.0124-0158.1 424158	∅ 280 24 21,8 V + S
			→	→ 02/03; + ASR		24.0324-0158.1 524158	∅ 280 24 21,8 V + S PD
			→			24.0108-0108.1 408108	∅ 238 8 7 - ABS Ring
1.9 dTi (DA0N)	72	03/97→02/01	←	05/97→ 02/99		24.0121-0106.1 421106	∅ 259 20,7 17,7 V + S
			←	03/99→		24.0124-0158.1 424158	∅ 280 24 21,8 V + S
↓							







	kW					! #		
RENAULT - MEGANE I Coach (DA0/1_) 03/96→08/03								
Bremsscheibe								
1.9 dTi (DA0N)	72	03/97→02/01	←	03/99→		24.0324-0158.1	524158	Ø 280 24 21,8 V + S PD
2.0 16V	102	01/02→08/03	←	→ 02/03		24.0124-0158.1	424158	Ø 280 24 21,8 V + S
			→	→ 02/03		24.0324-0158.1	524158	Ø 280 24 21,8 V + S PD
2.0 16V (DA0H)	108	03/96→11/99	←	→ 08/98; für Linkslenker		24.0122-0148.1	422148	Ø 262 22 19,8 V + S
			←	für Rechtslenker		24.0124-0158.1	424158	Ø 280 24 21,8 V + S
			←	09/98→; für Linkslenker		24.0324-0158.1	524158	Ø 280 24 21,8 V + S PD
			←			24.0124-0158.1	424158	Ø 280 24 21,8 V + S
			→			24.0324-0158.1	524158	Ø 280 24 21,8 V + S PD
2.0 16V IDE (DA03, DA0P, DA14)	103	11/99→08/03	←	10/00→ 02/03		24.0124-0158.1	424158	Ø 280 24 21,8 V + S
			←	→ 02/03		24.0324-0158.1	524158	Ø 280 24 21,8 V + S PD
			←			24.0124-0158.1	424158	Ø 280 24 21,8 V + S
			→	10/00→ 02/03		24.0324-0158.1	524158	Ø 280 24 21,8 V + S PD
			→	→ 02/03		24.0108-0108.1	408108	Ø 238 8 7 - ABS Ring
2.0 i	80	03/99→08/03	←	→ 02/03		24.0121-0106.1	421106	Ø 259 20,7 17,7 V + S
2.0 i (DA0G)	84	03/96→08/03	←					
RENAULT - MEGANE I Grandtour (KA0/1_) 03/99→08/03								
Bremsbelagsatz, Scheibenbremse								
1.4 16V (KA0D, KA1H, KA0W, KA10)	70	03/99→08/03	←			13.0460-2834.2	602834	TRW 21463 18,0 + WK
			→			13.0460-2845.2	602845	TRW 23554 16,4 - WK + Zub
			→			13.0470-2845.2	LD2845	TRW 23554 16,4 - WK + Zub Ceramic
1.4 e (KA0V) 1.6 e (KA0F) 1.9 D (KA0J, KA0R)	55	03/99→08/03	←			13.0460-2834.2	602834	TRW 21463 18,0 + WK
	66	03/99→08/03	←					
	47	04/99→08/03	←					
1.6 16V (KA0B, KA04, KA11)	79	03/99→08/03	←			13.0460-2895.2	602895	TRW 23172 18,0 - WK
			→	07/99→		13.0460-2845.2	602845	TRW 23554 16,4 - WK + Zub
			→			13.0470-2845.2	LD2845	TRW 23554 16,4 - WK + Zub Ceramic
1.6 Bifuel	80	03/99→09/00	←			13.0460-2895.2	602895	TRW 23172 18,0 - WK
1.8 16V (KA0S, KA12, KA1A, KA1M, KA1R) 1.9 dCi (KA05, KA1F) 1.9 dTi (KA1U)	85	01/01→08/03	←			13.0460-2895.2	602895	TRW 23172 18,0 - WK
	75	02/01→08/03	→			13.0460-2845.2	602845	TRW 23554 16,4 - WK + Zub
	59	02/01→08/03	→			13.0470-2845.2	LD2845	TRW 23554 16,4 - WK + Zub Ceramic
1.9 dTi (KA0N)	72	03/99→02/01	←			13.0460-2983.2	602983	TRW 20919 18,0 + WK
			→	07/99→		13.0460-2845.2	602845	TRW 23554 16,4 - WK + Zub
			→			13.0470-2845.2	LD2845	TRW 23554 16,4 - WK + Zub Ceramic
Zubehörsatz, Scheibenbremsbelag								
1.4 16V (KA0D, KA1H, KA0W, KA10)	70	03/99→08/03	→			13.0460-0072.2	610072	TRW
1.6 16V (KA0B, KA04, KA11)	79	03/99→08/03	←			13.0460-0262.2	610262	TRW
			→	07/99→		13.0460-0072.2	610072	TRW
1.6 Bifuel	80	03/99→09/00	←			13.0460-0262.2	610262	TRW
1.8 16V (KA0S, KA12, KA1A, KA1M, KA1R) 1.9 dCi (KA05, KA1F) 1.9 dTi (KA1U)	85	01/01→08/03	←			13.0460-0262.2	610262	TRW
	75	02/01→08/03	→			13.0460-0072.2	610072	TRW
	59	02/01→08/03	→					
1.9 dTi (KA0N)	72	03/99→02/01	→	07/99→		13.0460-0072.2	610072	TRW
Bremsscheibe								
1.4 16V (KA0D, KA1H, KA0W, KA10)	70	03/99→08/03	←			24.0121-0106.1	421106	Ø 259 20,7 17,7 V + S
			→			24.0111-0166.2	411166	Ø 274 10,9 9,5 + LG / + ABS Ring
1.4 e (KA0V) 1.6 e (KA0F) 1.9 D (KA0J, KA0R)	55	03/99→08/03	←			24.0121-0106.1	421106	Ø 259 20,7 17,7 V + S
	66	03/99→08/03	←					
	47	04/99→08/03	←					
1.6 16V (KA0B, KA04, KA11)	79	03/99→08/03	←			24.0124-0158.1	424158	Ø 280 24 21,8 V + S
1.9 dTi (KA0N)	72	03/99→02/01	←			24.0324-0158.1	524158	Ø 280 24 21,8 V + S PD
↓								



















	kw					! #		
RENAULT - MEGANE I Grandtour (KA0/1_) 03/99→08/03								
Bremsscheibe								
1.6 16V (KA0B, KA04, KA11)	79	03/99→08/03	➔	07/99→			24.0111-0166.2 411166	Ø 274 10,9 9,5 + LG / + ABS Ring
1.9 dTi (KA0N)	72	03/99→02/01						
1.6 Bifuel	80	03/99→09/00	➔				24.0124-0158.1 424158 24.0324-0158.1 524158	Ø 280 24 21,8 V + S Ø 280 24 21,8 V + S PD
1.8 16V (KA0S, KA12, KA1A, KA1M, KA1R)	85	01/01→08/03	➔				24.0124-0158.1 424158 24.0324-0158.1 524158	Ø 280 24 21,8 V + S Ø 280 24 21,8 V + S PD
1.9 dCi (KA05, KA1F)	75	02/01→08/03						
1.9 dTi (KA1U)	59	02/01→08/03	➔				24.0111-0166.2 411166	Ø 274 10,9 9,5 + LG / + ABS Ring
RENAULT - MEGANE II (BM0/1_, CM0/1_) 11/02→01/11								
Bremsbelagsatz, Scheibenbremse								
1.4 16V	60	10/03→02/08	➔	→ 09/05			13.0460-3814.2 603814	BOS 23934 18,2 - WE / - WK
1.4 16V (BM0B, CM0B)	72	11/02→02/08					13.0470-3814.2 LD3814	BOS 23934 18,2 - WE / - WK Ceramic
			➔	10/05→			13.0460-7221.2 607221 13.0470-7221.2 LD7221	ATE 23215 18,3 - WE / - WK ATE 23215 18,3 - WE / - WK Ceramic
			➔				13.0460-2845.2 602845 13.0470-2845.2 LD2845	TRW 23554 16,4 - WK + Zub TRW 23554 16,4 - WK + Zub Ceramic
			➔	PR 1334			13.0460-7137.2 607137 13.0470-7137.2 LD7137	ATE 23482 15,8 - WE / - WK ATE 23482 15,8 - WE / - WK Ceramic
1.5 dCi	63	05/05→02/08	➔	→ 09/05			13.0460-3815.2 603815	BOS 23930 18,2 - WK + Zub
1.5 dCi (BM0F, CM0F)	60	11/02→02/08					13.0470-3815.2 LD3815	BOS 23930 18,2 - WK + Zub Ceramic
1.6 16V (BM0C, CM0C)	83	11/02→02/08						
1.9 dCi (BM0G, CM0G)	88	11/02→02/08						
2.0 16V (BM0U, CM0U)	99	11/02→02/08	➔	10/05→			13.0460-7221.2 607221 13.0470-7221.2 LD7221	ATE 23215 18,3 - WE / - WK ATE 23215 18,3 - WE / - WK Ceramic
2.0 16V Turbo	120	05/04→02/08						
			➔				13.0460-2845.2 602845 13.0470-2845.2 LD2845	TRW 23554 16,4 - WK + Zub TRW 23554 16,4 - WK + Zub Ceramic
			➔	PR 1334			13.0460-7137.2 607137 13.0470-7137.2 LD7137	ATE 23482 15,8 - WE / - WK ATE 23482 15,8 - WE / - WK Ceramic
1.5 dCi	76	01/07→02/08	➔				13.0460-7221.2 607221	ATE 23215 18,3 - WE / - WK
1.5 dCi	78	05/05→06/08					13.0470-7221.2 LD7221	ATE 23215 18,3 - WE / - WK Ceramic
1.6	77	06/05→02/08						
1.6 16V	82	01/06→06/08						
1.6 Flex-Fuel	77	01/07→02/08	➔				13.0460-2845.2 602845 13.0470-2845.2 LD2845	TRW 23554 16,4 - WK + Zub TRW 23554 16,4 - WK + Zub Ceramic
2.0	102	06/06→12/10						
2.0 dCi (BM1K, CM1K)	110	09/05→02/08	➔				13.0460-7137.2 607137 13.0470-7137.2 LD7137	ATE 23482 15,8 - WE / - WK ATE 23482 15,8 - WE / - WK Ceramic
1.6 Bifuel	77	06/05→02/08	➔	01/07→			13.0460-7221.2 607221 13.0470-7221.2 LD7221	ATE 23215 18,3 - WE / - WK ATE 23215 18,3 - WE / - WK Ceramic
			➔	01/07→			13.0460-2845.2 602845 13.0470-2845.2 LD2845	TRW 23554 16,4 - WK + Zub TRW 23554 16,4 - WK + Zub Ceramic
			➔	01/07→; PR 1334			13.0460-7137.2 607137 13.0470-7137.2 LD7137	ATE 23482 15,8 - WE / - WK ATE 23482 15,8 - WE / - WK Ceramic
1.9 dCi	68	03/04→08/06	➔	01/06→			13.0460-7221.2 607221	ATE 23215 18,3 - WE / - WK
1.9 dCi	81	05/05→02/08					13.0470-7221.2 LD7221	ATE 23215 18,3 - WE / - WK Ceramic
1.9 dCi	85	11/02→02/08						
			➔	01/06→			13.0460-2845.2 602845 13.0470-2845.2 LD2845	TRW 23554 16,4 - WK + Zub TRW 23554 16,4 - WK + Zub Ceramic
			➔	01/06→; PR 1334			13.0460-7137.2 607137 13.0470-7137.2 LD7137	ATE 23482 15,8 - WE / - WK ATE 23482 15,8 - WE / - WK Ceramic
1.9 dCi	96	05/05→12/09	➔	→ 11/08			13.0460-7221.2 607221 13.0470-7221.2 LD7221	ATE 23215 18,3 - WE / - WK ATE 23215 18,3 - WE / - WK Ceramic
			➔	→ 11/08			13.0460-2845.2 602845	TRW 23554 16,4 - WK + Zub









	kW			 	! #		
RENAULT - MEGANE II (BM0/1_, CM0/1_) 11/02→01/11							
 Bremsbelagsatz, Scheibenbremse							
1.9 dCi	96	05/05→12/09	➡	→ 11/08		13.0470-2845.2 LD2845	TRW 23554 16,4 - WK + Zub Ceramic
			➡	→ 11/08; PR 1334		13.0460-7137.2 607137 13.0470-7137.2 LD7137	ATE 23482 15,8 - WE / - WK ATE 23482 15,8 - WE / - WK Ceramic
2.0	169	08/06→02/08	⬅			13.0460-4805.2 604805	BRE 24162 15,2 - WE / - WK
			➡			13.0460-2845.2 602845 13.0470-2845.2 LD2845	TRW 23554 16,4 - WK + Zub TRW 23554 16,4 - WK + Zub Ceramic
			➡	PR 1334		13.0460-7137.2 607137 13.0470-7137.2 LD7137	ATE 23482 15,8 - WE / - WK ATE 23482 15,8 - WE / - WK Ceramic
2.0 dCi	127	01/07→02/08	⬅			13.0460-4805.2 604805	BRE 24162 15,2 - WE / - WK
2.0 Renault Sport	165	05/04→10/09	⬅	→ 11/08		13.0460-4805.2 604805	BRE 24162 15,2 - WE / - WK
			➡	→ 11/08		13.0460-2845.2 602845 13.0470-2845.2 LD2845	TRW 23554 16,4 - WK + Zub TRW 23554 16,4 - WK + Zub Ceramic
			➡	→ 11/08; PR 1334		13.0460-7137.2 607137 13.0470-7137.2 LD7137	ATE 23482 15,8 - WE / - WK ATE 23482 15,8 - WE / - WK Ceramic
Zubehörsatz, Scheibenbremsbelag							
1.4 16V	60	10/03→02/08	➡			13.0460-0077.2 610077	TRW
1.4 16V (BM0B, CM0B)	72	11/02→02/08					
1.5 dCi	63	05/05→02/08					
1.5 dCi	76	01/07→02/08					
1.5 dCi	78	05/05→06/08					
1.5 dCi (BM0F, CM0F)	60	11/02→02/08					
1.6	77	06/05→02/08					
1.6 16V	82	01/06→06/08					
1.6 16V (BM0C, CM0C)	83	11/02→02/08					
1.6 Flex-Fuel	77	01/07→02/08					
1.9 dCi (BM0G, CM0G)	88	11/02→02/08					
2.0	102	06/06→12/10					
2.0	169	08/06→02/08					
2.0 16V (BM0U, CM0U)	99	11/02→02/08					
2.0 16V Turbo	120	05/04→02/08					
2.0 dCi (BM1K, CM1K)	110	09/05→02/08					
1.6 Bifuel	77	06/05→02/08	➡	01/07→		13.0460-0077.2 610077	TRW
1.9 dCi	68	03/04→08/06	➡	01/06→		13.0460-0077.2 610077	TRW
1.9 dCi	81	05/05→02/08					
1.9 dCi	85	11/02→02/08					
1.9 dCi	96	05/05→12/09	➡	→ 11/08		13.0460-0077.2 610077	TRW
2.0 Renault Sport	165	05/04→10/09					
 Bremsscheibe							
1.4 16V	60	10/03→02/08	⬅			24.0122-0216.1 422216	Ø 260 22 19,8 V + S
1.4 16V (BM0B, CM0B)	72	11/02→02/08	➡			24.0108-0114.2 408114	Ø 240 8 7 + LG / + ABS Ring
1.5 dCi	63	05/05→02/08	⬅			24.0124-0158.1 424158	Ø 280 24 21,8 V + S
1.5 dCi	76	01/07→02/08				24.0324-0158.1 524158	Ø 280 24 21,8 V + S PD
1.5 dCi	78	05/05→06/08					
1.5 dCi (BM0F, CM0F)	60	11/02→02/08	➡			24.0108-0114.2 408114	Ø 240 8 7 + LG / + ABS Ring
1.6	77	06/05→02/08					
1.6 16V	82	01/06→06/08					
1.6 16V (BM0C, CM0C)	83	11/02→02/08					
1.6 Flex-Fuel	77	01/07→02/08					
1.9 dCi (BM0G, CM0G)	88	11/02→02/08					
2.0	102	06/06→12/10					
2.0 16V (BM0U, CM0U)	99	11/02→02/08					
2.0 16V Turbo	120	05/04→02/08					
1.6 Bifuel	77	06/05→02/08	⬅	01/07→		24.0124-0158.1 424158 24.0324-0158.1 524158	Ø 280 24 21,8 V + S Ø 280 24 21,8 V + S PD
			➡	01/07→		24.0108-0114.2 408114	Ø 240 8 7 + LG / + ABS Ring
1.9 dCi	68	03/04→08/06	⬅	01/06→		24.0124-0158.1 424158 24.0324-0158.1 524158	Ø 280 24 21,8 V + S Ø 280 24 21,8 V + S PD
1.9 dCi	81	05/05→02/08					
1.9 dCi	85	11/02→02/08	➡	01/06→		24.0108-0114.2 408114	Ø 240 8 7 + LG / + ABS Ring
1.9 dCi	96	05/05→12/09	⬅	→ 11/08		24.0124-0158.1 424158 24.0324-0158.1 524158	Ø 280 24 21,8 V + S Ø 280 24 21,8 V + S PD
			➡	→ 11/08		24.0108-0114.2 408114	Ø 240 8 7 + LG / + ABS Ring
2.0	169	08/06→02/08	⬅			24.0128-0223.1 428223	Ø 312,5 28 26 V + S
↓							











	kw			 	! #		
RENAULT - MEGANE II (BM0/1_, CM0/1_) 11/02→01/11							
Bremsscheibe							
2.0 dCi	127	01/07→02/08	←			24.0128-0223.1 428223	Ø 312,5 28 26 V + S
			→			24.0111-0183.2 411183	Ø 300 11 9,5 + LG / + ABS Ring
2.0 dCi (BM1K, CM1K)	110	09/05→02/08	←			24.0124-0223.1 424223	Ø 280 24 21,8 V + S
			→			24.0110-0389.2 410389	Ø 270 10 9 + LG / + ABS Ring
2.0 Renault Sport	165	05/04→10/09	←	→ 11/08		24.0128-0223.1 428223	Ø 312,5 28 26 V + S
RENAULT - MEGANE II Coupé-Cabriolet (EM0/1_) 09/03→12/09							
Bremsbelagsatz, Scheibenbremse							
1.5 dCi (EM16)	76	01/07→06/09	←			13.0460-7221.2 607221	ATE 23215 18,3 - WE / - WK
1.5 dCi (EM1E)	78	03/06→06/08				13.0470-7221.2 LD7221	ATE 23215 18,3 - WE / - WK Ceramic
2.0 dCi	110	09/05→03/09					
			→	→ 04/07		13.0460-2845.2 602845	TRW 23554 16,4 - WK + Zub
						13.0470-2845.2 LD2845	TRW 23554 16,4 - WK + Zub Ceramic
1.6	77	06/05→03/09	←	→ 09/05		13.0460-3815.2 603815	BOS 23930 18,2 - WK + Zub
1.6	83	09/03→03/09				13.0470-3815.2 LD3815	BOS 23930 18,2 - WK + Zub Ceramic
1.9 dCi	81	05/05→03/09					
1.9 dCi	88	09/03→03/09					
2.0 16V Turbo	120	05/04→03/09	←	10/05→		13.0460-7221.2 607221	ATE 23215 18,3 - WE / - WK
						13.0470-7221.2 LD7221	ATE 23215 18,3 - WE / - WK Ceramic
			→	→ 04/07		13.0460-2845.2 602845	TRW 23554 16,4 - WK + Zub
						13.0470-2845.2 LD2845	TRW 23554 16,4 - WK + Zub Ceramic
1.6 16V	82	01/06→06/08	←	01/07→		13.0460-7221.2 607221	ATE 23215 18,3 - WE / - WK
						13.0470-7221.2 LD7221	ATE 23215 18,3 - WE / - WK Ceramic
			→	01/07→ 04/07		13.0460-2845.2 602845	TRW 23554 16,4 - WK + Zub
						13.0470-2845.2 LD2845	TRW 23554 16,4 - WK + Zub Ceramic
1.9 dCi	85	09/03→03/09	←	01/06→		13.0460-7221.2 607221	ATE 23215 18,3 - WE / - WK
						13.0470-7221.2 LD7221	ATE 23215 18,3 - WE / - WK Ceramic
			→	01/06→ 04/07		13.0460-2845.2 602845	TRW 23554 16,4 - WK + Zub
						13.0470-2845.2 LD2845	TRW 23554 16,4 - WK + Zub Ceramic
1.9 dCi	96	05/05→02/07	←	→ 09/05		13.0460-3815.2 603815	BOS 23930 18,2 - WK + Zub
2.0	102	09/03→02/07				13.0470-3815.2 LD3815	BOS 23930 18,2 - WK + Zub Ceramic
			←	10/05→		13.0460-7221.2 607221	ATE 23215 18,3 - WE / - WK
						13.0470-7221.2 LD7221	ATE 23215 18,3 - WE / - WK Ceramic
			→			13.0460-2845.2 602845	TRW 23554 16,4 - WK + Zub
						13.0470-2845.2 LD2845	TRW 23554 16,4 - WK + Zub Ceramic
2.0	99	09/03→12/09	←	→ 09/05		13.0460-3815.2 603815	BOS 23930 18,2 - WK + Zub
						13.0470-3815.2 LD3815	BOS 23930 18,2 - WK + Zub Ceramic
			←	10/05→ 03/07		13.0460-7221.2 607221	ATE 23215 18,3 - WE / - WK
						13.0470-7221.2 LD7221	ATE 23215 18,3 - WE / - WK Ceramic
			→	→ 03/07		13.0460-2845.2 602845	TRW 23554 16,4 - WK + Zub
						13.0470-2845.2 LD2845	TRW 23554 16,4 - WK + Zub Ceramic
Zubehörsatz, Scheibenbremsbelag							
1.5 dCi (EM16)	76	01/07→06/09	→	→ 04/07		13.0460-0077.2 610077	TRW
1.5 dCi (EM1E)	78	03/06→06/08					
1.6	77	06/05→03/09					
1.6	83	09/03→03/09					
1.9 dCi	81	05/05→03/09					
1.9 dCi	88	09/03→03/09					
2.0 16V Turbo	120	05/04→03/09					
2.0 dCi	110	09/05→03/09					
1.6 16V	82	01/06→06/08	→	01/07→ 04/07		13.0460-0077.2 610077	TRW
1.9 dCi	85	09/03→03/09	→	01/06→ 04/07		13.0460-0077.2 610077	TRW
1.9 dCi	96	05/05→02/07	→			13.0460-0077.2 610077	TRW
2.0	102	09/03→02/07					
↓							











	kW					! #		
RENAULT - MEGANE II Coupé-Cabriolet (EM0/1_) 09/03→12/09								
Zubehörsatz, Scheibenbremsbelag								
2.0	99	09/03→12/09	➡	→ 03/07			13.0460-0077.2 610077	TRW
 Bremsscheibe								
1.5 dCi (EM16)	76	01/07→06/09	←				24.0124-0158.1 424158	Ø 280 24 21,8 V + S
1.5 dCi (EM1E)	78	03/06→06/08					24.0324-0158.1 524158	Ø 280 24 21,8 V + S PD
1.6	77	06/05→03/09						
1.6	83	09/03→03/09	➡				24.0108-0114.2 408114	Ø 240 8 7 + LG / + ABS Ring
1.9 dCi	81	05/05→03/09						
1.9 dCi	88	09/03→03/09						
1.9 dCi	96	05/05→02/07						
2.0	102	09/03→02/07						
2.0 16V Turbo	120	05/04→03/09						
1.6 16V	82	01/06→06/08	←	01/07→			24.0124-0158.1 424158	Ø 280 24 21,8 V + S
							24.0324-0158.1 524158	Ø 280 24 21,8 V + S PD
			➡	01/07→			24.0108-0114.2 408114	Ø 240 8 7 + LG / + ABS Ring
1.9 dCi	85	09/03→03/09	←	01/06→			24.0124-0158.1 424158	Ø 280 24 21,8 V + S
							24.0324-0158.1 524158	Ø 280 24 21,8 V + S PD
			➡	01/06→			24.0108-0114.2 408114	Ø 240 8 7 + LG / + ABS Ring
2.0	99	09/03→12/09	←	→ 03/07			24.0124-0158.1 424158	Ø 280 24 21,8 V + S
							24.0324-0158.1 524158	Ø 280 24 21,8 V + S PD
			➡	→ 03/07			24.0108-0114.2 408114	Ø 240 8 7 + LG / + ABS Ring
2.0 dCi	110	09/05→03/09	←				24.0124-0158.1 424158	Ø 280 24 21,8 V + S
							24.0124-0223.1 424223	Ø 280 24 21,8 V + S
							24.0324-0158.1 524158	Ø 280 24 21,8 V + S PD
			➡				24.0110-0389.2 410389	Ø 270 10 9 + LG / + ABS Ring
RENAULT - MEGANE II Grandtour (KM0/1_) 08/03→08/12								
 Bremsbelagsatz, Scheibenbremse								
1.4	72	08/03→07/09	←	09/03→ 09/05			13.0460-3815.2 603815	BOS 23930 18,2 - WK + Zub
1.6	83	08/03→07/09					13.0470-3815.2 LD3815	BOS 23930 18,2 - WK + Zub Ceramic
1.9 dCi	88	08/03→07/09						
2.0	99	08/03→07/09	←	10/05→ 12/08			13.0460-7221.2 607221	ATE 23215 18,3 - WE / - WK
							13.0470-7221.2 LD7221	ATE 23215 18,3 - WE / - WK Ceramic
			➡	09/03→ 04/07			13.0460-2845.2 602845	TRW 23554 16,4 - WK + Zub
							13.0470-2845.2 LD2845	TRW 23554 16,4 - WK + Zub Ceramic
1.5 dCi	60	08/03→05/06	←	09/03→ 09/05			13.0460-3815.2 603815	BOS 23930 18,2 - WK + Zub
							13.0470-3815.2 LD3815	BOS 23930 18,2 - WK + Zub Ceramic
			←	10/05→			13.0460-7221.2 607221	ATE 23215 18,3 - WE / - WK
							13.0470-7221.2 LD7221	ATE 23215 18,3 - WE / - WK Ceramic
			➡	09/03→			13.0460-2845.2 602845	TRW 23554 16,4 - WK + Zub
							13.0470-2845.2 LD2845	TRW 23554 16,4 - WK + Zub Ceramic
1.5 dCi	63	05/05→07/09	←	→ 09/05			13.0460-3815.2 603815	BOS 23930 18,2 - WK + Zub
1.9 dCi	81	05/05→07/09					13.0470-3815.2 LD3815	BOS 23930 18,2 - WK + Zub Ceramic
1.9 dCi	85	05/05→07/09						
			←	10/05→ 12/08			13.0460-7221.2 607221	ATE 23215 18,3 - WE / - WK
							13.0470-7221.2 LD7221	ATE 23215 18,3 - WE / - WK Ceramic
			➡	→ 04/07			13.0460-2845.2 602845	TRW 23554 16,4 - WK + Zub
							13.0470-2845.2 LD2845	TRW 23554 16,4 - WK + Zub Ceramic
1.5 dCi	74	02/04→03/06	←	→ 09/05			13.0460-3815.2 603815	BOS 23930 18,2 - WK + Zub
1.9 dCi	66	04/04→12/05					13.0470-3815.2 LD3815	BOS 23930 18,2 - WK + Zub Ceramic
1.9 dCi	68	03/04→02/07						
			←	10/05→			13.0460-7221.2 607221	ATE 23215 18,3 - WE / - WK
							13.0470-7221.2 LD7221	ATE 23215 18,3 - WE / - WK Ceramic
			➡				13.0460-2845.2 602845	TRW 23554 16,4 - WK + Zub
							13.0470-2845.2 LD2845	TRW 23554 16,4 - WK + Zub Ceramic
1.5 dCi (KM13)	76	01/07→07/09	←	→ 12/08			13.0460-7221.2 607221	ATE 23215 18,3 - WE / - WK
2.0 dCi	110	09/05→07/09					13.0470-7221.2 LD7221	ATE 23215 18,3 - WE / - WK Ceramic
↓								









	kW			 	! #		
RENAULT - MEGANE II Grandtour (KM0/1_) 08/03→08/12							
Bremsbelagsatz, Scheibenbremse							
1.5 dCi (KM13) 2.0 dCi	76 110	01/07→07/09 09/05→07/09	➡	→ 04/07		13.0460-2845.2 602845 13.0470-2845.2 LD2845	TRW 23554 16,4 - WK + Zub TRW 23554 16,4 - WK + Zub Ceramic
1.5 dCi (KM16, KM1E)	78	05/05→06/08	←	→ 09/05		13.0460-3815.2 603815 13.0470-3815.2 LD3815	BOS 23930 18,2 - WK + Zub BOS 23930 18,2 - WK + Zub Ceramic
			←	10/05→		13.0460-7221.2 607221 13.0470-7221.2 LD7221	ATE 23215 18,3 - WE / - WK ATE 23215 18,3 - WE / - WK Ceramic
			➡	→ 04/07		13.0460-2845.2 602845 13.0470-2845.2 LD2845	TRW 23554 16,4 - WK + Zub TRW 23554 16,4 - WK + Zub Ceramic
1.6 16V 1.6 16V	75 77	05/05→07/09 05/05→07/09	←	→ 09/05		13.0460-3815.2 603815 13.0470-3815.2 LD3815	BOS 23930 18,2 - WK + Zub BOS 23930 18,2 - WK + Zub Ceramic
			←			13.0460-7221.2 607221 13.0470-7221.2 LD7221	ATE 23215 18,3 - WE / - WK ATE 23215 18,3 - WE / - WK Ceramic
			➡	→ 04/07		13.0460-2845.2 602845 13.0470-2845.2 LD2845	TRW 23554 16,4 - WK + Zub TRW 23554 16,4 - WK + Zub Ceramic
1.6 16V	81	05/06→10/11	←	→ 07/09		13.0460-7221.2 607221 13.0470-7221.2 LD7221	ATE 23215 18,3 - WE / - WK ATE 23215 18,3 - WE / - WK Ceramic
			➡	→ 04/07		13.0460-2845.2 602845 13.0470-2845.2 LD2845	TRW 23554 16,4 - WK + Zub TRW 23554 16,4 - WK + Zub Ceramic
1.6 16V 1.6 Flex	82 81	01/06→08/09 12/06→08/12	←	01/07→ 12/08		13.0460-7221.2 607221 13.0470-7221.2 LD7221	ATE 23215 18,3 - WE / - WK ATE 23215 18,3 - WE / - WK Ceramic
			➡	01/07→ 04/07		13.0460-2845.2 602845 13.0470-2845.2 LD2845	TRW 23554 16,4 - WK + Zub TRW 23554 16,4 - WK + Zub Ceramic
1.6 16V Hi-Flex	77	02/08→07/09	←	→ 12/08		13.0460-7221.2 607221 13.0470-7221.2 LD7221	ATE 23215 18,3 - WE / - WK ATE 23215 18,3 - WE / - WK Ceramic
1.6 LPG 16V	82	01/06→08/09	←			13.0460-7221.2 607221 13.0470-7221.2 LD7221	ATE 23215 18,3 - WE / - WK ATE 23215 18,3 - WE / - WK Ceramic
			➡			13.0460-2845.2 602845 13.0470-2845.2 LD2845	TRW 23554 16,4 - WK + Zub TRW 23554 16,4 - WK + Zub Ceramic
1.9 dCi	96	05/05→07/09	←	→ 09/05		13.0460-3815.2 603815 13.0470-3815.2 LD3815	BOS 23930 18,2 - WK + Zub BOS 23930 18,2 - WK + Zub Ceramic
			←	10/05→ 02/07		13.0460-7221.2 607221 13.0470-7221.2 LD7221	ATE 23215 18,3 - WE / - WK ATE 23215 18,3 - WE / - WK Ceramic
			➡	→ 02/07		13.0460-2845.2 602845 13.0470-2845.2 LD2845	TRW 23554 16,4 - WK + Zub TRW 23554 16,4 - WK + Zub Ceramic
2.0	102	12/06→01/11	←			13.0460-7221.2 607221 13.0470-7221.2 LD7221	ATE 23215 18,3 - WE / - WK ATE 23215 18,3 - WE / - WK Ceramic
			➡	→ 04/07		13.0460-2845.2 602845 13.0470-2845.2 LD2845	TRW 23554 16,4 - WK + Zub TRW 23554 16,4 - WK + Zub Ceramic
Zubehörsatz, Scheibenbremsbelag							
1.4 1.6 1.9 dCi 2.0	72 83 88 99	08/03→07/09 08/03→07/09 08/03→07/09 08/03→07/09	➡	09/03→ 04/07		13.0460-0077.2 610077	TRW
1.5 dCi	60	08/03→05/06	➡	09/03→		13.0460-0077.2 610077	TRW
1.5 dCi 1.5 dCi (KM13) 1.5 dCi (KM16, KM1E) 1.6 16V 1.6 16V	63 76 78 75 77	05/05→07/09 01/07→07/09 05/05→06/08 05/05→07/09 05/05→07/09	➡	→ 04/07		13.0460-0077.2 610077	TRW









	kW				! #		
RENAULT - MEGANE II Grandtour (KM0/1_) 08/03→08/12							
Zubehörsatz, Scheibenbremsbelag							
1.6 16V 1.9 dCi 1.9 dCi 2.0 2.0 dCi	81 81 85 102 110	05/06→10/11 05/05→07/09 05/05→07/09 12/06→01/11 09/05→07/09	➡	→ 04/07		13.0460-0077.2 610077	TRW
1.5 dCi 1.6 LPG 16V 1.9 dCi 1.9 dCi	74 82 66 68	02/04→03/06 01/06→08/09 04/04→12/05 03/04→02/07	➡			13.0460-0077.2 610077	TRW
1.6 16V 1.6 Flex 1.9 dCi	82 81 96	01/06→08/09 12/06→08/12 05/05→07/09	➡	01/07→ 04/07 → 02/07		13.0460-0077.2 610077	TRW
 Bremsscheibe							
1.4 1.6 1.9 dCi 2.0	72 83 88 99	08/03→07/09 08/03→07/09 08/03→07/09 08/03→07/09	←	09/03→ 12/08		24.0124-0158.1 424158 24.0324-0158.1 524158	Ø 280 24 21,8 V + S Ø 280 24 21,8 V + S PD
1.5 dCi	60	08/03→05/06	←	09/03→		24.0110-0325.2 410325	Ø 270 10 9 + LG / + ABS Ring
1.5 dCi 1.5 dCi (KM13) 1.6 16V Hi-Flex 1.9 dCi 1.9 dCi	63 76 77 81 85	05/05→07/09 01/07→07/09 02/08→07/09 05/05→07/09 05/05→07/09	←	→ 12/08		24.0124-0158.1 424158 24.0324-0158.1 524158	Ø 280 24 21,8 V + S Ø 280 24 21,8 V + S PD
1.5 dCi 1.5 dCi (KM16, KM1E) 1.6 16V 1.6 16V 1.6 LPG 16V 1.9 dCi 1.9 dCi 2.0	74 78 75 77 82 66 68 102	02/04→03/06 05/05→06/08 05/05→07/09 05/05→07/09 01/06→08/09 04/04→12/05 03/04→02/07 12/06→01/11	←			24.0124-0158.1 424158 24.0324-0158.1 524158	Ø 280 24 21,8 V + S Ø 280 24 21,8 V + S PD
1.6 16V	81	05/06→10/11	←	→ 07/09		24.0110-0325.2 410325	Ø 270 10 9 + LG / + ABS Ring
1.6 16V 1.6 Flex	82 81	01/06→08/09 12/06→08/12	←	01/07→ 12/08		24.0124-0158.1 424158 24.0324-0158.1 524158	Ø 280 24 21,8 V + S Ø 280 24 21,8 V + S PD
1.9 dCi	96	05/05→07/09	←	→ 02/07		24.0110-0325.2 410325	Ø 270 10 9 + LG / + ABS Ring
2.0 dCi	110	09/05→07/09	←	→ 12/08		24.0124-0158.1 424158 24.0124-0223.1 424223 24.0324-0158.1 524158	Ø 280 24 21,8 V + S Ø 280 24 21,8 V + S Ø 280 24 21,8 V + S PD
			➡	→ 12/08		24.0110-0389.2 410389	Ø 270 10 9 + LG / + ABS Ring
RENAULT - MEGANE II Stufenheck (LM0/1_) 09/03→							
 Bremsbelagsatz, Scheibenbremse							
1.4	60	09/03→	←	→ 08/06		13.0460-3814.2 603814 13.0470-3814.2 LD3814	BOS 23934 18,2 - WE / - WK BOS 23934 18,2 - WE / - WK Ceramic
			➡	→ 08/06		13.0460-2845.2 602845 13.0470-2845.2 LD2845	TRW 23554 16,4 - WK + Zub TRW 23554 16,4 - WK + Zub Ceramic
			➡	→ 08/06; PR 1334		13.0460-7137.2 607137 13.0470-7137.2 LD7137	ATE 23482 15,8 - WE / - WK ATE 23482 15,8 - WE / - WK Ceramic
1.4	72	09/03→	←	→ 12/08		13.0460-3814.2 603814 13.0470-3814.2 LD3814	BOS 23934 18,2 - WE / - WK BOS 23934 18,2 - WE / - WK Ceramic
			➡	→ 04/07		13.0460-2845.2 602845 13.0470-2845.2 LD2845	TRW 23554 16,4 - WK + Zub TRW 23554 16,4 - WK + Zub Ceramic
			➡	→ 12/08; PR 1334		13.0460-7137.2 607137 13.0470-7137.2 LD7137	ATE 23482 15,8 - WE / - WK ATE 23482 15,8 - WE / - WK Ceramic
1.5 dCi ↓	60	09/03→	←	→ 09/05		13.0460-3815.2 603815	BOS 23930 18,2 - WK + Zub



	kw			 	! #		
RENAULT - MEGANE II Stufenheck (LM0/1_) 09/03→							
 Bremsbelagsatz, Scheibenbremse							
1.5 dCi	63	05/05→	←	→ 09/05		13.0470-3815.2 LD3815	BOS 23930 18,2 - WK + Zub Ceramic
1.5 dCi	78	05/05→					
1.6	75	09/03→					
1.6	77	05/05→	←	10/05→ 12/08		13.0460-7221.2 607221	ATE 23215 18,3 - WE / - WK
1.6	83	09/03→				13.0470-7221.2 LD7221	ATE 23215 18,3 - WE / - WK Ceramic
1.9 dCi	68	03/04→					
1.9 dCi	96	05/05→	→	→ 04/07		13.0460-2845.2 602845	TRW 23554 16,4 - WK + Zub
1.9 dCi (LM0G, LM1G, LM2C)	88	09/03→				13.0470-2845.2 LD2845	TRW 23554 16,4 - WK + Zub Ceramic
1.9 dCi (LM14, LM1D)	81	05/05→					
2.0	99	09/03→	→	→ 12/08; PR 1334		13.0460-7137.2 607137	ATE 23482 15,8 - WE / - WK
						13.0470-7137.2 LD7137	ATE 23482 15,8 - WE / - WK Ceramic
1.5 dCi	74	02/04→	←	→ 09/05		13.0460-3815.2 603815	BOS 23930 18,2 - WK + Zub
						13.0470-3815.2 LD3815	BOS 23930 18,2 - WK + Zub Ceramic
			←	10/05→ 03/06		13.0460-7221.2 607221	ATE 23215 18,3 - WE / - WK
						13.0470-7221.2 LD7221	ATE 23215 18,3 - WE / - WK Ceramic
			→	→ 03/06		13.0460-2845.2 602845	TRW 23554 16,4 - WK + Zub
						13.0470-2845.2 LD2845	TRW 23554 16,4 - WK + Zub Ceramic
			→	→ 03/06; PR 1334		13.0460-7137.2 607137	ATE 23482 15,8 - WE / - WK
						13.0470-7137.2 LD7137	ATE 23482 15,8 - WE / - WK Ceramic
1.5 dCi	76	01/07→	←	→ 12/08		13.0460-7221.2 607221	ATE 23215 18,3 - WE / - WK
1.6 Hi-Flex	85	03/06→				13.0470-7221.2 LD7221	ATE 23215 18,3 - WE / - WK Ceramic
2.0 dCi	110	09/05→					
			→	→ 04/07		13.0460-2845.2 602845	TRW 23554 16,4 - WK + Zub
						13.0470-2845.2 LD2845	TRW 23554 16,4 - WK + Zub Ceramic
			→	→ 12/08; PR 1334		13.0460-7137.2 607137	ATE 23482 15,8 - WE / - WK
						13.0470-7137.2 LD7137	ATE 23482 15,8 - WE / - WK Ceramic
1.6	81	09/03→11/08	←	→ 09/05		13.0460-3815.2 603815	BOS 23930 18,2 - WK + Zub
						13.0470-3815.2 LD3815	BOS 23930 18,2 - WK + Zub Ceramic
			←	10/05→		13.0460-7221.2 607221	ATE 23215 18,3 - WE / - WK
						13.0470-7221.2 LD7221	ATE 23215 18,3 - WE / - WK Ceramic
			→	→ 04/07		13.0460-2845.2 602845	TRW 23554 16,4 - WK + Zub
						13.0470-2845.2 LD2845	TRW 23554 16,4 - WK + Zub Ceramic
			→	PR 1334		13.0460-7137.2 607137	ATE 23482 15,8 - WE / - WK
						13.0470-7137.2 LD7137	ATE 23482 15,8 - WE / - WK Ceramic
1.6 16V	82	01/06→	←	01/07→ 12/08		13.0460-7221.2 607221	ATE 23215 18,3 - WE / - WK
						13.0470-7221.2 LD7221	ATE 23215 18,3 - WE / - WK Ceramic
			→	01/07→ 04/07		13.0460-2845.2 602845	TRW 23554 16,4 - WK + Zub
						13.0470-2845.2 LD2845	TRW 23554 16,4 - WK + Zub Ceramic
			→	01/07→ 12/08; PR 1334		13.0460-7137.2 607137	ATE 23482 15,8 - WE / - WK
						13.0470-7137.2 LD7137	ATE 23482 15,8 - WE / - WK Ceramic
1.9 dCi	66	09/03→12/05	←	→ 09/05		13.0460-3815.2 603815	BOS 23930 18,2 - WK + Zub
						13.0470-3815.2 LD3815	BOS 23930 18,2 - WK + Zub Ceramic
			←	10/05→		13.0460-7221.2 607221	ATE 23215 18,3 - WE / - WK
						13.0470-7221.2 LD7221	ATE 23215 18,3 - WE / - WK Ceramic
			→			13.0460-2845.2 602845	TRW 23554 16,4 - WK + Zub
						13.0470-2845.2 LD2845	TRW 23554 16,4 - WK + Zub Ceramic
			→	PR 1334		13.0460-7137.2 607137	ATE 23482 15,8 - WE / - WK
						13.0470-7137.2 LD7137	ATE 23482 15,8 - WE / - WK Ceramic
2.0	101	04/06→11/10	←			13.0460-7221.2 607221	ATE 23215 18,3 - WE / - WK
↓							

	kw			 	! #		
RENAULT - MEGANE II Stufenheck (LM0/1_) 09/03→							
 Bremsbelagsatz, Scheibenbremse							
2.0	101	04/06→11/10	←			13.0470-7221.2 LD7221	ATE 23215 18,3 - WE / - WK Ceramic
			→			13.0460-2845.2 602845	TRW 23554 16,4 - WK + Zub
						13.0470-2845.2 LD2845	TRW 23554 16,4 - WK + Zub Ceramic
Zubehörsatz, Scheibenbremsbelag							
1.4	60	09/03→	→	→ 08/06		13.0460-0077.2 610077	TRW
1.4	72	09/03→	→	→ 04/07		13.0460-0077.2 610077	TRW
1.5 dCi	60	09/03→					
1.5 dCi	63	05/05→					
1.5 dCi	76	01/07→					
1.5 dCi	78	05/05→					
1.6	75	09/03→					
1.6	77	05/05→					
1.6	81	09/03→11/08					
1.6	83	09/03→					
1.6 Hi-Flex	85	03/06→					
1.9 dCi	68	03/04→					
1.9 dCi	96	05/05→					
1.9 dCi (LM0G, LM1G, LM2C)	88	09/03→					
1.9 dCi (LM14, LM1D)	81	05/05→					
2.0	99	09/03→					
2.0 dCi	110	09/05→					
1.5 dCi	74	02/04→	→	→ 03/06		13.0460-0077.2 610077	TRW
1.6 16V	82	01/06→	→	01/07→ 04/07		13.0460-0077.2 610077	TRW
1.9 dCi	66	09/03→12/05	→			13.0460-0077.2 610077	TRW
2.0	101	04/06→11/10					
 Bremsscheibe							
1.4	60	09/03→	←	→ 08/06		24.0122-0216.1 422216	Ø 260 22 19,8 V + S
			→	→ 08/06		24.0108-0114.2 408114	Ø 240 8 7 + LG / + ABS Ring
1.4	72	09/03→	←	→ 12/08		24.0122-0216.1 422216	Ø 260 22 19,8 V + S
			→	→ 12/08		24.0108-0114.2 408114	Ø 240 8 7 + LG / + ABS Ring
1.5 dCi	60	09/03→	←	→ 12/08		24.0124-0158.1 424158	Ø 280 24 21,8 V + S
1.5 dCi	63	05/05→				24.0324-0158.1 524158	Ø 280 24 21,8 V + S PD
1.5 dCi	76	01/07→					
1.5 dCi	78	05/05→	→	→ 12/08		24.0108-0114.2 408114	Ø 240 8 7 + LG / + ABS Ring
1.6	75	09/03→					
1.6	77	05/05→					
1.6	83	09/03→					
1.6 Hi-Flex	85	03/06→					
1.9 dCi	68	03/04→					
1.9 dCi	96	05/05→					
1.9 dCi (LM0G, LM1G, LM2C)	88	09/03→					
1.9 dCi (LM14, LM1D)	81	05/05→					
2.0	99	09/03→					
1.5 dCi	74	02/04→	←	→ 03/06		24.0124-0158.1 424158	Ø 280 24 21,8 V + S
						24.0324-0158.1 524158	Ø 280 24 21,8 V + S PD
			→	→ 03/06		24.0108-0114.2 408114	Ø 240 8 7 + LG / + ABS Ring
1.6	81	09/03→11/08	←			24.0124-0158.1 424158	Ø 280 24 21,8 V + S
1.9 dCi	66	09/03→12/05				24.0324-0158.1 524158	Ø 280 24 21,8 V + S PD
2.0	101	04/06→11/10	→			24.0108-0114.2 408114	Ø 240 8 7 + LG / + ABS Ring
1.6 16V	82	01/06→	←	01/07→ 12/08		24.0124-0158.1 424158	Ø 280 24 21,8 V + S
						24.0324-0158.1 524158	Ø 280 24 21,8 V + S PD
			→	01/07→ 12/08		24.0108-0114.2 408114	Ø 240 8 7 + LG / + ABS Ring
2.0 dCi	110	09/05→	←	→ 12/08		24.0124-0158.1 424158	Ø 280 24 21,8 V + S
						24.0124-0223.1 424223	Ø 280 24 21,8 V + S
						24.0324-0158.1 524158	Ø 280 24 21,8 V + S PD
			→	→ 12/08		24.0110-0389.2 410389	Ø 270 10 9 + LG / + ABS Ring
RENAULT - MEGANE III Coupe (DZ0/1_) 11/08→							
 Bremsbelagsatz, Scheibenbremse							
1.2 TCe	85	03/12→	←			13.0460-7266.2 607266	ATE 24538 17,9 - WE / - WK
1.4 TCe (DZ0F, DZ1V)	96	04/09→				13.0470-7266.2 LD7266	ATE 24538 17,9 - WE / - WK Ceramic
1.5 dCi	70	07/14→					
1.5 dCi (DZ09, DZ0D, DZ1F, DZ1G)	81	02/09→	→	- eFSB		13.0460-2740.2 602740	TRW 23554 17,0 - WE / - WK + Zub
1.5 dCi (DZ0A)	63	11/08→					

	kw			 	! #		
RENAULT - MEGANE III Coupe (DZ0/1_) 11/08→							
 Bremsbelagsatz, Scheibenbremse							
1.5 dCi (DZ0B)	78	02/09→	➡	- eFSB		13.0470-2740.2 LD2740	TRW 23554 17,0 - WE / - WK + Zub Ceramic
1.5 dCi (DZ0C, DZ1A)	66	11/08→					
1.6 16V (DZ0H)	74	11/08→					
1.6 16V (DZ0U, DZ1B, DZ1H)	81	11/08→	➡	+ eFSB		13.0460-2756.2 602756	TRW 24820 16,1 - WE / - WK + Zub
1.6 16V Bifuel (DZ03, DZ1Y)	81	11/08→					
1.6 dCi (DZ00)	96	04/11→					
1.9 dCi (DZ0N, DZ0J, DZ1J, DZ1K)	96	11/08→					
2.0 CVT (DZ0G, DZ1E)	103	05/09→					
1.2 TCe (DZ16)	97	01/13→	←			13.0460-7266.2 607266	ATE 24538 17,9 - WE / - WK
						13.0470-7266.2 LD7266	ATE 24538 17,9 - WE / - WK Ceramic
			➡	- eFSB		13.0460-2740.2 602740	TRW 23554 17,0 - WE / - WK + Zub
						13.0470-2740.2 LD2740	TRW 23554 17,0 - WE / - WK + Zub Ceramic
2.0 dCi	120	07/12→	←				
2.0 dCi (DZ0L) 2.0 dCi (DZ0Y) 2.0 TCe 2.0 TCe (DZ0K) 2.0 TCe 220	118 110 140 132 162	04/09→ 04/09→ 06/12→ 11/08→ 11/13→	←			13.0460-7249.2 607249	ATE 24709 18,6 - WE / - WK
						13.0470-7249.2 LD7249	ATE 24709 18,6 - WE / - WK Ceramic
			➡	- eFSB		13.0460-2740.2 602740	TRW 23554 17,0 - WE / - WK + Zub
						13.0470-2740.2 LD2740	TRW 23554 17,0 - WE / - WK + Zub Ceramic
			➡	+ eFSB		13.0460-2756.2 602756	TRW 24820 16,1 - WE / - WK + Zub
2.0 R.S.	195	11/08→	←	08/11→		13.0460-4804.2 604804	BRE 23092 15,6 - WE / - WK
			➡	08/11→; - eFSB		13.0460-2753.2 602753	TRW 23554 16,0 - WK + Zub
2.0 R.S. 2.0 TCe (DZ1N)	201 184	07/14→ 05/09→	←			13.0460-4804.2 604804	BRE 23092 15,6 - WE / - WK
			➡	- eFSB		13.0460-2753.2 602753	TRW 23554 16,0 - WK + Zub
 Bremsscheibe							
1.2 TCe	85	03/12→	←			24.0124-0221.1 424221	Ø 280 24 21,8 V + S
1.2 TCe (DZ16)	97	01/13→					
1.4 TCe (DZ0F, DZ1V)	96	04/09→	➡			24.0108-0116.2 408116	Ø 260 8 7 + LG / + ABS Ring
1.5 dCi	70	07/14→					
1.5 dCi (DZ09, DZ0D, DZ1F, DZ1G)	81	02/09→					
1.5 dCi (DZ0A)	63	11/08→					
1.5 dCi (DZ0B)	78	02/09→					
1.5 dCi (DZ0C, DZ1A)	66	11/08→					
1.6 16V (DZ0H)	74	11/08→					
1.6 16V (DZ0U, DZ1B, DZ1H)	81	11/08→					
1.6 16V Bifuel (DZ03, DZ1Y)	81	11/08→					
1.6 dCi (DZ00)	96	04/11→					
1.9 dCi (DZ0N, DZ0J, DZ1J, DZ1K)	96	11/08→					
2.0 CVT (DZ0G, DZ1E)	103	05/09→					
2.0 dCi	120	07/12→	←			24.0126-0158.1 426158	Ø 296 26 23,4 V + S
2.0 dCi (DZ0L)	118	04/09→	➡			24.0108-0116.2 408116	Ø 260 8 7 + LG / + ABS Ring
2.0 dCi (DZ0Y)	110	04/09→					
2.0 TCe	140	06/12→					
2.0 TCe (DZ0K)	132	11/08→					
2.0 R.S.	195	11/08→	←	08/11→		24.0128-0261.1 428261	Ø 340 28 26 V + S
			←	08/11→; CUP Edition		24.0128-0288.1 428288	Ø 340 28 26 V/ + S
2.0 R.S.	201	07/14→	←			24.0128-0261.1 428261	Ø 340 28 26 V + S
			←	CUP Edition		24.0128-0288.1 428288	Ø 340 28 26 V/ + S
2.0 TCe (DZ1N)	184	05/09→	←			24.0128-0261.1 428261	Ø 340 28 26 V + S
			←	CUP Edition		24.0128-0288.1 428288	Ø 340 28 26 V/ + S
			➡			24.0111-0186.2 411186	Ø 290 11 9,5 + LG / + ABS Ring
2.0 TCe 220	162	11/13→	←			24.0128-0245.1 428245	Ø 320 28 25,4 V + S
			➡			24.0108-0116.2 408116	Ø 260 8 7 + LG / + ABS Ring

	kW			 	! #		
RENAULT - MEGANE III Grandtour (KZ0/1) 11/08→							
 Bremsbelagsatz, Scheibenbremse							
1.2 TCe	85	03/12→	←			13.0460-7266.2 607266	ATE 24538 17,9 - WE / - WK
1.2 TCe (KZ16)	97	01/13→				13.0470-7266.2 LD7266	ATE 24538 17,9 - WE / - WK Ceramic
1.4 TCe (KZ0F, KZ1V)	96	05/09→					
1.5 dCi	70	11/13→	→	- eFSB		13.0460-2740.2 602740	TRW 23554 17,0 - WE / - WK + Zub
1.5 dCi (KZ09, KZ0D, KZ1G, KZ1M, KZ1W)	81	02/09→					
1.5 dCi (KZ0C, KZ1A)	66	05/09→				13.0470-2740.2 LD2740	TRW 23554 17,0 - WE / - WK + Zub Ceramic
1.6 16V (KZ0H)	74	05/09→					
1.6 16V (KZ0U, KZ1B, KZ1U)	81	05/09→	→	+ eFSB		13.0460-2756.2 602756	TRW 24820 16,1 - WE / - WK + Zub
1.6 16V Bifuel (KZ03)	81	11/08→					
1.6 dCi (KZ00, KZ12)	96	04/11→					
1.9 dCi (KZ0J, KZ0N, KZ1S)	96	05/09→					
2.0 CVT (KZ0G, KZ1P)	103	05/09→					
1.5 dCi	63	03/09→	←	08/09→		13.0460-7266.2 607266	ATE 24538 17,9 - WE / - WK
						13.0470-7266.2 LD7266	ATE 24538 17,9 - WE / - WK Ceramic
			→	08/09→; - eFSB		13.0460-2740.2 602740	TRW 23554 17,0 - WE / - WK + Zub
					13.0470-2740.2 LD2740	TRW 23554 17,0 - WE / - WK + Zub Ceramic	
			→	08/09→; + eFSB		13.0460-2756.2 602756	TRW 24820 16,1 - WE / - WK + Zub
1.5 dCi (KZ1M, KZ1W)	78	02/09→	←	05/09→		13.0460-7266.2 607266	ATE 24538 17,9 - WE / - WK
						13.0470-7266.2 LD7266	ATE 24538 17,9 - WE / - WK Ceramic
			→	05/09→; - eFSB		13.0460-2740.2 602740	TRW 23554 17,0 - WE / - WK + Zub
					13.0470-2740.2 LD2740	TRW 23554 17,0 - WE / - WK + Zub Ceramic	
			→	05/09→; + eFSB		13.0460-2756.2 602756	TRW 24820 16,1 - WE / - WK + Zub
2.0 dCi	120	07/12→	←			13.0460-7249.2 607249	ATE 24709 18,6 - WE / - WK
						13.0470-7249.2 LD7249	ATE 24709 18,6 - WE / - WK Ceramic
			→	+ eFSB		13.0460-2756.2 602756	TRW 24820 16,1 - WE / - WK + Zub
2.0 dCi (KZ0L) 2.0 dCi (KZ0Y) 2.0 TCe 2.0 TCe	118	04/09→	←			13.0460-7249.2 607249	ATE 24709 18,6 - WE / - WK
	110	10/10→				13.0470-7249.2 LD7249	ATE 24709 18,6 - WE / - WK Ceramic
	140	09/12→					
	162	09/12→					
			→	- eFSB		13.0460-2740.2 602740	TRW 23554 17,0 - WE / - WK + Zub
						13.0470-2740.2 LD2740	TRW 23554 17,0 - WE / - WK + Zub Ceramic
			→	+ eFSB		13.0460-2756.2 602756	TRW 24820 16,1 - WE / - WK + Zub
2.0 TCe (KZ0K, KZ1T)	132	11/08→	←	05/09→		13.0460-7249.2 607249	ATE 24709 18,6 - WE / - WK
						13.0470-7249.2 LD7249	ATE 24709 18,6 - WE / - WK Ceramic
			→	05/09→; - eFSB		13.0460-2740.2 602740	TRW 23554 17,0 - WE / - WK + Zub
					13.0470-2740.2 LD2740	TRW 23554 17,0 - WE / - WK + Zub Ceramic	
			→	05/09→; + eFSB		13.0460-2756.2 602756	TRW 24820 16,1 - WE / - WK + Zub
 Bremsscheibe							
1.2 TCe	85	03/12→	←			24.0124-0221.1 424221	Ø 280 24 21,8 V + S
1.4 TCe (KZ0F, KZ1V)	96	05/09→					
1.5 dCi	70	11/13→	→			24.0108-0118.2 408118	Ø 260 8 7 + LG / + ABS Ring
1.5 dCi (KZ09, KZ0D, KZ1G, KZ1M, KZ1W)	81	02/09→					
1.5 dCi (KZ0C, KZ1A)	66	05/09→					
1.6 16V (KZ0H)	74	05/09→					
1.6 16V (KZ0U, KZ1B, KZ1U)	81	05/09→					
1.6 16V Bifuel (KZ03)	81	11/08→					
1.6 dCi (KZ00, KZ12)	96	04/11→					
1.9 dCi (KZ0J, KZ0N, KZ1S)	96	05/09→					
2.0 CVT (KZ0G, KZ1P)	103	05/09→					
1.2 TCe (KZ16)	97	01/13→	←			24.0124-0221.1 424221	Ø 280 24 21,8 V + S
↓							













RENAULT - MEGANE III Grandtour (KZ0/1) 11/08→











Bremsscheibe							
1.2 TCe (KZ16)	97	01/13→	➔			24.0108-0116.2 408116	Ø 260 8 7 + LG / + ABS Ring
1.5 dCi	63	03/09→	➔	08/09→		24.0124-0221.1 424221	Ø 280 24 21,8 V + S
			➔	08/09→		24.0108-0118.2 408118	Ø 260 8 7 + LG / + ABS Ring
1.5 dCi (KZ1M, KZ1W)	78	02/09→	➔	05/09→		24.0124-0221.1 424221	Ø 280 24 21,8 V + S
			➔	05/09→		24.0108-0118.2 408118	Ø 260 8 7 + LG / + ABS Ring
2.0 dCi	120	07/12→	➔			24.0126-0158.1 426158	Ø 296 26 23,4 V + S
2.0 dCi (KZ0L)	118	04/09→	➔			24.0108-0118.2 408118	Ø 260 8 7 + LG / + ABS Ring
2.0 dCi (KZ0Y)	110	10/10→	➔			24.0108-0118.2 408118	Ø 260 8 7 + LG / + ABS Ring
2.0 TCe	140	09/12→	➔			24.0126-0158.1 426158	Ø 296 26 23,4 V + S
			➔			24.0108-0116.2 408116	Ø 260 8 7 + LG / + ABS Ring
2.0 TCe	162	09/12→	➔			24.0128-0245.1 428245	Ø 320 28 25,4 V + S
			➔			24.0108-0118.2 408118	Ø 260 8 7 + LG / + ABS Ring
2.0 TCe (KZ0K, KZ1T)	132	11/08→	➔	05/09→		24.0126-0158.1 426158	Ø 296 26 23,4 V + S
			➔	05/09→		24.0108-0118.2 408118	Ø 260 8 7 + LG / + ABS Ring









RENAULT - MEGANE III Schrägheck (BZ0_) 11/08→











Bremsbelagsatz, Scheibenbremse							
1.2 TCe	85	03/12→	➔			13.0460-7266.2 607266	ATE 24538 17,9 - WE / - WK
1.2 TCe (BZ16)	97	01/13→	➔			13.0470-7266.2 LD7266	ATE 24538 17,9 - WE / - WK Ceramic
1.4 TCe (BZ0F, BZ1V)	96	04/09→	➔				
1.5 dCi	63	12/09→	➔				
1.5 dCi	70	11/13→	➔	- eFSB		13.0460-2740.2 602740	TRW 23554 17,0 - WE / - WK + Zub
1.5 dCi	78	02/09→	➔			13.0470-2740.2 LD2740	TRW 23554 17,0 - WE / - WK + Zub Ceramic
1.5 dCi (BZ09, BZ0D)	81	02/09→	➔				
1.5 dCi (BZ0C)	66	11/08→	➔				
1.6 16V	82	11/08→	➔	+ eFSB		13.0460-2756.2 602756	TRW 24820 16,1 - WE / - WK + Zub
1.6 16V	85	10/15→	➔				
1.6 16V (BZ0H)	74	11/08→	➔				
1.6 16V (BZ1B, BZ1H)	81	11/08→	➔				
1.6 16V Bifuel (BZ03)	81	11/08→	➔				
1.6 dCi (BZ00, BZ12)	96	04/11→	➔				
1.9 dCi (BZ0N, BZ0J)	96	11/08→	➔				
2.0	105	01/11→	➔				
2.0 CVT (BZ0G, BZ1P)	103	02/09→	➔				
2.0 dCi	120	07/12→	➔			13.0460-7249.2 607249	ATE 24709 18,6 - WE / - WK
			➔			13.0470-7249.2 LD7249	ATE 24709 18,6 - WE / - WK Ceramic
2.0 dCi (BZ0L)	118	04/09→	➔			13.0460-7249.2 607249	ATE 24709 18,6 - WE / - WK
2.0 dCi (BZ0Y)	110	10/10→	➔			13.0470-7249.2 LD7249	ATE 24709 18,6 - WE / - WK Ceramic
2.0 TCe	140	06/12→	➔				
2.0 TCe (BZ0K)	132	11/08→	➔				
2.0 TCe 220	162	11/13→	➔	- eFSB		13.0460-2740.2 602740	TRW 23554 17,0 - WE / - WK + Zub
			➔			13.0470-2740.2 LD2740	TRW 23554 17,0 - WE / - WK + Zub Ceramic
➔			➔	+ eFSB		13.0460-2756.2 602756	TRW 24820 16,1 - WE / - WK + Zub









Bremsscheibe							
1.2 TCe	85	03/12→	➔			24.0124-0221.1 424221	Ø 280 24 21,8 V + S
1.2 TCe (BZ16)	97	01/13→	➔			24.0108-0116.2 408116	Ø 260 8 7 + LG / + ABS Ring
1.4 TCe (BZ0F, BZ1V)	96	04/09→	➔				
1.5 dCi	63	12/09→	➔				
1.5 dCi	70	11/13→	➔				
1.5 dCi	78	02/09→	➔				
1.5 dCi (BZ09, BZ0D)	81	02/09→	➔				
1.5 dCi (BZ0C)	66	11/08→	➔				
1.6 16V	82	11/08→	➔				
1.6 16V	85	10/15→	➔				
1.6 16V (BZ0H)	74	11/08→	➔				
1.6 16V (BZ1B, BZ1H)	81	11/08→	➔				
1.6 16V Bifuel (BZ03)	81	11/08→	➔				
1.6 dCi (BZ00, BZ12)	96	04/11→	➔				
1.9 dCi (BZ0N, BZ0J)	96	11/08→	➔				
2.0	105	01/11→	➔				
2.0 CVT (BZ0G, BZ1P)	103	02/09→	➔				
2.0 dCi	120	07/12→	➔			24.0126-0158.1 426158	Ø 296 26 23,4 V + S
2.0 dCi (BZ0L)	118	04/09→	➔			24.0126-0158.1 426158	Ø 296 26 23,4 V + S
2.0 TCe	140	06/12→	➔			24.0108-0116.2 408116	Ø 260 8 7 + LG / + ABS Ring
2.0 TCe (BZ0K)	132	11/08→	➔				
2.0 dCi (BZ0Y)	110	10/10→	➔			24.0126-0158.1 426158	Ø 296 26 23,4 V + S
			➔			24.0108-0116.2 408116	Ø 260 8 7 + LG / + ABS Ring











	kw					! #		
RENAULT - MEGANE III Schrägheck (BZ0_) 11/08→								
 Bremsscheibe								
2.0 dCi (BZ0Y)	110	10/10→	➡	07/12→		24.0108-0116.2	408116	Ø 260 8 7 + LG / + ABS Ring
2.0 TCe 220	162	11/13→	⬅			24.0128-0245.1	428245	Ø 320 28 25,4 V + S
			➡			24.0108-0116.2	408116	Ø 260 8 7 + LG / + ABS Ring
RENAULT - MEGANE IV (B9A/M_) 11/15→								
 Bremsbelagsatz, Scheibenbremse								
1.2 TCe 100 (B9MS) 1.6 16V	74 84	11/15→ 11/15→	⬅			13.0460-2709.2	602709	TRW 23973 17,1 - WE / - WK + Zub
						13.0470-2709.2	LD2709	TRW 23973 17,1 - WE / - WK + Zub Ceramic
			➡	- eFSB		13.0460-2740.2	602740	TRW 23554 17,0 - WE / - WK + Zub
						13.0470-2740.2	LD2740	TRW 23554 17,0 - WE / - WK + Zub Ceramic
1.2 TCe 130 (B9MR)	97	11/15→	⬅	Schaltgetriebe		13.0460-2709.2	602709	TRW 23973 17,1 - WE / - WK + Zub
						13.0470-2709.2	LD2709	TRW 23973 17,1 - WE / - WK + Zub Ceramic
			➡	- eFSB		13.0460-2740.2	602740	TRW 23554 17,0 - WE / - WK + Zub
			➡	+ eFSB		13.0470-2740.2	LD2740	TRW 23554 17,0 - WE / - WK + Zub Ceramic
			➡	+ eFSB		13.0460-2756.2	602756	TRW 24820 16,1 - WE / - WK + Zub
1.5 dCi 110 (B9A3) 1.5 dCi 90 (B9A1) 1.6 dCi 130 (B9A4)	81 66 96	11/15→ 11/15→ 11/15→	➡	- eFSB		13.0460-2740.2	602740	TRW 23554 17,0 - WE / - WK + Zub
						13.0470-2740.2	LD2740	TRW 23554 17,0 - WE / - WK + Zub Ceramic
			➡	+ eFSB		13.0460-2756.2	602756	TRW 24820 16,1 - WE / - WK + Zub
1.6 dCi 165	120	11/15→	➡	- eFSB		13.0460-2740.2	602740	TRW 23554 17,0 - WE / - WK + Zub
						13.0470-2740.2	LD2740	TRW 23554 17,0 - WE / - WK + Zub Ceramic
 Bremsscheibe								
1.2 TCe 130 (B9MR)	97	11/15→	⬅			24.0124-0221.1	424221	Ø 280 24 21,8 V + S
1.5 dCi 110 (B9A3) 1.5 dCi 90 (B9A1)	81 66	11/15→ 11/15→	⬅	Automatikgetriebe		24.0124-0221.1	424221	Ø 280 24 21,8 V + S
1.6 dCi 165 1.6 TCe 205 (B9MV)	120 151	11/15→ 11/15→	⬅			24.0128-0245.1	428245	Ø 320 28 25,4 V + S
RENAULT - MEGANE IV Grandtour (K9A/M_) 04/16→								
 Bremsbelagsatz, Scheibenbremse								
1.2 TCe 100 1.2 TCe 130 1.5 dCi 110 1.6 dCi 130	74 97 81 96	04/16→ 04/16→ 04/16→ 04/16→	➡	- eFSB		13.0460-2740.2	602740	TRW 23554 17,0 - WE / - WK + Zub
						13.0470-2740.2	LD2740	TRW 23554 17,0 - WE / - WK + Zub Ceramic
			➡	+ eFSB		13.0460-2756.2	602756	TRW 24820 16,1 - WE / - WK + Zub
1.5 dCi 90	66	04/16→	⬅			13.0460-2709.2	602709	TRW 23973 17,1 - WE / - WK + Zub
						13.0470-2709.2	LD2709	TRW 23973 17,1 - WE / - WK + Zub Ceramic
			➡	- eFSB		13.0460-2740.2	602740	TRW 23554 17,0 - WE / - WK + Zub
						13.0470-2740.2	LD2740	TRW 23554 17,0 - WE / - WK + Zub Ceramic
			➡	+ eFSB		13.0460-2756.2	602756	TRW 24820 16,1 - WE / - WK + Zub
 Bremsscheibe								
1.2 TCe 100 1.2 TCe 130 1.5 dCi 110 1.5 dCi 90	74 97 81 66	04/16→ 04/16→ 04/16→ 04/16→	⬅			24.0124-0221.1	424221	Ø 280 24 21,8 V + S













	kw			 	! #		
RENAULT - MEGANE CC (EZ0/1_) 06/10→							
 Bremsbelagsatz, Scheibenbremse							
1.2 TCe (EZ16)	97	01/13→	←	04/13→		13.0460-7266.2 607266	ATE 24538 17,9 - WE / - WK
			→	04/13→; - eFSB		13.0470-7266.2 LD7266	ATE 24538 17,9 - WE / - WK Ceramic
			→	04/13→; + eFSB		13.0460-2740.2 602740	TRW 23554 17,0 - WE / - WK + Zub
						13.0470-2740.2 LD2740	TRW 23554 17,0 - WE / - WK + Zub Ceramic
						13.0460-2756.2 602756	TRW 24820 16,1 - WE / - WK + Zub
1.4 TCe (EZ0F, EZ1V) 1.5 dCi (EZ09, EZ1G, EZ0D) 1.6 16V (EZ0U, EZ1U) 1.9 dCi (EZ0J, EZ1S) 2.0 CVT (EZ0G, EZ1E, EZ1P)	96 81 81 96 103	06/10→ 06/10→ 06/10→ 06/10→ 06/10→	←			13.0460-7266.2 607266	ATE 24538 17,9 - WE / - WK
			→	- eFSB		13.0470-7266.2 LD7266	ATE 24538 17,9 - WE / - WK Ceramic
			→	+ eFSB		13.0460-2740.2 602740	TRW 23554 17,0 - WE / - WK + Zub
						13.0470-2740.2 LD2740	TRW 23554 17,0 - WE / - WK + Zub Ceramic
						13.0460-2756.2 602756	TRW 24820 16,1 - WE / - WK + Zub
1.6 dCi (EZ00)	96	04/11→	←			13.0460-7266.2 607266	ATE 24538 17,9 - WE / - WK
			→	+ eFSB		13.0470-7266.2 LD7266	ATE 24538 17,9 - WE / - WK Ceramic
						13.0460-2756.2 602756	TRW 24820 16,1 - WE / - WK + Zub
2.0 dCi (EZ0L) 2.0 TCe (EZ1T) 2.0 Turbo	118 132 195	06/10→ 06/10→ 10/11→	←			13.0460-7249.2 607249	ATE 24709 18,6 - WE / - WK
			→	- eFSB		13.0470-7249.2 LD7249	ATE 24709 18,6 - WE / - WK Ceramic
			→	+ eFSB		13.0460-2740.2 602740	TRW 23554 17,0 - WE / - WK + Zub
						13.0470-2740.2 LD2740	TRW 23554 17,0 - WE / - WK + Zub Ceramic
						13.0460-2756.2 602756	TRW 24820 16,1 - WE / - WK + Zub
 Bremsscheibe							
1.2 TCe (EZ16)	97	01/13→	←	04/13→		24.0124-0221.1 424221	Ø 280 24 21,8 V + S
			→	04/13→		24.0108-0118.2 408118	Ø 260 8 7 + LG / + ABS Ring
1.4 TCe (EZ0F, EZ1V) 1.6 dCi (EZ00)	96 96	06/10→ 04/11→	←			24.0124-0221.1 424221	Ø 280 24 21,8 V + S
			→			24.0108-0118.2 408118	Ø 260 8 7 + LG / + ABS Ring
1.5 dCi (EZ09, EZ1G, EZ0D) 1.6 16V (EZ0U, EZ1U) 1.9 dCi (EZ0J, EZ1S) 2.0 CVT (EZ0G, EZ1E, EZ1P)	81 81 96 103	06/10→ 06/10→ 06/10→ 06/10→	←			24.0124-0221.1 424221	Ø 280 24 21,8 V + S
			→			24.0108-0116.2 408116	Ø 260 8 7 + LG / + ABS Ring
2.0 dCi (EZ0L) 2.0 TCe (EZ1T) 2.0 Turbo	118 132 195	06/10→ 06/10→ 10/11→	←			24.0126-0158.1 426158	Ø 296 26 23,4 V + S
			→			24.0108-0116.2 408116	Ø 260 8 7 + LG / + ABS Ring
RENAULT - MEGANE Scenic (JA0/1_) 10/96→12/01							
 Bremsbelagsatz, Scheibenbremse							
1.4 i (JA0E) 1.6 i (JA0L)	55 55	01/97→09/99 01/97→09/99	←	→ 09/98		13.0460-2834.2 602834	TRW 21463 18,0 + WK
			←	10/98→		13.0460-2983.2 602983	TRW 20919 18,0 + WK
1.6 16V (JA0B, JA04, JA11)	79	04/98→10/99	←	04/99→ 09/99		13.0460-2895.2 602895	TRW 23172 18,0 - WK
			←	→ 03/99		13.0460-2983.2 602983	TRW 20919 18,0 + WK
			→	→ 09/99		13.0460-2845.2 602845	TRW 23554 16,4 - WK + Zub
						13.0470-2845.2 LD2845	TRW 23554 16,4 - WK + Zub Ceramic
1.6 e (JA0F)	66	10/96→10/99	←	11/96→ 09/98; Schaltgetriebe		13.0460-2834.2 602834	TRW 21463 18,0 + WK
			←	01/99→ 09/99; Vollautomatik		13.0460-2895.2 602895	TRW 23172 18,0 - WK
			←	01/99→ 09/99; Schaltgetriebe		13.0460-2895.2 602895	TRW 23172 18,0 - WK
			←	11/96→ 12/98; Vollautomatik		13.0460-2983.2 602983	TRW 20919 18,0 + WK
			←	10/98→ 12/98; Schaltgetriebe		13.0460-2983.2 602983	TRW 20919 18,0 + WK
1.9 D (JA0J)	47	03/97→09/99	←			13.0460-2895.2 602895	TRW 23172 18,0 - WK
			←	10/98→		13.0460-2983.2 602983	TRW 20919 18,0 + WK
						13.0460-2895.2 602895	TRW 23172 18,0 - WK











	kw			 	! #		
RENAULT - MEGANE Scenic (JA0/1_) 10/96→12/01							
 Bremsbelagsatz, Scheibenbremse							
1.9 D (JA0J)	47	03/97→09/99	← → 09/98			13.0460-2983.2 602983	TRW 20919 18,0 + WK
1.9 dT (JA0K, JA0Y)	66	01/97→09/99	← → 12/97			13.0460-2983.2 602983	TRW 20919 18,0 + WK
1.9 dT (JA0Y)	69	03/97→08/99	←			13.0460-2983.2 602983	TRW 20919 18,0 + WK
2.0 i (JA02, JA0G)	80	01/99→09/99					
2.0 i (JA0G)	84	01/97→09/99					
1.9 dTi (JA0N)	72	04/97→09/99	← 10/98→			13.0460-2895.2 602895	TRW 23172 18,0 - WK
			← → 09/98			13.0460-2983.2 602983	TRW 20919 18,0 + WK
			← 03/98→			13.0460-2983.2 602983	TRW 20919 18,0 + WK
			➔ + ABS			13.0460-2845.2 602845 13.0470-2845.2 LD2845	TRW 23554 16,4 - WK + Zub TRW 23554 16,4 - WK + Zub Ceramic
2.0 RXE 4x4	84	05/97→10/99	← → 09/99			13.0460-2983.2 602983	TRW 20919 18,0 + WK
Zubehörsatz, Scheibenbremsbelag							
1.6 16V (JA0B, JA04, JA11)	79	04/98→10/99	← 04/99→ 09/99			13.0460-0262.2 610262	TRW
			➔ → 09/99			13.0460-0077.2 610077	TRW
1.6 e (JA0F)	66	10/96→10/99	← 01/99→ 09/99; Schaltgetriebe			13.0460-0262.2 610262	TRW
			← 01/99→ 09/99; Vollautomatik			13.0460-0262.2 610262	TRW
1.9 D (JA0J)	47	03/97→09/99	←			13.0460-0262.2 610262	TRW
			← 10/98→			13.0460-0262.2 610262	TRW
1.9 dTi (JA0N)	72	04/97→09/99	← 10/98→			13.0460-0262.2 610262	TRW
			➔ + ABS			13.0460-0077.2 610077	TRW
 Bremsscheibe							
1.4 i (JA0E)	55	01/97→09/99	← → 09/98			24.0121-0106.1 421106	Ø 259 20,7 17,7 V + S
1.6 i (JA0L)	55	01/97→09/99	← 10/98→			24.0124-0158.1 424158 24.0324-0158.1 524158	Ø 280 24 21,8 V + S Ø 280 24 21,8 V + S PD
1.6 16V (JA0B, JA04, JA11)	79	04/98→10/99	← → 09/98			24.0122-0148.1 422148	Ø 262 22 19,8 V + S
			← 10/98→ 09/99			24.0124-0158.1 424158 24.0324-0158.1 524158	Ø 280 24 21,8 V + S Ø 280 24 21,8 V + S PD
			➔ → 09/99			24.0111-0166.2 411166	Ø 274 10,9 9,5 + LG / + ABS Ring
1.6 e (JA0F)	66	10/96→10/99	← 11/96→ 09/98; Schaltgetriebe			24.0121-0106.1 421106	Ø 259 20,7 17,7 V + S
			← 11/96→ 09/98; Vollautomatik			24.0122-0148.1 422148	Ø 262 22 19,8 V + S
			← 10/98→ 09/99			24.0124-0158.1 424158 24.0324-0158.1 524158	Ø 280 24 21,8 V + S Ø 280 24 21,8 V + S PD
1.9 D (JA0J)	47	03/97→09/99	←			24.0122-0148.1 422148	Ø 262 22 19,8 V + S
			← → 09/98			24.0122-0148.1 422148	Ø 262 22 19,8 V + S
			← 10/98→			24.0124-0158.1 424158 24.0324-0158.1 524158	Ø 280 24 21,8 V + S Ø 280 24 21,8 V + S PD
1.9 dT (JA0K, JA0Y)	66	01/97→09/99	← → 12/97			24.0122-0148.1 422148	Ø 262 22 19,8 V + S
1.9 dT (JA0Y)	69	03/97→08/99	←			24.0122-0148.1 422148	Ø 262 22 19,8 V + S
1.9 dTi (JA0N)	72	04/97→09/99	← 03/98→ 09/98			24.0122-0148.1 422148	Ø 262 22 19,8 V + S
			← → 09/98			24.0122-0148.1 422148	Ø 262 22 19,8 V + S
			← 10/98→			24.0124-0158.1 424158 24.0324-0158.1 524158	Ø 280 24 21,8 V + S Ø 280 24 21,8 V + S PD
			➔ + ABS			24.0111-0166.2 411166	Ø 274 10,9 9,5 + LG / + ABS Ring
2.0 i (JA02, JA0G)	80	01/99→09/99	←			24.0124-0158.1 424158 24.0324-0158.1 524158	Ø 280 24 21,8 V + S Ø 280 24 21,8 V + S PD
2.0 i (JA0G)	84	01/97→09/99	← → 09/98			24.0122-0148.1 422148	Ø 262 22 19,8 V + S
			← 10/98→			24.0124-0158.1 424158 24.0324-0158.1 524158	Ø 280 24 21,8 V + S Ø 280 24 21,8 V + S PD
2.0 RXE 4x4	84	05/97→10/99	← → 09/98			24.0122-0148.1 422148	Ø 262 22 19,8 V + S
			← 10/98→ 09/99			24.0124-0158.1 424158 24.0324-0158.1 524158	Ø 280 24 21,8 V + S Ø 280 24 21,8 V + S PD









	kw				! #		
RENAULT - MODUS / GRAND MODUS (F/JPO_) 09/04 →							
 Bremsbelagsatz, Scheibenbremse							
1.2	76	04/11 →	←	→ 06/13		13.0460-2709.2 602709	TRW 23973 17,1 - WE / - WK + Zub
1.2 (JP0S)	58	12/04 →					
1.4 (JP01, JP0J)	72	12/04 →				13.0470-2709.2 LD2709	TRW 23973 17,1 - WE / - WK + Zub Ceramic
1.5 dCi (FP0F, JP0F)	63	12/04 →					
1.5 dCi (JP02)	76	05/07 →					
1.5 dCi (JP0G, JP0H)	78	05/05 →	→	→ 06/13		13.0460-2845.2 602845	TRW 23554 16,4 - WK + Zub
1.6 (JP03, JP0B, JP0U, JP0Y, JP1G)	82	12/04 →				13.0470-2845.2 LD2845	TRW 23554 16,4 - WK + Zub Ceramic
1.6 (JP0L, JP0V)	65	12/04 →					
1.2 (FP0C, FP0K, FP0P)	48	05/05 →	←	→ 06/13		13.0460-2709.2 602709	TRW 23973 17,1 - WE / - WK + Zub
1.2 (JP0C, JP0K, FP0C, FP0K, FP0P, JP0P, JP0T)	55	12/04 →				13.0470-2709.2 LD2709	TRW 23973 17,1 - WE / - WK + Zub Ceramic
1.2 16V (JP0W)	74	05/07 →					
1.2 16V Hi-Flex	55	10/08 →	→	+ ESP; → 06/13		13.0460-2845.2 602845	TRW 23554 16,4 - WK + Zub
1.5 dCi (FP0D, JP0D)	60	09/04 →				13.0470-2845.2 LD2845	TRW 23554 16,4 - WK + Zub Ceramic
1.5 dCi (FP0E, JP0E)	48	12/04 →					
1.5 dCi (FP0G, JP0G)	50	12/04 →					
1.5 dCi 75	55	10/10 →					
1.5 dCi 90	65	10/10 →					
 Bremsscheibe							
1.2	76	04/11 →	←	→ 06/13		24.0122-0216.1 422216	Ø 260 22 19,8 V + S
1.2 (FP0C, FP0K, FP0P)	48	05/05 →	←	→ 06/13		24.0122-0216.1 422216	Ø 260 22 19,8 V + S
			→	+ ESP; → 06/13; Achszapfendurchmesser [mm]: 25		24.0108-0114.2 408114	Ø 240 8 7 + LG / + ABS Ring
1.2 (JP0C, JP0K, FP0C, FP0K, FP0P, JP0P, JP0T)	55	12/04 →	←	→ 06/13		24.0122-0216.1 422216	Ø 260 22 19,8 V + S
			→	→ 06/13; + ESP		24.0108-0114.2 408114	Ø 240 8 7 + LG / + ABS Ring
1.2 16V (JP0W)	74	05/07 →					
1.2 16V Hi-Flex	55	10/08 →					
1.5 dCi (FP0D, JP0D)	60	09/04 →					
1.5 dCi (FP0E, JP0E)	48	12/04 →					
1.5 dCi (FP0G, JP0G)	50	12/04 →					
1.5 dCi 75	55	10/10 →					
1.5 dCi 90	65	10/10 →					
1.2 (JP0S)	58	12/04 →	←	→ 06/13		24.0122-0216.1 422216	Ø 260 22 19,8 V + S
1.4 (JP01, JP0J)	72	12/04 →					
1.5 dCi (FP0F, JP0F)	63	12/04 →	→	→ 06/13		24.0108-0114.2 408114	Ø 240 8 7 + LG / + ABS Ring
1.5 dCi (JP02)	76	05/07 →					
1.5 dCi (JP0G, JP0H)	78	05/05 →					
1.6 (JP03, JP0B, JP0U, JP0Y, JP1G)	82	12/04 →					
1.6 (JP0L, JP0V)	65	12/04 →					
RENAULT - RAPID 09/94 → 03/98							
 Bremsbelagsatz, Scheibenbremse							
1.9 D	47	09/94 → 03/98	←	07/95 →		13.0460-3911.2 603911	BDX 20905 18,0 + WK
Zubehörsatz, Scheibenbremsbelag							
1.9 D	47	09/94 → 03/98	←	07/95 →		13.0460-0411.2 610411	BDX
 Bremsscheibe							
1.9 D	47	09/94 → 03/98	←	07/95 →		24.0112-0116.1 412116	Ø 238 12 10,5 + S
RENAULT - RAPID Kasten (F40_, G40_) 07/85 → 11/01							
 Bremsbelagsatz, Scheibenbremse							
1.1	35	09/93 → 04/95	←			13.0460-2834.2 602834	TRW 21463 18,0 + WK
1.2	48	05/95 → 11/98				13.0460-3911.2 603911	BDX 20905 18,0 + WK
1.4	59	05/95 → 08/97					
1.4 (F40U, F40V)	55	09/91 → 03/98					
1.4 Cat (F407)	43	08/88 → 03/98					
1.6 D	40	09/93 → 04/95					
Electric	21	01/94 → 11/98					
1.1 (F401)	33	07/85 → 04/95	←	09/91 →		13.0460-2834.2 602834	TRW 21463 18,0 + WK
			←	→ 05/88		13.0460-2834.2 602834	TRW 21463 18,0 + WK
			←			13.0460-3911.2 603911	BDX 20905 18,0 + WK
			←	06/88 →		13.0460-3955.2 603955	BDX 20634 15,0 + WK
			←			13.0460-2834.2 602834	TRW 21463 18,0 + WK
			←			13.0460-3911.2 603911	BDX 20905 18,0 + WK
1.2 (F406, G40A)	40	09/91 → 03/98	←			13.0460-2834.2 602834	TRW 21463 18,0 + WK
						13.0460-3911.2 603911	BDX 20905 18,0 + WK
↓							









	kw			 	! #		
RENAULT - RAPID Kasten (F40_, G40_) 07/85→11/01							
 Bremsbelagsatz, Scheibenbremse							
1.2 (F406, G40A)	40	09/91→03/98	←	10/92→		13.0460-2834.2 602834 13.0460-3911.2 603911	TRW 21463 18,0 + WK BDX 20905 18,0 + WK
1.4 (F40D)	58	01/94→03/98	←			13.0460-2834.2 602834 13.0460-3911.2 603911	TRW 21463 18,0 + WK BDX 20905 18,0 + WK
			←	09/94→		13.0460-2834.2 602834 13.0460-3911.2 603911	TRW 21463 18,0 + WK BDX 20905 18,0 + WK
1.6 D (F404)	40	03/86→08/98	←			13.0460-2834.2 602834 13.0460-3911.2 603911	TRW 21463 18,0 + WK BDX 20905 18,0 + WK
			←	07/86→		13.0460-2834.2 602834 13.0460-3911.2 603911	TRW 21463 18,0 + WK BDX 20905 18,0 + WK
			←	→ 06/86		13.0460-3955.2 603955	BDX 20634 15,0 + WK
1.9 D (F40P, F40N, F40E)	47	09/91→03/98	←			13.0460-2834.2 602834 13.0460-3911.2 603911	TRW 21463 18,0 + WK BDX 20905 18,0 + WK
			←	09/92→		13.0460-2834.2 602834 13.0460-3911.2 603911	TRW 21463 18,0 + WK BDX 20905 18,0 + WK
			←	09/95→		13.0460-3911.2 603911	BDX 20905 18,0 + WK
1.9 D (F40R)	40	09/94→03/98	←			13.0460-3911.2 603911	BDX 20905 18,0 + WK
Zubehörsatz, Scheibenbremsbelag							
1.1 1.2 1.4 1.4 (F40U, F40V) 1.4 Cat (F407) 1.6 D 1.9 D (F40R) Electric	35 48 59 55 43 40 40 21	09/93→04/95 05/95→11/98 05/95→08/97 09/91→03/98 08/88→03/98 09/93→04/95 09/94→03/98 01/94→11/98	←			13.0460-0411.2 610411	BDX
1.1 (F401)	33	07/85→04/95	←	09/91→		13.0460-0411.2 610411	BDX
			←	→ 05/88		13.0460-0411.2 610411 13.0460-0423.2 610423	BDX BDX
			←	06/88→		13.0460-0411.2 610411	BDX
1.2 (F406, G40A)	40	09/91→03/98	←			13.0460-0411.2 610411	BDX
			←	10/92→		13.0460-0411.2 610411	BDX
1.4 (F40D)	58	01/94→03/98	←			13.0460-0411.2 610411	BDX
			←	09/94→		13.0460-0411.2 610411	BDX
1.6 D (F404)	40	03/86→08/98	←			13.0460-0411.2 610411	BDX
			←	07/86→		13.0460-0411.2 610411	BDX
			←	→ 06/86		13.0460-0423.2 610423	BDX
1.9 D (F40P, F40N, F40E)	47	09/91→03/98	←			13.0460-0411.2 610411	BDX
			←	09/95→		13.0460-0411.2 610411	BDX
			←	09/92→		13.0460-0411.2 610411	BDX
 Bremsscheibe							
1.1 1.2 1.4 1.4 (F40U, F40V) 1.4 Cat (F407) 1.6 D 1.9 D (F40R) Electric	35 48 59 55 43 40 40 21	09/93→04/95 05/95→11/98 05/95→08/97 09/91→03/98 08/88→03/98 09/93→04/95 09/94→03/98 01/94→11/98	←			24.0112-0116.1 412116	Ø 238 12 10,5 + S
1.1 (F401)	33	07/85→04/95	←	→ 05/88		24.0108-0104.1 408104	Ø 238 8,2 7 + S
			←	01/86→		24.0112-0116.1 412116	Ø 238 12 10,5 + S
			←	09/91→		24.0112-0116.1 412116	Ø 238 12 10,5 + S
			←	06/88→		24.0112-0116.1 412116	Ø 238 12 10,5 + S
1.2 (F406, G40A)	40	09/91→03/98	←			24.0112-0116.1 412116	Ø 238 12 10,5 + S
			←	10/92→		24.0112-0116.1 412116	Ø 238 12 10,5 + S
1.4 (F40D)	58	01/94→03/98	←			24.0112-0116.1 412116	Ø 238 12 10,5 + S
			←	09/94→		24.0112-0116.1 412116	Ø 238 12 10,5 + S
1.6 D (F404)	40	03/86→08/98	←	→ 06/86		24.0108-0104.1 408104	Ø 238 8,2 7 + S
			←			24.0112-0116.1 412116	Ø 238 12 10,5 + S
↓							









	kW					! #		
RENAULT - RAPID Kasten (F40_, G40_) 07/85→11/01								
 Bremsscheibe								
1.6 D (F404)	40	03/86→08/98	←	07/86→			24.0112-0116.1 412116	∅ 238 12 10,5 + S
1.9 D (F40P, F40N, F40E)	47	09/91→03/98	←				24.0112-0116.1 412116	∅ 238 12 10,5 + S
			←	09/95→		24.0112-0116.1 412116	∅ 238 12 10,5 + S	
			←	09/92→		24.0112-0116.1 412116	∅ 238 12 10,5 + S	
RENAULT - SAFRANE I (B54_) 04/92→10/97								
 Bremsbelagsatz, Scheibenbremse								
2.0 (B540)	77	11/92→07/96	←				13.0460-2983.2 602983	TRW 20919 18,0 + WK
2.1 dT (B546)	65	11/93→07/96	→	→ 01/95; + ABS			13.0460-4957.2 604957	BRE 20410 15,0 - WE / - WK
2.2 (B541)	79	04/92→07/96	→	02/95→			13.0460-4957.2 604957	BRE 20410 15,0 - WE / - WK
			→					
2.0 12V (B542, B54E)	97	04/92→07/96	←				13.0460-2983.2 602983	TRW 20919 18,0 + WK
2.2 (B543)	101	04/92→07/96	→					
2.5 dT (B548)	83	12/92→07/96	→				13.0460-4957.2 604957	BRE 20410 15,0 - WE / - WK
3.0 V6 (B54B, B544)	123	12/92→07/96	→					
3.0 V6 4x4 (B54B, B544)	123	12/92→07/96	→					
3.0	125	02/93→06/96	→				13.0460-4957.2 604957	BRE 20410 15,0 - WE / - WK
3.0	125	03/93→10/96	→	→ 07/96			13.0460-4957.2 604957	BRE 20410 15,0 - WE / - WK
Zubehörsatz, Scheibenbremsbelag								
2.0 (B540)	77	11/92→07/96	→	→ 01/95; + ABS			13.0460-0438.2 610438	BRE
2.1 dT (B546)	65	11/93→07/96	→					
2.2 (B541)	79	04/92→07/96	→	02/95→			13.0460-0438.2 610438	BRE
			→					
2.0 12V (B542, B54E)	97	04/92→07/96	→				13.0460-0438.2 610438	BRE
2.2 (B543)	101	04/92→07/96	→					
2.5 dT (B548)	83	12/92→07/96	→					
3.0	125	02/93→06/96	→					
3.0 V6 (B54B, B544)	123	12/92→07/96	→					
3.0	125	03/93→10/96	→	→ 07/96			13.0460-0438.2 610438	BRE
3.0 Biturbo 4x4 (B545)	193	02/93→07/96	→				13.0460-0423.2 610423	BDX
3.0 V6 4x4 (B54B, B544)	123	12/92→07/96	→	02/93→			13.0460-0423.2 610423	BDX
			→					
 Bremsscheibe								
2.0 (B540)	77	11/92→07/96	←				24.0122-0148.1 422148	∅ 262 22 19,8 V + S
2.1 dT (B546)	65	11/93→07/96	→	→ 01/95; + ABS			24.0110-0219.1 410219	∅ 265 10,5 9,5
			→	02/95→		24.0110-0219.1 410219	∅ 265 10,5 9,5	
			→					
2.0 12V (B542, B54E)	97	04/92→07/96	←	→ 01/95			24.0122-0148.1 422148	∅ 262 22 19,8 V + S
			←	02/95→		24.0122-0149.1 422149	∅ 262 22 19,8 V	
			→	→ 01/95		24.0110-0219.1 410219	∅ 265 10,5 9,5	
			→	02/95→		24.0110-0220.1 410220	∅ 265 10,5 9,5	
2.2 (B543)	101	04/92→07/96	←	→ 01/95			24.0122-0148.1 422148	∅ 262 22 19,8 V + S
			←	02/95→		24.0122-0149.1 422149	∅ 262 22 19,8 V	
			→	→ 01/95		24.0110-0219.1 410219	∅ 265 10,5 9,5	
			→	02/95→		24.0110-0220.1 410220	∅ 265 10,5 9,5	
			→					
2.2 (B541)	79	04/92→07/96	←	→ 01/95			24.0122-0148.1 422148	∅ 262 22 19,8 V + S
			←	02/95→		24.0122-0148.1 422148	∅ 262 22 19,8 V + S	
			←			24.0122-0149.1 422149	∅ 262 22 19,8 V	
			→	→ 01/95; + ABS		24.0110-0219.1 410219	∅ 265 10,5 9,5	
			→	02/95→		24.0110-0219.1 410219	∅ 265 10,5 9,5	
2.5 dT (B548)	83	12/92→07/96	←	→ 06/93; Automatikgetriebe			24.0122-0149.1 422149	∅ 262 22 19,8 V
			←	→ 05/94; Schaltgetriebe		24.0122-0149.1 422149	∅ 262 22 19,8 V	
			←	06/94→; Schaltgetriebe		24.0124-0171.1 424171	∅ 280 24 21,8 V + S	
			←			24.0324-0171.1 524171	∅ 280 24 21,8 V + S PD	
			←	07/93→; Automatikgetriebe		24.0124-0171.1 424171	∅ 280 24 21,8 V + S	
			←			24.0324-0171.1 524171	∅ 280 24 21,8 V + S PD	
3.0	125	02/93→06/96	→				24.0110-0220.1 410220	∅ 265 10,5 9,5
			→					
3.0	125	03/93→10/96	→	→ 07/96			24.0110-0220.1 410220	∅ 265 10,5 9,5
3.0 Biturbo 4x4 (B545)	193	02/93→07/96	→				24.0111-0144.1 411144	∅ 265 10,5 9,5
3.0 V6 (B54B, B544)	123	12/92→07/96	←				24.0124-0171.1 424171	∅ 280 24 21,8 V + S
			←				24.0324-0171.1 524171	∅ 280 24 21,8 V + S PD
			→				24.0110-0220.1 410220	∅ 265 10,5 9,5
3.0 V6 4x4 (B54B, B544)	123	12/92→07/96	←				24.0124-0171.1 424171	∅ 280 24 21,8 V + S
↓								









	kW			 	! #					
RENAULT - SAFRANE I (B54_) 04/92→10/97										
 Bremsscheibe										
3.0 V6 4x4 (B54B, B544)	123	12/92→07/96	←			24.0324-0171.1 524171	Ø 280 24 21,8 V + S PD			
			→			24.0110-0220.1 410220	Ø 265 10,5 9,5			
			→	02/93→		24.0111-0144.1 411144	Ø 265 10,5 9,5			
RENAULT - SAFRANE II (B54_) 07/96→12/00										
 Bremsbelagsatz, Scheibenbremse										
2.0 16V (B54L)	100	07/96→12/00	←	08/96→		13.0460-2983.2 602983	TRW 20919 18,0 + WK			
2.2 dT (B54G)	83	07/96→12/00	→	08/96→		13.0460-4957.2 604957	BRE 20410 15,0 - WE / - WK			
2.5 20V (B54F)	121	07/96→12/00								
2.9 24V (B54N)	140	03/99→12/00	←			13.0460-2895.2 602895	TRW 23172 18,0 - WK			
			→			13.0460-4957.2 604957	BRE 20410 15,0 - WE / - WK			
3.0 V6 (B54M)	123	07/96→12/00	←	08/96→		13.0460-2983.2 602983	TRW 20919 18,0 + WK			
			←	→ 07/96		13.0460-2983.2 602983	TRW 20919 18,0 + WK			
			→	08/96→		13.0460-4957.2 604957	BRE 20410 15,0 - WE / - WK			
			→	→ 07/96		13.0460-4957.2 604957	BRE 20410 15,0 - WE / - WK			
Zubehörsatz, Scheibenbremsbelag										
2.0 16V (B54L)	100	07/96→12/00	→	08/96→		13.0460-0438.2 610438	BRE			
2.2 dT (B54G)	83	07/96→12/00								
2.5 20V (B54F)	121	07/96→12/00	←			13.0460-0262.2 610262	TRW			
2.9 24V (B54N)	140	03/99→12/00								
3.0 V6 (B54M)	123	07/96→12/00	→	08/96→		13.0460-0438.2 610438	BRE			
			→	→ 07/96		13.0460-0438.2 610438	BRE			
			→			13.0460-0438.2 610438	BRE			
 Bremsscheibe										
2.0 16V (B54L)	100	07/96→12/00	←	08/96→ 12/97		24.0122-0149.1 422149	Ø 262 22 19,8 V			
			←	01/98→		24.0124-0171.1 424171	Ø 280 24 21,8 V + S			
			→	08/96→		24.0324-0171.1 524171	Ø 280 24 21,8 V + S PD			
2.2 dT (B54G)	83	07/96→12/00	←	08/96→		24.0124-0171.1 424171	Ø 280 24 21,8 V + S			
					2.5 20V (B54F)			121	07/96→12/00	→
2.9 24V (B54N)	140	03/99→12/00	←			24.0124-0171.1 424171	Ø 280 24 21,8 V + S			
					→				24.0324-0171.1 524171	Ø 280 24 21,8 V + S PD
					→				24.0110-0220.1 410220	Ø 265 10,5 9,5
3.0 V6 (B54M)	123	07/96→12/00	←	08/96→		24.0124-0171.1 424171	Ø 280 24 21,8 V + S			
			←	→ 07/96		24.0324-0171.1 524171	Ø 280 24 21,8 V + S PD			
			→	→ 07/96		24.0124-0171.1 424171	Ø 280 24 21,8 V + S			
			→	08/96→		24.0324-0171.1 524171	Ø 280 24 21,8 V + S PD			
			→	07/96		24.0110-0220.1 410220	Ø 265 10,5 9,5			
			→	08/96→		24.0110-0220.1 410220	Ø 265 10,5 9,5			
RENAULT - SANDERO/STEPWAY I (BS_) 11/07→										
 Bremsbelagsatz, Scheibenbremse										
1.4	55	02/09→	←			13.0460-2834.2 602834	TRW 21463 18,0 + WK			
1.6	62	11/10→								
1.6	64	02/09→								
1.6	66	05/09→								
1.6	75	12/07→								
1.6	76	12/07→								
 Bremsscheibe										
1.4	55	02/09→	←	- ABS		24.0112-0116.1 412116	Ø 238 12 10,5 + S			
1.6	62	11/10→	←	+ ABS		24.0112-0171.1 412171	Ø 259 12 10,6 + S			
1.6	64	02/09→								
1.6	66	05/09→	←			24.0121-0106.1 421106	Ø 259 20,7 17,7 V + S			
1.6	75	12/07→								
1.6	76	12/07→								
RENAULT - SANDERO/STEPWAY II (B8_) 11/13→										
 Bremsbelagsatz, Scheibenbremse										
1.2 16V	54	12/13→	←			13.0460-7298.2 607298	ATE 25702 18,2 - WE / - WK			
1.2 16V LPG	53	12/13→								













	kW					! #		
RENAULT - SANDERO/STEPWAY II (B8_) 11/13→								
 Bremsbelagsatz, Scheibenbremse								
1.6	59	11/13→	←			13.0460-7298.2	607298	ATE 25702 18,2 - WE / - WK
1.6	60	11/13→						
1.6	75	04/14→						
 Bremsscheibe								
1.2 16V	54	12/13→	←			24.0112-0171.1	412171	Ø 259 12 10,6 + S
1.2 16V LPG	53	12/13→						
1.6	59	11/13→						
1.6	60	11/13→						
1.6	75	04/14→						
1.5 dCi	62	12/13→	←			24.0122-0289.1	422289	Ø 258 22 19,8 V + S
RENAULT - SCÉNIC I (JA0/1_) 09/99→09/03								
 Bremsbelagsatz, Scheibenbremse								
1.4 16V (JA0D, JA1H, Ja0W, JA10)	70	09/99→08/03	←	→ 06/03		13.0460-2895.2	602895	TRW 23172 18,0 - WK
1.6	75	03/01→08/03	→	→ 06/03; + ABS		13.0460-2845.2	602845	TRW 23554 16,4 - WK + Zub
1.6	79	09/99→09/03				13.0470-2845.2	LD2845	TRW 23554 16,4 - WK + Zub
1.6	81	06/01→09/03						Ceramic
1.6 16V	85	09/99→08/03						
1.6 BiFuel	75	03/01→08/03						
1.9 dTi (JA0N)	72	09/99→08/03						
1.6 BiFuel (JA04)	79	09/99→04/01	←			13.0460-2895.2	602895	TRW 23172 18,0 - WK
			→	+ ABS		13.0460-2845.2	602845	TRW 23554 16,4 - WK + Zub
						13.0470-2845.2	LD2845	TRW 23554 16,4 - WK + Zub
								Ceramic
1.8 16V (JA12, JA1R, JA1M, JA1A)	85	01/01→08/03	←	→ 06/03		13.0460-2895.2	602895	TRW 23172 18,0 - WK
1.9 dCi (JA05, JA1F)	75	09/99→08/03	→	→ 06/03		13.0460-2845.2	602845	TRW 23554 16,4 - WK + Zub
1.9 dTi (JA1U)	59	02/01→08/03				13.0470-2845.2	LD2845	TRW 23554 16,4 - WK + Zub
2.0 16V	103	09/99→08/03						Ceramic
2.0 16V (JA1B, JA1D)	102	07/00→08/03						
1.8 4x4	85	07/00→04/01	←			13.0460-2895.2	602895	TRW 23172 18,0 - WK
1.9 D	47	09/99→03/01	→			13.0460-2845.2	602845	TRW 23554 16,4 - WK + Zub
						13.0470-2845.2	LD2845	TRW 23554 16,4 - WK + Zub
								Ceramic
1.9 dCi RX4	74	12/02→08/03	←			13.0460-7158.2	607158	ATE 23245 18,3 - WE / - WK
						13.0470-7158.2	LD7158	ATE 23245 18,3 - WE / - WK
								Ceramic
			→	→ 06/03		13.0460-2845.2	602845	TRW 23554 16,4 - WK + Zub
						13.0470-2845.2	LD2845	TRW 23554 16,4 - WK + Zub
								Ceramic
1.9 dCi RX4	75	11/00→08/03	←	→ 03/02		13.0460-2895.2	602895	TRW 23172 18,0 - WK
2.0 16V RX4	102	06/00→08/03	←	04/02→		13.0460-7158.2	607158	ATE 23245 18,3 - WE / - WK
						13.0470-7158.2	LD7158	ATE 23245 18,3 - WE / - WK
								Ceramic
			→	→ 06/03		13.0460-2845.2	602845	TRW 23554 16,4 - WK + Zub
						13.0470-2845.2	LD2845	TRW 23554 16,4 - WK + Zub
								Ceramic
Zubehörsatz, Scheibenbremsbelag								
1.4 16V (JA0D, JA1H, Ja0W, JA10)	70	09/99→08/03	←	→ 06/03		13.0460-0262.2	610262	TRW
1.6	75	03/01→08/03	→	→ 06/03; + ABS		13.0460-0077.2	610077	TRW
1.6	79	09/99→09/03						
1.6	81	06/01→09/03						
1.6 16V	85	09/99→08/03						
1.6 BiFuel	75	03/01→08/03						
1.9 dTi (JA0N)	72	09/99→08/03						
1.6 BiFuel (JA04)	79	09/99→04/01	←			13.0460-0262.2	610262	TRW
			→	+ ABS		13.0460-0077.2	610077	TRW
1.8 16V (JA12, JA1R, JA1M, JA1A)	85	01/01→08/03	←	→ 06/03		13.0460-0262.2	610262	TRW
1.9 dCi (JA05, JA1F)	75	09/99→08/03	→	→ 06/03		13.0460-0077.2	610077	TRW
1.9 dTi (JA1U)	59	02/01→08/03						
2.0 16V	103	09/99→08/03						
2.0 16V (JA1B, JA1D)	102	07/00→08/03						
1.8 4x4	85	07/00→04/01	←			13.0460-0262.2	610262	TRW
1.9 D	47	09/99→03/01	→			13.0460-0077.2	610077	TRW
1.9 dCi RX4	74	12/02→08/03	→	→ 06/03		13.0460-0077.2	610077	TRW
1.9 dCi RX4	75	11/00→08/03	←	→ 03/02		13.0460-0262.2	610262	TRW
↓								















	kw			 	! #		
RENAULT - SCÉNIC I (JA0/1_) 09/99→09/03							
Zubehörsatz, Scheibenbremsbelag							
2.0 16V RX4	102	06/00→08/03	➡	→ 06/03		13.0460-0077.2 610077	TRW
 Bremsscheibe							
1.4 16V (JA0D, JA1H, Ja0W, JA10)	70	09/99→08/03	←	→ 06/03		24.0124-0158.1 424158	Ø 280 24 21,8 V + S
1.6	75	03/01→08/03				24.0324-0158.1 524158	Ø 280 24 21,8 V + S PD
1.6	79	09/99→09/03	➡	→ 06/03; + ABS		24.0111-0166.2 411166	Ø 274 10,9 9,5 + LG / + ABS Ring
1.6	81	06/01→09/03					
1.6 16V	85	09/99→08/03					
1.6 BiFuel	75	03/01→08/03					
1.9 dTi (JA0N)	72	09/99→08/03					
1.6 BiFuel (JA04)	79	09/99→04/01	←			24.0124-0158.1 424158	Ø 280 24 21,8 V + S
			➡	+ ABS		24.0324-0158.1 524158	Ø 280 24 21,8 V + S PD
						24.0111-0166.2 411166	Ø 274 10,9 9,5 + LG / + ABS Ring
1.8 16V (JA12, JA1R, JA1M, JA1A)	85	01/01→08/03	←	→ 06/03		24.0124-0158.1 424158	Ø 280 24 21,8 V + S
1.9 dCi (JA05, JA1F)	75	09/99→08/03				24.0324-0158.1 524158	Ø 280 24 21,8 V + S PD
1.9 dTi (JA1U)	59	02/01→08/03	➡	→ 06/03		24.0111-0166.2 411166	Ø 274 10,9 9,5 + LG / + ABS Ring
2.0 16V	103	09/99→08/03					
2.0 16V (JA1B, JA1D)	102	07/00→08/03					
1.8 4x4	85	07/00→04/01	←			24.0124-0158.1 424158	Ø 280 24 21,8 V + S
1.9 D	47	09/99→03/01				24.0324-0158.1 524158	Ø 280 24 21,8 V + S PD
			➡			24.0111-0166.2 411166	Ø 274 10,9 9,5 + LG / + ABS Ring
1.9 dCi RX4	74	12/02→08/03	←	→ 06/03		24.0126-0142.1 426142	Ø 300 26 22,8 V
			➡	→ 06/03		24.0111-0144.1 411144	Ø 265 10,5 9,5
1.9 dCi RX4	75	11/00→08/03	←	→ 02/02		24.0124-0171.1 424171	Ø 280 24 21,8 V + S
2.0 16V RX4	102	06/00→08/03				24.0324-0171.1 524171	Ø 280 24 21,8 V + S PD
			←	03/02→ 06/03		24.0126-0142.1 426142	Ø 300 26 22,8 V
			➡	→ 06/03		24.0111-0144.1 411144	Ø 265 10,5 9,5
RENAULT - SCÉNIC II (JM0/1_) 06/03→							
 Bremsbelagsatz, Scheibenbremse							
1.4 (JM0B, JM0H, JM1A)	72	06/03→	←	→ 09/05		13.0460-3815.2 603815	BOS 23930 18,2 - WK + Zub
1.5 dCi (JM02, JM13)	74	11/03→				13.0470-3815.2 LD3815	BOS 23930 18,2 - WK + Zub Ceramic
1.5 dCi (JM0F)	60	06/03→					
1.5 dCi (JM1E)	78	05/05→	←	10/05→ 03/09		13.0460-7221.2 607221	ATE 23215 18,3 - WE / - WK
1.5 dCi (JM1F)	63	05/05→				13.0470-7221.2 LD7221	ATE 23215 18,3 - WE / - WK Ceramic
1.6 (JM0C, JM0J, JM1B)	83	06/03→	➡	→ 03/09		13.0460-2845.2 602845	TRW 23554 16,4 - WK + Zub
						13.0470-2845.2 LD2845	TRW 23554 16,4 - WK + Zub Ceramic
1.5 dCi (JM16)	76	01/07→	←	→ 03/09		13.0460-7221.2 607221	ATE 23215 18,3 - WE / - WK
1.6	77	06/06→				13.0470-7221.2 LD7221	ATE 23215 18,3 - WE / - WK Ceramic
			➡	→ 03/09		13.0460-2845.2 602845	TRW 23554 16,4 - WK + Zub
						13.0470-2845.2 LD2845	TRW 23554 16,4 - WK + Zub Ceramic
1.6 16V (JM1R)	82	10/05→	←	01/07→ 03/09		13.0460-7221.2 607221	ATE 23215 18,3 - WE / - WK
						13.0470-7221.2 LD7221	ATE 23215 18,3 - WE / - WK Ceramic
			➡	01/07→ 03/09		13.0460-2845.2 602845	TRW 23554 16,4 - WK + Zub
						13.0470-2845.2 LD2845	TRW 23554 16,4 - WK + Zub Ceramic
1.6 BiFuel	83	08/03→05/06	←	→ 09/05		13.0460-3815.2 603815	BOS 23930 18,2 - WK + Zub
1.6 Hi-Flex	81	03/05→07/10				13.0470-3815.2 LD3815	BOS 23930 18,2 - WK + Zub Ceramic
			←	10/05→		13.0460-7221.2 607221	ATE 23215 18,3 - WE / - WK
						13.0470-7221.2 LD7221	ATE 23215 18,3 - WE / - WK Ceramic
			➡			13.0460-2845.2 602845	TRW 23554 16,4 - WK + Zub
						13.0470-2845.2 LD2845	TRW 23554 16,4 - WK + Zub Ceramic
1.9 D	85	06/06→	←	→ 03/09		13.0460-7222.2 607222	ATE 23245 18,3 - WE / - WK
2.0	101	02/08→04/09					
2.0 dCi (JM1K)	110	09/05→	➡	→ 03/09		13.0460-2845.2 602845	TRW 23554 16,4 - WK + Zub
						13.0470-2845.2 LD2845	TRW 23554 16,4 - WK + Zub Ceramic
↓							











	kw			 	! #		
RENAULT - SCÉNIC II (JM0/1_) 06/03→							
 Bremsbelagsatz, Scheibenbremse							
1.9 dCi	92	06/03→	←	→ 09/05		13.0460-3815.2 603815	BOS 23930 18,2 - WK + Zub
1.9 dCi (JM0G, JM12, JM1G, JM2C)	88	06/03→				13.0470-3815.2 LD3815	BOS 23930 18,2 - WK + Zub Ceramic
1.9 dCi (JM14)	96	05/05→					
1.9 dCi (JM15)	81	05/05→	←	10/05→ 03/09		13.0460-7222.2 607222	ATE 23245 18,3 - WE / - WK
2.0	103	06/03→07/10					
2.0 (JM05, JM0U, JM1N, JM1U, JM2V)	99	06/03→	→	→ 03/09		13.0460-2845.2 602845	TRW 23554 16,4 - WK + Zub
2.0 16V Turbo (JM0W)	120	05/04→				13.0470-2845.2 LD2845	TRW 23554 16,4 - WK + Zub Ceramic
1.9 dCi 130	97	10/05→12/09	←			13.0460-7222.2 607222	ATE 23245 18,3 - WE / - WK
			→			13.0460-2845.2 602845	TRW 23554 16,4 - WK + Zub
						13.0470-2845.2 LD2845	TRW 23554 16,4 - WK + Zub Ceramic
Zubehörsatz, Scheibenbremsbelag							
1.4 (JM0B, JM0H, JM1A)	72	06/03→	→	→ 03/09		13.0460-0077.2 610077	TRW
1.5 dCi (JM02, JM13)	74	11/03→					
1.5 dCi (JM0F)	60	06/03→					
1.5 dCi (JM16)	76	01/07→					
1.5 dCi (JM1E)	78	05/05→					
1.5 dCi (JM1F)	63	05/05→					
1.6	77	06/06→					
1.6 (JM0C, JM0J, JM1B)	83	06/03→					
1.9 D	85	06/06→					
1.9 dCi	92	06/03→					
1.9 dCi (JM0G, JM12, JM1G, JM2C)	88	06/03→					
1.9 dCi (JM14)	96	05/05→					
1.9 dCi (JM15)	81	05/05→					
2.0	101	02/08→04/09					
2.0	103	06/03→07/10					
2.0 (JM05, JM0U, JM1N, JM1U, JM2V)	99	06/03→					
2.0 16V Turbo (JM0W)	120	05/04→					
2.0 dCi (JM1K)	110	09/05→					
1.6 16V (JM1R)	82	10/05→	→	01/07→ 03/09		13.0460-0077.2 610077	TRW
1.6 BiFuel	83	08/03→05/06	→			13.0460-0077.2 610077	TRW
1.6 Hi-Flex	81	03/05→07/10					
1.9 dCi 130	97	10/05→12/09					
 Bremsscheibe							
1.4 (JM0B, JM0H, JM1A)	72	06/03→	←	→ 03/09		24.0124-0158.1 424158	Ø 280 24 21,8 V + S
1.5 dCi (JM02, JM13)	74	11/03→				24.0324-0158.1 524158	Ø 280 24 21,8 V + S PD
1.5 dCi (JM0F)	60	06/03→	→	→ 03/09;		24.0110-0325.2 410325	Ø 270 10 9 + LG / + ABS Ring
1.5 dCi (JM16)	76	01/07→		Achszapfendurchmesser [mm]: 25			
1.5 dCi (JM1E)	78	05/05→					
1.5 dCi (JM1F)	63	05/05→					
1.6	77	06/06→					
1.6 (JM0C, JM0J, JM1B)	83	06/03→					
1.6 16V (JM1R)	82	10/05→	←	01/07→ 03/09		24.0124-0158.1 424158	Ø 280 24 21,8 V + S
						24.0324-0158.1 524158	Ø 280 24 21,8 V + S PD
			→	01/07→ 03/09;		24.0110-0325.2 410325	Ø 270 10 9 + LG / + ABS Ring
				Achszapfendurchmesser [mm]: 25			
1.6 BiFuel	83	08/03→05/06	←			24.0124-0158.1 424158	Ø 280 24 21,8 V + S
1.6 Hi-Flex	81	03/05→07/10				24.0324-0158.1 524158	Ø 280 24 21,8 V + S PD
			→	Achszapfendurchmesser [mm]: 25		24.0110-0325.2 410325	Ø 270 10 9 + LG / + ABS Ring
1.9 D	85	06/06→	←	→ 03/09		24.0124-0191.1 424191	Ø 300 24 21,8 V + S
1.9 dCi	92	06/03→					
1.9 dCi (JM0G, JM12, JM1G, JM2C)	88	06/03→	→	→ 03/09;		24.0110-0325.2 410325	Ø 270 10 9 + LG / + ABS Ring
1.9 dCi (JM14)	96	05/05→		Achszapfendurchmesser [mm]: 25			
1.9 dCi (JM15)	81	05/05→					
2.0	101	02/08→04/09					
2.0	103	06/03→07/10					
2.0 (JM05, JM0U, JM1N, JM1U, JM2V)	99	06/03→					
2.0 16V Turbo (JM0W)	120	05/04→					
1.9 dCi 130	97	10/05→12/09	←			24.0124-0191.1 424191	Ø 300 24 21,8 V + S
			→	Achszapfendurchmesser [mm]: 25		24.0110-0325.2 410325	Ø 270 10 9 + LG / + ABS Ring
2.0 dCi (JM1K)	110	09/05→	←	→ 03/09		24.0124-0224.1 424224	Ø 300 24 21,8 V + S
			→	→ 03/09;		24.0111-0101.2 411101	Ø 274 10,9 9,5 + LG / + ABS Ring
				Achszapfendurchmesser [mm]: 30			













	kw			 	! #		
RENAULT - SCÉNIC III (JZ0/1_) 02/09→							
 Bremsbelagsatz, Scheibenbremse							
1.2 TCe 1.6 dCi (JZ00, JZ12)	85 96	04/12→ 04/11→	←			13.0460-7249.2 607249 13.0470-7249.2 LD7249	ATE 24709 18,6 - WE / - WK ATE 24709 18,6 - WE / - WK Ceramic
			→	- eFSB		13.0460-2740.2 602740 13.0470-2740.2 LD2740	TRW 23554 17,0 - WE / - WK + Zub TRW 23554 17,0 - WE / - WK + Zub Ceramic
			→	+ eFSB		13.0460-2756.2 602756	TRW 24820 16,1 - WE / - WK + Zub
1.2 TCe (JZ16)	97	01/13→	←	03/13→		13.0460-7249.2 607249 13.0470-7249.2 LD7249	ATE 24709 18,6 - WE / - WK ATE 24709 18,6 - WE / - WK Ceramic
			→	03/13→; - eFSB		13.0460-2740.2 602740 13.0470-2740.2 LD2740	TRW 23554 17,0 - WE / - WK + Zub TRW 23554 17,0 - WE / - WK + Zub Ceramic
			→	03/13→; + eFSB		13.0460-2756.2 602756	TRW 24820 16,1 - WE / - WK + Zub
1.4 16V (JZ0F, JZ1V) 1.9 dCi (JZ0J, JZ1J, JZ1K, JZ1S) 2.0 16V (JZ0G, JZ0P, JZ1E, JZ1P)	96 96 103	02/09→ 02/09→ 02/09→	←	04/09→		13.0460-7249.2 607249 13.0470-7249.2 LD7249	ATE 24709 18,6 - WE / - WK ATE 24709 18,6 - WE / - WK Ceramic
			→	04/09→; - eFSB		13.0460-2740.2 602740 13.0470-2740.2 LD2740	TRW 23554 17,0 - WE / - WK + Zub TRW 23554 17,0 - WE / - WK + Zub Ceramic
			→	04/09→; + eFSB		13.0460-2756.2 602756	TRW 24820 16,1 - WE / - WK + Zub
1.5 dCi	63	04/09→	←	passend für Felgengröße [Zoll]: 15		13.0460-7266.2 607266 13.0470-7266.2 LD7266	ATE 24538 17,9 - WE / - WK ATE 24538 17,9 - WE / - WK Ceramic
			→	- eFSB		13.0460-2740.2 602740 13.0470-2740.2 LD2740	TRW 23554 17,0 - WE / - WK + Zub TRW 23554 17,0 - WE / - WK + Zub Ceramic
			→	+ eFSB		13.0460-2756.2 602756	TRW 24820 16,1 - WE / - WK + Zub
1.5 dCi	78	02/09→	←	04/09→; passend für Felgengröße [Zoll]: 16 / 17		13.0460-7249.2 607249 13.0470-7249.2 LD7249	ATE 24709 18,6 - WE / - WK ATE 24709 18,6 - WE / - WK Ceramic
			←	04/09→; passend für Felgengröße [Zoll]: 15		13.0460-7266.2 607266 13.0470-7266.2 LD7266	ATE 24538 17,9 - WE / - WK ATE 24538 17,9 - WE / - WK Ceramic
			→	04/09→; - eFSB		13.0460-2740.2 602740 13.0470-2740.2 LD2740	TRW 23554 17,0 - WE / - WK + Zub TRW 23554 17,0 - WE / - WK + Zub Ceramic
			→	04/09→; + eFSB		13.0460-2756.2 602756	TRW 24820 16,1 - WE / - WK + Zub
1.5 dCi 1.5 dCi (JZ02, JZ0R) 1.6 16V Bifuel	81 70 79	04/09→ 11/10→ 04/12→	←	passend für Felgengröße [Zoll]: 16 / 17		13.0460-7249.2 607249 13.0470-7249.2 LD7249	ATE 24709 18,6 - WE / - WK ATE 24709 18,6 - WE / - WK Ceramic
			←	passend für Felgengröße [Zoll]: 15		13.0460-7266.2 607266 13.0470-7266.2 LD7266	ATE 24538 17,9 - WE / - WK ATE 24538 17,9 - WE / - WK Ceramic
			→	- eFSB		13.0460-2740.2 602740 13.0470-2740.2 LD2740	TRW 23554 17,0 - WE / - WK + Zub TRW 23554 17,0 - WE / - WK + Zub Ceramic
			→	+ eFSB		13.0460-2756.2 602756	TRW 24820 16,1 - WE / - WK + Zub
1.6 16V (JZ0U, JZ1B)	81	02/09→	←	04/09→; passend für Felgengröße [Zoll]: 17 / 16		13.0460-7249.2 607249 13.0470-7249.2 LD7249	ATE 24709 18,6 - WE / - WK ATE 24709 18,6 - WE / - WK Ceramic
			←	04/09→; passend für Felgengröße [Zoll]: 15		13.0460-7266.2 607266 13.0470-7266.2 LD7266	ATE 24538 17,9 - WE / - WK ATE 24538 17,9 - WE / - WK Ceramic
			→	04/09→; - eFSB		13.0460-2740.2 602740	TRW 23554 17,0 - WE / - WK + Zub

















	kw			 	! #		
RENAULT - SCÉNIC III (JZ0/1_) 02/09→							
 Bremsbelagsatz, Scheibenbremse							
1.6 16V (JZ0U, JZ1B)	81	02/09→	➡	04/09→; - eFSB	13.0470-2740.2	LD2740	TRW 23554 17,0 - WE / - WK + Zub Ceramic
			➡	04/09→; + eFSB	13.0460-2756.2	602756	TRW 24820 16,1 - WE / - WK + Zub
1.6 16V Bifuel 1.6 E85 (JZ03, JZ1Y)	81 81	02/09→ 02/09→	←	06/09→; passend für Felgenreöße [Zoll]: 16 / 17	13.0460-7249.2	607249	ATE 24709 18,6 - WE / - WK
			←	06/09→; passend für Felgenreöße [Zoll]: 15	13.0460-7266.2	607266	ATE 24538 17,9 - WE / - WK
			←	06/09→; passend für Felgenreöße [Zoll]: 15	13.0470-7266.2	LD7266	ATE 24538 17,9 - WE / - WK Ceramic
			➡	06/09→; - eFSB	13.0460-2740.2	602740	TRW 23554 17,0 - WE / - WK + Zub
			➡	06/09→; - eFSB	13.0470-2740.2	LD2740	TRW 23554 17,0 - WE / - WK + Zub Ceramic
➡	06/09→; + eFSB	13.0460-2756.2	602756	TRW 24820 16,1 - WE / - WK + Zub			
2.0 dCi (JZ0L)	118	04/09→	←		13.0460-7249.2	607249	ATE 24709 18,6 - WE / - WK
			←		13.0470-7249.2	LD7249	ATE 24709 18,6 - WE / - WK Ceramic
			➡	- eFSB	13.0460-2753.2	602753	TRW 23554 16,0 - WK + Zub
➡	+ eFSB	13.0460-2756.2	602756	TRW 24820 16,1 - WE / - WK + Zub			
2.0 dCi (JZ0Y, JZ26)	110	02/09→	←	04/09→	13.0460-7249.2	607249	ATE 24709 18,6 - WE / - WK
			←		13.0470-7249.2	LD7249	ATE 24709 18,6 - WE / - WK Ceramic
			➡	04/09→; - eFSB	13.0460-2753.2	602753	TRW 23554 16,0 - WK + Zub
➡	04/09→; + eFSB	13.0460-2756.2	602756	TRW 24820 16,1 - WE / - WK + Zub			
 Bremsscheibe							
1.2 TCe 1.6 dCi (JZ00, JZ12)	85 96	04/12→ 04/11→	←		24.0126-0158.1	426158	Ø 296 26 23,4 V + S
			➡		24.0108-0118.2	408118	Ø 260 8 7 + LG / + ABS Ring
1.2 TCe (JZ16)	97	01/13→	←	03/13→	24.0126-0158.1	426158	Ø 296 26 23,4 V + S
			➡	03/13→	24.0108-0118.2	408118	Ø 260 8 7 + LG / + ABS Ring
1.4 16V (JZ0F, JZ1V) 1.9 dCi (JZ0J, JZ1J, JZ1K, JZ1S) 2.0 16V (JZ0G, JZ0P, JZ1E, JZ1P)	96 96 103	02/09→ 02/09→ 02/09→	←	04/09→	24.0126-0158.1	426158	Ø 296 26 23,4 V + S
			➡	04/09→	24.0108-0118.2	408118	Ø 260 8 7 + LG / + ABS Ring
			←	passend für Felgenreöße [Zoll]: 15	24.0124-0221.1	424221	Ø 280 24 21,8 V + S
1.5 dCi	63	04/09→	➡		24.0108-0118.2	408118	Ø 260 8 7 + LG / + ABS Ring
			←	04/09→; passend für Felgenreöße [Zoll]: 15	24.0124-0221.1	424221	Ø 280 24 21,8 V + S
1.5 dCi 1.6 16V (JZ0U, JZ1B)	78 81	02/09→ 02/09→	←	04/09→; passend für Felgenreöße [Zoll]: 15	24.0126-0158.1	426158	Ø 296 26 23,4 V + S
			←	04/09→; passend für Felgenreöße [Zoll]: 16 / 17	24.0108-0118.2	408118	Ø 260 8 7 + LG / + ABS Ring
			➡	04/09→	24.0108-0118.2	408118	Ø 260 8 7 + LG / + ABS Ring
1.5 dCi 1.6 16V Bifuel	81 79	04/09→ 04/12→	←	passend für Felgenreöße [Zoll]: 15	24.0124-0221.1	424221	Ø 280 24 21,8 V + S
			←	passend für Felgenreöße [Zoll]: 16 / 17	24.0126-0158.1	426158	Ø 296 26 23,4 V + S
			➡		24.0108-0118.2	408118	Ø 260 8 7 + LG / + ABS Ring
1.5 dCi (JZ02, JZ0R)	70	11/10→	←	passend für Felgenreöße [Zoll]: 15	24.0124-0221.1	424221	Ø 280 24 21,8 V + S
			←		24.0126-0158.1	426158	Ø 296 26 23,4 V + S
			➡		24.0108-0118.2	408118	Ø 260 8 7 + LG / + ABS Ring
1.6 16V Bifuel 1.6 E85 (JZ03, JZ1Y)	81 81	02/09→ 02/09→	←	06/09→; passend für Felgenreöße [Zoll]: 15	24.0124-0221.1	424221	Ø 280 24 21,8 V + S
			←	06/09→; passend für Felgenreöße [Zoll]: 16 / 17	24.0126-0158.1	426158	Ø 296 26 23,4 V + S
			➡	06/09→	24.0108-0118.2	408118	Ø 260 8 7 + LG / + ABS Ring
2.0 dCi (JZ0L)	118	04/09→	←		24.0126-0158.1	426158	Ø 296 26 23,4 V + S
			➡		24.0111-0180.2	411180	Ø 274 11 9,5 + LG / + ABS Ring
2.0 dCi (JZ0Y, JZ26)	110	02/09→	←	04/09→	24.0126-0158.1	426158	Ø 296 26 23,4 V + S
			➡	04/09→	24.0111-0180.2	411180	Ø 274 11 9,5 + LG / + ABS Ring











	kW			 	! #		
RENAULT - SCÉNIC IV (J9_) 09/16→							
 Bremsbelagsatz, Scheibenbremse							
1.2 TCe 115	85	09/16→	➔	- eFSB		13.0460-2740.2 602740	TRW 23554 17,0 - WE / - WK + Zub
1.2 TCe 130	96	09/16→					
1.5 dCi 110	81	09/16→				13.0470-2740.2 LD2740	TRW 23554 17,0 - WE / - WK + Zub Ceramic
1.5 dCi 95	70	09/16→					
 Bremsscheibe							
1.2 TCe 115	85	09/16→	➔			24.0128-0245.1 428245	Ø 320 28 25,4 V + S
1.2 TCe 130	96	09/16→					
1.5 dCi 110	81	09/16→					
1.5 dCi 95	70	09/16→					
1.6 dCi 130	96	09/16→					
1.6 dCi 160	118	09/16→					
RENAULT - SUPER 5 (B/C40_) 10/84→12/96							
 Bremsbelagsatz, Scheibenbremse							
1.1 (B/C/401, B/C40H)	33	01/86→03/95	➔			13.0460-3955.2 603955	BDX 20634 15,0 + WK
			➔	06/87→ 08/90		13.0460-3955.2 603955	BDX 20634 15,0 + WK
1.4 Cat (B/C/407)	43	10/85→12/96	➔			13.0460-2834.2 602834	TRW 21463 18,0 + WK
						13.0460-3911.2 603911	BDX 20905 18,0 + WK
1.6 D (B/C/404)	40	08/85→12/96	➔	01/86→		13.0460-2834.2 602834	TRW 21463 18,0 + WK
						13.0460-3911.2 603911	BDX 20905 18,0 + WK
1.7 (B/C408)	54	10/86→03/95	➔	06/87→		13.0460-2834.2 602834	TRW 21463 18,0 + WK
			➔	01/87→		13.0460-2834.2 602834	TRW 21463 18,0 + WK
			➔	06/87→		13.0460-3911.2 603911	BDX 20905 18,0 + WK
			➔			13.0460-3954.2 603954	BDX 20973 11,0 - WK
1.7 (B/C40K, B/C40G)	64	06/87→03/95	➔			13.0460-2834.2 602834	TRW 21463 18,0 + WK
			➔			13.0460-3911.2 603911	BDX 20905 18,0 + WK
			➔			13.0460-3954.2 603954	BDX 20973 11,0 - WK
Zubehörsatz, Scheibenbremsbelag							
1.4 Cat (B/C/407)	43	10/85→12/96	➔			13.0460-0411.2 610411	BDX
1.7 (B/C40K, B/C40G)	64	06/87→03/95	➔				
1.6 D (B/C/404)	40	08/85→12/96	➔	01/86→		13.0460-0411.2 610411	BDX
1.7 (B/C408)	54	10/86→03/95	➔	06/87→		13.0460-0411.2 610411	BDX
			➔	01/87→		13.0460-0411.2 610411	BDX
 Bremsscheibe							
1.1 (B/C/401, B/C40H)	33	01/86→03/95	➔			24.0108-0104.1 408104	Ø 238 8,2 7 + S
			➔	06/87→ 08/90		24.0108-0104.1 408104	Ø 238 8,2 7 + S
1.4 Cat (B/C/407)	43	10/85→12/96	➔			24.0112-0116.1 412116	Ø 238 12 10,5 + S
1.6 D (B/C/404)	40	08/85→12/96	➔				
1.7 (B/C408)	54	10/86→03/95	➔	01/87→		24.0112-0116.1 412116	Ø 238 12 10,5 + S
			➔	06/87→		24.0120-0125.1 420125	Ø 238 20,1 17,7 V + S
1.7 (B/C40K, B/C40G)	64	06/87→03/95	➔			24.0120-0125.1 420125	Ø 238 20,1 17,7 V + S
RENAULT - SUPER 5 Kasten (S40_) 10/84→12/96							
 Bremsbelagsatz, Scheibenbremse							
1.1 (S401)	34	10/84→12/96	➔	01/85→ 03/95		13.0460-3955.2 603955	BDX 20634 15,0 + WK
1.2 (S40F, S407)	44	01/87→12/96	➔	→ 08/90		13.0460-2834.2 602834	TRW 21463 18,0 + WK
						13.0460-3911.2 603911	BDX 20905 18,0 + WK
1.6 D (S404)	40	10/84→12/96	➔	01/86→		13.0460-2834.2 602834	TRW 21463 18,0 + WK
						13.0460-3911.2 603911	BDX 20905 18,0 + WK
Zubehörsatz, Scheibenbremsbelag							
1.2 (S40F, S407)	44	01/87→12/96	➔	→ 08/90		13.0460-0411.2 610411	BDX
1.6 D (S404)	40	10/84→12/96	➔	01/86→		13.0460-0411.2 610411	BDX
 Bremsscheibe							
1.1 (S401)	34	10/84→12/96	➔	01/85→ 03/95		24.0108-0104.1 408104	Ø 238 8,2 7 + S
1.2 (S40F, S407)	44	01/87→12/96	➔	→ 08/90		24.0112-0116.1 412116	Ø 238 12 10,5 + S
1.6 D (S404)	40	10/84→12/96	➔	01/85→		24.0112-0116.1 412116	Ø 238 12 10,5 + S













	kW			 	! #		
RENAULT - TALISMAN (L2M_) 07/13→							
 Bremsscheibe							
1.6 dCi 130	96	11/15→	←	Automatikgetriebe		24.0128-0245.1 428245	Ø 320 28 25,4 V + S
1.6 dCi 160	118	06/15→	←			24.0128-0245.1 428245	Ø 320 28 25,4 V + S
1.6 TCe 150	110	11/15→					
1.6 TCe 200	147	11/15→					
RENAULT - TALISMAN Grandtour (KP_) 03/16→							
 Bremsscheibe							
1.6 dCi 130	96	03/16→	←	Automatikgetriebe		24.0128-0245.1 428245	Ø 320 28 25,4 V + S
1.6 dCi 160	118	03/16→	←			24.0128-0245.1 428245	Ø 320 28 25,4 V + S
1.6 TCe 150	110	03/16→					
1.6 TCe 200	147	03/16→					
RENAULT - THALIA I (LB0/1/2_) 02/98→							
 Bremsbelagsatz, Scheibenbremse							
1.2 16V	55	04/02→	←			13.0460-2834.2 602834	TRW 21463 18,0 + WK
1.4	55	08/00→	←				
1.4 16V	72	08/00→	←				
1.5 dCi	47	06/05→					
1.5 dCi	48	04/02→					
1.5 dCi	50	02/03→					
1.5 dCi	58	04/04→11/09					
1.5 dCi	60	06/01→					
1.6 16V	79	04/02→					
1.9 D	48	02/98→05/01					
1.6	66	03/98→	←	04/02→		13.0460-2834.2 602834	TRW 21463 18,0 + WK
 Bremsscheibe							
1.2 16V	55	04/02→	←			24.0112-0116.1 412116	Ø 238 12 10,5 + S
						24.0120-0125.1 420125	Ø 238 20,1 17,7 V + S
1.4	55	08/00→	←			24.0112-0116.1 412116	Ø 238 12 10,5 + S
1.4 16V	72	08/00→	←			24.0120-0125.1 420125	Ø 238 20,1 17,7 V + S
1.5 dCi	47	06/05→					
1.5 dCi	48	04/02→					
1.5 dCi	50	02/03→					
1.5 dCi	58	04/04→11/09					
1.5 dCi	60	06/01→					
1.6 16V	79	04/02→					
1.9 D	48	02/98→05/01					
1.6	66	03/98→	←	04/02→		24.0120-0125.1 420125	Ø 238 20,1 17,7 V + S
RENAULT - THALIA II (LU1/2_) 09/08→							
 Bremsbelagsatz, Scheibenbremse							
0.9 TCe	66	11/12→06/14	←			13.0460-7298.2 607298	ATE 25702 18,2 - WE / - WK
1.2 16V (LU2V)	55	09/08→	←			13.0460-2834.2 602834	TRW 21463 18,0 + WK
1.2 LPG	55	01/10→12/13					
1.4	55	09/08→06/14					
1.4	72	09/08→12/12					
1.5 dCi	47	09/08→					
1.5 dCi	48	01/09→					
1.5 dCi	55	11/12→06/14					
1.5 dCi	62	09/08→					
1.5 dCi	66	01/09→					
1.6 16V	77	09/08→					
 Bremsscheibe							
0.9 TCe	66	11/12→06/14	←			24.0122-0289.1 422289	Ø 258 22 19,8 V + S
1.2 16V (LU2V)	55	09/08→	←			24.0112-0116.1 412116	Ø 238 12 10,5 + S
1.2 LPG	55	01/10→12/13					
1.4	55	09/08→06/14					
1.4	72	09/08→12/12					
1.5 dCi	47	09/08→	←			24.0120-0125.1 420125	Ø 238 20,1 17,7 V + S
1.5 dCi	48	01/09→					
1.5 dCi	55	11/12→06/14					
1.5 dCi	62	09/08→					
1.5 dCi	66	01/09→					
1.6 16V	77	09/08→	←			24.0121-0106.1 421106	Ø 259 20,7 17,7 V + S
RENAULT - THALIA III (L8_) 12/13→							
 Bremsbelagsatz, Scheibenbremse							
0.9 TCe	66	04/14→	←			13.0460-7298.2 607298	ATE 25702 18,2 - WE / - WK
1.2 16V	55	12/13→					
1.5 dCi	66	12/13→					
↓							

	kw					! #		
RENAULT - THALIA III (L8_) 12/13→								
 Bremsscheibe								
0.9 TCe 1.2 16V 1.5 dCi	66 55 66	04/14→ 12/13→ 12/13→	←			24.0122-0289.1	422289	Ø 258 22 19,8 V + S
RENAULT - TRAFIC II Bus (JL) 03/01→								
 Bremsbelagsatz, Scheibenbremse								
1.9 dCi 2.5 DTi	59 99	04/01→07/03 03/03→07/03	← →			13.0460-2870.2	602870	TRW 23099 18,4 - WK
						13.0460-2840.2	602840	TRW 23980 16,5 + WE / - WK
1.9 dCi 100 (JLOC) 1.9 dCi 80 (JLOB) 2.0 (JLOA) 2.0 16V 2.5 dCi 115 2.5 dCi 135 (JLOD)	74 60 88 86 84 99	03/01→ 03/01→ 03/01→ 08/06→ 02/08→ 05/03→	← →	→ 08/14 → 08/14		13.0460-2870.2	602870	TRW 23099 18,4 - WK
						13.0460-2840.2	602840	TRW 23980 16,5 + WE / - WK
2.0 dCi 115 (JLOH) 2.0 dCi 90 (JLOH) 2.5 dCi 145 (JLOJ)	84 66 107	08/06→ 08/06→ 08/06→	← →	10/06→ 08/14 10/06→ 08/14		13.0460-2870.2	602870	TRW 23099 18,4 - WK
						13.0460-2840.2	602840	TRW 23980 16,5 + WE / - WK
Zubehörsatz, Scheibenbremsbelag								
1.9 dCi 2.5 DTi	59 99	04/01→07/03 03/03→07/03	→			13.0460-0072.2	610072	TRW
1.9 dCi 100 (JLOC) 1.9 dCi 80 (JLOB) 2.0 (JLOA) 2.0 16V 2.5 dCi 115 2.5 dCi 135 (JLOD)	74 60 88 86 84 99	03/01→ 03/01→ 03/01→ 08/06→ 02/08→ 05/03→	→	→ 08/14		13.0460-0072.2	610072	TRW
2.0 dCi 115 (JLOH) 2.0 dCi 90 (JLOH) 2.5 dCi 145 (JLOJ)	84 66 107	08/06→ 08/06→ 08/06→	→	10/06→ 08/14		13.0460-0072.2	610072	TRW
Bremsscheibe								
1.9 dCi 2.5 DTi	59 99	04/01→07/03 03/03→07/03	← →			24.0128-0132.1	428132	Ø 305 28 24 V + S
						24.0112-0177.2	412177	Ø 280 12 10 + LG / + ABS Ring
1.9 dCi 100 (JLOC) 1.9 dCi 80 (JLOB) 2.0 (JLOA) 2.0 16V 2.5 dCi 115 2.5 dCi 135 (JLOD)	74 60 88 86 84 99	03/01→ 03/01→ 03/01→ 08/06→ 02/08→ 05/03→	← →	→ 08/14 → 08/14		24.0128-0132.1	428132	Ø 305 28 24 V + S
						24.0112-0177.2	412177	Ø 280 12 10 + LG / + ABS Ring
2.0 dCi 115 (JLOH) 2.0 dCi 90 (JLOH) 2.5 dCi 145 (JLOJ)	84 66 107	08/06→ 08/06→ 08/06→	← →	10/06→ 08/14 10/06→ 08/14		24.0128-0132.1	428132	Ø 305 28 24 V + S
						24.0112-0177.2	412177	Ø 280 12 10 + LG / + ABS Ring
RENAULT - TRAFIC II Kasten (FL) 03/01→								
 Bremsbelagsatz, Scheibenbremse								
1.9 dCi 2.5 DTi	59 99	04/01→07/03 03/03→07/03	← →			13.0460-2870.2	602870	TRW 23099 18,4 - WK
						13.0460-2840.2	602840	TRW 23980 16,5 + WE / - WK
1.9 dCi 1.9 dCi 100 (FLOC) 1.9 dCi 80 (FLOB) 2.0 (FLOA) 2.0 16V 2.5 dCi 2.5 dCi 135 (FLOD)	75 74 60 88 86 84 99	03/01→ 03/01→ 03/01→ 03/01→ 08/06→ 08/07→ 05/03→	← →	→ 08/14 → 08/14		13.0460-2870.2	602870	TRW 23099 18,4 - WK
						13.0460-2840.2	602840	TRW 23980 16,5 + WE / - WK
2.0 dCi 115 (FLO1, FLOU) 2.0 dCi 90 (FLOH) 2.5 dCi 145 (FLOJ)	84 66 107	08/06→ 08/06→ 08/06→	← →	10/06→ 08/14 10/06→ 08/14		13.0460-2870.2	602870	TRW 23099 18,4 - WK
						13.0460-2840.2	602840	TRW 23980 16,5 + WE / - WK
Zubehörsatz, Scheibenbremsbelag								
1.9 dCi 2.5 DTi	59 99	04/01→07/03 03/03→07/03	→			13.0460-0072.2	610072	TRW
1.9 dCi 1.9 dCi 100 (FLOC) 1.9 dCi 80 (FLOB) 2.0 (FLOA) 2.0 16V 2.5 dCi 2.5 dCi 135 (FLOD)	75 74 60 88 86 84 99	03/01→ 03/01→ 03/01→ 03/01→ 08/06→ 08/07→ 05/03→	→	→ 08/14		13.0460-0072.2	610072	TRW
2.0 dCi 115 (FLO1, FLOU) 2.0 dCi 90 (FLOH) 2.5 dCi 145 (FLOJ)	84 66 107	08/06→ 08/06→ 08/06→	→	10/06→ 08/14		13.0460-0072.2	610072	TRW













	kw			 	! #		
RENAULT - TRAFIC II Kasten (FL) 03/01→							
 Bremsscheibe							
1.9 dCi 2.5 DTi	59 99	04/01→07/03 03/03→07/03	← →			24.0128-0132.1 428132 24.0112-0177.2 412177	∅ 305 28 24 V + S ∅ 280 12 10 + LG / + ABS Ring
1.9 dCi 1.9 dCi 100 (FLOC) 1.9 dCi 80 (FL0B)	75 74 60	03/01→ 03/01→ 03/01→	← →	→ 08/14 → 08/14		24.0128-0132.1 428132 24.0112-0177.2 412177	∅ 305 28 24 V + S ∅ 280 12 10 + LG / + ABS Ring
2.0 (FL0A) 2.0 16V 2.5 dCi 2.5 dCi 135 (FL0D)	88 86 84 99	03/01→ 08/06→ 08/07→ 05/03→					
2.0 dCi 115 (FL01, FLOU) 2.0 dCi 90 (FL0H) 2.5 dCi 145 (FL0J)	84 66 107	08/06→ 08/06→ 08/06→	← →	10/06→ 08/14 10/06→ 08/14		24.0128-0132.1 428132 24.0112-0177.2 412177	∅ 305 28 24 V + S ∅ 280 12 10 + LG / + ABS Ring
RENAULT - TRAFIC II Pritsche/Fahrgestell (EL) 03/01→							
 Bremsbelagsatz, Scheibenbremse							
1.9 dCi	59	09/01→07/03	← →			13.0460-2870.2 602870 13.0460-2840.2 602840	TRW 23099 18,4 - WK TRW 23980 16,5 + WE / - WK
1.9 dCi 100 (EL0C) 1.9 dCi 80 (EL0B) 2.0 (EL0A) 2.0 16V 2.5 dCi	74 60 88 86 84	03/01→ 03/01→ 03/01→ 08/06→ 08/07→	← →	→ 08/14 → 08/14		13.0460-2870.2 602870 13.0460-2840.2 602840	TRW 23099 18,4 - WK TRW 23980 16,5 + WE / - WK
2.0 dCi 115 (EL0H) 2.0 dCi 90 (EL0H) 2.5 dCi 145 (EL0J)	84 66 107	08/06→ 08/06→ 08/06→	← →	10/06→ 08/14 10/06→ 08/14		13.0460-2870.2 602870 13.0460-2840.2 602840	TRW 23099 18,4 - WK TRW 23980 16,5 + WE / - WK
2.5 dCi 135 (EL0D)	99	03/01→	← →	05/03→ 08/14 05/03→ 08/14		13.0460-2870.2 602870 13.0460-2840.2 602840	TRW 23099 18,4 - WK TRW 23980 16,5 + WE / - WK
Zubehörsatz, Scheibenbremsbelag							
1.9 dCi	59	09/01→07/03	→			13.0460-0072.2 610072	TRW
1.9 dCi 100 (EL0C) 1.9 dCi 80 (EL0B) 2.0 (EL0A) 2.0 16V 2.5 dCi	74 60 88 86 84	03/01→ 03/01→ 03/01→ 08/06→ 08/07→	→	→ 08/14		13.0460-0072.2 610072	TRW
2.0 dCi 115 (EL0H) 2.0 dCi 90 (EL0H) 2.5 dCi 145 (EL0J)	84 66 107	08/06→ 08/06→ 08/06→	→	10/06→ 08/14		13.0460-0072.2 610072	TRW
2.5 dCi 135 (EL0D)	99	03/01→	→	05/03→ 08/14		13.0460-0072.2 610072	TRW
 Bremsscheibe							
1.9 dCi	59	09/01→07/03	← →			24.0128-0132.1 428132 24.0112-0177.2 412177	∅ 305 28 24 V + S ∅ 280 12 10 + LG / + ABS Ring
1.9 dCi 100 (EL0C) 1.9 dCi 80 (EL0B) 2.0 (EL0A) 2.0 16V 2.5 dCi	74 60 88 86 84	03/01→ 03/01→ 03/01→ 08/06→ 08/07→	← →	→ 08/14 → 08/14		24.0128-0132.1 428132 24.0112-0177.2 412177	∅ 305 28 24 V + S ∅ 280 12 10 + LG / + ABS Ring
2.0 dCi 115 (EL0H) 2.0 dCi 90 (EL0H) 2.5 dCi 145 (EL0J)	84 66 107	08/06→ 08/06→ 08/06→	← →	10/06→ 08/14 10/06→ 08/14		24.0128-0132.1 428132 24.0112-0177.2 412177	∅ 305 28 24 V + S ∅ 280 12 10 + LG / + ABS Ring
2.5 dCi 135 (EL0D)	99	03/01→	← →	05/03→ 08/14 05/03→ 08/14		24.0128-0132.1 428132 24.0112-0177.2 412177	∅ 305 28 24 V + S ∅ 280 12 10 + LG / + ABS Ring
RENAULT - TRAFIC III Bus (JG_) 05/14→							
 Bremsbelagsatz, Scheibenbremse							
1.6 dCi 115 1.6 dCi 120 1.6 dCi 125 1.6 dCi 140 1.6 dCi 145 1.6 dCi 90 1.6 dCi 95	85 88 92 103 107 66 70	05/14→ 05/14→ 07/15→ 05/14→ 07/15→ 05/14→ 07/15→	→			13.0460-2840.2 602840	TRW 23980 16,5 + WE / - WK
 Bremsscheibe							
1.6 dCi 115 1.6 dCi 120 1.6 dCi 125 1.6 dCi 140 1.6 dCi 145 1.6 dCi 90 1.6 dCi 95	85 88 92 103 107 66 70	05/14→ 05/14→ 07/15→ 05/14→ 07/15→ 05/14→ 07/15→	←			24.0128-0287.1 428287	∅ 296 28 23,4 V + S













	kw			 	! #		
RENAULT - TRAFIC III Kasten (FG_) 05/14→							
 Bremsbelagsatz, Scheibenbremse							
1.6 dCi 115	85	05/14→	→			13.0460-2840.2 602840	TRW 23980 16,5 + WE / - WK
1.6 dCi 120	88	05/14→					
1.6 dCi 125	92	07/15→					
1.6 dCi 140	103	05/14→					
1.6 dCi 145	107	07/15→					
1.6 dCi 90	66	05/14→					
1.6 dCi 95	70	07/15→					
 Bremsscheibe							
1.6 dCi 115	85	05/14→	←			24.0128-0287.1 428287	Ø 296 28 23,4 V + S
1.6 dCi 120	88	05/14→					
1.6 dCi 125	92	07/15→					
1.6 dCi 140	103	05/14→					
1.6 dCi 145	107	07/15→					
1.6 dCi 90	66	05/14→					
1.6 dCi 95	70	07/15→					
RENAULT - TRAFIC III Pritsche/Fahrgestell (EG_) 05/14→							
 Bremsbelagsatz, Scheibenbremse							
1.6 dCi 125	92	07/15→	→			13.0460-2840.2 602840	TRW 23980 16,5 + WE / - WK
1.6 dCi 145	107	07/15→					
1.6 dCi 90	66	05/14→					
 Bremsscheibe							
1.6 dCi 125	92	07/15→	←			24.0128-0287.1 428287	Ø 296 28 23,4 V + S
1.6 dCi 145	107	07/15→					
1.6 dCi 90	66	05/14→					
RENAULT - TRAFIC Bus (TXW) 03/89→03/01							
 Bremsbelagsatz, Scheibenbremse							
1.9 D	44	06/97→03/01	←			13.0460-3969.2 603969	BDX 20926 18,5 + WK
2.1 D	47	06/94→10/97					
2.2	74	06/94→10/97					
2.2 4x4	74	06/94→10/97					
2.5 D	55	05/89→03/01					
2.5 D 4x4	55	08/89→03/01					
 Bremsscheibe							
1.9 D	44	06/97→03/01	←			24.0124-0103.1 424103	Ø 252,5 24 22 V
2.1 D	47	06/94→10/97					
2.2	74	06/94→10/97					
2.2 4x4	74	06/94→10/97					
2.5 D	55	05/89→03/01					
2.5 D 4x4	55	08/89→03/01					
RENAULT - TRAFIC Kasten (TXX) 03/89→12/01							
 Bremsbelagsatz, Scheibenbremse							
1.9 D	44	06/97→03/01	←			13.0460-3969.2 603969	BDX 20926 18,5 + WK
2.2	74	06/94→10/97					
2.2 4x4	74	06/94→10/97					
2.5 D	55	05/89→03/01					
2.5 D 4x4	55	05/89→03/01					
2.1 D	47	06/94→10/97	←	→ 08/94		13.0460-3968.2 603968	BDX 20488 18,5 + WK + Zub
			←			13.0460-3969.2 603969	BDX 20926 18,5 + WK
			←	09/94→		13.0460-3969.2 603969	BDX 20926 18,5 + WK
 Bremsscheibe							
1.9 D	44	06/97→03/01	←			24.0124-0103.1 424103	Ø 252,5 24 22 V
2.1 D	47	06/94→10/97					
2.2	74	06/94→10/97					
2.2 4x4	74	06/94→10/97					
2.5 D	55	05/89→03/01					
2.5 D 4x4	55	05/89→03/01					
RENAULT - TRAFIC Pritsche/Fahrgestell (PXX) 03/89→03/01							
 Bremsbelagsatz, Scheibenbremse							
2.0 [RWD]	59	05/89→10/97	←			13.0460-3969.2 603969	BDX 20926 18,5 + WK
2.5 D	55	05/98→03/01					
2.1 D	47	09/94→04/98	←	→ 10/97		13.0460-3969.2 603969	BDX 20926 18,5 + WK
2.1 D [RWD]	47	06/94→10/97	←	→ 0005150		13.0460-3968.2 603968	BDX 20488 18,5 + WK + Zub
			←			13.0460-3969.2 603969	BDX 20926 18,5 + WK
2.2	74	09/94→04/98	←	→ 12/97		13.0460-3969.2 603969	BDX 20926 18,5 + WK
2.2 4x4	74	09/94→04/98					
↓							













	kw				! #		
RENAULT - TRAFIC Pritsche/Fahrgestell (PXX) 03/89→03/01							
 Bremsbelagsatz, Scheibenbremse							
2.5 D	51	05/89→03/01	←	→ 12/97		13.0460-3969.2 603969	BDX 20926 18,5 + WK
2.5 D	58	09/94→04/98					
2.5 D 4x4	58	09/94→01/99					
 Bremsscheibe							
2.0 [RWD]	59	05/89→10/97	←			24.0124-0103.1 424103	∅ 252,5 24 22 V
2.1 D [RWD]	47	06/94→10/97					
2.5 D	55	05/98→03/01					
2.1 D	47	09/94→04/98	←	→ 10/97		24.0124-0103.1 424103	∅ 252,5 24 22 V
2.2	74	09/94→04/98	←	→ 12/97		24.0124-0103.1 424103	∅ 252,5 24 22 V
2.2 4x4	74	09/94→04/98					
2.5 D	51	05/89→03/01					
2.5 D	58	09/94→04/98					
2.5 D 4x4	58	09/94→01/99					
RENAULT - TWINGO I (C06_) 03/93→10/12							
 Bremsbelagsatz, Scheibenbremse							
1.2	44	09/98→08/00	←	Automatikgetriebe		13.0460-2834.2 602834	TRW 21463 18,0 + WK
1.2 (C066, C068)	43	05/96→06/07	←	10/98→; Schaltgetriebe		13.0460-2834.2 602834	TRW 21463 18,0 + WK
1.2 (C067)	40	05/96→03/07	←	→ 09/98; Schaltgetriebe		13.0460-3953.2 603953	BDX 20634 15,0 - WK
						13.0460-3955.2 603955	BDX 20634 15,0 + WK
1.2 (C063, C064)	40	03/93→10/96	←			13.0460-3953.2 603953	BDX 20634 15,0 - WK
						13.0460-3955.2 603955	BDX 20634 15,0 + WK
1.2 16V (C060)	44	08/04→06/07	←			13.0460-2834.2 602834	TRW 21463 18,0 + WK
1.2 16V (C06C, C06D, C06K)	55	01/01→06/07					
1.2 LPG	44	10/03→06/07	←	08/04→		13.0460-2834.2 602834	TRW 21463 18,0 + WK
Zubehörsatz, Scheibenbremsbelag							
1.2	44	09/98→08/00	←	→ 09/98; Schaltgetriebe		13.0460-0423.2 610423	BDX
1.2 (C066, C068)	43	05/96→06/07					
1.2 (C067)	40	05/96→03/07					
1.2 (C063, C064)	40	03/93→10/96	←			13.0460-0423.2 610423	BDX
 Bremsscheibe							
1.2	44	09/98→08/00	←	→ 09/98; Schaltgetriebe		24.0108-0104.1 408104	∅ 238 8,2 7 + S
1.2 (C067)	40	05/96→03/07	←	10/98→		24.0112-0116.1 412116	∅ 238 12 10,5 + S
			←	→ 09/98; Automatikgetriebe		24.0112-0116.1 412116	∅ 238 12 10,5 + S
1.2 (C063, C064)	40	03/93→10/96	←			24.0108-0104.1 408104	∅ 238 8,2 7 + S
1.2 (C066, C068)	43	05/96→06/07	←	→ 09/98; Schaltgetriebe		24.0108-0104.1 408104	∅ 238 8,2 7 + S
			←	10/98→ 08/00		24.0112-0116.1 412116	∅ 238 12 10,5 + S
			←	→ 09/98; Automatikgetriebe		24.0112-0116.1 412116	∅ 238 12 10,5 + S
			←	11/03→		24.0112-0171.1 412171	∅ 259 12 10,6 + S
			←	09/00→ 10/03		24.0121-0106.1 421106	∅ 259 20,7 17,7 V + S
1.2 16V (C060)	44	08/04→06/07	←			24.0121-0106.1 421106	∅ 259 20,7 17,7 V + S
1.2 16V (C06C, C06D, C06K)	55	01/01→06/07	←	→ 10/03; für Fahrzeuge mit verstärktem Fahrwerk		24.0112-0116.1 412116	∅ 238 12 10,5 + S
			←	11/03→		24.0112-0171.1 412171	∅ 259 12 10,6 + S
			←	→ 10/03; für Fahrzeuge ohne verstärktes Fahrwerk		24.0121-0106.1 421106	∅ 259 20,7 17,7 V + S
1.2 LPG	44	10/03→06/07	←	08/04→		24.0121-0106.1 421106	∅ 259 20,7 17,7 V + S
RENAULT - TWINGO I Kasten (S06_) 03/93→08/04							
 Bremsbelagsatz, Scheibenbremse							
1.2 (S063, S064)	40	03/93→05/96	←	→ 04/96		13.0460-3953.2 603953	BDX 20634 15,0 - WK
1.2 (S066, S068)	43	05/96→08/04	←	Vollautomatik		13.0460-2834.2 602834	TRW 21463 18,0 + WK
			←	10/98→; Schaltgetriebe		13.0460-2834.2 602834	TRW 21463 18,0 + WK
			←	→ 09/98; Schaltgetriebe		13.0460-3953.2 603953	BDX 20634 15,0 - WK
Zubehörsatz, Scheibenbremsbelag							
1.2 (S063, S064)	40	03/93→05/96	←	→ 04/96		13.0460-0423.2 610423	BDX
1.2 (S066, S068)	43	05/96→08/04	←	→ 09/98; Schaltgetriebe		13.0460-0423.2 610423	BDX
↓							















	kw			 	! #		
RENAULT - TWINGO I Kasten (S06_) 03/93→08/04							
 Bremsscheibe							
1.2 (S063, S064)	40	03/93→05/96	←	→ 04/96		24.0108-0104.1 408104	Ø 238 8,2 7 + S
1.2 (S066, S068)	43	05/96→08/04	←	→ 09/98; Schaltgetriebe		24.0108-0104.1 408104	Ø 238 8,2 7 + S
				10/98→ 08/00; Schaltgetriebe		24.0112-0116.1 412116	Ø 238 12 10,5 + S
				→ 08/00; Automatikgetriebe		24.0112-0116.1 412116	Ø 238 12 10,5 + S
				11/03→		24.0112-0171.1 412171	Ø 259 12 10,6 + S
				09/00→; Schaltgetriebe		24.0121-0106.1 421106	Ø 259 20,7 17,7 V + S
				09/00→; Vollautomatik		24.0121-0106.1 421106	Ø 259 20,7 17,7 V + S
RENAULT - TWINGO II (CN0_) 03/07→							
 Bremsbelagsatz, Scheibenbremse							
1.2 (CN0D)	43	03/07→	←	→ 07/14		13.0460-2834.2 602834	TRW 21463 18,0 + WK
1.2 16V	55	03/08→					
1.2 16V (CN04, CN0A, CN0B)	55	03/07→					
1.2 16V (CN0K, CN0V)	56	03/07→					
1.2 TCe 100 (CN0P)	75	02/11→					
1.2 Turbo (CN0C, CN0F)	74	03/07→					
1.5 dCi (CN0E)	47	03/07→					
1.5 dCi (CN0U)	62	04/08→					
1.5 dCi 75	55	10/10→					
1.5 dCi 90	63	10/10→					
1.6 RS (CN0N, CN0R, CN0S)	98	05/08→	←	→ 07/14		13.0460-7248.2 607248	ATE 23215 17,5 - WE / - WK
 Bremsscheibe							
1.2 (CN0D)	43	03/07→	←	→ 07/14		24.0112-0171.1 412171	Ø 259 12 10,6 + S
1.5 dCi (CN0E)	47	03/07→				24.0121-0106.1 421106	Ø 259 20,7 17,7 V + S
1.2 16V 1.2 16V (CN04, CN0A, CN0B) 1.2 16V (CN0K, CN0V) 1.2 TCe 100 (CN0P) 1.2 Turbo (CN0C, CN0F) 1.5 dCi (CN0U) 1.5 dCi 75 1.5 dCi 90	55	03/08→	←	→ 07/14		24.0121-0106.1 421106	Ø 259 20,7 17,7 V + S
	55	03/07→					
	56	03/07→					
	75	02/11→					
	74	03/07→					
	62	04/08→					
	55	10/10→					
	63	10/10→					
	98	05/08→	←	→ 07/14		24.0124-0158.1 424158	Ø 280 24 21,8 V + S
					24.0324-0158.1 524158	Ø 280 24 21,8 V + S PD	
			→	→ 07/14		24.0108-0114.2 408114	Ø 240 8 7 + LG / + ABS Ring
RENAULT - TWINGO III (BCM_) 09/14→							
 Bremsbelagsatz, Scheibenbremse							
0.9 TCe 110	80	11/16→	←			13.0460-7298.2 607298	ATE 25702 18,2 - WE / - WK
0.9 TCe 90	66	09/14→					
1.0 SCe 70	51	09/15→					
1.0 SCe 70	52	09/14→					
 Bremsscheibe							
0.9 TCe 110	80	11/16→	←			24.0122-0289.1 422289	Ø 258 22 19,8 V + S
0.9 TCe 90	66	09/14→					
1.0 SCe 70	51	09/15→					
1.0 SCe 70	52	09/14→					
RENAULT - VEL SATIS (BJ0_) 06/02→							
 Bremsbelagsatz, Scheibenbremse							
2.0 16 V Turbo	125	04/04→	←	→ 12/09		13.0460-7159.2 607159	ATE 23245 18,3 - WE / - WK
2.0 16V Turbo (BJ0K)	120	06/02→				13.0470-7159.2 LD7159	ATE 23245 18,3 - WE / - WK
2.0 dCi (BJ03, BJ0B)	127	01/06→					Ceramic
2.0 dCi (BJ03)	110	08/05→					
2.0 Turbo	108	04/05→	→	→ 12/09		13.0460-7137.2 607137	ATE 23482 15,8 - WE / - WK
2.2 dCi (BJ0E, BJ0F, BJ0G, BJ0H)	102	09/04→				13.0470-7137.2 LD7137	ATE 23482 15,8 - WE / - WK
2.2 dCi (BJ0E, BJ0F)	110	06/02→					Ceramic
2.2 dCi (BJ0H)	85	04/04→					
2.2 dCi (BJ0M)	83	12/04→					
3.0 dCi (BJ0J, BJ0N)	130	06/02→					
3.0 dCi (BJ0S)	133	06/06→					
3.5 (BJ01)	170	10/04→					
3.5 V6 (BJ0R, BJ0V, BJ0U)	177	06/02→					
↓							























	kw			 	! #			
RENAULT - VEL SATIS (BJ0_) 06/02→								
 Bremsscheibe								
2.0 16 V Turbo	125	04/04→	←	→ 12/09		24.0128-0133.1	428133	Ø 324 28 25,4 V
2.0 dCi (BJ03, BJ0B)	127	01/06→	→	→ 12/09;	Achszapfendurchmesser [mm]: 30	24.0111-0100.2	411100	Ø 300 11 9,5 + LG / + ABS Ring
2.0 dCi (BJ03)	110	08/05→						
2.0 Turbo	108	04/05→						
2.2 dCi (BJ0E, BJ0F, BJ0G, BJ0H)	102	09/04→						
2.2 dCi (BJ0H)	85	04/04→						
2.2 dCi (BJ0M)	83	12/04→						
3.0 dCi (BJ0S)	133	06/06→						
3.5 (BJ01)	170	10/04→						
3.5 V6 (BJ0R, BJ0V, BJ0U)	177	06/02→						
2.0 16V Turbo (BJ0K)	120	06/02→	←	→ 12/09				
2.2 dCi (BJ0E, BJ0F)	110	06/02→	→	Orga 020919→; → 12/09;	Achszapfendurchmesser [mm]: 30	24.0111-0100.2	411100	Ø 300 11 9,5 + LG / + ABS Ring
3.0 dCi (BJ0J, BJ0N)	130	06/02→	→	→Orga 020918;				
			→	Achszapfendurchmesser [mm]: 30		24.0111-0167.2	411167	Ø 300 11 9,5 + LG / + ABS Ring
RENAULT - WIND (E4M_) 07/10→								
 Bremsbelagsatz, Scheibenbremse								
1.2 (E4MF)	74	07/10→	←	→ 09/13		13.0460-7248.2	607248	ATE 23215 17,5 - WE / - WK
1.2 TCe 100 (E4MA)	75	02/11→						
1.6 (E4MB, E4MC)	98	07/10→						
 Bremsscheibe								
1.2 (E4MF)	74	07/10→	←	→ 09/13		24.0124-0158.1	424158	Ø 280 24 21,8 V + S
1.2 TCe 100 (E4MA)	75	02/11→				24.0324-0158.1	524158	Ø 280 24 21,8 V + S PD
1.6 (E4MB, E4MC)	98	07/10→	→	→ 09/13		24.0108-0114.2	408114	Ø 240 8 7 + LG / + ABS Ring
RENAULT - ZOE (BFM_) 06/12→								
 Bremsscheibe								
ZOE	65	06/12→	←			24.0122-0270.1	422270	Ø 258 22 19,8 V + S
ZOE	68	09/16→						
RENAULT TRUCKS - MASCOTT Kasten/Kombi 01/99→12/10								
 Bremsbelagsatz, Scheibenbremse								
110.35	78	01/99→06/04	←			13.0460-4847.2	604847	BRE 29160 20,3 + WE / - WK + Zub
110.50	78	01/99→06/04	→			13.0460-4860.2	604860	BRE 29121 20,3 + WK + Zub
130.35	92	01/99→06/04				13.0460-4966.2	604966	BRE 29121 20,3 + WE / - WK
140.35	103	01/01→06/04	→			13.0460-4860.2	604860	BRE 29121 20,3 + WK + Zub
150.35 (A02300161)	107	10/01→06/04	→			13.0460-4966.2	604966	BRE 29121 20,3 + WE / - WK
110.55	78	01/99→06/04	←			13.0460-4860.2	604860	BRE 29121 20,3 + WK + Zub
130.55	92	01/99→06/04	→			13.0460-4860.2	604860	BRE 29121 20,3 + WK + Zub
140.55	103	01/01→06/04	→			13.0460-4966.2	604966	BRE 29121 20,3 + WE / - WK
150.55 (A02300164)	107	10/01→06/04	→			13.0460-4860.2	604860	BRE 29121 20,3 + WK + Zub
150.65 (A00300166)	107	10/01→06/04	→			13.0460-4966.2	604966	BRE 29121 20,3 + WE / - WK
120.35 (A02100003)	85	05/04→10/10	←			13.0460-4966.2	604966	BRE 29121 20,3 + WE / - WK
120.55 (A02300005)	85	05/04→10/10	→			13.0460-4966.2	604966	BRE 29121 20,3 + WE / - WK
160.35 (A02100013)	115	05/04→10/10	→			13.0460-4847.2	604847	BRE 29160 20,3 + WE / - WK + Zub
160.55 (A02300015)	115	05/04→10/10	→			13.0460-4860.2	604860	BRE 29121 20,3 + WK + Zub
150.35	78	11/02→10/10	←	→ 06/04		13.0460-4860.2	604860	BRE 29121 20,3 + WE / - WK
			→	→ 06/04		13.0460-4966.2	604966	BRE 29121 20,3 + WE / - WK
			→	→ 06/04		13.0460-4860.2	604860	BRE 29121 20,3 + WK + Zub
90.35	63	01/99→12/01	←	→ 06/01		13.0460-4860.2	604860	BRE 29121 20,3 + WK + Zub
			→	→ 06/01		13.0460-4860.2	604860	BRE 29121 20,3 + WK + Zub
			→	→ 06/01		13.0460-4966.2	604966	BRE 29121 20,3 + WE / - WK
 Bremsscheibe								
110.35	78	01/99→06/04	←			24.0122-0266.1	422266	Ø 290 22 19 V
110.50	78	01/99→06/04	→			24.0122-0267.1	422267	Ø 290 22 19 V
130.35	92	01/99→06/04						
140.35	103	01/01→06/04	→					
150.35 (A02300161)	107	10/01→06/04	→					
110.55	78	01/99→06/04	←			24.0126-0161.1	426161	Ø 290 26 23 V
130.55	92	01/99→06/04	→			24.0122-0267.1	422267	Ø 290 22 19 V
140.55	103	01/01→06/04	→					
150.55 (A02300164)	107	10/01→06/04	→					
150.65 (A00300166)	107	10/01→06/04	→					
150.35	78	11/02→10/10	←	→ 06/04		24.0122-0266.1	422266	Ø 290 22 19 V
			→	→ 06/04		24.0122-0267.1	422267	Ø 290 22 19 V
90.35	63	01/99→12/01	←	→ 06/01		24.0122-0266.1	422266	Ø 290 22 19 V
↓								











	kw					! #		
RENAULT TRUCKS - MASCOTT Kasten/Kombi 01/99→12/10								
 Bremsscheibe								
90.35	63	01/99→12/01	→	→ 06/01			24.0122-0267.1 422267	Ø 290 22 19 V
RENAULT TRUCKS - MASCOTT Pritsche/Fahrgestell 01/99→12/13								
 Bremsbelagsatz, Scheibenbremse								
110 140 150.35 (A00300161) 150.35 (A00300164)	78 103 107 107	01/99→06/04 01/01→06/04 10/01→06/04 10/01→06/04	← →				13.0460-4847.2 604847 13.0460-4860.2 604860 13.0460-4966.2 604966	BRE 29160 20,3 + WE / - WK + Zub BRE 29121 20,3 + WK + Zub BRE 29121 20,3 + WE / - WK
120.35 (A00100003, A01100003) 120.55 (A00300005, A01300005) 160.35 (A00100013, A01100013) 160.55 (A00300015, A01300015)	85 85 115 115	05/04→12/10 05/04→12/10 05/04→12/10 05/04→12/10	← →				13.0460-4966.2 604966 13.0460-4966.2 604966	BRE 29121 20,3 + WE / - WK BRE 29121 20,3 + WE / - WK
120.65 (A00500007) 160.65 (A00500017, A01500017, B03200017)	85 115	05/04→12/10 05/04→12/10	→				13.0460-4966.2 604966	BRE 29121 20,3 + WE / - WK
130	92	01/99→06/04	← →				13.0460-4860.2 604860 13.0460-4860.2 604860 13.0460-4966.2 604966	BRE 29121 20,3 + WK + Zub BRE 29121 20,3 + WK + Zub BRE 29121 20,3 + WE / - WK
90	63	01/99→12/01	← →	→ 06/01 → 06/01			13.0460-4860.2 604860 13.0460-4860.2 604860 13.0460-4966.2 604966	BRE 29121 20,3 + WK + Zub BRE 29121 20,3 + WK + Zub BRE 29121 20,3 + WE / - WK
 Bremsscheibe								
110 140 150.35 (A00300161) 150.35 (A00300164)	78 103 107 107	01/99→06/04 01/01→06/04 10/01→06/04 10/01→06/04	← →				24.0122-0266.1 422266 24.0122-0267.1 422267	Ø 290 22 19 V Ø 290 22 19 V
130	92	01/99→06/04	← →				24.0126-0161.1 426161 24.0122-0267.1 422267	Ø 290 26 23 V Ø 290 22 19 V
90	63	01/99→12/01	← →	→ 06/01 → 06/01			24.0122-0266.1 422266 24.0122-0267.1 422267	Ø 290 22 19 V Ø 290 22 19 V
ROLLS-ROYCE - SILVER SERAPH 03/98→09/02								
 Bremsbelagsatz, Scheibenbremse								
5.4	240	03/98→09/02	←				13.0460-7183.2 607183	ATE 21484 20,5 + WE / - WK
ROVER - 25 (RF) 09/99→06/06								
 Bremsbelagsatz, Scheibenbremse								
1.1 16V 1.4 16V 1.4 16V 1.6 16V 1.8 16V 1.8 16V 2.0 iDT 2.0 iDT	55 62 76 80 85 107 74 83	01/04→05/05 10/99→05/05 10/99→05/05 10/99→05/05 10/99→05/05 02/00→05/05 10/99→05/05 01/02→12/04	← →				13.0460-2803.2 602803 13.0460-5998.2 605998	TRW 21515 17,5 + WK AKE 21312 12,8 + WK
Zubehörsatz, Scheibenbremsbelag								
1.1 16V 1.4 16V 1.4 16V 1.6 16V 1.8 16V 1.8 16V 2.0 iDT 2.0 iDT	55 62 76 80 85 107 74 83	01/04→05/05 10/99→05/05 10/99→05/05 10/99→05/05 10/99→05/05 02/00→05/05 10/99→05/05 01/02→12/04	←				13.0460-0142.2 610142	
 Bremsscheibe								
1.1 16V 1.4 16V 1.4 16V 1.6 16V 1.8 16V 1.8 16V 2.0 iDT 2.0 iDT	55 62 76 80 85 107 74 83	01/04→05/05 10/99→05/05 10/99→05/05 10/99→05/05 10/99→05/05 02/00→05/05 10/99→05/05 01/02→12/04	← →				24.0113-0198.1 413198 24.0121-0105.1 421105 24.0110-0212.1 410212 24.0121-0105.1 421105 24.0110-0212.1 410212	Ø 262 13 11 Ø 262 21 19 V + S Ø 238,5 10 8 + S Ø 262 21 19 V + S Ø 238,5 10 8 + S













	kw			 	! #		
ROVER - 45 (RT) 02/00→05/05							
 Bremsbelagsatz, Scheibenbremse							
1.4	76	02/00→05/05	←			13.0460-2803.2 602803	TRW 21515 17,5 + WK
1.6	80	02/00→05/05	→			13.0460-5998.2 605998	AKE 21312 12,8 + WK
1.8	86	02/00→05/05					
2.0 iDT	74	02/00→05/05					
2.0 iDT	83	01/04→05/05					
2.0 V6	110	02/00→05/05					
Zubehörsatz, Scheibenbremsbelag							
1.4	76	02/00→05/05	←			13.0460-0142.2 610142	
1.6	80	02/00→05/05	→			13.0460-0142.2 610142	
1.8	86	02/00→05/05					
2.0 iDT	74	02/00→05/05					
2.0 iDT	83	01/04→05/05					
2.0 V6	110	02/00→05/05					
 Bremsscheibe							
1.4	76	02/00→05/05	←			24.0121-0105.1 421105	Ø 262 21 19 V + S
1.6	80	02/00→05/05	→			24.0110-0212.1 410212	Ø 238,5 10 8 + S
1.8	86	02/00→05/05					
2.0 iDT	74	02/00→05/05					
2.0 iDT	83	01/04→05/05					
2.0 V6	110	02/00→05/05					
ROVER - 45 Stufenheck (RT) 02/00→05/05							
 Bremsbelagsatz, Scheibenbremse							
1.4	76	02/00→05/05	←			13.0460-2803.2 602803	TRW 21515 17,5 + WK
1.6	80	02/00→05/05	→			13.0460-5998.2 605998	AKE 21312 12,8 + WK
1.8	86	02/00→05/05					
2.0 iDT	74	02/00→05/05					
2.0 iDT	83	01/04→05/05					
2.0 V6	110	02/00→05/05					
Zubehörsatz, Scheibenbremsbelag							
1.4	76	02/00→05/05	←			13.0460-0142.2 610142	
1.6	80	02/00→05/05	→			13.0460-0142.2 610142	
1.8	86	02/00→05/05					
2.0 iDT	74	02/00→05/05					
2.0 iDT	83	01/04→05/05					
2.0 V6	110	02/00→05/05					
 Bremsscheibe							
1.4	76	02/00→05/05	←			24.0121-0105.1 421105	Ø 262 21 19 V + S
1.6	80	02/00→05/05	→			24.0110-0212.1 410212	Ø 238,5 10 8 + S
1.8	86	02/00→05/05					
2.0 iDT	74	02/00→05/05					
2.0 iDT	83	01/04→05/05					
2.0 V6	110	02/00→05/05					
ROVER - 75 (RJ) 02/99→05/05							
 Bremsbelagsatz, Scheibenbremse							
1.8	88	02/99→05/05	←			13.0460-7144.2 607144	ATE 23112 19,1 + WE / - WK
1.8 Turbo	110	05/03→05/05	→			13.0460-3605.2 603605	ATE 20180 17,3 + WE / - WK
2.0 CDT	85	02/99→05/05					
2.0 CDTi	96	02/03→05/05				13.0470-3605.2 LD3605	ATE 20180 17,3 + WE / - WK Ceramic
2.0 V6	110	02/99→05/05					
2.5 V6	129	02/99→10/01					
2.5 V6	130	10/01→05/05					
Warnkontakt, Bremsbelagverschleiß							
1.8	88	02/99→05/05	←		1	24.8190-2801.2 622801	L= 1.103
1.8 Turbo	110	05/03→05/05	→		1	24.8190-2802.2 622802	L= 846
2.0 CDT	85	02/99→05/05					
2.0 CDTi	96	02/03→05/05					
2.0 V6	110	02/99→05/05					
2.5 V6	129	02/99→10/01					
2.5 V6	130	10/01→05/05					
 Bremsscheibe							
1.8	88	02/99→05/05	←			24.0122-0206.1 422206	Ø 284 22 19 V
1.8 Turbo	110	05/03→05/05	→			24.0110-0270.1 410270	Ø 280 10 8
2.0 CDT	85	02/99→05/05					
2.0 CDTi	96	02/03→05/05					
2.0 V6	110	02/99→05/05					
2.5 V6	129	02/99→10/01					
2.5 V6	130	10/01→05/05					

	kW			 	! #		
ROVER - 75 Tourer (RJ) 08/01→06/06							
 Bremsbelagsatz, Scheibenbremse							
1.8	88	08/01→05/05	←			13.0460-7144.2 607144	ATE 23112 19,1 + WE / - WK
1.8 Turbo	110	05/03→05/05					
2.0 CDT	85	08/01→05/05	→			13.0460-3605.2 603605	ATE 20180 17,3 + WE / - WK
2.0 CDTi	96	02/03→05/05				13.0470-3605.2 LD3605	ATE 20180 17,3 + WE / - WK Ceramic
2.0 V6	110	08/01→05/05					
2.5 V6	130	08/01→05/05					
Warnkontakt, Bremsbelagverschleiß							
1.8	88	08/01→05/05	←		1	24.8190-2801.2 622801	L= 1.103
1.8 Turbo	110	05/03→05/05					
2.0 CDT	85	08/01→05/05	→		1	24.8190-2802.2 622802	L= 846
2.0 CDTi	96	02/03→05/05					
2.0 V6	110	08/01→05/05					
2.5 V6	130	08/01→05/05					
 Bremsscheibe							
1.8	88	08/01→05/05	←			24.0122-0206.1 422206	Ø 284 22 19 V
1.8 Turbo	110	05/03→05/05					
2.0 CDT	85	08/01→05/05	→			24.0110-0270.1 410270	Ø 280 10 8
2.0 CDTi	96	02/03→05/05					
2.0 V6	110	08/01→05/05					
2.5 V6	130	08/01→05/05					
ROVER - 100 / METRO (XP) 11/89→12/98							
 Bremsbelagsatz, Scheibenbremse							
114 GSi	76	10/94→10/95	←			13.0460-2804.2 602804	TRW 21518 17,0 - WK
114 GTI 16V	76	08/91→12/98					
114 GTI/GT 16V Cat	66	03/90→12/98	←	05/90→		13.0460-2804.2 602804	TRW 21518 17,0 - WK
114 S/L/GTA	55	03/90→12/98					
 Bremsscheibe							
111 C/L/S	44	03/90→12/98	←	05/90→		24.0113-0190.1 413190	Ø 240 12,8 11,6
114 GTI/GT 16V Cat	66	03/90→12/98				24.0122-0177.1 422177	Ø 240,5 22 20 V
114 S/L/GTA	55	03/90→12/98					
114 GSi	76	10/94→10/95	←			24.0113-0190.1 413190	Ø 240 12,8 11,6
114 GTI 16V	76	08/91→12/98				24.0122-0177.1 422177	Ø 240,5 22 20 V
ROVER - 100 Cabriolet (XP) 04/94→12/98							
 Bremsbelagsatz, Scheibenbremse							
114	55	04/94→10/97	←			13.0460-2804.2 602804	TRW 21518 17,0 - WK
114	75	03/97→10/98					
 Bremsscheibe							
111	44	04/94→10/97	←			24.0113-0190.1 413190	Ø 240 12,8 11,6
114	55	04/94→10/97				24.0122-0177.1 422177	Ø 240,5 22 20 V
114	75	03/97→10/98					
ROVER - 200 Cabriolet (XW) 04/90→11/99							
 Bremsbelagsatz, Scheibenbremse							
214 1.4	66	01/92→11/99	←	→ 10/95; + ABS		13.0460-2803.2 602803	TRW 21515 17,5 + WK
216 1.6i	90	01/92→11/99	←	→ 10/95; - ABS		13.0460-2805.2 602805	TRW 21520 17,5 + WK
			→	→ 10/95		13.0460-5998.2 605998	AKE 21312 12,8 + WK
214 1.4i 16V	76	01/93→11/99	←	→ 10/95; + ABS		13.0460-2803.2 602803	TRW 21515 17,5 + WK
			←	→ 10/95; - ABS		13.0460-2805.2 602805	TRW 21520 17,5 + WK
Zubehörsatz, Scheibenbremsbelag							
214 1.4	66	01/92→11/99	←	→ 10/95		13.0460-0142.2 610142	
216 1.6i	90	01/92→11/99	→	→ 10/95		13.0460-0430.2 610430	AKE
214 1.4i 16V	76	01/93→11/99	←	→ 10/95		13.0460-0142.2 610142	
 Bremsscheibe							
214 1.4	66	01/92→11/99	←	09/93→ 10/95; - ABS		24.0113-0188.1 413188	Ø 238 12,7 10,7
214 1.4i 16V	76	01/93→11/99	←	→ 10/95; + ABS		24.0121-0107.1 421107	Ø 262 21 19 V
			→	→ 10/95; + ABS		24.0110-0212.1 410212	Ø 238,5 10 8 + S
216 1.6i	90	01/92→11/99	←	→ 10/95		24.0121-0107.1 421107	Ø 262 21 19 V













	kW			 	! #		
ROVER - 200 Coupe (XW) 10/92→06/99							
 Bremsbelagsatz, Scheibenbremse							
216	82	01/96→12/97	←	+ ABS		13.0460-2803.2 602803	TRW 21515 17,5 + WK
			→	+ ABS		13.0460-5998.2 605998	AKE 21312 12,8 + WK
216 220 GSi	90 100	10/92→06/99 05/94→06/99	←	→ 10/95; + ABS		13.0460-2803.2 602803	TRW 21515 17,5 + WK
			←	→ 10/95; - ABS		13.0460-2805.2 602805	TRW 21520 17,5 + WK
220 Turbo	147	10/92→06/99	←	01/93→ 10/95; + ABS		13.0460-2803.2 602803	TRW 21515 17,5 + WK
			←	01/93→ 10/95; - ABS		13.0460-2805.2 602805	TRW 21520 17,5 + WK
			→	01/93→ 10/95		13.0460-5998.2 605998	AKE 21312 12,8 + WK
Zubehörsatz, Scheibenbremsbelag							
216	82	01/96→12/97	←	+ ABS		13.0460-0142.2 610142	
216 220 GSi	90 100	10/92→06/99 05/94→06/99	←	→ 10/95		13.0460-0142.2 610142	
220 Turbo	147	10/92→06/99	←	01/93→ 10/95		13.0460-0142.2 610142	
			→	01/93→ 10/95		13.0460-0430.2 610430	AKE
 Bremsscheibe							
216	82	01/96→12/97	←	+ ABS		24.0121-0105.1 421105	Ø 262 21 19 V + S
			→	+ ABS		24.0110-0212.1 410212	Ø 238,5 10 8 + S
216	90	10/92→06/99	←	→ 10/95		24.0121-0107.1 421107	Ø 262 21 19 V
			→	→ 10/95; + ABS		24.0110-0212.1 410212	Ø 238,5 10 8 + S
220 GSi	100	05/94→06/99	←	→ 10/95		24.0121-0107.1 421107	Ø 262 21 19 V
			→	→ 10/95		24.0110-0212.1 410212	Ø 238,5 10 8 + S
220 Turbo	147	10/92→06/99	←	01/93→ 10/95		24.0121-0107.1 421107	Ø 262 21 19 V
ROVER - 200 Hatchback (RF) 11/95→11/00							
 Bremsbelagsatz, Scheibenbremse							
211	44	01/98→03/00	←			13.0460-2803.2 602803	TRW 21515 17,5 + WK
			→	+ ABS		13.0460-2805.2 602805	TRW 21520 17,5 + WK
			→	+ ABS		13.0460-5998.2 605998	AKE 21312 12,8 + WK
214 i 220 D/SD	55 63	11/95→03/00 11/95→03/00	←	01/96→		13.0460-2803.2 602803	TRW 21515 17,5 + WK
			→	01/96→; + ABS		13.0460-2805.2 602805	TRW 21520 17,5 + WK
			→	01/96→; + ABS		13.0460-5998.2 605998	AKE 21312 12,8 + WK
214 Si	76	11/95→03/00	←	+ ABS		13.0460-2803.2 602803	TRW 21515 17,5 + WK
			←	- ABS		13.0460-2805.2 602805	TRW 21520 17,5 + WK
			→	+ ABS		13.0460-5998.2 605998	AKE 21312 12,8 + WK
216 Si	82	11/95→03/00	←	+ ABS		13.0460-2803.2 602803	TRW 21515 17,5 + WK
			→	01/96→; + ABS		13.0460-5998.2 605998	AKE 21312 12,8 + WK
218 K Vi	107	11/95→03/00	←	01/96→		13.0460-2803.2 602803	TRW 21515 17,5 + WK
			→	01/97→; + ABS		13.0460-5998.2 605998	AKE 21312 12,8 + WK
218 Si	88	08/99→03/00	←			13.0460-2803.2 602803	TRW 21515 17,5 + WK
			→	+ ABS		13.0460-5998.2 605998	AKE 21312 12,8 + WK
220 SDi	77	11/95→03/00	←	01/96→; + ABS		13.0460-2803.2 602803	TRW 21515 17,5 + WK
			←	01/96→; - ABS		13.0460-2805.2 602805	TRW 21520 17,5 + WK
			→	01/96→; + ABS		13.0460-5998.2 605998	AKE 21312 12,8 + WK
Zubehörsatz, Scheibenbremsbelag							
211 218 Si	44 88	01/98→03/00 08/99→03/00	←			13.0460-0142.2 610142	
214 i 218 K Vi 220 D/SD	55 107 63	11/95→03/00 11/95→03/00 11/95→03/00	←	01/96→		13.0460-0142.2 610142	
214 Si 216 Si	76 82	11/95→03/00 11/95→03/00	←	+ ABS		13.0460-0142.2 610142	
220 SDi	77	11/95→03/00	←	01/96→; + ABS		13.0460-0142.2 610142	
 Bremsscheibe							
211	44	01/98→03/00	←			24.0113-0198.1 413198	Ø 262 13 11
			→	+ ABS		24.0121-0105.1 421105	Ø 262 21 19 V + S
			→	+ ABS		24.0110-0212.1 410212	Ø 238,5 10 8 + S
↓							

















	kW			 	! #		
ROVER - 200 Hatchback (RF) 11/95→11/00							
 Bremsscheibe							
214 i 220 D/SD	55 63	11/95→03/00 11/95→03/00	←	01/96→		24.0113-0198.1 413198	Ø 262 13 11
			→	01/96→; + ABS		24.0121-0105.1 421105	Ø 262 21 19 V + S
			→	01/96→; + ABS		24.0110-0212.1 410212	Ø 238,5 10 8 + S
214 Si	76	11/95→03/00	←	- ABS		24.0113-0198.1 413198	Ø 262 13 11
			←	+ ABS		24.0121-0105.1 421105	Ø 262 21 19 V + S
			→	+ ABS		24.0110-0212.1 410212	Ø 238,5 10 8 + S
216 Si	82	11/95→03/00	←	+ ABS		24.0121-0105.1 421105	Ø 262 21 19 V + S
			→	01/96→; + ABS		24.0110-0212.1 410212	Ø 238,5 10 8 + S
218 K Vi	107	11/95→03/00	←	01/96→		24.0121-0105.1 421105	Ø 262 21 19 V + S
			→	01/97→; + ABS		24.0110-0212.1 410212	Ø 238,5 10 8 + S
218 Si	88	08/99→03/00	←			24.0121-0105.1 421105	Ø 262 21 19 V + S
			→	+ ABS		24.0110-0212.1 410212	Ø 238,5 10 8 + S
220 SDi	77	11/95→03/00	←	01/96→; - ABS		24.0113-0198.1 413198	Ø 262 13 11
			←	01/96→; + ABS		24.0121-0105.1 421105	Ø 262 21 19 V + S
			→	01/96→; + ABS		24.0110-0212.1 410212	Ø 238,5 10 8 + S
ROVER - 200 Hatchback (XW) 10/89→10/95							
 Bremsbelagsatz, Scheibenbremse							
214 214 GSi/Si	55 76	09/93→10/95 12/92→10/95	←	+ ABS		13.0460-2803.2 602803	TRW 21515 17,5 + WK
214 Si/Gsi	66	10/89→10/95	←	- ABS		13.0460-2805.2 602805	TRW 21520 17,5 + WK
216 GSi	82	10/89→10/95	→			13.0460-5998.2 605998	AKE 21312 12,8 + WK
216 GSi	85	10/89→10/95					
218 D	52	09/91→10/95					
220 Turbo	147	01/93→10/95					
214 GSi/Si	70	01/90→10/95	←	+ ABS		13.0460-2803.2 602803	TRW 21515 17,5 + WK
216 GTi	90	09/90→10/95	←	- ABS		13.0460-2805.2 602805	TRW 21520 17,5 + WK
216 GTi	96	09/90→10/95					
218 TD	65	09/91→10/95					
220 GTi	100	01/93→10/95					
220 GTi	103	09/91→10/95					
Zubehörsatz, Scheibenbremsbelag							
214 214 GSi/Si	55 76	09/93→10/95 12/92→10/95	←			13.0460-0142.2 610142	
214 Si/Gsi	66	10/89→10/95	→			13.0460-0430.2 610430	AKE
216 GSi	82	10/89→10/95					
216 GSi	85	10/89→10/95					
218 D	52	09/91→10/95					
220 Turbo	147	01/93→10/95					
214 GSi/Si	70	01/90→10/95	←			13.0460-0142.2 610142	
216 GTi	90	09/90→10/95					
216 GTi	96	09/90→10/95					
218 TD	65	09/91→10/95					
220 GTi	100	01/93→10/95					
220 GTi	103	09/91→10/95					
 Bremsscheibe							
214	55	09/93→10/95	←	- ABS		24.0113-0188.1 413188	Ø 238 12,7 10,7
			←	+ ABS		24.0121-0107.1 421107	Ø 262 21 19 V
			→	+ ABS		24.0110-0212.1 410212	Ø 238,5 10 8 + S
214 GSi/Si 214 GSi/Si	70 76	01/90→10/95 12/92→10/95	←	09/93→; - ABS		24.0113-0188.1 413188	Ø 238 12,7 10,7
			←	+ ABS		24.0121-0107.1 421107	Ø 262 21 19 V
			→	+ ABS		24.0110-0212.1 410212	Ø 238,5 10 8 + S
214 Si/Gsi	66	10/89→10/95	←	09/93→; - ABS		24.0113-0188.1 413188	Ø 238 12,7 10,7
			←	+ ABS		24.0121-0107.1 421107	Ø 262 21 19 V
			→	01/90→; + ABS		24.0110-0212.1 410212	Ø 238,5 10 8 + S
216 GSi	82	10/89→10/95	←			24.0121-0107.1 421107	Ø 262 21 19 V
216 GSi	85	10/89→10/95					
218 D	52	09/91→10/95					
220 Turbo	147	01/93→10/95					
216 GTi	90	09/90→10/95	←			24.0121-0107.1 421107	Ø 262 21 19 V
216 GTi	96	09/90→10/95					
218 TD	65	09/91→10/95	→	+ ABS		24.0110-0212.1 410212	Ø 238,5 10 8 + S
220 GTi	100	01/93→10/95	←			24.0121-0107.1 421107	Ø 262 21 19 V
220 GTi	103	09/91→10/95	→			24.0110-0212.1 410212	Ø 238,5 10 8 + S











	kW			 	! #		
ROVER - 400 (RT) 05/95→03/00							
 Bremsbelagsatz, Scheibenbremse							
414	55	03/96→12/99	←			13.0460-2803.2 602803	TRW 21515 17,5 + WK
414 Si	76	05/95→03/00	→			13.0460-5998.2 605998	AKE 21312 12,8 + WK
420 D	63	11/95→03/00					
420 Di	77	05/95→03/00					
420 Si Lux	100	12/95→03/00					
416 Si	82	05/95→03/00	←	06/95→		13.0460-2803.2 602803	TRW 21515 17,5 + WK
416 Si	83	05/95→03/00					
416 Si	85	05/95→03/00	→	06/95→		13.0460-5998.2 605998	AKE 21312 12,8 + WK
Zubehörsatz, Scheibenbremsbelag							
414	55	03/96→12/99	←			13.0460-0142.2 610142	
414 Si	76	05/95→03/00	→			13.0460-0430.2 610430	AKE
420 D	63	11/95→03/00					
420 Di	77	05/95→03/00					
420 Si Lux	100	12/95→03/00					
416 Si	82	05/95→03/00	←	06/95→		13.0460-0142.2 610142	
416 Si	83	05/95→03/00					
416 Si	85	05/95→03/00	→	06/95→		13.0460-0430.2 610430	AKE
 Bremsscheibe							
414	55	03/96→12/99	←	- ABS		24.0113-0198.1 413198	Ø 262 13 11
			←	+ ABS		24.0121-0105.1 421105	Ø 262 21 19 V + S
			→			24.0110-0212.1 410212	Ø 238,5 10 8 + S
414 Si	76	05/95→03/00	←	- ABS		24.0113-0198.1 413198	Ø 262 13 11
			←	06/95→; + ABS		24.0121-0105.1 421105	Ø 262 21 19 V + S
			→	06/95→		24.0110-0212.1 410212	Ø 238,5 10 8 + S
416 Si	82	05/95→03/00	←	06/95→		24.0113-0198.1 413198	Ø 262 13 11
416 Si	83	05/95→03/00				24.0121-0105.1 421105	Ø 262 21 19 V + S
416 Si	85	05/95→03/00	→	06/95→		24.0110-0212.1 410212	Ø 238,5 10 8 + S
420 D	63	11/95→03/00	←			24.0113-0198.1 413198	Ø 262 13 11
420 Di	77	05/95→03/00				24.0121-0105.1 421105	Ø 262 21 19 V + S
420 Si Lux	100	12/95→03/00	→			24.0110-0212.1 410212	Ø 238,5 10 8 + S
ROVER - 400 (XW) 04/90→04/95							
 Bremsbelagsatz, Scheibenbremse							
414	70	01/93→04/95	←	+ ABS		13.0460-2803.2 602803	TRW 21515 17,5 + WK
416 GSI	82	04/90→04/95	←	- ABS		13.0460-2805.2 602805	TRW 21520 17,5 + WK
416 GSI/GSE	85	04/90→04/95	→			13.0460-5998.2 605998	AKE 21312 12,8 + WK
416 GTI	90	04/90→04/95					
416 GTI/GTE	96	04/90→04/95					
418 TD	65	09/91→04/95					
414 GSI/SI	66	04/90→04/95	←	+ ABS		13.0460-2803.2 602803	TRW 21515 17,5 + WK
414 GSI/SI Cat	76	10/92→04/95	←	- ABS		13.0460-2805.2 602805	TRW 21520 17,5 + WK
418 D	49	09/91→04/95					
420 GSI/SLI/GTI/Vite	100	01/93→04/95					
420 GTI/GSI/Vitesse	103	02/92→04/95					
420 Turbo	147	01/93→04/95					
Zubehörsatz, Scheibenbremsbelag							
414	70	01/93→04/95	←			13.0460-0142.2 610142	
416 GSI	82	04/90→04/95	→			13.0460-0430.2 610430	AKE
416 GSI/GSE	85	04/90→04/95					
416 GTI	90	04/90→04/95					
416 GTI/GTE	96	04/90→04/95					
418 TD	65	09/91→04/95					
414 GSI/SI	66	04/90→04/95	←			13.0460-0142.2 610142	
414 GSI/SI Cat	76	10/92→04/95					
418 D	49	09/91→04/95					
420 GSI/SLI/GTI/Vite	100	01/93→04/95					
420 GTI/GSI/Vitesse	103	02/92→04/95					
420 Turbo	147	01/93→04/95					
 Bremsscheibe							
414	70	01/93→04/95	←	- ABS		24.0113-0188.1 413188	Ø 238 12,7 10,7
414 GSI/SI	66	04/90→04/95	←	+ ABS		24.0121-0107.1 421107	Ø 262 21 19 V
414 GSI/SI Cat	76	10/92→04/95	→	+ ABS		24.0110-0212.1 410212	Ø 238,5 10 8 + S
416 GSI	82	04/90→04/95	←			24.0121-0107.1 421107	Ø 262 21 19 V
416 GSI/GSE	85	04/90→04/95	→	+ ABS		24.0110-0212.1 410212	Ø 238,5 10 8 + S
416 GTI	90	04/90→04/95					
416 GTI/GTE	96	04/90→04/95					
418 TD	65	09/91→04/95					
↓							









	kw			 	! #		
ROVER - 400 (XW) 04/90→04/95							
 Bremsscheibe							
418 D	49	09/91→04/95	←			24.0121-0107.1 421107	Ø 262 21 19 V
420 GSI/SLI/GTI/Vite	100	01/93→04/95	←			24.0121-0107.1 421107	Ø 262 21 19 V
420 GTI/GSI/Vitesse	103	02/92→04/95	→			24.0110-0212.1 410212	Ø 238,5 10 8 + S
420 Turbo	147	01/93→04/95	→				
ROVER - 400 Hatchback (RT) 05/95→03/00							
 Bremsbelagsatz, Scheibenbremse							
414	55	03/96→12/97	←			13.0460-2803.2 602803	TRW 21515 17,5 + WK
414 Si	76	05/95→03/00	←			13.0460-5998.2 605998	AKE 21312 12,8 + WK
416 Si	83	06/95→03/00	→				
416 Si	85	06/95→03/00	→				
420 D	63	11/95→03/00	→				
420 Di	77	05/95→03/00	→				
420 Si Lux	100	12/95→03/00	→				
416 Si	82	05/95→03/00	←	06/95→		13.0460-2803.2 602803	TRW 21515 17,5 + WK
			→	06/95→		13.0460-5998.2 605998	AKE 21312 12,8 + WK
Zubehörsatz, Scheibenbremsbelag							
414	55	03/96→12/97	←			13.0460-0142.2 610142	
414 Si	76	05/95→03/00	←			13.0460-0430.2 610430	AKE
416 Si	83	06/95→03/00	→				
416 Si	85	06/95→03/00	→				
420 D	63	11/95→03/00	→				
420 Di	77	05/95→03/00	→				
420 Si Lux	100	12/95→03/00	→				
416 Si	82	05/95→03/00	←	06/95→		13.0460-0142.2 610142	
			→	06/95→		13.0460-0430.2 610430	AKE
 Bremsscheibe							
414	55	03/96→12/97	←	- ABS		24.0113-0198.1 413198	Ø 262 13 11
			←	+ ABS		24.0121-0105.1 421105	Ø 262 21 19 V + S
			→			24.0110-0212.1 410212	Ø 238,5 10 8 + S
414 Si	76	05/95→03/00	←	- ABS		24.0113-0198.1 413198	Ø 262 13 11
			←	06/95→; + ABS		24.0121-0105.1 421105	Ø 262 21 19 V + S
			→	06/95→		24.0110-0212.1 410212	Ø 238,5 10 8 + S
416 Si	82	05/95→03/00	←	06/95→		24.0113-0198.1 413198	Ø 262 13 11
			←			24.0121-0105.1 421105	Ø 262 21 19 V + S
			→	06/95→		24.0110-0212.1 410212	Ø 238,5 10 8 + S
416 Si	83	06/95→03/00	←			24.0113-0198.1 413198	Ø 262 13 11
416 Si	85	06/95→03/00	←			24.0121-0105.1 421105	Ø 262 21 19 V + S
420 D	63	11/95→03/00	→			24.0110-0212.1 410212	Ø 238,5 10 8 + S
420 Di	77	05/95→03/00	→				
420 Si Lux	100	12/95→03/00	→				
ROVER - 400 Tourer (XW) 09/93→11/98							
 Bremsbelagsatz, Scheibenbremse							
1.6 i	82	05/94→11/98	←	→ 04/95; + ABS		13.0460-2803.2 602803	TRW 21515 17,5 + WK
1.6 i	90	05/94→11/98	←	→ 04/95; - ABS		13.0460-2805.2 602805	TRW 21520 17,5 + WK
1.8 TD	65	09/93→11/98	→	→ 04/95		13.0460-5998.2 605998	AKE 21312 12,8 + WK
2.0 i	100	05/94→11/98	←	→ 04/95; + ABS		13.0460-2803.2 602803	TRW 21515 17,5 + WK
			←	→ 04/95; - ABS		13.0460-2805.2 602805	TRW 21520 17,5 + WK
Zubehörsatz, Scheibenbremsbelag							
1.6 i	82	05/94→11/98	←	→ 04/95		13.0460-0142.2 610142	
1.6 i	90	05/94→11/98	→	→ 04/95		13.0460-0430.2 610430	AKE
1.8 TD	65	09/93→11/98	→	→ 04/95			
2.0 i	100	05/94→11/98	←	→ 04/95		13.0460-0142.2 610142	
 Bremsscheibe							
1.6 i	82	05/94→11/98	←	→ 04/95		24.0121-0107.1 421107	Ø 262 21 19 V
1.6 i	90	05/94→11/98	→	→ 04/95; + ABS		24.0110-0212.1 410212	Ø 238,5 10 8 + S
1.8 TD	65	09/93→11/98	→	→ 04/95		24.0121-0107.1 421107	Ø 262 21 19 V
2.0 i	100	05/94→11/98	←	→ 04/95		24.0110-0212.1 410212	Ø 238,5 10 8 + S









	kw			 	! #		
ROVER - 600 (RH) 08/93→10/00							
 Bremsbelagsatz, Scheibenbremse							
618 i/Si	85	03/96→02/99	←			13.0460-5955.2 605955	AKE 21879 18,6 + WK
620 i	85	08/93→06/96					
620 Sdi	77	12/94→02/99	→			13.0460-5929.2 605929	AKE 21719 15,0 + WK
620 Si	96	08/93→02/99					
620 Ti Vitesse	147	07/94→02/99					
623 Si	116	08/93→02/99					
Zubehörsatz, Scheibenbremsbelag							
618 i/Si	85	03/96→02/99	←			13.0460-0453.2 610453	AKE
620 i	85	08/93→06/96					
620 Sdi	77	12/94→02/99					
620 Si	96	08/93→02/99					
620 Ti Vitesse	147	07/94→02/99					
623 Si	116	08/93→02/99					
 Bremsscheibe							
618 i/Si	85	03/96→02/99	←			24.0123-0103.1 423103	Ø 260 23 21 V
620 Si	96	08/93→02/99	→			24.0110-0233.1 410233	Ø 260 10 8 + S
620 i	85	08/93→06/96	←	passend für Felgenreöße [Zoll]: 14		24.0123-0103.1 423103	Ø 260 23 21 V
620 Sdi	77	12/94→02/99	→			24.0110-0233.1 410233	Ø 260 10 8 + S
620 Ti Vitesse	147	07/94→02/99	→			24.0110-0233.1 410233	Ø 260 10 8 + S
623 Si	116	08/93→02/99					
ROVER - 800 (XS) 10/86→02/99							
 Bremsbelagsatz, Scheibenbremse							
820 Sport	145	04/94→03/96	→			13.0460-2800.2 602800	TRW 20087 14,6 + WK
825 Si Lux (RS)	129	04/96→02/99					
825 D/SD (XS)	87	01/90→02/99	→	01/92→		13.0460-2800.2 602800	TRW 20087 14,6 + WK
827 Si/Sterling Catalytic-Conv (XS)	124	02/88→02/99	→	09/88→		13.0460-2800.2 602800	TRW 20087 14,6 + WK
Zubehörsatz, Scheibenbremsbelag							
820 Sport	145	04/94→03/96	←			13.0460-0142.2 610142	
825 Si Lux (RS)	129	04/96→02/99					
825 D/SD (XS)	87	01/90→02/99	←	01/92→		13.0460-0142.2 610142	
827 Si/Sterling Catalytic-Conv (XS)	124	02/88→02/99	←	09/88→		13.0460-0142.2 610142	
 Bremsscheibe							
820 16V Turbo (RS)	132	01/92→02/99	←			24.0121-0100.1 421100	Ø 285 21 19 V
825 Si Lux (RS)	129	04/96→02/99	→			24.0110-0255.1 410255	Ø 260 10 8
820 I/SI (RS)	100	01/92→02/99	←			24.0121-0110.1 421110	Ø 262 21 18 V
			→			24.0110-0255.1 410255	Ø 260 10 8
820 Sport	145	04/94→03/96	→			24.0110-0255.1 410255	Ø 260 10 8
825 D/SD (XS)	87	01/90→02/99	←	01/92→		24.0121-0110.1 421110	Ø 262 21 18 V
			→			24.0110-0255.1 410255	Ø 260 10 8
827 Si/Sterling Catalytic-Conv (XS)	124	02/88→02/99	←			24.0121-0100.1 421100	Ø 285 21 19 V
			→	09/88→		24.0110-0255.1 410255	Ø 260 10 8
ROVER - 800 Coupe 08/92→02/99							
 Bremsbelagsatz, Scheibenbremse							
825 SD	87	09/93→02/99	→			13.0460-2800.2 602800	TRW 20087 14,6 + WK
825 Si (RS)	129	04/96→02/99					
827 24V (RS)	124	08/92→02/99					
Zubehörsatz, Scheibenbremsbelag							
825 SD	87	09/93→02/99	←			13.0460-0142.2 610142	
825 Si (RS)	129	04/96→02/99					
827 24V (RS)	124	08/92→02/99					
 Bremsscheibe							
820 16V	100	07/97→02/99	←			24.0121-0110.1 421110	Ø 262 21 18 V
825 SD	87	09/93→02/99	→			24.0110-0255.1 410255	Ø 260 10 8
825 Si (RS)	129	04/96→02/99	←			24.0121-0100.1 421100	Ø 285 21 19 V
827 24V (RS)	124	08/92→02/99	→			24.0110-0255.1 410255	Ø 260 10 8











	kW			 	! #		
ROVER - 800 Hatchback (XS) 10/86→02/99							
 Bremsbelagsatz, Scheibenbremse							
820 Sport	145	04/94→03/96	➔			13.0460-2800.2 602800	TRW 20087 14,6 + WK
825 D/SD (XS)	87	01/92→02/99					
827 24V I/Sl Cat (RS)	124	01/92→02/99					
Zubehörsatz, Scheibenbremsbelag							
820 Sport	145	04/94→03/96	➔			13.0460-0142.2 610142	
825 D/SD (XS)	87	01/92→02/99					
827 24V I/Sl Cat (RS)	124	01/92→02/99					
 Bremsscheibe							
820 16V Turbo (RS)	132	01/92→02/99	➔			24.0121-0100.1 421100	Ø 285 21 19 V
827 24V I/Sl Cat (RS)	124	01/92→02/99	➔			24.0110-0255.1 410255	Ø 260 10 8
820 I/Sl (XS)	100	01/93→02/99	➔			24.0121-0110.1 421110	Ø 262 21 18 V
825 D/SD (XS)	87	01/92→02/99	➔			24.0110-0255.1 410255	Ø 260 10 8
820 Sport	145	04/94→03/96	➔			24.0110-0255.1 410255	Ø 260 10 8
ROVER - COUPE 03/96→11/99							
 Bremsbelagsatz, Scheibenbremse							
1.8 16 V	107	03/96→11/99	➔			13.0460-2803.2 602803	TRW 21515 17,5 + WK
			➔	01/97→; + ABS		13.0460-5998.2 605998	AKE 21312 12,8 + WK
Zubehörsatz, Scheibenbremsbelag							
1.8 16 V	107	03/96→11/99	➔			13.0460-0142.2 610142	
 Bremsscheibe							
1.8 16 V	107	03/96→11/99	➔			24.0121-0105.1 421105	Ø 262 21 19 V + S
			➔	01/97→; + ABS		24.0110-0212.1 410212	Ø 238,5 10 8 + S
ROVER - MINI 01/91→11/00							
 Bremsbelagsatz, Scheibenbremse							
1300	37	04/92→10/96	➔	→ 04/95		13.0460-6914.2 606914	AP 20038 14,0 - WE / - WK
1300	37	10/92→11/00					
1300	46	01/92→11/00					
1300	39	01/92→04/95	➔			13.0460-6914.2 606914	AP 20038 14,0 - WE / - WK
 Bremsscheibe							
1300	37	04/92→10/96	➔	→ 04/95		24.0110-0239.1 410239	Ø 213,5 9,6 8,6
1300	37	10/92→11/00					
1300	46	01/92→11/00					
1300	39	01/92→04/95	➔			24.0110-0239.1 410239	Ø 213,5 9,6 8,6
ROVER - MINI Cabriolet (XN) 09/92→05/01							
 Bremsbelagsatz, Scheibenbremse							
1300	46	09/92→04/95	➔	→ 06/93		13.0460-6914.2 606914	AP 20038 14,0 - WE / - WK
ROVER - STREETWISE 08/03→05/05							
 Bremsbelagsatz, Scheibenbremse							
1.4	62	08/03→05/05	➔			13.0460-2803.2 602803	TRW 21515 17,5 + WK
1.4	76	08/03→05/05					
1.8	86	08/03→05/05					
2.0 TD	74	08/03→05/05					
Zubehörsatz, Scheibenbremsbelag							
1.4	62	08/03→05/05	➔			13.0460-0142.2 610142	
1.4	76	08/03→05/05					
1.8	86	08/03→05/05					
2.0 TD	74	08/03→05/05					
 Bremsscheibe							
1.4	62	08/03→05/05	➔			24.0113-0198.1 413198	Ø 262 13 11
1.4	76	08/03→05/05				24.0121-0105.1 421105	Ø 262 21 19 V + S
1.8	86	08/03→05/05					
2.0 TD	74	08/03→05/05					









	kW			 	! #		
SAAB - 9-3 (YS3D) 02/98→08/03							
 Bremsbelagsatz, Scheibenbremse							
2.0 i	96	02/98→09/02	←			13.0460-7173.2 607173	ATE 21829 20,3 - WK / + WK
2.0 SE Turbo	147	02/98→09/02					
2.0 Turbo	110	01/01→09/02	→			13.0460-4040.2 604040	ATE 21050 15,8 - WE / - WK
2.0 Turbo	113	10/98→09/02					
2.0 Turbo	136	02/98→09/02					
2.0 Turbo	151	10/99→09/02					
2.2 TiD	85	02/98→11/00					
2.2 TiD	92	11/00→09/02					
2.3	169	09/99→01/02					
2.3 i	110	02/98→09/02					
2.3 Turbo	165	10/98→09/02					
Warnkontakt, Bremsbelagverschleiß							
2.0 i	96	02/98→09/02	←		2	24.8190-0718.2 620718	L= 720
2.0 SE Turbo	147	02/98→09/02					
2.0 Turbo	110	01/01→09/02					
2.0 Turbo	113	10/98→09/02					
2.0 Turbo	136	02/98→09/02					
2.0 Turbo	151	10/99→09/02					
2.2 TiD	85	02/98→11/00					
2.2 TiD	92	11/00→09/02					
2.3	169	09/99→01/02					
2.3 i	110	02/98→09/02					
2.3 Turbo	165	10/98→09/02					
Zubehörsatz, Scheibenbremsbelag							
2.0 i	96	02/98→09/02	→			13.0460-0347.2 610347	
2.0 SE Turbo	147	02/98→09/02					
2.0 Turbo	110	01/01→09/02					
2.0 Turbo	113	10/98→09/02					
2.0 Turbo	136	02/98→09/02					
2.0 Turbo	151	10/99→09/02					
2.2 TiD	85	02/98→11/00					
2.2 TiD	92	11/00→09/02					
2.3	169	09/99→01/02					
2.3 i	110	02/98→09/02					
2.3 Turbo	165	10/98→09/02					
 Bremsscheibe							
2.0 i	96	02/98→09/02	←			24.0125-0119.1 425119	Ø 288 25 22 V + S
2.0 SE Turbo	147	02/98→09/02				24.0325-0119.1 525119	Ø 288 25 22 V + S PD
2.0 Turbo	110	01/01→09/02					
2.0 Turbo	113	10/98→09/02	→			24.0110-0226.1 410226	Ø 286 10 8 + S
2.0 Turbo	136	02/98→09/02				24.0310-0226.1 510226	Ø 286 10 8 + S PD
2.0 Turbo	151	10/99→09/02					
2.2 TiD	85	02/98→11/00					
2.2 TiD	92	11/00→09/02					
2.3 i	110	02/98→09/02					
SAAB - 9-3 (YS3F) 09/02→02/15							
 Bremsbelagsatz, Scheibenbremse							
1,8t	110	09/02→02/15	←	→ 12/05; passend für Felgengröße [Zoll]: 16; für Bremssattel mit Kunststoffkolben		13.0460-7172.2 607172 13.0470-7172.2 LD7172	ATE 23378 20,1 + WE / - WK ATE 23378 20,1 + WE / - WK Ceramic
			←	→ 12/05; passend für Felgengröße [Zoll]: 15; für Bremssattel mit Kunststoffkolben		13.0460-7172.2 607172 13.0470-7172.2 LD7172	ATE 23378 20,1 + WE / - WK ATE 23378 20,1 + WE / - WK Ceramic
			←	→ 12/05; passend für Felgengröße [Zoll]: 16; für Bremssattel mit Stahlkolben		13.0460-7212.2 607212	ATE 23738 20,1 + WE / - WK
			←	→ 12/05; passend für Felgengröße [Zoll]: 15; für Bremssattel mit Stahlkolben		13.0460-7212.2 607212	ATE 23738 20,1 + WE / - WK
			→	→ 76001222		13.0460-7194.2 607194 13.0470-7194.2 LD7194	ATE 23482 16,6 - WE / - WK ATE 23482 16,6 - WE / - WK Ceramic
			→	76001223→; → 06/12		13.0460-7195.2 607195 13.0470-7195.2 LD7195	ATE 23482 16,6 - WE / - WK ATE 23482 16,6 - WE / - WK Ceramic
1,8t BioPower	110	01/07→02/15	←	→ 12/08; passend für Felgengröße [Zoll]: 16; für Bremssattel mit Kunststoffkolben		13.0460-7172.2 607172 13.0470-7172.2 LD7172	ATE 23378 20,1 + WE / - WK ATE 23378 20,1 + WE / - WK Ceramic
1.9 TTiD	96	12/07→02/15					
1.9 TTiD	118	12/07→02/15					
1.9 TTiD	132	12/07→02/15					
2.0 t	120	01/07→02/15	←	→ 12/08; passend für Felgengröße [Zoll]: 16		13.0460-7199.2 607199	ATE 23404 20,6 + WE / - WK
2.0 t	154	09/02→02/15					
2.0 t BioPower	129	01/07→02/15	←	01/09→ 06/12; passend für Felgengröße [Zoll]: 17		13.0460-7204.2 607204	ATE 23801 18,8 - WE / - WK
2.0 t BioPower	145	06/07→02/15					
2.0 t Bio Power	120	01/07→02/15					

	kw			 	! #		
SAAB - 9-3 (YS3F) 09/02→02/15							
 Bremsbelagsatz, Scheibenbremse							
2.0 t BioPower XWD	120	01/08→02/15	←	01/09→ 06/12; passend für Felgengröße [Zoll]: 17		13.0470-7204.2 LD7204	ATE 23801 18,8 - WE / - WK Ceramic
2.0 t BioPower XWD	154	01/08→02/15					
2.0 t BioPower XWD	162	01/08→02/15	←	→ 12/08;		13.0460-7212.2 607212	ATE 23738 20,1 + WE / - WK
2.0 Turbo XWD	154	01/08→02/15					
2.0 t XWD	120	01/07→02/15	←	passend für Felgengröße [Zoll]: 16; für Bremssattel mit Stahlkolben			
2.0 t XWD	162	01/08→02/15					
2.8 Turbo V6	184	03/05→02/15	→	→ 76001222		13.0460-7194.2 607194	ATE 23482 16,6 - WE / - WK
2.8 Turbo V6	203	04/08→02/15				13.0470-7194.2 LD7194	ATE 23482 16,6 - WE / - WK Ceramic
2.8 Turbo V6 XWD	206	05/08→02/15					
			→	76001223→; → 06/12		13.0460-7195.2 607195	ATE 23482 16,6 - WE / - WK
						13.0470-7195.2 LD7195	ATE 23482 16,6 - WE / - WK Ceramic
1.8 i	90	01/04→02/15	←	→ 12/08; passend für Felgengröße [Zoll]: 16; für Bremssattel mit Kunststoffkolben		13.0460-7172.2 607172	ATE 23378 20,1 + WE / - WK
						13.0470-7172.2 LD7172	ATE 23378 20,1 + WE / - WK Ceramic
			←	01/06→ 12/08; passend für Felgengröße [Zoll]: 16; für Bremssattel mit Kunststoffkolben		13.0460-7172.2 607172	ATE 23378 20,1 + WE / - WK
						13.0470-7172.2 LD7172	ATE 23378 20,1 + WE / - WK Ceramic
			←	03/04→ 12/05; passend für Felgengröße [Zoll]: 15; für Bremssattel mit Kunststoffkolben		13.0460-7172.2 607172	ATE 23378 20,1 + WE / - WK
						13.0470-7172.2 LD7172	ATE 23378 20,1 + WE / - WK Ceramic
			←	03/04→ 12/05; passend für Felgengröße [Zoll]: 16; für Bremssattel mit Kunststoffkolben		13.0460-7172.2 607172	ATE 23378 20,1 + WE / - WK
						13.0470-7172.2 LD7172	ATE 23378 20,1 + WE / - WK Ceramic
			←	→ 12/08; passend für Felgengröße [Zoll]: 16		13.0460-7199.2 607199	ATE 23404 20,6 + WE / - WK
			←	01/06→ 12/08; passend für Felgengröße [Zoll]: 16		13.0460-7199.2 607199	ATE 23404 20,6 + WE / - WK
			←	01/09→ 06/12; passend für Felgengröße [Zoll]: 17		13.0460-7204.2 607204	ATE 23801 18,8 - WE / - WK
						13.0470-7204.2 LD7204	ATE 23801 18,8 - WE / - WK Ceramic
			←	→ 12/08; passend für Felgengröße [Zoll]: 16; für Bremssattel mit Stahlkolben		13.0460-7212.2 607212	ATE 23738 20,1 + WE / - WK
			←	01/06→ 12/08; passend für Felgengröße [Zoll]: 16; für Bremssattel mit Stahlkolben		13.0460-7212.2 607212	ATE 23738 20,1 + WE / - WK
			←	03/04→ 12/05; passend für Felgengröße [Zoll]: 16; für Bremssattel mit Stahlkolben		13.0460-7212.2 607212	ATE 23738 20,1 + WE / - WK
			←	03/04→ 12/05; passend für Felgengröße [Zoll]: 15; für Bremssattel mit Stahlkolben		13.0460-7212.2 607212	ATE 23738 20,1 + WE / - WK
			→	03/04→; → 76001222		13.0460-7194.2 607194	ATE 23482 16,6 - WE / - WK
						13.0470-7194.2 LD7194	ATE 23482 16,6 - WE / - WK Ceramic
			→	76001223→; → 06/12		13.0460-7195.2 607195	ATE 23482 16,6 - WE / - WK
						13.0470-7195.2 LD7195	ATE 23482 16,6 - WE / - WK Ceramic
1.9 TiD	88	09/04→02/15	←	→ 12/05; passend für Felgengröße [Zoll]: 16; für Bremssattel mit Kunststoffkolben		13.0460-7172.2 607172	ATE 23378 20,1 + WE / - WK
1.9 TiD	110	09/04→02/15					
2.0 t	129	09/02→02/15	←	→ 12/05; passend für Felgengröße [Zoll]: 15; für Bremssattel mit Kunststoffkolben		13.0460-7172.2 607172	ATE 23378 20,1 + WE / - WK
2.2 TiD	92	09/02→02/15				13.0470-7172.2 LD7172	ATE 23378 20,1 + WE / - WK Ceramic
			←	→ 12/05; passend für Felgengröße [Zoll]: 16; für Bremssattel mit Kunststoffkolben		13.0460-7172.2 607172	ATE 23378 20,1 + WE / - WK
						13.0470-7172.2 LD7172	ATE 23378 20,1 + WE / - WK Ceramic
			←	01/06→ 12/08; passend für Felgengröße [Zoll]: 16; für Bremssattel mit Kunststoffkolben		13.0460-7172.2 607172	ATE 23378 20,1 + WE / - WK
						13.0470-7172.2 LD7172	ATE 23378 20,1 + WE / - WK Ceramic
			←	→ 12/08; passend für Felgengröße [Zoll]: 16; für Bremssattel mit Kunststoffkolben		13.0460-7172.2 607172	ATE 23378 20,1 + WE / - WK
						13.0470-7172.2 LD7172	ATE 23378 20,1 + WE / - WK Ceramic
			←	→ 12/08; passend für Felgengröße [Zoll]: 16		13.0460-7199.2 607199	ATE 23404 20,6 + WE / - WK
			←	01/06→ 12/08; passend für Felgengröße [Zoll]: 16		13.0460-7199.2 607199	ATE 23404 20,6 + WE / - WK
			←	01/09→ 06/12; passend für Felgengröße [Zoll]: 17		13.0460-7204.2 607204	ATE 23801 18,8 - WE / - WK
						13.0470-7204.2 LD7204	ATE 23801 18,8 - WE / - WK Ceramic
			←	→ 12/05; passend für Felgengröße [Zoll]: 16; für Bremssattel mit Stahlkolben		13.0460-7212.2 607212	ATE 23738 20,1 + WE / - WK











	kw			 	! #		
SAAB - 9-3 (YS3F) 09/02→02/15							
Bremsscheibe							
1,8t	110	09/02→02/15	➔	→ 06/12; passend für Felgengröße [Zoll]: 16		24.0120-0173.1 420173 24.0320-0173.1 520173	Ø 292 19,9 18 V + S Ø 292 19,9 18 V + S PD
1,8t BioPower	110	01/07→02/15	➔	→ 06/12;		24.0125-0141.1 425141	Ø 285 24,9 22 V + S
1,9 TiD	88	09/04→02/15	➔	passend für Felgengröße [Zoll]: 15		24.0325-0141.1 525141	Ø 285 24,9 22 V + S PD
1,9 TiD	110	09/04→02/15	➔	→ 06/12;		24.0130-0189.1 430189	Ø 345 29,9 27,5 V
1,9 TTiD	96	12/07→02/15	➔	passend für Felgengröße [Zoll]: 17		24.0112-0157.1 412157	Ø 278 11,9 10 + S
1,9 TTiD	118	12/07→02/15	➔	→ 06/12;		24.0312-0157.1 512157	Ø 278 11,9 10 + S PD
1,9 TTiD	132	12/07→02/15	➔	passend für Felgengröße [Zoll]: 15		24.0120-0173.1 420173	Ø 292 19,9 18 V + S
2,0 t BioPower	129	01/07→02/15	➔	→ 06/12;		24.0320-0173.1 520173	Ø 292 19,9 18 V + S PD
2,0 t BioPower	145	06/07→02/15	➔	passend für Felgengröße [Zoll]: 16		24.0120-0173.1 420173	Ø 292 19,9 18 V + S
2,0 t Bio Power	120	01/07→02/15	➔	→ 06/12;		24.0320-0173.1 520173	Ø 292 19,9 18 V + S PD
2,2 TiD	92	09/02→02/15	➔	passend für Felgengröße [Zoll]: 16			
1.8 i	90	01/04→02/15	➔	03/04→ 06/12; passend für Felgengröße [Zoll]: 15		24.0125-0141.1 425141 24.0325-0141.1 525141	Ø 285 24,9 22 V + S Ø 285 24,9 22 V + S PD
			➔	03/04→ 06/12; passend für Felgengröße [Zoll]: 17		24.0130-0189.1 430189	Ø 345 29,9 27,5 V
			➔	03/04→ 06/12; passend für Felgengröße [Zoll]: 15		24.0112-0157.1 412157 24.0312-0157.1 512157	Ø 278 11,9 10 + S Ø 278 11,9 10 + S PD
			➔	03/04→ 06/12; passend für Felgengröße [Zoll]: 16		24.0120-0173.1 420173 24.0320-0173.1 520173	Ø 292 19,9 18 V + S Ø 292 19,9 18 V + S PD
			➔	03/04→ 06/12; passend für Felgengröße [Zoll]: 16			
2.0 t 2.0 t	120 162	01/07→02/15 01/11→02/15	➔	→ 06/12; passend für Felgengröße [Zoll]: 17		24.0130-0189.1 430189	Ø 345 29,9 27,5 V
			➔	→ 06/12; passend für Felgengröße [Zoll]: 15		24.0112-0157.1 412157 24.0312-0157.1 512157	Ø 278 11,9 10 + S Ø 278 11,9 10 + S PD
			➔	→ 06/12; passend für Felgengröße [Zoll]: 16		24.0120-0173.1 420173 24.0320-0173.1 520173	Ø 292 19,9 18 V + S Ø 292 19,9 18 V + S PD
2.0 t 2.0 t 2.0 Turbo Performance	129 177 185	09/02→02/15 05/09→02/15 04/04→02/15	➔	→ 06/12; passend für Felgengröße [Zoll]: 15		24.0125-0141.1 425141 24.0325-0141.1 525141	Ø 285 24,9 22 V + S Ø 285 24,9 22 V + S PD
			➔	→ 06/12; passend für Felgengröße [Zoll]: 16		24.0128-0164.1 428164	Ø 314 28 25 V + S
			➔	→ 06/12; passend für Felgengröße [Zoll]: 17		24.0130-0189.1 430189	Ø 345 29,9 27,5 V
			➔	→ 06/12; passend für Felgengröße [Zoll]: 15		24.0112-0157.1 412157 24.0312-0157.1 512157	Ø 278 11,9 10 + S Ø 278 11,9 10 + S PD
			➔	→ 06/12; passend für Felgengröße [Zoll]: 16		24.0120-0173.1 420173 24.0320-0173.1 520173	Ø 292 19,9 18 V + S Ø 292 19,9 18 V + S PD
			➔	→ 06/12; passend für Felgengröße [Zoll]: 16			
2.0 t 2.8 Turbo V6	154 184	09/02→02/15 03/05→02/15	➔	→ 12/05; passend für Felgengröße [Zoll]: 16		24.0128-0137.1 428137 24.0328-0137.1 528137	Ø 302 28 25 V + S Ø 302 28 25 V + S PD
			➔	nicht für USA; → 06/12; passend für Felgengröße [Zoll]: 16		24.0128-0164.1 428164	Ø 314 28 25 V + S
			➔	01/06→; für USA; → 06/12; passend für Felgengröße [Zoll]: 16		24.0128-0164.1 428164	Ø 314 28 25 V + S
			➔	→ 06/12; passend für Felgengröße [Zoll]: 17		24.0130-0189.1 430189	Ø 345 29,9 27,5 V
			➔	→ 06/12; passend für Felgengröße [Zoll]: 15		24.0112-0157.1 412157 24.0312-0157.1 512157	Ø 278 11,9 10 + S Ø 278 11,9 10 + S PD
			➔	→ 06/12; passend für Felgengröße [Zoll]: 16		24.0120-0173.1 420173 24.0320-0173.1 520173	Ø 292 19,9 18 V + S Ø 292 19,9 18 V + S PD
			➔	→ 06/12; passend für Felgengröße [Zoll]: 16			
2.0 t BioPower XWD 2.0 t BioPower XWD 2.0 t BioPower XWD 2.0 t XWD 2.0 t XWD 2.0 t XWD 2.8 Turbo V6 XWD	120 154 162 120 162 177 206	01/08→02/15 01/08→02/15 01/08→02/15 01/07→02/15 01/08→02/15 05/09→02/15 05/08→02/15	➔	→ 06/12; passend für Felgengröße [Zoll]: 16		24.0128-0164.1 428164	Ø 314 28 25 V + S
			➔	→ 06/12; passend für Felgengröße [Zoll]: 17		24.0130-0189.1 430189	Ø 345 29,9 27,5 V
			➔	→ 06/12; passend für Felgengröße [Zoll]: 16		24.0120-0239.1 420239	Ø 292 20 18 V
			➔	→ 06/12; passend für Felgengröße [Zoll]: 16			
			➔	→ 06/12; passend für Felgengröße [Zoll]: 16			
			➔	→ 06/12; passend für Felgengröße [Zoll]: 16			
			➔	→ 06/12; passend für Felgengröße [Zoll]: 16			
2.0 Turbo XWD	154	01/08→02/15	➔	nicht für USA; → 06/12; passend für Felgengröße [Zoll]: 16		24.0128-0164.1 428164	Ø 314 28 25 V + S
			➔	für USA; → 06/12; passend für Felgengröße [Zoll]: 16		24.0128-0164.1 428164	Ø 314 28 25 V + S
			➔	→ 06/12; passend für Felgengröße [Zoll]: 17		24.0130-0189.1 430189	Ø 345 29,9 27,5 V
			➔	→ 06/12; passend für Felgengröße [Zoll]: 15		24.0112-0157.1 412157 24.0312-0157.1 512157	Ø 278 11,9 10 + S Ø 278 11,9 10 + S PD
			➔	→ 06/12; passend für Felgengröße [Zoll]: 16		24.0120-0173.1 420173 24.0320-0173.1 520173	Ø 292 19,9 18 V + S Ø 292 19,9 18 V + S PD
			➔	→ 06/12; passend für Felgengröße [Zoll]: 16			
2.8 Turbo V6 2.8 Turbo V6	169 188	03/05→02/15 12/07→02/15	➔	04/08→ 06/12; passend für Felgengröße [Zoll]: 16		24.0128-0164.1 428164	Ø 314 28 25 V + S
			➔	04/08→ 06/12; passend für Felgengröße [Zoll]: 17		24.0130-0189.1 430189	Ø 345 29,9 27,5 V
↓							







	kw			 	! #		
SAAB - 9-3 (YS3F) 09/02→02/15							
 Bremsscheibe							
2.8 Turbo V6 2.8 Turbo V6	169 188	03/05→02/15 12/07→02/15	➔	04/08→06/12; passend für Felgengröße [Zoll]: 15		24.0112-0157.1 412157 24.0312-0157.1 512157	Ø 278 11,9 10 + S Ø 278 11,9 10 + S PD
			➔	04/08→06/12; passend für Felgengröße [Zoll]: 16		24.0120-0173.1 420173 24.0320-0173.1 520173	Ø 292 19,9 18 V + S Ø 292 19,9 18 V + S PD
2.8 Turbo V6	203	04/08→02/15	➔	→ 06/12; passend für Felgengröße [Zoll]: 16		24.0128-0164.1 428164	Ø 314 28 25 V + S
			➔	→ 06/12; passend für Felgengröße [Zoll]: 17		24.0130-0189.1 430189	Ø 345 29,9 27,5 V
			➔	→ 06/12; passend für Felgengröße [Zoll]: 15		24.0112-0157.1 412157 24.0312-0157.1 512157	Ø 278 11,9 10 + S Ø 278 11,9 10 + S PD
			➔	→ 06/12; passend für Felgengröße [Zoll]: 16		24.0120-0173.1 420173 24.0320-0173.1 520173	Ø 292 19,9 18 V + S Ø 292 19,9 18 V + S PD
SAAB - 9-3 Cabriolet (YS3D) 02/98→08/03							
 Bremsbelagsatz, Scheibenbremse							
2.0 i 2.0 SE Turbo 2.0 Turbo 2.0 Turbo 2.0 Turbo 2.3 i 2.3 Turbo	96 147 110 113 136 151 110 165	02/98→08/03 02/98→08/03 01/01→08/03 10/98→08/03 02/98→08/03 10/99→08/03 02/98→08/03 10/99→08/03	➔	09/02→07/03; für Bremssattel mit Kunststoffkolben		13.0460-7172.2 607172 13.0470-7172.2 LD7172	ATE 23378 20,1 + WE / - WK ATE 23378 20,1 + WE / - WK Ceramic
			➔	→ 08/02		13.0460-7173.2 607173	ATE 21829 20,3 - WK / + WK
			➔	09/02→07/03; für Bremssattel mit Stahlkolben		13.0460-7212.2 607212	ATE 23738 20,1 + WE / - WK
			➔	→ 08/02		13.0460-4040.2 604040	ATE 21050 15,8 - WE / - WK
			➔	09/02→07/03		13.0460-7194.2 607194 13.0470-7194.2 LD7194	ATE 23482 16,6 - WE / - WK ATE 23482 16,6 - WE / - WK Ceramic
2.3	169	09/99→01/02	➔	10/99→		13.0460-7173.2 607173	ATE 21829 20,3 - WK / + WK
			➔	10/99→		13.0460-4040.2 604040	ATE 21050 15,8 - WE / - WK
Warnkontakt, Bremsbelagverschleiß							
2.0 i 2.0 SE Turbo 2.0 Turbo 2.0 Turbo 2.0 Turbo 2.3 i 2.3 Turbo	96 147 110 113 136 151 110 165	02/98→08/03 02/98→08/03 01/01→08/03 10/98→08/03 02/98→08/03 10/99→08/03 02/98→08/03 10/99→08/03	➔	→ 08/02	2	24.8190-0718.2 620718	L= 720
2.3	169	09/99→01/02	➔	10/99→	2	24.8190-0718.2 620718	L= 720
Zubehörsatz, Scheibenbremsbelag							
2.0 i 2.0 SE Turbo 2.0 Turbo 2.0 Turbo 2.0 Turbo 2.0 Turbo 2.3 i 2.3 Turbo	96 147 110 113 136 151 110 165	02/98→08/03 02/98→08/03 01/01→08/03 10/98→08/03 02/98→08/03 10/99→08/03 02/98→08/03 10/99→08/03	➔	→ 08/02		13.0460-0347.2 610347	
2.3	169	09/99→01/02	➔	10/99→		13.0460-0347.2 610347	
 Bremsscheibe							
2.0 i 2.0 SE Turbo 2.0 Turbo 2.0 Turbo 2.0 Turbo 2.3 i	96 147 110 113 136 151 110	02/98→08/03 02/98→08/03 01/01→08/03 10/98→08/03 02/98→08/03 10/99→08/03 02/98→08/03	➔	→ 07/03		24.0125-0119.1 425119 24.0325-0119.1 525119	Ø 288 25 22 V + S Ø 288 25 22 V + S PD
			➔	→ 07/03		24.0110-0226.1 410226 24.0310-0226.1 510226	Ø 286 10 8 + S Ø 286 10 8 + S PD
SAAB - 9-3 Cabriolet (YS3F) 08/03→02/15							
 Bremsbelagsatz, Scheibenbremse							
1,8t 1,8t BioPower 1.8 i 1.9 TiD 1.9 TiD 1.9 TTiD 1.9 TTiD 1.9 TTiD 2.0 t 2.0 t	110 110 90 88 110 96 118 132 120 129	08/03→02/15 01/07→02/15 01/04→02/15 09/04→02/15 01/06→02/15 12/07→02/15 12/07→02/15 12/07→02/15 01/11→02/15 08/03→02/15	➔	→ 06/12; passend für Felgengröße [Zoll]: 15 / 16; für Bremssattel mit Kunststoffkolben		13.0460-7172.2 607172 13.0470-7172.2 LD7172	ATE 23378 20,1 + WE / - WK ATE 23378 20,1 + WE / - WK Ceramic
			➔	→ 06/12; passend für Felgengröße [Zoll]: 15 / 16; für Bremssattel mit Stahlkolben		13.0460-7212.2 607212	ATE 23738 20,1 + WE / - WK
			➔	→ 76001222		13.0460-7194.2 607194 13.0470-7194.2 LD7194	ATE 23482 16,6 - WE / - WK ATE 23482 16,6 - WE / - WK Ceramic

	kw			 	! #		
SAAB - 9-3 Cabriolet (YS3F) 08/03→02/15							
 Bremsbelagsatz, Scheibenbremse							
2.0 t	162	01/11→02/15	➡	76001223→; → 06/12		13.0460-7195.2 607195	ATE 23482 16,6 - WE / - WK
2.0 t BioPower	120	01/11→02/15				13.0470-7195.2 LD7195	ATE 23482 16,6 - WE / - WK
2.0 t BioPower	129	01/07→02/15					Ceramic
2.0 t BioPower	162	01/11→02/15					
1.8t BioPower	129	01/07→02/15	⬅	07/07→ 06/12;		13.0460-7172.2 607172	ATE 23378 20,1 + WE / - WK
2.0 t BioPower	147	06/07→02/15		passend für Felgenreöße [Zoll]: 15 / 16;		13.0470-7172.2 LD7172	ATE 23378 20,1 + WE / - WK
				für Bremssattel mit Kunststoffkolben			Ceramic
			⬅	07/07→ 06/12;		13.0460-7212.2 607212	ATE 23738 20,1 + WE / - WK
				passend für Felgenreöße [Zoll]: 15 / 16;			
				für Bremssattel mit Stahlkolben			
			➡	07/07→; → 76001222		13.0460-7194.2 607194	ATE 23482 16,6 - WE / - WK
						13.0470-7194.2 LD7194	ATE 23482 16,6 - WE / - WK
							Ceramic
			➡	76001223→; → 06/12		13.0460-7195.2 607195	ATE 23482 16,6 - WE / - WK
						13.0470-7195.2 LD7195	ATE 23482 16,6 - WE / - WK
							Ceramic
2.0	143	04/06→09/07	⬅	passend für Felgenreöße [Zoll]: 15 / 16;		13.0460-7172.2 607172	ATE 23378 20,1 + WE / - WK
				für Bremssattel mit Kunststoffkolben		13.0470-7172.2 LD7172	ATE 23378 20,1 + WE / - WK
			⬅	passend für Felgenreöße [Zoll]: 15 / 16;		13.0460-7212.2 607212	ATE 23738 20,1 + WE / - WK
				für Bremssattel mit Stahlkolben			
			➡	→ 76001222		13.0460-7194.2 607194	ATE 23482 16,6 - WE / - WK
						13.0470-7194.2 LD7194	ATE 23482 16,6 - WE / - WK
							Ceramic
			➡	76001223→		13.0460-7195.2 607195	ATE 23482 16,6 - WE / - WK
						13.0470-7195.2 LD7195	ATE 23482 16,6 - WE / - WK
							Ceramic
2.0 t	154	08/03→02/15	⬅	→ 06/12;		13.0460-7172.2 607172	ATE 23378 20,1 + WE / - WK
				passend für Felgenreöße [Zoll]: 15 / 16;		13.0470-7172.2 LD7172	ATE 23378 20,1 + WE / - WK
				für Bremssattel mit Kunststoffkolben			Ceramic
			⬅	→ 06/12;		13.0460-7172.2 607172	ATE 23378 20,1 + WE / - WK
				passend für Felgenreöße [Zoll]: 16;		13.0470-7172.2 LD7172	ATE 23378 20,1 + WE / - WK
				für Bremssattel mit Kunststoffkolben			Ceramic
			⬅	→ 12/08;		13.0460-7199.2 607199	ATE 23404 20,6 + WE / - WK
				passend für Felgenreöße [Zoll]: 16;			
				+ 16"plus Rad			
			⬅	01/09→ 06/12;		13.0460-7204.2 607204	ATE 23801 18,8 - WE / - WK
				passend für Felgenreöße [Zoll]: 17		13.0470-7204.2 LD7204	ATE 23801 18,8 - WE / - WK
							Ceramic
			⬅	→ 06/12;		13.0460-7212.2 607212	ATE 23738 20,1 + WE / - WK
				passend für Felgenreöße [Zoll]: 15 / 16;			
				für Bremssattel mit Stahlkolben			
			⬅	→ 06/12;		13.0460-7212.2 607212	ATE 23738 20,1 + WE / - WK
				passend für Felgenreöße [Zoll]: 16;			
				für Bremssattel mit Stahlkolben			
			➡	→ 76001222		13.0460-7194.2 607194	ATE 23482 16,6 - WE / - WK
						13.0470-7194.2 LD7194	ATE 23482 16,6 - WE / - WK
							Ceramic
			➡	76001223→; → 06/12		13.0460-7195.2 607195	ATE 23482 16,6 - WE / - WK
						13.0470-7195.2 LD7195	ATE 23482 16,6 - WE / - WK
							Ceramic
2.8 Turbo V6	169	02/06→02/15	⬅	06/08→ 12/08;		13.0460-7199.2 607199	ATE 23404 20,6 + WE / - WK
				passend für Felgenreöße [Zoll]: 16;			
				+ 16"plus Rad			
			⬅	01/09→ 06/12;		13.0460-7204.2 607204	ATE 23801 18,8 - WE / - WK
				passend für Felgenreöße [Zoll]: 17		13.0470-7204.2 LD7204	ATE 23801 18,8 - WE / - WK
							Ceramic
			➡	06/08→; → 76001222		13.0460-7194.2 607194	ATE 23482 16,6 - WE / - WK
						13.0470-7194.2 LD7194	ATE 23482 16,6 - WE / - WK
							Ceramic
			➡	76001223→; → 06/12		13.0460-7195.2 607195	ATE 23482 16,6 - WE / - WK
						13.0470-7195.2 LD7195	ATE 23482 16,6 - WE / - WK
							Ceramic
2.8 Turbo V6	184	02/06→02/15	⬅	→ 12/08;		13.0460-7199.2 607199	ATE 23404 20,6 + WE / - WK
2.8 Turbo V6	188	12/07→02/15		passend für Felgenreöße [Zoll]: 16;			
				+ 16"plus Rad			
			⬅	01/09→ 06/12;		13.0460-7204.2 607204	ATE 23801 18,8 - WE / - WK
				passend für Felgenreöße [Zoll]: 17		13.0470-7204.2 LD7204	ATE 23801 18,8 - WE / - WK
							Ceramic
			➡	→ 76001222		13.0460-7194.2 607194	ATE 23482 16,6 - WE / - WK



















	kw			 	! #		
SAAB - 9-3 Cabriolet (YS3F) 08/03→02/15							
 Bremsbelagsatz, Scheibenbremse							
2.8 Turbo V6 2.8 Turbo V6	184 188	02/06→02/15 12/07→02/15	➔	→ 76001222		13.0470-7194.2 LD7194	ATE 23482 16,6 - WE / - WK Ceramic
			➔	76001223→; → 06/12		13.0460-7195.2 607195 13.0470-7195.2 LD7195	ATE 23482 16,6 - WE / - WK Ceramic
2.8 Turbo V6 2.8 Turbo V6	203 206	02/09→02/15 02/09→02/15	➔	→ 06/12; passend für Felgenreöße [Zoll]: 17		13.0460-7204.2 607204 13.0470-7204.2 LD7204	ATE 23801 18,8 - WE / - WK Ceramic
			➔	→ 76001222		13.0460-7194.2 607194 13.0470-7194.2 LD7194	ATE 23482 16,6 - WE / - WK Ceramic
			➔	76001223→; → 06/12		13.0460-7195.2 607195 13.0470-7195.2 LD7195	ATE 23482 16,6 - WE / - WK Ceramic
 Bremsscheibe							
1,8t	110	08/03→02/15	➔	→ 06/12; passend für Felgenreöße [Zoll]: 15		24.0125-0141.1 425141 24.0325-0141.1 525141	Ø 285 24,9 22 V + S Ø 285 24,9 22 V + S PD
			➔	→ 06/12; passend für Felgenreöße [Zoll]: 17		24.0130-0189.1 430189	Ø 345 29,9 27,5 V
			➔	→ 08/05		24.0112-0157.1 412157 24.0312-0157.1 512157	Ø 278 11,9 10 + S Ø 278 11,9 10 + S PD
			➔	09/05→ 06/12; passend für Felgenreöße [Zoll]: 15		24.0112-0157.1 412157 24.0312-0157.1 512157	Ø 278 11,9 10 + S Ø 278 11,9 10 + S PD
			➔	09/05→ 06/12; passend für Felgenreöße [Zoll]: 16		24.0120-0173.1 420173 24.0320-0173.1 520173	Ø 292 19,9 18 V + S Ø 292 19,9 18 V + S PD
1,8t BioPower 1.8 i 1.9 TiD 1.9 TiD 1.9 TTiD 1.9 TTiD 1.9 TTiD 2.0 t 2.0 t 2.0 t BioPower 2.0 t BioPower 2.0 t BioPower	110 90 88 110 96 118 132 120 162 120 129 162	01/07→02/15 01/04→02/15 09/04→02/15 01/06→02/15 12/07→02/15 12/07→02/15 12/07→02/15 01/11→02/15 01/11→02/15 01/11→02/15 01/07→02/15 01/11→02/15	➔	→ 06/12; passend für Felgenreöße [Zoll]: 15		24.0125-0141.1 425141 24.0325-0141.1 525141	Ø 285 24,9 22 V + S Ø 285 24,9 22 V + S PD
			➔	→ 06/12; passend für Felgenreöße [Zoll]: 17		24.0130-0189.1 430189	Ø 345 29,9 27,5 V
			➔	→ 06/12; passend für Felgenreöße [Zoll]: 15		24.0112-0157.1 412157 24.0312-0157.1 512157	Ø 278 11,9 10 + S Ø 278 11,9 10 + S PD
			➔	→ 06/12; passend für Felgenreöße [Zoll]: 16		24.0120-0173.1 420173 24.0320-0173.1 520173	Ø 292 19,9 18 V + S Ø 292 19,9 18 V + S PD
1,8t BioPower 2.0 t BioPower	129 147	01/07→02/15 06/07→02/15	➔	07/07→ 06/12; passend für Felgenreöße [Zoll]: 15		24.0125-0141.1 425141 24.0325-0141.1 525141	Ø 285 24,9 22 V + S Ø 285 24,9 22 V + S PD
			➔	07/07→ 06/12; passend für Felgenreöße [Zoll]: 17		24.0130-0189.1 430189	Ø 345 29,9 27,5 V
			➔	07/07→ 06/12; passend für Felgenreöße [Zoll]: 15		24.0112-0157.1 412157 24.0312-0157.1 512157	Ø 278 11,9 10 + S Ø 278 11,9 10 + S PD
			➔	07/07→ 06/12; passend für Felgenreöße [Zoll]: 16		24.0120-0173.1 420173 24.0320-0173.1 520173	Ø 292 19,9 18 V + S Ø 292 19,9 18 V + S PD
2.0	143	04/06→09/07	➔	passend für Felgenreöße [Zoll]: 15		24.0125-0141.1 425141 24.0325-0141.1 525141	Ø 285 24,9 22 V + S Ø 285 24,9 22 V + S PD
			➔	passend für Felgenreöße [Zoll]: 17		24.0130-0189.1 430189	Ø 345 29,9 27,5 V
			➔	passend für Felgenreöße [Zoll]: 15		24.0112-0157.1 412157 24.0312-0157.1 512157	Ø 278 11,9 10 + S Ø 278 11,9 10 + S PD
			➔	passend für Felgenreöße [Zoll]: 16		24.0120-0173.1 420173 24.0320-0173.1 520173	Ø 292 19,9 18 V + S Ø 292 19,9 18 V + S PD
2.0 t	129	08/03→02/15	➔	→ 06/12; passend für Felgenreöße [Zoll]: 15		24.0125-0141.1 425141 24.0325-0141.1 525141	Ø 285 24,9 22 V + S Ø 285 24,9 22 V + S PD
			➔	→ 06/12; passend für Felgenreöße [Zoll]: 16		24.0128-0137.1 428137 24.0328-0137.1 528137	Ø 302 28 25 V + S Ø 302 28 25 V + S PD
			➔	→ 06/12; 16" plus Rad		24.0128-0164.1 428164	Ø 314 28 25 V + S
			➔	→ 06/12; passend für Felgenreöße [Zoll]: 17		24.0130-0189.1 430189	Ø 345 29,9 27,5 V
			➔	09/05→ 06/12; passend für Felgenreöße [Zoll]: 15		24.0112-0157.1 412157 24.0312-0157.1 512157	Ø 278 11,9 10 + S Ø 278 11,9 10 + S PD
			➔	→ 08/05		24.0112-0157.1 412157 24.0120-0173.1 420173 24.0312-0157.1 512157 24.0320-0173.1 520173	Ø 278 11,9 10 + S Ø 292 19,9 18 V + S Ø 278 11,9 10 + S PD Ø 292 19,9 18 V + S PD





















	kw			 	! #		
SAAB - 9-3 Cabriolet (YS3F) 08/03→02/15							
Bremsscheibe							
2.0 t	129	08/03→02/15	➔	09/05→06/12; passend für Felgenreöße [Zoll]: 16		24.0120-0173.1 420173 24.0320-0173.1 520173	Ø 292 19,9 18 V + S Ø 292 19,9 18 V + S PD
2.0 t	154	08/03→02/15	➔	→ 06/12; passend für Felgenreöße [Zoll]: 15		24.0125-0141.1 425141 24.0325-0141.1 525141	Ø 285 24,9 22 V + S Ø 285 24,9 22 V + S PD
			➔	→ 06/12; passend für Felgenreöße [Zoll]: 16		24.0128-0137.1 428137 24.0328-0137.1 528137	Ø 302 28 25 V + S Ø 302 28 25 V + S PD
			➔	→ 06/12; 16" plus Rad		24.0128-0164.1 428164	Ø 314 28 25 V + S
			➔	→ 06/12; passend für Felgenreöße [Zoll]: 17		24.0130-0189.1 430189	Ø 345 29,9 27,5 V
			➔	09/05→06/12; passend für Felgenreöße [Zoll]: 15		24.0112-0157.1 412157 24.0312-0157.1 512157	Ø 278 11,9 10 + S Ø 278 11,9 10 + S PD
			➔	→ 08/05		24.0120-0173.1 420173 24.0320-0173.1 520173	Ø 292 19,9 18 V + S Ø 292 19,9 18 V + S PD
			➔	09/05→06/12; passend für Felgenreöße [Zoll]: 16		24.0120-0173.1 420173 24.0320-0173.1 520173	Ø 292 19,9 18 V + S Ø 292 19,9 18 V + S PD
2.8 Turbo V6	169	02/06→02/15	➔	06/08→06/12; passend für Felgenreöße [Zoll]: 16		24.0128-0137.1 428137 24.0328-0137.1 528137	Ø 302 28 25 V + S Ø 302 28 25 V + S PD
			➔	06/08→06/12; 16" plus Rad		24.0128-0164.1 428164	Ø 314 28 25 V + S
			➔	06/08→06/12; passend für Felgenreöße [Zoll]: 17		24.0130-0189.1 430189	Ø 345 29,9 27,5 V
			➔	06/08→06/12; passend für Felgenreöße [Zoll]: 15		24.0112-0157.1 412157 24.0312-0157.1 512157	Ø 278 11,9 10 + S Ø 278 11,9 10 + S PD
			➔	06/08→06/12; passend für Felgenreöße [Zoll]: 16		24.0120-0173.1 420173 24.0320-0173.1 520173	Ø 292 19,9 18 V + S Ø 292 19,9 18 V + S PD
2.8 Turbo V6 2.8 Turbo V6 2.8 Turbo V6 2.8 Turbo V6	184 188 203 206	02/06→02/15 12/07→02/15 02/09→02/15 02/09→02/15	➔	→ 06/12; passend für Felgenreöße [Zoll]: 16		24.0128-0137.1 428137 24.0328-0137.1 528137	Ø 302 28 25 V + S Ø 302 28 25 V + S PD
			➔	→ 06/12; 16" plus Rad		24.0128-0164.1 428164	Ø 314 28 25 V + S
			➔	→ 06/12; passend für Felgenreöße [Zoll]: 17		24.0130-0189.1 430189	Ø 345 29,9 27,5 V
			➔	→ 06/12; passend für Felgenreöße [Zoll]: 15		24.0112-0157.1 412157 24.0312-0157.1 512157	Ø 278 11,9 10 + S Ø 278 11,9 10 + S PD
			➔	→ 06/12; passend für Felgenreöße [Zoll]: 16		24.0120-0173.1 420173 24.0320-0173.1 520173	Ø 292 19,9 18 V + S Ø 292 19,9 18 V + S PD
			➔	→ 06/12; passend für Felgenreöße [Zoll]: 16		24.0120-0173.1 420173 24.0320-0173.1 520173	Ø 292 19,9 18 V + S Ø 292 19,9 18 V + S PD
SAAB - 9-3 Kombi (YS3F) 03/05→02/15							
Bremsbelagsatz, Scheibenbremse							
1.8 i	90	03/05→02/15	➔	→ 06/12; passend für Felgenreöße [Zoll]: 15 / 16; für Bremssattel mit Kunststoffkolben		13.0460-7172.2 607172 13.0470-7172.2 LD7172	ATE 23378 20,1 + WE / - WK ATE 23378 20,1 + WE / - WK Ceramic
1.8t 2.0	110	03/05→02/15	➔	→ 06/12; passend für Felgenreöße [Zoll]: 15 / 16; für Bremssattel mit Stahlkolben		13.0460-7212.2 607212	ATE 23738 20,1 + WE / - WK
1.9 TiD	88	03/05→02/15					
1.9 TiD	110	03/05→02/15	➔	→ 06/12; passend für Felgenreöße [Zoll]: 15 / 16; für Bremssattel mit Stahlkolben		13.0460-7194.2 607194 13.0470-7194.2 LD7194	ATE 23482 16,6 - WE / - WK ATE 23482 16,6 - WE / - WK Ceramic
2.0 t	110	03/05→02/15	➔	→ 76001222		13.0460-7195.2 607195 13.0470-7195.2 LD7195	ATE 23482 16,6 - WE / - WK ATE 23482 16,6 - WE / - WK Ceramic
2.0 t	120	01/07→02/15					
2.0 t	129	03/05→02/15	➔	76001223→; → 06/12		13.0460-7195.2 607195 13.0470-7195.2 LD7195	ATE 23482 16,6 - WE / - WK ATE 23482 16,6 - WE / - WK Ceramic
2.0 t BioPower	110	01/07→02/15					
2.0 t BioPower	120	01/11→02/15	➔	→ 76001222		13.0460-7194.2 607194 13.0470-7194.2 LD7194	ATE 23482 16,6 - WE / - WK ATE 23482 16,6 - WE / - WK Ceramic
2.0 t BioPower	129	01/07→02/15					
2.0 t BioPower	145	06/07→02/15	➔	76001223→; → 06/12		13.0460-7195.2 607195 13.0470-7195.2 LD7195	ATE 23482 16,6 - WE / - WK ATE 23482 16,6 - WE / - WK Ceramic
2.0 t BioPower	162	01/11→02/15					
2.0 t BioPower	147	02/09→02/15	➔	→ 76001222		13.0460-7194.2 607194 13.0470-7194.2 LD7194	ATE 23482 16,6 - WE / - WK ATE 23482 16,6 - WE / - WK Ceramic
2.0 t BioPower XWD	120	01/11→02/15					
2.0 t BioPower XWD	162	01/11→02/15	➔	76001223→; → 06/12		13.0460-7195.2 607195 13.0470-7195.2 LD7195	ATE 23482 16,6 - WE / - WK ATE 23482 16,6 - WE / - WK Ceramic
2.0 t Bio Power XWD	154	06/08→02/15					
2.0 t XWD	120	01/07→02/15	➔	→ 76001222		13.0460-7194.2 607194 13.0470-7194.2 LD7194	ATE 23482 16,6 - WE / - WK ATE 23482 16,6 - WE / - WK Ceramic
2.0 t XWD	162	01/11→02/15					
1.9 TTiD 1.9 TTiD 1.9 TTiD	96 118 132	12/07→02/15 12/07→02/15 12/07→02/15	➔	→ 06/12; passend für Felgenreöße [Zoll]: 15 / 16; für Bremssattel mit Kunststoffkolben		13.0460-7172.2 607172 13.0470-7172.2 LD7172	ATE 23378 20,1 + WE / - WK ATE 23378 20,1 + WE / - WK Ceramic
			➔	→ 12/08; + 16" plus Rad		13.0460-7199.2 607199	ATE 23404 20,6 + WE / - WK
			➔	→ 06/12; passend für Felgenreöße [Zoll]: 15 / 16; für Bremssattel mit Stahlkolben		13.0460-7212.2 607212	ATE 23738 20,1 + WE / - WK
			➔	→ 76001222		13.0460-7194.2 607194 13.0470-7194.2 LD7194	ATE 23482 16,6 - WE / - WK ATE 23482 16,6 - WE / - WK Ceramic
			➔	76001223→; → 06/12		13.0460-7195.2 607195 13.0470-7195.2 LD7195	ATE 23482 16,6 - WE / - WK ATE 23482 16,6 - WE / - WK Ceramic
↓							























	kw			 	! #		
SAAB - 9-3 Kombi (YS3F) 03/05→02/15							
 Bremsbelagsatz, Scheibenbremse							
2.0 t 2.0 t 2.0 t 2.0 t XWD	147 162 177 177	02/09→02/15 01/11→02/15 05/09→02/15 05/09→02/15	← → →	→ 06/12; passend für Felgengröße [Zoll]: 17 → 76001222 76001223→; → 06/12		13.0460-7204.2 607204 13.0470-7204.2 LD7204 13.0460-7194.2 607194 13.0470-7194.2 LD7194 13.0460-7195.2 607195 13.0470-7195.2 LD7195	ATE 23801 18,8 - WE / - WK ATE 23801 18,8 - WE / - WK Ceramic ATE 23482 16,6 - WE / - WK ATE 23482 16,6 - WE / - WK Ceramic ATE 23482 16,6 - WE / - WK ATE 23482 16,6 - WE / - WK Ceramic
2.0 t 2.8 Turbo V6 2.8 Turbo V6 2.8 Turbo V6 2.8 Turbo V6 2.8 Turbo V6 XWD	154 169 184 188 203 206	03/05→02/15 03/05→02/15 03/05→02/15 12/07→02/15 05/08→02/15 05/08→02/15	← ← → →	→ 12/08; + 16" plus Rad 01/09→ 06/12; passend für Felgengröße [Zoll]: 17 → 76001222 76001223→; → 06/12		13.0460-7199.2 607199 13.0460-7204.2 607204 13.0470-7204.2 LD7204 13.0460-7194.2 607194 13.0470-7194.2 LD7194 13.0460-7195.2 607195 13.0470-7195.2 LD7195	ATE 23404 20,6 + WE / - WK ATE 23801 18,8 - WE / - WK ATE 23801 18,8 - WE / - WK Ceramic ATE 23482 16,6 - WE / - WK ATE 23482 16,6 - WE / - WK Ceramic ATE 23482 16,6 - WE / - WK ATE 23482 16,6 - WE / - WK Ceramic
2.0 t XWD	154	06/08→02/15	← ← → →	07/08→ 12/08; + 16" plus Rad 01/09→ 06/12; passend für Felgengröße [Zoll]: 17 07/08→; → 76001222 76001223→; → 06/12		13.0460-7199.2 607199 13.0460-7204.2 607204 13.0470-7204.2 LD7204 13.0460-7194.2 607194 13.0470-7194.2 LD7194 13.0460-7195.2 607195 13.0470-7195.2 LD7195	ATE 23404 20,6 + WE / - WK ATE 23801 18,8 - WE / - WK ATE 23801 18,8 - WE / - WK Ceramic ATE 23482 16,6 - WE / - WK ATE 23482 16,6 - WE / - WK Ceramic ATE 23482 16,6 - WE / - WK ATE 23482 16,6 - WE / - WK Ceramic
 Bremsscheibe							
1.8 i 1.8t 2.0 1.9 TiD 1.9 TiD 2.0 t 2.0 t	90 110 88 110 110 129	03/05→02/15 03/05→02/15 03/05→02/15 03/05→02/15 03/05→02/15 03/05→02/15	← ← ← → → →	→ 06/12; passend für Felgengröße [Zoll]: 15 → 06/12; passend für Felgengröße [Zoll]: 17 → 08/05 09/05→ 06/12; passend für Felgengröße [Zoll]: 15 09/05→ 06/12; passend für Felgengröße [Zoll]: 16		24.0125-0141.1 425141 24.0325-0141.1 525141 24.0130-0189.1 430189 24.0112-0157.1 412157 24.0312-0157.1 512157 24.0112-0157.1 412157 24.0312-0157.1 512157 24.0120-0173.1 420173 24.0320-0173.1 520173	Ø 285 24,9 22 V + S Ø 285 24,9 22 V + S PD Ø 345 29,9 27,5 V Ø 278 11,9 10 + S Ø 278 11,9 10 + S PD Ø 278 11,9 10 + S Ø 278 11,9 10 + S PD Ø 292 19,9 18 V + S Ø 292 19,9 18 V + S PD
1.9 TTiD 1.9 TTiD 1.9 TTiD	96 118 132	12/07→02/15 12/07→02/15 12/07→02/15	← ← ← → → →	→ 06/12; passend für Felgengröße [Zoll]: 15 → 06/12; passend für Felgengröße [Zoll]: 16 → 06/12; passend für Felgengröße [Zoll]: 17 → 06/12; passend für Felgengröße [Zoll]: 15 → 06/12; passend für Felgengröße [Zoll]: 16		24.0125-0141.1 425141 24.0325-0141.1 525141 24.0128-0137.1 428137 24.0128-0164.1 428164 24.0328-0137.1 528137 24.0130-0189.1 430189 24.0112-0157.1 412157 24.0312-0157.1 512157 24.0120-0173.1 420173 24.0320-0173.1 520173	Ø 285 24,9 22 V + S Ø 285 24,9 22 V + S PD Ø 302 28 25 V + S Ø 314 28 25 V + S Ø 302 28 25 V + S PD Ø 345 29,9 27,5 V Ø 278 11,9 10 + S Ø 278 11,9 10 + S PD Ø 292 19,9 18 V + S Ø 292 19,9 18 V + S PD
2.0 t 2.0 t BioPower 2.0 t BioPower 2.0 t BioPower 2.0 t BioPower 2.0 t Bio Power 2.0 t BioPower XWD 2.0 t Bio Power XWD 2.0 t XWD 2.0 t XWD	120 110 120 129 145 147 120 154 120 162	01/07→02/15 01/07→02/15 01/11→02/15 01/07→02/15 06/07→02/15 02/09→02/15 01/11→02/15 06/08→02/15 01/07→02/15 01/11→02/15	← ← ← → → →	→ 06/12; passend für Felgengröße [Zoll]: 15 → 06/12; passend für Felgengröße [Zoll]: 17 → 06/12; passend für Felgengröße [Zoll]: 15 → 06/12; passend für Felgengröße [Zoll]: 15 → 06/12; passend für Felgengröße [Zoll]: 16		24.0125-0141.1 425141 24.0325-0141.1 525141 24.0130-0189.1 430189 24.0112-0157.1 412157 24.0312-0157.1 512157 24.0120-0173.1 420173 24.0320-0173.1 520173	Ø 285 24,9 22 V + S Ø 285 24,9 22 V + S PD Ø 345 29,9 27,5 V Ø 278 11,9 10 + S Ø 278 11,9 10 + S PD Ø 292 19,9 18 V + S Ø 292 19,9 18 V + S PD
2.0 t 2.0 t 2.0 t 2.0 t XWD 2.8 Turbo V6 2.8 Turbo V6	147 162 177 177 188 203	02/09→02/15 01/11→02/15 05/09→02/15 05/09→02/15 12/07→02/15 05/08→02/15	← ← → →	→ 06/12; passend für Felgengröße [Zoll]: 16 → 06/12; passend für Felgengröße [Zoll]: 15 → 06/12; passend für Felgengröße [Zoll]: 15		24.0128-0137.1 428137 24.0128-0164.1 428164 24.0328-0137.1 528137 24.0112-0157.1 412157 24.0312-0157.1 512157	Ø 302 28 25 V + S Ø 314 28 25 V + S Ø 302 28 25 V + S PD Ø 278 11,9 10 + S Ø 278 11,9 10 + S PD

	kw			 	! #		
SAAB - 9-3 Kombi (YS3F) 03/05→02/15							
Bremsscheibe							
2.8 Turbo V6 XWD	206	05/08→02/15	➔	→ 06/12; passend für Felgengröße [Zoll]: 16		24.0120-0173.1 420173 24.0320-0173.1 520173	Ø 292 19,9 18 V + S Ø 292 19,9 18 V + S PD
2.0 t 2.8 Turbo V6	154 184	03/05→02/15 03/05→02/15	➔	→ 06/12; passend für Felgengröße [Zoll]: 16		24.0128-0137.1 428137 24.0128-0164.1 428164 24.0328-0137.1 528137	Ø 302 28 25 V + S Ø 314 28 25 V + S Ø 302 28 25 V + S PD
			➔	09/05→ 06/12; passend für Felgengröße [Zoll]: 15		24.0112-0157.1 412157 24.0312-0157.1 512157	Ø 278 11,9 10 + S Ø 278 11,9 10 + S PD
			➔	→ 08/05		24.0120-0173.1 420173 24.0320-0173.1 520173	Ø 292 19,9 18 V + S Ø 292 19,9 18 V + S PD
			➔	09/05→ 06/12; passend für Felgengröße [Zoll]: 16		24.0120-0173.1 420173 24.0320-0173.1 520173	Ø 292 19,9 18 V + S Ø 292 19,9 18 V + S PD
			➔	→ 06/12; passend für Felgengröße [Zoll]: 15		24.0125-0141.1 425141 24.0325-0141.1 525141	Ø 285 24,9 22 V + S Ø 285 24,9 22 V + S PD
2.0 t BioPower	162	01/11→02/15	➔	→ 06/11; passend für Felgengröße [Zoll]: 15		24.0112-0157.1 412157 24.0312-0157.1 512157	Ø 278 11,9 10 + S Ø 278 11,9 10 + S PD
			➔	→ 06/11; passend für Felgengröße [Zoll]: 16		24.0120-0173.1 420173 24.0320-0173.1 520173	Ø 292 19,9 18 V + S Ø 292 19,9 18 V + S PD
			➔	→ 06/12; passend für Felgengröße [Zoll]: 15		24.0125-0141.1 425141 24.0325-0141.1 525141	Ø 285 24,9 22 V + S Ø 285 24,9 22 V + S PD
2.0 t BioPower XWD	162	01/11→02/15	➔	→ 06/12; passend für Felgengröße [Zoll]: 15		24.0112-0157.1 412157 24.0312-0157.1 512157	Ø 278 11,9 10 + S Ø 278 11,9 10 + S PD
			➔	→ 06/12; passend für Felgengröße [Zoll]: 16		24.0120-0173.1 420173 24.0320-0173.1 520173	Ø 292 19,9 18 V + S Ø 292 19,9 18 V + S PD
			➔	→ 06/12; passend für Felgengröße [Zoll]: 15		24.0125-0141.1 425141 24.0325-0141.1 525141	Ø 285 24,9 22 V + S Ø 285 24,9 22 V + S PD
2.0 t XWD	154	06/08→02/15	➔	07/08→ 06/12; passend für Felgengröße [Zoll]: 16		24.0128-0137.1 428137 24.0128-0164.1 428164 24.0328-0137.1 528137	Ø 302 28 25 V + S Ø 314 28 25 V + S Ø 302 28 25 V + S PD
			➔	07/08→ 06/12; passend für Felgengröße [Zoll]: 15		24.0112-0157.1 412157 24.0312-0157.1 512157	Ø 278 11,9 10 + S Ø 278 11,9 10 + S PD
			➔	07/08→ 06/12; passend für Felgengröße [Zoll]: 16		24.0120-0173.1 420173 24.0320-0173.1 520173	Ø 292 19,9 18 V + S Ø 292 19,9 18 V + S PD
2.8 Turbo V6	169	03/05→02/15	➔	→ 06/12; passend für Felgengröße [Zoll]: 16		24.0128-0137.1 428137 24.0128-0164.1 428164 24.0328-0137.1 528137	Ø 302 28 25 V + S Ø 314 28 25 V + S Ø 302 28 25 V + S PD
			➔	→ 06/12; passend für Felgengröße [Zoll]: 15		24.0112-0157.1 412157 24.0312-0157.1 512157	Ø 278 11,9 10 + S Ø 278 11,9 10 + S PD
			➔	→ 06/12; passend für Felgengröße [Zoll]: 16		24.0120-0173.1 420173 24.0320-0173.1 520173	Ø 292 19,9 18 V + S Ø 292 19,9 18 V + S PD
			➔	→ 08/05		24.0120-0173.1 420173 24.0320-0173.1 520173	Ø 292 19,9 18 V + S Ø 292 19,9 18 V + S PD
SAAB - 9-3X 02/09→12/12							
Bremsbelagsatz, Scheibenbremse							
1.9 TTiD 2.0 t BioPower XWD 2.0 t XWD	132 154 154	02/09→12/12 02/09→12/12 02/09→12/12	➔	03/09→ 06/12; passend für Felgengröße [Zoll]: 15 / 16; für Bremssattel mit Kunststoffkolben		13.0460-7172.2 607172 13.0470-7172.2 LD7172	ATE 23378 20,1 + WE / - WK ATE 23378 20,1 + WE / - WK Ceramic
			➔	03/09→ 06/12; + 16" plus Rad		13.0460-7199.2 607199	ATE 23404 20,6 + WE / - WK
			➔	03/09→ 06/12; passend für Felgengröße [Zoll]: 17		13.0460-7204.2 607204 13.0470-7204.2 LD7204	ATE 23801 18,8 - WE / - WK ATE 23801 18,8 - WE / - WK Ceramic
			➔	03/09→ 06/12; passend für Felgengröße [Zoll]: 15 / 16; für Bremssattel mit Stahlkolben		13.0460-7212.2 607212	ATE 23738 20,1 + WE / - WK
			➔	03/09→ 06/12		13.0460-7195.2 607195 13.0470-7195.2 LD7195	ATE 23482 16,6 - WE / - WK ATE 23482 16,6 - WE / - WK Ceramic
2.0 t BioPower XWD	162	01/11→12/12	➔	→ 06/12; passend für Felgengröße [Zoll]: 15 / 16; für Bremssattel mit Kunststoffkolben		13.0460-7172.2 607172 13.0470-7172.2 LD7172	ATE 23378 20,1 + WE / - WK ATE 23378 20,1 + WE / - WK Ceramic
			➔	→ 06/12; + 16" plus Rad		13.0460-7199.2 607199	ATE 23404 20,6 + WE / - WK
			➔	→ 06/12; passend für Felgengröße [Zoll]: 17		13.0460-7204.2 607204 13.0470-7204.2 LD7204	ATE 23801 18,8 - WE / - WK ATE 23801 18,8 - WE / - WK Ceramic
↓							











	kw			 	! #		
SAAB - 9-3X 02/09→12/12							
 Bremsbelagsatz, Scheibenbremse							
2.0 t BioPower XWD	162	01/11→12/12	←	→ 06/12; passend für Felgenreöße [Zoll]: 15 / 16; für Bremssattel mit Stahlkolben		13.0460-7212.2 607212	ATE 23738 20,1 + WE / - WK
			→	→ 06/12		13.0460-7195.2 607195 13.0470-7195.2 LD7195	ATE 23482 16,6 - WE / - WK ATE 23482 16,6 - WE / - WK Ceramic
 Bremsscheibe							
1.9 TTiD	132	02/09→12/12	←	03/09→ 06/12;		24.0125-0141.1 425141	Ø 285 24,9 22 V + S
2.0 t BioPower XWD	154	02/09→12/12		passend für Felgenreöße [Zoll]: 15		24.0325-0141.1 525141	Ø 285 24,9 22 V + S PD
2.0 t XWD	154	02/09→12/12	←	03/09→ 06/12;		24.0128-0137.1 428137 24.0328-0137.1 528137	Ø 302 28 25 V + S Ø 302 28 25 V + S PD
			←	passend für Felgenreöße [Zoll]: 16		24.0128-0164.1 428164	Ø 314 28 25 V + S
			←	03/09→ 06/12; + 16" plus Rad		24.0130-0189.1 430189	Ø 345 29,9 27,5 V
			←	03/09→ 06/12;		24.0112-0157.1 412157 24.0312-0157.1 512157	Ø 278 11,9 10 + S Ø 278 11,9 10 + S PD
			→	passend für Felgenreöße [Zoll]: 15		24.0120-0173.1 420173 24.0320-0173.1 520173	Ø 292 19,9 18 V + S Ø 292 19,9 18 V + S PD
2.0 t BioPower XWD	162	01/11→12/12	←	→ 06/12;		24.0125-0141.1 425141 24.0325-0141.1 525141	Ø 285 24,9 22 V + S Ø 285 24,9 22 V + S PD
			←	→ 06/12;		24.0128-0137.1 428137 24.0328-0137.1 528137	Ø 302 28 25 V + S Ø 302 28 25 V + S PD
			←	passend für Felgenreöße [Zoll]: 16		24.0128-0164.1 428164	Ø 314 28 25 V + S
			←	→ 06/12; + 16" plus Rad		24.0130-0189.1 430189	Ø 345 29,9 27,5 V
			←	→ 06/12;		24.0112-0157.1 412157 24.0312-0157.1 512157	Ø 278 11,9 10 + S Ø 278 11,9 10 + S PD
			→	passend für Felgenreöße [Zoll]: 15		24.0120-0173.1 420173 24.0320-0173.1 520173	Ø 292 19,9 18 V + S Ø 292 19,9 18 V + S PD
			→	→ 06/12; nicht für Felgenreöße [Zoll]: 15			
SAAB - 9-5 (YS3E) 09/97→12/09							
 Bremsbelagsatz, Scheibenbremse							
1.9 TiD	110	01/06→12/09	←	passend für Felgenreöße [Zoll]: 16		13.0460-7091.2 607091	ATE 21829 20,3 + WE / - WK
2.0 t	136	07/00→12/09	←			13.0460-7173.2 607173	ATE 21829 20,3 - WK / + WK
2.0 t BioPower	110	01/05→12/09	←			13.0460-3605.2 603605	ATE 20180 17,3 + WE / - WK
2.2 TiD	88	03/02→12/09	→			13.0470-3605.2 LD3605	ATE 20180 17,3 + WE / - WK Ceramic
2.3 t	136	01/01→12/09	→				
2.3 t BioPower	136	01/07→12/09	→				
2.3 t BioPower	152	11/06→12/09	→				
2.3 Turbo	134	04/08→12/09	→				
2.3 Turbo	162	07/03→12/09	→				
2.3 Turbo	184	09/01→12/09	→				
2.3 Turbo	188	04/08→12/09	→				
2.3 Turbo	191	11/05→12/09	→				
3.0 TiD	130	07/01→12/09	→				
2.0 t	110	09/97→12/09	←	passend für Felgenreöße [Zoll]: 16		13.0460-7091.2 607091	ATE 21829 20,3 + WE / - WK
2.0 Turbo SE	141	10/98→07/00	←			13.0460-7173.2 607173	ATE 21829 20,3 - WK / + WK
2.3 t	125	09/97→12/09	←			13.0460-3605.2 603605 13.0470-3605.2 LD3605	ATE 20180 17,3 + WE / - WK ATE 20180 17,3 + WE / - WK Ceramic
3.0 V6t	147	01/98→12/09	→	X3025752→		13.0460-4040.2 604040	ATE 21050 15,8 - WE / - WK
			→	→ X3025751			
2.0 t Biopower	132	09/05→12/09	←	06/06→;		13.0460-7091.2 607091	ATE 21829 20,3 + WE / - WK
			←	passend für Felgenreöße [Zoll]: 16		13.0460-7173.2 607173	ATE 21829 20,3 - WK / + WK
			→	06/06→		13.0460-3605.2 603605 13.0470-3605.2 LD3605	ATE 20180 17,3 + WE / - WK ATE 20180 17,3 + WE / - WK Ceramic
2.3 Turbo	169	10/99→09/01	←	01/00→;		13.0460-7091.2 607091	ATE 21829 20,3 + WE / - WK
			←	passend für Felgenreöße [Zoll]: 16		13.0460-7173.2 607173	ATE 21829 20,3 - WK / + WK
			→	01/00→		13.0460-3605.2 603605 13.0470-3605.2 LD3605	ATE 20180 17,3 + WE / - WK ATE 20180 17,3 + WE / - WK Ceramic
2.3 Turbo	224	06/03→08/05	←	→ 03/04;		13.0460-7091.2 607091	ATE 21829 20,3 + WE / - WK
			←	passend für Felgenreöße [Zoll]: 16		13.0460-7173.2 607173	ATE 21829 20,3 - WK / + WK
			→	→ 03/04			











	kW			 	! #		
SAAB - 9-5 (YS3E) 09/97→12/09							
 Bremsbelagsatz, Scheibenbremse							
2.3 Turbo	224	06/03→08/05	➡	→ 03/04		13.0460-3605.2 603605 13.0470-3605.2 LD3605	ATE 20180 17,3 + WE / - WK ATE 20180 17,3 + WE / - WK Ceramic
Warnkontakt, Bremsbelagverschleiß							
1.9 TiD	110	01/06→12/09	⬅		2	24.8190-0718.2 620718	L= 720
2.0 t	110	09/97→12/09					
2.0 t	136	07/00→12/09					
2.0 t BioPower	110	01/05→12/09					
2.0 Turbo SE	141	10/98→07/00					
2.2 TiD	88	03/02→12/09					
2.3 t	125	09/97→12/09					
2.3 t	136	01/01→12/09					
2.3 t BioPower	136	01/07→12/09					
2.3 t BioPower	152	11/06→12/09					
2.3 Turbo	134	04/08→12/09					
2.3 Turbo	162	07/03→12/09					
2.3 Turbo	184	09/01→12/09					
2.3 Turbo	188	04/08→12/09					
2.3 Turbo	191	11/05→12/09					
3.0 TiD	130	07/01→12/09					
3.0 V6t	147	01/98→12/09					
2.0 t Biopower	132	09/05→12/09	⬅	06/06→	2	24.8190-0718.2 620718	L= 720
2.3 Turbo	169	10/99→09/01	⬅	01/00→	2	24.8190-0718.2 620718	L= 720
2.3 Turbo	224	06/03→08/05	⬅	→ 03/04	2	24.8190-0718.2 620718	L= 720
Zubehörsatz, Scheibenbremsbelag							
2.0 t	110	09/97→12/09	➡	→ X3025751		13.0460-0347.2 610347	
2.0 Turbo SE	141	10/98→07/00					
2.3 t	125	09/97→12/09					
3.0 V6t	147	01/98→12/09					
 Bremsscheibe							
1.9 TiD	110	01/06→12/09	⬅	passend für Felgenreöße [Zoll]: 15		24.0125-0119.1 425119	Ø 288 25 22 V + S
2.0 t	136	07/00→12/09				24.0325-0119.1 525119	Ø 288 25 22 V + S PD
2.0 t BioPower	110	01/05→12/09					
2.2 TiD	88	03/02→12/09	➡			24.0110-0274.1 410274	Ø 286 10 8 + S
2.3 t	136	01/01→12/09					
2.3 t BioPower	136	01/07→12/09					
2.3 t BioPower	152	11/06→12/09					
2.3 Turbo	134	04/08→12/09					
2.0 t	110	09/97→12/09	⬅	passend für Felgenreöße [Zoll]: 15		24.0125-0119.1 425119	Ø 288 25 22 V + S
2.0 Turbo SE	141	10/98→07/00				24.0325-0119.1 525119	Ø 288 25 22 V + S PD
2.3 t	125	09/97→12/09	➡	→ X3025751		24.0110-0226.1 410226	Ø 286 10 8 + S
			➡			24.0310-0226.1 510226	Ø 286 10 8 + S PD
			➡	X3025752→		24.0110-0274.1 410274	Ø 286 10 8 + S
2.0 t Biopower	132	09/05→12/09	⬅	06/06→; passend für Felgenreöße [Zoll]: 15		24.0125-0119.1 425119	Ø 288 25 22 V + S
			➡	06/06→		24.0325-0119.1 525119	Ø 288 25 22 V + S PD
			➡			24.0110-0274.1 410274	Ø 286 10 8 + S
2.3 Turbo	162	07/03→12/09	⬅	43510123→; für USA; passend für Felgenreöße [Zoll]: 15		24.0125-0119.1 425119	Ø 288 25 22 V + S
			⬅	nicht für USA; passend für Felgenreöße [Zoll]: 15		24.0325-0119.1 525119	Ø 288 25 22 V + S PD
			⬅	→ 43510122; für USA; passend für Felgenreöße [Zoll]: 16		24.0125-0142.1 425142	Ø 308 25 22 V + S
			⬅			24.0325-0142.1 525142	Ø 308 25 23 V + S PD
			➡			24.0110-0274.1 410274	Ø 286 10 8 + S
2.3 Turbo	169	10/99→09/01	⬅	passend für Felgenreöße [Zoll]: 16		24.0125-0142.1 425142	Ø 308 25 22 V + S
			➡			24.0325-0142.1 525142	Ø 308 25 23 V + S PD
			➡			24.0110-0274.1 410274	Ø 286 10 8 + S
2.3 Turbo	184	09/01→12/09	⬅	passend für Felgenreöße [Zoll]: 16		24.0125-0142.1 425142	Ø 308 25 22 V + S
3.0 TiD	130	07/01→12/09				24.0325-0142.1 525142	Ø 308 25 23 V + S PD
			➡	→ 12/01		24.0110-0274.1 410274	Ø 286 10 8 + S
			➡	01/02→		24.0120-0196.1 420196	Ø 300 20 18 V + S
2.3 Turbo	188	04/08→12/09	⬅	passend für Felgenreöße [Zoll]: 16		24.0125-0142.1 425142	Ø 308 25 22 V + S
2.3 Turbo	191	11/05→12/09				24.0325-0142.1 525142	Ø 308 25 23 V + S PD
			➡			24.0120-0196.1 420196	Ø 300 20 18 V + S
2.3 Turbo	224	06/03→08/05	⬅	→ 03/04; passend für Felgenreöße [Zoll]: 16		24.0125-0142.1 425142	Ø 308 25 22 V + S
						24.0325-0142.1 525142	Ø 308 25 23 V + S PD
↓							











	kW			 	! #		
SAAB - 9-5 (YS3E) 09/97→12/09							
 Bremsscheibe							
2.3 Turbo	224	06/03→08/05	➡	→ 03/04		24.0120-0196.1 420196	Ø 300 20 18 V + S
3.0 V6t	147	01/98→12/09	←	passend für Felgenreöße [Zoll]: 16		24.0125-0142.1 425142	Ø 308 25 22 V + S
						24.0325-0142.1 525142	Ø 308 25 23 V + S PD
			➡	→ X3025751		24.0110-0226.1 410226	Ø 286 10 8 + S
						24.0310-0226.1 510226	Ø 286 10 8 + S PD
			➡	→ 12/01; X3025752→		24.0110-0274.1 410274	Ø 286 10 8 + S
			➡	01/02→		24.0120-0196.1 420196	Ø 300 20 18 V + S
SAAB - 9-5 (YS3G) 01/10→01/12							
 Bremsbelagsatz, Scheibenbremse							
1.6 Turbo	132	05/10→01/12	←	+ 17plus" Rad		13.0460-2754.2 602754	TRW 24418 17,0 + WK + Zub
2.0 t BioPower	162	05/10→01/12	←	passend für Felgenreöße [Zoll]: 16		13.0460-5611.2 605611	MAN 24415 19,1 + WK + Zub
2.0 t BioPower XWD	162	05/10→01/12	←				13.0470-5611.2 LD5611
2.0 TiD	118	05/10→01/12	←				Ceramic
2.0 TTiD	140	05/10→01/12	←				
2.0 TTiD XWD	140	05/10→01/12	←	passend für Felgenreöße [Zoll]: 17		13.0460-5612.2 605612	MAN 24412 19,0 + WK + Zub
2.0 Turbo	162	05/10→01/12	←				13.0470-5612.2 LD5612
2.0 Turbo XWD	162	05/10→01/12	←				Ceramic
2.8 Turbo V6 XWD	221	05/10→01/12	➡	passend für Felgenreöße [Zoll]: 16 / 17		13.0460-2755.2 602755	TRW 24421 17,2 + WK + Zub
						13.0470-2755.2 LD2755	Ceramic
 Bremsscheibe							
1.6 Turbo	132	05/10→01/12	←	passend für Felgenreöße [Zoll]: 16		24.0130-0207.1 430207	Ø 296 30 27 V + S
2.0 t BioPower	162	05/10→01/12	←				24.0330-0207.1 530207
2.0 t BioPower XWD	162	05/10→01/12	←				
2.0 TiD	118	05/10→01/12	←	+ 17plus" Rad		24.0130-0208.1 430208	Ø 337 30 27 V + S
2.0 TTiD	140	05/10→01/12	←	passend für Felgenreöße [Zoll]: 17		24.0130-0209.1 430209	Ø 321 30 27 V + S
2.0 TTiD XWD	140	05/10→01/12	←				24.0330-0209.1 530209
2.0 Turbo	162	05/10→01/12	←				
2.0 Turbo XWD	162	05/10→01/12	➡	passend für Felgenreöße [Zoll]: 16		24.0112-0187.1 412187	Ø 292 12 10,5 + S
2.8 Turbo V6 XWD	221	05/10→01/12	➡				24.0312-0187.1 512187
			➡	passend für Felgenreöße [Zoll]: 17		24.0123-0114.1 423114	Ø 315 22,9 21,5 V + S
						24.0323-0114.1 523114	Ø 315 22,9 21,5 V + S PD
SAAB - 9-5 Kombi (YS3E) 10/98→12/09							
 Bremsbelagsatz, Scheibenbremse							
1.9 TiD	110	01/06→12/09	←	passend für Felgenreöße [Zoll]: 16		13.0460-7091.2 607091	ATE 21829 20,3 + WE / - WK
1.9 TiD	129	01/07→12/09	←				13.0460-7173.2 607173
2.2 TiD	88	03/02→12/09	←				
2.3 Turbo	162	07/03→12/09	➡				
2.3 Turbo	169	10/99→09/01	➡			13.0460-3605.2 603605	ATE 20180 17,3 + WE / - WK
2.3 Turbo	184	09/01→12/09	➡			13.0470-3605.2 LD3605	ATE 20180 17,3 + WE / - WK
2.3 Turbo	188	04/08→12/09	➡				Ceramic
2.3 Turbo	191	01/06→12/09	➡				
2.3 Turbo	224	06/03→08/05	➡				
3.0 TiD	130	07/01→12/09	➡				
2.0 t	110	10/98→12/09	←	passend für Felgenreöße [Zoll]: 16		13.0460-7091.2 607091	ATE 21829 20,3 + WE / - WK
2.0 t	136	07/00→07/01	←				13.0460-7173.2 607173
2.0 t	141	10/98→07/00	←				
2.0 t BioPower	110	01/06→12/09	➡	X3025752→		13.0460-3605.2 603605	ATE 20180 17,3 + WE / - WK
2.3 t	125	10/98→12/09	➡			13.0470-3605.2 LD3605	ATE 20180 17,3 + WE / - WK
2.3 t BioPower	136	01/07→12/09	➡				Ceramic
2.3 t BioPower	152	11/06→12/09	➡				
3.0 V6t	147	10/98→12/09	➡	→ X3025751		13.0460-4040.2 604040	ATE 21050 15,8 - WE / - WK
2.0 t Biopower	132	09/05→12/09	←	06/06→;		13.0460-7091.2 607091	ATE 21829 20,3 + WE / - WK
				passend für Felgenreöße [Zoll]: 16			
			←	06/06→		13.0460-7173.2 607173	ATE 21829 20,3 - WK / + WK
			➡	X3025752→		13.0460-3605.2 603605	ATE 20180 17,3 + WE / - WK
			➡			13.0470-3605.2 LD3605	ATE 20180 17,3 + WE / - WK
			➡	06/06→; → X3025751		13.0460-4040.2 604040	ATE 21050 15,8 - WE / - WK
2.3 t	136	01/01→12/09	←	01/02→;		13.0460-7091.2 607091	ATE 21829 20,3 + WE / - WK
				passend für Felgenreöße [Zoll]: 16			
			←	01/02→		13.0460-7173.2 607173	ATE 21829 20,3 - WK / + WK
			➡			13.0460-3605.2 603605	ATE 20180 17,3 + WE / - WK
						13.0470-3605.2 LD3605	ATE 20180 17,3 + WE / - WK
							Ceramic
2.3 t BioPower	154	11/06→12/09	←	01/07→;		13.0460-7091.2 607091	ATE 21829 20,3 + WE / - WK
				passend für Felgenreöße [Zoll]: 16			











	kW			 	! #		
SAAB - 9-5 Kombi (YS3E) 10/98→12/09							
 Bremsbelagsatz, Scheibenbremse							
2.3 t BioPower	154	11/06→12/09	←	01/07→		13.0460-7173.2 607173	ATE 21829 20,3 - WK / + WK
			→	X3025752→		13.0460-3605.2 603605 13.0470-3605.2 LD3605	ATE 20180 17,3 + WE / - WK ATE 20180 17,3 + WE / - WK Ceramic
			→	01/07→; → X3025751		13.0460-4040.2 604040	ATE 21050 15,8 - WE / - WK
Warnkontakt, Bremsbelagverschleiß							
1.9 TiD	110	01/06→12/09	←		2	24.8190-0718.2 620718	L= 720
1.9 TiD	129	01/07→12/09					
2.0 t	110	10/98→12/09					
2.0 t	136	07/00→07/01					
2.0 t	141	10/98→07/00					
2.0 t BioPower	110	01/06→12/09					
2.2 TiD	88	03/02→12/09					
2.3 t	125	10/98→12/09					
2.3 t BioPower	136	01/07→12/09					
2.3 t BioPower	152	11/06→12/09					
2.3 Turbo	162	07/03→12/09					
2.3 Turbo	169	10/99→09/01					
2.3 Turbo	184	09/01→12/09					
2.3 Turbo	188	04/08→12/09					
2.3 Turbo	191	01/06→12/09					
2.3 Turbo	224	06/03→08/05					
3.0 TiD	130	07/01→12/09					
3.0 V6t	147	10/98→12/09					
2.0 t Biopower	132	09/05→12/09	←	06/06→	2	24.8190-0718.2 620718	L= 720
2.3 t	136	01/01→12/09	←	01/02→	2	24.8190-0718.2 620718	L= 720
2.3 t BioPower	154	11/06→12/09	←	01/07→	2	24.8190-0718.2 620718	L= 720
Zubehörsatz, Scheibenbremsbelag							
2.0 t	110	10/98→12/09	→	→ X3025751		13.0460-0347.2 610347	
2.0 t	136	07/00→07/01					
2.0 t	141	10/98→07/00					
2.0 t BioPower	110	01/06→12/09					
2.3 t	125	10/98→12/09					
2.3 t BioPower	136	01/07→12/09					
2.3 t BioPower	152	11/06→12/09					
3.0 V6t	147	10/98→12/09					
2.0 t Biopower	132	09/05→12/09	→	06/06→; → X3025751		13.0460-0347.2 610347	
2.3 t BioPower	154	11/06→12/09	→	01/07→; → X3025751		13.0460-0347.2 610347	
 Bremsscheibe							
1.9 TiD	110	01/06→12/09	←	passend für Felgenreöße [Zoll]: 15		24.0125-0119.1 425119	Ø 288 25 22 V + S
1.9 TiD	129	01/07→12/09				24.0325-0119.1 525119	Ø 288 25 22 V + S PD
2.2 TiD	88	03/02→12/09					
2.3 t	136	01/01→12/09	→			24.0110-0274.1 410274	Ø 286 10 8 + S
2.0 t	110	10/98→12/09	←	passend für Felgenreöße [Zoll]: 15		24.0125-0119.1 425119	Ø 288 25 22 V + S
2.0 t	136	07/00→07/01				24.0325-0119.1 525119	Ø 288 25 22 V + S PD
2.0 t	141	10/98→07/00					
2.3 t	125	10/98→12/09	←	passend für Felgenreöße [Zoll]: 16		24.0125-0142.1 425142	Ø 308 25 22 V + S
2.3 t BioPower	136	01/07→12/09				24.0325-0142.1 525142	Ø 308 25 23 V + S PD
2.3 t BioPower	152	11/06→12/09	→	→ X3025751		24.0110-0226.1 410226	Ø 286 10 8 + S
			→	X3025752→		24.0310-0226.1 510226	Ø 286 10 8 + S PD
			→	X3025752→		24.0110-0274.1 410274	Ø 286 10 8 + S
2.0 t Biopower	132	09/05→12/09	←	06/06→; passend für Felgenreöße [Zoll]: 15		24.0125-0119.1 425119	Ø 288 25 22 V + S
			→	06/06→; → X3025751		24.0325-0119.1 525119	Ø 288 25 22 V + S PD
			→	X3025752→		24.0110-0226.1 410226	Ø 286 10 8 + S
			→	X3025752→		24.0310-0226.1 510226	Ø 286 10 8 + S PD
			→	X3025752→		24.0110-0274.1 410274	Ø 286 10 8 + S
2.0 t BioPower	110	01/06→12/09	←	passend für Felgenreöße [Zoll]: 15		24.0125-0119.1 425119	Ø 288 25 22 V + S
			→	→ X3025751		24.0110-0226.1 410226	Ø 286 10 8 + S
			→	X3025752→		24.0310-0226.1 510226	Ø 286 10 8 + S PD
			→	X3025752→		24.0110-0274.1 410274	Ø 286 10 8 + S
2.3 t BioPower	154	11/06→12/09	←	01/07→; passend für Felgenreöße [Zoll]: 15		24.0125-0119.1 425119	Ø 288 25 22 V + S
			←	01/07→; passend für Felgenreöße [Zoll]: 16		24.0325-0119.1 525119	Ø 288 25 22 V + S PD
			←	01/07→; passend für Felgenreöße [Zoll]: 16		24.0125-0142.1 425142	Ø 308 25 22 V + S
			→	01/07→; → X3025751		24.0325-0142.1 525142	Ø 308 25 23 V + S PD
			→	01/07→; → X3025751		24.0110-0226.1 410226	Ø 286 10 8 + S























	kw			 	! #		
SAAB - 9-5 Kombi (YS3E) 10/98→12/09							
 Bremsscheibe							
2.3 t BioPower	154	11/06→12/09	➡	01/07→; → X3025751		24.0310-0226.1 510226	Ø 286 10 8 + S PD
			➡	X3025752→		24.0110-0274.1 410274	Ø 286 10 8 + S
2.3 Turbo	162	07/03→12/09	←	43510123→; nur für USA; passend für Felgenreöße [Zoll]: 15		24.0125-0119.1 425119	Ø 288 25 22 V + S
						24.0325-0119.1 525119	Ø 288 25 22 V + S PD
			←	nicht für USA; passend für Felgenreöße [Zoll]: 15		24.0125-0119.1 425119	Ø 288 25 22 V + S
						24.0325-0119.1 525119	Ø 288 25 22 V + S PD
			←	→ 43510122; für USA; passend für Felgenreöße [Zoll]: 16		24.0125-0142.1 425142	Ø 308 25 22 V + S
			24.0325-0142.1 525142	Ø 308 25 23 V + S PD			
			➡			24.0110-0274.1 410274	Ø 286 10 8 + S
2.3 Turbo	169	10/99→09/01	←	passend für Felgenreöße [Zoll]: 16		24.0125-0142.1 425142	Ø 308 25 22 V + S
						24.0325-0142.1 525142	Ø 308 25 23 V + S PD
			➡			24.0110-0274.1 410274	Ø 286 10 8 + S
2.3 Turbo 3.0 TiD	184 130	09/01→12/09 07/01→12/09	←	passend für Felgenreöße [Zoll]: 16		24.0125-0142.1 425142	Ø 308 25 22 V + S
						24.0325-0142.1 525142	Ø 308 25 23 V + S PD
			➡	→ 12/01		24.0110-0274.1 410274	Ø 286 10 8 + S
			➡	01/02→		24.0120-0196.1 420196	Ø 300 20 18 V + S
2.3 Turbo 2.3 Turbo 2.3 Turbo	188 191 224	04/08→12/09 01/06→12/09 06/03→08/05	←	passend für Felgenreöße [Zoll]: 16		24.0125-0142.1 425142	Ø 308 25 22 V + S
						24.0325-0142.1 525142	Ø 308 25 23 V + S PD
			➡			24.0120-0196.1 420196	Ø 300 20 18 V + S
3.0 V6t	147	10/98→12/09	←	passend für Felgenreöße [Zoll]: 15		24.0125-0119.1 425119	Ø 288 25 22 V + S
						24.0325-0119.1 525119	Ø 288 25 22 V + S PD
			←	passend für Felgenreöße [Zoll]: 16		24.0125-0142.1 425142	Ø 308 25 22 V + S
						24.0325-0142.1 525142	Ø 308 25 23 V + S PD
			➡	→ X3025751		24.0110-0226.1 410226	Ø 286 10 8 + S
			➡	→ 12/01; X3025752→		24.0310-0226.1 510226	Ø 286 10 8 + S PD
			➡	→ 12/01; X3025752→		24.0110-0274.1 410274	Ø 286 10 8 + S
			➡	01/02→		24.0120-0196.1 420196	Ø 300 20 18 V + S
SAAB - 900 II 07/93→04/99							
 Bremsbelagsatz, Scheibenbremse							
2.0 -16 Turbo 2.3 -16 2.5 -24 V6	136 110 125	07/93→02/98 07/93→02/98 07/93→02/98	←	09/93→ 08/96		13.0460-7080.2 607080	ATE 21411 17,5 - WK
			←	09/96→		13.0460-7091.2 607091	ATE 21829 20,3 + WE / - WK
						13.0460-7173.2 607173	ATE 21829 20,3 - WK / + WK
			➡	09/96→		13.0460-4040.2 604040	ATE 21050 15,8 - WE / - WK
			➡	09/93→ 08/96		13.0460-4043.2 604043	ATE 21140 15,0 - WE / - WK
2.0 i	96	08/94→02/98	←	→ 08/96		13.0460-7080.2 607080	ATE 21411 17,5 - WK
			←	09/96→		13.0460-7091.2 607091	ATE 21829 20,3 + WE / - WK
						13.0460-7173.2 607173	ATE 21829 20,3 - WK / + WK
			➡	09/96→		13.0460-4040.2 604040	ATE 21050 15,8 - WE / - WK
			➡	→ 08/96		13.0460-4043.2 604043	ATE 21140 15,0 - WE / - WK
Warnkontakt, Bremsbelagverschleiß							
2.0 -16 Turbo 2.0 i 2.3 -16 2.5 -24 V6	136 96 110 125	07/93→02/98 08/94→02/98 07/93→02/98 07/93→02/98	←	09/96→	2	24.8190-0718.2 620718	L= 720
Zubehörsatz, Scheibenbremsbelag							
2.0 -16 Turbo 2.3 -16 2.5 -24 V6	136 110 125	07/93→02/98 07/93→02/98 07/93→02/98	➡	09/93→ 08/96		13.0460-0217.2 610217	ATE
			➡	09/96→		13.0460-0347.2 610347	
			➡	→ 08/96		13.0460-0217.2 610217	ATE
2.0 i	96	08/94→02/98	➡	09/96→		13.0460-0347.2 610347	
 Bremsscheibe							
2.0 -16 Turbo 2.3 -16 2.5 -24 V6	136 110 125	07/93→02/98 07/93→02/98 07/93→02/98	←	09/93→ 08/96		24.0124-0133.1 424133	Ø 284 24 21 V
			←	09/96→		24.0125-0119.1 425119	Ø 288 25 22 V + S
						24.0325-0119.1 525119	Ø 288 25 22 V + S PD
			➡	V7004690→		24.0110-0226.1 410226	Ø 286 10 8 + S
						24.0310-0226.1 510226	Ø 286 10 8 + S PD
			➡	V2022962→		24.0110-0226.1 410226	Ø 286 10 8 + S











	kW			 	! #		
SAAB - 900 II 07/93→04/99							
 Bremsscheibe							
2.0 -16 Turbo	136	07/93→02/98	➡	V2022962→		24.0310-0226.1 510226	Ø 286 10 8 + S PD
2.3 -16	110	07/93→02/98	➡	09/93→; → V2022961		24.0110-0249.1 410249	Ø 260 10 8
2.5 -24 V6	125	07/93→02/98	➡	09/93→; → V7004689		24.0110-0249.1 410249	Ø 260 10 8
2.0 i	96	08/94→02/98	←	→ 08/96		24.0124-0133.1 424133	Ø 284 24 21 V
			←	09/96→		24.0125-0119.1 425119	Ø 288 25 22 V + S
						24.0325-0119.1 525119	Ø 288 25 22 V + S PD
			➡	V2022962→		24.0110-0226.1 410226	Ø 286 10 8 + S
						24.0310-0226.1 510226	Ø 286 10 8 + S PD
			➡	V7004690→		24.0110-0226.1 410226	Ø 286 10 8 + S
						24.0310-0226.1 510226	Ø 286 10 8 + S PD
SAAB - 900 II Cabriolet 09/93→04/99							
 Bremsbelagsatz, Scheibenbremse							
2.0 -16 Turbo	136	12/93→02/98	←	→ 08/96		13.0460-7080.2 607080	ATE 21411 17,5 - WK
2.0 i	96	12/93→02/98	←	09/96→		13.0460-7091.2 607091	ATE 21829 20,3 + WE / - WK
2.3 -16	110	12/93→02/98	←			13.0460-7173.2 607173	ATE 21829 20,3 - WK / + WK
2.5 -24 V6	125	12/93→02/98	➡	09/96→		13.0460-4040.2 604040	ATE 21050 15,8 - WE / - WK
			➡	→ 08/96		13.0460-4043.2 604043	ATE 21140 15,0 - WE / - WK
Warnkontakt, Bremsbelagsverschleiß							
2.0 -16 Turbo	136	12/93→02/98	←	09/96→	2	24.8190-0718.2 620718	L= 720
2.0 i	96	12/93→02/98					
2.3 -16	110	12/93→02/98					
2.5 -24 V6	125	12/93→02/98					
Zubehörsatz, Scheibenbremsbelag							
2.0 -16 Turbo	136	12/93→02/98	➡	→ 08/96		13.0460-0217.2 610217	ATE
2.0 i	96	12/93→02/98	➡	09/96→		13.0460-0347.2 610347	
2.3 -16	110	12/93→02/98					
2.5 -24 V6	125	12/93→02/98					
 Bremsscheibe							
2.0 -16 Turbo	136	12/93→02/98	←	→ 08/96		24.0124-0133.1 424133	Ø 284 24 21 V
2.0 i	96	12/93→02/98	←	09/96→		24.0125-0119.1 425119	Ø 288 25 22 V + S
2.3 -16	110	12/93→02/98	←			24.0325-0119.1 525119	Ø 288 25 22 V + S PD
2.5 -24 V6	125	12/93→02/98	➡	V2022962→		24.0110-0226.1 410226	Ø 286 10 8 + S
						24.0310-0226.1 510226	Ø 286 10 8 + S PD
			➡	V7004690→		24.0110-0226.1 410226	Ø 286 10 8 + S
						24.0310-0226.1 510226	Ø 286 10 8 + S PD
			➡	→ V7004689		24.0110-0249.1 410249	Ø 260 10 8
			➡	→ V2022961		24.0110-0249.1 410249	Ø 260 10 8
SAAB - 900 II Coupe 12/93→04/99							
 Bremsbelagsatz, Scheibenbremse							
2.0 -16 Turbo	136	12/93→02/98	←	→ 08/96		13.0460-7080.2 607080	ATE 21411 17,5 - WK
2.0 i	96	08/94→02/98	←	09/96→		13.0460-7091.2 607091	ATE 21829 20,3 + WE / - WK
2.3 -16	110	12/93→02/98	←			13.0460-7173.2 607173	ATE 21829 20,3 - WK / + WK
2.5 -24 V6	125	12/93→02/98	➡	09/96→		13.0460-4040.2 604040	ATE 21050 15,8 - WE / - WK
			➡	→ 08/96		13.0460-4043.2 604043	ATE 21140 15,0 - WE / - WK
Warnkontakt, Bremsbelagsverschleiß							
2.0 -16 Turbo	136	12/93→02/98	←	09/96→	2	24.8190-0718.2 620718	L= 720
2.0 i	96	08/94→02/98					
2.3 -16	110	12/93→02/98					
2.5 -24 V6	125	12/93→02/98					
Zubehörsatz, Scheibenbremsbelag							
2.0 -16 Turbo	136	12/93→02/98	➡	→ 08/96		13.0460-0217.2 610217	ATE
2.0 i	96	08/94→02/98	➡	09/96→		13.0460-0347.2 610347	
2.3 -16	110	12/93→02/98					
2.5 -24 V6	125	12/93→02/98					
↓							











	kW			 	! #		
SAAB - 900 II Coupe 12/93→04/99							
 Bremsscheibe							
2.0 -16 Turbo	136	12/93→02/98	←	→ 08/96		24.0124-0133.1 424133	Ø 284 24 21 V
2.0 i	96	08/94→02/98	←	09/96→		24.0125-0119.1 425119	Ø 288 25 22 V + S
2.3 -16	110	12/93→02/98	←			24.0325-0119.1 525119	Ø 288 25 22 V + S PD
2.5 -24 V6	125	12/93→02/98	→	V2022962→		24.0110-0226.1 410226	Ø 286 10 8 + S
			→	V7004690→		24.0310-0226.1 510226	Ø 286 10 8 + S PD
			→	V7004689		24.0110-0226.1 410226	Ø 286 10 8 + S
			→	V7004689		24.0310-0226.1 510226	Ø 286 10 8 + S PD
			→	V7004689		24.0110-0249.1 410249	Ø 260 10 8
			→	V2022961		24.0110-0249.1 410249	Ø 260 10 8
SAAB - 9000 04/85→12/98							
 Bremsbelagsatz, Scheibenbremse							
2.0 -16 CD	96	09/93→12/98	←	→ 05/98		13.0460-5703.2 605703	ATE 21154 19,5 + WE / - WK
2.0 -16 CD	110	09/93→12/98	→	→ 05/98		13.0460-3306.2 603306	ATE 21089 15,0 - WE / - WK
2.3 -16 CDE	108	09/93→12/98	→	→ 05/98			
2.3 -16 CDE Eco-Power	125	09/93→12/98	→	→ 05/98			
2.0 -16 Turbo CD	108	09/92→12/98	←	09/93→ 05/98		13.0460-5703.2 605703	ATE 21154 19,5 + WE / - WK
2.0 -16 Turbo CD	136	09/89→12/98	←	→ 08/93		13.0460-5703.2 605703	ATE 21154 19,5 + WE / - WK
			→	09/93→ 05/98		13.0460-3306.2 603306	ATE 21089 15,0 - WE / - WK
			→	→ 08/93		13.0460-3306.2 603306	ATE 21089 15,0 - WE / - WK
2.3 -16 CD	107	08/89→12/98	←	09/89→ 08/93		13.0460-5703.2 605703	ATE 21154 19,5 + WE / - WK
			→	09/89→ 08/93		13.0460-3306.2 603306	ATE 21089 15,0 - WE / - WK
2.3 -16 CD Turbo	147	07/90→12/98	←	09/93→ 05/98		13.0460-5703.2 605703	ATE 21154 19,5 + WE / - WK
			→	09/93→ 05/98		13.0460-3306.2 603306	ATE 21089 15,0 - WE / - WK
3.0 -24 V6 CD/CDE	155	07/94→12/98	←	09/94→ 05/98		13.0460-5703.2 605703	ATE 21154 19,5 + WE / - WK
			→	09/94→ 05/98		13.0460-3306.2 603306	ATE 21089 15,0 - WE / - WK
 Bremsscheibe							
2.0 -16 CD	96	09/93→12/98	←	→ 05/98		24.0125-0125.1 425125	Ø 280 25 23 V
2.0 -16 CD	110	09/93→12/98	→	→ 05/98		24.0109-0130.1 409130	Ø 258 9 7,5
2.3 -16 CDE	108	09/93→12/98	→	→ 05/98			
2.3 -16 CDE Eco-Power	125	09/93→12/98	→	→ 05/98			
2.0 -16 Turbo CD	108	09/92→12/98	←	09/93→ 05/98		24.0125-0125.1 425125	Ø 280 25 23 V
2.0 -16 Turbo CD	136	09/89→12/98	←	→ 08/93		24.0125-0125.1 425125	Ø 280 25 23 V
			→	09/93→ 05/98		24.0109-0130.1 409130	Ø 258 9 7,5
			→	→ 08/93		24.0109-0130.1 409130	Ø 258 9 7,5
2.3 -16 CD	107	08/89→12/98	←	09/89→ 08/93		24.0125-0125.1 425125	Ø 280 25 23 V
			→	09/89→ 08/93		24.0109-0130.1 409130	Ø 258 9 7,5
2.3 -16 CD Turbo	147	07/90→12/98	←	09/93→ 05/98		24.0125-0125.1 425125	Ø 280 25 23 V
			→	09/93→ 05/98		24.0109-0130.1 409130	Ø 258 9 7,5
3.0 -24 V6 CD/CDE	155	07/94→12/98	←	09/94→ 05/98		24.0125-0125.1 425125	Ø 280 25 23 V
			→	09/94→ 05/98		24.0109-0130.1 409130	Ø 258 9 7,5
SAAB - 9000 Schrägheck 09/84→12/98							
 Bremsbelagsatz, Scheibenbremse							
2.0 -16 CS	94	01/89→12/98	←	→ 08/89		13.0460-2811.2 602811	TRW 21068 17,0 - WK
			←	09/89→ 08/93		13.0460-5703.2 605703	ATE 21154 19,5 + WE / - WK
			→	→ 08/93		13.0460-3306.2 603306	ATE 21089 15,0 - WE / - WK
2.0 -16 CS	96	09/93→12/98	←	→ 05/98		13.0460-5703.2 605703	ATE 21154 19,5 + WE / - WK
2.0 -16 ND Turbo	110	09/93→12/98	→	→ 05/98		13.0460-3306.2 603306	ATE 21089 15,0 - WE / - WK
2.3 -16 CSE	108	09/93→12/98	→	→ 05/98			
2.3 -16 CSE Eco Power	125	09/93→12/98	→	→ 05/98			
2.3 -16 Turbo CSE	147	09/93→12/98	→	→ 05/98			
2.0 -16 Turbo CS	136	09/88→12/98	←	09/93→ 05/98		13.0460-5703.2 605703	ATE 21154 19,5 + WE / - WK
			←	→ 08/93		13.0460-5703.2 605703	ATE 21154 19,5 + WE / - WK
			→	09/93→ 05/98		13.0460-3306.2 603306	ATE 21089 15,0 - WE / - WK
			→	→ 08/93		13.0460-3306.2 603306	ATE 21089 15,0 - WE / - WK
2.3 -16 Aero CS	162	02/93→12/98	←	09/93→ 05/98		13.0460-5703.2 605703	ATE 21154 19,5 + WE / - WK
2.3 -16 Aero CS	165	02/93→12/98	→	09/93→ 05/98		13.0460-3306.2 603306	ATE 21089 15,0 - WE / - WK
2.3 -16 Turbo	143	09/90→12/98	→	09/93→ 05/98		13.0460-3306.2 603306	ATE 21089 15,0 - WE / - WK
↓							











	kw			 	! #		
SAAB - 9000 Schrägheck 09/84→12/98							
 Bremsbelagsatz, Scheibenbremse							
2.3 -16 CS	107	09/89→12/98	←	→ 08/93		13.0460-5703.2 605703	ATE 21154 19,5 + WE / - WK
			→	→ 08/93		13.0460-3306.2 603306	ATE 21089 15,0 - WE / - WK
3.0 -24 V6 CS/CSE	155	07/94→12/98	←	09/94→ 05/98		13.0460-5703.2 605703	ATE 21154 19,5 + WE / - WK
			→	09/94→ 05/98		13.0460-3306.2 603306	ATE 21089 15,0 - WE / - WK
 Bremsscheibe							
2.0 -16 CS	94	01/89→12/98	←	→ 08/89		24.0123-0101.1 423101	Ø 280 23,4 21,5 V
			←	09/89→ 08/93		24.0125-0125.1 425125	Ø 280 25 23 V
			→	→ 08/93		24.0109-0130.1 409130	Ø 258 9 7,5
2.0 -16 CS	96	09/93→12/98	←	→ 05/98		24.0125-0125.1 425125	Ø 280 25 23 V
2.0 -16 ND Turbo	110	09/93→12/98	→	→ 05/98		24.0109-0130.1 409130	Ø 258 9 7,5
2.3 -16 CSE	108	09/93→12/98	←	→ 05/98			
2.3 -16 CSE Eco Power	125	09/93→12/98	→	→ 05/98			
2.3 -16 Turbo CSE	147	09/93→12/98	←	→ 05/98			
2.0 -16 Turbo CS	136	09/88→12/98	←	09/93→ 05/98		24.0125-0125.1 425125	Ø 280 25 23 V
			←	→ 08/93		24.0125-0125.1 425125	Ø 280 25 23 V
			→	09/93→ 05/98		24.0109-0130.1 409130	Ø 258 9 7,5
			→	→ 08/93		24.0109-0130.1 409130	Ø 258 9 7,5
2.3 -16 Aero CS	162	02/93→12/98	←	09/93→ 05/98		24.0125-0125.1 425125	Ø 280 25 23 V
2.3 -16 Aero CS	165	02/93→12/98	→	09/93→ 05/98		24.0109-0130.1 409130	Ø 258 9 7,5
2.3 -16 Turbo	143	09/90→12/98	←	09/93→ 05/98		24.0109-0130.1 409130	Ø 258 9 7,5
2.3 -16 CS	107	09/89→12/98	←	→ 08/93		24.0125-0125.1 425125	Ø 280 25 23 V
			→	→ 08/93		24.0109-0130.1 409130	Ø 258 9 7,5
3.0 -24 V6 CS/CSE	155	07/94→12/98	←	09/94→ 05/98		24.0125-0125.1 425125	Ø 280 25 23 V
			→	09/94→ 05/98		24.0109-0130.1 409130	Ø 258 9 7,5
SEAT - ALHAMBRA (7V8, 7V9) 04/96→03/10							
 Bremsbelagsatz, Scheibenbremse							
1.8 T 20V	110	10/97→03/10	←	05/98→; → 7M-W-070000		13.0460-7076.2 607076	ATE 21848 19,8 - WE / - WK
			←	7M-X-000001→ 7M-1-530756		13.0460-7143.2 607143	ATE 21848 19,8 + WK
			←	7M-2-500001→		13.0460-7153.2 607153	ATE 23269 19,8 + WK
			→	05/98→ 05/00		13.0460-2819.2 602819	TRW 20961 17,2 - WK
			→	06/00→; → 7M-1-530756		13.0460-2859.2 602859	TRW 20961 17,0 + WK + Zub
			→	7M-2-500001→		13.0460-2872.2 602872	TRW 23224 16,5 + WK + Zub
1.9 TDI	66	04/96→03/10	←	→ 7M-W-070000		13.0460-7076.2 607076	ATE 21848 19,8 - WE / - WK
2.0 i	85	04/96→03/10	←	7M-X-000001→ 7M-1-530756		13.0460-7143.2 607143	ATE 21848 19,8 + WK
			←	7M-2-500001→		13.0460-7154.2 607154	ATE 23034 18,8 + WK
			→	→ 05/00		13.0460-2819.2 602819	TRW 20961 17,2 - WK
			→	06/00→		13.0460-2859.2 602859	TRW 20961 17,0 + WK + Zub
1.9 TDI	81	08/96→06/00	←	10/97→; → 7M-W-070000		13.0460-7076.2 607076	ATE 21848 19,8 - WE / - WK
			←	7M-X-000001→; → 05/00		13.0460-7143.2 607143	ATE 21848 19,8 + WK
			→	10/97→ 05/00		13.0460-2819.2 602819	TRW 20961 17,2 - WK
1.9 TDI	85	06/00→03/10	←	7M-X-000001→ 7M-1-530756		13.0460-7143.2 607143	ATE 21848 19,8 + WK
			←	7M-2-500001→		13.0460-7154.2 607154	ATE 23034 18,8 + WK
			→	→ 7M-1-530756		13.0460-2859.2 602859	TRW 20961 17,0 + WK + Zub
			→	7M-2-500001→		13.0460-2872.2 602872	TRW 23224 16,5 + WK + Zub
1.9 TDI	96	11/02→11/08	←			13.0460-7154.2 607154	ATE 23034 18,8 + WK
2.0 TDI	103	11/05→03/10	→			13.0460-2859.2 602859	TRW 20961 17,0 + WK + Zub
1.9 TDI	110	05/05→05/07	←			13.0460-7153.2 607153	ATE 23269 19,8 + WK
2.8 V6	150	06/00→03/10	→			13.0460-2872.2 602872	TRW 23224 16,5 + WK + Zub
1.9 TDI 4motion	85	06/00→03/10	←	02/01→		13.0460-7153.2 607153	ATE 23269 19,8 + WK
2.8 V6 4motion	150	06/00→03/10	→	02/01→		13.0460-2872.2 602872	TRW 23224 16,5 + WK + Zub
Zubehörsatz, Scheibenbremsbelag							
1.8 T 20V	110	10/97→03/10	→	05/98→ 05/00		13.0460-0072.2 610072	TRW
↓							









	kW			 	! #		
SEAT - ALHAMBRA (7V8, 7V9) 04/96→03/10							
Zubehörsatz, Scheibenbremsbelag							
1.8 T 20V	110	10/97→03/10	➡	7M-2-500001→		13.0460-0225.2 610225	
1.9 TDI	66	04/96→03/10	➡	→ 05/00		13.0460-0072.2 610072	TRW
2.0 i	85	04/96→03/10					
1.9 TDI	81	08/96→06/00	➡	10/97→ 05/00		13.0460-0072.2 610072	TRW
1.9 TDI	85	06/00→03/10	➡	7M-2-500001→		13.0460-0225.2 610225	
1.9 TDI	110	05/05→05/07	➡			13.0460-0225.2 610225	
2.8 V6	150	06/00→03/10					
1.9 TDI 4motion	85	06/00→03/10	➡	02/01→		13.0460-0225.2 610225	
2.8 V6 4motion	150	06/00→03/10					
 Bremsscheibe							
1.8 T 20V	110	10/97→03/10	←	05/98→; → 7M-1-530756		24.0125-0114.1 425114	Ø 288 25,1 21 V + S
			←	7M-2-500001→		24.0325-0114.1 525114	Ø 288 25,1 21 V + S PD
			←	7M-2-500001→		24.0126-0119.1 426119	Ø 313 25,9 22 V
			←	7M-2-500001→		24.0326-0119.1 526119	Ø 313 25,9 22 V PD
			➡	05/98→; → 7M-1-530756		24.0110-0223.1 410223	Ø 268 10 8 + S
			➡	7M-2-500001→		24.0310-0223.1 510223	Ø 268 10 8 + S PD
			➡	7M-2-500001→		24.0113-0194.1 413194	Ø 294 13,5 11,5
1.9 TDI	66	04/96→03/10	←	→ 7M-1-530756		24.0125-0114.1 425114	Ø 288 25,1 21 V + S
2.0 i	85	04/96→03/10				24.0325-0114.1 525114	Ø 288 25,1 21 V + S PD
			←	7M-2-500001→		24.0126-0115.1 426115	Ø 300 26 22 V
			←	7M-2-500001→		24.0326-0115.1 526115	Ø 300 26 22 V PD
			➡			24.0110-0223.1 410223	Ø 268 10 8 + S
			➡			24.0310-0223.1 510223	Ø 268 10 8 + S PD
1.9 TDI	81	08/96→06/00	←	10/97→ 05/00		24.0125-0114.1 425114	Ø 288 25,1 21 V + S
			←	10/97→ 05/00		24.0325-0114.1 525114	Ø 288 25,1 21 V + S PD
			➡	10/97→ 05/00		24.0110-0223.1 410223	Ø 268 10 8 + S
			➡	10/97→ 05/00		24.0310-0223.1 510223	Ø 268 10 8 + S PD
1.9 TDI	85	06/00→03/10	←	→ 7M-1-530756		24.0125-0114.1 425114	Ø 288 25,1 21 V + S
			←	7M-2-500001→		24.0325-0114.1 525114	Ø 288 25,1 21 V + S PD
			←	7M-2-500001→		24.0126-0115.1 426115	Ø 300 26 22 V
			←	7M-2-500001→		24.0326-0115.1 526115	Ø 300 26 22 V PD
			➡	→ 7M-1-530756		24.0110-0223.1 410223	Ø 268 10 8 + S
			➡	7M-2-500001→		24.0310-0223.1 510223	Ø 268 10 8 + S PD
			➡	7M-2-500001→		24.0113-0194.1 413194	Ø 294 13,5 11,5
1.9 TDI	96	11/02→11/08	←			24.0126-0115.1 426115	Ø 300 26 22 V
2.0 TDI	103	11/05→03/10				24.0326-0115.1 526115	Ø 300 26 22 V PD
			➡			24.0110-0223.1 410223	Ø 268 10 8 + S
			➡			24.0310-0223.1 510223	Ø 268 10 8 + S PD
1.9 TDI	110	05/05→05/07	←			24.0126-0119.1 426119	Ø 313 25,9 22 V
2.8 V6	150	06/00→03/10				24.0326-0119.1 526119	Ø 313 25,9 22 V PD
			➡			24.0113-0194.1 413194	Ø 294 13,5 11,5
1.9 TDI 4motion	85	06/00→03/10	←	02/01→		24.0126-0119.1 426119	Ø 313 25,9 22 V
2.8 V6 4motion	150	06/00→03/10				24.0326-0119.1 526119	Ø 313 25,9 22 V PD
			➡	02/01→		24.0113-0194.1 413194	Ø 294 13,5 11,5
SEAT - ALHAMBRA (710, 711) 06/10→							
 Bremsbelagsatz, Scheibenbremse							
1.4 TSI	110	06/10→	←	09/10→; +PR 1LW		13.0460-2764.2 602764	TRW 24738 20,0 + WK
2.0 TDI	100	06/10→05/11				13.0470-2764.2 LD2764	TRW 24738 20,0 + WK Ceramic
2.0 TDI	125	06/10→	←	09/10→; +PR 1LJ		13.0460-7242.2 607242	ATE 24332 19,8 + WK
			←	09/10→; +PR 1LJ		13.0470-7242.2 LD7242	ATE 24332 19,8 + WK Ceramic
			➡	09/10→		13.0460-2749.2 602749	TRW 24483 16,9 - WE / - WK + Zub
						13.0460-2880.2 602880	TRW 23914 17,1 + WE / - WK + Zub
						13.0470-2749.2 LD2749	TRW 24483 16,9 - WE / - WK + Zub Ceramic
						13.0470-2880.2 LD2880	TRW 23914 17,1 + WE / - WK + Zub Ceramic
1.4 TSI	110	05/15→	←	+PR 1LW		13.0460-2764.2 602764	TRW 24738 20,0 + WK
1.8 TSI	118	11/12→				13.0470-2764.2 LD2764	TRW 24738 20,0 + WK Ceramic
2.0 TDI	85	05/11→					
2.0 TDI	103	06/10→	←	+PR 1LJ		13.0460-7242.2 607242	ATE 24332 19,8 + WK
↓							

	kw			 	! #		
SEAT - ALHAMBRA (710, 711) 06/10→							
 Bremsbelagsatz, Scheibenbremse							
2.0 TDI	130	11/12→	←	+PR 1LJ		13.0470-7242.2 LD7242	ATE 24332 19,8 + WK Ceramic
2.0 TDI 4Drive	103	05/11→	→			13.0460-2749.2 602749	TRW 24483 16,9 - WE / - WK + Zub
2.0 TSI	147	11/10→				13.0460-2880.2 602880	TRW 23914 17,1 + WE / - WK + Zub
						13.0470-2749.2 LD2749	TRW 24483 16,9 - WE / - WK + Zub Ceramic
						13.0470-2880.2 LD2880	TRW 23914 17,1 + WE / - WK + Zub Ceramic
2.0 TDI	110	05/15→	←	+PR 1LW		13.0460-2764.2 602764	TRW 24738 20,0 + WK
2.0 TDI	135	05/15→				13.0470-2764.2 LD2764	TRW 24738 20,0 + WK Ceramic
2.0 TDI 4Drive	110	05/15→					
2.0 TDI 4Drive	135	05/16→	→	+ eFSB		13.0460-2790.2 602790	TRW 25110 17,5 - WE / - WK
2.0 TSI	162	05/15→				13.0470-2790.2 LD2790	TRW 25110 17,5 - WE / - WK Ceramic
 Bremsscheibe							
1.4 TSI	110	06/10→	←	09/10→; +PR 1LJ		24.0125-0158.1 425158	Ø 312 25 22 V + S
2.0 TDI	100	06/10→05/11				24.0325-0158.1 525158	Ø 312 25 22 V + S PD
2.0 TDI	125	06/10→	←	09/10→; +PR 1LW		24.0130-0220.1 430220	Ø 314 30 27 V + S
			→	09/10→		24.0112-0169.1 412169	Ø 282 12 10 + S
						24.0312-0169.1 512169	Ø 282 12 10 + S PD
1.4 TSI	110	05/15→	←	+PR 1LJ		24.0125-0158.1 425158	Ø 312 25 22 V + S
1.8 TSI	118	11/12→				24.0325-0158.1 525158	Ø 312 25 22 V + S PD
2.0 TDI	85	05/11→					
2.0 TDI	103	06/10→	←	+PR 1LW		24.0130-0220.1 430220	Ø 314 30 27 V + S
2.0 TDI	130	11/12→	→			24.0112-0169.1 412169	Ø 282 12 10 + S
2.0 TDI 4Drive	103	05/11→				24.0312-0169.1 512169	Ø 282 12 10 + S PD
2.0 TSI	147	11/10→					
2.0 TDI	110	05/15→	←	+PR 1LW		24.0130-0220.1 430220	Ø 314 30 27 V + S
2.0 TDI	135	05/15→	→	+ eFSB		24.0112-0210.1 412210	Ø 300 12 10 + S
2.0 TDI 4Drive	110	05/15→					
2.0 TDI 4Drive	135	05/16→					
2.0 TSI	162	05/15→					
SEAT - ALTEA (5P1) 03/04→							
 Bremsbelagsatz, Scheibenbremse							
1.2 TSI	77	04/10→	←	+PR 1ZF		13.0460-7117.2 607117	VW 23130 19,6 + WK
1.4 16V	63	05/06→				13.0470-7117.2 LD7117	VW 23130 19,6 + WK Ceramic
1.4 TSI	92	11/07→					
1.6	75	03/04→	←	+PR 1ZA,1ZE,1LJ		13.0460-7184.2 607184	ATE 23587 20,6 + WK
1.6 LPG	75	09/09→				13.0470-7184.2 LD7184	ATE 23587 20,6 + WK Ceramic
1.6 TDI	66	11/10→	→	+PR 1KF,1KJ		13.0460-2749.2 602749	TRW 24483 16,9 - WE / - WK + Zub
1.6 TDI	77	10/09→					
1.8 TFSI	118	01/07→				13.0460-2880.2 602880	TRW 23914 17,1 + WE / - WK + Zub
1.9 TDI	66	08/09→					
1.9 TDI	77	04/04→					
2.0 FSI	110	05/04→03/09				13.0470-2749.2 LD2749	TRW 24483 16,9 - WE / - WK + Zub Ceramic
2.0 TDI	100	03/04→05/09					
2.0 TDI	103	11/05→				13.0470-2880.2 LD2880	TRW 23914 17,1 + WE / - WK + Zub Ceramic
2.0 TDI	125	03/06→					
2.0 TDI 16V	103	03/04→	→	+PR 1KD,1KQ,1KZ		13.0460-2820.2 602820	TRW 20961 17,2 - WK
2.0 TFSI	147	04/06→05/09	→	+PR 1KS		13.0470-2820.2 LD2820	TRW 20961 17,2 - WK Ceramic
						13.0460-3858.2 603858	BOS 24563 17,7 - WE / - WK + Zub
						13.0470-3858.2 LD3858	BOS 24563 17,7 - WE / - WK + Zub Ceramic
 Bremsscheibe							
1.2 TSI	77	04/10→	←	+PR 1ZF		24.0122-0210.1 422210	Ø 280 22 19 V + S
1.6 LPG	75	09/09→				24.0322-0210.1 522210	Ø 280 22 19 V + S PD
1.6 TDI	66	11/10→	←	+PR 1ZE		24.0125-0145.1 425145	Ø 288 25 22 V + S
1.6 TDI	77	10/09→	←	+PR 1LJ,1ZA		24.0325-0145.1 525145	Ø 288 25 22 V + S PD
			←	+PR 1LJ,1ZA		24.0125-0158.1 425158	Ø 312 25 22 V + S
						24.0325-0158.1 525158	Ø 312 25 22 V + S PD
			→	+PR 1KD,1KQ		24.0110-0277.1 410277	Ø 253 10 8 + S
						24.0310-0277.1 510277	Ø 253 10 8 + S PD
			→	+PR 1KS		24.0110-0356.1 410356	Ø 272 9,7 8 + S
						24.0310-0356.1 510356	Ø 272 9,7 8 + S PD
			→	+PR 1KF		24.0112-0158.1 412158	Ø 256 12 10 + S









	kW			 	! #		
SEAT - ALTEA (5P1) 03/04 →							
 Bremsscheibe							
1.2 TSI	77	04/10 →	➡	+PR 1KF		24.0312-0158.1 512158	Ø 256 12 10 PD
1.6 LPG	75	09/09 →	➡	+PR 1KJ,1KZ		24.0112-0169.1 412169	Ø 282 12 10 + S
1.6 TDI	66	11/10 →				24.0312-0169.1 512169	Ø 282 12 10 + S PD
1.6 TDI	77	10/09 →					
1.4 16V	63	05/06 →	⬅	+PR 1ZF		24.0122-0210.1 422210	Ø 280 22 19 V + S
1.4 TSI	92	11/07 →				24.0322-0210.1 522210	Ø 280 22 19 V + S PD
1.6	75	03/04 →					
1.8 TFSI	118	01/07 →	⬅	+PR 1ZE		24.0125-0145.1 425145	Ø 288 25 22 V + S
1.9 TDI	66	08/09 →				24.0325-0145.1 525145	Ø 288 25 22 V + S PD
1.9 TDI	77	04/04 →					
2.0 FSI	110	05/04 → 03/09	⬅	+PR 1LJ,1ZA		24.0125-0158.1 425158	Ø 312 25 22 V + S
2.0 TDI	100	03/04 → 05/09				24.0325-0158.1 525158	Ø 312 25 22 V + S PD
2.0 TDI	103	11/05 →	➡	+PR 1KD;1KQ		24.0110-0277.1 410277	Ø 253 10 8 + S
2.0 TDI	125	03/06 →				24.0310-0277.1 510277	Ø 253 10 8 + S PD
2.0 TDI 16V	103	03/04 →					
2.0 TFSI	147	04/06 → 05/09	➡	+PR 1KS		24.0110-0356.1 410356	Ø 272 9,7 8 + S
						24.0310-0356.1 510356	Ø 272 9,7 8 + S PD
			➡	+PR 1KF		24.0112-0158.1 412158	Ø 256 12 10 + S
						24.0312-0158.1 512158	Ø 256 12 10 PD
			➡	+PR 1KJ,1KZ		24.0112-0169.1 412169	Ø 282 12 10 + S
						24.0312-0169.1 512169	Ø 282 12 10 + S PD
SEAT - ALTEA XL (5P5, 5P8) 10/06 →							
 Bremsbelagsatz, Scheibenbremse							
1.2 TSI	77	04/10 →	⬅	+PR 1ZF		13.0460-7117.2 607117	VW 23130 19,6 + WK
1.4 TSI	92	11/07 →				13.0470-7117.2 LD7117	VW 23130 19,6 + WK Ceramic
1.6	75	10/06 →	⬅	+PR 1ZA,1ZE,1LJ		13.0460-7184.2 607184	ATE 23587 20,6 + WK
1.6 LPG	75	09/09 →				13.0470-7184.2 LD7184	ATE 23587 20,6 + WK Ceramic
1.6 Multifuel	75	10/06 →					
1.6 TDI	66	11/10 →	➡	+PR 1KD,1KQ,1KZ		13.0460-2820.2 602820	TRW 20961 17,2 - WK
1.6 TDI	77	10/09 →				13.0470-2820.2 LD2820	TRW 20961 17,2 - WK Ceramic
1.8 TFSI	118	01/07 →					
1.9 TDI	66	08/09 →	➡	+PR 1KS		13.0460-3858.2 603858	BOS 24563 17,7 - WE / - WK + Zub
1.9 TDI	77	10/06 →				13.0470-3858.2 LD3858	BOS 24563 17,7 - WE / - WK + Zub Ceramic
1.9 TDI 4x4	77	06/09 → 12/10					
2.0 FSI	110	10/06 → 03/09					
2.0 TDI	100	11/06 → 03/09					
2.0 TDI	103	10/06 →					
2.0 TDI	125	06/07 →					
2.0 TDI 16V	103	10/06 →					
2.0 TDI 16V 4x4	103	10/10 →					
2.0 TDI 4x4	103	06/07 →					
2.0 TDI 4x4	125	06/07 →					
2.0 TFSI	147	10/06 → 05/09					
2.0 TFSI 4x4	147	06/07 → 05/09					
2.0 TFSI 4x4	155	05/09 →					
1.4 16V	63	10/06 →	⬅	05/08 →; +PR 1ZF		13.0460-7117.2 607117	VW 23130 19,6 + WK
						13.0470-7117.2 LD7117	VW 23130 19,6 + WK Ceramic
			⬅	05/08 →; +PR 1ZA,1ZE,1LJ		13.0460-7184.2 607184	ATE 23587 20,6 + WK
						13.0470-7184.2 LD7184	ATE 23587 20,6 + WK Ceramic
			➡	05/08 →; +PR 1KD,1KQ,1KZ		13.0460-2820.2 602820	TRW 20961 17,2 - WK
						13.0470-2820.2 LD2820	TRW 20961 17,2 - WK Ceramic
			➡	05/08 →; +PR 1KS		13.0460-3858.2 603858	BOS 24563 17,7 - WE / - WK + Zub
						13.0470-3858.2 LD3858	BOS 24563 17,7 - WE / - WK + Zub Ceramic
 Bremsscheibe							
1.2 TSI	77	04/10 →	⬅	+PR 1ZF		24.0122-0210.1 422210	Ø 280 22 19 V + S
1.6 LPG	75	09/09 →				24.0322-0210.1 522210	Ø 280 22 19 V + S PD
1.9 TDI 4x4	77	06/09 → 12/10	⬅	+PR 1ZE		24.0125-0145.1 425145	Ø 288 25 22 V + S
						24.0325-0145.1 525145	Ø 288 25 22 V + S PD
			⬅	+PR 1LJ,1ZA		24.0125-0158.1 425158	Ø 312 25 22 V + S
						24.0325-0158.1 525158	Ø 312 25 22 V + S PD
			➡	+PR 1KD,1KQ		24.0110-0277.1 410277	Ø 253 10 8 + S
						24.0310-0277.1 510277	Ø 253 10 8 + S PD
			➡	+PR 1KS		24.0110-0356.1 410356	Ø 272 9,7 8 + S
						24.0310-0356.1 510356	Ø 272 9,7 8 + S PD
			➡	+PR 1KJ,1KZ		24.0112-0169.1 412169	Ø 282 12 10 + S
						24.0312-0169.1 512169	Ø 282 12 10 + S PD
1.4 16V	63	10/06 →	⬅	05/08 →; +PR 1ZF		24.0122-0210.1 422210	Ø 280 22 19 V + S
						24.0322-0210.1 522210	Ø 280 22 19 V + S PD







	kw			 	! #		
SEAT - ALTEA XL (5P5, 5P8) 10/06→							
 Bremsscheibe							
1.4 16V	63	10/06→	←	05/08→; +PR 1ZE	24.0125-0145.1	425145	Ø 288 25 22 V + S
					24.0325-0145.1	525145	Ø 288 25 22 V + S PD
			←	05/08→; +PR 1LJ,1ZA	24.0125-0158.1	425158	Ø 312 25 22 V + S
					24.0325-0158.1	525158	Ø 312 25 22 V + S PD
			→	05/08→; +PR 1KD;1KQ	24.0110-0277.1	410277	Ø 253 10 8 + S
		24.0310-0277.1	510277	Ø 253 10 8 + S PD			
			→	05/08→; +PR 1KS	24.0110-0356.1	410356	Ø 272 9,7 8 + S
					24.0310-0356.1	510356	Ø 272 9,7 8 + S PD
			→	05/08→; +PR 1KJ,1KZ	24.0112-0169.1	412169	Ø 282 12 10 + S
					24.0312-0169.1	512169	Ø 282 12 10 + S PD
1.4 TSI	92	11/07→	←	+PR 1ZF	24.0122-0210.1	422210	Ø 280 22 19 V + S
1.6	75	10/06→			24.0322-0210.1	522210	Ø 280 22 19 V + S PD
1.6 Multifuel	75	10/06→					
1.8 TFSI	118	01/07→	←	+PR 1ZE	24.0125-0145.1	425145	Ø 288 25 22 V + S
1.9 TDI	66	08/09→			24.0325-0145.1	525145	Ø 288 25 22 V + S PD
1.9 TDI	77	10/06→					
2.0 FSI	110	10/06→03/09	←	+PR 1LJ,1ZA	24.0125-0158.1	425158	Ø 312 25 22 V + S
2.0 TDI	100	11/06→03/09			24.0325-0158.1	525158	Ø 312 25 22 V + S PD
2.0 TDI	103	10/06→	→	+PR 1KD;1KQ	24.0110-0277.1	410277	Ø 253 10 8 + S
2.0 TDI	125	06/07→			24.0310-0277.1	510277	Ø 253 10 8 + S PD
2.0 TDI 16V	103	10/06→					
2.0 TDI 16V 4x4	103	10/10→	→	+PR 1KS	24.0110-0356.1	410356	Ø 272 9,7 8 + S
2.0 TDI 4x4	103	06/07→			24.0310-0356.1	510356	Ø 272 9,7 8 + S PD
2.0 TDI 4x4	125	06/07→					
2.0 TFSI	147	10/06→05/09	→	+PR 1KJ,1KZ	24.0112-0169.1	412169	Ø 282 12 10 + S
2.0 TFSI 4x4	147	06/07→05/09			24.0312-0169.1	512169	Ø 282 12 10 + S PD
2.0 TFSI 4x4	155	05/09→					
1.6 TDI	66	11/10→	←	+PR 1ZF	24.0122-0210.1	422210	Ø 280 22 19 V + S
1.6 TDI	77	10/09→			24.0322-0210.1	522210	Ø 280 22 19 V + S PD
			←	+PR 1ZE	24.0125-0145.1	425145	Ø 288 25 22 V + S
					24.0325-0145.1	525145	Ø 288 25 22 V + S PD
			←	+PR 1LJ,1ZA	24.0125-0158.1	425158	Ø 312 25 22 V + S
					24.0325-0158.1	525158	Ø 312 25 22 V + S PD
			→	+PR 1KD, 1KQ	24.0110-0277.1	410277	Ø 253 10 8 + S
					24.0310-0277.1	510277	Ø 253 10 8 + S PD
			→	+PR 1KS	24.0110-0356.1	410356	Ø 272 9,7 8 + S
					24.0310-0356.1	510356	Ø 272 9,7 8 + S PD
			→	+PR 1KJ,1KZ	24.0112-0169.1	412169	Ø 282 12 10 + S
					24.0312-0169.1	512169	Ø 282 12 10 + S PD
SEAT - AROSA (6H) 05/97→06/04							
 Bremsbelagsatz, Scheibenbremse							
1.0	37	05/97→06/04	←		13.0460-7100.2	607100	VW 21866 17,2 - WE / - WK
1.0	37	10/98→01/01			13.0470-7100.2	LD7100	VW 21866 17,2 - WE / - WK Ceramic
1.4	44	05/97→06/04					
1.4 16V	74	01/00→06/04	←		13.0460-2821.2	602821	TRW 21945 16,0 - WK
			→		13.0460-2894.2	602894	TRW 20961 17,2 - WK + Zub
					13.0470-2894.2	LD2894	TRW 20961 17,2 - WK + Zub Ceramic
1.4 TDI	55	01/00→06/04	←		13.0460-2821.2	602821	TRW 21945 16,0 - WK
1.7 SDI	44	08/97→06/04	←	11/97→	13.0460-7100.2	607100	VW 21866 17,2 - WE / - WK
					13.0470-7100.2	LD7100	VW 21866 17,2 - WE / - WK Ceramic
Zubehörsatz, Scheibenbremsbelag							
1.4 16V	74	01/00→06/04	→		13.0460-0072.2	610072	TRW
 Bremsscheibe							
1.0	37	05/97→06/04	←		24.0110-0232.1	410232	Ø 239 9,9 8 + S
					24.0118-0106.1	418106	Ø 239 18 16 V + S
					24.0318-0106.1	518106	Ø 239 18 16 V + S PD
1.4	44	05/97→06/04	←		24.0118-0106.1	418106	Ø 239 18 16 V + S
					24.0318-0106.1	518106	Ø 239 18 16 V + S PD
1.4 16V	74	01/00→06/04	←		24.0120-0128.1	420128	Ø 256 20 18 V + S
					24.0320-0128.1	520128	Ø 256 20 18 V + S PD
				→	24.0109-0124.1	409124	Ø 232 9 7
↓							











	kw			 	! #		
SEAT - AROSA (6H) 05/97→06/04							
 Bremsscheibe							
1.4 TDI	55	01/00→06/04	←			24.0120-0128.1 420128 24.0320-0128.1 520128	Ø 256 20 18 V + S Ø 256 20 18 V + S PD
1.7 SDI	44	08/97→06/04	←	11/97→		24.0118-0106.1 418106 24.0318-0106.1 518106	Ø 239 18 16 V + S Ø 239 18 16 V + S PD
SEAT - ATECA (KH7) 04/16→							
 Bremsbelagsatz, Scheibenbremse							
1.0 TSI 1.6 TDI 2.0 TDI 2.0 TDI 4Drive	85 85 110 110	05/16→ 04/16→ 04/16→ 04/16→	←	06/16→; +PR 1ZA		13.0460-2785.2 602785 13.0470-2785.2 LD2785	TRW 25683 20,4 + WE / + WK TRW 25683 20,4 + WE / + WK Ceramic
			→	06/16→; +PR 1KE; + eFSB		13.0460-7293.2 607293 13.0470-7293.2 LD7293	ATE 25008 16,3 - WE / - WK ATE 25008 16,3 - WE / - WK Ceramic
1.4 TSI 1.4 TSI 4Drive 2.0 TDI 2.0 TDI 2.0 TDI 4Drive	110 110 81 105 140	06/16→ 06/16→ 10/16→ 10/16→ 06/16→	←	+PR 1ZA		13.0460-2785.2 602785 13.0470-2785.2 LD2785	TRW 25683 20,4 + WE / + WK TRW 25683 20,4 + WE / + WK Ceramic
			→	+PR 1KE; + eFSB		13.0460-7293.2 607293 13.0470-7293.2 LD7293	ATE 25008 16,3 - WE / - WK ATE 25008 16,3 - WE / - WK Ceramic
Warnkontakt, Bremsbelagverschleiß							
1.0 TSI 1.6 TDI 2.0 TDI 2.0 TDI 4Drive	85 85 110 110	05/16→ 04/16→ 04/16→ 04/16→	←	06/16→; +PR 1ZA	1	24.8190-0065.2 620065	L= 172
1.4 TSI 1.4 TSI 4Drive 2.0 TDI 2.0 TDI 2.0 TDI 4Drive	110 110 81 105 140	06/16→ 06/16→ 10/16→ 10/16→ 06/16→	←	+PR 1ZA	1	24.8190-0065.2 620065	L= 172
 Bremsscheibe							
1.0 TSI 1.6 TDI 2.0 TDI 2.0 TDI 4Drive	85 85 110 110	05/16→ 04/16→ 04/16→ 04/16→	←	06/16→; +PR 1ZA		24.0125-0158.1 425158 24.0110-0356.1 410356	Ø 312 25 22 V + S Ø 272 9,7 8 + S
			→	06/16→; +PR 1KE			
1.4 TSI 1.4 TSI 4Drive 2.0 TDI 2.0 TDI 2.0 TDI 4Drive	110 110 81 105 140	06/16→ 06/16→ 10/16→ 10/16→ 06/16→	←	+PR 1ZA		24.0125-0158.1 425158 24.0110-0356.1 410356	Ø 312 25 22 V + S Ø 272 9,7 8 + S
			→	+PR 1KE			
SEAT - CORDOBA (6K1, 6K2) 02/93→10/99							
 Bremsbelagsatz, Scheibenbremse							
1.0 i	37	09/96→06/99	←	06/99→		13.0460-7101.2 607101	VW 21866 15,3 - WE / - WK
1.4	40	12/97→04/99	←	+PR 1LY,1ZK		13.0460-2821.2 602821	TRW 21945 16,0 - WK
			←	+PR 1LV,1LW,1LD		13.0460-2958.2 602958	TRW 20168 19,3 - WK
			←	→ 6K-TR09920; - ABS		13.0460-7030.2 607030	VW 20889 17,3 - WE / - WK + Zub
			←	→ 6K-TR046558; + ABS		13.0460-7032.2 20887	VW 20887 19,7 - WE / - WK + Zub
			←	+PR 1LA		13.0460-7059.2 607059	VW 20887 17,3 - WE / - WK + Zub
			←	+PR 1LM		13.0460-7072.2 607072	VW 21866 19,7 - WE / - WK
			←	+PR 1LG		13.0460-7101.2 607101	VW 21866 15,3 - WE / - WK
1.4 i 1.4 i 16V	44 74	06/94→06/99 09/96→06/99	←	01/97→ 05/99; +PR 1LY,1ZK		13.0460-2821.2 602821	TRW 21945 16,0 - WK
			←	01/97→ 05/99; +PR 1LV,1LW,1LD		13.0460-2958.2 602958	TRW 20168 19,3 - WK
			←	→ 6K-TR09920; - ABS		13.0460-7030.2 607030	VW 20889 17,3 - WE / - WK + Zub
			←	→ 6K-TR046558; + ABS		13.0460-7032.2 20887	VW 20887 19,7 - WE / - WK + Zub
			←	01/97→ 05/99; +PR 1LA		13.0460-7059.2 607059	VW 20887 17,3 - WE / - WK + Zub
			←	6K-TR09921→; → 12/96; - ABS		13.0460-7059.2 607059	VW 20887 17,3 - WE / - WK + Zub
			←	01/97→ 05/99; +PR 1LM		13.0460-7072.2 607072	VW 21866 19,7 - WE / - WK
			←	6K-TR046559→; → 12/96; + ABS		13.0460-7072.2 607072	VW 21866 19,7 - WE / - WK
↓							









	kw			 	! #		
SEAT - CORDOBA (6K1, 6K2) 02/93→10/99							
 Bremsbelagsatz, Scheibenbremse							
1.4 i 1.4 i 16V	44 74	06/94→06/99 09/96→06/99	←	01/97→ 05/99; +PR 1LG		13.0460-7101.2 607101	VW 21866 15,3 - WE / - WK
1.6 i 1.8 i	55 66	02/93→06/99 02/93→06/99	←	01/97→ 05/99; +PR 1LY,1ZK		13.0460-2821.2 602821	TRW 21945 16,0 - WK
			←	01/97→ 05/99; +PR 1LV,1LW,1LD		13.0460-2958.2 602958	TRW 20168 19,3 - WK
			←	11/93→; → 6K-TR046558		13.0460-7032.2 20887	VW 20887 19,7 - WE / - WK + Zub
			←	11/93→ 12/96; V		13.0460-7033.2 20887	VW 20887 15,3 - WE / - WK
			←	01/97→ 05/99; +PR 1LA		13.0460-7059.2 607059	VW 20887 17,3 - WE / - WK + Zub
			←	01/97→ 05/99; +PR 1LM		13.0460-7072.2 607072	VW 21866 19,7 - WE / - WK
			←	6K-TR046559→; → 12/96		13.0460-7072.2 607072	VW 21866 19,7 - WE / - WK
			←	01/97→ 05/99; +PR 1LG		13.0460-7101.2 607101	VW 21866 15,3 - WE / - WK
1.6 i	55	05/94→06/99	←	→ 05/99; +PR 1LY,1ZK		13.0460-2821.2 602821	TRW 21945 16,0 - WK
			←	→ 05/99; +PR 1LV,1LW,1LD		13.0460-2958.2 602958	TRW 20168 19,3 - WK
			←	→ 05/99; +PR 1LA		13.0460-7059.2 607059	VW 20887 17,3 - WE / - WK + Zub
			←	→ 05/99; +PR 1LM		13.0460-7072.2 607072	VW 21866 19,7 - WE / - WK
			←	→ 05/99; +PR 1LG		13.0460-7101.2 607101	VW 21866 15,3 - WE / - WK
1.6 i	74	07/96→10/99	←	01/97→ 05/99; +PR 1LY,1ZK		13.0460-2821.2 602821	TRW 21945 16,0 - WK
			←	01/97→ 05/99; +PR 1LV,1LW,1LD		13.0460-2958.2 602958	TRW 20168 19,3 - WK
			←	→ 6K-TR046558		13.0460-7032.2 20887	VW 20887 19,7 - WE / - WK + Zub
			←	→ 12/96; V		13.0460-7033.2 20887	VW 20887 15,3 - WE / - WK
			←	01/97→ 05/99; +PR 1LA		13.0460-7059.2 607059	VW 20887 17,3 - WE / - WK + Zub
			←	01/97→ 05/99; +PR 1LM		13.0460-7072.2 607072	VW 21866 19,7 - WE / - WK
			←	6K-TR046559→; → 12/96		13.0460-7072.2 607072	VW 21866 19,7 - WE / - WK
1.8 i 16V	95	10/93→08/96	←	02/94→		13.0460-2821.2 602821	TRW 21945 16,0 - WK
			→	6K-X-290000→; +PR 1KE,1KK,1KQ		13.0460-2894.2 602894 13.0470-2894.2 LD2894	TRW 20961 17,2 - WK + Zub TRW 20961 17,2 - WK + Zub Ceramic
			→	02/94→; → 6K-X-289999		13.0460-2937.2 602937	TRW 20961 15,2 - WK + Zub
1.9 D	47	01/96→08/96	←	→ 6K-TR046558		13.0460-7032.2 20887	VW 20887 19,7 - WE / - WK + Zub
			←	V		13.0460-7033.2 20887	VW 20887 15,3 - WE / - WK
			←	6K-TR046559→		13.0460-7072.2 607072	VW 21866 19,7 - WE / - WK
1.9 D 1.9 TD	50 55	02/93→08/96 02/93→08/96	←	11/93→; → 6K-TR046558		13.0460-7032.2 20887	VW 20887 19,7 - WE / - WK + Zub
			←	11/93→; V		13.0460-7033.2 20887	VW 20887 15,3 - WE / - WK
			←	6K-TR046559→		13.0460-7072.2 607072	VW 21866 19,7 - WE / - WK
1.9 SDI	47	08/96→06/99	←	01/97→ 05/99; +PR 1LY,1ZK		13.0460-2821.2 602821	TRW 21945 16,0 - WK
			←	01/97→ 05/99; +PR 1LV,1LW,1LD		13.0460-2958.2 602958	TRW 20168 19,3 - WK
			←	→ 12/96; V		13.0460-7033.2 20887	VW 20887 15,3 - WE / - WK
			←	01/97→ 05/99; +PR 1LA		13.0460-7059.2 607059	VW 20887 17,3 - WE / - WK + Zub
			←	01/97→ 05/99; +PR 1LM		13.0460-7072.2 607072	VW 21866 19,7 - WE / - WK
			←	→ 12/96		13.0460-7072.2 607072	VW 21866 19,7 - WE / - WK
			←	01/97→ 05/99; +PR 1LG		13.0460-7101.2 607101	VW 21866 15,3 - WE / - WK
1.9 TDI	66	08/96→06/99	←	01/97→ 05/99; +PR 1LY,1ZK		13.0460-2821.2 602821	TRW 21945 16,0 - WK
			←	01/97→ 05/99; +PR 1LV,1LW,1LD		13.0460-2958.2 602958	TRW 20168 19,3 - WK
			←	01/97→ 05/99; +PR 1LA		13.0460-7059.2 607059	VW 20887 17,3 - WE / - WK + Zub
			←	01/97→ 05/99; +PR 1LM		13.0460-7072.2 607072	VW 21866 19,7 - WE / - WK
1.9 TDI	81	03/97→06/99	←	→ 05/99; +PR 1LY,1ZK		13.0460-2821.2 602821	TRW 21945 16,0 - WK
			←	→ 05/99; +PR 1LV,1LW,1LD		13.0460-2958.2 602958	TRW 20168 19,3 - WK
			←	→ 05/99; +PR 1LA		13.0460-7059.2 607059	VW 20887 17,3 - WE / - WK + Zub





















	kw			 	! #		
SEAT - CORDOBA (6K1, 6K2) 02/93→10/99							
 Bremsbelagsatz, Scheibenbremse							
1.9 TDI	81	03/97→06/99	←	→ 05/99; +PR 1LM	13.0460-7072.2	607072	VW 21866 19,7 - WE / - WK
			←	→ 05/99; +PR 1LG	13.0460-7101.2	607101	VW 21866 15,3 - WE / - WK
			→	6K-X-290000→; → 05/99; +PR 1KE,1KK,1KQ	13.0460-2894.2	602894	TRW 20961 17,2 - WK + Zub
			→	→ 6K-X-289999	13.0470-2894.2	LD2894	TRW 20961 17,2 - WK + Zub Ceramic
2.0 i	85	02/93→06/99	←	01/97→ 05/99; +PR 1LY,1ZK	13.0460-2821.2	602821	TRW 21945 16,0 - WK
			←	11/93→ 12/96	13.0460-2821.2	602821	TRW 21945 16,0 - WK
			←	01/97→ 05/99; +PR 1LV,1LW,1LD	13.0460-2958.2	602958	TRW 20168 19,3 - WK
			←	01/97→ 05/99; +PR 1LA	13.0460-7059.2	607059	VW 20887 17,3 - WE / - WK + Zub
			←	01/97→ 05/99; +PR 1LM	13.0460-7072.2	607072	VW 21866 19,7 - WE / - WK
			←	01/97→ 05/99; +PR 1LG	13.0460-7101.2	607101	VW 21866 15,3 - WE / - WK
			→	6K-X-290000→; → 05/99; +PR 1KE,1KK,1KQ	13.0460-2894.2	602894	TRW 20961 17,2 - WK + Zub
			→	11/93→; → 6K-X-289999	13.0470-2894.2	LD2894	TRW 20961 17,2 - WK + Zub Ceramic
2.0 i 16V	110	08/96→06/99	←	→ 05/99	13.0460-2937.2	602937	TRW 20961 15,2 - WK + Zub
			→	6K-X-290000→; → 05/99; +PR 1KE,1KK,1KQ	13.0460-2958.2	602958	TRW 20168 19,3 - WK
			→	→ 6K-X-289999	13.0460-2894.2	602894	TRW 20961 17,2 - WK + Zub Ceramic
→	→ 6K-X-289999	13.0470-2894.2	LD2894	TRW 20961 17,2 - WK + Zub Ceramic			
→	→ 6K-X-289999	13.0460-2984.2	602984	TRW 20961 17,2 - WK + Zub			
Zubehörsatz, Scheibenbremsbelag							
1.8 i 16V	95	10/93→08/96	→	02/94→; → 6K-X-289999	13.0460-0419.2	610419	TRW
1.9 TDI	81	03/97→06/99	→	→ 6K-X-289999	13.0460-0419.2	610419	TRW
2.0 i	85	02/93→06/99	→	11/93→; → 6K-X-289999	13.0460-0419.2	610419	TRW
2.0 i 16V	110	08/96→06/99	→	→ 6K-X-289999	13.0460-0072.2	610072	TRW
 Bremsscheibe							
1.0 i	37	09/96→06/99	←	06/99→	24.0120-0123.1	420123	Ø 239 20 18 V + S
1.4	40	12/97→04/99	←	+PR 1LA	24.0320-0123.1	520123	Ø 239 20 18 V + S PD
			←	+PR 1LM	24.0110-0151.1	410151	Ø 239 10 8 + S
			←	+PR 1LG	24.0310-0151.1	510151	Ø 239 10 8 + S PD
			←	+PR 1LM	24.0112-0106.1	412106	Ø 239 12 10 + S
			←	+PR 1LG	24.0312-0106.1	512106	Ø 239 12 10 + S PD
			←	+PR 1LY,1ZK	24.0120-0123.1	420123	Ø 239 20 18 V + S
1.4 i 1.4 i 16V	44 74	06/94→06/99 09/96→06/99	←	01/97→ 05/99; +PR 1LA	24.0320-0123.1	520123	Ø 239 20 18 V + S PD
			←	→ 12/96; - ABS	24.0110-0151.1	410151	Ø 239 10 8 + S
			←	01/97→ 05/99; +PR 1LM	24.0310-0151.1	510151	Ø 239 10 8 + S PD
			←	→ 12/96; + ABS	24.0112-0106.1	412106	Ø 239 12 10 + S
			←	01/97→ 05/99; +PR 1LM	24.0312-0106.1	512106	Ø 239 12 10 + S PD
			←	→ 12/96; + ABS	24.0112-0106.1	412106	Ø 239 12 10 + S
			←	01/97→ 05/99; +PR 1LG	24.0120-0123.1	420123	Ø 239 20 18 V + S
			←	01/97→ 05/99; +PR 1LG	24.0312-0106.1	512106	Ø 239 12 10 + S PD
			←	01/97→ 05/99; +PR 1LM	24.0320-0123.1	520123	Ø 239 20 18 V + S PD
			←	01/97→ 05/99; +PR 1LY,1ZK	24.0120-0128.1	420128	Ø 256 20 18 V + S
1.6 i 1.8 i	55 66	02/93→06/99 02/93→06/99	←	01/97→ 05/99; +PR 1LA	24.0320-0128.1	520128	Ø 256 20 18 V + S PD
			←	01/97→ 05/99; +PR 1LV,1LW,1LD	24.0122-0101.1	422101	Ø 280 22 20 V
			←	01/97→ 05/99; +PR 1LA	24.0110-0151.1	410151	Ø 239 10 8 + S
			←	11/93→ 12/96	24.0310-0151.1	510151	Ø 239 10 8 + S PD
←	01/97→ 05/99; +PR 1LA	24.0112-0106.1	412106	Ø 239 12 10 + S			
←	01/97→ 05/99; +PR 1LA	24.0120-0123.1	420123	Ø 239 20 18 V + S			
←	01/97→ 05/99; +PR 1LA	24.0312-0106.1	512106	Ø 239 12 10 + S PD			
←	01/97→ 05/99; +PR 1LA	24.0120-0123.1	420123	Ø 239 20 18 V + S			









	kw			 	! #		
SEAT - CORDOBA (6K1, 6K2) 02/93→10/99							
Bremsscheibe							
1.6 i 1.8 i	55 66	02/93→06/99 02/93→06/99	←	11/93→ 12/96		24.0312-0106.1 512106 24.0320-0123.1 520123	Ø 239 12 10 + S PD Ø 239 20 18 V + S PD
			←	01/97→ 05/99; +PR 1LM		24.0112-0106.1 412106 24.0312-0106.1 512106	Ø 239 12 10 + S Ø 239 12 10 + S PD
			←	01/97→ 05/99; +PR 1LG		24.0120-0123.1 420123 24.0320-0123.1 520123	Ø 239 20 18 V + S Ø 239 20 18 V + S PD
			←	01/97→ 05/99; +PR 1LY,1ZK		24.0120-0128.1 420128 24.0320-0128.1 520128	Ø 256 20 18 V + S Ø 256 20 18 V + S PD
			←	01/97→ 05/99; +PR 1LV,1LW,1LD		24.0122-0101.1 422101	Ø 280 22 20 V
1.6 i	55	05/94→06/99	←	→ 05/99; +PR 1LA		24.0110-0151.1 410151 24.0310-0151.1 510151	Ø 239 10 8 + S Ø 239 10 8 + S PD
			←	→ 05/99; +PR 1LM		24.0112-0106.1 412106 24.0312-0106.1 512106	Ø 239 12 10 + S Ø 239 12 10 + S PD
			←	→ 05/99; +PR 1LG		24.0120-0123.1 420123 24.0320-0123.1 520123	Ø 239 20 18 V + S Ø 239 20 18 V + S PD
			←	→ 05/99; +PR 1LY,1ZK		24.0120-0128.1 420128 24.0320-0128.1 520128	Ø 256 20 18 V + S Ø 256 20 18 V + S PD
			←	→ 05/99; +PR 1LV,1LW,1LD		24.0122-0101.1 422101	Ø 280 22 20 V
1.6 i 1.9 SDI	74 47	07/96→10/99 08/96→06/99	←	01/97→ 05/99; +PR 1LA		24.0110-0151.1 410151 24.0310-0151.1 510151	Ø 239 10 8 + S Ø 239 10 8 + S PD
			←	01/97→ 05/99; +PR 1LM		24.0112-0106.1 412106 24.0312-0106.1 512106	Ø 239 12 10 + S Ø 239 12 10 + S PD
			←	→ 12/96		24.0112-0106.1 412106 24.0120-0123.1 420123 24.0312-0106.1 512106 24.0320-0123.1 520123	Ø 239 12 10 + S Ø 239 20 18 V + S Ø 239 12 10 + S PD Ø 239 20 18 V + S PD
			←	01/97→ 05/99; +PR 1LG		24.0120-0123.1 420123 24.0320-0123.1 520123	Ø 239 20 18 V + S Ø 239 20 18 V + S PD
			←	01/97→ 05/99; +PR 1LY,1ZK		24.0120-0128.1 420128 24.0320-0128.1 520128	Ø 256 20 18 V + S Ø 256 20 18 V + S PD
			←	01/97→ 05/99; +PR 1LV,1LW,1LD		24.0122-0101.1 422101	Ø 280 22 20 V
1.8 i 16V	95	10/93→08/96	←	02/94→		24.0120-0128.1 420128 24.0320-0128.1 520128	Ø 256 20 18 V + S Ø 256 20 18 V + S PD
			→	6K-X-290000→; +PR 1KE,1KK,1KQ		24.0109-0124.1 409124	Ø 232 9 7
			→	02/94→; → 6K-X-289999		24.0110-0111.1 410111 24.0110-0275.2 410275	Ø 226 10 8 - ABS Ring / - RLG Ø 226 10 8 + ABS Ring / - RLG
1.9 D	47	01/96→08/96	←			24.0112-0106.1 412106 24.0120-0123.1 420123 24.0312-0106.1 512106 24.0320-0123.1 520123	Ø 239 12 10 + S Ø 239 20 18 V + S Ø 239 12 10 + S PD Ø 239 20 18 V + S PD
1.9 D 1.9 TD	50 55	02/93→08/96 02/93→08/96	←	11/93→		24.0112-0106.1 412106 24.0120-0123.1 420123 24.0312-0106.1 512106 24.0320-0123.1 520123	Ø 239 12 10 + S Ø 239 20 18 V + S Ø 239 12 10 + S PD Ø 239 20 18 V + S PD
1.9 TDI	66	08/96→06/99	←	01/97→ 05/99; +PR 1LA		24.0110-0151.1 410151 24.0310-0151.1 510151	Ø 239 10 8 + S Ø 239 10 8 + S PD
			←	01/97→ 05/99; +PR 1LM		24.0112-0106.1 412106 24.0312-0106.1 512106	Ø 239 12 10 + S Ø 239 12 10 + S PD
			←	01/97→ 05/99; +PR 1LG		24.0120-0123.1 420123 24.0320-0123.1 520123	Ø 239 20 18 V + S Ø 239 20 18 V + S PD
			←	01/97→ 05/99; +PR 1LY,1ZK		24.0120-0128.1 420128 24.0320-0128.1 520128	Ø 256 20 18 V + S Ø 256 20 18 V + S PD
			←	01/97→ 05/99; +PR 1LV,1LW,1LD		24.0122-0101.1 422101	Ø 280 22 20 V
1.9 TDI	81	03/97→06/99	←	→ 05/99; +PR 1LA		24.0110-0151.1 410151 24.0310-0151.1 510151	Ø 239 10 8 + S Ø 239 10 8 + S PD
			←	→ 05/99; +PR 1LM		24.0112-0106.1 412106 24.0312-0106.1 512106	Ø 239 12 10 + S Ø 239 12 10 + S PD
			←	→ 05/99; +PR 1LG		24.0120-0123.1 420123 24.0320-0123.1 520123	Ø 239 20 18 V + S Ø 239 20 18 V + S PD
			←	→ 05/99; +PR 1LY,1ZK		24.0120-0128.1 420128	Ø 256 20 18 V + S









	kw					! #				
SEAT - CORDOBA (6K1, 6K2) 02/93→10/99										
 Bremsscheibe										
1.9 TDI	81	03/97→06/99	←	→ 05/99; +PR 1LY,1ZK	24.0320-0128.1	520128	∅ 256 20 18 V + S PD			
			←	→ 05/99; +PR 1LV,1LW,1LD	24.0122-0101.1	422101	∅ 280 22 20 V			
			→	6K-X-290000→; → 05/99; +PR 1KE,1KK,1KQ	24.0109-0124.1	409124	∅ 232 9 7			
			→	→ 6K-X-289999	24.0110-0111.1	410111	∅ 226 10 8 - ABS Ring / - RLG			
					24.0110-0275.2	410275	∅ 226 10 8 + ABS Ring / - RLG			
2.0 i	85	02/93→06/99	←	01/97→ 05/99; +PR 1LA	24.0110-0151.1	410151	∅ 239 10 8 + S			
					24.0310-0151.1	510151	∅ 239 10 8 + S PD			
			←	01/97→ 05/99; +PR 1LM	24.0112-0106.1	412106	∅ 239 12 10 + S			
					24.0312-0106.1	512106	∅ 239 12 10 + S PD			
			←	01/97→ 05/99; +PR 1LG	24.0120-0123.1	420123	∅ 239 20 18 V + S			
					24.0320-0123.1	520123	∅ 239 20 18 V + S PD			
			←	01/97→ 05/99; +PR 1LY,1ZK	24.0120-0128.1	420128	∅ 256 20 18 V + S			
					24.0320-0128.1	520128	∅ 256 20 18 V + S PD			
			←	11/93→ 12/96	24.0120-0128.1	420128	∅ 256 20 18 V + S			
		24.0320-0128.1	520128	∅ 256 20 18 V + S PD						
2.0 i	85	02/93→06/99	←	01/97→ 05/99; +PR 1LV,1LW,1LD	24.0122-0101.1	422101	∅ 280 22 20 V			
			→	6K-X-290000→; → 05/99; +PR 1KE,1KK,1KQ	24.0109-0124.1	409124	∅ 232 9 7			
			→	11/93→; → 6K-X-289999	24.0110-0111.1	410111	∅ 226 10 8 - ABS Ring / - RLG			
					24.0110-0275.2	410275	∅ 226 10 8 + ABS Ring / - RLG			
			2.0 i 16V	110	08/96→06/99	←	→ 05/99	24.0122-0101.1	422101	∅ 280 22 20 V
						→	6K-X-290000→; → 05/99; +PR 1KE,1KK,1KQ	24.0109-0124.1	409124	∅ 232 9 7
						→	→ 6K-X-289999	24.0110-0111.1	410111	∅ 226 10 8 - ABS Ring / - RLG
							24.0110-0275.2	410275	∅ 226 10 8 + ABS Ring / - RLG	
			SEAT - CORDOBA (6K2) 06/99→10/02							
 Bremselagsatz, Scheibenbremse										
1.0	37	06/99→10/02	←	→ 09/02	13.0460-7101.2	607101	VW 21866 15,3 - WE / - WK			
1.4	44	06/99→10/02								
1.4 16V	55	05/00→10/02								
1.4 16V	74	02/00→10/02								
1.6	55	06/99→10/02								
1.9 SDI	50	06/99→10/02								
1.6	74	06/99→10/02	←	→ 09/02	13.0460-2821.2	602821	TRW 21945 16,0 - WK			
1.9 TDI	66	06/99→10/02								
1.8 T 20V Cupra	115	07/00→10/02	←	→ 09/02	13.0460-2958.2	602958	TRW 20168 19,3 - WK			
1.9 TDI	81	06/99→10/02	→	→ 09/02	13.0460-2894.2	602894	TRW 20961 17,2 - WK + Zub			
					13.0470-2894.2	LD2894	TRW 20961 17,2 - WK + Zub Ceramic			
Zubehörsatz, Scheibenbremsbelag										
1.8 T 20V Cupra	115	07/00→10/02	→	→ 09/02	13.0460-0072.2	610072	TRW			
1.9 TDI	81	06/99→10/02								
 Bremsscheibe										
1.0	37	06/99→10/02	←	→ 09/02	24.0120-0123.1	420123	∅ 239 20 18 V + S			
1.4	44	06/99→10/02								
1.4 16V	55	05/00→10/02								
1.4 16V	74	02/00→10/02								
1.6	55	06/99→10/02								
1.9 SDI	50	06/99→10/02								
1.6	74	06/99→10/02	←	→ 09/02	24.0120-0128.1	420128	∅ 256 20 18 V + S			
1.9 TDI	66	06/99→10/02								
					24.0320-0128.1	520128	∅ 256 20 18 V + S PD			
1.8 T 20V Cupra	115	07/00→10/02	←	→ 09/02	24.0122-0101.1	422101	∅ 280 22 20 V			
1.9 TDI	81	06/99→10/02	→	→ 09/02	24.0109-0124.1	409124	∅ 232 9 7			
SEAT - CORDOBA (6L2) 09/02→11/09										
 Bremselagsatz, Scheibenbremse										
1.2	47	10/02→06/06	←	+PR 1LN;1ZH	13.0460-2883.2	602883	TRW 23581 18,8 - WE / - WK			
1.4 TDI	55	10/02→12/05								
					13.0460-2884.2	602884	TRW 23581 18,8 + WK			
					13.0470-2884.2	LD2884	TRW 23581 18,8 + WK Ceramic			
			←	+PR 1LQ;1ZF	13.0460-7111.2	607111	VW 23130 19,6 - WE / - WK			
					13.0470-7111.2	LD7111	VW 23130 19,6 - WE / - WK Ceramic			
↓										







	kw			 	! #		
SEAT - CORDOBA (6L2) 09/02→11/09							
 Bremsbelagsatz, Scheibenbremse							
1.2 1.4 TDI	47 55	10/02→06/06 10/02→12/05	➡			13.0460-2864.2 602864 13.0460-2877.2 602877 13.0460-2894.2 602894 13.0470-2877.2 LD2877 13.0470-2894.2 LD2894	TRW 20961 17,2 - WK TRW 23554 17,2 + WK TRW 20961 17,2 - WK + Zub TRW 23554 17,2 + WK Ceramic TRW 20961 17,2 - WK + Zub Ceramic
1.2 12V 1.4 16V 1.4 16V 1.4 TDI 1.4 TDI 1.6 1.6 16V 1.9 TDI	51 63 74 51 59 74 77 96	05/06→11/09 05/06→11/09 10/02→11/09 05/05→11/09 06/05→11/09 04/03→11/09 11/06→11/09 10/02→11/09	←	→ 06/09; +PR 1LN;1ZH		13.0460-2883.2 602883 13.0460-2884.2 602884 13.0470-2884.2 LD2884	TRW 23581 18,8 - WE / - WK TRW 23581 18,8 + WK TRW 23581 18,8 + WK Ceramic
			←	→ 06/09; +PR 1LQ;1ZF		13.0460-7111.2 607111 13.0470-7111.2 LD7111	VW 23130 19,6 - WE / - WK VW 23130 19,6 - WE / - WK Ceramic
			➡	→ 06/09		13.0460-2864.2 602864 13.0460-2877.2 602877 13.0460-2894.2 602894 13.0470-2877.2 LD2877 13.0470-2894.2 LD2894	TRW 20961 17,2 - WK TRW 23554 17,2 + WK TRW 20961 17,2 - WK + Zub TRW 23554 17,2 + WK Ceramic TRW 20961 17,2 - WK + Zub Ceramic
1.4 16V	55	09/02→12/07	←	10/02→; +PR 1LN;1ZH		13.0460-2883.2 602883 13.0460-2884.2 602884 13.0470-2884.2 LD2884	TRW 23581 18,8 - WE / - WK TRW 23581 18,8 + WK TRW 23581 18,8 + WK Ceramic
			←	10/02→; +PR 1LQ;1ZF		13.0460-7111.2 607111 13.0470-7111.2 LD7111	VW 23130 19,6 - WE / - WK VW 23130 19,6 - WE / - WK Ceramic
			➡	10/02→		13.0460-2864.2 602864 13.0460-2877.2 602877 13.0460-2894.2 602894 13.0470-2877.2 LD2877 13.0470-2894.2 LD2894	TRW 20961 17,2 - WK TRW 23554 17,2 + WK TRW 20961 17,2 - WK + Zub TRW 23554 17,2 + WK Ceramic TRW 20961 17,2 - WK + Zub Ceramic
1.9 SDI 1.9 TDI	47 74	09/02→11/09 09/02→11/09	←	10/02→ 06/09; +PR 1LN;1ZH		13.0460-2883.2 602883 13.0460-2884.2 602884 13.0470-2884.2 LD2884	TRW 23581 18,8 - WE / - WK TRW 23581 18,8 + WK TRW 23581 18,8 + WK Ceramic
			←	10/02→ 06/09; +PR 1LQ;1ZF		13.0460-7111.2 607111 13.0470-7111.2 LD7111	VW 23130 19,6 - WE / - WK VW 23130 19,6 - WE / - WK Ceramic
			➡	10/02→ 06/09		13.0460-2864.2 602864 13.0460-2877.2 602877 13.0460-2894.2 602894 13.0470-2877.2 LD2877 13.0470-2894.2 LD2894	TRW 20961 17,2 - WK TRW 23554 17,2 + WK TRW 20961 17,2 - WK + Zub TRW 23554 17,2 + WK Ceramic TRW 20961 17,2 - WK + Zub Ceramic
2.0	85	09/02→11/09	←	10/02→ 06/09; +PR 1LN,1ZH		13.0460-2883.2 602883 13.0460-2884.2 602884 13.0470-2884.2 LD2884	TRW 23581 18,8 - WE / - WK TRW 23581 18,8 + WK TRW 23581 18,8 + WK Ceramic
			←	10/02→ 06/09; +PR 1LQ,1ZF		13.0460-7111.2 607111 13.0470-7111.2 LD7111	VW 23130 19,6 - WE / - WK VW 23130 19,6 - WE / - WK Ceramic
			➡	10/02→ 06/09		13.0460-2864.2 602864 13.0460-2877.2 602877 13.0460-2894.2 602894 13.0470-2877.2 LD2877 13.0470-2894.2 LD2894	TRW 20961 17,2 - WK TRW 23554 17,2 + WK TRW 20961 17,2 - WK + Zub TRW 23554 17,2 + WK Ceramic TRW 20961 17,2 - WK + Zub Ceramic
Zubehörsatz, Scheibenbremsbelag							
1.2 1.4 TDI	47 55	10/02→06/06 10/02→12/05	➡			13.0460-0072.2 610072	TRW
1.2 12V 1.4 16V 1.4 16V 1.4 TDI 1.4 TDI 1.6 1.6 16V 1.9 TDI	51 63 74 51 59 74 77 96	05/06→11/09 05/06→11/09 10/02→11/09 05/05→11/09 06/05→11/09 04/03→11/09 11/06→11/09 10/02→11/09	➡	→ 06/09		13.0460-0072.2 610072	TRW
1.4 16V	55	09/02→12/07	➡	10/02→		13.0460-0072.2 610072	TRW
↓							









	kW			 	! #		
SEAT - CORDOBA (6L2) 09/02→11/09							
Zubehörsatz, Scheibenbremsbelag							
1.9 SDI 1.9 TDI 2.0	47 74 85	09/02→11/09 09/02→11/09 09/02→11/09	➡	10/02→ 06/09		13.0460-0072.2 610072	TRW
 Bremsscheibe							
1.2 1.4 TDI	47 55	10/02→06/06 10/02→12/05	←	+PR 1LQ;1ZF		24.0122-0151.1 422151 24.0322-0151.1 522151	Ø 256 22 19 V + S Ø 256 22 19 V + S PD
			←	+PR 1LN;1ZH		24.0125-0113.1 425113 24.0325-0113.1 525113	Ø 288 25 22 V + S Ø 288 25 22 V + S PD
			➡			24.0109-0123.1 409123 24.0309-0123.1 509123	Ø 230 9 7 + S Ø 230 9 7 + S PD
1.2 12V 1.4 16V 1.4 16V 1.4 TDI 1.4 TDI 1.6 1.6 16V 1.9 TDI	51 63 74 51 59 74 77 96	05/06→11/09 05/06→11/09 10/02→11/09 05/05→11/09 06/05→11/09 04/03→11/09 11/06→11/09 10/02→11/09	←	→ 06/09; +PR 1LQ;1ZF		24.0122-0151.1 422151 24.0322-0151.1 522151	Ø 256 22 19 V + S Ø 256 22 19 V + S PD
			←	→ 06/09; +PR 1LN;1ZH		24.0125-0113.1 425113 24.0325-0113.1 525113	Ø 288 25 22 V + S Ø 288 25 22 V + S PD
			➡	→ 06/09		24.0109-0123.1 409123 24.0309-0123.1 509123	Ø 230 9 7 + S Ø 230 9 7 + S PD
1.4 16V	55	09/02→12/07	←	10/02→; +PR 1LQ;1ZF		24.0122-0151.1 422151 24.0322-0151.1 522151	Ø 256 22 19 V + S Ø 256 22 19 V + S PD
			←	10/02→; +PR 1LN;1ZH		24.0125-0113.1 425113 24.0325-0113.1 525113	Ø 288 25 22 V + S Ø 288 25 22 V + S PD
			➡	10/02→		24.0109-0123.1 409123 24.0309-0123.1 509123	Ø 230 9 7 + S Ø 230 9 7 + S PD
1.9 SDI 1.9 TDI	47 74	09/02→11/09 09/02→11/09	←	10/02→ 06/09; +PR 1LQ;1ZF		24.0122-0151.1 422151 24.0322-0151.1 522151	Ø 256 22 19 V + S Ø 256 22 19 V + S PD
			←	10/02→ 06/09; +PR 1LN;1ZH		24.0125-0113.1 425113 24.0325-0113.1 525113	Ø 288 25 22 V + S Ø 288 25 22 V + S PD
			➡	10/02→ 06/09		24.0109-0123.1 409123 24.0309-0123.1 509123	Ø 230 9 7 + S Ø 230 9 7 + S PD
2.0	85	09/02→11/09	←	10/02→ 06/09; +PR 1LQ;1ZF		24.0122-0151.1 422151 24.0322-0151.1 522151	Ø 256 22 19 V + S Ø 256 22 19 V + S PD
			←	10/02→ 06/09; +PR 1LN;1ZH		24.0125-0113.1 425113 24.0325-0113.1 525113	Ø 288 25 22 V + S Ø 288 25 22 V + S PD
			➡	10/02→ 06/09		24.0109-0123.1 409123 24.0309-0123.1 509123	Ø 230 9 7 + S Ø 230 9 7 + S PD
SEAT - CORDOBA Vario (6K5) 08/96→06/99							
 Bremsbelagsatz, Scheibenbremse							
1.4 i	44	09/96→06/99	←	01/97→ 05/99; +PR 1LY,1ZK		13.0460-2821.2 602821	TRW 21945 16,0 - WK
			←	01/97→ 05/99; +PR 1LV,1LW,1LD		13.0460-2958.2 602958	TRW 20168 19,3 - WK
			←	→ 6K-TR09920; - ABS		13.0460-7030.2 607030	VW 20889 17,3 - WE / - WK + Zub
			←	→ 6K-TR046558; + ABS		13.0460-7032.2 20887	VW 20887 19,7 - WE / - WK + Zub
			←	01/97→ 05/99; +PR 1LA		13.0460-7059.2 607059	VW 20887 17,3 - WE / - WK + Zub
			←	6K-TR09921→; → 12/96; - ABS		13.0460-7059.2 607059	VW 20887 17,3 - WE / - WK + Zub
			←	01/97→ 05/99; +PR 1LM		13.0460-7072.2 607072	VW 21866 19,7 - WE / - WK
			←	6K-TR046559→; → 12/96; + ABS		13.0460-7072.2 607072	VW 21866 19,7 - WE / - WK
			←	01/97→ 05/99; +PR 1LG		13.0460-7101.2 607101	VW 21866 15,3 - WE / - WK
1.6 i 1.6 i	55 74	09/96→06/99 09/96→06/99	←	01/97→ 05/99; +PR 1LY,1ZK		13.0460-2821.2 602821	TRW 21945 16,0 - WK
			←	01/97→ 05/99; +PR 1LV,1LW,1LD		13.0460-2958.2 602958	TRW 20168 19,3 - WK
			←	→ 6K-TR046558		13.0460-7032.2 20887	VW 20887 19,7 - WE / - WK + Zub
			←	→ 12/96; V		13.0460-7033.2 20887	VW 20887 15,3 - WE / - WK
			←	01/97→ 05/99; +PR 1LA		13.0460-7059.2 607059	VW 20887 17,3 - WE / - WK + Zub
			←	01/97→ 05/99; +PR 1LM		13.0460-7072.2 607072	VW 21866 19,7 - WE / - WK
			←	6K-TR046559→; → 12/96		13.0460-7072.2 607072	VW 21866 19,7 - WE / - WK
			←	01/97→ 05/99; +PR 1LG		13.0460-7101.2 607101	VW 21866 15,3 - WE / - WK
1.6 i ↓	55	05/97→06/99	←	→ 05/99; +PR 1LY,1ZK		13.0460-2821.2 602821	TRW 21945 16,0 - WK









	kw			 	! #		
SEAT - CORDOBA Vario (6K5) 08/96→06/99							
 Bremsscheibe							
1.6 i	55	09/96→06/99	←	01/97→ 05/99; +PR 1LG		24.0320-0123.1 520123	Ø 239 20 18 V + S PD
1.6 i	74	09/96→06/99	←	01/97→ 05/99; +PR 1LY,1ZK		24.0120-0128.1 420128	Ø 256 20 18 V + S
1.9 SDI	47	09/96→06/99				24.0320-0128.1 520128	Ø 256 20 18 V + S PD
			←	01/97→ 05/99; +PR 1LV,1LW,1LD		24.0122-0101.1 422101	Ø 280 22 20 V
1.6 i	55	05/97→06/99	←	→ 05/99; +PR 1LA		24.0110-0151.1 410151	Ø 239 10 8 + S
						24.0310-0151.1 510151	Ø 239 10 8 + S PD
			←	→ 05/99; +PR 1LM		24.0112-0106.1 412106	Ø 239 12 10 + S
						24.0312-0106.1 512106	Ø 239 12 10 + S PD
			←	→ 05/99; +PR 1LG		24.0120-0123.1 420123	Ø 239 20 18 V + S
						24.0320-0123.1 520123	Ø 239 20 18 V + S PD
			←	→ 05/99; +PR 1LY,1ZK		24.0120-0128.1 420128	Ø 256 20 18 V + S
						24.0320-0128.1 520128	Ø 256 20 18 V + S PD
			←	→ 05/99; +PR 1LV,1LW,1LD		24.0122-0101.1 422101	Ø 280 22 20 V
1.9 TDI	66	08/96→06/99	←	01/97→ 05/99; +PR 1LA		24.0110-0151.1 410151	Ø 239 10 8 + S
						24.0310-0151.1 510151	Ø 239 10 8 + S PD
			←	01/97→ 05/99; +PR 1LM		24.0112-0106.1 412106	Ø 239 12 10 + S
						24.0312-0106.1 512106	Ø 239 12 10 + S PD
			←	01/97→ 05/99; +PR 1LG		24.0120-0123.1 420123	Ø 239 20 18 V + S
						24.0320-0123.1 520123	Ø 239 20 18 V + S PD
			←	01/97→ 05/99; +PR 1LY,1ZK		24.0120-0128.1 420128	Ø 256 20 18 V + S
						24.0320-0128.1 520128	Ø 256 20 18 V + S PD
			←	01/97→ 05/99; +PR 1LV,1LW,1LD		24.0122-0101.1 422101	Ø 280 22 20 V
1.9 TDI	81	07/97→06/99	←	→ 05/99; +PR 1LA		24.0110-0151.1 410151	Ø 239 10 8 + S
						24.0310-0151.1 510151	Ø 239 10 8 + S PD
			←	→ 05/99; +PR 1LM		24.0112-0106.1 412106	Ø 239 12 10 + S
						24.0312-0106.1 512106	Ø 239 12 10 + S PD
			←	→ 05/99; +PR 1LG		24.0120-0123.1 420123	Ø 239 20 18 V + S
						24.0320-0123.1 520123	Ø 239 20 18 V + S PD
			←	→ 05/99; +PR 1LY,1ZK		24.0120-0128.1 420128	Ø 256 20 18 V + S
						24.0320-0128.1 520128	Ø 256 20 18 V + S PD
			←	→ 05/99; +PR 1LV,1LW,1LD		24.0122-0101.1 422101	Ø 280 22 20 V
			→	6K-X-290000→; → 05/99; +PR 1KE,1KK,1KQ		24.0109-0124.1 409124	Ø 232 9 7
			→	→ 6K-X-289999		24.0110-0111.1 410111	Ø 226 10 8 - ABS Ring / - RLG
						24.0110-0275.2 410275	Ø 226 10 8 + ABS Ring / - RLG
SEAT - CORDOBA Vario (6K5) 06/99→12/02							
 Bremsbelagsatz, Scheibenbremse							
1.4	44	06/99→12/02	←	→ 09/02		13.0460-7101.2 607101	VW 21866 15,3 - WE / - WK
1.4 16V	55	06/99→12/02					
1.6	55	06/99→12/02					
1.9 SDI	50	06/99→12/02					
1.6	74	06/99→12/02	←	→ 09/02		13.0460-2821.2 602821	TRW 21945 16,0 - WK
1.9 TDI	66	06/99→12/02					
1.9 TDI	81	06/99→12/02	←	→ 09/02		13.0460-2958.2 602958	TRW 20168 19,3 - WK
			→	→ 09/02		13.0460-2894.2 602894	TRW 20961 17,2 - WK + Zub
						13.0470-2894.2 LD2894	TRW 20961 17,2 - WK + Zub Ceramic
Zubehörsatz, Scheibenbremsbelag							
1.9 TDI	81	06/99→12/02	→	→ 09/02		13.0460-0072.2 610072	TRW
 Bremsscheibe							
1.4	44	06/99→12/02	←	→ 09/02		24.0120-0123.1 420123	Ø 239 20 18 V + S
1.4 16V	55	06/99→12/02				24.0320-0123.1 520123	Ø 239 20 18 V + S PD
1.6	55	06/99→12/02					
1.9 SDI	50	06/99→12/02					
1.6	74	06/99→12/02	←	→ 09/02		24.0120-0128.1 420128	Ø 256 20 18 V + S
1.9 TDI	66	06/99→12/02				24.0320-0128.1 520128	Ø 256 20 18 V + S PD
1.9 TDI	81	06/99→12/02	←	→ 09/02		24.0122-0101.1 422101	Ø 280 22 20 V
			→	→ 09/02		24.0109-0124.1 409124	Ø 232 9 7







	kw			 	! #		
SEAT - EXEO (3R2) 12/08→							
 Bremsbelagsatz, Scheibenbremse							
1.6 1.8 T	75 110	03/09→09/10 12/08→05/10	←	04/09→; +PR 1LZ	13.0460-2837.2	602837	TRW 21945 19,6 + WK
					13.0470-2837.2	LD2837	TRW 21945 19,6 + WK Ceramic
			←	04/09→; +PR 1LB,1LT	13.0460-7110.2	607110	ATE 20676 19,8 + WK
					13.0470-7110.2	LD7110	ATE 20676 19,8 + WK Ceramic
			←	04/09→; +PR 1LA	13.0460-7201.2	607201	ATE 23763 20,3 + WK
					13.0470-7201.2	LD7201	ATE 23763 20,3 + WK Ceramic
			→	04/09→; +PR 1KW	13.0460-2749.2	602749	TRW 24483 16,9 - WE / - WK + Zub
					13.0460-2880.2	602880	TRW 23914 17,1 + WE / - WK + Zub
					13.0470-2749.2	LD2749	TRW 24483 16,9 - WE / - WK + Zub Ceramic
					13.0470-2880.2	LD2880	TRW 23914 17,1 + WE / - WK + Zub Ceramic
			→	04/09→; +PR 1KD,1KP	13.0460-2886.2	602886	TRW 20961 16,0 - WK
					13.0470-2886.2	LD2886	TRW 20961 16,0 - WK Ceramic
1.8 TSI 1.8 TSI 2.0 TFSI	88 118 155	09/10→ 05/10→ 05/10→	←	→ 06/13; +PR 1LZ	13.0460-2837.2	602837	TRW 21945 19,6 + WK
					13.0470-2837.2	LD2837	TRW 21945 19,6 + WK Ceramic
			←	→ 06/13; +PR 1LB,1LT	13.0460-7110.2	607110	ATE 20676 19,8 + WK
					13.0470-7110.2	LD7110	ATE 20676 19,8 + WK Ceramic
			←	→ 06/13; +PR 1LA	13.0460-7201.2	607201	ATE 23763 20,3 + WK
					13.0470-7201.2	LD7201	ATE 23763 20,3 + WK Ceramic
			→	→ 06/13; +PR 1KW	13.0460-2749.2	602749	TRW 24483 16,9 - WE / - WK + Zub
					13.0460-2880.2	602880	TRW 23914 17,1 + WE / - WK + Zub
					13.0470-2749.2	LD2749	TRW 24483 16,9 - WE / - WK + Zub Ceramic
					13.0470-2880.2	LD2880	TRW 23914 17,1 + WE / - WK + Zub Ceramic
			→	→ 06/13; +PR 1KD,1KP	13.0460-2886.2	602886	TRW 20961 16,0 - WK
					13.0470-2886.2	LD2886	TRW 20961 16,0 - WK Ceramic
2.0 TDI 2.0 TDI 2.0 TDI 2.0 TFSI	88 105 125 147	12/08→ 12/08→ 02/09→ 03/09→	←	04/09→ 06/13; +PR 1LZ	13.0460-2837.2	602837	TRW 21945 19,6 + WK
					13.0470-2837.2	LD2837	TRW 21945 19,6 + WK Ceramic
			←	04/09→ 06/13; +PR 1LB,1LT	13.0460-7110.2	607110	ATE 20676 19,8 + WK
					13.0470-7110.2	LD7110	ATE 20676 19,8 + WK Ceramic
			←	04/09→ 06/13; +PR 1LA	13.0460-7201.2	607201	ATE 23763 20,3 + WK
					13.0470-7201.2	LD7201	ATE 23763 20,3 + WK Ceramic
			→	04/09→ 06/13; +PR 1KW	13.0460-2749.2	602749	TRW 24483 16,9 - WE / - WK + Zub
					13.0460-2880.2	602880	TRW 23914 17,1 + WE / - WK + Zub
					13.0470-2749.2	LD2749	TRW 24483 16,9 - WE / - WK + Zub Ceramic
					13.0470-2880.2	LD2880	TRW 23914 17,1 + WE / - WK + Zub Ceramic
			→	04/09→ 06/13; +PR 1KD,1KP	13.0460-2886.2	602886	TRW 20961 16,0 - WK
					13.0470-2886.2	LD2886	TRW 20961 16,0 - WK Ceramic
 Bremsscheibe							
1.6 1.8 T	75 110	03/09→09/10 12/08→05/10	←	04/09→; +PR 1LZ	24.0122-0152.1	422152	∅ 280 22 20 V + S
					24.0322-0152.1	522152	∅ 280 22 20 V PD
			←	04/09→; +PR 1LB	24.0125-0105.1	425105	∅ 288 25 23 V + S
					24.0325-0105.1	525105	∅ 288 25 23 V PD
			←	04/09→; +PR 1LT	24.0125-0137.1	425137	∅ 312 25 23 V + S
					24.0325-0137.1	525137	∅ 312 25 23 V PD
			←	04/09→; +PR 1LA	24.0130-0113.1	430113	∅ 320 30 28 V + S
					24.0330-0113.1	530113	∅ 320 30 28 V PD
			→	04/09→; +PR 1KD	24.0110-0261.1	410261	∅ 245 10 8 + S
					24.0310-0261.1	510261	∅ 245 10 8 PD
			→	04/09→; +PR 1KP	24.0112-0148.1	412148	∅ 255 12 10
					24.0312-0148.1	512148	∅ 255 12 10 PD
			→	04/09→; +PR 1KW	24.0112-0166.1	412166	∅ 288 12 10
					24.0312-0166.1	512166	∅ 288 12 10 PD
1.8 TSI ↓	88	09/10→	←	→ 06/13; +PR 1LZ	24.0122-0152.1	422152	∅ 280 22 20 V + S











	kw			 	! #		
SEAT - EXEO (3R2) 12/08→							
 Bremsscheibe							
1.8 TSI 2.0 TFSI	118	05/10→	←	→ 06/13; +PR 1LZ		24.0322-0152.1 522152	Ø 280 22 20 V PD
	155	05/10→	←	→ 06/13; +PR 1LB		24.0125-0105.1 425105	Ø 288 25 23 V + S
					24.0325-0105.1 525105	Ø 288 25 23 V PD	
			←	→ 06/13; +PR 1LT		24.0125-0137.1 425137	Ø 312 25 23 V + S
					24.0325-0137.1 525137	Ø 312 25 23 V PD	
			←	→ 06/13; +PR 1LA		24.0130-0113.1 430113	Ø 320 30 28 V + S
					24.0330-0113.1 530113	Ø 320 30 28 V PD	
			→	→ 06/13; +PR 1KD		24.0110-0261.1 410261	Ø 245 10 8 + S
		24.0310-0261.1 510261	Ø 245 10 8 PD				
2.0 TDI 2.0 TDI 2.0 TDI 2.0 TFSI	88	12/08→	←	04/09→ 06/13; +PR 1LZ		24.0122-0152.1 422152	Ø 280 22 20 V + S
	105	12/08→				24.0322-0152.1 522152	Ø 280 22 20 V PD
	125	02/09→	←	04/09→ 06/13; +PR 1LB		24.0125-0105.1 425105	Ø 288 25 23 V + S
	147	03/09→			24.0325-0105.1 525105	Ø 288 25 23 V PD	
			←	04/09→ 06/13; +PR 1LT		24.0125-0137.1 425137	Ø 312 25 23 V + S
					24.0325-0137.1 525137	Ø 312 25 23 V PD	
			←	04/09→ 06/13; +PR 1LA		24.0130-0113.1 430113	Ø 320 30 28 V + S
					24.0330-0113.1 530113	Ø 320 30 28 V PD	
→			04/09→ 06/13; +PR 1KD		24.0110-0261.1 410261	Ø 245 10 8 + S	
				24.0310-0261.1 510261	Ø 245 10 8 PD		
→	04/09→ 06/13; +PR 1KP		24.0112-0148.1 412148	Ø 255 12 10			
		24.0312-0148.1 512148	Ø 255 12 10 PD				
		→	04/09→ 06/13; +PR 1KW		24.0112-0166.1 412166	Ø 288 12 10	
				24.0312-0166.1 512166	Ø 288 12 10 PD		
SEAT - EXEO ST (3R5) 05/09→							
 Bremsbelagsatz, Scheibenbremse							
1.6 1.8 T	75	06/09→09/10	←	+PR 1LZ		13.0460-2837.2 602837	TRW 21945 19,6 + WK
	110	06/09→05/10				13.0470-2837.2 LD2837	TRW 21945 19,6 + WK Ceramic
			←	+PR 1LB,1LT		13.0460-7110.2 607110	ATE 20676 19,8 + WK
					13.0470-7110.2 LD7110	ATE 20676 19,8 + WK Ceramic	
			←	+PR 1LA		13.0460-7201.2 607201	ATE 23763 20,3 + WK
					13.0470-7201.2 LD7201	ATE 23763 20,3 + WK Ceramic	
→	+PR 1KW		13.0460-2749.2 602749	TRW 24483 16,9 - WE / - WK + Zub			
				13.0460-2880.2 602880	TRW 23914 17,1 + WE / - WK + Zub		
				13.0470-2749.2 LD2749	TRW 24483 16,9 - WE / - WK + Zub Ceramic		
				13.0470-2880.2 LD2880	TRW 23914 17,1 + WE / - WK + Zub Ceramic		
→	+PR 1KD,1KP		13.0460-2886.2 602886	TRW 20961 16,0 - WK			
			13.0470-2886.2 LD2886	TRW 20961 16,0 - WK Ceramic			
1.8 TSI 1.8 TSI 2.0 TDI 2.0 TDI 2.0 TFSI 2.0 TFSI	88	09/10→	←	→ 06/13; +PR 1LZ		13.0460-2837.2 602837	TRW 21945 19,6 + WK
	118	05/10→				13.0470-2837.2 LD2837	TRW 21945 19,6 + WK Ceramic
	88	07/09→					
	105	05/09→	←	→ 06/13; +PR 1LB,1LT		13.0460-7110.2 607110	ATE 20676 19,8 + WK
	125	05/09→				13.0470-7110.2 LD7110	ATE 20676 19,8 + WK Ceramic
	147	06/09→	←	→ 06/13; +PR 1LA		13.0460-7201.2 607201	ATE 23763 20,3 + WK
	155	05/10→			13.0470-7201.2 LD7201	ATE 23763 20,3 + WK Ceramic	
			→	→ 06/13; +PR 1KW		13.0460-2749.2 602749	TRW 24483 16,9 - WE / - WK + Zub
				13.0460-2880.2 602880	TRW 23914 17,1 + WE / - WK + Zub		
				13.0470-2749.2 LD2749	TRW 24483 16,9 - WE / - WK + Zub Ceramic		
				13.0470-2880.2 LD2880	TRW 23914 17,1 + WE / - WK + Zub Ceramic		
→	→ 06/13; +PR 1KD,1KP		13.0460-2886.2 602886	TRW 20961 16,0 - WK			
			13.0470-2886.2 LD2886	TRW 20961 16,0 - WK Ceramic			









	kw			 	! #		
SEAT - EXEO ST (3R5) 05/09→							
Bremsscheibe							
1.6 1.8 T	75 110	06/09→09/10 06/09→05/10	← +PR 1LZ	24.0122-0152.1 422152	∅ 280 22 20 V + S		
			← +PR 1LB	24.0125-0105.1 425105	∅ 280 22 20 V PD		
			← +PR 1LT	24.0125-0137.1 425137	∅ 288 25 23 V + S		
			← +PR 1LA	24.0130-0113.1 430113	∅ 288 25 23 V PD		
			→ +PR 1KD	24.0325-0105.1 525105	∅ 312 25 23 V + S		
			→ +PR 1KP	24.0325-0137.1 525137	∅ 312 25 23 V PD		
			→ +PR 1KW	24.0130-0113.1 430113	∅ 320 30 28 V + S		
			→ +PR 1KW	24.0330-0113.1 530113	∅ 320 30 28 V PD		
1.8 TSI 1.8 TSI 2.0 TDI 2.0 TDI 2.0 TFSI 2.0 TFSI	88 118 88 105 125 147 155	09/10→ 05/10→ 07/09→ 05/09→ 05/09→ 06/09→ 05/10→	← → 06/13; +PR 1LZ	24.0122-0152.1 422152	∅ 245 10 8 + S		
			← → 06/13; +PR 1LB	24.0322-0152.1 522152	∅ 245 10 8 PD		
			← → 06/13; +PR 1LT	24.0125-0105.1 425105	∅ 280 22 20 V + S		
			← → 06/13; +PR 1LA	24.0125-0105.1 425105	∅ 280 22 20 V PD		
			→ → 06/13; +PR 1KD	24.0125-0137.1 425137	∅ 288 25 23 V + S		
			→ → 06/13; +PR 1KP	24.0325-0105.1 525105	∅ 288 25 23 V PD		
			→ → 06/13; +PR 1KW	24.0125-0137.1 425137	∅ 312 25 23 V + S		
			→ → 06/13; +PR 1KW	24.0325-0137.1 525137	∅ 312 25 23 V PD		
			→ → 06/13; +PR 1KD	24.0130-0113.1 430113	∅ 320 30 28 V + S		
			→ → 06/13; +PR 1KP	24.0330-0113.1 530113	∅ 320 30 28 V PD		
			→ → 06/13; +PR 1KW	24.0110-0261.1 410261	∅ 245 10 8 + S		
			→ → 06/13; +PR 1KW	24.0310-0261.1 510261	∅ 245 10 8 PD		
SEAT - IBIZA II (6K1) 03/93→08/99							
Bremsbelagsatz, Scheibenbremse							
1.0	33	03/93→09/96	← - ABS	13.0460-7030.2 607030	VW 20889 17,3 - WE / - WK + Zub		
			← + ABS	13.0460-7032.2 20887	VW 20887 19,7 - WE / - WK + Zub		
			→ +PR 1KK	13.0460-2894.2 602894 13.0470-2894.2 LD2894	TRW 20961 17,2 - WK + Zub TRW 20961 17,2 - WK + Zub Ceramic		
1.0 i 1.3 i 1.4 i	37 40 44	09/96→08/99 03/93→08/99 09/93→08/99	← 01/97→ 07/99; +PR 1LY,1ZK	13.0460-2821.2 602821	TRW 21945 16,0 - WK		
			← 01/97→ 07/99; +PR 1LD,1LV,1LW	13.0460-2958.2 602958	TRW 20168 19,3 - WK		
			← → 12/96; - ABS	13.0460-7030.2 607030	VW 20889 17,3 - WE / - WK + Zub		
			← → 12/96; + ABS	13.0460-7032.2 20887	VW 20887 19,7 - WE / - WK + Zub		
			← 01/97→ 07/99; +PR 1LA	13.0460-7059.2 607059	VW 20887 17,3 - WE / - WK + Zub		
			← 01/97→ 07/99; +PR 1LM	13.0460-7072.2 607072	VW 21866 19,7 - WE / - WK		
			← 01/97→ 07/99; +PR 1LG	13.0460-7101.2 607101	VW 21866 15,3 - WE / - WK		
			→ → 07/99; +PR 1KK	13.0460-2894.2 602894 13.0470-2894.2 LD2894	TRW 20961 17,2 - WK + Zub TRW 20961 17,2 - WK + Zub Ceramic		
1.4	40	12/97→04/99	← +PR 1LY,1ZK	13.0460-2821.2 602821	TRW 21945 16,0 - WK		
			← +PR 1LD,1LV,1LW	13.0460-2958.2 602958	TRW 20168 19,3 - WK		
			← +PR 1LA	13.0460-7059.2 607059	VW 20887 17,3 - WE / - WK + Zub		
			← +PR 1LM	13.0460-7072.2 607072	VW 21866 19,7 - WE / - WK		
			← +PR 1LG	13.0460-7101.2 607101	VW 21866 15,3 - WE / - WK		
			→ +PR 1KK	13.0460-2894.2 602894 13.0470-2894.2 LD2894	TRW 20961 17,2 - WK + Zub TRW 20961 17,2 - WK + Zub Ceramic		
1.4 i 16V 1.9 SDI 1.9 TDI ↓	74 47 66	06/97→08/99 08/96→08/99 08/96→08/99	← → 07/99; +PR 1LY,1ZK	13.0460-2821.2 602821	TRW 21945 16,0 - WK		
			← → 07/99; +PR 1LD,1LV,1LW	13.0460-2958.2 602958	TRW 20168 19,3 - WK		







	kw			 	! #		
SEAT - IBIZA II (6K1) 03/93→08/99							
 Bremsbelagsatz, Scheibenbremse							
1.4 i 16V 1.9 SDI 1.9 TDI	74	06/97→08/99	←	→ 07/99; +PR 1LA		13.0460-7059.2 607059	VW 20887 17,3 - WE / - WK + Zub
	47	08/96→08/99	←	→ 07/99; +PR 1LM		13.0460-7072.2 607072	VW 21866 19,7 - WE / - WK
	66	08/96→08/99	←	→ 07/99; +PR 1LG		13.0460-7101.2 607101	VW 21866 15,3 - WE / - WK
			→	→ 07/99; +PR 1KK		13.0460-2894.2 602894 13.0470-2894.2 LD2894	TRW 20961 17,2 - WK + Zub TRW 20961 17,2 - WK + Zub Ceramic
1.6 i 1.6 i	55	03/93→08/99 04/96→08/99	←	01/97→ 07/99; +PR 1LY,1ZK		13.0460-2821.2 602821	TRW 21945 16,0 - WK
			←	→ 12/96		13.0460-2957.2 602957 13.0460-7032.2 20887	TRW 20168 16,0 - WK VW 20887 19,7 - WE / - WK + Zub
	74		←	01/97→ 07/99; +PR 1LD,1LV,1LW		13.0460-2958.2 602958	TRW 20168 19,3 - WK
			←	01/97→ 07/99; +PR 1LA		13.0460-7059.2 607059	VW 20887 17,3 - WE / - WK + Zub
			←	01/97→ 07/99; +PR 1LM		13.0460-7072.2 607072	VW 21866 19,7 - WE / - WK
			←	01/97→ 07/99; +PR 1LG		13.0460-7101.2 607101	VW 21866 15,3 - WE / - WK
			→	→ 07/99; +PR 1KK		13.0460-2894.2 602894 13.0470-2894.2 LD2894	TRW 20961 17,2 - WK + Zub TRW 20961 17,2 - WK + Zub Ceramic
			→	→ 07/99; +PR 1KK		13.0460-2894.2 602894 13.0470-2894.2 LD2894	TRW 20961 17,2 - WK + Zub TRW 20961 17,2 - WK + Zub Ceramic
1.6 i	55	09/94→06/99	←	01/97→; +PR 1LY,1ZK		13.0460-2821.2 602821	TRW 21945 16,0 - WK
			←	→ 12/96		13.0460-2957.2 602957 13.0460-7032.2 20887	TRW 20168 16,0 - WK VW 20887 19,7 - WE / - WK + Zub
			←	01/97→; +PR 1LD,1LV,1LW		13.0460-2958.2 602958	TRW 20168 19,3 - WK
			←	01/97→; +PR 1LA		13.0460-7059.2 607059	VW 20887 17,3 - WE / - WK + Zub
			←	01/97→; +PR 1LM		13.0460-7072.2 607072	VW 21866 19,7 - WE / - WK
			←	01/97→; +PR 1LG		13.0460-7101.2 607101	VW 21866 15,3 - WE / - WK
			→	+PR 1KK		13.0460-2894.2 602894 13.0470-2894.2 LD2894	TRW 20961 17,2 - WK + Zub TRW 20961 17,2 - WK + Zub Ceramic
			→	+PR 1KK		13.0460-2894.2 602894 13.0470-2894.2 LD2894	TRW 20961 17,2 - WK + Zub TRW 20961 17,2 - WK + Zub Ceramic
1.8 i	66	03/93→08/99	←	01/97→ 07/99; +PR 1LY,1ZK		13.0460-2821.2 602821	TRW 21945 16,0 - WK
			←	→ 12/96		13.0460-2957.2 602957	TRW 20168 16,0 - WK
			←	01/97→ 07/99; +PR 1LD,1LV,1LW		13.0460-2958.2 602958	TRW 20168 19,3 - WK
			←	→ 6K-ZR003620		13.0460-7032.2 20887	VW 20887 19,7 - WE / - WK + Zub
			←	6K-ZR003621→; → 12/96		13.0460-7033.2 20887 13.0460-7101.2 607101	VW 20887 15,3 - WE / - WK VW 21866 15,3 - WE / - WK
			←	01/97→ 07/99; +PR 1LA		13.0460-7059.2 607059	VW 20887 17,3 - WE / - WK + Zub
			←	01/97→ 07/99; +PR 1LM		13.0460-7072.2 607072	VW 21866 19,7 - WE / - WK
			←	01/97→ 07/99; +PR 1LG		13.0460-7101.2 607101	VW 21866 15,3 - WE / - WK
			→	→ 07/99; +PR 1KK		13.0460-2894.2 602894 13.0470-2894.2 LD2894	TRW 20961 17,2 - WK + Zub TRW 20961 17,2 - WK + Zub Ceramic
1.8 i 16V	95	11/93→08/96	←	02/94→		13.0460-2957.2 602957	TRW 20168 16,0 - WK
			→	02/94→; +PR 1KK		13.0460-2894.2 602894 13.0470-2894.2 LD2894	TRW 20961 17,2 - WK + Zub TRW 20961 17,2 - WK + Zub Ceramic
			→	02/94→		13.0460-2937.2 602937	TRW 20961 15,2 - WK + Zub
			←	→ 6K-ZR003611		13.0460-7032.2 20887	VW 20887 19,7 - WE / - WK + Zub
1.9 D 1.9 D	47 50	04/93→08/96 10/94→08/96	←	6K-ZR003612→		13.0460-7033.2 20887 13.0460-7101.2 607101	VW 20887 15,3 - WE / - WK VW 21866 15,3 - WE / - WK
			→	+PR 1KK		13.0460-2894.2 602894 13.0470-2894.2 LD2894	TRW 20961 17,2 - WK + Zub TRW 20961 17,2 - WK + Zub Ceramic
			←	→ 6K-ZR003513		13.0460-7032.2 20887	VW 20887 19,7 - WE / - WK + Zub
1.9 TD	55	03/93→08/96	←	6K-ZR003514→		13.0460-7033.2 20887 13.0460-7101.2 607101	VW 20887 15,3 - WE / - WK VW 21866 15,3 - WE / - WK
			→	+PR 1KK		13.0460-2894.2 602894	TRW 20961 17,2 - WK + Zub
			↓				

	kw			 	! #		
SEAT - IBIZA II (6K1) 03/93→08/99							
 Bremsbelagsatz, Scheibenbremse							
1.9 TD	55	03/93→08/96	➡	+PR 1KK		13.0470-2894.2 LD2894	TRW 20961 17,2 - WK + Zub Ceramic
1.9 TDI	81	02/97→08/99	←	03/97→ 07/99; +PR 1LY,1ZK		13.0460-2821.2 602821	TRW 21945 16,0 - WK
			←	03/97→ 07/99; +PR 1LD,1LV,1LW		13.0460-2958.2 602958	TRW 20168 19,3 - WK
			←	03/97→ 07/99; +PR 1LA		13.0460-7059.2 607059	VW 20887 17,3 - WE / - WK + Zub
			←	03/97→ 07/99; +PR 1LM		13.0460-7072.2 607072	VW 21866 19,7 - WE / - WK
			←	03/97→ 07/99; +PR 1LG		13.0460-7101.2 607101	VW 21866 15,3 - WE / - WK
			➡	03/97→ 07/99; +PR 1KK		13.0460-2894.2 602894	TRW 20961 17,2 - WK + Zub Ceramic
			➡	03/97→ 07/99		13.0460-2937.2 602937	TRW 20961 15,2 - WK + Zub
2.0 i	85	03/93→08/99	←	01/97→ 07/99; +PR 1LY,1ZK		13.0460-2821.2 602821	TRW 21945 16,0 - WK
			←	→ 12/96		13.0460-2957.2 602957	TRW 20168 16,0 - WK
			←	01/97→ 07/99; +PR 1LD,1LV,1LW		13.0460-2958.2 602958	TRW 20168 19,3 - WK
			←	01/97→ 07/99; +PR 1LA		13.0460-7059.2 607059	VW 20887 17,3 - WE / - WK + Zub
			←	01/97→ 07/99; +PR 1LM		13.0460-7072.2 607072	VW 21866 19,7 - WE / - WK
			←	01/97→ 07/99; +PR 1LG		13.0460-7101.2 607101	VW 21866 15,3 - WE / - WK
			➡	→ 07/99; +PR 1KK		13.0460-2894.2 602894	TRW 20961 17,2 - WK + Zub Ceramic
			➡	→ 07/99		13.0460-2937.2 602937	TRW 20961 15,2 - WK + Zub
2.0 i 16V	110	08/96→08/99	←	01/97→ 07/99; +PR 1LY,1ZK		13.0460-2821.2 602821	TRW 21945 16,0 - WK
			←	→ 12/96		13.0460-2957.2 602957	TRW 20168 16,0 - WK
			←	01/97→ 07/99; +PR 1LD,1LV,1LW		13.0460-2958.2 602958	TRW 20168 19,3 - WK
			←	01/97→ 07/99; +PR 1LA		13.0460-7059.2 607059	VW 20887 17,3 - WE / - WK + Zub
			←	01/97→ 07/99; +PR 1LM		13.0460-7072.2 607072	VW 21866 19,7 - WE / - WK
			←	01/97→ 07/99; +PR 1LG		13.0460-7101.2 607101	VW 21866 15,3 - WE / - WK
			➡	→ 07/99; +PR 1KK		13.0460-2894.2 602894	TRW 20961 17,2 - WK + Zub Ceramic
			➡	→ 07/99		13.0460-2984.2 602984	TRW 20961 17,2 - WK + Zub
Zubehörsatz, Scheibenbremsbelag							
1.8 i 16V	95	11/93→08/96	➡	02/94→		13.0460-0419.2 610419	TRW
1.9 TDI	81	02/97→08/99	➡	03/97→ 07/99		13.0460-0419.2 610419	TRW
2.0 i	85	03/93→08/99	➡	→ 07/99		13.0460-0419.2 610419	TRW
2.0 i 16V	110	08/96→08/99	➡	→ 07/99		13.0460-0072.2 610072	TRW
 Bremsscheibe							
1.0	33	03/93→09/96	←	+PR 1LA		24.0110-0151.1 410151	Ø 239 10 8 + S
1.9 D	47	04/93→08/96				24.0310-0151.1 510151	Ø 239 10 8 + S PD
1.9 D	50	10/94→08/96					
1.9 TD	55	03/93→08/96	←	+PR 1LG		24.0120-0123.1 420123	Ø 239 20 18 V + S
						24.0320-0123.1 520123	Ø 239 20 18 V + S PD
			➡	+PR 1KK		24.0109-0124.1 409124	Ø 232 9 7
1.0 i	37	09/96→08/99	←	→ 07/99; +PR 1LA		24.0110-0151.1 410151	Ø 239 10 8 + S
1.3 i	40	03/93→08/99				24.0310-0151.1 510151	Ø 239 10 8 + S PD
1.4 i	44	09/93→08/99					
1.6 i	55	03/93→08/99	←	01/97→ 07/99; +PR 1LM		24.0112-0106.1 412106	Ø 239 12 10 + S
1.6 i	74	04/96→08/99				24.0312-0106.1 512106	Ø 239 12 10 + S PD
1.8 i	66	03/93→08/99	←	→ 07/99; +PR 1LG		24.0120-0123.1 420123	Ø 239 20 18 V + S
2.0 i 16V	110	08/96→08/99				24.0320-0123.1 520123	Ø 239 20 18 V + S PD
			←	01/97→ 07/99; +PR 1LY,1ZK		24.0120-0128.1 420128	Ø 256 20 18 V + S
						24.0320-0128.1 520128	Ø 256 20 18 V + S PD
			←	01/97→ 07/99; +PR 1LD,1LV,1LW		24.0122-0101.1 422101	Ø 280 22 20 V
			➡	→ 07/99; +PR 1KK		24.0109-0124.1 409124	Ø 232 9 7
1.4	40	12/97→04/99	←	+PR 1LA		24.0110-0151.1 410151	Ø 239 10 8 + S
						24.0310-0151.1 510151	Ø 239 10 8 + S PD
↓							

	kw			 	! #		
SEAT - IBIZA II (6K1) 03/93→08/99							
Bremsscheibe							
1.4	40	12/97→04/99	← +PR 1LM	24.0112-0106.1 412106	∅ 239 12 10 + S		
				24.0312-0106.1 512106	∅ 239 12 10 + S PD		
			← +PR 1LG	24.0120-0123.1 420123	∅ 239 20 18 V + S		
				24.0320-0123.1 520123	∅ 239 20 18 V + S PD		
			← +PR 1LY,1ZK	24.0120-0128.1 420128	∅ 256 20 18 V + S		
				24.0320-0128.1 520128	∅ 256 20 18 V + S PD		
1.4 i 16V 1.9 SDI 1.9 TDI	74 47 66	06/97→08/99 08/96→08/99 08/96→08/99	← → 07/99; +PR 1LA	24.0110-0151.1 410151	∅ 239 10 8 + S		
				24.0310-0151.1 510151	∅ 239 10 8 + S PD		
			← → 07/99; +PR 1LM	24.0112-0106.1 412106	∅ 239 12 10 + S		
				24.0312-0106.1 512106	∅ 239 12 10 + S PD		
			← → 07/99; +PR 1LG	24.0120-0123.1 420123	∅ 239 20 18 V + S		
				24.0320-0123.1 520123	∅ 239 20 18 V + S PD		
1.6 i	55	09/94→06/99	← +PR 1LA	24.0110-0151.1 410151	∅ 239 10 8 + S		
				24.0310-0151.1 510151	∅ 239 10 8 + S PD		
			← 01/97→; +PR 1LM	24.0112-0106.1 412106	∅ 239 12 10 + S		
				24.0312-0106.1 512106	∅ 239 12 10 + S PD		
			← +PR 1LG	24.0120-0123.1 420123	∅ 239 20 18 V + S		
				24.0320-0123.1 520123	∅ 239 20 18 V + S PD		
1.8 i 16V	95	11/93→08/96	← 01/97→; +PR 1LY,1ZK	24.0120-0128.1 420128	∅ 256 20 18 V + S		
				24.0320-0128.1 520128	∅ 256 20 18 V + S PD		
			← 01/97→; +PR 1LD,1LV,1LW	24.0122-0101.1 422101	∅ 280 22 20 V		
				24.0109-0124.1 409124	∅ 232 9 7		
			← 02/94→; +PR 1LA	24.0110-0151.1 410151	∅ 239 10 8 + S		
				24.0310-0151.1 510151	∅ 239 10 8 + S PD		
1.9 TDI	81	02/97→08/99	← 02/94→; +PR 1LG	24.0120-0123.1 420123	∅ 239 20 18 V + S		
				24.0320-0123.1 520123	∅ 239 20 18 V + S PD		
			→ 02/94→; +PR 1KK	24.0109-0124.1 409124	∅ 232 9 7		
			→ 02/94→	24.0110-0111.1 410111	∅ 226 10 8 - ABS Ring / - RLG		
				24.0110-0275.2 410275	∅ 226 10 8 + ABS Ring / - RLG		
			← 03/97→ 07/99; +PR 1LA	24.0110-0151.1 410151	∅ 239 10 8 + S		
2.0 i	85	03/93→08/99	← 03/97→ 07/99; +PR 1LM	24.0310-0151.1 510151	∅ 239 10 8 + S PD		
				24.0112-0106.1 412106	∅ 239 12 10 + S		
				24.0312-0106.1 512106	∅ 239 12 10 + S PD		
			← 03/97→ 07/99; +PR 1LG	24.0120-0123.1 420123	∅ 239 20 18 V + S		
				24.0320-0123.1 520123	∅ 239 20 18 V + S PD		
			← 03/97→ 07/99; +PR 1LY,1ZK	24.0120-0128.1 420128	∅ 256 20 18 V + S		
1.9 TDI	81	02/97→08/99		24.0320-0128.1 520128	∅ 256 20 18 V + S PD		
			← 03/97→ 07/99; +PR 1LD,1LV,1LW	24.0122-0101.1 422101	∅ 280 22 20 V		
			→ 03/97→ 07/99; +PR 1KK	24.0109-0124.1 409124	∅ 232 9 7		
			→ 03/97→ 07/99	24.0110-0111.1 410111	∅ 226 10 8 - ABS Ring / - RLG		
				24.0110-0275.2 410275	∅ 226 10 8 + ABS Ring / - RLG		
			← 03/97→ 07/99; +PR 1LA	24.0110-0151.1 410151	∅ 239 10 8 + S		
2.0 i	85	03/93→08/99	← 01/97→ 07/99; +PR 1LM	24.0310-0151.1 510151	∅ 239 10 8 + S PD		
				24.0112-0106.1 412106	∅ 239 12 10 + S		
				24.0312-0106.1 512106	∅ 239 12 10 + S PD		
			← → 07/99; +PR 1LG	24.0120-0123.1 420123	∅ 239 20 18 V + S		
				24.0320-0123.1 520123	∅ 239 20 18 V + S PD		
			← 01/97→ 07/99; +PR 1LY,1ZK	24.0120-0128.1 420128	∅ 256 20 18 V + S		
1.9 TDI	81	02/97→08/99		24.0320-0128.1 520128	∅ 256 20 18 V + S PD		
			← 01/97→ 07/99; +PR 1LD,1LV,1LW	24.0122-0101.1 422101	∅ 280 22 20 V		
			→ 07/99; +PR 1KK	24.0109-0124.1 409124	∅ 232 9 7		
			→ 07/99	24.0110-0111.1 410111	∅ 226 10 8 - ABS Ring / - RLG		
				24.0110-0275.2 410275	∅ 226 10 8 + ABS Ring / - RLG		
			← 03/97→ 07/99; +PR 1LA	24.0110-0151.1 410151	∅ 239 10 8 + S		

	kw			 	! #		
SEAT - IBIZA III (6K1) 08/99→02/02							
 Bremsbelagsatz, Scheibenbremse							
1.0	37	08/99→02/02	←	→ 01/02; +PR 1ZK		13.0460-2821.2 602821	TRW 21945 16,0 - WK
1.0 16V	51	10/99→02/02	←	→ 01/02; +PR 1LV,1LW		13.0460-2958.2 602958	TRW 20168 19,3 - WK
1.4 16V	55	05/00→02/02	←	→ 6K-W-000 500; +PR 1LA; - ABS		13.0460-7059.2 607059	VW 20887 17,3 - WE / - WK + Zub
1.4 16V	74	08/99→02/02	←	→ 01/02; +PR 1LG		13.0460-7101.2 607101	VW 21866 15,3 - WE / - WK
1.6	55	08/99→02/02	←	→ 01/02; +PR 1LG		13.0460-7101.2 607101	VW 21866 15,3 - WE / - WK
1.6	74	08/99→02/02	←	→ 01/02; +PR 1LG		13.0460-7101.2 607101	VW 21866 15,3 - WE / - WK
1.9 TDI	66	08/99→02/02	←	→ 01/02; +PR 1LG		13.0460-7101.2 607101	VW 21866 15,3 - WE / - WK
1.9 TDI	81	08/99→02/02	→	→ 01/02; +PR 1KE,1KK,1KQ		13.0460-2894.2 602894 13.0470-2894.2 LD2894	TRW 20961 17,2 - WK + Zub TRW 20961 17,2 - WK + Zub Ceramic
1.4	44	08/99→02/02	←	→ 01/02; +PR 1LM,1ZK		13.0460-2821.2 602821	TRW 21945 16,0 - WK
1.9 SDI	50	08/99→02/02	←	→ 01/02; +PR 1LV,1LW		13.0460-2958.2 602958	TRW 20168 19,3 - WK
			←	→ 6K-W-000 500; +PR 1LA; - ABS		13.0460-7059.2 607059	VW 20887 17,3 - WE / - WK + Zub
			←	→ 01/02; +PR 1LG		13.0460-7101.2 607101	VW 21866 15,3 - WE / - WK
			→	→ 01/02; +PR 1KE,1KK,1KQ		13.0460-2894.2 602894 13.0470-2894.2 LD2894	TRW 20961 17,2 - WK + Zub TRW 20961 17,2 - WK + Zub Ceramic
1.8 T 20V Cupra	115	07/00→02/02	←	→ 01/02		13.0460-4964.2 604964	BRE 21381 15,0 - WE / - WK
			→	→ 01/02; +PR 1KE,1KK,1KQ		13.0460-2894.2 602894 13.0470-2894.2 LD2894	TRW 20961 17,2 - WK + Zub TRW 20961 17,2 - WK + Zub Ceramic
Zubehörsatz, Scheibenbremsbelag							
1.0	37	08/99→02/02	→	→ 01/02; +PR 1KE,1KK,1KQ		13.0460-0072.2 610072	TRW
1.0 16V	51	10/99→02/02	→	→ 01/02; +PR 1KE,1KK,1KQ		13.0460-0072.2 610072	TRW
1.4	44	08/99→02/02	→	→ 01/02; +PR 1KE,1KK,1KQ		13.0460-0072.2 610072	TRW
1.4 16V	55	05/00→02/02	→	→ 01/02; +PR 1KE,1KK,1KQ		13.0460-0072.2 610072	TRW
1.4 16V	74	08/99→02/02	→	→ 01/02; +PR 1KE,1KK,1KQ		13.0460-0072.2 610072	TRW
1.6	55	08/99→02/02	→	→ 01/02; +PR 1KE,1KK,1KQ		13.0460-0072.2 610072	TRW
1.6	74	08/99→02/02	→	→ 01/02; +PR 1KE,1KK,1KQ		13.0460-0072.2 610072	TRW
1.8 T 20V Cupra	115	07/00→02/02	→	→ 01/02; +PR 1KE,1KK,1KQ		13.0460-0072.2 610072	TRW
1.9 SDI	50	08/99→02/02	→	→ 01/02; +PR 1KE,1KK,1KQ		13.0460-0072.2 610072	TRW
1.9 TDI	66	08/99→02/02	→	→ 01/02; +PR 1KE,1KK,1KQ		13.0460-0072.2 610072	TRW
1.9 TDI	81	08/99→02/02	→	→ 01/02; +PR 1KE,1KK,1KQ		13.0460-0072.2 610072	TRW
 Bremsscheibe							
1.0	37	08/99→02/02	←	→ 6K-W-000 500; +PR 1LA; - ABS		24.0110-0151.1 410151	Ø 239 10 8 + S
1.0 16V	51	10/99→02/02	←	→ 01/02; +PR 1LG		24.0120-0123.1 420123	Ø 239 20 18 V + S
1.4 16V	55	05/00→02/02	←	→ 01/02; +PR 1LG		24.0320-0123.1 520123	Ø 239 20 18 V + S PD
1.4 16V	74	08/99→02/02	←	→ 01/02; +PR 1ZK		24.0120-0128.1 420128	Ø 256 20 18 V + S
1.6	55	08/99→02/02	←	→ 01/02; +PR 1ZK		24.0120-0128.1 420128	Ø 256 20 18 V + S
1.6	74	08/99→02/02	←	→ 01/02; +PR 1ZK		24.0320-0128.1 520128	Ø 256 20 18 V + S PD
1.9 TDI	66	08/99→02/02	←	→ 01/02; +PR 1LV,1LW		24.0122-0101.1 422101	Ø 280 22 20 V
1.9 TDI	81	08/99→02/02	←	→ 01/02; +PR 1LV,1LW		24.0122-0101.1 422101	Ø 280 22 20 V
			←	→ 6K-W-000 500; +PR 1LA		24.0310-0151.1 510151	Ø 239 10 8 + S PD
			→	→ 01/02; +PR 1KE,1KK,1KQ		24.0109-0124.1 409124	Ø 232 9 7
1.4	44	08/99→02/02	←	→ 6K-W-000 500; +PR 1LA; - ABS		24.0110-0151.1 410151	Ø 239 10 8 + S
1.9 SDI	50	08/99→02/02	←	→ 01/02; +PR 1LM		24.0112-0106.1 412106	Ø 239 12 10 + S
			←	→ 01/02; +PR 1LM		24.0312-0106.1 512106	Ø 239 12 10 + S PD
			←	→ 01/02; +PR 1LG		24.0120-0123.1 420123	Ø 239 20 18 V + S
			←	→ 01/02; +PR 1LG		24.0320-0123.1 520123	Ø 239 20 18 V + S PD
			←	→ 01/02; +PR 1ZK		24.0120-0128.1 420128	Ø 256 20 18 V + S
			←	→ 01/02; +PR 1ZK		24.0320-0128.1 520128	Ø 256 20 18 V + S PD
			←	→ 01/02; +PR 1LV,1LW		24.0122-0101.1 422101	Ø 280 22 20 V
			←	→ 6K-W-000 500; +PR 1LA		24.0310-0151.1 510151	Ø 239 10 8 + S PD
			→	→ 01/02; +PR 1KE,1KK,1KQ		24.0109-0124.1 409124	Ø 232 9 7
1.8 T 20V Cupra	115	07/00→02/02	→	→ 01/02; +PR 1KE,1KK,1KQ		24.0109-0124.1 409124	Ø 232 9 7
SEAT - IBIZA IV (6L1) 02/02→11/09							
 Bremsbelagsatz, Scheibenbremse							
1.2	44	06/07→05/08	←	+PR 1LN,1ZH		13.0460-2883.2 602883	TRW 23581 18,8 - WE / - WK
1.8 T FR	110	12/03→05/08	←	+PR 1LN,1ZH		13.0460-2884.2 602884	TRW 23581 18,8 + WK
2.0	85	04/02→11/09	←	+PR 1LN,1ZH		13.0470-2884.2 LD2884	TRW 23581 18,8 + WK Ceramic
			←	+PR 1LQ,1LR,1ZF,1ZG		13.0460-7111.2 607111 13.0470-7111.2 LD7111	VW 23130 19,6 - WE / - WK VW 23130 19,6 - WE / - WK Ceramic
↓							

	kw			 	! #		
SEAT - IBIZA V (6J5, 6P1) 03/08→							
 Bremsbelagsatz, Scheibenbremse							
1.2 TSI 1.4 TDI 1.6 LPG 1.9 TDI 2.0 2.0 TDI	77 59 60 66 85 105	09/10→ 07/08→06/10 05/11→ 07/08→06/10 10/08→ 01/10→	← ← ← →	+PR 1LQ,1LR,1ZG +PR 1LN,1ZH; 15" +PR 1ZR,1ZS +PR 1KK,1KT		13.0470-7111.2 LD7111 13.0460-7184.2 607184 13.0470-7184.2 LD7184 13.0460-7285.2 607285 13.0470-7285.2 LD7285 13.0460-2894.2 602894 13.0470-2894.2 LD2894	VW 23130 19,6 - WE / - WK Ceramic ATE 23587 20,6 + WK ATE 23587 20,6 + WK Ceramic ATE 23587 20,6 - WE / - WK ATE 23587 20,6 - WE / - WK Ceramic TRW 20961 17,2 - WK + Zub TRW 20961 17,2 - WK + Zub Ceramic
1.2 TSI	81	09/15→	← ← ← → →	+PR 1LQ,1LR,1ZG +PR 1ZC +PR 1ZR,1ZS +PR 1KV +PR 1KK,1KT		13.0460-7111.2 607111 13.0470-7111.2 LD7111 13.0460-7184.2 607184 13.0470-7184.2 LD7184 13.0460-7285.2 607285 13.0470-7285.2 LD7285 13.0460-2820.2 602820 13.0470-2820.2 LD2820 13.0460-2894.2 602894 13.0470-2894.2 LD2894	VW 23130 19,6 - WE / - WK VW 23130 19,6 - WE / - WK Ceramic ATE 23587 20,6 + WK ATE 23587 20,6 + WK Ceramic ATE 23587 20,6 - WE / - WK ATE 23587 20,6 - WE / - WK Ceramic TRW 20961 17,2 - WK TRW 20961 17,2 - WK Ceramic TRW 20961 17,2 - WK + Zub TRW 20961 17,2 - WK + Zub Ceramic
1.4 1.6 1.9 TDI	63 77 77	03/08→ 05/08→ 03/08→06/10	← ← ← →	07/08→; +PR 1LQ,1LR,1ZG 07/08→; +PR 1LN,1ZH; 15" 07/08→; +PR 1ZR,1ZS 07/08→; +PR 1KK,1KT		13.0460-7111.2 607111 13.0470-7111.2 LD7111 13.0460-7184.2 607184 13.0470-7184.2 LD7184 13.0460-7285.2 607285 13.0470-7285.2 LD7285 13.0460-2894.2 602894 13.0470-2894.2 LD2894	VW 23130 19,6 - WE / - WK VW 23130 19,6 - WE / - WK Ceramic ATE 23587 20,6 + WK ATE 23587 20,6 + WK Ceramic ATE 23587 20,6 - WE / - WK ATE 23587 20,6 - WE / - WK Ceramic TRW 20961 17,2 - WK + Zub TRW 20961 17,2 - WK + Zub Ceramic
1.4 TDI 1.4 TDI 1.4 TDI	55 66 77	05/15→ 05/15→ 05/15→	← ← ← → →	+PR 1ZG +PR 1ZC +PR 1ZR,1ZS +PR 1KV +PR 1KK,1KT		13.0460-7111.2 607111 13.0470-7111.2 LD7111 13.0460-7184.2 607184 13.0470-7184.2 LD7184 13.0460-7285.2 607285 13.0470-7285.2 LD7285 13.0460-2820.2 602820 13.0470-2820.2 LD2820 13.0460-2894.2 602894 13.0470-2894.2 LD2894	VW 23130 19,6 - WE / - WK VW 23130 19,6 - WE / - WK Ceramic ATE 23587 20,6 + WK ATE 23587 20,6 + WK Ceramic ATE 23587 20,6 - WE / - WK ATE 23587 20,6 - WE / - WK Ceramic TRW 20961 17,2 - WK TRW 20961 17,2 - WK Ceramic TRW 20961 17,2 - WK + Zub TRW 20961 17,2 - WK + Zub Ceramic
1.4 TSI	103	10/13→	← ← ← →	12/13→; +PR 1LQ,1LR,1ZG 12/13→; +PR 1LN,1ZH; 15" 12/13→; +PR 1ZR,1ZS 12/13→; +PR 1KD,1KS		13.0460-7111.2 607111 13.0470-7111.2 LD7111 13.0460-7184.2 607184 13.0470-7184.2 LD7184 13.0460-7285.2 607285 13.0470-7285.2 LD7285 13.0460-2864.2 602864	VW 23130 19,6 - WE / - WK VW 23130 19,6 - WE / - WK Ceramic ATE 23587 20,6 + WK ATE 23587 20,6 + WK Ceramic ATE 23587 20,6 - WE / - WK ATE 23587 20,6 - WE / - WK Ceramic TRW 20961 17,2 - WK
1.4 TSI 1.4 TSI	110 110	06/09→ 11/15→	← ← ← →	+PR 1LQ,1LR,1ZG +PR 1LN,1ZH; 15" +PR 1ZR,1ZS +PR 1KD,1KS		13.0460-7111.2 607111 13.0470-7111.2 LD7111 13.0460-7184.2 607184 13.0470-7184.2 LD7184 13.0460-7285.2 607285 13.0470-7285.2 LD7285 13.0460-2864.2 602864	VW 23130 19,6 - WE / - WK VW 23130 19,6 - WE / - WK Ceramic ATE 23587 20,6 + WK ATE 23587 20,6 + WK Ceramic ATE 23587 20,6 - WE / - WK ATE 23587 20,6 - WE / - WK Ceramic TRW 20961 17,2 - WK
↓							

	kw			 	! #		
SEAT - IBIZA V (6J5, 6P1) 03/08→							
Bremsbelagsatz, Scheibenbremse							
1.6 TDI 1.6 TDI	66 77	05/09→ 05/09→	←	06/09→; +PR 1LQ,1LR,1ZG	13.0460-7111.2 13.0470-7111.2	607111 LD7111	VW 23130 19,6 - WE / - WK VW 23130 19,6 - WE / - WK Ceramic
			←	06/09→; +PR 1LN,1ZH; 15"	13.0460-7184.2 13.0470-7184.2	607184 LD7184	ATE 23587 20,6 + WK ATE 23587 20,6 + WK Ceramic
			←	06/09→; +PR 1ZR,1ZS	13.0460-7285.2 13.0470-7285.2	607285 LD7285	ATE 23587 20,6 - WE / - WK ATE 23587 20,6 - WE / - WK Ceramic
			→	06/09→; +PR 1KK,1KT	13.0460-2894.2 13.0470-2894.2	602894 LD2894	TRW 20961 17,2 - WK + Zub TRW 20961 17,2 - WK + Zub Ceramic
Zubehörsatz, Scheibenbremsbelag							
1.0 1.0 TSI 1.0 TSI 1.2 TSI	55 70 81 66	05/15→ 05/15→ 05/15→ 05/15→		+PR 1KT	13.0460-0072.2	610072	TRW
1.2 1.2 TDI 1.2 TSI 1.2 TSI 1.2 TSI 1.4 TDI 1.4 TDI 1.4 TDI 1.4 TDI 1.4 TDI 1.6 LPG 1.9 TDI 2.0 2.0 TDI	44 55 63 77 81 55 59 66 77 60 66 85 105	07/09→ 05/10→ 08/12→ 09/10→ 09/15→ 05/15→ 07/08→06/10 05/15→ 05/15→ 05/11→ 07/08→06/10 10/08→ 01/10→		+PR 1KK,1KT	13.0460-0072.2	610072	TRW
1.2 1.4 1.6 1.9 TDI	51 63 77 77	03/08→ 03/08→ 05/08→ 03/08→06/10		07/08→; +PR 1KK,1KT	13.0460-0072.2	610072	TRW
1.6 TDI 1.6 TDI	66 77	05/09→ 05/09→		06/09→; +PR 1KK,1KT	13.0460-0072.2	610072	TRW
Bremsscheibe							
1.0 1.0 TSI 1.0 TSI 1.2 TSI	55 70 81 66	05/15→ 05/15→ 05/15→ 05/15→	←	+PR 1ZG	24.0122-0151.1 24.0322-0151.1	422151 522151	Ø 256 22 19 V + S Ø 256 22 19 V + S PD
			←	+PR 1ZC	24.0125-0113.1 24.0325-0113.1	425113 525113	Ø 288 25 22 V + S Ø 288 25 22 V + S PD
			←	+PR 1ZR,1ZS	24.0125-0123.1 24.0325-0123.1	425123 525123	Ø 310 25 22 V + S Ø 310 25 22 V PD
			→	+PR 1KV,1KT	24.0109-0123.1 24.0309-0123.1	409123 509123	Ø 230 9 7 + S Ø 230 9 7 + S PD
1.2 1.2 TDI 1.2 TSI 1.2 TSI 1.4 TDI 1.6 LPG 2.0 2.0 TDI	44 55 63 77 59 60 85 105	07/09→ 05/10→ 08/12→ 09/10→ 07/08→06/10 05/11→ 10/08→ 01/10→	←	+PR 1LQ,1LR,1ZG	24.0122-0151.1 24.0322-0151.1	422151 522151	Ø 256 22 19 V + S Ø 256 22 19 V + S PD
			←	15"	24.0125-0113.1 24.0325-0113.1	425113 525113	Ø 288 25 22 V + S Ø 288 25 22 V + S PD
			←	+PR 1ZR,1ZS	24.0125-0123.1 24.0325-0123.1	425123 525123	Ø 310 25 22 V + S Ø 310 25 22 V PD
			→	+PR 1KK,1KT	24.0109-0123.1 24.0309-0123.1	409123 509123	Ø 230 9 7 + S Ø 230 9 7 + S PD
1.2 1.4 1.6 1.9 TDI	51 63 77 77	03/08→ 03/08→ 05/08→ 03/08→06/10	←	07/08→; +PR 1LQ,1LR,1ZG	24.0122-0151.1 24.0322-0151.1	422151 522151	Ø 256 22 19 V + S Ø 256 22 19 V + S PD
			←	07/08→; 15"	24.0125-0113.1 24.0325-0113.1	425113 525113	Ø 288 25 22 V + S Ø 288 25 22 V + S PD
			←	07/08→; +PR 1ZR,1ZS	24.0125-0123.1 24.0325-0123.1	425123 525123	Ø 310 25 22 V + S Ø 310 25 22 V PD
			→	07/08→; +PR 1KK,1KT	24.0109-0123.1 24.0309-0123.1	409123 509123	Ø 230 9 7 + S Ø 230 9 7 + S PD
1.2 TSI	81	09/15→	←	+PR 1LQ,1LR,1ZG	24.0122-0151.1 24.0322-0151.1	422151 522151	Ø 256 22 19 V + S Ø 256 22 19 V + S PD
			←	+PR 1ZC	24.0125-0113.1 24.0325-0113.1	425113 525113	Ø 288 25 22 V + S Ø 288 25 22 V + S PD
			←	+PR 1ZR,1ZS	24.0125-0123.1 24.0325-0123.1	425123 525123	Ø 310 25 22 V + S Ø 310 25 22 V PD
↓							



SEAT - IBIZA V (6J5, 6P1) 03/08→









Bremsscheibe







1.2 TSI	81	09/15→	➔	+PR 1KK,1KT		24.0109-0123.1 409123	Ø 230 9 7 + S
						24.0309-0123.1 509123	Ø 230 9 7 + S PD
1.4 TDI	55	05/15→	➔	+PR 1ZG		24.0122-0151.1 422151	Ø 256 22 19 V + S
1.4 TDI	66	05/15→				24.0322-0151.1 522151	Ø 256 22 19 V + S PD
1.4 TDI	77	05/15→	➔	+PR 1ZC		24.0125-0113.1 425113	Ø 288 25 22 V + S
						24.0325-0113.1 525113	Ø 288 25 22 V + S PD
			➔	+PR 1ZR,1ZS		24.0125-0123.1 425123	Ø 310 25 22 V + S
						24.0325-0123.1 525123	Ø 310 25 22 V PD
			➔	+PR 1KK,1KT		24.0109-0123.1 409123	Ø 230 9 7 + S
						24.0309-0123.1 509123	Ø 230 9 7 + S PD
1.4 TSI	103	10/13→	➔	12/13→; +PR 1LQ,1LR,1ZG		24.0122-0151.1 422151	Ø 256 22 19 V + S
						24.0322-0151.1 522151	Ø 256 22 19 V + S PD
			➔	12/13→; 15"		24.0125-0113.1 425113	Ø 288 25 22 V + S
						24.0325-0113.1 525113	Ø 288 25 22 V + S PD
			➔	12/13→; +PR 1ZR,1ZS		24.0125-0123.1 425123	Ø 310 25 22 V + S
						24.0325-0123.1 525123	Ø 310 25 22 V PD
			➔	12/13→; +PR 1KD,1KS		24.0109-0123.1 409123	Ø 230 9 7 + S
						24.0309-0123.1 509123	Ø 230 9 7 + S PD
1.4 TSI	110	06/09→	➔	+PR 1LQ,1LR,1ZG		24.0122-0151.1 422151	Ø 256 22 19 V + S
1.4 TSI	110	11/15→				24.0322-0151.1 522151	Ø 256 22 19 V + S PD
			➔	15"		24.0125-0113.1 425113	Ø 288 25 22 V + S
						24.0325-0113.1 525113	Ø 288 25 22 V + S PD
			➔	+PR 1ZR,1ZS		24.0125-0123.1 425123	Ø 310 25 22 V + S
						24.0325-0123.1 525123	Ø 310 25 22 V PD
			➔	+PR 1KD,1KS		24.0109-0123.1 409123	Ø 230 9 7 + S
						24.0309-0123.1 509123	Ø 230 9 7 + S PD
1.6 TDI	66	05/09→	➔	06/09→; +PR 1LQ,1LR,1ZG		24.0122-0151.1 422151	Ø 256 22 19 V + S
1.6 TDI	77	05/09→				24.0322-0151.1 522151	Ø 256 22 19 V + S PD
			➔	06/09→; 15"		24.0125-0113.1 425113	Ø 288 25 22 V + S
						24.0325-0113.1 525113	Ø 288 25 22 V + S PD
			➔	06/09→; +PR 1ZR,1ZS		24.0125-0123.1 425123	Ø 310 25 22 V + S
						24.0325-0123.1 525123	Ø 310 25 22 V PD
			➔	06/09→; +PR 1KK,1KT		24.0109-0123.1 409123	Ø 230 9 7 + S
						24.0309-0123.1 509123	Ø 230 9 7 + S PD
1.9 TDI	66	07/08→06/10	➔	+PR 1LQ,1LR,1ZG		24.0122-0151.1 422151	Ø 256 22 19 V + S
						24.0322-0151.1 522151	Ø 256 22 19 V + S PD
			➔	15"		24.0125-0113.1 425113	Ø 288 25 22 V + S
						24.0325-0113.1 525113	Ø 288 25 22 V + S PD
			➔	+PR 1ZR,1ZS		24.0125-0123.1 425123	Ø 310 25 22 V + S
						24.0325-0123.1 525123	Ø 310 25 22 V PD
			➔	+PR 1KK,1KT		24.0109-0123.1 409123	Ø 230 9 7 + S
						24.0309-0123.1 509123	Ø 230 9 7 + S PD









SEAT - IBIZA V SPORTCOUPE (6J1, 6P5) 07/08→

Bremsbelagsatz, Scheibenbremse









1.0	55	05/15→	➔	+PR 1ZG		13.0460-7111.2 607111	VW 23130 19,6 - WE / - WK
1.0 TSI	70	05/15→				13.0470-7111.2 LD7111	VW 23130 19,6 - WE / - WK Ceramic
1.0 TSI	81	05/15→					
1.2 TSI	66	05/15→	➔	+PR 1ZC		13.0460-7184.2 607184	ATE 23587 20,6 + WK
1.8 TSI Cupra	141	11/15→				13.0470-7184.2 LD7184	ATE 23587 20,6 + WK Ceramic
			➔	+PR 1ZR,1ZS		13.0460-7285.2 607285	ATE 23587 20,6 - WE / - WK
						13.0470-7285.2 LD7285	ATE 23587 20,6 - WE / - WK Ceramic
			➔	+PR 1KV		13.0460-2820.2 602820	TRW 20961 17,2 - WK
						13.0470-2820.2 LD2820	TRW 20961 17,2 - WK Ceramic
			➔	+PR 1KT		13.0460-2894.2 602894	TRW 20961 17,2 - WK + Zub
						13.0470-2894.2 LD2894	TRW 20961 17,2 - WK + Zub Ceramic
1.2	44	07/09→	➔	+PR 1LQ,1LR,1ZG		13.0460-7111.2 607111	VW 23130 19,6 - WE / - WK
1.2	51	07/08→				13.0470-7111.2 LD7111	VW 23130 19,6 - WE / - WK Ceramic
			➔	15"		13.0460-7184.2 607184	ATE 23587 20,6 + WK









	kw			 	! #		
SEAT - IBIZA V SPORTCOUPE (6J1, 6P5) 07/08→							
 Bremsbelagsatz, Scheibenbremse							
1.2 1.2	44 51	07/09→ 07/08→	←	15"		13.0470-7184.2 LD7184	ATE 23587 20,6 + WK Ceramic
			←	+PR 1ZR,1ZS		13.0460-7285.2 607285 13.0470-7285.2 LD7285	ATE 23587 20,6 - WE / - WK ATE 23587 20,6 - WE / - WK Ceramic
			→	+PR 1KK,1KT		13.0460-2894.2 602894 13.0470-2894.2 LD2894	TRW 20961 17,2 - WK + Zub TRW 20961 17,2 - WK + Zub Ceramic
1.2 TDI 1.2 TSI 1.2 TSI 1.4 1.4 TDI 1.6 1.6 LPG 1.9 TDI 1.9 TDI 2.0 2.0 TDI	55 63 77 63 59 77 60 66 77 85 105	05/10→ 08/12→ 09/10→ 07/08→ 07/08→06/10 07/08→ 05/11→ 07/08→06/10 07/08→06/10 10/08→ 01/10→	←	+PR 1LQ,1LR,1ZG		13.0460-7111.2 607111 13.0470-7111.2 LD7111	VW 23130 19,6 - WE / - WK VW 23130 19,6 - WE / - WK Ceramic
			←	+PR 1LN,1ZH; 15"		13.0460-7184.2 607184 13.0470-7184.2 LD7184	ATE 23587 20,6 + WK ATE 23587 20,6 + WK Ceramic
			←	+PR 1ZR,1ZS		13.0460-7285.2 607285 13.0470-7285.2 LD7285	ATE 23587 20,6 - WE / - WK ATE 23587 20,6 - WE / - WK Ceramic
			→	+PR 1KK,1KT		13.0460-2894.2 602894 13.0470-2894.2 LD2894	TRW 20961 17,2 - WK + Zub TRW 20961 17,2 - WK + Zub Ceramic
1.2 TSI	81	09/15→	←	+PR 1LQ,1LR,1ZG		13.0460-7111.2 607111 13.0470-7111.2 LD7111	VW 23130 19,6 - WE / - WK VW 23130 19,6 - WE / - WK Ceramic
			←	+PR 1ZC		13.0460-7184.2 607184 13.0470-7184.2 LD7184	ATE 23587 20,6 + WK ATE 23587 20,6 + WK Ceramic
			←	+PR 1ZR,1ZS		13.0460-7285.2 607285 13.0470-7285.2 LD7285	ATE 23587 20,6 - WE / - WK ATE 23587 20,6 - WE / - WK Ceramic
			→	+PR 1KV		13.0460-2820.2 602820 13.0470-2820.2 LD2820	TRW 20961 17,2 - WK TRW 20961 17,2 - WK Ceramic
			→	+PR 1KK,1KT		13.0460-2894.2 602894 13.0470-2894.2 LD2894	TRW 20961 17,2 - WK + Zub TRW 20961 17,2 - WK + Zub Ceramic
1.4 TDI 1.4 TDI 1.4 TDI	55 66 77	05/15→ 05/15→ 05/15→	←	+PR 1ZG		13.0460-7111.2 607111 13.0470-7111.2 LD7111	VW 23130 19,6 - WE / - WK VW 23130 19,6 - WE / - WK Ceramic
			←	+PR 1ZC		13.0460-7184.2 607184 13.0470-7184.2 LD7184	ATE 23587 20,6 + WK ATE 23587 20,6 + WK Ceramic
			←	+PR 1ZR,1ZS		13.0460-7285.2 607285 13.0470-7285.2 LD7285	ATE 23587 20,6 - WE / - WK ATE 23587 20,6 - WE / - WK Ceramic
			→	+PR 1KV		13.0460-2820.2 602820 13.0470-2820.2 LD2820	TRW 20961 17,2 - WK TRW 20961 17,2 - WK Ceramic
			→	+PR 1KK,1KT		13.0460-2894.2 602894 13.0470-2894.2 LD2894	TRW 20961 17,2 - WK + Zub TRW 20961 17,2 - WK + Zub Ceramic
1.4 TSI	103	10/13→	←	12/13→; +PR 1LQ,1LR,1ZG		13.0460-7111.2 607111 13.0470-7111.2 LD7111	VW 23130 19,6 - WE / - WK VW 23130 19,6 - WE / - WK Ceramic
			←	12/13→; +PR 1LN,1ZH; 15"		13.0460-7184.2 607184 13.0470-7184.2 LD7184	ATE 23587 20,6 + WK ATE 23587 20,6 + WK Ceramic
			←	12/13→; +PR 1ZR,1ZS		13.0460-7285.2 607285 13.0470-7285.2 LD7285	ATE 23587 20,6 - WE / - WK ATE 23587 20,6 - WE / - WK Ceramic
			→	12/13→; +PR 1KD,1KS		13.0460-2864.2 602864	TRW 20961 17,2 - WK
1.4 TSI 1.4 TSI	110 110	06/09→ 11/15→	←	+PR 1LQ,1LR,1ZG		13.0460-7111.2 607111 13.0470-7111.2 LD7111	VW 23130 19,6 - WE / - WK VW 23130 19,6 - WE / - WK Ceramic
			←	+PR 1LN,1ZH; 15"		13.0460-7184.2 607184 13.0470-7184.2 LD7184	ATE 23587 20,6 + WK ATE 23587 20,6 + WK Ceramic
			←	+PR 1ZR,1ZS		13.0460-7285.2 607285 13.0470-7285.2 LD7285	ATE 23587 20,6 - WE / - WK ATE 23587 20,6 - WE / - WK Ceramic
			→	+PR 1KD,1KS		13.0460-2864.2 602864	TRW 20961 17,2 - WK
1.4 TSI Cupra	132	06/09→	←	+PR 1LV		13.0460-6921.2 606921	AP 24974 16,8 - WE / - WK
			←	15"		13.0460-7184.2 607184 13.0470-7184.2 LD7184	ATE 23587 20,6 + WK ATE 23587 20,6 + WK Ceramic











	kw			 	! #		
SEAT - IBIZA V SPORTCOUPE (6J1, 6P5) 07/08→							
Bremsbelagsatz, Scheibenbremse							
1.4 TSI Cupra	132	06/09→	➔	+PR 1KP		13.0460-2820.2 602820	TRW 20961 17,2 - WK
			➔	+PR 1KK,1KT		13.0470-2820.2 LD2820	TRW 20961 17,2 - WK Ceramic
1.6 TDI	66	05/09→	➔	06/09→; +PR 1LQ,1LR,1ZG		13.0460-7111.2 607111	VW 23130 19,6 - WE / - WK
1.6 TDI	77	05/09→	➔	06/09→; +PR 1LN,1ZH; 15"		13.0470-7111.2 LD7111	VW 23130 19,6 - WE / - WK Ceramic
			➔	06/09→; +PR 1ZR,1ZS		13.0460-7184.2 607184	ATE 23587 20,6 + WK
			➔	06/09→; +PR 1ZR,1ZS		13.0470-7184.2 LD7184	ATE 23587 20,6 + WK Ceramic
			➔	06/09→; +PR 1ZR,1ZS		13.0460-7285.2 607285	ATE 23587 20,6 - WE / - WK
			➔	06/09→; +PR 1ZR,1ZS		13.0470-7285.2 LD7285	ATE 23587 20,6 - WE / - WK Ceramic
			➔	06/09→; +PR 1KK,1KT		13.0460-2894.2 602894	TRW 20961 17,2 - WK + Zub
			➔	06/09→; +PR 1KK,1KT		13.0470-2894.2 LD2894	TRW 20961 17,2 - WK + Zub Ceramic
Zubehörsatz, Scheibenbremsbelag							
1.0	55	05/15→		+PR 1KT		13.0460-0072.2 610072	TRW
1.0 TSI	70	05/15→					
1.0 TSI	81	05/15→					
1.2 TSI	66	05/15→					
1.8 TSI Cupra	141	11/15→					
1.2	44	07/09→		+PR 1KK,1KT		13.0460-0072.2 610072	TRW
1.2	51	07/08→					
1.2 TDI	55	05/10→					
1.2 TSI	63	08/12→					
1.2 TSI	77	09/10→					
1.2 TSI	81	09/15→					
1.4	63	07/08→					
1.4 TDI	55	05/15→					
1.4 TDI	59	07/08→06/10					
1.4 TDI	66	05/15→					
1.4 TDI	77	05/15→					
1.4 TSI Cupra	132	06/09→					
1.6	77	07/08→					
1.6 LPG	60	05/11→					
1.9 TDI	66	07/08→06/10					
1.9 TDI	77	07/08→06/10					
2.0	85	10/08→					
2.0 TDI	105	01/10→					
1.6 TDI	66	05/09→		06/09→; +PR 1KK,1KT		13.0460-0072.2 610072	TRW
1.6 TDI	77	05/09→					
Bremsscheibe							
1.0	55	05/15→	➔	+PR 1ZG		24.0122-0151.1 422151	Ø 256 22 19 V + S
1.0 TSI	70	05/15→	➔			24.0322-0151.1 522151	Ø 256 22 19 V + S PD
1.0 TSI	81	05/15→	➔				
1.2 TSI	66	05/15→	➔	+PR 1ZC		24.0125-0113.1 425113	Ø 288 25 22 V + S
1.8 TSI Cupra	141	11/15→	➔			24.0325-0113.1 525113	Ø 288 25 22 V + S PD
			➔	+PR 1ZR,1ZS		24.0125-0123.1 425123	Ø 310 25 22 V + S
			➔	+PR 1ZR,1ZS		24.0325-0123.1 525123	Ø 310 25 22 V PD
			➔	+PR 1KV,1KT		24.0109-0123.1 409123	Ø 230 9 7 + S
			➔	+PR 1KV,1KT		24.0309-0123.1 509123	Ø 230 9 7 + S PD
1.2	44	07/09→	➔	+PR 1LQ,1LR,1ZG		24.0122-0151.1 422151	Ø 256 22 19 V + S
1.2 TDI	55	05/10→	➔			24.0322-0151.1 522151	Ø 256 22 19 V + S PD
1.2 TSI	63	08/12→	➔				
1.2 TSI	77	09/10→	➔	15"		24.0125-0113.1 425113	Ø 288 25 22 V + S
1.4 TDI	59	07/08→06/10	➔			24.0325-0113.1 525113	Ø 288 25 22 V + S PD
1.6 LPG	60	05/11→	➔				
2.0	85	10/08→	➔	+PR 1ZR,1ZS		24.0125-0123.1 425123	Ø 310 25 22 V + S
2.0 TDI	105	01/10→	➔			24.0325-0123.1 525123	Ø 310 25 22 V PD
			➔	+PR 1KK,1KT		24.0109-0123.1 409123	Ø 230 9 7 + S
			➔	+PR 1KK,1KT		24.0309-0123.1 509123	Ø 230 9 7 + S PD
1.2	51	07/08→	➔	+PR 1LQ,1LR,1ZG		24.0122-0151.1 422151	Ø 256 22 19 V + S
1.4	63	07/08→	➔			24.0322-0151.1 522151	Ø 256 22 19 V + S PD
1.6	77	07/08→	➔				
1.9 TDI	66	07/08→06/10	➔	15"		24.0125-0113.1 425113	Ø 288 25 22 V + S
1.9 TDI	77	07/08→06/10	➔			24.0325-0113.1 525113	Ø 288 25 22 V + S PD
			➔	+PR 1ZR,1ZS		24.0125-0123.1 425123	Ø 310 25 22 V + S
			➔	+PR 1ZR,1ZS		24.0325-0123.1 525123	Ø 310 25 22 V PD
			➔	+PR 1KK,1KT		24.0109-0123.1 409123	Ø 230 9 7 + S
			➔	+PR 1KK,1KT		24.0309-0123.1 509123	Ø 230 9 7 + S PD
↓							









	kw			 	! #		
SEAT - IBIZA V SPORTCOUPE (6J1, 6P5) 07/08→							
 Bremsscheibe							
1.2 TSI	81	09/15→	←	+PR 1LQ,1LR,1ZG	24.0122-0151.1	422151	Ø 256 22 19 V + S
					24.0322-0151.1	522151	Ø 256 22 19 V + S PD
			←	+PR 1ZC	24.0125-0113.1	425113	Ø 288 25 22 V + S
					24.0325-0113.1	525113	Ø 288 25 22 V + S PD
			←	+PR 1ZR,1ZS	24.0125-0123.1	425123	Ø 310 25 22 V + S
		24.0325-0123.1	525123	Ø 310 25 22 V PD			
			➔	+PR 1KK,1KT	24.0109-0123.1	409123	Ø 230 9 7 + S
					24.0309-0123.1	509123	Ø 230 9 7 + S PD
1.4 TDI 1.4 TDI 1.4 TDI	55 66 77	05/15→ 05/15→ 05/15→	←	+PR 1ZG	24.0122-0151.1	422151	Ø 256 22 19 V + S
					24.0322-0151.1	522151	Ø 256 22 19 V + S PD
			←	+PR 1ZC	24.0125-0113.1	425113	Ø 288 25 22 V + S
					24.0325-0113.1	525113	Ø 288 25 22 V + S PD
			←	+PR 1ZR,1ZS	24.0125-0123.1	425123	Ø 310 25 22 V + S
		24.0325-0123.1	525123	Ø 310 25 22 V PD			
			➔	+PR 1KK,1KT	24.0109-0123.1	409123	Ø 230 9 7 + S
					24.0309-0123.1	509123	Ø 230 9 7 + S PD
1.4 TSI	103	10/13→	←	12/13→; +PR 1LQ,1LR,1ZG	24.0122-0151.1	422151	Ø 256 22 19 V + S
					24.0322-0151.1	522151	Ø 256 22 19 V + S PD
			←	12/13→; 15"	24.0125-0113.1	425113	Ø 288 25 22 V + S
					24.0325-0113.1	525113	Ø 288 25 22 V + S PD
			←	12/13→; +PR 1ZR,1ZS	24.0125-0123.1	425123	Ø 310 25 22 V + S
		24.0325-0123.1	525123	Ø 310 25 22 V PD			
			➔	12/13→; +PR 1KD,1KS	24.0109-0123.1	409123	Ø 230 9 7 + S
					24.0309-0123.1	509123	Ø 230 9 7 + S PD
1.4 TSI 1.4 TSI	110 110	06/09→ 11/15→	←	+PR 1LQ,1LR,1ZG	24.0122-0151.1	422151	Ø 256 22 19 V + S
					24.0322-0151.1	522151	Ø 256 22 19 V + S PD
			←	15"	24.0125-0113.1	425113	Ø 288 25 22 V + S
					24.0325-0113.1	525113	Ø 288 25 22 V + S PD
			←	+PR 1ZR,1ZS	24.0125-0123.1	425123	Ø 310 25 22 V + S
		24.0325-0123.1	525123	Ø 310 25 22 V PD			
			➔	+PR 1KD,1KS	24.0109-0123.1	409123	Ø 230 9 7 + S
					24.0309-0123.1	509123	Ø 230 9 7 + S PD
1.4 TSI Cupra	132	06/09→	←	15"	24.0125-0113.1	425113	Ø 288 25 22 V + S
					24.0325-0113.1	525113	Ø 288 25 22 V + S PD
			←	+PR 1LV	24.0125-0123.1	425123	Ø 310 25 22 V + S
					24.0325-0123.1	525123	Ø 310 25 22 V PD
			➔	+PR 1KP	24.0109-0123.1	409123	Ø 230 9 7 + S
				24.0309-0123.1	509123	Ø 230 9 7 + S PD	
1.6 TDI 1.6 TDI	66 77	05/09→ 05/09→	←	06/09→; +PR 1LQ,1LR,1ZG	24.0122-0151.1	422151	Ø 256 22 19 V + S
					24.0322-0151.1	522151	Ø 256 22 19 V + S PD
			←	06/09→; 15"	24.0125-0113.1	425113	Ø 288 25 22 V + S
					24.0325-0113.1	525113	Ø 288 25 22 V + S PD
			←	06/09→; +PR 1ZR,1ZS	24.0125-0123.1	425123	Ø 310 25 22 V + S
		24.0325-0123.1	525123	Ø 310 25 22 V PD			
			➔	06/09→; +PR 1KK,1KT	24.0109-0123.1	409123	Ø 230 9 7 + S
					24.0309-0123.1	509123	Ø 230 9 7 + S PD
SEAT - IBIZA V ST (6J8, 6P8) 03/10→							
 Bremsbelagsatz, Scheibenbremse							
1.0 1.0 TSI 1.0 TSI 1.2 TSI	55 70 81 66	05/15→ 05/15→ 05/15→ 05/15→	←	+PR 1ZG	13.0460-7111.2	607111	VW 23130 19,6 - WE / - WK
					13.0470-7111.2	LD7111	VW 23130 19,6 - WE / - WK Ceramic
			←	+PR 1ZC	13.0460-7184.2	607184	ATE 23587 20,6 + WK
					13.0470-7184.2	LD7184	ATE 23587 20,6 + WK Ceramic
			←	+PR 1ZR,1ZS	13.0460-7285.2	607285	ATE 23587 20,6 - WE / - WK
					13.0470-7285.2	LD7285	ATE 23587 20,6 - WE / - WK Ceramic
			➔	+PR 1KV	13.0460-2820.2	602820	TRW 20961 17,2 - WK
					13.0470-2820.2	LD2820	TRW 20961 17,2 - WK Ceramic
			➔	+PR 1KT	13.0460-2894.2	602894	TRW 20961 17,2 - WK + Zub
					13.0470-2894.2	LD2894	TRW 20961 17,2 - WK + Zub Ceramic
↓							

















	kw			 	! #		
SEAT - IBIZA V ST (6J8, 6P8) 03/10→							
 Bremsbelagsatz, Scheibenbremse							
1.2 1.2	44 51	05/10→ 05/10→	←	+PR 1LQ,1LR,1ZG		13.0460-7111.2 607111 13.0470-7111.2 LD7111	VW 23130 19,6 - WE / - WK VW 23130 19,6 - WE / - WK Ceramic
			←	15"		13.0460-7184.2 607184 13.0470-7184.2 LD7184	ATE 23587 20,6 + WK ATE 23587 20,6 + WK Ceramic
			←	+PR 1ZR,1ZS		13.0460-7285.2 607285 13.0470-7285.2 LD7285	ATE 23587 20,6 - WE / - WK ATE 23587 20,6 - WE / - WK Ceramic
			→	+PR 1KK,1KT		13.0460-2894.2 602894 13.0470-2894.2 LD2894	TRW 20961 17,2 - WK + Zub TRW 20961 17,2 - WK + Zub Ceramic
1.2 TDI 1.2 TSI 1.2 TSI 1.4 1.6 TDI 1.6 TDI	55 63 77 63 66 77	04/10→ 09/12→ 09/10→ 03/10→ 03/10→ 03/10→	←	+PR 1LQ,1LR,1ZG		13.0460-7111.2 607111 13.0470-7111.2 LD7111	VW 23130 19,6 - WE / - WK VW 23130 19,6 - WE / - WK Ceramic
			←	+PR 1LN,1ZH; 15"		13.0460-7184.2 607184 13.0470-7184.2 LD7184	ATE 23587 20,6 + WK ATE 23587 20,6 + WK Ceramic
			←	+PR 1ZR,1ZS		13.0460-7285.2 607285 13.0470-7285.2 LD7285	ATE 23587 20,6 - WE / - WK ATE 23587 20,6 - WE / - WK Ceramic
			→	+PR 1KK,1KT		13.0460-2894.2 602894 13.0470-2894.2 LD2894	TRW 20961 17,2 - WK + Zub TRW 20961 17,2 - WK + Zub Ceramic
1.2 TSI	81	09/15→	←	+PR 1LQ,1LR,1ZG		13.0460-7111.2 607111 13.0470-7111.2 LD7111	VW 23130 19,6 - WE / - WK VW 23130 19,6 - WE / - WK Ceramic
			←	+PR 1ZC		13.0460-7184.2 607184 13.0470-7184.2 LD7184	ATE 23587 20,6 + WK ATE 23587 20,6 + WK Ceramic
			←	+PR 1ZR,1ZS		13.0460-7285.2 607285 13.0470-7285.2 LD7285	ATE 23587 20,6 - WE / - WK ATE 23587 20,6 - WE / - WK Ceramic
			→	+PR 1KV		13.0460-2820.2 602820 13.0470-2820.2 LD2820	TRW 20961 17,2 - WK TRW 20961 17,2 - WK Ceramic
			→	+PR 1KK,1KT		13.0460-2894.2 602894 13.0470-2894.2 LD2894	TRW 20961 17,2 - WK + Zub TRW 20961 17,2 - WK + Zub Ceramic
1.4 TDI 1.4 TDI 1.4 TDI	55 66 77	05/15→ 05/15→ 05/15→	←	+PR 1ZG		13.0460-7111.2 607111 13.0470-7111.2 LD7111	VW 23130 19,6 - WE / - WK VW 23130 19,6 - WE / - WK Ceramic
			←	+PR 1ZC		13.0460-7184.2 607184 13.0470-7184.2 LD7184	ATE 23587 20,6 + WK ATE 23587 20,6 + WK Ceramic
			←	+PR 1ZR,1ZS		13.0460-7285.2 607285 13.0470-7285.2 LD7285	ATE 23587 20,6 - WE / - WK ATE 23587 20,6 - WE / - WK Ceramic
			→	+PR 1KV		13.0460-2820.2 602820 13.0470-2820.2 LD2820	TRW 20961 17,2 - WK TRW 20961 17,2 - WK Ceramic
			→	+PR 1KK,1KT		13.0460-2894.2 602894 13.0470-2894.2 LD2894	TRW 20961 17,2 - WK + Zub TRW 20961 17,2 - WK + Zub Ceramic
1.4 TSI	103	10/13→	←	12/13→; +PR 1LQ,1LR,1ZG		13.0460-7111.2 607111 13.0470-7111.2 LD7111	VW 23130 19,6 - WE / - WK VW 23130 19,6 - WE / - WK Ceramic
			←	12/13→; +PR 1LN,1ZH; 15"		13.0460-7184.2 607184 13.0470-7184.2 LD7184	ATE 23587 20,6 + WK ATE 23587 20,6 + WK Ceramic
			←	12/13→; +PR 1ZR,1ZS		13.0460-7285.2 607285 13.0470-7285.2 LD7285	ATE 23587 20,6 - WE / - WK ATE 23587 20,6 - WE / - WK Ceramic
			→	12/13→; +PR 1KD,1KS		13.0460-2864.2 602864	TRW 20961 17,2 - WK
1.4 TSI 1.4 TSI	110 110	02/12→ 11/15→	←	+PR 1LQ,1LR,1ZG		13.0460-7111.2 607111 13.0470-7111.2 LD7111	VW 23130 19,6 - WE / - WK VW 23130 19,6 - WE / - WK Ceramic
			←	+PR 1LN,1ZH; 15"		13.0460-7184.2 607184 13.0470-7184.2 LD7184	ATE 23587 20,6 + WK ATE 23587 20,6 + WK Ceramic
			←	+PR 1ZR,1ZS		13.0460-7285.2 607285 13.0470-7285.2 LD7285	ATE 23587 20,6 - WE / - WK ATE 23587 20,6 - WE / - WK Ceramic









	kw			 	! #		
SEAT - IBIZA V ST (6J8, 6P8) 03/10→							
 Bremsbelagsatz, Scheibenbremse							
1.4 TSI 1.4 TSI	110 110	02/12→ 11/15→	➔	+PR 1KD,1KS		13.0460-2864.2 602864	TRW 20961 17,2 - WK
Zubehörsatz, Scheibenbremsbelag							
1.0 1.0 TSI 1.0 TSI 1.2 TSI	55 70 81 66	05/15→ 05/15→ 05/15→ 05/15→		+PR 1KT		13.0460-0072.2 610072	TRW
1.2 1.2 1.2 TDI 1.2 TSI 1.2 TSI 1.2 TSI 1.4 1.4 TDI 1.4 TDI 1.4 TDI 1.6 TDI 1.6 TDI	44 51 55 63 77 81 63 55 66 77 66 77	05/10→ 05/10→ 04/10→ 09/12→ 09/10→ 09/15→ 03/10→ 05/15→ 05/15→ 05/15→ 03/10→ 03/10→		+PR 1KK,1KT		13.0460-0072.2 610072	TRW
 Brems Scheibe							
1.0 1.0 TSI 1.0 TSI 1.2 TSI	55 70 81 66	05/15→ 05/15→ 05/15→ 05/15→	←	+PR 1ZG		24.0122-0151.1 422151 24.0322-0151.1 522151	Ø 256 22 19 V + S Ø 256 22 19 V + S PD
			←	+PR 1ZC		24.0125-0113.1 425113 24.0325-0113.1 525113	Ø 288 25 22 V + S Ø 288 25 22 V + S PD
			←	+PR 1ZR,1ZS		24.0125-0123.1 425123 24.0325-0123.1 525123	Ø 310 25 22 V + S Ø 310 25 22 V PD
			➔	+PR 1KV,1KT		24.0109-0123.1 409123 24.0309-0123.1 509123	Ø 230 9 7 + S Ø 230 9 7 + S PD
1.2 1.2 TDI 1.2 TSI 1.2 TSI 1.6 TDI 1.6 TDI	44 55 63 77 66 77	05/10→ 04/10→ 09/12→ 09/10→ 03/10→ 03/10→	←	+PR 1LQ,1LR,1ZG		24.0122-0151.1 422151 24.0322-0151.1 522151	Ø 256 22 19 V + S Ø 256 22 19 V + S PD
			←	15"		24.0125-0113.1 425113 24.0325-0113.1 525113	Ø 288 25 22 V + S Ø 288 25 22 V + S PD
			←	+PR 1ZR,1ZS		24.0125-0123.1 425123 24.0325-0123.1 525123	Ø 310 25 22 V + S Ø 310 25 22 V PD
			➔	+PR 1KK,1KT		24.0109-0123.1 409123 24.0309-0123.1 509123	Ø 230 9 7 + S Ø 230 9 7 + S PD
1.2 1.4	51 63	05/10→ 03/10→	←	+PR 1LQ,1LR,1ZG		24.0122-0151.1 422151 24.0322-0151.1 522151	Ø 256 22 19 V + S Ø 256 22 19 V + S PD
			←	15"		24.0125-0113.1 425113 24.0325-0113.1 525113	Ø 288 25 22 V + S Ø 288 25 22 V + S PD
			←	+PR 1ZR,1ZS		24.0125-0123.1 425123 24.0325-0123.1 525123	Ø 310 25 22 V + S Ø 310 25 22 V PD
			➔	+PR 1KK,1KT		24.0109-0123.1 409123 24.0309-0123.1 509123	Ø 230 9 7 + S Ø 230 9 7 + S PD
1.2 TSI	81	09/15→	←	+PR 1LQ,1LR,1ZG		24.0122-0151.1 422151 24.0322-0151.1 522151	Ø 256 22 19 V + S Ø 256 22 19 V + S PD
			←	+PR 1ZC		24.0125-0113.1 425113 24.0325-0113.1 525113	Ø 288 25 22 V + S Ø 288 25 22 V + S PD
			←	+PR 1ZR,1ZS		24.0125-0123.1 425123 24.0325-0123.1 525123	Ø 310 25 22 V + S Ø 310 25 22 V PD
			➔	+PR 1KK,1KT		24.0109-0123.1 409123 24.0309-0123.1 509123	Ø 230 9 7 + S Ø 230 9 7 + S PD
1.4 TDI 1.4 TDI 1.4 TDI	55 66 77	05/15→ 05/15→ 05/15→	←	+PR 1ZG		24.0122-0151.1 422151 24.0322-0151.1 522151	Ø 256 22 19 V + S Ø 256 22 19 V + S PD
			←	+PR 1ZC		24.0125-0113.1 425113 24.0325-0113.1 525113	Ø 288 25 22 V + S Ø 288 25 22 V + S PD
			←	+PR 1ZR,1ZS		24.0125-0123.1 425123 24.0325-0123.1 525123	Ø 310 25 22 V + S Ø 310 25 22 V PD
			➔	+PR 1KK,1KT		24.0109-0123.1 409123 24.0309-0123.1 509123	Ø 230 9 7 + S Ø 230 9 7 + S PD
1.4 TSI	103	10/13→	←	12/13→; +PR 1LQ,1LR,1ZG		24.0122-0151.1 422151 24.0322-0151.1 522151	Ø 256 22 19 V + S Ø 256 22 19 V + S PD
			←	12/13→; 15"		24.0125-0113.1 425113 24.0325-0113.1 525113	Ø 288 25 22 V + S Ø 288 25 22 V + S PD







	kw			 	! #		
SEAT - IBIZA V ST (6J8, 6P8) 03/10→							
 Bremsscheibe							
1.4 TSI	103	10/13→	←	12/13→; +PR 1ZR,1ZS	24.0125-0123.1	425123	Ø 310 25 22 V + S
			→	12/13→; +PR 1KD,1KS	24.0325-0123.1	525123	Ø 310 25 22 V PD
1.4 TSI	110	02/12→ 11/15→	←	+PR 1LQ,1LR,1ZG	24.0122-0151.1	422151	Ø 256 22 19 V + S
			←	15"	24.0322-0151.1	522151	Ø 256 22 19 V + S PD
1.4 TSI	110	02/12→ 11/15→	←	+PR 1ZR,1ZS	24.0125-0123.1	425123	Ø 310 25 22 V + S
			→	+PR 1KD,1KS	24.0325-0123.1	525123	Ø 310 25 22 V PD
1.4 TSI	110	02/12→ 11/15→	←	+PR 1ZR,1ZS	24.0125-0123.1	425123	Ø 310 25 22 V + S
			→	+PR 1KD,1KS	24.0325-0123.1	525123	Ø 310 25 22 V PD
SEAT - INCA (6K9) 11/95→06/03							
 Bremsbelagsatz, Scheibenbremse							
1.4 16V	55	04/00→06/03	←		13.0460-2821.2	602821	TRW 21945 16,0 - WK
					13.0460-2958.2	602958	TRW 20168 19,3 - WK
1.4 i	44	11/95→06/03	←	9K-T-011101→	13.0460-2821.2	602821	TRW 21945 16,0 - WK
1.6 i	55	11/95→05/98	←	→ 9K-T-011100	13.0460-2958.2	602958	TRW 20168 19,3 - WK
1.6 i	55	06/97→09/00	←				
1.9 D	47	11/95→06/03	←				
1.9 SDI	47	11/95→06/03	←				
1.9 TDI	66	09/96→06/03	←				
1.7 D	42	09/96→06/03	←		13.0460-2821.2	602821	TRW 21945 16,0 - WK
 Bremsscheibe							
1.4 16V	55	04/00→06/03	←		24.0113-0178.1	413178	Ø 255,6 12,9 11 + S
					24.0313-0178.1	513178	Ø 255,6 12,9 11 + S PD
1.4 i	44	11/95→06/03	←	→ 9K-T-011100	24.0113-0178.1	413178	Ø 255,6 12,9 11 + S
1.6 i	55	11/95→05/98	←		24.0313-0178.1	513178	Ø 255,6 12,9 11 + S PD
1.6 i	55	06/97→09/00	←				
1.9 D	47	11/95→06/03	←	9K-T-011101→	24.0120-0128.1	420128	Ø 256 20 18 V + S
1.9 SDI	47	11/95→06/03	←		24.0320-0128.1	520128	Ø 256 20 18 V + S PD
1.9 TDI	66	09/96→06/03	←				
1.7 D	42	09/96→06/03	←		24.0120-0128.1	420128	Ø 256 20 18 V + S
					24.0320-0128.1	520128	Ø 256 20 18 V + S PD
SEAT - LEON (1M1) 11/99→06/06							
 Bremsbelagsatz, Scheibenbremse							
1.4 16V	55	11/99→06/06	←	→ 07/05; +PR 1LE	13.0460-7081.2	607081	ATE 20676 19,8 - WE / - WK
1.6	74	11/99→06/06	←		13.0470-7081.2	LD7081	ATE 20676 19,8 - WE / - WK Ceramic
1.6 16 V	77	09/00→06/06	←				
1.8 20V	92	11/99→06/06	←				
1.8 20V T	132	11/99→06/06	←	→ 07/05; +PR 1LQ	13.0460-7111.2	607111	VW 23130 19,6 - WE / - WK
1.8 20V T 4	132	11/99→06/06	←		13.0470-7111.2	LD7111	VW 23130 19,6 - WE / - WK Ceramic
1.9 SDI	50	11/99→06/06	←				
1.9 TDI	66	11/99→06/06	←	→ 07/05; +PR 1LS	13.0460-7117.2	607117	VW 23130 19,6 + WK
1.9 TDI	81	11/99→06/06	←		13.0470-7117.2	LD7117	VW 23130 19,6 + WK Ceramic
1.9 TDI	96	05/03→06/06	←				
1.9 TDI Syncro	110	05/02→06/06	←	→ 07/05; +PR 1LJ,1ZQ	13.0460-7122.2	607122	ATE 20676 19,8 + WK
			→	→ 07/05; +PR 1KY,2EE	13.0470-7122.2	LD7122	ATE 20676 19,8 + WK Ceramic
			→	→ 07/05; +PR 1KK,1KP,1KQ	13.0460-2886.2	602886	TRW 20961 16,0 - WK
			→	→ 07/05; +PR 1KK,1KP,1KQ	13.0470-2886.2	LD2886	TRW 20961 16,0 - WK Ceramic
			→	→ 07/05; +PR 1KK,1KP,1KQ	13.0460-2894.2	602894	TRW 20961 17,2 - WK + Zub
			→	→ 07/05; +PR 1KK,1KP,1KQ	13.0470-2894.2	LD2894	TRW 20961 17,2 - WK + Zub Ceramic
1.8 T Cupra R	154	02/02→06/06	←	05/02→ 07/05; passend für Felgenreöße [Zoll]: 18	13.0460-4801.2	604801	BRE 21381 15,0 + WK
			←	05/02→ 07/05; +PR 1LT	13.0460-7122.2	607122	ATE 20676 19,8 + WK
			←		13.0470-7122.2	LD7122	ATE 20676 19,8 + WK Ceramic
			→	05/02→ 07/05; +PR 1KY,2EM	13.0460-2886.2	602886	TRW 20961 16,0 - WK
			→		13.0470-2886.2	LD2886	TRW 20961 16,0 - WK Ceramic
1.8 T Cupra R	165	07/03→06/06	←	→ 07/05; passend für Felgenreöße [Zoll]: 18	13.0460-4801.2	604801	BRE 21381 15,0 + WK
2.8 Cupra 4	150	02/01→06/06	←	→ 07/05; +PR 1LT	13.0460-7122.2	607122	ATE 20676 19,8 + WK
			←		13.0470-7122.2	LD7122	ATE 20676 19,8 + WK Ceramic
			→	→ 07/05; +PR 1KY,2EM	13.0460-2886.2	602886	TRW 20961 16,0 - WK
			→		13.0470-2886.2	LD2886	TRW 20961 16,0 - WK Ceramic









	kw			 	! #		
SEAT - LEON (1M1) 11/99→06/06							
 Bremsbelagsatz, Scheibenbremse							
1.8 Turbo 4x4	154	05/02→05/03	←	+PR 1LQ		13.0460-7111.2 607111 13.0470-7111.2 LD7111	VW 23130 19,6 - WE / - WK VW 23130 19,6 - WE / - WK Ceramic
			←	+PR 1LS		13.0460-7117.2 607117 13.0470-7117.2 LD7117	VW 23130 19,6 + WK VW 23130 19,6 + WK Ceramic
			→	+PR 1KY,2EE		13.0460-2886.2 602886 13.0470-2886.2 LD2886	TRW 20961 16,0 - WK TRW 20961 16,0 - WK Ceramic
			→	+PR 1KK,1KP,1KQ		13.0460-2894.2 602894 13.0470-2894.2 LD2894	TRW 20961 17,2 - WK + Zub TRW 20961 17,2 - WK + Zub Ceramic
1.9 TDI	110	09/00→06/06	←	02/01→ 07/05; +PR 1LE		13.0460-7081.2 607081 13.0470-7081.2 LD7081	ATE 20676 19,8 - WE / - WK ATE 20676 19,8 - WE / - WK Ceramic
			←	02/01→ 07/05; +PR 1LQ		13.0460-7111.2 607111 13.0470-7111.2 LD7111	VW 23130 19,6 - WE / - WK VW 23130 19,6 - WE / - WK Ceramic
			←	02/01→ 07/05; +PR 1LS		13.0460-7117.2 607117 13.0470-7117.2 LD7117	VW 23130 19,6 + WK VW 23130 19,6 + WK Ceramic
			←	02/01→ 07/05; +PR 1LJ,1ZQ		13.0460-7122.2 607122 13.0470-7122.2 LD7122	ATE 20676 19,8 + WK ATE 20676 19,8 + WK Ceramic
			→	02/01→ 07/05; +PR 1KY,2EE		13.0460-2886.2 602886 13.0470-2886.2 LD2886	TRW 20961 16,0 - WK TRW 20961 16,0 - WK Ceramic
			→	02/01→ 07/05; +PR 1KK,1KP,1KQ		13.0460-2894.2 602894 13.0470-2894.2 LD2894	TRW 20961 17,2 - WK + Zub TRW 20961 17,2 - WK + Zub Ceramic
2.8	150	05/02→06/04	←	+PR 1LE		13.0460-7081.2 607081 13.0470-7081.2 LD7081	ATE 20676 19,8 - WE / - WK ATE 20676 19,8 - WE / - WK Ceramic
			←	+PR 1LQ		13.0460-7111.2 607111 13.0470-7111.2 LD7111	VW 23130 19,6 - WE / - WK VW 23130 19,6 - WE / - WK Ceramic
			←	+PR 1LS		13.0460-7117.2 607117 13.0470-7117.2 LD7117	VW 23130 19,6 + WK VW 23130 19,6 + WK Ceramic
			←	+PR 1LJ,1ZQ		13.0460-7122.2 607122 13.0470-7122.2 LD7122	ATE 20676 19,8 + WK ATE 20676 19,8 + WK Ceramic
			→	+PR 1KY,2EE		13.0460-2886.2 602886 13.0470-2886.2 LD2886	TRW 20961 16,0 - WK TRW 20961 16,0 - WK Ceramic
			→	+PR 1KK,1KP,1KQ		13.0460-2894.2 602894 13.0470-2894.2 LD2894	TRW 20961 17,2 - WK + Zub TRW 20961 17,2 - WK + Zub Ceramic
Zubehörsatz, Scheibenbremsbelag							
1.4 16V	55	11/99→06/06		→ 07/05; +PR 1KY,2EE		13.0460-0072.2 610072	TRW
1.6	74	11/99→06/06	→	→ 07/05; +PR 1KK,1KP,1KQ		13.0460-0072.2 610072	TRW
1.6 16 V	77	09/00→06/06					
1.8 20V	92	11/99→06/06					
1.8 20V T	132	11/99→06/06					
1.8 20V T 4	132	11/99→06/06					
1.9 SDI	50	11/99→06/06					
1.9 TDI	66	11/99→06/06					
1.9 TDI	81	11/99→06/06					
1.9 TDI	96	05/03→06/06					
1.9 TDI Syncro	110	05/02→06/06					
1.8 T Cupra R	154	02/02→06/06		05/02→ 07/05; +PR 1KY,2EM		13.0460-0072.2 610072	TRW
1.8 T Cupra R	165	07/03→06/06		→ 07/05; +PR 1KY,2EM		13.0460-0072.2 610072	TRW
2.8 Cupra 4	150	02/01→06/06					
1.8 Turbo 4x4	154	05/02→05/03		+PR 1KY,2EE		13.0460-0072.2 610072	TRW
2.8	150	05/02→06/04	→	+PR 1KK,1KP,1KQ		13.0460-0072.2 610072	TRW
1.9 TDI	110	09/00→06/06		02/01→ 07/05; +PR 1KY,2EE		13.0460-0072.2 610072	TRW
			→	02/01→ 07/05; +PR 1KK,1KP,1KQ		13.0460-0072.2 610072	TRW
 Bremsscheibe							
1.4 16V	55	11/99→06/06	←	→ 07/05; +PR 1LR,1LS		24.0122-0150.1 422150	Ø 280 22 19 V + S
1.6	74	11/99→06/06				24.0322-0150.1 522150	Ø 280 22 19 V + S PD
1.6 16 V	77	09/00→06/06					
1.8 20V	92	11/99→06/06	←	→ 07/05; +PR 1LQ		24.0122-0151.1 422151	Ø 256 22 19 V + S
1.8 20V T 4	132	11/99→06/06				24.0322-0151.1 522151	Ø 256 22 19 V + S PD
1.9 SDI	50	11/99→06/06					
1.9 TDI	66	11/99→06/06	←	→ 07/05; +PR 1LE		24.0125-0113.1 425113	Ø 288 25 22 V + S

	kw			 	! #		
SEAT - LEON (1M1) 11/99→06/06							
Bremsscheibe							
1.9 TDI 1.9 TDI 1.9 TDI Syncro	81	11/99→06/06	←	→ 07/05; +PR 1LE		24.0325-0113.1 525113	Ø 288 25 22 V + S PD
	96	05/03→06/06	←	→ 07/05; +PR 1LJ,1ZQ		24.0125-0123.1 425123	Ø 310 25 22 V + S
	110	05/02→06/06	→	→ 07/05; +PR 1KK,1KP,1KQ		24.0325-0123.1 525123	Ø 310 25 22 V PD
			→	→ 07/05; +PR 1KK,1KP,1KQ		24.0109-0123.1 409123	Ø 230 9 7 + S
			→	→ 07/05; +PR 1KY,2EE		24.0309-0123.1 509123	Ø 230 9 7 + S PD
			→	→ 07/05; +PR 1KY,2EE		24.0122-0163.1 422163	Ø 256 22 20 V
			→	→ 07/05; +PR 1KY,2EE		24.0322-0163.1 522163	Ø 256 22 20 V PD
1.8 20V T	132	11/99→06/06	←	→ 07/05; +PR 1LR,1LS		24.0122-0150.1 422150	Ø 280 22 19 V + S
						24.0322-0150.1 522150	Ø 280 22 19 V + S PD
			←	→ 07/05; +PR 1LQ		24.0122-0151.1 422151	Ø 256 22 19 V + S
						24.0322-0151.1 522151	Ø 256 22 19 V + S PD
			←	→ 07/05; +PR 1LE		24.0125-0113.1 425113	Ø 288 25 22 V + S
						24.0325-0113.1 525113	Ø 288 25 22 V + S PD
			←	→ 07/05; +PR 1LJ, 1ZQ		24.0125-0123.1 425123	Ø 310 25 22 V + S
			24.0325-0123.1 525123	Ø 310 25 22 V PD			
			→	→ 07/05; +PR 1KK,1KP,1KQ		24.0109-0123.1 409123	Ø 230 9 7 + S
			→	→ 07/05; +PR 1KK,1KP,1KQ		24.0309-0123.1 509123	Ø 230 9 7 + S PD
			→	→ 07/05; +PR 1KY,2EE		24.0122-0163.1 422163	Ø 256 22 20 V
			→	→ 07/05; +PR 1KY,2EE		24.0322-0163.1 522163	Ø 256 22 20 V PD
1.8 T Cupra R	154	02/02→06/06	←	05/02→ 07/05; +PR 1LT		24.0125-0123.1 425123	Ø 310 25 22 V + S
						24.0325-0123.1 525123	Ø 310 25 22 V PD
			→	05/02→ 07/05; +PR 1KY,2EM		24.0122-0163.1 422163	Ø 256 22 20 V
						24.0322-0163.1 522163	Ø 256 22 20 V PD
1.8 T Cupra R 2.8 Cupra 4	165 150	07/03→06/06 02/01→06/06	←	→ 07/05; +PR 1LT		24.0125-0123.1 425123	Ø 310 25 22 V + S
						24.0325-0123.1 525123	Ø 310 25 22 V PD
			→	→ 07/05; +PR 1KY,2EM		24.0122-0163.1 422163	Ø 256 22 20 V
						24.0322-0163.1 522163	Ø 256 22 20 V PD
1.8 Turbo 4x4 2.8	154 150	05/02→05/03 05/02→06/04	←	+PR 1LR,1LS		24.0122-0150.1 422150	Ø 280 22 19 V + S
						24.0322-0150.1 522150	Ø 280 22 19 V + S PD
			←	+PR 1LQ		24.0122-0151.1 422151	Ø 256 22 19 V + S
						24.0322-0151.1 522151	Ø 256 22 19 V + S PD
			←	+PR 1LE		24.0125-0113.1 425113	Ø 288 25 22 V + S
						24.0325-0113.1 525113	Ø 288 25 22 V + S PD
			←	+PR 1LJ,1ZQ		24.0125-0123.1 425123	Ø 310 25 22 V + S
			24.0325-0123.1 525123	Ø 310 25 22 V PD			
			→	+PR 1KK,1KP,1KQ		24.0109-0123.1 409123	Ø 230 9 7 + S
			→	+PR 1KK,1KP,1KQ		24.0309-0123.1 509123	Ø 230 9 7 + S PD
			→	+PR 1KY,2EE		24.0122-0163.1 422163	Ø 256 22 20 V
			→	+PR 1KY,2EE		24.0322-0163.1 522163	Ø 256 22 20 V PD
1.9 TDI	110	09/00→06/06	←	02/01→ 07/05; +PR 1LR,1LS		24.0122-0150.1 422150	Ø 280 22 19 V + S
						24.0322-0150.1 522150	Ø 280 22 19 V + S PD
			←	02/01→ 07/05; +PR 1LQ		24.0122-0151.1 422151	Ø 256 22 19 V + S
						24.0322-0151.1 522151	Ø 256 22 19 V + S PD
			←	02/01→ 07/05; +PR 1LE		24.0125-0113.1 425113	Ø 288 25 22 V + S
						24.0325-0113.1 525113	Ø 288 25 22 V + S PD
			←	02/01→ 07/05; +PR 1LJ,1ZQ		24.0125-0123.1 425123	Ø 310 25 22 V + S
			24.0325-0123.1 525123	Ø 310 25 22 V PD			
			→	02/01→ 07/05; +PR 1KK,1KP,1KQ		24.0109-0123.1 409123	Ø 230 9 7 + S
			→	02/01→ 07/05; +PR 1KK,1KP,1KQ		24.0309-0123.1 509123	Ø 230 9 7 + S PD
			→	02/01→ 07/05; +PR 1KY,2EE		24.0122-0163.1 422163	Ø 256 22 20 V
			→	02/01→ 07/05; +PR 1KY,2EE		24.0322-0163.1 522163	Ø 256 22 20 V PD
SEAT - LEON (1P1) 05/05→12/12							
Bremsbelagsatz, Scheibenbremse							
1.2 TSI 1.6 LPG 1.6 MultiFuel 1.6 TDI 1.6 TDI 2.0 Cupra R	77	02/10→12/12	←	+PR 1ZF,1ZM; → 10/12		13.0460-7117.2 607117	VW 23130 19,6 + WK
	75	12/09→12/12				13.0470-7117.2 LD7117	VW 23130 19,6 + WK Ceramic
	75	11/10→12/12	←	+PR 1ZE,1LJ; → 10/12		13.0460-7184.2 607184	ATE 23587 20,6 + WK
	66	11/10→12/12				13.0470-7184.2 LD7184	ATE 23587 20,6 + WK Ceramic
	77	02/10→12/12	←	→ 10/12; +PR 1LU		13.0460-7200.2 607200	ATE 23801 20,3 + WK
	195	09/09→12/12				13.0470-7200.2 LD7200	ATE 23801 20,3 + WK Ceramic
			←	→ 10/12; +PR 1LB		13.0460-7227.2 607227	ATE 23801 20,3 + WK









	kw			 	! #		
SEAT - LEON (1P1) 05/05→12/12							
 Bremsbelagsatz, Scheibenbremse							
1.2 TSI	77	02/10→12/12	←	→ 10/12; +PR 1LB		13.0470-7227.2 LD7227	ATE 23912 20,3 + WK Ceramic
1.6 LPG	75	12/09→12/12	→	→ 10/12; +PR 1KY,1KZ		13.0460-2749.2 602749	TRW 24483 16,9 - WE / - WK + Zub
1.6 MultiFuel	75	11/10→12/12					
1.6 TDI	66	11/10→12/12				13.0460-2880.2 602880	TRW 23914 17,1 + WE / - WK + Zub
1.6 TDI	77	02/10→12/12				13.0470-2749.2 LD2749	TRW 24483 16,9 - WE / - WK + Zub Ceramic
2.0 Cupra R	195	09/09→12/12				13.0470-2880.2 LD2880	TRW 23914 17,1 + WE / - WK + Zub Ceramic
			→	→ 10/12; +PR 1KD		13.0460-2820.2 602820	TRW 20961 17,2 - WK
			→	→ 10/12; +PR 1KS,1KT		13.0460-3858.2 603858	TRW 20961 17,2 - WK Ceramic
						13.0470-3858.2 LD3858	BOS 24563 17,7 - WE / - WK + Zub
						13.0470-3858.2 LD3858	BOS 24563 17,7 - WE / - WK + Zub Ceramic
1.4 16V	63	06/06→12/12	←	→ 10/12; +PR 1ZF;1ZM		13.0460-7117.2 607117	VW 23130 19,6 + WK
1.4 TSI	92	11/07→12/12				13.0470-7117.2 LD7117	VW 23130 19,6 + WK Ceramic
1.8 TSI	118	06/07→12/12					
2.0 TDI	125	05/06→12/12	←	→ 10/12; +PR 1ZE;1LJ		13.0460-7184.2 607184	ATE 23587 20,6 + WK
2.0 TFSI	155	06/09→12/12				13.0470-7184.2 LD7184	ATE 23587 20,6 + WK Ceramic
			←	→ 10/12; +PR 1LU		13.0460-7200.2 607200	ATE 23801 20,3 + WK
						13.0470-7200.2 LD7200	ATE 23801 20,3 + WK Ceramic
			←	→ 10/12; +PR 1LB		13.0460-7227.2 607227	ATE 23801 20,3 + WK
						13.0470-7227.2 LD7227	ATE 23912 20,3 + WK Ceramic
			→	→ 10/12; +PR 1KY,1KZ		13.0460-2749.2 602749	TRW 24483 16,9 - WE / - WK + Zub
						13.0460-2880.2 602880	TRW 23914 17,1 + WE / - WK + Zub
						13.0470-2749.2 LD2749	TRW 24483 16,9 - WE / - WK + Zub Ceramic
						13.0470-2880.2 LD2880	TRW 23914 17,1 + WE / - WK + Zub Ceramic
			→	→ 10/12; +PR 1KD		13.0460-2820.2 602820	TRW 20961 17,2 - WK
						13.0470-2820.2 LD2820	TRW 20961 17,2 - WK Ceramic
			→	→ 10/12; +PR 1KS,1KT		13.0460-3858.2 603858	BOS 24563 17,7 - WE / - WK + Zub
						13.0470-3858.2 LD3858	BOS 24563 17,7 - WE / - WK + Zub Ceramic
1.6	75	07/05→12/12	←	08/05→ 10/12; +PR 1ZF;1ZM		13.0460-7117.2 607117	VW 23130 19,6 + WK
2.0 TDI 16V	103	07/05→12/12				13.0470-7117.2 LD7117	VW 23130 19,6 + WK Ceramic
			←	08/05→ 10/12; +PR 1ZE;1LJ		13.0460-7184.2 607184	ATE 23587 20,6 + WK
						13.0470-7184.2 LD7184	ATE 23587 20,6 + WK Ceramic
			←	08/05→ 10/12; +PR 1LU		13.0460-7200.2 607200	ATE 23801 20,3 + WK
						13.0470-7200.2 LD7200	ATE 23801 20,3 + WK Ceramic
			←	08/05→ 10/12; +PR 1LB		13.0460-7227.2 607227	ATE 23801 20,3 + WK
						13.0470-7227.2 LD7227	ATE 23912 20,3 + WK Ceramic
			→	08/05→ 10/12; +PR 1KY,1KZ		13.0460-2749.2 602749	TRW 24483 16,9 - WE / - WK + Zub
						13.0460-2880.2 602880	TRW 23914 17,1 + WE / - WK + Zub
						13.0470-2749.2 LD2749	TRW 24483 16,9 - WE / - WK + Zub Ceramic
						13.0470-2880.2 LD2880	TRW 23914 17,1 + WE / - WK + Zub Ceramic
			→	08/05→ 10/12; +PR 1KD		13.0460-2820.2 602820	TRW 20961 17,2 - WK
						13.0470-2820.2 LD2820	TRW 20961 17,2 - WK Ceramic
			→	08/05→ 10/12; +PR 1KS,1KT		13.0460-3858.2 603858	BOS 24563 17,7 - WE / - WK + Zub
						13.0470-3858.2 LD3858	BOS 24563 17,7 - WE / - WK + Zub Ceramic
1.9 TDI	66	06/07→12/10	←	+PR 1ZF;1ZM		13.0460-7117.2 607117	VW 23130 19,6 + WK
2.0 TDI	103	10/05→10/10				13.0470-7117.2 LD7117	VW 23130 19,6 + WK Ceramic
2.0 TFSI	136	09/05→05/06	←	+PR 1ZE;1LJ		13.0460-7184.2 607184	ATE 23587 20,6 + WK
2.0 TFSI	177	11/06→05/11				13.0470-7184.2 LD7184	ATE 23587 20,6 + WK Ceramic
			←	+PR 1LU		13.0460-7200.2 607200	ATE 23801 20,3 + WK
						13.0470-7200.2 LD7200	ATE 23801 20,3 + WK Ceramic
			←	+PR 1LB		13.0460-7227.2 607227	ATE 23801 20,3 + WK









	kw			 	! #		
SEAT - LEON (1P1) 05/05→12/12							
 Bremsbelagsatz, Scheibenbremse							
1.9 TDI 2.0 TDI 2.0 TFSI 2.0 TFSI	66 103 136 177	06/07→12/10 10/05→10/10 09/05→05/06 11/06→05/11	← → → →	+PR 1LB +PR 1KY,1KZ +PR 1KD +PR 1KS,1KT		13.0470-7227.2 LD7227 13.0460-2749.2 602749 13.0460-2880.2 602880 13.0470-2749.2 LD2749 13.0470-2880.2 LD2880 13.0460-2820.2 602820 13.0470-2820.2 LD2820 13.0460-3858.2 603858 13.0470-3858.2 LD3858	ATE 23912 20,3 + WK Ceramic TRW 24483 16,9 - WE / - WK + Zub TRW 23914 17,1 + WE / - WK + Zub TRW 24483 16,9 - WE / - WK + Zub Ceramic TRW 23914 17,1 + WE / - WK + Zub Ceramic TRW 20961 17,2 - WK TRW 20961 17,2 - WK Ceramic BOS 24563 17,7 - WE / - WK + Zub BOS 24563 17,7 - WE / - WK + Zub Ceramic
1.9 TDI 2.0 FSI 2.0 TDI 2.0 TFSI	77 110 100 147	07/05→12/10 07/05→05/10 07/05→05/10 05/05→03/09	← ← ← ← ← → →	08/05→; +PR 1ZF;1ZM 08/05→; +PR 1ZE;1LJ 08/05→; +PR 1LU 08/05→; +PR 1LB 08/05→; +PR 1KY,1KZ 08/05→; +PR 1KD 08/05→; +PR 1KS,1KT		13.0460-7117.2 607117 13.0470-7117.2 LD7117 13.0460-7184.2 607184 13.0470-7184.2 LD7184 13.0460-7200.2 607200 13.0470-7200.2 LD7200 13.0460-7227.2 607227 13.0470-7227.2 LD7227 13.0460-2749.2 602749 13.0460-2880.2 602880 13.0470-2749.2 LD2749 13.0470-2880.2 LD2880 13.0460-2820.2 602820 13.0470-2820.2 LD2820 13.0460-3858.2 603858 13.0470-3858.2 LD3858	VW 23130 19,6 + WK VW 23130 19,6 + WK Ceramic ATE 23587 20,6 + WK ATE 23587 20,6 + WK Ceramic ATE 23801 20,3 + WK ATE 23801 20,3 + WK Ceramic ATE 23801 20,3 + WK ATE 23912 20,3 + WK Ceramic TRW 24483 16,9 - WE / - WK + Zub TRW 23914 17,1 + WE / - WK + Zub TRW 24483 16,9 - WE / - WK + Zub Ceramic TRW 23914 17,1 + WE / - WK + Zub Ceramic TRW 20961 17,2 - WK TRW 20961 17,2 - WK Ceramic BOS 24563 17,7 - WE / - WK + Zub BOS 24563 17,7 - WE / - WK + Zub Ceramic
 Bremsscheibe							
1.2 TSI 1.6 LPG 1.6 MultiFuel 1.6 TDI 1.6 TDI 2.0 Cupra R	77 75 75 66 77 195	02/10→12/12 12/09→12/12 11/10→12/12 11/10→12/12 02/10→12/12 09/09→12/12	← ← ← ← ← → → → → → →	+PR 1ZF,1ZM; → 10/12 → 10/12; +PR 1ZE → 10/12; +PR 1LJ → 10/12; +PR 1LB,1LU → 10/12; +PR 1KD → 10/12; +PR 1KS,1KT → 10/12; +PR 1KY,1KZ		24.0122-0210.1 422210 24.0322-0210.1 522210 24.0125-0145.1 425145 24.0325-0145.1 525145 24.0125-0158.1 425158 24.0325-0158.1 525158 24.0130-0115.1 430115 24.0330-0115.1 530115 24.0110-0277.1 410277 24.0310-0277.1 510277 24.0110-0356.1 410356 24.0310-0356.1 510356 24.0112-0169.1 412169 24.0312-0169.1 512169	∅ 280 22 19 V + S ∅ 280 22 19 V + S PD ∅ 288 25 22 V + S ∅ 288 25 22 V + S PD ∅ 312 25 22 V + S ∅ 312 25 22 V + S PD ∅ 345 30 27 V ∅ 345 30 27 V PD ∅ 253 10 8 + S ∅ 253 10 8 + S PD ∅ 272 9,7 8 + S ∅ 272 9,7 8 + S PD ∅ 282 12 10 + S ∅ 282 12 10 + S PD
1.4 16V 1.4 TSI 1.8 TSI 2.0 TDI 2.0 TFSI	63 92 118 125 155	06/06→12/12 11/07→12/12 06/07→12/12 05/06→12/12 06/09→12/12	← ← ← ← ← → →	→ 10/12; +PR 1ZF,1ZM → 10/12; +PR 1ZE → 10/12; +PR 1LJ → 10/12; +PR 1LB,1LU → 10/12; +PR 1KD → 10/12; +PR 1KS,1KT		24.0122-0210.1 422210 24.0322-0210.1 522210 24.0125-0145.1 425145 24.0325-0145.1 525145 24.0125-0158.1 425158 24.0325-0158.1 525158 24.0130-0115.1 430115 24.0330-0115.1 530115 24.0110-0277.1 410277 24.0310-0277.1 510277 24.0110-0356.1 410356 24.0310-0356.1 510356	∅ 280 22 19 V + S ∅ 280 22 19 V + S PD ∅ 288 25 22 V + S ∅ 288 25 22 V + S PD ∅ 312 25 22 V + S ∅ 312 25 22 V + S PD ∅ 345 30 27 V ∅ 345 30 27 V PD ∅ 253 10 8 + S ∅ 253 10 8 + S PD ∅ 272 9,7 8 + S ∅ 272 9,7 8 + S PD
↓							









	kw			 	! #		
SEAT - LEON (1P1) 05/05→12/12							
Bremsscheibe							
1.4 16V	63	06/06→12/12	→	→ 10/12; +PR 1KY,1KZ		24.0112-0169.1 412169	Ø 282 12 10 + S
1.4 TSI	92	11/07→12/12				24.0312-0169.1 512169	Ø 282 12 10 + S PD
1.8 TSI	118	06/07→12/12					
2.0 TDI	125	05/06→12/12					
2.0 TFSI	155	06/09→12/12					
1.6	75	07/05→12/12	←	08/05→ 10/12; +PR 1ZF;1ZM		24.0122-0210.1 422210	Ø 280 22 19 V + S
2.0 TDI 16V	103	07/05→12/12				24.0322-0210.1 522210	Ø 280 22 19 V + S PD
			←	08/05→ 10/12; +PR 1ZE		24.0125-0145.1 425145	Ø 288 25 22 V + S
						24.0325-0145.1 525145	Ø 288 25 22 V + S PD
			←	08/05→ 10/12; +PR 1LJ		24.0125-0158.1 425158	Ø 312 25 22 V + S
						24.0325-0158.1 525158	Ø 312 25 22 V + S PD
			←	08/05→ 10/12; +PR 1LB,1LU		24.0130-0115.1 430115	Ø 345 30 27 V
						24.0330-0115.1 530115	Ø 345 30 27 V PD
			→	08/05→ 10/12; +PR 1KD		24.0110-0277.1 410277	Ø 253 10 8 + S
						24.0310-0277.1 510277	Ø 253 10 8 + S PD
			→	08/05→ 10/12; +PR 1KS,1KT		24.0110-0356.1 410356	Ø 272 9,7 8 + S
						24.0310-0356.1 510356	Ø 272 9,7 8 + S PD
			→	08/05→ 10/12; +PR 1KY,1KZ		24.0112-0169.1 412169	Ø 282 12 10 + S
						24.0312-0169.1 512169	Ø 282 12 10 + S PD
1.9 TDI	66	06/07→12/10	←	+PR 1ZF;1ZM		24.0122-0210.1 422210	Ø 280 22 19 V + S
2.0 TDI	103	10/05→10/10				24.0322-0210.1 522210	Ø 280 22 19 V + S PD
2.0 TFSI	136	09/05→05/06					
2.0 TFSI	177	11/06→05/11	←	+PR 1ZE		24.0125-0145.1 425145	Ø 288 25 22 V + S
						24.0325-0145.1 525145	Ø 288 25 22 V + S PD
			←	+PR 1LJ		24.0125-0158.1 425158	Ø 312 25 22 V + S
						24.0325-0158.1 525158	Ø 312 25 22 V + S PD
			←	+PR 1LB,1LU		24.0130-0115.1 430115	Ø 345 30 27 V
						24.0330-0115.1 530115	Ø 345 30 27 V PD
			→	+PR 1KD		24.0110-0277.1 410277	Ø 253 10 8 + S
						24.0310-0277.1 510277	Ø 253 10 8 + S PD
			→	+PR 1KS,1KT		24.0110-0356.1 410356	Ø 272 9,7 8 + S
						24.0310-0356.1 510356	Ø 272 9,7 8 + S PD
			→	+PR 1KY,1KZ		24.0112-0169.1 412169	Ø 282 12 10 + S
						24.0312-0169.1 512169	Ø 282 12 10 + S PD
1.9 TDI	77	07/05→12/10	←	08/05→; +PR 1ZF;1ZM		24.0122-0210.1 422210	Ø 280 22 19 V + S
2.0 FSI	110	07/05→05/10				24.0322-0210.1 522210	Ø 280 22 19 V + S PD
2.0 TDI	100	07/05→05/10					
2.0 TFSI	147	05/05→03/09	←	08/05→; +PR 1ZE		24.0125-0145.1 425145	Ø 288 25 22 V + S
						24.0325-0145.1 525145	Ø 288 25 22 V + S PD
			←	08/05→; +PR 1LJ		24.0125-0158.1 425158	Ø 312 25 22 V + S
						24.0325-0158.1 525158	Ø 312 25 22 V + S PD
			←	08/05→; +PR 1LB,1LU		24.0130-0115.1 430115	Ø 345 30 27 V
						24.0330-0115.1 530115	Ø 345 30 27 V PD
			→	08/05→; +PR 1KD		24.0110-0277.1 410277	Ø 253 10 8 + S
						24.0310-0277.1 510277	Ø 253 10 8 + S PD
			→	08/05→; +PR 1KS,1KT		24.0110-0356.1 410356	Ø 272 9,7 8 + S
						24.0310-0356.1 510356	Ø 272 9,7 8 + S PD
			→	08/05→; +PR 1KY,1KZ		24.0112-0169.1 412169	Ø 282 12 10 + S
						24.0312-0169.1 512169	Ø 282 12 10 + S PD
SEAT - LEON (5F1) 09/12→							
Bremsbelagsatz, Scheibenbremse							
1.0 TSI	85	05/15→	←	+PR 1ZA,1ZE		13.0460-2785.2 602785	TRW 25683 20,4 + WE / + WK
1.2 TSI	63	12/12→				13.0470-2785.2 LD2785	TRW 25683 20,4 + WE / + WK Ceramic
1.2 TSI	77	01/13→					
1.2 TSI	81	04/14→					
1.4 TSI	90	11/12→	←	+PR 1ZF,1ZH		13.0460-7303.2 607303	ATE 22035 17,5 + WK
1.4 TSI	92	05/14→				13.0470-7303.2 LD7303	ATE 22035 17,5 + WK Ceramic
1.4 TSI	103	09/12→					
1.4 TSI	110	05/14→	→	+PR 1KF,1KW		13.0460-2749.2 602749	TRW 24483 16,9 - WE / - WK + Zub
1.6 TDI	66	11/12→					
1.6 TDI	77	11/12→				13.0460-2880.2 602880	TRW 23914 17,1 + WE / - WK + Zub
1.6 TDI	81	09/13→					
1.8 TSI	132	02/13→				13.0470-2749.2 LD2749	TRW 24483 16,9 - WE / - WK + Zub Ceramic
2.0 TDI	81	05/13→					
2.0 TDI	105	05/13→				13.0470-2880.2 LD2880	TRW 23914 17,1 + WE / - WK + Zub Ceramic
2.0 TDI	110	10/12→					
2.0 TDI	135	09/12→					
			→	+PR 1KD		13.0460-2787.2 602787	TRW 23554 17,3 - WK / - WE







	kw			 	! #		
SEAT - LEON (5F1) 09/12→							
 Bremsbelagsatz, Scheibenbremse							
1.0 TSI	85	05/15→	➔	+PR 1KS		13.0460-2790.2 602790	TRW 25110 17,5 - WE / - WK
1.2 TSI	63	12/12→				13.0470-2790.2 LD2790	TRW 25110 17,5 - WE / - WK
1.2 TSI	77	01/13→					Ceramic
1.2 TSI	81	04/14→					
1.4 TSI	90	11/12→	➔	+PR 1KE		13.0460-7293.2 607293	ATE 25008 16,3 - WE / - WK
1.4 TSI	92	05/14→				13.0470-7293.2 LD7293	ATE 25008 16,3 - WE / - WK
1.4 TSI	103	09/12→					Ceramic
1.4 TSI	110	05/14→	➔	+PR 1KJ,1KY; + eFSB		13.0460-7294.2 607294	ATE 25009 16,4 - WE / - WK
1.6 TDI	66	11/12→				13.0470-7294.2 LD7294	ATE 25009 16,4 - WE / - WK
1.6 TDI	77	11/12→					Ceramic
1.6 TDI	81	09/13→					
1.8 TSI	132	02/13→					
2.0 TDI	81	05/13→					
2.0 TDI	105	05/13→					
2.0 TDI	110	10/12→					
2.0 TDI	135	09/12→					
1.4 TGI	81	02/13→	⬅	10/13→; +PR 1ZA,1ZE		13.0460-2785.2 602785	TRW 25683 20,4 + WE / + WK
						13.0470-2785.2 LD2785	TRW 25683 20,4 + WE / + WK
			⬅	10/13→; +PR 1ZF,1ZH		13.0460-7303.2 607303	ATE 22035 17,5 + WK
						13.0470-7303.2 LD7303	ATE 22035 17,5 + WK Ceramic
			➔	10/13→; +PR 1KF,1KW		13.0460-2749.2 602749	TRW 24483 16,9 - WE / - WK
						13.0460-2880.2 602880	+ Zub
						13.0470-2749.2 LD2749	TRW 23914 17,1 + WE / - WK
						13.0470-2880.2 LD2880	+ Zub
							Ceramic
			➔	10/13→; +PR 1KD		13.0460-2787.2 602787	TRW 23554 17,3 - WK / - WE
			➔	10/13→; +PR 1KS		13.0460-2790.2 602790	TRW 25110 17,5 - WE / - WK
						13.0470-2790.2 LD2790	TRW 25110 17,5 - WE / - WK
							Ceramic
			➔	10/13→; +PR 1KE		13.0460-7293.2 607293	ATE 25008 16,3 - WE / - WK
						13.0470-7293.2 LD7293	ATE 25008 16,3 - WE / - WK
							Ceramic
			➔	10/13→; +PR 1KJ,1KY; + eFSB		13.0460-7294.2 607294	ATE 25009 16,4 - WE / - WK
						13.0470-7294.2 LD7294	ATE 25009 16,4 - WE / - WK
							Ceramic
1.6 TDI	85	11/16→	⬅	01/17→; +PR 1ZA,1ZE		13.0460-2785.2 602785	TRW 25683 20,4 + WE / + WK
						13.0470-2785.2 LD2785	TRW 25683 20,4 + WE / + WK
			⬅	01/17→; +PR 1ZF,1ZH		13.0460-7303.2 607303	ATE 22035 17,5 + WK
						13.0470-7303.2 LD7303	ATE 22035 17,5 + WK Ceramic
			➔	01/17→; +PR 1KD		13.0460-2787.2 602787	TRW 23554 17,3 - WK / - WE
			➔	01/17→; +PR 1KS		13.0460-2790.2 602790	TRW 25110 17,5 - WE / - WK
						13.0470-2790.2 LD2790	TRW 25110 17,5 - WE / - WK
							Ceramic
			➔	01/17→; +PR 1KE		13.0460-7293.2 607293	ATE 25008 16,3 - WE / - WK
						13.0470-7293.2 LD7293	ATE 25008 16,3 - WE / - WK
							Ceramic
			➔	01/17→; +PR 1KJ,1KY; + eFSB		13.0460-7294.2 607294	ATE 25009 16,4 - WE / - WK
						13.0470-7294.2 LD7294	ATE 25009 16,4 - WE / - WK
							Ceramic
2.0 Cupra	195	10/13→	⬅	+PR 1ZA,1ZE		13.0460-2785.2 602785	TRW 25683 20,4 + WE / + WK
2.0 Cupra	206	10/13→				13.0470-2785.2 LD2785	TRW 25683 20,4 + WE / + WK
2.0 Cupra	213	10/15→					Ceramic
			⬅	+ Performance Pack		13.0460-4833.2 604833	BRE 24098 17,1 + WE / - WK
						13.0470-4833.2 LD4833	BRE 24098 17,1 + WE / - WK
							Ceramic
			⬅	+PR 1ZF,1ZH		13.0460-7303.2 607303	ATE 22035 17,5 + WK
						13.0470-7303.2 LD7303	ATE 22035 17,5 + WK Ceramic
			➔	+PR 1KF,1KW		13.0460-2749.2 602749	TRW 24483 16,9 - WE / - WK
						13.0460-2880.2 602880	+ Zub
						13.0470-2749.2 LD2749	TRW 23914 17,1 + WE / - WK
						13.0470-2880.2 LD2880	+ Zub
							Ceramic









↓

	kw			 	! #		
SEAT - LEON (5F1) 09/12→							
 Bremsbelagsatz, Scheibenbremse							
2.0 Cupra 2.0 Cupra 2.0 Cupra	195 206 213	10/13→ 10/13→ 10/15→	➡ ➡ ➡	+PR 1KD +PR 1KS +PR 1KE +PR 1KJ,1KY; + eFSB		13.0460-2787.2 602787 13.0460-2790.2 602790 13.0470-2790.2 LD2790 13.0460-7293.2 607293 13.0470-7293.2 LD7293 13.0460-7294.2 607294 13.0470-7294.2 LD7294	TRW 23554 17,3 - WK / - WE TRW 25110 17,5 - WE / - WK TRW 25110 17,5 - WE / - WK Ceramic ATE 25008 16,3 - WE / - WK ATE 25008 16,3 - WE / - WK Ceramic ATE 25009 16,4 - WE / - WK ATE 25009 16,4 - WE / - WK Ceramic
2.0 Cupra	221	01/17→	⬅ ⬅ ⬅ ➡ ➡ ➡ ➡	+PR 1ZA,1ZE + Performance Pack +PR 1ZF,1ZH +PR 1KD +PR 1KS +PR 1KE +PR 1KJ,1KY; + eFSB		13.0460-2785.2 602785 13.0470-2785.2 LD2785 13.0460-4833.2 604833 13.0470-4833.2 LD4833 13.0460-7303.2 607303 13.0470-7303.2 LD7303 13.0460-2787.2 602787 13.0460-2790.2 602790 13.0470-2790.2 LD2790 13.0460-7293.2 607293 13.0470-7293.2 LD7293 13.0460-7294.2 607294 13.0470-7294.2 LD7294	TRW 25683 20,4 + WE / + WK TRW 25683 20,4 + WE / + WK Ceramic BRE 24098 17,1 + WE / - WK BRE 24098 17,1 + WE / - WK Ceramic ATE 22035 17,5 + WK ATE 22035 17,5 + WK Ceramic TRW 23554 17,3 - WK / - WE TRW 25110 17,5 - WE / - WK TRW 25110 17,5 - WE / - WK Ceramic ATE 25008 16,3 - WE / - WK ATE 25008 16,3 - WE / - WK Ceramic ATE 25009 16,4 - WE / - WK ATE 25009 16,4 - WE / - WK Ceramic
Warnkontakt, Bremsbelagverschleiß							
1.0 TSI 1.2 TSI 1.2 TSI 1.2 TSI 1.4 TSI 1.4 TSI 1.4 TSI 1.4 TSI 1.4 TSI 1.6 TDI 1.6 TDI 1.6 TDI 1.8 TSI 2.0 TDI 2.0 TDI 2.0 TDI 2.0 TDI	85 63 77 81 90 92 103 110 66 77 81 132 81 105 110 135	05/15→ 12/12→ 01/13→ 04/14→ 11/12→ 05/14→ 09/12→ 05/14→ 11/12→ 11/12→ 09/13→ 02/13→ 05/13→ 05/13→ 10/12→ 09/12→	⬅	+PR 1ZA,1ZE	1	24.8190-0065.2 620065	L= 172
1.4 TGI	81	02/13→	⬅	10/13→; +PR 1ZA,1ZE	1	24.8190-0065.2 620065	L= 172
1.6 TDI	85	11/16→	⬅	01/17→; +PR 1ZA,1ZE	1	24.8190-0065.2 620065	L= 172
2.0 Cupra 2.0 Cupra 2.0 Cupra 2.0 Cupra	195 206 213 221	10/13→ 10/13→ 10/15→ 01/17→	⬅ ⬅ ⬅	+PR 1ZA,1ZE + Performance Pack	1	24.8190-0065.2 620065 24.8190-0302.2 620302	L= 172 L= 367,4
 Bremsscheibe							
1.0 TSI 1.2 TSI 1.2 TSI 1.4 TSI 1.4 TSI 1.4 TSI 1.4 TSI 1.6 TDI 1.6 TDI 1.6 TDI 1.8 TSI 2.0 TDI 2.0 TDI 2.0 TDI 2.0 TDI	85 63 81 90 92 103 110 66 77 81 132 81 105 110 135	05/15→ 12/12→ 04/14→ 11/12→ 05/14→ 09/12→ 05/14→ 11/12→ 11/12→ 09/13→ 02/13→ 05/13→ 05/13→ 10/12→ 09/12→	⬅ ⬅ ⬅ ⬅ ⬅ ⬅ ⬅ ⬅ ➡ ➡ ➡ ➡ ➡ ➡ ➡	+PR 1ZF,1ZH +PR 1ZE +PR 1ZA +PR 1LG +PR 1KD +PR 1KS +PR 1KF,1KW		24.0124-0258.1 424258 24.0125-0145.1 425145 24.0325-0145.1 525145 24.0125-0158.1 425158 24.0325-0158.1 525158 24.0130-0225.1 430225 24.0110-0277.1 410277 24.0310-0277.1 510277 24.0110-0356.1 410356 24.0310-0356.1 510356 24.0122-0219.1 422219	∅ 276 24 21 V + S ∅ 288 25 22 V + S ∅ 288 25 22 V + S PD ∅ 312 25 22 V + S ∅ 312 25 22 V + S PD ∅ 340 30 27 V + S ∅ 253 10 8 + S ∅ 253 10 8 + S PD ∅ 272 9,7 8 + S ∅ 272 9,7 8 + S PD ∅ 310 22 20 V
1.2 TSI	77	01/13→	⬅ ⬅	+PR 1ZF,1ZH +PR 1ZE		24.0124-0258.1 424258 24.0125-0145.1 425145 24.0325-0145.1 525145	∅ 276 24 21 V + S ∅ 288 25 22 V + S ∅ 288 25 22 V + S PD
↓							









	kw			 	! #					
SEAT - LEON (5F1) 09/12→										
 Bremsscheibe										
1.2 TSI	77	01/13→	←	+PR 1ZA	24.0125-0158.1	425158	Ø 312 25 22 V + S			
					24.0325-0158.1	525158	Ø 312 25 22 V + S PD			
			←	+PR 1LJ,1LG	24.0130-0225.1	430225	Ø 340 30 27 V + S			
			→	+PR 1KD	24.0110-0277.1	410277	Ø 253 10 8 + S			
					24.0310-0277.1	510277	Ø 253 10 8 + S PD			
			→	+PR 1KS	24.0110-0356.1	410356	Ø 272 9,7 8 + S			
					24.0310-0356.1	510356	Ø 272 9,7 8 + S PD			
			→	+PR 1KF,1KW	24.0122-0219.1	422219	Ø 310 22 20 V			
			1.4 TGI	81	02/13→	←	10/13→; +PR 1ZF,1ZH	24.0124-0258.1	424258	Ø 276 24 21 V + S
						←	10/13→; +PR 1ZE	24.0125-0145.1	425145	Ø 288 25 22 V + S
		24.0325-0145.1				525145	Ø 288 25 22 V + S PD			
←	10/13→; +PR 1ZA	24.0125-0158.1				425158	Ø 312 25 22 V + S			
		24.0325-0158.1				525158	Ø 312 25 22 V + S PD			
			←	10/13→; +PR 1LG	24.0130-0225.1	430225	Ø 340 30 27 V + S			
			→	10/13→	24.0110-0277.1	410277	Ø 253 10 8 + S			
					24.0310-0277.1	510277	Ø 253 10 8 + S PD			
			→	10/13→; +PR 1KS	24.0110-0356.1	410356	Ø 272 9,7 8 + S			
					24.0310-0356.1	510356	Ø 272 9,7 8 + S PD			
			→	10/13→; +PR 1KF,1KW	24.0122-0219.1	422219	Ø 310 22 20 V			
			1.6 TDI	85	11/16→	←	01/17→; +PR 1ZF,1ZH	24.0124-0258.1	424258	Ø 276 24 21 V + S
						←	01/17→; +PR 1ZE	24.0125-0145.1	425145	Ø 288 25 22 V + S
								24.0325-0145.1	525145	Ø 288 25 22 V + S PD
						←	01/17→; +PR 1ZA	24.0125-0158.1	425158	Ø 312 25 22 V + S
		24.0325-0158.1				525158	Ø 312 25 22 V + S PD			
			→	01/17→; +PR 1KD	24.0110-0277.1	410277	Ø 253 10 8 + S			
					24.0310-0277.1	510277	Ø 253 10 8 + S PD			
			→	01/17→; +PR 1KS	24.0110-0356.1	410356	Ø 272 9,7 8 + S			
					24.0310-0356.1	510356	Ø 272 9,7 8 + S PD			
			2.0 Cupra 2.0 Cupra 2.0 Cupra	195 206 213	10/13→ 10/13→ 10/15→	←	+PR 1ZF,1ZH	24.0124-0258.1	424258	Ø 276 24 21 V + S
←	+PR 1ZE	24.0125-0145.1				425145	Ø 288 25 22 V + S			
		24.0325-0145.1				525145	Ø 288 25 22 V + S PD			
←	+PR 1ZA	24.0125-0158.1				425158	Ø 312 25 22 V + S			
		24.0325-0158.1				525158	Ø 312 25 22 V + S PD			
			←	+PR 1LJ	24.0130-0225.1	430225	Ø 340 30 27 V + S			
			→	+PR 1KD	24.0110-0277.1	410277	Ø 253 10 8 + S			
			→	+PR 1KS	24.0110-0356.1	410356	Ø 272 9,7 8 + S			
					24.0310-0356.1	510356	Ø 272 9,7 8 + S PD			
			→	+PR 1KF,1KW	24.0122-0219.1	422219	Ø 310 22 20 V			
2.0 Cupra	221	01/17→	←	+PR 1ZF,1ZH	24.0124-0258.1	424258	Ø 276 24 21 V + S			
			←	+PR 1ZE	24.0125-0145.1	425145	Ø 288 25 22 V + S			
					24.0325-0145.1	525145	Ø 288 25 22 V + S PD			
			←	+PR 1ZA	24.0125-0158.1	425158	Ø 312 25 22 V + S			
					24.0325-0158.1	525158	Ø 312 25 22 V + S PD			
			→	+PR 1KD	24.0110-0277.1	410277	Ø 253 10 8 + S			
			→	+PR 1KS	24.0110-0356.1	410356	Ø 272 9,7 8 + S			
					24.0310-0356.1	510356	Ø 272 9,7 8 + S PD			
SEAT - LEON SC (5F5) 01/13→										
 Bremsbelagsatz, Scheibenbremse										
1.0 TSI	85	05/15→	←	+PR 1ZA,1ZE	13.0460-2785.2	602785	TRW 25683 20,4 + WE / + WK			
1.2 TSI	63	01/13→			13.0470-2785.2	LD2785	TRW 25683 20,4 + WE / + WK			
1.2 TSI	77	02/13→					Ceramic			
1.2 TSI	81	05/14→								
1.4 TSI	90	02/13→	←	+PR 1ZF,1ZH	13.0460-7303.2	607303	ATE 22035 17,5 + WK			
1.4 TSI	92	05/14→			13.0470-7303.2	LD7303	ATE 22035 17,5 + WK Ceramic			
1.4 TSI	103	02/13→								
1.4 TSI	110	05/14→	→	+PR 1KF,1KW	13.0460-2749.2	602749	TRW 24483 16,9 - WE / - WK			
1.6 TDI	66	02/13→					+ Zub			
1.6 TDI	77	02/13→			13.0460-2880.2	602880	TRW 23914 17,1 + WE / - WK			
1.6 TDI	81	09/13→					+ Zub			
1.8 TSI	132	02/13→			13.0470-2749.2	LD2749	TRW 24483 16,9 - WE / - WK			
2.0 TDI	105	05/13→					+ Zub Ceramic			
2.0 TDI	110	02/13→								
↓										

	kw			 	! #		
SEAT - LEON SC (5F5) 01/13→							
 Bremsbelagsatz, Scheibenbremse							
2.0 TDI	135	03/13→	➔	+PR 1KF,1KW	13.0470-2880.2	LD2880	TRW 23914 17,1 + WE / - WK + Zub Ceramic
			➔	+PR 1KD	13.0460-2787.2	602787	TRW 23554 17,3 - WK / - WE
			➔	+PR 1KS	13.0460-2790.2	602790	TRW 25110 17,5 - WE / - WK
					13.0470-2790.2	LD2790	TRW 25110 17,5 - WE / - WK Ceramic
			➔	+PR 1KE	13.0460-7293.2	607293	ATE 25008 16,3 - WE / - WK
		13.0470-7293.2	LD7293	ATE 25008 16,3 - WE / - WK Ceramic			
			➔	+PR 1KJ,1KY; + eFSB	13.0460-7294.2	607294	ATE 25009 16,4 - WE / - WK
					13.0470-7294.2	LD7294	ATE 25009 16,4 - WE / - WK Ceramic
1.6 TDI	85	11/16→	←	01/17→; +PR 1ZA,1ZE	13.0460-2785.2	602785	TRW 25683 20,4 + WE / + WK
					13.0470-2785.2	LD2785	TRW 25683 20,4 + WE / + WK Ceramic
			←	01/17→; +PR 1ZF,1ZH	13.0460-7303.2	607303	ATE 22035 17,5 + WK
					13.0470-7303.2	LD7303	ATE 22035 17,5 + WK Ceramic
			➔	01/17→; +PR 1KD	13.0460-2787.2	602787	TRW 23554 17,3 - WK / - WE
			➔	01/17→; +PR 1KS	13.0460-2790.2	602790	TRW 25110 17,5 - WE / - WK
		13.0470-2790.2	LD2790	TRW 25110 17,5 - WE / - WK Ceramic			
			➔	01/17→; +PR 1KE	13.0460-7293.2	607293	ATE 25008 16,3 - WE / - WK
					13.0470-7293.2	LD7293	ATE 25008 16,3 - WE / - WK Ceramic
			➔	01/17→; +PR 1KJ,1KY; + eFSB	13.0460-7294.2	607294	ATE 25009 16,4 - WE / - WK
					13.0470-7294.2	LD7294	ATE 25009 16,4 - WE / - WK Ceramic
2.0 Cupra 2.0 Cupra 2.0 Cupra	195 206 213	10/13→ 10/13→ 10/15→	←	+PR 1ZA,1ZE	13.0460-2785.2	602785	TRW 25683 20,4 + WE / + WK
					13.0470-2785.2	LD2785	TRW 25683 20,4 + WE / + WK Ceramic
			←	+ Performance Pack	13.0460-4833.2	604833	BRE 24098 17,1 + WE / - WK
					13.0470-4833.2	LD4833	BRE 24098 17,1 + WE / - WK Ceramic
			←	+PR 1ZF,1ZH	13.0460-7303.2	607303	ATE 22035 17,5 + WK
					13.0470-7303.2	LD7303	ATE 22035 17,5 + WK Ceramic
			➔	+PR 1KF,1KW	13.0460-2749.2	602749	TRW 24483 16,9 - WE / - WK + Zub
					13.0460-2880.2	602880	TRW 23914 17,1 + WE / - WK + Zub
					13.0470-2749.2	LD2749	TRW 24483 16,9 - WE / - WK + Zub Ceramic
				13.0470-2880.2	LD2880	TRW 23914 17,1 + WE / - WK + Zub Ceramic	
			➔	+PR 1KD	13.0460-2787.2	602787	TRW 23554 17,3 - WK / - WE
			➔	+PR 1KS	13.0460-2790.2	602790	TRW 25110 17,5 - WE / - WK
					13.0470-2790.2	LD2790	TRW 25110 17,5 - WE / - WK Ceramic
			➔	+PR 1KE	13.0460-7293.2	607293	ATE 25008 16,3 - WE / - WK
					13.0470-7293.2	LD7293	ATE 25008 16,3 - WE / - WK Ceramic
			➔	+PR 1KJ,1KY; + eFSB	13.0460-7294.2	607294	ATE 25009 16,4 - WE / - WK
					13.0470-7294.2	LD7294	ATE 25009 16,4 - WE / - WK Ceramic
2.0 Cupra	221	01/17→	←	+PR 1ZA,1ZE	13.0460-2785.2	602785	TRW 25683 20,4 + WE / + WK
					13.0470-2785.2	LD2785	TRW 25683 20,4 + WE / + WK Ceramic
			←	+ Performance Pack	13.0460-4833.2	604833	BRE 24098 17,1 + WE / - WK
					13.0470-4833.2	LD4833	BRE 24098 17,1 + WE / - WK Ceramic
			←	+PR 1ZF,1ZH	13.0460-7303.2	607303	ATE 22035 17,5 + WK
					13.0470-7303.2	LD7303	ATE 22035 17,5 + WK Ceramic
			➔	+PR 1KD	13.0460-2787.2	602787	TRW 23554 17,3 - WK / - WE
			➔	+PR 1KS	13.0460-2790.2	602790	TRW 25110 17,5 - WE / - WK
					13.0470-2790.2	LD2790	TRW 25110 17,5 - WE / - WK Ceramic
			➔	+PR 1KE	13.0460-7293.2	607293	ATE 25008 16,3 - WE / - WK









	kw			 	! #		
SEAT - LEON SC (5F5) 01/13→							
Bremsbelagsatz, Scheibenbremse							
2.0 Cupra	221	01/17→	➡	+PR 1KE		13.0470-7293.2 LD7293	ATE 25008 16,3 - WE / - WK Ceramic
			➡	+PR 1KJ,1KY; + eFSB		13.0460-7294.2 607294	ATE 25009 16,4 - WE / - WK
						13.0470-7294.2 LD7294	ATE 25009 16,4 - WE / - WK Ceramic
2.0 TDI	81	02/13→	⬅	05/13→; +PR 1ZA,1ZE		13.0460-2785.2 602785	TRW 25683 20,4 + WE / + WK
						13.0470-2785.2 LD2785	TRW 25683 20,4 + WE / + WK Ceramic
			⬅	05/13→; +PR 1ZF,1ZH		13.0460-7303.2 607303	ATE 22035 17,5 + WK
						13.0470-7303.2 LD7303	ATE 22035 17,5 + WK Ceramic
			➡	05/13→; +PR 1KF,1KW		13.0460-2749.2 602749	TRW 24483 16,9 - WE / - WK + Zub
						13.0460-2880.2 602880	TRW 23914 17,1 + WE / - WK + Zub
						13.0470-2749.2 LD2749	TRW 24483 16,9 - WE / - WK + Zub Ceramic
						13.0470-2880.2 LD2880	TRW 23914 17,1 + WE / - WK + Zub Ceramic
			➡	05/13→; +PR 1KD		13.0460-2787.2 602787	TRW 23554 17,3 - WK / - WE
			➡	05/13→; +PR 1KS		13.0460-2790.2 602790	TRW 25110 17,5 - WE / - WK
						13.0470-2790.2 LD2790	TRW 25110 17,5 - WE / - WK Ceramic
			➡	05/13→; +PR 1KE		13.0460-7293.2 607293	ATE 25008 16,3 - WE / - WK
						13.0470-7293.2 LD7293	ATE 25008 16,3 - WE / - WK Ceramic
			➡	05/13→; +PR 1KJ,1KY; + eFSB		13.0460-7294.2 607294	ATE 25009 16,4 - WE / - WK
						13.0470-7294.2 LD7294	ATE 25009 16,4 - WE / - WK Ceramic
Warnkontakt, Bremsbelagverschleiß							
1.0 TSI	85	05/15→	⬅	+PR 1ZA,1ZE	1	24.8190-0065.2 620065	L= 172
1.2 TSI	63	01/13→					
1.2 TSI	77	02/13→					
1.2 TSI	81	05/14→					
1.4 TSI	90	02/13→					
1.4 TSI	92	05/14→					
1.4 TSI	103	02/13→					
1.4 TSI	110	05/14→					
1.6 TDI	66	02/13→					
1.6 TDI	77	02/13→					
1.6 TDI	81	09/13→					
1.8 TSI	132	02/13→					
2.0 TDI	105	05/13→					
2.0 TDI	110	02/13→					
2.0 TDI	135	03/13→					
1.6 TDI	85	11/16→	⬅	01/17→; +PR 1ZA,1ZE	1	24.8190-0065.2 620065	L= 172
2.0 Cupra	195	10/13→	⬅	+PR 1ZA,1ZE	1	24.8190-0065.2 620065	L= 172
2.0 Cupra	206	10/13→					
2.0 Cupra	213	10/15→	⬅	+ Performance Pack	1	24.8190-0302.2 620302	L= 367,4
2.0 Cupra	221	01/17→					
2.0 TDI	81	02/13→	⬅	05/13→; +PR 1ZA,1ZE	1	24.8190-0065.2 620065	L= 172
Bremsscheibe							
1.0 TSI	85	05/15→	⬅	+PR 1ZF,1ZH		24.0124-0258.1 424258	Ø 276 24 21 V + S
1.2 TSI	63	01/13→					
1.2 TSI	81	05/14→	⬅	+PR 1ZE		24.0125-0145.1 425145	Ø 288 25 22 V + S
1.4 TSI	90	02/13→				24.0325-0145.1 525145	Ø 288 25 22 V + S PD
1.4 TSI	92	05/14→	⬅	+PR 1ZA		24.0125-0158.1 425158	Ø 312 25 22 V + S
1.4 TSI	103	02/13→				24.0325-0158.1 525158	Ø 312 25 22 V + S PD
1.4 TSI	110	05/14→					
1.6 TDI	66	02/13→	⬅	+PR 1LG		24.0130-0225.1 430225	Ø 340 30 27 V + S
1.6 TDI	77	02/13→					
1.6 TDI	81	09/13→	➡	+PR 1KD		24.0110-0277.1 410277	Ø 253 10 8 + S
1.8 TSI	132	02/13→				24.0310-0277.1 510277	Ø 253 10 8 + S PD
2.0 TDI	105	05/13→	➡	+PR 1KS		24.0110-0356.1 410356	Ø 272 9,7 8 + S
2.0 TDI	110	02/13→				24.0310-0356.1 510356	Ø 272 9,7 8 + S PD
2.0 TDI	135	03/13→					
			➡	+PR 1KF,1KW		24.0122-0219.1 422219	Ø 310 22 20 V
1.2 TSI	77	02/13→	⬅	+PR 1ZF,1ZH		24.0124-0258.1 424258	Ø 276 24 21 V + S
			⬅	+PR 1ZE		24.0125-0145.1 425145	Ø 288 25 22 V + S
						24.0325-0145.1 525145	Ø 288 25 22 V + S PD
			⬅	+PR 1ZA		24.0125-0158.1 425158	Ø 312 25 22 V + S













	kw			 	! #		
SEAT - LEON SC (5F5) 01/13→							
 Bremsscheibe							
1.2 TSI	77	02/13→	← +PR 1ZA	24.0325-0158.1	525158	∅ 312 25 22 V + S PD	
			← +PR 1LJ,1LG	24.0130-0225.1	430225	∅ 340 30 27 V + S	
			→ +PR 1KD	24.0110-0277.1	410277	∅ 253 10 8 + S	
			→ +PR 1KS	24.0110-0356.1	410356	∅ 272 9,7 8 + S	
			→ +PR 1KF,1KW	24.0310-0277.1	510277	∅ 253 10 8 + S PD	
			→ +PR 1KS	24.0310-0356.1	510356	∅ 272 9,7 8 + S PD	
1.6 TDI	85	11/16→	← 01/17→; +PR 1ZF,1ZH	24.0124-0258.1	424258	∅ 276 24 21 V + S	
			← 01/17→; +PR 1ZE	24.0125-0145.1	425145	∅ 288 25 22 V + S	
			← 01/17→; +PR 1ZA	24.0325-0145.1	525145	∅ 288 25 22 V + S PD	
			→ 01/17→; +PR 1KD	24.0125-0158.1	425158	∅ 312 25 22 V + S	
			→ 01/17→; +PR 1KS	24.0325-0158.1	525158	∅ 312 25 22 V + S PD	
			→ 01/17→; +PR 1KS	24.0110-0277.1	410277	∅ 253 10 8 + S	
2.0 Cupra 2.0 Cupra 2.0 Cupra	195 206 213	10/13→ 10/13→ 10/15→	← +PR 1ZF,1ZH	24.0110-0277.1	410277	∅ 253 10 8 + S	
			← +PR 1ZE	24.0310-0277.1	510277	∅ 253 10 8 + S PD	
			← +PR 1ZA	24.0110-0356.1	410356	∅ 272 9,7 8 + S	
			← +PR 1LJ	24.0310-0356.1	510356	∅ 272 9,7 8 + S PD	
			→ +PR 1KD	24.0122-0219.1	422219	∅ 310 22 20 V	
			→ +PR 1KS	24.0124-0258.1	424258	∅ 276 24 21 V + S	
			→ +PR 1KF,1KW	24.0125-0145.1	425145	∅ 288 25 22 V + S	
			→ +PR 1KS	24.0325-0145.1	525145	∅ 288 25 22 V + S PD	
2.0 Cupra	221	01/17→	← +PR 1ZF,1ZH	24.0125-0158.1	425158	∅ 312 25 22 V + S	
			← +PR 1ZE	24.0325-0158.1	525158	∅ 312 25 22 V + S PD	
			← +PR 1ZA	24.0130-0225.1	430225	∅ 340 30 27 V + S	
			→ +PR 1KD	24.0110-0277.1	410277	∅ 253 10 8 + S	
			→ +PR 1KS	24.0110-0356.1	410356	∅ 272 9,7 8 + S	
			→ +PR 1KS	24.0310-0356.1	510356	∅ 272 9,7 8 + S PD	
			→ +PR 1KF,1KW	24.0122-0219.1	422219	∅ 310 22 20 V	
			→ +PR 1KS	24.0124-0258.1	424258	∅ 276 24 21 V + S	
2.0 TDI	81	02/13→	← 05/13→; +PR 1ZF,1ZH	24.0125-0145.1	425145	∅ 288 25 22 V + S	
			← 05/13→; +PR 1ZE	24.0325-0145.1	525145	∅ 288 25 22 V + S PD	
			← 05/13→; +PR 1ZA	24.0125-0158.1	425158	∅ 312 25 22 V + S	
			← 05/13→; +PR 1LG	24.0325-0158.1	525158	∅ 312 25 22 V + S PD	
			→ 05/13→; +PR 1KD	24.0130-0225.1	430225	∅ 340 30 27 V + S	
			→ 05/13→; +PR 1KS	24.0110-0277.1	410277	∅ 253 10 8 + S	
			→ 05/13→; +PR 1KS	24.0310-0277.1	510277	∅ 253 10 8 + S PD	
			→ 05/13→; +PR 1KS	24.0110-0356.1	410356	∅ 272 9,7 8 + S	
SEAT - LEON ST (5F8) 08/13→							
 Bremsbelagsatz, Scheibenbremse							
1.0 TSI	85	05/15→	← +PR 1ZA,1ZE	13.0460-2785.2	602785	TRW 25683 20,4 + WE / + WK	
1.2 TSI	63	11/13→		13.0470-2785.2	LD2785	TRW 25683 20,4 + WE / + WK	
1.2 TSI	77	08/13→				Ceramic	
1.2 TSI	81	05/14→					
1.4 TGI	81	10/13→	← +PR 1ZF,1ZH	13.0460-7303.2	607303	ATE 22035 17,5 + WK	
1.4 TSI	90	10/13→		13.0470-7303.2	LD7303	ATE 22035 17,5 + WK Ceramic	
1.4 TSI	92	05/14→					
1.4 TSI	103	10/13→	→ +PR 1KF,1KW	13.0460-2749.2	602749	TRW 24483 16,9 - WE / - WK	
1.4 TSI	110	05/14→				+ Zub	
1.6 TDI	66	11/13→		13.0460-2880.2	602880	TRW 23914 17,1 + WE / - WK	
1.6 TDI	77	10/13→				+ Zub	
1.6 TDI	81	09/13→		13.0470-2749.2	LD2749	TRW 24483 16,9 - WE / - WK	
1.6 TDI 4Drive	77	04/14→				+ Zub Ceramic	
1.6 TDI 4Drive	81	11/14→		13.0470-2880.2	LD2880	TRW 23914 17,1 + WE / - WK	
1.8 TSI	132	10/13→				+ Zub Ceramic	





















	kW			 	! #		
SEAT - LEON ST (5F8) 08/13→							
 Bremsbelagsatz, Scheibenbremse							
1.8 TSI 4Drive	132	11/14→	➡	+PR 1KD		13.0460-2787.2 602787	TRW 23554 17,3 - WK / - WE
2.0 TDI	81	11/13→	➡	+PR 1KS		13.0460-2790.2 602790	TRW 25110 17,5 - WE / - WK
2.0 TDI	105	10/13→				13.0470-2790.2 LD2790	TRW 25110 17,5 - WE / - WK
2.0 TDI	110	10/13→					Ceramic
2.0 TDI	135	08/13→					
2.0 TDI 4Drive	110	04/14→	➡	+PR 1KE		13.0460-7293.2 607293	ATE 25008 16,3 - WE / - WK
2.0 TDI 4Drive	135	11/14→				13.0470-7293.2 LD7293	ATE 25008 16,3 - WE / - WK
							Ceramic
			➡	+PR 1KJ,1KY; + eFSB		13.0460-7294.2 607294	ATE 25009 16,4 - WE / - WK
						13.0470-7294.2 LD7294	ATE 25009 16,4 - WE / - WK
							Ceramic
1.6 TDI	85	11/16→	⬅	01/17→; +PR 1ZA,1ZE		13.0460-2785.2 602785	TRW 25683 20,4 + WE / + WK
						13.0470-2785.2 LD2785	TRW 25683 20,4 + WE / + WK
							Ceramic
			⬅	01/17→; +PR 1ZF,1ZH		13.0460-7303.2 607303	ATE 22035 17,5 + WK
						13.0470-7303.2 LD7303	ATE 22035 17,5 + WK
							Ceramic
			➡	01/17→; +PR 1KD		13.0460-2787.2 602787	TRW 23554 17,3 - WK / - WE
			➡	01/17→; +PR 1KS		13.0460-2790.2 602790	TRW 25110 17,5 - WE / - WK
						13.0470-2790.2 LD2790	TRW 25110 17,5 - WE / - WK
							Ceramic
			➡	01/17→; +PR 1KE		13.0460-7293.2 607293	ATE 25008 16,3 - WE / - WK
						13.0470-7293.2 LD7293	ATE 25008 16,3 - WE / - WK
							Ceramic
			➡	01/17→; +PR 1KJ,1KY; + eFSB		13.0460-7294.2 607294	ATE 25009 16,4 - WE / - WK
						13.0470-7294.2 LD7294	ATE 25009 16,4 - WE / - WK
							Ceramic
2.0 Cupra	195	10/13→	⬅	+PR 1ZA,1ZE		13.0460-2785.2 602785	TRW 25683 20,4 + WE / + WK
2.0 Cupra	206	10/13→				13.0470-2785.2 LD2785	TRW 25683 20,4 + WE / + WK
2.0 Cupra	213	10/15→					Ceramic
			⬅	+ Performance Pack		13.0460-4833.2 604833	BRE 24098 17,1 + WE / - WK
						13.0470-4833.2 LD4833	BRE 24098 17,1 + WE / - WK
							Ceramic
			⬅	+PR 1ZF,1ZH		13.0460-7303.2 607303	ATE 22035 17,5 + WK
						13.0470-7303.2 LD7303	ATE 22035 17,5 + WK
							Ceramic
			➡	+PR 1KF,1KW		13.0460-2749.2 602749	TRW 24483 16,9 - WE / - WK
							+ Zub
						13.0460-2880.2 602880	TRW 23914 17,1 + WE / - WK
							+ Zub
						13.0470-2749.2 LD2749	TRW 24483 16,9 - WE / - WK
							+ Zub Ceramic
						13.0470-2880.2 LD2880	TRW 23914 17,1 + WE / - WK
							+ Zub Ceramic
			➡	+PR 1KD		13.0460-2787.2 602787	TRW 23554 17,3 - WK / - WE
			➡	+PR 1KS		13.0460-2790.2 602790	TRW 25110 17,5 - WE / - WK
						13.0470-2790.2 LD2790	TRW 25110 17,5 - WE / - WK
							Ceramic
			➡	+PR 1KE		13.0460-7293.2 607293	ATE 25008 16,3 - WE / - WK
						13.0470-7293.2 LD7293	ATE 25008 16,3 - WE / - WK
							Ceramic
			➡	+PR 1KJ,1KY; + eFSB		13.0460-7294.2 607294	ATE 25009 16,4 - WE / - WK
						13.0470-7294.2 LD7294	ATE 25009 16,4 - WE / - WK
							Ceramic
2.0 Cupra	221	11/16→	⬅	+PR 1ZA,1ZE		13.0460-2785.2 602785	TRW 25683 20,4 + WE / + WK
2.0 Cupra 4Drive	221	11/16→				13.0470-2785.2 LD2785	TRW 25683 20,4 + WE / + WK
							Ceramic
			⬅	+ Performance Pack		13.0460-4833.2 604833	BRE 24098 17,1 + WE / - WK
						13.0470-4833.2 LD4833	BRE 24098 17,1 + WE / - WK
							Ceramic
			⬅	+PR 1ZF,1ZH		13.0460-7303.2 607303	ATE 22035 17,5 + WK
						13.0470-7303.2 LD7303	ATE 22035 17,5 + WK
							Ceramic
			➡	+PR 1KD		13.0460-2787.2 602787	TRW 23554 17,3 - WK / - WE
			➡	+PR 1KS		13.0460-2790.2 602790	TRW 25110 17,5 - WE / - WK
						13.0470-2790.2 LD2790	TRW 25110 17,5 - WE / - WK
							Ceramic
			➡	+PR 1KE		13.0460-7293.2 607293	ATE 25008 16,3 - WE / - WK
						13.0470-7293.2 LD7293	ATE 25008 16,3 - WE / - WK
							Ceramic









↓







	kW			 	! #		
SEAT - LEON ST (5F8) 08/13→							
 Bremsbelagsatz, Scheibenbremse							
2.0 Cupra	221	11/16→	➡	+PR 1KJ,1KY; + eFSB		13.0460-7294.2 607294	ATE 25009 16,4 - WE / - WK
2.0 Cupra 4Drive	221	11/16→				13.0470-7294.2 LD7294	ATE 25009 16,4 - WE / - WK Ceramic
Warnkontakt, Bremsbelagverschleiß							
1.0 TSI	85	05/15→	←	+PR 1ZA,1ZE	1	24.8190-0065.2 620065	L= 172
1.2 TSI	63	11/13→					
1.2 TSI	77	08/13→					
1.2 TSI	81	05/14→					
1.4 TGI	81	10/13→					
1.4 TSI	90	10/13→					
1.4 TSI	92	05/14→					
1.4 TSI	103	10/13→					
1.4 TSI	110	05/14→					
1.6 TDI	66	11/13→					
1.6 TDI	77	10/13→					
1.6 TDI	81	09/13→					
1.6 TDI 4Drive	77	04/14→					
1.6 TDI 4Drive	81	11/14→					
1.8 TSI	132	10/13→					
1.8 TSI 4Drive	132	11/14→					
2.0 TDI	81	11/13→					
2.0 TDI	105	10/13→					
2.0 TDI	110	10/13→					
2.0 TDI	135	08/13→					
2.0 TDI 4Drive	110	04/14→					
2.0 TDI 4Drive	135	11/14→					
1.6 TDI	85	11/16→	←	01/17→; +PR 1ZA,1ZE	1	24.8190-0065.2 620065	L= 172
2.0 Cupra	195	10/13→	←	+PR 1ZA,1ZE	1	24.8190-0065.2 620065	L= 172
2.0 Cupra	206	10/13→					
2.0 Cupra	213	10/15→	←	+ Performance Pack	1	24.8190-0302.2 620302	L= 367,4
2.0 Cupra	221	11/16→					
2.0 Cupra 4Drive	221	11/16→					
 Bremsscheibe							
1.0 TSI	85	05/15→	←	+PR 1ZF,1ZH		24.0124-0258.1 424258	Ø 276 24 21 V + S
1.2 TSI	63	11/13→	←	+PR 1ZE		24.0125-0145.1 425145	Ø 288 25 22 V + S
1.2 TSI	81	05/14→				24.0325-0145.1 525145	Ø 288 25 22 V + S PD
1.4 TSI	90	10/13→					
1.4 TSI	92	05/14→	←	+PR 1ZA		24.0125-0158.1 425158	Ø 312 25 22 V + S
1.4 TSI	103	10/13→				24.0325-0158.1 525158	Ø 312 25 22 V + S PD
1.4 TSI	110	05/14→					
1.6 TDI	66	11/13→	←	+PR 1LG		24.0130-0225.1 430225	Ø 340 30 27 V + S
1.6 TDI	77	10/13→	➡	+PR 1KD		24.0110-0277.1 410277	Ø 253 10 8 + S
1.6 TDI	81	09/13→				24.0310-0277.1 510277	Ø 253 10 8 + S PD
1.6 TDI 4Drive	77	04/14→	➡	+PR 1KS		24.0110-0356.1 410356	Ø 272 9,7 8 + S
1.6 TDI 4Drive	81	11/14→				24.0310-0356.1 510356	Ø 272 9,7 8 + S PD
1.8 TSI	132	10/13→	➡	+PR 1KF,1KW		24.0122-0219.1 422219	Ø 310 22 20 V
1.8 TSI 4Drive	132	11/14→					
2.0 TDI	81	11/13→					
2.0 TDI	105	10/13→					
2.0 TDI	110	10/13→					
2.0 TDI	135	08/13→					
2.0 TDI 4Drive	110	04/14→					
2.0 TDI 4Drive	135	11/14→					
1.2 TSI	77	08/13→	←	+PR 1ZF,1ZH		24.0124-0258.1 424258	Ø 276 24 21 V + S
			←	+PR 1ZE		24.0125-0145.1 425145	Ø 288 25 22 V + S
						24.0325-0145.1 525145	Ø 288 25 22 V + S PD
			←	+PR 1ZA		24.0125-0158.1 425158	Ø 312 25 22 V + S
						24.0325-0158.1 525158	Ø 312 25 22 V + S PD
			←	+PR 1LJ,1LG		24.0130-0225.1 430225	Ø 340 30 27 V + S
			➡	+PR 1KD		24.0110-0277.1 410277	Ø 253 10 8 + S
						24.0310-0277.1 510277	Ø 253 10 8 + S PD
			➡	+PR 1KS		24.0110-0356.1 410356	Ø 272 9,7 8 + S
						24.0310-0356.1 510356	Ø 272 9,7 8 + S PD
			➡	+PR 1KF,1KW		24.0122-0219.1 422219	Ø 310 22 20 V
1.4 TGI	81	10/13→	←	+PR 1ZF,1ZH		24.0124-0258.1 424258	Ø 276 24 21 V + S
			←	+PR 1ZE		24.0125-0145.1 425145	Ø 288 25 22 V + S
						24.0325-0145.1 525145	Ø 288 25 22 V + S PD
			←	+PR 1ZA		24.0125-0158.1 425158	Ø 312 25 22 V + S
						24.0325-0158.1 525158	Ø 312 25 22 V + S PD
			←	+PR 1LG		24.0130-0225.1 430225	Ø 340 30 27 V + S
			➡			24.0110-0277.1 410277	Ø 253 10 8 + S

	kw			 	! #		
SEAT - LEON ST (5F8) 08/13→							
 Bremsscheibe							
1.4 TGI	81	10/13→	→		24.0310-0277.1	510277	Ø 253 10 8 + S PD
			→	+PR 1KS	24.0110-0356.1	410356	Ø 272 9,7 8 + S
			→	+PR 1KF,1KW	24.0310-0356.1	510356	Ø 272 9,7 8 + S PD
1.6 TDI	85	11/16→	←	01/17→; +PR 1ZF,1ZH	24.0124-0258.1	424258	Ø 276 24 21 V + S
			←	01/17→; +PR 1ZE	24.0125-0145.1	425145	Ø 288 25 22 V + S
					24.0325-0145.1	525145	Ø 288 25 22 V + S PD
			←	01/17→; +PR 1ZA	24.0125-0158.1	425158	Ø 312 25 22 V + S
					24.0325-0158.1	525158	Ø 312 25 22 V + S PD
			→	01/17→; +PR 1KD	24.0110-0277.1	410277	Ø 253 10 8 + S
2.0 Cupra 2.0 Cupra 2.0 Cupra	195 206 213	10/13→ 10/13→ 10/15→	←	+PR 1ZF,1ZH	24.0124-0258.1	424258	Ø 276 24 21 V + S
			←	+PR 1ZE	24.0125-0145.1	425145	Ø 288 25 22 V + S
					24.0325-0145.1	525145	Ø 288 25 22 V + S PD
			←	+PR 1ZA	24.0125-0158.1	425158	Ø 312 25 22 V + S
					24.0325-0158.1	525158	Ø 312 25 22 V + S PD
			←	+PR 1LJ	24.0130-0225.1	430225	Ø 340 30 27 V + S
			→	+PR 1KD	24.0110-0277.1	410277	Ø 253 10 8 + S
			→	+PR 1KS	24.0110-0356.1	410356	Ø 272 9,7 8 + S
2.0 Cupra 2.0 Cupra 4Drive	221 221	11/16→ 11/16→	←	+PR 1ZF,1ZH	24.0124-0258.1	424258	Ø 276 24 21 V + S
			←	+PR 1ZE	24.0125-0145.1	425145	Ø 288 25 22 V + S
					24.0325-0145.1	525145	Ø 288 25 22 V + S PD
			←	+PR 1ZA	24.0125-0158.1	425158	Ø 312 25 22 V + S
					24.0325-0158.1	525158	Ø 312 25 22 V + S PD
			→	+PR 1KD	24.0110-0277.1	410277	Ø 253 10 8 + S
			→	+PR 1KS	24.0110-0356.1	410356	Ø 272 9,7 8 + S
			→	+PR 1KF,1KW	24.0310-0356.1	510356	Ø 272 9,7 8 + S PD
			→	+PR 1KS	24.0122-0219.1	422219	Ø 310 22 20 V
SEAT - MARBELLA (28) 08/86→10/98							
 Bremsbelagsatz, Scheibenbremse							
0.9	32	07/97→10/98	←		13.0460-3939.2	603939	BDX 20775 18,0 + WE / - WK
0.9 Cat	29	01/90→11/96					
0.9 Cat	30	11/96→10/98					
Zubehörsatz, Scheibenbremsbelag							
0.9	32	07/97→10/98	←		13.0460-0410.2	610410	BDX
0.9 Cat	29	01/90→11/96					
0.9 Cat	30	11/96→10/98					
 Bremsscheibe							
0.9	32	07/97→10/98	←		24.0111-0130.1	411130	Ø 227 10,8 9
0.9 Cat	29	01/90→11/96					
0.9 Cat	30	11/96→10/98					
SEAT - Mii (KF1) 10/11→							
 Bremsbelagsatz, Scheibenbremse							
1.0	44	10/11→	←	05/12→	13.0460-7111.2	607111	VW 23130 19,6 - WE / - WK
1.0	55	10/11→			13.0470-7111.2	LD7111	VW 23130 19,6 - WE / - WK Ceramic
1.0 EcoFuel	50	11/12→	←		13.0460-7111.2	607111	VW 23130 19,6 - WE / - WK
					13.0470-7111.2	LD7111	VW 23130 19,6 - WE / - WK Ceramic
 Bremsscheibe							
1.0	44	10/11→	←	05/12→	24.0122-0281.1	422281	Ø 256 22 19 V + S
1.0	55	10/11→					
1.0 EcoFuel	50	11/12→	←		24.0122-0281.1	422281	Ø 256 22 19 V + S







	kw				! #		
SEAT - TERRA (24) 01/87→12/96							
 Bremsbelagsatz, Scheibenbremse							
0.9	29	02/87→12/96	←	03/87→		13.0460-3939.2 603939	BDX 20775 18,0 + WE / - WK
1.4 D	35	10/90→12/95	←			13.0460-3939.2 603939	BDX 20775 18,0 + WE / - WK
Zubehörsatz, Scheibenbremsbelag							
0.9	29	02/87→12/96	←	03/87→		13.0460-0410.2 610410	BDX
1.4 D	35	10/90→12/95	←			13.0460-0410.2 610410	BDX
 Bremsscheibe							
0.9	29	02/87→12/96	←	03/87→		24.0111-0130.1 411130	Ø 227 10,8 9
1.4 D	35	10/90→12/95	←			24.0111-0130.1 411130	Ø 227 10,8 9
SEAT - TERRA Kasten (024A) 01/87→02/96							
 Bremsbelagsatz, Scheibenbremse							
0.9	29	01/87→12/95	←	03/87→		13.0460-3939.2 603939	BDX 20775 18,0 + WE / - WK
0.9 Cat	29	01/90→12/95	←			13.0460-3939.2 603939	BDX 20775 18,0 + WE / - WK
Zubehörsatz, Scheibenbremsbelag							
0.9	29	01/87→12/95	←	03/87→		13.0460-0410.2 610410	BDX
0.9 Cat	29	01/90→12/95	←			13.0460-0410.2 610410	BDX
 Bremsscheibe							
0.9	29	01/87→12/95	←	03/87→		24.0111-0130.1 411130	Ø 227 10,8 9
0.9 Cat	29	01/90→12/95	←			24.0111-0130.1 411130	Ø 227 10,8 9
SEAT - TOLEDO I (1L) 01/91→10/99							
 Bremsbelagsatz, Scheibenbremse							
1.6 i	54	05/91→03/99	←	09/96→ 09/98; +PR 1LY,1ZK		13.0460-2821.2 602821	TRW 21945 16,0 - WK
			←	09/96→ 09/98; +PR 1LD,1LV		13.0460-2958.2 602958	TRW 20168 19,3 - WK
			←	09/91→ 08/96		13.0460-7032.2 20887	VW 20887 19,7 - WE / - WK + Zub
			←	09/96→ 09/98; +PR 1LK,1LM		13.0460-7072.2 607072	VW 21866 19,7 - WE / - WK
			←	09/96→ 09/98; +PR 1LG		13.0460-7101.2 607101	VW 21866 15,3 - WE / - WK
			→	09/96→ 09/98; +PR 1KD,1KK		13.0460-2984.2 602984	TRW 20961 17,2 - WK + Zub
1.6 i	55	01/93→03/99	←	09/96→ 09/98; +PR 1LY,1ZK		13.0460-2821.2 602821	TRW 21945 16,0 - WK
			←	09/96→ 09/98; +PR 1LD,1LV		13.0460-2958.2 602958	TRW 20168 19,3 - WK
			←	→ 08/96		13.0460-7032.2 20887	VW 20887 19,7 - WE / - WK + Zub
			←	09/96→ 09/98; +PR 1LK,1LM		13.0460-7072.2 607072	VW 21866 19,7 - WE / - WK
			←	09/96→ 09/98; +PR 1LG		13.0460-7101.2 607101	VW 21866 15,3 - WE / - WK
			→	09/96→ 09/98; +PR 1KD,1KK		13.0460-2984.2 602984	TRW 20961 17,2 - WK + Zub
1.6 i	74	11/96→03/99	←	→ 09/98; +PR 1LY,1ZK		13.0460-2821.2 602821	TRW 21945 16,0 - WK
			←	→ 09/98; +PR 1LD,1LV		13.0460-2958.2 602958	TRW 20168 19,3 - WK
			←	→ 09/98; +PR 1LK,1LM		13.0460-7072.2 607072	VW 21866 19,7 - WE / - WK
			←	→ 09/98; +PR 1LG		13.0460-7101.2 607101	VW 21866 15,3 - WE / - WK
			→	→ 09/98; +PR 1KD,1KK		13.0460-2984.2 602984	TRW 20961 17,2 - WK + Zub
1.8 16V 1.8 16V	92	05/91→03/99	←	09/91→ 03/94		13.0460-2821.2 602821	TRW 21945 16,0 - WK
	98	05/91→03/99	→	09/91→ 03/94		13.0460-2937.2 602937	TRW 20961 15,2 - WK + Zub
1.8 i	65	05/91→12/96	←	09/96→; +PR 1LY,1ZK		13.0460-2821.2 602821	TRW 21945 16,0 - WK
			←	09/96→; +PR 1LD,1LV		13.0460-2958.2 602958	TRW 20168 19,3 - WK
			←	09/91→ 08/96		13.0460-7032.2 20887	VW 20887 19,7 - WE / - WK + Zub
			←	09/96→; +PR 1LG,1LK,1LM		13.0460-7072.2 607072	VW 21866 19,7 - WE / - WK
			←	09/96→; +PR 1LG		13.0460-7101.2 607101	VW 21866 15,3 - WE / - WK
			→	09/96→; +PR 1KD,1KK		13.0460-2984.2 602984	TRW 20961 17,2 - WK + Zub
1.8 i	66	11/93→12/96	←	09/96→; +PR 1LY,1ZK		13.0460-2821.2 602821	TRW 21945 16,0 - WK
			←	09/96→; +PR 1LD,1LV		13.0460-2958.2 602958	TRW 20168 19,3 - WK
↓							

	kw			 	! #			
SEAT - TOLEDO I (1L) 01/91→10/99								
 Bremsbelagsatz, Scheibenbremse								
1.8 i	66	11/93→12/96	←	→ 08/96		13.0460-7032.2	20887	VW 20887 19,7 - WE / - WK + Zub
			←	09/96→; +PR 1LG,1LK,1LM		13.0460-7072.2	607072	VW 21866 19,7 - WE / - WK
			←	09/96→; +PR 1LG		13.0460-7101.2	607101	VW 21866 15,3 - WE / - WK
			→	09/96→; +PR 1KD,1KK		13.0460-2984.2	602984	TRW 20961 17,2 - WK + Zub
1.9 D	47	12/95→03/99	←	09/96→ 09/98; +PR 1LY,1ZK		13.0460-2821.2	602821	TRW 21945 16,0 - WK
			←	09/96→ 09/98; +PR 1LD,1LV		13.0460-2958.2	602958	TRW 20168 19,3 - WK
			←	→ 08/96		13.0460-7032.2	20887	VW 20887 19,7 - WE / - WK + Zub
			←	09/96→ 09/98; +PR 1LG,1LK,1LM		13.0460-7072.2	607072	VW 21866 19,7 - WE / - WK
			←	09/96→ 09/98; +PR 1LG		13.0460-7101.2	607101	VW 21866 15,3 - WE / - WK
			→	09/96→ 09/98; +PR 1KD,1KK		13.0460-2984.2	602984	TRW 20961 17,2 - WK + Zub
			→	09/96→ 09/98; +PR 1KD,1KK		13.0460-2984.2	602984	TRW 20961 17,2 - WK + Zub
1.9 D 1.9 TD	50 55	05/91→03/99 05/91→03/99	←	09/96→ 09/98; +PR 1LY,1ZK		13.0460-2821.2	602821	TRW 21945 16,0 - WK
			←	09/96→ 09/98; +PR 1LD,1LV		13.0460-2958.2	602958	TRW 20168 19,3 - WK
			←	09/91→ 08/96		13.0460-7032.2	20887	VW 20887 19,7 - WE / - WK + Zub
			←	09/96→ 09/98; +PR 1LG,1LK,1LM		13.0460-7072.2	607072	VW 21866 19,7 - WE / - WK
			←	09/96→ 09/98; +PR 1LG		13.0460-7101.2	607101	VW 21866 15,3 - WE / - WK
			→	09/96→ 09/98; +PR 1KD,1KK		13.0460-2984.2	602984	TRW 20961 17,2 - WK + Zub
			→	09/96→ 09/98; +PR 1KD,1KK		13.0460-2984.2	602984	TRW 20961 17,2 - WK + Zub
1.9 TDI	66	08/95→03/99	←	09/96→ 09/98; +PR 1LY,1ZK		13.0460-2821.2	602821	TRW 21945 16,0 - WK
			←	1L-TR017000→; → 08/96		13.0460-2821.2	602821	TRW 21945 16,0 - WK
			←	09/96→ 09/98; +PR 1LD,1LV		13.0460-2958.2	602958	TRW 20168 19,3 - WK
			←	→ 1L-TR016999		13.0460-2958.2	602958	TRW 20168 19,3 - WK
			←	09/96→ 09/98; +PR 1LG,1LK,1LM		13.0460-7072.2	607072	VW 21866 19,7 - WE / - WK
			←	09/96→ 09/98; +PR 1LG		13.0460-7101.2	607101	VW 21866 15,3 - WE / - WK
			→	→ 08/96		13.0460-2984.2	602984	TRW 20961 17,2 - WK + Zub
			→	09/96→ 09/98; +PR 1KD,1KK		13.0460-2984.2	602984	TRW 20961 17,2 - WK + Zub
1.9 TDI	81	11/96→03/99	←	→ 09/98; +PR 1LY,1ZK		13.0460-2821.2	602821	TRW 21945 16,0 - WK
			←	→ 09/98; +PR 1LD,1LV		13.0460-2958.2	602958	TRW 20168 19,3 - WK
			←	→ 1L-TR016999		13.0460-2958.2	602958	TRW 20168 19,3 - WK
			←	→ 09/98; +PR 1LG,1LK,1LM		13.0460-7072.2	607072	VW 21866 19,7 - WE / - WK
			←	→ 09/98; +PR 1LG		13.0460-7101.2	607101	VW 21866 15,3 - WE / - WK
			→	→ 09/98; +PR 1KD,1KK		13.0460-2984.2	602984	TRW 20961 17,2 - WK + Zub
2.0 i	85	05/91→03/99	←	09/91→ 08/96		13.0460-2821.2	602821	TRW 21945 16,0 - WK
			←	09/96→ 09/98; +PR 1LY,1ZK		13.0460-2821.2	602821	TRW 21945 16,0 - WK
			←	09/96→ 09/98; +PR 1LD,1LV		13.0460-2958.2	602958	TRW 20168 19,3 - WK
			←	09/96→ 09/98; +PR 1LG,1LK,1LM		13.0460-7072.2	607072	VW 21866 19,7 - WE / - WK
			←	09/96→ 09/98; +PR 1LG		13.0460-7101.2	607101	VW 21866 15,3 - WE / - WK
			→	09/91→; → 1L-ZD328000		13.0460-2937.2	602937	TRW 20961 15,2 - WK + Zub
			→	→ 08/96; 1L-ZD328001→		13.0460-2984.2	602984	TRW 20961 17,2 - WK + Zub
			→	09/96→ 09/98; +PR 1KD,1KK		13.0460-2984.2	602984	TRW 20961 17,2 - WK + Zub
2.0 i 16V	110	11/93→03/99	←	09/96→ 09/98; +PR 1LY,1ZK		13.0460-2821.2	602821	TRW 21945 16,0 - WK
			←	09/96→ 09/98; +PR 1LD,1LV		13.0460-2958.2	602958	TRW 20168 19,3 - WK
			←	03/94→ 08/96		13.0460-2958.2	602958	TRW 20168 19,3 - WK
			←	09/96→ 09/98; +PR 1LG,1LK,1LM		13.0460-7072.2	607072	VW 21866 19,7 - WE / - WK
			←	09/96→ 09/98; +PR 1LG		13.0460-7101.2	607101	VW 21866 15,3 - WE / - WK
			→	09/96→ 09/98; +PR 1KD,1KK		13.0460-2984.2	602984	TRW 20961 17,2 - WK + Zub
			→	03/94→ 08/96		13.0460-2984.2	602984	TRW 20961 17,2 - WK + Zub
Zubehörsatz, Scheibenbremsbelag								
1.6 i	54	05/91→03/99	→	09/96→ 09/98; +PR 1KD,1KK		13.0460-0072.2	610072	TRW
1.6 i	55	01/93→03/99						
1.9 D	47	12/95→03/99						
1.9 D	50	05/91→03/99						
1.9 TD	55	05/91→03/99						
1.6 i	74	11/96→03/99	→	→ 09/98; +PR 1KD,1KK		13.0460-0072.2	610072	TRW
1.9 TDI	81	11/96→03/99						
↓								









	kw			 	! #					
SEAT - TOLEDO I (1L) 01/91→10/99										
Zubehörsatz, Scheibenbremsbelag										
1.8 16V 1.8 16V	92 98	05/91→03/99 05/91→03/99	➡	09/91→ 03/94		13.0460-0419.2 610419	TRW			
1.8 i 1.8 i	65 66	05/91→12/96 11/93→12/96	➡	09/96→; +PR 1KD,1KK		13.0460-0072.2 610072	TRW			
1.9 TDI	66	08/95→03/99	➡	→ 08/96		13.0460-0072.2 610072	TRW			
			➡	09/96→ 09/98; +PR 1KD,1KK		13.0460-0072.2 610072	TRW			
2.0 i	85	05/91→03/99	➡	→ 08/96; 1L-ZD328001→		13.0460-0072.2 610072	TRW			
			➡	09/96→ 09/98; +PR 1KD,1KK		13.0460-0072.2 610072	TRW			
			➡	09/91→; → 1L-ZD328000		13.0460-0419.2 610419	TRW			
2.0 i 16V	110	11/93→03/99	➡	09/96→ 09/98; +PR 1KD,1KK		13.0460-0072.2 610072	TRW			
			➡	03/94→ 08/96		13.0460-0072.2 610072	TRW			
 Bremsscheibe										
1.6 i	54	05/91→03/99	←	09/91→ 08/96		24.0112-0106.1 412106	Ø 239 12 10 + S			
						24.0312-0106.1 512106	Ø 239 12 10 + S PD			
			←	09/96→ 09/98; +PR 1LK,1LM		24.0112-0106.1 412106	Ø 239 12 10 + S			
						24.0312-0106.1 512106	Ø 239 12 10 + S PD			
			←	09/96→ 09/98; +PR 1LG		24.0120-0123.1 420123	Ø 239 20 18 V + S			
						24.0320-0123.1 520123	Ø 239 20 18 V + S PD			
			←	09/96→ 09/98; +PR 1LY,1ZK		24.0120-0128.1 420128	Ø 256 20 18 V + S			
						24.0320-0128.1 520128	Ø 256 20 18 V + S PD			
1.6 i	55	01/93→03/99	←	→ 08/96		24.0112-0106.1 412106	Ø 239 12 10 + S			
						24.0312-0106.1 512106	Ø 239 12 10 + S PD			
			←	09/96→ 09/98; +PR 1LK,1LM		24.0112-0106.1 412106	Ø 239 12 10 + S			
						24.0312-0106.1 512106	Ø 239 12 10 + S PD			
			←	09/96→ 09/98; +PR 1LG		24.0120-0123.1 420123	Ø 239 20 18 V + S			
						24.0320-0123.1 520123	Ø 239 20 18 V + S PD			
			←	09/96→ 09/98; +PR 1LY,1ZK		24.0120-0128.1 420128	Ø 256 20 18 V + S			
						24.0320-0128.1 520128	Ø 256 20 18 V + S PD			
1.6 i	74	11/96→03/99	←	→ 09/98; +PR 1LK,1LM		24.0112-0106.1 412106	Ø 239 12 10 + S			
						24.0312-0106.1 512106	Ø 239 12 10 + S PD			
			←	→ 09/98; +PR 1LG		24.0120-0123.1 420123	Ø 239 20 18 V + S			
						24.0320-0123.1 520123	Ø 239 20 18 V + S PD			
			←	→ 09/98; +PR 1LY,1ZK		24.0120-0128.1 420128	Ø 256 20 18 V + S			
						24.0320-0128.1 520128	Ø 256 20 18 V + S PD			
			←	→ 09/98; +PR 1LD		24.0122-0100.1 422100	Ø 280 22 20 V			
						24.0322-0100.1 522100	Ø 280 22 20 V PD			
1.8 16V 1.8 16V	92 98	05/91→03/99 05/91→03/99	←	09/91→ 03/94		24.0120-0128.1 420128	Ø 256 20 18 V + S			
						24.0320-0128.1 520128	Ø 256 20 18 V + S PD			
			➡	09/91→ 03/94		24.0110-0111.1 410111	Ø 226 10 8 - ABS Ring / - RLG			
						24.0110-0275.2 410275	Ø 226 10 8 + ABS Ring / - RLG			
			1.8 i	65	05/91→12/96	←	09/96→; +PR 1LG,1LK,1LM		24.0112-0106.1 412106	Ø 239 12 10 + S
									24.0312-0106.1 512106	Ø 239 12 10 + S PD
						←	09/91→ 08/96		24.0112-0106.1 412106	Ø 239 12 10 + S
									24.0120-0128.1 420128	Ø 256 20 18 V + S











	kw			 	! #		
SEAT - TOLEDO I (1L) 01/91→10/99							
Bremsscheibe							
1.8 i	65	05/91→12/96	←	09/91→ 08/96	24.0312-0106.1 512106	Ø 239 12 10 + S PD	
					24.0320-0128.1 520128	Ø 256 20 18 V + S PD	
			←	09/96→; +PR 1LG	24.0120-0123.1 420123	Ø 239 20 18 V + S	
					24.0320-0123.1 520123	Ø 239 20 18 V + S PD	
			←	09/96→; +PR 1LY,1ZK	24.0120-0128.1 420128	Ø 256 20 18 V + S	
					24.0320-0128.1 520128	Ø 256 20 18 V + S PD	
			←	09/96→; +PR 1LD	24.0122-0100.1 422100	Ø 280 22 20 V	
		24.0322-0100.1 522100	Ø 280 22 20 V PD				
			→	09/96→; +PR 1KD	24.0110-0111.1 410111	Ø 226 10 8 - ABS Ring / - RLG	
				24.0110-0275.2 410275	Ø 226 10 8 + ABS Ring / - RLG		
			→	09/96→; +PR 1KK	24.0110-0203.1 410203	Ø 226 10 8 - ABS Ring	
				24.0110-0276.2 410276	Ø 226 10 8 + ABS Ring		
1.8 i	66	11/93→12/96	←	→ 08/96	24.0112-0106.1 412106	Ø 239 12 10 + S	
					24.0120-0128.1 420128	Ø 256 20 18 V + S	
					24.0312-0106.1 512106	Ø 239 12 10 + S PD	
					24.0320-0128.1 520128	Ø 256 20 18 V + S PD	
			←	09/96→; +PR 1LG,1LK,1LM	24.0112-0106.1 412106	Ø 239 12 10 + S	
					24.0312-0106.1 512106	Ø 239 12 10 + S PD	
			←	09/96→; +PR 1LG	24.0120-0123.1 420123	Ø 239 20 18 V + S	
		24.0320-0123.1 520123	Ø 239 20 18 V + S PD				
			←	09/96→; +PR 1LY,1ZK	24.0120-0128.1 420128	Ø 256 20 18 V + S	
				24.0320-0128.1 520128	Ø 256 20 18 V + S PD		
			←	09/96→; +PR 1LD	24.0122-0100.1 422100	Ø 280 22 20 V	
				24.0322-0100.1 522100	Ø 280 22 20 V PD		
			→	09/96→; +PR 1KD	24.0110-0111.1 410111	Ø 226 10 8 - ABS Ring / - RLG	
				24.0110-0275.2 410275	Ø 226 10 8 + ABS Ring / - RLG		
			→	09/96→; +PR 1KK	24.0110-0203.1 410203	Ø 226 10 8 - ABS Ring	
				24.0110-0276.2 410276	Ø 226 10 8 + ABS Ring		
1.9 D	47	12/95→03/99	←	09/96→ 09/98; +PR 1LG,1LK,1LM	24.0112-0106.1 412106	Ø 239 12 10 + S	
					24.0312-0106.1 512106	Ø 239 12 10 + S PD	
			←	→ 08/96	24.0112-0106.1 412106	Ø 239 12 10 + S	
					24.0312-0106.1 512106	Ø 239 12 10 + S PD	
			←	09/96→ 09/98; +PR 1LG	24.0120-0123.1 420123	Ø 239 20 18 V + S	
					24.0320-0123.1 520123	Ø 239 20 18 V + S PD	
			←	09/96→ 09/98; +PR 1LY,1ZK	24.0120-0128.1 420128	Ø 256 20 18 V + S	
		24.0320-0128.1 520128	Ø 256 20 18 V + S PD				
			←	09/96→ 09/98; +PR 1LD	24.0122-0100.1 422100	Ø 280 22 20 V	
				24.0322-0100.1 522100	Ø 280 22 20 V PD		
			→	09/96→ 09/98; +PR 1KD	24.0110-0111.1 410111	Ø 226 10 8 - ABS Ring / - RLG	
				24.0110-0275.2 410275	Ø 226 10 8 + ABS Ring / - RLG		
			→	09/96→ 09/98; +PR 1KK	24.0110-0203.1 410203	Ø 226 10 8 - ABS Ring	
				24.0110-0276.2 410276	Ø 226 10 8 + ABS Ring		
1.9 D 1.9 TD	50 55	05/91→03/99 05/91→03/99	←	09/91→ 08/96	24.0112-0106.1 412106	Ø 239 12 10 + S	
					24.0312-0106.1 512106	Ø 239 12 10 + S PD	
			←	09/96→ 09/98; +PR 1LG,1LK,1LM	24.0112-0106.1 412106	Ø 239 12 10 + S	
					24.0312-0106.1 512106	Ø 239 12 10 + S PD	
			←	09/96→ 09/98; +PR 1LG	24.0120-0123.1 420123	Ø 239 20 18 V + S	
					24.0320-0123.1 520123	Ø 239 20 18 V + S PD	
			←	09/96→ 09/98; +PR 1LY,1ZK	24.0120-0128.1 420128	Ø 256 20 18 V + S	
		24.0320-0128.1 520128	Ø 256 20 18 V + S PD				
			←	09/96→ 09/98; +PR 1LD	24.0122-0100.1 422100	Ø 280 22 20 V	
				24.0322-0100.1 522100	Ø 280 22 20 V PD		
			→	09/96→ 09/98; +PR 1KD	24.0110-0111.1 410111	Ø 226 10 8 - ABS Ring / - RLG	
				24.0110-0275.2 410275	Ø 226 10 8 + ABS Ring / - RLG		
			→	09/96→ 09/98; +PR 1KK	24.0110-0203.1 410203	Ø 226 10 8 - ABS Ring	
				24.0110-0276.2 410276	Ø 226 10 8 + ABS Ring		
1.9 TDI	66	08/95→03/99	←	09/96→ 09/98; +PR 1LG,1LK,1LM	24.0112-0106.1 412106	Ø 239 12 10 + S	
					24.0312-0106.1 512106	Ø 239 12 10 + S PD	
			←	→ 1L-TR016999	24.0113-0178.1 413178	Ø 255,6 12,9 11 + S	
				24.0313-0178.1 513178	Ø 255,6 12,9 11 + S PD		
			←	09/96→ 09/98; +PR 1LG	24.0120-0123.1 420123	Ø 239 20 18 V + S	















	kw			 	! #		
SEAT - TOLEDO I (1L) 01/91→10/99							
Bremsscheibe							
1.9 TDI	66	08/95→03/99	←	09/96→ 09/98; +PR 1LG	24.0320-0123.1	520123	Ø 239 20 18 V + S PD
			←	1L-TR017000→; → 08/96	24.0120-0128.1	420128	Ø 256 20 18 V + S
					24.0320-0128.1	520128	Ø 256 20 18 V + S PD
			←	09/96→ 09/98; +PR 1LY,1ZK	24.0120-0128.1	420128	Ø 256 20 18 V + S
					24.0320-0128.1	520128	Ø 256 20 18 V + S PD
			←	09/96→ 09/98; +PR 1LD	24.0122-0100.1	422100	Ø 280 22 20 V
					24.0322-0100.1	522100	Ø 280 22 20 V PD
			→	09/96→ 09/98; +PR 1KD	24.0110-0111.1	410111	Ø 226 10 8 - ABS Ring / - RLG
		24.0110-0275.2	410275	Ø 226 10 8 + ABS Ring / - RLG			
		→ 11/95→ 08/96	24.0110-0111.1	410111	Ø 226 10 8 - ABS Ring / - RLG		
			24.0110-0275.2	410275	Ø 226 10 8 + ABS Ring / - RLG		
		→ 09/96→ 09/98; +PR 1KK	24.0110-0203.1	410203	Ø 226 10 8 - ABS Ring		
			24.0110-0276.2	410276	Ø 226 10 8 + ABS Ring		
1.9 TDI	81	11/96→03/99	←	→ 09/98; +PR 1LG,1LK,1LM	24.0112-0106.1	412106	Ø 239 12 10 + S
					24.0312-0106.1	512106	Ø 239 12 10 + S PD
			←	→ 1L-TR016999	24.0113-0178.1	413178	Ø 255,6 12,9 11 + S
					24.0313-0178.1	513178	Ø 255,6 12,9 11 + S PD
			←	→ 09/98; +PR 1LG	24.0120-0123.1	420123	Ø 239 20 18 V + S
					24.0320-0123.1	520123	Ø 239 20 18 V + S PD
			←	→ 09/98; +PR 1LY,1ZK	24.0120-0128.1	420128	Ø 256 20 18 V + S
					24.0320-0128.1	520128	Ø 256 20 18 V + S PD
←	→ 09/98; +PR 1LD	24.0122-0100.1	422100	Ø 280 22 20 V			
		24.0322-0100.1	522100	Ø 280 22 20 V PD			
→	→ 09/98; +PR 1KD	24.0110-0111.1	410111	Ø 226 10 8 - ABS Ring / - RLG			
		24.0110-0275.2	410275	Ø 226 10 8 + ABS Ring / - RLG			
→	→ 09/98; +PR 1KK	24.0110-0203.1	410203	Ø 226 10 8 - ABS Ring			
		24.0110-0276.2	410276	Ø 226 10 8 + ABS Ring			
2.0 i	85	05/91→03/99	←	09/96→ 09/98; +PR 1LG,1LK,1LM	24.0112-0106.1	412106	Ø 239 12 10 + S
					24.0312-0106.1	512106	Ø 239 12 10 + S PD
			←	09/96→ 09/98; +PR 1LG	24.0120-0123.1	420123	Ø 239 20 18 V + S
					24.0320-0123.1	520123	Ø 239 20 18 V + S PD
			←	09/91→ 08/96	24.0120-0128.1	420128	Ø 256 20 18 V + S
					24.0320-0128.1	520128	Ø 256 20 18 V + S PD
			←	09/96→ 09/98; +PR 1LY,1ZK	24.0120-0128.1	420128	Ø 256 20 18 V + S
					24.0320-0128.1	520128	Ø 256 20 18 V + S PD
←	09/96→ 09/98; +PR 1LD	24.0122-0100.1	422100	Ø 280 22 20 V			
		24.0322-0100.1	522100	Ø 280 22 20 V PD			
→	09/91→ 08/96	24.0110-0111.1	410111	Ø 226 10 8 - ABS Ring / - RLG			
		24.0110-0275.2	410275	Ø 226 10 8 + ABS Ring / - RLG			
→	09/96→ 09/98; +PR 1KD	24.0110-0111.1	410111	Ø 226 10 8 - ABS Ring / - RLG			
		24.0110-0275.2	410275	Ø 226 10 8 + ABS Ring / - RLG			
→	09/96→ 09/98; +PR 1KK	24.0110-0203.1	410203	Ø 226 10 8 - ABS Ring			
		24.0110-0276.2	410276	Ø 226 10 8 + ABS Ring			
2.0 i 16V	110	11/93→03/99	←	09/96→ 09/98; +PR 1LG,1LK,1LM	24.0112-0106.1	412106	Ø 239 12 10 + S
					24.0312-0106.1	512106	Ø 239 12 10 + S PD
			←	09/96→ 09/98; +PR 1LG	24.0120-0123.1	420123	Ø 239 20 18 V + S
					24.0320-0123.1	520123	Ø 239 20 18 V + S PD
			←	09/96→ 09/98; +PR 1LY,1ZK	24.0120-0128.1	420128	Ø 256 20 18 V + S
					24.0320-0128.1	520128	Ø 256 20 18 V + S PD
			←	03/94→ 08/96	24.0122-0100.1	422100	Ø 280 22 20 V
					24.0322-0100.1	522100	Ø 280 22 20 V PD
←	09/96→ 09/98; +PR 1LD	24.0122-0100.1	422100	Ø 280 22 20 V			
		24.0322-0100.1	522100	Ø 280 22 20 V PD			
→	09/96→ 09/98; +PR 1KD	24.0110-0111.1	410111	Ø 226 10 8 - ABS Ring / - RLG			
		24.0110-0275.2	410275	Ø 226 10 8 + ABS Ring / - RLG			
→	09/96→ 09/98; +PR 1KK	24.0110-0203.1	410203	Ø 226 10 8 - ABS Ring			
		24.0110-0276.2	410276	Ø 226 10 8 + ABS Ring			
→	03/94→ 08/96	24.0110-0203.1	410203	Ø 226 10 8 - ABS Ring			
		24.0110-0276.2	410276	Ø 226 10 8 + ABS Ring			











	kW			 	! #		
SEAT - TOLEDO II (1M2) 10/98→05/06							
 Bremsbelagsatz, Scheibenbremse							
1.9 TDI	66	03/99→07/04	←	Y-000 001→; +PR 1LN,1LE,1ZE,1ZH		13.0460-7122.2 607122	ATE 20676 19,8 + WK
			→	+PR 1KY,2EE		13.0470-7122.2 LD7122	ATE 20676 19,8 + WK Ceramic
			→	+PR 1KK,1KP,1KQ		13.0460-2886.2 602886	TRW 20961 16,0 - WK
			→	+PR 1KK,1KP,1KQ		13.0470-2886.2 LD2886	TRW 20961 16,0 - WK Ceramic
			→	+PR 1KK,1KP,1KQ		13.0460-2894.2 602894	TRW 20961 17,2 - WK + Zub
			→	+PR 1KK,1KP,1KQ		13.0470-2894.2 LD2894	TRW 20961 17,2 - WK + Zub Ceramic
Zubehörsatz, Scheibenbremsbelag							
1.4 16V	55	01/00→05/02	→	+PR 1KY,2EE		13.0460-0072.2 610072	TRW
1.6	74	10/98→07/04	→	+PR 1KK,1KP,1KQ		13.0460-0072.2 610072	TRW
1.8 20V	92	10/98→07/04	→	+PR 1KK,1KP,1KQ		13.0460-0072.2 610072	TRW
1.9 TDI	66	03/99→07/04	→	+PR 1KK,1KP,1KQ		13.0460-0072.2 610072	TRW
1.9 TDI	81	10/98→07/04	→	+PR 1KK,1KP,1KQ		13.0460-0072.2 610072	TRW
1.9 TDI	110	10/00→07/04	→	+PR 1KK,1KP,1KQ		13.0460-0072.2 610072	TRW
2.3 V5	110	10/98→11/00	→	+PR 1KK,1KP,1KQ		13.0460-0072.2 610072	TRW
2.3 V5 20V	125	09/00→11/03	→	+PR 1KK,1KP,1KQ		13.0460-0072.2 610072	TRW
2.8	150	10/00→07/01	→	+PR 1KK,1KP,1KQ		13.0460-0072.2 610072	TRW
1.6 16V	77	06/00→05/06	→	→ 09/04; +PR 1KY,2EE		13.0460-0072.2 610072	TRW
1.9 TDI	96	05/03→05/06	→	→ 09/04; +PR 1KK,1KP,1KQ		13.0460-0072.2 610072	TRW
1.8 20VT	132	09/00→07/04	→	05/01→; +PR 1KY,2EE		13.0460-0072.2 610072	TRW
			→	05/01→; +PR 1KK,1KP,1KQ		13.0460-0072.2 610072	TRW
 Bremsscheibe							
1.4 16V	55	01/00→05/02	←	+PR 1LR,1LS		24.0122-0150.1 422150	Ø 280 22 19 V + S
1.6	74	10/98→07/04	←	+PR 1LQ		24.0122-0151.1 422151	Ø 256 22 19 V + S
1.8 20V	92	10/98→07/04	←	+PR 1LQ		24.0322-0151.1 522151	Ø 256 22 19 V + S PD
1.9 TDI	81	10/98→07/04	←	+PR 1LN,1LE,1ZE,1ZH		24.0125-0113.1 425113	Ø 288 25 22 V + S
1.9 TDI	110	10/00→07/04	←	+PR 1LN,1LE,1ZE,1ZH		24.0325-0113.1 525113	Ø 288 25 22 V + S PD
2.3 V5	110	10/98→11/00	←	+PR 1LN,1LE,1ZE,1ZH		24.0125-0113.1 425113	Ø 288 25 22 V + S
2.3 V5 20V	125	09/00→11/03	←	+PR 1LN,1LE,1ZE,1ZH		24.0325-0113.1 525113	Ø 288 25 22 V + S PD
2.8	150	10/00→07/01	←	+PR 1LJ,1ZQ		24.0125-0123.1 425123	Ø 310 25 22 V + S
			→	+PR 1KK,1KP,1KQ		24.0109-0123.1 409123	Ø 230 9 7 + S
			→	+PR 1KK,1KP,1KQ		24.0309-0123.1 509123	Ø 230 9 7 + S PD
			→	+PR 1KY,2EE		24.0122-0163.1 422163	Ø 256 22 20 V
			→	+PR 1KY,2EE		24.0322-0163.1 522163	Ø 256 22 20 V PD
1.6 16V	77	06/00→05/06	←	→ 09/04; +PR 1LR,1LS		24.0122-0150.1 422150	Ø 280 22 19 V + S
1.9 TDI	96	05/03→05/06	←	→ 09/04; +PR 1LQ		24.0122-0151.1 422151	Ø 256 22 19 V + S
			←	→ 09/04; +PR 1LQ		24.0322-0151.1 522151	Ø 256 22 19 V + S PD
			←	→ 09/04; +PR 1LN,1LE,1ZE,1ZH		24.0125-0113.1 425113	Ø 288 25 22 V + S
			←	→ 09/04; +PR 1LN,1LE,1ZE,1ZH		24.0325-0113.1 525113	Ø 288 25 22 V + S PD
			←	→ 09/04; +PR 1LJ,1ZQ		24.0125-0123.1 425123	Ø 310 25 22 V + S
			→	→ 09/04; +PR 1KK,1KP,1KQ		24.0109-0123.1 409123	Ø 230 9 7 + S
			→	→ 09/04; +PR 1KK,1KP,1KQ		24.0309-0123.1 509123	Ø 230 9 7 + S PD
			→	→ 09/04; +PR 1KY,2EE		24.0122-0163.1 422163	Ø 256 22 20 V
			→	→ 09/04; +PR 1KY,2EE		24.0322-0163.1 522163	Ø 256 22 20 V PD
1.8 20VT	132	09/00→07/04	←	05/01→; +PR 1LR,1LS		24.0122-0150.1 422150	Ø 280 22 19 V + S
			←	05/01→; +PR 1LQ		24.0122-0151.1 422151	Ø 256 22 19 V + S
			←	05/01→; +PR 1LQ		24.0322-0151.1 522151	Ø 256 22 19 V + S PD
			←	05/01→; +PR 1LN,1LE,1ZE,1ZH		24.0125-0113.1 425113	Ø 288 25 22 V + S
			←	05/01→; +PR 1LN,1LE,1ZE,1ZH		24.0325-0113.1 525113	Ø 288 25 22 V + S PD
			←	05/01→; +PR 1LJ,1ZQ		24.0125-0123.1 425123	Ø 310 25 22 V + S
			→	05/01→; +PR 1KK,1KP,1KQ		24.0109-0123.1 409123	Ø 230 9 7 + S
			→	05/01→; +PR 1KK,1KP,1KQ		24.0309-0123.1 509123	Ø 230 9 7 + S PD
			→	05/01→; +PR 1KY,2EE		24.0122-0163.1 422163	Ø 256 22 20 V
			→	05/01→; +PR 1KY,2EE		24.0322-0163.1 522163	Ø 256 22 20 V PD
1.9 TDI	66	03/99→07/04	←	+PR 1LR,1LS		24.0122-0150.1 422150	Ø 280 22 19 V + S
			←	+PR 1LQ		24.0122-0151.1 422151	Ø 256 22 19 V + S
			←	+PR 1LQ		24.0322-0151.1 522151	Ø 256 22 19 V + S PD
			←	04/99→; +PR 1LN,1LE,1ZE,1ZH		24.0125-0113.1 425113	Ø 288 25 22 V + S
			←	04/99→; +PR 1LN,1LE,1ZE,1ZH		24.0325-0113.1 525113	Ø 288 25 22 V + S PD
			←	04/99→; +PR 1LJ,1ZQ		24.0125-0123.1 425123	Ø 310 25 22 V + S
			→	+PR 1KK,1KP,1KQ		24.0109-0123.1 409123	Ø 230 9 7 + S
			→	+PR 1KK,1KP,1KQ		24.0309-0123.1 509123	Ø 230 9 7 + S PD











	kw					! #		
SEAT - TOLEDO II (1M2) 10/98→05/06								
 Bremsscheibe								
1.9 TDI	66	03/99→07/04	➡	+PR 1KY,2EE		24.0122-0163.1	422163	Ø 256 22 20 V
						24.0322-0163.1	522163	Ø 256 22 20 V PD
SEAT - TOLEDO III (5P2) 04/04→05/09								
 Bremsbelagsatz, Scheibenbremse								
1.4 16V	63	05/06→05/09	←	→ 03/09; +PR 1ZF		13.0460-7117.2	607117	VW 23130 19,6 + WK
1.4 TSI	92	11/07→05/09				13.0470-7117.2	LD7117	VW 23130 19,6 + WK Ceramic
1.6	75	10/04→05/09						
1.8 TFSI	118	01/07→05/09	←	→ 03/09; +PR 1ZE		13.0460-7184.2	607184	ATE 23587 20,6 + WK
1.9 TDI	77	10/04→05/09				13.0470-7184.2	LD7184	ATE 23587 20,6 + WK Ceramic
2.0 FSI	110	10/04→05/09						
2.0 TDI	103	11/05→05/09	➡	→ 03/09; +PR 1KF,1KJ,1KZ		13.0460-2749.2	602749	TRW 24483 16,9 - WE / - WK + Zub
2.0 TDI	125	01/06→05/09				13.0460-2880.2	602880	TRW 23914 17,1 + WE / - WK + Zub
2.0 TFSI	147	11/05→05/09				13.0470-2749.2	LD2749	TRW 24483 16,9 - WE / - WK + Zub Ceramic
						13.0470-2880.2	LD2880	TRW 23914 17,1 + WE / - WK + Zub Ceramic
			➡	→ 03/09; +PR 1KD		13.0460-2820.2	602820	TRW 20961 17,2 - WK
						13.0470-2820.2	LD2820	TRW 20961 17,2 - WK Ceramic
2.0 TDI	100	09/04→05/09	←	10/04→ 03/09; +PR 1ZF		13.0460-7117.2	607117	VW 23130 19,6 + WK
2.0 TDI 16V	103	04/04→05/09				13.0470-7117.2	LD7117	VW 23130 19,6 + WK Ceramic
			←	10/04→ 03/09; +PR 1ZE		13.0460-7184.2	607184	ATE 23587 20,6 + WK
						13.0470-7184.2	LD7184	ATE 23587 20,6 + WK Ceramic
			➡	10/04→ 03/09; +PR 1KF,1KJ,1KZ		13.0460-2749.2	602749	TRW 24483 16,9 - WE / - WK + Zub
						13.0460-2880.2	602880	TRW 23914 17,1 + WE / - WK + Zub
						13.0470-2749.2	LD2749	TRW 24483 16,9 - WE / - WK + Zub Ceramic
						13.0470-2880.2	LD2880	TRW 23914 17,1 + WE / - WK + Zub Ceramic
			➡	10/04→ 03/09; +PR 1KD		13.0460-2820.2	602820	TRW 20961 17,2 - WK
						13.0470-2820.2	LD2820	TRW 20961 17,2 - WK Ceramic
Zubehörsatz, Scheibenbremsbelag								
1.4 16V	63	05/06→05/09	➡	→ 03/09; +PR 1KF,1KJ,1KZ		13.0460-0259.2	610259	
1.4 TSI	92	11/07→05/09						
1.6	75	10/04→05/09						
1.8 TFSI	118	01/07→05/09						
1.9 TDI	77	10/04→05/09						
2.0 FSI	110	10/04→05/09						
2.0 TDI	103	11/05→05/09						
2.0 TDI	125	01/06→05/09						
2.0 TFSI	147	11/05→05/09						
2.0 TDI	100	09/04→05/09	➡	10/04→ 03/09; +PR 1KF,1KJ,1KZ		13.0460-0259.2	610259	
2.0 TDI 16V	103	04/04→05/09						
 Bremsscheibe								
1.4 16V	63	05/06→05/09	←	→ 03/09; +PR 1ZF		24.0122-0210.1	422210	Ø 280 22 19 V + S
1.4 TSI	92	11/07→05/09				24.0322-0210.1	522210	Ø 280 22 19 V + S PD
1.6	75	10/04→05/09						
1.8 TFSI	118	01/07→05/09	←	→ 03/09; +PR 1ZE		24.0125-0145.1	425145	Ø 288 25 22 V + S
1.9 TDI	77	10/04→05/09				24.0325-0145.1	525145	Ø 288 25 22 V + S PD
2.0 FSI	110	10/04→05/09	➡	→ 03/09; +PR 1KD		24.0110-0277.1	410277	Ø 253 10 8 + S
2.0 TDI	103	11/05→05/09				24.0310-0277.1	510277	Ø 253 10 8 + S PD
2.0 TDI	125	01/06→05/09						
2.0 TFSI	147	11/05→05/09	➡	→ 03/09; +PR 1KF		24.0112-0158.1	412158	Ø 256 12 10 + S
						24.0312-0158.1	512158	Ø 256 12 10 PD
			➡	→ 03/09; +PR 1KJ,1KZ		24.0112-0169.1	412169	Ø 282 12 10 + S
						24.0312-0169.1	512169	Ø 282 12 10 + S PD
2.0 TDI	100	09/04→05/09	←	10/04→ 03/09; +PR 1ZF		24.0122-0210.1	422210	Ø 280 22 19 V + S
2.0 TDI 16V	103	04/04→05/09				24.0322-0210.1	522210	Ø 280 22 19 V + S PD
			←	10/04→ 03/09; +PR 1ZE		24.0125-0145.1	425145	Ø 288 25 22 V + S
						24.0325-0145.1	525145	Ø 288 25 22 V + S PD
			➡	10/04→ 03/09; +PR 1KD		24.0110-0277.1	410277	Ø 253 10 8 + S
						24.0310-0277.1	510277	Ø 253 10 8 + S PD
			➡	10/04→ 03/09; +PR 1KF		24.0112-0158.1	412158	Ø 256 12 10 + S
						24.0312-0158.1	512158	Ø 256 12 10 PD
			➡	10/04→ 03/09; +PR 1KJ,1KZ		24.0112-0169.1	412169	Ø 282 12 10 + S











	kW			 	! #		
SEAT - TOLEDO III (5P2) 04/04→05/09							
 Bremsscheibe							
2.0 TDI	100	09/04→05/09	➔	10/04→ 03/09; +PR 1KJ,1KZ		24.0312-0169.1 512169	Ø 282 12 10 + S PD
2.0 TDI 16V	103	04/04→05/09					
SEAT - TOLEDO IV (KG3) 07/12→							
 Bremsbelagsatz, Scheibenbremse							
1.2	55	07/12→	←	+PR 1ZG		13.0460-7111.2 607111	VW 23130 19,6 - WE / - WK
1.2 TSI	63	07/12→				13.0470-7111.2 LD7111	VW 23130 19,6 - WE / - WK Ceramic
1.2 TSI	77	07/12→					
1.4 TSI	90	07/12→					
1.6	77	07/13→	←	für Bremsscheibendurchmesser [mm]: 288		13.0460-7184.2 607184	ATE 23587 20,6 + WK
1.6 TDI	66	06/13→				13.0470-7184.2 LD7184	ATE 23587 20,6 + WK Ceramic
1.6 TDI	77	07/12→	➔			13.0460-2820.2 602820	TRW 20961 17,2 - WK
						13.0470-2820.2 LD2820	TRW 20961 17,2 - WK Ceramic
1.2 TSI	66	05/15→	←	+PR 1ZG		13.0460-7111.2 607111	VW 23130 19,6 - WE / - WK
1.2 TSI	81	05/15→				13.0470-7111.2 LD7111	VW 23130 19,6 - WE / - WK Ceramic
1.4 TDI	66	05/15→					
1.4 TSI	92	05/15→	←	+PR 1ZC		13.0460-7184.2 607184	ATE 23587 20,6 + WK
1.6 TDI	85	05/15→				13.0470-7184.2 LD7184	ATE 23587 20,6 + WK Ceramic
			➔			13.0460-2820.2 602820	TRW 20961 17,2 - WK
						13.0470-2820.2 LD2820	TRW 20961 17,2 - WK Ceramic
 Bremsscheibe							
1.2	55	07/12→	←	+PR 1ZG		24.0122-0151.1 422151	Ø 256 22 19 V + S
1.2 TSI	63	07/12→				24.0322-0151.1 522151	Ø 256 22 19 V + S PD
1.2 TSI	77	07/12→					
1.4 TSI	90	07/12→	←	für Bremsscheibendurchmesser [mm]: 288		24.0125-0113.1 425113	Ø 288 25 22 V + S
1.6	77	07/13→				24.0325-0113.1 525113	Ø 288 25 22 V + S PD
1.6 TDI	66	06/13→	➔			24.0109-0123.1 409123	Ø 230 9 7 + S
1.6 TDI	77	07/12→				24.0309-0123.1 509123	Ø 230 9 7 + S PD
1.2 TSI	66	05/15→	←	+PR 1ZG		24.0122-0151.1 422151	Ø 256 22 19 V + S
1.2 TSI	81	05/15→				24.0322-0151.1 522151	Ø 256 22 19 V + S PD
1.4 TDI	66	05/15→					
1.4 TSI	92	05/15→	←	+PR 1ZC		24.0125-0113.1 425113	Ø 288 25 22 V + S
1.6 TDI	85	05/15→				24.0325-0113.1 525113	Ø 288 25 22 V + S PD
			➔			24.0109-0123.1 409123	Ø 230 9 7 + S
						24.0309-0123.1 509123	Ø 230 9 7 + S PD
SKODA - CITIGO 10/11→							
 Bremsbelagsatz, Scheibenbremse							
1.0	44	10/11→	←	05/12→		13.0460-7111.2 607111	VW 23130 19,6 - WE / - WK
1.0	55	10/11→				13.0470-7111.2 LD7111	VW 23130 19,6 - WE / - WK Ceramic
1.0 CNG	50	11/12→	←			13.0460-7111.2 607111	VW 23130 19,6 - WE / - WK
						13.0470-7111.2 LD7111	VW 23130 19,6 - WE / - WK Ceramic
 Bremsscheibe							
1.0	44	10/11→	←	05/12→		24.0122-0281.1 422281	Ø 256 22 19 V + S
1.0	55	10/11→					
1.0 CNG	50	11/12→	←			24.0122-0281.1 422281	Ø 256 22 19 V + S
SKODA - FABIA I (6Y2) 08/99→03/08							
 Bremsbelagsatz, Scheibenbremse							
1.0	37	12/99→08/02	←	02/00→; +PR 1LN;1LP		13.0460-2883.2 602883	TRW 23581 18,8 - WE / - WK
1.4	50	08/99→05/03				13.0460-2884.2 602884	TRW 23581 18,8 + WK
						13.0470-2884.2 LD2884	TRW 23581 18,8 + WK Ceramic
			←	02/00→; +PR 1LB;1LM		13.0460-7100.2 607100	VW 21866 17,2 - WE / - WK
						13.0460-7164.2 607164	VW 21866 17,2 + WK
						13.0470-7100.2 LD7100	VW 21866 17,2 - WE / - WK Ceramic
			←	02/00→; +PR 1LQ;1LR		13.0460-7111.2 607111	VW 23130 19,6 - WE / - WK
						13.0460-7117.2 607117	VW 23130 19,6 + WK
						13.0470-7111.2 LD7111	VW 23130 19,6 - WE / - WK Ceramic
						13.0470-7117.2 LD7117	VW 23130 19,6 + WK Ceramic
1.2	40	08/02→03/08	←	→ 12/07; +PR 1LN;1LP		13.0460-2883.2 602883	TRW 23581 18,8 - WE / - WK
1.2	47	01/03→03/08				13.0460-2884.2 602884	TRW 23581 18,8 + WK
1.9 SDI	47	12/99→03/08					





















	kw			 	! #		
SKODA - FABIA I (6Y2) 08/99→03/08							
 Bremsbelagsatz, Scheibenbremse							
1.2	40	08/02→03/08	←	→ 12/07; +PR 1LN;1LP		13.0470-2884.2 LD2884	TRW 23581 18,8 + WK Ceramic
1.2	47	01/03→03/08	←	→ 12/07; +PR 1LB;1LM		13.0460-7100.2 607100	VW 21866 17,2 - WE / - WK
1.9 SDI	47	12/99→03/08	←	→ 12/07; +PR 1LB;1LM		13.0460-7164.2 607164	VW 21866 17,2 + WK
			←	→ 12/07; +PR 1LQ;1LR		13.0470-7100.2 LD7100	VW 21866 17,2 - WE / - WK Ceramic
			←	→ 12/07; +PR 1LQ;1LR		13.0460-7111.2 607111	VW 23130 19,6 - WE / - WK
			←	→ 12/07; +PR 1LQ;1LR		13.0460-7117.2 607117	VW 23130 19,6 + WK
			←	→ 12/07; +PR 1LQ;1LR		13.0470-7111.2 LD7111	VW 23130 19,6 - WE / - WK Ceramic
			←	→ 12/07; +PR 1LQ;1LR		13.0470-7117.2 LD7117	VW 23130 19,6 + WK Ceramic
1.4	44	08/00→08/02	←	+PR 1LN;1LP		13.0460-2883.2 602883	TRW 23581 18,8 - WE / - WK
			←	+PR 1LB;1LM		13.0460-2884.2 602884	TRW 23581 18,8 + WK
			←	+PR 1LB;1LM		13.0470-2884.2 LD2884	TRW 23581 18,8 + WK Ceramic
			←	+PR 1LB;1LM		13.0460-7100.2 607100	VW 21866 17,2 - WE / - WK
			←	+PR 1LB;1LM		13.0460-7164.2 607164	VW 21866 17,2 + WK
			←	+PR 1LB;1LM		13.0470-7100.2 LD7100	VW 21866 17,2 - WE / - WK Ceramic
			←	+PR 1LQ;1LR		13.0460-7111.2 607111	VW 23130 19,6 - WE / - WK
			←	+PR 1LQ;1LR		13.0460-7117.2 607117	VW 23130 19,6 + WK
			←	+PR 1LQ;1LR		13.0470-7111.2 LD7111	VW 23130 19,6 - WE / - WK Ceramic
			←	+PR 1LQ;1LR		13.0470-7117.2 LD7117	VW 23130 19,6 + WK Ceramic
1.4 16V	55	12/99→03/08	←	→ 12/07; +PR 1LN;1LP		13.0460-2883.2 602883	TRW 23581 18,8 - WE / - WK
1.4 16V	74	12/99→03/08	←	→ 12/07; +PR 1LN;1LP		13.0460-2884.2 602884	TRW 23581 18,8 + WK
1.4 TDI	51	10/05→03/08	←	→ 12/07; +PR 1LB;1LM		13.0470-2884.2 LD2884	TRW 23581 18,8 + WK Ceramic
1.4 TDI	55	04/03→03/08	←	→ 12/07; +PR 1LB;1LM		13.0460-7100.2 607100	VW 21866 17,2 - WE / - WK
1.4 TDI	59	10/05→03/08	←	→ 12/07; +PR 1LB;1LM		13.0460-7164.2 607164	VW 21866 17,2 + WK
2.0	85	12/99→03/08	←	→ 12/07; +PR 1LB;1LM		13.0470-7100.2 LD7100	VW 21866 17,2 - WE / - WK Ceramic
			←	→ 12/07; +PR 1LQ;1LR		13.0460-7111.2 607111	VW 23130 19,6 - WE / - WK
			←	→ 12/07; +PR 1LQ;1LR		13.0460-7117.2 607117	VW 23130 19,6 + WK
			←	→ 12/07; +PR 1LQ;1LR		13.0470-7111.2 LD7111	VW 23130 19,6 - WE / - WK Ceramic
			←	→ 12/07; +PR 1LQ;1LR		13.0470-7117.2 LD7117	VW 23130 19,6 + WK Ceramic
			→	→ 12/07; +PR 1KK,1KP		13.0460-2894.2 602894	TRW 20961 17,2 - WK + Zub
			→	→ 12/07; +PR 1KK,1KP		13.0470-2894.2 LD2894	TRW 20961 17,2 - WK + Zub Ceramic
1.9 TDI	74	01/00→03/08	←	02/00→ 12/07; +PR 1LN;1LP		13.0460-2883.2 602883	TRW 23581 18,8 - WE / - WK
			←	02/00→ 12/07; +PR 1LB;1LM		13.0460-2884.2 602884	TRW 23581 18,8 + WK
			←	02/00→ 12/07; +PR 1LB;1LM		13.0470-2884.2 LD2884	TRW 23581 18,8 + WK Ceramic
			←	02/00→ 12/07; +PR 1LB;1LM		13.0460-7100.2 607100	VW 21866 17,2 - WE / - WK
			←	02/00→ 12/07; +PR 1LB;1LM		13.0460-7164.2 607164	VW 21866 17,2 + WK
			←	02/00→ 12/07; +PR 1LB;1LM		13.0470-7100.2 LD7100	VW 21866 17,2 - WE / - WK Ceramic
			←	02/00→ 12/07; +PR 1LQ;1LR		13.0460-7111.2 607111	VW 23130 19,6 - WE / - WK
			←	02/00→ 12/07; +PR 1LQ;1LR		13.0460-7117.2 607117	VW 23130 19,6 + WK
			←	02/00→ 12/07; +PR 1LQ;1LR		13.0470-7111.2 LD7111	VW 23130 19,6 - WE / - WK Ceramic
			←	02/00→ 12/07; +PR 1LQ;1LR		13.0470-7117.2 LD7117	VW 23130 19,6 + WK Ceramic
			→	02/00→ 12/07; +PR 1KK,1KP		13.0460-2894.2 602894	TRW 20961 17,2 - WK + Zub
			→	02/00→ 12/07; +PR 1KK,1KP		13.0470-2894.2 LD2894	TRW 20961 17,2 - WK + Zub Ceramic
1.9 TDI RS	96	06/03→03/08	←	09/03→ 12/07; +PR 1LN;1LP		13.0460-2883.2 602883	TRW 23581 18,8 - WE / - WK
			←	09/03→ 12/07; +PR 1LB;1LM		13.0460-2884.2 602884	TRW 23581 18,8 + WK
			←	09/03→ 12/07; +PR 1LB;1LM		13.0470-2884.2 LD2884	TRW 23581 18,8 + WK Ceramic
			←	09/03→ 12/07; +PR 1LB;1LM		13.0460-7100.2 607100	VW 21866 17,2 - WE / - WK
			←	09/03→ 12/07; +PR 1LB;1LM		13.0460-7164.2 607164	VW 21866 17,2 + WK
			←	09/03→ 12/07; +PR 1LB;1LM		13.0470-7100.2 LD7100	VW 21866 17,2 - WE / - WK Ceramic
			←	09/03→ 12/07; +PR 1LQ;1LR		13.0460-7111.2 607111	VW 23130 19,6 - WE / - WK
			←	09/03→ 12/07; +PR 1LQ;1LR		13.0460-7117.2 607117	VW 23130 19,6 + WK
			←	09/03→ 12/07; +PR 1LQ;1LR		13.0470-7111.2 LD7111	VW 23130 19,6 - WE / - WK Ceramic
			←	09/03→ 12/07; +PR 1LQ;1LR		13.0470-7117.2 LD7117	VW 23130 19,6 + WK Ceramic
			→	09/03→ 12/07; +PR 1KK,1KP		13.0460-2894.2 602894	TRW 20961 17,2 - WK + Zub

















	kw					! #		
SKODA - FABIA I (6Y2) 08/99→03/08								
 Bremsbelagsatz, Scheibenbremse								
1.9 TDI RS	96	06/03→03/08	➡	09/03→ 12/07; +PR 1KK,1KP			13.0470-2894.2 LD2894	TRW 20961 17,2 - WK + Zub Ceramic
 Bremsscheibe								
1.0 1.4	37 50	12/99→08/02 08/99→05/03	←	02/00→; +PR 1LB;1LM			24.0118-0137.1 418137 24.0318-0137.1 518137	Ø 239 18 16 V + S Ø 239 18 16 V + S PD
			←	02/00→; +PR 1LQ;1LR			24.0122-0151.1 422151 24.0322-0151.1 522151	Ø 256 22 19 V + S Ø 256 22 19 V + S PD
			←	02/00→; +PR 1LN;1LP			24.0125-0113.1 425113 24.0325-0113.1 525113	Ø 288 25 22 V + S Ø 288 25 22 V + S PD
1.2 1.2 1.9 SDI	40 47 47	08/02→03/08 01/03→03/08 12/99→03/08	←	→ 12/07; +PR 1LB;1LM			24.0118-0137.1 418137 24.0318-0137.1 518137	Ø 239 18 16 V + S Ø 239 18 16 V + S PD
			←	→ 12/07; +PR 1LQ;1LR			24.0122-0151.1 422151 24.0322-0151.1 522151	Ø 256 22 19 V + S Ø 256 22 19 V + S PD
			←	→ 12/07; +PR 1LN;1LP			24.0125-0113.1 425113 24.0325-0113.1 525113	Ø 288 25 22 V + S Ø 288 25 22 V + S PD
1.4	44	08/00→08/02	←	+PR 1LB;1LM			24.0118-0137.1 418137 24.0318-0137.1 518137	Ø 239 18 16 V + S Ø 239 18 16 V + S PD
			←	+PR 1LQ;1LR			24.0122-0151.1 422151 24.0322-0151.1 522151	Ø 256 22 19 V + S Ø 256 22 19 V + S PD
			←	+PR 1LN;1LP			24.0125-0113.1 425113 24.0325-0113.1 525113	Ø 288 25 22 V + S Ø 288 25 22 V + S PD
1.4 16V 1.4 16V 1.4 TDI 1.4 TDI 1.4 TDI 2.0	55 74 51 55 59 85	12/99→03/08 12/99→03/08 10/05→03/08 04/03→03/08 10/05→03/08 12/99→03/08	←	→ 12/07; +PR 1LB;1LM			24.0118-0137.1 418137 24.0318-0137.1 518137	Ø 239 18 16 V + S Ø 239 18 16 V + S PD
			←	→ 12/07; +PR 1LQ;1LR			24.0122-0151.1 422151 24.0322-0151.1 522151	Ø 256 22 19 V + S Ø 256 22 19 V + S PD
			←	→ 12/07; +PR 1LN;1LP			24.0125-0113.1 425113 24.0325-0113.1 525113	Ø 288 25 22 V + S Ø 288 25 22 V + S PD
			➡	→ 12/07; +PR 1KK,1KP			24.0109-0123.1 409123 24.0309-0123.1 509123	Ø 230 9 7 + S Ø 230 9 7 + S PD
1.9 TDI	74	01/00→03/08	←	02/00→ 12/07; +PR 1LB;1LM			24.0118-0137.1 418137 24.0318-0137.1 518137	Ø 239 18 16 V + S Ø 239 18 16 V + S PD
			←	02/00→ 12/07; +PR 1LQ;1LR			24.0122-0151.1 422151 24.0322-0151.1 522151	Ø 256 22 19 V + S Ø 256 22 19 V + S PD
			←	02/00→ 12/07; +PR 1LN;1LP			24.0125-0113.1 425113 24.0325-0113.1 525113	Ø 288 25 22 V + S Ø 288 25 22 V + S PD
			➡	02/00→ 12/07; +PR 1KK,1KP			24.0109-0123.1 409123 24.0309-0123.1 509123	Ø 230 9 7 + S Ø 230 9 7 + S PD
1.9 TDI RS	96	06/03→03/08	←	09/03→ 12/07; +PR 1LB;1LM			24.0118-0137.1 418137 24.0318-0137.1 518137	Ø 239 18 16 V + S Ø 239 18 16 V + S PD
			←	09/03→ 12/07; +PR 1LQ;1LR			24.0122-0151.1 422151 24.0322-0151.1 522151	Ø 256 22 19 V + S Ø 256 22 19 V + S PD
			←	09/03→ 12/07; +PR 1LN;1LP			24.0125-0113.1 425113 24.0325-0113.1 525113	Ø 288 25 22 V + S Ø 288 25 22 V + S PD
			➡	09/03→ 12/07; +PR 1KK,1KP			24.0109-0123.1 409123 24.0309-0123.1 509123	Ø 230 9 7 + S Ø 230 9 7 + S PD
SKODA - FABIA I Combi (6Y5) 04/00→12/07								
 Bremsbelagsatz, Scheibenbremse								
1.2	40	07/01→12/07	←	08/02→; +PR 1LN;1LP			13.0460-2883.2 602883 13.0460-2884.2 602884 13.0470-2884.2 LD2884	TRW 23581 18,8 - WE / - WK TRW 23581 18,8 + WK TRW 23581 18,8 + WK Ceramic
			←	08/02→; +PR 1LB;1LM			13.0460-7100.2 607100 13.0460-7164.2 607164 13.0470-7100.2 LD7100	VW 21866 17,2 - WE / - WK VW 21866 17,2 + WK VW 21866 17,2 - WE / - WK Ceramic
			←	08/02→; +PR 1LQ;1LR			13.0460-7111.2 607111 13.0460-7117.2 607117 13.0470-7111.2 LD7111 13.0470-7117.2 LD7117	VW 23130 19,6 - WE / - WK VW 23130 19,6 + WK VW 23130 19,6 - WE / - WK Ceramic VW 23130 19,6 + WK Ceramic
1.2 1.4 ↓	47 44	01/03→12/07 04/00→03/03	←	+PR 1LN;1LP			13.0460-2883.2 602883	TRW 23581 18,8 - WE / - WK

	kw			 	! #		
SKODA - FABIA I Combi (6Y5) 04/00→12/07							
 Bremsbelagsatz, Scheibenbremse							
1.4 1.9 SDI	50 47	04/00→05/03 04/00→12/07	←	+PR 1LN;1LP	13.0460-2884.2	602884	TRW 23581 18,8 + WK
					13.0470-2884.2	LD2884	TRW 23581 18,8 + WK Ceramic
			←	+PR 1LB;1LM	13.0460-7100.2	607100	VW 21866 17,2 - WE / - WK
				13.0460-7164.2	607164	VW 21866 17,2 + WK	
				13.0470-7100.2	LD7100	VW 21866 17,2 - WE / - WK Ceramic	
			←	+PR 1LQ;1LR	13.0460-7111.2	607111	VW 23130 19,6 - WE / - WK
					13.0460-7117.2	607117	VW 23130 19,6 + WK
					13.0470-7111.2	LD7111	VW 23130 19,6 - WE / - WK Ceramic
					13.0470-7117.2	LD7117	VW 23130 19,6 + WK Ceramic
1.4 16V 1.4 16V 1.4 16V 1.4 TDI 1.4 TDI 1.4 TDI 1.9 TDI 2.0	55 59 74 51 55 59 74 85	05/00→12/07 04/06→12/07 04/00→12/07 10/05→12/07 04/03→12/07 10/05→12/07 04/00→12/07 04/00→12/07	←	+PR 1LN;1LP	13.0460-2883.2	602883	TRW 23581 18,8 - WE / - WK
					13.0460-2884.2	602884	TRW 23581 18,8 + WK
					13.0470-2884.2	LD2884	TRW 23581 18,8 + WK Ceramic
			←	+PR 1LB;1LM	13.0460-7100.2	607100	VW 21866 17,2 - WE / - WK
					13.0460-7164.2	607164	VW 21866 17,2 + WK
					13.0470-7100.2	LD7100	VW 21866 17,2 - WE / - WK Ceramic
			←	+PR 1LQ;1LR	13.0460-7111.2	607111	VW 23130 19,6 - WE / - WK
				13.0460-7117.2	607117	VW 23130 19,6 + WK	
				13.0470-7111.2	LD7111	VW 23130 19,6 - WE / - WK Ceramic	
					13.0470-7117.2	LD7117	VW 23130 19,6 + WK Ceramic
			→	+PR 1KK,1KP	13.0460-2894.2	602894	TRW 20961 17,2 - WK + Zub
					13.0470-2894.2	LD2894	TRW 20961 17,2 - WK + Zub Ceramic
 Bremsscheibe							
1.2	40	07/01→12/07	←	08/02→; +PR 1LB;1LM	24.0118-0137.1	418137	Ø 239 18 16 V + S
					24.0318-0137.1	518137	Ø 239 18 16 V + S PD
			←	08/02→; +PR 1LQ;1LR	24.0122-0151.1	422151	Ø 256 22 19 V + S
				24.0322-0151.1	522151	Ø 256 22 19 V + S PD	
			←	08/02→; +PR 1LN;1LP	24.0125-0113.1	425113	Ø 288 25 22 V + S
					24.0325-0113.1	525113	Ø 288 25 22 V + S PD
1.2 1.4 1.4 1.9 SDI	47 44 50 47	01/03→12/07 04/00→03/03 04/00→05/03 04/00→12/07	←	+PR 1LB;1LM	24.0118-0137.1	418137	Ø 239 18 16 V + S
					24.0318-0137.1	518137	Ø 239 18 16 V + S PD
			←	+PR 1LQ;1LR	24.0122-0151.1	422151	Ø 256 22 19 V + S
					24.0322-0151.1	522151	Ø 256 22 19 V + S PD
			←	+PR 1LN;1LP	24.0125-0113.1	425113	Ø 288 25 22 V + S
					24.0325-0113.1	525113	Ø 288 25 22 V + S PD
1.4 16V 1.4 16V 1.4 16V 1.4 TDI 1.4 TDI 1.4 TDI 1.9 TDI 2.0	55 59 74 51 55 59 74 85	05/00→12/07 04/06→12/07 04/00→12/07 10/05→12/07 04/03→12/07 10/05→12/07 04/00→12/07 04/00→12/07	←	+PR 1LB;1LM	24.0118-0137.1	418137	Ø 239 18 16 V + S
					24.0318-0137.1	518137	Ø 239 18 16 V + S PD
			←	+PR 1LQ;1LR	24.0122-0151.1	422151	Ø 256 22 19 V + S
					24.0322-0151.1	522151	Ø 256 22 19 V + S PD
			←	+PR 1LN;1LP	24.0125-0113.1	425113	Ø 288 25 22 V + S
					24.0325-0113.1	525113	Ø 288 25 22 V + S PD
			→	+PR 1KK,1KP	24.0109-0123.1	409123	Ø 230 9 7 + S
		24.0309-0123.1	509123	Ø 230 9 7 + S PD			
SKODA - FABIA I Praktik (6Y5) 07/01→12/07							
 Bremsbelagsatz, Scheibenbremse							
1.2	40	07/01→12/07	←	08/02→; +PR 1LN;1LP	13.0460-2883.2	602883	TRW 23581 18,8 - WE / - WK
					13.0460-2884.2	602884	TRW 23581 18,8 + WK
					13.0470-2884.2	LD2884	TRW 23581 18,8 + WK Ceramic
			←	08/02→; +PR 1LB;1LM	13.0460-7100.2	607100	VW 21866 17,2 - WE / - WK
					13.0460-7164.2	607164	VW 21866 17,2 + WK
					13.0470-7100.2	LD7100	VW 21866 17,2 - WE / - WK Ceramic
			←	08/02→; +PR 1LQ;1LR	13.0460-7111.2	607111	VW 23130 19,6 - WE / - WK
					13.0460-7117.2	607117	VW 23130 19,6 + WK
					13.0470-7111.2	LD7111	VW 23130 19,6 - WE / - WK Ceramic
					13.0470-7117.2	LD7117	VW 23130 19,6 + WK Ceramic
↓							









	kw			 	! #		
SKODA - FABIA I Praktik (6Y5) 07/01→12/07							
 Bremsbelagsatz, Scheibenbremse							
1.2 1.4 1.9 SDI	47 50 47	01/03→12/07 07/01→05/03 07/01→12/07	←	+PR 1LN;1LP	13.0460-2883.2 602883	TRW 23581 18,8 - WE / - WK	
					13.0460-2884.2 602884	TRW 23581 18,8 + WK	
					13.0470-2884.2 LD2884	TRW 23581 18,8 + WK Ceramic	
				←	+PR 1LB;1LM	13.0460-7100.2 607100	VW 21866 17,2 - WE / - WK
						13.0460-7164.2 607164	VW 21866 17,2 + WK
						13.0470-7100.2 LD7100	VW 21866 17,2 - WE / - WK Ceramic
				←	+PR 1LQ;1LR	13.0460-7111.2 607111	VW 23130 19,6 - WE / - WK
						13.0460-7117.2 607117	VW 23130 19,6 + WK
						13.0470-7111.2 LD7111	VW 23130 19,6 - WE / - WK Ceramic
				13.0470-7117.2 LD7117	VW 23130 19,6 + WK Ceramic		
1.4 TDI	51	10/05→12/07	←	+PR 1LN;1LP	13.0460-2883.2 602883	TRW 23581 18,8 - WE / - WK	
					13.0460-2884.2 602884	TRW 23581 18,8 + WK	
					13.0470-2884.2 LD2884	TRW 23581 18,8 + WK Ceramic	
			←	+PR 1LB;1LM	13.0460-7100.2 607100	VW 21866 17,2 - WE / - WK	
					13.0460-7164.2 607164	VW 21866 17,2 + WK	
				←	+PR 1LQ;1LR	13.0460-7111.2 607111	VW 23130 19,6 - WE / - WK
						13.0460-7117.2 607117	VW 23130 19,6 + WK
						13.0470-7111.2 LD7111	VW 23130 19,6 - WE / - WK Ceramic
						13.0470-7117.2 LD7117	VW 23130 19,6 + WK Ceramic
		→	+PR 1KK,1KP	13.0460-2894.2 602894	TRW 20961 17,2 - WK + Zub		
				13.0470-2894.2 LD2894	TRW 20961 17,2 - WK + Zub Ceramic		
 Bremsscheibe							
1.2	40	07/01→12/07	←	08/02→; +PR 1LB;1LM	24.0118-0137.1 418137	Ø 239 18 16 V + S	
					24.0318-0137.1 518137	Ø 239 18 16 V + S PD	
			←	08/02→; +PR 1LQ;1LR	24.0122-0151.1 422151	Ø 256 22 19 V + S	
					24.0322-0151.1 522151	Ø 256 22 19 V + S PD	
		←	08/02→; +PR 1LN;1LP	24.0125-0113.1 425113	Ø 288 25 22 V + S		
				24.0325-0113.1 525113	Ø 288 25 22 V + S PD		
1.2 1.4 1.9 SDI	47 50 47	01/03→12/07 07/01→05/03 07/01→12/07	←	+PR 1LB;1LM	24.0118-0137.1 418137	Ø 239 18 16 V + S	
					24.0318-0137.1 518137	Ø 239 18 16 V + S PD	
			←	+PR 1LQ;1LR	24.0122-0151.1 422151	Ø 256 22 19 V + S	
				24.0322-0151.1 522151	Ø 256 22 19 V + S PD		
		←	+PR 1LN;1LP	24.0125-0113.1 425113	Ø 288 25 22 V + S		
				24.0325-0113.1 525113	Ø 288 25 22 V + S PD		
1.4 TDI	51	10/05→12/07	←	+PR 1LB;1LM	24.0118-0137.1 418137	Ø 239 18 16 V + S	
					24.0318-0137.1 518137	Ø 239 18 16 V + S PD	
			←	+PR 1LQ;1LR	24.0122-0151.1 422151	Ø 256 22 19 V + S	
					24.0322-0151.1 522151	Ø 256 22 19 V + S PD	
			←	+PR 1LN;1LP	24.0125-0113.1 425113	Ø 288 25 22 V + S	
				24.0325-0113.1 525113	Ø 288 25 22 V + S PD		
		→	+PR 1KK,1KP	24.0109-0123.1 409123	Ø 230 9 7 + S		
				24.0309-0123.1 509123	Ø 230 9 7 + S PD		
SKODA - FABIA I Stufenheck (6Y3) 10/99→12/07							
 Bremsbelagsatz, Scheibenbremse							
1.2	40	07/01→12/07	←	08/02→; +PR 1LN;1LP	13.0460-2883.2 602883	TRW 23581 18,8 - WE / - WK	
					13.0460-2884.2 602884	TRW 23581 18,8 + WK	
					13.0470-2884.2 LD2884	TRW 23581 18,8 + WK Ceramic	
		←	08/02→; +PR 1LB;1LM	13.0460-7100.2 607100	VW 21866 17,2 - WE / - WK		
				13.0460-7164.2 607164	VW 21866 17,2 + WK		
				13.0470-7100.2 LD7100	VW 21866 17,2 - WE / - WK Ceramic		
		←	08/02→; +PR 1LQ;1LR	13.0460-7111.2 607111	VW 23130 19,6 - WE / - WK		
				13.0460-7117.2 607117	VW 23130 19,6 + WK		
				13.0470-7111.2 LD7111	VW 23130 19,6 - WE / - WK Ceramic		
↓							

	kw			 	! #		
SKODA - FABIA I Stufenheck (6Y3) 10/99→12/07							
 Bremsbelagsatz, Scheibenbremse							
1.2	40	07/01→12/07	←	08/02→; +PR 1LQ;1LR		13.0470-7117.2 LD7117	VW 23130 19,6 + WK Ceramic
1.2	47	01/03→12/07	←	+PR 1LN;1LP		13.0460-2883.2 602883	TRW 23581 18,8 - WE / - WK
1.4	44	04/00→08/02				13.0460-2884.2 602884	TRW 23581 18,8 + WK
1.4	50	07/01→05/03				13.0470-2884.2 LD2884	TRW 23581 18,8 + WK Ceramic
			←	+PR 1LB;1LM		13.0460-7100.2 607100	VW 21866 17,2 - WE / - WK
						13.0460-7164.2 607164	VW 21866 17,2 + WK
						13.0470-7100.2 LD7100	VW 21866 17,2 - WE / - WK Ceramic
			←	+PR 1LQ;1LR		13.0460-7111.2 607111	VW 23130 19,6 - WE / - WK
						13.0460-7117.2 607117	VW 23130 19,6 + WK
						13.0470-7111.2 LD7111	VW 23130 19,6 - WE / - WK Ceramic
						13.0470-7117.2 LD7117	VW 23130 19,6 + WK Ceramic
1.4 16V	55	10/99→12/07	←	+PR 1LN;1LP		13.0460-2883.2 602883	TRW 23581 18,8 - WE / - WK
1.4 16V	59	04/06→12/07				13.0460-2884.2 602884	TRW 23581 18,8 + WK
1.4 16V	74	12/99→12/07				13.0470-2884.2 LD2884	TRW 23581 18,8 + WK Ceramic
1.4 TDI	51	10/05→12/07				13.0460-2884.2 LD2884	TRW 23581 18,8 + WK Ceramic
1.4 TDI	55	04/03→12/07	←	+PR 1LB;1LM		13.0460-7100.2 607100	VW 21866 17,2 - WE / - WK
1.4 TDI	59	10/05→12/07				13.0460-7164.2 607164	VW 21866 17,2 + WK
2.0	85	12/99→12/07				13.0470-7100.2 LD7100	VW 21866 17,2 - WE / - WK Ceramic
			←	+PR 1LQ;1LR		13.0460-7111.2 607111	VW 23130 19,6 - WE / - WK
						13.0460-7117.2 607117	VW 23130 19,6 + WK
						13.0470-7111.2 LD7111	VW 23130 19,6 - WE / - WK Ceramic
						13.0470-7117.2 LD7117	VW 23130 19,6 + WK Ceramic
			→	+PR 1KK,1KP		13.0460-2894.2 602894	TRW 20961 17,2 - WK + Zub
						13.0470-2894.2 LD2894	TRW 20961 17,2 - WK + Zub Ceramic
1.9 SDI	47	11/99→12/07	←	12/99→; +PR 1LN;1LP		13.0460-2883.2 602883	TRW 23581 18,8 - WE / - WK
						13.0460-2884.2 602884	TRW 23581 18,8 + WK
						13.0470-2884.2 LD2884	TRW 23581 18,8 + WK Ceramic
			←	12/99→; +PR 1LB;1LM		13.0460-7100.2 607100	VW 21866 17,2 - WE / - WK
						13.0460-7164.2 607164	VW 21866 17,2 + WK
						13.0470-7100.2 LD7100	VW 21866 17,2 - WE / - WK Ceramic
			←	12/99→; +PR 1LQ;1LR		13.0460-7111.2 607111	VW 23130 19,6 - WE / - WK
						13.0460-7117.2 607117	VW 23130 19,6 + WK
						13.0470-7111.2 LD7111	VW 23130 19,6 - WE / - WK Ceramic
						13.0470-7117.2 LD7117	VW 23130 19,6 + WK Ceramic
			→	+PR 1KK,1KP		13.0460-2894.2 602894	TRW 20961 17,2 - WK + Zub
						13.0470-2894.2 LD2894	TRW 20961 17,2 - WK + Zub Ceramic
1.9 TDI	74	01/00→12/07	←	02/00→; +PR 1LN;1LP		13.0460-2883.2 602883	TRW 23581 18,8 - WE / - WK
						13.0460-2884.2 602884	TRW 23581 18,8 + WK
						13.0470-2884.2 LD2884	TRW 23581 18,8 + WK Ceramic
			←	02/00→; +PR 1LB;1LM		13.0460-7100.2 607100	VW 21866 17,2 - WE / - WK
						13.0460-7164.2 607164	VW 21866 17,2 + WK
						13.0470-7100.2 LD7100	VW 21866 17,2 - WE / - WK Ceramic
			←	02/00→; +PR 1LQ;1LR		13.0460-7111.2 607111	VW 23130 19,6 - WE / - WK
						13.0460-7117.2 607117	VW 23130 19,6 + WK
						13.0470-7111.2 LD7111	VW 23130 19,6 - WE / - WK Ceramic
						13.0470-7117.2 LD7117	VW 23130 19,6 + WK Ceramic
			→	02/00→; +PR 1KK,1KP		13.0460-2894.2 602894	TRW 20961 17,2 - WK + Zub
						13.0470-2894.2 LD2894	TRW 20961 17,2 - WK + Zub Ceramic
 Bremsscheibe							
1.2	40	07/01→12/07	←	08/02→; +PR 1LB;1LM		24.0118-0137.1 418137	Ø 239 18 16 V + S
						24.0318-0137.1 518137	Ø 239 18 16 V + S PD
			←	08/02→; +PR 1LQ;1LR		24.0122-0151.1 422151	Ø 256 22 19 V + S
						24.0322-0151.1 522151	Ø 256 22 19 V + S PD
			←	08/02→; +PR 1LN;1LP		24.0125-0113.1 425113	Ø 288 25 22 V + S
						24.0325-0113.1 525113	Ø 288 25 22 V + S PD
1.2	47	01/03→12/07	←	+PR 1LB;1LM		24.0118-0137.1 418137	Ø 239 18 16 V + S
1.4	44	04/00→08/02					
↓							









	kw			 	! #		
SKODA - FABIA I Stufenheck (6Y3) 10/99→12/07							
Bremsscheibe							
1.4	50	07/01→05/03	←	+PR 1LB;1LM		24.0318-0137.1 518137	Ø 239 18 16 V + S PD
			←	+PR 1LQ;1LR		24.0122-0151.1 422151	Ø 256 22 19 V + S
						24.0322-0151.1 522151	Ø 256 22 19 V + S PD
			←	+PR 1LN;1LP		24.0125-0113.1 425113	Ø 288 25 22 V + S
						24.0325-0113.1 525113	Ø 288 25 22 V + S PD
1.4 16V	55	10/99→12/07	←	+PR 1LB;1LM		24.0118-0137.1 418137	Ø 239 18 16 V + S
1.4 16V	59	04/06→12/07				24.0318-0137.1 518137	Ø 239 18 16 V + S PD
1.4 16V	74	12/99→12/07					
1.4 TDI	51	10/05→12/07	←	+PR 1LQ;1LR		24.0122-0151.1 422151	Ø 256 22 19 V + S
1.4 TDI	55	04/03→12/07				24.0322-0151.1 522151	Ø 256 22 19 V + S PD
1.4 TDI	59	10/05→12/07	←	+PR 1LN;1LP		24.0125-0113.1 425113	Ø 288 25 22 V + S
2.0	85	12/99→12/07				24.0325-0113.1 525113	Ø 288 25 22 V + S PD
			→	+PR 1KK,1KP		24.0109-0123.1 409123	Ø 230 9 7 + S
						24.0309-0123.1 509123	Ø 230 9 7 + S PD
1.9 SDI	47	11/99→12/07	←	12/99→; +PR 1LB;1LM		24.0118-0137.1 418137	Ø 239 18 16 V + S
						24.0318-0137.1 518137	Ø 239 18 16 V + S PD
			←	12/99→; +PR 1LQ;1LR		24.0122-0151.1 422151	Ø 256 22 19 V + S
						24.0322-0151.1 522151	Ø 256 22 19 V + S PD
			←	12/99→; +PR 1LN;1LP		24.0125-0113.1 425113	Ø 288 25 22 V + S
						24.0325-0113.1 525113	Ø 288 25 22 V + S PD
1.9 TDI	74	01/00→12/07	←	02/00→; +PR 1LB;1LM		24.0118-0137.1 418137	Ø 239 18 16 V + S
						24.0318-0137.1 518137	Ø 239 18 16 V + S PD
			←	02/00→; +PR 1LQ;1LR		24.0122-0151.1 422151	Ø 256 22 19 V + S
						24.0322-0151.1 522151	Ø 256 22 19 V + S PD
			←	02/00→; +PR 1LN;1LP		24.0125-0113.1 425113	Ø 288 25 22 V + S
						24.0325-0113.1 525113	Ø 288 25 22 V + S PD
			→	02/00→; +PR 1KK,1KP		24.0109-0123.1 409123	Ø 230 9 7 + S
						24.0309-0123.1 509123	Ø 230 9 7 + S PD
SKODA - FABIA II (542) 12/06→12/14							
Bremsbelagsatz, Scheibenbremse							
1.2	44	12/06→12/14	←	03/07→ 06/14; +PR 1LN,1ZH		13.0460-2883.2 602883	TRW 23581 18,8 - WE / - WK
1.2	51	01/07→12/14				13.0460-2884.2 602884	TRW 23581 18,8 + WK
1.4	63	01/07→12/14				13.0470-2884.2 LD2884	TRW 23581 18,8 + WK Ceramic
			←	03/07→ 06/14; +PR 1LB;1LM		13.0460-7100.2 607100	VW 21866 17,2 - WE / - WK
						13.0460-7164.2 607164	VW 21866 17,2 + WK
						13.0470-7100.2 LD7100	VW 21866 17,2 - WE / - WK Ceramic
			←	03/07→ 06/14; +PR 1LQ,1LR,1ZG		13.0460-7111.2 607111	VW 23130 19,6 - WE / - WK
						13.0460-7117.2 607117	VW 23130 19,6 + WK
						13.0470-7111.2 LD7111	VW 23130 19,6 - WE / - WK Ceramic
						13.0470-7117.2 LD7117	VW 23130 19,6 + WK Ceramic
			←	03/07→ 06/14; +PR 1ZC		13.0460-7184.2 607184	ATE 23587 20,6 + WK
						13.0470-7184.2 LD7184	ATE 23587 20,6 + WK Ceramic
			→	03/07→ 06/14; +PR 1KT,1KV		13.0460-2820.2 602820	TRW 20961 17,2 - WK
						13.0470-2820.2 LD2820	TRW 20961 17,2 - WK Ceramic
			→	03/07→ 06/14; +PR 1KK		13.0460-2894.2 602894	TRW 20961 17,2 - WK + Zub
						13.0470-2894.2 LD2894	TRW 20961 17,2 - WK + Zub Ceramic
1.2 12V	44	11/11→12/14	←	→ 06/14; +PR 1LN,1ZH		13.0460-2883.2 602883	TRW 23581 18,8 - WE / - WK
1.6	77	04/07→12/14				13.0460-2884.2 602884	TRW 23581 18,8 + WK
						13.0470-2884.2 LD2884	TRW 23581 18,8 + WK Ceramic
			←	→ 06/14; +PR 1LB;1LM		13.0460-7100.2 607100	VW 21866 17,2 - WE / - WK
						13.0460-7164.2 607164	VW 21866 17,2 + WK
						13.0470-7100.2 LD7100	VW 21866 17,2 - WE / - WK Ceramic
			←	→ 06/14; +PR 1LQ,1LR,1ZG		13.0460-7111.2 607111	VW 23130 19,6 - WE / - WK
						13.0460-7117.2 607117	VW 23130 19,6 + WK
						13.0470-7111.2 LD7111	VW 23130 19,6 - WE / - WK Ceramic
						13.0470-7117.2 LD7117	VW 23130 19,6 + WK Ceramic
			←	→ 06/14; +PR 1ZC		13.0460-7184.2 607184	ATE 23587 20,6 + WK
						13.0470-7184.2 LD7184	ATE 23587 20,6 + WK Ceramic













	kw			 	! #		
SKODA - FABIA II (542) 12/06→12/14							
 Bremsbelagsatz, Scheibenbremse							
1.2 12V 1.6	44 77	11/11→12/14 04/07→12/14	➔	→ 06/14; +PR 1KT,1KV		13.0460-2820.2 602820	TRW 20961 17,2 - WK
						13.0470-2820.2 LD2820	TRW 20961 17,2 - WK Ceramic
			➔	→ 06/14; +PR 1KK		13.0460-2894.2 602894	TRW 20961 17,2 - WK + Zub
						13.0470-2894.2 LD2894	TRW 20961 17,2 - WK + Zub Ceramic
1.2 TDI 1.2 TSI 1.2 TSI 1.4 TSI RS 1.6 TDI 1.6 TDI 1.6 TDI	55 63 77 132 55 66 77	05/10→12/14 03/10→12/14 03/10→12/14 05/10→12/14 04/10→12/14 03/10→12/14 03/10→12/14	➔	→ 06/14; +PR 1LN,1ZH		13.0460-2883.2 602883	TRW 23581 18,8 - WE / - WK
						13.0460-2884.2 602884	TRW 23581 18,8 + WK
						13.0470-2884.2 LD2884	TRW 23581 18,8 + WK Ceramic
			➔	→ 06/14; +PR 1LB,1LM		13.0460-7100.2 607100	VW 21866 17,2 - WE / - WK
						13.0460-7164.2 607164	VW 21866 17,2 + WK
						13.0470-7100.2 LD7100	VW 21866 17,2 - WE / - WK Ceramic
			➔	→ 06/14; +PR 1LQ,1LR,1ZG		13.0460-7111.2 607111	VW 23130 19,6 - WE / - WK
						13.0460-7117.2 607117	VW 23130 19,6 + WK
						13.0470-7111.2 LD7111	VW 23130 19,6 - WE / - WK Ceramic
						13.0470-7117.2 LD7117	VW 23130 19,6 + WK Ceramic
			➔	→ 06/14; +PR 1ZC		13.0460-7184.2 607184	ATE 23587 20,6 + WK
						13.0470-7184.2 LD7184	ATE 23587 20,6 + WK Ceramic
			➔	→ 06/14; +PR 1KT,1KV		13.0460-2820.2 602820	TRW 20961 17,2 - WK
						13.0470-2820.2 LD2820	TRW 20961 17,2 - WK Ceramic
			➔	→ 06/14; +PR 1KK		13.0460-2894.2 602894	TRW 20961 17,2 - WK + Zub
						13.0470-2894.2 LD2894	TRW 20961 17,2 - WK + Zub Ceramic
1.4 TDI 1.4 TDI	51 59	02/07→03/10 01/07→03/10	➔	03/07→; +PR 1LN,1ZH		13.0460-2883.2 602883	TRW 23581 18,8 - WE / - WK
						13.0460-2884.2 602884	TRW 23581 18,8 + WK
						13.0470-2884.2 LD2884	TRW 23581 18,8 + WK Ceramic
			➔	03/07→; +PR 1LB;1LM		13.0460-7100.2 607100	VW 21866 17,2 - WE / - WK
						13.0460-7164.2 607164	VW 21866 17,2 + WK
						13.0470-7100.2 LD7100	VW 21866 17,2 - WE / - WK Ceramic
			➔	03/07→; +PR 1LQ,1LR,1ZG		13.0460-7111.2 607111	VW 23130 19,6 - WE / - WK
						13.0460-7117.2 607117	VW 23130 19,6 + WK
			13.0470-7111.2 LD7111	VW 23130 19,6 - WE / - WK Ceramic			
			13.0470-7117.2 LD7117	VW 23130 19,6 + WK Ceramic			
			➔	03/07→; +PR 1ZC		13.0460-7184.2 607184	ATE 23587 20,6 + WK
						13.0470-7184.2 LD7184	ATE 23587 20,6 + WK Ceramic
			➔	03/07→; +PR 1KT,1KV		13.0460-2820.2 602820	TRW 20961 17,2 - WK
						13.0470-2820.2 LD2820	TRW 20961 17,2 - WK Ceramic
			➔	03/07→; +PR 1KK		13.0460-2894.2 602894	TRW 20961 17,2 - WK + Zub
						13.0470-2894.2 LD2894	TRW 20961 17,2 - WK + Zub Ceramic
1.9 TDI	77	04/07→03/10	➔	+PR 1LN,1ZH		13.0460-2883.2 602883	TRW 23581 18,8 - WE / - WK
						13.0460-2884.2 602884	TRW 23581 18,8 + WK
						13.0470-2884.2 LD2884	TRW 23581 18,8 + WK Ceramic
			➔	+PR 1LB;1LM		13.0460-7100.2 607100	VW 21866 17,2 - WE / - WK
						13.0460-7164.2 607164	VW 21866 17,2 + WK
						13.0470-7100.2 LD7100	VW 21866 17,2 - WE / - WK Ceramic
			➔	+PR 1LQ,1LR,1ZG		13.0460-7111.2 607111	VW 23130 19,6 - WE / - WK
						13.0460-7117.2 607117	VW 23130 19,6 + WK
			13.0470-7111.2 LD7111	VW 23130 19,6 - WE / - WK Ceramic			
			13.0470-7117.2 LD7117	VW 23130 19,6 + WK Ceramic			
			➔	+PR 1ZC		13.0460-7184.2 607184	ATE 23587 20,6 + WK
						13.0470-7184.2 LD7184	ATE 23587 20,6 + WK Ceramic
			➔	+PR 1KT,1KV		13.0460-2820.2 602820	TRW 20961 17,2 - WK
						13.0470-2820.2 LD2820	TRW 20961 17,2 - WK Ceramic
			➔	+PR 1KK		13.0460-2894.2 602894	TRW 20961 17,2 - WK + Zub
						13.0470-2894.2 LD2894	TRW 20961 17,2 - WK + Zub Ceramic

↓

















	kw			 	! #		
SKODA - FABIA II (542) 12/06→12/14							
 Bremsscheibe							
1.2	44	12/06→12/14	←	03/07→ 06/14; +PR 1LB;1LM		24.0118-0137.1 418137	Ø 239 18 16 V + S
1.2	51	01/07→12/14				24.0318-0137.1 518137	Ø 239 18 16 V + S PD
1.4	63	01/07→12/14	←	03/07→ 06/14; +PR 1LQ,1LR,1ZE,1ZG		24.0122-0151.1 422151	Ø 256 22 19 V + S
						24.0322-0151.1 522151	Ø 256 22 19 V + S PD
			←	03/07→ 06/14; +PR 1LN,1ZC,1ZH		24.0125-0113.1 425113	Ø 288 25 22 V + S
						24.0325-0113.1 525113	Ø 288 25 22 V + S PD
			→	03/07→ 06/14; +PR 1KT,2EJ,1KK,1KV		24.0109-0123.1 409123	Ø 230 9 7 + S
1.2 12V	44	11/11→12/14	←	→ 06/14; +PR 1LB;1LM		24.0118-0137.1 418137	Ø 239 18 16 V + S
1.6	77	04/07→12/14				24.0318-0137.1 518137	Ø 239 18 16 V + S PD
			←	→ 06/14; +PR 1LQ,1LR,1ZE,1ZG		24.0122-0151.1 422151	Ø 256 22 19 V + S
						24.0322-0151.1 522151	Ø 256 22 19 V + S PD
			←	→ 06/14; +PR 1LN,1ZC,1ZH		24.0125-0113.1 425113	Ø 288 25 22 V + S
						24.0325-0113.1 525113	Ø 288 25 22 V + S PD
			→	→ 06/14; +PR 1KT,2EJ,1KK,1KV		24.0109-0123.1 409123	Ø 230 9 7 + S
1.2 TDI	55	05/10→12/14	←	→ 06/14; +PR 1LB,1LM		24.0118-0137.1 418137	Ø 239 18 16 V + S
1.2 TSI	63	03/10→12/14				24.0318-0137.1 518137	Ø 239 18 16 V + S PD
1.2 TSI	77	03/10→12/14					
1.4 TSI RS	132	05/10→12/14	←	→ 06/14; +PR 1LQ,1LR,1ZE,1ZG		24.0122-0151.1 422151	Ø 256 22 19 V + S
1.6 TDI	55	04/10→12/14				24.0322-0151.1 522151	Ø 256 22 19 V + S PD
1.6 TDI	66	03/10→12/14	←	→ 06/14; +PR 1LN,1ZC,1ZH		24.0125-0113.1 425113	Ø 288 25 22 V + S
1.6 TDI	77	03/10→12/14				24.0325-0113.1 525113	Ø 288 25 22 V + S PD
			→	→ 06/14; +PR 1KT,1KV,2EJ		24.0109-0123.1 409123	Ø 230 9 7 + S
1.4 TDI	51	02/07→03/10	←	03/07→; +PR 1LB;1LM		24.0118-0137.1 418137	Ø 239 18 16 V + S
1.4 TDI	59	01/07→03/10				24.0318-0137.1 518137	Ø 239 18 16 V + S PD
			←	03/07→; +PR 1LQ,1LR,1ZE,1ZG		24.0122-0151.1 422151	Ø 256 22 19 V + S
						24.0322-0151.1 522151	Ø 256 22 19 V + S PD
			←	03/07→; +PR 1LN,1ZC,1ZH		24.0125-0113.1 425113	Ø 288 25 22 V + S
						24.0325-0113.1 525113	Ø 288 25 22 V + S PD
			→	03/07→; +PR 1KT,2EJ,1KK,1KV		24.0109-0123.1 409123	Ø 230 9 7 + S
1.9 TDI	77	04/07→03/10	←	+PR 1LB;1LM		24.0118-0137.1 418137	Ø 239 18 16 V + S
						24.0318-0137.1 518137	Ø 239 18 16 V + S PD
			←	+PR 1LQ,1LR,1ZE,1ZG		24.0122-0151.1 422151	Ø 256 22 19 V + S
						24.0322-0151.1 522151	Ø 256 22 19 V + S PD
			←	+PR 1LN,1ZC,1ZH		24.0125-0113.1 425113	Ø 288 25 22 V + S
						24.0325-0113.1 525113	Ø 288 25 22 V + S PD
			→	06/09→; +PR 1KT,2EJ,1KK,1KV		24.0109-0123.1 409123	Ø 230 9 7 + S
SKODA - FABIA II Combi (545) 10/07→12/14							
 Bremsbelagsatz, Scheibenbremse							
1.2	44	10/07→11/14	←	→ 06/14; +PR 1LN,1ZH		13.0460-2883.2 602883	TRW 23581 18,8 - WE / - WK
1.2	51	10/07→12/14				13.0460-2884.2 602884	TRW 23581 18,8 + WK
1.2 12V	44	11/11→12/14					
1.4	63	10/07→12/14				13.0470-2884.2 LD2884	TRW 23581 18,8 + WK Ceramic
1.6	77	10/07→12/14	←	→ 06/14; +PR 1LB;1LM		13.0460-7100.2 607100	VW 21866 17,2 - WE / - WK
						13.0460-7164.2 607164	VW 21866 17,2 + WK
						13.0470-7100.2 LD7100	VW 21866 17,2 - WE / - WK Ceramic
			←	→ 06/14; +PR 1LQ,1LR,1ZG		13.0460-7111.2 607111	VW 23130 19,6 - WE / - WK
						13.0460-7117.2 607117	VW 23130 19,6 + WK
						13.0470-7111.2 LD7111	VW 23130 19,6 - WE / - WK Ceramic
						13.0470-7117.2 LD7117	VW 23130 19,6 + WK Ceramic
			←	→ 06/14; +PR 1ZC		13.0460-7184.2 607184	ATE 23587 20,6 + WK
						13.0470-7184.2 LD7184	ATE 23587 20,6 + WK Ceramic
			→	→ 06/14; +PR 1KT,1KV		13.0460-2820.2 602820	TRW 20961 17,2 - WK
						13.0470-2820.2 LD2820	TRW 20961 17,2 - WK Ceramic
			→	→ 06/14; +PR 1KK		13.0460-2894.2 602894	TRW 20961 17,2 - WK + Zub
						13.0470-2894.2 LD2894	TRW 20961 17,2 - WK + Zub Ceramic
1.2 TDI	55	05/10→12/14	←	→ 06/14; +PR 1LN,1ZH		13.0460-2883.2 602883	TRW 23581 18,8 - WE / - WK
1.2 TSI	63	03/10→12/14				13.0460-2884.2 602884	TRW 23581 18,8 + WK
1.2 TSI	77	03/10→12/14					
1.4 TSI RS	132	05/10→12/14				13.0470-2884.2 LD2884	TRW 23581 18,8 + WK Ceramic
1.6 TDI	55	04/10→12/14	←	→ 06/14; +PR 1LB,1LM		13.0460-7100.2 607100	VW 21866 17,2 - WE / - WK
1.6 TDI	66	03/10→12/14					

























	kw			 	! #		
SKODA - FABIA II Combi (545) 10/07→12/14							
 Bremsbelagsatz, Scheibenbremse							
1.6 TDI	77	03/10→12/14	←	→ 06/14; +PR 1LB,1LM	13.0460-7164.2	607164	VW 21866 17,2 + WK
					13.0470-7100.2	LD7100	VW 21866 17,2 - WE / - WK Ceramic
			←	→ 06/14; +PR 1LQ,1LR,1ZG	13.0460-7111.2	607111	VW 23130 19,6 - WE / - WK
					13.0460-7117.2	607117	VW 23130 19,6 + WK
					13.0470-7111.2	LD7111	VW 23130 19,6 - WE / - WK Ceramic
					13.0470-7117.2	LD7117	VW 23130 19,6 + WK Ceramic
1.4 TDI 1.4 TDI 1.9 TDI	51 59 77	10/07→03/10 10/07→03/10 10/07→03/10	←	+PR 1LN,1ZH	13.0460-2883.2	602883	TRW 23581 18,8 - WE / - WK
					13.0460-2884.2	602884	TRW 23581 18,8 + WK
					13.0470-2884.2	LD2884	TRW 23581 18,8 + WK Ceramic
			←	+PR 1LB;1LM	13.0460-7100.2	607100	VW 21866 17,2 - WE / - WK
					13.0460-7164.2	607164	VW 21866 17,2 + WK
					13.0470-7100.2	LD7100	VW 21866 17,2 - WE / - WK Ceramic
1.2 TDI 1.2 TSI 1.2 TSI 1.4 TSI RS 1.6 TDI 1.6 TDI 1.6 TDI	55 63 77 132 55 66 77	05/10→12/14 03/10→12/14 03/10→12/14 05/10→12/14 04/10→12/14 03/10→12/14 03/10→12/14	←	→ 06/14; +PR 1LQ,1LR,1ZE,1ZG	24.0122-0151.1	422151	Ø 256 22 19 V + S
					24.0322-0151.1	522151	Ø 256 22 19 V + S PD
			←	→ 06/14; +PR 1LN,1ZC,1ZH	24.0125-0113.1	425113	Ø 288 25 22 V + S
					24.0325-0113.1	525113	Ø 288 25 22 V + S PD
			→	→ 06/14; +PR 1KT,2EJ,1KK,1KV	24.0109-0123.1	409123	Ø 230 9 7 + S
			←	→ 06/14; +PR 1LB,1LM	24.0118-0137.1	418137	Ø 239 18 16 V + S
1.4 TDI 1.4 TDI	51 59	10/07→03/10 10/07→03/10	←	+PR 1LB;1LM	24.0118-0137.1	418137	Ø 239 18 16 V + S
					24.0318-0137.1	518137	Ø 239 18 16 V + S PD
			←	+PR 1LQ,1LR,1ZE,1ZG	24.0122-0151.1	422151	Ø 256 22 19 V + S
					24.0322-0151.1	522151	Ø 256 22 19 V + S PD
			←	+PR 1LN,1ZC,1ZH	24.0125-0113.1	425113	Ø 288 25 22 V + S
					24.0325-0113.1	525113	Ø 288 25 22 V + S PD
1.9 TDI	77	10/07→03/10	→	→ 06/14; +PR 1KT,1KV	13.0460-2820.2	602820	TRW 20961 17,2 - WK
					13.0470-2820.2	LD2820	TRW 20961 17,2 - WK Ceramic
			→	→ 06/14; +PR 1KK	13.0460-2894.2	602894	TRW 20961 17,2 - WK + Zub
					13.0470-2894.2	LD2894	TRW 20961 17,2 - WK + Zub Ceramic
			←	+PR 1LB;1LM	24.0118-0137.1	418137	Ø 239 18 16 V + S
					24.0318-0137.1	518137	Ø 239 18 16 V + S PD
1.2 TDI 1.2 TSI 1.2 TSI 1.4 TSI RS 1.6 TDI 1.6 TDI 1.6 TDI	55 63 77 132 55 66 77	05/10→12/14 03/10→12/14 03/10→12/14 05/10→12/14 04/10→12/14 03/10→12/14 03/10→12/14	←	→ 06/14; +PR 1LQ,1LR,1ZE,1ZG	24.0122-0151.1	422151	Ø 256 22 19 V + S
					24.0322-0151.1	522151	Ø 256 22 19 V + S PD
			←	→ 06/14; +PR 1LN,1ZC,1ZH	24.0125-0113.1	425113	Ø 288 25 22 V + S
					24.0325-0113.1	525113	Ø 288 25 22 V + S PD
			→	→ 06/14; +PR 1KT,2EJ,1KK,1KV	24.0109-0123.1	409123	Ø 230 9 7 + S
			←	+PR 1LB;1LM	24.0118-0137.1	418137	Ø 239 18 16 V + S
1.4 TDI 1.4 TDI	51 59	10/07→03/10 10/07→03/10	←	+PR 1LB;1LM	24.0118-0137.1	418137	Ø 239 18 16 V + S
					24.0318-0137.1	518137	Ø 239 18 16 V + S PD
			←	+PR 1LQ,1LR,1ZE,1ZG	24.0122-0151.1	422151	Ø 256 22 19 V + S
					24.0322-0151.1	522151	Ø 256 22 19 V + S PD
			←	+PR 1LN,1ZC,1ZH	24.0125-0113.1	425113	Ø 288 25 22 V + S
					24.0325-0113.1	525113	Ø 288 25 22 V + S PD
1.9 TDI	77	10/07→03/10	→	→ 06/14; +PR 1KT,2EJ,1KK,1KV	13.0460-2820.2	602820	TRW 20961 17,2 - WK
					13.0470-2820.2	LD2820	TRW 20961 17,2 - WK Ceramic
			→	→ 06/14; +PR 1KK	13.0460-2894.2	602894	TRW 20961 17,2 - WK + Zub
					13.0470-2894.2	LD2894	TRW 20961 17,2 - WK + Zub Ceramic
			←	+PR 1LB;1LM	24.0118-0137.1	418137	Ø 239 18 16 V + S
					24.0318-0137.1	518137	Ø 239 18 16 V + S PD
1.2 TDI 1.2 TSI 1.2 TSI 1.4 TSI RS 1.6 TDI 1.6 TDI 1.6 TDI	55 63 77 132 55 66 77	05/10→12/14 03/10→12/14 03/10→12/14 05/10→12/14 04/10→12/14 03/10→12/14 03/10→12/14	←	+PR 1LQ,1LR,1ZE,1ZG	24.0122-0151.1	422151	Ø 256 22 19 V + S
					24.0322-0151.1	522151	Ø 256 22 19 V + S PD
			←	+PR 1LN,1ZC,1ZH	24.0125-0113.1	425113	Ø 288 25 22 V + S
					24.0325-0113.1	525113	Ø 288 25 22 V + S PD
			→	→ 06/14; +PR 1KT,2EJ,1KK,1KV	24.0109-0123.1	409123	Ø 230 9 7 + S
			←	+PR 1LB;1LM	24.0118-0137.1	418137	Ø 239 18 16 V + S
1.4 TDI 1.4 TDI	51 59	10/07→03/10 10/07→03/10	←	+PR 1LB;1LM	24.0118-0137.1	418137	Ø 239 18 16 V + S
					24.0318-0137.1	518137	Ø 239 18 16 V + S PD
			←	+PR 1LQ,1LR,1ZE,1ZG	24.0122-0151.1	422151	Ø 256 22 19 V + S
					24.0322-0151.1	522151	Ø 256 22 19 V + S PD
			←	+PR 1LN,1ZC,1ZH	24.0125-0113.1	425113	Ø 288 25 22 V + S
					24.0325-0113.1	525113	Ø 288 25 22 V + S PD
1.9 TDI	77	10/07→03/10	→	→ 06/14; +PR 1KT,2EJ,1KK,1KV	13.0460-2820.2	602820	TRW 20961 17,2 - WK
					13.0470-2820.2	LD2820	TRW 20961 17,2 - WK Ceramic
			→	→ 06/14; +PR 1KK	13.0460-2894.2	602894	TRW 20961 17,2 - WK + Zub
					13.0470-2894.2	LD2894	TRW 20961 17,2 - WK + Zub Ceramic
			←	+PR 1LB;1LM	24.0118-0137.1	418137	Ø 239 18 16 V + S
					24.0318-0137.1	518137	Ø 239 18 16 V + S PD
1.2 TDI 1.2 TSI 1.2 TSI 1.4 TSI RS 1.6 TDI 1.6 TDI 1.6 TDI	55 63 77 132 55 66 77	05/10→12/14 03/10→12/14 03/10→12/14 05/10→12/14 04/10→12/14 03/10→12/14 03/10→12/14	←	+PR 1LQ,1LR,1ZE,1ZG	24.0122-0151.1	422151	Ø 256 22 19 V + S
					24.0322-0151.1	522151	Ø 256 22 19 V + S PD
			←	+PR 1LN,1ZC,1ZH	24.0125-0113.1	425113	Ø 288 25 22 V + S
					24.0325-0113.1	525113	Ø 288 25 22 V + S PD
			→	→ 06/14; +PR 1KT,2EJ,1KK,1KV	24.0109-0123.1	409123	Ø 230 9 7 + S
			←	+PR 1LB;1LM	24.0118-0137.1	418137	Ø 239 18 16 V + S
1.4 TDI 1.4 TDI	51 59	10/07→03/10 10/07→03/10	←	+PR 1LB;1LM	24.0118-0137.1	418137	Ø 239 18 16 V + S
					24.0318-0137.1	518137	Ø 239 18 16 V + S PD
			←	+PR 1LQ,1LR,1ZE,1ZG	24.0122-0151.1	422151	Ø 256 22 19 V + S
					24.0322-0151.1	522151	Ø 256 22 19 V + S PD
			←	+PR 1LN,1ZC,1ZH	24.0125-0113.1	425113	Ø 288 25 22 V + S
					24.0325-0113.1	525113	Ø 288 25 22 V + S PD
1.9 TDI	77	10/07→03/10	→	→ 06/14; +PR 1KT,2EJ,1KK,1KV	13.0460-2820.2	602820	TRW 20961 17,2 - WK
					13.0470-2820.2	LD2820	TRW 20961 17,2 - WK Ceramic
			→	→ 06/14; +PR 1KK	13.0460-2894.2	602894	TRW 20961 17,2 - WK + Zub
					13.0470-2894.2	LD2894	TRW 20961 17,2 - WK + Zub Ceramic
			←	+PR 1LB;1LM	24.0118-0137.1	418137	Ø 239 18 16 V + S
					24.0318-0137.1	518137	Ø 239 18 16 V + S PD









	kw					! #		
SKODA - FABIA II Combi (545) 10/07→12/14								
 Bremsscheibe								
1.9 TDI	77	10/07→03/10	➔	06/09→; +PR 1KT,2EJ,1KK,1KV		24.0109-0123.1	409123	Ø 230 9 7 + S
SKODA - FABIA III (NJ3) 08/14→								
 Bremsbelagsatz, Scheibenbremse								
1.0	44	08/14→	←	+PR 1ZG		13.0460-7111.2	607111	VW 23130 19,6 - WE / - WK
1.0	55	08/14→				13.0470-7111.2	LD7111	VW 23130 19,6 - WE / - WK Ceramic
1.2 TSI	66	08/14→						
1.2 TSI	81	08/14→	←	+PR 1ZC		13.0460-7184.2	607184	ATE 23587 20,6 + WK
1.4 TDI	66	08/14→				13.0470-7184.2	LD7184	ATE 23587 20,6 + WK Ceramic
1.4 TDI	77	08/14→	➔	+PR 1KK,1KT,2EJ		13.0460-2820.2	602820	TRW 20961 17,2 - WK
						13.0470-2820.2	LD2820	TRW 20961 17,2 - WK Ceramic
1.4 TDI	55	05/15→	←	+PR 1ZG		13.0460-7111.2	607111	VW 23130 19,6 - WE / - WK
1.6	81	01/15→				13.0470-7111.2	LD7111	VW 23130 19,6 - WE / - WK Ceramic
			←	+PR 1ZC		13.0460-7184.2	607184	ATE 23587 20,6 + WK
						13.0470-7184.2	LD7184	ATE 23587 20,6 + WK Ceramic
			➔	+PR 1KT		13.0460-2820.2	602820	TRW 20961 17,2 - WK
						13.0470-2820.2	LD2820	TRW 20961 17,2 - WK Ceramic
 Bremsscheibe								
1.0	44	08/14→	←	+PR 1ZG		24.0122-0151.1	422151	Ø 256 22 19 V + S
1.0	55	08/14→				24.0322-0151.1	522151	Ø 256 22 19 V + S PD
1.2 TSI	66	08/14→	←	+PR 1ZC		24.0125-0113.1	425113	Ø 288 25 22 V + S
1.2 TSI	81	08/14→				24.0325-0113.1	525113	Ø 288 25 22 V + S PD
1.4 TDI	66	08/14→						
1.4 TDI	77	08/14→	➔	+PR 1KK,1KT,2EJ		24.0109-0123.1	409123	Ø 230 9 7 + S
1.4 TDI	55	05/15→	←	+PR 1ZG		24.0122-0151.1	422151	Ø 256 22 19 V + S
1.6	81	01/15→				24.0322-0151.1	522151	Ø 256 22 19 V + S PD
			←	+PR 1ZC		24.0125-0113.1	425113	Ø 288 25 22 V + S
						24.0325-0113.1	525113	Ø 288 25 22 V + S PD
			➔	+PR 1KT		24.0109-0123.1	409123	Ø 230 9 7 + S
SKODA - FABIA III Kombi (NJ5) 10/14→								
 Bremsbelagsatz, Scheibenbremse								
1.0	44	10/14→	←	+PR 1ZG		13.0460-7111.2	607111	VW 23130 19,6 - WE / - WK
1.0	55	10/14→				13.0470-7111.2	LD7111	VW 23130 19,6 - WE / - WK Ceramic
1.2 TSI	66	10/14→						
1.2 TSI	81	10/14→	←	+PR 1ZC		13.0460-7184.2	607184	ATE 23587 20,6 + WK
1.4 TDI	66	10/14→				13.0470-7184.2	LD7184	ATE 23587 20,6 + WK Ceramic
1.4 TDI	77	10/14→	➔	+PR 1KK,1KT,2EJ		13.0460-2820.2	602820	TRW 20961 17,2 - WK
						13.0470-2820.2	LD2820	TRW 20961 17,2 - WK Ceramic
1.4 TDI	55	05/15→	←	+PR 1ZG		13.0460-7111.2	607111	VW 23130 19,6 - WE / - WK
1.6	81	01/15→				13.0470-7111.2	LD7111	VW 23130 19,6 - WE / - WK Ceramic
			←	+PR 1ZC		13.0460-7184.2	607184	ATE 23587 20,6 + WK
						13.0470-7184.2	LD7184	ATE 23587 20,6 + WK Ceramic
			➔	+PR 1KT		13.0460-2820.2	602820	TRW 20961 17,2 - WK
						13.0470-2820.2	LD2820	TRW 20961 17,2 - WK Ceramic
 Bremsscheibe								
1.0	44	10/14→	←	+PR 1ZG		24.0122-0151.1	422151	Ø 256 22 19 V + S
1.0	55	10/14→				24.0322-0151.1	522151	Ø 256 22 19 V + S PD
1.2 TSI	66	10/14→	←	+PR 1ZC		24.0125-0113.1	425113	Ø 288 25 22 V + S
1.2 TSI	81	10/14→				24.0325-0113.1	525113	Ø 288 25 22 V + S PD
1.4 TDI	66	10/14→						
1.4 TDI	77	10/14→	➔	+PR 1KK,1KT,2EJ		24.0109-0123.1	409123	Ø 230 9 7 + S
1.4 TDI	55	05/15→	←	+PR 1ZG		24.0122-0151.1	422151	Ø 256 22 19 V + S
1.6	81	01/15→				24.0322-0151.1	522151	Ø 256 22 19 V + S PD
			←	+PR 1ZC		24.0125-0113.1	425113	Ø 288 25 22 V + S
						24.0325-0113.1	525113	Ø 288 25 22 V + S PD
			➔	+PR 1KT		24.0109-0123.1	409123	Ø 230 9 7 + S

















	kw			 	! #		
SKODA - FAVORIT Forman (785) 06/88→06/95							
 Bremsbelagsatz, Scheibenbremse							
1.3	50	01/94→06/95	←			13.0460-2964.2 602964	TRW 20861 17,5 - WK
1.3 (135)	44	12/91→06/95	←	02/94→		13.0460-2964.2 602964	TRW 20861 17,5 - WK
1.3 (135 E)	40	09/91→06/95	←				
1.3 (136)	45	08/91→06/95	←	02/94→		13.0460-2964.2 602964	TRW 20861 17,5 - WK
			←	09/91→		13.0460-2964.2 602964	TRW 20861 17,5 - WK
 Bremsscheibe							
1.3	50	01/94→06/95	←	04/94→		24.0113-0182.1 413182	Ø 236 12,8 11,4
			←			24.0113-0193.1 413193	Ø 236 12,8 11,4
1.3 (135)	44	12/91→06/95	←	→ 12/92		24.0113-0169.1 413169	Ø 236 12,8 11,4
1.3 (135 E)	40	09/91→06/95	←	04/94→		24.0113-0182.1 413182	Ø 236 12,8 11,4
			←	01/93→		24.0113-0193.1 413193	Ø 236 12,8 11,4
1.3 (136)	45	08/91→06/95	←	09/91→ 12/92		24.0113-0169.1 413169	Ø 236 12,8 11,4
			←	04/94→		24.0113-0182.1 413182	Ø 236 12,8 11,4
			←	01/93→		24.0113-0193.1 413193	Ø 236 12,8 11,4
SKODA - FAVORIT Pick-up (787) 06/92→06/97							
 Bremsbelagsatz, Scheibenbremse							
1.3	40	12/92→06/97	←	→ 12/95		13.0460-2964.2 602964	TRW 20861 17,5 - WK
1.3	42	12/92→06/97					
1.3	50	12/92→06/97					
 Bremsscheibe							
1.3	40	12/92→06/97	←	04/94→ 12/95		24.0113-0182.1 413182	Ø 236 12,8 11,4
1.3	42	12/92→06/97					
1.3	50	12/92→06/97					
SKODA - FELICIA I (6U1) 10/94→03/98							
 Bremsbelagsatz, Scheibenbremse							
1.3	40	10/94→03/98	←	→ 02/98		13.0460-2964.2 602964	TRW 20861 17,5 - WK
1.3	43	10/94→03/98					
1.3	50	10/94→03/98					
1.6 LX	55	08/95→03/98					
1.9 D	47	10/95→03/98	←	10/96→ 02/98		13.0460-2964.2 602964	TRW 20861 17,5 - WK
 Bremsscheibe							
1.3	40	10/94→03/98	←	→ 02/98		24.0113-0182.1 413182	Ø 236 12,8 11,4
1.3	43	10/94→03/98					
1.3	50	10/94→03/98					
1.6 LX	55	08/95→03/98					
1.9 D	47	10/95→03/98	←	10/96→ 02/98		24.0113-0182.1 413182	Ø 236 12,8 11,4
SKODA - FELICIA I Kombi (6U5) 07/95→03/98							
 Bremsbelagsatz, Scheibenbremse							
1.3	43	08/95→03/98	←	→ 02/98		13.0460-2964.2 602964	TRW 20861 17,5 - WK
1.3 LX	40	08/95→03/98					
1.3 LXI	50	08/95→03/98					
1.6 GLX	55	08/95→03/98					
1.9 D	47	10/95→03/98	←	10/96→ 02/98		13.0460-2964.2 602964	TRW 20861 17,5 - WK
 Bremsscheibe							
1.3	43	08/95→03/98	←	→ 02/98		24.0113-0182.1 413182	Ø 236 12,8 11,4
1.3 LX	40	08/95→03/98					
1.3 LXI	50	08/95→03/98					
1.6 GLX	55	08/95→03/98					
1.9 D	47	10/95→03/98	←	10/96→ 02/98		24.0113-0182.1 413182	Ø 236 12,8 11,4
SKODA - FELICIA I Pick-up (6UF, 6U7) 10/95→04/02							
 Bremsbelagsatz, Scheibenbremse							
1.3	40	06/97→04/02	←	→ 12/00		13.0460-2964.2 602964	TRW 20861 17,5 - WK
1.3	50	06/97→04/02					
1.9 D	47	06/97→04/02					
1.3	43	10/95→04/02	←	06/97→ 12/00		13.0460-2964.2 602964	TRW 20861 17,5 - WK
1.6	55	06/97→04/02	←	→ 12/99		13.0460-2964.2 602964	TRW 20861 17,5 - WK
↓							









	kW					! #		
SKODA - FELICIA I Pick-up (6UF, 6U7) 10/95→04/02								
 Bremsscheibe								
1.3	40	06/97→04/02	←	→ 12/00			24.0113-0182.1 413182	Ø 236 12,8 11,4
1.3	50	06/97→04/02						
1.9 D	47	06/97→04/02						
1.3	43	10/95→04/02	←	06/97→ 12/00			24.0113-0182.1 413182	Ø 236 12,8 11,4
1.6	55	06/97→04/02	←	→ 12/99			24.0113-0182.1 413182	Ø 236 12,8 11,4
SKODA - FELICIA II (6U1) 01/98→06/01								
 Bremsbelagsatz, Scheibenbremse								
1.3	40	01/98→06/01	←	03/98→			13.0460-2964.2 602964	TRW 20861 17,5 - WK
1.3	43	01/98→06/01						
1.3	50	01/98→06/01						
1.6	55	01/98→06/01						
1.9 D	47	01/98→06/01						
 Bremsscheibe								
1.3	40	01/98→06/01	←	03/98→			24.0113-0182.1 413182	Ø 236 12,8 11,4
1.3	43	01/98→06/01						
1.3	50	01/98→06/01						
1.6	55	01/98→06/01						
1.9 D	47	01/98→06/01						
SKODA - FELICIA II Kombi (6U5) 01/98→06/01								
 Bremsbelagsatz, Scheibenbremse								
1.3	50	01/98→06/01	←	03/98→			13.0460-2964.2 602964	TRW 20861 17,5 - WK
1.6	55	01/98→06/01						
1.9 D	47	01/98→06/01						
 Bremsscheibe								
1.3	50	01/98→06/01	←	03/98→			24.0113-0182.1 413182	Ø 236 12,8 11,4
1.6	55	01/98→06/01						
1.9 D	47	01/98→06/01						
SKODA - KODIAQ (NS7) 10/16→								
 Bremsbelagsatz, Scheibenbremse								
1.4 TSI	92	03/17→	→	+PR 1KU; + eFSB			13.0460-7294.2 607294	ATE 25009 16,4 - WE / - WK
1.4 TSI	110	03/17→					13.0470-7294.2 LD7294	ATE 25009 16,4 - WE / - WK Ceramic
1.4 TSI 4x4	110	03/17→						
2.0 TDI	110	03/17→						
2.0 TDI 4x4	110	03/17→						
2.0 TDI 4x4	140	03/17→						
2.0 TSI 4x4	132	03/17→						
Warnkontakt, Bremsbelagverschleiß								
1.4 TSI	92	03/17→	←	+PR 1LA,1LW	1	24.8190-0065.2 620065		L= 172
1.4 TSI	110	03/17→						
1.4 TSI 4x4	110	03/17→	←	+PR 1ZA	1	24.8190-0065.2 620065		L= 172
2.0 TDI	110	03/17→						
2.0 TDI 4x4	110	03/17→						
2.0 TDI 4x4	140	03/17→						
2.0 TSI 4x4	132	03/17→						
 Bremsscheibe								
1.4 TSI	92	03/17→	←	+PR 1ZA			24.0125-0158.1 425158	Ø 312 25 22 V + S
1.4 TSI	110	03/17→						
1.4 TSI 4x4	110	03/17→	←	+PR 1LW			24.0130-0220.1 430220	Ø 314 30 27 V + S
2.0 TDI	110	03/17→						
2.0 TDI 4x4	110	03/17→	←	+PR 1LA			24.0130-0225.1 430225	Ø 340 30 27 V + S
2.0 TDI 4x4	140	03/17→						
2.0 TSI 4x4	132	03/17→	→	+PR 1KU; + eFSB			24.0112-0210.1 412210	Ø 300 12 10 + S
SKODA - OCTAVIA (1Z3) 02/04→06/13								
 Bremsbelagsatz, Scheibenbremse								
1.2 TSI	77	02/10→06/13	←	→ 01/13; +PR 1ZF,1ZM,1ZC			13.0460-7117.2 607117	VW 23130 19,6 + WK
1.4	59	06/04→04/13					13.0470-7117.2 LD7117	VW 23130 19,6 + WK Ceramic
1.4 TSI	90	11/08→06/13						
1.6	75	06/04→06/13	←	→ 01/13; +PR 1ZE			13.0460-7184.2 607184	ATE 23587 20,6 + WK
1.6 TDI	77	06/09→04/13					13.0470-7184.2 LD7184	ATE 23587 20,6 + WK Ceramic
1.8 TSI	112	03/09→06/13						
1.8 TSI	118	06/07→04/13	→	→ 01/13; +PR 1KF			13.0460-2749.2 602749	TRW 24483 16,9 - WE / - WK + Zub
2.0 TDI	81	03/10→06/13					13.0460-2880.2 602880	TRW 23914 17,1 + WE / - WK + Zub
							13.0470-2749.2 LD2749	TRW 24483 16,9 - WE / - WK + Zub Ceramic
↓								









	kw			 	! #		
SKODA - OCTAVIA (1Z3) 02/04→06/13							
 Bremsbelagsatz, Scheibenbremse							
1.2 TSI	77	02/10→06/13	➡	→ 01/13; +PR 1KF		13.0470-2880.2 LD2880	TRW 23914 17,1 + WE / - WK + Zub Ceramic
1.4	59	06/04→04/13					
1.4 TSI	90	11/08→06/13					
1.6	75	06/04→06/13	➡	→ 01/13; +PR 1KD		13.0460-2820.2 602820	TRW 20961 17,2 - WK
1.6 TDI	77	06/09→04/13				13.0470-2820.2 LD2820	TRW 20961 17,2 - WK Ceramic
1.8 TSI	112	03/09→06/13	➡	→ 01/13; +PR 1KS,1KT		13.0460-3858.2 603858	BOS 24563 17,7 - WE / - WK + Zub
1.8 TSI	118	06/07→04/13					
2.0 TDI	81	03/10→06/13				13.0470-3858.2 LD3858	BOS 24563 17,7 - WE / - WK + Zub Ceramic
1.4	55	05/04→05/06	⬅	06/04→; +PR 1ZF,1ZM,1ZC		13.0460-7117.2 607117	VW 23130 19,6 + WK
1.6 FSI	85	02/04→10/08				13.0470-7117.2 LD7117	VW 23130 19,6 + WK Ceramic
2.0 TDI	100	02/04→05/10	⬅	06/04→; +PR 1ZE		13.0460-7184.2 607184	ATE 23587 20,6 + WK
						13.0470-7184.2 LD7184	ATE 23587 20,6 + WK Ceramic
			➡	06/04→; +PR 1KF		13.0460-2749.2 602749	TRW 24483 16,9 - WE / - WK + Zub
						13.0460-2880.2 602880	TRW 23914 17,1 + WE / - WK + Zub
						13.0470-2749.2 LD2749	TRW 24483 16,9 - WE / - WK + Zub Ceramic
						13.0470-2880.2 LD2880	TRW 23914 17,1 + WE / - WK + Zub Ceramic
			➡	06/04→; +PR 1KD		13.0460-2820.2 602820	TRW 20961 17,2 - WK
						13.0470-2820.2 LD2820	TRW 20961 17,2 - WK Ceramic
			➡	06/04→; +PR 1KS,1KT		13.0460-3858.2 603858	BOS 24563 17,7 - WE / - WK + Zub
						13.0470-3858.2 LD3858	BOS 24563 17,7 - WE / - WK + Zub Ceramic
1.6 LPG	75	08/09→11/12	⬅	09/09→; +PR 1ZF,1ZM,1ZC		13.0460-7117.2 607117	VW 23130 19,6 + WK
						13.0470-7117.2 LD7117	VW 23130 19,6 + WK Ceramic
			⬅	09/09→; +PR 1ZE		13.0460-7184.2 607184	ATE 23587 20,6 + WK
						13.0470-7184.2 LD7184	ATE 23587 20,6 + WK Ceramic
			➡	09/09→; +PR 1KF		13.0460-2749.2 602749	TRW 24483 16,9 - WE / - WK + Zub
						13.0460-2880.2 602880	TRW 23914 17,1 + WE / - WK + Zub
						13.0470-2749.2 LD2749	TRW 24483 16,9 - WE / - WK + Zub Ceramic
						13.0470-2880.2 LD2880	TRW 23914 17,1 + WE / - WK + Zub Ceramic
			➡	09/09→; +PR 1KD		13.0460-2820.2 602820	TRW 20961 17,2 - WK
						13.0470-2820.2 LD2820	TRW 20961 17,2 - WK Ceramic
			➡	09/09→; +PR 1KS,1KT		13.0460-3858.2 603858	BOS 24563 17,7 - WE / - WK + Zub
						13.0470-3858.2 LD3858	BOS 24563 17,7 - WE / - WK + Zub Ceramic
1.6 MultiFuel	75	01/08→06/13	⬅	09/09→; +PR 1ZF,1ZM,1ZC; → 01/13		13.0460-7117.2 607117	VW 23130 19,6 + WK
						13.0470-7117.2 LD7117	VW 23130 19,6 + WK Ceramic
			⬅	09/09→; +PR 1ZE; → 01/13		13.0460-7184.2 607184	ATE 23587 20,6 + WK
						13.0470-7184.2 LD7184	ATE 23587 20,6 + WK Ceramic
			➡	09/09→; +PR 1KF; → 01/13		13.0460-2749.2 602749	TRW 24483 16,9 - WE / - WK + Zub
						13.0460-2880.2 602880	TRW 23914 17,1 + WE / - WK + Zub
						13.0470-2749.2 LD2749	TRW 24483 16,9 - WE / - WK + Zub Ceramic
						13.0470-2880.2 LD2880	TRW 23914 17,1 + WE / - WK + Zub Ceramic
			➡	09/09→; +PR 1KD; → 01/13		13.0460-2820.2 602820	TRW 20961 17,2 - WK
						13.0470-2820.2 LD2820	TRW 20961 17,2 - WK Ceramic
			➡	09/09→; +PR 1KS,1KT; → 01/13		13.0460-3858.2 603858	BOS 24563 17,7 - WE / - WK + Zub
						13.0470-3858.2 LD3858	BOS 24563 17,7 - WE / - WK + Zub Ceramic
1.8 T	110	09/05→12/08	⬅	06/07→; +PR 1ZF,1ZM,1ZC		13.0460-7117.2 607117	VW 23130 19,6 + WK
						13.0470-7117.2 LD7117	VW 23130 19,6 + WK Ceramic
			⬅	06/07→; +PR 1ZE		13.0460-7184.2 607184	ATE 23587 20,6 + WK
						13.0470-7184.2 LD7184	ATE 23587 20,6 + WK Ceramic
↓							

	kw			 	! #		
SKODA - OCTAVIA (1Z3) 02/04→06/13							
 Bremsbelagsatz, Scheibenbremse							
1.8 T	110	09/05→12/08	➡	06/07→; +PR 1KF		13.0460-2749.2 602749	TRW 24483 16,9 - WE / - WK + Zub
						13.0460-2880.2 602880	TRW 23914 17,1 + WE / - WK + Zub
						13.0470-2749.2 LD2749	TRW 24483 16,9 - WE / - WK + Zub Ceramic
						13.0470-2880.2 LD2880	TRW 23914 17,1 + WE / - WK + Zub Ceramic
			➡	06/07→; +PR 1KD		13.0460-2820.2 602820	TRW 20961 17,2 - WK
						13.0470-2820.2 LD2820	TRW 20961 17,2 - WK Ceramic
			➡	06/07→; +PR 1KS,1KT		13.0460-3858.2 603858	BOS 24563 17,7 - WE / - WK + Zub
						13.0470-3858.2 LD3858	BOS 24563 17,7 - WE / - WK + Zub Ceramic
1.9 TDI 2.0 FSI 2.0 TDI	77 110 103	06/04→12/10 11/04→10/08 11/05→05/10	←	+PR 1ZF,1ZM,1ZC		13.0460-7117.2 607117	VW 23130 19,6 + WK
						13.0470-7117.2 LD7117	VW 23130 19,6 + WK Ceramic
			←	+PR 1ZE		13.0460-7184.2 607184	ATE 23587 20,6 + WK
						13.0470-7184.2 LD7184	ATE 23587 20,6 + WK Ceramic
			➡	+PR 1KF		13.0460-2749.2 602749	TRW 24483 16,9 - WE / - WK + Zub
						13.0460-2880.2 602880	TRW 23914 17,1 + WE / - WK + Zub
						13.0470-2749.2 LD2749	TRW 24483 16,9 - WE / - WK + Zub Ceramic
						13.0470-2880.2 LD2880	TRW 23914 17,1 + WE / - WK + Zub Ceramic
			➡	+PR 1KD		13.0460-2820.2 602820	TRW 20961 17,2 - WK
						13.0470-2820.2 LD2820	TRW 20961 17,2 - WK Ceramic
			➡	+PR 1KS,1KT		13.0460-3858.2 603858	BOS 24563 17,7 - WE / - WK + Zub
						13.0470-3858.2 LD3858	BOS 24563 17,7 - WE / - WK + Zub Ceramic
2.0 RS 2.0 TDI RS	147 125	10/05→02/13 04/06→02/13	←	+PR 1LL,1LP,1ZB; → 01/13		13.0460-7184.2 607184	ATE 23587 20,6 + WK
						13.0470-7184.2 LD7184	ATE 23587 20,6 + WK Ceramic
			➡	→ 01/13; +PR 1KP		13.0460-2749.2 602749	TRW 24483 16,9 - WE / - WK + Zub
						13.0460-2880.2 602880	TRW 23914 17,1 + WE / - WK + Zub
						13.0470-2749.2 LD2749	TRW 24483 16,9 - WE / - WK + Zub Ceramic
						13.0470-2880.2 LD2880	TRW 23914 17,1 + WE / - WK + Zub Ceramic
			➡	→ 01/13; +PR 1KS,1KT		13.0460-3858.2 603858	BOS 24563 17,7 - WE / - WK + Zub
						13.0470-3858.2 LD3858	BOS 24563 17,7 - WE / - WK + Zub Ceramic
2.0 TDI 16V	103	02/04→04/13	←	06/04→ 01/13; +PR 1ZF,1ZM,1ZC		13.0460-7117.2 607117	VW 23130 19,6 + WK
						13.0470-7117.2 LD7117	VW 23130 19,6 + WK Ceramic
			←	06/04→ 01/13; +PR 1ZE		13.0460-7184.2 607184	ATE 23587 20,6 + WK
						13.0470-7184.2 LD7184	ATE 23587 20,6 + WK Ceramic
			➡	06/04→ 01/13; +PR 1KF		13.0460-2749.2 602749	TRW 24483 16,9 - WE / - WK + Zub
						13.0460-2880.2 602880	TRW 23914 17,1 + WE / - WK + Zub
						13.0470-2749.2 LD2749	TRW 24483 16,9 - WE / - WK + Zub Ceramic
						13.0470-2880.2 LD2880	TRW 23914 17,1 + WE / - WK + Zub Ceramic
			➡	06/04→ 01/13; +PR 1KD		13.0460-2820.2 602820	TRW 20961 17,2 - WK
						13.0470-2820.2 LD2820	TRW 20961 17,2 - WK Ceramic
			➡	06/04→ 01/13; +PR 1KS,1KT		13.0460-3858.2 603858	BOS 24563 17,7 - WE / - WK + Zub
						13.0470-3858.2 LD3858	BOS 24563 17,7 - WE / - WK + Zub Ceramic
 Bremsscheibe							
1.2 TSI 1.4 TSI 1.6 TDI ↓	77 90 77	02/10→06/13 11/08→06/13 06/09→04/13	←	+PR 1ZF,1ZM; → 01/13		24.0122-0210.1 422210	Ø 280 22 19 V + S
						24.0322-0210.1 522210	Ø 280 22 19 V + S PD









	kw			 	! #		
SKODA - OCTAVIA (1Z3) 02/04→06/13							
Bremsscheibe							
2.0 TDI	81	03/10→06/13	←	→ 01/13; +PR 1ZE	24.0125-0145.1	425145	Ø 288 25 22 V + S
					24.0325-0145.1	525145	Ø 288 25 22 V + S PD
			→	→ 01/13; +PR 1KD	24.0110-0277.1	410277	Ø 253 10 8 + S
					24.0310-0277.1	510277	Ø 253 10 8 + S PD
			→	→ 01/13; +PR 1KS,1KT	24.0110-0356.1	410356	Ø 272 9,7 8 + S
		24.0310-0356.1	510356	Ø 272 9,7 8 + S PD			
		→	→ 01/13; +PR 1KF	24.0112-0158.1	412158	Ø 256 12 10 + S	
				24.0312-0158.1	512158	Ø 256 12 10 PD	
1.4 1.6 FSI 2.0 TDI	55 85 100	05/04→05/06 02/04→10/08 02/04→05/10	←	06/04→; +PR 1ZF;1ZM	24.0122-0210.1	422210	Ø 280 22 19 V + S
					24.0322-0210.1	522210	Ø 280 22 19 V + S PD
			←	06/04→; +PR 1ZE	24.0125-0145.1	425145	Ø 288 25 22 V + S
					24.0325-0145.1	525145	Ø 288 25 22 V + S PD
			→	06/04→; +PR 1KD	24.0110-0277.1	410277	Ø 253 10 8 + S
		24.0310-0277.1	510277	Ø 253 10 8 + S PD			
		→	06/04→; +PR 1KS,1KT	24.0110-0356.1	410356	Ø 272 9,7 8 + S	
				24.0310-0356.1	510356	Ø 272 9,7 8 + S PD	
		→	06/04→; +PR 1KF	24.0112-0158.1	412158	Ø 256 12 10 + S	
				24.0312-0158.1	512158	Ø 256 12 10 PD	
1.4 1.6 1.8 TSI 1.8 TSI	59 75 112 118	06/04→04/13 06/04→06/13 03/09→06/13 06/07→04/13	←	→ 01/13; +PR 1ZF;1ZM	24.0122-0210.1	422210	Ø 280 22 19 V + S
					24.0322-0210.1	522210	Ø 280 22 19 V + S PD
			←	→ 01/13; +PR 1ZE	24.0125-0145.1	425145	Ø 288 25 22 V + S
					24.0325-0145.1	525145	Ø 288 25 22 V + S PD
			→	→ 01/13; +PR 1KD	24.0110-0277.1	410277	Ø 253 10 8 + S
		24.0310-0277.1	510277	Ø 253 10 8 + S PD			
		→	→ 01/13; +PR 1KS,1KT	24.0110-0356.1	410356	Ø 272 9,7 8 + S	
				24.0310-0356.1	510356	Ø 272 9,7 8 + S PD	
		→	→ 01/13; +PR 1KF	24.0112-0158.1	412158	Ø 256 12 10 + S	
				24.0312-0158.1	512158	Ø 256 12 10 PD	
1.6 LPG	75	08/09→11/12	←	09/09→; +PR 1ZF,1ZM	24.0122-0210.1	422210	Ø 280 22 19 V + S
					24.0322-0210.1	522210	Ø 280 22 19 V + S PD
			←	09/09→; +PR 1ZE	24.0125-0145.1	425145	Ø 288 25 22 V + S
					24.0325-0145.1	525145	Ø 288 25 22 V + S PD
			→	09/09→; +PR 1KD	24.0110-0277.1	410277	Ø 253 10 8 + S
		24.0310-0277.1	510277	Ø 253 10 8 + S PD			
		→	09/09→; +PR 1KS,1KT	24.0110-0356.1	410356	Ø 272 9,7 8 + S	
				24.0310-0356.1	510356	Ø 272 9,7 8 + S PD	
		→	09/09→; +PR 1KF	24.0112-0158.1	412158	Ø 256 12 10 + S	
				24.0312-0158.1	512158	Ø 256 12 10 PD	
1.6 MultiFuel	75	01/08→06/13	←	09/09→; +PR 1ZF,1ZM; → 01/13	24.0122-0210.1	422210	Ø 280 22 19 V + S
					24.0322-0210.1	522210	Ø 280 22 19 V + S PD
			←	09/09→; +PR 1ZE; → 01/13	24.0125-0145.1	425145	Ø 288 25 22 V + S
					24.0325-0145.1	525145	Ø 288 25 22 V + S PD
			→	09/09→; +PR 1KD; → 01/13	24.0110-0277.1	410277	Ø 253 10 8 + S
		24.0310-0277.1	510277	Ø 253 10 8 + S PD			
		→	09/09→; +PR 1KS,1KT; → 01/13	24.0110-0356.1	410356	Ø 272 9,7 8 + S	
				24.0310-0356.1	510356	Ø 272 9,7 8 + S PD	
		→	09/09→; +PR 1KF; → 01/13	24.0112-0158.1	412158	Ø 256 12 10 + S	
				24.0312-0158.1	512158	Ø 256 12 10 PD	
1.8 T	110	09/05→12/08	←	06/07→; +PR 1ZF;1ZM	24.0122-0210.1	422210	Ø 280 22 19 V + S
					24.0322-0210.1	522210	Ø 280 22 19 V + S PD
			←	06/07→; +PR 1ZE	24.0125-0145.1	425145	Ø 288 25 22 V + S
					24.0325-0145.1	525145	Ø 288 25 22 V + S PD
			→	06/07→; +PR 1KD	24.0110-0277.1	410277	Ø 253 10 8 + S
		24.0310-0277.1	510277	Ø 253 10 8 + S PD			
		→	06/07→; +PR 1KS,1KT	24.0110-0356.1	410356	Ø 272 9,7 8 + S	
				24.0310-0356.1	510356	Ø 272 9,7 8 + S PD	
		→	06/07→; +PR 1KF	24.0112-0158.1	412158	Ø 256 12 10 + S	
				24.0312-0158.1	512158	Ø 256 12 10 PD	
1.9 TDI 2.0 FSI 2.0 TDI	77 110 103	06/04→12/10 11/04→10/08 11/05→05/10	←	+PR 1ZF;1ZM	24.0122-0210.1	422210	Ø 280 22 19 V + S
					24.0322-0210.1	522210	Ø 280 22 19 V + S PD
			←	+PR 1ZE	24.0125-0145.1	425145	Ø 288 25 22 V + S









	kw			 	! #		
SKODA - OCTAVIA (1Z3) 02/04→06/13							
Bremsscheibe							
1.9 TDI	77	06/04→12/10	←	+PR 1ZE		24.0325-0145.1 525145	Ø 288 25 22 V + S PD
2.0 FSI	110	11/04→10/08	→	+PR 1KD		24.0110-0277.1 410277	Ø 253 10 8 + S
2.0 TDI	103	11/05→05/10	→	+PR 1KS,1KT		24.0310-0277.1 510277	Ø 253 10 8 + S PD
			→	+PR 1KF		24.0112-0158.1 412158	Ø 256 12 10 + S
			→	+PR 1KP		24.0312-0158.1 512158	Ø 256 12 10 PD
2.0 RS	147	10/05→02/13	←	+PR 1LL,1LP,1ZB; → 01/13		24.0125-0158.1 425158	Ø 312 25 22 V + S
2.0 TDI RS	125	04/06→02/13	→	→ 01/13; +PR 1KS,1KT		24.0110-0356.1 410356	Ø 272 9,7 8 + S
			→	+PR 1KP; → 01/13		24.0310-0356.1 510356	Ø 272 9,7 8 + S PD
			→			24.0112-0169.1 412169	Ø 282 12 10 + S
			→			24.0312-0169.1 512169	Ø 282 12 10 + S PD
2.0 TDI 16V	103	02/04→04/13	←	06/04→ 01/13; +PR 1ZF;1ZM		24.0122-0210.1 422210	Ø 280 22 19 V + S
			←	06/04→ 01/13; +PR 1ZE		24.0322-0210.1 522210	Ø 280 22 19 V + S PD
			→	06/04→ 01/13; +PR 1KD		24.0125-0145.1 425145	Ø 288 25 22 V + S
			→	06/04→ 01/13; +PR 1KS,1KT		24.0325-0145.1 525145	Ø 288 25 22 V + S PD
			→	06/04→ 01/13; +PR 1KF		24.0110-0277.1 410277	Ø 253 10 8 + S
			→	06/04→ 01/13; +PR 1KS,1KT		24.0310-0277.1 510277	Ø 253 10 8 + S PD
			→	06/04→ 01/13; +PR 1KF		24.0110-0356.1 410356	Ø 272 9,7 8 + S
			→	06/04→ 01/13; +PR 1KF		24.0310-0356.1 510356	Ø 272 9,7 8 + S PD
			→	06/04→ 01/13; +PR 1KF		24.0112-0158.1 412158	Ø 256 12 10 + S
			→	06/04→ 01/13; +PR 1KF		24.0312-0158.1 512158	Ø 256 12 10 PD
SKODA - OCTAVIA I (1U2) 09/96→12/10							
Bremsbelagsatz, Scheibenbremse							
1.4	44	04/99→03/01	←	+PR 1LN,1LE,1ZD,1ZE / 1ZH		13.0460-7081.2 607081	ATE 20676 19,8 - WE / - WK
			←	+PR 1LQ,1LR,1LS,1ZM; → 1U-X-415000		13.0460-7122.2 607122	ATE 20676 19,8 + WK
			←	1U-Y-000001→; +PR 1LQ,1LR,1LS,1ZM		13.0470-7081.2 LD7081	ATE 20676 19,8 - WE / - WK Ceramic
			←			13.0470-7122.2 LD7122	ATE 20676 19,8 + WK Ceramic
1.4 16V	55	09/00→12/10	←	+PR 1LN,1LE,1ZD,1ZE / 1ZH; → 06/10		13.0460-7111.2 607111	VW 23130 19,6 - WE / - WK
			←	+PR 1LQ,1LR,1LS,1ZM; → 1U-X-415000		13.0470-7111.2 LD7111	VW 23130 19,6 - WE / - WK Ceramic
			←	1U-Y-000001→; → 06/10; +PR 1LQ,1LR,1LS,1ZM		13.0460-7117.2 607117	VW 23130 19,6 + WK
			←			13.0470-7117.2 LD7117	VW 23130 19,6 + WK Ceramic
1.6	55	09/96→09/04	←	10/96→; +PR 1LN,1LE,1ZD,1ZE / 1ZH		13.0460-7081.2 607081	ATE 20676 19,8 - WE / - WK
1.8	92	09/96→07/00	←			13.0460-7122.2 607122	ATE 20676 19,8 + WK
			←	10/96→; +PR 1LQ,1LR,1LS,1ZM; → 1U-X-415000		13.0470-7081.2 LD7081	ATE 20676 19,8 - WE / - WK Ceramic
			←			13.0470-7122.2 LD7122	ATE 20676 19,8 + WK Ceramic
			←	1U-Y-000001→; +PR 1LQ,1LR,1LS,1ZM		13.0460-7111.2 607111	VW 23130 19,6 - WE / - WK
			←			13.0470-7111.2 LD7111	VW 23130 19,6 - WE / - WK Ceramic
			→	10/96→; +PR 1KK,1KS,1KP		13.0460-7117.2 607117	VW 23130 19,6 + WK
			→			13.0470-7117.2 LD7117	VW 23130 19,6 + WK Ceramic
			→			13.0460-2894.2 602894	TRW 20961 17,2 - WK + Zub
			→			13.0470-2894.2 LD2894	TRW 20961 17,2 - WK + Zub Ceramic
1.6	74	02/97→12/07	←	+PR 1LN,1LE,1ZD,1ZE / 1ZH		13.0460-7081.2 607081	ATE 20676 19,8 - WE / - WK
1.9 SDI	50	06/97→12/03	←			13.0460-7122.2 607122	ATE 20676 19,8 + WK
1.9 TDI	81	08/97→01/06	←			13.0470-7081.2 LD7081	ATE 20676 19,8 - WE / - WK Ceramic
2.0	85	04/99→05/07	←				
↓							







	kw			 	! #		
SKODA - OCTAVIA I (1U2) 09/96→12/10							
 Bremsbelagsatz, Scheibenbremse							
1.6 1.9 SDI 1.9 TDI 2.0	74	02/97→12/07	←	+PR 1LN,1LE,1ZD,1ZE / 1ZH		13.0470-7122.2 LD7122	ATE 20676 19,8 + WK Ceramic
	50	06/97→12/03	←	+PR 1LQ,1LR,1LS,1ZM; → 1U-X-415000		13.0460-7111.2 607111	VW 23130 19,6 - WE / - WK
	81	08/97→01/06				13.0470-7111.2 LD7111	VW 23130 19,6 - WE / - WK Ceramic
	85	04/99→05/07	←	1U-Y-000001→; +PR 1LQ,1LR,1LS,1ZM		13.0460-7117.2 607117	VW 23130 19,6 + WK
			→	+PR 1KK,1KS,1KP		13.0460-2894.2 602894	TRW 20961 17,2 - WK + Zub
						13.0470-2894.2 LD2894	TRW 20961 17,2 - WK + Zub Ceramic
1.6	75	11/00→12/10	←	+PR 1LN,1LE,1ZD,1ZE / 1ZH; → 06/10		13.0460-7081.2 607081	ATE 20676 19,8 - WE / - WK
						13.0460-7122.2 607122	ATE 20676 19,8 + WK
						13.0470-7081.2 LD7081	ATE 20676 19,8 - WE / - WK Ceramic
						13.0470-7122.2 LD7122	ATE 20676 19,8 + WK Ceramic
			←	+PR 1LQ,1LR,1LS,1ZM; → 1U-X-415000		13.0460-7111.2 607111	VW 23130 19,6 - WE / - WK
						13.0470-7111.2 LD7111	VW 23130 19,6 - WE / - WK Ceramic
			←	1U-Y-000001→; → 06/10; +PR 1LQ,1LR,1LS,1ZM		13.0460-7117.2 607117	VW 23130 19,6 + WK
						13.0470-7117.2 LD7117	VW 23130 19,6 + WK Ceramic
			→	→ 06/10; +PR 1KK,1KS,1KP		13.0460-2894.2 602894	TRW 20961 17,2 - WK + Zub
						13.0470-2894.2 LD2894	TRW 20961 17,2 - WK + Zub Ceramic
1.8 T	110	08/97→12/10	←	03/98→ 06/10; +PR 1LN,1LE,1ZD,1ZE / 1ZH		13.0460-7081.2 607081	ATE 20676 19,8 - WE / - WK
						13.0460-7122.2 607122	ATE 20676 19,8 + WK
						13.0470-7081.2 LD7081	ATE 20676 19,8 - WE / - WK Ceramic
						13.0470-7122.2 LD7122	ATE 20676 19,8 + WK Ceramic
			←	03/98→; → 1U-X-415000; +PR 1LQ,1LR,1LS,1ZM		13.0460-7111.2 607111	VW 23130 19,6 - WE / - WK
						13.0470-7111.2 LD7111	VW 23130 19,6 - WE / - WK Ceramic
			←	1U-Y-000001→; → 06/10; +PR 1LQ,1LR,1LS,1ZM		13.0460-7117.2 607117	VW 23130 19,6 + WK
						13.0470-7117.2 LD7117	VW 23130 19,6 + WK Ceramic
			→	03/98→ 06/10; +PR 1KK,1KS,1KP		13.0460-2894.2 602894	TRW 20961 17,2 - WK + Zub
						13.0470-2894.2 LD2894	TRW 20961 17,2 - WK + Zub Ceramic
1.8 T 4x4	110	05/01→05/06	←	+PR 1LN,1LE,1ZD,1ZE / 1ZH		13.0460-7081.2 607081	ATE 20676 19,8 - WE / - WK
						13.0460-7122.2 607122	ATE 20676 19,8 + WK
						13.0470-7081.2 LD7081	ATE 20676 19,8 - WE / - WK Ceramic
			←	+PR 1LQ,1LR,1LS,1ZM		13.0470-7122.2 LD7122	ATE 20676 19,8 + WK Ceramic
			→	+PR 1KE		13.0460-7117.2 607117	VW 23130 19,6 + WK
						13.0470-7117.2 LD7117	VW 23130 19,6 + WK Ceramic
			→	+PR 1KE		13.0460-2894.2 602894	TRW 20961 17,2 - WK + Zub
						13.0470-2894.2 LD2894	TRW 20961 17,2 - WK + Zub Ceramic
1.9 TDI	66	09/96→03/10	←	10/96→; +PR 1LN,1LE,1ZD,1ZE / 1ZH		13.0460-7081.2 607081	ATE 20676 19,8 - WE / - WK
						13.0460-7122.2 607122	ATE 20676 19,8 + WK
						13.0470-7081.2 LD7081	ATE 20676 19,8 - WE / - WK Ceramic
						13.0470-7122.2 LD7122	ATE 20676 19,8 + WK Ceramic
			←	10/96→; +PR 1LQ,1LR,1LS,1ZM; → 1U-X-415000		13.0460-7111.2 607111	VW 23130 19,6 - WE / - WK
						13.0470-7111.2 LD7111	VW 23130 19,6 - WE / - WK Ceramic
			←	1U-Y-000001→; +PR 1LQ,1LR,1LS,1ZM		13.0460-7117.2 607117	VW 23130 19,6 + WK
						13.0470-7117.2 LD7117	VW 23130 19,6 + WK Ceramic
			→	08/97→; +PR 1KK,1KS,1KP		13.0460-2894.2 602894	TRW 20961 17,2 - WK + Zub
						13.0470-2894.2 LD2894	TRW 20961 17,2 - WK + Zub Ceramic
1.9 TDI	74	10/05→12/10	←	+PR 1LN,1LE,1ZD,1ZE / 1ZH; → 06/10		13.0460-7081.2 607081	ATE 20676 19,8 - WE / - WK
						13.0460-7122.2 607122	ATE 20676 19,8 + WK
						13.0470-7081.2 LD7081	ATE 20676 19,8 - WE / - WK Ceramic
						13.0470-7122.2 LD7122	ATE 20676 19,8 + WK Ceramic
			←	→ 06/10; +PR 1LQ,1LR,1LS,1ZM		13.0460-7117.2 607117	VW 23130 19,6 + WK
						13.0470-7117.2 LD7117	VW 23130 19,6 + WK Ceramic







	kw			 	! #		
SKODA - OCTAVIA I (1U2) 09/96→12/10							
 Bremsbelagsatz, Scheibenbremse							
1.9 TDI	74	10/05→12/10	➡	→ 06/10; +PR 1KK,1KS,1KP		13.0460-2894.2 602894 13.0470-2894.2 LD2894	TRW 20961 17,2 - WK + Zub TRW 20961 17,2 - WK + Zub Ceramic
1.9 TDI	96	09/02→09/04	⬅	01/03→; +PR 1LN,1LE,1ZD,1ZE / 1ZH		13.0460-7081.2 607081 13.0460-7122.2 607122 13.0470-7081.2 LD7081 13.0470-7122.2 LD7122	ATE 20676 19,8 - WE / - WK ATE 20676 19,8 + WK ATE 20676 19,8 - WE / - WK Ceramic ATE 20676 19,8 + WK Ceramic
			⬅	01/03→; +PR 1LQ,1LR,1LS,1ZM		13.0460-7117.2 607117 13.0470-7117.2 LD7117	VW 23130 19,6 + WK VW 23130 19,6 + WK Ceramic
			➡	01/03→; +PR 1KK,1KS,1KP		13.0460-2894.2 602894 13.0470-2894.2 LD2894	TRW 20961 17,2 - WK + Zub TRW 20961 17,2 - WK + Zub Ceramic
RS 1.8 T	132	05/01→01/06	⬅	+PR 1ZN		13.0460-7081.2 607081 13.0460-7122.2 607122 13.0470-7081.2 LD7081 13.0470-7122.2 LD7122	ATE 20676 19,8 - WE / - WK ATE 20676 19,8 + WK ATE 20676 19,8 - WE / - WK Ceramic ATE 20676 19,8 + WK Ceramic
			➡	01/03→; +PR 2ED		13.0460-2886.2 602886 13.0470-2886.2 LD2886	TRW 20961 16,0 - WK TRW 20961 16,0 - WK Ceramic
Zubehörsatz, Scheibenbremsbelag							
1.6 1.8	55 92	09/96→09/04 09/96→07/00	➡	10/96→; +PR 1KK,1KS,1KP		13.0460-0072.2 610072	TRW
1.6 1.9 SDI 1.9 TDI 2.0	74 50 81 85	02/97→12/07 06/97→12/03 08/97→01/06 04/99→05/07	➡	+PR 1KK,1KS,1KP		13.0460-0072.2 610072	TRW
1.6 1.9 TDI	75 74	11/00→12/10 10/05→12/10	➡	→ 06/10; +PR 1KK,1KS,1KP		13.0460-0072.2 610072	TRW
1.8 T	110	08/97→12/10	➡	03/98→ 06/10; +PR 1KK,1KS,1KP		13.0460-0072.2 610072	TRW
1.8 T 4x4	110	05/01→05/06	➡	+PR 1KE		13.0460-0072.2 610072	TRW
1.9 TDI	66	09/96→03/10	➡	08/97→; +PR 1KK,1KS,1KP		13.0460-0072.2 610072	TRW
1.9 TDI	96	09/02→09/04	➡	01/03→; +PR 1KK,1KS,1KP		13.0460-0072.2 610072	TRW
 Bremsscheibe							
1.4	44	04/99→03/01	⬅	+PR 1LR,1LS,1ZM		24.0122-0150.1 422150 24.0322-0150.1 522150	Ø 280 22 19 V + S Ø 280 22 19 V + S PD
			⬅	+PR 1LQ		24.0122-0151.1 422151 24.0322-0151.1 522151	Ø 256 22 19 V + S Ø 256 22 19 V + S PD
			⬅	+PR 1LE,1LN,1ZE,1ZH		24.0125-0113.1 425113 24.0325-0113.1 525113	Ø 288 25 22 V + S Ø 288 25 22 V + S PD
			➡	10/96→; +PR 1KK,1KS,1KP		24.0109-0123.1 409123 24.0309-0123.1 509123	Ø 230 9 7 + S Ø 230 9 7 + S PD
1.4 16V	55	09/00→12/10	⬅	→ 06/10; +PR 1LR,1LS,1ZM		24.0122-0150.1 422150 24.0322-0150.1 522150	Ø 280 22 19 V + S Ø 280 22 19 V + S PD
			⬅	→ 06/10; +PR 1LQ		24.0122-0151.1 422151 24.0322-0151.1 522151	Ø 256 22 19 V + S Ø 256 22 19 V + S PD
			⬅	→ 06/10; +PR 1LE,1LN,1ZE,1ZH		24.0125-0113.1 425113 24.0325-0113.1 525113	Ø 288 25 22 V + S Ø 288 25 22 V + S PD
1.6 1.8 1.9 TDI	55 92 66	09/96→09/04 09/96→07/00 09/96→03/10	⬅	10/96→; +PR 1LR,1LS,1ZM		24.0122-0150.1 422150 24.0322-0150.1 522150	Ø 280 22 19 V + S Ø 280 22 19 V + S PD
			⬅	10/96→; +PR 1LQ		24.0122-0151.1 422151 24.0322-0151.1 522151	Ø 256 22 19 V + S Ø 256 22 19 V + S PD
			⬅	10/96→; +PR 1LE,1LN,1ZE,1ZH		24.0125-0113.1 425113 24.0325-0113.1 525113	Ø 288 25 22 V + S Ø 288 25 22 V + S PD
			➡	10/96→; +PR 1KK,1KS,1KP		24.0109-0123.1 409123 24.0309-0123.1 509123	Ø 230 9 7 + S Ø 230 9 7 + S PD
1.6 1.9 SDI 1.9 TDI 2.0	74 50 81 85	02/97→12/07 06/97→12/03 08/97→01/06 04/99→05/07	⬅	+PR 1LR,1LS,1ZM		24.0122-0150.1 422150 24.0322-0150.1 522150	Ø 280 22 19 V + S Ø 280 22 19 V + S PD
			⬅	+PR 1LQ		24.0122-0151.1 422151 24.0322-0151.1 522151	Ø 256 22 19 V + S Ø 256 22 19 V + S PD
			⬅	+PR 1LE,1LN,1ZE,1ZH		24.0125-0113.1 425113 24.0325-0113.1 525113	Ø 288 25 22 V + S Ø 288 25 22 V + S PD
			➡	+PR 1KK,1KS,1KP		24.0109-0123.1 409123 24.0309-0123.1 509123	Ø 230 9 7 + S Ø 230 9 7 + S PD
↓							



















	kw			 	! #				
SKODA - OCTAVIA I (1U2) 09/96→12/10									
 Bremsscheibe									
1.6 1.9 TDI	75 74	11/00→12/10 10/05→12/10	←	→ 06/10; +PR 1LR,1LS,1ZM	24.0122-0150.1	422150	Ø 280 22 19 V + S		
					24.0322-0150.1	522150	Ø 280 22 19 V + S PD		
			←	→ 06/10; +PR 1LQ	24.0122-0151.1	422151	Ø 256 22 19 V + S		
					24.0322-0151.1	522151	Ø 256 22 19 V + S PD		
			←	→ 06/10; +PR 1LE,1LN,1ZE,1ZH	24.0125-0113.1	425113	Ø 288 25 22 V + S		
					24.0325-0113.1	525113	Ø 288 25 22 V + S PD		
			→	→ 06/10; +PR 1KK,1KS,1KP	24.0109-0123.1	409123	Ø 230 9 7 + S		
					24.0309-0123.1	509123	Ø 230 9 7 + S PD		
1.8 T	110	08/97→12/10	←	03/98→ 06/10; +PR 1LR,1LS,1ZM	24.0122-0150.1	422150	Ø 280 22 19 V + S		
					24.0322-0150.1	522150	Ø 280 22 19 V + S PD		
			←	03/98→ 06/10; +PR 1LQ	24.0122-0151.1	422151	Ø 256 22 19 V + S		
					24.0322-0151.1	522151	Ø 256 22 19 V + S PD		
			←	03/98→ 06/10; +PR 1LE,1LN,1ZE,1ZH	24.0125-0113.1	425113	Ø 288 25 22 V + S		
					24.0325-0113.1	525113	Ø 288 25 22 V + S PD		
			→	03/98→ 06/10; +PR 1KK,1KS,1KP	24.0109-0123.1	409123	Ø 230 9 7 + S		
					24.0309-0123.1	509123	Ø 230 9 7 + S PD		
1.8 T 4x4	110	05/01→05/06	←	+PR 1LR,1LS,1ZM	24.0122-0150.1	422150	Ø 280 22 19 V + S		
					24.0322-0150.1	522150	Ø 280 22 19 V + S PD		
			←	+PR 1LQ	24.0122-0151.1	422151	Ø 256 22 19 V + S		
					24.0322-0151.1	522151	Ø 256 22 19 V + S PD		
			←	+PR 1LE,1LN,1ZE,1ZH	24.0125-0113.1	425113	Ø 288 25 22 V + S		
					24.0325-0113.1	525113	Ø 288 25 22 V + S PD		
			→	+PR 1KE	24.0109-0133.1	409133	Ø 239 8,9 7 + S		
					24.0309-0133.1	509133	Ø 239 8,9 7 + S PD		
1.9 TDI	96	09/02→09/04	←	01/03→; +PR 1LR,1LS,1ZM	24.0122-0150.1	422150	Ø 280 22 19 V + S		
					24.0322-0150.1	522150	Ø 280 22 19 V + S PD		
			←	01/03→; +PR 1LQ	24.0122-0151.1	422151	Ø 256 22 19 V + S		
					24.0322-0151.1	522151	Ø 256 22 19 V + S PD		
			←	01/03→; +PR 1LE,1LN,1ZE,1ZH	24.0125-0113.1	425113	Ø 288 25 22 V + S		
					24.0325-0113.1	525113	Ø 288 25 22 V + S PD		
			→	01/03→; +PR 1KK,1KS,1KP	24.0109-0123.1	409123	Ø 230 9 7 + S		
					24.0309-0123.1	509123	Ø 230 9 7 + S PD		
RS 1.8 T	132	05/01→01/06	←	+PR 1ZN	24.0125-0123.1	425123	Ø 310 25 22 V + S		
					24.0325-0123.1	525123	Ø 310 25 22 V PD		
			→	01/03→; +PR 2ED	24.0122-0163.1	422163	Ø 256 22 20 V		
					24.0322-0163.1	522163	Ø 256 22 20 V PD		
SKODA - OCTAVIA I Combi (1U5) 07/98→12/10									
 Bremsbelagsatz, Scheibenbremse									
1.4 16V	55	08/00→12/10	←	→ 06/10; +PR 1LN,1LE,1ZD,1ZE / 1ZH	13.0460-7081.2	607081	ATE 20676 19,8 - WE / - WK		
					13.0460-7122.2	607122	ATE 20676 19,8 + WK		
					13.0470-7081.2	LD7081	ATE 20676 19,8 - WE / - WK Ceramic		
			←	→ 1U-X-415000; +PR 1LQ,1LR,1LS,1ZM	13.0470-7122.2	LD7122	ATE 20676 19,8 + WK Ceramic		
			←	→ 1U-X-415000; +PR 1LQ,1LR,1LS,1ZM	13.0460-7111.2	607111	VW 23130 19,6 - WE / - WK		
					13.0470-7111.2	LD7111	VW 23130 19,6 - WE / - WK Ceramic		
			←	1U-Y-000001→; → 06/10; +PR 1LQ,1LR,1LS,1ZM	13.0460-7117.2	607117	VW 23130 19,6 + WK		
					13.0470-7117.2	LD7117	VW 23130 19,6 + WK Ceramic		
1.6 1.6 1.8 20V 1.9 SDI 1.9 TDI 1.9 TDI 2.0	55 74 92 50 66 81 85	07/98→09/04 07/98→12/07 07/98→07/00 07/98→12/03 07/98→03/10 07/98→01/06 04/99→05/07	←	+PR 1LN,1LE,1ZD,1ZE / 1ZH	13.0460-7081.2	607081	ATE 20676 19,8 - WE / - WK		
					13.0460-7122.2	607122	ATE 20676 19,8 + WK		
					13.0470-7081.2	LD7081	ATE 20676 19,8 - WE / - WK Ceramic		
					13.0470-7122.2	LD7122	ATE 20676 19,8 + WK Ceramic		
					←	→ 1U-X-415000; +PR 1LQ,1LR,1LS,1ZM	13.0460-7111.2	607111	VW 23130 19,6 - WE / - WK
							13.0470-7111.2	LD7111	VW 23130 19,6 - WE / - WK Ceramic
			←	1U-Y-000001→; +PR 1LQ,1LR,1LS,1ZM	13.0460-7117.2	607117	VW 23130 19,6 + WK		
					13.0470-7117.2	LD7117	VW 23130 19,6 + WK Ceramic		
			→	+PR 1KK,1KS,1KP	13.0460-2894.2	602894	TRW 20961 17,2 - WK + Zub		
					13.0470-2894.2	LD2894	TRW 20961 17,2 - WK + Zub Ceramic		
1.6 ↓	75	09/00→12/10	←	→ 06/10; +PR 1LN,1LE,1ZD,1ZE / 1ZH	13.0460-7081.2	607081	ATE 20676 19,8 - WE / - WK		

	kw			 	! #		
SKODA - OCTAVIA I Combi (1U5) 07/98→12/10							
 Bremsbelagsatz, Scheibenbremse							
1.8 T	110	07/98→12/10	←	→ 06/10; +PR 1LN,1LE,1ZD,1ZE / 1ZH	13.0460-7122.2	607122	ATE 20676 19,8 + WK
					13.0470-7081.2	LD7081	ATE 20676 19,8 - WE / - WK Ceramic
					13.0470-7122.2	LD7122	ATE 20676 19,8 + WK Ceramic
			←	→ 1U-X-415000; +PR 1LQ,1LR,1LS,1ZM	13.0460-7111.2	607111	VW 23130 19,6 - WE / - WK
				13.0470-7111.2	LD7111	VW 23130 19,6 - WE / - WK Ceramic	
			←	1U-Y-000001→; → 06/10; +PR 1LQ,1LR,1LS,1ZM	13.0460-7117.2	607117	VW 23130 19,6 + WK
					13.0470-7117.2	LD7117	VW 23130 19,6 + WK Ceramic
			→	→ 06/10; +PR 1KK,1KS,1KP	13.0460-2894.2	602894	TRW 20961 17,2 - WK + Zub
					13.0470-2894.2	LD2894	TRW 20961 17,2 - WK + Zub Ceramic
1.8 T 4x4 1.9 TDI 4x4 1.9 TDI 4x4	110 66 74	05/01→05/06 11/99→02/06 09/00→01/06	←	+PR 1LN,1LE,1ZD,1ZE / 1ZH	13.0460-7081.2	607081	ATE 20676 19,8 - WE / - WK
					13.0460-7122.2	607122	ATE 20676 19,8 + WK
					13.0470-7081.2	LD7081	ATE 20676 19,8 - WE / - WK Ceramic
					13.0470-7122.2	LD7122	ATE 20676 19,8 + WK Ceramic
			←	+PR 1LQ,1LR,1LS,1ZM	13.0460-7117.2	607117	VW 23130 19,6 + WK
					13.0470-7117.2	LD7117	VW 23130 19,6 + WK Ceramic
			→	+PR 1KE	13.0460-2894.2	602894	TRW 20961 17,2 - WK + Zub
					13.0470-2894.2	LD2894	TRW 20961 17,2 - WK + Zub Ceramic
1.9 TDI	74	08/00→12/10	←	→ 06/10; +PR 1LN,1LE,1ZD,1ZE / 1ZH	13.0460-7081.2	607081	ATE 20676 19,8 - WE / - WK
					13.0460-7122.2	607122	ATE 20676 19,8 + WK
					13.0470-7081.2	LD7081	ATE 20676 19,8 - WE / - WK Ceramic
					13.0470-7122.2	LD7122	ATE 20676 19,8 + WK Ceramic
			←	→ 06/10; +PR 1LQ,1LR,1LS,1ZM	13.0460-7117.2	607117	VW 23130 19,6 + WK
					13.0470-7117.2	LD7117	VW 23130 19,6 + WK Ceramic
			→	→ 06/10; +PR 1KK,1KS,1KP	13.0460-2894.2	602894	TRW 20961 17,2 - WK + Zub
					13.0470-2894.2	LD2894	TRW 20961 17,2 - WK + Zub Ceramic
1.9 TDI	96	09/02→09/04	←	01/03→; +PR 1LN,1LE,1ZD,1ZE / 1ZH	13.0460-7081.2	607081	ATE 20676 19,8 - WE / - WK
					13.0460-7122.2	607122	ATE 20676 19,8 + WK
					13.0470-7081.2	LD7081	ATE 20676 19,8 - WE / - WK Ceramic
					13.0470-7122.2	LD7122	ATE 20676 19,8 + WK Ceramic
			←	01/03→; +PR 1LQ,1LR,1LS,1ZM	13.0460-7117.2	607117	VW 23130 19,6 + WK
					13.0470-7117.2	LD7117	VW 23130 19,6 + WK Ceramic
			→	01/03→; +PR 1KK,1KS,1KP	13.0460-2894.2	602894	TRW 20961 17,2 - WK + Zub
					13.0470-2894.2	LD2894	TRW 20961 17,2 - WK + Zub Ceramic
2.0 4x4	85	08/00→09/04	←	05/01→; +PR 1LN,1LE,1ZD,1ZE / 1ZH	13.0460-7081.2	607081	ATE 20676 19,8 - WE / - WK
					13.0460-7122.2	607122	ATE 20676 19,8 + WK
					13.0470-7081.2	LD7081	ATE 20676 19,8 - WE / - WK Ceramic
					13.0470-7122.2	LD7122	ATE 20676 19,8 + WK Ceramic
			←	05/01→; +PR 1LQ,1LR,1LS,1ZM	13.0460-7117.2	607117	VW 23130 19,6 + WK
					13.0470-7117.2	LD7117	VW 23130 19,6 + WK Ceramic
			→	05/01→; +PR 1KE	13.0460-2894.2	602894	TRW 20961 17,2 - WK + Zub
					13.0470-2894.2	LD2894	TRW 20961 17,2 - WK + Zub Ceramic
2.0 4x4	88	01/00→12/10	←	→ 06/10; +PR 1LN,1LE,1ZD,1ZE / 1ZH	13.0460-7081.2	607081	ATE 20676 19,8 - WE / - WK
					13.0460-7122.2	607122	ATE 20676 19,8 + WK
					13.0470-7081.2	LD7081	ATE 20676 19,8 - WE / - WK Ceramic
					13.0470-7122.2	LD7122	ATE 20676 19,8 + WK Ceramic
			←	→ 06/10; +PR 1LQ,1LR,1LS,1ZM	13.0460-7117.2	607117	VW 23130 19,6 + WK
					13.0470-7117.2	LD7117	VW 23130 19,6 + WK Ceramic
			→	→ 06/10; +PR 1KE	13.0460-2894.2	602894	TRW 20961 17,2 - WK + Zub
					13.0470-2894.2	LD2894	TRW 20961 17,2 - WK + Zub Ceramic
RS 1.8 T	132	08/02→01/06	←	+PR 1ZN	13.0460-7081.2	607081	ATE 20676 19,8 - WE / - WK
↓					13.0460-7122.2	607122	ATE 20676 19,8 + WK







	kw			 	! #		
SKODA - OCTAVIA I Combi (1U5) 07/98→12/10							
Bremsbelagsatz, Scheibenbremse							
RS 1.8 T	132	08/02→01/06	←	+PR 1ZN		13.0470-7081.2 LD7081	ATE 20676 19,8 - WE / - WK Ceramic
			→	01/03→; +PR 2ED		13.0470-7122.2 LD7122	ATE 20676 19,8 + WK Ceramic
						13.0460-2886.2 602886	TRW 20961 16,0 - WK
						13.0470-2886.2 LD2886	TRW 20961 16,0 - WK Ceramic
Zubehörsatz, Scheibenbremsbelag							
1.6	55	07/98→09/04	→	+PR 1KK,1KS,1KP		13.0460-0072.2 610072	TRW
1.6	74	07/98→12/07					
1.8 20V	92	07/98→07/00					
1.9 SDI	50	07/98→12/03					
1.9 TDI	66	07/98→03/10					
1.9 TDI	81	07/98→01/06					
2.0	85	04/99→05/07					
1.6	75	09/00→12/10	→	→ 06/10; +PR 1KK,1KS,1KP		13.0460-0072.2 610072	TRW
1.8 T	110	07/98→12/10					
1.9 TDI	74	08/00→12/10					
1.8 T 4x4	110	05/01→05/06	→	+PR 1KE		13.0460-0072.2 610072	TRW
1.9 TDI 4x4	66	11/99→02/06					
1.9 TDI 4x4	74	09/00→01/06					
1.9 TDI	96	09/02→09/04	→	01/03→; +PR 1KK,1KS,1KP		13.0460-0072.2 610072	TRW
2.0 4x4	85	08/00→09/04	→	05/01→; +PR 1KE		13.0460-0072.2 610072	TRW
2.0 4x4	88	01/00→12/10	→	→ 06/10; +PR 1KE		13.0460-0072.2 610072	TRW
Bremsscheibe							
1.4 16V	55	08/00→12/10	←	→ 06/10; +PR 1LR,1LS,1ZM		24.0122-0150.1 422150	Ø 280 22 19 V + S
			←	→ 06/10; +PR 1LQ		24.0322-0150.1 522150	Ø 280 22 19 V + S PD
			←	→ 06/10; +PR 1LQ		24.0122-0151.1 422151	Ø 256 22 19 V + S
			←	→ 06/10; +PR 1LQ		24.0322-0151.1 522151	Ø 256 22 19 V + S PD
			←	→ 06/10; +PR 1LE,1LN,1ZE,1ZH		24.0125-0113.1 425113	Ø 288 25 22 V + S
			←	→ 06/10; +PR 1LE,1LN,1ZE,1ZH		24.0325-0113.1 525113	Ø 288 25 22 V + S PD
1.6	55	07/98→09/04	←	+PR 1LR,1LS,1ZM		24.0122-0150.1 422150	Ø 280 22 19 V + S
1.6	74	07/98→12/07				24.0322-0150.1 522150	Ø 280 22 19 V + S PD
1.8 20V	92	07/98→07/00					
1.9 SDI	50	07/98→12/03	←	+PR 1LQ		24.0122-0151.1 422151	Ø 256 22 19 V + S
1.9 TDI	66	07/98→03/10				24.0322-0151.1 522151	Ø 256 22 19 V + S PD
1.9 TDI	81	07/98→01/06	←	+PR 1LE,1LN,1ZE,1ZH		24.0125-0113.1 425113	Ø 288 25 22 V + S
2.0	85	04/99→05/07	←	+PR 1LE,1LN,1ZE,1ZH		24.0325-0113.1 525113	Ø 288 25 22 V + S PD
			→	+PR 1KK,1KS,1KP		24.0109-0123.1 409123	Ø 230 9 7 + S
			→	+PR 1KK,1KS,1KP		24.0309-0123.1 509123	Ø 230 9 7 + S PD
1.6	75	09/00→12/10	←	→ 06/10; +PR 1LR,1LS,1ZM		24.0122-0150.1 422150	Ø 280 22 19 V + S
1.8 T	110	07/98→12/10				24.0322-0150.1 522150	Ø 280 22 19 V + S PD
1.9 TDI	74	08/00→12/10	←	→ 06/10; +PR 1LQ		24.0122-0151.1 422151	Ø 256 22 19 V + S
			←	→ 06/10; +PR 1LQ		24.0322-0151.1 522151	Ø 256 22 19 V + S PD
			←	→ 06/10; +PR 1LE,1LN,1ZE,1ZH		24.0125-0113.1 425113	Ø 288 25 22 V + S
			←	→ 06/10; +PR 1LE,1LN,1ZE,1ZH		24.0325-0113.1 525113	Ø 288 25 22 V + S PD
			→	→ 06/10; +PR 1KK,1KS,1KP		24.0109-0123.1 409123	Ø 230 9 7 + S
			→	→ 06/10; +PR 1KK,1KS,1KP		24.0309-0123.1 509123	Ø 230 9 7 + S PD
1.8 T 4x4	110	05/01→05/06	←	+PR 1LR,1LS,1ZM		24.0122-0150.1 422150	Ø 280 22 19 V + S
1.9 TDI 4x4	66	11/99→02/06				24.0322-0150.1 522150	Ø 280 22 19 V + S PD
1.9 TDI 4x4	74	09/00→01/06	←	+PR 1LQ		24.0122-0151.1 422151	Ø 256 22 19 V + S
			←	+PR 1LQ		24.0322-0151.1 522151	Ø 256 22 19 V + S PD
			←	+PR 1LE,1LN,1ZE,1ZH		24.0125-0113.1 425113	Ø 288 25 22 V + S
			←	+PR 1LE,1LN,1ZE,1ZH		24.0325-0113.1 525113	Ø 288 25 22 V + S PD
			→	+PR 1KE		24.0109-0133.1 409133	Ø 239 8,9 7 + S
			→	+PR 1KE		24.0309-0133.1 509133	Ø 239 8,9 7 + S PD
1.9 TDI	96	09/02→09/04	←	01/03→; +PR 1LR,1LS,1ZM		24.0122-0150.1 422150	Ø 280 22 19 V + S
			←	01/03→; +PR 1LR,1LS,1ZM		24.0322-0150.1 522150	Ø 280 22 19 V + S PD
			←	01/03→; +PR 1LQ		24.0122-0151.1 422151	Ø 256 22 19 V + S
			←	01/03→; +PR 1LQ		24.0322-0151.1 522151	Ø 256 22 19 V + S PD
			←	01/03→; +PR 1LE,1LN,1ZE,1ZH		24.0125-0113.1 425113	Ø 288 25 22 V + S
			←	01/03→; +PR 1LE,1LN,1ZE,1ZH		24.0325-0113.1 525113	Ø 288 25 22 V + S PD
			→	01/03→; +PR 1KK,1KS,1KP		24.0109-0123.1 409123	Ø 230 9 7 + S
			→	01/03→; +PR 1KK,1KS,1KP		24.0309-0123.1 509123	Ø 230 9 7 + S PD
2.0 4x4	85	08/00→09/04	←	05/01→; +PR 1LR,1LS,1ZM		24.0122-0150.1 422150	Ø 280 22 19 V + S
			←	05/01→; +PR 1LR,1LS,1ZM		24.0322-0150.1 522150	Ø 280 22 19 V + S PD











	kw			 	! #		
SKODA - OCTAVIA I Combi (1U5) 07/98→12/10							
Bremsscheibe							
2.0 4x4	85	08/00→09/04	←	05/01→; +PR 1LQ	24.0122-0151.1 422151	Ø 256 22 19 V + S	
					24.0322-0151.1 522151	Ø 256 22 19 V + S PD	
			←	05/01→; +PR 1LE,1LN,1ZE,1ZH	24.0125-0113.1 425113	Ø 288 25 22 V + S	
					24.0325-0113.1 525113	Ø 288 25 22 V + S PD	
2.0 4x4	88	01/00→12/10	→	06/10; +PR 1LR,1LS,1ZM	24.0122-0150.1 422150	Ø 280 22 19 V + S	
					24.0322-0150.1 522150	Ø 280 22 19 V + S PD	
			←	06/10; +PR 1LQ	24.0122-0151.1 422151	Ø 256 22 19 V + S	
					24.0322-0151.1 522151	Ø 256 22 19 V + S PD	
2.0 4x4	88	01/00→12/10	←	06/10; +PR 1LE,1LN,1ZE,1ZH	24.0125-0113.1 425113	Ø 288 25 22 V + S	
					24.0325-0113.1 525113	Ø 288 25 22 V + S PD	
			→	06/10; +PR 1KE	24.0109-0133.1 409133	Ø 239 8,9 7 + S	
					24.0309-0133.1 509133	Ø 239 8,9 7 + S PD	
RS 1.8 T	132	08/02→01/06	←	+PR 1ZN	24.0125-0123.1 425123	Ø 310 25 22 V + S	
					24.0325-0123.1 525123	Ø 310 25 22 V PD	
			→	01/03→; +PR 2ED	24.0122-0163.1 422163	Ø 256 22 20 V	
				24.0322-0163.1 522163	Ø 256 22 20 V PD		
SKODA - OCTAVIA II Combi (1Z5) 02/04→06/13							
Bremsbelagsatz, Scheibenbremse							
1.2 TSI 1.4 1.4 TSI 1.6 TSI 1.6 TDI 1.8 TSI 1.8 TSI 2.0 TDI 2.0 TDI 4x4	77 59 90 75 77 112 118 81 81	02/10→04/13 05/06→06/13 11/08→06/13 09/04→06/13 06/09→04/13 03/09→06/13 06/07→04/13 03/10→06/13 05/11→02/13	←	01/13; +PR 1ZF,1ZM,1ZC	13.0460-7117.2 607117	VW 23130 19,6 + WK	
					13.0470-7117.2 LD7117	VW 23130 19,6 + WK Ceramic	
			←	01/13; +PR 1ZE	13.0460-7184.2 607184	ATE 23587 20,6 + WK	
					13.0470-7184.2 LD7184	ATE 23587 20,6 + WK Ceramic	
			→	01/13; +PR 1KF	13.0460-2749.2 602749	TRW 24483 16,9 - WE / - WK + Zub	
					13.0460-2880.2 602880	TRW 23914 17,1 + WE / - WK + Zub	
					13.0470-2749.2 LD2749	TRW 24483 16,9 - WE / - WK + Zub Ceramic	
					13.0470-2880.2 LD2880	TRW 23914 17,1 + WE / - WK + Zub Ceramic	
			→	01/13; +PR 1KD	13.0460-2820.2 602820	TRW 20961 17,2 - WK	
					13.0470-2820.2 LD2820	TRW 20961 17,2 - WK Ceramic	
		→	01/13; +PR 1KS,1KT	13.0460-3858.2 603858	BOS 24563 17,7 - WE / - WK + Zub		
				13.0470-3858.2 LD3858	BOS 24563 17,7 - WE / - WK + Zub Ceramic		
1.4 1.6 FSI 2.0 TDI 16V	55 85 100	05/04→05/06 02/04→10/08 02/04→05/10	←	06/04→; +PR 1ZF,1ZM,1ZC	13.0460-7117.2 607117	VW 23130 19,6 + WK	
					13.0470-7117.2 LD7117	VW 23130 19,6 + WK Ceramic	
			←	06/04→; +PR 1ZE	13.0460-7184.2 607184	ATE 23587 20,6 + WK	
					13.0470-7184.2 LD7184	ATE 23587 20,6 + WK Ceramic	
			→	06/04→; +PR 1KF	13.0460-2749.2 602749	TRW 24483 16,9 - WE / - WK + Zub	
					13.0460-2880.2 602880	TRW 23914 17,1 + WE / - WK + Zub	
					13.0470-2749.2 LD2749	TRW 24483 16,9 - WE / - WK + Zub Ceramic	
		13.0470-2880.2 LD2880	TRW 23914 17,1 + WE / - WK + Zub Ceramic				
→	06/04→; +PR 1KD	13.0460-2820.2 602820	TRW 20961 17,2 - WK				
		13.0470-2820.2 LD2820	TRW 20961 17,2 - WK Ceramic				
		→	06/04→; +PR 1KS,1KT	13.0460-3858.2 603858	BOS 24563 17,7 - WE / - WK + Zub		
				13.0470-3858.2 LD3858	BOS 24563 17,7 - WE / - WK + Zub Ceramic		
1.6 LPG	75	08/09→11/12	←	09/09→; +PR 1ZF,1ZM,1ZC	13.0460-7117.2 607117	VW 23130 19,6 + WK	
					13.0470-7117.2 LD7117	VW 23130 19,6 + WK Ceramic	
			←	09/09→; +PR 1ZE	13.0460-7184.2 607184	ATE 23587 20,6 + WK	
				13.0470-7184.2 LD7184	ATE 23587 20,6 + WK Ceramic		
		→	09/09→; +PR 1KF	13.0460-2749.2 602749	TRW 24483 16,9 - WE / - WK + Zub		
				13.0460-2880.2 602880	TRW 23914 17,1 + WE / - WK + Zub		







	kw			 	! #		
SKODA - OCTAVIA II Combi (1Z5) 02/04→06/13							
 Bremsbelagsatz, Scheibenbremse							
1.6 LPG	75	08/09→11/12	➡	09/09→; +PR 1KF	13.0470-2749.2	LD2749	TRW 24483 16,9 - WE / - WK + Zub Ceramic
					13.0470-2880.2	LD2880	TRW 23914 17,1 + WE / - WK + Zub Ceramic
			➡	09/09→; +PR 1KD	13.0460-2820.2	602820	TRW 20961 17,2 - WK
					13.0470-2820.2	LD2820	TRW 20961 17,2 - WK Ceramic
		➡	09/09→; +PR 1KS,1KT	13.0460-3858.2	603858	BOS 24563 17,7 - WE / - WK + Zub	
				13.0470-3858.2	LD3858	BOS 24563 17,7 - WE / - WK + Zub Ceramic	
1.6 MultiFuel	75	01/08→06/13	←	09/09→; +PR 1ZF,1ZM,1ZC; → 01/13	13.0460-7117.2	607117	VW 23130 19,6 + WK
					13.0470-7117.2	LD7117	VW 23130 19,6 + WK Ceramic
			←	09/09→; +PR 1ZE; → 01/13	13.0460-7184.2	607184	ATE 23587 20,6 + WK
					13.0470-7184.2	LD7184	ATE 23587 20,6 + WK Ceramic
			➡	09/09→; +PR 1KF; → 01/13	13.0460-2749.2	602749	TRW 24483 16,9 - WE / - WK + Zub
					13.0460-2880.2	602880	TRW 23914 17,1 + WE / - WK + Zub
					13.0470-2749.2	LD2749	TRW 24483 16,9 - WE / - WK + Zub Ceramic
				13.0470-2880.2	LD2880	TRW 23914 17,1 + WE / - WK + Zub Ceramic	
		➡	09/09→; +PR 1KD; → 01/13	13.0460-2820.2	602820	TRW 20961 17,2 - WK	
				13.0470-2820.2	LD2820	TRW 20961 17,2 - WK Ceramic	
		➡	09/09→; +PR 1KS,1KT; → 01/13	13.0460-3858.2	603858	BOS 24563 17,7 - WE / - WK + Zub	
				13.0470-3858.2	LD3858	BOS 24563 17,7 - WE / - WK + Zub Ceramic	
1.6 TDI 4x4 1.8 TSI 4x4 1.8 TSI 4x4 2.0 TDI 16V 4x4	77 112 118 103	06/09→02/13 03/09→02/13 11/08→02/13 05/10→02/13	←	→ 01/13; +PR 1ZF,1ZM,1ZC	13.0460-7117.2	607117	VW 23130 19,6 + WK
					13.0470-7117.2	LD7117	VW 23130 19,6 + WK Ceramic
			←	→ 01/13; +PR 1ZE	13.0460-7184.2	607184	ATE 23587 20,6 + WK
					13.0470-7184.2	LD7184	ATE 23587 20,6 + WK Ceramic
			➡	→ 01/13; +PR 1KF	13.0460-2749.2	602749	TRW 24483 16,9 - WE / - WK + Zub
					13.0460-2880.2	602880	TRW 23914 17,1 + WE / - WK + Zub
		13.0470-2749.2	LD2749	TRW 24483 16,9 - WE / - WK + Zub Ceramic			
				13.0470-2880.2	LD2880	TRW 23914 17,1 + WE / - WK + Zub Ceramic	
		➡	→ 01/13; +PR 1KS,1KT	13.0460-3858.2	603858	BOS 24563 17,7 - WE / - WK + Zub	
				13.0470-3858.2	LD3858	BOS 24563 17,7 - WE / - WK + Zub Ceramic	
1.9 TDI 2.0 FSI 2.0 TDI	77 110 103	09/04→12/10 11/04→10/08 11/05→05/10	←	+PR 1ZF,1ZM,1ZC	13.0460-7117.2	607117	VW 23130 19,6 + WK
					13.0470-7117.2	LD7117	VW 23130 19,6 + WK Ceramic
			←	+PR 1ZE	13.0460-7184.2	607184	ATE 23587 20,6 + WK
					13.0470-7184.2	LD7184	ATE 23587 20,6 + WK Ceramic
			➡	+PR 1KF	13.0460-2749.2	602749	TRW 24483 16,9 - WE / - WK + Zub
					13.0460-2880.2	602880	TRW 23914 17,1 + WE / - WK + Zub
					13.0470-2749.2	LD2749	TRW 24483 16,9 - WE / - WK + Zub Ceramic
				13.0470-2880.2	LD2880	TRW 23914 17,1 + WE / - WK + Zub Ceramic	
		➡	+PR 1KD	13.0460-2820.2	602820	TRW 20961 17,2 - WK	
				13.0470-2820.2	LD2820	TRW 20961 17,2 - WK Ceramic	
		➡	+PR 1KS,1KT	13.0460-3858.2	603858	BOS 24563 17,7 - WE / - WK + Zub	
				13.0470-3858.2	LD3858	BOS 24563 17,7 - WE / - WK + Zub Ceramic	
1.9 TDI 4x4 2.0 FSI 4x4 2.0 TDI 4x4	77 110 103	11/04→12/10 11/04→10/08 07/06→05/10	←	+PR 1ZF,1ZM,1ZC	13.0460-7117.2	607117	VW 23130 19,6 + WK
					13.0470-7117.2	LD7117	VW 23130 19,6 + WK Ceramic
			←	+PR 1ZE	13.0460-7184.2	607184	ATE 23587 20,6 + WK
				13.0470-7184.2	LD7184	ATE 23587 20,6 + WK Ceramic	
↓							







	kw			 	! #		
SKODA - OCTAVIA II Combi (1Z5) 02/04→06/13							
 Bremsbelagsatz, Scheibenbremse							
1.9 TDI 4x4 2.0 FSI 4x4 2.0 TDI 4x4	77 110 103	11/04→12/10 11/04→10/08 07/06→05/10	➡	+PR 1KF		13.0460-2749.2 602749 13.0460-2880.2 602880 13.0470-2749.2 LD2749 13.0470-2880.2 LD2880	TRW 24483 16,9 - WE / - WK + Zub TRW 23914 17,1 + WE / - WK + Zub TRW 24483 16,9 - WE / - WK + Zub Ceramic TRW 23914 17,1 + WE / - WK + Zub Ceramic
			➡	+PR 1KS,1KT		13.0460-3858.2 603858 13.0470-3858.2 LD3858	BOS 24563 17,7 - WE / - WK + Zub BOS 24563 17,7 - WE / - WK + Zub Ceramic
2.0 RS 2.0 TDI RS	147 125	10/05→02/13 04/06→02/13	⬅	+PR 1LL,1LP,1ZB; → 01/13		13.0460-7184.2 607184 13.0470-7184.2 LD7184	ATE 23587 20,6 + WK ATE 23587 20,6 + WK Ceramic
			➡	+PR 1KP; → 01/13		13.0460-2749.2 602749 13.0460-2880.2 602880 13.0470-2749.2 LD2749 13.0470-2880.2 LD2880	TRW 24483 16,9 - WE / - WK + Zub TRW 23914 17,1 + WE / - WK + Zub TRW 24483 16,9 - WE / - WK + Zub Ceramic TRW 23914 17,1 + WE / - WK + Zub Ceramic
			➡	→ 01/13; +PR 1KS,1KT		13.0460-3858.2 603858 13.0470-3858.2 LD3858	BOS 24563 17,7 - WE / - WK + Zub BOS 24563 17,7 - WE / - WK + Zub Ceramic
2.0 TDI 16V	103	02/04→05/13	⬅	06/04→ 01/13; +PR 1ZF,1ZM,1ZC		13.0460-7117.2 607117 13.0470-7117.2 LD7117	VW 23130 19,6 + WK VW 23130 19,6 + WK Ceramic
			⬅	06/04→ 01/13; +PR 1ZE		13.0460-7184.2 607184 13.0470-7184.2 LD7184	ATE 23587 20,6 + WK ATE 23587 20,6 + WK Ceramic
			➡	06/04→ 01/13; +PR 1KF		13.0460-2749.2 602749 13.0460-2880.2 602880 13.0470-2749.2 LD2749 13.0470-2880.2 LD2880	TRW 24483 16,9 - WE / - WK + Zub TRW 23914 17,1 + WE / - WK + Zub TRW 24483 16,9 - WE / - WK + Zub Ceramic TRW 23914 17,1 + WE / - WK + Zub Ceramic
			➡	06/04→ 01/13; +PR 1KD		13.0460-2820.2 602820 13.0470-2820.2 LD2820	TRW 20961 17,2 - WK TRW 20961 17,2 - WK Ceramic
			➡	06/04→ 01/13; +PR 1KS,1KT		13.0460-3858.2 603858 13.0470-3858.2 LD3858	BOS 24563 17,7 - WE / - WK + Zub BOS 24563 17,7 - WE / - WK + Zub Ceramic
 Bremsscheibe							
1.2 TSI 1.4 TSI 1.6 TDI 2.0 TDI 2.0 TDI 4x4	77 90 77 81 81	02/10→04/13 11/08→06/13 06/09→04/13 03/10→06/13 05/11→02/13	⬅	+PR 1ZF,1ZM; → 01/13		24.0122-0210.1 422210 24.0322-0210.1 522210	Ø 280 22 19 V + S Ø 280 22 19 V + S PD
			⬅	→ 01/13; +PR 1ZE		24.0125-0145.1 425145 24.0325-0145.1 525145	Ø 288 25 22 V + S Ø 288 25 22 V + S PD
			➡	→ 01/13; +PR 1KD		24.0110-0277.1 410277 24.0310-0277.1 510277	Ø 253 10 8 + S Ø 253 10 8 + S PD
			➡	→ 01/13; +PR 1KS,1KT		24.0110-0356.1 410356 24.0310-0356.1 510356	Ø 272 9,7 8 + S Ø 272 9,7 8 + S PD
			➡	→ 01/13; +PR 1KF		24.0112-0158.1 412158 24.0312-0158.1 512158	Ø 256 12 10 + S Ø 256 12 10 PD
1.4 1.6 FSI 2.0 TDI 16V	55 85 100	05/04→05/06 02/04→10/08 02/04→05/10	⬅	06/04→; +PR 1ZF,1ZM		24.0122-0210.1 422210 24.0322-0210.1 522210	Ø 280 22 19 V + S Ø 280 22 19 V + S PD
			⬅	06/04→; +PR 1ZE		24.0125-0145.1 425145 24.0325-0145.1 525145	Ø 288 25 22 V + S Ø 288 25 22 V + S PD
			➡	06/04→; +PR 1KD		24.0110-0277.1 410277 24.0310-0277.1 510277	Ø 253 10 8 + S Ø 253 10 8 + S PD
			➡	06/04→; +PR 1KS,1KT		24.0110-0356.1 410356 24.0310-0356.1 510356	Ø 272 9,7 8 + S Ø 272 9,7 8 + S PD
			➡	06/04→; +PR 1KF		24.0112-0158.1 412158 24.0312-0158.1 512158	Ø 256 12 10 + S Ø 256 12 10 PD
↓							























	kw			 	! #		
SKODA - OCTAVIA II Combi (1Z5) 02/04→06/13							
Bremsscheibe							
1.4 1.6 1.8 TSI 1.8 TSI	59 75 112 118	05/06→06/13 09/04→06/13 03/09→06/13 06/07→04/13	← ← → → →	→ 01/13; +PR 1ZF;1ZM → 01/13; +PR 1ZE → 01/13; +PR 1KD → 01/13; +PR 1KS,1KT → 01/13; +PR 1KF		24.0122-0210.1 422210 24.0322-0210.1 522210 24.0125-0145.1 425145 24.0325-0145.1 525145 24.0110-0277.1 410277 24.0310-0277.1 510277 24.0110-0356.1 410356 24.0310-0356.1 510356 24.0112-0158.1 412158 24.0312-0158.1 512158	Ø 280 22 19 V + S Ø 280 22 19 V + S PD Ø 288 25 22 V + S Ø 288 25 22 V + S PD Ø 253 10 8 + S Ø 253 10 8 + S PD Ø 272 9,7 8 + S Ø 272 9,7 8 + S PD Ø 256 12 10 + S Ø 256 12 10 PD
1.6 LPG	75	08/09→11/12	← ← → → →	09/09→; +PR 1ZF,1ZM 09/09→; +PR 1ZE 09/09→; +PR 1KD 09/09→; +PR 1KS,1KT 09/09→; +PR 1KF		24.0122-0210.1 422210 24.0322-0210.1 522210 24.0125-0145.1 425145 24.0325-0145.1 525145 24.0110-0277.1 410277 24.0310-0277.1 510277 24.0110-0356.1 410356 24.0310-0356.1 510356 24.0112-0158.1 412158 24.0312-0158.1 512158	Ø 280 22 19 V + S Ø 280 22 19 V + S PD Ø 288 25 22 V + S Ø 288 25 22 V + S PD Ø 253 10 8 + S Ø 253 10 8 + S PD Ø 272 9,7 8 + S Ø 272 9,7 8 + S PD Ø 256 12 10 + S Ø 256 12 10 PD
1.6 MultiFuel	75	01/08→06/13	← ← → → →	09/09→; +PR 1ZF,1ZM; → 01/13 09/09→; +PR 1ZE; → 01/13 09/09→; +PR 1KD; → 01/13 09/09→; +PR 1KS,1KT; → 01/13 09/09→; +PR 1KF; → 01/13		24.0122-0210.1 422210 24.0322-0210.1 522210 24.0125-0145.1 425145 24.0325-0145.1 525145 24.0110-0277.1 410277 24.0310-0277.1 510277 24.0110-0356.1 410356 24.0310-0356.1 510356 24.0112-0158.1 412158 24.0312-0158.1 512158	Ø 280 22 19 V + S Ø 280 22 19 V + S PD Ø 288 25 22 V + S Ø 288 25 22 V + S PD Ø 253 10 8 + S Ø 253 10 8 + S PD Ø 272 9,7 8 + S Ø 272 9,7 8 + S PD Ø 256 12 10 + S Ø 256 12 10 PD
1.6 TDI 4x4 1.8 TSI 4x4 1.8 TSI 4x4 2.0 TDI 16V 4x4	77 112 118 103	06/09→02/13 03/09→02/13 11/08→02/13 05/10→02/13	← ← → →	+PR 1ZF,1ZM; → 01/13 → 01/13; +PR 1ZE → 01/13; +PR 1KS,1KT → 01/13; +PR 1KF		24.0122-0210.1 422210 24.0322-0210.1 522210 24.0125-0145.1 425145 24.0325-0145.1 525145 24.0110-0356.1 410356 24.0310-0356.1 510356 24.0112-0158.1 412158 24.0312-0158.1 512158	Ø 280 22 19 V + S Ø 280 22 19 V + S PD Ø 288 25 22 V + S Ø 288 25 22 V + S PD Ø 272 9,7 8 + S Ø 272 9,7 8 + S PD Ø 256 12 10 + S Ø 256 12 10 PD
1.9 TDI 2.0 FSI 2.0 TDI	77 110 103	09/04→12/10 11/04→10/08 11/05→05/10	← ← → → →	+PR 1ZF;1ZM +PR 1ZE +PR 1KD +PR 1KS,1KT +PR 1KF		24.0122-0210.1 422210 24.0322-0210.1 522210 24.0125-0145.1 425145 24.0325-0145.1 525145 24.0110-0277.1 410277 24.0310-0277.1 510277 24.0110-0356.1 410356 24.0310-0356.1 510356 24.0112-0158.1 412158 24.0312-0158.1 512158	Ø 280 22 19 V + S Ø 280 22 19 V + S PD Ø 288 25 22 V + S Ø 288 25 22 V + S PD Ø 253 10 8 + S Ø 253 10 8 + S PD Ø 272 9,7 8 + S Ø 272 9,7 8 + S PD Ø 256 12 10 + S Ø 256 12 10 PD
1.9 TDI 4x4 2.0 FSI 4x4 2.0 TDI 4x4	77 110 103	11/04→12/10 11/04→10/08 07/06→05/10	← ← → →	+PR 1ZF,1ZM +PR 1ZE +PR 1KS,1KT +PR 1KF		24.0122-0210.1 422210 24.0322-0210.1 522210 24.0125-0145.1 425145 24.0325-0145.1 525145 24.0110-0356.1 410356 24.0310-0356.1 510356 24.0112-0158.1 412158 24.0312-0158.1 512158	Ø 280 22 19 V + S Ø 280 22 19 V + S PD Ø 288 25 22 V + S Ø 288 25 22 V + S PD Ø 272 9,7 8 + S Ø 272 9,7 8 + S PD Ø 256 12 10 + S Ø 256 12 10 PD
2.0 RS 2.0 TDI RS	147 125	10/05→02/13 04/06→02/13	← → →	→ 01/13; +PR 1LL,1LP,1ZB → 01/13; +PR 1KS,1KT → 01/13; +PR 1KP		24.0125-0158.1 425158 24.0325-0158.1 525158 24.0110-0356.1 410356 24.0310-0356.1 510356 24.0112-0169.1 412169	Ø 312 25 22 V + S Ø 312 25 22 V + S PD Ø 272 9,7 8 + S Ø 272 9,7 8 + S PD Ø 282 12 10 + S
↓							











	kw			 	! #		
SKODA - OCTAVIA II Combi (1Z5) 02/04→06/13							
 Bremsscheibe							
2.0 RS	147	10/05→02/13	→	→ 01/13; +PR 1KP		24.0312-0169.1 512169	Ø 282 12 10 + S PD
2.0 TDI RS	125	04/06→02/13					
2.0 TDI 16V	103	02/04→05/13	←	06/04→ 01/13; +PR 1ZF;1ZM		24.0122-0210.1 422210	Ø 280 22 19 V + S
						24.0322-0210.1 522210	Ø 280 22 19 V + S PD
			←	06/04→ 01/13; +PR 1ZE		24.0125-0145.1 425145	Ø 288 25 22 V + S
						24.0325-0145.1 525145	Ø 288 25 22 V + S PD
			→	06/04→ 01/13; +PR 1KD		24.0110-0277.1 410277	Ø 253 10 8 + S
						24.0310-0277.1 510277	Ø 253 10 8 + S PD
			→	06/04→ 01/13; +PR 1KS,1KT		24.0110-0356.1 410356	Ø 272 9,7 8 + S
			24.0310-0356.1 510356	Ø 272 9,7 8 + S PD			
			→	06/04→ 01/13; +PR 1KF		24.0112-0158.1 412158	Ø 256 12 10 + S
						24.0312-0158.1 512158	Ø 256 12 10 PD
SKODA - OCTAVIA III (5E3) 11/12→							
 Bremsbelagsatz, Scheibenbremse							
1.0 TSI	85	05/16→	←	+PR 1ZA,1ZB,1ZE		13.0460-2785.2 602785	TRW 25683 20,4 + WE / + WK
1.2 TSI	81	05/15→				13.0470-2785.2 LD2785	TRW 25683 20,4 + WE / + WK Ceramic
1.4 TSI	103	11/12→					
1.4 TSI G-TEC	81	11/13→					
1.6	81	01/14→	←	+PR 1ZF		13.0460-7303.2 607303	ATE 22035 17,5 + WK
1.6 TDI	81	05/13→				13.0470-7303.2 LD7303	ATE 22035 17,5 + WK Ceramic
1.6 TDI	85	02/17→	→	+PR 1KD		13.0460-2787.2 602787	TRW 23554 17,3 - WK / - WE
1.6 TDI 4x4	77	09/14→					
1.6 TDI 4x4	81	05/15→	→	+PR 1KS,1KT		13.0460-2790.2 602790	TRW 25110 17,5 - WE / - WK
1.8 TSI	132	11/12→				13.0470-2790.2 LD2790	TRW 25110 17,5 - WE / - WK Ceramic
1.8 TSI 4x4	132	09/14→					
2.0 TDI	105	11/12→					
2.0 TDI / TDI RS 4x4	135	09/14→	→	+PR 1KW		13.0460-2887.2 602887	TRW 23914 17,1 + WE / - WK + Zub
2.0 TDI 4x4	110	09/14→					
2.0 TDI RS	135	05/13→				13.0470-2621.2 LD2621	TRW - WE / - WK + Zub Ceramic
2.0 TSI RS	162	05/13→				13.0470-2887.2 LD2887	TRW 23914 17,1 + WE / - WK + Zub Ceramic
2.0 TSI RS	169	05/15→					
2.0 TSI RS	180	02/17→					
1.2 TSI	63	11/12→	←	02/13→; +PR 1ZA,1ZB,1ZE		13.0460-2785.2 602785	TRW 25683 20,4 + WE / + WK
1.2 TSI	77	11/12→				13.0470-2785.2 LD2785	TRW 25683 20,4 + WE / + WK Ceramic
1.6 TDI	66	11/12→					
1.6 TDI	77	11/12→					
2.0 TDI	110	11/12→	←	02/13→; +PR 1ZF		13.0460-7303.2 607303	ATE 22035 17,5 + WK
						13.0470-7303.2 LD7303	ATE 22035 17,5 + WK Ceramic
			→	02/13→; +PR 1KD		13.0460-2787.2 602787	TRW 23554 17,3 - WK / - WE
			→	02/13→; +PR 1KS,1KT		13.0460-2790.2 602790	TRW 25110 17,5 - WE / - WK
						13.0470-2790.2 LD2790	TRW 25110 17,5 - WE / - WK Ceramic
			→	02/13→; +PR 1KW		13.0460-2887.2 602887	TRW 23914 17,1 + WE / - WK + Zub
						13.0470-2621.2 LD2621	TRW - WE / - WK + Zub Ceramic
						13.0470-2887.2 LD2887	TRW 23914 17,1 + WE / - WK + Zub Ceramic
1.4 TSI	110	08/14→	←	05/15→; +PR 1ZA,1ZB,1ZE		13.0460-2785.2 602785	TRW 25683 20,4 + WE / + WK
						13.0470-2785.2 LD2785	TRW 25683 20,4 + WE / + WK Ceramic
			←	05/15→; +PR 1ZF		13.0460-7303.2 607303	ATE 22035 17,5 + WK
						13.0470-7303.2 LD7303	ATE 22035 17,5 + WK Ceramic
			→	05/15→; +PR 1KD		13.0460-2787.2 602787	TRW 23554 17,3 - WK / - WE
			→	05/15→; +PR 1KS,1KT		13.0460-2790.2 602790	TRW 25110 17,5 - WE / - WK
						13.0470-2790.2 LD2790	TRW 25110 17,5 - WE / - WK Ceramic
			→	05/15→; +PR 1KW		13.0460-2887.2 602887	TRW 23914 17,1 + WE / - WK + Zub
						13.0470-2621.2 LD2621	TRW - WE / - WK + Zub Ceramic
						13.0470-2887.2 LD2887	TRW 23914 17,1 + WE / - WK + Zub Ceramic
 Bremsscheibe							
1.0 TSI	85	05/16→	←	+PR 1ZF		24.0124-0258.1 424258	Ø 276 24 21 V + S
1.2 TSI	81	05/15→				24.0125-0145.1 425145	Ø 288 25 22 V + S
1.4 TSI	103	11/12→	←	+PR 1ZE		24.0325-0145.1 525145	Ø 288 25 22 V + S PD
1.4 TSI G-TEC	81	11/13→					
1.6	81	01/14→	←	+PR 1ZA,1ZB		24.0125-0158.1 425158	Ø 312 25 22 V + S
1.6 TDI	81	05/13→				24.0325-0158.1 525158	Ø 312 25 22 V + S PD
1.6 TDI	85	02/17→					
↓							











	kw			 	! #		
SKODA - OCTAVIA III (5E3) 11/12→							
Bremsscheibe							
1.6 TDI 4x4	77	09/14→	←	+PR 1LG		24.0130-0225.1 430225	Ø 340 30 27 V + S
1.6 TDI 4x4	81	05/15→	→	+PR 1KD		24.0110-0277.1 410277	Ø 253 10 8 + S
1.8 TSI	132	11/12→				24.0310-0277.1 510277	Ø 253 10 8 + S PD
1.8 TSI 4x4	132	09/14→					
2.0 TDI	105	11/12→	→	+PR 1KS,1KT		24.0110-0356.1 410356	Ø 272 9,7 8 + S
2.0 TDI / TDI RS 4x4	135	09/14→				24.0310-0356.1 510356	Ø 272 9,7 8 + S PD
2.0 TDI 4x4	110	09/14→					
2.0 TDI RS	135	05/13→					
2.0 TSI RS	162	05/13→					
2.0 TSI RS	169	05/15→					
2.0 TSI RS	180	02/17→					
1.2 TSI	63	11/12→	←	02/13→; +PR 1ZF		24.0124-0258.1 424258	Ø 276 24 21 V + S
1.2 TSI	77	11/12→	←	02/13→; +PR 1ZE		24.0125-0145.1 425145	Ø 288 25 22 V + S
1.6 TDI	66	11/12→				24.0325-0145.1 525145	Ø 288 25 22 V + S PD
1.6 TDI	77	11/12→	←	02/13→; +PR 1ZA,1ZB		24.0125-0158.1 425158	Ø 312 25 22 V + S
2.0 TDI	110	11/12→				24.0325-0158.1 525158	Ø 312 25 22 V + S PD
			←	02/13→; +PR 1LG		24.0130-0225.1 430225	Ø 340 30 27 V + S
			→	02/13→; +PR 1KD		24.0110-0277.1 410277	Ø 253 10 8 + S
						24.0310-0277.1 510277	Ø 253 10 8 + S PD
			→	02/13→; +PR 1KS,1KT		24.0110-0356.1 410356	Ø 272 9,7 8 + S
						24.0310-0356.1 510356	Ø 272 9,7 8 + S PD
1.4 TSI	110	08/14→	←	05/15→; +PR 1ZF		24.0124-0258.1 424258	Ø 276 24 21 V + S
			←	05/15→; +PR 1ZE		24.0125-0145.1 425145	Ø 288 25 22 V + S
						24.0325-0145.1 525145	Ø 288 25 22 V + S PD
			←	05/15→; +PR 1ZA,1ZB		24.0125-0158.1 425158	Ø 312 25 22 V + S
						24.0325-0158.1 525158	Ø 312 25 22 V + S PD
			←	05/15→; +PR 1LG		24.0130-0225.1 430225	Ø 340 30 27 V + S
			→	05/15→; +PR 1KD		24.0110-0277.1 410277	Ø 253 10 8 + S
						24.0310-0277.1 510277	Ø 253 10 8 + S PD
			→	05/15→; +PR 1KS,1KT		24.0110-0356.1 410356	Ø 272 9,7 8 + S
						24.0310-0356.1 510356	Ø 272 9,7 8 + S PD
SKODA - OCTAVIA III Combi (5E5) 11/12→							
Bremsbelagsatz, Scheibenbremse							
1.0 TSI	85	05/16→	←	+PR 1ZA,1ZB,1ZE		13.0460-2785.2 602785	TRW 25683 20,4 + WE / + WK
1.2 TSI	81	05/15→				13.0470-2785.2 LD2785	TRW 25683 20,4 + WE / + WK Ceramic
1.4 TSI	103	11/12→					
1.4 TSI G-TEC	81	11/13→	←	+PR 1ZF		13.0460-7303.2 607303	ATE 22035 17,5 + WK
1.6	81	01/14→				13.0470-7303.2 LD7303	ATE 22035 17,5 + WK Ceramic
1.6 TDI	81	05/13→					
1.6 TDI	85	02/17→	→	+PR 1KD		13.0460-2787.2 602787	TRW 23554 17,3 - WK / - WE
1.6 TDI 4x4	77	11/12→	→	+PR 1KS,1KT		13.0460-2790.2 602790	TRW 25110 17,5 - WE / - WK
1.6 TDI 4x4	81	05/15→				13.0470-2790.2 LD2790	TRW 25110 17,5 - WE / - WK Ceramic
1.8 TSI	132	11/12→					
1.8 TSI 4x4	132	11/12→					
2.0 TDI	105	11/12→	→	+PR 1KW		13.0460-2887.2 602887	TRW 23914 17,1 + WE / - WK + Zub
2.0 TDI / TDI RS 4x4	135	09/14→				13.0470-2621.2 LD2621	TRW - WE / - WK + Zub Ceramic
2.0 TDI 4x4	110	11/12→				13.0470-2887.2 LD2887	TRW 23914 17,1 + WE / - WK + Zub Ceramic
2.0 TDI RS	135	05/13→					
2.0 TSI RS	169	05/15→					
2.0 TSI RS	180	02/17→					
1.2 TSI	63	11/12→	←	02/13→; +PR 1ZA,1ZB,1ZE		13.0460-2785.2 602785	TRW 25683 20,4 + WE / + WK
1.2 TSI	77	11/12→				13.0470-2785.2 LD2785	TRW 25683 20,4 + WE / + WK Ceramic
1.6 TDI	66	11/12→					
1.6 TDI	77	11/12→	←	02/13→; +PR 1ZF		13.0460-7303.2 607303	ATE 22035 17,5 + WK
2.0 TDI	110	11/12→				13.0470-7303.2 LD7303	ATE 22035 17,5 + WK Ceramic
			→	02/13→; +PR 1KD		13.0460-2787.2 602787	TRW 23554 17,3 - WK / - WE
			→	02/13→; +PR 1KS,1KT		13.0460-2790.2 602790	TRW 25110 17,5 - WE / - WK
						13.0470-2790.2 LD2790	TRW 25110 17,5 - WE / - WK Ceramic
			→	02/13→; +PR 1KW		13.0460-2887.2 602887	TRW 23914 17,1 + WE / - WK + Zub
						13.0470-2621.2 LD2621	TRW - WE / - WK + Zub Ceramic
						13.0470-2887.2 LD2887	TRW 23914 17,1 + WE / - WK + Zub Ceramic
1.4 TSI	110	08/14→	←	05/15→; +PR 1ZA,1ZB,1ZE		13.0460-2785.2 602785	TRW 25683 20,4 + WE / + WK
						13.0470-2785.2 LD2785	TRW 25683 20,4 + WE / + WK Ceramic
↓							







	kw			 	! #		
SKODA - OCTAVIA III Combi (5E5) 11/12→							
Bremsbelagsatz, Scheibenbremse							
1.4 TSI	110	08/14→	←	05/15→; +PR 1ZF	13.0460-7303.2 607303	ATE 22035 17,5 + WK	
			→	05/15→; +PR 1KD	13.0470-7303.2 LD7303	ATE 22035 17,5 + WK Ceramic	
			→	05/15→; +PR 1KS,1KT	13.0460-2787.2 602787	TRW 23554 17,3 - WK / - WE	
			→	05/15→; +PR 1KW	13.0460-2790.2 602790	TRW 25110 17,5 - WE / - WK	
			→	05/15→; +PR 1KW	13.0470-2790.2 LD2790	TRW 25110 17,5 - WE / - WK Ceramic	
			→	05/15→; +PR 1KW	13.0460-2887.2 602887	TRW 23914 17,1 + WE / - WK + Zub	
					13.0470-2621.2 LD2621	TRW - WE / - WK + Zub Ceramic	
					13.0470-2887.2 LD2887	TRW 23914 17,1 + WE / - WK + Zub Ceramic	
2.0 TSI RS	162	11/12→	←	05/13→; +PR 1ZA,1ZB,1ZE	13.0460-2785.2 602785	TRW 25683 20,4 + WE / + WK	
			←	05/13→; +PR 1ZF	13.0470-2785.2 LD2785	TRW 25683 20,4 + WE / + WK Ceramic	
			→	05/13→; +PR 1KD	13.0460-7303.2 607303	ATE 22035 17,5 + WK	
			→	05/13→; +PR 1KS,1KT	13.0470-7303.2 LD7303	ATE 22035 17,5 + WK Ceramic	
			→	05/13→; +PR 1KW	13.0460-2787.2 602787	TRW 23554 17,3 - WK / - WE	
			→	05/13→; +PR 1KW	13.0460-2790.2 602790	TRW 25110 17,5 - WE / - WK	
					13.0470-2790.2 LD2790	TRW 25110 17,5 - WE / - WK Ceramic	
			→	05/13→; +PR 1KW	13.0460-2887.2 602887	TRW 23914 17,1 + WE / - WK + Zub	
					13.0470-2621.2 LD2621	TRW - WE / - WK + Zub Ceramic	
					13.0470-2887.2 LD2887	TRW 23914 17,1 + WE / - WK + Zub Ceramic	
Bremsscheibe							
1.0 TSI	85	05/16→	←	+PR 1ZF	24.0124-0258.1 424258	Ø 276 24 21 V + S	
1.2 TSI	81	05/15→	←	+PR 1ZE	24.0125-0145.1 425145	Ø 288 25 22 V + S	
1.4 TSI	103	11/12→	←		24.0325-0145.1 525145	Ø 288 25 22 V + S PD	
1.4 TSI G-TEC	81	11/13→	←				
1.6	81	01/14→	←	+PR 1ZA,1ZB	24.0125-0158.1 425158	Ø 312 25 22 V + S	
1.6 TDI	81	05/13→	←		24.0325-0158.1 525158	Ø 312 25 22 V + S PD	
1.6 TDI	85	02/17→	←				
1.6 TDI 4x4	77	11/12→	←	+PR 1LG	24.0130-0225.1 430225	Ø 340 30 27 V + S	
1.6 TDI 4x4	81	05/15→	→	+PR 1KD	24.0110-0277.1 410277	Ø 253 10 8 + S	
1.8 TSI	132	11/12→	→		24.0310-0277.1 510277	Ø 253 10 8 + S PD	
1.8 TSI 4x4	132	11/12→	→				
2.0 TDI	105	11/12→	→	+PR 1KS,1KT	24.0110-0356.1 410356	Ø 272 9,7 8 + S	
2.0 TDI / TDI RS 4x4	135	09/14→	→		24.0310-0356.1 510356	Ø 272 9,7 8 + S PD	
2.0 TDI 4x4	110	11/12→	→				
2.0 TDI RS	135	05/13→	→				
2.0 TSI RS	169	05/15→	→				
2.0 TSI RS	180	02/17→	→				
1.2 TSI	63	11/12→	←	02/13→; +PR 1ZF	24.0124-0258.1 424258	Ø 276 24 21 V + S	
1.2 TSI	77	11/12→	←	02/13→; +PR 1ZE	24.0125-0145.1 425145	Ø 288 25 22 V + S	
1.6 TDI	66	11/12→	←		24.0325-0145.1 525145	Ø 288 25 22 V + S PD	
1.6 TDI	77	11/12→	←				
2.0 TDI	110	11/12→	←	02/13→; +PR 1ZA,1ZB	24.0125-0158.1 425158	Ø 312 25 22 V + S	
			←		24.0325-0158.1 525158	Ø 312 25 22 V + S PD	
			←	02/13→; +PR 1LG	24.0130-0225.1 430225	Ø 340 30 27 V + S	
			→	02/13→; +PR 1KD	24.0110-0277.1 410277	Ø 253 10 8 + S	
			→		24.0310-0277.1 510277	Ø 253 10 8 + S PD	
			→	02/13→; +PR 1KS,1KT	24.0110-0356.1 410356	Ø 272 9,7 8 + S	
			→		24.0310-0356.1 510356	Ø 272 9,7 8 + S PD	
1.4 TSI	110	08/14→	←	05/15→; +PR 1ZF	24.0124-0258.1 424258	Ø 276 24 21 V + S	
			←	05/15→; +PR 1ZE	24.0125-0145.1 425145	Ø 288 25 22 V + S	
			←		24.0325-0145.1 525145	Ø 288 25 22 V + S PD	
			←	05/15→; +PR 1ZA,1ZB	24.0125-0158.1 425158	Ø 312 25 22 V + S	
			←		24.0325-0158.1 525158	Ø 312 25 22 V + S PD	
			←	05/15→; +PR 1LG	24.0130-0225.1 430225	Ø 340 30 27 V + S	
			→	05/15→; +PR 1KD	24.0110-0277.1 410277	Ø 253 10 8 + S	
			→		24.0310-0277.1 510277	Ø 253 10 8 + S PD	
			→	05/15→; +PR 1KS,1KT	24.0110-0356.1 410356	Ø 272 9,7 8 + S	
			→		24.0310-0356.1 510356	Ø 272 9,7 8 + S PD	
2.0 TSI RS	162	11/12→	←	05/13→; +PR 1ZF	24.0124-0258.1 424258	Ø 276 24 21 V + S	
			←	05/13→; +PR 1ZE	24.0125-0145.1 425145	Ø 288 25 22 V + S	
					24.0325-0145.1 525145	Ø 288 25 22 V + S PD	









	kw				! #		
SKODA - OCTAVIA III Combi (5E5) 11/12→							
 Bremsscheibe							
2.0 TSI RS	162	11/12→	←	05/13→; +PR 1ZA,1ZB	24.0125-0158.1 425158	Ø 312 25 22 V + S	
					24.0325-0158.1 525158	Ø 312 25 22 V + S PD	
			←	05/13→; +PR 1LG	24.0130-0225.1 430225	Ø 340 30 27 V + S	
			→	05/13→; +PR 1KD	24.0110-0277.1 410277	Ø 253 10 8 + S	
					24.0310-0277.1 510277	Ø 253 10 8 + S PD	
			→	05/13→; +PR 1KS,1KT	24.0110-0356.1 410356	Ø 272 9,7 8 + S	
					24.0310-0356.1 510356	Ø 272 9,7 8 + S PD	
SKODA - RAPID (NH3) 07/12→							
 Bremsbelagsatz, Scheibenbremse							
1.2	55	07/12→	←	10/12→; +PR 1ZG	13.0460-7111.2 607111	VW 23130 19,6 - WE / - WK	
1.2 TSI	63	07/12→			13.0470-7111.2 LD7111	VW 23130 19,6 - WE / - WK Ceramic	
1.2 TSI	77	07/12→					
1.4 TSI	90	07/12→	←	10/12→; +PR 1ZC	13.0460-7184.2 607184	ATE 23587 20,6 + WK	
1.6 TDI	77	07/12→			13.0470-7184.2 LD7184	ATE 23587 20,6 + WK Ceramic	
			→	10/12→; +PR 1KT	13.0460-2820.2 602820	TRW 20961 17,2 - WK	
					13.0470-2820.2 LD2820	TRW 20961 17,2 - WK Ceramic	
1.2 TSI	66	05/15→	←	+PR 1ZG	13.0460-7111.2 607111	VW 23130 19,6 - WE / - WK	
1.2 TSI	81	05/15→			13.0470-7111.2 LD7111	VW 23130 19,6 - WE / - WK Ceramic	
1.4 TDI	66	05/15→					
1.4 TSI	92	05/15→	←	+PR 1ZC	13.0460-7184.2 607184	ATE 23587 20,6 + WK	
1.6	81	05/15→			13.0470-7184.2 LD7184	ATE 23587 20,6 + WK Ceramic	
1.6 TDI	66	08/13→	→	+PR 1KT	13.0460-2820.2 602820	TRW 20961 17,2 - WK	
1.6 TDI	85	05/15→			13.0470-2820.2 LD2820	TRW 20961 17,2 - WK Ceramic	
1.6	77	07/12→	←	07/13→; +PR 1ZG	13.0460-7111.2 607111	VW 23130 19,6 - WE / - WK	
					13.0470-7111.2 LD7111	VW 23130 19,6 - WE / - WK Ceramic	
			←	07/13→; +PR 1ZC	13.0460-7184.2 607184	ATE 23587 20,6 + WK	
					13.0470-7184.2 LD7184	ATE 23587 20,6 + WK Ceramic	
			→	07/13→; +PR 1KT	13.0460-2820.2 602820	TRW 20961 17,2 - WK	
					13.0470-2820.2 LD2820	TRW 20961 17,2 - WK Ceramic	
 Bremsscheibe							
1.2	55	07/12→	←	10/12→; +PR 1ZG	24.0122-0151.1 422151	Ø 256 22 19 V + S	
1.2 TSI	63	07/12→			24.0322-0151.1 522151	Ø 256 22 19 V + S PD	
1.2 TSI	77	07/12→					
1.4 TSI	90	07/12→	←	10/12→; +PR 1ZC	24.0125-0113.1 425113	Ø 288 25 22 V + S	
1.6 TDI	77	07/12→			24.0325-0113.1 525113	Ø 288 25 22 V + S PD	
			→	10/12→; +PR 1KT	24.0109-0123.1 409123	Ø 230 9 7 + S	
					24.0309-0123.1 509123	Ø 230 9 7 + S PD	
1.2 TSI	66	05/15→	←	+PR 1ZG	24.0122-0151.1 422151	Ø 256 22 19 V + S	
1.2 TSI	81	05/15→			24.0322-0151.1 522151	Ø 256 22 19 V + S PD	
1.4 TDI	66	05/15→					
1.4 TSI	92	05/15→	←	+PR 1ZC	24.0125-0113.1 425113	Ø 288 25 22 V + S	
1.6	81	05/15→			24.0325-0113.1 525113	Ø 288 25 22 V + S PD	
1.6 TDI	66	08/13→	→	+PR 1KT	24.0109-0123.1 409123	Ø 230 9 7 + S	
1.6 TDI	85	05/15→			24.0309-0123.1 509123	Ø 230 9 7 + S PD	
1.6	77	07/12→	←	07/13→; +PR 1ZG	24.0122-0151.1 422151	Ø 256 22 19 V + S	
					24.0322-0151.1 522151	Ø 256 22 19 V + S PD	
			←	07/13→; +PR 1ZC	24.0125-0113.1 425113	Ø 288 25 22 V + S	
					24.0325-0113.1 525113	Ø 288 25 22 V + S PD	
			→	07/13→; +PR 1KT	24.0109-0123.1 409123	Ø 230 9 7 + S	
					24.0309-0123.1 509123	Ø 230 9 7 + S PD	
SKODA - RAPID Spaceback (NH1) 07/12→							
 Bremsbelagsatz, Scheibenbremse							
1.2	55	07/12→	←	10/12→; +PR 1ZG	13.0460-7111.2 607111	VW 23130 19,6 - WE / - WK	
1.2 TSI	63	07/12→			13.0470-7111.2 LD7111	VW 23130 19,6 - WE / - WK Ceramic	
1.2 TSI	77	07/12→					
1.4 TSI	90	07/12→	←	10/12→; +PR 1ZC	13.0460-7184.2 607184	ATE 23587 20,6 + WK	
1.6 TDI	77	07/12→			13.0470-7184.2 LD7184	ATE 23587 20,6 + WK Ceramic	
			→	10/12→; +PR 1KT	13.0460-2820.2 602820	TRW 20961 17,2 - WK	
					13.0470-2820.2 LD2820	TRW 20961 17,2 - WK Ceramic	
1.2 TSI	66	05/15→	←	+PR 1ZG	13.0460-7111.2 607111	VW 23130 19,6 - WE / - WK	
1.2 TSI	81	05/15→					







	kw			 	! #		
SKODA - RAPID Spaceback (NH1) 07/12→							
 Bremsbelagsatz, Scheibenbremse							
1.4 TDI 1.4 TSI 1.6 TDI 1.6 TDI	66 92 66 85	05/15→ 05/15→ 08/13→ 05/15→	← ← ← →	+PR 1ZG +PR 1ZC +PR 1ZC +PR 1KT		13.0470-7111.2 LD7111 13.0460-7184.2 607184 13.0470-7184.2 LD7184 13.0460-2820.2 602820 13.0470-2820.2 LD2820	VW 23130 19,6 - WE / - WK Ceramic ATE 23587 20,6 + WK ATE 23587 20,6 + WK Ceramic TRW 20961 17,2 - WK TRW 20961 17,2 - WK Ceramic
1.6	77	07/12→	← ← →	07/13→; +PR 1ZG 07/13→; +PR 1ZC 07/13→; +PR 1KT		13.0460-7111.2 607111 13.0470-7111.2 LD7111 13.0460-7184.2 607184 13.0470-7184.2 LD7184 13.0460-2820.2 602820 13.0470-2820.2 LD2820	VW 23130 19,6 - WE / - WK Ceramic VW 23130 19,6 - WE / - WK Ceramic ATE 23587 20,6 + WK ATE 23587 20,6 + WK Ceramic TRW 20961 17,2 - WK TRW 20961 17,2 - WK Ceramic
 Bremsscheibe							
1.2 1.2 TSI 1.2 TSI 1.4 TSI 1.6 TDI	55 63 77 90 77	07/12→ 07/12→ 07/12→ 07/12→ 07/12→	← ← ← →	10/12→; +PR 1ZG 10/12→; +PR 1ZC 10/12→; +PR 1ZC 10/12→; +PR 1KT		24.0122-0151.1 422151 24.0322-0151.1 522151 24.0125-0113.1 425113 24.0325-0113.1 525113 24.0109-0123.1 409123 24.0309-0123.1 509123	Ø 256 22 19 V + S Ø 256 22 19 V + S PD Ø 288 25 22 V + S Ø 288 25 22 V + S PD Ø 230 9 7 + S Ø 230 9 7 + S PD
1.2 TSI 1.2 TSI 1.4 TDI 1.4 TSI 1.6 TDI 1.6 TDI	66 81 66 92 66 85	05/15→ 05/15→ 05/15→ 05/15→ 08/13→ 05/15→	← ← ← →	+PR 1ZG +PR 1ZC +PR 1ZC +PR 1KT		24.0122-0151.1 422151 24.0322-0151.1 522151 24.0125-0113.1 425113 24.0325-0113.1 525113 24.0109-0123.1 409123 24.0309-0123.1 509123	Ø 256 22 19 V + S Ø 256 22 19 V + S PD Ø 288 25 22 V + S Ø 288 25 22 V + S PD Ø 230 9 7 + S Ø 230 9 7 + S PD
1.6	77	07/12→	← ← →	07/13→; +PR 1ZG 07/13→; +PR 1ZC 07/13→; +PR 1KT		24.0122-0151.1 422151 24.0322-0151.1 522151 24.0125-0113.1 425113 24.0325-0113.1 525113 24.0109-0123.1 409123 24.0309-0123.1 509123	Ø 256 22 19 V + S Ø 256 22 19 V + S PD Ø 288 25 22 V + S Ø 288 25 22 V + S PD Ø 230 9 7 + S Ø 230 9 7 + S PD
SKODA - ROOMSTER (5J) 03/06→05/15							
 Bremsbelagsatz, Scheibenbremse							
1.2	47	05/06→01/07	← ← ← → →	07/06→; +PR 1LN,1ZH 07/06→; +PR 1LQ,1LR,1ZG 07/06→; +PR 1ZC 07/06→; +PR 1KT 07/06→; +PR 1KK		13.0460-2883.2 602883 13.0460-2884.2 602884 13.0470-2884.2 LD2884 13.0460-7111.2 607111 13.0460-7117.2 607117 13.0470-7111.2 LD7111 13.0470-7117.2 LD7117 13.0460-7184.2 607184 13.0470-7184.2 LD7184 13.0460-2820.2 602820 13.0470-2820.2 LD2820 13.0460-2894.2 602894 13.0470-2894.2 LD2894	TRW 23581 18,8 - WE / - WK TRW 23581 18,8 + WK TRW 23581 18,8 + WK Ceramic VW 23130 19,6 - WE / - WK VW 23130 19,6 + WK VW 23130 19,6 - WE / - WK Ceramic VW 23130 19,6 + WK Ceramic ATE 23587 20,6 + WK ATE 23587 20,6 + WK Ceramic TRW 20961 17,2 - WK TRW 20961 17,2 - WK Ceramic TRW 20961 17,2 - WK + Zub TRW 20961 17,2 - WK + Zub Ceramic
1.2 1.2 TDI 1.2 TSI 1.2 TSI 1.4 1.6 1.6 TDI 1.6 TDI	51 55 63 77 63 77 66 77	01/07→05/15 03/10→05/15 03/10→05/15 03/10→05/15 09/06→05/15 09/06→05/15 03/10→05/15 03/10→05/15	← ← ← ← → →	→ 04/15; +PR 1LN,1ZH → 04/15; +PR 1LQ,1LR,1ZG → 04/15; +PR 1ZC → 04/15; +PR 1KT		13.0460-2883.2 602883 13.0460-2884.2 602884 13.0470-2884.2 LD2884 13.0460-7111.2 607111 13.0460-7117.2 607117 13.0470-7111.2 LD7111 13.0470-7117.2 LD7117 13.0460-7184.2 607184 13.0470-7184.2 LD7184 13.0460-2820.2 602820 13.0470-2820.2 LD2820	TRW 23581 18,8 - WE / - WK TRW 23581 18,8 + WK TRW 23581 18,8 + WK Ceramic VW 23130 19,6 - WE / - WK VW 23130 19,6 + WK VW 23130 19,6 - WE / - WK Ceramic VW 23130 19,6 + WK Ceramic ATE 23587 20,6 + WK ATE 23587 20,6 + WK Ceramic TRW 20961 17,2 - WK TRW 20961 17,2 - WK Ceramic
↓							









	kw			 	! #		
SKODA - ROOMSTER (5J) 03/06→05/15							
 Bremsbelagsatz, Scheibenbremse							
1.2	51	01/07→05/15	➔	→ 04/15; +PR 1KK		13.0460-2894.2 602894	TRW 20961 17,2 - WK + Zub
1.2 TDI	55	03/10→05/15				13.0470-2894.2 LD2894	TRW 20961 17,2 - WK + Zub
1.2 TSI	63	03/10→05/15					Ceramic
1.2 TSI	77	03/10→05/15					
1.4	63	09/06→05/15					
1.6	77	09/06→05/15					
1.6 TDI	66	03/10→05/15					
1.6 TDI	77	03/10→05/15					
1.4 TDI	51	07/06→03/10	➔	+PR 1LN,1ZH		13.0460-2883.2 602883	TRW 23581 18,8 - WE / - WK
1.4 TDI	59	09/06→03/10				13.0460-2884.2 602884	TRW 23581 18,8 + WK
1.9 TDI	77	09/06→03/10				13.0470-2884.2 LD2884	TRW 23581 18,8 + WK Ceramic
			➔	+PR 1LQ,1LR,1ZG		13.0460-7111.2 607111	VW 23130 19,6 - WE / - WK
						13.0460-7117.2 607117	VW 23130 19,6 + WK
						13.0470-7111.2 LD7111	VW 23130 19,6 - WE / - WK Ceramic
						13.0470-7117.2 LD7117	VW 23130 19,6 + WK Ceramic
			➔	+PR 1ZC		13.0460-7184.2 607184	ATE 23587 20,6 + WK
						13.0470-7184.2 LD7184	ATE 23587 20,6 + WK Ceramic
			➔	+PR 1KT		13.0460-2820.2 602820	TRW 20961 17,2 - WK
						13.0470-2820.2 LD2820	TRW 20961 17,2 - WK Ceramic
			➔	+PR 1KK		13.0460-2894.2 602894	TRW 20961 17,2 - WK + Zub
						13.0470-2894.2 LD2894	TRW 20961 17,2 - WK + Zub Ceramic
 Bremsscheibe							
1.2	47	05/06→01/07	➔	07/06→; +PR 1LQ,1LR,1ZG		24.0122-0151.1 422151	Ø 256 22 19 V + S
						24.0322-0151.1 522151	Ø 256 22 19 V + S PD
			➔	07/06→; +PR 1LN,1ZC,1ZH		24.0125-0113.1 425113	Ø 288 25 22 V + S
						24.0325-0113.1 525113	Ø 288 25 22 V + S PD
			➔	07/06→; +PR 1KK,1KT		24.0109-0123.1 409123	Ø 230 9 7 + S
						24.0309-0123.1 509123	Ø 230 9 7 + S PD
1.2	51	01/07→05/15	➔	→ 04/15; +PR 1LQ,1LR,1ZG		24.0122-0151.1 422151	Ø 256 22 19 V + S
1.2 TDI	55	03/10→05/15				24.0322-0151.1 522151	Ø 256 22 19 V + S PD
1.2 TSI	63	03/10→05/15					
1.2 TSI	77	03/10→05/15	➔	→ 04/15; +PR 1LN,1ZC,1ZH		24.0125-0113.1 425113	Ø 288 25 22 V + S
1.4	63	09/06→05/15				24.0325-0113.1 525113	Ø 288 25 22 V + S PD
1.6	77	09/06→05/15					
1.6 TDI	66	03/10→05/15	➔	→ 04/15; +PR 1KK,1KT		24.0109-0123.1 409123	Ø 230 9 7 + S
1.6 TDI	77	03/10→05/15				24.0309-0123.1 509123	Ø 230 9 7 + S PD
1.4 TDI	51	07/06→03/10	➔	+PR 1LQ,1LR,1ZG		24.0122-0151.1 422151	Ø 256 22 19 V + S
1.4 TDI	59	09/06→03/10				24.0322-0151.1 522151	Ø 256 22 19 V + S PD
1.9 TDI	77	09/06→03/10					
			➔	+PR 1LN,1ZC,1ZH		24.0125-0113.1 425113	Ø 288 25 22 V + S
						24.0325-0113.1 525113	Ø 288 25 22 V + S PD
			➔	+PR 1KK,1KT		24.0109-0123.1 409123	Ø 230 9 7 + S
						24.0309-0123.1 509123	Ø 230 9 7 + S PD
SKODA - ROOMSTER Praktik (5J) 03/07→05/15							
 Bremsbelagsatz, Scheibenbremse							
1.2	51	03/07→05/15	➔	→ 04/15; +PR 1LN,1ZH		13.0460-2883.2 602883	TRW 23581 18,8 - WE / - WK
1.2 TDI	55	03/10→05/15				13.0460-2884.2 602884	TRW 23581 18,8 + WK
1.2 TSI	63	03/10→05/15				13.0470-2884.2 LD2884	TRW 23581 18,8 + WK Ceramic
1.4	63	03/07→05/15					
1.6 TDI	66	03/10→05/15	➔	→ 04/15; +PR 1LQ,1LR,1ZG		13.0460-7111.2 607111	VW 23130 19,6 - WE / - WK
						13.0460-7117.2 607117	VW 23130 19,6 + WK
						13.0470-7111.2 LD7111	VW 23130 19,6 - WE / - WK Ceramic
						13.0470-7117.2 LD7117	VW 23130 19,6 + WK Ceramic
			➔	→ 04/15; +PR 1ZC		13.0460-7184.2 607184	ATE 23587 20,6 + WK
						13.0470-7184.2 LD7184	ATE 23587 20,6 + WK Ceramic
			➔	→ 04/15; +PR 1KT		13.0460-2820.2 602820	TRW 20961 17,2 - WK
						13.0470-2820.2 LD2820	TRW 20961 17,2 - WK Ceramic
			➔	→ 04/15; +PR 1KK		13.0460-2894.2 602894	TRW 20961 17,2 - WK + Zub
						13.0470-2894.2 LD2894	TRW 20961 17,2 - WK + Zub Ceramic
1.4 TDI	51	03/07→03/10	➔	+PR 1LN,1ZH		13.0460-2883.2 602883	TRW 23581 18,8 - WE / - WK
1.4 TDI	59	03/07→03/10				13.0460-2884.2 602884	TRW 23581 18,8 + WK
						13.0470-2884.2 LD2884	TRW 23581 18,8 + WK Ceramic
			➔	+PR 1LQ,1LR,1ZG		13.0460-7111.2 607111	VW 23130 19,6 - WE / - WK









	kw			 	! #		
SKODA - ROOMSTER Praktik (5J) 03/07→05/15							
 Bremsbelagsatz, Scheibenbremse							
1.4 TDI 1.4 TDI	51 59	03/07→03/10 03/07→03/10	←	+PR 1LQ,1LR,1ZG		13.0460-7117.2 607117 13.0470-7111.2 LD7111 13.0470-7117.2 LD7117	VW 23130 19,6 + WK VW 23130 19,6 - WE / - WK Ceramic VW 23130 19,6 + WK Ceramic
			←	+PR 1ZC		13.0460-7184.2 607184 13.0470-7184.2 LD7184	ATE 23587 20,6 + WK ATE 23587 20,6 + WK Ceramic
			→	+PR 1KT		13.0460-2820.2 602820 13.0470-2820.2 LD2820	TRW 20961 17,2 - WK TRW 20961 17,2 - WK Ceramic
			→	+PR 1KK		13.0460-2894.2 602894 13.0470-2894.2 LD2894	TRW 20961 17,2 - WK + Zub TRW 20961 17,2 - WK + Zub Ceramic
 Bremsscheibe							
1.2 1.2 TDI 1.2 TSI 1.4 1.6 TDI	51 55 63 63 66	03/07→05/15 03/10→05/15 03/10→05/15 03/07→05/15 03/10→05/15	←	→ 04/15; +PR 1LQ,1LR,1ZG		24.0122-0151.1 422151 24.0322-0151.1 522151	Ø 256 22 19 V + S Ø 256 22 19 V + S PD
			←	→ 04/15; +PR 1LN,1ZC,1ZH		24.0125-0113.1 425113 24.0325-0113.1 525113	Ø 288 25 22 V + S Ø 288 25 22 V + S PD
			→	→ 04/15; +PR 1KK,1KT		24.0109-0123.1 409123 24.0309-0123.1 509123	Ø 230 9 7 + S Ø 230 9 7 + S PD
1.4 TDI 1.4 TDI	51 59	03/07→03/10 03/07→03/10	←	+PR 1LQ,1LR,1ZG		24.0122-0151.1 422151 24.0322-0151.1 522151	Ø 256 22 19 V + S Ø 256 22 19 V + S PD
			←	+PR 1LN,1ZC,1ZH		24.0125-0113.1 425113 24.0325-0113.1 525113	Ø 288 25 22 V + S Ø 288 25 22 V + S PD
			→	+PR 1KK,1KT		24.0109-0123.1 409123 24.0309-0123.1 509123	Ø 230 9 7 + S Ø 230 9 7 + S PD
SKODA - SUPERB I (3U4) 12/01→03/08							
 Bremsbelagsatz, Scheibenbremse							
1.8 T 2.0	110 85	12/01→03/08 12/01→03/08	←	→ 02/08		13.0460-7110.2 607110 13.0470-7110.2 LD7110	ATE 20676 19,8 + WK ATE 20676 19,8 + WK Ceramic
			→	→ 02/08		13.0460-2820.2 602820 13.0470-2820.2 LD2820	TRW 20961 17,2 - WK TRW 20961 17,2 - WK Ceramic
1.9 TDI 1.9 TDI 2.5 TDI	74 77 114	08/02→10/05 10/05→05/07 12/01→08/03	←			13.0460-7110.2 607110 13.0470-7110.2 LD7110	ATE 20676 19,8 + WK ATE 20676 19,8 + WK Ceramic
			→			13.0460-2820.2 602820 13.0470-2820.2 LD2820	TRW 20961 17,2 - WK TRW 20961 17,2 - WK Ceramic
1.9 TDI 1.9 TDI 2.0 TDI 2.5 TDI 2.8 V6 2.8 V6	85 96 103 120 140 142	01/07→03/08 12/01→03/08 10/05→03/08 06/03→03/08 06/02→03/08 12/01→03/08	←	→ 12/07		13.0460-7110.2 607110 13.0470-7110.2 LD7110	ATE 20676 19,8 + WK ATE 20676 19,8 + WK Ceramic
			→	→ 12/07		13.0460-2820.2 602820 13.0470-2820.2 LD2820	TRW 20961 17,2 - WK TRW 20961 17,2 - WK Ceramic
 Bremsscheibe							
1.8 T 2.0	110 85	12/01→03/08 12/01→03/08	←	→ 3U-39046708		24.0125-0105.1 425105 24.0325-0105.1 525105	Ø 288 25 23 V + S Ø 288 25 23 V PD
			←	3U-69101370→; → 02/08		24.0125-0145.1 425145 24.0325-0145.1 525145	Ø 288 25 22 V + S Ø 288 25 22 V + S PD
			←	3U-39046709→ 3U-69101369		24.0125-0171.1 425171 24.0325-0171.1 525171	Ø 288 25 23 V Ø 288 25 23 V PD
			→	→ 02/08		24.0110-0201.1 410201 24.0310-0201.1 510201	Ø 245 10 8 Ø 245 10 8 PD
1.9 TDI	74	08/02→10/05	←	→ 3U-39046708		24.0125-0105.1 425105 24.0325-0105.1 525105	Ø 288 25 23 V + S Ø 288 25 23 V PD
			←	3U-69101370→		24.0125-0145.1 425145 24.0325-0145.1 525145	Ø 288 25 22 V + S Ø 288 25 22 V + S PD
			←	3U-39046709→ 3U-69101369		24.0125-0171.1 425171 24.0325-0171.1 525171	Ø 288 25 23 V Ø 288 25 23 V PD
			→			24.0110-0201.1 410201 24.0310-0201.1 510201	Ø 245 10 8 Ø 245 10 8 PD
1.9 TDI	77	10/05→05/07	←	3U-69101370→		24.0125-0145.1 425145 24.0325-0145.1 525145	Ø 288 25 22 V + S Ø 288 25 22 V + S PD
			←	→ 3U-69101369		24.0125-0171.1 425171 24.0325-0171.1 525171	Ø 288 25 23 V Ø 288 25 23 V PD

	kw			 	! #		
SKODA - SUPERB I (3U4) 12/01→03/08							
Bremsscheibe							
1.9 TDI	77	10/05→05/07	➔			24.0110-0201.1 410201 24.0310-0201.1 510201	Ø 245 10 8 Ø 245 10 8 PD
1.9 TDI	85	01/07→03/08	➔	→ 12/07		24.0125-0145.1 425145 24.0325-0145.1 525145	Ø 288 25 22 V + S Ø 288 25 22 V + S PD
			➔	→ 12/07		24.0110-0201.1 410201 24.0310-0201.1 510201	Ø 245 10 8 Ø 245 10 8 PD
1.9 TDI	96	12/01→03/08	➔	→ 3U-39046708		24.0125-0105.1 425105 24.0325-0105.1 525105	Ø 288 25 23 V + S Ø 288 25 23 V PD
			➔	3U-69101370→; → 12/07		24.0125-0145.1 425145 24.0325-0145.1 525145	Ø 288 25 22 V + S Ø 288 25 22 V + S PD
			➔	3U-39046709→ 3U-69101369		24.0125-0171.1 425171 24.0325-0171.1 525171	Ø 288 25 23 V Ø 288 25 23 V PD
			➔	→ 12/07		24.0110-0201.1 410201 24.0310-0201.1 510201	Ø 245 10 8 Ø 245 10 8 PD
2.0 TDI 2.5 TDI	103 120	10/05→03/08 06/03→03/08	➔	→ 3U-39043704		24.0125-0137.1 425137 24.0325-0137.1 525137	Ø 312 25 23 V + S Ø 312 25 23 V PD
			➔	3U-69100011→; → 12/07		24.0125-0158.1 425158 24.0325-0158.1 525158	Ø 312 25 22 V + S Ø 312 25 22 V + S PD
			➔	3U-39043705→ 3U-69100010		24.0125-0172.1 425172 24.0325-0172.1 525172	Ø 312 25 23 V Ø 312 25 23 V PD
			➔	→ 12/07		24.0110-0201.1 410201 24.0310-0201.1 510201	Ø 245 10 8 Ø 245 10 8 PD
2.5 TDI	114	12/01→08/03	➔	→ 3U-39043704		24.0125-0137.1 425137 24.0325-0137.1 525137	Ø 312 25 23 V + S Ø 312 25 23 V PD
			➔	3U-69100011→		24.0125-0158.1 425158 24.0325-0158.1 525158	Ø 312 25 22 V + S Ø 312 25 22 V + S PD
			➔	3U-39043705→ 3U-69100010		24.0125-0172.1 425172 24.0325-0172.1 525172	Ø 312 25 23 V Ø 312 25 23 V PD
			➔	→ 12/07		24.0110-0201.1 410201 24.0310-0201.1 510201	Ø 245 10 8 Ø 245 10 8 PD
2.8 V6 2.8 V6	140 142	06/02→03/08 12/01→03/08	➔	→ 3U-39043704		24.0125-0137.1 425137 24.0325-0137.1 525137	Ø 312 25 23 V + S Ø 312 25 23 V PD
			➔	3U-69100011→; → 12/07		24.0125-0158.1 425158 24.0325-0158.1 525158	Ø 312 25 22 V + S Ø 312 25 22 V + S PD
			➔	3U-39043705→ 3U-69100010		24.0125-0172.1 425172 24.0325-0172.1 525172	Ø 312 25 23 V Ø 312 25 23 V PD
			➔	→ 12/07		24.0110-0201.1 410201 24.0310-0201.1 510201	Ø 245 10 8 Ø 245 10 8 PD
SKODA - SUPERB II (3T4) 03/08→05/15							
Bremsbelagsatz, Scheibenbremse							
1.4 TSI 1.8 TSI 2.0 TDI	92 118 125	07/08→05/15 03/08→05/15 07/08→05/15	➔	08/08→ 02/15; +PR 1ZE,1LJ,1ZA		13.0460-7184.2 607184 13.0470-7184.2 LD7184	ATE 23587 20,6 + WK ATE 23587 20,6 + WK Ceramic
			➔	08/08→ 02/15; +PR 1LK		13.0460-7200.2 607200 13.0470-7200.2 LD7200	ATE 23801 20,3 + WK ATE 23801 20,3 + WK Ceramic
			➔	08/08→ 02/15; +PR 1KF,1KJ		13.0460-2749.2 602749 13.0460-2880.2 602880 13.0470-2749.2 LD2749 13.0470-2880.2 LD2880	TRW 24483 16,9 - WE / - WK + Zub TRW 23914 17,1 + WE / - WK + Zub TRW 24483 16,9 - WE / - WK + Zub Ceramic TRW 23914 17,1 + WE / - WK + Zub Ceramic
			➔	08/08→ 02/15; +PR 1KS		13.0460-3858.2 603858 13.0470-3858.2 LD3858	BOS 24563 17,7 - WE / - WK + Zub BOS 24563 17,7 - WE / - WK + Zub Ceramic
1.6 TDI 1.8 TSI 2.0 TDI 16V 2.0 TSI	77 112 103 147	09/10→05/15 03/09→05/15 01/09→05/15 05/10→05/15	➔	→ 02/15; +PR 1ZE,1LJ,1ZA		13.0460-7184.2 607184 13.0470-7184.2 LD7184	ATE 23587 20,6 + WK ATE 23587 20,6 + WK Ceramic
			➔	→ 02/15; +PR 1LK		13.0460-7200.2 607200 13.0470-7200.2 LD7200	ATE 23801 20,3 + WK ATE 23801 20,3 + WK Ceramic
			➔	→ 02/15; +PR 1KF,1KJ		13.0460-2749.2 602749	TRW 24483 16,9 - WE / - WK + Zub
↓							







	kw			 	! #		
SKODA - SUPERB II (3T4) 03/08→05/15							
 Bremsbelagsatz, Scheibenbremse							
1.6 TDI 1.8 TSI 2.0 TDI 16V 2.0 TSI	77 112 103 147	09/10→05/15 03/09→05/15 01/09→05/15 05/10→05/15	➡	→ 02/15; +PR 1KF,1KJ		13.0460-2880.2 602880 13.0470-2749.2 LD2749 13.0470-2880.2 LD2880	TRW 23914 17,1 + WE / - WK + Zub TRW 24483 16,9 - WE / - WK + Zub Ceramic TRW 23914 17,1 + WE / - WK + Zub Ceramic
			➡	→ 02/15; +PR 1KS		13.0460-3858.2 603858 13.0470-3858.2 LD3858	BOS 24563 17,7 - WE / - WK + Zub BOS 24563 17,7 - WE / - WK + Zub Ceramic
1.8 TSI 4x4 1.8 TSI 4x4 2.0 TDI 16V 4x4 3.6 FSI 4x4	112 118 103 191	03/09→05/15 11/08→05/15 11/10→05/15 11/08→05/15	⬅	→ 02/15; +PR 1ZE,1LJ,1ZA		13.0460-7184.2 607184 13.0470-7184.2 LD7184	ATE 23587 20,6 + WK ATE 23587 20,6 + WK Ceramic
			⬅	→ 02/15; +PR 1LK		13.0460-7200.2 607200 13.0470-7200.2 LD7200	ATE 23801 20,3 + WK ATE 23801 20,3 + WK Ceramic
			➡	→ 02/15; +PR 2EA		13.0460-2749.2 602749 13.0460-2880.2 602880 13.0470-2749.2 LD2749 13.0470-2880.2 LD2880	TRW 24483 16,9 - WE / - WK + Zub TRW 23914 17,1 + WE / - WK + Zub TRW 24483 16,9 - WE / - WK + Zub Ceramic TRW 23914 17,1 + WE / - WK + Zub Ceramic
			➡	→ 02/15; +PR 1KS		13.0460-3858.2 603858 13.0470-3858.2 LD3858	BOS 24563 17,7 - WE / - WK + Zub BOS 24563 17,7 - WE / - WK + Zub Ceramic
1.9 TDI 2.0 TDI	77 103	03/08→11/10 03/08→05/10	⬅	08/08→; +PR 1ZE,1LJ,1ZA		13.0460-7184.2 607184 13.0470-7184.2 LD7184	ATE 23587 20,6 + WK ATE 23587 20,6 + WK Ceramic
			⬅	08/08→; +PR 1LK		13.0460-7200.2 607200 13.0470-7200.2 LD7200	ATE 23801 20,3 + WK ATE 23801 20,3 + WK Ceramic
			➡	08/08→; +PR 1KF,1KJ		13.0460-2749.2 602749 13.0460-2880.2 602880 13.0470-2749.2 LD2749 13.0470-2880.2 LD2880	TRW 24483 16,9 - WE / - WK + Zub TRW 23914 17,1 + WE / - WK + Zub TRW 24483 16,9 - WE / - WK + Zub Ceramic TRW 23914 17,1 + WE / - WK + Zub Ceramic
			➡	08/08→; +PR 1KS		13.0460-3858.2 603858 13.0470-3858.2 LD3858	BOS 24563 17,7 - WE / - WK + Zub BOS 24563 17,7 - WE / - WK + Zub Ceramic
2.0 TDI 4x4	125	09/08→05/15	⬅	10/08→ 02/15; +PR 1ZE,1LJ,1ZA		13.0460-7184.2 607184 13.0470-7184.2 LD7184	ATE 23587 20,6 + WK ATE 23587 20,6 + WK Ceramic
			⬅	10/08→ 02/15; +PR 1LK		13.0460-7200.2 607200 13.0470-7200.2 LD7200	ATE 23801 20,3 + WK ATE 23801 20,3 + WK Ceramic
			➡	10/08→ 02/15; +PR 2EA		13.0460-2749.2 602749 13.0460-2880.2 602880 13.0470-2749.2 LD2749 13.0470-2880.2 LD2880	TRW 24483 16,9 - WE / - WK + Zub TRW 23914 17,1 + WE / - WK + Zub TRW 24483 16,9 - WE / - WK + Zub Ceramic TRW 23914 17,1 + WE / - WK + Zub Ceramic
			➡	10/08→ 02/15; +PR 1KS		13.0460-3858.2 603858 13.0470-3858.2 LD3858	BOS 24563 17,7 - WE / - WK + Zub BOS 24563 17,7 - WE / - WK + Zub Ceramic
 Bremsscheibe							
1.4 TSI 1.8 TSI 2.0 TDI	92 118 125	07/08→05/15 03/08→05/15 07/08→05/15	⬅	08/08→ 02/15; +PR 1ZE		24.0125-0145.1 425145 24.0325-0145.1 525145	Ø 288 25 22 V + S Ø 288 25 22 V + S PD
			⬅	08/08→ 02/15; +PR 1LJ,1ZA		24.0125-0158.1 425158 24.0325-0158.1 525158	Ø 312 25 22 V + S Ø 312 25 22 V + S PD
			⬅	08/08→ 02/15; +PR 1LK		24.0130-0115.1 430115 24.0330-0115.1 530115	Ø 345 30 27 V Ø 345 30 27 V PD
			➡	08/08→ 02/15; +PR 1KS		24.0110-0356.1 410356 24.0310-0356.1 510356	Ø 272 9,7 8 + S Ø 272 9,7 8 + S PD
↓							











	kw			 	! #		
SKODA - SUPERB II (3T4) 03/08→05/15							
Bremsscheibe							
1.4 TSI 1.8 TSI 2.0 TDI	92 118 125	07/08→05/15 03/08→05/15 07/08→05/15	➡	08/08→ 02/15; +PR 1KF		24.0112-0158.1 412158 24.0312-0158.1 512158	Ø 256 12 10 + S Ø 256 12 10 PD
			➡	08/08→ 02/15; +PR 1KJ		24.0112-0169.1 412169 24.0312-0169.1 512169	Ø 282 12 10 + S Ø 282 12 10 + S PD
1.6 TDI 1.8 TSI 2.0 TDI 16V 2.0 TSI	77 112 103 147	09/10→05/15 03/09→05/15 01/09→05/15 05/10→05/15	←	→ 02/15; +PR 1ZE		24.0125-0145.1 425145 24.0325-0145.1 525145	Ø 288 25 22 V + S Ø 288 25 22 V + S PD
			←	→ 02/15; +PR 1LJ,1ZA		24.0125-0158.1 425158 24.0325-0158.1 525158	Ø 312 25 22 V + S Ø 312 25 22 V + S PD
			←	→ 02/15; +PR 1LK		24.0130-0115.1 430115 24.0330-0115.1 530115	Ø 345 30 27 V Ø 345 30 27 V PD
			➡	→ 02/15; +PR 1KS		24.0110-0356.1 410356 24.0310-0356.1 510356	Ø 272 9,7 8 + S Ø 272 9,7 8 + S PD
			➡	→ 02/15; +PR 1KF		24.0112-0158.1 412158 24.0312-0158.1 512158	Ø 256 12 10 + S Ø 256 12 10 PD
			➡	→ 02/15; +PR 1KJ		24.0112-0169.1 412169 24.0312-0169.1 512169	Ø 282 12 10 + S Ø 282 12 10 + S PD
1.8 TSI 4x4 1.8 TSI 4x4 2.0 TDI 16V 4x4 3.6 FSI 4x4	112 118 103 191	03/09→05/15 11/08→05/15 11/10→05/15 11/08→05/15	←	→ 02/15; +PR 1ZE		24.0125-0145.1 425145 24.0325-0145.1 525145	Ø 288 25 22 V + S Ø 288 25 22 V + S PD
			←	→ 02/15; +PR 1LJ,1ZA		24.0125-0158.1 425158 24.0325-0158.1 525158	Ø 312 25 22 V + S Ø 312 25 22 V + S PD
			←	→ 02/15; +PR 1LK		24.0130-0115.1 430115 24.0330-0115.1 530115	Ø 345 30 27 V Ø 345 30 27 V PD
			➡	→ 02/15; +PR 1KS		24.0110-0356.1 410356 24.0310-0356.1 510356	Ø 272 9,7 8 + S Ø 272 9,7 8 + S PD
			➡	→ 02/15; +PR 2EA		24.0122-0219.1 422219	Ø 310 22 20 V
1.9 TDI 2.0 TDI	77 103	03/08→11/10 03/08→05/10	←	08/08→; +PR 1ZE		24.0125-0145.1 425145 24.0325-0145.1 525145	Ø 288 25 22 V + S Ø 288 25 22 V + S PD
			←	08/08→; +PR 1LJ,1ZA		24.0125-0158.1 425158 24.0325-0158.1 525158	Ø 312 25 22 V + S Ø 312 25 22 V + S PD
			←	08/08→; +PR 1LK		24.0130-0115.1 430115 24.0330-0115.1 530115	Ø 345 30 27 V Ø 345 30 27 V PD
			➡	08/08→; +PR 1KS		24.0110-0356.1 410356 24.0310-0356.1 510356	Ø 272 9,7 8 + S Ø 272 9,7 8 + S PD
			➡	08/08→; +PR 1KF		24.0112-0158.1 412158 24.0312-0158.1 512158	Ø 256 12 10 + S Ø 256 12 10 PD
			➡	08/08→; +PR 1KJ		24.0112-0169.1 412169 24.0312-0169.1 512169	Ø 282 12 10 + S Ø 282 12 10 + S PD
2.0 TDI 4x4	125	09/08→05/15	←	10/08→ 02/15; +PR 1ZE		24.0125-0145.1 425145 24.0325-0145.1 525145	Ø 288 25 22 V + S Ø 288 25 22 V + S PD
			←	10/08→ 02/15; +PR 1LJ,1ZA		24.0125-0158.1 425158 24.0325-0158.1 525158	Ø 312 25 22 V + S Ø 312 25 22 V + S PD
			←	10/08→ 02/15; +PR 1LK		24.0130-0115.1 430115 24.0330-0115.1 530115	Ø 345 30 27 V Ø 345 30 27 V PD
			➡	10/08→ 02/15; +PR 1KS		24.0110-0356.1 410356 24.0310-0356.1 510356	Ø 272 9,7 8 + S Ø 272 9,7 8 + S PD
			➡	10/08→ 02/15; +PR 2EA		24.0122-0219.1 422219	Ø 310 22 20 V
SKODA - SUPERB II Kombi (3T5) 10/09→05/15							
Bremsbelagsatz, Scheibenbremse							
1.4 TSI 1.8 TSI 1.8 TSI 2.0 TDI 2.0 TDI 16V	92 112 118 125 103	10/09→05/15 10/09→05/15 10/09→05/15 10/09→05/15 10/09→05/15	←	11/09→ 02/15; +PR 1LJ,1ZA,1ZE		13.0460-7184.2 607184 13.0470-7184.2 LD7184	ATE 23587 20,6 + WK ATE 23587 20,6 + WK Ceramic
			←	11/09→ 02/15; +PR 1LK		13.0460-7200.2 607200 13.0470-7200.2 LD7200	ATE 23801 20,3 + WK ATE 23801 20,3 + WK Ceramic
			➡	11/09→ 02/15; +PR 1KF,1KJ		13.0460-2749.2 602749 13.0460-2880.2 602880 13.0470-2749.2 LD2749 13.0470-2880.2 LD2880	TRW 24483 16,9 - WE / - WK + Zub TRW 23914 17,1 + WE / - WK + Zub TRW 24483 16,9 - WE / - WK + Zub Ceramic TRW 23914 17,1 + WE / - WK + Zub Ceramic
↓							









	kw			 	! #		
SKODA - SUPERB II Kombi (3T5) 10/09→05/15							
 Bremsbelagsatz, Scheibenbremse							
1.4 TSI	92	10/09→05/15	➡	11/09→ 02/15; +PR 1KS		13.0460-3858.2	603858 BOS 24563 17,7 - WE / - WK + Zub
1.8 TSI	112	10/09→05/15				13.0470-3858.2	LD3858 BOS 24563 17,7 - WE / - WK + Zub Ceramic
1.8 TSI	118	10/09→05/15					
2.0 TDI	125	10/09→05/15					
2.0 TDI 16V	103	10/09→05/15					
1.6 TDI	77	09/10→05/15	⬅	→ 02/15; +PR 1LJ,1ZA,1ZE		13.0460-7184.2	607184 ATE 23587 20,6 + WK
2.0 TSI	147	05/10→05/15				13.0470-7184.2	LD7184 ATE 23587 20,6 + WK Ceramic
			⬅	→ 02/15; +PR 1LK		13.0460-7200.2	607200 ATE 23801 20,3 + WK
						13.0470-7200.2	LD7200 ATE 23801 20,3 + WK Ceramic
			➡	→ 02/15; +PR 1KF,1KJ		13.0460-2749.2	602749 TRW 24483 16,9 - WE / - WK + Zub
						13.0460-2880.2	602880 TRW 23914 17,1 + WE / - WK + Zub
						13.0470-2749.2	LD2749 TRW 24483 16,9 - WE / - WK + Zub Ceramic
						13.0470-2880.2	LD2880 TRW 23914 17,1 + WE / - WK + Zub Ceramic
			➡	→ 02/15; +PR 1KS		13.0460-3858.2	603858 BOS 24563 17,7 - WE / - WK + Zub
						13.0470-3858.2	LD3858 BOS 24563 17,7 - WE / - WK + Zub Ceramic
1.8 TSI 4x4	112	10/09→05/15	⬅	11/09→ 02/15; +PR 1LJ,1ZA,1ZE		13.0460-7184.2	607184 ATE 23587 20,6 + WK
1.8 TSI 4x4	118	10/09→05/15				13.0470-7184.2	LD7184 ATE 23587 20,6 + WK Ceramic
2.0 TDI 4x4	125	10/09→05/15					
3.6 V6 4x4	191	10/09→05/15	⬅	11/09→ 02/15; +PR 1LK		13.0460-7200.2	607200 ATE 23801 20,3 + WK
						13.0470-7200.2	LD7200 ATE 23801 20,3 + WK Ceramic
			➡	11/09→ 02/15; +PR 2EA		13.0460-2749.2	602749 TRW 24483 16,9 - WE / - WK + Zub
						13.0460-2880.2	602880 TRW 23914 17,1 + WE / - WK + Zub
						13.0470-2749.2	LD2749 TRW 24483 16,9 - WE / - WK + Zub Ceramic
						13.0470-2880.2	LD2880 TRW 23914 17,1 + WE / - WK + Zub Ceramic
			➡	11/09→ 02/15; +PR 1KF,1KJ		13.0460-2749.2	602749 TRW 24483 16,9 - WE / - WK + Zub
						13.0460-2880.2	602880 TRW 23914 17,1 + WE / - WK + Zub
						13.0470-2749.2	LD2749 TRW 24483 16,9 - WE / - WK + Zub Ceramic
						13.0470-2880.2	LD2880 TRW 23914 17,1 + WE / - WK + Zub Ceramic
			➡	11/09→ 02/15; +PR 1KS		13.0460-3858.2	603858 BOS 24563 17,7 - WE / - WK + Zub
						13.0470-3858.2	LD3858 BOS 24563 17,7 - WE / - WK + Zub Ceramic
1.9 TDI	77	10/09→11/10	⬅	+PR 1LJ,1ZA,1ZE		13.0460-7184.2	607184 ATE 23587 20,6 + WK
						13.0470-7184.2	LD7184 ATE 23587 20,6 + WK Ceramic
			⬅	+PR 1LK		13.0460-7200.2	607200 ATE 23801 20,3 + WK
						13.0470-7200.2	LD7200 ATE 23801 20,3 + WK Ceramic
			➡	+PR 1KF,1KJ		13.0460-2749.2	602749 TRW 24483 16,9 - WE / - WK + Zub
						13.0460-2880.2	602880 TRW 23914 17,1 + WE / - WK + Zub
						13.0470-2749.2	LD2749 TRW 24483 16,9 - WE / - WK + Zub Ceramic
						13.0470-2880.2	LD2880 TRW 23914 17,1 + WE / - WK + Zub Ceramic
			➡	+PR 1KS		13.0460-3858.2	603858 BOS 24563 17,7 - WE / - WK + Zub
						13.0470-3858.2	LD3858 BOS 24563 17,7 - WE / - WK + Zub Ceramic
2.0 TDI	103	10/09→03/10	⬅	11/09→; +PR 1LJ,1ZA,1ZE		13.0460-7184.2	607184 ATE 23587 20,6 + WK
						13.0470-7184.2	LD7184 ATE 23587 20,6 + WK Ceramic
			⬅	11/09→; +PR 1LK		13.0460-7200.2	607200 ATE 23801 20,3 + WK
						13.0470-7200.2	LD7200 ATE 23801 20,3 + WK Ceramic
			➡	11/09→; +PR 1KF,1KJ		13.0460-2749.2	602749 TRW 24483 16,9 - WE / - WK + Zub
						13.0460-2880.2	602880 TRW 23914 17,1 + WE / - WK + Zub

	kw			 	! #		
SKODA - SUPERB II Kombi (3T5) 10/09→05/15							
 Bremsbelagsatz, Scheibenbremse							
2.0 TDI	103	10/09→03/10	➡	11/09→; +PR 1KF,1KJ	13.0470-2749.2	LD2749	TRW 24483 16,9 - WE / - WK + Zub Ceramic
					13.0470-2880.2	LD2880	TRW 23914 17,1 + WE / - WK + Zub Ceramic
			➡	11/09→; +PR 1KS	13.0460-3858.2	603858	BOS 24563 17,7 - WE / - WK + Zub
					13.0470-3858.2	LD3858	BOS 24563 17,7 - WE / - WK + Zub Ceramic
2.0 TDI 16V 4x4	103	11/10→05/15	←	→ 02/15; +PR 1LJ,1ZA,1ZE	13.0460-7184.2	607184	ATE 23587 20,6 + WK
					13.0470-7184.2	LD7184	ATE 23587 20,6 + WK Ceramic
			←	→ 02/15; +PR 1LK	13.0460-7200.2	607200	ATE 23801 20,3 + WK
					13.0470-7200.2	LD7200	ATE 23801 20,3 + WK Ceramic
			➡	→ 02/15; +PR 2EA	13.0460-2749.2	602749	TRW 24483 16,9 - WE / - WK + Zub
					13.0460-2880.2	602880	TRW 23914 17,1 + WE / - WK + Zub
					13.0470-2749.2	LD2749	TRW 24483 16,9 - WE / - WK + Zub Ceramic
					13.0470-2880.2	LD2880	TRW 23914 17,1 + WE / - WK + Zub Ceramic
			➡	→ 02/15; +PR 1KF,1KJ	13.0460-2749.2	602749	TRW 24483 16,9 - WE / - WK + Zub
					13.0460-2880.2	602880	TRW 23914 17,1 + WE / - WK + Zub
				13.0470-2749.2	LD2749	TRW 24483 16,9 - WE / - WK + Zub Ceramic	
				13.0470-2880.2	LD2880	TRW 23914 17,1 + WE / - WK + Zub Ceramic	
			➡	→ 02/15; +PR 1KS	13.0460-3858.2	603858	BOS 24563 17,7 - WE / - WK + Zub
					13.0470-3858.2	LD3858	BOS 24563 17,7 - WE / - WK + Zub Ceramic
 Bremsscheibe							
1.4 TSI	92	10/09→05/15	←	11/09→ 02/15; +PR 1ZE	24.0125-0145.1	425145	Ø 288 25 22 V + S
1.8 TSI	112	10/09→05/15	←	11/09→ 02/15; +PR 1LJ,1ZA	24.0125-0158.1	425158	Ø 312 25 22 V + S
1.8 TSI	118	10/09→05/15	←	11/09→ 02/15; +PR 1LJ,1ZA	24.0325-0158.1	525158	Ø 312 25 22 V + S PD
2.0 TDI	125	10/09→05/15	←	11/09→ 02/15; +PR 1LK	24.0130-0115.1	430115	Ø 345 30 27 V
2.0 TDI 16V	103	10/09→05/15	←	11/09→ 02/15; +PR 1LK	24.0330-0115.1	530115	Ø 345 30 27 V PD
			➡	11/09→ 02/15; +PR 1KS	24.0110-0356.1	410356	Ø 272 9,7 8 + S
					24.0310-0356.1	510356	Ø 272 9,7 8 + S PD
			➡	11/09→ 02/15; +PR 1KF	24.0112-0158.1	412158	Ø 256 12 10 + S
					24.0312-0158.1	512158	Ø 256 12 10 PD
			➡	11/09→ 02/15; +PR 1KJ	24.0112-0169.1	412169	Ø 282 12 10 + S
					24.0312-0169.1	512169	Ø 282 12 10 + S PD
1.6 TDI	77	09/10→05/15	←	→ 02/15; +PR 1ZE	24.0125-0145.1	425145	Ø 288 25 22 V + S
2.0 TSI	147	05/10→05/15	←	→ 02/15; +PR 1LJ,1ZA	24.0125-0158.1	425158	Ø 312 25 22 V + S
			←	→ 02/15; +PR 1LK	24.0325-0158.1	525158	Ø 312 25 22 V + S PD
			←	→ 02/15; +PR 1LK	24.0130-0115.1	430115	Ø 345 30 27 V
					24.0330-0115.1	530115	Ø 345 30 27 V PD
			➡	→ 02/15; +PR 1KS	24.0110-0356.1	410356	Ø 272 9,7 8 + S
					24.0310-0356.1	510356	Ø 272 9,7 8 + S PD
			➡	→ 02/15; +PR 1KF	24.0112-0158.1	412158	Ø 256 12 10 + S
					24.0312-0158.1	512158	Ø 256 12 10 PD
			➡	→ 02/15; +PR 1KJ	24.0112-0169.1	412169	Ø 282 12 10 + S
					24.0312-0169.1	512169	Ø 282 12 10 + S PD
1.8 TSI 4x4	112	10/09→05/15	←	11/09→ 02/15; +PR 1ZE	24.0125-0145.1	425145	Ø 288 25 22 V + S
1.8 TSI 4x4	118	10/09→05/15	←	11/09→ 02/15; +PR 1LJ,1ZA	24.0125-0158.1	425158	Ø 312 25 22 V + S
2.0 TDI 4x4	125	10/09→05/15	←	11/09→ 02/15; +PR 1LJ,1ZA	24.0325-0158.1	525158	Ø 312 25 22 V + S PD
			←	11/09→ 02/15; +PR 1LK	24.0130-0115.1	430115	Ø 345 30 27 V
					24.0330-0115.1	530115	Ø 345 30 27 V PD
			➡	11/09→ 02/15; +PR 1KS	24.0110-0356.1	410356	Ø 272 9,7 8 + S
					24.0310-0356.1	510356	Ø 272 9,7 8 + S PD
			➡	11/09→ 02/15; +PR 1KF	24.0112-0158.1	412158	Ø 256 12 10 + S
					24.0312-0158.1	512158	Ø 256 12 10 PD























	kw			 	! #		
SKODA - SUPERB II Kombi (3T5) 10/09→05/15							
Bremsscheibe							
1.8 TSI 4x4	112	10/09→05/15	➔	11/09→ 02/15; +PR 1KJ		24.0112-0169.1 412169	Ø 282 12 10 + S
1.8 TSI 4x4	118	10/09→05/15				24.0312-0169.1 512169	Ø 282 12 10 + S PD
2.0 TDI 4x4	125	10/09→05/15	➔	11/09→ 02/15; +PR 2EA		24.0122-0219.1 422219	Ø 310 22 20 V
1.9 TDI	77	10/09→11/10	➔	+PR 1ZE		24.0125-0145.1 425145	Ø 288 25 22 V + S
			➔	+PR 1LJ,1ZA		24.0125-0158.1 425158	Ø 312 25 22 V + S
						24.0325-0158.1 525158	Ø 312 25 22 V + S PD
			➔	+PR 1LK		24.0130-0115.1 430115	Ø 345 30 27 V
						24.0330-0115.1 530115	Ø 345 30 27 V PD
			➔	+PR 1KS		24.0110-0356.1 410356	Ø 272 9,7 8 + S
						24.0310-0356.1 510356	Ø 272 9,7 8 + S PD
2.0 TDI	103	10/09→03/10	➔	+PR 1KF		24.0112-0158.1 412158	Ø 256 12 10 + S
						24.0312-0158.1 512158	Ø 256 12 10 PD
			➔	+PR 1KJ		24.0112-0169.1 412169	Ø 282 12 10 + S
						24.0312-0169.1 512169	Ø 282 12 10 + S PD
			➔	+PR 1ZE		24.0125-0145.1 425145	Ø 288 25 22 V + S
			➔	+PR 1LJ,1ZA		24.0125-0158.1 425158	Ø 312 25 22 V + S
						24.0325-0158.1 525158	Ø 312 25 22 V + S PD
2.0 TDI 16V 4x4	103	11/10→05/15	➔	+PR 1LK		24.0130-0115.1 430115	Ø 345 30 27 V
						24.0330-0115.1 530115	Ø 345 30 27 V PD
			➔	+PR 1KS		24.0110-0356.1 410356	Ø 272 9,7 8 + S
						24.0310-0356.1 510356	Ø 272 9,7 8 + S PD
			➔	+PR 1KF		24.0112-0158.1 412158	Ø 256 12 10 + S
						24.0312-0158.1 512158	Ø 256 12 10 PD
			➔	+PR 1KJ		24.0112-0169.1 412169	Ø 282 12 10 + S
						24.0312-0169.1 512169	Ø 282 12 10 + S PD
3.6 V6 4x4	191	10/09→05/15	➔	+PR 2EA		24.0122-0219.1 422219	Ø 310 22 20 V
			➔	+PR 1ZE		24.0125-0145.1 425145	Ø 288 25 22 V + S
			➔	+PR 1LJ,1ZA		24.0125-0158.1 425158	Ø 312 25 22 V + S
						24.0325-0158.1 525158	Ø 312 25 22 V + S PD
			➔	+PR 1LK		24.0130-0115.1 430115	Ø 345 30 27 V
						24.0330-0115.1 530115	Ø 345 30 27 V PD
			➔	+PR 1KS		24.0110-0356.1 410356	Ø 272 9,7 8 + S
			24.0310-0356.1 510356	Ø 272 9,7 8 + S PD			
SKODA - SUPERB III (3V3) 03/15→							
Bremsbelagsatz, Scheibenbremse							
1.4 TSI	92	03/15→	➔	+PR 1ZA		13.0460-2785.2 602785	TRW 25683 20,4 + WE / + WK
1.4 TSI	110	03/15→				13.0470-2785.2 LD2785	TRW 25683 20,4 + WE / + WK Ceramic
1.4 TSI 4x4	110	03/15→					
1.6 TDI	88	03/15→	➔	+PR 1KU,1KZ; + eFSB		13.0460-7294.2 607294	ATE 25009 16,4 - WE / - WK
1.8 TSI	132	03/15→				13.0470-7294.2 LD7294	ATE 25009 16,4 - WE / - WK Ceramic
2.0 TDI	110	03/15→					
2.0 TDI	140	03/15→					
2.0 TDI 4x4	110	03/15→					
2.0 TDI 4x4	140	03/15→					
2.0 TSI	162	03/15→					
2.0 TSI 4x4	206	03/15→					
↓							

















	kW			 	! #		
SKODA - SUPERB III (3V3) 03/15→							
Warnkontakt, Bremsbelagverschleiß							
1.4 TSI	92	03/15→	←	+PR 1LA	1	24.8190-0065.2 620065	L= 172
1.4 TSI	110	03/15→	←	+PR 1ZA	1	24.8190-0065.2 620065	L= 172
1.4 TSI 4x4	110	03/15→					
1.6 TDI	88	03/15→					
1.8 TSI	132	03/15→					
2.0 TDI	110	03/15→					
2.0 TDI	140	03/15→					
2.0 TDI 4x4	110	03/15→					
2.0 TDI 4x4	140	03/15→					
2.0 TSI	162	03/15→					
2.0 TSI 4x4	206	03/15→					
 Bremsscheibe							
1.4 TSI	92	03/15→	←	+PR 1ZA		24.0125-0158.1 425158	Ø 312 25 22 V + S
1.4 TSI	110	03/15→	←	+PR 1LA		24.0130-0225.1 430225	Ø 340 30 27 V + S
1.4 TSI 4x4	110	03/15→					
1.6 TDI	88	03/15→	→	+PR 1KU; + eFSB		24.0112-0210.1 412210	Ø 300 12 10 + S
1.8 TSI	132	03/15→					
2.0 TDI	110	03/15→	→	+PR 1KZ		24.0122-0219.1 422219	Ø 310 22 20 V
2.0 TDI	140	03/15→					
2.0 TDI 4x4	110	03/15→					
2.0 TDI 4x4	140	03/15→					
2.0 TSI	162	03/15→					
2.0 TSI 4x4	206	03/15→					
SKODA - SUPERB III Kombi (3V5) 03/15→							
 Bremsbelagsatz, Scheibenbremse							
1.4 TSI	92	03/15→	←	+PR 1ZA		13.0460-2785.2 602785	TRW 25683 20,4 + WE / + WK
1.4 TSI	110	03/15→	←			13.0470-2785.2 LD2785	TRW 25683 20,4 + WE / + WK Ceramic
1.4 TSI 4x4	110	03/15→					
1.6 TDI	88	03/15→					
1.8 TSI	132	03/15→	→	+PR 1KU,1KZ; + eFSB		13.0460-7294.2 607294	ATE 25009 16,4 - WE / - WK
2.0 TDI	110	03/15→				13.0470-7294.2 LD7294	ATE 25009 16,4 - WE / - WK Ceramic
2.0 TDI	140	03/15→					
2.0 TDI 4x4	110	03/15→					
2.0 TDI 4x4	140	03/15→					
2.0 TSI	162	03/15→					
2.0 TSI 4x4	206	03/15→					
Warnkontakt, Bremsbelagverschleiß							
1.4 TSI	92	03/15→	←	+PR 1LA	1	24.8190-0065.2 620065	L= 172
1.4 TSI	110	03/15→	←	+PR 1ZA	1	24.8190-0065.2 620065	L= 172
1.4 TSI 4x4	110	03/15→					
1.6 TDI	88	03/15→					
1.8 TSI	132	03/15→					
2.0 TDI	110	03/15→					
2.0 TDI	140	03/15→					
2.0 TDI 4x4	110	03/15→					
2.0 TDI 4x4	140	03/15→					
2.0 TSI	162	03/15→					
2.0 TSI 4x4	206	03/15→					
 Bremsscheibe							
1.4 TSI	92	03/15→	←	+PR 1ZA		24.0125-0158.1 425158	Ø 312 25 22 V + S
1.4 TSI	110	03/15→	←			24.0325-0158.1 525158	Ø 312 25 22 V + S PD
1.4 TSI 4x4	110	03/15→					
1.6 TDI	88	03/15→	←	+PR 1LA		24.0130-0225.1 430225	Ø 340 30 27 V + S
1.8 TSI	132	03/15→	→	+PR 1KU,1KZ; + eFSB		24.0112-0210.1 412210	Ø 300 12 10 + S
2.0 TDI	110	03/15→					
2.0 TDI	140	03/15→					
2.0 TDI 4x4	110	03/15→					
2.0 TDI 4x4	140	03/15→					
2.0 TSI	162	03/15→					
2.0 TSI 4x4	206	03/15→					
SKODA - YETI (5L) 05/09→							
 Bremsbelagsatz, Scheibenbremse							
1.2 TSI	77	09/09→	←	+PR 1ZF		13.0460-7117.2 607117	VW 23130 19,6 + WK
			←	+PR 1ZA,1ZE		13.0470-7117.2 LD7117	VW 23130 19,6 + WK Ceramic
			←			13.0460-7184.2 607184	ATE 23587 20,6 + WK
			→	+PR 1KJ		13.0470-7184.2 LD7184	ATE 23587 20,6 + WK Ceramic
						13.0460-2749.2 602749	TRW 24483 16,9 - WE / - WK + Zub
						13.0460-2880.2 602880	TRW 23914 17,1 + WE / - WK + Zub
						13.0470-2749.2 LD2749	TRW 24483 16,9 - WE / - WK + Zub Ceramic















	kw			 	! #		
SKODA - YETI (5L) 05/09→							
 Bremsbelagsatz, Scheibenbremse							
1.2 TSI	77	09/09→	➔	+PR 1KJ		13.0470-2880.2 LD2880	TRW 23914 17,1 + WE / - WK + Zub Ceramic
			➔	+PR 1KD		13.0460-2820.2 602820	TRW 20961 17,2 - WK
			➔	11/09→; +PR 1KS		13.0470-2820.2 LD2820	TRW 20961 17,2 - WK Ceramic
			➔			13.0460-3858.2 603858	BOS 24563 17,7 - WE / - WK + Zub
						13.0470-3858.2 LD3858	BOS 24563 17,7 - WE / - WK + Zub Ceramic
1.2 TSI 1.4 TSI 1.6 2.0 TDI 2.0 TDI	81 92 81 103 110	05/15→ 05/15→ 04/14→ 11/11→ 05/15→	←	+PR 1ZF		13.0460-7117.2 607117	VW 23130 19,6 + WK
						13.0470-7117.2 LD7117	VW 23130 19,6 + WK Ceramic
			←	+PR 1ZA,1ZE		13.0460-7184.2 607184	ATE 23587 20,6 + WK
						13.0470-7184.2 LD7184	ATE 23587 20,6 + WK Ceramic
			➔	+PR 1KD		13.0460-2820.2 602820	TRW 20961 17,2 - WK
						13.0470-2820.2 LD2820	TRW 20961 17,2 - WK Ceramic
			➔	+PR 1KS		13.0460-3858.2 603858	BOS 24563 17,7 - WE / - WK + Zub
						13.0470-3858.2 LD3858	BOS 24563 17,7 - WE / - WK + Zub Ceramic
1.4 TSI 1.6 TDI 2.0 TDI	90 77 81	06/10→ 11/10→ 11/09→	←	+PR 1ZF		13.0460-7117.2 607117	VW 23130 19,6 + WK
						13.0470-7117.2 LD7117	VW 23130 19,6 + WK Ceramic
			←	+PR 1ZA,1ZE		13.0460-7184.2 607184	ATE 23587 20,6 + WK
						13.0470-7184.2 LD7184	ATE 23587 20,6 + WK Ceramic
			➔	+PR 1KJ		13.0460-2749.2 602749	TRW 24483 16,9 - WE / - WK + Zub
						13.0460-2880.2 602880	TRW 23914 17,1 + WE / - WK + Zub
						13.0470-2749.2 LD2749	TRW 24483 16,9 - WE / - WK + Zub Ceramic
						13.0470-2880.2 LD2880	TRW 23914 17,1 + WE / - WK + Zub Ceramic
➔	+PR 1KD		13.0460-2820.2 602820	TRW 20961 17,2 - WK			
			13.0470-2820.2 LD2820	TRW 20961 17,2 - WK Ceramic			
			➔	+PR 1KS		13.0460-3858.2 603858	BOS 24563 17,7 - WE / - WK + Zub
						13.0470-3858.2 LD3858	BOS 24563 17,7 - WE / - WK + Zub Ceramic
1.4 TSI 4x4	110	05/15→	←	+PR 1ZF		13.0460-7117.2 607117	VW 23130 19,6 + WK
						13.0470-7117.2 LD7117	VW 23130 19,6 + WK Ceramic
			←	+PR 1ZA,1ZE		13.0460-7184.2 607184	ATE 23587 20,6 + WK
						13.0470-7184.2 LD7184	ATE 23587 20,6 + WK Ceramic
			➔	+PR 1KS		13.0460-3858.2 603858	BOS 24563 17,7 - WE / - WK + Zub
						13.0470-3858.2 LD3858	BOS 24563 17,7 - WE / - WK + Zub Ceramic
1.8 TSI 4x4 2.0 TDI 4x4 2.0 TDI 4x4	112 81 125	11/09→ 11/09→ 11/09→	←	+PR 1ZF		13.0460-7117.2 607117	VW 23130 19,6 + WK
						13.0470-7117.2 LD7117	VW 23130 19,6 + WK Ceramic
			←	+PR 1ZA,1ZE		13.0460-7184.2 607184	ATE 23587 20,6 + WK
						13.0470-7184.2 LD7184	ATE 23587 20,6 + WK Ceramic
			➔	+PR 1KJ		13.0460-2749.2 602749	TRW 24483 16,9 - WE / - WK + Zub
						13.0460-2880.2 602880	TRW 23914 17,1 + WE / - WK + Zub
						13.0470-2749.2 LD2749	TRW 24483 16,9 - WE / - WK + Zub Ceramic
						13.0470-2880.2 LD2880	TRW 23914 17,1 + WE / - WK + Zub Ceramic
➔	+PR 1KS		13.0460-3858.2 603858	BOS 24563 17,7 - WE / - WK + Zub			
						13.0470-3858.2 LD3858	BOS 24563 17,7 - WE / - WK + Zub Ceramic
1.8 TSI 4x4 2.0 TDI 4x4	118 103	05/09→ 05/09→	←	+PR 1ZF		13.0460-7117.2 607117	VW 23130 19,6 + WK
						13.0470-7117.2 LD7117	VW 23130 19,6 + WK Ceramic
			←	+PR 1ZA,1ZE		13.0460-7184.2 607184	ATE 23587 20,6 + WK
						13.0470-7184.2 LD7184	ATE 23587 20,6 + WK Ceramic
			➔	+PR 1KJ		13.0460-2749.2 602749	TRW 24483 16,9 - WE / - WK + Zub

↓















	kw			 	! #		
SKODA - YETI (5L) 05/09→							
 Bremsbelagsatz, Scheibenbremse							
1.8 TSI 4x4 2.0 TDI 4x4	118 103	05/09→ 05/09→	➡	+PR 1KJ		13.0460-2880.2 602880 13.0470-2749.2 LD2749 13.0470-2880.2 LD2880	TRW 23914 17,1 + WE / - WK + Zub TRW 24483 16,9 - WE / - WK + Zub Ceramic TRW 23914 17,1 + WE / - WK + Zub Ceramic
			➡	11/09→; +PR 1KS		13.0460-3858.2 603858 13.0470-3858.2 LD3858	BOS 24563 17,7 - WE / - WK + Zub BOS 24563 17,7 - WE / - WK + Zub Ceramic
2.0 TDI 4x4	110	05/15→	←	+PR 1ZF		13.0460-7117.2 607117 13.0470-7117.2 LD7117	VW 23130 19,6 + WK VW 23130 19,6 + WK Ceramic
			➡	+PR 1KS		13.0460-3858.2 603858 13.0470-3858.2 LD3858	BOS 24563 17,7 - WE / - WK + Zub BOS 24563 17,7 - WE / - WK + Zub Ceramic
 Bremsscheibe							
1.2 TSI	77	09/09→	←	+PR 1ZF		24.0122-0210.1 422210 24.0322-0210.1 522210	Ø 280 22 19 V + S Ø 280 22 19 V + S PD
			←	+PR 1ZE		24.0125-0145.1 425145 24.0325-0145.1 525145	Ø 288 25 22 V + S Ø 288 25 22 V + S PD
			←	+PR 1ZA		24.0125-0158.1 425158 24.0325-0158.1 525158	Ø 312 25 22 V + S Ø 312 25 22 V + S PD
			➡	+PR 1KD		24.0110-0277.1 410277 24.0310-0277.1 510277	Ø 253 10 8 + S Ø 253 10 8 + S PD
			➡	11/09→; +PR 1KS		24.0110-0356.1 410356 24.0310-0356.1 510356	Ø 272 9,7 8 + S Ø 272 9,7 8 + S PD
			➡	+PR 1KJ		24.0112-0169.1 412169 24.0312-0169.1 512169	Ø 282 12 10 + S Ø 282 12 10 + S PD
1.2 TSI 1.4 TSI 1.6 TDI 2.0 TDI 2.0 TDI	81 92 81 103 110	05/15→ 05/15→ 04/14→ 11/11→ 05/15→	←	+PR 1ZF		24.0122-0210.1 422210 24.0322-0210.1 522210	Ø 280 22 19 V + S Ø 280 22 19 V + S PD
			←	+PR 1ZE		24.0125-0145.1 425145 24.0325-0145.1 525145	Ø 288 25 22 V + S Ø 288 25 22 V + S PD
			←	+PR 1ZA		24.0125-0158.1 425158 24.0325-0158.1 525158	Ø 312 25 22 V + S Ø 312 25 22 V + S PD
			➡	+PR 1KD		24.0110-0277.1 410277 24.0310-0277.1 510277	Ø 253 10 8 + S Ø 253 10 8 + S PD
			➡	+PR 1KS		24.0110-0356.1 410356 24.0310-0356.1 510356	Ø 272 9,7 8 + S Ø 272 9,7 8 + S PD
1.4 TSI 1.6 TDI 2.0 TDI	90 77 81	06/10→ 11/10→ 11/09→	←	+PR 1ZF		24.0122-0210.1 422210 24.0322-0210.1 522210	Ø 280 22 19 V + S Ø 280 22 19 V + S PD
			←	+PR 1ZE		24.0125-0145.1 425145 24.0325-0145.1 525145	Ø 288 25 22 V + S Ø 288 25 22 V + S PD
			←	+PR 1ZA		24.0125-0158.1 425158 24.0325-0158.1 525158	Ø 312 25 22 V + S Ø 312 25 22 V + S PD
			➡	+PR 1KD		24.0110-0277.1 410277 24.0310-0277.1 510277	Ø 253 10 8 + S Ø 253 10 8 + S PD
			➡	+PR 1KS		24.0110-0356.1 410356 24.0310-0356.1 510356	Ø 272 9,7 8 + S Ø 272 9,7 8 + S PD
			➡	+PR 1KJ		24.0112-0169.1 412169 24.0312-0169.1 512169	Ø 282 12 10 + S Ø 282 12 10 + S PD
1.4 TSI 4x4	110	05/15→	←	+PR 1ZF		24.0122-0210.1 422210 24.0322-0210.1 522210	Ø 280 22 19 V + S Ø 280 22 19 V + S PD
			←	+PR 1ZE		24.0125-0145.1 425145 24.0325-0145.1 525145	Ø 288 25 22 V + S Ø 288 25 22 V + S PD
			←	+PR 1ZA		24.0125-0158.1 425158 24.0325-0158.1 525158	Ø 312 25 22 V + S Ø 312 25 22 V + S PD
			➡	+PR 1KS		24.0110-0356.1 410356 24.0310-0356.1 510356	Ø 272 9,7 8 + S Ø 272 9,7 8 + S PD
1.8 TSI 4x4 2.0 TDI 4x4 2.0 TDI 4x4	112 81 125	11/09→ 11/09→ 11/09→	←	+PR 1ZF		24.0122-0210.1 422210 24.0322-0210.1 522210	Ø 280 22 19 V + S Ø 280 22 19 V + S PD
			←	+PR 1ZE		24.0125-0145.1 425145	Ø 288 25 22 V + S

















	kW			 	! #		
SKODA - YETI (5L) 05/09→							
 Bremsscheibe							
1.8 TSI 4x4	112	11/09→	←	+PR 1ZE		24.0325-0145.1 525145	Ø 288 25 22 V + S PD
2.0 TDI 4x4	81	11/09→	←	+PR 1ZA		24.0125-0158.1 425158	Ø 312 25 22 V + S
2.0 TDI 4x4	125	11/09→				24.0325-0158.1 525158	Ø 312 25 22 V + S PD
			→	+PR 1KS		24.0110-0356.1 410356	Ø 272 9,7 8 + S
			→	+PR 1KJ		24.0310-0356.1 510356	Ø 272 9,7 8 + S PD
						24.0112-0169.1 412169	Ø 282 12 10 + S
						24.0312-0169.1 512169	Ø 282 12 10 + S PD
1.8 TSI 4x4	118	05/09→	←	+PR 1ZF		24.0122-0210.1 422210	Ø 280 22 19 V + S
						24.0322-0210.1 522210	Ø 280 22 19 V + S PD
			←	+PR 1ZE		24.0125-0145.1 425145	Ø 288 25 22 V + S
						24.0325-0145.1 525145	Ø 288 25 22 V + S PD
			←	+PR 1ZA		24.0125-0158.1 425158	Ø 312 25 22 V + S
						24.0325-0158.1 525158	Ø 312 25 22 V + S PD
			→	11/09→; +PR 1KS		24.0110-0356.1 410356	Ø 272 9,7 8 + S
						24.0310-0356.1 510356	Ø 272 9,7 8 + S PD
			→	+PR 1KJ		24.0112-0169.1 412169	Ø 282 12 10 + S
						24.0312-0169.1 512169	Ø 282 12 10 + S PD
2.0 TDI 4x4	103	05/09→	←	+PR 1ZF		24.0122-0210.1 422210	Ø 280 22 19 V + S
						24.0322-0210.1 522210	Ø 280 22 19 V + S PD
			←	+PR 1ZE		24.0125-0145.1 425145	Ø 288 25 22 V + S
						24.0325-0145.1 525145	Ø 288 25 22 V + S PD
			←	+PR 1ZA		24.0125-0158.1 425158	Ø 312 25 22 V + S
						24.0325-0158.1 525158	Ø 312 25 22 V + S PD
			←	05/15→; +PR 1ZA		24.0125-0158.1 425158	Ø 312 25 22 V + S
						24.0325-0158.1 525158	Ø 312 25 22 V + S PD
			→	11/09→; +PR 1KS		24.0110-0356.1 410356	Ø 272 9,7 8 + S
						24.0310-0356.1 510356	Ø 272 9,7 8 + S PD
			→	+PR 1KJ		24.0112-0169.1 412169	Ø 282 12 10 + S
						24.0312-0169.1 512169	Ø 282 12 10 + S PD
2.0 TDI 4x4	110	05/15→	←	+PR 1ZF		24.0122-0210.1 422210	Ø 280 22 19 V + S
						24.0322-0210.1 522210	Ø 280 22 19 V + S PD
			←	+PR 1ZE		24.0125-0145.1 425145	Ø 288 25 22 V + S
						24.0325-0145.1 525145	Ø 288 25 22 V + S PD
			→	+PR 1KS		24.0110-0356.1 410356	Ø 272 9,7 8 + S
						24.0310-0356.1 510356	Ø 272 9,7 8 + S PD
SMART - CABRIO (450) 03/00→01/04							
 Bremsbelagsatz, Scheibenbremse							
0.6 (450.432)	52	06/02→01/04	←			13.0460-3979.2 603979	BOS 21999 15,8 + WK - Zub
0.6 (S1OLA1, 450.441, 450.442, 450.443)	40	03/00→01/04					
0.6 (S1OLD2, 450.452)	45	01/01→01/04					
0.7 (450.433)	55	01/03→01/04					
0.7 (450.452, 450.432)	45	01/03→01/04					
0.8 CDI (S1OLC1, 450.401, 450.402, 450.403, 450.400)	30	03/01→01/04					
 Bremsscheibe							
0.6 (450.432)	52	06/02→01/04	←			24.0110-0331.1 410331	Ø 280 9,6 8 + S
0.6 (S1OLA1, 450.441, 450.442, 450.443)	40	03/00→01/04					
0.6 (S1OLD2, 450.452)	45	01/01→01/04					
0.7 (450.433)	55	01/03→01/04					
0.7 (450.452, 450.432)	45	01/03→01/04					
0.8 CDI (S1OLC1, 450.401, 450.402, 450.403, 450.400)	30	03/01→01/04					
SMART - CITY-COUPÉ (450) 07/98→01/04							
 Bremsbelagsatz, Scheibenbremse							
0.6 (450.330, 450.332)	52	06/02→01/04	←			13.0460-3979.2 603979	BOS 21999 15,8 + WK - Zub
0.6 (450.352, 450.353)	45	01/01→01/04					
0.6 (S1CLA1, 450.341)	40	07/98→01/04					
0.6 (S1CLB1, 450.331, 450.336)	33	07/98→01/04					
0.7 (450.330)	37	01/03→01/04					
0.7 (450.333)	55	01/03→01/04					















	kw					! #		
SMART - CITY-COUPE (450) 07/98→01/04								
 Bremsbelagsatz, Scheibenbremse								
0.7 (450.352, 450.353) 0.8 CDI (S1CLC1, 450.300, 450.301, 450.302, 450.303...)	45 30	01/03→01/04 11/99→01/04	←				13.0460-3979.2 603979	BOS 21999 15,8 + WK - Zub
 Bremsscheibe								
0.6 (450.330, 450.332) 0.6 (450.352, 450.353) 0.6 (S1CLA1, 450.341) 0.6 (S1CLB1, 450.331, 450.336) 0.7 (450.330) 0.7 (450.333) 0.7 (450.352, 450.353) 0.8 CDI (S1CLC1, 450.300, 450.301, 450.302, 450.303...)	52 45 40 33 37 55 45 30	06/02→01/04 01/01→01/04 07/98→01/04 07/98→01/04 01/03→01/04 01/03→01/04 01/03→01/04 11/99→01/04	←				24.0110-0331.1 410331	Ø 280 9,6 8 + S
SMART - CROSSBLADE (450) 06/02→12/03								
 Bremsbelagsatz, Scheibenbremse								
0.6 (450.418)	52	06/02→12/03	←				13.0460-3979.2 603979	BOS 21999 15,8 + WK - Zub
 Bremsscheibe								
0.6 (450.418)	52	06/02→12/03	←				24.0110-0331.1 410331	Ø 280 9,6 8 + S
SMART - FORFOUR (454) 01/04→06/06								
 Bremsbelagsatz, Scheibenbremse								
1.1 (454.030) 1.3 (454.031) 1.5 (454.032)	55 70 80	01/04→06/06 01/04→06/06 01/04→06/06	← →	03/04→ 03/04→			13.0460-2896.2 602896 13.0460-2897.2 602897	TRW 21920 16,6 + WK + Zub TRW 21861 15,2 + WK
1.1 (454.033) 1.5 CDI (454.000) 1.5 CDI (454.001)	47 50 70	02/05→06/06 09/04→06/06 09/04→06/06	← →				13.0460-2896.2 602896 13.0460-2897.2 602897	TRW 21920 16,6 + WK + Zub TRW 21861 15,2 + WK
1.5 (454.032)	90	01/04→06/06	← →	11/04→ 11/04→			13.0460-2896.2 602896 13.0460-2897.2 602897	TRW 21920 16,6 + WK + Zub TRW 21861 15,2 + WK
1.5 BRABUS (454.034)	130	05/05→06/06	→				13.0460-2897.2 602897	TRW 21861 15,2 + WK
 Bremsscheibe								
1.1 (454.030) 1.3 (454.031) 1.5 (454.032)	55 70 80	01/04→06/06 01/04→06/06 01/04→06/06	← →	03/04→ 03/04→			24.0124-0192.1 424192 24.0110-0304.1 410304	Ø 256 24 21,5 V Ø 250 10 8
1.1 (454.033) 1.5 CDI (454.000) 1.5 CDI (454.001)	47 50 70	02/05→06/06 09/04→06/06 09/04→06/06	← →				24.0124-0192.1 424192 24.0110-0304.1 410304	Ø 256 24 21,5 V Ø 250 10 8
1.5 (454.032)	90	01/04→06/06	← →	11/04→ 11/04→			24.0124-0192.1 424192 24.0110-0304.1 410304	Ø 256 24 21,5 V Ø 250 10 8
1.5 BRABUS (454.034)	130	05/05→06/06	→				24.0110-0304.1 410304	Ø 250 10 8
SMART - FORFOUR Schrägheck (453) 07/14→								
 Bremsbelagsatz, Scheibenbremse								
0.9 (453.044, 453.053) 0.9 Brabus (453.062)	66 80	11/14→ 07/16→	←				13.0460-7298.2 607298	ATE 25702 18,2 - WE / - WK
1.0 (453.041)	45	11/14→	←	01/15→			13.0460-7298.2 607298	ATE 25702 18,2 - WE / - WK
1.0 (453.042)	52	07/14→	←	11/14→			13.0460-7298.2 607298	ATE 25702 18,2 - WE / - WK
 Bremsscheibe								
0.9 (453.044, 453.053) 0.9 Brabus (453.062)	66 80	11/14→ 07/16→	←				24.0112-0171.1 412171 24.0122-0289.1 422289	Ø 259 12 10,6 + S Ø 258 22 19,8 V + S
1.0 (453.041)	45	11/14→	←	01/15→			24.0112-0171.1 412171 24.0122-0289.1 422289	Ø 259 12 10,6 + S Ø 258 22 19,8 V + S
1.0 (453.042)	52	07/14→	←	11/14→			24.0112-0171.1 412171 24.0122-0289.1 422289	Ø 259 12 10,6 + S Ø 258 22 19,8 V + S
electric drive (453.091) electric drive (453.091)	41 60	05/17→ 05/17→	←				24.0122-0289.1 422289	Ø 258 22 19,8 V + S
SMART - FORTWO Cabrio (450) 01/04→01/07								
 Bremsbelagsatz, Scheibenbremse								
0.6 Brabus (450.433)	55	01/04→12/06	←				13.0460-3979.2 603979	BOS 21999 15,8 + WK - Zub













	kW			 	! #		
SMART - FORTWO Cabrio (450) 01/04→01/07							
 Bremsbelagsatz, Scheibenbremse							
0.7 (450.433) 0.7 (450.452) 0.8 CDI (450.401, 450.402, 450.403, 450.400)	55 45 30	01/04→01/07 01/04→01/07 01/04→01/07	←			13.0460-3979.2 603979	BOS 21999 15,8 + WK - Zub
 Bremsscheibe							
0.6 Brabus (450.433) 0.7 (450.433) 0.7 (450.452) 0.8 CDI (450.401, 450.402, 450.403, 450.400)	55 55 45 30	01/04→12/06 01/04→01/07 01/04→01/07 01/04→01/07	←			24.0110-0331.1 410331	Ø 280 9,6 8 + S
SMART - FORTWO Cabrio (451) 01/07→							
 Bremsbelagsatz, Scheibenbremse							
0.8 CDi (451.400) 1.0 (451.431, 451.480) 1.0 Turbo (451.432)	33 52 62	01/07→ 01/07→ 01/07→	←	04/07→		13.0460-3979.2 603979	BOS 21999 15,8 + WK - Zub
0.8 CDi (451.401) 1.0 Brabus 1.0 Brabus (451.433) 1.0 Turbo Brabus (451.433) electric drive (451.490, 451.491) electric drive (451.490, 451.491) electric drive (451.490) electric drive (451.491) electric drive Brabus (451.492)	40 88 72 75 20 55 35 30 60	08/09→ 04/12→ 01/08→ 07/10→ 12/10→12/12 01/13→ 12/11→12/12 11/09→12/11 01/13→	←			13.0460-3979.2 603979	BOS 21999 15,8 + WK - Zub
 Bremsscheibe							
0.8 CDi (451.400) 1.0 (451.431, 451.480) 1.0 Turbo (451.432)	33 52 62	01/07→ 01/07→ 01/07→	←	04/07→		24.0110-0331.1 410331	Ø 280 9,6 8 + S
0.8 CDi (451.401) 1.0 Brabus 1.0 Brabus (451.433) 1.0 Turbo Brabus (451.433) electric drive (451.490, 451.491) electric drive (451.490, 451.491) electric drive (451.490) electric drive (451.491) electric drive Brabus (451.492)	40 88 72 75 20 55 35 30 60	08/09→ 04/12→ 01/08→ 07/10→ 12/10→12/12 01/13→ 12/11→12/12 11/09→12/11 01/13→	←			24.0110-0331.1 410331	Ø 280 9,6 8 + S
SMART - FORTWO Cabriolet (453) 09/15→							
 Bremsbelagsatz, Scheibenbremse							
0.9 (453.444, 453.453) 0.9 Brabus (453.462) 1.0 (453.442, 453.443)	66 80 52	09/15→ 07/16→ 09/15→	←			13.0460-7298.2 607298	ATE 25702 18,2 - WE / - WK
 Bremsscheibe							
0.9 (453.444, 453.453) 0.9 Brabus (453.462) 1.0 (453.442, 453.443)	66 80 52	09/15→ 07/16→ 09/15→	←			24.0112-0171.1 412171 24.0122-0289.1 422289	Ø 259 12 10,6 + S Ø 258 22 19,8 V + S
SMART - FORTWO Coupe (450) 01/04→02/07							
 Bremsbelagsatz, Scheibenbremse							
0.6 (450.332) 0.7 (450.330) 0.7 (450.333) 0.7 (450.335) 0.7 (450.352, 450.332) 0.8 CDI (450.300, 450.301, 450.302, 450.303, 450.306)	45 37 55 40 45 30	01/04→02/07 01/04→01/07 01/04→01/07 01/04→01/07 01/04→01/07 01/04→01/07	←			13.0460-3979.2 603979	BOS 21999 15,8 + WK - Zub
 Bremsscheibe							
0.6 (450.332) 0.7 (450.330) 0.7 (450.333) ↓	45 37 55	01/04→02/07 01/04→01/07 01/04→01/07	←			24.0110-0331.1 410331	Ø 280 9,6 8 + S















	kW					! #		
SMART - FORTWO Coupe (450) 01/04→02/07								
 Bremsscheibe								
0.7 (450.335) 0.7 (450.352, 450.332) 0.8 CDI (450.300, 450.301, 450.302, 450.303, 450.306)	40 45 30	01/04→01/07 01/04→01/07 01/04→01/07	←				24.0110-0331.1 410331	Ø 280 9,6 8 + S
SMART - FORTWO Coupe (451) 01/07→								
 Bremsbelagsatz, Scheibenbremse								
0.8 CDi (451.300) 1.0 (451.330, 451.334) 1.0 (451.331, 451.380) 1.0 Turbo (451.332)	33 45 52 62	01/07→ 01/07→ 01/07→ 01/07→	←	04/07→			13.0460-3979.2 603979	BOS 21999 15,8 + WK - Zub
0.8 CDi (451.301) 1.0 Brabus (451.333) 1.0 Turbo Brabus (451.333) electric drive (451.390, 451.391) electric drive (451.390) electric drive (451.391, 451.390) electric drive (451.391) electric drive Brabus (451.392)	40 72 75 55 35 20 30 60	08/09→ 01/08→ 07/10→ 01/13→ 12/11→12/12 12/10→12/12 11/09→12/11 01/13→	←				13.0460-3979.2 603979	BOS 21999 15,8 + WK - Zub
 Bremsscheibe								
0.8 CDi (451.300) 1.0 (451.330, 451.334) 1.0 (451.331, 451.380) 1.0 Turbo (451.332)	33 45 52 62	01/07→ 01/07→ 01/07→ 01/07→	←	04/07→			24.0110-0331.1 410331	Ø 280 9,6 8 + S
0.8 CDi (451.301) 1.0 Brabus (451.333) 1.0 Turbo Brabus (451.333) electric drive (451.390, 451.391) electric drive (451.390) electric drive (451.391, 451.390) electric drive (451.391) electric drive Brabus (451.392)	40 72 75 55 35 20 30 60	08/09→ 01/08→ 07/10→ 01/13→ 12/11→12/12 12/10→12/12 11/09→12/11 01/13→	←				24.0110-0331.1 410331	Ø 280 9,6 8 + S
SMART - FORTWO Coupe (453) 07/14→								
 Bremsbelagsatz, Scheibenbremse								
0.9 (453.344, 453.353) 1.0 (453.342, 453.343)	66 52	09/14→ 07/14→	←	11/14→			13.0460-7298.2 607298	ATE 25702 18,2 - WE / - WK
0.9 Brabus (453.362)	80	07/16→	←				13.0460-7298.2 607298	ATE 25702 18,2 - WE / - WK
1.0 (453.341)	45	11/14→	←	01/15→			13.0460-7298.2 607298	ATE 25702 18,2 - WE / - WK
 Bremsscheibe								
0.9 (453.344, 453.353) 1.0 (453.342, 453.343)	66 52	09/14→ 07/14→	←	11/14→			24.0112-0171.1 412171 24.0122-0289.1 422289	Ø 259 12 10,6 + S Ø 258 22 19,8 V + S
0.9 Brabus (453.362)	80	07/16→	←				24.0112-0171.1 412171 24.0122-0289.1 422289	Ø 259 12 10,6 + S Ø 258 22 19,8 V + S
1.0 (453.341)	45	11/14→	←	01/15→			24.0112-0171.1 412171 24.0122-0289.1 422289	Ø 259 12 10,6 + S Ø 258 22 19,8 V + S
electric drive (453.391) electric drive (453.391)	41 60	05/17→ 05/17→	←				24.0122-0289.1 422289	Ø 258 22 19,8 V + S
SMART - ROADSTER (452) 04/03→11/05								
 Bremsbelagsatz, Scheibenbremse								
0.7 (452.432) 0.7 (452.434)	45 60	04/03→11/05 04/03→11/05	←				13.0460-3979.2 603979	BOS 21999 15,8 + WK - Zub
0.7 Brabus (452.437)	74	12/03→11/05	←	03/04→			13.0460-3979.2 603979	BOS 21999 15,8 + WK - Zub
 Bremsscheibe								
0.7 (452.432) 0.7 (452.434)	45 60	04/03→11/05 04/03→11/05	←				24.0110-0331.1 410331	Ø 280 9,6 8 + S
0.7 Brabus (452.437)	74	12/03→11/05	←	03/04→			24.0110-0331.1 410331	Ø 280 9,6 8 + S











	kW					! #		
SMART - ROADSTER Coupe (452) 04/03→11/05								
 Bremsbelagsatz, Scheibenbremse								
0.7 (452.332)	45	06/03→11/05	←	04/05→		13.0460-3979.2	603979	BOS 21999 15,8 + WK - Zub
0.7 (452.334)	60	04/03→11/05	←			13.0460-3979.2	603979	BOS 21999 15,8 + WK - Zub
0.7 Brabus (452.337)	74	12/03→11/05	←	03/04→		13.0460-3979.2	603979	BOS 21999 15,8 + WK - Zub
 Bremsscheibe								
0.7 (452.332)	45	06/03→11/05	←	04/05→		24.0110-0331.1	410331	Ø 280 9,6 8 + S
0.7 (452.334)	60	04/03→11/05	←			24.0110-0331.1	410331	Ø 280 9,6 8 + S
0.7 Brabus (452.337)	74	12/03→11/05	←	03/04→		24.0110-0331.1	410331	Ø 280 9,6 8 + S
SSANGYONG - ACTYON SPORTS II 10/12→								
 Bremsbelagsatz, Scheibenbremse								
2.2 Xdi	131	07/15→	→			13.0460-5623.2	605623	MAN 23673 15,9 + WK
2.2 Xdi 4WD	131	07/15→						
SSANGYONG - KORANDO (KJ) 12/96→11/06								
 Bremsscheibe								
2.3	103	05/97→02/00	→	→ 01/99		24.0110-0352.1	410352	Ø 299 10,4 8,5
2.3	105	01/99→11/06						
2.3 TDiC 4x4	74	07/98→11/06						
2.9 D	73	06/97→10/00						
2.9 D (KJ)	72	12/96→10/00						
2.9 TD	88	04/98→11/06						
3.2	156	01/99→02/00						
3.2	162	06/97→11/06						
3.2 (KJ)	154	12/96→11/02						
2.3 D (KJ)	58	12/96→06/98	→			24.0110-0352.1	410352	Ø 299 10,4 8,5
SSANGYONG - KORANDO Cabrio (KJ) 12/96→11/06								
 Bremsscheibe								
2.3	103	11/97→02/00	→	→ 01/99		24.0110-0352.1	410352	Ø 299 10,4 8,5
2.9 D	72	11/97→10/00						
2.9 TD	88	04/98→02/00						
3.2	156	01/99→11/02						
3.2	162	06/97→11/06						
SSANGYONG - MUSSO (FJ) 01/93→09/07								
 Bremsscheibe								
2.0	93	10/96→05/05	→	01/99→		24.0110-0352.1	410352	Ø 299 10,4 8,5
2.3	103	10/96→11/02						
2.3 D	59	10/95→04/99						
3.2	162	06/96→09/04						
2.3	110	04/03→08/06	→	→ 11/05		24.0110-0352.1	410352	Ø 299 10,4 8,5
2.9 TD	88	04/98→09/07	→	01/99→ 11/05		24.0110-0352.1	410352	Ø 299 10,4 8,5
SSANGYONG - MUSSO SPORTS 08/04→								
 Bremsscheibe								
2.9 D	88	08/04→09/07	→	→ 11/05		24.0110-0352.1	410352	Ø 299 10,4 8,5
2.9 D 4x4	88	08/04→						
SSANGYONG - REXTON (GAB_) 04/02→								
 Bremsbelagsatz, Scheibenbremse								
2.3 RX230 4x4	110	05/02→	→	→ 08/06		13.0460-5623.2	605623	MAN 23673 15,9 + WK
2.7 Xdi	120	08/04→						
2.9 TD	88	04/02→						
3.2	162	04/02→						
2.7 Xdi	121	03/05→08/06	→			13.0460-5623.2	605623	MAN 23673 15,9 + WK
 Bremsscheibe								
2.3 RX230 4x4	110	05/02→	→	→ 02/06		24.0110-0352.1	410352	Ø 299 10,4 8,5
2.7 Xdi	120	08/04→						
2.7 Xdi	121	03/05→08/06						
2.9 TD	88	04/02→						
3.2	162	04/02→						
SUBARU - BRZ 06/12→								
 Bremsscheibe								
2.0	147	06/12→	←	Low-Type		24.0124-0145.1	424145	Ø 277 24 22 V
↓								

	kw			 	! #		
SUBARU - BRZ 06/12→							
 Bremsscheibe							
2.0	147	06/12→	←	High-Type		24.0124-0196.1 424196	Ø 293,5 24 22 V
			→	Low-Type		24.0110-0366.1 410366	Ø 286 10 8,5
SUBARU - FORESTER (SF) 03/97→09/02							
 Bremsbelagsatz, Scheibenbremse							
2.0 AWD	90	08/97→09/02	←			13.0460-5851.2 605851	AKE 21915 17,2 + WK
2.0 AWD	92	06/98→09/02	←	07/98→		13.0460-5851.2 605851	AKE 21915 17,2 + WK
2.0 S Turbo AWD	125	06/98→04/01	←	07/98→			
2.0 S Turbo AWD	130	04/01→09/02	←	09/02→		13.0460-5787.2 605787	TOK 23865 17,6 + WK + Zub
 Bremsscheibe							
2.0 AWD	90	08/97→09/02	←			24.0124-0145.1 424145	Ø 277 24 22 V
2.0 AWD	92	06/98→09/02	←	07/98→		24.0124-0145.1 424145	Ø 277 24 22 V
2.0 S Turbo AWD	125	06/98→04/01	←	07/98→		24.0124-0145.1 424145	Ø 277 24 22 V
			→	07/98→		24.0110-0237.1 410237	Ø 266 10 8,5
2.0 S Turbo AWD	130	04/01→09/02	←	09/02→		24.0124-0196.1 424196	Ø 293,5 24 22 V
			→	09/02→		24.0110-0237.1 410237	Ø 266 10 8,5
SUBARU - FORESTER (SG) 06/02→10/12							
 Bremsbelagsatz, Scheibenbremse							
2.0 AWD	92	06/02→05/05	←	09/02→		13.0460-5787.2 605787	TOK 23865 17,6 + WK + Zub
2.0 S Turbo AWD	130	09/02→05/05	←			13.0460-5787.2 605787	TOK 23865 17,6 + WK + Zub
			→	06/03→		13.0460-5628.2 605628	24331 13,8 + WK
2.0 X AWD	116	06/05→05/08	←	09/05→		13.0460-5787.2 605787	TOK 23865 17,6 + WK + Zub
2.5 AWD	112	06/02→05/05	←			13.0460-5787.2 605787	TOK 23865 17,6 + WK + Zub
2.5 AWD	155	12/03→05/05	←				
2.5 AWD	185	05/05→09/05	→			13.0460-5628.2 605628	24331 13,8 + WK
2.5 RX Nato AWD	115	11/02→08/05	→				
2.5 AWD	121	06/05→05/08	←	07/05→		13.0460-5787.2 605787	TOK 23865 17,6 + WK + Zub
			→	07/05→		13.0460-5628.2 605628	24331 13,8 + WK
2.5 AWD	171	01/04→12/09	←	07/05→ 05/08		13.0460-5787.2 605787	TOK 23865 17,6 + WK + Zub
			→	07/05→ 05/08		13.0460-5628.2 605628	24331 13,8 + WK
2.5 XT AWD	169	06/05→05/08	←	09/05→		13.0460-5787.2 605787	TOK 23865 17,6 + WK + Zub
			→	09/05→		13.0460-5628.2 605628	24331 13,8 + WK
 Bremsscheibe							
2.0 AWD	92	06/02→05/05	←	09/02→		24.0124-0145.1 424145	Ø 277 24 22 V
2.0 S Turbo AWD	130	09/02→05/05	←			24.0124-0196.1 424196	Ø 293,5 24 22 V
2.5 AWD	112	06/02→05/05	←				
2.5 AWD	155	12/03→05/05	→			24.0110-0237.1 410237	Ø 266 10 8,5
2.5 AWD	185	05/05→09/05	→				
2.5 RX Nato AWD	115	11/02→08/05	→				
2.0 X AWD	116	06/05→05/08	←	09/05→		24.0124-0145.1 424145	Ø 277 24 22 V
2.5 AWD	121	06/05→05/08	←	07/05→		24.0124-0196.1 424196	Ø 293,5 24 22 V
			→	07/05→		24.0110-0237.1 410237	Ø 266 10 8,5
2.5 AWD	171	01/04→12/09	←	07/05→ 05/08		24.0124-0196.1 424196	Ø 293,5 24 22 V
			→	07/05→ 05/08		24.0110-0237.1 410237	Ø 266 10 8,5
2.5 XT AWD	169	06/05→05/08	←	09/05→		24.0124-0196.1 424196	Ø 293,5 24 22 V
			→	09/05→		24.0110-0237.1 410237	Ø 266 10 8,5
SUBARU - FORESTER (SH) 01/08→							
 Bremsbelagsatz, Scheibenbremse							
2.0 AWD	110	01/08→09/13	←	→ 03/10		13.0460-5787.2 605787	TOK 23865 17,6 + WK + Zub
2.0 D AWD	108	09/08→09/13	←				
2.5 AWD	126	01/09→09/13	←	→ 02/13		13.0460-5787.2 605787	TOK 23865 17,6 + WK + Zub
 Bremsscheibe							
2.0 AWD	110	01/08→09/13	←	→ 02/13		24.0124-0145.1 424145	Ø 277 24 22 V
2.0 AWD	110	01/10→	→	→ 02/13		24.0110-0366.1 410366	Ø 286 10 8,5
2.0 D AWD	108	09/08→09/13	←	→ 02/13		24.0124-0196.1 424196	Ø 293,5 24 22 V











	kw			 	! #		
SUBARU - FORESTER (SH) 01/08→							
 Bremsscheibe							
2.5 AWD	126	01/09→09/13	→	→ 02/13		24.0110-0366.1 410366	Ø 286 10 8,5
2.5 AWD	169	06/08→09/13	→				
2.5 Turbo AWD	193	02/11→	→				
2.5 AWD	165	01/12→	←			24.0124-0196.1 424196	Ø 293,5 24 22 V
			→			24.0110-0366.1 410366	Ø 286 10 8,5
SUBARU - FORESTER (SJ) 03/13→							
 Bremsbelagsatz, Scheibenbremse							
2.0 D AWD	108	03/13→	←	Baumuster: XTC+DS,XTC+DL		13.0460-5797.2 605797	AKE 24222 16,9 + WK + Zub
2.0 XT AWD	177	03/13→	←			13.0460-5797.2 605797	AKE 24222 16,9 + WK + Zub
 Bremsscheibe							
2.0 D AWD	108	03/13→	←	für Fahrzeuge ohne PCS (Pre-Crash Safety System)		24.0124-0196.1 424196	Ø 293,5 24 22 V
			←	für Fahrzeuge mit PCS (Pre-Crash Safety System)		24.0130-0204.1 430204	Ø 316 30 28 V
			→			24.0110-0384.1 410384	Ø 273,8 10 8,5
			→			24.0118-0160.1 418160	Ø 278 18 16 V
2.0 i AWD	110	03/13→	←			24.0124-0196.1 424196	Ø 293,5 24 22 V
			→			24.0110-0384.1 410384	Ø 273,8 10 8,5
2.0 XT AWD	177	03/13→	←			24.0130-0204.1 430204	Ø 316 30 28 V
			→			24.0118-0160.1 418160	Ø 278 18 16 V
SUBARU - IMPREZA Coupe (GFC) 01/93→12/00							
 Bremsbelagsatz, Scheibenbremse							
1.6	66	12/96→12/00	→			13.0460-5850.2 605850	SUM 21703 15,0 + WK
1.6 AWD	66	12/96→12/00	←			13.0460-5978.2 605978	21495 17,0 + WK
1.8 AWD	76	01/93→10/95	→			13.0460-5850.2 605850	SUM 21703 15,0 + WK
2.0 AWD	85	12/95→12/00	←	09/96→		13.0460-5895.2 605895	23780 16,7 + WK + Zub
			←	→ 08/96		13.0460-5978.2 605978	21495 17,0 + WK
			→			13.0460-5850.2 605850	SUM 21703 15,0 + WK
2.0 AWD	206	09/98→09/00	←			13.0460-5895.2 605895	23780 16,7 + WK + Zub
			→			13.0460-5850.2 605850	SUM 21703 15,0 + WK
2.0 i	85	11/95→09/00	←	08/96→		13.0460-5978.2 605978	21495 17,0 + WK
			→	08/96→		13.0460-5850.2 605850	SUM 21703 15,0 + WK
2.0 Turbo AWD	155	12/96→12/00	←			13.0460-5851.2 605851	AKE 21915 17,2 + WK
			→			13.0460-5850.2 605850	SUM 21703 15,0 + WK
Zubehörsatz, Scheibenbremsbelag							
1.6	66	12/96→12/00	→			13.0460-0143.2 610143	
1.6 AWD	66	12/96→12/00	→				
1.8 AWD	76	01/93→10/95	→				
2.0 AWD	85	12/95→12/00	→				
2.0 AWD	206	09/98→09/00	→				
2.0 Turbo AWD	155	12/96→12/00	→				
2.0 i	85	11/95→09/00	→	08/96→		13.0460-0143.2 610143	
 Bremsscheibe							
1.6	66	12/96→12/00	←	- ABS		24.0118-0125.1 418125	Ø 242 18 16 V
1.6 AWD	66	12/96→12/00	←	+ ABS		24.0124-0141.1 424141	Ø 260 24 22 V
1.8 AWD	76	01/93→10/95	→			24.0110-0237.1 410237	Ø 266 10 8,5
2.0 AWD	85	12/95→12/00	←	→ 08/96; - ABS		24.0118-0125.1 418125	Ø 242 18 16 V
			←	09/96→; + ABS		24.0124-0141.1 424141	Ø 260 24 22 V
			→			24.0110-0237.1 410237	Ø 266 10 8,5
2.0 AWD	206	09/98→09/00	←	+ ABS		24.0124-0141.1 424141	Ø 260 24 22 V
			→			24.0110-0237.1 410237	Ø 266 10 8,5
2.0 i	85	11/95→09/00	←	08/96→; + ABS		24.0124-0141.1 424141	Ø 260 24 22 V
			→	08/96→		24.0110-0237.1 410237	Ø 266 10 8,5
2.0 Turbo AWD	155	12/96→12/00	→	→ 07/98		24.0110-0237.1 410237	Ø 266 10 8,5





























	kw					! #		
SUBARU - IMPREZA Schrägheck 10/00→12/07								
 Bremsbelagsatz, Scheibenbremse								
2.0 i AWD	92	12/02→12/07	←	→ 09/05			13.0460-5787.2 605787	TOK 23865 17,6 + WK + Zub
2.0 i WRX AWD	168	12/02→09/05	←				13.0460-5640.2 605640	21854 15,0 + WK
2.0 WRX STi AWD	195	12/02→09/05	←				13.0460-4973.2 604973	BRE 23092 16,0 + WK
2.5 AWD	112	12/02→09/05	←				13.0460-5851.2 605851	AKE 21915 17,2 + WK
2.5 WRX AWD	169	09/05→12/07	←	10/05→ 08/07			13.0460-5640.2 605640	21854 15,0 + WK
 Bremsscheibe								
2.0 i AWD	92	12/02→12/07	←	→ 09/05			24.0124-0145.1 424145	Ø 277 24 22 V
			→	→ 09/05			24.0110-0237.1 410237	Ø 266 10 8,5
2.0 i WRX AWD	168	12/02→09/05	←				24.0124-0196.1 424196	Ø 293,5 24 22 V
			→				24.0118-0725.1 418725	Ø 290 18 16 V
2.5 AWD	112	12/02→09/05	←				24.0124-0145.1 424145	Ø 277 24 22 V
			→				24.0110-0237.1 410237	Ø 266 10 8,5
2.5 WRX AWD	169	09/05→12/07	←	10/05→ 08/07			24.0124-0196.1 424196	Ø 293,5 24 22 V
			→	10/05→ 08/07			24.0118-0725.1 418725	Ø 290 18 16 V
SUBARU - IMPREZA Schrägheck (GP) 10/11→								
 Bremsscheibe								
1.6 i	84	06/12→	←				24.0124-0145.1 424145	Ø 277 24 22 V
1.6 i AWD	84	06/12→	→				24.0110-0384.1 410384	Ø 273,8 10 8,5
2.0 AWD	110	01/12→	←				24.0124-0196.1 424196	Ø 293,5 24 22 V
			→				24.0110-0384.1 410384	Ø 273,8 10 8,5
SUBARU - IMPREZA Schrägheck (GR, GH, G3) 03/07→								
 Bremsbelagsatz, Scheibenbremse								
1.5 AWD	79	02/08→	←	→ 12/11			13.0460-5787.2 605787	TOK 23865 17,6 + WK + Zub
1.5 F	79	02/08→						
2.0 D AWD	80	01/11→						
2.0 D AWD	110	01/09→						
2.0 R AWD	110	01/08→	←	02/08→ 12/11			13.0460-5787.2 605787	TOK 23865 17,6 + WK + Zub
 Bremsscheibe								
1.5 AWD	79	02/08→	←	→ 12/11; - ESP			24.0124-0141.1 424141	Ø 260 24 22 V
			←	→ 12/11; + ESP			24.0124-0145.1 424145	Ø 277 24 22 V
2.0 D AWD	80	01/11→	←	→ 12/11			24.0124-0196.1 424196	Ø 293,5 24 22 V
2.0 D AWD	110	01/09→	→	→ 12/11			24.0110-0366.1 410366	Ø 286 10 8,5
2.0 R AWD	110	01/08→	←	02/08→ 12/11			24.0124-0145.1 424145	Ø 277 24 22 V
			→	02/08→ 12/11			24.0110-0366.1 410366	Ø 286 10 8,5
2.5 AWD	169	01/08→	←	02/08→ 12/11			24.0124-0196.1 424196	Ø 293,5 24 22 V
			→	02/08→ 12/11			24.0110-0366.1 410366	Ø 286 10 8,5
2.5 STI CS400 AWD	294	04/10→	←	→ 12/11			24.0130-0203.1 430203	Ø 326 30 28 V
2.5 WRX SE AWD	195	01/11→						
2.5 WRX S AWD	188	02/09→12/10	←				24.0130-0203.1 430203	Ø 326 30 28 V
2.5 WRX STI 330S AWD	243	05/09→12/10						
2.5 WRX STI AWD	221	01/08→	←	02/08→ 12/11			24.0130-0203.1 430203	Ø 326 30 28 V
SUBARU - IMPREZA Station Wagon (GF) 08/92→12/00								
 Bremsbelagsatz, Scheibenbremse								
1.6 i	70	06/98→12/00	←				13.0460-5895.2 605895	23780 16,7 + WK + Zub
1.6 i AWD	70	06/98→12/00	→				13.0460-5850.2 605850	SUM 21703 15,0 + WK
2.0 i 16V AWD	92	06/98→12/00						
1.6 i AWD	66	08/92→12/00	←	09/96→			13.0460-5895.2 605895	23780 16,7 + WK + Zub
			←	01/93→ 08/96			13.0460-5978.2 605978	21495 17,0 + WK
			→	01/93→			13.0460-5850.2 605850	SUM 21703 15,0 + WK
1.8 i	76	11/95→06/96	←				13.0460-5978.2 605978	21495 17,0 + WK
			→				13.0460-5850.2 605850	SUM 21703 15,0 + WK
1.8 i AWD	76	08/92→12/00	←	01/93→ 06/96			13.0460-5978.2 605978	21495 17,0 + WK
			→	01/93→ 06/96			13.0460-5850.2 605850	SUM 21703 15,0 + WK
↓								













	kw			 	! #		
SUBARU - IMPREZA Station Wagon (GF) 08/92→12/00							
 Bremsbelagsatz, Scheibenbremse							
2.0 i AWD	85	12/95→12/00	←	09/96→		13.0460-5895.2 605895	23780 16,7 + WK + Zub
			←	→ 08/96		13.0460-5978.2 605978	21495 17,0 + WK
			→			13.0460-5850.2 605850	SUM 21703 15,0 + WK
2.0 i Turbo AWD	155	03/94→12/00	→			13.0460-5850.2 605850	SUM 21703 15,0 + WK
2.0 Turbo GT AWD	160	06/98→12/00	←			13.0460-5640.2 605640	21854 15,0 + WK
						13.0460-5851.2 605851	AKE 21915 17,2 + WK
Zubehörsatz, Scheibenbremsbelag							
1.6 i	70	06/98→12/00	→			13.0460-0143.2 610143	
1.6 i AWD	70	06/98→12/00					
1.8 i	76	11/95→06/96					
2.0 i 16V AWD	92	06/98→12/00					
2.0 i AWD	85	12/95→12/00					
2.0 i Turbo AWD	155	03/94→12/00					
1.6 i AWD	66	08/92→12/00	→	01/93→		13.0460-0143.2 610143	
1.8 i AWD	76	08/92→12/00	→	01/93→ 06/96		13.0460-0143.2 610143	
 Bremsscheibe							
1.6 i	70	06/98→12/00	←	- ABS		24.0118-0125.1 418125	Ø 242 18 16 V
1.6 i AWD	70	06/98→12/00	←	+ ABS		24.0124-0141.1 424141	Ø 260 24 22 V
1.8 i	76	11/95→06/96	→			24.0110-0237.1 410237	Ø 266 10 8,5
1.6 i AWD	66	08/92→12/00	←	01/93→; - ABS		24.0118-0125.1 418125	Ø 242 18 16 V
			←	01/93→; + ABS		24.0124-0141.1 424141	Ø 260 24 22 V
			→	01/93→		24.0110-0237.1 410237	Ø 266 10 8,5
1.8 i AWD	76	08/92→12/00	←	01/93→ 06/96; - ABS		24.0118-0125.1 418125	Ø 242 18 16 V
			←	01/93→ 06/96; + ABS		24.0124-0141.1 424141	Ø 260 24 22 V
			→	01/93→ 06/96		24.0110-0237.1 410237	Ø 266 10 8,5
2.0 i 16V AWD	92	06/98→12/00	←	+ ABS		24.0124-0141.1 424141	Ø 260 24 22 V
			→			24.0110-0237.1 410237	Ø 266 10 8,5
2.0 i AWD	85	12/95→12/00	←	→ 08/96; - ABS		24.0118-0125.1 418125	Ø 242 18 16 V
			←	09/96→; + ABS		24.0124-0141.1 424141	Ø 260 24 22 V
			→			24.0110-0237.1 410237	Ø 266 10 8,5
2.0 i Turbo AWD	155	03/94→12/00	←	→ 07/96		24.0124-0145.1 424145	Ø 277 24 22 V
			→			24.0110-0237.1 410237	Ø 266 10 8,5
2.0 Turbo GT AWD	160	06/98→12/00	←			24.0124-0196.1 424196	Ø 293,5 24 22 V
SUBARU - IMPREZA Station Wagon (GG) 10/00→							
 Bremsbelagsatz, Scheibenbremse							
1.5 AWD	77	05/06→	←	→ 08/07		13.0460-5793.2 605793	AKE 24372 17,3 + WK + Zub
1.6 AWD	70	12/00→	←	→ 09/05; + EU		13.0460-5851.2 605851	AKE 21915 17,2 + WK
			←	→ 09/05; Europa		13.0460-5895.2 605895	23780 16,7 + WK + Zub
2.0 AWD	92	12/00→	←	11/02→ 09/05		13.0460-5787.2 605787	TOK 23865 17,6 + WK + Zub
			←	→ 10/02		13.0460-5851.2 605851	AKE 21915 17,2 + WK
			→	11/02→ 09/05		13.0460-5628.2 605628	24331 13,8 + WK
2.0 i R AWD	118	09/05→06/07	←	10/05→		13.0460-5787.2 605787	TOK 23865 17,6 + WK + Zub
			→	10/05→		13.0460-5628.2 605628	24331 13,8 + WK
2.0 Turbo AWD	160	12/00→	←	→ 09/05		13.0460-5640.2 605640	21854 15,0 + WK
2.0 WRX Turbo AWD	165	12/02→					
2.0 WRX STi AWD	206	10/05→	←	→ 08/07		13.0460-4973.2 604973	BRE 23092 16,0 + WK
			→	→ 08/07		13.0460-4974.2 604974	BRE 21580 14,6 + WK
2.5 WRX AWD	169	09/05→	←	10/05→ 08/07		13.0460-5640.2 605640	21854 15,0 + WK
 Bremsscheibe							
1.5 AWD	77	05/06→	←	→ 08/07		24.0124-0141.1 424141	Ø 260 24 22 V
1.6 AWD	70	12/00→	←	→ 09/05		24.0124-0141.1 424141	Ø 260 24 22 V
2.0 AWD	92	12/00→	←	→ 09/05		24.0124-0145.1 424145	Ø 277 24 22 V
			→	→ 09/05		24.0110-0237.1 410237	Ø 266 10 8,5
↓							































	kw			 	! #		
SUBARU - IMPREZA Station Wagon (GG) 10/00→							
 Bremsscheibe							
2.0 i R AWD	118	09/05→06/07	←	10/05→		24.0124-0145.1 424145	Ø 277 24 22 V
			→	10/05→		24.0110-0237.1 410237	Ø 266 10 8,5
2.0 Turbo AWD	160	12/00→	←	→ 09/05		24.0124-0196.1 424196	Ø 293,5 24 22 V
2.0 WRX Turbo AWD	165	12/02→	→	→ 09/05		24.0118-0725.1 418725	Ø 290 18 16 V
2.0 WRX STi AWD	206	10/05→	←	→ 08/07		24.0130-0203.1 430203	Ø 326 30 28 V
2.5 WRX AWD	169	09/05→	←	10/05→ 08/07		24.0124-0196.1 424196	Ø 293,5 24 22 V
			→	10/05→ 08/07		24.0118-0725.1 418725	Ø 290 18 16 V
SUBARU - IMPREZA Stufenheck (GC) 08/92→09/01							
 Bremsbelagsatz, Scheibenbremse							
1.6 i	66	08/92→12/00	←	01/93→ 08/96		13.0460-5978.2 605978	21495 17,0 + WK
			→	01/93→		13.0460-5850.2 605850	SUM 21703 15,0 + WK
1.6 i	70	06/98→12/00	→			13.0460-5850.2 605850	SUM 21703 15,0 + WK
1.6 i AWD	66	08/92→12/00	←	01/93→		13.0460-5978.2 605978	21495 17,0 + WK
			→	01/93→		13.0460-5850.2 605850	SUM 21703 15,0 + WK
1.6 i AWD	70	06/98→12/00	←			13.0460-5978.2 605978	21495 17,0 + WK
2.0 i	92	09/98→09/00	→			13.0460-5850.2 605850	SUM 21703 15,0 + WK
1.8 i AWD	76	08/92→12/00	←	01/93→ 06/96		13.0460-5978.2 605978	21495 17,0 + WK
			→	01/93→ 06/96		13.0460-5850.2 605850	SUM 21703 15,0 + WK
2.0 AWD	206	09/98→09/00	←			13.0460-5895.2 605895	23780 16,7 + WK + Zub
2.0 i AWD	92	06/98→12/00	→			13.0460-5850.2 605850	SUM 21703 15,0 + WK
2.0 i	85	07/96→08/98	←	08/96→		13.0460-5978.2 605978	21495 17,0 + WK
			→	08/96→		13.0460-5850.2 605850	SUM 21703 15,0 + WK
2.0 i AWD	85	10/95→12/00	←	09/96→		13.0460-5895.2 605895	23780 16,7 + WK + Zub
			→	→ 08/96		13.0460-5978.2 605978	21495 17,0 + WK
			→			13.0460-5850.2 605850	SUM 21703 15,0 + WK
2.0 Turbo GT AWD	155	03/94→12/00	←	08/96→		13.0460-5851.2 605851	AKE 21915 17,2 + WK
			→			13.0460-5850.2 605850	SUM 21703 15,0 + WK
2.0 Turbo GT AWD	160	06/98→12/00	←			13.0460-5640.2 605640	21854 15,0 + WK
Zubehörsatz, Scheibenbremsbelag							
1.6 i	66	08/92→12/00	→	01/93→		13.0460-0143.2 610143	
1.6 i AWD	66	08/92→12/00	→				
1.6 i	70	06/98→12/00	→			13.0460-0143.2 610143	
1.6 i AWD	70	06/98→12/00	→				
2.0 AWD	206	09/98→09/00	→				
2.0 i	92	09/98→09/00	→				
2.0 i AWD	85	10/95→12/00	→				
2.0 i AWD	92	06/98→12/00	→				
2.0 Turbo GT AWD	155	03/94→12/00	→				
1.8 i AWD	76	08/92→12/00	→	01/93→ 06/96		13.0460-0143.2 610143	
2.0 i	85	07/96→08/98	→	08/96→		13.0460-0143.2 610143	
 Bremsscheibe							
1.6 i	66	08/92→12/00	←	01/93→; - ABS		24.0118-0125.1 418125	Ø 242 18 16 V
1.6 i AWD	66	08/92→12/00	←	01/93→; + ABS		24.0124-0141.1 424141	Ø 260 24 22 V
			→	01/93→		24.0110-0237.1 410237	Ø 266 10 8,5
1.6 i	70	06/98→12/00	←	- ABS		24.0118-0125.1 418125	Ø 242 18 16 V
1.6 i AWD	70	06/98→12/00	←	+ ABS		24.0124-0141.1 424141	Ø 260 24 22 V
			→			24.0110-0237.1 410237	Ø 266 10 8,5
1.8 i AWD	76	08/92→12/00	←	01/93→ 06/96; - ABS		24.0118-0125.1 418125	Ø 242 18 16 V
			←	01/93→ 06/96; + ABS		24.0124-0141.1 424141	Ø 260 24 22 V
			→	01/93→ 06/96		24.0110-0237.1 410237	Ø 266 10 8,5
2.0 AWD	206	09/98→09/00	←	+ ABS		24.0124-0141.1 424141	Ø 260 24 22 V
2.0 i	92	09/98→09/00	→			24.0110-0237.1 410237	Ø 266 10 8,5
2.0 i AWD	92	06/98→12/00	→				
2.0 i	85	07/96→08/98	←	08/96→; + ABS		24.0124-0141.1 424141	Ø 260 24 22 V
			→	08/96→		24.0110-0237.1 410237	Ø 266 10 8,5
↓							

	kW			 	! #			
SUBARU - IMPREZA Stufenheck (GC) 08/92→09/01								
 Bremsscheibe								
2.0 i AWD	85	10/95→12/00	←	→ 08/96; - ABS		24.0118-0125.1	418125	Ø 242 18 16 V
			←	09/96→; + ABS		24.0124-0141.1	424141	Ø 260 24 22 V
			→			24.0110-0237.1	410237	Ø 266 10 8,5
2.0 Turbo GT AWD	155	03/94→12/00	←	→ 07/96		24.0124-0145.1	424145	Ø 277 24 22 V
			→	→ 07/98		24.0110-0237.1	410237	Ø 266 10 8,5
2.0 Turbo GT AWD	160	06/98→12/00	←			24.0124-0196.1	424196	Ø 293,5 24 22 V
SUBARU - IMPREZA Stufenheck (GD) 09/99→								
 Bremsbelagsatz, Scheibenbremse								
1.5	74	06/01→09/05	←			13.0460-5793.2	605793	AKE 24372 17,3 + WK + Zub
1.5	81	10/05→	←	→ 03/07		13.0460-5793.2	605793	AKE 24372 17,3 + WK + Zub
1.5 AWD	77	05/06→	←	→ 08/07		13.0460-5793.2	605793	AKE 24372 17,3 + WK + Zub
1.6 1.6 AWD	70	06/01→09/06 12/00→	←	→ 09/05		13.0460-5851.2	605851	AKE 21915 17,2 + WK
	70				13.0460-5895.2	605895	23780 16,7 + WK + Zub	
2.0 AWD	206	10/05→	←	→ 08/07		13.0460-4973.2	604973	BRE 23092 16,0 + WK
			→	→ 08/07		13.0460-4974.2	604974	BRE 21580 14,6 + WK
2.0 i AWD	92	12/00→	←	11/02→ 09/05		13.0460-5787.2	605787	TOK 23865 17,6 + WK + Zub
			←	→ 10/02		13.0460-5851.2	605851	AKE 21915 17,2 + WK
2.0 i AWD	150	12/01→11/02	←			13.0460-5640.2	605640	21854 15,0 + WK
2.0 i WRX AWD	168	12/02→09/05						
2.0 i R AWD	118	09/05→	←	10/05→ 08/07		13.0460-5787.2	605787	TOK 23865 17,6 + WK + Zub
			→	10/05→ 08/07		13.0460-5628.2	605628	24331 13,8 + WK
2.0 WRX STi AWD	195	11/01→	←	11/02→ 09/05		13.0460-4973.2	604973	BRE 23092 16,0 + WK
2.0 WRX STi AWD	235	02/04→	←	10/05→ 08/07		13.0460-4973.2	604973	BRE 23092 16,0 + WK
			→	10/05→ 08/07		13.0460-4974.2	604974	BRE 21580 14,6 + WK
2.0 WRX Turbo AWD	160	12/00→	←	→ 09/05		13.0460-5640.2	605640	21854 15,0 + WK
2.0 WRX Turbo AWD	165	12/02→						
2.5 AWD	130	03/01→09/05	←			13.0460-5851.2	605851	AKE 21915 17,2 + WK
2.5 i AWD	112	12/02→09/05						
2.5 AWD	221	10/05→	←	→ 03/07		13.0460-4973.2	604973	BRE 23092 16,0 + WK
			→	→ 03/07		13.0460-4974.2	604974	BRE 21580 14,6 + WK
2.5 i WRX AWD	169	09/05→	←	10/05→ 08/07		13.0460-5640.2	605640	21854 15,0 + WK
2.5 WRX STi AWD	206	09/05→						
 Bremsscheibe								
1.5	74	06/01→09/05	←			24.0124-0141.1	424141	Ø 260 24 22 V
1.5	81	10/05→	←	→ 03/07		24.0124-0141.1	424141	Ø 260 24 22 V
1.5 AWD	77	05/06→	←	→ 08/07		24.0124-0141.1	424141	Ø 260 24 22 V
1.6 1.6 AWD	70	06/01→09/06 12/00→	←	→ 09/05		24.0124-0141.1	424141	Ø 260 24 22 V
	70							
2.0 AWD	184	10/05→	←	→ 03/07		24.0124-0196.1	424196	Ø 293,5 24 22 V
			→	→ 03/07		24.0118-0725.1	418725	Ø 290 18 16 V
2.0 AWD	206	10/05→	←	→ 08/07		24.0130-0203.1	430203	Ø 326 30 28 V
2.0 i AWD	92	12/00→	←	→ 09/05		24.0124-0145.1	424145	Ø 277 24 22 V
			→	→ 09/05		24.0110-0237.1	410237	Ø 266 10 8,5
2.0 i AWD	150	12/01→11/02	←			24.0124-0196.1	424196	Ø 293,5 24 22 V
2.0 i WRX AWD	168	12/02→09/05	→			24.0118-0725.1	418725	Ø 290 18 16 V
2.0 i R AWD	118	09/05→	←	10/05→ 08/07		24.0124-0145.1	424145	Ø 277 24 22 V
			→	10/05→ 08/07		24.0110-0237.1	410237	Ø 266 10 8,5
2.0 WRX STi AWD	235	02/04→	←	10/05→ 08/07		24.0130-0203.1	430203	Ø 326 30 28 V
2.0 WRX Turbo AWD	160	12/00→	←	→ 09/05		24.0124-0196.1	424196	Ø 293,5 24 22 V
2.0 WRX Turbo AWD	165	12/02→	→	→ 09/05		24.0118-0725.1	418725	Ø 290 18 16 V
2.5 AWD	130	03/01→09/05	←			24.0124-0145.1	424145	Ø 277 24 22 V
2.5 i AWD	112	12/02→09/05	→			24.0110-0237.1	410237	Ø 266 10 8,5
2.5 AWD	221	10/05→	←	→ 03/07		24.0130-0203.1	430203	Ø 326 30 28 V
2.5 i WRX AWD 2.5 WRX STi AWD	169	09/05→ 09/05→	←	10/05→ 08/07		24.0124-0196.1	424196	Ø 293,5 24 22 V
	206		→	10/05→ 08/07		24.0118-0725.1	418725	Ø 290 18 16 V

















	kw					! #		
SUBARU - IMPREZA Stufenheck (GR) 03/07→								
 Bremsbelagsatz, Scheibenbremse								
1.5	79	02/08→	←	→ 12/11		13.0460-5787.2	605787	TOK 23865 17,6 + WK + Zub
1.5 AWD	79	02/08→						
2.0 AWD	125	01/11→						
2.0 i AWD	110	01/11→						
 Bremsscheibe								
1.5	79	02/08→	←	→ 12/11; - ESP		24.0124-0141.1	424141	Ø 260 24 22 V
1.5 AWD	79	02/08→	←	→ 12/11; + ESP		24.0124-0145.1	424145	Ø 277 24 22 V
2.0 AWD	125	01/11→	←	→ 12/11		24.0124-0145.1	424145	Ø 277 24 22 V
2.0 i AWD	110	01/11→	→	→ 12/11		24.0110-0366.1	410366	Ø 286 10 8,5
2.5 AWD	169	01/10→	←	→ 12/11		24.0124-0196.1	424196	Ø 293,5 24 22 V
			→	→ 12/11		24.0110-0366.1	410366	Ø 286 10 8,5
2.5 WRX SE AWD	195	01/11→	←	→ 12/11		24.0130-0203.1	430203	Ø 326 30 28 V
2.5 WRX STI AWD	221	01/11→						
SUBARU - JUSTY I (KAD) 11/84→08/96								
 Bremsbelagsatz, Scheibenbremse								
1000	37	05/87→10/95	←	→ 12/88		13.0460-5963.2	605963	AKE 20958 16,0 - WE / - WK
 Bremsscheibe								
1200	49	05/87→10/95	←	01/89→ 09/95		24.0118-0116.1	418116	Ø 240 18 15,5 V
SUBARU - JUSTY II (JMA, MS) 10/95→11/03								
 Bremsbelagsatz, Scheibenbremse								
1.3 4x4	63	04/01→11/03	←			13.0460-5837.2	605837	BOS 23296 14,5 + WK
1.3 GX 4x4	50	10/95→11/03	←	07/98→ 09/00		13.0460-5837.2	605837	BOS 23296 14,5 + WK
			←	→ 06/98		13.0460-5985.2	605985	TOK 21333 15,0 + WK
 Bremsscheibe								
1.3 4x4	63	04/01→11/03	←			24.0117-0103.1	417103	Ø 231,2 17 15 V
1.3 GX 4x4	50	10/95→11/03	←	→ 09/00		24.0117-0103.1	417103	Ø 231,2 17 15 V
SUBARU - JUSTY III (G3X) 09/03→								
 Bremsbelagsatz, Scheibenbremse								
1.3 AWD	69	09/03→	←	→ 08/07		13.0460-3995.2	603995	BOS 23605 15,7 + WK + Zub
1.5 AWD	73	09/03→						
 Bremsscheibe								
1.3 AWD	69	09/03→	←	→ 08/07		24.0117-0106.1	417106	Ø 253 17 15 V
1.5 AWD	73	09/03→						
SUBARU - JUSTY IV 01/07→								
 Bremsbelagsatz, Scheibenbremse								
1.0	51	01/07→	←	09/07→ 05/11; passend für Felgenreöße [Zoll]: 14; Schaltgetriebe		13.0460-5794.2	605794	TRW 24283 15,5 + WK + Zub
			←	09/07→ 05/11; passend für Felgenreöße [Zoll]: 14; Vollautomatik		13.0460-5887.2	605887	SUM 23507 15,2 + WK
1.3 AWD	67	03/08→	←	→ 05/11		13.0460-5613.2	605613	25262 15,0 + WK + Zub
			←	→ 05/11; passend für Felgenreöße [Zoll]: 14; Schaltgetriebe		13.0460-5794.2	605794	TRW 24283 15,5 + WK + Zub
			←	→ 05/11; passend für Felgenreöße [Zoll]: 14; Vollautomatik		13.0460-5887.2	605887	SUM 23507 15,2 + WK
 Bremsscheibe								
1.0	51	01/07→	←	09/07→ 05/11; passend für Felgenreöße [Zoll]: 13		24.0116-0130.1	416130	Ø 234 16 15 V
			←	09/07→ 05/11; passend für Felgenreöße [Zoll]: 14; Vollautomatik		24.0117-0107.1	417107	Ø 246 17 16 V
			←	09/07→ 05/11; passend für Felgenreöße [Zoll]: 14; Schaltgetriebe		24.0122-0263.1	422263	Ø 254 22 20 V
↓								

















	kw			 	! #		
SUBARU - JUSTY IV 01/07→							
 Bremsscheibe							
1.3 AWD	67	03/08→	←	→ 05/11; passend für Felgengröße [Zoll]: 13		24.0116-0130.1 416130	Ø 234 16 15 V
			←	→ 05/11; passend für Felgengröße [Zoll]: 14; Vollautomatik		24.0117-0107.1 417107	Ø 246 17 16 V
			←	→ 05/11; passend für Felgengröße [Zoll]: 14; Schaltgetriebe		24.0122-0263.1 422263	Ø 254 22 20 V
SUBARU - LEGACY II (BD) 03/94→10/99							
 Bremsbelagsatz, Scheibenbremse							
1.8 4WD	76	05/96→09/98	←			13.0460-5895.2 605895	23780 16,7 + WK + Zub
2.2 i 4WD	96	06/96→03/99	→			13.0460-5850.2 605850	SUM 21703 15,0 + WK
2.0 i	85	09/94→03/99	←	02/96→		13.0460-5895.2 605895	23780 16,7 + WK + Zub
2.0 i 4WD	85	09/94→03/99	←	→ 01/96		13.0460-5978.2 605978	21495 17,0 + WK
2.2	94	07/94→11/98	→			13.0460-5850.2 605850	SUM 21703 15,0 + WK
2.2 4WD	100	07/94→11/98	→			13.0460-5850.2 605850	SUM 21703 15,0 + WK
2.2 i 4WD	94	09/94→03/99	←			13.0460-5851.2 605851	AKE 21915 17,2 + WK
2.5 4WD	115	09/96→11/98	←			13.0460-5850.2 605850	SUM 21703 15,0 + WK
2.5 i 4WD	110	06/96→03/99	→			13.0460-5850.2 605850	SUM 21703 15,0 + WK
Zubehörsatz, Scheibenbremsbelag							
1.8 4WD	76	05/96→09/98	→			13.0460-0143.2 610143	
2.0 i	85	09/94→03/99	→			13.0460-0143.2 610143	
2.0 i 4WD	85	09/94→03/99	→			13.0460-0143.2 610143	
2.2	94	07/94→11/98	→			13.0460-0143.2 610143	
2.2 4WD	100	07/94→11/98	→			13.0460-0143.2 610143	
2.2 i 4WD	94	09/94→03/99	→			13.0460-0143.2 610143	
2.2 i 4WD	96	06/96→03/99	→			13.0460-0143.2 610143	
2.5 4WD	115	09/96→11/98	→			13.0460-0143.2 610143	
2.5 i 4WD	110	06/96→03/99	→			13.0460-0143.2 610143	
 Bremsscheibe							
1.8 4WD	76	05/96→09/98	←			24.0124-0141.1 424141	Ø 260 24 22 V
2.0 i	85	09/94→03/99	→			24.0110-0237.1 410237	Ø 266 10 8,5
2.0 i 4WD	85	09/94→03/99	→			24.0110-0237.1 410237	Ø 266 10 8,5
2.2	94	07/94→11/98	→			24.0110-0237.1 410237	Ø 266 10 8,5
2.2 4WD	100	07/94→11/98	→			24.0110-0237.1 410237	Ø 266 10 8,5
2.2 i 4WD	94	09/94→03/99	→			24.0110-0237.1 410237	Ø 266 10 8,5
2.2 i 4WD	96	06/96→03/99	→			24.0110-0237.1 410237	Ø 266 10 8,5
2.5 4WD	115	09/96→11/98	←			24.0124-0145.1 424145	Ø 277 24 22 V
2.5 i 4WD	110	06/96→03/99	→			24.0110-0237.1 410237	Ø 266 10 8,5
SUBARU - LEGACY II Station Wagon (BG) 02/94→12/99							
 Bremsbelagsatz, Scheibenbremse							
2.0 i	85	09/94→11/98	←	02/96→		13.0460-5895.2 605895	23780 16,7 + WK + Zub
2.0 i 4WD	85	09/94→11/98	←	→ 01/96		13.0460-5978.2 605978	21495 17,0 + WK
2.2 i 4WD	100	07/94→11/98	→			13.0460-5850.2 605850	SUM 21703 15,0 + WK
2.2 i 4WD	94	02/94→12/98	←	02/96→ 11/98		13.0460-5895.2 605895	23780 16,7 + WK + Zub
			←	→ 01/96		13.0460-5978.2 605978	21495 17,0 + WK
			→	→ 11/98		13.0460-5850.2 605850	SUM 21703 15,0 + WK
2.2 i 4WD	96	06/96→11/98	←			13.0460-5895.2 605895	23780 16,7 + WK + Zub
			→			13.0460-5850.2 605850	SUM 21703 15,0 + WK
2.5 i 4WD	110	06/96→11/98	←			13.0460-5851.2 605851	AKE 21915 17,2 + WK
2.5 i 4WD	115	09/96→11/98	→			13.0460-5850.2 605850	SUM 21703 15,0 + WK
Zubehörsatz, Scheibenbremsbelag							
2.0 i	85	09/94→11/98	→			13.0460-0143.2 610143	
2.0 i 4WD	85	09/94→11/98	→			13.0460-0143.2 610143	
2.2 i 4WD	96	06/96→11/98	→			13.0460-0143.2 610143	
2.2 i 4WD	100	07/94→11/98	→			13.0460-0143.2 610143	
2.5 i 4WD	110	06/96→11/98	→			13.0460-0143.2 610143	
2.5 i 4WD	115	09/96→11/98	→			13.0460-0143.2 610143	
2.2 i 4WD	94	02/94→12/98	→	→ 11/98		13.0460-0143.2 610143	
 Bremsscheibe							
2.0 i	85	09/94→11/98	←			24.0124-0141.1 424141	Ø 260 24 22 V
2.0 i 4WD	85	09/94→11/98	→			24.0110-0237.1 410237	Ø 266 10 8,5
2.2 i 4WD	96	06/96→11/98	→			24.0110-0237.1 410237	Ø 266 10 8,5















	kw					! #		
SUBARU - LEGACY II Station Wagon (BG) 02/94→12/99								
 Bremsscheibe								
2.2 i 4WD	100	07/94→11/98	←			24.0124-0141.1	424141	Ø 260 24 22 V
			→			24.0110-0237.1	410237	Ø 266 10 8,5
2.2 i 4WD	94	02/94→12/98	←	→ 11/98		24.0124-0141.1	424141	Ø 260 24 22 V
			→	→ 11/98		24.0110-0237.1	410237	Ø 266 10 8,5
2.5 i 4WD	110	06/96→11/98	←			24.0124-0145.1	424145	Ø 277 24 22 V
2.5 i 4WD	115	09/96→11/98	→			24.0110-0237.1	410237	Ø 266 10 8,5
SUBARU - LEGACY III (BE) 10/98→08/03								
 Bremsbelagsatz, Scheibenbremse								
2.0 AWD	92	04/99→08/03	←	08/00→		13.0460-5851.2	605851	AKE 21915 17,2 + WK
			←	→ 07/00		13.0460-5895.2	605895	23780 16,7 + WK + Zub
2.5 AWD	115	10/98→08/03	←			13.0460-5851.2	605851	AKE 21915 17,2 + WK
Zubehörsatz, Scheibenbremsbelag								
2.0 AWD	92	04/99→08/03	→	+ ABS		13.0460-0143.2	610143	
2.5 AWD	115	10/98→08/03	→			13.0460-0143.2	610143	
 Bremsscheibe								
2.0 AWD	92	04/99→08/03	←	→ 07/00		24.0124-0141.1	424141	Ø 260 24 22 V
			←	08/00→		24.0124-0145.1	424145	Ø 277 24 22 V
2.5 AWD	115	10/98→08/03	←			24.0124-0145.1	424145	Ø 277 24 22 V
SUBARU - LEGACY III Station Wagon (BH) 10/98→08/03								
 Bremsbelagsatz, Scheibenbremse								
2.0 AWD	92	12/98→08/03	←	08/00→		13.0460-5851.2	605851	AKE 21915 17,2 + WK
			←	04/99→ 07/00		13.0460-5895.2	605895	23780 16,7 + WK + Zub
2.5 AWD	115	12/98→08/03	←			13.0460-5851.2	605851	AKE 21915 17,2 + WK
Zubehörsatz, Scheibenbremsbelag								
2.0 AWD	92	12/98→08/03	→	04/99→; + ABS		13.0460-0143.2	610143	
2.5 AWD	115	12/98→08/03	→			13.0460-0143.2	610143	
 Bremsscheibe								
2.0 AWD	92	12/98→08/03	←	04/99→ 07/00		24.0124-0141.1	424141	Ø 260 24 22 V
			←	08/00→		24.0124-0145.1	424145	Ø 277 24 22 V
2.5 AWD	115	12/98→08/03	←			24.0124-0145.1	424145	Ø 277 24 22 V
SUBARU - LEGACY IV (BL) 09/03→12/15								
 Bremsbelagsatz, Scheibenbremse								
2.0 AWD	101	09/03→10/05	←			13.0460-5787.2	605787	TOK 23865 17,6 + WK + Zub
2.0 AWD	121	06/05→04/09	←			13.0460-5797.2	605797	AKE 24222 16,9 + WK + Zub
2.0 AWD	132	06/05→04/09						
2.0 AWD	140	06/05→04/09						
2.0 D AWD	110	02/08→12/09	←	→ 04/09		13.0460-5787.2	605787	TOK 23865 17,6 + WK + Zub
2.0 R AWD	110	09/07→12/09						
2.5 i AWD	127	09/07→12/09						
2.0 Turbo AWD	180	09/03→11/06	←	06/05→		13.0460-5797.2	605797	AKE 24222 16,9 + WK + Zub
2.5 AWD	121	09/03→04/09	←			13.0460-5787.2	605787	TOK 23865 17,6 + WK + Zub
						13.0460-5797.2	605797	AKE 24222 16,9 + WK + Zub
3.0 R AWD	180	09/03→06/09	←	→ 04/09		13.0460-5797.2	605797	AKE 24222 16,9 + WK + Zub
 Bremsscheibe								
2.0 AWD	101	09/03→10/05	←			24.0124-0145.1	424145	Ø 277 24 22 V
2.5 AWD	121	09/03→04/09	→			24.0110-0728.1	410728	Ø 273,8 10 8,5
2.0 AWD	121	06/05→04/09	←			24.0130-0204.1	430204	Ø 316 30 28 V
2.0 AWD	132	06/05→04/09						
2.0 AWD	140	06/05→04/09	→			24.0118-0725.1	418725	Ø 290 18 16 V
3.0 R AWD	180	09/03→06/09						
2.0 D AWD	110	02/08→12/09	←	→ 04/09		24.0124-0196.1	424196	Ø 293,5 24 22 V
			→	→ 04/09		24.0110-0728.1	410728	Ø 273,8 10 8,5
↓								













	kw					! #		
SUBARU - LEGACY IV (BL) 09/03→12/15								
 Bremsscheibe								
2.0 R AWD 2.5 i AWD	110 127	09/07→12/09 09/07→12/09	← →	→ 04/09 → 04/09			24.0124-0145.1 424145 24.0110-0728.1 410728	Ø 277 24 22 V Ø 273,8 10 8,5
2.0 Turbo AWD	180	09/03→11/06	← →	06/05→ 06/05→			24.0130-0204.1 430204 24.0118-0725.1 418725	Ø 316 30 28 V Ø 290 18 16 V
SUBARU - LEGACY IV Station Wagon (BP) 09/03→12/09								
 Bremsbelagsatz, Scheibenbremse								
2.0 AWD	101	09/03→10/05	←				13.0460-5787.2 605787	TOK 23865 17,6 + WK + Zub
2.0 AWD 2.0 AWD 2.0 AWD 3.0 R AWD	121 132 140 180	06/05→04/09 06/05→04/09 06/05→04/09 09/03→04/09	← ← ← ←				13.0460-5797.2 605797	AKE 24222 16,9 + WK + Zub
2.0 D AWD 2.0 R AWD 2.5 i AWD	110 110 127	02/08→12/09 09/07→12/09 01/08→12/09	← ← ←	→ 04/09 → 04/09			13.0460-5787.2 605787	TOK 23865 17,6 + WK + Zub
2.0 Turbo AWD	180	09/03→11/06	←	06/05→			13.0460-5797.2 605797	AKE 24222 16,9 + WK + Zub
2.5 AWD	121	09/03→04/09	←				13.0460-5787.2 605787 13.0460-5797.2 605797	TOK 23865 17,6 + WK + Zub AKE 24222 16,9 + WK + Zub
 Bremsscheibe								
2.0 AWD 2.5 AWD	101 121	09/03→10/05 09/03→04/09	← →				24.0124-0145.1 424145 24.0110-0728.1 410728	Ø 277 24 22 V Ø 273,8 10 8,5
2.0 AWD 2.0 AWD 2.0 AWD 3.0 R AWD	121 132 140 180	06/05→04/09 06/05→04/09 06/05→04/09 09/03→04/09	← ← ← ←				24.0130-0204.1 430204 24.0118-0725.1 418725	Ø 316 30 28 V Ø 290 18 16 V
2.0 D AWD	110	02/08→12/09	←	→ 04/09			24.0124-0196.1 424196	Ø 293,5 24 22 V
2.0 R AWD 2.5 i AWD	110 127	09/07→12/09 01/08→12/09	← →	→ 04/09 → 04/09			24.0110-0728.1 410728 24.0124-0145.1 424145	Ø 273,8 10 8,5 Ø 277 24 22 V
2.0 Turbo AWD	180	09/03→11/06	← →	06/05→ 06/05→			24.0130-0204.1 430204 24.0118-0725.1 418725	Ø 316 30 28 V Ø 290 18 16 V
SUBARU - LEGACY V (BM) 05/09→								
 Bremsbelagsatz, Scheibenbremse								
2.0 D AWD 2.0 i AWD 2.0 i LPG AWD	110 110 108	09/09→12/14 09/09→12/14 09/09→12/11	← ← ←				13.0460-5787.2 605787	TOK 23865 17,6 + WK + Zub
2.5 i AWD 2.5 i AWD	123 125	09/09→12/14 01/12→	← ←				13.0460-5793.2 605793	AKE 24372 17,3 + WK + Zub
3.6 AWD	191	09/09→12/14	←	09/10→			13.0460-5797.2 605797	AKE 24222 16,9 + WK + Zub
 Bremsscheibe								
2.0 D AWD	110	09/09→12/14	← →				24.0124-0196.1 424196 24.0110-0366.1 410366	Ø 293,5 24 22 V Ø 286 10 8,5
2.0 i AWD 2.0 i LPG AWD 2.5 i AWD 2.5 i AWD	110 108 123 125	09/09→12/14 09/09→12/11 09/09→12/14 01/12→	← ← ← ←				24.0124-0145.1 424145 24.0110-0366.1 410366	Ø 277 24 22 V Ø 286 10 8,5
2.5 GT AWD	195	07/10→12/14	←				24.0130-0204.1 430204	Ø 316 30 28 V
3.6 AWD	191	09/09→12/14	← →	09/10→ 09/10→			24.0130-0204.1 430204 24.0110-0366.1 410366	Ø 316 30 28 V Ø 286 10 8,5
SUBARU - LEGACY V Station Wagon (BR) 06/08→12/14								
 Bremsbelagsatz, Scheibenbremse								
2.0 D AWD 2.0 D AWD 2.0 i AWD 2.0 i LPG AWD	108 110 110 108	01/13→12/14 09/09→12/14 09/09→12/14 09/09→12/11	← ← ← ←				13.0460-5787.2 605787	TOK 23865 17,6 + WK + Zub
2.5 i AWD 2.5 i AWD	123 127	09/09→12/14 07/12→12/14	← ←				13.0460-5793.2 605793	AKE 24372 17,3 + WK + Zub
 Bremsscheibe								
2.0 D AWD 2.0 D AWD ↓	108 110	01/13→12/14 09/09→12/14	← ←				24.0124-0196.1 424196	Ø 293,5 24 22 V































	kW					! #		
SUBARU - LEGACY V Station Wagon (BR) 06/08→12/14								
 Bremsscheibe								
2.0 D AWD	108	01/13→12/14	→				24.0110-0366.1 410366	Ø 286 10 8,5
2.0 D AWD	110	09/09→12/14	→					
2.0 i AWD	110	09/09→12/14	←				24.0124-0145.1 424145	Ø 277 24 22 V
2.0 i AWD	110	06/12→12/14	←					
2.0 i LPG AWD	108	09/09→12/11	→				24.0110-0366.1 410366	Ø 286 10 8,5
2.5 i AWD	123	09/09→12/14	→					
2.5 i AWD	127	07/12→12/14	→					
2.5 GT AWD	195	07/10→12/14	←				24.0130-0204.1 430204	Ø 316 30 28 V
SUBARU - LEGACY OUTBACK (BG) 01/96→12/99								
 Bremsbelagsatz, Scheibenbremse								
2.5	110	01/96→12/99	←	06/96→ 11/98			13.0460-5851.2 605851	AKE 21915 17,2 + WK
			→	06/96→ 11/98			13.0460-5850.2 605850	SUM 21703 15,0 + WK
Zubehörsatz, Scheibenbremsbelag								
2.5	110	01/96→12/99	→	06/96→ 11/98			13.0460-0143.2 610143	
 Bremsscheibe								
2.5	110	01/96→12/99	←	06/96→ 11/98			24.0124-0145.1 424145	Ø 277 24 22 V
			→	06/96→ 11/98			24.0110-0237.1 410237	Ø 266 10 8,5
SUBARU - LIBERO Bus (E10, E12) 01/83→02/00								
 Bremsbelagsatz, Scheibenbremse								
1.2 AWD (E12, KJ8)	38	08/86→02/00	←	01/87→ 04/93			13.0460-5963.2 605963	AKE 20958 16,0 - WE / - WK
SUBARU - OUTBACK (BE, BH) 10/98→08/03								
 Bremsbelagsatz, Scheibenbremse								
2.5 AWD	115	10/00→08/03	←				13.0460-5851.2 605851	AKE 21915 17,2 + WK
3.0 H6 AWD	154	10/00→08/03	←					
 Bremsscheibe								
2.5 AWD	115	10/00→08/03	←				24.0124-0196.1 424196	Ø 293,5 24 22 V
3.0 H6 AWD	154	10/00→08/03	←					
SUBARU - OUTBACK (BL, BP) 09/03→06/10								
 Bremsbelagsatz, Scheibenbremse								
2.0 AWD	101	09/03→10/05	←				13.0460-5787.2 605787	TOK 23865 17,6 + WK + Zub
			→				13.0460-5797.2 605797	AKE 24222 16,9 + WK + Zub
2.0 D AWD	110	09/08→09/09	←	→ 04/09			13.0460-5787.2 605787	TOK 23865 17,6 + WK + Zub
2.5 AWD	121	11/03→09/09	←	→ 04/09			13.0460-5797.2 605797	AKE 24222 16,9 + WK + Zub
2.5 AWD	127	09/08→09/09	←	→ 06/09			13.0460-5787.2 605787	TOK 23865 17,6 + WK + Zub
3.0 AWD	180	11/03→09/09	←	→ 06/09			13.0460-5797.2 605797	AKE 24222 16,9 + WK + Zub
 Bremsscheibe								
2.0 AWD	101	09/03→10/05	←				24.0124-0145.1 424145	Ø 277 24 22 V
			→				24.0110-0728.1 410728	Ø 273,8 10 8,5
2.0 D AWD	110	09/08→09/09	←	→ 04/09			24.0124-0196.1 424196	Ø 293,5 24 22 V
			→	→ 04/09			24.0110-0728.1 410728	Ø 273,8 10 8,5
2.5 AWD	121	11/03→09/09	←	→ 04/09			24.0124-0196.1 424196	Ø 293,5 24 22 V
			→	→ 04/09			24.0110-0728.1 410728	Ø 273,8 10 8,5
			→				24.0118-0725.1 418725	Ø 290 18 16 V
2.5 AWD	127	09/08→09/09	←	→ 06/09			24.0124-0196.1 424196	Ø 293,5 24 22 V
			→	→ 06/09			24.0110-0728.1 410728	Ø 273,8 10 8,5
3.0 AWD	180	11/03→09/09	←	→ 06/09			24.0124-0196.1 424196	Ø 293,5 24 22 V
			→	→ 06/09			24.0110-0728.1 410728	Ø 273,8 10 8,5
			→				24.0118-0725.1 418725	Ø 290 18 16 V
SUBARU - OUTBACK (BR) 09/09→								
 Bremsbelagsatz, Scheibenbremse								
2.0 D AWD	108	01/13→	←				13.0460-5787.2 605787	TOK 23865 17,6 + WK + Zub
2.0 D AWD	110	09/09→	←					
2.5 i AWD	123	09/09→	←					
2.5 i AWD	125	09/12→	←				13.0460-5793.2 605793	AKE 24372 17,3 + WK + Zub
↓								















	kW			 	! #		
SUBARU - OUTBACK (BR) 09/09→							
 Bremsbelagsatz, Scheibenbremse							
2.5 i AWD	127	01/13→	←			13.0460-5793.2 605793	AKE 24372 17,3 + WK + Zub
3.6 AWD	182	06/11→	←	→ 12/14		13.0460-5797.2 605797	AKE 24222 16,9 + WK + Zub
3.6 R AWD	188	01/12→	←			13.0460-5797.2 605797	AKE 24222 16,9 + WK + Zub
3.6 R AWD	191	09/09→	←				
 Bremsscheibe							
2.0 D AWD	108	01/13→	←			24.0124-0196.1 424196	Ø 293,5 24 22 V
2.0 D AWD	110	09/09→	←				
2.5 i AWD	123	09/09→	→			24.0110-0366.1 410366	Ø 286 10 8,5
2.5 i AWD	125	09/12→	←			24.0124-0145.1 424145	Ø 277 24 22 V
			→			24.0110-0366.1 410366	Ø 286 10 8,5
2.5 i AWD	127	01/13→	←			24.0124-0145.1 424145	Ø 277 24 22 V
			→	passend für Felgenreöße [Zoll]: 15		24.0118-0159.1 418159	Ø 266 18 16 V
3.6 AWD	182	06/11→	←	→ 12/14		24.0130-0204.1 430204	Ø 316 30 28 V
3.6 R AWD	188	01/12→	←			24.0130-0204.1 430204	Ø 316 30 28 V
3.6 R AWD	191	09/09→	→			24.0110-0366.1 410366	Ø 286 10 8,5
SUBARU - TREZIA 11/10→							
 Bremsbelagsatz, Scheibenbremse							
1.3 (NSP120X)	73	03/11→	←			13.0460-5767.2 605767	AKE 24336 17,5 - WE / - WK
1.4 D	66	03/11→	→			13.0460-5769.2 605769	24610 15,0 + WK
 Bremsscheibe							
1.3 (NSP120X)	73	03/11→	←			24.0122-0276.1 422276	Ø 275 22 19 V
1.4 D	66	03/11→	→			24.0109-0163.1 409163	Ø 259 9 7,5
SUBARU - TRIBECA (B9) 01/05→							
 Bremsbelagsatz, Scheibenbremse							
3.0	180	10/06→	←	→ 11/07		13.0460-5797.2 605797	AKE 24222 16,9 + WK + Zub
3.0	184	01/05→	←	→ 09/06		13.0460-5797.2 605797	AKE 24222 16,9 + WK + Zub
3.6	188	09/09→	←	→ 10/10		13.0460-5797.2 605797	AKE 24222 16,9 + WK + Zub
3.6	190	09/07→	←	12/07→ 10/10		13.0460-5797.2 605797	AKE 24222 16,9 + WK + Zub
SUBARU - XV 12/11→							
 Bremsscheibe							
1.6 i AWD	84	03/12→	←			24.0124-0196.1 424196	Ø 293,5 24 22 V
2.0 D AWD	80	03/12→	←				
2.0 D AWD	108	03/12→	→			24.0110-0384.1 410384	Ø 273,8 10 8,5
2.0 i AWD	110	03/12→	→				
SUZUKI - ALTO (EF) 10/93→09/98							
 Bremsbelagsatz, Scheibenbremse							
0.8	25	11/93→06/96	←			13.0460-5916.2 605916	AKE 20731 15,3 - WE / - WK
1.0	43	01/00→06/02	←			13.0460-5985.2 605985	TOK 21333 15,0 + WK
1.0 (SH410)	39	09/94→09/98	←				
1.3	63	10/98→09/00	←	02/99→		13.0460-5839.2 605839	AIS 23795 15,0 + WK
1.6	71	10/98→09/00	←				
 Bremsscheibe							
0.8	25	11/93→06/96	←			24.0110-0136.1 410136	Ø 215 10 8
1.0	43	01/00→06/02	←			24.0117-0103.1 417103	Ø 231,2 17 15 V
1.0 (SH410)	39	09/94→09/98	←				
1.3	63	10/98→09/00	←			24.0120-0163.1 420163	Ø 235 20 18 V
1.6	71	10/98→09/00	←				
SUZUKI - ALTO (FF) 09/04→12/09							
 Bremsbelagsatz, Scheibenbremse							
1.1 (RF410)	46	09/04→12/08	←			13.0460-5621.2 605621	24423 14,6 + WK
 Bremsscheibe							
1.1 (RF410)	46	09/04→12/08	←			24.0117-0105.1 417105	Ø 231 17 15 V

















	kw			 	! #		
SUZUKI - ALTO (GF) 01/09→							
 Bremsbelagsatz, Scheibenbremse							
1.0 (AMF310)	50	01/09→	←			13.0460-5887.2 605887	SUM 23507 15,2 + WK
 Bremsscheibe							
1.0 (AMF310)	50	01/09→	←			24.0120-0225.1 420225	Ø 231 20 18 V
SUZUKI - BALENO (EG) 03/95→12/09							
 Bremsbelagsatz, Scheibenbremse							
1.3 (SY413)	52	09/96→05/02	←	→ 01/99		13.0460-5838.2 605838	AIS 23400 15,5 + WK
			←	02/99→		13.0460-5839.2 605839	AIS 23795 15,0 + WK
1.3 i 16V (SY413)	63	07/95→05/02	←	→ 01/97		13.0460-5838.2 605838	AIS 23400 15,5 + WK
1.6 i 16V (SY416)	72	07/95→05/02	←	02/97→		13.0460-5839.2 605839	AIS 23795 15,0 + WK
1.6 i 16V 4x4 (SY416)	72	07/95→05/02	←				
1.8 GTX (SY418)	89	03/96→05/02	←	→ 01/97		13.0460-5838.2 605838	AIS 23400 15,5 + WK
			←	02/97→		13.0460-5839.2 605839	AIS 23795 15,0 + WK
			→			13.0460-5972.2 605972	21559 11,5 - WE / - WK
1.9 TD (SY419)	55	04/98→05/02	←	→ 01/99		13.0460-5838.2 605838	AIS 23400 15,5 + WK
			←	02/99→		13.0460-5839.2 605839	AIS 23795 15,0 + WK
			→			13.0460-5972.2 605972	21559 11,5 - WE / - WK
Zubehörsatz, Scheibenbremsbelag							
1.3 (SY413)	52	09/96→05/02	←	→ 01/99		13.0460-0265.2 610265	
1.9 TD (SY419)	55	04/98→05/02	←				
1.3 i 16V (SY413)	63	07/95→05/02	←	→ 01/97		13.0460-0265.2 610265	
1.6 i 16V (SY416)	72	07/95→05/02	←				
1.6 i 16V 4x4 (SY416)	72	07/95→05/02	←				
1.8 GTX (SY418)	89	03/96→05/02	←				
 Bremsscheibe							
1.3 (SY413)	52	09/96→05/02	←			24.0120-0163.1 420163	Ø 235 20 18 V
1.3 i 16V (SY413)	63	07/95→05/02	←				
1.6 i 16V (SY416)	72	07/95→05/02	←				
1.6 i 16V 4x4 (SY416)	72	07/95→05/02	←				
1.8 GTX (SY418)	89	03/96→05/02	←			24.0120-0197.1 420197	Ø 246 20 18 V
1.9 TD (SY419)	55	04/98→05/02	←				
SUZUKI - BALENO (FW, EW) 02/16→							
 Bremsbelagsatz, Scheibenbremse							
1.0 (A1K310)	82	02/16→	←			13.0460-5794.2 605794	TRW 24283 15,5 + WK + Zub
1.2 (A1K412)	66	02/16→	←				
1.2 Hybrid (A1K412)	66	02/16→	←				
SUZUKI - BALENO Kombi (EG) 08/96→05/02							
 Bremsbelagsatz, Scheibenbremse							
1.3 16V (SY413)	63	03/97→05/02	←			13.0460-5839.2 605839	AIS 23795 15,0 + WK
1.6 i 16V (SY416)	72	08/96→05/02	←	→ 01/97		13.0460-5838.2 605838	AIS 23400 15,5 + WK
1.6 i 16V (SY416)	73	08/96→05/02	←	02/97→		13.0460-5839.2 605839	AIS 23795 15,0 + WK
1.6 i 16V 4x4 (SY416)	72	08/96→05/02	←				
1.6 i 16V 4x4 (SY416)	73	08/96→05/02	←				
1.8 i 16V (SY418)	89	08/96→05/02	←	→ 01/97		13.0460-5838.2 605838	AIS 23400 15,5 + WK
			←	02/97→		13.0460-5839.2 605839	AIS 23795 15,0 + WK
			→			13.0460-5972.2 605972	21559 11,5 - WE / - WK
1.9 TD (SY419)	55	04/98→05/02	←	→ 01/99		13.0460-5838.2 605838	AIS 23400 15,5 + WK
			←	02/99→		13.0460-5839.2 605839	AIS 23795 15,0 + WK
			→			13.0460-5972.2 605972	21559 11,5 - WE / - WK
Zubehörsatz, Scheibenbremsbelag							
1.6 i 16V (SY416)	72	08/96→05/02	←	→ 01/97		13.0460-0265.2 610265	
1.6 i 16V (SY416)	73	08/96→05/02	←				
1.6 i 16V 4x4 (SY416)	72	08/96→05/02	←				
1.6 i 16V 4x4 (SY416)	73	08/96→05/02	←				
1.8 i 16V (SY418)	89	08/96→05/02	←				
1.9 TD (SY419)	55	04/98→05/02	←	→ 01/99		13.0460-0265.2 610265	
 Bremsscheibe							
1.3 16V (SY413)	63	03/97→05/02	←			24.0120-0163.1 420163	Ø 235 20 18 V
1.6 i 16V (SY416)	72	08/96→05/02	←				
1.6 i 16V (SY416)	73	08/96→05/02	←				













	kW			 	! #		
SUZUKI - BALENO Kombi (EG) 08/96→05/02							
 Bremsscheibe							
1.6 i 16V 4x4 (SY416)	72	08/96→05/02	←			24.0120-0163.1 420163	Ø 235 20 18 V
1.6 i 16V 4x4 (SY416)	73	08/96→05/02					
1.8 i 16V (SY418)	89	08/96→05/02	←			24.0120-0197.1 420197	Ø 246 20 18 V
1.9 TD (SY419)	55	04/98→05/02					
SUZUKI - BALENO Schrägheck (EG) 03/95→05/02							
 Bremsbelagsatz, Scheibenbremse							
1.3 (SY413)	52	09/96→05/02	←	→ 01/99		13.0460-5838.2 605838	AIS 23400 15,5 + WK
			←	02/99→		13.0460-5839.2 605839	AIS 23795 15,0 + WK
1.3 i 16V (SY413)	63	07/95→05/02	←	→ 01/97		13.0460-5838.2 605838	AIS 23400 15,5 + WK
1.6 i 16V (SY416)	72	07/95→05/02					
1.6 i 16V 4x4 (SY416)	72	07/95→05/02	←	02/97→		13.0460-5839.2 605839	AIS 23795 15,0 + WK
1.8 GTX (SY418)	89	03/96→05/02	←	→ 01/97		13.0460-5838.2 605838	AIS 23400 15,5 + WK
			←	02/97→		13.0460-5839.2 605839	AIS 23795 15,0 + WK
			→			13.0460-5972.2 605972	21559 11,5 - WE / - WK
1.9 TD (SY419)	55	04/98→05/02	←	→ 01/99		13.0460-5838.2 605838	AIS 23400 15,5 + WK
			←	02/99→		13.0460-5839.2 605839	AIS 23795 15,0 + WK
			→			13.0460-5972.2 605972	21559 11,5 - WE / - WK
Zubehörsatz, Scheibenbremsbelag							
1.3 (SY413)	52	09/96→05/02	←	→ 01/99		13.0460-0265.2 610265	
1.9 TD (SY419)	55	04/98→05/02					
1.3 i 16V (SY413)	63	07/95→05/02	←	→ 01/97		13.0460-0265.2 610265	
1.6 i 16V (SY416)	72	07/95→05/02					
1.6 i 16V 4x4 (SY416)	72	07/95→05/02					
1.8 GTX (SY418)	89	03/96→05/02					
 Bremsscheibe							
1.3 (SY413)	52	09/96→05/02	←			24.0120-0163.1 420163	Ø 235 20 18 V
1.3 i 16V (SY413)	63	07/95→05/02					
1.6 i 16V (SY416)	72	07/95→05/02					
1.6 i 16V 4x4 (SY416)	72	07/95→05/02					
1.8 GTX (SY418)	89	03/96→05/02	←			24.0120-0197.1 420197	Ø 246 20 18 V
1.9 TD (SY419)	55	04/98→05/02					
SUZUKI - CAPPUCINO (EE) 02/92→08/98							
 Bremsbelagsatz, Scheibenbremse							
0.7 (SX306)	47	02/92→08/95	←			13.0460-5985.2 605985	TOK 21333 15,0 + WK
 Bremsscheibe							
0.7 (SX306)	47	02/92→08/95	←			24.0117-0103.1 417103	Ø 231,2 17 15 V
SUZUKI - GRAND VITARA I (FT, HT) 03/98→08/06							
 Bremsbelagsatz, Scheibenbremse							
1.6 4x4 (SQ 416)	69	03/98→07/03	←			13.0460-5864.2 605864	21907 15,5 + WK
1.6 4x4 (SQ 416)	71	09/03→09/05					
1.6 4x4 (SQ 416)	73	02/00→09/02					
2.0 4x4 (SQ 420)	94	03/98→07/03	←	2S2GTA52C00470001→		13.0460-5609.2 605609	24346 16,4 + WK
			←			13.0460-5857.2 605857	SUM 23314 15,0 + WK
			←			13.0460-5864.2 605864	21907 15,5 + WK
2.0 4x4 (SQ 420)	97	08/98→12/00	←			13.0460-5857.2 605857	SUM 23314 15,0 + WK
2.0 4x4 (SQ 420)	103	04/98→08/05					
2.0 TD 4x4 (SQ 420D)	63	04/00→09/05					
2.0 TD 4x4 (SQ 420D)	64	03/98→07/03					
2.5 V6 24V 4x4 (SQ 625)	116	04/01→07/03					
2.7 4x4 (JA 627)	127	09/01→07/03					
2.0 HDI 110 16V 4x4 (SQ 420D)	80	07/01→09/05	←	Baumuster: SQ420		13.0460-5857.2 605857	SUM 23314 15,0 + WK
2.0 HDI 110 4x4 (SQ 420D)	80	07/01→09/05					
2.5 V6 24V 4x4 (SQ 625)	106	04/98→07/03	←	→ 09/00		13.0460-5857.2 605857	SUM 23314 15,0 + WK
2.7 (JA 627)	127	06/01→08/03	←	09/01→		13.0460-5857.2 605857	SUM 23314 15,0 + WK
2.7 4x4 (JA 627)	130	07/01→07/03					
2.7 (JA 627)	135	09/03→08/06	←	→ 09/05		13.0460-5609.2 605609	24346 16,4 + WK
			←	→ 09/05		13.0460-5857.2 605857	SUM 23314 15,0 + WK
2.7 4x4 (JA 627)	135	04/03→07/03	←			13.0460-5609.2 605609	24346 16,4 + WK
↓							













	kW					! #		
SUZUKI - GRAND VITARA I (FT, HT) 03/98→08/06								
 Bremsbelagsatz, Scheibenbremse								
2.7 4x4 (JA 627)	135	04/03→07/03	←				13.0460-5857.2 605857	SUM 23314 15,0 + WK
 Bremsscheibe								
1.6 4x4 (SQ 416)	69	03/98→07/03	←				24.0117-0109.1 417109	Ø 287 17 15 V
			←	08/98→			24.0122-0200.1 422200	Ø 310 22 20 V
1.6 4x4 (SQ 416)	71	09/03→09/05	←	→ 11/04; Baumuster: Grand Vitara			24.0117-0109.1 417109	Ø 287 17 15 V
			←	Baumuster: Grand Escudo			24.0122-0200.1 422200	Ø 310 22 20 V
1.6 4x4 (SQ 416)	73	02/00→09/02	←				24.0117-0109.1 417109	Ø 287 17 15 V
2.0 4x4 (SQ 420)	94	03/98→07/03	←				24.0117-0109.1 417109	Ø 287 17 15 V
			←				24.0122-0200.1 422200	Ø 310 22 20 V
2.0 4x4 (SQ 420)	97	08/98→12/00	←				24.0122-0200.1 422200	Ø 310 22 20 V
2.0 4x4 (SQ 420)	103	04/98→08/05						
2.0 HDI 110 16V 4x4 (SQ 420D)	80	07/01→09/05						
2.0 HDI 110 4x4 (SQ 420D)	80	07/01→09/05						
2.0 TD 4x4 (SQ 420D)	63	04/00→09/05						
2.0 TD 4x4 (SQ 420D)	64	03/98→07/03						
2.5 V6 24V 4x4 (SQ 625)	116	04/01→07/03						
2.7 4x4 (JA 627)	127	09/01→07/03						
2.7 4x4 (JA 627)	135	04/03→07/03						
2.5 V6 24V 4x4 (SQ 625)	106	04/98→07/03	←	→ 09/00			24.0122-0200.1 422200	Ø 310 22 20 V
2.7 (JA 627)	127	06/01→08/03	←	09/01→			24.0122-0200.1 422200	Ø 310 22 20 V
2.7 4x4 (JA 627)	130	07/01→07/03						
2.7 (JA 627)	135	09/03→08/06	←	→ 09/05			24.0122-0200.1 422200	Ø 310 22 20 V
SUZUKI - GRAND VITARA I Cabriolet (GT) 03/98→09/05								
 Bremsbelagsatz, Scheibenbremse								
1.6 4x4 (SQ 416)	69	03/98→07/03	←				13.0460-5864.2 605864	21907 15,5 + WK
2.0 4x4 (SQ 420)	94	03/98→07/03	←	2S2GTA52C00470001→			13.0460-5609.2 605609	24346 16,4 + WK
			←				13.0460-5857.2 605857	SUM 23314 15,0 + WK
			←				13.0460-5864.2 605864	21907 15,5 + WK
 Bremsscheibe								
1.6 4x4 (SQ 416)	69	03/98→07/03	←				24.0117-0109.1 417109	Ø 287 17 15 V
			←	08/98→			24.0122-0200.1 422200	Ø 310 22 20 V
2.0 4x4 (SQ 420)	94	03/98→07/03	←				24.0117-0109.1 417109	Ø 287 17 15 V
			←				24.0122-0200.1 422200	Ø 310 22 20 V
SUZUKI - GRAND VITARA II (JT, TE, TD) 04/05→02/15								
 Bremsbelagsatz, Scheibenbremse								
1.6 (JB416)	78	10/05→02/15	←	→ 02/15			13.0460-5609.2 605609	24346 16,4 + WK
1.6 Allrad (JB416)	73	09/05→02/15	←				13.0460-5609.2 605609	24346 16,4 + WK
1.6 Allrad (JB416)	78	04/05→02/15						
1.9 DDiS (JB419D)	95	03/06→08/08						
1.9 DDiS Allrad (JB419D)	95	10/05→02/15						
2.0 Allrad (JB420)	103	10/05→02/15						
2.0 (JB420)	103	10/05→02/15	←	→ 12/11			13.0460-5609.2 605609	24346 16,4 + WK
2.7 (JB627)	138	09/05→12/08	←	10/05→ 08/08			13.0460-5609.2 605609	24346 16,4 + WK
 Bremsscheibe								
1.6 (JB416)	78	10/05→02/15	←	→ 02/15			24.0125-0190.1 425190	Ø 294,5 25 23 V
1.6 Allrad (JB416)	73	09/05→02/15	←				24.0125-0190.1 425190	Ø 294,5 25 23 V
1.6 Allrad (JB416)	78	04/05→02/15						
1.9 DDiS (JB419D)	95	03/06→08/08						
1.9 DDiS Allrad (JB419D)	95	10/05→02/15						
2.0 Allrad (JB420)	103	10/05→02/15						
2.4 Allrad (JB424)	120	09/13→02/15						
2.4 Allrad (JB424)	122	01/09→02/15						
2.4 Allrad (JB424)	124	01/09→02/15						
3.2 Allrad (JB632)	165	06/08→02/15						
3.2 Allrad (JB632)	171	01/09→02/15						
↓								















	kw					! #		
SUZUKI - GRAND VITARA II (JT, TE, TD) 04/05→02/15								
 Bremsscheibe								
2.0 (JB420)	103	10/05→02/15	←	→ 12/11			24.0125-0190.1 425190	Ø 294,5 25 23 V
2.7 (JB627)	138	09/05→12/08	←	10/05→ 08/08			24.0125-0190.1 425190	Ø 294,5 25 23 V
SUZUKI - IGNIS (FH) 10/00→12/05								
 Bremsbelagsatz, Scheibenbremse								
1.3 (RG413)	61	10/00→09/03	←	→ 08/03			13.0460-5887.2 605887	SUM 23507 15,2 + WK
1.3 4WD (RG413)	61	10/00→09/03						
1.5 (HV81, RG415)	83	08/03→12/05	←	12/03→			13.0460-5887.2 605887	SUM 23507 15,2 + WK
			→	12/03→; für Fahrzeuge mit Sportfahrwerk			13.0460-5856.2 605856	24039 14,4 + WK
 Bremsscheibe								
1.3 (RG413)	61	10/00→09/03	←	→ 08/03			24.0117-0108.1 417108	Ø 257 17 15 V
1.3 4WD (RG413)	61	10/00→09/03						
1.5 (HV81, RG415)	83	08/03→12/05	←	12/03→			24.0117-0108.1 417108	Ø 257 17 15 V
SUZUKI - IGNIS II (MH) 09/03→								
 Bremsbelagsatz, Scheibenbremse								
1.3 (RM413)	69	09/03→	←	→ 12/12			13.0460-3995.2 603995	BOS 23605 15,7 + WK + Zub
1.3 4x4 (RM413)	69	09/03→						
1.3 DDiS (RM413D)	51	09/03→						
1.5 (RM415)	73	09/03→						
1.5 4x4 (RM415)	73	09/03→						
1.5 Sport (RM415)	80	12/03→	←	→ 12/12			13.0460-5887.2 605887	SUM 23507 15,2 + WK
			→	→ 12/12; für Fahrzeuge mit Sportfahrwerk			13.0460-5856.2 605856	24039 14,4 + WK
 Bremsscheibe								
1.3 (RM413)	69	09/03→	←	→ 12/12			24.0117-0106.1 417106	Ø 253 17 15 V
1.3 4x4 (RM413)	69	09/03→						
1.3 DDiS (RM413D)	51	09/03→						
1.5 (RM415)	73	09/03→						
1.5 4x4 (RM415)	73	09/03→						
1.5 Sport (RM415)	80	12/03→	←	→ 12/12			24.0117-0108.1 417108	Ø 257 17 15 V
SUZUKI - JIMNY (FJ) 07/98→								
 Bremsbelagsatz, Scheibenbremse								
1.3 (SN413)	63	08/04→	←				13.0460-5966.2 605966	SUM 21142 15,0 - WE / - WK
1.3 16V (SN413)	59	09/98→						
1.3 16V (SN413)	60	02/01→						
1.3 16V 4WD (SN413)	59	09/98→						
1.3 16V 4WD (SN413)	60	02/01→						
1.3 16V 4x4 (SN413)	63	08/05→						
1.3 4WD (SN413)	62	05/14→						
1.3 4x4 (SN413)	63	09/98→08/00						
1.3 4x4 (SN413)	65	09/00→08/02						
1.5 DDiS 4WD (SN415D)	48	12/03→	←				13.0460-5864.2 605864	21907 15,5 + WK
1.5 DDiS 4x4	63	08/05→						
 Bremsscheibe								
1.3 (SN413)	63	08/04→	←	→ 00203804			24.0110-0242.1 410242	Ø 290 10 8
1.3 16V (SN413)	59	09/98→						
1.3 16V (SN413)	60	02/01→	←	00203805→			24.0110-0355.1 410355	Ø 290 10 8
1.3 16V 4WD (SN413)	59	09/98→						
1.3 16V 4WD (SN413)	60	02/01→						
1.3 16V 4x4 (SN413)	63	08/05→						
1.3 4WD (SN413)	62	05/14→						
1.3 4x4 (SN413)	63	09/98→08/00						
1.3 4x4 (SN413)	65	09/00→08/02						
1.5 DDiS 4WD (SN415D)	48	12/03→	←	→ 00201861			24.0117-0104.1 417104	Ø 287 17 15 V
1.5 DDiS 4x4	63	08/05→						
SUZUKI - KIZASHI (FR) 10/10→								
 Bremsscheibe								
2.4 (A6B 424)	131	10/10→	←				24.0126-0172.1 426172	Ø 300 26 24 V
2.4 (A6B 424)	134	10/10→						
2.4 (A6B 424)	136	10/10→	→				24.0112-0195.1 412195	Ø 278 12 11
2.4 (A6B 424)	138	04/12→						
2.4 4x4 (A6B 424)	131	10/10→						
2.4 4WD (A6B 424)	138	10/10→	←	04/12→			24.0126-0172.1 426172	Ø 300 26 24 V
↓								

















	kw			 	! #		
SUZUKI - KIZASHI (FR) 10/10→							
 Bremsscheibe							
2.4 4WD (A6B 424)	138	10/10→	→	04/12→		24.0112-0195.1 412195	Ø 278 12 11
SUZUKI - LIANA (ER, RH_) 10/01→							
 Bremsbelagsatz, Scheibenbremse							
1.3 (RH 413)	66	03/02→	←	→ 12/07		13.0460-5774.2 605774	24830 16,1 + WK
1.4 DDiS (RH 414D)	66	04/04→				13.0460-5888.2 605888	23817 16,6 + WK
1.6 (RH 416)	76	03/02→					
1.6 (RH 416)	79	01/05→					
1.6 4WD (RH 416)	76	03/02→					
1.6 4WD (RH 416)	78	04/02→					
1.6 i	78	04/02→					
1.5 (RH415)	81	04/04→11/07	←	01/05→		13.0460-5774.2 605774	24830 16,1 + WK
						13.0460-5888.2 605888	23817 16,6 + WK
1.6 4WD (RH 416)	79	01/05→12/07	←			13.0460-5774.2 605774	24830 16,1 + WK
						13.0460-5888.2 605888	23817 16,6 + WK
1.8 i	92	10/01→	←	01/05→ 12/07		13.0460-5774.2 605774	24830 16,1 + WK
						13.0460-5888.2 605888	23817 16,6 + WK
 Bremsscheibe							
1.3 (RH 413)	66	03/02→	←	→ 12/07		24.0120-0197.1 420197	Ø 246 20 18 V
1.4 DDiS (RH 414D)	66	04/04→					
1.6 (RH 416)	76	03/02→					
1.6 (RH 416)	79	01/05→					
1.6 4WD (RH 416)	76	03/02→					
1.6 4WD (RH 416)	78	04/02→					
1.6 i	78	04/02→					
1.5 (RH415)	81	04/04→11/07	←	01/05→		24.0120-0197.1 420197	Ø 246 20 18 V
1.6 4WD (RH 416)	79	01/05→12/07	←			24.0120-0197.1 420197	Ø 246 20 18 V
1.8 i	92	10/01→	←	01/05→ 12/07		24.0120-0197.1 420197	Ø 246 20 18 V
SUZUKI - LIANA Kombi (ER) 07/01→12/07							
 Bremsbelagsatz, Scheibenbremse							
1.3	66	07/01→12/07	←			13.0460-5774.2 605774	24830 16,1 + WK
1.4 DDiS	66	04/04→12/07				13.0460-5888.2 605888	23817 16,6 + WK
1.6	76	07/01→12/07					
1.6	79	01/05→12/07					
1.6 4WD	76	07/01→12/07					
1.6 4WD	78	04/02→12/07					
1.6 4WD	79	01/05→12/07					
1.6 i	78	04/02→12/07					
1.8 i	92	10/01→12/07	←	01/05→		13.0460-5774.2 605774	24830 16,1 + WK
						13.0460-5888.2 605888	23817 16,6 + WK
 Bremsscheibe							
1.3	66	07/01→12/07	←			24.0120-0197.1 420197	Ø 246 20 18 V
1.4 DDiS	66	04/04→12/07					
1.6	76	07/01→12/07					
1.6	79	01/05→12/07					
1.6 4WD	76	07/01→12/07					
1.6 4WD	78	04/02→12/07					
1.6 4WD	79	01/05→12/07					
1.6 i	78	04/02→12/07					
1.8 i	92	10/01→12/07	←	01/05→		24.0120-0197.1 420197	Ø 246 20 18 V
SUZUKI - SAMURAI (SJ) 11/88→12/04							
 Bremsbelagsatz, Scheibenbremse							
1.0 Allrad (SJ 410)	33	11/88→12/04	←	→ 12/92		13.0460-2997.2 602997	TRW 20708 15,8 + WE / - WK
1.3 Allrad (SJ 413)	44	11/88→12/04				13.0460-5966.2 605966	SUM 21142 15,0 - WE / - WK
1.3 Allrad (SJ 413)	47	11/88→12/04					
1.3 Allrad (SJ 413)	51	11/88→12/04					
1.3 (SJ 413)	63	11/88→12/04	←	09/00→		13.0460-5966.2 605966	SUM 21142 15,0 - WE / - WK
1.3 Allrad (SJ 413)	59	01/00→12/04					
1.9 D	46	09/00→12/04	←			13.0460-5720.2 605720	TRW 20708 14,5 - WE / - WK
1.9 D Allrad	47	11/98→12/04					
1.9 TD Allrad (SJ 419TD)	46	11/98→12/04					
 Bremsscheibe							
1.0 Allrad (SJ 410)	33	11/88→12/04	←	→ 12/92		24.0110-0192.1 410192	Ø 289,8 10 9
1.3 Allrad (SJ 413)	44	11/88→12/04					
1.3 Allrad (SJ 413)	47	11/88→12/04					
1.3 (SJ 413)	63	11/88→12/04	←	09/00→		24.0110-0192.1 410192	Ø 289,8 10 9











	kW			 	! #		
SUZUKI - SAMURAI (SJ) 11/88→12/04							
 Bremsscheibe							
1.3 Allrad (SJ 413)	59	01/00→12/04	←	09/00→		24.0110-0242.1 410242	Ø 290 10 8
1.3 Allrad (SJ 413)	51	11/88→12/04	←	11/98→		24.0110-0192.1 410192	Ø 289,8 10 9
			←	→ 12/92		24.0110-0192.1 410192	Ø 289,8 10 9
1.9 D	46	09/00→12/04	←			24.0110-0242.1 410242	Ø 290 10 8
1.9 D Allrad	47	11/98→12/04					
1.9 TD Allrad (SJ 419TD)	46	11/98→12/04					
SUZUKI - SIERRA II Pick-up (SJ) 12/88→02/00							
 Bremsbelagsatz, Scheibenbremse							
1.0 Allrad	33	12/88→02/00	←	→ 12/92		13.0460-2997.2 602997 13.0460-5966.2 605966	TRW 20708 15,8 + WE / - WK SUM 21142 15,0 - WE / - WK
 Bremsscheibe							
1.0 Allrad	33	12/88→02/00	←	→ 12/92		24.0110-0192.1 410192	Ø 289,8 10 9
SUZUKI - SIERRA Geländewagen offen (SJ) 09/84→07/99							
 Bremsbelagsatz, Scheibenbremse							
1.3 (SJ 413, SF413)	51	01/89→07/99	←	→ 12/92		13.0460-2997.2 602997 13.0460-5966.2 605966	TRW 20708 15,8 + WE / - WK SUM 21142 15,0 - WE / - WK
 Bremsscheibe							
1.3 (SJ 413, SF413)	51	01/89→07/99	←	→ 12/92		24.0110-0192.1 410192	Ø 289,8 10 9
SUZUKI - SPLASH (EX) 01/08→							
 Bremsbelagsatz, Scheibenbremse							
1.0 (A5B 310)	48	01/08→	←			13.0460-5700.2 605700	TRW 23973 17,0 + WK
1.0 (A5B 310)	50	06/11→					
1.2 (A5B 412)	63	01/08→					
1.2 VVT (A5B 412)	66	06/11→					
1.2 VVT (A5B 412)	67	08/12→					
1.2 VVT (A5B 412)	69	09/10→					
1.3 CDTI (A5B 413D)	55	01/08→					
 Bremsscheibe							
1.0 (A5B 310)	48	01/08→	←			24.0120-0211.1 420211	Ø 252 20 18 V + S
1.0 (A5B 310)	50	06/11→					
1.2 (A5B 412)	63	01/08→					
1.2 VVT (A5B 412)	66	06/11→					
1.2 VVT (A5B 412)	67	08/12→					
1.2 VVT (A5B 412)	69	09/10→					
1.3 CDTI (A5B 413D)	55	01/08→					
SUZUKI - SUPER CARRY Bus (ED) 07/85→03/99							
 Bremsbelagsatz, Scheibenbremse							
1.0 (SK410)	33	10/85→03/99	←	→ 02/88		13.0460-5916.2 605916	AKE 20731 15,3 - WE / - WK
 Bremsscheibe							
1.0 (SK410)	33	10/85→03/99	←	→ 02/88		24.0110-0136.1 410136 24.0110-0192.1 410192	Ø 215 10 8 Ø 289,8 10 9
SUZUKI - SWIFT II Schrägheck (EA, MA) 03/89→12/05							
 Bremsbelagsatz, Scheibenbremse							
1.0 (SF310, AA44)	37	03/89→05/01	←	320340→; → 10/96		13.0460-5837.2 605837	BOS 23296 14,5 + WK
			←	08/92→; → 320339		13.0460-5985.2 605985	TOK 21333 15,0 + WK
1.0 i (SF310, AA44)	39	01/95→12/05	←	11/96→ 12/04; - ABS		13.0460-5763.2 605763	21730 14,0 + WK
			←	320340→; → 10/96		13.0460-5837.2 605837	BOS 23296 14,5 + WK
			←	→ 320339		13.0460-5985.2 605985	TOK 21333 15,0 + WK
			←	11/96→ 12/04; + ABS		13.0460-5985.2 605985	TOK 21333 15,0 + WK
1.3 (SF413, AB35)	50	03/89→05/01	←	11/96→		13.0460-5763.2 605763	21730 14,0 + WK
1.3 (SF 413)	51	03/89→10/96	←	320340→		13.0460-5837.2 605837	BOS 23296 14,5 + WK
			←	04/89→; → 320339		13.0460-5985.2 605985	TOK 21333 15,0 + WK
1.3 (SF 413)	63	06/01→12/03	←			13.0460-5763.2 605763	21730 14,0 + WK
1.3 4WD (SF413, AA35)	50	03/89→05/01	←	11/96→		13.0460-5985.2 605985	TOK 21333 15,0 + WK













	kw			 	! #		
SUZUKI - SWIFT II Schrägheck (EA, MA) 03/89→12/05							
 Bremsscheibe							
1.0 (SF310, AA44)	37	03/89→05/01	←	08/91→ 10/96		24.0117-0103.1 417103	Ø 231,2 17 15 V
1.0 i (SF310, AA44)	39	01/95→12/05	←	11/96→ 12/04; - ABS		24.0112-0173.1 412173	Ø 232 12 9,5
			←	11/96→ 12/04; + ABS		24.0117-0103.1 417103	Ø 231,2 17 15 V
			←	→ 10/96		24.0117-0103.1 417103	Ø 231,2 17 15 V
1.3 (SF413, AB35)	50	03/89→05/01	←	11/96→		24.0112-0173.1 412173	Ø 232 12 9,5
1.3 (SF 413)	51	03/89→10/96	←	04/89→		24.0117-0103.1 417103	Ø 231,2 17 15 V
1.3 (SF 413)	63	06/01→12/03	←			24.0112-0173.1 412173	Ø 232 12 9,5
1.3 4WD (SF413, AA35)	50	03/89→05/01	←	11/96→		24.0117-0103.1 417103	Ø 231,2 17 15 V
SUZUKI - SWIFT III (MZ, EZ) 02/05→							
 Bremsbelagsatz, Scheibenbremse							
1.3 (RS 413)	68	02/05→	←	→ 09/10		13.0460-5700.2 605700	TRW 23973 17,0 + WK
1.3 4x4 (RS 413)	66	01/06→					
1.3 4x4 (RS 413)	68	02/05→					
1.3 DDiS (RS 413D)	55	08/05→					
1.5 (RS 415)	75	02/05→					
1.5 4x4 (RS 415)	74	02/05→					
1.3 DDiS (RS 413D)	51	08/05→	←	→ 09/07		13.0460-5700.2 605700	TRW 23973 17,0 + WK
1.6 (RS 416)	92	05/06→	←	→ 09/10		13.0460-5700.2 605700	TRW 23973 17,0 + WK
			→	→ 09/10		13.0460-5929.2 605929	AKE 21719 15,0 + WK
 Bremsscheibe							
1.3 (RS 413)	68	02/05→	←	→ 09/10		24.0120-0211.1 420211	Ø 252 20 18 V + S
1.3 4x4 (RS 413)	66	01/06→					
1.3 4x4 (RS 413)	68	02/05→					
1.3 DDiS (RS 413D)	55	08/05→					
1.5 (RS 415)	75	02/05→					
1.5 4x4 (RS 415)	74	02/05→					
1.3 DDiS (RS 413D)	51	08/05→	←	→ 09/07		24.0120-0211.1 420211	Ø 252 20 18 V + S
1.6 (RS 416)	92	05/06→	←	→ 09/10		24.0120-0216.1 420216	Ø 276 20 18 V
			→	→ 09/10		24.0109-0160.1 409160	Ø 278 9 8
SUZUKI - SWIFT IV (FZ, NZ) 10/10→							
 Bremsscheibe							
1.2 (AZG 412)	66	10/10→	←			24.0122-0280.1 422280	Ø 256 22 20 V
1.2 (AZH 412, AZG 412)	67	08/12→					
1.2 (AZH 412)	69	10/10→	←	für Geschwindigkeitsregelanlage		24.0122-0282.1 422282	Ø 272 22 20 V
1.2 4WD (AZH 412, AZG 412)	67	08/12→	→			24.0109-0175.1 409175	Ø 259 9 8
1.2 4x4 (AZG 412)	66	10/10→					
1.2 4x4 (AZH 412)	69	10/10→					
1.3 DDiS (AZG 413D)	55	10/10→					
1.4 (AZH 414)	70	02/11→					
1.4 (AZH 414)	75	01/12→					
SUZUKI - SX4 (EY, GY) 06/06→							
 Bremsbelagsatz, Scheibenbremse							
1.5 (RW 415)	73	06/06→07/10	←	Made in Ungarn		13.0460-2715.2 602715	TRW 24391 16,6 + WK + Zub
1.5 VVTi	81	07/07→12/15					
1.6 (RW 416)	74	06/06→	←	Made in Japan		13.0460-5716.2 605716	21561 17,0 + WK
1.6 VVT (RW 416)	79	06/06→	→	+ ABS		13.0460-5929.2 605929	AKE 21719 15,0 + WK
1.6 VVT (RW 416)	88	07/09→					
1.6 VVT 4x4 (RW 416)	79	06/06→					
1.6 VVT 4x4 (RW 416)	88	07/09→					
1.5 VVT (RW 415)	82	07/10→	←			13.0460-2715.2 602715	TRW 24391 16,6 + WK + Zub
1.5 VVT 4x4 (RW 415)	82	07/10→					
1.6 DDiS (RW 416D)	66	04/07→	→	+ ABS		13.0460-5929.2 605929	AKE 21719 15,0 + WK
1.6 VVT 4x4 (RW 416)	82	07/09→					
1.9 DDiS (RW 419D)	88	06/06→					
1.9 DDiS 4x4 (RW 419D)	88	06/06→					
2.0 DDiS (RW 420D)	99	07/09→					
2.0 DDiS 4x4 (RW 420D)	99	07/09→					
2.0	107	06/06→	←			13.0460-5716.2 605716	21561 17,0 + WK
2.0	112	01/10→					
2.0 16V 4x4	112	01/10→	→	+ ABS		13.0460-5929.2 605929	AKE 21719 15,0 + WK
2.0 4x4	107	06/06→					
↓							

	kW			 	! #		
SUZUKI - SX4 (EY, GY) 06/06→							
 Bremsscheibe							
1.5 (RW 415)	73	06/06→07/10	←			24.0122-0252.1 422252	Ø 280 22 20 V
1.5 VVT (RW 415)	82	07/10→					
1.5 VVT 4x4 (RW 415)	82	07/10→	→			24.0109-0167.1 409167	Ø 278 9 8
1.5 VVTi	81	07/07→12/15					
1.6 (RW 416)	74	06/06→					
1.6 DDiS (RW 416D)	66	04/07→					
1.6 VVT (RW 416)	79	06/06→					
1.6 VVT (RW 416)	88	07/09→					
1.6 VVT 4x4 (RW 416)	79	06/06→					
1.6 VVT 4x4 (RW 416)	82	07/09→					
1.6 VVT 4x4 (RW 416)	88	07/09→					
1.9 DDiS (RW 419D)	88	06/06→					
1.9 DDiS 4x4 (RW 419D)	88	06/06→					
2.0	107	06/06→					
2.0	112	01/10→					
2.0 16V 4x4	112	01/10→					
2.0 4x4	107	06/06→					
2.0 DDiS (RW 420D)	99	07/09→					
2.0 DDiS 4x4 (RW 420D)	99	07/09→					
SUZUKI - SX4 S-Cross (JY) 08/13→							
 Bremsscheibe							
1.0	82	08/16→	←			24.0122-0290.1 422290	Ø 280 22 20 V
1.0 AllGrip	82	08/16→					
1.4 T (AKK 414)	103	08/16→	→			24.0109-0182.1 409182	Ø 259,4 9 8
1.4 T AllGrip	103	08/16→					
1.6 (AKK 416)	86	12/13→					
1.6 (AKK 416)	88	08/13→					
1.6 AllGrip	86	12/13→					
1.6 AllGrip	88	08/13→					
1.6 DDiS (AKK 416D)	88	08/13→					
1.6 DDiS AllGrip	88	08/13→					
SUZUKI - SX4 Stufenheck (GY) 10/07→							
 Bremsbelagsatz, Scheibenbremse							
1.6 (RW 416)	74	10/07→	←	Made in Ungarn		13.0460-2715.2 602715	TRW 24391 16,6 + WK + Zub
1.6 (RW 416)	75	10/07→					
1.6 (RW 416)	79	10/07→	←	Made in Japan		13.0460-5716.2 605716	21561 17,0 + WK
1.6 (RW 416)	88	10/07→					
1.6 AWD (RW 416)	79	10/07→12/11	→	+ ABS		13.0460-5929.2 605929	AKE 21719 15,0 + WK
2.0	107	10/07→01/10	←			13.0460-5716.2 605716	21561 17,0 + WK
2.0	112	01/10→	→	+ ABS		13.0460-5929.2 605929	AKE 21719 15,0 + WK
 Bremsscheibe							
1.6 (RW 416)	74	10/07→	←			24.0122-0252.1 422252	Ø 280 22 20 V
1.6 (RW 416)	75	10/07→					
1.6 (RW 416)	79	10/07→	→			24.0109-0167.1 409167	Ø 278 9 8
1.6 (RW 416)	88	10/07→					
1.6 AWD (RW 416)	79	10/07→12/11					
2.0	107	10/07→01/10					
2.0	112	01/10→					
SUZUKI - VITARA (ET, TA) 07/88→08/99							
 Bremsbelagsatz, Scheibenbremse							
1.6 Allrad (TA, TA01)	59	07/88→03/98	←	01/89→ 01/95		13.0460-2997.2 602997	TRW 20708 15,8 + WE / - WK
						13.0460-5967.2 605967	AKE 21500 15,0 + WK
1.9 D Allrad (SE 419TD)	50	01/95→03/98	←			13.0460-5857.2 605857	SUM 23314 15,0 + WK
1.9 D Allrad (SE 419TD)	55	08/96→03/98					
2.0 16V Allrad (SV420)	97	12/96→03/98					
2.0 TD Allrad (SV 420D)	52	12/94→03/98					
2.0 TD Intercooler Allrad (SV 420D)	64	12/95→03/98					
2.0 V6 24V Allrad (SV620)	100	12/94→03/98					
Zubehörsatz, Scheibenbremsbelag							
1.6 Allrad (TA, TA01)	59	07/88→03/98	←	01/89→ 01/95		13.0460-0449.2 610449	AKE
 Bremsscheibe							
1.6 Allrad (TA, TA01)	59	07/88→03/98	←	01/89→ 01/95		24.0110-0242.1 410242	Ø 290 10 8
1.6 i 16V Allrad (ET, TA02)	71	07/90→03/98	←	02/91→ 12/94		24.0117-0104.1 417104	Ø 287 17 15 V

	kw			 	! #		
SUZUKI - VITARA (LY) 02/15→							
 Bremsscheibe							
1.4 T (APK 414)	103	09/15→	←			24.0122-0290.1 422290	Ø 280 22 20 V
1.4 T AllGrip	103	09/15→					
1.6 (APK 416)	86	05/15→	→			24.0109-0182.1 409182	Ø 259,4 9 8
1.6 (APK 416)	88	02/15→					
1.6 AllGrip	86	05/15→					
1.6 AllGrip	88	02/15→					
1.6 DDiS (APK 416D)	88	02/15→					
1.6 DDiS AllGrip	88	02/15→					
SUZUKI - VITARA Cabrio (ET, TA) 07/88→10/02							
 Bremsbelagsatz, Scheibenbremse							
1.6	59	07/88→01/95	←	01/89→		13.0460-2997.2 602997	TRW 20708 15,8 + WE / - WK
						13.0460-5967.2 605967	AKE 21500 15,0 + WK
1.6 i 16V	71	07/90→03/99	←	→ 01/95		13.0460-2997.2 602997	TRW 20708 15,8 + WE / - WK
						13.0460-5967.2 605967	AKE 21500 15,0 + WK
1.9 D (SE 419TD)	50	01/95→03/98	←			13.0460-5857.2 605857	SUM 23314 15,0 + WK
1.9 D (SE 419TD)	55	08/96→03/99	←	→ 03/98		13.0460-5857.2 605857	SUM 23314 15,0 + WK
2.0 16V	97	12/96→03/99					
Zubehörsatz, Scheibenbremsbelag							
1.6	59	07/88→01/95	←	01/89→		13.0460-0449.2 610449	AKE
1.6 i 16V	71	07/90→03/99	←	→ 01/95		13.0460-0449.2 610449	AKE
 Bremsscheibe							
1.6	59	07/88→01/95	←	01/89→		24.0110-0242.1 410242	Ø 290 10 8
1.6 i 16V	71	07/90→03/99	←	→ 01/95		24.0110-0242.1 410242	Ø 290 10 8
SUZUKI - WAGON R 07/03→08/05							
 Bremsbelagsatz, Scheibenbremse							
1.0	39	07/03→08/05	←			13.0460-5836.2 605836	23662 15,0 + WK + Zub
1.0	44	06/04→08/05	←			13.0460-3995.2 603995	BOS 23605 15,7 + WK + Zub
1.2	59	06/04→08/05					
Zubehörsatz, Scheibenbremsbelag							
1.0	39	07/03→08/05	←			13.0460-0141.2 610141	
 Bremsscheibe							
1.0	39	07/03→08/05	←			24.0117-0105.1 417105	Ø 231 17 15 V
1.0	44	06/04→08/05	←			24.0117-0106.1 417106	Ø 253 17 15 V
1.2	59	06/04→08/05					
SUZUKI - WAGON R+ (EM) 10/97→10/00							
 Bremsbelagsatz, Scheibenbremse							
1.0 (SR410)	48	02/98→05/00	←	→ 04/00		13.0460-5836.2 605836	23662 15,0 + WK + Zub
1.2 (SR412)	51	02/98→05/00					
1.2 4WD (SR412)	51	02/98→05/00					
Zubehörsatz, Scheibenbremsbelag							
1.0 (SR410)	48	02/98→05/00	←	→ 04/00		13.0460-0141.2 610141	
1.2 (SR412)	51	02/98→05/00					
1.2 4WD (SR412)	51	02/98→05/00					
 Bremsscheibe							
1.0 (SR410)	48	02/98→05/00	←	→ 04/00		24.0117-0105.1 417105	Ø 231 17 15 V
1.2 (SR412)	51	02/98→05/00					
1.2 4WD (SR412)	51	02/98→05/00					
SUZUKI - WAGON R+ (MM) 05/00→							
 Bremsbelagsatz, Scheibenbremse							
1.0	51	08/00→07/03	←			13.0460-5836.2 605836	23662 15,0 + WK + Zub
1.0 XT Plus	74	08/00→07/01					
1.3 (RB 413)	56	05/00→12/04	←			13.0460-3995.2 603995	BOS 23605 15,7 + WK + Zub
1.3 (RB 413)	65	08/01→	←	→ 04/08		13.0460-3995.2 603995	BOS 23605 15,7 + WK + Zub
1.3 (RB 413)	69	09/03→					
1.3 4WD (RB 413)	69	09/03→					
1.3 DDiS (RB 413D)	51	09/03→					
1.3 4WD (RB 413)	56	10/01→	←	→ 12/04		13.0460-3995.2 603995	BOS 23605 15,7 + WK + Zub
↓							

	kw			 	! #		
SUZUKI - WAGON R+ (MM) 05/00→							
Zubehörsatz, Scheibenbremsbelag							
1.0	51	08/00→07/03	←			13.0460-0141.2	610141
1.0 XT Plus	74	08/00→07/01	←				
 Bremsscheibe							
1.0	51	08/00→07/03	←			24.0117-0105.1	417105
1.0 XT Plus	74	08/00→07/01	←				
1.3 (RB 413)	56	05/00→12/04	←	→ 210000		24.0112-0153.1	412153
			←	210001→		24.0117-0106.1	417106
1.3 (RB 413)	65	08/01→	←	→ 04/08		24.0117-0106.1	417106
1.3 (RB 413)	69	09/03→					
1.3 4WD (RB 413)	69	09/03→					
1.3 DDiS (RB 413D)	51	09/03→					
1.3 4WD (RB 413)	56	10/01→	←	→ 210000		24.0112-0153.1	412153
			←	210001→; → 12/04		24.0117-0106.1	417106
SUZUKI - X-90 (EL) 09/95→12/97							
 Bremsbelagsatz, Scheibenbremse							
1.6 i 16V (SZ 416)	71	09/95→12/97	←	→ 10/97		13.0460-5967.2	605967
1.6 i 16V 4x4	71	09/95→12/97	←				AKE 21500 15,0 + WK
 Bremsscheibe							
1.6 i 16V (SZ 416)	71	09/95→12/97	←	→ 10/97		24.0110-0242.1	410242
1.6 i 16V 4x4	71	09/95→12/97	←				Ø 290 10 8
TOYOTA - 4 RUNNER (_N1_) 08/87→03/96							
 Bremsbelagsatz, Scheibenbremse							
3.0 (VZN1_)	112	08/88→10/95	←			13.0460-5992.2	605992
 Bremsscheibe							
3.0 (VZN1_)	112	08/88→10/95	←			24.0120-0168.1	420168
3.0 (VZN13_)	105	07/90→11/95	←			24.0125-0135.1	425135
3.0 Turbo-D (KZN130_)	92	10/93→03/96					Ø 291 25 23 V
TOYOTA - 4 RUNNER (_N18_) 11/95→11/02							
 Bremsscheibe							
2.7	112	11/95→07/02	←	→ 06/99;		24.0122-0185.1	422185
3.4	136	11/95→07/02	←	passend für Felgengröße [Zoll]: 16		24.0122-0253.1	422253
2.7 4WD	112	11/95→08/02	←			24.0122-0185.1	422185
3.0 Turbo-D	92	11/95→11/02	←	→ 03/96		24.0125-0135.1	425135
3.4 4WD	136	09/98→11/02	←	→ 08/02		24.0122-0185.1	422185
TOYOTA - ALPHARD / VELLFIRE (_H2_) 04/08→12/14							
 Bremsbelagsatz, Scheibenbremse							
3.5	202	04/08→12/14	←			13.0460-5614.2	605614
			→			13.0460-5814.2	605814
 Bremsscheibe							
3.5	202	04/08→12/14	←			24.0128-0232.1	428232
TOYOTA - AURIS (_E15_) 10/06→09/12							
 Bremsbelagsatz, Scheibenbremse							
1.33 Dual-VVTi (NRE150_)	73	01/10→09/12	←	Made in Großbritannien		13.0460-5602.2	605602
1.33 Dual-VVTi (NRE150_)	74	05/09→09/12	←	Made in Japan		13.0460-5767.2	605767
1.4 (ZZE150_)	71	03/07→09/12	→	Made in Großbritannien		13.0460-5604.2	605604
1.5 (NZE151_)	81	09/09→09/12	→	Made in Japan		13.0460-5769.2	605769
1.5 4WD (NZE154_)	77	09/09→09/12					24664 15,2 + WK + Zub
1.6 (ZRE151_)	91	03/07→09/12					
1.6 (ZRE151_)	97	05/09→09/12					
1.8 (ZRE152_)	100	10/06→09/12					
1.8 (ZRE152_)	106	02/09→09/12					
1.8 (ZRE152_)	108	02/09→09/12					
1.8 4WD (ZRE154_)	100	02/09→09/12					
1.4 D-4D (NDE150_)	66	03/07→09/12	←			13.0460-5602.2	605602
			→	Made in Großbritannien		13.0460-5604.2	605604
↓							

	kw			 	! #		
TOYOTA - AURIS (E15) 10/06→09/12							
 Bremsbelagsatz, Scheibenbremse							
1.8 Hybrid (ZWE150_)	73	09/10→09/12	←			13.0460-5602.2 605602	24122 19,0 + WK + Zub
			→			13.0460-5766.2 605766	24337 17,5 - WK
			←			13.0460-5769.2 605769	24610 15,0 + WK
2.0 D-4D (ADE150_)	93	03/07→09/12	←			13.0460-5603.2 605603	24204 19,2 + WK + Zub
			→	Made in Großbritannien		13.0460-5604.2 605604	24664 15,2 + WK + Zub
2.2 D (ADE157_)	130	03/07→09/12	←			13.0460-5603.2 605603	24204 19,2 + WK + Zub
			→			13.0460-5604.2 605604	24664 15,2 + WK + Zub
 Bremsscheibe							
1.33 Dual-VVTi (NRE150_)	73	01/10→09/12	←	Made in Japan		24.0122-0256.1 422256	Ø 275 22 19 V
1.33 Dual-VVTi (NRE150_)	74	05/09→09/12	←	Made in Großbritannien		24.0126-0148.1 426148	Ø 273 26 23 V
			→	Made in Japan		24.0109-0155.1 409155	Ø 259 9 7,5
1.4 (ZZE150_)	71	03/07→09/12	←				
1.5 (NZE151_)	81	09/09→09/12	→	Made in Großbritannien		24.0110-0337.1 410337	Ø 270 9,9 8
1.5 4WD (NZE154_)	77	09/09→09/12	←				
1.6 (ZRE151_)	91	03/07→09/12	←				
1.6 (ZRE151_)	97	05/09→09/12	←				
1.8 (ZRE152_)	100	10/06→09/12	←				
1.8 (ZRE152_)	106	02/09→09/12	←				
1.8 (ZRE152_)	108	02/09→09/12	←				
1.8 4WD (ZRE154_)	100	02/09→09/12	←				
1.4 D-4D (NDE150_)	66	03/07→09/12	←			24.0126-0148.1 426148	Ø 273 26 23 V
			→			24.0110-0337.1 410337	Ø 270 9,9 8
1.8 Hybrid (ZWE150_)	73	09/10→09/12	←			24.0126-0148.1 426148	Ø 273 26 23 V
			→			24.0128-0159.1 428159	Ø 296 28 25 V
			←			24.0109-0155.1 409155	Ø 259 9 7,5
2.0 D-4D (ADE150_)	93	03/07→09/12	←			24.0126-0156.1 426156	Ø 295 26 23 V
2.2 D (ADE157_)	130	03/07→09/12	→			24.0110-0337.1 410337	Ø 270 9,9 8
TOYOTA - AURIS (E18) 10/12→							
 Bremsbelagsatz, Scheibenbremse							
1.2 (NRE185_)	85	03/15→	←			13.0460-3868.2 603868	BOS 25698 18,7 + WK + Zub
1.3 (NRE180_)	73	10/12→	→			13.0460-5604.2 605604	24664 15,2 + WK + Zub
1.4 D-4D (NDE180_)	66	10/12→	←				
1.6 (ZRE181_)	97	10/12→	←				
ZRE185_)			→				
1.6 D4-D (WWE185_)	82	04/15→	←				
1.8 (ZRE182)	103	10/12→	←			13.0460-5766.2 605766	24337 17,5 - WK
1.8 (ZRE186_)	106	10/12→	→			13.0460-5604.2 605604	24664 15,2 + WK + Zub
1.8 Hybrid (ZWE186_)	73	10/12→	←	für Fahrzeuge ohne Panorama-Sonnendach		13.0460-3868.2 603868	BOS 25698 18,7 + WK + Zub
			←	für Fahrzeuge mit Panorama-Sonnendach		13.0460-5766.2 605766	24337 17,5 - WK
			→			13.0460-5604.2 605604	24664 15,2 + WK + Zub
2.0 D-4D (ADE186_)	91	10/12→	←			13.0460-5603.2 605603	24204 19,2 + WK + Zub
			→			13.0460-5604.2 605604	24664 15,2 + WK + Zub
 Bremsscheibe							
1.2 (NRE185_)	85	03/15→	←			24.0126-0184.1 426184	Ø 277 26 23 V
1.3 (NRE180_)	73	10/12→	→			24.0110-0337.1 410337	Ø 270 9,9 8
1.4 D-4D (NDE180_)	66	10/12→	←				
1.6 (ZRE181_)	97	10/12→	←				
ZRE185_)			→				
1.6 D4-D (WWE185_)	82	04/15→	←				
1.8 (ZRE182)	103	10/12→	←			24.0128-0159.1 428159	Ø 296 28 25 V
1.8 (ZRE186_)	106	10/12→	→			24.0110-0337.1 410337	Ø 270 9,9 8
1.8 Hybrid (ZWE186_)	73	10/12→	←	für Fahrzeuge ohne Panorama-Sonnendach		24.0126-0184.1 426184	Ø 277 26 23 V
			←	für Fahrzeuge mit Panorama-Sonnendach		24.0128-0159.1 428159	Ø 296 28 25 V
			→			24.0110-0337.1 410337	Ø 270 9,9 8
2.0 D-4D (ADE186_)	91	10/12→	←			24.0126-0156.1 426156	Ø 295 26 23 V
			→			24.0110-0337.1 410337	Ø 270 9,9 8

	kw					! #			
TOYOTA - AURIS TOURING SPORTS (E18) 07/13→									
 Bremsbelagsatz, Scheibenbremse									
1.2 (NRE185_)	85	03/15→	←				13.0460-3868.2	603868	BOS 25698 18,7 + WK + Zub
1.3 (NRE180_)	73	07/13→	→				13.0460-5604.2	605604	24664 15,2 + WK + Zub
1.4 D-4D (NDE180_)	66	07/13→							
1.6 (ZRE185_)	97	07/13→							
1.6 D4-D (WWE185_)	82	04/15→							
1.8 Hybrid (ZWE186_)	73	07/13→	←	für Fahrzeuge ohne Panorama-Sonnendach			13.0460-3868.2	603868	BOS 25698 18,7 + WK + Zub
			←	für Fahrzeuge mit Panorama-Sonnendach			13.0460-5766.2	605766	24337 17,5 - WK
			→				13.0460-5604.2	605604	24664 15,2 + WK + Zub
2.0 D-4D (ADE186_)	91	07/13→	←				13.0460-5603.2	605603	24204 19,2 + WK + Zub
			→				13.0460-5604.2	605604	24664 15,2 + WK + Zub
 Bremsscheibe									
1.2 (NRE185_)	85	03/15→	←				24.0126-0184.1	426184	Ø 277 26 23 V
1.3 (NRE180_)	73	07/13→	→				24.0110-0337.1	410337	Ø 270 9,9 8
1.4 D-4D (NDE180_)	66	07/13→							
1.6 (ZRE185_)	97	07/13→							
1.6 D4-D (WWE185_)	82	04/15→							
1.8 Hybrid (ZWE186_)	73	07/13→	←	für Fahrzeuge ohne Panorama-Sonnendach			24.0126-0184.1	426184	Ø 277 26 23 V
			←	für Fahrzeuge mit Panorama-Sonnendach			24.0128-0159.1	428159	Ø 296 28 25 V
			→				24.0110-0337.1	410337	Ø 270 9,9 8
2.0 D-4D (ADE186_)	91	07/13→	←				24.0126-0156.1	426156	Ø 295 26 23 V
			→				24.0110-0337.1	410337	Ø 270 9,9 8
TOYOTA - AURIS VAN Kasten (E18) 03/13→									
 Bremsbelagsatz, Scheibenbremse									
1.4 D-4D (NDE180_)	66	03/13→	←				13.0460-3868.2	603868	BOS 25698 18,7 + WK + Zub
			→				13.0460-5604.2	605604	24664 15,2 + WK + Zub
 Bremsscheibe									
1.4 D-4D (NDE180_)	66	03/13→	←				24.0126-0184.1	426184	Ø 277 26 23 V
			→				24.0110-0337.1	410337	Ø 270 9,9 8
TOYOTA - AVENSIS (T22) 09/97→02/03									
 Bremsbelagsatz, Scheibenbremse									
1.6 (AT220_)	74	09/97→10/00	←	→ 09/00; für Fahrzeuge mit Trommelbremse an der Hinterachse			13.0460-5809.2	605809	ATE 21975 18,2 + WK
1.6 (AT220_)	81	09/97→10/00							
1.8 (AT221_)	81	09/97→10/00							
1.6 VVT-i (ZZT220_)	81	10/00→02/03	←	07/01→; für Fahrzeuge mit Scheibenbremse an der Hinterachse			13.0460-5844.2	605844	ATE 23996 17,5 + WK
1.8 VVT-i (ZZT221_)	95	10/00→02/03							
2.0 VVT-i (AZT220_)	110	10/00→02/03	←	→ 06/01; für Fahrzeuge mit Scheibenbremse an der Hinterachse			13.0460-5845.2	605845	AKE 21961 15,5 + WK
			→	→ 06/01			13.0460-5840.2	605840	AKE 21833 15,0 + WK
			→	07/01→			13.0460-5869.2	605869	TRW 24013 14,9 + WK
2.0 (ST220_)	94	09/97→10/00	←	→ 09/00; für Fahrzeuge mit Trommelbremse an der Hinterachse			13.0460-5809.2	605809	ATE 21975 18,2 + WK
			←	10/00→; für Fahrzeuge mit Scheibenbremse an der Hinterachse			13.0460-5845.2	605845	AKE 21961 15,5 + WK
			→	10/00→			13.0460-5840.2	605840	AKE 21833 15,0 + WK
2.0 D (CT220_)	61	10/97→05/98	←	für Fahrzeuge mit Trommelbremse an der Hinterachse			13.0460-5809.2	605809	ATE 21975 18,2 + WK
2.0 D-4D (CDT220_)	81	10/99→02/03	←	für Fahrzeuge mit Trommelbremse an der Hinterachse			13.0460-5809.2	605809	ATE 21975 18,2 + WK
2.0 TD (CT220_)	66	09/97→02/03	←	07/01→; für Fahrzeuge mit Scheibenbremse an der Hinterachse			13.0460-5844.2	605844	ATE 23996 17,5 + WK
			←	→ 06/01; für Fahrzeuge mit Scheibenbremse an der Hinterachse			13.0460-5845.2	605845	AKE 21961 15,5 + WK
			→	→ 06/01			13.0460-5840.2	605840	AKE 21833 15,0 + WK
			→	07/01→			13.0460-5869.2	605869	TRW 24013 14,9 + WK

TOYOTA - AVENSIS (_T22_) 09/97→02/03

Bremsscheibe							
1.6 (AT220_) 1.6 (AT220_) 1.8 (AT221_)	74 81 81	09/97→10/00 09/97→10/00 09/97→10/00	←	→ 09/00; für Fahrzeuge mit Trommelbremse an der Hinterachse	24.0125-0140.1	425140	Ø 260 25 23 V
1.6 VVT-i (ZZT220_) 1.8 VVT-i (ZZT221_) 2.0 VVT-i (AZT220_)	81 95 110	10/00→02/03 10/00→02/03 10/00→02/03	←	07/01→; für Fahrzeuge mit Scheibenbremse an der Hinterachse	24.0125-0156.1	425156	Ø 276 25 23 V
			←	→ 06/01; für Fahrzeuge mit Scheibenbremse an der Hinterachse	24.0128-0183.1	428183	Ø 275 28 26 V
			→	07/01→	24.0110-0284.1	410284	Ø 271 10 9
			→	→ 06/01	24.0110-0305.1	410305	Ø 288 10 8,5
2.0 (ST220_)	94	09/97→10/00	←	→ 09/00; für Fahrzeuge mit Trommelbremse an der Hinterachse	24.0125-0140.1	425140	Ø 260 25 23 V
			←	10/00→; für Fahrzeuge mit Scheibenbremse an der Hinterachse	24.0128-0183.1	428183	Ø 275 28 26 V
			→	10/00→	24.0110-0305.1	410305	Ø 288 10 8,5
2.0 D (CT220_)	61	10/97→05/98	←	für Fahrzeuge mit Trommelbremse an der Hinterachse	24.0125-0140.1	425140	Ø 260 25 23 V
2.0 D-4D (CDT220_) 2.0 TD (CT220_)	81 66	10/99→02/03 09/97→02/03	←	für Fahrzeuge mit Trommelbremse an der Hinterachse	24.0125-0140.1	425140	Ø 260 25 23 V
			←	07/01→; für Fahrzeuge mit Scheibenbremse an der Hinterachse	24.0125-0156.1	425156	Ø 276 25 23 V
			←	→ 06/01; für Fahrzeuge mit Scheibenbremse an der Hinterachse	24.0128-0183.1	428183	Ø 275 28 26 V
			→	07/01→	24.0110-0284.1	410284	Ø 271 10 9
			→	→ 06/01	24.0110-0305.1	410305	Ø 288 10 8,5

TOYOTA - AVENSIS (_T25_) 04/03→11/08











Bremsbelagsatz, Scheibenbremse							
1.6 VVT-i (ZZT250_) 1.8 (ZZT251_) 2.0 (AZT250_)	81 95 108	04/03→11/08 04/03→11/08 04/03→11/08	←	01/08→	13.0460-5813.2	605813	BOS 23480 19,3 + WK
2.0 D-4D (ADT250_) 2.0 D-4D (CDT250_) 2.0 VVTi (AZT250_) 2.2 D-4D (ADT251_) 2.2 D-CAT (ADT251_) 2.2 TD 2.4 (AZT251_) 2.4 (AZT251_)	93 85 114 110 130 74 120 125	03/06→11/08 04/03→11/08 04/03→11/08 10/05→11/08 07/05→11/08 04/05→11/08 10/03→11/08 09/03→11/08	←	→ 12/07	13.0460-5813.2	605813	BOS 23480 19,3 + WK
			→		13.0460-5814.2	605814	BOS 23620 16,4 + WK

Zubehörsatz, Scheibenbremsbelag							
1.6 VVT-i (ZZT250_) 1.8 (ZZT251_) 2.0 (AZT250_)	81 95 108	04/03→11/08 04/03→11/08 04/03→11/08	←	→ 12/07	13.0460-0454.2	610454	BOS
2.0 D-4D (ADT250_) 2.0 D-4D (CDT250_) 2.0 VVTi (AZT250_) 2.2 D-4D (ADT251_) 2.2 D-CAT (ADT251_) 2.2 TD 2.4 (AZT251_) 2.4 (AZT251_)	93 85 114 110 130 74 120 125	03/06→11/08 04/03→11/08 04/03→11/08 10/05→11/08 07/05→11/08 04/05→11/08 10/03→11/08 09/03→11/08	→		13.0460-0256.2	610256	BOS

Bremsscheibe							
1.6 VVT-i (ZZT250_) 1.8 (ZZT251_) 2.0 VVTi (AZT250_)	81 95 114	04/03→11/08 04/03→11/08 04/03→11/08	←		24.0126-0139.1	426139	Ø 277 26 24 V
2.0 (AZT250_) 2.0 D-4D (ADT250_) 2.0 D-4D (CDT250_) 2.4 (AZT251_) 2.4 (AZT251_)	108 93 85 120 125	04/03→11/08 03/06→11/08 04/03→11/08 10/03→11/08 09/03→11/08	→		24.0110-0311.1	410311	Ø 280 10 9
2.2 D-4D (ADT251_) 2.2 D-CAT (ADT251_) 2.2 TD	110 130 74	10/05→11/08 07/05→11/08 04/05→11/08	←		24.0126-0141.1	426141	Ø 295 26 24 V
			→		24.0110-0311.1	410311	Ø 280 10 9
			→		24.0126-0138.1	426138	Ø 295 26 24 V
			→		24.0110-0333.1	410333	Ø 280 10 8,5

TOYOTA - AVENSIS Combi (_T25_) 04/03→11/08

Bremsbelagsatz, Scheibenbremse							
1.6 VVT-i (ZZT250_) 1.8 (ZZT251_) ↓	81 95	04/03→11/08 04/03→11/08	←	01/08→	13.0460-5813.2	605813	BOS 23480 19,3 + WK

	kw			 	! #		
TOYOTA - AVENSIS Combi (_T25_) 04/03→11/08							
 Bremsbelagsatz, Scheibenbremse							
2.0 (AZT250_)	108	04/03→11/08	←	→ 12/07		13.0460-5813.2 605813	BOS 23480 19,3 + WK
2.0 D-4D (ADT250_)	93	03/06→11/08	→			13.0460-5814.2 605814	BOS 23620 16,4 + WK
2.0 D-4D (CDT250_)	85	04/03→11/08					
2.0 VVTi (AZT250_)	114	04/03→11/08					
2.2 D-4D (ADT251_)	110	10/05→11/08					
2.2 D-CAT (ADT251_)	130	07/05→11/08					
2.2 TD	74	04/05→11/08					
2.4 (AZT251_)	120	10/03→11/08					
2.4 (AZT251_)	125	09/03→11/08					
Zubehörsatz, Scheibenbremsbelag							
1.6 VVT-i (ZZT250_)	81	04/03→11/08	←	→ 12/07		13.0460-0454.2 610454	BOS
1.8 (ZZT251_)	95	04/03→11/08	→			13.0460-0256.2 610256	BOS
2.0 (AZT250_)	108	04/03→11/08					
2.0 D-4D (ADT250_)	93	03/06→11/08					
2.0 D-4D (CDT250_)	85	04/03→11/08					
2.0 VVTi (AZT250_)	114	04/03→11/08					
2.2 D-4D (ADT251_)	110	10/05→11/08					
2.2 D-CAT (ADT251_)	130	07/05→11/08					
2.2 TD	74	04/05→11/08					
2.4 (AZT251_)	120	10/03→11/08					
2.4 (AZT251_)	125	09/03→11/08					
 Bremsscheibe							
1.6 VVT-i (ZZT250_)	81	04/03→11/08	←			24.0126-0139.1 426139	Ø 277 26 24 V
1.8 (ZZT251_)	95	04/03→11/08	→			24.0110-0311.1 410311	Ø 280 10 9
2.0 VVTi (AZT250_)	114	04/03→11/08					
2.0 (AZT250_)	108	04/03→11/08	←			24.0126-0141.1 426141	Ø 295 26 24 V
2.0 D-4D (ADT250_)	93	03/06→11/08	→			24.0110-0311.1 410311	Ø 280 10 9
2.0 D-4D (CDT250_)	85	04/03→11/08					
2.4 (AZT251_)	120	10/03→11/08					
2.4 (AZT251_)	125	09/03→11/08					
2.2 D-4D (ADT251_)	110	10/05→11/08	←			24.0126-0138.1 426138	Ø 295 26 24 V
2.2 D-CAT (ADT251_)	130	07/05→11/08	→			24.0110-0333.1 410333	Ø 280 10 8,5
2.2 TD	74	04/05→11/08					
TOYOTA - AVENSIS Liftback (_T22_) 09/97→02/03							
 Bremsbelagsatz, Scheibenbremse							
1.6 (AT220_)	74	09/97→10/00	←	→ 09/00;		13.0460-5809.2 605809	ATE 21975 18,2 + WK
1.6 (AT220_)	81	09/97→10/00	→	für Fahrzeuge mit Trommelbremse an		13.0460-5844.2 605844	ATE 23996 17,5 + WK
1.8 (AT221_)	81	09/97→10/00		der Hinterachse			
1.6 (ZZT220_)	81	10/00→02/03	←	07/01→;		13.0460-5845.2 605845	AKE 21961 15,5 + WK
1.8 (ZZT221_)	95	10/00→02/03	→	für Fahrzeuge mit Scheibenbremse an			
2.0 (AZT220_)	110	10/00→02/03			der Hinterachse		13.0460-5840.2 605840
			←	→ 06/01;		13.0460-5869.2 605869	TRW 24013 14,9 + WK
			→	für Fahrzeuge mit Scheibenbremse an			
				der Hinterachse		13.0460-5840.2 605840	AKE 21833 15,0 + WK
			→	→ 06/01		13.0460-5869.2 605869	TRW 24013 14,9 + WK
			→	07/01→		13.0460-5809.2 605809	ATE 21975 18,2 + WK
2.0 (ST220_)	94	09/97→10/00	←	→ 09/00;		13.0460-5845.2 605845	AKE 21961 15,5 + WK
			←	für Fahrzeuge mit Trommelbremse an			
			←	der Hinterachse		13.0460-5840.2 605840	AKE 21833 15,0 + WK
			→	10/00→;		13.0460-5844.2 605844	ATE 23996 17,5 + WK
			→	für Fahrzeuge mit Scheibenbremse an			
			→	der Hinterachse		13.0460-5869.2 605869	TRW 24013 14,9 + WK
			→	10/00→		13.0460-5809.2 605809	ATE 21975 18,2 + WK
2.0 D (CDT220_)	85	09/02→02/03	←	für Fahrzeuge mit Scheibenbremse an		13.0460-5844.2 605844	ATE 23996 17,5 + WK
			→	der Hinterachse			
			→			13.0460-5869.2 605869	TRW 24013 14,9 + WK
2.0 D (CT220_)	61	10/97→05/98	←	für Fahrzeuge mit Trommelbremse an		13.0460-5809.2 605809	ATE 21975 18,2 + WK
			←	der Hinterachse			
2.0 D-4D (CDT220_)	81	10/99→02/03	←	für Fahrzeuge mit Trommelbremse an		13.0460-5844.2 605844	ATE 23996 17,5 + WK
2.0 TD (CT220_)	66	09/97→02/03	←	der Hinterachse			
			←	07/01→;		13.0460-5845.2 605845	AKE 21961 15,5 + WK
			←	für Fahrzeuge mit Scheibenbremse an			
			←	der Hinterachse		13.0460-5840.2 605840	AKE 21833 15,0 + WK
			→	→ 06/01		13.0460-5869.2 605869	TRW 24013 14,9 + WK
			→	07/01→		13.0460-5809.2 605809	ATE 21975 18,2 + WK



TOYOTA - AVENSIS Liftback (_T22_) 09/97→02/03

Bremsscheibe











1.6 (AT220_) 1.6 (AT220_) 1.8 (AT221_)	74	09/97→10/00	←	→ 09/00; für Fahrzeuge mit Trommelbremse an der Hinterachse	24.0125-0140.1	425140	Ø 260 25 23 V
	81	09/97→10/00					
	81	09/97→10/00					
1.6 (ZZT220_) 1.8 (ZZT221_) 2.0 (AZT220_)	81	10/00→02/03	←	07/01→; für Fahrzeuge mit Scheibenbremse an der Hinterachse	24.0125-0156.1	425156	Ø 276 25 23 V
	95	10/00→02/03					
	110	10/00→02/03	←	→ 06/01; für Fahrzeuge mit Scheibenbremse an der Hinterachse	24.0128-0183.1	428183	Ø 275 28 26 V
			→	07/01→	24.0110-0284.1	410284	Ø 271 10 9
			→	06/01	24.0110-0305.1	410305	Ø 288 10 8,5
2.0 (ST220_)	94	09/97→10/00	←	→ 09/00; für Fahrzeuge mit Trommelbremse an der Hinterachse	24.0125-0140.1	425140	Ø 260 25 23 V
			←	10/00→; für Fahrzeuge mit Scheibenbremse an der Hinterachse	24.0128-0183.1	428183	Ø 275 28 26 V
			→	10/00→	24.0110-0305.1	410305	Ø 288 10 8,5
2.0 D (CDT220_)	85	09/02→02/03	←	für Fahrzeuge mit Scheibenbremse an der Hinterachse	24.0125-0156.1	425156	Ø 276 25 23 V
			→		24.0110-0284.1	410284	Ø 271 10 9
2.0 D (CT220_)	61	10/97→05/98	←	für Fahrzeuge mit Trommelbremse an der Hinterachse	24.0125-0140.1	425140	Ø 260 25 23 V
2.0 D-4D (CDT220_) 2.0 TD (CT220_)	81	10/99→02/03	←	für Fahrzeuge mit Trommelbremse an der Hinterachse	24.0125-0140.1	425140	Ø 260 25 23 V
			←	07/01→; für Fahrzeuge mit Scheibenbremse an der Hinterachse	24.0125-0156.1	425156	Ø 276 25 23 V
	66	09/97→02/03	←	→ 06/01; für Fahrzeuge mit Scheibenbremse an der Hinterachse	24.0128-0183.1	428183	Ø 275 28 26 V
			→	07/01→	24.0110-0284.1	410284	Ø 271 10 9
			→	06/01	24.0110-0305.1	410305	Ø 288 10 8,5

TOYOTA - AVENSIS Station Wagon (_T22_) 09/97→02/03













Bremsbelagsatz, Scheibenbremse



















1.6 (AT220_, ZZT220_) 1.6 (AT220_) 1.8 (AT221_)	81	09/97→10/00	←	→ 09/00; für Fahrzeuge mit Trommelbremse an der Hinterachse	13.0460-5809.2	605809	ATE 21975 18,2 + WK
	74	09/97→10/00					
	81	09/97→10/00					
1.6 (ZZT250_) 1.8 (ZZT221_) 2.0 (AZT220_)	81	10/00→02/03	←	07/01→; für Fahrzeuge mit Scheibenbremse an der Hinterachse	13.0460-5844.2	605844	ATE 23996 17,5 + WK
	95	10/00→02/03					
	110	10/00→02/03	←	→ 06/01; für Fahrzeuge mit Scheibenbremse an der Hinterachse	13.0460-5845.2	605845	AKE 21961 15,5 + WK
			→	06/01	13.0460-5840.2	605840	AKE 21833 15,0 + WK
			→	07/01→	13.0460-5869.2	605869	TRW 24013 14,9 + WK
2.0 (ST220_)	94	09/97→10/00	←	→ 09/00; für Fahrzeuge mit Trommelbremse an der Hinterachse	13.0460-5809.2	605809	ATE 21975 18,2 + WK
			←	10/00→; für Fahrzeuge mit Scheibenbremse an der Hinterachse	13.0460-5845.2	605845	AKE 21961 15,5 + WK
			→	10/00→	13.0460-5840.2	605840	AKE 21833 15,0 + WK
2.0 D (CDT220_)	85	09/02→02/03	←	für Fahrzeuge mit Scheibenbremse an der Hinterachse	13.0460-5844.2	605844	ATE 23996 17,5 + WK
			→		13.0460-5869.2	605869	TRW 24013 14,9 + WK
2.0 D (CT220_)	61	10/97→05/98	←	für Fahrzeuge mit Trommelbremse an der Hinterachse	13.0460-5809.2	605809	ATE 21975 18,2 + WK
2.0 D-4D (CDT220_) 2.0 TD (CT220_)	81	10/99→02/03	←	für Fahrzeuge mit Trommelbremse an der Hinterachse	13.0460-5809.2	605809	ATE 21975 18,2 + WK
			←	07/01→; für Fahrzeuge mit Scheibenbremse an der Hinterachse	13.0460-5844.2	605844	ATE 23996 17,5 + WK
	66	09/97→02/03	←	→ 06/01; für Fahrzeuge mit Scheibenbremse an der Hinterachse	13.0460-5845.2	605845	AKE 21961 15,5 + WK
			→	06/01	13.0460-5840.2	605840	AKE 21833 15,0 + WK
			→	07/01→	13.0460-5869.2	605869	TRW 24013 14,9 + WK















↓











	kw					! #		
TOYOTA - AVENSIS Station Wagon (_T22_) 09/97→02/03								
 Bremsscheibe								
1.6 (AT220_, ZZT220_) 1.6 (AT220_) 1.8 (AT221_)	81 74 81	09/97→10/00 09/97→10/00 09/97→10/00	←	→ 09/00; für Fahrzeuge mit Trommelbremse an der Hinterachse			24.0125-0140.1 425140	Ø 260 25 23 V
1.6 (ZZT250_) 1.8 (ZZT221_) 2.0 (AZT220_)	81 95 110	10/00→02/03 10/00→02/03 10/00→02/03	←	07/01→; für Fahrzeuge mit Scheibenbremse an der Hinterachse			24.0125-0156.1 425156	Ø 276 25 23 V
			←	→ 06/01; für Fahrzeuge mit Scheibenbremse an der Hinterachse			24.0128-0183.1 428183	Ø 275 28 26 V
			→	07/01→			24.0110-0284.1 410284	Ø 271 10 9
			→	→ 06/01			24.0110-0305.1 410305	Ø 288 10 8,5
2.0 (ST220_)	94	09/97→10/00	←	→ 09/00; für Fahrzeuge mit Trommelbremse an der Hinterachse			24.0125-0140.1 425140	Ø 260 25 23 V
			←	10/00→; für Fahrzeuge mit Scheibenbremse an der Hinterachse			24.0128-0183.1 428183	Ø 275 28 26 V
			→	10/00→			24.0110-0305.1 410305	Ø 288 10 8,5
2.0 D (CDT220_)	85	09/02→02/03	←	für Fahrzeuge mit Scheibenbremse an der Hinterachse			24.0125-0156.1 425156	Ø 276 25 23 V
			→				24.0110-0284.1 410284	Ø 271 10 9
2.0 D (CT220_)	61	10/97→05/98	←	für Fahrzeuge mit Trommelbremse an der Hinterachse			24.0125-0140.1 425140	Ø 260 25 23 V
2.0 D-4D (CDT220_) 2.0 TD (CT220_)	81 66	10/99→02/03 09/97→02/03	←	für Fahrzeuge mit Trommelbremse an der Hinterachse			24.0125-0140.1 425140	Ø 260 25 23 V
			←	07/01→; für Fahrzeuge mit Scheibenbremse an der Hinterachse			24.0125-0156.1 425156	Ø 276 25 23 V
			←	→ 06/01; für Fahrzeuge mit Scheibenbremse an der Hinterachse			24.0128-0183.1 428183	Ø 275 28 26 V
			→	07/01→			24.0110-0284.1 410284	Ø 271 10 9
			→	→ 06/01			24.0110-0305.1 410305	Ø 288 10 8,5
TOYOTA - AVENSIS Station Wagon (_T27_) 02/09→								
 Bremsbelagsatz, Scheibenbremse								
1.6 (ZRT270_) 1.8 (ZRT271_) 2.0 (ZRT272_) 2.0 D-4D (ADT270_) 2.0 D-4D (ADT270_)	97 108 112 91 93	02/09→ 02/09→ 02/09→ 11/11→ 02/09→	← →				13.0460-5603.2 605603	24204 19,2 + WK + Zub
			←	→ 06/15			13.0460-5603.2 605603	24204 19,2 + WK + Zub
			→	→ 06/15			13.0460-3853.2 603853	BOS 24885 16,8 + WK + Zub
2.0 D-4D (WWT271_)	105	04/15→	←	→ 06/15; Kasten/Kombi			13.0460-5603.2 605603	24204 19,2 + WK + Zub
			→	→ 06/15			13.0460-3853.2 603853	BOS 24885 16,8 + WK + Zub
2.2 D-4D (ADT271_) 2.2 D-4D (ADT271_)	110 130	02/09→ 02/09→	←	→ 11/10			13.0460-5615.2 605615	BOS 24946 19,0 + WK + Zub
			→				13.0460-3853.2 603853	BOS 24885 16,8 + WK + Zub
 Bremsscheibe								
1.6 (ZRT270_) 1.6 D4-D (WWT270_) 1.8 (ZRT271_) 2.0 (ZRT272_) 2.0 D-4D (ADT270_) 2.0 D-4D (ADT270_)	97 82 108 112 91 93	02/09→ 04/15→ 02/09→ 02/09→ 11/11→ 02/09→	← →				24.0126-0156.1 426156	Ø 295 26 23 V
			←				24.0111-0169.1 411169	Ø 290 11 9
2.0 D-4D (WWT271_) 2.2 D-4D (ADT271_) 2.2 D-4D (ADT271_)	105 110 130	04/15→ 02/09→ 02/09→	← →				24.0126-0160.1 426160	Ø 320 26 23 V
			→				24.0111-0169.1 411169	Ø 290 11 9
TOYOTA - AVENSIS Stufenheck (_T25_) 04/03→11/08								
 Bremsbelagsatz, Scheibenbremse								
1.6 VVT-i (ZZT250_) 1.8 (ZZT251_) 2.0 (AZT250_) 2.0 D-4D (ADT250_) 2.0 D-4D (CDT250_) 2.0 VVTi (AZT250_) 2.2 D-4D (ADT251_) 2.2 D-CAT (ADT251_) 2.2 TD 2.4 (AZT251_) ↓	81 95 108 93 85 114 110 130 74 120	04/03→11/08 04/03→11/08 04/03→11/08 03/06→11/08 04/03→11/08 04/03→11/08 10/05→11/08 07/05→11/08 04/05→11/08 10/03→11/08	← ← →	01/08→ → 12/07			13.0460-5813.2 605813	BOS 23480 19,3 + WK
			←				13.0460-5813.2 605813	BOS 23480 19,3 + WK
			→				13.0460-5814.2 605814	BOS 23620 16,4 + WK



























	kw					! #		
TOYOTA - AVENSIS Stufenheck (_T25_) 04/03→11/08								
 Bremsbelagsatz, Scheibenbremse								
2.4 (AZT251_)	125	09/03→11/08	←	01/08→		13.0460-5813.2	605813	BOS 23480 19,3 + WK
			←	→ 12/07		13.0460-5813.2	605813	BOS 23480 19,3 + WK
			→			13.0460-5814.2	605814	BOS 23620 16,4 + WK
Zubehörsatz, Scheibenbremsbelag								
1.6 VVT-i (ZZT250_)	81	04/03→11/08	←	→ 12/07		13.0460-0454.2	610454	BOS
1.8 (ZZT251_)	95	04/03→11/08	→					
2.0 (AZT250_)	108	04/03→11/08	→			13.0460-0256.2	610256	BOS
2.0 D-4D (ADT250_)	93	03/06→11/08						
2.0 D-4D (CDT250_)	85	04/03→11/08						
2.0 VVTi (AZT250_)	114	04/03→11/08						
2.2 D-4D (ADT251_)	110	10/05→11/08						
2.2 D-CAT (ADT251_)	130	07/05→11/08						
2.2 TD	74	04/05→11/08						
2.4 (AZT251_)	120	10/03→11/08						
2.4 (AZT251_)	125	09/03→11/08						
 Bremsscheibe								
1.6 VVT-i (ZZT250_)	81	04/03→11/08	←			24.0126-0139.1	426139	Ø 277 26 24 V
1.8 (ZZT251_)	95	04/03→11/08	→					
2.0 VVTi (AZT250_)	114	04/03→11/08	→			24.0110-0311.1	410311	Ø 280 10 9
2.0 (AZT250_)	108	04/03→11/08	←			24.0126-0141.1	426141	Ø 295 26 24 V
2.0 D-4D (ADT250_)	93	03/06→11/08	→					
2.0 D-4D (CDT250_)	85	04/03→11/08	→			24.0110-0311.1	410311	Ø 280 10 9
2.4 (AZT251_)	120	10/03→11/08						
2.4 (AZT251_)	125	09/03→11/08						
2.2 D-4D (ADT251_)	110	10/05→11/08	←			24.0126-0138.1	426138	Ø 295 26 24 V
2.2 D-CAT (ADT251_)	130	07/05→11/08	→					
2.2 TD	74	04/05→11/08	→			24.0110-0333.1	410333	Ø 280 10 8,5
TOYOTA - AVENSIS Stufenheck (_T27_) 11/08→								
 Bremsbelagsatz, Scheibenbremse								
1.6 (ZRT270_)	97	11/08→	←	02/09→		13.0460-5603.2	605603	24204 19,2 + WK + Zub
1.8 (ZRT271_)	108	11/08→	→	02/09→		13.0460-3853.2	603853	BOS 24885 16,8 + WK + Zub
2.0 (ZRT272_)	112	11/08→						
2.0 D-4D (ADT270_)	93	11/08→						
1.6 D4-D (WWT270_)	82	04/15→	←	→ 06/15		13.0460-5603.2	605603	24204 19,2 + WK + Zub
			→	→ 06/15		13.0460-3853.2	603853	BOS 24885 16,8 + WK + Zub
2.0 D-4D (ADT270_)	91	11/11→	←			13.0460-5603.2	605603	24204 19,2 + WK + Zub
			→			13.0460-3853.2	603853	BOS 24885 16,8 + WK + Zub
2.0 D-4D (WWT271_)	105	04/15→	←	→ 06/15; Kasten/Kombi		13.0460-5603.2	605603	24204 19,2 + WK + Zub
			→	→ 06/15		13.0460-3853.2	603853	BOS 24885 16,8 + WK + Zub
2.2 D-4D (ADT271_)	110	11/08→	←	02/09→ 11/10		13.0460-5615.2	605615	BOS 24946 19,0 + WK + Zub
2.2 D-4D (ADT271_)	130	11/08→	→	02/09→		13.0460-3853.2	603853	BOS 24885 16,8 + WK + Zub
 Bremsscheibe								
1.6 (ZRT270_)	97	11/08→	←	02/09→		24.0126-0156.1	426156	Ø 295 26 23 V
1.8 (ZRT271_)	108	11/08→	→	02/09→		24.0111-0169.1	411169	Ø 290 11 9
2.0 (ZRT272_)	112	11/08→						
2.0 D-4D (ADT270_)	93	11/08→						
1.6 D4-D (WWT270_)	82	04/15→	←			24.0126-0156.1	426156	Ø 295 26 23 V
2.0 D-4D (ADT270_)	91	11/11→	→			24.0111-0169.1	411169	Ø 290 11 9
2.0 D-4D (WWT271_)	105	04/15→	←			24.0126-0160.1	426160	Ø 320 26 23 V
			→			24.0111-0169.1	411169	Ø 290 11 9
2.2 D-4D (ADT271_)	110	11/08→	←	02/09→		24.0126-0160.1	426160	Ø 320 26 23 V
2.2 D-4D (ADT271_)	130	11/08→	→	02/09→		24.0111-0169.1	411169	Ø 290 11 9
TOYOTA - AVENSIS VERSO (_M2_) 08/01→11/09								
 Bremsbelagsatz, Scheibenbremse								
2.0 (ACM20_)	110	08/01→11/09	←			13.0460-5846.2	605846	AKE 23836 17,0 - WK
2.0 D (CLM20_)	85	08/01→08/05	→			13.0460-5847.2	605847	SUM 23646 16,5 + WK
2.4 (ACM21)	115	10/03→11/09						
 Bremsscheibe								
2.0 (ACM20_)	110	08/01→11/09	←			24.0128-0115.1	428115	Ø 275 28 26 V
2.0 D (CLM20_)	85	08/01→08/05	→			24.0112-0164.1	412164	Ø 291 12 10,5
2.4 (ACM21)	115	10/03→11/09						









	kW					! #		
TOYOTA - AYGO (_B1_) 02/05→								
 Bremsbelagsatz, Scheibenbremse								
1.0 (KGB10_) 1.0 GPL (KGB10_)	50 50	07/05→ 07/05→	←	→ 06/14		13.0460-3829.2	603829	BOS 23959 17,0 - WE / - WK + Zub
1.4 HDi (WNB10_)	40	07/05→08/10	←			13.0460-3829.2	603829	BOS 23959 17,0 - WE / - WK + Zub
 Bremsscheibe								
1.0 (KGB10_) 1.0 GPL (KGB10_)	50 50	07/05→ 07/05→	←	→ 06/14		24.0120-0180.1	420180	Ø 247 20 18 V + S
1.4 HDi (WNB10_)	40	07/05→08/10	←			24.0120-0180.1	420180	Ø 247 20 18 V + S
TOYOTA - AYGO (_B4_) 05/14→								
 Bremsbelagsatz, Scheibenbremse								
1.0 (KGB40_) 1.2 (PAB40_)	51 60	05/14→ 05/14→	←			13.0460-3829.2	603829	BOS 23959 17,0 - WE / - WK + Zub
 Bremsscheibe								
1.0 (KGB40_) 1.2 (PAB40_)	51 60	05/14→ 05/14→	←			24.0120-0180.1	420180	Ø 247 20 18 V + S
TOYOTA - CAMRY (_V1_) 06/91→09/97								
 Bremsbelagsatz, Scheibenbremse								
2.2 2.2 (SXV10_)	93 100	02/93→04/95 06/91→08/96	→	+ ABS		13.0460-5835.2	605835	AKE 20076 15,5 + WK
3.0 3.0	135 136	09/93→07/96 02/93→09/95	→			13.0460-5835.2	605835	AKE 20076 15,5 + WK
3.0 (VCV10_)	138	06/91→08/96						
 Bremsscheibe								
2.2 2.2 (SXV10_)	93 100	02/93→04/95 06/91→08/96	←	→ 07/93		24.0128-0114.1	428114	Ø 255 28 26 V
			←	08/93→		24.0128-0115.1	428115	Ø 275 28 26 V
			→	+ ABS		24.0110-0700.1	410700	Ø 269 10 9
3.0 3.0 3.0 (VCV10_)	135 136 138	09/93→07/96 02/93→09/95 06/91→08/96	←			24.0128-0115.1	428115	Ø 275 28 26 V
TOYOTA - CAMRY (_V2_) 08/96→11/01								
 Bremsbelagsatz, Scheibenbremse								
2.2 (SXV20_) 2.5 3.0 (VDV10) 3.0 24V (MCV20_) 3.0 V6 (MCV20_)	96 147 140 140 135	08/96→11/01 08/96→07/01 08/96→07/01 08/96→11/01 08/96→11/01	→	→ 07/99		13.0460-5835.2	605835	AKE 20076 15,5 + WK
 Bremsscheibe								
2.2 (SXV20_) 2.2 (SXV20_) 2.5 3.0 (VDV10) 3.0 24V (MCV20_) 3.0 V6 (MCV20_)	93 96 147 140 140 135	11/00→11/01 08/96→11/01 08/96→07/01 08/96→07/01 08/96→11/01 08/96→11/01	←			24.0128-0115.1	428115	Ø 275 28 26 V
			→	passend für Felgengröße [Zoll]: 14		24.0110-0700.1	410700	Ø 269 10 9
TOYOTA - CAMRY Station Wagon (_V1_) 06/91→08/97								
 Bremsbelagsatz, Scheibenbremse								
2.2 (SXV10_) 2.2 (SXV10, SDV10)	100 93	03/92→07/96 02/93→04/95	→	+ ABS		13.0460-5835.2	605835	AKE 20076 15,5 + WK
3.0 3.0 (VCV10_)	136 138	06/91→09/95 03/92→07/96	→			13.0460-5835.2	605835	AKE 20076 15,5 + WK
 Bremsscheibe								
2.2 (SXV10_) 2.2 (SXV10, SDV10)	100 93	03/92→07/96 02/93→04/95	←	→ 07/93		24.0128-0114.1	428114	Ø 255 28 26 V
			←	08/93→		24.0128-0115.1	428115	Ø 275 28 26 V
			→	+ ABS		24.0110-0700.1	410700	Ø 269 10 9
3.0 3.0 (VCV10_)	136 138	06/91→09/95 03/92→07/96	←			24.0128-0115.1	428115	Ø 275 28 26 V
TOYOTA - CAMRY Station Wagon (_V2_) 08/96→09/02								
 Bremsbelagsatz, Scheibenbremse								
2.5 3.0 (MCV20) ↓	147 140	08/96→07/01 08/96→07/01	→	→ 07/99		13.0460-5835.2	605835	AKE 20076 15,5 + WK









	kw					! #		
TOYOTA - CAMRY Station Wagon (_V2_) 08/96→09/02								
 Bremsscheibe								
2.2 (SXV20)	93	08/97→09/02	←	11/00→11/01		24.0128-0115.1	428115	Ø 275 28 26 V
			→	11/00→11/01; passend für Felgenreöße [Zoll]: 14		24.0110-0700.1	410700	Ø 269 10 9
2.5	147	08/96→07/01	←			24.0128-0115.1	428115	Ø 275 28 26 V
3.0 (MCV20)	140	08/96→07/01	→	passend für Felgenreöße [Zoll]: 14		24.0110-0700.1	410700	Ø 269 10 9
TOYOTA - CAMRY Stufenheck (_V3_) 08/01→11/06								
 Bremsbelagsatz, Scheibenbremse								
2.0	110	08/01→11/06	←	12/01→12/05		13.0460-5743.2	605743	23928 17,3 - WK
2.4 (ACV30_)	112	11/01→11/06	→	12/01→12/05		13.0460-5738.2	605738	23702 15,1 - WE / - WK
3.0 (MCV30_)	137	08/01→11/06	→	12/01→12/05		13.0460-5738.2	605738	23702 15,1 - WE / - WK
3.0 (MCV36)	141	09/02→11/06	←	→ 12/05		13.0460-5743.2	605743	23928 17,3 - WK
			→	→ 12/05		13.0460-5738.2	605738	23702 15,1 - WE / - WK
 Bremsscheibe								
2.0	110	08/01→11/06	←	12/01→12/05; für Linkslenker		24.0128-0190.1	428190	Ø 296 28 26 V
2.4 (ACV30_)	112	11/01→11/06	←	12/01→12/05; für Rechtslenker		24.0128-0212.1	428212	Ø 296 28 26 V
3.0 (MCV30_)	137	08/01→11/06	←	12/01→12/05; für Rechtslenker		24.0128-0212.1	428212	Ø 296 28 26 V
3.0 (MCV36)	141	09/02→11/06	←	→ 12/05; für Linkslenker		24.0128-0190.1	428190	Ø 296 28 26 V
			←	→ 12/05; für Rechtslenker		24.0128-0212.1	428212	Ø 296 28 26 V
TOYOTA - CAMRY Stufenheck (_V4_) 01/06→09/11								
 Bremsbelagsatz, Scheibenbremse								
2.0	108	01/06→09/11	←	→ 08/11		13.0460-5764.2	605764	AKE 24350 17,3 - WE / - WK + Zub
2.4	127	10/06→09/11	→	→ 08/11		13.0460-5765.2	605765	AKE 24338 15,5 - WE / - WK
2.4 (ACV40_)	123	01/06→09/11	→	→ 08/11		13.0460-5765.2	605765	AKE 24338 15,5 - WE / - WK
2.4 (ACV40)	116	01/06→09/11	→	→ 08/11		13.0460-5765.2	605765	AKE 24338 15,5 - WE / - WK
2.4 Hybrid	105	01/06→09/11	→	→ 08/11		13.0460-5765.2	605765	AKE 24338 15,5 - WE / - WK
2.4 Hybrid	110	01/06→09/11	→	→ 08/11		13.0460-5765.2	605765	AKE 24338 15,5 - WE / - WK
2.5	129	01/10→09/11	→	→ 08/11		13.0460-5765.2	605765	AKE 24338 15,5 - WE / - WK
3.5	209	01/08→09/11	→	→ 08/11		13.0460-5765.2	605765	AKE 24338 15,5 - WE / - WK
3.5 (GSV40_)	204	01/08→09/11	→	→ 08/11		13.0460-5765.2	605765	AKE 24338 15,5 - WE / - WK
2.5 (ASV40_)	124	01/10→09/11	←	→ 08/11		13.0460-5764.2	605764	AKE 24350 17,3 - WE / - WK + Zub
			→	→ 08/11		13.0460-5765.2	605765	AKE 24338 15,5 - WE / - WK
 Bremsscheibe								
2.0	108	01/06→09/11	←	→ 08/11		24.0128-0159.1	428159	Ø 296 28 25 V
2.4	127	10/06→09/11	→	→ 08/11		24.0128-0159.1	428159	Ø 296 28 25 V
2.4 (ACV40_)	123	01/06→09/11	→	→ 08/11		24.0128-0159.1	428159	Ø 296 28 25 V
2.4 (ACV40)	116	01/06→09/11	→	→ 08/11		24.0128-0159.1	428159	Ø 296 28 25 V
2.4 Hybrid	105	01/06→09/11	→	→ 08/11		24.0128-0159.1	428159	Ø 296 28 25 V
2.4 Hybrid	110	01/06→09/11	→	→ 08/11		24.0128-0159.1	428159	Ø 296 28 25 V
2.5	129	01/10→09/11	→	→ 08/11		24.0128-0159.1	428159	Ø 296 28 25 V
3.5	209	01/08→09/11	→	→ 08/11		24.0128-0159.1	428159	Ø 296 28 25 V
3.5 (GSV40_)	204	01/08→09/11	→	→ 08/11		24.0128-0159.1	428159	Ø 296 28 25 V
2.5 (ASV40_)	124	01/10→09/11	←	→ 08/11		24.0128-0159.1	428159	Ø 296 28 25 V
			→	→ 08/11		24.0128-0159.1	428159	Ø 296 28 25 V
TOYOTA - CAMRY Stufenheck (_V5_) 09/11→								
 Bremsbelagsatz, Scheibenbremse								
2.0 (ACV51_)	109	09/11→	←	Made in Japan		13.0460-5764.2	605764	AKE 24350 17,3 - WE / - WK + Zub
2.5 (ASV50_)	133	09/11→	→	Made in USA		13.0460-5765.2	605765	AKE 24338 15,5 - WE / - WK
2.5 (ASV50_)	135	01/12→	→	Made in USA		13.0460-5765.2	605765	AKE 24338 15,5 - WE / - WK
2.5 Hybrid (AVV50_)	118	09/11→	→	Made in Japan		13.0460-5765.2	605765	AKE 24338 15,5 - WE / - WK
3.5 (GSV50_)	183	12/12→	→	Made in Japan		13.0460-5765.2	605765	AKE 24338 15,5 - WE / - WK
3.5 (GSV50_)	204	09/11→	→	Made in Japan		13.0460-5765.2	605765	AKE 24338 15,5 - WE / - WK
2.0 (ASV51_)	110	04/15→	←	Made in Japan		13.0460-5764.2	605764	AKE 24350 17,3 - WE / - WK + Zub
			→	Made in USA		13.0460-5765.2	605765	AKE 24338 15,5 - WE / - WK
 Bremsscheibe								
2.0 (ACV51_)	109	09/11→	←	Made in Japan		24.0128-0159.1	428159	Ø 296 28 25 V
2.5 (ASV50_)	133	09/11→	←	Made in USA		24.0128-0274.1	428274	Ø 296 28 25 V
2.5 (ASV50_)	135	01/12→	←	Made in USA		24.0128-0274.1	428274	Ø 296 28 25 V
2.5 Hybrid (AVV50_)	118	09/11→	→	Made in USA		24.0110-0374.1	410374	Ø 281 10 8,5
3.5 (GSV50_)	183	12/12→	→	Made in USA		24.0110-0374.1	410374	Ø 281 10 8,5
3.5 (GSV50_)	204	09/11→	→	Made in USA		24.0110-0374.1	410374	Ø 281 10 8,5
2.0 (ASV51_)	110	04/15→	←	Made in Japan		24.0128-0159.1	428159	Ø 296 28 25 V

	kW			 	! #		
TOYOTA - CARINA E (_T19_) 04/92→09/97							
 Bremsbelagsatz, Scheibenbremse							
1.6 (AT190)	73	12/93→09/97	←			13.0460-5951.2 605951	SUM 21601 17,5 + WK
1.6 (AT190)	85	12/93→09/97					
1.6 16V (AT190_)	78	10/95→09/97					
1.6 GLI (AT190)	79	04/92→09/97					
1.8 (AT191)	79	01/95→09/97					
2.0 D (CT190)	54	04/92→01/96					
2.0 GLI (ST191)	98	04/92→09/97					
2.0 i (ST191)	93	12/93→09/97					
2.0 TD (CT190)	61	01/96→09/97					
Zubehörsatz, Scheibenbremsbelag							
1.6 (AT190)	73	12/93→09/97	←			13.0460-0441.2 610441	SUM
1.6 (AT190)	85	12/93→09/97					
1.6 16V (AT190_)	78	10/95→09/97					
1.6 GLI (AT190)	79	04/92→09/97					
1.8 (AT191)	79	01/95→09/97					
2.0 D (CT190)	54	04/92→01/96					
2.0 GLI (ST191)	98	04/92→09/97					
2.0 i (ST191)	93	12/93→09/97					
2.0 TD (CT190)	61	01/96→09/97					
Bremsscheibe							
1.6 (AT190)	73	12/93→09/97	←			24.0125-0124.1 425124	Ø 255 24,9 24 V
1.6 (AT190)	85	12/93→09/97					
1.6 16V (AT190_)	78	10/95→09/97					
1.6 GLI (AT190)	79	04/92→09/97					
2.0 D (CT190)	54	04/92→01/96					
2.0 TD (CT190)	61	01/96→09/97					
1.8 (AT191)	79	01/95→09/97	←			24.0128-0113.1 428113	Ø 255 28 26 V
2.0 GLI (ST191)	98	04/92→09/97	←			24.0128-0116.1 428116	Ø 255 28 26 V
2.0 i (ST191)	93	12/93→09/97					
TOYOTA - CARINA E Sportswagon (_T19_) 02/92→09/97							
 Bremsbelagsatz, Scheibenbremse							
1.6	85	04/92→09/97	←			13.0460-5951.2 605951	SUM 21601 17,5 + WK
1.6 GLI (AT190_)	79	01/93→09/97					
1.6 i (AT190_)	73	02/95→09/97					
1.8 i (AT191_)	79	02/95→09/97					
2.0 D (CT190_)	54	01/93→01/96					
2.0 GLI (ST191_)	98	01/93→09/97					
2.0 i (ST191_)	93	05/95→09/97					
2.0 TD (CT190_)	61	01/96→09/97					
Zubehörsatz, Scheibenbremsbelag							
1.6	85	04/92→09/97	←			13.0460-0441.2 610441	SUM
1.6 GLI (AT190_)	79	01/93→09/97					
1.6 i (AT190_)	73	02/95→09/97					
1.8 i (AT191_)	79	02/95→09/97					
2.0 D (CT190_)	54	01/93→01/96					
2.0 GLI (ST191_)	98	01/93→09/97					
2.0 i (ST191_)	93	05/95→09/97					
2.0 TD (CT190_)	61	01/96→09/97					
Bremsscheibe							
1.6	85	04/92→09/97	←			24.0125-0124.1 425124	Ø 255 24,9 24 V
1.6 GLI (AT190_)	79	01/93→09/97					
1.6 i (AT190_)	73	02/95→09/97					
2.0 D (CT190_)	54	01/93→01/96					
2.0 TD (CT190_)	61	01/96→09/97					
1.8 i (AT191_)	79	02/95→09/97	←			24.0128-0113.1 428113	Ø 255 28 26 V
2.0 GLI (ST191_)	98	01/93→09/97	←			24.0128-0116.1 428116	Ø 255 28 26 V
2.0 i (ST191_)	93	05/95→09/97					
TOYOTA - CARINA E Stufenheck (_T19_) 04/92→09/97							
 Bremsbelagsatz, Scheibenbremse							
1.6 (AT190)	73	01/95→09/97	←			13.0460-5951.2 605951	SUM 21601 17,5 + WK
1.6 (AT190)	78	10/95→09/97					
1.6 (AT190)	79	01/93→09/97					
1.6 16V (AT190_)	85	12/94→09/97					
1.8 i 16V (AT191)	79	01/95→09/97					
2.0 (ST191)	98	01/93→09/97					
2.0 D (CT190)	54	08/92→01/96					
2.0 i (ST191)	93	12/92→09/97					
2.0 TD (CT190_)	61	01/96→09/97					
Zubehörsatz, Scheibenbremsbelag							
1.6 (AT190)	73	01/95→09/97	←			13.0460-0441.2 610441	SUM
↓							











	kw					! #		
TOYOTA - CARINA E Stufenheck (_T19_) 04/92→09/97								
Zubehörsatz, Scheibenbremsbelag								
1.6 (AT190)	78	10/95→09/97	←				13.0460-0441.2 610441	SUM
1.6 (AT190)	79	01/93→09/97						
1.6 16V (AT190_)	85	12/94→09/97						
1.8 i 16V (AT191)	79	01/95→09/97						
2.0 (ST191)	98	01/93→09/97						
2.0 D (CT190)	54	08/92→01/96						
2.0 i (ST191)	93	12/92→09/97						
2.0 TD (CT190_)	61	01/96→09/97						
 Bremsscheibe								
1.6 (AT190)	73	01/95→09/97	←				24.0125-0124.1 425124	Ø 255 24,9 24 V
1.6 (AT190)	78	10/95→09/97						
1.6 (AT190)	79	01/93→09/97						
1.6 16V (AT190_)	85	12/94→09/97						
2.0 D (CT190)	54	08/92→01/96						
2.0 TD (CT190_)	61	01/96→09/97						
1.8 i 16V (AT191)	79	01/95→09/97	←				24.0128-0113.1 428113	Ø 255 28 26 V
2.0 (ST191)	98	01/93→09/97	←				24.0128-0116.1 428116	Ø 255 28 26 V
2.0 i (ST191)	93	12/92→09/97						
TOYOTA - CELICA (_T20_) 09/93→11/99								
 Bremsbelagsatz, Scheibenbremse								
1.8 i 16V (AT200/ST)	85	11/93→11/99	←				13.0460-5951.2 605951	SUM 21601 17,5 + WK
			→				13.0460-5835.2 605835	AKE 20076 15,5 + WK
2.0 i 16V (ST202_)	125	04/96→11/99	→				13.0460-5835.2 605835	AKE 20076 15,5 + WK
2.0 i 16V (ST202/GT)	129	11/93→11/99						
2.2 GT	100	11/93→08/99						
Zubehörsatz, Scheibenbremsbelag								
1.8 i 16V (AT200/ST)	85	11/93→11/99	←				13.0460-0441.2 610441	SUM
 Bremsscheibe								
1.8 i 16V (AT200/ST)	85	11/93→11/99	←				24.0125-0124.1 425124	Ø 255 24,9 24 V
			→	09/95→			24.0109-0148.1 409148	Ø 269 9 8
			→	→ 08/95			24.0110-0350.1 410350	Ø 269 10 9
2.0 i 16V (ST202_)	125	04/96→11/99	→				24.0109-0148.1 409148	Ø 269 9 8
2.0 i 16V (ST202/GT)	129	11/93→11/99						
2.2 GT	100	11/93→08/99						
TOYOTA - CELICA (_T23_) 08/99→09/05								
 Bremsbelagsatz, Scheibenbremse								
1.8 16V TS (ZZT231_)	141	08/99→09/05	←	11/99→ 07/02			13.0460-5817.2 605817	AKE 23526 17,5 + WE / - WK
			←	08/02→			13.0460-5817.2 605817	AKE 23526 17,5 + WE / - WK
			→	11/99→			13.0460-5812.2 605812	SUM 23521 14,0 + WK
1.8 16V VT-i (ZZT230_)	105	08/99→07/05	←	11/99→ 07/02			13.0460-5810.2 605810	AKE 23510 16,5 + WK
			←	08/02→			13.0460-5817.2 605817	AKE 23526 17,5 + WE / - WK
			→	11/99→			13.0460-5812.2 605812	SUM 23521 14,0 + WK
Zubehörsatz, Scheibenbremsbelag								
1.8 16V TS (ZZT231_)	141	08/99→09/05	→	11/99→			13.0460-0136.2 610136	SUM
1.8 16V VT-i (ZZT230_)	105	08/99→07/05						
 Bremsscheibe								
1.8 16V TS (ZZT231_)	141	08/99→09/05	←	11/99→			24.0125-0700.1 425700	Ø 275 25 23 V
			→	11/99→			24.0109-0711.1 409711	Ø 269 9 7,5
1.8 16V VT-i (ZZT230_)	105	08/99→07/05	←	11/99→ 07/02			24.0125-0124.1 425124	Ø 255 24,9 24 V
			←	08/02→			24.0125-0700.1 425700	Ø 275 25 23 V
			→	11/99→			24.0109-0711.1 409711	Ø 269 9 7,5
TOYOTA - CELICA Cabriolet (_T20_) 11/93→08/99								
 Bremsbelagsatz, Scheibenbremse								
2.0 GTi	129	08/94→08/99	→				13.0460-5835.2 605835	AKE 20076 15,5 + WK
2.0 i 16V	125	11/93→08/99						
 Bremsscheibe								
2.0 GTi	129	08/94→08/99	→				24.0109-0148.1 409148	Ø 269 9 8
2.0 i 16V	125	11/93→08/99						











	kw			 	! #		
TOYOTA - COROLLA (_E10_) 06/91→11/99							
 Bremsbelagsatz, Scheibenbremse							
1.3 12V (EE100_)	53	07/92→04/97	←	→ 05/95		13.0460-5976.2 605976	AKE 20870 15,0 - WE / - WK
1.3 XLI (EE101_)	55	09/95→04/97	←			13.0460-5951.2 605951	SUM 21601 17,5 + WK
1.3 XLI 16V (EE101)	65	07/92→09/95				13.0460-5976.2 605976	AKE 20870 15,0 - WE / - WK
1.6	76	07/92→07/95					
1.6	85	05/92→07/95					
1.6 Si (AE101_)	84	09/95→04/97					
2.0 D (CE100_)	53	07/92→04/97					
1.6 i 20V (AE101)	117	06/91→08/98	←	05/92→ 05/95		13.0460-5976.2 605976	AKE 20870 15,0 - WE / - WK
Zubehörsatz, Scheibenbremsbelag							
1.3 12V (EE100_)	53	07/92→04/97	←	→ 05/95		13.0460-0325.2 610325	AKE
1.3 XLI (EE101_)	55	09/95→04/97	←			13.0460-0325.2 610325	AKE
1.3 XLI 16V (EE101)	65	07/92→09/95				13.0460-0441.2 610441	SUM
1.6	76	07/92→07/95					
1.6	85	05/92→07/95					
1.6 Si (AE101_)	84	09/95→04/97					
2.0 D (CE100_)	53	07/92→04/97					
1.6 i 20V (AE101)	117	06/91→08/98	←	05/92→ 05/95		13.0460-0325.2 610325	AKE
 Bremsscheibe							
1.3 12V (EE100_)	53	07/92→04/97	←	→ 05/95		24.0118-0110.1 418110	Ø 238 18 17 V
1.3 XLI (EE101_)	55	09/95→04/97	←			24.0122-0158.1 422158	Ø 255 22 20 V
1.3 XLI 16V (EE101)	65	07/92→09/95					
1.6	76	07/92→07/95					
1.6	85	05/92→07/95					
1.6 Si (AE101_)	84	09/95→04/97					
2.0 D (CE100_)	53	07/92→04/97					
1.6 i 20V (AE101)	117	06/91→08/98	→	05/92→ 05/95		24.0109-0159.1 409159	Ø 266 9 8
TOYOTA - COROLLA (_E11_) 04/97→06/02							
 Bremsbelagsatz, Scheibenbremse							
1.3	55	05/97→10/01	←	Made in Japan		13.0460-5976.2 605976	AKE 20870 15,0 - WE / - WK
1.4 (EE111_)	63	04/97→02/00	←	05/97→ 01/00; für Fahrzeuge ohne Schlechtwegeausführung; Made in Japan		13.0460-5951.2 605951	SUM 21601 17,5 + WK
			←	05/97→ 01/00; für Fahrzeuge mit Schlechtwegeausführung; Made in Japan		13.0460-5976.2 605976	AKE 20870 15,0 - WE / - WK
			→	05/97→ 09/99		13.0460-5835.2 605835	AKE 20076 15,5 + WK
1.4 16V (ZZE111_)	71	02/00→11/01	←	für Fahrzeuge ohne Schlechtwegeausführung; Made in Japan		13.0460-5951.2 605951	SUM 21601 17,5 + WK
1.6 16V (ZZE112_)	81	02/00→11/01	←	für Fahrzeuge mit Schlechtwegeausführung; Made in Japan		13.0460-5976.2 605976	AKE 20870 15,0 - WE / - WK
			→	Made in Japan		13.0460-5835.2 605835	AKE 20076 15,5 + WK
			→	Made in Großbritannien		13.0460-5869.2 605869	TRW 24013 14,9 + WK
1.6	81	04/97→02/00	←	05/97→ 01/00; für Fahrzeuge ohne Schlechtwegeausführung; Made in Japan		13.0460-5951.2 605951	SUM 21601 17,5 + WK
1.6 Aut. (AE111_)	79	04/97→02/00	←	05/97→ 01/00; für Fahrzeuge mit Schlechtwegeausführung; Made in Japan		13.0460-5976.2 605976	AKE 20870 15,0 - WE / - WK
			→	08/98→ 09/99		13.0460-5835.2 605835	AKE 20076 15,5 + WK
1.6 i 20V (AE111)	121	08/98→08/00	←	→ 01/00; für Fahrzeuge ohne Schlechtwegeausführung; Made in Japan		13.0460-5951.2 605951	SUM 21601 17,5 + WK
			←	→ 01/00; für Fahrzeuge mit Schlechtwegeausführung; Made in Japan		13.0460-5976.2 605976	AKE 20870 15,0 - WE / - WK
			→	→ 09/99		13.0460-5835.2 605835	AKE 20076 15,5 + WK
1.8	85	08/98→06/02	←	→ 12/01; Made in Japan		13.0460-5951.2 605951	SUM 21601 17,5 + WK
1.9 D (WZE110_)	51	02/00→11/01	←	Made in Japan		13.0460-5951.2 605951	SUM 21601 17,5 + WK
			→	Made in Japan		13.0460-5835.2 605835	AKE 20076 15,5 + WK
			→	Made in Großbritannien		13.0460-5869.2 605869	TRW 24013 14,9 + WK
2.0 D (CE110_)	53	04/97→02/00	←	05/97→ 01/00; Made in Japan		13.0460-5951.2 605951	SUM 21601 17,5 + WK
			→	08/98→ 09/99		13.0460-5835.2 605835	AKE 20076 15,5 + WK
2.0 D-4D (CDE110_)	66	09/00→11/01	←	Made in Japan		13.0460-5951.2 605951	SUM 21601 17,5 + WK
↓			→			13.0460-5835.2 605835	AKE 20076 15,5 + WK

	kw			 	! #		
TOYOTA - COROLLA (_E11_) 04/97→06/02							
Zubehörsatz, Scheibenbremsbelag							
1.4 (EE111_) 1.6 1.6 Aut. (AE111_)	63 81 79	04/97→02/00 04/97→02/00 04/97→02/00	←	05/97→ 01/00; für Fahrzeuge ohne Schlechtwegeausführung		13.0460-0074.2 610074	
1.4 16V (ZZE111_) 1.6 16V (ZZE112_)	71 81	02/00→11/01 02/00→11/01	←	für Fahrzeuge ohne Schlechtwegeausführung		13.0460-0074.2 610074	
1.6 i 20V (AE111)	121	08/98→08/00	←	→ 01/00; für Fahrzeuge ohne Schlechtwegeausführung		13.0460-0074.2 610074	
1.8	85	08/98→06/02	←	→ 12/01		13.0460-0074.2 610074	
1.9 D (WZE110_) 2.0 D-4D (CDE110_)	51 66	02/00→11/01 09/00→11/01	←			13.0460-0074.2 610074	
2.0 D (CE110_)	53	04/97→02/00	←	05/97→ 01/00		13.0460-0074.2 610074	
 Bremsscheibe							
1.3	55	05/97→10/01	←			24.0118-0110.1 418110	Ø 238 18 17 V
1.4 (EE111_)	63	04/97→02/00	←	05/97→ 01/00; für Fahrzeuge ohne Schlechtwegeausführung		24.0122-0158.1 422158	Ø 255 22 20 V
			→	05/97→ 01/00		24.0109-0159.1 409159	Ø 266 9 8
1.4 16V (ZZE111_) 1.6 16V (ZZE112_)	71 81	02/00→11/01 02/00→11/01	←	für Fahrzeuge ohne Schlechtwegeausführung		24.0122-0158.1 422158	Ø 255 22 20 V
			→	Made in Japan		24.0109-0159.1 409159	Ø 266 9 8
1.6 1.6 Aut. (AE111_)	81 79	04/97→02/00 04/97→02/00	←	05/97→ 01/00; für Fahrzeuge ohne Schlechtwegeausführung		24.0122-0158.1 422158	Ø 255 22 20 V
			→	08/98→ 01/00		24.0109-0159.1 409159	Ø 266 9 8
1.6 i 20V (AE111)	121	08/98→08/00	←	→ 01/00; für Fahrzeuge ohne Schlechtwegeausführung		24.0122-0158.1 422158	Ø 255 22 20 V
			→	→ 01/00		24.0109-0159.1 409159	Ø 266 9 8
1.8	85	08/98→06/02	←	→ 12/01		24.0122-0158.1 422158	Ø 255 22 20 V
1.9 D (WZE110_)	51	02/00→11/01	←			24.0122-0158.1 422158	Ø 255 22 20 V
			→	Made in Japan		24.0109-0159.1 409159	Ø 266 9 8
2.0 D (CE110_)	53	04/97→02/00	←	05/97→ 01/00		24.0122-0158.1 422158	Ø 255 22 20 V
			→	08/98→ 01/00		24.0109-0159.1 409159	Ø 266 9 8
2.0 D-4D (CDE110_)	66	09/00→11/01	←			24.0122-0158.1 422158	Ø 255 22 20 V
			→			24.0109-0159.1 409159	Ø 266 9 8
TOYOTA - COROLLA (_E12_) 01/01→02/07							
 Bremsbelagsatz, Scheibenbremse							
1.4 D (NDE120_)	66	07/04→02/07	←	→ 10/06		13.0460-5815.2 605815	TRW 23766 17,8 + WK
			→	→ 12/06		13.0460-5819.2 605819	TRW 23816 16,0 + WK
1.4 VVT-i (ZZE120_)	71	01/02→12/06	←	→ 05/04; Made in Japan		13.0460-5810.2 605810	AKE 23510 16,5 + WK
			←	02/02→ 05/04; Made in Großbritannien		13.0460-5815.2 605815	TRW 23766 17,8 + WK
			←	06/04→ 10/06		13.0460-5815.2 605815	TRW 23766 17,8 + WK
			→	→ 05/04; Made in Japan		13.0460-5812.2 605812	SUM 23521 14,0 + WK
			→	06/04→ 10/06		13.0460-5819.2 605819	TRW 23816 16,0 + WK
			→	02/02→ 05/04; Made in Großbritannien		13.0460-5819.2 605819	TRW 23816 16,0 + WK
1.6 VVTi	91	10/06→02/07	←	11/06→		13.0460-5767.2 605767	AKE 24336 17,5 - WE / - WK
			→	11/06→		13.0460-5769.2 605769	24610 15,0 + WK
1.6 VVT-i (ZZE121_)	81	01/02→12/06	←	→ 05/04; Made in Japan		13.0460-5810.2 605810	AKE 23510 16,5 + WK
			←	08/02→ 05/04; Made in Großbritannien		13.0460-5815.2 605815	TRW 23766 17,8 + WK
			←	06/04→ 10/06		13.0460-5815.2 605815	TRW 23766 17,8 + WK
			→	→ 05/04; Made in Japan		13.0460-5812.2 605812	SUM 23521 14,0 + WK
			→	06/04→ 10/06		13.0460-5819.2 605819	TRW 23816 16,0 + WK
			→	08/02→ 05/04; Made in Großbritannien		13.0460-5819.2 605819	TRW 23816 16,0 + WK
1.8 4WD	100	12/01→02/07	←	→ 12/01; Made in Japan		13.0460-5951.2 605951	SUM 21601 17,5 + WK
1.8 VVTi 1.8 VVTL-i TS (ZZE123_) 1.8 VVTL-i TS (ZZE123_)	100 160	06/04→02/07 10/05→12/06	←	→ 10/06		13.0460-5815.2 605815	TRW 23766 17,8 + WK
			→	→ 10/06		13.0460-5819.2 605819	TRW 23816 16,0 + WK
↓							













	kw			 	! #		
TOYOTA - COROLLA (_E12_) 01/01→02/07							
 Bremsbelagsatz, Scheibenbremse							
1.8 VVTL-i TS 2.0 D-4D (CDE120R_ CDE120L_)	141 81	01/02→02/07 01/02→12/06	← → 05/04; Made in Großbritannien → 05/04; Made in Großbritannien		13.0460-5815.2 13.0460-5819.2	605815 605819	TRW 23766 17,8 + WK TRW 23816 16,0 + WK
2.0 D-4D (CDE120_)	66	01/02→12/06	← 08/02→ 05/04; Made in Großbritannien → 05/04; Made in Japan → 05/04; Made in Japan → 05/04; Made in Japan → 08/02→ 05/04; Made in Großbritannien		13.0460-5815.2 13.0460-5817.2 13.0460-5812.2 13.0460-5819.2	605815 605817 605812 605819	TRW 23766 17,8 + WK AKE 23526 17,5 + WE / - WK SUM 23521 14,0 + WK TRW 23816 16,0 + WK
2.0 D-4D (CDE120R_ CDE120L_)	85	05/03→02/07	← 06/04→ 10/06 → 05/04; Made in Großbritannien → 05/04; Made in Großbritannien → 06/04→ 10/06		13.0460-5815.2 13.0460-5815.2 13.0460-5819.2 13.0460-5819.2	605815 605815 605819 605819	TRW 23766 17,8 + WK TRW 23766 17,8 + WK TRW 23816 16,0 + WK TRW 23816 16,0 + WK
Zubehörsatz, Scheibenbremsbelag							
1.4 D (NDE120_) 1.8 VVTi 1.8 VVTL-i TS (ZZE123_) 1.8 VVTL-i TS (ZZE123_)	66 100 160 165	07/04→02/07 06/04→02/07 10/05→12/06 02/05→02/07	← → 10/06		13.0460-0138.2	610138	TRW
1.4 VVT-i (ZZE120_)	71	01/02→12/06	← 02/02→ 05/04; Made in Großbritannien ← 06/04→ 10/06 → 05/04; Made in Japan		13.0460-0138.2 13.0460-0138.2 13.0460-0136.2	610138 610138 610136	TRW TRW SUM
1.6 VVT-i (ZZE121_)	81	01/02→12/06	← 08/02→ 05/04; Made in Großbritannien ← 06/04→ 10/06 → 05/04; Made in Japan		13.0460-0138.2 13.0460-0138.2 13.0460-0136.2	610138 610138 610136	TRW TRW SUM
1.8 4WD	100	12/01→02/07	← → 12/01		13.0460-0074.2	610074	
1.8 VVTL-i TS 2.0 D-4D (CDE120R_ CDE120L_)	141 81	01/02→02/07 01/02→12/06	← → 05/04; Made in Großbritannien		13.0460-0138.2	610138	TRW
2.0 D-4D (CDE120_)	66	01/02→12/06	← 08/02→ 05/04; Made in Großbritannien → 05/04; Made in Japan		13.0460-0138.2 13.0460-0136.2	610138 610136	TRW SUM
2.0 D-4D (CDE120R_ CDE120L_)	85	05/03→02/07	← → 05/04; Made in Großbritannien ← 06/04→ 10/06		13.0460-0138.2 13.0460-0138.2	610138 610138	TRW TRW
 Bremsscheibe							
1.4 D (NDE120_) 1.8 VVTi 1.8 VVTL-i TS (ZZE123_) 1.8 VVTL-i TS (ZZE123_)	66 100 160 165	07/04→02/07 06/04→02/07 10/05→12/06 02/05→02/07	← → 10/06 → 10/06		24.0125-0157.1 24.0109-0140.1	425157 409140	∅ 275 25 23 V ∅ 279 9 8
1.4 VVT-i (ZZE120_)	71	01/02→12/06	← → 05/04 ← 06/04→ 10/06 → 02/02→ 05/04; Made in Großbritannien → 06/04→ 10/06 → 05/04; Made in Japan		24.0125-0155.1 24.0125-0155.1 24.0109-0138.1 24.0109-0138.1 24.0109-0139.1	425155 425155 409138 409138 409139	∅ 255 25 23 V ∅ 255 25 23 V ∅ 258 9 8 ∅ 258 9 8 ∅ 269 9 8
1.6 VVTi	91	10/06→02/07	← 11/06→ → 11/06→		24.0122-0256.1 24.0109-0155.1	422256 409155	∅ 275 22 19 V ∅ 259 9 7,5
1.6 VVT-i (ZZE121_)	81	01/02→12/06	← 06/04→ 10/06 ← → 05/04 → 08/02→ 05/04; Made in Großbritannien → 06/04→ 10/06 → 05/04; Made in Japan		24.0125-0155.1 24.0125-0155.1 24.0109-0138.1 24.0109-0138.1 24.0109-0139.1	425155 425155 409138 409138 409139	∅ 255 25 23 V ∅ 255 25 23 V ∅ 258 9 8 ∅ 258 9 8 ∅ 269 9 8
1.8 4WD	100	12/01→02/07	← → 12/01		24.0122-0158.1	422158	∅ 255 22 20 V
1.8 VVTL-i TS 2.0 D-4D (CDE120R_ CDE120L_)	141 81	01/02→02/07 01/02→12/06	← → 05/04; Made in Großbritannien → 05/04; Made in Großbritannien		24.0125-0157.1 24.0109-0140.1	425157 409140	∅ 275 25 23 V ∅ 279 9 8
2.0 D-4D (CDE120_)	66	01/02→12/06	← 08/02→ 05/04; Made in Großbritannien ← → 05/04; Made in Japan → 05/04; Made in Japan → 08/02→ 05/04; Made in Großbritannien		24.0125-0157.1 24.0125-0168.1 24.0109-0139.1 24.0109-0140.1	425157 425168 409139 409140	∅ 275 25 23 V ∅ 275 25 23 V ∅ 269 9 8 ∅ 279 9 8
↓							















	kw			 	! #		
TOYOTA - COROLLA (_E12_) 01/01→02/07							
 Bremsscheibe							
2.0 D-4D (CDE120R_, CDE120L_)	85	05/03→02/07	←	→ 05/04; Made in Großbritannien	24.0125-0157.1	425157	Ø 275 25 23 V
			←	06/04→ 10/06	24.0125-0157.1	425157	Ø 275 25 23 V
			→	06/04→ 10/06	24.0109-0140.1	409140	Ø 279 9 8
			→	→ 05/04; Made in Großbritannien	24.0109-0140.1	409140	Ø 279 9 8
TOYOTA - COROLLA Combi (_E12_) 03/01→02/07							
 Bremsbelagsatz, Scheibenbremse							
1.4 D4-D (NDE120_)	66	07/04→02/07	←	→ 10/06	13.0460-5815.2	605815	TRW 23766 17,8 + WK
			→	→ 12/06	13.0460-5819.2	605819	TRW 23816 16,0 + WK
1.4 VVT-i (ZZE120_)	71	01/02→02/07	←	→ 05/04; Made in Japan	13.0460-5810.2	605810	AKE 23510 16,5 + WK
			←	02/02→ 05/04; Made in Großbritannien	13.0460-5815.2	605815	TRW 23766 17,8 + WK
			←	06/04→ 10/06	13.0460-5815.2	605815	TRW 23766 17,8 + WK
			→	→ 05/04; Made in Japan	13.0460-5812.2	605812	SUM 23521 14,0 + WK
			→	06/04→ 10/06	13.0460-5819.2	605819	TRW 23816 16,0 + WK
			→	02/02→ 05/04; Made in Großbritannien	13.0460-5819.2	605819	TRW 23816 16,0 + WK
1.6 VVT-i (ZZE121_)	81	01/02→02/07	←	→ 05/04; Made in Japan	13.0460-5810.2	605810	AKE 23510 16,5 + WK
			←	08/02→ 05/04; Made in Großbritannien	13.0460-5815.2	605815	TRW 23766 17,8 + WK
			←	06/04→ 10/06	13.0460-5815.2	605815	TRW 23766 17,8 + WK
			→	→ 05/04; Made in Japan	13.0460-5812.2	605812	SUM 23521 14,0 + WK
			→	06/04→ 10/06	13.0460-5819.2	605819	TRW 23816 16,0 + WK
			→	08/02→ 05/04; Made in Großbritannien	13.0460-5819.2	605819	TRW 23816 16,0 + WK
1.8	100	06/04→02/07	←	→ 10/06	13.0460-5815.2	605815	TRW 23766 17,8 + WK
			→	→ 10/06	13.0460-5819.2	605819	TRW 23816 16,0 + WK
1.8 4WD	100	12/01→02/07	←	→ 12/01; Made in Japan	13.0460-5951.2	605951	SUM 21601 17,5 + WK
2.0 D-4D (CDE120_)	66	01/02→02/07	←	08/02→ 05/04; Made in Großbritannien	13.0460-5815.2	605815	TRW 23766 17,8 + WK
			←	→ 05/04; Made in Japan	13.0460-5817.2	605817	AKE 23526 17,5 + WE / - WK
			→	→ 05/04; Made in Japan	13.0460-5812.2	605812	SUM 23521 14,0 + WK
			→	08/02→ 05/04; Made in Großbritannien	13.0460-5819.2	605819	TRW 23816 16,0 + WK
2.0 D-4D (CDE120_)	85	04/04→02/07	←	06/04→ 10/06	13.0460-5815.2	605815	TRW 23766 17,8 + WK
			←	→ 05/04; Made in Großbritannien	13.0460-5815.2	605815	TRW 23766 17,8 + WK
			→	→ 05/04; Made in Großbritannien	13.0460-5819.2	605819	TRW 23816 16,0 + WK
			→	06/04→ 10/06	13.0460-5819.2	605819	TRW 23816 16,0 + WK
Zubehörsatz, Scheibenbremsbelag							
1.4 D4-D (NDE120_)	66	07/04→02/07	←	→ 10/06	13.0460-0138.2	610138	TRW
			1.8	100	06/04→02/07	→	→ 10/06
1.4 VVT-i (ZZE120_)	71	01/02→02/07	←	02/02→ 05/04; Made in Großbritannien	13.0460-0138.2	610138	TRW
			←	06/04→ 10/06	13.0460-0138.2	610138	TRW
			→	→ 05/04; Made in Japan	13.0460-0136.2	610136	SUM
1.6 VVT-i (ZZE121_)	81	01/02→02/07	←	08/02→ 05/04; Made in Großbritannien	13.0460-0138.2	610138	TRW
			←	06/04→ 10/06	13.0460-0138.2	610138	TRW
			→	→ 05/04; Made in Japan	13.0460-0136.2	610136	SUM
1.8 4WD	100	12/01→02/07	←	→ 12/01	13.0460-0074.2	610074	
2.0 D-4D (CDE120_)	66	01/02→02/07	←	08/02→ 05/04; Made in Großbritannien	13.0460-0138.2	610138	TRW
			→	→ 05/04; Made in Japan	13.0460-0136.2	610136	SUM
2.0 D-4D (CDE120_)	85	04/04→02/07	←	→ 05/04; Made in Großbritannien	13.0460-0138.2	610138	TRW
			←	06/04→ 10/06	13.0460-0138.2	610138	TRW
 Bremsscheibe							
1.4 D4-D (NDE120_)	66	07/04→02/07	←	→ 10/06	24.0125-0157.1	425157	Ø 275 25 23 V
			1.8	100	06/04→02/07	→	→ 10/06
1.4 VVT-i (ZZE120_)	71	01/02→02/07	←	→ 05/04	24.0125-0155.1	425155	Ø 255 25 23 V
			←	06/04→ 10/06	24.0125-0155.1	425155	Ø 255 25 23 V
			→	02/02→ 05/04; Made in Großbritannien	24.0109-0138.1	409138	Ø 258 9 8
			→	06/04→ 10/06	24.0109-0138.1	409138	Ø 258 9 8
↓							













	kw					! #		
TOYOTA - COROLLA Combi (_E12_) 03/01→02/07								
 Bremsscheibe								
1.4 VVT-i (ZZE120_)	71	01/02→02/07	➔	→ 05/04; Made in Japan			24.0109-0139.1 409139	Ø 269 9 8
1.6 VVT-i (ZZE121_)	81	01/02→02/07	➔	06/04→ 10/06			24.0125-0155.1 425155	Ø 255 25 23 V
			➔	→ 05/04			24.0125-0155.1 425155	Ø 255 25 23 V
			➔	08/02→ 05/04; Made in Großbritannien			24.0109-0138.1 409138	Ø 258 9 8
			➔	06/04→ 10/06			24.0109-0138.1 409138	Ø 258 9 8
			➔	→ 05/04; Made in Japan			24.0109-0139.1 409139	Ø 269 9 8
1.8 4WD	100	12/01→02/07	➔	→ 12/01			24.0122-0158.1 422158	Ø 255 22 20 V
2.0 D-4D (CDE120_)	66	01/02→02/07	➔	08/02→ 05/04; Made in Großbritannien			24.0125-0157.1 425157	Ø 275 25 23 V
			➔	→ 05/04; Made in Japan			24.0125-0168.1 425168	Ø 275 25 23 V
			➔	→ 05/04; Made in Japan			24.0109-0139.1 409139	Ø 269 9 8
			➔	08/02→ 05/04; Made in Großbritannien			24.0109-0140.1 409140	Ø 279 9 8
2.0 D-4D (CDE120_)	85	04/04→02/07	➔	→ 05/04; Made in Großbritannien			24.0125-0157.1 425157	Ø 275 25 23 V
			➔	06/04→ 10/06			24.0125-0157.1 425157	Ø 275 25 23 V
			➔	06/04→ 10/06			24.0109-0140.1 409140	Ø 279 9 8
			➔	→ 05/04; Made in Großbritannien			24.0109-0140.1 409140	Ø 279 9 8
TOYOTA - COROLLA Compact (_E10_) 05/92→11/99								
 Bremsbelagsatz, Scheibenbremse								
1.3 12V (EE100_)	53	07/92→05/95	➔				13.0460-5976.2 605976	AKE 20870 15,0 - WE / - WK
1.3 XLI (EE101_)	55	09/95→04/97	➔				13.0460-5951.2 605951	SUM 21601 17,5 + WK
1.3 XLI 16V (EE101)	65	07/92→09/95	➔				13.0460-5976.2 605976	AKE 20870 15,0 - WE / - WK
1.6 Si (AE101_)	84	07/92→04/97						
1.8 GT (AE102_)	86	11/92→05/95						
2.0 D (CE100_)	53	07/92→04/97						
1.6 i (AE101)	78	09/94→11/99	➔	→ 04/97			13.0460-5951.2 605951	SUM 21601 17,5 + WK
							13.0460-5976.2 605976	AKE 20870 15,0 - WE / - WK
1.8 GTi 4WD	81	11/92→04/95	➔				13.0460-5951.2 605951	SUM 21601 17,5 + WK
Zubehörsatz, Scheibenbremsbelag								
1.3 12V (EE100_)	53	07/92→05/95	➔				13.0460-0325.2 610325	AKE
1.3 XLI (EE101_)	55	09/95→04/97	➔				13.0460-0325.2 610325	AKE
1.3 XLI 16V (EE101)	65	07/92→09/95	➔				13.0460-0441.2 610441	SUM
1.6 Si (AE101_)	84	07/92→04/97						
1.8 GT (AE102_)	86	11/92→05/95						
2.0 D (CE100_)	53	07/92→04/97						
1.6 i (AE101)	78	09/94→11/99	➔	→ 04/97			13.0460-0325.2 610325	AKE
							13.0460-0441.2 610441	SUM
1.8 GTi 4WD	81	11/92→04/95	➔				13.0460-0441.2 610441	SUM
 Bremsscheibe								
1.3 12V (EE100_)	53	07/92→05/95	➔				24.0118-0110.1 418110	Ø 238 18 17 V
1.3 XLI (EE101_)	55	09/95→04/97	➔				24.0122-0158.1 422158	Ø 255 22 20 V
			➔					
1.3 XLI 16V (EE101)	65	07/92→09/95	➔					
1.6 Si (AE101_)	84	07/92→04/97						
1.8 GTi 4WD	81	11/92→04/95						
2.0 D (CE100_)	53	07/92→04/97						
1.6 i (AE101)	78	09/94→11/99	➔	→ 04/97			24.0122-0158.1 422158	Ø 255 22 20 V
1.8 GT (AE102_)	86	11/92→05/95	➔				24.0122-0158.1 422158	Ø 255 22 20 V
			➔				24.0109-0159.1 409159	Ø 266 9 8
TOYOTA - COROLLA Compact (_E11_) 04/97→01/02								
 Bremsbelagsatz, Scheibenbremse								
1.4 (EE111_)	63	04/97→02/00	➔	05/97→ 01/00; für Fahrzeuge ohne Schlechtwegeausführung; Made in Japan			13.0460-5951.2 605951	SUM 21601 17,5 + WK
			➔	05/97→ 01/00; für Fahrzeuge mit Schlechtwegeausführung; Made in Japan			13.0460-5976.2 605976	AKE 20870 15,0 - WE / - WK
			➔	05/97→ 09/99			13.0460-5835.2 605835	AKE 20076 15,5 + WK
1.4 (ZZE111_)	71	02/00→01/02	➔	→ 12/01; für Fahrzeuge ohne Schlechtwegeausführung; Made in Japan			13.0460-5951.2 605951	SUM 21601 17,5 + WK
1.6 (ZZE112_)	81	02/00→01/02						
↓								















	kW					! #		
TOYOTA - COROLLA Compact (_E11_) 04/97→01/02								
 Bremsbelagsatz, Scheibenbremse								
1.4 (ZZE111_) 1.6 (ZZE112_)	71 81	02/00→01/02 02/00→01/02	←	→ 12/01; für Fahrzeuge mit Schlechtwegeausführung; Made in Japan			13.0460-5976.2 605976	AKE 20870 15,0 - WE / - WK
			→	→ 12/01; Made in Japan			13.0460-5835.2 605835	AKE 20076 15,5 + WK
			→	→ 12/01; Made in Großbritannien			13.0460-5869.2 605869	TRW 24013 14,9 + WK
1.6 (AE111_) 1.6 Aut. (AE111_)	81 79	04/97→02/00 04/97→02/00	←	05/97→ 01/00; für Fahrzeuge ohne Schlechtwegeausführung; Made in Japan			13.0460-5951.2 605951	SUM 21601 17,5 + WK
			←	05/97→ 01/00; für Fahrzeuge mit Schlechtwegeausführung; Made in Japan			13.0460-5976.2 605976	AKE 20870 15,0 - WE / - WK
			→	08/98→ 09/99			13.0460-5835.2 605835	AKE 20076 15,5 + WK
1.9 D (WZE110_)	51	02/00→01/02	←	→ 12/01; Made in Japan			13.0460-5951.2 605951	SUM 21601 17,5 + WK
			→	→ 12/01; Made in Japan			13.0460-5835.2 605835	AKE 20076 15,5 + WK
			→	→ 12/01; Made in Großbritannien			13.0460-5869.2 605869	TRW 24013 14,9 + WK
2.0 D (CE110_)	53	04/97→02/00	←	05/97→ 01/00; Made in Japan			13.0460-5951.2 605951	SUM 21601 17,5 + WK
			→	08/98→ 09/99			13.0460-5835.2 605835	AKE 20076 15,5 + WK
2.0 D-4D (CDE110_)	66	09/00→01/02	←	→ 12/01; Made in Japan			13.0460-5951.2 605951	SUM 21601 17,5 + WK
			→	→ 12/01			13.0460-5835.2 605835	AKE 20076 15,5 + WK
Zubehörsatz, Scheibenbremsbelag								
1.4 (EE111_) 1.6 (AE111_) 1.6 Aut. (AE111_)	63 81 79	04/97→02/00 04/97→02/00 04/97→02/00	←	05/97→ 01/00; für Fahrzeuge ohne Schlechtwegeausführung			13.0460-0074.2 610074	
1.4 (ZZE111_) 1.6 (ZZE112_)	71 81	02/00→01/02 02/00→01/02	←	→ 12/01; für Fahrzeuge ohne Schlechtwegeausführung			13.0460-0074.2 610074	
1.9 D (WZE110_) 2.0 D-4D (CDE110_)	51 66	02/00→01/02 09/00→01/02	←	→ 12/01			13.0460-0074.2 610074	
2.0 D (CE110_)	53	04/97→02/00	←	05/97→ 01/00			13.0460-0074.2 610074	
 Bremsscheibe								
1.4 (EE111_)	63	04/97→02/00	←	05/97→ 01/00; für Fahrzeuge ohne Schlechtwegeausführung			24.0122-0158.1 422158	Ø 255 22 20 V
			→	05/97→ 01/00			24.0109-0159.1 409159	Ø 266 9 8
1.4 (ZZE111_) 1.6 (ZZE112_)	71 81	02/00→01/02 02/00→01/02	←	→ 12/01; für Fahrzeuge ohne Schlechtwegeausführung			24.0122-0158.1 422158	Ø 255 22 20 V
			→	→ 12/01; Made in Japan			24.0109-0159.1 409159	Ø 266 9 8
1.6 (AE111_) 1.6 Aut. (AE111_)	81 79	04/97→02/00 04/97→02/00	←	05/97→ 01/00; für Fahrzeuge ohne Schlechtwegeausführung			24.0122-0158.1 422158	Ø 255 22 20 V
			→	08/98→ 01/00			24.0109-0159.1 409159	Ø 266 9 8
1.9 D (WZE110_)	51	02/00→01/02	←	→ 12/01			24.0122-0158.1 422158	Ø 255 22 20 V
			→	→ 12/01; Made in Japan			24.0109-0159.1 409159	Ø 266 9 8
2.0 D (CE110_)	53	04/97→02/00	←	05/97→ 01/00			24.0122-0158.1 422158	Ø 255 22 20 V
			→	08/98→ 01/00			24.0109-0159.1 409159	Ø 266 9 8
2.0 D-4D (CDE110_)	66	09/00→01/02	←	→ 12/01			24.0122-0158.1 422158	Ø 255 22 20 V
			→	→ 12/01			24.0109-0159.1 409159	Ø 266 9 8
TOYOTA - COROLLA LEVIN Coupe (_E10_) 06/91→08/97								
 Bremsbelagsatz, Scheibenbremse								
1.6 GT	85	06/91→08/97	←	05/92→ 05/95			13.0460-5976.2 605976	AKE 20870 15,0 - WE / - WK
Zubehörsatz, Scheibenbremsbelag								
1.6 GT	85	06/91→08/97	←	05/92→ 05/95			13.0460-0325.2 610325	AKE
 Bremsscheibe								
1.6 GT	85	06/91→08/97	→	05/92→ 05/95			24.0109-0159.1 409159	Ø 266 9 8
TOYOTA - COROLLA Liftback (_E10_) 05/92→04/97								
 Bremsbelagsatz, Scheibenbremse								
1.3 12V (EE100_)	53	07/92→05/95	←				13.0460-5976.2 605976	AKE 20870 15,0 - WE / - WK
↓								









	kw					! #		
TOYOTA - COROLLA Liftback (E10) 05/92→04/97								
 Bremsbelagsatz, Scheibenbremse								
1.3 XLI (EE101_) 1.6 GLI (AE101_) 1.8 GT (AE102_) 2.0 D (CE100_)	65 84 86 53	07/92→04/97 07/92→04/97 11/92→05/95 07/92→04/97	←				13.0460-5951.2 605951 13.0460-5976.2 605976	SUM 21601 17,5 + WK AKE 20870 15,0 - WE / - WK
Zubehörsatz, Scheibenbremsbelag								
1.3 12V (EE100_) 1.3 XLI (EE101_) 1.6 GLI (AE101_) 1.8 GT (AE102_) 2.0 D (CE100_)	53 65 84 86 53	07/92→05/95 07/92→04/97 07/92→04/97 11/92→05/95 07/92→04/97	←				13.0460-0325.2 610325 13.0460-0325.2 610325 13.0460-0441.2 610441	AKE AKE SUM
 Bremsscheibe								
1.3 12V (EE100_) 1.3 XLI (EE101_) 1.6 GLI (AE101_) 2.0 D (CE100_) 1.8 GT (AE102_)	53 65 84 53 86	07/92→05/95 07/92→04/97 07/92→04/97 07/92→04/97 11/92→05/95	← ← ← ← ←				24.0118-0110.1 418110 24.0122-0158.1 422158 24.0122-0158.1 422158 24.0109-0159.1 409159	Ø 238 18 17 V Ø 255 22 20 V Ø 255 22 20 V Ø 266 9 8
TOYOTA - COROLLA Liftback (E11) 04/97→01/02								
 Bremsbelagsatz, Scheibenbremse								
1.4 (EE111_) 1.4 (ZZE111_) 1.6 (ZZE112_) 1.6 (AE111_) 1.6 Aut. (AE111_) 1.9 D (WZE110_) 2.0 D (CE110) 2.0 D-4D (CDE110_)	63 71 81 79 71 51 53 66	04/97→02/00 02/00→01/02 02/00→01/02 04/97→02/00 04/97→02/00 02/00→01/02 04/97→02/00 09/00→01/02	← ← ← ← ← ← ← ←	05/97→ 01/00; für Fahrzeuge ohne Schlechtwegeausführung; Made in Japan 05/97→ 01/00; für Fahrzeuge mit Schlechtwegeausführung; Made in Japan 05/97→ 09/99 → 12/01; für Fahrzeuge ohne Schlechtwegeausführung; Made in Japan → 12/01; für Fahrzeuge mit Schlechtwegeausführung; Made in Japan → 12/01; Made in Japan → 12/01; Made in Großbritannien 05/97→ 01/00; für Fahrzeuge ohne Schlechtwegeausführung; Made in Japan 05/97→ 01/00; für Fahrzeuge mit Schlechtwegeausführung; Made in Japan 08/98→ 09/99 → 12/01; Made in Japan → 12/01; Made in Japan → 12/01; Made in Großbritannien 05/97→ 01/00; Made in Japan 08/98→ 09/99 → 12/01; Made in Japan → 12/01			13.0460-5951.2 605951 13.0460-5976.2 605976 13.0460-5835.2 605835 13.0460-5951.2 605951 13.0460-5976.2 605976 13.0460-5835.2 605835 13.0460-5869.2 605869 13.0460-5951.2 605951 13.0460-5976.2 605976 13.0460-5835.2 605835 13.0460-5951.2 605951 13.0460-5835.2 605835 13.0460-5951.2 605951 13.0460-5835.2 605835 13.0460-0074.2 610074 13.0460-0074.2 610074 13.0460-0074.2 610074 13.0460-0074.2 610074 24.0122-0158.1 422158 24.0109-0159.1 409159	SUM 21601 17,5 + WK AKE 20870 15,0 - WE / - WK AKE 20076 15,5 + WK SUM 21601 17,5 + WK AKE 20870 15,0 - WE / - WK AKE 20076 15,5 + WK TRW 24013 14,9 + WK SUM 21601 17,5 + WK AKE 20076 15,5 + WK SUM 21601 17,5 + WK AKE 20076 15,5 + WK SUM 21601 17,5 + WK AKE 20076 15,5 + WK SUM 21601 17,5 + WK AKE 20076 15,5 + WK SUM 21601 17,5 + WK AKE 20076 15,5 + WK SUM 21601 17,5 + WK AKE 20076 15,5 + WK
Zubehörsatz, Scheibenbremsbelag								
1.4 (EE111_) 1.6 (AE111_) 1.6 Aut. (AE111_) 1.4 (ZZE111_) 1.6 (ZZE112_) 1.9 D (WZE110_) 2.0 D-4D (CDE110_) 2.0 D (CE110)	63 81 79 71 81 51 66 53	04/97→02/00 04/97→02/00 04/97→02/00 02/00→01/02 02/00→01/02 02/00→01/02 09/00→01/02 04/97→02/00	← ← ← ← ← ← ← ←	05/97→ 01/00; für Fahrzeuge ohne Schlechtwegeausführung → 12/01; für Fahrzeuge ohne Schlechtwegeausführung → 12/01 05/97→ 01/00			13.0460-0074.2 610074 13.0460-0074.2 610074 13.0460-0074.2 610074 13.0460-0074.2 610074 13.0460-0074.2 610074	
 Bremsscheibe								
1.4 (EE111_)	63	04/97→02/00	←	05/97→ 01/00; für Fahrzeuge ohne Schlechtwegeausführung			24.0122-0158.1 422158 24.0109-0159.1 409159	Ø 255 22 20 V Ø 266 9 8
			→	05/97→ 01/00				
↓								















	kw					! #		
TOYOTA - COROLLA Liftback (_E11_) 04/97→01/02								
Bremsscheibe								
1.4 (ZZE111_) 1.6 (ZZE112_)	71 81	02/00→01/02 02/00→01/02	←	→ 12/01; für Fahrzeuge ohne Schlechtwegeausführung			24.0122-0158.1 422158	Ø 255 22 20 V
			→	→ 12/01; Made in Japan			24.0109-0159.1 409159	Ø 266 9 8
1.6 (AE111_) 1.6 Aut. (AE111_)	81 79	04/97→02/00 04/97→02/00	←	05/97→ 01/00; für Fahrzeuge ohne Schlechtwegeausführung			24.0122-0158.1 422158	Ø 255 22 20 V
			→	08/98→ 01/00			24.0109-0159.1 409159	Ø 266 9 8
1.9 D (WZE110_)	51	02/00→01/02	←	→ 12/01			24.0122-0158.1 422158	Ø 255 22 20 V
			→	→ 12/01; Made in Japan			24.0109-0159.1 409159	Ø 266 9 8
2.0 D (CE110)	53	04/97→02/00	←	05/97→ 01/00			24.0122-0158.1 422158	Ø 255 22 20 V
			→	08/98→ 01/00			24.0109-0159.1 409159	Ø 266 9 8
2.0 D-4D (CDE110_)	66	09/00→01/02	←	→ 12/01			24.0122-0158.1 422158	Ø 255 22 20 V
			→	→ 12/01			24.0109-0159.1 409159	Ø 266 9 8
TOYOTA - COROLLA Stufenheck (_E12_) 08/00→03/08								
Bremselagersatz, Scheibenbremse								
1.4 D-4D 1.4 D-4D (NDE120_)	55 66	07/04→07/07 07/04→07/07	←	→ 10/06			13.0460-5815.2 605815	TRW 23766 17,8 + WK
			→	→ 12/06			13.0460-5819.2 605819	TRW 23816 16,0 + WK
1.4 VVT-i (ZZE120_) 1.6 VVT-i (ZZE121_)	71 81	08/02→07/07 08/02→07/07	←	→ 05/04; Made in Japan			13.0460-5810.2 605810	AKE 23510 16,5 + WK
			←	→ 05/04; Made in Großbritannien			13.0460-5815.2 605815	TRW 23766 17,8 + WK
			←	06/04→ 10/06			13.0460-5815.2 605815	TRW 23766 17,8 + WK
			→	→ 05/04; Made in Japan			13.0460-5812.2 605812	SUM 23521 14,0 + WK
			→	→ 05/04; Made in Großbritannien			13.0460-5819.2 605819	TRW 23816 16,0 + WK
			→	06/04→ 10/06			13.0460-5819.2 605819	TRW 23816 16,0 + WK
1.8	100	11/01→07/07	←	06/04→ 10/06			13.0460-5815.2 605815	TRW 23766 17,8 + WK
			→	06/04→ 10/06			13.0460-5819.2 605819	TRW 23816 16,0 + WK
2.0 D-4D (CDE120_)	66	08/02→07/07	←	→ 05/04; Made in Großbritannien			13.0460-5815.2 605815	TRW 23766 17,8 + WK
			←	05/03→ 05/04; Made in Großbritannien			13.0460-5815.2 605815	TRW 23766 17,8 + WK
			←	→ 05/04; Made in Japan			13.0460-5817.2 605817	AKE 23526 17,5 + WE / - WK
			→	→ 05/04; Made in Japan			13.0460-5812.2 605812	SUM 23521 14,0 + WK
			→	→ 05/04; Made in Großbritannien			13.0460-5819.2 605819	TRW 23816 16,0 + WK
			→	05/03→ 05/04; Made in Großbritannien			13.0460-5819.2 605819	TRW 23816 16,0 + WK
2.0 D-4D (CDE120_)	85	06/04→07/07	←	→ 10/06			13.0460-5815.2 605815	TRW 23766 17,8 + WK
			→	→ 10/06			13.0460-5819.2 605819	TRW 23816 16,0 + WK
Zubehörsatz, Scheibenbremsbelag								
1.4 D-4D 1.4 D-4D (NDE120_) 2.0 D-4D (CDE120_)	55 66 85	07/04→07/07 07/04→07/07 06/04→07/07	←	→ 10/06			13.0460-0138.2 610138	TRW
1.4 VVT-i (ZZE120_) 1.6 VVT-i (ZZE121_)	71 81	08/02→07/07 08/02→07/07	←	→ 05/04; Made in Großbritannien			13.0460-0138.2 610138	TRW
			←	06/04→ 10/06			13.0460-0138.2 610138	TRW
			→	→ 05/04; Made in Japan			13.0460-0136.2 610136	SUM
1.8	100	11/01→07/07	←	06/04→ 10/06			13.0460-0138.2 610138	TRW
2.0 D-4D (CDE120_)	66	08/02→07/07	←	→ 05/04; Made in Großbritannien			13.0460-0138.2 610138	TRW
			←	05/03→ 05/04; Made in Großbritannien			13.0460-0138.2 610138	TRW
			→	→ 05/04; Made in Japan			13.0460-0136.2 610136	SUM
Bremsscheibe								
1.4 D-4D 1.4 D-4D (NDE120_) 2.0 D-4D (CDE120_)	55 66 85	07/04→07/07 07/04→07/07 06/04→07/07	←	→ 10/06			24.0125-0157.1 425157	Ø 275 25 23 V
			→	→ 10/06			24.0109-0140.1 409140	Ø 279 9 8
1.4 VVT-i (ZZE120_) 1.6 VVT-i (ZZE121_)	71 81	08/02→07/07 08/02→07/07	←	→ 05/04			24.0125-0155.1 425155	Ø 255 25 23 V
			←	06/04→ 10/06			24.0125-0155.1 425155	Ø 255 25 23 V
			→	06/04→ 10/06			24.0109-0138.1 409138	Ø 258 9 8
			→	→ 05/04; Made in Großbritannien			24.0109-0138.1 409138	Ø 258 9 8
			→	→ 05/04; Made in Japan			24.0109-0139.1 409139	Ø 269 9 8
1.8 ↓	100	11/01→07/07	←	06/04→ 10/06			24.0125-0157.1 425157	Ø 275 25 23 V













	kw			 	! #		
TOYOTA - COROLLA Stufenheck (_E12_) 08/00→03/08							
 Bremsscheibe							
1.8	100	11/01→07/07	➔	06/04→ 10/06		24.0109-0140.1 409140	Ø 279 9 8
2.0 D-4D (CDE120_)	66	08/02→07/07	➔	05/03→ 05/04; Made in Großbritannien		24.0125-0157.1 425157	Ø 275 25 23 V
			➔	→ 05/04; Made in Großbritannien		24.0125-0157.1 425157	Ø 275 25 23 V
			➔	→ 05/04; Made in Japan		24.0125-0168.1 425168	Ø 275 25 23 V
			➔	→ 05/04; Made in Japan		24.0109-0139.1 409139	Ø 269 9 8
			➔	05/03→ 05/04; Made in Großbritannien		24.0109-0140.1 409140	Ø 279 9 8
			➔	→ 05/04; Made in Großbritannien		24.0109-0140.1 409140	Ø 279 9 8
TOYOTA - COROLLA Stufenheck (_E15_) 10/06→							
 Bremsbelagsatz, Scheibenbremse							
1.33	74	01/07→	➔	10/08→ 05/13		13.0460-5767.2 605767	AKE 24336 17,5 - WE / - WK
1.3 VVT-i	63	03/08→	➔	10/08→ 05/13		13.0460-5769.2 605769	24610 15,0 + WK
			➔	10/08→ 05/13		13.0460-5769.2 605769	24610 15,0 + WK
1.4 D-4D	66	10/06→	➔	01/09→ 05/13		13.0460-5602.2 605602	24122 19,0 + WK + Zub
			➔	01/09→ 05/13		13.0460-5604.2 605604	24664 15,2 + WK + Zub
1.4 VVT-i	71	01/07→	➔	→ 12/08		13.0460-5767.2 605767	AKE 24336 17,5 - WE / - WK
1.6 CNG	80	08/07→	➔	→ 12/08		13.0460-5769.2 605769	24610 15,0 + WK
1.6 Dual VVTi (ZRE141)	91	01/07→	➔	→ 12/08		13.0460-5769.2 605769	24610 15,0 + WK
1.6 VVT-i	81	08/07→	➔	→ 12/08		13.0460-5769.2 605769	24610 15,0 + WK
1.6	97	01/09→	➔	→ 05/13		13.0460-5767.2 605767	AKE 24336 17,5 - WE / - WK
			➔	→ 05/13		13.0460-5769.2 605769	24610 15,0 + WK
2.0 D-4D	93	01/07→	➔	→ 05/13		13.0460-5603.2 605603	24204 19,2 + WK + Zub
			➔	→ 05/13		13.0460-5604.2 605604	24664 15,2 + WK + Zub
 Bremsscheibe							
1.33	74	01/07→	➔	10/08→ 05/13		24.0122-0256.1 422256	Ø 275 22 19 V
1.3 VVT-i	63	03/08→	➔	10/08→ 05/13		24.0109-0155.1 409155	Ø 259 9 7,5
			➔	10/08→ 05/13		24.0109-0155.1 409155	Ø 259 9 7,5
1.4 D-4D	66	10/06→	➔	01/09→ 05/13		24.0126-0148.1 426148	Ø 273 26 23 V
			➔	01/09→ 05/13		24.0110-0337.1 410337	Ø 270 9,9 8
1.4 VVT-i	71	01/07→	➔	→ 12/08		24.0122-0256.1 422256	Ø 275 22 19 V
1.6 CNG	80	08/07→	➔	→ 12/08		24.0109-0155.1 409155	Ø 259 9 7,5
1.6 Dual VVTi (ZRE141)	91	01/07→	➔	→ 12/08		24.0109-0155.1 409155	Ø 259 9 7,5
1.6 VVT-i	81	08/07→	➔	→ 12/08		24.0109-0155.1 409155	Ø 259 9 7,5
1.6	97	01/09→	➔	→ 05/13		24.0122-0256.1 422256	Ø 275 22 19 V
			➔	→ 05/13		24.0109-0155.1 409155	Ø 259 9 7,5
2.0 D-4D	93	01/07→	➔	→ 05/13		24.0126-0156.1 426156	Ø 295 26 23 V
			➔	→ 05/13		24.0110-0337.1 410337	Ø 270 9,9 8
TOYOTA - COROLLA Stufenheck (_E18_, ZRE17_) 06/13→							
 Bremsbelagsatz, Scheibenbremse							
1.3 (NRE180_)	73	06/13→	➔			13.0460-3868.2 603868	BOS 25698 18,7 + WK + Zub
			➔			13.0460-5767.2 605767	AKE 24336 17,5 - WE / - WK
1.4 D-4D (NDE180_)	66	06/13→	➔			13.0460-5604.2 605604	24664 15,2 + WK + Zub
			➔			13.0460-3868.2 603868	BOS 25698 18,7 + WK + Zub
			➔			13.0460-5767.2 605767	AKE 24336 17,5 - WE / - WK
1.6 (ZRE181_)	97	06/13→	➔			13.0460-5604.2 605604	24664 15,2 + WK + Zub
			➔			13.0460-5769.2 605769	24610 15,0 + WK
			➔	für Fahrzeuge mit Bremsassistent		13.0460-5769.2 605769	24610 15,0 + WK
1.6 BiFuel	90	06/13→	➔			13.0460-3868.2 603868	BOS 25698 18,7 + WK + Zub
			➔			13.0460-5767.2 605767	AKE 24336 17,5 - WE / - WK
			➔	für Fahrzeuge ohne Bremsassistent		13.0460-5604.2 605604	24664 15,2 + WK + Zub
1.8 VVTi	103	06/13→	➔			13.0460-5604.2 605604	24664 15,2 + WK + Zub
			➔	für Fahrzeuge mit Bremsassistent		13.0460-5769.2 605769	24610 15,0 + WK
 Bremsscheibe							
1.3 (NRE180_)	73	06/13→	➔			24.0126-0184.1 426184	Ø 277 26 23 V
1.4 D-4D (NDE180_)	66	06/13→	➔			24.0110-0337.1 410337	Ø 270 9,9 8
			➔			24.0110-0337.1 410337	Ø 270 9,9 8
1.6 (ZRE181_)	97	06/13→	➔	für Fahrzeuge mit Bremsassistent		24.0122-0256.1 422256	Ø 275 22 19 V
1.6 BiFuel	90	06/13→	➔	für Fahrzeuge ohne Bremsassistent		24.0126-0184.1 426184	Ø 277 26 23 V
1.8 VVTi	103	06/13→	➔	für Fahrzeuge mit Bremsassistent		24.0109-0155.1 409155	Ø 259 9 7,5
			➔	für Fahrzeuge ohne Bremsassistent		24.0110-0337.1 410337	Ø 270 9,9 8













	kw					! #		
TOYOTA - COROLLA Verso (_E12_) 07/01→07/04								
 Bremsbelagsatz, Scheibenbremse								
1.6 VVT-i (ZZE121_)	81	01/02→05/04	←				13.0460-5810.2 605810	AKE 23510 16,5 + WK
			→				13.0460-5812.2 605812	SUM 23521 14,0 + WK
1.8 VVT-i (ZZE122_)	99	01/02→05/04	←				13.0460-5817.2 605817	AKE 23526 17,5 + WE / - WK
2.0 D-4D (CDE120_)	66	01/02→05/04	→				13.0460-5812.2 605812	SUM 23521 14,0 + WK
2.0 D-4D (CDE120_)	85	09/01→07/04	←	06/04→			13.0460-5815.2 605815	TRW 23766 17,8 + WK
			→	06/04→			13.0460-5819.2 605819	TRW 23816 16,0 + WK
Zubehörsatz, Scheibenbremsbelag								
1.6 VVT-i (ZZE121_)	81	01/02→05/04	→				13.0460-0136.2 610136	SUM
1.8 VVT-i (ZZE122_)	99	01/02→05/04						
2.0 D-4D (CDE120_)	66	01/02→05/04						
2.0 D-4D (CDE120_)	85	09/01→07/04	←	06/04→			13.0460-0138.2 610138	TRW
 Bremsscheibe								
1.6 VVT-i (ZZE121_)	81	01/02→05/04	←				24.0125-0155.1 425155	Ø 255 25 23 V
			→				24.0109-0139.1 409139	Ø 269 9 8
1.8 VVT-i (ZZE122_)	99	01/02→05/04	←				24.0125-0168.1 425168	Ø 275 25 23 V
2.0 D-4D (CDE120_)	66	01/02→05/04	→				24.0109-0139.1 409139	Ø 269 9 8
2.0 D-4D (CDE120_)	85	09/01→07/04	←	06/04→			24.0125-0157.1 425157	Ø 275 25 23 V
			→	06/04→			24.0109-0140.1 409140	Ø 279 9 8
TOYOTA - COROLLA Verso (ZER_, ZZE12_, R1_) 03/04→04/09								
 Bremsbelagsatz, Scheibenbremse								
1.4 D-4D	66	03/04→03/09	←	06/04→ 10/06			13.0460-5815.2 605815	TRW 23766 17,8 + WK
			→	06/04→ 12/06			13.0460-5819.2 605819	TRW 23816 16,0 + WK
1.6 (ZNR10_)	81	04/04→03/09	←	05/04→			13.0460-5813.2 605813	BOS 23480 19,3 + WK
1.8	92	03/04→03/09	→	05/04→			13.0460-5814.2 605814	BOS 23620 16,4 + WK
1.8 (ZNR11_)	95	04/04→03/09						
2.0 D-4D (CUR10_)	85	04/04→03/09						
2.2 D-4D (AUR10_)	100	10/05→03/09	←				13.0460-5813.2 605813	BOS 23480 19,3 + WK
2.2 D-4D (AUR10_)	130	10/05→03/09	→				13.0460-5814.2 605814	BOS 23620 16,4 + WK
Zubehörsatz, Scheibenbremsbelag								
1.4 D-4D	66	03/04→03/09	←	06/04→ 10/06			13.0460-0138.2 610138	TRW
1.6 (ZNR10_)	81	04/04→03/09	←	05/04→			13.0460-0454.2 610454	BOS
1.8	92	03/04→03/09	→	05/04→			13.0460-0256.2 610256	BOS
1.8 (ZNR11_)	95	04/04→03/09						
2.0 D-4D (CUR10_)	85	04/04→03/09						
2.2 D-4D (AUR10_)	100	10/05→03/09	←				13.0460-0454.2 610454	BOS
2.2 D-4D (AUR10_)	130	10/05→03/09	→				13.0460-0256.2 610256	BOS
 Bremsscheibe								
1.4 D-4D	66	03/04→03/09	←	06/04→ 10/06			24.0125-0157.1 425157	Ø 275 25 23 V
			→	06/04→ 10/06			24.0109-0140.1 409140	Ø 279 9 8
1.6 (ZNR10_)	81	04/04→03/09	←	05/04→			24.0126-0138.1 426138	Ø 295 26 24 V
1.8	92	03/04→03/09	→	05/04→			24.0110-0320.1 410320	Ø 290 10 8,5
1.8 (ZNR11_)	95	04/04→03/09						
2.0 D-4D (CUR10_)	85	04/04→03/09						
2.2 D-4D (AUR10_)	100	10/05→03/09	←				24.0126-0138.1 426138	Ø 295 26 24 V
2.2 D-4D (AUR10_)	130	10/05→03/09	→				24.0110-0320.1 410320	Ø 290 10 8,5
TOYOTA - COROLLA Wagon (_E10_) 05/92→04/97								
 Bremsbelagsatz, Scheibenbremse								
1.3 12V (EE100_)	53	07/92→05/95	←				13.0460-5976.2 605976	AKE 20870 15,0 - WE / - WK
1.3 XLI (EE101_)	55	09/95→04/97	←				13.0460-5951.2 605951	SUM 21601 17,5 + WK
1.3 XLI 16V (EE101_)	65	07/92→09/95					13.0460-5976.2 605976	AKE 20870 15,0 - WE / - WK
1.6 Si (AE101_)	84	07/92→04/97						
2.0 D (CE100_)	53	07/92→04/97						
1.8	81	09/92→04/97	←	→ 05/95			13.0460-5951.2 605951	SUM 21601 17,5 + WK
							13.0460-5976.2 605976	AKE 20870 15,0 - WE / - WK
1.8 16V 4WD (AE103_)	81	09/95→04/97	←				13.0460-5951.2 605951	SUM 21601 17,5 + WK
1.8 4WD	92	08/95→04/97						















	kw					! #		
TOYOTA - COROLLA Wagon (_E10_) 05/92→04/97								
Zubehörsatz, Scheibenbremsbelag								
1.3 12V (EE100_)	53	07/92→05/95	←				13.0460-0325.2 610325	AKE
1.3 XLI (EE101_)	55	09/95→04/97	←				13.0460-0325.2 610325	AKE
1.3 XLI 16V (EE101_)	65	07/92→09/95					13.0460-0441.2 610441	SUM
1.6 Si (AE101_)	84	07/92→04/97						
2.0 D (CE100_)	53	07/92→04/97						
1.8	81	09/92→04/97	←	→ 05/95			13.0460-0325.2 610325	AKE
							13.0460-0441.2 610441	SUM
1.8 16V 4WD (AE103_)	81	09/95→04/97	←				13.0460-0441.2 610441	SUM
1.8 4WD	92	08/95→04/97						
 Bremsscheibe								
1.3 12V (EE100_)	53	07/92→05/95	←				24.0118-0110.1 418110	Ø 238 18 17 V
1.3 XLI (EE101_)	55	09/95→04/97	←				24.0122-0158.1 422158	Ø 255 22 20 V
1.3 XLI 16V (EE101_)	65	07/92→09/95						
1.6 Si (AE101_)	84	07/92→04/97						
2.0 D (CE100_)	53	07/92→04/97						
1.8	81	09/92→04/97	←	→ 05/95			24.0122-0158.1 422158	Ø 255 22 20 V
			→	→ 05/95			24.0109-0159.1 409159	Ø 266 9 8
1.8 16V 4WD (AE103_)	81	09/95→04/97	←				24.0122-0158.1 422158	Ø 255 22 20 V
1.8 4WD	92	08/95→04/97						
TOYOTA - COROLLA Wagon (_E11_) 04/97→10/01								
 Bremsbelagsatz, Scheibenbremse								
1.4 (EE111_)	63	04/97→02/00	←	05/97→01/00; für Fahrzeuge ohne Schlechtwegeausführung; Made in Japan			13.0460-5951.2 605951	SUM 21601 17,5 + WK
			←	05/97→01/00; für Fahrzeuge mit Schlechtwegeausführung; Made in Japan			13.0460-5976.2 605976	AKE 20870 15,0 - WE / - WK
			→	05/97→09/99			13.0460-5835.2 605835	AKE 20076 15,5 + WK
1.4 16V (ZZE111_)	71	02/00→10/01	←	für Fahrzeuge ohne Schlechtwegeausführung; Made in Japan			13.0460-5951.2 605951	SUM 21601 17,5 + WK
1.6 16V (ZZE112_)	81	02/00→10/01	←	für Fahrzeuge mit Schlechtwegeausführung; Made in Japan			13.0460-5976.2 605976	AKE 20870 15,0 - WE / - WK
			→	Made in Japan			13.0460-5835.2 605835	AKE 20076 15,5 + WK
			→	Made in Großbritannien			13.0460-5869.2 605869	TRW 24013 14,9 + WK
1.6 (AE111_)	81	04/97→02/00	←	05/97→01/00; für Fahrzeuge ohne Schlechtwegeausführung; Made in Japan			13.0460-5951.2 605951	SUM 21601 17,5 + WK
1.6 Aut. (AE111_)	79	04/97→02/00	←	05/97→01/00; für Fahrzeuge mit Schlechtwegeausführung; Made in Japan			13.0460-5976.2 605976	AKE 20870 15,0 - WE / - WK
			→	08/98→09/99			13.0460-5835.2 605835	AKE 20076 15,5 + WK
1.8	81	10/97→10/01	←	Made in Japan			13.0460-5951.2 605951	SUM 21601 17,5 + WK
1.8 4WD (AE115_)	81	04/97→10/01	←	05/97→; Made in Japan			13.0460-5951.2 605951	SUM 21601 17,5 + WK
1.9 D (WZE110_)	51	02/00→10/01	←	Made in Japan			13.0460-5951.2 605951	SUM 21601 17,5 + WK
			→	Made in Japan			13.0460-5835.2 605835	AKE 20076 15,5 + WK
			→	Made in Großbritannien			13.0460-5869.2 605869	TRW 24013 14,9 + WK
2.0 D (CE110_)	53	04/97→02/00	←	05/97→01/00; Made in Japan			13.0460-5951.2 605951	SUM 21601 17,5 + WK
			→	08/98→09/99			13.0460-5835.2 605835	AKE 20076 15,5 + WK
2.0 D-4D (CDE110_)	66	09/00→10/01	←	Made in Japan			13.0460-5951.2 605951	SUM 21601 17,5 + WK
			→				13.0460-5835.2 605835	AKE 20076 15,5 + WK
Zubehörsatz, Scheibenbremsbelag								
1.4 (EE111_)	63	04/97→02/00	←	05/97→01/00; für Fahrzeuge ohne Schlechtwegeausführung			13.0460-0074.2 610074	
1.6 (AE111_)	81	04/97→02/00						
1.6 Aut. (AE111_)	79	04/97→02/00						
1.4 16V (ZZE111_)	71	02/00→10/01	←	für Fahrzeuge ohne Schlechtwegeausführung			13.0460-0074.2 610074	
1.6 16V (ZZE112_)	81	02/00→10/01						
1.8	81	10/97→10/01	←				13.0460-0074.2 610074	
1.8 4WD (AE115_)	81	04/97→10/01	←	05/97→			13.0460-0074.2 610074	
1.9 D (WZE110_)	51	02/00→10/01	←				13.0460-0074.2 610074	
2.0 D-4D (CDE110_)	66	09/00→10/01						
2.0 D (CE110_)	53	04/97→02/00	←	05/97→01/00			13.0460-0074.2 610074	
↓								















	kw					! #		
TOYOTA - COROLLA Wagon (_E11_) 04/97→10/01								
 Bremsscheibe								
1.4 (EE111_)	63	04/97→02/00	←	05/97→ 01/00; für Fahrzeuge ohne Schlechtwegeausführung			24.0122-0158.1 422158	Ø 255 22 20 V
			→	05/97→ 01/00			24.0109-0159.1 409159	Ø 266 9 8
1.4 16V (ZZE111_)	71	02/00→10/01	←	für Fahrzeuge ohne Schlechtwegeausführung			24.0122-0158.1 422158	Ø 255 22 20 V
1.6 16V (ZZE112_)	81	02/00→10/01	→	Made in Japan			24.0109-0159.1 409159	Ø 266 9 8
1.6 (AE111_)	81	04/97→02/00	←	05/97→ 01/00; für Fahrzeuge ohne Schlechtwegeausführung			24.0122-0158.1 422158	Ø 255 22 20 V
1.6 Aut. (AE111_)	79	04/97→02/00	→	08/98→ 01/00			24.0109-0159.1 409159	Ø 266 9 8
1.8	81	10/97→10/01	←				24.0122-0158.1 422158	Ø 255 22 20 V
1.8 4WD (AE115_)	81	04/97→10/01	←	05/97→			24.0122-0158.1 422158	Ø 255 22 20 V
1.9 D (WZE110_)	51	02/00→10/01	←				24.0122-0158.1 422158	Ø 255 22 20 V
			→	Made in Japan			24.0109-0159.1 409159	Ø 266 9 8
2.0 D (CE110_)	53	04/97→02/00	←	05/97→ 01/00			24.0122-0158.1 422158	Ø 255 22 20 V
			→	08/98→ 01/00			24.0109-0159.1 409159	Ø 266 9 8
2.0 D-4D (CDE110_)	66	09/00→10/01	←				24.0122-0158.1 422158	Ø 255 22 20 V
			→				24.0109-0159.1 409159	Ø 266 9 8
TOYOTA - FJ CRUISER (GSJ1_) 01/06→								
 Bremsbelagsatz, Scheibenbremse								
4.0 (GSJ10_)	178	01/06→10/10	←				13.0460-5747.2 605747	24024 17,0 + WK
4.0 4WD (GSJ15_)	178	01/06→10/10	→				13.0460-5744.2 605744	21947 15,4 - WE / - WK
4.0 4WD (GSJ15_)	193	11/10→	←	12/10→ 06/14			13.0460-5747.2 605747	24024 17,0 + WK
			→	12/10→ 06/14			13.0460-5744.2 605744	21947 15,4 - WE / - WK
4.0 4WD (GSJ15_)	200	12/10→	←	→ 06/14			13.0460-5747.2 605747	24024 17,0 + WK
4.0 4WD (GSJ15_)	203	01/11→	→	→ 06/14			13.0460-5744.2 605744	21947 15,4 - WE / - WK
TOYOTA - HARRIER (_U3_) 02/03→12/13								
 Bremsbelagsatz, Scheibenbremse								
2.4 (ACU30_)	118	02/03→06/12	←	10/03→			13.0460-5750.2 605750	23734 16,8 - WK
			→	10/03→			13.0460-5734.2 605734	SUM 23967 15,1
2.4 4WD (ACU35_)	118	10/03→06/12	←				13.0460-5750.2 605750	23734 16,8 - WK
3.3 Hybrid 4WD (MHU38_)	155	04/05→05/12	→				13.0460-5734.2 605734	SUM 23967 15,1
3.5 (GSU30_, GSU31_)	206	04/05→12/08						
3.5 4WD (GSU35_, GSU36_)	206	04/05→12/08						
 Bremsscheibe								
2.4 (ACU30_)	118	02/03→06/12	←	10/03→			24.0128-0753.1 428753	Ø 319 28 26 V
			→	10/03→			24.0110-0316.1 410316	Ø 288 10 8,5
2.4 4WD (ACU35_)	118	10/03→06/12	←				24.0128-0753.1 428753	Ø 319 28 26 V
3.3 Hybrid 4WD (MHU38_)	155	04/05→05/12	→				24.0110-0316.1 410316	Ø 288 10 8,5
3.5 (GSU30_, GSU31_)	206	04/05→12/08						
3.5 4WD (GSU35_, GSU36_)	206	04/05→12/08						
TOYOTA - HIACE / COMMUTER V (TRH2_, KDH2_) 08/04→								
 Bremsbelagsatz, Scheibenbremse								
2.5 D-4D	75	09/06→	←				13.0460-5722.2 605722	21468 15,5 - WK
2.5 D-4D (KDH222)	80	09/06→06/14						
2.5 D-4D 4WD	94	01/05→	←	09/06→			13.0460-5722.2 605722	21468 15,5 - WK
 Bremsscheibe								
2.5 D-4D	75	09/06→	←				24.0128-0189.1 428189	Ø 285 28 26 V
2.5 D-4D (KDH222)	80	09/06→06/14						
TOYOTA - HIACE III Kasten (YH7_, LH6_, LH7_, LH5_, YH5_, YH6_) 08/87→08/04								
 Bremsbelagsatz, Scheibenbremse								
2.0 (RCH102_, RCH112_)	74	02/90→08/95	←				13.0460-5892.2 605892	21689 15,5 - WE / - WK
↓								











	kw			 	! #		
TOYOTA - HIACE III Kasten (YH7_, LH6_, LH7_, LH5_, YH5_, YH6_) 08/87→08/04							
 Bremsbelagsatz, Scheibenbremse							
2.4	88	08/89→08/95	←			13.0460-5892.2 605892	21689 15,5 - WE / - WK
2.4 D	53	01/92→08/95					
2.4 D	57	09/89→08/95					
2.4 D (LH10_, LH11_)	55	08/89→08/95					
2.2	69	08/95→12/03	←	→ 04/98; - ABS		13.0460-5722.2 605722	21468 15,5 - WK
2.4 4WD (RCH103_, RCH113_)	88	08/89→08/95	←			13.0460-5722.2 605722	21468 15,5 - WK
2.5 D-4D 4WD	65	08/01→08/04	←	+ ABS		13.0460-5722.2 605722	21468 15,5 - WK
			←	- ABS		13.0460-5722.2 605722	21468 15,5 - WK
3.0 D	65	08/98→08/04	←	08/01→ 10/03; - ABS		13.0460-5722.2 605722	21468 15,5 - WK
			←	08/01→ 10/03; + ABS		13.0460-5722.2 605722	21468 15,5 - WK
 Bremsscheibe							
2.2	69	08/95→12/03	←	→ 04/98		24.0128-0189.1 428189	Ø 285 28 26 V
3.0 D	65	08/98→08/04	←	08/01→ 10/03		24.0128-0189.1 428189	Ø 285 28 26 V
TOYOTA - HIACE III Wagon (_H1_) 08/87→12/04							
 Bremsbelagsatz, Scheibenbremse							
2.0 (RZH102)	74	08/89→04/98	←	08/95→; - ABS		13.0460-5722.2 605722	21468 15,5 - WK
			←	02/90→ 08/95		13.0460-5892.2 605892	21689 15,5 - WE / - WK
2.4 (RZH103)	88	08/89→08/95	←			13.0460-5892.2 605892	21689 15,5 - WE / - WK
2.4 D (LH102)	55	08/89→08/95					
2.4 4WD (RZH103_, RZH109_, RZH113_, RZH115_)	88	08/89→07/95	←			13.0460-5722.2 605722	21468 15,5 - WK
2.4 D (LH5_, LH6_, LH7_, LH10_, LH11_)	57	08/87→12/04	←	08/89→ 08/95		13.0460-5892.2 605892	21689 15,5 - WE / - WK
2.5 D-4D 4WD	75	08/01→08/04	←	+ ABS		13.0460-5722.2 605722	21468 15,5 - WK
			←	- ABS		13.0460-5722.2 605722	21468 15,5 - WK
 Bremsscheibe							
2.0 (RZH102)	74	08/89→04/98	←	08/95→		24.0128-0189.1 428189	Ø 285 28 26 V
TOYOTA - HIACE IV Bus (_H1_, _H2_) 08/95→							
 Bremsbelagsatz, Scheibenbremse							
2.4 (RCH12_, RCH22_)	85	08/95→04/98	←	- ABS		13.0460-5722.2 605722	21468 15,5 - WK
2.4 4WD (RCH18_)	85	08/95→04/98					
2.4 D	61	08/95→08/06	←	→ 08/01; - ABS		13.0460-5722.2 605722	21468 15,5 - WK
2.4 D (LH10_, LH11_, LXH12_, LXH22_)	58	08/95→08/06	←	07/99→ 08/01; + ABS		13.0460-5722.2 605722	21468 15,5 - WK
2.4 TD (LXH12_, LXH22_)	66	08/95→08/06					
2.4 D (LH10_, LH11_, LXH12_)	55	07/99→08/06	←	→ 08/01; - ABS		13.0460-5722.2 605722	21468 15,5 - WK
			←	→ 08/01; + ABS		13.0460-5722.2 605722	21468 15,5 - WK
2.4 TD 4WD (H18/28)	66	08/95→08/06	←	→ 08/01; - ABS		13.0460-5722.2 605722	21468 15,5 - WK
2.5 D-4D (KLH12_, KLH18_, KLH22_)	86	08/06→	←	09/06→		13.0460-5722.2 605722	21468 15,5 - WK
2.5 D-4D (KLH12_, KLH22_)	70	08/01→					
2.5 D-4D 4WD (KLH12_, KLH18_, KLH22_, KDH20_, KDH21_,...)	86	01/05→					
2.5 D-4D (KLH12_, KLH22_)	75	11/01→08/06	←	+ ABS		13.0460-5722.2 605722	21468 15,5 - WK
			←	- ABS		13.0460-5722.2 605722	21468 15,5 - WK
2.5 D-4D (KLH12_)	65	11/01→08/06					
2.5 D-4D 4WD (KLH12_, KLH22_)	75	08/01→07/06	←	11/01→; - ABS		13.0460-5722.2 605722	21468 15,5 - WK
			←	11/01→; + ABS		13.0460-5722.2 605722	21468 15,5 - WK
2.7 (RCH13_, RCH23_)	105	04/98→11/01	←	07/99→; + ABS		13.0460-5722.2 605722	21468 15,5 - WK
			←	- ABS		13.0460-5722.2 605722	21468 15,5 - WK
2.7 (RCH13_, RCH23_)	106	11/01→12/06	←	→ 06/06; - ABS		13.0460-5722.2 605722	21468 15,5 - WK
			←	→ 06/06; + ABS		13.0460-5722.2 605722	21468 15,5 - WK
2.7 4WD (RCH13_, RCH19_, RCH23_)	106	07/99→	←	→ 06/06; - ABS		13.0460-5722.2 605722	21468 15,5 - WK
2.7 4WD (RCH19_) ↓	105	04/98→08/06					















	kw					! #		
TOYOTA - HIACE IV Bus (_H1_, _H2_) 08/95→								
 Bremsscheibe								
2.4 (RCH12_, RCH22_) 2.5 D-4D (KLH12_, KLH22_) 2.5 D-4D (KLH12_) 2.7 (RCH13_, RCH23_)	85 75 65 105	08/95→04/98 11/01→08/06 11/01→08/06 04/98→11/01	←				24.0128-0189.1 428189	Ø 285 28 26 V
2.4 D 2.4 D (LH10_, LH11_, LXH12_, LXH22_) 2.4 D (LH10_, LH11_, LXH12_) 2.4 TD (LXH12_, LXH22_)	61 58 55 66	08/95→08/06 08/95→08/06 07/99→08/06 08/95→08/06	←	→ 08/01			24.0128-0189.1 428189	Ø 285 28 26 V
2.5 D-4D (KLH12_, KLH18_, KLH22_) 2.5 D-4D (KLH12_, KLH22_)	86 70	08/06→ 08/01→	←	09/06→			24.0128-0189.1 428189	Ø 285 28 26 V
2.5 D-4D 4WD (KLH12_, KLH22_) 2.7 (RCH13_, RCH23_)	75 106	08/01→07/06 11/01→12/06	←	11/01→ → 06/06			24.0128-0189.1 428189	Ø 285 28 26 V
TOYOTA - HIACE IV Kasten (LXH1_, RZH1_, LH1_) 08/95→								
 Bremsbelagsatz, Scheibenbremse								
2.4 (RCH12_, RCH22_) 2.4 i (RZH10)	85 88	08/95→02/05 08/95→02/05	←	→ 04/98; - ABS			13.0460-5722.2 605722	21468 15,5 - WK
2.4 4WD (RCH18_, RCH28_) 2.4 D (LXH12_, LXH22_) 2.4 D (LXH12_, LXH22_)	85 55 61	08/95→04/98 09/95→08/01 08/95→07/01	←	- ABS 07/99→; + ABS - ABS			13.0460-5722.2 605722	21468 15,5 - WK
2.4 D (LXH12_, LXH22_) 2.4 TD (LXH12_, LXH22_) 2.4 TD 4WD (LXH18_, LXH28_)	58 66 66	08/95→08/06 08/95→08/06 08/95→08/06	←	→ 08/01; - ABS 07/99→ 08/01; + ABS → 08/01; - ABS			13.0460-5722.2 605722	21468 15,5 - WK
2.5 D-4D (KLH12_, KLH22_) 2.5 D-4D (KLH12_, KLH22_) 2.5 D-4D 4WD (KLH12_, KLH22_)	65 75 75	11/01→08/06 11/01→08/06 11/01→08/06	←	+ ABS - ABS			13.0460-5722.2 605722	21468 15,5 - WK
2.5 D-4D (KLH12_, KLH22_) 2.5 D-4D (KLH12_, KLH22_) 2.5 D-4D 4WD (KLH22_, KLH28_)	70 86 86	09/06→ 09/06→ 09/06→	←				13.0460-5722.2 605722	21468 15,5 - WK
2.7 (RCH13_, RCH23_) 2.7 4WD (RCH19_, RCH29_)	105 106	04/98→08/06 04/98→	←	07/99→ 06/06; + ABS → 06/06; - ABS → 06/06; - ABS			13.0460-5722.2 605722	21468 15,5 - WK
 Bremsscheibe								
2.4 (RCH12_, RCH22_) 2.4 i (RZH10)	85 88	08/95→02/05 08/95→02/05	←	→ 04/98			24.0128-0189.1 428189	Ø 285 28 26 V
2.4 D (LXH12_, LXH22_) 2.4 D (LXH12_, LXH22_) 2.5 D-4D (KLH12_, KLH22_) 2.5 D-4D (KLH12_, KLH22_) 2.5 D-4D (KLH12_, KLH22_) 2.5 D-4D (KLH12_, KLH22_)	55 61 65 70 75 86	09/95→08/01 08/95→07/01 11/01→08/06 09/06→ 11/01→08/06 09/06→	←				24.0128-0189.1 428189	Ø 285 28 26 V
2.4 D (LXH12_, LXH22_) 2.4 TD (LXH12_, LXH22_) 2.7 (RCH13_, RCH23_)	58 66 105	08/95→08/06 08/95→08/06 04/98→08/06	←	→ 08/01 → 06/06			24.0128-0189.1 428189	Ø 285 28 26 V
TOYOTA - HIACE V Kasten (TRH2_, KDH2_) 08/04→								
 Bremsbelagsatz, Scheibenbremse								
2.5 D-4D 2.5 D-4D 2.5 D-4D 2.5 D-4D (KDH200, KDH220) ↓	70 75 86 80	09/06→ 09/06→ 09/06→ 09/06→	←				13.0460-5722.2 605722	21468 15,5 - WK















	kw					! #		
TOYOTA - HIACE V Kasten (TRH2_, KDH2_) 08/04→								
 Bremsscheibe								
2.5 D-4D	70	09/06→	←			24.0128-0189.1	428189	Ø 285 28 26 V
2.5 D-4D	75	09/06→						
2.5 D-4D	86	09/06→						
2.5 D-4D (KDH200, KDH220)	80	09/06→						
TOYOTA - HILUX VII Pick-up (_N1_, _N2_, _N3_) 08/04→								
 Bremsbelagsatz, Scheibenbremse								
2.5 D-4D (KUN15_, KDN1_)	65	10/05→11/08	←	→ 10/06; kurzer Radstand		13.0460-5616.2	605616	24567 16,0 - WE / - WK
2.5 D-4D (KUN15_, KUN25_, KUN35_)	75	10/05→	←	06/06→; kurzer Radstand		13.0460-5616.2	605616	24567 16,0 - WE / - WK
2.5 D-4D (KUN15_)	88	12/07→	←	kurzer Radstand		13.0460-5616.2	605616	24567 16,0 - WE / - WK
2.5 D-4D 4WD (KDN165_, KDN170_, KDN190_)	94	11/04→12/05	←			13.0460-5616.2	605616	24567 16,0 - WE / - WK
3.0 D-4D 4WD	145	05/08→12/08	←	Brems-/Fahr dyn. Artikelbezug: für ESP		13.0460-5747.2	605747	24024 17,0 + WK
 Bremsscheibe								
2.5 D-4D	106	01/10→	←	→ 05/15; Brems-/Fahr dyn. Artikelbezug: für ESP		24.0125-0192.1	425192	Ø 297 24,9 23,5 V
			←	→ 05/15; kurzer Radstand; Baumuster: KUN15		24.0128-0249.1	428249	Ø 258 28 26 V
2.5 D-4D (KUN15_, KDN1_)	65	10/05→11/08	←	→ 10/06		24.0128-0249.1	428249	Ø 258 28 26 V
2.5 D-4D (KUN15_, KUN25_, KUN35_)	75	10/05→	←	06/06→ 10/08		24.0128-0249.1	428249	Ø 258 28 26 V
2.5 D-4D (KUN15_)	88	12/07→	←	→ 10/08		24.0128-0249.1	428249	Ø 258 28 26 V
2.5 D-4D 4WD (KUN25_)	106	09/09→	←			24.0125-0192.1	425192	Ø 297 24,9 23,5 V
2.5 D-4D 4WD (KUN25_)	88	12/07→						
2.5 D 4WD (KUN25_)	75	10/05→						
3.0 D-4D 4WD (KUN36_)	126	12/07→						
2.5 D-4D 4WD (KDN165_, KDN170_, KDN190_)	94	11/04→12/05	←			24.0128-0249.1	428249	Ø 258 28 26 V
2.7 4WD	118	01/05→03/12	←	12/07→		24.0125-0192.1	425192	Ø 297 24,9 23,5 V
3.0 D (KUN16, KUN26)	126	10/06→						
3.0 D 4WD (KUN26_)	120	08/05→						
4.0	175	08/05→						
3.0 D-4D 4WD	145	05/08→12/08	←	→ 10/08		24.0125-0192.1	425192	Ø 297 24,9 23,5 V
TOYOTA - HILUX Geländewagen geschlossen (_N1_) 08/95→08/05								
 Bremsbelagsatz, Scheibenbremse								
2.4 TD 4WD	66	08/97→07/01	←			13.0460-5992.2	605992	21679 15,0 + WK
 Bremsscheibe								
2.4 TD 4WD	66	08/97→07/01	←			24.0120-0168.1	420168	Ø 289 20 18 V
TOYOTA - HILUX Geländewagen geschlossen (LN_, KZN1_, VZN1_) 08/88→08/97								
 Bremsbelagsatz, Scheibenbremse								
2.4 TD 4WD	92	08/88→08/97	←	→ 07/97		13.0460-5992.2	605992	21679 15,0 + WK
 Bremsscheibe								
2.4 TD 4WD	92	08/88→08/97	←	→ 07/97		24.0120-0168.1	420168	Ø 289 20 18 V
TOYOTA - HILUX Pick-up 08/83→02/06								
 Bremsbelagsatz, Scheibenbremse								
1.8 (YN5_, YN8_, YN85)	61	09/88→06/98	←	→ 07/97		13.0460-5938.2	605938	AKE 21158 15,5 - WE / - WK
2.4 D	58	03/95→08/97						
2.4 D (LN85_)	61	09/88→08/97						
2.4 D 4WD (LN110_)	58	01/94→12/97						
2.4 4WD	75	10/88→08/97	←	→ 07/97		13.0460-5992.2	605992	21679 15,0 + WK
2.4 D 4WD	92	08/88→08/97						
2.4 D 4WD (LN1_)	61	09/88→08/97						
2.4 i 4WD	84	08/91→08/97						
2.4 D (LN150, LN145)	55	08/97→02/06	←	→ 01/02		13.0460-5892.2	605892	21689 15,5 - WE / - WK
2.4 D 4WD (LN11_)	73	08/91→07/97	←			13.0460-5992.2	605992	21679 15,0 + WK
2.4 i 4WD	84	08/89→07/97						
↓								

















	kw					! #		
TOYOTA - HILUX Pick-up 08/83→02/06								
 Bremsbelagsatz, Scheibenbremse								
2.4 TD 4WD (LN165_, LN170_, LN190_) 2.5 D-4D 4WD (KDN165_, KDN170_, KDN190_) 3.0 TD 4WD (KZN165)	66 75 87	08/98→01/02 11/01→07/05 11/01→04/05	←				13.0460-5992.2 605992	21679 15,0 + WK
2.4 i 4WD (RZN14_, RZN16_, RZN19_) 2.7 4WD	103 108	08/97→10/05 11/97→04/05	←	→ 07/01			13.0460-5992.2 605992	21679 15,0 + WK
2.4 TD (LN190)	66	08/98→01/02	←	→ 08/01			13.0460-5892.2 605892	21689 15,5 - WE / - WK
2.5 D-4D (KDN14_, KDN15_, KDN16_, KDN19_)	65	11/01→07/05	←				13.0460-5892.2 605892	21689 15,5 - WE / - WK
3.0 D 3.0 D (LN14_)	65 71	11/97→04/05 12/00→04/05	←	11/01→			13.0460-5892.2 605892	21689 15,5 - WE / - WK
3.0 D 4WD (LN152_)	65	11/97→04/05	←	11/01→			13.0460-5992.2 605992	21679 15,0 + WK
 Bremsscheibe								
1.8 (YN5_, YN8_, YN85) 2.4 D 2.4 D (LN85_) 2.4 D 4WD (LN110_)	61 58 61 58	09/88→06/98 03/95→08/97 09/88→08/97 01/94→12/97	←	→ 07/97			24.0125-0118.1 425118	Ø 257 25 23 V
2.4 4WD 2.4 D 4WD 2.4 D 4WD (LN1_) 2.4 i 4WD	75 92 61 84	10/88→08/97 08/88→08/97 09/88→08/97 08/91→08/97	←	→ 07/97			24.0120-0168.1 420168	Ø 289 20 18 V
2.4 D (LN150, LN145)	55	08/97→02/06	←	→ 01/02			24.0125-0118.1 425118	Ø 257 25 23 V
2.4 D 4WD (LN11_) 2.4 i 4WD 2.4 TD 4WD (LN165_, LN170_, LN190_) 2.5 D-4D 4WD (KDN165_, KDN170_, KDN190_) 3.0 TD 4WD (KZN165)	73 84 66 75 87	08/91→07/97 08/89→07/97 08/98→01/02 11/01→07/05 11/01→04/05	←				24.0120-0168.1 420168	Ø 289 20 18 V
2.4 i 4WD (RZN14_, RZN16_, RZN19_) 2.7 4WD	103 108	08/97→10/05 11/97→04/05	←	→ 07/01			24.0120-0168.1 420168	Ø 289 20 18 V
2.4 TD (LN190)	66	08/98→01/02	←	→ 08/01			24.0125-0118.1 425118	Ø 257 25 23 V
2.5 D-4D (KDN14_, KDN15_, KDN16_, KDN19_)	65	11/01→07/05	←				24.0125-0118.1 425118	Ø 257 25 23 V
3.0 D 3.0 D (LN14_)	65 71	11/97→04/05 12/00→04/05	←	11/01→			24.0125-0118.1 425118	Ø 257 25 23 V
3.0 D 4WD (LN152_)	65	11/97→04/05	←	11/01→			24.0120-0168.1 420168	Ø 289 20 18 V
TOYOTA - HILUX Pritsche/Fahrgestell (_N1_, _N2_) 02/05→								
 Bremsscheibe								
3.0 D 4WD	126	02/05→	←	12/07→			24.0125-0192.1 425192	Ø 297 24,9 23,5 V
TOYOTA - HILUX Pritsche/Fahrgestell (LN_, _N1_) 08/83→08/05								
 Bremsbelagsatz, Scheibenbremse								
2.4 4WD	75	10/88→12/97	←	→ 07/97			13.0460-5992.2 605992	21679 15,0 + WK
 Bremsscheibe								
2.4 4WD	75	10/88→12/97	←	→ 07/97			24.0120-0168.1 420168	Ø 289 20 18 V
TOYOTA - IQ (_J1_) 11/08→								
 Bremsbelagsatz, Scheibenbremse								
1.0 (KGJ10_) 1.33 (NGJ10_) 1.33 (NGJ10_) 1.4 D-4D (NUJ10_)	50 69 72 66	01/09→ 01/09→ 01/09→ 01/09→	← → → →	+ ABS			13.0460-5810.2 605810 13.0460-5769.2 605769	AKE 23510 16,5 + WK 24610 15,0 + WK
 Bremsscheibe								
1.0 (KGJ10_) 1.33 (NGJ10_) 1.33 (NGJ10_) 1.4 D-4D (NUJ10_)	50 69 72 66	01/09→ 01/09→ 01/09→ 01/09→	← → → →	+ ABS			24.0120-0219.1 420219 24.0109-0156.1 409156	Ø 255 20 18 V Ø 259 9 7,5

















	kw			 	! #		
TOYOTA - LAND CRUISER (_J7_) 03/84→							
 Bremsbelagsatz, Scheibenbremse							
2.4 (RJ70_V, RJ73_V)	84	12/88→12/96	←	01/90→; für Fahrzeuge mit Scheibenbremse an der Hinterachse		13.0460-5992.2 605992	21679 15,0 + WK
			→	01/90→		13.0460-5744.2 605744	21947 15,4 - WE / - WK
3.0 TD (KZJ70_, KZJ73_, KZJ77_)	92	05/93→05/96	←			13.0460-5992.2 605992	21679 15,0 + WK
3.4 D (BJ70_V, BJ73_)	70	11/84→12/96	←	→ 12/89		13.0460-5935.2 605935	SUM 20852 15,5 - WE / - WK
			←	01/90→		13.0460-5992.2 605992	21679 15,0 + WK
4.2 D (HZJ7_)	96	01/90→12/99	←	→ 12/96		13.0460-5992.2 605992	21679 15,0 + WK
4.2 D 4x4 (HZJ74, HZJ78, HZJ75)	123	08/90→08/01	→	→ 12/96		13.0460-5744.2 605744	21947 15,4 - WE / - WK
4.2 TD 24V 4x4 (HDJ78)	122	11/01→02/07	←			13.0460-5746.2 605746	23524 17,4 + WK
			→			13.0460-5749.2 605749	23539 17,3 - WE / - WK
4.2 TDi 4x4	150	09/01→06/06	←	11/01→		13.0460-5746.2 605746	23524 17,4 + WK
			→			13.0460-5749.2 605749	23539 17,3 - WE / - WK
4.5 EFi 4x4 (FZJ75)	158	11/92→11/99	←	→ 12/97		13.0460-5745.2 605745	21775 15,0 + WK
			→	→ 12/97		13.0460-5744.2 605744	21947 15,4 - WE / - WK
4.5 TD 24V 4x4 (VDJ76, VDJ78, VDJ79_)	151	03/07→	←	08/07→		13.0460-5618.2 605618	24386 17,9 + WK
			→	08/07→		13.0460-5619.2 605619	24653 17,3 - WE / - WK
Zubehörsatz, Scheibenbremsbelag							
3.4 D (BJ70_V, BJ73_)	70	11/84→12/96	←	→ 12/89		13.0460-0327.2 610327	SUM
 Bremsscheibe							
2.4 (RJ70_V, RJ73_V)	84	12/88→12/96	←	01/90→; für Fahrzeuge mit Trommelbremse an der Hinterachse		24.0113-0105.1 413105	Ø 302 12,5 11,5
			←	01/90→; für Fahrzeuge mit Scheibenbremse an der Hinterachse		24.0120-0153.1 420153	Ø 302 20 19 V
3.0 TD (KZJ70_, KZJ73_, KZJ77_)	92	05/93→05/96	←			24.0120-0153.1 420153	Ø 302 20 19 V
3.4 D (BJ70_V, BJ73_)	70	11/84→12/96	←	→ 12/89		24.0120-0153.1 420153	Ø 302 20 19 V
			←	01/90→		24.0120-0153.1 420153	Ø 302 20 19 V
4.2 D (HZJ7_)	96	01/90→12/99	←	→ 12/96		24.0120-0153.1 420153	Ø 302 20 19 V
4.2 D 4x4 (HZJ74, HZJ78, HZJ75)	123	08/90→08/01					
4.2 TD 24V 4x4 (HDJ78)	122	11/01→02/07	←			24.0132-0148.1 432148	Ø 313 32 30 V
4.2 TDi 4x4	150	09/01→06/06	→			24.0118-0143.1 418143	Ø 329,2 18 16 V
4.5 EFi 4x4 (FZJ75)	158	11/92→11/99	←	→ 12/97		24.0132-0111.1 432111	Ø 311 32 30 V
TOYOTA - LAND CRUISER (_J12_) 09/02→07/09							
 Bremsbelagsatz, Scheibenbremse							
2.7 (RZJ12)	112	09/02→08/04	←	01/03→		13.0460-5747.2 605747	24024 17,0 + WK
3.0 D	70	09/02→07/09	→	01/03→		13.0460-5744.2 605744	21947 15,4 - WE / - WK
3.0 D-4D (KZJ12)	92	09/02→07/09	→				
2.7 (TRJ12)	120	11/03→07/09	←			13.0460-5747.2 605747	24024 17,0 + WK
3.0 D-4D (KDJ120, KDJ150, KDJ125)	120	01/03→07/09	→			13.0460-5744.2 605744	21947 15,4 - WE / - WK
4.0	179	09/02→08/04					
4.0 (GRJ120)	203	08/05→07/09					
4.0 (GRJ125_, GRJ120_)	183	01/03→07/09					
4.0 V6 VVT-i	207	01/03→07/09					
3.0 D (KDJ120)	98	08/05→	←	01/05→ 10/06		13.0460-5747.2 605747	24024 17,0 + WK
3.0 D-4D (KDJ120, KDJ125)	122	08/04→07/09	→	01/05→ 10/06		13.0460-5744.2 605744	21947 15,4 - WE / - WK
3.0 D (KDJ125)	96	08/05→07/09	←	→ 10/06		13.0460-5747.2 605747	24024 17,0 + WK
			→	→ 10/06		13.0460-5744.2 605744	21947 15,4 - WE / - WK
3.0 D-4D (KDJ120, KDJ125)	127	09/02→07/09	←	11/06→		13.0460-5747.2 605747	24024 17,0 + WK
			→	11/06→		13.0460-5744.2 605744	21947 15,4 - WE / - WK
4.5 D	151	02/05→02/10	←	08/07→		13.0460-5618.2 605618	24386 17,9 + WK
↓			→	08/07→		13.0460-5619.2 605619	24653 17,3 - WE / - WK







































	kw			 	! #		
TOYOTA - LAND CRUISER (_J12_) 09/02→07/09							
 Bremsscheibe							
2.7 (RZJ12)	112	09/02→08/04	←	01/03→		24.0128-0194.1 428194	Ø 338 28 26 V
3.0 D	70	09/02→07/09	→	01/03→		24.0118-0709.1 418709	Ø 312 18 16 V
3.0 D-4D (KZJ12)	92	09/02→07/09					
2.7 (TRJ12)	120	11/03→07/09	←			24.0128-0194.1 428194	Ø 338 28 26 V
3.0 D-4D (KDJ120, KDJ150, KDJ125)	120	01/03→07/09	→			24.0118-0709.1 418709	Ø 312 18 16 V
4.0	179	09/02→08/04					
4.0 (GRJ120)	203	08/05→07/09					
4.0 (GRJ125_, GRJ120_)	183	01/03→07/09					
4.0 V6 VVT-i	207	01/03→07/09					
3.0 D (KDJ120)	98	08/05→	←	01/05→ 10/06		24.0128-0194.1 428194	Ø 338 28 26 V
3.0 D-4D (KDJ120, KDJ125)	122	08/04→07/09	→	01/05→ 10/06		24.0118-0709.1 418709	Ø 312 18 16 V
3.0 D (KDJ125)	96	08/05→07/09					
				→ 10/06		24.0128-0194.1 428194	Ø 338 28 26 V
				→ 10/06		24.0118-0709.1 418709	Ø 312 18 16 V
3.0 D-4D (KDJ120, KDJ125)	127	09/02→07/09	←	11/06→		24.0128-0194.1 428194	Ø 338 28 26 V
			→	11/06→		24.0118-0709.1 418709	Ø 312 18 16 V
TOYOTA - LAND CRUISER (_J15_) 07/09→							
 Bremsbelagsatz, Scheibenbremse							
2.7 (TRJ150_, TRJ155_)	120	08/09→	←	01/10→		13.0460-5747.2 605747	24024 17,0 + WK
3.0 D-4D (KDJ155_, KDJ150_)	140	08/09→	→	01/10→		13.0460-5744.2 605744	21947 15,4 - WE / - WK
3.0 TDi (KDJ150_)	120	01/10→					
4.0 V6 Dual VVTi (GRJ150_)	205	08/09→					
4.0 V6 VVT-i (GRJ150_)	207	08/09→					
4.0 V6 VVTi (GRJ150)	202	08/09→					
2.8 D-4D (GDJ150_, GDJ155_)	130	06/15→	←			13.0460-5747.2 605747	24024 17,0 + WK
4.0 V6 VVTi (GRJ150_)	183	01/10→	→			13.0460-5744.2 605744	21947 15,4 - WE / - WK
4.0 V6 VVTi (GRJ150_)	203	01/10→					
3.0 D-4D (KDJ150_)	127	08/09→	←	03/10→		13.0460-5747.2 605747	24024 17,0 + WK
			→	03/10→		13.0460-5744.2 605744	21947 15,4 - WE / - WK
 Bremsscheibe							
2.7 (TRJ150_, TRJ155_)	120	08/09→	←	01/10→		24.0132-0174.1 432174	Ø 338 32 29 V
3.0 D-4D (KDJ155_, KDJ150_)	140	08/09→					
3.0 TDi (KDJ150_)	120	01/10→					
4.0 V6 Dual VVTi (GRJ150_)	205	08/09→					
4.0 V6 VVT-i (GRJ150_)	207	08/09→					
4.0 V6 VVTi (GRJ150)	202	08/09→					
2.8 D-4D (GDJ150_, GDJ155_)	130	06/15→	←			24.0132-0174.1 432174	Ø 338 32 29 V
4.0 V6 VVTi (GRJ150_)	203	01/10→					
3.0 D-4D (KDJ150_)	127	08/09→	←	03/10→		24.0132-0174.1 432174	Ø 338 32 29 V
4.0 V6 VVTi (GRJ150_)	183	01/10→	←			24.0128-0194.1 428194	Ø 338 28 26 V
			→			24.0132-0174.1 432174	Ø 338 32 29 V
			→			24.0118-0709.1 418709	Ø 312 18 16 V
TOYOTA - LAND CRUISER 100 (_J1_) 01/98→08/07							
 Bremsbelagsatz, Scheibenbremse							
4.2 D (HZJ105)	96	03/98→08/07	←	11/01→		13.0460-5746.2 605746	23524 17,4 + WK
4.2 TD (HDJ100_)	150	01/98→08/07	→			13.0460-5749.2 605749	23539 17,3 - WE / - WK
4.7 (UZJ100_)	173	01/98→08/07					
				11/01→ 04/02		13.0460-5746.2 605746	23524 17,4 + WK
				→ 04/02		13.0460-5749.2 605749	23539 17,3 - WE / - WK
4.7 (UZJ100)	175	02/02→08/07	←	05/02→		13.0460-5746.2 605746	23524 17,4 + WK
			→	05/02→		13.0460-5749.2 605749	23539 17,3 - WE / - WK
 Bremsscheibe							
4.2 D (HZJ105)	96	03/98→08/07	←			24.0132-0148.1 432148	Ø 313 32 30 V
4.2 TD (HDJ100_)	150	01/98→08/07	→			24.0118-0143.1 418143	Ø 329,2 18 16 V
4.7 (UZJ100_)	173	01/98→08/07					
				→ 04/02		24.0132-0148.1 432148	Ø 313 32 30 V
				→ 04/02		24.0118-0143.1 418143	Ø 329,2 18 16 V
4.7 (UZJ100)	175	02/02→08/07	←	05/02→		24.0132-0148.1 432148	Ø 313 32 30 V











	kw					! #		
TOYOTA - LAND CRUISER 100 (_J1_) 01/98→08/07								
 Bremsscheibe								
4.7 (UZJ100)	175	02/02→08/07	➔	05/02→		24.0118-0143.1	418143	Ø 329,2 18 16 V
TOYOTA - LAND CRUISER 200 (_J2_) 08/07→								
 Bremsbelagsatz, Scheibenbremse								
4.0 (GRJ200_)	176	01/10→	←			13.0460-5747.2	605747	24024 17,0 + WK
			➔			13.0460-5744.2	605744	21947 15,4 - WE / - WK
4.5 D4-D	173	08/07→	←			13.0460-5618.2	605618	24386 17,9 + WK
4.5 D4-D	200	01/12→	←					
4.5 D-4D (VDJ200)	195	01/08→	➔			13.0460-5619.2	605619	24653 17,3 - WE / - WK
4.5 D V8 (VDJ200)	210	01/08→	➔					
4.6 V8	227	09/10→	➔					
4.6 V8 (_URJ202W_)	234	01/12→	➔					
4.7 V8 (UZJ200)	202	08/07→	➔					
4.7 V8 (UZJ200)	212	01/08→	➔					
 Bremsscheibe								
4.0 (GRJ200_)	176	01/10→	←			24.0132-0174.1	432174	Ø 338 32 29 V
TOYOTA - LAND CRUISER 80 (_J8_) 01/90→02/98								
 Bremsbelagsatz, Scheibenbremse								
4.2 D (HZJ80_)	99	01/90→12/97	←			13.0460-5745.2	605745	21775 15,0 + WK
4.2 TD (HDJ80)	118	10/92→12/97	←					
4.2 TD (HDJ80)	123	01/90→12/97	➔			13.0460-5744.2	605744	21947 15,4 - WE / - WK
4.2 TD 24V (HDJ80_)	125	03/95→12/97	➔					
4.5 24V (FZJ80_)	151	08/92→12/97	➔					
 Bremsscheibe								
4.5 24V (FZJ80_)	151	08/92→12/97	←			24.0132-0111.1	432111	Ø 311 32 30 V
TOYOTA - LAND CRUISER 90 (_J9_) 04/95→								
 Bremsbelagsatz, Scheibenbremse								
2.7	110	04/95→07/02	←	04/96→ 07/00		13.0460-5992.2	605992	21679 15,0 + WK
			➔	04/96→ 07/00		13.0460-5744.2	605744	21947 15,4 - WE / - WK
3.0 D-4D (KDJ90, KDJ95)	125	02/00→	←	08/00→ 08/02		13.0460-5992.2	605992	21679 15,0 + WK
			➔	08/00→ 08/02		13.0460-5744.2	605744	21947 15,4 - WE / - WK
3.0 D-4D 4WD (KDJ90_, KDJ95_)	120	08/00→08/02	←			13.0460-5992.2	605992	21679 15,0 + WK
			➔			13.0460-5744.2	605744	21947 15,4 - WE / - WK
3.0 TD	103	04/95→07/00	←	04/96→		13.0460-5992.2	605992	21679 15,0 + WK
			➔	04/96→		13.0460-5744.2	605744	21947 15,4 - WE / - WK
3.0 TD (KZJ90_, KZJ95_)	92	04/96→12/02	←	→ 07/00		13.0460-5992.2	605992	21679 15,0 + WK
			➔	→ 07/00		13.0460-5744.2	605744	21947 15,4 - WE / - WK
3.4 i 24V (VZJ90_, VZJ95_)	131	03/96→12/02	←	04/96→ 08/02		13.0460-5992.2	605992	21679 15,0 + WK
			➔	04/96→ 08/02		13.0460-5744.2	605744	21947 15,4 - WE / - WK
4.7	175	08/02→	←	→ 07/08		13.0460-5746.2	605746	23524 17,4 + WK
			➔	→ 07/08		13.0460-5749.2	605749	23539 17,3 - WE / - WK
 Bremsscheibe								
2.7	110	04/95→07/02	←	04/96→ 07/00		24.0122-0185.1	422185	Ø 319 22 20 V
			➔	04/96→ 07/00		24.0118-0709.1	418709	Ø 312 18 16 V
3.0 D-4D (KDJ90, KDJ95)	125	02/00→	←	08/00→ 08/02		24.0122-0185.1	422185	Ø 319 22 20 V
			➔	08/00→ 08/02		24.0118-0709.1	418709	Ø 312 18 16 V
3.0 D-4D 4WD (KDJ90_, KDJ95_)	120	08/00→08/02	←			24.0122-0185.1	422185	Ø 319 22 20 V
			➔			24.0118-0709.1	418709	Ø 312 18 16 V
3.0 TD	103	04/95→07/00	←	04/96→		24.0122-0185.1	422185	Ø 319 22 20 V
			➔	04/96→		24.0118-0709.1	418709	Ø 312 18 16 V
3.0 TD (KZJ90_, KZJ95_)	92	04/96→12/02	←	→ 07/00		24.0122-0185.1	422185	Ø 319 22 20 V
			➔	→ 07/00		24.0118-0709.1	418709	Ø 312 18 16 V
3.4 i 24V (VZJ90_, VZJ95_)	131	03/96→12/02	←	04/96→ 08/02		24.0122-0185.1	422185	Ø 319 22 20 V
			➔	04/96→ 08/02		24.0118-0709.1	418709	Ø 312 18 16 V
4.7	175	08/02→	←	→ 07/08		24.0132-0148.1	432148	Ø 313 32 30 V
↓								















	kw			 	! #		
TOYOTA - LAND CRUISER 90 (_J9_) 04/95→							
 Bremsscheibe							
4.7	175	08/02→	→	→ 07/08		24.0118-0143.1 418143	Ø 329,2 18 16 V
TOYOTA - LAND CRUISER Hardtop (_J7_) 07/90→05/96							
 Bremsbelagsatz, Scheibenbremse							
2.4 TD (LJ70_)	66	07/90→05/96	←	für Fahrzeuge mit Scheibenbremse an der Hinterachse		13.0460-5992.2 605992	21679 15,0 + WK
			→			13.0460-5744.2 605744	21947 15,4 - WE / - WK
3.0 TD (KZJ70_)	92	05/93→05/96	←			13.0460-5992.2 605992	21679 15,0 + WK
 Bremsscheibe							
2.4 TD (LJ70_)	66	07/90→05/96	←	für Fahrzeuge mit Trommelbremse an der Hinterachse		24.0113-0105.1 413105	Ø 302 12,5 11,5
			←	für Fahrzeuge mit Scheibenbremse an der Hinterachse		24.0120-0153.1 420153	Ø 302 20 19 V
3.0 TD (KZJ70_)	92	05/93→05/96	←			24.0120-0153.1 420153	Ø 302 20 19 V
TOYOTA - LAND CRUISER Pick-up (_J7_) 11/84→							
 Bremsbelagsatz, Scheibenbremse							
4.0 4x4	170	03/07→	←			13.0460-5747.2 605747	24024 17,0 + WK
			→			13.0460-5744.2 605744	21947 15,4 - WE / - WK
4.2 D 4x4 (HZJ7__V)	96	01/90→02/07	←	→ 12/96		13.0460-5992.2 605992	21679 15,0 + WK
			→	→ 12/96		13.0460-5744.2 605744	21947 15,4 - WE / - WK
4.2 TD 24V 4x4	122	11/01→02/07	←			13.0460-5746.2 605746	23524 17,4 + WK
			→			13.0460-5749.2 605749	23539 17,3 - WE / - WK
4.5 EFi 4x4 (FZJ75)	158	11/92→11/99	←	→ 12/97		13.0460-5745.2 605745	21775 15,0 + WK
			→	→ 12/97		13.0460-5744.2 605744	21947 15,4 - WE / - WK
4.5 MPFi 4x4 (FZJ79)	165	11/92→11/99	←	08/92→ 12/97		13.0460-5745.2 605745	21775 15,0 + WK
			→	08/92→ 12/97		13.0460-5744.2 605744	21947 15,4 - WE / - WK
4.5 TD 24V 4x4 (VDJ79)	151	03/07→	←	08/07→		13.0460-5618.2 605618	24386 17,9 + WK
			→	08/07→		13.0460-5619.2 605619	24653 17,3 - WE / - WK
 Bremsscheibe							
4.0 4x4	170	03/07→	←			24.0128-0194.1 428194	Ø 338 28 26 V
			→			24.0118-0709.1 418709	Ø 312 18 16 V
4.2 D 4x4 (HZJ7__V)	96	01/90→02/07	←	→ 12/96		24.0120-0153.1 420153	Ø 302 20 19 V
4.2 TD 24V 4x4	122	11/01→02/07	←			24.0132-0148.1 432148	Ø 313 32 30 V
			→			24.0118-0143.1 418143	Ø 329,2 18 16 V
4.5 EFi 4x4 (FZJ75)	158	11/92→11/99	←	→ 12/97		24.0132-0111.1 432111	Ø 311 32 30 V
4.5 MPFi 4x4 (FZJ79)	165	11/92→11/99	←	08/92→ 12/97		24.0132-0111.1 432111	Ø 311 32 30 V
TOYOTA - MATRIX (_E13_) 01/02→12/07							
 Bremsbelagsatz, Scheibenbremse							
1.8 VVTi	96	01/02→02/04	←	02/02→		13.0460-5817.2 605817	AKE 23526 17,5 + WE / - WK
			→	02/02→		13.0460-5812.2 605812	SUM 23521 14,0 + WK
 Bremsscheibe							
1.8 VVTi	96	01/02→02/04	←	02/02→		24.0125-0168.1 425168	Ø 275 25 23 V
			→	02/02→		24.0109-0139.1 409139	Ø 269 9 8
TOYOTA - MIRAI (JPD1_) 10/14→							
 Bremsbelagsatz, Scheibenbremse							
FCV (JPD10_)	113	10/14→	←	01/15→; Herstellereinschränkung Advics-Ohio		13.0460-5766.2 605766	24337 17,5 - WK
 Bremsscheibe							
FCV (JPD10_)	113	10/14→	←	01/15→		24.0128-0159.1 428159	Ø 296 28 25 V













	kw					! #		
TOYOTA - MR 2 II (SW2_) 12/89→07/99								
 Bremsscheibe								
2.0 16V (SW20_)	115	12/89→07/99	←	→ 11/91			24.0125-0129.1 425129	Ø 258 25 24 V
2.0 16V (SW20_)	125	12/89→07/99						
2.0 16V (SW20_)	129	12/89→07/99						
2.0 Turbo (SW20_)	167	12/89→07/99						
2.0 Turbo (SW20_)	180	12/89→07/99						
TOYOTA - MR 2 III (ZZW3_) 10/99→06/07								
 Bremsbelagsatz, Scheibenbremse								
1.8 16V VT-i (ZZW30)	103	10/99→06/07	←	01/00→			13.0460-5810.2 605810	AKE 23510 16,5 + WK
 Bremsscheibe								
1.8 16V VT-i (ZZW30)	103	10/99→06/07	←	01/00→			24.0120-0175.1 420175	Ø 255 20 18 V
							24.0320-0175.1 520175	Ø 255 20 18 V PD
TOYOTA - PASEO Cabriolet (EL54_) 10/96→01/98								
 Bremsbelagsatz, Scheibenbremse								
1.5 (EL54_)	66	10/96→01/98	←				13.0460-5976.2 605976	AKE 20870 15,0 - WE / - WK
TOYOTA - PASEO Coupe (EL44_) 06/88→08/95								
 Bremsbelagsatz, Scheibenbremse								
1.5	85	06/88→07/95	←	04/91→			13.0460-5976.2 605976	AKE 20870 15,0 - WE / - WK
Zubehörsatz, Scheibenbremsbelag								
1.5	85	06/88→07/95	←	04/91→			13.0460-0325.2 610325	AKE
TOYOTA - PASEO Coupe (EL54_) 08/95→12/99								
 Bremsbelagsatz, Scheibenbremse								
1.5 16V (EL54_)	66	08/95→06/99	←				13.0460-5976.2 605976	AKE 20870 15,0 - WE / - WK
TOYOTA - PICNIC (_XM1_) 05/96→12/01								
 Bremsbelagsatz, Scheibenbremse								
2.0	99	09/96→05/01	←				13.0460-5951.2 605951	SUM 21601 17,5 + WK
2.0 (SXM10_)	90	01/01→12/01						
2.0 (SXM10_)	100	05/96→04/01						
2.0 16V (SXM10_)	94	05/96→12/01						
2.2 D (CMX10_)	66	08/97→12/01	←	09/97→			13.0460-5951.2 605951	SUM 21601 17,5 + WK
Zubehörsatz, Scheibenbremsbelag								
2.0	99	09/96→05/01	←				13.0460-0441.2 610441	SUM
2.0 (SXM10_)	90	01/01→12/01						
2.0 (SXM10_)	100	05/96→04/01						
2.0 16V (SXM10_)	94	05/96→12/01						
2.2 D (CMX10_)	66	08/97→12/01	←	09/97→			13.0460-0441.2 610441	SUM
 Bremsscheibe								
2.0	99	09/96→05/01	←				24.0128-0114.1 428114	Ø 255 28 26 V
2.0 (SXM10_)	90	01/01→12/01						
2.0 (SXM10_)	100	05/96→04/01						
2.0 16V (SXM10_)	94	05/96→12/01						
2.2 D (CMX10_)	66	08/97→12/01	←	09/97→			24.0128-0114.1 428114	Ø 255 28 26 V
TOYOTA - PREVIA (_R1_, _R2_) 05/90→08/00								
 Bremsbelagsatz, Scheibenbremse								
2.4 (TCR1_)	97	05/90→08/00	←	- ABS			13.0460-5968.2 605968	21369 15,5 + WK
2.4 4WD (TCR2_)	97	05/90→08/00						
2.4 4WD (TCR20_)	110	05/90→12/99	→	+ ABS			13.0460-5862.2 605862	21688 15,3 - WE / - WK
2.4 GX (TCR10_)	110	01/94→07/97						
Zubehörsatz, Scheibenbremsbelag								
2.4 (TCR1_)	97	05/90→08/00	←	- ABS			13.0460-0450.2 610450	
2.4 4WD (TCR2_)	97	05/90→08/00						
2.4 4WD (TCR20_)	110	05/90→12/99	→	+ ABS			13.0460-0325.2 610325	AKE
2.4 GX (TCR10_)	110	01/94→07/97						
 Bremsscheibe								
2.4 (TCR1_)	97	05/90→08/00	←	- ABS			24.0125-0116.1 425116	Ø 255 25 23 V
			←	10/90→; + ABS			24.0125-0126.1 425126	Ø 271 25 23 V
↓								









	kw					! #		
TOYOTA - PREVIA (_R1_, _R2_) 05/90→08/00								
 Bremsscheibe								
2.4 4WD (TCR2_) 2.4 4WD (TCR20_)	97 110	05/90→08/00 05/90→12/99	←	- ABS		24.0122-0183.1	422183	Ø 279 22 20 V
			←	+ ABS		24.0125-0126.1	425126	Ø 271 25 23 V
2.4 GX (TCR10_)	110	01/94→07/97	←	- ABS		24.0125-0116.1	425116	Ø 255 25 23 V
			←	+ ABS		24.0125-0126.1	425126	Ø 271 25 23 V
TOYOTA - PREVIA (_R3_) 02/00→01/06								
 Bremsbelagsatz, Scheibenbremse								
2.0 D-4D (CLR30_) 2.4 (ACR30)	85 115	03/01→01/06 08/00→01/06	←	→ 03/03		13.0460-5891.2	605891	AKE 23513 17,0 - WE / - WK
			←	04/03→ 12/05		13.0460-5894.2	605894	23759 17,0 - WK
			→	→ 12/05		13.0460-5847.2	605847	SUM 23646 16,5 + WK
 Bremsscheibe								
2.0 D-4D (CLR30_) 2.4 (ACR30)	85 115	03/01→01/06 08/00→01/06	←	→ 03/03		24.0128-0115.1	428115	Ø 275 28 26 V
			←	04/03→ 12/05		24.0128-0190.1	428190	Ø 296 28 26 V
			→	→ 12/05		24.0112-0164.1	412164	Ø 291 12 10,5
TOYOTA - PREVIA III (_R2_, _R5_) 10/05→								
 Bremsbelagsatz, Scheibenbremse								
2.4 (ACR50_)	125	10/05→	←			13.0460-5614.2	605614	24601 18,0 - WE / - WK
			→			13.0460-5814.2	605814	BOS 23620 16,4 + WK
 Bremsscheibe								
2.4 (ACR50_)	125	10/05→	←			24.0128-0232.1	428232	Ø 296 28 25 V
			→			24.0110-0346.1	410346	Ø 298 10 8,5
TOYOTA - PRIUS (_W3_) 04/09→								
 Bremsbelagsatz, Scheibenbremse								
1.8 Hybrid (ZVW3_)	73	04/09→	←			13.0460-5617.2	605617	24451 15,6 - WE / - WK
			→	→ 05/11		13.0460-5769.2	605769	24610 15,0 + WK
 Bremsscheibe								
1.8 Hybrid (ZVW3_)	73	04/09→	←			24.0125-0196.1	425196	Ø 255 25 22 V
			→			24.0109-0163.1	409163	Ø 259 9 7,5
TOYOTA - PRIUS (_W5_) 09/15→								
 Bremsbelagsatz, Scheibenbremse								
1.8 Hybrid (ZVW5_)	72	09/15→	←	MARK AK NS380H		13.0460-5617.2	605617	24451 15,6 - WE / - WK
			→			13.0460-5769.2	605769	24610 15,0 + WK
 Bremsscheibe								
1.8 Hybrid (ZVW5_)	72	09/15→	→			24.0109-0163.1	409163	Ø 259 9 7,5
TOYOTA - PRIUS Liftback (_W2_) 08/03→03/09								
 Bremsbelagsatz, Scheibenbremse								
1.5 (NHW2_)	57	08/03→03/09	←			13.0460-5810.2	605810	AKE 23510 16,5 + WK
			→	→ 07/04		13.0460-5812.2	605812	SUM 23521 14,0 + WK
Zubehörsatz, Scheibenbremsbelag								
1.5 (NHW2_)	57	08/03→03/09	→	→ 07/04		13.0460-0136.2	610136	SUM
 Bremsscheibe								
1.5 (NHW2_)	57	08/03→03/09	←			24.0122-0258.1	422258	Ø 255 22 20 V
			→			24.0109-0711.1	409711	Ø 269 9 7,5
TOYOTA - PRIUS PLUS (_W4_) 05/11→								
 Bremsbelagsatz, Scheibenbremse								
1.8 Hybrid (ZVW4_)	73	05/11→	←	03/12→		13.0460-5766.2	605766	24337 17,5 - WK
			→	03/12→		13.0460-5635.2	605635	AKE 24918 15,0 - WK
↓								





	kw			 	! #		
TOYOTA - PRIUS PLUS (_W4_) 05/11→							
 Bremsbelagsatz, Scheibenbremse							
1.8 Hybrid (ZVW4_)	73	05/11→	➡	03/12→		13.0470-5635.2 LD5635	AKE 24918 15,0 - WK Ceramic
 Bremsscheibe							
1.8 Hybrid (ZVW4_)	73	05/11→	←	03/12→		24.0128-0159.1 428159	Ø 296 28 25 V
			➡	03/12→		24.0112-0203.1 412203	Ø 290 12 10,5
TOYOTA - PRIUS Stufenheck (_W1_) 05/00→01/04							
 Bremsbelagsatz, Scheibenbremse							
1.5 Hybrid (NHW1_)	53	05/00→01/04	←	→ 07/03		13.0460-5810.2 605810	AKE 23510 16,5 + WK
			➡	→ 07/03		13.0460-5812.2 605812	SUM 23521 14,0 + WK
Zubehörsatz, Scheibenbremsbelag							
1.5 Hybrid (NHW1_)	53	05/00→01/04	➡	→ 07/03		13.0460-0136.2 610136	SUM
 Bremsscheibe							
1.5 Hybrid (NHW1_)	53	05/00→01/04	←	→ 07/03		24.0125-0155.1 425155	Ø 255 25 23 V
			➡	→ 07/03		24.0109-0139.1 409139	Ø 269 9 8
TOYOTA - PROACE Kasten/Kombi (MDX_) 06/13→03/16							
 Bremsscheibe							
1.6 D (MDX9_)	66	06/13→03/16	←	passend für Felgenreöße [Zoll]: 15		24.0128-0214.1 428214	Ø 280 28 26 V + S
2.0 D (MDX3_)	94	06/13→03/16	←	passend für Felgenreöße [Zoll]: 16		24.0128-0216.1 428216	Ø 304 28 26 V + S
2.0 D (MDX6_)	120	06/13→03/16	➡			24.0114-0116.1 414116	Ø 290 14 12 + S
TOYOTA - RAV 4 I (_A1_) 01/94→09/00							
 Bremsbelagsatz, Scheibenbremse							
2.0 4WD	99	01/94→09/99	←	04/94→		13.0460-5951.2 605951	SUM 21601 17,5 + WK
2.0 4WD (SXA10)	95	06/94→06/00	←			13.0460-5951.2 605951	SUM 21601 17,5 + WK
Zubehörsatz, Scheibenbremsbelag							
2.0 4WD	99	01/94→09/99	←	04/94→		13.0460-0441.2 610441	SUM
2.0 4WD (SXA10)	95	06/94→06/00	←			13.0460-0441.2 610441	SUM
 Bremsscheibe							
2.0 4WD	99	01/94→09/99	←	04/94→		24.0118-0129.1 418129	Ø 302 18 16 V
2.0 4WD (SXA10)	95	06/94→06/00	←			24.0118-0129.1 418129	Ø 302 18 16 V
TOYOTA - RAV 4 I Cabrio (_A1_) 12/97→06/00							
 Bremsbelagsatz, Scheibenbremse							
2.0 16V 4WD	94	12/97→06/00	←			13.0460-5951.2 605951	SUM 21601 17,5 + WK
Zubehörsatz, Scheibenbremsbelag							
2.0 16V 4WD	94	12/97→06/00	←			13.0460-0441.2 610441	SUM
 Bremsscheibe							
2.0 16V 4WD	94	12/97→06/00	←			24.0118-0129.1 418129	Ø 302 18 16 V
TOYOTA - RAV 4 II (_A2_) 06/00→11/05							
 Bremsbelagsatz, Scheibenbremse							
1.8 (ZCA25_, ZCA26_)	92	08/00→11/05	←	02/01→		13.0460-5848.2 605848	AKE 23585 17,4 - WK
			➡	02/01→; + ABS		13.0460-5849.2 605849	AKE 23656 14,0 + WK
2.0 4WD	110	06/00→11/05	←			13.0460-5848.2 605848	AKE 23585 17,4 - WK
			➡	+ ABS		13.0460-5849.2 605849	AKE 23656 14,0 + WK
2.0 D-4D 4WD (CLA20_, CLA21_)	85	05/01→11/05	←	09/01→		13.0460-5848.2 605848	AKE 23585 17,4 - WK
			➡	09/01→; + ABS		13.0460-5849.2 605849	AKE 23656 14,0 + WK
2.4 4WD	112	08/03→11/05	←			13.0460-5848.2 605848	AKE 23585 17,4 - WK
2.4 4WD ↓	120	08/03→11/05					











	kW					! #		
TOYOTA - RAV 4 II (_A2_) 06/00→11/05								
 Bremsscheibe								
1.8 (ZCA25_, ZCA26_)	92	08/00→11/05	←	02/01→		24.0125-0143.1	425143	Ø 275 25 23 V
			→	02/01→; + ABS		24.0109-0152.1	409152	Ø 303 9 8
2.0 4WD	110	06/00→11/05	←			24.0125-0143.1	425143	Ø 275 25 23 V
2.4 4WD	112	08/03→11/05	←			24.0109-0152.1	409152	Ø 303 9 8
2.4 4WD	120	08/03→11/05	→	+ ABS		24.0109-0152.1	409152	Ø 303 9 8
2.0 D-4D 4WD (CLA20_, CLA21_)	85	05/01→11/05	←	09/01→		24.0125-0143.1	425143	Ø 275 25 23 V
			→	09/01→; + ABS		24.0109-0152.1	409152	Ø 303 9 8
TOYOTA - RAV 4 III (_A3_) 06/05→								
 Bremsbelagsatz, Scheibenbremse								
2.0 (ZSA35_)	116	12/08→	←			13.0460-5766.2	605766	24337 17,5 - WK
2.0 4WD (ZSA30_)	116	12/08→	←			13.0460-5766.2	605766	24337 17,5 - WK
2.0 VVT-i	109	03/09→	→			13.0460-5765.2	605765	AKE 24338 15,5 - WE / - WK
2.0 VVT-i 4WD	109	03/09→	→			13.0460-5765.2	605765	AKE 24338 15,5 - WE / - WK
2.0 VVT-i 4WD (ACA30_)	112	03/06→	→			13.0460-5765.2	605765	AKE 24338 15,5 - WE / - WK
2.2 D-4D (ALA35_)	110	12/08→12/13	←			13.0460-5766.2	605766	24337 17,5 - WK
2.2 D-4D 4WD (ALA30_)	100	03/06→	→			13.0460-5765.2	605765	AKE 24338 15,5 - WE / - WK
2.2 D-4D 4WD (ALA30_)	110	12/08→12/13	←			13.0460-5766.2	605766	24337 17,5 - WK
2.2 D-CAT 4WD (ALA30_)	130	03/06→	→			13.0460-5765.2	605765	AKE 24338 15,5 - WE / - WK
2.4 VVTi	125	11/05→	→			13.0460-5765.2	605765	AKE 24338 15,5 - WE / - WK
2.4 VVTi 4WD	125	11/05→	→			13.0460-5765.2	605765	AKE 24338 15,5 - WE / - WK
2.5	132	11/08→	→			13.0460-5765.2	605765	AKE 24338 15,5 - WE / - WK
2.5 4WD	132	11/08→	→			13.0460-5765.2	605765	AKE 24338 15,5 - WE / - WK
3.5 4WD	206	08/07→	←			13.0460-5767.2	605767	AKE 24336 17,5 - WE / - WK
3.5 VVTi 4WD	198	11/05→	→			13.0460-5765.2	605765	AKE 24338 15,5 - WE / - WK
3.5 VVTi 4WD (GSA33)	201	11/05→	→			13.0460-5765.2	605765	AKE 24338 15,5 - WE / - WK
 Bremsscheibe								
2.0 (ZSA35_)	116	12/08→	←			24.0128-0159.1	428159	Ø 296 28 25 V
2.0 4WD (ZSA30_)	116	12/08→	←			24.0128-0159.1	428159	Ø 296 28 25 V
2.0 VVT-i	109	03/09→	→			24.0112-0714.1	412714	Ø 281 12 10,5
2.0 VVT-i 4WD	109	03/09→	→			24.0112-0714.1	412714	Ø 281 12 10,5
2.0 VVT-i 4WD (ACA30_)	112	03/06→	→			24.0112-0714.1	412714	Ø 281 12 10,5
2.2 D-4D (ALA35_)	110	12/08→12/13	←			24.0128-0159.1	428159	Ø 296 28 25 V
2.2 D-4D 4WD (ALA30_)	100	03/06→	→			24.0112-0714.1	412714	Ø 281 12 10,5
2.2 D-4D 4WD (ALA30_)	110	12/08→12/13	←			24.0128-0159.1	428159	Ø 296 28 25 V
2.2 D-CAT 4WD (ALA30_)	130	03/06→	→			24.0112-0714.1	412714	Ø 281 12 10,5
2.4 VVTi	125	11/05→	→			24.0112-0714.1	412714	Ø 281 12 10,5
2.4 VVTi 4WD	125	11/05→	→			24.0112-0714.1	412714	Ø 281 12 10,5
2.5	132	11/08→	→			24.0112-0714.1	412714	Ø 281 12 10,5
2.5 4WD	132	11/08→	→			24.0112-0714.1	412714	Ø 281 12 10,5
3.5 4WD	206	08/07→	←			24.0125-0178.1	425178	Ø 275 25 22 V
3.5 VVTi 4WD	198	11/05→	→			24.0112-0714.1	412714	Ø 281 12 10,5
3.5 VVTi 4WD (GSA33)	201	11/05→	→			24.0112-0714.1	412714	Ø 281 12 10,5
TOYOTA - RAV 4 IV (_A4_) 12/12→								
 Bremsbelagsatz, Scheibenbremse								
2.0 D4-D (ALA40_)	91	12/12→	←			13.0460-5634.2	605634	ADV 24452 17,5 - WK + Zub
2.0 D-4D (WWA42_)	105	10/15→	←			13.0470-5634.2	LD5634	ADV 24452 17,5 - WK + Zub Ceramic
			→			13.0460-5765.2	605765	AKE 24338 15,5 - WE / - WK
2.0 D4-D 4WD (ALA41_)	91	01/13→	←	11/13→		13.0460-5634.2	605634	ADV 24452 17,5 - WK + Zub
			→	11/13→		13.0470-5634.2	LD5634	ADV 24452 17,5 - WK + Zub Ceramic
			→	11/13→		13.0460-5765.2	605765	AKE 24338 15,5 - WE / - WK
2.0 VVT-i	107	12/12→	←			13.0460-5766.2	605766	24337 17,5 - WK
2.0 VVT-i 4WD (ZSA44_)	111	12/12→	←			13.0460-5766.2	605766	24337 17,5 - WK
2.0 VVT-i 4WD (ZSA44_)	112	04/15→	→			13.0460-5765.2	605765	AKE 24338 15,5 - WE / - WK
2.5 Hybrid (AVA42_, AVA44_)	114	10/15→	→			13.0460-5765.2	605765	AKE 24338 15,5 - WE / - WK
2.5 Hybrid 4WD (AVA44_)	114	10/15→	→			13.0460-5765.2	605765	AKE 24338 15,5 - WE / - WK
2.5 VVT-i 4WD	132	12/12→	→			13.0460-5765.2	605765	AKE 24338 15,5 - WE / - WK
2.2 D4-D 4WD	110	12/12→	←			13.0460-5634.2	605634	ADV 24452 17,5 - WK + Zub
			←			13.0460-5766.2	605766	24337 17,5 - WK
			←			13.0470-5634.2	LD5634	ADV 24452 17,5 - WK + Zub Ceramic
↓								











	kw			 	! #		
TOYOTA - RAV 4 IV (_A4_) 12/12→							
 Bremsbelagsatz, Scheibenbremse							
2.2 D4-D 4WD	110	12/12→	➔			13.0460-5765.2 605765	AKE 24338 15,5 - WE / - WK
 Bremsscheibe							
2.0 D4-D (ALA40_)	91	12/12→	←	passend für Felgenreöße [Zoll]: 16		24.0128-0159.1 428159	Ø 296 28 25 V
2.5 Hybrid (AVA42_, AVA44_)	114	10/15→	➔			24.0112-0714.1 412714	Ø 281 12 10,5
2.5 Hybrid 4WD (AVA44_)	114	10/15→					
2.0 D-4D (WWA42_)	105	10/15→	➔			24.0112-0714.1 412714	Ø 281 12 10,5
2.0 VVT-i 4WD (ZSA44_)	112	04/15→					
2.0 D4-D 4WD (ALA41_)	91	01/13→	←	12/13→; passend für Felgenreöße [Zoll]: 16		24.0128-0159.1 428159	Ø 296 28 25 V
			➔	11/13→		24.0112-0714.1 412714	Ø 281 12 10,5
2.0 VVT-i	107	12/12→	←			24.0128-0159.1 428159	Ø 296 28 25 V
2.0 VVT-i 4WD (ZSA44_)	111	12/12→	←	passend für Felgenreöße [Zoll]: 16		24.0128-0159.1 428159	Ø 296 28 25 V
2.2 D4-D 4WD	110	12/12→	➔			24.0112-0714.1 412714	Ø 281 12 10,5
2.5 VVT-i 4WD	132	12/12→					
TOYOTA - STARLET (_P8_) 12/89→03/96							
 Bremsbelagsatz, Scheibenbremse							
1.3 12V Cat (EP81)	55	12/89→03/96	←	- ABS		13.0460-5969.2 605969	SUM 21948 13,5 - WE / - WK
			←	→ 11/90; + ABS		13.0460-5976.2 605976	AKE 20870 15,0 - WE / - WK
1.5 D (NP80_)	40	12/89→03/96	←			13.0460-5969.2 605969	SUM 21948 13,5 - WE / - WK
Zubehörsatz, Scheibenbremsbelag							
1.3 12V Cat (EP81)	55	12/89→03/96	←	→ 11/90; + ABS		13.0460-0325.2 610325	AKE
 Bremsscheibe							
1.3 12V Cat (EP81)	55	12/89→03/96	←	01/92→; + ABS		24.0118-0124.1 418124	Ø 238 18 17 V
TOYOTA - STARLET (_P9_) 01/96→10/99							
 Bremsbelagsatz, Scheibenbremse							
1.3 (EP91_, EP95_)	55	01/96→10/99	←	→ 04/96		13.0460-5969.2 605969	SUM 21948 13,5 - WE / - WK
			←	05/96→ 07/99		13.0460-5976.2 605976	AKE 20870 15,0 - WE / - WK
 Bremsscheibe							
1.3 (EP91_, EP95_)	55	01/96→10/99	←	05/96→ 07/99		24.0118-0124.1 418124	Ø 238 18 17 V
TOYOTA - URBAN CRUISER (_P1_) 07/07→							
 Bremsbelagsatz, Scheibenbremse							
1.33 (NSP110_)	73	01/09→	←	04/10→		13.0460-5767.2 605767	AKE 24336 17,5 - WE / - WK
			➔	04/10→		13.0460-5769.2 605769	24610 15,0 + WK
1.33 (NSP110_)	74	04/09→	←			13.0460-5767.2 605767	AKE 24336 17,5 - WE / - WK
			➔			13.0460-5769.2 605769	24610 15,0 + WK
1.4 D-4D (NLP110_)	66	01/09→04/14	←	04/09→		13.0460-5767.2 605767	AKE 24336 17,5 - WE / - WK
			➔	04/09→		13.0460-5769.2 605769	24610 15,0 + WK
1.4 D-4D 4WD (NLP115_)	66	01/09→04/14	←	04/09→		13.0460-5767.2 605767	AKE 24336 17,5 - WE / - WK
 Bremsscheibe							
1.33 (NSP110_)	73	01/09→	←	04/10→		24.0122-0276.1 422276	Ø 275 22 19 V
			➔	04/10→		24.0109-0170.1 409170	Ø 259 9 7,5
1.33 (NSP110_)	74	04/09→	←			24.0122-0276.1 422276	Ø 275 22 19 V
			➔			24.0109-0170.1 409170	Ø 259 9 7,5
1.4 D-4D (NLP110_)	66	01/09→04/14	←	04/09→		24.0122-0276.1 422276	Ø 275 22 19 V
			➔	04/09→		24.0109-0170.1 409170	Ø 259 9 7,5
1.4 D-4D 4WD (NLP115_)	66	01/09→04/14	←	04/09→		24.0122-0276.1 422276	Ø 275 22 19 V
			➔	04/09→		24.0110-0364.1 410364	Ø 279 10 8,5















	kw			 	! #		
TOYOTA - VERSO (_R2_) 04/09→							
 Bremsbelagsatz, Scheibenbremse							
1.6 (ZGR20_)	97	04/09→	←			13.0460-5603.2 605603	24204 19,2 + WK + Zub
1.6 D4-D (WAR20_)	82	11/13→	→				
1.8 (ZGR21_)	108	04/09→	→			13.0460-3854.2 603854	BOS 24926 16,5 + WK + Zub
2.0 D-4D (AUR20_)	91	11/12→					
2.0 D-4D (AUR20_)	93	04/09→					
2.2 D-4D (AUR21_)	110	04/09→	←	→ 10/10		13.0460-5615.2 605615	BOS 24946 19,0 + WK + Zub
2.2 D-CAT (AUR21_)	130	04/09→	→			13.0460-3854.2 603854	BOS 24926 16,5 + WK + Zub
 Bremsscheibe							
1.6 (ZGR20_)	97	04/09→	←			24.0126-0156.1 426156	Ø 295 26 23 V
1.6 D4-D (WAR20_)	82	11/13→	→				
1.8 (ZGR21_)	108	04/09→	→			24.0111-0168.1 411168	Ø 297 11 9
2.0 D-4D (AUR20_)	91	11/12→					
2.0 D-4D (AUR20_)	93	04/09→					
2.2 D-4D (AUR21_)	110	04/09→	←			24.0126-0160.1 426160	Ø 320 26 23 V
2.2 D-CAT (AUR21_)	130	04/09→	→			24.0111-0168.1 411168	Ø 297 11 9
TOYOTA - VERSO S (_P12_) 11/10→10/16							
 Bremsbelagsatz, Scheibenbremse							
1.33 (NSP120_)	70	11/10→10/16	←			13.0460-5767.2 605767	AKE 24336 17,5 - WE / - WK
1.33 (NSP120_)	73	11/10→10/16	→			13.0460-5769.2 605769	24610 15,0 + WK
1.4 D4-D (NLP121_)	66	11/10→10/16	→				
 Bremsscheibe							
1.33 (NSP120_)	70	11/10→10/16	←			24.0122-0276.1 422276	Ø 275 22 19 V
1.33 (NSP120_)	73	11/10→10/16	→			24.0109-0163.1 409163	Ø 259 9 7,5
1.4 D4-D (NLP121_)	66	11/10→10/16	→				
TOYOTA - VIOS/YARIS Stufenheck (_P9_) 08/05→							
 Bremsscheibe							
1.3 (NCP92_)	63	08/05→	←	01/06→ 12/12		24.0122-0246.1 422246	Ø 255 22 19 V
TOYOTA - YARIS (_P1_) 01/99→12/05							
 Bremsbelagsatz, Scheibenbremse							
1.0 (SCP10_)	48	03/03→09/05	←	04/03→ 08/05; für Fahrzeuge mit Trommelbremse an der Hinterachse		13.0460-5800.2 605800	BOS 23340 17,0 + WK
			←	04/03→ 08/05; für Fahrzeuge mit Scheibenbremse an der Hinterachse		13.0460-5810.2 605810	AKE 23510 16,5 + WK
			→	04/03→ 08/05; + ABS		13.0460-5812.2 605812	SUM 23521 14,0 + WK
1.0 (SCP10_)	50	04/99→09/05	←	08/99→ 03/03		13.0460-5800.2 605800	BOS 23340 17,0 + WK
			←	→ 07/99		13.0460-5811.2 605811	23348 16,5 + WK
			→	→ 03/03; + ABS		13.0460-5812.2 605812	SUM 23521 14,0 + WK
1.3 (NCP10_, SCP12_)	63	11/99→10/05	←	→ 10/04; für Fahrzeuge mit Scheibenbremse an der Hinterachse		13.0460-5810.2 605810	AKE 23510 16,5 + WK
			←	→ 10/04; für Fahrzeuge mit Trommelbremse an der Hinterachse		13.0460-5811.2 605811	23348 16,5 + WK
			→	→ 10/04; + ABS		13.0460-5812.2 605812	SUM 23521 14,0 + WK
1.3 (SCP12_)	57	09/03→12/04	←	für Fahrzeuge mit Trommelbremse an der Hinterachse		13.0460-5800.2 605800	BOS 23340 17,0 + WK
			←	→ 03/03; für Fahrzeuge mit Scheibenbremse an der Hinterachse		13.0460-5810.2 605810	AKE 23510 16,5 + WK
			→	+ ABS		13.0460-5812.2 605812	SUM 23521 14,0 + WK
1.3 (SCP12_)	64	08/99→09/05	←	04/02→ 08/05; für Fahrzeuge mit Trommelbremse an der Hinterachse		13.0460-5800.2 605800	BOS 23340 17,0 + WK
			←	04/02→ 03/03; für Fahrzeuge mit Scheibenbremse an der Hinterachse		13.0460-5810.2 605810	AKE 23510 16,5 + WK
			→	04/02→ 08/05; + ABS		13.0460-5812.2 605812	SUM 23521 14,0 + WK
1.4 D-4D (NLP10_)	55	10/01→09/05	←	04/03→ 08/05; für Fahrzeuge mit Trommelbremse an der Hinterachse		13.0460-5800.2 605800	BOS 23340 17,0 + WK
↓							















	kw			 	! #		
TOYOTA - YARIS (P1) 01/99→12/05							
 Bremsbelagsatz, Scheibenbremse							
1.4 D-4D (NLP10_)	55	10/01→09/05	←	12/01→ 08/05; für Fahrzeuge mit Scheibenbremse an der Hinterachse	13.0460-5810.2	605810	AKE 23510 16,5 + WK
			←	12/01→ 03/03; für Fahrzeuge mit Trommelbremse an der Hinterachse	13.0460-5811.2	605811	23348 16,5 + WK
			→	12/01→ 08/05; + ABS	13.0460-5812.2	605812	SUM 23521 14,0 + WK
1.5 (NCP13_)	77	01/03→11/05	←	→ 08/05; für Fahrzeuge mit Scheibenbremse an der Hinterachse	13.0460-5810.2	605810	AKE 23510 16,5 + WK
			→	→ 08/05	13.0460-5812.2	605812	SUM 23521 14,0 + WK
1.5 (NCP13_)	78	04/01→09/05	←	→ 03/03; für Fahrzeuge mit Scheibenbremse an der Hinterachse	13.0460-5810.2	605810	AKE 23510 16,5 + WK
			→	→ 03/03	13.0460-5812.2	605812	SUM 23521 14,0 + WK
1.5 (NCP13_)	110	03/00→07/05	←	04/03→ 10/04; für Fahrzeuge mit Scheibenbremse an der Hinterachse	13.0460-5810.2	605810	AKE 23510 16,5 + WK
			→	04/03→ 10/04	13.0460-5812.2	605812	SUM 23521 14,0 + WK
Zubehörsatz, Scheibenbremsbelag							
1.0 (SCP10_)	48	03/03→09/05	→	04/03→ 08/05; + ABS	13.0460-0136.2	610136	SUM
1.0 (SCP10_)	50	04/99→09/05	→	→ 03/03; + ABS	13.0460-0136.2	610136	SUM
1.3 (NCP10_, SCP12_)	63	11/99→10/05	→	→ 10/04; + ABS	13.0460-0136.2	610136	SUM
1.3 (SCP12_)	57	09/03→12/04	→	+ ABS	13.0460-0136.2	610136	SUM
1.3 (SCP12_)	64	08/99→09/05	→	04/02→ 08/05; + ABS	13.0460-0136.2	610136	SUM
1.4 D-4D (NLP10_)	55	10/01→09/05	→	12/01→ 08/05; + ABS	13.0460-0136.2	610136	SUM
1.5 (NCP13_)	77	01/03→11/05	→	→ 08/05	13.0460-0136.2	610136	SUM
1.5 (NCP13_)	78	04/01→09/05	→	→ 03/03	13.0460-0136.2	610136	SUM
1.5 (NCP13_)	110	03/00→07/05	→	04/03→ 10/04	13.0460-0136.2	610136	SUM
 Bremsscheibe							
1.0 (SCP10_)	48	03/03→09/05	←	04/03→ 08/05; für Fahrzeuge mit Trommelbremse an der Hinterachse	24.0118-0131.1	418131	Ø 235 17,9 16 V
			←	04/03→ 08/05; für Fahrzeuge mit Scheibenbremse an der Hinterachse	24.0120-0175.1	420175	Ø 255 20 18 V
			→	04/03→ 08/05; + ABS	24.0320-0175.1	520175	Ø 255 20 18 V PD
1.0 (SCP10_)	50	04/99→09/05	←	→ 07/99	24.0118-0131.1	418131	Ø 235 17,9 16 V
			←	08/99→ 03/03	24.0120-0175.1	420175	Ø 255 20 18 V
			→	→ 03/03; + ABS	24.0320-0175.1	520175	Ø 255 20 18 V PD
1.3 (NCP10_, SCP12_)	63	11/99→10/05	←	→ 10/04; für Fahrzeuge mit Trommelbremse an der Hinterachse	24.0118-0131.1	418131	Ø 235 17,9 16 V
			←	→ 10/04; für Fahrzeuge mit Scheibenbremse an der Hinterachse	24.0120-0175.1	420175	Ø 255 20 18 V
			→	→ 10/04; + ABS	24.0320-0175.1	520175	Ø 255 20 18 V PD
1.3 (SCP12_)	57	09/03→12/04	←	für Fahrzeuge mit Trommelbremse an der Hinterachse	24.0118-0131.1	418131	Ø 235 17,9 16 V
			←	für Fahrzeuge mit Scheibenbremse an der Hinterachse	24.0120-0175.1	420175	Ø 255 20 18 V
			→	+ ABS	24.0320-0175.1	520175	Ø 255 20 18 V PD
1.3 (SCP12_)	64	08/99→09/05	←	04/02→ 08/05; für Fahrzeuge mit Trommelbremse an der Hinterachse	24.0118-0131.1	418131	Ø 235 17,9 16 V
			←	04/02→ 08/05; für Fahrzeuge mit Scheibenbremse an der Hinterachse	24.0120-0175.1	420175	Ø 255 20 18 V
			→	04/02→ 08/05; + ABS	24.0320-0175.1	520175	Ø 255 20 18 V PD
1.4 D-4D (NLP10_)	55	10/01→09/05	←	12/01→ 08/05; für Fahrzeuge mit Trommelbremse an der Hinterachse	24.0118-0131.1	418131	Ø 235 17,9 16 V
↓							











	kw			 	! #		
TOYOTA - YARIS (_P1_) 01/99→12/05							
Bremsscheibe							
1.4 D-4D (NLP10_)	55	10/01→09/05	←	12/01→ 08/05; für Fahrzeuge mit Scheibenbremse an der Hinterachse	24.0120-0175.1	420175	Ø 255 20 18 V
			→	12/01→ 08/05; + ABS	24.0320-0175.1	520175	Ø 255 20 18 V PD
1.5 (NCP13_)	77	01/03→11/05	←	→ 08/05; für Fahrzeuge mit Scheibenbremse an der Hinterachse	24.0120-0175.1	420175	Ø 255 20 18 V
			→	→ 08/05	24.0320-0175.1	520175	Ø 255 20 18 V PD
1.5 (NCP13_)	78	04/01→09/05	←	→ 03/03; für Fahrzeuge mit Scheibenbremse an der Hinterachse	24.0120-0175.1	420175	Ø 255 20 18 V
			→	→ 03/03	24.0320-0175.1	520175	Ø 255 20 18 V PD
1.5 (NCP13_)	110	03/00→07/05	←	04/03→ 10/04; für Fahrzeuge mit Scheibenbremse an der Hinterachse	24.0120-0175.1	420175	Ø 255 20 18 V
			→	04/03→ 10/04	24.0320-0175.1	520175	Ø 255 20 18 V PD
TOYOTA - YARIS (_P9_) 01/05→							
Bremsbelagsatz, Scheibenbremse							
1.0 GPL (KSP90_)	51	01/06→	←	→ 08/11; + ABS; Made in Japan	13.0460-5768.2	605768	AKE 24347 17,5 - WK
			←	→ 08/11; Made in Frankreich	13.0460-7213.2	607213	ATE 23202 17,8 + WK
			→	→ 08/11; Made in Japan	13.0460-5769.2	605769	24610 15,0 + WK
			→	→ 08/11; Made in Frankreich	13.0460-7214.2	607214	ATE 24574 15,0 + WK
1.0 VVT-i (KSP90_)	51	01/05→11/11	←	01/06→ 08/11; + ABS; Made in Japan	13.0460-5768.2	605768	AKE 24347 17,5 - WK
			←	01/06→ 08/11; Made in Frankreich	13.0460-7213.2	607213	ATE 23202 17,8 + WK
			→	01/06→ 08/11; Made in Japan	13.0460-5769.2	605769	24610 15,0 + WK
			→	01/06→ 08/11; Made in Frankreich	13.0460-7214.2	607214	ATE 24574 15,0 + WK
1.33 VVT-i (NSP90_)	73	07/10→	←	→ 08/11; Made in Frankreich	13.0460-7213.2	607213	ATE 23202 17,8 + WK
			→	→ 08/11; Made in Frankreich	13.0460-7214.2	607214	ATE 24574 15,0 + WK
1.33 VVT-i (NSP90_)	74	11/08→	←	03/09→ 08/11; Made in Frankreich	13.0460-7213.2	607213	ATE 23202 17,8 + WK
			→	03/09→ 08/11; Made in Frankreich	13.0460-7214.2	607214	ATE 24574 15,0 + WK
1.3 VVT-i (NCP90_)	63	01/05→	←	01/06→ 08/11; Made in Frankreich	13.0460-7213.2	607213	ATE 23202 17,8 + WK
1.3 VVT-i (SCP90_)	64	08/05→	→	01/06→ 08/11; Made in Frankreich	13.0460-7214.2	607214	ATE 24574 15,0 + WK
1.4 D-4D (NLP90_)	66	08/05→					
1.8 VVTi	97	11/05→	←	01/06→ 08/11; Made in Japan	13.0460-5768.2	605768	AKE 24347 17,5 - WK
			→	01/06→ 08/11; Made in Japan	13.0460-5769.2	605769	24610 15,0 + WK
1.8 VVTi (ZSP90_)	98	01/07→	←	→ 08/11; Made in Japan	13.0460-5768.2	605768	AKE 24347 17,5 - WK
			→	→ 08/11; Made in Japan	13.0460-5769.2	605769	24610 15,0 + WK
Bremsscheibe							
1.0 GPL (KSP90_)	51	01/06→	←	→ 08/11; Made in Frankreich	24.0122-0240.1	422240	Ø 258 22 20 V
			←	→ 08/11; - ABS; Made in Japan	24.0122-0246.1	422246	Ø 255 22 19 V
			←	→ 08/11; + ABS; Made in Japan	24.0122-0254.1	422254	Ø 275 22 19 V
			→	→ 08/11; Made in Frankreich	24.0109-0142.1	409142	Ø 278 9 7
			→	→ 08/11; Made in Japan	24.0109-0156.1	409156	Ø 259 9 7,5
1.0 VVT-i (KSP90_)	51	01/05→11/11	←	01/06→ 08/11; Made in Frankreich	24.0122-0240.1	422240	Ø 258 22 20 V
			←	01/06→ 08/11; - ABS; Made in Japan	24.0122-0246.1	422246	Ø 255 22 19 V
			←	01/06→ 08/11; + ABS; Made in Japan	24.0122-0254.1	422254	Ø 275 22 19 V
			→	01/06→ 08/11; Made in Frankreich	24.0109-0142.1	409142	Ø 278 9 7
			→	01/06→ 08/11; Made in Japan	24.0109-0156.1	409156	Ø 259 9 7,5
1.33 VVT-i (NSP90_)	73	07/10→	←	→ 08/11; Made in Frankreich	24.0122-0240.1	422240	Ø 258 22 20 V
			→	→ 08/11; Made in Frankreich	24.0109-0142.1	409142	Ø 278 9 7
1.33 VVT-i (NSP90_)	74	11/08→	←	03/09→ 08/11; Made in Frankreich	24.0122-0240.1	422240	Ø 258 22 20 V
			→	03/09→ 08/11; Made in Frankreich	24.0109-0142.1	409142	Ø 278 9 7
1.3 VVT-i (NCP90_)	63	01/05→	←	01/06→ 08/11; Made in Frankreich	24.0122-0240.1	422240	Ø 258 22 20 V
1.3 VVT-i (SCP90_)	64	08/05→	→	01/06→ 08/11; Made in Frankreich	24.0109-0142.1	409142	Ø 278 9 7
1.4 D-4D (NLP90_)	66	08/05→					
1.8 VVTi	97	11/05→	←	01/06→ 08/11; Made in Japan	24.0122-0254.1	422254	Ø 275 22 19 V
↓							









	kw				! #		
TOYOTA - YARIS (_P9_) 01/05→							
 Bremsscheibe							
1.8 VVTi	97	11/05→	➡	01/06→ 08/11; Made in Japan		24.0109-0156.1 409156	Ø 259 9 7,5
1.8 VVTi (ZSP90_)	98	01/07→	←	→ 08/11; Made in Japan		24.0122-0254.1 422254	Ø 275 22 19 V
			➡	→ 08/11; Made in Japan		24.0109-0156.1 409156	Ø 259 9 7,5
TOYOTA - YARIS (_P13_) 12/10→							
 Bremsbelagsatz, Scheibenbremse							
1.0 (KSP130_)	51	12/10→	←	09/11→; Made in Frankreich		13.0460-7213.2 607213	ATE 23202 17,8 + WK
			➡	09/11→; Made in Frankreich; + ESP		13.0460-7214.2 607214	ATE 24574 15,0 + WK
1.3 (NCP130_)	63	08/11→	←	Made in Japan		13.0460-5768.2 605768	AKE 24347 17,5 - WK
			➡	Made in Frankreich		13.0460-7213.2 607213	ATE 23202 17,8 + WK
1.3 (NSP130_)	70	09/11→	←	Made in Frankreich		13.0460-7213.2 607213	ATE 23202 17,8 + WK
			➡	Made in Frankreich; + ESP		13.0460-7214.2 607214	ATE 24574 15,0 + WK
1.3 (NSP130_)	73	09/11→	←	Made in Frankreich		13.0460-7213.2 607213	ATE 23202 17,8 + WK
			➡	Made in Frankreich; + ESP		13.0460-7214.2 607214	ATE 24574 15,0 + WK
			←	Made in Frankreich		13.0460-7213.2 607213	ATE 23202 17,8 + WK
1.3 4WD (NSP135_)	70	12/10→	←	09/11→; Made in Japan		13.0460-5768.2 605768	AKE 24347 17,5 - WK
			←	09/11→; Made in Frankreich		13.0460-7213.2 607213	ATE 23202 17,8 + WK
			➡	09/11→; Made in Frankreich; + ESP		13.0460-7214.2 607214	ATE 24574 15,0 + WK
1.4 D-4D (NLP130_)	66	09/11→	←			13.0460-7213.2 607213	ATE 23202 17,8 + WK
			➡	+ ESP		13.0460-7214.2 607214	ATE 24574 15,0 + WK
1.5 Hybrid (NHP130_)	54	04/15→	←			13.0460-5767.2 605767	AKE 24336 17,5 - WE / - WK
			➡	+ ESP		13.0460-7214.2 607214	ATE 24574 15,0 + WK
1.5 Hybrid (NHP130_)	55	03/12→	←			13.0460-5767.2 605767	AKE 24336 17,5 - WE / - WK
			➡	+ ESP		13.0460-7214.2 607214	ATE 24574 15,0 + WK
 Bremsscheibe							
1.0 (KSP130_)	51	12/10→	←	09/11→; Made in Frankreich		24.0122-0240.1 422240	Ø 258 22 20 V
			←	09/11→; Made in Japan		24.0122-0246.1 422246	Ø 255 22 19 V
			➡	09/11→; Made in Frankreich; + ESP		24.0109-0142.1 409142	Ø 278 9 7
1.3 (NCP130_)	63	08/11→	←	Made in Frankreich		24.0122-0240.1 422240	Ø 258 22 20 V
			➡	Made in Frankreich; + ESP		24.0109-0142.1 409142	Ø 278 9 7
1.3 (NSP130_)	70	09/11→	←	Made in Japan		24.0122-0254.1 422254	Ø 275 22 19 V
			➡	Made in Frankreich; + ESP		24.0109-0142.1 409142	Ø 278 9 7
1.3 (NSP130_)	73	09/11→	←	Made in Japan		24.0122-0254.1 422254	Ø 275 22 19 V
			➡	Made in Frankreich; + ESP		24.0109-0142.1 409142	Ø 278 9 7
			←	Made in Frankreich		24.0122-0240.1 422240	Ø 258 22 20 V
1.3 4WD (NSP135_)	70	12/10→	←	09/11→; Made in Frankreich		24.0122-0240.1 422240	Ø 258 22 20 V
			←	09/11→; Made in Japan		24.0122-0254.1 422254	Ø 275 22 19 V
			➡	09/11→; Made in Frankreich; + ESP		24.0109-0142.1 409142	Ø 278 9 7
1.4 D-4D (NLP130_)	66	09/11→	←			24.0122-0240.1 422240	Ø 258 22 20 V
			➡	+ ESP		24.0109-0142.1 409142	Ø 278 9 7
1.5 Hybrid (NHP130_)	54	04/15→	←			24.0122-0254.1 422254	Ø 275 22 19 V
			➡	+ ESP		24.0109-0142.1 409142	Ø 278 9 7
1.5 Hybrid (NHP130_)	55	03/12→	←	→ 02/13		24.0122-0254.1 422254	Ø 275 22 19 V
			➡	+ ESP		24.0109-0142.1 409142	Ø 278 9 7
TOYOTA - YARIS (_P15_) 10/13→							
 Bremsbelagsatz, Scheibenbremse							
1.2 (NSP152_)	63	10/13→	←	Made in Japan		13.0460-5768.2 605768	AKE 24347 17,5 - WK
			←	Made in Frankreich		13.0460-7213.2 607213	ATE 23202 17,8 + WK
			➡	Made in Frankreich; + ESP		13.0460-7214.2 607214	ATE 24574 15,0 + WK
 Bremsscheibe							
1.2 (NSP152_)	63	10/13→	←	Made in Frankreich		24.0122-0240.1 422240	Ø 258 22 20 V
			←	Made in Japan		24.0122-0254.1 422254	Ø 275 22 19 V
			➡	Made in Frankreich; + ESP		24.0109-0142.1 409142	Ø 278 9 7
TOYOTA - YARIS VERSO (_P2_) 08/99→09/05							
 Bremsbelagsatz, Scheibenbremse							
1.3 (NCP20_, NCP22_)	62	11/02→09/05	←	01/03→		13.0460-5800.2 605800	BOS 23340 17,0 + WK
			➡	01/03→; + ABS		13.0460-5810.2 605810	AKE 23510 16,5 + WK
			➡	01/03→; + ABS		13.0460-5812.2 605812	SUM 23521 14,0 + WK
1.3 (NCP20_, NCP22_)	63	08/99→10/02	←	11/99→		13.0460-5800.2 605800	BOS 23340 17,0 + WK
			➡	11/99→		13.0460-5810.2 605810	AKE 23510 16,5 + WK
			➡	11/99→; + ABS		13.0460-5812.2 605812	SUM 23521 14,0 + WK
			↓				







	kw			 	! #		
TOYOTA - YARIS VERSO (_P2_) 08/99→09/05							
 Bremsbelagsatz, Scheibenbremse							
1.4 D-4D (NLP20_, NLP22_) 1.5 (NCP21_) 1.5 4WD (NCP21_)	55 77 78	12/01→09/05 05/03→09/05 03/00→09/05	← → →	+ ABS		13.0460-5800.2 605800 13.0460-5810.2 605810 13.0460-5812.2 605812	BOS 23340 17,0 + WK AKE 23510 16,5 + WK SUM 23521 14,0 + WK
1.5 (NCP21_)	78	03/00→09/05	← →	→ 03/03 → 03/03; + ABS		13.0460-5800.2 605800 13.0460-5810.2 605810 13.0460-5812.2 605812	BOS 23340 17,0 + WK AKE 23510 16,5 + WK SUM 23521 14,0 + WK
Zubehörsatz, Scheibenbremsbelag							
1.3 (NCP20_, NCP22_)	62	11/02→09/05	→	01/03→; + ABS		13.0460-0136.2 610136	SUM
1.3 (NCP20_, NCP22_)	63	08/99→10/02	→	11/99→; + ABS		13.0460-0136.2 610136	SUM
1.4 D-4D (NLP20_, NLP22_) 1.5 (NCP21_) 1.5 4WD (NCP21_)	55 77 78	12/01→09/05 05/03→09/05 03/00→09/05	→	+ ABS		13.0460-0136.2 610136	SUM
1.5 (NCP21_)	78	03/00→09/05	→	→ 03/03; + ABS		13.0460-0136.2 610136	SUM
 Bremsscheibe							
1.3 (NCP20_, NCP22_)	62	11/02→09/05	← →	01/03→ 01/03→; + ABS		24.0120-0175.1 420175 24.0320-0175.1 520175 24.0109-0139.1 409139	Ø 255 20 18 V Ø 255 20 18 V PD Ø 269 9 8
1.3 (NCP20_, NCP22_)	63	08/99→10/02	← →	11/99→ 11/99→; + ABS		24.0120-0175.1 420175 24.0320-0175.1 520175 24.0109-0139.1 409139	Ø 255 20 18 V Ø 255 20 18 V PD Ø 269 9 8
1.4 D-4D (NLP20_, NLP22_) 1.5 (NCP21_) 1.5 4WD (NCP21_)	55 77 78	12/01→09/05 05/03→09/05 03/00→09/05	← →	+ ABS		24.0120-0175.1 420175 24.0320-0175.1 520175 24.0109-0139.1 409139	Ø 255 20 18 V Ø 255 20 18 V PD Ø 269 9 8
1.5 (NCP21_)	78	03/00→09/05	← →	→ 03/03 → 03/03; + ABS		24.0120-0175.1 420175 24.0320-0175.1 520175 24.0109-0139.1 409139	Ø 255 20 18 V Ø 255 20 18 V PD Ø 269 9 8
VAUXHALL - ADAM 10/12→							
 Bremsbelagsatz, Scheibenbremse							
1.0 1.0 1.4 LPG 1.4 S	66 85 64 110	07/14→ 07/14→ 07/13→ 11/14→	← ← ← →	für Bremsscheibendurchmesser [mm]: 257 für Bremsscheibendurchmesser [mm]: 308 für Bremsscheibendurchmesser [mm]: 284		13.0460-3839.2 603839 13.0470-3839.2 LD3839 13.0460-7179.2 607179 13.0470-7179.2 LD7179 13.0460-7308.2 607308 13.0460-2793.2 602793	BOS 23707 17,9 + WK + Zub BOS 23982 18,1 + WK + Zub Ceramic ATE 23832 20,2 - WK / + WK Ceramic ATE 23832 20,2 - WK / + WK Ceramic ATE 22123 18,2 + WK + Zub TRW 25973 17,2 + WK + Zub
1.2 1.4 1.4	51 64 74	10/12→ 10/12→ 10/12→	← ← ← →	01/13→; für Bremsscheibendurchmesser [mm]: 257 01/13→; für Bremsscheibendurchmesser [mm]: 308 01/13→; für Bremsscheibendurchmesser [mm]: 284		13.0460-3839.2 603839 13.0470-3839.2 LD3839 13.0460-7179.2 607179 13.0470-7179.2 LD7179 13.0460-7308.2 607308 13.0460-2793.2 602793	BOS 23707 17,9 + WK + Zub BOS 23982 18,1 + WK + Zub Ceramic ATE 23832 20,2 - WK / + WK Ceramic ATE 23832 20,2 - WK / + WK Ceramic ATE 22123 18,2 + WK + Zub TRW 25973 17,2 + WK + Zub
 Bremsscheibe							
1.0 1.0 1.4 LPG 1.4 S	66 85 64 110	07/14→ 07/14→ 07/13→ 11/14→	← ← ← →			24.0122-0231.1 422231 24.0122-0241.1 422241 24.0125-0142.1 425142 24.0322-0231.1 522231 24.0325-0142.1 525142 24.0110-0323.1 410323 24.0110-0347.1 410347	Ø 257 22 20 V + S Ø 284 22 20 V + S Ø 308 25 22 V + S Ø 257 22 20 V + S PD Ø 308 25 23 V + S PD Ø 264 10 8 Ø 264 10 8
1.2 1.4 1.4	51 64 74	10/12→ 10/12→ 10/12→	←	01/13→		24.0122-0231.1 422231 24.0122-0241.1 422241 24.0125-0142.1 425142	Ø 257 22 20 V + S Ø 284 22 20 V + S Ø 308 25 22 V + S









	kw			 	! #		
VAUXHALL - ADAM 10/12→							
 Bremsscheibe							
1.2	51	10/12→	←	01/13→		24.0322-0231.1 522231	Ø 257 22 20 V + S PD
1.4	64	10/12→				24.0325-0142.1 525142	Ø 308 25 23 V + S PD
1.4	74	10/12→					
			→	01/13→		24.0110-0323.1 410323	Ø 264 10 8
						24.0110-0347.1 410347	Ø 264 10 8
VAUXHALL - AGILA Mk I (A) 02/00→03/08							
 Bremsbelagsatz, Scheibenbremse							
1.0 12V	43	09/00→08/05	←			13.0460-3995.2 603995	BOS 23605 15,7 + WK + Zub
1.2 16V Twinport	59	07/04→11/06					
1.0 12V	44	02/00→11/06	←	09/00→		13.0460-3995.2 603995	BOS 23605 15,7 + WK + Zub
1.2 16V	55	09/00→03/08	←	→ 07/07		13.0460-3995.2 603995	BOS 23605 15,7 + WK + Zub
 Bremsscheibe							
1.0 12V	43	09/00→08/05	←	→ 3G002367		24.0112-0153.1 412153	Ø 247 12 10,5
1.2 16V Twinport	59	07/04→11/06					
			←	3G002368→		24.0117-0106.1 417106	Ø 253 17 15 V
1.0 12V	44	02/00→11/06	←	09/00→; → 3G002367		24.0112-0153.1 412153	Ø 247 12 10,5
			←	3G002368→		24.0117-0106.1 417106	Ø 253 17 15 V
1.2 16V	55	09/00→03/08	←	→ 3G002367		24.0112-0153.1 412153	Ø 247 12 10,5
			←	3G002368→; → 07/07		24.0117-0106.1 417106	Ø 253 17 15 V
VAUXHALL - AGILA Mk II (B) 01/08→11/14							
 Bremsbelagsatz, Scheibenbremse							
1.0 12V	48	01/08→11/14	←			13.0460-5700.2 605700	TRW 23973 17,0 + WK
1.0 i	50	08/11→11/14					
1.2 i 16V	63	01/08→11/14					
1.2 i 16V	69	01/08→11/14					
1.3 CDTI	55	01/08→11/14					
 Bremsscheibe							
1.0 12V	48	01/08→11/14	←			24.0120-0211.1 420211	Ø 252 20 18 V + S
1.0 i	50	08/11→11/14					
1.2 i 16V	63	01/08→11/14					
1.2 i 16V	69	01/08→11/14					
1.3 CDTI	55	01/08→11/14					
VAUXHALL - AMPERA 03/12→							
 Bremsbelagsatz, Scheibenbremse							
EV 150 (D1JOI)	111	03/12→	←			13.0460-7263.2 607263	24034 19,1 + WK + Zub
			→	+ eFSB		13.0460-7264.2 607264	ATE 25096 17,0 + WK + Zub
						13.0470-7264.2 LD7264	ATE 25096 17,0 + WK + Zub Ceramic
 Bremsscheibe							
EV 150 (D1JOI)	111	03/12→	←			24.0126-0166.1 426166	Ø 300 26 23 V + S
						24.0326-0166.1 526166	Ø 300 26 23 V + S PD
			→	+ eFSB		24.0112-0189.1 412189	Ø 292 12 10 + S
						24.0312-0189.1 512189	Ø 292 12 10 + S PD
VAUXHALL - ANTARA (J26, H26) 08/06→							
 Bremsbelagsatz, Scheibenbremse							
2.0 CDTi	93	08/06→04/15	←	09/08→		13.0460-5785.2 605785	24510 17,0 + WK
			→	09/08→		13.0460-5788.2 605788	24498 14,7 + WK
2.0 CDTi	110	08/06→04/15	←			13.0460-5785.2 605785	24510 17,0 + WK
2.0 CDTi 4x4	110	08/06→04/15					
2.2 CDTi 4x4	120	12/10→	→			13.0460-5788.2 605788	24498 14,7 + WK
2.2 CDTi 4x4	135	12/10→					
2.2 CDTi FWD	120	12/10→					
2.4	103	08/06→04/15					
2.4	123	12/10→04/15					
2.4 4x4	123	12/10→04/15					
3.2 V6 4x4	167	11/06→04/15					
2.0 CDTi 4x4	93	08/06→04/15	←	03/07→		13.0460-5785.2 605785	24510 17,0 + WK
			→	03/07→		13.0460-5788.2 605788	24498 14,7 + WK
2.4	126	11/10→04/15	←	12/10→		13.0460-5785.2 605785	24510 17,0 + WK
2.4 4x4	126	11/10→04/15					
3.0 4x4	188	11/10→04/15	→	12/10→		13.0460-5788.2 605788	24498 14,7 + WK
↓							









	kw			 	! #		
VAUXHALL - ANTARA (J26, H26) 08/06→							
 Bremsbelagsatz, Scheibenbremse							
2.4 4x4 2.4 LPG 4x4	103 103	08/06→04/15 08/06→	← →	01/07→ 01/07→		13.0460-5785.2 605785 13.0460-5788.2 605788	24510 17,0 + WK 24498 14,7 + WK
Zubehörsatz, Scheibenbremsbelag							
2.0 CDTi	93	08/06→04/15	→	09/08→		13.0460-0135.2 610135	
2.0 CDTi 2.0 CDTi 4x4 2.2 CDTi 4x4 2.2 CDTi 4x4 2.2 CDTi FWD 2.4 2.4 2.4 4x4 3.2 V6 4x4	110 110 120 135 120 103 123 123 167	08/06→04/15 08/06→04/15 12/10→ 12/10→ 12/10→ 08/06→04/15 12/10→04/15 12/10→04/15 11/06→04/15	→			13.0460-0135.2 610135	
2.0 CDTi 4x4	93	08/06→04/15	→	03/07→		13.0460-0135.2 610135	
2.4 2.4 4x4 3.0 4x4	126 126 188	11/10→04/15 11/10→04/15 11/10→04/15	→	12/10→		13.0460-0135.2 610135	
2.4 4x4 2.4 LPG 4x4	103 103	08/06→04/15 08/06→	→	01/07→		13.0460-0135.2 610135	
 Bremsscheibe							
2.0 CDTi	93	08/06→04/15	← →	09/08→ 09/08→		24.0129-0101.1 429101 24.0120-0209.1 420209	Ø 296 29 27,5 V Ø 303 20 18,4 V
2.0 CDTi 2.0 CDTi 4x4 2.2 CDTi 4x4 2.2 CDTi 4x4 2.2 CDTi FWD 2.4 2.4 2.4 4x4 3.2 V6 4x4	110 110 120 135 120 103 123 123 167	08/06→04/15 08/06→04/15 12/10→ 12/10→ 12/10→ 08/06→04/15 12/10→04/15 12/10→04/15 11/06→04/15	← →			24.0129-0101.1 429101 24.0120-0209.1 420209	Ø 296 29 27,5 V Ø 303 20 18,4 V
2.0 CDTi 4x4	93	08/06→04/15	← →	03/07→ 03/07→		24.0129-0101.1 429101 24.0120-0209.1 420209	Ø 296 29 27,5 V Ø 303 20 18,4 V
2.4 2.4 4x4 3.0 4x4	126 126 188	11/10→04/15 11/10→04/15 11/10→04/15	← →	12/10→ 12/10→		24.0129-0101.1 429101 24.0120-0209.1 420209	Ø 296 29 27,5 V Ø 303 20 18,4 V
2.4 4x4 2.4 LPG 4x4	103 103	08/06→04/15 08/06→	← →	01/07→ 01/07→		24.0129-0101.1 429101 24.0120-0209.1 420209	Ø 296 29 27,5 V Ø 303 20 18,4 V
VAUXHALL - ARENA Combi 01/97→08/01							
 Bremsbelagsatz, Scheibenbremse							
1.9 D 2.5 D	44 55	03/98→08/01 03/98→08/01	←			13.0460-3969.2 603969	BDX 20926 18,5 + WK
 Bremsscheibe							
1.9 D 2.5 D	44 55	03/98→08/01 03/98→08/01	←			24.0124-0103.1 424103	Ø 252,5 24 22 V
VAUXHALL - ARENA Van 01/97→08/01							
 Bremsbelagsatz, Scheibenbremse							
1.9 D 2.5 D	44 55	03/98→08/01 03/98→08/01	←			13.0460-3969.2 603969	BDX 20926 18,5 + WK
 Bremsscheibe							
1.9 D 2.5 D	44 55	03/98→08/01 03/98→08/01	←			24.0124-0103.1 424103	Ø 252,5 24 22 V
VAUXHALL - ASTRA Mk III (F) 09/91→09/98							
 Bremsbelagsatz, Scheibenbremse							
1.4 i 1.8 i	44 66	04/92→09/98 03/92→09/98	←			13.0460-7051.2 607051	ATE 20547 16,5 + WE / - WK
1.4 i 1.4 i 16V	60 66	04/92→09/98 02/96→09/98	←	nicht für Fahrzeuge mit verstärkter Bremse		13.0460-7051.2 607051	ATE 20547 16,5 + WE / - WK
1.7 D 1.7 TD 1.7 TD	44 50 60	07/92→09/98 08/94→09/98 12/91→09/98	←	für Fahrzeuge mit verstärkter Bremse		13.0460-7052.2 607052	ATE 21190 17,5 + WE / - WK
1.6 i 1.6 i	52 55	08/94→07/96 03/92→09/98	←	Motorcode: C16NZ / X16SZR		13.0460-7051.2 607051	ATE 20547 16,5 + WE / - WK
			←	nicht für Motorcode: C16NZ / X16SZR		13.0460-7052.2 607052	ATE 21190 17,5 + WE / - WK
↓							









	kw			 	! #		
VAUXHALL - ASTRA Mk III (F) 09/91→09/98							
 Bremsbelagsatz, Scheibenbremse							
1.6 i 16V	74	08/94→09/98	←			13.0460-7052.2 607052	ATE 21190 17,5 + WE / - WK
			←	nicht für Motorcode: C16NZ / X16SZR		13.0460-7052.2 607052	ATE 21190 17,5 + WE / - WK
1.8 i 16V	82	09/95→02/98	←			13.0460-7052.2 607052	ATE 21190 17,5 + WE / - WK
1.8 i 16V	85	01/94→12/96	←				
2.0 i 16V	100	02/95→09/98	→			13.0460-4043.2 604043	ATE 21140 15,0 - WE / - WK
2.0 i	85	03/92→09/98	←			13.0460-7052.2 607052	ATE 21190 17,5 + WE / - WK
Warnkontakt, Bremsbelagverschleiß							
1.4 i	44	04/92→09/98	←		2	24.8190-0707.2 620707	L= 685
1.8 i	66	03/92→09/98	←				
1.4 i	60	04/92→09/98	←	für Fahrzeuge mit verstärkter Bremse	2	24.8190-0705.2 620705	L= 670
1.4 i 16V	66	02/96→09/98	←				
1.7 D	44	07/92→09/98	←	nicht für Fahrzeuge mit verstärkter Bremse	2	24.8190-0707.2 620707	L= 685
1.7 TD	50	08/94→09/98	←				
1.7 TD	60	12/91→09/98	←				
1.6 i	52	08/94→07/96	←	nicht für Motorcode: C16NZ / X16SZR	2	24.8190-0705.2 620705	L= 670
1.6 i	55	03/92→09/98	←	Motorcode: C16NZ / X16SZR	2	24.8190-0707.2 620707	L= 685
1.6 i 16V	74	08/94→09/98	←	nicht für Motorcode: C16NZ / X16SZR	2	24.8190-0705.2 620705	L= 670
			←		2	24.8190-0705.2 620705	L= 670
1.8 i 16V	82	09/95→02/98	←		2	24.8190-0705.2 620705	L= 670
1.8 i 16V	85	01/94→12/96	←				
2.0 i	85	03/92→09/98	←				
2.0 i 16V	100	02/95→09/98	←				
Zubehörsatz, Scheibenbremsbelag							
1.8 i 16V	82	09/95→02/98	→			13.0460-0217.2 610217	ATE
1.8 i 16V	85	01/94→12/96	→				
2.0 i 16V	100	02/95→09/98	→				
 Bremsscheibe							
1.4 i	44	04/92→09/98	←			24.0113-0161.1 413161	Ø 236 12,7 9,7 + S
						24.0313-0161.1 513161	Ø 236 12,7 9,7 + S PD
1.4 i	60	04/92→09/98	←			24.0120-0115.1 420115	Ø 236 20 17 V + S
1.4 i 16V	66	02/96→09/98	←			24.0124-0115.1 424115	Ø 256 24 21 V + S
						24.0320-0115.1 520115	Ø 236 20 17 V + S PD
						24.0324-0115.1 524115	Ø 256 24 21 V + S PD
1.6 i	52	08/94→07/96	←	→ T5000073; Schaltgetriebe		24.0113-0161.1 413161	Ø 236 12,7 9,7 + S
1.6 i	55	03/92→09/98	←	Vollautomatik		24.0120-0115.1 420115	Ø 236 20 17 V + S
						24.0320-0115.1 520115	Ø 236 20 17 V + S PD
			←	T5000074 →; Schaltgetriebe		24.0120-0115.1 420115	Ø 236 20 17 V + S
						24.0320-0115.1 520115	Ø 236 20 17 V + S PD
			←			24.0124-0115.1 424115	Ø 256 24 21 V + S
						24.0324-0115.1 524115	Ø 256 24 21 V + S PD
1.6 i 16V	74	08/94→09/98	←			24.0124-0115.1 424115	Ø 256 24 21 V + S
2.0 i	85	03/92→09/98	←			24.0324-0115.1 524115	Ø 256 24 21 V + S PD
1.7 D	44	07/92→09/98	←	nicht für Fahrzeuge mit verstärkter Bremse		24.0120-0115.1 420115	Ø 236 20 17 V + S
1.7 TD	50	08/94→09/98	←			24.0320-0115.1 520115	Ø 236 20 17 V + S PD
1.7 TD	60	12/91→09/98	←	für Fahrzeuge mit verstärkter Bremse		24.0124-0115.1 424115	Ø 256 24 21 V + S
						24.0324-0115.1 524115	Ø 256 24 21 V + S PD
1.8 i	66	03/92→09/98	←			24.0120-0140.1 420140	Ø 256 20 17 V + S
1.8 i 16V	82	09/95→02/98	←			24.0124-0115.1 424115	Ø 256 24 21 V + S
1.8 i 16V	85	01/94→12/96	←			24.0324-0115.1 524115	Ø 256 24 21 V + S PD
2.0 i 16V	100	02/95→09/98	→			24.0110-0204.1 410204	Ø 260 10 8
VAUXHALL - ASTRA Mk III (F) CC 09/91→02/98							
 Bremsbelagsatz, Scheibenbremse							
1.4 i	44	09/91→02/98	←	10/91→		13.0460-7051.2 607051	ATE 20547 16,5 + WE / - WK
1.4 S	55	09/91→02/98	←				
1.8 i	66	09/91→02/98	←				
1.4 i	60	03/92→02/98	←	nicht für Fahrzeuge mit verstärkter Bremse		13.0460-7051.2 607051	ATE 20547 16,5 + WE / - WK
1.4 i 16V	66	02/96→02/98	←				
1.7 D	42	12/91→02/98	←	für Fahrzeuge mit verstärkter Bremse		13.0460-7052.2 607052	ATE 21190 17,5 + WE / - WK
1.7 TD	50	08/94→02/98	←				
1.7 TD	60	12/91→02/98	←				
1.6 i	52	02/93→12/96	←	Motorcode: C16NZ / X16SZR		13.0460-7051.2 607051	ATE 20547 16,5 + WE / - WK
↓							









	kw			 	! #		
VAUXHALL - ASTRA Mk III (F) CC 09/91→02/98							
 Bremsbelagsatz, Scheibenbremse							
1.6 i	52	02/93→12/96	←	nicht für Motorcode: C16NZ / X16SZR		13.0460-7052.2 607052	ATE 21190 17,5 + WE / - WK
1.6 i	55	09/91→02/98	←	10/91→; Motorcode: C16NZ / X16SZR		13.0460-7051.2 607051	ATE 20547 16,5 + WE / - WK
			←	10/91→; nicht für Motorcode: C16NZ / X16SZR		13.0460-7052.2 607052	ATE 21190 17,5 + WE / - WK
1.6 i	74	03/92→02/98	←			13.0460-7052.2 607052	ATE 21190 17,5 + WE / - WK
1.6 i 16V	74	01/94→02/98	←	nicht für Motorcode: C16NZ / X16SZR		13.0460-7052.2 607052	ATE 21190 17,5 + WE / - WK
1.8 i 16V	85	09/94→02/98	←			13.0460-7051.2 607051	ATE 20547 16,5 + WE / - WK
1.8 i 16V	92	09/94→02/98	←			13.0460-7051.2 607051	ATE 20547 16,5 + WE / - WK
			←			13.0460-7052.2 607052	ATE 21190 17,5 + WE / - WK
			→			13.0460-4043.2 604043	ATE 21140 15,0 - WE / - WK
2.0 i	85	09/91→02/98	←	10/91→		13.0460-7052.2 607052	ATE 21190 17,5 + WE / - WK
2.0 i 16V	100	01/94→02/98	←			13.0460-7052.2 607052	ATE 21190 17,5 + WE / - WK
2.0 i 16V	110	09/91→02/98	←	10/91→		13.0460-7052.2 607052	ATE 21190 17,5 + WE / - WK
			→	10/91→		13.0460-4043.2 604043	ATE 21140 15,0 - WE / - WK
Warnkontakt, Bremsbelagverschleiß							
1.4 i	44	09/91→02/98	←	10/91→	2	24.8190-0707.2 620707	L= 685
1.4 S	55	09/91→02/98	←				
1.8 i	66	09/91→02/98	←				
1.4 i	60	03/92→02/98	←	für Fahrzeuge mit verstärkter Bremse	2	24.8190-0705.2 620705	L= 670
1.4 i 16V	66	02/96→02/98	←				
1.7 D	42	12/91→02/98	←	nicht für Fahrzeuge mit verstärkter Bremse	2	24.8190-0707.2 620707	L= 685
1.7 TD	50	08/94→02/98	←				
1.7 TD	60	12/91→02/98	←				
1.6 i	52	02/93→12/96	←	nicht für Motorcode: C16NZ / X16SZR	2	24.8190-0705.2 620705	L= 670
			←	Motorcode: C16NZ / X16SZR	2	24.8190-0707.2 620707	L= 685
1.6 i	55	09/91→02/98	←	10/91→; nicht für Motorcode: C16NZ / X16SZR	2	24.8190-0705.2 620705	L= 670
			←	10/91→; Motorcode: C16NZ / X16SZR	2	24.8190-0707.2 620707	L= 685
1.6 i	74	03/92→02/98	←	nicht für Motorcode: C16NZ / X16SZR	2	24.8190-0705.2 620705	L= 670
1.6 i 16V	74	01/94→02/98	←		2	24.8190-0705.2 620705	L= 670
1.8 i 16V	85	09/94→02/98	←		2	24.8190-0707.2 620707	L= 685
1.8 i 16V	92	09/94→02/98	←		2	24.8190-0705.2 620705	L= 670
			←		2	24.8190-0707.2 620707	L= 685
2.0 i	85	09/91→02/98	←	10/91→	2	24.8190-0705.2 620705	L= 670
2.0 i 16V	110	09/91→02/98	←				
2.0 i 16V	100	01/94→02/98	←		2	24.8190-0705.2 620705	L= 670
Zubehörsatz, Scheibenbremsbelag							
1.8 i 16V	92	09/94→02/98	→			13.0460-0217.2 610217	ATE
2.0 i 16V	110	09/91→02/98	→	10/91→		13.0460-0217.2 610217	ATE
 Bremsscheibe							
1.4 i	44	09/91→02/98	←	10/91→		24.0113-0161.1 413161	Ø 236 12,7 9,7 + S
1.4 S	55	09/91→02/98	←			24.0313-0161.1 513161	Ø 236 12,7 9,7 + S PD
1.4 i	60	03/92→02/98	←	Schaltgetriebe; nicht für Fahrzeuge mit verstärkter Bremse		24.0113-0161.1 413161	Ø 236 12,7 9,7 + S
			←	Vollautomatik; nicht für Fahrzeuge mit verstärkter Bremse		24.0120-0115.1 420115	Ø 236 20 17 V + S
			←	für Fahrzeuge mit verstärkter Bremse		24.0124-0115.1 424115	Ø 256 24 21 V + S
						24.0324-0115.1 524115	Ø 256 24 21 V + S PD
1.4 i 16V	66	02/96→02/98	←			24.0120-0115.1 420115	Ø 236 20 17 V + S
1.6 i	74	03/92→02/98	←			24.0124-0115.1 424115	Ø 256 24 21 V + S
1.6 i 16V	74	01/94→02/98	←			24.0320-0115.1 520115	Ø 236 20 17 V + S PD
						24.0324-0115.1 524115	Ø 256 24 21 V + S PD
1.6 i	52	02/93→12/96	←	→ T5000073; Schaltgetriebe		24.0113-0161.1 413161	Ø 236 12,7 9,7 + S
			←			24.0313-0161.1 513161	Ø 236 12,7 9,7 + S PD
			←	Vollautomatik		24.0120-0115.1 420115	Ø 236 20 17 V + S
			←			24.0320-0115.1 520115	Ø 236 20 17 V + S PD
			←	T5000074→; Schaltgetriebe		24.0120-0115.1 420115	Ø 236 20 17 V + S
						24.0320-0115.1 520115	Ø 236 20 17 V + S PD
↓							







	kw			 	! #		
VAUXHALL - ASTRA Mk III (F) CC 09/91→02/98							
Bremsscheibe							
1.6 i	52	02/93→12/96	←			24.0124-0115.1 424115 24.0324-0115.1 524115	Ø 256 24 21 V + S Ø 256 24 21 V + S PD
1.6 i	55	09/91→02/98	←	10/91→; → T5000073; Schaltgetriebe		24.0113-0161.1 413161 24.0313-0161.1 513161	Ø 236 12,7 9,7 + S Ø 236 12,7 9,7 + S PD
			←	10/91→; Vollautomatik		24.0120-0115.1 420115 24.0320-0115.1 520115	Ø 236 20 17 V + S Ø 236 20 17 V + S PD
			←	T5000074 →; Schaltgetriebe		24.0120-0115.1 420115 24.0320-0115.1 520115	Ø 236 20 17 V + S Ø 236 20 17 V + S PD
			←	10/91→		24.0124-0115.1 424115 24.0324-0115.1 524115	Ø 256 24 21 V + S Ø 256 24 21 V + S PD
			←				
1.7 D 1.7 TD 1.7 TD	42 50 60	12/91→02/98 08/94→02/98 12/91→02/98	←	nicht für Fahrzeuge mit verstärkter Bremse		24.0120-0115.1 420115 24.0320-0115.1 520115	Ø 236 20 17 V + S Ø 236 20 17 V + S PD
			←	für Fahrzeuge mit verstärkter Bremse		24.0124-0115.1 424115 24.0324-0115.1 524115	Ø 256 24 21 V + S Ø 256 24 21 V + S PD
1.8 i	66	09/91→02/98	←	10/91→		24.0120-0140.1 420140	Ø 256 20 17 V + S
1.8 i 16V	92	09/94→02/98	←			24.0124-0115.1 424115 24.0324-0115.1 524115	Ø 256 24 21 V + S Ø 256 24 21 V + S PD
			→			24.0110-0204.1 410204	Ø 260 10 8
			←				
2.0 i	85	09/91→02/98	←	10/91→		24.0124-0115.1 424115 24.0324-0115.1 524115	Ø 256 24 21 V + S Ø 256 24 21 V + S PD
2.0 i 16V	100	01/94→02/98	←			24.0124-0115.1 424115 24.0324-0115.1 524115	Ø 256 24 21 V + S Ø 256 24 21 V + S PD
2.0 i 16V	110	09/91→02/98	←	10/91→		24.0124-0115.1 424115 24.0324-0115.1 524115	Ø 256 24 21 V + S Ø 256 24 21 V + S PD
			→	10/91→		24.0110-0204.1 410204	Ø 260 10 8
VAUXHALL - ASTRA Mk III (F) Convertible 03/93→03/01							
Bremsbelagsatz, Scheibenbremse							
1.4 i 1.4 i 16V	60 66	05/93→03/01 01/96→03/01	←			13.0460-7051.2 607051	ATE 20547 16,5 + WE / - WK
1.6	74	03/94→08/95	←			13.0460-7051.2 607051 13.0460-7052.2 607052	ATE 20547 16,5 + WE / - WK ATE 21190 17,5 + WE / - WK
1.6 i	52	03/93→08/96	←			13.0460-7051.2 607051	ATE 20547 16,5 + WE / - WK
			←	Motorcode: C16NZ / X16SZR		13.0460-7051.2 607051	ATE 20547 16,5 + WE / - WK
			←	nicht für Motorcode: C16NZ / X16SZR		13.0460-7052.2 607052	ATE 21190 17,5 + WE / - WK
1.6 i	55	01/96→03/01	←			13.0460-7051.2 607051	ATE 20547 16,5 + WE / - WK
			←	→ 09/98; Motorcode: C16NZ / X16SZR		13.0460-7051.2 607051	ATE 20547 16,5 + WE / - WK
			←	→ 09/98; nicht für Motorcode: C16NZ / X16SZR		13.0460-7052.2 607052	ATE 21190 17,5 + WE / - WK
1.8	92	09/94→08/96	←			13.0460-7052.2 607052	ATE 21190 17,5 + WE / - WK
			→			13.0460-4043.2 604043	ATE 21140 15,0 - WE / - WK
1.8 16V	85	11/94→03/01	←	→ 09/98		13.0460-7051.2 607051	ATE 20547 16,5 + WE / - WK
			←			13.0460-7052.2 607052	ATE 21190 17,5 + WE / - WK
2.0 i 16V	100	01/94→02/98	←	→ 10/94		13.0460-7052.2 607052	ATE 21190 17,5 + WE / - WK
Warnkontakt, Bremsbelagsverschleiß							
1.4 i 1.4 i 16V	60 66	05/93→03/01 01/96→03/01	←		2	24.8190-0707.2 620707	L= 685
1.6	74	03/94→08/95	←		2	24.8190-0705.2 620705 24.8190-0707.2 620707	L= 670 L= 685
			←		2	24.8190-0705.2 620705	L= 670
1.6 i	52	03/93→08/96	←	nicht für Motorcode: C16NZ / X16SZR	2	24.8190-0705.2 620705	L= 670
			←		2	24.8190-0707.2 620707	L= 685
			←	Motorcode: C16NZ / X16SZR	2	24.8190-0707.2 620707	L= 685
1.6 i	55	01/96→03/01	←	→ 09/98; nicht für Motorcode: C16NZ / X16SZR	2	24.8190-0705.2 620705	L= 670
			←	→ 09/98; Motorcode: C16NZ / X16SZR	2	24.8190-0707.2 620707	L= 685
			←		2	24.8190-0707.2 620707	L= 685
1.8	92	09/94→08/96	←		2	24.8190-0705.2 620705	L= 670
1.8 16V	85	11/94→03/01	←		2	24.8190-0705.2 620705	L= 670
			←	→ 09/98	2	24.8190-0707.2 620707	L= 685
↓							











	kw					! #		
VAUXHALL - ASTRA Mk III (F) Convertible 03/93→03/01								
Warnkontakt, Bremsbelagverschleiß								
2.0 i 16V	100	01/94→02/98	←	→ 10/94		2	24.8190-0705.2 620705	L= 670
Zubehörsatz, Scheibenbremsbelag								
1.8	92	09/94→08/96	→				13.0460-0217.2 610217	ATE
 Bremsscheibe								
1.4 i	60	05/93→03/01	←				24.0120-0115.1 420115	Ø 236 20 17 V + S
1.4 i 16V	66	01/96→03/01	←				24.0320-0115.1 520115	Ø 236 20 17 V + S PD
1.6	74	03/94→08/95	←				24.0120-0115.1 420115	Ø 236 20 17 V + S
1.6 i	52	03/93→08/96	←				24.0124-0115.1 424115	Ø 256 24 21 V + S
							24.0320-0115.1 520115	Ø 236 20 17 V + S PD
							24.0324-0115.1 524115	Ø 256 24 21 V + S PD
1.6 i	55	01/96→03/01	←				24.0120-0115.1 420115	Ø 236 20 17 V + S
			←	→ 09/98			24.0320-0115.1 520115	Ø 236 20 17 V + S PD
			←				24.0124-0115.1 424115	Ø 256 24 21 V + S
			←				24.0324-0115.1 524115	Ø 256 24 21 V + S PD
1.8	92	09/94→08/96	←				24.0124-0115.1 424115	Ø 256 24 21 V + S
			→				24.0324-0115.1 524115	Ø 256 24 21 V + S PD
			←				24.0110-0204.1 410204	Ø 260 10 8
1.8 16V	85	11/94→03/01	←				24.0124-0115.1 424115	Ø 256 24 21 V + S
			←				24.0324-0115.1 524115	Ø 256 24 21 V + S PD
2.0 i 16V	100	01/94→02/98	←	→ 10/94			24.0124-0115.1 424115	Ø 256 24 21 V + S
			←				24.0324-0115.1 524115	Ø 256 24 21 V + S PD
VAUXHALL - ASTRA Mk III (F) Estate 03/91→02/98								
 Bremsbelagsatz, Scheibenbremse								
1.4 i	44	09/91→02/98	←	10/91→			13.0460-7051.2 607051	ATE 20547 16,5 + WE / - WK
1.4 S	55	09/91→02/98	←					
1.8 i	66	09/91→02/98	←					
1.4 i	60	03/91→02/98	←	10/91→; nicht für Fahrzeuge mit verstärkter Bremsen			13.0460-7051.2 607051	ATE 20547 16,5 + WE / - WK
			←	10/91→; für Fahrzeuge mit verstärkter Bremsen			13.0460-7052.2 607052	ATE 21190 17,5 + WE / - WK
1.4 i 16V	66	02/96→01/98	←	nicht für Fahrzeuge mit verstärkter Bremsen			13.0460-7051.2 607051	ATE 20547 16,5 + WE / - WK
1.7 D	42	12/91→02/98	←					
1.7 TD	50	01/94→02/98	←	für Fahrzeuge mit verstärkter Bremsen			13.0460-7052.2 607052	ATE 21190 17,5 + WE / - WK
1.7 TD	60	12/91→02/98	←					
1.6 i	52	07/94→02/98	←				13.0460-7051.2 607051	ATE 20547 16,5 + WE / - WK
			←	Motorcode: C16NZ / X16SZR			13.0460-7051.2 607051	ATE 20547 16,5 + WE / - WK
			←	nicht für Motorcode: C16NZ / X16SZR			13.0460-7052.2 607052	ATE 21190 17,5 + WE / - WK
1.6 i	55	09/91→02/98	←	10/91→; Motorcode: C16NZ / X16SZR			13.0460-7051.2 607051	ATE 20547 16,5 + WE / - WK
			←	10/91→			13.0460-7051.2 607051	ATE 20547 16,5 + WE / - WK
			←	10/91→; nicht für Motorcode: C16NZ / X16SZR			13.0460-7052.2 607052	ATE 21190 17,5 + WE / - WK
1.6 i 16V	74	01/94→02/98	←				13.0460-7052.2 607052	ATE 21190 17,5 + WE / - WK
2.0 i 16V	100	01/94→02/98	←					
1.8 i 16V	85	09/94→02/98	←				13.0460-7051.2 607051	ATE 20547 16,5 + WE / - WK
1.8 i 16V	92	09/94→02/98	←					
2.0 i	85	09/91→02/98	←	10/91→			13.0460-7052.2 607052	ATE 21190 17,5 + WE / - WK
Warnkontakt, Bremsbelagverschleiß								
1.4 i	44	09/91→02/98	←	10/91→		2	24.8190-0707.2 620707	L= 685
1.4 S	55	09/91→02/98	←					
1.8 i	66	09/91→02/98	←					
1.4 i	60	03/91→02/98	←	10/91→; für Fahrzeuge mit verstärkter Bremsen		2	24.8190-0705.2 620705	L= 670
			←	10/91→; nicht für Fahrzeuge mit verstärkter Bremsen		2	24.8190-0707.2 620707	L= 685
1.4 i 16V	66	02/96→01/98	←	für Fahrzeuge mit verstärkter Bremsen		2	24.8190-0705.2 620705	L= 670
1.7 D	42	12/91→02/98	←					
1.7 TD	50	01/94→02/98	←	nicht für Fahrzeuge mit verstärkter Bremsen		2	24.8190-0707.2 620707	L= 685
1.7 TD	60	12/91→02/98	←					
1.6 i	52	07/94→02/98	←	nicht für Motorcode: C16NZ / X16SZR		2	24.8190-0705.2 620705	L= 670
			←			2	24.8190-0707.2 620707	L= 685
			←	Motorcode: C16NZ / X16SZR		2	24.8190-0707.2 620707	L= 685
↓								











	kw			 	! #		
VAUXHALL - ASTRA Mk III (F) Estate 03/91→02/98							
Warnkontakt, Bremsbelagverschleiß							
1.6 i	55	09/91→02/98	←	10/91→; nicht für Motorcode: C16NZ / X16SZR	2	24.8190-0705.2 620705	L= 670
			←	10/91→; Motorcode: C16NZ / X16SZR	2	24.8190-0707.2 620707	L= 685
			←	10/91→	2	24.8190-0707.2 620707	L= 685
1.6 i 16V 2.0 i 16V	74 100	01/94→02/98 01/94→02/98	←		2	24.8190-0705.2 620705	L= 670
1.8 i 16V 1.8 i 16V	85 92	09/94→02/98 09/94→02/98	←		2	24.8190-0707.2 620707	L= 685
2.0 i	85	09/91→02/98	←	10/91→	2	24.8190-0705.2 620705	L= 670
 Bremsscheibe							
1.4 i 1.4 S	44 55	09/91→02/98 09/91→02/98	←	10/91→		24.0113-0161.1 413161 24.0313-0161.1 513161	Ø 236 12,7 9,7 + S Ø 236 12,7 9,7 + S PD
1.4 i	60	03/91→02/98	←	10/91→; Schaltgetriebe; nicht für Fahrzeuge mit verstärkter Bremsen		24.0113-0161.1 413161 24.0313-0161.1 513161	Ø 236 12,7 9,7 + S Ø 236 12,7 9,7 + S PD
			←	10/91→; Vollautomatik; nicht für Fahrzeuge mit verstärkter Bremsen		24.0120-0115.1 420115 24.0320-0115.1 520115	Ø 236 20 17 V + S Ø 236 20 17 V + S PD
			←	10/91→; für Fahrzeuge mit verstärkter Bremsen		24.0124-0115.1 424115 24.0324-0115.1 524115	Ø 256 24 21 V + S Ø 256 24 21 V + S PD
1.4 i 16V 1.6 i	66 52	02/96→01/98 07/94→02/98	←			24.0120-0115.1 420115 24.0124-0115.1 424115 24.0320-0115.1 520115 24.0324-0115.1 524115	Ø 236 20 17 V + S Ø 256 24 21 V + S Ø 236 20 17 V + S PD Ø 256 24 21 V + S PD
1.6 i	55	09/91→02/98	←	10/91→		24.0120-0115.1 420115 24.0124-0115.1 424115 24.0320-0115.1 520115 24.0324-0115.1 524115	Ø 236 20 17 V + S Ø 256 24 21 V + S Ø 236 20 17 V + S PD Ø 256 24 21 V + S PD
1.6 i 16V 2.0 i 16V	74 100	01/94→02/98 01/94→02/98	←			24.0124-0115.1 424115 24.0324-0115.1 524115	Ø 256 24 21 V + S Ø 256 24 21 V + S PD
1.7 D 1.7 TD 1.7 TD	42 50 60	12/91→02/98 01/94→02/98 12/91→02/98	←	nicht für Fahrzeuge mit verstärkter Bremsen		24.0120-0115.1 420115 24.0320-0115.1 520115	Ø 236 20 17 V + S Ø 236 20 17 V + S PD
			←	für Fahrzeuge mit verstärkter Bremsen		24.0124-0115.1 424115 24.0324-0115.1 524115	Ø 256 24 21 V + S Ø 256 24 21 V + S PD
1.8 i	66	09/91→02/98	←	10/91→		24.0120-0140.1 420140	Ø 256 20 17 V + S
2.0 i	85	09/91→02/98	←	10/91→		24.0124-0115.1 424115 24.0324-0115.1 524115	Ø 256 24 21 V + S Ø 256 24 21 V + S PD
VAUXHALL - ASTRA Mk IV (G) CC 02/98→05/05							
 Bremsbelagsatz, Scheibenbremse							
1.2 16V 1.4 16V 1.6 1.6 16V 1.7 TD	48 66 55 74 50	02/98→09/00 02/98→05/05 02/98→09/00 02/98→05/05 02/98→08/00	←	04/98→		13.0460-7115.2 607115 13.0470-7115.2 LD7115	ATE 23063 17,5 ohne integrierten Verschleiß- sensor / + WK ATE 23063 17,5 - WK / + WK Ceramic
			→	04/98→		13.0460-2868.2 602868 13.0460-3976.2 603976 13.0470-2868.2 LD2868	TRW 23417 15,3 + WK + Zub BOS 23258 16,5 + WK + Zub TRW 23417 15,3 + WK + Zub Ceramic
1.2 16V 1.6 1.6 1.6 Dualfuel 1.6 Dualfuel 1.7 CDTI 16V 1.7 DTI 16V	55 62 76 62 63 59 55	09/00→05/05 09/00→05/05 12/02→05/05 07/00→05/05 09/02→05/05 04/03→05/05 02/00→05/05	←			13.0460-7115.2 607115 13.0470-7115.2 LD7115	ATE 23063 17,5 ohne integrierten Verschleiß- sensor / + WK ATE 23063 17,5 - WK / + WK Ceramic
			→			13.0460-2868.2 602868 13.0460-3976.2 603976 13.0470-2868.2 LD2868	TRW 23417 15,3 + WK + Zub BOS 23258 16,5 + WK + Zub TRW 23417 15,3 + WK + Zub Ceramic
1.8 16V	85	02/98→09/00	←	04/98→; - ABS		13.0460-7115.2 607115 13.0470-7115.2 LD7115	ATE 23063 17,5 ohne integrierten Verschleiß- sensor / + WK ATE 23063 17,5 - WK / + WK Ceramic
			←	04/98→; + ABS		13.0460-7116.2 607116 13.0470-7116.2 LD7116	ATE 23057 20,2 - WK / + WK ATE 23057 20,2 - WK / + WK Ceramic









	kW			 	! #		
VAUXHALL - ASTRA Mk IV (G) CC 02/98→05/05							
 Bremsbelagsatz, Scheibenbremse							
1.8 16V	85	02/98→09/00	➔	04/98→		13.0460-2868.2 602868 13.0460-3976.2 603976 13.0470-2868.2 LD2868	TRW 23417 15,3 + WK + Zub BOS 23258 16,5 + WK + Zub TRW 23417 15,3 + WK + Zub Ceramic
1.8 16V 1.8 16V Dualfuel	92 87	09/00→05/05 09/02→05/05	←	- ABS		13.0460-7115.2 607115 13.0470-7115.2 LD7115	ATE 23063 17,5 ohne integrierten Verschleißsensor / + WK ATE 23063 17,5 - WK / + WK Ceramic
			←	+ ABS		13.0460-7116.2 607116 13.0470-7116.2 LD7116	ATE 23057 20,2 - WK / + WK ATE 23057 20,2 - WK / + WK Ceramic
			➔			13.0460-2868.2 602868 13.0460-3976.2 603976 13.0470-2868.2 LD2868	TRW 23417 15,3 + WK + Zub BOS 23258 16,5 + WK + Zub TRW 23417 15,3 + WK + Zub Ceramic
2.0 2.0 SRI Turbo	118 141	10/99→08/00 11/01→05/05	←			13.0460-7173.2 607173	ATE 21829 20,3 - WK / + WK
			➔			13.0460-2868.2 602868 13.0460-3976.2 603976 13.0470-2868.2 LD2868	TRW 23417 15,3 + WK + Zub BOS 23258 16,5 + WK + Zub TRW 23417 15,3 + WK + Zub Ceramic
2.0 16V	100	02/98→05/05	←	04/98→		13.0460-7116.2 607116 13.0470-7116.2 LD7116	ATE 23057 20,2 - WK / + WK ATE 23057 20,2 - WK / + WK Ceramic
			➔	04/98→		13.0460-2868.2 602868 13.0460-3976.2 603976 13.0470-2868.2 LD2868	TRW 23417 15,3 + WK + Zub BOS 23258 16,5 + WK + Zub TRW 23417 15,3 + WK + Zub Ceramic
2.0 DI	60	02/98→05/05	←	04/98→		13.0460-7115.2 607115 13.0470-7115.2 LD7115	ATE 23063 17,5 ohne integrierten Verschleißsensor / + WK ATE 23063 17,5 - WK / + WK Ceramic
			←	04/98→; + ABS		13.0460-7116.2 607116 13.0470-7116.2 LD7116	ATE 23057 20,2 - WK / + WK ATE 23057 20,2 - WK / + WK Ceramic
			➔	04/98→		13.0460-2868.2 602868 13.0460-3976.2 603976 13.0470-2868.2 LD2868	TRW 23417 15,3 + WK + Zub BOS 23258 16,5 + WK + Zub TRW 23417 15,3 + WK + Zub Ceramic
2.0 DTI 16V 2.2 16V	74 108	08/99→05/05 03/01→05/05	←			13.0460-7116.2 607116 13.0470-7116.2 LD7116	ATE 23057 20,2 - WK / + WK ATE 23057 20,2 - WK / + WK Ceramic
			➔			13.0460-2868.2 602868 13.0460-3976.2 603976 13.0470-2868.2 LD2868	TRW 23417 15,3 + WK + Zub BOS 23258 16,5 + WK + Zub TRW 23417 15,3 + WK + Zub Ceramic
Warnkontakt, Bremsbelagverschleiß							
1.2 16V 1.4 16V 1.6 1.6 16V 1.7 TD 2.0 16V	48 66 55 74 50 100	02/98→09/00 02/98→05/05 02/98→09/00 02/98→05/05 02/98→08/00 02/98→05/05	←	04/98→; 42187759→ 04/98→; → 42187758	2 2	24.8190-0018.2 620018 24.8190-0718.2 620718	L= 755 L= 720
1.2 16V 1.6 1.6 1.6 Dualfuel 1.6 Dualfuel 1.7 CDTI 16V 1.7 DTI 16V 2.0 2.0 DTI 16V 2.0 SRI Turbo 2.2 16V	55 62 76 62 63 59 55 118 74 141 108	09/00→05/05 09/00→05/05 12/02→05/05 07/00→05/05 09/02→05/05 04/03→05/05 02/00→05/05 10/99→08/00 08/99→05/05 11/01→05/05 03/01→05/05	←	42187759→ → 42187758	2 2	24.8190-0018.2 620018 24.8190-0718.2 620718	L= 755 L= 720
1.8 16V	85	02/98→09/00	←	04/98→; - ABS; 42187759→ 04/98→; + ABS; 42187759→ 04/98→; + ABS; → 42187758	2 2 2	24.8190-0018.2 620018 24.8190-0018.2 620018 24.8190-0718.2 620718	L= 755 L= 755 L= 720
↓							







	kw			 	! #		
VAUXHALL - ASTRA Mk IV (G) CC 02/98→05/05							
Warnkontakt, Bremsbelagverschleiß							
1.8 16V	85	02/98→09/00	←	04/98→; - ABS; → 42187758	2	24.8190-0718.2 620718	L= 720
1.8 16V 1.8 16V Dualfuel	92	09/00→05/05	←	+ ABS; 42187759→	2	24.8190-0018.2 620018	L= 755
	87	09/02→05/05	←	- ABS; 42187759→	2	24.8190-0018.2 620018	L= 755
			←	- ABS; → 42187758	2	24.8190-0718.2 620718	L= 720
			←	+ ABS; → 42187758	2	24.8190-0718.2 620718	L= 720
2.0 DI	60	02/98→05/05	←	04/98→; 42187759→	2	24.8190-0018.2 620018	L= 755
			←	04/98→; + ABS; 42187759→	2	24.8190-0018.2 620018	L= 755
			←	04/98→; + ABS; → 42187758	2	24.8190-0718.2 620718	L= 720
			←	04/98→; → 42187758	2	24.8190-0718.2 620718	L= 720
 Bremsscheibe							
1.2 16V	48	02/98→09/00	←	04/98→; → 18999999; für Fahrzeuge mit Trommelbremse an der Hinterachse		24.0111-0141.1 411141 24.0311-0141.1 511141	Ø 256 10,8 8 Ø 256 10,8 8 PD
			←	04/98→; → 18999999; für Fahrzeuge mit Scheibenbremse an der Hinterachse; Felge Lochzahl: 4		24.0124-0152.1 424152 24.0324-0152.1 524152	Ø 256 23,8 21 V + S Ø 256 23,8 21 V + S PD
			←	22000001→; Felge Lochzahl: 4		24.0124-0152.1 424152 24.0324-0152.1 524152	Ø 256 23,8 21 V + S Ø 256 23,8 21 V + S PD
			→	04/98→; Felge Lochzahl: 4		24.0110-0251.1 410251 24.0310-0251.1 510251	Ø 240 9,8 8 + S Ø 240 9,8 8 + S PD
1.2 16V	55	09/00→05/05	←	→ 18999999; für Fahrzeuge mit Trommelbremse an der Hinterachse		24.0111-0141.1 411141 24.0311-0141.1 511141	Ø 256 10,8 8 Ø 256 10,8 8 PD
			←	22000001→; Felge Lochzahl: 4		24.0124-0152.1 424152 24.0324-0152.1 524152	Ø 256 23,8 21 V + S Ø 256 23,8 21 V + S PD
			←	→ 18999999; für Fahrzeuge mit Scheibenbremse an der Hinterachse; Felge Lochzahl: 4		24.0124-0152.1 424152 24.0324-0152.1 524152	Ø 256 23,8 21 V + S Ø 256 23,8 21 V + S PD
			→	Felge Lochzahl: 4		24.0110-0251.1 410251 24.0310-0251.1 510251	Ø 240 9,8 8 + S Ø 240 9,8 8 + S PD
1.4 16V 1.7 TD	66 50	02/98→05/05 02/98→08/00	←	04/98→; Felge Lochzahl: 4		24.0124-0152.1 424152 24.0324-0152.1 524152	Ø 256 23,8 21 V + S Ø 256 23,8 21 V + S PD
			→	04/98→; Felge Lochzahl: 4		24.0110-0251.1 410251 24.0310-0251.1 510251	Ø 240 9,8 8 + S Ø 240 9,8 8 + S PD
1.6	55	02/98→09/00	←	04/98→; Felge Lochzahl: 4		24.0124-0152.1 424152 24.0324-0152.1 524152	Ø 256 23,8 21 V + S Ø 256 23,8 21 V + S PD
			←	04/98→; Felge Lochzahl: 5		24.0125-0131.1 425131 24.0325-0131.1 525131	Ø 280 24,8 22 V + S Ø 280 24,8 22 V + S PD
			→	04/98→; Felge Lochzahl: 4		24.0110-0251.1 410251 24.0310-0251.1 510251	Ø 240 9,8 8 + S Ø 240 9,8 8 + S PD
1.6 1.6 Dualfuel	62 62	09/00→05/05 07/00→05/05	←	Felge Lochzahl: 4		24.0124-0152.1 424152 24.0324-0152.1 524152	Ø 256 23,8 21 V + S Ø 256 23,8 21 V + S PD
			←	Felge Lochzahl: 5		24.0125-0131.1 425131 24.0325-0131.1 525131	Ø 280 24,8 22 V + S Ø 280 24,8 22 V + S PD
			→	Felge Lochzahl: 4		24.0110-0251.1 410251 24.0310-0251.1 510251	Ø 240 9,8 8 + S Ø 240 9,8 8 + S PD
1.6 1.7 CDTi 16V 1.7 DTi 16V	76 59 55	12/02→05/05 04/03→05/05 02/00→05/05	←	Felge Lochzahl: 4		24.0124-0152.1 424152 24.0324-0152.1 524152	Ø 256 23,8 21 V + S Ø 256 23,8 21 V + S PD
			→	Felge Lochzahl: 4		24.0110-0251.1 410251 24.0310-0251.1 510251	Ø 240 9,8 8 + S Ø 240 9,8 8 + S PD
1.6 16V	74	02/98→05/05	←	04/98→; Felge Lochzahl: 4		24.0124-0152.1 424152 24.0324-0152.1 524152	Ø 256 23,8 21 V + S Ø 256 23,8 21 V + S PD
			←	04/98→; Felge Lochzahl: 5		24.0125-0131.1 425131 24.0325-0131.1 525131	Ø 280 24,8 22 V + S Ø 280 24,8 22 V + S PD
			→	04/98→; Felge Lochzahl: 5		24.0110-0250.1 410250 24.0310-0250.1 510250	Ø 264 9,8 8 + S Ø 264 9,8 8 + S PD
			→	04/98→; Felge Lochzahl: 4		24.0110-0251.1 410251 24.0310-0251.1 510251	Ø 240 9,8 8 + S Ø 240 9,8 8 + S PD
1.6 Dualfuel	63	09/02→05/05	←	Felge Lochzahl: 4		24.0124-0152.1 424152 24.0324-0152.1 524152	Ø 256 23,8 21 V + S Ø 256 23,8 21 V + S PD
			←	Felge Lochzahl: 5		24.0125-0131.1 425131 24.0325-0131.1 525131	Ø 280 24,8 22 V + S Ø 280 24,8 22 V + S PD







	kw			 	! #		
VAUXHALL - ASTRA Mk IV (G) CC 02/98→05/05							
Bremsscheibe							
1.6 Dualfuel	63	09/02→05/05	→	Felge Lochzahl: 5		24.0110-0250.1 410250 24.0310-0250.1 510250	∅ 264 9,8 8 + S ∅ 264 9,8 8 + S PD
			→	Felge Lochzahl: 4		24.0110-0251.1 410251 24.0310-0251.1 510251	∅ 240 9,8 8 + S ∅ 240 9,8 8 + S PD
1.8 16V 2.0 DI	85 60	02/98→09/00 02/98→05/05	←	04/98→; - ABS; Felge Lochzahl: 4		24.0124-0152.1 424152 24.0324-0152.1 524152	∅ 256 23,8 21 V + S ∅ 256 23,8 21 V + S PD
			←	04/98→; + ABS; Felge Lochzahl: 5		24.0125-0131.1 425131 24.0325-0131.1 525131	∅ 280 24,8 22 V + S ∅ 280 24,8 22 V + S PD
			→	04/98→; + ABS; Felge Lochzahl: 5		24.0110-0250.1 410250 24.0310-0250.1 510250	∅ 264 9,8 8 + S ∅ 264 9,8 8 + S PD
			→	04/98→; - ABS; Felge Lochzahl: 4		24.0110-0251.1 410251 24.0310-0251.1 510251	∅ 240 9,8 8 + S ∅ 240 9,8 8 + S PD
			→	04/98→; - ABS; Felge Lochzahl: 4		24.0110-0251.1 410251 24.0310-0251.1 510251	∅ 240 9,8 8 + S ∅ 240 9,8 8 + S PD
1.8 16V 1.8 16V Dualfuel	92 87	09/00→05/05 09/02→05/05	←	- ABS; Felge Lochzahl: 4		24.0124-0152.1 424152 24.0324-0152.1 524152	∅ 256 23,8 21 V + S ∅ 256 23,8 21 V + S PD
			←	+ ABS; Felge Lochzahl: 5		24.0125-0131.1 425131 24.0325-0131.1 525131	∅ 280 24,8 22 V + S ∅ 280 24,8 22 V + S PD
			→	+ ABS; Felge Lochzahl: 5		24.0110-0250.1 410250 24.0310-0250.1 510250	∅ 264 9,8 8 + S ∅ 264 9,8 8 + S PD
			→	- ABS; Felge Lochzahl: 4		24.0110-0251.1 410251 24.0310-0251.1 510251	∅ 240 9,8 8 + S ∅ 240 9,8 8 + S PD
2.0 2.0 SRI Turbo	118 141	10/99→08/00 11/01→05/05	←			24.0125-0142.1 425142 24.0325-0142.1 525142	∅ 308 25 22 V + S ∅ 308 25 23 V + S PD
			→	Felge Lochzahl: 5		24.0110-0250.1 410250 24.0310-0250.1 510250	∅ 264 9,8 8 + S ∅ 264 9,8 8 + S PD
2.0 16V	100	02/98→05/05	←	04/98→; Felge Lochzahl: 5		24.0125-0131.1 425131 24.0325-0131.1 525131	∅ 280 24,8 22 V + S ∅ 280 24,8 22 V + S PD
			→	04/98→; Felge Lochzahl: 5		24.0110-0250.1 410250 24.0310-0250.1 510250	∅ 264 9,8 8 + S ∅ 264 9,8 8 + S PD
2.0 DTI 16V 2.2 16V	74 108	08/99→05/05 03/01→05/05	←	Felge Lochzahl: 5		24.0125-0131.1 425131 24.0325-0131.1 525131	∅ 280 24,8 22 V + S ∅ 280 24,8 22 V + S PD
			→	Felge Lochzahl: 5		24.0110-0250.1 410250 24.0310-0250.1 510250	∅ 264 9,8 8 + S ∅ 264 9,8 8 + S PD
VAUXHALL - ASTRA Mk IV (G) Convertible 03/01→10/05							
Bremsbelagsatz, Scheibenbremse							
1.6 16V 1.6 16V	74 76	03/01→10/05 03/03→10/05	←			13.0460-7115.2 607115 13.0470-7115.2 LD7115	ATE 23063 17,5 ohne integrierten Verschleiß- sensor / + WK ATE 23063 17,5 - WK / + WK Ceramic
			→			13.0460-2868.2 602868 13.0460-3976.2 603976 13.0470-2868.2 LD2868	TRW 23417 15,3 + WK + Zub BOS 23258 16,5 + WK + Zub TRW 23417 15,3 + WK + Zub Ceramic
1.8 16V	92	03/01→10/05	←	- ABS		13.0460-7115.2 607115 13.0470-7115.2 LD7115	ATE 23063 17,5 ohne integrierten Verschleiß- sensor / + WK ATE 23063 17,5 - WK / + WK Ceramic
			←	+ ABS		13.0460-7116.2 607116 13.0470-7116.2 LD7116	ATE 23057 20,2 - WK / + WK ATE 23057 20,2 - WK / + WK Ceramic
			→			13.0460-2868.2 602868 13.0460-3976.2 603976 13.0470-2868.2 LD2868	TRW 23417 15,3 + WK + Zub BOS 23258 16,5 + WK + Zub TRW 23417 15,3 + WK + Zub Ceramic
2.0 2.0 Turbo	147 141	09/02→10/05 03/02→10/05	←			13.0460-7173.2 607173	ATE 21829 20,3 - WK / + WK
			→			13.0460-2868.2 602868 13.0460-3976.2 603976 13.0470-2868.2 LD2868	TRW 23417 15,3 + WK + Zub BOS 23258 16,5 + WK + Zub TRW 23417 15,3 + WK + Zub Ceramic
2.2 16V	108	03/01→10/05	←			13.0460-7116.2 607116 13.0470-7116.2 LD7116	ATE 23057 20,2 - WK / + WK ATE 23057 20,2 - WK / + WK Ceramic
↓							









	kW					! #		
VAUXHALL - ASTRA Mk IV (G) Convertible 03/01→10/05								
 Bremsbelagsatz, Scheibenbremse								
2.2 16V	108	03/01→10/05	→				13.0460-2868.2 602868 13.0460-3976.2 603976 13.0470-2868.2 LD2868	TRW 23417 15,3 + WK + Zub BOS 23258 16,5 + WK + Zub TRW 23417 15,3 + WK + Zub Ceramic
Warnkontakt, Bremsbelagverschleiß								
1.6 16V	74	03/01→10/05	←	42187759→	2	24.8190-0018.2 620018		L= 755
1.6 16V	76	03/03→10/05	←	→ 42187758	2	24.8190-0718.2 620718		L= 720
2.0	147	09/02→10/05	←					
2.0 Turbo	141	03/02→10/05	←					
2.2 16V	108	03/01→10/05	←					
1.8 16V	92	03/01→10/05	←	+ ABS; 42187759→	2	24.8190-0018.2 620018		L= 755
			←	- ABS; 42187759→	2	24.8190-0018.2 620018		L= 755
			←	- ABS; → 42187758	2	24.8190-0718.2 620718		L= 720
			←	+ ABS; → 42187758	2	24.8190-0718.2 620718		L= 720
 Bremsscheibe								
1.6 16V	74	03/01→10/05	←	Felge Lochzahl: 4		24.0124-0152.1 424152		Ø 256 23,8 21 V + S
1.6 16V	76	03/03→10/05	←	Felge Lochzahl: 4		24.0324-0152.1 524152		Ø 256 23,8 21 V + S PD
			→	Felge Lochzahl: 4		24.0110-0251.1 410251		Ø 240 9,8 8 + S
			→	Felge Lochzahl: 4		24.0310-0251.1 510251		Ø 240 9,8 8 + S PD
1.8 16V	92	03/01→10/05	←	- ABS; Felge Lochzahl: 4		24.0124-0152.1 424152		Ø 256 23,8 21 V + S
			←	- ABS; Felge Lochzahl: 4		24.0324-0152.1 524152		Ø 256 23,8 21 V + S PD
			←	+ ABS; Felge Lochzahl: 5		24.0125-0131.1 425131		Ø 280 24,8 22 V + S
			←	+ ABS; Felge Lochzahl: 5		24.0325-0131.1 525131		Ø 280 24,8 22 V + S PD
			→	+ ABS; Felge Lochzahl: 5		24.0110-0250.1 410250		Ø 264 9,8 8 + S
			→	+ ABS; Felge Lochzahl: 5		24.0310-0250.1 510250		Ø 264 9,8 8 + S PD
			→	- ABS; Felge Lochzahl: 4		24.0110-0251.1 410251		Ø 240 9,8 8 + S
			→	- ABS; Felge Lochzahl: 4		24.0310-0251.1 510251		Ø 240 9,8 8 + S PD
2.0	147	09/02→10/05	←			24.0125-0142.1 425142		Ø 308 25 22 V + S
2.0 Turbo	141	03/02→10/05	←			24.0325-0142.1 525142		Ø 308 25 23 V + S PD
			→	Felge Lochzahl: 5		24.0110-0250.1 410250		Ø 264 9,8 8 + S
			→	Felge Lochzahl: 5		24.0310-0250.1 510250		Ø 264 9,8 8 + S PD
2.2 16V	108	03/01→10/05	←	Felge Lochzahl: 5		24.0125-0131.1 425131		Ø 280 24,8 22 V + S
			←	Felge Lochzahl: 5		24.0325-0131.1 525131		Ø 280 24,8 22 V + S PD
			→	Felge Lochzahl: 5		24.0110-0250.1 410250		Ø 264 9,8 8 + S
			→	Felge Lochzahl: 5		24.0310-0250.1 510250		Ø 264 9,8 8 + S PD
VAUXHALL - ASTRA Mk IV (G) Coupe (F67) 03/00→08/05								
 Bremsbelagsatz, Scheibenbremse								
1.6 16V	76	03/00→08/05	←			13.0460-7115.2 607115		ATE 23063 17,5 ohne integrierten Verschleiß- sensor / + WK
			→			13.0470-7115.2 LD7115		ATE 23063 17,5 - WK / + WK Ceramic
			→			13.0460-2868.2 602868		TRW 23417 15,3 + WK + Zub
			→			13.0460-3976.2 603976		BOS 23258 16,5 + WK + Zub
			→			13.0470-2868.2 LD2868		TRW 23417 15,3 + WK + Zub Ceramic
1.8 16V	85	03/00→08/05	←			13.0460-7116.2 607116		ATE 23057 20,2 - WK / + WK
1.8 16V	92	09/00→08/05	←			13.0470-7116.2 LD7116		ATE 23057 20,2 - WK / + WK Ceramic
1.8 16V Dualfuel	87	09/02→08/05	←					
			→			13.0460-2868.2 602868		TRW 23417 15,3 + WK + Zub
			→			13.0460-3976.2 603976		BOS 23258 16,5 + WK + Zub
			→			13.0470-2868.2 LD2868		TRW 23417 15,3 + WK + Zub Ceramic
2.0	147	08/02→05/05	←			13.0460-7173.2 607173		ATE 21829 20,3 - WK / + WK
2.0 16V Turbo	140	09/00→08/05	→					
			→			13.0460-2868.2 602868		TRW 23417 15,3 + WK + Zub
			→			13.0460-3976.2 603976		BOS 23258 16,5 + WK + Zub
			→			13.0470-2868.2 LD2868		TRW 23417 15,3 + WK + Zub Ceramic
2.2 16V	108	03/00→08/05	←	09/00→		13.0460-7116.2 607116		ATE 23057 20,2 - WK / + WK
			←	09/00→		13.0470-7116.2 LD7116		ATE 23057 20,2 - WK / + WK Ceramic
			→	09/00→		13.0460-2868.2 602868		TRW 23417 15,3 + WK + Zub







	kw					! #		
VAUXHALL - ASTRA Mk IV (G) Coupe (F67) 03/00→08/05								
 Bremsbelagsatz, Scheibenbremse								
2.2 16V	108	03/00→08/05	➡	09/00→			13.0460-3976.2 603976 13.0470-2868.2 LD2868	BOS 23258 16,5 + WK + Zub TRW 23417 15,3 + WK + Zub Ceramic
Warnkontakt, Bremsbelagverschleiß								
1.6 16V	76	03/00→08/05	⬅	42187759→	2	24.8190-0018.2 620018		L= 755
1.8 16V	85	03/00→08/05						
1.8 16V	92	09/00→08/05	⬅	→ 42187758	2	24.8190-0718.2 620718		L= 720
1.8 16V Dualfuel	87	09/02→08/05						
2.0	147	08/02→05/05						
2.0 16V Turbo	140	09/00→08/05						
2.2 16V	108	03/00→08/05	⬅	09/00→; 42187759→	2	24.8190-0018.2 620018		L= 755
			⬅	09/00→; → 42187758	2	24.8190-0718.2 620718		L= 720
 Bremsscheibe								
1.6 16V	76	03/00→08/05	⬅	Felge Lochzahl: 4		24.0124-0152.1 424152 24.0324-0152.1 524152		Ø 256 23,8 21 V + S Ø 256 23,8 21 V + S PD
			⬅	Felge Lochzahl: 5		24.0125-0131.1 425131 24.0325-0131.1 525131		Ø 280 24,8 22 V + S Ø 280 24,8 22 V + S PD
			➡	Felge Lochzahl: 5		24.0110-0250.1 410250 24.0310-0250.1 510250		Ø 264 9,8 8 + S Ø 264 9,8 8 + S PD
			➡	Felge Lochzahl: 4		24.0110-0251.1 410251 24.0310-0251.1 510251		Ø 240 9,8 8 + S Ø 240 9,8 8 + S PD
1.8 16V	85	03/00→08/05	⬅	Felge Lochzahl: 5		24.0125-0131.1 425131 24.0325-0131.1 525131		Ø 280 24,8 22 V + S Ø 280 24,8 22 V + S PD
1.8 16V	92	09/00→08/05						
1.8 16V Dualfuel	87	09/02→08/05	➡	Felge Lochzahl: 5		24.0110-0250.1 410250 24.0310-0250.1 510250		Ø 264 9,8 8 + S Ø 264 9,8 8 + S PD
2.0	147	08/02→05/05	⬅			24.0125-0142.1 425142 24.0325-0142.1 525142		Ø 308 25 22 V + S Ø 308 25 23 V + S PD
2.0 16V Turbo	140	09/00→08/05	➡	Felge Lochzahl: 5		24.0110-0250.1 410250 24.0310-0250.1 510250		Ø 264 9,8 8 + S Ø 264 9,8 8 + S PD
2.2 16V	108	03/00→08/05	⬅	09/00→; Felge Lochzahl: 5		24.0125-0131.1 425131 24.0325-0131.1 525131		Ø 280 24,8 22 V + S Ø 280 24,8 22 V + S PD
			➡	09/00→; Felge Lochzahl: 5		24.0110-0250.1 410250 24.0310-0250.1 510250		Ø 264 9,8 8 + S Ø 264 9,8 8 + S PD
VAUXHALL - ASTRA Mk IV (G) Estate 02/98→05/05								
 Bremsbelagsatz, Scheibenbremse								
1.2 16V	48	02/98→09/00	⬅	04/98→		13.0460-7115.2 607115		ATE 23063 17,5 ohne integrierten Verschleiß- sensor / + WK
1.4 16V	66	02/98→05/05						
1.6	55	03/98→04/04						
1.6	62	03/98→04/04						
1.6 16V	74	03/98→04/04				13.0470-7115.2 LD7115		ATE 23063 17,5 - WK / + WK Ceramic
1.6 Dualfuel	63	03/98→04/04						
1.7 TD	50	02/98→08/00	➡	04/98→		13.0460-2868.2 602868 13.0460-3976.2 603976 13.0470-2868.2 LD2868		TRW 23417 15,3 + WK + Zub BOS 23258 16,5 + WK + Zub TRW 23417 15,3 + WK + Zub Ceramic
1.2 16V	55	09/00→05/05	⬅			13.0460-7115.2 607115		ATE 23063 17,5 ohne integrierten Verschleiß- sensor / + WK
1.6	76	12/02→05/05						
1.6 Dualfuel	62	07/00→05/05						
1.7 CDTI 16V	59	04/03→05/05				13.0470-7115.2 LD7115		ATE 23063 17,5 - WK / + WK Ceramic
1.7 DTI 16V	55	02/00→05/05	➡			13.0460-2868.2 602868 13.0460-3976.2 603976 13.0470-2868.2 LD2868		TRW 23417 15,3 + WK + Zub BOS 23258 16,5 + WK + Zub TRW 23417 15,3 + WK + Zub Ceramic
1.8 16V	85	02/98→08/00	⬅	04/98→; - ABS		13.0460-7115.2 607115 13.0470-7115.2 LD7115		ATE 23063 17,5 ohne integrierten Verschleiß- sensor / + WK ATE 23063 17,5 - WK / + WK Ceramic
			⬅	04/98→; + ABS		13.0460-7116.2 607116 13.0470-7116.2 LD7116		ATE 23057 20,2 - WK / + WK ATE 23057 20,2 - WK / + WK Ceramic
			➡	04/98→		13.0460-2868.2 602868 13.0460-3976.2 603976		TRW 23417 15,3 + WK + Zub BOS 23258 16,5 + WK + Zub

	kw			 	! #		
VAUXHALL - ASTRA Mk IV (G) Estate 02/98→05/05							
 Bremsbelagsatz, Scheibenbremse							
1.8 16V	85	02/98→08/00	➡	04/98→		13.0470-2868.2 LD2868	TRW 23417 15,3 + WK + Zub Ceramic
1.8 16V 1.8 16V Dualfuel	92 87	09/00→05/05 09/02→05/05	←	- ABS		13.0460-7115.2 607115	ATE 23063 17,5 ohne integrierten Verschleißsensor / + WK
						13.0470-7115.2 LD7115	ATE 23063 17,5 - WK / + WK Ceramic
			←	+ ABS		13.0460-7116.2 607116	ATE 23057 20,2 - WK / + WK
						13.0470-7116.2 LD7116	ATE 23057 20,2 - WK / + WK Ceramic
			➡			13.0460-2868.2 602868	TRW 23417 15,3 + WK + Zub
						13.0460-3976.2 603976	BOS 23258 16,5 + WK + Zub
						13.0470-2868.2 LD2868	TRW 23417 15,3 + WK + Zub Ceramic
2.0 16V	100	02/98→05/05	←	04/98→		13.0460-7116.2 607116	ATE 23057 20,2 - WK / + WK
						13.0470-7116.2 LD7116	ATE 23057 20,2 - WK / + WK Ceramic
			➡	04/98→		13.0460-2868.2 602868	TRW 23417 15,3 + WK + Zub
						13.0460-3976.2 603976	BOS 23258 16,5 + WK + Zub
						13.0470-2868.2 LD2868	TRW 23417 15,3 + WK + Zub Ceramic
2.0 DI	60	03/98→04/04	←	04/98→		13.0460-7115.2 607115	ATE 23063 17,5 ohne integrierten Verschleißsensor / + WK
						13.0470-7115.2 LD7115	ATE 23063 17,5 - WK / + WK Ceramic
			←	04/98→; + ABS		13.0460-7116.2 607116	ATE 23057 20,2 - WK / + WK
						13.0470-7116.2 LD7116	ATE 23057 20,2 - WK / + WK Ceramic
			➡	04/98→		13.0460-2868.2 602868	TRW 23417 15,3 + WK + Zub
						13.0460-3976.2 603976	BOS 23258 16,5 + WK + Zub
						13.0470-2868.2 LD2868	TRW 23417 15,3 + WK + Zub Ceramic
2.0 DTI 16V	74	03/98→04/04	←	08/99→		13.0460-7116.2 607116	ATE 23057 20,2 - WK / + WK
						13.0470-7116.2 LD7116	ATE 23057 20,2 - WK / + WK Ceramic
			➡	08/99→		13.0460-2868.2 602868	TRW 23417 15,3 + WK + Zub
						13.0460-3976.2 603976	BOS 23258 16,5 + WK + Zub
						13.0470-2868.2 LD2868	TRW 23417 15,3 + WK + Zub Ceramic
2.2 16V	108	03/01→05/05	←			13.0460-7116.2 607116	ATE 23057 20,2 - WK / + WK
						13.0470-7116.2 LD7116	ATE 23057 20,2 - WK / + WK Ceramic
			➡			13.0460-2868.2 602868	TRW 23417 15,3 + WK + Zub
						13.0460-3976.2 603976	BOS 23258 16,5 + WK + Zub
						13.0470-2868.2 LD2868	TRW 23417 15,3 + WK + Zub Ceramic
Warnkontakt, Bremsbelagverschleiß							
1.2 16V	48	02/98→09/00	←	04/98→; 42187759→	2	24.8190-0018.2 620018	L= 755
1.4 16V	66	02/98→05/05	←	04/98→; → 42187758	2	24.8190-0718.2 620718	L= 720
1.6	55	03/98→04/04					
1.6	62	03/98→04/04					
1.6 16V	74	03/98→04/04					
1.6 Dualfuel	63	03/98→04/04					
1.7 TD	50	02/98→08/00					
2.0 16V	100	02/98→05/05					
1.2 16V	55	09/00→05/05	←	42187759→	2	24.8190-0018.2 620018	L= 755
1.6	76	12/02→05/05					
1.6 Dualfuel	62	07/00→05/05	←	→ 42187758	2	24.8190-0718.2 620718	L= 720
1.7 CDTI 16V	59	04/03→05/05					
1.7 DTI 16V	55	02/00→05/05					
2.2 16V	108	03/01→05/05					
1.8 16V	85	02/98→08/00	←	04/98→; - ABS; 42187759→	2	24.8190-0018.2 620018	L= 755
			←	04/98→; + ABS; 42187759→	2	24.8190-0018.2 620018	L= 755
			←	04/98→; + ABS; → 42187758	2	24.8190-0718.2 620718	L= 720
			←	04/98→; - ABS; → 42187758	2	24.8190-0718.2 620718	L= 720
1.8 16V 1.8 16V Dualfuel	92 87	09/00→05/05 09/02→05/05	←	+ ABS; 42187759→	2	24.8190-0018.2 620018	L= 755
			←	- ABS; 42187759→	2	24.8190-0018.2 620018	L= 755
↓							

	kw				! #		
VAUXHALL - ASTRA Mk IV (G) Estate 02/98→05/05							
Warnkontakt, Bremsbelagverschleiß							
1.8 16V 1.8 16V Dualfuel	92 87	09/00→05/05 09/02→05/05	←	- ABS; → 42187758	2	24.8190-0718.2 620718	L= 720
			←	+ ABS; → 42187758	2	24.8190-0718.2 620718	L= 720
2.0 DI	60	03/98→04/04	←	04/98→; 42187759→	2	24.8190-0018.2 620018	L= 755
			←	04/98→; + ABS; 42187759→	2	24.8190-0018.2 620018	L= 755
			←	04/98→; + ABS; → 42187758	2	24.8190-0718.2 620718	L= 720
			←	04/98→; → 42187758	2	24.8190-0718.2 620718	L= 720
2.0 DTI 16V	74	03/98→04/04	←	08/99→; 42187759→	2	24.8190-0018.2 620018	L= 755
			←	08/99→; → 42187758	2	24.8190-0718.2 620718	L= 720
 Bremsscheibe							
1.2 16V	48	02/98→09/00	←	04/98→; → 18999999; für Fahrzeuge mit Trommelbremse an der Hinterachse		24.0111-0141.1 411141 24.0311-0141.1 511141	Ø 256 10,8 8 Ø 256 10,8 8 PD
			←	04/98→; → 18999999; für Fahrzeuge mit Scheibenbremse an der Hinterachse; Felge Lochzahl: 4		24.0124-0152.1 424152 24.0324-0152.1 524152	Ø 256 23,8 21 V + S Ø 256 23,8 21 V + S PD
			←	22000001→; Felge Lochzahl: 4		24.0124-0152.1 424152 24.0324-0152.1 524152	Ø 256 23,8 21 V + S Ø 256 23,8 21 V + S PD
			→	04/98→; Felge Lochzahl: 4		24.0110-0251.1 410251 24.0310-0251.1 510251	Ø 240 9,8 8 + S Ø 240 9,8 8 + S PD
1.2 16V	55	09/00→05/05	←	→ 18999999; für Fahrzeuge mit Trommelbremse an der Hinterachse		24.0111-0141.1 411141 24.0311-0141.1 511141	Ø 256 10,8 8 Ø 256 10,8 8 PD
			←	22000001→; Felge Lochzahl: 4		24.0124-0152.1 424152 24.0324-0152.1 524152	Ø 256 23,8 21 V + S Ø 256 23,8 21 V + S PD
			←	→ 18999999; für Fahrzeuge mit Scheibenbremse an der Hinterachse; Felge Lochzahl: 4		24.0124-0152.1 424152 24.0324-0152.1 524152	Ø 256 23,8 21 V + S Ø 256 23,8 21 V + S PD
			→	Felge Lochzahl: 4		24.0110-0251.1 410251 24.0310-0251.1 510251	Ø 240 9,8 8 + S Ø 240 9,8 8 + S PD
1.4 16V 1.7 TD	66 50	02/98→05/05 02/98→08/00	←	04/98→; Felge Lochzahl: 4		24.0124-0152.1 424152 24.0324-0152.1 524152	Ø 256 23,8 21 V + S Ø 256 23,8 21 V + S PD
			→	04/98→; Felge Lochzahl: 4		24.0110-0251.1 410251 24.0310-0251.1 510251	Ø 240 9,8 8 + S Ø 240 9,8 8 + S PD
1.6 1.6 1.6 Dualfuel	55 62 63	03/98→04/04 03/98→04/04 03/98→04/04	←	04/98→; Felge Lochzahl: 4		24.0124-0152.1 424152 24.0324-0152.1 524152	Ø 256 23,8 21 V + S Ø 256 23,8 21 V + S PD
			←	04/98→; Felge Lochzahl: 5		24.0125-0131.1 425131 24.0325-0131.1 525131	Ø 280 24,8 22 V + S Ø 280 24,8 22 V + S PD
			→	04/98→; Felge Lochzahl: 4		24.0110-0251.1 410251 24.0310-0251.1 510251	Ø 240 9,8 8 + S Ø 240 9,8 8 + S PD
1.6 1.6 Dualfuel	76 62	12/02→05/05 07/00→05/05	←	Felge Lochzahl: 4		24.0124-0152.1 424152 24.0324-0152.1 524152	Ø 256 23,8 21 V + S Ø 256 23,8 21 V + S PD
			←	Felge Lochzahl: 5		24.0125-0131.1 425131 24.0325-0131.1 525131	Ø 280 24,8 22 V + S Ø 280 24,8 22 V + S PD
			→	Felge Lochzahl: 4		24.0110-0251.1 410251 24.0310-0251.1 510251	Ø 240 9,8 8 + S Ø 240 9,8 8 + S PD
1.6 16V	74	03/98→04/04	←	04/98→; Felge Lochzahl: 4		24.0124-0152.1 424152 24.0324-0152.1 524152	Ø 256 23,8 21 V + S Ø 256 23,8 21 V + S PD
			←	04/98→; Felge Lochzahl: 5		24.0125-0131.1 425131 24.0325-0131.1 525131	Ø 280 24,8 22 V + S Ø 280 24,8 22 V + S PD
			→	04/98→; Felge Lochzahl: 5		24.0110-0250.1 410250 24.0310-0250.1 510250	Ø 264 9,8 8 + S Ø 264 9,8 8 + S PD
			→	04/98→; Felge Lochzahl: 4		24.0110-0251.1 410251 24.0310-0251.1 510251	Ø 240 9,8 8 + S Ø 240 9,8 8 + S PD
1.7 CDTI 16V 1.7 DTI 16V	59 55	04/03→05/05 02/00→05/05	←	Felge Lochzahl: 4		24.0124-0152.1 424152 24.0324-0152.1 524152	Ø 256 23,8 21 V + S Ø 256 23,8 21 V + S PD
			→	Felge Lochzahl: 4		24.0110-0251.1 410251 24.0310-0251.1 510251	Ø 240 9,8 8 + S Ø 240 9,8 8 + S PD
1.8 16V 2.0 DI	85 60	02/98→08/00 03/98→04/04	←	04/98→; - ABS; Felge Lochzahl: 4		24.0124-0152.1 424152 24.0324-0152.1 524152	Ø 256 23,8 21 V + S Ø 256 23,8 21 V + S PD
			←	04/98→; + ABS; Felge Lochzahl: 5		24.0125-0131.1 425131 24.0325-0131.1 525131	Ø 280 24,8 22 V + S Ø 280 24,8 22 V + S PD
			→	04/98→; + ABS; Felge Lochzahl: 5		24.0110-0250.1 410250	Ø 264 9,8 8 + S

	kw			 	! #		
VAUXHALL - ASTRA Mk IV (G) Estate 02/98→05/05							
Bremsscheibe							
1.8 16V 2.0 DI	85	02/98→08/00	➡	04/98→; + ABS; Felge Lochzahl: 5		24.0310-0250.1 510250	Ø 264 9,8 8 + S PD
	60	03/98→04/04	➡	04/98→; - ABS; Felge Lochzahl: 4		24.0110-0251.1 410251 24.0310-0251.1 510251	Ø 240 9,8 8 + S Ø 240 9,8 8 + S PD
1.8 16V 1.8 16V Dualfuel	92	09/00→05/05	←	- ABS; Felge Lochzahl: 4		24.0124-0152.1 424152	Ø 256 23,8 21 V + S
	87	09/02→05/05	←	+ ABS; Felge Lochzahl: 5		24.0324-0152.1 524152	Ø 256 23,8 21 V + S PD
			➡	+ ABS; Felge Lochzahl: 5		24.0125-0131.1 425131 24.0325-0131.1 525131	Ø 280 24,8 22 V + S Ø 280 24,8 22 V + S PD
			➡	+ ABS; Felge Lochzahl: 5		24.0110-0250.1 410250 24.0310-0250.1 510250	Ø 264 9,8 8 + S Ø 264 9,8 8 + S PD
			➡	- ABS; Felge Lochzahl: 4		24.0110-0251.1 410251 24.0310-0251.1 510251	Ø 240 9,8 8 + S Ø 240 9,8 8 + S PD
2.0 16V	100	02/98→05/05	←	04/98→; Felge Lochzahl: 5		24.0125-0131.1 425131 24.0325-0131.1 525131	Ø 280 24,8 22 V + S Ø 280 24,8 22 V + S PD
			➡	04/98→; Felge Lochzahl: 5		24.0110-0250.1 410250 24.0310-0250.1 510250	Ø 264 9,8 8 + S Ø 264 9,8 8 + S PD
2.0 DTI 16V	74	03/98→04/04	←	08/99→; Felge Lochzahl: 5		24.0125-0131.1 425131 24.0325-0131.1 525131	Ø 280 24,8 22 V + S Ø 280 24,8 22 V + S PD
			➡	08/99→; Felge Lochzahl: 5		24.0110-0250.1 410250 24.0310-0250.1 510250	Ø 264 9,8 8 + S Ø 264 9,8 8 + S PD
2.2 16V	108	03/01→05/05	←	Felge Lochzahl: 5		24.0125-0131.1 425131 24.0325-0131.1 525131	Ø 280 24,8 22 V + S Ø 280 24,8 22 V + S PD
			➡	Felge Lochzahl: 5		24.0110-0250.1 410250 24.0310-0250.1 510250	Ø 264 9,8 8 + S Ø 264 9,8 8 + S PD
VAUXHALL - ASTRA Mk IV (G) Sedan 02/98→05/05							
Bremsbelagsatz, Scheibenbremse							
1.2 16V	48	09/98→09/00	←			13.0460-7115.2 607115	ATE 23063 17,5 ohne integrierten Verschleißsensor / + WK
1.2 16V	55	09/00→05/05	←				
1.4 16V	66	09/98→05/05	←				
1.6	55	09/98→09/00	←			13.0470-7115.2 LD7115	ATE 23063 17,5 - WK / + WK Ceramic
1.6	62	09/00→05/05	←				
1.6 16V	74	09/98→05/05	←				
1.6 Dualfuel	62	07/00→05/05	➡			13.0460-2868.2 602868	TRW 23417 15,3 + WK + Zub
1.6 Dualfuel	63	09/02→05/05	➡			13.0460-3976.2 603976	BOS 23258 16,5 + WK + Zub
1.7 CDTI 16V	59	04/03→05/05	➡			13.0470-2868.2 LD2868	TRW 23417 15,3 + WK + Zub Ceramic
1.7 DTI 16V	55	02/00→05/05	➡				
1.7 TD	50	09/98→08/00	➡				
1.8 16V 1.8 16V 1.8 16V Dualfuel	85	02/98→07/04	←	04/98→; - ABS		13.0460-7115.2 607115	ATE 23063 17,5 ohne integrierten Verschleißsensor / + WK
	92	02/98→07/04	←			13.0470-7115.2 LD7115	ATE 23063 17,5 - WK / + WK Ceramic
	87	02/98→07/04	←	04/98→; + ABS		13.0460-7116.2 607116 13.0470-7116.2 LD7116	ATE 23057 20,2 - WK / + WK ATE 23057 20,2 - WK / + WK Ceramic
			➡	04/98→		13.0460-2868.2 602868 13.0460-3976.2 603976 13.0470-2868.2 LD2868	TRW 23417 15,3 + WK + Zub BOS 23258 16,5 + WK + Zub TRW 23417 15,3 + WK + Zub Ceramic
2.0 16V 2.0 16V 2.2 16V 2.2 DTI	100	09/98→05/05	←			13.0460-7116.2 607116 13.0470-7116.2 LD7116	ATE 23057 20,2 - WK / + WK ATE 23057 20,2 - WK / + WK Ceramic
	118 108 92	10/99→05/05 03/01→05/05 09/02→05/05	➡			13.0460-2868.2 602868 13.0460-3976.2 603976 13.0470-2868.2 LD2868	TRW 23417 15,3 + WK + Zub BOS 23258 16,5 + WK + Zub TRW 23417 15,3 + WK + Zub Ceramic
2.0 DI	60	02/98→07/04	←	04/98→		13.0460-7115.2 607115 13.0470-7115.2 LD7115	ATE 23063 17,5 ohne integrierten Verschleißsensor / + WK ATE 23063 17,5 - WK / + WK Ceramic
			←	04/98→; + ABS		13.0460-7116.2 607116 13.0470-7116.2 LD7116	ATE 23057 20,2 - WK / + WK ATE 23057 20,2 - WK / + WK Ceramic
			➡	04/98→		13.0460-2868.2 602868 13.0460-3976.2 603976	TRW 23417 15,3 + WK + Zub BOS 23258 16,5 + WK + Zub

	kW			 	! #		
VAUXHALL - ASTRA Mk IV (G) Sedan 02/98→05/05							
 Bremsbelagsatz, Scheibenbremse							
2.0 DI	60	02/98→07/04	➡	04/98→		13.0470-2868.2 LD2868	TRW 23417 15,3 + WK + Zub Ceramic
2.0 DTI 16V	74	02/98→07/04	⬅	08/99→		13.0460-7116.2 607116	ATE 23057 20,2 - WK / + WK
						13.0470-7116.2 LD7116	ATE 23057 20,2 - WK / + WK Ceramic
			➡	08/99→		13.0460-2868.2 602868	TRW 23417 15,3 + WK + Zub
						13.0460-3976.2 603976	BOS 23258 16,5 + WK + Zub
						13.0470-2868.2 LD2868	TRW 23417 15,3 + WK + Zub Ceramic
Warnkontakt, Bremsbelagverschleiß							
1.2 16V	48	09/98→09/00	⬅	42187759→	2	24.8190-0018.2 620018	L= 755
1.2 16V	55	09/00→05/05					
1.4 16V	66	09/98→05/05	⬅	→ 42187758	2	24.8190-0718.2 620718	L= 720
1.6	55	09/98→09/00					
1.6	62	09/00→05/05					
1.6 16V	74	09/98→05/05					
1.6 Dualfuel	62	07/00→05/05					
1.6 Dualfuel	63	09/02→05/05					
1.7 CDTI 16V	59	04/03→05/05					
1.7 DTI 16V	55	02/00→05/05					
1.7 TD	50	09/98→08/00					
2.0 16V	100	09/98→05/05					
2.0 16V	118	10/99→05/05					
2.2 16V	108	03/01→05/05					
2.2 DTI	92	09/02→05/05					
1.8 16V	85	02/98→07/04	⬅	04/98→; - ABS; 42187759→	2	24.8190-0018.2 620018	L= 755
1.8 16V	92	02/98→07/04	⬅	04/98→; + ABS; 42187759→	2	24.8190-0018.2 620018	L= 755
1.8 16V Dualfuel	87	02/98→07/04	⬅	04/98→; + ABS; → 42187758	2	24.8190-0718.2 620718	L= 720
			⬅	04/98→; - ABS; → 42187758	2	24.8190-0718.2 620718	L= 720
2.0 DI	60	02/98→07/04	⬅	04/98→; 42187759→	2	24.8190-0018.2 620018	L= 755
			⬅	04/98→; + ABS; 42187759→	2	24.8190-0018.2 620018	L= 755
			⬅	04/98→; + ABS; → 42187758	2	24.8190-0718.2 620718	L= 720
			⬅	04/98→; → 42187758	2	24.8190-0718.2 620718	L= 720
2.0 DTI 16V	74	02/98→07/04	⬅	08/99→; 42187759→	2	24.8190-0018.2 620018	L= 755
			⬅	08/99→; → 42187758	2	24.8190-0718.2 620718	L= 720
 Bremsscheibe							
1.2 16V	48	09/98→09/00	⬅	→ 18999999;		24.0111-0141.1 411141	Ø 256 10,8 8
1.2 16V	55	09/00→05/05		für Fahrzeuge mit Trommelbremse an der Hinterachse		24.0311-0141.1 511141	Ø 256 10,8 8 PD
			⬅	22000001→; Felge Lochzahl: 4		24.0124-0152.1 424152	Ø 256 23,8 21 V + S
						24.0324-0152.1 524152	Ø 256 23,8 21 V + S PD
			⬅	→ 18999999;		24.0124-0152.1 424152	Ø 256 23,8 21 V + S
				für Fahrzeuge mit Scheibenbremse an der Hinterachse; Felge Lochzahl: 4		24.0324-0152.1 524152	Ø 256 23,8 21 V + S PD
			➡	Felge Lochzahl: 4		24.0110-0251.1 410251	Ø 240 9,8 8 + S
						24.0310-0251.1 510251	Ø 240 9,8 8 + S PD
1.4 16V	66	09/98→05/05	⬅	Felge Lochzahl: 4		24.0124-0152.1 424152	Ø 256 23,8 21 V + S
1.7 CDTI 16V	59	04/03→05/05				24.0324-0152.1 524152	Ø 256 23,8 21 V + S PD
1.7 DTI 16V	55	02/00→05/05					
1.7 TD	50	09/98→08/00	➡	Felge Lochzahl: 4		24.0110-0251.1 410251	Ø 240 9,8 8 + S
						24.0310-0251.1 510251	Ø 240 9,8 8 + S PD
1.6	55	09/98→09/00	⬅	Felge Lochzahl: 4		24.0124-0152.1 424152	Ø 256 23,8 21 V + S
1.6	62	09/00→05/05				24.0324-0152.1 524152	Ø 256 23,8 21 V + S PD
1.6 Dualfuel	62	07/00→05/05					
1.6 Dualfuel	63	09/02→05/05	⬅	Felge Lochzahl: 5		24.0125-0131.1 425131	Ø 280 24,8 22 V + S
						24.0325-0131.1 525131	Ø 280 24,8 22 V + S PD
			➡	Felge Lochzahl: 4		24.0110-0251.1 410251	Ø 240 9,8 8 + S
						24.0310-0251.1 510251	Ø 240 9,8 8 + S PD
1.6 16V	74	09/98→05/05	⬅	Felge Lochzahl: 4		24.0124-0152.1 424152	Ø 256 23,8 21 V + S
						24.0324-0152.1 524152	Ø 256 23,8 21 V + S PD
			⬅	Felge Lochzahl: 5		24.0125-0131.1 425131	Ø 280 24,8 22 V + S
						24.0325-0131.1 525131	Ø 280 24,8 22 V + S PD
			➡	Felge Lochzahl: 5		24.0110-0250.1 410250	Ø 264 9,8 8 + S
						24.0310-0250.1 510250	Ø 264 9,8 8 + S PD
			➡	Felge Lochzahl: 4		24.0110-0251.1 410251	Ø 240 9,8 8 + S
						24.0310-0251.1 510251	Ø 240 9,8 8 + S PD
↓							

	kw					! #		
VAUXHALL - ASTRA Mk IV (G) Sedan 02/98→05/05								
Bremsscheibe								
1.8 16V	85	02/98→07/04	←	04/98→; - ABS; Felge Lochzahl: 4		24.0124-0152.1	424152	Ø 256 23,8 21 V + S
1.8 16V	92	02/98→07/04				24.0324-0152.1	524152	Ø 256 23,8 21 V + S PD
1.8 16V Dualfuel	87	02/98→07/04						
2.0 DI	60	02/98→07/04	←	04/98→; + ABS; Felge Lochzahl: 5		24.0125-0131.1	425131	Ø 280 24,8 22 V + S
						24.0325-0131.1	525131	Ø 280 24,8 22 V + S PD
			→	04/98→; + ABS; Felge Lochzahl: 5		24.0110-0250.1	410250	Ø 264 9,8 8 + S
						24.0310-0250.1	510250	Ø 264 9,8 8 + S PD
			→	04/98→; - ABS; Felge Lochzahl: 4		24.0110-0251.1	410251	Ø 240 9,8 8 + S
						24.0310-0251.1	510251	Ø 240 9,8 8 + S PD
2.0 16V	100	09/98→05/05	←	Felge Lochzahl: 5		24.0125-0131.1	425131	Ø 280 24,8 22 V + S
2.0 16V	118	10/99→05/05				24.0325-0131.1	525131	Ø 280 24,8 22 V + S PD
2.2 16V	108	03/01→05/05						
2.2 DTI	92	09/02→05/05	→	Felge Lochzahl: 5		24.0110-0250.1	410250	Ø 264 9,8 8 + S
						24.0310-0250.1	510250	Ø 264 9,8 8 + S PD
2.0 DTI 16V	74	02/98→07/04	←	08/99→; Felge Lochzahl: 5		24.0125-0131.1	425131	Ø 280 24,8 22 V + S
						24.0325-0131.1	525131	Ø 280 24,8 22 V + S PD
			→	08/99→; Felge Lochzahl: 5		24.0110-0250.1	410250	Ø 264 9,8 8 + S
						24.0310-0250.1	510250	Ø 264 9,8 8 + S PD
VAUXHALL - ASTRA Mk V (H) CC 01/04→09/09								
Bremsbelagsatz, Scheibenbremse								
1.3 CDTI	66	01/04→05/09	←	08/05→		13.0460-7179.2	607179	ATE 23832 20,2 - WK / + WK
						13.0470-7179.2	LD7179	ATE 23832 20,2 - WK / + WK Ceramic
			→	08/05→		13.0460-2868.2	602868	TRW 23417 15,3 + WK + Zub
						13.0470-2868.2	LD2868	TRW 23417 15,3 + WK + Zub Ceramic
1.4	55	04/04→12/05	←			13.0460-7179.2	607179	ATE 23832 20,2 - WK / + WK
1.4	66	01/04→05/09				13.0470-7179.2	LD7179	ATE 23832 20,2 - WK / + WK Ceramic
1.6	77	01/04→05/09						
1.7 CDTI	59	01/04→05/09						
1.7 CDTI	74	01/04→05/09	→			13.0460-2868.2	602868	TRW 23417 15,3 + WK + Zub
1.8	92	01/04→05/09				13.0470-2868.2	LD2868	TRW 23417 15,3 + WK + Zub Ceramic
2.0 Turbo	125	01/04→05/09						
1.6	85	01/04→05/09	←	01/07→		13.0460-7179.2	607179	ATE 23832 20,2 - WK / + WK
1.6 Turbo	132	09/06→09/09				13.0470-7179.2	LD7179	ATE 23832 20,2 - WK / + WK Ceramic
			→	01/07→		13.0460-2868.2	602868	TRW 23417 15,3 + WK + Zub
						13.0470-2868.2	LD2868	TRW 23417 15,3 + WK + Zub Ceramic
1.7 CDTi	81	01/04→05/09	←	04/07→		13.0460-7179.2	607179	ATE 23832 20,2 - WK / + WK
						13.0470-7179.2	LD7179	ATE 23832 20,2 - WK / + WK Ceramic
			→	04/07→		13.0460-2868.2	602868	TRW 23417 15,3 + WK + Zub
						13.0470-2868.2	LD2868	TRW 23417 15,3 + WK + Zub Ceramic
1.8	103	01/04→05/09	←	01/06→		13.0460-7179.2	607179	ATE 23832 20,2 - WK / + WK
						13.0470-7179.2	LD7179	ATE 23832 20,2 - WK / + WK Ceramic
			→	01/06→		13.0460-2868.2	602868	TRW 23417 15,3 + WK + Zub
						13.0470-2868.2	LD2868	TRW 23417 15,3 + WK + Zub Ceramic
1.9 CDTI	88	01/04→05/09	←	09/04→		13.0460-7179.2	607179	ATE 23832 20,2 - WK / + WK
1.9 CDTI	110	01/04→05/09				13.0470-7179.2	LD7179	ATE 23832 20,2 - WK / + WK Ceramic
1.9 CDTI 16V	88	01/04→05/09						
2.0 Turbo	147	01/04→05/09	→	09/04→		13.0460-2868.2	602868	TRW 23417 15,3 + WK + Zub
						13.0470-2868.2	LD2868	TRW 23417 15,3 + WK + Zub Ceramic
2.0 Turbo	177	01/04→05/09	←	03/05→; für Bremssattel mit Kunststoffkolben		13.0460-7172.2	607172	ATE 23378 20,1 + WE / - WK
						13.0470-7172.2	LD7172	ATE 23378 20,1 + WE / - WK Ceramic
			←	03/05→; für Bremssattel mit Stahlkolben		13.0460-7212.2	607212	ATE 23738 20,1 + WE / - WK
			→	03/05→		13.0460-2868.2	602868	TRW 23417 15,3 + WK + Zub
						13.0470-2868.2	LD2868	TRW 23417 15,3 + WK + Zub Ceramic
Warnkontakt, Bremsbelagverschleiß								
1.3 CDTI	66	01/04→05/09	←	08/05→	1	24.8190-0720.2	620720	L= 287
↓								







VAUXHALL - ASTRA Mk V (H) CC 01/04→09/09









Warnkontakt, Bremsbelagverschleiß







1.4	55	04/04→12/05	←		1	24.8190-0720.2	620720	L= 287
1.4	66	01/04→05/09						
1.6	77	01/04→05/09						
1.7 CDTI	59	01/04→05/09						
1.7 CDTI	74	01/04→05/09						
1.8	92	01/04→05/09						
2.0 Turbo	125	01/04→05/09						
1.6	85	01/04→05/09	←	01/07→	1	24.8190-0720.2	620720	L= 287
1.6 Turbo	132	09/06→09/09						
1.7 CDTi	81	01/04→05/09	←	04/07→	1	24.8190-0720.2	620720	L= 287
1.8	103	01/04→05/09	←	01/06→	1	24.8190-0720.2	620720	L= 287
1.9 CDTI	88	01/04→05/09	←	09/04→	1	24.8190-0720.2	620720	L= 287
1.9 CDTI	110	01/04→05/09						
1.9 CDTI 16V	88	01/04→05/09						
2.0 Turbo	147	01/04→05/09						
2.0 Turbo	177	01/04→05/09	←	03/05→	1	24.8190-0720.2	620720	L= 287







Bremsscheibe







1.3 CDTI	66	01/04→05/09	←	08/05→; Felge Lochzahl: 5	24.0125-0131.1	425131	Ø 280 24,8 22 V + S
					24.0325-0131.1	525131	Ø 280 24,8 22 V + S PD
			←	08/05→; Felge Lochzahl: 4	24.0125-0198.1	425198	Ø 280 25 22 V + S
					24.0325-0198.1	525198	Ø 280 25 22 V + S PD
			→	08/05→; Felge Lochzahl: 5	24.0110-0250.1	410250	Ø 264 9,8 8 + S
					24.0310-0250.1	510250	Ø 264 9,8 8 + S PD
			→	08/05→; Felge Lochzahl: 4	24.0110-0251.1	410251	Ø 240 9,8 8 + S
					24.0310-0251.1	510251	Ø 240 9,8 8 + S PD
1.4 1.4 1.6 1.7 CDTI 1.7 CDTI 1.8	55 66 77 59 74 92	04/04→12/05 01/04→05/09 01/04→05/09 01/04→05/09 01/04→05/09 01/04→05/09	←	Felge Lochzahl: 5	24.0125-0131.1	425131	Ø 280 24,8 22 V + S
					24.0325-0131.1	525131	Ø 280 24,8 22 V + S PD
			←	Felge Lochzahl: 4	24.0125-0198.1	425198	Ø 280 25 22 V + S
					24.0325-0198.1	525198	Ø 280 25 22 V + S PD
			→	Felge Lochzahl: 5	24.0110-0250.1	410250	Ø 264 9,8 8 + S
					24.0310-0250.1	510250	Ø 264 9,8 8 + S PD
			→	Felge Lochzahl: 4	24.0110-0251.1	410251	Ø 240 9,8 8 + S
					24.0310-0251.1	510251	Ø 240 9,8 8 + S PD
			←	01/07→; Felge Lochzahl: 5	24.0125-0131.1	425131	Ø 280 24,8 22 V + S
					24.0325-0131.1	525131	Ø 280 24,8 22 V + S PD
			←	01/07→; Felge Lochzahl: 4	24.0125-0198.1	425198	Ø 280 25 22 V + S
					24.0325-0198.1	525198	Ø 280 25 22 V + S PD
			→	01/07→; Felge Lochzahl: 5	24.0110-0250.1	410250	Ø 264 9,8 8 + S
					24.0310-0250.1	510250	Ø 264 9,8 8 + S PD
			→	01/07→; Felge Lochzahl: 4	24.0110-0251.1	410251	Ø 240 9,8 8 + S
					24.0310-0251.1	510251	Ø 240 9,8 8 + S PD
			←	01/07→; Felge Lochzahl: 5	24.0125-0142.1	425142	Ø 308 25 22 V + S
					24.0325-0142.1	525142	Ø 308 25 23 V + S PD
			←	01/07→; Felge Lochzahl: 4	24.0125-0198.1	425198	Ø 280 25 22 V + S
					24.0325-0198.1	525198	Ø 280 25 22 V + S PD
			→	01/07→; Felge Lochzahl: 5	24.0110-0250.1	410250	Ø 264 9,8 8 + S
					24.0310-0250.1	510250	Ø 264 9,8 8 + S PD
			→	01/07→; Felge Lochzahl: 4	24.0110-0251.1	410251	Ø 240 9,8 8 + S
					24.0310-0251.1	510251	Ø 240 9,8 8 + S PD
			←	04/07→; Felge Lochzahl: 5	24.0125-0131.1	425131	Ø 280 24,8 22 V + S
					24.0325-0131.1	525131	Ø 280 24,8 22 V + S PD
			←	04/07→; Felge Lochzahl: 4	24.0125-0198.1	425198	Ø 280 25 22 V + S
					24.0325-0198.1	525198	Ø 280 25 22 V + S PD
			→	04/07→; Felge Lochzahl: 5	24.0110-0250.1	410250	Ø 264 9,8 8 + S
					24.0310-0250.1	510250	Ø 264 9,8 8 + S PD
			→	04/07→; Felge Lochzahl: 4	24.0110-0251.1	410251	Ø 240 9,8 8 + S
					24.0310-0251.1	510251	Ø 240 9,8 8 + S PD
			←	01/06→; Felge Lochzahl: 5	24.0125-0131.1	425131	Ø 280 24,8 22 V + S
					24.0325-0131.1	525131	Ø 280 24,8 22 V + S PD
			←	01/06→; Felge Lochzahl: 4	24.0125-0198.1	425198	Ø 280 25 22 V + S
					24.0325-0198.1	525198	Ø 280 25 22 V + S PD
			→	01/06→; Felge Lochzahl: 5	24.0110-0250.1	410250	Ø 264 9,8 8 + S
					24.0310-0250.1	510250	Ø 264 9,8 8 + S PD

	kw			 	! #		
VAUXHALL - ASTRA Mk V (H) CC 01/04→09/09							
Bremsscheibe							
1.8	103	01/04→05/09	➔	01/06→; Felge Lochzahl: 4		24.0110-0251.1 410251 24.0310-0251.1 510251	Ø 240 9,8 8 + S Ø 240 9,8 8 + S PD
1.9 CDTi	88	01/04→05/09	➔	09/04→; Felge Lochzahl: 5		24.0125-0142.1 425142	Ø 308 25 22 V + S
1.9 CDTi	110	01/04→05/09				24.0325-0142.1 525142	Ø 308 25 23 V + S PD
1.9 CDTi 16V	88	01/04→05/09	➔	09/04→; Felge Lochzahl: 4		24.0125-0198.1 425198	Ø 280 25 22 V + S
2.0 Turbo	147	01/04→05/09	➔	09/04→; Felge Lochzahl: 5		24.0325-0198.1 525198	Ø 280 25 22 V + S PD
			➔	09/04→; Felge Lochzahl: 5		24.0110-0250.1 410250	Ø 264 9,8 8 + S
			➔	09/04→; Felge Lochzahl: 4		24.0310-0250.1 510250	Ø 264 9,8 8 + S PD
			➔	09/04→; Felge Lochzahl: 4		24.0110-0251.1 410251	Ø 240 9,8 8 + S
			➔	09/04→; Felge Lochzahl: 4		24.0310-0251.1 510251	Ø 240 9,8 8 + S PD
2.0 Turbo	125	01/04→05/09	➔	Felge Lochzahl: 5		24.0125-0142.1 425142	Ø 308 25 22 V + S
			➔	Felge Lochzahl: 4		24.0325-0142.1 525142	Ø 308 25 23 V + S PD
			➔	Felge Lochzahl: 5		24.0125-0198.1 425198	Ø 280 25 22 V + S
			➔	Felge Lochzahl: 5		24.0325-0198.1 525198	Ø 280 25 22 V + S PD
			➔	Felge Lochzahl: 5		24.0110-0250.1 410250	Ø 264 9,8 8 + S
			➔	Felge Lochzahl: 4		24.0310-0250.1 510250	Ø 264 9,8 8 + S PD
			➔	Felge Lochzahl: 4		24.0110-0251.1 410251	Ø 240 9,8 8 + S
			➔	Felge Lochzahl: 4		24.0310-0251.1 510251	Ø 240 9,8 8 + S PD
2.0 Turbo	177	01/04→05/09	➔	03/05→; Felge Lochzahl: 5		24.0128-0201.1 428201	Ø 321 28 25 V
			➔	03/05→		24.0110-0339.1 410339	Ø 278 10 8 + S
VAUXHALL - ASTRA Mk V (H) Estate 08/04→10/12							
Bremsbelagsatz, Scheibenbremse							
1.3 CDTi	66	08/04→03/09	➔	08/05→		13.0460-7179.2 607179 13.0470-7179.2 LD7179	ATE 23832 20,2 - WK / + WK ATE 23832 20,2 - WK / + WK Ceramic
			➔	08/05→		13.0460-2868.2 602868 13.0470-2868.2 LD2868	TRW 23417 15,3 + WK + Zub TRW 23417 15,3 + WK + Zub Ceramic
1.4	55	08/04→10/10	➔			13.0460-7179.2 607179	ATE 23832 20,2 - WK / + WK
1.4	66	08/04→03/09				13.0470-7179.2 LD7179	ATE 23832 20,2 - WK / + WK Ceramic
1.6	77	08/04→03/09					
1.7 CDTi	74	08/04→03/09	➔			13.0460-2868.2 602868	TRW 23417 15,3 + WK + Zub
1.7 CDTi	59	08/04→05/09				13.0470-2868.2 LD2868	TRW 23417 15,3 + WK + Zub Ceramic
1.8	92	10/04→03/09					
1.8	103	12/05→10/10					
1.9 CDTi	88	08/04→03/09					
2.0 Turbo	125	08/04→10/10					
1.6	85	08/04→03/09	➔	01/07→		13.0460-7179.2 607179	ATE 23832 20,2 - WK / + WK
1.6	132	08/04→03/09	➔	01/07→		13.0470-7179.2 LD7179	ATE 23832 20,2 - WK / + WK Ceramic
			➔	01/07→		13.0460-2868.2 602868	TRW 23417 15,3 + WK + Zub
			➔	01/07→		13.0470-2868.2 LD2868	TRW 23417 15,3 + WK + Zub Ceramic
1.7 CDTi	81	08/04→10/12	➔	04/07→ 11/10		13.0460-7179.2 607179	ATE 23832 20,2 - WK / + WK
			➔	04/07→ 11/10		13.0470-7179.2 LD7179	ATE 23832 20,2 - WK / + WK Ceramic
			➔	04/07→ 11/10		13.0460-2868.2 602868	TRW 23417 15,3 + WK + Zub
			➔	04/07→ 11/10		13.0470-2868.2 LD2868	TRW 23417 15,3 + WK + Zub Ceramic
1.7 CDTi	92	02/07→10/10	➔	04/07→		13.0460-7179.2 607179	ATE 23832 20,2 - WK / + WK
			➔	04/07→		13.0470-7179.2 LD7179	ATE 23832 20,2 - WK / + WK Ceramic
			➔	04/07→		13.0460-2868.2 602868	TRW 23417 15,3 + WK + Zub
			➔	04/07→		13.0470-2868.2 LD2868	TRW 23417 15,3 + WK + Zub Ceramic
1.9 CDTi	74	08/04→03/09	➔	09/05→		13.0460-7179.2 607179	ATE 23832 20,2 - WK / + WK
			➔	09/05→		13.0470-7179.2 LD7179	ATE 23832 20,2 - WK / + WK Ceramic
			➔	09/05→		13.0460-2868.2 602868	TRW 23417 15,3 + WK + Zub
			➔	09/05→		13.0470-2868.2 LD2868	TRW 23417 15,3 + WK + Zub Ceramic
1.9 CDTi	110	08/04→03/09	➔	09/04→		13.0460-7179.2 607179	ATE 23832 20,2 - WK / + WK
2.0 Turbo	147	08/04→10/10	➔	09/04→		13.0470-7179.2 LD7179	ATE 23832 20,2 - WK / + WK Ceramic
			➔	09/04→		13.0460-2868.2 602868	TRW 23417 15,3 + WK + Zub







	kW				! #		
VAUXHALL - ASTRA Mk V (H) Estate 08/04→10/12							
 Bremsbelagsatz, Scheibenbremse							
1.9 CDTi 2.0 Turbo	110 147	08/04→03/09 08/04→10/10	➡	09/04→		13.0470-2868.2 LD2868	TRW 23417 15,3 + WK + Zub Ceramic
Warnkontakt, Bremsbelagverschleiß							
1.3 CDTi	66	08/04→03/09	←	08/05→	1	24.8190-0720.2 620720	L= 287
1.4 1.4 1.6 1.7 CDTi 1.7 CDTI 1.8 1.8 1.9 CDTi 2.0 Turbo	55 66 77 74 59 92 103 88 125	08/04→10/10 08/04→03/09 08/04→03/09 08/04→03/09 08/04→05/09 10/04→03/09 12/05→10/10 08/04→03/09 08/04→10/10	←		1	24.8190-0720.2 620720	L= 287
1.6 1.6	85 132	08/04→03/09 08/04→03/09	←	01/07→	1	24.8190-0720.2 620720	L= 287
1.7 CDTi	81	08/04→10/12	←	04/07→ 11/10	1	24.8190-0720.2 620720	L= 287
1.7 CDTI	92	02/07→10/10	←	04/07→	1	24.8190-0720.2 620720	L= 287
1.9 CDTi	74	08/04→03/09	←	09/05→	1	24.8190-0720.2 620720	L= 287
1.9 CDTi 2.0 Turbo	110 147	08/04→03/09 08/04→10/10	←	09/04→	1	24.8190-0720.2 620720	L= 287
 Bremsscheibe							
1.3 CDTi	66	08/04→03/09	←	08/05→; Felge Lochzahl: 5		24.0125-0131.1 425131	Ø 280 24,8 22 V + S
			←	08/05→; Felge Lochzahl: 4		24.0125-0198.1 425198	Ø 280 25 22 V + S
			➡	08/05→; Felge Lochzahl: 5		24.0325-0198.1 525198	Ø 280 25 22 V + S PD
			➡	08/05→; Felge Lochzahl: 4		24.0110-0250.1 410250	Ø 264 9,8 8 + S
			➡	08/05→; Felge Lochzahl: 5		24.0310-0250.1 510250	Ø 264 9,8 8 + S PD
			➡	08/05→; Felge Lochzahl: 4		24.0110-0251.1 410251	Ø 240 9,8 8 + S
			➡	08/05→; Felge Lochzahl: 5		24.0310-0251.1 510251	Ø 240 9,8 8 + S PD
1.4 1.4 1.6 1.7 CDTi 1.7 CDTI 1.8	55 66 77 74 59 103	08/04→10/10 08/04→03/09 08/04→03/09 08/04→03/09 08/04→05/09 12/05→10/10	←	Felge Lochzahl: 5		24.0125-0131.1 425131	Ø 280 24,8 22 V + S
			←	Felge Lochzahl: 4		24.0125-0198.1 425198	Ø 280 25 22 V + S
			➡	Felge Lochzahl: 5		24.0325-0198.1 525198	Ø 280 25 22 V + S PD
			➡	Felge Lochzahl: 4		24.0110-0250.1 410250	Ø 264 9,8 8 + S
			➡	Felge Lochzahl: 5		24.0310-0250.1 510250	Ø 264 9,8 8 + S PD
			➡	Felge Lochzahl: 4		24.0110-0251.1 410251	Ø 240 9,8 8 + S
			➡	Felge Lochzahl: 5		24.0310-0251.1 510251	Ø 240 9,8 8 + S PD
1.6	85	08/04→03/09	←	01/07→; Felge Lochzahl: 5		24.0125-0131.1 425131	Ø 280 24,8 22 V + S
			←	01/07→; Felge Lochzahl: 4		24.0125-0198.1 425198	Ø 280 25 22 V + S
			➡	01/07→; Felge Lochzahl: 5		24.0325-0198.1 525198	Ø 280 25 22 V + S PD
			➡	01/07→; Felge Lochzahl: 4		24.0110-0250.1 410250	Ø 264 9,8 8 + S
			➡	01/07→; Felge Lochzahl: 5		24.0310-0250.1 510250	Ø 264 9,8 8 + S PD
			➡	01/07→; Felge Lochzahl: 4		24.0110-0251.1 410251	Ø 240 9,8 8 + S
			➡	01/07→; Felge Lochzahl: 5		24.0310-0251.1 510251	Ø 240 9,8 8 + S PD
1.6	132	08/04→03/09	←	01/07→; Felge Lochzahl: 5		24.0125-0142.1 425142	Ø 308 25 22 V + S
			←	01/07→; Felge Lochzahl: 4		24.0325-0142.1 525142	Ø 308 25 23 V + S PD
			➡	01/07→; Felge Lochzahl: 5		24.0125-0198.1 425198	Ø 280 25 22 V + S
			➡	01/07→; Felge Lochzahl: 4		24.0325-0198.1 525198	Ø 280 25 22 V + S PD
			➡	01/07→; Felge Lochzahl: 5		24.0110-0250.1 410250	Ø 264 9,8 8 + S
			➡	01/07→; Felge Lochzahl: 4		24.0310-0250.1 510250	Ø 264 9,8 8 + S PD
			➡	01/07→; Felge Lochzahl: 5		24.0110-0251.1 410251	Ø 240 9,8 8 + S
			➡	01/07→; Felge Lochzahl: 4		24.0310-0251.1 510251	Ø 240 9,8 8 + S PD
1.7 CDTi	81	08/04→10/12	←	04/07→ 11/10; Felge Lochzahl: 5		24.0125-0131.1 425131	Ø 280 24,8 22 V + S
			←	04/07→ 11/10; Felge Lochzahl: 4		24.0125-0198.1 425198	Ø 280 25 22 V + S
			➡	04/07→ 11/10; Felge Lochzahl: 5		24.0325-0198.1 525198	Ø 280 25 22 V + S PD
			➡	04/07→ 11/10; Felge Lochzahl: 4		24.0110-0250.1 410250	Ø 264 9,8 8 + S
			➡	04/07→ 11/10; Felge Lochzahl: 5		24.0310-0250.1 510250	Ø 264 9,8 8 + S PD
			➡	04/07→ 11/10; Felge Lochzahl: 4		24.0110-0251.1 410251	Ø 240 9,8 8 + S
			➡	04/07→ 11/10; Felge Lochzahl: 5		24.0310-0251.1 510251	Ø 240 9,8 8 + S PD
1.7 CDTI	92	02/07→10/10	←	04/07→; Felge Lochzahl: 5		24.0125-0142.1 425142	Ø 308 25 22 V + S
			←	04/07→; Felge Lochzahl: 4		24.0325-0142.1 525142	Ø 308 25 23 V + S PD
			➡	04/07→; Felge Lochzahl: 5		24.0125-0198.1 425198	Ø 280 25 22 V + S
			➡	04/07→; Felge Lochzahl: 4		24.0325-0198.1 525198	Ø 280 25 22 V + S PD
			➡	04/07→; Felge Lochzahl: 5		24.0110-0250.1 410250	Ø 264 9,8 8 + S











	kw			 	! #				
VAUXHALL - ASTRA Mk V (H) Estate 08/04→10/12									
Bremsscheibe									
1.7 CDTi	92	02/07→10/10	➡	04/07→; Felge Lochzahl: 5		24.0310-0250.1 510250	Ø 264 9,8 8 + S PD		
			➡	04/07→; Felge Lochzahl: 4		24.0110-0251.1 410251 24.0310-0251.1 510251	Ø 240 9,8 8 + S Ø 240 9,8 8 + S PD		
1.8	92	10/04→03/09	←	Felge Lochzahl: 5		24.0125-0131.1 425131 24.0325-0131.1 525131	Ø 280 24,8 22 V + S Ø 280 24,8 22 V + S PD		
			←	Felge Lochzahl: 4		24.0125-0198.1 425198 24.0325-0198.1 525198	Ø 280 25 22 V + S Ø 280 25 22 V + S PD		
			➡	Felge Lochzahl: 5		24.0110-0250.1 410250 24.0310-0250.1 510250	Ø 264 9,8 8 + S Ø 264 9,8 8 + S PD		
			➡	Felge Lochzahl: 4		24.0110-0251.1 410251 24.0310-0251.1 510251	Ø 240 9,8 8 + S Ø 240 9,8 8 + S PD		
1.9 CDTi	74	08/04→03/09	←	09/05→; Felge Lochzahl: 5		24.0125-0142.1 425142 24.0325-0142.1 525142	Ø 308 25 22 V + S Ø 308 25 23 V + S PD		
			←	09/05→; Felge Lochzahl: 4		24.0125-0198.1 425198 24.0325-0198.1 525198	Ø 280 25 22 V + S Ø 280 25 22 V + S PD		
			➡	09/05→; Felge Lochzahl: 5		24.0110-0250.1 410250 24.0310-0250.1 510250	Ø 264 9,8 8 + S Ø 264 9,8 8 + S PD		
			➡	09/05→; Felge Lochzahl: 4		24.0110-0251.1 410251 24.0310-0251.1 510251	Ø 240 9,8 8 + S Ø 240 9,8 8 + S PD		
1.9 CDTi 2.0 Turbo	88 125	08/04→03/09 08/04→10/10	←	Felge Lochzahl: 5		24.0125-0142.1 425142 24.0325-0142.1 525142	Ø 308 25 22 V + S Ø 308 25 23 V + S PD		
			←	Felge Lochzahl: 4		24.0125-0198.1 425198 24.0325-0198.1 525198	Ø 280 25 22 V + S Ø 280 25 22 V + S PD		
			➡	Felge Lochzahl: 5		24.0110-0250.1 410250 24.0310-0250.1 510250	Ø 264 9,8 8 + S Ø 264 9,8 8 + S PD		
			➡	Felge Lochzahl: 4		24.0110-0251.1 410251 24.0310-0251.1 510251	Ø 240 9,8 8 + S Ø 240 9,8 8 + S PD		
1.9 CDTi 2.0 Turbo	110 147	08/04→03/09 08/04→10/10	←	09/04→; Felge Lochzahl: 5		24.0125-0142.1 425142 24.0325-0142.1 525142	Ø 308 25 22 V + S Ø 308 25 23 V + S PD		
			←	09/04→; Felge Lochzahl: 4		24.0125-0198.1 425198 24.0325-0198.1 525198	Ø 280 25 22 V + S Ø 280 25 22 V + S PD		
			➡	09/04→; Felge Lochzahl: 5		24.0110-0250.1 410250 24.0310-0250.1 510250	Ø 264 9,8 8 + S Ø 264 9,8 8 + S PD		
			➡	09/04→; Felge Lochzahl: 4		24.0110-0251.1 410251 24.0310-0251.1 510251	Ø 240 9,8 8 + S Ø 240 9,8 8 + S PD		
VAUXHALL - ASTRA Mk V (H) Sport Hatch 02/05→11/10									
Bremsbelagsatz, Scheibenbremse									
1.3 CDTi	66	04/05→11/10	←	08/05→		13.0460-7179.2 607179 13.0470-7179.2 LD7179	ATE 23832 20,2 - WK / + WK ATE 23832 20,2 - WK / + WK Ceramic		
			➡	08/05→		13.0460-2868.2 602868 13.0470-2868.2 LD2868	TRW 23417 15,3 + WK + Zub TRW 23417 15,3 + WK + Zub Ceramic		
1.4 1.4 i 16V 1.6 1.7 CDTi 1.8 1.8 i 16V 1.9 CDTi 1.9 CDTi 2.0 Turbo	55 66 77 74 92 103 88 110 125	02/05→11/10 03/05→11/10 02/05→11/10 02/05→11/10 02/05→11/10 03/07→11/10 02/05→11/10 02/05→11/10 02/05→11/10	←			13.0460-7179.2 607179 13.0470-7179.2 LD7179	ATE 23832 20,2 - WK / + WK ATE 23832 20,2 - WK / + WK Ceramic		
			➡			13.0460-2868.2 602868 13.0470-2868.2 LD2868	TRW 23417 15,3 + WK + Zub TRW 23417 15,3 + WK + Zub Ceramic		
1.6 1.6 i 16V	132 85	10/06→11/10 12/06→11/10	←	01/07→		13.0460-7179.2 607179 13.0470-7179.2 LD7179	ATE 23832 20,2 - WK / + WK ATE 23832 20,2 - WK / + WK Ceramic		
			➡	01/07→		13.0460-2868.2 602868 13.0470-2868.2 LD2868	TRW 23417 15,3 + WK + Zub TRW 23417 15,3 + WK + Zub Ceramic		
1.7 CDTi	81	02/07→11/10	←	04/07→		13.0460-7179.2 607179 13.0470-7179.2 LD7179	ATE 23832 20,2 - WK / + WK ATE 23832 20,2 - WK / + WK Ceramic		
			➡	04/07→		13.0460-2868.2 602868 13.0470-2868.2 LD2868	TRW 23417 15,3 + WK + Zub TRW 23417 15,3 + WK + Zub Ceramic		
↓									

	kw				! #		
VAUXHALL - ASTRA Mk V (H) Sport Hatch 02/05→11/10							
Bremsbelagsatz, Scheibenbremse							
1.9 CDTi	74	08/05→11/10	←	09/05→		13.0460-7179.2 607179 13.0470-7179.2 LD7179	ATE 23832 20,2 - WK / + WK ATE 23832 20,2 - WK / + WK Ceramic
			→	09/05→		13.0460-2868.2 602868 13.0470-2868.2 LD2868	TRW 23417 15,3 + WK + Zub Ceramic TRW 23417 15,3 + WK + Zub Ceramic
2.0 VXR	176	02/09→11/10	←	für Bremssattel mit Kunststoffkolben		13.0460-7172.2 607172 13.0470-7172.2 LD7172	ATE 23378 20,1 + WE / - WK ATE 23378 20,1 + WE / - WK Ceramic
			←	für Bremssattel mit Stahlkolben		13.0460-7212.2 607212	ATE 23738 20,1 + WE / - WK
			→			13.0460-2868.2 602868 13.0470-2868.2 LD2868	TRW 23417 15,3 + WK + Zub Ceramic TRW 23417 15,3 + WK + Zub Ceramic
Warnkontakt, Bremsbelagverschleiß							
1.3 CDTi	66	04/05→11/10	←	08/05→	1	24.8190-0720.2 620720	L= 287
1.4	55	02/05→11/10	←		1	24.8190-0720.2 620720	L= 287
1.4 i 16V	66	03/05→11/10					
1.6	77	02/05→11/10					
1.7 CDTi	74	02/05→11/10					
1.8	92	02/05→11/10					
1.8 i 16V	103	03/07→11/10					
1.9 CDTi	88	02/05→11/10					
1.9 CDTi	110	02/05→11/10					
2.0 Turbo	125	02/05→11/10					
2.0 VXR	176	02/09→11/10					
1.6	132	10/06→11/10	←	01/07→	1	24.8190-0720.2 620720	L= 287
1.6 i 16V	85	12/06→11/10					
1.7 CDTi	81	02/07→11/10	←	04/07→	1	24.8190-0720.2 620720	L= 287
1.9 CDTi	74	08/05→11/10	←	09/05→	1	24.8190-0720.2 620720	L= 287
Bremsscheibe							
1.3 CDTi	66	04/05→11/10	←	08/05→; Felge Lochzahl: 5		24.0125-0131.1 425131 24.0325-0131.1 525131	Ø 280 24,8 22 V + S Ø 280 24,8 22 V + S PD
			←	08/05→; Felge Lochzahl: 4		24.0125-0198.1 425198 24.0325-0198.1 525198	Ø 280 25 22 V + S Ø 280 25 22 V + S PD
			→	08/05→; Felge Lochzahl: 5		24.0110-0250.1 410250 24.0310-0250.1 510250	Ø 264 9,8 8 + S Ø 264 9,8 8 + S PD
			→	08/05→; Felge Lochzahl: 4		24.0110-0251.1 410251 24.0310-0251.1 510251	Ø 240 9,8 8 + S Ø 240 9,8 8 + S PD
			←	Felge Lochzahl: 5		24.0125-0131.1 425131 24.0325-0131.1 525131	Ø 280 24,8 22 V + S Ø 280 24,8 22 V + S PD
1.4	55	02/05→11/10	←	Felge Lochzahl: 5		24.0125-0131.1 425131 24.0325-0131.1 525131	Ø 280 24,8 22 V + S Ø 280 24,8 22 V + S PD
			←	Felge Lochzahl: 4		24.0125-0198.1 425198 24.0325-0198.1 525198	Ø 280 25 22 V + S Ø 280 25 22 V + S PD
			→	Felge Lochzahl: 5		24.0110-0250.1 410250 24.0310-0250.1 510250	Ø 264 9,8 8 + S Ø 264 9,8 8 + S PD
1.4 i 16V	66	03/05→11/10	→	Felge Lochzahl: 4		24.0110-0251.1 410251 24.0310-0251.1 510251	Ø 240 9,8 8 + S Ø 240 9,8 8 + S PD
			→	Felge Lochzahl: 5		24.0125-0131.1 425131 24.0325-0131.1 525131	Ø 280 24,8 22 V + S Ø 280 24,8 22 V + S PD
1.6	77	02/05→11/10	←	Felge Lochzahl: 4		24.0125-0198.1 425198 24.0325-0198.1 525198	Ø 280 25 22 V + S Ø 280 25 22 V + S PD
1.7 CDTi	74	02/05→11/10	←	Felge Lochzahl: 4		24.0125-0198.1 425198 24.0325-0198.1 525198	Ø 280 25 22 V + S Ø 280 25 22 V + S PD
1.8	92	02/05→11/10	→	Felge Lochzahl: 5		24.0110-0250.1 410250 24.0310-0250.1 510250	Ø 264 9,8 8 + S Ø 264 9,8 8 + S PD
1.8 i 16V	103	03/07→11/10	→	Felge Lochzahl: 4		24.0110-0251.1 410251 24.0310-0251.1 510251	Ø 240 9,8 8 + S Ø 240 9,8 8 + S PD
1.6	132	10/06→11/10	←	01/07→; Felge Lochzahl: 5		24.0125-0142.1 425142 24.0325-0142.1 525142	Ø 308 25 22 V + S Ø 308 25 23 V + S PD
			←	01/07→; Felge Lochzahl: 4		24.0125-0198.1 425198 24.0325-0198.1 525198	Ø 280 25 22 V + S Ø 280 25 22 V + S PD
			→	01/07→; Felge Lochzahl: 5		24.0110-0250.1 410250 24.0310-0250.1 510250	Ø 264 9,8 8 + S Ø 264 9,8 8 + S PD
			→	01/07→; Felge Lochzahl: 4		24.0110-0251.1 410251 24.0310-0251.1 510251	Ø 240 9,8 8 + S Ø 240 9,8 8 + S PD
			←	01/07→; Felge Lochzahl: 5		24.0125-0131.1 425131 24.0325-0131.1 525131	Ø 280 24,8 22 V + S Ø 280 24,8 22 V + S PD
1.6 i 16V	85	12/06→11/10	←	01/07→; Felge Lochzahl: 4		24.0125-0198.1 425198 24.0325-0198.1 525198	Ø 280 25 22 V + S Ø 280 25 22 V + S PD
			→	01/07→; Felge Lochzahl: 5		24.0110-0250.1 410250 24.0310-0250.1 510250	Ø 264 9,8 8 + S Ø 264 9,8 8 + S PD
			→	01/07→; Felge Lochzahl: 4		24.0110-0251.1 410251 24.0310-0251.1 510251	Ø 240 9,8 8 + S Ø 240 9,8 8 + S PD
			←	01/07→; Felge Lochzahl: 5		24.0125-0131.1 425131 24.0325-0131.1 525131	Ø 280 24,8 22 V + S Ø 280 24,8 22 V + S PD
1.7 CDTi	81	02/07→11/10	←	04/07→; Felge Lochzahl: 5		24.0125-0131.1 425131	Ø 280 24,8 22 V + S











	kw					! #			
VAUXHALL - ASTRA Mk V (H) Sport Hatch 02/05→11/10									
Bremsscheibe									
1.7 CDTi	81	02/07→11/10	←	04/07→; Felge Lochzahl: 5		24.0325-0131.1	525131	Ø 280 24,8 22 V + S PD	
			←	04/07→; Felge Lochzahl: 4		24.0125-0198.1	425198	Ø 280 25 22 V + S	
						24.0325-0198.1	525198	Ø 280 25 22 V + S PD	
			→	04/07→; Felge Lochzahl: 5		24.0110-0250.1	410250	Ø 264 9,8 8 + S	
			→	04/07→; Felge Lochzahl: 4		24.0310-0250.1	510250	Ø 264 9,8 8 + S PD	
			→	04/07→; Felge Lochzahl: 4		24.0110-0251.1	410251	Ø 240 9,8 8 + S	
			→	04/07→; Felge Lochzahl: 4		24.0310-0251.1	510251	Ø 240 9,8 8 + S PD	
1.9 CDTi	74	08/05→11/10	←	09/05→; Felge Lochzahl: 5		24.0125-0142.1	425142	Ø 308 25 22 V + S	
						24.0325-0142.1	525142	Ø 308 25 23 V + S PD	
			←	09/05→; Felge Lochzahl: 4		24.0125-0198.1	425198	Ø 280 25 22 V + S	
						24.0325-0198.1	525198	Ø 280 25 22 V + S PD	
			→	09/05→; Felge Lochzahl: 5		24.0110-0250.1	410250	Ø 264 9,8 8 + S	
			→	09/05→; Felge Lochzahl: 5		24.0310-0250.1	510250	Ø 264 9,8 8 + S PD	
			→	09/05→; Felge Lochzahl: 4		24.0110-0251.1	410251	Ø 240 9,8 8 + S	
			→	09/05→; Felge Lochzahl: 4		24.0310-0251.1	510251	Ø 240 9,8 8 + S PD	
1.9 CDTi 1.9 CDTi 2.0 Turbo	88 110 125	02/05→11/10 02/05→11/10 02/05→11/10	←	Felge Lochzahl: 5		24.0125-0142.1	425142	Ø 308 25 22 V + S	
						24.0325-0142.1	525142	Ø 308 25 23 V + S PD	
			←	Felge Lochzahl: 4		24.0125-0198.1	425198	Ø 280 25 22 V + S	
						24.0325-0198.1	525198	Ø 280 25 22 V + S PD	
			→	Felge Lochzahl: 5		24.0110-0250.1	410250	Ø 264 9,8 8 + S	
			→	Felge Lochzahl: 5		24.0310-0250.1	510250	Ø 264 9,8 8 + S PD	
			→	Felge Lochzahl: 4		24.0110-0251.1	410251	Ø 240 9,8 8 + S	
			→	Felge Lochzahl: 4		24.0310-0251.1	510251	Ø 240 9,8 8 + S PD	
2.0 VXR	176	02/09→11/10	←	Felge Lochzahl: 5		24.0128-0201.1	428201	Ø 321 28 25 V	
			→			24.0110-0339.1	410339	Ø 278 10 8 + S	
VAUXHALL - ASTRA Mk V (H) TwinTop 09/05→11/10									
Bremsbelagsatz, Scheibenbremse									
1.6 1.9 CDTi 2.0 2.0 Turbo	77 110 125 147	09/05→11/10 01/06→11/10 02/06→11/10 01/06→11/10	←	03/06→		13.0460-7179.2	607179	ATE 23832 20,2 - WK / + WK	
						13.0470-7179.2	LD7179	ATE 23832 20,2 - WK / + WK Ceramic	
			→	03/06→		13.0460-2868.2	602868	TRW 23417 15,3 + WK + Zub	
						13.0470-2868.2	LD2868	TRW 23417 15,3 + WK + Zub Ceramic	
1.6	132	10/06→11/10	←	02/07→		13.0460-7179.2	607179	ATE 23832 20,2 - WK / + WK	
						13.0470-7179.2	LD7179	ATE 23832 20,2 - WK / + WK Ceramic	
			→	02/07→		13.0460-2868.2	602868	TRW 23417 15,3 + WK + Zub	
			→	02/07→		13.0470-2868.2	LD2868	TRW 23417 15,3 + WK + Zub Ceramic	
1.6 i 16V	85	10/06→11/10	←	12/06→		13.0460-7179.2	607179	ATE 23832 20,2 - WK / + WK	
						13.0470-7179.2	LD7179	ATE 23832 20,2 - WK / + WK Ceramic	
			→	12/06→		13.0460-2868.2	602868	TRW 23417 15,3 + WK + Zub	
			→	12/06→		13.0470-2868.2	LD2868	TRW 23417 15,3 + WK + Zub Ceramic	
1.8	103	05/08→11/10	←			13.0460-7179.2	607179	ATE 23832 20,2 - WK / + WK	
						13.0470-7179.2	LD7179	ATE 23832 20,2 - WK / + WK Ceramic	
			→			13.0460-2868.2	602868	TRW 23417 15,3 + WK + Zub	
			→			13.0470-2868.2	LD2868	TRW 23417 15,3 + WK + Zub Ceramic	
Warnkontakt, Bremsbelagverschleiß									
1.6 1.9 CDTi 2.0 2.0 Turbo	77 110 125 147	09/05→11/10 01/06→11/10 02/06→11/10 01/06→11/10	←	03/06→	1	24.8190-0720.2	620720	L= 287	
			←	02/07→	1	24.8190-0720.2	620720	L= 287	
1.6 i 16V	85	10/06→11/10	←	12/06→	1	24.8190-0720.2	620720	L= 287	
1.8	103	05/08→11/10	←		1	24.8190-0720.2	620720	L= 287	
Bremsscheibe									
1.6 ↓	77	09/05→11/10	←	03/06→; Felge Lochzahl: 5		24.0125-0131.1	425131	Ø 280 24,8 22 V + S	

























	kw				! #					
VAUXHALL - ASTRA Mk V (H) TwinTop 09/05→11/10										
Bremsscheibe										
1.6	77	09/05→11/10	←	03/06→; Felge Lochzahl: 5	24.0325-0131.1	525131	Ø 280 24,8 22 V + S PD			
			←	03/06→; Felge Lochzahl: 4	24.0125-0198.1	425198	Ø 280 25 22 V + S			
					24.0325-0198.1	525198	Ø 280 25 22 V + S PD			
			→	03/06→; Felge Lochzahl: 5	24.0110-0250.1	410250	Ø 264 9,8 8 + S			
			→	03/06→; Felge Lochzahl: 4	24.0110-0291.1	410291	Ø 264 10 8 + S			
					24.0310-0291.1	510291	Ø 264 10 8 + S PD			
1.6	132	10/06→11/10	←	02/07→; Felge Lochzahl: 5	24.0125-0142.1	425142	Ø 308 25 22 V + S			
			←	02/07→; Felge Lochzahl: 4	24.0125-0198.1	425198	Ø 280 25 22 V + S			
					24.0325-0198.1	525198	Ø 280 25 22 V + S PD			
			←	02/07→	24.0325-0142.1	525142	Ø 308 25 23 V + S PD			
			→	02/07→; Felge Lochzahl: 5	24.0110-0250.1	410250	Ø 264 9,8 8 + S			
			→	02/07→; Felge Lochzahl: 4	24.0110-0291.1	410291	Ø 264 10 8 + S			
		24.0310-0291.1	510291	Ø 264 10 8 + S PD						
1.6 i 16V	85	10/06→11/10	←	12/06→; Felge Lochzahl: 5	24.0125-0131.1	425131	Ø 280 24,8 22 V + S			
					24.0325-0131.1	525131	Ø 280 24,8 22 V + S PD			
			←	12/06→; Felge Lochzahl: 4	24.0125-0198.1	425198	Ø 280 25 22 V + S			
					24.0325-0198.1	525198	Ø 280 25 22 V + S PD			
			→	12/06→; Felge Lochzahl: 5	24.0110-0250.1	410250	Ø 264 9,8 8 + S			
			→	12/06→; Felge Lochzahl: 4	24.0110-0291.1	410291	Ø 264 10 8 + S			
		24.0310-0291.1	510291	Ø 264 10 8 + S PD						
1.8	103	05/08→11/10	←	Felge Lochzahl: 5	24.0125-0131.1	425131	Ø 280 24,8 22 V + S			
					24.0325-0131.1	525131	Ø 280 24,8 22 V + S PD			
			←	Felge Lochzahl: 4	24.0125-0198.1	425198	Ø 280 25 22 V + S			
					24.0325-0198.1	525198	Ø 280 25 22 V + S PD			
			→	Felge Lochzahl: 5	24.0110-0250.1	410250	Ø 264 9,8 8 + S			
			→	Felge Lochzahl: 4	24.0110-0291.1	410291	Ø 264 10 8 + S			
		24.0310-0291.1	510291	Ø 264 10 8 + S PD						
1.9 CDTi 2.0 2.0 Turbo	110 125 147	01/06→11/10 02/06→11/10 01/06→11/10	←	03/06→; Felge Lochzahl: 5	24.0125-0142.1	425142	Ø 308 25 22 V + S			
			←	03/06→; Felge Lochzahl: 4	24.0125-0198.1	425198	Ø 280 25 22 V + S			
					24.0325-0198.1	525198	Ø 280 25 22 V + S PD			
			←	03/06→	24.0325-0142.1	525142	Ø 308 25 23 V + S PD			
			→	03/06→; Felge Lochzahl: 5	24.0110-0250.1	410250	Ø 264 9,8 8 + S			
			→	03/06→; Felge Lochzahl: 4	24.0110-0291.1	410291	Ø 264 10 8 + S			
		24.0310-0291.1	510291	Ø 264 10 8 + S PD						
VAUXHALL - ASTRA Mk VI (J) 12/09→										
Bremsbelagsatz, Scheibenbremse										
1.3 CDTi 1.4 1.4 1.4 Turbo 1.4 Turbo 1.6 1.6 SIDI 1.6 Turbo 1.7 CDTi 1.7 CDTi 1.7 CDTi 2.0 BiTurbo CDTi 2.0 CDTi 2.0 CDTi	70 64 74 88 103 85 125 132 81 92 96 143 118 121	12/09→ 12/09→ 12/09→ 08/11→ 12/09→ 12/09→ 12/12→ 12/09→ 12/09→ 12/09→ 06/11→ 12/12→ 12/09→ 08/11→	←	für Bremsscheibendurchmesser [mm]: 321	13.0460-5612.2	605612	MAN 24412 19,0 + WK + Zub			
					13.0470-5612.2	LD5612	MAN 24412 19,0 + WK + Zub Ceramic			
			←	für Bremsscheibendurchmesser [mm]: 276	13.0460-7262.2	607262	25031 19,1 + WK + Zub			
					13.0470-7262.2	LD7262	25031 19,1 + WK + Zub Ceramic			
			←	für Bremsscheibendurchmesser [mm]: 300	13.0460-7263.2	607263	24034 19,1 + WK + Zub			
					13.0470-7263.2	LD7263	24034 19,1 + WK + Zub Ceramic			
			→		13.0460-7264.2	607264	ATE 25096 17,0 + WK + Zub			
					13.0470-7264.2	LD7264	ATE 25096 17,0 + WK + Zub Ceramic			
			1.6 CDTi	81	11/13→	←	02/14→; für Bremsscheibendurchmesser [mm]: 321	13.0460-5612.2	605612	MAN 24412 19,0 + WK + Zub
								13.0470-5612.2	LD5612	MAN 24412 19,0 + WK + Zub Ceramic
						←	02/14→; für Bremsscheibendurchmesser [mm]: 276	13.0460-7262.2	607262	25031 19,1 + WK + Zub
								13.0470-7262.2	LD7262	25031 19,1 + WK + Zub Ceramic
			←	02/14→; für Bremsscheibendurchmesser [mm]: 300	13.0460-7263.2	607263	24034 19,1 + WK + Zub			
					13.0470-7263.2	LD7263	24034 19,1 + WK + Zub Ceramic			
→	02/14→	13.0460-7264.2	607264	ATE 25096 17,0 + WK + Zub						
		13.0470-7264.2	LD7264	ATE 25096 17,0 + WK + Zub Ceramic						
1.6 CDTi	100	11/13→	←	01/14→; für Bremsscheibendurchmesser [mm]: 321	13.0460-5612.2	605612	MAN 24412 19,0 + WK + Zub			











	kw			 	! #		
VAUXHALL - ASTRA Mk VI (J) 12/09→							
 Bremsbelagsatz, Scheibenbremse							
1.6 CDTi	100	11/13→	←	01/14→; für Bremsscheibendurchmesser [mm]: 321	13.0470-5612.2	LD5612	MAN 24412 19,0 + WK + Zub Ceramic
			←	01/14→; für Bremsscheibendurchmesser [mm]: 276	13.0460-7262.2	607262	25031 19,1 + WK + Zub 25031 19,1 + WK + Zub Ceramic
			←	01/14→; für Bremsscheibendurchmesser [mm]: 300	13.0460-7263.2	607263	24034 19,1 + WK + Zub 24034 19,1 + WK + Zub Ceramic
			→	01/14→	13.0460-7264.2	607264	ATE 25096 17,0 + WK + Zub ATE 25096 17,0 + WK + Zub Ceramic
 Bremsscheibe							
1.3 CDTI	70	12/09→	←		24.0126-0165.1	426165	Ø 276 26 23 V + S
1.4	64	12/09→			24.0126-0166.1	426166	Ø 300 26 23 V + S
1.4	74	12/09→			24.0130-0224.1	430224	Ø 321 30 27 V + S
1.4 Turbo	88	08/11→			24.0326-0165.1	526165	Ø 276 26 23 V + S PD
1.4 Turbo	103	12/09→			24.0326-0166.1	526166	Ø 300 26 23 V + S PD
1.6	85	12/09→	→		24.0112-0188.1	412188	Ø 268 12 10 + S
1.6 SIDI	125	12/12→			24.0112-0189.1	412189	Ø 292 12 10 + S
1.6 Turbo	132	12/09→			24.0312-0188.1	512188	Ø 268 12 10 + S PD
1.7 CDTi	81	12/09→			24.0312-0189.1	512189	Ø 292 12 10 + S PD
1.7 CDTi	92	12/09→					
1.7 CDTi	96	06/11→					
2.0 BiTurbo CDTI	143	12/12→					
2.0 CDTi	118	12/09→					
2.0 CDTi	121	08/11→					
1.6 CDTi	81	11/13→	←	02/14→	24.0126-0165.1	426165	Ø 276 26 23 V + S
					24.0126-0166.1	426166	Ø 300 26 23 V + S
					24.0130-0224.1	430224	Ø 321 30 27 V + S
					24.0326-0165.1	526165	Ø 276 26 23 V + S PD
				24.0326-0166.1	526166	Ø 300 26 23 V + S PD	
			→	02/14→	24.0112-0188.1	412188	Ø 268 12 10 + S
					24.0112-0189.1	412189	Ø 292 12 10 + S
					24.0312-0188.1	512188	Ø 268 12 10 + S PD
					24.0312-0189.1	512189	Ø 292 12 10 + S PD
1.6 CDTi	100	11/13→	←	01/14→	24.0126-0165.1	426165	Ø 276 26 23 V + S
					24.0126-0166.1	426166	Ø 300 26 23 V + S
					24.0130-0224.1	430224	Ø 321 30 27 V + S
					24.0326-0165.1	526165	Ø 276 26 23 V + S PD
				24.0326-0166.1	526166	Ø 300 26 23 V + S PD	
			→	01/14→	24.0112-0188.1	412188	Ø 268 12 10 + S
					24.0112-0189.1	412189	Ø 292 12 10 + S
					24.0312-0188.1	512188	Ø 268 12 10 + S PD
					24.0312-0189.1	512189	Ø 292 12 10 + S PD
VAUXHALL - ASTRA Mk VI (J) Estate 10/10→							
 Bremsbelagsatz, Scheibenbremse							
1.3 CDTI	70	10/10→	←	11/10→; für Bremsscheibendurchmesser [mm]: 321	13.0460-5612.2	605612	MAN 24412 19,0 + WK + Zub
					13.0470-5612.2	LD5612	MAN 24412 19,0 + WK + Zub Ceramic
			←	11/10→; für Bremsscheibendurchmesser [mm]: 276	13.0460-7262.2	607262	25031 19,1 + WK + Zub
					13.0470-7262.2	LD7262	25031 19,1 + WK + Zub Ceramic
1.4 Turbo	88	10/10→	←	11/10→; für Bremsscheibendurchmesser [mm]: 300	13.0460-7263.2	607263	24034 19,1 + WK + Zub
					13.0470-7263.2	LD7263	24034 19,1 + WK + Zub Ceramic
			→	11/10→	13.0460-7264.2	607264	ATE 25096 17,0 + WK + Zub
					13.0470-7264.2	LD7264	ATE 25096 17,0 + WK + Zub Ceramic
1.6 CDTi	81	01/14→	←	02/14→; für Bremsscheibendurchmesser [mm]: 321	13.0460-5612.2	605612	MAN 24412 19,0 + WK + Zub
					13.0470-5612.2	LD5612	MAN 24412 19,0 + WK + Zub Ceramic
			←	02/14→; für Bremsscheibendurchmesser [mm]: 276	13.0460-7262.2	607262	25031 19,1 + WK + Zub
					13.0470-7262.2	LD7262	25031 19,1 + WK + Zub Ceramic
1.6 CDTi	81	01/14→	←	02/14→; für Bremsscheibendurchmesser [mm]: 300	13.0460-7263.2	607263	24034 19,1 + WK + Zub
					13.0470-7263.2	LD7263	24034 19,1 + WK + Zub Ceramic
			→	02/14→	13.0460-7264.2	607264	ATE 25096 17,0 + WK + Zub
					13.0470-7264.2	LD7264	ATE 25096 17,0 + WK + Zub Ceramic























	kw			 	! #				
VAUXHALL - ASTRA Mk VI (J) Estate 10/10→									
 Bremsbelagsatz, Scheibenbremse									
1.6 CDTi	81	01/14→	→	02/14→		13.0470-7264.2 LD7264	ATE 25096 17,0 + WK + Zub Ceramic		
1.6 CDTi	100	01/14→	←	für Bremsscheibendurchmesser [mm]: 321		13.0460-5612.2 605612	MAN 24412 19,0 + WK + Zub		
1.6 SIDI	125	12/12→				13.0470-5612.2 LD5612	MAN 24412 19,0 + WK + Zub Ceramic		
1.7 CDTi	96	06/11→05/14							
2.0 BiTurbo CDTi	143	12/12→				13.0460-7262.2 607262	25031 19,1 + WK + Zub		
2.0 CDTi	121	08/11→				13.0470-7262.2 LD7262	25031 19,1 + WK + Zub Ceramic		
			←	für Bremsscheibendurchmesser [mm]: 276		13.0460-7263.2 607263	24034 19,1 + WK + Zub		
			←	für Bremsscheibendurchmesser [mm]: 300		13.0470-7263.2 LD7263	24034 19,1 + WK + Zub Ceramic		
			→			13.0460-7264.2 607264	ATE 25096 17,0 + WK + Zub		
			→			13.0470-7264.2 LD7264	ATE 25096 17,0 + WK + Zub Ceramic		
 Bremsscheibe									
1.3 CDTi	70	10/10→	←	11/10→		24.0126-0165.1 426165	Ø 276 26 23 V + S		
1.4	64	10/10→				24.0126-0166.1 426166	Ø 300 26 23 V + S		
1.4	74	10/10→				24.0130-0224.1 430224	Ø 321 30 27 V + S		
1.4 Turbo	88	10/10→				24.0326-0165.1 526165	Ø 276 26 23 V + S PD		
1.4 Turbo	103	10/10→				24.0326-0166.1 526166	Ø 300 26 23 V + S PD		
1.6	85	10/10→							
1.6 Turbo	132	10/10→							
1.7 CDTi	81	10/10→			→	11/10→		24.0112-0188.1 412188	Ø 268 12 10 + S
1.7 CDTi	92	10/10→						24.0112-0189.1 412189	Ø 292 12 10 + S
2.0 CDTi	118	10/10→						24.0312-0188.1 512188	Ø 268 12 10 + S PD
						24.0312-0189.1 512189	Ø 292 12 10 + S PD		
1.6 CDTi	81	01/14→	←	02/14→		24.0126-0165.1 426165	Ø 276 26 23 V + S		
						24.0126-0166.1 426166	Ø 300 26 23 V + S		
						24.0130-0224.1 430224	Ø 321 30 27 V + S		
						24.0326-0165.1 526165	Ø 276 26 23 V + S PD		
						24.0326-0166.1 526166	Ø 300 26 23 V + S PD		
			→	02/14→		24.0112-0188.1 412188	Ø 268 12 10 + S		
						24.0112-0189.1 412189	Ø 292 12 10 + S		
						24.0312-0188.1 512188	Ø 268 12 10 + S PD		
						24.0312-0189.1 512189	Ø 292 12 10 + S PD		
1.6 CDTi	100	01/14→	←			24.0126-0165.1 426165	Ø 276 26 23 V + S		
1.6 SIDI	125	12/12→				24.0126-0166.1 426166	Ø 300 26 23 V + S		
1.7 CDTi	96	06/11→05/14				24.0130-0224.1 430224	Ø 321 30 27 V + S		
2.0 BiTurbo CDTi	143	12/12→				24.0326-0165.1 526165	Ø 276 26 23 V + S PD		
2.0 CDTi	121	08/11→				24.0326-0166.1 526166	Ø 300 26 23 V + S PD		
			→			24.0112-0188.1 412188	Ø 268 12 10 + S		
						24.0112-0189.1 412189	Ø 292 12 10 + S		
						24.0312-0188.1 512188	Ø 268 12 10 + S PD		
						24.0312-0189.1 512189	Ø 292 12 10 + S PD		
VAUXHALL - ASTRA Mk VI (J) GTC 10/11→									
 Bremsbelagsatz, Scheibenbremse									
1.4	74	10/11→	←	für Bremsscheibendurchmesser [mm]: 321		13.0460-5612.2 605612	MAN 24412 19,0 + WK + Zub		
1.4	88	10/11→				13.0470-5612.2 LD5612	MAN 24412 19,0 + WK + Zub Ceramic		
1.4	103	10/11→							
1.6	132	10/11→							
1.6 CDTi	81	07/14→			←	für Bremsscheibendurchmesser [mm]: 276		13.0460-7262.2 607262	25031 19,1 + WK + Zub
1.6 CDTi	100	07/14→						13.0470-7262.2 LD7262	25031 19,1 + WK + Zub Ceramic
1.6 SIDI	125	12/12→			←	für Bremsscheibendurchmesser [mm]: 300		13.0460-7263.2 607263	24034 19,1 + WK + Zub
1.6 SIDI	147	09/13→						13.0470-7263.2 LD7263	24034 19,1 + WK + Zub Ceramic
1.7 CDTi	81	10/11→			→			13.0460-7264.2 607264	ATE 25096 17,0 + WK + Zub
2.0 BiTurbo CDTi	143	12/12→						13.0470-7264.2 LD7264	ATE 25096 17,0 + WK + Zub Ceramic
2.0 CDTi	121	10/11→							
2.0 VXR	206	04/12→	←	06/12→		13.0460-4855.2 604855	BRE 23325 16,4 + WK		
				→	F0000001→		13.0460-7309.2 607309	ATE 25096 16,7 + WK + Zub	
						13.0470-7309.2 LD7309	ATE 25096 16,7 + WK + Zub Ceramic		
 Bremsscheibe									
1.4	74	10/11→	←			24.0126-0165.1 426165	Ø 276 26 23 V + S		
1.4	88	10/11→				24.0126-0166.1 426166	Ø 300 26 23 V + S		
1.4	103	10/11→				24.0130-0224.1 430224	Ø 321 30 27 V + S		
1.6	132	10/11→							
1.6 CDTi	81	07/14→							









	kw					! #		
VAUXHALL - ASTRA Mk VI (J) GTC 10/11→								
 Bremsscheibe								
1.6 CDTi	100	07/14→	←			24.0326-0165.1	526165	Ø 276 26 23 V + S PD
1.6 SIDI	125	12/12→				24.0326-0166.1	526166	Ø 300 26 23 V + S PD
1.6 SIDI	147	09/13→						
1.7 CDTi	81	10/11→	→			24.0112-0188.1	412188	Ø 268 12 10 + S
1.7 CDTi	96	10/11→				24.0112-0189.1	412189	Ø 292 12 10 + S
2.0 BiTurbo CDTi	143	12/12→				24.0312-0188.1	512188	Ø 268 12 10 + S PD
2.0 CDTi	121	10/11→				24.0312-0189.1	512189	Ø 292 12 10 + S PD
VAUXHALL - ASTRA Mk VI (J) Sedan 06/12→								
 Bremsbelagsatz, Scheibenbremse								
1.3 CDTi	70	06/12→	←	für Bremsscheibendurchmesser [mm]:		13.0460-5612.2	605612	MAN 24412 19,0 + WK + Zub
1.4	74	06/12→		321		13.0470-5612.2	LD5612	MAN 24412 19,0 + WK + Zub Ceramic
1.4 Turbo	103	06/12→						
1.6	85	06/12→						
1.6 SIDI	125	12/12→	←	für Bremsscheibendurchmesser [mm]:		13.0460-7262.2	607262	25031 19,1 + WK + Zub
1.6 Turbo	132	06/12→		276		13.0470-7262.2	LD7262	25031 19,1 + WK + Zub Ceramic
1.7 CDTi	81	06/12→						
1.7 CDTi	96	06/12→	←	für Bremsscheibendurchmesser [mm]:		13.0460-7263.2	607263	24034 19,1 + WK + Zub
2.0 BiTurbo CDTi	143	12/12→		300		13.0470-7263.2	LD7263	24034 19,1 + WK + Zub Ceramic
			→			13.0460-7264.2	607264	ATE 25096 17,0 + WK + Zub
						13.0470-7264.2	LD7264	ATE 25096 17,0 + WK + Zub Ceramic
 Bremsscheibe								
1.3 CDTi	70	06/12→	←			24.0126-0165.1	426165	Ø 276 26 23 V + S
1.4	74	06/12→				24.0126-0166.1	426166	Ø 300 26 23 V + S
1.4 Turbo	103	06/12→						
1.6	85	06/12→				24.0130-0224.1	430224	Ø 321 30 27 V + S
1.6 SIDI	125	12/12→				24.0326-0165.1	526165	Ø 276 26 23 V + S PD
1.6 Turbo	132	06/12→				24.0326-0166.1	526166	Ø 300 26 23 V + S PD
1.7 CDTi	81	06/12→						
1.7 CDTi	96	06/12→	→			24.0112-0188.1	412188	Ø 268 12 10 + S
2.0 BiTurbo CDTi	143	12/12→				24.0112-0189.1	412189	Ø 292 12 10 + S
						24.0312-0188.1	512188	Ø 268 12 10 + S PD
						24.0312-0189.1	512189	Ø 292 12 10 + S PD
VAUXHALL - ASTRVAN Mk III (F) 01/91→08/98								
 Bremsbelagsatz, Scheibenbremse								
1.6 i	52	02/94→10/96	←			13.0460-7052.2	607052	ATE 21190 17,5 + WE / - WK
			←	nicht für Motorcode: C16NZ / X16SZR		13.0460-7052.2	607052	ATE 21190 17,5 + WE / - WK
1.6 i	55	01/91→08/98	←	10/91→		13.0460-7052.2	607052	ATE 21190 17,5 + WE / - WK
			←	10/91→; nicht für Motorcode: C16NZ / X16SZR		13.0460-7052.2	607052	ATE 21190 17,5 + WE / - WK
1.7 TD	50	01/94→08/98	←	nicht für Fahrzeuge mit verstärkter Bremsen		13.0460-7051.2	607051	ATE 20547 16,5 + WE / - WK
			←	für Fahrzeuge mit verstärkter Bremsen		13.0460-7052.2	607052	ATE 21190 17,5 + WE / - WK
Warnkontakt, Bremsbelagsverschleiß								
1.6 i	52	02/94→10/96	←	nicht für Motorcode: C16NZ / X16SZR	2	24.8190-0705.2	620705	L= 670
			←		2	24.8190-0705.2	620705	L= 670
1.6 i	55	01/91→08/98	←	10/91→; nicht für Motorcode: C16NZ / X16SZR	2	24.8190-0705.2	620705	L= 670
			←	10/91→	2	24.8190-0705.2	620705	L= 670
1.7 TD	50	01/94→08/98	←	für Fahrzeuge mit verstärkter Bremsen	2	24.8190-0705.2	620705	L= 670
			←	nicht für Fahrzeuge mit verstärkter Bremsen	2	24.8190-0707.2	620707	L= 685
 Bremsscheibe								
1.6 i	52	02/94→10/96	←			24.0120-0115.1	420115	Ø 236 20 17 V + S
						24.0124-0115.1	424115	Ø 256 24 21 V + S
						24.0320-0115.1	520115	Ø 236 20 17 V + S PD
						24.0324-0115.1	524115	Ø 256 24 21 V + S PD
1.6 i	55	01/91→08/98	←	10/91→		24.0120-0115.1	420115	Ø 236 20 17 V + S
						24.0124-0115.1	424115	Ø 256 24 21 V + S
						24.0320-0115.1	520115	Ø 236 20 17 V + S PD
						24.0324-0115.1	524115	Ø 256 24 21 V + S PD
1.7 TD	50	01/94→08/98	←	nicht für Fahrzeuge mit verstärkter Bremsen		24.0120-0115.1	420115	Ø 236 20 17 V + S
						24.0320-0115.1	520115	Ø 236 20 17 V + S PD
↓								







	kw			 	! #		
VAUXHALL - ASTRAVAN Mk III (F) 01/91→08/98							
 Bremsscheibe							
1.7 TD	50	01/94→08/98	←	für Fahrzeuge mit verstärkter Bremse		24.0124-0115.1 424115 24.0324-0115.1 524115	Ø 256 24 21 V + S Ø 256 24 21 V + S PD
VAUXHALL - ASTRAVAN Mk IV (G) 08/98→08/06							
 Bremsbelagsatz, Scheibenbremse							
1.6 i 1.6 i 1.7 CDTI 1.7 DTI 16V 1.7 TD	55 62 59 55 50	08/98→09/00 09/00→08/06 04/04→08/06 04/01→08/06 08/98→08/06	←			13.0460-7115.2 607115 13.0470-7115.2 LD7115	ATE 23063 17,5 ohne integrierten Verschleiß- sensor / + WK ATE 23063 17,5 - WK / + WK Ceramic
			→			13.0460-2868.2 602868 13.0460-3976.2 603976 13.0470-2868.2 LD2868	TRW 23417 15,3 + WK + Zub BOS 23258 16,5 + WK + Zub TRW 23417 15,3 + WK + Zub Ceramic
2.0 DI	60	08/98→08/06	←			13.0460-7115.2 607115 13.0470-7115.2 LD7115	ATE 23063 17,5 ohne integrierten Verschleiß- sensor / + WK ATE 23063 17,5 - WK / + WK Ceramic
			←	+ ABS		13.0460-7116.2 607116 13.0470-7116.2 LD7116	ATE 23057 20,2 - WK / + WK ATE 23057 20,2 - WK / + WK Ceramic
			→			13.0460-2868.2 602868 13.0460-3976.2 603976 13.0470-2868.2 LD2868	TRW 23417 15,3 + WK + Zub BOS 23258 16,5 + WK + Zub TRW 23417 15,3 + WK + Zub Ceramic
2.0 DTI	74	04/04→08/06	←			13.0460-7116.2 607116 13.0470-7116.2 LD7116	ATE 23057 20,2 - WK / + WK ATE 23057 20,2 - WK / + WK Ceramic
			→			13.0460-2868.2 602868 13.0460-3976.2 603976 13.0470-2868.2 LD2868	TRW 23417 15,3 + WK + Zub BOS 23258 16,5 + WK + Zub TRW 23417 15,3 + WK + Zub Ceramic
Warnkontakt, Bremsbelagverschleiß							
1.6 i 1.6 i 1.7 CDTI 1.7 DTI 16V 1.7 TD 2.0 DTI	55 62 59 55 50 74	08/98→09/00 09/00→08/06 04/04→08/06 04/01→08/06 08/98→08/06 04/04→08/06	←	42187759→	2	24.8190-0018.2 620018	L= 755
			←	→ 42187758	2	24.8190-0718.2 620718	L= 720
2.0 DI	60	08/98→08/06	←	+ ABS; 42187759→	2	24.8190-0018.2 620018	L= 755
			←	42187759→	2	24.8190-0018.2 620018	L= 755
			←	→ 42187758	2	24.8190-0718.2 620718	L= 720
			←	+ ABS; → 42187758	2	24.8190-0718.2 620718	L= 720
 Bremsscheibe							
1.6 i 1.6 i	55 62	08/98→09/00 09/00→08/06	←	Felge Lochzahl: 4		24.0124-0152.1 424152 24.0324-0152.1 524152	Ø 256 23,8 21 V + S Ø 256 23,8 21 V + S PD
			←	Felge Lochzahl: 5		24.0125-0131.1 425131 24.0325-0131.1 525131	Ø 280 24,8 22 V + S Ø 280 24,8 22 V + S PD
			→	Felge Lochzahl: 4		24.0110-0251.1 410251 24.0310-0251.1 510251	Ø 240 9,8 8 + S Ø 240 9,8 8 + S PD
1.7 CDTI 1.7 DTI 16V 1.7 TD	59 55 50	04/04→08/06 04/01→08/06 08/98→08/06	←	Felge Lochzahl: 4		24.0124-0152.1 424152 24.0324-0152.1 524152	Ø 256 23,8 21 V + S Ø 256 23,8 21 V + S PD
			→	Felge Lochzahl: 4		24.0110-0251.1 410251 24.0310-0251.1 510251	Ø 240 9,8 8 + S Ø 240 9,8 8 + S PD
2.0 DI	60	08/98→08/06	←	- ABS; Felge Lochzahl: 4		24.0124-0152.1 424152 24.0324-0152.1 524152	Ø 256 23,8 21 V + S Ø 256 23,8 21 V + S PD
			←	+ ABS; Felge Lochzahl: 5		24.0125-0131.1 425131 24.0325-0131.1 525131	Ø 280 24,8 22 V + S Ø 280 24,8 22 V + S PD
			→	+ ABS; Felge Lochzahl: 5		24.0110-0250.1 410250 24.0310-0250.1 510250	Ø 264 9,8 8 + S Ø 264 9,8 8 + S PD
			→	- ABS; Felge Lochzahl: 4		24.0110-0251.1 410251 24.0310-0251.1 510251	Ø 240 9,8 8 + S Ø 240 9,8 8 + S PD
2.0 DTI	74	04/04→08/06	←	Felge Lochzahl: 5		24.0125-0131.1 425131	Ø 280 24,8 22 V + S











	kw					! #		
VAUXHALL - ASTRAVAN Mk IV (G) 08/98→08/06								
 Bremsscheibe								
2.0 DTI	74	04/04→08/06	←	Felge Lochzahl: 5		24.0325-0131.1	525131	Ø 280 24,8 22 V + S PD
			→	Felge Lochzahl: 5		24.0110-0250.1	410250	Ø 264 9,8 8 + S
						24.0310-0250.1	510250	Ø 264 9,8 8 + S PD
VAUXHALL - ASTRAVAN Mk V (H) 03/05→								
 Bremsbelagsatz, Scheibenbremse								
1.3 CDTi	66	08/05→	←	→ 11/10		13.0460-7179.2	607179	ATE 23832 20,2 - WK / + WK
1.4 i	66	03/05→				13.0470-7179.2	LD7179	ATE 23832 20,2 - WK / + WK
1.6	76	03/05→						Ceramic
1.7 CDTi	74	03/05→11/11						
1.9 CDTi	88	03/05→11/11	→	→ 11/10		13.0460-2868.2	602868	TRW 23417 15,3 + WK + Zub
1.9 CDTi	110	03/05→11/11				13.0470-2868.2	LD2868	TRW 23417 15,3 + WK + Zub
								Ceramic
1.7 CDTi	59	03/05→07/06	←			13.0460-7179.2	607179	ATE 23832 20,2 - WK / + WK
						13.0470-7179.2	LD7179	ATE 23832 20,2 - WK / + WK
								Ceramic
			→			13.0460-2868.2	602868	TRW 23417 15,3 + WK + Zub
						13.0470-2868.2	LD2868	TRW 23417 15,3 + WK + Zub
								Ceramic
Warnkontakt, Bremsbelagsverschleiß								
1.3 CDTi	66	08/05→	←	→ 11/10	1	24.8190-0720.2	620720	L= 287
1.4 i	66	03/05→						
1.6	76	03/05→						
1.7 CDTi	74	03/05→11/11						
1.9 CDTi	88	03/05→11/11						
1.9 CDTi	110	03/05→11/11						
1.7 CDTi	59	03/05→07/06	←		1	24.8190-0720.2	620720	L= 287
 Bremsscheibe								
1.3 CDTi	66	08/05→	←	→ 11/10; Felge Lochzahl: 5		24.0125-0131.1	425131	Ø 280 24,8 22 V + S
1.4 i	66	03/05→				24.0125-0198.1	425198	Ø 280 25 22 V + S
1.6	76	03/05→	←	→ 11/10; Felge Lochzahl: 4		24.0325-0198.1	525198	Ø 280 25 22 V + S PD
1.7 CDTi	74	03/05→11/11	→	→ 11/10; Felge Lochzahl: 5		24.0110-0250.1	410250	Ø 264 9,8 8 + S
						24.0310-0250.1	510250	Ø 264 9,8 8 + S PD
			→	→ 11/10; Felge Lochzahl: 4		24.0110-0251.1	410251	Ø 240 9,8 8 + S
						24.0310-0251.1	510251	Ø 240 9,8 8 + S PD
1.7 CDTi	59	03/05→07/06	←	Felge Lochzahl: 5		24.0125-0131.1	425131	Ø 280 24,8 22 V + S
			←	Felge Lochzahl: 4		24.0125-0198.1	425198	Ø 280 25 22 V + S
						24.0325-0198.1	525198	Ø 280 25 22 V + S PD
			→	Felge Lochzahl: 5		24.0110-0250.1	410250	Ø 264 9,8 8 + S
						24.0310-0250.1	510250	Ø 264 9,8 8 + S PD
			→	Felge Lochzahl: 4		24.0110-0251.1	410251	Ø 240 9,8 8 + S
						24.0310-0251.1	510251	Ø 240 9,8 8 + S PD
1.9 CDTi	88	03/05→11/11	←	→ 11/10; Felge Lochzahl: 5		24.0125-0142.1	425142	Ø 308 25 22 V + S
1.9 CDTi	110	03/05→11/11				24.0325-0142.1	525142	Ø 308 25 23 V + S PD
			←	→ 11/10; Felge Lochzahl: 4		24.0125-0198.1	425198	Ø 280 25 22 V + S
						24.0325-0198.1	525198	Ø 280 25 22 V + S PD
			→	→ 11/10; Felge Lochzahl: 5		24.0110-0250.1	410250	Ø 264 9,8 8 + S
						24.0310-0250.1	510250	Ø 264 9,8 8 + S PD
			→	→ 11/10; Felge Lochzahl: 4		24.0110-0251.1	410251	Ø 240 9,8 8 + S
						24.0310-0251.1	510251	Ø 240 9,8 8 + S PD
VAUXHALL - BRAVA Pick-up 12/88→12/02								
 Bremsbelagsatz, Scheibenbremse								
2.2 D (TFR52)	39	12/88→09/96	←	01/92→ 08/96		13.0460-5942.2	605942	AKE 21543 16,5 + WK
2.2 D 4x4 (TFS52)	39	12/88→09/96	←	09/90→ 08/96		13.0460-5942.2	605942	AKE 21543 16,5 + WK
2.3 (TFR16)	72	08/94→09/96	←	→ 08/96		13.0460-5942.2	605942	AKE 21543 16,5 + WK
2.3 4x4 (TFS16)	72	08/94→09/96						
2.5 TD (TFR54)	56	07/94→12/02						
2.5 TD 4x4 (TFS54)	56	07/94→12/02						
2.5 DTI	74	08/01→12/02	←			13.0460-5942.2	605942	AKE 21543 16,5 + WK
2.5 DTI 4x4	74	08/01→12/02						
Zubehörsatz, Scheibenbremsbelag								
2.2 D (TFR52)	39	12/88→09/96	←	01/92→ 08/96		13.0460-0337.2	610337	AKE
↓								











	kw					! #		
VAUXHALL - BRAVA Pick-up 12/88→12/02								
Zubehörsatz, Scheibenbremsbelag								
2.2 D 4x4 (TFS52)	39	12/88→09/96	←	09/90→08/96			13.0460-0337.2 610337	AKE
2.3 (TFR16)	72	08/94→09/96	←	→08/96			13.0460-0337.2 610337	AKE
2.3 4x4 (TFS16)	72	08/94→09/96						
2.5 TD (TFR54)	56	07/94→12/02						
2.5 TD 4x4 (TFS54)	56	07/94→12/02						
2.5 DTI	74	08/01→12/02	←				13.0460-0337.2 610337	AKE
2.5 DTI 4x4	74	08/01→12/02						
 Bremsscheibe								
2.2 D (TFR52)	39	12/88→09/96	←	01/92→08/96			24.0122-0156.1 422156	Ø 257 22 20,6 V
2.2 D 4x4 (TFS52)	39	12/88→09/96	←	09/90→08/96			24.0122-0156.1 422156	Ø 257 22 20,6 V
2.3 (TFR16)	72	08/94→09/96	←	→08/96			24.0122-0156.1 422156	Ø 257 22 20,6 V
2.3 4x4 (TFS16)	72	08/94→09/96						
2.5 TD (TFR54)	56	07/94→12/02						
2.5 TD 4x4 (TFS54)	56	07/94→12/02						
2.5 DTI	74	08/01→12/02	←				24.0122-0156.1 422156	Ø 257 22 20,6 V
2.5 DTI 4x4	74	08/01→12/02						
VAUXHALL - CALIBRA 06/90→07/97								
 Bremsbelagsatz, Scheibenbremse								
2.0 i	85	06/90→07/97	←				13.0460-7052.2 607052	ATE 21190 17,5 + WE / - WK
2.0 i 16V	100	06/90→07/97						
2.0 i 16V 4x4	100	02/94→07/97	→				13.0460-4043.2 604043	ATE 21140 15,0 - WE / - WK
2.0 i 4x4	85	06/90→07/97						
2.0 i Turbo 4x4	150	03/92→07/97	←	→ S9999999			13.0460-7080.2 607080	ATE 21411 17,5 - WK
			←	T1000001→			13.0460-7091.2 607091	ATE 21829 20,3 + WE / - WK
			→				13.0460-4043.2 604043	ATE 21140 15,0 - WE / - WK
2.5 i V6	125	04/93→07/97	←	→ S9999999			13.0460-7080.2 607080	ATE 21411 17,5 - WK
			←	T1000001→			13.0460-7091.2 607091	ATE 21829 20,3 + WE / - WK
			→	T1000001→			13.0460-4040.2 604040	ATE 21050 15,8 - WE / - WK
			→	→ S9999999			13.0460-4043.2 604043	ATE 21140 15,0 - WE / - WK
Warnkontakt, Bremsbelagsverschleiß								
2.0 i	85	06/90→07/97	←		2	24.8190-0705.2 620705		L= 670
2.0 i 16V	100	06/90→07/97						
2.0 i 16V 4x4	100	02/94→07/97						
2.0 i 4x4	85	06/90→07/97						
2.0 i Turbo 4x4	150	03/92→07/97	←	→ S9999999	2	24.8190-0707.2 620707		L= 685
2.5 i V6	125	04/93→07/97	←	T1000001→	2	24.8190-0713.2 620713		L= 685
Zubehörsatz, Scheibenbremsbelag								
2.0 i	85	06/90→07/97	→				13.0460-0217.2 610217	ATE
2.0 i 16V	100	06/90→07/97						
2.0 i 16V 4x4	100	02/94→07/97						
2.0 i 4x4	85	06/90→07/97						
2.0 i Turbo 4x4	150	03/92→07/97						
2.5 i V6	125	04/93→07/97	→	→ S9999999			13.0460-0217.2 610217	ATE
			→	T1000001→			13.0460-0347.2 610347	
 Bremsscheibe								
2.0 i	85	06/90→07/97	←				24.0124-0115.1 424115	Ø 256 24 21 V + S
2.0 i 16V	100	06/90→07/97					24.0324-0115.1 524115	Ø 256 24 21 V + S PD
2.0 i 16V 4x4	100	02/94→07/97						
2.0 i 4x4	85	06/90→07/97	→				24.0110-0205.1 410205	Ø 270 9,9 8
2.0 i Turbo 4x4	150	03/92→07/97	←	→ S9999999			24.0124-0133.1 424133	Ø 284 24 21 V
2.5 i V6	125	04/93→07/97	←	T1000001→			24.0125-0119.1 425119	Ø 288 25 22 V + S
			→				24.0325-0119.1 525119	Ø 288 25 22 V + S PD
			→				24.0110-0253.1 410253	Ø 270 10 8
VAUXHALL - CASCADA Convertible 02/13→								
 Bremsbelagsatz, Scheibenbremse								
1.4	88	02/13→	←				13.0460-5612.2 605612	MAN 24412 19,0 + WK + Zub
1.4	103	02/13→					13.0470-5612.2 LD5612	MAN 24412 19,0 + WK + Zub
1.6	125	02/13→						Ceramic
1.6	147	11/13→						
2.0 CDTI	121	02/13→	→				13.0460-7264.2 607264	ATE 25096 17,0 + WK + Zub
2.0 CDTI	125	07/15→					13.0470-7264.2 LD7264	ATE 25096 17,0 + WK + Zub
2.0 CDTI	143	02/13→						Ceramic
↓								











	kW			 	! #		
VAUXHALL - CASCADA Convertible 02/13→							
 Bremsscheibe							
1.4	88	02/13→	←			24.0130-0224.1 430224	Ø 321 30 27 V + S
1.4	103	02/13→	←				
1.6	125	02/13→	→			24.0112-0189.1 412189	Ø 292 12 10 + S
1.6	147	11/13→				24.0312-0189.1 512189	Ø 292 12 10 + S PD
2.0 CDTI	121	02/13→					
2.0 CDTI	125	07/15→					
2.0 CDTI	143	02/13→					
VAUXHALL - CAVALIER Mk III (87) 08/88→11/95							
 Bremsbelagsatz, Scheibenbremse							
1.4 S	55	09/88→11/95	←	→ M5999999		13.0460-7048.2 607048	DEL 20939 15,8 + WE / - WK
1.6 i	52	09/93→11/95	←	→ N1038529		13.0460-7048.2 607048	DEL 20939 15,8 + WE / - WK
1.6 i	55	09/88→11/95	←	N5000001→; → 08/95		13.0460-7051.2 607051	ATE 20547 16,5 + WE / - WK
			←	N1038530→; → 08/95		13.0460-7051.2 607051	ATE 20547 16,5 + WE / - WK
1.7 D	44	07/92→11/95	←	→ M5999999		13.0460-7048.2 607048	DEL 20939 15,8 + WE / - WK
1.7 TD	60	09/88→11/95	←	→ N1038529		13.0460-7048.2 607048	DEL 20939 15,8 + WE / - WK
1.8 i Cat	66	03/90→11/95	←	N5000001→ R5999999		13.0460-7051.2 607051	ATE 20547 16,5 + WE / - WK
			←	N1038530→ R1999999		13.0460-7051.2 607051	ATE 20547 16,5 + WE / - WK
			←	S1000001→; → 08/95		13.0460-7052.2 607052	ATE 21190 17,5 + WE / - WK
			←	S5000001→; → 08/95		13.0460-7052.2 607052	ATE 21190 17,5 + WE / - WK
1.8	66	09/88→08/95	←	→ M5999999		13.0460-7048.2 607048	DEL 20939 15,8 + WE / - WK
			←	→ N1038529		13.0460-7048.2 607048	DEL 20939 15,8 + WE / - WK
			←	N5000001→ R5999999		13.0460-7051.2 607051	ATE 20547 16,5 + WE / - WK
			←	N1038530→ R1999999		13.0460-7051.2 607051	ATE 20547 16,5 + WE / - WK
			←	S1000001→		13.0460-7052.2 607052	ATE 21190 17,5 + WE / - WK
			←	S5000001→		13.0460-7052.2 607052	ATE 21190 17,5 + WE / - WK
2.0 i 16V	110	09/88→11/95	←	→ 08/95		13.0460-7052.2 607052	ATE 21190 17,5 + WE / - WK
2.0 i 16V 4x4	110	09/88→11/95	←	→ 08/95		13.0460-7052.2 607052	ATE 21190 17,5 + WE / - WK
2.0 i Cat	85	09/90→11/95	→	→ 08/95		13.0460-4043.2 604043	ATE 21140 15,0 - WE / - WK
2.0 SRi 16V	100	09/93→11/95	←	→ 08/95		13.0460-4043.2 604043	ATE 21140 15,0 - WE / - WK
Warnkontakt, Bremsbelagverschleiß							
1.4 S	55	09/88→11/95	←	→ M5999999	2	24.8190-0704.2 620704	L= 660
1.6 i	52	09/93→11/95	←	→ N1038529	2	24.8190-0704.2 620704	L= 660
1.6 i	55	09/88→11/95	←	N1038530→; → 08/95	2	24.8190-0707.2 620707	L= 685
			←	N5000001→; → 08/95	2	24.8190-0707.2 620707	L= 685
1.7 D	44	07/92→11/95	←	→ M5999999	2	24.8190-0704.2 620704	L= 660
1.7 TD	60	09/88→11/95	←	→ N1038529	2	24.8190-0704.2 620704	L= 660
1.8 i Cat	66	03/90→11/95	←	S5000001→; → 08/95	2	24.8190-0705.2 620705	L= 670
			←	S1000001→; → 08/95	2	24.8190-0705.2 620705	L= 670
			←	N5000001→ R5999999	2	24.8190-0707.2 620707	L= 685
			←	N1038530→ R1999999	2	24.8190-0707.2 620707	L= 685
1.8	66	09/88→08/95	←	→ M5999999	2	24.8190-0704.2 620704	L= 660
			←	→ N1038529	2	24.8190-0704.2 620704	L= 660
			←	S1000001→	2	24.8190-0705.2 620705	L= 670
			←	S5000001→	2	24.8190-0705.2 620705	L= 670
			←	N5000001→ R5999999	2	24.8190-0707.2 620707	L= 685
			←	N1038530→ R1999999	2	24.8190-0707.2 620707	L= 685
2.0 i 16V	110	09/88→11/95	←	→ 08/95	2	24.8190-0705.2 620705	L= 670
2.0 i 16V 4x4	110	09/88→11/95	←	→ 08/95	2	24.8190-0705.2 620705	L= 670
2.0 i Cat	85	09/90→11/95	←	→ 08/95	2	24.8190-0705.2 620705	L= 670
2.0 SRi 16V	100	09/93→11/95	←	→ 08/95	2	24.8190-0705.2 620705	L= 670
Zubehörsatz, Scheibenbremsbelag							
1.4 S	55	09/88→11/95	←	→ M5999999		13.0460-0127.2 610127	DEL
1.6 i	52	09/93→11/95	←	→ N1038529		13.0460-0127.2 610127	DEL
1.6 i	55	09/88→11/95	←	→ N1038529		13.0460-0127.2 610127	DEL
1.7 D	44	07/92→11/95	←	→ M5999999			
1.7 TD	60	09/88→11/95	←	→ N1038529			
1.8	66	09/88→08/95	←	→ M5999999			
1.8 i Cat	66	03/90→11/95	←	→ N1038529			
2.0 i 16V	110	09/88→11/95	→	→ 08/95		13.0460-0217.2 610217	ATE
2.0 i 16V 4x4	110	09/88→11/95	→	→ 08/95		13.0460-0217.2 610217	ATE







	kW			 	! #		
VAUXHALL - CAVALIER Mk III (87) 08/88→11/95							
Zubehörsatz, Scheibenbremsbelag							
2.0 i Cat 2.0 SRi 16V	85 100	09/90→11/95 09/93→11/95	➡	→ 08/95		13.0460-0217.2 610217	ATE
 Bremsscheibe							
1.4 S 1.6 i 1.6 i	55 52 55	09/88→11/95 09/93→11/95 09/88→11/95	➡	→ M5999999		24.0113-0161.1 413161	Ø 236 12,7 9,7 + S
			➡	→ N1038529		24.0313-0161.1 513161	Ø 236 12,7 9,7 + S PD
			➡	→ N1038529		24.0113-0161.1 413161	Ø 236 12,7 9,7 + S
			➡	→ N1038529		24.0313-0161.1 513161	Ø 236 12,7 9,7 + S PD
			➡	N5000001→; → 08/95		24.0120-0115.1 420115	Ø 236 20 17 V + S
1.7 D 1.7 TD 1.8 i Cat	44 60 66	07/92→11/95 09/88→11/95 03/90→11/95	➡	→ M5999999		24.0113-0161.1 413161	Ø 236 12,7 9,7 + S
			➡	→ N1038529		24.0313-0161.1 513161	Ø 236 12,7 9,7 + S PD
			➡	N1038530→ R1999999		24.0120-0140.1 420140	Ø 256 20 17 V + S
			➡	N5000001→ R5999999		24.0120-0140.1 420140	Ø 256 20 17 V + S
			➡	S1000001→; → 08/95		24.0124-0115.1 424115	Ø 256 24 21 V + S
1.8	66	09/88→08/95	➡	→ M5999999		24.0113-0161.1 413161	Ø 236 12,7 9,7 + S
			➡	→ N1038529		24.0313-0161.1 513161	Ø 236 12,7 9,7 + S PD
			➡	N5000001→ R5999999		24.0120-0140.1 420140	Ø 256 20 17 V + S
			➡	N1038530→ R1999999		24.0120-0140.1 420140	Ø 256 20 17 V + S
			➡	S5000001→		24.0124-0115.1 424115	Ø 256 24 21 V + S
2.0 i 16V 2.0 SRi 16V	110 100	09/88→11/95 09/93→11/95	➡	→ 08/95		24.0124-0115.1 424115	Ø 256 24 21 V + S
			➡	P1000001→; → 08/95		24.0324-0115.1 524115	Ø 256 24 21 V + S PD
			➡	→ N1299999		24.0110-0204.1 410204	Ø 260 10 8
			➡	→ N5299999		24.0110-0205.1 410205	Ø 270 9,9 8
			➡	→ NV299999		24.0110-0205.1 410205	Ø 270 9,9 8
2.0 i 16V 4x4	110	09/88→11/95	➡	→ 08/95		24.0124-0115.1 424115	Ø 256 24 21 V + S
			➡	→ 08/95		24.0324-0115.1 524115	Ø 256 24 21 V + S PD
2.0 i Cat	85	09/90→11/95	➡	→ 08/95		24.0110-0205.1 410205	Ø 270 9,9 8
			➡	→ N1299999		24.0124-0115.1 424115	Ø 256 24 21 V + S
			➡	→ N5299999		24.0324-0115.1 524115	Ø 256 24 21 V + S PD
			➡	→ NV299999		24.0110-0144.1 410144	Ø 261 9,9 8
			➡	P1000001→; → 08/95		24.0110-0144.1 410144	Ø 261 9,9 8
VAUXHALL - CAVALIER Mk III CC 09/88→11/95							
 Bremsbelagsatz, Scheibenbremse							
1.4 S 1.6 i 1.6 i	55 52 55	09/88→11/95 09/93→11/95 09/88→11/95	➡	→ M5999999		13.0460-7048.2 607048	DEL 20939 15,8 + WE / - WK
			➡	→ N1038529		13.0460-7048.2 607048	DEL 20939 15,8 + WE / - WK
			➡	N1038530→; → 08/95		13.0460-7051.2 607051	ATE 20547 16,5 + WE / - WK
			➡	N5000001→; → 08/95		13.0460-7051.2 607051	ATE 20547 16,5 + WE / - WK
1.7 D 1.7 TD 1.8 i Cat	44 60 66	07/92→11/95 09/88→11/95 03/90→11/95	➡	→ M5999999		13.0460-7048.2 607048	DEL 20939 15,8 + WE / - WK
			➡	→ N1038529		13.0460-7048.2 607048	DEL 20939 15,8 + WE / - WK
			➡	N1038530→ R1999999		13.0460-7051.2 607051	ATE 20547 16,5 + WE / - WK
			➡	N5000001→ R5999999		13.0460-7051.2 607051	ATE 20547 16,5 + WE / - WK
↓							







	kw			 	! #		
VAUXHALL - CAVALIER Mk III CC 09/88→11/95							
Bremsbelagsatz, Scheibenbremse							
1.7 D	44	07/92→11/95	←	S1000001→; → 08/95		13.0460-7052.2 607052	ATE 21190 17,5 + WE / - WK
1.7 TD	60	09/88→11/95	←	S5000001→; → 08/95		13.0460-7052.2 607052	ATE 21190 17,5 + WE / - WK
1.8 i Cat	66	03/90→11/95	←				
2.0 i 16V	100	09/93→11/95	←	→ 08/95		13.0460-7052.2 607052	ATE 21190 17,5 + WE / - WK
2.0 i 16V	110	09/88→11/95	←				
2.0 i Cat	85	09/90→11/95	→	→ 08/95		13.0460-4043.2 604043	ATE 21140 15,0 - WE / - WK
Warnkontakt, Bremsbelagverschleiß							
1.4 S	55	09/88→11/95	←	→ M5999999	2	24.8190-0704.2 620704	L= 660
1.6 i	52	09/93→11/95	←	→ N1038529	2	24.8190-0704.2 620704	L= 660
1.6 i	55	09/88→11/95	←	N1038530→; → 08/95	2	24.8190-0707.2 620707	L= 685
			←	N5000001→; → 08/95	2	24.8190-0707.2 620707	L= 685
1.7 D	44	07/92→11/95	←	→ M5999999	2	24.8190-0704.2 620704	L= 660
1.7 TD	60	09/88→11/95	←	→ N1038529	2	24.8190-0704.2 620704	L= 660
1.8 i Cat	66	03/90→11/95	←	S5000001→; → 08/95	2	24.8190-0705.2 620705	L= 670
			←	S1000001→; → 08/95	2	24.8190-0705.2 620705	L= 670
			←	N5000001→ R5999999	2	24.8190-0707.2 620707	L= 685
			←	N1038530→ R1999999	2	24.8190-0707.2 620707	L= 685
2.0 i 16V	100	09/93→11/95	←	→ 08/95	2	24.8190-0705.2 620705	L= 670
2.0 i 16V	110	09/88→11/95					
2.0 i Cat	85	09/90→11/95					
Zubehörsatz, Scheibenbremsbelag							
1.4 S	55	09/88→11/95	←	→ M5999999		13.0460-0127.2 610127	DEL
1.6 i	52	09/93→11/95	←	→ N1038529		13.0460-0127.2 610127	DEL
1.6 i	55	09/88→11/95	←				
1.7 D	44	07/92→11/95					
1.7 TD	60	09/88→11/95					
1.8 i Cat	66	03/90→11/95					
2.0 i 16V	100	09/93→11/95	→	→ 08/95		13.0460-0217.2 610217	ATE
2.0 i 16V	110	09/88→11/95					
2.0 i Cat	85	09/90→11/95					
Bremsscheibe							
1.4 S	55	09/88→11/95	←	→ M5999999		24.0113-0161.1 413161	Ø 236 12,7 9,7 + S
1.6 i	52	09/93→11/95	←			24.0313-0161.1 513161	Ø 236 12,7 9,7 + S PD
1.6 i	55	09/88→11/95	←	→ N1038529		24.0113-0161.1 413161	Ø 236 12,7 9,7 + S
						24.0313-0161.1 513161	Ø 236 12,7 9,7 + S PD
			←	N5000001→; → 08/95		24.0120-0115.1 420115	Ø 236 20 17 V + S
						24.0320-0115.1 520115	Ø 236 20 17 V + S PD
			←	N1038530→; → 08/95		24.0120-0115.1 420115	Ø 236 20 17 V + S
						24.0320-0115.1 520115	Ø 236 20 17 V + S PD
1.7 D	44	07/92→11/95	←	→ M5999999		24.0113-0161.1 413161	Ø 236 12,7 9,7 + S
1.7 TD	60	09/88→11/95	←	→ N1038529		24.0313-0161.1 513161	Ø 236 12,7 9,7 + S PD
1.8 i Cat	66	03/90→11/95	←			24.0113-0161.1 413161	Ø 236 12,7 9,7 + S
						24.0313-0161.1 513161	Ø 236 12,7 9,7 + S PD
			←	N5000001→ R5999999		24.0120-0140.1 420140	Ø 256 20 17 V + S
			←	N1038530→ R1999999		24.0120-0140.1 420140	Ø 256 20 17 V + S
			←	S1000001→; → 08/95		24.0124-0115.1 424115	Ø 256 24 21 V + S
						24.0324-0115.1 524115	Ø 256 24 21 V + S PD
			←	S5000001→; → 08/95		24.0124-0115.1 424115	Ø 256 24 21 V + S
						24.0324-0115.1 524115	Ø 256 24 21 V + S PD
2.0 i 16V	100	09/93→11/95	←	→ 08/95		24.0124-0115.1 424115	Ø 256 24 21 V + S
2.0 i 16V	110	09/88→11/95	←			24.0324-0115.1 524115	Ø 256 24 21 V + S PD
			→	P1000001→; → 08/95		24.0110-0204.1 410204	Ø 260 10 8
			→	→ N1299999		24.0110-0205.1 410205	Ø 270 9,9 8
			→	→ N5299999		24.0110-0205.1 410205	Ø 270 9,9 8
			→	→ NV299999		24.0110-0205.1 410205	Ø 270 9,9 8
2.0 i Cat	85	09/90→11/95	←	→ 08/95		24.0124-0115.1 424115	Ø 256 24 21 V + S
						24.0324-0115.1 524115	Ø 256 24 21 V + S PD
			→	→ N1299999		24.0110-0144.1 410144	Ø 261 9,9 8
			→	→ N5299999		24.0110-0144.1 410144	Ø 261 9,9 8
			→	→ NV299999		24.0110-0144.1 410144	Ø 261 9,9 8







	kw				! #		
VAUXHALL - CAVALIER Mk III CC 09/88→11/95							
 Bremsscheibe							
2.0 i Cat	85	09/90→11/95	➔	P1000001→; → 08/95		24.0110-0204.1 410204	Ø 260 10 8
VAUXHALL - COMBO Mk I (B) 07/94→10/01							
 Bremsbelagsatz, Scheibenbremse							
1.2 1.4 1.4 1.4 16V 1.7 D	33 44 60 66 44	07/94→10/01 07/94→10/01 07/94→10/01 08/99→10/01 07/94→10/01	←	→ 09/00		13.0460-7051.2 607051	ATE 20547 16,5 + WE / - WK
 Bremsscheibe							
1.2 1.4 1.4 1.4 16V 1.7 D	33 44 60 66 44	07/94→10/01 07/94→10/01 07/94→10/01 08/99→10/01 07/94→10/01	←	→ 09/00		24.0120-0115.1 420115 24.0320-0115.1 520115	Ø 236 20 17 V + S Ø 236 20 17 V + S PD
VAUXHALL - COMBO Mk II (C) Kasten/Kombi (F25) 09/01→02/12							
 Bremsbelagsatz, Scheibenbremse							
1.3 CDTI 16V 1.3 CDTI 16V 1.4 i 16V 1.6 1.7 DTI 16V	51 55 66 64 55	09/04→02/12 10/05→11/11 01/04→11/11 10/01→11/11 10/01→11/11	←	→ 43033898, 53000000; für erhöhte Nutzlast		13.0460-2857.2 602857 13.0470-2857.2 LD2857	TRW 23225 17,0 + WK + Zub TRW 23225 17,0 + WK + Zub Ceramic
			←	→ 10/11; nicht für erhöhte Nutzlast		13.0460-2857.2 602857 13.0470-2857.2 LD2857	TRW 23225 17,0 + WK + Zub Ceramic
			←	43033899, 53000001→; → 10/11; für erhöhte Nutzlast		13.0460-7179.2 607179 13.0470-7179.2 LD7179	ATE 23832 20,2 - WK / + WK Ceramic
			➔	→ 10/11		13.0460-2868.2 602868 13.0470-2868.2 LD2868	TRW 23417 15,3 + WK + Zub Ceramic
1.4 16V	66	10/01→05/07	←	nicht für erhöhte Nutzlast		13.0460-2857.2 602857 13.0470-2857.2 LD2857	TRW 23225 17,0 + WK + Zub Ceramic
			←	→ 43033898, 53000000; für erhöhte Nutzlast		13.0460-2857.2 602857 13.0470-2857.2 LD2857	TRW 23225 17,0 + WK + Zub Ceramic
			←	43033899, 53000001→; für erhöhte Nutzlast		13.0460-7179.2 607179 13.0470-7179.2 LD7179	ATE 23832 20,2 - WK / + WK Ceramic
			➔			13.0460-2868.2 602868 13.0470-2868.2 LD2868	TRW 23417 15,3 + WK + Zub Ceramic
1.6	62	09/01→10/04	←	10/01→; → 43033898, 53000000; für erhöhte Nutzlast		13.0460-2857.2 602857 13.0470-2857.2 LD2857	TRW 23225 17,0 + WK + Zub Ceramic
			←	10/01→; nicht für erhöhte Nutzlast		13.0460-2857.2 602857 13.0470-2857.2 LD2857	TRW 23225 17,0 + WK + Zub Ceramic
			←	43033899, 53000001→; für erhöhte Nutzlast		13.0460-7179.2 607179 13.0470-7179.2 LD7179	ATE 23832 20,2 - WK / + WK Ceramic
			➔	10/01→		13.0460-2868.2 602868 13.0470-2868.2 LD2868	TRW 23417 15,3 + WK + Zub Ceramic
1.6 CNG 16V 1.6 CNG 16V 1.7 CDTI 16V	69 71 74	06/06→02/12 04/05→02/12 12/04→11/11	←	→ 10/11		13.0460-7179.2 607179 13.0470-7179.2 LD7179	ATE 23832 20,2 - WK / + WK Ceramic
			➔	→ 10/11		13.0460-2868.2 602868 13.0470-2868.2 LD2868	TRW 23417 15,3 + WK + Zub Ceramic
1.7 DI 16V	48	09/01→11/11	←	10/01→ 10/11; nicht für erhöhte Nutzlast		13.0460-2857.2 602857 13.0470-2857.2 LD2857	TRW 23225 17,0 + WK + Zub Ceramic
			←	10/01→; → 43033898, 53000000; für erhöhte Nutzlast		13.0460-2857.2 602857 13.0470-2857.2 LD2857	TRW 23225 17,0 + WK + Zub Ceramic
↓							









	kw				! #		
VAUXHALL - COMBO Mk II (C) Kasten/Kombi (F25) 09/01→02/12							
 Bremsbelagsatz, Scheibenbremse							
1.7 DI 16V	48	09/01→11/11	←	43033899, 53000001→; → 10/11; für erhöhte Nutzlast		13.0460-7179.2 607179 13.0470-7179.2 LD7179	ATE 23832 20,2 - WK / + WK ATE 23832 20,2 - WK / + WK Ceramic
			→	10/01→ 10/11		13.0460-2868.2 602868 13.0470-2868.2 LD2868	TRW 23417 15,3 + WK + Zub TRW 23417 15,3 + WK + Zub Ceramic
 Bremsscheibe							
1.3 CDTi 16V	51	09/04→02/12	←	→ 10/11; nicht für erhöhte Nutzlast		24.0124-0166.1 424166	Ø 260 24 21 V + S
1.3 CDTi 16V	55	10/05→11/11				24.0324-0166.1 524166	Ø 260 24 21 V PD
1.4 i 16V	66	01/04→11/11	←	→ 43033898, 53000000; für erhöhte Nutzlast		24.0124-0166.1 424166	Ø 260 24 21 V + S
1.6	64	10/01→11/11	←	→ 43033899, 53000001→; → 10/11; für erhöhte Nutzlast		24.0125-0148.1 425148	Ø 280 25 22 V + S
1.7 DTi 16V	55	10/01→11/11	←	→ 10/11		24.0325-0148.1 525148	Ø 280 25 22 V + S PD
			→	→ 10/11		24.0110-0291.1 410291	Ø 264 10 8 + S
			→	→ 10/11		24.0310-0291.1 510291	Ø 264 10 8 + S PD
1.4 16V	66	10/01→05/07	←	nicht für erhöhte Nutzlast		24.0124-0166.1 424166	Ø 260 24 21 V + S
			←	→ 43033898, 53000000; für erhöhte Nutzlast		24.0324-0166.1 524166	Ø 260 24 21 V PD
			←	→ 43033899, 53000001→; für erhöhte Nutzlast		24.0125-0148.1 425148	Ø 280 25 22 V + S
			←	→ 43033899, 53000001→; für erhöhte Nutzlast		24.0325-0148.1 525148	Ø 280 25 22 V + S PD
			→	→ 10/11		24.0110-0291.1 410291	Ø 264 10 8 + S
			→	→ 10/11		24.0310-0291.1 510291	Ø 264 10 8 + S PD
1.6	62	09/01→10/04	←	10/01→; → 43033898, 53000000; für erhöhte Nutzlast		24.0124-0166.1 424166	Ø 260 24 21 V + S
			←	10/01→; nicht für erhöhte Nutzlast		24.0324-0166.1 524166	Ø 260 24 21 V PD
			←	→ 43033899, 53000001→; für erhöhte Nutzlast		24.0125-0148.1 425148	Ø 280 25 22 V + S
			←	→ 43033899, 53000001→; für erhöhte Nutzlast		24.0325-0148.1 525148	Ø 280 25 22 V + S PD
			→	10/01→		24.0110-0291.1 410291	Ø 264 10 8 + S
			→	10/01→		24.0310-0291.1 510291	Ø 264 10 8 + S PD
1.6 CNG 16V	69	06/06→02/12	←	→ 10/11		24.0125-0148.1 425148	Ø 280 25 22 V + S
1.6 CNG 16V	71	04/05→02/12	←	→ 10/11		24.0325-0148.1 525148	Ø 280 25 22 V + S PD
			→	→ 10/11		24.0110-0291.1 410291	Ø 264 10 8 + S
			→	→ 10/11		24.0310-0291.1 510291	Ø 264 10 8 + S PD
1.7 CDTi 16V	74	12/04→11/11	←	→ 10/11		24.0125-0131.1 425131	Ø 280 24,8 22 V + S
			←	→ 10/11		24.0325-0131.1 525131	Ø 280 24,8 22 V + S PD
			→	→ 10/11		24.0110-0250.1 410250	Ø 264 9,8 8 + S
1.7 DI 16V	48	09/01→11/11	←	10/01→; → 43033898, 53000000; für erhöhte Nutzlast		24.0124-0166.1 424166	Ø 260 24 21 V + S
			←	10/01→ 10/11; nicht für erhöhte Nutzlast		24.0324-0166.1 524166	Ø 260 24 21 V PD
			←	→ 43033899, 53000001→; → 10/11; für erhöhte Nutzlast		24.0125-0148.1 425148	Ø 280 25 22 V + S
			←	→ 43033899, 53000001→; → 10/11; für erhöhte Nutzlast		24.0325-0148.1 525148	Ø 280 25 22 V + S PD
			→	10/01→ 10/11		24.0110-0291.1 410291	Ø 264 10 8 + S
			→	10/01→ 10/11		24.0310-0291.1 510291	Ø 264 10 8 + S PD
VAUXHALL - COMBO Mk III (D) Kasten/Kombi 11/11→							
 Bremsbelagsatz, Scheibenbremse							
1.3 CDTi	66	11/11→	←	für Bremsscheibendurchmesser [mm]: 284		13.0460-3827.2 603827 13.0470-3827.2 LD3827	BOS 23709 19,6 + WK + Zub BOS 23709 19,6 + WK + Zub Ceramic
1.3 CDTi	70	03/16→					
1.4	70	11/11→					
1.4 CNG	88	11/11→	←	für Bremsscheibendurchmesser [mm]: 305		13.0460-7265.2 607265	ATE 24727 20,7 + WK
1.6 CDTi	66	11/11→					
1.6 CDTi	74	11/11→					
1.6 CDTi	77	11/11→					
2.0 CDTi	99	11/11→					
 Bremsscheibe							
1.3 CDTi	66	11/11→	←			24.0122-0145.1 422145	Ø 284 22 20,2 V
1.3 CDTi	70	03/16→				24.0128-0253.1 428253	Ø 305 28 26 V
1.4	70	11/11→					
1.4 CNG	88	11/11→					
1.6 CDTi	66	11/11→					











	kw			 	! #		
VAUXHALL - COMBO Mk III (D) Kasten/Kombi 11/11→							
 Bremsscheibe							
1.6 CDTi	74	11/11→	←		24.0122-0145.1	422145	Ø 284 22 20,2 V
1.6 CDTi	77	11/11→			24.0128-0253.1	428253	Ø 305 28 26 V
2.0 CDTi	99	11/11→					
VAUXHALL - COMBO TOUR Mk II (C) (F25) 09/01→02/12							
 Bremsbelagsatz, Scheibenbremse							
1.3 CDTI 16V	51	09/04→09/06	←	nicht für erhöhte Nutzlast	13.0460-2857.2	602857	TRW 23225 17,0 + WK + Zub
1.4	66	10/04→09/10			13.0470-2857.2	LD2857	TRW 23225 17,0 + WK + Zub
1.6	64	10/01→06/04					Ceramic
			←	→ 43033898, 53000000; für erhöhte Nutzlast	13.0460-2857.2	602857	TRW 23225 17,0 + WK + Zub
					13.0470-2857.2	LD2857	TRW 23225 17,0 + WK + Zub
			←	43033899, 53000001→; für erhöhte Nutzlast	13.0460-7179.2	607179	ATE 23832 20,2 - WK / + WK
					13.0470-7179.2	LD7179	ATE 23832 20,2 - WK / + WK
			→		13.0460-2868.2	602868	TRW 23417 15,3 + WK + Zub
					13.0470-2868.2	LD2868	TRW 23417 15,3 + WK + Zub
							Ceramic
1.3 CDTI 16V	55	07/06→02/12	←	→ 43033898, 53000000; für erhöhte Nutzlast	13.0460-2857.2	602857	TRW 23225 17,0 + WK + Zub
1.7 DTI 16V	55	10/01→02/12			13.0470-2857.2	LD2857	TRW 23225 17,0 + WK + Zub
			←	→ 10/11; nicht für erhöhte Nutzlast	13.0460-2857.2	602857	TRW 23225 17,0 + WK + Zub
					13.0470-2857.2	LD2857	TRW 23225 17,0 + WK + Zub
			←	43033899, 53000001→; → 10/11; für erhöhte Nutzlast	13.0460-7179.2	607179	ATE 23832 20,2 - WK / + WK
					13.0470-7179.2	LD7179	ATE 23832 20,2 - WK / + WK
			→	→ 10/11	13.0460-2868.2	602868	TRW 23417 15,3 + WK + Zub
					13.0470-2868.2	LD2868	TRW 23417 15,3 + WK + Zub
							Ceramic
1.6 CNG	69	06/06→09/10	←		13.0460-7179.2	607179	ATE 23832 20,2 - WK / + WK
1.7 CDTI 16V	74	12/04→09/10			13.0470-7179.2	LD7179	ATE 23832 20,2 - WK / + WK
			→		13.0460-2868.2	602868	TRW 23417 15,3 + WK + Zub
					13.0470-2868.2	LD2868	TRW 23417 15,3 + WK + Zub
							Ceramic
1.6 CNG	71	04/05→02/12	←	→ 10/11	13.0460-7179.2	607179	ATE 23832 20,2 - WK / + WK
					13.0470-7179.2	LD7179	ATE 23832 20,2 - WK / + WK
			→	→ 10/11	13.0460-2868.2	602868	TRW 23417 15,3 + WK + Zub
					13.0470-2868.2	LD2868	TRW 23417 15,3 + WK + Zub
							Ceramic
1.7 DI 16V	48	09/01→06/04	←	10/01→; → 43033898, 53000000; für erhöhte Nutzlast	13.0460-2857.2	602857	TRW 23225 17,0 + WK + Zub
					13.0470-2857.2	LD2857	TRW 23225 17,0 + WK + Zub
			←	10/01→; nicht für erhöhte Nutzlast	13.0460-2857.2	602857	TRW 23225 17,0 + WK + Zub
					13.0470-2857.2	LD2857	TRW 23225 17,0 + WK + Zub
			←	43033899, 53000001→; für erhöhte Nutzlast	13.0460-7179.2	607179	ATE 23832 20,2 - WK / + WK
					13.0470-7179.2	LD7179	ATE 23832 20,2 - WK / + WK
			→	10/01→	13.0460-2868.2	602868	TRW 23417 15,3 + WK + Zub
					13.0470-2868.2	LD2868	TRW 23417 15,3 + WK + Zub
							Ceramic
 Bremsscheibe							
1.3 CDTI 16V	51	09/04→09/06	←	nicht für erhöhte Nutzlast	24.0124-0166.1	424166	Ø 260 24 21 V + S
1.4	66	10/04→09/10			24.0324-0166.1	524166	Ø 260 24 21 V PD
1.6	64	10/01→06/04					
			←	→ 43033898, 53000000; für erhöhte Nutzlast	24.0124-0166.1	424166	Ø 260 24 21 V + S
					24.0324-0166.1	524166	Ø 260 24 21 V PD
			←	43033899, 53000001→; für erhöhte Nutzlast	24.0125-0148.1	425148	Ø 280 25 22 V + S
					24.0325-0148.1	525148	Ø 280 25 22 V + S PD
			→		24.0110-0291.1	410291	Ø 264 10 8 + S
					24.0310-0291.1	510291	Ø 264 10 8 + S PD
1.3 CDTI 16V	55	07/06→02/12	←	→ 10/11; nicht für erhöhte Nutzlast	24.0124-0166.1	424166	Ø 260 24 21 V + S
1.7 DTI 16V	55	10/01→02/12			24.0324-0166.1	524166	Ø 260 24 21 V PD













	kW			 	! #		
VAUXHALL - COMBO TOUR Mk II (C) (F25) 09/01→02/12							
Bremsscheibe							
1.3 CDTI 16V 1.7 DTI 16V	55 55	07/06→02/12 10/01→02/12	←	→ 43033898, 53000000; für erhöhte Nutzlast		24.0124-0166.1 424166 24.0324-0166.1 524166	Ø 260 24 21 V + S Ø 260 24 21 V PD
			←	43033899, 53000001→; → 10/11; für erhöhte Nutzlast		24.0125-0148.1 425148 24.0325-0148.1 525148	Ø 280 25 22 V + S Ø 280 25 22 V + S PD
			→	→ 10/11		24.0110-0291.1 410291 24.0310-0291.1 510291	Ø 264 10 8 + S Ø 264 10 8 + S PD
1.6 CNG	69	06/06→09/10	←			24.0125-0148.1 425148 24.0325-0148.1 525148	Ø 280 25 22 V + S Ø 280 25 22 V + S PD
			→			24.0110-0291.1 410291 24.0310-0291.1 510291	Ø 264 10 8 + S Ø 264 10 8 + S PD
1.6 CNG	71	04/05→02/12	←	→ 10/11		24.0125-0148.1 425148 24.0325-0148.1 525148	Ø 280 25 22 V + S Ø 280 25 22 V + S PD
			→	→ 10/11		24.0110-0291.1 410291 24.0310-0291.1 510291	Ø 264 10 8 + S Ø 264 10 8 + S PD
1.7 CDTI 16V	74	12/04→09/10	←			24.0125-0131.1 425131 24.0325-0131.1 525131	Ø 280 24,8 22 V + S Ø 280 24,8 22 V + S PD
			→			24.0110-0250.1 410250	Ø 264 9,8 8 + S
1.7 DI 16V	48	09/01→06/04	←	10/01→; → 43033898, 53000000; für erhöhte Nutzlast		24.0124-0166.1 424166 24.0324-0166.1 524166	Ø 260 24 21 V + S Ø 260 24 21 V PD
			←	10/01→; nicht für erhöhte Nutzlast		24.0124-0166.1 424166 24.0324-0166.1 524166	Ø 260 24 21 V + S Ø 260 24 21 V PD
			←	43033899, 53000001→; für erhöhte Nutzlast		24.0125-0148.1 425148 24.0325-0148.1 525148	Ø 280 25 22 V + S Ø 280 25 22 V + S PD
			→	10/01→		24.0110-0291.1 410291 24.0310-0291.1 510291	Ø 264 10 8 + S Ø 264 10 8 + S PD
VAUXHALL - CORSA Mk I (B) 12/92→09/00							
Bremsbelagsatz, Scheibenbremse							
1.0 i 12V 1.4 i 1.4 i 16V 1.4 i 16V 1.4 i S 1.5 TD 1.6 i 16V 1.6 i 16V 1.7 D	40 44 63 66 60 49 74 78 44	11/96→09/00 03/93→09/00 08/97→09/00 09/94→09/00 03/93→09/00 03/93→10/96 08/97→09/00 09/94→09/00 02/96→09/00	←			13.0460-7051.2 607051	ATE 20547 16,5 + WE / - WK
1.2 i	33	03/93→09/00	←			13.0460-7051.2 607051	ATE 20547 16,5 + WE / - WK
			←	04/98→		13.0460-7051.2 607051	ATE 20547 16,5 + WE / - WK
1.2 i 16V	48	03/98→09/00	←	04/98→		13.0460-7051.2 607051	ATE 20547 16,5 + WE / - WK
1.5 D	37	12/92→12/96	←	03/93→		13.0460-7051.2 607051	ATE 20547 16,5 + WE / - WK
1.6 GSI 16V	80	03/93→09/00	←	09/93→		13.0460-7051.2 607051	ATE 20547 16,5 + WE / - WK
Bremsscheibe							
1.0 i 12V 1.5 TD 1.7 D	40 49 44	11/96→09/00 03/93→10/96 02/96→09/00	←			24.0113-0161.1 413161 24.0313-0161.1 513161	Ø 236 12,7 9,7 + S Ø 236 12,7 9,7 + S PD
1.2 i	33	03/93→09/00	←	04/98→; für Fahrzeuge ohne Klimaanlage; für Automatikgetriebe		24.0113-0161.1 413161 24.0313-0161.1 513161	Ø 236 12,7 9,7 + S Ø 236 12,7 9,7 + S PD
			←			24.0113-0161.1 413161 24.0313-0161.1 513161	Ø 236 12,7 9,7 + S Ø 236 12,7 9,7 + S PD
			←	04/98→; für Schaltgetriebe		24.0113-0161.1 413161 24.0313-0161.1 513161	Ø 236 12,7 9,7 + S Ø 236 12,7 9,7 + S PD
			←	04/98→; für Fahrzeuge mit Klimaanlage; für Automatikgetriebe		24.0120-0115.1 420115 24.0320-0115.1 520115	Ø 236 20 17 V + S Ø 236 20 17 V + S PD
			←	04/98→		24.0120-0115.1 420115 24.0320-0115.1 520115	Ø 236 20 17 V + S Ø 236 20 17 V + S PD
1.2 i 16V	48	03/98→09/00	←	04/98→; für Schaltgetriebe		24.0113-0161.1 413161 24.0313-0161.1 513161	Ø 236 12,7 9,7 + S Ø 236 12,7 9,7 + S PD
			←	04/98→; für Fahrzeuge ohne Klimaanlage; für Automatikgetriebe		24.0113-0161.1 413161 24.0313-0161.1 513161	Ø 236 12,7 9,7 + S Ø 236 12,7 9,7 + S PD
			←	04/98→; für Fahrzeuge mit Klimaanlage; für Automatikgetriebe		24.0120-0115.1 420115 24.0320-0115.1 520115	Ø 236 20 17 V + S Ø 236 20 17 V + S PD











	kW				! #		
VAUXHALL - CORSA Mk I (B) 12/92→09/00							
Bremsscheibe							
1.2 i 16V	48	03/98→09/00	←	04/98→		24.0120-0115.1 420115 24.0320-0115.1 520115	Ø 236 20 17 V + S Ø 236 20 17 V + S PD
1.4 i	44	03/93→09/00	←	für Automatikgetriebe; für Fahrzeuge ohne Klimaanlage		24.0113-0161.1 413161 24.0313-0161.1 513161	Ø 236 12,7 9,7 + S Ø 236 12,7 9,7 + S PD
			←	für Schaltgetriebe		24.0113-0161.1 413161 24.0313-0161.1 513161	Ø 236 12,7 9,7 + S Ø 236 12,7 9,7 + S PD
			←			24.0120-0115.1 420115 24.0320-0115.1 520115	Ø 236 20 17 V + S Ø 236 20 17 V + S PD
			←	für Fahrzeuge mit Klimaanlage; für Automatikgetriebe		24.0120-0115.1 420115 24.0320-0115.1 520115	Ø 236 20 17 V + S Ø 236 20 17 V + S PD
			←			24.0120-0115.1 420115 24.0320-0115.1 520115	Ø 236 20 17 V + S Ø 236 20 17 V + S PD
1.4 i 16V 1.4 i 16V 1.4 i S	63 66 60	08/97→09/00 09/94→09/00 03/93→09/00	←			24.0120-0115.1 420115 24.0320-0115.1 520115	Ø 236 20 17 V + S Ø 236 20 17 V + S PD
1.5 D	37	12/92→12/96	←	03/93→		24.0113-0161.1 413161 24.0313-0161.1 513161	Ø 236 12,7 9,7 + S Ø 236 12,7 9,7 + S PD
1.6 GSI 16V	80	03/93→09/00	←	09/93→		24.0120-0140.1 420140	Ø 256 20 17 V + S
1.6 i 16V 1.6 i 16V	74 78	08/97→09/00 09/94→09/00	←			24.0120-0140.1 420140	Ø 256 20 17 V + S
VAUXHALL - CORSA Mk II (C) (W5L, F08) 08/00→10/06							
Brembelagsatz, Scheibenbremse							
1.0 12V	43	09/00→10/03	←			13.0460-2857.2 602857 13.0470-2857.2 LD2857	TRW 23225 17,0 + WK + Zub TRW 23225 17,0 + WK + Zub Ceramic
1.0 12V 1.2 16V 1.2 16V Dualfuel 1.2 Twinport	44 55 55 59	11/03→10/06 09/00→10/06 08/01→10/06 07/04→10/06	←	→ 09/06		13.0460-2857.2 602857 13.0470-2857.2 LD2857	TRW 23225 17,0 + WK + Zub TRW 23225 17,0 + WK + Zub Ceramic
			←	06/03→		13.0460-2857.2 602857 13.0470-2857.2 LD2857	TRW 23225 17,0 + WK + Zub TRW 23225 17,0 + WK + Zub Ceramic
			→	06/03→		13.0460-2858.2 602858 13.0470-2858.2 LD2858	TRW 23284 14,0 + WK TRW 23284 14,0 + WK Ceramic
			←			13.0460-2857.2 602857 13.0470-2857.2 LD2857	TRW 23225 17,0 + WK + Zub TRW 23225 17,0 + WK + Zub Ceramic
1.3 CDTI 16V	52	08/00→09/06	←			13.0460-2857.2 602857 13.0470-2857.2 LD2857	TRW 23225 17,0 + WK + Zub TRW 23225 17,0 + WK + Zub Ceramic
			→			13.0460-2858.2 602858 13.0470-2858.2 LD2858	TRW 23284 14,0 + WK TRW 23284 14,0 + WK Ceramic
1.3 CDTI 16V	55	09/05→09/06	←			13.0460-2857.2 602857 13.0470-2857.2 LD2857	TRW 23225 17,0 + WK + Zub TRW 23225 17,0 + WK + Zub Ceramic
			→			13.0460-2858.2 602858 13.0470-2858.2 LD2858	TRW 23284 14,0 + WK TRW 23284 14,0 + WK Ceramic
1.4 16V 1.4 Twinport	66 66	09/00→10/06 06/03→10/06	←	→ 09/06		13.0460-2857.2 602857 13.0470-2857.2 LD2857	TRW 23225 17,0 + WK + Zub TRW 23225 17,0 + WK + Zub Ceramic
			→	→ 09/06		13.0460-2858.2 602858 13.0470-2858.2 LD2858	TRW 23284 14,0 + WK TRW 23284 14,0 + WK Ceramic
1.6	62	08/00→10/04	←	09/01→		13.0460-2857.2 602857 13.0470-2857.2 LD2857	TRW 23225 17,0 + WK + Zub TRW 23225 17,0 + WK + Zub Ceramic
			←	06/03→		13.0460-2857.2 602857 13.0470-2857.2 LD2857	ATE 23832 20,2 - WK / + WK ATE 23832 20,2 - WK / + WK Ceramic
1.7 CDTI 16V	74	08/00→09/06	←	06/03→		13.0460-2858.2 602858 13.0470-2858.2 LD2858	TRW 23284 14,0 + WK TRW 23284 14,0 + WK Ceramic
			→	06/03→		13.0460-2858.2 602858 13.0470-2858.2 LD2858	TRW 23284 14,0 + WK TRW 23284 14,0 + WK Ceramic
1.7 DI 16V 1.7 DTI 16V 1.8 16V	48 55 92	08/00→09/06 08/00→09/06 08/00→09/06	←	09/00→		13.0460-2857.2 602857 13.0470-2857.2 LD2857	TRW 23225 17,0 + WK + Zub TRW 23225 17,0 + WK + Zub Ceramic
			→	09/00→		13.0460-2858.2 602858 13.0470-2858.2 LD2858	TRW 23284 14,0 + WK TRW 23284 14,0 + WK Ceramic
Bremsscheibe							
1.0 12V	43	09/00→10/03	←	- ABS		24.0111-0152.1 411152	Ø 240 11 8
			←	+ ABS		24.0120-0174.1 420174	Ø 240 20 17 V + S
1.0 12V 1.2 16V 1.2 16V Dualfuel 1.2 Twinport	44 55 55 59	11/03→10/06 09/00→10/06 08/01→10/06 07/04→10/06	←	- ABS; → 09/06		24.0111-0152.1 411152	Ø 240 11 8
			←	+ ABS; → 09/06		24.0120-0174.1 420174	Ø 240 20 17 V + S
			←			24.0124-0166.1 424166 24.0324-0166.1 524166	Ø 260 24 21 V + S Ø 260 24 21 V PD
1.3 CDTI 16V	52	08/00→09/06	←	06/03→		24.0124-0166.1 424166 24.0324-0166.1 524166	Ø 260 24 21 V + S Ø 260 24 21 V PD











	kw			 	! #		
VAUXHALL - CORSA Mk II (C) (W5L, F08) 08/00→10/06							
Bremsscheibe							
1.3 CDTI 16V	52	08/00→09/06	➔	06/03→		24.0110-0268.1 410268 24.0110-0291.1 410291 24.0310-0291.1 510291	Ø 240 10,2 8,2 Ø 264 10 8 + S Ø 264 10 8 + S PD
1.3 CDTI 16V	55	09/05→09/06	➔			24.0124-0166.1 424166 24.0324-0166.1 524166	Ø 260 24 21 V + S Ø 260 24 21 V PD
			➔			24.0110-0268.1 410268 24.0110-0291.1 410291 24.0310-0291.1 510291	Ø 240 10,2 8,2 Ø 264 10 8 + S Ø 264 10 8 + S PD
1.4 16V 1.4 Twinport	66 66	09/00→10/06 06/03→10/06	➔	→ 09/06		24.0124-0166.1 424166 24.0324-0166.1 524166	Ø 260 24 21 V + S Ø 260 24 21 V PD
			➔	→ 09/06		24.0110-0268.1 410268 24.0110-0291.1 410291 24.0310-0291.1 510291	Ø 240 10,2 8,2 Ø 264 10 8 + S Ø 264 10 8 + S PD
1.6	62	08/00→10/04	➔	09/01→		24.0124-0166.1 424166 24.0324-0166.1 524166	Ø 260 24 21 V + S Ø 260 24 21 V PD
1.7 CDTI 16V	74	08/00→09/06	➔	06/03→		24.0125-0131.1 425131 24.0325-0131.1 525131	Ø 280 24,8 22 V + S Ø 280 24,8 22 V + S PD
			➔	06/03→		24.0110-0250.1 410250 24.0310-0250.1 510250	Ø 264 9,8 8 + S Ø 264 9,8 8 + S PD
1.7 DI 16V	48	08/00→09/06	➔	09/00→		24.0120-0174.1 420174	Ø 240 20 17 V + S
			➔	09/00→		24.0110-0268.1 410268 24.0110-0291.1 410291 24.0310-0291.1 510291	Ø 240 10,2 8,2 Ø 264 10 8 + S Ø 264 10 8 + S PD
1.7 DTI 16V 1.8 16V	55 92	08/00→09/06 08/00→09/06	➔	09/00→		24.0124-0166.1 424166 24.0324-0166.1 524166	Ø 260 24 21 V + S Ø 260 24 21 V PD
			➔	09/00→		24.0110-0268.1 410268 24.0110-0291.1 410291 24.0310-0291.1 510291	Ø 240 10,2 8,2 Ø 264 10 8 + S Ø 264 10 8 + S PD
VAUXHALL - CORSA Mk III (D) (L_8) 07/06→08/14							
Bremsbelagsatz, Scheibenbremse							
1.0 1.0 i 12V	44 48	11/06→08/14 06/10→08/14	➔	V		13.0460-3839.2 603839 13.0470-3839.2 LD3839	BOS 23707 17,9 + WK + Zub BOS 23982 18,1 + WK + Zub Ceramic
			➔			13.0460-3839.2 603839 13.0470-3839.2 LD3839	BOS 23707 17,9 + WK + Zub BOS 23982 18,1 + WK + Zub Ceramic
1.2 1.2 1.2 LPG 1.2 LPG 1.2 LPG 1.4 1.4 1.4 LPG	51 59 59 61 63 64 74 64	06/10→08/14 11/06→08/14 09/09→08/14 06/11→08/14 08/11→08/14 09/09→08/14 07/10→08/14 09/09→08/14	➔			13.0460-3839.2 603839 13.0470-3839.2 LD3839	BOS 23707 17,9 + WK + Zub BOS 23982 18,1 + WK + Zub Ceramic
			➔			13.0460-3839.2 603839 13.0470-3839.2 LD3839	BOS 23707 17,9 + WK + Zub BOS 23982 18,1 + WK + Zub Ceramic
			➔			13.0460-3839.2 603839 13.0470-3839.2 LD3839	BOS 23707 17,9 + WK + Zub BOS 23982 18,1 + WK + Zub Ceramic
			➔			13.0460-3839.2 603839 13.0470-3839.2 LD3839	BOS 23707 17,9 + WK + Zub BOS 23982 18,1 + WK + Zub Ceramic
			➔			13.0460-3839.2 603839 13.0470-3839.2 LD3839	BOS 23707 17,9 + WK + Zub BOS 23982 18,1 + WK + Zub Ceramic
			➔			13.0460-3839.2 603839 13.0470-3839.2 LD3839	BOS 23707 17,9 + WK + Zub BOS 23982 18,1 + WK + Zub Ceramic
1.2 i 16V	63	11/06→08/14	➔	06/10→		13.0460-3839.2 603839 13.0470-3839.2 LD3839	BOS 23707 17,9 + WK + Zub BOS 23982 18,1 + WK + Zub Ceramic
1.3 CDTI	55	07/06→08/14	➔	10/06→; für Bremsscheibendurchmesser [mm]: 257		13.0460-3839.2 603839 13.0470-3839.2 LD3839	BOS 23707 17,9 + WK + Zub BOS 23982 18,1 + WK + Zub Ceramic
			➔	10/06→; für Bremsscheibendurchmesser [mm]: 284		13.0460-3840.2 603840 13.0470-3840.2 LD3840	BOS 23981 19,6 + WK + Zub BOS 23981 19,6 + WK + Zub Ceramic
1.3 CDTI	66	07/06→08/14	➔	10/06→		13.0460-3840.2 603840 13.0470-3840.2 LD3840	BOS 23981 19,6 + WK + Zub BOS 23981 19,6 + WK + Zub Ceramic
1.3 CDTI	70	06/10→08/14	➔	für Bremsscheibendurchmesser [mm]: 257		13.0460-3839.2 603839 13.0470-3839.2 LD3839	BOS 23707 17,9 + WK + Zub BOS 23982 18,1 + WK + Zub Ceramic
			➔	für Bremsscheibendurchmesser [mm]: 284		13.0460-3840.2 603840 13.0470-3840.2 LD3840	BOS 23981 19,6 + WK + Zub BOS 23981 19,6 + WK + Zub Ceramic
1.4 1.4 LPG	66 66	07/06→08/14 07/06→08/14	➔	10/06→		13.0460-3839.2 603839 13.0470-3839.2 LD3839	BOS 23707 17,9 + WK + Zub BOS 23982 18,1 + WK + Zub Ceramic
↓							









	kw			 	! #		
VAUXHALL - CORSA Mk III (D) (L_8) 07/06→08/14							
 Bremsbelagsatz, Scheibenbremse							
1.4 1.7 CDTI	88 92	07/12→08/14 11/06→08/14	← →			13.0460-3841.2 603841 13.0460-3848.2 603848	BOS 24550 19,5 + WK + Zub BOS 24349 17,6 - WE / - WK + Zub
1.6 SRi	110	05/07→08/14	← →	06/07→ 06/07→		13.0460-7179.2 607179 13.0470-7179.2 LD7179 13.0460-3848.2 603848	ATE 23832 20,2 - WK / + WK ATE 23832 20,2 - WK / + WK Ceramic BOS 24349 17,6 - WE / - WK + Zub
1.6 VXR	141	02/07→08/14	← →	03/07→ 03/07→		13.0460-7179.2 607179 13.0470-7179.2 LD7179 13.0460-3848.2 603848	ATE 23832 20,2 - WK / + WK ATE 23832 20,2 - WK / + WK Ceramic BOS 24349 17,6 - WE / - WK + Zub
1.6 VXR	150	06/11→08/14	← →			13.0460-7179.2 607179 13.0470-7179.2 LD7179 13.0460-3848.2 603848	ATE 23832 20,2 - WK / + WK ATE 23832 20,2 - WK / + WK Ceramic BOS 24349 17,6 - WE / - WK + Zub
1.7 CDTI	96	11/06→08/14	← →	06/10→ 06/10→		13.0460-3841.2 603841 13.0460-3848.2 603848	BOS 24550 19,5 + WK + Zub BOS 24349 17,6 - WE / - WK + Zub
 Bremsscheibe							
1.0 1.0 i 12V	44 48	11/06→08/14 06/10→08/14	←			24.0112-0184.1 412184 24.0122-0231.1 422231 24.0322-0231.1 522231	Ø 257 12 10 + S Ø 257 22 20 V + S Ø 257 22 20 V + S PD
1.2 1.2 1.2 LPG 1.2 LPG 1.2 LPG 1.4 1.4 LPG	51 59 59 61 63 64 64	06/10→08/14 11/06→08/14 09/09→08/14 06/11→08/14 08/11→08/14 09/09→08/14 09/09→08/14	←			24.0122-0231.1 422231 24.0322-0231.1 522231	Ø 257 22 20 V + S Ø 257 22 20 V + S PD
1.2 i 16V	63	11/06→08/14	←	06/10→		24.0122-0231.1 422231 24.0322-0231.1 522231	Ø 257 22 20 V + S Ø 257 22 20 V + S PD
1.3 CDTI	55	07/06→08/14	←	10/06→; für Bremsscheibendurchmesser [mm]: 257		24.0122-0231.1 422231 24.0322-0231.1 522231	Ø 257 22 20 V + S Ø 257 22 20 V + S PD
1.3 CDTI	66	07/06→08/14	←	10/06→		24.0122-0241.1 422241	Ø 284 22 20 V + S
1.3 CDTI	70	06/10→08/14	←	für Bremsscheibendurchmesser [mm]: 257		24.0122-0231.1 422231 24.0322-0231.1 522231	Ø 257 22 20 V + S Ø 257 22 20 V + S PD
1.3 CDTI	70	06/10→08/14	←	für Bremsscheibendurchmesser [mm]: 284		24.0122-0241.1 422241	Ø 284 22 20 V + S
1.4 1.4 LPG	66 66	07/06→08/14 07/06→08/14	←	10/06→		24.0122-0231.1 422231 24.0322-0231.1 522231	Ø 257 22 20 V + S Ø 257 22 20 V + S PD
1.4	74	07/10→08/14	←	für Bremsscheibendurchmesser [mm]: 257		24.0122-0231.1 422231 24.0322-0231.1 522231	Ø 257 22 20 V + S Ø 257 22 20 V + S PD
1.4 1.7 CDTI	88 92	07/12→08/14 11/06→08/14	← →			24.0126-0146.1 426146 24.0110-0347.1 410347	Ø 278 26 23 V Ø 264 10 8
1.6 SRi	110	05/07→08/14	← →	06/07→ 06/07→		24.0125-0142.1 425142 24.0325-0142.1 525142 24.0110-0347.1 410347	Ø 308 25 22 V + S Ø 308 25 23 V + S PD Ø 264 10 8
1.6 VXR	141	02/07→08/14	← →	03/07→; nicht für Ausstattungsvariante: Nuerburg- ring Edit. 03/07→		24.0125-0142.1 425142 24.0325-0142.1 525142 24.0110-0347.1 410347	Ø 308 25 22 V + S Ø 308 25 23 V + S PD Ø 264 10 8
1.6 VXR	150	06/11→08/14	← →	nicht für Ausstattungsvariante: Nuerburg- ring Edit.		24.0125-0142.1 425142 24.0325-0142.1 525142 24.0110-0347.1 410347	Ø 308 25 22 V + S Ø 308 25 23 V + S PD Ø 264 10 8
1.7 CDTI	96	11/06→08/14	← →	06/10→ 06/10→		24.0126-0146.1 426146 24.0110-0347.1 410347	Ø 278 26 23 V Ø 264 10 8

	kw			 	! #		
VAUXHALL - CORSA Mk IV (E) 08/14→							
 Bremsbelagsatz, Scheibenbremse							
1.0	66	08/14→	←	11/14→; für Bremsscheibendurchmesser [mm]: 308	13.0460-7179.2	607179	ATE 23832 20,2 - WK / + WK
1.0	85	08/14→			13.0470-7179.2	LD7179	ATE 23832 20,2 - WK / + WK Ceramic
1.2	51	08/14→					
1.3 CDTi	55	08/14→					
1.3 CDTi	70	08/14→	←	11/14→; für Bremsscheibendurchmesser [mm]: 284	13.0460-7308.2	607308	ATE 22123 18,2 + WK + Zub
1.4	55	09/14→					
1.4	66	08/14→					
1.4	74	08/14→	←	11/14→; für Bremsscheibendurchmesser [mm]: 257	13.0460-7310.2	607310	ATE 22143 17,5 + WK + Zub
			→	11/14→	13.0460-2793.2	602793	TRW 25973 17,2 + WK + Zub
1.4	110	07/15→	←	für Bremsscheibendurchmesser [mm]: 308	13.0460-7179.2	607179	ATE 23832 20,2 - WK / + WK
					13.0470-7179.2	LD7179	ATE 23832 20,2 - WK / + WK Ceramic
			←	für Bremsscheibendurchmesser [mm]: 284	13.0460-7308.2	607308	ATE 22123 18,2 + WK + Zub
			←	für Bremsscheibendurchmesser [mm]: 257	13.0460-7310.2	607310	ATE 22143 17,5 + WK + Zub
			→		13.0460-2793.2	602793	TRW 25973 17,2 + WK + Zub
1.4 LPG	66	08/14→	←	03/15→; für Bremsscheibendurchmesser [mm]: 308	13.0460-7179.2	607179	ATE 23832 20,2 - WK / + WK
					13.0470-7179.2	LD7179	ATE 23832 20,2 - WK / + WK Ceramic
			←	03/15→; für Bremsscheibendurchmesser [mm]: 284	13.0460-7308.2	607308	ATE 22123 18,2 + WK + Zub
			←	03/15→; für Bremsscheibendurchmesser [mm]: 257	13.0460-7310.2	607310	ATE 22143 17,5 + WK + Zub
			→	03/15→	13.0460-2793.2	602793	TRW 25973 17,2 + WK + Zub
1.6 VXR	151	04/15→	→		13.0460-2793.2	602793	TRW 25973 17,2 + WK + Zub
 Bremsscheibe							
1.0	66	08/14→	←	11/14→	24.0122-0231.1	422231	Ø 257 22 20 V + S
1.0	85	08/14→			24.0122-0241.1	422241	Ø 284 22 20 V + S
1.2	51	08/14→			24.0125-0142.1	425142	Ø 308 25 22 V + S
1.3 CDTi	55	08/14→			24.0322-0231.1	522231	Ø 257 22 20 V + S PD
1.3 CDTi	70	08/14→			24.0325-0142.1	525142	Ø 308 25 23 V + S PD
1.4	55	09/14→					
1.4	66	08/14→					
1.4	74	08/14→	→	11/14→; +POC J67	24.0110-0323.1	410323	Ø 264 10 8
			→	11/14→; +POC J7A	24.0110-0347.1	410347	Ø 264 10 8
1.4	110	07/15→	←		24.0122-0231.1	422231	Ø 257 22 20 V + S
					24.0122-0241.1	422241	Ø 284 22 20 V + S
					24.0125-0142.1	425142	Ø 308 25 22 V + S
					24.0322-0231.1	522231	Ø 257 22 20 V + S PD
					24.0325-0142.1	525142	Ø 308 25 23 V + S PD
			→	+POC J67	24.0110-0323.1	410323	Ø 264 10 8
			→	+POC J7A	24.0110-0347.1	410347	Ø 264 10 8
1.4 LPG	66	08/14→	←	03/15→	24.0122-0231.1	422231	Ø 257 22 20 V + S
					24.0122-0241.1	422241	Ø 284 22 20 V + S
					24.0125-0142.1	425142	Ø 308 25 22 V + S
					24.0322-0231.1	522231	Ø 257 22 20 V + S PD
					24.0325-0142.1	525142	Ø 308 25 23 V + S PD
			→	03/15→; +POC J67	24.0110-0323.1	410323	Ø 264 10 8
			→	03/15→; +POC J7A	24.0110-0347.1	410347	Ø 264 10 8
1.6 VXR	151	04/15→	→		24.0110-0347.1	410347	Ø 264 10 8
VAUXHALL - CORSAVAN Mk I (B) 01/94→09/00							
 Bremsbelagsatz, Scheibenbremse							
1.4 i	44	01/94→09/00	←		13.0460-7051.2	607051	ATE 20547 16,5 + WE / - WK
1.5 D	37	08/94→12/95					
1.7 D	44	01/94→09/00					
 Bremsscheibe							
1.4 i	44	01/94→09/00	←	für Automatikgetriebe; für Fahrzeuge ohne Klimaanlage	24.0113-0161.1	413161	Ø 236 12,7 9,7 + S
					24.0313-0161.1	513161	Ø 236 12,7 9,7 + S PD
			←	für Schaltgetriebe	24.0113-0161.1	413161	Ø 236 12,7 9,7 + S
					24.0313-0161.1	513161	Ø 236 12,7 9,7 + S PD
↓							









	kw					! #		
VAUXHALL - CORSAVAN Mk I (B) 01/94→09/00								
 Bremsscheibe								
1.4 i	44	01/94→09/00	←			24.0120-0115.1 420115	Ø 236 20 17 V + S	
			←			24.0320-0115.1 520115	Ø 236 20 17 V + S PD	
			←			24.0120-0115.1 420115	Ø 236 20 17 V + S	
			←	für Fahrzeuge mit Klimaanlage; für Automatikgetriebe		24.0320-0115.1 520115	Ø 236 20 17 V + S PD	
1.5 D	37	08/94→12/95	←			24.0113-0161.1 413161	Ø 236 12,7 9,7 + S	
1.7 D	44	01/94→09/00	←			24.0313-0161.1 513161	Ø 236 12,7 9,7 + S PD	
VAUXHALL - CORSAVAN Mk II (C) 09/00→06/06								
 Bremsbelagsatz, Scheibenbremse								
1.2 16V	55	09/00→06/06	←			13.0460-2857.2 602857	TRW 23225 17,0 + WK + Zub	
1.2 16V Dualfuel	55	08/01→06/06	←			13.0470-2857.2 LD2857	TRW 23225 17,0 + WK + Zub Ceramic	
1.3 CDTI 16V	52	04/04→06/06	←			13.0460-2857.2 602857	TRW 23225 17,0 + WK + Zub	
1.4	66	11/03→06/06	←			13.0470-2857.2 LD2857	TRW 23225 17,0 + WK + Zub Ceramic	
1.7 DI 16V	48	09/00→06/06	←					
1.7 DTI 16V	55	09/00→06/06	→			13.0460-2858.2 602858	TRW 23284 14,0 + WK	
			→			13.0470-2858.2 LD2858	TRW 23284 14,0 + WK Ceramic	
 Bremsscheibe								
1.2 16V	55	09/00→06/06	←	- ABS		24.0111-0152.1 411152	Ø 240 11 8	
1.2 16V Dualfuel	55	08/01→06/06	←	+ ABS		24.0120-0174.1 420174	Ø 240 20 17 V + S	
1.3 CDTI 16V	52	04/04→06/06	←			24.0124-0166.1 424166	Ø 260 24 21 V + S	
1.4	66	11/03→06/06	←			24.0324-0166.1 524166	Ø 260 24 21 V PD	
1.7 DTI 16V	55	09/00→06/06	→			24.0110-0268.1 410268	Ø 240 10,2 8,2	
			→			24.0110-0291.1 410291	Ø 264 10 8 + S	
			→			24.0310-0291.1 510291	Ø 264 10 8 + S PD	
1.7 DI 16V	48	09/00→06/06	←			24.0120-0174.1 420174	Ø 240 20 17 V + S	
			→			24.0110-0268.1 410268	Ø 240 10,2 8,2	
			→			24.0110-0291.1 410291	Ø 264 10 8 + S	
			→			24.0310-0291.1 510291	Ø 264 10 8 + S PD	
VAUXHALL - CORSAVAN Mk III (D) 07/06→								
 Bremsbelagsatz, Scheibenbremse								
1.2	51	01/10→	←	06/10→		13.0460-3839.2 603839	BOS 23707 17,9 + WK + Zub	
			←			13.0470-3839.2 LD3839	BOS 23982 18,1 + WK + Zub Ceramic	
1.2	59	07/09→	←			13.0460-3839.2 603839	BOS 23707 17,9 + WK + Zub	
			←			13.0470-3839.2 LD3839	BOS 23982 18,1 + WK + Zub Ceramic	
1.3 CDTI	55	07/06→	←	10/06→; für Bremsscheibendurchmesser [mm]: 257		13.0460-3839.2 603839	BOS 23707 17,9 + WK + Zub	
			←	10/06→; für Bremsscheibendurchmesser [mm]: 284		13.0470-3839.2 LD3839	BOS 23982 18,1 + WK + Zub Ceramic	
			←			13.0460-3840.2 603840	BOS 23981 19,6 + WK + Zub	
			←			13.0470-3840.2 LD3840	BOS 23981 19,6 + WK + Zub Ceramic	
1.3 CDTI	66	07/06→	←	10/06→		13.0460-3840.2 603840	BOS 23981 19,6 + WK + Zub	
			←			13.0470-3840.2 LD3840	BOS 23981 19,6 + WK + Zub Ceramic	
1.3 CDTI	70	07/06→	←	06/10→; für Bremsscheibendurchmesser [mm]: 257		13.0460-3839.2 603839	BOS 23707 17,9 + WK + Zub	
			←	06/10→; für Bremsscheibendurchmesser [mm]: 284		13.0470-3839.2 LD3839	BOS 23982 18,1 + WK + Zub Ceramic	
			←			13.0460-3840.2 603840	BOS 23981 19,6 + WK + Zub	
			←			13.0470-3840.2 LD3840	BOS 23981 19,6 + WK + Zub Ceramic	
 Bremsscheibe								
1.2	51	01/10→	←	06/10→		24.0122-0231.1 422231	Ø 257 22 20 V + S	
			←			24.0322-0231.1 522231	Ø 257 22 20 V + S PD	
1.2	59	07/09→	←			24.0122-0231.1 422231	Ø 257 22 20 V + S	
			←			24.0322-0231.1 522231	Ø 257 22 20 V + S PD	
↓								









	kw			 	! #		
VAUXHALL - CORSAVAN Mk III (D) 07/06→							
 Bremsscheibe							
1.3 CDTi	55	07/06→	←	10/06→; für Bremsscheibendurchmesser [mm]: 257	24.0122-0231.1 422231 24.0322-0231.1 522231	Ø 257 22 20 V + S Ø 257 22 20 V + S PD	
			←	10/06→; für Bremsscheibendurchmesser [mm]: 284	24.0122-0241.1 422241	Ø 284 22 20 V + S	
1.3 CDTi	66	07/06→	←	10/06→	24.0122-0241.1 422241	Ø 284 22 20 V + S	
1.3 CDTi	70	07/06→	←	06/10→; für Bremsscheibendurchmesser [mm]: 257	24.0122-0231.1 422231 24.0322-0231.1 522231	Ø 257 22 20 V + S Ø 257 22 20 V + S PD	
			←	06/10→; für Bremsscheibendurchmesser [mm]: 284	24.0122-0241.1 422241	Ø 284 22 20 V + S	
VAUXHALL - CORSAVAN Mk IV (E) 10/14→							
 Bremsbelagsatz, Scheibenbremse							
1.2 1.3 CDTi 1.3 CDTi 1.4	51 55 70 55	10/14→ 10/14→ 10/14→ 10/14→	←	11/14→; für Bremsscheibendurchmesser [mm]: 308	13.0460-7179.2 607179 13.0470-7179.2 LD7179	ATE 23832 20,2 - WK / + WK ATE 23832 20,2 - WK / + WK Ceramic	
			←	11/14→; für Bremsscheibendurchmesser [mm]: 284	13.0460-7308.2 607308	ATE 22123 18,2 + WK + Zub	
			←	11/14→; für Bremsscheibendurchmesser [mm]: 257	13.0460-7310.2 607310	ATE 22143 17,5 + WK + Zub	
			→	11/14→	13.0460-2793.2 602793	TRW 25973 17,2 + WK + Zub	
 Bremsscheibe							
1.2 1.3 CDTi 1.3 CDTi 1.4	51 55 70 55	10/14→ 10/14→ 10/14→ 10/14→	←	11/14→	24.0122-0231.1 422231 24.0122-0241.1 422241 24.0125-0142.1 425142 24.0322-0231.1 522231 24.0325-0142.1 525142	Ø 257 22 20 V + S Ø 284 22 20 V + S Ø 308 25 22 V + S Ø 257 22 20 V + S PD Ø 308 25 23 V + S PD	
			→	11/14→; +POC J67	24.0110-0323.1 410323	Ø 264 10 8	
			→	11/14→; +POC J7A	24.0110-0347.1 410347	Ø 264 10 8	
VAUXHALL - FRONTERA Mk I (A) 09/91→10/98							
 Bremsbelagsatz, Scheibenbremse							
2.0 2.2 i 2.4 i	85 100 92	04/95→08/98 03/95→10/98 03/92→10/98	←	SV720103→	13.0460-5926.2 605926	AKE 21845 16,5 + WK	
			←	→ SV720102	13.0460-5942.2 605942	AKE 21543 16,5 + WK	
			→	SV720103→	13.0460-5927.2 605927	AKE 21875 16,0 + WK	
2.3 TD	74	09/91→06/98	←	SV720103→	13.0460-5926.2 605926	AKE 21845 16,5 + WK	
			←	03/92→; → SV720102	13.0460-5942.2 605942	AKE 21543 16,5 + WK	
			→	SV720103→	13.0460-5927.2 605927	AKE 21875 16,0 + WK	
2.5 TDS	85	11/91→06/98	←	SV720103→	13.0460-5926.2 605926	AKE 21845 16,5 + WK	
			←	09/96→; → SV720102	13.0460-5942.2 605942	AKE 21543 16,5 + WK	
			→	SV720103→	13.0460-5927.2 605927	AKE 21875 16,0 + WK	
2.8 TD	83	01/95→12/96	←	SV720103→	13.0460-5926.2 605926	AKE 21845 16,5 + WK	
			←	03/95→; → SV720102	13.0460-5942.2 605942	AKE 21543 16,5 + WK	
			→	SV720103→	13.0460-5927.2 605927	AKE 21875 16,0 + WK	
Zubehörsatz, Scheibenbremsbelag							
2.0 2.2 i 2.4 i	85 100 92	04/95→08/98 03/95→10/98 03/92→10/98	←	→ SV720102	13.0460-0337.2 610337	AKE	
			←	SV720103→	13.0460-0446.2 610446	AKE	
			→	SV720103→	13.0460-0447.2 610447	AKE	
2.3 TD	74	09/91→06/98	←	03/92→; → SV720102	13.0460-0337.2 610337	AKE	
			←	SV720103→	13.0460-0446.2 610446	AKE	
			→	SV720103→	13.0460-0447.2 610447	AKE	
2.5 TDS	85	11/91→06/98	←	09/96→; → SV720102	13.0460-0337.2 610337	AKE	
			←	SV720103→	13.0460-0446.2 610446	AKE	
			→	SV720103→	13.0460-0447.2 610447	AKE	
2.8 TD	83	01/95→12/96	←	03/95→; → SV720102	13.0460-0337.2 610337	AKE	
↓							











	kW			 	! #		
VAUXHALL - FRONTERA Mk I (A) 09/91→10/98							
Zubehörsatz, Scheibenbremsbelag							
2.8 TD	83	01/95→12/96	←	SV720103→		13.0460-0446.2 610446	AKE
			→	SV720103→		13.0460-0447.2 610447	AKE
 Bremsscheibe							
2.0 2.2 i 2.4 i	85 100 92	04/95→08/98 03/95→10/98 03/92→10/98	←	→ SV720102		24.0122-0156.1 422156	Ø 257 22 20,6 V
			←	SV720103→; + ABS		24.0126-0111.1 426111	Ø 280 26 24,6 V
			←	SV720103→; - ABS		24.0126-0111.1 426111	Ø 280 26 24,6 V
			→	SV720103→		24.0118-0122.1 418122	Ø 313,5 18 16,6 V
2.3 TD	74	09/91→06/98	←	03/92→; → SV720102		24.0122-0156.1 422156	Ø 257 22 20,6 V
			←	SV720103→; + ABS		24.0126-0111.1 426111	Ø 280 26 24,6 V
			←	SV720103→; - ABS		24.0126-0111.1 426111	Ø 280 26 24,6 V
			→	SV720103→		24.0118-0122.1 418122	Ø 313,5 18 16,6 V
2.5 TDS	85	11/91→06/98	←	09/96→; → SV720102		24.0122-0156.1 422156	Ø 257 22 20,6 V
			←	SV720103→; + ABS		24.0126-0111.1 426111	Ø 280 26 24,6 V
			←	SV720103→; - ABS		24.0126-0111.1 426111	Ø 280 26 24,6 V
			→	SV720103→		24.0118-0122.1 418122	Ø 313,5 18 16,6 V
2.8 TD	83	01/95→12/96	←	03/95→; → SV720102		24.0122-0156.1 422156	Ø 257 22 20,6 V
			←	SV720103→; + ABS		24.0126-0111.1 426111	Ø 280 26 24,6 V
			←	SV720103→; - ABS		24.0126-0111.1 426111	Ø 280 26 24,6 V
			→	SV720103→		24.0118-0122.1 418122	Ø 313,5 18 16,6 V
VAUXHALL - FRONTERA Mk I (A) Sport 03/92→10/98							
 Bremsbelagsatz, Scheibenbremse							
2.0 i 2.5 TDS	85 85	03/92→10/98 09/96→10/98	←	SV720103→		13.0460-5926.2 605926	AKE 21845 16,5 + WK
			←	→ SV720102		13.0460-5942.2 605942	AKE 21543 16,5 + WK
			→	SV720103→		13.0460-5927.2 605927	AKE 21875 16,0 + WK
2.8 TD	83	01/95→12/96	←	SV720103→		13.0460-5926.2 605926	AKE 21845 16,5 + WK
			←	03/95→; → SV720102		13.0460-5942.2 605942	AKE 21543 16,5 + WK
			→	SV720103→		13.0460-5927.2 605927	AKE 21875 16,0 + WK
Zubehörsatz, Scheibenbremsbelag							
2.0 i 2.5 TDS	85 85	03/92→10/98 09/96→10/98	←	→ SV720102		13.0460-0337.2 610337	AKE
			←	SV720103→		13.0460-0446.2 610446	AKE
			→	SV720103→		13.0460-0447.2 610447	AKE
2.8 TD	83	01/95→12/96	←	03/95→; → SV720102		13.0460-0337.2 610337	AKE
			←	SV720103→		13.0460-0446.2 610446	AKE
			→	SV720103→		13.0460-0447.2 610447	AKE
 Bremsscheibe							
2.0 i 2.5 TDS	85 85	03/92→10/98 09/96→10/98	←	→ SV720102		24.0122-0156.1 422156	Ø 257 22 20,6 V
			←	SV720103→; + ABS		24.0126-0111.1 426111	Ø 280 26 24,6 V
			←	SV720103→; - ABS		24.0126-0111.1 426111	Ø 280 26 24,6 V
			→	SV720103→		24.0118-0122.1 418122	Ø 313,5 18 16,6 V
2.8 TD	83	01/95→12/96	←	03/95→; → SV720102		24.0122-0156.1 422156	Ø 257 22 20,6 V
			←	SV720103→; + ABS		24.0126-0111.1 426111	Ø 280 26 24,6 V
			←	SV720103→; - ABS		24.0126-0111.1 426111	Ø 280 26 24,6 V
			→	SV720103→		24.0118-0122.1 418122	Ø 313,5 18 16,6 V
VAUXHALL - FRONTERA Mk II (B) 10/98→10/04							
 Bremsbelagsatz, Scheibenbremse							
2.2 DTI 2.2 i 3.2 i	85 100 151	10/98→09/04 10/98→10/04 10/98→10/04	←	→ 02/04; für Fahrzeuge ohne Bordcomputer		13.0460-5926.2 605926	AKE 21845 16,5 + WK
			→	→ 02/04		13.0460-5927.2 605927	AKE 21875 16,0 + WK
Zubehörsatz, Scheibenbremsbelag							
2.2 DTI 2.2 i ↓	85 100	10/98→09/04 10/98→10/04	→	→ 02/04		13.0460-0447.2 610447	AKE









	kw			 	! #		
VAUXHALL - FRONTERA Mk II (B) 10/98→10/04							
Zubehörsatz, Scheibenbremsbelag							
3.2 i	151	10/98→10/04	➡	→ 02/04		13.0460-0447.2 610447	AKE
 Bremsscheibe							
2.2 DTI	85	10/98→09/04	←	→ 02/04		24.0126-0111.1 426111	Ø 280 26 24,6 V
2.2 i	100	10/98→10/04					
3.2 i	151	10/98→10/04	➡	→ 02/04		24.0118-0122.1 418122	Ø 313,5 18 16,6 V
VAUXHALL - INSIGNIA Mk I (A) 07/08→05/17							
 Bremsbelagsatz, Scheibenbremse							
1.4	103	04/11→05/17	←	06/11→; für Bremsscheibendurchmesser [mm]: 337		13.0460-2754.2 602754	TRW 24418 17,0 + WK + Zub
			←	06/11→; für Bremsscheibendurchmesser [mm]: 296		13.0460-5611.2 605611 13.0470-5611.2 LD5611	MAN 24415 19,1 + WK + Zub MAN 24415 19,1 + WK + Zub Ceramic
			←	06/11→; für Bremsscheibendurchmesser [mm]: 321		13.0460-5612.2 605612 13.0470-5612.2 LD5612	MAN 24412 19,0 + WK + Zub MAN 24412 19,0 + WK + Zub Ceramic
			➡	06/11→; für Bremsscheibendurchmesser [mm]: 315		13.0460-2755.2 602755 13.0470-2755.2 LD2755	TRW 24421 17,2 + WK + Zub TRW 24421 17,2 + WK + Zub Ceramic
			➡	06/11→; für Bremsscheibendurchmesser [mm]: 292		13.0460-2758.2 602758 13.0470-2758.2 LD2758	TRW 24421 17,2 + WK + Zub TRW 24421 17,2 + WK + Zub Ceramic
1.4 LPG	103	07/12→05/17	←	für Bremsscheibendurchmesser [mm]: 337		13.0460-2754.2 602754	TRW 24418 17,0 + WK + Zub
1.6	85	07/08→05/17					
1.6 CDTI	100	07/15→05/17	←	für Bremsscheibendurchmesser [mm]: 296		13.0460-5611.2 605611 13.0470-5611.2 LD5611	MAN 24415 19,1 + WK + Zub MAN 24415 19,1 + WK + Zub Ceramic
1.6 Turbo	125	07/13→05/17					
1.6 Turbo	132	01/09→05/17					
1.8	103	07/08→05/17					
2.0 Biturbo CDTI	143	03/12→05/17	←	für Bremsscheibendurchmesser [mm]: 321		13.0460-5612.2 605612 13.0470-5612.2 LD5612	MAN 24412 19,0 + WK + Zub MAN 24412 19,0 + WK + Zub Ceramic
2.0 Biturbo CDTI 4x4	143	03/12→05/17					
2.0 CDTI	81	07/08→05/17					
2.0 CDTI	96	07/08→12/14					
2.0 CDTI	103	07/13→05/17	➡	für Bremsscheibendurchmesser [mm]: 315		13.0460-2755.2 602755 13.0470-2755.2 LD2755	TRW 24421 17,2 + WK + Zub TRW 24421 17,2 + WK + Zub Ceramic
2.0 CDTI	118	07/08→05/17					
2.0 CDTI	120	07/13→05/17					
2.0 CDTI	125	11/14→05/17					
2.0 CDTI	140	10/08→05/17	➡	für Bremsscheibendurchmesser [mm]: 292		13.0460-2758.2 602758 13.0470-2758.2 LD2758	TRW 24421 17,2 + WK + Zub TRW 24421 17,2 + WK + Zub Ceramic
2.0 CDTI 4x4	120	07/13→05/17					
2.0 CDTI 4x4	125	11/14→05/17					
2.0 CDTI 4x4	140	05/09→05/17					
2.0 Turbo	162	07/08→05/17					
2.0 Turbo	184	04/14→05/17					
2.0 Turbo 4x4	162	07/08→05/17					
2.0 Turbo 4x4	184	09/11→05/17					
2.0 CDTI	88	03/12→03/16	←	03/13→; für Bremsscheibendurchmesser [mm]: 337		13.0460-2754.2 602754	TRW 24418 17,0 + WK + Zub
			←	03/13→; für Bremsscheibendurchmesser [mm]: 296		13.0460-5611.2 605611 13.0470-5611.2 LD5611	MAN 24415 19,1 + WK + Zub MAN 24415 19,1 + WK + Zub Ceramic
			←	03/13→; für Bremsscheibendurchmesser [mm]: 321		13.0460-5612.2 605612 13.0470-5612.2 LD5612	MAN 24412 19,0 + WK + Zub MAN 24412 19,0 + WK + Zub Ceramic
			➡	03/13→; für Bremsscheibendurchmesser [mm]: 315		13.0460-2755.2 602755 13.0470-2755.2 LD2755	TRW 24421 17,2 + WK + Zub TRW 24421 17,2 + WK + Zub Ceramic
			➡	03/13→; für Bremsscheibendurchmesser [mm]: 292		13.0460-2758.2 602758 13.0470-2758.2 LD2758	TRW 24421 17,2 + WK + Zub TRW 24421 17,2 + WK + Zub Ceramic
2.0 CDTI 4x4	118	07/08→05/17	←	06/10→; für Bremsscheibendurchmesser [mm]: 337		13.0460-2754.2 602754	TRW 24418 17,0 + WK + Zub
			←	06/10→; für Bremsscheibendurchmesser [mm]: 296		13.0460-5611.2 605611 13.0470-5611.2 LD5611	MAN 24415 19,1 + WK + Zub MAN 24415 19,1 + WK + Zub Ceramic
			←	06/10→; für Bremsscheibendurchmesser [mm]: 321		13.0460-5612.2 605612 13.0470-5612.2 LD5612	MAN 24412 19,0 + WK + Zub MAN 24412 19,0 + WK + Zub Ceramic
			➡	06/10→; für Bremsscheibendurchmesser [mm]: 315		13.0460-2755.2 602755 13.0470-2755.2 LD2755	TRW 24421 17,2 + WK + Zub TRW 24421 17,2 + WK + Zub Ceramic





















	kw			 	! #		
VAUXHALL - INSIGNIA Mk I (A) 07/08→05/17							
 Bremsbelagsatz, Scheibenbremse							
2.0 CDTI 4x4	118	07/08→05/17	➡	06/10→; für Bremsscheidendurchmesser [mm]: 292		13.0460-2758.2 602758 13.0470-2758.2 LD2758	TRW 24421 17,2 + WK + Zub TRW 24421 17,2 + WK + Zub Ceramic
2.8 V6 Turbo 4x4	191	07/08→05/17	⬅	für Bremsscheidendurchmesser [mm]: 337		13.0460-2754.2 602754	TRW 24418 17,0 + WK + Zub
			➡			13.0460-2755.2 602755	TRW 24421 17,2 + WK + Zub
2.8 VXR	239	07/09→05/17	⬅			13.0460-4855.2 604855	BRE 23325 16,4 + WK
			➡			13.0460-2755.2 602755	TRW 24421 17,2 + WK + Zub
 Bremsscheibe							
1.4	103	04/11→05/17	⬅	06/11→		24.0130-0207.1 430207 24.0130-0208.1 430208 24.0130-0209.1 430209 24.0330-0207.1 530207 24.0330-0209.1 530209	Ø 296 30 27 V + S Ø 337 30 27 V + S Ø 321 30 27 V + S Ø 296 30 27 V + S PD Ø 321 30 27 V + S PD
			➡	06/11→		24.0112-0187.1 412187 24.0123-0114.1 423114 24.0312-0187.1 512187 24.0323-0114.1 523114	Ø 292 12 10,5 + S Ø 315 22,9 21,5 V + S Ø 292 12 10,5 + S PD Ø 315 22,9 21,5 V + S PD
1.4 LPG	103	07/12→05/17	⬅			24.0130-0207.1 430207	Ø 296 30 27 V + S
1.6	85	07/08→05/17				24.0130-0208.1 430208	Ø 337 30 27 V + S
1.6 CDTI	100	07/15→05/17				24.0130-0209.1 430209	Ø 321 30 27 V + S
1.6 Turbo	125	07/13→05/17				24.0330-0207.1 530207	Ø 296 30 27 V + S PD
1.6 Turbo	132	01/09→05/17				24.0330-0209.1 530209	Ø 321 30 27 V + S PD
1.8	103	07/08→05/17					
2.0 Biturbo CDTI	143	03/12→05/17				24.0112-0187.1 412187	Ø 292 12 10,5 + S
2.0 Biturbo CDTI 4x4	143	03/12→05/17	➡			24.0123-0114.1 423114	Ø 315 22,9 21,5 V + S
2.0 CDTI	81	07/08→05/17				24.0312-0187.1 512187	Ø 292 12 10,5 + S PD
2.0 CDTI	96	07/08→12/14				24.0323-0114.1 523114	Ø 315 22,9 21,5 V + S PD
2.0 CDTI	103	07/13→05/17					
2.0 CDTI	118	07/08→05/17					
2.0 CDTI	120	07/13→05/17					
2.0 CDTI	125	11/14→05/17					
2.0 CDTI	140	10/08→05/17					
2.0 CDTI 4x4	120	07/13→05/17					
2.0 CDTI 4x4	125	11/14→05/17					
2.0 CDTI 4x4	140	05/09→05/17					
2.0 Turbo	162	07/08→05/17					
2.0 Turbo	184	04/14→05/17					
2.0 Turbo 4x4	162	07/08→05/17					
2.0 Turbo 4x4	184	09/11→05/17					
2.0 CDTI	88	03/12→03/16	⬅	03/13→		24.0130-0207.1 430207 24.0130-0208.1 430208 24.0130-0209.1 430209 24.0330-0207.1 530207 24.0330-0209.1 530209	Ø 296 30 27 V + S Ø 337 30 27 V + S Ø 321 30 27 V + S Ø 296 30 27 V + S PD Ø 321 30 27 V + S PD
			➡	03/13→		24.0112-0187.1 412187 24.0123-0114.1 423114 24.0312-0187.1 512187 24.0323-0114.1 523114	Ø 292 12 10,5 + S Ø 315 22,9 21,5 V + S Ø 292 12 10,5 + S PD Ø 315 22,9 21,5 V + S PD
2.0 CDTI 4x4	118	07/08→05/17	⬅	06/10→		24.0130-0207.1 430207 24.0130-0208.1 430208 24.0130-0209.1 430209 24.0330-0207.1 530207 24.0330-0209.1 530209	Ø 296 30 27 V + S Ø 337 30 27 V + S Ø 321 30 27 V + S Ø 296 30 27 V + S PD Ø 321 30 27 V + S PD
			➡	06/10→		24.0112-0187.1 412187 24.0123-0114.1 423114 24.0312-0187.1 512187 24.0323-0114.1 523114	Ø 292 12 10,5 + S Ø 315 22,9 21,5 V + S Ø 292 12 10,5 + S PD Ø 315 22,9 21,5 V + S PD
2.8 V6 Turbo 4x4	191	07/08→05/17	⬅			24.0130-0208.1 430208	Ø 337 30 27 V + S
			➡			24.0123-0114.1 423114 24.0323-0114.1 523114	Ø 315 22,9 21,5 V + S Ø 315 22,9 21,5 V + S PD
2.8 VXR	239	07/09→05/17	➡			24.0123-0114.1 423114 24.0323-0114.1 523114	Ø 315 22,9 21,5 V + S Ø 315 22,9 21,5 V + S PD









	kW			 	! #		
VAUXHALL - INSIGNIA Mk I (A) Estate 07/08→05/17							
 Bremsbelagsatz, Scheibenbremse							
1.4	103	04/11→05/17	←	06/11→; für Bremsscheibendurchmesser [mm]: 337		13.0460-2754.2 602754	TRW 24418 17,0 + WK + Zub
			←	06/11→; für Bremsscheibendurchmesser [mm]: 296		13.0460-5611.2 605611 13.0470-5611.2 LD5611	MAN 24415 19,1 + WK + Zub MAN 24415 19,1 + WK + Zub Ceramic
			←	06/11→; für Bremsscheibendurchmesser [mm]: 321		13.0460-5612.2 605612 13.0470-5612.2 LD5612	MAN 24412 19,0 + WK + Zub MAN 24412 19,0 + WK + Zub Ceramic
			→	06/11→; für Bremsscheibendurchmesser [mm]: 315		13.0460-2755.2 602755 13.0470-2755.2 LD2755	TRW 24421 17,2 + WK + Zub TRW 24421 17,2 + WK + Zub Ceramic
			→	06/11→; für Bremsscheibendurchmesser [mm]: 292		13.0460-2758.2 602758 13.0470-2758.2 LD2758	TRW 24421 17,2 + WK + Zub TRW 24421 17,2 + WK + Zub Ceramic
1.4 LPG	103	07/12→05/17	←	für Bremsscheibendurchmesser [mm]: 337		13.0460-2754.2 602754	TRW 24418 17,0 + WK + Zub
1.6	85	07/08→05/17					
1.6 CDTI	100	07/15→05/17	←	für Bremsscheibendurchmesser [mm]: 296		13.0460-5611.2 605611 13.0470-5611.2 LD5611	MAN 24415 19,1 + WK + Zub MAN 24415 19,1 + WK + Zub Ceramic
1.6 Turbo	125	07/13→05/17					
1.6 Turbo	132	01/09→05/17					
1.8	103	07/08→05/17					
2.0 Biturbo CDTI	143	03/12→05/17	←	für Bremsscheibendurchmesser [mm]: 321		13.0460-5612.2 605612 13.0470-5612.2 LD5612	MAN 24412 19,0 + WK + Zub MAN 24412 19,0 + WK + Zub Ceramic
2.0 Biturbo CDTI 4x4	143	03/12→05/17					
2.0 CDTI	81	07/08→05/17					
2.0 CDTI	96	07/08→12/14					
2.0 CDTI	103	07/13→05/17	→	für Bremsscheibendurchmesser [mm]: 315		13.0460-2755.2 602755 13.0470-2755.2 LD2755	TRW 24421 17,2 + WK + Zub TRW 24421 17,2 + WK + Zub Ceramic
2.0 CDTI	118	07/08→05/17					
2.0 CDTI	120	07/13→05/17					
2.0 CDTI	125	11/14→05/17	→	für Bremsscheibendurchmesser [mm]: 292		13.0460-2758.2 602758 13.0470-2758.2 LD2758	TRW 24421 17,2 + WK + Zub TRW 24421 17,2 + WK + Zub Ceramic
2.0 CDTI	140	11/08→05/17					
2.0 CDTI 4x4	120	07/13→05/17					
2.0 CDTI 4x4	125	11/14→05/17					
2.0 CDTI 4x4	140	05/09→05/17					
2.0 Turbo	162	07/08→05/17					
2.0 Turbo	184	04/14→05/17					
2.0 Turbo 4x4	162	07/08→05/17					
2.0 Turbo 4x4	184	09/11→05/17					
2.0 CDTI	88	03/12→03/16	←	03/13→; für Bremsscheibendurchmesser [mm]: 337		13.0460-2754.2 602754	TRW 24418 17,0 + WK + Zub
			←	03/13→; für Bremsscheibendurchmesser [mm]: 296		13.0460-5611.2 605611 13.0470-5611.2 LD5611	MAN 24415 19,1 + WK + Zub MAN 24415 19,1 + WK + Zub Ceramic
			←	03/13→; für Bremsscheibendurchmesser [mm]: 321		13.0460-5612.2 605612 13.0470-5612.2 LD5612	MAN 24412 19,0 + WK + Zub MAN 24412 19,0 + WK + Zub Ceramic
			→	03/13→; für Bremsscheibendurchmesser [mm]: 315		13.0460-2755.2 602755 13.0470-2755.2 LD2755	TRW 24421 17,2 + WK + Zub TRW 24421 17,2 + WK + Zub Ceramic
			→	03/13→; für Bremsscheibendurchmesser [mm]: 292		13.0460-2758.2 602758 13.0470-2758.2 LD2758	TRW 24421 17,2 + WK + Zub TRW 24421 17,2 + WK + Zub Ceramic
2.0 CDTI 4x4	118	07/08→05/17	←	06/10→; für Bremsscheibendurchmesser [mm]: 337		13.0460-2754.2 602754	TRW 24418 17,0 + WK + Zub
			←	06/10→; für Bremsscheibendurchmesser [mm]: 296		13.0460-5611.2 605611 13.0470-5611.2 LD5611	MAN 24415 19,1 + WK + Zub MAN 24415 19,1 + WK + Zub Ceramic
			←	06/10→; für Bremsscheibendurchmesser [mm]: 321		13.0460-5612.2 605612 13.0470-5612.2 LD5612	MAN 24412 19,0 + WK + Zub MAN 24412 19,0 + WK + Zub Ceramic
			→	06/10→; für Bremsscheibendurchmesser [mm]: 315		13.0460-2755.2 602755 13.0470-2755.2 LD2755	TRW 24421 17,2 + WK + Zub TRW 24421 17,2 + WK + Zub Ceramic
			→	06/10→; für Bremsscheibendurchmesser [mm]: 292		13.0460-2758.2 602758 13.0470-2758.2 LD2758	TRW 24421 17,2 + WK + Zub TRW 24421 17,2 + WK + Zub Ceramic
2.8 V6 Turbo	191	08/08→05/17	←	für Bremsscheibendurchmesser [mm]: 337		13.0460-2754.2 602754	TRW 24418 17,0 + WK + Zub
			→			13.0460-2755.2 602755 13.0470-2755.2 LD2755	TRW 24421 17,2 + WK + Zub TRW 24421 17,2 + WK + Zub Ceramic
2.8 VXR	239	07/09→05/17	←			13.0460-4855.2 604855	BRE 23325 16,4 + WK















	kw			 	! #		
VAUXHALL - INSIGNIA Mk I (A) Estate 07/08→05/17							
 Bremsbelagsatz, Scheibenbremse							
2.8 VXR	239	07/09→05/17	➔			13.0460-2755.2 602755 13.0470-2755.2 LD2755	TRW 24421 17,2 + WK + Zub TRW 24421 17,2 + WK + Zub Ceramic
 Bremsscheibe							
1.4	103	04/11→05/17	←	06/11→		24.0130-0207.1 430207 24.0130-0208.1 430208 24.0130-0209.1 430209 24.0330-0207.1 530207 24.0330-0209.1 530209	Ø 296 30 27 V + S Ø 337 30 27 V + S Ø 321 30 27 V + S Ø 296 30 27 V + S PD Ø 321 30 27 V + S PD
			➔	06/11→		24.0112-0187.1 412187 24.0123-0114.1 423114 24.0312-0187.1 512187 24.0323-0114.1 523114	Ø 292 12 10,5 + S Ø 315 22,9 21,5 V + S Ø 292 12 10,5 + S PD Ø 315 22,9 21,5 V + S PD
1.4 LPG	103	07/12→05/17	←			24.0130-0207.1 430207	Ø 296 30 27 V + S
1.6	85	07/08→05/17				24.0130-0208.1 430208	Ø 337 30 27 V + S
1.6 CDTI	100	07/15→05/17				24.0130-0209.1 430209	Ø 321 30 27 V + S
1.6 Turbo	125	07/13→05/17				24.0330-0207.1 530207	Ø 296 30 27 V + S PD
1.6 Turbo	132	01/09→05/17				24.0330-0209.1 530209	Ø 321 30 27 V + S PD
1.8	103	07/08→05/17					
2.0 Biturbo CDTI	143	03/12→05/17	➔			24.0112-0187.1 412187	Ø 292 12 10,5 + S
2.0 Biturbo CDTI 4x4	143	03/12→05/17				24.0123-0114.1 423114	Ø 315 22,9 21,5 V + S
2.0 CDTI	81	07/08→05/17				24.0312-0187.1 512187	Ø 292 12 10,5 + S PD
2.0 CDTI	96	07/08→12/14				24.0323-0114.1 523114	Ø 315 22,9 21,5 V + S PD
2.0 CDTI	103	07/13→05/17					
2.0 CDTI	118	07/08→05/17					
2.0 CDTI	120	07/13→05/17					
2.0 CDTI	125	11/14→05/17					
2.0 CDTI	140	11/08→05/17					
2.0 CDTI 4x4	120	07/13→05/17					
2.0 CDTI 4x4	125	11/14→05/17					
2.0 CDTI 4x4	140	05/09→05/17					
2.0 Turbo	162	07/08→05/17					
2.0 Turbo	184	04/14→05/17					
2.0 Turbo 4x4	162	07/08→05/17					
2.0 Turbo 4x4	184	09/11→05/17					
2.0 CDTI	88	03/12→03/16	←	03/13→		24.0130-0207.1 430207 24.0130-0208.1 430208 24.0130-0209.1 430209 24.0330-0207.1 530207 24.0330-0209.1 530209	Ø 296 30 27 V + S Ø 337 30 27 V + S Ø 321 30 27 V + S Ø 296 30 27 V + S PD Ø 321 30 27 V + S PD
			➔	03/13→		24.0112-0187.1 412187 24.0123-0114.1 423114 24.0312-0187.1 512187 24.0323-0114.1 523114	Ø 292 12 10,5 + S Ø 315 22,9 21,5 V + S Ø 292 12 10,5 + S PD Ø 315 22,9 21,5 V + S PD
2.0 CDTI 4x4	118	07/08→05/17	←	06/10→		24.0130-0207.1 430207 24.0130-0208.1 430208 24.0130-0209.1 430209 24.0330-0207.1 530207 24.0330-0209.1 530209	Ø 296 30 27 V + S Ø 337 30 27 V + S Ø 321 30 27 V + S Ø 296 30 27 V + S PD Ø 321 30 27 V + S PD
			➔	06/10→		24.0112-0187.1 412187 24.0123-0114.1 423114 24.0312-0187.1 512187 24.0323-0114.1 523114	Ø 292 12 10,5 + S Ø 315 22,9 21,5 V + S Ø 292 12 10,5 + S PD Ø 315 22,9 21,5 V + S PD
2.8 V6 Turbo	191	08/08→05/17	←			24.0130-0208.1 430208	Ø 337 30 27 V + S
			➔			24.0123-0114.1 423114 24.0323-0114.1 523114	Ø 315 22,9 21,5 V + S Ø 315 22,9 21,5 V + S PD
2.8 VXR	239	07/09→05/17	➔			24.0123-0114.1 423114 24.0323-0114.1 523114	Ø 315 22,9 21,5 V + S Ø 315 22,9 21,5 V + S PD
VAUXHALL - INSIGNIA Mk I (A) Sedan 07/08→05/17							
 Bremsbelagsatz, Scheibenbremse							
1.4	103	04/11→05/17	←	06/11→; für Bremsscheibendurchmesser [mm]: 337		13.0460-2754.2 602754	TRW 24418 17,0 + WK + Zub
			←	06/11→; für Bremsscheibendurchmesser [mm]: 296		13.0460-5611.2 605611 13.0470-5611.2 LD5611	MAN 24415 19,1 + WK + Zub MAN 24415 19,1 + WK + Zub Ceramic
↓							

	kw			 	! #		
VAUXHALL - INSIGNIA Mk I (A) Sedan 07/08→05/17							
 Bremsbelagsatz, Scheibenbremse							
1.4	103	04/11→05/17	←	06/11→; für Bremsscheibendurchmesser [mm]: 321	13.0460-5612.2	605612	MAN 24412 19,0 + WK + Zub Ceramic
			→	06/11→; für Bremsscheibendurchmesser [mm]: 315	13.0460-2755.2	602755	TRW 24421 17,2 + WK + Zub Ceramic
			→	06/11→; für Bremsscheibendurchmesser [mm]: 292	13.0460-2758.2	602758	TRW 24421 17,2 + WK + Zub Ceramic
1.4 LPG 1.6 1.6 Turbo 1.6 Turbo 1.8 2.0 Biturbo CDTI 2.0 Biturbo CDTI 4x4 2.0 CDTI 2.0 CDTI 2.0 CDTI 2.0 CDTI 2.0 CDTI 2.0 CDTI 2.0 CDTI 4x4 2.0 CDTI 4x4 2.0 CDTI 4x4 2.0 Turbo 2.0 Turbo 4x4 2.0 Turbo 4x4	103 85 125 132 103 143 143 81 96 103 118 120 125 140 120 125 140 162 162 184	07/12→05/17 07/08→05/17 07/13→05/17 01/09→05/17 07/08→05/17 03/12→05/17 03/12→05/17 07/08→05/17 07/13→05/17 07/08→05/17 07/13→05/17 11/14→05/17 11/08→05/17 07/13→05/17 11/14→05/17 05/09→05/17 07/08→05/17 07/08→05/17 09/11→05/17	←	für Bremsscheibendurchmesser [mm]: 337	13.0460-2754.2	602754	TRW 24418 17,0 + WK + Zub
			←	für Bremsscheibendurchmesser [mm]: 296	13.0460-5611.2	605611	MAN 24415 19,1 + WK + Zub Ceramic
			←	für Bremsscheibendurchmesser [mm]: 321	13.0460-5612.2	605612	MAN 24412 19,0 + WK + Zub Ceramic
			→	für Bremsscheibendurchmesser [mm]: 315	13.0460-2755.2	602755	TRW 24421 17,2 + WK + Zub Ceramic
			→	für Bremsscheibendurchmesser [mm]: 292	13.0460-2758.2	602758	TRW 24421 17,2 + WK + Zub Ceramic
			→	für Bremsscheibendurchmesser [mm]: 292	13.0460-2758.2	602758	TRW 24421 17,2 + WK + Zub Ceramic
			→	für Bremsscheibendurchmesser [mm]: 321	13.0460-5612.2	605612	MAN 24412 19,0 + WK + Zub Ceramic
			→	für Bremsscheibendurchmesser [mm]: 315	13.0460-2755.2	602755	TRW 24421 17,2 + WK + Zub Ceramic
			→	für Bremsscheibendurchmesser [mm]: 292	13.0460-2758.2	602758	TRW 24421 17,2 + WK + Zub Ceramic
			→	für Bremsscheibendurchmesser [mm]: 296	13.0460-5611.2	605611	MAN 24415 19,1 + WK + Zub Ceramic
			→	für Bremsscheibendurchmesser [mm]: 321	13.0460-5612.2	605612	MAN 24412 19,0 + WK + Zub Ceramic
			→	für Bremsscheibendurchmesser [mm]: 315	13.0460-2755.2	602755	TRW 24421 17,2 + WK + Zub Ceramic
			→	für Bremsscheibendurchmesser [mm]: 292	13.0460-2758.2	602758	TRW 24421 17,2 + WK + Zub Ceramic
			2.0 CDTI	88	03/12→12/14	←	03/13→; für Bremsscheibendurchmesser [mm]: 337
			←	03/13→; für Bremsscheibendurchmesser [mm]: 296	13.0460-5611.2	605611	MAN 24415 19,1 + WK + Zub Ceramic
			←	03/13→; für Bremsscheibendurchmesser [mm]: 321	13.0460-5612.2	605612	MAN 24412 19,0 + WK + Zub Ceramic
			→	03/13→; für Bremsscheibendurchmesser [mm]: 315	13.0460-2755.2	602755	TRW 24421 17,2 + WK + Zub Ceramic
			→	03/13→; für Bremsscheibendurchmesser [mm]: 292	13.0460-2758.2	602758	TRW 24421 17,2 + WK + Zub Ceramic
2.0 CDTI 4x4	118	07/08→05/17	←	06/10→; für Bremsscheibendurchmesser [mm]: 337	13.0460-2754.2	602754	TRW 24418 17,0 + WK + Zub
			←	06/10→; für Bremsscheibendurchmesser [mm]: 296	13.0460-5611.2	605611	MAN 24415 19,1 + WK + Zub Ceramic
			←	06/10→; für Bremsscheibendurchmesser [mm]: 321	13.0460-5612.2	605612	MAN 24412 19,0 + WK + Zub Ceramic
			→	06/10→; für Bremsscheibendurchmesser [mm]: 315	13.0460-2755.2	602755	TRW 24421 17,2 + WK + Zub Ceramic
			→	06/10→; für Bremsscheibendurchmesser [mm]: 292	13.0460-2758.2	602758	TRW 24421 17,2 + WK + Zub Ceramic
2.0 Turbo	184	09/11→05/17	←	04/14→; für Bremsscheibendurchmesser [mm]: 337	13.0460-2754.2	602754	TRW 24418 17,0 + WK + Zub
			←	04/14→; für Bremsscheibendurchmesser [mm]: 296	13.0460-5611.2	605611	MAN 24415 19,1 + WK + Zub Ceramic
			←	04/14→; für Bremsscheibendurchmesser [mm]: 321	13.0460-5612.2	605612	MAN 24412 19,0 + WK + Zub Ceramic
			→	04/14→; für Bremsscheibendurchmesser [mm]: 315	13.0460-2755.2	602755	TRW 24421 17,2 + WK + Zub Ceramic







	kw				! #		
VAUXHALL - INSIGNIA Mk I (A) Sedan 07/08→05/17							
 Bremsbelagsatz, Scheibenbremse							
2.0 Turbo	184	09/11→05/17	➔	04/14→; für Bremsscheibendurchmesser [mm]: 292		13.0460-2758.2 602758 13.0470-2758.2 LD2758	TRW 24421 17,2 + WK + Zub TRW 24421 17,2 + WK + Zub Ceramic
2.8 V6 Turbo 4x4	191	07/08→05/17	➔	für Bremsscheibendurchmesser [mm]: 337		13.0460-2754.2 602754	TRW 24418 17,0 + WK + Zub
			➔			13.0460-2755.2 602755	TRW 24421 17,2 + WK + Zub
2.8 VXR	239	07/09→05/17	➔			13.0460-4855.2 604855	BRE 23325 16,4 + WK
			➔			13.0460-2755.2 602755	TRW 24421 17,2 + WK + Zub
 Bremsscheibe							
1.4	103	04/11→05/17	➔	06/11→		24.0130-0207.1 430207 24.0130-0208.1 430208 24.0130-0209.1 430209 24.0330-0207.1 530207 24.0330-0209.1 530209	Ø 296 30 27 V + S Ø 337 30 27 V + S Ø 321 30 27 V + S Ø 296 30 27 V + S PD Ø 321 30 27 V + S PD
			➔	06/11→		24.0112-0187.1 412187 24.0123-0114.1 423114 24.0312-0187.1 512187 24.0323-0114.1 523114	Ø 292 12 10,5 + S Ø 315 22,9 21,5 V + S Ø 292 12 10,5 + S PD Ø 315 22,9 21,5 V + S PD
1.4 LPG	103	07/12→05/17	➔			24.0130-0207.1 430207	Ø 296 30 27 V + S
1.6	85	07/08→05/17	➔			24.0130-0208.1 430208	Ø 337 30 27 V + S
1.6 Turbo	125	07/13→05/17	➔			24.0130-0209.1 430209	Ø 321 30 27 V + S
1.6 Turbo	132	01/09→05/17	➔			24.0130-0209.1 430209	Ø 321 30 27 V + S
1.8	103	07/08→05/17	➔			24.0330-0207.1 530207	Ø 296 30 27 V + S PD
2.0 Biturbo CDTI	143	03/12→05/17	➔			24.0330-0209.1 530209	Ø 321 30 27 V + S PD
2.0 Biturbo CDTI 4x4	143	03/12→05/17	➔			24.0330-0209.1 530209	Ø 321 30 27 V + S PD
2.0 CDTI	81	07/08→05/17	➔			24.0112-0187.1 412187	Ø 292 12 10,5 + S
2.0 CDTI	96	07/08→12/14	➔			24.0123-0114.1 423114	Ø 315 22,9 21,5 V + S
2.0 CDTI	103	07/13→05/17	➔			24.0312-0187.1 512187	Ø 292 12 10,5 + S PD
2.0 CDTI	118	07/08→05/17	➔			24.0312-0187.1 512187	Ø 292 12 10,5 + S PD
2.0 CDTI	120	07/13→05/17	➔			24.0323-0114.1 523114	Ø 315 22,9 21,5 V + S PD
2.0 CDTI	125	11/14→05/17	➔				
2.0 CDTI	140	11/08→05/17	➔				
2.0 CDTI 4x4	120	07/13→05/17	➔				
2.0 CDTI 4x4	125	11/14→05/17	➔				
2.0 CDTI 4x4	140	05/09→05/17	➔				
2.0 Turbo	162	07/08→05/17	➔				
2.0 Turbo 4x4	162	07/08→05/17	➔				
2.0 Turbo 4x4	184	09/11→05/17	➔				
2.0 CDTI	88	03/12→12/14	➔	03/13→		24.0130-0207.1 430207 24.0130-0208.1 430208 24.0130-0209.1 430209 24.0330-0207.1 530207 24.0330-0209.1 530209	Ø 296 30 27 V + S Ø 337 30 27 V + S Ø 321 30 27 V + S Ø 296 30 27 V + S PD Ø 321 30 27 V + S PD
			➔	03/13→		24.0112-0187.1 412187 24.0123-0114.1 423114 24.0312-0187.1 512187 24.0323-0114.1 523114	Ø 292 12 10,5 + S Ø 315 22,9 21,5 V + S Ø 292 12 10,5 + S PD Ø 315 22,9 21,5 V + S PD
2.0 CDTI 4x4	118	07/08→05/17	➔	06/10→		24.0130-0207.1 430207 24.0130-0208.1 430208 24.0130-0209.1 430209 24.0330-0207.1 530207 24.0330-0209.1 530209	Ø 296 30 27 V + S Ø 337 30 27 V + S Ø 321 30 27 V + S Ø 296 30 27 V + S PD Ø 321 30 27 V + S PD
			➔	06/10→		24.0112-0187.1 412187 24.0123-0114.1 423114 24.0312-0187.1 512187 24.0323-0114.1 523114	Ø 292 12 10,5 + S Ø 315 22,9 21,5 V + S Ø 292 12 10,5 + S PD Ø 315 22,9 21,5 V + S PD
2.0 Turbo	184	09/11→05/17	➔	04/14→		24.0130-0207.1 430207 24.0130-0208.1 430208 24.0130-0209.1 430209 24.0330-0207.1 530207 24.0330-0209.1 530209	Ø 296 30 27 V + S Ø 337 30 27 V + S Ø 321 30 27 V + S Ø 296 30 27 V + S PD Ø 321 30 27 V + S PD
			➔	04/14→		24.0112-0187.1 412187 24.0123-0114.1 423114 24.0312-0187.1 512187 24.0323-0114.1 523114	Ø 292 12 10,5 + S Ø 315 22,9 21,5 V + S Ø 292 12 10,5 + S PD Ø 315 22,9 21,5 V + S PD
2.8 V6 Turbo 4x4	191	07/08→05/17	➔			24.0130-0208.1 430208	Ø 337 30 27 V + S
↓							









	kw			 	! #		
VAUXHALL - INSIGNIA Mk I (A) Sedan 07/08→05/17							
 Bremsscheibe							
2.8 V6 Turbo 4x4	191	07/08→05/17	➔			24.0123-0114.1 423114 24.0323-0114.1 523114	Ø 315 22,9 21,5 V + S Ø 315 22,9 21,5 V + S PD
2.8 VXR	239	07/09→05/17	➔			24.0123-0114.1 423114 24.0323-0114.1 523114	Ø 315 22,9 21,5 V + S Ø 315 22,9 21,5 V + S PD
VAUXHALL - MERIVA Mk I (A) 01/03→06/10							
 Bremsbelagsatz, Scheibenbremse							
1.3 CDTI 1.6 Turbo 1.7 CDTI 1.7 DTI 1.8 i 16V	51 132 74 55 92	04/05→06/10 05/06→06/10 09/03→06/10 06/03→06/10 05/03→06/10	← ➔ ➔	→ 05/10 → 05/10		13.0460-7179.2 607179 13.0470-7179.2 LD7179 13.0460-2868.2 602868 13.0470-2868.2 LD2868	ATE 23832 20,2 - WK / + WK ATE 23832 20,2 - WK / + WK Ceramic TRW 23417 15,3 + WK + Zub TRW 23417 15,3 + WK + Zub Ceramic
1.3 CDTI	55	01/03→10/09	← ➔ ➔	09/03→ 09/03→		13.0460-7179.2 607179 13.0470-7179.2 LD7179 13.0460-2868.2 602868 13.0470-2868.2 LD2868	ATE 23832 20,2 - WK / + WK ATE 23832 20,2 - WK / + WK Ceramic TRW 23417 15,3 + WK + Zub TRW 23417 15,3 + WK + Zub Ceramic
1.4 16V Twinport	66	01/03→06/10	← ➔ ← ➔ ➔	07/04→ 05/10; Felge Lochzahl: 4 07/04→ 05/10; Felge Lochzahl: 5 07/04→ 05/10		13.0460-2857.2 602857 13.0470-2857.2 LD2857 13.0460-7179.2 607179 13.0470-7179.2 LD7179 13.0460-2868.2 602868 13.0470-2868.2 LD2868	TRW 23225 17,0 + WK + Zub TRW 23225 17,0 + WK + Zub Ceramic ATE 23832 20,2 - WK / + WK ATE 23832 20,2 - WK / + WK Ceramic TRW 23417 15,3 + WK + Zub TRW 23417 15,3 + WK + Zub Ceramic
1.6 i	64	01/03→06/10	← ➔ ➔	05/03→ 05/10 05/03→ 05/10		13.0460-2857.2 602857 13.0470-2857.2 LD2857 13.0460-2868.2 602868 13.0470-2868.2 LD2868	TRW 23225 17,0 + WK + Zub TRW 23225 17,0 + WK + Zub Ceramic TRW 23417 15,3 + WK + Zub TRW 23417 15,3 + WK + Zub Ceramic
1.6 i 16V	74	01/03→09/05	← ➔ ➔	05/03→ 05/03→		13.0460-7179.2 607179 13.0470-7179.2 LD7179 13.0460-2868.2 602868 13.0470-2868.2 LD2868	ATE 23832 20,2 - WK / + WK ATE 23832 20,2 - WK / + WK Ceramic TRW 23417 15,3 + WK + Zub TRW 23417 15,3 + WK + Zub Ceramic
1.6 i 16V Twinport	77	05/03→06/10	← ➔ ➔	01/06→ 05/10 01/06→ 05/10		13.0460-7179.2 607179 13.0470-7179.2 LD7179 13.0460-2868.2 602868 13.0470-2868.2 LD2868	ATE 23832 20,2 - WK / + WK ATE 23832 20,2 - WK / + WK Ceramic TRW 23417 15,3 + WK + Zub TRW 23417 15,3 + WK + Zub Ceramic
1.7 CDTI	92	08/06→05/10	← ➔ ➔	09/06→ 09/06→		13.0460-7179.2 607179 13.0470-7179.2 LD7179 13.0460-2868.2 602868 13.0470-2868.2 LD2868	ATE 23832 20,2 - WK / + WK ATE 23832 20,2 - WK / + WK Ceramic TRW 23417 15,3 + WK + Zub TRW 23417 15,3 + WK + Zub Ceramic
 Bremsscheibe							
1.3 CDTI 1.7 DTI 1.8 i 16V	51 55 92	04/05→06/10 06/03→06/10 05/03→06/10	← ➔ ← ➔ ➔ ➔	→ 05/10; Felge Lochzahl: 5 → 05/10; Felge Lochzahl: 4 → 05/10; Felge Lochzahl: 5 → 05/10; Felge Lochzahl: 4		24.0125-0131.1 425131 24.0325-0131.1 525131 24.0125-0148.1 425148 24.0325-0148.1 525148 24.0110-0250.1 410250 24.0310-0250.1 510250 24.0110-0291.1 410291 24.0310-0291.1 510291	Ø 280 24,8 22 V + S Ø 280 24,8 22 V + S PD Ø 280 25 22 V + S Ø 280 25 22 V + S PD Ø 264 9,8 8 + S Ø 264 9,8 8 + S PD Ø 264 10 8 + S Ø 264 10 8 + S PD
1.3 CDTI	55	01/03→10/09	← ➔ ← ➔	09/03→; Felge Lochzahl: 5 09/03→; Felge Lochzahl: 4		24.0125-0131.1 425131 24.0325-0131.1 525131 24.0125-0148.1 425148	Ø 280 24,8 22 V + S Ø 280 24,8 22 V + S PD Ø 280 25 22 V + S
↓							

	kw			 	! #		
VAUXHALL - MERIVA Mk I (A) 01/03→06/10							
 Bremsscheibe							
1.3 CDTI	55	01/03→10/09	←	09/03→; Felge Lochzahl: 4	24.0325-0148.1	525148	Ø 280 25 22 V + S PD
			→	09/03→; Felge Lochzahl: 5	24.0110-0250.1	410250	Ø 264 9,8 8 + S
					24.0310-0250.1	510250	Ø 264 9,8 8 + S PD
			→	09/03→; Felge Lochzahl: 4	24.0110-0291.1	410291	Ø 264 10 8 + S
1.4 16V Twinport	66	01/03→06/10	←	07/04→ 05/10; Felge Lochzahl: 4	24.0124-0166.1	424166	Ø 260 24 21 V + S
					24.0324-0166.1	524166	Ø 260 24 21 V PD
			←	07/04→ 05/10; Felge Lochzahl: 5	24.0125-0131.1	425131	Ø 280 24,8 22 V + S
			→	07/04→ 05/10; Felge Lochzahl: 5	24.0110-0250.1	410250	Ø 264 9,8 8 + S
1.6 i	64	01/03→06/10	←	05/03→ 05/10; Felge Lochzahl: 4	24.0124-0166.1	424166	Ø 260 24 21 V + S
					24.0324-0166.1	524166	Ø 260 24 21 V PD
			←	05/03→ 05/10; Felge Lochzahl: 5	24.0125-0131.1	425131	Ø 280 24,8 22 V + S
			→	05/03→ 05/10; Felge Lochzahl: 5	24.0110-0250.1	410250	Ø 264 9,8 8 + S
1.6 i 16V	74	01/03→09/05	←	05/03→; Felge Lochzahl: 5	24.0125-0131.1	425131	Ø 280 24,8 22 V + S
					24.0325-0131.1	525131	Ø 280 24,8 22 V + S PD
			←	05/03→; Felge Lochzahl: 4	24.0125-0148.1	425148	Ø 280 25 22 V + S
			→	05/03→; Felge Lochzahl: 5	24.0110-0250.1	410250	Ø 264 9,8 8 + S
1.6 i 16V Twinport	77	05/03→06/10	←	01/06→ 05/10; Felge Lochzahl: 5	24.0125-0131.1	425131	Ø 280 24,8 22 V + S
					24.0325-0131.1	525131	Ø 280 24,8 22 V + S PD
			←	01/06→ 05/10; Felge Lochzahl: 4	24.0125-0148.1	425148	Ø 280 25 22 V + S
			→	01/06→ 05/10; Felge Lochzahl: 5	24.0110-0250.1	410250	Ø 264 9,8 8 + S
1.6 Turbo	132	05/06→06/10	←	→ 05/10	24.0125-0142.1	425142	Ø 308 25 22 V + S
					24.0325-0142.1	525142	Ø 308 25 23 V + S PD
			→	→ 05/10; Felge Lochzahl: 5	24.0110-0250.1	410250	Ø 264 9,8 8 + S
					24.0310-0250.1	510250	Ø 264 9,8 8 + S PD
1.7 CDTI	74	09/03→06/10	←	→ 05/10; Felge Lochzahl: 5	24.0125-0131.1	425131	Ø 280 24,8 22 V + S
					24.0325-0131.1	525131	Ø 280 24,8 22 V + S PD
1.7 CDTI	92	08/06→05/10	←	09/06→; Felge Lochzahl: 5	24.0125-0131.1	425131	Ø 280 24,8 22 V + S
					24.0325-0131.1	525131	Ø 280 24,8 22 V + S PD
1.7 CDTI	74	08/06→05/10	→	→ 05/10; Felge Lochzahl: 5	24.0110-0250.1	410250	Ø 264 9,8 8 + S
					24.0310-0250.1	510250	Ø 264 9,8 8 + S PD
VAUXHALL - MERIVA Mk II (B) 06/10→							
 Bremsbelagsatz, Scheibenbremse							
1.3 CDTi	70	06/10→	←		13.0460-7179.2	607179	ATE 23832 20,2 - WK / + WK
1.3 CDTi	55	06/10→			13.0470-7179.2	LD7179	ATE 23832 20,2 - WK / + WK
1.4	74	06/10→					Ceramic
1.4	88	06/10→					
1.4	103	06/10→	→		13.0460-2868.2	602868	TRW 23417 15,3 + WK + Zub
1.4 LPG	88	06/11→			13.0470-2868.2	LD2868	TRW 23417 15,3 + WK + Zub
1.6 CDTi	81	07/14→					Ceramic
1.6 CDTi	100	08/13→					
1.7 CDTi	81	06/10→					
1.7 CDTi	96	06/10→					
1.7 CDTi	74	06/10→					
1.6 CDTI	70	01/14→	←	03/14→	13.0460-7179.2	607179	ATE 23832 20,2 - WK / + WK
↓							











	kW			 	! #		
VAUXHALL - MERIVA Mk II (B) 06/10→							
 Bremsbelagsatz, Scheibenbremse							
1.6 CDTi	70	01/14→	←	03/14→		13.0470-7179.2 LD7179	ATE 23832 20,2 - WK / + WK Ceramic
			→	03/14→		13.0460-2868.2 602868	TRW 23417 15,3 + WK + Zub
						13.0470-2868.2 LD2868	TRW 23417 15,3 + WK + Zub Ceramic
 Bremsscheibe							
1.3 CDTi	70	06/10→	←			24.0125-0131.1 425131	Ø 280 24,8 22 V + S
1.3 CDTi	55	06/10→				24.0325-0131.1 525131	Ø 280 24,8 22 V + S PD
1.4	74	06/10→	→			24.0110-0250.1 410250	Ø 264 9,8 8 + S
						24.0310-0250.1 510250	Ø 264 9,8 8 + S PD
1.4	88	06/10→	←			24.0125-0131.1 425131	Ø 280 24,8 22 V + S
1.4 LPG	88	06/11→				24.0125-0142.1 425142	Ø 308 25 22 V + S
1.7 CDTi	81	06/10→				24.0325-0131.1 525131	Ø 280 24,8 22 V + S PD
1.7 CDTi	96	06/10→					
1.7 CDTi	74	06/10→	→			24.0110-0250.1 410250	Ø 264 9,8 8 + S
						24.0310-0250.1 510250	Ø 264 9,8 8 + S PD
1.4	103	06/10→	←			24.0125-0142.1 425142	Ø 308 25 22 V + S
1.6 CDTi	81	07/14→					
1.6 CDTi	100	08/13→	→			24.0110-0250.1 410250	Ø 264 9,8 8 + S
						24.0310-0250.1 510250	Ø 264 9,8 8 + S PD
1.6 CDTi	70	01/14→	←	03/14→		24.0125-0142.1 425142	Ø 308 25 22 V + S
			→	03/14→		24.0110-0250.1 410250	Ø 264 9,8 8 + S
						24.0310-0250.1 510250	Ø 264 9,8 8 + S PD
VAUXHALL - MOKKA / MOKKA X 06/12→							
 Bremsbelagsatz, Scheibenbremse							
1.4	103	04/13→	←			13.0460-7263.2 607263	24034 19,1 + WK + Zub
1.4 4x4	103	06/12→				13.0470-7263.2 LD7263	24034 19,1 + WK + Zub Ceramic
1.4 4x4	112	06/16→	→				
1.6	85	06/12→				13.0460-7264.2 607264	ATE 25096 17,0 + WK + Zub
1.6 CDTi	100	01/15→				13.0470-7264.2 LD7264	ATE 25096 17,0 + WK + Zub Ceramic
1.6 CDTi	81	06/15→					
1.6 CDTi 4x4	100	01/15→					
1.7 CDTi	96	06/12→					
1.7 CDTi 4x4	96	06/12→					
 Bremsscheibe							
1.4	103	04/13→	←			24.0126-0182.1 426182	Ø 300 26 23 V + S
1.4 4x4	103	06/12→					
1.4 4x4	112	06/16→	→			24.0112-0188.1 412188	Ø 268 12 10 + S
1.6	85	06/12→				24.0312-0188.1 512188	Ø 268 12 10 + S PD
1.6 CDTi	100	01/15→					
1.6 CDTi	81	06/15→					
1.6 CDTi 4x4	100	01/15→					
1.7 CDTi	96	06/12→					
1.7 CDTi 4x4	96	06/12→					
VAUXHALL - MONTEREY 09/91→07/98							
 Bremsbelagsatz, Scheibenbremse							
3.1 TD	84	09/91→07/98	←			13.0460-5926.2 605926	AKE 21845 16,5 + WK
3.2	130	06/92→07/98	→			13.0460-5927.2 605927	AKE 21875 16,0 + WK
Zubehörsatz, Scheibenbremsbelag							
3.1 TD	84	09/91→07/98	←			13.0460-0446.2 610446	AKE
3.2	130	06/92→07/98	→			13.0460-0447.2 610447	AKE
 Bremsscheibe							
3.1 TD	84	09/91→07/98	←	+ ABS		24.0126-0111.1 426111	Ø 280 26 24,6 V
3.2	130	06/92→07/98	←	- ABS		24.0126-0111.1 426111	Ø 280 26 24,6 V
			→			24.0118-0122.1 418122	Ø 313,5 18 16,6 V
VAUXHALL - MONTEREY Mk II 07/98→08/99							
 Bremsbelagsatz, Scheibenbremse							
3.0 DTi	117	07/98→08/99	←			13.0460-5926.2 605926	AKE 21845 16,5 + WK
3.5 V6 24V	158	07/98→08/99	→			13.0460-5927.2 605927	AKE 21875 16,0 + WK
↓							



	kw				! #		
VAUXHALL - MONTEREY Mk II 07/98→08/99							
Zubehörsatz, Scheibenbremsbelag							
3.0 DTI	117	07/98→08/99	←			13.0460-0446.2 610446	AKE
3.5 V6 24V	158	07/98→08/99	→			13.0460-0447.2 610447	AKE
Bremsscheibe							
3.0 DTI	117	07/98→08/99	←	+ ABS		24.0126-0111.1 426111	Ø 280 26 24,6 V
3.5 V6 24V	158	07/98→08/99	←	- ABS		24.0126-0111.1 426111	Ø 280 26 24,6 V
			→			24.0118-0122.1 418122	Ø 313,5 18 16,6 V
VAUXHALL - MOVANO Mk I (A) Chassis/Cab (ED, UD, HD) 10/98→05/10							
Brembelagsatz, Scheibenbremse							
2.2 DTI	66	09/00→05/10	←	→ 01/10;		13.0460-3800.2 603800	BOS 23613 17,7 - WE / - WK
2.5 DTI	84	10/01→05/10		passend für Felgengröße [Zoll]: 16			
3.0 DTi	100	10/03→05/10	←	→ 01/10;		13.0460-3946.2 603946	BDX 23302 18,0 + WE / - WK
				passend für Felgengröße [Zoll]: 15			
			→	→ 01/10		13.0460-3806.2 603806	BOS 23669 16,8 - WE / - WK
2.5 CDTI	74	04/04→05/10	←	09/06→ 01/10;		13.0460-3800.2 603800	BOS 23613 17,7 - WE / - WK
2.5 CDTI	88	08/06→05/10		passend für Felgengröße [Zoll]: 16			
2.5 CDTI	107	08/06→05/10	←	09/06→ 01/10;		13.0460-3946.2 603946	BDX 23302 18,0 + WE / - WK
				passend für Felgengröße [Zoll]: 15			
			→	09/06→ 01/10		13.0460-3806.2 603806	BOS 23669 16,8 - WE / - WK
2.5 D	59	10/98→08/02	←	→ 09/00;		13.0460-3800.2 603800	BOS 23613 17,7 - WE / - WK
				passend für Felgengröße [Zoll]: 16			
			←	→ 09/00;		13.0460-3946.2 603946	BDX 23302 18,0 + WE / - WK
				passend für Felgengröße [Zoll]: 15			
			→	→ 09/00		13.0460-3806.2 603806	BOS 23669 16,8 - WE / - WK
2.8 DTI	84	10/98→10/01	←	passend für Felgengröße [Zoll]: 16		13.0460-3800.2 603800	BOS 23613 17,7 - WE / - WK
			←	passend für Felgengröße [Zoll]: 15		13.0460-3946.2 603946	BDX 23302 18,0 + WE / - WK
			→			13.0460-3806.2 603806	BOS 23669 16,8 - WE / - WK
Zubehörsatz, Scheibenbremsbelag							
2.2 DTI	66	09/00→05/10	←	→ 01/10;		13.0460-0344.2 610344	
2.5 DTI	84	10/01→05/10		passend für Felgengröße [Zoll]: 16			
3.0 DTi	100	10/03→05/10	←	→ 01/10;		13.0460-0344.2 610344	
				passend für Felgengröße [Zoll]: 16			
2.5 CDTI	74	04/04→05/10	←	09/06→ 01/10;		13.0460-0344.2 610344	
2.5 CDTI	88	08/06→05/10		passend für Felgengröße [Zoll]: 16			
2.5 CDTI	107	08/06→05/10	←	→ 09/00;		13.0460-0344.2 610344	
2.5 D	59	10/98→08/02	←	passend für Felgengröße [Zoll]: 16			
2.8 DTI	84	10/98→10/01	←	passend für Felgengröße [Zoll]: 16		13.0460-0344.2 610344	
Bremsscheibe							
2.2 DTI	66	09/00→05/10	←	→ 01/10;		24.0124-0162.1 424162	Ø 280 24 21 V
2.5 DTI	84	10/01→05/10		passend für Felgengröße [Zoll]: 15			
3.0 DTi	100	10/03→05/10	←	→ 01/10;		24.0128-0129.1 428129	Ø 305,5 28 25 V + S
				passend für Felgengröße [Zoll]: 16		24.0328-0129.1 528129	Ø 305,5 28 25 V + S PD
			→	→ 01/10		24.0112-0155.1 412155	Ø 305 12 10,5 + S
2.5 CDTI	74	04/04→05/10	←	09/06→ 01/10;		24.0124-0162.1 424162	Ø 280 24 21 V
2.5 CDTI	88	08/06→05/10		passend für Felgengröße [Zoll]: 15			
2.5 CDTI	107	08/06→05/10	←	09/06→ 01/10;		24.0128-0129.1 428129	Ø 305,5 28 25 V + S
				passend für Felgengröße [Zoll]: 16		24.0328-0129.1 528129	Ø 305,5 28 25 V + S PD
			→	09/06→ 01/10		24.0112-0155.1 412155	Ø 305 12 10,5 + S
2.5 D	59	10/98→08/02	←	→ 09/00;		24.0124-0162.1 424162	Ø 280 24 21 V
				passend für Felgengröße [Zoll]: 15			
			←	→ 09/00;		24.0128-0129.1 428129	Ø 305,5 28 25 V + S
				passend für Felgengröße [Zoll]: 16		24.0328-0129.1 528129	Ø 305,5 28 25 V + S PD
			→	→ 09/00		24.0112-0155.1 412155	Ø 305 12 10,5 + S
2.8 DTI	84	10/98→10/01	←	passend für Felgengröße [Zoll]: 15		24.0124-0162.1 424162	Ø 280 24 21 V
			←	passend für Felgengröße [Zoll]: 16		24.0128-0129.1 428129	Ø 305,5 28 25 V + S
						24.0328-0129.1 528129	Ø 305,5 28 25 V + S PD
			→			24.0112-0155.1 412155	Ø 305 12 10,5 + S
VAUXHALL - MOVANO Mk I (A) Combi (JD) 10/98→05/10							
Brembelagsatz, Scheibenbremse							
1.9 DTI	59	09/00→10/01	←	passend für Felgengröße [Zoll]: 16		13.0460-3800.2 603800	BOS 23613 17,7 - WE / - WK
2.5 D	59	10/98→09/00					
↓							

	kw				! #		
VAUXHALL - MOVANO Mk I (A) Combi (JD) 10/98→05/10							
 Bremsbelagsatz, Scheibenbremse							
2.5 DTI 2.8 DTI	84 84	10/01→08/09 10/98→10/01	← →	passend für Felgengröße [Zoll]: 15		13.0460-3946.2 603946	BDX 23302 18,0 + WE / - WK
						13.0460-3806.2 603806	BOS 23669 16,8 - WE / - WK
1.9 DTI 2.2 DTI 3.0 DTI	60 66 100	10/01→05/10 09/00→05/10 10/03→05/10	← ← ←	→ 01/10; passend für Felgengröße [Zoll]: 16		13.0460-3800.2 603800	BOS 23613 17,7 - WE / - WK
			← →	→ 01/10; passend für Felgengröße [Zoll]: 15		13.0460-3946.2 603946	BDX 23302 18,0 + WE / - WK
				→ 01/10		13.0460-3806.2 603806	BOS 23669 16,8 - WE / - WK
2.5 CDTI 2.5 CDTI	74 88	10/01→08/09 02/03→08/09	← ←	09/06→; passend für Felgengröße [Zoll]: 16		13.0460-3800.2 603800	BOS 23613 17,7 - WE / - WK
			← →	09/06→; passend für Felgengröße [Zoll]: 15		13.0460-3946.2 603946	BDX 23302 18,0 + WE / - WK
				09/06→		13.0460-3806.2 603806	BOS 23669 16,8 - WE / - WK
2.5 CDTI	107	08/06→05/10	← ← →	09/06→ 01/10; passend für Felgengröße [Zoll]: 16		13.0460-3800.2 603800	BOS 23613 17,7 - WE / - WK
				09/06→ 01/10; passend für Felgengröße [Zoll]: 15		13.0460-3946.2 603946	BDX 23302 18,0 + WE / - WK
				09/06→ 01/10		13.0460-3806.2 603806	BOS 23669 16,8 - WE / - WK
Zubehörsatz, Scheibenbremsbelag							
1.9 DTI 2.5 D 2.5 DTI 2.8 DTI	59 59 84 84	09/00→10/01 10/98→09/00 10/01→08/09 10/98→10/01	← ← ← ←	passend für Felgengröße [Zoll]: 16		13.0460-0344.2 610344	
1.9 DTI 2.2 DTI 3.0 DTI	60 66 100	10/01→05/10 09/00→05/10 10/03→05/10	←	→ 01/10; passend für Felgengröße [Zoll]: 16		13.0460-0344.2 610344	
2.5 CDTI 2.5 CDTI	74 88	10/01→08/09 02/03→08/09	←	09/06→; passend für Felgengröße [Zoll]: 16		13.0460-0344.2 610344	
2.5 CDTI	107	08/06→05/10	←	09/06→ 01/10; passend für Felgengröße [Zoll]: 16		13.0460-0344.2 610344	
 Bremsscheibe							
1.9 DTI 2.5 D 2.5 DTI 2.8 DTI	59 59 84 84	09/00→10/01 10/98→09/00 10/01→08/09 10/98→10/01	← ← ← ←	passend für Felgengröße [Zoll]: 15		24.0124-0162.1 424162	Ø 280 24 21 V
			← →	passend für Felgengröße [Zoll]: 16		24.0128-0129.1 428129	Ø 305,5 28 25 V + S
						24.0328-0129.1 528129	Ø 305,5 28 25 V + S PD
						24.0112-0155.1 412155	Ø 305 12 10,5 + S
1.9 DTI 2.2 DTI 3.0 DTI	60 66 100	10/01→05/10 09/00→05/10 10/03→05/10	← ← ←	→ 01/10; passend für Felgengröße [Zoll]: 15		24.0124-0162.1 424162	Ø 280 24 21 V
			← →	→ 01/10; passend für Felgengröße [Zoll]: 16		24.0128-0129.1 428129	Ø 305,5 28 25 V + S
						24.0328-0129.1 528129	Ø 305,5 28 25 V + S PD
				→ 01/10		24.0112-0155.1 412155	Ø 305 12 10,5 + S
2.5 CDTI 2.5 CDTI	74 88	10/01→08/09 02/03→08/09	← ← →	09/06→; passend für Felgengröße [Zoll]: 15		24.0124-0162.1 424162	Ø 280 24 21 V
				09/06→; passend für Felgengröße [Zoll]: 16		24.0128-0129.1 428129	Ø 305,5 28 25 V + S
						24.0328-0129.1 528129	Ø 305,5 28 25 V + S PD
				09/06→		24.0112-0155.1 412155	Ø 305 12 10,5 + S
2.5 CDTI	107	08/06→05/10	← ← →	09/06→ 01/10; passend für Felgengröße [Zoll]: 15		24.0124-0162.1 424162	Ø 280 24 21 V
				09/06→ 01/10; passend für Felgengröße [Zoll]: 16		24.0128-0129.1 428129	Ø 305,5 28 25 V + S
						24.0328-0129.1 528129	Ø 305,5 28 25 V + S PD
				09/06→ 01/10		24.0112-0155.1 412155	Ø 305 12 10,5 + S
VAUXHALL - MOVANO Mk I (A) Van (FD) 10/98→05/10							
 Bremsbelagsatz, Scheibenbremse							
1.9 DTI 2.5 D 2.8 TDI	59 59 84	09/00→10/01 10/98→09/00 10/98→10/01	← ← ←	passend für Felgengröße [Zoll]: 16		13.0460-3800.2 603800	BOS 23613 17,7 - WE / - WK
			← →	passend für Felgengröße [Zoll]: 15		13.0460-3946.2 603946	BDX 23302 18,0 + WE / - WK
						13.0460-3806.2 603806	BOS 23669 16,8 - WE / - WK
1.9 DTI 2.2 DTI 2.5 DTI 3.0 DTI	60 66 84 100	10/01→05/10 09/00→05/10 10/01→05/10 10/03→05/10	← ← ← ←	→ 01/10; passend für Felgengröße [Zoll]: 16		13.0460-3800.2 603800	BOS 23613 17,7 - WE / - WK
			← →	→ 01/10; passend für Felgengröße [Zoll]: 15		13.0460-3946.2 603946	BDX 23302 18,0 + WE / - WK
				→ 01/10		13.0460-3806.2 603806	BOS 23669 16,8 - WE / - WK
2.5 CDTI 2.5 CDTI 2.5 CDTI	74 88 107	04/04→05/10 08/06→05/10 08/06→05/10	← ← ←	09/06→ 01/10; passend für Felgengröße [Zoll]: 16		13.0460-3800.2 603800	BOS 23613 17,7 - WE / - WK
			←	09/06→ 01/10; passend für Felgengröße [Zoll]: 15		13.0460-3946.2 603946	BDX 23302 18,0 + WE / - WK
↓							



	kw				! #		
VAUXHALL - MOVANO Mk I (A) Van (FD) 10/98→05/10							
 Bremsbelagsatz, Scheibenbremse							
2.5 CDTI 2.5 CDTI 2.5 CDTI	74 88 107	04/04→05/10 08/06→05/10 08/06→05/10	➔	09/06→ 01/10		13.0460-3806.2 603806	BOS 23669 16,8 - WE / - WK
Zubehörsatz, Scheibenbremsbelag							
1.9 DTI 2.5 D 2.8 TDI	59 59 84	09/00→10/01 10/98→09/00 10/98→10/01	←	passend für Felgengröße [Zoll]: 16		13.0460-0344.2 610344	
1.9 DTI 2.2 DTI 2.5 DTI 3.0 DTi	60 66 84 100	10/01→05/10 09/00→05/10 10/01→05/10 10/03→05/10	←	→ 01/10; passend für Felgengröße [Zoll]: 16		13.0460-0344.2 610344	
2.5 CDTI 2.5 CDTI 2.5 CDTI	74 88 107	04/04→05/10 08/06→05/10 08/06→05/10	←	09/06→ 01/10; passend für Felgengröße [Zoll]: 16		13.0460-0344.2 610344	
 Bremsscheibe							
1.9 DTI 2.5 D 2.8 TDI	59 59 84	09/00→10/01 10/98→09/00 10/98→10/01	←	passend für Felgengröße [Zoll]: 15		24.0124-0162.1 424162	Ø 280 24 21 V
			←	passend für Felgengröße [Zoll]: 16		24.0128-0129.1 428129	Ø 305,5 28 25 V + S
			➔			24.0328-0129.1 528129	Ø 305,5 28 25 V + S PD
			➔			24.0112-0155.1 412155	Ø 305 12 10,5 + S
1.9 DTI 2.2 DTI 2.5 DTI 3.0 DTi	60 66 84 100	10/01→05/10 09/00→05/10 10/01→05/10 10/03→05/10	←	→ 01/10; passend für Felgengröße [Zoll]: 15		24.0124-0162.1 424162	Ø 280 24 21 V
			←	→ 01/10; passend für Felgengröße [Zoll]: 16		24.0128-0129.1 428129	Ø 305,5 28 25 V + S
			➔			24.0328-0129.1 528129	Ø 305,5 28 25 V + S PD
			➔			24.0112-0155.1 412155	Ø 305 12 10,5 + S
2.5 CDTI 2.5 CDTI 2.5 CDTI	74 88 107	04/04→05/10 08/06→05/10 08/06→05/10	←	09/06→ 01/10; passend für Felgengröße [Zoll]: 15		24.0124-0162.1 424162	Ø 280 24 21 V
			←	09/06→ 01/10; passend für Felgengröße [Zoll]: 16		24.0128-0129.1 428129	Ø 305,5 28 25 V + S
			➔			24.0328-0129.1 528129	Ø 305,5 28 25 V + S PD
			➔			24.0112-0155.1 412155	Ø 305 12 10,5 + S
VAUXHALL - MOVANO Mk II (B) Chassis/Cab 05/10→							
 Bremsbelagsatz, Scheibenbremse							
2.3 CDTI [RWD] 2.3 CDTI [RWD] 2.3 CDTI [RWD] 2.3 CDTI [RWD] 2.3 CDTI [RWD] 2.3 CDTI FWD 2.3 CDTI FWD 2.3 CDTI FWD 2.3 CDTI FWD 2.3 CDTI FWD 2.3 CDTI FWD 2.3 CDTI FWD 2.3 CDTI FWD	74 92 100 107 110 120 74 81 92 100 107 110 125	07/10→ 07/10→ 05/14→ 07/10→ 01/13→ 05/14→ 05/10→ 05/14→ 05/10→ 05/14→ 05/10→ 01/13→ 11/16→	←			13.0460-4856.2 604856	BRE 25147 18,4 + WK
			➔	für Doppelbereifung		13.0460-4857.2 604857	BRE 25172 18,4 + WK
			➔	für Einfachbereifung		13.0460-4858.2 604858	BRE 25112 18,4 + WK
2.3 CDTI [RWD] 2.3 CDTI FWD	96 96	10/16→ 10/16→	←	11/16→		13.0460-4856.2 604856	BRE 25147 18,4 + WK
			➔	11/16→; für Doppelbereifung		13.0460-4857.2 604857	BRE 25172 18,4 + WK
			➔	11/16→; für Einfachbereifung		13.0460-4858.2 604858	BRE 25112 18,4 + WK
 Bremsscheibe							
2.3 CDTI [RWD] 2.3 CDTI [RWD] 2.3 CDTI [RWD] 2.3 CDTI [RWD] 2.3 CDTI [RWD]	74 92 100 107 110	07/10→ 07/10→ 05/14→ 07/10→ 01/13→	←			24.0128-0252.1 428252	Ø 302 28 24,5 V + S
			➔	für Einfachbereifung		24.0112-0190.1 412190	Ø 305 12 10 + S
			➔	für Doppelbereifung		24.0118-0153.1 418153	Ø 302 18 15
2.3 CDTI [RWD]	96	10/16→	←	11/16→		24.0128-0252.1 428252	Ø 302 28 24,5 V + S
			➔	11/16→; für Einfachbereifung		24.0112-0190.1 412190	Ø 305 12 10 + S
			➔	11/16→; für Doppelbereifung		24.0118-0153.1 418153	Ø 302 18 15
2.3 CDTI [RWD] 2.3 CDTI FWD 2.3 CDTI FWD 2.3 CDTI FWD 2.3 CDTI FWD 2.3 CDTI FWD 2.3 CDTI FWD	120 74 81 92 100 107 110 125	05/14→ 05/10→ 05/14→ 05/10→ 05/14→ 05/10→ 01/13→ 11/16→	←			24.0128-0252.1 428252	Ø 302 28 24,5 V + S
			➔			24.0112-0191.1 412191	Ø 305 12 10 + S
2.3 CDTI FWD	96	10/16→	←	11/16→		24.0128-0252.1 428252	Ø 302 28 24,5 V + S
			➔	11/16→		24.0112-0191.1 412191	Ø 305 12 10 + S

VAUXHALL - MOVANO Mk II (B) Combi 05/10→

Bremsbelagsatz, Scheibenbremse

2.3 CDTI [RWD] 2.3 CDTI FWD	96 96	10/16→ 10/16→	←	11/16→		13.0460-4856.2	604856	BRE 25147 18,4 + WK		
			→	11/16→; für Doppelbereifung				13.0460-4857.2	604857	BRE 25172 18,4 + WK
			→	11/16→; für Einfachbereifung				13.0460-4858.2	604858	BRE 25112 18,4 + WK
2.3 CDTI FWD 2.3 CDTI FWD 2.3 CDTI FWD 2.3 CDTI FWD 2.3 CDTI FWD 2.3 CDTI FWD 2.3 CDTI FWD	74 81 92 100 107 110 120 125	05/10→ 05/14→ 05/10→ 05/14→ 05/10→ 01/13→ 05/14→ 07/15→	←			13.0460-4856.2	604856	BRE 25147 18,4 + WK		
			→	für Doppelbereifung				13.0460-4857.2	604857	BRE 25172 18,4 + WK
			→	für Einfachbereifung				13.0460-4858.2	604858	BRE 25112 18,4 + WK
			←							
			→							
			→							

Bremsscheibe

2.3 CDTI [RWD]	96	10/16→	←	11/16→		24.0128-0252.1	428252	Ø 302 28 24,5 V + S		
			→	11/16→; für Einfachbereifung				24.0112-0190.1	412190	Ø 305 12 10 + S
			→	11/16→; für Doppelbereifung				24.0118-0153.1	418153	Ø 302 18 15
2.3 CDTI FWD 2.3 CDTI FWD 2.3 CDTI FWD 2.3 CDTI FWD 2.3 CDTI FWD 2.3 CDTI FWD 2.3 CDTI FWD 2.3 CDTI FWD	74 81 92 100 107 110 120 125	05/10→ 05/14→ 05/10→ 05/14→ 05/10→ 01/13→ 05/14→ 07/15→	←			24.0128-0252.1	428252	Ø 302 28 24,5 V + S		
			→					24.0112-0191.1	412191	Ø 305 12 10 + S
			←							
			→							
			←							
			→							
			←							
			→							
2.3 CDTI FWD	96	10/16→	←	11/16→		24.0128-0252.1	428252	Ø 302 28 24,5 V + S		
			→	11/16→				24.0112-0191.1	412191	Ø 305 12 10 + S









VAUXHALL - MOVANO Mk II (B) VAN 05/10→







Bremsbelagsatz, Scheibenbremse

2.3 CDTI [RWD] 2.3 CDTI [RWD] 2.3 CDTI [RWD] 2.3 CDTI [RWD]	74 92 100 107	05/10→ 05/10→ 05/14→ 05/10→	←			13.0460-4856.2	604856	BRE 25147 18,4 + WK		
			→	für Doppelbereifung				13.0460-4857.2	604857	BRE 25172 18,4 + WK
			→	für Einfachbereifung				13.0460-4858.2	604858	BRE 25112 18,4 + WK
			→							
2.3 CDTI [RWD] 2.3 CDTI [RWD] 2.3 CDTI [RWD] 2.3 CDTI [RWD]	110 120 74 92	01/13→ 05/14→ 05/10→ 05/10→	←			13.0460-4856.2	604856	BRE 25147 18,4 + WK		
			→					13.0460-4857.2	604857	BRE 25172 18,4 + WK
			→					13.0460-4858.2	604858	BRE 25112 18,4 + WK
			→							
2.3 CDTI FWD 2.3 CDTI FWD 2.3 CDTI FWD	81	02/12→	←	05/14→		13.0460-4856.2	604856	BRE 25147 18,4 + WK		
			→	05/14→; für Doppelbereifung				13.0460-4857.2	604857	BRE 25172 18,4 + WK
			→	05/14→; für Einfachbereifung				13.0460-4858.2	604858	BRE 25112 18,4 + WK









Bremsscheibe

2.3 CDTI [RWD] 2.3 CDTI [RWD] 2.3 CDTI [RWD]	74 92 100	05/10→ 05/10→ 05/14→	←			24.0128-0252.1	428252	Ø 302 28 24,5 V + S		
			→	für Einfachbereifung				24.0112-0190.1	412190	Ø 305 12 10 + S
			→	für Doppelbereifung				24.0118-0153.1	418153	Ø 302 18 15
2.3 CDTI [RWD] 2.3 CDTI [RWD] 2.3 CDTI [RWD]	110 120 96	01/13→ 05/14→ 10/16→	←	11/16→		24.0128-0252.1	428252	Ø 302 28 24,5 V + S		
			→	11/16→; für Einfachbereifung				24.0112-0190.1	412190	Ø 305 12 10 + S
			→	11/16→; für Doppelbereifung				24.0118-0153.1	418153	Ø 302 18 15
2.3 CDTI FWD 2.3 CDTI FWD 2.3 CDTI FWD 2.3 CDTI FWD 2.3 CDTI FWD 2.3 CDTI FWD	74 92 100 107 110 120 125	05/10→ 05/10→ 05/14→ 05/10→ 01/13→ 05/14→ 11/16→	←			24.0128-0252.1	428252	Ø 302 28 24,5 V + S		
			→					24.0112-0191.1	412191	Ø 305 12 10 + S
			←							
			→							
			←							
			→							
2.3 CDTI FWD	81	02/12→	←	05/14→		24.0128-0252.1	428252	Ø 302 28 24,5 V + S		
			→	05/14→				24.0112-0191.1	412191	Ø 305 12 10 + S
2.3 CDTI FWD	96	10/16→	←	11/16→		24.0128-0252.1	428252	Ø 302 28 24,5 V + S		
			→	11/16→				24.0112-0191.1	412191	Ø 305 12 10 + S

	kw			 	! #		
VAUXHALL - OMEGA (B) 12/93→07/03							
 Bremsbelagsatz, Scheibenbremse							
2.0 2.0	85 85	03/94→09/99 09/95→09/96	←	W1000001→		13.0460-2815.2 602815	TRW 21368 18,3 - WK
			←	→ V1999999; nicht für Sonderfahrzeuge / nicht für Poli- zeifahrzeuge		13.0460-7080.2 607080	ATE 21411 17,5 - WK
			→			13.0460-4040.2 604040	ATE 21050 15,8 - WE / - WK
2.0 16V	100	03/94→07/01	←	W1000001→; → 09/99		13.0460-2815.2 602815	TRW 21368 18,3 - WK
			←	→ V1999999; nicht für Sonderfahrzeuge / nicht für Poli- zeifahrzeuge		13.0460-7080.2 607080	ATE 21411 17,5 - WK
			→	→ 09/99		13.0460-4040.2 604040	ATE 21050 15,8 - WE / - WK
2.0 DTI 16V	74	01/98→09/00	←	→ 08/00		13.0460-2815.2 602815	TRW 21368 18,3 - WK
			→	→ 08/00		13.0460-4040.2 604040	ATE 21050 15,8 - WE / - WK
2.2 16V	106	01/94→06/03	←	10/99→		13.0460-2815.2 602815	TRW 21368 18,3 - WK
			→	10/99→		13.0460-4040.2 604040	ATE 21050 15,8 - WE / - WK
2.2 DTI 16V 2.6 V6	88 132	08/00→07/03 08/00→07/03	←	09/00→		13.0460-2815.2 602815	TRW 21368 18,3 - WK
			→	09/00→		13.0460-4040.2 604040	ATE 21050 15,8 - WE / - WK
2.5 DTI 24V 2.5 TD 2.5 V6 3.0 V6 3.2 V6	110 96 125 155 160	09/01→07/03 04/94→07/01 03/94→09/00 04/94→07/00 02/01→07/03	←			13.0460-2815.2 602815	TRW 21368 18,3 - WK
			→			13.0460-4040.2 604040	ATE 21050 15,8 - WE / - WK
Warnkontakt, Bremsbelagsverschleiß							
2.0 2.0	85 85	03/94→09/99 09/95→09/96	←	→ V1999999; nicht für Sonderfahrzeuge / nicht für Poli- zeifahrzeuge	2	24.8190-0710.2 620710	L= 730
			←	W1000001→	2	24.8190-0711.2 620711	L= 730
2.0 16V	100	03/94→07/01	←	→ V1999999; nicht für Sonderfahrzeuge / nicht für Poli- zeifahrzeuge	2	24.8190-0710.2 620710	L= 730
			←	W1000001→; → 09/99	2	24.8190-0711.2 620711	L= 730
2.0 DTI 16V	74	01/98→09/00	←	→ 08/00	2	24.8190-0711.2 620711	L= 730
2.2 16V	106	01/94→06/03	←	10/99→	2	24.8190-0711.2 620711	L= 730
2.2 DTI 16V 2.6 V6	88 132	08/00→07/03 08/00→07/03	←	09/00→	2	24.8190-0711.2 620711	L= 730
2.5 DTI 24V 2.5 TD 2.5 V6 3.0 V6 3.2 V6	110 96 125 155 160	09/01→07/03 04/94→07/01 03/94→09/00 04/94→07/00 02/01→07/03	←		2	24.8190-0711.2 620711	L= 730
Zubehörsatz, Scheibenbremsbelag							
2.0 2.0 2.5 DTI 24V 2.5 TD 2.5 V6 3.0 V6 3.2 V6	85 85 110 96 125 155 160	03/94→09/99 09/95→09/96 09/01→07/03 04/94→07/01 03/94→09/00 04/94→07/00 02/01→07/03	→			13.0460-0246.2 610246	
2.0 16V	100	03/94→07/01	→	→ 09/99		13.0460-0246.2 610246	
2.0 DTI 16V	74	01/98→09/00	→	→ 08/00		13.0460-0246.2 610246	
2.2 16V	106	01/94→06/03	→	10/99→		13.0460-0246.2 610246	
2.2 DTI 16V 2.6 V6	88 132	08/00→07/03 08/00→07/03	→	09/00→		13.0460-0246.2 610246	
 Bremsscheibe							
2.0 2.0	85 85	03/94→09/99 09/95→09/96	←	→ V1999999; nicht für Sonderfahrzeuge / nicht für Poli- zeifahrzeuge		24.0124-0119.1 424119	Ø 286 24 21 V
			←	W1000001→		24.0128-0104.1 428104	Ø 296 28 25 V + S
			→			24.0112-0131.1 412131	Ø 286 12 10
			→			24.0120-0171.1 420171	Ø 286 20 18 V
2.0 16V	100	03/94→07/01	←	→ V1999999; nicht für Sonderfahrzeuge / nicht für Poli- zeifahrzeuge		24.0124-0119.1 424119	Ø 286 24 21 V
			←	W1000001→; → 09/99		24.0128-0104.1 428104	Ø 296 28 25 V + S
			→	→ 09/99		24.0112-0131.1 412131	Ø 286 12 10
			→			24.0120-0171.1 420171	Ø 286 20 18 V
↓							

	kw			 	! #		
VAUXHALL - OMEGA (B) 12/93→07/03							
Bremsscheibe							
2.0 DTI 16V	74	01/98→09/00	←	→ 08/00		24.0128-0104.1 428104	∅ 296 28 25 V + S
			→	→ 08/00		24.0112-0131.1 412131	∅ 286 12 10
						24.0120-0171.1 420171	∅ 286 20 18 V
2.2 16V	106	01/94→06/03	←	10/99→		24.0128-0104.1 428104	∅ 296 28 25 V + S
			→	10/99→		24.0112-0131.1 412131	∅ 286 12 10
						24.0120-0171.1 420171	∅ 286 20 18 V
2.2 DTI 16V	88	08/00→07/03	←	09/00→		24.0128-0104.1 428104	∅ 296 28 25 V + S
2.6 V6	132	08/00→07/03	→	09/00→		24.0112-0131.1 412131	∅ 286 12 10
						24.0120-0171.1 420171	∅ 286 20 18 V
2.5 DTI 24V	110	09/01→07/03	←			24.0128-0104.1 428104	∅ 296 28 25 V + S
2.5 TD	96	04/94→07/01	→			24.0112-0131.1 412131	∅ 286 12 10
2.5 V6	125	03/94→09/00				24.0120-0171.1 420171	∅ 286 20 18 V
3.0 V6	155	04/94→07/00					
3.2 V6	160	02/01→07/03					
VAUXHALL - OMEGA (B) Estate 12/93→06/03							
Bremsbelagsatz, Scheibenbremse							
2.0	85	03/94→09/99	←	W1000001→		13.0460-2815.2 602815	TRW 21368 18,3 - WK
			←	→ V1999999; nicht für Sonderfahrzeuge / nicht für Polizei- fahrzeuge		13.0460-7080.2 607080	ATE 21411 17,5 - WK
			→			13.0460-4040.2 604040	ATE 21050 15,8 - WE / - WK
2.0 16V	100	03/94→07/01	←	W1000001→; → 09/99		13.0460-2815.2 602815	TRW 21368 18,3 - WK
			←	→ V1999999; nicht für Sonderfahrzeuge / nicht für Polizei- fahrzeuge		13.0460-7080.2 607080	ATE 21411 17,5 - WK
			→	→ 09/99		13.0460-4040.2 604040	ATE 21050 15,8 - WE / - WK
2.0 DTI 16V	74	01/98→09/00	←	→ 08/00		13.0460-2815.2 602815	TRW 21368 18,3 - WK
			→	→ 08/00		13.0460-4040.2 604040	ATE 21050 15,8 - WE / - WK
2.2 16V	106	02/94→06/03	←	10/99→		13.0460-2815.2 602815	TRW 21368 18,3 - WK
			→	10/99→		13.0460-4040.2 604040	ATE 21050 15,8 - WE / - WK
2.2 DTI 16V	88	08/00→06/03	←	09/00→		13.0460-2815.2 602815	TRW 21368 18,3 - WK
2.6 V6	132	08/00→06/03	→	09/00→		13.0460-4040.2 604040	ATE 21050 15,8 - WE / - WK
2.5 DTI 24V	110	09/01→06/03	←			13.0460-2815.2 602815	TRW 21368 18,3 - WK
2.5 TD	96	04/94→07/01	→			13.0460-4040.2 604040	ATE 21050 15,8 - WE / - WK
2.5 V6	125	03/94→09/00					
3.0 V6	155	07/94→07/00					
3.2 V6	160	02/01→06/03					
Warnkontakt, Bremsbelagverschleiß							
2.0	85	03/94→09/99	←	→ V1999999; nicht für Sonderfahrzeuge / nicht für Polizei- fahrzeuge	2	24.8190-0710.2 620710	L= 730
			←	W1000001→	2	24.8190-0711.2 620711	L= 730
2.0 16V	100	03/94→07/01	←	→ V1999999; nicht für Sonderfahrzeuge / nicht für Polizei- fahrzeuge	2	24.8190-0710.2 620710	L= 730
			←	W1000001→; → 09/99	2	24.8190-0711.2 620711	L= 730
2.0 DTI 16V	74	01/98→09/00	←	→ 08/00	2	24.8190-0711.2 620711	L= 730
2.2 16V	106	02/94→06/03	←	10/99→	2	24.8190-0711.2 620711	L= 730
2.2 DTI 16V	88	08/00→06/03	←	09/00→	2	24.8190-0711.2 620711	L= 730
2.6 V6	132	08/00→06/03					
2.5 DTI 24V	110	09/01→06/03	←		2	24.8190-0711.2 620711	L= 730
2.5 TD	96	04/94→07/01					
2.5 V6	125	03/94→09/00					
3.0 V6	155	07/94→07/00					
3.2 V6	160	02/01→06/03					
Zubehörsatz, Scheibenbremsbelag							
2.0	85	03/94→09/99	→			13.0460-0246.2 610246	
2.5 DTI 24V	110	09/01→06/03					
2.5 TD	96	04/94→07/01					
2.5 V6	125	03/94→09/00					
3.0 V6	155	07/94→07/00					
3.2 V6	160	02/01→06/03					
2.0 16V	100	03/94→07/01	→	→ 09/99		13.0460-0246.2 610246	
2.0 DTI 16V	74	01/98→09/00	→	→ 08/00		13.0460-0246.2 610246	
↓							



	kw			 	! #		
VAUXHALL - OMEGA (B) Estate 12/93→06/03							
Zubehörsatz, Scheibenbremsbelag							
2.2 16V	106	02/94→06/03	➡	10/99→		13.0460-0246.2 610246	
2.2 DTI 16V	88	08/00→06/03	➡	09/00→		13.0460-0246.2 610246	
2.6 V6	132	08/00→06/03					
 Bremsscheibe							
2.0	85	03/94→09/99	←	→ V1999999; nicht für Sonderfahrzeuge / nicht für Polizei- fahrzeuge		24.0124-0119.1 424119	Ø 286 24 21 V
			←	W1000001→		24.0128-0104.1 428104	Ø 296 28 25 V + S
			➡			24.0112-0131.1 412131	Ø 286 12 10
2.0 16V	100	03/94→07/01	←	→ V1999999; nicht für Sonderfahrzeuge / nicht für Polizei- fahrzeuge		24.0124-0119.1 424119	Ø 286 24 21 V
			←	W1000001→; → 09/99		24.0128-0104.1 428104	Ø 296 28 25 V + S
			➡	→ 09/99		24.0112-0131.1 412131	Ø 286 12 10
2.0 DTI 16V	74	01/98→09/00	←	→ 08/00		24.0128-0104.1 428104	Ø 296 28 25 V + S
			➡	→ 08/00		24.0112-0131.1 412131	Ø 286 12 10
						24.0120-0171.1 420171	Ø 286 20 18 V
2.2 16V	106	02/94→06/03	←	10/99→		24.0128-0104.1 428104	Ø 296 28 25 V + S
			➡	10/99→		24.0112-0131.1 412131	Ø 286 12 10
						24.0120-0171.1 420171	Ø 286 20 18 V
2.2 DTI 16V	88	08/00→06/03	←	09/00→		24.0128-0104.1 428104	Ø 296 28 25 V + S
			➡	09/00→		24.0112-0131.1 412131	Ø 286 12 10
						24.0120-0171.1 420171	Ø 286 20 18 V
2.5 DTI 24V	110	09/01→06/03	←			24.0128-0104.1 428104	Ø 296 28 25 V + S
			➡			24.0112-0131.1 412131	Ø 286 12 10
						24.0120-0171.1 420171	Ø 286 20 18 V
						24.0112-0131.1 412131	Ø 286 12 10
						24.0120-0171.1 420171	Ø 286 20 18 V
2.5 TD	96	04/94→07/01					
2.5 V6	125	03/94→09/00					
3.0 V6	155	07/94→07/00					
3.2 V6	160	02/01→06/03					
VAUXHALL - SIGNUM 03/03→10/08							
 Bremsbelagsatz, Scheibenbremse							
1.8 1.9 CDTI 1.9 CDTI 16V 1.9 Turbo 2.0 DTI 2.2 DTI 2.2 i	90 88 110 74 74 92 114	06/03→07/05 04/04→03/08 04/04→03/08 01/05→05/08 05/03→05/08 05/03→05/08 05/03→05/08	←	für Bremssattel mit Kunststoffkolben		13.0460-7172.2 607172	ATE 23378 20,1 + WE / - WK
						13.0470-7172.2 LD7172	ATE 23378 20,1 + WE / - WK Ceramic
			←	für Bremssattel mit Stahlkolben		13.0460-7212.2 607212	ATE 23738 20,1 + WE / - WK
			➡	41096249 / 48091179→		13.0460-7194.2 607194	ATE 23482 16,6 - WE / - WK
						13.0460-7195.2 607195	ATE 23482 16,6 - WE / - WK
						13.0470-7194.2 LD7194	ATE 23482 16,6 - WE / - WK Ceramic
						13.0470-7195.2 LD7195	ATE 23482 16,6 - WE / - WK Ceramic
			➡	→ 41096248 / 48091178		13.0460-7194.2 607194	ATE 23482 16,6 - WE / - WK
						13.0470-7194.2 LD7194	ATE 23482 16,6 - WE / - WK Ceramic
			1.8	103	08/05→05/08	←	09/05→; für Bremssattel mit Kunststoffkolben
						13.0470-7172.2 LD7172	ATE 23378 20,1 + WE / - WK Ceramic
←	09/05→; für Bremssattel mit Stahlkolben					13.0460-7212.2 607212	ATE 23738 20,1 + WE / - WK
➡	09/05→					13.0460-7194.2 607194	ATE 23482 16,6 - WE / - WK
						13.0460-7195.2 607195	ATE 23482 16,6 - WE / - WK
			13.0470-7194.2 LD7194	ATE 23482 16,6 - WE / - WK Ceramic			
			13.0470-7195.2 LD7195	ATE 23482 16,6 - WE / - WK Ceramic			
2.0 i Turbo	129	03/03→10/08	←	05/03→ 05/08; für Bremssattel mit Kunststoffkolben		13.0460-7172.2 607172	ATE 23378 20,1 + WE / - WK
						13.0470-7172.2 LD7172	ATE 23378 20,1 + WE / - WK Ceramic
			←	05/03→ 05/08; für Bremssattel mit Stahlkolben		13.0460-7212.2 607212	ATE 23738 20,1 + WE / - WK
➡	41096249 / 48091179→; → 05/08		13.0460-7194.2 607194	ATE 23482 16,6 - WE / - WK			
			13.0460-7195.2 607195	ATE 23482 16,6 - WE / - WK			
			13.0470-7194.2 LD7194	ATE 23482 16,6 - WE / - WK Ceramic			











VAUXHALL - SIGNUM 03/03→10/08













Bremsbelagsatz, Scheibenbremse









2.0 i Turbo	129	03/03→10/08	➡	41096249 / 48091179→; → 05/08	13.0470-7195.2	LD7195	ATE 23482 16,6 - WE / - WK Ceramic
			➡	05/03→; → 41096248 / 48091178	13.0460-7194.2	607194	ATE 23482 16,6 - WE / - WK
2.8 V6 Turbo	169	07/05→05/08	←	61000001→	13.0460-7199.2	607199	ATE 23404 20,6 + WE / - WK
			➡	09/05→	13.0460-7194.2	607194	ATE 23482 16,6 - WE / - WK
					13.0460-7195.2	607195	ATE 23482 16,6 - WE / - WK
					13.0470-7194.2	LD7194	ATE 23482 16,6 - WE / - WK Ceramic
2.8 V6 Turbo	184	05/07→10/08	←	→ 05/08	13.0460-7199.2	607199	ATE 23404 20,6 + WE / - WK
			➡	→ 05/08	13.0460-7194.2	607194	ATE 23482 16,6 - WE / - WK
					13.0460-7195.2	607195	ATE 23482 16,6 - WE / - WK
					13.0470-7194.2	LD7194	ATE 23482 16,6 - WE / - WK Ceramic
3.0 CDTi 3.2 V6	130	05/03→05/08	←	→ 31068238; für Bremssattel mit Kunststoffkolben	13.0460-7172.2	607172	ATE 23378 20,1 + WE / - WK
					13.0470-7172.2	LD7172	ATE 23378 20,1 + WE / - WK Ceramic
	155	05/03→05/08	←	31068239→	13.0460-7199.2	607199	ATE 23404 20,6 + WE / - WK
			←	→ 31068238; für Bremssattel mit Stahlkolben	13.0460-7212.2	607212	ATE 23738 20,1 + WE / - WK
			➡	41096249 / 48091179→	13.0460-7194.2	607194	ATE 23482 16,6 - WE / - WK
					13.0460-7195.2	607195	ATE 23482 16,6 - WE / - WK
		13.0470-7194.2	LD7194	ATE 23482 16,6 - WE / - WK Ceramic			
		13.0470-7195.2	LD7195	ATE 23482 16,6 - WE / - WK Ceramic			
3.0 V6 CDTi	135	07/05→06/08	←	61000001→; → 05/08	13.0460-7199.2	607199	ATE 23404 20,6 + WE / - WK
			➡	09/05→ 05/08	13.0460-7194.2	607194	ATE 23482 16,6 - WE / - WK
				13.0460-7195.2	607195	ATE 23482 16,6 - WE / - WK	
				13.0470-7194.2	LD7194	ATE 23482 16,6 - WE / - WK Ceramic	
				13.0470-7195.2	LD7195	ATE 23482 16,6 - WE / - WK Ceramic	







Warnkontakt, Bremsbelagverschleiß

1.8 1.9 CDTi 1.9 CDTi 16V 1.9 Turbo 2.0 DTi 2.2 DTi 2.2 i	90	06/03→07/05	←	bis Bj. 08.2004	1	24.8190-0719.2	620719	L= 685,5
	88	04/04→03/08	←	ab Bj. 09.2004	1	24.8190-0720.2	620720	L= 287
	110	04/04→03/08	←					
	74	01/05→05/08						
	74	05/03→05/08						
1.8	103	08/05→05/08	←	09/05→; bis Bj. 08.2004	1	24.8190-0719.2	620719	L= 685,5
			←	09/05→; ab Bj. 09.2004	1	24.8190-0720.2	620720	L= 287
2.0 i Turbo	129	03/03→10/08	←	05/03→ 05/08; bis Bj. 08.2004	1	24.8190-0719.2	620719	L= 685,5
			←	05/03→ 05/08; ab Bj. 09.2004	1	24.8190-0720.2	620720	L= 287
2.8 V6 Turbo	169	07/05→05/08	←	61000001→; bis ChNr. 41048790	1	24.8190-0721.2	620721	L= 700
			←	61000001→; ab ChNr. 41048791	1	24.8190-0722.2	620722	L= 302
2.8 V6 Turbo	184	05/07→10/08	←	→ 05/08; bis ChNr. 41048790	1	24.8190-0721.2	620721	L= 700
			←	→ 05/08; ab ChNr. 41048791	1	24.8190-0722.2	620722	L= 302
3.0 CDTi 3.2 V6	130	05/03→05/08	←	→ 31068238; bis Bj. 08.2004	1	24.8190-0719.2	620719	L= 685,5
			←	→ 31068238; ab Bj. 09.2004	1	24.8190-0720.2	620720	L= 287
	155	05/03→05/08	←	31068239→; bis ChNr. 41048790	1	24.8190-0721.2	620721	L= 700
			←	31068239→; ab ChNr. 41048791	1	24.8190-0722.2	620722	L= 302
3.0 V6 CDTi	135	07/05→06/08	←	61000001→; → 05/08; bis ChNr. 41048790	1	24.8190-0721.2	620721	L= 700
↓								

	kw				! #		
VAUXHALL - SIGNUM 03/03→10/08							
Warnkontakt, Bremsbelagverschleiß							
3.0 V6 CDTi	135	07/05→06/08	←	61000001→; → 05/08; ab ChNr. 41048791	1	24.8190-0722.2 620722	L= 302
 Bremsscheibe							
1.8 1.9 CDTi 1.9 CDTi 16V 1.9 Turbo 2.0 DTi 2.2 DTi 2.2 i	90 88 110 74 74 92 114	06/03→07/05 04/04→03/08 04/04→03/08 01/05→05/08 05/03→05/08 05/03→05/08 05/03→05/08	←	für Fahrzeuge ohne Sportfahrwerk		24.0125-0141.1 425141 24.0325-0141.1 525141	Ø 285 24,9 22 V + S Ø 285 24,9 22 V + S PD
			←	für Fahrzeuge mit Sportfahrwerk		24.0128-0137.1 428137 24.0328-0137.1 528137	Ø 302 28 25 V + S Ø 302 28 25 V + S PD
			→			24.0112-0157.1 412157 24.0120-0173.1 420173 24.0312-0157.1 512157 24.0320-0173.1 520173	Ø 278 11,9 10 + S Ø 292 19,9 18 V + S Ø 278 11,9 10 + S PD Ø 292 19,9 18 V + S PD
1.8	103	08/05→05/08	←	09/05→; nicht für Polizeifahrzeuge; für Fahrzeuge mit Sportfahrwerk		24.0125-0141.1 425141 24.0325-0141.1 525141	Ø 285 24,9 22 V + S Ø 285 24,9 22 V + S PD
			←	09/05→; für Polizeifahrzeuge; für Fahrzeuge mit Sportfahrwerk		24.0128-0137.1 428137 24.0328-0137.1 528137	Ø 302 28 25 V + S Ø 302 28 25 V + S PD
			→	09/05→		24.0112-0157.1 412157 24.0120-0173.1 420173 24.0312-0157.1 512157 24.0320-0173.1 520173	Ø 278 11,9 10 + S Ø 292 19,9 18 V + S Ø 278 11,9 10 + S PD Ø 292 19,9 18 V + S PD
2.0 i Turbo	129	03/03→10/08	←	05/03→ 05/08		24.0128-0137.1 428137 24.0328-0137.1 528137	Ø 302 28 25 V + S Ø 302 28 25 V + S PD
			→	05/03→ 05/08		24.0120-0173.1 420173 24.0320-0173.1 520173	Ø 292 19,9 18 V + S Ø 292 19,9 18 V + S PD
2.8 V6 Turbo	169	07/05→05/08	←	61000001→		24.0128-0164.1 428164	Ø 314 28 25 V + S
			→	09/05→		24.0112-0157.1 412157 24.0120-0173.1 420173 24.0312-0157.1 512157 24.0320-0173.1 520173	Ø 278 11,9 10 + S Ø 292 19,9 18 V + S Ø 278 11,9 10 + S PD Ø 292 19,9 18 V + S PD
2.8 V6 Turbo	184	05/07→10/08	←	→ 05/08		24.0128-0164.1 428164	Ø 314 28 25 V + S
			→	→ 05/08		24.0112-0157.1 412157 24.0120-0173.1 420173 24.0312-0157.1 512157 24.0320-0173.1 520173	Ø 278 11,9 10 + S Ø 292 19,9 18 V + S Ø 278 11,9 10 + S PD Ø 292 19,9 18 V + S PD
3.0 CDTi 3.2 V6	130 155	05/03→05/08 05/03→05/08	←	→ 31068238		24.0128-0137.1 428137 24.0328-0137.1 528137	Ø 302 28 25 V + S Ø 302 28 25 V + S PD
			←	31068239→		24.0128-0164.1 428164	Ø 314 28 25 V + S
			→			24.0120-0173.1 420173 24.0320-0173.1 520173	Ø 292 19,9 18 V + S Ø 292 19,9 18 V + S PD
3.0 V6 CDTi	135	07/05→06/08	←	61000001→; → 05/08		24.0128-0164.1 428164	Ø 314 28 25 V + S
			→	09/05→ 05/08		24.0112-0157.1 412157 24.0120-0173.1 420173 24.0312-0157.1 512157 24.0320-0173.1 520173	Ø 278 11,9 10 + S Ø 292 19,9 18 V + S Ø 278 11,9 10 + S PD Ø 292 19,9 18 V + S PD
VAUXHALL - SINTRA 09/96→04/99							
 Bremsbelagsatz, Scheibenbremse							
2.2 DTi 2.2 i 16 V 3.0 i 24V	85 104 148	07/97→04/99 11/96→04/99 11/96→04/99	←			13.0460-8002.2 608002	23358 18,0 + WK
			→			13.0460-8011.2 608011	23361 14,8 + WK
 Bremsscheibe							
2.2 DTi 2.2 i 16 V 3.0 i 24V	85 104 148	07/97→04/99 11/96→04/99 11/96→04/99	←			24.0132-0110.1 432110	Ø 278 32,2 30,7 V
			→			24.0111-0133.1 411133	Ø 278 11 9
VAUXHALL - SPEEDSTER 03/01→09/06							
 Bremsscheibe							
2.2	108	03/01→09/06	←	→ 09/05		24.0125-0119.1 425119 24.0325-0119.1 525119	Ø 288 25 22 V + S Ø 288 25 22 V + S PD
			→	→ 09/05		24.0125-0119.1 425119 24.0325-0119.1 525119	Ø 288 25 22 V + S Ø 288 25 22 V + S PD

	kw					! #		
VAUXHALL - TIGRA Mk I (F07) 07/94→12/00								
 Bremsbelagsatz, Scheibenbremse								
1.4 16V	66	07/94→12/00	←				13.0460-7051.2 607051	ATE 20547 16,5 + WE / - WK
1.6 16V	78	07/94→12/00	←	→ 08/98			13.0460-7051.2 607051	ATE 20547 16,5 + WE / - WK
 Bremsscheibe								
1.4 16V	66	07/94→12/00	←				24.0120-0140.1 420140	Ø 256 20 17 V + S
1.6 16V	78	07/94→12/00	←	→ 08/98			24.0120-0140.1 420140	Ø 256 20 17 V + S
VAUXHALL - TIGRA TwinTop 06/04→08/09								
 Bremsbelagsatz, Scheibenbremse								
1.3 CDTI	51	06/04→08/09	←				13.0460-2857.2 602857	TRW 23225 17,0 + WK + Zub
1.4	66	06/04→08/09	←				13.0470-2857.2 LD2857	TRW 23225 17,0 + WK + Zub
1.8	92	06/04→08/09	←					Ceramic
			→	Orga 7E000001→			13.0460-2858.2 602858	TRW 23284 14,0 + WK
			→	→Orga 6E999999			13.0470-2858.2 LD2858	TRW 23284 14,0 + WK Ceramic
			→				13.0460-2858.2 602858	TRW 23284 14,0 + WK
			→				13.0470-2858.2 LD2858	TRW 23284 14,0 + WK Ceramic
 Bremsscheibe								
1.3 CDTI	51	06/04→08/09	←				24.0124-0166.1 424166	Ø 260 24 21 V + S
1.4	66	06/04→08/09	←				24.0324-0166.1 524166	Ø 260 24 21 V PD
1.8	92	06/04→08/09	←				24.0110-0268.1 410268	Ø 240 10,2 8,2
VAUXHALL - VECTRA (B) 08/95→03/02								
 Bremsbelagsatz, Scheibenbremse								
1.6 i	55	08/95→10/01	←	09/95→; → W7999999			13.0460-7052.2 607052	ATE 21190 17,5 + WE / - WK
			←	X1000001→			13.0460-7091.2 607091	ATE 21829 20,3 + WE / - WK
1.6 i 16V	74	08/95→10/01	←	09/95→; → W7999999			13.0460-7052.2 607052	ATE 21190 17,5 + WE / - WK
			←	X1000001→			13.0460-7091.2 607091	ATE 21829 20,3 + WE / - WK
			→	09/95→			13.0460-4040.2 604040	ATE 21050 15,8 - WE / - WK
1.7 TD	60	10/95→11/96	←				13.0460-7052.2 607052	ATE 21190 17,5 + WE / - WK
			→				13.0460-4040.2 604040	ATE 21050 15,8 - WE / - WK
1.8 Dualfuel	92	09/00→03/02	←	→ W7999999			13.0460-7052.2 607052	ATE 21190 17,5 + WE / - WK
1.8 i 16V	85	10/95→09/00	←				13.0460-7091.2 607091	ATE 21829 20,3 + WE / - WK
1.8 i 16V	92	09/00→03/02	←	X1000001→			13.0460-7091.2 607091	ATE 21829 20,3 + WE / - WK
			→				13.0460-4040.2 604040	ATE 21050 15,8 - WE / - WK
2.0 DI 16V	60	08/95→10/01	←	11/96→; → W7999999			13.0460-7052.2 607052	ATE 21190 17,5 + WE / - WK
			←	X1000001→			13.0460-7091.2 607091	ATE 21829 20,3 + WE / - WK
2.0 DTI 16V	74	08/95→10/01	←	06/97→; → W7999999			13.0460-7052.2 607052	ATE 21190 17,5 + WE / - WK
			←	X1000001→			13.0460-7091.2 607091	ATE 21829 20,3 + WE / - WK
			→	06/97→			13.0460-4040.2 604040	ATE 21050 15,8 - WE / - WK
2.0 i 16V	100	10/95→01/01	←				13.0460-7091.2 607091	ATE 21829 20,3 + WE / - WK
2.5 i GSi	143	03/98→07/00	→				13.0460-4040.2 604040	ATE 21050 15,8 - WE / - WK
2.5 i V6	125	09/95→08/00	→					
2.6 i V6	125	09/00→03/02	→					
2.2 DTI 16V	92	08/95→10/01	←	09/00→			13.0460-7091.2 607091	ATE 21829 20,3 + WE / - WK
2.2 i 16V	108	08/95→10/01	→	09/00→			13.0460-4040.2 604040	ATE 21050 15,8 - WE / - WK
Warnkontakt, Bremsbelagverschleiß								
1.6 i	55	08/95→10/01	←	X1000001→	2	24.8190-0714.2 620714		L= 660
1.6 i 16V	74	08/95→10/01	←	09/95→; → W7999999	2	24.8190-0715.2 620715		L= 660
1.7 TD	60	10/95→11/96	←		2	24.8190-0715.2 620715		L= 660
1.8 Dualfuel	92	09/00→03/02	←	X1000001→	2	24.8190-0714.2 620714		L= 660
1.8 i 16V	85	10/95→09/00	←	→ W7999999	2	24.8190-0715.2 620715		L= 660
1.8 i 16V	92	09/00→03/02	←		2	24.8190-0715.2 620715		L= 660
2.0 DI 16V	60	08/95→10/01	←	X1000001→	2	24.8190-0714.2 620714		L= 660
			←	11/96→; → W7999999	2	24.8190-0715.2 620715		L= 660
2.0 DTI 16V	74	08/95→10/01	←	X1000001→	2	24.8190-0714.2 620714		L= 660
			←	06/97→; → W7999999	2	24.8190-0715.2 620715		L= 660
2.0 i 16V	100	10/95→01/01	←		2	24.8190-0714.2 620714		L= 660
2.5 i GSi	143	03/98→07/00	→					
2.5 i V6	125	09/95→08/00	→					
↓								

	kw			 	! #		
VAUXHALL - VECTRA (B) 08/95→03/02							
Warnkontakt, Bremsbelagverschleiß							
2.6 i V6	125	09/00→03/02	←		2	24.8190-0714.2 620714	L= 660
2.2 DTI 16V	92	08/95→10/01	←	09/00→	2	24.8190-0714.2 620714	L= 660
2.2 i 16V	108	08/95→10/01					
Zubehörsatz, Scheibenbremsbelag							
1.6 i 16V	74	08/95→10/01	→	09/95→		13.0460-0347.2 610347	
1.7 TD	60	10/95→11/96	→			13.0460-0347.2 610347	
1.8 Dualfuel	92	09/00→03/02					
1.8 i 16V	85	10/95→09/00					
1.8 i 16V	92	09/00→03/02					
2.0 i 16V	100	10/95→01/01					
2.5 i GSi	143	03/98→07/00					
2.5 i V6	125	09/95→08/00					
2.6 i V6	125	09/00→03/02					
2.0 DTI 16V	74	08/95→10/01	→	06/97→		13.0460-0347.2 610347	
2.2 DTI 16V	92	08/95→10/01	→	09/00→		13.0460-0347.2 610347	
2.2 i 16V	108	08/95→10/01					
 Bremsscheibe							
1.6 i	55	08/95→10/01	←	09/95→; → W7999999		24.0124-0115.1 424115	Ø 256 24 21 V + S
						24.0324-0115.1 524115	Ø 256 24 21 V + S PD
			←	X1000001→		24.0125-0119.1 425119	Ø 288 25 22 V + S
1.6 i 16V	74	08/95→10/01	←	09/95→; → W7999999		24.0124-0115.1 424115	Ø 256 24 21 V + S
						24.0324-0115.1 524115	Ø 256 24 21 V + S PD
			←	X1000001→		24.0125-0119.1 425119	Ø 288 25 22 V + S
						24.0325-0119.1 525119	Ø 288 25 22 V + S PD
			→	09/95→; → W7999999		24.0110-0225.1 410225	Ø 270 10 8 + S
1.7 TD	60	10/95→11/96	←			24.0124-0115.1 424115	Ø 256 24 21 V + S
						24.0324-0115.1 524115	Ø 256 24 21 V + S PD
			→			24.0110-0225.1 410225	Ø 270 10 8 + S
						24.0310-0225.1 510225	Ø 270 10 8 + S PD
			→			24.0110-0226.1 410226	Ø 286 10 8 + S
1.8 Dualfuel	92	09/00→03/02	←	→ W7999999		24.0124-0115.1 424115	Ø 256 24 21 V + S
						24.0324-0115.1 524115	Ø 256 24 21 V + S PD
			←	X1000001→		24.0125-0119.1 425119	Ø 288 25 22 V + S
						24.0325-0119.1 525119	Ø 288 25 22 V + S PD
			→	→ W7999999		24.0110-0225.1 410225	Ø 270 10 8 + S
1.8 i 16V	85	10/95→09/00				24.0110-0225.1 410225	Ø 270 10 8 + S
						24.0310-0225.1 510225	Ø 270 10 8 + S PD
			→	X1000001→		24.0110-0226.1 410226	Ø 286 10 8 + S
						24.0310-0226.1 510226	Ø 286 10 8 + S PD
			→			24.0110-0225.1 410225	Ø 270 10 8 + S
2.0 DI 16V	60	08/95→10/01	←	11/96→; → W7999999		24.0124-0115.1 424115	Ø 256 24 21 V + S
						24.0324-0115.1 524115	Ø 256 24 21 V + S PD
			←	X1000001→		24.0125-0119.1 425119	Ø 288 25 22 V + S
						24.0325-0119.1 525119	Ø 288 25 22 V + S PD
			→			24.0110-0225.1 410225	Ø 270 10 8 + S
2.0 DTI 16V	74	08/95→10/01	←	06/97→; → W7999999		24.0124-0115.1 424115	Ø 256 24 21 V + S
						24.0324-0115.1 524115	Ø 256 24 21 V + S PD
			←	X1000001→		24.0125-0119.1 425119	Ø 288 25 22 V + S
						24.0325-0119.1 525119	Ø 288 25 22 V + S PD
			→	06/97→; → W7999999		24.0110-0225.1 410225	Ø 270 10 8 + S
2.0 i 16V	100	10/95→01/01				24.0110-0225.1 410225	Ø 270 10 8 + S
						24.0310-0225.1 510225	Ø 270 10 8 + S PD
			→	X1000001→		24.0110-0226.1 410226	Ø 286 10 8 + S
						24.0310-0226.1 510226	Ø 286 10 8 + S PD
			→			24.0110-0225.1 410225	Ø 270 10 8 + S
2.5 i GSi	143	03/98→07/00	←			24.0125-0119.1 425119	Ø 288 25 22 V + S
						24.0325-0119.1 525119	Ø 288 25 22 V + S PD
			→			24.0110-0226.1 410226	Ø 286 10 8 + S
						24.0310-0226.1 510226	Ø 286 10 8 + S PD
			→			24.0110-0225.1 410225	Ø 270 10 8 + S
2.5 i V6	125	09/95→08/00				24.0110-0225.1 410225	Ø 270 10 8 + S
						24.0310-0225.1 510225	Ø 270 10 8 + S PD
			→			24.0110-0226.1 410226	Ø 286 10 8 + S
						24.0310-0226.1 510226	Ø 286 10 8 + S PD
			→			24.0110-0225.1 410225	Ø 270 10 8 + S
2.6 i V6	125	09/00→03/02				24.0110-0225.1 410225	Ø 270 10 8 + S
						24.0310-0225.1 510225	Ø 270 10 8 + S PD
			→			24.0110-0226.1 410226	Ø 286 10 8 + S
						24.0310-0226.1 510226	Ø 286 10 8 + S PD
			→			24.0110-0225.1 410225	Ø 270 10 8 + S
2.2 DTI 16V	92	08/95→10/01	←	09/00→		24.0125-0119.1 425119	Ø 288 25 22 V + S
						24.0325-0119.1 525119	Ø 288 25 22 V + S PD
			→			24.0110-0226.1 410226	Ø 286 10 8 + S
						24.0310-0226.1 510226	Ø 286 10 8 + S PD
			→			24.0110-0225.1 410225	Ø 270 10 8 + S
2.2 i 16V	108	08/95→10/01				24.0110-0225.1 410225	Ø 270 10 8 + S
						24.0310-0225.1 510225	Ø 270 10 8 + S PD
			→			24.0110-0226.1 410226	Ø 286 10 8 + S
						24.0310-0226.1 510226	Ø 286 10 8 + S PD
			→			24.0110-0225.1 410225	Ø 270 10 8 + S

	kW			 	! #		
VAUXHALL - VECTRA (B) CC 08/95→07/03							
Bremsbelagsatz, Scheibenbremse							
1.6 i	55	08/95→10/01	←	09/95→; → W7999999		13.0460-7052.2 607052	ATE 21190 17,5 + WE / - WK
			←	X1000001→		13.0460-7091.2 607091	ATE 21829 20,3 + WE / - WK
1.6 i 16V	74	08/95→10/01	←	09/95→; → W7999999		13.0460-7052.2 607052	ATE 21190 17,5 + WE / - WK
			←	X1000001→		13.0460-7091.2 607091	ATE 21829 20,3 + WE / - WK
			→	09/95→		13.0460-4040.2 604040	ATE 21050 15,8 - WE / - WK
1.7 TD	60	10/95→11/96	←			13.0460-7052.2 607052	ATE 21190 17,5 + WE / - WK
			→			13.0460-4040.2 604040	ATE 21050 15,8 - WE / - WK
1.8 Dualfuel	92	09/00→07/03	←	→ W7999999		13.0460-7052.2 607052	ATE 21190 17,5 + WE / - WK
1.8 i 16V	92	09/00→07/03	←	X1000001→; → 04/02		13.0460-7091.2 607091	ATE 21829 20,3 + WE / - WK
			→	→ 04/02		13.0460-4040.2 604040	ATE 21050 15,8 - WE / - WK
1.8 i 16V	85	10/95→09/00	←	→ W7999999		13.0460-7052.2 607052	ATE 21190 17,5 + WE / - WK
2.0 DTi 16V	74	06/97→10/01	←	X1000001→		13.0460-7091.2 607091	ATE 21829 20,3 + WE / - WK
			→			13.0460-4040.2 604040	ATE 21050 15,8 - WE / - WK
2.0 Di 16V	60	08/95→10/01	←	11/96→; → W7999999		13.0460-7052.2 607052	ATE 21190 17,5 + WE / - WK
			←	X1000001→		13.0460-7091.2 607091	ATE 21829 20,3 + WE / - WK
2.0 i 16V	100	10/95→01/01	←			13.0460-7091.2 607091	ATE 21829 20,3 + WE / - WK
2.5 i GSi	143	03/98→07/00	→			13.0460-4040.2 604040	ATE 21050 15,8 - WE / - WK
2.5 i V6	125	09/95→08/00	→			13.0460-4040.2 604040	ATE 21050 15,8 - WE / - WK
2.2 DTi 16V	92	08/95→10/01	←	09/00→		13.0460-7091.2 607091	ATE 21829 20,3 + WE / - WK
			→	09/00→		13.0460-4040.2 604040	ATE 21050 15,8 - WE / - WK
2.2 i 16V	108	09/00→07/03	←	→ 04/02		13.0460-7091.2 607091	ATE 21829 20,3 + WE / - WK
2.6 i V6	125	09/00→07/03	→	→ 04/02		13.0460-4040.2 604040	ATE 21050 15,8 - WE / - WK
Warnkontakt, Bremsbelagsverschleiß							
1.6 i	55	08/95→10/01	←	X1000001→	2	24.8190-0714.2 620714	L= 660
1.6 i 16V	74	08/95→10/01	←	09/95→; → W7999999	2	24.8190-0715.2 620715	L= 660
1.7 TD	60	10/95→11/96	←		2	24.8190-0715.2 620715	L= 660
1.8 Dualfuel	92	09/00→07/03	←	X1000001→; → 04/02	2	24.8190-0714.2 620714	L= 660
1.8 i 16V	92	09/00→07/03	←	→ W7999999	2	24.8190-0715.2 620715	L= 660
1.8 i 16V	85	10/95→09/00	←	X1000001→	2	24.8190-0714.2 620714	L= 660
2.0 DTi 16V	74	06/97→10/01	←	→ W7999999	2	24.8190-0715.2 620715	L= 660
2.0 Di 16V	60	08/95→10/01	←	X1000001→	2	24.8190-0714.2 620714	L= 660
			←	11/96→; → W7999999	2	24.8190-0715.2 620715	L= 660
2.0 i 16V	100	10/95→01/01	←		2	24.8190-0714.2 620714	L= 660
2.5 i GSi	143	03/98→07/00					
2.5 i V6	125	09/95→08/00					
2.2 DTi 16V	92	08/95→10/01	←	09/00→	2	24.8190-0714.2 620714	L= 660
2.2 i 16V	108	09/00→07/03	←	→ 04/02	2	24.8190-0714.2 620714	L= 660
2.6 i V6	125	09/00→07/03					
Zubehörsatz, Scheibenbremsbelag							
1.6 i 16V	74	08/95→10/01	→	09/95→		13.0460-0347.2 610347	
1.7 TD	60	10/95→11/96	→			13.0460-0347.2 610347	
1.8 i 16V	85	10/95→09/00					
2.0 DTi 16V	74	06/97→10/01					
2.0 i 16V	100	10/95→01/01					
2.5 i GSi	143	03/98→07/00					
2.5 i V6	125	09/95→08/00					
1.8 Dualfuel	92	09/00→07/03	→	→ 04/02		13.0460-0347.2 610347	
1.8 i 16V	92	09/00→07/03					
2.2 i 16V	108	09/00→07/03					
2.6 i V6	125	09/00→07/03					
2.2 DTi 16V	92	08/95→10/01	→	09/00→		13.0460-0347.2 610347	
Bremsscheibe							
1.6 i	55	08/95→10/01	←	09/95→; → W7999999		24.0124-0115.1 424115	Ø 256 24 21 V + S
						24.0324-0115.1 524115	Ø 256 24 21 V + S PD
			←	X1000001→		24.0125-0119.1 425119	Ø 288 25 22 V + S
						24.0325-0119.1 525119	Ø 288 25 22 V + S PD
1.6 i 16V	74	08/95→10/01	←	09/95→; → W7999999		24.0124-0115.1 424115	Ø 256 24 21 V + S
						24.0324-0115.1 524115	Ø 256 24 21 V + S PD
↓							

VAUXHALL - VECTRA (B) CC 08/95→07/03

Bremsscheibe









1.6 i 16V	74	08/95→10/01	←	X1000001→	24.0125-0119.1 425119	Ø 288 25 22 V + S
					24.0325-0119.1 525119	Ø 288 25 22 V + S PD
			→	09/95→; → W7999999	24.0110-0225.1 410225	Ø 270 10 8 + S
			→	X1000001→	24.0310-0225.1 510225	Ø 270 10 8 + S PD
1.7 TD	60	10/95→11/96	←		24.0124-0115.1 424115	Ø 256 24 21 V + S
					24.0324-0115.1 524115	Ø 256 24 21 V + S PD
			→		24.0110-0225.1 410225	Ø 270 10 8 + S
1.8 Dualfuel 1.8 i 16V	92 92	09/00→07/03 09/00→07/03	←	→ W7999999	24.0124-0115.1 424115	Ø 256 24 21 V + S
					24.0324-0115.1 524115	Ø 256 24 21 V + S PD
			←	X1000001→; → 04/02	24.0125-0119.1 425119	Ø 288 25 22 V + S
					24.0325-0119.1 525119	Ø 288 25 22 V + S PD
			→	→ W7999999	24.0110-0225.1 410225	Ø 270 10 8 + S
1.8 i 16V 2.0 DTi 16V	85 74	10/95→09/00 06/97→10/01	←	→ W7999999	24.0124-0115.1 424115	Ø 256 24 21 V + S
					24.0324-0115.1 524115	Ø 256 24 21 V + S PD
			←	X1000001→	24.0125-0119.1 425119	Ø 288 25 22 V + S
					24.0325-0119.1 525119	Ø 288 25 22 V + S PD
2.0 Di 16V	60	08/95→10/01	←	11/96→; → W7999999	24.0124-0115.1 424115	Ø 256 24 21 V + S
					24.0324-0115.1 524115	Ø 256 24 21 V + S PD
			←	X1000001→	24.0125-0119.1 425119	Ø 288 25 22 V + S
					24.0325-0119.1 525119	Ø 288 25 22 V + S PD
2.0 i 16V 2.5 i GSi 2.5 i V6	100 143 125	10/95→01/01 03/98→07/00 09/95→08/00	←		24.0125-0119.1 425119	Ø 288 25 22 V + S
					24.0325-0119.1 525119	Ø 288 25 22 V + S PD
			→		24.0110-0226.1 410226	Ø 286 10 8 + S
2.2 DTi 16V	92	08/95→10/01	←	09/00→	24.0125-0119.1 425119	Ø 288 25 22 V + S
					24.0325-0119.1 525119	Ø 288 25 22 V + S PD
			→	09/00→	24.0110-0226.1 410226	Ø 286 10 8 + S
2.2 i 16V 2.6 i V6	108 125	09/00→07/03 09/00→07/03	←	→ 04/02	24.0125-0119.1 425119	Ø 288 25 22 V + S
					24.0325-0119.1 525119	Ø 288 25 22 V + S PD
			→	→ 04/02	24.0110-0226.1 410226	Ø 286 10 8 + S
				24.0310-0226.1 510226	Ø 286 10 8 + S PD	









VAUXHALL - VECTRA (B) Estate 08/95→03/02







Bremsbelagsatz, Scheibenbremse

1.8 Dualfuel 1.8 i 16V 1.8 i 16V	92 85 92	09/00→03/02 11/96→09/00 09/00→03/02	←	→ W7999999	13.0460-7052.2 607052	ATE 21190 17,5 + WE / - WK
			←	X1000001→	13.0460-7091.2 607091	ATE 21829 20,3 + WE / - WK
			→		13.0460-4040.2 604040	ATE 21050 15,8 - WE / - WK
2.0 DI 16V	60	08/95→10/01	←	11/96→; → W7999999	13.0460-7052.2 607052	ATE 21190 17,5 + WE / - WK
			←	X1000001→	13.0460-7091.2 607091	ATE 21829 20,3 + WE / - WK
			→	11/96→	13.0460-4040.2 604040	ATE 21050 15,8 - WE / - WK
2.0 DTi 16V	74	08/95→10/01	←	06/97→; → W7999999	13.0460-7052.2 607052	ATE 21190 17,5 + WE / - WK
			←	X1000001→	13.0460-7091.2 607091	ATE 21829 20,3 + WE / - WK
			→	06/97→	13.0460-4040.2 604040	ATE 21050 15,8 - WE / - WK
2.0 i 16V 2.5 i GSi 2.5 i V6 2.6 i V6	100 143 125 125	10/95→01/01 05/98→09/99 11/96→08/00 09/00→03/02	←		13.0460-7091.2 607091	ATE 21829 20,3 + WE / - WK
			→		13.0460-4040.2 604040	ATE 21050 15,8 - WE / - WK
2.2 DTi 16V 2.2 i 16V	92 108	08/95→10/01 08/95→10/01	←	09/00→	13.0460-7091.2 607091	ATE 21829 20,3 + WE / - WK
			→	09/00→	13.0460-4040.2 604040	ATE 21050 15,8 - WE / - WK







↓











	kW			 	! #		
VAUXHALL - VECTRA (B) Estate 08/95→03/02							
Warnkontakt, Bremsbelagverschleiß							
1.8 Dualfuel	92	09/00→03/02	←	X1000001→	2	24.8190-0714.2 620714	L= 660
1.8 i 16V	85	11/96→09/00	←	→ W7999999	2	24.8190-0715.2 620715	L= 660
1.8 i 16V	92	09/00→03/02	←				
2.0 DI 16V	60	08/95→10/01	←	X1000001→	2	24.8190-0714.2 620714	L= 660
			←	11/96→; → W7999999	2	24.8190-0715.2 620715	L= 660
2.0 DTI 16V	74	08/95→10/01	←	X1000001→	2	24.8190-0714.2 620714	L= 660
			←	06/97→; → W7999999	2	24.8190-0715.2 620715	L= 660
2.0 i 16V	100	10/95→01/01	←		2	24.8190-0714.2 620714	L= 660
2.5 i GSi	143	05/98→09/99	←				
2.5 i V6	125	11/96→08/00	←				
2.6 i V6	125	09/00→03/02	←				
2.2 DTI 16V	92	08/95→10/01	←	09/00→	2	24.8190-0714.2 620714	L= 660
2.2 i 16V	108	08/95→10/01	←				
Zubehörsatz, Scheibenbremsbelag							
1.8 Dualfuel	92	09/00→03/02	→			13.0460-0347.2 610347	
1.8 i 16V	85	11/96→09/00	→				
1.8 i 16V	92	09/00→03/02	→				
2.0 i 16V	100	10/95→01/01	→				
2.5 i GSi	143	05/98→09/99	→				
2.5 i V6	125	11/96→08/00	→				
2.6 i V6	125	09/00→03/02	→				
2.0 DI 16V	60	08/95→10/01	→	11/96→		13.0460-0347.2 610347	
2.0 DTI 16V	74	08/95→10/01	→	06/97→		13.0460-0347.2 610347	
2.2 DTI 16V	92	08/95→10/01	→	09/00→		13.0460-0347.2 610347	
2.2 i 16V	108	08/95→10/01	→				
 Bremsscheibe							
1.8 Dualfuel	92	09/00→03/02	←	→ W7999999		24.0124-0115.1 424115	Ø 256 24 21 V + S
1.8 i 16V	85	11/96→09/00	←			24.0324-0115.1 524115	Ø 256 24 21 V + S PD
1.8 i 16V	92	09/00→03/02	←	X1000001→		24.0125-0119.1 425119	Ø 288 25 22 V + S
			←			24.0325-0119.1 525119	Ø 288 25 22 V + S PD
			→	→ W7999999		24.0110-0225.1 410225	Ø 270 10 8 + S
			→			24.0310-0225.1 510225	Ø 270 10 8 + S PD
			→	X1000001→		24.0110-0226.1 410226	Ø 286 10 8 + S
			→			24.0310-0226.1 510226	Ø 286 10 8 + S PD
2.0 DI 16V	60	08/95→10/01	←	11/96→; → W7999999		24.0124-0115.1 424115	Ø 256 24 21 V + S
			←			24.0324-0115.1 524115	Ø 256 24 21 V + S PD
			←	X1000001→		24.0125-0119.1 425119	Ø 288 25 22 V + S
			←			24.0325-0119.1 525119	Ø 288 25 22 V + S PD
			→	11/96→; → W7999999		24.0110-0225.1 410225	Ø 270 10 8 + S
			→			24.0310-0225.1 510225	Ø 270 10 8 + S PD
			→	X1000001→		24.0110-0226.1 410226	Ø 286 10 8 + S
			→			24.0310-0226.1 510226	Ø 286 10 8 + S PD
2.0 DTI 16V	74	08/95→10/01	←	06/97→; → W7999999		24.0124-0115.1 424115	Ø 256 24 21 V + S
			←			24.0324-0115.1 524115	Ø 256 24 21 V + S PD
			←	X1000001→		24.0125-0119.1 425119	Ø 288 25 22 V + S
			←			24.0325-0119.1 525119	Ø 288 25 22 V + S PD
			→	06/97→; → W7999999		24.0110-0225.1 410225	Ø 270 10 8 + S
			→			24.0310-0225.1 510225	Ø 270 10 8 + S PD
			→	X1000001→		24.0110-0226.1 410226	Ø 286 10 8 + S
			→			24.0310-0226.1 510226	Ø 286 10 8 + S PD
2.0 i 16V	100	10/95→01/01	←			24.0125-0119.1 425119	Ø 288 25 22 V + S
2.5 i GSi	143	05/98→09/99	←			24.0325-0119.1 525119	Ø 288 25 22 V + S PD
2.5 i V6	125	11/96→08/00	←				
2.6 i V6	125	09/00→03/02	←				
			→			24.0110-0226.1 410226	Ø 286 10 8 + S
			→			24.0310-0226.1 510226	Ø 286 10 8 + S PD
2.2 DTI 16V	92	08/95→10/01	←	09/00→		24.0125-0119.1 425119	Ø 288 25 22 V + S
2.2 i 16V	108	08/95→10/01	←			24.0325-0119.1 525119	Ø 288 25 22 V + S PD
			→	09/00→		24.0110-0226.1 410226	Ø 286 10 8 + S
			→			24.0310-0226.1 510226	Ø 286 10 8 + S PD
VAUXHALL - VECTRA Mk II (C) 01/00→10/08							
 Bremsbelagsatz, Scheibenbremse							
1.8 ↓	103	01/06→07/08	←	für Bremssattel mit Kunststoffkolben		13.0460-7172.2 607172	ATE 23378 20,1 + WE / - WK

	kw			 	! #		
VAUXHALL - VECTRA Mk II (C) 01/00→10/08							
 Bremsbelagsatz, Scheibenbremse							
1.8	103	01/06→07/08	←	für Bremssattel mit Kunststoffkolben	13.0470-7172.2	LD7172	ATE 23378 20,1 + WE / - WK Ceramic
			←	für Bremssattel mit Stahlkolben	13.0460-7212.2	607212	ATE 23738 20,1 + WE / - WK
			→		13.0460-7194.2	607194	ATE 23482 16,6 - WE / - WK
					13.0460-7195.2	607195	ATE 23482 16,6 - WE / - WK
				13.0470-7194.2	LD7194	ATE 23482 16,6 - WE / - WK Ceramic	
				13.0470-7195.2	LD7195	ATE 23482 16,6 - WE / - WK Ceramic	
1.8 16V 1.8 16V Dualfuel 1.9 CDTI 16V 2.0 DTI 16V 2.2 DTI 16V	90 90 110 74 92	04/02→07/08 04/02→07/08 04/04→08/08 04/02→10/08 04/02→10/08	←	für Bremssattel mit Kunststoffkolben	13.0460-7172.2	607172	ATE 23378 20,1 + WE / - WK
					13.0470-7172.2	LD7172	ATE 23378 20,1 + WE / - WK Ceramic
			←	für Bremssattel mit Stahlkolben	13.0460-7212.2	607212	ATE 23738 20,1 + WE / - WK
			→	41096249 / 48091179→	13.0460-7194.2	607194	ATE 23482 16,6 - WE / - WK
					13.0460-7195.2	607195	ATE 23482 16,6 - WE / - WK
					13.0470-7194.2	LD7194	ATE 23482 16,6 - WE / - WK Ceramic
				13.0470-7195.2	LD7195	ATE 23482 16,6 - WE / - WK Ceramic	
			→	41096248 / 48091178	13.0460-7194.2	607194	ATE 23482 16,6 - WE / - WK
					13.0470-7194.2	LD7194	ATE 23482 16,6 - WE / - WK Ceramic
1.9 CDTI	88	04/02→09/08	←	04/04→; für Bremssattel mit Kunststoffkolben	13.0460-7172.2	607172	ATE 23378 20,1 + WE / - WK
					13.0470-7172.2	LD7172	ATE 23378 20,1 + WE / - WK Ceramic
			←	04/04→; für Bremssattel mit Stahlkolben	13.0460-7212.2	607212	ATE 23738 20,1 + WE / - WK
			→	41096249 / 48091179→	13.0460-7194.2	607194	ATE 23482 16,6 - WE / - WK
					13.0460-7195.2	607195	ATE 23482 16,6 - WE / - WK
				13.0470-7194.2	LD7194	ATE 23482 16,6 - WE / - WK Ceramic	
					13.0470-7195.2	LD7195	ATE 23482 16,6 - WE / - WK Ceramic
			→	04/04→; → 41096248 / 48091178	13.0460-7194.2	607194	ATE 23482 16,6 - WE / - WK
					13.0470-7194.2	LD7194	ATE 23482 16,6 - WE / - WK Ceramic
2.0 16V Turbo	129	01/00→10/08	←	03/03→; für Bremssattel mit Kunststoffkolben	13.0460-7172.2	607172	ATE 23378 20,1 + WE / - WK
					13.0470-7172.2	LD7172	ATE 23378 20,1 + WE / - WK Ceramic
			←	03/03→; für Bremssattel mit Stahlkolben	13.0460-7212.2	607212	ATE 23738 20,1 + WE / - WK
			→	41096249 / 48091179→	13.0460-7194.2	607194	ATE 23482 16,6 - WE / - WK
					13.0460-7195.2	607195	ATE 23482 16,6 - WE / - WK
				13.0470-7194.2	LD7194	ATE 23482 16,6 - WE / - WK Ceramic	
					13.0470-7195.2	LD7195	ATE 23482 16,6 - WE / - WK Ceramic
			→	03/03→; → 41096248 / 48091178	13.0460-7194.2	607194	ATE 23482 16,6 - WE / - WK
					13.0470-7194.2	LD7194	ATE 23482 16,6 - WE / - WK Ceramic
2.2 16V	108	01/02→10/08	←	04/02→; für Bremssattel mit Kunststoffkolben	13.0460-7172.2	607172	ATE 23378 20,1 + WE / - WK
					13.0470-7172.2	LD7172	ATE 23378 20,1 + WE / - WK Ceramic
			←	04/02→; für Bremssattel mit Stahlkolben	13.0460-7212.2	607212	ATE 23738 20,1 + WE / - WK
			→	04/02→; → 41096248 / 48091178	13.0460-7194.2	607194	ATE 23482 16,6 - WE / - WK
					13.0470-7194.2	LD7194	ATE 23482 16,6 - WE / - WK Ceramic
					13.0470-7195.2	LD7195	ATE 23482 16,6 - WE / - WK Ceramic
			→	41096249 / 48091179→	13.0460-7194.2	607194	ATE 23482 16,6 - WE / - WK
					13.0460-7195.2	607195	ATE 23482 16,6 - WE / - WK
					13.0470-7194.2	LD7194	ATE 23482 16,6 - WE / - WK Ceramic
					13.0470-7195.2	LD7195	ATE 23482 16,6 - WE / - WK Ceramic
2.2 direct	114	01/02→10/08	←	10/03→; für Bremssattel mit Kunststoffkolben	13.0460-7172.2	607172	ATE 23378 20,1 + WE / - WK
					13.0470-7172.2	LD7172	ATE 23378 20,1 + WE / - WK Ceramic
			←	10/03→; für Bremssattel mit Stahlkolben	13.0460-7212.2	607212	ATE 23738 20,1 + WE / - WK
			→	41096249 / 48091179→	13.0460-7194.2	607194	ATE 23482 16,6 - WE / - WK

	kw			 	! #		
VAUXHALL - VECTRA Mk II (C) 01/00→10/08							
Bremsbelagsatz, Scheibenbremse							
2.2 direct	114	01/02→10/08	➡	41096249 / 48091179→		13.0460-7195.2 607195 13.0470-7194.2 LD7194 13.0470-7195.2 LD7195	ATE 23482 16,6 - WE / - WK ATE 23482 16,6 - WE / - WK Ceramic ATE 23482 16,6 - WE / - WK Ceramic
			➡	10/03→; → 41096248 / 48091178		13.0460-7194.2 607194 13.0470-7194.2 LD7194	ATE 23482 16,6 - WE / - WK ATE 23482 16,6 - WE / - WK Ceramic
3.0 CDTi	135	08/05→07/08	←			13.0460-7199.2 607199	ATE 23404 20,6 + WE / - WK
			➡			13.0460-7194.2 607194 13.0460-7195.2 607195 13.0470-7194.2 LD7194 13.0470-7195.2 LD7195	ATE 23482 16,6 - WE / - WK ATE 23482 16,6 - WE / - WK ATE 23482 16,6 - WE / - WK Ceramic ATE 23482 16,6 - WE / - WK Ceramic
3.0 V6 CDTI	130	06/03→08/05	←			13.0460-7199.2 607199	ATE 23404 20,6 + WE / - WK
			➡	41096249 / 48091179→		13.0460-7194.2 607194 13.0460-7195.2 607195 13.0470-7194.2 LD7194 13.0470-7195.2 LD7195	ATE 23482 16,6 - WE / - WK ATE 23482 16,6 - WE / - WK ATE 23482 16,6 - WE / - WK Ceramic ATE 23482 16,6 - WE / - WK Ceramic
			➡	→ 41096248 / 48091178		13.0460-7194.2 607194 13.0470-7194.2 LD7194	ATE 23482 16,6 - WE / - WK ATE 23482 16,6 - WE / - WK Ceramic
3.2 V6	155	06/03→07/08	←	→ 31070293 / 38047797; für Bremssattel mit Kunststoffkolben		13.0460-7172.2 607172 13.0470-7172.2 LD7172	ATE 23378 20,1 + WE / - WK ATE 23378 20,1 + WE / - WK Ceramic
			←	31070294 / 38047798→ 48045597		13.0460-7199.2 607199	ATE 23404 20,6 + WE / - WK
			←	48045598→		13.0460-7199.2 607199	ATE 23404 20,6 + WE / - WK
			←	→ 31070293 / 38047797; für Bremssattel mit Stahlkolben		13.0460-7212.2 607212	ATE 23738 20,1 + WE / - WK
			➡	→ 41096248 / 48091178		13.0460-7194.2 607194 13.0470-7194.2 LD7194	ATE 23482 16,6 - WE / - WK ATE 23482 16,6 - WE / - WK Ceramic
			➡	41096249 / 48091179→		13.0460-7194.2 607194 13.0460-7195.2 607195 13.0470-7194.2 LD7194 13.0470-7195.2 LD7195	ATE 23482 16,6 - WE / - WK ATE 23482 16,6 - WE / - WK ATE 23482 16,6 - WE / - WK Ceramic ATE 23482 16,6 - WE / - WK Ceramic
Warnkontakt, Bremsbelagverschleiß							
1.8	103	01/06→07/08	←	→ 48045597	1	24.8190-0719.2 620719	L= 685,5
1.8 16V	90	04/02→07/08	←				
1.8 16V Dualfuel	90	04/02→07/08	←	48045598→	1	24.8190-0720.2 620720	L= 287
1.9 CDTI 16V	110	04/04→08/08					
2.0 DTI 16V	74	04/02→10/08					
2.2 DTI 16V	92	04/02→10/08					
1.9 CDTI	88	04/02→09/08	←	04/04→; → 48045597	1	24.8190-0719.2 620719	L= 685,5
			←	04/04→; 48045598→	1	24.8190-0720.2 620720	L= 287
2.0 16V Turbo	129	01/00→10/08	←	03/03→; → 48045597	1	24.8190-0719.2 620719	L= 685,5
			←	03/03→; 48045598→	1	24.8190-0720.2 620720	L= 287
2.2 16V	108	01/02→10/08	←	04/02→; → 48045597	1	24.8190-0719.2 620719	L= 685,5
			←	04/02→; 48045598→	1	24.8190-0720.2 620720	L= 287
2.2 direct	114	01/02→10/08	←	10/03→; → 48045597	1	24.8190-0719.2 620719	L= 685,5
			←	10/03→; 48045598→	1	24.8190-0720.2 620720	L= 287
3.0 CDTi	135	08/05→07/08	←	→ 48045597	1	24.8190-0721.2 620721	L= 700
3.0 V6 CDTI	130	06/03→08/05	←	48045598→	1	24.8190-0722.2 620722	L= 302
3.2 V6	155	06/03→07/08	←	→ 31070293 / 38047797	1	24.8190-0719.2 620719	L= 685,5
			←	31070294 / 38047798→ 48045597	1	24.8190-0721.2 620721	L= 700
			←	48045598→	1	24.8190-0722.2 620722	L= 302
↓							



	kw			 	! #		
VAUXHALL - VECTRA Mk II (C) 01/00→10/08							
Bremsscheibe							
1.8	103	01/06→07/08	←	für Fahrzeuge mit Sportfahrwerk; nicht für Polizeifahrzeuge	24.0125-0141.1 425141	Ø 285 24,9 22 V + S	
			←	für Fahrzeuge mit Sportfahrwerk; für Polizeifahrzeuge	24.0128-0137.1 428137	Ø 302 28 25 V + S	
			→		24.0112-0157.1 412157	Ø 278 11,9 10 + S	
1.8 16V 1.8 16V Dualfuel 2.2 DTI 16V	90 90 92	04/02→07/08 04/02→10/08	←	für Fahrzeuge ohne Sportfahrwerk	24.0125-0141.1 425141	Ø 285 24,9 22 V + S	
			←	für Fahrzeuge mit Sportfahrwerk	24.0128-0137.1 428137	Ø 302 28 25 V + S	
			→		24.0112-0157.1 412157	Ø 278 11,9 10 + S	
1.9 CDTI	88	04/02→09/08	←	04/04→	24.0125-0141.1 425141	Ø 285 24,9 22 V + S	
			→	04/04→	24.0112-0157.1 412157	Ø 278 11,9 10 + S	
					24.0120-0173.1 420173	Ø 292 19,9 18 V + S	
1.9 CDTI 16V 2.0 DTI 16V	110 74	04/04→08/08 04/02→10/08	←		24.0125-0141.1 425141	Ø 285 24,9 22 V + S	
			→		24.0112-0157.1 412157	Ø 278 11,9 10 + S	
					24.0120-0173.1 420173	Ø 292 19,9 18 V + S	
2.0 16V Turbo	129	01/00→10/08	←	03/03→	24.0128-0137.1 428137	Ø 302 28 25 V + S	
			→	03/03→	24.0112-0157.1 412157	Ø 278 11,9 10 + S	
					24.0120-0173.1 420173	Ø 292 19,9 18 V + S	
2.2 16V	108	01/02→10/08	←	04/02→; für Fahrzeuge ohne Sportfahrwerk	24.0125-0141.1 425141	Ø 285 24,9 22 V + S	
			←	04/02→; für Fahrzeuge mit Sportfahrwerk	24.0128-0137.1 428137	Ø 302 28 25 V + S	
			→	04/02→	24.0112-0157.1 412157	Ø 278 11,9 10 + S	
2.2 direct	114	01/02→10/08	←	10/03→; für Fahrzeuge ohne Sportfahrwerk	24.0125-0141.1 425141	Ø 285 24,9 22 V + S	
			←	10/03→; für Fahrzeuge mit Sportfahrwerk	24.0128-0137.1 428137	Ø 302 28 25 V + S	
			→	10/03→	24.0112-0157.1 412157	Ø 278 11,9 10 + S	
3.0 CDTi	135	08/05→07/08	←	61000001→	24.0128-0164.1 428164	Ø 314 28 25 V + S	
			→		24.0112-0157.1 412157	Ø 278 11,9 10 + S	
					24.0120-0173.1 420173	Ø 292 19,9 18 V + S	
3.0 V6 CDTI 3.2 V6	130 155	06/03→08/05 06/03→07/08	←	→ 31070293	24.0128-0137.1 428137	Ø 302 28 25 V + S	
			←	31070294→	24.0328-0137.1 528137	Ø 302 28 25 V + S PD	
			→		24.0128-0164.1 428164	Ø 314 28 25 V + S	
↓			→		24.0112-0157.1 412157	Ø 278 11,9 10 + S	
					24.0120-0173.1 420173	Ø 292 19,9 18 V + S	
					24.0312-0157.1 512157	Ø 278 11,9 10 + S PD	

	kw			 	! #		
VAUXHALL - VECTRA Mk II (C) 01/00→10/08							
 Bremsscheibe							
3.0 V6 CDTi 3.2 V6	130 155	06/03→08/05 06/03→07/08	→			24.0320-0173.1 520173	Ø 292 19,9 18 V + S PD
VAUXHALL - VECTRA Mk II (C) Estate 10/03→07/08							
 Bremsbelagsatz, Scheibenbremse							
1.8 1.8 16V 1.9 CDTi 1.9 CDTi 16V 2.0 16V Turbo 2.0 DTi 16V 2.2 direct 2.2 DTi 16V	103 90 88 110 129 74 114 92	01/06→07/08 10/03→08/05 04/04→07/08 04/04→07/08 10/03→07/08 10/03→07/08 10/03→07/08 10/03→07/08	← ← ← ← → → → →	für Bremssattel mit Kunststoffkolben für Bremssattel mit Stahlkolben → 41096248 / 48091178 41096249 / 48091179→		13.0460-7172.2 607172 13.0470-7172.2 LD7172 13.0460-7212.2 607212 13.0460-7194.2 607194 13.0470-7194.2 LD7194 13.0460-7195.2 607195 13.0470-7195.2 LD7195	ATE 23378 20,1 + WE / - WK ATE 23378 20,1 + WE / - WK Ceramic ATE 23738 20,1 + WE / - WK ATE 23482 16,6 - WE / - WK ATE 23482 16,6 - WE / - WK Ceramic ATE 23482 16,6 - WE / - WK ATE 23482 16,6 - WE / - WK Ceramic
2.8 V6 Turbo 3.0 CDTi 3.0 V6 CDTi 3.2 V6	169 135 130 155	08/05→07/08 08/05→07/08 10/03→08/05 10/03→08/05	← → → →	→ 41096248 / 48091178 41096249 / 48091179→		13.0460-7199.2 607199 13.0460-7194.2 607194 13.0470-7194.2 LD7194 13.0460-7195.2 607195 13.0470-7195.2 LD7195	ATE 23404 20,6 + WE / - WK ATE 23482 16,6 - WE / - WK ATE 23482 16,6 - WE / - WK Ceramic ATE 23482 16,6 - WE / - WK ATE 23482 16,6 - WE / - WK Ceramic
2.8 V6 Turbo 2.8 V6 Turbo	188 206	08/06→07/08 10/06→07/08	→ →	→ 41096248 / 48091178 41096249 / 48091179→		13.0460-7194.2 607194 13.0470-7194.2 LD7194 13.0460-7195.2 607195 13.0470-7195.2 LD7195	ATE 23482 16,6 - WE / - WK ATE 23482 16,6 - WE / - WK Ceramic ATE 23482 16,6 - WE / - WK ATE 23482 16,6 - WE / - WK Ceramic
Warnkontakt, Bremsbelagverschleiß							
1.8 1.8 16V 1.9 CDTi 1.9 CDTi 16V 2.0 16V Turbo 2.0 DTi 16V 2.2 direct 2.2 DTi 16V	103 90 88 110 129 74 114 92	01/06→07/08 10/03→08/05 04/04→07/08 04/04→07/08 10/03→07/08 10/03→07/08 10/03→07/08 10/03→07/08	← ← ← ← → → → →	→ 48045597 48045598→	1 1	24.8190-0719.2 620719 24.8190-0720.2 620720	L= 685,5 L= 287
2.8 V6 Turbo 3.0 CDTi 3.0 V6 CDTi 3.2 V6	169 135 130 155	08/05→07/08 08/05→07/08 10/03→08/05 10/03→08/05	← ← ← ←	→ 48045597 48045598→	1 1	24.8190-0721.2 620721 24.8190-0722.2 620722	L= 700 L= 302
2.8 V6 Turbo 2.8 V6 Turbo	188 206	08/06→07/08 10/06→07/08	← ←		1 1	24.8190-0722.2 620722	L= 302
 Bremsscheibe							
1.8	103	01/06→07/08	← ← → → → → →	für Fahrzeuge mit Sportfahrwerk; nicht für Polizeifahrzeuge für Fahrzeuge mit Sportfahrwerk; für Polizeifahrzeuge		24.0125-0141.1 425141 24.0325-0141.1 525141 24.0128-0137.1 428137 24.0328-0137.1 528137 24.0112-0157.1 412157 24.0120-0173.1 420173 24.0312-0157.1 512157 24.0320-0173.1 520173	Ø 285 24,9 22 V + S Ø 285 24,9 22 V + S PD Ø 302 28 25 V + S Ø 302 28 25 V + S PD Ø 278 11,9 10 + S Ø 292 19,9 18 V + S Ø 278 11,9 10 + S PD Ø 292 19,9 18 V + S PD
1.8 16V 1.9 CDTi 16V 2.2 direct 2.2 DTi 16V	90 110 114 92	10/03→08/05 04/04→07/08 10/03→07/08 10/03→07/08	← ← → →	für Fahrzeuge ohne Sportfahrwerk für Fahrzeuge mit Sportfahrwerk		24.0125-0141.1 425141 24.0325-0141.1 525141 24.0128-0137.1 428137 24.0328-0137.1 528137 24.0112-0157.1 412157 24.0120-0173.1 420173 24.0312-0157.1 512157 24.0320-0173.1 520173	Ø 285 24,9 22 V + S Ø 285 24,9 22 V + S PD Ø 302 28 25 V + S Ø 302 28 25 V + S PD Ø 278 11,9 10 + S Ø 292 19,9 18 V + S Ø 278 11,9 10 + S PD Ø 292 19,9 18 V + S PD
1.9 CDTi	88	04/04→07/08	← ← →	für Fahrzeuge ohne Sportfahrwerk; nicht für Polizeifahrzeuge für Fahrzeuge mit Sportfahrwerk; für Polizeifahrzeuge		24.0125-0141.1 425141 24.0325-0141.1 525141 24.0128-0137.1 428137 24.0328-0137.1 528137 24.0112-0157.1 412157	Ø 285 24,9 22 V + S Ø 285 24,9 22 V + S PD Ø 302 28 25 V + S Ø 302 28 25 V + S PD Ø 278 11,9 10 + S
↓							



VAUXHALL - VECTRA Mk II (C) Estate 10/03→07/08







Bremsscheibe









1.9 CDTi	88	04/04→07/08	➔			24.0120-0173.1 420173 Ø 292 19,9 18 V + S 24.0312-0157.1 512157 Ø 278 11,9 10 + S PD 24.0320-0173.1 520173 Ø 292 19,9 18 V + S PD
2.0 16V Turbo	129	10/03→07/08	➔			24.0128-0137.1 428137 Ø 302 28 25 V + S 24.0328-0137.1 528137 Ø 302 28 25 V + S PD
			➔			24.0112-0157.1 412157 Ø 278 11,9 10 + S 24.0120-0173.1 420173 Ø 292 19,9 18 V + S 24.0312-0157.1 512157 Ø 278 11,9 10 + S PD 24.0320-0173.1 520173 Ø 292 19,9 18 V + S PD
2.0 DTI 16V	74	10/03→07/08	➔			24.0125-0141.1 425141 Ø 285 24,9 22 V + S 24.0325-0141.1 525141 Ø 285 24,9 22 V + S PD
			➔			24.0112-0157.1 412157 Ø 278 11,9 10 + S 24.0120-0173.1 420173 Ø 292 19,9 18 V + S 24.0312-0157.1 512157 Ø 278 11,9 10 + S PD 24.0320-0173.1 520173 Ø 292 19,9 18 V + S PD
2.8 V6 Turbo	169	08/05→07/08	➔	61000001→		24.0128-0164.1 428164 Ø 314 28 25 V + S 24.0112-0157.1 412157 Ø 278 11,9 10 + S 24.0120-0173.1 420173 Ø 292 19,9 18 V + S 24.0312-0157.1 512157 Ø 278 11,9 10 + S PD 24.0320-0173.1 520173 Ø 292 19,9 18 V + S PD
			➔			24.0130-0189.1 430189 Ø 345 29,9 27,5 V 24.0112-0157.1 412157 Ø 278 11,9 10 + S 24.0120-0173.1 420173 Ø 292 19,9 18 V + S 24.0312-0157.1 512157 Ø 278 11,9 10 + S PD 24.0320-0173.1 520173 Ø 292 19,9 18 V + S PD
2.8 V6 Turbo	188	08/06→07/08	➔	61000001→		24.0130-0189.1 430189 Ø 345 29,9 27,5 V 24.0112-0157.1 412157 Ø 278 11,9 10 + S 24.0120-0173.1 420173 Ø 292 19,9 18 V + S 24.0312-0157.1 512157 Ø 278 11,9 10 + S PD 24.0320-0173.1 520173 Ø 292 19,9 18 V + S PD
			➔			24.0130-0189.1 430189 Ø 345 29,9 27,5 V 24.0112-0157.1 412157 Ø 278 11,9 10 + S 24.0120-0173.1 420173 Ø 292 19,9 18 V + S 24.0312-0157.1 512157 Ø 278 11,9 10 + S PD 24.0320-0173.1 520173 Ø 292 19,9 18 V + S PD
2.8 V6 Turbo	206	10/06→07/08	➔			24.0130-0189.1 430189 Ø 345 29,9 27,5 V 24.0112-0157.1 412157 Ø 278 11,9 10 + S 24.0120-0173.1 420173 Ø 292 19,9 18 V + S 24.0312-0157.1 512157 Ø 278 11,9 10 + S PD 24.0320-0173.1 520173 Ø 292 19,9 18 V + S PD
			➔			24.0130-0189.1 430189 Ø 345 29,9 27,5 V 24.0112-0157.1 412157 Ø 278 11,9 10 + S 24.0120-0173.1 420173 Ø 292 19,9 18 V + S 24.0312-0157.1 512157 Ø 278 11,9 10 + S PD 24.0320-0173.1 520173 Ø 292 19,9 18 V + S PD
3.0 CDTi	135	08/05→07/08	➔			24.0128-0164.1 428164 Ø 314 28 25 V + S 24.0112-0157.1 412157 Ø 278 11,9 10 + S 24.0120-0173.1 420173 Ø 292 19,9 18 V + S 24.0312-0157.1 512157 Ø 278 11,9 10 + S PD 24.0320-0173.1 520173 Ø 292 19,9 18 V + S PD
			➔			24.0128-0164.1 428164 Ø 314 28 25 V + S 24.0112-0157.1 412157 Ø 278 11,9 10 + S 24.0120-0173.1 420173 Ø 292 19,9 18 V + S 24.0312-0157.1 512157 Ø 278 11,9 10 + S PD 24.0320-0173.1 520173 Ø 292 19,9 18 V + S PD
3.0 V6 CDTi 3.2 V6	130 155	10/03→08/05 10/03→08/05	➔	→ 31070293		24.0128-0137.1 428137 Ø 302 28 25 V + S 24.0328-0137.1 528137 Ø 302 28 25 V + S PD
			➔	31070294→		24.0128-0164.1 428164 Ø 314 28 25 V + S 24.0112-0157.1 412157 Ø 278 11,9 10 + S 24.0120-0173.1 420173 Ø 292 19,9 18 V + S 24.0312-0157.1 512157 Ø 278 11,9 10 + S PD 24.0320-0173.1 520173 Ø 292 19,9 18 V + S PD
			➔			24.0128-0164.1 428164 Ø 314 28 25 V + S 24.0112-0157.1 412157 Ø 278 11,9 10 + S 24.0120-0173.1 420173 Ø 292 19,9 18 V + S 24.0312-0157.1 512157 Ø 278 11,9 10 + S PD 24.0320-0173.1 520173 Ø 292 19,9 18 V + S PD













VAUXHALL - VECTRA Mk II (C) GTS 08/02→07/08

Bremsbelagsatz, Scheibenbremse















1.8	103	01/06→07/08	➔	für Bremssattel mit Kunststoffkolben		13.0460-7172.2 607172 ATE 23378 20,1 + WE / - WK 13.0470-7172.2 LD7172 ATE 23378 20,1 + WE / - WK Ceramic
			➔	für Bremssattel mit Stahlkolben		13.0460-7212.2 607212 ATE 23738 20,1 + WE / - WK 13.0460-7194.2 607194 ATE 23482 16,6 - WE / - WK 13.0460-7195.2 607195 ATE 23482 16,6 - WE / - WK 13.0470-7194.2 LD7194 ATE 23482 16,6 - WE / - WK Ceramic 13.0470-7195.2 LD7195 ATE 23482 16,6 - WE / - WK Ceramic
			➔			13.0460-7194.2 607194 ATE 23482 16,6 - WE / - WK 13.0460-7195.2 607195 ATE 23482 16,6 - WE / - WK
1.8 16V 1.8 16V Dualfuel 1.9 CDTi 16V 2.0 16V Turbo 2.0 DTI 16V 2.2 16V 2.2 direct 2.2 DTI 16V ↓	90	08/02→07/08	➔	für Bremssattel mit Kunststoffkolben		13.0460-7172.2 607172 ATE 23378 20,1 + WE / - WK 13.0470-7172.2 LD7172 ATE 23378 20,1 + WE / - WK Ceramic
	90	08/02→07/08	➔	für Bremssattel mit Stahlkolben		13.0460-7212.2 607212 ATE 23738 20,1 + WE / - WK
	110	04/04→07/08	➔			13.0460-7194.2 607194 ATE 23482 16,6 - WE / - WK 13.0460-7195.2 607195 ATE 23482 16,6 - WE / - WK 13.0470-7194.2 LD7194 ATE 23482 16,6 - WE / - WK Ceramic 13.0470-7195.2 LD7195 ATE 23482 16,6 - WE / - WK Ceramic
	129	03/03→07/08	➔			13.0460-7194.2 607194 ATE 23482 16,6 - WE / - WK 13.0460-7195.2 607195 ATE 23482 16,6 - WE / - WK 13.0470-7194.2 LD7194 ATE 23482 16,6 - WE / - WK Ceramic 13.0470-7195.2 LD7195 ATE 23482 16,6 - WE / - WK Ceramic
	74	08/02→07/08	➔			13.0460-7194.2 607194 ATE 23482 16,6 - WE / - WK 13.0460-7195.2 607195 ATE 23482 16,6 - WE / - WK











	kw			 	! #			
VAUXHALL - VECTRA Mk II (C) GTS 08/02→07/08								
Bremsbelagsatz, Scheibenbremse								
1.8 16V	90	08/02→07/08	➔	41096249 / 48091179→		13.0470-7194.2	LD7194	ATE 23482 16,6 - WE / - WK Ceramic
1.8 16V Dualfuel	90	08/02→07/08						
1.9 CDTi 16V	110	04/04→07/08				13.0470-7195.2	LD7195	ATE 23482 16,6 - WE / - WK Ceramic
2.0 16V Turbo	129	03/03→07/08						
2.0 DTI 16V	74	08/02→07/08						
2.2 16V	108	08/02→07/08	➔	→ 41096248 / 48091178		13.0460-7194.2	607194	ATE 23482 16,6 - WE / - WK Ceramic
2.2 direct	114	10/03→08/05				13.0470-7194.2	LD7194	ATE 23482 16,6 - WE / - WK Ceramic
2.2 DTI 16V	92	08/02→07/08						
1.9 CDTi	88	08/02→07/08	⬅	04/04→; für Bremssattel mit Kunststoffkolben		13.0460-7172.2	607172	ATE 23378 20,1 + WE / - WK Ceramic
			⬅	04/04→; für Bremssattel mit Stahlkolben		13.0470-7172.2	LD7172	ATE 23378 20,1 + WE / - WK Ceramic
			➔	41096249 / 48091179→		13.0460-7194.2	607194	ATE 23482 16,6 - WE / - WK Ceramic
						13.0460-7195.2	607195	ATE 23482 16,6 - WE / - WK Ceramic
						13.0470-7194.2	LD7194	ATE 23482 16,6 - WE / - WK Ceramic
						13.0470-7195.2	LD7195	ATE 23482 16,6 - WE / - WK Ceramic
			➔	04/04→; → 41096248 / 48091178		13.0460-7194.2	607194	ATE 23482 16,6 - WE / - WK Ceramic
						13.0470-7194.2	LD7194	ATE 23482 16,6 - WE / - WK Ceramic
2.8 V6 Turbo	169	08/05→07/08	⬅			13.0460-7199.2	607199	ATE 23404 20,6 + WE / - WK Ceramic
2.8 V6 Turbo	184	08/06→07/08						
3.0 CDTi	135	08/05→07/08	➔			13.0460-7194.2	607194	ATE 23482 16,6 - WE / - WK Ceramic
						13.0460-7195.2	607195	ATE 23482 16,6 - WE / - WK Ceramic
						13.0470-7194.2	LD7194	ATE 23482 16,6 - WE / - WK Ceramic
						13.0470-7195.2	LD7195	ATE 23482 16,6 - WE / - WK Ceramic
2.8 V6 Turbo	188	08/05→07/08	➔			13.0460-7194.2	607194	ATE 23482 16,6 - WE / - WK Ceramic
2.8 V6 Turbo	206	08/06→07/08				13.0460-7195.2	607195	ATE 23482 16,6 - WE / - WK Ceramic
						13.0470-7194.2	LD7194	ATE 23482 16,6 - WE / - WK Ceramic
						13.0470-7195.2	LD7195	ATE 23482 16,6 - WE / - WK Ceramic
3.0 V6 CDTi	130	06/03→08/05	⬅			13.0460-7199.2	607199	ATE 23404 20,6 + WE / - WK Ceramic
			➔	41096249 / 48091179→		13.0460-7194.2	607194	ATE 23482 16,6 - WE / - WK Ceramic
						13.0460-7195.2	607195	ATE 23482 16,6 - WE / - WK Ceramic
						13.0470-7194.2	LD7194	ATE 23482 16,6 - WE / - WK Ceramic
						13.0470-7195.2	LD7195	ATE 23482 16,6 - WE / - WK Ceramic
			➔	→ 41096248 / 48091178		13.0460-7194.2	607194	ATE 23482 16,6 - WE / - WK Ceramic
						13.0470-7194.2	LD7194	ATE 23482 16,6 - WE / - WK Ceramic
3.2 V6	155	08/02→07/08	⬅	→ 31070293 / 38047797; für Bremssattel mit Kunststoffkolben		13.0460-7172.2	607172	ATE 23378 20,1 + WE / - WK Ceramic
			⬅	31070294 / 38047798→ 48045597		13.0470-7172.2	LD7172	ATE 23378 20,1 + WE / - WK Ceramic
			⬅	48045598→		13.0460-7199.2	607199	ATE 23404 20,6 + WE / - WK Ceramic
			⬅	→ 31070293 / 38047797; für Bremssattel mit Stahlkolben		13.0460-7199.2	607199	ATE 23404 20,6 + WE / - WK Ceramic
			⬅	→ 31070293 / 38047797; für Bremssattel mit Stahlkolben		13.0460-7212.2	607212	ATE 23738 20,1 + WE / - WK Ceramic
			➔	→ 41096248 / 48091178		13.0460-7194.2	607194	ATE 23482 16,6 - WE / - WK Ceramic
						13.0470-7194.2	LD7194	ATE 23482 16,6 - WE / - WK Ceramic
			➔	41096249 / 48091179→		13.0460-7194.2	607194	ATE 23482 16,6 - WE / - WK Ceramic
						13.0460-7195.2	607195	ATE 23482 16,6 - WE / - WK Ceramic
						13.0470-7194.2	LD7194	ATE 23482 16,6 - WE / - WK Ceramic
						13.0470-7195.2	LD7195	ATE 23482 16,6 - WE / - WK Ceramic
Warnkontakt, Bremsbelagverschleiß								
1.8	103	01/06→07/08	⬅	→ 48045597	1	24.8190-0719.2	620719	L= 685,5
1.8 16V	90	08/02→07/08						
1.8 16V Dualfuel	90	08/02→07/08	⬅	48045598→	1	24.8190-0720.2	620720	L= 287
1.9 CDTi 16V	110	04/04→07/08						
2.0 16V Turbo	129	03/03→07/08						
2.0 DTI 16V	74	08/02→07/08						
2.2 16V	108	08/02→07/08						
↓								







	kW			 	! #		
VAUXHALL - VECTRA Mk II (C) GTS 08/02→07/08							
Warnkontakt, Bremsbelagverschleiß							
2.2 direct 2.2 DTI 16V	114 92	10/03→08/05 08/02→07/08	← → 48045597		1	24.8190-0719.2 620719	L= 685,5
			← 48045598→		1	24.8190-0720.2 620720	L= 287
1.9 CDTI	88	08/02→07/08	← 04/04→; → 48045597		1	24.8190-0719.2 620719	L= 685,5
			← 04/04→; 48045598→		1	24.8190-0720.2 620720	L= 287
2.8 V6 Turbo 2.8 V6 Turbo 3.0 CDTi 3.0 V6 CDTI	169 184 135 130	08/05→07/08 08/06→07/08 08/05→07/08 06/03→08/05	← → 48045597		1	24.8190-0721.2 620721	L= 700
			← 48045598→		1	24.8190-0722.2 620722	L= 302
2.8 V6 Turbo 2.8 V6 Turbo	188 206	08/05→07/08 08/06→07/08	←		1	24.8190-0722.2 620722	L= 302
3.2 V6	155	08/02→07/08	← → 31070293 / 38047797		1	24.8190-0719.2 620719	L= 685,5
			← 31070294 / 38047798→ 48045597		1	24.8190-0721.2 620721	L= 700
			← 48045598→		1	24.8190-0722.2 620722	L= 302
 Bremsscheibe							
1.8	103	01/06→07/08	← für Fahrzeuge mit Sportfahrwerk; nicht für Polizeifahrzeuge			24.0125-0141.1 425141 24.0325-0141.1 525141	Ø 285 24,9 22 V + S Ø 285 24,9 22 V + S PD
			← für Fahrzeuge mit Sportfahrwerk; für Polizeifahrzeuge			24.0128-0137.1 428137 24.0328-0137.1 528137	Ø 302 28 25 V + S Ø 302 28 25 V + S PD
			→			24.0112-0157.1 412157 24.0120-0173.1 420173 24.0312-0157.1 512157 24.0320-0173.1 520173	Ø 278 11,9 10 + S Ø 292 19,9 18 V + S Ø 278 11,9 10 + S PD Ø 292 19,9 18 V + S PD
1.8 16V 1.8 16V Dualfuel 2.2 16V 2.2 direct 2.2 DTI 16V	90 90 108 114 92	08/02→07/08 08/02→07/08 08/02→07/08 10/03→08/05 08/02→07/08	← für Fahrzeuge ohne Sportfahrwerk			24.0125-0141.1 425141 24.0325-0141.1 525141	Ø 285 24,9 22 V + S Ø 285 24,9 22 V + S PD
			← für Fahrzeuge mit Sportfahrwerk			24.0128-0137.1 428137 24.0328-0137.1 528137	Ø 302 28 25 V + S Ø 302 28 25 V + S PD
			→			24.0112-0157.1 412157 24.0120-0173.1 420173 24.0312-0157.1 512157 24.0320-0173.1 520173	Ø 278 11,9 10 + S Ø 292 19,9 18 V + S Ø 278 11,9 10 + S PD Ø 292 19,9 18 V + S PD
1.9 CDTI	88	08/02→07/08	← 04/04→			24.0125-0141.1 425141 24.0325-0141.1 525141	Ø 285 24,9 22 V + S Ø 285 24,9 22 V + S PD
			→ 04/04→			24.0112-0157.1 412157 24.0120-0173.1 420173 24.0312-0157.1 512157 24.0320-0173.1 520173	Ø 278 11,9 10 + S Ø 292 19,9 18 V + S Ø 278 11,9 10 + S PD Ø 292 19,9 18 V + S PD
1.9 CDTI 16V 2.0 DTI 16V	110 74	04/04→07/08 08/02→07/08	←			24.0125-0141.1 425141 24.0325-0141.1 525141	Ø 285 24,9 22 V + S Ø 285 24,9 22 V + S PD
			→			24.0112-0157.1 412157 24.0120-0173.1 420173 24.0312-0157.1 512157 24.0320-0173.1 520173	Ø 278 11,9 10 + S Ø 292 19,9 18 V + S Ø 278 11,9 10 + S PD Ø 292 19,9 18 V + S PD
2.0 16V Turbo	129	03/03→07/08	←			24.0128-0137.1 428137 24.0328-0137.1 528137	Ø 302 28 25 V + S Ø 302 28 25 V + S PD
			→			24.0112-0157.1 412157 24.0120-0173.1 420173 24.0312-0157.1 512157 24.0320-0173.1 520173	Ø 278 11,9 10 + S Ø 292 19,9 18 V + S Ø 278 11,9 10 + S PD Ø 292 19,9 18 V + S PD
2.8 V6 Turbo 3.0 CDTi	169 135	08/05→07/08 08/05→07/08	← 61000001→			24.0128-0164.1 428164	Ø 314 28 25 V + S
			→			24.0112-0157.1 412157 24.0120-0173.1 420173 24.0312-0157.1 512157 24.0320-0173.1 520173	Ø 278 11,9 10 + S Ø 292 19,9 18 V + S Ø 278 11,9 10 + S PD Ø 292 19,9 18 V + S PD
2.8 V6 Turbo	184	08/06→07/08	←			24.0128-0164.1 428164	Ø 314 28 25 V + S
			→			24.0112-0157.1 412157 24.0120-0173.1 420173 24.0312-0157.1 512157 24.0320-0173.1 520173	Ø 278 11,9 10 + S Ø 292 19,9 18 V + S Ø 278 11,9 10 + S PD Ø 292 19,9 18 V + S PD
2.8 V6 Turbo 2.8 V6 Turbo	188 206	08/05→07/08 08/06→07/08	← 61000001→			24.0130-0189.1 430189	Ø 345 29,9 27,5 V
			→			24.0112-0157.1 412157 24.0120-0173.1 420173	Ø 278 11,9 10 + S Ø 292 19,9 18 V + S







	kW					! #		
VAUXHALL - VECTRA Mk II (C) GTS 08/02→07/08								
 Bremsscheibe								
2.8 V6 Turbo	188	08/05→07/08	→			24.0312-0157.1	512157	Ø 278 11,9 10 + S PD
2.8 V6 Turbo	206	08/06→07/08				24.0320-0173.1	520173	Ø 292 19,9 18 V + S PD
3.0 V6 CDTi	130	06/03→08/05	←	→ 31070293		24.0128-0137.1	428137	Ø 302 28 25 V + S
3.2 V6	155	08/02→07/08				24.0328-0137.1	528137	Ø 302 28 25 V + S PD
			←	31070294→		24.0128-0164.1	428164	Ø 314 28 25 V + S
			→			24.0112-0157.1	412157	Ø 278 11,9 10 + S
						24.0120-0173.1	420173	Ø 292 19,9 18 V + S
						24.0312-0157.1	512157	Ø 278 11,9 10 + S PD
						24.0320-0173.1	520173	Ø 292 19,9 18 V + S PD
VAUXHALL - VIVARO Combi 05/14→								
 Bremsbelagsatz, Scheibenbremse								
1.6 CDTi	66	05/14→	→	07/14→		13.0460-2840.2	602840	TRW 23980 16,5 + WE / - WK
1.6 CDTi	85	05/14→						
1.6 CDTi	88	05/14→						
1.6 CDTi	103	06/14→						
1.6 CDTi	70	08/16→	→			13.0460-2840.2	602840	TRW 23980 16,5 + WE / - WK
1.6 CDTi	89	09/16→						
1.6 CDTi	92	08/16→						
1.6 CDTi	107	08/16→						
 Bremsscheibe								
1.6 CDTi	66	05/14→	←	07/14→		24.0128-0287.1	428287	Ø 296 28 23,4 V + S
1.6 CDTi	85	05/14→						
1.6 CDTi	88	05/14→						
1.6 CDTi	103	06/14→						
1.6 CDTi	70	08/16→	←			24.0128-0287.1	428287	Ø 296 28 23,4 V + S
1.6 CDTi	89	09/16→						
1.6 CDTi	92	08/16→						
1.6 CDTi	107	08/16→						
VAUXHALL - VIVARO Combi (J7) 08/01→07/14								
 Bremsbelagsatz, Scheibenbremse								
1.9 DI	59	08/01→12/06	←			13.0460-2870.2	602870	TRW 23099 18,4 - WK
1.9 DTI	74	08/01→12/06						
2.0 16V	88	08/01→12/06	→			13.0460-2840.2	602840	TRW 23980 16,5 + WE / - WK
2.0 CDTi	66	01/06→07/14	←	08/06→ 06/14		13.0460-2870.2	602870	TRW 23099 18,4 - WK
2.5 CDTi	107	01/06→07/14	→	08/06→ 06/14		13.0460-2840.2	602840	TRW 23980 16,5 + WE / - WK
2.0 CDTi	84	08/06→07/14	←	→ 06/14		13.0460-2870.2	602870	TRW 23099 18,4 - WK
2.0 ECOTEC	86	08/06→07/14						
2.5 CDTi	84	08/06→07/14	→	→ 06/14		13.0460-2840.2	602840	TRW 23980 16,5 + WE / - WK
2.5 DTI	99	07/03→07/14						
Zubehörsatz, Scheibenbremsbelag								
1.9 DI	59	08/01→12/06	→			13.0460-0072.2	610072	TRW
1.9 DTI	74	08/01→12/06						
2.0 16V	88	08/01→12/06						
2.0 CDTi	66	01/06→07/14	→	08/06→ 06/14		13.0460-0072.2	610072	TRW
2.5 CDTi	107	01/06→07/14						
2.0 CDTi	84	08/06→07/14	→	→ 06/14		13.0460-0072.2	610072	TRW
2.0 ECOTEC	86	08/06→07/14						
2.5 CDTi	84	08/06→07/14						
2.5 DTI	99	07/03→07/14						
 Bremsscheibe								
1.9 DI	59	08/01→12/06	←			24.0128-0132.1	428132	Ø 305 28 24 V + S
1.9 DTI	74	08/01→12/06						
2.0 16V	88	08/01→12/06	→			24.0112-0177.2	412177	Ø 280 12 10 + LG / + ABS Ring
2.0 CDTi	66	01/06→07/14	←	08/06→ 06/14		24.0128-0132.1	428132	Ø 305 28 24 V + S
2.5 CDTi	107	01/06→07/14	→	08/06→ 06/14		24.0112-0177.2	412177	Ø 280 12 10 + LG / + ABS Ring
2.0 CDTi	84	08/06→07/14	←	→ 06/14		24.0128-0132.1	428132	Ø 305 28 24 V + S
2.0 ECOTEC	86	08/06→07/14						
2.5 CDTi	84	08/06→07/14	→	→ 06/14		24.0112-0177.2	412177	Ø 280 12 10 + LG / + ABS Ring
2.5 DTI	99	07/03→07/14						
VAUXHALL - VIVARO Kasten 05/14→								
 Bremsbelagsatz, Scheibenbremse								
1.6 CDTi	66	05/14→	→	07/14→		13.0460-2840.2	602840	TRW 23980 16,5 + WE / - WK
1.6 CDTi	85	05/14→						
1.6 CDTi	88	05/14→						
1.6 CDTi	103	05/14→						
↓								





















	kw					! #		
VAUXHALL - VIVARO Kasten 05/14→								
 Bremsbelagsatz, Scheibenbremse								
1.6 CDTi	70	08/16→	➔			13.0460-2840.2	602840	TRW 23980 16,5 + WE / - WK
1.6 CDTi	89	09/16→						
1.6 CDTi	92	08/16→						
1.6 CDTi	107	08/16→						
 Bremsscheibe								
1.6 CDTi	66	05/14→	➔	07/14→		24.0128-0287.1	428287	Ø 296 28 23,4 V + S
1.6 CDTi	85	05/14→						
1.6 CDTi	88	05/14→						
1.6 CDTi	103	05/14→						
1.6 CDTi	70	08/16→	➔			24.0128-0287.1	428287	Ø 296 28 23,4 V + S
1.6 CDTi	89	09/16→						
1.6 CDTi	92	08/16→						
1.6 CDTi	107	08/16→						
VAUXHALL - VIVARO Kasten (F7) 08/01→07/14								
 Bremsbelagsatz, Scheibenbremse								
1.9 DI	59	08/01→12/06	➔			13.0460-2870.2	602870	TRW 23099 18,4 - WK
1.9 DTI	74	08/01→12/06						
2.0 16V	88	08/01→12/06	➔			13.0460-2840.2	602840	TRW 23980 16,5 + WE / - WK
2.5 CDTI	84	08/06→08/08						
2.0 CDTI	66	01/06→07/14	➔	08/06→06/14		13.0460-2870.2	602870	TRW 23099 18,4 - WK
			➔	08/06→06/14		13.0460-2840.2	602840	TRW 23980 16,5 + WE / - WK
2.0 CDTI	84	08/06→07/14	➔	→06/14		13.0460-2870.2	602870	TRW 23099 18,4 - WK
2.0 ECOTEC	86	08/06→07/14						
2.5 CDTI	107	08/06→07/14	➔	→06/14		13.0460-2840.2	602840	TRW 23980 16,5 + WE / - WK
2.5 DTI	99	07/03→07/14						
Zubehörsatz, Scheibenbremsbelag								
1.9 DI	59	08/01→12/06	➔			13.0460-0072.2	610072	TRW
1.9 DTI	74	08/01→12/06						
2.0 16V	88	08/01→12/06	➔					
2.5 CDTI	84	08/06→08/08						
2.0 CDTI	66	01/06→07/14	➔	08/06→06/14		13.0460-0072.2	610072	TRW
2.0 CDTI	84	08/06→07/14	➔	→06/14		13.0460-0072.2	610072	TRW
2.0 ECOTEC	86	08/06→07/14						
2.5 CDTI	107	08/06→07/14						
2.5 DTI	99	07/03→07/14						
 Bremsscheibe								
1.9 DI	59	08/01→12/06	➔			24.0128-0132.1	428132	Ø 305 28 24 V + S
1.9 DTI	74	08/01→12/06						
2.0 16V	88	08/01→12/06	➔			24.0112-0177.2	412177	Ø 280 12 10 + LG / + ABS Ring
2.5 CDTI	84	08/06→08/08						
2.0 CDTI	66	01/06→07/14	➔	08/06→06/14		24.0128-0132.1	428132	Ø 305 28 24 V + S
			➔	08/06→06/14		24.0112-0177.2	412177	Ø 280 12 10 + LG / + ABS Ring
2.0 CDTI	84	08/06→07/14	➔	→06/14		24.0128-0132.1	428132	Ø 305 28 24 V + S
2.0 ECOTEC	86	08/06→07/14						
2.5 CDTI	107	08/06→07/14	➔	→06/14		24.0112-0177.2	412177	Ø 280 12 10 + LG / + ABS Ring
2.5 DTI	99	07/03→07/14						
VAUXHALL - VIVARO Pritsche/Fahrgestell 05/14→								
 Bremsbelagsatz, Scheibenbremse								
1.6 CDTi	85	05/14→	➔	07/14→		13.0460-2840.2	602840	TRW 23980 16,5 + WE / - WK
1.6 CDTi	88	05/14→						
1.6 CDTi	103	05/14→						
1.6 CDTi	107	08/16→	➔			13.0460-2840.2	602840	TRW 23980 16,5 + WE / - WK
1.6 CDTi	92	08/16→						
 Bremsscheibe								
1.6 CDTi	85	05/14→	➔	07/14→		24.0128-0287.1	428287	Ø 296 28 23,4 V + S
1.6 CDTi	88	05/14→						
1.6 CDTi	103	05/14→						
1.6 CDTi	107	08/16→	➔			24.0128-0287.1	428287	Ø 296 28 23,4 V + S
1.6 CDTi	92	08/16→						
VAUXHALL - VIVARO Pritsche/Fahrgestell (E7) 04/03→07/14								
 Bremsbelagsatz, Scheibenbremse								
1.9 DI	59	04/03→07/14	➔	→06/14		13.0460-2870.2	602870	TRW 23099 18,4 - WK
2.0 16V	88	04/03→07/14						
2.0 CDTI	84	08/06→07/14	➔	→06/14		13.0460-2840.2	602840	TRW 23980 16,5 + WE / - WK
2.0 ECOTEC	86	08/06→07/14						
2.5 CDTI	84	08/06→07/14						
2.5 CDTI	107	08/06→07/14						
↓								















	kw				! #		
VAUXHALL - VIVARO Pritsche/Fahrgestell (E7) 04/03→07/14							
 Bremsbelagsatz, Scheibenbremse							
2.0 CDTI	66	01/06→07/14	←	08/06→ 06/14		13.0460-2870.2 602870	TRW 23099 18,4 - WK
			→	08/06→ 06/14		13.0460-2840.2 602840	TRW 23980 16,5 + WE / - WK
2.5 CDTI	99	04/03→07/06	←	05/03→		13.0460-2870.2 602870	TRW 23099 18,4 - WK
			→	05/03→		13.0460-2840.2 602840	TRW 23980 16,5 + WE / - WK
Zubehörsatz, Scheibenbremsbelag							
1.9 DI	59	04/03→07/14	→	→ 06/14		13.0460-0072.2 610072	TRW
2.0 16V	88	04/03→07/14					
2.0 CDTI	84	08/06→07/14					
2.0 ECOTEC	86	08/06→07/14					
2.5 CDTI	84	08/06→07/14					
2.5 CDTI	107	08/06→07/14					
2.0 CDTI	66	01/06→07/14	→	08/06→ 06/14		13.0460-0072.2 610072	TRW
2.5 CDTI	99	04/03→07/06	→	05/03→		13.0460-0072.2 610072	TRW
 Bremsscheibe							
1.9 DI	59	04/03→07/14	←	→ 06/14		24.0128-0132.1 428132	Ø 305 28 24 V + S
2.0 16V	88	04/03→07/14					
2.0 CDTI	84	08/06→07/14	→	→ 06/14		24.0112-0177.2 412177	Ø 280 12 10 + LG / + ABS Ring
2.0 ECOTEC	86	08/06→07/14					
2.5 CDTI	84	08/06→07/14					
2.5 CDTI	107	08/06→07/14					
2.0 CDTI	66	01/06→07/14	←	08/06→ 06/14		24.0128-0132.1 428132	Ø 305 28 24 V + S
			→	08/06→ 06/14		24.0112-0177.2 412177	Ø 280 12 10 + LG / + ABS Ring
2.5 CDTI	99	04/03→07/06	←	05/03→		24.0128-0132.1 428132	Ø 305 28 24 V + S
			→	05/03→		24.0112-0177.2 412177	Ø 280 12 10 + LG / + ABS Ring
VAUXHALL - VX220 09/00→07/05							
 Bremsscheibe							
2.0 i Turbo	147	03/01→07/05	←	04/03→		24.0125-0119.1 425119	Ø 288 25 22 V + S
						24.0325-0119.1 525119	Ø 288 25 22 V + S PD
			→	04/03→		24.0125-0119.1 425119	Ø 288 25 22 V + S
						24.0325-0119.1 525119	Ø 288 25 22 V + S PD
2.2 i	108	09/00→07/05	←			24.0125-0119.1 425119	Ø 288 25 22 V + S
						24.0325-0119.1 525119	Ø 288 25 22 V + S PD
			→			24.0125-0119.1 425119	Ø 288 25 22 V + S
						24.0325-0119.1 525119	Ø 288 25 22 V + S PD
VAUXHALL - ZAFIRA Mk I (A) (F75) 11/98→08/05							
 Bremsbelagsatz, Scheibenbremse							
1.6 16V	74	04/99→08/05	←	→ 06/05; - ABS		13.0460-7115.2 607115	ATE 23063 17,5 ohne integrierten Verschleißsensor / + WK
1.8 16V	92	09/00→08/05					
1.8 Dualfuel	92	09/00→08/05					
2.0 DI 16V	60	10/99→08/05				13.0470-7115.2 LD7115	ATE 23063 17,5 - WK / + WK Ceramic
			←	→ 06/05; + ABS		13.0460-7116.2 607116	ATE 23057 20,2 - WK / + WK
						13.0470-7116.2 LD7116	ATE 23057 20,2 - WK / + WK Ceramic
			→	→ 06/05		13.0460-2868.2 602868	TRW 23417 15,3 + WK + Zub
						13.0460-3976.2 603976	BOS 23258 16,5 + WK + Zub
						13.0470-2868.2 LD2868	TRW 23417 15,3 + WK + Zub Ceramic
1.6 CNG	71	09/01→06/05	←	- ABS		13.0460-7115.2 607115	ATE 23063 17,5 ohne integrierten Verschleißsensor / + WK
1.8 16V	85	05/99→08/00					
						13.0470-7115.2 LD7115	ATE 23063 17,5 - WK / + WK Ceramic
			←	+ ABS		13.0460-7116.2 607116	ATE 23057 20,2 - WK / + WK
						13.0470-7116.2 LD7116	ATE 23057 20,2 - WK / + WK Ceramic
			→			13.0460-2868.2 602868	TRW 23417 15,3 + WK + Zub
						13.0460-3976.2 603976	BOS 23258 16,5 + WK + Zub
						13.0470-2868.2 LD2868	TRW 23417 15,3 + WK + Zub Ceramic
↓							











	kw			 	! #		
VAUXHALL - ZAFIRA Mk I (A) (F75) 11/98→08/05							
Bremsbelagsatz, Scheibenbremse							
1.6 Dualfuel	74	11/98→08/05	←	04/99→ 06/05; - ABS		13.0460-7115.2 607115	ATE 23063 17,5 ohne integrierten Verschleißsensor / + WK
						13.0470-7115.2 LD7115	ATE 23063 17,5 - WK / + WK Ceramic
			←	04/99→ 06/05; + ABS		13.0460-7116.2 607116	ATE 23057 20,2 - WK / + WK
						13.0470-7116.2 LD7116	ATE 23057 20,2 - WK / + WK Ceramic
			→	04/99→ 06/05		13.0460-2868.2 602868	TRW 23417 15,3 + WK + Zub
						13.0460-3976.2 603976	BOS 23258 16,5 + WK + Zub
						13.0470-2868.2 LD2868	TRW 23417 15,3 + WK + Zub Ceramic
2.0 2.0 GSI Turbo	147 141	06/02→06/05 09/01→06/05	←			13.0460-7173.2 607173	ATE 21829 20,3 - WK / + WK
			→			13.0460-2868.2 602868	TRW 23417 15,3 + WK + Zub
						13.0460-3976.2 603976	BOS 23258 16,5 + WK + Zub
						13.0470-2868.2 LD2868	TRW 23417 15,3 + WK + Zub Ceramic
2.0 DTI 16V	74	04/99→08/05	←	06/00→ 06/05; - ABS		13.0460-7115.2 607115	ATE 23063 17,5 ohne integrierten Verschleißsensor / + WK
						13.0470-7115.2 LD7115	ATE 23063 17,5 - WK / + WK Ceramic
			←	06/00→ 06/05; + ABS		13.0460-7116.2 607116	ATE 23057 20,2 - WK / + WK
						13.0470-7116.2 LD7116	ATE 23057 20,2 - WK / + WK Ceramic
			→	06/00→ 06/05		13.0460-2868.2 602868	TRW 23417 15,3 + WK + Zub
						13.0460-3976.2 603976	BOS 23258 16,5 + WK + Zub
						13.0470-2868.2 LD2868	TRW 23417 15,3 + WK + Zub Ceramic
2.2 16V	108	11/98→08/04	←	09/00→		13.0460-7116.2 607116	ATE 23057 20,2 - WK / + WK
						13.0470-7116.2 LD7116	ATE 23057 20,2 - WK / + WK Ceramic
			→	09/00→		13.0460-2868.2 602868	TRW 23417 15,3 + WK + Zub
						13.0460-3976.2 603976	BOS 23258 16,5 + WK + Zub
						13.0470-2868.2 LD2868	TRW 23417 15,3 + WK + Zub Ceramic
2.2 D	92	06/01→06/05	←	01/02→		13.0460-7116.2 607116	ATE 23057 20,2 - WK / + WK
						13.0470-7116.2 LD7116	ATE 23057 20,2 - WK / + WK Ceramic
			→	01/02→		13.0460-2868.2 602868	TRW 23417 15,3 + WK + Zub
						13.0460-3976.2 603976	BOS 23258 16,5 + WK + Zub
						13.0470-2868.2 LD2868	TRW 23417 15,3 + WK + Zub Ceramic
Warnkontakt, Bremsbelagverschleiß							
1.6 16V	74	04/99→08/05	←	→ 06/05; 42187759→	2	24.8190-0018.2 620018	L= 755
1.8 16V	92	09/00→08/05	←	→ 06/05; → 42187758	2	24.8190-0718.2 620718	L= 720
1.8 Dualfuel	92	09/00→08/05	←				
2.0 DI 16V	60	10/99→08/05	←				
1.6 CNG	71	09/01→06/05	←	42187759→	2	24.8190-0018.2 620018	L= 755
1.8 16V	85	05/99→08/00	←	→ 42187758	2	24.8190-0718.2 620718	L= 720
2.0	147	06/02→06/05	←				
2.0 GSI Turbo	141	09/01→06/05	←				
1.6 Dualfuel	74	11/98→08/05	←	04/99→ 06/05; 42187759→	2	24.8190-0018.2 620018	L= 755
			←	04/99→ 06/05; → 42187758	2	24.8190-0718.2 620718	L= 720
2.0 DTI 16V	74	04/99→08/05	←	06/00→ 06/05; 42187759→	2	24.8190-0018.2 620018	L= 755
			←	06/00→ 06/05; → 42187758	2	24.8190-0718.2 620718	L= 720
2.2 16V	108	11/98→08/04	←	09/00→	2	24.8190-0718.2 620718	L= 720
2.2 D	92	06/01→06/05	←	01/02→	2	24.8190-0718.2 620718	L= 720
Bremsscheibe							
1.6 16V	74	04/99→08/05	←	→ 06/05		24.0125-0131.1 425131	Ø 280 24,8 22 V + S
1.8 16V	92	09/00→08/05	←			24.0325-0131.1 525131	Ø 280 24,8 22 V + S PD
1.8 Dualfuel	92	09/00→08/05	←				
2.0 DI 16V	60	10/99→08/05	→	→ 06/05		24.0110-0250.1 410250	Ø 264 9,8 8 + S
						24.0310-0250.1 510250	Ø 264 9,8 8 + S PD
1.6 CNG	71	09/01→06/05	←			24.0125-0131.1 425131	Ø 280 24,8 22 V + S
1.8 16V	85	05/99→08/00	←			24.0325-0131.1 525131	Ø 280 24,8 22 V + S PD
↓							

	kW				! #		
VAUXHALL - ZAFIRA Mk I (A) (F75) 11/98→08/05							
Bremsscheibe							
1.6 CNG 1.8 16V	71 85	09/01→06/05 05/99→08/00	→			24.0110-0250.1 410250 24.0310-0250.1 510250	Ø 264 9,8 8 + S Ø 264 9,8 8 + S PD
1.6 Dualfuel	74	11/98→08/05	←	04/99→ 06/05		24.0125-0131.1 425131 24.0325-0131.1 525131	Ø 280 24,8 22 V + S Ø 280 24,8 22 V + S PD
			→	04/99→ 06/05		24.0110-0250.1 410250 24.0310-0250.1 510250	Ø 264 9,8 8 + S Ø 264 9,8 8 + S PD
2.0 2.0 GSI Turbo	147 141	06/02→06/05 09/01→06/05	←			24.0125-0142.1 425142 24.0325-0142.1 525142	Ø 308 25 22 V + S Ø 308 25 23 V + S PD
			→			24.0110-0250.1 410250 24.0310-0250.1 510250	Ø 264 9,8 8 + S Ø 264 9,8 8 + S PD
2.0 DTI 16V	74	04/99→08/05	←	06/00→ 06/05		24.0125-0131.1 425131 24.0325-0131.1 525131	Ø 280 24,8 22 V + S Ø 280 24,8 22 V + S PD
			→	06/00→ 06/05		24.0110-0250.1 410250 24.0310-0250.1 510250	Ø 264 9,8 8 + S Ø 264 9,8 8 + S PD
2.2 16V	108	11/98→08/04	←	09/00→		24.0125-0131.1 425131 24.0325-0131.1 525131	Ø 280 24,8 22 V + S Ø 280 24,8 22 V + S PD
			→	09/00→		24.0110-0250.1 410250 24.0310-0250.1 510250	Ø 264 9,8 8 + S Ø 264 9,8 8 + S PD
2.2 D	92	06/01→06/05	←	01/02→		24.0125-0131.1 425131 24.0325-0131.1 525131	Ø 280 24,8 22 V + S Ø 280 24,8 22 V + S PD
			→	01/02→		24.0110-0250.1 410250 24.0310-0250.1 510250	Ø 264 9,8 8 + S Ø 264 9,8 8 + S PD
VAUXHALL - ZAFIRA Mk II (B) (M75) 04/05→11/14							
Bremsbelagsatz, Scheibenbremse							
1.6 1.6 CNG Turbo 1.7 CDTI 1.7 CDTI 1.9 CDTI 1.9 CDTI 1.9 CDTI 2.0 2.2	77 85 110 81 92 74 88 110 147 110	07/05→11/14 12/07→11/14 02/09→11/14 04/09→11/14 01/08→11/14 07/05→11/14 07/05→11/14 07/05→11/14 07/05→11/14 07/05→11/14	←			13.0460-7179.2 607179 13.0470-7179.2 LD7179	ATE 23832 20,2 - WK / + WK ATE 23832 20,2 - WK / + WK Ceramic
			→			13.0460-2868.2 602868 13.0470-2868.2 LD2868	TRW 23417 15,3 + WK + Zub TRW 23417 15,3 + WK + Zub Ceramic
			←	01/06→		13.0460-7179.2 607179 13.0470-7179.2 LD7179	ATE 23832 20,2 - WK / + WK ATE 23832 20,2 - WK / + WK Ceramic
			→	01/06→		13.0460-2868.2 602868 13.0470-2868.2 LD2868	TRW 23417 15,3 + WK + Zub TRW 23417 15,3 + WK + Zub Ceramic
			←	06/13→		13.0460-7179.2 607179 13.0470-7179.2 LD7179	ATE 23832 20,2 - WK / + WK ATE 23832 20,2 - WK / + WK Ceramic
			→	06/13→		13.0460-2868.2 602868 13.0470-2868.2 LD2868	TRW 23417 15,3 + WK + Zub TRW 23417 15,3 + WK + Zub Ceramic
			←	07/05→		13.0460-7179.2 607179 13.0470-7179.2 LD7179	ATE 23832 20,2 - WK / + WK ATE 23832 20,2 - WK / + WK Ceramic
→	07/05→		13.0460-2868.2 602868 13.0470-2868.2 LD2868	TRW 23417 15,3 + WK + Zub TRW 23417 15,3 + WK + Zub Ceramic			
2.0	176	01/06→11/14	←	für Bremssattel mit Kunststoffkolben		13.0460-7172.2 607172 13.0470-7172.2 LD7172	ATE 23378 20,1 + WE / - WK ATE 23378 20,1 + WE / - WK Ceramic
			←	für Bremssattel mit Stahlkolben		13.0460-7212.2 607212	ATE 23738 20,1 + WE / - WK
			→			13.0460-2868.2 602868 13.0470-2868.2 LD2868	TRW 23417 15,3 + WK + Zub TRW 23417 15,3 + WK + Zub Ceramic
Warnkontakt, Bremsbelagverschleiß							
1.6 1.6 1.6 CNG Turbo 1.7 CDTI 1.7 CDTI 1.9 CDTI	77 85 110 81 92 74	07/05→11/14 12/07→11/14 02/09→11/14 04/09→11/14 01/08→11/14 07/05→11/14	←		1	24.8190-0720.2 620720	L= 287











	kw			 	! #		
VAUXHALL - ZAFIRA Mk II (B) (M75) 04/05→11/14							
Warnkontakt, Bremsbelagverschleiß							
1.9 CDTI 1.9 CDTI 2.0 2.0 2.2	88 110 147 176 110	07/05→11/14 07/05→11/14 07/05→11/14 01/06→11/14 07/05→11/14	←		1	24.8190-0720.2 620720	L= 287
1.6 CNG	69	07/05→11/14	←	01/06→	1	24.8190-0720.2 620720	L= 287
1.8	88	04/13→11/14	←	06/13→	1	24.8190-0720.2 620720	L= 287
1.8	103	04/05→11/14	←	07/05→	1	24.8190-0720.2 620720	L= 287
 Bremsscheibe							
1.6 1.6	77 85	07/05→11/14 12/07→11/14	←			24.0125-0131.1 425131 24.0325-0131.1 525131	Ø 280 24,8 22 V + S Ø 280 24,8 22 V + S PD
			→			24.0110-0250.1 410250 24.0310-0250.1 510250	Ø 264 9,8 8 + S Ø 264 9,8 8 + S PD
1.6 CNG	69	07/05→11/14	←	01/06→		24.0125-0142.1 425142 24.0325-0142.1 525142	Ø 308 25 22 V + S Ø 308 25 23 V + S PD
1.6 CNG Turbo	110	02/09→11/14	←			24.0125-0142.1 425142 24.0325-0142.1 525142	Ø 308 25 22 V + S Ø 308 25 23 V + S PD
1.7 CDTI 1.7 CDTI	81 92	04/09→11/14 01/08→11/14	←			24.0125-0131.1 425131 24.0125-0142.1 425142 24.0325-0131.1 525131 24.0325-0142.1 525142	Ø 280 24,8 22 V + S Ø 308 25 22 V + S Ø 280 24,8 22 V + S PD Ø 308 25 23 V + S PD
			→	nicht für Fahrzeuge mit verstärkter Bremse		24.0110-0250.1 410250 24.0310-0250.1 510250	Ø 264 9,8 8 + S Ø 264 9,8 8 + S PD
			→	für Fahrzeuge mit verstärkter Bremse		24.0110-0339.1 410339	Ø 278 10 8 + S
1.8	88	04/13→11/14	←	06/13→		24.0125-0131.1 425131 24.0125-0142.1 425142 24.0325-0131.1 525131 24.0325-0142.1 525142	Ø 280 24,8 22 V + S Ø 308 25 22 V + S Ø 280 24,8 22 V + S PD Ø 308 25 23 V + S PD
			→	06/13→; nicht für Fahrzeuge mit verstärkter Bremse		24.0110-0250.1 410250 24.0310-0250.1 510250	Ø 264 9,8 8 + S Ø 264 9,8 8 + S PD
			→	06/13→; für Fahrzeuge mit verstärkter Bremse		24.0110-0339.1 410339	Ø 278 10 8 + S
1.8	103	04/05→11/14	←	07/05→		24.0125-0131.1 425131 24.0125-0142.1 425142 24.0325-0131.1 525131 24.0325-0142.1 525142	Ø 280 24,8 22 V + S Ø 308 25 22 V + S Ø 280 24,8 22 V + S PD Ø 308 25 23 V + S PD
			→	07/05→; nicht für Fahrzeuge mit verstärkter Bremse		24.0110-0250.1 410250 24.0310-0250.1 510250	Ø 264 9,8 8 + S Ø 264 9,8 8 + S PD
			→	07/05→; für Fahrzeuge mit verstärkter Bremse		24.0110-0339.1 410339	Ø 278 10 8 + S
1.9 CDTI 1.9 CDTI 1.9 CDTI 2.2	74 88 110 110	07/05→11/14 07/05→11/14 07/05→11/14 07/05→11/14	←			24.0125-0142.1 425142 24.0325-0142.1 525142	Ø 308 25 22 V + S Ø 308 25 23 V + S PD
			→	nicht für Fahrzeuge mit verstärkter Bremse		24.0110-0250.1 410250 24.0310-0250.1 510250	Ø 264 9,8 8 + S Ø 264 9,8 8 + S PD
			→	für Fahrzeuge mit verstärkter Bremse		24.0110-0339.1 410339	Ø 278 10 8 + S
2.0	147	07/05→11/14	←			24.0125-0142.1 425142 24.0325-0142.1 525142	Ø 308 25 22 V + S Ø 308 25 23 V + S PD
			→	→ 52999999		24.0110-0250.1 410250 24.0310-0250.1 510250	Ø 264 9,8 8 + S Ø 264 9,8 8 + S PD
			→	62000001→		24.0110-0339.1 410339	Ø 278 10 8 + S
2.0	176	01/06→11/14	←			24.0128-0201.1 428201	Ø 321 28 25 V
			→			24.0110-0339.1 410339	Ø 278 10 8 + S
VAUXHALL - ZAFIRA Mk III (P12) 10/11→							
 Bremsbelagsatz, Scheibenbremse							
1.4 1.4 1.4 LPG 1.6 CNG	88 103 103 110	10/11→ 10/11→ 10/11→ 10/11→	←	11/11→; für Bremsscheibendurchmesser [mm]: 321		13.0460-5612.2 605612 13.0470-5612.2 LD5612	MAN 24412 19,0 + WK + Zub MAN 24412 19,0 + WK + Zub Ceramic
1.8 1.8 1.8 2.0 CDTi	85 88 103 81	10/11→ 10/11→ 10/11→ 10/11→	←	11/11→; für Bremsscheibendurchmesser [mm]: 300		13.0460-7263.2 607263 13.0470-7263.2 LD7263	24034 19,1 + WK + Zub 24034 19,1 + WK + Zub Ceramic
↓							













	kw			 	! #		
VAUXHALL - ZAFIRA Mk III (P12) 10/11→							
 Bremsbelagsatz, Scheibenbremse							
2.0 CDTi 2.0 CDTi 2.0 CDTi	96 118 121	10/11→ 10/11→ 10/11→	➔	F0000001→; für Bremsscheibendurchmesser [mm]: 292		13.0460-7264.2 607264 13.0470-7264.2 LD7264	ATE 25096 17,0 + WK + Zub ATE 25096 17,0 + WK + Zub Ceramic
			➔	11/11→; für Bremsscheibendurchmesser [mm]: 292; → E9999999		13.0460-7264.2 607264 13.0470-7264.2 LD7264	ATE 25096 17,0 + WK + Zub ATE 25096 17,0 + WK + Zub Ceramic
			➔	F0000001→; für Bremsscheibendurchmesser [mm]: 315		13.0460-7309.2 607309 13.0470-7309.2 LD7309	ATE 25096 16,7 + WK + Zub ATE 25096 16,7 + WK + Zub Ceramic
1.6 CDTi 1.6 CDTi 1.6 SIDI 1.6 Turbo 2.0 BiTurbo CDTI	99 100 147 125 143	10/16→ 03/13→ 07/13→ 12/12→ 01/13→	➔	für Bremsscheibendurchmesser [mm]: 321		13.0460-5612.2 605612 13.0470-5612.2 LD5612	MAN 24412 19,0 + WK + Zub MAN 24412 19,0 + WK + Zub Ceramic
			➔	für Bremsscheibendurchmesser [mm]: 300		13.0460-7263.2 607263 13.0470-7263.2 LD7263	24034 19,1 + WK + Zub 24034 19,1 + WK + Zub Ceramic
			➔	für Bremsscheibendurchmesser [mm]: 292; → E9999999		13.0460-7264.2 607264 13.0470-7264.2 LD7264	ATE 25096 17,0 + WK + Zub ATE 25096 17,0 + WK + Zub Ceramic
			➔	F0000001→; für Bremsscheibendurchmesser [mm]: 292		13.0460-7264.2 607264 13.0470-7264.2 LD7264	ATE 25096 17,0 + WK + Zub ATE 25096 17,0 + WK + Zub Ceramic
			➔	F0000001→; für Bremsscheibendurchmesser [mm]: 315		13.0460-7309.2 607309 13.0470-7309.2 LD7309	ATE 25096 16,7 + WK + Zub ATE 25096 16,7 + WK + Zub Ceramic
2.0 CDTi	125	01/15→	➔	für Bremsscheibendurchmesser [mm]: 321		13.0460-5612.2 605612 13.0470-5612.2 LD5612	MAN 24412 19,0 + WK + Zub MAN 24412 19,0 + WK + Zub Ceramic
			➔	für Bremsscheibendurchmesser [mm]: 300		13.0460-7263.2 607263 13.0470-7263.2 LD7263	24034 19,1 + WK + Zub 24034 19,1 + WK + Zub Ceramic
			➔	für Bremsscheibendurchmesser [mm]: 292		13.0460-7264.2 607264 13.0470-7264.2 LD7264	ATE 25096 17,0 + WK + Zub ATE 25096 17,0 + WK + Zub Ceramic
			➔	für Bremsscheibendurchmesser [mm]: 315		13.0460-7309.2 607309 13.0470-7309.2 LD7309	ATE 25096 16,7 + WK + Zub ATE 25096 16,7 + WK + Zub Ceramic
 Bremsscheibe							
1.4 1.4 1.4 LPG 1.6 CNG 1.8 1.8 1.8 2.0 CDTi 2.0 CDTi 2.0 CDTi 2.0 CDTi	88 103 103 110 85 88 103 81 96 118 121	10/11→ 10/11→ 10/11→ 10/11→ 10/11→ 10/11→ 10/11→ 10/11→ 10/11→ 10/11→ 10/11→ 10/11→	➔	11/11→		24.0126-0166.1 426166 24.0130-0224.1 430224 24.0326-0166.1 526166	Ø 300 26 23 V + S Ø 321 30 27 V + S Ø 300 26 23 V + S PD
			➔	11/11→		24.0112-0189.1 412189 24.0123-0116.1 423116 24.0312-0189.1 512189	Ø 292 12 10 + S Ø 315 23 20 V + S Ø 292 12 10 + S PD
1.6 CDTi 1.6 CDTi 1.6 SIDI 1.6 Turbo 2.0 BiTurbo CDTI 2.0 CDTi	99 100 147 125 143 125	10/16→ 03/13→ 07/13→ 12/12→ 01/13→ 01/15→	➔			24.0126-0166.1 426166 24.0130-0224.1 430224 24.0326-0166.1 526166	Ø 300 26 23 V + S Ø 321 30 27 V + S Ø 300 26 23 V + S PD
			➔			24.0112-0189.1 412189 24.0123-0116.1 423116 24.0312-0189.1 512189	Ø 292 12 10 + S Ø 315 23 20 V + S Ø 292 12 10 + S PD
VOLVO - 440 K (445) 08/88→12/96							
 Bremsbelagsatz, Scheibenbremse							
1.6 1.7 1.7	61 75 78	09/88→12/96 08/89→12/96 09/88→12/96	➔	EKC 006387→		13.0460-2812.2 602812	TRW 21217 18,0 - WK
			➔	→ EKC 006386		13.0460-2846.2 602846	TRW 21010 15,8 - WK
			➔			13.0460-3306.2 603306	ATE 21089 15,0 - WE / - WK
1.7	64	09/88→12/96	➔	EKC 006387→		13.0460-2812.2 602812	TRW 21217 18,0 - WK
			➔	→ EKC 006386		13.0460-2846.2 602846	TRW 21010 15,8 - WK
1.7 Turbo 1.7 Turbo 2.0	88 90 81	08/88→07/96 01/91→12/96 08/92→07/95	➔			13.0460-7146.2 607146 13.0460-3306.2 603306	ATE 20147 17,0 - WE / - WK ATE 21089 15,0 - WE / - WK
1.8 1.8 1.9 Turbo-Diesel	66 66 66	08/91→07/96 09/95→12/96 07/94→12/96	➔			13.0460-2812.2 602812 13.0460-3306.2 603306	TRW 21217 18,0 - WK ATE 21089 15,0 - WE / - WK
↓							

	kw					! #		
VOLVO - 440 K (445) 08/88→12/96								
 Bremsbelagsatz, Scheibenbremse								
2.0	80	08/93→07/96	←	EKC 006387→		13.0460-2812.2	602812	TRW 21217 18,0 - WK
			←			13.0460-7146.2	607146	ATE 20147 17,0 - WE / - WK
 Bremsscheibe								
1.6	61	09/88→12/96	←			24.0112-0135.1	412135	Ø 260 12 10,8
1.7	75	08/89→12/96	→					
1.7	78	09/88→12/96	→			24.0109-0125.1	409125	Ø 228 9 8
1.8	66	08/91→07/96						
1.8	66	09/95→12/96						
1.9 Turbo-Diesel	66	07/94→12/96						
1.7	64	09/88→12/96	←			24.0112-0135.1	412135	Ø 260 12 10,8
1.7 Turbo	88	08/88→07/96	→			24.0109-0125.1	409125	Ø 228 9 8
1.7 Turbo	90	01/91→12/96	→					
2.0	81	08/92→07/95						
2.0	80	08/93→07/96	←	EKC 006387→		24.0112-0135.1	412135	Ø 260 12 10,8
VOLVO - 460 L (464) 09/88→07/96								
 Bremsbelagsatz, Scheibenbremse								
1.6	61	07/92→07/96	←			13.0460-2812.2	602812	TRW 21217 18,0 - WK
1.7	64	09/88→07/96	←	EKC 006387→		13.0460-2812.2	602812	TRW 21217 18,0 - WK
1.7	66	09/90→07/96	←	→ EKC 006386		13.0460-2846.2	602846	TRW 21010 15,8 - WK
1.7 Turbo	88	08/89→07/96	←			13.0460-7146.2	607146	ATE 20147 17,0 - WE / - WK
1.7 Turbo	90	01/91→07/96	→			13.0460-3306.2	603306	ATE 21089 15,0 - WE / - WK
1.8	66	08/91→07/96	←			13.0460-2812.2	602812	TRW 21217 18,0 - WK
1.9 Turbo-Diesel	66	07/94→07/96	→			13.0460-3306.2	603306	ATE 21089 15,0 - WE / - WK
2.0	80	08/93→07/96	←	EKC 006387→		13.0460-2812.2	602812	TRW 21217 18,0 - WK
			←			13.0460-7146.2	607146	ATE 20147 17,0 - WE / - WK
2.0	81	08/92→07/95	←			13.0460-2812.2	602812	TRW 21217 18,0 - WK
			→			13.0460-7146.2	607146	ATE 20147 17,0 - WE / - WK
			→			13.0460-3306.2	603306	ATE 21089 15,0 - WE / - WK
 Bremsscheibe								
1.6	61	07/92→07/96	←	Herstellereinschränkung TRW		24.0112-0135.1	412135	Ø 260 12 10,8
1.7	64	09/88→07/96						
1.7	66	09/90→07/96						
1.7 Turbo	88	08/89→07/96	→			24.0109-0125.1	409125	Ø 228 9 8
1.7 Turbo	90	01/91→07/96	→					
1.8	66	08/91→07/96	←	Herstellereinschränkung TRW		24.0112-0135.1	412135	Ø 260 12 10,8
1.9 Turbo-Diesel	66	07/94→07/96	→			24.0109-0125.1	409125	Ø 228 9 8
2.0	81	08/92→07/95						
2.0	80	08/93→07/96	←	EKC 006387→; Herstellereinschränkung TRW		24.0112-0135.1	412135	Ø 260 12 10,8
VOLVO - 480 E 04/86→07/96								
 Bremsbelagsatz, Scheibenbremse								
1.7	75	08/89→07/96	←			13.0460-2812.2	602812	TRW 21217 18,0 - WK
			→			13.0460-3306.2	603306	ATE 21089 15,0 - WE / - WK
1.7 Turbo	88	08/87→07/96	←			13.0460-7146.2	607146	ATE 20147 17,0 - WE / - WK
1.7 Turbo	90	01/91→07/96	→			13.0460-3306.2	603306	ATE 21089 15,0 - WE / - WK
2.0	81	08/92→09/95						
 Bremsscheibe								
1.7	75	08/89→07/96	←			24.0112-0135.1	412135	Ø 260 12 10,8
1.7 Turbo	88	08/87→07/96	→			24.0109-0125.1	409125	Ø 228 9 8
1.7 Turbo	90	01/91→07/96	→			24.0109-0125.1	409125	Ø 228 9 8
2.0	81	08/92→09/95						
VOLVO - 850 (LS) 06/91→10/97								
 Bremsbelagsatz, Scheibenbremse								
2.0	93	08/94→12/96	←			13.0460-7053.2	607053	ATE 21273 19,5 + WE / - WK
2.0	105	06/91→12/96				13.0470-7053.2	LD7053	ATE 21273 19,5 + WE / - WK
2.0 Turbo	132	09/93→10/96						Ceramic
2.0 Turbo	155	08/93→12/96	→					
2.4	106	08/94→12/96	→			13.0460-3403.2	603403	ATE 20755 14,4 - WE / - WK
2.4	125	08/91→12/96						
2.5 TDI	103	08/95→12/96						
↓								













	kW			 	! #		
VOLVO - 850 (LS) 06/91→10/97							
 Bremsbelagsatz, Scheibenbremse							
2.3 T5	166	08/93→07/96	←			13.0460-7053.2 607053	ATE 21273 19,5 + WE / - WK
2.3 T5 R	176	04/96→10/96	→			13.0460-3403.2 603403	ATE 20755 14,4 - WE / - WK
2.3 T5-R	184	08/95→12/96	→				
2.3 Turbo R	177	06/95→10/96	←	08/95→		13.0460-7053.2 607053	ATE 21273 19,5 + WE / - WK
			→	08/95→		13.0460-3403.2 603403	ATE 20755 14,4 - WE / - WK
2.3 Turbo R	179	09/94→10/97	←	08/95→ 12/96		13.0460-7053.2 607053	ATE 21273 19,5 + WE / - WK
			→	08/95→ 12/96		13.0460-3403.2 603403	ATE 20755 14,4 - WE / - WK
Zubehörsatz, Scheibenbremsbelag							
2.0	93	08/94→12/96	→			13.0460-0088.2 610088	ATE
2.0	105	06/91→12/96	→				
2.0 Turbo	132	09/93→10/96	→				
2.0 Turbo	155	08/93→12/96	→				
2.3 T5	166	08/93→07/96	→				
2.3 T5 R	176	04/96→10/96	→				
2.3 T5-R	184	08/95→12/96	→				
2.4	106	08/94→12/96	→				
2.4	125	08/91→12/96	→				
2.5 TDI	103	08/95→12/96	→				
2.3 Turbo R	177	06/95→10/96	→	08/95→		13.0460-0088.2 610088	ATE
2.3 Turbo R	179	09/94→10/97	→	08/95→ 12/96		13.0460-0088.2 610088	ATE
 Bremsscheibe							
2.0	93	08/94→12/96	←			24.0126-0102.1 426102	Ø 280,3 26 23 V
2.0	105	06/91→12/96	→			24.0110-0214.1 410214	Ø 295 9,6 8,4
2.0 Turbo	132	09/93→10/96	→				
2.0 Turbo	155	08/93→12/96	→				
2.3 T5	166	08/93→07/96	→				
2.3 T5 R	176	04/96→10/96	→				
2.3 T5-R	184	08/95→12/96	→				
2.4	106	08/94→12/96	→				
2.5 TDI	103	08/95→12/96	→				
2.3 Turbo R	177	06/95→10/96	←	08/95→		24.0126-0102.1 426102	Ø 280,3 26 23 V
			→	08/95→		24.0110-0214.1 410214	Ø 295 9,6 8,4
2.3 Turbo R	179	09/94→10/97	←	08/95→ 12/96		24.0126-0102.1 426102	Ø 280,3 26 23 V
			→	08/95→ 12/96		24.0110-0214.1 410214	Ø 295 9,6 8,4
2.4	125	08/91→12/96	←	→ 08/93		24.0126-0101.1 426101	Ø 280,3 26 23 V
			←	09/93→		24.0126-0102.1 426102	Ø 280,3 26 23 V
			→	09/93→		24.0110-0214.1 410214	Ø 295 9,6 8,4
			→	→ 08/93		24.0110-0216.1 410216	Ø 295 9,6 8,4
VOLVO - 850 Kombi (LW) 04/92→10/97							
 Bremsbelagsatz, Scheibenbremse							
2.0	93	08/94→12/96	←			13.0460-7053.2 607053	ATE 21273 19,5 + WE / - WK
2.0	105	02/93→12/96	←			13.0470-7053.2 LD7053	ATE 21273 19,5 + WE / - WK Ceramic
2.0 Turbo	155	02/93→12/96	←				
2.4	106	08/94→12/96	→			13.0460-3403.2 603403	ATE 20755 14,4 - WE / - WK
2.4	125	09/92→12/96	→				
2.5 TDI	103	08/95→12/96	→				
2.0 Turbo	132	09/93→10/97	←	→ 12/96		13.0460-7053.2 607053	ATE 21273 19,5 + WE / - WK
			→	→ 12/96		13.0470-7053.2 LD7053	ATE 21273 19,5 + WE / - WK Ceramic
2.0 Turbo	132	09/93→10/97	→	→ 12/96		13.0460-3403.2 603403	ATE 20755 14,4 - WE / - WK
			→	→ 12/96			
2.3 T5	166	02/93→12/96	←			13.0460-7053.2 607053	ATE 21273 19,5 + WE / - WK
2.3 T5 R	176	04/96→10/96	→			13.0460-3403.2 603403	ATE 20755 14,4 - WE / - WK
2.3 T5-R	184	08/95→12/96	→				
2.3 Turbo R	177	06/95→10/97	←	08/95→ 12/96		13.0460-7053.2 607053	ATE 21273 19,5 + WE / - WK
			→	08/95→ 12/96		13.0460-3403.2 603403	ATE 20755 14,4 - WE / - WK
2.4 AWD	142	04/96→12/96	←			13.0460-7053.2 607053	ATE 21273 19,5 + WE / - WK
			→			13.0470-7053.2 LD7053	ATE 21273 19,5 + WE / - WK Ceramic
2.4 AWD	142	04/96→12/96	→			13.0460-2935.2 602935	TRW 21385 13,8 - WK
			→				
Zubehörsatz, Scheibenbremsbelag							
2.0	93	08/94→12/96	→			13.0460-0088.2 610088	ATE
2.0	105	02/93→12/96	→				
2.0 Turbo	155	02/93→12/96	→				
2.3 T5	166	02/93→12/96	→				
2.3 T5 R	176	04/96→10/96	→				













	kw			 	! #		
VOLVO - 850 Kombi (LW) 04/92→10/97							
Zubehörsatz, Scheibenbremsbelag							
2.3 T5-R	184	08/95→12/96	➡			13.0460-0088.2 610088	ATE
2.4	106	08/94→12/96					
2.4	125	09/92→12/96					
2.5 TDI	103	08/95→12/96					
2.0 Turbo	132	09/93→10/97	➡	→ 12/96		13.0460-0088.2 610088	ATE
2.3 Turbo R	177	06/95→10/97	➡	08/95→ 12/96		13.0460-0088.2 610088	ATE
 Bremsscheibe							
2.0	93	08/94→12/96	⬅			24.0126-0102.1 426102	Ø 280,3 26 23 V
2.0	105	02/93→12/96					
2.0 Turbo	155	02/93→12/96	➡			24.0110-0214.1 410214	Ø 295 9,6 8,4
2.3 T5	166	02/93→12/96					
2.3 T5 R	176	04/96→10/96					
2.3 T5-R	184	08/95→12/96					
2.4	106	08/94→12/96					
2.5 TDI	103	08/95→12/96					
2.0 Turbo	132	09/93→10/97	⬅	→ 12/96		24.0126-0102.1 426102	Ø 280,3 26 23 V
			➡	→ 12/96		24.0110-0214.1 410214	Ø 295 9,6 8,4
2.3 Turbo R	177	06/95→10/97	⬅	08/95→ 12/96		24.0126-0102.1 426102	Ø 280,3 26 23 V
			➡	08/95→ 12/96		24.0110-0214.1 410214	Ø 295 9,6 8,4
2.4	125	09/92→12/96	⬅	→ 08/93		24.0126-0101.1 426101	Ø 280,3 26 23 V
			⬅	08/93→		24.0126-0102.1 426102	Ø 280,3 26 23 V
			➡	09/93→		24.0110-0214.1 410214	Ø 295 9,6 8,4
			➡	→ 08/93		24.0110-0216.1 410216	Ø 295 9,6 8,4
2.4 AWD	142	04/96→12/96	⬅			24.0126-0102.1 426102	Ø 280,3 26 23 V
			➡	Allrad		24.0110-0292.1 410292	Ø 283 10 8
VOLVO - 940 II (944) 08/94→12/98							
 Bremsbelagsatz, Scheibenbremse							
2.0 Turbo	114	04/96→10/98	⬅			13.0460-2985.2 602985	TRW 20164 18,2 - WK
2.3	85	08/94→07/95				13.0460-3914.2 603914	BDX 21233 16,7 - WE / - WK
2.3	96	08/94→10/98	➡				
2.3 ti	99	01/95→10/98	➡	Multi-link Achse		13.0460-2935.2 602935	TRW 21385 13,8 - WK
2.3 Turbo	121	08/94→10/98	➡	nicht für Multi-link Achse		13.0460-3401.2 603401	ATE 20755 14,4 - WE / - WK
2.4 TD Interc.	90	08/94→10/98					
2.3 Turbo	126	01/95→12/98	⬅	→ 10/98		13.0460-2985.2 602985	TRW 20164 18,2 - WK
			➡	→ 10/98; Multi-link Achse		13.0460-3914.2 603914	BDX 21233 16,7 - WE / - WK
			➡	→ 10/98; nicht für Multi-link Achse		13.0460-2935.2 602935	TRW 21385 13,8 - WK
			➡	→ 10/98; nicht für Multi-link Achse		13.0460-3401.2 603401	ATE 20755 14,4 - WE / - WK
Zubehörsatz, Scheibenbremsbelag							
2.0 Turbo	114	04/96→10/98	⬅			13.0460-0429.2 610429	BDX
2.3	85	08/94→07/95					
2.3	96	08/94→10/98	➡	nicht für Multi-link Achse		13.0460-0088.2 610088	ATE
2.3 ti	99	01/95→10/98					
2.3 Turbo	121	08/94→10/98					
2.4 TD Interc.	90	08/94→10/98					
2.3 Turbo	126	01/95→12/98	⬅	→ 10/98		13.0460-0429.2 610429	BDX
			➡	→ 10/98; nicht für Multi-link Achse		13.0460-0088.2 610088	ATE
 Bremsscheibe							
2.0 Turbo	114	04/96→10/98	⬅			24.0126-0105.1 426105	Ø 280 26 23 V
2.3	85	08/94→07/95					
2.3	96	08/94→10/98	➡	nicht für Multi-link Achse		24.0110-0189.1 410189	Ø 281 9,6 8,4
2.3 ti	99	01/95→10/98	➡	Multi-link Achse		24.0110-0206.1 410206	Ø 265 10 8
2.3 Turbo	121	08/94→10/98					
2.4 TD Interc.	90	08/94→10/98					
2.3 Turbo	126	01/95→12/98	⬅	→ 10/98		24.0126-0105.1 426105	Ø 280 26 23 V
			➡	→ 10/98; nicht für Multi-link Achse		24.0110-0189.1 410189	Ø 281 9,6 8,4
			➡	→ 10/98; Multi-link Achse		24.0110-0206.1 410206	Ø 265 10 8
VOLVO - 940 II Kombi (945) 08/94→10/98							
 Bremsbelagsatz, Scheibenbremse							
2.0 Turbo	114	04/96→10/98	⬅			13.0460-2985.2 602985	TRW 20164 18,2 - WK
2.3	85	08/94→07/95				13.0460-3914.2 603914	BDX 21233 16,7 - WE / - WK
2.3	96	08/94→10/98	➡				
2.3 ti	99	01/95→10/98	➡	Multi-link Achse		13.0460-2935.2 602935	TRW 21385 13,8 - WK
2.3 Turbo	121	08/94→10/98					
2.3 Turbo	121	08/94→10/98					
↓							













	kw			 	! #		
VOLVO - 940 II Kombi (945) 08/94→10/98							
 Bremsbelagsatz, Scheibenbremse							
2.3 Turbo 2.4 TD Interc.	126 90	08/95→10/98 08/94→10/98	➔	nicht für Multi-link Achse		13.0460-3401.2 603401	ATE 20755 14,4 - WE / - WK
Zubehörsatz, Scheibenbremsbelag							
2.0 Turbo 2.3 2.3 2.3 ti 2.3 Turbo 2.3 Turbo 2.4 TD Interc.	114 85 96 99 121 126 90	04/96→10/98 08/94→07/95 08/94→10/98 01/95→10/98 08/94→10/98 08/95→10/98 08/94→10/98	← ➔ ➔ ➔ ➔ ➔ ➔	 nicht für Multi-link Achse 		13.0460-0429.2 610429 13.0460-0088.2 610088	BDX ATE
 Bremsscheibe							
2.0 Turbo 2.3 2.3 2.3 ti 2.3 Turbo 2.3 Turbo 2.4 TD Interc.	114 85 96 99 121 126 90	04/96→10/98 08/94→07/95 08/94→10/98 01/95→10/98 08/94→10/98 08/95→10/98 08/94→10/98	← ➔ ➔ ➔ ➔ ➔ ➔	 nicht für Multi-link Achse Multi-link Achse 		24.0126-0105.1 426105 24.0110-0189.1 410189 24.0110-0206.1 410206	Ø 280 26 23 V Ø 281 9,6 8,4 Ø 265 10 8
VOLVO - 940 Kombi (945) 08/90→10/95							
 Bremsbelagsatz, Scheibenbremse							
2.0 Turbo	114	01/91→07/95	←	→ 12/91; - ABS		13.0460-2943.2 602943 13.0460-3914.2 603914	TRW 21266 17,0 - WK BDX 21233 16,7 - WE / - WK
			←	01/92→; - ABS		13.0460-2943.2 602943 13.0460-3914.2 603914	TRW 21266 17,0 - WK BDX 21233 16,7 - WE / - WK
			←	01/92→; + ABS		13.0460-2985.2 602985	TRW 20164 18,2 - WK
			←	→ 12/91; + ABS		13.0460-2985.2 602985	TRW 20164 18,2 - WK
			➔	Multi-link Achse		13.0460-2935.2 602935	TRW 21385 13,8 - WK
			➔	nicht für Multi-link Achse		13.0460-3401.2 603401	ATE 20755 14,4 - WE / - WK
2.4 D	60	08/90→07/95	←	→ 12/91; - ABS		13.0460-2943.2 602943 13.0460-3914.2 603914	TRW 21266 17,0 - WK BDX 21233 16,7 - WE / - WK
			←	01/92→; - ABS		13.0460-2943.2 602943 13.0460-3914.2 603914	TRW 21266 17,0 - WK BDX 21233 16,7 - WE / - WK
			←	01/92→; + ABS		13.0460-2985.2 602985	TRW 20164 18,2 - WK
			←	→ 12/91; + ABS		13.0460-2985.2 602985	TRW 20164 18,2 - WK
			➔			13.0460-2935.2 602935	TRW 21385 13,8 - WK
			➔	nicht für Multi-link Achse		13.0460-3401.2 603401	ATE 20755 14,4 - WE / - WK
Zubehörsatz, Scheibenbremsbelag							
2.0 Turbo 2.4 D	114 60	01/91→07/95 08/90→07/95	←	01/92→		13.0460-0429.2 610429	BDX
			←	→ 12/91; - ABS		13.0460-0429.2 610429	BDX
			➔	nicht für Multi-link Achse		13.0460-0088.2 610088	ATE
 Bremsscheibe							
2.0 Turbo	114	01/91→07/95	←	→ 12/91; - ABS		24.0122-0137.1 422137 24.0126-0105.1 426105	Ø 287 22 20 V Ø 280 26 23 V
			←	01/92→; + ABS		24.0126-0105.1 426105	Ø 280 26 23 V
			←	→ 12/91; + ABS		24.0126-0105.1 426105	Ø 280 26 23 V
			➔	nicht für Multi-link Achse		24.0110-0189.1 410189	Ø 281 9,6 8,4
			➔	Multi-link Achse		24.0110-0206.1 410206	Ø 265 10 8
2.4 D	60	08/90→07/95	←	→ 12/91; - ABS		24.0122-0137.1 422137 24.0126-0105.1 426105	Ø 287 22 20 V Ø 280 26 23 V
			←	01/92→; + ABS		24.0126-0105.1 426105	Ø 280 26 23 V
			←	→ 12/91; + ABS		24.0126-0105.1 426105	Ø 280 26 23 V
			➔	nicht für Multi-link Achse		24.0110-0189.1 410189	Ø 281 9,6 8,4
			➔			24.0110-0206.1 410206	Ø 265 10 8
VOLVO - 960 II (964) 07/94→12/96							
 Bremsbelagsatz, Scheibenbremse							
2.5 2.9	125 150	07/94→12/96 07/94→12/96	←	08/94→		13.0460-2985.2 602985	TRW 20164 18,2 - WK
			➔	08/94→; Multi-link Achse		13.0460-2935.2 602935	TRW 21385 13,8 - WK
			➔	08/94→; nicht für Multi-link Achse		13.0460-3401.2 603401	ATE 20755 14,4 - WE / - WK
↓							













	kW			 	! #		
VOLVO - 960 II (964) 07/94→12/96							
Zubehörsatz, Scheibenbremsbelag							
2.5 2.9	125 150	07/94→12/96 07/94→12/96	➡	08/94→; nicht für Multi-link Achse		13.0460-0088.2 610088	ATE
 Bremsscheibe							
2.5	125	07/94→12/96	←	08/94→		24.0126-0102.1 426102	Ø 280,3 26 23 V
			➡	08/94→; nicht für Multi-link Achse		24.0110-0189.1 410189	Ø 281 9,6 8,4
			➡	08/94→; Multi-link Achse		24.0110-0289.1 410289	Ø 265 10 8
2.9	150	07/94→12/96	←	01/95→		24.0126-0102.1 426102	Ø 280,3 26 23 V
			←	08/94→ 12/94		24.0126-0105.1 426105	Ø 280 26 23 V
			➡	08/94→; nicht für Multi-link Achse		24.0110-0189.1 410189	Ø 281 9,6 8,4
			➡	08/94→; Multi-link Achse		24.0110-0206.1 410206	Ø 265 10 8
VOLVO - 960 II Kombi (965) 07/94→12/96							
 Bremsbelagsatz, Scheibenbremse							
2.5 2.9	125 150	08/94→12/96 09/94→12/96	←			13.0460-2985.2 602985	TRW 20164 18,2 - WK
			➡	Multi-link Achse		13.0460-2935.2 602935	TRW 21385 13,8 - WK
			➡	nicht für Multi-link Achse		13.0460-3401.2 603401	ATE 20755 14,4 - WE / - WK
Zubehörsatz, Scheibenbremsbelag							
2.5 2.9	125 150	08/94→12/96 09/94→12/96	➡	nicht für Multi-link Achse		13.0460-0088.2 610088	ATE
 Bremsscheibe							
2.5	125	08/94→12/96	←			24.0126-0102.1 426102	Ø 280,3 26 23 V
			➡	nicht für Multi-link Achse		24.0110-0189.1 410189	Ø 281 9,6 8,4
			➡	Multi-link Achse		24.0110-0289.1 410289	Ø 265 10 8
2.9	150	09/94→12/96	←	01/95→		24.0126-0102.1 426102	Ø 280,3 26 23 V
			←	→ 12/94		24.0126-0105.1 426105	Ø 280 26 23 V
			➡	nicht für Multi-link Achse		24.0110-0189.1 410189	Ø 281 9,6 8,4
			➡	Multi-link Achse		24.0110-0206.1 410206	Ø 265 10 8
VOLVO - C30 10/06→12/13							
 Bremsbelagsatz, Scheibenbremse							
1.6 1.6 D 1.6 D2 1.8 2.0 2.0 D 2.0 FlexFuel 2.4 i D3 D4 D5 D5 T5 T5	74 80 84 92 107 100 107 125 110 130 120 132 162 169	10/06→12/12 10/06→12/12 10/10→12/12 10/06→12/12 10/06→12/12 10/06→12/12 01/10→12/12 10/06→12/12 10/10→12/12 10/10→12/12 10/06→12/12 10/06→12/12 10/06→12/12 03/07→12/12	←	passend für Felgenreöße [Zoll]: 15 / 16		13.0460-7193.2 607193 13.0470-7193.2 LD7193	ATE 23723 18,1 - WE / - WK ATE 23723 18,1 - WE / - WK Ceramic
1.8 FlexFuel	92	01/07→12/12	←	04/07→; passend für Felgenreöße [Zoll]: 15 / 16		13.0460-7193.2 607193 13.0470-7193.2 LD7193	ATE 23723 18,1 - WE / - WK ATE 23723 18,1 - WE / - WK Ceramic
			➡	04/07→		13.0460-7195.2 607195 13.0470-7195.2 LD7195	ATE 23482 16,6 - WE / - WK ATE 23482 16,6 - WE / - WK Ceramic
Electric Electric	82 89	12/10→12/12 12/10→12/12	←	passend für Felgenreöße [Zoll]: 15 / 16		13.0460-7193.2 607193 13.0470-7193.2 LD7193	ATE 23723 18,1 - WE / - WK ATE 23723 18,1 - WE / - WK Ceramic
 Bremsscheibe							
1.6 1.6 D 1.6 D2 1.8 2.0 2.0 D	74 80 84 92 107 100	10/06→12/12 10/06→12/12 10/10→12/12 10/06→12/12 10/06→12/12 10/06→12/12	←	passend für Felgenreöße [Zoll]: 15		24.0125-0117.1 425117 24.0325-0117.1 525117	Ø 278 25 23 V Ø 278 25 23 V PD
			←	passend für Felgenreöße [Zoll]: 16		24.0125-0162.1 425162 24.0325-0162.1 525162	Ø 300 25 23 V Ø 300 25 23 V PD
			➡			24.0111-0158.1 411158 24.0311-0158.1 511158	Ø 280 11 9 + S Ø 280 11 9 PD
			↓				







	kw			 	! #		
VOLVO - C30 10/06→12/13							
 Bremsscheibe							
D4	130	10/10→12/12	←	passend für Felgengröße [Zoll]: 15		24.0125-0117.1 425117	Ø 278 25 23 V
D5	120	10/06→12/12				24.0325-0117.1 525117	Ø 278 25 23 V PD
D5	132	10/06→12/12					
T5	162	10/06→12/12	←	passend für Felgengröße [Zoll]: 16		24.0125-0162.1 425162	Ø 300 25 23 V
T5	169	03/07→12/12				24.0325-0162.1 525162	Ø 300 25 23 V PD
			→			24.0111-0158.1 411158	Ø 280 11 9 + S
						24.0311-0158.1 511158	Ø 280 11 9 PD
1.8 FlexFuel	92	01/07→12/12	←	04/07→; passend für Felgengröße [Zoll]: 15		24.0125-0117.1 425117	Ø 278 25 23 V
						24.0325-0117.1 525117	Ø 278 25 23 V PD
			←	04/07→; passend für Felgengröße [Zoll]: 16		24.0125-0162.1 425162	Ø 300 25 23 V
						24.0325-0162.1 525162	Ø 300 25 23 V PD
			→	04/07→		24.0111-0158.1 411158	Ø 280 11 9 + S
						24.0311-0158.1 511158	Ø 280 11 9 PD
Electric	82	12/10→12/12	←	passend für Felgengröße [Zoll]: 15		24.0125-0117.1 425117	Ø 278 25 23 V
Electric	89	12/10→12/12				24.0325-0117.1 525117	Ø 278 25 23 V PD
			←	passend für Felgengröße [Zoll]: 16		24.0125-0162.1 425162	Ø 300 25 23 V
						24.0325-0162.1 525162	Ø 300 25 23 V PD
VOLVO - C70 I Cabriolet 03/98→10/05							
 Bremsbelagsatz, Scheibenbremse							
2.0	132	03/98→10/05	←			13.0460-7053.2 607053	ATE 21273 19,5 + WE / - WK
2.0 T	120	03/00→10/05				13.0470-7053.2 LD7053	ATE 21273 19,5 + WE / - WK Ceramic
2.4	125	06/98→10/05					
2.4 T	142	03/98→10/05					
2.4 T	147	07/02→10/05	→			13.0460-4044.2 604044	ATE 20755 15,1 - WE / - WK
						13.0470-4044.2 LD4044	ATE 20755 15,1 - WE / - WK Ceramic
2.0 T	166	03/98→10/05	←			13.0460-7053.2 607053	ATE 21273 19,5 + WE / - WK
2.3 T5	176	03/98→10/05					
2.3 T5	180	07/02→10/05	→			13.0460-4044.2 604044	ATE 20755 15,1 - WE / - WK
						13.0470-4044.2 LD4044	ATE 20755 15,1 - WE / - WK Ceramic
 Bremsscheibe							
2.0	132	03/98→10/05	←	passend für Felgengröße [Zoll]: 15		24.0126-0102.1 426102	Ø 280,3 26 23 V
2.0 T	120	03/00→10/05					
2.0 T	166	03/98→10/05	←	passend für Felgengröße [Zoll]: 16		24.0126-0107.1 426107	Ø 302 26 23 V
2.3 T5	176	03/98→10/05				24.0326-0107.1 526107	Ø 302 26 23 V PD
2.3 T5	180	07/02→10/05					
2.4	125	06/98→10/05	→			24.0110-0214.1 410214	Ø 295 9,6 8,4
2.4 T	142	03/98→10/05					
2.4 T	147	07/02→10/05					
VOLVO - C70 I Coupe 03/97→09/02							
 Bremsbelagsatz, Scheibenbremse							
2.0	132	03/97→09/02	←	01/99→; passend für Felgengröße [Zoll]: 15 / 16		13.0460-7053.2 607053	ATE 21273 19,5 + WE / - WK
2.0 T	166	03/97→09/02				13.0470-7053.2 LD7053	ATE 21273 19,5 + WE / - WK Ceramic
2.4 T	142	03/97→09/02					
			←	→ 12/98; passend für Felgengröße [Zoll]: 15 / 16		13.0460-7193.2 607193	ATE 23723 18,1 - WE / - WK
						13.0470-7193.2 LD7193	ATE 23723 18,1 - WE / - WK Ceramic
			→			13.0460-4044.2 604044	ATE 20755 15,1 - WE / - WK
						13.0470-4044.2 LD4044	ATE 20755 15,1 - WE / - WK Ceramic
2.0 T	120	03/00→09/02	←	passend für Felgengröße [Zoll]: 15 / 16		13.0460-7053.2 607053	ATE 21273 19,5 + WE / - WK
						13.0470-7053.2 LD7053	ATE 21273 19,5 + WE / - WK Ceramic
			→			13.0460-4044.2 604044	ATE 20755 15,1 - WE / - WK
						13.0470-4044.2 LD4044	ATE 20755 15,1 - WE / - WK Ceramic
2.3 T-5	176	03/97→09/02	←	01/99→; passend für Felgengröße [Zoll]: 15 / 16		13.0460-7053.2 607053	ATE 21273 19,5 + WE / - WK
			←	→ 12/98; passend für Felgengröße [Zoll]: 15 / 16		13.0460-7193.2 607193	ATE 23723 18,1 - WE / - WK
			→			13.0460-4044.2 604044	ATE 20755 15,1 - WE / - WK
						13.0470-4044.2 LD4044	ATE 20755 15,1 - WE / - WK Ceramic
2.4	121	03/99→09/02	←	09/99→; passend für Felgengröße [Zoll]: 15 / 16		13.0460-7053.2 607053	ATE 21273 19,5 + WE / - WK
						13.0470-7053.2 LD7053	ATE 21273 19,5 + WE / - WK Ceramic
↓							



















	kw			 	! #		
VOLVO - C70 I Coupe 03/97→09/02							
 Bremsbelagsatz, Scheibenbremse							
2.4	121	03/99→09/02	➔			13.0460-4044.2 604044 13.0470-4044.2 LD4044	ATE 20755 15,1 - WE / - WK ATE 20755 15,1 - WE / - WK Ceramic
2.4	125	05/99→09/02	➔	11/99→; passend für Felgenreöße [Zoll]: 15 / 16		13.0460-7053.2 607053 13.0470-7053.2 LD7053	ATE 21273 19,5 + WE / - WK ATE 21273 19,5 + WE / - WK Ceramic
			➔	11/99→		13.0460-4044.2 604044 13.0470-4044.2 LD4044	ATE 20755 15,1 - WE / - WK ATE 20755 15,1 - WE / - WK Ceramic
 Bremsscheibe							
2.0	132	03/97→09/02	➔	passend für Felgenreöße [Zoll]: 15		24.0126-0102.1 426102	Ø 280,3 26 23 V
2.0 T	120	03/00→09/02	➔	passend für Felgenreöße [Zoll]: 16		24.0126-0107.1 426107	Ø 302 26 23 V
2.0 T	166	03/97→09/02	➔	passend für Felgenreöße [Zoll]: 16		24.0326-0107.1 526107	Ø 302 26 23 V PD
2.3 T-5	176	03/97→09/02	➔			24.0110-0214.1 410214	Ø 295 9,6 8,4
2.4	121	03/99→09/02	➔			24.0126-0102.1 426102	Ø 280,3 26 23 V
2.4 T	142	03/97→09/02	➔			24.0126-0107.1 426107	Ø 302 26 23 V
2.4	125	05/99→09/02	➔	11/99→; passend für Felgenreöße [Zoll]: 15		24.0326-0107.1 526107	Ø 302 26 23 V PD
			➔	11/99→		24.0326-0107.1 526107	Ø 302 26 23 V PD
			➔	11/99→		24.0110-0214.1 410214	Ø 295 9,6 8,4
VOLVO - C70 II Cabriolet 03/06→06/13							
 Bremsbelagsatz, Scheibenbremse							
2.0 D	100	01/08→10/09	➔	06/08→; nicht für Felgenreöße [Zoll]: 17		13.0460-7193.2 607193 13.0470-7193.2 LD7193	ATE 23723 18,1 - WE / - WK ATE 23723 18,1 - WE / - WK Ceramic
			➔	06/08→; passend für Felgenreöße [Zoll]: 17		13.0460-7204.2 607204 13.0470-7204.2 LD7204	ATE 23801 18,8 - WE / - WK ATE 23801 18,8 - WE / - WK Ceramic
			➔	06/08→		13.0460-7195.2 607195 13.0470-7195.2 LD7195	ATE 23482 16,6 - WE / - WK ATE 23482 16,6 - WE / - WK Ceramic
2.4	103	03/06→10/09	➔	nicht für Felgenreöße [Zoll]: 17		13.0460-7193.2 607193	ATE 23723 18,1 - WE / - WK
2.4 D	120	03/07→06/13	➔			13.0470-7193.2 LD7193	ATE 23723 18,1 - WE / - WK Ceramic
2.4 i	125	03/06→10/09	➔			13.0460-7204.2 607204	ATE 23801 18,8 - WE / - WK
D3	110	10/10→06/13	➔	passend für Felgenreöße [Zoll]: 17		13.0470-7204.2 LD7204	ATE 23801 18,8 - WE / - WK Ceramic
D4	130	10/10→06/13	➔			13.0460-7195.2 607195	ATE 23482 16,6 - WE / - WK
D5	132	03/06→06/13	➔			13.0470-7195.2 LD7195	ATE 23482 16,6 - WE / - WK Ceramic
T5	162	03/06→02/07	➔			13.0460-7195.2 607195	ATE 23482 16,6 - WE / - WK
T5	169	03/07→10/09	➔			13.0470-7195.2 LD7195	ATE 23482 16,6 - WE / - WK Ceramic
 Bremsscheibe							
2.0 D	100	01/08→10/09	➔	06/08→; passend für Felgenreöße [Zoll]: 15		24.0125-0117.1 425117 24.0325-0117.1 525117	Ø 278 25 23 V Ø 278 25 23 V PD
			➔	06/08→; passend für Felgenreöße [Zoll]: 16		24.0125-0162.1 425162 24.0325-0162.1 525162	Ø 300 25 23 V Ø 300 25 23 V PD
			➔	06/08→; passend für Felgenreöße [Zoll]: 17		24.0125-0197.1 425197 24.0325-0197.1 525197	Ø 320 25 23 V Ø 320 25 23 V PD
			➔	06/08→		24.0111-0158.1 411158 24.0311-0158.1 511158	Ø 280 11 9 + S Ø 280 11 9 PD
2.4	103	03/06→10/09	➔	passend für Felgenreöße [Zoll]: 15		24.0125-0117.1 425117	Ø 278 25 23 V
2.4 D	120	03/07→06/13	➔			24.0325-0117.1 525117	Ø 278 25 23 V PD
2.4 i	125	03/06→10/09	➔	passend für Felgenreöße [Zoll]: 16		24.0125-0162.1 425162	Ø 300 25 23 V
D3	110	10/10→06/13	➔	passend für Felgenreöße [Zoll]: 16		24.0325-0162.1 525162	Ø 300 25 23 V PD
D4	130	10/10→06/13	➔			24.0125-0197.1 425197	Ø 320 25 23 V
D5	132	03/06→06/13	➔	passend für Felgenreöße [Zoll]: 17		24.0325-0197.1 525197	Ø 320 25 23 V PD
T5	162	03/06→02/07	➔			24.0111-0158.1 411158	Ø 280 11 9 + S
T5	169	03/07→10/09	➔			24.0311-0158.1 511158	Ø 280 11 9 PD
VOLVO - S40 I (VS) 07/95→06/04							
 Bremsbelagsatz, Scheibenbremse							
1.6	77	09/95→08/99	➔	→ 08/97		13.0460-2830.2 602830	TRW 21920 14,6 + WK + Zub
1.8	85	07/95→08/99					
↓							

	kW			 	! #		
VOLVO - S40 I (VS) 07/95→06/04							
 Bremsbelagsatz, Scheibenbremse							
1.9 T4	147	05/97→07/00	←	09/97→		13.0460-2853.2 602853	TRW 21983 17,2 + WK
1.9 TD	66	07/95→08/99	→			13.0460-2831.2 602831	TRW 21861 15,2 + WK
2.0	100	07/95→12/03					
2.0	103	07/95→08/99					
1.6	80	03/99→12/03	←			13.0460-2853.2 602853	TRW 21983 17,2 + WK
1.8	90	03/99→12/03	→			13.0460-2831.2 602831	TRW 21861 15,2 + WK
1.8 i	90	06/01→12/03					
1.8 i	92	03/98→12/03					
1.9 DI	70	03/99→07/00					
1.9 DI	75	07/00→12/03					
1.9 DI	85	07/00→12/03					
2.0 T	120	06/01→12/03					
2.0 T	121	07/00→06/01					
2.0 T4	147	07/00→12/03					
2.0 T	118	10/97→12/03	←	→ 07/00		13.0460-2853.2 602853	TRW 21983 17,2 + WK
			→	→ 07/00		13.0460-2831.2 602831	TRW 21861 15,2 + WK
 Bremsscheibe							
1.6	77	09/95→08/99	←	→ 08/97		24.0124-0136.1 424136	Ø 256 24 21,5 V
1.8	85	07/95→08/99	←	09/97→		24.0124-0159.1 424159	Ø 281 23,9 21,5 V
1.9 T4	147	05/97→07/00				24.0324-0159.1 524159	Ø 281 23,9 21,5 V PD
1.9 TD	66	07/95→08/99					
2.0	100	07/95→12/03	→			24.0110-0229.1 410229	Ø 260 10 8,4
2.0	103	07/95→08/99					
1.6	80	03/99→12/03	←			24.0124-0159.1 424159	Ø 281 23,9 21,5 V
1.8	90	03/99→12/03	→			24.0324-0159.1 524159	Ø 281 23,9 21,5 V PD
1.8 i	90	06/01→12/03					
1.8 i	92	03/98→12/03	→			24.0110-0229.1 410229	Ø 260 10 8,4
1.9 DI	70	03/99→07/00					
1.9 DI	75	07/00→12/03					
1.9 DI	85	07/00→12/03					
2.0 T	120	06/01→12/03					
2.0 T	121	07/00→06/01					
2.0 T4	147	07/00→12/03					
2.0 T	118	10/97→12/03	←	→ 07/00		24.0124-0159.1 424159	Ø 281 23,9 21,5 V
			→	→ 07/00		24.0324-0159.1 524159	Ø 281 23,9 21,5 V PD
			→	→ 07/00		24.0110-0229.1 410229	Ø 260 10 8,4
VOLVO - S40 II (MS) 01/04→12/12							
 Bremsbelagsatz, Scheibenbremse							
1.6	74	01/05→12/12	←	→ 05/12; nicht für Felgenreöße [Zoll]: 17		13.0460-7193.2 607193	ATE 23723 18,1 - WE / - WK
1.6 D	81	01/05→12/12				13.0470-7193.2 LD7193	ATE 23723 18,1 - WE / - WK Ceramic
1.6 D2	84	10/10→12/12					
2.0	107	10/06→12/12					
2.0 F	107	10/09→12/12	←	→ 05/12;		13.0460-7204.2 607204	ATE 23801 18,8 - WE / - WK
2.4 AWD	125	08/06→12/12		passend für Felgenreöße [Zoll]: 17		13.0470-7204.2 LD7204	ATE 23801 18,8 - WE / - WK Ceramic
D3	110	10/10→12/12					
D4	130	10/10→12/12					
T5	169	03/07→12/12	→	→ 05/12		13.0460-7195.2 607195	ATE 23482 16,6 - WE / - WK
						13.0470-7195.2 LD7195	ATE 23482 16,6 - WE / - WK Ceramic
1.8	92	04/04→12/10	←	nicht für Felgenreöße [Zoll]: 17		13.0460-7193.2 607193	ATE 23723 18,1 - WE / - WK
2.0 D	100	01/04→12/10				13.0470-7193.2 LD7193	ATE 23723 18,1 - WE / - WK Ceramic
2.0 D4	96	07/05→12/06					
2.4	103	01/04→12/10	←	passend für Felgenreöße [Zoll]: 17		13.0460-7204.2 607204	ATE 23801 18,8 - WE / - WK
2.4	125	01/04→12/10				13.0470-7204.2 LD7204	ATE 23801 18,8 - WE / - WK Ceramic
2.4 D5	132	03/06→12/10					
T5	162	01/04→12/07					
T5 AWD	162	04/04→12/07	→			13.0460-7195.2 607195	ATE 23482 16,6 - WE / - WK
T5 AWD	169	03/07→12/10				13.0470-7195.2 LD7195	ATE 23482 16,6 - WE / - WK Ceramic
1.8 FlexFuel	92	01/06→12/10	←	04/07→; nicht für Felgenreöße [Zoll]: 17		13.0460-7193.2 607193	ATE 23723 18,1 - WE / - WK
						13.0470-7193.2 LD7193	ATE 23723 18,1 - WE / - WK Ceramic
			←	04/07→; passend für Felgenreöße [Zoll]: 17		13.0460-7204.2 607204	ATE 23801 18,8 - WE / - WK
						13.0470-7204.2 LD7204	ATE 23801 18,8 - WE / - WK Ceramic
			→	04/07→		13.0460-7195.2 607195	ATE 23482 16,6 - WE / - WK
						13.0470-7195.2 LD7195	ATE 23482 16,6 - WE / - WK Ceramic
 Bremsscheibe							
1.6	74	01/05→12/12	←	→ 05/12;		24.0125-0117.1 425117	Ø 278 25 23 V
1.6 D	81	01/05→12/12		passend für Felgenreöße [Zoll]: 15		24.0325-0117.1 525117	Ø 278 25 23 V PD
1.6 D2	84	10/10→12/12					
↓							



	kw			 	! #		
VOLVO - S40 II (MS) 01/04→12/12							
Bremsscheibe							
2.0	107	10/06→12/12	←	→ 05/12;		24.0125-0162.1 425162	Ø 300 25 23 V
2.0 F	107	10/09→12/12		passend für Felgengröße [Zoll]: 16		24.0325-0162.1 525162	Ø 300 25 23 V PD
2.4 AWD	125	08/06→12/12					
D3	110	10/10→12/12	←	→ 05/12;		24.0125-0197.1 425197	Ø 320 25 23 V
D4	130	10/10→12/12		passend für Felgengröße [Zoll]: 17		24.0325-0197.1 525197	Ø 320 25 23 V PD
T5	169	03/07→12/12	→	→ 05/12		24.0111-0158.1 411158	Ø 280 11 9 + S
						24.0311-0158.1 511158	Ø 280 11 9 PD
1.8	92	04/04→12/10	←	passend für Felgengröße [Zoll]: 15		24.0125-0117.1 425117	Ø 278 25 23 V
2.0 D	100	01/04→12/10				24.0325-0117.1 525117	Ø 278 25 23 V PD
2.0 D4	96	07/05→12/06					
2.4	103	01/04→12/10	←	passend für Felgengröße [Zoll]: 16		24.0125-0162.1 425162	Ø 300 25 23 V
2.4	125	01/04→12/10				24.0325-0162.1 525162	Ø 300 25 23 V PD
2.4 D5	132	03/06→12/10					
T5	162	01/04→12/07	←	passend für Felgengröße [Zoll]: 17		24.0125-0197.1 425197	Ø 320 25 23 V
T5 AWD	162	04/04→12/07				24.0325-0197.1 525197	Ø 320 25 23 V PD
T5 AWD	169	03/07→12/10	→			24.0111-0158.1 411158	Ø 280 11 9 + S
						24.0311-0158.1 511158	Ø 280 11 9 PD
1.8 FlexFuel	92	01/06→12/10	←	04/07→;		24.0125-0117.1 425117	Ø 278 25 23 V
				passend für Felgengröße [Zoll]: 15		24.0325-0117.1 525117	Ø 278 25 23 V PD
			←	04/07→;		24.0125-0162.1 425162	Ø 300 25 23 V
				passend für Felgengröße [Zoll]: 16		24.0325-0162.1 525162	Ø 300 25 23 V PD
			←	04/07→;		24.0125-0197.1 425197	Ø 320 25 23 V
				passend für Felgengröße [Zoll]: 17		24.0325-0197.1 525197	Ø 320 25 23 V PD
			→	04/07→		24.0111-0158.1 411158	Ø 280 11 9 + S
						24.0311-0158.1 511158	Ø 280 11 9 PD
VOLVO - S60 I 07/00→04/10							
Bremsbelagsatz, Scheibenbremse							
2.0 T	132	07/00→04/10	←	09/01→ 01/09;		13.0460-7145.2 607145	ATE 23073 18,8 - WE / - WK
				nicht für Felgengröße [Zoll]: 17		13.0470-7145.2 LD7145	ATE 23073 18,8 - WE / - WK Ceramic
			←	09/01→ 01/09;		13.0460-7187.2 607187	ATE 23591 18,0 - WE / - WK
				passend für Felgengröße [Zoll]: 17		13.0470-7187.2 LD7187	ATE 23590 19,5 - WE / - WK Ceramic
			→	09/01→ 01/09		13.0460-7135.2 607135	ATE 23076 17,5 - WE / - WK
						13.0470-7135.2 LD7135	ATE 23076 17,5 - WE / - WK Ceramic
2.3 T5	195	07/00→09/02	←	nicht für Felgengröße [Zoll]: 17		13.0460-7145.2 607145	ATE 23073 18,8 - WE / - WK
2.4	132	01/05→10/06				13.0470-7145.2 LD7145	ATE 23073 18,8 - WE / - WK Ceramic
2.4 D	90	05/05→12/06					
			←	passend für Felgengröße [Zoll]: 17		13.0460-7187.2 607187	ATE 23591 18,0 - WE / - WK
						13.0470-7187.2 LD7187	ATE 23590 19,5 - WE / - WK Ceramic
			→			13.0460-7135.2 607135	ATE 23076 17,5 - WE / - WK
						13.0470-7135.2 LD7135	ATE 23076 17,5 - WE / - WK Ceramic
2.4	103	07/00→04/10	←	11/00→ 01/09;		13.0460-7145.2 607145	ATE 23073 18,8 - WE / - WK
2.4 T	147	07/00→04/10		nicht für Felgengröße [Zoll]: 17		13.0470-7145.2 LD7145	ATE 23073 18,8 - WE / - WK Ceramic
			←	11/00→ 01/09;		13.0460-7187.2 607187	ATE 23591 18,0 - WE / - WK
				passend für Felgengröße [Zoll]: 17		13.0470-7187.2 LD7187	ATE 23590 19,5 - WE / - WK Ceramic
			→	11/00→ 01/09		13.0460-7135.2 607135	ATE 23076 17,5 - WE / - WK
						13.0470-7135.2 LD7135	ATE 23076 17,5 - WE / - WK Ceramic
2.4	125	11/00→04/10	←	→ 01/09; nicht für Felgengröße [Zoll]: 17		13.0460-7145.2 607145	ATE 23073 18,8 - WE / - WK
2.4 D	120	07/05→12/09				13.0470-7145.2 LD7145	ATE 23073 18,8 - WE / - WK Ceramic
2.4 T5	191	04/04→04/10					
			←	→ 01/09;		13.0460-7187.2 607187	ATE 23591 18,0 - WE / - WK
				passend für Felgengröße [Zoll]: 17		13.0470-7187.2 LD7187	ATE 23590 19,5 - WE / - WK Ceramic
			→	→ 01/09		13.0460-7135.2 607135	ATE 23076 17,5 - WE / - WK
						13.0470-7135.2 LD7135	ATE 23076 17,5 - WE / - WK Ceramic
2.4 AWD	191	02/04→04/10	←	04/04→ 01/09;		13.0460-7145.2 607145	ATE 23073 18,8 - WE / - WK
2.5 T AWD	154	07/02→04/10		nicht für Felgengröße [Zoll]: 17		13.0470-7145.2 LD7145	ATE 23073 18,8 - WE / - WK Ceramic
↓							

	kw			 	! #		
VOLVO - S60 I 07/00→04/10							
 Bremsbelagsatz, Scheibenbremse							
2.4 AWD 2.5 T AWD	191	02/04→04/10 07/02→04/10	←	04/04→ 01/09; passend für Felgengröße [Zoll]: 17	13.0460-7187.2	607187	ATE 23591 18,0 - WE / - WK
	154		→	04/04→ 01/09	13.0460-7135.2	607135	ATE 23076 17,5 - WE / - WK Ceramic
2.4 Bifuel (CNG) 2.4 Bifuel (LPG)	103	07/01→04/10 07/01→04/10	←	06/02→ 01/09; nicht für Felgengröße [Zoll]: 17	13.0460-7145.2	607145	ATE 23073 18,8 - WE / - WK Ceramic
	103		←	06/02→ 01/09; passend für Felgengröße [Zoll]: 17	13.0460-7187.2	607187	ATE 23591 18,0 - WE / - WK ATE 23590 19,5 - WE / - WK Ceramic
			→	06/02→ 01/09	13.0460-7135.2	607135	ATE 23076 17,5 - WE / - WK ATE 23076 17,5 - WE / - WK Ceramic
2.4 D 2.4 D5	93	03/05→04/10 03/05→04/10	←	09/05→ 01/09; nicht für Felgengröße [Zoll]: 17	13.0460-7145.2	607145	ATE 23073 18,8 - WE / - WK Ceramic
	136		←	09/05→ 01/09; passend für Felgengröße [Zoll]: 17	13.0460-7187.2	607187	ATE 23591 18,0 - WE / - WK ATE 23590 19,5 - WE / - WK Ceramic
			→	09/05→ 01/09	13.0460-7135.2	607135	ATE 23076 17,5 - WE / - WK ATE 23076 17,5 - WE / - WK Ceramic
2.4 D	96	05/01→04/10	←	12/01→ 01/09; nicht für Felgengröße [Zoll]: 17	13.0460-7145.2	607145	ATE 23073 18,8 - WE / - WK Ceramic
			←	12/01→ 01/09; passend für Felgengröße [Zoll]: 17	13.0460-7187.2	607187	ATE 23591 18,0 - WE / - WK ATE 23590 19,5 - WE / - WK Ceramic
			→	12/01→ 01/09	13.0460-7135.2	607135	ATE 23076 17,5 - WE / - WK ATE 23076 17,5 - WE / - WK Ceramic
2.4 D5	120	01/01→04/10	←	07/01→ 01/09; nicht für Felgengröße [Zoll]: 17	13.0460-7145.2	607145	ATE 23073 18,8 - WE / - WK Ceramic
			←	07/01→ 01/09; passend für Felgengröße [Zoll]: 17	13.0460-7187.2	607187	ATE 23591 18,0 - WE / - WK ATE 23590 19,5 - WE / - WK Ceramic
			→	07/01→ 01/09	13.0460-7135.2	607135	ATE 23076 17,5 - WE / - WK ATE 23076 17,5 - WE / - WK Ceramic
2.4 T AWD	147	06/01→04/10	←	11/01→ 01/09; nicht für Felgengröße [Zoll]: 17	13.0460-7145.2	607145	ATE 23073 18,8 - WE / - WK Ceramic
			←	11/01→ 01/09; passend für Felgengröße [Zoll]: 17	13.0460-7187.2	607187	ATE 23591 18,0 - WE / - WK ATE 23590 19,5 - WE / - WK Ceramic
			→	11/01→ 01/09	13.0460-7135.2	607135	ATE 23076 17,5 - WE / - WK ATE 23076 17,5 - WE / - WK Ceramic
2.5 T	154	01/03→04/10	←	02/04→ 01/09; nicht für Felgengröße [Zoll]: 17	13.0460-7145.2	607145	ATE 23073 18,8 - WE / - WK ATE 23073 18,8 - WE / - WK Ceramic
			←	02/04→ 01/09; passend für Felgengröße [Zoll]: 17	13.0460-7187.2	607187	ATE 23591 18,0 - WE / - WK ATE 23590 19,5 - WE / - WK Ceramic
			→	02/04→ 01/09	13.0460-7135.2	607135	ATE 23076 17,5 - WE / - WK ATE 23076 17,5 - WE / - WK Ceramic
R 2,5 T AWD	221	01/03→04/10	←	03/03→ 01/09	13.0460-4804.2	604804	BRE 23092 15,6 - WE / - WK
			→	03/03→ 01/09	13.0460-4964.2	604964	BRE 21381 15,0 - WE / - WK
T5	184	07/00→04/10	←	08/00→ 04/04; nicht für Felgengröße [Zoll]: 17	13.0460-7145.2	607145	ATE 23073 18,8 - WE / - WK ATE 23073 18,8 - WE / - WK Ceramic
			←	08/00→ 04/04; passend für Felgengröße [Zoll]: 17	13.0460-7187.2	607187	ATE 23591 18,0 - WE / - WK
↓							

	kw			 	! #		
VOLVO - S60 I 07/00→04/10							
 Bremsbelagsatz, Scheibenbremse							
T5	184	07/00→04/10	←	08/00→04/04; passend für Felgenreöße [Zoll]: 17	13.0470-7187.2	LD7187	ATE 23590 19,5 - WE / - WK Ceramic
			→	08/00→04/04	13.0460-7135.2	607135	ATE 23076 17,5 - WE / - WK
					13.0470-7135.2	LD7135	ATE 23076 17,5 - WE / - WK Ceramic
 Bremsscheibe							
2.0 T	132	07/00→04/10	←	09/01→01/09; passend für Felgenreöße [Zoll]: 15	24.0126-0122.1	426122	Ø 285,5 26 23 V
			←	09/01→01/09; passend für Felgenreöße [Zoll]: 16	24.0128-0123.1	428123	Ø 305 27,9 25 V
			←	09/01→01/09; passend für Felgenreöße [Zoll]: 17	24.0128-0144.1	428144	Ø 316 28 25 V
			→	09/01→01/09	24.0128-0184.1	428184	Ø 320 28 25 V
2.3 T5 2.4 2.4 D	195 132 90	07/00→09/02 01/05→10/06 05/05→12/06	←	passend für Felgenreöße [Zoll]: 15	24.0126-0122.1	426122	Ø 285,5 26 23 V
			←	passend für Felgenreöße [Zoll]: 16	24.0128-0123.1	428123	Ø 305 27,9 25 V
			←	passend für Felgenreöße [Zoll]: 17	24.0328-0123.1	528123	Ø 305 27,9 25 V PD
			→		24.0128-0144.1	428144	Ø 316 28 25 V
2.4 2.4 T	103 147	07/00→04/10 07/00→04/10	←	11/00→01/09; passend für Felgenreöße [Zoll]: 15	24.0128-0123.1	428123	Ø 305 27,9 25 V
			←	11/00→01/09; passend für Felgenreöße [Zoll]: 16	24.0126-0122.1	426122	Ø 285,5 26 23 V
			←	11/00→01/09; passend für Felgenreöße [Zoll]: 17	24.0328-0123.1	528123	Ø 305 27,9 25 V PD
			→	11/00→01/09	24.0128-0144.1	428144	Ø 316 28 25 V
2.4 2.4 D 2.4 T5	125 120 191	11/00→04/10 07/05→12/09 04/04→04/10	←	→ 01/09; passend für Felgenreöße [Zoll]: 15	24.0128-0184.1	428184	Ø 320 28 25 V
			←	→ 01/09; passend für Felgenreöße [Zoll]: 16	24.0112-0151.1	412151	Ø 288 11,9 10
			←	→ 01/09; passend für Felgenreöße [Zoll]: 17	24.0126-0122.1	426122	Ø 285,5 26 23 V
			→	→ 01/09	24.0328-0123.1	528123	Ø 305 27,9 25 V PD
2.4 AWD 2.5 T AWD	191 154	02/04→04/10 07/02→04/10	←	04/04→01/09; passend für Felgenreöße [Zoll]: 15	24.0128-0144.1	428144	Ø 316 28 25 V
			←	04/04→01/09; passend für Felgenreöße [Zoll]: 16	24.0128-0184.1	428184	Ø 320 28 25 V
			←	04/04→01/09; passend für Felgenreöße [Zoll]: 17	24.0112-0151.1	412151	Ø 288 11,9 10
			→	04/04→01/09	24.0328-0123.1	528123	Ø 305 27,9 25 V PD
2.4 Bifuel (CNG) 2.4 Bifuel (LPG)	103 103	07/01→04/10 07/01→04/10	←	06/02→01/09; passend für Felgenreöße [Zoll]: 15	24.0126-0122.1	426122	Ø 285,5 26 23 V
			←	06/02→01/09; passend für Felgenreöße [Zoll]: 16	24.0128-0123.1	428123	Ø 305 27,9 25 V
			←	06/02→01/09; passend für Felgenreöße [Zoll]: 17	24.0328-0123.1	528123	Ø 305 27,9 25 V PD
			→	06/02→01/09	24.0128-0144.1	428144	Ø 316 28 25 V
2.4 D 2.4 D5	93 136	03/05→04/10 03/05→04/10	←	09/05→01/09; passend für Felgenreöße [Zoll]: 15	24.0128-0184.1	428184	Ø 320 28 25 V
			←	09/05→01/09; passend für Felgenreöße [Zoll]: 16	24.0112-0151.1	412151	Ø 288 11,9 10
			←	09/05→01/09; passend für Felgenreöße [Zoll]: 17	24.0126-0122.1	426122	Ø 285,5 26 23 V
			→	09/05→01/09	24.0328-0123.1	528123	Ø 305 27,9 25 V PD
2.4 D	96	05/01→04/10	←	12/01→01/09; passend für Felgenreöße [Zoll]: 15	24.0128-0144.1	428144	Ø 316 28 25 V
					24.0128-0184.1	428184	Ø 320 28 25 V
↓							

VOLVO - S60 I 07/00→04/10







Bremsscheibe

2.4 D	96	05/01→04/10	←	12/01→ 01/09; passend für Felgengröße [Zoll]: 16	24.0128-0123.1 428123	∅ 305 27,9 25 V
					24.0328-0123.1 528123	∅ 305 27,9 25 V PD
			←	12/01→ 01/09; passend für Felgengröße [Zoll]: 17	24.0128-0144.1 428144	∅ 316 28 25 V
					24.0128-0184.1 428184	∅ 320 28 25 V
2.4 D5	120	01/01→04/10	→	12/01→ 01/09	24.0112-0151.1 412151	∅ 288 11,9 10
					24.0312-0151.1 512151	∅ 288 11,9 10 PD
			←	07/01→ 01/09; passend für Felgengröße [Zoll]: 15	24.0126-0122.1 426122	∅ 285,5 26 23 V
					24.0128-0123.1 428123	∅ 305 27,9 25 V
2.4 T AWD	147	06/01→04/10	←	07/01→ 01/09; passend für Felgengröße [Zoll]: 16	24.0328-0123.1 528123	∅ 305 27,9 25 V PD
					24.0128-0144.1 428144	∅ 316 28 25 V
			←	07/01→ 01/09; passend für Felgengröße [Zoll]: 17	24.0128-0184.1 428184	∅ 320 28 25 V
					24.0112-0151.1 412151	∅ 288 11,9 10
2.5 T	154	01/03→04/10	→	07/01→ 01/09	24.0312-0151.1 512151	∅ 288 11,9 10 PD
					24.0126-0122.1 426122	∅ 285,5 26 23 V
			←	11/01→ 01/09; passend für Felgengröße [Zoll]: 15	24.0128-0123.1 428123	∅ 305 27,9 25 V
					24.0328-0123.1 528123	∅ 305 27,9 25 V PD
T5	184	07/00→04/10	←	11/01→ 01/09; passend für Felgengröße [Zoll]: 16	24.0128-0144.1 428144	∅ 316 28 25 V
					24.0128-0184.1 428184	∅ 320 28 25 V
			←	02/04→ 01/09; passend für Felgengröße [Zoll]: 15	24.0128-0144.1 428144	∅ 316 28 25 V
					24.0128-0184.1 428184	∅ 320 28 25 V
T5	184	07/00→04/10	→	02/04→ 01/09	24.0112-0151.1 412151	∅ 288 11,9 10
					24.0312-0151.1 512151	∅ 288 11,9 10 PD
			←	02/04→ 01/09; passend für Felgengröße [Zoll]: 16	24.0128-0123.1 428123	∅ 305 27,9 25 V
					24.0328-0123.1 528123	∅ 305 27,9 25 V PD
T5	184	07/00→04/10	←	02/04→ 01/09; passend für Felgengröße [Zoll]: 17	24.0128-0144.1 428144	∅ 316 28 25 V
					24.0128-0184.1 428184	∅ 320 28 25 V
			←	08/00→ 04/04; passend für Felgengröße [Zoll]: 15	24.0126-0122.1 426122	∅ 285,5 26 23 V
					24.0128-0123.1 428123	∅ 305 27,9 25 V
T5	184	07/00→04/10	←	08/00→ 04/04; passend für Felgengröße [Zoll]: 16	24.0328-0123.1 528123	∅ 305 27,9 25 V PD
					24.0128-0144.1 428144	∅ 316 28 25 V
			←	08/00→ 04/04; passend für Felgengröße [Zoll]: 17	24.0128-0184.1 428184	∅ 320 28 25 V
					24.0112-0151.1 412151	∅ 288 11,9 10
T5	184	07/00→04/10	→	08/00→ 04/04	24.0312-0151.1 512151	∅ 288 11,9 10 PD
					24.0126-0122.1 426122	∅ 285,5 26 23 V







VOLVO - S60 II 04/10→











Bremsbelagsatz, Scheibenbremse









1.5 T2	90	10/15→	←	für Bremsscheibendurchmesser [mm]: 300	13.0460-7228.2 607228	ATE 24123 20,3 - WE / - WK
					13.0470-7228.2 LD7228	ATE 24123 20,3 - WE / - WK Ceramic
1.5 T3	112	03/15→	←	für Bremsscheibendurchmesser [mm]: 316 / 336	13.0460-7243.2 607243	ATE 24142 20,6 - WE / - WK
2.0 D2	88	03/15→			13.0470-7243.2 LD7243	ATE 24142 20,6 - WE / - WK Ceramic
2.0 D3	110	03/15→	→		13.0460-2722.2 602722	TRW 24496 17,3 - WE / - WK + Zub
2.0 D4	140	03/15→			13.0470-2722.2 LD2722	TRW 24496 17,3 - WE / - WK + Zub Ceramic
2.0 D5	165	03/15→	→	V	13.0460-2736.2 602736	TRW 24496 17,3 - WE / - WK + Zub
2.0 T	149	04/10→12/11			13.0470-2736.2 LD2736	TRW 24496 17,3 - WE / - WK + Zub Ceramic
2.0 T3	112	03/15→	→		13.0460-2722.2 602722	TRW 24496 17,3 - WE / - WK + Zub
2.4 D4 AWD	140	03/15→			13.0470-2722.2 LD2722	TRW 24496 17,3 - WE / - WK + Zub Ceramic
2.5 T5	186	09/11→	→		13.0460-2722.2 602722	TRW 24496 17,3 - WE / - WK + Zub
2.5 T5 AWD	186	09/12→			13.0470-2722.2 LD2722	TRW 24496 17,3 - WE / - WK + Zub Ceramic
D3	100	05/12→12/15	→		13.0460-2736.2 602736	TRW 24496 17,3 - WE / - WK + Zub
D3	120	04/10→12/14			13.0470-2736.2 LD2736	TRW 24496 17,3 - WE / - WK + Zub Ceramic
D4	133	09/13→12/15	→		13.0460-2722.2 602722	TRW 24496 17,3 - WE / - WK + Zub
D5	151	04/10→12/11			13.0470-2722.2 LD2722	TRW 24496 17,3 - WE / - WK + Zub Ceramic
D5	169	04/14→12/15	→		13.0460-2736.2 602736	TRW 24496 17,3 - WE / - WK + Zub
D5 AWD	151	04/10→12/11			13.0470-2736.2 LD2736	TRW 24496 17,3 - WE / - WK + Zub Ceramic
D5 AWD	169	04/14→12/15	→		13.0460-2722.2 602722	TRW 24496 17,3 - WE / - WK + Zub
DRIVE / D2	84	01/11→12/15			13.0470-2722.2 LD2722	TRW 24496 17,3 - WE / - WK + Zub Ceramic
T3	110	04/10→12/15	→		13.0460-2736.2 602736	TRW 24496 17,3 - WE / - WK + Zub
T4	132	04/10→12/15			13.0470-2736.2 LD2736	TRW 24496 17,3 - WE / - WK + Zub Ceramic
T4F	132	04/11→12/15	→		13.0460-2722.2 602722	TRW 24496 17,3 - WE / - WK + Zub
T5	177	04/10→12/14			13.0470-2722.2 LD2722	TRW 24496 17,3 - WE / - WK + Zub Ceramic
T5	180	09/13→	→		13.0460-2736.2 602736	TRW 24496 17,3 - WE / - WK + Zub
T5 AWD	180	07/14→			13.0470-2736.2 LD2736	TRW 24496 17,3 - WE / - WK + Zub Ceramic
T5 AWD	187	08/15→	→		13.0460-2722.2 602722	TRW 24496 17,3 - WE / - WK + Zub
T5 AWD	187	08/15→			13.0470-2722.2 LD2722	TRW 24496 17,3 - WE / - WK + Zub Ceramic
2.0 T	132	05/12→12/15	←	12/13→; für Bremsscheibendurchmesser [mm]: 300	13.0460-7228.2 607228	ATE 24123 20,3 - WE / - WK
					13.0470-7228.2 LD7228	ATE 24123 20,3 - WE / - WK Ceramic

	kw			 	! #		
VOLVO - S60 II 04/10→							
Bremsbelagsatz, Scheibenbremse							
2.0 T	132	05/12→12/15	←	12/13→; für Bremsscheibendurchmesser [mm]: 316 / 336		13.0460-7243.2 607243 13.0470-7243.2 LD7243	ATE 24142 20,6 - WE / - WK ATE 24142 20,6 - WE / - WK Ceramic
2.0 T4	140	03/15→	←	05/15→; für Bremsscheibendurchmesser [mm]: 300		13.0460-7228.2 607228 13.0470-7228.2 LD7228	ATE 24123 20,3 - WE / - WK ATE 24123 20,3 - WE / - WK Ceramic
			←	05/15→; für Bremsscheibendurchmesser [mm]: 316 / 336		13.0460-7243.2 607243 13.0470-7243.2 LD7243	ATE 24142 20,6 - WE / - WK ATE 24142 20,6 - WE / - WK Ceramic
			→	05/15→		13.0460-2722.2 602722 13.0470-2722.2 LD2722	TRW 24496 17,3 - WE / - WK + Zub TRW 24496 17,3 - WE / - WK + Zub Ceramic
			→	05/15→; V		13.0460-2736.2 602736 13.0470-2736.2 LD2736	TRW 24496 17,3 - WE / - WK + Zub TRW 24496 17,3 - WE / - WK + Zub Ceramic
D4	120	04/10→12/14	←	05/12→; für Bremsscheibendurchmesser [mm]: 300		13.0460-7228.2 607228 13.0470-7228.2 LD7228	ATE 24123 20,3 - WE / - WK ATE 24123 20,3 - WE / - WK Ceramic
			←	05/12→; für Bremsscheibendurchmesser [mm]: 316 / 336		13.0460-7243.2 607243 13.0470-7243.2 LD7243	ATE 24142 20,6 - WE / - WK ATE 24142 20,6 - WE / - WK Ceramic
			→	05/12→		13.0460-2722.2 602722 13.0470-2722.2 LD2722	TRW 24496 17,3 - WE / - WK + Zub TRW 24496 17,3 - WE / - WK + Zub Ceramic
			→	05/12→; V		13.0460-2736.2 602736 13.0470-2736.2 LD2736	TRW 24496 17,3 - WE / - WK + Zub TRW 24496 17,3 - WE / - WK + Zub Ceramic
D5 D5 AWD	158 158	04/11→12/15 04/11→12/15	←	06/11→; für Bremsscheibendurchmesser [mm]: 300		13.0460-7228.2 607228 13.0470-7228.2 LD7228	ATE 24123 20,3 - WE / - WK ATE 24123 20,3 - WE / - WK Ceramic
			←	06/11→; für Bremsscheibendurchmesser [mm]: 316 / 336		13.0460-7243.2 607243 13.0470-7243.2 LD7243	ATE 24142 20,6 - WE / - WK ATE 24142 20,6 - WE / - WK Ceramic
			→	06/11→		13.0460-2722.2 602722 13.0470-2722.2 LD2722	TRW 24496 17,3 - WE / - WK + Zub TRW 24496 17,3 - WE / - WK + Zub Ceramic
			→	06/11→; V		13.0460-2736.2 602736 13.0470-2736.2 LD2736	TRW 24496 17,3 - WE / - WK + Zub TRW 24496 17,3 - WE / - WK + Zub Ceramic
T5 T6 T6 AWD T6 AWD	225 225 225 242	08/13→ 09/13→ 09/15→ 04/14→12/15	←	für Bremsscheibendurchmesser [mm]: 300		13.0460-7228.2 607228	ATE 24123 20,3 - WE / - WK
			←	für Bremsscheibendurchmesser [mm]: 316 / 336		13.0460-7243.2 607243	ATE 24142 20,6 - WE / - WK
			→			13.0460-2722.2 602722 13.0470-2722.2 LD2722	TRW 24496 17,3 - WE / - WK + Zub TRW 24496 17,3 - WE / - WK + Zub Ceramic
			→	V		13.0460-2736.2 602736 13.0470-2736.2 LD2736	TRW 24496 17,3 - WE / - WK + Zub TRW 24496 17,3 - WE / - WK + Zub Ceramic
T6 AWD	224	04/10→12/15	←	für Bremsscheibendurchmesser [mm]: 300		13.0460-7228.2 607228	ATE 24123 20,3 - WE / - WK
			←	für Bremsscheibendurchmesser [mm]: 316 / 336		13.0460-7243.2 607243 13.0470-7243.2 LD7243	ATE 24142 20,6 - WE / - WK ATE 24142 20,6 - WE / - WK Ceramic
			→			13.0460-2722.2 602722 13.0470-2722.2 LD2722	TRW 24496 17,3 - WE / - WK + Zub TRW 24496 17,3 - WE / - WK + Zub Ceramic
			→	V		13.0460-2736.2 602736 13.0470-2736.2 LD2736	TRW 24496 17,3 - WE / - WK + Zub TRW 24496 17,3 - WE / - WK + Zub Ceramic























	kw			 	! #		
VOLVO - S60 II 04/10→							
Bremsscheibe							
1.5 T2	90	10/15→	←			24.0128-0154.1 428154	Ø 300 28 26 V + S
1.5 T3	112	03/15→				24.0128-0162.1 428162	Ø 316 28 26 V + S
2.0 D2	88	03/15→				24.0128-0210.1 428210	Ø 336 28 26 V + S
2.0 D3	110	03/15→				24.0328-0154.1 528154	Ø 300 28 26 V + S PD
2.0 D4	140	03/15→				24.0328-0162.1 528162	Ø 316 28 26 V + S PD
2.0 D5	165	03/15→					
2.0 T	149	04/10→12/11					
2.0 T3	112	03/15→	→			24.0111-0147.1 411147	Ø 302 11 9 + S
2.4 D4 AWD	140	03/15→				24.0122-0259.1 422259	Ø 302 22 20 V + S
2.5 T5	186	09/11→					
2.5 T5 AWD	186	09/12→					
D3	100	05/12→12/15					
D3	120	04/10→12/14					
D4	133	09/13→12/15					
D5	151	04/10→12/11					
D5 AWD	151	04/10→12/11					
DRiVe / D2	84	01/11→12/15					
T3	110	04/10→12/15					
T4	132	04/10→12/15					
T4F	132	04/11→12/15					
T5	177	04/10→12/14					
T5	180	09/13→					
T5	225	08/13→					
T5 AWD	180	07/14→					
T5 AWD	187	08/15→					
T6	225	09/13→					
T6 AWD	225	09/15→					
T6 AWD	224	04/10→12/15					
T6 AWD	242	04/14→12/15					
2.0 T	132	05/12→12/15	←	12/13→		24.0128-0154.1 428154	Ø 300 28 26 V + S
						24.0328-0154.1 528154	Ø 300 28 26 V + S PD
2.0 T4	140	03/15→	←	05/15→		24.0128-0154.1 428154	Ø 300 28 26 V + S
						24.0128-0162.1 428162	Ø 316 28 26 V + S
						24.0128-0210.1 428210	Ø 336 28 26 V + S
						24.0328-0154.1 528154	Ø 300 28 26 V + S PD
						24.0328-0162.1 528162	Ø 316 28 26 V + S PD
			→	05/15→		24.0111-0147.1 411147	Ø 302 11 9 + S
						24.0122-0259.1 422259	Ø 302 22 20 V + S
D4	120	04/10→12/14	←	05/12→		24.0128-0154.1 428154	Ø 300 28 26 V + S
						24.0128-0162.1 428162	Ø 316 28 26 V + S
						24.0128-0210.1 428210	Ø 336 28 26 V + S
						24.0328-0154.1 528154	Ø 300 28 26 V + S PD
						24.0328-0162.1 528162	Ø 316 28 26 V + S PD
			→	05/12→		24.0111-0147.1 411147	Ø 302 11 9 + S
						24.0122-0259.1 422259	Ø 302 22 20 V + S
D5	158	04/11→12/15	←	06/11→		24.0128-0154.1 428154	Ø 300 28 26 V + S
D5 AWD	158	04/11→12/15				24.0128-0162.1 428162	Ø 316 28 26 V + S
						24.0128-0210.1 428210	Ø 336 28 26 V + S
						24.0328-0154.1 528154	Ø 300 28 26 V + S PD
						24.0328-0162.1 528162	Ø 316 28 26 V + S PD
			→	06/11→		24.0111-0147.1 411147	Ø 302 11 9 + S
						24.0122-0259.1 422259	Ø 302 22 20 V + S
D5	169	04/14→12/15	←			24.0128-0154.1 428154	Ø 300 28 26 V + S
D5 AWD	169	04/14→12/15				24.0128-0162.1 428162	Ø 316 28 26 V + S
						24.0128-0210.1 428210	Ø 336 28 26 V + S
						24.0328-0154.1 528154	Ø 300 28 26 V + S PD
						24.0328-0162.1 528162	Ø 316 28 26 V + S PD
			→			24.0111-0147.1 411147	Ø 302 11 9 + S
VOLVO - S70 (LS) 11/96→11/00							
Bremsbelagsatz, Scheibenbremse							
2.0	93	01/97→11/00	←			13.0460-7053.2 607053	ATE 21273 19,5 + WE / - WK
2.0	105	01/97→11/00				13.0470-7053.2 LD7053	ATE 21273 19,5 + WE / - WK Ceramic
2.0	120	01/97→11/00					
2.0	132	01/97→11/00					
2.0 Turbo	155	01/97→11/00	→			13.0460-4044.2 604044	ATE 20755 15,1 - WE / - WK
2.0 Turbo	166	01/97→11/00				13.0470-4044.2 LD4044	ATE 20755 15,1 - WE / - WK Ceramic
2.3	195	04/99→09/00					
2.4	103	08/99→11/00					
2.4	106	01/97→11/00					
2.4	121	06/98→11/00					
2.4	125	01/97→11/00					
↓							

	kw			 	! #		
VOLVO - S70 (LS) 11/96→11/00							
 Bremsbelagsatz, Scheibenbremse							
2.4 AWD	103	04/99→09/00	←			13.0460-7053.2 607053	ATE 21273 19,5 + WE / - WK
2.4 AWD	106	11/96→05/99				13.0470-7053.2 LD7053	ATE 21273 19,5 + WE / - WK
2.4 AWD	121	10/98→05/99					Ceramic
2.4 Bifuel	103	07/99→11/00					
2.4 Bifuel	106	10/98→11/00	→			13.0460-4044.2 604044	ATE 20755 15,1 - WE / - WK
2.4 Blu-Fuel	103	07/97→09/00				13.0470-4044.2 LD4044	ATE 20755 15,1 - WE / - WK
2.4 T5 AWD	142	11/96→04/99					Ceramic
2.4 Turbo	142	01/97→11/00					
2.5 TDI	103	01/97→11/00					
2.5 TDi AWD	103	10/99→09/00					
2.3	177	11/96→11/00	←	01/97→		13.0460-7053.2 607053	ATE 21273 19,5 + WE / - WK
			→	01/97→		13.0460-4044.2 604044	ATE 20755 15,1 - WE / - WK
						13.0470-4044.2 LD4044	ATE 20755 15,1 - WE / - WK
							Ceramic
2.3 T-5	176	01/97→11/00	←			13.0460-7053.2 607053	ATE 21273 19,5 + WE / - WK
2.3 Turbo	184	01/97→11/00	→			13.0460-4044.2 604044	ATE 20755 15,1 - WE / - WK
						13.0470-4044.2 LD4044	ATE 20755 15,1 - WE / - WK
							Ceramic
2.4 AWD	125	04/99→09/00	←	→ 05/99		13.0460-7053.2 607053	ATE 21273 19,5 + WE / - WK
						13.0470-7053.2 LD7053	ATE 21273 19,5 + WE / - WK
							Ceramic
			→	05/99		13.0460-4044.2 604044	ATE 20755 15,1 - WE / - WK
						13.0470-4044.2 LD4044	ATE 20755 15,1 - WE / - WK
							Ceramic
 Bremsscheibe							
2.0	93	01/97→11/00	←	passend für Felgenreöße [Zoll]: 15		24.0126-0102.1 426102	Ø 280,3 26 23 V
2.0	105	01/97→11/00					
2.0	120	01/97→11/00	←	passend für Felgenreöße [Zoll]: 16		24.0126-0107.1 426107	Ø 302 26 23 V
2.0	132	01/97→11/00				24.0326-0107.1 526107	Ø 302 26 23 V PD
2.0 Turbo	155	01/97→11/00					
2.0 Turbo	166	01/97→11/00	→			24.0110-0214.1 410214	Ø 295 9,6 8,4
2.3	195	04/99→09/00					
2.3 T-5	176	01/97→11/00					
2.3 Turbo	184	01/97→11/00					
2.4	103	08/99→11/00					
2.4	106	01/97→11/00					
2.4	121	06/98→11/00					
2.4	125	01/97→11/00					
2.4 AWD	103	04/99→09/00					
2.4 AWD	106	11/96→05/99					
2.4 AWD	121	10/98→05/99					
2.4 Bifuel	103	07/99→11/00					
2.4 Bifuel	106	10/98→11/00					
2.4 Blu-Fuel	103	07/97→09/00					
2.4 T5 AWD	142	11/96→04/99					
2.4 Turbo	142	01/97→11/00					
2.5 TDI	103	01/97→11/00					
2.5 TDi AWD	103	10/99→09/00					
2.3	177	11/96→11/00	←	01/97→; passend für Felgenreöße [Zoll]: 15		24.0126-0102.1 426102	Ø 280,3 26 23 V
			←	01/97→; passend für Felgenreöße [Zoll]: 16		24.0126-0107.1 426107	Ø 302 26 23 V
						24.0326-0107.1 526107	Ø 302 26 23 V PD
			→	01/97→		24.0110-0214.1 410214	Ø 295 9,6 8,4
2.4 AWD	125	04/99→09/00	←	→ 05/99; passend für Felgenreöße [Zoll]: 15		24.0126-0102.1 426102	Ø 280,3 26 23 V
			←	→ 05/99; passend für Felgenreöße [Zoll]: 16		24.0126-0107.1 426107	Ø 302 26 23 V
						24.0326-0107.1 526107	Ø 302 26 23 V PD
			→	05/99		24.0110-0214.1 410214	Ø 295 9,6 8,4
VOLVO - S80 I (TS, XY) 05/98→02/08							
 Bremsbelagsatz, Scheibenbremse							
2.0	120	06/98→07/06	←	→ 02/06; nicht für Felgenreöße [Zoll]: 17		13.0460-7145.2 607145	ATE 23073 18,8 - WE / - WK
2.0 T	132	12/99→07/06				13.0470-7145.2 LD7145	ATE 23073 18,8 - WE / - WK
2.0 T	166	06/98→07/06					Ceramic
2.4	103	01/99→07/06					
2.4	125	01/99→07/06	←	→ 02/06; passend für Felgenreöße [Zoll]: 17		13.0460-7187.2 607187	ATE 23591 18,0 - WE / - WK
2.4 Bifuel (CNG)	103	09/01→07/06				13.0470-7187.2 LD7187	ATE 23590 19,5 - WE / - WK
2.4 Bifuel (LPG)	103	09/01→07/06					Ceramic
2.4 D	96	10/01→07/06					
2.4 D5	120	08/01→07/06	→	02/06		13.0460-7135.2 607135	ATE 23076 17,5 - WE / - WK
2.4 T	147	06/00→07/06				13.0470-7135.2 LD7135	ATE 23076 17,5 - WE / - WK
2.5 T AWD	154	07/03→07/06					Ceramic
2.5 TDI	103	01/99→07/06					
2.9	147	03/99→07/06					
↓							







	kw			 	! #		
VOLVO - S80 I (TS, XY) 05/98→02/08							
 Bremsbelagsatz, Scheibenbremse							
2.9 3.0	150 144	05/98→07/06 06/01→07/06	←	→ 02/06; nicht für Felgengröße [Zoll]: 17		13.0460-7145.2 607145 13.0470-7145.2 LD7145	ATE 23073 18,8 - WE / - WK ATE 23073 18,8 - WE / - WK Ceramic
			←	→ 02/06; passend für Felgengröße [Zoll]: 17		13.0460-7187.2 607187 13.0470-7187.2 LD7187	ATE 23591 18,0 - WE / - WK ATE 23590 19,5 - WE / - WK Ceramic
			→	→ 02/06		13.0460-7135.2 607135 13.0470-7135.2 LD7135	ATE 23076 17,5 - WE / - WK ATE 23076 17,5 - WE / - WK Ceramic
2.4 T5 AWD	147	04/00→09/03	←	06/00→; nicht für Felgengröße [Zoll]: 17		13.0460-7145.2 607145 13.0470-7145.2 LD7145	ATE 23073 18,8 - WE / - WK ATE 23073 18,8 - WE / - WK Ceramic
			←	06/00→; passend für Felgengröße [Zoll]: 17		13.0460-7187.2 607187 13.0470-7187.2 LD7187	ATE 23591 18,0 - WE / - WK ATE 23590 19,5 - WE / - WK Ceramic
			→	06/00→		13.0460-7135.2 607135 13.0470-7135.2 LD7135	ATE 23076 17,5 - WE / - WK ATE 23076 17,5 - WE / - WK Ceramic
2.5 T	154	03/03→07/06	←	07/03→ 02/06; nicht für Felgengröße [Zoll]: 17		13.0460-7145.2 607145 13.0470-7145.2 LD7145	ATE 23073 18,8 - WE / - WK ATE 23073 18,8 - WE / - WK Ceramic
			←	07/03→ 02/06; passend für Felgengröße [Zoll]: 17		13.0460-7187.2 607187 13.0470-7187.2 LD7187	ATE 23591 18,0 - WE / - WK ATE 23590 19,5 - WE / - WK Ceramic
			→	07/03→ 02/06		13.0460-7135.2 607135 13.0470-7135.2 LD7135	ATE 23076 17,5 - WE / - WK ATE 23076 17,5 - WE / - WK Ceramic
2.8 T6 3.0 T6	200 200	05/98→07/06 06/01→07/06	←	→ 02/06; nicht für Felgengröße [Zoll]: 17		13.0460-7145.2 607145	ATE 23073 18,8 - WE / - WK
			←	→ 02/06; passend für Felgengröße [Zoll]: 17		13.0460-7187.2 607187	ATE 23591 18,0 - WE / - WK
			←	→ 02/06		13.0470-7187.2 LD7187	ATE 23590 19,5 - WE / - WK Ceramic
			→	→ 02/06		13.0460-7135.2 607135 13.0470-7135.2 LD7135	ATE 23076 17,5 - WE / - WK ATE 23076 17,5 - WE / - WK Ceramic
 Bremsscheibe							
2.0 2.0 T 2.0 T 2.4 2.4 2.4 Bifuel (CNG) 2.4 Bifuel (LPG) 2.4 D 2.4 D5 2.4 T 2.5 T AWD 2.5 TDI 2.8 T6 2.9 2.9 3.0 3.0 T6	120 132 166 103 125 103 103 96 120 147 154 103 200 147 150 144 200	06/98→07/06 12/99→07/06 06/98→07/06 01/99→07/06 01/99→07/06 09/01→07/06 09/01→07/06 10/01→07/06 08/01→07/06 06/00→07/06 07/03→07/06 01/99→07/06 05/98→07/06 03/99→07/06 05/98→07/06 06/01→07/06 06/01→07/06	←	→ 02/06; passend für Felgengröße [Zoll]: 15		24.0126-0122.1 426122	Ø 285,5 26 23 V
			←	→ 02/06; passend für Felgengröße [Zoll]: 16		24.0128-0123.1 428123 24.0328-0123.1 528123	Ø 305 27,9 25 V Ø 305 27,9 25 V PD
			←	→ 02/06; passend für Felgengröße [Zoll]: 17		24.0128-0184.1 428184	Ø 320 28 25 V
			→	→ 02/06		24.0112-0151.1 412151 24.0312-0151.1 512151	Ø 288 11,9 10 Ø 288 11,9 10 PD
2.4 T5 AWD	147	04/00→09/03	←	06/00→; passend für Felgengröße [Zoll]: 15		24.0126-0122.1 426122	Ø 285,5 26 23 V
			←	06/00→; passend für Felgengröße [Zoll]: 16		24.0128-0123.1 428123 24.0328-0123.1 528123	Ø 305 27,9 25 V Ø 305 27,9 25 V PD
			←	06/00→; passend für Felgengröße [Zoll]: 17		24.0128-0184.1 428184	Ø 320 28 25 V
			→	06/00→		24.0112-0151.1 412151 24.0312-0151.1 512151	Ø 288 11,9 10 Ø 288 11,9 10 PD
2.5 T	154	03/03→07/06	←	07/03→ 02/06; passend für Felgengröße [Zoll]: 15		24.0126-0122.1 426122	Ø 285,5 26 23 V
			←	07/03→ 02/06; passend für Felgengröße [Zoll]: 16		24.0128-0123.1 428123 24.0328-0123.1 528123	Ø 305 27,9 25 V Ø 305 27,9 25 V PD
			←	07/03→ 02/06; passend für Felgengröße [Zoll]: 17		24.0128-0184.1 428184	Ø 320 28 25 V
			→	07/03→ 02/06		24.0112-0151.1 412151 24.0312-0151.1 512151	Ø 288 11,9 10 Ø 288 11,9 10 PD





















	kW			 	! #		
VOLVO - S80 II (AS) 03/06→							
 Bremsbelagsatz, Scheibenbremse							
1.6 D DRIVe	80	01/10→	←	passend für Felgenreöße [Zoll]: 16		13.0460-7228.2 607228	ATE 24123 20,3 - WE / - WK
1.6 DRIVe	84	06/11→				13.0470-7228.2 LD7228	ATE 24123 20,3 - WE / - WK Ceramic
2.0	107	01/08→					
2.0 Drive- E	180	12/14→	←	passend für Felgenreöße [Zoll]: 17 / 18		13.0460-7243.2 607243	ATE 24142 20,6 - WE / - WK
2.0 FlexFuel	107	01/08→				13.0470-7243.2 LD7243	ATE 24142 20,6 - WE / - WK Ceramic
2.0 T	149	01/10→					
2.0 TDi	100	02/08→					
2.4 D	120	03/06→	→	+ eFSB		13.0460-2722.2 602722	TRW 24496 17,3 - WE / - WK + Zub
2.4 D	129	01/10→				13.0470-2722.2 LD2722	TRW 24496 17,3 - WE / - WK + Zub Ceramic
2.5 T	147	03/06→					
2.5 T	170	01/10→					
2.5 T	183	09/12→					
2.5 T	187	01/12→	→	V; + eFSB		13.0460-2736.2 602736	TRW 24496 17,3 - WE / - WK + Zub
2.5 T AWD	147	10/06→				13.0470-2736.2 LD2736	TRW 24496 17,3 - WE / - WK + Zub Ceramic
2.5 T FlexFuel	147	05/08→					
2.5 T FlexFuel	170	01/10→					
3.2	175	03/06→					
3.2	179	01/10→	→	- eFSB		13.0460-2737.2 602737	TRW 24537 15,8 - WE / - WK + Zub
3.2 AWD	175	01/07→					
3.2 AWD	179	01/10→					
D3	100	05/12→					
D3 / D4	120	01/10→					
D4	133	09/13→					
D5	136	03/06→					
D5	151	01/10→					
D5	158	06/11→					
D5 AWD	136	01/07→					
D5 AWD	151	01/10→					
D5 AWD	158	06/11→					
T4	132	10/10→					
T4F	132	05/11→					
T5	177	10/10→					
T5	180	09/13→					
T6 AWD	210	01/07→					
4.4 V8 AWD	232	03/06→	←	passend für Felgenreöße [Zoll]: 16		13.0460-7228.2 607228	ATE 24123 20,3 - WE / - WK
T6 AWD	224	10/10→	←	passend für Felgenreöße [Zoll]: 17 / 18		13.0460-7243.2 607243	ATE 24142 20,6 - WE / - WK
			→	+ eFSB		13.0460-2722.2 602722	TRW 24496 17,3 - WE / - WK + Zub
						13.0470-2722.2 LD2722	TRW 24496 17,3 - WE / - WK + Zub Ceramic
			→	V; + eFSB		13.0460-2736.2 602736	TRW 24496 17,3 - WE / - WK + Zub
						13.0470-2736.2 LD2736	TRW 24496 17,3 - WE / - WK + Zub Ceramic
			→	- eFSB		13.0460-2737.2 602737	TRW 24537 15,8 - WE / - WK + Zub
 Bremsscheibe							
1.6 D DRIVe	80	01/10→	←	passend für Felgenreöße [Zoll]: 16		24.0128-0154.1 428154	Ø 300 28 26 V + S
1.6 DRIVe	84	06/11→				24.0328-0154.1 528154	Ø 300 28 26 V + S PD
2.0	107	01/08→					
2.0 Drive- E	180	12/14→	←	passend für Felgenreöße [Zoll]: 17		24.0128-0162.1 428162	Ø 316 28 26 V + S
2.0 FlexFuel	107	01/08→				24.0328-0162.1 528162	Ø 316 28 26 V + S PD
2.0 T	149	01/10→					
2.0 TDi	100	02/08→	←	passend für Felgenreöße [Zoll]: 18		24.0128-0210.1 428210	Ø 336 28 26 V + S
2.4 D	120	03/06→	→	+ eFSB		24.0111-0147.1 411147	Ø 302 11 9 + S
2.4 D	129	01/10→				24.0122-0259.1 422259	Ø 302 22 20 V + S
2.5 T	147	03/06→					
2.5 T	170	01/10→	→	- eFSB		24.0112-0180.1 412180	Ø 302 12 10 + S
2.5 T	183	09/12→					
2.5 T	187	01/12→					
2.5 T AWD	147	10/06→					
2.5 T FlexFuel	147	05/08→					
2.5 T FlexFuel	170	01/10→					
3.2	175	03/06→					
3.2	179	01/10→					
3.2 AWD	175	01/07→					
3.2 AWD	179	01/10→					
4.4 V8 AWD	232	03/06→					
D3	100	05/12→					
D3 / D4	120	01/10→					
D4	133	09/13→					
D5	136	03/06→					
D5	151	01/10→					
D5	158	06/11→					
D5 AWD	136	01/07→					
D5 AWD	151	01/10→					
D5 AWD	158	06/11→					
T5	177	10/10→					
T5	180	09/13→					
↓							









	kw				! #		
VOLVO - S80 II (AS) 03/06→							
 Bremsscheibe							
T6 AWD T6 AWD	210 224	01/07→ 10/10→	←	passend für Felgenreöße [Zoll]: 16	24.0128-0154.1	428154	∅ 300 28 26 V + S
					24.0328-0154.1	528154	∅ 300 28 26 V + S PD
			←	passend für Felgenreöße [Zoll]: 17	24.0128-0162.1	428162	∅ 316 28 26 V + S
					24.0328-0162.1	528162	∅ 316 28 26 V + S PD
			←	passend für Felgenreöße [Zoll]: 18	24.0128-0210.1	428210	∅ 336 28 26 V + S
			→	+ eFSB	24.0111-0147.1	411147	∅ 302 11 9 + S
		24.0122-0259.1	422259	∅ 302 22 20 V + S			
		24.0112-0180.1	412180	∅ 302 12 10 + S			
T4 T4F	132 132	10/10→ 05/11→	←	passend für Felgenreöße [Zoll]: 16	24.0128-0154.1	428154	∅ 300 28 26 V + S
					24.0328-0154.1	528154	∅ 300 28 26 V + S PD
			←	passend für Felgenreöße [Zoll]: 17	24.0128-0162.1	428162	∅ 316 28 26 V + S
					24.0328-0162.1	528162	∅ 316 28 26 V + S PD
			→	+ eFSB	24.0111-0147.1	411147	∅ 302 11 9 + S
					24.0122-0259.1	422259	∅ 302 22 20 V + S
		24.0112-0180.1	412180	∅ 302 12 10 + S			
VOLVO - S90 11/96→12/98							
 Bremsbelagsatz, Scheibenbremse							
2.5	125	11/96→10/98	←		13.0460-2985.2	602985	TRW 20164 18,2 - WK
2.5	132	11/96→10/97					
2.9	132	01/97→05/98	→		13.0460-2935.2	602935	TRW 21385 13,8 - WK
2.9	150	01/97→05/98					
 Bremsscheibe							
2.5	125	11/96→10/98	←		24.0126-0102.1	426102	∅ 280,3 26 23 V
2.5	132	11/96→10/97					
2.9	132	01/97→05/98	→		24.0112-0150.1	412150	∅ 277 11,9 10
2.9	150	01/97→05/98					
VOLVO - S90 II 03/16→							
 Bremsscheibe							
2.0 D4	140	03/16→	→	passend für Felgenreöße [Zoll]: 17	24.0120-0246.1	420246	∅ 320 20 17,5 V + S
2.0 D5 AWD	173	03/16→					
2.0 T5	187	03/16→					
2.0 T6 AWD	235	03/16→					
VOLVO - V40 Kombi (VW) 07/95→06/04							
 Bremsbelagsatz, Scheibenbremse							
1.6	77	12/95→08/99	←	→ 08/97	13.0460-2830.2	602830	TRW 21920 14,6 + WK + Zub
1.8	85	07/95→08/99					
1.9 TD	66	07/95→08/99	←	09/97→	13.0460-2853.2	602853	TRW 21983 17,2 + WK
2.0	100	07/95→06/04	→		13.0460-2831.2	602831	TRW 21861 15,2 + WK
2.0	103	07/95→08/99					
1.6	80	03/99→06/04	←		13.0460-2853.2	602853	TRW 21983 17,2 + WK
1.8	90	03/99→06/04					
1.8 i	90	06/01→06/04	→		13.0460-2831.2	602831	TRW 21861 15,2 + WK
1.8 i	92	03/98→06/04					
1.9 DI	70	03/99→07/00					
1.9 DI	75	07/00→06/04					
1.9 DI	85	07/00→06/04					
2.0 T	118	10/97→07/00					
2.0 T	120	06/01→06/04					
1.9 T4	147	05/97→07/00	←	→ 08/97; + ABS	13.0460-2830.2	602830	TRW 21920 14,6 + WK + Zub
			←	09/97→	13.0460-2853.2	602853	TRW 21983 17,2 + WK
			→		13.0460-2831.2	602831	TRW 21861 15,2 + WK
2.0 T	121	07/99→06/04	←	07/00→ 06/01	13.0460-2853.2	602853	TRW 21983 17,2 + WK
			→	07/00→ 06/01	13.0460-2831.2	602831	TRW 21861 15,2 + WK
2.0 T4	147	07/00→06/04	←	→ 04/04	13.0460-2853.2	602853	TRW 21983 17,2 + WK
			→	→ 04/04	13.0460-2831.2	602831	TRW 21861 15,2 + WK
 Bremsscheibe							
1.6	77	12/95→08/99	←	→ 08/97	24.0124-0136.1	424136	∅ 256 24 21,5 V
1.8	85	07/95→08/99					
1.9 TD	66	07/95→08/99	←	09/97→	24.0124-0159.1	424159	∅ 281 23,9 21,5 V
2.0	100	07/95→06/04			24.0324-0159.1	524159	∅ 281 23,9 21,5 V PD
2.0	103	07/95→08/99	→		24.0110-0229.1	410229	∅ 260 10 8,4
1.6	80	03/99→06/04	←		24.0124-0159.1	424159	∅ 281 23,9 21,5 V
↓							



















	kw			 	! #		
VOLVO - V40 Kombi (VW) 07/95→06/04							
Bremsscheibe							
1.8	90	03/99→06/04	←			24.0324-0159.1 524159	Ø 281 23,9 21,5 V PD
1.8 i	90	06/01→06/04	→			24.0110-0229.1 410229	Ø 260 10 8,4
1.8 i	92	03/98→06/04					
1.9 DI	70	03/99→07/00					
1.9 DI	75	07/00→06/04					
1.9 DI	85	07/00→06/04					
2.0 T	118	10/97→07/00					
2.0 T	120	06/01→06/04					
1.9 T4	147	05/97→07/00	←	→ 08/97; + ABS		24.0124-0136.1 424136	Ø 256 24 21,5 V
			←	09/97→		24.0124-0159.1 424159	Ø 281 23,9 21,5 V
						24.0324-0159.1 524159	Ø 281 23,9 21,5 V PD
			→			24.0110-0229.1 410229	Ø 260 10 8,4
2.0 T	121	07/99→06/04	←	07/00→ 06/01		24.0124-0159.1 424159	Ø 281 23,9 21,5 V
						24.0324-0159.1 524159	Ø 281 23,9 21,5 V PD
			→	07/00→ 06/01		24.0110-0229.1 410229	Ø 260 10 8,4
2.0 T4	147	07/00→06/04	←	→ 04/04		24.0124-0159.1 424159	Ø 281 23,9 21,5 V
						24.0324-0159.1 524159	Ø 281 23,9 21,5 V PD
			→	→ 04/04		24.0110-0229.1 410229	Ø 260 10 8,4
VOLVO - V40 Schrägheck 03/12→							
Bremsbelagsatz, Scheibenbremse							
D2	84	03/12→	←	09/12→; passend für Felgenreöße [Zoll]: 15 / 16		13.0460-7193.2 607193 13.0470-7193.2 LD7193	ATE 23723 18,1 - WE / - WK ATE 23723 18,1 - WE / - WK Ceramic
			←	09/12→; passend für Felgenreöße [Zoll]: 17		13.0460-7204.2 607204 13.0470-7204.2 LD7204	ATE 23801 18,8 - WE / - WK ATE 23801 18,8 - WE / - WK Ceramic
			→	09/12→; - ALU Bremsscheibe		13.0460-7195.2 607195 13.0470-7195.2 LD7195	ATE 23482 16,6 - WE / - WK ATE 23482 16,6 - WE / - WK Ceramic
D2	88	02/15→	←	passend für Felgenreöße [Zoll]: 15 / 16		13.0460-7193.2 607193	ATE 23723 18,1 - WE / - WK
D3	110	04/15→				13.0470-7193.2 LD7193	ATE 23723 18,1 - WE / - WK Ceramic
D4	140	05/14→					
T2	90	02/15→					
T2 GTDi	88	03/13→12/15	←	passend für Felgenreöße [Zoll]: 17		13.0460-7204.2 607204	ATE 23801 18,8 - WE / - WK
T3	112	02/15→				13.0470-7204.2 LD7204	ATE 23801 18,8 - WE / - WK Ceramic
T4	147	04/14→					
T4	132	07/13→	→			13.0460-7195.2 607195	ATE 23482 16,6 - WE / - WK
T4	140	08/15→				13.0470-7195.2 LD7195	ATE 23482 16,6 - WE / - WK Ceramic
T5	157	03/13→					
T5	180	05/14→					
T5 AWD	157	03/13→					
T5 AWD	180	05/14→					
D3	110	03/12→03/15	←	09/12→; passend für Felgenreöße [Zoll]: 15 / 16		13.0460-7193.2 607193	ATE 23723 18,1 - WE / - WK
D4	130	03/12→				13.0470-7193.2 LD7193	ATE 23723 18,1 - WE / - WK Ceramic
T3 GTDi	110	03/12→	←	09/12→; passend für Felgenreöße [Zoll]: 17		13.0460-7204.2 607204	ATE 23801 18,8 - WE / - WK
T4 GTDi	132	03/12→				13.0470-7204.2 LD7204	ATE 23801 18,8 - WE / - WK Ceramic
			→	09/12→		13.0460-7195.2 607195	ATE 23482 16,6 - WE / - WK
						13.0470-7195.2 LD7195	ATE 23482 16,6 - WE / - WK Ceramic
T4 AWD	132	07/13→	←	passend für Felgenreöße [Zoll]: 17		13.0460-7204.2 607204	ATE 23801 18,8 - WE / - WK
T4 AWD	140	05/14→				13.0470-7204.2 LD7204	ATE 23801 18,8 - WE / - WK Ceramic
T5	187	12/12→					
T5 AWD	187	01/13→	→			13.0460-7195.2 607195	ATE 23482 16,6 - WE / - WK
						13.0470-7195.2 LD7195	ATE 23482 16,6 - WE / - WK Ceramic
T5	183	01/14→	←	05/14→; passend für Felgenreöße [Zoll]: 15 / 16		13.0460-7193.2 607193	ATE 23723 18,1 - WE / - WK
						13.0470-7193.2 LD7193	ATE 23723 18,1 - WE / - WK Ceramic
			←	05/14→; passend für Felgenreöße [Zoll]: 17		13.0460-7204.2 607204	ATE 23801 18,8 - WE / - WK
						13.0470-7204.2 LD7204	ATE 23801 18,8 - WE / - WK Ceramic
			→	05/14→		13.0460-7195.2 607195	ATE 23482 16,6 - WE / - WK
						13.0470-7195.2 LD7195	ATE 23482 16,6 - WE / - WK Ceramic
↓							









	kw			 	! #		
VOLVO - V40 Schrägheck 03/12→							
 Bremsscheibe							
D2	84	03/12→	←	09/12→; passend für Felgengröße [Zoll]: 16		24.0125-0162.1 425162	Ø 300 25 23 V
			←	09/12→; passend für Felgengröße [Zoll]: 17		24.0125-0197.1 425197 24.0325-0197.1 525197	Ø 320 25 23 V Ø 320 25 23 V PD
			←	09/12→; passend für Felgengröße [Zoll]: 15		24.0125-0203.1 425203	Ø 278 25 23 V
			→	09/12→; nicht für Ausstattungsvariante: ALU Bremsscheibe		24.0111-0158.1 411158	Ø 280 11 9 + S
D2	88	02/15→	←	passend für Felgengröße [Zoll]: 16		24.0125-0162.1 425162	Ø 300 25 23 V
D3	110	04/15→	←	passend für Felgengröße [Zoll]: 17		24.0125-0197.1 425197	Ø 320 25 23 V
D4	140	05/14→			24.0325-0197.1 525197	Ø 320 25 23 V PD	
T2	90	02/15→	←	passend für Felgengröße [Zoll]: 15		24.0125-0203.1 425203	Ø 278 25 23 V
T3	112	02/15→			24.0111-0158.1 411158	Ø 280 11 9 + S	
T4	140	08/15→	→			24.0111-0158.1 411158	Ø 280 11 9 + S
T5	157	03/13→					
T5	180	05/14→					
T5 AWD	157	03/13→					
T5 AWD	180	05/14→					
D3	110	03/12→03/15	←	09/12→; passend für Felgengröße [Zoll]: 16		24.0125-0162.1 425162	Ø 300 25 23 V
D4	130	03/12→	←	09/12→; passend für Felgengröße [Zoll]: 17		24.0125-0197.1 425197	Ø 320 25 23 V
T3 GTDi	110	03/12→			24.0325-0197.1 525197	Ø 320 25 23 V PD	
T4 GTDi	132	03/12→	←	09/12→; passend für Felgengröße [Zoll]: 15		24.0125-0203.1 425203	Ø 278 25 23 V
			→	09/12→		24.0111-0158.1 411158	Ø 280 11 9 + S
T2 GTDi	88	03/13→12/15	←	passend für Felgengröße [Zoll]: 17		24.0125-0197.1 425197	Ø 320 25 23 V
T4 AWD	132	07/13→			24.0325-0197.1 525197	Ø 320 25 23 V PD	
T4 AWD	140	05/14→	→			24.0111-0158.1 411158	Ø 280 11 9 + S
T5	187	12/12→					
T5 AWD	187	01/13→					
T4	147	04/14→	←	passend für Felgengröße [Zoll]: 16		24.0125-0162.1 425162	Ø 300 25 23 V
T4	132	07/13→			←	passend für Felgengröße [Zoll]: 17	
			→			24.0111-0158.1 411158	Ø 280 11 9 + S
T5	183	01/14→	←	05/14→; passend für Felgengröße [Zoll]: 16		24.0125-0162.1 425162	Ø 300 25 23 V
			←	05/14→; passend für Felgengröße [Zoll]: 17		24.0125-0197.1 425197 24.0325-0197.1 525197	Ø 320 25 23 V Ø 320 25 23 V PD
			←	05/14→; passend für Felgengröße [Zoll]: 15		24.0125-0203.1 425203	Ø 278 25 23 V
			→	05/14→		24.0111-0158.1 411158	Ø 280 11 9 + S
VOLVO - V50 (MW) 12/03→12/12							
 Bremsbelagsatz, Scheibenbremse							
1.6	74	01/05→12/12	←	→ 05/12; nicht für Felgengröße [Zoll]: 17		13.0460-7193.2 607193	ATE 23723 18,1 - WE / - WK
1.6 D2	84	01/10→12/12			13.0470-7193.2 LD7193	ATE 23723 18,1 - WE / - WK Ceramic	
2.0	107	10/06→12/12	←	→ 05/12; passend für Felgengröße [Zoll]: 17		13.0460-7204.2 607204	ATE 23801 18,8 - WE / - WK
2.0 FlexFuel	107	01/10→12/12			13.0470-7204.2 LD7204	ATE 23801 18,8 - WE / - WK Ceramic	
D3	110	10/10→12/12	→	→ 05/12		13.0460-7195.2 607195	ATE 23482 16,6 - WE / - WK
D4	130	10/10→12/12			13.0470-7195.2 LD7195	ATE 23482 16,6 - WE / - WK Ceramic	
T5	169	03/07→12/12					
1.6 D	81	01/05→12/11	←	nicht für Felgengröße [Zoll]: 17		13.0460-7193.2 607193	ATE 23723 18,1 - WE / - WK
1.8	92	04/04→12/10			13.0470-7193.2 LD7193	ATE 23723 18,1 - WE / - WK Ceramic	
2.0 D	100	04/04→12/10	←	passend für Felgengröße [Zoll]: 17		13.0460-7204.2 607204	ATE 23801 18,8 - WE / - WK
2.4	103	04/04→12/10			13.0470-7204.2 LD7204	ATE 23801 18,8 - WE / - WK Ceramic	
2.4 AWD	125	04/04→12/10	→			13.0460-7195.2 607195	ATE 23482 16,6 - WE / - WK
2.4 D5	132	03/06→12/10			13.0470-7195.2 LD7195	ATE 23482 16,6 - WE / - WK Ceramic	
2.4 Tdi	120	05/07→12/10	→			13.0460-7195.2 607195	ATE 23482 16,6 - WE / - WK
T5	162	04/04→12/07			13.0470-7195.2 LD7195	ATE 23801 18,8 - WE / - WK Ceramic	
T5 AWD	162	04/04→12/07					
T5 AWD	169	03/07→12/10	←	04/07→; nicht für Felgengröße [Zoll]: 17		13.0460-7193.2 607193	ATE 23723 18,1 - WE / - WK Ceramic
			←	04/07→; passend für Felgengröße [Zoll]: 17		13.0460-7204.2 607204	ATE 23801 18,8 - WE / - WK Ceramic
↓							









	kW			 	! #		
VOLVO - V50 (MW) 12/03→12/12							
 Bremsbelagsatz, Scheibenbremse							
1.8 FlexFuel	92	01/05→12/10	➔	04/07→		13.0460-7195.2 607195 13.0470-7195.2 LD7195	ATE 23482 16,6 - WE / - WK ATE 23482 16,6 - WE / - WK Ceramic
 Bremsscheibe							
1.6	74	01/05→12/12	←	→ 05/12;		24.0125-0117.1 425117	Ø 278 25 23 V
1.6 D2	84	01/10→12/12		passend für Felgengröße [Zoll]: 15		24.0325-0117.1 525117	Ø 278 25 23 V PD
2.0	107	10/06→12/12					
2.0 FlexFuel	107	01/10→12/12	←	→ 05/12;		24.0125-0162.1 425162	Ø 300 25 23 V
D3	110	10/10→12/12		passend für Felgengröße [Zoll]: 16		24.0325-0162.1 525162	Ø 300 25 23 V PD
D4	130	10/10→12/12					
T5	169	03/07→12/12	←	→ 05/12;		24.0125-0197.1 425197	Ø 320 25 23 V
				passend für Felgengröße [Zoll]: 17		24.0325-0197.1 525197	Ø 320 25 23 V PD
			➔	→ 05/12		24.0111-0158.1 411158	Ø 280 11 9 + S
						24.0311-0158.1 511158	Ø 280 11 9 PD
1.6 D	81	01/05→12/11	←	passend für Felgengröße [Zoll]: 15		24.0125-0117.1 425117	Ø 278 25 23 V
1.8	92	04/04→12/10				24.0325-0117.1 525117	Ø 278 25 23 V PD
2.0 D	100	04/04→12/10					
2.4	103	04/04→12/10	←	passend für Felgengröße [Zoll]: 16		24.0125-0162.1 425162	Ø 300 25 23 V
2.4	125	04/04→12/10				24.0325-0162.1 525162	Ø 300 25 23 V PD
2.4 AWD	125	08/06→12/09					
2.4 D5	132	03/06→12/10	←	passend für Felgengröße [Zoll]: 17		24.0125-0197.1 425197	Ø 320 25 23 V
2.4 Tdi	120	05/07→12/10				24.0325-0197.1 525197	Ø 320 25 23 V PD
T5	162	04/04→12/07	➔			24.0111-0158.1 411158	Ø 280 11 9 + S
T5 AWD	162	04/04→12/07				24.0311-0158.1 511158	Ø 280 11 9 PD
T5 AWD	169	03/07→12/10					
1.8 FlexFuel	92	01/05→12/10	←	04/07→;		24.0125-0117.1 425117	Ø 278 25 23 V
				passend für Felgengröße [Zoll]: 15		24.0325-0117.1 525117	Ø 278 25 23 V PD
			←	04/07→;		24.0125-0162.1 425162	Ø 300 25 23 V
				passend für Felgengröße [Zoll]: 16		24.0325-0162.1 525162	Ø 300 25 23 V PD
			←	04/07→;		24.0125-0197.1 425197	Ø 320 25 23 V
				passend für Felgengröße [Zoll]: 17		24.0325-0197.1 525197	Ø 320 25 23 V PD
			➔	04/07→		24.0111-0158.1 411158	Ø 280 11 9 + S
						24.0311-0158.1 511158	Ø 280 11 9 PD
VOLVO - V60 07/10→							
 Bremsbelagsatz, Scheibenbremse							
1.5 T2	90	10/15→	←	01/16→;		13.0460-7228.2 607228	ATE 24123 20,3 - WE / - WK
				für Bremsscheibendurchmesser [mm]: 300		13.0470-7228.2 LD7228	ATE 24123 20,3 - WE / - WK Ceramic
			←	01/16→;		13.0460-7243.2 607243	ATE 24142 20,6 - WE / - WK
				für Bremsscheibendurchmesser [mm]: 316 / 336		13.0470-7243.2 LD7243	ATE 24142 20,6 - WE / - WK Ceramic
			➔	01/16→; - CDN / - USA		13.0460-2722.2 602722	TRW 24496 17,3 - WE / - WK + Zub
						13.0470-2722.2 LD2722	TRW 24496 17,3 - WE / - WK + Zub Ceramic
			➔	01/16→; V		13.0460-2736.2 602736	TRW 24496 17,3 - WE / - WK + Zub
						13.0470-2736.2 LD2736	TRW 24496 17,3 - WE / - WK + Zub Ceramic
1.6 DRIVe	84	02/11→12/15	←	06/11→;		13.0460-7228.2 607228	ATE 24123 20,3 - WE / - WK
2.4 D5	158	04/11→12/15		für Bremsscheibendurchmesser [mm]: 300		13.0470-7228.2 LD7228	ATE 24123 20,3 - WE / - WK Ceramic
2.4 D5 AWD	158	04/11→12/15					
			←	06/11→;		13.0460-7243.2 607243	ATE 24142 20,6 - WE / - WK
				für Bremsscheibendurchmesser [mm]: 316 / 336		13.0470-7243.2 LD7243	ATE 24142 20,6 - WE / - WK Ceramic
			➔	06/11→; - CDN / - USA		13.0460-2722.2 602722	TRW 24496 17,3 - WE / - WK + Zub
						13.0470-2722.2 LD2722	TRW 24496 17,3 - WE / - WK + Zub Ceramic
			➔	06/11→; V		13.0460-2736.2 602736	TRW 24496 17,3 - WE / - WK + Zub
						13.0470-2736.2 LD2736	TRW 24496 17,3 - WE / - WK + Zub Ceramic
2.0 D2	88	03/15→	←	für Bremsscheibendurchmesser [mm]: 300		13.0460-7228.2 607228	ATE 24123 20,3 - WE / - WK
2.0 D3	110	03/15→				13.0470-7228.2 LD7228	ATE 24123 20,3 - WE / - WK Ceramic
2.0 D4	140	03/15→					
2.4 D5 Hybrid AWD	120	03/15→					
D4	133	10/13→12/15	←	für Bremsscheibendurchmesser [mm]: 316 / 336		13.0460-7243.2 607243	ATE 24142 20,6 - WE / - WK
D4 AWD	133	10/13→12/15					
↓							

	kW			 	! #		
VOLVO - V60 07/10→							
 Bremsbelagsatz, Scheibenbremse							
D4 AWD D5 D5 D5 AWD D6 Hybrid AWD T3 T4F T5 T5	140 165 169 169 162 112 132 176 180	03/15→ 03/15→ 04/14→12/15 04/14→12/15 03/15→ 03/15→ 04/11→12/15 08/12→ 10/13→	← ← → → → → → → →	für Bremsscheibendurchmesser [mm]: 316 / 336 - CDN / - USA V		13.0470-7243.2 LD7243 13.0460-2722.2 602722 13.0470-2722.2 LD2722 13.0460-2736.2 602736 13.0470-2736.2 LD2736	ATE 24142 20,6 - WE / - WK Ceramic TRW 24496 17,3 - WE / - WK + Zub TRW 24496 17,3 - WE / - WK + Zub Ceramic TRW 24496 17,3 - WE / - WK + Zub TRW 24496 17,3 - WE / - WK + Zub Ceramic
2.0 T D3 / D4 D5 D5 AWD T3 T4 T5	149 120 151 151 110 132 177	07/10→12/12 07/10→12/14 07/10→12/11 07/10→12/11 09/10→12/15 09/10→12/15 09/10→12/14	← ← ← → →	11/10→; für Bremsscheibendurchmesser [mm]: 300 11/10→; für Bremsscheibendurchmesser [mm]: 316 / 336 11/10→; - CDN / - USA 11/10→; V		13.0460-7228.2 607228 13.0470-7228.2 LD7228 13.0460-7243.2 607243 13.0470-7243.2 LD7243 13.0460-2722.2 602722 13.0470-2722.2 LD2722 13.0460-2736.2 602736 13.0470-2736.2 LD2736	ATE 24123 20,3 - WE / - WK Ceramic ATE 24123 20,3 - WE / - WK Ceramic ATE 24142 20,6 - WE / - WK Ceramic ATE 24142 20,6 - WE / - WK Ceramic TRW 24496 17,3 - WE / - WK + Zub TRW 24496 17,3 - WE / - WK + Zub Ceramic TRW 24496 17,3 - WE / - WK + Zub
2.0 T4	140	03/15→	← ← → →	05/15→; für Bremsscheibendurchmesser [mm]: 300 05/15→; für Bremsscheibendurchmesser [mm]: 316 / 336 05/15→; - CDN / - USA 05/15→; V		13.0460-7228.2 607228 13.0470-7228.2 LD7228 13.0460-7243.2 607243 13.0470-7243.2 LD7243 13.0460-2722.2 602722 13.0470-2722.2 LD2722 13.0460-2736.2 602736 13.0470-2736.2 LD2736	ATE 24123 20,3 - WE / - WK Ceramic ATE 24142 20,6 - WE / - WK Ceramic ATE 24142 20,6 - WE / - WK Ceramic TRW 24496 17,3 - WE / - WK + Zub TRW 24496 17,3 - WE / - WK + Zub Ceramic TRW 24496 17,3 - WE / - WK + Zub
2.4 Hybrid D6 AWD	158	06/12→12/15	← ← → →	11/12→; für Bremsscheibendurchmesser [mm]: 300 11/12→; für Bremsscheibendurchmesser [mm]: 316 / 336 11/12→; - CDN / - USA 11/12→; V		13.0460-7228.2 607228 13.0470-7228.2 LD7228 13.0460-7243.2 607243 13.0470-7243.2 LD7243 13.0460-2722.2 602722 13.0470-2722.2 LD2722 13.0460-2736.2 602736 13.0470-2736.2 LD2736	ATE 24123 20,3 - WE / - WK Ceramic ATE 24123 20,3 - WE / - WK Ceramic ATE 24142 20,6 - WE / - WK Ceramic ATE 24142 20,6 - WE / - WK Ceramic TRW 24496 17,3 - WE / - WK + Zub TRW 24496 17,3 - WE / - WK + Zub Ceramic TRW 24496 17,3 - WE / - WK + Zub TRW 24496 17,3 - WE / - WK + Zub Ceramic
3.0 T AWD	258	04/14→	→ →	05/14→; - CDN / - USA 05/14→; V		13.0460-2722.2 602722 13.0470-2722.2 LD2722 13.0460-2736.2 602736 13.0470-2736.2 LD2736	TRW 24496 17,3 - WE / - WK + Zub TRW 24496 17,3 - WE / - WK + Zub Ceramic TRW 24496 17,3 - WE / - WK + Zub TRW 24496 17,3 - WE / - WK + Zub Ceramic
D3	100	05/12→12/15	← ← →	10/12→; für Bremsscheibendurchmesser [mm]: 300 11/12→; für Bremsscheibendurchmesser [mm]: 316 / 336 10/12→; - CDN / - USA		13.0460-7228.2 607228 13.0470-7228.2 LD7228 13.0460-7243.2 607243 13.0470-7243.2 LD7243 13.0460-2722.2 602722	ATE 24123 20,3 - WE / - WK Ceramic ATE 24123 20,3 - WE / - WK Ceramic ATE 24142 20,6 - WE / - WK Ceramic ATE 24142 20,6 - WE / - WK Ceramic TRW 24496 17,3 - WE / - WK + Zub
↓							







	kw			 	! #		
VOLVO - V60 07/10→							
 Bremsbelagsatz, Scheibenbremse							
D3	100	05/12→12/15	➔	10/12→; - CDN / - USA		13.0470-2722.2 LD2722	TRW 24496 17,3 - WE / - WK + Zub Ceramic
			➔	10/12→; V		13.0460-2736.2 602736 13.0470-2736.2 LD2736	TRW 24496 17,3 - WE / - WK + Zub TRW 24496 17,3 - WE / - WK + Zub Ceramic
D4 AWD	120	05/12→	←	12/12→; für Bremsscheibendurchmesser [mm]: 300		13.0460-7228.2 607228 13.0470-7228.2 LD7228	ATE 24123 20,3 - WE / - WK ATE 24123 20,3 - WE / - WK Ceramic
			←	12/12→; für Bremsscheibendurchmesser [mm]: 316 / 336		13.0460-7243.2 607243 13.0470-7243.2 LD7243	ATE 24142 20,6 - WE / - WK ATE 24142 20,6 - WE / - WK Ceramic
			➔	12/12→; - CDN / - USA		13.0460-2722.2 602722 13.0470-2722.2 LD2722	TRW 24496 17,3 - WE / - WK + Zub TRW 24496 17,3 - WE / - WK + Zub Ceramic
			➔	12/12→; V		13.0460-2736.2 602736 13.0470-2736.2 LD2736	TRW 24496 17,3 - WE / - WK + Zub TRW 24496 17,3 - WE / - WK + Zub Ceramic
T5	157	10/13→	←	04/14→; für Bremsscheibendurchmesser [mm]: 300		13.0460-7228.2 607228 13.0470-7228.2 LD7228	ATE 24123 20,3 - WE / - WK ATE 24123 20,3 - WE / - WK Ceramic
			←	04/14→; für Bremsscheibendurchmesser [mm]: 316 / 336		13.0460-7243.2 607243 13.0470-7243.2 LD7243	ATE 24142 20,6 - WE / - WK ATE 24142 20,6 - WE / - WK Ceramic
			➔	04/14→; - CDN / - USA		13.0460-2722.2 602722 13.0470-2722.2 LD2722	TRW 24496 17,3 - WE / - WK + Zub TRW 24496 17,3 - WE / - WK + Zub Ceramic
			➔	04/14→; V		13.0460-2736.2 602736 13.0470-2736.2 LD2736	TRW 24496 17,3 - WE / - WK + Zub TRW 24496 17,3 - WE / - WK + Zub Ceramic
T6 T6 AWD T6 AWD	225 225 242	10/13→ 10/13→ 04/14→12/15	←	für Bremsscheibendurchmesser [mm]: 300		13.0460-7228.2 607228	ATE 24123 20,3 - WE / - WK
			←	für Bremsscheibendurchmesser [mm]: 316 / 336		13.0460-7243.2 607243	ATE 24142 20,6 - WE / - WK
	➔	- CDN / - USA		13.0460-2722.2 602722 13.0470-2722.2 LD2722	TRW 24496 17,3 - WE / - WK + Zub TRW 24496 17,3 - WE / - WK + Zub Ceramic		
	➔	V		13.0460-2736.2 602736 13.0470-2736.2 LD2736	TRW 24496 17,3 - WE / - WK + Zub TRW 24496 17,3 - WE / - WK + Zub Ceramic		
T6 AWD	224	07/10→12/15	←	11/10→; für Bremsscheibendurchmesser [mm]: 300		13.0460-7228.2 607228	ATE 24123 20,3 - WE / - WK
			←	11/10→; für Bremsscheibendurchmesser [mm]: 316 / 336		13.0460-7243.2 607243	ATE 24142 20,6 - WE / - WK
			➔	11/10→; - CDN / - USA		13.0460-2722.2 602722 13.0470-2722.2 LD2722	TRW 24496 17,3 - WE / - WK + Zub TRW 24496 17,3 - WE / - WK + Zub Ceramic
			➔	11/10→; V		13.0460-2736.2 602736 13.0470-2736.2 LD2736	TRW 24496 17,3 - WE / - WK + Zub TRW 24496 17,3 - WE / - WK + Zub Ceramic
 Bremsscheibe							
1.5 T2	90	10/15→	←	01/16→		24.0128-0154.1 428154 24.0128-0162.1 428162 24.0128-0210.1 428210 24.0328-0154.1 528154 24.0328-0162.1 528162	Ø 300 28 26 V + S Ø 316 28 26 V + S Ø 336 28 26 V + S Ø 300 28 26 V + S PD Ø 316 28 26 V + S PD
			➔			24.0122-0259.1 422259	Ø 302 22 20 V + S
1.6 DRiVe 2.4 D5 ↓	84 158	02/11→12/15 04/11→12/15	←	06/11→		24.0128-0154.1 428154	Ø 300 28 26 V + S









	kW			 	! #		
VOLVO - V60 07/10→							
Bremsscheibe							
2.4 D5 AWD	158	04/11→12/15	←	06/11→		24.0128-0162.1 428162 24.0128-0210.1 428210 24.0328-0154.1 528154 24.0328-0162.1 528162	Ø 316 28 26 V + S Ø 336 28 26 V + S Ø 300 28 26 V + S PD Ø 316 28 26 V + S PD
			→	06/11→		24.0111-0147.1 411147 24.0122-0259.1 422259	Ø 302 11 9 + S Ø 302 22 20 V + S
2.0 D2 2.0 D3 2.0 D4 2.4 D5 Hybrid AWD D4 D4 AWD D4 AWD D5 D5 D5 AWD D6 Hybrid AWD T3 T4F T5 T5 T6 T6 AWD T6 AWD	88 110 140 120 133 133 140 165 169 169 162 112 132 176 180 225 225 242	03/15→ 03/15→ 03/15→ 03/15→ 10/13→12/15 10/13→12/15 03/15→ 03/15→ 04/14→12/15 04/14→12/15 03/15→ 03/15→ 04/11→12/15 08/12→ 10/13→ 10/13→ 10/13→ 04/14→12/15	←			24.0128-0154.1 428154 24.0128-0162.1 428162 24.0128-0210.1 428210 24.0328-0154.1 528154 24.0328-0162.1 528162	Ø 300 28 26 V + S Ø 316 28 26 V + S Ø 336 28 26 V + S Ø 300 28 26 V + S PD Ø 316 28 26 V + S PD
			→			24.0111-0147.1 411147 24.0122-0259.1 422259	Ø 302 11 9 + S Ø 302 22 20 V + S
2.0 T D3 / D4 D5 D5 AWD T3 T4 T5 T6 AWD	149 120 151 151 110 132 177 224	07/10→12/12 07/10→12/14 07/10→12/11 07/10→12/11 09/10→12/15 09/10→12/15 09/10→12/14 07/10→12/15	←	11/10→		24.0128-0154.1 428154 24.0128-0162.1 428162 24.0128-0210.1 428210 24.0328-0154.1 528154 24.0328-0162.1 528162	Ø 300 28 26 V + S Ø 316 28 26 V + S Ø 336 28 26 V + S Ø 300 28 26 V + S PD Ø 316 28 26 V + S PD
			→	11/10→		24.0111-0147.1 411147 24.0122-0259.1 422259	Ø 302 11 9 + S Ø 302 22 20 V + S
2.0 T4	140	03/15→	←	05/15→		24.0128-0154.1 428154 24.0128-0162.1 428162 24.0128-0210.1 428210 24.0328-0154.1 528154 24.0328-0162.1 528162	Ø 300 28 26 V + S Ø 316 28 26 V + S Ø 336 28 26 V + S Ø 300 28 26 V + S PD Ø 316 28 26 V + S PD
			→	05/15→		24.0111-0147.1 411147 24.0122-0259.1 422259	Ø 302 11 9 + S Ø 302 22 20 V + S
2.4 Hybrid D6 AWD	158	06/12→12/15	←	11/12→		24.0128-0154.1 428154 24.0128-0162.1 428162 24.0128-0210.1 428210 24.0328-0154.1 528154 24.0328-0162.1 528162	Ø 300 28 26 V + S Ø 316 28 26 V + S Ø 336 28 26 V + S Ø 300 28 26 V + S PD Ø 316 28 26 V + S PD
			→	11/12→		24.0111-0147.1 411147 24.0122-0259.1 422259	Ø 302 11 9 + S Ø 302 22 20 V + S
3.0 T AWD	258	04/14→	→	05/14→		24.0111-0147.1 411147 24.0122-0259.1 422259	Ø 302 11 9 + S Ø 302 22 20 V + S
D3	100	05/12→12/15	←	10/12→		24.0128-0154.1 428154 24.0128-0162.1 428162 24.0128-0210.1 428210 24.0328-0154.1 528154 24.0328-0162.1 528162	Ø 300 28 26 V + S Ø 316 28 26 V + S Ø 336 28 26 V + S Ø 300 28 26 V + S PD Ø 316 28 26 V + S PD
			→	10/12→		24.0111-0147.1 411147 24.0122-0259.1 422259	Ø 302 11 9 + S Ø 302 22 20 V + S
D4 AWD	120	05/12→	←	12/12→		24.0128-0154.1 428154 24.0128-0162.1 428162 24.0128-0210.1 428210 24.0328-0154.1 528154 24.0328-0162.1 528162	Ø 300 28 26 V + S Ø 316 28 26 V + S Ø 336 28 26 V + S Ø 300 28 26 V + S PD Ø 316 28 26 V + S PD
			→	12/12→		24.0111-0147.1 411147 24.0122-0259.1 422259	Ø 302 11 9 + S Ø 302 22 20 V + S
T5	157	10/13→	←	04/14→		24.0128-0154.1 428154 24.0128-0162.1 428162 24.0128-0210.1 428210 24.0328-0154.1 528154 24.0328-0162.1 528162	Ø 300 28 26 V + S Ø 316 28 26 V + S Ø 336 28 26 V + S Ø 300 28 26 V + S PD Ø 316 28 26 V + S PD
↓							









	kw			 	! #		
VOLVO - V60 07/10→							
 Bremsscheibe							
T5	157	10/13→	→	04/14→		24.0111-0147.1 411147 24.0122-0259.1 422259	Ø 302 11 9 + S Ø 302 22 20 V + S
VOLVO - V70 I (LV) 12/95→12/00							
 Bremsbelagsatz, Scheibenbremse							
2.0 2.0 2.0 2.0 Turbo 2.4 2.5 TDi AWD	93 105 132 155 106 103	12/95→03/00 12/95→03/00 11/96→03/00 12/95→03/00 12/95→03/00 11/96→02/00	← ← ← → → →	01/97→ 01/97→ 12/99 01/00→		13.0460-7053.2 607053 13.0470-7053.2 LD7053 13.0460-4044.2 604044 13.0470-4044.2 LD4044 13.0460-7135.2 607135 13.0470-7135.2 LD7135	ATE 21273 19,5 + WE / - WK ATE 21273 19,5 + WE / - WK Ceramic ATE 20755 15,1 - WE / - WK ATE 20755 15,1 - WE / - WK Ceramic ATE 23076 17,5 - WE / - WK ATE 23076 17,5 - WE / - WK Ceramic
2.0 2.4 Bifuel	120 103	01/97→12/00 08/99→12/00	← → →	→ 03/00 → 12/99 01/00→ 03/00		13.0460-7053.2 607053 13.0470-7053.2 LD7053 13.0460-4044.2 604044 13.0470-4044.2 LD4044 13.0460-7135.2 607135 13.0470-7135.2 LD7135	ATE 21273 19,5 + WE / - WK ATE 21273 19,5 + WE / - WK Ceramic ATE 20755 15,1 - WE / - WK ATE 20755 15,1 - WE / - WK Ceramic ATE 23076 17,5 - WE / - WK ATE 23076 17,5 - WE / - WK Ceramic
2.0 Turbo 2.3 2.3 T-5	166 177 176	11/96→12/00 11/96→11/00 11/96→12/00	← → →	01/97→ 03/00 01/97→ 12/99 01/00→ 03/00		13.0460-7053.2 607053 13.0460-4044.2 604044 13.0470-4044.2 LD4044 13.0460-7135.2 607135 13.0470-7135.2 LD7135	ATE 21273 19,5 + WE / - WK ATE 20755 15,1 - WE / - WK ATE 20755 15,1 - WE / - WK Ceramic ATE 23076 17,5 - WE / - WK ATE 23076 17,5 - WE / - WK Ceramic
2.0 Turbo AWD	166	11/96→12/00	← → →	01/97→ 03/00 01/97→ 12/99 01/00→ 03/00		13.0460-7053.2 607053 13.0460-2935.2 602935 13.0460-7135.2 607135 13.0470-7135.2 LD7135	ATE 21273 19,5 + WE / - WK TRW 21385 13,8 - WK ATE 23076 17,5 - WE / - WK ATE 23076 17,5 - WE / - WK Ceramic
2.3 AWD 2.4	177 121	04/97→09/98 06/98→12/99	← →			13.0460-7053.2 607053 13.0470-7053.2 LD7053 13.0460-4044.2 604044 13.0470-4044.2 LD4044	ATE 21273 19,5 + WE / - WK ATE 21273 19,5 + WE / - WK Ceramic ATE 20755 15,1 - WE / - WK ATE 20755 15,1 - WE / - WK Ceramic
2.3 T-5 AWD	176	01/97→12/00	← → →	→ 03/00 → 12/99 01/00→ 03/00		13.0460-7053.2 607053 13.0470-7053.2 LD7053 13.0460-2935.2 602935 13.0460-7135.2 607135 13.0470-7135.2 LD7135	ATE 21273 19,5 + WE / - WK ATE 21273 19,5 + WE / - WK Ceramic TRW 21385 13,8 - WK ATE 23076 17,5 - WE / - WK ATE 23076 17,5 - WE / - WK Ceramic
2.3 T AWD	184	04/97→03/00	← → →	→ 12/99 01/00→		13.0460-7053.2 607053 13.0460-2935.2 602935 13.0460-7135.2 607135 13.0470-7135.2 LD7135	ATE 21273 19,5 + WE / - WK TRW 21385 13,8 - WK ATE 23076 17,5 - WE / - WK ATE 23076 17,5 - WE / - WK Ceramic
2.3 Turbo	184	12/95→03/00	← → →	01/97→ 01/97→ 12/99 01/00→		13.0460-7053.2 607053 13.0460-4044.2 604044 13.0470-4044.2 LD4044 13.0460-7135.2 607135 13.0470-7135.2 LD7135	ATE 21273 19,5 + WE / - WK ATE 20755 15,1 - WE / - WK ATE 20755 15,1 - WE / - WK Ceramic ATE 23076 17,5 - WE / - WK ATE 23076 17,5 - WE / - WK Ceramic
2.4 ↓	103	03/99→12/00	← →	08/99→ 03/00 08/99→ 12/99		13.0460-7053.2 607053 13.0470-7053.2 LD7053 13.0460-4044.2 604044	ATE 21273 19,5 + WE / - WK ATE 21273 19,5 + WE / - WK Ceramic ATE 20755 15,1 - WE / - WK







	kw			 	! #		
VOLVO - V70 I (LV) 12/95→12/00							
 Bremsbelagsatz, Scheibenbremse							
2.4	103	03/99→12/00	➡	08/99→ 12/99		13.0470-4044.2 LD4044	ATE 20755 15,1 - WE / - WK Ceramic
			➡	01/00→ 03/00		13.0460-7135.2 607135 13.0470-7135.2 LD7135	ATE 23076 17,5 - WE / - WK ATE 23076 17,5 - WE / - WK Ceramic
2.4 2.4 Turbo 2.5 TDI	125 142 103	12/95→05/00 04/96→12/00 12/95→12/00	←	01/97→ 03/00		13.0460-7053.2 607053 13.0470-7053.2 LD7053	ATE 21273 19,5 + WE / - WK ATE 21273 19,5 + WE / - WK Ceramic
			➡	01/97→ 12/99		13.0460-4044.2 604044 13.0470-4044.2 LD4044	ATE 20755 15,1 - WE / - WK ATE 20755 15,1 - WE / - WK Ceramic
			➡	01/00→ 03/00		13.0460-7135.2 607135 13.0470-7135.2 LD7135	ATE 23076 17,5 - WE / - WK ATE 23076 17,5 - WE / - WK Ceramic
2.4 AWD	121	06/98→12/99	←	10/98→ 05/99		13.0460-7053.2 607053 13.0470-7053.2 LD7053	ATE 21273 19,5 + WE / - WK ATE 21273 19,5 + WE / - WK Ceramic
			➡	10/98→ 05/99		13.0460-4044.2 604044 13.0470-4044.2 LD4044	ATE 20755 15,1 - WE / - WK ATE 20755 15,1 - WE / - WK Ceramic
2.4 Bifuel	106	05/98→12/99	←	10/98→ 08/99		13.0460-7053.2 607053 13.0470-7053.2 LD7053	ATE 21273 19,5 + WE / - WK ATE 21273 19,5 + WE / - WK Ceramic
			➡	10/98→ 08/99		13.0460-4044.2 604044 13.0470-4044.2 LD4044	ATE 20755 15,1 - WE / - WK ATE 20755 15,1 - WE / - WK Ceramic
2.4 Turbo AWD	142	04/96→12/00	←	01/97→ 03/00		13.0460-7053.2 607053 13.0470-7053.2 LD7053	ATE 21273 19,5 + WE / - WK ATE 21273 19,5 + WE / - WK Ceramic
			➡	01/97→ 12/99		13.0460-2935.2 602935	TRW 21385 13,8 - WK
			➡	01/00→ 03/00		13.0460-7135.2 607135 13.0470-7135.2 LD7135	ATE 23076 17,5 - WE / - WK ATE 23076 17,5 - WE / - WK Ceramic
2.4 Turbo AWD	195	03/99→12/00	←	→ 03/00		13.0460-7053.2 607053	ATE 21273 19,5 + WE / - WK
			➡	→ 12/99		13.0460-2935.2 602935	TRW 21385 13,8 - WK
			➡	01/00→ 03/00		13.0460-7135.2 607135 13.0470-7135.2 LD7135	ATE 23076 17,5 - WE / - WK ATE 23076 17,5 - WE / - WK Ceramic
 Bremsscheibe							
2.0	93	12/95→03/00	←	01/97→;		24.0126-0102.1 426102	Ø 280,3 26 23 V
2.0	105	12/95→03/00	←	passend für Felgenreöße [Zoll]: 15			
2.0	132	11/96→03/00	←	01/97→;		24.0126-0107.1 426107	Ø 302 26 23 V
2.0 Turbo	155	12/95→03/00	←	passend für Felgenreöße [Zoll]: 16		24.0326-0107.1 526107	Ø 302 26 23 V PD
2.3 Turbo	184	12/95→03/00	➡	01/97→		24.0110-0214.1 410214	Ø 295 9,6 8,4
2.4	106	12/95→03/00	➡	01/97→			
2.5 TDi AWD	103	11/96→02/00	←	→ 03/00;		24.0126-0102.1 426102	Ø 280,3 26 23 V
2.0	120	01/97→12/00	←	passend für Felgenreöße [Zoll]: 15			
2.4 Bifuel	103	08/99→12/00	←	→ 03/00;		24.0126-0107.1 426107	Ø 302 26 23 V
			←	passend für Felgenreöße [Zoll]: 16		24.0326-0107.1 526107	Ø 302 26 23 V PD
			➡	→ 03/00		24.0110-0214.1 410214	Ø 295 9,6 8,4
2.0 Turbo	166	11/96→12/00	←	01/97→ 03/00;		24.0126-0102.1 426102	Ø 280,3 26 23 V
2.3	177	11/96→11/00	←	passend für Felgenreöße [Zoll]: 15			
2.3 T-5	176	11/96→12/00	←	01/97→ 03/00;		24.0126-0107.1 426107	Ø 302 26 23 V
2.4	125	12/95→05/00	←	passend für Felgenreöße [Zoll]: 16		24.0326-0107.1 526107	Ø 302 26 23 V PD
2.4 Turbo	142	04/96→12/00	➡	01/97→ 03/00		24.0110-0214.1 410214	Ø 295 9,6 8,4
2.5 TDI	103	12/95→12/00	➡	01/97→ 03/00			
2.0 Turbo AWD	166	11/96→12/00	←	01/97→ 03/00;		24.0126-0102.1 426102	Ø 280,3 26 23 V
2.4 Turbo AWD	142	04/96→12/00	←	passend für Felgenreöße [Zoll]: 15			
			←	01/97→ 03/00;		24.0126-0107.1 426107	Ø 302 26 23 V
			←	passend für Felgenreöße [Zoll]: 16		24.0326-0107.1 526107	Ø 302 26 23 V PD
			➡	01/97→ 03/00		24.0110-0214.1 410214	Ø 295 9,6 8,4
			➡	01/97→;	→ 587043	24.0110-0292.1 410292	Ø 283 10 8
			➡	→ 03/00; 587044→		24.0112-0165.1 412165	Ø 288 12 10
2.3 AWD	177	04/97→09/98	←	passend für Felgenreöße [Zoll]: 15		24.0126-0102.1 426102	Ø 280,3 26 23 V
2.4	121	06/98→12/99	←	passend für Felgenreöße [Zoll]: 16		24.0126-0107.1 426107	Ø 302 26 23 V
↓							



















	kw			 	! #		
VOLVO - V70 I (LV) 12/95→12/00							
Bremsscheibe							
2.3 AWD 2.4	177 121	04/97→09/98 06/98→12/99	← →	passend für Felgengröße [Zoll]: 16		24.0326-0107.1 526107 24.0110-0214.1 410214	Ø 302 26 23 V PD Ø 295 9,6 8,4
2.3 T-5 AWD	176	01/97→12/00	← ← → → →	→ 03/00; passend für Felgengröße [Zoll]: 15 → 03/00; passend für Felgengröße [Zoll]: 16 → 03/00 → 587043 → 03/00; 587044→		24.0126-0102.1 426102 24.0126-0107.1 426107 24.0326-0107.1 526107 24.0110-0214.1 410214 24.0110-0292.1 410292 24.0112-0165.1 412165	Ø 280,3 26 23 V Ø 302 26 23 V Ø 302 26 23 V PD Ø 295 9,6 8,4 Ø 283 10 8 Ø 288 12 10
2.3 T AWD	184	04/97→03/00	← ← → →	passend für Felgengröße [Zoll]: 15 passend für Felgengröße [Zoll]: 16 → 587043 587044→		24.0126-0102.1 426102 24.0126-0107.1 426107 24.0326-0107.1 526107 24.0110-0214.1 410214 24.0110-0292.1 410292 24.0112-0165.1 412165	Ø 280,3 26 23 V Ø 302 26 23 V Ø 302 26 23 V PD Ø 295 9,6 8,4 Ø 283 10 8 Ø 288 12 10
2.4	103	03/99→12/00	← ← →	08/99→ 03/00; passend für Felgengröße [Zoll]: 15 08/99→ 03/00; passend für Felgengröße [Zoll]: 16 08/99→ 03/00		24.0126-0102.1 426102 24.0126-0107.1 426107 24.0326-0107.1 526107 24.0110-0214.1 410214	Ø 280,3 26 23 V Ø 302 26 23 V Ø 302 26 23 V PD Ø 295 9,6 8,4
2.4 AWD	121	06/98→12/99	← ← →	10/98→ 05/99; passend für Felgengröße [Zoll]: 15 10/98→ 05/99; passend für Felgengröße [Zoll]: 16 10/98→ 05/99		24.0126-0102.1 426102 24.0126-0107.1 426107 24.0326-0107.1 526107 24.0110-0214.1 410214	Ø 280,3 26 23 V Ø 302 26 23 V Ø 302 26 23 V PD Ø 295 9,6 8,4
2.4 Bifuel	106	05/98→12/99	← ← →	10/98→ 08/99; passend für Felgengröße [Zoll]: 15 10/98→ 08/99; passend für Felgengröße [Zoll]: 16 10/98→ 08/99		24.0126-0102.1 426102 24.0126-0107.1 426107 24.0326-0107.1 526107 24.0110-0214.1 410214	Ø 280,3 26 23 V Ø 302 26 23 V Ø 302 26 23 V PD Ø 295 9,6 8,4
2.4 Turbo AWD	195	03/99→12/00	← ← →	→ 03/00; passend für Felgengröße [Zoll]: 15 → 03/00; passend für Felgengröße [Zoll]: 16 → 03/00		24.0126-0102.1 426102 24.0126-0107.1 426107 24.0326-0107.1 526107 24.0110-0214.1 410214 24.0112-0165.1 412165	Ø 280,3 26 23 V Ø 302 26 23 V Ø 302 26 23 V PD Ø 295 9,6 8,4 Ø 288 12 10
VOLVO - V70 II (SW) 11/99→12/08							
Bremsbelagsatz, Scheibenbremse							
2.0 T	132	11/99→08/07	← ← →	07/01→ 07/07; nicht für Felgengröße [Zoll]: 17 07/01→ 07/07; passend für Felgengröße [Zoll]: 17 07/01→ 07/07		13.0460-7145.2 607145 13.0470-7145.2 LD7145 13.0460-7187.2 607187 13.0470-7187.2 LD7187 13.0460-7135.2 607135 13.0470-7135.2 LD7135	ATE 23073 18,8 - WE / - WK ATE 23073 18,8 - WE / - WK Ceramic ATE 23591 18,0 - WE / - WK ATE 23590 19,5 - WE / - WK Ceramic ATE 23076 17,5 - WE / - WK ATE 23076 17,5 - WE / - WK Ceramic
2.3 2.4 2.4 AWD 2.4 T AWD 2.5 AWD	195 121 121 147 155	10/00→09/04 03/00→09/03 03/00→09/03 09/01→08/02 09/02→12/04	← ← →	nicht für Felgengröße [Zoll]: 17 passend für Felgengröße [Zoll]: 17		13.0460-7145.2 607145 13.0470-7145.2 LD7145 13.0460-7187.2 607187 13.0470-7187.2 LD7187 13.0460-7135.2 607135 13.0470-7135.2 LD7135	ATE 23073 18,8 - WE / - WK ATE 23073 18,8 - WE / - WK Ceramic ATE 23591 18,0 - WE / - WK ATE 23590 19,5 - WE / - WK Ceramic ATE 23076 17,5 - WE / - WK ATE 23076 17,5 - WE / - WK Ceramic
2.3 T5	184	11/99→12/04	← ← →	03/00→; nicht für Felgengröße [Zoll]: 17 03/00→; passend für Felgengröße [Zoll]: 17 03/00→		13.0460-7145.2 607145 13.0460-7187.2 607187 13.0470-7187.2 LD7187 13.0460-7135.2 607135	ATE 23073 18,8 - WE / - WK ATE 23591 18,0 - WE / - WK ATE 23590 19,5 - WE / - WK Ceramic ATE 23076 17,5 - WE / - WK
↓							









	kw			 	! #		
VOLVO - V70 II (SW) 11/99→12/08							
 Bremsbelagsatz, Scheibenbremse							
2.3 T5	184	11/99→12/04	➡	03/00→		13.0470-7135.2 LD7135	ATE 23076 17,5 - WE / - WK Ceramic
2.4 2.4 Bifuel (CNG) 2.4 Bifuel (LPG)	103	03/00→08/07	←	→ 07/07; nicht für Felgengröße [Zoll]: 17		13.0460-7145.2 607145	ATE 23073 18,8 - WE / - WK
	125	03/00→08/07				13.0470-7145.2 LD7145	ATE 23073 18,8 - WE / - WK Ceramic
	103	09/01→08/07	←	→ 07/07; passend für Felgengröße [Zoll]: 17		13.0460-7187.2 607187	ATE 23591 18,0 - WE / - WK
	103	09/01→08/07		→ 07/07		13.0470-7187.2 LD7187	ATE 23590 19,5 - WE / - WK Ceramic
			➡	→ 07/07		13.0460-7135.2 607135	ATE 23076 17,5 - WE / - WK
						13.0470-7135.2 LD7135	ATE 23076 17,5 - WE / - WK Ceramic
2.4 D	93	04/05→12/08	←	05/05→ 07/07; nicht für Felgengröße [Zoll]: 17		13.0460-7145.2 607145	ATE 23073 18,8 - WE / - WK
						13.0470-7145.2 LD7145	ATE 23073 18,8 - WE / - WK Ceramic
			←	05/05→ 07/07; passend für Felgengröße [Zoll]: 17		13.0460-7187.2 607187	ATE 23591 18,0 - WE / - WK
						13.0470-7187.2 LD7187	ATE 23590 19,5 - WE / - WK Ceramic
			➡	05/05→ 07/07		13.0460-7135.2 607135	ATE 23076 17,5 - WE / - WK
						13.0470-7135.2 LD7135	ATE 23076 17,5 - WE / - WK Ceramic
2.4 D	96	07/01→08/07	←	12/01→ 07/07; nicht für Felgengröße [Zoll]: 17		13.0460-7145.2 607145	ATE 23073 18,8 - WE / - WK
						13.0470-7145.2 LD7145	ATE 23073 18,8 - WE / - WK Ceramic
			←	12/01→ 07/07; passend für Felgengröße [Zoll]: 17		13.0460-7187.2 607187	ATE 23591 18,0 - WE / - WK
						13.0470-7187.2 LD7187	ATE 23590 19,5 - WE / - WK Ceramic
			➡	12/01→ 07/07		13.0460-7135.2 607135	ATE 23076 17,5 - WE / - WK
						13.0470-7135.2 LD7135	ATE 23076 17,5 - WE / - WK Ceramic
2.4 D5	120	01/01→12/08	←	08/01→ 07/07; nicht für Felgengröße [Zoll]: 17		13.0460-7145.2 607145	ATE 23073 18,8 - WE / - WK
						13.0470-7145.2 LD7145	ATE 23073 18,8 - WE / - WK Ceramic
			←	08/01→ 07/07; passend für Felgengröße [Zoll]: 17		13.0460-7187.2 607187	ATE 23591 18,0 - WE / - WK
						13.0470-7187.2 LD7187	ATE 23590 19,5 - WE / - WK Ceramic
			➡	08/01→ 07/07		13.0460-7135.2 607135	ATE 23076 17,5 - WE / - WK
						13.0470-7135.2 LD7135	ATE 23076 17,5 - WE / - WK Ceramic
2.4 D5 2.4 D5 AWD	136 136	04/05→12/08 07/05→12/08	←	12/05→ 07/07; nicht für Felgengröße [Zoll]: 17		13.0460-7145.2 607145	ATE 23073 18,8 - WE / - WK
						13.0470-7145.2 LD7145	ATE 23073 18,8 - WE / - WK Ceramic
			←	12/05→ 07/07; passend für Felgengröße [Zoll]: 17		13.0460-7187.2 607187	ATE 23591 18,0 - WE / - WK
						13.0470-7187.2 LD7187	ATE 23590 19,5 - WE / - WK Ceramic
			➡	12/05→ 07/07		13.0460-7135.2 607135	ATE 23076 17,5 - WE / - WK
						13.0470-7135.2 LD7135	ATE 23076 17,5 - WE / - WK Ceramic
2.4 D5 AWD	120	07/02→08/07	←	03/03→ 07/07; nicht für Felgengröße [Zoll]: 17		13.0460-7145.2 607145	ATE 23073 18,8 - WE / - WK
						13.0470-7145.2 LD7145	ATE 23073 18,8 - WE / - WK Ceramic
			←	03/03→ 07/07; passend für Felgengröße [Zoll]: 17		13.0460-7187.2 607187	ATE 23591 18,0 - WE / - WK
						13.0470-7187.2 LD7187	ATE 23590 19,5 - WE / - WK Ceramic
			➡	03/03→ 07/07		13.0460-7135.2 607135	ATE 23076 17,5 - WE / - WK
						13.0470-7135.2 LD7135	ATE 23076 17,5 - WE / - WK Ceramic
2.4 T	147	11/99→08/03	←	03/00→; nicht für Felgengröße [Zoll]: 17		13.0460-7145.2 607145	ATE 23073 18,8 - WE / - WK
						13.0470-7145.2 LD7145	ATE 23073 18,8 - WE / - WK Ceramic
			←	03/00→; passend für Felgengröße [Zoll]: 17		13.0460-7187.2 607187	ATE 23591 18,0 - WE / - WK
						13.0470-7187.2 LD7187	ATE 23590 19,5 - WE / - WK Ceramic
			➡	03/00→		13.0460-7135.2 607135	ATE 23076 17,5 - WE / - WK
						13.0470-7135.2 LD7135	ATE 23076 17,5 - WE / - WK Ceramic
2.4 T5 ↓	191	04/04→08/07	←	→ 07/07; nicht für Felgengröße [Zoll]: 17		13.0460-7145.2 607145	ATE 23073 18,8 - WE / - WK









	kw			 	! #		
VOLVO - V70 II (SW) 11/99→12/08							
 Bremsbelagsatz, Scheibenbremse							
2.4 T5	191	04/04→08/07	←	→ 07/07; passend für Felgengröße [Zoll]: 17	13.0460-7187.2	607187	ATE 23591 18,0 - WE / - WK
			→	→ 07/07	13.0470-7187.2	LD7187	ATE 23590 19,5 - WE / - WK Ceramic
2.5 R Sport	221	12/02→08/07	←		13.0460-4804.2	604804	BRE 23092 15,6 - WE / - WK
			→		13.0460-4964.2	604964	BRE 21381 15,0 - WE / - WK
2.5 T	154	07/01→08/07	←	04/04→ 07/07; nicht für Felgengröße [Zoll]: 17	13.0460-7145.2	607145	ATE 23073 18,8 - WE / - WK
			←	04/04→ 07/07; passend für Felgengröße [Zoll]: 17	13.0470-7145.2	LD7145	ATE 23073 18,8 - WE / - WK Ceramic
			→	04/04→ 07/07	13.0460-7187.2	607187	ATE 23591 18,0 - WE / - WK
2.5 T AWD	154	07/02→08/07	←	09/02→ 07/07; nicht für Felgengröße [Zoll]: 17	13.0460-7187.2	607187	ATE 23590 19,5 - WE / - WK
			←	09/02→ 07/07; passend für Felgengröße [Zoll]: 17	13.0470-7187.2	LD7187	ATE 23591 18,0 - WE / - WK Ceramic
			→	09/02→ 07/07	13.0460-7135.2	607135	ATE 23076 17,5 - WE / - WK
2.5 TDI	103	11/99→08/07	←	03/00→ 07/07; nicht für Felgengröße [Zoll]: 17	13.0460-7135.2	607135	ATE 23076 17,5 - WE / - WK
			←	03/00→ 07/07; passend für Felgengröße [Zoll]: 17	13.0470-7135.2	LD7135	ATE 23076 17,5 - WE / - WK Ceramic
			→	03/00→ 07/07	13.0460-7145.2	607145	ATE 23073 18,8 - WE / - WK
R 2,5 T AWD	221	03/03→08/07	←	→ 07/07	13.0460-4804.2	604804	BRE 23092 15,6 - WE / - WK
			→	→ 07/07	13.0460-4964.2	604964	BRE 21381 15,0 - WE / - WK
 Bremsscheibe							
2.0 T	132	11/99→08/07	←	07/01→ 07/07; passend für Felgengröße [Zoll]: 15	24.0126-0122.1	426122	Ø 285,5 26 23 V
			←	07/01→ 07/07; passend für Felgengröße [Zoll]: 16	24.0128-0123.1	428123	Ø 305 27,9 25 V
			←	07/01→ 07/07; passend für Felgengröße [Zoll]: 17	24.0328-0123.1	528123	Ø 305 27,9 25 V PD
			→	07/01→ 07/07	24.0128-0184.1	428184	Ø 320 28 25 V
2.3 2.4 2.4 AWD 2.4 T AWD 2.5 AWD	195 121 121 147 155	10/00→09/04 03/00→09/03 03/00→09/03 09/01→08/02 09/02→12/04	←	passend für Felgengröße [Zoll]: 15	24.0112-0151.1	412151	Ø 288 11,9 10
			←	passend für Felgengröße [Zoll]: 16	24.0312-0151.1	512151	Ø 288 11,9 10 PD
			←	passend für Felgengröße [Zoll]: 15	24.0126-0122.1	426122	Ø 285,5 26 23 V
			←	passend für Felgengröße [Zoll]: 16	24.0128-0123.1	428123	Ø 305 27,9 25 V
2.3 T5 2.4 T	184 147	11/99→12/04 11/99→08/03	←	03/00→; passend für Felgengröße [Zoll]: 15	24.0328-0123.1	528123	Ø 305 27,9 25 V PD
			←	03/00→; passend für Felgengröße [Zoll]: 16	24.0128-0184.1	428184	Ø 320 28 25 V
			←	03/00→; passend für Felgengröße [Zoll]: 17	24.0126-0122.1	426122	Ø 285,5 26 23 V
			→	03/00→	24.0128-0123.1	428123	Ø 305 27,9 25 V
2.4 2.4 Bifuel (CNG) 2.4 Bifuel (LPG) 2.4 T5 ↓	103 125 103 103 191	03/00→08/07 03/00→08/07 09/01→08/07 09/01→08/07 04/04→08/07	←	→ 07/07; passend für Felgengröße [Zoll]: 15	24.0126-0122.1	426122	Ø 285,5 26 23 V
			←	→ 07/07; passend für Felgengröße [Zoll]: 16	24.0128-0123.1	428123	Ø 305 27,9 25 V
			←	→ 07/07; passend für Felgengröße [Zoll]: 15	24.0328-0123.1	528123	Ø 305 27,9 25 V PD
			←	→ 07/07; passend für Felgengröße [Zoll]: 16	24.0128-0123.1	428123	Ø 305 27,9 25 V









	kw			 	! #		
VOLVO - V70 II (SW) 11/99→12/08							
Bremsscheibe							
2.4	103	03/00→08/07	←	→ 07/07; passend für Felgengröße [Zoll]: 17		24.0128-0184.1 428184	Ø 320 28 25 V
2.4	125	03/00→08/07					
2.4 Bifuel (CNG)	103	09/01→08/07	→	→ 07/07		24.0112-0151.1 412151	Ø 288 11,9 10
2.4 Bifuel (LPG)	103	09/01→08/07				24.0312-0151.1 512151	Ø 288 11,9 10 PD
2.4 T5	191	04/04→08/07					
2.4 D	93	04/05→12/08	←	05/05→ 07/07; passend für Felgengröße [Zoll]: 15		24.0126-0122.1 426122	Ø 285,5 26 23 V
			←	05/05→ 07/07; passend für Felgengröße [Zoll]: 16		24.0128-0123.1 428123 24.0328-0123.1 528123	Ø 305 27,9 25 V Ø 305 27,9 25 V PD
			←	05/05→ 07/07; passend für Felgengröße [Zoll]: 17		24.0128-0184.1 428184	Ø 320 28 25 V
			→	05/05→ 07/07		24.0112-0151.1 412151 24.0312-0151.1 512151	Ø 288 11,9 10 Ø 288 11,9 10 PD
2.4 D	96	07/01→08/07	←	12/01→ 07/07; passend für Felgengröße [Zoll]: 15		24.0126-0122.1 426122	Ø 285,5 26 23 V
			←	12/01→ 07/07; passend für Felgengröße [Zoll]: 16		24.0128-0123.1 428123 24.0328-0123.1 528123	Ø 305 27,9 25 V Ø 305 27,9 25 V PD
			←	12/01→ 07/07; passend für Felgengröße [Zoll]: 17		24.0128-0184.1 428184	Ø 320 28 25 V
			→	12/01→ 07/07		24.0112-0151.1 412151 24.0312-0151.1 512151	Ø 288 11,9 10 Ø 288 11,9 10 PD
2.4 D5	120	01/01→12/08	←	08/01→ 07/07; passend für Felgengröße [Zoll]: 15		24.0126-0122.1 426122	Ø 285,5 26 23 V
			←	08/01→ 07/07; passend für Felgengröße [Zoll]: 16		24.0128-0123.1 428123 24.0328-0123.1 528123	Ø 305 27,9 25 V Ø 305 27,9 25 V PD
			←	08/01→ 07/07; passend für Felgengröße [Zoll]: 17		24.0128-0184.1 428184	Ø 320 28 25 V
			→	08/01→ 07/07		24.0112-0151.1 412151 24.0312-0151.1 512151	Ø 288 11,9 10 Ø 288 11,9 10 PD
2.4 D5	136	04/05→12/08	←	12/05→ 07/07; passend für Felgengröße [Zoll]: 15		24.0126-0122.1 426122	Ø 285,5 26 23 V
2.4 D5 AWD	136	07/05→12/08	←	12/05→ 07/07; passend für Felgengröße [Zoll]: 16		24.0128-0123.1 428123 24.0328-0123.1 528123	Ø 305 27,9 25 V Ø 305 27,9 25 V PD
			←	12/05→ 07/07; passend für Felgengröße [Zoll]: 17		24.0128-0184.1 428184	Ø 320 28 25 V
			→	12/05→ 07/07		24.0112-0151.1 412151 24.0312-0151.1 512151	Ø 288 11,9 10 Ø 288 11,9 10 PD
2.4 D5 AWD	120	07/02→08/07	←	03/03→ 07/07; passend für Felgengröße [Zoll]: 15		24.0126-0122.1 426122	Ø 285,5 26 23 V
			←	03/03→ 07/07; passend für Felgengröße [Zoll]: 16		24.0128-0123.1 428123 24.0328-0123.1 528123	Ø 305 27,9 25 V Ø 305 27,9 25 V PD
			←	03/03→ 07/07; passend für Felgengröße [Zoll]: 17		24.0128-0184.1 428184	Ø 320 28 25 V
			→	03/03→ 07/07		24.0112-0151.1 412151 24.0312-0151.1 512151	Ø 288 11,9 10 Ø 288 11,9 10 PD
2.5 T	154	07/01→08/07	←	04/04→ 07/07; passend für Felgengröße [Zoll]: 15		24.0126-0122.1 426122	Ø 285,5 26 23 V
			←	04/04→ 07/07; passend für Felgengröße [Zoll]: 16		24.0128-0123.1 428123 24.0328-0123.1 528123	Ø 305 27,9 25 V Ø 305 27,9 25 V PD
			←	04/04→ 07/07; passend für Felgengröße [Zoll]: 17		24.0128-0184.1 428184	Ø 320 28 25 V
			→	04/04→ 07/07		24.0112-0151.1 412151 24.0312-0151.1 512151	Ø 288 11,9 10 Ø 288 11,9 10 PD
2.5 T AWD	154	07/02→08/07	←	09/02→ 07/07; passend für Felgengröße [Zoll]: 15		24.0126-0122.1 426122	Ø 285,5 26 23 V
			←	09/02→ 07/07; passend für Felgengröße [Zoll]: 16		24.0128-0123.1 428123 24.0328-0123.1 528123	Ø 305 27,9 25 V Ø 305 27,9 25 V PD
			←	09/02→ 07/07; passend für Felgengröße [Zoll]: 17		24.0128-0184.1 428184	Ø 320 28 25 V
			→	09/02→ 07/07		24.0112-0151.1 412151 24.0312-0151.1 512151	Ø 288 11,9 10 Ø 288 11,9 10 PD
2.5 TDI	103	11/99→08/07	←	03/00→ 07/07; passend für Felgengröße [Zoll]: 15		24.0126-0122.1 426122	Ø 285,5 26 23 V
			←	03/00→ 07/07; passend für Felgengröße [Zoll]: 16		24.0128-0123.1 428123 24.0328-0123.1 528123	Ø 305 27,9 25 V Ø 305 27,9 25 V PD
			←	03/00→ 07/07; passend für Felgengröße [Zoll]: 17		24.0128-0184.1 428184	Ø 320 28 25 V
			→	03/00→ 07/07		24.0112-0151.1 412151	Ø 288 11,9 10











	kw			 	! #		
VOLVO - V70 II (SW) 11/99→12/08							
 Bremsscheibe							
2.5 TDI	103	11/99→08/07	➡	03/00→ 07/07		24.0312-0151.1 512151	Ø 288 11,9 10 PD
VOLVO - V70 III (BW) 04/07→							
 Bremsbelagsatz, Scheibenbremse							
1.6 D 2.0 T	80 149	07/09→12/11 09/09→12/11	←	01/10→; für Bremsscheibendurchmesser [mm]: 300		13.0460-7228.2 607228 13.0470-7228.2 LD7228	ATE 24123 20,3 - WE / - WK ATE 24123 20,3 - WE / - WK Ceramic
			←	01/10→; für Bremsscheibendurchmesser [mm]: 316 / 336		13.0460-7243.2 607243 13.0470-7243.2 LD7243	ATE 24142 20,6 - WE / - WK ATE 24142 20,6 - WE / - WK Ceramic
			➡	01/10→; + eFSB		13.0460-2722.2 602722 13.0470-2722.2 LD2722	TRW 24496 17,3 - WE / - WK + Zub TRW 24496 17,3 - WE / - WK + Zub Ceramic
			➡	01/10→; V; + eFSB		13.0460-2736.2 602736 13.0470-2736.2 LD2736	TRW 24496 17,3 - WE / - WK + Zub TRW 24496 17,3 - WE / - WK + Zub Ceramic
			➡	01/10→; - eFSB		13.0460-2737.2 602737	TRW 24537 15,8 - WE / - WK + Zub
1.6 DRiVe / D2 1.6 T4F 2.0 2.0 BiFuel 2.0 D 2.0 FlexiFuel 2.5 T 2.5 T FlexiFuel D2 D3 D3 / D4 D4 D4 AWD D5 AWD T4 T4 T5 T5	84 132 107 157 100 107 147 147 88 110 120 133 133 151 132 140 177 180	04/11→12/15 01/11→12/15 10/07→12/11 03/13→12/15 10/07→12/15 01/08→12/11 08/07→12/09 05/08→12/09 03/15→ 03/15→ 03/10→12/15 10/13→ 10/13→ 12/09→12/11 10/10→12/15 03/15→ 01/10→12/14 10/13→	←	für Bremsscheibendurchmesser [mm]: 300		13.0460-7228.2 607228 13.0470-7228.2 LD7228	ATE 24123 20,3 - WE / - WK ATE 24123 20,3 - WE / - WK Ceramic
			←	für Bremsscheibendurchmesser [mm]: 316 / 336		13.0460-7243.2 607243 13.0470-7243.2 LD7243	ATE 24142 20,6 - WE / - WK ATE 24142 20,6 - WE / - WK Ceramic
			➡	+ eFSB		13.0460-2722.2 602722	TRW 24496 17,3 - WE / - WK + Zub
			➡	V; + eFSB		13.0460-2736.2 602736 13.0470-2736.2 LD2736	TRW 24496 17,3 - WE / - WK + Zub TRW 24496 17,3 - WE / - WK + Zub Ceramic
			➡	- eFSB		13.0460-2737.2 602737	TRW 24537 15,8 - WE / - WK + Zub
2.0 GDI	157	04/12→12/15	←	03/13→; für Bremsscheibendurchmesser [mm]: 300		13.0460-7228.2 607228 13.0470-7228.2 LD7228	ATE 24123 20,3 - WE / - WK ATE 24123 20,3 - WE / - WK Ceramic
			←	03/13→; für Bremsscheibendurchmesser [mm]: 316 / 336		13.0460-7243.2 607243 13.0470-7243.2 LD7243	ATE 24142 20,6 - WE / - WK ATE 24142 20,6 - WE / - WK Ceramic
			➡	03/13→; + eFSB		13.0460-2722.2 602722 13.0470-2722.2 LD2722	TRW 24496 17,3 - WE / - WK + Zub TRW 24496 17,3 - WE / - WK + Zub Ceramic
			➡	03/13→; V; + eFSB		13.0460-2736.2 602736 13.0470-2736.2 LD2736	TRW 24496 17,3 - WE / - WK + Zub TRW 24496 17,3 - WE / - WK + Zub Ceramic
			➡	03/13→; - eFSB		13.0460-2737.2 602737	TRW 24537 15,8 - WE / - WK + Zub
2.4 D D5	120 136	04/07→12/10 04/07→12/09	←	08/07→; für Bremsscheibendurchmesser [mm]: 300		13.0460-7228.2 607228 13.0470-7228.2 LD7228	ATE 24123 20,3 - WE / - WK ATE 24123 20,3 - WE / - WK Ceramic
			←	08/07→; für Bremsscheibendurchmesser [mm]: 316 / 336		13.0460-7243.2 607243 13.0470-7243.2 LD7243	ATE 24142 20,6 - WE / - WK ATE 24142 20,6 - WE / - WK Ceramic
			➡	08/07→; + eFSB		13.0460-2722.2 602722 13.0470-2722.2 LD2722	TRW 24496 17,3 - WE / - WK + Zub TRW 24496 17,3 - WE / - WK + Zub Ceramic
			➡	08/07→; V; + eFSB		13.0460-2736.2 602736 13.0470-2736.2 LD2736	TRW 24496 17,3 - WE / - WK + Zub TRW 24496 17,3 - WE / - WK + Zub Ceramic
			➡	08/07→; - eFSB		13.0460-2737.2 602737	TRW 24537 15,8 - WE / - WK + Zub
↓							

	kw			 	! #		
VOLVO - V70 III (BW) 04/07→							
 Bremsbelagsatz, Scheibenbremse							
2.4 D 2.5 T 2.5 T FlexiFuel	129 170 170	04/09→12/10 04/09→12/12 04/09→12/11	←	10/09→; für Bremsscheibendurchmesser [mm]: 300	13.0460-7228.2 13.0470-7228.2	607228 LD7228	ATE 24123 20,3 - WE / - WK ATE 24123 20,3 - WE / - WK Ceramic
			←	10/09→; für Bremsscheibendurchmesser [mm]: 316 / 336	13.0460-7243.2 13.0470-7243.2	607243 LD7243	ATE 24142 20,6 - WE / - WK ATE 24142 20,6 - WE / - WK Ceramic
			→	10/09→; + eFSB	13.0460-2722.2 13.0470-2722.2	602722 LD2722	TRW 24496 17,3 - WE / - WK + Zub TRW 24496 17,3 - WE / - WK + Zub Ceramic
			→	10/09→; V; + eFSB	13.0460-2736.2 13.0470-2736.2	602736 LD2736	TRW 24496 17,3 - WE / - WK + Zub TRW 24496 17,3 - WE / - WK + Zub Ceramic
			→	10/09→; - eFSB	13.0460-2737.2	602737	TRW 24537 15,8 - WE / - WK + Zub
3.2 3.2 3.2 AWD T6 AWD	175 179 179 210	08/07→12/10 04/10→12/14 04/10→12/15 08/07→12/10	←	für Bremsscheibendurchmesser [mm]: 300	13.0460-7228.2 13.0470-7228.2	607228 LD7228	ATE 24123 20,3 - WE / - WK ATE 24123 20,3 - WE / - WK Ceramic
			←	für Bremsscheibendurchmesser [mm]: 316 / 336	13.0460-7243.2 13.0470-7243.2	607243 LD7243	ATE 24142 20,6 - WE / - WK ATE 24142 20,6 - WE / - WK Ceramic
			←	für Bremsscheibendurchmesser [mm]: 336	13.0460-7243.2	607243	ATE 24142 20,6 - WE / - WK
			→	+ eFSB	13.0460-2722.2 13.0470-2722.2	602722 LD2722	TRW 24496 17,3 - WE / - WK + Zub TRW 24496 17,3 - WE / - WK + Zub Ceramic
			→	V; + eFSB	13.0460-2736.2 13.0470-2736.2	602736 LD2736	TRW 24496 17,3 - WE / - WK + Zub TRW 24496 17,3 - WE / - WK + Zub Ceramic
			→	- eFSB	13.0460-2737.2	602737	TRW 24537 15,8 - WE / - WK + Zub
3.2 AWD	175	04/07→12/10	←	08/07→; für Bremsscheibendurchmesser [mm]: 300	13.0460-7228.2 13.0470-7228.2	607228 LD7228	ATE 24123 20,3 - WE / - WK ATE 24123 20,3 - WE / - WK Ceramic
			←	08/07→; für Bremsscheibendurchmesser [mm]: 316 / 336	13.0460-7243.2 13.0470-7243.2	607243 LD7243	ATE 24142 20,6 - WE / - WK ATE 24142 20,6 - WE / - WK Ceramic
			←	08/07→; für Bremsscheibendurchmesser [mm]: 336	13.0460-7243.2	607243	ATE 24142 20,6 - WE / - WK
			→	08/07→; + eFSB	13.0460-2722.2 13.0470-2722.2	602722 LD2722	TRW 24496 17,3 - WE / - WK + Zub TRW 24496 17,3 - WE / - WK + Zub Ceramic
			→	08/07→; V; + eFSB	13.0460-2736.2 13.0470-2736.2	602736 LD2736	TRW 24496 17,3 - WE / - WK + Zub TRW 24496 17,3 - WE / - WK + Zub Ceramic
			→	08/07→; - eFSB	13.0460-2737.2	602737	TRW 24537 15,8 - WE / - WK + Zub
D3	100	10/07→12/15	←	05/12→; für Bremsscheibendurchmesser [mm]: 300	13.0460-7228.2 13.0470-7228.2	607228 LD7228	ATE 24123 20,3 - WE / - WK ATE 24123 20,3 - WE / - WK Ceramic
			←	05/12→; für Bremsscheibendurchmesser [mm]: 316 / 336	13.0460-7243.2 13.0470-7243.2	607243 LD7243	ATE 24142 20,6 - WE / - WK ATE 24142 20,6 - WE / - WK Ceramic
			→	05/12→; + eFSB	13.0460-2722.2 13.0470-2722.2	602722 LD2722	TRW 24496 17,3 - WE / - WK + Zub TRW 24496 17,3 - WE / - WK + Zub Ceramic
			→	05/12→; V; + eFSB	13.0460-2736.2 13.0470-2736.2	602736 LD2736	TRW 24496 17,3 - WE / - WK + Zub TRW 24496 17,3 - WE / - WK + Zub Ceramic
			→	05/12→; - eFSB	13.0460-2737.2	602737	TRW 24537 15,8 - WE / - WK + Zub
↓							









	kw			 	! #		
VOLVO - V70 III (BW) 04/07→							
 Bremsbelagsatz, Scheibenbremse							
D4 AWD	120	10/07→12/15	←	01/13→; für Bremsscheibendurchmesser [mm]: 300	13.0460-7228.2	607228	ATE 24123 20,3 - WE / - WK ATE 24123 20,3 - WE / - WK Ceramic
			←	01/13→; für Bremsscheibendurchmesser [mm]: 316 / 336	13.0460-7243.2	607243	ATE 24142 20,6 - WE / - WK ATE 24142 20,6 - WE / - WK Ceramic
			→	01/13→; + eFSB	13.0460-2722.2	602722	TRW 24496 17,3 - WE / - WK + Zub
			→	01/13→; V; + eFSB	13.0460-2736.2	602736	TRW 24496 17,3 - WE / - WK + Zub
			→	01/13→; - eFSB	13.0460-2737.2	602737	TRW 24496 17,3 - WE / - WK + Zub Ceramic TRW 24537 15,8 - WE / - WK + Zub
D5	151	10/08→12/11	←	12/09→; für Bremsscheibendurchmesser [mm]: 300	13.0460-7228.2	607228	ATE 24123 20,3 - WE / - WK ATE 24123 20,3 - WE / - WK Ceramic
			←	12/09→; für Bremsscheibendurchmesser [mm]: 316 / 336	13.0460-7243.2	607243	ATE 24142 20,6 - WE / - WK ATE 24142 20,6 - WE / - WK Ceramic
			→	12/09→; + eFSB	13.0460-2722.2	602722	TRW 24496 17,3 - WE / - WK + Zub
			→	12/09→; V; + eFSB	13.0460-2736.2	602736	TRW 24496 17,3 - WE / - WK + Zub
			→	12/09→; - eFSB	13.0460-2737.2	602737	TRW 24496 17,3 - WE / - WK + Zub Ceramic TRW 24537 15,8 - WE / - WK + Zub
D5 D5 AWD	158 158	04/11→12/15 04/11→12/15	←	06/11→; für Bremsscheibendurchmesser [mm]: 300	13.0460-7228.2	607228	ATE 24123 20,3 - WE / - WK ATE 24123 20,3 - WE / - WK Ceramic
			←	06/11→; für Bremsscheibendurchmesser [mm]: 316 / 336	13.0460-7243.2	607243	ATE 24142 20,6 - WE / - WK ATE 24142 20,6 - WE / - WK Ceramic
			→	06/11→; + eFSB	13.0460-2722.2	602722	TRW 24496 17,3 - WE / - WK + Zub
			→	06/11→; V; + eFSB	13.0460-2736.2	602736	TRW 24496 17,3 - WE / - WK + Zub
			→	06/11→; - eFSB	13.0460-2737.2	602737	TRW 24496 17,3 - WE / - WK + Zub Ceramic TRW 24537 15,8 - WE / - WK + Zub
D5 AWD	136	04/07→12/09	←	10/07→; für Bremsscheibendurchmesser [mm]: 300	13.0460-7228.2	607228	ATE 24123 20,3 - WE / - WK ATE 24123 20,3 - WE / - WK Ceramic
			←	10/07→; für Bremsscheibendurchmesser [mm]: 316 / 336	13.0460-7243.2	607243	ATE 24142 20,6 - WE / - WK ATE 24142 20,6 - WE / - WK Ceramic
			→	10/07→; + eFSB	13.0460-2722.2	602722	TRW 24496 17,3 - WE / - WK + Zub
			→	10/07→; V; + eFSB	13.0460-2736.2	602736	TRW 24496 17,3 - WE / - WK + Zub
			→	10/07→; - eFSB	13.0460-2737.2	602737	TRW 24496 17,3 - WE / - WK + Zub Ceramic TRW 24537 15,8 - WE / - WK + Zub
T6 AWD ↓	224	01/10→12/15	←	04/11→; für Bremsscheibendurchmesser [mm]: 300	13.0460-7228.2	607228	ATE 24123 20,3 - WE / - WK ATE 24123 20,3 - WE / - WK Ceramic









	kw			 	! #				
VOLVO - V70 III (BW) 04/07→									
 Bremsbelagsatz, Scheibenbremse									
T6 AWD	224	01/10→12/15	←	04/11→; für Bremsscheibendurchmesser [mm]: 316 / 336	13.0460-7243.2	607243	ATE 24142 20,6 - WE / - WK		
			→	04/11→; + eFSB	13.0470-7243.2	LD7243	ATE 24142 20,6 - WE / - WK Ceramic		
			→	04/11→; V; + eFSB	13.0460-2722.2	602722	TRW 24496 17,3 - WE / - WK + Zub		
			→	04/11→; - eFSB	13.0470-2722.2	LD2722	TRW 24496 17,3 - WE / - WK + Zub Ceramic		
			→	04/11→; V; + eFSB	13.0460-2736.2	602736	TRW 24496 17,3 - WE / - WK + Zub		
			→	04/11→; - eFSB	13.0470-2736.2	LD2736	TRW 24496 17,3 - WE / - WK + Zub Ceramic		
			→	04/11→; - eFSB	13.0460-2737.2	602737	TRW 24537 15,8 - WE / - WK + Zub		
 Bremsscheibe									
1.6 D 2.0 T	80 149	07/09→12/11 09/09→12/11	←	01/10→	24.0128-0154.1	428154	Ø 300 28 26 V + S		
					24.0128-0162.1	428162	Ø 316 28 26 V + S		
					24.0128-0210.1	428210	Ø 336 28 26 V + S		
			→	01/10→; + eFSB	24.0328-0154.1	528154	Ø 300 28 26 V + S PD		
			→	01/10→; - eFSB	24.0328-0162.1	528162	Ø 316 28 26 V + S PD		
			→	01/10→; + eFSB	24.0111-0147.1	411147	Ø 302 11 9 + S		
			→	01/10→; - eFSB	24.0122-0259.1	422259	Ø 302 22 20 V + S		
			→	01/10→; - eFSB	24.0112-0180.1	412180	Ø 302 12 10 + S		
1.6 DRiVe / D2 1.6 T4F 2.0 2.0 BiFuel 2.0 D 2.0 FlexiFuel 2.5 T 2.5 T FlexiFuel 3.2 3.2 3.2 AWD D3 / D4 D4 D4 AWD D5 AWD T4 T5 T5 T6 AWD	84 132 107 157 100 107 147 147 175 179 179 120 133 133 151 132 177 180 210	04/11→12/15 01/11→12/15 10/07→12/11 03/13→12/15 10/07→12/15 01/08→12/11 08/07→12/09 05/08→12/09 08/07→12/10 04/10→12/14 04/10→12/15 03/10→12/15 10/13→ 10/13→ 12/09→12/11 10/10→12/15 01/10→12/14 10/13→ 08/07→12/10	←		24.0128-0154.1	428154	Ø 300 28 26 V + S		
					24.0128-0162.1	428162	Ø 316 28 26 V + S		
					24.0128-0210.1	428210	Ø 336 28 26 V + S		
					24.0328-0154.1	528154	Ø 300 28 26 V + S PD		
					24.0328-0162.1	528162	Ø 316 28 26 V + S PD		
					→	+ eFSB	24.0111-0147.1	411147	Ø 302 11 9 + S
					→	- eFSB	24.0122-0259.1	422259	Ø 302 22 20 V + S
					→	- eFSB	24.0112-0180.1	412180	Ø 302 12 10 + S
2.0 GDI	157	04/12→12/15	←	03/13→	24.0128-0154.1	428154	Ø 300 28 26 V + S		
					24.0128-0162.1	428162	Ø 316 28 26 V + S		
					24.0128-0210.1	428210	Ø 336 28 26 V + S		
			→	03/13→; + eFSB	24.0328-0154.1	528154	Ø 300 28 26 V + S PD		
			→	03/13→; - eFSB	24.0328-0162.1	528162	Ø 316 28 26 V + S PD		
			→	03/13→; + eFSB	24.0111-0147.1	411147	Ø 302 11 9 + S		
			→	03/13→; - eFSB	24.0122-0259.1	422259	Ø 302 22 20 V + S		
			→	03/13→; - eFSB	24.0112-0180.1	412180	Ø 302 12 10 + S		
2.4 D 3.2 AWD D5	120 175 136	04/07→12/10 04/07→12/10 04/07→12/09	←	08/07→	24.0128-0154.1	428154	Ø 300 28 26 V + S		
					24.0128-0162.1	428162	Ø 316 28 26 V + S		
					24.0128-0210.1	428210	Ø 336 28 26 V + S		
			→	08/07→; + eFSB	24.0328-0154.1	528154	Ø 300 28 26 V + S PD		
			→	08/07→; - eFSB	24.0328-0162.1	528162	Ø 316 28 26 V + S PD		
			→	08/07→; + eFSB	24.0111-0147.1	411147	Ø 302 11 9 + S		
			→	08/07→; - eFSB	24.0122-0259.1	422259	Ø 302 22 20 V + S		
			→	08/07→; - eFSB	24.0112-0180.1	412180	Ø 302 12 10 + S		
2.4 D 2.5 T 2.5 T FlexiFuel	129 170 170	04/09→12/10 04/09→12/12 04/09→12/11	←	10/09→	24.0128-0154.1	428154	Ø 300 28 26 V + S		
					24.0128-0162.1	428162	Ø 316 28 26 V + S		
					24.0128-0210.1	428210	Ø 336 28 26 V + S		
			→	10/09→; + eFSB	24.0328-0154.1	528154	Ø 300 28 26 V + S PD		
			→	10/09→; - eFSB	24.0328-0162.1	528162	Ø 316 28 26 V + S PD		
			→	10/09→; + eFSB	24.0111-0147.1	411147	Ø 302 11 9 + S		
			→	10/09→; - eFSB	24.0122-0259.1	422259	Ø 302 22 20 V + S		
			→	10/09→; - eFSB	24.0112-0180.1	412180	Ø 302 12 10 + S		
D2 D3	88 110	03/15→ 03/15→	←	für Bremsscheibendurchmesser [mm]: 300	24.0128-0154.1	428154	Ø 300 28 26 V + S		
					24.0328-0154.1	528154	Ø 300 28 26 V + S PD		

	kW			 	! #		
VOLVO - V70 III (BW) 04/07→							
 Bremsscheibe							
T4	140	03/15→	←	für Bremsscheibendurchmesser [mm]: 316	24.0128-0162.1	428162	Ø 316 28 26 V + S
					24.0328-0162.1	528162	Ø 316 28 26 V + S PD
			←	für Bremsscheibendurchmesser [mm]: 336	24.0128-0210.1	428210	Ø 336 28 26 V + S
			→	+ eFSB	24.0111-0147.1	411147	Ø 302 11 9 + S
			- eFSB	24.0122-0259.1	422259	Ø 302 22 20 V + S	
				24.0112-0180.1	412180	Ø 302 12 10 + S	
D3	100	10/07→12/15	←	05/12→	24.0128-0154.1	428154	Ø 300 28 26 V + S
					24.0128-0162.1	428162	Ø 316 28 26 V + S
					24.0128-0210.1	428210	Ø 336 28 26 V + S
					24.0328-0154.1	528154	Ø 300 28 26 V + S PD
					24.0328-0162.1	528162	Ø 316 28 26 V + S PD
			→	05/12→; + eFSB	24.0111-0147.1	411147	Ø 302 11 9 + S
		24.0122-0259.1	422259	Ø 302 22 20 V + S			
			05/12→; - eFSB	24.0112-0180.1	412180	Ø 302 12 10 + S	
D4 AWD	120	10/07→12/15	←	01/13→	24.0128-0154.1	428154	Ø 300 28 26 V + S
					24.0128-0162.1	428162	Ø 316 28 26 V + S
					24.0128-0210.1	428210	Ø 336 28 26 V + S
					24.0328-0154.1	528154	Ø 300 28 26 V + S PD
			01/13→; + eFSB	24.0328-0162.1	528162	Ø 316 28 26 V + S PD	
			01/13→; - eFSB	24.0111-0147.1	411147	Ø 302 11 9 + S	
				24.0122-0259.1	422259	Ø 302 22 20 V + S	
				24.0112-0180.1	412180	Ø 302 12 10 + S	
D5	151	10/08→12/11	←	12/09→	24.0128-0154.1	428154	Ø 300 28 26 V + S
					24.0128-0162.1	428162	Ø 316 28 26 V + S
					24.0128-0210.1	428210	Ø 336 28 26 V + S
					24.0328-0154.1	528154	Ø 300 28 26 V + S PD
			12/09→; + eFSB	24.0328-0162.1	528162	Ø 316 28 26 V + S PD	
			12/09→; - eFSB	24.0111-0147.1	411147	Ø 302 11 9 + S	
				24.0122-0259.1	422259	Ø 302 22 20 V + S	
				24.0112-0180.1	412180	Ø 302 12 10 + S	
D5 D5 AWD	158 158	04/11→12/15 04/11→12/15	←	06/11→	24.0128-0154.1	428154	Ø 300 28 26 V + S
					24.0128-0162.1	428162	Ø 316 28 26 V + S
					24.0128-0210.1	428210	Ø 336 28 26 V + S
					24.0328-0154.1	528154	Ø 300 28 26 V + S PD
			06/11→; + eFSB	24.0328-0162.1	528162	Ø 316 28 26 V + S PD	
			06/11→; - eFSB	24.0111-0147.1	411147	Ø 302 11 9 + S	
				24.0122-0259.1	422259	Ø 302 22 20 V + S	
				24.0112-0180.1	412180	Ø 302 12 10 + S	
D5 AWD	136	04/07→12/09	←	10/07→	24.0128-0154.1	428154	Ø 300 28 26 V + S
					24.0128-0162.1	428162	Ø 316 28 26 V + S
					24.0128-0210.1	428210	Ø 336 28 26 V + S
					24.0328-0154.1	528154	Ø 300 28 26 V + S PD
			10/07→; + eFSB	24.0328-0162.1	528162	Ø 316 28 26 V + S PD	
			10/07→; - eFSB	24.0111-0147.1	411147	Ø 302 11 9 + S	
				24.0122-0259.1	422259	Ø 302 22 20 V + S	
				24.0112-0180.1	412180	Ø 302 12 10 + S	
T6 AWD	224	01/10→12/15	←	04/11→	24.0128-0154.1	428154	Ø 300 28 26 V + S
					24.0128-0162.1	428162	Ø 316 28 26 V + S
					24.0128-0210.1	428210	Ø 336 28 26 V + S
					24.0328-0154.1	528154	Ø 300 28 26 V + S PD
					24.0328-0162.1	528162	Ø 316 28 26 V + S PD
			→	04/11→; + eFSB	24.0111-0147.1	411147	Ø 302 11 9 + S
			04/11→; - eFSB	24.0122-0259.1	422259	Ø 302 22 20 V + S	
				24.0112-0180.1	412180	Ø 302 12 10 + S	
VOLVO - V90 Kombi 11/96→12/98							
 Bremsbelagsatz, Scheibenbremse							
2.5	125	11/96→10/98	←		13.0460-2985.2	602985	TRW 20164 18,2 - WK
2.5	132	11/96→10/97	→		13.0460-2935.2	602935	TRW 21385 13,8 - WK
2.9	132	01/97→12/98					
2.9	150	01/97→12/98					
↓							









	kW			 	! #			
VOLVO - V90 Kombi 11/96→12/98								
 Bremsscheibe								
2.5	125	11/96→10/98	←			24.0126-0102.1 426102	Ø 280,3 26 23 V	
2.5	132	11/96→10/97	→			24.0112-0150.1 412150	Ø 277 11,9 10	
2.9	132	01/97→12/98						
2.9	150	01/97→12/98						
VOLVO - XC60 05/08→								
 Bremsbelagsatz, Scheibenbremse								
2.0 T	149	12/09→12/12	←	03/10→		13.0460-7272.2 607272	ATE 24399 20,4 + WE / - WK	
			→	03/10→		13.0460-2736.2 602736	TRW 24496 17,3 - WE / - WK + Zub	
						13.0470-2736.2 LD2736	TRW 24496 17,3 - WE / - WK + Zub Ceramic	
2.4 D	129	04/09→12/10	←			13.0460-7272.2 607272	ATE 24399 20,4 + WE / - WK	
2.4 D AWD	129	06/09→12/10	→			13.0460-2736.2 602736	TRW 24496 17,3 - WE / - WK + Zub	
3.2 AWD	175	07/09→12/10						
3.2 AWD	179	03/10→12/15						
D3	100	04/12→12/15						
D3 / D4	120	03/10→12/14						
D4	133	10/13→12/15						
D4 AWD	133	10/13→12/15						
D5	158	06/11→						
D5 AWD	151	07/09→06/11						
T5	177	09/10→12/14						
T5	180	10/13→						
T5 AWD	180	10/15→						
T5 AWD	187	04/14→						
T6	225	10/13→						
T6 AWD	225	10/13→						
T6 AWD	224	03/10→12/15						
2.4 D / D3 / D4 AWD	120	05/08→	←	09/08→		13.0460-7272.2 607272	ATE 24399 20,4 + WE / - WK	
D5 AWD	136	05/08→12/09	→	09/08→		13.0460-2736.2 602736	TRW 24496 17,3 - WE / - WK + Zub	
T6 AWD	210	05/08→12/10					13.0470-2736.2 LD2736	TRW 24496 17,3 - WE / - WK + Zub Ceramic
D3	110	03/15→	→	789938→		13.0460-2736.2 602736	TRW 24496 17,3 - WE / - WK + Zub	
D4	140	03/15→					13.0470-2736.2 LD2736	TRW 24496 17,3 - WE / - WK + Zub Ceramic
D4 AWD	140	03/15→						
D5 AWD	162	03/15→						
			→	789937		13.0460-2736.2 602736		
						13.0470-2736.2 LD2736	TRW 24496 17,3 - WE / - WK + Zub Ceramic	
D5 AWD	158	04/11→12/15	←	06/11→		13.0460-7272.2 607272	ATE 24399 20,4 + WE / - WK	
			→	06/11→		13.0460-2736.2 602736	TRW 24496 17,3 - WE / - WK + Zub	
						13.0470-2736.2 LD2736	TRW 24496 17,3 - WE / - WK + Zub Ceramic	
D5 AWD	169	04/14→12/15	←	→ 775000		13.0460-7272.2 607272	ATE 24399 20,4 + WE / - WK	
T6 AWD	242	04/14→12/15	→	789938→		13.0460-2736.2 602736	TRW 24496 17,3 - WE / - WK + Zub	
						13.0470-2736.2 LD2736	TRW 24496 17,3 - WE / - WK + Zub Ceramic	
			→	789937		13.0460-2736.2 602736	TRW 24496 17,3 - WE / - WK + Zub	
						13.0470-2736.2 LD2736	TRW 24496 17,3 - WE / - WK + Zub Ceramic	
 Bremsscheibe								
2.0 T	149	12/09→12/12	←	03/10→		24.0130-0212.1 430212	Ø 328 30 28 V	
			→	03/10→		24.0122-0261.1 422261	Ø 302 22 20 V	
2.4 D	129	04/09→12/10	←			24.0130-0212.1 430212	Ø 328 30 28 V	
2.4 D AWD	129	06/09→12/10	→			24.0122-0261.1 422261	Ø 302 22 20 V	
3.2 AWD	175	07/09→12/10						
3.2 AWD	179	03/10→12/15						
D3	100	04/12→12/15						
D3 / D4	120	03/10→12/14						
D4	133	10/13→12/15						
D4 AWD	133	10/13→12/15						
D5	158	06/11→						
D5 AWD	151	07/09→06/11						
D5 AWD	169	04/14→12/15						
T5	177	09/10→12/14						
T5	180	10/13→						
↓								

























	kw			 	! #		
VOLVO - XC60 05/08 →							
 Bremsscheibe							
T5 AWD	180	10/15 →	←			24.0130-0212.1 430212	Ø 328 30 28 V
T5 AWD	187	04/14 →	→				
T6	225	10/13 →				24.0122-0261.1 422261	Ø 302 22 20 V
T6 AWD	225	10/13 →					
T6 AWD	224	03/10 → 12/15					
T6 AWD	242	04/14 → 12/15					
2.4 D / D3 / D4 AWD	120	05/08 →	←	09/08 →		24.0130-0212.1 430212	Ø 328 30 28 V
D5 AWD	136	05/08 → 12/09	→	09/08 →		24.0122-0261.1 422261	Ø 302 22 20 V
T6 AWD	210	05/08 → 12/10					
D3	110	03/15 →	→			24.0122-0261.1 422261	Ø 302 22 20 V
D4	140	03/15 →					
D4 AWD	140	03/15 →					
D5 AWD	162	03/15 →					
D5 AWD	158	04/11 → 12/15	←	06/11 →		24.0130-0212.1 430212	Ø 328 30 28 V
			→	06/11 →		24.0122-0261.1 422261	Ø 302 22 20 V
VOLVO - XC70 II 04/07 →							
 Bremsbelagsatz, Scheibenbremse							
2.4 D	129	06/09 → 12/10	←	01/10 →; passend für Felgengröße [Zoll]: 16		13.0460-7228.2 607228 13.0470-7228.2 LD7228	ATE 24123 20,3 - WE / - WK ATE 24123 20,3 - WE / - WK Ceramic
			←	01/10 →; passend für Felgengröße [Zoll]: 17 / 18		13.0460-7243.2 607243 13.0470-7243.2 LD7243	ATE 24142 20,6 - WE / - WK ATE 24142 20,6 - WE / - WK Ceramic
			→	01/10 →; + eFSB		13.0460-2722.2 602722 13.0470-2722.2 LD2722	TRW 24496 17,3 - WE / - WK + Zub TRW 24496 17,3 - WE / - WK + Zub Ceramic
			→	01/10 →; V; + eFSB		13.0460-2736.2 602736 13.0470-2736.2 LD2736	TRW 24496 17,3 - WE / - WK + Zub TRW 24496 17,3 - WE / - WK + Zub Ceramic
			→	01/10 →; - eFSB		13.0460-2737.2 602737	TRW 24537 15,8 - WE / - WK + Zub
2.4 D / D4 AWD	120	08/07 →	←	passend für Felgengröße [Zoll]: 16		13.0460-7228.2 607228 13.0470-7228.2 LD7228	ATE 24123 20,3 - WE / - WK ATE 24123 20,3 - WE / - WK Ceramic
3.2 AWD	175	08/07 →					
3.2 AWD	179	08/07 →					
D4	133	10/13 →	←	passend für Felgengröße [Zoll]: 17 / 18		13.0460-7243.2 607243 13.0470-7243.2 LD7243	ATE 24142 20,6 - WE / - WK ATE 24142 20,6 - WE / - WK Ceramic
D4 AWD	133	10/13 →					
D5 AWD	162	03/15 →	→	+ eFSB		13.0460-2722.2 602722 13.0470-2722.2 LD2722	TRW 24496 17,3 - WE / - WK + Zub TRW 24496 17,3 - WE / - WK + Zub Ceramic
T5	180	10/13 →					
T5 AWD	187	08/15 →	→	V; + eFSB		13.0460-2736.2 602736 13.0470-2736.2 LD2736	TRW 24496 17,3 - WE / - WK + Zub TRW 24496 17,3 - WE / - WK + Zub Ceramic
T6 AWD	210	01/08 →	→	- eFSB		13.0460-2737.2 602737	TRW 24537 15,8 - WE / - WK + Zub
T6 AWD	224	01/10 →					
D3	120	04/10 → 12/15	←	08/11 →; passend für Felgengröße [Zoll]: 16		13.0460-7228.2 607228 13.0470-7228.2 LD7228	ATE 24123 20,3 - WE / - WK ATE 24123 20,3 - WE / - WK Ceramic
			←	08/11 →; passend für Felgengröße [Zoll]: 17 / 18		13.0460-7243.2 607243 13.0470-7243.2 LD7243	ATE 24142 20,6 - WE / - WK ATE 24142 20,6 - WE / - WK Ceramic
			→	08/11 →; + eFSB		13.0460-2722.2 602722 13.0470-2722.2 LD2722	TRW 24496 17,3 - WE / - WK + Zub TRW 24496 17,3 - WE / - WK + Zub Ceramic
			→	08/11 →; V; + eFSB		13.0460-2736.2 602736 13.0470-2736.2 LD2736	TRW 24496 17,3 - WE / - WK + Zub TRW 24496 17,3 - WE / - WK + Zub Ceramic
			→	08/11 →; - eFSB		13.0460-2737.2 602737	TRW 24537 15,8 - WE / - WK + Zub
D5 AWD	136	04/07 → 12/09	←	08/07 →; passend für Felgengröße [Zoll]: 16		13.0460-7228.2 607228 13.0470-7228.2 LD7228	ATE 24123 20,3 - WE / - WK ATE 24123 20,3 - WE / - WK Ceramic
↓							









	kw			 	! #		
VOLVO - XC70 II 04/07→							
 Bremsbelagsatz, Scheibenbremse							
D5 AWD	136	04/07→12/09	←	08/07→; passend für Felgengröße [Zoll]: 17 / 18	13.0460-7243.2	607243	ATE 24142 20,6 - WE / - WK
					13.0470-7243.2	LD7243	ATE 24142 20,6 - WE / - WK Ceramic
			→	08/07→; + eFSB	13.0460-2722.2	602722	TRW 24496 17,3 - WE / - WK + Zub
					13.0470-2722.2	LD2722	TRW 24496 17,3 - WE / - WK + Zub Ceramic
D5 AWD	151	04/09→12/11	←	12/09→; passend für Felgengröße [Zoll]: 16	13.0460-7228.2	607228	ATE 24123 20,3 - WE / - WK
					13.0470-7228.2	LD7228	ATE 24123 20,3 - WE / - WK Ceramic
			←	12/09→; passend für Felgengröße [Zoll]: 17 / 18	13.0460-7243.2	607243	ATE 24142 20,6 - WE / - WK
					13.0470-7243.2	LD7243	ATE 24142 20,6 - WE / - WK Ceramic
D5 AWD	158	04/11→12/15	←	06/11→; passend für Felgengröße [Zoll]: 16	13.0460-7228.2	607228	ATE 24123 20,3 - WE / - WK
					13.0470-7228.2	LD7228	ATE 24123 20,3 - WE / - WK Ceramic
			←	06/11→; passend für Felgengröße [Zoll]: 17 / 18	13.0460-7243.2	607243	ATE 24142 20,6 - WE / - WK
					13.0470-7243.2	LD7243	ATE 24142 20,6 - WE / - WK Ceramic
D5 AWD	158	04/11→12/15	→	06/11→; + eFSB	13.0460-2722.2	602722	TRW 24496 17,3 - WE / - WK + Zub
					13.0470-2722.2	LD2722	TRW 24496 17,3 - WE / - WK + Zub Ceramic
			→	06/11→; V; + eFSB	13.0460-2736.2	602736	TRW 24496 17,3 - WE / - WK + Zub
					13.0470-2736.2	LD2736	TRW 24496 17,3 - WE / - WK + Zub Ceramic
D5 AWD	158	04/11→12/15	→	06/11→; - eFSB	13.0460-2737.2	602737	TRW 24537 15,8 - WE / - WK + Zub
 Bremsscheibe							
2.4 D	129	06/09→12/10	←	01/10→; passend für Felgengröße [Zoll]: 16	24.0128-0154.1	428154	Ø 300 28 26 V + S
					24.0328-0154.1	528154	Ø 300 28 26 V + S PD
			←	01/10→; passend für Felgengröße [Zoll]: 17	24.0128-0162.1	428162	Ø 316 28 26 V + S
					24.0328-0162.1	528162	Ø 316 28 26 V + S PD
			←	01/10→; passend für Felgengröße [Zoll]: 18	24.0128-0210.1	428210	Ø 336 28 26 V + S
2.4 D / D4 AWD	120	08/07→	→	01/10→; + eFSB	24.0111-0147.1	411147	Ø 302 11 9 + S
					24.0122-0259.1	422259	Ø 302 22 20 V + S
			→	01/10→; - eFSB	24.0112-0180.1	412180	Ø 302 12 10 + S
3.2 AWD D4 D4 AWD D5 AWD T5 T5 AWD T6 AWD T6 AWD	175 179 133 133 162 180 187 210 224	08/07→ 08/07→ 10/13→ 10/13→ 03/15→ 10/13→ 08/15→ 01/08→ 01/10→	←	passend für Felgengröße [Zoll]: 16	24.0128-0154.1	428154	Ø 300 28 26 V + S
					24.0328-0154.1	528154	Ø 300 28 26 V + S PD
			←	passend für Felgengröße [Zoll]: 17	24.0128-0162.1	428162	Ø 316 28 26 V + S
					24.0328-0162.1	528162	Ø 316 28 26 V + S PD
			←	passend für Felgengröße [Zoll]: 18	24.0128-0210.1	428210	Ø 336 28 26 V + S
			→	+ eFSB	24.0111-0147.1	411147	Ø 302 11 9 + S
					24.0122-0259.1	422259	Ø 302 22 20 V + S
			→	- eFSB	24.0112-0180.1	412180	Ø 302 12 10 + S
D3 ↓	120	04/10→12/15	←	08/11→; passend für Felgengröße [Zoll]: 16	24.0128-0154.1	428154	Ø 300 28 26 V + S
					24.0328-0154.1	528154	Ø 300 28 26 V + S PD





















	kw				! #		
VOLVO - XC70 II 04/07→							
 Bremsscheibe							
D3	120	04/10→12/15	←	08/11→; passend für Felgengröße [Zoll]: 17	24.0128-0162.1	428162	Ø 316 28 26 V + S
					24.0328-0162.1	528162	Ø 316 28 26 V + S PD
			←	08/11→; passend für Felgengröße [Zoll]: 18	24.0128-0210.1	428210	Ø 336 28 26 V + S
			→	08/11→; + eFSB	24.0111-0147.1	411147	Ø 302 11 9 + S
			→	08/11→; - eFSB	24.0122-0259.1	422259	Ø 302 22 20 V + S
			→	08/11→; - eFSB	24.0112-0180.1	412180	Ø 302 12 10 + S
D5 AWD	136	04/07→12/09	←	08/07→; passend für Felgengröße [Zoll]: 16	24.0128-0154.1	428154	Ø 300 28 26 V + S
					24.0328-0154.1	528154	Ø 300 28 26 V + S PD
			←	08/07→; passend für Felgengröße [Zoll]: 17	24.0128-0162.1	428162	Ø 316 28 26 V + S
					24.0328-0162.1	528162	Ø 316 28 26 V + S PD
			←	08/07→; passend für Felgengröße [Zoll]: 18	24.0128-0210.1	428210	Ø 336 28 26 V + S
			→	08/07→; + eFSB	24.0111-0147.1	411147	Ø 302 11 9 + S
			→	08/07→; - eFSB	24.0122-0259.1	422259	Ø 302 22 20 V + S
			→	08/07→; - eFSB	24.0112-0180.1	412180	Ø 302 12 10 + S
D5 AWD	151	04/09→12/11	←	12/09→; passend für Felgengröße [Zoll]: 16	24.0128-0154.1	428154	Ø 300 28 26 V + S
					24.0328-0154.1	528154	Ø 300 28 26 V + S PD
			←	12/09→; passend für Felgengröße [Zoll]: 17	24.0128-0162.1	428162	Ø 316 28 26 V + S
					24.0328-0162.1	528162	Ø 316 28 26 V + S PD
			←	12/09→; passend für Felgengröße [Zoll]: 18	24.0128-0210.1	428210	Ø 336 28 26 V + S
			→	12/09→; + eFSB	24.0111-0147.1	411147	Ø 302 11 9 + S
			→	12/09→; - eFSB	24.0122-0259.1	422259	Ø 302 22 20 V + S
			→	12/09→; - eFSB	24.0112-0180.1	412180	Ø 302 12 10 + S
D5 AWD	158	04/11→12/15	←	06/11→; passend für Felgengröße [Zoll]: 16	24.0128-0154.1	428154	Ø 300 28 26 V + S
					24.0328-0154.1	528154	Ø 300 28 26 V + S PD
			←	06/11→; passend für Felgengröße [Zoll]: 17	24.0128-0162.1	428162	Ø 316 28 26 V + S
					24.0328-0162.1	528162	Ø 316 28 26 V + S PD
			←	06/11→; passend für Felgengröße [Zoll]: 18	24.0128-0210.1	428210	Ø 336 28 26 V + S
			→	06/11→; + eFSB	24.0111-0147.1	411147	Ø 302 11 9 + S
			→	06/11→; - eFSB	24.0122-0259.1	422259	Ø 302 22 20 V + S
			→	06/11→; - eFSB	24.0112-0180.1	412180	Ø 302 12 10 + S
VOLVO - XC70 CROSS COUNTRY 10/97→08/07							
 Bremsbelagsatz, Scheibenbremse							
2.4 D5 AWD	136	12/05→08/07	←	→ 07/07	13.0460-7145.2	607145	ATE 23073 18,8 - WE / - WK
2.4 D5 XC AWD	120	09/02→08/07			13.0470-7145.2	LD7145	ATE 23073 18,8 - WE / - WK
2.5 T XC AWD	154	09/02→08/07					Ceramic
			→	→ 07/07	13.0460-7135.2	607135	ATE 23076 17,5 - WE / - WK
					13.0470-7135.2	LD7135	ATE 23076 17,5 - WE / - WK
							Ceramic
2.4 T XC AWD	142	11/97→09/02	←		13.0460-7145.2	607145	ATE 23073 18,8 - WE / - WK
2.4 T XC AWD	147	03/00→09/02			13.0470-7145.2	LD7145	ATE 23073 18,8 - WE / - WK
							Ceramic
			→		13.0460-7135.2	607135	ATE 23076 17,5 - WE / - WK
					13.0470-7135.2	LD7135	ATE 23076 17,5 - WE / - WK
							Ceramic
 Bremsscheibe							
2.4 D5 AWD	136	12/05→08/07	←	→ 07/07; passend für Felgengröße [Zoll]: 15	24.0126-0122.1	426122	Ø 285,5 26 23 V
2.4 D5 XC AWD	120	09/02→08/07			24.0128-0123.1	428123	Ø 305 27,9 25 V
2.5 T XC AWD	154	09/02→08/07	←	→ 07/07; passend für Felgengröße [Zoll]: 16	24.0328-0123.1	528123	Ø 305 27,9 25 V PD
			←	→ 07/07; passend für Felgengröße [Zoll]: 17	24.0128-0184.1	428184	Ø 320 28 25 V
			→	→ 07/07	24.0112-0151.1	412151	Ø 288 11,9 10
					24.0312-0151.1	512151	Ø 288 11,9 10 PD
2.4 T XC AWD	142	11/97→09/02	←	passend für Felgengröße [Zoll]: 15	24.0126-0122.1	426122	Ø 285,5 26 23 V
2.4 T XC AWD	147	03/00→09/02	←	passend für Felgengröße [Zoll]: 16	24.0128-0123.1	428123	Ø 305 27,9 25 V
					24.0328-0123.1	528123	Ø 305 27,9 25 V PD
			←	passend für Felgengröße [Zoll]: 17	24.0128-0184.1	428184	Ø 320 28 25 V
			→		24.0112-0151.1	412151	Ø 288 11,9 10









	kw			 	! #		
VOLVO - XC70 CROSS COUNTRY 10/97→08/07							
 Bremsscheibe							
2.4 T XC AWD	142	11/97→09/02	➔			24.0312-0151.1 512151	Ø 288 11,9 10 PD
2.4 T XC AWD	147	03/00→09/02					
VOLVO - XC90 I 10/02→12/14							
 Bremsbelagsatz, Scheibenbremse							
2.5 T	154	10/02→12/06	←	passend für Felgenreöße [Zoll]: 16		13.0460-7187.2 607187	ATE 23591 18,0 - WE / - WK
2.5 T AWD	154	10/12→09/14				13.0470-7187.2 LD7187	ATE 23590 19,5 - WE / - WK Ceramic
3.2 AWD	179	04/10→12/12					
D3 / D5	120	04/09→12/14	←	+ 17,5" Rad		13.0460-7188.2 607188	ATE 24141 19,1 - WE / - WK
D5 AWD	120	10/02→12/06				13.0470-7188.2 LD7188	ATE 24141 19,1 - WE / - WK Ceramic
D5 AWD	120	10/07→12/10					
D5 AWD	147	01/11→12/14	←	passend für Felgenreöße [Zoll]: 17		13.0460-7272.2 607272	ATE 24399 20,4 + WE / - WK
T6 AWD	200	10/02→12/06	➔			13.0460-7189.2 607189	ATE 24011 18,7 - WE / - WK
3.2 AWD D5 AWD	175 136	03/06→12/10 04/05→12/10	←	05/06→; passend für Felgenreöße [Zoll]: 16		13.0460-7187.2 607187	ATE 23591 18,0 - WE / - WK
						13.0470-7187.2 LD7187	ATE 23590 19,5 - WE / - WK Ceramic
			←	05/06→; + 17,5" Rad		13.0460-7188.2 607188	ATE 24141 19,1 - WE / - WK
						13.0470-7188.2 LD7188	ATE 24141 19,1 - WE / - WK Ceramic
V8 AWD	232	01/05→12/10	←	05/06→; passend für Felgenreöße [Zoll]: 17		13.0460-7272.2 607272	ATE 24399 20,4 + WE / - WK
			➔			13.0460-7189.2 607189	ATE 24011 18,7 - WE / - WK
			←	05/06→; passend für Felgenreöße [Zoll]: 16		13.0460-7187.2 607187	ATE 23591 18,0 - WE / - WK
			←	passend für Felgenreöße [Zoll]: 17,5		13.0460-7188.2 607188	ATE 24141 19,1 - WE / - WK
			←	passend für Felgenreöße [Zoll]: 17		13.0460-7272.2 607272	ATE 24399 20,4 + WE / - WK
			➔			13.0460-7189.2 607189	ATE 24011 18,7 - WE / - WK
 Bremsscheibe							
2.5 T	154	10/02→12/06	←	passend für Felgenreöße [Zoll]: 16		24.0128-0144.1 428144	Ø 316 28 25 V
2.5 T AWD	154	10/12→09/14					
3.2 AWD	179	04/10→12/12	←	+ 17,5" Rad		24.0130-0116.1 430116	Ø 336 30 27 V
D3 / D5	120	04/09→12/14	←	passend für Felgenreöße [Zoll]: 17		24.0130-0240.1 430240	Ø 327,5 30 27 V
D5 AWD	120	10/02→12/06					
D5 AWD	120	10/07→12/10	➔			24.0120-0122.1 420122	Ø 308 20 18 V
D5 AWD	147	01/11→12/14					
T6 AWD	200	10/02→12/06					
V8 AWD	232	01/05→12/10					
3.2 AWD D5 AWD	175 136	03/06→12/10 04/05→12/10	←	05/06→; passend für Felgenreöße [Zoll]: 16		24.0128-0144.1 428144	Ø 316 28 25 V
			←	05/06→; + 17,5" Rad		24.0130-0116.1 430116	Ø 336 30 27 V
			←	05/06→; passend für Felgenreöße [Zoll]: 17		24.0130-0240.1 430240	Ø 327,5 30 27 V
			➔	05/06→		24.0120-0122.1 420122	Ø 308 20 18 V
VOLVO - XC90 II 09/14→							
 Bremsscheibe							
2.0 T5 AWD	183	06/15→	➔	passend für Felgenreöße [Zoll]: 17		24.0120-0246.1 420246	Ø 320 20 17,5 V + S
D5 AWD	165	09/14→					
D5 AWD	173	09/14→	➔	passend für Felgenreöße [Zoll]: 18		24.0120-0247.1 420246	Ø 340 20 17,5 V + S
T5 AWD	187	06/15→					
T6 AWD	235	09/14→					
T8 Hybrid AWD	235	06/15→					
VW - AMAROK (2H_, S1B) 09/10→							
 Bremsbelagsatz, Scheibenbremse							
2.0 BiTDI	120	09/10→	←	+PR 2E3		13.0460-3860.2 603860	BOS 24484 18,8 + WE / - WK + Zub
2.0 BiTDI	132	11/11→					
2.0 BiTDI 4motion	120	09/10→				13.0470-3860.2 LD3860	BOS 24484 18,8 + WE / - WK + Zub Ceramic
2.0 BiTDI 4motion	132	11/11→					
2.0 TDI	90	09/10→					
2.0 TDI	103	07/12→					
2.0 TDI 4motion	90	09/10→					
2.0 TDI 4motion	103	06/12→					
2.0 TSI	118	12/10→					
3.0 TDI 4motion	150	06/16→					
3.0 TDI 4motion	165	06/16→	←	09/16→; +PR 2E3		13.0460-3860.2 603860	BOS 24484 18,8 + WE / - WK + Zub
						13.0470-3860.2 LD3860	BOS 24484 18,8 + WE / - WK + Zub Ceramic
↓							









	kW			 	! #		
VW - AMAROK (2H_, S1B) 09/10→							
 Bremsscheibe							
2.0 BiTDI	120	09/10→	←	+PR 2E3		24.0128-0251.1 428251	Ø 303 28 26 V
2.0 BiTDI	132	11/11→					
2.0 BiTDI 4motion	120	09/10→					
2.0 BiTDI 4motion	132	11/11→					
2.0 TDI	90	09/10→					
2.0 TDI	103	07/12→					
2.0 TDI 4motion	90	09/10→					
2.0 TDI 4motion	103	06/12→					
2.0 TSI	118	12/10→					
3.0 TDI 4motion	150	06/16→					
3.0 TDI 4motion	165	06/16→	←	09/16→; +PR 2E3		24.0128-0251.1 428251	Ø 303 28 26 V
VW - AMAROK Pritsche/Fahrgestell (S1B) 09/11→							
 Bremsbelagsatz, Scheibenbremse							
2.0 TDI	103	09/11→	←	07/12→; +PR 2E3		13.0460-3860.2 603860	BOS 24484 18,8 + WE / - WK + Zub
						13.0470-3860.2 LD3860	BOS 24484 18,8 + WE / - WK + Zub Ceramic
2.0 TDI	132	09/11→	←	11/11→; +PR 2E3		13.0460-3860.2 603860	BOS 24484 18,8 + WE / - WK + Zub
						13.0470-3860.2 LD3860	BOS 24484 18,8 + WE / - WK + Zub Ceramic
2.0 TDI 4motion	103	09/11→	←	06/12→; +PR 2E3		13.0460-3860.2 603860	BOS 24484 18,8 + WE / - WK + Zub
						13.0470-3860.2 LD3860	BOS 24484 18,8 + WE / - WK + Zub Ceramic
 Bremsscheibe							
2.0 TDI	103	09/11→	←	07/12→; +PR 2E3		24.0128-0251.1 428251	Ø 303 28 26 V
2.0 TDI	132	09/11→	←	11/11→; +PR 2E3		24.0128-0251.1 428251	Ø 303 28 26 V
2.0 TDI 4motion	103	09/11→	←	06/12→; +PR 2E3		24.0128-0251.1 428251	Ø 303 28 26 V
VW - BEETLE (5C1, 5C2) 04/11→							
 Bremsbelagsatz, Scheibenbremse							
1.2 TSI	77	07/11→	←	+PR 1ZQ		13.0460-7111.2 607111	VW 23130 19,6 - WE / - WK
2.0 TDI	103	04/11→				13.0470-7111.2 LD7111	VW 23130 19,6 - WE / - WK Ceramic
2.0 TSI	147	04/11→					
			←	+PR 1LV,1ZD,1ZM,1ZP		13.0460-7117.2 607117	VW 23130 19,6 + WK
						13.0470-7117.2 LD7117	VW 23130 19,6 + WK Ceramic
			←	10/11→; +PR 1ZA,1ZB,1ZE		13.0460-7184.2 607184	ATE 23587 20,6 + WK
						13.0470-7184.2 LD7184	ATE 23587 20,6 + WK Ceramic
			→	+PR 1KD,1KU		13.0460-2820.2 602820	TRW 20961 17,2 - WK
						13.0470-2823.2 LD2823	TRW 23554 17,2 - WK Ceramic
			→	+PR 1KS,1KT		13.0460-3858.2 603858	BOS 24563 17,7 - WE / - WK + Zub
						13.0470-3858.2 LD3858	BOS 24563 17,7 - WE / - WK + Zub Ceramic
1.2 TSI 16V	77	12/14→	←	+PR 1ZQ		13.0460-7111.2 607111	VW 23130 19,6 - WE / - WK
1.4 TSI	110	12/14→				13.0470-7111.2 LD7111	VW 23130 19,6 - WE / - WK Ceramic
1.4 TSI	118	10/11→					
1.6 TDI	77	10/11→					
2.0 TSI	162	12/14→	←	+PR 1LV,1ZD,1ZM,1ZP		13.0460-7117.2 607117	VW 23130 19,6 + WK
2.5	125	04/11→				13.0470-7117.2 LD7117	VW 23130 19,6 + WK Ceramic
			←	+PR 1ZA,1ZB,1ZE		13.0460-7184.2 607184	ATE 23587 20,6 + WK
						13.0470-7184.2 LD7184	ATE 23587 20,6 + WK Ceramic
			→	+PR 1KD,1KU		13.0460-2820.2 602820	TRW 20961 17,2 - WK
						13.0470-2823.2 LD2823	TRW 23554 17,2 - WK Ceramic
			→	+PR 1KS,1KT		13.0460-3858.2 603858	BOS 24563 17,7 - WE / - WK + Zub
						13.0470-3858.2 LD3858	BOS 24563 17,7 - WE / - WK + Zub Ceramic
2.0 TDI	81	06/14→	←	12/14→; +PR 1LV,1ZD,1ZM,1ZP		13.0460-7117.2 607117	VW 23130 19,6 + WK
						13.0470-7117.2 LD7117	VW 23130 19,6 + WK Ceramic
			←	12/14→; +PR 1ZA,1ZB,1ZE		13.0460-7184.2 607184	ATE 23587 20,6 + WK
						13.0470-7184.2 LD7184	ATE 23587 20,6 + WK Ceramic
			→	12/14→; +PR 1KD,1KU		13.0460-2820.2 602820	TRW 20961 17,2 - WK
						13.0470-2823.2 LD2823	TRW 23554 17,2 - WK Ceramic
↓							

	kw			 	! #		
VW - BEETLE (5C1, 5C2) 04/11→							
 Bremsbelagsatz, Scheibenbremse							
2.0 TDI	81	06/14→	➡	12/14→; +PR 1KS,1KT		13.0460-3858.2 603858 13.0470-3858.2 LD3858	BOS 24563 17,7 - WE / - WK + Zub BOS 24563 17,7 - WE / - WK + Zub Ceramic
2.0 TDI	110	07/14→	←	09/14→; +PR 1ZQ		13.0460-7111.2 607111 13.0470-7111.2 LD7111	VW 23130 19,6 - WE / - WK VW 23130 19,6 - WE / - WK Ceramic
			←	09/14→; +PR 1LV,1ZD,1ZM,1ZP		13.0460-7117.2 607117 13.0470-7117.2 LD7117	VW 23130 19,6 + WK VW 23130 19,6 + WK Ceramic
			←	09/14→; +PR 1ZA,1ZB,1ZE		13.0460-7184.2 607184 13.0470-7184.2 LD7184	ATE 23587 20,6 + WK ATE 23587 20,6 + WK Ceramic
			➡	09/14→; +PR 1KD,1KU		13.0460-2820.2 602820 13.0470-2823.2 LD2823	TRW 20961 17,2 - WK TRW 23554 17,2 - WK Ceramic
			➡	09/14→; +PR 1KS,1KT		13.0460-3858.2 603858 13.0470-3858.2 LD3858	BOS 24563 17,7 - WE / - WK + Zub BOS 24563 17,7 - WE / - WK + Zub Ceramic
			2.0 TSI	155	12/12→	←	05/13→; +PR 1ZQ
			←	05/13→; +PR 1LV,1ZD,1ZM,1ZP		13.0460-7117.2 607117 13.0470-7117.2 LD7117	VW 23130 19,6 + WK VW 23130 19,6 + WK Ceramic
			←	05/13→; +PR 1ZA,1ZB,1ZE		13.0460-7184.2 607184 13.0470-7184.2 LD7184	ATE 23587 20,6 + WK ATE 23587 20,6 + WK Ceramic
			➡	05/13→; +PR 1KD,1KU		13.0460-2820.2 602820 13.0470-2823.2 LD2823	TRW 20961 17,2 - WK TRW 23554 17,2 - WK Ceramic
			➡	05/13→; +PR 1KS,1KT		13.0460-3858.2 603858 13.0470-3858.2 LD3858	BOS 24563 17,7 - WE / - WK + Zub BOS 24563 17,7 - WE / - WK + Zub Ceramic
			 Bremsscheibe				
1.2 TSI	77	07/11→	←	+PR 1ZM,1ZQ		24.0122-0210.1 422210	Ø 280 22 19 V + S
1.2 TSI 16V	77	12/14→				24.0322-0210.1 522210	Ø 280 22 19 V + S PD
1.4 TSI	110	12/14→					
1.4 TSI	118	10/11→	←	+PR 1ZE,1ZP		24.0125-0145.1 425145	Ø 288 25 22 V + S
1.6 TDI	77	10/11→				24.0325-0145.1 525145	Ø 288 25 22 V + S PD
2.0 TDI	103	04/11→	←	+PR 1ZA,1ZB,1ZD,1LV		24.0125-0158.1 425158	Ø 312 25 22 V + S
2.0 TSI	147	04/11→				24.0325-0158.1 525158	Ø 312 25 22 V + S PD
2.0 TSI	162	12/14→					
2.5	125	04/11→	➡	+PR 1KD,1KU		24.0110-0277.1 410277	Ø 253 10 8 + S
2.0 TDI	81	06/14→	←	12/14→; +PR 1ZM,1ZQ		24.0122-0210.1 422210	Ø 280 22 19 V + S
						24.0322-0210.1 522210	Ø 280 22 19 V + S PD
			←	12/14→; +PR 1ZE,1ZP		24.0125-0145.1 425145	Ø 288 25 22 V + S
						24.0325-0145.1 525145	Ø 288 25 22 V + S PD
			←	12/14→; +PR 1ZA,1ZB,1ZD,1LV		24.0125-0158.1 425158	Ø 312 25 22 V + S
						24.0325-0158.1 525158	Ø 312 25 22 V + S PD
➡	12/14→; +PR 1KD,1KU		24.0110-0277.1 410277	Ø 253 10 8 + S			
➡	12/14→; +PR 1KS,1KT		24.0110-0356.1 410356	Ø 272 9,7 8 + S			
			24.0310-0356.1 510356	Ø 272 9,7 8 + S PD			
2.0 TDI	110	07/14→	←	09/14→; +PR 1ZM,1ZQ		24.0122-0210.1 422210	Ø 280 22 19 V + S
						24.0322-0210.1 522210	Ø 280 22 19 V + S PD
			←	09/14→; +PR 1ZE,1ZP		24.0125-0145.1 425145	Ø 288 25 22 V + S
						24.0325-0145.1 525145	Ø 288 25 22 V + S PD
			←	09/14→; +PR 1ZA,1ZB,1ZD,1LV		24.0125-0158.1 425158	Ø 312 25 22 V + S
						24.0325-0158.1 525158	Ø 312 25 22 V + S PD
➡	09/14→; +PR 1KD,1KU		24.0110-0277.1 410277	Ø 253 10 8 + S			
➡	09/14→; +PR 1KS,1KT		24.0110-0356.1 410356	Ø 272 9,7 8 + S			
			24.0310-0356.1 510356	Ø 272 9,7 8 + S PD			
2.0 TSI	155	12/12→	←	05/13→; +PR 1ZM,1ZQ		24.0122-0210.1 422210	Ø 280 22 19 V + S
						24.0322-0210.1 522210	Ø 280 22 19 V + S PD
			←	05/13→; +PR 1ZE,1ZP		24.0125-0145.1 425145	Ø 288 25 22 V + S
			24.0325-0145.1 525145	Ø 288 25 22 V + S PD			
↓							









	kw			 	! #		
VW - BEETLE (5C1, 5C2) 04/11→							
 Bremsscheibe							
2.0 TSI	155	12/12→	←	05/13→; +PR 1ZA,1ZB,1ZD,1LV	24.0125-0158.1	425158	Ø 312 25 22 V + S
					24.0325-0158.1	525158	Ø 312 25 22 V + S PD
			→	05/13→; +PR 1KD,1KU	24.0110-0277.1	410277	Ø 253 10 8 + S
			→	05/13→; +PR 1KS,1KT	24.0110-0356.1	410356	Ø 272 9,7 8 + S
				24.0310-0356.1	510356	Ø 272 9,7 8 + S PD	
VW - BEETLE Cabriolet (5C7, 5C8) 12/11→							
 Bremsbelagsatz, Scheibenbremse							
1.2 TSI	77	12/11→	←	11/12→; +PR 1ZQ	13.0460-7111.2	607111	VW 23130 19,6 - WE / - WK
1.4 TSI	118	12/11→			13.0470-7111.2	LD7111	VW 23130 19,6 - WE / - WK Ceramic
1.6 TDI	77	12/11→					
2.0 TDI	103	04/12→					
2.0 TSI	147	12/11→	←	11/12→; +PR 1ZM	13.0460-7117.2	607117	VW 23130 19,6 + WK
					13.0470-7117.2	LD7117	VW 23130 19,6 + WK Ceramic
			←	11/12→; +PR 1ZA,1ZB,1ZE	13.0460-7184.2	607184	ATE 23587 20,6 + WK
					13.0470-7184.2	LD7184	ATE 23587 20,6 + WK Ceramic
			←	11/12→; +PR 1LV,1ZP	13.0460-7285.2	607285	ATE 23587 20,6 - WE / - WK
					13.0470-7285.2	LD7285	ATE 23587 20,6 - WE / - WK Ceramic
			→	11/12→; +PR 1KD,1KU	13.0460-2820.2	602820	TRW 20961 17,2 - WK
					13.0470-2823.2	LD2823	TRW 23554 17,2 - WK Ceramic
			→	11/12→; +PR 1KS,1KT	13.0460-3858.2	603858	BOS 24563 17,7 - WE / - WK + Zub
					13.0470-3858.2	LD3858	BOS 24563 17,7 - WE / - WK + Zub Ceramic
1.2 TSI 16V	77	12/14→	←	+PR 1ZQ	13.0460-7111.2	607111	VW 23130 19,6 - WE / - WK
1.4 TSI	110	12/14→			13.0470-7111.2	LD7111	VW 23130 19,6 - WE / - WK Ceramic
1.8 TSI	125	12/13→					
2.0 TDI	110	09/14→					
2.0 TSI	162	12/14→	←	+PR 1ZM	13.0460-7117.2	607117	VW 23130 19,6 + WK
					13.0470-7117.2	LD7117	VW 23130 19,6 + WK Ceramic
			←	+PR 1ZA,1ZB,1ZE	13.0460-7184.2	607184	ATE 23587 20,6 + WK
					13.0470-7184.2	LD7184	ATE 23587 20,6 + WK Ceramic
			←	+PR 1LV,1ZP	13.0460-7285.2	607285	ATE 23587 20,6 - WE / - WK
					13.0470-7285.2	LD7285	ATE 23587 20,6 - WE / - WK Ceramic
			→	+PR 1KD,1KU	13.0460-2820.2	602820	TRW 20961 17,2 - WK
					13.0470-2823.2	LD2823	TRW 23554 17,2 - WK Ceramic
			→	+PR 1KS,1KT	13.0460-3858.2	603858	BOS 24563 17,7 - WE / - WK + Zub
					13.0470-3858.2	LD3858	BOS 24563 17,7 - WE / - WK + Zub Ceramic
2.0 TDI	81	06/14→	←	12/14→; +PR 1ZQ	13.0460-7111.2	607111	VW 23130 19,6 - WE / - WK
					13.0470-7111.2	LD7111	VW 23130 19,6 - WE / - WK Ceramic
			←	12/14→; +PR 1ZM	13.0460-7117.2	607117	VW 23130 19,6 + WK
					13.0470-7117.2	LD7117	VW 23130 19,6 + WK Ceramic
			←	12/14→; +PR 1ZA,1ZB,1ZE	13.0460-7184.2	607184	ATE 23587 20,6 + WK
					13.0470-7184.2	LD7184	ATE 23587 20,6 + WK Ceramic
			←	12/14→; +PR 1LV,1ZP	13.0460-7285.2	607285	ATE 23587 20,6 - WE / - WK
					13.0470-7285.2	LD7285	ATE 23587 20,6 - WE / - WK Ceramic
			→	12/14→; +PR 1KD,1KU	13.0460-2820.2	602820	TRW 20961 17,2 - WK
					13.0470-2823.2	LD2823	TRW 23554 17,2 - WK Ceramic
			→	12/14→; +PR 1KS,1KT	13.0460-3858.2	603858	BOS 24563 17,7 - WE / - WK + Zub
					13.0470-3858.2	LD3858	BOS 24563 17,7 - WE / - WK + Zub Ceramic
2.0 TSI	155	12/12→	←	05/13→; +PR 1ZQ	13.0460-7111.2	607111	VW 23130 19,6 - WE / - WK
					13.0470-7111.2	LD7111	VW 23130 19,6 - WE / - WK Ceramic
			←	05/13→; +PR 1ZM	13.0460-7117.2	607117	VW 23130 19,6 + WK
					13.0470-7117.2	LD7117	VW 23130 19,6 + WK Ceramic
			←	05/13→; +PR 1ZA,1ZB,1ZE	13.0460-7184.2	607184	ATE 23587 20,6 + WK
					13.0470-7184.2	LD7184	ATE 23587 20,6 + WK Ceramic
			←	05/13→; +PR 1LV,1ZP	13.0460-7285.2	607285	ATE 23587 20,6 - WE / - WK

	kw			 	! #			
VW - BEETLE Cabriolet (5C7, 5C8) 12/11→								
 Bremsbelagsatz, Scheibenbremse								
2.0 TSI	155	12/12→	←	05/13→; +PR 1LV,1ZP	13.0470-7285.2	LD7285	ATE 23587 20,6 - WE / - WK Ceramic	
			→	05/13→; +PR 1KD,1KU	13.0460-2820.2	602820	TRW 20961 17,2 - WK	
			→	05/13→; +PR 1KS,1KT	13.0470-2823.2	LD2823	TRW 23554 17,2 - WK Ceramic	
			→	05/13→; +PR 1KS,1KT	13.0460-3858.2	603858	BOS 24563 17,7 - WE / - WK + Zub	
			→		13.0470-3858.2	LD3858	BOS 24563 17,7 - WE / - WK + Zub Ceramic	
2.5	125	12/11→	←	12/12→; +PR 1ZQ	13.0460-7111.2	607111	VW 23130 19,6 - WE / - WK	
			←	12/12→; +PR 1ZM	13.0470-7111.2	LD7111	VW 23130 19,6 - WE / - WK Ceramic	
			←	12/12→; +PR 1ZA,1ZB,1ZE	13.0460-7117.2	607117	VW 23130 19,6 + WK	
			←	12/12→; +PR 1ZA,1ZB,1ZE	13.0470-7117.2	LD7117	VW 23130 19,6 + WK Ceramic	
			←	12/12→; +PR 1ZA,1ZB,1ZE	13.0460-7184.2	607184	ATE 23587 20,6 + WK	
			←	12/12→; +PR 1ZA,1ZB,1ZE	13.0470-7184.2	LD7184	ATE 23587 20,6 + WK Ceramic	
			←	12/12→; +PR 1LV,1ZP	13.0460-7285.2	607285	ATE 23587 20,6 - WE / - WK	
			→	12/12→; +PR 1LV,1ZP	13.0470-7285.2	LD7285	ATE 23587 20,6 - WE / - WK Ceramic	
			→	12/12→; +PR 1KD,1KU	13.0460-2820.2	602820	TRW 20961 17,2 - WK	
			→	12/12→; +PR 1KD,1KU	13.0470-2823.2	LD2823	TRW 23554 17,2 - WK Ceramic	
			→	12/12→; +PR 1KS,1KT	13.0460-3858.2	603858	BOS 24563 17,7 - WE / - WK + Zub	
			→	12/12→; +PR 1KS,1KT	13.0470-3858.2	LD3858	BOS 24563 17,7 - WE / - WK + Zub Ceramic	
 Bremsscheibe								
1.2 TSI 1.4 TSI 1.6 TDI 2.0 TDI 2.0 TSI	77 118 77 103 147	12/11→ 12/11→ 12/11→ 04/12→ 12/11→	←	11/12→; +PR 1ZM,1ZQ	24.0122-0210.1	422210	Ø 280 22 19 V + S	
			←	11/12→; +PR 1ZE,1ZP	24.0322-0210.1	522210	Ø 280 22 19 V + S PD	
			←	11/12→; +PR 1ZE,1ZP	24.0125-0145.1	425145	Ø 288 25 22 V + S	
			←	11/12→; +PR 1ZE,1ZP	24.0325-0145.1	525145	Ø 288 25 22 V + S PD	
			←	11/12→; +PR 1ZA,1ZB,1LV	24.0125-0158.1	425158	Ø 312 25 22 V + S	
			←	11/12→; +PR 1ZA,1ZB,1LV	24.0325-0158.1	525158	Ø 312 25 22 V + S PD	
			→	11/12→; +PR 1KD,1KU	24.0110-0277.1	410277	Ø 253 10 8 + S	
1.2 TSI 16V 1.4 TSI 1.8 TSI 2.0 TDI 2.0 TSI	77 110 125 110 162	12/14→ 12/14→ 12/13→ 09/14→ 12/14→	←	11/12→; +PR 1KS,1KT	24.0110-0356.1	410356	Ø 272 9,7 8 + S	
			←	11/12→; +PR 1KS,1KT	24.0310-0356.1	510356	Ø 272 9,7 8 + S PD	
			←	+PR 1ZM,1ZQ	24.0122-0210.1	422210	Ø 280 22 19 V + S	
			←	+PR 1ZM,1ZQ	24.0322-0210.1	522210	Ø 280 22 19 V + S PD	
			←	+PR 1ZE,1ZP	24.0125-0145.1	425145	Ø 288 25 22 V + S	
			←	+PR 1ZE,1ZP	24.0325-0145.1	525145	Ø 288 25 22 V + S PD	
			←	+PR 1ZA,1ZB,1LV	24.0125-0158.1	425158	Ø 312 25 22 V + S	
2.0 TDI	81	06/14→	←	+PR 1ZA,1ZB,1LV	24.0325-0158.1	525158	Ø 312 25 22 V + S PD	
			→	+PR 1KD,1KU	24.0110-0277.1	410277	Ø 253 10 8 + S	
			→	+PR 1KS,1KT	24.0110-0356.1	410356	Ø 272 9,7 8 + S	
			→	+PR 1KS,1KT	24.0310-0356.1	510356	Ø 272 9,7 8 + S PD	
			←	12/14→; +PR 1ZM,1ZQ	24.0122-0210.1	422210	Ø 280 22 19 V + S	
			←	12/14→; +PR 1ZM,1ZQ	24.0322-0210.1	522210	Ø 280 22 19 V + S PD	
			←	12/14→; +PR 1ZE,1ZP	24.0125-0145.1	425145	Ø 288 25 22 V + S	
2.0 TSI	155	12/12→	←	12/14→; +PR 1ZE,1ZP	24.0325-0145.1	525145	Ø 288 25 22 V + S PD	
			←	12/14→; +PR 1ZA,1ZB,1LV	24.0125-0158.1	425158	Ø 312 25 22 V + S	
			←	12/14→; +PR 1ZA,1ZB,1LV	24.0325-0158.1	525158	Ø 312 25 22 V + S PD	
			→	12/14→; +PR 1KD,1KU	24.0110-0277.1	410277	Ø 253 10 8 + S	
			→	12/14→; +PR 1KS,1KT	24.0110-0356.1	410356	Ø 272 9,7 8 + S	
			→	12/14→; +PR 1KS,1KT	24.0310-0356.1	510356	Ø 272 9,7 8 + S PD	
			←	05/13→; +PR 1ZM,1ZQ	24.0122-0210.1	422210	Ø 280 22 19 V + S	
			←	05/13→; +PR 1ZM,1ZQ	24.0322-0210.1	522210	Ø 280 22 19 V + S PD	
			←	05/13→; +PR 1ZE,1ZP	24.0125-0145.1	425145	Ø 288 25 22 V + S	
			←	05/13→; +PR 1ZE,1ZP	24.0325-0145.1	525145	Ø 288 25 22 V + S PD	
			←	05/13→; +PR 1ZA,1ZB,1LV	24.0125-0158.1	425158	Ø 312 25 22 V + S	
			←	05/13→; +PR 1ZA,1ZB,1LV	24.0325-0158.1	525158	Ø 312 25 22 V + S PD	
			→	05/13→; +PR 1KD,1KU	24.0110-0277.1	410277	Ø 253 10 8 + S	
			→	05/13→; +PR 1KS,1KT	24.0110-0356.1	410356	Ø 272 9,7 8 + S	
			→	05/13→; +PR 1KS,1KT	24.0310-0356.1	510356	Ø 272 9,7 8 + S PD	
↓								







	kw			 	! #		
VW - BEETLE Cabriolet (5C7, 5C8) 12/11→							
 Bremsscheibe							
2.5	125	12/11→	←	12/12→; +PR 1ZM,1ZQ	24.0122-0210.1	422210	∅ 280 22 19 V + S
					24.0322-0210.1	522210	∅ 280 22 19 V + S PD
			←	12/12→; +PR 1ZE,1ZP	24.0125-0145.1	425145	∅ 288 25 22 V + S
					24.0325-0145.1	525145	∅ 288 25 22 V + S PD
			←	12/12→; +PR 1ZA,1ZB,1LV	24.0125-0158.1	425158	∅ 312 25 22 V + S
					24.0325-0158.1	525158	∅ 312 25 22 V + S PD
		→	12/12→; +PR 1KD,1KU	24.0110-0277.1	410277	∅ 253 10 8 + S	
		→	12/12→; +PR 1KS,1KT	24.0110-0356.1	410356	∅ 272 9,7 8 + S	
				24.0310-0356.1	510356	∅ 272 9,7 8 + S PD	
VW - BORA (1J2) 10/98→09/05							
 Bremsbelagsatz, Scheibenbremse							
1.4 16V 1.6 1.6 1.8 1.8 4motion 1.9 SDI 2.0 2.3 V5 2.3 V5 4motion	55 74 75 92 92 50 85 125 125	03/00→05/05 10/98→05/05 08/00→05/05 10/98→05/05 02/99→05/05 10/98→05/05 10/98→05/05 10/00→05/05 10/00→05/05	←	→ 1J-X-800000; +PR 1LR,1LS,1LQ,1ZM	13.0460-7111.2	607111	VW 23130 19,6 - WE / - WK
					13.0470-7111.2	LD7111	VW 23130 19,6 - WE / - WK Ceramic
			←	1J-Y-000001→; → 12/04; +PR 1LS,1LQ,1ZP,1ZM	13.0460-7117.2	607117	VW 23130 19,6 + WK
					13.0470-7117.2	LD7117	VW 23130 19,6 + WK Ceramic
			←	→ 12/04; +PR 1LN,1ZD,1ZE,1ZH	13.0460-7122.2	607122	ATE 20676 19,8 + WK
					13.0470-7122.2	LD7122	ATE 20676 19,8 + WK Ceramic
			→	→ 12/04; +PR 1KU,2EE	13.0460-2820.2	602820	TRW 20961 17,2 - WK
					13.0470-2820.2	LD2820	TRW 20961 17,2 - WK Ceramic
			→	→ 12/04; +PR 1KY	13.0460-2886.2	602886	TRW 20961 16,0 - WK
					13.0470-2886.2	LD2886	TRW 20961 16,0 - WK Ceramic
		→	→ 12/04; +PR 1KE,1KP,1KT	13.0460-2894.2	602894	TRW 20961 17,2 - WK + Zub	
				13.0470-2894.2	LD2894	TRW 20961 17,2 - WK + Zub Ceramic	
1.6 1.9 TDI 1.9 TDI 4motion 2.3 V5	78 81 85 110	06/02→10/04 10/98→06/01 02/99→06/01 10/98→10/00	←	→ 1J-X-800000; +PR 1LR,1LS,1LQ,1ZM	13.0460-7111.2	607111	VW 23130 19,6 - WE / - WK
					13.0470-7111.2	LD7111	VW 23130 19,6 - WE / - WK Ceramic
			←	1J-Y-000001→; +PR 1LS,1LQ,1ZP,1ZM	13.0460-7117.2	607117	VW 23130 19,6 + WK
					13.0470-7117.2	LD7117	VW 23130 19,6 + WK Ceramic
			←	+PR 1LN,1ZD,1ZE,1ZH	13.0460-7122.2	607122	ATE 20676 19,8 + WK
					13.0470-7122.2	LD7122	ATE 20676 19,8 + WK Ceramic
			→	+PR 1KU,2EE	13.0460-2820.2	602820	TRW 20961 17,2 - WK
					13.0470-2820.2	LD2820	TRW 20961 17,2 - WK Ceramic
			→	+PR 1KY	13.0460-2886.2	602886	TRW 20961 16,0 - WK
					13.0470-2886.2	LD2886	TRW 20961 16,0 - WK Ceramic
		→	+PR 1KE,1KP,1KT	13.0460-2894.2	602894	TRW 20961 17,2 - WK + Zub	
				13.0470-2894.2	LD2894	TRW 20961 17,2 - WK + Zub Ceramic	
1.6 16V 1.6 FSI 1.9 TDI 1.9 TDI 4motion 2.0 4motion	77 81 74 74 85	05/00→05/05 01/02→05/05 09/00→05/05 09/00→05/05 04/00→05/05	←	→ 12/04; +PR 1LS,1LQ,1ZP,1ZM	13.0460-7117.2	607117	VW 23130 19,6 + WK
					13.0470-7117.2	LD7117	VW 23130 19,6 + WK Ceramic
			←	→ 12/04; +PR 1LN,1ZD,1ZE,1ZH	13.0460-7122.2	607122	ATE 20676 19,8 + WK
					13.0470-7122.2	LD7122	ATE 20676 19,8 + WK Ceramic
			→	→ 12/04; +PR 1KU,2EE	13.0460-2820.2	602820	TRW 20961 17,2 - WK
					13.0470-2820.2	LD2820	TRW 20961 17,2 - WK Ceramic
			→	→ 12/04; +PR 1KY	13.0460-2886.2	602886	TRW 20961 16,0 - WK
					13.0470-2886.2	LD2886	TRW 20961 16,0 - WK Ceramic
			→	→ 12/04; +PR 1KE,1KP,1KT	13.0460-2894.2	602894	TRW 20961 17,2 - WK + Zub
					13.0470-2894.2	LD2894	TRW 20961 17,2 - WK + Zub Ceramic
1.8 T	110	05/00→05/05	←	09/00→ 12/04; +PR 1LS,1LQ,1ZP,1ZM	13.0460-7117.2	607117	VW 23130 19,6 + WK
					13.0470-7117.2	LD7117	VW 23130 19,6 + WK Ceramic
			←	09/00→ 12/04; +PR 1LN,1ZD,1ZE,1ZH	13.0460-7122.2	607122	ATE 20676 19,8 + WK
					13.0470-7122.2	LD7122	ATE 20676 19,8 + WK Ceramic
			→	09/00→ 12/04; +PR 1KU,2EE	13.0460-2820.2	602820	TRW 20961 17,2 - WK
					13.0470-2820.2	LD2820	TRW 20961 17,2 - WK Ceramic
→	09/00→ 12/04; +PR 1KY	13.0460-2886.2	602886	TRW 20961 16,0 - WK			
		13.0470-2886.2	LD2886	TRW 20961 16,0 - WK Ceramic			
→	09/00→ 12/04; +PR 1KE,1KP,1KT	13.0460-2894.2	602894	TRW 20961 17,2 - WK + Zub			
		13.0470-2894.2	LD2894	TRW 20961 17,2 - WK + Zub Ceramic			
1.8 T	132	03/02→05/05	←	05/02→ 12/04; +PR 1LS,1LQ,1ZP,1ZM	13.0460-7117.2	607117	VW 23130 19,6 + WK

	kw			 	! #		
VW - BORA (1J2) 10/98→09/05							
 Bremsbelagsatz, Scheibenbremse							
1.8 T	132	03/02→05/05	←	05/02→ 12/04; +PR 1LS,1LQ,1ZP,1ZM	13.0470-7117.2	LD7117	VW 23130 19,6 + WK Ceramic
			←	05/02→ 12/04; +PR 1LN,1ZD,1ZE,1ZH	13.0460-7122.2	607122	ATE 20676 19,8 + WK
					13.0470-7122.2	LD7122	ATE 20676 19,8 + WK Ceramic
			→	05/02→ 12/04; +PR 1KU,2EE	13.0460-2820.2	602820	TRW 20961 17,2 - WK
					13.0470-2820.2	LD2820	TRW 20961 17,2 - WK Ceramic
			→	05/02→ 12/04; +PR 1KY	13.0460-2886.2	602886	TRW 20961 16,0 - WK
		13.0470-2886.2	LD2886	TRW 20961 16,0 - WK Ceramic			
1.9 TDI	66	10/98→05/05	←	→ 1J-X-800000; +PR 1LR,1LS,1LQ,1ZM	13.0460-7111.2	607111	VW 23130 19,6 - WE / - WK
					13.0470-7111.2	LD7111	VW 23130 19,6 - WE / - WK Ceramic
			←	1J-Y-000001→; → 06/01; +PR 1LS,1LQ,1ZP,1ZM	13.0460-7117.2	607117	VW 23130 19,6 + WK
					13.0470-7117.2	LD7117	VW 23130 19,6 + WK Ceramic
			←	→ 06/01; +PR 1LN,1ZD,1ZE,1ZH	13.0460-7122.2	607122	ATE 20676 19,8 + WK
					13.0470-7122.2	LD7122	ATE 20676 19,8 + WK Ceramic
1.9 TDI 1.9 TDI 4motion	85 66	12/98→01/02 11/98→04/02	←	02/99→; → 1J-X-800000; +PR 1LR,1LS,1LQ,1ZM	13.0460-7111.2	607111	VW 23130 19,6 - WE / - WK
					13.0470-7111.2	LD7111	VW 23130 19,6 - WE / - WK Ceramic
			←	1J-Y-000001→; → 06/01; +PR 1LS,1LQ,1ZP,1ZM	13.0460-7117.2	607117	VW 23130 19,6 + WK
					13.0470-7117.2	LD7117	VW 23130 19,6 + WK Ceramic
			←	02/99→ 06/01; +PR 1LN,1ZD,1ZE,1ZH	13.0460-7122.2	607122	ATE 20676 19,8 + WK
					13.0470-7122.2	LD7122	ATE 20676 19,8 + WK Ceramic
1.9 TDI 1.9 TDI 4motion	96 96	11/00→05/05 11/00→05/05	←	04/01→ 12/04; +PR 1LS,1LQ,1ZP,1ZM	13.0460-7117.2	607117	VW 23130 19,6 + WK
					13.0470-7117.2	LD7117	VW 23130 19,6 + WK Ceramic
			←	04/01→ 12/04; +PR 1LN,1ZD,1ZE,1ZH	13.0460-7122.2	607122	ATE 20676 19,8 + WK
					13.0470-7122.2	LD7122	ATE 20676 19,8 + WK Ceramic
			→	04/01→ 12/04; +PR 1KU,2EE	13.0460-2820.2	602820	TRW 20961 17,2 - WK
					13.0470-2820.2	LD2820	TRW 20961 17,2 - WK Ceramic
1.9 TDI 1.9 TDI 4motion	110 110	05/00→05/05 05/00→05/05	←	10/00→ 12/04; +PR 1LS,1LQ,1ZP,1ZM	13.0460-7117.2	607117	VW 23130 19,6 + WK
					13.0470-7117.2	LD7117	VW 23130 19,6 + WK Ceramic
			←	10/00→ 12/04; +PR 1LN,1ZD,1ZE,1ZH	13.0460-7122.2	607122	ATE 20676 19,8 + WK
					13.0470-7122.2	LD7122	ATE 20676 19,8 + WK Ceramic
			→	10/00→ 12/04; +PR 1KU,2EE	13.0460-2820.2	602820	TRW 20961 17,2 - WK
					13.0470-2820.2	LD2820	TRW 20961 17,2 - WK Ceramic
2.3 V5 4motion	110	12/98→10/00	←	02/99→; → 1J-X-800000; +PR 1LR,1LS,1LQ,1ZM	13.0460-7111.2	607111	VW 23130 19,6 - WE / - WK
					13.0470-7111.2	LD7111	VW 23130 19,6 - WE / - WK Ceramic



	kw			 	! #		
VW - BORA (1J2) 10/98→09/05							
 Bremsbelagsatz, Scheibenbremse							
2.3 V5 4motion	110	12/98→10/00	←	1J-Y-000001→; +PR 1LS,1LQ,1ZP,1ZM	13.0460-7117.2 607117	VW 23130 19,6 + WK	
			←	02/99→; +PR 1LN,1ZD,1ZE,1ZH	13.0460-7117.2 LD7117	VW 23130 19,6 + WK Ceramic	
			→	02/99→; +PR 1KU,2EE	13.0460-7122.2 607122	ATE 20676 19,8 + WK	
			→	02/99→; +PR 1KY	13.0460-7122.2 LD7122	ATE 20676 19,8 + WK Ceramic	
			→	02/99→; +PR 1KE,1KP,1KT	13.0460-2820.2 602820	TRW 20961 17,2 - WK	
2.8 V6 4motion	150	03/99→05/05	←	05/99→ 12/04; +PR 1LS,1LQ,1ZP,1ZM	13.0460-2820.2 LD2820	TRW 20961 17,2 - WK Ceramic	
			←	05/99→ 12/04; +PR 1LN,1ZD,1ZE,1ZH	13.0460-2886.2 602886	TRW 20961 16,0 - WK	
			→	05/99→ 12/04; +PR 1KY	13.0460-2886.2 LD2886	TRW 20961 16,0 - WK Ceramic	
			→	05/99→ 12/04; +PR 1KE,1KP,1KT	13.0460-2894.2 602894	TRW 20961 17,2 - WK + Zub	
			→	05/99→ 12/04; +PR 1KE,1KP,1KT	13.0460-2894.2 LD2894	TRW 20961 17,2 - WK + Zub Ceramic	
 Bremsscheibe							
1.4 16V	55	03/00→05/05	←	→ 12/04; +PR 1LR,1LS,1ZP,1ZM	24.0122-0150.1 422150	Ø 280 22 19 V + S	
1.6	74	10/98→05/05			24.0322-0150.1 522150	Ø 280 22 19 V + S PD	
1.6	75	08/00→05/05					
1.6 16V	77	05/00→05/05	←	→ 12/04; +PR 1LQ	24.0122-0151.1 422151	Ø 256 22 19 V + S	
1.6 FSI	81	01/02→05/05			24.0322-0151.1 522151	Ø 256 22 19 V + S PD	
1.8	92	10/98→05/05					
1.8 4motion	92	02/99→05/05	←	→ 12/04; +PR 1LN,1ZD,1ZE,1ZH	24.0125-0113.1 425113	Ø 288 25 22 V + S	
1.9 SDI	50	10/98→05/05			24.0325-0113.1 525113	Ø 288 25 22 V + S PD	
1.9 TDI	74	09/00→05/05	←	→ 12/04; +PR 1LJ,1ZQ	24.0125-0123.1 425123	Ø 310 25 22 V + S	
1.9 TDI 4motion	74	09/00→05/05			24.0325-0123.1 525123	Ø 310 25 22 V PD	
2.0	85	10/98→05/05					
2.0 4motion	85	04/00→05/05	→	→ 12/04; +PR 1KP,1KT	24.0109-0123.1 409123	Ø 230 9 7 + S	
2.3 V5	125	10/00→05/05			24.0309-0123.1 509123	Ø 230 9 7 + S PD	
2.3 V5 4motion	125	10/00→05/05	→	→ 12/04; +PR 1KE	24.0109-0133.1 409133	Ø 239 8,9 7 + S	
			→	→ 12/04; +PR 1KU,1KY,2EE	24.0309-0133.1 509133	Ø 239 8,9 7 + S PD	
			→	→ 12/04; +PR 1KE	24.0122-0163.1 422163	Ø 256 22 20 V	
					24.0322-0163.1 522163	Ø 256 22 20 V PD	
1.6	78	06/02→10/04	←	+PR 1LR,1LS,1ZP,1ZM	24.0122-0150.1 422150	Ø 280 22 19 V + S	
1.9 TDI	81	10/98→06/01			24.0322-0150.1 522150	Ø 280 22 19 V + S PD	
1.9 TDI 4motion	85	02/99→06/01	←	+PR 1LQ	24.0122-0151.1 422151	Ø 256 22 19 V + S	
2.3 V5	110	10/98→10/00	←	+PR 1LQ	24.0322-0151.1 522151	Ø 256 22 19 V + S PD	
			←	+PR 1LN,1ZD,1ZE,1ZH	24.0125-0113.1 425113	Ø 288 25 22 V + S	
			←	+PR 1LN,1ZD,1ZE,1ZH	24.0325-0113.1 525113	Ø 288 25 22 V + S PD	
			←	+PR 1LJ,1ZQ	24.0125-0123.1 425123	Ø 310 25 22 V + S	
			←	+PR 1LJ,1ZQ	24.0325-0123.1 525123	Ø 310 25 22 V PD	
			→	+PR 1KP,1KT	24.0109-0123.1 409123	Ø 230 9 7 + S	
			→	+PR 1KP,1KT	24.0309-0123.1 509123	Ø 230 9 7 + S PD	
			→	+PR 1KE	24.0109-0133.1 409133	Ø 239 8,9 7 + S	
			→	+PR 1KE	24.0309-0133.1 509133	Ø 239 8,9 7 + S PD	
			→	+PR 1KU,1KY,2EE	24.0122-0163.1 422163	Ø 256 22 20 V	
					24.0322-0163.1 522163	Ø 256 22 20 V PD	
1.8 T	110	05/00→05/05	←	09/00→ 12/04; +PR 1LR,1LS,1ZP,1ZM	24.0122-0150.1 422150	Ø 280 22 19 V + S	
					24.0322-0150.1 522150	Ø 280 22 19 V + S PD	
			←	09/00→ 12/04; +PR 1LQ	24.0122-0151.1 422151	Ø 256 22 19 V + S	
					24.0322-0151.1 522151	Ø 256 22 19 V + S PD	
			←	09/00→ 12/04; +PR 1LN,1ZD,1ZE,1ZH	24.0125-0113.1 425113	Ø 288 25 22 V + S	
					24.0325-0113.1 525113	Ø 288 25 22 V + S PD	
			←	09/00→ 12/04; +PR 1LJ,1ZQ	24.0125-0123.1 425123	Ø 310 25 22 V + S	
					24.0325-0123.1 525123	Ø 310 25 22 V PD	
			→	09/00→ 12/04; +PR 1KP,1KT	24.0109-0123.1 409123	Ø 230 9 7 + S	
					24.0309-0123.1 509123	Ø 230 9 7 + S PD	



	kw			 	! #		
VW - BORA (1J2) 10/98→09/05							
Bremsscheibe							
1.8 T	110	05/00→05/05	➔	09/00→ 12/04; +PR 1KE	24.0109-0133.1 409133	Ø 239 8,9 7 + S	
			➔	09/00→ 12/04; +PR 1KU;1KY;2EE	24.0309-0133.1 509133	Ø 239 8,9 7 + S PD	
1.8 T	132	03/02→05/05	➔	09/00→ 12/04; +PR 1KU;1KY;2EE	24.0122-0163.1 422163	Ø 256 22 20 V	
			➔	09/00→ 12/04; +PR 1KE	24.0322-0163.1 522163	Ø 256 22 20 V PD	
			➔	05/02→ 12/04; +PR 1LR,1LS,1ZP,1ZM	24.0122-0150.1 422150	Ø 280 22 19 V + S	
			➔	05/02→ 12/04; +PR 1LQ	24.0322-0150.1 522150	Ø 280 22 19 V + S PD	
			➔	05/02→ 12/04; +PR 1LQ	24.0122-0151.1 422151	Ø 256 22 19 V + S	
			➔	05/02→ 12/04; +PR 1LN,1ZD,1ZE,1ZH	24.0322-0151.1 522151	Ø 256 22 19 V + S PD	
			➔	05/02→ 12/04; +PR 1LN,1ZD,1ZE,1ZH	24.0125-0113.1 425113	Ø 288 25 22 V + S	
			➔	05/02→ 12/04; +PR 1LJ,1ZQ	24.0325-0113.1 525113	Ø 288 25 22 V + S PD	
1.9 TDI	66	10/98→05/05	➔	05/02→ 12/04; +PR 1LQ	24.0125-0123.1 425123	Ø 310 25 22 V + S	
			➔	05/02→ 12/04; +PR 1LQ	24.0325-0123.1 525123	Ø 310 25 22 V PD	
			➔	05/02→ 12/04; +PR 1KP,1KT	24.0109-0123.1 409123	Ø 230 9 7 + S	
			➔	05/02→ 12/04; +PR 1KE	24.0309-0123.1 509123	Ø 230 9 7 + S PD	
			➔	05/02→ 12/04; +PR 1KE	24.0109-0133.1 409133	Ø 239 8,9 7 + S	
			➔	05/02→ 12/04; +PR 1KE	24.0309-0133.1 509133	Ø 239 8,9 7 + S PD	
			➔	05/02→ 12/04; +PR 1KU;1KY;2EE	24.0122-0163.1 422163	Ø 256 22 20 V	
			➔	05/02→ 12/04; +PR 1KU;1KY;2EE	24.0322-0163.1 522163	Ø 256 22 20 V PD	
1.9 TDI	66	10/98→05/05	➔	→ 06/01; +PR 1LR,1LS,1ZP,1ZM	24.0122-0150.1 422150	Ø 280 22 19 V + S	
			➔	→ 06/01; +PR 1LQ	24.0322-0150.1 522150	Ø 280 22 19 V + S PD	
			➔	→ 06/01; +PR 1LQ	24.0122-0151.1 422151	Ø 256 22 19 V + S	
			➔	→ 06/01; +PR 1LN,1ZD,1ZE,1ZH	24.0322-0151.1 522151	Ø 256 22 19 V + S PD	
			➔	→ 06/01; +PR 1LN,1ZD,1ZE,1ZH	24.0125-0113.1 425113	Ø 288 25 22 V + S	
			➔	→ 06/01; +PR 1LJ,1ZQ	24.0325-0113.1 525113	Ø 288 25 22 V + S PD	
			➔	→ 06/01; +PR 1LJ,1ZQ	24.0125-0123.1 425123	Ø 310 25 22 V + S	
			➔	→ 06/01; +PR 1LJ,1ZQ	24.0325-0123.1 525123	Ø 310 25 22 V PD	
1.9 TDI 1.9 TDI 4motion	85 66	12/98→01/02 11/98→04/02	➔	→ 06/01; +PR 1KP,1KT	24.0109-0123.1 409123	Ø 230 9 7 + S	
			➔	→ 06/01; +PR 1KE	24.0309-0123.1 509123	Ø 230 9 7 + S PD	
			➔	→ 06/01; +PR 1KE	24.0109-0133.1 409133	Ø 239 8,9 7 + S	
			➔	→ 06/01; +PR 1KE	24.0309-0133.1 509133	Ø 239 8,9 7 + S PD	
			➔	→ 06/01; +PR 1KU;1KY;2EE	24.0122-0163.1 422163	Ø 256 22 20 V	
			➔	→ 06/01; +PR 1KU;1KY;2EE	24.0322-0163.1 522163	Ø 256 22 20 V PD	
			➔	02/99→ 06/01; +PR 1LR,1LS,1ZP,1ZM	24.0122-0150.1 422150	Ø 280 22 19 V + S	
			➔	02/99→ 06/01; +PR 1LQ	24.0322-0150.1 522150	Ø 280 22 19 V + S PD	
1.9 TDI 1.9 TDI 4motion	96 96	11/00→05/05 11/00→05/05	➔	02/99→ 06/01; +PR 1LQ	24.0122-0151.1 422151	Ø 256 22 19 V + S	
			➔	02/99→ 06/01; +PR 1LN,1ZD,1ZE,1ZH	24.0322-0151.1 522151	Ø 256 22 19 V + S PD	
			➔	02/99→ 06/01; +PR 1LN,1ZD,1ZE,1ZH	24.0125-0113.1 425113	Ø 288 25 22 V + S	
			➔	02/99→ 06/01; +PR 1LJ,1ZQ	24.0325-0113.1 525113	Ø 288 25 22 V + S PD	
			➔	02/99→ 06/01; +PR 1LJ,1ZQ	24.0125-0123.1 425123	Ø 310 25 22 V + S	
			➔	02/99→ 06/01; +PR 1LJ,1ZQ	24.0325-0123.1 525123	Ø 310 25 22 V PD	
			➔	02/99→ 06/01; +PR 1KP,1KT	24.0109-0123.1 409123	Ø 230 9 7 + S	
			➔	02/99→ 06/01; +PR 1KE	24.0309-0123.1 509123	Ø 230 9 7 + S PD	
1.9 TDI 1.9 TDI 4motion	110 110	05/00→05/05 05/00→05/05	➔	02/99→ 06/01; +PR 1KE	24.0109-0133.1 409133	Ø 239 8,9 7 + S	
			➔	02/99→ 06/01; +PR 1KE	24.0309-0133.1 509133	Ø 239 8,9 7 + S PD	
			➔	02/99→ 06/01; +PR 1KU;1KY;2EE	24.0122-0163.1 422163	Ø 256 22 20 V	
			➔	02/99→ 06/01; +PR 1KU;1KY;2EE	24.0322-0163.1 522163	Ø 256 22 20 V PD	
			➔	04/01→ 12/04; +PR 1LR,1LS,1ZP,1ZM	24.0122-0150.1 422150	Ø 280 22 19 V + S	
			➔	04/01→ 12/04; +PR 1LQ	24.0322-0150.1 522150	Ø 280 22 19 V + S PD	
			➔	04/01→ 12/04; +PR 1LQ	24.0122-0151.1 422151	Ø 256 22 19 V + S	
			➔	04/01→ 12/04; +PR 1LN,1ZD,1ZE,1ZH	24.0322-0151.1 522151	Ø 256 22 19 V + S PD	
1.9 TDI 1.9 TDI 4motion	110 110	05/00→05/05 05/00→05/05	➔	04/01→ 12/04; +PR 1LN,1ZD,1ZE,1ZH	24.0125-0113.1 425113	Ø 288 25 22 V + S	
			➔	04/01→ 12/04; +PR 1LJ,1ZQ	24.0325-0113.1 525113	Ø 288 25 22 V + S PD	
			➔	04/01→ 12/04; +PR 1LJ,1ZQ	24.0125-0123.1 425123	Ø 310 25 22 V + S	
			➔	04/01→ 12/04; +PR 1LJ,1ZQ	24.0325-0123.1 525123	Ø 310 25 22 V PD	
			➔	04/01→ 12/04; +PR 1KP,1KT	24.0109-0123.1 409123	Ø 230 9 7 + S	
			➔	04/01→ 12/04; +PR 1KE	24.0309-0123.1 509123	Ø 230 9 7 + S PD	
			➔	04/01→ 12/04; +PR 1KE	24.0109-0133.1 409133	Ø 239 8,9 7 + S	
			➔	04/01→ 12/04; +PR 1KE	24.0309-0133.1 509133	Ø 239 8,9 7 + S PD	
1.9 TDI 1.9 TDI 4motion	110 110	05/00→05/05 05/00→05/05	➔	04/01→ 12/04; +PR 1KU;1KY;2EE	24.0122-0163.1 422163	Ø 256 22 20 V	
			➔	04/01→ 12/04; +PR 1KU;1KY;2EE	24.0322-0163.1 522163	Ø 256 22 20 V PD	
1.9 TDI 1.9 TDI 4motion	110 110	05/00→05/05 05/00→05/05	➔	10/00→ 12/04; +PR 1LR,1LS,1ZP,1ZM	24.0122-0150.1 422150	Ø 280 22 19 V + S	



VW - BORA (1J2) 10/98→09/05









Bremsscheibe

1.9 TDI 1.9 TDI 4motion	110	05/00→05/05	←	10/00→ 12/04; +PR 1LR,1LS,1ZP,1ZM	24.0322-0150.1	522150	Ø 280 22 19 V + S PD
	110	05/00→05/05	←	10/00→ 12/04; +PR 1LQ	24.0122-0151.1	422151	Ø 256 22 19 V + S
			←	10/00→ 12/04; +PR 1LN,1ZD,1ZE,1ZH	24.0322-0151.1	522151	Ø 256 22 19 V + S PD
			←	10/00→ 12/04; +PR 1LN,1ZD,1ZE,1ZH	24.0125-0113.1	425113	Ø 288 25 22 V + S
			←	10/00→ 12/04; +PR 1LJ,1ZQ	24.0325-0113.1	525113	Ø 288 25 22 V + S PD
			←	10/00→ 12/04; +PR 1LJ,1ZQ	24.0125-0123.1	425123	Ø 310 25 22 V + S
			→	10/00→ 12/04; +PR 1KP,1KT	24.0325-0123.1	525123	Ø 310 25 22 V PD
			→	10/00→ 12/04; +PR 1KP,1KT	24.0109-0123.1	409123	Ø 230 9 7 + S
		→	10/00→ 12/04; +PR 1KE	24.0309-0123.1	509123	Ø 230 9 7 + S PD	
		→	10/00→ 12/04; +PR 1KE	24.0109-0133.1	409133	Ø 239 8,9 7 + S	
		→	10/00→ 12/04; +PR 1KE	24.0309-0133.1	509133	Ø 239 8,9 7 + S PD	
		→	10/00→ 12/04; +PR 1KU;1KY;2EE	24.0122-0163.1	422163	Ø 256 22 20 V	
		→	10/00→ 12/04; +PR 1KU;1KY;2EE	24.0322-0163.1	522163	Ø 256 22 20 V PD	
2.3 V5 4motion	110	12/98→10/00	←	02/99→; +PR 1LR,1LS,1ZP,1ZM	24.0122-0150.1	422150	Ø 280 22 19 V + S
			←	02/99→; +PR 1LQ	24.0322-0150.1	522150	Ø 280 22 19 V + S PD
			←	02/99→; +PR 1LQ	24.0122-0151.1	422151	Ø 256 22 19 V + S
			←	02/99→; +PR 1LN,1ZD,1ZE,1ZH	24.0322-0151.1	522151	Ø 256 22 19 V + S PD
			←	02/99→; +PR 1LN,1ZD,1ZE,1ZH	24.0125-0113.1	425113	Ø 288 25 22 V + S
			←	02/99→; +PR 1LN,1ZD,1ZE,1ZH	24.0325-0113.1	525113	Ø 288 25 22 V + S PD
			←	02/99→; +PR 1LJ,1ZQ	24.0125-0123.1	425123	Ø 310 25 22 V + S
			←	02/99→; +PR 1LJ,1ZQ	24.0325-0123.1	525123	Ø 310 25 22 V PD
		→	02/99→; +PR 1KP,1KT	24.0109-0123.1	409123	Ø 230 9 7 + S	
		→	02/99→; +PR 1KP,1KT	24.0309-0123.1	509123	Ø 230 9 7 + S PD	
		→	02/99→; +PR 1KE	24.0109-0133.1	409133	Ø 239 8,9 7 + S	
		→	02/99→; +PR 1KE	24.0309-0133.1	509133	Ø 239 8,9 7 + S PD	
		→	02/99→; +PR 1KU;1KY;2EE	24.0122-0163.1	422163	Ø 256 22 20 V	
		→	02/99→; +PR 1KU;1KY;2EE	24.0322-0163.1	522163	Ø 256 22 20 V PD	
2.8 V6 4motion	150	03/99→05/05	←	05/99→ 12/04; +PR 1LR,1LS,1ZP,1ZM	24.0122-0150.1	422150	Ø 280 22 19 V + S
			←	05/99→ 12/04; +PR 1LR,1LS,1ZP,1ZM	24.0322-0150.1	522150	Ø 280 22 19 V + S PD
			←	05/99→ 12/04; +PR 1LQ	24.0122-0151.1	422151	Ø 256 22 19 V + S
			←	05/99→ 12/04; +PR 1LQ	24.0322-0151.1	522151	Ø 256 22 19 V + S PD
			←	05/99→ 12/04; +PR 1LN,1ZD,1ZE,1ZH	24.0125-0113.1	425113	Ø 288 25 22 V + S
			←	05/99→ 12/04; +PR 1LN,1ZD,1ZE,1ZH	24.0325-0113.1	525113	Ø 288 25 22 V + S PD
			←	05/99→ 12/04; +PR 1LJ,1ZQ	24.0125-0123.1	425123	Ø 310 25 22 V + S
			←	05/99→ 12/04; +PR 1LJ,1ZQ	24.0325-0123.1	525123	Ø 310 25 22 V PD
		→	05/99→ 12/04; +PR 1KP,1KT	24.0109-0123.1	409123	Ø 230 9 7 + S	
		→	05/99→ 12/04; +PR 1KP,1KT	24.0309-0123.1	509123	Ø 230 9 7 + S PD	
		→	05/99→ 12/04; +PR 1KE	24.0109-0133.1	409133	Ø 239 8,9 7 + S	
		→	05/99→ 12/04; +PR 1KE	24.0309-0133.1	509133	Ø 239 8,9 7 + S PD	
		→	05/99→ 12/04; +PR 1KU;1KY;2EE	24.0122-0163.1	422163	Ø 256 22 20 V	
		→	05/99→ 12/04; +PR 1KU;1KY;2EE	24.0322-0163.1	522163	Ø 256 22 20 V PD	









VW - BORA Kombi (1J6) 05/99→05/05

Bremsbelagsatz, Scheibenbremse















1.4 16V 1.6 1.6 1.8 4motion 2.0 2.3 V5 2.3 V5 4motion	55	09/01→05/05	←	→ 1J-X-800000; +PR 1LR,1LS,1LQ,1ZM	13.0460-7111.2	607111	VW 23130 19,6 - WE / - WK
	74	05/99→05/05			13.0470-7111.2	LD7111	VW 23130 19,6 - WE / - WK Ceramic
	75	08/00→05/05					
	92	05/99→05/05					
	85	05/99→05/05	←	1J-Y-000001→; → 12/04;	13.0460-7117.2	607117	VW 23130 19,6 + WK
	125	10/00→05/05		+PR 1LS,1LQ,1ZP,1ZM	13.0470-7117.2	LD7117	VW 23130 19,6 + WK Ceramic
	125	10/00→05/05	←	→ 12/04; +PR 1LN,1ZD,1ZE,1ZH	13.0460-7122.2	607122	ATE 20676 19,8 + WK
					13.0470-7122.2	LD7122	ATE 20676 19,8 + WK Ceramic
			→ 12/04; +PR 1KU,2EE	13.0460-2820.2	602820	TRW 20961 17,2 - WK	
				13.0470-2820.2	LD2820	TRW 20961 17,2 - WK Ceramic	
			→ 12/04; +PR 1KY	13.0460-2886.2	602886	TRW 20961 16,0 - WK	
				13.0470-2886.2	LD2886	TRW 20961 16,0 - WK Ceramic	
			→ 12/04; +PR 1KE,1KP,1KT	13.0460-2894.2	602894	TRW 20961 17,2 - WK + Zub	
				13.0470-2894.2	LD2894	TRW 20961 17,2 - WK + Zub Ceramic	
1.6 16V 1.6 FSI 1.8 T 1.9 TDI 1.9 TDI ↓	77	02/00→05/05	←	→ 12/04; +PR 1LS,1LQ,1ZP,1ZM	13.0460-7117.2	607117	VW 23130 19,6 + WK
	81	01/02→05/05			13.0470-7117.2	LD7117	VW 23130 19,6 + WK Ceramic
	132	05/02→05/05					
	74	09/00→05/05	←	→ 12/04; +PR 1LN,1ZD,1ZE,1ZH	13.0460-7122.2	607122	ATE 20676 19,8 + WK
	110	05/01→05/05			13.0470-7122.2	LD7122	ATE 20676 19,8 + WK Ceramic









	kw			 	! #		
VW - BORA Kombi (1J6) 05/99→05/05							
 Bremsbelagsatz, Scheibenbremse							
1.9 TDI 4motion	74	09/00→05/05	➔	→ 12/04; +PR 1KU,2EE		13.0460-2820.2 602820	TRW 20961 17,2 - WK
1.9 TDI 4motion	110	05/01→05/05				13.0470-2820.2 LD2820	TRW 20961 17,2 - WK Ceramic
2.0 4motion	85	04/00→05/05					
2.8 V6 4motion	150	05/99→05/05	➔	→ 12/04; +PR 1KY		13.0460-2886.2 602886	TRW 20961 16,0 - WK
						13.0470-2886.2 LD2886	TRW 20961 16,0 - WK Ceramic
			➔	→ 12/04; +PR 1KE,1KP,1KT		13.0460-2894.2 602894	TRW 20961 17,2 - WK + Zub
						13.0470-2894.2 LD2894	TRW 20961 17,2 - WK + Zub Ceramic
1.8 T	110	05/00→05/05	➔	09/00→ 12/04; +PR 1LS,1LQ,1ZP,1ZM		13.0460-7117.2 607117	VW 23130 19,6 + WK
			➔	09/00→ 12/04; +PR 1LN,1ZD,1ZE,1ZH		13.0470-7117.2 LD7117	VW 23130 19,6 + WK Ceramic
			➔	09/00→ 12/04; +PR 1LN,1ZD,1ZE,1ZH		13.0460-7122.2 607122	ATE 20676 19,8 + WK
						13.0470-7122.2 LD7122	ATE 20676 19,8 + WK Ceramic
			➔	09/00→ 12/04; +PR 1KU,2EE		13.0460-2820.2 602820	TRW 20961 17,2 - WK
						13.0470-2820.2 LD2820	TRW 20961 17,2 - WK Ceramic
			➔	09/00→ 12/04; +PR 1KY		13.0460-2886.2 602886	TRW 20961 16,0 - WK
						13.0470-2886.2 LD2886	TRW 20961 16,0 - WK Ceramic
			➔	09/00→ 12/04; +PR 1KE,1KP,1KT		13.0460-2894.2 602894	TRW 20961 17,2 - WK + Zub
						13.0470-2894.2 LD2894	TRW 20961 17,2 - WK + Zub Ceramic
1.9 TDI	66	07/04→05/05	➔	→ 1J-X-800000; +PR 1LR,1LS,1LQ,1ZM		13.0460-7111.2 607111	VW 23130 19,6 - WE / - WK
						13.0470-7111.2 LD7111	VW 23130 19,6 - WE / - WK Ceramic
1.9 TDI	81	05/99→06/01	➔	→ 1J-X-800000; +PR 1LR,1LS,1LQ,1ZM		13.0460-7111.2 607111	VW 23130 19,6 - WE / - WK
1.9 TDI	85	05/99→06/01				13.0470-7111.2 LD7111	VW 23130 19,6 - WE / - WK Ceramic
1.9 TDI 4motion	85	05/99→06/01					
2.3 V5	110	05/99→10/00	➔	1J-Y-000001→; +PR 1LS,1LQ,1ZP,1ZM		13.0460-7117.2 607117	VW 23130 19,6 + WK
2.3 V5 4motion	110	05/99→10/00	➔	+PR 1LN,1ZD,1ZE,1ZH		13.0470-7117.2 LD7117	VW 23130 19,6 + WK Ceramic
			➔	+PR 1LN,1ZD,1ZE,1ZH		13.0460-7122.2 607122	ATE 20676 19,8 + WK
						13.0470-7122.2 LD7122	ATE 20676 19,8 + WK Ceramic
			➔	+PR 1KU,2EE		13.0460-2820.2 602820	TRW 20961 17,2 - WK
						13.0470-2820.2 LD2820	TRW 20961 17,2 - WK Ceramic
			➔	+PR 1KY		13.0460-2886.2 602886	TRW 20961 16,0 - WK
						13.0470-2886.2 LD2886	TRW 20961 16,0 - WK Ceramic
			➔	+PR 1KE,1KP,1KT		13.0460-2894.2 602894	TRW 20961 17,2 - WK + Zub
						13.0470-2894.2 LD2894	TRW 20961 17,2 - WK + Zub Ceramic
1.9 TDI	96	11/00→05/05	➔	04/01→ 12/04; +PR 1LS,1LQ,1ZP,1ZM		13.0460-7117.2 607117	VW 23130 19,6 + WK
1.9 TDI 4motion	96	11/00→05/05	➔	04/01→ 12/04; +PR 1LN,1ZD,1ZE,1ZH		13.0470-7117.2 LD7117	VW 23130 19,6 + WK Ceramic
			➔	04/01→ 12/04; +PR 1LN,1ZD,1ZE,1ZH		13.0460-7122.2 607122	ATE 20676 19,8 + WK
						13.0470-7122.2 LD7122	ATE 20676 19,8 + WK Ceramic
			➔	04/01→ 12/04; +PR 1KU,2EE		13.0460-2820.2 602820	TRW 20961 17,2 - WK
						13.0470-2820.2 LD2820	TRW 20961 17,2 - WK Ceramic
			➔	04/01→ 12/04; +PR 1KY		13.0460-2886.2 602886	TRW 20961 16,0 - WK
						13.0470-2886.2 LD2886	TRW 20961 16,0 - WK Ceramic
			➔	04/01→ 12/04; +PR 1KE,1KP,1KT		13.0460-2894.2 602894	TRW 20961 17,2 - WK + Zub
						13.0470-2894.2 LD2894	TRW 20961 17,2 - WK + Zub Ceramic
2.0 4motion	88	12/99→05/03	➔	04/00→; +PR 1LS,1LQ,1ZP,1ZM		13.0460-7117.2 607117	VW 23130 19,6 + WK
			➔	04/00→; +PR 1LN,1ZD,1ZE,1ZH		13.0470-7117.2 LD7117	VW 23130 19,6 + WK Ceramic
			➔	04/00→; +PR 1LN,1ZD,1ZE,1ZH		13.0460-7122.2 607122	ATE 20676 19,8 + WK
						13.0470-7122.2 LD7122	ATE 20676 19,8 + WK Ceramic
			➔	04/00→; +PR 1KU,2EE		13.0460-2820.2 602820	TRW 20961 17,2 - WK
						13.0470-2820.2 LD2820	TRW 20961 17,2 - WK Ceramic
			➔	04/00→; +PR 1KY		13.0460-2886.2 602886	TRW 20961 16,0 - WK
						13.0470-2886.2 LD2886	TRW 20961 16,0 - WK Ceramic
			➔	04/00→; +PR 1KE,1KP,1KT		13.0460-2894.2 602894	TRW 20961 17,2 - WK + Zub
						13.0470-2894.2 LD2894	TRW 20961 17,2 - WK + Zub Ceramic
2.8 VR6	150	03/00→05/00	➔	+PR 1LS,1LQ,1ZP,1ZM		13.0460-7117.2 607117	VW 23130 19,6 + WK
			➔	+PR 1LN,1ZD,1ZE,1ZH		13.0470-7117.2 LD7117	VW 23130 19,6 + WK Ceramic
			➔	+PR 1LN,1ZD,1ZE,1ZH		13.0460-7122.2 607122	ATE 20676 19,8 + WK
						13.0470-7122.2 LD7122	ATE 20676 19,8 + WK Ceramic
			➔	+PR 1KU,2EE		13.0460-2820.2 602820	TRW 20961 17,2 - WK
						13.0470-2820.2 LD2820	TRW 20961 17,2 - WK Ceramic









	kw			 	! #		
VW - BORA Kombi (1J6) 05/99→05/05							
 Bremsbelagsatz, Scheibenbremse							
2.8 VR6	150	03/00→05/00	➡	+PR 1KY		13.0460-2886.2 602886 13.0470-2886.2 LD2886	TRW 20961 16,0 - WK TRW 20961 16,0 - WK Ceramic
			➡	+PR 1KE,1KP,1KT		13.0460-2894.2 602894 13.0470-2894.2 LD2894	TRW 20961 17,2 - WK + Zub TRW 20961 17,2 - WK + Zub Ceramic
 Bremsscheibe							
1.4 16V	55	09/01→05/05	←	→ 12/04; +PR 1LR,1LS,1ZP,1ZM		24.0122-0150.1 422150	Ø 280 22 19 V + S
1.6	74	05/99→05/05				24.0322-0150.1 522150	Ø 280 22 19 V + S PD
1.6	75	08/00→05/05					
1.6 16V	77	02/00→05/05	←	→ 12/04; +PR 1LQ		24.0122-0151.1 422151	Ø 256 22 19 V + S
1.6 FSI	81	01/02→05/05				24.0322-0151.1 522151	Ø 256 22 19 V + S PD
1.8 4motion	92	05/99→05/05					
1.8 T	132	05/02→05/05	←	→ 12/04; +PR 1LN,1ZD,1ZE,1ZH		24.0125-0113.1 425113	Ø 288 25 22 V + S
1.9 TDI	74	09/00→05/05				24.0325-0113.1 525113	Ø 288 25 22 V + S PD
1.9 TDI	110	05/01→05/05	←	→ 12/04; +PR 1LJ,1ZQ		24.0125-0123.1 425123	Ø 310 25 22 V + S
1.9 TDI 4motion	74	09/00→05/05				24.0325-0123.1 525123	Ø 310 25 22 V PD
1.9 TDI 4motion	110	05/01→05/05					
2.0	85	05/99→05/05	➡	→ 12/04; +PR 1KP,1KT		24.0109-0123.1 409123	Ø 230 9 7 + S
2.0 4motion	85	04/00→05/05				24.0309-0123.1 509123	Ø 230 9 7 + S PD
2.3 V5	125	10/00→05/05					
2.3 V5 4motion	125	10/00→05/05	➡	→ 12/04; +PR 1KE		24.0109-0133.1 409133	Ø 239 8,9 7 + S
2.8 V6 4motion	150	05/99→05/05	➡	→ 12/04; +PR 1KE		24.0309-0133.1 509133	Ø 239 8,9 7 + S PD
			➡	→ 12/04; +PR 1KU;1KY;2EE		24.0122-0163.1 422163	Ø 256 22 20 V
						24.0322-0163.1 522163	Ø 256 22 20 V PD
1.8 T	110	05/00→05/05	←	09/00→ 12/04; +PR 1LR,1LS,1ZP,1ZM		24.0122-0150.1 422150	Ø 280 22 19 V + S
						24.0322-0150.1 522150	Ø 280 22 19 V + S PD
			←	09/00→ 12/04; +PR 1LQ		24.0122-0151.1 422151	Ø 256 22 19 V + S
						24.0322-0151.1 522151	Ø 256 22 19 V + S PD
			←	09/00→ 12/04; +PR 1LN,1ZD,1ZE,1ZH		24.0125-0113.1 425113	Ø 288 25 22 V + S
						24.0325-0113.1 525113	Ø 288 25 22 V + S PD
			←	09/00→ 12/04; +PR 1LJ,1ZQ		24.0125-0123.1 425123	Ø 310 25 22 V + S
						24.0325-0123.1 525123	Ø 310 25 22 V PD
			➡	09/00→ 12/04; +PR 1KP,1KT		24.0109-0123.1 409123	Ø 230 9 7 + S
						24.0309-0123.1 509123	Ø 230 9 7 + S PD
			➡	09/00→ 12/04; +PR 1KE		24.0109-0133.1 409133	Ø 239 8,9 7 + S
						24.0309-0133.1 509133	Ø 239 8,9 7 + S PD
			➡	09/00→ 12/04; +PR 1KU;1KY;2EE		24.0122-0163.1 422163	Ø 256 22 20 V
						24.0322-0163.1 522163	Ø 256 22 20 V PD
1.9 TDI	81	05/99→06/01	←	+PR 1LR,1LS,1ZP,1ZM		24.0122-0150.1 422150	Ø 280 22 19 V + S
1.9 TDI	85	05/99→06/01				24.0322-0150.1 522150	Ø 280 22 19 V + S PD
1.9 TDI 4motion	85	05/99→06/01					
2.3 V5	110	05/99→10/00	←	+PR 1LQ		24.0122-0151.1 422151	Ø 256 22 19 V + S
2.3 V5 4motion	110	05/99→10/00				24.0322-0151.1 522151	Ø 256 22 19 V + S PD
2.8 VR6	150	03/00→05/00	←	+PR 1LN,1ZD,1ZE,1ZH		24.0125-0113.1 425113	Ø 288 25 22 V + S
						24.0325-0113.1 525113	Ø 288 25 22 V + S PD
			←	+PR 1LJ,1ZQ		24.0125-0123.1 425123	Ø 310 25 22 V + S
						24.0325-0123.1 525123	Ø 310 25 22 V PD
			➡	+PR 1KP,1KT		24.0109-0123.1 409123	Ø 230 9 7 + S
						24.0309-0123.1 509123	Ø 230 9 7 + S PD
			➡	+PR 1KE		24.0109-0133.1 409133	Ø 239 8,9 7 + S
						24.0309-0133.1 509133	Ø 239 8,9 7 + S PD
			➡	+PR 1KU;1KY;2EE		24.0122-0163.1 422163	Ø 256 22 20 V
						24.0322-0163.1 522163	Ø 256 22 20 V PD
1.9 TDI	96	11/00→05/05	←	04/01→ 12/04; +PR 1LR,1LS,1ZP,1ZM		24.0122-0150.1 422150	Ø 280 22 19 V + S
1.9 TDI 4motion	96	11/00→05/05				24.0322-0150.1 522150	Ø 280 22 19 V + S PD
			←	04/01→ 12/04; +PR 1LQ		24.0122-0151.1 422151	Ø 256 22 19 V + S
						24.0322-0151.1 522151	Ø 256 22 19 V + S PD
			←	04/01→ 12/04; +PR 1LN,1ZD,1ZE,1ZH		24.0125-0113.1 425113	Ø 288 25 22 V + S
						24.0325-0113.1 525113	Ø 288 25 22 V + S PD
			←	04/01→ 12/04; +PR 1LJ,1ZQ		24.0125-0123.1 425123	Ø 310 25 22 V + S
						24.0325-0123.1 525123	Ø 310 25 22 V PD
			➡	04/01→ 12/04; +PR 1KP,1KT		24.0109-0123.1 409123	Ø 230 9 7 + S
						24.0309-0123.1 509123	Ø 230 9 7 + S PD
			➡	04/01→ 12/04; +PR 1KE		24.0109-0133.1 409133	Ø 239 8,9 7 + S
						24.0309-0133.1 509133	Ø 239 8,9 7 + S PD











	kw			 	! #		
VW - BORA Kombi (1J6) 05/99→05/05							
 Bremsscheibe							
1.9 TDI	96	11/00→05/05	➔	04/01→ 12/04; +PR 1KU;1KY;2EE		24.0122-0163.1 422163	Ø 256 22 20 V
1.9 TDI 4motion	96	11/00→05/05				24.0322-0163.1 522163	Ø 256 22 20 V PD
2.0 4motion	88	12/99→05/03	➔	04/00→; +PR 1LR,1LS,1ZP,1ZM		24.0122-0150.1 422150	Ø 280 22 19 V + S
			➔	04/00→; +PR 1LQ		24.0322-0150.1 522150	Ø 280 22 19 V + S PD
			➔	04/00→; +PR 1LN,1ZD,1ZE,1ZH		24.0122-0151.1 422151	Ø 256 22 19 V + S
			➔	04/00→; +PR 1LJ,1ZQ		24.0322-0151.1 522151	Ø 256 22 19 V + S PD
			➔	04/00→; +PR 1KE		24.0125-0113.1 425113	Ø 288 25 22 V + S
			➔	04/00→; +PR 1KP,1KT		24.0325-0113.1 525113	Ø 288 25 22 V + S PD
			➔	04/00→; +PR 1KE		24.0125-0123.1 425123	Ø 310 25 22 V + S
			➔	04/00→; +PR 1KE		24.0325-0123.1 525123	Ø 310 25 22 V PD
			➔	04/00→; +PR 1KU;1KY;2EE		24.0109-0123.1 409123	Ø 230 9 7 + S
			➔	04/00→; +PR 1KE		24.0309-0123.1 509123	Ø 230 9 7 + S PD
			➔	04/00→; +PR 1KE		24.0109-0133.1 409133	Ø 239 8,9 7 + S
			➔	04/00→; +PR 1KE		24.0309-0133.1 509133	Ø 239 8,9 7 + S PD
			➔	04/00→; +PR 1KU;1KY;2EE		24.0122-0163.1 422163	Ø 256 22 20 V
			➔	04/00→; +PR 1KU;1KY;2EE		24.0322-0163.1 522163	Ø 256 22 20 V PD
VW - CADDY II Kasten (9K9A) 11/95→01/04							
 Bremsbelagsatz, Scheibenbremse							
1.4	55	08/00→01/04	➔	9K-T-514501→		13.0460-2821.2 602821	TRW 21945 16,0 - WK
1.9 D	47	11/95→01/04	➔	→ 9K-T-514500		13.0460-2958.2 602958	TRW 20168 19,3 - WK
1.9 SDI	47	11/95→01/04	➔	→ 9K-T-514500			
60 1.4	44	11/95→01/04	➔				
75 1.6	55	11/95→05/97	➔				
75 1.6	55	11/95→09/00	➔				
1.7 SDI	42	07/96→09/00	➔			13.0460-2821.2 602821	TRW 21945 16,0 - WK
1.9 TDI	66	09/96→01/04	➔				
 Bremsscheibe							
1.4	55	08/00→01/04	➔	→ 9K-T-514500		24.0113-0178.1 413178	Ø 255,6 12,9 11 + S
1.9 D	47	11/95→01/04	➔	→ 9K-T-514500		24.0313-0178.1 513178	Ø 255,6 12,9 11 + S PD
1.9 SDI	47	11/95→01/04	➔	→ 9K-T-514500			
60 1.4	44	11/95→01/04	➔	→ 9K-T-514500		24.0120-0128.1 420128	Ø 256 20 18 V + S
75 1.6	55	11/95→05/97	➔	→ 9K-T-514500		24.0320-0128.1 520128	Ø 256 20 18 V + S PD
75 1.6	55	11/95→09/00	➔	→ 9K-T-514500			
1.7 SDI	42	07/96→09/00	➔	→ 9K-T-514500		24.0120-0128.1 420128	Ø 256 20 18 V + S
1.9 TDI	66	09/96→01/04	➔	→ 9K-T-514500		24.0320-0128.1 520128	Ø 256 20 18 V + S PD
VW - CADDY II Kombi (9K9B) 11/95→01/04							
 Bremsbelagsatz, Scheibenbremse							
1.4	44	11/95→01/04	➔	9K-T-514501→		13.0460-2821.2 602821	TRW 21945 16,0 - WK
1.4 16V	55	08/00→01/04	➔	→ 9K-T-514500		13.0460-2958.2 602958	TRW 20168 19,3 - WK
1.6	55	11/95→05/97	➔	→ 9K-T-514500			
1.6	55	06/97→09/00	➔				
1.9 D	47	11/95→01/04	➔				
1.9 SDI	47	11/95→01/04	➔				
1.7 SDI	42	07/96→09/00	➔			13.0460-2821.2 602821	TRW 21945 16,0 - WK
1.9 TDI	66	10/96→01/04	➔				
 Bremsscheibe							
1.4	44	11/95→01/04	➔	→ 9K-T-514500		24.0113-0178.1 413178	Ø 255,6 12,9 11 + S
1.4 16V	55	08/00→01/04	➔	→ 9K-T-514500		24.0313-0178.1 513178	Ø 255,6 12,9 11 + S PD
1.6	55	11/95→05/97	➔	→ 9K-T-514500			
1.6	55	06/97→09/00	➔	→ 9K-T-514500		24.0120-0128.1 420128	Ø 256 20 18 V + S
1.9 D	47	11/95→01/04	➔	→ 9K-T-514500		24.0320-0128.1 520128	Ø 256 20 18 V + S PD
1.9 SDI	47	11/95→01/04	➔	→ 9K-T-514500			
1.7 SDI	42	07/96→09/00	➔	→ 9K-T-514500		24.0120-0128.1 420128	Ø 256 20 18 V + S
1.9 TDI	66	10/96→01/04	➔	→ 9K-T-514500		24.0320-0128.1 520128	Ø 256 20 18 V + S PD
VW - CADDY II Pick-up (9U7) 06/96→12/00							
 Bremsbelagsatz, Scheibenbremse							
1.6	55	06/96→12/00	➔	10/97→		13.0460-2964.2 602964	TRW 20861 17,5 - WK
1.9 D	47	06/96→12/00	➔	10/97→			
 Bremsscheibe							
1.6	55	06/96→12/00	➔	10/97→		24.0113-0182.1 413182	Ø 236 12,8 11,4
1.9 D	47	06/96→12/00	➔	10/97→			







	kW			 	! #		
VW - CADDY III Kasten (2KA, 2KH, 2CA, 2CH) 03/04→05/15							
 Bremsbelagsatz, Scheibenbremse							
1.6 BiFuel 2.0 TDI 2.0 TDI 16V 2.0 TDI 16V 4motion	75 62 103 103	05/11→05/15 11/10→05/15 11/10→05/15 11/10→05/15	➡	+PR 1ZE,1LJ; → 2K-B-200 000		13.0470-2749.2 LD2749 13.0470-2880.2 LD2880	TRW 24483 16,9 - WE / - WK + Zub Ceramic TRW 23914 17,1 + WE / - WK + Zub Ceramic
			➡	+PR 1ZF,2E2		13.0460-2820.2 602820 13.0470-2820.2 LD2820	TRW 20961 17,2 - WK TRW 20961 17,2 - WK Ceramic
			➡	2K-B-200 001→; +PR 1ZA,1ZE,1ZF,2E3		13.0460-3858.2 603858 13.0470-3858.2 LD3858	BOS 24563 17,7 - WE / - WK + Zub BOS 24563 17,7 - WE / - WK + Zub Ceramic
2.0 TDI 2.0 TDI 4motion	81 81	08/10→05/15 08/10→05/15	⬅	10/10→; +PR 1ZF,1ZM		13.0460-7117.2 607117 13.0470-7117.2 LD7117	VW 23130 19,6 + WK VW 23130 19,6 + WK Ceramic
			⬅	10/10→; +PR 1ZE,1LJ,1ZA		13.0460-7184.2 607184 13.0470-7184.2 LD7184	ATE 23587 20,6 + WK ATE 23587 20,6 + WK Ceramic
			➡	10/10→; +PR 1ZE,1LJ; → 2K-B-200 000		13.0460-2749.2 602749 13.0460-2880.2 602880 13.0470-2749.2 LD2749 13.0470-2880.2 LD2880	TRW 24483 16,9 - WE / - WK + Zub TRW 23914 17,1 + WE / - WK + Zub TRW 24483 16,9 - WE / - WK + Zub Ceramic TRW 23914 17,1 + WE / - WK + Zub Ceramic
			➡	10/10→; +PR 1ZF,2E2		13.0460-2820.2 602820 13.0470-2820.2 LD2820	TRW 20961 17,2 - WK TRW 20961 17,2 - WK Ceramic
			➡	2K-B-200 001→; +PR 1ZA,1ZE,1ZF,2E3		13.0460-3858.2 603858 13.0470-3858.2 LD3858	BOS 24563 17,7 - WE / - WK + Zub BOS 24563 17,7 - WE / - WK + Zub Ceramic
2.0 TDI	125	05/12→05/15	⬅	+PR 1ZF,1ZM		13.0460-7117.2 607117 13.0470-7117.2 LD7117	VW 23130 19,6 + WK VW 23130 19,6 + WK Ceramic
			⬅	+PR 1ZE,1LJ,1ZA		13.0460-7184.2 607184 13.0470-7184.2 LD7184	ATE 23587 20,6 + WK ATE 23587 20,6 + WK Ceramic
			➡	+PR 1ZF,2E2		13.0460-2820.2 602820 13.0470-2820.2 LD2820	TRW 20961 17,2 - WK TRW 20961 17,2 - WK Ceramic
			➡	+PR 1ZA,1ZE,1ZF,2E3		13.0460-3858.2 603858 13.0470-3858.2 LD3858	BOS 24563 17,7 - WE / - WK + Zub BOS 24563 17,7 - WE / - WK + Zub Ceramic
Zubehörsatz, Scheibenbremsbelag							
1.2 TSI 1.2 TSI 1.6 BiFuel 1.6 TDI 1.6 TDI 1.9 TDI 4motion 2.0 TDI 2.0 TDI 16V 2.0 TDI 16V 4motion 2.0 TDI 4motion	63 77 75 55 75 77 62 103 103 62	09/10→05/15 09/10→05/15 05/11→05/15 08/10→05/15 08/10→05/15 11/08→08/10 11/10→05/15 11/10→05/15 11/10→05/15 12/10→05/15	➡	+PR 1ZF,2E2		13.0460-0259.2 610259	
			➡	+PR 1ZE,1LJ; → 2K-B-200 000		13.0460-0259.2 610259	
1.4	55	03/04→05/06	➡			13.0460-0259.2 610259	
1.4 1.6 1.9 TDI 1.9 TDI 2.0 EcoFuel 2.0 SDI 2.0 TDI	59 75 55 77 80 51 103	05/06→08/10 04/04→05/15 09/05→08/10 04/04→08/10 04/06→05/15 03/04→08/10 09/07→08/10	➡	12/07→; +PR 1ZE,1LJ; → 2K-B-200 000		13.0460-0259.2 610259	
			➡	→ 11/07		13.0460-0259.2 610259	
			➡	12/07→; +PR 1ZF,2E2		13.0460-0259.2 610259	
2.0 TDI 2.0 TDI 4motion	81 81	08/10→05/15 08/10→05/15	➡	10/10→; +PR 1ZE,1LJ; → 2K-B-200 000		13.0460-0259.2 610259	
			➡	10/10→; +PR 1ZF,2E2		13.0460-0259.2 610259	
2.0 TDI	125	05/12→05/15	➡	+PR 1ZF,2E2		13.0460-0259.2 610259	
 Bremsscheibe							
1.2 TSI 1.2 TSI 1.6 TDI 1.6 TDI 1.9 TDI 4motion 2.0 TDI 4motion	63 77 55 75 77 62	09/10→05/15 09/10→05/15 08/10→05/15 08/10→05/15 11/08→08/10 12/10→05/15	⬅	+PR 1ZF,1ZM		24.0122-0210.1 422210 24.0322-0210.1 522210	∅ 280 22 19 V + S ∅ 280 22 19 V + S PD
			⬅	+PR 1ZE		24.0125-0145.1 425145 24.0325-0145.1 525145	∅ 288 25 22 V + S ∅ 288 25 22 V + S PD
			⬅	+PR 1LJ,1ZA		24.0125-0158.1 425158 24.0325-0158.1 525158	∅ 312 25 22 V + S ∅ 312 25 22 V + S PD
↓							







	kw				! #		
VW - CADDY III Kasten (2KA, 2KH, 2CA, 2CH) 03/04→05/15							
Bremsscheibe							
1.2 TSI	63	09/10→05/15	➡	+PR 1ZF,2E2		24.0110-0277.1 410277	Ø 253 10 8 + S
1.2 TSI	77	09/10→05/15				24.0310-0277.1 510277	Ø 253 10 8 + S PD
1.6 TDI	55	08/10→05/15					
1.6 TDI	75	08/10→05/15	➡	2K-B-200 001→; +PR 1ZA,1ZE,1ZF,2E3		24.0110-0356.1 410356	Ø 272 9,7 8 + S
1.9 TDI 4motion	77	11/08→08/10				24.0310-0356.1 510356	Ø 272 9,7 8 + S PD
2.0 TDI 4motion	62	12/10→05/15	➡	+PR 1ZE,1LJ; → 2K-B-200 000		24.0112-0158.1 412158	Ø 256 12 10 + S
						24.0312-0158.1 512158	Ø 256 12 10 PD
1.4	55	03/04→05/06	←	+PR 1ZF;1ZM		24.0122-0210.1 422210	Ø 280 22 19 V + S
						24.0322-0210.1 522210	Ø 280 22 19 V + S PD
			←	+PR 1ZE		24.0125-0145.1 425145	Ø 288 25 22 V + S
						24.0325-0145.1 525145	Ø 288 25 22 V + S PD
			←	+PR 1LJ,1ZA		24.0125-0158.1 425158	Ø 312 25 22 V + S
						24.0325-0158.1 525158	Ø 312 25 22 V + S PD
			➡	2K-B-200 001→; +PR 1ZA,1ZE,1ZF,2E3		24.0110-0356.1 410356	Ø 272 9,7 8 + S
						24.0310-0356.1 510356	Ø 272 9,7 8 + S PD
			➡			24.0112-0158.1 412158	Ø 256 12 10 + S
						24.0312-0158.1 512158	Ø 256 12 10 PD
1.4	59	05/06→08/10	←	+PR 1ZF;1ZM		24.0122-0210.1 422210	Ø 280 22 19 V + S
1.6	75	04/04→05/15				24.0322-0210.1 522210	Ø 280 22 19 V + S PD
1.9 TDI	55	09/05→08/10					
1.9 TDI	77	04/04→08/10	←	+PR 1ZE		24.0125-0145.1 425145	Ø 288 25 22 V + S
2.0 EcoFuel	80	04/06→05/15				24.0325-0145.1 525145	Ø 288 25 22 V + S PD
2.0 SDI	51	03/04→08/10	←	+PR 1LJ,1ZA		24.0125-0158.1 425158	Ø 312 25 22 V + S
2.0 TDI	103	09/07→08/10				24.0325-0158.1 525158	Ø 312 25 22 V + S PD
			➡	12/07→; +PR 1ZF,2E2		24.0110-0277.1 410277	Ø 253 10 8 + S
						24.0310-0277.1 510277	Ø 253 10 8 + S PD
			➡	2K-B-200 001→; +PR 1ZA,1ZE,1ZF,2E3		24.0110-0356.1 410356	Ø 272 9,7 8 + S
						24.0310-0356.1 510356	Ø 272 9,7 8 + S PD
			➡	12/07→; +PR 1ZE,1LJ; → 2K-B-200 000		24.0112-0158.1 412158	Ø 256 12 10 + S
						24.0312-0158.1 512158	Ø 256 12 10 PD
			➡	→ 11/07		24.0112-0158.1 412158	Ø 256 12 10 + S
						24.0312-0158.1 512158	Ø 256 12 10 PD
1.6 BiFuel	75	05/11→05/15	←	+PR 1ZF;1ZM		24.0122-0210.1 422210	Ø 280 22 19 V + S
2.0 TDI	62	11/10→05/15				24.0322-0210.1 522210	Ø 280 22 19 V + S PD
2.0 TDI 16V	103	11/10→05/15	←	+PR 1ZE		24.0125-0145.1 425145	Ø 288 25 22 V + S
2.0 TDI 16V 4motion	103	11/10→05/15				24.0325-0145.1 525145	Ø 288 25 22 V + S PD
			←	+PR 1LJ,1ZA		24.0125-0158.1 425158	Ø 312 25 22 V + S
						24.0325-0158.1 525158	Ø 312 25 22 V + S PD
			➡	+PR 1ZF,2E2		24.0110-0277.1 410277	Ø 253 10 8 + S
						24.0310-0277.1 510277	Ø 253 10 8 + S PD
			➡	2K-B-200 001→; +PR 1ZA,1ZE,1ZF,2E3		24.0110-0356.1 410356	Ø 272 9,7 8 + S
						24.0310-0356.1 510356	Ø 272 9,7 8 + S PD
			➡	+PR 1ZE,1LJ; → 2K-B-200 000		24.0112-0158.1 412158	Ø 256 12 10 + S
						24.0312-0158.1 512158	Ø 256 12 10 PD
2.0 TDI	81	08/10→05/15	←	10/10→; +PR 1ZF,1ZM		24.0122-0210.1 422210	Ø 280 22 19 V + S
2.0 TDI 4motion	81	08/10→05/15				24.0322-0210.1 522210	Ø 280 22 19 V + S PD
			←	10/10→; +PR 1ZE		24.0125-0145.1 425145	Ø 288 25 22 V + S
						24.0325-0145.1 525145	Ø 288 25 22 V + S PD
			←	10/10→; +PR 1LJ,1ZA		24.0125-0158.1 425158	Ø 312 25 22 V + S
						24.0325-0158.1 525158	Ø 312 25 22 V + S PD
			➡	10/10→; +PR 1ZF,2E2		24.0110-0277.1 410277	Ø 253 10 8 + S
						24.0310-0277.1 510277	Ø 253 10 8 + S PD
			➡	2K-B-200 001→; +PR 1ZA,1ZE,1ZF,2E3		24.0110-0356.1 410356	Ø 272 9,7 8 + S
						24.0310-0356.1 510356	Ø 272 9,7 8 + S PD
			➡	10/10→; +PR 1ZE,1LJ; → 2K-B-200 000		24.0112-0158.1 412158	Ø 256 12 10 + S
						24.0312-0158.1 512158	Ø 256 12 10 PD
2.0 TDI	125	05/12→05/15	←	+PR 1ZF,1ZM		24.0122-0210.1 422210	Ø 280 22 19 V + S
						24.0322-0210.1 522210	Ø 280 22 19 V + S PD
			←	+PR 1ZE		24.0125-0145.1 425145	Ø 288 25 22 V + S
						24.0325-0145.1 525145	Ø 288 25 22 V + S PD
			←	+PR 1LJ,1ZA		24.0125-0158.1 425158	Ø 312 25 22 V + S
						24.0325-0158.1 525158	Ø 312 25 22 V + S PD
			➡	+PR 1ZF,2E2		24.0110-0277.1 410277	Ø 253 10 8 + S



























	kw					! #		
VW - CADDY III Kasten (2KA, 2KH, 2CA, 2CH) 03/04→05/15								
 Bremsscheibe								
2.0 TDI	125	05/12→05/15	➡	+PR 1ZF,2E2	24.0310-0277.1	510277	Ø 253 10 8 + S PD	
				+PR 1ZA,1ZE,1ZF,2E3	24.0110-0356.1	410356	Ø 272 9,7 8 + S	
					24.0310-0356.1	510356	Ø 272 9,7 8 + S PD	
VW - CADDY III Kombi (2KB, 2KJ, 2CB, 2CJ) 03/04→05/15								
 Bremsbelagsatz, Scheibenbremse								
1.2 TSI	63	09/10→05/15	←	+PR 1ZF,1ZM	13.0460-7117.2	607117	VW 23130 19,6 + WK	
1.2 TSI	77	09/10→05/15			13.0470-7117.2	LD7117	VW 23130 19,6 + WK Ceramic	
1.6 TDI	55	08/10→05/15						
1.6 TDI	75	08/10→05/15	←	+PR 1ZE,1LJ,1ZA	13.0460-7184.2	607184	ATE 23587 20,6 + WK	
1.9 TDI 4motion	77	05/08→08/10			13.0470-7184.2	LD7184	ATE 23587 20,6 + WK Ceramic	
2.0 TDI 16V 4motion	103	11/10→05/15	➡	+PR 1ZE,1LJ; → 2K-B-200 000	13.0460-2749.2	602749	TRW 24483 16,9 - WE / - WK + Zub	
					13.0460-2880.2	602880	TRW 23914 17,1 + WE / - WK + Zub	
					13.0470-2749.2	LD2749	TRW 24483 16,9 - WE / - WK + Zub Ceramic	
					13.0470-2880.2	LD2880	TRW 23914 17,1 + WE / - WK + Zub Ceramic	
			➡	+PR 1ZF,2E2	13.0460-2820.2	602820	TRW 20961 17,2 - WK	
					13.0470-2820.2	LD2820	TRW 20961 17,2 - WK Ceramic	
			➡	2K-B-200 001→; +PR 1ZA,1ZE,1ZF,2E3	13.0460-3858.2	603858	BOS 24563 17,7 - WE / - WK + Zub	
					13.0470-3858.2	LD3858	BOS 24563 17,7 - WE / - WK + Zub Ceramic	
1.4	55	03/04→05/06	←	+PR 1ZF,1ZM	13.0460-7117.2	607117	VW 23130 19,6 + WK	
					13.0470-7117.2	LD7117	VW 23130 19,6 + WK Ceramic	
			←	+PR 1ZE,1LJ,1ZA	13.0460-7184.2	607184	ATE 23587 20,6 + WK	
					13.0470-7184.2	LD7184	ATE 23587 20,6 + WK Ceramic	
			➡		13.0460-2749.2	602749	TRW 24483 16,9 - WE / - WK + Zub	
					13.0460-2880.2	602880	TRW 23914 17,1 + WE / - WK + Zub	
					13.0470-2749.2	LD2749	TRW 24483 16,9 - WE / - WK + Zub Ceramic	
					13.0470-2880.2	LD2880	TRW 23914 17,1 + WE / - WK + Zub Ceramic	
			➡	2K-B-200 001→; +PR 1ZA,1ZE,1ZF,2E3	13.0460-3858.2	603858	BOS 24563 17,7 - WE / - WK + Zub	
					13.0470-3858.2	LD3858	BOS 24563 17,7 - WE / - WK + Zub Ceramic	
1.4 1.6 1.6 1.9 TDI 1.9 TDI 2.0 EcoFuel 2.0 SDI 2.0 TDI	59 74 75 55 77 80 51 103	05/06→08/10 03/05→05/15 04/04→05/15 09/05→08/10 04/04→08/10 04/06→05/15 03/04→08/10 09/07→08/10	←	+PR 1ZF,1ZM	13.0460-7117.2	607117	VW 23130 19,6 + WK	
					13.0470-7117.2	LD7117	VW 23130 19,6 + WK Ceramic	
			←	+PR 1ZE,1LJ,1ZA	13.0460-7184.2	607184	ATE 23587 20,6 + WK	
					13.0470-7184.2	LD7184	ATE 23587 20,6 + WK Ceramic	
			➡	→ 11/07	13.0460-2749.2	602749	TRW 24483 16,9 - WE / - WK + Zub	
					13.0460-2880.2	602880	TRW 23914 17,1 + WE / - WK + Zub	
					13.0470-2749.2	LD2749	TRW 24483 16,9 - WE / - WK + Zub Ceramic	
					13.0470-2880.2	LD2880	TRW 23914 17,1 + WE / - WK + Zub Ceramic	
			➡	12/07→; +PR 1ZE,1LJ; → 2K-B-200 000	13.0460-2749.2	602749	TRW 24483 16,9 - WE / - WK + Zub	
					13.0460-2880.2	602880	TRW 23914 17,1 + WE / - WK + Zub	
		13.0470-2749.2	LD2749	TRW 24483 16,9 - WE / - WK + Zub Ceramic				
		13.0470-2880.2	LD2880	TRW 23914 17,1 + WE / - WK + Zub Ceramic				
			➡	12/07→; +PR 1ZF,2E2	13.0460-2820.2	602820	TRW 20961 17,2 - WK	
					13.0470-2820.2	LD2820	TRW 20961 17,2 - WK Ceramic	
			➡	2K-B-200 001→; +PR 1ZA,1ZE,1ZF,2E3	13.0460-3858.2	603858	BOS 24563 17,7 - WE / - WK + Zub	
					13.0470-3858.2	LD3858	BOS 24563 17,7 - WE / - WK + Zub Ceramic	
1.6 BiFuel 2.0 TDI 16V ↓	75 103	05/11→05/15 11/10→05/15	←	+PR 1ZF,1ZM	13.0460-7117.2	607117	VW 23130 19,6 + WK	























	kw			 	! #		
VW - CADDY III Kombi (2KB, 2KJ, 2CB, 2CJ) 03/04→05/15							
Bremsbelagsatz, Scheibenbremse							
1.6 BiFuel 2.0 TDI 16V	75	05/11→05/15	←	+PR 1ZF;1ZM		13.0470-7117.2 LD7117	VW 23130 19,6 + WK Ceramic
	103	11/10→05/15	←	+PR 1ZE,1LJ,1ZA		13.0460-7184.2 607184 13.0470-7184.2 LD7184	ATE 23587 20,6 + WK ATE 23587 20,6 + WK Ceramic
			→	+PR 1ZE,1LJ; → 2K-B-200 000		13.0460-2749.2 602749 13.0460-2880.2 602880 13.0470-2749.2 LD2749 13.0470-2880.2 LD2880	TRW 24483 16,9 - WE / - WK + Zub TRW 23914 17,1 + WE / - WK + Zub TRW 24483 16,9 - WE / - WK + Zub Ceramic TRW 23914 17,1 + WE / - WK + Zub Ceramic
			→	+PR 1ZF,2E2		13.0460-2820.2 602820 13.0470-2820.2 LD2820	TRW 20961 17,2 - WK TRW 20961 17,2 - WK Ceramic
			→	2K-B-200 001→; +PR 1ZA,1ZE,1ZF,2E3		13.0460-3858.2 603858 13.0470-3858.2 LD3858	BOS 24563 17,7 - WE / - WK + Zub BOS 24563 17,7 - WE / - WK + Zub Ceramic
2.0 TDI 2.0 TDI 4motion	81	08/10→05/15	←	10/10→; +PR 1ZF,1ZM		13.0460-7117.2 607117 13.0470-7117.2 LD7117	VW 23130 19,6 + WK VW 23130 19,6 + WK Ceramic
	81	08/10→05/15	←	10/10→; +PR 1ZE,1LJ,1ZA		13.0460-7184.2 607184 13.0470-7184.2 LD7184	ATE 23587 20,6 + WK ATE 23587 20,6 + WK Ceramic
			→	10/10→; +PR 1ZE,1LJ; → 2K-B-200 000		13.0460-2749.2 602749 13.0460-2880.2 602880 13.0470-2749.2 LD2749 13.0470-2880.2 LD2880	TRW 24483 16,9 - WE / - WK + Zub TRW 23914 17,1 + WE / - WK + Zub TRW 24483 16,9 - WE / - WK + Zub Ceramic TRW 23914 17,1 + WE / - WK + Zub Ceramic
			→	10/10→; +PR 1ZF,2E2		13.0460-2820.2 602820 13.0470-2820.2 LD2820	TRW 20961 17,2 - WK TRW 20961 17,2 - WK Ceramic
			→	2K-B-200 001→; +PR 1ZA,1ZE,1ZF,2E3		13.0460-3858.2 603858 13.0470-3858.2 LD3858	BOS 24563 17,7 - WE / - WK + Zub BOS 24563 17,7 - WE / - WK + Zub Ceramic
2.0 TDI	125	05/12→05/15	←	+PR 1ZF,1ZM		13.0460-7117.2 607117 13.0470-7117.2 LD7117	VW 23130 19,6 + WK VW 23130 19,6 + WK Ceramic
			←	+PR 1ZE,1LJ,1ZA		13.0460-7184.2 607184 13.0470-7184.2 LD7184	ATE 23587 20,6 + WK ATE 23587 20,6 + WK Ceramic
			→	+PR 1ZF,2E2		13.0460-2820.2 602820 13.0470-2820.2 LD2820	TRW 20961 17,2 - WK TRW 20961 17,2 - WK Ceramic
			→	+PR 1ZA,1ZE,1ZF,2E3		13.0460-3858.2 603858 13.0470-3858.2 LD3858	BOS 24563 17,7 - WE / - WK + Zub BOS 24563 17,7 - WE / - WK + Zub Ceramic
Zubehörsatz, Scheibenbremsbelag							
1.2 TSI	63	09/10→05/15	→	+PR 1ZF,2E2		13.0460-0259.2 610259	
1.2 TSI	77	09/10→05/15	→	+PR 1ZE,1LJ; → 2K-B-200 000		13.0460-0259.2 610259	
1.6 BiFuel	75	05/11→05/15	→				
1.6 TDI	55	08/10→05/15	→				
1.6 TDI	75	08/10→05/15	→				
1.9 TDI 4motion	77	05/08→08/10	→				
2.0 TDI 16V	103	11/10→05/15	→				
2.0 TDI 16V 4motion	103	11/10→05/15	→				
1.4	55	03/04→05/06	→			13.0460-0259.2 610259	
1.4	59	05/06→08/10	→	12/07→; +PR 1ZE,1LJ; → 2K-B-200 000		13.0460-0259.2 610259	
1.6	74	03/05→05/15	→				
1.6	75	04/04→05/15	→	→ 11/07		13.0460-0259.2 610259	
1.9 TDI	55	09/05→08/10	→	12/07→; +PR 1ZF,2E2		13.0460-0259.2 610259	
1.9 TDI	77	04/04→08/10	→				
2.0 EcoFuel	80	04/06→05/15	→				
2.0 SDI	51	03/04→08/10	→				
2.0 TDI	103	09/07→08/10	→				
2.0 TDI	81	08/10→05/15	→	10/10→; +PR 1ZE,1LJ; → 2K-B-200 000		13.0460-0259.2 610259	
2.0 TDI 4motion	81	08/10→05/15	→	10/10→; +PR 1ZF,2E2		13.0460-0259.2 610259	
2.0 TDI	125	05/12→05/15	→	+PR 1ZF,2E2		13.0460-0259.2 610259	
↓							









	kw			 	! #		
VW - CADDY III Kombi (2KB, 2KJ, 2CB, 2CJ) 03/04→05/15							
Bremsscheibe							
1.2 TSI	63	09/10→05/15	←	+PR 1ZF,1ZM		24.0122-0210.1 422210	Ø 280 22 19 V + S
1.2 TSI	77	09/10→05/15				24.0322-0210.1 522210	Ø 280 22 19 V + S PD
1.6 TDI	55	08/10→05/15					
1.6 TDI	75	08/10→05/15	←	+PR 1ZE		24.0125-0145.1 425145	Ø 288 25 22 V + S
1.9 TDI 4motion	77	05/08→08/10				24.0325-0145.1 525145	Ø 288 25 22 V + S PD
2.0 TDI 16V 4motion	103	11/10→05/15	←	+PR 1LJ,1ZA		24.0125-0158.1 425158	Ø 312 25 22 V + S
						24.0325-0158.1 525158	Ø 312 25 22 V + S PD
			→	+PR 1ZF,2E2		24.0110-0277.1 410277	Ø 253 10 8 + S
						24.0310-0277.1 510277	Ø 253 10 8 + S PD
			→	2K-B-200 001→; +PR 1ZA,1ZE,1ZF,2E3		24.0110-0356.1 410356	Ø 272 9,7 8 + S
						24.0310-0356.1 510356	Ø 272 9,7 8 + S PD
			→	+PR 1ZE,1LJ; → 2K-B-200 000		24.0112-0158.1 412158	Ø 256 12 10 + S
						24.0312-0158.1 512158	Ø 256 12 10 PD
1.4	55	03/04→05/06	←	+PR 1ZF,1ZM		24.0122-0210.1 422210	Ø 280 22 19 V + S
						24.0322-0210.1 522210	Ø 280 22 19 V + S PD
			←	+PR 1ZE		24.0125-0145.1 425145	Ø 288 25 22 V + S
						24.0325-0145.1 525145	Ø 288 25 22 V + S PD
			←	+PR 1LJ,1ZA		24.0125-0158.1 425158	Ø 312 25 22 V + S
						24.0325-0158.1 525158	Ø 312 25 22 V + S PD
			→	2K-B-200 001→; +PR 1ZA,1ZE,1ZF,2E3		24.0110-0356.1 410356	Ø 272 9,7 8 + S
						24.0310-0356.1 510356	Ø 272 9,7 8 + S PD
			→			24.0112-0158.1 412158	Ø 256 12 10 + S
						24.0312-0158.1 512158	Ø 256 12 10 PD
1.4	59	05/06→08/10	←	+PR 1ZF,1ZM		24.0122-0210.1 422210	Ø 280 22 19 V + S
1.6	74	03/05→05/15				24.0322-0210.1 522210	Ø 280 22 19 V + S PD
1.6	75	04/04→05/15					
1.9 TDI	55	09/05→08/10	←	+PR 1ZE		24.0125-0145.1 425145	Ø 288 25 22 V + S
1.9 TDI	77	04/04→08/10				24.0325-0145.1 525145	Ø 288 25 22 V + S PD
2.0 EcoFuel	80	04/06→05/15	←	+PR 1LJ,1ZA		24.0125-0158.1 425158	Ø 312 25 22 V + S
2.0 SDI	51	03/04→08/10				24.0325-0158.1 525158	Ø 312 25 22 V + S PD
2.0 TDI	103	09/07→08/10	→	12/07→; +PR 1ZF,2E2		24.0110-0277.1 410277	Ø 253 10 8 + S
						24.0310-0277.1 510277	Ø 253 10 8 + S PD
			→	2K-B-200 001→; +PR 1ZA,1ZE,1ZF,2E3		24.0110-0356.1 410356	Ø 272 9,7 8 + S
						24.0310-0356.1 510356	Ø 272 9,7 8 + S PD
			→	12/07→; +PR 1ZE,1LJ; → 2K-B-200 000		24.0112-0158.1 412158	Ø 256 12 10 + S
						24.0312-0158.1 512158	Ø 256 12 10 PD
			→	→ 11/07		24.0112-0158.1 412158	Ø 256 12 10 + S
						24.0312-0158.1 512158	Ø 256 12 10 PD
1.6 BiFuel	75	05/11→05/15	←	+PR 1ZF,1ZM		24.0122-0210.1 422210	Ø 280 22 19 V + S
2.0 TDI 16V	103	11/10→05/15				24.0322-0210.1 522210	Ø 280 22 19 V + S PD
			←	+PR 1ZE		24.0125-0145.1 425145	Ø 288 25 22 V + S
						24.0325-0145.1 525145	Ø 288 25 22 V + S PD
			←	+PR 1LJ,1ZA		24.0125-0158.1 425158	Ø 312 25 22 V + S
						24.0325-0158.1 525158	Ø 312 25 22 V + S PD
			→	+PR 1ZF,2E2		24.0110-0277.1 410277	Ø 253 10 8 + S
						24.0310-0277.1 510277	Ø 253 10 8 + S PD
			→	2K-B-200 001→; +PR 1ZA,1ZE,1ZF,2E3		24.0110-0356.1 410356	Ø 272 9,7 8 + S
						24.0310-0356.1 510356	Ø 272 9,7 8 + S PD
			→	+PR 1ZE,1LJ; → 2K-B-200 000		24.0112-0158.1 412158	Ø 256 12 10 + S
						24.0312-0158.1 512158	Ø 256 12 10 PD
2.0 TDI	81	08/10→05/15	←	10/10→; +PR 1ZF,1ZM		24.0122-0210.1 422210	Ø 280 22 19 V + S
2.0 TDI 4motion	81	08/10→05/15				24.0322-0210.1 522210	Ø 280 22 19 V + S PD
			←	10/10→; +PR 1ZE		24.0125-0145.1 425145	Ø 288 25 22 V + S
						24.0325-0145.1 525145	Ø 288 25 22 V + S PD
			←	10/10→; +PR 1LJ,1ZA		24.0125-0158.1 425158	Ø 312 25 22 V + S
						24.0325-0158.1 525158	Ø 312 25 22 V + S PD
			→	10/10→; +PR 1ZF,2E2		24.0110-0277.1 410277	Ø 253 10 8 + S
						24.0310-0277.1 510277	Ø 253 10 8 + S PD
			→	2K-B-200 001→; +PR 1ZA,1ZE,1ZF,2E3		24.0110-0356.1 410356	Ø 272 9,7 8 + S
						24.0310-0356.1 510356	Ø 272 9,7 8 + S PD
			→	10/10→; +PR 1ZE,1LJ; → 2K-B-200 000		24.0112-0158.1 412158	Ø 256 12 10 + S
						24.0312-0158.1 512158	Ø 256 12 10 PD
2.0 TDI	125	05/12→05/15	←	+PR 1ZF,1ZM		24.0122-0210.1 422210	Ø 280 22 19 V + S
↓							









	kw					! #		
VW - CADDY III Kombi (2KB, 2KJ, 2CB, 2CJ) 03/04→05/15								
 Bremsscheibe								
2.0 TDI	125	05/12→05/15	←	+PR 1ZF,1ZM		24.0322-0210.1	522210	Ø 280 22 19 V + S PD
			←	+PR 1ZE		24.0125-0145.1	425145	Ø 288 25 22 V + S
						24.0325-0145.1	525145	Ø 288 25 22 V + S PD
			←	+PR 1LJ,1ZA		24.0125-0158.1	425158	Ø 312 25 22 V + S
						24.0325-0158.1	525158	Ø 312 25 22 V + S PD
			→	+PR 1ZF,2E2		24.0110-0277.1	410277	Ø 253 10 8 + S
						24.0310-0277.1	510277	Ø 253 10 8 + S PD
			→	+PR 1ZA,1ZE,1ZF,2E3		24.0110-0356.1	410356	Ø 272 9,7 8 + S
						24.0310-0356.1	510356	Ø 272 9,7 8 + S PD
VW - CADDY IV Kasten (SAA, SAH) 05/15→								
 Bremsbelagsatz, Scheibenbremse								
1.0 TSI	75	11/15→	→			13.0460-2790.2	602790	TRW 25110 17,5 - WE / - WK
1.2 TSI	62	06/15→				13.0470-2790.2	LD2790	TRW 25110 17,5 - WE / - WK
1.4 TGI CNG	81	06/15→						Ceramic
1.4 TSI	92	05/15→						
1.6	81	11/15→						
1.6 TDI	55	05/15→						
1.6 TDI	75	05/15→						
2.0 TDI	55	05/15→						
2.0 TDI	75	05/15→						
2.0 TDI	81	09/15→						
2.0 TDI	103	05/15→						
2.0 TDI	110	05/15→						
2.0 TDI 4motion	55	11/15→						
2.0 TDI 4motion	81	05/15→						
2.0 TDI 4motion	90	05/15→						
2.0 TDI 4motion	103	05/15→						
2.0 TDI 4motion	110	11/15→						
 Bremsscheibe								
1.0 TSI	75	11/15→	←	+PR 1ZE		24.0125-0145.1	425145	Ø 288 25 22 V + S
1.2 TSI	62	06/15→				24.0325-0145.1	525145	Ø 288 25 22 V + S PD
1.4 TGI CNG	81	06/15→						
1.4 TSI	92	05/15→	←	+PR 1ZA		24.0125-0158.1	425158	Ø 312 25 22 V + S
1.6	81	11/15→				24.0325-0158.1	525158	Ø 312 25 22 V + S PD
1.6 TDI	55	05/15→						
1.6 TDI	75	05/15→	→			24.0110-0356.1	410356	Ø 272 9,7 8 + S
2.0 TDI	55	05/15→				24.0310-0356.1	510356	Ø 272 9,7 8 + S PD
2.0 TDI	75	05/15→						
2.0 TDI	81	09/15→						
2.0 TDI	103	05/15→						
2.0 TDI	110	05/15→						
2.0 TDI 4motion	55	11/15→						
2.0 TDI 4motion	81	05/15→						
2.0 TDI 4motion	90	05/15→						
2.0 TDI 4motion	103	05/15→						
2.0 TDI 4motion	110	11/15→						
VW - CADDY IV Kombi (SAB, SAJ) 05/15→								
 Bremsbelagsatz, Scheibenbremse								
1.0 TSI	75	11/15→	→			13.0460-2790.2	602790	TRW 25110 17,5 - WE / - WK
1.2 TSI	62	06/15→				13.0470-2790.2	LD2790	TRW 25110 17,5 - WE / - WK
1.4 TGI CNG	81	06/15→						Ceramic
1.4 TSI	92	05/15→						
1.6	81	11/15→						
1.6 TDI	55	05/15→						
1.6 TDI	75	05/15→						
2.0 TDI	55	05/15→						
2.0 TDI	75	05/15→						
2.0 TDI	81	09/15→						
2.0 TDI	103	05/15→						
2.0 TDI	110	05/15→						
2.0 TDI 4motion	81	05/15→						
2.0 TDI 4motion	90	05/15→						
2.0 TDI 4motion	103	05/15→						
2.0 TDI 4motion	110	11/15→						
 Bremsscheibe								
1.0 TSI	75	11/15→	←	+PR 1ZE		24.0125-0145.1	425145	Ø 288 25 22 V + S
1.2 TSI	62	06/15→				24.0325-0145.1	525145	Ø 288 25 22 V + S PD
1.4 TGI CNG	81	06/15→						
1.4 TSI	92	05/15→	←	+PR 1ZA		24.0125-0158.1	425158	Ø 312 25 22 V + S
1.6	81	11/15→				24.0325-0158.1	525158	Ø 312 25 22 V + S PD
1.6 TDI	55	05/15→						
1.6 TDI	75	05/15→	→			24.0110-0356.1	410356	Ø 272 9,7 8 + S
2.0 TDI	55	05/15→				24.0310-0356.1	510356	Ø 272 9,7 8 + S PD







	kw			 	! #		
VW - CADDY IV Kombi (SAB, SAJ) 05/15→							
 Bremsscheibe							
2.0 TDI	75	05/15→	←	+PR 1ZE		24.0125-0145.1 425145	Ø 288 25 22 V + S
2.0 TDI	81	09/15→					24.0325-0145.1 525145
2.0 TDI	103	05/15→	←	+PR 1ZA		24.0125-0158.1 425158	Ø 312 25 22 V + S
2.0 TDI 4motion	81	05/15→					24.0325-0158.1 525158
2.0 TDI 4motion	90	05/15→	→			24.0110-0356.1 410356	Ø 272 9,7 8 + S
2.0 TDI 4motion	103	05/15→					24.0310-0356.1 510356
2.0 TDI 4motion	110	11/15→					
VW - CADDY ALLTRACK Kasten (SAA) 05/15→							
 Bremsbelagsatz, Scheibenbremse							
1.0 TSI	75	11/15→	→			13.0460-2790.2 602790	TRW 25110 17,5 - WE / - WK
1.2 TSI	62	06/15→					13.0470-2790.2 LD2790
1.4 TGI CNG	81	06/15→					
1.4 TSI	92	05/15→					
2.0 TDI	55	05/15→					
2.0 TDI	75	05/15→					
2.0 TDI	110	05/15→					
2.0 TDI 4motion	90	05/15→					
2.0 TDI 4motion	110	11/15→					
 Bremsscheibe							
1.0 TSI	75	11/15→	←	+PR 1ZE		24.0125-0145.1 425145	Ø 288 25 22 V + S
1.2 TSI	62	06/15→					24.0325-0145.1 525145
1.4 TGI CNG	81	06/15→	←	+PR 1ZA		24.0125-0158.1 425158	Ø 312 25 22 V + S
1.4 TSI	92	05/15→					24.0325-0158.1 525158
2.0 TDI	55	05/15→	→			24.0110-0356.1 410356	Ø 272 9,7 8 + S
2.0 TDI	75	05/15→					24.0310-0356.1 510356
2.0 TDI	110	05/15→					
2.0 TDI 4motion	90	05/15→					
2.0 TDI 4motion	110	11/15→					
VW - CADDY ALLTRACK Kombi (SAB) 05/15→							
 Bremsbelagsatz, Scheibenbremse							
1.0 TSI	75	11/15→	→			13.0460-2790.2 602790	TRW 25110 17,5 - WE / - WK
1.2 TSI	62	06/15→					13.0470-2790.2 LD2790
1.4 TGI CNG	81	06/15→					
1.4 TSI	92	05/15→					
2.0 TDI	55	05/15→					
2.0 TDI	75	05/15→					
2.0 TDI	110	05/15→					
2.0 TDI 4motion	90	05/15→					
2.0 TDI 4motion	110	11/15→					
 Bremsscheibe							
1.0 TSI	75	11/15→	←	+PR 1ZE		24.0125-0145.1 425145	Ø 288 25 22 V + S
1.2 TSI	62	06/15→					24.0325-0145.1 525145
1.4 TGI CNG	81	06/15→	←	+PR 1ZA		24.0125-0158.1 425158	Ø 312 25 22 V + S
1.4 TSI	92	05/15→					24.0325-0158.1 525158
2.0 TDI	55	05/15→	→			24.0110-0356.1 410356	Ø 272 9,7 8 + S
2.0 TDI	75	05/15→					24.0310-0356.1 510356
2.0 TDI	110	05/15→					
2.0 TDI 4motion	90	05/15→					
2.0 TDI 4motion	110	11/15→					
VW - CC (358) 11/11→12/16							
 Bremsbelagsatz, Scheibenbremse							
1.4 TSI	110	05/15→12/16	←	+PR 1LA, 1LB		13.0460-2764.2 602764	TRW 24738 20,0 + WK
1.4 TSI	118	11/11→12/16					13.0470-2764.2 LD2764
1.4 TSI MultiFuel	118	11/11→12/16	←	+PR 1ZM, 1ZG		13.0460-7184.2 607184	ATE 23587 20,6 + WK
1.8 TSI	112	11/11→12/16					13.0470-7184.2 LD7184
1.8 TSI	118	11/11→12/16	→	+PR 1KW		13.0460-2749.2 602749	TRW 24483 16,9 - WE / - WK + Zub
2.0 TDI	100	11/11→12/16					13.0460-2880.2 602880
2.0 TDI	103	11/11→12/16	→			13.0470-2749.2 LD2749	TRW 24483 16,9 - WE / - WK + Zub Ceramic
2.0 TDI	110	05/15→12/16					13.0470-2880.2 LD2880
2.0 TDI	125	11/11→12/16	→			13.0470-2880.2 LD2880	TRW 23914 17,1 + WE / - WK + Zub Ceramic
2.0 TDI	130	12/12→12/16					13.0470-2621.2 LD2621
2.0 TDI	135	05/15→12/16	→	+PR 2EA		13.0470-2887.2 LD2887	TRW 23914 17,1 + WE / - WK + Zub Ceramic
2.0 TDI 4motion	103	11/11→12/16					13.0470-2887.2 LD2887
2.0 TDI 4motion	125	11/11→01/13	→			13.0470-2887.2 LD2887	TRW 23914 17,1 + WE / - WK + Zub Ceramic
2.0 TDI 4motion	130	12/12→12/16					13.0470-2887.2 LD2887
2.0 TSI	155	11/11→12/16	→	+PR 2EA		13.0470-2887.2 LD2887	TRW 23914 17,1 + WE / - WK + Zub Ceramic
3.6 FSI 4motion	206	11/11→					13.0470-2887.2 LD2887
3.6 FSI 4motion	220	11/11→12/16					
↓							

	kW			 	! #		
VW - CC (358) 11/11→12/16							
 Bremsscheibe							
1.4 TSI	110	05/15→12/16	←	+PR 1ZM,1ZG		24.0125-0158.1 425158	Ø 312 25 22 V + S
1.4 TSI	118	11/11→12/16				24.0325-0158.1 525158	Ø 312 25 22 V + S PD
1.4 TSI MultiFuel	118	11/11→12/16					
1.8 TSI	112	11/11→12/16	←	+PR 1LA,1LB		24.0130-0225.1 430225	Ø 340 30 27 V + S
1.8 TSI	118	11/11→12/16					
2.0 TDI	100	11/11→12/16	→	+PR 1KW		24.0112-0169.1 412169	Ø 282 12 10 + S
2.0 TDI	103	11/11→12/16				24.0312-0169.1 512169	Ø 282 12 10 + S PD
2.0 TDI	110	05/15→12/16	→	+PR 2EA		24.0122-0219.1 422219	Ø 310 22 20 V
2.0 TDI	125	11/11→12/16					
2.0 TDI	130	12/12→12/16					
2.0 TDI	135	05/15→12/16					
2.0 TDI 4motion	103	11/11→12/16					
2.0 TDI 4motion	125	11/11→01/13					
2.0 TDI 4motion	130	12/12→12/16					
2.0 TSI	155	11/11→12/16					
3.6 FSI 4motion	206	11/11→					
3.6 FSI 4motion	220	11/11→12/16					
VW - CORRADO (53i) 08/87→12/95							
 Bremsbelagsatz, Scheibenbremse							
2.0 i	85	04/93→12/95	←	→ 07/95		13.0460-2957.2 602957	TRW 20168 16,0 - WK
2.0 i 16V	100	08/91→12/95	→	→ 07/95		13.0460-2937.2 602937	TRW 20961 15,2 - WK + Zub
2.9 VR6	140	08/91→12/95	←	→ 07/95		13.0460-2958.2 602958	TRW 20168 19,3 - WK
			→	→ 50-P-009000		13.0460-2937.2 602937	TRW 20961 15,2 - WK + Zub
			→	50-P-009001→; → 07/95		13.0460-2984.2 602984	TRW 20961 17,2 - WK + Zub
Zubehörsatz, Scheibenbremsbelag							
2.0 i	85	04/93→12/95	→	→ 07/95		13.0460-0419.2 610419	TRW
2.0 i 16V	100	08/91→12/95					
2.9 VR6	140	08/91→12/95	→	50-P-009001→; → 07/95		13.0460-0072.2 610072	TRW
			→	→ 50-P-009000		13.0460-0419.2 610419	TRW
 Bremsscheibe							
2.0 i	85	04/93→12/95	←	→ 07/95		24.0120-0128.1 420128	Ø 256 20 18 V + S
2.0 i 16V	100	08/91→12/95	→	→ 07/95		24.0320-0128.1 520128	Ø 256 20 18 V + S PD
			→	→ 07/95		24.0110-0111.1 410111	Ø 226 10 8 - ABS Ring / - RLG
						24.0110-0275.2 410275	Ø 226 10 8 + ABS Ring / - RLG
2.9 VR6	140	08/91→12/95	←	→ 07/95		24.0122-0100.1 422100	Ø 280 22 20 V
			→	→ 07/95		24.0322-0100.1 522100	Ø 280 22 20 V PD
			←	→ 07/95		24.0110-0203.1 410203	Ø 226 10 8 - ABS Ring
						24.0110-0276.2 410276	Ø 226 10 8 + ABS Ring
VW - CRAFTER 30-35 Bus (2E_) 04/06→12/16							
 Bremsbelagsatz, Scheibenbremse							
2.0 TDI	80	05/11→12/16	←	07/11→; +PR 0WC, 0WL		13.0460-4826.2 604826	BRE 29192 20,7 + WE / - WK + Zub
2.0 TDI	100	05/11→12/16				13.0460-4877.2 604877	BRE 29192 20,3 + WE / - WK + Zub
			←	07/11→; +PR 0WF		13.0460-4827.2 604827	BRE 29200 21,0 + WE / - WK + Zub
			→	07/11→; +PR 0WC, 0WL		13.0460-3832.2 603832	BOS 29190 20,2 + WE / - WK
			→	07/11→; +PR 0WF		13.0460-3842.2 603842	BOS 29217 20,5 + WE / - WK
2.0 TDI	84	11/13→12/16	←	+PR 0WC, 0WL		13.0460-4826.2 604826	BRE 29192 20,7 + WE / - WK + Zub
2.0 TDI	105	10/11→12/16				13.0460-4877.2 604877	BRE 29192 20,3 + WE / - WK + Zub
2.0 TDI	120	07/11→12/16	←	+PR 0WF		13.0460-4827.2 604827	BRE 29200 21,0 + WE / - WK + Zub
			→	+PR 0WC, 0WL		13.0460-3832.2 603832	BOS 29190 20,2 + WE / - WK
			→	+PR 0WF		13.0460-3842.2 603842	BOS 29217 20,5 + WE / - WK
2.0 TDI 4motion	120	11/11→12/16	←	+PR 0WC,0WL		13.0460-4826.2 604826	BRE 29192 20,7 + WE / - WK + Zub
						13.0460-4877.2 604877	BRE 29192 20,3 + WE / - WK + Zub
			←	+PR 0WF		13.0460-4827.2 604827	BRE 29200 21,0 + WE / - WK + Zub
			→	+PR 0WC,0WL		13.0460-3832.2 603832	BOS 29190 20,2 + WE / - WK











	kw			 	! #		
VW - CRAFTER 30-35 Bus (2E_) 04/06→12/16							
 Bremsbelagsatz, Scheibenbremse							
2.0 TDI 4motion	120	11/11→12/16	➡	+PR 0WF		13.0460-3842.2 603842	BOS 29217 20,5 + WE / - WK
2.5 TDI	65	04/06→07/11	⬅	+PR 0WC, 0WL		13.0460-4826.2 604826	BRE 29192 20,7 + WE / - WK + Zub
2.5 TDI	80	04/06→05/13					
2.5 TDI	100	04/06→05/13				13.0460-4877.2 604877	BRE 29192 20,3 + WE / - WK + Zub
2.5 TDI	120	04/06→07/11	⬅	→ 06/11; +PR 0WF		13.0460-4827.2 604827	BRE 29200 21,0 + WE / - WK + Zub
			⬅	07/11→; +PR 0WF		13.0460-4827.2 604827	BRE 29200 21,0 + WE / - WK + Zub
			➡	+PR 0WC, 0WL		13.0460-3832.2 603832	BOS 29190 20,2 + WE / - WK
			➡	+PR 0WF		13.0460-3842.2 603842	BOS 29217 20,5 + WE / - WK
Warnkontakt, Bremsbelagverschleiß							
2.0 TDI	80	05/11→12/16	⬅	07/11→; +PR 0WF	2	24.8190-0424.2 620424	L= 103,2
2.0 TDI	100	05/11→12/16	⬅	07/11→; +PR 0WC, 0WL	2	24.8190-0424.2 620424	L= 103,2
			➡	07/11→; +PR 0WF	2	24.8190-0005.2 620005	L= 84
			➡	07/11→; +PR 0WC, 0WL	2	24.8190-0418.2 620418	L= 95
2.0 TDI	84	11/13→12/16	⬅	+PR 0WF	2	24.8190-0424.2 620424	L= 103,2
2.0 TDI	105	10/11→12/16	⬅	+PR 0WC, 0WL	2	24.8190-0424.2 620424	L= 103,2
2.0 TDI	120	07/11→12/16	➡	+PR 0WF	2	24.8190-0005.2 620005	L= 84
			➡	+PR 0WC, 0WL	2	24.8190-0418.2 620418	L= 95
2.0 TDI 4motion	120	11/11→12/16	⬅	+PR 0WC,0WL	2	24.8190-0005.2 620005	L= 84
			⬅	+PR 0WF	2	24.8190-0005.2 620005	L= 84
			➡	+PR 0WF	2	24.8190-0005.2 620005	L= 84
			➡	+PR 0WC,0WL	2	24.8190-0418.2 620418	L= 95
2.5 TDI	65	04/06→07/11	⬅	→ 06/11; +PR 0WF	2	24.8190-0424.2 620424	L= 103,2
2.5 TDI	80	04/06→05/13	⬅	07/11→; +PR 0WF	2	24.8190-0424.2 620424	L= 103,2
2.5 TDI	100	04/06→05/13	⬅	+PR 0WC, 0WL	2	24.8190-0424.2 620424	L= 103,2
2.5 TDI	120	04/06→07/11	➡	+PR 0WF	2	24.8190-0005.2 620005	L= 84
			➡	+PR 0WC, 0WL	2	24.8190-0418.2 620418	L= 95
 Bremsscheibe							
2.0 TDI	80	05/11→12/16	⬅	07/11→; +PR 0WC, 0WF, 0WL		24.0128-0203.1 428203	Ø 300 28 25 V + S
2.0 TDI	100	05/11→12/16	➡	07/11→; +PR 0WC, 0WL		24.0116-0121.1 416121	Ø 298 16 14 + S
			➡	07/11→; +PR 0WF		24.0128-0202.1 428202	Ø 303 28 25 V
2.0 TDI	84	11/13→12/16	⬅	+PR 0WC, 0WF, 0WL		24.0128-0203.1 428203	Ø 300 28 25 V + S
2.0 TDI	105	10/11→12/16	➡	+PR 0WC, 0WL		24.0116-0121.1 416121	Ø 298 16 14 + S
2.5 TDI	65	04/06→07/11	➡	+PR 0WF		24.0128-0202.1 428202	Ø 303 28 25 V
2.5 TDI	80	04/06→05/13	➡	+PR 0WF		24.0128-0202.1 428202	Ø 303 28 25 V
2.5 TDI	100	04/06→05/13					
2.5 TDI	120	04/06→07/11					
2.0 TDI	120	07/11→12/16	⬅	+PR 0WC,0WF,0WL		24.0128-0203.1 428203	Ø 300 28 25 V + S
2.0 TDI 4motion	120	11/11→12/16	➡	+PR 0WC, 0WL		24.0116-0121.1 416121	Ø 298 16 14 + S
			➡	+PR 0WF		24.0128-0202.1 428202	Ø 303 28 25 V
VW - CRAFTER 30-50 Kasten (2E_) 04/06→12/16							
 Bremsbelagsatz, Scheibenbremse							
2.0 TDI	80	05/11→12/16	⬅	07/11→; +PR 0WC, 0WL		13.0460-4826.2 604826	BRE 29192 20,7 + WE / - WK + Zub
2.0 TDI	100	05/11→12/16				13.0460-4877.2 604877	BRE 29192 20,3 + WE / - WK + Zub
			⬅	07/11→; +PR 0WF		13.0460-4827.2 604827	BRE 29200 21,0 + WE / - WK + Zub
			➡	07/11→; +PR 0WC, 0WL		13.0460-3832.2 603832	BOS 29190 20,2 + WE / - WK
			➡	07/11→; +PR 0WF		13.0460-3842.2 603842	BOS 29217 20,5 + WE / - WK
2.0 TDI	84	11/13→12/16	⬅	+PR 0WC, 0WL		13.0460-4826.2 604826	BRE 29192 20,7 + WE / - WK + Zub
2.0 TDI	105	10/11→12/16				13.0460-4877.2 604877	BRE 29192 20,3 + WE / - WK + Zub
2.0 TDI	120	07/11→12/16	⬅	+PR 0WF		13.0460-4827.2 604827	BRE 29200 21,0 + WE / - WK + Zub

	kw			 	! #		
VW - CRAFTER 30-50 Kasten (2E_) 04/06→12/16							
 Bremsbelagsatz, Scheibenbremse							
2.0 TDI	84	11/13→12/16	➡	+PR 0WC, 0WL		13.0460-3832.2 603832	BOS 29190 20,2 + WE / - WK
2.0 TDI	105	10/11→12/16	➡	+PR 0WF		13.0460-3842.2 603842	BOS 29217 20,5 + WE / - WK
2.0 TDI	120	07/11→12/16	➡	+PR 0WF			
2.0 TDI	103	11/15→12/16	⬅	+PR 0WC,0WL		13.0460-4826.2 604826	BRE 29192 20,7 + WE / - WK + Zub
2.0 TDI 4motion	120	11/11→12/16	⬅	+PR 0WC,0WL		13.0460-4877.2 604877	BRE 29192 20,3 + WE / - WK + Zub
			⬅	+PR 0WF		13.0460-4827.2 604827	BRE 29200 21,0 + WE / - WK + Zub
			➡	+PR 0WC,0WL		13.0460-3832.2 603832	BOS 29190 20,2 + WE / - WK
			➡	+PR 0WF		13.0460-3842.2 603842	BOS 29217 20,5 + WE / - WK
2.5 TDI	65	04/06→07/11	⬅	+PR 0WC, 0WL		13.0460-4826.2 604826	BRE 29192 20,7 + WE / - WK + Zub
2.5 TDI	80	04/06→05/13					
2.5 TDI	100	04/06→05/13				13.0460-4877.2 604877	BRE 29192 20,3 + WE / - WK + Zub
2.5 TDI	120	04/06→07/11	⬅	07/11→; +PR 0WF		13.0460-4827.2 604827	BRE 29200 21,0 + WE / - WK + Zub
			⬅	→ 06/11; +PR 0WF		13.0460-4827.2 604827	BRE 29200 21,0 + WE / - WK + Zub
			➡	+PR 0WC, 0WL		13.0460-3832.2 603832	BOS 29190 20,2 + WE / - WK
			➡	+PR 0WF		13.0460-3842.2 603842	BOS 29217 20,5 + WE / - WK
Warnkontakt, Bremsbelagsverschleiß							
2.0 TDI	80	05/11→12/16	⬅	07/11→; +PR 0WF	2	24.8190-0424.2 620424	L= 103,2
2.0 TDI	100	05/11→12/16	⬅	07/11→; +PR 0WC, 0WL	2	24.8190-0424.2 620424	L= 103,2
			➡	07/11→; +PR 0WF	2	24.8190-0005.2 620005	L= 84
			➡	07/11→; +PR 0WC, 0WL	2	24.8190-0418.2 620418	L= 95
2.0 TDI	84	11/13→12/16	⬅	+PR 0WF	2	24.8190-0424.2 620424	L= 103,2
2.0 TDI	105	10/11→12/16	⬅	+PR 0WC, 0WL	2	24.8190-0424.2 620424	L= 103,2
2.0 TDI	120	07/11→12/16	➡	+PR 0WF	2	24.8190-0005.2 620005	L= 84
			➡	+PR 0WC, 0WL	2	24.8190-0418.2 620418	L= 95
2.0 TDI	103	11/15→12/16	⬅	+PR 0WF	2	24.8190-0424.2 620424	L= 103,2
			⬅	+PR 0WC,0WL	2	24.8190-0424.2 620424	L= 103,2
			➡	+PR 0WF	2	24.8190-0005.2 620005	L= 84
			➡	+PR 0WC,0WL	2	24.8190-0418.2 620418	L= 95
2.0 TDI 4motion	120	11/11→12/16	⬅	+PR 0WC,0WL	2	24.8190-0005.2 620005	L= 84
			⬅	+PR 0WF	2	24.8190-0005.2 620005	L= 84
			➡	+PR 0WF	2	24.8190-0005.2 620005	L= 84
			➡	+PR 0WC,0WL	2	24.8190-0418.2 620418	L= 95
2.5 TDI	65	04/06→07/11	⬅	07/11→; +PR 0WF	2	24.8190-0424.2 620424	L= 103,2
2.5 TDI	80	04/06→05/13					
2.5 TDI	100	04/06→05/13	⬅	→ 06/11; +PR 0WF	2	24.8190-0424.2 620424	L= 103,2
2.5 TDI	120	04/06→07/11	⬅	+PR 0WC, 0WL	2	24.8190-0424.2 620424	L= 103,2
			➡	+PR 0WF	2	24.8190-0005.2 620005	L= 84
			➡	+PR 0WC, 0WL	2	24.8190-0418.2 620418	L= 95
 Bremsscheibe							
2.0 TDI	80	05/11→12/16	⬅	07/11→; +PR 0WC, 0WF, 0WL		24.0128-0203.1 428203	Ø 300 28 25 V + S
2.0 TDI	100	05/11→12/16	➡	07/11→; +PR 0WC, 0WL		24.0116-0121.1 416121	Ø 298 16 14 + S
			➡	07/11→; +PR 0WF		24.0128-0202.1 428202	Ø 303 28 25 V
2.0 TDI	84	11/13→12/16	⬅	+PR 0WC, 0WF, 0WL		24.0128-0203.1 428203	Ø 300 28 25 V + S
2.5 TDI	65	04/06→07/11	➡	+PR 0WC, 0WL		24.0116-0121.1 416121	Ø 298 16 14 + S
2.5 TDI	80	04/06→05/13	➡	+PR 0WF			
2.5 TDI	100	04/06→05/13	➡	+PR 0WF		24.0128-0202.1 428202	Ø 303 28 25 V
2.5 TDI	120	04/06→07/11	⬅	+PR 0WC, 0WF, 0WL		24.0128-0203.1 428203	Ø 300 28 25 V + S
2.0 TDI	103	11/15→12/16	➡	+PR 0WC,0WL		24.0116-0121.1 416121	Ø 298 16 14 + S
			➡	+PR 0WF		24.0128-0202.1 428202	Ø 303 28 25 V
2.0 TDI	105	10/11→12/16	⬅	+PR 0WC,0WF,0WL		24.0128-0203.1 428203	Ø 300 28 25 V + S
2.0 TDI	120	07/11→12/16	➡	+PR 0WC, 0WL		24.0116-0121.1 416121	Ø 298 16 14 + S
2.0 TDI 4motion	120	11/11→12/16	➡	+PR 0WF		24.0128-0202.1 428202	Ø 303 28 25 V









	kw			 	! #		
VW - CRAFTER 30-50 Pritsche/Fahrgestell (2F_) 04/06→12/16							
 Bremsbelagsatz, Scheibenbremse							
2.0 TDI 2.0 TDI	80 100	05/11→12/16 05/11→12/16	←	07/11→; +PR 0WC, 0WL		13.0460-4826.2 604826 13.0460-4877.2 604877	BRE 29192 20,7 + WE / - WK + Zub BRE 29192 20,3 + WE / - WK + Zub
			←	07/11→; +PR 0WF		13.0460-4827.2 604827	BRE 29200 21,0 + WE / - WK + Zub
			→	07/11→; +PR 0WC, 0WL		13.0460-3832.2 603832	BOS 29190 20,2 + WE / - WK
			→	07/11→; +PR 0WF		13.0460-3842.2 603842	BOS 29217 20,5 + WE / - WK
2.0 TDI 2.0 TDI 2.0 TDI	84 105 120	11/13→12/16 10/11→12/16 07/11→12/16	←	+PR 0WC, 0WL		13.0460-4826.2 604826 13.0460-4877.2 604877	BRE 29192 20,7 + WE / - WK + Zub BRE 29192 20,3 + WE / - WK + Zub
			←	+PR 0WF		13.0460-4827.2 604827	BRE 29200 21,0 + WE / - WK + Zub
			→	+PR 0WC, 0WL		13.0460-3832.2 603832	BOS 29190 20,2 + WE / - WK
			→	+PR 0WF		13.0460-3842.2 603842	BOS 29217 20,5 + WE / - WK
2.0 TDI 2.0 TDI 4motion	103 120	11/15→12/16 11/11→12/16	←	+PR 0WC,0WL		13.0460-4826.2 604826 13.0460-4877.2 604877	BRE 29192 20,7 + WE / - WK + Zub BRE 29192 20,3 + WE / - WK + Zub
			←	+PR 0WF		13.0460-4827.2 604827	BRE 29200 21,0 + WE / - WK + Zub
			→	+PR 0WC,0WL		13.0460-3832.2 603832	BOS 29190 20,2 + WE / - WK
			→	+PR 0WF		13.0460-3842.2 603842	BOS 29217 20,5 + WE / - WK
2.5 TDI 2.5 TDI 2.5 TDI 2.5 TDI	65 80 100 120	04/06→07/11 04/06→05/13 04/06→05/13 04/06→07/11	←	+PR 0WC, 0WL		13.0460-4826.2 604826 13.0460-4877.2 604877	BRE 29192 20,7 + WE / - WK + Zub BRE 29192 20,3 + WE / - WK + Zub
			←	→ 06/11; +PR 0WF		13.0460-4827.2 604827	BRE 29200 21,0 + WE / - WK + Zub
			←	07/11→; +PR 0WF		13.0460-4827.2 604827	BRE 29200 21,0 + WE / - WK + Zub
			→	+PR 0WC, 0WL		13.0460-3832.2 603832	BOS 29190 20,2 + WE / - WK
			→	+PR 0WF		13.0460-3842.2 603842	BOS 29217 20,5 + WE / - WK
Warnkontakt, Bremsbelagverschleiß							
2.0 TDI 2.0 TDI	80 100	05/11→12/16 05/11→12/16	←	07/11→; +PR 0WF	2	24.8190-0424.2 620424	L= 103,2
			←	07/11→; +PR 0WC, 0WL	2	24.8190-0424.2 620424	L= 103,2
			→	07/11→; +PR 0WF	2	24.8190-0005.2 620005	L= 84
			→	07/11→; +PR 0WC, 0WL	2	24.8190-0418.2 620418	L= 95
2.0 TDI 2.0 TDI 2.0 TDI	84 105 120	11/13→12/16 10/11→12/16 07/11→12/16	←	+PR 0WF	2	24.8190-0424.2 620424	L= 103,2
			←	+PR 0WC, 0WL	2	24.8190-0424.2 620424	L= 103,2
			→	+PR 0WF	2	24.8190-0005.2 620005	L= 84
			→	+PR 0WC, 0WL	2	24.8190-0418.2 620418	L= 95
2.0 TDI	103	11/15→12/16	←	+PR 0WF	2	24.8190-0424.2 620424	L= 103,2
			←	+PR 0WC,0WL	2	24.8190-0424.2 620424	L= 103,2
			→	+PR 0WF	2	24.8190-0005.2 620005	L= 84
			→	+PR 0WC,0WL	2	24.8190-0418.2 620418	L= 95
2.0 TDI 4motion	120	11/11→12/16	←	+PR 0WC,0WL	2	24.8190-0005.2 620005	L= 84
			←	+PR 0WF	2	24.8190-0005.2 620005	L= 84
			→	+PR 0WF	2	24.8190-0005.2 620005	L= 84
			→	+PR 0WC,0WL	2	24.8190-0418.2 620418	L= 95
2.5 TDI 2.5 TDI 2.5 TDI 2.5 TDI	65 80 100 120	04/06→07/11 04/06→05/13 04/06→05/13 04/06→07/11	←	07/11→; +PR 0WF	2	24.8190-0424.2 620424	L= 103,2
			←	→ 06/11; +PR 0WF	2	24.8190-0424.2 620424	L= 103,2
			←	+PR 0WC, 0WL	2	24.8190-0424.2 620424	L= 103,2
			→	+PR 0WF	2	24.8190-0005.2 620005	L= 84
			→	+PR 0WC, 0WL	2	24.8190-0418.2 620418	L= 95
 Bremsscheibe							
2.0 TDI 2.0 TDI ↓	80 100	05/11→12/16 05/11→12/16	←	07/11→; +PR 0WC, 0WF, 0WL		24.0128-0203.1 428203	Ø 300 28 25 V + S









	kw			 	! #		
VW - CRAFTER 30-50 Pritsche/Fahrgestell (2F_) 04/06→12/16							
Bremsscheibe							
2.0 TDI	80	05/11→12/16	➡	07/11→; +PR 0WC, 0WL		24.0116-0121.1 416121	Ø 298 16 14 + S
2.0 TDI	100	05/11→12/16	➡	07/11→; +PR 0WF		24.0128-0202.1 428202	Ø 303 28 25 V
2.0 TDI	84	11/13→12/16	⬅	+PR 0WC, 0WF, 0WL		24.0128-0203.1 428203	Ø 300 28 25 V + S
2.0 TDI	105	10/11→12/16	➡	+PR 0WC, 0WL		24.0116-0121.1 416121	Ø 298 16 14 + S
2.5 TDI	65	04/06→07/11	➡	+PR 0WF		24.0128-0202.1 428202	Ø 303 28 25 V
2.5 TDI	80	04/06→05/13	➡	+PR 0WC, 0WL		24.0116-0121.1 416121	Ø 298 16 14 + S
2.5 TDI	100	04/06→05/13	➡	+PR 0WF		24.0128-0202.1 428202	Ø 303 28 25 V
2.5 TDI	120	04/06→07/11	➡	+PR 0WC, 0WL		24.0116-0121.1 416121	Ø 298 16 14 + S
2.0 TDI	103	11/15→12/16	⬅	+PR 0WC, 0WF, 0WL		24.0128-0203.1 428203	Ø 300 28 25 V + S
			➡	+PR 0WC, 0WL		24.0116-0121.1 416121	Ø 298 16 14 + S
			➡	+PR 0WF		24.0128-0202.1 428202	Ø 303 28 25 V
2.0 TDI	120	07/11→12/16	⬅	+PR 0WC, 0WF, 0WL		24.0128-0203.1 428203	Ø 300 28 25 V + S
2.0 TDI 4motion	120	11/11→12/16	➡	+PR 0WC, 0WL		24.0116-0121.1 416121	Ø 298 16 14 + S
			➡	+PR 0WF		24.0128-0202.1 428202	Ø 303 28 25 V
VW - EOS (1F7, 1F8) 03/06→08/15							
Bremsbelagsatz, Scheibenbremse							
1.4 TSI	90	11/07→08/15	⬅	+PR 1LJ,1ZA,1ZD,1ZE		13.0460-7184.2 607184	ATE 23587 20,6 + WK
1.4 TSI	118	05/08→08/15	⬅			13.0470-7184.2 LD7184	ATE 23587 20,6 + WK Ceramic
1.6 FSI	85	06/06→05/08	⬅	+PR 1LK		13.0460-7200.2 607200	ATE 23801 20,3 + WK
2.0 TDI	100	11/10→08/15	⬅			13.0470-7200.2 LD7200	ATE 23801 20,3 + WK Ceramic
2.0 TDI	103	06/06→05/08	➡	+PR 2EA		13.0460-2749.2 602749	TRW 24483 16,9 - WE / - WK + Zub
2.0 TDI 16V	103	05/08→08/15	➡			13.0460-2880.2 602880	TRW 23914 17,1 + WE / - WK + Zub
2.0 TSI	155	11/09→08/15	➡			13.0470-2749.2 LD2749	TRW 24483 16,9 - WE / - WK + Zub Ceramic
3.2 V6	184	06/06→05/09	➡			13.0470-2880.2 LD2880	TRW 23914 17,1 + WE / - WK + Zub Ceramic
3.6 V6	191	05/09→11/10	➡	+PR 1KJ,1KZ		13.0460-2749.2 602749	TRW 24483 16,9 - WE / - WK + Zub
			➡			13.0460-2880.2 602880	TRW 23914 17,1 + WE / - WK + Zub
			➡			13.0470-2749.2 LD2749	TRW 24483 16,9 - WE / - WK + Zub Ceramic
			➡			13.0470-2880.2 LD2880	TRW 23914 17,1 + WE / - WK + Zub Ceramic
			➡	+PR 1KD		13.0460-2820.2 602820	TRW 20961 17,2 - WK
			➡			13.0470-2820.2 LD2820	TRW 20961 17,2 - WK Ceramic
			➡	+PR 1KS		13.0460-3858.2 603858	BOS 24563 17,7 - WE / - WK + Zub
			➡			13.0470-3858.2 LD3858	BOS 24563 17,7 - WE / - WK + Zub Ceramic
2.0 FSI	110	03/06→05/08	⬅	05/06→; +PR 1LJ,1ZA,1ZD,1ZE		13.0460-7184.2 607184	ATE 23587 20,6 + WK
2.0 TFSI	147	03/06→08/15	⬅			13.0470-7184.2 LD7184	ATE 23587 20,6 + WK Ceramic
			⬅	05/06→; +PR 1LK		13.0460-7200.2 607200	ATE 23801 20,3 + WK
			⬅			13.0470-7200.2 LD7200	ATE 23801 20,3 + WK Ceramic
			➡	05/06→; +PR 1KJ,1KZ		13.0460-2749.2 602749	TRW 24483 16,9 - WE / - WK + Zub
			➡			13.0460-2880.2 602880	TRW 23914 17,1 + WE / - WK + Zub
			➡			13.0470-2749.2 LD2749	TRW 24483 16,9 - WE / - WK + Zub Ceramic
			➡			13.0470-2880.2 LD2880	TRW 23914 17,1 + WE / - WK + Zub Ceramic
			➡	05/06→; +PR 2EA		13.0460-2749.2 602749	TRW 24483 16,9 - WE / - WK + Zub
			➡			13.0460-2880.2 602880	TRW 23914 17,1 + WE / - WK + Zub
			➡			13.0470-2749.2 LD2749	TRW 24483 16,9 - WE / - WK + Zub Ceramic
			➡			13.0470-2880.2 LD2880	TRW 23914 17,1 + WE / - WK + Zub Ceramic
			➡	05/06→; +PR 1KD		13.0460-2820.2 602820	TRW 20961 17,2 - WK
			➡			13.0470-2820.2 LD2820	TRW 20961 17,2 - WK Ceramic
			➡	05/06→; +PR 1KS		13.0460-3858.2 603858	BOS 24563 17,7 - WE / - WK + Zub



















	kw			 	! #		
VW - EOS (1F7, 1F8) 03/06→08/15							
 Bremsbelagsatz, Scheibenbremse							
2.0 FSI 2.0 TFSI	110 147	03/06→05/08 03/06→08/15	➡	05/06→; +PR 1KS		13.0470-3858.2 LD7100	BOS 24563 17,7 - WE / - WK + Zub Ceramic
Zubehörsatz, Scheibenbremsbelag							
1.4 TSI 1.4 TSI 1.6 FSI 2.0 TDI 2.0 TDI 2.0 TDI 16V 2.0 TSI 3.2 V6 3.6 V6	90 118 85 100 103 103 155 184 191	11/07→08/15 05/08→08/15 06/06→05/08 11/10→08/15 06/06→05/08 05/08→08/15 11/09→08/15 06/06→05/09 05/09→11/10	➡	+PR 2EA +PR 1KD +PR 1KJ,1KZ		13.0460-0035.2 610035 13.0460-0259.2 610259 13.0460-0259.2 610259	
2.0 FSI 2.0 TFSI	110 147	03/06→05/08 03/06→08/15	➡	05/06→; +PR 2EA 05/06→; +PR 1KD 05/06→; +PR 1KJ,1KZ		13.0460-0035.2 610035 13.0460-0259.2 610259 13.0460-0259.2 610259	
 Bremsscheibe							
1.4 TSI 1.4 TSI 1.6 FSI 2.0 TDI 2.0 TDI 2.0 TDI 16V 2.0 TSI 3.2 V6 3.6 V6	90 118 85 100 103 103 155 184 191	11/07→08/15 05/08→08/15 06/06→05/08 11/10→08/15 06/06→05/08 05/08→08/15 11/09→08/15 06/06→05/09 05/09→11/10	←	+PR 1ZE +PR 1LJ,1ZA,1ZD +PR 1LK +PR 1KD +PR 1KS +PR 1KJ,1KZ +PR 2EA		24.0125-0145.1 425145 24.0325-0145.1 525145 24.0125-0158.1 425158 24.0325-0158.1 525158 24.0130-0115.1 430115 24.0330-0115.1 530115 24.0110-0277.1 410277 24.0310-0277.1 510277 24.0110-0356.1 410356 24.0310-0356.1 510356 24.0112-0169.1 412169 24.0312-0169.1 512169 24.0122-0219.1 422219	Ø 288 25 22 V + S Ø 288 25 22 V + S PD Ø 312 25 22 V + S Ø 312 25 22 V + S PD Ø 345 30 27 V Ø 345 30 27 V PD Ø 253 10 8 + S Ø 253 10 8 + S PD Ø 272 9,7 8 + S Ø 272 9,7 8 + S PD Ø 282 12 10 + S Ø 282 12 10 + S PD Ø 310 22 20 V
2.0 FSI 2.0 TFSI	110 147	03/06→05/08 03/06→08/15	←	05/06→; +PR 1ZE 05/06→; +PR 1LJ,1ZA,1ZD 05/06→; +PR 1LK 05/06→; +PR 1KD 05/06→; +PR 1KS 05/06→; +PR 1KJ,1KZ 05/06→; +PR 2EA		24.0125-0145.1 425145 24.0325-0145.1 525145 24.0125-0158.1 425158 24.0325-0158.1 525158 24.0130-0115.1 430115 24.0330-0115.1 530115 24.0110-0277.1 410277 24.0310-0277.1 510277 24.0110-0356.1 410356 24.0310-0356.1 510356 24.0112-0169.1 412169 24.0312-0169.1 512169 24.0122-0219.1 422219	Ø 288 25 22 V + S Ø 288 25 22 V + S PD Ø 312 25 22 V + S Ø 312 25 22 V + S PD Ø 345 30 27 V Ø 345 30 27 V PD Ø 253 10 8 + S Ø 253 10 8 + S PD Ø 272 9,7 8 + S Ø 272 9,7 8 + S PD Ø 282 12 10 + S Ø 282 12 10 + S PD Ø 310 22 20 V
VW - FOX (5Z1, 5Z3) 10/03→							
 Bremsbelagsatz, Scheibenbremse							
1.0 1.0 1.0 Total Flex 1.0 Total Flex 1.2 1.2 1.4 1.4 TDI 1.6 1.6 Total Flex 1.9 D	53 54 53 54 40 44 55 51 74 74 47	10/03→ 04/08→ 10/03→ 05/05→ 04/05→ 09/10→ 04/05→ 04/05→ 10/03→ 10/03→ 12/07→	←	→ 08/11; +PR 1ZN → 08/11; +PR 1ZF		13.0460-7100.2 607100 13.0470-7100.2 LD7100 13.0460-7111.2 607111 13.0470-7111.2 LD7111	VW 21866 17,2 - WE / - WK VW 21866 17,2 - WE / - WK Ceramic VW 23130 19,6 - WE / - WK VW 23130 19,6 - WE / - WK Ceramic
 Bremsscheibe							
1.0 1.0 1.0 Total Flex 1.0 Total Flex 1.2 1.2 1.4 1.4 TDI 1.6	53 54 53 54 40 44 55 51 74	10/03→ 04/08→ 10/03→ 05/05→ 04/05→ 09/10→ 04/05→ 04/05→ 10/03→	←	→ 08/11; +PR 1ZN → 08/11; +PR 1ZF		24.0118-0137.1 418137 24.0318-0137.1 518137 24.0122-0151.1 422151 24.0322-0151.1 522151	Ø 239 18 16 V + S Ø 239 18 16 V + S PD Ø 256 22 19 V + S Ø 256 22 19 V + S PD





















	kw			 	! #		
VW - FOX (5Z1, 5Z3) 10/03→							
 Bremsscheibe							
1.6 Total Flex 1.9 D	74	10/03→ 12/07→	←	→ 08/11; +PR 1ZN	24.0118-0137.1	418137	Ø 239 18 16 V + S
	47		←	→ 08/11; +PR 1ZF	24.0318-0137.1	518137	Ø 239 18 16 V + S PD
					24.0122-0151.1	422151	Ø 256 22 19 V + S
					24.0322-0151.1	522151	Ø 256 22 19 V + S PD
VW - GOLF III (1H1) 08/91→07/98							
 Bremsbelagsatz, Scheibenbremse							
1.4 1.6 1.9 SDI 1.9 TD,GTD	40	11/91→08/97 09/92→08/97 07/95→08/97 11/91→08/97	←	05/96→ 09/96; + ABS	13.0460-2821.2	602821	TRW 21945 16,0 - WK
	55		←	→ 1H-T-028354	13.0460-7032.2	20887	VW 20887 19,7 - WE / - WK + Zub
	47		←	1H-T-028355→; - ABS	13.0460-7072.2	607072	VW 21866 19,7 - WE / - WK
	55		←	10/96→; + ABS	13.0460-7101.2	607101	VW 21866 15,3 - WE / - WK
1.4	44	10/91→08/97	←	05/96→ 09/96; + ABS	13.0460-2821.2	602821	TRW 21945 16,0 - WK
			←	11/91→; → 1H-T-028354	13.0460-7032.2	20887	VW 20887 19,7 - WE / - WK + Zub
			←	1H-T-028355→; - ABS	13.0460-7072.2	607072	VW 21866 19,7 - WE / - WK
			←	10/96→; + ABS	13.0460-7101.2	607101	VW 21866 15,3 - WE / - WK
1.6	74	07/95→08/97	←		13.0460-2821.2	602821	TRW 21945 16,0 - WK
			←	- ABS	13.0460-2958.2	602958	TRW 20168 19,3 - WK
			→		13.0460-2984.2	602984	TRW 20961 17,2 - WK + Zub
1.8 1.8	55 66	11/91→08/97 11/91→08/97	←	05/96→; + ABS	13.0460-2821.2	602821	TRW 21945 16,0 - WK
			←		13.0460-2821.2	602821	TRW 21945 16,0 - WK
			←	1H-S-246941→; - ABS	13.0460-2958.2	602958	TRW 20168 19,3 - WK
			←	→ 1H-S-246940; Vollautomatik	13.0460-7032.2	20887	VW 20887 19,7 - WE / - WK + Zub
			←	→ 1H-T-028354; Schaltgetriebe	13.0460-7032.2	20887	VW 20887 19,7 - WE / - WK + Zub
			←	1H-T-028355→; Schaltgetriebe; - ABS	13.0460-7072.2	607072	VW 21866 19,7 - WE / - WK
1.8 Syncro (1HX1)	66	01/93→08/97	←	+ ABS	13.0460-2821.2	602821	TRW 21945 16,0 - WK
			←	1H-S-089451→; - ABS	13.0460-2958.2	602958	TRW 20168 19,3 - WK
			←	→ 1H-S-089450; - ABS	13.0460-7032.2	20887	VW 20887 19,7 - WE / - WK + Zub
1.9 D	48	11/91→08/97	←	1H-S-246941→; → 07/95	13.0460-2821.2	602821	TRW 21945 16,0 - WK
			←	05/96→ 09/96; + ABS	13.0460-2821.2	602821	TRW 21945 16,0 - WK
			←	08/93→; → 1H-S-246940	13.0460-7032.2	20887	VW 20887 19,7 - WE / - WK + Zub
			←	→ 1H-T-028354	13.0460-7032.2	20887	VW 20887 19,7 - WE / - WK + Zub
			←	1H-T-028355→; - ABS	13.0460-7072.2	607072	VW 21866 19,7 - WE / - WK
			←	10/96→; + ABS	13.0460-7101.2	607101	VW 21866 15,3 - WE / - WK
1.9 TDI	66	09/93→08/97	←	05/96→	13.0460-2821.2	602821	TRW 21945 16,0 - WK
			←	10/93→ 04/96	13.0460-2958.2	602958	TRW 20168 19,3 - WK
1.9 TDI	81	04/96→08/97	←	nicht für Bremssattelfarbe: rot	13.0460-2821.2	602821	TRW 21945 16,0 - WK
			←	→ 04/96; Bremssattelfarbe: rot	13.0460-2958.2	602958	TRW 20168 19,3 - WK
			←	05/96→; Bremssattelfarbe: rot	13.0460-7081.2	607081	ATE 20676 19,8 - WE / - WK
					13.0470-7081.2	LD7081	ATE 20676 19,8 - WE / - WK Ceramic
1.9 TDI Syncro (1HX1)	66	08/95→08/97	→		13.0460-2984.2	602984	TRW 20961 17,2 - WK + Zub
			←	05/96→	13.0460-2821.2	602821	TRW 21945 16,0 - WK
			←	→ 04/96	13.0460-2958.2	602958	TRW 20168 19,3 - WK
2.0	85	11/91→08/97	←	→ 1H-S-560000	13.0460-2806.2	602806	TRW 20168 19,3 + WK
			←	1H-S-560001→; → 04/96	13.0460-2958.2	602958	TRW 20168 19,3 - WK
			←	05/96→	13.0460-7081.2	607081	ATE 20676 19,8 - WE / - WK
					13.0470-7081.2	LD7081	ATE 20676 19,8 - WE / - WK Ceramic
			→		13.0460-2937.2	602937	TRW 20961 15,2 - WK + Zub
			→	1H-P-240001→	13.0460-2984.2	602984	TRW 20961 17,2 - WK + Zub
↓							







	kw			 	! #		
VW - GOLF III (1H1) 08/91→07/98							
 Bremsbelagsatz, Scheibenbremse							
2.0 GL	79	08/95→09/97	←	→ 08/97		13.0460-2821.2 602821	TRW 21945 16,0 - WK
2.0 GTI 16V	110	08/92→08/97	←	→ 1H-S-560000		13.0460-2806.2 602806	TRW 20168 19,3 + WK
			←	1H-S-560001→; → 04/96		13.0460-2958.2 602958	TRW 20168 19,3 - WK
			←	05/96→		13.0460-7081.2 607081	ATE 20676 19,8 - WE / - WK
					13.0470-7081.2 LD7081	ATE 20676 19,8 - WE / - WK Ceramic	
			→	→ 1H-P-240000		13.0460-2937.2 602937	TRW 20961 15,2 - WK + Zub
		→	→ 1H-P-240001→		13.0460-2984.2 602984	TRW 20961 17,2 - WK + Zub	
2.0 Syncro (1HX1)	85	08/95→08/97	←			13.0460-2821.2 602821	TRW 21945 16,0 - WK
2.8 VR6	120	08/95→09/97	←	→ 1H-S-399999		13.0460-2806.2 602806	TRW 20168 19,3 + WK
			←	1H-S-400001→; → 08/97		13.0460-7081.2 607081	ATE 20676 19,8 - WE / - WK
					13.0470-7081.2 LD7081	ATE 20676 19,8 - WE / - WK Ceramic	
			→	→ 1H-P-240000		13.0460-2937.2 602937	TRW 20961 15,2 - WK + Zub
		→	→ 1H-P-240001→; → 08/97		13.0460-2984.2 602984	TRW 20961 17,2 - WK + Zub	
2.8 VR6	128	01/92→08/97	←	→ 1H-S-399999		13.0460-2806.2 602806	TRW 20168 19,3 + WK
			←	1H-S-400001→		13.0460-7081.2 607081	ATE 20676 19,8 - WE / - WK
					13.0470-7081.2 LD7081	ATE 20676 19,8 - WE / - WK Ceramic	
			→	→ 1H-P-240000		13.0460-2937.2 602937	TRW 20961 15,2 - WK + Zub
		→	→ 1H-P-240001→		13.0460-2984.2 602984	TRW 20961 17,2 - WK + Zub	
2.9 VR6 Syncro (1HX1)	140	10/94→08/97	←			13.0460-7081.2 607081	ATE 20676 19,8 - WE / - WK
					13.0470-7081.2 LD7081	ATE 20676 19,8 - WE / - WK Ceramic	
			→			13.0460-2984.2 602984	TRW 20961 17,2 - WK + Zub
Zubehörsatz, Scheibenbremsbelag							
1.6	74	07/95→08/97	→			13.0460-0072.2 610072	TRW
1.9 TDI	81	04/96→08/97	→				
2.9 VR6 Syncro (1HX1)	140	10/94→08/97	→				
1.8	55	11/91→08/97	→			13.0460-0419.2 610419	TRW
			→				
2.0	85	11/91→08/97	→	→ 1H-P-240001→		13.0460-0072.2 610072	TRW
			→			13.0460-0419.2 610419	TRW
2.0 GTI 16V	110	08/92→08/97	→	→ 1H-P-240001→		13.0460-0072.2 610072	TRW
			→	→ 1H-P-240000		13.0460-0419.2 610419	TRW
2.8 VR6	128	01/92→08/97	→	→ 1H-P-240001→; → 08/97		13.0460-0072.2 610072	TRW
			→	→ 1H-P-240000		13.0460-0419.2 610419	TRW
2.8 VR6	120	08/95→09/97	→	→ 1H-P-240001→; → 08/97		13.0460-0072.2 610072	TRW
			→	→ 1H-P-240000		13.0460-0419.2 610419	TRW
 Bremsscheibe							
1.4 1.6 1.9 SDI 1.9 TD,GTD	40 55 47 55	11/91→08/97 09/92→08/97 07/95→08/97 11/91→08/97	←	- ABS		24.0112-0106.1 412106	Ø 239 12 10 + S
						24.0312-0106.1 512106	Ø 239 12 10 + S PD
			←	10/96→; + ABS		24.0120-0123.1 420123	Ø 239 20 18 V + S
						24.0320-0123.1 520123	Ø 239 20 18 V + S PD
			←	05/96→ 09/96; + ABS; Felge Lochzahl: 4		24.0120-0128.1 420128	Ø 256 20 18 V + S
						24.0320-0128.1 520128	Ø 256 20 18 V + S PD
1.4	44	10/91→08/97	←	11/91→; - ABS		24.0112-0106.1 412106	Ø 239 12 10 + S
						24.0312-0106.1 512106	Ø 239 12 10 + S PD
			←	10/96→; + ABS		24.0120-0123.1 420123	Ø 239 20 18 V + S
						24.0320-0123.1 520123	Ø 239 20 18 V + S PD
			←	05/96→ 09/96; + ABS; Felge Lochzahl: 4		24.0120-0128.1 420128	Ø 256 20 18 V + S
						24.0320-0128.1 520128	Ø 256 20 18 V + S PD
1.6	74	07/95→08/97	←	- ABS / - ESP		24.0113-0178.1 413178	Ø 255,6 12,9 11 + S
			←	Felge Lochzahl: 4		24.0120-0128.1 420128	Ø 256 20 18 V + S
						24.0320-0128.1 520128	Ø 256 20 18 V + S PD
			←	- ABS		24.0313-0178.1 513178	Ø 255,6 12,9 11 + S PD
			→	Felge Lochzahl: 4		24.0110-0111.1 410111	Ø 226 10 8 - ABS Ring / - RLG
			→			24.0110-0275.2 410275	Ø 226 10 8 + ABS Ring / - RLG
1.8 1.8	55 66	11/91→08/97 11/91→08/97	←	→ 1H-S-246940; Vollautomatik; - ABS		24.0112-0106.1 412106	Ø 239 12 10 + S
						24.0312-0106.1 512106	Ø 239 12 10 + S PD
↓							









	kw			 	! #				
VW - GOLF III (1H1) 08/91→07/98									
Bremsscheibe									
1.8 1.8	55 66	11/91→08/97 11/91→08/97	← Schaltgetriebe; - ABS	24.0112-0106.1	412106	Ø 239 12 10 + S			
				24.0312-0106.1	512106	Ø 239 12 10 + S PD			
			← 1H-S-246941→; Vollautomatik; - ABS / - ESP	24.0113-0178.1	413178	Ø 255,6 12,9 11 + S			
			← Felge Lochzahl: 4	24.0120-0128.1	420128	Ø 256 20 18 V + S			
				24.0320-0128.1	520128	Ø 256 20 18 V + S PD			
			← 05/96→; + ABS; Felge Lochzahl: 4	24.0120-0128.1	420128	Ø 256 20 18 V + S			
				24.0320-0128.1	520128	Ø 256 20 18 V + S PD			
			← 1H-S-246941→; Vollautomatik; - ABS	24.0313-0178.1	513178	Ø 255,6 12,9 11 + S PD			
1.8 Syncro (1HX1)	66	01/93→08/97	← Felge Lochzahl: 4	24.0110-0111.1	410111	Ø 226 10 8 - ABS Ring / - RLG			
				24.0110-0275.2	410275	Ø 226 10 8 + ABS Ring / - RLG			
			← → 1H-S-089450; - ABS	24.0112-0106.1	412106	Ø 239 12 10 + S			
				24.0312-0106.1	512106	Ø 239 12 10 + S PD			
			← 1H-S-089451→; - ESP	24.0113-0178.1	413178	Ø 255,6 12,9 11 + S			
			← + ABS; Felge Lochzahl: 4	24.0120-0128.1	420128	Ø 256 20 18 V + S			
				24.0320-0128.1	520128	Ø 256 20 18 V + S PD			
			← 1H-S-089451→	24.0313-0178.1	513178	Ø 255,6 12,9 11 + S PD			
1.9 D	48	11/91→08/97	← → 1H-S-246940	24.0112-0106.1	412106	Ø 239 12 10 + S			
				24.0312-0106.1	512106	Ø 239 12 10 + S PD			
			← - ABS	24.0112-0106.1	412106	Ø 239 12 10 + S			
				24.0312-0106.1	512106	Ø 239 12 10 + S PD			
			← 10/96→; + ABS	24.0120-0123.1	420123	Ø 239 20 18 V + S			
				24.0320-0123.1	520123	Ø 239 20 18 V + S PD			
			← 05/96→ 09/96; + ABS; Felge Lochzahl: 4	24.0120-0128.1	420128	Ø 256 20 18 V + S			
				24.0320-0128.1	520128	Ø 256 20 18 V + S PD			
1.9 TDI	66	09/93→08/97	← 1H-S-246941→; → 07/95; Felge Lochzahl: 4	24.0120-0128.1	420128	Ø 256 20 18 V + S			
				24.0320-0128.1	520128	Ø 256 20 18 V + S PD			
			← 10/93→ 04/96; - ESP	24.0113-0178.1	413178	Ø 255,6 12,9 11 + S			
			← 05/96→; Felge Lochzahl: 4	24.0120-0128.1	420128	Ø 256 20 18 V + S			
				24.0320-0128.1	520128	Ø 256 20 18 V + S PD			
			← 10/93→ 04/96	24.0313-0178.1	513178	Ø 255,6 12,9 11 + S PD			
			1.9 TDI	81	04/96→08/97	← nicht für Bremssattelfarbe: rot; Felge Lochzahl: 4	24.0120-0128.1	420128	Ø 256 20 18 V + S
							24.0320-0128.1	520128	Ø 256 20 18 V + S PD
← → 04/96; Bremssattelfarbe: rot; Felge Lochzahl: 5	24.0122-0100.1	422100				Ø 280 22 20 V			
	24.0322-0100.1	522100				Ø 280 22 20 V PD			
← 05/96→; Bremssattelfarbe: rot	24.0125-0108.1	425108				Ø 288 25 23 V			
→ nicht für Bremssattelfarbe: rot; Felge Lochzahl: 4	24.0110-0111.1	410111				Ø 226 10 8 - ABS Ring / - RLG			
→ Bremssattelfarbe: rot; Felge Lochzahl: 5	24.0110-0203.1	410203				Ø 226 10 8 - ABS Ring			
→ nicht für Bremssattelfarbe: rot	24.0110-0275.2	410275				Ø 226 10 8 + ABS Ring / - RLG			
1.9 TDI Syncro (1HX1)	66	08/95→08/97	→ Bremssattelfarbe: rot	24.0110-0276.2	410276	Ø 226 10 8 + ABS Ring			
			← → 04/96; - ESP	24.0113-0178.1	413178	Ø 255,6 12,9 11 + S			
			← 05/96→; Felge Lochzahl: 4	24.0120-0128.1	420128	Ø 256 20 18 V + S			
				24.0320-0128.1	520128	Ø 256 20 18 V + S PD			
			← → 04/96	24.0313-0178.1	513178	Ø 255,6 12,9 11 + S PD			
			2.0 2.0 GTI 16V	85 110	11/91→08/97 08/92→08/97	← Felge Lochzahl: 5	24.0110-0203.1	410203	Ø 226 10 8 - ABS Ring
							24.0110-0276.2	410276	Ø 226 10 8 + ABS Ring
						← 05/96→	24.0125-0108.1	425108	Ø 288 25 23 V
→ 04/96; Felge Lochzahl: 5	24.0122-0100.1	422100				Ø 280 22 20 V			
	24.0322-0100.1	522100				Ø 280 22 20 V PD			
2.0 GL	79	08/95→09/97				← 05/96→	24.0125-0108.1	425108	Ø 288 25 23 V
						→ 08/97; Felge Lochzahl: 4	24.0120-0128.1	420128	Ø 256 20 18 V + S
							24.0320-0128.1	520128	Ø 256 20 18 V + S PD
			→ Felge Lochzahl: 5	24.0110-0203.1	410203	Ø 226 10 8 - ABS Ring			
			→ 08/97; Felge Lochzahl: 4	24.0110-0111.1	410111	Ø 226 10 8 - ABS Ring / - RLG			
			→ 08/97	24.0110-0275.2	410275	Ø 226 10 8 + ABS Ring / - RLG			
			2.0 Syncro (1HX1)	85	08/95→08/97	← Felge Lochzahl: 4	24.0120-0128.1	420128	Ø 256 20 18 V + S
							24.0320-0128.1	520128	Ø 256 20 18 V + S PD
2.8 VR6	120	08/95→09/97				← 1H-S-399999; Felge Lochzahl: 5	24.0122-0100.1	422100	Ø 280 22 20 V
							24.0322-0100.1	522100	Ø 280 22 20 V PD
						← 1H-S-400001→; → 08/97	24.0125-0108.1	425108	Ø 288 25 23 V
						↓			

	kw			 	! #		
VW - GOLF III (1H1) 08/91→07/98							
 Bremsscheibe							
2.8 VR6	120	08/95→09/97	➔	→ 08/97; Felge Lochzahl: 5		24.0110-0203.1 410203	Ø 226 10 8 - ABS Ring
			➔	→ 08/97		24.0110-0276.2 410276	Ø 226 10 8 + ABS Ring
2.8 VR6	128	01/92→08/97	➔	→ 1H-S-399999; Felge Lochzahl: 5		24.0122-0100.1 422100	Ø 280 22 20 V
			➔	→ 1H-S-400001→		24.0322-0100.1 522100	Ø 280 22 20 V PD
			➔	1H-S-400001→		24.0125-0108.1 425108	Ø 288 25 23 V
			➔	Felge Lochzahl: 5		24.0110-0203.1 410203	Ø 226 10 8 - ABS Ring
			➔			24.0110-0276.2 410276	Ø 226 10 8 + ABS Ring
2.9 VR6 Syncro (1HX1)	140	10/94→08/97	➔			24.0125-0108.1 425108	Ø 288 25 23 V
VW - GOLF III Cabriolet (1E7) 07/93→05/98							
 Bremsbelagsatz, Scheibenbremse							
1.6	74	10/94→05/98	➔	1E-V-000001→		13.0460-2821.2 602821	TRW 21945 16,0 - WK
			➔	→ 1E-T-030000		13.0460-2958.2 602958	TRW 20168 19,3 - WK
			➔	04/98→; → 1E-X-014000		13.0460-2937.2 602937	TRW 20961 15,2 - WK + Zub
			➔	1E-X-014001→		13.0460-2984.2 602984	TRW 20961 17,2 - WK + Zub
1.8 1.8	55 66	07/93→05/98 07/93→05/98	➔	1E-V-000001→		13.0460-2821.2 602821	TRW 21945 16,0 - WK
			➔	09/93→; → 1E-T-030000		13.0460-2958.2 602958	TRW 20168 19,3 - WK
			➔	04/98→; → 1E-X-014000		13.0460-2937.2 602937	TRW 20961 15,2 - WK + Zub
			➔	1E-X-014001→		13.0460-2984.2 602984	TRW 20961 17,2 - WK + Zub
1.9 TDI	66	08/95→05/98	➔	1E-V-000001→		13.0460-2821.2 602821	TRW 21945 16,0 - WK
			➔	→ 1E-T-030000		13.0460-2958.2 602958	TRW 20168 19,3 - WK
			➔	1E-X-014001→; - ABS		13.0460-2937.2 602937	TRW 20961 15,2 - WK + Zub
			➔	04/98→; → 1E-X-014000		13.0460-2937.2 602937	TRW 20961 15,2 - WK + Zub
			➔	1E-X-014001→; + ABS		13.0460-2984.2 602984	TRW 20961 17,2 - WK + Zub
1.9 TDI	81	07/96→05/98	➔	09/96→		13.0460-2821.2 602821	TRW 21945 16,0 - WK
			➔	09/96→; → 1E-X-014000		13.0460-2937.2 602937	TRW 20961 15,2 - WK + Zub
			➔	1E-X-014001→; - ABS		13.0460-2937.2 602937	TRW 20961 15,2 - WK + Zub
			➔	1E-X-014001→; + ABS		13.0460-2984.2 602984	TRW 20961 17,2 - WK + Zub
2.0	85	07/93→05/98	➔	1E-V-000001→		13.0460-2821.2 602821	TRW 21945 16,0 - WK
			➔	09/93→; → 1E-T-030000		13.0460-2958.2 602958	TRW 20168 19,3 - WK
			➔	1E-2-800 001→		13.0460-2894.2 602894	TRW 20961 17,2 - WK + Zub
			➔			13.0470-2894.2 LD2894	TRW 20961 17,2 - WK + Zub Ceramic
			➔	04/98→; → 1E-X-014000		13.0460-2937.2 602937	TRW 20961 15,2 - WK + Zub
			➔	1E-X-014001→ 1E-2-015 000		13.0460-2984.2 602984	TRW 20961 17,2 - WK + Zub
Zubehörsatz, Scheibenbremsbelag							
1.6 1.8 1.8	74 55 66	10/94→05/98 07/93→05/98 07/93→05/98	➔	1E-X-014001→		13.0460-0072.2 610072	TRW
			➔	04/98→; → 1E-X-014000		13.0460-0419.2 610419	TRW
1.9 TDI	66	08/95→05/98	➔	1E-X-014001→; + ABS		13.0460-0072.2 610072	TRW
			➔	04/98→; → 1E-X-014000		13.0460-0419.2 610419	TRW
1.9 TDI	81	07/96→05/98	➔	1E-X-014001→; + ABS		13.0460-0072.2 610072	TRW
			➔	09/96→; → 1E-X-014000		13.0460-0419.2 610419	TRW
2.0	85	07/93→05/98	➔	1E-X-014001→ 1E-2-015 000		13.0460-0072.2 610072	TRW
			➔	04/98→; → 1E-X-014000		13.0460-0419.2 610419	TRW
 Bremsscheibe							
1.6 1.9 TDI	74 66	10/94→05/98 08/95→05/98	➔	→ 1E-T-030000		24.0113-0178.1 413178	Ø 255,6 12,9 11 + S
			➔			24.0313-0178.1 513178	Ø 255,6 12,9 11 + S PD
			➔	1E-V-000001→		24.0120-0128.1 420128	Ø 256 20 18 V + S
			➔			24.0320-0128.1 520128	Ø 256 20 18 V + S PD
			➔	04/98→		24.0110-0111.1 410111	Ø 226 10 8 - ABS Ring / - RLG
			➔			24.0110-0275.2 410275	Ø 226 10 8 + ABS Ring / - RLG
1.8 1.8 2.0	55 66 85	07/93→05/98 07/93→05/98 07/93→05/98	➔	09/93→; → 1E-T-030000		24.0113-0178.1 413178	Ø 255,6 12,9 11 + S
			➔			24.0313-0178.1 513178	Ø 255,6 12,9 11 + S PD
			➔	1E-V-000001→		24.0120-0128.1 420128	Ø 256 20 18 V + S







	kw			 	! #		
VW - GOLF III Cabriolet (1E7) 07/93→05/98							
 Bremsscheibe							
1.8	55	07/93→05/98	←	1E-V-000001→		24.0320-0128.1 520128	Ø 256 20 18 V + S PD
1.8	66	07/93→05/98	→	04/98→		24.0110-0111.1 410111	Ø 226 10 8 - ABS Ring / - RLG
2.0	85	07/93→05/98	→			24.0110-0275.2 410275	Ø 226 10 8 + ABS Ring / - RLG
1.9 TDI	81	07/96→05/98	←	09/96→		24.0120-0128.1 420128	Ø 256 20 18 V + S
			→	09/96→		24.0320-0128.1 520128	Ø 256 20 18 V + S PD
			→	09/96→		24.0110-0111.1 410111	Ø 226 10 8 - ABS Ring / - RLG
			→	09/96→		24.0110-0275.2 410275	Ø 226 10 8 + ABS Ring / - RLG
VW - GOLF III Van (1H1) 08/91→12/97							
 Bremsbelagsatz, Scheibenbremse							
1.8	66	08/91→12/97	←	05/96→ 08/97; + ABS		13.0460-2821.2 602821	TRW 21945 16,0 - WK
 Bremsscheibe							
1.8	66	08/91→12/97	←	11/91→ 08/97; Schaltgetriebe; - ABS		24.0112-0106.1 412106	Ø 239 12 10 + S
			←	11/91→; → 1H-S-246940; Vollautomatik; - ABS		24.0312-0106.1 512106	Ø 239 12 10 + S PD
			←	1H-S-246941→; → 08/97; Vollautomatik; - ABS / - ESP		24.0112-0106.1 412106	Ø 239 12 10 + S PD
			←	1H-S-246941→; → 08/97; Vollautomatik; - ABS / - ESP		24.0113-0178.1 413178	Ø 255,6 12,9 11 + S
			←	05/96→ 08/97; + ABS; Felge Lochzahl: 4		24.0120-0128.1 420128	Ø 256 20 18 V + S
			←			24.0320-0128.1 520128	Ø 256 20 18 V + S PD
			←	1H-S-246941→; → 08/97; Vollautomatik; - ABS		24.0313-0178.1 513178	Ø 255,6 12,9 11 + S PD
VW - GOLF III Variant (1H5) 07/93→04/99							
 Bremsbelagsatz, Scheibenbremse							
1.4	40	07/93→04/99	←	05/96→ 09/96; + ABS		13.0460-2821.2 602821	TRW 21945 16,0 - WK
1.4	44	07/93→04/99	←	→ 1H-TB015953		13.0460-7032.2 20887	VW 20887 19,7 - WE / - WK + Zub
			←	1H-TB015954→; → 04/96		13.0460-7072.2 607072	VW 21866 19,7 - WE / - WK
			←	05/96→; - ABS		13.0460-7072.2 607072	VW 21866 19,7 - WE / - WK
			←	10/96→; + ABS		13.0460-7101.2 607101	VW 21866 15,3 - WE / - WK
1.6	74	07/94→04/99	←	05/96→ 09/96		13.0460-2821.2 602821	TRW 21945 16,0 - WK
			←	→ 04/96		13.0460-2958.2 602958	TRW 20168 19,3 - WK
1.8	55	07/93→04/99	←	05/96→; + ABS		13.0460-2821.2 602821	TRW 21945 16,0 - WK
1.8	66	07/93→04/99	←	05/96→; - ABS		13.0460-2958.2 602958	TRW 20168 19,3 - WK
1.9 TDI	66	03/94→04/99	←	→ 04/96		13.0460-2958.2 602958	TRW 20168 19,3 - WK
1.8 Syncro	66	10/94→04/99	←	1H-TD365210→		13.0460-2821.2 602821	TRW 21945 16,0 - WK
			←	1H-SW369001→ 1H-TD365209		13.0460-2958.2 602958	TRW 20168 19,3 - WK
			←	→ 1H-SW369000		13.0460-7032.2 20887	VW 20887 19,7 - WE / - WK + Zub
1.9 D	48	07/93→04/99	←	05/96→ 09/96; + ABS		13.0460-2821.2 602821	TRW 21945 16,0 - WK
1.9 SDI	47	07/95→04/99	←	05/96→; - ABS		13.0460-2958.2 602958	TRW 20168 19,3 - WK
1.9 TD	55	07/93→04/99	←	→ 04/96		13.0460-2958.2 602958	TRW 20168 19,3 - WK
			←	10/96→; + ABS		13.0460-7101.2 607101	VW 21866 15,3 - WE / - WK
1.9 TDI	81	04/96→04/99	←			13.0460-2821.2 602821	TRW 21945 16,0 - WK
1.9 TDI Syncro	66	07/95→04/99	←				
2.0	79	08/95→04/96	←				
2.0	85	07/93→04/99	←				
2.0 Syncro	85	08/95→04/99	←				
2.9 VR6 Syncro	140	10/94→04/99	←	07/95→		13.0460-7081.2 607081	ATE 20676 19,8 - WE / - WK
			→	07/95→		13.0470-7081.2 LD7081	ATE 20676 19,8 - WE / - WK Ceramic
			→	07/95→		13.0460-2984.2 602984	TRW 20961 17,2 - WK + Zub
Zubehörsatz, Scheibenbremsbelag							
2.9 VR6 Syncro	140	10/94→04/99	→	07/95→		13.0460-0072.2 610072	TRW
 Bremsscheibe							
1.4	40	07/93→04/99	←	05/96→; - ABS		24.0112-0106.1 412106	Ø 239 12 10 + S
1.4	44	07/93→04/99	←	→ 04/96		24.0312-0106.1 512106	Ø 239 12 10 + S PD
			←	→ 04/96		24.0112-0106.1 412106	Ø 239 12 10 + S









	kw			 	! #		
VW - GOLF III Variant (1H5) 07/93→04/99							
Bremsscheibe							
1.4	40	07/93→04/99	←	→ 04/96		24.0312-0106.1 512106	Ø 239 12 10 + S PD
1.4	44	07/93→04/99	←	10/96→; + ABS		24.0120-0123.1 420123	Ø 239 20 18 V + S
						24.0320-0123.1 520123	Ø 239 20 18 V + S PD
			←	05/96→ 09/96; + ABS		24.0120-0128.1 420128	Ø 256 20 18 V + S
						24.0320-0128.1 520128	Ø 256 20 18 V + S PD
1.6	74	07/94→04/99	←	→ 04/96		24.0113-0178.1 413178	Ø 255,6 12,9 11 + S
						24.0313-0178.1 513178	Ø 255,6 12,9 11 + S PD
			←	05/96→		24.0120-0128.1 420128	Ø 256 20 18 V + S
						24.0320-0128.1 520128	Ø 256 20 18 V + S PD
1.8	55	07/93→04/99	←	05/96→; - ABS		24.0113-0178.1 413178	Ø 255,6 12,9 11 + S
1.8	66	07/93→04/99				24.0313-0178.1 513178	Ø 255,6 12,9 11 + S PD
1.9 TDI	66	03/94→04/99	←	→ 04/96		24.0113-0178.1 413178	Ø 255,6 12,9 11 + S
						24.0313-0178.1 513178	Ø 255,6 12,9 11 + S PD
			←	05/96→; + ABS		24.0120-0128.1 420128	Ø 256 20 18 V + S
						24.0320-0128.1 520128	Ø 256 20 18 V + S PD
1.8 Syncro	66	10/94→04/99	←	→ 1H-SW369000		24.0112-0106.1 412106	Ø 239 12 10 + S
						24.0312-0106.1 512106	Ø 239 12 10 + S PD
			←	1H-SW369001→ 1H-TD365209		24.0113-0178.1 413178	Ø 255,6 12,9 11 + S
						24.0313-0178.1 513178	Ø 255,6 12,9 11 + S PD
			←	1H-TD365210→		24.0120-0128.1 420128	Ø 256 20 18 V + S
						24.0320-0128.1 520128	Ø 256 20 18 V + S PD
1.9 D	48	07/93→04/99	←	05/96→; - ABS		24.0113-0178.1 413178	Ø 255,6 12,9 11 + S
1.9 SDI	47	07/95→04/99				24.0313-0178.1 513178	Ø 255,6 12,9 11 + S PD
1.9 TD	55	07/93→04/99	←	→ 04/96		24.0113-0178.1 413178	Ø 255,6 12,9 11 + S
						24.0313-0178.1 513178	Ø 255,6 12,9 11 + S PD
			←	10/96→; + ABS		24.0120-0123.1 420123	Ø 239 20 18 V + S
						24.0320-0123.1 520123	Ø 239 20 18 V + S PD
			←	05/96→ 09/96; + ABS		24.0120-0128.1 420128	Ø 256 20 18 V + S
						24.0320-0128.1 520128	Ø 256 20 18 V + S PD
1.9 TDI	81	04/96→04/99	←			24.0120-0128.1 420128	Ø 256 20 18 V + S
1.9 TDI Syncro	66	07/95→04/99				24.0320-0128.1 520128	Ø 256 20 18 V + S PD
2.0	79	08/95→04/96					
2.0	85	07/93→04/99					
2.0 Syncro	85	08/95→04/99					
2.9 VR6 Syncro	140	10/94→04/99	←	07/95→		24.0125-0108.1 425108	Ø 288 25 23 V
VW - GOLF IV (1J1) 08/97→06/05							
Brembelagsatz, Scheibenbremse							
1.4 16V	55	08/97→06/05	←	10/97→; → 1J-X-800000; +PR 1LQ,1LR,1ZF		13.0460-7111.2 607111	VW 23130 19,6 - WE / - WK
1.6	74	08/97→05/04				13.0470-7111.2 LD7111	VW 23130 19,6 - WE / - WK Ceramic
1.9 SDI	50	08/97→06/05					
1.9 TDI	81	08/97→05/04	←	1J-Y-000001→; → 10/03; +PR 1LS,1LQ,1ZF,1ZM		13.0460-7117.2 607117	VW 23130 19,6 + WK
						13.0470-7117.2 LD7117	VW 23130 19,6 + WK Ceramic
			→	10/97→ 10/03; +PR 1KY		13.0460-2886.2 602886	TRW 20961 16,0 - WK
						13.0470-2886.2 LD2886	TRW 20961 16,0 - WK Ceramic
			→	10/97→ 10/03; +PR 1KK,1KS,1KV / 1KQ,1KW		13.0460-2894.2 602894	TRW 20961 17,2 - WK + Zub
						13.0470-2894.2 LD2894	TRW 20961 17,2 - WK + Zub Ceramic
1.6	74	02/01→06/01	←	→ 1J-X-800000; +PR 1LQ,1LR,1ZF		13.0460-7111.2 607111	VW 23130 19,6 - WE / - WK
1.9 TDI	74	09/00→06/05				13.0470-7111.2 LD7111	VW 23130 19,6 - WE / - WK Ceramic
			←	1J-Y-000001→; +PR 1LS,1LQ,1ZF,1ZM		13.0460-7117.2 607117	VW 23130 19,6 + WK
						13.0470-7117.2 LD7117	VW 23130 19,6 + WK Ceramic
			→	+PR 1KY		13.0460-2886.2 602886	TRW 20961 16,0 - WK
						13.0470-2886.2 LD2886	TRW 20961 16,0 - WK Ceramic
			→	+PR 1KK,1KS,1KV / 1KQ,1KW		13.0460-2894.2 602894	TRW 20961 17,2 - WK + Zub
						13.0470-2894.2 LD2894	TRW 20961 17,2 - WK + Zub Ceramic
1.6	75	08/00→06/05	←	→ 1J-X-800000; +PR 1LQ,1LR,1ZF		13.0460-7111.2 607111	VW 23130 19,6 - WE / - WK
1.6	78	08/03→06/05				13.0470-7111.2 LD7111	VW 23130 19,6 - WE / - WK Ceramic
1.6 16V	77	02/00→06/05					
			←	1J-Y-000001→; → 10/03; +PR 1LS,1LQ,1ZF,1ZM		13.0460-7117.2 607117	VW 23130 19,6 + WK
						13.0470-7117.2 LD7117	VW 23130 19,6 + WK Ceramic
↓							

	kw				! #		
VW - GOLF IV (1J1) 08/97→06/05							
 Bremsbelagsatz, Scheibenbremse							
1.6 1.6 1.6 16V	75 78 77	08/00→06/05 08/03→06/05 02/00→06/05	➔	→ 10/03; +PR 1KY		13.0460-2886.2 602886 13.0470-2886.2 LD2886	TRW 20961 16,0 - WK TRW 20961 16,0 - WK Ceramic
			➔	→ 10/03; +PR 1KK,1KS,1KV / 1KQ,1KW		13.0460-2894.2 602894 13.0470-2894.2 LD2894	TRW 20961 17,2 - WK + Zub TRW 20961 17,2 - WK + Zub Ceramic
1.6 FSI	81	01/02→06/05	➔	→ 10/03; +PR 1LS,1LQ,1ZF,1ZM		13.0460-7117.2 607117 13.0470-7117.2 LD7117	VW 23130 19,6 + WK VW 23130 19,6 + WK Ceramic
			➔	→ 10/03; +PR 1KY		13.0460-2886.2 602886 13.0470-2886.2 LD2886	TRW 20961 16,0 - WK TRW 20961 16,0 - WK Ceramic
			➔	→ 10/03; +PR 1KK,1KS,1KV / 1KQ,1KW		13.0460-2894.2 602894 13.0470-2894.2 LD2894	TRW 20961 17,2 - WK + Zub TRW 20961 17,2 - WK + Zub Ceramic
1.8 1.8 T	92 110	08/97→06/05 08/97→06/05	➔	10/97→; → 1J-X-800000; +PR 1LQ,1LR,1ZF		13.0460-7111.2 607111 13.0470-7111.2 LD7111	VW 23130 19,6 - WE / - WK VW 23130 19,6 - WE / - WK Ceramic
			➔	1J-Y-000001→; → 10/03; +PR 1LS,1LQ,1ZF,1ZM		13.0460-7117.2 607117 13.0470-7117.2 LD7117	VW 23130 19,6 + WK VW 23130 19,6 + WK Ceramic
			➔	10/97→ 10/03; +PR 1LE,1LJ,1LN,1ZE / 1ZH,1ZQ		13.0460-7122.2 607122 13.0470-7122.2 LD7122	ATE 20676 19,8 + WK ATE 20676 19,8 + WK Ceramic
			➔	10/97→ 10/03; +PR 1KY		13.0460-2886.2 602886 13.0470-2886.2 LD2886	TRW 20961 16,0 - WK TRW 20961 16,0 - WK Ceramic
			➔	10/97→ 10/03; +PR 1KK,1KS,1KV / 1KQ,1KW		13.0460-2894.2 602894 13.0470-2894.2 LD2894	TRW 20961 17,2 - WK + Zub TRW 20961 17,2 - WK + Zub Ceramic
1.8 4motion	92	05/98→06/05	➔	07/98→ 10/03; +PR 1LS,1LQ,1ZF,1ZM		13.0460-7117.2 607117 13.0470-7117.2 LD7117	VW 23130 19,6 + WK VW 23130 19,6 + WK Ceramic
			➔	07/98→ 10/03; +PR 1LE,1LJ,1LN,1ZE / 1ZH,1ZQ		13.0460-7122.2 607122 13.0470-7122.2 LD7122	ATE 20676 19,8 + WK ATE 20676 19,8 + WK Ceramic
			➔	07/98→ 10/03; +PR 1KU,2EE,2EL		13.0460-2820.2 602820 13.0470-2820.2 LD2820	TRW 20961 17,2 - WK TRW 20961 17,2 - WK Ceramic
			➔	07/98→ 10/03; +PR 1KE		13.0460-2894.2 602894 13.0470-2894.2 LD2894	TRW 20961 17,2 - WK + Zub TRW 20961 17,2 - WK + Zub Ceramic
1.8 T GTI	132	08/01→06/05	➔	→ 10/03		13.0460-7081.2 607081 13.0470-7081.2 LD7081	ATE 20676 19,8 - WE / - WK ATE 20676 19,8 - WE / - WK Ceramic
			➔	→ 10/03		13.0460-2886.2 602886 13.0470-2886.2 LD2886	TRW 20961 16,0 - WK TRW 20961 16,0 - WK Ceramic
1.9 TDI	66	10/97→05/04	➔	→ 1J-X-800000; +PR 1LQ,1LR,1ZF		13.0460-7111.2 607111 13.0470-7111.2 LD7111	VW 23130 19,6 - WE / - WK VW 23130 19,6 - WE / - WK Ceramic
			➔	1J-Y-000001→; → 06/01; +PR 1LS,1LQ,1ZF,1ZM		13.0460-7117.2 607117 13.0470-7117.2 LD7117	VW 23130 19,6 + WK VW 23130 19,6 + WK Ceramic
			➔	→ 06/01; +PR 1KY		13.0460-2886.2 602886 13.0470-2886.2 LD2886	TRW 20961 16,0 - WK TRW 20961 16,0 - WK Ceramic
			➔	→ 06/01; +PR 1KK,1KS,1KV / 1KQ,1KW		13.0460-2894.2 602894 13.0470-2894.2 LD2894	TRW 20961 17,2 - WK + Zub TRW 20961 17,2 - WK + Zub Ceramic
1.9 TDI	85	12/98→06/01	➔	05/99→; → 1J-X-800000; +PR 1LQ,1LR,1ZF		13.0460-7111.2 607111 13.0470-7111.2 LD7111	VW 23130 19,6 - WE / - WK VW 23130 19,6 - WE / - WK Ceramic
			➔	1J-Y-000001→; +PR 1LS,1LQ,1ZF,1ZM		13.0460-7117.2 607117 13.0470-7117.2 LD7117	VW 23130 19,6 + WK VW 23130 19,6 + WK Ceramic
			➔	05/99→; +PR 1KY		13.0460-2886.2 602886 13.0470-2886.2 LD2886	TRW 20961 16,0 - WK TRW 20961 16,0 - WK Ceramic
			➔	05/99→; +PR 1KK,1KS,1KV / 1KQ,1KW		13.0460-2894.2 602894 13.0470-2894.2 LD2894	TRW 20961 17,2 - WK + Zub TRW 20961 17,2 - WK + Zub Ceramic
1.9 TDI	96	11/00→06/05	➔	04/01→ 10/03; +PR 1LE,1LJ,1LN,1ZE / 1ZH,1ZQ		13.0460-7122.2 607122 13.0470-7122.2 LD7122	ATE 20676 19,8 + WK ATE 20676 19,8 + WK Ceramic
			➔	04/01→ 10/03; +PR 1KY		13.0460-2886.2 602886 13.0470-2886.2 LD2886	TRW 20961 16,0 - WK TRW 20961 16,0 - WK Ceramic
			➔	04/01→ 10/03; +PR 1KK,1KS,1KV / 1KQ,1KW		13.0460-2894.2 602894	TRW 20961 17,2 - WK + Zub







	kw			 	! #		
VW - GOLF IV (1J1) 08/97→06/05							
 Bremsbelagsatz, Scheibenbremse							
1.9 TDI	96	11/00→06/05	➡	04/01→ 10/03; +PR 1KK,1KS,1KV / 1KQ,1KW		13.0470-2894.2 LD2894	TRW 20961 17,2 - WK + Zub Ceramic
1.9 TDI	110	05/00→06/05	←	09/00→ 10/03; +PR 1LE,1LJ,1LN,1ZE / 1ZH,1ZQ		13.0460-7122.2 607122 13.0470-7122.2 LD7122	ATE 20676 19,8 + WK ATE 20676 19,8 + WK Ceramic
			➡	09/00→ 10/03; +PR 1KY		13.0460-2886.2 602886 13.0470-2886.2 LD2886	TRW 20961 16,0 - WK TRW 20961 16,0 - WK Ceramic
			➡	09/00→ 10/03; +PR 1KK,1KS,1KV / 1KQ,1KW		13.0460-2894.2 602894 13.0470-2894.2 LD2894	TRW 20961 17,2 - WK + Zub TRW 20961 17,2 - WK + Zub Ceramic
			➡	09/00→ 10/03; +PR 1KK,1KS,1KV / 1KQ,1KW		13.0460-2894.2 602894 13.0470-2894.2 LD2894	TRW 20961 17,2 - WK + Zub TRW 20961 17,2 - WK + Zub Ceramic
1.9 TDI 4motion	66	07/98→04/02	←	→ 06/01; +PR 1LS,1LQ,1ZF,1ZM		13.0460-7117.2 607117 13.0470-7117.2 LD7117	VW 23130 19,6 + WK VW 23130 19,6 + WK Ceramic
			➡	→ 06/01; +PR 1KU,2EE,2EL		13.0460-2820.2 602820 13.0470-2820.2 LD2820	TRW 20961 17,2 - WK TRW 20961 17,2 - WK Ceramic
			➡	→ 06/01; +PR 1KE		13.0460-2894.2 602894 13.0470-2894.2 LD2894	TRW 20961 17,2 - WK + Zub TRW 20961 17,2 - WK + Zub Ceramic
1.9 TDI 4motion	74	09/00→06/05	←	+PR 1LS,1LQ,1ZF,1ZM		13.0460-7117.2 607117 13.0470-7117.2 LD7117	VW 23130 19,6 + WK VW 23130 19,6 + WK Ceramic
			➡	+PR 1KU,2EE,2EL		13.0460-2820.2 602820 13.0470-2820.2 LD2820	TRW 20961 17,2 - WK TRW 20961 17,2 - WK Ceramic
			➡	+PR 1KE		13.0460-2894.2 602894 13.0470-2894.2 LD2894	TRW 20961 17,2 - WK + Zub TRW 20961 17,2 - WK + Zub Ceramic
1.9 TDI 4motion	85	09/99→06/01	←	11/99→; +PR 1LS,1LQ,1ZF,1ZM		13.0460-7117.2 607117 13.0470-7117.2 LD7117	VW 23130 19,6 + WK VW 23130 19,6 + WK Ceramic
			➡	11/99→; +PR 1KU,2EE,2EL		13.0460-2820.2 602820 13.0470-2820.2 LD2820	TRW 20961 17,2 - WK TRW 20961 17,2 - WK Ceramic
			➡	11/99→; +PR 1KE		13.0460-2894.2 602894 13.0470-2894.2 LD2894	TRW 20961 17,2 - WK + Zub TRW 20961 17,2 - WK + Zub Ceramic
1.9 TDI 4motion	96	11/00→06/05	←	04/01→ 10/03; +PR 1LE,1LJ,1LN,1ZE / 1ZH,1ZQ		13.0460-7122.2 607122 13.0470-7122.2 LD7122	ATE 20676 19,8 + WK ATE 20676 19,8 + WK Ceramic
			➡	04/01→ 10/03; +PR 1KU,2EE,2EL		13.0460-2820.2 602820 13.0470-2820.2 LD2820	TRW 20961 17,2 - WK TRW 20961 17,2 - WK Ceramic
			➡	04/01→ 10/03; +PR 1KE		13.0460-2894.2 602894 13.0470-2894.2 LD2894	TRW 20961 17,2 - WK + Zub TRW 20961 17,2 - WK + Zub Ceramic
1.9 TDI 4motion	110	02/00→06/05	←	09/00→ 10/03; +PR 1LE,1LJ,1LN,1ZE / 1ZH,1ZQ		13.0460-7122.2 607122 13.0470-7122.2 LD7122	ATE 20676 19,8 + WK ATE 20676 19,8 + WK Ceramic
			➡	09/00→ 10/03; +PR 1KU,2EE,2EL		13.0460-2820.2 602820 13.0470-2820.2 LD2820	TRW 20961 17,2 - WK TRW 20961 17,2 - WK Ceramic
			➡	09/00→ 10/03; +PR 1KE		13.0460-2894.2 602894 13.0470-2894.2 LD2894	TRW 20961 17,2 - WK + Zub TRW 20961 17,2 - WK + Zub Ceramic
2.0	85	07/98→05/04	←	08/98→ 10/03; +PR 1LS,1LQ,1ZF,1ZM		13.0460-7117.2 607117 13.0470-7117.2 LD7117	VW 23130 19,6 + WK VW 23130 19,6 + WK Ceramic
			➡	08/98→ 10/03; +PR 1KY		13.0460-2886.2 602886 13.0470-2886.2 LD2886	TRW 20961 16,0 - WK TRW 20961 16,0 - WK Ceramic
			➡	08/98→ 10/03; +PR 1KK,1KS,1KV / 1KQ,1KW		13.0460-2894.2 602894 13.0470-2894.2 LD2894	TRW 20961 17,2 - WK + Zub TRW 20961 17,2 - WK + Zub Ceramic
2.0 4motion	85	10/00→06/05	←	→ 10/03; +PR 1LS,1LQ,1ZF,1ZM		13.0460-7117.2 607117 13.0470-7117.2 LD7117	VW 23130 19,6 + WK VW 23130 19,6 + WK Ceramic
			➡	→ 10/03; +PR 1KU,2EE,2EL		13.0460-2820.2 602820 13.0470-2820.2 LD2820	TRW 20961 17,2 - WK TRW 20961 17,2 - WK Ceramic
			➡	→ 10/03; +PR 1KE		13.0460-2894.2 602894 13.0470-2894.2 LD2894	TRW 20961 17,2 - WK + Zub TRW 20961 17,2 - WK + Zub Ceramic
2.3 V5	110	08/97→10/00	←	10/97→; → 1J-X-800000; +PR 1LE,1LN,1ZE,1ZH		13.0460-7081.2 607081 13.0470-7081.2 LD7081	ATE 20676 19,8 - WE / - WK ATE 20676 19,8 - WE / - WK Ceramic
			←	1J-Y-000001→; +PR 1LJ,1ZE,1ZQ		13.0460-7122.2 607122 13.0470-7122.2 LD7122	ATE 20676 19,8 + WK ATE 20676 19,8 + WK Ceramic
			➡	10/97→; +PR 1KY		13.0460-2886.2 602886	TRW 20961 16,0 - WK









	kw			 	! #		
VW - GOLF IV (1J1) 08/97→06/05							
Bremsbelagsatz, Scheibenbremse							
2.3 V5	110	08/97→10/00	➡	10/97→; +PR 1KY		13.0470-2886.2 LD2886	TRW 20961 16,0 - WK Ceramic
			➡	10/97→; +PR 1KK,1KS,1KV / 1KQ,1KW		13.0460-2894.2 602894 13.0470-2894.2 LD2894	TRW 20961 17,2 - WK + Zub Ceramic
2.3 V5	125	10/00→06/05	←	→ 1J-X-800000; +PR 1LE,1LN,1ZE,1ZH		13.0460-7081.2 607081 13.0470-7081.2 LD7081	ATE 20676 19,8 - WE / - WK Ceramic
			←	1J-Y-000001→; → 10/03; +PR 1LJ,1ZE,1ZQ		13.0460-7122.2 607122 13.0470-7122.2 LD7122	ATE 20676 19,8 + WK Ceramic
			➡	→ 10/03; +PR 1KY		13.0460-2886.2 602886 13.0470-2886.2 LD2886	TRW 20961 16,0 - WK Ceramic
			➡	→ 10/03; +PR 1KK,1KS,1KV / 1KQ,1KW		13.0460-2894.2 602894 13.0470-2894.2 LD2894	TRW 20961 17,2 - WK + Zub Ceramic
2.3 V5 4motion	110	12/98→10/00	←	→ 1J-X-800000; +PR 1LE,1LN,1ZE,1ZH		13.0460-7081.2 607081 13.0470-7081.2 LD7081	ATE 20676 19,8 - WE / - WK Ceramic
			←	1J-Y-000001→; +PR 1LJ,1ZE,1ZQ		13.0460-7122.2 607122 13.0470-7122.2 LD7122	ATE 20676 19,8 + WK Ceramic
			➡	+PR 1KU,2EE,2EL		13.0460-2820.2 602820 13.0470-2820.2 LD2820	TRW 20961 17,2 - WK Ceramic
			➡	+PR 1KE		13.0460-2894.2 602894 13.0470-2894.2 LD2894	TRW 20961 17,2 - WK + Zub Ceramic
2.3 V5 4motion 2.8 V6 4motion	125 150	10/00→06/05 03/99→06/05	←	→ 1J-X-800000; +PR 1LE,1LN,1ZE,1ZH		13.0460-7081.2 607081 13.0470-7081.2 LD7081	ATE 20676 19,8 - WE / - WK Ceramic
			←	1J-Y-000001→; → 10/03; +PR 1LJ,1ZE,1ZQ		13.0460-7122.2 607122 13.0470-7122.2 LD7122	ATE 20676 19,8 + WK Ceramic
			➡	→ 10/03; +PR 1KU,2EE,2EL		13.0460-2820.2 602820 13.0470-2820.2 LD2820	TRW 20961 17,2 - WK Ceramic
			➡	→ 10/03; +PR 1KE		13.0460-2894.2 602894 13.0470-2894.2 LD2894	TRW 20961 17,2 - WK + Zub Ceramic
3.2 R32 4motion	177	09/02→06/05	←	→ 10/03; +PR 1ZT		13.0460-7183.2 607183	ATE 21484 20,5 + WE / - WK
			➡	→ 10/03; +PR 1KU,2EE,2EL		13.0460-2820.2 602820 13.0470-2820.2 LD2820	TRW 20961 17,2 - WK Ceramic
			➡	→ 10/03; +PR 1KE		13.0460-2894.2 602894 13.0470-2894.2 LD2894	TRW 20961 17,2 - WK + Zub Ceramic
Warnkontakt, Bremsbelagsverschleiß							
3.2 R32 4motion	177	09/02→06/05	←	→ 10/03; +PR 1ZT	1	24.8190-0106.2 620106	L= 270
Zubehörsatz, Scheibenbremsbelag							
1.4 16V 1.6 1.8 1.8 T 1.9 SDI 1.9 TDI	55 74 92 110 50 81	08/97→06/05 08/97→05/04 08/97→06/05 08/97→06/05 08/97→06/05 08/97→05/04	➡	10/97→ 10/03; +PR 1KY		13.0460-0072.2 610072	TRW
			➡	10/97→ 10/03; +PR 1KK,1KS,1KV / 1KQ,1KW		13.0460-0072.2 610072	TRW
1.6 1.9 TDI	74 74	02/01→06/01 09/00→06/05	➡	+PR 1KK,1KS,1KV / 1KQ,1KW		13.0460-0072.2 610072	TRW
			➡	+PR 1KY		13.0460-0072.2 610072	TRW
1.6 1.6 1.6 16V 1.6 FSI 2.3 V5	75 78 77 81 125	08/00→06/05 08/03→06/05 02/00→06/05 01/02→06/05 10/00→06/05	➡	→ 10/03; +PR 1KY		13.0460-0072.2 610072	TRW
			➡	→ 10/03; +PR 1KK,1KS,1KV / 1KQ,1KW		13.0460-0072.2 610072	TRW
			➡	07/98→ 10/03; +PR 1KE		13.0460-0072.2 610072	TRW
			➡	07/98→ 10/03; +PR 1KU,2EE,2EL		13.0460-0072.2 610072	TRW
			➡	→ 10/03		13.0460-0072.2 610072	TRW
1.8 4motion 1.8 T GTI	92 132	05/98→06/05 08/01→06/05	➡	→ 06/01; +PR 1KY		13.0460-0072.2 610072	TRW
			➡	→ 06/01; +PR 1KK,1KS,1KV / 1KQ,1KW		13.0460-0072.2 610072	TRW
1.9 TDI	66	10/97→05/04	➡	05/99→; +PR 1KY		13.0460-0072.2 610072	TRW
			➡	05/99→; +PR 1KK,1KS,1KV / 1KQ,1KW		13.0460-0072.2 610072	TRW
↓							

	kw			 	! #		
VW - GOLF IV (1J1) 08/97→06/05							
Zubehörsatz, Scheibenbremsbelag							
1.9 TDI	96	11/00→06/05	➡	04/01→ 10/03; +PR 1KY		13.0460-0072.2 610072	TRW
			➡	04/01→ 10/03; +PR 1KK,1KS,1KV / 1KQ,1KW		13.0460-0072.2 610072	TRW
1.9 TDI	110	05/00→06/05	➡	09/00→ 10/03; +PR 1KK,1KS,1KV / 1KQ,1KW		13.0460-0072.2 610072	TRW
			➡	09/00→ 10/03; +PR 1KY		13.0460-0072.2 610072	TRW
1.9 TDI 4motion	66	07/98→04/02	➡	→ 06/01; +PR 1KU,2EE,2EL		13.0460-0072.2 610072	TRW
			➡	→ 06/01; +PR 1KE		13.0460-0072.2 610072	TRW
1.9 TDI 4motion 2.3 V5 4motion	74	09/00→06/05	➡	+PR 1KE		13.0460-0072.2 610072	TRW
	110	12/98→10/00	➡	+PR 1KU,2EE,2EL		13.0460-0072.2 610072	TRW
1.9 TDI 4motion	85	09/99→06/01	➡	11/99→; +PR 1KU,2EE,2EL		13.0460-0072.2 610072	TRW
			➡	11/99→; +PR 1KE		13.0460-0072.2 610072	TRW
1.9 TDI 4motion	96	11/00→06/05	➡	04/01→ 10/03; +PR 1KU,2EE,2EL		13.0460-0072.2 610072	TRW
			➡	04/01→ 10/03; +PR 1KE		13.0460-0072.2 610072	TRW
1.9 TDI 4motion	110	02/00→06/05	➡	09/00→ 10/03; +PR 1KU,2EE,2EL		13.0460-0072.2 610072	TRW
			➡	09/00→ 10/03; +PR 1KE		13.0460-0072.2 610072	TRW
2.0	85	07/98→05/04	➡	08/98→ 10/03; +PR 1KY		13.0460-0072.2 610072	TRW
			➡	08/98→ 10/03; +PR 1KK,1KS,1KV / 1KQ,1KW		13.0460-0072.2 610072	TRW
2.0 4motion 2.3 V5 4motion 2.8 V6 4motion 3.2 R32 4motion	85	10/00→06/05	➡	→ 10/03; +PR 1KE		13.0460-0072.2 610072	TRW
	125	10/00→06/05	➡	→ 10/03; +PR 1KU,2EE,2EL		13.0460-0072.2 610072	TRW
	150	03/99→06/05	➡	→ 10/03; +PR 1KU,2EE,2EL		13.0460-0072.2 610072	TRW
2.3 V5	110	08/97→10/00	➡	10/97→; +PR 1KY		13.0460-0072.2 610072	TRW
			➡	10/97→; +PR 1KK,1KS,1KV / 1KQ,1KW		13.0460-0072.2 610072	TRW
 Bremsscheibe							
1.4 16V 1.6 1.8 1.8 T 1.9 SDI 1.9 TDI	55	08/97→06/05	←	10/97→ 10/03; +PR 1LR,1LS,1ZM		24.0122-0150.1 422150	Ø 280 22 19 V + S
	74	08/97→05/04	←			24.0322-0150.1 522150	Ø 280 22 19 V + S PD
	92	08/97→06/05	←	10/97→ 10/03; +PR 1LQ,1ZF		24.0122-0151.1 422151	Ø 256 22 19 V + S
	110	08/97→06/05	←			24.0322-0151.1 522151	Ø 256 22 19 V + S PD
	50	08/97→06/05	←	10/97→ 10/03; +PR 1LE,1LN,1ZE,1ZH		24.0125-0113.1 425113	Ø 288 25 22 V + S
	81	08/97→05/04	←			24.0325-0113.1 525113	Ø 288 25 22 V + S PD
	➡		➡	10/97→ 10/03; +PR 1KK,1KS,1KV / 1KQ,1KW		24.0109-0123.1 409123	Ø 230 9 7 + S
1.6 1.9 TDI	74	02/01→06/01	←	+PR 1LR,1LS,1ZM		24.0122-0150.1 422150	Ø 280 22 19 V + S
	74	09/00→06/05	←			24.0322-0150.1 522150	Ø 280 22 19 V + S PD
			←	+PR 1LQ,1ZF		24.0122-0151.1 422151	Ø 256 22 19 V + S
			←			24.0322-0151.1 522151	Ø 256 22 19 V + S PD
			←	+PR 1LE,1LN,1ZE,1ZH		24.0125-0113.1 425113	Ø 288 25 22 V + S
			←			24.0325-0113.1 525113	Ø 288 25 22 V + S PD
			➡	+PR 1KK,1KS,1KV / 1KQ,1KW		24.0109-0123.1 409123	Ø 230 9 7 + S
1.6 1.6 1.6 16V 1.6 FSI	75	08/00→06/05	←	→ 10/03; +PR 1LR,1LS,1ZM		24.0122-0150.1 422150	Ø 280 22 19 V + S
	78	08/03→06/05	←			24.0322-0150.1 522150	Ø 280 22 19 V + S PD
	77	02/00→06/05	←	→ 10/03; +PR 1LQ,1ZF		24.0122-0151.1 422151	Ø 256 22 19 V + S
	81	01/02→06/05	←			24.0322-0151.1 522151	Ø 256 22 19 V + S PD
			←	→ 10/03; +PR 1LE,1LN,1ZE,1ZH		24.0125-0113.1 425113	Ø 288 25 22 V + S
			←			24.0325-0113.1 525113	Ø 288 25 22 V + S PD
			➡	→ 10/03; +PR 1KK,1KS,1KV / 1KQ,1KW		24.0109-0123.1 409123	Ø 230 9 7 + S
1.8 4motion	92	05/98→06/05	←	07/98→ 10/03; +PR 1LR,1LS,1ZM		24.0122-0150.1 422150	Ø 280 22 19 V + S
			←			24.0322-0150.1 522150	Ø 280 22 19 V + S PD
			←	07/98→ 10/03; +PR 1LQ,1ZF		24.0122-0151.1 422151	Ø 256 22 19 V + S
			←			24.0322-0151.1 522151	Ø 256 22 19 V + S PD
			➡	→ 10/03; +PR 1KY		24.0122-0163.1 422163	Ø 256 22 20 V
			➡			24.0322-0163.1 522163	Ø 256 22 20 V PD
			➡	→ 10/03; +PR 1KY		24.0122-0163.1 422163	Ø 256 22 20 V
			24.0322-0163.1 522163	Ø 256 22 20 V PD			
			→ 10/03; +PR 1KY		24.0122-0163.1 422163	Ø 256 22 20 V	
					24.0322-0163.1 522163	Ø 256 22 20 V PD	
			→ 10/03; +PR 1KY		24.0122-0163.1 422163	Ø 256 22 20 V	
					24.0322-0163.1 522163	Ø 256 22 20 V PD	



	kw			 	! #		
VW - GOLF IV (1J1) 08/97→06/05							
Bremsscheibe							
1.8 4motion	92	05/98→06/05	←	→ 06/01; +PR 1LE,1LN,1ZE,1ZH	24.0125-0113.1 425113	Ø 288 25 22 V + S	
			→	07/98→ 10/03; +PR 1KE	24.0325-0113.1 525113	Ø 288 25 22 V + S PD	
1.8 T GTI	132	08/01→06/05	←	→ 10/03	24.0109-0133.1 409133	Ø 239 8,9 7 + S	
			→	→ 10/03	24.0309-0133.1 509133	Ø 239 8,9 7 + S PD	
1.9 TDI	66	10/97→05/04	←	→ 06/01; +PR 1LR,1LS,1ZM	24.0125-0123.1 425123	Ø 310 25 22 V + S	
			←	→ 06/01; +PR 1LQ,1ZF	24.0325-0123.1 525123	Ø 310 25 22 V PD	
			←	→ 06/01; +PR 1LE,1LN,1ZE,1ZH	24.0122-0163.1 422163	Ø 256 22 20 V	
			→	→ 06/01; +PR 1KK,1KS,1KV / 1KQ,1KW	24.0322-0163.1 522163	Ø 256 22 20 V PD	
			→	→ 06/01; +PR 1KY	24.0122-0150.1 422150	Ø 280 22 19 V + S	
			→	→ 06/01; +PR 1KY	24.0322-0150.1 522150	Ø 280 22 19 V + S PD	
1.9 TDI	85	12/98→06/01	←	05/99→; +PR 1LR,1LS,1ZM	24.0122-0151.1 422151	Ø 256 22 19 V + S	
			←	05/99→; +PR 1LQ,1ZF	24.0322-0151.1 522151	Ø 256 22 19 V + S PD	
			←	05/99→; +PR 1LE,1LN,1ZE,1ZH	24.0125-0113.1 425113	Ø 288 25 22 V + S	
			→	05/99→; +PR 1KK,1KS,1KV / 1KQ,1KW	24.0325-0113.1 525113	Ø 288 25 22 V + S PD	
			→	05/99→; +PR 1KY	24.0109-0123.1 409123	Ø 230 9 7 + S	
			→	05/99→; +PR 1KY	24.0309-0123.1 509123	Ø 230 9 7 + S PD	
1.9 TDI	96	11/00→06/05	←	04/01→ 10/03; +PR 1LR,1LS,1ZM	24.0122-0163.1 422163	Ø 256 22 20 V	
			←	04/01→ 10/03; +PR 1LQ,1ZF	24.0322-0163.1 522163	Ø 256 22 20 V PD	
			←	04/01→ 10/03; +PR 1LE,1LN,1ZE,1ZH	24.0122-0150.1 422150	Ø 280 22 19 V + S	
			→	04/01→ 10/03; +PR 1LQ,1ZF	24.0322-0150.1 522150	Ø 280 22 19 V + S PD	
			→	04/01→ 10/03; +PR 1KY	24.0122-0151.1 422151	Ø 256 22 19 V + S	
			→	04/01→ 10/03; +PR 1KY	24.0322-0151.1 522151	Ø 256 22 19 V + S PD	
1.9 TDI	110	05/00→06/05	←	09/00→ 10/03; +PR 1LR,1LS,1ZM	24.0125-0113.1 425113	Ø 288 25 22 V + S	
			←	09/00→ 10/03; +PR 1LQ,1ZF	24.0325-0113.1 525113	Ø 288 25 22 V + S PD	
			←	09/00→ 10/03; +PR 1LE,1LN,1ZE,1ZH	24.0109-0123.1 409123	Ø 230 9 7 + S	
			→	09/00→ 10/03; +PR 1LQ,1ZF	24.0309-0123.1 509123	Ø 230 9 7 + S PD	
			→	09/00→ 10/03; +PR 1KY	24.0122-0163.1 422163	Ø 256 22 20 V	
			→	09/00→ 10/03; +PR 1KY	24.0322-0163.1 522163	Ø 256 22 20 V PD	
1.9 TDI 4motion	66	07/98→04/02	←	→ 06/01; +PR 1LR,1LS,1ZM	24.0122-0150.1 422150	Ø 280 22 19 V + S	
			←	→ 06/01; +PR 1LQ,1ZF	24.0322-0150.1 522150	Ø 280 22 19 V + S PD	
			←	→ 06/01; +PR 1LE,1LN,1ZE,1ZH	24.0122-0151.1 422151	Ø 256 22 19 V + S	
			→	→ 06/01; +PR 1KE	24.0322-0151.1 522151	Ø 256 22 19 V + S PD	
			→	→ 06/01; +PR 1KY	24.0125-0113.1 425113	Ø 288 25 22 V + S	
1.9 TDI 4motion	74	09/00→06/05	←	+PR 1LR,1LS,1ZM	24.0325-0113.1 525113	Ø 288 25 22 V + S PD	
			←	+PR 1LQ,1ZF	24.0109-0123.1 409123	Ø 239 8,9 7 + S	
			←	+PR 1LE,1LN,1ZE,1ZH	24.0309-0123.1 509133	Ø 239 8,9 7 + S PD	



	kw			 	! #		
VW - GOLF IV (1J1) 08/97→06/05							
Bremsscheibe							
1.9 TDI 4motion	74	09/00→06/05	← +PR 1LE,1LN,1ZE,1ZH	24.0325-0113.1	525113	Ø 288 25 22 V + S PD	
			→ +PR 1KE	24.0109-0133.1	409133	Ø 239 8,9 7 + S	
				24.0309-0133.1	509133	Ø 239 8,9 7 + S PD	
1.9 TDI 4motion	85	09/99→06/01	← 11/99→; +PR 1LR,1LS,1ZM	24.0122-0150.1	422150	Ø 280 22 19 V + S	
				24.0322-0150.1	522150	Ø 280 22 19 V + S PD	
			← 11/99→; +PR 1LQ,1ZF	24.0122-0151.1	422151	Ø 256 22 19 V + S	
				24.0322-0151.1	522151	Ø 256 22 19 V + S PD	
			← 11/99→; +PR 1LE,1LN,1ZE,1ZH	24.0125-0113.1	425113	Ø 288 25 22 V + S	
	24.0325-0113.1	525113	Ø 288 25 22 V + S PD				
			→ 11/99→; +PR 1KE	24.0109-0133.1	409133	Ø 239 8,9 7 + S	
				24.0309-0133.1	509133	Ø 239 8,9 7 + S PD	
1.9 TDI 4motion	96	11/00→06/05	← 04/01→ 10/03; +PR 1LR,1LS,1ZM	24.0122-0150.1	422150	Ø 280 22 19 V + S	
				24.0322-0150.1	522150	Ø 280 22 19 V + S PD	
			← 04/01→ 10/03; +PR 1LQ,1ZF	24.0122-0151.1	422151	Ø 256 22 19 V + S	
				24.0322-0151.1	522151	Ø 256 22 19 V + S PD	
			← 04/01→ 10/03; +PR 1LE,1LN,1ZE,1ZH	24.0125-0113.1	425113	Ø 288 25 22 V + S	
	24.0325-0113.1	525113	Ø 288 25 22 V + S PD				
			→ 04/01→ 10/03; +PR 1KE	24.0109-0133.1	409133	Ø 239 8,9 7 + S	
				24.0309-0133.1	509133	Ø 239 8,9 7 + S PD	
1.9 TDI 4motion	110	02/00→06/05	← 09/00→ 10/03; +PR 1LR,1LS,1ZM	24.0122-0150.1	422150	Ø 280 22 19 V + S	
				24.0322-0150.1	522150	Ø 280 22 19 V + S PD	
			← 09/00→ 10/03; +PR 1LQ,1ZF	24.0122-0151.1	422151	Ø 256 22 19 V + S	
				24.0322-0151.1	522151	Ø 256 22 19 V + S PD	
			← 09/00→ 10/03; +PR 1LE,1LN,1ZE,1ZH	24.0125-0113.1	425113	Ø 288 25 22 V + S	
				24.0325-0113.1	525113	Ø 288 25 22 V + S PD	
			→ 09/00→ 10/03; +PR 1KE	24.0109-0133.1	409133	Ø 239 8,9 7 + S	
				24.0309-0133.1	509133	Ø 239 8,9 7 + S PD	
2.0	85	07/98→05/04	← 08/98→ 10/03; +PR 1LR,1LS,1ZM	24.0122-0150.1	422150	Ø 280 22 19 V + S	
				24.0322-0150.1	522150	Ø 280 22 19 V + S PD	
			← 08/98→ 10/03; +PR 1LQ,1ZF	24.0122-0151.1	422151	Ø 256 22 19 V + S	
				24.0322-0151.1	522151	Ø 256 22 19 V + S PD	
			← 08/98→ 10/03; +PR 1LE,1LN,1ZE,1ZH	24.0125-0113.1	425113	Ø 288 25 22 V + S	
	24.0325-0113.1	525113	Ø 288 25 22 V + S PD				
			→ 08/98→ 10/03; +PR 1KK,1KS,1KV / 1KQ,1KW	24.0109-0123.1	409123	Ø 230 9 7 + S	
				24.0309-0123.1	509123	Ø 230 9 7 + S PD	
			→ 08/98→ 10/03; +PR 1KY	24.0122-0163.1	422163	Ø 256 22 20 V	
				24.0322-0163.1	522163	Ø 256 22 20 V PD	
2.0 4motion	85	10/00→06/05	← → 10/03; +PR 1LR,1LS,1ZM	24.0122-0150.1	422150	Ø 280 22 19 V + S	
				24.0322-0150.1	522150	Ø 280 22 19 V + S PD	
			← → 10/03; +PR 1LQ,1ZF	24.0122-0151.1	422151	Ø 256 22 19 V + S	
				24.0322-0151.1	522151	Ø 256 22 19 V + S PD	
			← → 10/03; +PR 1LE,1LN,1ZE,1ZH	24.0125-0113.1	425113	Ø 288 25 22 V + S	
				24.0325-0113.1	525113	Ø 288 25 22 V + S PD	
			→ 10/03; +PR 1KE	24.0109-0133.1	409133	Ø 239 8,9 7 + S	
				24.0309-0133.1	509133	Ø 239 8,9 7 + S PD	
2.3 V5	110	08/97→10/00	← 10/97→; +PR 1LR,1LS,1ZM	24.0122-0150.1	422150	Ø 280 22 19 V + S	
				24.0322-0150.1	522150	Ø 280 22 19 V + S PD	
			← 10/97→; +PR 1LQ,1ZF	24.0122-0151.1	422151	Ø 256 22 19 V + S	
				24.0322-0151.1	522151	Ø 256 22 19 V + S PD	
			← 10/97→; +PR 1LE,1LN,1ZE,1ZH	24.0125-0113.1	425113	Ø 288 25 22 V + S	
				24.0325-0113.1	525113	Ø 288 25 22 V + S PD	
			← 10/97→; +PR 1LJ,1ZQ	24.0125-0123.1	425123	Ø 310 25 22 V + S	
				24.0325-0123.1	525123	Ø 310 25 22 V PD	
			→ 10/97→; +PR 1KK,1KS,1KV / 1KQ,1KW	24.0109-0123.1	409123	Ø 230 9 7 + S	
				24.0309-0123.1	509123	Ø 230 9 7 + S PD	
			→ 10/97→; +PR 1KY	24.0122-0163.1	422163	Ø 256 22 20 V	
				24.0322-0163.1	522163	Ø 256 22 20 V PD	
2.3 V5	125	10/00→06/05	← → 10/03; +PR 1LR,1LS,1ZM	24.0122-0150.1	422150	Ø 280 22 19 V + S	
				24.0322-0150.1	522150	Ø 280 22 19 V + S PD	
			← → 10/03; +PR 1LQ,1ZF	24.0122-0151.1	422151	Ø 256 22 19 V + S	
				24.0322-0151.1	522151	Ø 256 22 19 V + S PD	



VW - GOLF IV (1J1) 08/97→06/05











Bremsscheibe









2.3 V5	125	10/00→06/05	←	→ 10/03; +PR 1LE,1LN,1ZE,1ZH	24.0125-0113.1 425113	Ø 288 25 22 V + S
			←	→ 10/03; +PR 1LJ,1ZQ	24.0325-0113.1 525113	Ø 288 25 22 V + S PD
			→	→ 10/03; +PR 1KK,1KS,1KV / 1KQ,1KW	24.0125-0123.1 425123	Ø 310 25 22 V + S
			→	→ 10/03; +PR 1KY	24.0325-0123.1 525123	Ø 310 25 22 V PD
2.3 V5 4motion	110	12/98→10/00	←	+PR 1LR,1LS,1ZM	24.0109-0123.1 409123	Ø 230 9 7 + S
			←	+PR 1LQ,1ZF	24.0309-0123.1 509123	Ø 230 9 7 + S PD
			←	+PR 1LE,1LN,1ZE,1ZH	24.0122-0163.1 422163	Ø 256 22 20 V
			←	+PR 1LJ,1ZQ	24.0322-0163.1 522163	Ø 256 22 20 V PD
			→	+PR 1KE	24.0122-0150.1 422150	Ø 280 22 19 V + S
			→	+PR 1KU,2EE,2EL	24.0322-0150.1 522150	Ø 280 22 19 V + S PD
2.3 V5 4motion	125	10/00→06/05	←	→ 10/03; +PR 1LR,1LS,1ZM	24.0122-0151.1 422151	Ø 256 22 19 V + S
			←	→ 10/03; +PR 1LQ,1ZF	24.0322-0151.1 522151	Ø 256 22 19 V + S PD
			←	→ 10/03; +PR 1LE,1LN,1ZE,1ZH	24.0125-0113.1 425113	Ø 288 25 22 V + S
			←	→ 10/03; +PR 1LJ,1ZQ	24.0325-0113.1 525113	Ø 288 25 22 V + S PD
			→	→ 10/03; +PR 1KE	24.0125-0123.1 425123	Ø 310 25 22 V + S
			→	→ 10/03; +PR 1KU,2EE,2EL	24.0325-0123.1 525123	Ø 310 25 22 V PD
			→	→ 10/03; +PR 1KE	24.0109-0133.1 409133	Ø 239 8,9 7 + S
2.8 V6 4motion	150	03/99→06/05	←	→ 10/03; +PR 1LJ,1ZQ	24.0309-0133.1 509133	Ø 239 8,9 7 + S PD
			→	→ 10/03; +PR 1KE	24.0122-0163.1 422163	Ø 256 22 20 V
3.2 R32 4motion	177	09/02→06/05	←	→ 10/03; +PR 1ZT	24.0322-0163.1 522163	Ø 256 22 20 V PD
			←	→ 10/03; +PR 1ZT	24.0132-0165.2 432165	Ø 334 32 30 V Bremsscheibe zweiteilig
			→	→ 10/03; +PR 1KU,2EE,2EL	24.0132-0166.2 432166	Ø 334 32 30 V Bremsscheibe zweiteilig









VW - GOLF IV Cabriolet (1E7) 06/98→06/02









Bremsbelagsatz, Scheibenbremse







1.6 1.8 1.8	74 55 66	06/98→06/02 06/98→06/02 06/98→06/02	←	1E-V-000001→; → 02/02	13.0460-2821.2 602821	TRW 21945 16,0 - WK
			←	→ 1E-T-030000	13.0460-2958.2 602958	TRW 20168 19,3 - WK
			→	→ 1E-X-014000	13.0460-2937.2 602937	TRW 20961 15,2 - WK + Zub
			→	1E-X-014001→; → 02/02	13.0460-2984.2 602984	TRW 20961 17,2 - WK + Zub
1.9 TDI	66	06/98→06/02	←	1E-V-000001→; → 02/02	13.0460-2821.2 602821	TRW 21945 16,0 - WK
			←	→ 1E-T-030000	13.0460-2958.2 602958	TRW 20168 19,3 - WK
			→	1E-X-014001→; → 02/02; - ABS	13.0460-2937.2 602937	TRW 20961 15,2 - WK + Zub
			→	→ 1E-X-014000	13.0460-2937.2 602937	TRW 20961 15,2 - WK + Zub
			→	1E-X-014001→; + ABS; → 02/02	13.0460-2984.2 602984	TRW 20961 17,2 - WK + Zub
1.9 TDI	81	06/98→06/02	←	→ 02/02	13.0460-2821.2 602821	TRW 21945 16,0 - WK
			→	→ 1E-X-014000	13.0460-2937.2 602937	TRW 20961 15,2 - WK + Zub
			→	1E-X-014001→; → 02/02; - ABS	13.0460-2937.2 602937	TRW 20961 15,2 - WK + Zub
			→	1E-X-014001→; + ABS; → 02/02	13.0460-2984.2 602984	TRW 20961 17,2 - WK + Zub
2.0 ↓	85	06/98→06/02	←	1E-V-000001→; → 02/02	13.0460-2821.2 602821	TRW 21945 16,0 - WK

	kw			 	! #		
VW - GOLF IV Cabriolet (1E7) 06/98→06/02							
 Bremsbelagsatz, Scheibenbremse							
2.0	85	06/98→06/02	←	→ 1E-T-030000		13.0460-2958.2 602958	TRW 20168 19,3 - WK
			→	1E-2-800 001→; → 02/02		13.0460-2894.2 602894 13.0470-2894.2 LD2894	TRW 20961 17,2 - WK + Zub TRW 20961 17,2 - WK + Zub Ceramic
			→	→ 1E-X-014000		13.0460-2937.2 602937	TRW 20961 15,2 - WK + Zub
			→	1E-X-014001→ 1E-2-015 000		13.0460-2984.2 602984	TRW 20961 17,2 - WK + Zub
Zubehörsatz, Scheibenbremsbelag							
1.6	74	06/98→06/02	→	1E-X-014001→; → 02/02		13.0460-0072.2 610072	TRW
1.8	55	06/98→06/02	→	→ 1E-X-014000		13.0460-0419.2 610419	TRW
1.8	66	06/98→06/02	→	→ 1E-X-014000		13.0460-0419.2 610419	TRW
1.9 TDI	66	06/98→06/02	→	1E-X-014001→; + ABS; → 02/02		13.0460-0072.2 610072	TRW
1.9 TDI	81	06/98→06/02	→	→ 1E-X-014000		13.0460-0419.2 610419	TRW
2.0	85	06/98→06/02	→	1E-X-014001→ 1E-2-015 000		13.0460-0072.2 610072	TRW
			→	→ 1E-X-014000		13.0460-0419.2 610419	TRW
 Bremsscheibe							
1.6	74	06/98→06/02	←	→ 1E-T-030000		24.0113-0178.1 413178	Ø 255,6 12,9 11 + S
1.8	55	06/98→06/02	←	→ 1E-T-030000		24.0313-0178.1 513178	Ø 255,6 12,9 11 + S PD
1.8	66	06/98→06/02	←	→ 1E-T-030000		24.0313-0178.1 513178	Ø 255,6 12,9 11 + S PD
1.9 TDI	66	06/98→06/02	←	1E-V-000001→; → 02/02		24.0120-0128.1 420128	Ø 256 20 18 V + S
2.0	85	06/98→06/02	←	1E-V-000001→; → 02/02		24.0320-0128.1 520128	Ø 256 20 18 V + S PD
			→	→ 02/02		24.0110-0111.1 410111 24.0110-0275.2 410275	Ø 226 10 8 - ABS Ring / - RLG Ø 226 10 8 + ABS Ring / - RLG
1.9 TDI	81	06/98→06/02	←	→ 02/02		24.0120-0128.1 420128 24.0320-0128.1 520128	Ø 256 20 18 V + S Ø 256 20 18 V + S PD
			→	→ 02/02		24.0110-0111.1 410111 24.0110-0275.2 410275	Ø 226 10 8 - ABS Ring / - RLG Ø 226 10 8 + ABS Ring / - RLG
VW - GOLF IV Van (1J1) 05/00→05/04							
 Bremsbelagsatz, Scheibenbremse							
1.9 TDI	66	05/00→09/02	←	→ 1J-X-800000; +PR 1LQ,1LR,1ZF		13.0460-7111.2 607111 13.0470-7111.2 LD7111	VW 23130 19,6 - WE / - WK VW 23130 19,6 - WE / - WK Ceramic
			←	1J-Y-000001→; → 06/01; +PR 1LS,1LQ,1ZF,1ZM		13.0460-7117.2 607117 13.0470-7117.2 LD7117	VW 23130 19,6 + WK VW 23130 19,6 + WK Ceramic
			→	→ 06/01; +PR 1KY		13.0460-2886.2 602886 13.0470-2886.2 LD2886	TRW 20961 16,0 - WK TRW 20961 16,0 - WK Ceramic
			→	→ 06/01; +PR 1KK,1KS,1KV / 1KQ,1KW		13.0460-2894.2 602894 13.0470-2894.2 LD2894	TRW 20961 17,2 - WK + Zub TRW 20961 17,2 - WK + Zub Ceramic
1.9 TDI	96	04/01→05/04	←	→ 1J-X-800000; +PR 1LQ,1LR,1ZF		13.0460-7111.2 607111 13.0470-7111.2 LD7111	VW 23130 19,6 - WE / - WK VW 23130 19,6 - WE / - WK Ceramic
			←	1J-Y-000001→; → 06/01; +PR 1LS,1LQ,1ZF,1ZM		13.0460-7117.2 607117 13.0470-7117.2 LD7117	VW 23130 19,6 + WK VW 23130 19,6 + WK Ceramic
			←	→ 10/03; +PR 1LE,1LJ,1LN,1ZE / 1ZH,1ZQ		13.0460-7122.2 607122 13.0470-7122.2 LD7122	ATE 20676 19,8 + WK ATE 20676 19,8 + WK Ceramic
			→	→ 06/01; +PR 1KY		13.0460-2886.2 602886 13.0470-2886.2 LD2886	TRW 20961 16,0 - WK TRW 20961 16,0 - WK Ceramic
			→	→ 10/03; +PR 1KY		13.0460-2886.2 602886 13.0470-2886.2 LD2886	TRW 20961 16,0 - WK TRW 20961 16,0 - WK Ceramic
			→	→ 10/03; +PR 1KK,1KS,1KV / 1KQ,1KW		13.0460-2894.2 602894 13.0470-2894.2 LD2894	TRW 20961 17,2 - WK + Zub TRW 20961 17,2 - WK + Zub Ceramic
			→	→ 06/01; +PR 1KK,1KS,1KV / 1KQ,1KW		13.0460-2894.2 602894 13.0470-2894.2 LD2894	TRW 20961 17,2 - WK + Zub TRW 20961 17,2 - WK + Zub Ceramic
Zubehörsatz, Scheibenbremsbelag							
1.9 TDI	66	05/00→09/02	→	→ 06/01; +PR 1KY		13.0460-0072.2 610072	TRW
			→	→ 06/01; +PR 1KK,1KS,1KV / 1KQ,1KW		13.0460-0072.2 610072	TRW
1.9 TDI	96	04/01→05/04	→	→ 06/01; +PR 1KY		13.0460-0072.2 610072	TRW
			→	→ 10/03; +PR 1KY		13.0460-0072.2 610072	TRW









	kw			 	! #		
VW - GOLF IV Van (1J1) 05/00→05/04							
Zubehörsatz, Scheibenbremsbelag							
1.9 TDI	96	04/01→05/04	➡	→ 06/01; +PR 1KK,1KS,1KV / 1KQ,1KW	13.0460-0072.2	610072	TRW
			➡	→ 10/03; +PR 1KK,1KS,1KV / 1KQ,1KW	13.0460-0072.2	610072	TRW
 Bremsscheibe							
1.9 TDI	66	05/00→09/02	⬅	→ 06/01; +PR 1LR,1LS,1ZM	24.0122-0150.1	422150	Ø 280 22 19 V + S
					24.0322-0150.1	522150	Ø 280 22 19 V + S PD
			⬅	→ 06/01; +PR 1LQ,1ZF	24.0122-0151.1	422151	Ø 256 22 19 V + S
					24.0322-0151.1	522151	Ø 256 22 19 V + S PD
			⬅	→ 06/01; +PR 1LE,1LN,1ZE,1ZH	24.0125-0113.1	425113	Ø 288 25 22 V + S
					24.0325-0113.1	525113	Ø 288 25 22 V + S PD
			➡	→ 06/01; +PR 1KK,1KS,1KV / 1KQ,1KW	24.0109-0123.1	409123	Ø 230 9 7 + S
					24.0309-0123.1	509123	Ø 230 9 7 + S PD
			➡	→ 06/01; +PR 1KY	24.0122-0163.1	422163	Ø 256 22 20 V
					24.0322-0163.1	522163	Ø 256 22 20 V PD
1.9 TDI	96	04/01→05/04	⬅	→ 10/03; +PR 1LR,1LS,1ZM	24.0122-0150.1	422150	Ø 280 22 19 V + S
					24.0322-0150.1	522150	Ø 280 22 19 V + S PD
			⬅	→ 06/01; +PR 1LR,1LS,1ZM	24.0122-0150.1	422150	Ø 280 22 19 V + S
					24.0322-0150.1	522150	Ø 280 22 19 V + S PD
			⬅	→ 06/01; +PR 1LQ,1ZF	24.0122-0151.1	422151	Ø 256 22 19 V + S
					24.0322-0151.1	522151	Ø 256 22 19 V + S PD
			⬅	→ 10/03; +PR 1LQ,1ZF	24.0122-0151.1	422151	Ø 256 22 19 V + S
					24.0322-0151.1	522151	Ø 256 22 19 V + S PD
			⬅	→ 06/01; +PR 1LE,1LN,1ZE,1ZH	24.0125-0113.1	425113	Ø 288 25 22 V + S
					24.0325-0113.1	525113	Ø 288 25 22 V + S PD
			⬅	→ 10/03; +PR 1LE,1LN,1ZE,1ZH	24.0125-0113.1	425113	Ø 288 25 22 V + S
					24.0325-0113.1	525113	Ø 288 25 22 V + S PD
			➡	→ 10/03; +PR 1KK,1KS,1KV / 1KQ,1KW	24.0109-0123.1	409123	Ø 230 9 7 + S
					24.0309-0123.1	509123	Ø 230 9 7 + S PD
			➡	→ 06/01; +PR 1KK,1KS,1KV / 1KQ,1KW	24.0109-0123.1	409123	Ø 230 9 7 + S
					24.0309-0123.1	509123	Ø 230 9 7 + S PD
			➡	→ 10/03; +PR 1KY	24.0122-0163.1	422163	Ø 256 22 20 V
					24.0322-0163.1	522163	Ø 256 22 20 V PD
			➡	→ 06/01; +PR 1KY	24.0122-0163.1	422163	Ø 256 22 20 V
					24.0322-0163.1	522163	Ø 256 22 20 V PD
VW - GOLF IV Variant (1J5) 05/99→06/06							
 Bremsbelagsatz, Scheibenbremse							
1.4 16V	55	05/99→06/06	⬅	+PR 1LR,1LS,1ZF,1ZP / 1ZM	13.0460-7117.2	607117	VW 23130 19,6 + WK
1.6	74	05/99→04/02			13.0470-7117.2	LD7117	VW 23130 19,6 + WK Ceramic
1.6	75	08/00→06/06					
1.6 16V	77	02/00→06/06	➡	+PR 1KE,1KP,1KT	13.0460-2894.2	602894	TRW 20961 17,2 - WK + Zub
1.6 FSI	81	01/02→06/06			13.0470-2894.2	LD2894	TRW 20961 17,2 - WK + Zub
1.9 SDI	50	05/99→06/06					Ceramic
1.9 TDI	66	05/99→05/06					
1.9 TDI	74	09/00→06/06					
1.9 TDI	81	05/99→06/01					
1.9 TDI	85	08/99→06/01					
2.0	85	05/99→06/06					
2.0 Bi-Fuel	85	02/02→06/06					
1.8 4motion	92	05/99→06/06	⬅	+PR 1LR,1LS,1ZF,1ZP / 1ZM	13.0460-7117.2	607117	VW 23130 19,6 + WK
1.9 TDI 4motion	66	05/99→04/02			13.0470-7117.2	LD7117	VW 23130 19,6 + WK Ceramic
1.9 TDI 4motion	74	09/00→06/06					
2.0 4motion	85	10/00→06/06	➡	+PR 2EE,2EL	13.0460-2820.2	602820	TRW 20961 17,2 - WK
					13.0470-2820.2	LD2820	TRW 20961 17,2 - WK Ceramic
			➡	+PR 1KE	13.0460-2894.2	602894	TRW 20961 17,2 - WK + Zub
					13.0470-2894.2	LD2894	TRW 20961 17,2 - WK + Zub Ceramic
1.8 T	110	05/00→06/06	⬅	+PR 1ZD;1ZE / 1ZE	13.0460-7122.2	607122	ATE 20676 19,8 + WK
			⬅	+PR 1ZD;1ZE	13.0470-7122.2	LD7122	ATE 20676 19,8 + WK Ceramic
			➡	+PR 1KE,1KP,1KT	13.0460-2894.2	602894	TRW 20961 17,2 - WK + Zub
					13.0470-2894.2	LD2894	TRW 20961 17,2 - WK + Zub Ceramic
1.9 TDI	96	11/00→06/06	⬅	04/01→; +PR 1LR,1LS,1ZF,1ZP / 1ZM	13.0460-7117.2	607117	VW 23130 19,6 + WK
					13.0470-7117.2	LD7117	VW 23130 19,6 + WK Ceramic
			⬅	04/01→; +PR 1ZD;1ZE / 1ZE	13.0460-7122.2	607122	ATE 20676 19,8 + WK
↓							

	kw			 	! #		
VW - GOLF IV Variant (1J5) 05/99→06/06							
 Bremsbelagsatz, Scheibenbremse							
1.9 TDI	96	11/00→06/06	←	04/01→; +PR 1ZD;1ZE	13.0470-7122.2	LD7122	ATE 20676 19,8 + WK Ceramic
			→	04/01→; +PR 1KE,1KP,1KT	13.0460-2894.2	602894	TRW 20961 17,2 - WK + Zub
1.9 TDI	110	06/01→06/06	←	+PR 1LR,1LS,1ZF,1ZP / 1ZM	13.0460-7117.2	607117	VW 23130 19,6 + WK
			←	+PR 1ZD;1ZE / 1ZE	13.0470-7117.2	LD7117	VW 23130 19,6 + WK Ceramic
			←	+PR 1ZD;1ZE	13.0460-7122.2	607122	ATE 20676 19,8 + WK
			←	+PR 1ZD;1ZE	13.0470-7122.2	LD7122	ATE 20676 19,8 + WK Ceramic
			→	+PR 1KE,1KP,1KT	13.0460-2894.2	602894	TRW 20961 17,2 - WK + Zub
1.9 TDI 4motion	85	05/99→06/01	←	11/99→; +PR 1LR,1LS,1ZF,1ZP / 1ZM	13.0460-7117.2	607117	VW 23130 19,6 + WK
			→	11/99→; +PR 2EE,2EL	13.0470-7117.2	LD7117	VW 23130 19,6 + WK Ceramic
1.9 TDI 4motion	96	11/00→06/06	←	+PR 1ZD;1ZE / 1ZE	13.0460-2820.2	602820	TRW 20961 17,2 - WK
			←	+PR 1ZD;1ZE	13.0470-2820.2	LD2820	TRW 20961 17,2 - WK Ceramic
			→	+PR 1KE	13.0460-2894.2	602894	TRW 20961 17,2 - WK + Zub
			→	+PR 1KE	13.0470-2894.2	LD2894	TRW 20961 17,2 - WK + Zub Ceramic
1.9 TDI 4motion	110	05/02→06/05	←	+PR 1ZD;1ZE / 1ZE	13.0460-2820.2	602820	TRW 20961 17,2 - WK
			←	+PR 1ZD;1ZE	13.0470-2820.2	LD2820	TRW 20961 17,2 - WK Ceramic
			→	+PR 1KE	13.0460-2894.2	602894	TRW 20961 17,2 - WK + Zub
			→	+PR 1KE	13.0470-2894.2	LD2894	TRW 20961 17,2 - WK + Zub Ceramic
2.0 4motion	88	12/99→06/06	←	04/00→; +PR 1LR,1LS,1ZF,1ZP / 1ZM	13.0460-7117.2	607117	VW 23130 19,6 + WK
			→	04/00→; +PR 2EE,2EL	13.0470-7117.2	LD7117	VW 23130 19,6 + WK Ceramic
			→	04/00→; +PR 1KE	13.0460-2820.2	602820	TRW 20961 17,2 - WK
2.3 V5 2.3 V5	110 125	05/99→06/06 10/00→06/06	←	→ 1J-X-800000; +PR 1ZE	13.0460-2820.2	LD2820	TRW 20961 17,2 - WK Ceramic
			←	→ 1J-X-800000; +PR 1ZE	13.0470-2820.2	LD2820	TRW 20961 17,2 - WK Ceramic
			←	1J-Y-000001→; +PR 1ZD;1ZE / 1ZE	13.0460-2894.2	602894	TRW 20961 17,2 - WK + Zub
			→	1J-Y-000001→; +PR 1ZD;1ZE	13.0470-2894.2	LD2894	TRW 20961 17,2 - WK + Zub Ceramic
2.3 V5 4motion 2.3 V5 4motion	110 125	05/99→06/06 10/00→06/06	←	→ 1J-X-800000; +PR 1ZE	13.0460-7081.2	607081	ATE 20676 19,8 - WE / - WK
			←	→ 1J-X-800000; +PR 1ZE	13.0470-7081.2	LD7081	ATE 20676 19,8 - WE / - WK Ceramic
			←	1J-Y-000001→; +PR 1ZD;1ZE / 1ZE	13.0460-7122.2	607122	ATE 20676 19,8 + WK
			←	1J-Y-000001→; +PR 1ZD;1ZE	13.0470-7122.2	LD7122	ATE 20676 19,8 + WK Ceramic
			→	+PR 1KE,1KP,1KT	13.0460-2894.2	602894	TRW 20961 17,2 - WK + Zub
2.8 V6 4motion	150	05/99→06/06	←	→ 1J-X-800000; +PR 1ZE	13.0460-2894.2	LD2894	TRW 20961 17,2 - WK + Zub Ceramic
			←	→ 1J-X-800000; +PR 1ZE	13.0470-2894.2	LD2894	TRW 20961 17,2 - WK + Zub Ceramic
			←	1J-Y-000001→; +PR 1ZD;1ZE / 1ZE	13.0460-2820.2	602820	TRW 20961 17,2 - WK
			←	1J-Y-000001→; +PR 1ZD;1ZE	13.0470-2820.2	LD2820	TRW 20961 17,2 - WK Ceramic
			→	+PR 1KE	13.0460-2894.2	602894	TRW 20961 17,2 - WK + Zub
↓			→	+PR 2EE,2EL	13.0460-2894.2	LD2894	TRW 20961 17,2 - WK + Zub Ceramic
			→	+PR 2EE,2EL	13.0470-2894.2	LD2894	TRW 20961 17,2 - WK + Zub Ceramic







	kw				! #		
VW - GOLF IV Variant (1J5) 05/99→06/06							
 Bremsbelagsatz, Scheibenbremse							
2.8 V6 4motion	150	05/99→06/06	➡	+PR 1KE		13.0460-2894.2 602894 13.0470-2894.2 LD2894	TRW 20961 17,2 - WK + Zub TRW 20961 17,2 - WK + Zub Ceramic
Zubehörsatz, Scheibenbremsbelag							
1.4 16V	55	05/99→06/06	➡	+PR 1KE,1KP,1KT		13.0460-0072.2 610072	TRW
1.6	74	05/99→04/02					
1.6	75	08/00→06/06					
1.6 16V	77	02/00→06/06					
1.6 FSI	81	01/02→06/06					
1.8 T	110	05/00→06/06					
1.9 SDI	50	05/99→06/06					
1.9 TDI	66	05/99→05/06					
1.9 TDI	74	09/00→06/06					
1.9 TDI	81	05/99→06/01					
1.9 TDI	85	08/99→06/01					
1.9 TDI	110	06/01→06/06					
2.0	85	05/99→06/06					
2.0 Bi-Fuel	85	02/02→06/06					
2.3 V5	110	05/99→06/06					
2.3 V5	125	10/00→06/06					
1.8 4motion	92	05/99→06/06	➡	+PR 1KE		13.0460-0072.2 610072	TRW
1.9 TDI 4motion	66	05/99→04/02					
1.9 TDI 4motion	74	09/00→06/06					
1.9 TDI 4motion	110	05/02→06/05					
2.0 4motion	85	10/00→06/06					
2.3 V5 4motion	110	05/99→06/06					
2.3 V5 4motion	125	10/00→06/06					
2.8 V6 4motion	150	05/99→06/06					
1.9 TDI	96	11/00→06/06	➡	04/01→; +PR 1KE,1KP,1KT		13.0460-0072.2 610072	TRW
1.9 TDI 4motion	85	05/99→06/01	➡	11/99→; +PR 1KE		13.0460-0072.2 610072	TRW
1.9 TDI 4motion	96	11/00→06/06	➡	04/01→; +PR 1KE		13.0460-0072.2 610072	TRW
2.0 4motion	88	12/99→06/06	➡	04/00→; +PR 1KE		13.0460-0072.2 610072	TRW
 Bremsscheibe							
1.4 16V	55	05/99→06/06	←	+PR 1LR,1LS,1ZF,1ZP / 1ZM		24.0122-0150.1 422150	Ø 280 22 19 V + S
1.6	74	05/99→04/02				24.0322-0150.1 522150	Ø 280 22 19 V + S PD
1.6	75	08/00→06/06					
1.6 16V	77	02/00→06/06	➡	+PR 1KP,1KT		24.0109-0123.1 409123	Ø 230 9 7 + S
1.6 FSI	81	01/02→06/06				24.0309-0123.1 509123	Ø 230 9 7 + S PD
1.9 SDI	50	05/99→06/06					
1.9 TDI	66	05/99→05/06					
1.9 TDI	74	09/00→06/06					
1.9 TDI	81	05/99→06/01					
1.9 TDI	85	08/99→06/01					
2.0	85	05/99→06/06					
2.0 Bi-Fuel	85	02/02→06/06					
1.8 4motion	92	05/99→06/06	←	+PR 1LR,1LS,1ZF,1ZP / 1ZM		24.0122-0150.1 422150	Ø 280 22 19 V + S
1.9 TDI 4motion	66	05/99→04/02				24.0322-0150.1 522150	Ø 280 22 19 V + S PD
1.9 TDI 4motion	74	09/00→06/06					
2.0 4motion	85	10/00→06/06	➡	+PR 1KE		24.0109-0133.1 409133	Ø 239 8,9 7 + S
			➡	+PR 2EE,2EL		24.0309-0133.1 509133	Ø 239 8,9 7 + S PD
			➡	+PR 1KE		24.0122-0163.1 422163	Ø 256 22 20 V
			➡	+PR 2EE,2EL		24.0322-0163.1 522163	Ø 256 22 20 V PD
1.8 T	110	05/00→06/06	←	+PR 1ZD,1ZE		24.0125-0113.1 425113	Ø 288 25 22 V + S
2.3 V5	110	05/99→06/06				24.0325-0113.1 525113	Ø 288 25 22 V + S PD
2.3 V5	125	10/00→06/06	➡	+PR 1KP,1KT		24.0109-0123.1 409123	Ø 230 9 7 + S
			➡	+PR 1KP,1KT		24.0309-0123.1 509123	Ø 230 9 7 + S PD
1.9 TDI	96	11/00→06/06	←	04/01→; +PR 1LR,1LS,1ZF,1ZP / 1ZM		24.0122-0150.1 422150	Ø 280 22 19 V + S
			←	04/01→; +PR 1LR,1LS,1ZF,1ZP / 1ZM		24.0322-0150.1 522150	Ø 280 22 19 V + S PD
			←	04/01→; +PR 1ZD,1ZE		24.0125-0113.1 425113	Ø 288 25 22 V + S
			←	04/01→; +PR 1ZD,1ZE		24.0325-0113.1 525113	Ø 288 25 22 V + S PD
			➡	04/01→; +PR 1KP,1KT		24.0109-0123.1 409123	Ø 230 9 7 + S
			➡	04/01→; +PR 1KP,1KT		24.0309-0123.1 509123	Ø 230 9 7 + S PD
1.9 TDI	110	06/01→06/06	←	+PR 1LR,1LS,1ZF,1ZP / 1ZM		24.0122-0150.1 422150	Ø 280 22 19 V + S
			←	+PR 1LR,1LS,1ZF,1ZP / 1ZM		24.0322-0150.1 522150	Ø 280 22 19 V + S PD
			←	+PR 1ZD,1ZE		24.0125-0113.1 425113	Ø 288 25 22 V + S
			←	+PR 1ZD,1ZE		24.0325-0113.1 525113	Ø 288 25 22 V + S PD
			➡	+PR 1KP,1KT		24.0109-0123.1 409123	Ø 230 9 7 + S
			➡	+PR 1KP,1KT		24.0309-0123.1 509123	Ø 230 9 7 + S PD
1.9 TDI 4motion	85	05/99→06/01	←	11/99→; +PR 1LR,1LS,1ZF,1ZP / 1ZM		24.0122-0150.1 422150	Ø 280 22 19 V + S
			←	11/99→; +PR 1LR,1LS,1ZF,1ZP / 1ZM		24.0322-0150.1 522150	Ø 280 22 19 V + S PD









	kw			 	! #		
VW - GOLF IV Variant (1J5) 05/99→06/06							
Bremsscheibe							
1.9 TDI 4motion	85	05/99→06/01	➔	11/99→; +PR 1KE	24.0109-0133.1	409133	Ø 239 8,9 7 + S
					24.0309-0133.1	509133	Ø 239 8,9 7 + S PD
			➔	11/99→; +PR 2EE,2EL	24.0122-0163.1	422163	Ø 256 22 20 V
1.9 TDI 4motion	96	11/00→06/06	➔	04/01→; +PR 1ZD,1ZE	24.0125-0113.1	425113	Ø 288 25 22 V + S
					24.0325-0113.1	525113	Ø 288 25 22 V + S PD
			➔	04/01→; +PR 1KE	24.0109-0133.1	409133	Ø 239 8,9 7 + S
1.9 TDI 4motion 2.3 V5 4motion 2.3 V5 4motion	110 110 125	05/02→06/05 05/99→06/06 10/00→06/06	➔	04/01→; +PR 2EE,2EL	24.0122-0163.1	422163	Ø 256 22 20 V
					24.0322-0163.1	522163	Ø 256 22 20 V PD
			➔	+PR 1ZD,1ZE	24.0125-0113.1	425113	Ø 288 25 22 V + S
2.0 4motion	88	12/99→06/06	➔	+PR 1KE	24.0109-0133.1	409133	Ø 239 8,9 7 + S
					24.0309-0133.1	509133	Ø 239 8,9 7 + S PD
			➔	+PR 2EE,2EL	24.0122-0163.1	422163	Ø 256 22 20 V
2.8 V6 4motion	150	05/99→06/06	➔	04/00→; +PR 1LR,1LS,1ZF,1ZP / 1ZM	24.0122-0150.1	422150	Ø 280 22 19 V + S
					24.0322-0150.1	522150	Ø 280 22 19 V + S PD
			➔	04/00→; +PR 1KE	24.0109-0133.1	409133	Ø 239 8,9 7 + S
2.8 V6 4motion	150	05/99→06/06	➔	04/00→; +PR 2EE,2EL	24.0122-0163.1	422163	Ø 256 22 20 V
					24.0322-0163.1	522163	Ø 256 22 20 V PD
			➔	+PR 1KE	24.0109-0133.1	409133	Ø 239 8,9 7 + S
2.8 V6 4motion	150	05/99→06/06	➔	+PR 2EE,2EL	24.0122-0163.1	422163	Ø 256 22 20 V
					24.0322-0163.1	522163	Ø 256 22 20 V PD
			➔	+PR 1KE	24.0109-0133.1	409133	Ø 239 8,9 7 + S
VW - GOLF V (1K1) 10/03→02/09							
Bremsbelagsatz, Scheibenbremse							
1.4 16V 1.4 FSI 1.6 FSI	55 66 85	10/03→05/06 10/03→07/06 10/03→07/08	➔	+PR 1ZF;1ZM;1ZC	13.0460-7117.2	607117	VW 23130 19,6 + WK
					13.0470-7117.2	LD7117	VW 23130 19,6 + WK Ceramic
			➔	+PR 1ZE;1ZP / 1LJ,1LL,1LV,1ZD	13.0460-7184.2	607184	ATE 23587 20,6 + WK
					13.0470-7184.2	LD7184	ATE 23587 20,6 + WK Ceramic
			➔	+PR 1LK;1LM	13.0460-7200.2	607200	ATE 23801 20,3 + WK
					13.0470-7200.2	LD7200	ATE 23801 20,3 + WK Ceramic
			➔	+PR 1KY,1KZ,1KF,2EL / 1KE	13.0460-2748.2	602748	TRW 24606 17,4 - WE / - WK + Zub
					13.0460-2880.2	602880	TRW 23914 17,1 + WE / - WK + Zub
1.4 16V 1.4 TSI 1.4 TSI 1.6 1.6 MultiFuel 1.9 TDI 1.9 TDI 2.0 FSI 2.0 GTI 2.0 GTI 2.0 SDI 2.0 TDI	59 90 103 75 75 66 77 110 147 169 55 100	05/06→11/08 05/07→11/08 05/06→11/08 01/04→11/08 10/07→11/08 05/04→11/08 10/03→11/08 01/04→11/08 10/04→02/09 09/06→12/08 01/04→11/08 10/03→11/08	➔	+PR 1KE	24.0109-0133.1	409133	Ø 239 8,9 7 + S
					24.0309-0133.1	509133	Ø 239 8,9 7 + S PD
			➔	+PR 1ZD,1ZE	24.0125-0113.1	425113	Ø 288 25 22 V + S
					24.0325-0113.1	525113	Ø 288 25 22 V + S PD
			➔	+PR 1KE	24.0109-0133.1	409133	Ø 239 8,9 7 + S
					24.0309-0133.1	509133	Ø 239 8,9 7 + S PD
			➔	+PR 2EE,2EL	24.0122-0163.1	422163	Ø 256 22 20 V
					24.0322-0163.1	522163	Ø 256 22 20 V PD
1.4 16V 1.4 TSI 1.4 TSI 1.6 1.6 MultiFuel 1.9 TDI 1.9 TDI 2.0 FSI 2.0 GTI 2.0 GTI 2.0 SDI 2.0 TDI	59 90 103 75 75 66 77 110 147 169 55 100	05/06→11/08 05/07→11/08 05/06→11/08 01/04→11/08 10/07→11/08 05/04→11/08 10/03→11/08 01/04→11/08 10/04→02/09 09/06→12/08 01/04→11/08 10/03→11/08	➔	+PR 1ZF;1ZM;1ZC; → 09/08	13.0460-7117.2	607117	VW 23130 19,6 + WK
					13.0470-7117.2	LD7117	VW 23130 19,6 + WK Ceramic
			➔	→ 09/08; +PR 1ZE;1ZP / 1LJ,1LL,1LV,1ZD	13.0460-7184.2	607184	ATE 23587 20,6 + WK
					13.0470-7184.2	LD7184	ATE 23587 20,6 + WK Ceramic
			➔	+PR 1LK;1LM; → 09/08	13.0460-7200.2	607200	ATE 23801 20,3 + WK
					13.0470-7200.2	LD7200	ATE 23801 20,3 + WK Ceramic
			➔	→ 09/08; +PR 1KY,1KZ,1KF,2EL / 1KE	13.0460-2748.2	602748	TRW 24606 17,4 - WE / - WK + Zub
					13.0460-2880.2	602880	TRW 23914 17,1 + WE / - WK + Zub
↓							













	kw			 	! #		
VW - GOLF V (1K1) 10/03—02/09							
 Bremsbelagsatz, Scheibenbremse							
2.0 TDI 2.0 TDI 16V	103 103	12/04→11/08 10/03→11/08	➡	→ 09/08; +PR 1KY,1KZ,1KF,2EL / 1KE	13.0460-2880.2	602880	TRW 23914 17,1 + WE / - WK + Zub
					13.0470-2748.2	LD2748	TRW 24606 17,4 - WE / - WK + Zub Ceramic
					13.0470-2880.2	LD2880	TRW 23914 17,1 + WE / - WK + Zub Ceramic
			➡	→ 09/08; +PR 1KV	13.0460-2749.2	602749	TRW 24483 16,9 - WE / - WK + Zub
				13.0460-2880.2	602880	TRW 23914 17,1 + WE / - WK + Zub	
				13.0470-2749.2	LD2749	TRW 24483 16,9 - WE / - WK + Zub Ceramic	
				13.0470-2880.2	LD2880	TRW 23914 17,1 + WE / - WK + Zub Ceramic	
			➡	+PR 1KD;1KQ; → 09/08	13.0460-2820.2	602820	TRW 20961 17,2 - WK
					13.0470-2820.2	LD2820	TRW 20961 17,2 - WK Ceramic
1.4 TSI	125	11/05→11/08	⬅	+PR 1ZF;1ZM;1ZC; → 09/08	13.0460-7117.2	607117	VW 23130 19,6 + WK
					13.0470-7117.2	LD7117	VW 23130 19,6 + WK Ceramic
			⬅	→ 09/08; +PR 1LJ,1LL,1LV,1ZD / 1ZE;1ZP	13.0460-7184.2	607184	ATE 23587 20,6 + WK
					13.0470-7184.2	LD7184	ATE 23587 20,6 + WK Ceramic
			⬅	+PR 1LK;1LM; → 09/08	13.0460-7200.2	607200	ATE 23801 20,3 + WK
					13.0470-7200.2	LD7200	ATE 23801 20,3 + WK Ceramic
			➡	→ 09/08; +PR 1KY,1KZ,1KF,2EL / 1KE	13.0460-2748.2	602748	TRW 24606 17,4 - WE / - WK + Zub
				13.0460-2880.2	602880	TRW 23914 17,1 + WE / - WK + Zub	
				13.0470-2748.2	LD2748	TRW 24606 17,4 - WE / - WK + Zub Ceramic	
				13.0470-2880.2	LD2880	TRW 23914 17,1 + WE / - WK + Zub Ceramic	
			➡	→ 09/08; +PR 1KV	13.0460-2749.2	602749	TRW 24483 16,9 - WE / - WK + Zub
					13.0460-2880.2	602880	TRW 23914 17,1 + WE / - WK + Zub
					13.0470-2749.2	LD2749	TRW 24483 16,9 - WE / - WK + Zub Ceramic
					13.0470-2880.2	LD2880	TRW 23914 17,1 + WE / - WK + Zub Ceramic
			➡	+PR 1KD;1KQ; → 09/08	13.0460-2820.2	602820	TRW 20961 17,2 - WK
					13.0470-2820.2	LD2820	TRW 20961 17,2 - WK Ceramic
1.9 TDI 4motion 2.0 FSI 4motion 2.0 TDI 16V 4motion 2.0 TDI 4motion	77 110 103 103	08/04→11/08 08/04→11/08 08/04→11/08 08/04→11/08	⬅	+PR 1ZF;1ZM;1ZC; → 09/08	13.0460-7117.2	607117	VW 23130 19,6 + WK
					13.0470-7117.2	LD7117	VW 23130 19,6 + WK Ceramic
			⬅	→ 09/08; +PR 1LJ,1LL,1LV,1ZD / 1ZE;1ZP	13.0460-7184.2	607184	ATE 23587 20,6 + WK
					13.0470-7184.2	LD7184	ATE 23587 20,6 + WK Ceramic
			⬅	+PR 1LK;1LM; → 09/08	13.0460-7200.2	607200	ATE 23801 20,3 + WK
					13.0470-7200.2	LD7200	ATE 23801 20,3 + WK Ceramic
			➡	→ 09/08; +PR 1KY,1KZ,1KF,2EL / 1KE	13.0460-2748.2	602748	TRW 24606 17,4 - WE / - WK + Zub
				13.0460-2880.2	602880	TRW 23914 17,1 + WE / - WK + Zub	
				13.0470-2748.2	LD2748	TRW 24606 17,4 - WE / - WK + Zub Ceramic	
				13.0470-2880.2	LD2880	TRW 23914 17,1 + WE / - WK + Zub Ceramic	
			➡	→ 09/08; +PR 1KV	13.0460-2749.2	602749	TRW 24483 16,9 - WE / - WK + Zub
					13.0460-2880.2	602880	TRW 23914 17,1 + WE / - WK + Zub
					13.0470-2749.2	LD2749	TRW 24483 16,9 - WE / - WK + Zub Ceramic
					13.0470-2880.2	LD2880	TRW 23914 17,1 + WE / - WK + Zub Ceramic
2.0 TDI	125	11/05→11/08	⬅	+PR 1ZF;1ZM;1ZC; → 09/08	13.0460-7117.2	607117	VW 23130 19,6 + WK
					13.0470-7117.2	LD7117	VW 23130 19,6 + WK Ceramic
			⬅	→ 09/08; +PR 1LJ,1LL,1LV,1ZD / 1ZE;1ZP	13.0460-7184.2	607184	ATE 23587 20,6 + WK
					13.0470-7184.2	LD7184	ATE 23587 20,6 + WK Ceramic
			⬅	+PR 1LK;1LM; → 09/08	13.0460-7200.2	607200	ATE 23801 20,3 + WK
					13.0470-7200.2	LD7200	ATE 23801 20,3 + WK Ceramic



















	kw			 	! #		
VW - GOLF V (1K1) 10/03—02/09							
Bremsbelagsatz, Scheibenbremse							
2.0 TDI	125	11/05→11/08	➡	+PR 1KD;1KQ; → 09/08		13.0460-2820.2 602820 13.0470-2820.2 LD2820	TRW 20961 17,2 - WK TRW 20961 17,2 - WK Ceramic
3.2	184	09/05→11/08	←	11/05→ 09/08; +PR 1ZF;1ZM;1ZC		13.0460-7117.2 607117 13.0470-7117.2 LD7117	VW 23130 19,6 + WK VW 23130 19,6 + WK Ceramic
			←	11/05→ 09/08; +PR 1ZE;1ZP / 1LJ,1LL,1LV,1ZD		13.0460-7184.2 607184 13.0470-7184.2 LD7184	ATE 23587 20,6 + WK ATE 23587 20,6 + WK Ceramic
			←	11/05→ 09/08; +PR 1LK;1LM		13.0460-7200.2 607200 13.0470-7200.2 LD7200	ATE 23801 20,3 + WK ATE 23801 20,3 + WK Ceramic
			➡	11/05→ 09/08; +PR 1KY,1KZ,1KF,2EL / 1KE		13.0460-2748.2 602748 13.0460-2880.2 602880 13.0470-2748.2 LD2748 13.0470-2880.2 LD2880	TRW 24606 17,4 - WE / - WK + Zub TRW 23914 17,1 + WE / - WK + Zub TRW 24606 17,4 - WE / - WK + Zub Ceramic TRW 23914 17,1 + WE / - WK + Zub Ceramic
			➡	11/05→ 09/08; +PR 1KV		13.0460-2749.2 602749 13.0460-2880.2 602880 13.0470-2749.2 LD2749 13.0470-2880.2 LD2880	TRW 24483 16,9 - WE / - WK + Zub TRW 23914 17,1 + WE / - WK + Zub TRW 24483 16,9 - WE / - WK + Zub Ceramic TRW 23914 17,1 + WE / - WK + Zub Ceramic
3.2 R32 4motion	184	11/05→11/08	←	+PR 1ZF;1ZM;1ZC; → 09/08		13.0460-7117.2 607117 13.0470-7117.2 LD7117	VW 23130 19,6 + WK VW 23130 19,6 + WK Ceramic
			←	→ 09/08; +PR 1ZE;1ZP / 1LJ,1LL,1LV,1ZD		13.0460-7184.2 607184 13.0470-7184.2 LD7184	ATE 23587 20,6 + WK ATE 23587 20,6 + WK Ceramic
			←	+PR 1LK;1LM; → 09/08		13.0460-7200.2 607200 13.0470-7200.2 LD7200	ATE 23801 20,3 + WK ATE 23801 20,3 + WK Ceramic
			➡	→ 09/08; +PR 1KY,1KZ,1KF,2EL / 1KE		13.0460-2748.2 602748 13.0460-2880.2 602880 13.0470-2748.2 LD2748 13.0470-2880.2 LD2880	TRW 24606 17,4 - WE / - WK + Zub TRW 23914 17,1 + WE / - WK + Zub TRW 24606 17,4 - WE / - WK + Zub Ceramic TRW 23914 17,1 + WE / - WK + Zub Ceramic
			➡	→ 09/08; +PR 1KV		13.0460-2749.2 602749 13.0460-2880.2 602880 13.0470-2749.2 LD2749 13.0470-2880.2 LD2880	TRW 24483 16,9 - WE / - WK + Zub TRW 23914 17,1 + WE / - WK + Zub TRW 24483 16,9 - WE / - WK + Zub Ceramic TRW 23914 17,1 + WE / - WK + Zub Ceramic
Zubehörsatz, Scheibenbremsbelag							
1.4 16V	55	10/03→05/06	➡	+PR 1KD;1KQ		13.0460-0072.2 610072	TRW
1.4 FSI	66	10/03→07/06	➡	+PR 1KV		13.0460-0259.2 610259	
1.6 FSI	85	10/03→07/08					
				+PR 1KY,1KZ,1KF,2EL / 1KE		13.0460-0259.2 610259	
1.4 16V	59	05/06→11/08	➡	+PR 1KD;1KQ; → 09/08		13.0460-0072.2 610072	TRW
1.4 TSI	90	05/07→11/08	➡	→ 09/08; +PR 1KY,1KZ,1KF,2EL / 1KE		13.0460-0259.2 610259	
1.4 TSI	103	05/06→11/08					
1.4 TSI	125	11/05→11/08					
1.6	75	01/04→11/08					
1.6 MultiFuel	75	10/07→11/08					
1.9 TDI	66	05/04→11/08					
1.9 TDI	77	10/03→11/08					
2.0 FSI	110	01/04→11/08					
2.0 GTI	147	10/04→02/09					
2.0 GTI	169	09/06→12/08					
2.0 SDI	55	01/04→11/08					
2.0 TDI	100	10/03→11/08					
2.0 TDI	103	12/04→11/08					
2.0 TDI 16V	103	10/03→11/08					
1.9 TDI 4motion	77	08/04→11/08	➡	→ 09/08; +PR 1KY,1KZ,1KF,2EL / 1KE		13.0460-0259.2 610259	
2.0 FSI 4motion	110	08/04→11/08	➡	→ 09/08; +PR 1KV		13.0460-0259.2 610259	
2.0 TDI 16V 4motion	103	08/04→11/08					
2.0 TDI 4motion	103	08/04→11/08					
3.2 R32 4motion	184	11/05→11/08					

	kw			 	! #		
VW - GOLF V (1K1) 10/03→02/09							
Zubehörsatz, Scheibenbremsbelag							
2.0 TDI	125	11/05→11/08	➡	+PR 1KD;1KQ; → 09/08		13.0460-0072.2 610072	TRW
3.2	184	09/05→11/08	➡	11/05→ 09/08; +PR 1KV		13.0460-0259.2 610259	
			➡	11/05→ 09/08; +PR 1KY,1KZ,1KF,2EL / 1KE		13.0460-0259.2 610259	
 Bremsscheibe							
1.4 16V	55	10/03→05/06	←	+PR 1ZF;1ZM;1ZC		24.0122-0210.1 422210	Ø 280 22 19 V + S
1.4 FSI	66	10/03→07/06				24.0322-0210.1 522210	Ø 280 22 19 V + S PD
1.6 FSI	85	10/03→07/08	←	+PR 1ZE;1ZP		24.0125-0145.1 425145	Ø 288 25 22 V + S
						24.0325-0145.1 525145	Ø 288 25 22 V + S PD
			←	+PR 1LJ;1LL;1LV;1ZD		24.0125-0158.1 425158	Ø 312 25 22 V + S
						24.0325-0158.1 525158	Ø 312 25 22 V + S PD
			←	+PR 1LK;1LM		24.0130-0115.1 430115	Ø 345 30 27 V
						24.0330-0115.1 530115	Ø 345 30 27 V PD
			➡	+PR 1KD;1KQ		24.0110-0277.1 410277	Ø 253 10 8 + S
						24.0310-0277.1 510277	Ø 253 10 8 + S PD
			➡	+PR 1KE;1KF		24.0112-0158.1 412158	Ø 256 12 10 + S
						24.0312-0158.1 512158	Ø 256 12 10 PD
			➡	+PR 1KY;1KZ;1KV		24.0112-0169.1 412169	Ø 282 12 10 + S
						24.0312-0169.1 512169	Ø 282 12 10 + S PD
1.4 16V	59	05/06→11/08	←	+PR 1ZF;1ZM;1ZC; → 09/08		24.0122-0210.1 422210	Ø 280 22 19 V + S
1.4 TSI	90	05/07→11/08				24.0322-0210.1 522210	Ø 280 22 19 V + S PD
1.4 TSI	103	05/06→11/08					
1.4 TSI	125	11/05→11/08	←	+PR 1ZE;1ZP; → 09/08		24.0125-0145.1 425145	Ø 288 25 22 V + S
1.6	75	01/04→11/08				24.0325-0145.1 525145	Ø 288 25 22 V + S PD
1.6 MultiFuel	75	10/07→11/08					
1.9 TDI	66	05/04→11/08	←	+PR 1LJ;1LL;1LV;1ZD; → 09/08		24.0125-0158.1 425158	Ø 312 25 22 V + S
1.9 TDI	77	10/03→11/08				24.0325-0158.1 525158	Ø 312 25 22 V + S PD
2.0 FSI	110	01/04→11/08	←	+PR 1LK;1LM; → 09/08		24.0130-0115.1 430115	Ø 345 30 27 V
2.0 GTI	147	10/04→02/09				24.0330-0115.1 530115	Ø 345 30 27 V PD
2.0 GTI	169	09/06→12/08					
2.0 SDI	55	01/04→11/08	➡	+PR 1KD;1KQ; → 09/08		24.0110-0277.1 410277	Ø 253 10 8 + S
2.0 TDI	100	10/03→11/08				24.0310-0277.1 510277	Ø 253 10 8 + S PD
2.0 TDI	103	12/04→11/08	➡	+PR 1KE;1KF; → 09/08		24.0112-0158.1 412158	Ø 256 12 10 + S
2.0 TDI	125	11/05→11/08				24.0312-0158.1 512158	Ø 256 12 10 PD
2.0 TDI 16V	103	10/03→11/08	➡	+PR 1KY;1KZ;1KV; → 09/08		24.0112-0169.1 412169	Ø 282 12 10 + S
						24.0312-0169.1 512169	Ø 282 12 10 + S PD
1.9 TDI 4motion	77	08/04→11/08	←	+PR 1ZF;1ZM;1ZC; → 09/08		24.0122-0210.1 422210	Ø 280 22 19 V + S
2.0 FSI 4motion	110	08/04→11/08				24.0322-0210.1 522210	Ø 280 22 19 V + S PD
2.0 TDI 16V 4motion	103	08/04→11/08	←	+PR 1ZE;1ZP; → 09/08		24.0125-0145.1 425145	Ø 288 25 22 V + S
2.0 TDI 4motion	103	08/04→11/08				24.0325-0145.1 525145	Ø 288 25 22 V + S PD
			←	+PR 1LJ;1LL;1LV;1ZD; → 09/08		24.0125-0158.1 425158	Ø 312 25 22 V + S
						24.0325-0158.1 525158	Ø 312 25 22 V + S PD
			←	+PR 1LK;1LM; → 09/08		24.0130-0115.1 430115	Ø 345 30 27 V
						24.0330-0115.1 530115	Ø 345 30 27 V PD
			➡	+PR 1KE;1KF; → 09/08		24.0112-0158.1 412158	Ø 256 12 10 + S
						24.0312-0158.1 512158	Ø 256 12 10 PD
			➡	→ 09/08; +PR 2EL		24.0122-0219.1 422219	Ø 310 22 20 V
3.2	184	09/05→11/08	←	11/05→ 09/08; +PR 1ZF;1ZM;1ZC		24.0122-0210.1 422210	Ø 280 22 19 V + S
						24.0322-0210.1 522210	Ø 280 22 19 V + S PD
			←	11/05→ 09/08; +PR 1ZE;1ZP		24.0125-0145.1 425145	Ø 288 25 22 V + S
			←	11/05→ 09/08; +PR 1LJ;1LL;1LV;1ZD		24.0125-0158.1 425158	Ø 312 25 22 V + S
						24.0325-0158.1 525158	Ø 312 25 22 V + S PD
			←	11/05→ 09/08; +PR 1LK;1LM		24.0130-0115.1 430115	Ø 345 30 27 V
						24.0330-0115.1 530115	Ø 345 30 27 V PD
			➡	11/05→ 09/08; +PR 1KE;1KF		24.0112-0158.1 412158	Ø 256 12 10 + S
						24.0312-0158.1 512158	Ø 256 12 10 PD
			➡	11/05→ 09/08; +PR 2EL		24.0122-0219.1 422219	Ø 310 22 20 V
3.2 R32 4motion	184	11/05→11/08	←	+PR 1ZF;1ZM;1ZC; → 09/08		24.0122-0210.1 422210	Ø 280 22 19 V + S
						24.0322-0210.1 522210	Ø 280 22 19 V + S PD
			←	+PR 1ZE;1ZP; → 09/08		24.0125-0145.1 425145	Ø 288 25 22 V + S
			←	+PR 1LJ;1LL;1LV;1ZD; → 09/08		24.0125-0158.1 425158	Ø 312 25 22 V + S
						24.0325-0158.1 525158	Ø 312 25 22 V + S PD
			←	+PR 1LK;1LM; → 09/08		24.0130-0115.1 430115	Ø 345 30 27 V























	kw			 	! #		
VW - GOLF V (1K1) 10/03→02/09							
 Bremsscheibe							
3.2 R32 4motion	184	11/05→11/08	←	+PR 1LK;1LM; → 09/08	24.0330-0115.1	530115	Ø 345 30 27 V PD
			→	+PR 1KE;1KF; → 09/08	24.0112-0158.1	412158	Ø 256 12 10 + S
					24.0312-0158.1	512158	Ø 256 12 10 PD
			→	→ 09/08; +PR 2EL	24.0122-0219.1	422219	Ø 310 22 20 V
VW - GOLF V Variant (1K5) 06/07→07/09							
 Bremsbelagsatz, Scheibenbremse							
1.4	59	06/07→07/09	←	→ 06/09; +PR 1ZM	13.0460-7117.2	607117	VW 23130 19,6 + WK
1.4 TSI	90	06/07→07/09			13.0470-7117.2	LD7117	VW 23130 19,6 + WK Ceramic
1.4 TSI	103	06/07→07/09					
1.4 TSI	125	06/07→07/09	←	→ 06/09; +PR 1LJ;1ZD;1ZE;1ZP	13.0460-7184.2	607184	ATE 23587 20,6 + WK
1.6	75	06/07→07/09			13.0470-7184.2	LD7184	ATE 23587 20,6 + WK Ceramic
1.6 MultiFuel	75	11/07→07/09					
1.9 TDI	77	06/07→07/09	→	→ 06/09; +PR 1KE,1KF,1KJ	13.0460-2749.2	602749	TRW 24483 16,9 - WE / - WK + Zub
1.9 TDI 4motion	77	01/08→07/09					
2.0	147	06/07→07/09			13.0460-2880.2	602880	TRW 23914 17,1 + WE / - WK + Zub
2.0 TDI	100	06/07→07/09					
2.0 TDI	103	06/07→07/09			13.0470-2749.2	LD2749	TRW 24483 16,9 - WE / - WK + Zub Ceramic
2.0 TDI 16V	103	06/07→07/09			13.0470-2880.2	LD2880	TRW 23914 17,1 + WE / - WK + Zub Ceramic
			→	→ 06/09; +PR 1KV	13.0460-2749.2	602749	TRW 24483 16,9 - WE / - WK + Zub
					13.0460-2880.2	602880	TRW 23914 17,1 + WE / - WK + Zub
					13.0470-2749.2	LD2749	TRW 24483 16,9 - WE / - WK + Zub Ceramic
					13.0470-2880.2	LD2880	TRW 23914 17,1 + WE / - WK + Zub Ceramic
1.4 TSI	118	07/08→07/09	←	→ 06/09; +PR 1ZM	13.0460-7117.2	607117	VW 23130 19,6 + WK
					13.0470-7117.2	LD7117	VW 23130 19,6 + WK Ceramic
			←	→ 06/09; +PR 1LJ;1ZD;1ZE;1ZP	13.0460-7184.2	607184	ATE 23587 20,6 + WK
					13.0470-7184.2	LD7184	ATE 23587 20,6 + WK Ceramic
			→	→ 06/09; +PR 1KE,1KF,1KJ	13.0460-2749.2	602749	TRW 24483 16,9 - WE / - WK + Zub
					13.0460-2880.2	602880	TRW 23914 17,1 + WE / - WK + Zub
					13.0470-2749.2	LD2749	TRW 24483 16,9 - WE / - WK + Zub Ceramic
					13.0470-2880.2	LD2880	TRW 23914 17,1 + WE / - WK + Zub Ceramic
			→	→ 06/09; +PR 1KV	13.0460-2749.2	602749	TRW 24483 16,9 - WE / - WK + Zub
					13.0460-2880.2	602880	TRW 23914 17,1 + WE / - WK + Zub
					13.0470-2749.2	LD2749	TRW 24483 16,9 - WE / - WK + Zub Ceramic
					13.0470-2880.2	LD2880	TRW 23914 17,1 + WE / - WK + Zub Ceramic
Zubehörsatz, Scheibenbremsbelag							
1.4	59	06/07→07/09	→	→ 06/09; +PR 1KE,1KF,1KJ	13.0460-0259.2	610259	
1.4 TSI	90	06/07→07/09					
1.4 TSI	103	06/07→07/09	→	→ 06/09; +PR 1KV	13.0460-0259.2	610259	
1.4 TSI	118	07/08→07/09					
1.4 TSI	125	06/07→07/09					
1.6	75	06/07→07/09					
1.6 MultiFuel	75	11/07→07/09					
1.9 TDI	77	06/07→07/09					
1.9 TDI 4motion	77	01/08→07/09					
2.0	147	06/07→07/09					
2.0 TDI	100	06/07→07/09					
2.0 TDI	103	06/07→07/09					
2.0 TDI 16V	103	06/07→07/09					
 Bremsscheibe							
1.4	59	06/07→07/09	←	→ 06/09; +PR 1ZM	24.0122-0210.1	422210	Ø 280 22 19 V + S
1.4 TSI	90	06/07→07/09			24.0322-0210.1	522210	Ø 280 22 19 V + S PD
1.4 TSI	103	06/07→07/09					
1.4 TSI	125	06/07→07/09	←	→ 06/09; +PR 1ZE,1ZP	24.0125-0145.1	425145	Ø 288 25 22 V + S
1.6	75	06/07→07/09			24.0325-0145.1	525145	Ø 288 25 22 V + S PD
1.6 MultiFuel	75	11/07→07/09					
1.9 TDI	77	06/07→07/09	←	→ 06/09; +PR 1LJ;1ZD	24.0125-0158.1	425158	Ø 312 25 22 V + S
↓							

	kw			 	! #		
VW - GOLF V Variant (1K5) 06/07→07/09							
Bremsscheibe							
1.9 TDI 4motion	77	01/08→07/09	←	→ 06/09; +PR 1LJ;1ZD		24.0325-0158.1 525158	Ø 312 25 22 V + S PD
2.0	147	06/07→07/09	→	→ 06/09; +PR 1KE;1KF		24.0112-0158.1 412158	Ø 256 12 10 + S
2.0 TDI	100	06/07→07/09	→	→ 06/09; +PR 1KE;1KF		24.0312-0158.1 512158	Ø 256 12 10 PD
2.0 TDI	103	06/07→07/09	→	→ 06/09; +PR 1KJ;1KV		24.0112-0169.1 412169	Ø 282 12 10 + S
2.0 TDI 16V	103	06/07→07/09	→	→ 06/09; +PR 1KJ;1KV		24.0312-0169.1 512169	Ø 282 12 10 + S PD
1.4 TSI	118	07/08→07/09	←	→ 06/09; +PR 1ZM		24.0122-0210.1 422210	Ø 280 22 19 V + S
			←	→ 06/09; +PR 1ZE;1ZP		24.0125-0145.1 425145	Ø 288 25 22 V + S
			←	→ 06/09; +PR 1ZE;1ZP		24.0325-0145.1 525145	Ø 288 25 22 V + S PD
			←	→ 06/09; +PR 1LJ;1ZD		24.0125-0158.1 425158	Ø 312 25 22 V + S
			←	→ 06/09; +PR 1LJ;1ZD		24.0325-0158.1 525158	Ø 312 25 22 V + S PD
			→	→ 06/09; +PR 1KE;1KF		24.0112-0158.1 412158	Ø 256 12 10 + S
			→	→ 06/09; +PR 1KE;1KF		24.0312-0158.1 512158	Ø 256 12 10 PD
			→	→ 06/09; +PR 1KJ;1KV		24.0112-0169.1 412169	Ø 282 12 10 + S
			→	→ 06/09; +PR 1KJ;1KV		24.0312-0169.1 512169	Ø 282 12 10 + S PD
VW - GOLF VI (5K1) 10/08→11/13							
Bremsbelagsatz, Scheibenbremse							
1.2 TSI	63	05/10→11/12	←	+PR 1ZF		13.0460-7117.2 607117	VW 23130 19,6 + WK
1.4	59	10/08→11/12	←	+PR 1ZA,1ZB,1ZD,1ZE / 1ZP,1LJ,1LL		13.0470-7117.2 LD7117	VW 23130 19,6 + WK Ceramic
1.4 TSI	90	10/08→11/12	←	+PR 1ZA,1ZB,1ZD,1ZE / 1ZP,1LJ,1LL		13.0460-7184.2 607184	ATE 23587 20,6 + WK
1.4 TSI	118	10/08→11/12	←	+PR 1ZA,1ZB,1ZD,1ZE / 1ZP,1LJ,1LL		13.0470-7184.2 LD7184	ATE 23587 20,6 + WK Ceramic
1.6	75	10/08→11/12	←	+PR 1LM		13.0460-7200.2 607200	ATE 23801 20,3 + WK
1.6 BiFuel	75	03/09→11/12	←	+PR 1LM		13.0470-7200.2 LD7200	ATE 23801 20,3 + WK Ceramic
1.6 MultiFuel	75	10/08→11/12	←	+PR 1LM		13.0460-7200.2 607200	ATE 23801 20,3 + WK
1.6 TDI	66	02/09→11/12	←	+PR 1ZK		13.0470-7200.2 LD7200	ATE 23801 20,3 + WK Ceramic
1.6 TDI	77	02/09→11/12	←	+PR 1ZK		13.0460-7227.2 607227	ATE 23801 20,3 + WK
1.8 TSI	118	06/09→01/11	←	+PR 1ZK		13.0470-7227.2 LD7227	ATE 23912 20,3 + WK Ceramic
2.0 GTI	155	04/09→11/12	→	+PR 1KF,1KY,1KZ,1KE / 1KV		13.0460-2749.2 602749	TRW 24483 16,9 - WE / - WK + Zub
2.0 GTI	173	05/11→11/12	→	+PR 1KF,1KY,1KZ,1KE / 1KV		13.0460-2749.2 602749	TRW 24483 16,9 - WE / - WK + Zub
2.0 TDI	81	10/08→11/12	→	+PR 1KF,1KY,1KZ,1KE / 1KV		13.0460-2880.2 602880	TRW 23914 17,1 + WE / - WK + Zub
2.0 TDI	100	10/08→11/12	→	+PR 1KF,1KY,1KZ,1KE / 1KV		13.0460-2880.2 602880	TRW 23914 17,1 + WE / - WK + Zub
2.0 TDI	103	10/08→05/13	→	+PR 1KF,1KY,1KZ,1KE / 1KV		13.0470-2749.2 LD2749	TRW 24483 16,9 - WE / - WK + Zub Ceramic
2.0 TDI	125	04/09→11/12	→	+PR 1KF,1KY,1KZ,1KE / 1KV		13.0470-2880.2 LD2880	TRW 23914 17,1 + WE / - WK + Zub Ceramic
			→	+PR 1KD		13.0460-2820.2 602820	TRW 20961 17,2 - WK
			→	+PR 1KD		13.0470-2820.2 LD2820	TRW 20961 17,2 - WK Ceramic
			→	+PR 1KS,1KT		13.0460-3858.2 603858	BOS 24563 17,7 - WE / - WK + Zub
			→	+PR 1KS,1KT		13.0470-3858.2 LD3858	BOS 24563 17,7 - WE / - WK + Zub Ceramic
1.2 TSI	77	11/08→11/12	←	05/09→; +PR 1ZF		13.0460-7117.2 607117	VW 23130 19,6 + WK
			←	05/09→; +PR 1ZF		13.0470-7117.2 LD7117	VW 23130 19,6 + WK Ceramic
			←	05/09→; +PR 1ZA,1ZB,1ZD,1ZE / 1ZP,1LJ,1LL		13.0460-7184.2 607184	ATE 23587 20,6 + WK
			←	05/09→; +PR 1ZA,1ZB,1ZD,1ZE / 1ZP,1LJ,1LL		13.0470-7184.2 LD7184	ATE 23587 20,6 + WK Ceramic
			←	05/09→; +PR 1LM		13.0460-7200.2 607200	ATE 23801 20,3 + WK
			←	05/09→; +PR 1LM		13.0470-7200.2 LD7200	ATE 23801 20,3 + WK Ceramic
			←	05/09→; +PR 1ZK		13.0460-7227.2 607227	ATE 23801 20,3 + WK
			←	05/09→; +PR 1ZK		13.0470-7227.2 LD7227	ATE 23912 20,3 + WK Ceramic
			→	05/09→; +PR 1KF,1KY,1KZ,1KE / 1KV		13.0460-2749.2 602749	TRW 24483 16,9 - WE / - WK + Zub
			→	05/09→; +PR 1KF,1KY,1KZ,1KE / 1KV		13.0460-2880.2 602880	TRW 23914 17,1 + WE / - WK + Zub
			→	05/09→; +PR 1KF,1KY,1KZ,1KE / 1KV		13.0470-2749.2 LD2749	TRW 24483 16,9 - WE / - WK + Zub Ceramic
			→	05/09→; +PR 1KF,1KY,1KZ,1KE / 1KV		13.0470-2880.2 LD2880	TRW 23914 17,1 + WE / - WK + Zub Ceramic
			→	05/09→; +PR 1KD		13.0460-2820.2 602820	TRW 20961 17,2 - WK
			→	05/09→; +PR 1KD		13.0470-2820.2 LD2820	TRW 20961 17,2 - WK Ceramic
			→	05/09→; +PR 1KS,1KT		13.0460-3858.2 603858	BOS 24563 17,7 - WE / - WK + Zub
			→	05/09→; +PR 1KS,1KT		13.0470-3858.2 LD3858	BOS 24563 17,7 - WE / - WK + Zub Ceramic
2.0 R 4motion	188	11/09→11/13	←	+PR 1ZF		13.0460-7117.2 607117	VW 23130 19,6 + WK
2.0 R 4motion	195	11/09→05/11	←	+PR 1ZF		13.0470-7117.2 LD7117	VW 23130 19,6 + WK Ceramic
2.0 R 4motion	199	11/09→11/12	←	+PR 1ZF		13.0460-7117.2 607117	VW 23130 19,6 + WK
↓							









	kw			 	! #		
VW - GOLF VI (5K1) 10/08→11/13							
 Bremsbelagsatz, Scheibenbremse							
2.0 TDI 4motion	103	05/09→11/12	←	+PR 1ZA,1ZB,1ZD,1ZE / 1ZP,1LJ,1LL	13.0460-7184.2 607184	ATE 23587 20,6 + WK	
			←	+PR 1LM	13.0470-7184.2 LD7184	ATE 23587 20,6 + WK Ceramic	
			←	+PR 1ZK	13.0460-7200.2 607200	ATE 23801 20,3 + WK	
			←	+PR 1ZK	13.0470-7200.2 LD7200	ATE 23801 20,3 + WK Ceramic	
			→	+PR 1KF,1KY,1KZ,1KE / 1KV,1KW,2EL	13.0460-7227.2 607227	ATE 23801 20,3 + WK	
			→	+PR 1KF,1KY,1KZ,1KE / 1KV,1KW,2EL	13.0470-7227.2 LD7227	ATE 23912 20,3 + WK Ceramic	
			→	+PR 1KS,1KT	13.0460-2749.2 602749	TRW 24483 16,9 - WE / - WK + Zub	
					13.0460-2880.2 602880	TRW 23914 17,1 + WE / - WK + Zub	
					13.0470-2749.2 LD2749	TRW 24483 16,9 - WE / - WK + Zub Ceramic	
					13.0470-2880.2 LD2880	TRW 23914 17,1 + WE / - WK + Zub Ceramic	
			→	+PR 1KS,1KT	13.0460-3858.2 603858	BOS 24563 17,7 - WE / - WK + Zub	
					13.0470-3858.2 LD3858	BOS 24563 17,7 - WE / - WK + Zub Ceramic	
 Bremsscheibe							
1.2 TSI	63	05/10→11/12	←	+PR 1ZF	24.0122-0210.1 422210	Ø 280 22 19 V + S	
1.4	59	10/08→11/12			24.0322-0210.1 522210	Ø 280 22 19 V + S PD	
1.4 TSI	90	10/08→11/12					
1.4 TSI	118	10/08→11/12	←	+PR 1ZE,1ZP	24.0125-0145.1 425145	Ø 288 25 22 V + S	
1.6	75	10/08→11/12			24.0325-0145.1 525145	Ø 288 25 22 V + S PD	
1.6 BiFuel	75	03/09→11/12	←	+PR 1LJ,1LL,1LV,1ZA / 1ZB,1ZD	24.0125-0158.1 425158	Ø 312 25 22 V + S	
1.6 MultiFuel	75	10/08→11/12			24.0325-0158.1 525158	Ø 312 25 22 V + S PD	
1.6 TDI	66	02/09→11/12					
1.6 TDI	77	02/09→11/12	←	+PR 1LM,1ZK	24.0130-0115.1 430115	Ø 345 30 27 V	
1.8 TSI	118	06/09→01/11			24.0330-0115.1 530115	Ø 345 30 27 V PD	
2.0 GTi	155	04/09→11/12					
2.0 GTi	173	05/11→11/12	→	+PR 1KD	24.0110-0277.1 410277	Ø 253 10 8 + S	
2.0 TDI	81	10/08→11/12			24.0310-0277.1 510277	Ø 253 10 8 + S PD	
2.0 TDI	100	10/08→11/12	→	+PR 1KS,1KT	24.0110-0356.1 410356	Ø 272 9,7 8 + S	
2.0 TDI	103	10/08→05/13			24.0310-0356.1 510356	Ø 272 9,7 8 + S PD	
2.0 TDI	125	04/09→11/12	→	+PR 1KE,1KF	24.0112-0158.1 412158	Ø 256 12 10 + S	
					24.0312-0158.1 512158	Ø 256 12 10 PD	
			→	+PR 1KV,1KY,1KZ	24.0112-0169.1 412169	Ø 282 12 10 + S	
					24.0312-0169.1 512169	Ø 282 12 10 + S PD	
1.2 TSI	77	11/08→11/12	←	05/09→; +PR 1ZF	24.0122-0210.1 422210	Ø 280 22 19 V + S	
			←	05/09→; +PR 1ZE,1ZP	24.0322-0210.1 522210	Ø 280 22 19 V + S PD	
			←	05/09→; +PR 1ZE,1ZP	24.0125-0145.1 425145	Ø 288 25 22 V + S	
			←	05/09→; +PR 1ZE,1ZP	24.0325-0145.1 525145	Ø 288 25 22 V + S PD	
			←	05/09→; +PR 1LJ,1LL,1LV,1ZA / 1ZB,1ZD	24.0125-0158.1 425158	Ø 312 25 22 V + S	
			←	05/09→; +PR 1LJ,1LL,1LV,1ZA / 1ZB,1ZD	24.0325-0158.1 525158	Ø 312 25 22 V + S PD	
			←	05/09→; +PR 1LM,1ZK	24.0130-0115.1 430115	Ø 345 30 27 V	
			←	05/09→; +PR 1LM,1ZK	24.0330-0115.1 530115	Ø 345 30 27 V PD	
			→	05/09→; +PR 1KD	24.0110-0277.1 410277	Ø 253 10 8 + S	
			→	05/09→; +PR 1KD	24.0310-0277.1 510277	Ø 253 10 8 + S PD	
			→	05/09→; +PR 1KS,1KT	24.0110-0356.1 410356	Ø 272 9,7 8 + S	
			→	05/09→; +PR 1KS,1KT	24.0310-0356.1 510356	Ø 272 9,7 8 + S PD	
			→	05/09→; +PR 1KE,1KF	24.0112-0158.1 412158	Ø 256 12 10 + S	
			→	05/09→; +PR 1KE,1KF	24.0312-0158.1 512158	Ø 256 12 10 PD	
			→	05/09→; +PR 1KV,1KY,1KZ	24.0112-0169.1 412169	Ø 282 12 10 + S	
			→	05/09→; +PR 1KV,1KY,1KZ	24.0312-0169.1 512169	Ø 282 12 10 + S PD	
2.0 R 4motion	188	11/09→11/13	←	+PR 1ZF	24.0122-0210.1 422210	Ø 280 22 19 V + S	
2.0 R 4motion	195	11/09→05/11			24.0322-0210.1 522210	Ø 280 22 19 V + S PD	
2.0 R 4motion	199	11/09→11/12					
2.0 TDI 4motion	103	05/09→11/12	←	+PR 1ZE,1ZP	24.0125-0145.1 425145	Ø 288 25 22 V + S	
			←	+PR 1ZE,1ZP	24.0325-0145.1 525145	Ø 288 25 22 V + S PD	
			←	+PR 1LJ,1LL,1LV,1ZA / 1ZB,1ZD	24.0125-0158.1 425158	Ø 312 25 22 V + S	
			←	+PR 1LJ,1LL,1LV,1ZA / 1ZB,1ZD	24.0325-0158.1 525158	Ø 312 25 22 V + S PD	
			←	+PR 1LM,1ZK	24.0130-0115.1 430115	Ø 345 30 27 V	
			←	+PR 1LM,1ZK	24.0330-0115.1 530115	Ø 345 30 27 V PD	
			→	+PR 1KS,1KT	24.0110-0356.1 410356	Ø 272 9,7 8 + S	
			→	+PR 1KS,1KT	24.0310-0356.1 510356	Ø 272 9,7 8 + S PD	
			→	+PR 1KE,1KF	24.0112-0158.1 412158	Ø 256 12 10 + S	









	kw			 	! #			
VW - GOLF VI (5K1) 10/08→11/13								
 Bremsscheibe								
2.0 R 4motion	188	11/09→11/13	➡	+PR 1KE,1KF		24.0312-0158.1 512158	Ø 256 12 10 PD	
2.0 R 4motion	195	11/09→05/11	➡	+PR 1KW,2EL		24.0122-0219.1 422219	Ø 310 22 20 V	
2.0 R 4motion	199	11/09→11/12						
2.0 TDI 4motion	103	05/09→11/12						
VW - GOLF VI Cabriolet (517) 03/11→								
 Bremsbelagsatz, Scheibenbremse								
1.2 TSI 1.4 TSI 1.6 TDI	77 118 77	03/11→11/13 03/11→ 03/11→	←	06/11→; +PR 1ZE,1ZD,1ZP,1ZA / 1ZB	13.0460-7184.2 607184	ATE 23587 20,6 + WK		
			←	06/11→; +PR 1ZK	13.0470-7184.2 LD7184	ATE 23587 20,6 + WK Ceramic		
			➡	06/11→; +PR 1KW	13.0460-7227.2 607227	ATE 23801 20,3 + WK		
					13.0470-7227.2 LD7227	ATE 23912 20,3 + WK Ceramic		
					13.0460-2749.2 602749	TRW 24483 16,9 - WE / - WK + Zub		
					13.0460-2880.2 602880	TRW 23914 17,1 + WE / - WK + Zub		
		13.0470-2749.2 LD2749	TRW 24483 16,9 - WE / - WK + Zub Ceramic					
		13.0470-2880.2 LD2880	TRW 23914 17,1 + WE / - WK + Zub Ceramic					
		➡	06/11→; +PR 1KD	13.0460-2820.2 602820	TRW 20961 17,2 - WK			
				13.0470-2820.2 LD2820	TRW 20961 17,2 - WK Ceramic			
			➡	06/11→; +PR 1KS,1KT	13.0460-3858.2 603858	BOS 24563 17,7 - WE / - WK + Zub		
				13.0470-3858.2 LD3858	BOS 24563 17,7 - WE / - WK + Zub Ceramic			
1.2 TSI 16V 1.4 TSI 1.4 TSI 1.4 TSI 2.0 GTI 2.0 R 2.0 TDI 2.0 TDI 2.0 TDI 2.0 TSI	77 90 92 110 155 195 81 103 110 162	11/13→ 11/11→ 11/13→ 11/13→ 11/11→ 01/13→ 11/13→ 11/11→ 11/13→ 11/13→	←	+PR 1ZE,1ZD,1ZP,1ZA / 1ZB	13.0460-7184.2 607184	ATE 23587 20,6 + WK		
			←	+PR 1ZK	13.0470-7184.2 LD7184	ATE 23587 20,6 + WK Ceramic		
			←	+PR 1ZK	13.0460-7227.2 607227	ATE 23801 20,3 + WK		
			➡	+PR 1KW	13.0470-7227.2 LD7227	ATE 23912 20,3 + WK Ceramic		
					13.0460-2749.2 602749	TRW 24483 16,9 - WE / - WK + Zub		
					13.0460-2880.2 602880	TRW 23914 17,1 + WE / - WK + Zub		
					13.0470-2749.2 LD2749	TRW 24483 16,9 - WE / - WK + Zub Ceramic		
					13.0470-2880.2 LD2880	TRW 23914 17,1 + WE / - WK + Zub Ceramic		
					➡	+PR 1KD	13.0460-2820.2 602820	TRW 20961 17,2 - WK
							13.0470-2820.2 LD2820	TRW 20961 17,2 - WK Ceramic
			➡	+PR 1KS,1KT	13.0460-3858.2 603858	BOS 24563 17,7 - WE / - WK + Zub		
				13.0470-3858.2 LD3858	BOS 24563 17,7 - WE / - WK + Zub Ceramic			
 Bremsscheibe								
1.2 TSI 1.4 TSI 1.6 TDI	77 118 77	03/11→11/13 03/11→ 03/11→	←	06/11→; +PR 1ZE,1ZP	24.0125-0145.1 425145	Ø 288 25 22 V + S		
					24.0325-0145.1 525145	Ø 288 25 22 V + S PD		
			←	06/11→; +PR 1ZA,1ZD,1ZB	24.0125-0158.1 425158	Ø 312 25 22 V + S		
					24.0325-0158.1 525158	Ø 312 25 22 V + S PD		
			←	06/11→; +PR 1ZK	24.0130-0115.1 430115	Ø 345 30 27 V		
			➡	06/11→; +PR 1KD	24.0110-0277.1 410277	Ø 253 10 8 + S		
					24.0310-0277.1 510277	Ø 253 10 8 + S PD		
		➡	06/11→; +PR 1KS,1KT	24.0110-0356.1 410356	Ø 272 9,7 8 + S			
				24.0310-0356.1 510356	Ø 272 9,7 8 + S PD			
			➡	06/11→; +PR 1KW	24.0122-0219.1 422219	Ø 310 22 20 V		
1.2 TSI 16V 1.4 TSI 1.4 TSI 1.4 TSI 2.0 GTI 2.0 R 2.0 TDI 2.0 TDI 2.0 TDI 2.0 TSI	77 90 92 110 155 195 81 103 110 162	11/13→ 11/11→ 11/13→ 11/13→ 11/11→ 01/13→ 11/13→ 11/11→ 11/13→ 11/13→	←	+PR 1ZE,1ZP	24.0125-0145.1 425145	Ø 288 25 22 V + S		
					24.0325-0145.1 525145	Ø 288 25 22 V + S PD		
			←	+PR 1ZA,1ZD,1ZB	24.0125-0158.1 425158	Ø 312 25 22 V + S		
					24.0325-0158.1 525158	Ø 312 25 22 V + S PD		
			←	+PR 1ZK	24.0130-0115.1 430115	Ø 345 30 27 V		
			➡	+PR 1KD	24.0110-0277.1 410277	Ø 253 10 8 + S		
					24.0310-0277.1 510277	Ø 253 10 8 + S PD		
					➡	+PR 1KS,1KT	24.0110-0356.1 410356	Ø 272 9,7 8 + S
							24.0310-0356.1 510356	Ø 272 9,7 8 + S PD
						➡	+PR 1KW	24.0122-0219.1 422219







	kw			 	! #		
VW - GOLF VI Variant (AJ5) 07/09→07/13							
 Bremsbelagsatz, Scheibenbremse							
1.2 TSI	63	07/10→07/13	←	+PR 1ZM		13.0460-7117.2 607117	VW 23130 19,6 + WK
1.4	59	07/09→07/13				13.0470-7117.2 LD7117	VW 23130 19,6 + WK Ceramic
1.4 TSI	90	07/09→07/13					
1.4 TSI	118	07/09→07/13	←	+PR 1ZA,1ZD,1ZE,1ZP / 1LJ		13.0460-7184.2 607184	ATE 23587 20,6 + WK
1.6	75	07/09→07/13				13.0470-7184.2 LD7184	ATE 23587 20,6 + WK Ceramic
1.6 MultiFuel	75	07/10→07/13					
1.6 TDI	66	12/09→07/13	→	+PR 1KE,1KF,1KJ		13.0460-2749.2 602749	TRW 24483 16,9 - WE / - WK + Zub
1.6 TDI	77	07/09→07/13				13.0460-2880.2 602880	TRW 23914 17,1 + WE / - WK + Zub
1.6 TDI 4motion	77	07/09→07/13					
2.0 TDI	81	01/10→07/13				13.0470-2749.2 LD2749	TRW 24483 16,9 - WE / - WK + Zub Ceramic
2.0 TDI	100	07/09→07/13					
2.0 TDI	103	07/09→07/13				13.0470-2880.2 LD2880	TRW 23914 17,1 + WE / - WK + Zub Ceramic
2.0 TSI	147	07/09→07/13					
			→	+PR 1KS		13.0460-3858.2 603858	BOS 24563 17,7 - WE / - WK + Zub
						13.0470-3858.2 LD3858	BOS 24563 17,7 - WE / - WK + Zub Ceramic
1.2 TSI	77	07/09→07/13	←	08/09→; +PR 1ZM		13.0460-7117.2 607117	VW 23130 19,6 + WK
						13.0470-7117.2 LD7117	VW 23130 19,6 + WK Ceramic
			←	08/09→; +PR 1ZA,1ZD,1ZE,1ZP / 1LJ		13.0460-7184.2 607184	ATE 23587 20,6 + WK
						13.0470-7184.2 LD7184	ATE 23587 20,6 + WK Ceramic
			→	08/09→; +PR 1KE,1KF,1KJ		13.0460-2749.2 602749	TRW 24483 16,9 - WE / - WK + Zub
						13.0460-2880.2 602880	TRW 23914 17,1 + WE / - WK + Zub
						13.0470-2749.2 LD2749	TRW 24483 16,9 - WE / - WK + Zub Ceramic
						13.0470-2880.2 LD2880	TRW 23914 17,1 + WE / - WK + Zub Ceramic
			→	08/09→; +PR 1KS		13.0460-3858.2 603858	BOS 24563 17,7 - WE / - WK + Zub
						13.0470-3858.2 LD3858	BOS 24563 17,7 - WE / - WK + Zub Ceramic
 Bremsscheibe							
1.2 TSI	63	07/10→07/13	←	+PR 1ZM		24.0122-0210.1 422210	Ø 280 22 19 V + S
1.4	59	07/09→07/13				24.0322-0210.1 522210	Ø 280 22 19 V + S PD
1.4 TSI	90	07/09→07/13					
1.4 TSI	118	07/09→07/13	←	+PR 1ZE,1ZP		24.0125-0145.1 425145	Ø 288 25 22 V + S
1.6	75	07/09→07/13				24.0325-0145.1 525145	Ø 288 25 22 V + S PD
1.6 MultiFuel	75	07/10→07/13					
1.6 TDI	66	12/09→07/13	←	+PR 1LJ,1ZA,1ZD		24.0125-0158.1 425158	Ø 312 25 22 V + S
1.6 TDI	77	07/09→07/13				24.0325-0158.1 525158	Ø 312 25 22 V + S PD
1.6 TDI 4motion	77	07/09→07/13	→	+PR 1KS		24.0110-0356.1 410356	Ø 272 9,7 8 + S
2.0 TDI	81	01/10→07/13				24.0310-0356.1 510356	Ø 272 9,7 8 + S PD
2.0 TDI	100	07/09→07/13					
2.0 TDI	103	07/09→07/13	→	+PR 1KE,1KF		24.0112-0158.1 412158	Ø 256 12 10 + S
2.0 TSI	147	07/09→07/13				24.0312-0158.1 512158	Ø 256 12 10 PD
			→	+PR 1KJ		24.0112-0169.1 412169	Ø 282 12 10 + S
						24.0312-0169.1 512169	Ø 282 12 10 + S PD
1.2 TSI	77	07/09→07/13	←	08/09→; +PR 1ZM		24.0122-0210.1 422210	Ø 280 22 19 V + S
						24.0322-0210.1 522210	Ø 280 22 19 V + S PD
			←	08/09→; +PR 1ZE,1ZP		24.0125-0145.1 425145	Ø 288 25 22 V + S
						24.0325-0145.1 525145	Ø 288 25 22 V + S PD
			←	08/09→; +PR 1LJ,1ZA,1ZD		24.0125-0158.1 425158	Ø 312 25 22 V + S
						24.0325-0158.1 525158	Ø 312 25 22 V + S PD
			→	08/09→; +PR 1KS		24.0110-0356.1 410356	Ø 272 9,7 8 + S
						24.0310-0356.1 510356	Ø 272 9,7 8 + S PD
			→	08/09→; +PR 1KE,1KF		24.0112-0158.1 412158	Ø 256 12 10 + S
						24.0312-0158.1 512158	Ø 256 12 10 PD
			→	08/09→; +PR 1KJ		24.0112-0169.1 412169	Ø 282 12 10 + S
						24.0312-0169.1 512169	Ø 282 12 10 + S PD
VW - GOLF VII (5G1, BQ1, BE1, BE2) 08/12→							
 Bremsbelagsatz, Scheibenbremse							
1.0 TSI	63	01/17→	←	+PR 1ZA,1ZB,1ZD,1ZE / 1ZP,1LV,1ZC,1ZG		13.0460-2785.2 602785	TRW 25683 20,4 + WE / + WK
1.0 TSI	81	11/16→				13.0470-2785.2 LD2785	TRW 25683 20,4 + WE / + WK Ceramic
1.0 TSI	85	05/15→					
1.2 TSI	77	11/12→					
1.2 TSI	81	04/14→	←	+PR 1ZF		13.0460-7303.2 607303	ATE 22035 17,5 + WK



	kw			 	! #		
VW - GOLF VII (5G1, BQ1, BE1, BE2) 08/12→							
 Bremsbelagsatz, Scheibenbremse							
1.4 GTE Hybrid	110	05/14→	←	+PR 1ZF		13.0470-7303.2 LD7303	ATE 22035 17,5 + WK Ceramic
1.4 TSI	90	11/12→	→	+PR 1KE,1KK; + eFSB		13.0460-7293.2 607293	ATE 25008 16,3 - WE / - WK
1.4 TSI	92	05/14→				13.0470-7293.2 LD7293	ATE 25008 16,3 - WE / - WK Ceramic
1.4 TSI	110	05/14→					
1.4 TSI MultiFuel	90	04/13→					
1.4 TSI MultiFuel	92	12/13→	→	+PR 1KJ,1KV,1KY; + eFSB		13.0460-7294.2 607294	ATE 25009 16,4 - WE / - WK
1.6	81	05/14→				13.0470-7294.2 LD7294	ATE 25009 16,4 - WE / - WK Ceramic
1.6 TDI	66	04/13→					
1.6 TDI	85	11/16→					
1.6 TDI 4motion	77	11/12→					
1.6 TDI 4motion	81	01/13→					
2.0 GTD	135	04/13→					
2.0 GTI	155	11/13→					
2.0 GTI	162	04/13→					
2.0 GTI	169	04/13→					
2.0 GTI	180	03/17→					
2.0 GTI Clubsport	195	02/16→					
2.0 GTI Clubsport S	228	09/16→					
2.0 R 360S 4motion	265	09/16→					
2.0 R 4motion	206	11/13→					
2.0 R 4motion	213	12/16→					
2.0 R 4motion	221	11/13→					
2.0 R 4motion	228	12/16→					
2.0 TDI	81	11/12→					
2.0 TDI	105	08/12→					
2.0 TDI	110	11/12→					
2.0 TDI 4motion	110	11/12→					
1.2 TSI	63	08/12→	←	11/12→; +PR 1ZA,1ZB,1ZD,1ZE / 1ZP,1LV,1ZC, 1ZG		13.0460-2785.2 602785	TRW 25683 20,4 + WE / + WK
1.4 TSI	103	08/12→				13.0470-2785.2 LD2785	TRW 25683 20,4 + WE / + WK Ceramic
1.6 TDI	77	08/12→	←	11/12→; +PR 1ZF		13.0460-7303.2 607303	ATE 22035 17,5 + WK
						13.0470-7303.2 LD7303	ATE 22035 17,5 + WK Ceramic
			→	11/12→; +PR 1KE,1KK; + eFSB		13.0460-7293.2 607293	ATE 25008 16,3 - WE / - WK
						13.0470-7293.2 LD7293	ATE 25008 16,3 - WE / - WK Ceramic
			→	11/12→; +PR 1KJ,1KV,1KY; + eFSB		13.0460-7294.2 607294	ATE 25009 16,4 - WE / - WK
						13.0470-7294.2 LD7294	ATE 25009 16,4 - WE / - WK Ceramic
1.4 TGI CNG	81	06/13→	←	08/13→; +PR 1ZA,1ZB,1ZD,1ZE / 1ZP,1LV,1ZC, 1ZG		13.0460-2785.2 602785	TRW 25683 20,4 + WE / + WK
						13.0470-2785.2 LD2785	TRW 25683 20,4 + WE / + WK Ceramic
			←	08/13→; +PR 1ZF		13.0460-7303.2 607303	ATE 22035 17,5 + WK
						13.0470-7303.2 LD7303	ATE 22035 17,5 + WK Ceramic
			→	08/13→; +PR 1KE,1KK; + eFSB		13.0460-7293.2 607293	ATE 25008 16,3 - WE / - WK
						13.0470-7293.2 LD7293	ATE 25008 16,3 - WE / - WK Ceramic
			→	08/13→; +PR 1KJ,1KV,1KY; + eFSB		13.0460-7294.2 607294	ATE 25009 16,4 - WE / - WK
						13.0470-7294.2 LD7294	ATE 25009 16,4 - WE / - WK Ceramic
1.6 TDI	81	01/13→	←	06/13→; +PR 1ZA,1ZB,1ZD,1ZE / 1ZP,1LV,1ZC, 1ZG		13.0460-2785.2 602785	TRW 25683 20,4 + WE / + WK
						13.0470-2785.2 LD2785	TRW 25683 20,4 + WE / + WK Ceramic
			←	06/13→; +PR 1ZF		13.0460-7303.2 607303	ATE 22035 17,5 + WK
						13.0470-7303.2 LD7303	ATE 22035 17,5 + WK Ceramic
			→	06/13→; +PR 1KE,1KK; + eFSB		13.0460-7293.2 607293	ATE 25008 16,3 - WE / - WK
						13.0470-7293.2 LD7293	ATE 25008 16,3 - WE / - WK Ceramic
			→	06/13→; +PR 1KJ,1KV,1KY; + eFSB		13.0460-7294.2 607294	ATE 25009 16,4 - WE / - WK
						13.0470-7294.2 LD7294	ATE 25009 16,4 - WE / - WK Ceramic
e-Golf	85	03/14→02/17	←	08/14→; +PR 1ZE,1ZP		13.0460-2785.2 602785	TRW 25683 20,4 + WE / + WK
						13.0470-2785.2 LD2785	TRW 25683 20,4 + WE / + WK Ceramic
			→	08/14→; +PR 1KE,1KR; + eFSB		13.0460-7293.2 607293	ATE 25008 16,3 - WE / - WK
						13.0470-7293.2 LD7293	ATE 25008 16,3 - WE / - WK Ceramic
e-Golf	100	12/16→	←	+PR 1ZE,1ZP		13.0460-2785.2 602785	TRW 25683 20,4 + WE / + WK
						13.0470-2785.2 LD2785	TRW 25683 20,4 + WE / + WK Ceramic
			→	+PR 1KE,1KR; + eFSB		13.0460-7293.2 607293	ATE 25008 16,3 - WE / - WK
						13.0470-7293.2 LD7293	ATE 25008 16,3 - WE / - WK Ceramic



	kW			 	! #		
VW - GOLF VII (5G1, BQ1, BE1, BE2) 08/12→							
Warnkontakt, Bremsbelagverschleiß							
1.0 TSI	63	01/17→	←	+PR 1LJ,1LM	1	24.8190-0065.2 620065	L= 172
1.0 TSI	81	11/16→					
1.0 TSI	85	05/15→					
1.2 TSI	77	11/12→					
1.2 TSI	81	04/14→					
1.4 GTE Hybrid	110	05/14→					
1.4 TSI	90	11/12→					
1.4 TSI	92	05/14→					
1.4 TSI	110	05/14→					
1.4 TSI MultiFuel	90	04/13→					
1.4 TSI MultiFuel	92	12/13→					
1.6	81	05/14→					
1.6 TDI	66	04/13→					
1.6 TDI	85	11/16→					
1.6 TDI 4motion	77	11/12→					
1.6 TDI 4motion	81	01/13→					
2.0 GTD	135	04/13→					
2.0 GTI	155	11/13→					
2.0 GTI	162	04/13→					
2.0 GTI	169	04/13→					
2.0 GTI	180	03/17→					
2.0 GTI Clubsport	195	02/16→					
2.0 GTI Clubsport S	228	09/16→					
2.0 R 360S 4motion	265	09/16→					
2.0 R 4motion	206	11/13→					
2.0 R 4motion	213	12/16→					
2.0 R 4motion	221	11/13→					
2.0 R 4motion	228	12/16→					
2.0 TDI	81	11/12→					
2.0 TDI	105	08/12→					
2.0 TDI	110	11/12→					
2.0 TDI 4motion	110	11/12→					
1.2 TSI	63	08/12→	←	11/12→; +PR 1LJ,1LM	1	24.8190-0065.2 620065	L= 172
1.4 TSI	103	08/12→					
1.6 TDI	77	08/12→					
1.4 TGI CNG	81	06/13→	←	08/13→; +PR 1LJ,1LM	1	24.8190-0065.2 620065	L= 172
1.6 TDI	81	01/13→	←	06/13→; +PR 1LJ,1LM	1	24.8190-0065.2 620065	L= 172
Bremsscheibe							
1.0 TSI	63	01/17→	←	+PR 1ZF		24.0124-0258.1 424258	Ø 276 24 21 V + S
1.0 TSI	81	11/16→	←	+PR 1ZE,1ZP		24.0125-0145.1 425145	Ø 288 25 22 V + S
1.0 TSI	85	05/15→	←			24.0325-0145.1 525145	Ø 288 25 22 V + S PD
1.2 TSI	77	11/12→					
1.2 TSI	81	04/14→	←	+PR 1ZA,1ZB,1ZD / 1LV,1ZC,1ZG		24.0125-0158.1 425158	Ø 312 25 22 V + S
1.4 GTE Hybrid	110	05/14→				24.0325-0158.1 525158	Ø 312 25 22 V + S PD
1.4 TSI	90	11/12→					
1.4 TSI	92	05/14→	←	+PR 1LJ,1LM		24.0130-0225.1 430225	Ø 340 30 27 V + S
1.4 TSI	110	05/14→					
1.4 TSI MultiFuel	90	04/13→	→	+PR 1KE,1KK; + eFSB		24.0110-0356.1 410356	Ø 272 9,7 8 + S
1.4 TSI MultiFuel	92	12/13→				24.0310-0356.1 510356	Ø 272 9,7 8 + S PD
1.6	81	05/14→	→	+PR 1KV; + eFSB		24.0112-0210.1 412210	Ø 300 12 10 + S
1.6 TDI	66	04/13→					
1.6 TDI	85	11/16→	→	+PR 1KJ,1KY; + eFSB		24.0122-0219.1 422219	Ø 310 22 20 V
1.6 TDI 4motion	77	11/12→					
1.6 TDI 4motion	81	01/13→					
2.0 GTD	135	04/13→					
2.0 GTI	155	11/13→					
2.0 GTI	162	04/13→					
2.0 GTI	169	04/13→					
2.0 GTI	180	03/17→					
2.0 GTI Clubsport	195	02/16→					
2.0 GTI Clubsport S	228	09/16→					
2.0 R 360S 4motion	265	09/16→					
2.0 R 4motion	206	11/13→					
2.0 R 4motion	213	12/16→					
2.0 R 4motion	221	11/13→					
2.0 R 4motion	228	12/16→					
2.0 TDI	81	11/12→					
2.0 TDI	105	08/12→					
2.0 TDI	110	11/12→					
2.0 TDI 4motion	110	11/12→					
1.2 TSI	63	08/12→	←	11/12→; +PR 1ZF		24.0124-0258.1 424258	Ø 276 24 21 V + S
1.4 TSI	103	08/12→	←	11/12→; +PR 1ZE,1ZP		24.0125-0145.1 425145	Ø 288 25 22 V + S
1.6 TDI	77	08/12→	←			24.0325-0145.1 525145	Ø 288 25 22 V + S PD
			←	11/12→; +PR 1ZA,1ZB,1ZD / 1LV,1ZC,1ZG		24.0125-0158.1 425158	Ø 312 25 22 V + S
			←	11/12→; +PR 1ZA,1ZB,1ZD / 1LV,1ZC,1ZG		24.0325-0158.1 525158	Ø 312 25 22 V + S PD
			←	11/12→; +PR 1LJ,1LM		24.0130-0225.1 430225	Ø 340 30 27 V + S
			→	11/12→; +PR 1KE,1KK; + eFSB		24.0110-0356.1 410356	Ø 272 9,7 8 + S
			→	11/12→; +PR 1KE,1KK; + eFSB		24.0310-0356.1 510356	Ø 272 9,7 8 + S PD

	kw			 	! #		
VW - GOLF VII (5G1, BQ1, BE1, BE2) 08/12→							
Bremsscheibe							
1.2 TSI	63	08/12→	➔	11/12→; +PR 1KV; + eFSB		24.0112-0210.1 412210	Ø 300 12 10 + S
1.4 TSI	103	08/12→	➔	11/12→; +PR 1KJ,1KY; + eFSB		24.0122-0219.1 422219	Ø 310 22 20 V
1.6 TDI	77	08/12→	➔	11/12→; +PR 1KJ,1KY; + eFSB		24.0122-0219.1 422219	Ø 310 22 20 V
1.4 TGI CNG	81	06/13→	➔	08/13→; +PR 1ZF		24.0124-0258.1 424258	Ø 276 24 21 V + S
			➔	08/13→; +PR 1ZE,1ZP		24.0125-0145.1 425145	Ø 288 25 22 V + S
			➔	08/13→; +PR 1ZE,1ZP		24.0325-0145.1 525145	Ø 288 25 22 V + S PD
			➔	08/13→; +PR 1ZA,1ZB,1ZD / 1LV,1ZC,1ZG		24.0125-0158.1 425158	Ø 312 25 22 V + S
			➔	08/13→; +PR 1ZA,1ZB,1ZD / 1LV,1ZC,1ZG		24.0325-0158.1 525158	Ø 312 25 22 V + S PD
			➔	08/13→; +PR 1LJ,1LM		24.0130-0225.1 430225	Ø 340 30 27 V + S
			➔	08/13→; +PR 1KE,1KK; + eFSB		24.0110-0356.1 410356	Ø 272 9,7 8 + S
			➔	08/13→; +PR 1KE,1KK; + eFSB		24.0310-0356.1 510356	Ø 272 9,7 8 + S PD
1.6 TDI	81	01/13→	➔	06/13→; +PR 1ZF		24.0124-0258.1 424258	Ø 276 24 21 V + S
			➔	06/13→; +PR 1ZE,1ZP		24.0125-0145.1 425145	Ø 288 25 22 V + S
			➔	06/13→; +PR 1ZE,1ZP		24.0325-0145.1 525145	Ø 288 25 22 V + S PD
			➔	06/13→; +PR 1ZA,1ZB,1ZD / 1LV,1ZC,1ZG		24.0125-0158.1 425158	Ø 312 25 22 V + S
			➔	06/13→; +PR 1ZA,1ZB,1ZD / 1LV,1ZC,1ZG		24.0325-0158.1 525158	Ø 312 25 22 V + S PD
			➔	06/13→; +PR 1LJ,1LM		24.0130-0225.1 430225	Ø 340 30 27 V + S
			➔	06/13→; +PR 1KE,1KK; + eFSB		24.0110-0356.1 410356	Ø 272 9,7 8 + S
			➔	06/13→; +PR 1KE,1KK; + eFSB		24.0310-0356.1 510356	Ø 272 9,7 8 + S PD
e-Golf	85	03/14→02/17	➔	08/14→; +PR 1ZE,1ZP		24.0125-0145.1 425145	Ø 288 25 22 V + S
			➔	08/14→; +PR 1ZE,1ZP		24.0325-0145.1 525145	Ø 288 25 22 V + S PD
			➔	08/14→; +PR 1KE,1KR; + eFSB		24.0110-0356.1 410356	Ø 272 9,7 8 + S
e-Golf	100	12/16→	➔	08/14→; +PR 1KE,1KR; + eFSB		24.0310-0356.1 510356	Ø 272 9,7 8 + S PD
			➔	+PR 1ZE,1ZP		24.0125-0145.1 425145	Ø 288 25 22 V + S
			➔	+PR 1ZE,1ZP		24.0325-0145.1 525145	Ø 288 25 22 V + S PD
e-Golf	100	12/16→	➔	+PR 1KE,1KR; + eFSB		24.0110-0356.1 410356	Ø 272 9,7 8 + S
			➔	+PR 1KE,1KR; + eFSB		24.0310-0356.1 510356	Ø 272 9,7 8 + S PD
			➔	+PR 1KE,1KR; + eFSB		24.0310-0356.1 510356	Ø 272 9,7 8 + S PD
VW - GOLF VII Kombi (BA5, BV5) 04/13→							
Brembelagsatz, Scheibenbremse							
1.0 TSI	63	01/17→	➔	+PR 1ZA,1ZB,1ZD,1ZE / 1ZP,1LV		13.0460-2785.2 602785	TRW 25683 20,4 + WE / + WK
1.0 TSI	81	11/16→	➔	+PR 1ZA,1ZB,1ZD,1ZE / 1ZP,1LV		13.0470-2785.2 LD2785	TRW 25683 20,4 + WE / + WK Ceramic
1.0 TSI	85	05/15→	➔	+PR 1ZA,1ZB,1ZD,1ZE / 1ZP,1LV		13.0470-2785.2 LD2785	TRW 25683 20,4 + WE / + WK Ceramic
1.2 TSI	81	04/14→	➔	+PR 1ZF		13.0460-7303.2 607303	ATE 22035 17,5 + WK
1.4 TGI CNG	81	09/13→	➔	+PR 1ZF		13.0460-7303.2 607303	ATE 22035 17,5 + WK Ceramic
1.4 TSI	92	05/14→	➔	+PR 1ZF		13.0470-7303.2 LD7303	ATE 22035 17,5 + WK Ceramic
1.4 TSI	110	05/14→	➔	+PR 1ZF		13.0470-7303.2 LD7303	ATE 22035 17,5 + WK Ceramic
1.4 TSI MultiFuel	90	04/13→	➔	+PR 1KE; + eFSB		13.0460-7293.2 607293	ATE 25008 16,3 - WE / - WK
1.4 TSI MultiFuel	92	05/14→	➔	+PR 1KE; + eFSB		13.0470-7293.2 LD7293	ATE 25008 16,3 - WE / - WK Ceramic
1.6	81	05/14→	➔	+PR 1KE; + eFSB		13.0470-7293.2 LD7293	ATE 25008 16,3 - WE / - WK Ceramic
1.6 TDI	85	11/16→	➔	+PR 1KV,1KY; + eFSB		13.0460-7294.2 607294	ATE 25009 16,4 - WE / - WK
2.0 GTD	135	01/15→	➔	+PR 1KV,1KY; + eFSB		13.0470-7294.2 LD7294	ATE 25009 16,4 - WE / - WK Ceramic
2.0 R 360S 4motion	265	09/16→	➔	+PR 1KV,1KY; + eFSB		13.0470-7294.2 LD7294	ATE 25009 16,4 - WE / - WK Ceramic
2.0 R 4motion	206	03/15→	➔	+PR 1KV,1KY; + eFSB		13.0470-7294.2 LD7294	ATE 25009 16,4 - WE / - WK Ceramic
2.0 R 4motion	213	12/16→	➔	+PR 1KV,1KY; + eFSB		13.0470-7294.2 LD7294	ATE 25009 16,4 - WE / - WK Ceramic
2.0 R 4motion	221	03/15→	➔	+PR 1KV,1KY; + eFSB		13.0470-7294.2 LD7294	ATE 25009 16,4 - WE / - WK Ceramic
2.0 R 4motion	228	12/16→	➔	+PR 1KV,1KY; + eFSB		13.0470-7294.2 LD7294	ATE 25009 16,4 - WE / - WK Ceramic
1.2 TSI	63	05/13→	➔	07/13→; +PR 1ZA,1ZB,1ZD,1ZE / 1ZP,1LV		13.0460-2785.2 602785	TRW 25683 20,4 + WE / + WK
1.2 TSI	77	05/13→	➔	07/13→; +PR 1ZA,1ZB,1ZD,1ZE / 1ZP,1LV		13.0470-2785.2 LD2785	TRW 25683 20,4 + WE / + WK Ceramic
1.4 TSI	90	05/13→	➔	07/13→; +PR 1ZA,1ZB,1ZD,1ZE / 1ZP,1LV		13.0470-2785.2 LD2785	TRW 25683 20,4 + WE / + WK Ceramic
1.4 TSI	103	05/13→	➔	07/13→; +PR 1ZA,1ZB,1ZD,1ZE / 1ZP,1LV		13.0470-2785.2 LD2785	TRW 25683 20,4 + WE / + WK Ceramic
1.6 TDI	66	05/13→	➔	07/13→; +PR 1ZF		13.0460-7303.2 607303	ATE 22035 17,5 + WK
1.6 TDI	77	05/13→	➔	07/13→; +PR 1ZF		13.0470-7303.2 LD7303	ATE 22035 17,5 + WK Ceramic
1.6 TDI	81	05/13→	➔	07/13→; +PR 1ZF		13.0470-7303.2 LD7303	ATE 22035 17,5 + WK Ceramic
1.6 TDI 4motion	77	05/13→	➔	07/13→; +PR 1KE; + eFSB		13.0460-7293.2 607293	ATE 25008 16,3 - WE / - WK
1.6 TDI 4motion	81	05/13→	➔	07/13→; +PR 1KE; + eFSB		13.0470-7293.2 LD7293	ATE 25008 16,3 - WE / - WK Ceramic
2.0 TDI	81	05/13→	➔	07/13→; +PR 1KE; + eFSB		13.0470-7293.2 LD7293	ATE 25008 16,3 - WE / - WK Ceramic
2.0 TDI	110	04/13→	➔	07/13→; +PR 1KV,1KY; + eFSB		13.0460-7294.2 607294	ATE 25009 16,4 - WE / - WK
2.0 TDI 4motion	110	04/13→	➔	07/13→; +PR 1KV,1KY; + eFSB		13.0470-7294.2 LD7294	ATE 25009 16,4 - WE / - WK Ceramic
Warnkontakt, Bremsbelagverschleiß							
1.0 TSI	63	01/17→	➔	+PR 1LM	1	24.8190-0065.2 620065	L= 172
1.0 TSI	81	11/16→	➔	+PR 1LM	1	24.8190-0065.2 620065	L= 172
1.0 TSI	85	05/15→	➔	+PR 1ZA,1ZB,1ZD,1ZE / 1ZP,1LV	1	24.8190-0065.2 620065	L= 172

VW - GOLF VII Kombi (BA5, BV5) 04/13→

Warnkontakt, Bremsbelagverschleiß

1.2 TSI	81	04/14→	←	+PR 1LM	1	24.8190-0065.2	620065	L= 172
1.4 TGI CNG	81	09/13→						
1.4 TSI	92	05/14→	←	+PR 1ZA,1ZB,1ZD,1ZE / 1ZP,1LV	1	24.8190-0065.2	620065	L= 172
1.4 TSI	110	05/14→						
1.4 TSI MultiFuel	90	04/13→						
1.4 TSI MultiFuel	92	05/14→						
1.6	81	05/14→						
1.6 TDI	85	11/16→						
2.0 GTD	135	01/15→						
2.0 R 360S 4motion	265	09/16→						
2.0 R 4motion	206	03/15→						
2.0 R 4motion	213	12/16→						
2.0 R 4motion	221	03/15→						
2.0 R 4motion	228	12/16→						
1.2 TSI	63	05/13→	←	07/13→; +PR 1ZA,1ZB,1ZD,1ZE / 1ZP,1LV	1	24.8190-0065.2	620065	L= 172
1.2 TSI	77	05/13→						
1.4 TSI	90	05/13→	←	07/13→; +PR 1LM	1	24.8190-0065.2	620065	L= 172
1.4 TSI	103	05/13→						
1.6 TDI	66	05/13→						
1.6 TDI	77	05/13→						
1.6 TDI	81	05/13→						
1.6 TDI 4motion	77	05/13→						
1.6 TDI 4motion	81	05/13→						
2.0 TDI	81	05/13→						
2.0 TDI	110	04/13→						
2.0 TDI 4motion	110	04/13→						











Bremsscheibe









1.0 TSI	63	01/17→	←	+PR 1ZF		24.0124-0258.1	424258	Ø 276 24 21 V + S
1.0 TSI	81	11/16→	←	+PR 1ZE,1ZP		24.0125-0145.1	425145	Ø 288 25 22 V + S
1.0 TSI	85	05/15→						
1.2 TSI	81	04/14→	←	+PR 1ZA,1ZB,1ZD,1LV		24.0125-0158.1	425158	Ø 312 25 22 V + S
1.4 TGI CNG	81	09/13→				24.0325-0158.1	525158	Ø 312 25 22 V + S PD
1.4 TSI	92	05/14→						
1.4 TSI	110	05/14→	←	+PR 1LM		24.0130-0225.1	430225	Ø 340 30 27 V + S
1.4 TSI MultiFuel	90	04/13→						
1.4 TSI MultiFuel	92	05/14→	→	+PR 1KE		24.0110-0356.1	410356	Ø 272 9,7 8 + S
1.6	81	05/14→				24.0310-0356.1	510356	Ø 272 9,7 8 + S PD
1.6 TDI	85	11/16→	→	+PR 1KV; + eFSB		24.0112-0210.1	412210	Ø 300 12 10 + S
2.0 R 360S 4motion	265	09/16→						
2.0 R 4motion	206	03/15→	→	+PR 1KY		24.0122-0219.1	422219	Ø 310 22 20 V
2.0 R 4motion	213	12/16→						
2.0 R 4motion	221	03/15→						
2.0 R 4motion	228	12/16→						
1.2 TSI	63	05/13→	←	07/13→; +PR 1ZF		24.0124-0258.1	424258	Ø 276 24 21 V + S
1.2 TSI	77	05/13→	←	07/13→; +PR 1ZE,1ZP		24.0125-0145.1	425145	Ø 288 25 22 V + S
1.4 TSI	90	05/13→	←	07/13→; +PR 1ZA,1ZB,1ZD,1LV		24.0125-0158.1	425158	Ø 312 25 22 V + S
1.4 TSI	103	05/13→				24.0325-0158.1	525158	Ø 312 25 22 V + S PD
1.6 TDI	66	05/13→	←	07/13→; +PR 1LM		24.0130-0225.1	430225	Ø 340 30 27 V + S
1.6 TDI	77	05/13→	→	07/13→; +PR 1KE		24.0110-0356.1	410356	Ø 272 9,7 8 + S
1.6 TDI 4motion	77	05/13→	→	07/13→; +PR 1KE		24.0310-0356.1	510356	Ø 272 9,7 8 + S PD
1.6 TDI 4motion	81	05/13→						
2.0 TDI	81	05/13→						
2.0 TDI	110	04/13→	→	07/13→; +PR 1KV; + eFSB		24.0112-0210.1	412210	Ø 300 12 10 + S
2.0 TDI 4motion	110	04/13→	→	07/13→; +PR 1KY		24.0122-0219.1	422219	Ø 310 22 20 V
2.0 GTD	135	01/15→	←	+PR 1ZF		24.0124-0258.1	424258	Ø 276 24 21 V + S
			←	+PR 1ZE,1ZP		24.0125-0145.1	425145	Ø 288 25 22 V + S
			←	+PR 1ZA,1ZB,1ZD,1LV		24.0125-0158.1	425158	Ø 312 25 22 V + S
						24.0325-0158.1	525158	Ø 312 25 22 V + S PD
			←	03/15→; +PR 1LM		24.0130-0225.1	430225	Ø 340 30 27 V + S
			→	+PR 1KE		24.0110-0356.1	410356	Ø 272 9,7 8 + S
						24.0310-0356.1	510356	Ø 272 9,7 8 + S PD
			→	+PR 1KV; + eFSB		24.0112-0210.1	412210	Ø 300 12 10 + S
			→	+PR 1KY		24.0122-0219.1	422219	Ø 310 22 20 V

VW - GOLF ALLTRACK (BA5) 12/14→











Bremsbelagsatz, Scheibenbremse









1.6 TDI 4motion	81	12/14→	←	+PR 1ZA,1ZB,1ZD,1ZE / 1ZP,1LV		13.0460-2785.2	602785	TRW 25683 20,4 + WE / + WK
1.8 TSI 4motion	132	12/14→				13.0470-2785.2	LD2785	TRW 25683 20,4 + WE / + WK Ceramic
2.0 TDI 4motion	110	12/14→						
2.0 TDI 4motion	135	12/14→	←	+PR 1ZF		13.0460-7303.2	607303	ATE 22035 17,5 + WK
						13.0470-7303.2	LD7303	ATE 22035 17,5 + WK Ceramic
			→	+PR 1KE; + eFSB		13.0460-7293.2	607293	ATE 25008 16,3 - WE / - WK











	kw			 	! #		
VW - GOLF ALLTRACK (BA5) 12/14→							
 Bremsbelagsatz, Scheibenbremse							
1.6 TDI 4motion	81	12/14→	➡	+PR 1KE; + eFSB	13.0470-7293.2	LD7293	ATE 25008 16,3 - WE / - WK Ceramic
1.8 TSI 4motion	132	12/14→					
2.0 TDI 4motion	110	12/14→			13.0460-7294.2	607294	ATE 25009 16,4 - WE / - WK
2.0 TDI 4motion	135	12/14→	➡	+PR 1KV,1KY; + eFSB	13.0470-7294.2	LD7294	ATE 25009 16,4 - WE / - WK Ceramic
 Bremsscheibe							
1.6 TDI 4motion	81	12/14→	←	+PR 1ZF	24.0124-0258.1	424258	Ø 276 24 21 V + S
1.8 TSI 4motion	132	12/14→	←	+PR 1ZE,1ZP	24.0125-0145.1	425145	Ø 288 25 22 V + S
2.0 TDI 4motion	110	12/14→			24.0325-0145.1	525145	Ø 288 25 22 V + S PD
2.0 TDI 4motion	135	12/14→	←	+PR 1ZA,1ZB,1ZD,1LV	24.0125-0158.1	425158	Ø 312 25 22 V + S
					24.0325-0158.1	525158	Ø 312 25 22 V + S PD
			←	+PR 1LM	24.0130-0225.1	430225	Ø 340 30 27 V + S
			➡	+PR 1KE	24.0110-0356.1	410356	Ø 272 9,7 8 + S
					24.0310-0356.1	510356	Ø 272 9,7 8 + S PD
			➡	+PR 1KV; + eFSB	24.0112-0210.1	412210	Ø 300 12 10 + S
			➡	+PR 1KY	24.0122-0219.1	422219	Ø 310 22 20 V
VW - GOLF PLUS (5M1, 521) 01/05→12/13							
 Bremsbelagsatz, Scheibenbremse							
1.2 TSI	63	05/10→12/13	←	+PR 1ZF,1ZM	13.0460-7117.2	607117	VW 23130 19,6 + WK
1.2 TSI	77	11/09→12/13			13.0470-7117.2	LD7117	VW 23130 19,6 + WK Ceramic
1.6 BiFuel	75	05/09→12/13					
1.6 TDI	66	02/09→12/13	←	+PR 1ZA,1ZP,1ZE,1LJ	13.0460-7184.2	607184	ATE 23587 20,6 + WK
1.6 TDI	77	03/09→12/13			13.0470-7184.2	LD7184	ATE 23587 20,6 + WK Ceramic
			➡	+PR 1KE,1KZ	13.0460-2749.2	602749	TRW 24483 16,9 - WE / - WK + Zub
					13.0460-2880.2	602880	TRW 23914 17,1 + WE / - WK + Zub
					13.0470-2749.2	LD2749	TRW 24483 16,9 - WE / - WK + Zub Ceramic
					13.0470-2880.2	LD2880	TRW 23914 17,1 + WE / - WK + Zub Ceramic
			➡	+PR 1KD	13.0460-2820.2	602820	TRW 20961 17,2 - WK
					13.0470-2820.2	LD2820	TRW 20961 17,2 - WK Ceramic
1.4 16V	55	01/05→11/06	←	+PR 1ZF;1ZM	13.0460-7117.2	607117	VW 23130 19,6 + WK
1.4 16V	59	05/06→12/13			13.0470-7117.2	LD7117	VW 23130 19,6 + WK Ceramic
1.4 TSI	90	06/07→12/13					
1.4 TSI	103	05/06→06/08	←	+PR 1ZA,1ZP,1ZE,1LJ	13.0460-7184.2	607184	ATE 23587 20,6 + WK
1.4 TSI	118	06/08→12/13			13.0470-7184.2	LD7184	ATE 23587 20,6 + WK Ceramic
1.4 TSI	125	05/06→06/08					
1.6	75	05/05→12/13	➡	+PR 1KE,1KZ	13.0460-2749.2	602749	TRW 24483 16,9 - WE / - WK + Zub
1.6 FSI	85	01/05→05/08					
1.6 MultiFuel	75	11/07→12/13			13.0460-2880.2	602880	TRW 23914 17,1 + WE / - WK + Zub
1.9 TDI	66	05/05→12/08					
1.9 TDI	77	01/05→01/09			13.0470-2749.2	LD2749	TRW 24483 16,9 - WE / - WK + Zub Ceramic
2.0 FSI	110	05/05→06/08					
2.0 TDI	81	01/09→12/13			13.0470-2880.2	LD2880	TRW 23914 17,1 + WE / - WK + Zub Ceramic
2.0 TDI	96	05/05→05/07					
2.0 TDI	100	05/05→12/13					
2.0 TDI	103	12/05→05/11	➡	+PR 1KD	13.0460-2820.2	602820	TRW 20961 17,2 - WK
2.0 TDI 16V	103	01/05→12/13			13.0470-2820.2	LD2820	TRW 20961 17,2 - WK Ceramic
1.4 FSI	66	07/05→11/06	←	+PR 1ZF,1ZM	13.0460-7117.2	607117	VW 23130 19,6 + WK
					13.0470-7117.2	LD7117	VW 23130 19,6 + WK Ceramic
			←	+PR 1ZA,1ZP,1ZE,1LJ	13.0460-7184.2	607184	ATE 23587 20,6 + WK
					13.0470-7184.2	LD7184	ATE 23587 20,6 + WK Ceramic
			➡	+PR 1KE;1KZ	13.0460-2749.2	602749	TRW 24483 16,9 - WE / - WK + Zub
					13.0460-2880.2	602880	TRW 23914 17,1 + WE / - WK + Zub
					13.0470-2749.2	LD2749	TRW 24483 16,9 - WE / - WK + Zub Ceramic
					13.0470-2880.2	LD2880	TRW 23914 17,1 + WE / - WK + Zub Ceramic
			➡	+PR 1KD	13.0460-2820.2	602820	TRW 20961 17,2 - WK
					13.0470-2820.2	LD2820	TRW 20961 17,2 - WK Ceramic
Zubehörsatz, Scheibenbremsbelag							
1.2 TSI	63	05/10→12/13	➡	+PR 1KD	13.0460-0259.2	610259	
↓							







	kw			 	! #			
VW - GOLF PLUS (5M1, 521) 01/05→12/13								
Zubehörsatz, Scheibenbremsbelag								
1.2 TSI	77	11/09→12/13	➔	+PR 1KE,1KZ		13.0460-0259.2	610259	
1.4 16V	55	01/05→11/06						
1.4 16V	59	05/06→12/13						
1.4 TSI	90	06/07→12/13						
1.4 TSI	103	05/06→06/08						
1.4 TSI	118	06/08→12/13						
1.4 TSI	125	05/06→06/08						
1.6	75	05/05→12/13						
1.6 BiFuel	75	05/09→12/13						
1.6 FSI	85	01/05→05/08						
1.6 MultiFuel	75	11/07→12/13						
1.6 TDI	66	02/09→12/13						
1.6 TDI	77	03/09→12/13						
1.9 TDI	66	05/05→12/08						
1.9 TDI	77	01/05→01/09						
2.0 FSI	110	05/05→06/08						
2.0 TDI	81	01/09→12/13						
2.0 TDI	96	05/05→05/07						
2.0 TDI	100	05/05→12/13						
2.0 TDI	103	12/05→05/11						
2.0 TDI 16V	103	01/05→12/13						
1.4 FSI	66	07/05→11/06	➔	+PR 1KD		13.0460-0259.2	610259	
			➔	+PR 1KE,1KZ		13.0460-0259.2	610259	
 Bremsscheibe								
1.2 TSI	63	05/10→12/13	←	+PR 1ZF,1ZM		24.0122-0210.1	422210	Ø 280 22 19 V + S
1.2 TSI	77	11/09→12/13				24.0322-0210.1	522210	Ø 280 22 19 V + S PD
1.6 BiFuel	75	05/09→12/13						
1.6 TDI	66	02/09→12/13	←	+PR 1ZE,1ZP		24.0125-0145.1	425145	Ø 288 25 22 V + S
1.6 TDI	77	03/09→12/13				24.0325-0145.1	525145	Ø 288 25 22 V + S PD
			←	+PR 1LJ,1ZA		24.0125-0158.1	425158	Ø 312 25 22 V + S
						24.0325-0158.1	525158	Ø 312 25 22 V + S PD
			➔	+PR 1KD		24.0110-0277.1	410277	Ø 253 10 8 + S
						24.0310-0277.1	510277	Ø 253 10 8 + S PD
			➔	+PR 1KE		24.0112-0158.1	412158	Ø 256 12 10 + S
						24.0312-0158.1	512158	Ø 256 12 10 PD
			➔	+PR 1KZ		24.0112-0169.1	412169	Ø 282 12 10 + S
						24.0312-0169.1	512169	Ø 282 12 10 + S PD
1.4 16V	55	01/05→11/06	←	+PR 1ZF,1ZM		24.0122-0210.1	422210	Ø 280 22 19 V + S
1.4 16V	59	05/06→12/13				24.0322-0210.1	522210	Ø 280 22 19 V + S PD
1.4 TSI	90	06/07→12/13						
1.4 TSI	103	05/06→06/08	←	+PR 1ZE,1ZP		24.0125-0145.1	425145	Ø 288 25 22 V + S
1.4 TSI	118	06/08→12/13				24.0325-0145.1	525145	Ø 288 25 22 V + S PD
1.4 TSI	125	05/06→06/08						
1.6	75	05/05→12/13	←	+PR 1LJ,1ZA		24.0125-0158.1	425158	Ø 312 25 22 V + S
1.6 FSI	85	01/05→05/08				24.0325-0158.1	525158	Ø 312 25 22 V + S PD
1.6 MultiFuel	75	11/07→12/13						
1.9 TDI	66	05/05→12/08	➔	+PR 1KD		24.0110-0277.1	410277	Ø 253 10 8 + S
1.9 TDI	77	01/05→01/09				24.0310-0277.1	510277	Ø 253 10 8 + S PD
2.0 FSI	110	05/05→06/08	➔	+PR 1KE		24.0112-0158.1	412158	Ø 256 12 10 + S
2.0 TDI	81	01/09→12/13				24.0312-0158.1	512158	Ø 256 12 10 PD
2.0 TDI	96	05/05→05/07						
2.0 TDI	100	05/05→12/13	➔	+PR 1KZ		24.0112-0169.1	412169	Ø 282 12 10 + S
2.0 TDI	103	12/05→05/11				24.0312-0169.1	512169	Ø 282 12 10 + S PD
2.0 TDI 16V	103	01/05→12/13						
1.4 FSI	66	07/05→11/06	←	+PR 1ZF,1ZM		24.0122-0210.1	422210	Ø 280 22 19 V + S
						24.0322-0210.1	522210	Ø 280 22 19 V + S PD
			←	+PR 1ZE,1ZP		24.0125-0145.1	425145	Ø 288 25 22 V + S
						24.0325-0145.1	525145	Ø 288 25 22 V + S PD
			←	+PR 1LJ,1ZA		24.0125-0158.1	425158	Ø 312 25 22 V + S
						24.0325-0158.1	525158	Ø 312 25 22 V + S PD
			➔	+PR 1KD		24.0110-0277.1	410277	Ø 253 10 8 + S
						24.0310-0277.1	510277	Ø 253 10 8 + S PD
			➔	+PR 1KE		24.0112-0158.1	412158	Ø 256 12 10 + S
						24.0312-0158.1	512158	Ø 256 12 10 PD
			➔			24.0112-0169.1	412169	Ø 282 12 10 + S
						24.0312-0169.1	512169	Ø 282 12 10 + S PD
VW - GOLF SPORTSVAN (AM1) 02/14→								
 Bremsbelagsatz, Scheibenbremse								
1.0 TSI	85	05/15→	←	+PR 1ZA,1ZE,1ZP		13.0460-2785.2	602785	TRW 25683 20,4 + WE / + WK
1.2 TSI	63	05/14→				13.0470-2785.2	LD2785	TRW 25683 20,4 + WE / + WK Ceramic
1.2 TSI	81	04/14→						
↓								























	kw			 	! #		
VW - GOLF SPORTSVAN (AM1) 02/14→							
 Bremsbelagsatz, Scheibenbremse							
1.4 TSI 1.4 TSI MultiFuel 1.6 1.6 TDI 2.0 TDI	92 92 81 66 81	04/14→ 04/14→ 05/14→ 02/14→ 05/14→	← ← →	+PR 1ZF +PR 1KE; + eFSB		13.0460-7303.2 607303 13.0470-7303.2 LD7303 13.0460-7293.2 607293 13.0470-7293.2 LD7293	ATE 22035 17,5 + WK ATE 22035 17,5 + WK Ceramic ATE 25008 16,3 - WE / - WK ATE 25008 16,3 - WE / - WK Ceramic
1.4 TSI 1.6 TDI 2.0 TDI	110 81 110	02/14→ 02/14→ 02/14→	← ← →	05/14→; +PR 1ZA,1ZE,1ZP 05/14→; +PR 1ZF 05/14→; +PR 1KE; + eFSB		13.0460-2785.2 602785 13.0470-2785.2 LD2785 13.0460-7303.2 607303 13.0470-7303.2 LD7303 13.0460-7293.2 607293 13.0470-7293.2 LD7293	TRW 25683 20,4 + WE / + WK TRW 25683 20,4 + WE / + WK Ceramic ATE 22035 17,5 + WK ATE 22035 17,5 + WK Ceramic ATE 25008 16,3 - WE / - WK ATE 25008 16,3 - WE / - WK Ceramic
1.6 TDI	85	11/16→	← ← →	+PR 1ZA,1ZE +PR 1ZF + eFSB		13.0460-2785.2 602785 13.0470-2785.2 LD2785 13.0460-7303.2 607303 13.0470-7303.2 LD7303 13.0460-7293.2 607293 13.0470-7293.2 LD7293	TRW 25683 20,4 + WE / + WK TRW 25683 20,4 + WE / + WK Ceramic ATE 22035 17,5 + WK ATE 22035 17,5 + WK Ceramic ATE 25008 16,3 - WE / - WK ATE 25008 16,3 - WE / - WK Ceramic
 Bremsscheibe							
1.0 TSI 1.2 TSI 1.2 TSI 1.4 TSI 1.4 TSI MultiFuel 1.6 1.6 TDI 2.0 TDI	85 63 81 92 92 81 66 81	05/15→ 05/14→ 04/14→ 04/14→ 04/14→ 05/14→ 02/14→ 05/14→	← ← ← ← →	+PR 1ZF +PR 1ZE,1ZP +PR 1ZA +PR 1KE		24.0124-0258.1 424258 24.0125-0145.1 425145 24.0325-0145.1 525145 24.0125-0158.1 425158 24.0325-0158.1 525158 24.0110-0356.1 410356 24.0310-0356.1 510356	Ø 276 24 21 V + S Ø 288 25 22 V + S Ø 288 25 22 V + S PD Ø 312 25 22 V + S Ø 312 25 22 V + S PD Ø 272 9,7 8 + S Ø 272 9,7 8 + S PD
1.4 TSI 1.6 TDI 2.0 TDI	110 81 110	02/14→ 02/14→ 02/14→	← ← ← →	05/14→; +PR 1ZF 05/14→; +PR 1ZE,1ZP 05/14→; +PR 1ZA 05/14→; +PR 1KE		24.0124-0258.1 424258 24.0125-0145.1 425145 24.0325-0145.1 525145 24.0125-0158.1 425158 24.0325-0158.1 525158 24.0110-0356.1 410356 24.0310-0356.1 510356	Ø 276 24 21 V + S Ø 288 25 22 V + S Ø 288 25 22 V + S PD Ø 312 25 22 V + S Ø 312 25 22 V + S PD Ø 272 9,7 8 + S Ø 272 9,7 8 + S PD
1.6 TDI	85	11/16→	← ← ← →	+PR 1ZF +PR 1ZE +PR 1ZA +PR 1KE		24.0124-0258.1 424258 24.0125-0145.1 425145 24.0325-0145.1 525145 24.0125-0158.1 425158 24.0325-0158.1 525158 24.0110-0356.1 410356 24.0310-0356.1 510356	Ø 276 24 21 V + S Ø 288 25 22 V + S Ø 288 25 22 V + S PD Ø 312 25 22 V + S Ø 312 25 22 V + S PD Ø 272 9,7 8 + S Ø 272 9,7 8 + S PD
VW - JETTA III (1K2) 08/05→10/10							
 Bremsbelagsatz, Scheibenbremse							
1.4 TSI 1.4 TSI 1.4 TSI 1.6 1.6 FSI 1.6 MultiFuel 1.9 TDI 2.0 FSI 2.0 TDI 2.0 TDI 2.0 TDI 2.0 TDI 16V 2.0 TFSI 2.0 TFSI 2.5 1.6 TDI 1.6 TDI	90 103 118 125 75 85 75 77 110 100 103 125 103 125 147 125 66 77	05/07→10/10 07/06→10/10 07/08→10/10 07/06→10/10 10/05→10/10 09/05→10/10 01/08→10/10 08/05→10/10 08/05→10/10 09/05→10/10 10/05→10/10 10/06→10/10 08/05→10/10 03/08→10/10 10/05→10/10 07/08→10/10 12/09→10/10 06/09→10/10	← ← ← → →	+PR 1ZM +PR 1ZE,1ZP,1ZD,1LJ +PR 1KE,1KF,1KJ,1KV		13.0460-7117.2 607117 13.0470-7117.2 LD7117 13.0460-7184.2 607184 13.0470-7184.2 LD7184 13.0460-2749.2 602749 13.0460-2880.2 602880 13.0470-2749.2 LD2749 13.0470-2880.2 LD2880 13.0460-7117.2 607117 13.0470-7117.2 LD7117 13.0460-7184.2 607184	VW 23130 19,6 + WK VW 23130 19,6 + WK Ceramic ATE 23587 20,6 + WK ATE 23587 20,6 + WK Ceramic TRW 24483 16,9 - WE / - WK + Zub TRW 23914 17,1 + WE / - WK + Zub TRW 24483 16,9 - WE / - WK + Zub Ceramic TRW 23914 17,1 + WE / - WK + Zub Ceramic VW 23130 19,6 + WK VW 23130 19,6 + WK Ceramic ATE 23587 20,6 + WK
↓			←	+PR 1ZM +PR 1ZE,1ZP,1ZD,1LJ		13.0460-7117.2 607117 13.0470-7117.2 LD7117 13.0460-7184.2 607184	VW 23130 19,6 + WK VW 23130 19,6 + WK Ceramic ATE 23587 20,6 + WK













	kw			 	! #		
VW - JETTA III (1K2) 08/05→10/10							
 Bremsbelagsatz, Scheibenbremse							
1.6 TDI	66	12/09→10/10	←	+PR 1ZE,1ZP,1ZD,1LJ		13.0470-7184.2 LD7184	ATE 23587 20,6 + WK Ceramic
1.6 TDI	77	06/09→10/10	→	+PR 1KE,1KF,1KJ,1KV		13.0460-2749.2 602749	TRW 24483 16,9 - WE / - WK + Zub
						13.0460-2880.2 602880	TRW 23914 17,1 + WE / - WK + Zub
						13.0470-2749.2 LD2749	TRW 24483 16,9 - WE / - WK + Zub Ceramic
						13.0470-2880.2 LD2880	TRW 23914 17,1 + WE / - WK + Zub Ceramic
2.5	110	01/06→10/10	←	07/08→; +PR 1ZM		13.0460-7117.2 607117	VW 23130 19,6 + WK
						13.0470-7117.2 LD7117	VW 23130 19,6 + WK Ceramic
			←	07/08→; +PR 1ZE;1ZP;1ZD;1LJ		13.0460-7184.2 607184	ATE 23587 20,6 + WK
						13.0470-7184.2 LD7184	ATE 23587 20,6 + WK Ceramic
			→	07/08→; +PR 1KE,1KF,1KJ,1KV		13.0460-2749.2 602749	TRW 24483 16,9 - WE / - WK + Zub
						13.0460-2880.2 602880	TRW 23914 17,1 + WE / - WK + Zub
						13.0470-2749.2 LD2749	TRW 24483 16,9 - WE / - WK + Zub Ceramic
						13.0470-2880.2 LD2880	TRW 23914 17,1 + WE / - WK + Zub Ceramic
Zubehörsatz, Scheibenbremsbelag							
1.4 TSI	90	05/07→10/10	→	+PR 1KE,1KF,1KJ,1KV		13.0460-0259.2 610259	
1.4 TSI	103	07/06→10/10					
1.4 TSI	118	07/08→10/10					
1.4 TSI	125	07/06→10/10					
1.6	75	10/05→10/10					
1.6 FSI	85	09/05→10/10					
1.6 MultiFuel	75	01/08→10/10					
1.6 TDI	66	12/09→10/10					
1.6 TDI	77	06/09→10/10					
1.9 TDI	77	08/05→10/10					
2.0 FSI	110	08/05→10/10					
2.0 TDI	100	09/05→10/10					
2.0 TDI	103	10/05→10/10					
2.0 TDI	125	10/06→10/10					
2.0 TDI 16V	103	08/05→10/10					
2.0 TFSI	125	03/08→10/10					
2.0 TFSI	147	10/05→10/10					
2.5	125	07/08→10/10					
2.5	110	01/06→10/10	→	07/08→; +PR 1KE,1KF,1KJ,1KV		13.0460-0259.2 610259	
 Bremsscheibe							
1.4 TSI	90	05/07→10/10	←	+PR 1ZM		24.0122-0210.1 422210	Ø 280 22 19 V + S
1.4 TSI	103	07/06→10/10				24.0322-0210.1 522210	Ø 280 22 19 V + S PD
1.4 TSI	118	07/08→10/10					
1.4 TSI	125	07/06→10/10	←	+PR 1ZE;1ZP		24.0125-0145.1 425145	Ø 288 25 22 V + S
1.6	75	10/05→10/10				24.0325-0145.1 525145	Ø 288 25 22 V + S PD
1.6 FSI	85	09/05→10/10					
1.6 MultiFuel	75	01/08→10/10	←	+PR 1LJ;1ZD		24.0125-0158.1 425158	Ø 312 25 22 V + S
1.9 TDI	77	08/05→10/10				24.0325-0158.1 525158	Ø 312 25 22 V + S PD
2.0 FSI	110	08/05→10/10	→	+PR 1KE;1KF		24.0112-0158.1 412158	Ø 256 12 10 + S
2.0 TDI	100	09/05→10/10				24.0312-0158.1 512158	Ø 256 12 10 PD
2.0 TDI	103	10/05→10/10					
2.0 TDI	125	10/06→10/10	→	+PR 1KJ,1KV		24.0112-0169.1 412169	Ø 282 12 10 + S
2.0 TDI 16V	103	08/05→10/10				24.0312-0169.1 512169	Ø 282 12 10 + S PD
2.0 TFSI	125	03/08→10/10					
2.0 TFSI	147	10/05→10/10					
2.5	125	07/08→10/10					
1.6 TDI	66	12/09→10/10	←	+PR 1ZM		24.0122-0210.1 422210	Ø 280 22 19 V + S
1.6 TDI	77	06/09→10/10				24.0322-0210.1 522210	Ø 280 22 19 V + S PD
			←	+PR 1ZE,1ZP		24.0125-0145.1 425145	Ø 288 25 22 V + S
						24.0325-0145.1 525145	Ø 288 25 22 V + S PD
			←	+PR 1LJ,1ZD		24.0125-0158.1 425158	Ø 312 25 22 V + S
						24.0325-0158.1 525158	Ø 312 25 22 V + S PD
			→	+PR 1KE,1KF		24.0112-0158.1 412158	Ø 256 12 10 + S
						24.0312-0158.1 512158	Ø 256 12 10 PD
			→	+PR 1KJ,1KV		24.0112-0169.1 412169	Ø 282 12 10 + S
						24.0312-0169.1 512169	Ø 282 12 10 + S PD
2.5	110	01/06→10/10	←	07/08→; +PR 1ZM		24.0122-0210.1 422210	Ø 280 22 19 V + S
						24.0322-0210.1 522210	Ø 280 22 19 V + S PD
↓							

	kw			 	! #		
VW - JETTA III (1K2) 08/05→10/10							
 Bremsscheibe							
2.5	110	01/06→10/10	←	07/08→; +PR 1ZE;1ZP	24.0125-0145.1	425145	Ø 288 25 22 V + S
					24.0325-0145.1	525145	Ø 288 25 22 V + S PD
			←	07/08→; +PR 1LJ;1ZD	24.0125-0158.1	425158	Ø 312 25 22 V + S
					24.0325-0158.1	525158	Ø 312 25 22 V + S PD
			→	07/08→; +PR 1KE;1KF	24.0112-0158.1	412158	Ø 256 12 10 + S
				24.0312-0158.1	512158	Ø 256 12 10 PD	
			→	07/08→; +PR 1KJ,1KV	24.0112-0169.1	412169	Ø 282 12 10 + S
					24.0312-0169.1	512169	Ø 282 12 10 + S PD
VW - JETTA IV (162, 163) 04/10→							
 Bremsbelagsatz, Scheibenbremse							
1.2 TSI 1.6 TDI 2.0 TDI 2.0 TSI	77 77 103 147	10/10→ 02/11→ 02/11→ 12/10→	←	04/11→; +PR 1ZQ	13.0460-7111.2	607111	VW 23130 19,6 - WE / - WK
					13.0470-7111.2	LD7111	VW 23130 19,6 - WE / - WK Ceramic
			←	04/11→; +PR 1ZM	13.0460-7117.2	607117	VW 23130 19,6 + WK
					13.0470-7117.2	LD7117	VW 23130 19,6 + WK Ceramic
			←	04/11→; +PR 1ZA,1ZB,1ZE	13.0460-7184.2	607184	ATE 23587 20,6 + WK
					13.0470-7184.2	LD7184	ATE 23587 20,6 + WK Ceramic
			←	04/11→; +PR 1LV,1ZP	13.0460-7285.2	607285	ATE 23587 20,6 - WE / - WK
				13.0470-7285.2	LD7285	ATE 23587 20,6 - WE / - WK Ceramic	
			→	04/11→; +PR 1KD,1KU	13.0460-2820.2	602820	TRW 20961 17,2 - WK
					13.0470-2823.2	LD2823	TRW 23554 17,2 - WK Ceramic
			→	04/11→; +PR 1KS,1KT	13.0460-3858.2	603858	BOS 24563 17,7 - WE / - WK + Zub
					13.0470-3858.2	LD3858	BOS 24563 17,7 - WE / - WK + Zub Ceramic
1.2 TSI 16V 1.4 TSI 1.4 TSI 1.4 TSI 1.4 TSI Hybrid 1.6 1.6 2.0 2.0 TDI 2.0 TSI	77 90 110 118 110 63 77 85 81 155	08/14→ 05/11→ 04/11→07/14 04/11→ 04/11→ 03/13→ 12/11→ 06/10→ 10/10→ 12/12→	←	+PR 1ZQ	13.0460-7111.2	607111	VW 23130 19,6 - WE / - WK
					13.0470-7111.2	LD7111	VW 23130 19,6 - WE / - WK Ceramic
			←	+PR 1ZM	13.0460-7117.2	607117	VW 23130 19,6 + WK
					13.0470-7117.2	LD7117	VW 23130 19,6 + WK Ceramic
			←	+PR 1ZA,1ZB,1ZE	13.0460-7184.2	607184	ATE 23587 20,6 + WK
					13.0470-7184.2	LD7184	ATE 23587 20,6 + WK Ceramic
			←	+PR 1LV,1ZP	13.0460-7285.2	607285	ATE 23587 20,6 - WE / - WK
				13.0470-7285.2	LD7285	ATE 23587 20,6 - WE / - WK Ceramic	
			→	+PR 1KD,1KU	13.0460-2820.2	602820	TRW 20961 17,2 - WK
					13.0470-2823.2	LD2823	TRW 23554 17,2 - WK Ceramic
			→	+PR 1KS,1KT	13.0460-3858.2	603858	BOS 24563 17,7 - WE / - WK + Zub
					13.0470-3858.2	LD3858	BOS 24563 17,7 - WE / - WK + Zub Ceramic
1.4 TSI 1.4 TSI 1.8 TSI 2.0 TDI	92 110 125 110	08/14→ 08/14→ 07/14→ 08/14→	←	+PR 1ZQ	13.0460-7111.2	607111	VW 23130 19,6 - WE / - WK
					13.0470-7111.2	LD7111	VW 23130 19,6 - WE / - WK Ceramic
			←	+PR 1ZM	13.0460-7117.2	607117	VW 23130 19,6 + WK
					13.0470-7117.2	LD7117	VW 23130 19,6 + WK Ceramic
			←	+PR 1ZA,1ZB,1ZE	13.0460-7184.2	607184	ATE 23587 20,6 + WK
				13.0470-7184.2	LD7184	ATE 23587 20,6 + WK Ceramic	
←	+PR 1LV,1ZP	13.0460-7285.2	607285	ATE 23587 20,6 - WE / - WK			
				13.0470-7285.2	LD7285	ATE 23587 20,6 - WE / - WK Ceramic	
			→	+PR 1KD,1KU	13.0460-2820.2	602820	TRW 20961 17,2 - WK
					13.0470-2823.2	LD2823	TRW 23554 17,2 - WK Ceramic
 Bremsscheibe							
1.2 TSI 1.6 TDI 2.0 TDI 2.0 TSI	77 77 103 147	10/10→ 02/11→ 02/11→ 12/10→	←	04/11→; +PR 1ZM,1ZQ	24.0122-0210.1	422210	Ø 280 22 19 V + S
					24.0322-0210.1	522210	Ø 280 22 19 V + S PD
			←	04/11→; +PR 1ZE,1ZP	24.0125-0145.1	425145	Ø 288 25 22 V + S
					24.0325-0158.1	525158	Ø 312 25 22 V + S PD
			←	04/11→; +PR 1ZA,1ZB,1LV	24.0125-0158.1	425158	Ø 312 25 22 V + S
				24.0325-0145.1	525145	Ø 288 25 22 V + S PD	
			→	04/11→; +PR 1KD,1KU	24.0110-0277.1	410277	Ø 253 10 8 + S











	kw				! #		
VW - JETTA IV (162, 163) 04/10→							
Bremsscheibe							
1.2 TSI	77	10/10→	➔	04/11→; +PR 1KD,1KU		24.0310-0277.1 510277	Ø 253 10 8 + S PD
1.6 TDI	77	02/11→	➔	04/11→; +PR 1KS,1KT		24.0110-0356.1 410356	Ø 272 9,7 8 + S
2.0 TDI	103	02/11→					
2.0 TSI	147	12/10→				24.0310-0356.1 510356	Ø 272 9,7 8 + S PD
1.2 TSI 16V	77	08/14→	➔	+PR 1ZM,1ZQ		24.0122-0210.1 422210	Ø 280 22 19 V + S
1.4 TSI	90	05/11→				24.0322-0210.1 522210	Ø 280 22 19 V + S PD
1.4 TSI	110	04/11→07/14					
1.4 TSI	118	04/11→	➔	+PR 1ZE,1ZP		24.0125-0145.1 425145	Ø 288 25 22 V + S
1.4 TSI Hybrid	110	04/11→				24.0325-0158.1 525158	Ø 312 25 22 V + S PD
1.6	63	03/13→					
1.6	77	12/11→	➔	+PR 1ZA,1ZB,1LV		24.0125-0158.1 425158	Ø 312 25 22 V + S
2.0	85	06/10→				24.0325-0145.1 525145	Ø 288 25 22 V + S PD
2.0 TDI	81	10/10→	➔	+PR 1KD,1KU		24.0110-0277.1 410277	Ø 253 10 8 + S
2.0 TSI	155	12/12→	➔	+PR 1KS,1KT		24.0110-0356.1 410356	Ø 272 9,7 8 + S
						24.0310-0356.1 510356	Ø 272 9,7 8 + S PD
1.4 TSI	92	08/14→	➔	+PR 1ZM,1ZQ		24.0122-0210.1 422210	Ø 280 22 19 V + S
1.4 TSI	110	08/14→				24.0322-0210.1 522210	Ø 280 22 19 V + S PD
1.8 TSI	125	07/14→					
2.0 TDI	110	08/14→	➔	+PR 1ZE,1ZP		24.0125-0145.1 425145	Ø 288 25 22 V + S
						24.0325-0158.1 525158	Ø 312 25 22 V + S PD
						24.0125-0158.1 425158	Ø 312 25 22 V + S
						24.0325-0145.1 525145	Ø 288 25 22 V + S PD
						24.0110-0277.1 410277	Ø 253 10 8 + S
						24.0310-0277.1 510277	Ø 253 10 8 + S PD
VW - LOAD UP 12/14→							
Brembelagsatz, Scheibenbremse							
1.0	44	12/14→	➔	+PR 1LA,1ZQ		13.0460-7111.2 607111	VW 23130 19,6 - WE / - WK
1.0 EcoFuel	50	12/14→				13.0470-7111.2 LD7111	VW 23130 19,6 - WE / - WK Ceramic
e-Load Up	60	12/14→	➔	+PR 1ZQ		13.0460-7111.2 607111	VW 23130 19,6 - WE / - WK
						13.0470-7111.2 LD7111	VW 23130 19,6 - WE / - WK Ceramic
Bremsscheibe							
1.0	44	12/14→	➔	+PR 1LA,1ZQ		24.0122-0281.1 422281	Ø 256 22 19 V + S
1.0 EcoFuel	50	12/14→					
e-Load Up	60	12/14→					
VW - LT 28-35 I Bus (281-363) 04/75→06/96							
Brembelagsatz, Scheibenbremse							
2.4 D	51	08/89→06/96	➔			13.0460-5701.2 605701	ATE 20392 18,5 + WE / - WK
2.4 i	69	08/89→06/96					
2.4 TD	70	09/92→06/96					
Zubehörsatz, Scheibenbremsbelag							
2.4 D	51	08/89→06/96	➔			13.0460-0091.2 610091	ATE
2.4 i	69	08/89→06/96					
2.4 TD	70	09/92→06/96					
Bremsscheibe							
2.4 D	51	08/89→06/96	➔	28-B-019163→ 28-D-007273; für Rechtslenker		24.0120-0114.2 420114	Ø 281 19,9 18
2.4 i	69	08/89→06/96					
2.4 TD	70	09/92→06/96	➔	28-B-018541→ 28-D-007273; für Linkslenker		24.0120-0114.2 420114	Ø 281 19,9 18
			➔	28-D-007274→		24.0120-0114.2 420114	Ø 281 19,9 18
VW - LT 28-35 I Kasten (281-363) 04/75→06/96							
Brembelagsatz, Scheibenbremse							
2.4 D	51	07/90→05/96	➔			13.0460-5701.2 605701	ATE 20392 18,5 + WE / - WK
2.4 i	69	03/94→06/96					
2.4 TD	70	06/92→05/96					
2.4 TD Syncro	70	08/92→04/96					
Zubehörsatz, Scheibenbremsbelag							
2.4 D	51	07/90→05/96	➔			13.0460-0091.2 610091	ATE
2.4 i	69	03/94→06/96					
2.4 TD	70	06/92→05/96					
2.4 TD Syncro	70	08/92→04/96					







	kW			 	! #		
VW - LT 28-35 I Kasten (281-363) 04/75→06/96							
 Bremsscheibe							
2.4 D	51	07/90→05/96	←	28-B-018541→ 28-D-007273; für Linkslenker		24.0120-0114.2 420114	Ø 281 19,9 18
2.4 i	69	03/94→06/96					
2.4 TD	70	06/92→05/96	←	28-B-019163→ 28-D-007273; für Rechtslenker		24.0120-0114.2 420114	Ø 281 19,9 18
2.4 TD Syncro	70	08/92→04/96					
			←	28-B-012411→		24.0120-0114.2 420114	Ø 281 19,9 18
			←	28-D-007274→		24.0120-0114.2 420114	Ø 281 19,9 18
VW - LT 28-35 I Pritsche/Fahrgestell (281-363) 04/75→06/96							
 Bremsbelagsatz, Scheibenbremse							
2.4 D	51	08/90→06/96	←			13.0460-5701.2 605701	ATE 20392 18,5 + WE / - WK
2.4 i	69	03/94→06/96					
2.4 TD	70	08/92→06/96					
2.4 TD Syncro	70	08/92→04/96					
Zubehörsatz, Scheibenbremsbelag							
2.4 D	51	08/90→06/96	←			13.0460-0091.2 610091	ATE
2.4 i	69	03/94→06/96					
2.4 TD	70	08/92→06/96					
2.4 TD Syncro	70	08/92→04/96					
 Bremsscheibe							
2.4 D	51	08/90→06/96	←	28-B-018541→ 28-D-007273; für Linkslenker		24.0120-0114.2 420114	Ø 281 19,9 18
2.4 i	69	03/94→06/96					
2.4 TD	70	08/92→06/96	←	28-B-019163→ 28-D-007273; für Rechtslenker		24.0120-0114.2 420114	Ø 281 19,9 18
2.4 TD Syncro	70	08/92→04/96					
			←	28-B-012411→		24.0120-0114.2 420114	Ø 281 19,9 18
			←	28-D-007274→		24.0120-0114.2 420114	Ø 281 19,9 18
VW - LT 28-35 II Bus (2DB, 2DE, 2DK) 04/96→07/06							
 Bremsbelagsatz, Scheibenbremse							
2.3	105	05/96→07/06	←	Baumuster: LT 35		13.0460-7196.2 607196	ATE 21576 20,7 + WE / - WK
2.5 SDI	55	07/96→07/06	←	Baumuster: LT 28		13.0460-7196.2 607196	ATE 21576 20,7 + WE / - WK
			←	Baumuster: LT 46		13.0460-7909.2 607909	PER 29153 20,0 + WE / - WK + Zub
			→	→ 12/03; Baumuster: LT 35		13.0460-3990.2 603990	BOS 23021 18,9 + WE / - WK
			→	Baumuster: LT 28		13.0460-7083.2 607083	ATE 21621 17,3 + WE / - WK
			→	Baumuster: LT 35		13.0460-7084.2 607084	ATE 21592 18,8 + WE / - WK
			→	Baumuster: LT 46		13.0460-7909.2 607909	PER 29153 20,0 + WE / - WK + Zub
2.5 TDI	61	05/01→07/06	←	Baumuster: LT 35		13.0460-7196.2 607196	ATE 21576 20,7 + WE / - WK
2.5 TDI	66	05/99→07/06	←	Baumuster: LT 28		13.0460-7196.2 607196	ATE 21576 20,7 + WE / - WK
2.5 TDI	70	05/01→07/06					
2.5 TDI	80	05/99→07/06	→	→ 12/03; Baumuster: LT 35		13.0460-3990.2 603990	BOS 23021 18,9 + WE / - WK
			→	Baumuster: LT 28		13.0460-7083.2 607083	ATE 21621 17,3 + WE / - WK
			→	Baumuster: LT 35		13.0460-7084.2 607084	ATE 21592 18,8 + WE / - WK
2.5 TDI	75	05/96→08/99	←	Baumuster: LT 35		13.0460-7196.2 607196	ATE 21576 20,7 + WE / - WK
			←	Baumuster: LT 28		13.0460-7196.2 607196	ATE 21576 20,7 + WE / - WK
			←	Baumuster: LT 46		13.0460-7909.2 607909	PER 29153 20,0 + WE / - WK + Zub
			→	Baumuster: LT 35		13.0460-3990.2 603990	BOS 23021 18,9 + WE / - WK
			→	Baumuster: LT 28		13.0460-7083.2 607083	ATE 21621 17,3 + WE / - WK
			→	Baumuster: LT 46		13.0460-7909.2 607909	PER 29153 20,0 + WE / - WK + Zub
2.8 TDI	96	01/99→01/02	←	Baumuster: LT 28		13.0460-7196.2 607196	ATE 21576 20,7 + WE / - WK
2.8 TDI	116	05/01→06/06	→	Baumuster: LT 28		13.0460-7083.2 607083	ATE 21621 17,3 + WE / - WK
Warnkontakt, Bremsbelagverschleiß							
2.3	105	05/96→07/06	←	Baumuster: LT 35	2	24.8190-0417.2 620417	L= 99 L= 167
2.5 SDI	55	07/96→07/06	←	Baumuster: LT 46	2	24.8190-0417.2 620417	L= 99 L= 167
2.5 TDI	75	05/96→08/99	←	Baumuster: LT 28	2	24.8190-0417.2 620417	L= 99 L= 167
			→	Baumuster: LT 28; nur in Verbindung mit: 13.0460-7083.2	2	24.8190-0407.2 620407	L= 84 L= 185
			→	Baumuster: LT 35; nur in Verbindung mit: 13.0460-7084.2	2	24.8190-0407.2 620407	L= 84 L= 185
↓							







	kW					! #		
VW - LT 28-35 II Bus (2DB, 2DE, 2DK) 04/96→07/06								
Warnkontakt, Bremsbelagverschleiß								
2.3 2.5 SDI 2.5 TDI	105 55 75	05/96→07/06 07/96→07/06 05/96→08/99	➡	Baumuster: LT 46	2	24.8190-0417.2	620417	L= 99 L= 167
2.5 TDI 2.5 TDI 2.5 TDI 2.5 TDI	61 66 70 80	05/01→07/06 05/99→07/06 05/01→07/06 05/99→07/06	⬅	Baumuster: LT 35	2	24.8190-0417.2	620417	L= 99 L= 167
			⬅	Baumuster: LT 28	2	24.8190-0417.2	620417	L= 99 L= 167
			➡	Baumuster: LT 28; nur in Verbindung mit: 13.0460-7083.2	2	24.8190-0407.2	620407	L= 84 L= 185
			➡	Baumuster: LT 35; nur in Verbindung mit: 13.0460-7084.2	2	24.8190-0407.2	620407	L= 84 L= 185
2.8 TDI 2.8 TDI	96 116	01/99→01/02 05/01→06/06	⬅	Baumuster: LT 28	2	24.8190-0417.2	620417	L= 99 L= 167
			➡	Baumuster: LT 28; nur in Verbindung mit: 13.0460-7083.2	2	24.8190-0407.2	620407	L= 84 L= 185
Zubehörsatz, Scheibenbremsbelag								
2.3 2.5 SDI	105 55	05/96→07/06 07/96→07/06	⬅	Baumuster: LT 46; nur in Verbindung mit: 13.0460-7904.2		13.0460-0281.2	610281	PER
			➡	→ 12/03; Baumuster: LT 35; nur in Verbindung mit: 13.0460-3990.2		13.0460-0250.2	610250	BOS
			➡	Baumuster: LT 46; nur in Verbindung mit: 13.0460-7904.2		13.0460-0281.2	610281	PER
2.5 TDI 2.5 TDI 2.5 TDI 2.5 TDI	61 66 70 80	05/01→07/06 05/99→07/06 05/01→07/06 05/99→07/06	➡	→ 12/03; Baumuster: LT 35; nur in Verbindung mit: 13.0460-3990.2		13.0460-0250.2	610250	BOS
2.5 TDI	75	05/96→08/99	⬅	Baumuster: LT 46; nur in Verbindung mit: 13.0460-7904.2		13.0460-0281.2	610281	PER
			➡	Baumuster: LT 35; nur in Verbindung mit: 13.0460-3990.2		13.0460-0250.2	610250	BOS
			➡	Baumuster: LT 46; nur in Verbindung mit: 13.0460-7904.2		13.0460-0281.2	610281	PER
 Bremsscheibe								
2.3 2.5 SDI 2.5 TDI	105 55 75	05/96→07/06 07/96→07/06 05/96→08/99	⬅			24.0122-0161.1	422161	Ø 276 22 19 V + S
			➡	Baumuster: LT 28		24.0322-0161.1	522161	Ø 276 22 19 V + S PD
			➡	Baumuster: LT 35		24.0112-0142.1	412142	Ø 258 12 10 + S
			➡	Baumuster: LT 46		24.0116-0110.1	416110	Ø 272 16 14 + S
			➡	Baumuster: LT 46		24.0122-0196.1	422196	Ø 285 21,9 19 V
2.5 TDI 2.5 TDI 2.5 TDI 2.5 TDI	61 66 70 80	05/01→07/06 05/99→07/06 05/01→07/06 05/99→07/06	⬅			24.0122-0161.1	422161	Ø 276 22 19 V + S
			➡	Baumuster: LT 28		24.0322-0161.1	522161	Ø 276 22 19 V + S PD
			➡	Baumuster: LT 28		24.0112-0142.1	412142	Ø 258 12 10 + S
			➡	Baumuster: LT 35		24.0116-0110.1	416110	Ø 272 16 14 + S
2.8 TDI	92	07/97→05/03	⬅	28-B-019163→ 28-D-007273; für Rechtslenker		24.0120-0114.2	420114	Ø 281 19,9 18
			⬅	28-B-018541→ 28-D-007273; für Linkslenker		24.0120-0114.2	420114	Ø 281 19,9 18
2.8 TDI 2.8 TDI	96 116	01/99→01/02 05/01→06/06	⬅			24.0122-0161.1	422161	Ø 276 22 19 V + S
			➡	Baumuster: LT 28		24.0322-0161.1	522161	Ø 276 22 19 V + S PD
			➡	Baumuster: LT 28		24.0112-0142.1	412142	Ø 258 12 10 + S
VW - LT 28-46 II Kasten (2DA, 2DD, 2DH) 04/96→07/06								
 Bremsbelagsatz, Scheibenbremse								
2.3 2.5 SDI 2.5 TDI 2.5 TDI 2.5 TDI 2.5 TDI 2.8 TDI 2.8 TDI	105 55 61 66 70 80 96 116	05/96→07/06 09/96→07/06 05/01→07/06 05/99→07/06 05/01→07/06 05/99→07/06 01/99→07/06 04/02→07/06	⬅	Baumuster: LT 35		13.0460-7196.2	607196	ATE 21576 20,7 + WE / - WK
			⬅	Baumuster: LT 28		13.0460-7196.2	607196	ATE 21576 20,7 + WE / - WK
			⬅	Baumuster: LT 46		13.0460-7909.2	607909	PER 29153 20,0 + WE / - WK + Zub
			➡	→ 12/03; Baumuster: LT 35		13.0460-3990.2	603990	BOS 23021 18,9 + WE / - WK
			➡	Baumuster: LT 28		13.0460-7083.2	607083	ATE 21621 17,3 + WE / - WK
			➡	Baumuster: LT 35		13.0460-7084.2	607084	ATE 21592 18,8 + WE / - WK
			➡	Baumuster: LT 46		13.0460-7909.2	607909	PER 29153 20,0 + WE / - WK + Zub
2.5 TDI 2.8 TDI	75 92	05/96→08/99 07/97→01/02	⬅	Baumuster: LT 35		13.0460-7196.2	607196	ATE 21576 20,7 + WE / - WK
			⬅	Baumuster: LT 28		13.0460-7196.2	607196	ATE 21576 20,7 + WE / - WK
			⬅	Baumuster: LT 46		13.0460-7909.2	607909	PER 29153 20,0 + WE / - WK + Zub
			➡	Baumuster: LT 35		13.0460-3990.2	603990	BOS 23021 18,9 + WE / - WK
			➡	Baumuster: LT 35		13.0460-7084.2	607084	ATE 21592 18,8 + WE / - WK









	kw					! #		
VW - LT 28-46 II Pritsche/Fahrgestell (2DC, 2DF, 2DG, 2DL, 2DM) 04/96→07/06								
Warnkontakt, Bremsbelagverschleiß								
2.5 TDI	80	05/99→07/06	➔	Baumuster: LT 28; nur in Verbindung mit: 13.0460-7083.2	2	24.8190-0407.2	620407	L= 84 L= 185
2.8 TDI	92	07/97→01/02						
2.8 TDI	96	01/99→07/06	➔	Baumuster: LT 35; nur in Verbindung mit: 13.0460-7084.2	2	24.8190-0407.2	620407	L= 84 L= 185
2.8 TDI	116	04/02→07/06	➔	Baumuster: LT 46	2	24.8190-0417.2	620417	L= 99 L= 167
Zubehörsatz, Scheibenbremsbelag								
2.3	105	06/96→07/06	➔	Baumuster: LT 46; nur in Verbindung mit: 13.0460-7904.2		13.0460-0281.2	610281	PER
2.5 SDI	55	09/96→07/06						
2.5 TDI	61	05/01→07/06	➔	→ 12/03; Baumuster: LT 35; nur in Verbindung mit: 13.0460-3990.2		13.0460-0250.2	610250	BOS
2.5 TDI	66	05/99→07/06	➔	Baumuster: LT 46; nur in Verbindung mit: 13.0460-7904.2		13.0460-0281.2	610281	PER
2.5 TDI	70	05/01→07/06	➔					
2.5 TDI	80	05/99→07/06	➔					
2.8 TDI	96	01/99→07/06	➔					
2.8 TDI	116	04/02→07/06	➔					
2.5 TDI	75	06/96→08/99	➔	Baumuster: LT 46; nur in Verbindung mit: 13.0460-7904.2		13.0460-0281.2	610281	PER
2.8 TDI	92	07/97→01/02	➔	Baumuster: LT 35; nur in Verbindung mit: 13.0460-3990.2		13.0460-0250.2	610250	BOS
			➔	Baumuster: LT 46; nur in Verbindung mit: 13.0460-7904.2		13.0460-0281.2	610281	PER
 Bremsscheibe								
2.3	105	06/96→07/06	➔			24.0122-0161.1	422161	Ø 276 22 19 V + S
2.5 SDI	55	09/96→07/06						
2.5 TDI	61	05/01→07/06	➔	Baumuster: LT 28		24.0322-0161.1	522161	Ø 276 22 19 V + S PD
2.5 TDI	66	05/99→07/06	➔			24.0112-0142.1	412142	Ø 258 12 10 + S
2.5 TDI	70	05/01→07/06	➔	Baumuster: LT 35		24.0116-0110.1	416110	Ø 272 16 14 + S
2.5 TDI	75	06/96→08/99	➔					
2.5 TDI	80	05/99→07/06	➔	Baumuster: LT 46		24.0122-0196.1	422196	Ø 285 21,9 19 V
2.8 TDI	92	07/97→01/02						
2.8 TDI	96	01/99→07/06						
2.8 TDI	116	04/02→07/06						
VW - LT 40-55 I Kasten (291-512) 04/75→06/96								
 Bremsbelagsatz, Scheibenbremse								
2.4 D	51	07/90→05/96	➔			13.0460-5701.2	605701	ATE 20392 18,5 + WE / - WK
2.4 i	69	01/93→06/96						
2.4 TD	70	06/92→05/96						
Zubehörsatz, Scheibenbremsbelag								
2.4 D	51	07/90→05/96	➔			13.0460-0091.2	610091	ATE
2.4 i	69	01/93→06/96						
2.4 TD	70	06/92→05/96						
 Bremsscheibe								
2.4 D	51	07/90→05/96	➔			24.0120-0114.2	420114	Ø 281 19,9 18
2.4 i	69	01/93→06/96	➔					
2.4 TD	70	06/92→05/96	➔	28-B-012411→		24.0120-0114.2	420114	Ø 281 19,9 18
VW - LT 40-55 I Pritsche/Fahrgestell (293-909) 04/75→06/96								
 Bremsbelagsatz, Scheibenbremse								
2.4 D	51	08/90→06/96	➔			13.0460-5701.2	605701	ATE 20392 18,5 + WE / - WK
2.4 i	69	03/94→06/96						
2.4 TD	70	08/92→06/96						
Zubehörsatz, Scheibenbremsbelag								
2.4 D	51	08/90→06/96	➔			13.0460-0091.2	610091	ATE
2.4 i	69	03/94→06/96						
2.4 TD	70	08/92→06/96						
 Bremsscheibe								
2.4 D	51	08/90→06/96	➔			24.0120-0114.2	420114	Ø 281 19,9 18
2.4 i	69	03/94→06/96	➔					
2.4 TD	70	08/92→06/96	➔	28-B-012411→		24.0120-0114.2	420114	Ø 281 19,9 18
VW - LUPO (6X1, 6E1) 09/98→07/05								
 Bremsbelagsatz, Scheibenbremse								
1.0	37	09/98→07/05	➔	+PR 1ZE,1ZJ,1ZK,1LX		13.0460-2821.2	602821	TRW 21945 16,0 - WK
1.0	37	10/98→05/00	➔			13.0460-7100.2	607100	VW 21866 17,2 - WE / - WK
1.4	44	10/00→07/05	➔	+PR 1LM,1ZN,1LB,1ZC		13.0470-7100.2	LD7100	VW 21866 17,2 - WE / - WK
1.4 TDI	55	01/99→07/05						Ceramic
1.7 SDI	44	09/98→07/05						
1.2 TDI 3L	45	07/99→07/05	➔	+PR 1ZB		13.0460-7177.2	607177	VW 23394 13,7 - WE / - WK
↓								





















	kw			 	! #		
VW - LUPO (6X1, 6E1) 09/98→07/05							
 Bremsbelagsatz, Scheibenbremse							
1.4 16V	55	09/98→07/05	←	10/98→; +PR 1ZE,1ZJ,1ZK,1LX		13.0460-2821.2 602821	TRW 21945 16,0 - WK
			←	10/98→; +PR 1LM,1ZN,1LB,1ZC		13.0460-7100.2 607100 13.0470-7100.2 LD7100	VW 21866 17,2 - WE / - WK VW 21866 17,2 - WE / - WK Ceramic
1.4 16V	74	08/99→07/05	←	+PR 1ZE,1ZJ,1ZK,1LX		13.0460-2821.2 602821	TRW 21945 16,0 - WK
1.4 FSI	77	02/01→07/05	←	+PR 1LM,1ZN,1LB,1ZC		13.0460-7100.2 607100 13.0470-7100.2 LD7100	VW 21866 17,2 - WE / - WK VW 21866 17,2 - WE / - WK Ceramic
1.6 GTI	92	09/00→07/05	←			13.0460-2864.2 602864 13.0460-2877.2 602877 13.0470-2877.2 LD2877	TRW 20961 17,2 - WK TRW 23554 17,2 + WK TRW 23554 17,2 + WK Ceramic
			→				
 Bremsscheibe							
1.0	37	09/98→07/05	←	+PR 1LM,1ZN,1LB,1ZC		24.0118-0106.1 418106	∅ 239 18 16 V + S
1.0	37	10/98→05/00	←			24.0120-0128.1 420128	∅ 256 20 18 V + S
1.4	44	10/00→07/05	←	+PR 1ZE,1ZJ,1ZK		24.0320-0128.1 520128	∅ 256 20 18 V + S PD
1.4 TDI	55	01/99→07/05	←			24.0125-0136.1 425136	∅ 256 25 23 V
1.7 SDI	44	09/98→07/05	←	+PR 1LX		24.0318-0106.1 518106	∅ 239 18 16 V + S PD
			←	+PR 1LM,1ZN,1LB,1ZC / 1LM,1ZN			
1.2 TDI 3L	45	07/99→07/05	←	+PR 1ZB		24.0115-0109.1 415109	∅ 239 15 13 V
1.4 16V	55	09/98→07/05	←	10/98→; +PR 1LM,1ZN,1LB,1ZC		24.0118-0106.1 418106	∅ 239 18 16 V + S
			←	10/98→; +PR 1ZE,1ZJ,1ZK		24.0120-0128.1 420128 24.0320-0128.1 520128	∅ 256 20 18 V + S ∅ 256 20 18 V + S PD
			←	10/98→; +PR 1LX		24.0125-0136.1 425136	∅ 256 25 23 V
			←	10/98→; +PR 1LM,1ZN,1LB,1ZC / 1LM,1ZN		24.0318-0106.1 518106	∅ 239 18 16 V + S PD
1.4 16V	74	08/99→07/05	←	+PR 1LM,1ZN,1LB,1ZC		24.0118-0106.1 418106	∅ 239 18 16 V + S
1.4 FSI	77	02/01→07/05	←	+PR 1ZE,1ZJ,1ZK		24.0120-0128.1 420128 24.0320-0128.1 520128	∅ 256 20 18 V + S ∅ 256 20 18 V + S PD
1.6 GTI	92	09/00→07/05	←			24.0125-0136.1 425136	∅ 256 25 23 V
			←	+PR 1LM,1ZN,1LB,1ZC / 1LM,1ZN		24.0318-0106.1 518106	∅ 239 18 16 V + S PD
			→			24.0109-0124.1 409124	∅ 232 9 7
VW - MULTIVAN T5 (7HM, 7HN, 7HF, 7EF, 7EM, 7EN) 04/03→08/15							
 Bremsbelagsatz, Scheibenbremse							
1.9 TDI	62	01/06→11/09	←	+PR 2E3		13.0460-7236.2 607236	ATE 23746 19,7 + WK
1.9 TDI	75	06/06→11/09	←	+PR 2E4; → 7H-A-050000		13.0460-7240.2 607240	ATE 23746 18,1 + WK
			←	7H-A-200001→; +PR 2E4		13.0460-7286.2 607286	ATE 24623 18,2 + WK
			→	7H-A-200001→		13.0460-2882.2 602882	TRW 23326 17,4 + WK + Zub
			→	7H-8-028000→; +PR 0WR; → 7H-8-200000		13.0460-2882.2 602882	TRW 23326 17,4 + WK + Zub
			→	7H-6-000001→; +PR 2E3,2E4; → 7H-A-050000		13.0460-2882.2 602882	TRW 23326 17,4 + WK + Zub
			→	+PR 0WR; → 7H-8-027999		13.0460-7218.2 607218	ATE 24367 19,1 + WK
1.9 TDI	63	04/03→11/09	←	+PR 2E3		13.0460-7236.2 607236	ATE 23746 19,7 + WK
1.9 TDI	77	04/03→11/09	←			13.0460-7240.2 607240	ATE 23746 18,1 + WK
2.0	85	11/03→08/15	←	+PR 2E4; → 7H-A-050000		13.0460-7286.2 607286	ATE 24623 18,2 + WK
2.5 TDI	96	04/03→11/09	←	7H-A-200001→; +PR 2E4		13.0460-2882.2 602882	TRW 23326 17,4 + WK + Zub
2.5 TDI	120	11/03→11/09	←			13.0460-2882.2 602882	TRW 23326 17,4 + WK + Zub
2.5 TDI	128	04/03→11/09	→	7H-8-028000→; +PR 0WR; → 7H-8-200000		13.0460-2882.2 602882	TRW 23326 17,4 + WK + Zub
2.5 TDI 4motion	96	07/04→11/09	→	7H-A-200001→		13.0460-2882.2 602882	TRW 23326 17,4 + WK + Zub
2.5 TDI 4motion	128	07/04→11/09	→			13.0460-2882.2 602882	TRW 23326 17,4 + WK + Zub
3.2 V6	170	02/04→06/04	→	7H-6-000001→; +PR 2E3,2E4; → 7H-A-050000		13.0460-2882.2 602882	TRW 23326 17,4 + WK + Zub
3.2 V6	173	02/04→11/09	→			13.0460-2882.2 602882	TRW 23326 17,4 + WK + Zub
3.2 V6 4motion	173	07/04→11/09	→	+PR 0WL,0WN / 0WM,0WP,0WQ; → 7H-5-120000		13.0460-2882.2 602882	TRW 23326 17,4 + WK + Zub
			→	+PR 0WR; → 7H-8-027999		13.0460-7218.2 607218	ATE 24367 19,1 + WK
2.0 BiTDI	132	09/09→08/15	←	+PR 2E3		13.0460-7236.2 607236	ATE 23746 19,7 + WK
2.0 BiTDI 4motion	132	09/09→08/15	←	+PR 2E4; → 7H-A-050000		13.0460-7240.2 607240	ATE 23746 18,1 + WK
2.0 TDI	62	09/09→08/15	←	7H-A-200001→; +PR 2E4		13.0460-7286.2 607286	ATE 24623 18,2 + WK
2.0 TDI	75	09/09→08/15	←			13.0460-2882.2 602882	TRW 23326 17,4 + WK + Zub
2.0 TDI	103	09/09→08/15	→	7H-A-200001→		13.0460-2882.2 602882	TRW 23326 17,4 + WK + Zub
2.0 TDI 4motion	103	09/09→08/15	→	7H-6-000001→; +PR 2E3,2E4; → 7H-A-050000		13.0460-2882.2 602882	TRW 23326 17,4 + WK + Zub
↓							

	kw					! #		
VW - MULTIVAN T5 (7HM, 7HN, 7HF, 7EF, 7EM, 7EN) 04/03→08/15								
Bremsbelagsatz, Scheibenbremse								
2.0 TDI	84	05/11→08/15	←	+PR 2E3		13.0460-7236.2	607236	ATE 23746 19,7 + WK
2.0 TSI	110	07/12→08/15	←	+PR 2E4		13.0460-7286.2	607286	ATE 24623 18,2 + WK
2.0 TSI	150	05/11→08/15	←					
2.0 TSI 4motion	150	07/11→08/15	→			13.0460-2882.2	602882	TRW 23326 17,4 + WK + Zub
2.0 TDI	100	05/10→08/15	←	+PR 2E3		13.0460-7236.2	607236	ATE 23746 19,7 + WK
2.0 TDI 4motion	100	05/10→08/15	←	7H-A-200001→; +PR 2E4		13.0460-7286.2	607286	ATE 24623 18,2 + WK
			→	7H-A-200001→		13.0460-2882.2	602882	TRW 23326 17,4 + WK + Zub
3.2 4motion	170	11/03→06/06	←	07/04→; +PR 2E3		13.0460-7236.2	607236	ATE 23746 19,7 + WK
			←	07/04→; +PR 2E4; → 7H-A-050000		13.0460-7240.2	607240	ATE 23746 18,1 + WK
			←	7H-A-200001→; +PR 2E4		13.0460-7286.2	607286	ATE 24623 18,2 + WK
			→	7H-8-028000→; +PR 0WR; → 7H-8-200000		13.0460-2882.2	602882	TRW 23326 17,4 + WK + Zub
			→	07/04→; +PR OWL,0WN / OWM,OWP,OWQ; → 7H-5-120000		13.0460-2882.2	602882	TRW 23326 17,4 + WK + Zub
			→	7H-A-200001→		13.0460-2882.2	602882	TRW 23326 17,4 + WK + Zub
			→	7H-6-000001→; +PR 2E3,2E4; → 7H-A-050000		13.0460-2882.2	602882	TRW 23326 17,4 + WK + Zub
			→	07/04→; +PR 0WR; → 7H-8-027999		13.0460-7218.2	607218	ATE 24367 19,1 + WK
Zubehörsatz, Scheibenbremsbelag								
1.9 TDI	62	01/06→11/09	→	7H-8-028000→; +PR 0WR; → 7H-8-200000		13.0460-0023.2	610023	
1.9 TDI	75	06/06→11/09	→	7H-A-200001→		13.0460-0023.2	610023	
			→	7H-6-000001→; +PR 2E3,2E4; → 7H-A-050000		13.0460-0023.2	610023	
1.9 TDI	63	04/03→11/09	→	7H-8-028000→; +PR 0WR; → 7H-8-200000		13.0460-0023.2	610023	
1.9 TDI	77	04/03→11/09	→					
2.0	85	11/03→08/15	→	+PR OWL,0WN / OWM,OWP,OWQ; → 7H-5-120000		13.0460-0023.2	610023	
2.5 TDI	96	04/03→11/09	→					
2.5 TDI	120	11/03→11/09	→	7H-6-000001→; +PR 2E3,2E4; → 7H-A-050000		13.0460-0023.2	610023	
2.5 TDI	128	04/03→11/09	→					
2.5 TDI 4motion	96	07/04→11/09	→	7H-A-200001→		13.0460-0023.2	610023	
2.5 TDI 4motion	128	07/04→11/09	→					
3.2 V6	170	02/04→06/04	→					
3.2 V6	173	02/04→11/09	→					
3.2 V6 4motion	173	07/04→11/09	→					
2.0 BiTDI	132	09/09→08/15	→	7H-A-200001→		13.0460-0023.2	610023	
2.0 BiTDI 4motion	132	09/09→08/15	→					
2.0 TDI	62	09/09→08/15	→	7H-6-000001→; +PR 2E3,2E4; → 7H-A-050000		13.0460-0023.2	610023	
2.0 TDI	75	09/09→08/15	→					
2.0 TDI	103	09/09→08/15	→					
2.0 TDI 4motion	103	09/09→08/15	→					
2.0 TDI	84	05/11→08/15	→			13.0460-0023.2	610023	
2.0 TSI	110	07/12→08/15	→					
2.0 TSI	150	05/11→08/15	→					
2.0 TSI 4motion	150	07/11→08/15	→					
2.0 TDI	100	05/10→08/15	→	7H-A-200001→		13.0460-0023.2	610023	
2.0 TDI 4motion	100	05/10→08/15	→					
3.2 4motion	170	11/03→06/06	→	7H-A-200001→		13.0460-0023.2	610023	
			→	7H-8-028000→; +PR 0WR; → 7H-8-200000		13.0460-0023.2	610023	
			→	7H-6-000001→; +PR 2E3,2E4; → 7H-A-050000		13.0460-0023.2	610023	
			→	07/04→; +PR OWL,0WN / OWM,OWP,OWQ; → 7H-5-120000		13.0460-0023.2	610023	
Bremsscheibe								
1.9 TDI	62	01/06→11/09	←	+PR 2E3		24.0130-0114.1	430114	Ø 308 29,5 25,5 V
1.9 TDI	75	06/06→11/09	←	→ 7H-A-050000; +PR 2E4		24.0132-0116.1	432116	Ø 333 32,5 28,5 V + S
			←	7H-A-200001→; +PR 2E4		24.0133-0100.1	433100	Ø 340 32,6 29,5 V + S
			→	7H-A-200001→		24.0122-0211.1	422211	Ø 294 21,9 19,5 V + S
			→	7H-8-028000→; +PR 0WR; → 7H-8-200000		24.0122-0211.1	422211	Ø 294 21,9 19,5 V + S
			→	7H-6-000001→; +PR 2E3,2E4; → 7H-A-050000		24.0122-0211.1	422211	Ø 294 21,9 19,5 V + S
			→	+PR 0WR; → 7H-8-027999		24.0122-0215.1	422215	Ø 314 22 18 V + S
1.9 TDI	63	04/03→11/09	←	+PR 2E3		24.0130-0114.1	430114	Ø 308 29,5 25,5 V
1.9 TDI	77	04/03→11/09	←					









	kw			 	! #		
VW - MULTIVAN T5 (7HM, 7HN, 7HF, 7EF, 7EM, 7EN) 04/03→08/15							
Bremsscheibe							
2.0	85	11/03→08/15	←	→ 7H-A-050000; +PR 2E4		24.0132-0116.1 432116	Ø 333 32,5 28,5 V + S
2.5 TDI	96	04/03→11/09	←	→ 7H-A-200001→; +PR 2E4		24.0133-0100.1 433100	Ø 340 32,6 29,5 V + S
2.5 TDI	120	11/03→11/09	←	→ 7H-A-200001→; +PR 2E4		24.0133-0100.1 433100	Ø 340 32,6 29,5 V + S
2.5 TDI	128	04/03→11/09	→	7H-8-028000→; +PR 0WR;		24.0122-0211.1 422211	Ø 294 21,9 19,5 V + S
2.5 TDI 4motion	96	07/04→11/09	→	→ 7H-8-200000		24.0122-0211.1 422211	Ø 294 21,9 19,5 V + S
2.5 TDI 4motion	128	07/04→11/09	→	7H-A-200001→		24.0122-0211.1 422211	Ø 294 21,9 19,5 V + S
3.2 V6	170	02/04→06/04	→	7H-A-200001→		24.0122-0211.1 422211	Ø 294 21,9 19,5 V + S
3.2 V6	173	02/04→11/09	→	7H-6-000001→; +PR 2E3,2E4;		24.0122-0211.1 422211	Ø 294 21,9 19,5 V + S
3.2 V6 4motion	173	07/04→11/09	→	→ 7H-A-050000		24.0122-0211.1 422211	Ø 294 21,9 19,5 V + S
			→	+PR OWL,OWN / OWM,OWP,OWQ;		24.0122-0211.1 422211	Ø 294 21,9 19,5 V + S
			→	→ 7H-5-120000		24.0122-0215.1 422215	Ø 314 22 18 V + S
			→	+PR 0WR; → 7H-8-027999		24.0122-0215.1 422215	Ø 314 22 18 V + S
2.0 BiTDI	132	09/09→08/15	←	+PR 2E3		24.0130-0114.1 430114	Ø 308 29,5 25,5 V
2.0 BiTDI 4motion	132	09/09→08/15	←	→ 7H-A-050000; +PR 2E4		24.0132-0116.1 432116	Ø 333 32,5 28,5 V + S
2.0 TDI	62	09/09→08/15	←	→ 7H-A-050000; +PR 2E4		24.0132-0116.1 432116	Ø 333 32,5 28,5 V + S
2.0 TDI	75	09/09→08/15	←	7H-A-200001→; +PR 2E4		24.0133-0100.1 433100	Ø 340 32,6 29,5 V + S
2.0 TDI	103	09/09→08/15	←	7H-A-200001→		24.0122-0211.1 422211	Ø 294 21,9 19,5 V + S
2.0 TDI 4motion	103	09/09→08/15	→	7H-6-000001→; +PR 2E3,2E4;		24.0122-0211.1 422211	Ø 294 21,9 19,5 V + S
			→	→ 7H-A-050000		24.0122-0211.1 422211	Ø 294 21,9 19,5 V + S
2.0 TDI	84	05/11→08/15	←	+PR 2E3		24.0130-0114.1 430114	Ø 308 29,5 25,5 V
2.0 TSI	110	07/12→08/15	←	+PR 2E4		24.0133-0100.1 433100	Ø 340 32,6 29,5 V + S
2.0 TSI	150	05/11→08/15	←	+PR 2E4		24.0133-0100.1 433100	Ø 340 32,6 29,5 V + S
2.0 TSI 4motion	150	07/11→08/15	→			24.0122-0211.1 422211	Ø 294 21,9 19,5 V + S
2.0 TDI	100	05/10→08/15	←	+PR 2E3		24.0130-0114.1 430114	Ø 308 29,5 25,5 V
2.0 TDI 4motion	100	05/10→08/15	←	7H-A-200001→; +PR 2E4		24.0133-0100.1 433100	Ø 340 32,6 29,5 V + S
			→	7H-A-200001→		24.0122-0211.1 422211	Ø 294 21,9 19,5 V + S
3.2 4motion	170	11/03→06/06	←	07/04→; +PR 2E3		24.0130-0114.1 430114	Ø 308 29,5 25,5 V
			←	07/04→; → 7H-A-050000; +PR 2E4		24.0132-0116.1 432116	Ø 333 32,5 28,5 V + S
			←	7H-A-200001→; +PR 2E4		24.0133-0100.1 433100	Ø 340 32,6 29,5 V + S
			→	7H-8-028000→; +PR 0WR;		24.0122-0211.1 422211	Ø 294 21,9 19,5 V + S
			→	→ 7H-8-200000		24.0122-0211.1 422211	Ø 294 21,9 19,5 V + S
			→	07/04→;		24.0122-0211.1 422211	Ø 294 21,9 19,5 V + S
			→	+PR OWL,OWN / OWM,OWP,OWQ;		24.0122-0211.1 422211	Ø 294 21,9 19,5 V + S
			→	→ 7H-5-120000		24.0122-0211.1 422211	Ø 294 21,9 19,5 V + S
			→	7H-A-200001→		24.0122-0211.1 422211	Ø 294 21,9 19,5 V + S
			→	7H-6-000001→; +PR 2E3,2E4;		24.0122-0211.1 422211	Ø 294 21,9 19,5 V + S
			→	→ 7H-A-050000		24.0122-0211.1 422211	Ø 294 21,9 19,5 V + S
			→	07/04→; +PR 0WR; → 7H-8-027999		24.0122-0215.1 422215	Ø 314 22 18 V + S
VW - MULTIVAN T6 (SGF, SGM, SGN) 04/15→							
Bremsbelagsatz, Scheibenbremse							
2.0 TDI	62	04/15→	←	passend für Felgenreöße [Zoll]: 16		13.0460-7236.2 607236	ATE 23746 19,7 + WK
2.0 TDI	75	04/15→	←	passend für Felgenreöße [Zoll]: 17		13.0460-7286.2 607286	ATE 24623 18,2 + WK
2.0 TDI	84	05/16→	←	passend für Felgenreöße [Zoll]: 17		13.0460-7286.2 607286	ATE 24623 18,2 + WK
2.0 TDI	103	04/15→	→			13.0460-2882.2 602882	TRW 23326 17,4 + WK + Zub
2.0 TDI	110	04/15→	→			13.0460-2882.2 602882	TRW 23326 17,4 + WK + Zub
2.0 TDI	132	04/15→	→			13.0460-2882.2 602882	TRW 23326 17,4 + WK + Zub
2.0 TDI	150	06/15→	→			13.0460-2882.2 602882	TRW 23326 17,4 + WK + Zub
2.0 TDI 4motion	103	06/15→	→			13.0460-2882.2 602882	TRW 23326 17,4 + WK + Zub
2.0 TDI 4motion	110	08/15→	→			13.0460-2882.2 602882	TRW 23326 17,4 + WK + Zub
2.0 TDI 4motion	132	06/15→	→			13.0460-2882.2 602882	TRW 23326 17,4 + WK + Zub
2.0 TDI 4motion	150	06/15→	→			13.0460-2882.2 602882	TRW 23326 17,4 + WK + Zub
2.0 TSI	110	04/15→	→			13.0460-2882.2 602882	TRW 23326 17,4 + WK + Zub
2.0 TSI	150	04/15→	→			13.0460-2882.2 602882	TRW 23326 17,4 + WK + Zub
2.0 TSI 4motion	150	06/15→	→			13.0460-2882.2 602882	TRW 23326 17,4 + WK + Zub
Bremsscheibe							
2.0 TDI	62	04/15→	←	passend für Felgenreöße [Zoll]: 16		24.0130-0114.1 430114	Ø 308 29,5 25,5 V
2.0 TDI	75	04/15→	←	passend für Felgenreöße [Zoll]: 17		24.0133-0100.1 433100	Ø 340 32,6 29,5 V + S
2.0 TDI	84	05/16→	←	passend für Felgenreöße [Zoll]: 17		24.0133-0100.1 433100	Ø 340 32,6 29,5 V + S
2.0 TDI	103	04/15→	→			24.0122-0211.1 422211	Ø 294 21,9 19,5 V + S
2.0 TDI	110	04/15→	→			24.0122-0211.1 422211	Ø 294 21,9 19,5 V + S
2.0 TDI	132	04/15→	→			24.0122-0211.1 422211	Ø 294 21,9 19,5 V + S
2.0 TDI	150	06/15→	→			24.0122-0211.1 422211	Ø 294 21,9 19,5 V + S
2.0 TDI 4motion	103	06/15→	→			24.0122-0211.1 422211	Ø 294 21,9 19,5 V + S
2.0 TDI 4motion	110	08/15→	→			24.0122-0211.1 422211	Ø 294 21,9 19,5 V + S
2.0 TDI 4motion	132	06/15→	→			24.0122-0211.1 422211	Ø 294 21,9 19,5 V + S
2.0 TDI 4motion	150	06/15→	→			24.0122-0211.1 422211	Ø 294 21,9 19,5 V + S
2.0 TSI	110	04/15→	→			24.0122-0211.1 422211	Ø 294 21,9 19,5 V + S
2.0 TSI	150	04/15→	→			24.0122-0211.1 422211	Ø 294 21,9 19,5 V + S
2.0 TSI 4motion	150	06/15→	→			24.0122-0211.1 422211	Ø 294 21,9 19,5 V + S









	kw			 	! #		
VW - NEW BEETLE (9C1, 1C1) 01/98—09/10							
 Bremsbelagsatz, Scheibenbremse							
1.4 1.6 1.8 T 1.9 TDI 1.9 TDI	55 75 110 74 77	11/01→09/10 06/00→09/10 10/99→09/10 02/01→09/10 07/05→09/10	← ← ← →	→ 05/10; +PR 1ZP;1ZM → 05/10; +PR 1ZD;1ZE → 05/10; +PR 1KS,1KV		13.0460-7117.2 607117 13.0470-7117.2 LD7117 13.0460-7122.2 607122 13.0470-7122.2 LD7122 13.0460-2894.2 602894 13.0470-2894.2 LD2894	VW 23130 19,6 + WK VW 23130 19,6 + WK Ceramic ATE 20676 19,8 + WK ATE 20676 19,8 + WK Ceramic TRW 20961 17,2 - WK + Zub TRW 20961 17,2 - WK + Zub Ceramic
1.6	74	10/99→09/00	← ← →	11/99→; +PR 1ZP;1ZM 11/99→; +PR 1ZD;1ZE 11/99→; +PR 1KS,1KV		13.0460-7117.2 607117 13.0470-7117.2 LD7117 13.0460-7122.2 607122 13.0470-7122.2 LD7122 13.0460-2894.2 602894 13.0470-2894.2 LD2894	VW 23130 19,6 + WK VW 23130 19,6 + WK Ceramic ATE 20676 19,8 + WK ATE 20676 19,8 + WK Ceramic TRW 20961 17,2 - WK + Zub TRW 20961 17,2 - WK + Zub Ceramic
1.8 T	132	11/01→06/05	← ← → →	+PR 1ZP;1ZM +PR 1ZD;1ZE +PR 1KY +PR 1KS,1KV		13.0460-7117.2 607117 13.0470-7117.2 LD7117 13.0460-7122.2 607122 13.0470-7122.2 LD7122 13.0460-2886.2 602886 13.0470-2886.2 LD2886 13.0460-2894.2 602894 13.0470-2894.2 LD2894	VW 23130 19,6 + WK VW 23130 19,6 + WK Ceramic ATE 20676 19,8 + WK ATE 20676 19,8 + WK Ceramic TRW 20961 16,0 - WK TRW 20961 16,0 - WK Ceramic TRW 20961 17,2 - WK + Zub TRW 20961 17,2 - WK + Zub Ceramic
1.9 TDI	66	01/98→06/04	← ← ← ← →	→ 9C-X-699000; +PR 1ZE;1ZH → 9C-X-999000; +PR 1ZM 9C-Y-600001→; → 02/01; +PR 1ZP;1ZM 9C-Y-600001→; → 02/01; +PR 1ZD;1ZE → 02/01; +PR 1KS,1KV		13.0460-7081.2 607081 13.0470-7081.2 LD7081 13.0460-7111.2 607111 13.0470-7111.2 LD7111 13.0460-7117.2 607117 13.0470-7117.2 LD7117 13.0460-7122.2 607122 13.0470-7122.2 LD7122 13.0460-2894.2 602894 13.0470-2894.2 LD2894	ATE 20676 19,8 - WE / - WK ATE 20676 19,8 - WE / - WK Ceramic VW 23130 19,6 - WE / - WK VW 23130 19,6 - WE / - WK Ceramic VW 23130 19,6 + WK VW 23130 19,6 + WK Ceramic ATE 20676 19,8 + WK ATE 20676 19,8 + WK Ceramic TRW 20961 17,2 - WK + Zub TRW 20961 17,2 - WK + Zub Ceramic
2.0	85	01/98→09/10	← ← ← ← →	→ 9C-X-699000; +PR 1ZE;1ZH → 9C-X-999000; +PR 1ZM 9C-Y-600001→; → 05/10; +PR 1ZP;1ZM 9C-Y-600001→; → 05/10; +PR 1ZD;1ZE → 05/10; +PR 1KS,1KV		13.0460-7081.2 607081 13.0470-7081.2 LD7081 13.0460-7111.2 607111 13.0470-7111.2 LD7111 13.0460-7117.2 607117 13.0470-7117.2 LD7117 13.0460-7122.2 607122 13.0470-7122.2 LD7122 13.0460-2894.2 602894 13.0470-2894.2 LD2894	ATE 20676 19,8 - WE / - WK ATE 20676 19,8 - WE / - WK Ceramic VW 23130 19,6 - WE / - WK VW 23130 19,6 - WE / - WK Ceramic VW 23130 19,6 + WK VW 23130 19,6 + WK Ceramic ATE 20676 19,8 + WK ATE 20676 19,8 + WK Ceramic TRW 20961 17,2 - WK + Zub TRW 20961 17,2 - WK + Zub Ceramic
2.3 V5	125	10/00→09/10	← → →	→ 05/05 → 05/05; +PR 1KY → 05/05; +PR 1KS,1KV		13.0460-7122.2 607122 13.0470-7122.2 LD7122 13.0460-2886.2 602886 13.0470-2886.2 LD2886 13.0460-2894.2 602894 13.0470-2894.2 LD2894	ATE 20676 19,8 + WK ATE 20676 19,8 + WK Ceramic TRW 20961 16,0 - WK TRW 20961 16,0 - WK Ceramic TRW 20961 17,2 - WK + Zub TRW 20961 17,2 - WK + Zub Ceramic
RSI 3.2 4motion (1C9)	165	04/00→05/01	← →			13.0460-7122.2 607122 13.0470-7122.2 LD7122 13.0460-2820.2 602820 13.0470-2820.2 LD2820	ATE 20676 19,8 + WK ATE 20676 19,8 + WK Ceramic TRW 20961 17,2 - WK TRW 20961 17,2 - WK Ceramic
Zubehörsatz, Scheibenbremsbelag							
1.4 1.6 1.8 T ↓	55 75 110	11/01→09/10 06/00→09/10 10/99→09/10	→	→ 05/10; +PR 1KS,1KV		13.0460-0072.2 610072	TRW







	kw			 	! #		
VW - NEW BEETLE (9C1, 1C1) 01/98→09/10							
Zubehörsatz, Scheibenbremsbelag							
1.9 TDI	74	02/01→09/10	➡	→ 05/10; +PR 1KS,1KV		13.0460-0072.2 610072	TRW
1.9 TDI	77	07/05→09/10					
2.0	85	01/98→09/10					
1.6	74	10/99→09/00	➡	11/99→; +PR 1KS,1KV		13.0460-0072.2 610072	TRW
1.8 T	132	11/01→06/05	➡	+PR 1KY		13.0460-0072.2 610072	TRW
			➡	+PR 1KS,1KV		13.0460-0072.2 610072	TRW
1.9 TDI	66	01/98→06/04	➡	→ 02/01; +PR 1KS,1KV		13.0460-0072.2 610072	TRW
2.3 V5	125	10/00→09/10	➡	→ 05/05; +PR 1KY		13.0460-0072.2 610072	TRW
			➡	→ 05/05; +PR 1KS,1KV		13.0460-0072.2 610072	TRW
 Bremsscheibe							
1.4	55	11/01→09/10	⬅	→ 05/10; +PR 1ZP;1ZM		24.0122-0150.1 422150	Ø 280 22 19 V + S
1.6	75	06/00→09/10				24.0322-0150.1 522150	Ø 280 22 19 V + S PD
1.8 T	110	10/99→09/10					
1.9 TDI	74	02/01→09/10	⬅	→ 05/10; +PR 1ZD;1ZE		24.0125-0113.1 425113	Ø 288 25 22 V + S
1.9 TDI	77	07/05→09/10				24.0325-0113.1 525113	Ø 288 25 22 V + S PD
2.0	85	01/98→09/10	➡	→ 05/10; +PR 1KS,1KV		24.0109-0123.1 409123	Ø 230 9 7 + S
						24.0309-0123.1 509123	Ø 230 9 7 + S PD
1.6	74	10/99→09/00	⬅	11/99→; +PR 1ZP;1ZM		24.0122-0150.1 422150	Ø 280 22 19 V + S
						24.0322-0150.1 522150	Ø 280 22 19 V + S PD
			⬅	11/99→; +PR 1ZD;1ZE		24.0125-0113.1 425113	Ø 288 25 22 V + S
						24.0325-0113.1 525113	Ø 288 25 22 V + S PD
			➡	11/99→; +PR 1KS,1KV		24.0109-0123.1 409123	Ø 230 9 7 + S
						24.0309-0123.1 509123	Ø 230 9 7 + S PD
1.8 T	132	11/01→06/05	⬅	+PR 1ZP;1ZM		24.0122-0150.1 422150	Ø 280 22 19 V + S
						24.0322-0150.1 522150	Ø 280 22 19 V + S PD
			⬅	+PR 1ZD;1ZE		24.0125-0113.1 425113	Ø 288 25 22 V + S
						24.0325-0113.1 525113	Ø 288 25 22 V + S PD
			➡	+PR 1KS,1KV		24.0109-0123.1 409123	Ø 230 9 7 + S
						24.0309-0123.1 509123	Ø 230 9 7 + S PD
			➡	+PR 1KY		24.0122-0163.1 422163	Ø 256 22 20 V
						24.0322-0163.1 522163	Ø 256 22 20 V PD
1.9 TDI	66	01/98→06/04	⬅	→ 02/01; +PR 1ZP;1ZM		24.0122-0150.1 422150	Ø 280 22 19 V + S
						24.0322-0150.1 522150	Ø 280 22 19 V + S PD
			⬅	→ 02/01; +PR 1ZD;1ZE		24.0125-0113.1 425113	Ø 288 25 22 V + S
						24.0325-0113.1 525113	Ø 288 25 22 V + S PD
			➡	→ 02/01; +PR 1KS,1KV		24.0109-0123.1 409123	Ø 230 9 7 + S
						24.0309-0123.1 509123	Ø 230 9 7 + S PD
2.3 V5	125	10/00→09/10	⬅	→ 12/05		24.0125-0123.1 425123	Ø 310 25 22 V + S
						24.0325-0123.1 525123	Ø 310 25 22 V PD
			➡	→ 05/05; +PR 1KY		24.0122-0163.1 422163	Ø 256 22 20 V
						24.0322-0163.1 522163	Ø 256 22 20 V PD
RSI 3.2 4motion (1C9)	165	04/00→05/01	⬅			24.0125-0123.1 425123	Ø 310 25 22 V + S
						24.0325-0123.1 525123	Ø 310 25 22 V PD
			➡			24.0122-0163.1 422163	Ø 256 22 20 V
						24.0322-0163.1 522163	Ø 256 22 20 V PD
VW - NEW BEETLE Cabriolet (1Y7) 09/02→10/10							
 Bremsbelagsatz, Scheibenbremse							
1.4	55	01/03→09/10	⬅	→ 05/10; +PR 1ZP;1ZM		13.0460-7117.2 607117	VW 23130 19,6 + WK
1.6	75	01/03→09/10				13.0470-7117.2 LD7117	VW 23130 19,6 + WK Ceramic
1.9 TDI	77	07/05→09/10	⬅	→ 05/10; +PR 1ZD;1ZE		13.0460-7122.2 607122	ATE 20676 19,8 + WK
						13.0470-7122.2 LD7122	ATE 20676 19,8 + WK Ceramic
			➡	→ 05/10; +PR 1KS,1KV		13.0460-2894.2 602894	TRW 20961 17,2 - WK + Zub
						13.0470-2894.2 LD2894	TRW 20961 17,2 - WK + Zub Ceramic
1.8 T	110	01/03→09/10	⬅	12/03→ 05/10; +PR 1ZP;1ZM		13.0460-7117.2 607117	VW 23130 19,6 + WK
						13.0470-7117.2 LD7117	VW 23130 19,6 + WK Ceramic
			⬅	12/03→ 05/10; +PR 1ZD;1ZE		13.0460-7122.2 607122	ATE 20676 19,8 + WK
						13.0470-7122.2 LD7122	ATE 20676 19,8 + WK Ceramic
			➡	12/03→ 05/10; +PR 1KS,1KV		13.0460-2894.2 602894	TRW 20961 17,2 - WK + Zub
						13.0470-2894.2 LD2894	TRW 20961 17,2 - WK + Zub Ceramic
↓							









	kw			 	! #		
VW - NEW BEETLE Cabriolet (1Y7) 09/02→10/10							
 Bremsbelagsatz, Scheibenbremse							
1.9 TDI	74	06/03→09/10	←	07/03→ 05/10; +PR 1ZP;1ZM	13.0460-7117.2	607117	VW 23130 19,6 + WK
			←	07/03→ 05/10; +PR 1ZD;1ZE	13.0470-7117.2	LD7117	VW 23130 19,6 + WK Ceramic
			→	07/03→ 05/10; +PR 1KS,1KV	13.0460-2894.2	602894	TRW 20961 17,2 - WK + Zub
2.0	85	09/02→10/10	←	01/03→ 05/10; +PR 1ZP;1ZM	13.0460-7117.2	607117	VW 23130 19,6 + WK
			←	01/03→ 05/10; +PR 1ZD;1ZE	13.0470-7117.2	LD7117	VW 23130 19,6 + WK Ceramic
			→	01/03→ 05/10; +PR 1KS,1KV	13.0460-2894.2	602894	TRW 20961 17,2 - WK + Zub
			←	01/03→ 05/10; +PR 1ZD;1ZE	13.0460-7122.2	607122	ATE 20676 19,8 + WK
			←	01/03→ 05/10; +PR 1ZD;1ZE	13.0470-7122.2	LD7122	ATE 20676 19,8 + WK Ceramic
			→	01/03→ 05/10; +PR 1KS,1KV	13.0460-2894.2	602894	TRW 20961 17,2 - WK + Zub
			→	01/03→ 05/10; +PR 1KS,1KV	13.0470-2894.2	LD2894	TRW 20961 17,2 - WK + Zub Ceramic
			→	01/03→ 05/10; +PR 1KS,1KV	13.0460-2894.2	602894	TRW 20961 17,2 - WK + Zub
			→	01/03→ 05/10; +PR 1KS,1KV	13.0470-2894.2	LD2894	TRW 20961 17,2 - WK + Zub Ceramic
Zubehörsatz, Scheibenbremsbelag							
1.4	55	01/03→09/10	→	→ 05/10; +PR 1KS,1KV	13.0460-0072.2	610072	TRW
1.6	75	01/03→09/10	→	→ 05/10; +PR 1KS,1KV	13.0460-0072.2	610072	TRW
1.9 TDI	77	07/05→09/10	→	→ 05/10; +PR 1KS,1KV	13.0460-0072.2	610072	TRW
1.8 T	110	01/03→09/10	→	12/03→ 05/10; +PR 1KS,1KV	13.0460-0072.2	610072	TRW
1.9 TDI	74	06/03→09/10	→	07/03→ 05/10; +PR 1KS,1KV	13.0460-0072.2	610072	TRW
2.0	85	09/02→10/10	→	01/03→ 05/10; +PR 1KS,1KV	13.0460-0072.2	610072	TRW
 Bremsscheibe							
1.4	55	01/03→09/10	←	→ 05/10; +PR 1ZP;1ZM	24.0122-0150.1	422150	Ø 280 22 19 V + S
			←	→ 05/10; +PR 1ZD;1ZE	24.0322-0150.1	522150	Ø 280 22 19 V + S PD
			→	→ 05/10; +PR 1KS,1KV	24.0109-0123.1	409123	Ø 230 9 7 + S
1.6	75	01/03→09/10	←	→ 05/10; +PR 1ZP;1ZM	24.0125-0113.1	425113	Ø 288 25 22 V + S
			←	→ 05/10; +PR 1ZD;1ZE	24.0325-0113.1	525113	Ø 288 25 22 V + S PD
			→	→ 05/10; +PR 1KS,1KV	24.0109-0123.1	409123	Ø 230 9 7 + S
1.9 TDI	77	07/05→09/10	←	→ 05/10; +PR 1ZP;1ZM	24.0125-0113.1	425113	Ø 288 25 22 V + S
			←	→ 05/10; +PR 1ZD;1ZE	24.0325-0113.1	525113	Ø 288 25 22 V + S PD
			→	→ 05/10; +PR 1KS,1KV	24.0109-0123.1	409123	Ø 230 9 7 + S
1.8 T	110	01/03→09/10	←	12/03→ 05/10; +PR 1ZP;1ZM	24.0109-0123.1	409123	Ø 230 9 7 + S
			←	12/03→ 05/10; +PR 1ZD;1ZE	24.0309-0123.1	509123	Ø 230 9 7 + S PD
			→	12/03→ 05/10; +PR 1KS,1KV	24.0122-0150.1	422150	Ø 280 22 19 V + S
1.8 T	110	01/03→09/10	←	12/03→ 05/10; +PR 1ZP;1ZM	24.0122-0150.1	422150	Ø 280 22 19 V + S
			←	12/03→ 05/10; +PR 1ZD;1ZE	24.0322-0150.1	522150	Ø 280 22 19 V + S PD
			→	12/03→ 05/10; +PR 1KS,1KV	24.0125-0113.1	425113	Ø 288 25 22 V + S
1.9 TDI	74	06/03→09/10	←	07/03→ 05/10; +PR 1ZP;1ZM	24.0125-0113.1	425113	Ø 288 25 22 V + S
			←	07/03→ 05/10; +PR 1ZD;1ZE	24.0325-0113.1	525113	Ø 288 25 22 V + S PD
			→	07/03→ 05/10; +PR 1KS,1KV	24.0109-0123.1	409123	Ø 230 9 7 + S
1.9 TDI	74	06/03→09/10	←	07/03→ 05/10; +PR 1ZP;1ZM	24.0109-0123.1	409123	Ø 230 9 7 + S
			←	07/03→ 05/10; +PR 1ZD;1ZE	24.0309-0123.1	509123	Ø 230 9 7 + S PD
			→	07/03→ 05/10; +PR 1KS,1KV	24.0122-0150.1	422150	Ø 280 22 19 V + S
2.0	85	09/02→10/10	←	01/03→ 05/10; +PR 1ZP;1ZM	24.0322-0150.1	522150	Ø 280 22 19 V + S PD
			←	01/03→ 05/10; +PR 1ZD;1ZE	24.0122-0150.1	422150	Ø 280 22 19 V + S
			→	01/03→ 05/10; +PR 1KS,1KV	24.0125-0113.1	425113	Ø 288 25 22 V + S
			←	01/03→ 05/10; +PR 1ZD;1ZE	24.0325-0113.1	525113	Ø 288 25 22 V + S PD
			→	01/03→ 05/10; +PR 1KS,1KV	24.0109-0123.1	409123	Ø 230 9 7 + S
			→	01/03→ 05/10; +PR 1KS,1KV	24.0309-0123.1	509123	Ø 230 9 7 + S PD
VW - PASSAT (3A2, 35I) 02/88→12/97							
 Bremsbelagsatz, Scheibenbremse							
1.6	74	10/94→08/96	←	3A-T-130757→	13.0460-2957.2	602957	TRW 20168 16,0 - WK
			←	→ 3A-T-130756	13.0460-2958.2	602958	TRW 20168 19,3 - WK
1.8	55	08/90→08/96	←	→ 10/93	13.0460-2958.2	602958	TRW 20168 19,3 - WK
			←	10/93→	13.0460-2958.2	602958	TRW 20168 19,3 - WK
1.9 TD	55	03/91→08/96	←	10/93→	13.0460-2958.2	602958	TRW 20168 19,3 - WK
			←	10/93→	13.0460-2958.2	602958	TRW 20168 19,3 - WK
1.8	66	02/88→08/96	←	10/93→	13.0460-2958.2	602958	TRW 20168 19,3 - WK
			←	04/88→ 10/93	13.0460-2958.2	602958	TRW 20168 19,3 - WK
1.8 G60 Syncro	118	08/88→08/96	←	→ 10/93	13.0460-2958.2	602958	TRW 20168 19,3 - WK
			→	→ 31-P-080000	13.0460-2937.2	602937	TRW 20961 15,2 - WK + Zub
			→	31-P-080001→; → 10/93	13.0460-2984.2	602984	TRW 20961 17,2 - WK + Zub
1.9 TDI	66	10/93→08/96	←	3A-T-000001→	13.0460-2957.2	602957	TRW 20168 16,0 - WK
↓							

















	kW			 	! #		
VW - PASSAT (3A2, 35I) 02/88→12/97							
 Bremsbelagsatz, Scheibenbremse							
1.9 TDI	66	10/93→08/96	←	→ 3A-S-300000		13.0460-2958.2 602958	TRW 20168 19,3 - WK
			→	3A-T-000001→		13.0460-2984.2 602984	TRW 20961 17,2 - WK + Zub
1.9 TDI	81	03/96→08/96	←			13.0460-2958.2 602958	TRW 20168 19,3 - WK
			→			13.0460-2984.2 602984	TRW 20961 17,2 - WK + Zub
2.0	79	03/95→08/96	←			13.0460-2957.2 602957	TRW 20168 16,0 - WK
			→			13.0460-2984.2 602984	TRW 20961 17,2 - WK + Zub
2.0	85	02/90→08/96	←	03/90→ 10/93		13.0460-2957.2 602957	TRW 20168 16,0 - WK
			←	10/93→		13.0460-2957.2 602957	TRW 20168 16,0 - WK
			→	03/90→; → 31-PB080000		13.0460-2937.2 602937	TRW 20961 15,2 - WK + Zub
			→	03/90→; → 31-PE080000		13.0460-2937.2 602937	TRW 20961 15,2 - WK + Zub
			→	31-PB080001→; → 10/93		13.0460-2984.2 602984	TRW 20961 17,2 - WK + Zub
			→	31-PE080001→; → 10/93		13.0460-2984.2 602984	TRW 20961 17,2 - WK + Zub
			→	10/93→		13.0460-2984.2 602984	TRW 20961 17,2 - WK + Zub
2.0 16V	110	01/94→08/96	←			13.0460-7081.2 607081	ATE 20676 19,8 - WE / - WK
						13.0470-7081.2 LD7081	ATE 20676 19,8 - WE / - WK Ceramic
			→			13.0460-2984.2 602984	TRW 20961 17,2 - WK + Zub
2.0 Syncro	85	10/90→08/96	←	→ 10/93		13.0460-2957.2 602957	TRW 20168 16,0 - WK
			←	01/94→		13.0460-2957.2 602957	TRW 20168 16,0 - WK
			→	→ 31-P-080000		13.0460-2937.2 602937	TRW 20961 15,2 - WK + Zub
			→	31-P-080001→; → 10/93		13.0460-2984.2 602984	TRW 20961 17,2 - WK + Zub
			→	01/94→		13.0460-2984.2 602984	TRW 20961 17,2 - WK + Zub
2.8 VR6	128	06/91→08/96	←	→ 10/93		13.0460-2958.2 602958	TRW 20168 19,3 - WK
			←	10/93→		13.0460-7081.2 607081	ATE 20676 19,8 - WE / - WK
						13.0470-7081.2 LD7081	ATE 20676 19,8 - WE / - WK Ceramic
			→	→ 31-PE080000		13.0460-2937.2 602937	TRW 20961 15,2 - WK + Zub
			→	→ 31-PB080000		13.0460-2937.2 602937	TRW 20961 15,2 - WK + Zub
			→	31-PB080001→; → 10/93		13.0460-2984.2 602984	TRW 20961 17,2 - WK + Zub
			→	10/93→		13.0460-2984.2 602984	TRW 20961 17,2 - WK + Zub
			→	31-PE080001→; → 10/93		13.0460-2984.2 602984	TRW 20961 17,2 - WK + Zub
Zubehörsatz, Scheibenbremsbelag							
1.8 G60 Syncro	118	08/88→08/96	→	31-P-080001→; → 10/93		13.0460-0072.2 610072	TRW
			→	→ 31-P-080000		13.0460-0419.2 610419	TRW
1.9 TDI	66	10/93→08/96	→	3A-T-000001→		13.0460-0072.2 610072	TRW
1.9 TDI	81	03/96→08/96	→			13.0460-0072.2 610072	TRW
2.0	79	03/95→08/96					
2.0 16V	110	01/94→08/96					
2.0	85	02/90→08/96	→	31-PB080001→; → 10/93		13.0460-0072.2 610072	TRW
			→	31-PE080001→; → 10/93		13.0460-0072.2 610072	TRW
			→	10/93→		13.0460-0072.2 610072	TRW
			→	03/90→; → 31-PB080000		13.0460-0419.2 610419	TRW
			→	03/90→; → 31-PE080000		13.0460-0419.2 610419	TRW
2.0 Syncro	85	10/90→08/96	→	01/94→		13.0460-0072.2 610072	TRW
			→	31-P-080001→; → 10/93		13.0460-0072.2 610072	TRW
			→	→ 31-P-080000		13.0460-0419.2 610419	TRW
2.8 VR6	128	06/91→08/96	→	31-PB080001→; → 10/93		13.0460-0072.2 610072	TRW
			→	31-PE080001→; → 10/93		13.0460-0072.2 610072	TRW
			→	10/93→		13.0460-0072.2 610072	TRW
			→	→ 31-PB080000		13.0460-0419.2 610419	TRW
			→	→ 31-PE080000		13.0460-0419.2 610419	TRW
 Bremsscheibe							
1.6	74	10/94→08/96	←	→ 3A-T-130756		24.0113-0178.1 413178	∅ 255,6 12,9 11 + S
						24.0313-0178.1 513178	∅ 255,6 12,9 11 + S PD
↓							

	kw			 	! #		
VW - PASSAT (3A2, 35I) 02/88→12/97							
 Bremsscheibe							
1.6	74	10/94→08/96	←	3A-T-130757→		24.0120-0128.1 420128 24.0320-0128.1 520128	Ø 256 20 18 V + S Ø 256 20 18 V + S PD
1.8 1.9 TD	55 55	08/90→08/96 03/91→08/96	←	→ 10/93		24.0113-0178.1 413178 24.0313-0178.1 513178	Ø 255,6 12,9 11 + S Ø 255,6 12,9 11 + S PD
			←	10/93→		24.0113-0178.1 413178 24.0313-0178.1 513178	Ø 255,6 12,9 11 + S Ø 255,6 12,9 11 + S PD
1.8	66	02/88→08/96	←	10/93→		24.0113-0178.1 413178 24.0313-0178.1 513178	Ø 255,6 12,9 11 + S Ø 255,6 12,9 11 + S PD
			←	04/88→ 10/93		24.0113-0178.1 413178 24.0313-0178.1 513178	Ø 255,6 12,9 11 + S Ø 255,6 12,9 11 + S PD
1.8 G60 Syncro	118	08/88→08/96	←	→ 10/93		24.0122-0101.1 422101	Ø 280 22 20 V
			→	→ 10/93		24.0110-0151.1 410151	Ø 239 10 8 + S
1.9 TDI	66	10/93→08/96	←	→ 3A-S-300000		24.0113-0178.1 413178 24.0313-0178.1 513178	Ø 255,6 12,9 11 + S Ø 255,6 12,9 11 + S PD
			←	3A-T-000001→		24.0120-0128.1 420128 24.0320-0128.1 520128	Ø 256 20 18 V + S Ø 256 20 18 V + S PD
			→	3A-T-000001→		24.0110-0111.1 410111 24.0110-0275.2 410275	Ø 226 10 8 - ABS Ring / - RLG Ø 226 10 8 + ABS Ring / - RLG
1.9 TDI	81	03/96→08/96	←			24.0122-0100.1 422100 24.0322-0100.1 522100	Ø 280 22 20 V Ø 280 22 20 V PD
			→			24.0110-0203.1 410203 24.0110-0276.2 410276	Ø 226 10 8 - ABS Ring Ø 226 10 8 + ABS Ring
2.0	79	03/95→08/96	←			24.0120-0128.1 420128 24.0320-0128.1 520128	Ø 256 20 18 V + S Ø 256 20 18 V + S PD
			→			24.0110-0111.1 410111 24.0110-0275.2 410275	Ø 226 10 8 - ABS Ring / - RLG Ø 226 10 8 + ABS Ring / - RLG
			←			24.0120-0128.1 420128 24.0320-0128.1 520128	Ø 256 20 18 V + S Ø 256 20 18 V + S PD
2.0	85	02/90→08/96	←	03/90→ 10/93		24.0120-0128.1 420128 24.0320-0128.1 520128	Ø 256 20 18 V + S Ø 256 20 18 V + S PD
			←	10/93→		24.0120-0128.1 420128 24.0320-0128.1 520128	Ø 256 20 18 V + S Ø 256 20 18 V + S PD
			→	10/93→		24.0110-0111.1 410111 24.0110-0275.2 410275	Ø 226 10 8 - ABS Ring / - RLG Ø 226 10 8 + ABS Ring / - RLG
			→	03/90→ 10/93		24.0110-0111.1 410111 24.0110-0275.2 410275	Ø 226 10 8 - ABS Ring / - RLG Ø 226 10 8 + ABS Ring / - RLG
2.0 16V	110	01/94→08/96	←			24.0125-0108.1 425108 24.0110-0203.1 410203	Ø 288 25 23 V Ø 226 10 8 - ABS Ring
			→			24.0110-0276.2 410276	Ø 226 10 8 + ABS Ring
2.0 Syncro	85	10/90→08/96	←	01/94→		24.0120-0128.1 420128 24.0320-0128.1 520128	Ø 256 20 18 V + S Ø 256 20 18 V + S PD
			←	→ 10/93		24.0120-0128.1 420128 24.0320-0128.1 520128	Ø 256 20 18 V + S Ø 256 20 18 V + S PD
			→	→ 10/93		24.0110-0151.1 410151	Ø 239 10 8 + S
			→	01/94→		24.0110-0151.1 410151	Ø 239 10 8 + S
2.8 VR6	128	06/91→08/96	←	→ 10/93; 31-N-255990→		24.0122-0100.1 422100 24.0322-0100.1 522100	Ø 280 22 20 V Ø 280 22 20 V PD
			←	10/93→		24.0125-0108.1 425108	Ø 288 25 23 V
			→	10/93→		24.0110-0203.1 410203 24.0110-0276.2 410276	Ø 226 10 8 - ABS Ring Ø 226 10 8 + ABS Ring
			→	→ 10/93		24.0110-0203.1 410203 24.0110-0276.2 410276	Ø 226 10 8 - ABS Ring Ø 226 10 8 + ABS Ring
VW - PASSAT (3B2) 08/96→12/01							
 Bremsbelagsatz, Scheibenbremse							
1.6	74	10/96→11/00	←	→ 3B-X-600000; +PR 1LZ,1ZJ		13.0460-2822.2 602822	TRW 21945 19,6 - WK
			←	3B-Y-000001→; → 09/00; +PR 1LZ,1ZJ		13.0460-2837.2 602837 13.0470-2837.2 LD2837	TRW 21945 19,6 + WK TRW 21945 19,6 + WK Ceramic
			←	→ 3B-X-600000; +PR 1LB,1ZC		13.0460-7077.2 607077	ATE 20676 19,8 - WE / - WK
			←	3B-Y-000001→; +PR 1LB,1ZC		13.0460-7110.2 607110 13.0470-7110.2 LD7110	ATE 20676 19,8 + WK ATE 20676 19,8 + WK Ceramic
			←	3B-Y-000001→; +PR 1LE, 1LT		13.0460-7110.2 607110	ATE 20676 19,8 + WK
↓							









	kw			 	! #		
VW - PASSAT (3B2) 08/96→12/01							
Bremsbelagsatz, Scheibenbremse							
1.6	74	10/96→11/00	←	3B-Y-000001→; +PR 1LE, 1LT		13.0470-7110.2 LD7110	ATE 20676 19,8 + WK Ceramic
			→	+PR 1KD,1KE,1KF,1KW		13.0460-2820.2 602820	TRW 20961 17,2 - WK
						13.0470-2820.2 LD2820	TRW 20961 17,2 - WK Ceramic
1.8	85	01/97→11/00	←	→ 3B-X-600000		13.0460-2822.2 602822	TRW 21945 19,6 - WK
			←	3B-Y-000001→; → 09/00		13.0460-2837.2 602837	TRW 21945 19,6 + WK
						13.0470-2837.2 LD2837	TRW 21945 19,6 + WK Ceramic
			→	→ 09/00		13.0460-2820.2 602820	TRW 20961 17,2 - WK
						13.0470-2820.2 LD2820	TRW 20961 17,2 - WK Ceramic
1.8	92	10/96→11/00	←	→ 3B-X-600000; +PR 1LZ,1ZJ		13.0460-2822.2 602822	TRW 21945 19,6 - WK
			←	3B-Y-000001→; → 09/00; +PR 1LZ,1ZJ		13.0460-2837.2 602837	TRW 21945 19,6 + WK
						13.0470-2837.2 LD2837	TRW 21945 19,6 + WK Ceramic
			←	→ 3B-X-600000; +PR 1LB,1ZC		13.0460-7077.2 607077	ATE 20676 19,8 - WE / - WK
			←	3B-Y-000001→; +PR 1LE, 1LT		13.0460-7110.2 607110	ATE 20676 19,8 + WK
						13.0470-7110.2 LD7110	ATE 20676 19,8 + WK Ceramic
			←	3B-Y-000001→; +PR 1LB,1ZC		13.0460-7110.2 607110	ATE 20676 19,8 + WK
						13.0470-7110.2 LD7110	ATE 20676 19,8 + WK Ceramic
			→	→ 09/00; +PR 1KD,1KE,1KF,1KW		13.0460-2820.2 602820	TRW 20961 17,2 - WK
						13.0470-2820.2 LD2820	TRW 20961 17,2 - WK Ceramic
1.8	112	01/00→12/01	←	→ 3B-X-600000; +PR 1LB,1ZC		13.0460-7077.2 607077	ATE 20676 19,8 - WE / - WK
1.8 T	110	10/96→11/00	←	3B-Y-000001→; +PR 1LB,1ZC		13.0460-7110.2 607110	ATE 20676 19,8 + WK
1.9 TDI	81	10/96→11/00	←	3B-Y-000001→; +PR 1LB,1ZC		13.0460-7110.2 607110	ATE 20676 19,8 + WK
1.9 TDI	85	08/98→11/00	←	3B-Y-000001→; +PR 1LE, 1LT		13.0470-7110.2 LD7110	ATE 20676 19,8 + WK Ceramic
1.9 TDI 4motion	85	08/99→11/00	←	3B-Y-000001→; +PR 1LE, 1LT		13.0460-7110.2 607110	ATE 20676 19,8 + WK
1.9 TDI Syncro/4motion	81	10/96→11/00	←	3B-Y-000001→; +PR 1LE, 1LT		13.0460-7110.2 607110	ATE 20676 19,8 + WK
2.3 VR5	110	10/96→11/00	←	3B-Y-000001→; +PR 1LE, 1LT		13.0470-7110.2 LD7110	ATE 20676 19,8 + WK Ceramic
2.3 VR5 Syncro/4motion	110	10/97→11/00	→	+PR 1KD,1KE,1KF,1KW		13.0460-2820.2 602820	TRW 20961 17,2 - WK
2.5 TDI Syncro/4motion	110	12/98→11/00	←	3B-Y-000001→; +PR 1LE, 1LT		13.0470-2820.2 LD2820	TRW 20961 17,2 - WK Ceramic
2.8 Syncro	132	05/97→09/99	←	3B-Y-000001→; +PR 1LE, 1LT		13.0460-7110.2 607110	ATE 20676 19,8 + WK
2.8 V6	140	09/99→11/00	←	3B-Y-000001→; +PR 1LE, 1LT		13.0470-7110.2 LD7110	ATE 20676 19,8 + WK Ceramic
2.8 V6	142	08/96→11/00	←	3B-Y-000001→; +PR 1LB,1ZC		13.0460-7110.2 607110	ATE 20676 19,8 + WK
2.8 V6 4motion	140	09/99→11/00	←	3B-Y-000001→; +PR 1LB,1ZC		13.0470-7110.2 LD7110	ATE 20676 19,8 + WK Ceramic
2.8 V6 Syncro/4motion	142	10/96→11/00	→	→ 09/00; +PR 1KD,1KE,1KF,1KW		13.0460-2820.2 602820	TRW 20961 17,2 - WK
						13.0470-2820.2 LD2820	TRW 20961 17,2 - WK Ceramic
1.8 Syncro/4motion	92	10/96→11/00	←	→ 3B-X-600000; +PR 1LZ,1ZJ		13.0460-2822.2 602822	TRW 21945 19,6 - WK
1.9 TDI	66	10/96→11/00	←	3B-Y-000001→; → 09/00; +PR 1LZ,1ZJ		13.0460-2837.2 602837	TRW 21945 19,6 + WK
						13.0470-2837.2 LD2837	TRW 21945 19,6 + WK Ceramic
			←	→ 3B-X-600000; +PR 1LB,1ZC		13.0460-7077.2 607077	ATE 20676 19,8 - WE / - WK
			←	3B-Y-000001→; +PR 1LE, 1LT		13.0460-7110.2 607110	ATE 20676 19,8 + WK
						13.0470-7110.2 LD7110	ATE 20676 19,8 + WK Ceramic
			←	3B-Y-000001→; +PR 1LB,1ZC		13.0460-7110.2 607110	ATE 20676 19,8 + WK
						13.0470-7110.2 LD7110	ATE 20676 19,8 + WK Ceramic
			→	→ 09/00; +PR 1KD,1KE,1KF,1KW		13.0460-2820.2 602820	TRW 20961 17,2 - WK
						13.0470-2820.2 LD2820	TRW 20961 17,2 - WK Ceramic
1.9 TDI	74	02/00→11/00	←	10/00→; +PR 1LE, 1LT		13.0460-7110.2 607110	ATE 20676 19,8 + WK
2.0	88	04/00→11/00	←	10/00→; +PR 1LE, 1LT		13.0470-7110.2 LD7110	ATE 20676 19,8 + WK Ceramic
2.0 4motion	88	04/00→11/00	←	10/00→; +PR 1LB,1ZC		13.0460-7110.2 607110	ATE 20676 19,8 + WK
						13.0470-7110.2 LD7110	ATE 20676 19,8 + WK Ceramic
			→	10/00→; +PR 1KD,1KE,1KF,1KW		13.0460-2820.2 602820	TRW 20961 17,2 - WK
						13.0470-2820.2 LD2820	TRW 20961 17,2 - WK Ceramic
2.5 TDI	110	07/98→11/00	←	08/98→; → 3B-X-600000; +PR 1LB,1ZC		13.0460-7077.2 607077	ATE 20676 19,8 - WE / - WK
			←	3B-Y-000001→; +PR 1LE, 1LT		13.0460-7110.2 607110	ATE 20676 19,8 + WK
						13.0470-7110.2 LD7110	ATE 20676 19,8 + WK Ceramic
			←	3B-Y-000001→; +PR 1LB,1ZC		13.0460-7110.2 607110	ATE 20676 19,8 + WK
						13.0470-7110.2 LD7110	ATE 20676 19,8 + WK Ceramic
			→	08/98→; +PR 1KD,1KE,1KF,1KW		13.0460-2820.2 602820	TRW 20961 17,2 - WK
						13.0470-2820.2 LD2820	TRW 20961 17,2 - WK Ceramic
2.8 V6	132	05/97→09/99	←	→ 3B-X-600000		13.0460-7077.2 607077	ATE 20676 19,8 - WE / - WK
			←	3B-Y-000001→		13.0460-7110.2 607110	ATE 20676 19,8 + WK
						13.0470-7110.2 LD7110	ATE 20676 19,8 + WK Ceramic
			→			13.0460-2820.2 602820	TRW 20961 17,2 - WK
						13.0470-2820.2 LD2820	TRW 20961 17,2 - WK Ceramic
Zubehörsatz, Scheibenbremsbelag							
1.6	74	10/96→11/00	→	+PR 1KD,1KE,1KF,1KW		13.0460-0072.2 610072	TRW
1.8	112	01/00→12/01					
1.8 T	110	10/96→11/00					
↓							

	kw			 	! #			
VW - PASSAT (3B2) 08/96→12/01								
Zubehörsatz, Scheibenbremsbelag								
1.9 TDI	81	10/96→11/00	➔	+PR 1KD,1KE,1KF,1KW		13.0460-0072.2 610072	TRW	
1.9 TDI	85	08/98→11/00						
1.9 TDI 4motion	85	08/99→11/00						
1.9 TDI Syncro/4motion	81	10/96→11/00						
2.3 VR5	110	10/96→11/00						
2.3 VR5 Syncro/4motion	110	10/97→11/00						
2.5 TDI Syncro/4motion	110	12/98→11/00						
2.8 Syncro	132	05/97→09/99						
2.8 V6	140	09/99→11/00						
2.8 V6	142	08/96→11/00						
2.8 V6 4motion	140	09/99→11/00						
2.8 V6 Syncro/4motion	142	10/96→11/00						
1.8	85	01/97→11/00	➔	→ 09/00		13.0460-0072.2 610072	TRW	
1.8	92	10/96→11/00	➔	→ 09/00; +PR 1KD,1KE,1KF,1KW		13.0460-0072.2 610072	TRW	
1.8 Syncro/4motion	92	10/96→11/00						
1.9 TDI	66	10/96→11/00						
1.9 TDI	74	02/00→11/00	➔	10/00→; +PR 1KD,1KE,1KF,1KW		13.0460-0072.2 610072	TRW	
2.0	88	04/00→11/00						
2.0 4motion	88	04/00→11/00						
2.5 TDI	110	07/98→11/00	➔	08/98→; +PR 1KD,1KE,1KF,1KW		13.0460-0072.2 610072	TRW	
2.8 V6	132	05/97→09/99	➔			13.0460-0072.2 610072	TRW	
 Bremsscheibe								
1.6	74	10/96→11/00	➔	→ 09/00; +PR 1LZ,1ZJ		24.0122-0152.1 422152 24.0322-0152.1 522152	Ø 280 22 20 V + S Ø 280 22 20 V PD	
			➔	→ 3B-X-124107; +PR 1LB,1ZC		24.0125-0115.1 425115 24.0325-0115.1 525115	Ø 282,5 25 23 V Ø 282,5 25 23 V PD	
			➔	3B-X-124108→; +PR 1LB,1LE,1ZC		24.0125-0171.1 425171 24.0325-0171.1 525171	Ø 288 25 23 V Ø 288 25 23 V PD	
			➔	+PR 1KD,1KE,1KF,1KW		24.0110-0201.1 410201 24.0310-0201.1 510201	Ø 245 10 8 Ø 245 10 8 PD	
1.8	85	01/97→11/00	➔	→ 09/00; fur Canada/GUS		24.0122-0152.1 422152 24.0322-0152.1 522152	Ø 280 22 20 V + S Ø 280 22 20 V PD	
			➔	→ 09/00; nicht China/GUS		24.0110-0201.1 410201 24.0310-0201.1 510201	Ø 245 10 8 Ø 245 10 8 PD	
1.8 1.9 TDI	92 66	10/96→11/00 10/96→11/00	➔	→ 09/00; +PR 1LZ,1ZJ		24.0122-0152.1 422152 24.0322-0152.1 522152	Ø 280 22 20 V + S Ø 280 22 20 V PD	
			➔	→ 3B-X-124107; +PR 1LB,1ZC		24.0125-0115.1 425115 24.0325-0115.1 525115	Ø 282,5 25 23 V Ø 282,5 25 23 V PD	
			➔	3B-X-124108→; +PR 1LB,1LE,1ZC		24.0125-0171.1 425171 24.0325-0171.1 525171	Ø 288 25 23 V Ø 288 25 23 V PD	
			➔	→ 09/00; +PR 1KD,1KE,1KF,1KW		24.0110-0201.1 410201 24.0310-0201.1 510201	Ø 245 10 8 Ø 245 10 8 PD	
1.8 1.8 T 1.9 TDI 1.9 TDI	112 110 81 85	01/00→12/01 10/96→11/00 10/96→11/00 08/98→11/00	➔	→ 3B-X-124107; +PR 1LB,1ZC		24.0125-0115.1 425115 24.0325-0115.1 525115	Ø 282,5 25 23 V Ø 282,5 25 23 V PD	
			➔	3B-X-124108→; +PR 1LB,1LE,1ZC		24.0125-0171.1 425171 24.0325-0171.1 525171	Ø 288 25 23 V Ø 288 25 23 V PD	
			➔	+PR 1KD,1KE,1KF,1KW		24.0110-0201.1 410201 24.0310-0201.1 510201	Ø 245 10 8 Ø 245 10 8 PD	
1.8 Syncro/4motion	92	10/96→11/00	➔	→ 09/00; +PR 1LZ,1ZJ		24.0122-0152.1 422152 24.0322-0152.1 522152	Ø 280 22 20 V + S Ø 280 22 20 V PD	
			➔	→ 3B-X-124107; +PR 1LB,1ZC		24.0125-0115.1 425115 24.0325-0115.1 525115	Ø 282,5 25 23 V Ø 282,5 25 23 V PD	
			➔	3B-X-124108→; +PR 1LB,1LE,1ZC		24.0125-0171.1 425171 24.0325-0171.1 525171	Ø 288 25 23 V Ø 288 25 23 V PD	
			➔	+PR 1KD;1KF		24.0110-0224.1 410224 24.0310-0224.1 510224	Ø 245 10 8 Ø 245 10 8 PD	
			➔	+PR 1KE		24.0122-0221.1 422221	Ø 256 22 20 V	
			➔	+PR 1KW		24.0122-0222.1 422222	Ø 269 22 20 V	
1.9 TDI 2.0	74 88	02/00→11/00 04/00→11/00	➔	10/00→; +PR 1LB,1LE,1ZC		24.0125-0171.1 425171 24.0325-0171.1 525171	Ø 288 25 23 V Ø 288 25 23 V PD	
			➔	10/00→; +PR 1KD,1KE,1KF,1KW		24.0110-0201.1 410201 24.0310-0201.1 510201	Ø 245 10 8 Ø 245 10 8 PD	
1.9 TDI 4motion 1.9 TDI Syncro/4motion	85 81	08/99→11/00 10/96→11/00	➔	→ 3B-X-124107; +PR 1LB,1ZC		24.0125-0115.1 425115 24.0325-0115.1 525115	Ø 282,5 25 23 V Ø 282,5 25 23 V PD	
↓								











	kw			 	! #		
VW - PASSAT (3B2) 08/96→12/01							
Bremsscheibe							
1.9 TDI 4motion 1.9 TDI Syncro/4motion	85 81	08/99→11/00 10/96→11/00	←	3B-X-124108→; +PR 1LB,1LE,1ZC	24.0125-0171.1 425171	Ø 288 25 23 V	
			→	+PR 1KD;1KF	24.0325-0171.1 525171	Ø 288 25 23 V PD	
			→	+PR 1KE	24.0110-0224.1 410224	Ø 245 10 8	
			→	+PR 1KW	24.0310-0224.1 510224	Ø 245 10 8 PD	
			→	+PR 1KE	24.0122-0221.1 422221	Ø 256 22 20 V	
2.0 4motion	88	04/00→11/00	←	10/00→; +PR 1LB,1LE,1ZC	24.0125-0171.1 425171	Ø 288 25 23 V	
			→	+PR 1KD;1KF	24.0325-0171.1 525171	Ø 288 25 23 V PD	
			→	10/00→; +PR 1KD;1KF	24.0110-0224.1 410224	Ø 245 10 8	
			→	+PR 1KE	24.0310-0224.1 510224	Ø 245 10 8 PD	
			→	+PR 1KW	24.0122-0221.1 422221	Ø 256 22 20 V	
2.3 VR5	110	10/96→11/00	←	→ 3B-X-124107; +PR 1LB,1ZC	24.0125-0115.1 425115	Ø 282,5 25 23 V	
			←	3B-X-124108→; → 09/00; +PR 1LB,1LE,1ZC	24.0325-0115.1 525115	Ø 282,5 25 23 V PD	
			←	10/00→; +PR 1LT	24.0125-0171.1 425171	Ø 288 25 23 V	
			→	+PR 1KD,1KE,1KF,1KW	24.0325-0171.1 525171	Ø 288 25 23 V PD	
			→	+PR 1KE	24.0125-0172.1 425172	Ø 312 25 23 V	
2.3 VR5 Syncro/4motion	110	10/97→11/00	←	→ 3B-X-124107; +PR 1LB,1ZC	24.0110-0201.1 410201	Ø 245 10 8	
			←	3B-X-124108→; → 09/00; +PR 1LB,1LE,1ZC	24.0310-0201.1 510201	Ø 245 10 8 PD	
			←	10/00→; +PR 1LT	24.0125-0115.1 425115	Ø 282,5 25 23 V	
			→	+PR 1KD;1KF	24.0325-0115.1 525115	Ø 282,5 25 23 V PD	
			→	+PR 1KE	24.0125-0171.1 425171	Ø 288 25 23 V	
2.5 TDI	110	07/98→11/00	←	08/98→ 09/00; +PR 1LB,1LE,1ZC	24.0325-0171.1 525171	Ø 288 25 23 V PD	
			←	10/00→; +PR 1LT	24.0125-0172.1 425172	Ø 312 25 23 V	
			→	08/98→; +PR 1KD,1KE,1KF,1KW	24.0325-0172.1 525172	Ø 312 25 23 V PD	
			→	+PR 1KE	24.0110-0201.1 410201	Ø 245 10 8	
			→	+PR 1KW	24.0310-0201.1 510201	Ø 245 10 8 PD	
2.5 TDI Syncro/4motion	110	12/98→11/00	←	→ 09/00; +PR 1LB,1LE,1ZC	24.0125-0171.1 425171	Ø 288 25 23 V	
			←	10/00→; +PR 1LT	24.0325-0171.1 525171	Ø 288 25 23 V PD	
			→	+PR 1KD;1KF	24.0125-0172.1 425172	Ø 312 25 23 V	
			→	+PR 1KE	24.0325-0172.1 525172	Ø 312 25 23 V PD	
			→	+PR 1KW	24.0110-0224.1 410224	Ø 245 10 8	
2.8 Syncro	132	05/97→09/99	←	→ 3B-X-124107; +PR 1LB,1ZC	24.0310-0224.1 510224	Ø 245 10 8 PD	
			←	3B-X-124108→; +PR 1LB,1LE,1ZC	24.0125-0115.1 425115	Ø 282,5 25 23 V	
			→	+PR 1KD;1KF	24.0325-0115.1 525115	Ø 282,5 25 23 V PD	
			→	+PR 1KE	24.0110-0224.1 410224	Ø 245 10 8	
			→	+PR 1KW	24.0310-0224.1 510224	Ø 245 10 8 PD	
2.8 V6	132	05/97→09/99	←	→ 3B-X-124107; fur Canada/GUS	24.0122-0221.1 422221	Ø 256 22 20 V	
			←	3B-X-124108→; fur Canada/GUS	24.0122-0222.1 422222	Ø 269 22 20 V	
			→	nicht China/GUS	24.0125-0115.1 425115	Ø 282,5 25 23 V	
			→	+PR 1KE	24.0325-0115.1 525115	Ø 282,5 25 23 V PD	
			→	+PR 1KW	24.0125-0171.1 425171	Ø 288 25 23 V	
2.8 V6 2.8 V6	140 142	09/99→11/00 08/96→11/00	←	→ 3B-X-124107; +PR 1LB,1ZC	24.0110-0201.1 410201	Ø 245 10 8	
			←	3B-X-124108→; → 09/00; +PR 1LB,1LE,1ZC	24.0310-0201.1 510201	Ø 245 10 8 PD	
			←	10/00→; +PR 1LT	24.0125-0115.1 425115	Ø 282,5 25 23 V	
↓							









	kW			 	! #		
VW - PASSAT (3B2) 08/96→12/01							
Bremsscheibe							
2.8 V6	140	09/99→11/00	➔	+PR 1KD,1KE,1KF,1KW		24.0110-0201.1 410201	Ø 245 10 8
2.8 V6	142	08/96→11/00				24.0310-0201.1 510201	Ø 245 10 8 PD
2.8 V6 4motion	140	09/99→11/00	➔	→ 3B-X-124107; +PR 1LB,1ZC		24.0125-0115.1 425115	Ø 282,5 25 23 V
2.8 V6 Syncro/4motion	142	10/96→11/00				24.0325-0115.1 525115	Ø 282,5 25 23 V PD
			➔	3B-X-124108→; → 09/00; +PR 1LB,1LE,1ZC		24.0125-0171.1 425171	Ø 288 25 23 V
			➔	10/00→; +PR 1LT		24.0125-0172.1 425172	Ø 312 25 23 V
			➔	+PR 1KD;1KF		24.0110-0224.1 410224	Ø 245 10 8
						24.0310-0224.1 510224	Ø 245 10 8 PD
			➔	+PR 1KE		24.0122-0221.1 422221	Ø 256 22 20 V
			➔	+PR 1KW		24.0122-0222.1 422222	Ø 269 22 20 V
VW - PASSAT (3B3) 11/00→05/05							
Bremsbelagsatz, Scheibenbremse							
1.6	75	11/00→05/05	➔	→ 3B-X-600000; +PR 1LZ,1ZJ		13.0460-2822.2 602822	TRW 21945 19,6 - WK
			➔	→ 3B-X-600000; +PR 1LB,1ZC		13.0460-7077.2 607077	ATE 20676 19,8 - WE / - WK
			➔	3B-Y-000001→; +PR 1LB,1ZC		13.0460-7110.2 607110	ATE 20676 19,8 + WK
						13.0470-7110.2 LD7110	ATE 20676 19,8 + WK Ceramic
			➔	3B-Y-000001→; +PR 1LE, 1LT		13.0460-7110.2 607110	ATE 20676 19,8 + WK
						13.0470-7110.2 LD7110	ATE 20676 19,8 + WK Ceramic
			➔	+PR 1KD,1KE,1KF,1KW		13.0460-2820.2 602820	TRW 20961 17,2 - WK
						13.0470-2820.2 LD2820	TRW 20961 17,2 - WK Ceramic
1.8 T	125	02/01→05/05	➔	→ 3B-X-600000; +PR 1LB,1ZC		13.0460-7077.2 607077	ATE 20676 19,8 - WE / - WK
1.8 T 20V	110	11/00→05/05					
2.3 V5	125	11/00→05/05	➔	3B-Y-000001→; +PR 1LB,1ZC		13.0460-7110.2 607110	ATE 20676 19,8 + WK
2.3 V5 4motion	125	11/00→05/05				13.0470-7110.2 LD7110	ATE 20676 19,8 + WK Ceramic
2.5 TDI	110	11/00→05/05					
2.5 TDI	120	05/03→05/05	➔	3B-Y-000001→; +PR 1LE, 1LT		13.0460-7110.2 607110	ATE 20676 19,8 + WK
2.5 TDI 4motion	110	11/00→05/05				13.0470-7110.2 LD7110	ATE 20676 19,8 + WK Ceramic
2.5 TDI 4motion	132	01/03→05/05	➔	+PR 1KD,1KE,1KF,1KW		13.0460-2820.2 602820	TRW 20961 17,2 - WK
2.8	142	05/02→05/03				13.0470-2820.2 LD2820	TRW 20961 17,2 - WK Ceramic
2.8 4motion	142	11/00→05/05					
1.8 T 4motion	125	03/01→05/05	➔	→ 3B-X-600000; +PR 1LZ,1ZJ		13.0460-2822.2 602822	TRW 21945 19,6 - WK
			➔	→ 3B-X-600000; +PR 1LB,1ZC		13.0460-7077.2 607077	ATE 20676 19,8 - WE / - WK
			➔	3B-Y-000001→; +PR 1LE, 1LT		13.0460-7110.2 607110	ATE 20676 19,8 + WK
						13.0470-7110.2 LD7110	ATE 20676 19,8 + WK Ceramic
			➔	3B-Y-000001→; +PR 1LB,1ZC		13.0460-7110.2 607110	ATE 20676 19,8 + WK
						13.0470-7110.2 LD7110	ATE 20676 19,8 + WK Ceramic
1.9 TDI	74	11/00→05/05	➔	+PR 1LE, 1LT		13.0460-7110.2 607110	ATE 20676 19,8 + WK
1.9 TDI	96	11/00→05/05				13.0470-7110.2 LD7110	ATE 20676 19,8 + WK Ceramic
1.9 TDI 4motion	96	11/00→05/05					
2.0	85	11/00→05/05	➔	+PR 1LB,1ZC		13.0460-7110.2 607110	ATE 20676 19,8 + WK
2.0 4motion	85	11/00→05/05				13.0470-7110.2 LD7110	ATE 20676 19,8 + WK Ceramic
2.0 TDI	100	12/03→05/05	➔	+PR 1KD,1KE,1KF,1KW		13.0460-2820.2 602820	TRW 20961 17,2 - WK
						13.0470-2820.2 LD2820	TRW 20961 17,2 - WK Ceramic
2.0	96	11/01→05/05	➔	05/02→; +PR 1LE, 1LT		13.0460-7110.2 607110	ATE 20676 19,8 + WK
						13.0470-7110.2 LD7110	ATE 20676 19,8 + WK Ceramic
			➔	05/02→; +PR 1LB,1ZC		13.0460-7110.2 607110	ATE 20676 19,8 + WK
						13.0470-7110.2 LD7110	ATE 20676 19,8 + WK Ceramic
			➔	05/02→; +PR 1KD,1KE,1KF,1KW		13.0460-2820.2 602820	TRW 20961 17,2 - WK
						13.0470-2820.2 LD2820	TRW 20961 17,2 - WK Ceramic
4.0 W8 4motion	202	09/01→09/04	➔	+PR 1ZF,1ZG; für gepanzerte Fahrzeuge		13.0460-2875.2 602875	TRW 23119 17,5 + WK
			➔	+PR 1ZF,1ZG; nicht für gepanzerte Fahrzeuge		13.0460-7183.2 607183	ATE 21484 20,5 + WE / - WK
			➔	+PR 1KD,1KE,1KF,1KW		13.0460-2820.2 602820	TRW 20961 17,2 - WK
						13.0470-2820.2 LD2820	TRW 20961 17,2 - WK Ceramic
Warnkontakt, Bremsbelagsverschleiß							
4.0 W8 4motion	202	09/01→09/04	➔	+PR 1ZF,1ZG; nicht für gepanzerte Fahrzeuge	1	24.8190-0107.2 620107	L= 235
Zubehörsatz, Scheibenbremsbelag							
1.6	75	11/00→05/05	➔	+PR 1KD,1KE,1KF,1KW		13.0460-0072.2 610072	TRW
1.8 T	125	02/01→05/05					
1.8 T 20V	110	11/00→05/05					
1.9 TDI	74	11/00→05/05					
1.9 TDI	96	11/00→05/05					























	kw			 	! #		
VW - PASSAT (3B3) 11/00→05/05							
 Bremsscheibe							
2.5 TDI	110	11/00→05/05	←	+PR 1LT		24.0325-0172.1 525172	Ø 312 25 23 V PD
2.5 TDI	120	05/03→05/05	→	+PR 1KD,1KE,1KF,1KW		24.0110-0201.1 410201	Ø 245 10 8
						24.0310-0201.1 510201	Ø 245 10 8 PD
2.5 TDI 4motion	110	11/00→05/05	←	+PR 1LT		24.0125-0172.1 425172	Ø 312 25 23 V
2.5 TDI 4motion	132	01/03→05/05	→	+PR 1KD;1KF		24.0325-0172.1 525172	Ø 312 25 23 V PD
			→	+PR 1KE		24.0110-0224.1 410224	Ø 245 10 8
			→	+PR 1KW		24.0310-0224.1 510224	Ø 245 10 8 PD
			→	+PR 1KE		24.0122-0221.1 422221	Ø 256 22 20 V
			→	+PR 1KW		24.0122-0222.1 422222	Ø 269 22 20 V
4.0 W8 4motion	202	09/01→09/04	→	+PR 1KD;1KF		24.0110-0224.1 410224	Ø 245 10 8
			→	+PR 1KE		24.0310-0224.1 510224	Ø 245 10 8 PD
			→	+PR 1KW		24.0122-0221.1 422221	Ø 256 22 20 V
			→	+PR 1KW		24.0122-0222.1 422222	Ø 269 22 20 V
VW - PASSAT (3C2) 03/05→11/10							
 Bremsbelagsatz, Scheibenbremse							
1.4 TSI	90	05/07→07/10	←	10/07→; +PR 1LJ,1LH,1ZG,1ZM		13.0460-7184.2 607184	ATE 23587 20,6 + WK
1.8 TSI	118	05/07→07/10	←	10/07→; +PR 1LK,1LM		13.0470-7184.2 LD7184	ATE 23587 20,6 + WK Ceramic
			←	10/07→; +PR 1LK,1LM		13.0460-7200.2 607200	ATE 23801 20,3 + WK
						13.0470-7200.2 LD7200	ATE 23801 20,3 + WK Ceramic
			→	10/07→; +PR 1KU,1KW		13.0460-2749.2 602749	TRW 24483 16,9 - WE / - WK + Zub
						13.0460-2880.2 602880	TRW 23914 17,1 + WE / - WK + Zub
						13.0470-2749.2 LD2749	TRW 24483 16,9 - WE / - WK + Zub Ceramic
						13.0470-2880.2 LD2880	TRW 23914 17,1 + WE / - WK + Zub Ceramic
			→	10/07→; +PR 2EA,2EL		13.0460-2887.2 602887	TRW 23914 17,1 + WE / - WK + Zub
						13.0470-2621.2 LD2621	TRW - WE / - WK + Zub Ceramic
						13.0470-2887.2 LD2887	TRW 23914 17,1 + WE / - WK + Zub Ceramic
1.4 TSI EcoFuel	110	01/09→07/10	←	+PR 1LJ,1LH,1ZG,1ZM		13.0460-7184.2 607184	ATE 23587 20,6 + WK
1.6	75	05/05→07/10				13.0470-7184.2 LD7184	ATE 23587 20,6 + WK Ceramic
1.6 FSI	85	03/05→06/08	←	+PR 1LK,1LM		13.0460-7200.2 607200	ATE 23801 20,3 + WK
1.6 TDI	77	08/09→07/10				13.0470-7200.2 LD7200	ATE 23801 20,3 + WK Ceramic
1.8 TSI	112	11/09→07/10	→	+PR 1KU,1KW		13.0460-2749.2 602749	TRW 24483 16,9 - WE / - WK + Zub
1.9 TDI	77	03/05→11/08				13.0460-2880.2 602880	TRW 23914 17,1 + WE / - WK + Zub
2.0 FSI	110	03/05→07/10				13.0470-2749.2 LD2749	TRW 24483 16,9 - WE / - WK + Zub Ceramic
2.0 FSI	125	08/07→07/10				13.0470-2880.2 LD2880	TRW 23914 17,1 + WE / - WK + Zub
2.0 FSI	147	07/05→07/10				13.0470-2749.2 LD2749	TRW 24483 16,9 - WE / - WK + Zub Ceramic
2.0 FSI 4motion	110	09/05→07/10				13.0470-2880.2 LD2880	TRW 23914 17,1 + WE / - WK + Zub Ceramic
2.0 TDI	81	11/08→07/10	→	+PR 2EA,2EL		13.0460-2887.2 602887	TRW 23914 17,1 + WE / - WK + Zub
2.0 TDI	88	11/05→05/07				13.0470-2621.2 LD2621	TRW - WE / - WK + Zub Ceramic
2.0 TDI	90	08/05→07/06				13.0470-2880.2 LD2880	TRW 23914 17,1 + WE / - WK + Zub Ceramic
2.0 TDI	103	03/05→05/09				13.0470-2887.2 LD2887	TRW 23914 17,1 + WE / - WK + Zub Ceramic
2.0 TDI	120	08/05→05/09				13.0470-2749.2 LD2749	TRW 24483 16,9 - WE / - WK + Zub
2.0 TDI	125	08/05→07/10	→	+PR 2EA,2EL		13.0460-2887.2 602887	TRW 23914 17,1 + WE / - WK + Zub
2.0 TDI 16V	103	03/05→07/10				13.0470-2621.2 LD2621	TRW - WE / - WK + Zub Ceramic
2.0 TDI 4motion	103	03/05→05/09				13.0470-2887.2 LD2887	TRW 23914 17,1 + WE / - WK + Zub Ceramic
2.0 TDI 4motion	125	05/09→07/10				13.0470-2887.2 LD2887	TRW 23914 17,1 + WE / - WK + Zub Ceramic
3.2 FSI 4motion	184	11/05→07/10				13.0470-2887.2 LD2887	TRW 23914 17,1 + WE / - WK + Zub Ceramic
3.6 R36 4motion	220	04/07→07/10				13.0470-2887.2 LD2887	TRW 23914 17,1 + WE / - WK + Zub Ceramic
2.0 BlueTDI	105	01/09→11/10	←	+PR 1LJ,1LH,1ZG,1ZM; → 07/10		13.0460-7184.2 607184	ATE 23587 20,6 + WK
2.0 TDI	100	03/05→11/10	←	+PR 1LK,1LM; → 07/10		13.0470-7184.2 LD7184	ATE 23587 20,6 + WK Ceramic
2.0 TDI 16V 4motion	103	03/05→08/10	←	+PR 1LK,1LM; → 07/10		13.0460-7200.2 607200	ATE 23801 20,3 + WK
						13.0470-7200.2 LD7200	ATE 23801 20,3 + WK Ceramic
			→	→ 07/10; +PR 1KU,1KW		13.0460-2749.2 602749	TRW 24483 16,9 - WE / - WK + Zub
						13.0460-2880.2 602880	TRW 23914 17,1 + WE / - WK + Zub
						13.0470-2749.2 LD2749	TRW 24483 16,9 - WE / - WK + Zub Ceramic
						13.0470-2880.2 LD2880	TRW 23914 17,1 + WE / - WK + Zub Ceramic
			→	→ 07/10; +PR 2EA,2EL		13.0460-2887.2 602887	TRW 23914 17,1 + WE / - WK + Zub
						13.0470-2621.2 LD2621	TRW - WE / - WK + Zub Ceramic



	kw			 	! #		
VW - PASSAT (3C2) 03/05→11/10							
 Bremsbelagsatz, Scheibenbremse							
2.0 BlueTDI 2.0 TDI 2.0 TDI 16V 4motion	105 100 103	01/09→11/10 03/05→11/10 03/05→08/10	➡	→ 07/10; +PR 2EA,2EL		13.0470-2887.2 LD2887	TRW 23914 17,1 + WE / - WK + Zub Ceramic
Zubehörsatz, Scheibenbremsbelag							
1.4 TSI 1.8 TSI	90 118	05/07→07/10 05/07→07/10	➡	10/07→; +PR 2EA,2EL		13.0460-0035.2 610035	
			➡	10/07→; +PR 1KU,1KW		13.0460-0259.2 610259	
1.4 TSI EcoFuel 1.6 1.6 FSI 1.6 TDI 1.8 TSI 1.9 TDI 2.0 FSI 2.0 FSI 2.0 FSI 2.0 FSI 4motion 2.0 TDI 2.0 TDI 2.0 TDI 2.0 TDI 2.0 TDI 2.0 TDI 16V 2.0 TDI 4motion 2.0 TDI 4motion 3.2 FSI 4motion 3.6 R36 4motion	110 75 85 77 112 77 110 125 147 110 81 88 90 103 120 125 103 103 125 184 220	01/09→07/10 05/05→07/10 03/05→06/08 08/09→07/10 11/09→07/10 03/05→11/08 03/05→07/10 08/07→07/10 07/05→07/10 09/05→07/10 11/08→07/10 11/05→05/07 08/05→07/06 03/05→05/09 08/05→05/09 08/05→07/10 03/05→07/10 03/05→05/09 05/09→07/10 11/05→07/10 04/07→07/10	➡	+PR 2EA,2EL +PR 1KU,1KW		13.0460-0035.2 610035 13.0460-0259.2 610259	
2.0 BlueTDI 2.0 TDI 2.0 TDI 16V 4motion	105 100 103	01/09→11/10 03/05→11/10 03/05→08/10	➡	→ 07/10; +PR 2EA,2EL → 07/10; +PR 1KU,1KW		13.0460-0035.2 610035 13.0460-0259.2 610259	
 Bremsscheibe							
1.4 TSI 1.8 TSI	90 118	05/07→07/10 05/07→07/10	←	10/07→; +PR 1LJ,1LH,1ZG,1ZM		24.0125-0158.1 425158 24.0325-0158.1 525158	Ø 312 25 22 V + S Ø 312 25 22 V + S PD
			←	10/07→; +PR 1LK,1LM		24.0130-0115.1 430115 24.0330-0115.1 530115	Ø 345 30 27 V Ø 345 30 27 V PD
			➡	10/07→; +PR 1KU,1KW		24.0112-0169.1 412169 24.0312-0169.1 512169	Ø 282 12 10 + S Ø 282 12 10 + S PD
			➡	10/07→; +PR 2EA,2EL; + eFSB		24.0122-0219.1 422219	Ø 310 22 20 V
1.4 TSI EcoFuel 1.6 1.6 FSI 1.6 TDI 1.8 TSI 1.9 TDI 2.0 FSI 2.0 FSI 2.0 FSI 2.0 FSI 4motion 2.0 TDI 2.0 TDI 2.0 TDI 2.0 TDI 2.0 TDI 2.0 TDI 16V 2.0 TDI 4motion 2.0 TDI 4motion 3.2 FSI 4motion 3.6 R36 4motion	110 75 85 77 112 77 110 125 147 110 81 88 90 103 120 125 103 103 125 184 220	01/09→07/10 05/05→07/10 03/05→06/08 08/09→07/10 11/09→07/10 03/05→11/08 03/05→07/10 08/07→07/10 07/05→07/10 09/05→07/10 11/08→07/10 11/05→05/07 08/05→07/06 03/05→05/09 08/05→05/09 08/05→07/10 03/05→07/10 03/05→05/09 05/09→07/10 11/05→07/10 04/07→07/10	←	+PR 1LJ,1LH,1ZG,1ZM +PR 1LK,1LM +PR 1KU,1KW +PR 2EA,2EL; + eFSB		24.0125-0158.1 425158 24.0325-0158.1 525158 24.0130-0115.1 430115 24.0330-0115.1 530115 24.0112-0169.1 412169 24.0312-0169.1 512169 24.0122-0219.1 422219	Ø 312 25 22 V + S Ø 312 25 22 V + S PD Ø 345 30 27 V Ø 345 30 27 V PD Ø 282 12 10 + S Ø 282 12 10 + S PD Ø 310 22 20 V
2.0 BlueTDI 2.0 TDI 2.0 TDI 16V 4motion	105 100 103	01/09→11/10 03/05→11/10 03/05→08/10	←	→ 07/10; +PR 1LJ,1LH,1ZG,1ZM → 07/10; +PR 1LK,1LM → 07/10; +PR 1KU,1KW → 07/10; +PR 2EA,2EL; + eFSB		24.0125-0158.1 425158 24.0325-0158.1 525158 24.0130-0115.1 430115 24.0330-0115.1 530115 24.0112-0169.1 412169 24.0312-0169.1 512169 24.0122-0219.1 422219	Ø 312 25 22 V + S Ø 312 25 22 V + S PD Ø 345 30 27 V Ø 345 30 27 V PD Ø 282 12 10 + S Ø 282 12 10 + S PD Ø 310 22 20 V
VW - PASSAT (3G2) 08/14→							
 Bremsbelagsatz, Scheibenbremse							
1.4 GTE Hybrid 1.4 TSI 1.4 TSI	115 92 110	06/15→ 11/14→ 11/14→	←	+PR 1ZA,1ZC,1ZD,1ZG / 1ZK,1ZL		13.0460-2785.2 602785 13.0470-2785.2 LD2785	TRW 25683 20,4 + WE / + WK TRW 25683 20,4 + WE / + WK Ceramic
↓							

	kw			 	! #		
VW - PASSAT (3G2) 08/14→							
 Bremsbelagsatz, Scheibenbremse							
1.4 TSI 4motion	110	02/15→	➡	+PR 1KU,1KZ,2EA; + eFSB		13.0460-7294.2 607294	ATE 25009 16,4 - WE / - WK
1.8 TSI	132	02/15→				13.0470-7294.2 LD7294	ATE 25009 16,4 - WE / - WK
2.0 TDI	110	11/14→					Ceramic
2.0 TDI	135	07/15→					
2.0 TDI	140	11/14→					
2.0 TDI 4motion	110	02/15→					
2.0 TDI 4motion	140	11/14→					
2.0 TSI 4motion	206	05/15→					
1.6 TDI	88	08/14→	⬅	11/14→;		13.0460-2785.2 602785	TRW 25683 20,4 + WE / + WK
2.0 TDI 4motion	176	08/14→		+PR 1ZA,1ZC,1ZD,1ZG / 1ZK,1ZL		13.0470-2785.2 LD2785	TRW 25683 20,4 + WE / + WK
			➡	11/14→; +PR 1KU,1KZ,2EA; + eFSB		13.0460-7294.2 607294	ATE 25009 16,4 - WE / - WK
						13.0470-7294.2 LD7294	ATE 25009 16,4 - WE / - WK
							Ceramic
2.0 TSI	162	02/15→	⬅	05/15→;		13.0460-2785.2 602785	TRW 25683 20,4 + WE / + WK
				+PR 1ZA,1ZC,1ZD,1ZG / 1ZK,1ZL		13.0470-2785.2 LD2785	TRW 25683 20,4 + WE / + WK
			➡	05/15→; +PR 1KU,1KZ,2EA; + eFSB		13.0460-7294.2 607294	ATE 25009 16,4 - WE / - WK
						13.0470-7294.2 LD7294	ATE 25009 16,4 - WE / - WK
							Ceramic
Warnkontakt, Bremsbelagverschleiß							
1.4 GTE Hybrid	115	06/15→	⬅	+PR 1ZA,1ZC,1ZD,1ZG / 1ZK,1ZL	1	24.8190-0065.2 620065	L= 172
1.4 TSI	92	11/14→	⬅	+PR 1LA	1	24.8190-0065.2 620065	L= 172
1.4 TSI	110	11/14→					
1.4 TSI 4motion	110	02/15→					
1.8 TSI	132	02/15→					
2.0 TDI	110	11/14→					
2.0 TDI	135	07/15→					
2.0 TDI	140	11/14→					
2.0 TDI 4motion	110	02/15→					
2.0 TDI 4motion	140	11/14→					
2.0 TSI 4motion	206	05/15→					
1.6 TDI	88	08/14→	⬅	11/14→; +PR 1LA	1	24.8190-0065.2 620065	L= 172
2.0 TDI 4motion	176	08/14→	⬅	11/14→;	1	24.8190-0065.2 620065	L= 172
				+PR 1ZA,1ZC,1ZD,1ZG / 1ZK,1ZL			
2.0 TSI	162	02/15→	⬅	05/15→; +PR 1LA	1	24.8190-0065.2 620065	L= 172
			⬅	05/15→;	1	24.8190-0065.2 620065	L= 172
				+PR 1ZA,1ZC,1ZD,1ZG / 1ZK,1ZL			
Bremsscheibe							
1.4 GTE Hybrid	115	06/15→	⬅	+PR 1ZA,1ZC,1ZD,1ZG / 1ZK,1ZL		24.0125-0158.1 425158	Ø 312 25 22 V + S
1.4 TSI	92	11/14→				24.0325-0158.1 525158	Ø 312 25 22 V + S PD
1.4 TSI	110	11/14→					
1.4 TSI 4motion	110	02/15→	⬅	+PR 1LA		24.0130-0225.1 430225	Ø 340 30 27 V + S
1.8 TSI	132	02/15→					
2.0 TDI	110	11/14→	➡	+PR 1KU,2EA; + eFSB		24.0112-0210.1 412210	Ø 300 12 10 + S
2.0 TDI	135	07/15→	➡	+PR 1KZ		24.0122-0219.1 422219	Ø 310 22 20 V
2.0 TDI	140	11/14→					
2.0 TDI 4motion	110	02/15→					
2.0 TDI 4motion	140	11/14→					
2.0 TSI 4motion	206	05/15→					
1.6 TDI	88	08/14→	⬅	11/14→;		24.0125-0158.1 425158	Ø 312 25 22 V + S
2.0 TDI 4motion	176	08/14→		+PR 1ZA,1ZC,1ZD,1ZG / 1ZK,1ZL		24.0325-0158.1 525158	Ø 312 25 22 V + S PD
			⬅	11/14→; +PR 1LA		24.0130-0225.1 430225	Ø 340 30 27 V + S
			➡	11/14→; +PR 1KU,2EA; + eFSB		24.0112-0210.1 412210	Ø 300 12 10 + S
			➡	11/14→; +PR 1KZ		24.0122-0219.1 422219	Ø 310 22 20 V
2.0 TSI	162	02/15→	⬅	05/15→;		24.0125-0158.1 425158	Ø 312 25 22 V + S
				+PR 1ZA,1ZC,1ZD,1ZG / 1ZK,1ZL		24.0325-0158.1 525158	Ø 312 25 22 V + S PD
			⬅	05/15→; +PR 1LA		24.0130-0225.1 430225	Ø 340 30 27 V + S
			➡	05/15→; +PR 1KU,2EA; + eFSB		24.0112-0210.1 412210	Ø 300 12 10 + S
			➡	05/15→; +PR 1KZ		24.0122-0219.1 422219	Ø 310 22 20 V
VW - PASSAT (362) 08/10→12/14							
 Bremsbelagsatz, Scheibenbremse							
1.4 TSI	90	08/10→12/14	⬅	→ 10/14; +PR 1LA,1LB		13.0460-2764.2 602764	TRW 24738 20,0 + WK
1.4 TSI EcoFuel	110	08/10→12/14				13.0470-2764.2 LD2764	TRW 24738 20,0 + WK Ceramic
1.4 TSI MultiFuel	118	11/10→12/14					
1.6 TDI	77	08/10→12/14	⬅	→ 10/14; +PR 1ZM,1ZG		13.0460-7184.2 607184	ATE 23587 20,6 + WK
1.8 TSI	112	02/11→12/14				13.0470-7184.2 LD7184	ATE 23587 20,6 + WK Ceramic
1.8 TSI	118	08/10→12/14					
2.0 TDI	100	08/10→12/14					
↓							

	kw			 	! #		
VW - PASSAT (362) 08/10→12/14							
 Bremsbelagsatz, Scheibenbremse							
2.0 TDI	103	08/10→12/14	➔	→ 10/14; +PR 1KW		13.0460-2749.2 602749	TRW 24483 16,9 - WE / - WK + Zub
2.0 TDI	125	08/10→12/14					
2.0 TDI	130	12/12→12/14				13.0460-2880.2 602880	TRW 23914 17,1 + WE / - WK + Zub
2.0 TDI 4motion	103	08/10→12/14					
2.0 TDI 4motion	130	01/13→12/14				13.0470-2749.2 LD2749	TRW 24483 16,9 - WE / - WK + Zub Ceramic
2.0 TSI	155	11/10→12/14				13.0470-2880.2 LD2880	TRW 23914 17,1 + WE / - WK + Zub Ceramic
3.6 FSI 4motion	220	01/11→12/14					
			➔	→ 10/14; +PR 2EA		13.0460-2887.2 602887	TRW 23914 17,1 + WE / - WK + Zub
						13.0470-2621.2 LD2621	TRW - WE / - WK + Zub Ceramic
						13.0470-2887.2 LD2887	TRW 23914 17,1 + WE / - WK + Zub Ceramic
1.4 TSI	118	11/12→12/14	➔	→ 10/14; +PR 1LA,1LB		13.0460-2764.2 602764	TRW 24738 20,0 + WK
						13.0470-2764.2 LD2764	TRW 24738 20,0 + WK Ceramic
			➔	→ 10/14; +PR 1ZM,1ZG		13.0460-7184.2 607184	ATE 23587 20,6 + WK
						13.0470-7184.2 LD7184	ATE 23587 20,6 + WK Ceramic
			➔	→ 10/14; +PR 1KW		13.0460-2749.2 602749	TRW 24483 16,9 - WE / - WK + Zub
						13.0460-2880.2 602880	TRW 23914 17,1 + WE / - WK + Zub
						13.0470-2749.2 LD2749	TRW 24483 16,9 - WE / - WK + Zub Ceramic
						13.0470-2880.2 LD2880	TRW 23914 17,1 + WE / - WK + Zub Ceramic
			➔	→ 10/14		13.0460-2887.2 602887	TRW 23914 17,1 + WE / - WK + Zub
						13.0470-2621.2 LD2621	TRW - WE / - WK + Zub Ceramic
						13.0470-2887.2 LD2887	TRW 23914 17,1 + WE / - WK + Zub Ceramic
2.0 TDI 4motion	125	08/10→01/13	➔	+PR 1LA,1LB		13.0460-2764.2 602764	TRW 24738 20,0 + WK
						13.0470-2764.2 LD2764	TRW 24738 20,0 + WK Ceramic
			➔	+PR 1ZM,1ZG		13.0460-7184.2 607184	ATE 23587 20,6 + WK
						13.0470-7184.2 LD7184	ATE 23587 20,6 + WK Ceramic
			➔	+PR 1KW		13.0460-2749.2 602749	TRW 24483 16,9 - WE / - WK + Zub
						13.0460-2880.2 602880	TRW 23914 17,1 + WE / - WK + Zub
						13.0470-2749.2 LD2749	TRW 24483 16,9 - WE / - WK + Zub Ceramic
						13.0470-2880.2 LD2880	TRW 23914 17,1 + WE / - WK + Zub Ceramic
			➔	+PR 2EA		13.0460-2887.2 602887	TRW 23914 17,1 + WE / - WK + Zub
						13.0470-2621.2 LD2621	TRW - WE / - WK + Zub Ceramic
						13.0470-2887.2 LD2887	TRW 23914 17,1 + WE / - WK + Zub Ceramic
 Bremsscheibe							
1.4 TSI	90	08/10→12/14	➔	→ 10/14; +PR 1ZM,1ZG		24.0125-0158.1 425158	Ø 312 25 22 V + S
1.4 TSI	118	11/12→12/14				24.0325-0158.1 525158	Ø 312 25 22 V + S PD
1.4 TSI EcoFuel	110	08/10→12/14					
1.4 TSI MultiFuel	118	11/10→12/14	➔	→ 10/14; +PR 1LA,1LB		24.0130-0225.1 430225	Ø 340 30 27 V + S
1.6 TDI	77	08/10→12/14	➔	→ 10/14; +PR 1KW		24.0112-0169.1 412169	Ø 282 12 10 + S
1.8 TSI	112	02/11→12/14				24.0312-0169.1 512169	Ø 282 12 10 + S PD
1.8 TSI	118	08/10→12/14					
2.0 TDI	100	08/10→12/14	➔	→ 10/14; +PR 2EA; + eFSB		24.0122-0219.1 422219	Ø 310 22 20 V
2.0 TDI	103	08/10→12/14					
2.0 TDI	125	08/10→12/14					
2.0 TDI	130	12/12→12/14					
2.0 TDI 4motion	103	08/10→12/14					
2.0 TDI 4motion	130	01/13→12/14					
2.0 TSI	155	11/10→12/14					
3.6 FSI 4motion	220	01/11→12/14					
2.0 TDI 4motion	125	08/10→01/13	➔	+PR 1ZM,1ZG		24.0125-0158.1 425158	Ø 312 25 22 V + S
						24.0325-0158.1 525158	Ø 312 25 22 V + S PD
			➔	+PR 1LA,1LB		24.0130-0225.1 430225	Ø 340 30 27 V + S
			➔	+PR 1KW		24.0112-0169.1 412169	Ø 282 12 10 + S
						24.0312-0169.1 512169	Ø 282 12 10 + S PD
			➔	+PR 2EA; + eFSB		24.0122-0219.1 422219	Ø 310 22 20 V

	kw			 	! #		
VW - PASSAT ALLTRACK (3G5) 05/15→							
 Bremsbelagsatz, Scheibenbremse							
1.4 TSI 4motion	110	05/15→	←	+PR 1ZA,1ZC,1ZD,1ZG / 1ZK,1ZL		13.0460-2785.2 602785	TRW 25683 20,4 + WE / + WK
2.0 TDI 4motion	110	05/15→				13.0470-2785.2 LD2785	TRW 25683 20,4 + WE / + WK Ceramic
2.0 TDI 4motion	135	07/15→					
2.0 TDI 4motion	140	05/15→					
2.0 TDI 4motion	176	05/15→	→	+PR 1KU,1KZ,2EA; + eFSB		13.0460-7294.2 607294	ATE 25009 16,4 - WE / - WK
2.0 TSI 4motion	162	07/15→				13.0470-7294.2 LD7294	ATE 25009 16,4 - WE / - WK Ceramic
Warnkontakt, Bremsbelagverschleiß							
1.4 TSI 4motion	110	05/15→	←	+PR 1ZA,1ZC,1ZD,1ZG / 1ZK,1ZL	1	24.8190-0065.2 620065	L= 172
2.0 TDI 4motion	110	05/15→					
2.0 TDI 4motion	135	07/15→	←	+PR 1LA	1	24.8190-0065.2 620065	L= 172
2.0 TDI 4motion	140	05/15→					
2.0 TDI 4motion	176	05/15→					
2.0 TSI 4motion	162	07/15→					
 Bremsscheibe							
1.4 TSI 4motion	110	05/15→	←	+PR 1ZA,1ZC,1ZD,1ZG / 1ZK,1ZL		24.0125-0158.1 425158	Ø 312 25 22 V + S
2.0 TDI 4motion	110	05/15→				24.0325-0158.1 525158	Ø 312 25 22 V + S PD
2.0 TDI 4motion	135	07/15→					
2.0 TDI 4motion	140	05/15→	←	+PR 1LA		24.0130-0225.1 430225	Ø 340 30 27 V + S
2.0 TDI 4motion	176	05/15→	→	+PR 1KU,2EA; + eFSB		24.0112-0210.1 412210	Ø 300 12 10 + S
2.0 TSI 4motion	162	07/15→	→	+PR 1KZ		24.0122-0219.1 422219	Ø 310 22 20 V
VW - PASSAT ALLTRACK (365) 01/12→12/14							
 Bremsbelagsatz, Scheibenbremse							
1.8 TSI	112	01/12→12/14	←	+PR 1LA,1LB		13.0460-2764.2 602764	TRW 24738 20,0 + WK
1.8 TSI	118	01/12→12/14				13.0470-2764.2 LD2764	TRW 24738 20,0 + WK Ceramic
2.0 TDI	103	01/12→12/14					
2.0 TDI 4motion	103	01/12→12/14	←	+PR 1ZM,1ZG		13.0460-7184.2 607184	ATE 23587 20,6 + WK
2.0 TDI 4motion	125	01/12→12/14				13.0470-7184.2 LD7184	ATE 23587 20,6 + WK Ceramic
2.0 TDI 4motion	130	01/13→12/14					
2.0 TSI 4motion	155	01/12→12/14	→	+PR 1KW		13.0460-2749.2 602749	TRW 24483 16,9 - WE / - WK + Zub
						13.0460-2880.2 602880	TRW 23914 17,1 + WE / - WK + Zub
						13.0470-2749.2 LD2749	TRW 24483 16,9 - WE / - WK + Zub Ceramic
						13.0470-2880.2 LD2880	TRW 23914 17,1 + WE / - WK + Zub Ceramic
			→	+PR 2EA		13.0460-2887.2 602887	TRW 23914 17,1 + WE / - WK + Zub
						13.0470-2621.2 LD2621	TRW - WE / - WK + Zub Ceramic
						13.0470-2887.2 LD2887	TRW 23914 17,1 + WE / - WK + Zub Ceramic
 Bremsscheibe							
1.8 TSI	112	01/12→12/14	←	+PR 1ZM,1ZG		24.0125-0158.1 425158	Ø 312 25 22 V + S
1.8 TSI	118	01/12→12/14				24.0325-0158.1 525158	Ø 312 25 22 V + S PD
2.0 TDI	103	01/12→12/14					
2.0 TDI 4motion	103	01/12→12/14	←	+PR 1LA,1LB		24.0130-0225.1 430225	Ø 340 30 27 V + S
2.0 TDI 4motion	125	01/12→12/14	→	+PR 1KW		24.0112-0169.1 412169	Ø 282 12 10 + S
2.0 TDI 4motion	130	01/13→12/14				24.0312-0169.1 512169	Ø 282 12 10 + S PD
2.0 TSI 4motion	155	01/12→12/14	→	+PR 2EA; + eFSB		24.0122-0219.1 422219	Ø 310 22 20 V
VW - PASSAT CC (357) 05/08→01/12							
 Bremsbelagsatz, Scheibenbremse							
1.4 TSI MultiFuel	118	01/11→01/12	←	→ 09/11; +PR 1LA,1LB		13.0460-2764.2 602764	TRW 24738 20,0 + WK
1.8 TSI	118	06/08→01/12				13.0470-2764.2 LD2764	TRW 24738 20,0 + WK Ceramic
2.0 TDI	103	06/08→01/12					
2.0 TDI	125	06/08→01/12	←	→ 09/11; +PR 1LH,1ZM,1ZG		13.0460-7184.2 607184	ATE 23587 20,6 + WK
2.0 TDI 4motion	103	08/09→01/12				13.0470-7184.2 LD7184	ATE 23587 20,6 + WK Ceramic
2.0 TDI 4motion	125	11/09→01/12					
2.0 TSI	147	06/08→01/12	←	→ 09/11; +PR 1LK		13.0460-7200.2 607200	ATE 23801 20,3 + WK
2.0 TSI	155	11/10→01/12				13.0470-7200.2 LD7200	ATE 23801 20,3 + WK Ceramic
3.6 FSI 4motion	206	06/08→01/12	→	→ 09/11; +PR 1KU,1KW		13.0460-2749.2 602749	TRW 24483 16,9 - WE / - WK + Zub
						13.0460-2880.2 602880	TRW 23914 17,1 + WE / - WK + Zub
						13.0470-2749.2 LD2749	TRW 24483 16,9 - WE / - WK + Zub Ceramic
						13.0470-2880.2 LD2880	TRW 23914 17,1 + WE / - WK + Zub Ceramic

VW - PASSAT CC (357) 05/08→01/12

Bremsbelagsatz, Scheibenbremse

1.4 TSI MultiFuel	118	01/11→01/12	➔	→ 09/11; +PR 2EA				TRW 23914 17,1 + WE / - WK + Zub
1.8 TSI	118	06/08→01/12						
2.0 TDI	103	06/08→01/12				13.0470-2621.2	LD2621	TRW - WE / - WK + Zub Ceramic
2.0 TDI	125	06/08→01/12				13.0470-2887.2	LD2887	TRW 23914 17,1 + WE / - WK + Zub Ceramic
2.0 TDI 4motion	103	08/09→01/12						
2.0 TDI 4motion	125	11/09→01/12						
2.0 TSI	147	06/08→01/12						
2.0 TSI	155	11/10→01/12						
3.6 FSI 4motion	206	06/08→01/12						
1.8 TSI	112	11/08→05/10	➔	+PR 1LA,1LB		13.0460-2764.2	602764	TRW 24738 20,0 + WK
2.0 BlueTDI	105	05/09→11/10				13.0470-2764.2	LD2764	TRW 24738 20,0 + WK Ceramic
2.0 TDI	100	06/08→05/11						
2.0 TDI	120	05/08→05/11	➔	+PR 1LH,1ZM,1ZG		13.0460-7184.2	607184	ATE 23587 20,6 + WK
3.6 FSI 4motion	220	06/08→05/10				13.0470-7184.2	LD7184	ATE 23587 20,6 + WK Ceramic
			➔	+PR 1LK		13.0460-7200.2	607200	ATE 23801 20,3 + WK
						13.0470-7200.2	LD7200	ATE 23801 20,3 + WK Ceramic
			➔	+PR 1KU,1KW		13.0460-2749.2	602749	TRW 24483 16,9 - WE / - WK + Zub
						13.0460-2880.2	602880	TRW 23914 17,1 + WE / - WK + Zub
						13.0470-2749.2	LD2749	TRW 24483 16,9 - WE / - WK + Zub Ceramic
						13.0470-2880.2	LD2880	TRW 23914 17,1 + WE / - WK + Zub Ceramic
			➔	+PR 2EA		13.0460-2887.2	602887	TRW 23914 17,1 + WE / - WK + Zub
						13.0470-2621.2	LD2621	TRW - WE / - WK + Zub Ceramic
						13.0470-2887.2	LD2887	TRW 23914 17,1 + WE / - WK + Zub Ceramic

Zubehörsatz, Scheibenbremsbelag

1.4 TSI MultiFuel	118	01/11→01/12	➔	→ 09/11; +PR 1KU,1KW				
1.8 TSI	118	06/08→01/12						
2.0 TDI	103	06/08→01/12						
2.0 TDI	125	06/08→01/12						
2.0 TDI 4motion	103	08/09→01/12						
2.0 TDI 4motion	125	11/09→01/12						
2.0 TSI	147	06/08→01/12						
2.0 TSI	155	11/10→01/12						
3.6 FSI 4motion	206	06/08→01/12						
1.8 TSI	112	11/08→05/10	➔	+PR 1KU,1KW		13.0460-0259.2	610259	
2.0 BlueTDI	105	05/09→11/10						
2.0 TDI	100	06/08→05/11						
2.0 TDI	120	05/08→05/11						
3.6 FSI 4motion	220	06/08→05/10						







Bremsscheibe









1.4 TSI MultiFuel	118	01/11→01/12	➔	→ 09/11; +PR 1LH,1ZM,1ZG				
1.8 TSI	118	06/08→01/12				24.0125-0158.1	425158	Ø 312 25 22 V + S
2.0 TDI	103	06/08→01/12				24.0325-0158.1	525158	Ø 312 25 22 V + S PD
2.0 TDI	125	06/08→01/12	➔	→ 09/11; +PR 1LK		24.0130-0115.1	430115	Ø 345 30 27 V
2.0 TDI 4motion	103	08/09→01/12						
2.0 TDI 4motion	125	11/09→01/12	➔	→ 09/11; +PR 1LA,1LB		24.0130-0225.1	430225	Ø 340 30 27 V + S
2.0 TSI	147	06/08→01/12	➔	→ 09/11; +PR 1KU,1KW		24.0112-0169.1	412169	Ø 282 12 10 + S
2.0 TSI	155	11/10→01/12				24.0312-0169.1	512169	Ø 282 12 10 + S PD
3.6 FSI 4motion	206	06/08→01/12	➔	→ 09/11; +PR 2EA; + eFSB		24.0122-0219.1	422219	Ø 310 22 20 V
1.8 TSI	112	11/08→05/10	➔	+PR 1LH,1ZM,1ZG		24.0125-0158.1	425158	Ø 312 25 22 V + S
2.0 BlueTDI	105	05/09→11/10				24.0325-0158.1	525158	Ø 312 25 22 V + S PD
2.0 TDI	100	06/08→05/11						
2.0 TDI	120	05/08→05/11	➔	+PR 1LK		24.0130-0115.1	430115	Ø 345 30 27 V
3.6 FSI 4motion	220	06/08→05/10						
			➔	+PR 1LA,1LB		24.0130-0225.1	430225	Ø 340 30 27 V + S
			➔	+PR 1KU,1KW		24.0112-0169.1	412169	Ø 282 12 10 + S
						24.0312-0169.1	512169	Ø 282 12 10 + S PD
			➔	+PR 2EA; + eFSB		24.0122-0219.1	422219	Ø 310 22 20 V







VW - PASSAT Kombi (3B5) 05/97→12/01









Bremsbelagsatz, Scheibenbremse









1.6	74	06/97→11/00	➔	→ 3B-X-600000; +PR 1LZ,1ZJ				TRW 21945 19,6 - WK
			➔	3B-Y-000001→; → 09/00; +PR 1LZ,1ZJ		13.0460-2837.2	602837	TRW 21945 19,6 + WK
						13.0470-2837.2	LD2837	TRW 21945 19,6 + WK Ceramic
			➔	→ 3B-X-600000; +PR 1LB,1ZC		13.0460-7077.2	607077	ATE 20676 19,8 - WE / - WK
			➔	3B-Y-000001→; +PR 1LB,1ZC		13.0460-7110.2	607110	ATE 20676 19,8 + WK







	kw			 	! #		
VW - PASSAT Kombi (3B5) 05/97→12/01							
Bremsbelagsatz, Scheibenbremse							
1.6	74	06/97→11/00	←	3B-Y-000001→; +PR 1LB,1ZC	13.0470-7110.2	LD7110	ATE 20676 19,8 + WK Ceramic
			←	3B-Y-000001→; +PR 1LE, 1LT	13.0460-7110.2	607110	ATE 20676 19,8 + WK
			→	+PR 1KD,1KE,1KF,1KW	13.0470-7110.2	LD7110	ATE 20676 19,8 + WK Ceramic
1.8	85	06/97→11/00	←	→ 3B-X-600000	13.0460-2822.2	602822	TRW 21945 19,6 - WK
			←	3B-Y-000001→; → 09/00	13.0460-2837.2	602837	TRW 21945 19,6 + WK
			→	→ 09/00	13.0470-2837.2	LD2837	TRW 21945 19,6 + WK Ceramic
1.8	92	06/97→11/00	←	→ 3B-X-600000; +PR 1LZ,1ZJ	13.0460-2822.2	602822	TRW 21945 19,6 - WK
			←	3B-Y-000001→; → 09/00; +PR 1LZ,1ZJ	13.0460-2837.2	602837	TRW 21945 19,6 + WK
			←	→ 3B-X-600000; +PR 1LB,1ZC	13.0470-2837.2	LD2837	TRW 21945 19,6 + WK Ceramic
1.8 1.8 T 1.9 TDI 1.9 TDI 1.9 TDI 4motion 1.9 TDI Syncro/4motion 2.3 VR5 2.3 VR5 Syncro/4motion 2.5 TDI Syncro/4motion 2.8 V6 2.8 V6 2.8 V6 4motion 2.8 V6 Syncro/4motion	112 110 81 85 85 81 110 110 110 140 142 140 142	01/00→12/01 06/97→11/00 06/97→11/00 08/98→11/00 08/99→11/00 06/97→11/00 06/97→11/00 10/97→11/00 12/98→11/00 09/99→11/00 06/97→11/00 09/99→11/00 06/97→11/00	←	→ 3B-X-600000; +PR 1LB,1ZC	13.0460-7077.2	607077	ATE 20676 19,8 - WE / - WK
			←	3B-Y-000001→; +PR 1LE, 1LT	13.0460-7110.2	607110	ATE 20676 19,8 + WK
			←	→ 3B-X-600000; +PR 1LB,1ZC	13.0470-7110.2	LD7110	ATE 20676 19,8 + WK Ceramic
			←	3B-Y-000001→; +PR 1LE, 1LT	13.0460-7110.2	607110	ATE 20676 19,8 + WK
			←	3B-Y-000001→; +PR 1LB,1ZC	13.0470-7110.2	LD7110	ATE 20676 19,8 + WK Ceramic
			←	3B-Y-000001→; +PR 1LB,1ZC	13.0460-7110.2	607110	ATE 20676 19,8 + WK
			→	→ 09/00; +PR 1KD,1KE,1KF,1KW	13.0470-7110.2	LD7110	ATE 20676 19,8 + WK Ceramic
1.8 Syncro/4motion 1.9 TDI	92 66	06/97→11/00 06/97→11/00	←	→ 3B-X-600000; +PR 1LZ,1ZJ	13.0460-2822.2	602822	TRW 21945 19,6 - WK
			←	3B-Y-000001→; → 09/00; +PR 1LZ,1ZJ	13.0460-2837.2	602837	TRW 21945 19,6 + WK
			←	→ 3B-X-600000; +PR 1LB,1ZC	13.0470-2837.2	LD2837	TRW 21945 19,6 + WK Ceramic
			←	→ 3B-X-600000; +PR 1LB,1ZC	13.0460-7077.2	607077	ATE 20676 19,8 - WE / - WK
			←	3B-Y-000001→; +PR 1LE,1LT	13.0460-7110.2	607110	ATE 20676 19,8 + WK
			←	3B-Y-000001→; +PR 1LE,1LT	13.0470-7110.2	LD7110	ATE 20676 19,8 + WK Ceramic
			←	3B-Y-000001→; +PR 1LB,1ZC	13.0460-7110.2	607110	ATE 20676 19,8 + WK
1.9 TDI 2.0 2.0 4motion	74 88 88	02/00→11/00 04/00→11/00 04/00→11/00	←	10/00→; +PR 1LE, 1LT	13.0460-2820.2	602820	TRW 20961 17,2 - WK
			←	10/00→; +PR 1KD,1KE,1KF,1KW	13.0470-2820.2	LD2820	TRW 20961 17,2 - WK Ceramic
			←	10/00→; +PR 1LE, 1LT	13.0460-7110.2	607110	ATE 20676 19,8 + WK
			←	10/00→; +PR 1LB,1ZC	13.0470-7110.2	LD7110	ATE 20676 19,8 + WK Ceramic
2.5 TDI	110	07/98→11/00	←	08/98→; → 3B-X-600000; +PR 1LB,1ZC	13.0460-2820.2	602820	TRW 20961 17,2 - WK
			←	08/98→; +PR 1KD,1KE,1KF,1KW	13.0470-2820.2	LD2820	TRW 20961 17,2 - WK Ceramic
			←	3B-Y-000001→; +PR 1LE, 1LT	13.0460-7110.2	607110	ATE 20676 19,8 + WK
			←	3B-Y-000001→; +PR 1LB,1ZC	13.0470-7110.2	LD7110	ATE 20676 19,8 + WK Ceramic
2.8 V6	132	09/97→09/99	←	→ 3B-X-600000	13.0460-7110.2	607110	ATE 20676 19,8 + WK
			←	3B-Y-000001→	13.0470-7110.2	LD7110	ATE 20676 19,8 + WK Ceramic
			→		13.0460-2820.2	602820	TRW 20961 17,2 - WK
Zubehörsatz, Scheibenbremsbelag							
1.6 ↓	74	06/97→11/00	→	+PR 1KD,1KE,1KF,1KW	13.0460-0072.2	610072	TRW









	kw			 	! #		
VW - PASSAT Kombi (3B5) 05/97→12/01							
Zubehörsatz, Scheibenbremsbelag							
1.8 1.8 T 1.9 TDI 1.9 TDI 1.9 TDI 4motion 1.9 TDI Syncro/4motion 2.3 VR5 2.3 VR5 Syncro/4motion 2.5 TDI Syncro/4motion 2.8 V6 2.8 V6 2.8 V6 4motion 2.8 V6 Syncro/4motion	112 110 81 85 85 81 110 110 110 140 142 140 142	01/00→12/01 06/97→11/00 06/97→11/00 08/98→11/00 08/99→11/00 06/97→11/00 06/97→11/00 10/97→11/00 12/98→11/00 09/99→11/00 06/97→11/00 09/99→11/00 06/97→11/00	➡	+PR 1KD,1KE,1KF,1KW		13.0460-0072.2 610072	TRW
1.8	85	06/97→11/00	➡	→ 09/00		13.0460-0072.2 610072	TRW
1.8 1.8 Syncro/4motion 1.9 TDI	92 92 66	06/97→11/00 06/97→11/00 06/97→11/00	➡	→ 09/00; +PR 1KD,1KE,1KF,1KW		13.0460-0072.2 610072	TRW
1.9 TDI 2.0 2.0 4motion	74 88 88	02/00→11/00 04/00→11/00 04/00→11/00	➡	10/00→; +PR 1KD,1KE,1KF,1KW		13.0460-0072.2 610072	TRW
2.5 TDI	110	07/98→11/00	➡	08/98→; +PR 1KD,1KE,1KF,1KW		13.0460-0072.2 610072	TRW
2.8 V6	132	09/97→09/99	➡			13.0460-0072.2 610072	TRW
 Bremsscheibe							
1.6	74	06/97→11/00	←	→ 09/00; +PR 1LZ,1ZJ		24.0122-0152.1 422152 24.0322-0152.1 522152	Ø 280 22 20 V + S Ø 280 22 20 V PD
			←	→ 3B-X-124107; +PR 1LB,1ZC		24.0125-0115.1 425115 24.0325-0115.1 525115	Ø 282,5 25 23 V Ø 282,5 25 23 V PD
			←	3B-X-124108→; +PR 1LB,1LE,1ZC		24.0125-0171.1 425171 24.0325-0171.1 525171	Ø 288 25 23 V Ø 288 25 23 V PD
			➡	+PR 1KD,1KE,1KF,1KW		24.0110-0201.1 410201 24.0310-0201.1 510201	Ø 245 10 8 Ø 245 10 8 PD
1.8	85	06/97→11/00	←	→ 09/00; fur Canada/GUS		24.0122-0152.1 422152 24.0322-0152.1 522152	Ø 280 22 20 V + S Ø 280 22 20 V PD
			➡	→ 09/00; nicht China/GUS		24.0110-0201.1 410201 24.0310-0201.1 510201	Ø 245 10 8 Ø 245 10 8 PD
1.8 1.9 TDI	92 66	06/97→11/00 06/97→11/00	←	→ 09/00; +PR 1LZ,1ZJ		24.0122-0152.1 422152 24.0322-0152.1 522152	Ø 280 22 20 V + S Ø 280 22 20 V PD
			←	→ 3B-X-124107; +PR 1LB,1ZC		24.0125-0115.1 425115 24.0325-0115.1 525115	Ø 282,5 25 23 V Ø 282,5 25 23 V PD
			←	3B-X-124108→; +PR 1LB,1LE,1ZC		24.0125-0171.1 425171 24.0325-0171.1 525171	Ø 288 25 23 V Ø 288 25 23 V PD
			➡	→ 09/00; +PR 1KD,1KE,1KF,1KW		24.0110-0201.1 410201 24.0310-0201.1 510201	Ø 245 10 8 Ø 245 10 8 PD
1.8 1.8 T 1.9 TDI 1.9 TDI	112 110 81 85	01/00→12/01 06/97→11/00 06/97→11/00 08/98→11/00	←	→ 3B-X-124107; +PR 1LB,1ZC		24.0125-0115.1 425115 24.0325-0115.1 525115	Ø 282,5 25 23 V Ø 282,5 25 23 V PD
			←	3B-X-124108→; +PR 1LB,1LE,1ZC		24.0125-0171.1 425171 24.0325-0171.1 525171	Ø 288 25 23 V Ø 288 25 23 V PD
			➡	+PR 1KD,1KE,1KF,1KW		24.0110-0201.1 410201 24.0310-0201.1 510201	Ø 245 10 8 Ø 245 10 8 PD
1.8 Syncro/4motion	92	06/97→11/00	←	→ 09/00; +PR 1LZ,1ZJ		24.0122-0152.1 422152 24.0322-0152.1 522152	Ø 280 22 20 V + S Ø 280 22 20 V PD
			←	→ 3B-X-124107; +PR 1LB,1ZC		24.0125-0115.1 425115 24.0325-0115.1 525115	Ø 282,5 25 23 V Ø 282,5 25 23 V PD
			←	3B-X-124108→; +PR 1LB,1LE,1ZC		24.0125-0171.1 425171 24.0325-0171.1 525171	Ø 288 25 23 V Ø 288 25 23 V PD
			➡	+PR 1KD;1KF		24.0110-0224.1 410224 24.0310-0224.1 510224	Ø 245 10 8 Ø 245 10 8 PD
			➡	+PR 1KE		24.0122-0221.1 422221	Ø 256 22 20 V
			➡	+PR 1KW		24.0122-0222.1 422222	Ø 269 22 20 V
1.9 TDI 2.0	74 88	02/00→11/00 04/00→11/00	←	10/00→; +PR 1LB,1LE,1ZC		24.0125-0171.1 425171 24.0325-0171.1 525171	Ø 288 25 23 V Ø 288 25 23 V PD
			➡	10/00→; +PR 1KD,1KE,1KF,1KW		24.0110-0201.1 410201 24.0310-0201.1 510201	Ø 245 10 8 Ø 245 10 8 PD
1.9 TDI 4motion 1.9 TDI Syncro/4motion	85 81	08/99→11/00 06/97→11/00	←	→ 3B-X-124107; +PR 1LB,1ZC		24.0125-0115.1 425115 24.0325-0115.1 525115	Ø 282,5 25 23 V Ø 282,5 25 23 V PD







	kw			 	! #		
VW - PASSAT Kombi (3B5) 05/97→12/01							
Bremsscheibe							
1.9 TDI 4motion 1.9 TDI Syncro/4motion	85	08/99→11/00 06/97→11/00	←	3B-X-124108→; +PR 1LB,1LE,1ZC	24.0125-0171.1	425171	Ø 288 25 23 V
	81		→	+PR 1KD;1KF	24.0325-0171.1	525171	Ø 288 25 23 V PD
			→	+PR 1KE	24.0110-0224.1	410224	Ø 245 10 8
			→	+PR 1KW	24.0310-0224.1	510224	Ø 245 10 8 PD
			→	+PR 1KE	24.0122-0221.1	422221	Ø 256 22 20 V
	→	+PR 1KW	24.0122-0222.1	422222	Ø 269 22 20 V		
2.0 4motion	88	04/00→11/00	←	10/00→; +PR 1LB,1LE,1ZC	24.0125-0171.1	425171	Ø 288 25 23 V
					24.0325-0171.1	525171	Ø 288 25 23 V PD
			→	10/00→; +PR 1KD;1KF	24.0110-0224.1	410224	Ø 245 10 8
					24.0310-0224.1	510224	Ø 245 10 8 PD
			→	10/00→; +PR 1KE	24.0122-0221.1	422221	Ø 256 22 20 V
	→	10/00→; +PR 1KW	24.0122-0222.1	422222	Ø 269 22 20 V		
2.3 VR5	110	06/97→11/00	←	→ 3B-X-124107; +PR 1LB,1ZC	24.0125-0115.1	425115	Ø 282,5 25 23 V
					24.0325-0115.1	525115	Ø 282,5 25 23 V PD
			←	3B-X-124108→; → 09/00; +PR 1LB,1LE,1ZC	24.0125-0171.1	425171	Ø 288 25 23 V
					24.0325-0171.1	525171	Ø 288 25 23 V PD
			←	10/00→; +PR 1LT	24.0125-0172.1	425172	Ø 312 25 23 V
	→	+PR 1KD,1KE,1KF,1KW	24.0110-0201.1	410201	Ø 245 10 8		
			24.0310-0201.1	510201	Ø 245 10 8 PD		
2.3 VR5 Syncro/4motion	110	10/97→11/00	←	→ 3B-X-124107; +PR 1LB,1ZC	24.0125-0115.1	425115	Ø 282,5 25 23 V
					24.0325-0115.1	525115	Ø 282,5 25 23 V PD
			←	3B-X-124108→; → 09/00; +PR 1LB,1LE,1ZC	24.0125-0171.1	425171	Ø 288 25 23 V
					24.0325-0171.1	525171	Ø 288 25 23 V PD
			←	10/00→; +PR 1LT	24.0125-0172.1	425172	Ø 312 25 23 V
			→	+PR 1KD;1KF	24.0110-0224.1	410224	Ø 245 10 8
					24.0310-0224.1	510224	Ø 245 10 8 PD
	→	+PR 1KE	24.0122-0221.1	422221	Ø 256 22 20 V		
	→	+PR 1KW	24.0122-0222.1	422222	Ø 269 22 20 V		
2.5 TDI	110	07/98→11/00	←	08/98→ 09/00; +PR 1LB,1LE,1ZC	24.0125-0171.1	425171	Ø 288 25 23 V
					24.0325-0171.1	525171	Ø 288 25 23 V PD
			←	10/00→; +PR 1LT	24.0125-0172.1	425172	Ø 312 25 23 V
					24.0325-0172.1	525172	Ø 312 25 23 V PD
			→	08/98→; +PR 1KD,1KE,1KF,1KW	24.0110-0201.1	410201	Ø 245 10 8
			24.0310-0201.1	510201	Ø 245 10 8 PD		
2.5 TDI Syncro/4motion	110	12/98→11/00	←	→ 09/00; +PR 1LB,1LE,1ZC	24.0125-0171.1	425171	Ø 288 25 23 V
					24.0325-0171.1	525171	Ø 288 25 23 V PD
			←	10/00→; +PR 1LT	24.0125-0172.1	425172	Ø 312 25 23 V
					24.0325-0172.1	525172	Ø 312 25 23 V PD
			→	+PR 1KD;1KF	24.0110-0224.1	410224	Ø 245 10 8
			24.0310-0224.1	510224	Ø 245 10 8 PD		
	→	+PR 1KE	24.0122-0221.1	422221	Ø 256 22 20 V		
	→	+PR 1KW	24.0122-0222.1	422222	Ø 269 22 20 V		
2.8 V6	132	09/97→09/99	←	→ 3B-X-124107; fur Canada/GUS	24.0125-0115.1	425115	Ø 282,5 25 23 V
					24.0325-0115.1	525115	Ø 282,5 25 23 V PD
			←	3B-X-124108→; fur Canada/GUS	24.0125-0171.1	425171	Ø 288 25 23 V
			→	nicht China/GUS	24.0110-0201.1	410201	Ø 245 10 8
			24.0310-0201.1	510201	Ø 245 10 8 PD		
2.8 V6 2.8 V6	140 142	09/99→11/00 06/97→11/00	←	→ 3B-X-124107; +PR 1LB,1ZC	24.0125-0115.1	425115	Ø 282,5 25 23 V
					24.0325-0115.1	525115	Ø 282,5 25 23 V PD
			←	3B-X-124108→; → 09/00; +PR 1LB,1LE,1ZC	24.0125-0171.1	425171	Ø 288 25 23 V
			←	10/00→; +PR 1LT	24.0125-0172.1	425172	Ø 312 25 23 V
			→	+PR 1KD,1KE,1KF,1KW	24.0110-0201.1	410201	Ø 245 10 8
			24.0310-0201.1	510201	Ø 245 10 8 PD		
2.8 V6 4motion 2.8 V6 Syncro/4motion	140 142	09/99→11/00 06/97→11/00	←	→ 3B-X-124107; +PR 1LB,1ZC	24.0125-0115.1	425115	Ø 282,5 25 23 V
					24.0325-0115.1	525115	Ø 282,5 25 23 V PD
			←	3B-X-124108→; → 09/00; +PR 1LB,1LE,1ZC	24.0125-0171.1	425171	Ø 288 25 23 V
			←	10/00→; +PR 1LT	24.0125-0172.1	425172	Ø 312 25 23 V
	→	+PR 1KD;1KF	24.0110-0224.1	410224	Ø 245 10 8		







	kw			 	! #		
VW - PASSAT Kombi (3B5) 05/97→12/01							
 Bremsscheibe							
2.8 V6 4motion	140	09/99→11/00	➡	+PR 1KD;1KF		24.0310-0224.1 510224	Ø 245 10 8 PD
2.8 V6 Syncro/4motion	142	06/97→11/00	➡	+PR 1KE		24.0122-0221.1 422221	Ø 256 22 20 V
			➡	+PR 1KW		24.0122-0222.1 422222	Ø 269 22 20 V
VW - PASSAT Variant (3A5, 35I) 02/88→06/97							
 Bremsbelagsatz, Scheibenbremse							
1.6	74	07/94→12/95	←	3A-T-130757→		13.0460-2957.2 602957	TRW 20168 16,0 - WK
			←	10/94→; → 3A-T-130756		13.0460-2958.2 602958	TRW 20168 19,3 - WK
1.8	55	08/90→05/97	←	10/93→ 12/96		13.0460-2958.2 602958	TRW 20168 19,3 - WK
1.9 TD	55	03/91→05/97	←	→ 10/93		13.0460-2958.2 602958	TRW 20168 19,3 - WK
1.8	66	02/88→05/97	←	10/93→ 12/96		13.0460-2958.2 602958	TRW 20168 19,3 - WK
			←	04/88→ 10/93		13.0460-2958.2 602958	TRW 20168 19,3 - WK
1.8 G60 Syncro	118	08/88→05/97	←	→ 10/93		13.0460-2958.2 602958	TRW 20168 19,3 - WK
			➡	→ 31-P-080000		13.0460-2937.2 602937	TRW 20961 15,2 - WK + Zub
			➡	31-P-080001→; → 10/93		13.0460-2984.2 602984	TRW 20961 17,2 - WK + Zub
1.9 TDI	66	10/93→05/97	←	3A-T-000001→; → 12/96		13.0460-2957.2 602957	TRW 20168 16,0 - WK
			←	→ 3A-S-300000		13.0460-2958.2 602958	TRW 20168 19,3 - WK
			➡	3A-T-000001→; → 12/96		13.0460-2984.2 602984	TRW 20961 17,2 - WK + Zub
1.9 TDI	81	03/96→05/97	←	→ 12/96		13.0460-2958.2 602958	TRW 20168 19,3 - WK
			➡	→ 12/96		13.0460-2984.2 602984	TRW 20961 17,2 - WK + Zub
2.0	79	03/95→08/96	←			13.0460-2957.2 602957	TRW 20168 16,0 - WK
2.0	85	10/93→10/96	➡			13.0460-2984.2 602984	TRW 20961 17,2 - WK + Zub
2.0	85	02/90→05/97	←	03/90→ 10/93		13.0460-2957.2 602957	TRW 20168 16,0 - WK
			←	10/93→ 12/96		13.0460-2957.2 602957	TRW 20168 16,0 - WK
			➡	03/90→; → 31-PE080000		13.0460-2937.2 602937	TRW 20961 15,2 - WK + Zub
			➡	03/90→; → 31-PB080000		13.0460-2937.2 602937	TRW 20961 15,2 - WK + Zub
			➡	31-PB080001→; → 10/93		13.0460-2984.2 602984	TRW 20961 17,2 - WK + Zub
			➡	10/93→ 12/96		13.0460-2984.2 602984	TRW 20961 17,2 - WK + Zub
			➡	31-PE080001→; → 10/93		13.0460-2984.2 602984	TRW 20961 17,2 - WK + Zub
2.0 16V	110	01/94→05/97	←	→ 12/96		13.0460-7081.2 607081	ATE 20676 19,8 - WE / - WK
						13.0470-7081.2 LD7081	ATE 20676 19,8 - WE / - WK Ceramic
			➡	→ 12/96		13.0460-2984.2 602984	TRW 20961 17,2 - WK + Zub
2.0 Syncro	85	10/90→05/97	←	01/94→ 12/96		13.0460-2957.2 602957	TRW 20168 16,0 - WK
			←	→ 10/93		13.0460-2957.2 602957	TRW 20168 16,0 - WK
			➡	→ 31-P-080000		13.0460-2937.2 602937	TRW 20961 15,2 - WK + Zub
			➡	31-P-080001→; → 10/93		13.0460-2984.2 602984	TRW 20961 17,2 - WK + Zub
			➡	01/94→ 12/96		13.0460-2984.2 602984	TRW 20961 17,2 - WK + Zub
2.8 VR6	128	06/91→05/97	←	→ 10/93		13.0460-2958.2 602958	TRW 20168 19,3 - WK
			←	10/93→ 12/96		13.0460-7081.2 607081	ATE 20676 19,8 - WE / - WK
						13.0470-7081.2 LD7081	ATE 20676 19,8 - WE / - WK Ceramic
			➡	→ 31-PE080000		13.0460-2937.2 602937	TRW 20961 15,2 - WK + Zub
			➡	→ 31-PB080000		13.0460-2937.2 602937	TRW 20961 15,2 - WK + Zub
			➡	31-PB080001→; → 10/93		13.0460-2984.2 602984	TRW 20961 17,2 - WK + Zub
			➡	31-PE080001→; → 10/93		13.0460-2984.2 602984	TRW 20961 17,2 - WK + Zub
			➡	10/93→ 12/96		13.0460-2984.2 602984	TRW 20961 17,2 - WK + Zub
2.9 VR6 Syncro	135	01/94→05/97	←	10/94→ 12/96		13.0460-7081.2 607081	ATE 20676 19,8 - WE / - WK
						13.0470-7081.2 LD7081	ATE 20676 19,8 - WE / - WK Ceramic
			➡	10/94→ 12/96		13.0460-2984.2 602984	TRW 20961 17,2 - WK + Zub
Zubehörsatz, Scheibenbremsbelag							
1.8 G60 Syncro	118	08/88→05/97	➡	31-P-080001→; → 10/93		13.0460-0072.2 610072	TRW
			➡	→ 31-P-080000		13.0460-0419.2 610419	TRW
1.9 TDI	66	10/93→05/97	➡	3A-T-000001→; → 12/96		13.0460-0072.2 610072	TRW
↓							

	kW			 	! #		
VW - PASSAT Variant (3A5, 35I) 02/88→06/97							
Zubehörsatz, Scheibenbremsbelag							
1.9 TDI 2.0 16V	81 110	03/96→05/97 01/94→05/97	➡	→ 12/96		13.0460-0072.2 610072	TRW
2.0 2.0	79 85	03/95→08/96 10/93→10/96	➡			13.0460-0072.2 610072	TRW
2.0	85	02/90→05/97	➡	31-PB080001→; → 10/93		13.0460-0072.2 610072	TRW
			➡	10/93→ 12/96		13.0460-0072.2 610072	TRW
			➡	31-PE080001→; → 10/93		13.0460-0072.2 610072	TRW
			➡	03/90→; → 31-PB080000		13.0460-0419.2 610419	TRW
			➡	03/90→; → 31-PE080000		13.0460-0419.2 610419	TRW
2.0 Syncro	85	10/90→05/97	➡	01/94→ 12/96		13.0460-0072.2 610072	TRW
			➡	31-P-080001→; → 10/93		13.0460-0072.2 610072	TRW
			➡	→ 31-P-080000		13.0460-0419.2 610419	TRW
2.8 VR6	128	06/91→05/97	➡	31-PB080001→; → 10/93		13.0460-0072.2 610072	TRW
			➡	10/93→ 12/96		13.0460-0072.2 610072	TRW
			➡	31-PE080001→; → 10/93		13.0460-0072.2 610072	TRW
			➡	→ 31-PB080000		13.0460-0419.2 610419	TRW
			➡	→ 31-PE080000		13.0460-0419.2 610419	TRW
2.9 VR6 Syncro	135	01/94→05/97	➡	10/94→ 12/96		13.0460-0072.2 610072	TRW
 Bremsscheibe							
1.6	74	07/94→12/95	⬅	10/94→; → 3A-T-130756		24.0113-0178.1 413178 24.0313-0178.1 513178	Ø 255,6 12,9 11 + S Ø 255,6 12,9 11 + S PD
			⬅	3A-T-130757→		24.0120-0128.1 420128 24.0320-0128.1 520128	Ø 256 20 18 V + S Ø 256 20 18 V + S PD
1.8 1.9 TD	55 55	08/90→05/97 03/91→05/97	⬅	10/93→ 12/96		24.0113-0178.1 413178 24.0313-0178.1 513178	Ø 255,6 12,9 11 + S Ø 255,6 12,9 11 + S PD
			⬅	→ 10/93		24.0113-0178.1 413178 24.0313-0178.1 513178	Ø 255,6 12,9 11 + S Ø 255,6 12,9 11 + S PD
1.8	66	02/88→05/97	⬅	10/93→ 12/96		24.0113-0178.1 413178 24.0313-0178.1 513178	Ø 255,6 12,9 11 + S Ø 255,6 12,9 11 + S PD
			⬅	04/88→ 10/93		24.0113-0178.1 413178 24.0313-0178.1 513178	Ø 255,6 12,9 11 + S Ø 255,6 12,9 11 + S PD
1.8 G60 Syncro	118	08/88→05/97	⬅	→ 10/93		24.0122-0101.1 422101	Ø 280 22 20 V
			➡	→ 10/93		24.0110-0151.1 410151	Ø 239 10 8 + S
1.9 TDI	66	10/93→05/97	⬅	→ 3A-S-300000		24.0113-0178.1 413178 24.0313-0178.1 513178	Ø 255,6 12,9 11 + S Ø 255,6 12,9 11 + S PD
			⬅	3A-T-000001→; → 12/96		24.0120-0128.1 420128 24.0320-0128.1 520128	Ø 256 20 18 V + S Ø 256 20 18 V + S PD
			➡	3A-T-000001→; → 12/96		24.0110-0111.1 410111 24.0110-0275.2 410275	Ø 226 10 8 - ABS Ring / - RLG Ø 226 10 8 + ABS Ring / - RLG
1.9 TDI	81	03/96→05/97	⬅	→ 12/96		24.0122-0100.1 422100 24.0322-0100.1 522100	Ø 280 22 20 V Ø 280 22 20 V PD
			➡	→ 12/96		24.0110-0203.1 410203 24.0110-0276.2 410276	Ø 226 10 8 - ABS Ring Ø 226 10 8 + ABS Ring
2.0 2.0	79 85	03/95→08/96 10/93→10/96	⬅			24.0120-0128.1 420128 24.0320-0128.1 520128	Ø 256 20 18 V + S Ø 256 20 18 V + S PD
			➡			24.0110-0111.1 410111 24.0110-0275.2 410275	Ø 226 10 8 - ABS Ring / - RLG Ø 226 10 8 + ABS Ring / - RLG
2.0	85	02/90→05/97	⬅	10/93→ 12/96		24.0120-0128.1 420128 24.0320-0128.1 520128	Ø 256 20 18 V + S Ø 256 20 18 V + S PD
			⬅	03/90→ 10/93		24.0120-0128.1 420128 24.0320-0128.1 520128	Ø 256 20 18 V + S Ø 256 20 18 V + S PD
			➡	03/90→ 10/93		24.0110-0111.1 410111 24.0110-0275.2 410275	Ø 226 10 8 - ABS Ring / - RLG Ø 226 10 8 + ABS Ring / - RLG
			➡	10/93→ 12/96		24.0110-0111.1 410111 24.0110-0275.2 410275	Ø 226 10 8 - ABS Ring / - RLG Ø 226 10 8 + ABS Ring / - RLG
2.0 16V	110	01/94→05/97	⬅	→ 12/96		24.0125-0108.1 425108 24.0110-0203.1 410203 24.0110-0276.2 410276	Ø 288 25 23 V Ø 226 10 8 - ABS Ring Ø 226 10 8 + ABS Ring
↓							

	kw			 	! #		
VW - PASSAT Variant (3A5, 35I) 02/88→06/97							
Bremsscheibe							
2.0 Syncro	85	10/90→05/97	←	→ 10/93		24.0120-0128.1 420128	Ø 256 20 18 V + S
						24.0320-0128.1 520128	Ø 256 20 18 V + S PD
			←	01/94→ 12/96		24.0120-0128.1 420128	Ø 256 20 18 V + S
						24.0320-0128.1 520128	Ø 256 20 18 V + S PD
2.8 VR6	128	06/91→05/97	←	→ 10/93; 31-N-255990→		24.0122-0100.1 422100	Ø 280 22 20 V
						24.0322-0100.1 522100	Ø 280 22 20 V PD
			←	10/93→ 12/96		24.0125-0108.1 425108	Ø 288 25 23 V
			→	→ 10/93		24.0110-0203.1 410203	Ø 226 10 8 - ABS Ring
2.9 VR6 Syncro	135	01/94→05/97	←	10/94→ 12/96		24.0110-0276.2 410276	Ø 226 10 8 + ABS Ring
						24.0110-0276.2 410276	Ø 226 10 8 + ABS Ring
			→	10/93→ 12/96		24.0110-0203.1 410203	Ø 226 10 8 - ABS Ring
						24.0110-0276.2 410276	Ø 226 10 8 + ABS Ring
VW - PASSAT Variant (3B6) 10/00→08/05							
Bremsbelagsatz, Scheibenbremse							
1.6	75	11/00→05/05	←	→ 3B-X-600000; +PR 1LZ,1ZJ		13.0460-2822.2 602822	TRW 21945 19,6 - WK
			←	→ 3B-X-600000; +PR 1LB,1ZC		13.0460-7077.2 607077	ATE 20676 19,8 - WE / - WK
			←	3B-Y-000001→; +PR 1LB,1ZC		13.0460-7110.2 607110	ATE 20676 19,8 + WK
						13.0470-7110.2 LD7110	ATE 20676 19,8 + WK Ceramic
			←	3B-Y-000001→; +PR 1LE, 1LT		13.0460-7110.2 607110	ATE 20676 19,8 + WK
						13.0470-7110.2 LD7110	ATE 20676 19,8 + WK Ceramic
1.8 T 2.8	125 142	05/02→08/05 10/00→08/05	←	→ 3B-X-600000; +PR 1LB,1ZC		13.0460-7077.2 607077	ATE 20676 19,8 - WE / - WK
			←	3B-Y-000001→; → 06/05; +PR 1LB,1ZC		13.0460-7110.2 607110	ATE 20676 19,8 + WK
						13.0470-7110.2 LD7110	ATE 20676 19,8 + WK Ceramic
			←	3B-Y-000001→; → 06/05; +PR 1LE, 1LT		13.0460-7110.2 607110	ATE 20676 19,8 + WK
						13.0470-7110.2 LD7110	ATE 20676 19,8 + WK Ceramic
			→	→ 06/05; +PR 1KD,1KE,1KF,1KW		13.0460-2820.2 602820	TRW 20961 17,2 - WK
1.8 T 20V 2.3 VR5 2.3 VR5 4motion 2.5 TDI 2.5 TDI 2.5 TDI 4motion 2.5 TDI 4motion 2.8 4motion	110 125 125 110 120 110 132 142	11/00→05/05 11/00→05/05 11/00→05/05 11/00→05/05 05/03→05/05 11/00→05/05 01/03→05/05 11/00→05/05	←	→ 3B-X-600000; +PR 1LB,1ZC		13.0460-7077.2 607077	ATE 20676 19,8 - WE / - WK
			←	3B-Y-000001→; +PR 1LB,1ZC		13.0460-7110.2 607110	ATE 20676 19,8 + WK
						13.0470-7110.2 LD7110	ATE 20676 19,8 + WK Ceramic
			←	3B-Y-000001→; +PR 1LE, 1LT		13.0460-7110.2 607110	ATE 20676 19,8 + WK
						13.0470-7110.2 LD7110	ATE 20676 19,8 + WK Ceramic
			→	+PR 1KD,1KE,1KF,1KW		13.0460-2820.2 602820	TRW 20961 17,2 - WK
1.9 TDI 1.9 TDI 1.9 TDI 4motion 2.0 2.0 4motion 2.0 TDI	74 96 96 85 85 100	11/00→05/05 11/00→05/05 11/00→05/05 11/00→05/05 11/00→05/05 12/03→05/05	←	+PR 1LE, 1LT		13.0460-7110.2 607110	ATE 20676 19,8 + WK
						13.0470-7110.2 LD7110	ATE 20676 19,8 + WK Ceramic
			←	+PR 1LB,1ZC		13.0460-7110.2 607110	ATE 20676 19,8 + WK
						13.0470-7110.2 LD7110	ATE 20676 19,8 + WK Ceramic
			→	+PR 1KD,1KE,1KF,1KW		13.0460-2820.2 602820	TRW 20961 17,2 - WK
						13.0470-2820.2 LD2820	TRW 20961 17,2 - WK Ceramic
2.0	96	11/01→05/05	←	05/02→; +PR 1LE, 1LT		13.0460-7110.2 607110	ATE 20676 19,8 + WK
						13.0470-7110.2 LD7110	ATE 20676 19,8 + WK Ceramic
			←	05/02→; +PR 1LB,1ZC		13.0460-7110.2 607110	ATE 20676 19,8 + WK
						13.0470-7110.2 LD7110	ATE 20676 19,8 + WK Ceramic
4.0 W8 4motion	202	09/01→09/04	←	+PR 1ZF,1ZG; für gepanzerte Fahrzeuge		13.0460-2820.2 602820	TRW 20961 17,2 - WK
						13.0470-2820.2 LD2820	TRW 20961 17,2 - WK Ceramic
			←	+PR 1ZF,1ZG; nicht für gepanzerte Fahrzeuge		13.0460-2875.2 602875	TRW 23119 17,5 + WK
						13.0460-7183.2 607183	ATE 21484 20,5 + WE / - WK
↓		09/01→09/04	→	+PR 1KD,1KE,1KF,1KW		13.0460-2820.2 602820	TRW 20961 17,2 - WK
						13.0470-2820.2 LD2820	TRW 20961 17,2 - WK Ceramic
Warnkontakt, Bremsbelagverschleiß							
4.0 W8 4motion	202	09/01→09/04	←	+PR 1ZF,1ZG; nicht für gepanzerte Fahrzeuge	1	24.8190-0107.2 620107	L= 235

	kw			 	! #		
VW - PASSAT Variant (3B6) 10/00→08/05							
Zubehörsatz, Scheibenbremsbelag							
1.6 1.8 T 20V 1.9 TDI 1.9 TDI 1.9 TDI 4motion 2.0 2.0 4motion 2.0 TDI 2.3 VR5 2.3 VR5 4motion 2.5 TDI 2.5 TDI 2.5 TDI 4motion 2.5 TDI 4motion 2.8 4motion 4.0 W8 4motion	75 110 74 96 96 85 85 100 125 125 110 120 110 132 142 202	11/00→05/05 11/00→05/05 11/00→05/05 11/00→05/05 11/00→05/05 11/00→05/05 12/03→05/05 11/00→05/05 11/00→05/05 11/00→05/05 05/03→05/05 11/00→05/05 01/03→05/05 11/00→05/05 09/01→09/04	➡	+PR 1KD,1KE,1KF,1KW		13.0460-0072.2 610072	TRW
1.8 T 2.8	125 142	05/02→08/05 10/00→08/05	➡	→ 06/05; +PR 1KD,1KE,1KF,1KW		13.0460-0072.2 610072	TRW
2.0	96	11/01→05/05	➡	05/02→; +PR 1KD,1KE,1KF,1KW		13.0460-0072.2 610072	TRW
 Bremsscheibe							
1.6 1.8 T 20V	75 110	11/00→05/05 11/00→05/05	←	→ 3B-X-124107; +PR 1LB,1ZC		24.0125-0115.1 425115 24.0325-0115.1 525115	Ø 282,5 25 23 V Ø 282,5 25 23 V PD
			←	3B-X-124108→; +PR 1LB,1LE,1ZC		24.0125-0171.1 425171 24.0325-0171.1 525171	Ø 288 25 23 V Ø 288 25 23 V PD
			➡	+PR 1KD,1KE,1KF,1KW		24.0110-0201.1 410201 24.0310-0201.1 510201	Ø 245 10 8 Ø 245 10 8 PD
1.8 T	125	05/02→08/05	←	→ 3B-X-124107; +PR 1LB,1ZC		24.0125-0115.1 425115 24.0325-0115.1 525115	Ø 282,5 25 23 V Ø 282,5 25 23 V PD
			←	3B-X-124108→; → 06/05; +PR 1LB,1LE,1ZC		24.0125-0171.1 425171 24.0325-0171.1 525171	Ø 288 25 23 V Ø 288 25 23 V PD
			➡	→ 06/05; +PR 1KD,1KE,1KF,1KW		24.0110-0201.1 410201 24.0310-0201.1 510201	Ø 245 10 8 Ø 245 10 8 PD
1.9 TDI 1.9 TDI 2.0	74 96 85	11/00→05/05 11/00→05/05 11/00→05/05	←	+PR 1LB,1LE,1ZC		24.0125-0171.1 425171 24.0325-0171.1 525171	Ø 288 25 23 V Ø 288 25 23 V PD
			➡	+PR 1KD,1KE,1KF,1KW		24.0110-0201.1 410201 24.0310-0201.1 510201	Ø 245 10 8 Ø 245 10 8 PD
1.9 TDI 4motion 2.0 4motion	96 85	11/00→05/05 11/00→05/05	←	+PR 1LB,1LE,1ZC		24.0125-0171.1 425171 24.0325-0171.1 525171	Ø 288 25 23 V Ø 288 25 23 V PD
			➡	+PR 1KD;1KF		24.0110-0224.1 410224 24.0310-0224.1 510224	Ø 245 10 8 Ø 245 10 8 PD
			➡	+PR 1KE		24.0122-0221.1 422221	Ø 256 22 20 V
			➡	+PR 1KW		24.0122-0222.1 422222	Ø 269 22 20 V
2.0	96	11/01→05/05	←	05/02→; +PR 1LB,1LE,1ZC		24.0125-0171.1 425171 24.0325-0171.1 525171	Ø 288 25 23 V Ø 288 25 23 V PD
			➡	05/02→; +PR 1KD,1KE,1KF,1KW		24.0110-0201.1 410201 24.0310-0201.1 510201	Ø 245 10 8 Ø 245 10 8 PD
2.0 TDI	100	12/03→05/05	←	+PR 1LB,1LE,1ZC		24.0125-0171.1 425171 24.0325-0171.1 525171	Ø 288 25 23 V Ø 288 25 23 V PD
			←	+PR 1LT		24.0125-0172.1 425172 24.0325-0172.1 525172	Ø 312 25 23 V Ø 312 25 23 V PD
			➡	+PR 1KD,1KE,1KF,1KW		24.0110-0201.1 410201 24.0310-0201.1 510201	Ø 245 10 8 Ø 245 10 8 PD
2.3 VR5	125	11/00→05/05	←	→ 3B-X-124107; +PR 1LB,1ZC		24.0125-0115.1 425115 24.0325-0115.1 525115	Ø 282,5 25 23 V Ø 282,5 25 23 V PD
			←	+PR 1LT		24.0125-0172.1 425172	Ø 312 25 23 V
			➡	+PR 1KD,1KE,1KF,1KW		24.0110-0201.1 410201 24.0310-0201.1 510201	Ø 245 10 8 Ø 245 10 8 PD
2.3 VR5 4motion 2.8 4motion	125 142	11/00→05/05 11/00→05/05	←	→ 3B-X-124107; +PR 1LB,1ZC		24.0125-0115.1 425115 24.0325-0115.1 525115	Ø 282,5 25 23 V Ø 282,5 25 23 V PD
			←	+PR 1LT		24.0125-0172.1 425172	Ø 312 25 23 V
			➡	+PR 1KD;1KF		24.0110-0224.1 410224 24.0310-0224.1 510224	Ø 245 10 8 Ø 245 10 8 PD
			➡	+PR 1KE		24.0122-0221.1 422221	Ø 256 22 20 V
			➡	+PR 1KW		24.0122-0222.1 422222	Ø 269 22 20 V
↓							

	kw			 	! #		
VW - PASSAT Variant (3B6) 10/00→08/05							
Bremsscheibe							
2.5 TDI	110	11/00→05/05	←	+PR 1LT		24.0125-0172.1 425172	Ø 312 25 23 V
2.5 TDI	120	05/03→05/05	→	+PR 1KD,1KE,1KF,1KW		24.0325-0172.1 525172	Ø 312 25 23 V PD
			→	+PR 1KD;1KF		24.0110-0201.1 410201	Ø 245 10 8
			→	+PR 1KE		24.0310-0201.1 510201	Ø 245 10 8 PD
2.5 TDI 4motion	110	11/00→05/05	←	+PR 1LT		24.0125-0172.1 425172	Ø 312 25 23 V
2.5 TDI 4motion	132	01/03→05/05	→	+PR 1KD;1KF		24.0325-0172.1 525172	Ø 312 25 23 V PD
			→	+PR 1KE		24.0110-0224.1 410224	Ø 245 10 8
			→	+PR 1KW		24.0310-0224.1 510224	Ø 245 10 8 PD
			→	+PR 1KE		24.0122-0221.1 422221	Ø 256 22 20 V
			→	+PR 1KW		24.0122-0222.1 422222	Ø 269 22 20 V
2.8	142	10/00→08/05	←	→ 3B-X-124107; +PR 1LB,1ZC		24.0125-0115.1 425115	Ø 282,5 25 23 V
			←	→ 06/05; +PR 1LT		24.0325-0115.1 525115	Ø 282,5 25 23 V PD
			←	→ 06/05; +PR 1LT		24.0125-0172.1 425172	Ø 312 25 23 V
			→	→ 06/05; +PR 1KD,1KE,1KF,1KW		24.0110-0201.1 410201	Ø 245 10 8
			→	→ 06/05; +PR 1KD,1KE,1KF,1KW		24.0310-0201.1 510201	Ø 245 10 8 PD
4.0 W8 4motion	202	09/01→09/04	→	+PR 1KD;1KF		24.0110-0224.1 410224	Ø 245 10 8
			→	+PR 1KE		24.0310-0224.1 510224	Ø 245 10 8 PD
			→	+PR 1KE		24.0122-0221.1 422221	Ø 256 22 20 V
			→	+PR 1KW		24.0122-0222.1 422222	Ø 269 22 20 V
VW - PASSAT Variant (3C5) 08/05→10/11							
Bremsbelagsatz, Scheibenbremse							
1.4 TSI	90	05/07→11/10	←	10/07→ 07/10; +PR 1LJ,1LH,1ZG,1ZM		13.0460-7184.2 607184	ATE 23587 20,6 + WK
1.8 TSI	118	05/07→10/11	←	10/07→ 07/10; +PR 1LJ,1LH,1ZG,1ZM		13.0470-7184.2 LD7184	ATE 23587 20,6 + WK Ceramic
			←	10/07→ 07/10; +PR 1LK,1LM		13.0460-7200.2 607200	ATE 23801 20,3 + WK
			←	10/07→ 07/10; +PR 1LK,1LM		13.0470-7200.2 LD7200	ATE 23801 20,3 + WK Ceramic
			→	10/07→ 07/10; +PR 1KU,1KW		13.0460-2749.2 602749	TRW 24483 16,9 - WE / - WK + Zub
			→	10/07→ 07/10; +PR 1KU,1KW		13.0460-2880.2 602880	TRW 23914 17,1 + WE / - WK + Zub
			→	10/07→ 07/10; +PR 1KU,1KW		13.0470-2749.2 LD2749	TRW 24483 16,9 - WE / - WK + Zub Ceramic
			→	10/07→ 07/10; +PR 1KU,1KW		13.0470-2880.2 LD2880	TRW 23914 17,1 + WE / - WK + Zub Ceramic
			→	10/07→ 07/10; +PR 2EA,2EL		13.0460-2887.2 602887	TRW 23914 17,1 + WE / - WK + Zub
			→	10/07→ 07/10; +PR 2EA,2EL		13.0470-2621.2 LD2621	TRW - WE / - WK + Zub Ceramic
			→	10/07→ 07/10; +PR 2EA,2EL		13.0470-2887.2 LD2887	TRW 23914 17,1 + WE / - WK + Zub Ceramic
1.4 TSI EcoFuel	110	01/09→11/10	←	→ 07/10; +PR 1LJ,1LH,1ZG,1ZM		13.0460-7184.2 607184	ATE 23587 20,6 + WK
1.6	75	08/05→11/10	←	→ 07/10; +PR 1LJ,1LH,1ZG,1ZM		13.0470-7184.2 LD7184	ATE 23587 20,6 + WK Ceramic
1.6 TDI	77	08/09→11/10	←	→ 07/10; +PR 1LJ,1LH,1ZG,1ZM		13.0460-7200.2 607200	ATE 23801 20,3 + WK
1.8 TSI	112	11/09→11/10	←	→ 07/10; +PR 1LK,1LM		13.0470-7200.2 LD7200	ATE 23801 20,3 + WK Ceramic
2.0 BlueTDI	105	01/09→11/10	→	→ 07/10; +PR 1KU,1KW		13.0460-2749.2 602749	TRW 24483 16,9 - WE / - WK + Zub
2.0 FSI	110	08/05→11/10	→	→ 07/10; +PR 1KU,1KW		13.0460-2880.2 602880	TRW 23914 17,1 + WE / - WK + Zub
2.0 FSI	125	08/07→11/10	→	→ 07/10; +PR 1KU,1KW		13.0470-2749.2 LD2749	TRW 24483 16,9 - WE / - WK + Zub Ceramic
2.0 FSI	147	08/05→11/10	→	→ 07/10; +PR 1KU,1KW		13.0470-2880.2 LD2880	TRW 23914 17,1 + WE / - WK + Zub Ceramic
2.0 FSI 4motion	110	09/05→11/10	→	→ 07/10; +PR 1KU,1KW		13.0460-2880.2 602880	TRW 23914 17,1 + WE / - WK + Zub
2.0 TDI	81	11/08→11/10	→	→ 07/10; +PR 1KU,1KW		13.0470-2749.2 LD2749	TRW 24483 16,9 - WE / - WK + Zub Ceramic
2.0 TDI	100	08/05→11/10	→	→ 07/10; +PR 1KU,1KW		13.0470-2880.2 LD2880	TRW 23914 17,1 + WE / - WK + Zub Ceramic
2.0 TDI	125	08/05→11/10	→	→ 07/10; +PR 1KU,1KW		13.0470-2749.2 LD2749	TRW 24483 16,9 - WE / - WK + Zub Ceramic
2.0 TDI 16V	103	08/05→11/10	→	→ 07/10; +PR 1KU,1KW		13.0470-2880.2 LD2880	TRW 23914 17,1 + WE / - WK + Zub Ceramic
2.0 TDI 4motion	125	05/09→11/10	→	→ 07/10; +PR 1KU,1KW		13.0470-2880.2 LD2880	TRW 23914 17,1 + WE / - WK + Zub Ceramic
3.2 FSI 4motion	184	11/05→11/10	→	→ 07/10; +PR 1KU,1KW		13.0470-2880.2 LD2880	TRW 23914 17,1 + WE / - WK + Zub Ceramic
3.6 R36 4motion	220	04/07→11/10	→	→ 07/10; +PR 2EA,2EL		13.0460-2887.2 602887	TRW 23914 17,1 + WE / - WK + Zub
			→	→ 07/10; +PR 2EA,2EL		13.0470-2621.2 LD2621	TRW - WE / - WK + Zub Ceramic
			→	→ 07/10; +PR 2EA,2EL		13.0470-2887.2 LD2887	TRW 23914 17,1 + WE / - WK + Zub Ceramic
1.6 FSI	85	08/05→06/08	←	+PR 1LJ,1LH,1ZG,1ZM		13.0460-7184.2 607184	ATE 23587 20,6 + WK
1.9 TDI	77	08/05→11/08	←	+PR 1LJ,1LH,1ZG,1ZM		13.0470-7184.2 LD7184	ATE 23587 20,6 + WK Ceramic
2.0 TDI	88	11/05→05/07	←	+PR 1LK,1LM		13.0460-7200.2 607200	ATE 23801 20,3 + WK
2.0 TDI	90	08/05→02/06	←	+PR 1LK,1LM		13.0470-7200.2 LD7200	ATE 23801 20,3 + WK Ceramic
2.0 TDI	103	08/05→05/09	←	+PR 1LK,1LM		13.0470-7200.2 LD7200	ATE 23801 20,3 + WK Ceramic
2.0 TDI	120	08/05→05/09	→	+PR 1KU,1KW		13.0460-2749.2 602749	TRW 24483 16,9 - WE / - WK + Zub
			→	+PR 1KU,1KW		13.0460-2880.2 602880	TRW 23914 17,1 + WE / - WK + Zub

	kw			 	! #		
VW - PASSAT Variant (3C5) 08/05→10/11							
Bremsbelagsatz, Scheibenbremse							
1.6 FSI 1.9 TDI 2.0 TDI 2.0 TDI 2.0 TDI	85 77 88 90 103 120	08/05→06/08 08/05→11/08 11/05→05/07 08/05→02/06 08/05→05/09 08/05→05/09	➡	+PR 1KU,1KW		13.0470-2749.2 LD2749 13.0470-2880.2 LD2880	TRW 24483 16,9 - WE / - WK + Zub Ceramic TRW 23914 17,1 + WE / - WK + Zub Ceramic
			➡	+PR 2EA,2EL		13.0460-2887.2 602887 13.0470-2621.2 LD2621 13.0470-2887.2 LD2887	TRW 23914 17,1 + WE / - WK + Zub TRW - WE / - WK + Zub Ceramic TRW 23914 17,1 + WE / - WK + Zub Ceramic
2.0 TDI 16V 4motion	103	08/05→11/10	⬅	09/05→ 07/10; +PR 1LJ,1LH,1ZG,1ZM		13.0460-7184.2 607184 13.0470-7184.2 LD7184	ATE 23587 20,6 + WK ATE 23587 20,6 + WK Ceramic
			⬅	09/05→ 07/10; +PR 1LK,1LM		13.0460-7200.2 607200 13.0470-7200.2 LD7200	ATE 23801 20,3 + WK ATE 23801 20,3 + WK Ceramic
			➡	09/05→ 07/10; +PR 1KU,1KW		13.0460-2749.2 602749 13.0460-2880.2 602880 13.0470-2749.2 LD2749 13.0470-2880.2 LD2880	TRW 24483 16,9 - WE / - WK + Zub TRW 23914 17,1 + WE / - WK + Zub TRW 24483 16,9 - WE / - WK + Zub Ceramic TRW 23914 17,1 + WE / - WK + Zub Ceramic
			➡	09/05→ 07/10; +PR 2EA,2EL		13.0460-2887.2 602887 13.0470-2621.2 LD2621 13.0470-2887.2 LD2887	TRW 23914 17,1 + WE / - WK + Zub TRW - WE / - WK + Zub Ceramic TRW 23914 17,1 + WE / - WK + Zub Ceramic
2.0 TDI 4motion	103	08/05→05/09	⬅	09/05→; +PR 1LJ,1LH,1ZG,1ZM		13.0460-7184.2 607184 13.0470-7184.2 LD7184	ATE 23587 20,6 + WK ATE 23587 20,6 + WK Ceramic
			⬅	09/05→; +PR 1LK,1LM		13.0460-7200.2 607200 13.0470-7200.2 LD7200	ATE 23801 20,3 + WK ATE 23801 20,3 + WK Ceramic
			➡	09/05→; +PR 1KU,1KW		13.0460-2749.2 602749 13.0460-2880.2 602880 13.0470-2749.2 LD2749 13.0470-2880.2 LD2880	TRW 24483 16,9 - WE / - WK + Zub TRW 23914 17,1 + WE / - WK + Zub TRW 24483 16,9 - WE / - WK + Zub Ceramic TRW 23914 17,1 + WE / - WK + Zub Ceramic
			➡	09/05→; +PR 2EA,2EL		13.0460-2887.2 602887 13.0470-2621.2 LD2621 13.0470-2887.2 LD2887	TRW 23914 17,1 + WE / - WK + Zub TRW - WE / - WK + Zub Ceramic TRW 23914 17,1 + WE / - WK + Zub Ceramic
Zubehörsatz, Scheibenbremsbelag							
1.4 TSI 1.8 TSI	90 118	05/07→11/10 05/07→10/11	➡	10/07→ 07/10; +PR 2EA,2EL		13.0460-0035.2 610035	
			➡	10/07→ 07/10; +PR 1KU,1KW		13.0460-0259.2 610259	
1.4 TSI EcoFuel 1.6 1.6 TDI 1.8 TSI 2.0 BlueTDI 2.0 FSI 2.0 FSI 2.0 FSI 2.0 FSI 4motion 2.0 TDI 2.0 TDI 2.0 TDI 16V 2.0 TDI 4motion 3.2 FSI 4motion 3.6 R36 4motion	110 75 77 112 105 110 125 147 110 81 100 125 103 125 184 220	01/09→11/10 08/05→11/10 08/09→11/10 11/09→11/10 01/09→11/10 08/05→11/10 08/07→11/10 08/05→11/10 09/05→11/10 11/08→11/10 08/05→11/10 08/05→11/10 08/05→11/10 05/09→11/10 11/05→11/10 04/07→11/10	➡	→ 07/10; +PR 2EA,2EL		13.0460-0035.2 610035	
			➡	→ 07/10; +PR 1KU,1KW		13.0460-0259.2 610259	
1.6 FSI 1.9 TDI 2.0 TDI 2.0 TDI 2.0 TDI	85 77 88 90 103 120	08/05→06/08 08/05→11/08 11/05→05/07 08/05→02/06 08/05→05/09 08/05→05/09	➡	+PR 2EA,2EL		13.0460-0035.2 610035	
			➡	+PR 1KU,1KW		13.0460-0259.2 610259	
2.0 TDI 16V 4motion	103	08/05→11/10	➡	09/05→ 07/10; +PR 2EA,2EL		13.0460-0035.2 610035	
			➡	09/05→ 07/10; +PR 1KU,1KW		13.0460-0259.2 610259	
↓							

VW - PASSAT Variant (3C5) 08/05→10/11

Zubehörsatz, Scheibenbremsbelag

2.0 TDI 4motion	103	08/05→05/09	➡	09/05→; +PR 2EA,2EL	13.0460-0035.2	610035	
			➡	09/05→; +PR 1KU,1KW	13.0460-0259.2	610259	











Bremsscheibe

1.4 TSI 1.8 TSI	90 118	05/07→11/10 05/07→10/11	←	10/07→ 07/10; +PR 1LJ,1LH,1ZG,1ZM	24.0125-0158.1	425158	Ø 312 25 22 V + S
			←	10/07→ 07/10; +PR 1LK,1LM	24.0325-0158.1	525158	Ø 312 25 22 V + S PD
			←	10/07→ 07/10; +PR 1LK,1LM	24.0130-0115.1	430115	Ø 345 30 27 V
			➡	10/07→ 07/10; +PR 1KU,1KW	24.0330-0115.1	530115	Ø 345 30 27 V PD
			➡	10/07→ 07/10; +PR 1KU,1KW	24.0112-0169.1	412169	Ø 282 12 10 + S
			➡	10/07→ 07/10; +PR 2EA,2EL	24.0312-0169.1	512169	Ø 282 12 10 + S PD
			➡	10/07→ 07/10; +PR 2EA,2EL	24.0122-0219.1	422219	Ø 310 22 20 V
1.4 TSI EcoFuel 1.6 1.6 TDI 1.8 TSI 2.0 BlueTDI 2.0 FSI 2.0 FSI 2.0 FSI 2.0 FSI 4motion 2.0 TDI 2.0 TDI 2.0 TDI 2.0 TDI 16V 2.0 TDI 4motion 3.2 FSI 4motion 3.6 R36 4motion	110 75 77 112 105 110 125 147 110 81 100 125 103 125 184 220	01/09→11/10 08/05→11/10 08/09→11/10 11/09→11/10 01/09→11/10 08/05→11/10 08/07→11/10 08/05→11/10 09/05→11/10 11/08→11/10 08/05→11/10 08/05→11/10 08/05→11/10 08/05→11/10 05/09→11/10 11/05→11/10 04/07→11/10	←	→ 07/10; +PR 1LJ,1LH,1ZG,1ZM	24.0125-0158.1	425158	Ø 312 25 22 V + S
			←	→ 07/10; +PR 1LK,1LM	24.0325-0158.1	525158	Ø 312 25 22 V + S PD
			←	→ 07/10; +PR 1LK,1LM	24.0130-0115.1	430115	Ø 345 30 27 V
			➡	→ 07/10; +PR 1KU,1KW	24.0330-0115.1	530115	Ø 345 30 27 V PD
			➡	→ 07/10; +PR 1KU,1KW	24.0112-0169.1	412169	Ø 282 12 10 + S
			➡	→ 07/10; +PR 1KU,1KW	24.0312-0169.1	512169	Ø 282 12 10 + S PD
			➡	→ 07/10; +PR 2EA,2EL	24.0122-0219.1	422219	Ø 310 22 20 V
1.6 FSI 1.9 TDI 2.0 TDI 2.0 TDI 2.0 TDI 2.0 TDI	85 77 88 90 103 120	08/05→06/08 08/05→11/08 11/05→05/07 08/05→02/06 08/05→05/09 08/05→05/09	←	+PR 1LJ,1LH,1ZG,1ZM	24.0125-0158.1	425158	Ø 312 25 22 V + S
			←	+PR 1LK,1LM	24.0325-0158.1	525158	Ø 312 25 22 V + S PD
			←	+PR 1LK,1LM	24.0130-0115.1	430115	Ø 345 30 27 V
			➡	+PR 1KU,1KW	24.0330-0115.1	530115	Ø 345 30 27 V PD
			➡	+PR 1KU,1KW	24.0112-0169.1	412169	Ø 282 12 10 + S
			➡	+PR 2EA,2EL	24.0312-0169.1	512169	Ø 282 12 10 + S PD
			➡	+PR 2EA,2EL	24.0122-0219.1	422219	Ø 310 22 20 V
2.0 TDI 16V 4motion	103	08/05→11/10	←	09/05→ 07/10; +PR 1LJ,1LH,1ZG,1ZM	24.0125-0158.1	425158	Ø 312 25 22 V + S
			←	09/05→ 07/10; +PR 1LK,1LM	24.0325-0158.1	525158	Ø 312 25 22 V + S PD
			←	09/05→ 07/10; +PR 1LK,1LM	24.0130-0115.1	430115	Ø 345 30 27 V
			➡	09/05→ 07/10; +PR 1KU,1KW	24.0330-0115.1	530115	Ø 345 30 27 V PD
			➡	09/05→ 07/10; +PR 1KU,1KW	24.0112-0169.1	412169	Ø 282 12 10 + S
			➡	09/05→ 07/10; +PR 2EA,2EL	24.0312-0169.1	512169	Ø 282 12 10 + S PD
			➡	09/05→ 07/10; +PR 2EA,2EL	24.0122-0219.1	422219	Ø 310 22 20 V
2.0 TDI 4motion	103	08/05→05/09	←	09/05→; +PR 1LJ,1LH,1ZG,1ZM	24.0125-0158.1	425158	Ø 312 25 22 V + S
			←	09/05→; +PR 1LK,1LM	24.0325-0158.1	525158	Ø 312 25 22 V + S PD
			←	09/05→; +PR 1LK,1LM	24.0130-0115.1	430115	Ø 345 30 27 V
			➡	09/05→; +PR 1KU,1KW	24.0330-0115.1	530115	Ø 345 30 27 V PD
			➡	09/05→; +PR 1KU,1KW	24.0112-0169.1	412169	Ø 282 12 10 + S
			➡	09/05→; +PR 2EA,2EL	24.0312-0169.1	512169	Ø 282 12 10 + S PD
			➡	09/05→; +PR 2EA,2EL	24.0122-0219.1	422219	Ø 310 22 20 V











VW - PASSAT Variant (3G5) 08/14→











Bremsbelagsatz, Scheibenbremse

1.4 GTE Hybrid 1.4 TSI 1.4 TSI 1.4 TSI 4motion 1.8 TSI 2.0 TDI 2.0 TDI 2.0 TDI 2.0 TDI 4motion 2.0 TDI 4motion 2.0 TSI 4motion	115 92 110 110 132 110 135 140 110 140 206	06/15→ 11/14→ 11/14→ 02/15→ 02/15→ 11/14→ 07/15→ 11/14→ 02/15→ 11/14→ 05/15→	←	+PR 1ZA,1ZC,1ZD,1ZG / 1ZK,1ZL	13.0460-2785.2	602785	TRW 25683 20,4 + WE / + WK
			←		13.0470-2785.2	LD2785	TRW 25683 20,4 + WE / + WK Ceramic
			➡	+PR 1KU,1KZ,2EA; + eFSB	13.0460-7294.2	607294	ATE 25009 16,4 - WE / - WK
			➡		13.0470-7294.2	LD7294	ATE 25009 16,4 - WE / - WK Ceramic
1.6 TDI 2.0 TDI 4motion	88 176	08/14→ 08/14→	←	11/14→; +PR 1ZA,1ZC,1ZD,1ZG / 1ZK,1ZL	13.0460-2785.2	602785	TRW 25683 20,4 + WE / + WK
			←		13.0470-2785.2	LD2785	TRW 25683 20,4 + WE / + WK Ceramic
			➡	11/14→; +PR 1KU,1KZ,2EA; + eFSB	13.0460-7294.2	607294	ATE 25009 16,4 - WE / - WK
			➡		13.0470-7294.2	LD7294	ATE 25009 16,4 - WE / - WK Ceramic











	kW			 	! #		
VW - PASSAT Variant (3G5) 08/14→							
 Bremsbelagsatz, Scheibenbremse							
2.0 TSI	162	02/15→	←	05/15→; +PR 1ZA,1ZC,1ZD,1ZG / 1ZK,1ZL		13.0460-2785.2 602785 13.0470-2785.2 LD2785	TRW 25683 20,4 + WE / + WK TRW 25683 20,4 + WE / + WK Ceramic
			→	05/15→; +PR 1KU,1KZ,2EA; + eFSB		13.0460-7294.2 607294 13.0470-7294.2 LD7294	ATE 25009 16,4 - WE / - WK ATE 25009 16,4 - WE / - WK Ceramic
Warnkontakt, Bremsbelagverschleiß							
1.4 GTE Hybrid	115	06/15→	←	+PR 1ZA,1ZC,1ZD,1ZG / 1ZK,1ZL	1	24.8190-0065.2 620065	L= 172
1.4 TSI	92	11/14→	←	+PR 1LA	1	24.8190-0065.2 620065	L= 172
1.4 TSI	110	11/14→					
1.4 TSI 4motion	110	02/15→					
1.8 TSI	132	02/15→					
2.0 TDI	110	11/14→					
2.0 TDI	135	07/15→					
2.0 TDI	140	11/14→					
2.0 TDI 4motion	110	02/15→					
2.0 TDI 4motion	140	11/14→					
2.0 TSI 4motion	206	05/15→					
1.6 TDI	88	08/14→	←	11/14→; +PR 1LA	1	24.8190-0065.2 620065	L= 172
2.0 TDI 4motion	176	08/14→	←	11/14→; +PR 1ZA,1ZC,1ZD,1ZG / 1ZK,1ZL	1	24.8190-0065.2 620065	L= 172
2.0 TSI	162	02/15→	←	05/15→; +PR 1LA	1	24.8190-0065.2 620065	L= 172
			←	05/15→; +PR 1ZA,1ZC,1ZD,1ZG / 1ZK,1ZL	1	24.8190-0065.2 620065	L= 172
 Bremsscheibe							
1.4 GTE Hybrid	115	06/15→	←	+PR 1ZA,1ZC,1ZD,1ZG / 1ZK,1ZL		24.0125-0158.1 425158	Ø 312 25 22 V + S
1.4 TSI	92	11/14→				24.0325-0158.1 525158	Ø 312 25 22 V + S PD
1.4 TSI	110	11/14→	←	+PR 1LA		24.0130-0225.1 430225	Ø 340 30 27 V + S
1.4 TSI 4motion	110	02/15→	←	+PR 1LA		24.0130-0225.1 430225	Ø 340 30 27 V + S
1.8 TSI	132	02/15→	→	+PR 1KU,2EA; + eFSB		24.0112-0210.1 412210	Ø 300 12 10 + S
2.0 TDI	110	11/14→	→	+PR 1KU,2EA; + eFSB		24.0112-0210.1 412210	Ø 300 12 10 + S
2.0 TDI	135	07/15→	→	+PR 1KZ		24.0122-0219.1 422219	Ø 310 22 20 V
2.0 TDI	140	11/14→					
2.0 TDI 4motion	110	02/15→					
2.0 TDI 4motion	140	11/14→					
2.0 TSI 4motion	206	05/15→					
1.6 TDI	88	08/14→	←	11/14→; +PR 1ZA,1ZC,1ZD,1ZG / 1ZK,1ZL		24.0125-0158.1 425158 24.0325-0158.1 525158	Ø 312 25 22 V + S Ø 312 25 22 V + S PD
2.0 TDI 4motion	176	08/14→	←	11/14→; +PR 1LA		24.0130-0225.1 430225	Ø 340 30 27 V + S
			→	11/14→; +PR 1KU,2EA; + eFSB		24.0112-0210.1 412210	Ø 300 12 10 + S
			→	11/14→; +PR 1KZ		24.0122-0219.1 422219	Ø 310 22 20 V
2.0 TSI	162	02/15→	←	05/15→; +PR 1ZA,1ZC,1ZD,1ZG / 1ZK,1ZL		24.0125-0158.1 425158 24.0325-0158.1 525158	Ø 312 25 22 V + S Ø 312 25 22 V + S PD
			←	05/15→; +PR 1LA		24.0130-0225.1 430225	Ø 340 30 27 V + S
			→	05/15→; +PR 1KU,2EA; + eFSB		24.0112-0210.1 412210	Ø 300 12 10 + S
			→	05/15→; +PR 1KZ		24.0122-0219.1 422219	Ø 310 22 20 V
VW - PASSAT Variant (365) 08/10→12/14							
 Bremsbelagsatz, Scheibenbremse							
1.4 TSI	90	08/10→12/14	←	→ 10/14; +PR 1LA,1LB		13.0460-2764.2 602764	TRW 24738 20,0 + WK
1.4 TSI EcoFuel	110	08/10→12/14				13.0470-2764.2 LD2764	TRW 24738 20,0 + WK Ceramic
1.4 TSI MultiFuel	118	11/10→12/14					
1.6 TDI	77	08/10→12/14	←	→ 10/14; +PR 1ZM,1ZG		13.0460-7184.2 607184	ATE 23587 20,6 + WK
1.8 TSI	112	02/11→12/14				13.0470-7184.2 LD7184	ATE 23587 20,6 + WK Ceramic
1.8 TSI	118	08/10→12/14					
2.0 TDI	100	08/10→12/14	→	→ 10/14; +PR 1KW		13.0460-2749.2 602749	TRW 24483 16,9 - WE / - WK + Zub
2.0 TDI	103	08/10→12/14					
2.0 TDI	125	08/10→12/14				13.0460-2880.2 602880	TRW 23914 17,1 + WE / - WK + Zub
2.0 TDI	130	12/12→12/14					
2.0 TDI 4motion	103	08/10→12/14				13.0470-2749.2 LD2749	TRW 24483 16,9 - WE / - WK + Zub Ceramic
2.0 TDI 4motion	130	01/13→12/14					
2.0 TSI	155	11/10→12/14				13.0470-2880.2 LD2880	TRW 23914 17,1 + WE / - WK + Zub Ceramic
3.6 FSI 4motion	220	01/11→12/14					
			→	→ 10/14; +PR 2EA		13.0460-2887.2 602887	TRW 23914 17,1 + WE / - WK + Zub
						13.0470-2621.2 LD2621	TRW - WE / - WK + Zub Ceramic
						13.0470-2887.2 LD2887	TRW 23914 17,1 + WE / - WK + Zub Ceramic
1.4 TSI	118	11/12→12/14	←	→ 10/14; +PR 1LA,1LB		13.0460-2764.2 602764	TRW 24738 20,0 + WK





















	kw			 	! #		
VW - PASSAT Variant (365) 08/10→12/14							
 Bremsbelagsatz, Scheibenbremse							
1.4 TSI	118	11/12→12/14	←	→ 10/14; +PR 1LA,1LB	13.0470-2764.2	LD2764	TRW 24738 20,0 + WK Ceramic
			←	→ 10/14; +PR 1ZM,1ZG	13.0460-7184.2	607184	ATE 23587 20,6 + WK
					13.0470-7184.2	LD7184	ATE 23587 20,6 + WK Ceramic
			→	→ 10/14; +PR 1KW	13.0460-2749.2	602749	TRW 24483 16,9 - WE / - WK + Zub
					13.0460-2880.2	602880	TRW 23914 17,1 + WE / - WK + Zub
				13.0470-2749.2	LD2749	TRW 24483 16,9 - WE / - WK + Zub Ceramic	
				13.0470-2880.2	LD2880	TRW 23914 17,1 + WE / - WK + Zub Ceramic	
2.0 TDI 4motion	125	08/10→01/13	←	+PR 1LA,1LB	13.0460-2764.2	602764	TRW 24738 20,0 + WK
					13.0470-2764.2	LD2764	TRW 24738 20,0 + WK Ceramic
			←	+PR 1ZM,1ZG	13.0460-7184.2	607184	ATE 23587 20,6 + WK
					13.0470-7184.2	LD7184	ATE 23587 20,6 + WK Ceramic
			→	+PR 1KW	13.0460-2749.2	602749	TRW 24483 16,9 - WE / - WK + Zub
				13.0460-2880.2	602880	TRW 23914 17,1 + WE / - WK + Zub	
				13.0470-2749.2	LD2749	TRW 24483 16,9 - WE / - WK + Zub Ceramic	
				13.0470-2880.2	LD2880	TRW 23914 17,1 + WE / - WK + Zub Ceramic	
			→	→ 10/14	13.0460-2887.2	602887	TRW 23914 17,1 + WE / - WK + Zub
					13.0470-2621.2	LD2621	TRW - WE / - WK + Zub Ceramic
					13.0470-2887.2	LD2887	TRW 23914 17,1 + WE / - WK + Zub Ceramic
 Bremsscheibe							
1.4 TSI	90	08/10→12/14	←	→ 10/14; +PR 1ZM,1ZG	24.0125-0158.1	425158	Ø 312 25 22 V + S
1.4 TSI	118	11/12→12/14			24.0325-0158.1	525158	Ø 312 25 22 V + S PD
1.4 TSI EcoFuel	110	08/10→12/14					
1.4 TSI MultiFuel	118	11/10→12/14	←	→ 10/14; +PR 1LA,1LB	24.0130-0225.1	430225	Ø 340 30 27 V + S
1.6 TDI	77	08/10→12/14	→	→ 10/14; +PR 1KW	24.0112-0169.1	412169	Ø 282 12 10 + S
1.8 TSI	112	02/11→12/14			24.0312-0169.1	512169	Ø 282 12 10 + S PD
1.8 TSI	118	08/10→12/14					
2.0 TDI	100	08/10→12/14	→	→ 10/14; +PR 2EA; + eFSB	24.0122-0219.1	422219	Ø 310 22 20 V
2.0 TDI	103	08/10→12/14					
2.0 TDI	125	08/10→12/14					
2.0 TDI	130	12/12→12/14					
2.0 TDI 4motion	103	08/10→12/14					
2.0 TDI 4motion	130	01/13→12/14					
2.0 TSI	155	11/10→12/14					
3.6 FSI 4motion	220	01/11→12/14					
2.0 TDI 4motion	125	08/10→01/13	←	+PR 1ZM,1ZG	24.0125-0158.1	425158	Ø 312 25 22 V + S
					24.0325-0158.1	525158	Ø 312 25 22 V + S PD
			←	+PR 1LA,1LB	24.0130-0225.1	430225	Ø 340 30 27 V + S
			→	+PR 1KW	24.0112-0169.1	412169	Ø 282 12 10 + S
					24.0312-0169.1	512169	Ø 282 12 10 + S PD
			→	+PR 2EA; + eFSB	24.0122-0219.1	422219	Ø 310 22 20 V
VW - PHAETON (3D_) 04/02→03/16							
 Bremsbelagsatz, Scheibenbremse							
3.0 V6 TDI 4motion	165	09/04→05/07	←	+PR 1LC	13.0460-4800.2	604800	BRE 23751 17,0 + WK
3.0 V6 TDI 4motion	176	11/08→03/16					
3.0 V6 TDI 4motion	180	11/13→03/16	←	+PR 1ZK;1ZL	13.0460-7182.2	607182	ATE 23896 20,6 + WK
4.2 V8 4motion	246	05/03→03/16	→	+PR 1KD,1KP,1KY	13.0460-2890.2	602890	TRW 23326 17,4 + WK
5.0 V10 TDI 4motion	230	11/02→10/06					
6.0 W12 4motion	309	04/02→05/05					
6.0 W12 4motion	331	05/05→03/16					
3.0 V6 TDI 4motion	171	06/07→11/08	←	04/08→; +PR 1LC	13.0460-4800.2	604800	BRE 23751 17,0 + WK
			←	04/08→; +PR 1ZK;1ZL	13.0460-7182.2	607182	ATE 23896 20,6 + WK
			→	04/08→; +PR 1KD,1KP,1KY	13.0460-2890.2	602890	TRW 23326 17,4 + WK
↓							









	kw			 	! #		
VW - PHAETON (3D_) 04/02→03/16							
 Bremsbelagsatz, Scheibenbremse							
3.2 V6	177	04/02→05/05	←	+PR 1LX		13.0460-2875.2 602875	TRW 23119 17,5 + WK
			←	+PR 1LC		13.0460-4800.2 604800	BRE 23751 17,0 + WK
			←	+PR 1ZK;1ZL		13.0460-7182.2 607182	ATE 23896 20,6 + WK
			→	+PR 1KD,1KP,1KY		13.0460-2890.2 602890	TRW 23326 17,4 + WK
3.2 V6 4motion 3.6 V6 4motion	177 206	02/04→11/08 11/08→03/16	←	+PR 1LC		13.0460-4800.2 604800	BRE 23751 17,0 + WK
			←	+PR 1ZK,1ZL		13.0460-7182.2 607182	ATE 23896 20,6 + WK
			→	+PR 1KD,1KP,1KY		13.0460-2890.2 602890	TRW 23326 17,4 + WK
Zubehörsatz, Scheibenbremsbelag							
3.0 V6 TDI 4motion	165	09/04→05/07	→	+PR 1KD,1KP,1KY		13.0460-0023.2 610023	
3.0 V6 TDI 4motion	176	11/08→03/16					
3.0 V6 TDI 4motion	180	11/13→03/16					
3.2 V6	177	04/02→05/05					
3.2 V6 4motion	177	02/04→11/08					
3.6 V6 4motion	206	11/08→03/16					
4.2 V8 4motion	246	05/03→03/16					
5.0 V10 TDI 4motion	230	11/02→10/06					
6.0 W12 4motion	309	04/02→05/05					
6.0 W12 4motion	331	05/05→03/16					
3.0 V6 TDI 4motion	171	06/07→11/08	→	04/08→; +PR 1KD,1KP,1KY		13.0460-0023.2 610023	
 Bremsscheibe							
3.0 V6 TDI 4motion	165	09/04→05/07	←	+PR 1ZK;1ZL		24.0134-0100.1 434100	∅ 360 34 31 V
3.0 V6 TDI 4motion	176	11/08→03/16	→	+PR 1KD		24.0122-0202.1 422202	∅ 280 22 20 V
3.0 V6 TDI 4motion	180	11/13→03/16	→	+PR 1KP		24.0122-0212.1 422212	∅ 310 22 20 V
4.2 V8 4motion	246	05/03→03/16	→	+PR 1KY		24.0122-0214.1 422214	∅ 335 22 20 V
5.0 V10 TDI 4motion	230	11/02→10/06	→	+PR 1KY		24.0122-0214.1 422214	∅ 335 22 20 V
6.0 W12 4motion	309	04/02→05/05	→	+PR 1KY		24.0122-0214.1 422214	∅ 335 22 20 V
6.0 W12 4motion	331	05/05→03/16	→	+PR 1KY		24.0122-0214.1 422214	∅ 335 22 20 V
3.0 V6 TDI 4motion	171	06/07→11/08	←	04/08→; +PR 1ZK;1ZL		24.0134-0100.1 434100	∅ 360 34 31 V
			→	04/08→; +PR 1KD		24.0122-0202.1 422202	∅ 280 22 20 V
			→	04/08→; +PR 1KP		24.0122-0212.1 422212	∅ 310 22 20 V
			→	04/08→; +PR 1KY		24.0122-0214.1 422214	∅ 335 22 20 V
3.2 V6	177	04/02→05/05	←	+PR 1LX		24.0130-0183.1 430183	∅ 323 30 28 V
			←	+PR 1ZK;1ZL		24.0134-0100.1 434100	∅ 360 34 31 V
			→	+PR 1KD		24.0122-0202.1 422202	∅ 280 22 20 V
			→	+PR 1KP		24.0122-0212.1 422212	∅ 310 22 20 V
			→	+PR 1KY		24.0122-0214.1 422214	∅ 335 22 20 V
3.2 V6 4motion 3.6 V6 4motion	177 206	02/04→11/08 11/08→03/16	←	+PR 1ZK,1ZL		24.0134-0100.1 434100	∅ 360 34 31 V
			→	+PR 1KD		24.0122-0202.1 422202	∅ 280 22 20 V
			→	+PR 1KP		24.0122-0212.1 422212	∅ 310 22 20 V
			→	+PR 1KY		24.0122-0214.1 422214	∅ 335 22 20 V
VW - POLO (6N1) 10/94→10/99							
 Bremsbelagsatz, Scheibenbremse							
1.7 SDI	42	04/97→10/99	←	05/97→		13.0460-7100.2 607100 13.0470-7100.2 LD7100	VW 21866 17,2 - WE / - WK VW 21866 17,2 - WE / - WK Ceramic
100 1.4 16V	74	04/96→10/99	←			13.0460-2821.2 602821	TRW 21945 16,0 - WK
			→	10/99→; nur für Deutschland		13.0460-2886.2 602886 13.0470-2886.2 LD2886 13.0470-2894.2 LD2894	TRW 20961 16,0 - WK TRW 20961 16,0 - WK Ceramic TRW 20961 17,2 - WK + Zub Ceramic
			→	10/99→; nur für Deutschland		13.0460-2894.2 602894	TRW 20961 17,2 - WK + Zub
			→	→ 09/99; nur für Deutschland		13.0460-2984.2 602984	TRW 20961 17,2 - WK + Zub
120 1.6 16V GTI	88	09/98→10/99	←			13.0460-2821.2 602821	TRW 21945 16,0 - WK
			→	10/99→		13.0460-2886.2 602886 13.0460-2894.2 602894 13.0470-2886.2 LD2886 13.0470-2894.2 LD2894	TRW 20961 16,0 - WK TRW 20961 17,2 - WK + Zub TRW 20961 16,0 - WK Ceramic TRW 20961 17,2 - WK + Zub Ceramic
			→	→ 09/99		13.0460-2984.2 602984	TRW 20961 17,2 - WK + Zub
↓							











	kW			 	! #		
VW - POLO (6N1) 10/94→10/99							
 Bremsbelagsatz, Scheibenbremse							
45 1.0 55 1.3 55 1.4 60 1.4 64 1.9 D 64 1.9 SDI 75 1.6 4motion	33 40 40 44 47 47 55	10/94→09/96 10/94→07/95 08/95→10/99 07/95→10/99 10/94→10/99 07/96→10/99 08/95→10/99	← ← ← ← ← ← ←	→ 6N-TW082000 → 6N-TY140000 6N-TY140001→ 6N-TW082001→		13.0460-7059.2 607059 13.0460-7059.2 607059 13.0460-7100.2 607100 13.0470-7100.2 LD7100 13.0460-7100.2 607100 13.0470-7100.2 LD7100	VW 20887 17,3 - WE / - WK + Zub VW 20887 17,3 - WE / - WK + Zub VW 21866 17,2 - WE / - WK VW 21866 17,2 - WE / - WK Ceramic VW 21866 17,2 - WE / - WK VW 21866 17,2 - WE / - WK Ceramic
50 1.0 60 1.7 SDI	37 44	09/96→10/99 08/97→10/99	←			13.0460-7100.2 607100 13.0470-7100.2 LD7100	VW 21866 17,2 - WE / - WK VW 21866 17,2 - WE / - WK Ceramic
75 1.6	55	10/94→10/99	← ← ← ←	→ 6N-TW082000 → 6N-TY140000 6N-TW082001→; → 09/99 6N-TY140001→; → 09/99		13.0460-7059.2 607059 13.0460-7059.2 607059 13.0460-7100.2 607100 13.0470-7100.2 LD7100 13.0460-7100.2 607100 13.0470-7100.2 LD7100	VW 20887 17,3 - WE / - WK + Zub VW 20887 17,3 - WE / - WK + Zub VW 21866 17,2 - WE / - WK VW 21866 17,2 - WE / - WK Ceramic VW 21866 17,2 - WE / - WK VW 21866 17,2 - WE / - WK Ceramic
Zubehörsatz, Scheibenbremsbelag							
100 1.4 16V	74	04/96→10/99	→ →	10/99→; nur für Deutschland → 09/99; nur für Deutschland		13.0460-0072.2 610072 13.0460-0072.2 610072	TRW TRW
120 1.6 16V GTI	88	09/98→10/99	→ →	10/99→ → 09/99		13.0460-0072.2 610072 13.0460-0072.2 610072	TRW TRW
 Bremsscheibe							
1.7 SDI	42	04/97→10/99	←	05/97→		24.0118-0106.1 418106 24.0318-0106.1 518106	Ø 239 18 16 V + S Ø 239 18 16 V + S PD
100 1.4 16V	74	04/96→10/99	← → →			24.0120-0128.1 420128 24.0320-0128.1 520128 24.0109-0124.1 409124	Ø 256 20 18 V + S Ø 256 20 18 V + S PD Ø 232 9 7
120 1.6 16V GTI	88	09/98→10/99	← → →			24.0110-0111.1 410111 24.0110-0275.2 410275 24.0125-0136.1 425136 24.0109-0124.1 409124	Ø 226 10 8 - ABS Ring / - RLG Ø 226 10 8 + ABS Ring / - RLG Ø 256 25 23 V Ø 232 9 7
45 1.0 55 1.3 64 1.9 D 64 1.9 SDI 75 1.6 4motion	33 40 47 47 55	10/94→09/96 10/94→07/95 10/94→10/99 07/96→10/99 08/95→10/99	← ← ← ← ←	→ 6N-SY087410 → 6N-SW008500 6N-SW008501→ 6N-SY087411→		24.0110-0232.1 410232 24.0118-0106.1 418106 24.0318-0106.1 518106 24.0118-0106.1 418106 24.0318-0106.1 518106	Ø 239 9,9 8 + S Ø 239 18 16 V + S Ø 239 18 16 V + S PD Ø 239 18 16 V + S Ø 239 18 16 V + S PD
50 1.0 55 1.4 60 1.4 60 1.7 SDI	37 40 44 44	09/96→10/99 08/95→10/99 07/95→10/99 08/97→10/99	←			24.0118-0106.1 418106 24.0318-0106.1 518106	Ø 239 18 16 V + S Ø 239 18 16 V + S PD
75 1.6	55	10/94→10/99	← ← ← ←	→ 6N-SY087410 → 6N-SW008500 6N-SW008501→; → 09/99 6N-SY087411→; → 09/99		24.0110-0232.1 410232 24.0118-0106.1 418106 24.0318-0106.1 518106 24.0118-0106.1 418106 24.0318-0106.1 518106	Ø 239 9,9 8 + S Ø 239 9,9 8 + S Ø 239 18 16 V + S Ø 239 18 16 V + S PD Ø 239 18 16 V + S Ø 239 18 16 V + S PD
VW - POLO (6N2) 10/99→10/01							
 Bremsbelagsatz, Scheibenbremse							
1.0 1.7 SDI ↓	37 44	10/99→09/01 10/99→09/01	←			13.0460-7100.2 607100	VW 21866 17,2 - WE / - WK









	kW			 	! #		
VW - POLO (6N2) 10/99→10/01							
 Bremsbelagsatz, Scheibenbremse							
1.0 1.7 SDI	37 44	10/99→09/01 10/99→09/01	←			13.0470-7100.2 LD7100	VW 21866 17,2 - WE / - WK Ceramic
1.4 1.4 1.9 D 1.9 SDI	40 44 47 47	10/99→09/01 10/99→09/01 10/99→09/01 10/99→09/01	←	→ 6N-TW082000		13.0460-7059.2 607059	VW 20887 17,3 - WE / - WK + Zub
			←	→ 6N-TY140000		13.0460-7059.2 607059	VW 20887 17,3 - WE / - WK + Zub
			←	6N-TY140001→		13.0460-7100.2 607100	VW 21866 17,2 - WE / - WK
			←	6N-TW082001→		13.0460-7100.2 607100	VW 21866 17,2 - WE / - WK Ceramic
1.4 16V	55	10/99→09/01	←	+ ABS		13.0460-2821.2 602821	TRW 21945 16,0 - WK
			←	- ABS		13.0460-7100.2 607100	VW 21866 17,2 - WE / - WK
			→	+ ABS		13.0460-2886.2 602886 13.0460-2894.2 602894 13.0470-2886.2 LD2886 13.0470-2894.2 LD2894	TRW 20961 16,0 - WK TRW 20961 17,2 - WK + Zub TRW 20961 16,0 - WK Ceramic TRW 20961 17,2 - WK + Zub Ceramic
1.4 16V	74	10/99→09/01	←			13.0460-2821.2 602821	TRW 21945 16,0 - WK
			→	nur für Deutschland		13.0460-2886.2 602886 13.0470-2886.2 LD2886 13.0470-2894.2 LD2894	TRW 20961 16,0 - WK TRW 20961 16,0 - WK Ceramic TRW 20961 17,2 - WK + Zub Ceramic
			→	nur für Deutschland		13.0460-2894.2 602894	TRW 20961 17,2 - WK + Zub
1.4 TDI	55	10/99→09/01	←			13.0460-2821.2 602821	TRW 21945 16,0 - WK
			→	+ ABS		13.0460-2886.2 602886 13.0460-2894.2 602894 13.0470-2886.2 LD2886 13.0470-2894.2 LD2894	TRW 20961 16,0 - WK TRW 20961 17,2 - WK + Zub TRW 20961 16,0 - WK Ceramic TRW 20961 17,2 - WK + Zub Ceramic
			←			13.0460-2821.2 602821	TRW 21945 16,0 - WK
			→			13.0460-2886.2 602886 13.0460-2894.2 602894 13.0470-2886.2 LD2886 13.0470-2894.2 LD2894	TRW 20961 16,0 - WK TRW 20961 17,2 - WK + Zub TRW 20961 16,0 - WK Ceramic TRW 20961 17,2 - WK + Zub Ceramic
1.6 16V GTI	92	10/99→09/01	←			13.0460-2821.2 602821	TRW 21945 16,0 - WK
			→			13.0460-2886.2 602886 13.0460-2894.2 602894 13.0470-2886.2 LD2886 13.0470-2894.2 LD2894	TRW 20961 16,0 - WK TRW 20961 17,2 - WK + Zub TRW 20961 16,0 - WK Ceramic TRW 20961 17,2 - WK + Zub Ceramic
			←			13.0460-2821.2 602821	TRW 21945 16,0 - WK
			→			13.0460-2886.2 602886 13.0460-2894.2 602894 13.0470-2886.2 LD2886 13.0470-2894.2 LD2894	TRW 20961 16,0 - WK TRW 20961 17,2 - WK + Zub TRW 20961 16,0 - WK Ceramic TRW 20961 17,2 - WK + Zub Ceramic
Zubehörsatz, Scheibenbremsbelag							
1.4 16V 1.4 TDI	55 55	10/99→09/01 10/99→09/01	→	+ ABS		13.0460-0072.2 610072	TRW
1.4 16V	74	10/99→09/01	→	nur für Deutschland		13.0460-0072.2 610072	TRW
1.6 16V GTI	92	10/99→09/01	→			13.0460-0072.2 610072	TRW
 Bremsscheibe							
1.0 1.4 1.4 1.7 SDI	37 40 44 44	10/99→09/01 10/99→09/01 10/99→09/01 10/99→09/01	←			24.0118-0106.1 418106 24.0318-0106.1 518106	Ø 239 18 16 V + S Ø 239 18 16 V + S PD
1.4 16V	55	10/99→09/01	←	- ABS		24.0118-0106.1 418106 24.0318-0106.1 518106	Ø 239 18 16 V + S Ø 239 18 16 V + S PD
			←	+ ABS		24.0120-0128.1 420128 24.0320-0128.1 520128	Ø 256 20 18 V + S Ø 256 20 18 V + S PD
			→	+ ABS		24.0109-0124.1 409124	Ø 232 9 7
1.4 16V	74	10/99→09/01	←			24.0120-0128.1 420128 24.0320-0128.1 520128	Ø 256 20 18 V + S Ø 256 20 18 V + S PD
			→			24.0109-0124.1 409124	Ø 232 9 7
1.4 TDI	55	10/99→09/01	←			24.0120-0128.1 420128 24.0320-0128.1 520128	Ø 256 20 18 V + S Ø 256 20 18 V + S PD
			→	+ ABS		24.0109-0124.1 409124	Ø 232 9 7
1.6 16V GTI	92	10/99→09/01	←			24.0125-0136.1 425136	Ø 256 25 23 V
			→			24.0109-0124.1 409124	Ø 232 9 7
↓							

	kw			 	! #		
VW - POLO (6N2) 10/99→10/01							
 Bremsscheibe							
1.9 D	47	10/99→09/01	←	→ 6N-SY087410		24.0110-0232.1 410232	Ø 239 9,9 8 + S
1.9 SDI	47	10/99→09/01	←	→ 6N-SW008500		24.0110-0232.1 410232	Ø 239 9,9 8 + S
			←	6N-SW008501→		24.0118-0106.1 418106	Ø 239 18 16 V + S
						24.0318-0106.1 518106	Ø 239 18 16 V + S PD
			←	6N-SY087411→		24.0118-0106.1 418106	Ø 239 18 16 V + S
						24.0318-0106.1 518106	Ø 239 18 16 V + S PD
VW - POLO (6R, 6C) 06/09→							
 Bremsbelagsatz, Scheibenbremse							
1.0	44	01/14→	←	+PR 1ZG,1LR,1ZJ		13.0460-7111.2 607111	VW 23130 19,6 - WE / - WK
1.0	55	01/14→				13.0470-7111.2 LD7111	VW 23130 19,6 - WE / - WK Ceramic
1.0 TSI	70	11/14→					
1.0 TSI	81	11/14→					
1.4 TDI	55	03/14→	←	+PR 1LN,1ZC		13.0460-7184.2 607184	ATE 23587 20,6 + WK
1.4 TDI	66	02/14→				13.0470-7184.2 LD7184	ATE 23587 20,6 + WK Ceramic
1.4 TDI	77	05/14→	→	+PR 1KK,1KT,2EJ		13.0460-2820.2 602820	TRW 20961 17,2 - WK
1.4 TSI	110	05/14→	→	+PR 2EJ		13.0460-2894.2 602894	TRW 20961 17,2 - WK + Zub
						13.0470-2894.2 LD2894	TRW 20961 17,2 - WK + Zub Ceramic
1.2	44	06/09→	←	+PR 1ZG,1LR,1ZJ		13.0460-7111.2 607111	VW 23130 19,6 - WE / - WK
1.2	51	06/09→				13.0470-7111.2 LD7111	VW 23130 19,6 - WE / - WK Ceramic
1.2 TDI	55	10/09→					
1.2 TSI	66	05/11→05/14	←	+PR 1LN,1ZC,1ZD		13.0460-7184.2 607184	ATE 23587 20,6 + WK
1.2 TSI	77	11/09→				13.0470-7184.2 LD7184	ATE 23587 20,6 + WK Ceramic
1.2 TSI 16V	66	02/14→					
1.4	63	06/09→	←	+PR 1ZP,1ZR		13.0460-7285.2 607285	ATE 23587 20,6 - WE / - WK
1.4 BiFuel	60	03/10→01/11				13.0470-7285.2 LD7285	ATE 23587 20,6 - WE / - WK Ceramic
1.4 GTI	132	05/10→					
1.4 TSI	103	10/12→					
1.6 BiFuel	60	01/11→	→	+PR 1KK,1KT,1KV		13.0460-2820.2 602820	TRW 20961 17,2 - WK
1.6 TDI	55	06/09→				13.0470-2820.2 LD2820	TRW 20961 17,2 - WK Ceramic
1.6 TDI	66	06/09→	→	+PR 2EJ		13.0460-2894.2 602894	TRW 20961 17,2 - WK + Zub
1.6 TDI	77	06/09→				13.0470-2894.2 LD2894	TRW 20961 17,2 - WK + Zub Ceramic
2.0 R WRC	162	08/13→					
1.2 TSI	81	01/14→	←	+PR 1ZG,1LR,1ZJ		13.0460-7111.2 607111	VW 23130 19,6 - WE / - WK
						13.0470-7111.2 LD7111	VW 23130 19,6 - WE / - WK Ceramic
			←	+PR 1LN,1ZC		13.0460-7184.2 607184	ATE 23587 20,6 + WK
						13.0470-7184.2 LD7184	ATE 23587 20,6 + WK Ceramic
			←	+PR 1ZP,1ZR		13.0460-7285.2 607285	ATE 23587 20,6 - WE / - WK
						13.0470-7285.2 LD7285	ATE 23587 20,6 - WE / - WK Ceramic
			→	+PR 1KK,1KT,2EJ		13.0460-2820.2 602820	TRW 20961 17,2 - WK
						13.0470-2820.2 LD2820	TRW 20961 17,2 - WK Ceramic
			→	+PR 2EJ		13.0460-2894.2 602894	TRW 20961 17,2 - WK + Zub
						13.0470-2894.2 LD2894	TRW 20961 17,2 - WK + Zub Ceramic
1.6	63	05/10→	←	07/14→; +PR 1ZG,1LR,1ZJ		13.0460-7111.2 607111	VW 23130 19,6 - WE / - WK
1.6	77	01/10→				13.0470-7111.2 LD7111	VW 23130 19,6 - WE / - WK Ceramic
			←	07/14→; +PR 1LN,1ZC		13.0460-7184.2 607184	ATE 23587 20,6 + WK
						13.0470-7184.2 LD7184	ATE 23587 20,6 + WK Ceramic
			←	07/14→; +PR 1ZP,1ZR		13.0460-7285.2 607285	ATE 23587 20,6 - WE / - WK
						13.0470-7285.2 LD7285	ATE 23587 20,6 - WE / - WK Ceramic
			→	07/14→; +PR 1KK,1KT,1KV		13.0460-2820.2 602820	TRW 20961 17,2 - WK
						13.0470-2820.2 LD2820	TRW 20961 17,2 - WK Ceramic
			→	07/14→; +PR 2EJ		13.0460-2894.2 602894	TRW 20961 17,2 - WK + Zub
						13.0470-2894.2 LD2894	TRW 20961 17,2 - WK + Zub Ceramic
1.6	66	07/14→	←	+PR 1ZG,1LR,1ZJ		13.0460-7111.2 607111	VW 23130 19,6 - WE / - WK
1.6	81	07/14→				13.0470-7111.2 LD7111	VW 23130 19,6 - WE / - WK Ceramic
			←	+PR 1LN,1ZC		13.0460-7184.2 607184	ATE 23587 20,6 + WK
						13.0470-7184.2 LD7184	ATE 23587 20,6 + WK Ceramic
			←	+PR 1ZP,1ZR		13.0460-7285.2 607285	ATE 23587 20,6 - WE / - WK









	kw			 	! #		
VW - POLO (6R, 6C) 06/09→							
 Bremsbelagsatz, Scheibenbremse							
1.6 1.6	66 81	07/14→ 07/14→	←	+PR 1ZP,1ZR	13.0470-7285.2	LD7285	ATE 23587 20,6 - WE / - WK Ceramic
			→	+PR 1KK,1KT,1KV	13.0460-2820.2	602820	TRW 20961 17,2 - WK
			→	+PR 2EJ	13.0470-2820.2	LD2820	TRW 20961 17,2 - WK Ceramic
			→	+PR 2EJ	13.0460-2894.2	602894	TRW 20961 17,2 - WK + Zub
			→	+PR 2EJ	13.0470-2894.2	LD2894	TRW 20961 17,2 - WK + Zub Ceramic
1.8 GTI 1.8 GTI 230	141 169	11/14→ 04/16→	←	+PR 1ZG,1LR,1ZJ	13.0460-7111.2	607111	VW 23130 19,6 - WE / - WK
			←	+PR 1LN,1ZC	13.0470-7111.2	LD7111	VW 23130 19,6 - WE / - WK Ceramic
			←	+PR 1LN,1ZC	13.0460-7184.2	607184	ATE 23587 20,6 + WK
			←	+PR 1LN,1ZC	13.0470-7184.2	LD7184	ATE 23587 20,6 + WK Ceramic
			←	+PR 1ZP,1ZR	13.0460-7285.2	607285	ATE 23587 20,6 - WE / - WK
			←	+PR 1ZP,1ZR	13.0470-7285.2	LD7285	ATE 23587 20,6 - WE / - WK Ceramic
			→	+PR 1KK,1KT,2EJ	13.0460-2820.2	602820	TRW 20961 17,2 - WK
			→	+PR 1KK,1KT,2EJ	13.0470-2820.2	LD2820	TRW 20961 17,2 - WK Ceramic
			→	+PR 1KK,1KT,2EJ	13.0460-2894.2	602894	TRW 20961 17,2 - WK + Zub
			→	+PR 1KK,1KT,2EJ	13.0470-2894.2	LD2894	TRW 20961 17,2 - WK + Zub Ceramic
 Bremsscheibe							
1.0 1.0	44 55	01/14→ 01/14→	←	+PR 1LR,1ZG,1ZJ	24.0122-0151.1	422151	Ø 256 22 19 V + S
1.0 TSI	70	11/14→	←	+PR 1LR,1ZG,1ZJ	24.0322-0151.1	522151	Ø 256 22 19 V + S PD
1.0 TSI	81	11/14→	←	+PR 1LN,1ZC	24.0125-0113.1	425113	Ø 288 25 22 V + S
1.4 TDI	55	03/14→	←	+PR 1LN,1ZC	24.0325-0113.1	525113	Ø 288 25 22 V + S PD
1.4 TDI	66	02/14→	→	+PR 1KK,1KT,2EJ	24.0109-0123.1	409123	Ø 230 9 7 + S
1.4 TDI	77	05/14→	→	+PR 1KK,1KT,2EJ	24.0309-0123.1	509123	Ø 230 9 7 + S PD
1.4 TSI	110	05/14→	→	+PR 1KK,1KT,2EJ	24.0109-0123.1	409123	Ø 230 9 7 + S
1.4 TSI	110	05/14→	→	+PR 1KK,1KT,2EJ	24.0309-0123.1	509123	Ø 230 9 7 + S PD
1.2 1.2	44 51	06/09→ 06/09→	←	+PR 1LR,1ZG,1ZJ	24.0122-0151.1	422151	Ø 256 22 19 V + S
1.2 TDI	55	10/09→	←	+PR 1LR,1ZG,1ZJ	24.0322-0151.1	522151	Ø 256 22 19 V + S PD
1.2 TSI	66	05/11→05/14	←	+PR 1LN,1ZC,1ZD	24.0125-0113.1	425113	Ø 288 25 22 V + S
1.2 TSI	77	11/09→	←	+PR 1LN,1ZC,1ZD	24.0325-0113.1	525113	Ø 288 25 22 V + S PD
1.2 TSI 16V	66	02/14→	←	+PR 1ZP,1ZR	24.0125-0123.1	425123	Ø 310 25 22 V + S
1.4	63	06/09→	←	+PR 1ZP,1ZR	24.0325-0123.1	525123	Ø 310 25 22 V PD
1.4 BiFuel	60	03/10→01/11	→	+PR 1KK,1KT,1KV,2EJ	24.0109-0123.1	409123	Ø 230 9 7 + S
1.4 GTI	132	05/10→	→	+PR 1KK,1KT,1KV,2EJ	24.0309-0123.1	509123	Ø 230 9 7 + S PD
1.4 TSI	103	10/12→	→	+PR 1KK,1KT,1KV,2EJ	24.0109-0123.1	409123	Ø 230 9 7 + S
1.6 BiFuel	60	01/11→	→	+PR 1KK,1KT,1KV,2EJ	24.0309-0123.1	509123	Ø 230 9 7 + S PD
1.6 TDI	55	06/09→	→	+PR 1KK,1KT,1KV,2EJ	24.0109-0123.1	409123	Ø 230 9 7 + S
1.6 TDI	66	06/09→	→	+PR 1KK,1KT,1KV,2EJ	24.0309-0123.1	509123	Ø 230 9 7 + S PD
1.6 TDI	77	06/09→	→	+PR 1KK,1KT,1KV,2EJ	24.0109-0123.1	409123	Ø 230 9 7 + S
1.2 TSI 1.8 GTI 1.8 GTI 230	81 141 169	01/14→ 11/14→ 04/16→	←	+PR 1LR,1ZG,1ZJ	24.0122-0151.1	422151	Ø 256 22 19 V + S
			←	+PR 1LR,1ZG,1ZJ	24.0322-0151.1	522151	Ø 256 22 19 V + S PD
			←	+PR 1LN,1ZC	24.0125-0113.1	425113	Ø 288 25 22 V + S
			←	+PR 1LN,1ZC	24.0325-0113.1	525113	Ø 288 25 22 V + S PD
			←	+PR 1ZP,1ZR	24.0125-0123.1	425123	Ø 310 25 22 V + S
			←	+PR 1ZP,1ZR	24.0325-0123.1	525123	Ø 310 25 22 V PD
			→	+PR 1KK,1KT,2EJ	24.0109-0123.1	409123	Ø 230 9 7 + S
			→	+PR 1KK,1KT,2EJ	24.0309-0123.1	509123	Ø 230 9 7 + S PD
1.6 1.6	63 77	05/10→ 01/10→	←	07/14→; +PR 1LR,1ZG,1ZJ	24.0122-0151.1	422151	Ø 256 22 19 V + S
			←	07/14→	24.0322-0151.1	522151	Ø 256 22 19 V + S PD
			←	07/14→	24.0125-0113.1	425113	Ø 288 25 22 V + S
			←	07/14→	24.0325-0113.1	525113	Ø 288 25 22 V + S PD
			←	07/14→; +PR 1ZP,1ZR	24.0125-0123.1	425123	Ø 310 25 22 V + S
			←	07/14→; +PR 1ZP,1ZR	24.0325-0123.1	525123	Ø 310 25 22 V PD
			→	07/14→; +PR 1KK,1KT,1KV,2EJ	24.0109-0123.1	409123	Ø 230 9 7 + S
			→	07/14→; +PR 1KK,1KT,1KV,2EJ	24.0309-0123.1	509123	Ø 230 9 7 + S PD
1.6 1.6	66 81	07/14→ 07/14→	←	+PR 1LR,1ZG,1ZJ	24.0122-0151.1	422151	Ø 256 22 19 V + S
			←	+PR 1LR,1ZG,1ZJ	24.0322-0151.1	522151	Ø 256 22 19 V + S PD
			←	+PR 1LN,1ZC	24.0125-0113.1	425113	Ø 288 25 22 V + S
			←	+PR 1LN,1ZC	24.0325-0113.1	525113	Ø 288 25 22 V + S PD
			←	+PR 1ZP,1ZR	24.0125-0123.1	425123	Ø 310 25 22 V + S
			←	+PR 1ZP,1ZR	24.0325-0123.1	525123	Ø 310 25 22 V PD
			→	+PR 1KK,1KT,1KV,2EJ	24.0109-0123.1	409123	Ø 230 9 7 + S
			→	+PR 1KK,1KT,1KV,2EJ	24.0309-0123.1	509123	Ø 230 9 7 + S PD
↓							







	kw			 	! #		
VW - POLO (6R, 6C) 06/09→							
 Bremsscheibe							
2.0 R WRC	162	08/13→	←	+PR 1LN,1ZC,1ZD	24.0125-0113.1	425113	∅ 288 25 22 V + S
					24.0325-0113.1	525113	∅ 288 25 22 V + S PD
			←	+PR 1ZP,1ZR	24.0125-0123.1	425123	∅ 310 25 22 V + S
					24.0325-0123.1	525123	∅ 310 25 22 V PD
		→	+PR 1KK,1KT,1KV,2EJ	24.0109-0123.1	409123	∅ 230 9 7 + S	
VW - POLO (9N_) 10/01→01/12							
 Bremsbelagsatz, Scheibenbremse							
1.2 1.4 FSI	40 63	01/02→05/07 02/02→07/06	←	+PR 1LN;1ZD;1ZH	13.0460-2883.2	602883	TRW 23581 18,8 - WE / - WK
					13.0460-2884.2	602884	TRW 23581 18,8 + WK
					13.0470-2884.2	LD2884	TRW 23581 18,8 + WK Ceramic
			←	+PR 1LM;1ZN	13.0460-7100.2	607100	VW 21866 17,2 - WE / - WK
					13.0460-7164.2	607164	VW 21866 17,2 + WK
					13.0470-7100.2	LD7100	VW 21866 17,2 - WE / - WK Ceramic
			←	+PR 1ZF	13.0460-7111.2	607111	VW 23130 19,6 - WE / - WK
					13.0470-7111.2	LD7111	VW 23130 19,6 - WE / - WK Ceramic
		←	+PR 1LQ;1LR;1ZG	13.0460-7117.2	607117	VW 23130 19,6 + WK	
				13.0470-7117.2	LD7117	VW 23130 19,6 + WK Ceramic	
		←	+PR 1LJ	13.0460-7122.2	607122	ATE 20676 19,8 + WK	
				13.0470-7122.2	LD7122	ATE 20676 19,8 + WK Ceramic	
		→	+PR 1KK,1KT	13.0460-2820.2	602820	TRW 20961 17,2 - WK	
				13.0460-2894.2	602894	TRW 20961 17,2 - WK + Zub	
				13.0470-2820.2	LD2820	TRW 20961 17,2 - WK Ceramic	
				13.0470-2894.2	LD2894	TRW 20961 17,2 - WK + Zub Ceramic	
		→	+PR 1KD,1KS,1KV	13.0460-2864.2	602864	TRW 20961 17,2 - WK	
				13.0460-2877.2	602877	TRW 23554 17,2 + WK	
				13.0470-2877.2	LD2877	TRW 23554 17,2 + WK Ceramic	
1.2 1.2 12V 1.4 16V 1.4 TDI 1.4 TDI 1.6 16V 1.8 GTI 1.9 TDI 2.0	44 51 59 51 59 77 110 96 85	05/07→11/09 05/07→11/09 05/06→11/09 04/05→11/09 04/05→11/09 05/06→11/09 09/05→11/09 11/03→11/09 10/04→01/12	←	→ 05/09; +PR 1LN;1ZD;1ZH	13.0460-2883.2	602883	TRW 23581 18,8 - WE / - WK
					13.0460-2884.2	602884	TRW 23581 18,8 + WK
					13.0470-2884.2	LD2884	TRW 23581 18,8 + WK Ceramic
			←	→ 05/09; +PR 1LM;1ZN	13.0460-7100.2	607100	VW 21866 17,2 - WE / - WK
					13.0460-7164.2	607164	VW 21866 17,2 + WK
					13.0470-7100.2	LD7100	VW 21866 17,2 - WE / - WK Ceramic
			←	→ 05/09; +PR 1ZF	13.0460-7111.2	607111	VW 23130 19,6 - WE / - WK
					13.0470-7111.2	LD7111	VW 23130 19,6 - WE / - WK Ceramic
			←	→ 05/09; +PR 1LQ;1LR;1ZG	13.0460-7117.2	607117	VW 23130 19,6 + WK
					13.0470-7117.2	LD7117	VW 23130 19,6 + WK Ceramic
			←	→ 05/09; +PR 1LJ	13.0460-7122.2	607122	ATE 20676 19,8 + WK
					13.0470-7122.2	LD7122	ATE 20676 19,8 + WK Ceramic
→	→ 05/09; +PR 1KK,1KT	13.0460-2820.2	602820	TRW 20961 17,2 - WK			
		13.0460-2894.2	602894	TRW 20961 17,2 - WK + Zub			
		13.0470-2820.2	LD2820	TRW 20961 17,2 - WK Ceramic			
		13.0470-2894.2	LD2894	TRW 20961 17,2 - WK + Zub Ceramic			
		→	→ 05/09; +PR 1KD,1KS,1KV	13.0460-2864.2	602864	TRW 20961 17,2 - WK	
				13.0460-2877.2	602877	TRW 23554 17,2 + WK	
				13.0470-2877.2	LD2877	TRW 23554 17,2 + WK Ceramic	
1.2 12V 1.4 16V 1.4 16V 1.4 TDI	47 55 74 55	10/01→07/07 10/01→05/08 10/01→05/08 10/01→06/05	←	11/01→; +PR 1LN;1ZD;1ZH	13.0460-2883.2	602883	TRW 23581 18,8 - WE / - WK
					13.0460-2884.2	602884	TRW 23581 18,8 + WK
					13.0470-2884.2	LD2884	TRW 23581 18,8 + WK Ceramic
			←	11/01→; +PR 1LM;1ZN	13.0460-7100.2	607100	VW 21866 17,2 - WE / - WK
				13.0460-7164.2	607164	VW 21866 17,2 + WK	
				13.0470-7100.2	LD7100	VW 21866 17,2 - WE / - WK Ceramic	
←	11/01→; +PR 1ZF	13.0460-7111.2	607111	VW 23130 19,6 - WE / - WK			
				13.0470-7111.2	LD7111	VW 23130 19,6 - WE / - WK Ceramic	
←	11/01→; +PR 1LQ;1LR;1ZG	13.0460-7117.2	607117	VW 23130 19,6 + WK			























	kw			 	! #		
VW - POLO (9N_) 10/01→01/12							
 Bremsbelagsatz, Scheibenbremse							
1.2 12V	47	10/01→07/07	←	11/01→; +PR 1LQ;1LR;1ZG		13.0470-7117.2 LD7117	VW 23130 19,6 + WK Ceramic
1.4 16V	55	10/01→05/08	←	11/01→; +PR 1LJ		13.0460-7122.2 607122	ATE 20676 19,8 + WK
1.4 16V	74	10/01→05/08				13.0470-7122.2 LD7122	ATE 20676 19,8 + WK Ceramic
1.4 TDI	55	10/01→06/05	→	11/01→; +PR 1KK,1KT		13.0460-2820.2 602820	TRW 20961 17,2 - WK
						13.0460-2894.2 602894	TRW 20961 17,2 - WK + Zub
						13.0470-2820.2 LD2820	TRW 20961 17,2 - WK Ceramic
						13.0470-2894.2 LD2894	TRW 20961 17,2 - WK + Zub Ceramic
			→	11/01→; +PR 1KD,1KS,1KV		13.0460-2864.2 602864	TRW 20961 17,2 - WK
						13.0460-2877.2 602877	TRW 23554 17,2 + WK
						13.0470-2877.2 LD2877	TRW 23554 17,2 + WK Ceramic
1.4	61	08/02→11/09	←	05/06→ 05/09; +PR 1LN;1ZD;1ZH		13.0460-2883.2 602883	TRW 23581 18,8 - WE / - WK
						13.0460-2884.2 602884	TRW 23581 18,8 + WK
						13.0470-2884.2 LD2884	TRW 23581 18,8 + WK Ceramic
			←	05/06→ 05/09; +PR 1LM;1ZN		13.0460-7100.2 607100	VW 21866 17,2 - WE / - WK
						13.0460-7164.2 607164	VW 21866 17,2 + WK
						13.0470-7100.2 LD7100	VW 21866 17,2 - WE / - WK Ceramic
			←	05/06→ 05/09; +PR 1ZF		13.0460-7111.2 607111	VW 23130 19,6 - WE / - WK
						13.0470-7111.2 LD7111	VW 23130 19,6 - WE / - WK Ceramic
			←	05/06→ 05/09; +PR 1LQ;1LR;1ZG		13.0460-7117.2 607117	VW 23130 19,6 + WK
						13.0470-7117.2 LD7117	VW 23130 19,6 + WK Ceramic
			←	05/06→ 05/09; +PR 1LJ		13.0460-7122.2 607122	ATE 20676 19,8 + WK
						13.0470-7122.2 LD7122	ATE 20676 19,8 + WK Ceramic
			→	05/06→ 05/09; +PR 1KK,1KT		13.0460-2820.2 602820	TRW 20961 17,2 - WK
						13.0460-2894.2 602894	TRW 20961 17,2 - WK + Zub
						13.0470-2820.2 LD2820	TRW 20961 17,2 - WK Ceramic
						13.0470-2894.2 LD2894	TRW 20961 17,2 - WK + Zub Ceramic
			→	05/06→ 05/09; +PR 1KD,1KS,1KV		13.0460-2864.2 602864	TRW 20961 17,2 - WK
						13.0460-2877.2 602877	TRW 23554 17,2 + WK
						13.0470-2877.2 LD2877	TRW 23554 17,2 + WK Ceramic
1.8 GTi Cup Edition	132	05/06→11/09	←	06/06→ 05/09; +PR 1LN;1ZD;1ZH		13.0460-2883.2 602883	TRW 23581 18,8 - WE / - WK
						13.0460-2884.2 602884	TRW 23581 18,8 + WK
						13.0470-2884.2 LD2884	TRW 23581 18,8 + WK Ceramic
			←	06/06→ 05/09; +PR 1LM;1ZN		13.0460-7100.2 607100	VW 21866 17,2 - WE / - WK
						13.0460-7164.2 607164	VW 21866 17,2 + WK
						13.0470-7100.2 LD7100	VW 21866 17,2 - WE / - WK Ceramic
			←	06/06→ 05/09; +PR 1ZF		13.0460-7111.2 607111	VW 23130 19,6 - WE / - WK
						13.0470-7111.2 LD7111	VW 23130 19,6 - WE / - WK Ceramic
			←	06/06→ 05/09; +PR 1LQ;1LR;1ZG		13.0460-7117.2 607117	VW 23130 19,6 + WK
						13.0470-7117.2 LD7117	VW 23130 19,6 + WK Ceramic
			←	06/06→ 05/09; +PR 1LJ		13.0460-7122.2 607122	ATE 20676 19,8 + WK
						13.0470-7122.2 LD7122	ATE 20676 19,8 + WK Ceramic
			→	06/06→ 05/09; +PR 1KK,1KT		13.0460-2820.2 602820	TRW 20961 17,2 - WK
						13.0460-2894.2 602894	TRW 20961 17,2 - WK + Zub
						13.0470-2820.2 LD2820	TRW 20961 17,2 - WK Ceramic
						13.0470-2894.2 LD2894	TRW 20961 17,2 - WK + Zub Ceramic
			→	06/06→ 05/09; +PR 1KD,1KS,1KV		13.0460-2864.2 602864	TRW 20961 17,2 - WK
						13.0460-2877.2 602877	TRW 23554 17,2 + WK
						13.0470-2877.2 LD2877	TRW 23554 17,2 + WK Ceramic
1.9 SDI	47	10/01→11/09	←	11/01→ 05/09; +PR 1LN;1ZD;1ZH		13.0460-2883.2 602883	TRW 23581 18,8 - WE / - WK
1.9 TDI	74	10/01→11/09				13.0460-2884.2 602884	TRW 23581 18,8 + WK
						13.0470-2884.2 LD2884	TRW 23581 18,8 + WK Ceramic
			←	11/01→ 05/09; +PR 1LM;1ZN		13.0460-7100.2 607100	VW 21866 17,2 - WE / - WK
						13.0460-7164.2 607164	VW 21866 17,2 + WK
						13.0470-7100.2 LD7100	VW 21866 17,2 - WE / - WK Ceramic
			←	11/01→ 05/09; +PR 1ZF		13.0460-7111.2 607111	VW 23130 19,6 - WE / - WK









↓











	kw			 	! #		
VW - POLO (9N_) 10/01→01/12							
 Bremsbelagsatz, Scheibenbremse							
1.9 SDI 1.9 TDI	47 74	10/01→11/09 10/01→11/09	←	11/01→ 05/09; +PR 1ZF		13.0470-7111.2 LD7111	VW 23130 19,6 - WE / - WK Ceramic
			←	11/01→ 05/09; +PR 1LQ;1LR;1ZG		13.0460-7117.2 607117 13.0470-7117.2 LD7117	VW 23130 19,6 + WK VW 23130 19,6 + WK Ceramic
			←	11/01→ 05/09; +PR 1LJ		13.0460-7122.2 607122 13.0470-7122.2 LD7122	ATE 20676 19,8 + WK ATE 20676 19,8 + WK Ceramic
			→	11/01→ 05/09; +PR 1KK,1KT		13.0460-2820.2 602820 13.0460-2894.2 602894 13.0470-2820.2 LD2820 13.0470-2894.2 LD2894	TRW 20961 17,2 - WK TRW 20961 17,2 - WK + Zub TRW 20961 17,2 - WK Ceramic TRW 20961 17,2 - WK + Zub Ceramic
			→	11/01→ 05/09; +PR 1KD,1KS,1KV		13.0460-2864.2 602864 13.0460-2877.2 602877 13.0470-2877.2 LD2877	TRW 20961 17,2 - WK TRW 23554 17,2 + WK TRW 23554 17,2 + WK Ceramic
Zubehörsatz, Scheibenbremsbelag							
1.2 1.4 FSI	40 63	01/02→05/07 02/02→07/06	→	+PR 1KD,1KS,1KV		13.0460-0072.2 610072	TRW
			→	+PR 1KK,1KT		13.0460-0072.2 610072	TRW
1.2 1.2 12V 1.4 16V 1.4 TDI 1.4 TDI 1.6 16V 1.8 GTI 1.9 TDI 2.0	44 51 59 51 59 77 110 96 85	05/07→11/09 05/07→11/09 05/06→11/09 04/05→11/09 04/05→11/09 05/06→11/09 09/05→11/09 11/03→11/09 10/04→01/12	→	→ 05/09; +PR 1KK,1KT		13.0460-0072.2 610072	TRW
			→	→ 05/09; +PR 1KD,1KS,1KV		13.0460-0072.2 610072	TRW
1.2 12V 1.4 16V 1.4 16V 1.4 TDI	47 55 74 55	10/01→07/07 10/01→05/08 10/01→05/08 10/01→06/05	→	11/01→; +PR 1KK,1KT		13.0460-0072.2 610072	TRW
			→	11/01→; +PR 1KD,1KS,1KV		13.0460-0072.2 610072	TRW
1.4	61	08/02→11/09	→	05/06→ 05/09; +PR 1KK,1KT		13.0460-0072.2 610072	TRW
			→	05/06→ 05/09; +PR 1KD,1KS,1KV		13.0460-0072.2 610072	TRW
1.8 GTi Cup Edition	132	05/06→11/09	→	06/06→ 05/09; +PR 1KK,1KT		13.0460-0072.2 610072	TRW
			→	06/06→ 05/09; +PR 1KD,1KS,1KV		13.0460-0072.2 610072	TRW
1.9 SDI 1.9 TDI	47 74	10/01→11/09 10/01→11/09	→	11/01→ 05/09; +PR 1KD,1KS,1KV		13.0460-0072.2 610072	TRW
			→	11/01→ 05/09; +PR 1KK,1KT		13.0460-0072.2 610072	TRW
 Bremsscheibe							
1.2 1.4 FSI	40 63	01/02→05/07 02/02→07/06	←	+PR 1LM;1ZN		24.0118-0137.1 418137 24.0318-0137.1 518137	Ø 239 18 16 V + S Ø 239 18 16 V + S PD
			←	+PR 1LQ;1LR;1ZF;1ZG		24.0122-0151.1 422151 24.0322-0151.1 522151	Ø 256 22 19 V + S Ø 256 22 19 V + S PD
			←	+PR 1LN;1ZD;1ZH		24.0125-0113.1 425113 24.0325-0113.1 525113	Ø 288 25 22 V + S Ø 288 25 22 V + S PD
			←	+PR 1LJ		24.0125-0123.1 425123 24.0325-0123.1 525123	Ø 310 25 22 V + S Ø 310 25 22 V PD
			→	+PR 1KD,1KS,1KT,1KV		24.0109-0123.1 409123 24.0309-0123.1 509123	Ø 230 9 7 + S Ø 230 9 7 + S PD
			→	+PR 1KK		24.0109-0174.1 409174	Ø 232 9 7 + S
1.2 1.2 12V 1.4 16V 1.4 TDI 1.4 TDI 1.6 16V 1.8 GTI 1.9 TDI 2.0	44 51 59 51 59 77 110 96 85	05/07→11/09 05/07→11/09 05/06→11/09 04/05→11/09 04/05→11/09 05/06→11/09 09/05→11/09 11/03→11/09 10/04→01/12	←	→ 05/09; +PR 1LM;1ZN		24.0118-0137.1 418137 24.0318-0137.1 518137	Ø 239 18 16 V + S Ø 239 18 16 V + S PD
			←	→ 05/09; +PR 1LQ;1LR;1ZF;1ZG		24.0122-0151.1 422151 24.0322-0151.1 522151	Ø 256 22 19 V + S Ø 256 22 19 V + S PD
			←	→ 05/09; +PR 1LN;1ZD;1ZH		24.0125-0113.1 425113 24.0325-0113.1 525113	Ø 288 25 22 V + S Ø 288 25 22 V + S PD
			←	→ 05/09; +PR 1LJ		24.0125-0123.1 425123 24.0325-0123.1 525123	Ø 310 25 22 V + S Ø 310 25 22 V PD
			→	→ 05/09; +PR 1KD,1KS,1KT,1KV		24.0109-0123.1 409123 24.0309-0123.1 509123	Ø 230 9 7 + S Ø 230 9 7 + S PD
			→	→ 05/09; +PR 1KK		24.0109-0174.1 409174	Ø 232 9 7 + S
1.2 12V 1.4 16V 1.4 16V 1.4 TDI	47 55 74 55	10/01→07/07 10/01→05/08 10/01→05/08 10/01→06/05	←	11/01→; +PR 1LM;1ZN		24.0118-0137.1 418137 24.0318-0137.1 518137	Ø 239 18 16 V + S Ø 239 18 16 V + S PD
			←	11/01→; +PR 1LQ;1LR;1ZF;1ZG		24.0122-0151.1 422151	Ø 256 22 19 V + S











	kw			 	! #		
VW - POLO (9N_) 10/01→01/12							
Bremsscheibe							
1.2 12V	47	10/01→07/07	←	11/01→; +PR 1LQ;1LR;1ZF;1ZG		24.0322-0151.1 522151	Ø 256 22 19 V + S PD
1.4 16V	55	10/01→05/08	←	11/01→; +PR 1LN;1ZD;1ZH		24.0125-0113.1 425113	Ø 288 25 22 V + S
1.4 16V	74	10/01→05/08				24.0325-0113.1 525113	Ø 288 25 22 V + S PD
1.4 TDI	55	10/01→06/05	←	11/01→; +PR 1LJ		24.0125-0123.1 425123	Ø 310 25 22 V + S
						24.0325-0123.1 525123	Ø 310 25 22 V PD
			→	11/01→; +PR 1KD,1KS,1KT,1KV		24.0109-0123.1 409123	Ø 230 9 7 + S
						24.0309-0123.1 509123	Ø 230 9 7 + S PD
			→	11/01→; +PR 1KK		24.0109-0174.1 409174	Ø 232 9 7 + S
1.4	61	08/02→11/09	←	05/06→ 05/09; +PR 1LM;1ZN		24.0118-0137.1 418137	Ø 239 18 16 V + S
						24.0318-0137.1 518137	Ø 239 18 16 V + S PD
			←	05/06→ 05/09; +PR 1LQ;1LR;1ZF;1ZG		24.0122-0151.1 422151	Ø 256 22 19 V + S
						24.0322-0151.1 522151	Ø 256 22 19 V + S PD
			←	05/06→ 05/09; +PR 1LN;1ZD;1ZH		24.0125-0113.1 425113	Ø 288 25 22 V + S
						24.0325-0113.1 525113	Ø 288 25 22 V + S PD
			←	05/06→ 05/09; +PR 1LJ		24.0125-0123.1 425123	Ø 310 25 22 V + S
						24.0325-0123.1 525123	Ø 310 25 22 V PD
			→	05/06→ 05/09; +PR 1KD,1KS,1KT,1KV		24.0109-0123.1 409123	Ø 230 9 7 + S
						24.0309-0123.1 509123	Ø 230 9 7 + S PD
			→	05/06→ 05/09; +PR 1KK		24.0109-0174.1 409174	Ø 232 9 7 + S
1.8 GTI Cup Edition	132	05/06→11/09	←	06/06→ 05/09; +PR 1LM;1ZN		24.0118-0137.1 418137	Ø 239 18 16 V + S
						24.0318-0137.1 518137	Ø 239 18 16 V + S PD
			←	06/06→ 05/09; +PR 1LQ;1LR;1ZF;1ZG		24.0122-0151.1 422151	Ø 256 22 19 V + S
						24.0322-0151.1 522151	Ø 256 22 19 V + S PD
			←	06/06→ 05/09; +PR 1LN;1ZD;1ZH		24.0125-0113.1 425113	Ø 288 25 22 V + S
						24.0325-0113.1 525113	Ø 288 25 22 V + S PD
			←	06/06→ 05/09; +PR 1LJ		24.0125-0123.1 425123	Ø 310 25 22 V + S
						24.0325-0123.1 525123	Ø 310 25 22 V PD
			→	06/06→ 05/09; +PR 1KD,1KS,1KT,1KV		24.0109-0123.1 409123	Ø 230 9 7 + S
						24.0309-0123.1 509123	Ø 230 9 7 + S PD
			→	06/06→ 05/09; +PR 1KK		24.0109-0174.1 409174	Ø 232 9 7 + S
1.9 SDI	47	10/01→11/09	←	11/01→ 05/09; +PR 1LM;1ZN		24.0118-0137.1 418137	Ø 239 18 16 V + S
1.9 TDI	74	10/01→11/09				24.0318-0137.1 518137	Ø 239 18 16 V + S PD
			←	11/01→ 05/09; +PR 1LQ;1LR;1ZF;1ZG		24.0122-0151.1 422151	Ø 256 22 19 V + S
						24.0322-0151.1 522151	Ø 256 22 19 V + S PD
			←	11/01→ 05/09; +PR 1LN;1ZD;1ZH		24.0125-0113.1 425113	Ø 288 25 22 V + S
						24.0325-0113.1 525113	Ø 288 25 22 V + S PD
			←	11/01→ 05/09; +PR 1LJ		24.0125-0123.1 425123	Ø 310 25 22 V + S
						24.0325-0123.1 525123	Ø 310 25 22 V PD
			→	11/01→ 05/09; +PR 1KD,1KS,1KT,1KV		24.0109-0123.1 409123	Ø 230 9 7 + S
						24.0309-0123.1 509123	Ø 230 9 7 + S PD
			→	11/01→ 05/09; +PR 1KK		24.0109-0174.1 409174	Ø 232 9 7 + S
VW - POLO CLASSIC (6V2) 11/95→07/06							
Bremsbelagsatz, Scheibenbremse							
1.9 SDI	48	06/96→09/01	←	→ 6K-V-022628		13.0460-7072.2 607072	VW 21866 19,7 - WE / - WK
57 1.7 SDI	42	07/97→09/01					
64 1.9 SDI	47	12/95→08/99	←	6K-V-022629→		13.0460-7101.2 607101	VW 21866 15,3 - WE / - WK
1.9 TDI	67	01/97→08/99	←			13.0460-2821.2 602821	TRW 21945 16,0 - WK
2.0	85	08/99→09/01					
90 1.9 TDI	66	09/96→09/01					
100 1.6	74	12/95→09/01	←	05/96→		13.0460-2821.2 602821	TRW 21945 16,0 - WK
110 1.9 TDI	81	06/98→01/02	←	→ 09/01		13.0460-2821.2 602821	TRW 21945 16,0 - WK
			→	10/99→ 09/01		13.0460-2886.2 602886	TRW 20961 16,0 - WK
						13.0460-2894.2 602894	TRW 20961 17,2 - WK + Zub
						13.0470-2886.2 LD2886	TRW 20961 16,0 - WK Ceramic
						13.0470-2894.2 LD2894	TRW 20961 17,2 - WK + Zub Ceramic
			→	→ 09/99; - ABS		13.0460-2937.2 602937	TRW 20961 15,2 - WK + Zub
			→	→ 09/99; + ABS		13.0460-2984.2 602984	TRW 20961 17,2 - WK + Zub
54 1.4	40	01/98→08/99	←	→ 6K-V-022628; - ABS		13.0460-7059.2 607059	VW 20887 17,3 - WE / - WK + Zub
60 1.4	44	12/95→09/01					
75 1.4 16V	55	10/99→09/01	←	→ 6K-V-022628; + ABS		13.0460-7072.2 607072	VW 21866 19,7 - WE / - WK









	kw			 	! #		
VW - POLO CLASSIC (6V2) 11/95→07/06							
 Bremsbelagsatz, Scheibenbremse							
54 1.4 60 1.4 75 1.4 16V	40 44 55	01/98→08/99 12/95→09/01 10/99→09/01	←	6K-V-022629→		13.0460-7101.2 607101	VW 21866 15,3 - WE / - WK
64 1,9 D	47	01/96→10/96	←	→ 6N-TW082000		13.0460-7059.2 607059	VW 20887 17,3 - WE / - WK + Zub
			←	→ 6N-TY140000		13.0460-7059.2 607059	VW 20887 17,3 - WE / - WK + Zub
			←	6N-TY140001→		13.0460-7100.2 607100 13.0470-7100.2 LD7100	VW 21866 17,2 - WE / - WK VW 21866 17,2 - WE / - WK Ceramic
			←	6N-TW082001→		13.0460-7100.2 607100 13.0470-7100.2 LD7100	VW 21866 17,2 - WE / - WK VW 21866 17,2 - WE / - WK Ceramic
68 1.9 SDI	50	08/99→01/02	←	→ 6K-V-022628		13.0460-7072.2 607072	VW 21866 19,7 - WE / - WK
			←	6K-V-022629→; → 09/01		13.0460-7101.2 607101	VW 21866 15,3 - WE / - WK
75 1.6 75 1.6	55 55	11/95→09/97 11/95→09/01	←	05/96→		13.0460-2821.2 602821	TRW 21945 16,0 - WK
			←	05/96→; → 6K-V-022628		13.0460-7072.2 607072	VW 21866 19,7 - WE / - WK
			←	6K-V-022629→		13.0460-7101.2 607101	VW 21866 15,3 - WE / - WK
90 1.8	66	01/97→09/01	←	03/98→		13.0460-2821.2 602821	TRW 21945 16,0 - WK
Zubehörsatz, Scheibenbremsbelag							
110 1.9 TDI	81	06/98→01/02	→	→ 09/99; + ABS		13.0460-0072.2 610072	TRW
			→	10/99→ 09/01		13.0460-0072.2 610072	TRW
 Bremsscheibe							
1.9 SDI 57 1.7 SDI 64 1.9 SDI	48 42 47	06/96→09/01 07/97→09/01 12/95→08/99	←	→ 6K-V-022628		24.0112-0106.1 412106	Ø 239 12 10 + S
			←	6K-V-022629→		24.0312-0106.1 512106	Ø 239 12 10 + S PD
1.9 TDI 90 1.9 TDI	67 66	01/97→08/99 09/96→09/01	←			24.0120-0123.1 420123	Ø 239 20 18 V + S
			←			24.0320-0123.1 520123	Ø 239 20 18 V + S PD
100 1.6	74	12/95→09/01	←	05/96→		24.0120-0128.1 420128	Ø 256 20 18 V + S
			←			24.0320-0128.1 520128	Ø 256 20 18 V + S PD
110 1.9 TDI	81	06/98→01/02	←	→ 09/01		24.0120-0128.1 420128	Ø 256 20 18 V + S
			→	10/99→ 09/01		24.0320-0128.1 520128	Ø 256 20 18 V + S PD
			→	09/99		24.0109-0124.1 409124	Ø 232 9 7
2.0	85	08/99→09/01	←	fur Mexico		24.0110-0111.1 410111	Ø 226 10 8 - ABS Ring / - RLG
			←			24.0110-0275.2 410275	Ø 226 10 8 + ABS Ring / - RLG
54 1.4 60 1.4 75 1.4 16V	40 44 55	01/98→08/99 12/95→09/01 10/99→09/01	←	→ 6K-V-022628; - ABS		24.0120-0128.1 420128	Ø 256 20 18 V + S
			←	→ 6K-V-022628; + ABS		24.0320-0128.1 520128	Ø 256 20 18 V + S PD
			←			24.0110-0151.1 410151	Ø 239 10 8 + S
			←			24.0310-0151.1 510151	Ø 239 10 8 + S PD
64 1,9 D	47	01/96→10/96	←	→ 6K-V-022629→		24.0112-0106.1 412106	Ø 239 12 10 + S
			←			24.0312-0106.1 512106	Ø 239 12 10 + S PD
			←	6K-V-022629→		24.0120-0123.1 420123	Ø 239 20 18 V + S
			←			24.0320-0123.1 520123	Ø 239 20 18 V + S PD
64 1,9 D	47	01/96→10/96	←	→ 6N-SY087410		24.0110-0151.1 410151	Ø 239 10 8 + S
			←	→ 6N-SW008500		24.0310-0151.1 510151	Ø 239 10 8 + S PD
			←	6N-SW008501→		24.0112-0106.1 412106	Ø 239 12 10 + S
			←			24.0312-0106.1 512106	Ø 239 12 10 + S PD
			←	6N-SY087411→		24.0120-0123.1 420123	Ø 239 20 18 V + S
64 1,9 D	47	01/96→10/96	←			24.0320-0123.1 520123	Ø 239 20 18 V + S PD
			←			24.0110-0232.1 410232	Ø 239 9,9 8 + S
			←			24.0110-0232.1 410232	Ø 239 9,9 8 + S
			←			24.0118-0106.1 418106	Ø 239 18 16 V + S
			←			24.0318-0106.1 518106	Ø 239 18 16 V + S PD
68 1.9 SDI	50	08/99→01/02	←	→ 6N-SY087411→		24.0118-0106.1 418106	Ø 239 18 16 V + S
			←			24.0318-0106.1 518106	Ø 239 18 16 V + S PD
			←	→ 6K-V-022628		24.0112-0106.1 412106	Ø 239 12 10 + S
			←	6K-V-022629→; → 09/01		24.0312-0106.1 512106	Ø 239 12 10 + S PD
			←			24.0120-0123.1 420123	Ø 239 20 18 V + S
75 1.6 75 1.6	55 55	11/95→09/97 11/95→09/01	←			24.0320-0123.1 520123	Ø 239 20 18 V + S PD
			←	05/96→; → 6K-V-022628		24.0112-0106.1 412106	Ø 239 12 10 + S
			←			24.0312-0106.1 512106	Ø 239 12 10 + S PD
			←	6K-V-022629→		24.0120-0123.1 420123	Ø 239 20 18 V + S
			←			24.0320-0123.1 520123	Ø 239 20 18 V + S PD
75 1.6 75 1.6	55 55	11/95→09/97 11/95→09/01	←	05/96→		24.0120-0128.1 420128	Ø 256 20 18 V + S
			←			24.0320-0128.1 520128	Ø 256 20 18 V + S PD
			←			24.0120-0128.1 420128	Ø 256 20 18 V + S
↓							







	kw					! #		
VW - POLO CLASSIC (6V2) 11/95→07/06								
 Bremsscheibe								
90 1.8	66	01/97→09/01	←	03/98→; für Mexico		24.0120-0128.1 420128	∅ 256 20 18 V + S	
						24.0320-0128.1 520128	∅ 256 20 18 V + S PD	
VW - POLO Kasten (6NF) 09/94→12/99								
 Bremsbelagsatz, Scheibenbremse								
1.0	33	10/94→12/99	←	→ 6N-TW082000		13.0460-7059.2 607059	VW 20887 17,3 - WE / - WK + Zub	
			←	→ 6N-TY140000		13.0460-7059.2 607059	VW 20887 17,3 - WE / - WK + Zub	
			←	6N-TW082001→; → 09/96		13.0460-7100.2 607100	VW 21866 17,2 - WE / - WK	
						13.0470-7100.2 LD7100	VW 21866 17,2 - WE / - WK Ceramic	
			←	6N-TY140001→; → 09/96		13.0460-7100.2 607100	VW 21866 17,2 - WE / - WK	
						13.0470-7100.2 LD7100	VW 21866 17,2 - WE / - WK Ceramic	
1.4 1.9 D	44 47	05/98→12/99 10/94→12/99	←	→ 6N-TW082000		13.0460-7059.2 607059	VW 20887 17,3 - WE / - WK + Zub	
			←	→ 6N-TY140000		13.0460-7059.2 607059	VW 20887 17,3 - WE / - WK + Zub	
			←	6N-TY140001→		13.0460-7100.2 607100	VW 21866 17,2 - WE / - WK	
						13.0470-7100.2 LD7100	VW 21866 17,2 - WE / - WK Ceramic	
			←	6N-TW082001→		13.0460-7100.2 607100	VW 21866 17,2 - WE / - WK	
						13.0470-7100.2 LD7100	VW 21866 17,2 - WE / - WK Ceramic	
1.7 SDI	44	08/97→12/99	←			13.0460-7100.2 607100	VW 21866 17,2 - WE / - WK	
						13.0470-7100.2 LD7100	VW 21866 17,2 - WE / - WK Ceramic	
1.9 SDI	47	07/96→12/99	←	03/97→; → 6K-V-022628		13.0460-7072.2 607072	VW 21866 19,7 - WE / - WK	
			←	6K-V-022629→		13.0460-7101.2 607101	VW 21866 15,3 - WE / - WK	
 Bremsscheibe								
1.0	33	10/94→12/99	←	→ 6N-SY087410		24.0110-0232.1 410232	∅ 239 9,9 8 + S	
			←	→ 6N-SW008500		24.0110-0232.1 410232	∅ 239 9,9 8 + S	
			←	6N-SY087411→; → 09/96		24.0118-0106.1 418106	∅ 239 18 16 V + S	
						24.0318-0106.1 518106	∅ 239 18 16 V + S PD	
			←	6N-SW008501→; → 09/96		24.0118-0106.1 418106	∅ 239 18 16 V + S	
						24.0318-0106.1 518106	∅ 239 18 16 V + S PD	
1.4 1.7 SDI	44 44	05/98→12/99 08/97→12/99	←			24.0118-0106.1 418106	∅ 239 18 16 V + S	
						24.0318-0106.1 518106	∅ 239 18 16 V + S PD	
1.9 D	47	10/94→12/99	←	→ 6N-SY087410		24.0110-0232.1 410232	∅ 239 9,9 8 + S	
			←	→ 6N-SW008500		24.0110-0232.1 410232	∅ 239 9,9 8 + S	
			←	6N-SW008501→		24.0118-0106.1 418106	∅ 239 18 16 V + S	
						24.0318-0106.1 518106	∅ 239 18 16 V + S PD	
			←	6N-SY087411→		24.0118-0106.1 418106	∅ 239 18 16 V + S	
						24.0318-0106.1 518106	∅ 239 18 16 V + S PD	
1.9 SDI	47	07/96→12/99	←	03/97→; → 6K-V-022628		24.0112-0106.1 412106	∅ 239 12 10 + S	
						24.0312-0106.1 512106	∅ 239 12 10 + S PD	
			←	6K-V-022629→		24.0120-0123.1 420123	∅ 239 20 18 V + S	
						24.0320-0123.1 520123	∅ 239 20 18 V + S PD	
VW - POLO Stufenheck (9A4) 09/02→								
 Bremsbelagsatz, Scheibenbremse								
1.4 1.4 1.4 TDI 1.9 SDI 1.9 TDi 2.0	55 74 55 47 74 85	07/03→ 11/03→ 07/03→ 09/02→ 09/02→ 09/02→	←	→ 05/09; +PR 1LN;1ZD;1ZH		13.0460-2883.2 602883	TRW 23581 18,8 - WE / - WK	
						13.0460-2884.2 602884	TRW 23581 18,8 + WK	
						13.0470-2884.2 LD2884	TRW 23581 18,8 + WK Ceramic	
			←	→ 05/09; +PR 1LM;1ZN		13.0460-7100.2 607100	VW 21866 17,2 - WE / - WK	
						13.0460-7164.2 607164	VW 21866 17,2 + WK	
						13.0470-7100.2 LD7100	VW 21866 17,2 - WE / - WK Ceramic	
			←	→ 05/09; +PR 1ZF		13.0460-7111.2 607111	VW 23130 19,6 - WE / - WK	
						13.0470-7111.2 LD7111	VW 23130 19,6 - WE / - WK Ceramic	
↓								









	kw			 	! #		
VW - POLO Stufenheck (9A4) 09/02→							
 Bremsbelagsatz, Scheibenbremse							
1.4	55	07/03→	←	→ 05/09; +PR 1LQ;1LR;1ZG	13.0460-7117.2	607117	VW 23130 19,6 + WK
1.4	74	11/03→			13.0470-7117.2	LD7117	VW 23130 19,6 + WK Ceramic
1.4 TDI	55	07/03→					
1.9 SDI	47	09/02→	←	→ 05/09; +PR 1LJ	13.0460-7122.2	607122	ATE 20676 19,8 + WK
1.9 TDi	74	09/02→			13.0470-7122.2	LD7122	ATE 20676 19,8 + WK Ceramic
2.0	85	09/02→	→	→ 05/09; +PR 1KK,1KT	13.0460-2820.2	602820	TRW 20961 17,2 - WK
					13.0460-2894.2	602894	TRW 20961 17,2 - WK + Zub
					13.0470-2820.2	LD2820	TRW 20961 17,2 - WK Ceramic
					13.0470-2894.2	LD2894	TRW 20961 17,2 - WK + Zub Ceramic
			→	→ 05/09; +PR 1KD,1KS,1KV	13.0460-2864.2	602864	TRW 20961 17,2 - WK
					13.0460-2877.2	602877	TRW 23554 17,2 + WK
					13.0470-2877.2	LD2877	TRW 23554 17,2 + WK Ceramic
1.6	74	09/02→	←	05/06→ 05/09; +PR 1LN;1ZD;1ZH	13.0460-2883.2	602883	TRW 23581 18,8 - WE / - WK
					13.0460-2884.2	602884	TRW 23581 18,8 + WK
					13.0470-2884.2	LD2884	TRW 23581 18,8 + WK Ceramic
			←	05/06→ 05/09; +PR 1LM;1ZN	13.0460-7100.2	607100	VW 21866 17,2 - WE / - WK
					13.0460-7164.2	607164	VW 21866 17,2 + WK
					13.0470-7100.2	LD7100	VW 21866 17,2 - WE / - WK Ceramic
			←	05/06→ 05/09; +PR 1ZF	13.0460-7111.2	607111	VW 23130 19,6 - WE / - WK
					13.0470-7111.2	LD7111	VW 23130 19,6 - WE / - WK Ceramic
			←	05/06→ 05/09; +PR 1LQ;1LR;1ZG	13.0460-7117.2	607117	VW 23130 19,6 + WK
					13.0470-7117.2	LD7117	VW 23130 19,6 + WK Ceramic
			←	05/06→ 05/09; +PR 1LJ	13.0460-7122.2	607122	ATE 20676 19,8 + WK
					13.0470-7122.2	LD7122	ATE 20676 19,8 + WK Ceramic
			→	05/06→ 05/09; +PR 1KK,1KT	13.0460-2820.2	602820	TRW 20961 17,2 - WK
					13.0460-2894.2	602894	TRW 20961 17,2 - WK + Zub
					13.0470-2820.2	LD2820	TRW 20961 17,2 - WK Ceramic
					13.0470-2894.2	LD2894	TRW 20961 17,2 - WK + Zub Ceramic
			→	05/06→ 05/09; +PR 1KD,1KS,1KV	13.0460-2864.2	602864	TRW 20961 17,2 - WK
					13.0460-2877.2	602877	TRW 23554 17,2 + WK
					13.0470-2877.2	LD2877	TRW 23554 17,2 + WK Ceramic
Zubehörsatz, Scheibenbremsbelag							
1.4	55	07/03→	→	→ 05/09; +PR 1KK,1KT	13.0460-0072.2	610072	TRW
1.4	74	11/03→					
1.4 TDI	55	07/03→	→	→ 05/09; +PR 1KD,1KS,1KV	13.0460-0072.2	610072	TRW
1.9 SDI	47	09/02→					
1.9 TDi	74	09/02→					
2.0	85	09/02→					
1.6	74	09/02→	→	05/06→ 05/09; +PR 1KK,1KT	13.0460-0072.2	610072	TRW
			→	05/06→ 05/09; +PR 1KD,1KS,1KV	13.0460-0072.2	610072	TRW
 Bremsscheibe							
1.4	55	07/03→	←	→ 05/09; +PR 1LM;1ZN	24.0118-0137.1	418137	Ø 239 18 16 V + S
1.4	74	11/03→			24.0318-0137.1	518137	Ø 239 18 16 V + S PD
1.4 TDI	55	07/03→					
1.9 SDI	47	09/02→	←	→ 05/09; +PR 1LQ;1LR;1ZF;1ZG	24.0122-0151.1	422151	Ø 256 22 19 V + S
1.9 TDi	74	09/02→			24.0322-0151.1	522151	Ø 256 22 19 V + S PD
2.0	85	09/02→	←	→ 05/09; +PR 1LN;1ZD;1ZH	24.0125-0113.1	425113	Ø 288 25 22 V + S
					24.0325-0113.1	525113	Ø 288 25 22 V + S PD
			←	→ 05/09; +PR 1LJ	24.0125-0123.1	425123	Ø 310 25 22 V + S
					24.0325-0123.1	525123	Ø 310 25 22 V PD
			→	→ 05/09; +PR 1KD,1KS,1KT,1KV	24.0109-0123.1	409123	Ø 230 9 7 + S
					24.0309-0123.1	509123	Ø 230 9 7 + S PD
			→	→ 05/09; +PR 1KK	24.0109-0174.1	409174	Ø 232 9 7 + S
1.6	74	09/02→	←	05/06→ 05/09; +PR 1LM;1ZN	24.0118-0137.1	418137	Ø 239 18 16 V + S
					24.0318-0137.1	518137	Ø 239 18 16 V + S PD
			←	05/06→ 05/09; +PR 1LQ;1LR;1ZF;1ZG	24.0122-0151.1	422151	Ø 256 22 19 V + S
					24.0322-0151.1	522151	Ø 256 22 19 V + S PD
			←	05/06→ 05/09; +PR 1LN;1ZD;1ZH	24.0125-0113.1	425113	Ø 288 25 22 V + S
					24.0325-0113.1	525113	Ø 288 25 22 V + S PD
			←	05/06→ 05/09; +PR 1LJ	24.0125-0123.1	425123	Ø 310 25 22 V + S

	kw			 	! #		
VW - POLO Stufenheck (9A4) 09/02→							
 Bremsscheibe							
1.6	74	09/02→	←	05/06→ 05/09; +PR 1LJ	24.0325-0123.1	525123	Ø 310 25 22 V PD
			→	05/06→ 05/09; +PR 1KD,1KS,1KT,1KV	24.0109-0123.1	409123	Ø 230 9 7 + S
					24.0309-0123.1	509123	Ø 230 9 7 + S PD
			→	05/06→ 05/09; +PR 1KK	24.0109-0174.1	409174	Ø 232 9 7 + S
VW - POLO Stufenheck (60_, 61_) 05/09→							
 Bremsbelagsatz, Scheibenbremse							
1.6	63	11/10→	←	07/14→; +PR 1ZG,1LR,1ZJ	13.0460-7111.2	607111	VW 23130 19,6 - WE / - WK
1.6	77	05/10→			13.0470-7111.2	LD7111	VW 23130 19,6 - WE / - WK Ceramic
			←	07/14→; +PR 1LN,1ZC	13.0460-7184.2	607184	ATE 23587 20,6 + WK
					13.0470-7184.2	LD7184	ATE 23587 20,6 + WK Ceramic
			←	07/14→; +PR 1ZP,1ZR	13.0460-7285.2	607285	ATE 23587 20,6 - WE / - WK
					13.0470-7285.2	LD7285	ATE 23587 20,6 - WE / - WK Ceramic
			→	07/14→; +PR 1KK,1KT,1KV	13.0460-2820.2	602820	TRW 20961 17,2 - WK
					13.0470-2820.2	LD2820	TRW 20961 17,2 - WK Ceramic
			→	07/14→; +PR 2EJ	13.0460-2894.2	602894	TRW 20961 17,2 - WK + Zub
					13.0470-2894.2	LD2894	TRW 20961 17,2 - WK + Zub Ceramic
 Bremsscheibe							
1.6	63	11/10→	←	07/14→; +PR 1LR,1ZG,1ZJ	24.0122-0151.1	422151	Ø 256 22 19 V + S
1.6	77	05/10→			24.0322-0151.1	522151	Ø 256 22 19 V + S PD
			←	07/14→	24.0125-0113.1	425113	Ø 288 25 22 V + S
					24.0325-0113.1	525113	Ø 288 25 22 V + S PD
			←	07/14→; +PR 1ZP,1ZR	24.0125-0123.1	425123	Ø 310 25 22 V + S
					24.0325-0123.1	525123	Ø 310 25 22 V PD
			→	07/14→; +PR 1KK,1KT,1KV,2EJ	24.0109-0123.1	409123	Ø 230 9 7 + S
					24.0309-0123.1	509123	Ø 230 9 7 + S PD
VW - POLO Van (6R) 01/14→							
 Bremsbelagsatz, Scheibenbremse							
1.0	44	01/14→	←	+PR 1ZG,1LR,1ZJ	13.0460-7111.2	607111	VW 23130 19,6 - WE / - WK
1.0	55	01/14→			13.0470-7111.2	LD7111	VW 23130 19,6 - WE / - WK Ceramic
1.0 TSI	70	11/14→					
1.4 TDI	55	03/14→	←	+PR 1LN,1ZC	13.0460-7184.2	607184	ATE 23587 20,6 + WK
1.4 TDI	66	02/14→			13.0470-7184.2	LD7184	ATE 23587 20,6 + WK Ceramic
1.4 TSI	110	05/14→	→	+PR 1KK,1KT,2EJ	13.0460-2820.2	602820	TRW 20961 17,2 - WK
					13.0470-2820.2	LD2820	TRW 20961 17,2 - WK Ceramic
			→	+PR 2EJ	13.0460-2894.2	602894	TRW 20961 17,2 - WK + Zub
					13.0470-2894.2	LD2894	TRW 20961 17,2 - WK + Zub Ceramic
1.2 TSI	66	02/14→	←	+PR 1ZG,1LR,1ZJ	13.0460-7111.2	607111	VW 23130 19,6 - WE / - WK
					13.0470-7111.2	LD7111	VW 23130 19,6 - WE / - WK Ceramic
			←	+PR 1LN,1ZC,1ZD	13.0460-7184.2	607184	ATE 23587 20,6 + WK
					13.0470-7184.2	LD7184	ATE 23587 20,6 + WK Ceramic
			←	+PR 1ZP,1ZR	13.0460-7285.2	607285	ATE 23587 20,6 - WE / - WK
					13.0470-7285.2	LD7285	ATE 23587 20,6 - WE / - WK Ceramic
			→	+PR 1KK,1KT,1KV	13.0460-2820.2	602820	TRW 20961 17,2 - WK
					13.0470-2820.2	LD2820	TRW 20961 17,2 - WK Ceramic
			→	+PR 2EJ	13.0460-2894.2	602894	TRW 20961 17,2 - WK + Zub
					13.0470-2894.2	LD2894	TRW 20961 17,2 - WK + Zub Ceramic
1.2 TSI	81	01/14→	←	+PR 1ZG,1LR,1ZJ	13.0460-7111.2	607111	VW 23130 19,6 - WE / - WK
					13.0470-7111.2	LD7111	VW 23130 19,6 - WE / - WK Ceramic
			←	+PR 1LN,1ZC	13.0460-7184.2	607184	ATE 23587 20,6 + WK
					13.0470-7184.2	LD7184	ATE 23587 20,6 + WK Ceramic
			←	+PR 1ZP,1ZR	13.0460-7285.2	607285	ATE 23587 20,6 - WE / - WK
					13.0470-7285.2	LD7285	ATE 23587 20,6 - WE / - WK Ceramic

	kw			 	! #		
VW - POLO Van (6R) 01/14→							
 Bremssattel, Scheibenbremse							
1.2 TSI	81	01/14→	➔	+PR 1KK,1KT,2EJ	13.0460-2820.2 602820	TRW 20961 17,2 - WK	
					13.0470-2820.2 LD2820	TRW 20961 17,2 - WK Ceramic	
			➔	+PR 2EJ	13.0460-2894.2 602894	TRW 20961 17,2 - WK + Zub	
					13.0470-2894.2 LD2894	TRW 20961 17,2 - WK + Zub Ceramic	
 Bremsscheibe							
1.0	44	01/14→	←	+PR 1LR,1ZG,1ZJ	24.0122-0151.1 422151	Ø 256 22 19 V + S	
1.0	55	01/14→			24.0322-0151.1 522151	Ø 256 22 19 V + S PD	
1.0 TSI	70	11/14→					
1.4 TDI	55	03/14→	←	+PR 1LN,1ZC	24.0125-0113.1 425113	Ø 288 25 22 V + S	
1.4 TDI	66	02/14→			24.0325-0113.1 525113	Ø 288 25 22 V + S PD	
1.4 TSI	110	05/14→	➔	+PR 1KK,1KT,2EJ	24.0109-0123.1 409123	Ø 230 9 7 + S	
					24.0309-0123.1 509123	Ø 230 9 7 + S PD	
1.2 TSI	66	02/14→	←	+PR 1LR,1ZG,1ZJ	24.0122-0151.1 422151	Ø 256 22 19 V + S	
					24.0322-0151.1 522151	Ø 256 22 19 V + S PD	
			←	+PR 1LN,1ZC,1ZD	24.0125-0113.1 425113	Ø 288 25 22 V + S	
					24.0325-0113.1 525113	Ø 288 25 22 V + S PD	
			←	+PR 1ZP,1ZR	24.0125-0123.1 425123	Ø 310 25 22 V + S	
					24.0325-0123.1 525123	Ø 310 25 22 V PD	
			➔	+PR 1KK,1KT,1KV,2EJ	24.0109-0123.1 409123	Ø 230 9 7 + S	
					24.0309-0123.1 509123	Ø 230 9 7 + S PD	
1.2 TSI	81	01/14→	←	+PR 1LR,1ZG,1ZJ	24.0122-0151.1 422151	Ø 256 22 19 V + S	
					24.0322-0151.1 522151	Ø 256 22 19 V + S PD	
			←	+PR 1LN,1ZC	24.0125-0113.1 425113	Ø 288 25 22 V + S	
					24.0325-0113.1 525113	Ø 288 25 22 V + S PD	
			←	+PR 1ZP,1ZR	24.0125-0123.1 425123	Ø 310 25 22 V + S	
					24.0325-0123.1 525123	Ø 310 25 22 V PD	
			➔	+PR 1KK,1KT,2EJ	24.0109-0123.1 409123	Ø 230 9 7 + S	
					24.0309-0123.1 509123	Ø 230 9 7 + S PD	
VW - POLO Variant (6V5) 04/97→09/01							
 Bremssattel, Scheibenbremse							
1.4	40	12/98→09/01	←	→ 6K-V-022628; - ABS	13.0460-7059.2 607059	VW 20887 17,3 - WE / - WK + Zub	
1.4	44	05/97→09/01					
1.4 16V	55	10/99→09/01	←	→ 6K-V-022628; + ABS	13.0460-7072.2 607072	VW 21866 19,7 - WE / - WK	
			←	6K-V-022629→	13.0460-7101.2 607101	VW 21866 15,3 - WE / - WK	
1.6	55	05/97→09/01	←	→ 6K-V-022628	13.0460-7072.2 607072	VW 21866 19,7 - WE / - WK	
1.7 SDI	42	08/97→09/01					
1.9 SDI	47	06/97→09/01	←	6K-V-022629→	13.0460-7101.2 607101	VW 21866 15,3 - WE / - WK	
1.9 SDI	50	08/99→09/01					
1.6	74	05/97→09/01	←		13.0460-2821.2 602821	TRW 21945 16,0 - WK	
1.8	66	05/97→09/01					
1.9 TDI	66	05/97→09/01					
1.9 TDI	81	06/98→09/01	←		13.0460-2821.2 602821	TRW 21945 16,0 - WK	
			➔		13.0460-2886.2 602886	TRW 20961 16,0 - WK	
					13.0460-2894.2 602894	TRW 20961 17,2 - WK + Zub	
					13.0470-2886.2 LD2886	TRW 20961 16,0 - WK Ceramic	
					13.0470-2894.2 LD2894	TRW 20961 17,2 - WK + Zub Ceramic	
Zubehörsatz, Scheibenbremsbelag							
1.9 TDI	81	06/98→09/01	➔		13.0460-0072.2 610072	TRW	
 Bremsscheibe							
1.4	40	12/98→09/01	←	→ 6K-V-022628; - ABS	24.0110-0151.1 410151	Ø 239 10 8 + S	
1.4	44	05/97→09/01			24.0310-0151.1 510151	Ø 239 10 8 + S PD	
1.4 16V	55	10/99→09/01	←	→ 6K-V-022628; + ABS	24.0112-0106.1 412106	Ø 239 12 10 + S	
					24.0312-0106.1 512106	Ø 239 12 10 + S PD	
			←	6K-V-022629→	24.0120-0123.1 420123	Ø 239 20 18 V + S	
					24.0320-0123.1 520123	Ø 239 20 18 V + S PD	
1.6	55	05/97→09/01	←	→ 6K-V-022628	24.0112-0106.1 412106	Ø 239 12 10 + S	
1.7 SDI	42	08/97→09/01			24.0312-0106.1 512106	Ø 239 12 10 + S PD	
1.9 SDI	47	06/97→09/01					
1.9 SDI	50	08/99→09/01	←	6K-V-022629→	24.0120-0123.1 420123	Ø 239 20 18 V + S	
					24.0320-0123.1 520123	Ø 239 20 18 V + S PD	
↓							

	kw			 	! #		
VW - POLO Variant (6V5) 04/97→09/01							
 Bremsscheibe							
1.6	74	05/97→09/01	←			24.0120-0128.1 420128	Ø 256 20 18 V + S
1.8	66	05/97→09/01				24.0320-0128.1 520128	Ø 256 20 18 V + S PD
1.9 TDI	66	05/97→09/01					
1.9 TDI	81	06/98→09/01	←			24.0120-0128.1 420128	Ø 256 20 18 V + S
						24.0320-0128.1 520128	Ø 256 20 18 V + S PD
			→			24.0109-0124.1 409124	Ø 232 9 7
VW - SCIROCCO (137, 138) 05/08→							
 Bremsbelagsatz, Scheibenbremse							
1.4 TSI	90	08/08→	←	09/08→; +PR 1LJ,1ZA,1ZB,1ZD / 1ZE,1ZP		13.0460-7184.2 607184 13.0470-7184.2 LD7184	ATE 23587 20,6 + WK ATE 23587 20,6 + WK Ceramic
			←	09/08→; +PR 1ZK		13.0460-7227.2 607227 13.0470-7227.2 LD7227	ATE 23801 20,3 + WK ATE 23912 20,3 + WK Ceramic
			→	09/08→; +PR 1KE,1KW		13.0460-2749.2 602749 13.0460-2880.2 602880 13.0470-2749.2 LD2749 13.0470-2880.2 LD2880	TRW 24483 16,9 - WE / - WK + Zub TRW 23914 17,1 + WE / - WK + Zub TRW 24483 16,9 - WE / - WK + Zub Ceramic TRW 23914 17,1 + WE / - WK + Zub Ceramic
			→	09/08→; +PR 1KD		13.0460-2820.2 602820 13.0470-2820.2 LD2820	TRW 20961 17,2 - WK TRW 20961 17,2 - WK Ceramic
			→	09/08→; +PR 1KT		13.0460-3858.2 603858 13.0470-3858.2 LD3858	BOS 24563 17,7 - WE / - WK + Zub BOS 24563 17,7 - WE / - WK + Zub Ceramic
			→	09/08→; +PR 1KS		13.0460-3858.2 603858 13.0470-3858.2 LD3858	BOS 24563 17,7 - WE / - WK + Zub BOS 24563 17,7 - WE / - WK + Zub Ceramic
1.4 TSI	92	11/13→	←	+PR 1LJ,1ZA,1ZB,1ZD / 1ZE,1ZP		13.0460-7184.2 607184	ATE 23587 20,6 + WK
1.4 TSI	110	07/15→				13.0470-7184.2 LD7184	ATE 23587 20,6 + WK Ceramic
2.0 R	188	11/09→	←	+PR 1ZK		13.0460-7227.2 607227	ATE 23801 20,3 + WK
2.0 TDI	195	11/09→				13.0470-7227.2 LD7227	ATE 23912 20,3 + WK Ceramic
2.0 TDI	100	11/10→					
2.0 TDI	110	11/13→	→	+PR 1KE,1KW		13.0460-2749.2 602749 13.0460-2880.2 602880	TRW 24483 16,9 - WE / - WK + Zub TRW 23914 17,1 + WE / - WK + Zub
2.0 TDI	125	05/09→				13.0470-2749.2 LD2749 13.0470-2880.2 LD2880	TRW 24483 16,9 - WE / - WK + Zub Ceramic TRW 23914 17,1 + WE / - WK + Zub Ceramic
2.0 TDI	130	01/13→					
2.0 TDI	135	05/14→					
2.0 TSI	132	11/13→					
2.0 TSI	155	11/09→05/11					
2.0 TSI	162	11/13→					
			→	+PR 1KD		13.0460-2820.2 602820 13.0470-2820.2 LD2820	TRW 20961 17,2 - WK TRW 20961 17,2 - WK Ceramic
			→	+PR 1KS		13.0460-3858.2 603858 13.0470-3858.2 LD3858	BOS 24563 17,7 - WE / - WK + Zub BOS 24563 17,7 - WE / - WK + Zub Ceramic
			→	+PR 1KT		13.0460-3858.2 603858 13.0470-3858.2 LD3858	BOS 24563 17,7 - WE / - WK + Zub BOS 24563 17,7 - WE / - WK + Zub Ceramic
1.4 TSI	118	05/08→	←	08/08→; +PR 1LJ,1ZA,1ZB,1ZD / 1ZE,1ZP		13.0460-7184.2 607184 13.0470-7184.2 LD7184	ATE 23587 20,6 + WK ATE 23587 20,6 + WK Ceramic
2.0 TSI	147	05/08→11/09	←	08/08→; +PR 1ZK		13.0460-7227.2 607227 13.0470-7227.2 LD7227	ATE 23801 20,3 + WK ATE 23912 20,3 + WK Ceramic
			→	08/08→; +PR 1KE,1KW		13.0460-2749.2 602749 13.0460-2880.2 602880 13.0470-2749.2 LD2749 13.0470-2880.2 LD2880	TRW 24483 16,9 - WE / - WK + Zub TRW 23914 17,1 + WE / - WK + Zub TRW 24483 16,9 - WE / - WK + Zub Ceramic TRW 23914 17,1 + WE / - WK + Zub Ceramic
			→	08/08→; +PR 1KD		13.0460-2820.2 602820 13.0470-2820.2 LD2820	TRW 20961 17,2 - WK TRW 20961 17,2 - WK Ceramic

	kw			 	! #		
VW - SCIROCCO (137, 138) 05/08→							
Bremsbelagsatz, Scheibenbremse							
1.4 TSI 2.0 TSI	118 147	05/08→ 05/08→11/09	➡	08/08→; +PR 1KT	13.0460-3858.2	603858	BOS 24563 17,7 - WE / - WK + Zub
					13.0470-3858.2	LD3858	BOS 24563 17,7 - WE / - WK + Zub Ceramic
			➡	08/08→; +PR 1KS	13.0460-3858.2	603858	BOS 24563 17,7 - WE / - WK + Zub
					13.0470-3858.2	LD3858	BOS 24563 17,7 - WE / - WK + Zub Ceramic
2.0 R	206	05/14→	←	08/14→; +PR 1LJ,1ZA,1ZB,1ZD / 1ZE,1ZP	13.0460-7184.2	607184	ATE 23587 20,6 + WK
					13.0470-7184.2	LD7184	ATE 23587 20,6 + WK Ceramic
			←	08/14→; +PR 1ZK	13.0460-7227.2	607227	ATE 23801 20,3 + WK
					13.0470-7227.2	LD7227	ATE 23912 20,3 + WK Ceramic
			➡	08/14→; +PR 1KE,1KW	13.0460-2749.2	602749	TRW 24483 16,9 - WE / - WK + Zub
					13.0460-2880.2	602880	TRW 23914 17,1 + WE / - WK + Zub
					13.0470-2749.2	LD2749	TRW 24483 16,9 - WE / - WK + Zub Ceramic
					13.0470-2880.2	LD2880	TRW 23914 17,1 + WE / - WK + Zub Ceramic
		➡	08/14→; +PR 1KD	13.0460-2820.2	602820	TRW 20961 17,2 - WK	
				13.0470-2820.2	LD2820	TRW 20961 17,2 - WK Ceramic	
			➡	08/14→; +PR 1KS	13.0460-3858.2	603858	BOS 24563 17,7 - WE / - WK + Zub
					13.0470-3858.2	LD3858	BOS 24563 17,7 - WE / - WK + Zub Ceramic
			➡	08/14→; +PR 1KT	13.0460-3858.2	603858	BOS 24563 17,7 - WE / - WK + Zub
					13.0470-3858.2	LD3858	BOS 24563 17,7 - WE / - WK + Zub Ceramic
2.0 TDI	103	08/08→	←	10/08→; +PR 1LJ,1ZA,1ZB,1ZD / 1ZE,1ZP	13.0460-7184.2	607184	ATE 23587 20,6 + WK
					13.0470-7184.2	LD7184	ATE 23587 20,6 + WK Ceramic
			←	10/08→; +PR 1ZK	13.0460-7227.2	607227	ATE 23801 20,3 + WK
					13.0470-7227.2	LD7227	ATE 23912 20,3 + WK Ceramic
			➡	10/08→; +PR 1KE,1KW	13.0460-2749.2	602749	TRW 24483 16,9 - WE / - WK + Zub
					13.0460-2880.2	602880	TRW 23914 17,1 + WE / - WK + Zub
					13.0470-2749.2	LD2749	TRW 24483 16,9 - WE / - WK + Zub Ceramic
					13.0470-2880.2	LD2880	TRW 23914 17,1 + WE / - WK + Zub Ceramic
		➡	10/08→; +PR 1KD	13.0460-2820.2	602820	TRW 20961 17,2 - WK	
				13.0470-2820.2	LD2820	TRW 20961 17,2 - WK Ceramic	
			➡	10/08→; +PR 1KT	13.0460-3858.2	603858	BOS 24563 17,7 - WE / - WK + Zub
					13.0470-3858.2	LD3858	BOS 24563 17,7 - WE / - WK + Zub Ceramic
			➡	10/08→; +PR 1KS	13.0460-3858.2	603858	BOS 24563 17,7 - WE / - WK + Zub
					13.0470-3858.2	LD3858	BOS 24563 17,7 - WE / - WK + Zub Ceramic
Zubehörsatz, Scheibenbremsbelag							
1.4 TSI	90	08/08→	➡	09/08→; +PR 1KD	13.0460-0259.2	610259	
					13.0460-0259.2	610259	
1.4 TSI	92	11/13→	➡	+PR 1KD	13.0460-0259.2	610259	
1.4 TSI	110	07/15→					
2.0 R	188	11/09→	➡	+PR 1KE,1KW	13.0460-0259.2	610259	
2.0 R	195	11/09→					
2.0 TDI	100	11/10→					
2.0 TDI	110	11/13→					
2.0 TDI	125	05/09→					
2.0 TDI	130	01/13→					
2.0 TDI	135	05/14→					
2.0 TSI	132	11/13→					
2.0 TSI	155	11/09→05/11					
2.0 TSI	162	11/13→					
1.4 TSI	118	05/08→	➡	08/08→; +PR 1KD	13.0460-0259.2	610259	
2.0 TSI	147	05/08→11/09					
↓							

	kW			 	! #		
VW - SCIROCCO (137, 138) 05/08→							
Zubehörsatz, Scheibenbremsbelag							
1.4 TSI	118	05/08→	➡	08/08→; +PR 1KE,1KW		13.0460-0259.2 610259	
2.0 TSI	147	05/08→11/09					
2.0 R	206	05/14→	➡	08/14→; +PR 1KD		13.0460-0259.2 610259	
			➡	08/14→; +PR 1KE,1KW		13.0460-0259.2 610259	
2.0 TDI	103	08/08→	➡	10/08→; +PR 1KE,1KW		13.0460-0259.2 610259	
			➡	10/08→; +PR 1KD		13.0460-0259.2 610259	
 Bremsscheibe							
1.4 TSI	90	08/08→	←	09/08→; +PR 1ZE,1ZP		24.0125-0145.1 425145 Ø 288 25 22 V + S 24.0325-0145.1 525145 Ø 288 25 22 V + S PD	
			←	09/08→; +PR 1LJ,1ZA,1ZB,1ZD		24.0125-0158.1 425158 Ø 312 25 22 V + S 24.0325-0158.1 525158 Ø 312 25 22 V + S PD	
			←	09/08→; +PR 1ZK		24.0130-0115.1 430115 Ø 345 30 27 V 24.0330-0115.1 530115 Ø 345 30 27 V PD	
			➡	09/08→; +PR 1KD		24.0110-0277.1 410277 Ø 253 10 8 + S 24.0310-0277.1 510277 Ø 253 10 8 + S PD	
			➡	09/08→; +PR 1KS,1KT		24.0110-0356.1 410356 Ø 272 9,7 8 + S 24.0310-0356.1 510356 Ø 272 9,7 8 + S PD	
			➡	09/08→; +PR 1KE		24.0112-0158.1 412158 Ø 256 12 10 + S 24.0312-0158.1 512158 Ø 256 12 10 PD	
			➡	09/08→; +PR 1KW		24.0122-0219.1 422219 Ø 310 22 20 V	
1.4 TSI	92	11/13→	←	+PR 1ZE,1ZP		24.0125-0145.1 425145 Ø 288 25 22 V + S	
1.4 TSI	110	07/15→				24.0325-0145.1 525145 Ø 288 25 22 V + S PD	
2.0 R	188	11/09→					
2.0 R	195	11/09→	←	+PR 1LJ,1ZA,1ZB,1ZD		24.0125-0158.1 425158 Ø 312 25 22 V + S	
2.0 TDI	100	11/10→				24.0325-0158.1 525158 Ø 312 25 22 V + S PD	
2.0 TDI	110	11/13→	←	+PR 1ZK		24.0130-0115.1 430115 Ø 345 30 27 V	
2.0 TDI	125	05/09→				24.0330-0115.1 530115 Ø 345 30 27 V PD	
2.0 TDI	130	01/13→					
2.0 TDI	135	05/14→	➡	+PR 1KD		24.0110-0277.1 410277 Ø 253 10 8 + S	
2.0 TSI	132	11/13→	➡	+PR 1KS,1KT		24.0310-0277.1 510277 Ø 253 10 8 + S PD	
			➡	+PR 1KE		24.0110-0356.1 410356 Ø 272 9,7 8 + S 24.0310-0356.1 510356 Ø 272 9,7 8 + S PD	
			➡	+PR 1KE		24.0112-0158.1 412158 Ø 256 12 10 + S 24.0312-0158.1 512158 Ø 256 12 10 PD	
			➡	+PR 1KW		24.0122-0219.1 422219 Ø 310 22 20 V	
1.4 TSI	118	05/08→	←	08/08→; +PR 1ZE,1ZP		24.0125-0145.1 425145 Ø 288 25 22 V + S	
2.0 TSI	147	05/08→11/09				24.0325-0145.1 525145 Ø 288 25 22 V + S PD	
			←	08/08→; +PR 1LJ,1ZA,1ZB,1ZD		24.0125-0158.1 425158 Ø 312 25 22 V + S 24.0325-0158.1 525158 Ø 312 25 22 V + S PD	
			←	08/08→; +PR 1ZK		24.0130-0115.1 430115 Ø 345 30 27 V 24.0330-0115.1 530115 Ø 345 30 27 V PD	
			➡	08/08→; +PR 1KD		24.0110-0277.1 410277 Ø 253 10 8 + S 24.0310-0277.1 510277 Ø 253 10 8 + S PD	
			➡	08/08→; +PR 1KS,1KT		24.0110-0356.1 410356 Ø 272 9,7 8 + S 24.0310-0356.1 510356 Ø 272 9,7 8 + S PD	
			➡	08/08→; +PR 1KE		24.0112-0158.1 412158 Ø 256 12 10 + S 24.0312-0158.1 512158 Ø 256 12 10 PD	
			➡	08/08→; +PR 1KW		24.0122-0219.1 422219 Ø 310 22 20 V	
2.0 R	206	05/14→	←	08/14→; +PR 1ZE,1ZP		24.0125-0145.1 425145 Ø 288 25 22 V + S 24.0325-0145.1 525145 Ø 288 25 22 V + S PD	
			←	08/14→; +PR 1LJ,1ZA,1ZB,1ZD		24.0125-0158.1 425158 Ø 312 25 22 V + S 24.0325-0158.1 525158 Ø 312 25 22 V + S PD	
			←	08/14→; +PR 1ZK		24.0130-0115.1 430115 Ø 345 30 27 V 24.0330-0115.1 530115 Ø 345 30 27 V PD	
			➡	08/14→; +PR 1KD		24.0110-0277.1 410277 Ø 253 10 8 + S 24.0310-0277.1 510277 Ø 253 10 8 + S PD	
			➡	08/14→; +PR 1KS,1KT		24.0110-0356.1 410356 Ø 272 9,7 8 + S 24.0310-0356.1 510356 Ø 272 9,7 8 + S PD	
			➡	08/14→; +PR 1KE		24.0112-0158.1 412158 Ø 256 12 10 + S 24.0312-0158.1 512158 Ø 256 12 10 PD	
			➡	08/14→; +PR 1KW		24.0122-0219.1 422219 Ø 310 22 20 V	
↓							

VW - SCIROCCO (137, 138) 05/08→









Bremsscheibe







2.0 TDI	103	08/08→	←	10/08→; +PR 1ZE,1ZP	24.0125-0145.1 425145	Ø 288 25 22 V + S
			←	10/08→; +PR 1LJ,1ZA,1ZB,1ZD	24.0125-0158.1 425158	Ø 288 25 22 V + S PD
			←	10/08→; +PR 1ZK	24.0130-0115.1 430115	Ø 312 25 22 V + S
			→	10/08→; +PR 1KD	24.0325-0158.1 525158	Ø 312 25 22 V + S PD
			→	10/08→; +PR 1KE	24.0130-0115.1 430115	Ø 345 30 27 V
			→	10/08→; +PR 1KW	24.0330-0115.1 530115	Ø 345 30 27 V PD
			→	10/08→; +PR 1KT	24.0110-0277.1 410277	Ø 253 10 8 + S
2.0 TSI	155	11/09→05/11	←	+PR 1ZE,1ZP	24.0110-0277.1 410277	Ø 253 10 8 + S
			←	+PR 1LJ,1ZA,1ZB,1ZD	24.0310-0277.1 510277	Ø 253 10 8 + S PD
			←	+PR 1ZK	24.0110-0356.1 410356	Ø 272 9,7 8 + S
			→	+PR 1KD	24.0310-0356.1 510356	Ø 272 9,7 8 + S PD
			→	+PR 1KE	24.0112-0158.1 412158	Ø 272 9,7 8 + S
			→	+PR 1KW	24.0312-0158.1 512158	Ø 272 9,7 8 + S PD
			→	11/13→; +PR 1KE	24.0112-0158.1 412158	Ø 256 12 10 + S
2.0 TSI	162	11/13→	←	+PR 1ZE,1ZP	24.0312-0158.1 512158	Ø 256 12 10 PD
			←	+PR 1LJ,1ZA,1ZB,1ZD	24.0122-0219.1 422219	Ø 256 12 10 PD
			←	+PR 1ZK	24.0122-0219.1 422219	Ø 310 22 20 V
			→	+PR 1KD	24.0125-0145.1 425145	Ø 288 25 22 V + S
			→	+PR 1KS,1KT	24.0325-0145.1 525145	Ø 288 25 22 V + S PD
			→	+PR 1KE	24.0125-0158.1 425158	Ø 312 25 22 V + S
			→	+PR 1KW	24.0325-0158.1 525158	Ø 312 25 22 V + S PD

VW - SHARAN (7M8, 7M9, 7M6) 05/95→03/10











Bremsbelagsatz, Scheibenbremse









1.8 T 20V	110	09/97→03/10	←	→ 7M-W-070000	13.0460-7076.2 607076	ATE 21848 19,8 - WE / - WK
			←	7M-X-000001→ 7M-1-070000	13.0460-7143.2 607143	ATE 21848 19,8 + WK
			←	7M-2-000001→	13.0460-7153.2 607153	ATE 23269 19,8 + WK
			→	→ 04/00	13.0460-2819.2 602819	TRW 20961 17,2 - WK
			→	05/00→; → 7M-1-070000	13.0460-2859.2 602859	TRW 20961 17,0 + WK + Zub
			→	7M-2-000001→	13.0460-2872.2 602872	TRW 23224 16,5 + WK + Zub
1.9 TDI 2.0	66 85	09/95→03/10 09/95→03/10	←	→ 7M-W-070000	13.0460-7076.2 607076	ATE 21848 19,8 - WE / - WK
			←	7M-X-000001→ 7M-1-070000	13.0460-7143.2 607143	ATE 21848 19,8 + WK
			←	7M-2-000001→	13.0460-7154.2 607154	ATE 23034 18,8 + WK
			→	→ 04/00	13.0460-2819.2 602819	TRW 20961 17,2 - WK
			→	05/00→	13.0460-2859.2 602859	TRW 20961 17,0 + WK + Zub
			→			
1.9 TDI	81	09/96→04/00	←	→ 7M-W-070000	13.0460-7076.2 607076	ATE 21848 19,8 - WE / - WK
			←	7M-X-000001→ 7M-1-070000	13.0460-7143.2 607143	ATE 21848 19,8 + WK
			→		13.0460-2819.2 602819	TRW 20961 17,2 - WK











	kw			 	! #		
VW - SHARAN (7M8, 7M9, 7M6) 05/95→03/10							
 Bremsbelagsatz, Scheibenbremse							
1.9 TDI	85	04/00→03/10	←	05/00→; → 7M-1-070000		13.0460-7143.2 607143	ATE 21848 19,8 + WK
			←	7M-2-000001→		13.0460-7154.2 607154	ATE 23034 18,8 + WK
			→	05/00→		13.0460-2859.2 602859	TRW 20961 17,0 + WK + Zub
1.9 TDI	96	11/02→03/10	←			13.0460-7154.2 607154	ATE 23034 18,8 + WK
			→			13.0460-2859.2 602859	TRW 20961 17,0 + WK + Zub
1.9 TDI 2.8 V6 24V	110 150	06/05→03/10 04/00→03/10	←			13.0460-7153.2 607153	ATE 23269 19,8 + WK
			→			13.0460-2872.2 602872	TRW 23224 16,5 + WK + Zub
2.8 V6 24V 4motion	150	04/00→03/10	←			13.0460-2872.2 602872	TRW 23224 16,5 + WK + Zub
			→			13.0460-2872.2 602872	TRW 23224 16,5 + WK + Zub
1.9 TDI 4motion	85	04/00→03/10	←	05/00→		13.0460-7153.2 607153	ATE 23269 19,8 + WK
			→	05/00→		13.0460-2872.2 602872	TRW 23224 16,5 + WK + Zub
2.0 16V	110	09/95→02/00	←	→ 7M-W-070000		13.0460-7076.2 607076	ATE 21848 19,8 - WE / - WK
			←	7M-X-000001→ 7M-1-070000		13.0460-7143.2 607143	ATE 21848 19,8 + WK
			←	7M-2-000001→		13.0460-7154.2 607154	ATE 23034 18,8 + WK
			→			13.0460-2819.2 602819	TRW 20961 17,2 - WK
2.0 LPG	85	04/06→03/10	←	→ 7M-W-070000		13.0460-7076.2 607076	ATE 21848 19,8 - WE / - WK
			←	7M-X-000001→ 7M-1-070000		13.0460-7143.2 607143	ATE 21848 19,8 + WK
			←	7M-2-000001→		13.0460-7154.2 607154	ATE 23034 18,8 + WK
			→			13.0460-2859.2 602859	TRW 20961 17,0 + WK + Zub
2.0 TDI	100 103	11/05→03/10 11/05→03/10	←	→ 7M-1-070000		13.0460-7143.2 607143	ATE 21848 19,8 + WK
			←	7M-2-000001→		13.0460-7154.2 607154	ATE 23034 18,8 + WK
2.8 VR6 2.8 VR6 Syncro	128 128	09/95→04/00 11/96→04/00	←	→ 7M-W-070000		13.0460-7076.2 607076	ATE 21848 19,8 - WE / - WK
			←	7M-X-000001→ 7M-Y-050000		13.0460-7143.2 607143	ATE 21848 19,8 + WK
			←	7M-1-000001→		13.0460-7153.2 607153	ATE 23269 19,8 + WK
			→			13.0460-2819.2 602819	TRW 20961 17,2 - WK
Zubehörsatz, Scheibenbremsbelag							
1.8 T 20V	110	09/97→03/10	→	→ 04/00		13.0460-0072.2 610072	TRW
			→	7M-2-000001→		13.0460-0225.2 610225	
1.9 TDI 2.0	66 85	09/95→03/10 09/95→03/10	→	→ 04/00		13.0460-0072.2 610072	TRW
			→			13.0460-0072.2 610072	TRW
1.9 TDI 2.0 16V	81 110	09/96→04/00 09/95→02/00	→			13.0460-0072.2 610072	TRW
			→			13.0460-0072.2 610072	TRW
2.8 VR6 2.8 VR6 Syncro	128 128	09/95→04/00 11/96→04/00	→			13.0460-0072.2 610072	TRW
			→			13.0460-0072.2 610072	TRW
1.9 TDI 2.8 V6 24V	110 150	06/05→03/10 04/00→03/10	→			13.0460-0225.2 610225	
			→			13.0460-0225.2 610225	
2.8 V6 24V 4motion 1.9 TDI 4motion	150 85	04/00→03/10 04/00→03/10	→			13.0460-0225.2 610225	
			→	05/00→		13.0460-0225.2 610225	
 Bremsscheibe							
1.8 T 20V	110	09/97→03/10	←	→ 7M-1-070000		24.0125-0114.1 425114	Ø 288 25,1 21 V + S
			←	7M-2-000001→		24.0325-0114.1 525114	Ø 288 25,1 21 V + S PD
			←	7M-2-000001→		24.0126-0119.1 426119	Ø 313 25,9 22 V
			←	7M-2-000001→		24.0326-0119.1 526119	Ø 313 25,9 22 V PD
			→	→ 7M-1-070000		24.0110-0223.1 410223	Ø 268 10 8 + S
1.9 TDI 2.0 2.0 16V 2.0 LPG	66 85 110 85	09/95→03/10 09/95→03/10 09/95→02/00 04/06→03/10	←	→ 7M-1-070000		24.0125-0114.1 425114	Ø 288 25,1 21 V + S
			←	7M-2-000001→		24.0325-0114.1 525114	Ø 288 25,1 21 V + S PD
			←	7M-2-000001→		24.0126-0115.1 426115	Ø 300 26 22 V
			←	7M-2-000001→		24.0326-0115.1 526115	Ø 300 26 22 V PD
			→			24.0110-0223.1 410223	Ø 268 10 8 + S
1.9 TDI 2.8 VR6 2.8 VR6 Syncro	81 128 128	09/96→04/00 09/95→04/00 11/96→04/00	←			24.0110-0223.1 410223	Ø 268 10 8 + S
			←			24.0310-0223.1 510223	Ø 268 10 8 + S PD
			←			24.0125-0114.1 425114	Ø 288 25,1 21 V + S
			←			24.0325-0114.1 525114	Ø 288 25,1 21 V + S PD
			→			24.0110-0223.1 410223	Ø 268 10 8 + S
↓			→			24.0310-0223.1 510223	Ø 268 10 8 + S PD
			→			24.0310-0223.1 510223	Ø 268 10 8 + S PD









	kw			 	! #		
VW - SHARAN (7M8, 7M9, 7M6) 05/95→03/10							
Bremsscheibe							
1.9 TDI	85	04/00→03/10	←	05/00→; → 7M-1-070000	24.0125-0114.1 425114	Ø 288 25,1 21 V + S	
					24.0325-0114.1 525114	Ø 288 25,1 21 V + S PD	
			←	7M-2-000001→	24.0126-0115.1 426115	Ø 300 26 22 V	
					24.0326-0115.1 526115	Ø 300 26 22 V PD	
			→	05/00→	24.0110-0223.1 410223	Ø 268 10 8 + S	
					24.0310-0223.1 510223	Ø 268 10 8 + S PD	
1.9 TDI 2.0 TDI	96 100	11/02→03/10 11/05→03/10	←		24.0126-0115.1 426115	Ø 300 26 22 V	
					24.0326-0115.1 526115	Ø 300 26 22 V PD	
2.0 TDI	103	11/05→03/10	→		24.0110-0223.1 410223	Ø 268 10 8 + S	
					24.0310-0223.1 510223	Ø 268 10 8 + S PD	
1.9 TDI 2.8 V6 24V 2.8 V6 24V 4motion	110 150 150	06/05→03/10 04/00→03/10 04/00→03/10	←		24.0126-0119.1 426119	Ø 313 25,9 22 V	
					24.0326-0119.1 526119	Ø 313 25,9 22 V PD	
1.9 TDI 4motion	85	04/00→03/10	→		24.0113-0194.1 413194	Ø 294 13,5 11,5	
					24.0113-0194.1 413194	Ø 294 13,5 11,5	
VW - SHARAN (7N1, 7N2) 05/10→							
Bremsbelagsatz, Scheibenbremse							
1.4 TSI 2.0 TDI 2.0 TDI	110 100 103	05/10→ 05/10→ 05/10→	←	07/10→; +PR 1LW	13.0460-2764.2 602764	TRW 24738 20,0 + WK	
					13.0470-2764.2 LD2764	TRW 24738 20,0 + WK Ceramic	
			←	07/12→; +PR 1LX	13.0460-2764.2 602764	TRW 24738 20,0 + WK	
					13.0470-2764.2 LD2764	TRW 24738 20,0 + WK Ceramic	
			←	07/10→; +PR 1LJ	13.0460-7242.2 607242	ATE 24332 19,8 + WK	
					13.0470-7242.2 LD7242	ATE 24332 19,8 + WK Ceramic	
			→	07/10→	13.0460-2749.2 602749	TRW 24483 16,9 - WE / - WK + Zub	
					13.0460-2880.2 602880	TRW 23914 17,1 + WE / - WK + Zub	
					13.0470-2749.2 LD2749	TRW 24483 16,9 - WE / - WK + Zub Ceramic	
					13.0470-2880.2 LD2880	TRW 23914 17,1 + WE / - WK + Zub Ceramic	
			←		13.0460-2764.2 602764	TRW 24738 20,0 + WK	
					13.0470-2764.2 LD2764	TRW 24738 20,0 + WK Ceramic	
1.4 TSI 2.0 TDI 2.0 TDI 2.0 TDI 4motion 2.0 TDI 4motion 2.0 TSI	110 110 135 110 135 162	05/15→ 05/15→ 05/15→ 05/15→ 05/16→ 05/15→	→	+ eFSB	13.0460-2790.2 602790	TRW 25110 17,5 - WE / - WK	
					13.0470-2790.2 LD2790	TRW 25110 17,5 - WE / - WK Ceramic	
1.8 TSI	118	11/11→	←	07/12→; +PR 1LX	13.0460-2764.2 602764	TRW 24738 20,0 + WK	
					13.0470-2764.2 LD2764	TRW 24738 20,0 + WK Ceramic	
			←	05/12→; +PR 1LW	13.0460-2764.2 602764	TRW 24738 20,0 + WK	
					13.0470-2764.2 LD2764	TRW 24738 20,0 + WK Ceramic	
			←	05/12→; +PR 1LJ	13.0460-7242.2 607242	ATE 24332 19,8 + WK	
					13.0470-7242.2 LD7242	ATE 24332 19,8 + WK Ceramic	
			→	05/12→	13.0460-2749.2 602749	TRW 24483 16,9 - WE / - WK + Zub	
					13.0460-2880.2 602880	TRW 23914 17,1 + WE / - WK + Zub	
					13.0470-2749.2 LD2749	TRW 24483 16,9 - WE / - WK + Zub Ceramic	
					13.0470-2880.2 LD2880	TRW 23914 17,1 + WE / - WK + Zub Ceramic	
			←	+PR 1LW	13.0460-2764.2 602764	TRW 24738 20,0 + WK	
					13.0470-2764.2 LD2764	TRW 24738 20,0 + WK Ceramic	
2.0 TDI 2.0 TDI 2.0 TDI 4motion 2.0 TSI	85 125 103 147	05/11→ 08/10→ 05/11→ 12/10→	←	07/12→; +PR 1LX	13.0460-2764.2 602764	TRW 24738 20,0 + WK	
					13.0470-2764.2 LD2764	TRW 24738 20,0 + WK Ceramic	
			←	+PR 1LJ	13.0460-7242.2 607242	ATE 24332 19,8 + WK	
					13.0470-7242.2 LD7242	ATE 24332 19,8 + WK Ceramic	
			→		13.0460-2749.2 602749	TRW 24483 16,9 - WE / - WK + Zub	
					13.0460-2880.2 602880	TRW 23914 17,1 + WE / - WK + Zub	
					13.0470-2749.2 LD2749	TRW 24483 16,9 - WE / - WK + Zub Ceramic	
					13.0470-2880.2 LD2880	TRW 23914 17,1 + WE / - WK + Zub Ceramic	











	kW			 	! #		
VW - SHARAN (7N1, 7N2) 05/10→							
 Bremsbelagsatz, Scheibenbremse							
2.0 TDI	85	05/11→	→			13.0470-2880.2 LD2880	TRW 23914 17,1 + WE / - WK + Zub Ceramic
2.0 TDI	125	08/10→					
2.0 TDI 4motion	103	05/11→					
2.0 TSI	147	12/10→					
2.0 TDI	130	01/13→	←	+PR 1LW		13.0460-2764.2 602764	TRW 24738 20,0 + WK
			←	+PR 1LX		13.0470-2764.2 LD2764	TRW 24738 20,0 + WK Ceramic
			←	+PR 1LJ		13.0460-2764.2 602764	TRW 24738 20,0 + WK
			←	+PR 1LJ		13.0470-2764.2 LD2764	TRW 24738 20,0 + WK Ceramic
			→			13.0460-2749.2 602749	ATE 24332 19,8 + WK
						13.0470-2749.2 LD2749	ATE 24332 19,8 + WK Ceramic
						13.0460-2749.2 602749	TRW 24483 16,9 - WE / - WK + Zub
						13.0460-2880.2 602880	TRW 23914 17,1 + WE / - WK + Zub
						13.0470-2749.2 LD2749	TRW 24483 16,9 - WE / - WK + Zub Ceramic
						13.0470-2880.2 LD2880	TRW 23914 17,1 + WE / - WK + Zub Ceramic
Bremsscheibe							
1.4 TSI	110	05/10→	←	07/10→; +PR 1LJ		24.0125-0158.1 425158	Ø 312 25 22 V + S
2.0 TDI	100	05/10→				24.0325-0158.1 525158	Ø 312 25 22 V + S PD
2.0 TDI	103	05/10→	←	07/10→; +PR 1LW,1LX		24.0130-0220.1 430220	Ø 314 30 27 V + S
			→	07/10→		24.0112-0169.1 412169	Ø 282 12 10 + S
						24.0312-0169.1 512169	Ø 282 12 10 + S PD
1.4 TSI	110	05/15→	←			24.0130-0220.1 430220	Ø 314 30 27 V + S
2.0 TDI	110	05/15→	→	+ eFSB		24.0112-0210.1 412210	Ø 300 12 10 + S
2.0 TDI	135	05/15→					
2.0 TDI 4motion	110	05/15→					
2.0 TDI 4motion	135	05/16→					
2.0 TSI	162	05/15→					
1.8 TSI	118	11/11→	←	05/12→; +PR 1LJ		24.0125-0158.1 425158	Ø 312 25 22 V + S
			←	05/12→; +PR 1LW,1LX		24.0325-0158.1 525158	Ø 312 25 22 V + S PD
			←	05/12→; +PR 1LW,1LX		24.0130-0220.1 430220	Ø 314 30 27 V + S
			→	05/12→		24.0112-0169.1 412169	Ø 282 12 10 + S
						24.0312-0169.1 512169	Ø 282 12 10 + S PD
2.0 TDI	85	05/11→	←	+PR 1LJ		24.0125-0158.1 425158	Ø 312 25 22 V + S
2.0 TDI	125	08/10→				24.0325-0158.1 525158	Ø 312 25 22 V + S PD
2.0 TDI	130	01/13→					
2.0 TDI 4motion	103	05/11→	←	+PR 1LW,1LX		24.0130-0220.1 430220	Ø 314 30 27 V + S
2.0 TSI	147	12/10→	→			24.0112-0169.1 412169	Ø 282 12 10 + S
						24.0312-0169.1 512169	Ø 282 12 10 + S PD
VW - TARO 04/89→03/97							
 Bremsbelagsatz, Scheibenbremse							
2.4 D	58	07/94→03/97	←			13.0460-5938.2 605938	AKE 21158 15,5 - WE / - WK
2.4 D	61	06/89→03/97					
Bremsscheibe							
2.4 D	58	07/94→03/97	←			24.0125-0118.1 425118	Ø 257 25 23 V
2.4 D	61	06/89→03/97					
2.4 D 4x4	58	07/94→03/97	←	Einzelradaufhängung		24.0120-0168.1 420168	Ø 289 20 18 V
2.4 i 4x4	84	06/89→03/97					
2.4 D 4x4	61	04/89→03/97	←	07/94→; Einzelradaufhängung		24.0120-0168.1 420168	Ø 289 20 18 V
VW - TIGUAN (5N_) 09/07→							
 Bremsbelagsatz, Scheibenbremse							
1.4 TSI	90	08/10→	←			13.0460-7242.2 607242	ATE 24332 19,8 + WK
1.4 TSI	92	05/15→				13.0470-7242.2 LD7242	ATE 24332 19,8 + WK Ceramic
1.4 TSI	110	05/08→	→				
1.4 TSI	110	05/15→				13.0460-2749.2 602749	TRW 24483 16,9 - WE / - WK + Zub
1.4 TSI	118	05/11→					
1.4 TSI 4motion	110	09/07→				13.0460-2880.2 602880	TRW 23914 17,1 + WE / - WK + Zub
1.4 TSI 4motion	118	05/11→					
2.0 TDI	81	05/10→				13.0470-2749.2 LD2749	TRW 24483 16,9 - WE / - WK + Zub Ceramic
2.0 TDI	103	03/08→					
2.0 TDI	110	05/15→					
2.0 TDI 4motion	100	11/07→				13.0470-2880.2 LD2880	TRW 23914 17,1 + WE / - WK + Zub Ceramic
2.0 TDI 4motion	110	05/15→					
2.0 TDI 4motion	120	02/08→08/09					









	kW			 	! #			
VW - TIGUAN (5N_) 09/07→								
 Bremsbelagsatz, Scheibenbremse								
2.0 TDI 4motion	130	11/12→	←			13.0460-7242.2 607242	ATE 24332 19,8 + WK	
2.0 TDI 4motion	135	05/15→				13.0470-7242.2 LD7242	ATE 24332 19,8 + WK Ceramic	
2.0 TSI 4motion	132	05/11→		→			13.0460-2749.2 602749	TRW 24483 16,9 - WE / - WK + Zub
2.0 TSI 4motion	155	05/11→					13.0460-2880.2 602880	TRW 23914 17,1 + WE / - WK + Zub
						13.0470-2749.2 LD2749	TRW 24483 16,9 - WE / - WK + Zub Ceramic	
						13.0470-2880.2 LD2880	TRW 23914 17,1 + WE / - WK + Zub Ceramic	
2.0 TDI 4motion	103	09/07→	←	11/07→		13.0460-7242.2 607242	ATE 24332 19,8 + WK	
					11/07→		13.0470-7242.2 LD7242	ATE 24332 19,8 + WK Ceramic
			→			13.0460-2749.2 602749	TRW 24483 16,9 - WE / - WK + Zub	
							13.0460-2880.2 602880	TRW 23914 17,1 + WE / - WK + Zub
							13.0470-2749.2 LD2749	TRW 24483 16,9 - WE / - WK + Zub Ceramic
							13.0470-2880.2 LD2880	TRW 23914 17,1 + WE / - WK + Zub Ceramic
2.0 TDI 4motion	125	09/07→	←	01/08→		13.0460-7242.2 607242	ATE 24332 19,8 + WK	
					01/08→		13.0470-7242.2 LD7242	ATE 24332 19,8 + WK Ceramic
			→			13.0460-2749.2 602749	TRW 24483 16,9 - WE / - WK + Zub	
							13.0460-2880.2 602880	TRW 23914 17,1 + WE / - WK + Zub
							13.0470-2749.2 LD2749	TRW 24483 16,9 - WE / - WK + Zub Ceramic
							13.0470-2880.2 LD2880	TRW 23914 17,1 + WE / - WK + Zub Ceramic
2.0 TFSI 4motion	125	09/07→	←	02/08→		13.0460-7242.2 607242	ATE 24332 19,8 + WK	
2.0 TFSI 4motion	147	09/07→			02/08→		13.0470-7242.2 LD7242	ATE 24332 19,8 + WK Ceramic
			→			13.0460-2749.2 602749	TRW 24483 16,9 - WE / - WK + Zub	
							13.0460-2880.2 602880	TRW 23914 17,1 + WE / - WK + Zub
							13.0470-2749.2 LD2749	TRW 24483 16,9 - WE / - WK + Zub Ceramic
							13.0470-2880.2 LD2880	TRW 23914 17,1 + WE / - WK + Zub Ceramic
Zubehörsatz, Scheibenbremsbelag								
1.4 TSI	90	08/10→	→			13.0460-0259.2 610259		
1.4 TSI	92	05/15→						
1.4 TSI	110	05/08→						
1.4 TSI	110	05/15→						
1.4 TSI	118	05/11→						
1.4 TSI 4motion	110	09/07→						
1.4 TSI 4motion	118	05/11→						
2.0 TDI	81	05/10→						
2.0 TDI	103	03/08→						
2.0 TDI	110	05/15→						
2.0 TDI 4motion	100	11/07→						
2.0 TDI 4motion	110	05/15→						
2.0 TDI 4motion	120	02/08→08/09						
2.0 TDI 4motion	130	11/12→						
2.0 TDI 4motion	135	05/15→						
2.0 TSI 4motion	132	05/11→						
2.0 TSI 4motion	155	05/11→						
2.0 TDI 4motion	103	09/07→		11/07→		13.0460-0259.2 610259		
2.0 TDI 4motion	125	09/07→		01/08→		13.0460-0259.2 610259		
2.0 TFSI 4motion	125	09/07→		02/08→		13.0460-0259.2 610259		
2.0 TFSI 4motion	147	09/07→						
 Bremsscheibe								
1.4 TSI	90	08/10→	←			24.0125-0158.1 425158	Ø 312 25 22 V + S	
1.4 TSI	92	05/15→					24.0325-0158.1 525158	Ø 312 25 22 V + S PD
1.4 TSI	110	05/08→	→			24.0112-0169.1 412169	Ø 282 12 10 + S	
1.4 TSI	110	05/15→					24.0312-0169.1 512169	Ø 282 12 10 + S PD
1.4 TSI	118	05/11→						
1.4 TSI 4motion	110	09/07→						
1.4 TSI 4motion	118	05/11→						
2.0 TDI	81	05/10→						
↓								







	kw			 	! #		
VW - TIGUAN (5N_) 09/07→							
 Bremsscheibe							
2.0 TDI	103	03/08→	←			24.0125-0158.1 425158	Ø 312 25 22 V + S
2.0 TDI	110	05/15→				24.0325-0158.1 525158	Ø 312 25 22 V + S PD
2.0 TDI 4motion	100	11/07→					
2.0 TDI 4motion	110	05/15→	→			24.0112-0169.1 412169	Ø 282 12 10 + S
2.0 TDI 4motion	120	02/08→08/09				24.0312-0169.1 512169	Ø 282 12 10 + S PD
2.0 TDI 4motion	130	11/12→					
2.0 TDI 4motion	135	05/15→					
2.0 TSI 4motion	132	05/11→					
2.0 TSI 4motion	155	05/11→					
2.0 TDI 4motion	103	09/07→	←	11/07→		24.0125-0158.1 425158	Ø 312 25 22 V + S
						24.0325-0158.1 525158	Ø 312 25 22 V + S PD
			→	11/07→		24.0112-0169.1 412169	Ø 282 12 10 + S
						24.0312-0169.1 512169	Ø 282 12 10 + S PD
2.0 TDI 4motion	125	09/07→	←	01/08→		24.0125-0158.1 425158	Ø 312 25 22 V + S
						24.0325-0158.1 525158	Ø 312 25 22 V + S PD
			→	01/08→		24.0112-0169.1 412169	Ø 282 12 10 + S
						24.0312-0169.1 512169	Ø 282 12 10 + S PD
2.0 TFSI 4motion	125	09/07→	←	02/08→		24.0125-0158.1 425158	Ø 312 25 22 V + S
2.0 TFSI 4motion	147	09/07→				24.0325-0158.1 525158	Ø 312 25 22 V + S PD
			→	02/08→		24.0112-0169.1 412169	Ø 282 12 10 + S
						24.0312-0169.1 512169	Ø 282 12 10 + S PD
VW - TIGUAN (AD1) 01/16→							
 Bremsbelagsatz, Scheibenbremse							
1.4 TSI	92	01/16→	←	+PR 1ZA,1ZD		13.0460-2785.2 602785	TRW 25683 20,4 + WE / + WK
1.4 TSI	110	05/16→				13.0470-2785.2 LD2785	TRW 25683 20,4 + WE / + WK Ceramic
1.4 TSI 4motion	110	05/16→					
1.6 TDI	85	05/16→					
2.0 TDI	81	08/16→	→	+PR 1KU,1KZ; + eFSB		13.0460-7294.2 607294	ATE 25009 16,4 - WE / - WK
2.0 TDI	85	05/16→				13.0470-7294.2 LD7294	ATE 25009 16,4 - WE / - WK Ceramic
2.0 TDI 4motion	105	06/16→					
2.0 TDI 4motion	130	08/16→					
2.0 TDI 4motion	140	04/16→					
2.0 TDI 4motion	176	05/16→					
2.0 TSI 4motion	162	06/16→					
2.0 TDI	110	01/16→	←	02/16→; +PR 1ZA,1ZD		13.0460-2785.2 602785	TRW 25683 20,4 + WE / + WK
2.0 TDI 4motion	110	01/16→				13.0470-2785.2 LD2785	TRW 25683 20,4 + WE / + WK Ceramic
2.0 TSI 4motion	132	01/16→					
			→	02/16→; +PR 1KU,1KZ; + eFSB		13.0460-7294.2 607294	ATE 25009 16,4 - WE / - WK
						13.0470-7294.2 LD7294	ATE 25009 16,4 - WE / - WK Ceramic
Warnkontakt, Bremsbelagverschleiß							
1.4 TSI	92	01/16→	←	+PR 1ZA,1ZD	1	24.8190-0065.2 620065	L= 172
1.4 TSI	110	05/16→					
1.4 TSI 4motion	110	05/16→	←	+PR 1LA,1LW	1	24.8190-0065.2 620065	L= 172
1.6 TDI	85	05/16→					
2.0 TDI	81	08/16→					
2.0 TDI	85	05/16→					
2.0 TDI 4motion	105	06/16→					
2.0 TDI 4motion	130	08/16→					
2.0 TDI 4motion	140	04/16→					
2.0 TDI 4motion	176	05/16→					
2.0 TSI 4motion	162	06/16→					
2.0 TDI	110	01/16→	←	02/16→; +PR 1ZA,1ZD	1	24.8190-0065.2 620065	L= 172
2.0 TDI 4motion	110	01/16→					
2.0 TSI 4motion	132	01/16→	←	02/16→; +PR 1LA,1LW	1	24.8190-0065.2 620065	L= 172
 Bremsscheibe							
1.4 TSI	92	01/16→	←	+PR 1ZA,1ZD		24.0125-0158.1 425158	Ø 312 25 22 V + S
1.4 TSI	110	05/16→				24.0325-0158.1 525158	Ø 312 25 22 V + S PD
1.4 TSI 4motion	110	05/16→					
1.6 TDI	85	05/16→	←	+PR 1LW		24.0130-0220.1 430220	Ø 314 30 27 V + S
2.0 TDI	81	08/16→	←	+PR 1LA		24.0130-0225.1 430225	Ø 340 30 27 V + S
2.0 TDI	85	05/16→					
2.0 TDI 4motion	105	06/16→	→	+PR 1KU; + eFSB		24.0112-0210.1 412210	Ø 300 12 10 + S
2.0 TDI 4motion	130	08/16→	→	+PR 1KZ; + eFSB		24.0122-0219.1 422219	Ø 310 22 20 V
2.0 TDI 4motion	140	04/16→					
2.0 TDI 4motion	176	05/16→					
2.0 TSI 4motion	162	06/16→					
2.0 TDI	110	01/16→	←	02/16→; +PR 1ZA,1ZD		24.0125-0158.1 425158	Ø 312 25 22 V + S
2.0 TDI 4motion	110	01/16→				24.0325-0158.1 525158	Ø 312 25 22 V + S PD
2.0 TSI 4motion	132	01/16→	←	02/16→; +PR 1LW		24.0130-0220.1 430220	Ø 314 30 27 V + S
			←	02/16→; +PR 1LA		24.0130-0225.1 430225	Ø 340 30 27 V + S







	kw			 	! #			
VW - TIGUAN (AD1) 01/16→								
 Bremsscheibe								
2.0 TDI	110	01/16→	➡	02/16→; +PR 1KU; + eFSB		24.0112-0210.1 412210	Ø 300 12 10 + S	
2.0 TDI 4motion	110	01/16→	➡	02/16→; +PR 1KZ; + eFSB		24.0122-0219.1 422219	Ø 310 22 20 V	
2.0 TSI 4motion	132	01/16→						
VW - TOUAREG (7LA, 7L6, 7L7) 10/02→05/10								
 Bremsbelagsatz, Scheibenbremse								
2.5 R5 TDI	120	08/03→05/10	←	01/06→ 03/10; +PR 1LE		13.0460-4833.2 604833	BRE 24098 17,1 + WE / - WK	
2.5 R5 TDI	128	01/03→05/10			+PR 1LT;1LU; → 03/10		13.0470-4833.2 LD4833	BRE 24098 17,1 + WE / - WK Ceramic
3.0 V6 TDI	165	11/04→05/10			+PR 1LC; → 03/10		13.0460-4992.2 604992	BRE 23692 16,6 + WE / - WK
					+PR 1LF; → 03/10		13.0470-4992.2 LD4992	BRE 23692 16,6 + WE / - WK Ceramic
					+PR 1LB; → 03/10		13.0460-4993.2 604993	BRE 23693 16,6 + WE / - WK
					+PR 1LB; → 03/10		13.0470-4993.2 LD4993	BRE 23693 16,6 + WE / - WK Ceramic
					+PR 1KQ		13.0460-4834.2 604834	BRE 24097 17,1 + WE / - WK
					+PR 1KD;2ED; → 03/10		13.0470-4834.2 LD4834	BRE 24097 17,1 + WE / - WK Ceramic
					+PR 1KF; → 03/10		13.0460-4850.2 604850	BRE 24296 15,5 + WE / - WK
					+PR 1KF; → 03/10		13.0470-4850.2 LD4850	BRE 24296 15,5 + WE / - WK Ceramic
	+PR 1KE; → 03/10		13.0460-4976.2 604976	BRE 23694 16,7 + WE / - WK				
				+PR 1KE; → 03/10		13.0470-4976.2 LD4976	BRE 23694 16,4 + WE / - WK Ceramic	
				+PR 1KE; → 03/10		13.0460-7190.2 607190	ATE 24368 19,1 + WK	
						13.0460-7247.2 607247	ATE 24367 19,2 + WK	
						13.0470-7190.2 LD7190	ATE 24367 19,1 + WK Ceramic	
3.0 TDI	155	04/06→05/10	←	+PR 1LE; → 03/10		13.0460-4833.2 604833	BRE 24098 17,1 + WE / - WK	
					+PR 1LT;1LU; → 03/10		13.0470-4833.2 LD4833	BRE 24098 17,1 + WE / - WK Ceramic
					+PR 1LC; → 03/10		13.0460-4852.2 604852	BRE 24553 15,8 + WE / - WK
					+PR 1LC; → 03/10		13.0470-4992.2 604992	BRE 24553 15,8 + WE / - WK + Zub
					+PR 1LF; → 03/10		13.0460-4992.2 LD4992	BRE 23692 16,6 + WE / - WK
					+PR 1LF; → 03/10		13.0470-4992.2 LD4992	BRE 23692 16,6 + WE / - WK Ceramic
					+PR 1LB; → 03/10		13.0460-4993.2 604993	BRE 23693 16,6 + WE / - WK
					+PR 1LB; → 03/10		13.0470-4993.2 LD4993	BRE 23693 16,6 + WE / - WK Ceramic
					+PR 1LB; → 03/10		13.0460-7191.2 607191	ATE 23749 19,1 + WK
					+PR 1LB; → 03/10		13.0470-7245.2 607245	ATE 23747 19,6 + WK
				+PR 1KQ; → 03/10		13.0470-7191.2 LD7191	ATE 23749 19,1 + WK Ceramic	
				+PR 1KQ; → 03/10		13.0460-4834.2 604834	BRE 24097 17,1 + WE / - WK	
				+PR 1KD;2ED; → 03/10		13.0470-4834.2 LD4834	BRE 24097 17,1 + WE / - WK Ceramic	
				+PR 1KD;2ED; → 03/10		13.0460-4850.2 604850	BRE 24296 15,5 + WE / - WK	
				+PR 1KF; → 03/10		13.0470-4850.2 LD4850	BRE 24296 15,5 + WE / - WK Ceramic	
				+PR 1KF; → 03/10		13.0460-4976.2 604976	BRE 23694 16,7 + WE / - WK	
				+PR 1KF; → 03/10		13.0470-4976.2 LD4976	BRE 23694 16,4 + WE / - WK Ceramic	
				+PR 1KE; → 03/10		13.0460-7190.2 607190	ATE 24368 19,1 + WK	
						13.0460-7247.2 607247	ATE 24367 19,2 + WK	
						13.0470-7190.2 LD7190	ATE 24367 19,1 + WK Ceramic	
3.0 V6 TDI	176	11/07→05/10	←	+PR 1LE; → 03/10		13.0460-4833.2 604833	BRE 24098 17,1 + WE / - WK	
					+PR 1LT;1LU; → 03/10		13.0470-4833.2 LD4833	BRE 24098 17,1 + WE / - WK Ceramic
					+PR 1LC; → 03/10		13.0460-4852.2 604852	BRE 24553 15,8 + WE / - WK
					+PR 1LC; → 03/10		13.0470-4992.2 604992	BRE 24553 15,8 + WE / - WK + Zub
				+PR 1LF; → 03/10		13.0460-4993.2 604993	BRE 23693 16,6 + WE / - WK	
				+PR 1LF; → 03/10		13.0470-4993.2 LD4993	BRE 23693 16,6 + WE / - WK Ceramic	







	kw			 	! #		
VW - TOUAREG (7LA, 7L6, 7L7) 10/02→05/10							
 Bremsbelagsatz, Scheibenbremse							
3.0 V6 TDI	176	11/07→05/10	←	+PR 1LB; → 03/10	13.0460-7191.2 607191	ATE 23749 19,1 + WK	
					13.0460-7245.2 607245	ATE 23747 19,6 + WK	
					13.0470-7191.2 LD7191	ATE 23749 19,1 + WK Ceramic	
			→	+PR 1KQ; → 03/10	13.0460-4834.2 604834	BRE 24097 17,1 + WE / - WK	
					13.0470-4834.2 LD4834	BRE 24097 17,1 + WE / - WK Ceramic	
3.2 V6	162	10/02→11/06	←	11/02→ 12/05; +PR 1LE	13.0460-4833.2 604833	BRE 24098 17,1 + WE / - WK	
					13.0470-4833.2 LD4833	BRE 24098 17,1 + WE / - WK Ceramic	
			←	11/02→; +PR 1LC; → 12/05	13.0460-4992.2 604992	BRE 23692 16,6 + WE / - WK	
					13.0470-4992.2 LD4992	BRE 23692 16,6 + WE / - WK Ceramic	
			←	11/02→; +PR 1LF; → 12/05	13.0460-4993.2 604993	BRE 23693 16,6 + WE / - WK	
		13.0470-4993.2 LD4993	BRE 23693 16,6 + WE / - WK Ceramic				
3.2 V6	177	11/04→11/06	←	→ 12/05; +PR 1LE	13.0460-4833.2 604833	BRE 24098 17,1 + WE / - WK	
					13.0470-4833.2 LD4833	BRE 24098 17,1 + WE / - WK Ceramic	
			←	+PR 1LC; → 12/05	13.0460-4992.2 604992	BRE 23692 16,6 + WE / - WK	
					13.0470-4992.2 LD4992	BRE 23692 16,6 + WE / - WK Ceramic	
			←	+PR 1LF; → 12/05	13.0460-4993.2 604993	BRE 23693 16,6 + WE / - WK	
		13.0470-4993.2 LD4993	BRE 23693 16,6 + WE / - WK Ceramic				
3.6 V6 FSI	206	10/05→05/10	←	01/06→ 03/10; +PR 1LE	13.0460-4833.2 604833	BRE 24098 17,1 + WE / - WK	
					13.0470-4833.2 LD4833	BRE 24098 17,1 + WE / - WK Ceramic	
			←	01/06→ 03/10; +PR 1LT;1LU	13.0460-4852.2 604852	BRE 24553 15,8 + WE / - WK + Zub	
			←	01/06→ 03/10; +PR 1LC	13.0460-4992.2 604992	BRE 23692 16,6 + WE / - WK	
					13.0470-4992.2 LD4992	BRE 23692 16,6 + WE / - WK Ceramic	









































	kw			 	! #		
VW - TOUAREG (7LA, 7L6, 7L7) 10/02—05/10							
 Bremsbelagsatz, Scheibenbremse							
3.6 V6 FSI	206	10/05→05/10	←	01/06→ 03/10; +PR 1LF	13.0460-4993.2	604993	BRE 23693 16,6 + WE / - WK
					13.0470-4993.2	LD4993	BRE 23693 16,6 + WE / - WK Ceramic
			←	01/06→ 03/10; +PR 1LB	13.0460-7191.2	607191	ATE 23749 19,1 + WK
					13.0460-7245.2	607245	ATE 23747 19,6 + WK
					13.0470-7191.2	LD7191	ATE 23749 19,1 + WK Ceramic
			→	01/06→ 03/10; +PR 1KQ	13.0460-4834.2	604834	BRE 24097 17,1 + WE / - WK
		13.0470-4834.2	LD4834	BRE 24097 17,1 + WE / - WK Ceramic			
		→	01/06→ 03/10; +PR 1KD;2ED	13.0460-4850.2	604850	BRE 24296 15,5 + WE / - WK	
				13.0470-4850.2	LD4850	BRE 24296 15,5 + WE / - WK Ceramic	
		→	01/06→ 03/10; +PR 1KF	13.0460-4976.2	604976	BRE 23694 16,7 + WE / - WK	
				13.0470-4976.2	LD4976	BRE 23694 16,4 + WE / - WK Ceramic	
		→	01/06→ 03/10; +PR 1KE	13.0460-7190.2	607190	ATE 24368 19,1 + WK	
				13.0460-7247.2	607247	ATE 24367 19,2 + WK	
				13.0470-7190.2	LD7190	ATE 24367 19,1 + WK Ceramic	
4.2 V8	228	12/02→11/06	←	01/06→; +PR 1LE	13.0460-4833.2	604833	BRE 24098 17,1 + WE / - WK
			←	+PR 1LC	13.0460-4992.2	604992	BRE 23692 16,6 + WE / - WK
			←	+PR 1LF	13.0460-4993.2	604993	BRE 23693 16,6 + WE / - WK
			←	+PR 1LB	13.0460-7191.2	607191	ATE 23749 19,1 + WK
					13.0460-7245.2	607245	ATE 23747 19,6 + WK
			→	01/06→; +PR 1KQ	13.0460-4834.2	604834	BRE 24097 17,1 + WE / - WK
					13.0470-4834.2	LD4834	BRE 24097 17,1 + WE / - WK Ceramic
			→	+PR 1KF	13.0460-4976.2	604976	BRE 23694 16,7 + WE / - WK
		13.0470-4976.2	LD4976	BRE 23694 16,4 + WE / - WK Ceramic			
		→	+PR 1KE	13.0460-7190.2	607190	ATE 24368 19,1 + WK	
				13.0460-7247.2	607247	ATE 24367 19,2 + WK	
				13.0470-7190.2	LD7190	ATE 24367 19,1 + WK Ceramic	
4.2 V8 FSI	257	06/06→05/10	←	12/06→ 03/10; +PR 1LE	13.0460-4833.2	604833	BRE 24098 17,1 + WE / - WK
			←	12/06→ 03/10; +PR 1LT;1LU	13.0460-4852.2	604852	BRE 24553 15,8 + WE / - WK + Zub
			←	12/06→ 03/10; +PR 1LC	13.0460-4992.2	604992	BRE 23692 16,6 + WE / - WK
			←	12/06→ 03/10; +PR 1LF	13.0460-4993.2	604993	BRE 23693 16,6 + WE / - WK
			←	12/06→ 03/10; +PR 1LB	13.0460-7191.2	607191	ATE 23749 19,1 + WK
					13.0460-7245.2	607245	ATE 23747 19,6 + WK
			→	12/06→ 03/10; +PR 1KQ	13.0460-4834.2	604834	BRE 24097 17,1 + WE / - WK
					13.0470-4834.2	LD4834	BRE 24097 17,1 + WE / - WK Ceramic
			→	12/06→ 03/10; +PR 1KD;2ED	13.0460-4850.2	604850	BRE 24296 15,5 + WE / - WK
		13.0470-4850.2	LD4850	BRE 24296 15,5 + WE / - WK Ceramic			
		→	12/06→ 03/10; +PR 1KF	13.0460-4976.2	604976	BRE 23694 16,7 + WE / - WK	
				13.0470-4976.2	LD4976	BRE 23694 16,4 + WE / - WK Ceramic	
		→	12/06→ 03/10; +PR 1KE	13.0460-7190.2	607190	ATE 24368 19,1 + WK	
				13.0460-7247.2	607247	ATE 24367 19,2 + WK	
				13.0470-7190.2	LD7190	ATE 24367 19,1 + WK Ceramic	
5.0 R50 TDI	257	08/07→05/10	←	01/08→ 03/10; +PR 1LE	13.0460-4833.2	604833	BRE 24098 17,1 + WE / - WK
			←	01/08→ 03/10; +PR 1LT;1LU	13.0460-4852.2	604852	BRE 24553 15,8 + WE / - WK + Zub
			←	01/08→ 03/10; +PR 1LF	13.0460-4993.2	604993	BRE 23693 16,6 + WE / - WK
			←	01/08→ 03/10; +PR 1LB	13.0460-7191.2	607191	ATE 23749 19,1 + WK
					13.0460-7245.2	607245	ATE 23747 19,6 + WK
			→	01/08→ 03/10; +PR 1KQ	13.0460-4834.2	604834	BRE 24097 17,1 + WE / - WK
					13.0470-4834.2	LD4834	BRE 24097 17,1 + WE / - WK Ceramic
→	01/08→ 03/10; +PR 1KD;2ED	13.0460-4850.2	604850	BRE 24296 15,5 + WE / - WK			
		13.0470-4850.2	LD4850	BRE 24296 15,5 + WE / - WK Ceramic			
↓							









	kw			 	! #		
VW - TOUAREG (7LA, 7L6, 7L7) 10/02→05/10							
Bremsbelagsatz, Scheibenbremse							
5.0 R50 TDI	257	08/07→05/10	➔	01/08→03/10; +PR 1KF		13.0460-4976.2 604976	BRE 23694 16,7 + WE / - WK
						13.0470-4976.2 LD4976	BRE 23694 16,4 + WE / - WK Ceramic
			➔	01/08→03/10; +PR 1KE		13.0460-7190.2 607190	ATE 24368 19,1 + WK
5.0 V10 TDI	230	10/02→05/10	⬅	01/06→03/10; +PR 1LE		13.0460-4833.2 604833	BRE 24098 17,1 + WE / - WK
			⬅	11/02→; +PR 1LT;1LU; → 03/10		13.0460-4852.2 604852	BRE 24553 15,8 + WE / - WK + Zub
			⬅	11/02→; +PR 1LC; → 03/10		13.0460-4992.2 604992	BRE 23692 16,6 + WE / - WK
			⬅	11/02→; +PR 1LF; → 03/10		13.0460-4993.2 604993	BRE 23693 16,6 + WE / - WK
			⬅	11/02→; +PR 1LB; → 03/10		13.0460-7191.2 607191	ATE 23749 19,1 + WK
						13.0460-7245.2 607245	ATE 23747 19,6 + WK
			➔	01/06→03/10; +PR 1KQ		13.0460-4834.2 604834	BRE 24097 17,1 + WE / - WK
						13.0470-4834.2 LD4834	BRE 24097 17,1 + WE / - WK Ceramic
			➔	11/02→; +PR 1KD;2ED; → 03/10		13.0460-4850.2 604850	BRE 24296 15,5 + WE / - WK
			13.0470-4850.2 LD4850	BRE 24296 15,5 + WE / - WK Ceramic			
			➔	11/02→; +PR 1KF; → 03/10		13.0460-4976.2 604976	BRE 23694 16,7 + WE / - WK
						13.0470-4976.2 LD4976	BRE 23694 16,4 + WE / - WK Ceramic
			➔	11/02→; +PR 1KE; → 03/10		13.0460-7190.2 607190	ATE 24368 19,1 + WK
						13.0460-7247.2 607247	ATE 24367 19,2 + WK
						13.0470-7190.2 LD7190	ATE 24367 19,1 + WK Ceramic
6.0 W12	331	08/04→05/10	⬅	01/06→; +PR 1LE; → 11/06		13.0460-4833.2 604833	BRE 24098 17,1 + WE / - WK
			⬅	+PR 1LC; → 11/06		13.0460-4992.2 604992	BRE 23692 16,6 + WE / - WK
			⬅	+PR 1LF; → 11/06		13.0460-4993.2 604993	BRE 23693 16,6 + WE / - WK
			⬅	+PR 1LB; → 11/06		13.0460-7191.2 607191	ATE 23749 19,1 + WK
						13.0460-7245.2 607245	ATE 23747 19,6 + WK
			➔	01/06→; +PR 1KQ; → 11/06		13.0460-4834.2 604834	BRE 24097 17,1 + WE / - WK
						13.0470-4834.2 LD4834	BRE 24097 17,1 + WE / - WK Ceramic
			➔	+PR 1KF; → 11/06		13.0460-4976.2 604976	BRE 23694 16,7 + WE / - WK
						13.0470-4976.2 LD4976	BRE 23694 16,4 + WE / - WK Ceramic
			➔	+PR 1KE; → 11/06		13.0460-7190.2 607190	ATE 24368 19,1 + WK
						13.0460-7247.2 607247	ATE 24367 19,2 + WK
						13.0470-7190.2 LD7190	ATE 24367 19,1 + WK Ceramic
Warnkontakt, Bremsbelagsverschleiß							
2.5 R5 TDI 2.5 R5 TDI 3.0 V6 TDI	120 128 165	08/03→05/10 01/03→05/10 11/04→05/10	⬅	01/06→03/10; +PR 1LE	2	24.8190-0929.2 620929	L= 417,4
			⬅	+PR 1LC; → 03/10	2	24.8190-0929.2 620929	L= 417,4
			⬅	+PR 1LF; → 03/10	2	24.8190-0929.2 620929	L= 417,4
			⬅	+PR 1LT;1LU; → 03/10	2	24.8190-0936.2 620936	L= 367,4
			➔	+PR 1KF; → 03/10	2	24.8190-0930.2 620930	L= 252,4
			➔	01/06→03/10; +PR 1KQ	2	24.8190-0930.2 620930	L= 252,4
			➔	+PR 1KD;2ED; → 03/10	2	24.8190-0930.2 620930	L= 252,4
3.0 TDI	155	04/06→05/10	⬅	+PR 1LC; → 03/10	2	24.8190-0929.2 620929	L= 417,4
			⬅	+PR 1LF; → 03/10	2	24.8190-0929.2 620929	L= 417,4
			⬅	+PR 1LE; → 03/10	2	24.8190-0929.2 620929	L= 417,4
			⬅	+PR 1LT;1LU; → 03/10	2	24.8190-0936.2 620936	L= 367,4
			➔	+PR 1KF; → 03/10	2	24.8190-0930.2 620930	L= 252,4
			➔	+PR 1KQ; → 03/10	2	24.8190-0930.2 620930	L= 252,4
			➔	+PR 1KD;2ED; → 03/10	2	24.8190-0930.2 620930	L= 252,4
3.0 V6 TDI	176	11/07→05/10	⬅	+PR 1LF; → 03/10	2	24.8190-0929.2 620929	L= 417,4
			⬅	+PR 1LE; → 03/10	2	24.8190-0929.2 620929	L= 417,4
			⬅	+PR 1LT;1LU; → 03/10	2	24.8190-0936.2 620936	L= 367,4
			➔	+PR 1KF; → 03/10	2	24.8190-0930.2 620930	L= 252,4
↓							

	kw			 	! #		
VW - TOUAREG (7LA, 7L6, 7L7) 10/02→05/10							
Warnkontakt, Bremsbelagverschleiß							
3.0 V6 TDI	176	11/07→05/10	➡	+PR 1KD;2ED; → 03/10	2	24.8190-0930.2 620930	L= 252,4
			➡	+PR 1KQ; → 03/10	2	24.8190-0930.2 620930	L= 252,4
3.2 V6	162	10/02→11/06	⬅	11/02→ 12/05; +PR 1LE	2	24.8190-0929.2 620929	L= 417,4
			⬅	11/02→; +PR 1LC; → 12/05	2	24.8190-0929.2 620929	L= 417,4
			⬅	11/02→; +PR 1LF; → 12/05	2	24.8190-0929.2 620929	L= 417,4
			➡	11/02→ 12/05; +PR 1KQ	2	24.8190-0930.2 620930	L= 252,4
			➡	11/02→; +PR 1KF; → 12/05	2	24.8190-0930.2 620930	L= 252,4
3.2 V6	177	11/04→11/06	⬅	+PR 1LC; → 12/05	2	24.8190-0929.2 620929	L= 417,4
			⬅	+PR 1LF; → 12/05	2	24.8190-0929.2 620929	L= 417,4
			⬅	→ 12/05; +PR 1LE	2	24.8190-0929.2 620929	L= 417,4
			➡	+PR 1KF; → 12/05	2	24.8190-0930.2 620930	L= 252,4
			➡	→ 12/05; +PR 1KQ	2	24.8190-0930.2 620930	L= 252,4
3.6 V6 FSI	206	10/05→05/10	⬅	01/06→ 03/10; +PR 1LE	2	24.8190-0929.2 620929	L= 417,4
			⬅	01/06→ 03/10; +PR 1LF	2	24.8190-0929.2 620929	L= 417,4
			⬅	01/06→ 03/10; +PR 1LC	2	24.8190-0929.2 620929	L= 417,4
			⬅	01/06→ 03/10; +PR 1LT;1LU	2	24.8190-0936.2 620936	L= 367,4
			➡	01/06→ 03/10; +PR 1KD;2ED	2	24.8190-0930.2 620930	L= 252,4
			➡	01/06→ 03/10; +PR 1KQ	2	24.8190-0930.2 620930	L= 252,4
			➡	01/06→ 03/10; +PR 1KF	2	24.8190-0930.2 620930	L= 252,4
4.2 V8	228	12/02→11/06	⬅	+PR 1LC	2	24.8190-0929.2 620929	L= 417,4
			⬅	01/06→; +PR 1LE	2	24.8190-0929.2 620929	L= 417,4
			⬅	+PR 1LF	2	24.8190-0929.2 620929	L= 417,4
			➡	+PR 1KF	2	24.8190-0930.2 620930	L= 252,4
			➡	01/06→; +PR 1KQ	2	24.8190-0930.2 620930	L= 252,4
4.2 V8 FSI	257	06/06→05/10	⬅	12/06→ 03/10; +PR 1LC	2	24.8190-0929.2 620929	L= 417,4
			⬅	12/06→ 03/10; +PR 1LE	2	24.8190-0929.2 620929	L= 417,4
			⬅	12/06→ 03/10; +PR 1LF	2	24.8190-0929.2 620929	L= 417,4
			⬅	12/06→ 03/10; +PR 1LT;1LU	2	24.8190-0936.2 620936	L= 367,4
			➡	12/06→ 03/10; +PR 1KD;2ED	2	24.8190-0930.2 620930	L= 252,4
			➡	12/06→ 03/10; +PR 1KF	2	24.8190-0930.2 620930	L= 252,4
			➡	12/06→ 03/10; +PR 1KQ	2	24.8190-0930.2 620930	L= 252,4
5.0 R50 TDI	257	08/07→05/10	⬅	01/08→ 03/10; +PR 1LE	2	24.8190-0929.2 620929	L= 417,4
			⬅	01/08→ 03/10; +PR 1LF	2	24.8190-0929.2 620929	L= 417,4
			⬅	01/08→ 03/10; +PR 1LT;1LU	2	24.8190-0936.2 620936	L= 367,4
			➡	01/08→ 03/10; +PR 1KQ	2	24.8190-0930.2 620930	L= 252,4
			➡	01/08→ 03/10; +PR 1KD;2ED	2	24.8190-0930.2 620930	L= 252,4
			➡	01/08→ 03/10; +PR 1KF	2	24.8190-0930.2 620930	L= 252,4
5.0 V10 TDI	230	10/02→05/10	⬅	01/06→ 03/10; +PR 1LE	2	24.8190-0929.2 620929	L= 417,4
			⬅	11/02→; +PR 1LC; → 03/10	2	24.8190-0929.2 620929	L= 417,4
			⬅	11/02→; +PR 1LF; → 03/10	2	24.8190-0929.2 620929	L= 417,4
			⬅	11/02→; +PR 1LT;1LU; → 03/10	2	24.8190-0936.2 620936	L= 367,4
			➡	11/02→; +PR 1KD;2ED; → 03/10	2	24.8190-0930.2 620930	L= 252,4
			➡	11/02→; +PR 1KF; → 03/10	2	24.8190-0930.2 620930	L= 252,4
			➡	01/06→ 03/10; +PR 1KQ	2	24.8190-0930.2 620930	L= 252,4
			➡	01/06→ 03/10; +PR 1KQ	2	24.8190-0930.2 620930	L= 252,4
6.0 W12	331	08/04→05/10	⬅	01/06→; +PR 1LE; → 11/06	2	24.8190-0929.2 620929	L= 417,4
			⬅	+PR 1LF; → 11/06	2	24.8190-0929.2 620929	L= 417,4
			⬅	+PR 1LC; → 11/06	2	24.8190-0929.2 620929	L= 417,4
			➡	01/06→; +PR 1KQ; → 11/06	2	24.8190-0930.2 620930	L= 252,4
			➡	+PR 1KF; → 11/06	2	24.8190-0930.2 620930	L= 252,4
Zubehörsatz, Scheibenbremsbelag							
2.5 R5 TDI	120	08/03→05/10	⬅	+PR 1LC; → 03/10		13.0460-0279.2 610279	
2.5 R5 TDI	128	01/03→05/10	⬅	+PR 1LF; → 03/10		13.0460-0279.2 610279	
3.0 TDI	155	04/06→05/10	⬅	+PR 1LF; → 03/10			
3.0 V6 TDI	165	11/04→05/10					
↓							









	kw			 	! #		
VW - TOUAREG (7LA, 7L6, 7L7) 10/02→05/10							
Zubehörsatz, Scheibenbremsbelag							
2.5 R5 TDI	120	08/03→05/10	➡	+PR 1KF; → 03/10		13.0460-0280.2 610280	
2.5 R5 TDI	128	01/03→05/10					
3.0 TDI	155	04/06→05/10					
3.0 V6 TDI	165	11/04→05/10					
3.0 V6 TDI	176	11/07→05/10	⬅	+PR 1LF; → 03/10		13.0460-0279.2 610279	
			➡	+PR 1KF; → 03/10		13.0460-0280.2 610280	
3.2 V6	162	10/02→11/06	⬅	11/02→; +PR 1LF; → 12/05		13.0460-0279.2 610279	
			⬅	11/02→; +PR 1LC; → 12/05		13.0460-0279.2 610279	
			➡	11/02→; +PR 1KF; → 12/05		13.0460-0280.2 610280	
3.2 V6	177	11/04→11/06	⬅	+PR 1LF; → 12/05		13.0460-0279.2 610279	
			⬅	+PR 1LC; → 12/05		13.0460-0279.2 610279	
			➡	+PR 1KF; → 12/05		13.0460-0280.2 610280	
3.6 V6 FSI	206	10/05→05/10	⬅	01/06→ 03/10; +PR 1LC		13.0460-0279.2 610279	
			⬅	01/06→ 03/10; +PR 1LF		13.0460-0279.2 610279	
			➡	01/06→ 03/10; +PR 1KF		13.0460-0280.2 610280	
4.2 V8	228	12/02→11/06	⬅	+PR 1LF		13.0460-0279.2 610279	
			⬅	+PR 1LC		13.0460-0279.2 610279	
			➡	+PR 1KF		13.0460-0280.2 610280	
4.2 V8 FSI	257	06/06→05/10	⬅	12/06→ 03/10; +PR 1LF		13.0460-0279.2 610279	
			⬅	12/06→ 03/10; +PR 1LC		13.0460-0279.2 610279	
			➡	12/06→ 03/10; +PR 1KF		13.0460-0280.2 610280	
5.0 R50 TDI	257	08/07→05/10	⬅	01/08→ 03/10; +PR 1LF		13.0460-0279.2 610279	
			➡	01/08→ 03/10; +PR 1KF		13.0460-0280.2 610280	
5.0 V10 TDI	230	10/02→05/10	⬅	11/02→; +PR 1LF; → 03/10		13.0460-0279.2 610279	
			⬅	11/02→; +PR 1LC; → 03/10		13.0460-0279.2 610279	
			➡	11/02→; +PR 1KF; → 03/10		13.0460-0280.2 610280	
6.0 W12	331	08/04→05/10	⬅	+PR 1LC; → 11/06		13.0460-0279.2 610279	
			⬅	+PR 1LF; → 11/06		13.0460-0279.2 610279	
			➡	+PR 1KF; → 11/06		13.0460-0280.2 610280	
Bremsscheibe							
2.5 R5 TDI	120	08/03→05/10	⬅	+PR 1LB; → 03/10		24.0130-0114.1 430114	Ø 308 29,5 25,5 V
2.5 R5 TDI	128	01/03→05/10	⬅	☐; +PR 1LC;1LE; → 03/10		24.0132-0117.1 432117	Ø 330 32 30 V + S
3.0 TDI	155	04/06→05/10	⬅	☐; +PR 1LC;1LE; → 03/10		24.0132-0118.1 432118	Ø 330 32 30 V + S
3.0 V6 TDI	165	11/04→05/10	⬅	☐; +PR 1LF; → 03/10		24.0134-0123.1 434123	Ø 350 34 32 V
3.0 V6 TDI	176	11/07→05/10	⬅	☐; +PR 1LF; → 03/10		24.0134-0124.1 434124	Ø 350 34 32 V
			⬅	+PR 1LT;1LU; → 03/10		24.0136-0111.1 436111	Ø 368 36 34 V
			➡	+PR 1KE; → 03/10		24.0122-0215.1 422215	Ø 314 22 18 V + S
			➡	+PR 1KF;1KQ; → 03/10		24.0128-0149.1 428149	Ø 330 28 26 V + S
			➡	+PR 1KD;2ED; → 03/10		24.0128-0169.1 428169	Ø 358 28 26 V
3.2 V6	162	10/02→11/06	⬅	11/02→; +PR 1LB; → 12/05		24.0130-0114.1 430114	Ø 308 29,5 25,5 V
			⬅	☐; 11/02→; +PR 1LC;1LE; → 12/05		24.0132-0117.1 432117	Ø 330 32 30 V + S
			⬅	☐; 11/02→; +PR 1LC;1LE; → 12/05		24.0132-0118.1 432118	Ø 330 32 30 V + S
			⬅	☐; 11/02→; +PR 1LF; → 12/05		24.0134-0123.1 434123	Ø 350 34 32 V
			⬅	☐; 11/02→; +PR 1LF; → 12/05		24.0134-0124.1 434124	Ø 350 34 32 V
			➡	11/02→; +PR 1KE; → 12/05		24.0122-0215.1 422215	Ø 314 22 18 V + S
			➡	11/02→; +PR 1KF;1KQ; → 12/05		24.0128-0149.1 428149	Ø 330 28 26 V + S
3.2 V6	177	11/04→11/06	⬅	+PR 1LB; → 12/05		24.0130-0114.1 430114	Ø 308 29,5 25,5 V
			⬅	☐; +PR 1LC;1LE; → 12/05		24.0132-0117.1 432117	Ø 330 32 30 V + S
			⬅	☐; +PR 1LC;1LE; → 12/05		24.0132-0118.1 432118	Ø 330 32 30 V + S
			⬅	☐; +PR 1LF; → 12/05		24.0134-0123.1 434123	Ø 350 34 32 V
			⬅	☐; +PR 1LF; → 12/05		24.0134-0124.1 434124	Ø 350 34 32 V
			➡	+PR 1KE; → 12/05		24.0122-0215.1 422215	Ø 314 22 18 V + S
			➡	+PR 1KF;1KQ; → 12/05		24.0128-0149.1 428149	Ø 330 28 26 V + S
↓							

	kw			 	! #		
VW - TOUAREG (7LA, 7L6, 7L7) 10/02→05/10							
Bremsscheibe							
3.6 V6 FSI	206	10/05→05/10	←	01/06→ 03/10; +PR 1LB	24.0130-0114.1	430114	Ø 308 29,5 25,5 V
			←	 ; 01/06→ 03/10; +PR 1LC;1LE	24.0132-0117.1	432117	Ø 330 32 30 V + S
			←	 ; 01/06→ 03/10; +PR 1LC;1LE	24.0132-0118.1	432118	Ø 330 32 30 V + S
			←	 ; 01/06→ 03/10; +PR 1LF	24.0134-0123.1	434123	Ø 350 34 32 V
			←	 ; 01/06→ 03/10; +PR 1LF	24.0134-0124.1	434124	Ø 350 34 32 V
			←	01/06→ 03/10; +PR 1LT;1LU	24.0136-0111.1	436111	Ø 368 36 34 V
			→	01/06→ 03/10; +PR 1KE	24.0122-0215.1	422215	Ø 314 22 18 V + S
			→	01/06→ 03/10; +PR 1KF;1KQ	24.0128-0149.1	428149	Ø 330 28 26 V + S
4.2 V8	228	12/02→11/06	←	+PR 1LB	24.0130-0114.1	430114	Ø 308 29,5 25,5 V
			←	 ; +PR 1LC;1LE	24.0132-0117.1	432117	Ø 330 32 30 V + S
			←	 ; +PR 1LC;1LE	24.0132-0118.1	432118	Ø 330 32 30 V + S
			←	 ; +PR 1LF	24.0134-0123.1	434123	Ø 350 34 32 V
			←	 ; +PR 1LF	24.0134-0124.1	434124	Ø 350 34 32 V
			→	+PR 1KE	24.0122-0215.1	422215	Ø 314 22 18 V + S
			→	+PR 1KF;1KQ	24.0128-0149.1	428149	Ø 330 28 26 V + S
			4.2 V8 FSI	257	06/06→05/10	←	12/06→ 03/10; +PR 1LB
←	 ; 12/06→ 03/10; +PR 1LC;1LE	24.0132-0117.1				432117	Ø 330 32 30 V + S
←	 ; 12/06→ 03/10; +PR 1LC;1LE	24.0132-0118.1				432118	Ø 330 32 30 V + S
←	 ; 12/06→ 03/10; +PR 1LF	24.0134-0123.1				434123	Ø 350 34 32 V
←	 ; 12/06→ 03/10; +PR 1LF	24.0134-0124.1				434124	Ø 350 34 32 V
←	12/06→ 03/10; +PR 1LT;1LU	24.0136-0111.1				436111	Ø 368 36 34 V
→	12/06→ 03/10; +PR 1KE	24.0122-0215.1				422215	Ø 314 22 18 V + S
→	12/06→ 03/10; +PR 1KF;1KQ	24.0128-0149.1				428149	Ø 330 28 26 V + S
5.0 R50 TDI	257	08/07→05/10	←	01/08→ 03/10; +PR 1LB	24.0130-0114.1	430114	Ø 308 29,5 25,5 V
			←	 ; 01/08→ 03/10; +PR 1LC;1LE	24.0132-0117.1	432117	Ø 330 32 30 V + S
			←	 ; 01/08→ 03/10; +PR 1LC;1LE	24.0132-0118.1	432118	Ø 330 32 30 V + S
			←	 ; 01/08→ 03/10; +PR 1LF	24.0134-0123.1	434123	Ø 350 34 32 V
			←	 ; 01/08→ 03/10; +PR 1LF	24.0134-0124.1	434124	Ø 350 34 32 V
			←	01/08→ 03/10; +PR 1LT;1LU	24.0136-0111.1	436111	Ø 368 36 34 V
			→	01/08→ 03/10; +PR 1KE	24.0122-0215.1	422215	Ø 314 22 18 V + S
			→	01/08→ 03/10; +PR 1KF;1KQ	24.0128-0149.1	428149	Ø 330 28 26 V + S
5.0 V10 TDI	230	10/02→05/10	←	11/02→; +PR 1LB; → 03/10	24.0130-0114.1	430114	Ø 308 29,5 25,5 V
			←	 ; 11/02→; +PR 1LC;1LE; → 03/10	24.0132-0117.1	432117	Ø 330 32 30 V + S
			←	 ; 11/02→; +PR 1LC;1LE; → 03/10	24.0132-0118.1	432118	Ø 330 32 30 V + S
			←	 ; 11/02→; +PR 1LF; → 03/10	24.0134-0123.1	434123	Ø 350 34 32 V
			←	 ; 11/02→; +PR 1LF; → 03/10	24.0134-0124.1	434124	Ø 350 34 32 V
			←	11/02→; +PR 1LT;1LU; → 03/10	24.0136-0111.1	436111	Ø 368 36 34 V
			→	11/02→; +PR 1KE; → 03/10	24.0122-0215.1	422215	Ø 314 22 18 V + S
			→	11/02→; +PR 1KF;1KQ; → 03/10	24.0128-0149.1	428149	Ø 330 28 26 V + S
6.0 W12	331	08/04→05/10	←	+PR 1LB; → 11/06	24.0130-0114.1	430114	Ø 308 29,5 25,5 V
			←	 ; +PR 1LC;1LE; → 11/06	24.0132-0117.1	432117	Ø 330 32 30 V + S
			←	 ; +PR 1LC;1LE; → 11/06	24.0132-0118.1	432118	Ø 330 32 30 V + S
			←	 ; +PR 1LF; → 11/06	24.0134-0123.1	434123	Ø 350 34 32 V
			←	 ; +PR 1LF; → 11/06	24.0134-0124.1	434124	Ø 350 34 32 V
			→	+PR 1KE; → 11/06	24.0122-0215.1	422215	Ø 314 22 18 V + S
			→	+PR 1KF;1KQ; → 11/06	24.0128-0149.1	428149	Ø 330 28 26 V + S







	kw			 	! #		
VW - TOUAREG (7P5) 01/10→							
 Bremsbelagsatz, Scheibenbremse							
3.0 V6 TDI	150	01/10→	←	04/10→; +PR 1LC,1LE	2	13.0460-4833.2 604833	BRE 24098 17,1 + WE / - WK
			←	04/10→; +PR 1LG,1LW	2	13.0470-4833.2 LD4833	BRE 24098 17,1 + WE / - WK Ceramic
			←	04/10→; +PR 1LJ	2	13.0460-4852.2 604852	BRE 24553 15,8 + WE / - WK + Zub
			→	04/10→; +PR 1KJ,1KQ,2EG	2	13.0460-4872.2 604872	BRE + WE / - WK
						13.0470-4872.2 LD4872	BRE + WE / - WK Ceramic
3.0 V6 TDI 3.0 V6 TDI 3.6 V6 FSI 3.6 V6 FSI	165 180 183 206	06/10→ 05/11→ 08/10→ 04/10→	←	+PR 1LC,1LE	2	13.0460-4833.2 604833	BRE 24098 17,1 + WE / - WK
			←	+PR 1LJ	2	13.0470-4833.2 LD4833	BRE 24098 17,1 + WE / - WK Ceramic
			←	+PR 1LG,1LW	2	13.0460-4852.2 604852	BRE 24553 15,8 + WE / - WK + Zub
			→	+PR 1KJ,1KQ,2EG	2	13.0460-4872.2 604872	BRE + WE / - WK
						13.0470-4872.2 LD4872	BRE + WE / - WK Ceramic
3.0 V6 TDI	176	01/10→	←	04/10→; +PR 1LC,1LE	2	13.0460-4833.2 604833	BRE 24098 17,1 + WE / - WK
			←	04/10→; +PR 1LG,1LW	2	13.0470-4833.2 LD4833	BRE 24098 17,1 + WE / - WK Ceramic
			←	04/10→; +PR 1LJ	2	13.0460-4852.2 604852	BRE 24553 15,8 + WE / - WK + Zub
			→	04/11→; +PR 1KJ,1KQ,2EG	2	13.0460-4872.2 604872	BRE + WE / - WK
						13.0470-4872.2 LD4872	BRE + WE / - WK Ceramic
3.0 V6 TDI	193	09/14→	←	+PR 1LC,1LE	2	13.0460-4833.2 604833	BRE 24098 17,1 + WE / - WK
			←	+PR 1LJ	2	13.0470-4833.2 LD4833	BRE 24098 17,1 + WE / - WK Ceramic
			←	+PR 1LG,1LW	2	13.0460-4852.2 604852	BRE 24553 15,8 + WE / - WK + Zub
			→	+PR 1KQ,2EG	2	13.0460-4872.2 604872	BRE + WE / - WK
						13.0470-4872.2 LD4872	BRE + WE / - WK Ceramic
3.0 V6 TSI 3.0 V6 TSI Hybrid 4.2 V8 FSI	213 245 265	08/10→ 04/10→ 01/11→	←	+PR 1LC,1LE	2	13.0460-4833.2 604833	BRE 24098 17,1 + WE / - WK
			←	+PR 1LJ	2	13.0460-4852.2 604852	BRE 24553 15,8 + WE / - WK + Zub
			←	+PR 1LG,1LW	2	13.0460-4852.2 604852	BRE 24553 15,8 + WE / - WK + Zub
			→	+PR 1KJ,1KQ,2EG	2	13.0460-4872.2 604872	BRE + WE / - WK
						13.0470-4872.2 LD4872	BRE + WE / - WK Ceramic
4.2 V8 TDI	250	01/10→	←	04/10→; +PR 1LC,1LE	2	13.0460-4833.2 604833	BRE 24098 17,1 + WE / - WK
			←	04/10→; +PR 1LG,1LW	2	13.0460-4852.2 604852	BRE 24553 15,8 + WE / - WK + Zub
			←	04/10→; +PR 1LJ	2	13.0460-4852.2 604852	BRE 24553 15,8 + WE / - WK + Zub
			→	04/10→; +PR 1KJ,1KQ,2EG	2	13.0460-4872.2 604872	BRE + WE / - WK
						13.0470-4872.2 LD4872	BRE + WE / - WK Ceramic
Warnkontakt, Bremsbelagsverschleiß							
3.0 V6 TDI 4.2 V8 TDI	150 250	01/10→ 01/10→	←	04/10→; +PR 1LC,1LE	2	24.8190-0013.2 620013	L= 323
			←	04/10→; +PR 1LJ	2	24.8190-0014.2 620014	L= 296
			←	04/10→; +PR 1LG,1LW	2	24.8190-0014.2 620014	L= 296
			→	04/10→; +PR 1KJ,1KQ,2EG	2	24.8190-0015.2 620015	L= 138
3.0 V6 TDI 3.0 V6 TDI 3.0 V6 TSI 3.0 V6 TSI Hybrid 3.6 V6 FSI 3.6 V6 FSI 4.2 V8 FSI	165 180 213 245 183 206 265	06/10→ 05/11→ 08/10→ 04/10→ 08/10→ 04/10→ 01/11→	←	+PR 1LC,1LE	2	24.8190-0013.2 620013	L= 323
			←	+PR 1LJ	2	24.8190-0014.2 620014	L= 296
			←	+PR 1LG,1LW	2	24.8190-0014.2 620014	L= 296
			→	+PR 1KJ,1KQ,2EG	2	24.8190-0015.2 620015	L= 138
			←	+PR 1KJ,1KQ,2EG	2	24.8190-0015.2 620015	L= 138
3.0 V6 TDI	176	01/10→	←	04/10→; +PR 1LC,1LE	2	24.8190-0013.2 620013	L= 323
			←	04/10→; +PR 1LJ	2	24.8190-0014.2 620014	L= 296
			←	04/10→; +PR 1LG,1LW	2	24.8190-0014.2 620014	L= 296
↓							











	kw			 	! #		
VW - TOUAREG (7P5) 01/10→							
Warnkontakt, Bremsbelagverschleiß							
3.0 V6 TDI	176	01/10→	➡	04/11→; +PR 1KJ,1KQ,2EG	2	24.8190-0015.2 620015	L= 138
3.0 V6 TDI	193	09/14→	⬅	+PR 1LC,1LE	2	24.8190-0013.2 620013	L= 323
			⬅	+PR 1LG,1LW	2	24.8190-0014.2 620014	L= 296
			⬅	+PR 1LJ	2	24.8190-0014.2 620014	L= 296
			➡	+PR 1KQ,2EG	2	24.8190-0015.2 620015	L= 138
 Brems Scheibe							
3.0 V6 TDI	150	01/10→	⬅	☐; 04/10→; +PR 1LC,1LE		24.0132-0117.1 432117	Ø 330 32 30 V + S
3.0 V6 TDI	176	01/10→	⬅	☐; 04/10→; +PR 1LC,1LE		24.0132-0118.1 432118	Ø 330 32 30 V + S
4.2 V8 TDI	250	01/10→	⬅	☐; 04/10→; +PR 1LG,1LJ,1LW		24.0136-0123.1 436123	Ø 360 36 34 V + S
			⬅	☐; 04/10→; +PR 1LG,1LJ,1LW		24.0136-0124.1 436124	Ø 360 36 34 V + S
			➡	04/10→; +PR 1KJ,1KQ,2EG; + eFSB		24.0128-0149.1 428149	Ø 330 28 26 V + S
3.0 V6 TDI	165	06/10→	⬅	☐; +PR 1LC,1LE		24.0132-0117.1 432117	Ø 330 32 30 V + S
3.0 V6 TDI	180	05/11→	⬅	☐; +PR 1LC,1LE		24.0132-0118.1 432118	Ø 330 32 30 V + S
3.0 V6 TSI	213	08/10→	⬅	☐; +PR 1LC,1LE		24.0132-0118.1 432118	Ø 330 32 30 V + S
3.0 V6 TSI Hybrid	245	04/10→	⬅	☐; +PR 1LG,1LJ,1LW		24.0136-0123.1 436123	Ø 360 36 34 V + S
3.6 V6 FSI	183	08/10→	⬅	☐; +PR 1LG,1LJ,1LW		24.0136-0124.1 436124	Ø 360 36 34 V + S
3.6 V6 FSI	206	04/10→	⬅	☐; +PR 1LG,1LJ,1LW		24.0136-0124.1 436124	Ø 360 36 34 V + S
4.2 V8 FSI	265	01/11→	➡	+PR 1KJ,1KQ,2EG; + eFSB		24.0128-0149.1 428149	Ø 330 28 26 V + S
3.0 V6 TDI	193	09/14→	⬅	☐; +PR 1LC,1LE		24.0132-0117.1 432117	Ø 330 32 30 V + S
			⬅	☐; +PR 1LC,1LE		24.0132-0118.1 432118	Ø 330 32 30 V + S
			⬅	☐; +PR 1LJ,1LW		24.0136-0123.1 436123	Ø 360 36 34 V + S
			⬅	☐; +PR 1LJ,1LW		24.0136-0124.1 436124	Ø 360 36 34 V + S
			➡	+PR 1KQ,2EG; + eFSB		24.0128-0149.1 428149	Ø 330 28 26 V + S
VW - TOURAN (1T1, 1T2) 02/03→05/10							
 Bremsbelagsatz, Scheibenbremse							
1.4 FSI	125	11/06→05/10	⬅	+PR 1ZD,1ZE,1ZP / 1ZA,1LJ		13.0460-7184.2 607184	ATE 23587 20,6 + WK
1.4 TSI EcoFuel	110	05/09→05/10				13.0470-7184.2 LD7184	ATE 23587 20,6 + WK Ceramic
1.6	75	07/03→05/10					
1.6 FSI	85	02/03→01/07	➡	+PR 1KE,1KF,1KJ		13.0460-2749.2 602749	TRW 24483 16,9 - WE / - WK + Zub
1.9 TDI	66	11/04→05/10					
1.9 TDI	74	02/03→05/04				13.0460-2880.2 602880	TRW 23914 17,1 + WE / - WK + Zub
1.9 TDI	77	08/03→05/10					
2.0 EcoFuel	80	02/06→05/09				13.0470-2749.2 LD2749	TRW 24483 16,9 - WE / - WK + Zub Ceramic
2.0 FSI	85	10/04→05/10					
2.0 FSI	110	10/03→01/07				13.0470-2880.2 LD2880	TRW 23914 17,1 + WE / - WK + Zub Ceramic
2.0 TDI	103	12/05→05/10					
2.0 TDI 16V	103	08/03→05/10					
			➡	+PR 1KS		13.0460-3858.2 603858	BOS 24563 17,7 - WE / - WK + Zub
						13.0470-3858.2 LD3858	BOS 24563 17,7 - WE / - WK + Zub Ceramic
1.4 TSI	103	02/06→05/10	⬅	09/06→; +PR 1ZD,1ZE,1ZP / 1ZA,1LJ		13.0460-7184.2 607184	ATE 23587 20,6 + WK
						13.0470-7184.2 LD7184	ATE 23587 20,6 + WK Ceramic
			➡	09/06→; +PR 1KE,1KF,1KJ		13.0460-2749.2 602749	TRW 24483 16,9 - WE / - WK + Zub
						13.0460-2880.2 602880	TRW 23914 17,1 + WE / - WK + Zub
						13.0470-2749.2 LD2749	TRW 24483 16,9 - WE / - WK + Zub Ceramic
						13.0470-2880.2 LD2880	TRW 23914 17,1 + WE / - WK + Zub Ceramic
			➡	09/06→; +PR 1KS		13.0460-3858.2 603858	BOS 24563 17,7 - WE / - WK + Zub
						13.0470-3858.2 LD3858	BOS 24563 17,7 - WE / - WK + Zub Ceramic
2.0 TDI	100	02/03→05/10	⬅	08/03→; +PR 1ZD,1ZE,1ZP / 1ZA,1LJ		13.0460-7184.2 607184	ATE 23587 20,6 + WK
						13.0470-7184.2 LD7184	ATE 23587 20,6 + WK Ceramic
			➡	08/03→; +PR 1KE,1KF,1KJ		13.0460-2749.2 602749	TRW 24483 16,9 - WE / - WK + Zub
						13.0460-2880.2 602880	TRW 23914 17,1 + WE / - WK + Zub
						13.0470-2749.2 LD2749	TRW 24483 16,9 - WE / - WK + Zub Ceramic
						13.0470-2880.2 LD2880	TRW 23914 17,1 + WE / - WK + Zub Ceramic











	kw			 	! #					
VW - TOURAN (1T1, 1T2) 02/03→05/10										
 Bremsbelagsatz, Scheibenbremse										
2.0 TDI	100	02/03→05/10	➡	08/03→; +PR 1KS		13.0460-3858.2 603858 13.0470-3858.2 LD3858	BOS 24563 17,7 - WE / - WK + Zub BOS 24563 17,7 - WE / - WK + Zub Ceramic			
2.0 TDI	125	12/05→05/10	⬅	02/06→; +PR 1ZA,1ZD,1ZE / 1ZP,1LJ		13.0460-7184.2 607184 13.0470-7184.2 LD7184	ATE 23587 20,6 + WK ATE 23587 20,6 + WK Ceramic			
			➡	02/06→; +PR 1KE,1KF,1KJ		13.0460-2749.2 602749 13.0460-2880.2 602880 13.0470-2749.2 LD2749 13.0470-2880.2 LD2880	TRW 24483 16,9 - WE / - WK + Zub TRW 23914 17,1 + WE / - WK + Zub TRW 24483 16,9 - WE / - WK + Zub Ceramic TRW 23914 17,1 + WE / - WK + Zub Ceramic			
			➡	02/06→; +PR 1KS		13.0460-3858.2 603858 13.0470-3858.2 LD3858	BOS 24563 17,7 - WE / - WK + Zub BOS 24563 17,7 - WE / - WK + Zub Ceramic			
Zubehörsatz, Scheibenbremsbelag										
1.4 FSI 1.4 TSI EcoFuel 1.6 1.6 FSI 1.9 TDI 1.9 TDI 1.9 TDI 2.0 EcoFuel 2.0 FSI 2.0 FSI 2.0 TDI 2.0 TDI 16V	125 110 75 85 66 74 77 80 85 110 103 103	11/06→05/10 05/09→05/10 07/03→05/10 02/03→01/07 11/04→05/10 02/03→05/04 08/03→05/10 02/06→05/09 10/04→05/10 10/03→01/07 12/05→05/10 08/03→05/10	➡	+PR 1KE,1KF,1KJ		13.0460-0259.2 610259				
1.4 TSI	103	02/06→05/10	➡	09/06→; +PR 1KE,1KF,1KJ		13.0460-0259.2 610259				
2.0 TDI	100	02/03→05/10	➡	08/03→; +PR 1KE,1KF,1KJ		13.0460-0259.2 610259				
2.0 TDI	125	12/05→05/10	➡	02/06→; +PR 1KE,1KF,1KJ		13.0460-0259.2 610259				
 Bremsscheibe										
1.4 FSI 1.6 1.6 FSI 1.9 TDI 1.9 TDI 1.9 TDI 2.0 EcoFuel 2.0 FSI 2.0 TDI 2.0 TDI 16V	125 75 85 66 74 77 80 110 103 103	11/06→05/10 07/03→05/10 02/03→01/07 11/04→05/10 02/03→05/04 08/03→05/10 02/06→05/09 10/03→01/07 12/05→05/10 08/03→05/10	⬅	+PR 1ZE,1ZP		24.0125-0145.1 425145 24.0325-0145.1 525145	Ø 288 25 22 V + S Ø 288 25 22 V + S PD			
			⬅	+PR 1LJ,1ZA,1ZD		24.0125-0158.1 425158 24.0325-0158.1 525158	Ø 312 25 22 V + S Ø 312 25 22 V + S PD			
			➡	+PR 1KS		24.0110-0356.1 410356 24.0310-0356.1 510356	Ø 272 9,7 8 + S Ø 272 9,7 8 + S PD			
			➡	+PR 1KE;1KF		24.0112-0158.1 412158 24.0312-0158.1 512158	Ø 256 12 10 + S Ø 256 12 10 PD			
			➡	+PR 1KJ		24.0112-0169.1 412169 24.0312-0169.1 512169	Ø 282 12 10 + S Ø 282 12 10 + S PD			
			1.4 TSI	103	02/06→05/10	⬅	09/06→; +PR 1ZE,1ZP		24.0125-0145.1 425145 24.0325-0145.1 525145	Ø 288 25 22 V + S Ø 288 25 22 V + S PD
						⬅	09/06→; +PR 1LJ,1ZA,1ZD		24.0125-0158.1 425158 24.0325-0158.1 525158	Ø 312 25 22 V + S Ø 312 25 22 V + S PD
						➡	09/06→; +PR 1KS		24.0110-0356.1 410356 24.0310-0356.1 510356	Ø 272 9,7 8 + S Ø 272 9,7 8 + S PD
						➡	09/06→; +PR 1KE;1KF		24.0112-0158.1 412158 24.0312-0158.1 512158	Ø 256 12 10 + S Ø 256 12 10 PD
						➡	09/06→; +PR 1KJ		24.0112-0169.1 412169 24.0312-0169.1 512169	Ø 282 12 10 + S Ø 282 12 10 + S PD
						1.4 TSI EcoFuel 2.0 FSI	110 85	05/09→05/10 10/04→05/10	⬅	+PR 1ZE,1ZP
			⬅	+PR 1LJ,1ZA,1ZD					24.0125-0158.1 425158 24.0325-0158.1 525158	Ø 312 25 22 V + S Ø 312 25 22 V + S PD
➡	+PR 1KS		24.0110-0356.1 410356 24.0310-0356.1 510356	Ø 272 9,7 8 + S Ø 272 9,7 8 + S PD						
➡	+PR 1KE,1KF		24.0112-0158.1 412158 24.0312-0158.1 512158	Ø 256 12 10 + S Ø 256 12 10 PD						
➡	+PR 1KJ		24.0112-0169.1 412169 24.0312-0169.1 512169	Ø 282 12 10 + S Ø 282 12 10 + S PD						
↓										











	kw			 	! #		
VW - TOURAN (1T1, 1T2) 02/03→05/10							
Bremsscheibe							
2.0 TDI	100	02/03→05/10	←	08/03→; +PR 1ZE,1ZP	24.0125-0145.1 425145	Ø 288 25 22 V + S	
			←	08/03→; +PR 1LJ,1ZA,1ZD	24.0125-0158.1 425158	Ø 312 25 22 V + S	
			→	08/03→; +PR 1KS	24.0110-0356.1 410356	Ø 272 9,7 8 + S	
			→	08/03→; +PR 1KE;1KF	24.0112-0158.1 412158	Ø 256 12 10 + S	
			→	08/03→; +PR 1KJ	24.0112-0169.1 412169	Ø 282 12 10 + S	
			→	08/03→; +PR 1KE;1KF	24.0310-0356.1 510356	Ø 272 9,7 8 + S PD	
2.0 TDI	125	12/05→05/10	←	02/06→; +PR 1ZE,1ZP	24.0125-0145.1 425145	Ø 288 25 22 V + S	
			←	02/06→; +PR 1LJ,1ZA,1ZD	24.0125-0158.1 425158	Ø 312 25 22 V + S	
			→	02/06→; +PR 1KS	24.0110-0356.1 410356	Ø 272 9,7 8 + S	
			→	02/06→; +PR 1KE;1KF	24.0112-0158.1 412158	Ø 256 12 10 + S	
			→	02/06→; +PR 1KJ	24.0112-0169.1 412169	Ø 282 12 10 + S	
			→	02/06→; +PR 1KE;1KF	24.0312-0158.1 512158	Ø 256 12 10 PD	
VW - TOURAN (1T3) 05/10→05/15							
Bremsbelagsatz, Scheibenbremse							
1.2 TSI 1.4 TSI 1.4 TSI 1.4 TSI EcoFuel 1.6 TDI 1.6 TDI 2.0 TDI 2.0 TDI	77 103 125 110 66 77 81 103	05/10→05/15 05/10→05/15 05/10→05/15 05/10→05/15 05/10→05/15 11/10→05/15 05/10→05/15	←	+PR 1ZD,1ZE,1ZP / 1ZA,1LJ	13.0460-7184.2 607184	ATE 23587 20,6 + WK	
			←	+PR 1LJ,1ZA,1ZD	13.0470-7184.2 LD7184	ATE 23587 20,6 + WK Ceramic	
			→	+PR 1KE,1KF,1KJ	13.0460-2749.2 602749	TRW 24483 16,9 - WE / - WK + Zub	
			→	+PR 1KE,1KF,1KJ	13.0460-2880.2 602880	TRW 23914 17,1 + WE / - WK + Zub	
			→	+PR 1KE,1KF,1KJ	13.0470-2749.2 LD2749	TRW 24483 16,9 - WE / - WK + Zub Ceramic	
			→	+PR 1KE,1KF,1KJ	13.0470-2880.2 LD2880	TRW 23914 17,1 + WE / - WK + Zub Ceramic	
2.0 TDI	125	05/10→01/13	←	+PR 1ZA,1ZD,1ZE / 1ZP,1LJ	13.0460-7184.2 607184	ATE 23587 20,6 + WK	
			←	+PR 1LJ,1ZA,1ZD	13.0470-7184.2 LD7184	ATE 23587 20,6 + WK Ceramic	
			→	+PR 1KE,1KF,1KJ	13.0460-2749.2 602749	TRW 24483 16,9 - WE / - WK + Zub	
			→	+PR 1KE,1KF,1KJ	13.0460-2880.2 602880	TRW 23914 17,1 + WE / - WK + Zub	
			→	+PR 1KE,1KF,1KJ	13.0470-2749.2 LD2749	TRW 24483 16,9 - WE / - WK + Zub Ceramic	
			→	+PR 1KE,1KF,1KJ	13.0470-2880.2 LD2880	TRW 23914 17,1 + WE / - WK + Zub Ceramic	
2.0 TDI	130	01/13→05/15	←	+PR 1ZA,1ZD,1ZE,1ZP / 1LJ	13.0460-7184.2 607184	ATE 23587 20,6 + WK	
			←	+PR 1LJ,1ZA,1ZD	13.0470-7184.2 LD7184	ATE 23587 20,6 + WK Ceramic	
			→	+PR 1KE,1KF,1KJ	13.0460-3858.2 603858	BOS 24563 17,7 - WE / - WK + Zub	
			→	+PR 1KE,1KF,1KJ	13.0470-3858.2 LD3858	BOS 24563 17,7 - WE / - WK + Zub Ceramic	
			→	+PR 1KE,1KF,1KJ	13.0460-3858.2 603858	BOS 24563 17,7 - WE / - WK + Zub	
			→	+PR 1KE,1KF,1KJ	13.0470-3858.2 LD3858	BOS 24563 17,7 - WE / - WK + Zub Ceramic	
Zubehörsatz, Scheibenbremsbelag							
1.2 TSI 1.4 TSI 1.4 TSI 1.4 TSI EcoFuel 1.6 TDI 1.6 TDI 2.0 TDI 2.0 TDI 2.0 TDI ↓	77 103 125 110 66 77 81 103 125	05/10→05/15 05/10→05/15 05/10→05/15 05/10→05/15 05/10→05/15 11/10→05/15 05/10→05/15 05/10→01/13	→	+PR 1KE,1KF,1KJ	13.0460-0259.2 610259		







	kw			 	! #		
VW - TOURAN (1T3) 05/10→05/15							
 Bremsscheibe							
1.2 TSI	77	05/10→05/15	←	+PR 1ZE,1ZP		24.0125-0145.1 425145	Ø 288 25 22 V + S
1.4 TSI EcoFuel	110	05/10→05/15				24.0325-0145.1 525145	Ø 288 25 22 V + S PD
1.6 TDI	66	05/10→05/15	←	+PR 1LJ,1ZA,1ZD		24.0125-0158.1 425158	Ø 312 25 22 V + S
1.6 TDI	77	05/10→05/15				24.0325-0158.1 525158	Ø 312 25 22 V + S PD
			→	+PR 1KS		24.0110-0356.1 410356	Ø 272 9,7 8 + S
			→	+PR 1KE,1KF		24.0310-0356.1 510356	Ø 272 9,7 8 + S PD
			→	+PR 1KJ		24.0112-0158.1 412158	Ø 256 12 10 + S
						24.0312-0158.1 512158	Ø 256 12 10 PD
						24.0112-0169.1 412169	Ø 282 12 10 + S
						24.0312-0169.1 512169	Ø 282 12 10 + S PD
1.4 TSI	103	05/10→05/15	←	+PR 1ZE,1ZP		24.0125-0145.1 425145	Ø 288 25 22 V + S
1.4 TSI	125	05/10→05/15				24.0325-0145.1 525145	Ø 288 25 22 V + S PD
2.0 TDI	81	11/10→05/15	←	+PR 1LJ,1ZA,1ZD		24.0125-0158.1 425158	Ø 312 25 22 V + S
2.0 TDI	103	05/10→05/15				24.0325-0158.1 525158	Ø 312 25 22 V + S PD
2.0 TDI	125	05/10→01/13	→	+PR 1KS		24.0110-0356.1 410356	Ø 272 9,7 8 + S
			→	+PR 1KE,1KF		24.0310-0356.1 510356	Ø 272 9,7 8 + S PD
			→	+PR 1KJ		24.0112-0158.1 412158	Ø 256 12 10 + S
						24.0312-0158.1 512158	Ø 256 12 10 PD
						24.0112-0169.1 412169	Ø 282 12 10 + S
						24.0312-0169.1 512169	Ø 282 12 10 + S PD
2.0 TDI	130	01/13→05/15	←	+PR 1ZE,1ZP		24.0125-0145.1 425145	Ø 288 25 22 V + S
						24.0325-0145.1 525145	Ø 288 25 22 V + S PD
			←	+PR 1LJ,1ZA,1ZD		24.0125-0158.1 425158	Ø 312 25 22 V + S
						24.0325-0158.1 525158	Ø 312 25 22 V + S PD
			→			24.0110-0356.1 410356	Ø 272 9,7 8 + S
						24.0310-0356.1 510356	Ø 272 9,7 8 + S PD
VW - TOURAN (5T1) 05/15→							
 Bremsbelagsatz, Scheibenbremse							
1.2 TSI	81	05/15→	←	09/15→; +PR 1ZA,1ZD		13.0460-2785.2 602785	TRW 25683 20,4 + WE / + WK
1.4 TSI	110	05/15→				13.0470-2785.2 LD2785	TRW 25683 20,4 + WE / + WK Ceramic
1.6 TDI	81	05/15→05/16	→	09/15→; +PR 1KE; + eFSB		13.0460-7293.2 607293	ATE 25008 16,3 - WE / - WK
2.0 TDI	110	05/15→				13.0470-7293.2 LD7293	ATE 25008 16,3 - WE / - WK Ceramic
			→	09/15→; +PR 1KU; + eFSB		13.0460-7294.2 607294	ATE 25009 16,4 - WE / - WK
						13.0470-7294.2 LD7294	ATE 25009 16,4 - WE / - WK Ceramic
1.6 TDI	85	05/16→	←	+PR 1ZA,1ZD		13.0460-2785.2 602785	TRW 25683 20,4 + WE / + WK
1.8 TSI	132	11/15→				13.0470-2785.2 LD2785	TRW 25683 20,4 + WE / + WK Ceramic
2.0 TDI	81	11/15→	→	+PR 1KE; + eFSB		13.0460-7293.2 607293	ATE 25008 16,3 - WE / - WK
2.0 TDI	140	11/15→				13.0470-7293.2 LD7293	ATE 25008 16,3 - WE / - WK Ceramic
			→	+PR 1KU; + eFSB		13.0460-7294.2 607294	ATE 25009 16,4 - WE / - WK
						13.0470-7294.2 LD7294	ATE 25009 16,4 - WE / - WK Ceramic
Warnkontakt, Bremsbelagsverschleiß							
1.2 TSI	81	05/15→	←	☐; 09/15→; +PR 1ZA,1ZD	1	24.8190-0065.2 620065	L= 172
1.4 TSI	110	05/15→					
1.6 TDI	81	05/15→05/16					
2.0 TDI	110	05/15→					
1.6 TDI	85	05/16→	←	☐; +PR 1ZA,1ZD	1	24.8190-0065.2 620065	L= 172
1.8 TSI	132	11/15→					
2.0 TDI	81	11/15→					
2.0 TDI	140	11/15→					
 Bremsscheibe							
1.2 TSI	81	05/15→	←	09/15→; +PR 1ZA,1ZD		24.0125-0158.1 425158	Ø 312 25 22 V + S
1.4 TSI	110	05/15→				24.0325-0158.1 525158	Ø 312 25 22 V + S PD
1.6 TDI	81	05/15→05/16	→	09/15→; +PR 1KE		24.0110-0356.1 410356	Ø 272 9,7 8 + S
2.0 TDI	110	05/15→				24.0310-0356.1 510356	Ø 272 9,7 8 + S PD
			→	09/15→; +PR 1KU; + eFSB		24.0112-0210.1 412210	Ø 300 12 10 + S
1.6 TDI	85	05/16→	←	+PR 1ZA,1ZD		24.0125-0158.1 425158	Ø 312 25 22 V + S
1.8 TSI	132	11/15→					



	kw			 	! #		
VW - TOURAN (5T1) 05/15→							
 Bremsscheibe							
2.0 TDI	81	11/15→	←	+PR 1ZA,1ZD	24.0325-0158.1	525158	Ø 312 25 22 V + S PD
2.0 TDI	140	11/15→	→	+PR 1KE	24.0110-0356.1	410356	Ø 272 9,7 8 + S
			→	+PR 1KU; + eFSB	24.0310-0356.1	510356	Ø 272 9,7 8 + S PD
			→	+PR 1KU; + eFSB	24.0112-0210.1	412210	Ø 300 12 10 + S
VW - TRANSPORTER T4 Bus (70XB, 70XC, 7DB, 7DW, 7DK) 09/90→04/03							
 Bremsbelagsatz, Scheibenbremse							
1.9 D	44	09/90→12/95	←	70-Y-000001→; +PR 1LP	13.0460-2838.2	602838	TRW 21479 19,2 + WK
1.9 D	45	09/90→12/95	←	70-Y-000001→; +PR 1LE	13.0460-2839.2	602839	TRW 20651 18,3 + WK
			←	+PR 1LA	13.0460-2972.2	602972	TRW 20124 18,9 - WK
			←	→ 70-X-250000; +PR 1LE	13.0460-2973.2	602973	TRW 20651 18,0 - WE / - WK
			←	70-P-160001→ 70-X-250000; +PR 1LP	13.0460-2982.2	602982	TRW 21479 19,2 - WK
			←	70-Y-000001→; +PR 1LU	13.0460-7124.2	607124	ATE 21883 19,8 + WK
			←	70-1-000955→; +PR 1LB	13.0460-7153.2	607153	ATE 23269 19,8 + WK
			→	70-T-200000→; +PR 2E2	13.0460-2874.2	602874	TRW 23224 16,5 + WK + Zub
1.9 TD	50	10/92→04/03	←	70-Y-000001→; +PR 1LP	13.0460-2838.2	602838	TRW 21479 19,2 + WK
2.0	62	09/90→04/03	←	70-Y-000001→; +PR 1LE	13.0460-2839.2	602839	TRW 20651 18,3 + WK
2.4 D	57	09/90→04/98	←	→ 04/96; +PR 1LA	13.0460-2972.2	602972	TRW 20124 18,9 - WK
2.5	81	11/90→04/03	←	→ 70-X-250000; +PR 1LE	13.0460-2973.2	602973	TRW 20651 18,0 - WE / - WK
			←	70-P-160001→ 70-X-250000; +PR 1LP	13.0460-2982.2	602982	TRW 21479 19,2 - WK
			←	05/96→; → 70-X-250000; +PR 1LU	13.0460-7102.2	607102	ATE 21883 19,8 - WE / - WK
			←	05/97→; → 70-1-000954; +PR 1LB	13.0460-7123.2	607123	ATE 23034 18,8 + WK
			←	70-Y-000001→; +PR 1LU	13.0460-7124.2	607124	ATE 21883 19,8 + WK
			←	70-1-000955→; +PR 1LB	13.0460-7153.2	607153	ATE 23269 19,8 + WK
			→	05/97→; +PR 2E3	13.0460-2872.2	602872	TRW 23224 16,5 + WK + Zub
			→	70-T-200000→; +PR 2E2	13.0460-2874.2	602874	TRW 23224 16,5 + WK + Zub
2.4 D	55	08/97→04/03	←	70-Y-000001→; +PR 1LP	13.0460-2838.2	602838	TRW 21479 19,2 + WK
			←	70-Y-000001→; +PR 1LE	13.0460-2839.2	602839	TRW 20651 18,3 + WK
			←	→ 70-X-250000; +PR 1LE	13.0460-2973.2	602973	TRW 20651 18,0 - WE / - WK
			←	70-P-160001→ 70-X-250000; +PR 1LP	13.0460-2982.2	602982	TRW 21479 19,2 - WK
			←	→ 70-X-250000; +PR 1LU	13.0460-7102.2	607102	ATE 21883 19,8 - WE / - WK
			←	→ 70-1-000954; +PR 1LB	13.0460-7123.2	607123	ATE 23034 18,8 + WK
			←	70-Y-000001→; +PR 1LU	13.0460-7124.2	607124	ATE 21883 19,8 + WK
			←	70-1-000955→; +PR 1LB	13.0460-7153.2	607153	ATE 23269 19,8 + WK
			→	+PR 2E3	13.0460-2872.2	602872	TRW 23224 16,5 + WK + Zub
			→	70-T-200000→; +PR 2E2	13.0460-2874.2	602874	TRW 23224 16,5 + WK + Zub
2.4 D Syncro	57	10/92→09/98	←	70-Y-000001→; +PR 1LP	13.0460-2838.2	602838	TRW 21479 19,2 + WK
			←	70-Y-000001→; +PR 1LE	13.0460-2839.2	602839	TRW 20651 18,3 + WK
			←	11/92→; → 70-X-250000; +PR 1LE	13.0460-2973.2	602973	TRW 20651 18,0 - WE / - WK
			←	11/92→; → 70-X-250000; +PR 1LP	13.0460-2982.2	602982	TRW 21479 19,2 - WK
			←	07/95→; → 70-X-250000; +PR 1LU	13.0460-7102.2	607102	ATE 21883 19,8 - WE / - WK
			←	70-Y-000001→; +PR 1LU	13.0460-7124.2	607124	ATE 21883 19,8 + WK
			←	07/95→; +PR 1LB	13.0460-7153.2	607153	ATE 23269 19,8 + WK
			→	05/97→; +PR 2E3	13.0460-2872.2	602872	TRW 23224 16,5 + WK + Zub
			→	70-T-200000→; +PR 2E2	13.0460-2874.2	602874	TRW 23224 16,5 + WK + Zub
2.5	85	08/96→04/03	←	70-Y-000001→; +PR 1LP	13.0460-2838.2	602838	TRW 21479 19,2 + WK
			←	70-Y-000001→; +PR 1LE	13.0460-2839.2	602839	TRW 20651 18,3 + WK
			←	→ 70-X-250000; +PR 1LE	13.0460-2973.2	602973	TRW 20651 18,0 - WE / - WK
			←	70-P-160001→ 70-X-250000; +PR 1LP	13.0460-2982.2	602982	TRW 21479 19,2 - WK
			←	→ 70-X-250000; +PR 1LU	13.0460-7102.2	607102	ATE 21883 19,8 - WE / - WK
			←	05/97→; → 70-1-000954; +PR 1LB	13.0460-7123.2	607123	ATE 23034 18,8 + WK
			←	70-Y-000001→; +PR 1LU	13.0460-7124.2	607124	ATE 21883 19,8 + WK
			←	70-1-000955→; +PR 1LB	13.0460-7153.2	607153	ATE 23269 19,8 + WK



	kw			 	! #		
VW - TRANSPORTER T4 Bus (70XB, 70XC, 7DB, 7DW, 7DK) 09/90→04/03							
 Bremsbelagsatz, Scheibenbremse							
2.5	85	08/96→04/03	➔	05/97→; +PR 2E3		13.0460-2872.2 602872	TRW 23224 16,5 + WK + Zub
			➔	70-T-200000→; +PR 2E2		13.0460-2874.2 602874	TRW 23224 16,5 + WK + Zub
2.5 Syncro	81	11/92→04/03	➔	70-Y-000001→; +PR 1LP		13.0460-2838.2 602838	TRW 21479 19,2 + WK
			➔	70-Y-000001→; +PR 1LE		13.0460-2839.2 602839	TRW 20651 18,3 + WK
			➔	→ 70-X-250000; +PR 1LE		13.0460-2973.2 602973	TRW 20651 18,0 - WE / - WK
			➔	→ 70-X-250000; +PR 1LP		13.0460-2982.2 602982	TRW 21479 19,2 - WK
			➔	07/95→; → 70-X-250000; +PR 1LU		13.0460-7102.2 607102	ATE 21883 19,8 - WE / - WK
			➔	70-Y-000001→; +PR 1LU		13.0460-7124.2 607124	ATE 21883 19,8 + WK
			➔	07/95→; +PR 1LB		13.0460-7153.2 607153	ATE 23269 19,8 + WK
			➔	05/97→; +PR 2E3		13.0460-2872.2 602872	TRW 23224 16,5 + WK + Zub
			➔	70-T-200000→; +PR 2E2		13.0460-2874.2 602874	TRW 23224 16,5 + WK + Zub
2.5 Syncro 2.5 TDI Syncro	85 75	07/96→04/03 01/96→04/03	➔	70-Y-000001→; +PR 1LP		13.0460-2838.2 602838	TRW 21479 19,2 + WK
			➔	70-Y-000001→; +PR 1LE		13.0460-2839.2 602839	TRW 20651 18,3 + WK
			➔	→ 70-X-250000; +PR 1LE		13.0460-2973.2 602973	TRW 20651 18,0 - WE / - WK
			➔	→ 70-X-250000; +PR 1LP		13.0460-2982.2 602982	TRW 21479 19,2 - WK
			➔	→ 70-X-250000; +PR 1LU		13.0460-7102.2 607102	ATE 21883 19,8 - WE / - WK
			➔	70-Y-000001→; +PR 1LU		13.0460-7124.2 607124	ATE 21883 19,8 + WK
			➔	+PR 1LB		13.0460-7153.2 607153	ATE 23269 19,8 + WK
			➔	05/97→; +PR 2E3		13.0460-2872.2 602872	TRW 23224 16,5 + WK + Zub
			➔	70-T-200000→; +PR 2E2		13.0460-2874.2 602874	TRW 23224 16,5 + WK + Zub
2.5 TDI 2.5 TDI 2.8 VR6	65 111 150	05/98→04/03 05/98→04/03 04/00→04/03	➔	70-Y-000001→; +PR 1LP		13.0460-2838.2 602838	TRW 21479 19,2 + WK
			➔	70-Y-000001→; +PR 1LE		13.0460-2839.2 602839	TRW 20651 18,3 + WK
			➔	→ 70-X-250000; +PR 1LE		13.0460-2973.2 602973	TRW 20651 18,0 - WE / - WK
			➔	→ 70-X-250000; +PR 1LP		13.0460-2982.2 602982	TRW 21479 19,2 - WK
			➔	→ 70-X-250000; +PR 1LU		13.0460-7102.2 607102	ATE 21883 19,8 - WE / - WK
			➔	→ 70-1-000954; +PR 1LB		13.0460-7123.2 607123	ATE 23034 18,8 + WK
			➔	70-Y-000001→; +PR 1LU		13.0460-7124.2 607124	ATE 21883 19,8 + WK
			➔	70-1-000955→; +PR 1LB		13.0460-7153.2 607153	ATE 23269 19,8 + WK
			➔	+PR 2E3		13.0460-2872.2 602872	TRW 23224 16,5 + WK + Zub
			➔	70-T-200000→; +PR 2E2		13.0460-2874.2 602874	TRW 23224 16,5 + WK + Zub
2.5 TDI	75	09/95→04/03	➔	70-Y-000001→; +PR 1LP		13.0460-2838.2 602838	TRW 21479 19,2 + WK
			➔	70-Y-000001→; +PR 1LE		13.0460-2839.2 602839	TRW 20651 18,3 + WK
			➔	→ 04/96; +PR 1LA		13.0460-2972.2 602972	TRW 20124 18,9 - WK
			➔	→ 70-X-250000; +PR 1LE		13.0460-2973.2 602973	TRW 20651 18,0 - WE / - WK
			➔	→ 70-X-250000; +PR 1LP		13.0460-2982.2 602982	TRW 21479 19,2 - WK
			➔	05/96→; → 70-X-250000; +PR 1LU		13.0460-7102.2 607102	ATE 21883 19,8 - WE / - WK
			➔	05/97→; → 70-1-000954; +PR 1LB		13.0460-7123.2 607123	ATE 23034 18,8 + WK
			➔	70-Y-000001→; +PR 1LU		13.0460-7124.2 607124	ATE 21883 19,8 + WK
			➔	70-1-000955→; +PR 1LB		13.0460-7153.2 607153	ATE 23269 19,8 + WK
			➔	05/97→; +PR 2E3		13.0460-2872.2 602872	TRW 23224 16,5 + WK + Zub
			➔	70-T-200000→; +PR 2E2		13.0460-2874.2 602874	TRW 23224 16,5 + WK + Zub
2.8 VR 6	103	11/95→04/00	➔	70-Y-000001→; +PR 1LP		13.0460-2838.2 602838	TRW 21479 19,2 + WK
			➔	70-Y-000001→; +PR 1LE		13.0460-2839.2 602839	TRW 20651 18,3 + WK
			➔	→ 70-X-250000; +PR 1LE		13.0460-2973.2 602973	TRW 20651 18,0 - WE / - WK
			➔	→ 70-X-250000; +PR 1LP		13.0460-2982.2 602982	TRW 21479 19,2 - WK
			➔	→ 70-X-250000; +PR 1LU		13.0460-7102.2 607102	ATE 21883 19,8 - WE / - WK
			➔	05/97→; → 70-1-000954; +PR 1LB		13.0460-7123.2 607123	ATE 23034 18,8 + WK
			➔	70-Y-000001→; +PR 1LU		13.0460-7124.2 607124	ATE 21883 19,8 + WK
			➔	70-1-000955→; +PR 1LB		13.0460-7153.2 607153	ATE 23269 19,8 + WK
			➔	05/97→; +PR 2E3		13.0460-2872.2 602872	TRW 23224 16,5 + WK + Zub
			➔	70-T-200000→; +PR 2E2		13.0460-2874.2 602874	TRW 23224 16,5 + WK + Zub

	kw				! #		
VW - TRANSPORTER T4 Bus (70XB, 70XC, 7DB, 7DW, 7DK) 09/90→04/03							
Zubehörsatz, Scheibenbremsbelag							
1.9 D	44	09/90→12/95	←	70-Y-000001→; +PR 1LE		13.0460-0286.2	610286
1.9 D	45	09/90→12/95	←	→ 70-X-250000; +PR 1LE		13.0460-0286.2	610286
			→	70-T-200000→; +PR 2E2		13.0460-0225.2	610225
1.9 TD	50	10/92→04/03	←	70-Y-000001→; +PR 1LE		13.0460-0286.2	610286
2.0	62	09/90→04/03	←	→ 70-X-250000; +PR 1LE		13.0460-0286.2	610286
2.4 D	57	09/90→04/98	→	70-T-200000→; +PR 2E2		13.0460-0225.2	610225
2.5	81	11/90→04/03	→	05/97→; +PR 2E3		13.0460-0225.2	610225
2.5	85	08/96→04/03					
2.5 Syncro	81	11/92→04/03					
2.5 Syncro	85	07/96→04/03					
2.5 TDI	75	09/95→04/03					
2.5 TDI Syncro	75	01/96→04/03					
2.8 VR 6	103	11/95→04/00					
2.4 D	55	08/97→04/03	←	70-Y-000001→; +PR 1LE		13.0460-0286.2	610286
2.5 TDI	65	05/98→04/03	←	→ 70-X-250000; +PR 1LE		13.0460-0286.2	610286
2.5 TDI	111	05/98→04/03	→	+PR 2E3		13.0460-0225.2	610225
2.8 VR6	150	04/00→04/03	→	70-T-200000→; +PR 2E2		13.0460-0225.2	610225
2.4 D Syncro	57	10/92→09/98	←	70-Y-000001→; +PR 1LE		13.0460-0286.2	610286
			←	11/92→; → 70-X-250000; +PR 1LE		13.0460-0286.2	610286
			→	70-T-200000→; +PR 2E2		13.0460-0225.2	610225
			→	05/97→; +PR 2E3		13.0460-0225.2	610225
Bremsscheibe							
1.9 D	44	09/90→12/95	←	+PR 1LA		24.0116-0108.1	416108 Ø 260 16 13
1.9 D	45	09/90→12/95	←	70-P-160001→; +PR 1LP		24.0118-0105.1	418105 Ø 282 18 15
			←	+PR 1LE,1LU		24.0124-0118.1	424118 Ø 280 24 20 V
			←	70-1-000955→; +PR 1LB		24.0126-0119.1	426119 Ø 313 25,9 22 V
						24.0326-0119.1	526119 Ø 313 25,9 22 V PD
			→	70-T-200000→; +PR 2E2		24.0112-0138.1	412138 Ø 280 12 10 + S
1.9 TD	50	10/92→04/03	←	→ 04/96; +PR 1LA		24.0116-0108.1	416108 Ø 260 16 13
2.0	62	09/90→04/03	←	70-P-160001→; → 04/96; +PR 1LP		24.0118-0105.1	418105 Ø 282 18 15
2.4 D	57	09/90→04/98	←	05/96→; +PR 1LP		24.0118-0111.1	418111 Ø 282 18 15 + S
2.5	81	11/90→04/03	←	→ 04/96; +PR 1LE,1LU		24.0124-0118.1	424118 Ø 280 24 20 V
			←	05/96→; +PR 1LE,1LU		24.0124-0128.1	424128 Ø 280 24 20 V + S
			←	05/97→; → 70-1-000954; +PR 1LB		24.0126-0115.1	426115 Ø 300 26 22 V
						24.0326-0115.1	526115 Ø 300 26 22 V PD
			←	70-1-000955→; +PR 1LB		24.0126-0119.1	426119 Ø 313 25,9 22 V
						24.0326-0119.1	526119 Ø 313 25,9 22 V PD
			→	70-T-200000→; +PR 2E2		24.0112-0138.1	412138 Ø 280 12 10 + S
			→	05/97→; +PR 2E3		24.0113-0194.1	413194 Ø 294 13,5 11,5
2.4 D	55	08/97→04/03	←	+PR 1LP		24.0118-0111.1	418111 Ø 282 18 15 + S
2.5 TDI	65	05/98→04/03	←	+PR 1LE,1LU		24.0124-0128.1	424128 Ø 280 24 20 V + S
2.5 TDI	111	05/98→04/03	←	→ 70-1-000954; +PR 1LB		24.0126-0115.1	426115 Ø 300 26 22 V
2.8 VR6	150	04/00→04/03				24.0326-0115.1	526115 Ø 300 26 22 V PD
			←	70-1-000955→; +PR 1LB		24.0126-0119.1	426119 Ø 313 25,9 22 V
						24.0326-0119.1	526119 Ø 313 25,9 22 V PD
			→	70-T-200000→; +PR 2E2		24.0112-0138.1	412138 Ø 280 12 10 + S
			→	+PR 2E3		24.0113-0194.1	413194 Ø 294 13,5 11,5
2.4 D Syncro	57	10/92→09/98	←	11/92→ 04/96; +PR 1LP		24.0118-0105.1	418105 Ø 282 18 15
			←	05/96→; +PR 1LP		24.0118-0111.1	418111 Ø 282 18 15 + S
			←	11/92→ 06/95; +PR 1LE,1LU		24.0124-0118.1	424118 Ø 280 24 20 V
			←	07/95→; +PR 1LE,1LU		24.0124-0128.1	424128 Ø 280 24 20 V + S
			←	07/95→; +PR 1LB		24.0126-0119.1	426119 Ø 313 25,9 22 V
						24.0326-0119.1	526119 Ø 313 25,9 22 V PD
			→	05/96→; +PR 2E2		24.0112-0138.1	412138 Ø 280 12 10 + S
			→	05/97→; +PR 2E3		24.0113-0194.1	413194 Ø 294 13,5 11,5
2.5	85	08/96→04/03	←	+PR 1LP		24.0118-0111.1	418111 Ø 282 18 15 + S
2.8 VR 6	103	11/95→04/00	←	+PR 1LE,1LU		24.0124-0128.1	424128 Ø 280 24 20 V + S
↓							

VW - TRANSPORTER T4 Bus (70XB, 70XC, 7DB, 7DW, 7DK) 09/90→04/03

Bremsscheibe









2.5 2.8 VR 6	85 103	08/96→04/03 11/95→04/00	← 05/97→; → 70-1-000954; +PR 1LB	24.0126-0115.1 426115	∅ 300 26 22 V
				24.0326-0115.1 526115	∅ 300 26 22 V PD
			← 70-1-000955→; +PR 1LB	24.0126-0119.1 426119	∅ 313 25,9 22 V
				24.0326-0119.1 526119	∅ 313 25,9 22 V PD
2.5 Syncro	81	11/92→04/03	→ 04/96; +PR 1LP	24.0118-0105.1 418105	∅ 282 18 15
			← 05/96→; +PR 1LP	24.0118-0111.1 418111	∅ 282 18 15 + S
			→ 06/95; +PR 1LE,1LU	24.0124-0118.1 424118	∅ 280 24 20 V
			← 07/95→; +PR 1LE,1LU	24.0124-0128.1 424128	∅ 280 24 20 V + S
			← 07/95→; +PR 1LB	24.0126-0119.1 426119	∅ 313 25,9 22 V
				24.0326-0119.1 526119	∅ 313 25,9 22 V PD
			→ 05/96→; +PR 2E2	24.0112-0138.1 412138	∅ 280 12 10 + S
			→ 05/97→; +PR 2E3	24.0113-0194.1 413194	∅ 294 13,5 11,5
2.5 Syncro	85	07/96→04/03	← +PR 1LP	24.0118-0111.1 418111	∅ 282 18 15 + S
			← +PR 1LE,1LU	24.0124-0128.1 424128	∅ 280 24 20 V + S
			← +PR 1LB	24.0126-0119.1 426119	∅ 313 25,9 22 V
				24.0326-0119.1 526119	∅ 313 25,9 22 V PD
			→ +PR 2E2	24.0112-0138.1 412138	∅ 280 12 10 + S
2.5 TDI	75	09/95→04/03	← → 04/96; +PR 1LA	24.0116-0108.1 416108	∅ 260 16 13
			← → 04/96; +PR 1LP	24.0118-0105.1 418105	∅ 282 18 15
			← 05/96→; +PR 1LP	24.0118-0111.1 418111	∅ 282 18 15 + S
			← → 04/96; +PR 1LE,1LU	24.0124-0118.1 424118	∅ 280 24 20 V
			← 05/96→; +PR 1LE,1LU	24.0124-0128.1 424128	∅ 280 24 20 V + S
			← 05/97→; → 70-1-000954; +PR 1LB	24.0126-0115.1 426115	∅ 300 26 22 V
				24.0326-0115.1 526115	∅ 300 26 22 V PD
			← 70-1-000955→; +PR 1LB	24.0126-0119.1 426119	∅ 313 25,9 22 V
				24.0326-0119.1 526119	∅ 313 25,9 22 V PD
			→ 70-T-200000→; +PR 2E2	24.0112-0138.1 412138	∅ 280 12 10 + S
2.5 TDI Syncro	75	01/96→04/03	← → 04/96; +PR 1LP	24.0118-0105.1 418105	∅ 282 18 15
			← 05/96→; +PR 1LP	24.0118-0111.1 418111	∅ 282 18 15 + S
			← +PR 1LE,1LU	24.0124-0128.1 424128	∅ 280 24 20 V + S
			← +PR 1LB	24.0126-0119.1 426119	∅ 313 25,9 22 V
				24.0326-0119.1 526119	∅ 313 25,9 22 V PD
			→ 05/96→; +PR 2E2	24.0112-0138.1 412138	∅ 280 12 10 + S
			→ 05/97→; +PR 2E3	24.0113-0194.1 413194	∅ 294 13,5 11,5









VW - TRANSPORTER T4 Kasten (70XA) 07/90→04/03







Bremsbelagsatz, Scheibenbremse









1.9 D 1.9 D	44 45	09/90→12/95 07/90→12/95	← 70-Y-000001→; +PR 1LP	13.0460-2838.2 602838	TRW 21479 19,2 + WK
			← 70-Y-000001→; +PR 1LE	13.0460-2839.2 602839	TRW 20651 18,3 + WK
			← +PR 1LA	13.0460-2972.2 602972	TRW 20124 18,9 - WK
			← → 70-X-250000; +PR 1LE	13.0460-2973.2 602973	TRW 20651 18,0 - WE / - WK
			← 70-P-160001→ 70-X-250000; +PR 1LP	13.0460-2982.2 602982	TRW 21479 19,2 - WK
			← 70-Y-000001→; +PR 1LU	13.0460-7124.2 607124	ATE 21883 19,8 + WK
			← 70-1-000955→; +PR 1LB	13.0460-7153.2 607153	ATE 23269 19,8 + WK
			→ 70-T-200000→; +PR 2E2	13.0460-2874.2 602874	TRW 23224 16,5 + WK + Zub
1.9 TD 2.0 2.4 D 2.5	50 62 57 81	10/92→04/03 07/90→04/03 07/90→04/98 11/90→04/03	← 70-Y-000001→; +PR 1LP	13.0460-2838.2 602838	TRW 21479 19,2 + WK
			← 70-Y-000001→; +PR 1LE	13.0460-2839.2 602839	TRW 20651 18,3 + WK
			← → 04/96; +PR 1LA	13.0460-2972.2 602972	TRW 20124 18,9 - WK
			← → 70-X-250000; +PR 1LE	13.0460-2973.2 602973	TRW 20651 18,0 - WE / - WK
			← 70-P-160001→ 70-X-250000; +PR 1LP	13.0460-2982.2 602982	TRW 21479 19,2 - WK
			← 05/96→; → 70-X-250000; +PR 1LU	13.0460-7102.2 607102	ATE 21883 19,8 - WE / - WK

↓







	kw			 	! #		
VW - TRANSPORTER T4 Kasten (70XA) 07/90→04/03							
 Bremsbelagsatz, Scheibenbremse							
1.9 TD 2.0 2.4 D 2.5	50 62 57 81	10/92→04/03 07/90→04/03 07/90→04/98 11/90→04/03	← 05/97→; → 70-1-000954; +PR 1LB ← 70-Y-000001→; +PR 1LU ← 70-1-000955→; +PR 1LB → 05/97→; +PR 2E3 → 70-T-200000→; +PR 2E2			13.0460-7123.2 607123 13.0460-7124.2 607124 13.0460-7153.2 607153 13.0460-2872.2 602872 13.0460-2874.2 602874	ATE 23034 18,8 + WK ATE 21883 19,8 + WK ATE 23269 19,8 + WK TRW 23224 16,5 + WK + Zub TRW 23224 16,5 + WK + Zub
2.4 D	55	08/97→04/03	← 70-Y-000001→; +PR 1LP ← 70-Y-000001→; +PR 1LE → 70-X-250000; +PR 1LE ← 70-P-160001→ 70-X-250000; +PR 1LP ← → 70-X-250000; +PR 1LU ← → 70-1-000954; +PR 1LB ← 70-Y-000001→; +PR 1LU ← 70-1-000955→; +PR 1LB → +PR 2E3 → 70-T-200000→; +PR 2E2			13.0460-2838.2 602838 13.0460-2839.2 602839 13.0460-2973.2 602973 13.0460-2982.2 602982 13.0460-7102.2 607102 13.0460-7123.2 607123 13.0460-7124.2 607124 13.0460-7153.2 607153 13.0460-2872.2 602872 13.0460-2874.2 602874	TRW 21479 19,2 + WK TRW 20651 18,3 + WK TRW 20651 18,0 - WE / - WK TRW 21479 19,2 - WK ATE 21883 19,8 - WE / - WK ATE 23034 18,8 + WK ATE 21883 19,8 + WK ATE 23269 19,8 + WK TRW 23224 16,5 + WK + Zub TRW 23224 16,5 + WK + Zub
2.4 D Syncro 2.5 Syncro	57 81	10/92→09/98 10/92→04/03	← 70-Y-000001→; +PR 1LP ← 70-Y-000001→; +PR 1LE ← 11/92→; → 70-X-250000; +PR 1LE ← 11/92→; → 70-X-250000; +PR 1LP ← 07/95→; → 70-X-250000; +PR 1LU ← 70-Y-000001→; +PR 1LU ← 07/95→; +PR 1LB → 05/97→; +PR 2E3 → 70-T-200000→; +PR 2E2			13.0460-2838.2 602838 13.0460-2839.2 602839 13.0460-2973.2 602973 13.0460-2982.2 602982 13.0460-7102.2 607102 13.0460-7124.2 607124 13.0460-7153.2 607153 13.0460-2872.2 602872 13.0460-2874.2 602874	TRW 21479 19,2 + WK TRW 20651 18,3 + WK TRW 20651 18,0 - WE / - WK TRW 21479 19,2 - WK ATE 21883 19,8 - WE / - WK ATE 21883 19,8 + WK ATE 23269 19,8 + WK TRW 23224 16,5 + WK + Zub TRW 23224 16,5 + WK + Zub
2.5	85	08/96→04/03	← 70-Y-000001→; +PR 1LP ← 70-Y-000001→; +PR 1LE → 70-X-250000; +PR 1LE ← 70-P-160001→ 70-X-250000; +PR 1LP ← → 70-X-250000; +PR 1LU ← 05/97→; → 70-1-000954; +PR 1LB ← 70-Y-000001→; +PR 1LU ← 70-1-000955→; +PR 1LB → 05/97→; +PR 2E3 → 70-T-200000→; +PR 2E2			13.0460-2838.2 602838 13.0460-2839.2 602839 13.0460-2973.2 602973 13.0460-2982.2 602982 13.0460-7102.2 607102 13.0460-7123.2 607123 13.0460-7124.2 607124 13.0460-7153.2 607153 13.0460-2872.2 602872 13.0460-2874.2 602874	TRW 21479 19,2 + WK TRW 20651 18,3 + WK TRW 20651 18,0 - WE / - WK TRW 21479 19,2 - WK ATE 21883 19,8 - WE / - WK ATE 23034 18,8 + WK ATE 21883 19,8 + WK ATE 23269 19,8 + WK TRW 23224 16,5 + WK + Zub TRW 23224 16,5 + WK + Zub
2.5 Syncro 2.5 TDI Syncro	85 75	08/96→04/03 09/95→04/03	← 70-Y-000001→; +PR 1LP ← 70-Y-000001→; +PR 1LE → 70-X-250000; +PR 1LE ← → 70-X-250000; +PR 1LP ← → 70-X-250000; +PR 1LU ← 70-Y-000001→; +PR 1LU ← +PR 1LB → 05/97→; +PR 2E3 → 70-T-200000→; +PR 2E2			13.0460-2838.2 602838 13.0460-2839.2 602839 13.0460-2973.2 602973 13.0460-2982.2 602982 13.0460-7102.2 607102 13.0460-7124.2 607124 13.0460-7153.2 607153 13.0460-2872.2 602872 13.0460-2874.2 602874	TRW 21479 19,2 + WK TRW 20651 18,3 + WK TRW 20651 18,0 - WE / - WK TRW 21479 19,2 - WK ATE 21883 19,8 - WE / - WK ATE 21883 19,8 + WK ATE 23269 19,8 + WK TRW 23224 16,5 + WK + Zub TRW 23224 16,5 + WK + Zub
2.5 TDI 2.5 TDI 2.8 VR6	65 111 150	12/98→04/03 09/00→04/03 06/00→04/03	← 70-Y-000001→; +PR 1LP ← 70-Y-000001→; +PR 1LE → 70-X-250000; +PR 1LE ← → 70-X-250000; +PR 1LP ← → 70-X-250000; +PR 1LU ← → 70-1-000954; +PR 1LB ← 70-Y-000001→; +PR 1LU ← 70-1-000955→; +PR 1LB → +PR 2E3			13.0460-2838.2 602838 13.0460-2839.2 602839 13.0460-2973.2 602973 13.0460-2982.2 602982 13.0460-7102.2 607102 13.0460-7123.2 607123 13.0460-7124.2 607124 13.0460-7153.2 607153 13.0460-2872.2 602872	TRW 21479 19,2 + WK TRW 20651 18,3 + WK TRW 20651 18,0 - WE / - WK TRW 21479 19,2 - WK ATE 21883 19,8 - WE / - WK ATE 23034 18,8 + WK ATE 21883 19,8 + WK ATE 23269 19,8 + WK TRW 23224 16,5 + WK + Zub
↓							







	kw				! #					
VW - TRANSPORTER T4 Kasten (70XA) 07/90→04/03										
 Bremsbelagsatz, Scheibenbremse										
2.5 TDI 2.5 TDI 2.8 VR6	65 111 150	12/98→04/03 09/00→04/03 06/00→04/03	➡	70-T-200000→; +PR 2E2		13.0460-2874.2 602874	TRW 23224 16,5 + WK + Zub			
2.5 TDI	75	09/95→04/03	⬅	70-Y-000001→; +PR 1LP		13.0460-2838.2 602838	TRW 21479 19,2 + WK			
			⬅	70-Y-000001→; +PR 1LE		13.0460-2839.2 602839	TRW 20651 18,3 + WK			
			⬅	→ 04/96; +PR 1LA		13.0460-2972.2 602972	TRW 20124 18,9 - WK			
			⬅	→ 70-X-250000; +PR 1LE		13.0460-2973.2 602973	TRW 20651 18,0 - WE / - WK			
			⬅	→ 70-X-250000; +PR 1LP		13.0460-2982.2 602982	TRW 21479 19,2 - WK			
			⬅	05/96→; → 70-X-250000; +PR 1LU		13.0460-7102.2 607102	ATE 21883 19,8 - WE / - WK			
			⬅	05/97→; → 70-1-000954; +PR 1LB		13.0460-7123.2 607123	ATE 23034 18,8 + WK			
			⬅	70-Y-000001→; +PR 1LU		13.0460-7124.2 607124	ATE 21883 19,8 + WK			
			⬅	70-1-000955→; +PR 1LB		13.0460-7153.2 607153	ATE 23269 19,8 + WK			
			➡	05/97→; +PR 2E3		13.0460-2872.2 602872	TRW 23224 16,5 + WK + Zub			
			➡	70-T-200000→; +PR 2E2		13.0460-2874.2 602874	TRW 23224 16,5 + WK + Zub			
2.8 VR6	103	05/96→05/00	⬅	70-Y-000001→; +PR 1LP		13.0460-2838.2 602838	TRW 21479 19,2 + WK			
			⬅	70-Y-000001→; +PR 1LE		13.0460-2839.2 602839	TRW 20651 18,3 + WK			
			⬅	→ 70-X-250000; +PR 1LE		13.0460-2973.2 602973	TRW 20651 18,0 - WE / - WK			
			⬅	→ 70-X-250000; +PR 1LP		13.0460-2982.2 602982	TRW 21479 19,2 - WK			
			⬅	→ 70-X-250000; +PR 1LU		13.0460-7102.2 607102	ATE 21883 19,8 - WE / - WK			
			⬅	05/97→; → 70-1-000954; +PR 1LB		13.0460-7123.2 607123	ATE 23034 18,8 + WK			
			⬅	70-Y-000001→; +PR 1LU		13.0460-7124.2 607124	ATE 21883 19,8 + WK			
			⬅	70-1-000955→; +PR 1LB		13.0460-7153.2 607153	ATE 23269 19,8 + WK			
			➡	05/97→; +PR 2E3		13.0460-2872.2 602872	TRW 23224 16,5 + WK + Zub			
			➡	70-T-200000→; +PR 2E2		13.0460-2874.2 602874	TRW 23224 16,5 + WK + Zub			
			Zubehörsatz, Scheibenbremsbelag							
1.9 D 1.9 D	44 45	09/90→12/95 07/90→12/95	⬅	70-Y-000001→; +PR 1LE		13.0460-0286.2 610286				
			⬅	→ 70-X-250000; +PR 1LE		13.0460-0286.2 610286				
			➡	70-T-200000→; +PR 2E2		13.0460-0225.2 610225				
1.9 TD 2.0 2.4 D 2.5 2.5 Syncro 2.5 TDI 2.5 TDI Syncro 2.8 VR6	50 62 57 81 85 85 75 75 103	10/92→04/03 07/90→04/03 07/90→04/98 11/90→04/03 08/96→04/03 08/96→04/03 09/95→04/03 09/95→04/03 05/96→05/00	⬅	70-Y-000001→; +PR 1LE		13.0460-0286.2 610286				
			⬅	→ 70-X-250000; +PR 1LE		13.0460-0286.2 610286				
			➡	70-T-200000→; +PR 2E2		13.0460-0225.2 610225				
			➡	05/97→; +PR 2E3		13.0460-0225.2 610225				
			2.4 D 2.5 TDI 2.5 TDI 2.8 VR6	55 65 111 150	08/97→04/03 12/98→04/03 09/00→04/03 06/00→04/03	⬅	70-Y-000001→; +PR 1LE		13.0460-0286.2 610286	
						⬅	→ 70-X-250000; +PR 1LE		13.0460-0286.2 610286	
						➡	+PR 2E3		13.0460-0225.2 610225	
						➡	70-T-200000→; +PR 2E2		13.0460-0225.2 610225	
2.4 D Syncro 2.5 Syncro	57 81	10/92→09/98 10/92→04/03				⬅	70-Y-000001→; +PR 1LE		13.0460-0286.2 610286	
			⬅	11/92→; → 70-X-250000; +PR 1LE		13.0460-0286.2 610286				
			➡	70-T-200000→; +PR 2E2		13.0460-0225.2 610225				
			➡	05/97→; +PR 2E3		13.0460-0225.2 610225				
 Bremsscheibe										
1.9 D 1.9 D	44 45	09/90→12/95 07/90→12/95	⬅	+PR 1LA		24.0116-0108.1 416108	Ø 260 16 13			
			⬅	70-P-160001→; +PR 1LP		24.0118-0105.1 418105	Ø 282 18 15			
			⬅	+PR 1LE,1LU		24.0124-0118.1 424118	Ø 280 24 20 V			
			⬅	70-1-000955→; +PR 1LB		24.0126-0119.1 426119	Ø 313 25,9 22 V			
						24.0326-0119.1 526119	Ø 313 25,9 22 V PD			
			➡	70-T-200000→; +PR 2E2		24.0112-0138.1 412138	Ø 280 12 10 + S			
1.9 TD 2.0 2.4 D 2.5	50 62 57 81	10/92→04/03 07/90→04/03 07/90→04/98 11/90→04/03	⬅	→ 04/96; +PR 1LA		24.0116-0108.1 416108	Ø 260 16 13			
			⬅	70-P-160001→; → 04/96; +PR 1LP		24.0118-0105.1 418105	Ø 282 18 15			
			⬅	05/96→; +PR 1LP		24.0118-0111.1 418111	Ø 282 18 15 + S			
			⬅	→ 04/96; +PR 1LE,1LU		24.0124-0118.1 424118	Ø 280 24 20 V			
↓										

	kw			 	! #		
VW - TRANSPORTER T4 Kasten (70XA) 07/90→04/03							
Bremsscheibe							
1.9 TD 2.0 2.4 D 2.5	50 62 57 81	10/92→04/03 07/90→04/03 07/90→04/98 11/90→04/03	← 05/96→; +PR 1LE,1LU ← 05/97→; → 70-1-000954; +PR 1LB ← 70-1-000955→; +PR 1LB → 70-T-200000→; +PR 2E2 → 05/97→; +PR 2E3			24.0124-0128.1 424128 24.0126-0115.1 426115 24.0326-0115.1 526115 24.0126-0119.1 426119 24.0326-0119.1 526119 24.0112-0138.1 412138 24.0113-0194.1 413194	Ø 280 24 20 V + S Ø 300 26 22 V Ø 300 26 22 V PD Ø 313 25,9 22 V Ø 313 25,9 22 V PD Ø 280 12 10 + S Ø 294 13,5 11,5
2.4 D 2.5 TDI 2.5 TDI 2.8 VR6	55 65 111 150	08/97→04/03 12/98→04/03 09/00→04/03 06/00→04/03	← +PR 1LP ← +PR 1LE,1LU ← → 70-1-000954; +PR 1LB ← 70-1-000955→; +PR 1LB → 70-T-200000→; +PR 2E2 → +PR 2E3			24.0118-0111.1 418111 24.0124-0128.1 424128 24.0126-0115.1 426115 24.0326-0115.1 526115 24.0126-0119.1 426119 24.0326-0119.1 526119 24.0112-0138.1 412138 24.0113-0194.1 413194	Ø 282 18 15 + S Ø 280 24 20 V + S Ø 300 26 22 V Ø 300 26 22 V PD Ø 313 25,9 22 V Ø 313 25,9 22 V PD Ø 280 12 10 + S Ø 294 13,5 11,5
2.4 D Syncro 2.5 Syncro	57 81	10/92→09/98 10/92→04/03	← 11/92→ 04/96; +PR 1LP ← 05/96→; +PR 1LP ← 11/92→ 06/95; +PR 1LE,1LU ← 07/95→; +PR 1LE,1LU ← 07/95→; +PR 1LB → 05/96→; +PR 2E2 → 05/97→; +PR 2E3			24.0118-0105.1 418105 24.0118-0111.1 418111 24.0124-0118.1 424118 24.0124-0128.1 424128 24.0126-0119.1 426119 24.0326-0119.1 526119 24.0112-0138.1 412138 24.0113-0194.1 413194	Ø 282 18 15 Ø 282 18 15 + S Ø 280 24 20 V Ø 280 24 20 V + S Ø 313 25,9 22 V Ø 313 25,9 22 V PD Ø 280 12 10 + S Ø 294 13,5 11,5
2.5 2.8 VR6	85 103	08/96→04/03 05/96→05/00	← +PR 1LP ← +PR 1LE,1LU ← 05/97→; → 70-1-000954; +PR 1LB ← 70-1-000955→; +PR 1LB → 70-T-200000→; +PR 2E2 → 05/97→; +PR 2E3			24.0118-0111.1 418111 24.0124-0128.1 424128 24.0126-0115.1 426115 24.0326-0115.1 526115 24.0126-0119.1 426119 24.0326-0119.1 526119 24.0112-0138.1 412138 24.0113-0194.1 413194	Ø 282 18 15 + S Ø 280 24 20 V + S Ø 300 26 22 V Ø 300 26 22 V PD Ø 313 25,9 22 V Ø 313 25,9 22 V PD Ø 280 12 10 + S Ø 294 13,5 11,5
2.5 Syncro	85	08/96→04/03	← +PR 1LP ← +PR 1LE,1LU ← +PR 1LB → +PR 2E2 → 05/97→; +PR 2E3			24.0118-0111.1 418111 24.0124-0128.1 424128 24.0126-0119.1 426119 24.0326-0119.1 526119 24.0112-0138.1 412138 24.0113-0194.1 413194	Ø 282 18 15 + S Ø 280 24 20 V + S Ø 313 25,9 22 V Ø 313 25,9 22 V PD Ø 280 12 10 + S Ø 294 13,5 11,5
2.5 TDI	75	09/95→04/03	← → 04/96; +PR 1LA ← → 04/96; +PR 1LP ← 05/96→; +PR 1LP ← → 04/96; +PR 1LE,1LU ← 05/96→; +PR 1LE,1LU ← 05/97→; → 70-1-000954; +PR 1LB ← 70-1-000955→; +PR 1LB → 70-T-200000→; +PR 2E2 → 05/97→; +PR 2E3			24.0116-0108.1 416108 24.0118-0105.1 418105 24.0118-0111.1 418111 24.0124-0118.1 424118 24.0124-0128.1 424128 24.0126-0115.1 426115 24.0326-0115.1 526115 24.0126-0119.1 426119 24.0326-0119.1 526119 24.0112-0138.1 412138 24.0113-0194.1 413194	Ø 260 16 13 Ø 282 18 15 Ø 282 18 15 + S Ø 280 24 20 V Ø 280 24 20 V + S Ø 300 26 22 V Ø 300 26 22 V PD Ø 313 25,9 22 V Ø 313 25,9 22 V PD Ø 280 12 10 + S Ø 294 13,5 11,5
2.5 TDI Syncro	75	09/95→04/03	← → 04/96; +PR 1LP ← 05/96→; +PR 1LP ← +PR 1LE,1LU ← +PR 1LB → 05/96→; +PR 2E2 → 05/97→; +PR 2E3			24.0118-0105.1 418105 24.0118-0111.1 418111 24.0124-0128.1 424128 24.0126-0119.1 426119 24.0326-0119.1 526119 24.0112-0138.1 412138 24.0113-0194.1 413194	Ø 282 18 15 Ø 282 18 15 + S Ø 280 24 20 V + S Ø 313 25,9 22 V Ø 313 25,9 22 V PD Ø 280 12 10 + S Ø 294 13,5 11,5







	kw			 	! #		
VW - TRANSPORTER T4 Pritsche/Fahrgestell (70XD) 07/90→04/03							
 Bremsbelagsatz, Scheibenbremse							
1.9 D	44	09/90→12/95	←	70-Y-000001→; +PR 1LP		13.0460-2838.2 602838	TRW 21479 19,2 + WK
1.9 D	45	07/90→12/95	←	70-Y-000001→; +PR 1LE		13.0460-2839.2 602839	TRW 20651 18,3 + WK
			←	+PR 1LA		13.0460-2972.2 602972	TRW 20124 18,9 - WK
			←	→ 70-X-250000; +PR 1LE		13.0460-2973.2 602973	TRW 20651 18,0 - WE / - WK
			←	70-P-160001→ 70-X-250000; +PR 1LP		13.0460-2982.2 602982	TRW 21479 19,2 - WK
			←	70-Y-000001→; +PR 1LU		13.0460-7124.2 607124	ATE 21883 19,8 + WK
			←	70-1-000955→; +PR 1LB		13.0460-7153.2 607153	ATE 23269 19,8 + WK
			→	70-T-200000→; +PR 2E2		13.0460-2874.2 602874	TRW 23224 16,5 + WK + Zub
1.9 TD	50	10/92→04/03	←	70-Y-000001→; +PR 1LP		13.0460-2838.2 602838	TRW 21479 19,2 + WK
2.0	62	07/90→04/03	←	70-Y-000001→; +PR 1LE		13.0460-2839.2 602839	TRW 20651 18,3 + WK
2.4 D	57	09/90→04/98	←	→ 04/96; +PR 1LA		13.0460-2972.2 602972	TRW 20124 18,9 - WK
2.5	81	11/90→04/03	←	→ 70-X-250000; +PR 1LE		13.0460-2973.2 602973	TRW 20651 18,0 - WE / - WK
			←	70-P-160001→ 70-X-250000; +PR 1LP		13.0460-2982.2 602982	TRW 21479 19,2 - WK
			←	05/96→; → 70-X-250000; +PR 1LU		13.0460-7102.2 607102	ATE 21883 19,8 - WE / - WK
			←	05/97→; → 70-1-000954; +PR 1LB		13.0460-7123.2 607123	ATE 23034 18,8 + WK
			←	70-Y-000001→; +PR 1LU		13.0460-7124.2 607124	ATE 21883 19,8 + WK
			←	70-1-000955→; +PR 1LB		13.0460-7153.2 607153	ATE 23269 19,8 + WK
			→	05/97→; +PR 2E3		13.0460-2872.2 602872	TRW 23224 16,5 + WK + Zub
			→	70-T-200000→; +PR 2E2		13.0460-2874.2 602874	TRW 23224 16,5 + WK + Zub
2.4 D	55	08/97→04/03	←	70-Y-000001→; +PR 1LP		13.0460-2838.2 602838	TRW 21479 19,2 + WK
			←	70-Y-000001→; +PR 1LE		13.0460-2839.2 602839	TRW 20651 18,3 + WK
			←	→ 70-X-250000; +PR 1LE		13.0460-2973.2 602973	TRW 20651 18,0 - WE / - WK
			←	70-P-160001→ 70-X-250000; +PR 1LP		13.0460-2982.2 602982	TRW 21479 19,2 - WK
			←	→ 70-X-250000; +PR 1LU		13.0460-7102.2 607102	ATE 21883 19,8 - WE / - WK
			←	→ 70-1-000954; +PR 1LB		13.0460-7123.2 607123	ATE 23034 18,8 + WK
			←	70-Y-000001→; +PR 1LU		13.0460-7124.2 607124	ATE 21883 19,8 + WK
			←	70-1-000955→; +PR 1LB		13.0460-7153.2 607153	ATE 23269 19,8 + WK
			→	+PR 2E3		13.0460-2872.2 602872	TRW 23224 16,5 + WK + Zub
			→	70-T-200000→; +PR 2E2		13.0460-2874.2 602874	TRW 23224 16,5 + WK + Zub
2.4 D Syncro	57	10/92→09/98	←	70-Y-000001→; +PR 1LP		13.0460-2838.2 602838	TRW 21479 19,2 + WK
2.5 Syncro	81	10/92→04/03	←	70-Y-000001→; +PR 1LE		13.0460-2839.2 602839	TRW 20651 18,3 + WK
			←	11/92→; → 70-X-250000; +PR 1LE		13.0460-2973.2 602973	TRW 20651 18,0 - WE / - WK
			←	11/92→; → 70-X-250000; +PR 1LP		13.0460-2982.2 602982	TRW 21479 19,2 - WK
			←	07/95→; → 70-X-250000; +PR 1LU		13.0460-7102.2 607102	ATE 21883 19,8 - WE / - WK
			←	70-Y-000001→; +PR 1LU		13.0460-7124.2 607124	ATE 21883 19,8 + WK
			←	07/95→; +PR 1LB		13.0460-7153.2 607153	ATE 23269 19,8 + WK
			→	05/97→; +PR 2E3		13.0460-2872.2 602872	TRW 23224 16,5 + WK + Zub
			→	70-T-200000→; +PR 2E2		13.0460-2874.2 602874	TRW 23224 16,5 + WK + Zub
2.5	85	08/96→04/03	←	70-Y-000001→; +PR 1LP		13.0460-2838.2 602838	TRW 21479 19,2 + WK
			←	70-Y-000001→; +PR 1LE		13.0460-2839.2 602839	TRW 20651 18,3 + WK
			←	→ 70-X-250000; +PR 1LE		13.0460-2973.2 602973	TRW 20651 18,0 - WE / - WK
			←	70-P-160001→ 70-X-250000; +PR 1LP		13.0460-2982.2 602982	TRW 21479 19,2 - WK
			←	→ 70-X-250000; +PR 1LU		13.0460-7102.2 607102	ATE 21883 19,8 - WE / - WK
			←	05/97→; → 70-1-000954; +PR 1LB		13.0460-7123.2 607123	ATE 23034 18,8 + WK
			←	70-Y-000001→; +PR 1LU		13.0460-7124.2 607124	ATE 21883 19,8 + WK
			←	70-1-000955→; +PR 1LB		13.0460-7153.2 607153	ATE 23269 19,8 + WK
			→	05/97→; +PR 2E3		13.0460-2872.2 602872	TRW 23224 16,5 + WK + Zub
			→	70-T-200000→; +PR 2E2		13.0460-2874.2 602874	TRW 23224 16,5 + WK + Zub
2.5 Syncro	85	08/96→04/03	←	70-Y-000001→; +PR 1LP		13.0460-2838.2 602838	TRW 21479 19,2 + WK
			←	70-Y-000001→; +PR 1LE		13.0460-2839.2 602839	TRW 20651 18,3 + WK
			←	→ 70-X-250000; +PR 1LE		13.0460-2973.2 602973	TRW 20651 18,0 - WE / - WK
			←	→ 70-X-250000; +PR 1LP		13.0460-2982.2 602982	TRW 21479 19,2 - WK

















	kw			 	! #		
VW - TRANSPORTER T4 Pritsche/Fahrgestell (70XD) 07/90→04/03							
Bremsbelagsatz, Scheibenbremse							
2.5 Syncro	85	08/96→04/03	←	→ 70-X-250000; +PR 1LU	13.0460-7102.2	607102	ATE 21883 19,8 - WE / - WK
			←	70-Y-000001→; +PR 1LU	13.0460-7124.2	607124	ATE 21883 19,8 + WK
			←	+PR 1LB	13.0460-7153.2	607153	ATE 23269 19,8 + WK
			→	05/97→; +PR 2E3	13.0460-2872.2	602872	TRW 23224 16,5 + WK + Zub
			→	70-T-200000→; +PR 2E2	13.0460-2874.2	602874	TRW 23224 16,5 + WK + Zub
2.5 TDI	65	05/98→04/03	←	70-Y-000001→; +PR 1LP	13.0460-2838.2	602838	TRW 21479 19,2 + WK
			←	70-Y-000001→; +PR 1LE	13.0460-2839.2	602839	TRW 20651 18,3 + WK
			←	→ 70-X-250000; +PR 1LE	13.0460-2973.2	602973	TRW 20651 18,0 - WE / - WK
			←	→ 70-X-250000; +PR 1LP	13.0460-2982.2	602982	TRW 21479 19,2 - WK
			←	→ 70-X-250000; +PR 1LU	13.0460-7102.2	607102	ATE 21883 19,8 - WE / - WK
			←	→ 70-1-000954; +PR 1LB	13.0460-7123.2	607123	ATE 23034 18,8 + WK
			←	70-Y-000001→; +PR 1LU	13.0460-7124.2	607124	ATE 21883 19,8 + WK
			←	70-1-000955→; +PR 1LB	13.0460-7153.2	607153	ATE 23269 19,8 + WK
			→	+PR 2E3	13.0460-2872.2	602872	TRW 23224 16,5 + WK + Zub
			→	70-T-200000→; +PR 2E2	13.0460-2874.2	602874	TRW 23224 16,5 + WK + Zub
2.5 TDI	75	09/95→04/03	←	70-Y-000001→; +PR 1LP	13.0460-2838.2	602838	TRW 21479 19,2 + WK
			←	70-Y-000001→; +PR 1LE	13.0460-2839.2	602839	TRW 20651 18,3 + WK
			←	→ 04/96; +PR 1LA	13.0460-2972.2	602972	TRW 20124 18,9 - WK
			←	→ 70-X-250000; +PR 1LE	13.0460-2973.2	602973	TRW 20651 18,0 - WE / - WK
			←	→ 70-X-250000; +PR 1LP	13.0460-2982.2	602982	TRW 21479 19,2 - WK
			←	05/96→; → 70-X-250000; +PR 1LU	13.0460-7102.2	607102	ATE 21883 19,8 - WE / - WK
			←	05/97→; → 70-1-000954; +PR 1LB	13.0460-7123.2	607123	ATE 23034 18,8 + WK
			←	70-Y-000001→; +PR 1LU	13.0460-7124.2	607124	ATE 21883 19,8 + WK
			←	70-1-000955→; +PR 1LB	13.0460-7153.2	607153	ATE 23269 19,8 + WK
			→	05/97→; +PR 2E3	13.0460-2872.2	602872	TRW 23224 16,5 + WK + Zub
→	70-T-200000→; +PR 2E2	13.0460-2874.2	602874	TRW 23224 16,5 + WK + Zub			
2.5 TDI Syncro	75	05/98→04/03	←	70-Y-000001→; +PR 1LP	13.0460-2838.2	602838	TRW 21479 19,2 + WK
			←	70-Y-000001→; +PR 1LE	13.0460-2839.2	602839	TRW 20651 18,3 + WK
			←	→ 70-X-250000; +PR 1LE	13.0460-2973.2	602973	TRW 20651 18,0 - WE / - WK
			←	→ 70-X-250000; +PR 1LP	13.0460-2982.2	602982	TRW 21479 19,2 - WK
			←	→ 70-X-250000; +PR 1LU	13.0460-7102.2	607102	ATE 21883 19,8 - WE / - WK
			←	70-Y-000001→; +PR 1LU	13.0460-7124.2	607124	ATE 21883 19,8 + WK
			←	+PR 1LB	13.0460-7153.2	607153	ATE 23269 19,8 + WK
			→	+PR 2E3	13.0460-2872.2	602872	TRW 23224 16,5 + WK + Zub
			→	70-T-200000→; +PR 2E2	13.0460-2874.2	602874	TRW 23224 16,5 + WK + Zub
			Zubehörsatz, Scheibenbremsbelag				
1.9 D	44	09/90→12/95	←	70-Y-000001→; +PR 1LE	13.0460-0286.2	610286	
	45	07/90→12/95	←	→ 70-X-250000; +PR 1LE	13.0460-0286.2	610286	
			→	70-T-200000→; +PR 2E2	13.0460-0225.2	610225	
1.9 TD	50	10/92→04/03	←	70-Y-000001→; +PR 1LE	13.0460-0286.2	610286	
2.0	62	07/90→04/03	←	→ 70-X-250000; +PR 1LE	13.0460-0286.2	610286	
2.4 D	57	09/90→04/98	←	→ 70-X-250000; +PR 1LE	13.0460-0286.2	610286	
2.5	81	11/90→04/03	→	70-T-200000→; +PR 2E2	13.0460-0225.2	610225	
2.5	85	08/96→04/03	→	05/97→; +PR 2E3	13.0460-0225.2	610225	
2.5 Syncro	85	08/96→04/03	→	05/97→; +PR 2E3	13.0460-0225.2	610225	
2.5 TDI	75	09/95→04/03	←	70-Y-000001→; +PR 1LE	13.0460-0286.2	610286	
2.4 D	55	08/97→04/03	←	→ 70-X-250000; +PR 1LE	13.0460-0286.2	610286	
2.5 TDI	65	05/98→04/03	←	→ 70-X-250000; +PR 1LE	13.0460-0286.2	610286	
2.5 TDI Syncro	75	05/98→04/03	→	+PR 2E3	13.0460-0225.2	610225	
			→	70-T-200000→; +PR 2E2	13.0460-0225.2	610225	
2.4 D Syncro	57	10/92→09/98	←	70-Y-000001→; +PR 1LE	13.0460-0286.2	610286	
2.5 Syncro	81	10/92→04/03	←	11/92→; → 70-X-250000; +PR 1LE	13.0460-0286.2	610286	
			→	70-T-200000→; +PR 2E2	13.0460-0225.2	610225	
			→	05/97→; +PR 2E3	13.0460-0225.2	610225	
↓							







	kw			 	! #		
VW - TRANSPORTER T4 Pritsche/Fahrgestell (70XD) 07/90→04/03							
Bremsscheibe							
1.9 D 1.9 D	44	09/90→12/95	←	+PR 1LA		24.0116-0108.1 416108	Ø 260 16 13
	45	07/90→12/95	←	70-P-160001→; +PR 1LP		24.0118-0105.1 418105	Ø 282 18 15
			←	+PR 1LE,1LU		24.0124-0118.1 424118	Ø 280 24 20 V
			←	70-1-000955→; +PR 1LB		24.0126-0119.1 426119	Ø 313 25,9 22 V
			→	70-T-200000→; +PR 2E2		24.0112-0138.1 412138	Ø 280 12 10 + S
1.9 TD 2.0 2.4 D 2.5	50	10/92→04/03	←	→ 04/96; +PR 1LA		24.0116-0108.1 416108	Ø 260 16 13
	62	07/90→04/03	←	70-P-160001→; → 04/96; +PR 1LP		24.0118-0105.1 418105	Ø 282 18 15
	57	09/90→04/98	←	05/96→; +PR 1LP		24.0118-0111.1 418111	Ø 282 18 15 + S
	81	11/90→04/03	←	→ 04/96; +PR 1LE,1LU		24.0124-0118.1 424118	Ø 280 24 20 V
			←	05/96→; +PR 1LE,1LU		24.0124-0128.1 424128	Ø 280 24 20 V + S
			←	05/97→; → 70-1-000954; +PR 1LB		24.0126-0115.1 426115	Ø 300 26 22 V
				24.0326-0115.1 526115		Ø 300 26 22 V PD	
			←	70-1-000955→; +PR 1LB		24.0126-0119.1 426119	Ø 313 25,9 22 V
				24.0326-0119.1 526119		Ø 313 25,9 22 V PD	
			→	70-T-200000→; +PR 2E2		24.0112-0138.1 412138	Ø 280 12 10 + S
2.4 D 2.5 TDI	55	08/97→04/03	←	+PR 1LP		24.0118-0111.1 418111	Ø 282 18 15 + S
	65	05/98→04/03	←	+PR 1LE,1LU		24.0124-0128.1 424128	Ø 280 24 20 V + S
			←	→ 70-1-000954; +PR 1LB		24.0126-0115.1 426115	Ø 300 26 22 V
				24.0326-0115.1 526115		Ø 300 26 22 V PD	
			←	70-1-000955→; +PR 1LB		24.0126-0119.1 426119	Ø 313 25,9 22 V
				24.0326-0119.1 526119		Ø 313 25,9 22 V PD	
2.4 D Syncro 2.5 Syncro	57	10/92→09/98	←	11/92→ 04/96; +PR 1LP		24.0118-0105.1 418105	Ø 282 18 15
	81	10/92→04/03	←	05/96→; +PR 1LP		24.0118-0111.1 418111	Ø 282 18 15 + S
			←	11/92→ 06/95; +PR 1LE,1LU		24.0124-0118.1 424118	Ø 280 24 20 V
			←	07/95→; +PR 1LE,1LU		24.0124-0128.1 424128	Ø 280 24 20 V + S
			←	07/95→; +PR 1LB		24.0126-0119.1 426119	Ø 313 25,9 22 V
				24.0326-0119.1 526119		Ø 313 25,9 22 V PD	
			→	05/96→; +PR 2E2		24.0112-0138.1 412138	Ø 280 12 10 + S
2.5	85	08/96→04/03	←	+PR 1LP		24.0118-0111.1 418111	Ø 282 18 15 + S
			←	+PR 1LE,1LU		24.0124-0128.1 424128	Ø 280 24 20 V + S
			←	05/97→; → 70-1-000954; +PR 1LB		24.0126-0115.1 426115	Ø 300 26 22 V
				24.0326-0115.1 526115		Ø 300 26 22 V PD	
			←	70-1-000955→; +PR 1LB		24.0126-0119.1 426119	Ø 313 25,9 22 V
				24.0326-0119.1 526119		Ø 313 25,9 22 V PD	
2.5 Syncro	85	08/96→04/03	←	+PR 1LP		24.0118-0111.1 418111	Ø 282 18 15 + S
			←	+PR 1LE,1LU		24.0124-0128.1 424128	Ø 280 24 20 V + S
			←	+PR 1LB		24.0126-0119.1 426119	Ø 313 25,9 22 V
				24.0326-0119.1 526119		Ø 313 25,9 22 V PD	
			→	+PR 2E2		24.0112-0138.1 412138	Ø 280 12 10 + S
2.5 TDI	75	09/95→04/03	←	→ 04/96; +PR 1LA		24.0116-0108.1 416108	Ø 260 16 13
			←	→ 04/96; +PR 1LP		24.0118-0105.1 418105	Ø 282 18 15
			←	05/96→; +PR 1LP		24.0118-0111.1 418111	Ø 282 18 15 + S
			←	→ 04/96; +PR 1LE,1LU		24.0124-0118.1 424118	Ø 280 24 20 V
			←	05/96→; +PR 1LE,1LU		24.0124-0128.1 424128	Ø 280 24 20 V + S
			←	05/97→; → 70-1-000954; +PR 1LB		24.0126-0115.1 426115	Ø 300 26 22 V
				24.0326-0115.1 526115		Ø 300 26 22 V PD	
		←	70-1-000955→; +PR 1LB		24.0126-0119.1 426119	Ø 313 25,9 22 V	
			24.0326-0119.1 526119		Ø 313 25,9 22 V PD		



	kw				! #		
VW - TRANSPORTER T4 Pritsche/Fahrgestell (70XD) 07/90→04/03							
Bremsscheibe							
2.5 TDI	75	09/95→04/03	➔	70-T-200000→; +PR 2E2		24.0112-0138.1 412138	Ø 280 12 10 + S
			➔	05/97→; +PR 2E3		24.0113-0194.1 413194	Ø 294 13,5 11,5
2.5 TDI Syncro	75	05/98→04/03	➔	+PR 1LP		24.0118-0111.1 418111	Ø 282 18 15 + S
			➔	+PR 1LE, 1LU		24.0124-0128.1 424128	Ø 280 24 20 V + S
			➔	+PR 1LB		24.0126-0119.1 426119	Ø 313 25,9 22 V
			➔	+PR 2E2		24.0326-0119.1 526119	Ø 313 25,9 22 V PD
			➔	+PR 2E2		24.0112-0138.1 412138	Ø 280 12 10 + S
			➔	+PR 2E3		24.0113-0194.1 413194	Ø 294 13,5 11,5
VW - TRANSPORTER T5 Bus (7HB, 7HJ, 7EB, 7EJ, 7EF, 7EG, 7HF, 7EC) 04/03→08/15							
Bremsbelagsatz, Scheibenbremse							
1.9 TDI	62	01/06→11/09	➔	+PR 2E3		13.0460-7236.2 607236	ATE 23746 19,7 + WK
1.9 TDI	75	06/06→11/09	➔	+PR 2E4; → 7H-A-050000		13.0460-7240.2 607240	ATE 23746 18,1 + WK
			➔	7H-A-200001→; +PR 2E4		13.0460-7286.2 607286	ATE 24623 18,2 + WK
			➔	7H-A-200001→		13.0460-2882.2 602882	TRW 23326 17,4 + WK + Zub
			➔	7H-8-028000→; +PR 0WR; → 7H-8-200000		13.0460-2882.2 602882	TRW 23326 17,4 + WK + Zub
			➔	7H-6-000001→; +PR 2E3,2E4; → 7H-A-050000		13.0460-2882.2 602882	TRW 23326 17,4 + WK + Zub
			➔	+PR 0WR; → 7H-8-027999		13.0460-7218.2 607218	ATE 24367 19,1 + WK
1.9 TDI	63	04/03→11/09	➔	+PR 2E3		13.0460-7236.2 607236	ATE 23746 19,7 + WK
1.9 TDI	77	04/03→11/09	➔	+PR 2E4; → 7H-A-050000		13.0460-7240.2 607240	ATE 23746 18,1 + WK
2.0	85	11/03→08/15	➔	7H-A-200001→; +PR 2E4		13.0460-7286.2 607286	ATE 24623 18,2 + WK
2.5 TDi	120	11/03→11/09	➔	7H-8-028000→; +PR 0WR; → 7H-8-200000		13.0460-2882.2 602882	TRW 23326 17,4 + WK + Zub
2.5 TDI	96	04/03→11/09	➔	7H-A-200001→		13.0460-2882.2 602882	TRW 23326 17,4 + WK + Zub
2.5 TDI	128	04/03→11/09	➔	7H-6-000001→; +PR 2E3,2E4; → 7H-A-050000		13.0460-2882.2 602882	TRW 23326 17,4 + WK + Zub
2.5 TDI 4motion	96	07/04→11/09	➔	7H-A-200001→		13.0460-2882.2 602882	TRW 23326 17,4 + WK + Zub
2.5 TDI 4motion	128	07/04→11/09	➔	7H-6-000001→; +PR 2E3,2E4; → 7H-A-050000		13.0460-2882.2 602882	TRW 23326 17,4 + WK + Zub
3.2 V6	170	02/04→06/04	➔	+PR OWL,OWN / OWM,OWP,OWQ; → 7H-5-120000		13.0460-2882.2 602882	TRW 23326 17,4 + WK + Zub
3.2 V6	173	02/04→11/09	➔	+PR 0WR; → 7H-8-027999		13.0460-7218.2 607218	ATE 24367 19,1 + WK
2.0 BiTDI	132	09/09→08/15	➔	+PR 2E3		13.0460-7236.2 607236	ATE 23746 19,7 + WK
2.0 BiTDI 4motion	132	09/09→08/15	➔	+PR 2E4; → 7H-A-050000		13.0460-7240.2 607240	ATE 23746 18,1 + WK
2.0 TDI	62	09/09→08/15	➔	7H-A-200001→; +PR 2E4		13.0460-7286.2 607286	ATE 24623 18,2 + WK
2.0 TDI	75	09/09→08/15	➔	7H-A-200001→		13.0460-2882.2 602882	TRW 23326 17,4 + WK + Zub
2.0 TDI	103	09/09→08/15	➔	7H-6-000001→; +PR 2E3,2E4; → 7H-A-050000		13.0460-2882.2 602882	TRW 23326 17,4 + WK + Zub
2.0 TDI 4motion	103	09/09→08/15	➔	+PR 2E3		13.0460-7236.2 607236	ATE 23746 19,7 + WK
2.0 TDI	84	05/11→08/15	➔	+PR 2E4		13.0460-7286.2 607286	ATE 24623 18,2 + WK
2.0 TSI	110	07/12→08/15	➔			13.0460-2882.2 602882	TRW 23326 17,4 + WK + Zub
2.0 TSI	150	05/11→08/15	➔				
2.0 TSI 4motion	150	07/11→08/15	➔				
2.0 TDI	100	05/10→08/15	➔	+PR 2E3		13.0460-7236.2 607236	ATE 23746 19,7 + WK
2.0 TDI 4motion	100	05/10→08/15	➔	7H-A-200001→; +PR 2E4		13.0460-7286.2 607286	ATE 24623 18,2 + WK
			➔	7H-A-200001→		13.0460-2882.2 602882	TRW 23326 17,4 + WK + Zub
3.2 V6 4motion	173	11/03→11/09	➔	07/04→; +PR 2E3		13.0460-7236.2 607236	ATE 23746 19,7 + WK
			➔	07/04→; +PR 2E4; → 7H-A-050000		13.0460-7240.2 607240	ATE 23746 18,1 + WK
			➔	7H-A-200001→; +PR 2E4		13.0460-7286.2 607286	ATE 24623 18,2 + WK
			➔	7H-8-028000→; +PR 0WR; → 7H-8-200000		13.0460-2882.2 602882	TRW 23326 17,4 + WK + Zub
			➔	07/04→; +PR OWL,OWN / OWM,OWP,OWQ; → 7H-5-120000		13.0460-2882.2 602882	TRW 23326 17,4 + WK + Zub
			➔	7H-A-200001→		13.0460-2882.2 602882	TRW 23326 17,4 + WK + Zub
			➔	7H-6-000001→; +PR 2E3,2E4; → 7H-A-050000		13.0460-2882.2 602882	TRW 23326 17,4 + WK + Zub
			➔	07/04→; +PR 0WR; → 7H-8-027999		13.0460-7218.2 607218	ATE 24367 19,1 + WK
Zubehörsatz, Scheibenbremsbelag							
1.9 TDI	62	01/06→11/09	➔	7H-8-028000→; +PR 0WR; → 7H-8-200000		13.0460-0023.2 610023	
1.9 TDI	75	06/06→11/09	➔	7H-A-200001→		13.0460-0023.2 610023	
↓							

	kW			 	! #		
VW - TRANSPORTER T5 Bus (7HB, 7HJ, 7EB, 7EJ, 7EF, 7EG, 7HF, 7EC) 04/03→08/15							
Zubehörsatz, Scheibenbremsbelag							
1.9 TDI 1.9 TDI	62 75	01/06→11/09 06/06→11/09	➡	7H-6-000001→; +PR 2E3,2E4; → 7H-A-050000		13.0460-0023.2 610023	
1.9 TDI 1.9 TDI 2.0 2.5 TDi 2.5 TDI 2.5 TDI 2.5 TDI 4motion 2.5 TDI 4motion 3.2 V6 3.2 V6	63 77 85 120 96 128 96 128 170 173	04/03→11/09 04/03→11/09 11/03→08/15 11/03→11/09 04/03→11/09 04/03→11/09 07/04→11/09 07/04→11/09 02/04→06/04 02/04→11/09	➡	7H-8-028000→; +PR 0WR; → 7H-8-200000		13.0460-0023.2 610023	
			➡	+PR 0WL,0WN / 0WM,0WP,0WQ; → 7H-5-120000		13.0460-0023.2 610023	
			➡	7H-6-000001→; +PR 2E3,2E4; → 7H-A-050000		13.0460-0023.2 610023	
			➡	7H-A-200001→		13.0460-0023.2 610023	
2.0 BiTDI 2.0 BiTDI 4motion 2.0 TDI 2.0 TDI 2.0 TDI 2.0 TDI 4motion	132 132 62 75 103 103	09/09→08/15 09/09→08/15 09/09→08/15 09/09→08/15 09/09→08/15 09/09→08/15	➡	7H-A-200001→		13.0460-0023.2 610023	
			➡	7H-6-000001→; +PR 2E3,2E4; → 7H-A-050000		13.0460-0023.2 610023	
2.0 TDI 2.0 TSI 2.0 TSI 2.0 TSI 4motion	84 110 150 150	05/11→08/15 07/12→08/15 05/11→08/15 07/11→08/15	➡			13.0460-0023.2 610023	
2.0 TDI 2.0 TDI 4motion	100 100	05/10→08/15 05/10→08/15	➡	7H-A-200001→		13.0460-0023.2 610023	
3.2 V6 4motion	173	11/03→11/09	➡	7H-A-200001→		13.0460-0023.2 610023	
			➡	7H-8-028000→; +PR 0WR; → 7H-8-200000		13.0460-0023.2 610023	
			➡	7H-6-000001→; +PR 2E3,2E4; → 7H-A-050000		13.0460-0023.2 610023	
			➡	07/04→; +PR 0WL,0WN / 0WM,0WP,0WQ; → 7H-5-120000		13.0460-0023.2 610023	
Bremsscheibe							
1.9 TDI 1.9 TDI	62 75	01/06→11/09 06/06→11/09	←	+PR 2E3		24.0130-0114.1 430114	Ø 308 29,5 25,5 V
			←	→ 7H-A-050000; +PR 2E4		24.0132-0116.1 432116	Ø 333 32,5 28,5 V + S
			←	7H-A-200001→; +PR 2E4		24.0133-0100.1 433100	Ø 340 32,6 29,5 V + S
			➡	7H-A-200001→		24.0122-0211.1 422211	Ø 294 21,9 19,5 V + S
			➡	7H-8-028000→; +PR 0WR; → 7H-8-200000		24.0122-0211.1 422211	Ø 294 21,9 19,5 V + S
			➡	7H-6-000001→; +PR 2E3,2E4; → 7H-A-050000		24.0122-0211.1 422211	Ø 294 21,9 19,5 V + S
			➡	+PR 0WR; → 7H-8-027999		24.0122-0215.1 422215	Ø 314 22 18 V + S
1.9 TDI 1.9 TDI 2.0 2.5 TDi 2.5 TDI 2.5 TDI 2.5 TDI 4motion 2.5 TDI 4motion 3.2 V6 3.2 V6	63 77 85 120 96 128 96 128 170 173	04/03→11/09 04/03→11/09 11/03→08/15 11/03→11/09 04/03→11/09 04/03→11/09 07/04→11/09 07/04→11/09 02/04→06/04 02/04→11/09	←	+PR 2E3		24.0130-0114.1 430114	Ø 308 29,5 25,5 V
			←	→ 7H-A-050000; +PR 2E4		24.0132-0116.1 432116	Ø 333 32,5 28,5 V + S
			←	7H-A-200001→; +PR 2E4		24.0133-0100.1 433100	Ø 340 32,6 29,5 V + S
			➡	7H-8-028000→; +PR 0WR; → 7H-8-200000		24.0122-0211.1 422211	Ø 294 21,9 19,5 V + S
			➡	7H-A-200001→		24.0122-0211.1 422211	Ø 294 21,9 19,5 V + S
			➡	7H-6-000001→; +PR 2E3,2E4; → 7H-A-050000		24.0122-0211.1 422211	Ø 294 21,9 19,5 V + S
			➡	+PR 0WL,0WN / 0WM,0WP,0WQ; → 7H-5-120000		24.0122-0211.1 422211	Ø 294 21,9 19,5 V + S
			➡	+PR 0WR; → 7H-8-027999		24.0122-0215.1 422215	Ø 314 22 18 V + S
2.0 BiTDI 2.0 BiTDI 4motion 2.0 TDI 2.0 TDI 2.0 TDI 2.0 TDI 4motion	132 132 62 75 103 103	09/09→08/15 09/09→08/15 09/09→08/15 09/09→08/15 09/09→08/15 09/09→08/15	←	+PR 2E3		24.0130-0114.1 430114	Ø 308 29,5 25,5 V
			←	→ 7H-A-050000; +PR 2E4		24.0132-0116.1 432116	Ø 333 32,5 28,5 V + S
			←	7H-A-200001→; +PR 2E4		24.0133-0100.1 433100	Ø 340 32,6 29,5 V + S
			➡	7H-A-200001→		24.0122-0211.1 422211	Ø 294 21,9 19,5 V + S
			➡	7H-6-000001→; +PR 2E3,2E4; → 7H-A-050000		24.0122-0211.1 422211	Ø 294 21,9 19,5 V + S
2.0 TDI 2.0 TSI 2.0 TSI 2.0 TSI 4motion	84 110 150 150	05/11→08/15 07/12→08/15 05/11→08/15 07/11→08/15	←	+PR 2E3		24.0130-0114.1 430114	Ø 308 29,5 25,5 V
			←	+PR 2E4		24.0133-0100.1 433100	Ø 340 32,6 29,5 V + S
			➡			24.0122-0211.1 422211	Ø 294 21,9 19,5 V + S
2.0 TDI 2.0 TDI 4motion	100 100	05/10→08/15 05/10→08/15	←	+PR 2E3		24.0130-0114.1 430114	Ø 308 29,5 25,5 V
			←	7H-A-200001→; +PR 2E4		24.0133-0100.1 433100	Ø 340 32,6 29,5 V + S
			➡	7H-A-200001→		24.0122-0211.1 422211	Ø 294 21,9 19,5 V + S
3.2 V6 4motion	173	11/03→11/09	←	07/04→; +PR 2E3		24.0130-0114.1 430114	Ø 308 29,5 25,5 V
↓							

	kw			 	! #					
VW - TRANSPORTER T5 Bus (7HB, 7HJ, 7EB, 7EJ, 7EF, 7EG, 7HF, 7EC) 04/03→08/15										
Bremsscheibe										
3.2 V6 4motion	173	11/03→11/09	←	07/04→; → 7H-A-050000; +PR 2E4	24.0132-0116.1	432116	∅ 333 32,5 28,5 V + S			
			←	7H-A-200001→; +PR 2E4	24.0133-0100.1	433100	∅ 340 32,6 29,5 V + S			
			→	7H-8-028000→; +PR 0WR; → 7H-8-200000	24.0122-0211.1	422211	∅ 294 21,9 19,5 V + S			
			→	07/04→; +PR 0WL,0WN / 0WM,0WP,0WQ; → 7H-5-120000	24.0122-0211.1	422211	∅ 294 21,9 19,5 V + S			
			→	7H-A-200001→	24.0122-0211.1	422211	∅ 294 21,9 19,5 V + S			
			→	7H-6-000001→; +PR 2E3,2E4; → 7H-A-050000	24.0122-0211.1	422211	∅ 294 21,9 19,5 V + S			
			→	07/04→; +PR 0WR; → 7H-8-027999	24.0122-0215.1	422215	∅ 314 22 18 V + S			
VW - TRANSPORTER T5 Kasten (7HA, 7HH, 7EA, 7EH) 04/03→08/15										
Bremsbelagsatz, Scheibenbremse										
1.9 TDI 1.9 TDI	62 75	01/06→11/09 06/06→11/09	←	+PR 2E3	13.0460-7236.2	607236	ATE 23746 19,7 + WK			
			←	+PR 2E4; → 7H-A-050000	13.0460-7240.2	607240	ATE 23746 18,1 + WK			
			←	7H-A-200001→; +PR 2E4	13.0460-7286.2	607286	ATE 24623 18,2 + WK			
			→	7H-A-200001→	13.0460-2882.2	602882	TRW 23326 17,4 + WK + Zub			
			→	7H-8-028000→; +PR 0WR; → 7H-8-200000	13.0460-2882.2	602882	TRW 23326 17,4 + WK + Zub			
			→	7H-6-000001→; +PR 2E3,2E4; → 7H-A-050000	13.0460-2882.2	602882	TRW 23326 17,4 + WK + Zub			
			→	+PR 0WR; → 7H-8-027999	13.0460-7218.2	607218	ATE 24367 19,1 + WK			
1.9 TDI 1.9 TDI 2.0 2.0 BiFuel 2.5 TDI 2.5 TDI 2.5 TDI 4motion 2.5 TDI 4motion 3.2 V6 3.2 V6	63 77 85 85 96 128 96 128 170 173	04/03→11/09 04/03→11/09 11/03→08/15 05/11→08/15 04/03→11/09 04/03→11/09 07/04→11/09 07/04→11/09 04/03→06/04 02/04→11/09	←	+PR 2E3	13.0460-7236.2	607236	ATE 23746 19,7 + WK			
			←	+PR 2E4; → 7H-A-050000	13.0460-7240.2	607240	ATE 23746 18,1 + WK			
			←	7H-A-200001→; +PR 2E4	13.0460-7286.2	607286	ATE 24623 18,2 + WK			
			→	7H-8-028000→; +PR 0WR; → 7H-8-200000	13.0460-2882.2	602882	TRW 23326 17,4 + WK + Zub			
			→	7H-A-200001→	13.0460-2882.2	602882	TRW 23326 17,4 + WK + Zub			
			→	7H-6-000001→; +PR 2E3,2E4; → 7H-A-050000	13.0460-2882.2	602882	TRW 23326 17,4 + WK + Zub			
			→	+PR 0WL,0WN / 0WM,0WP,0WQ; → 7H-5-120000	13.0460-2882.2	602882	TRW 23326 17,4 + WK + Zub			
			→	+PR 0WR; → 7H-8-027999	13.0460-7218.2	607218	ATE 24367 19,1 + WK			
			2.0 BiTDI 2.0 BiTDI 4motion 2.0 TDI 2.0 TDI 2.0 TDI 2.0 TDI 4motion	132 132 62 75 103 103	09/09→08/15 09/09→08/15 09/09→08/15 09/09→08/15 09/09→08/15	←	+PR 2E3	13.0460-7236.2	607236	ATE 23746 19,7 + WK
						←	+PR 2E4; → 7H-A-050000	13.0460-7240.2	607240	ATE 23746 18,1 + WK
←	7H-A-200001→; +PR 2E4	13.0460-7286.2				607286	ATE 24623 18,2 + WK			
→	7H-A-200001→	13.0460-2882.2				602882	TRW 23326 17,4 + WK + Zub			
→	7H-6-000001→; +PR 2E3,2E4; → 7H-A-050000	13.0460-2882.2				602882	TRW 23326 17,4 + WK + Zub			
2.0 TDI 2.0 TSI 2.0 TSI 2.0 TSI 4motion	84 110 150 150	05/11→08/15 07/12→08/15 05/11→08/15 07/11→08/15				←	+PR 2E3	13.0460-7236.2	607236	ATE 23746 19,7 + WK
			←	+PR 2E4	13.0460-7286.2	607286	ATE 24623 18,2 + WK			
			→		13.0460-2882.2	602882	TRW 23326 17,4 + WK + Zub			
			2.0 TDI 2.0 TDI 4motion	100 100	05/10→08/15 05/10→08/15	←	+PR 2E3	13.0460-7236.2	607236	ATE 23746 19,7 + WK
←	7H-A-200001→; +PR 2E4	13.0460-7286.2				607286	ATE 24623 18,2 + WK			
→	7H-A-200001→	13.0460-2882.2				602882	TRW 23326 17,4 + WK + Zub			
3.2 4motion	173	11/03→11/09	←	07/04→; +PR 2E3	13.0460-7236.2	607236	ATE 23746 19,7 + WK			
			←	07/04→; +PR 2E4; → 7H-A-050000	13.0460-7240.2	607240	ATE 23746 18,1 + WK			
			←	7H-A-200001→; +PR 2E4	13.0460-7286.2	607286	ATE 24623 18,2 + WK			
			→	7H-8-028000→; +PR 0WR; → 7H-8-200000	13.0460-2882.2	602882	TRW 23326 17,4 + WK + Zub			
			→	07/04→; +PR 0WL,0WN / 0WM,0WP,0WQ; → 7H-5-120000	13.0460-2882.2	602882	TRW 23326 17,4 + WK + Zub			
			→	7H-A-200001→	13.0460-2882.2	602882	TRW 23326 17,4 + WK + Zub			
			→	7H-6-000001→; +PR 2E3,2E4; → 7H-A-050000	13.0460-2882.2	602882	TRW 23326 17,4 + WK + Zub			
			→	07/04→; +PR 0WR; → 7H-8-027999	13.0460-7218.2	607218	ATE 24367 19,1 + WK			
Zubehörsatz, Scheibenbremsbelag										
1.9 TDI 1.9 TDI ↓	62 75	01/06→11/09 06/06→11/09	→	7H-8-028000→; +PR 0WR; → 7H-8-200000	13.0460-0023.2	610023				

	kw			 	! #		
VW - TRANSPORTER T5 Kasten (7HA, 7HH, 7EA, 7EH) 04/03→08/15							
Zubehörsatz, Scheibenbremsbelag							
1.9 TDI	62	01/06→11/09	➡	7H-A-200001→		13.0460-0023.2	610023
1.9 TDI	75	06/06→11/09	➡	7H-6-000001→; +PR 2E3,2E4; → 7H-A-050000		13.0460-0023.2	610023
1.9 TDI	63	04/03→11/09	➡	7H-8-028000→; +PR 0WR; → 7H-8-200000		13.0460-0023.2	610023
1.9 TDI	77	04/03→11/09	➡				
2.0	85	11/03→08/15	➡	+PR 0WL,0WN / 0WM,0WP,0WQ; → 7H-5-120000		13.0460-0023.2	610023
2.0 BiFuel	85	05/11→08/15	➡				
2.5 TDI	96	04/03→11/09	➡	7H-6-000001→; +PR 2E3,2E4; → 7H-A-050000		13.0460-0023.2	610023
2.5 TDI	128	04/03→11/09	➡				
2.5 TDI 4motion	96	07/04→11/09	➡	7H-A-200001→		13.0460-0023.2	610023
2.5 TDI 4motion	128	07/04→11/09	➡				
3.2 V6	170	04/03→06/04	➡				
3.2 V6	173	02/04→11/09	➡				
2.0 BiTDI	132	09/09→08/15	➡	7H-A-200001→		13.0460-0023.2	610023
2.0 BiTDI 4motion	132	09/09→08/15	➡				
2.0 TDI	62	09/09→08/15	➡	7H-6-000001→; +PR 2E3,2E4; → 7H-A-050000		13.0460-0023.2	610023
2.0 TDI	75	09/09→08/15	➡				
2.0 TDI	103	09/09→08/15	➡				
2.0 TDI 4motion	103	09/09→08/15	➡				
2.0 TDI	84	05/11→08/15	➡			13.0460-0023.2	610023
2.0 TSI	110	07/12→08/15	➡				
2.0 TSI	150	05/11→08/15	➡				
2.0 TSI 4motion	150	07/11→08/15	➡				
2.0 TDI	100	05/10→08/15	➡	7H-A-200001→		13.0460-0023.2	610023
2.0 TDI 4motion	100	05/10→08/15	➡				
3.2 4motion	173	11/03→11/09	➡	7H-A-200001→		13.0460-0023.2	610023
			➡	7H-8-028000→; +PR 0WR; → 7H-8-200000		13.0460-0023.2	610023
			➡	7H-6-000001→; +PR 2E3,2E4; → 7H-A-050000		13.0460-0023.2	610023
			➡	07/04→; +PR 0WL,0WN / 0WM,0WP,0WQ; → 7H-5-120000		13.0460-0023.2	610023
Bremsscheibe							
1.9 TDI	62	01/06→11/09	←	+PR 2E3		24.0130-0114.1	430114 Ø 308 29,5 25,5 V
1.9 TDI	75	06/06→11/09	←	→ 7H-A-050000; +PR 2E4		24.0132-0116.1	432116 Ø 333 32,5 28,5 V + S
			←	7H-A-200001→; +PR 2E4		24.0133-0100.1	433100 Ø 340 32,6 29,5 V + S
			➡	7H-A-200001→		24.0122-0211.1	422211 Ø 294 21,9 19,5 V + S
			➡	7H-8-028000→; +PR 0WR; → 7H-8-200000		24.0122-0211.1	422211 Ø 294 21,9 19,5 V + S
			➡	7H-6-000001→; +PR 2E3,2E4; → 7H-A-050000		24.0122-0211.1	422211 Ø 294 21,9 19,5 V + S
			➡	+PR 0WR; → 7H-8-027999		24.0122-0215.1	422215 Ø 314 22 18 V + S
1.9 TDI	63	04/03→11/09	←	+PR 2E3		24.0130-0114.1	430114 Ø 308 29,5 25,5 V
1.9 TDI	77	04/03→11/09	←	→ 7H-A-050000; +PR 2E4		24.0132-0116.1	432116 Ø 333 32,5 28,5 V + S
2.0	85	11/03→08/15	←	7H-A-200001→; +PR 2E4		24.0133-0100.1	433100 Ø 340 32,6 29,5 V + S
2.0 BiFuel	85	05/11→08/15	←				
2.5 TDI	96	04/03→11/09	➡	7H-8-028000→; +PR 0WR; → 7H-8-200000		24.0122-0211.1	422211 Ø 294 21,9 19,5 V + S
2.5 TDI	128	04/03→11/09	➡				
2.5 TDI 4motion	96	07/04→11/09	➡	7H-A-200001→		24.0122-0211.1	422211 Ø 294 21,9 19,5 V + S
2.5 TDI 4motion	128	07/04→11/09	➡				
3.2 V6	170	04/03→06/04	➡	7H-6-000001→; +PR 2E3,2E4; → 7H-A-050000		24.0122-0211.1	422211 Ø 294 21,9 19,5 V + S
3.2 V6	173	02/04→11/09	➡	+PR 0WL,0WN / 0WM,0WP,0WQ; → 7H-5-120000		24.0122-0211.1	422211 Ø 294 21,9 19,5 V + S
			➡	+PR 0WR; → 7H-8-027999		24.0122-0215.1	422215 Ø 314 22 18 V + S
2.0 BiTDI	132	09/09→08/15	←	+PR 2E3		24.0130-0114.1	430114 Ø 308 29,5 25,5 V
2.0 BiTDI 4motion	132	09/09→08/15	←	→ 7H-A-050000; +PR 2E4		24.0132-0116.1	432116 Ø 333 32,5 28,5 V + S
2.0 TDI	62	09/09→08/15	←	7H-A-200001→; +PR 2E4		24.0133-0100.1	433100 Ø 340 32,6 29,5 V + S
2.0 TDI	75	09/09→08/15	←				
2.0 TDI	103	09/09→08/15	➡	7H-A-200001→		24.0122-0211.1	422211 Ø 294 21,9 19,5 V + S
2.0 TDI 4motion	103	09/09→08/15	➡	7H-6-000001→; +PR 2E3,2E4; → 7H-A-050000		24.0122-0211.1	422211 Ø 294 21,9 19,5 V + S
2.0 TDI	84	05/11→08/15	←	+PR 2E3		24.0130-0114.1	430114 Ø 308 29,5 25,5 V
2.0 TSI	110	07/12→08/15	←	+PR 2E4		24.0133-0100.1	433100 Ø 340 32,6 29,5 V + S
2.0 TSI	150	05/11→08/15	←				
2.0 TSI 4motion	150	07/11→08/15	➡			24.0122-0211.1	422211 Ø 294 21,9 19,5 V + S
2.0 TDI	100	05/10→08/15	←	+PR 2E3		24.0130-0114.1	430114 Ø 308 29,5 25,5 V
2.0 TDI 4motion	100	05/10→08/15	←	7H-A-200001→; +PR 2E4		24.0133-0100.1	433100 Ø 340 32,6 29,5 V + S
			➡	7H-A-200001→		24.0122-0211.1	422211 Ø 294 21,9 19,5 V + S
↓							

VW - TRANSPORTER T5 Kasten (7HA, 7HH, 7EA, 7EH) 04/03→08/15

Bremsscheibe

3.2 4motion	173	11/03→11/09	←	07/04→; +PR 2E3	24.0130-0114.1	430114	Ø 308 29,5 25,5 V
			←	07/04→; → 7H-A-050000; +PR 2E4	24.0132-0116.1	432116	Ø 333 32,5 28,5 V + S
			←	7H-A-200001→; +PR 2E4	24.0133-0100.1	433100	Ø 340 32,6 29,5 V + S
			→	7H-8-028000→; +PR 0WR; → 7H-8-200000	24.0122-0211.1	422211	Ø 294 21,9 19,5 V + S
			→	07/04→; +PR 0WL,0WN / 0WM,0WP,0WQ; → 7H-5-120000	24.0122-0211.1	422211	Ø 294 21,9 19,5 V + S
			→	7H-A-200001→	24.0122-0211.1	422211	Ø 294 21,9 19,5 V + S
			→	7H-6-000001→; +PR 2E3,2E4; → 7H-A-050000	24.0122-0211.1	422211	Ø 294 21,9 19,5 V + S
			→	07/04→; +PR 0WR; → 7H-8-027999	24.0122-0215.1	422215	Ø 314 22 18 V + S









VW - TRANSPORTER T5 Pritsche/Fahrgestell (7JD, 7JE, 7JL, 7JY, 7JZ 04/03→08/15

Bremsbelagsatz, Scheibenbremse













1.9 TDI	62	01/06→11/09	←	+PR 2E3	13.0460-7236.2	607236	ATE 23746 19,7 + WK
			←	→ 7J-A-010000; +PR 2E4	13.0460-7240.2	607240	ATE 23746 18,1 + WK
1.9 TDI	75	06/06→11/09	←	7J-A-200001→; +PR 2E4	13.0460-7286.2	607286	ATE 24623 18,2 + WK
2.0	85	11/03→05/13	→	→ 7J-A-010000; +PR 2E3,2E4	13.0460-2882.2	602882	TRW 23326 17,4 + WK + Zub
2.5 TDI	96	04/03→11/09	→	7J-8-000789→ 7J-8-030000; +PR 0WR,0E0,0E9	13.0460-2882.2	602882	TRW 23326 17,4 + WK + Zub
2.5 TDI 4motion	96	07/04→11/09	→	7J-A-200001→	13.0460-2882.2	602882	TRW 23326 17,4 + WK + Zub
3.2 V6	170	02/04→11/09	→	→ 7J-8-000788; +PR 0WR,0E0,0E9	13.0460-7218.2	607218	ATE 24367 19,1 + WK
3.2 V6	173	08/03→05/06	→		13.0460-2882.2	602882	TRW 23326 17,4 + WK + Zub
2.0 BiTDI	132	09/09→08/15	←	+PR 2E3	13.0460-7236.2	607236	ATE 23746 19,7 + WK
2.0 BiTDI 4motion	132	09/09→08/15	←	→ 7J-A-010000; +PR 2E4	13.0460-7240.2	607240	ATE 23746 18,1 + WK
2.0 TDI	62	09/09→08/15	←	7J-A-200001→; +PR 2E4	13.0460-7286.2	607286	ATE 24623 18,2 + WK
2.0 TDI	75	09/09→08/15	←	→ 7J-A-010000; +PR 2E3,2E4	13.0460-2882.2	602882	TRW 23326 17,4 + WK + Zub
2.0 TDI 4motion	103	09/09→08/15	→	7J-A-200001→	13.0460-2882.2	602882	TRW 23326 17,4 + WK + Zub
2.0 TDI	84	05/11→08/15	←	+PR 2E3	13.0460-7236.2	607236	ATE 23746 19,7 + WK
2.0 TDI	100	05/10→08/15	←	+PR 2E4	13.0460-7286.2	607286	ATE 24623 18,2 + WK
2.0 TDI 4motion	100	05/10→08/15	←		13.0460-2882.2	602882	TRW 23326 17,4 + WK + Zub
2.0 TSI	110	07/12→08/15	→		13.0460-2882.2	602882	TRW 23326 17,4 + WK + Zub
2.5 TDI 4motion	128	04/04→11/09	←	07/04→; +PR 2E3	13.0460-7236.2	607236	ATE 23746 19,7 + WK
			←	07/04→; → 7J-A-010000; +PR 2E4	13.0460-7240.2	607240	ATE 23746 18,1 + WK
			←	7J-A-200001→; +PR 2E4	13.0460-7286.2	607286	ATE 24623 18,2 + WK
			→	7J-8-000789→ 7J-8-030000; +PR 0WR,0E0,0E9	13.0460-2882.2	602882	TRW 23326 17,4 + WK + Zub
			→	07/04→; → 7J-A-010000; +PR 2E3,2E4	13.0460-2882.2	602882	TRW 23326 17,4 + WK + Zub
			→	7J-A-200001→	13.0460-2882.2	602882	TRW 23326 17,4 + WK + Zub
			→	07/04→; → 7J-8-000788; +PR 0WR,0E0,0E9	13.0460-7218.2	607218	ATE 24367 19,1 + WK
			→		13.0460-2882.2	602882	TRW 23326 17,4 + WK + Zub
3.2 4motion	170	11/03→11/09	←	07/04→; +PR 2E3	13.0460-7236.2	607236	ATE 23746 19,7 + WK
			←	07/04→; +PR 2E4; → 7H-A-050000	13.0460-7240.2	607240	ATE 23746 18,1 + WK
			←	7H-A-200001→; +PR 2E4	13.0460-7286.2	607286	ATE 24623 18,2 + WK
			→	7H-8-028000→; +PR 0WR; → 7H-8-200000	13.0460-2882.2	602882	TRW 23326 17,4 + WK + Zub
			→	07/04→; +PR 0WL,0WN / 0WM,0WP,0WQ; → 7H-5-120000	13.0460-2882.2	602882	TRW 23326 17,4 + WK + Zub
			→	7H-A-200001→	13.0460-2882.2	602882	TRW 23326 17,4 + WK + Zub
			→	7H-6-000001→; +PR 2E3,2E4; → 7H-A-050000	13.0460-2882.2	602882	TRW 23326 17,4 + WK + Zub
			→	07/04→; +PR 0WR; → 7H-8-027999	13.0460-7218.2	607218	ATE 24367 19,1 + WK













Zubehörsatz, Scheibenbremsbelag









1.9 TDI	62	01/06→11/09	→	7J-8-000789→ 7J-8-030000; +PR 0WR,0E0,0E9	13.0460-0023.2	610023	
			→	→ 7J-A-010000; +PR 2E3,2E4	13.0460-0023.2	610023	
1.9 TDI	75	06/06→11/09	→	7J-A-200001→	13.0460-0023.2	610023	
2.0	85	11/03→05/13	→		13.0460-0023.2	610023	
2.5 TDI	96	04/03→11/09	→				
2.5 TDI	128	04/03→11/09	→				
2.5 TDI 4motion	96	07/04→11/09	→				
3.2 V6	170	02/04→11/09	→				







	kw					! #		
VW - TRANSPORTER T5 Pritsche/Fahrgestell (7JD, 7JE, 7JL, 7JY, 7JZ 04/03→08/15)								
Zubehörsatz, Scheibenbremsbelag								
3.2 V6	173	08/03→05/06	➡	7J-8-000789→ 7J-8-030000; +PR 0WR,0E0,0E9			13.0460-0023.2 610023	
			➡	→ 7J-A-010000; +PR 2E3,2E4			13.0460-0023.2 610023	
			➡	7J-A-200001→			13.0460-0023.2 610023	
2.0 BiTDI	132	09/09→08/15	➡	→ 7J-A-010000; +PR 2E3,2E4			13.0460-0023.2 610023	
2.0 BiTDI 4motion	132	09/09→08/15	➡					
2.0 TDI	62	09/09→08/15	➡	7J-A-200001→			13.0460-0023.2 610023	
2.0 TDI	75	09/09→08/15	➡					
2.0 TDI	103	09/09→08/15	➡					
2.0 TDI 4motion	103	09/09→08/15	➡					
2.0 TDI	84	05/11→08/15	➡				13.0460-0023.2 610023	
2.0 TDI	100	05/10→08/15	➡					
2.0 TDI 4motion	100	05/10→08/15	➡					
2.0 TSI	110	07/12→08/15	➡					
2.5 TDI 4motion	128	04/04→11/09	➡	07/04→; → 7J-A-010000; +PR 2E3,2E4			13.0460-0023.2 610023	
			➡	7J-8-000789→ 7J-8-030000; +PR 0WR,0E0,0E9			13.0460-0023.2 610023	
			➡	7J-A-200001→			13.0460-0023.2 610023	
3.2 4motion	170	11/03→11/09	➡	7H-A-200001→			13.0460-0023.2 610023	
			➡	7H-8-028000→; +PR 0WR; → 7H-8-200000			13.0460-0023.2 610023	
			➡	7H-6-000001→; +PR 2E3,2E4; → 7H-A-050000			13.0460-0023.2 610023	
			➡	07/04→; +PR 0WL,0WN / 0WM,0WP,0WQ; → 7H-5-120000			13.0460-0023.2 610023	
 Bremsscheibe								
1.9 TDI	62	01/06→11/09	←	+PR 2E3			24.0130-0114.1 430114	Ø 308 29,5 25,5 V
1.9 TDI	63	04/03→11/09	←					
1.9 TDI	75	06/06→11/09	←	→ 7J-A-010000; +PR 2E4			24.0132-0116.1 432116	Ø 333 32,5 28,5 V + S
1.9 TDI	77	04/03→11/09	←	7J-A-200001→; +PR 2E4			24.0133-0100.1 433100	Ø 340 32,6 29,5 V + S
2.0	85	11/03→05/13	←					
2.5 TDI	96	04/03→11/09	➡	→ 7J-A-010000; +PR 2E3,2E4			24.0122-0211.1 422211	Ø 294 21,9 19,5 V + S
2.5 TDI	128	04/03→11/09	➡	7J-8-000789→ 7J-8-030000; +PR 0WR,0E0,0E9			24.0122-0211.1 422211	Ø 294 21,9 19,5 V + S
2.5 TDI 4motion	96	07/04→11/09	➡					
3.2 V6	170	02/04→11/09	➡	7J-A-200001→			24.0122-0211.1 422211	Ø 294 21,9 19,5 V + S
3.2 V6	173	08/03→05/06	➡					
			➡	→ 7J-8-000788; +PR 0WR,0E0,0E9			24.0122-0215.1 422215	Ø 314 22 18 V + S
2.0 BiTDI	132	09/09→08/15	←	+PR 2E3			24.0130-0114.1 430114	Ø 308 29,5 25,5 V
2.0 BiTDI 4motion	132	09/09→08/15	←					
2.0 TDI	62	09/09→08/15	←	→ 7J-A-010000; +PR 2E4			24.0132-0116.1 432116	Ø 333 32,5 28,5 V + S
2.0 TDI	75	09/09→08/15	←	7J-A-200001→; +PR 2E4			24.0133-0100.1 433100	Ø 340 32,6 29,5 V + S
2.0 TDI	103	09/09→08/15	➡	→ 7J-A-010000; +PR 2E3,2E4			24.0122-0211.1 422211	Ø 294 21,9 19,5 V + S
2.0 TDI 4motion	103	09/09→08/15	➡	7J-A-200001→			24.0122-0211.1 422211	Ø 294 21,9 19,5 V + S
2.0 TDI	84	05/11→08/15	←	+PR 2E3			24.0130-0114.1 430114	Ø 308 29,5 25,5 V
2.0 TDI	100	05/10→08/15	←					
2.0 TDI 4motion	100	05/10→08/15	←	+PR 2E4			24.0133-0100.1 433100	Ø 340 32,6 29,5 V + S
2.0 TSI	110	07/12→08/15	➡				24.0122-0211.1 422211	Ø 294 21,9 19,5 V + S
2.5 TDI 4motion	128	04/04→11/09	←	07/04→; +PR 2E3			24.0130-0114.1 430114	Ø 308 29,5 25,5 V
			←	07/04→; → 7J-A-010000; +PR 2E4			24.0132-0116.1 432116	Ø 333 32,5 28,5 V + S
			←	7J-A-200001→; +PR 2E4			24.0133-0100.1 433100	Ø 340 32,6 29,5 V + S
			➡	7J-8-000789→ 7J-8-030000; +PR 0WR,0E0,0E9			24.0122-0211.1 422211	Ø 294 21,9 19,5 V + S
			➡	07/04→; → 7J-A-010000; +PR 2E3,2E4			24.0122-0211.1 422211	Ø 294 21,9 19,5 V + S
			➡	7J-A-200001→			24.0122-0211.1 422211	Ø 294 21,9 19,5 V + S
			➡	07/04→; → 7J-8-000788; +PR 0WR,0E0,0E9			24.0122-0215.1 422215	Ø 314 22 18 V + S
3.2 4motion	170	11/03→11/09	←	07/04→; +PR 2E3			24.0130-0114.1 430114	Ø 308 29,5 25,5 V
			←	07/04→; → 7H-A-050000; +PR 2E4			24.0132-0116.1 432116	Ø 333 32,5 28,5 V + S
			←	7H-A-200001→; +PR 2E4			24.0133-0100.1 433100	Ø 340 32,6 29,5 V + S
			➡	7H-8-028000→; +PR 0WR; → 7H-8-200000			24.0122-0211.1 422211	Ø 294 21,9 19,5 V + S
			➡	07/04→; +PR 0WL,0WN / 0WM,0WP,0WQ; → 7H-5-120000			24.0122-0211.1 422211	Ø 294 21,9 19,5 V + S
			➡	7H-A-200001→			24.0122-0211.1 422211	Ø 294 21,9 19,5 V + S
			➡	7H-6-000001→; +PR 2E3,2E4; → 7H-A-050000			24.0122-0211.1 422211	Ø 294 21,9 19,5 V + S



	kw					! #		
VW - TRANSPORTER T5 Pritsche/Fahrgestell (7JD, 7JE, 7JL, 7JY, 7JZ 04/03→08/15								
 Bremsscheibe								
3.2 4motion	170	11/03→11/09	➡	07/04→; +PR 0WR; → 7H-8-027999		24.0122-0215.1	422215	Ø 314 22 18 V + S
VW - TRANSPORTER T6 Bus (SGB, SGG, SGJ) 04/15→								
 Bremsbelagsatz, Scheibenbremse								
2.0 TDI	62	04/15→	←	passend für Felgengröße [Zoll]: 16		13.0460-7236.2	607236	ATE 23746 19,7 + WK
2.0 TDI	75	04/15→	←	passend für Felgengröße [Zoll]: 17		13.0460-7286.2	607286	ATE 24623 18,2 + WK
2.0 TDI	84	05/16→	➡			13.0460-2882.2	602882	TRW 23326 17,4 + WK + Zub
2.0 TDI	103	04/15→						
2.0 TDI	110	04/15→						
2.0 TDI	132	04/15→						
2.0 TDI	150	06/15→						
2.0 TDI 4motion	103	06/15→						
2.0 TDI 4motion	110	08/15→						
2.0 TDI 4motion	132	06/15→						
2.0 TDI 4motion	150	06/15→						
2.0 TSI	110	04/15→						
2.0 TSI	150	04/15→						
2.0 TSI 4motion	150	06/15→						
 Bremsscheibe								
2.0 TDI	62	04/15→	←	passend für Felgengröße [Zoll]: 16		24.0130-0114.1	430114	Ø 308 29,5 25,5 V
2.0 TDI	75	04/15→	←	passend für Felgengröße [Zoll]: 17		24.0133-0100.1	433100	Ø 340 32,6 29,5 V + S
2.0 TDI	84	05/16→	➡			24.0122-0211.1	422211	Ø 294 21,9 19,5 V + S
2.0 TDI	103	04/15→						
2.0 TDI	110	04/15→						
2.0 TDI	132	04/15→						
2.0 TDI	150	06/15→						
2.0 TDI 4motion	103	06/15→						
2.0 TDI 4motion	110	08/15→						
2.0 TDI 4motion	132	06/15→						
2.0 TDI 4motion	150	06/15→						
2.0 TSI	110	04/15→						
2.0 TSI	150	04/15→						
2.0 TSI 4motion	150	06/15→						
VW - TRANSPORTER T6 Kasten (SGA, SGH) 04/15→								
 Bremsbelagsatz, Scheibenbremse								
2.0 TDI	62	04/15→	←	passend für Felgengröße [Zoll]: 16		13.0460-7236.2	607236	ATE 23746 19,7 + WK
2.0 TDI	75	04/15→	←	passend für Felgengröße [Zoll]: 17		13.0460-7286.2	607286	ATE 24623 18,2 + WK
2.0 TDI	84	05/16→	➡			13.0460-2882.2	602882	TRW 23326 17,4 + WK + Zub
2.0 TDI	103	04/15→						
2.0 TDI	110	04/15→						
2.0 TDI	132	04/15→						
2.0 TDI	150	06/15→						
2.0 TDI 4motion	103	06/15→						
2.0 TDI 4motion	110	08/15→						
2.0 TDI 4motion	132	06/15→						
2.0 TDI 4motion	150	06/15→						
2.0 TSI	110	04/15→						
2.0 TSI	150	04/15→						
2.0 TSI 4motion	150	06/15→						
 Bremsscheibe								
2.0 TDI	62	04/15→	←	passend für Felgengröße [Zoll]: 16		24.0130-0114.1	430114	Ø 308 29,5 25,5 V
2.0 TDI	75	04/15→	←	passend für Felgengröße [Zoll]: 17		24.0133-0100.1	433100	Ø 340 32,6 29,5 V + S
2.0 TDI	84	05/16→	➡			24.0122-0211.1	422211	Ø 294 21,9 19,5 V + S
2.0 TDI	103	04/15→						
2.0 TDI	110	04/15→						
2.0 TDI	132	04/15→						
2.0 TDI	150	06/15→						
2.0 TDI 4motion	103	06/15→						
2.0 TDI 4motion	110	08/15→						
2.0 TDI 4motion	132	06/15→						
2.0 TDI 4motion	150	06/15→						
2.0 TSI	110	04/15→						
2.0 TSI	150	04/15→						
2.0 TSI 4motion	150	06/15→						
VW - TRANSPORTER T6 Pritsche/Fahrgestell (SFD, SFE, SFL, SFZ) 04/15→								
 Bremsbelagsatz, Scheibenbremse								
2.0 TDI	62	04/15→	←	passend für Felgengröße [Zoll]: 16		13.0460-7236.2	607236	ATE 23746 19,7 + WK
2.0 TDI	75	04/15→	←	passend für Felgengröße [Zoll]: 17		13.0460-7286.2	607286	ATE 24623 18,2 + WK
2.0 TDI	84	05/16→	➡			13.0460-2882.2	602882	TRW 23326 17,4 + WK + Zub
2.0 TDI	103	04/15→						
2.0 TDI	110	08/15→						
2.0 TDI	132	04/15→						
2.0 TDI	150	05/16→						
2.0 TDI 4motion	103	06/15→						

	kW					! #		
VW - TRANSPORTER T6 Pritsche/Fahrgestell (SFD, SFE, SFL, SFZ) 04/15→								
 Bremsbelagsatz, Scheibenbremse								
2.0 TDI 4motion	110	05/16→	←	passend für Felgenreöße [Zoll]: 16		13.0460-7236.2	607236	ATE 23746 19,7 + WK
2.0 TDI 4motion	132	06/15→	←	passend für Felgenreöße [Zoll]: 17		13.0460-7286.2	607286	ATE 24623 18,2 + WK
2.0 TDI 4motion	150	05/16→	←					
2.0 TSI	110	04/15→	→			13.0460-2882.2	602882	TRW 23326 17,4 + WK + Zub
 Bremsscheibe								
2.0 TDI	62	04/15→	←	passend für Felgenreöße [Zoll]: 16		24.0130-0114.1	430114	Ø 308 29,5 25,5 V
2.0 TDI	75	04/15→	←	passend für Felgenreöße [Zoll]: 17		24.0133-0100.1	433100	Ø 340 32,6 29,5 V + S
2.0 TDI	84	05/16→	←					
2.0 TDI	103	04/15→	→			24.0122-0211.1	422211	Ø 294 21,9 19,5 V + S
2.0 TDI	110	08/15→						
2.0 TDI	132	04/15→						
2.0 TDI	150	05/16→						
2.0 TDI 4motion	103	06/15→						
2.0 TDI 4motion	110	05/16→						
2.0 TDI 4motion	132	06/15→						
2.0 TDI 4motion	150	05/16→						
2.0 TSI	110	04/15→						
VW - UP 08/11→								
 Bremsbelagsatz, Scheibenbremse								
1.0	44	08/11→	←	12/11→; +PR 1LA,1ZQ		13.0460-7111.2	607111	VW 23130 19,6 - WE / - WK
1.0	55	08/11→	←			13.0470-7111.2	LD7111	VW 23130 19,6 - WE / - WK Ceramic
1.0 EcoFuel	50	11/12→	←	+PR 1LA,1ZQ		13.0460-7111.2	607111	VW 23130 19,6 - WE / - WK
1.0 TSI	66	05/16→	←			13.0470-7111.2	LD7111	VW 23130 19,6 - WE / - WK Ceramic
e-Up	60	07/13→	←	09/13→; +PR 1ZQ		13.0460-7111.2	607111	VW 23130 19,6 - WE / - WK
						13.0470-7111.2	LD7111	VW 23130 19,6 - WE / - WK Ceramic
 Bremsscheibe								
1.0	44	08/11→	←	12/11→; +PR 1LA,1ZQ		24.0122-0281.1	422281	Ø 256 22 19 V + S
1.0	55	08/11→	←					
1.0 EcoFuel	50	11/12→	←	+PR 1LA,1ZQ		24.0122-0281.1	422281	Ø 256 22 19 V + S
1.0 TSI	66	05/16→	←					
e-Up	60	07/13→	←	09/13→; +PR 1LA,1ZQ		24.0122-0281.1	422281	Ø 256 22 19 V + S
VW - VENTO (1H2) 11/91→09/98								
 Bremsbelagsatz, Scheibenbremse								
1.4	40	11/91→09/98	←	05/96→ 09/96; + ABS		13.0460-2821.2	602821	TRW 21945 16,0 - WK
1.4	44	11/91→09/98	←	→ 1H-T-015953		13.0460-7032.2	20887	VW 20887 19,7 - WE / - WK + Zub
1.9 D	48	11/91→09/98	←	1H-T-015954→; - ABS		13.0460-7072.2	607072	VW 21866 19,7 - WE / - WK
			←	10/96→; + ABS		13.0460-7101.2	607101	VW 21866 15,3 - WE / - WK
1.6	55	09/92→09/98	←	1H-S-430001→; Vollautomatik		13.0460-2958.2	602958	TRW 20168 19,3 - WK
			←	→ 1H-S-430000; Vollautomatik		13.0460-7032.2	20887	VW 20887 19,7 - WE / - WK + Zub
			←	→ 1H-T-015953; Schaltgetriebe		13.0460-7032.2	20887	VW 20887 19,7 - WE / - WK + Zub
			←	1H-T-015954→; Schaltgetriebe		13.0460-7072.2	607072	VW 21866 19,7 - WE / - WK
1.6	74	10/94→09/98	←			13.0460-2821.2	602821	TRW 21945 16,0 - WK
			→			13.0460-2958.2	602958	TRW 20168 19,3 - WK
			→			13.0460-2937.2	602937	TRW 20961 15,2 - WK + Zub
1.8	55	11/91→09/98	←	01/92→; Vollautomatik		13.0460-2958.2	602958	TRW 20168 19,3 - WK
			←	01/92→; → 1H-T-015953; Schaltgetriebe		13.0460-7032.2	20887	VW 20887 19,7 - WE / - WK + Zub
			←	1H-T-015954→; Schaltgetriebe		13.0460-7072.2	607072	VW 21866 19,7 - WE / - WK
1.8	66	11/91→09/98	←	01/92→		13.0460-2821.2	602821	TRW 21945 16,0 - WK
			←	1H-S-430001→		13.0460-2958.2	602958	TRW 20168 19,3 - WK
			←	01/92→; → 1H-S-430000		13.0460-7032.2	20887	VW 20887 19,7 - WE / - WK + Zub
			→	01/92→		13.0460-2937.2	602937	TRW 20961 15,2 - WK + Zub
1.9 SDI	47	04/97→09/98	←	- ABS		13.0460-7072.2	607072	VW 21866 19,7 - WE / - WK
			←	+ ABS		13.0460-7101.2	607101	VW 21866 15,3 - WE / - WK
1.9 TD	55	11/91→09/98	←	1H-S-430001→		13.0460-2958.2	602958	TRW 20168 19,3 - WK
↓								

	kw			 	! #		
VW - VENTO (1H2) 11/91→09/98							
 Bremsbelagsatz, Scheibenbremse							
1.9 TD	55	11/91→09/98	←	01/92→; → 1H-S-430000		13.0460-7032.2 20887	VW 20887 19,7 - WE / - WK + Zub
1.9 TDI	66	09/93→09/98	←			13.0460-2821.2 602821	TRW 21945 16,0 - WK
			←	- ABS		13.0460-2958.2 602958	TRW 20168 19,3 - WK
			→			13.0460-2937.2 602937	TRW 20961 15,2 - WK + Zub
1.9 TDI	81	04/96→09/98	←	+ ABS		13.0460-2821.2 602821	TRW 21945 16,0 - WK
			→			13.0460-2984.2 602984	TRW 20961 17,2 - WK + Zub
2.0	85	11/91→09/98	←	→ 1H-S-560000		13.0460-2806.2 602806	TRW 20168 19,3 + WK
			←			13.0460-2821.2 602821	TRW 21945 16,0 - WK
			←	1H-S-560001→; → 04/96		13.0460-2958.2 602958	TRW 20168 19,3 - WK
			←	05/96→		13.0460-7081.2 607081	ATE 20676 19,8 - WE / - WK
						13.0470-7081.2 LD7081	ATE 20676 19,8 - WE / - WK Ceramic
			→			13.0460-2937.2 602937	TRW 20961 15,2 - WK + Zub
			→	→ 1H-P-240000		13.0460-2937.2 602937	TRW 20961 15,2 - WK + Zub
2.8 VR6	128	01/92→09/98	←	→ 1H-S-560000		13.0460-2806.2 602806	TRW 20168 19,3 + WK
			←	1H-S-560001→		13.0460-7081.2 607081	ATE 20676 19,8 - WE / - WK
						13.0470-7081.2 LD7081	ATE 20676 19,8 - WE / - WK Ceramic
			→	→ 1H-P-240000		13.0460-2937.2 602937	TRW 20961 15,2 - WK + Zub
			→	1H-P-240001→		13.0460-2984.2 602984	TRW 20961 17,2 - WK + Zub
Zubehörsatz, Scheibenbremsbelag							
1.6	74	10/94→09/98	→			13.0460-0419.2 610419	TRW
1.9 TDI	66	09/93→09/98	→				
1.8	66	11/91→09/98	→	01/92→		13.0460-0419.2 610419	TRW
1.9 TDI	81	04/96→09/98	→			13.0460-0072.2 610072	TRW
2.0	85	11/91→09/98	→	1H-P-240001→		13.0460-0072.2 610072	TRW
			→			13.0460-0419.2 610419	TRW
			→	→ 1H-P-240000		13.0460-0419.2 610419	TRW
2.8 VR6	128	01/92→09/98	→	1H-P-240001→		13.0460-0072.2 610072	TRW
			→	→ 1H-P-240000		13.0460-0419.2 610419	TRW
 Bremsscheibe							
1.4	40	11/91→09/98	←	- ABS		24.0112-0106.1 412106	Ø 239 12 10 + S
1.4	44	11/91→09/98				24.0312-0106.1 512106	Ø 239 12 10 + S PD
1.9 D	48	11/91→09/98	←	10/96→; + ABS		24.0120-0123.1 420123	Ø 239 20 18 V + S
						24.0320-0123.1 520123	Ø 239 20 18 V + S PD
			←	05/96→ 09/96; + ABS		24.0120-0128.1 420128	Ø 256 20 18 V + S
					24.0320-0128.1 520128	Ø 256 20 18 V + S PD	
1.6	55	09/92→09/98	←	→ 1H-S-430000; Vollautomatik		24.0112-0106.1 412106	Ø 239 12 10 + S
						24.0312-0106.1 512106	Ø 239 12 10 + S PD
			←	Schaltgetriebe		24.0112-0106.1 412106	Ø 239 12 10 + S
						24.0312-0106.1 512106	Ø 239 12 10 + S PD
			←	1H-S-430001→; Vollautomatik		24.0113-0178.1 413178	Ø 255,6 12,9 11 + S
						24.0313-0178.1 513178	Ø 255,6 12,9 11 + S PD
1.6	74	10/94→09/98	←			24.0113-0178.1 413178	Ø 255,6 12,9 11 + S
						24.0120-0128.1 420128	Ø 256 20 18 V + S
						24.0313-0178.1 513178	Ø 255,6 12,9 11 + S PD
						24.0320-0128.1 520128	Ø 256 20 18 V + S PD
			→	Felge Lochzahl: 4		24.0110-0111.1 410111	Ø 226 10 8 - ABS Ring / - RLG
			→			24.0110-0275.2 410275	Ø 226 10 8 + ABS Ring / - RLG
1.8	55	11/91→09/98	←	01/92→; Schaltgetriebe		24.0112-0106.1 412106	Ø 239 12 10 + S
						24.0312-0106.1 512106	Ø 239 12 10 + S PD
			←	01/92→; Vollautomatik		24.0113-0178.1 413178	Ø 255,6 12,9 11 + S
						24.0313-0178.1 513178	Ø 255,6 12,9 11 + S PD
1.8	66	11/91→09/98	←	01/92→; → 1H-S-430000		24.0112-0106.1 412106	Ø 239 12 10 + S
						24.0312-0106.1 512106	Ø 239 12 10 + S PD
↓							

	kW			 	! #		
VW - VENTO (1H2) 11/91→09/98							
Bremsscheibe							
1.8	66	11/91→09/98	←	1H-S-430001→	24.0113-0178.1 413178	Ø 255,6 12,9 11 + S	
			←	01/92→	24.0313-0178.1 513178	Ø 255,6 12,9 11 + S PD	
			→	01/92→; Felge Lochzahl: 4	24.0120-0128.1 420128	Ø 256 20 18 V + S	
			→	01/92→	24.0320-0128.1 520128	Ø 256 20 18 V + S PD	
1.9 SDI	47	04/97→09/98	←	- ABS	24.0112-0106.1 412106	Ø 239 12 10 + S	
			←	+ ABS	24.0312-0106.1 512106	Ø 239 12 10 + S PD	
			→		24.0120-0123.1 420123	Ø 239 20 18 V + S	
			→		24.0320-0123.1 520123	Ø 239 20 18 V + S PD	
1.9 TD	55	11/91→09/98	←	→ 1H-S-430000	24.0112-0106.1 412106	Ø 239 12 10 + S	
			←		24.0312-0106.1 512106	Ø 239 12 10 + S PD	
			←	1H-S-430001→	24.0113-0178.1 413178	Ø 255,6 12,9 11 + S	
			←		24.0313-0178.1 513178	Ø 255,6 12,9 11 + S PD	
1.9 TDI	66	09/93→09/98	←	- ABS	24.0113-0178.1 413178	Ø 255,6 12,9 11 + S	
			←	+ ABS	24.0313-0178.1 513178	Ø 255,6 12,9 11 + S PD	
			→	Felge Lochzahl: 4	24.0120-0128.1 420128	Ø 256 20 18 V + S	
			→		24.0320-0128.1 520128	Ø 256 20 18 V + S PD	
1.9 TDI	81	04/96→09/98	←		24.0110-0111.1 410111	Ø 226 10 8 - ABS Ring / - RLG	
			→		24.0110-0275.2 410275	Ø 226 10 8 + ABS Ring / - RLG	
			→	Felge Lochzahl: 4	24.0120-0128.1 420128	Ø 256 20 18 V + S	
			→		24.0320-0128.1 520128	Ø 256 20 18 V + S PD	
2.0	85	11/91→09/98	←		24.0110-0111.1 410111	Ø 226 10 8 - ABS Ring / - RLG	
			→		24.0110-0275.2 410275	Ø 226 10 8 + ABS Ring / - RLG	
			←	→ 04/96	24.0122-0100.1 422100	Ø 280 22 20 V	
			←		24.0322-0100.1 522100	Ø 280 22 20 V PD	
			←	05/96→	24.0125-0108.1 425108	Ø 288 25 23 V	
			→	Felge Lochzahl: 4	24.0110-0111.1 410111	Ø 226 10 8 - ABS Ring / - RLG	
			→	Felge Lochzahl: 5	24.0110-0203.1 410203	Ø 226 10 8 - ABS Ring	
2.8 VR6	128	01/92→09/98	←	→ 1H-S-560000	24.0110-0275.2 410275	Ø 226 10 8 + ABS Ring / - RLG	
			←		24.0110-0276.2 410276	Ø 226 10 8 + ABS Ring	
			←	1H-S-560001→	24.0122-0100.1 422100	Ø 280 22 20 V	
			←		24.0322-0100.1 522100	Ø 280 22 20 V PD	
			→	Felge Lochzahl: 5	24.0125-0108.1 425108	Ø 288 25 23 V	
			→		24.0110-0203.1 410203	Ø 226 10 8 - ABS Ring	
			→		24.0110-0276.2 410276	Ø 226 10 8 + ABS Ring	



- DE** Abbildungen Scheibenbremsbeläge
- EN** Illustrations disc brake pads
- ES** Ilustraciones de pastillas
- FR** Illustrations Plaquettes de frein à disque
- IT** Illustrazioni Pastiglie Freno

2018



Abbildungen Scheibenbremsbeläge

Illustrations disc brake pads - Ilustraciones de pastillas - Illustrations Plaquettes de frein à disque - Illustrazioni Pastiglie Freno

13.0460-2600.2 602600

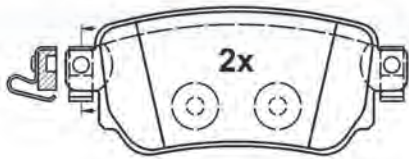

25965 15,0

103,6 x 44,6 x 15,0

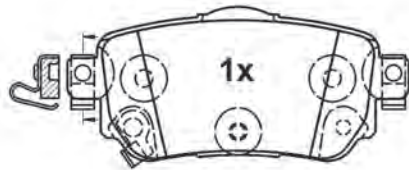

25966 15,0

103,6 x 46,4 x 15,0

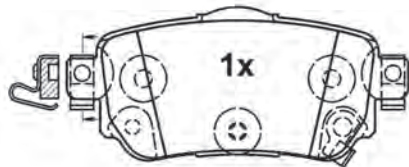

25967 15,0

103,6 x 46,4 x 15,0

13.0460-2700.2 602700



21454 17,0

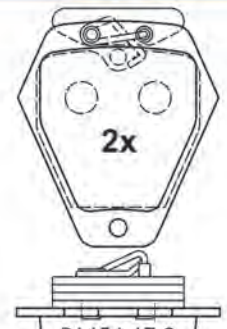

21454 17,0

76,1 x 85,6 x 17,0

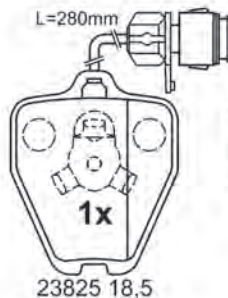

23825 18,5

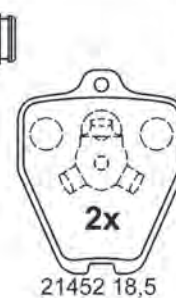

21452 18,5

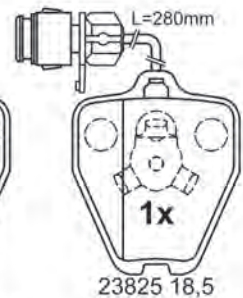

23825 18,5

63,3 x 77,4 x 18,5



13.0460-2701.2 602701

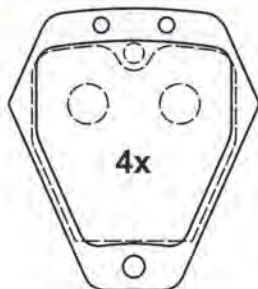

21454 17,0

76,1 x 85,6 x 17,0

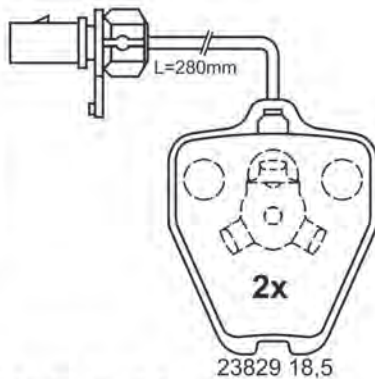

21452 18,5

63,3 x 77,4 x 18,5

23829 18,5



13.0460-2704.2 602704

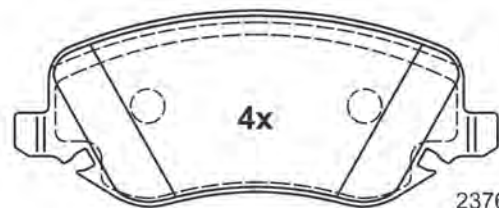

23761 18,8

146,5 x 59,2 x 18,8

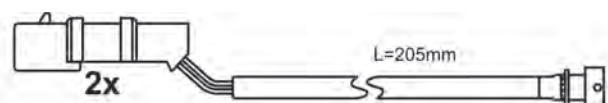

2x

L=205mm



M8x22

Abbildungen Scheibenbremsbeläge

Illustrations disc brake pads - Ilustraciones de pastillas - Illustrations Plaquettes de frein à disque - Illustrazioni Pastiglie Freno

13.0460-2705.2 602705

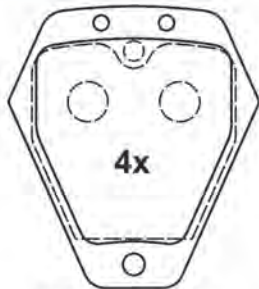

76,1 x 85,6 x 17,0

21454 17,0

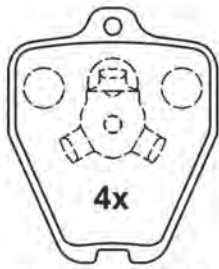

63,3 x 77,4 x 18,5

21452 18,5

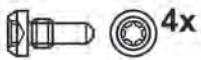

13.0460-2706.2 602706

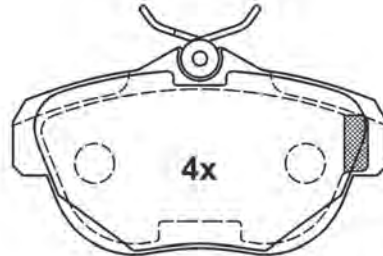

24462 16,7

113,8 x 62,7 x 16,7



13.0460-2707.2 602707

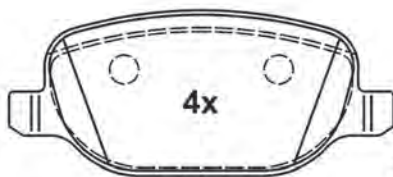

23760 17,7

116,8 x 49,8 x 17,7



13.0460-2708.2 602708

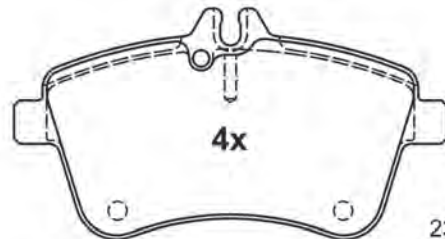

23881 20,0

131,3 x 69,8 x 20,0

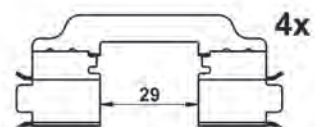

Abbildungen Scheibenbremsbeläge

Illustrations disc brake pads - Ilustraciones de pastillas - Illustrations Plaquettes de frein à disque - Illustrazioni Pastiglie Freno

13.0460-2709.2 602709

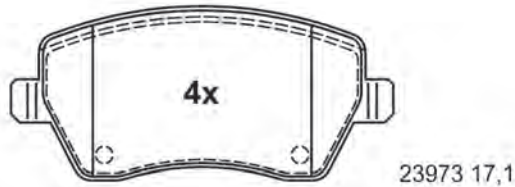

116,3 x 52,4 x 17,1

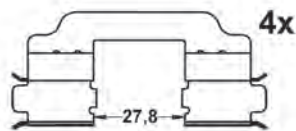

13.0460-2710.2 602710

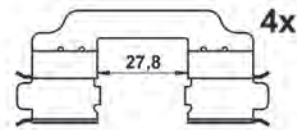
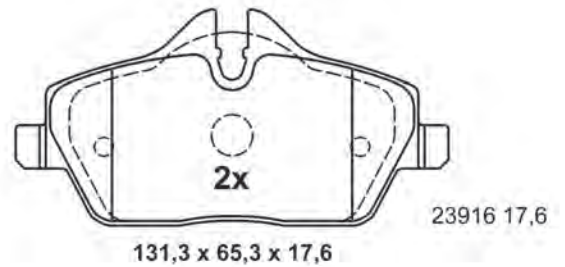
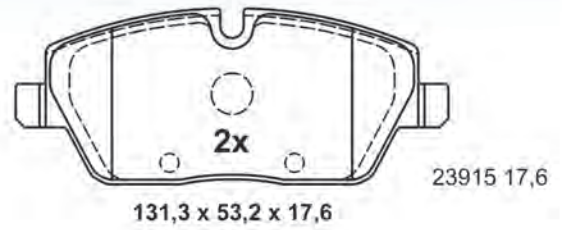

13.0460-2711.2 602711

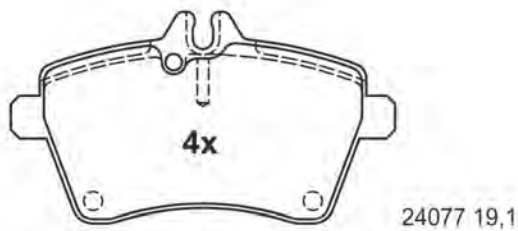

116,4 x 63,8 x 19,1

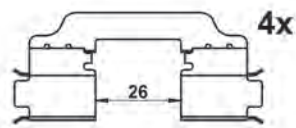

13.0460-2712.2 602712

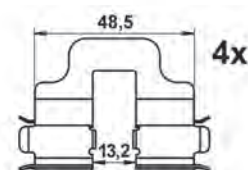
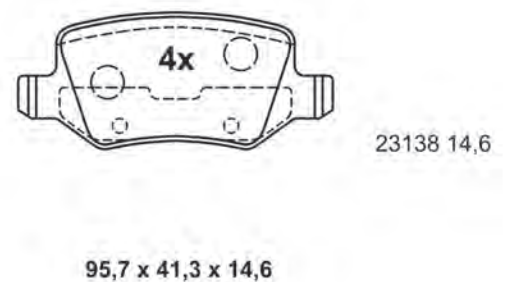

Abbildungen Scheibenbremsbeläge

Illustrations disc brake pads - Ilustraciones de pastillas - Illustrations Plaquettes de frein à disque - Illustrazioni Pastiglie Freno

13.0460-2713.2 602713

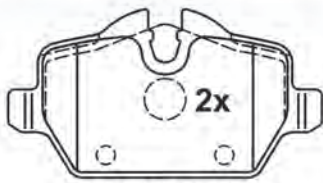

95,2 x 51,0 x 17,4

23623 17,4

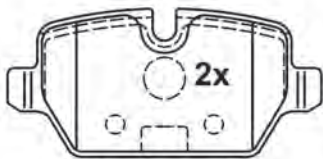

95,2 x 44,6 x 17,4

23624 17,4

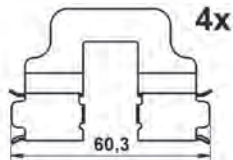

60,3



M8x21

13.0460-2714.2 602714

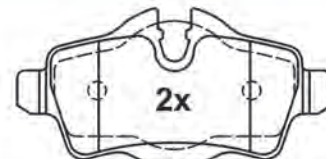

95,3 x 48,3 x 16,9

24289 16,9

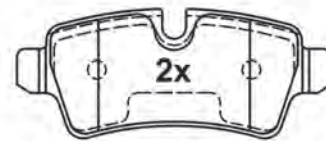

95,3 x 39,0 x 16,9

24290 16,9

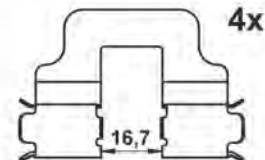

16,7



M8x22

13.0460-2715.2 602715

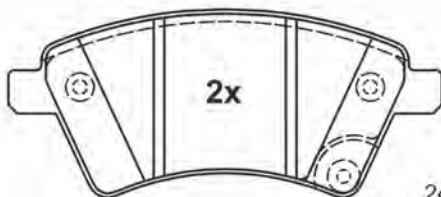

24391 16,6

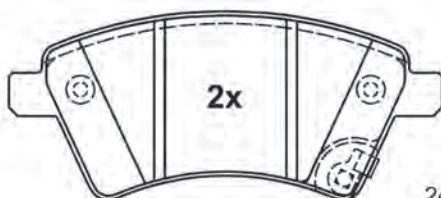

131,3 x 57,0 x 16,6

24392 16,6

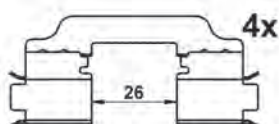

26



M8x21

13.0460-2716.2 602716

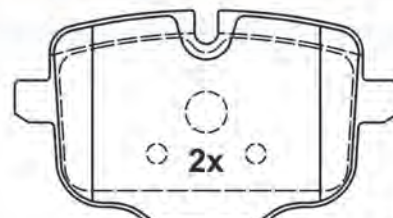

166,0 x 65,5 x 17,8

24703 17,8

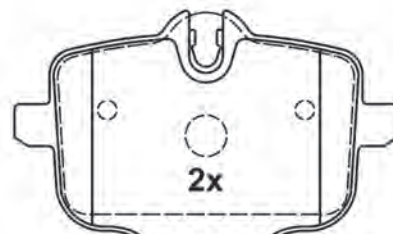

166,0 x 72,4 x 17,8

24704 17,8

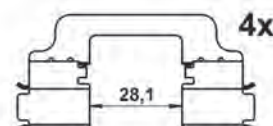

28,1



M8x21

Abbildungen Scheibenbremsbeläge

Illustrations disc brake pads - Ilustraciones de pastillas - Illustrations Plaquettes de frein à disque - Illustrazioni Pastiglie Freno

13.0460-2717.2 602717

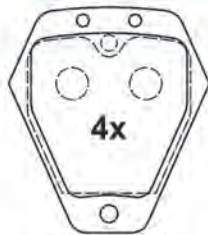

21454 17,0
76,1 x 85,6 x 17,0

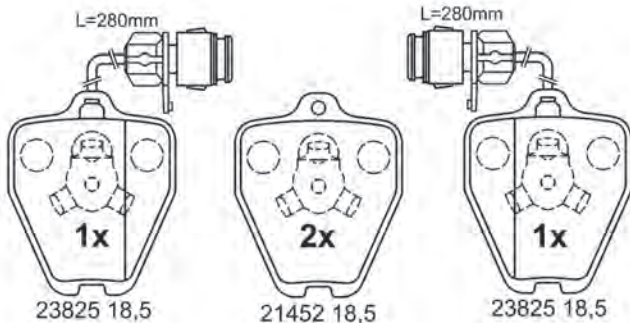

63,3 x 77,4 x 18,5



13.0460-2718.2 602718

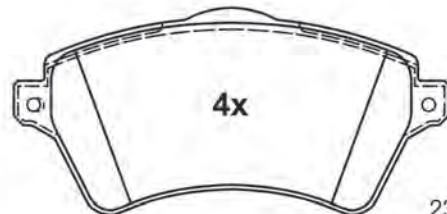

23615 18,3

131,4 x 62,1 x 18,3



13.0460-2719.2 602719

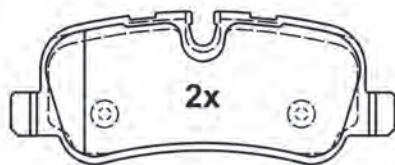

24192 17,4

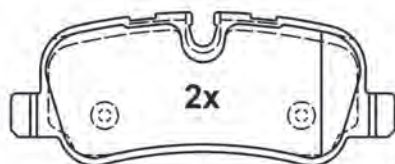

24192 17,4

116,6 x 46,4 x 17,4

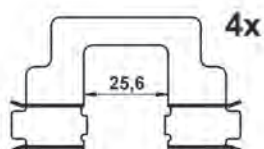

13.0460-2720.2 602720

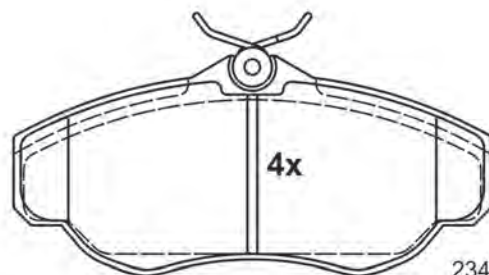

23452 19,0

144,8 x 66,3 x 19,0



Abbildungen Scheibenbremsbeläge

Illustrations disc brake pads - Ilustraciones de pastillas - Illustrations Plaquettes de frein à disque - Illustrazioni Pastiglie Freno

13.0460-2721.2 602721

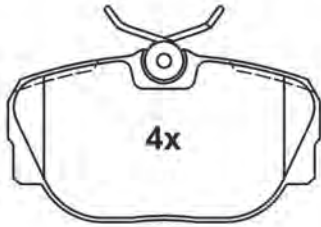

23458 15,6

94,7 x 51,9 x 15,6

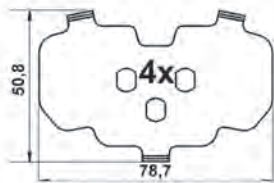

13.0460-2722.2 602722

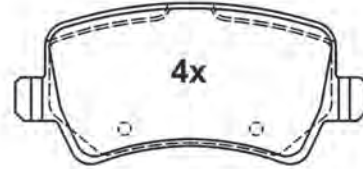

24496 17,3

106,0 x 48,7 x 17,3

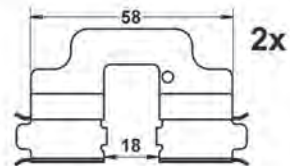
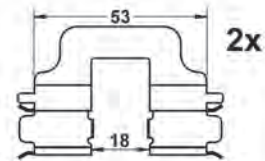

13.0460-2723.2 602723

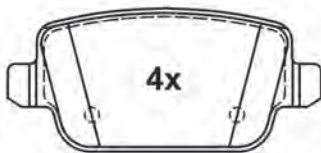

24537 16,1

95,1 x 43,2 x 16,1

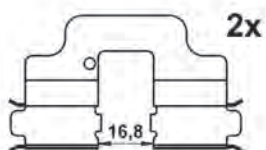
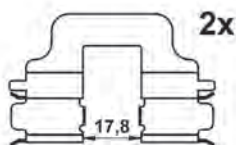

13.0460-2724.2 602724

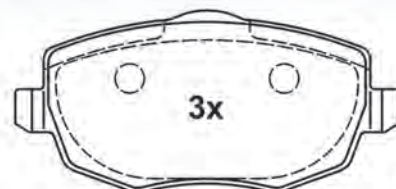

23073 16,7

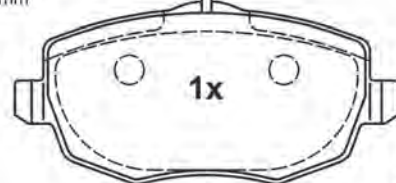

24515 16,7

116,8 x 55,2 x 16,7



Abbildungen Scheibenbremsbeläge

Illustrations disc brake pads - Ilustraciones de pastillas - Illustrations Plaquettes de frein à disque - Illustrazioni Pastiglie Freno

13.0460-2725.2 602725

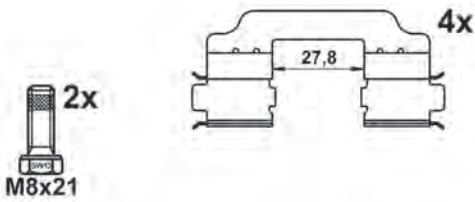
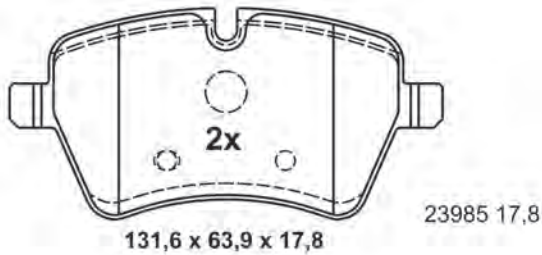
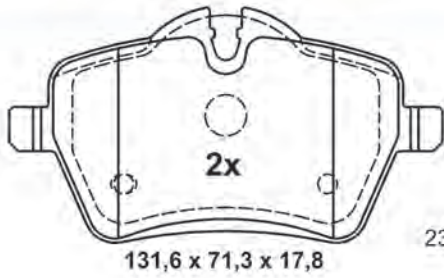

13.0460-2726.2 602726

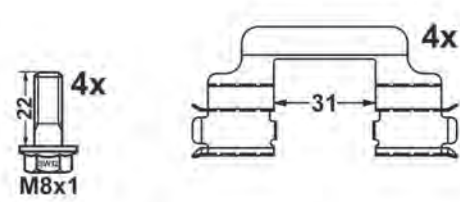
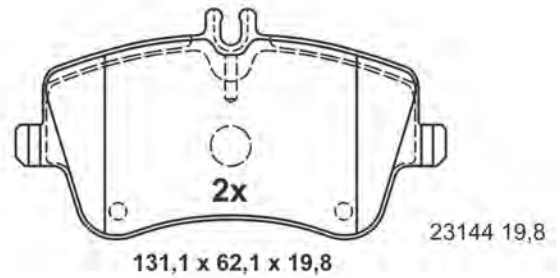
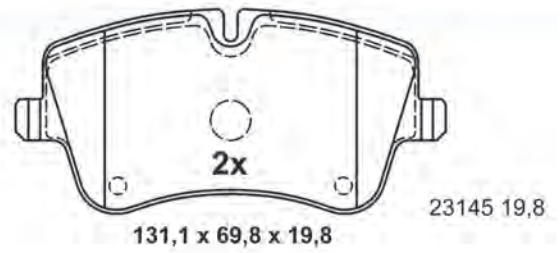

13.0460-2727.2 602727

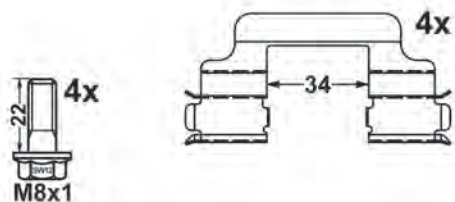
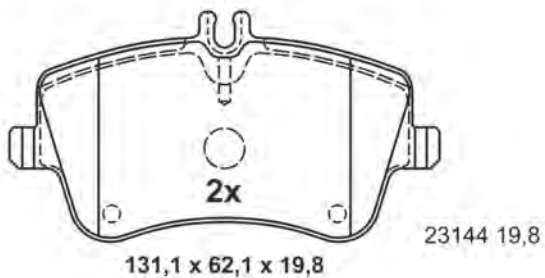
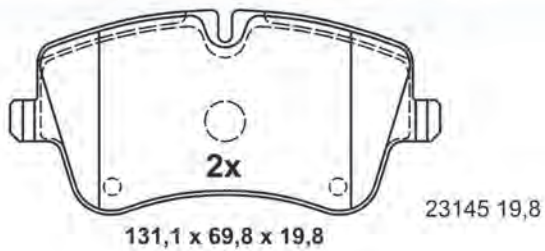

13.0460-2728.2 602728

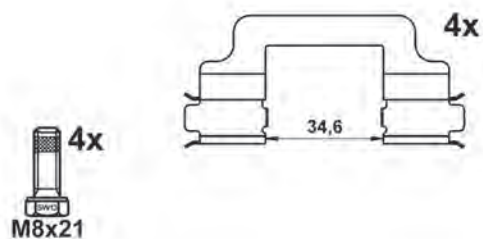
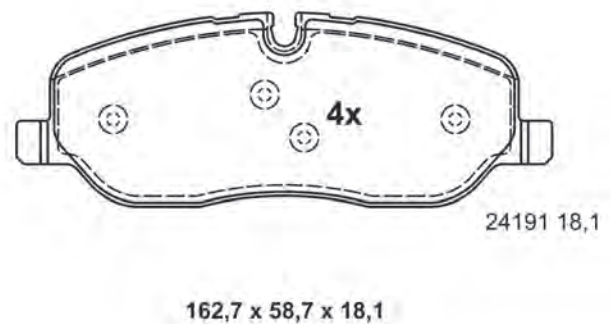

Abbildungen Scheibenbremsbeläge

Illustrations disc brake pads - Ilustraciones de pastillas - Illustrations Plaquettes de frein à disque - Illustrazioni Pastiglie Freno

13.0460-2729.2 602729

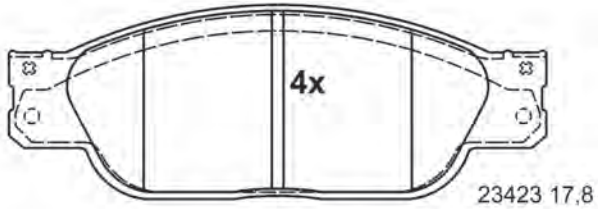

163,3 x 58,1 x 17,8

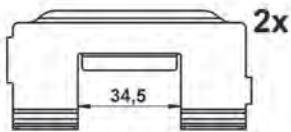
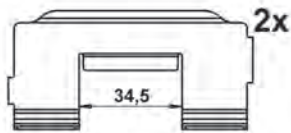

13.0460-2730.2 602730

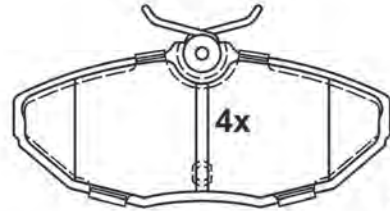

114,3 x 49,5 x 17,6



13.0460-2731.2 602731

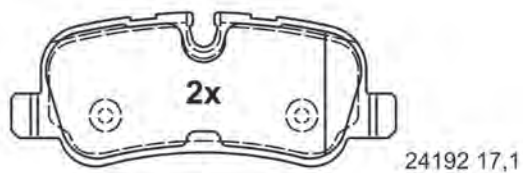

116,6 x 46,4 x 17,1

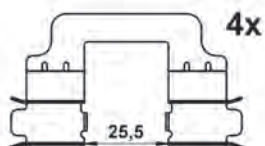

13.0460-2732.2 602732

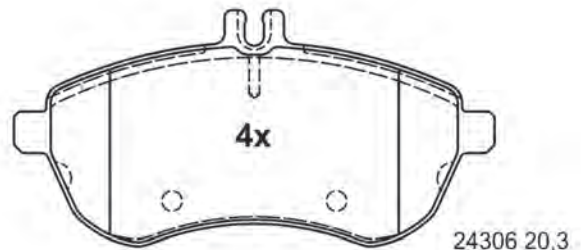

146,0 x 71,5 x 20,3

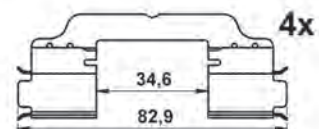

Abbildungen Scheibenbremsbeläge

Illustrations disc brake pads - Ilustraciones de pastillas - Illustrations Plaquettes de frein à disque - Illustrazioni Pastiglie Freno

13.0460-2733.2 602733

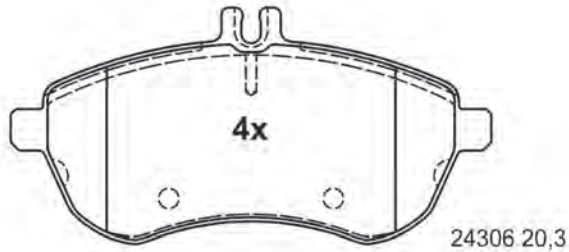

146,0 x 71,5 x 20,3

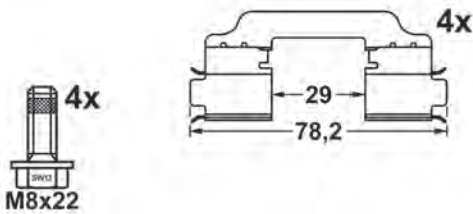

13.0460-2734.2 602734

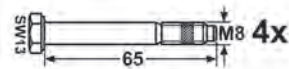
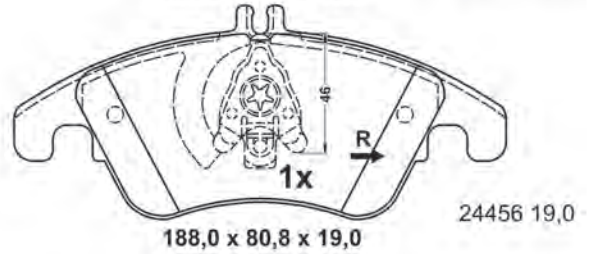
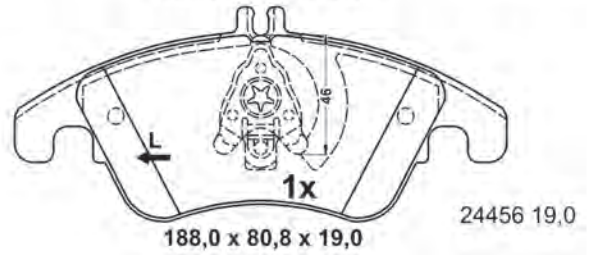
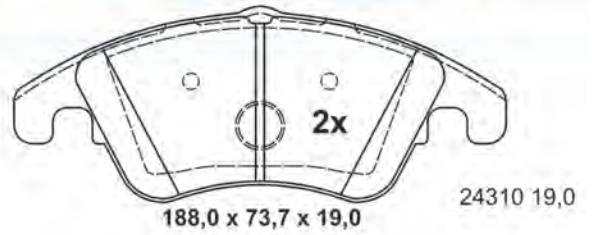

13.0460-2735.2 602735

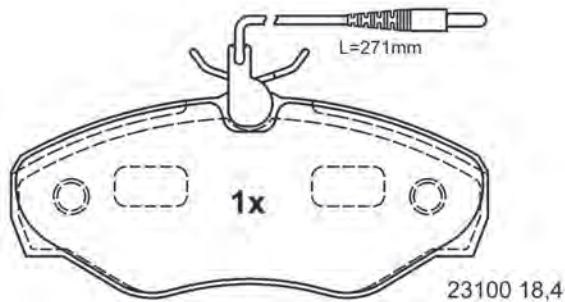
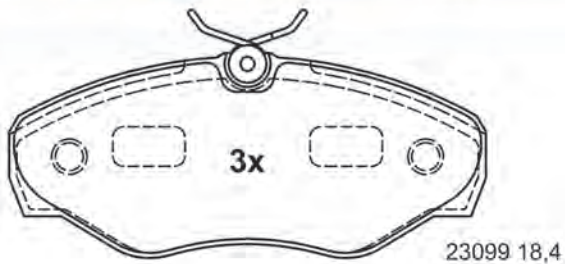

144,8 x 62,4 x 18,4



13.0460-2736.2 602736



106,1 x 48,7 x 17,3

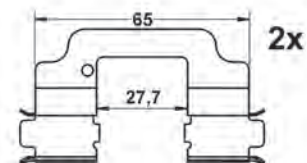
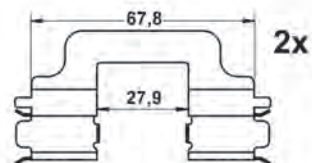

Abbildungen Scheibenbremsbeläge

Illustrations disc brake pads - Ilustraciones de pastillas - Illustrations Plaquettes de frein à disque - Illustrazioni Pastiglie Freno

13.0460-2737.2 602737

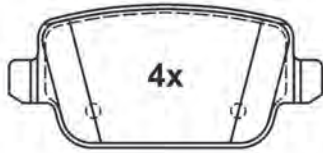

24537 15,8

95,1 x 43,2 x 15,8

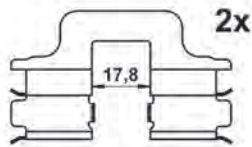
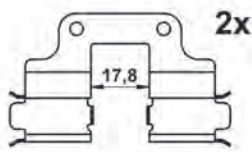

13.0460-2738.2 602738

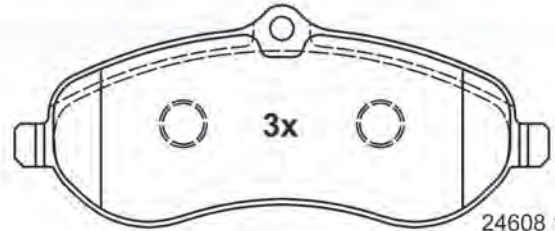

24608 18,5

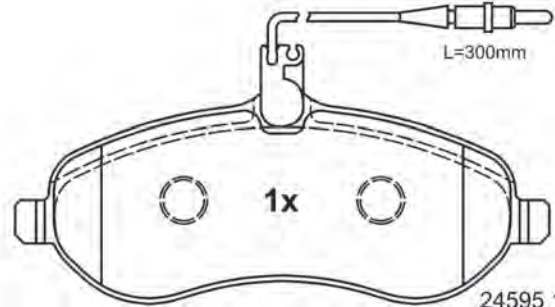

24595 18,5

162,0 x 67,3 x 18,5

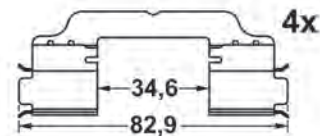

13.0460-2739.2 602739

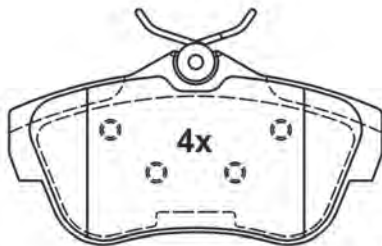

24578 16,5

113,3 x 58,5 x 16,5



13.0460-2740.2 602740

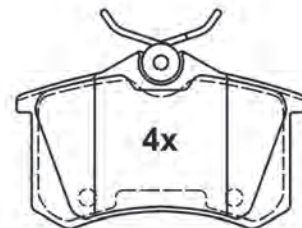

23554 17,0

87,6 x 52,9 x 17,0

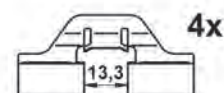

Abbildungen Scheibenbremsbeläge

Illustrations disc brake pads - Ilustraciones de pastillas - Illustrations Plaquettes de frein à disque - Illustrazioni Pastiglie Freno

13.0460-2741.2 602741

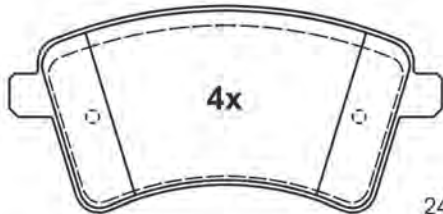

24693 18,5

131,0 x 62,3 x 18,5

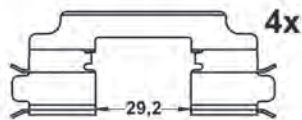

M8x22

13.0460-2742.2 602742

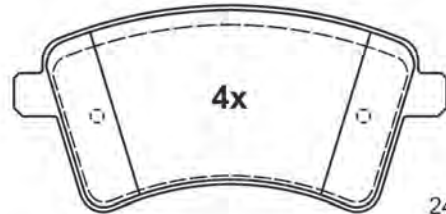

24693 17,5

131,0 x 62,3 x 17,5

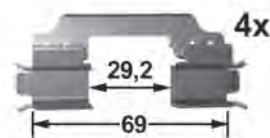

M8x22

13.0460-2743.2 602743

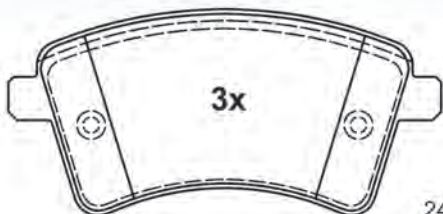

24693 17,5

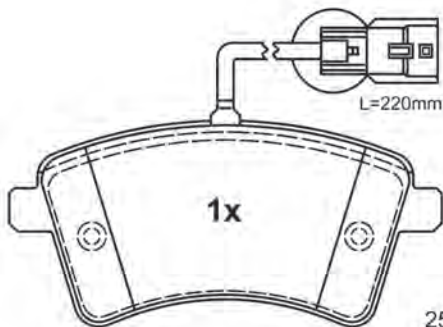

25291 17,5

131,0 x 62,3 x 17,5



M8x22

13.0460-2744.2 602744

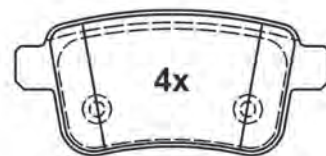

24692 15,9

95,4 x 43,8 x 15,9

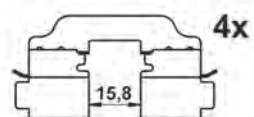

M8x22



Abbildungen Scheibenbremsbeläge

Illustrations disc brake pads - Ilustraciones de pastillas - Illustrations Plaquettes de frein à disque - Illustrazioni Pastiglie Freno

13.0460-2745.2 602745

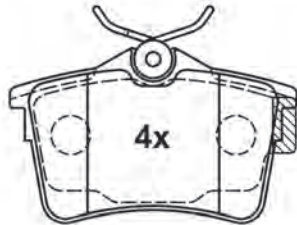

24765 16,5

87,2 x 52,8 x 16,5

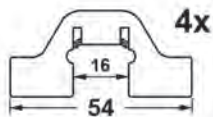

13.0460-2746.2 602746

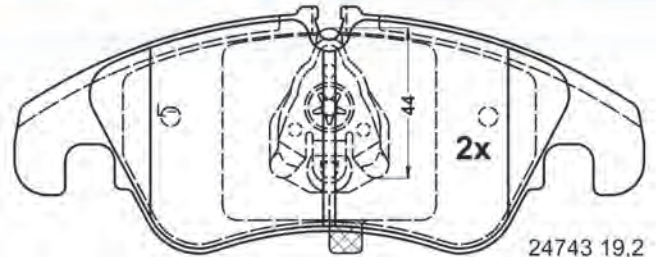

188,0 x 73,5 x 19,2

24743 19,2
(24408)

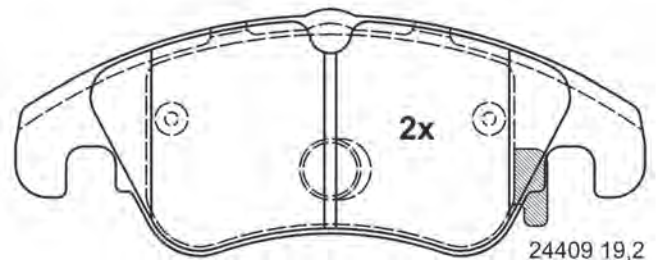

188,0 x 73,0 x 19,2

24409 19,2

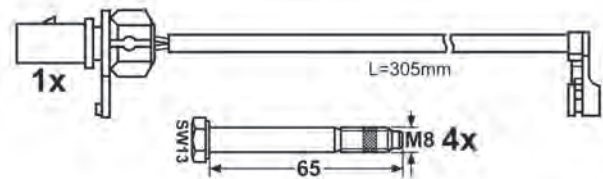

13.0460-2747.2 602747

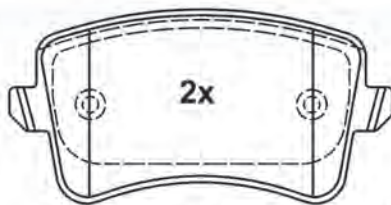

24606 17,4

116,4 x 58,5 x 17,4

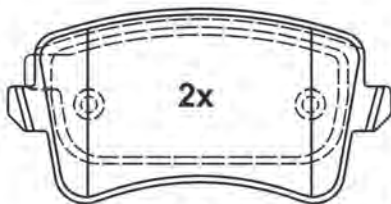

24606 17,7

116,4 x 58,5 x 17,7

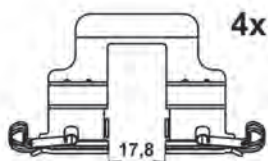

13.0460-2748.2 602748

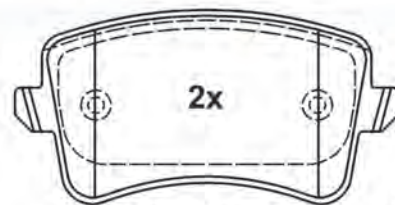

24606 17,4

116,4 x 58,5 x 17,4

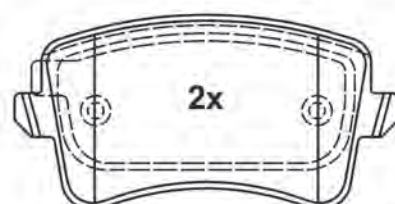

24606 17,7

116,4 x 58,5 x 17,7

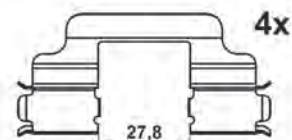

Abbildungen Scheibenbremsbeläge

Illustrations disc brake pads - Ilustraciones de pastillas - Illustrations Plaquettes de frein à disque - Illustrazioni Pastiglie Freno

13.0460-2750.2 602750

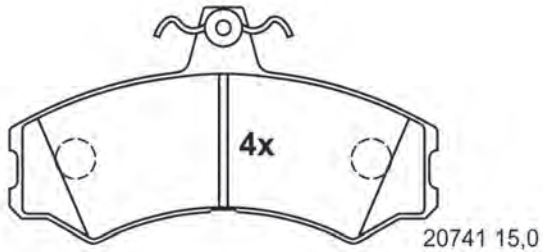

129,9 x 71,0 x 15,0

13.0460-2751.2 602751

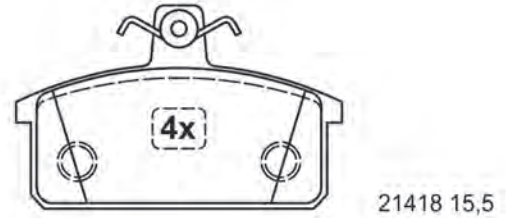

99,9 x 61,0 x 15,5

13.0460-2752.2 602752

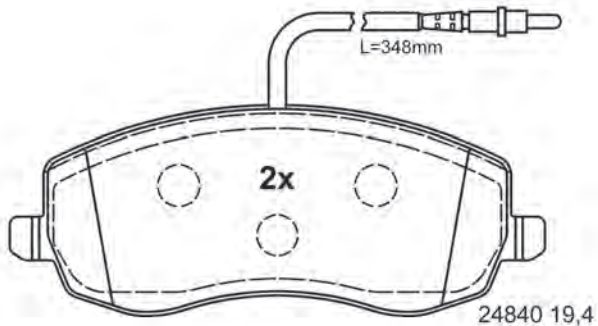
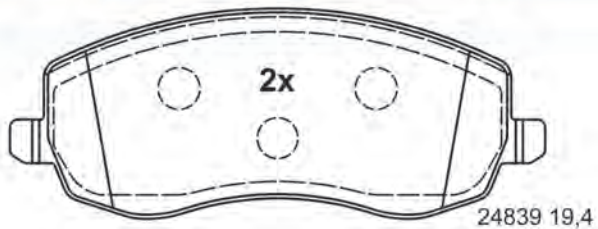

162,5 x 63,8 x 19,4

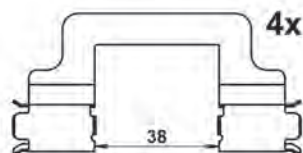

13.0460-2753.2 602753

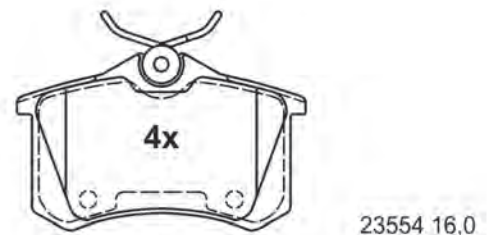

87,6 x 52,9 x 16,0



Abbildungen Scheibenbremsbeläge

Illustrations disc brake pads - Ilustraciones de pastillas - Illustrations Plaquettes de frein à disque - Illustrazioni Pastiglie Freno

13.0460-2754.2 602754

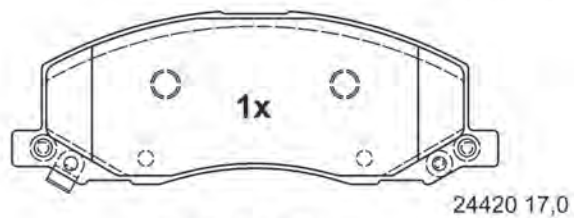
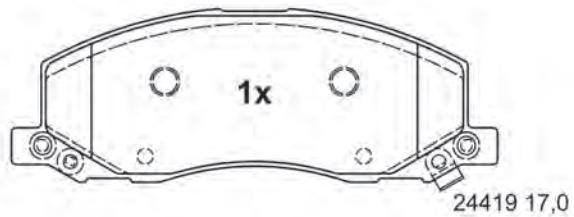
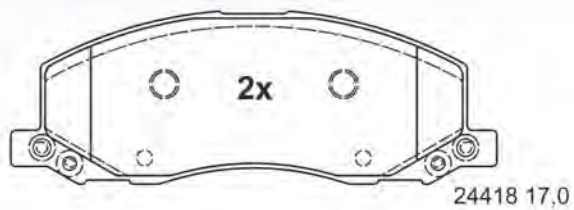

184,5 x 65,4 x 17,0



13.0460-2755.2 602755

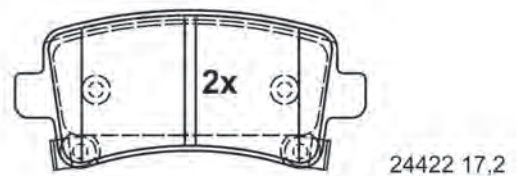
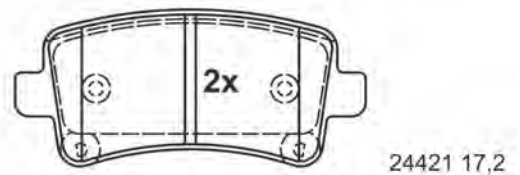

106,3 x 47,1 x 17,2

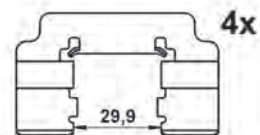

13.0460-2756.2 602756

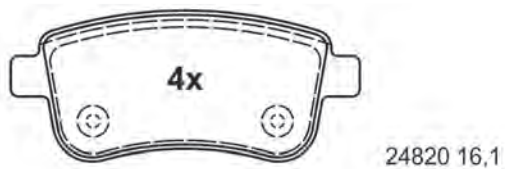

106,3 x 45,3 x 16,1

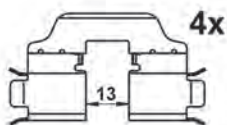

13.0460-2757.2 602757

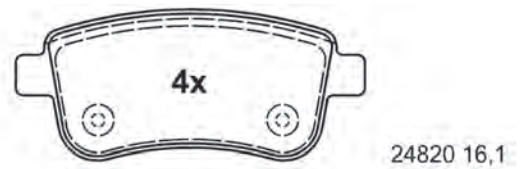

106,3 x 45,3 x 16,1

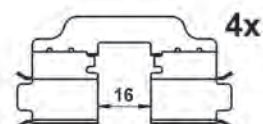

Abbildungen Scheibenbremsbeläge

Illustrations disc brake pads - Ilustraciones de pastillas - Illustrations Plaquettes de frein à disque - Illustrazioni Pastiglie Freno

13.0460-2758.2 602758

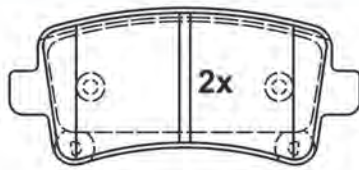

24421 17,2

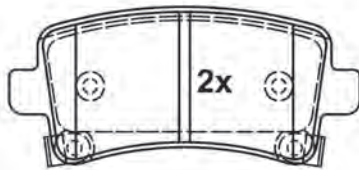

24422 17,2

106,3 x 47,1 x 17,2

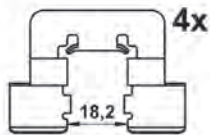

13.0460-2759.2 602759

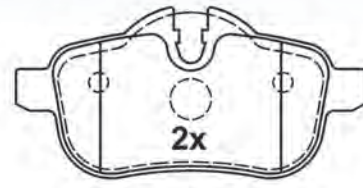

24559 17,8

106,0 x 52,3 x 17,8

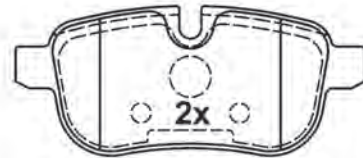

24560 17,8

106,0 x 45,1 x 17,8

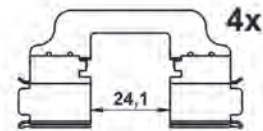

13.0460-2760.2 602760



24561 17,7

106,0 x 63,2 x 17,7

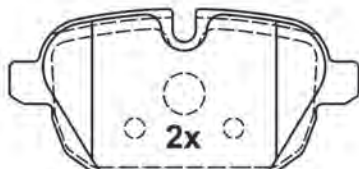

24562 17,7

106,0 x 56,2 x 17,7

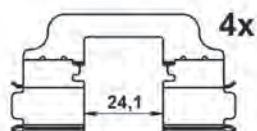

13.0460-2761.2 602761

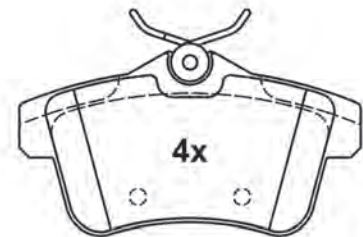

24922 17,5

103,8 x 55,6 x 17,5



Abbildungen Scheibenbremsbeläge

Illustrations disc brake pads - Ilustraciones de pastillas - Illustrations Plaquettes de frein à disque - Illustrazioni Pastiglie Freno

13.0460-2762.2 602762 [1]

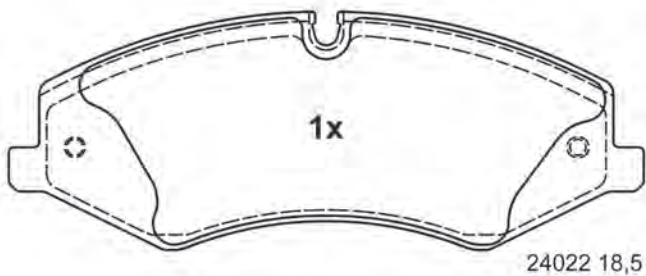
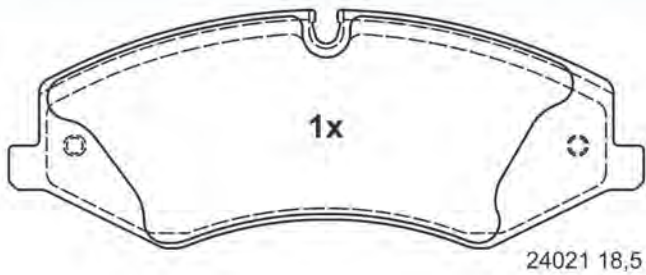

192,7 x 72,2 x 18,5

13.0460-2762.2 602762 [2]

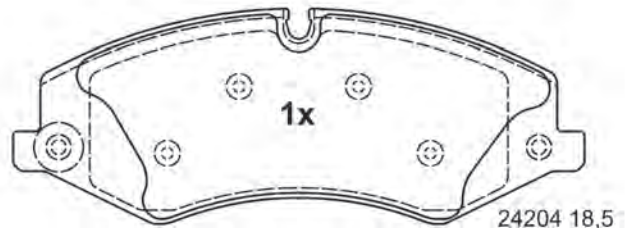
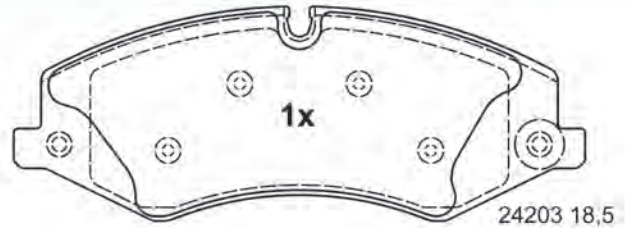

192,7 x 72,2 x 18,5

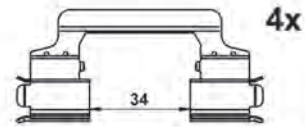

13.0460-2763.2 602763

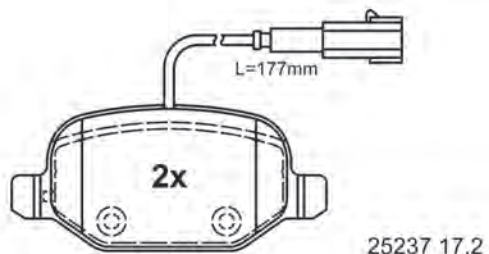

95,5 x 43,9 x 17,2

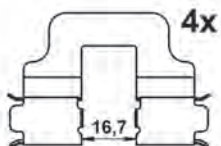

13.0460-2764.2 602764

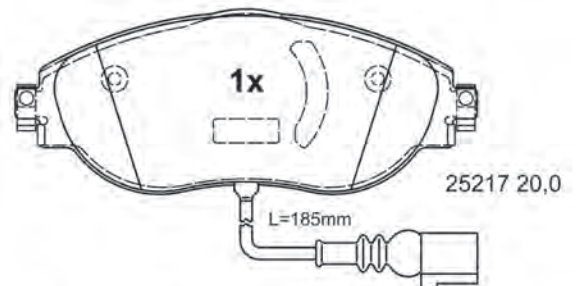
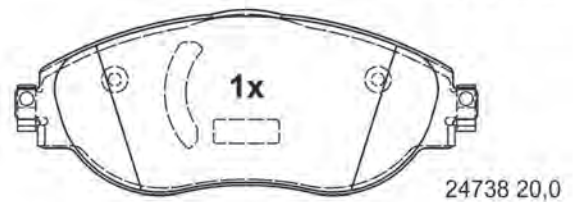
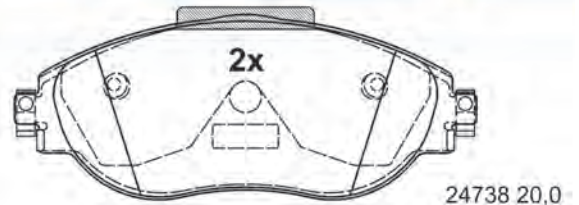

175,0 x 70,0 x 20,0



Abbildungen Scheibenbremsbeläge

Illustrations disc brake pads - Ilustraciones de pastillas - Illustrations Plaquettes de frein à disque - Illustrazioni Pastiglie Freno

13.0460-2765.2 602765

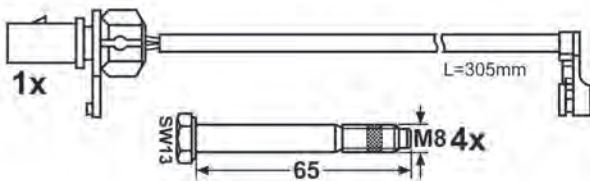
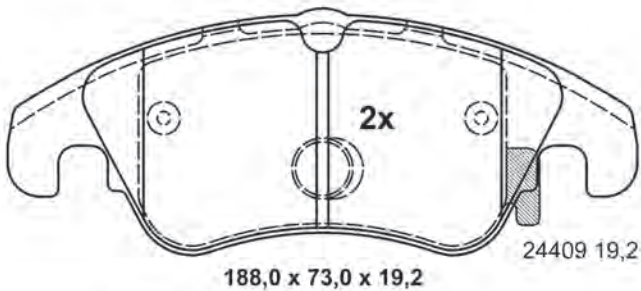
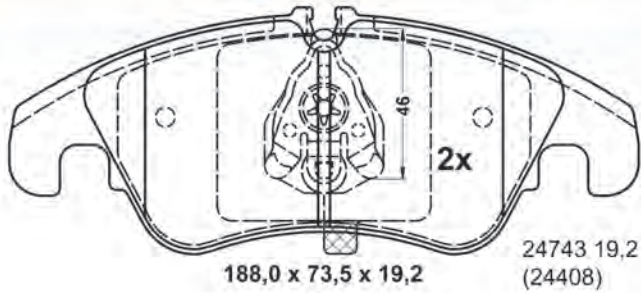

13.0460-2766.2 602766

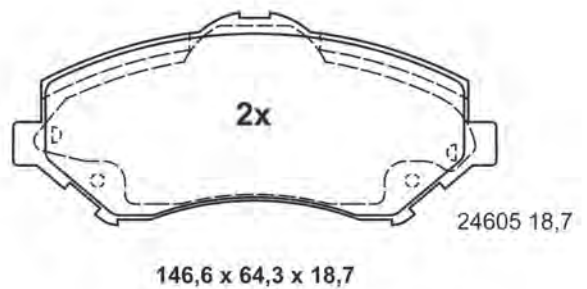
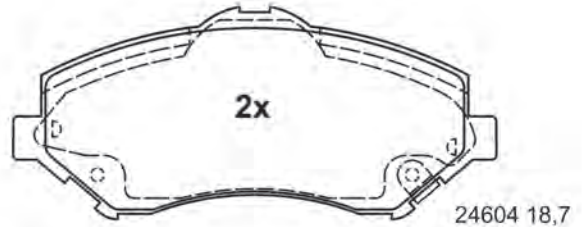

13.0460-2767.2 602767

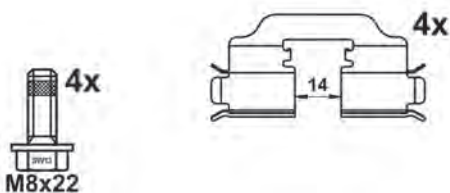
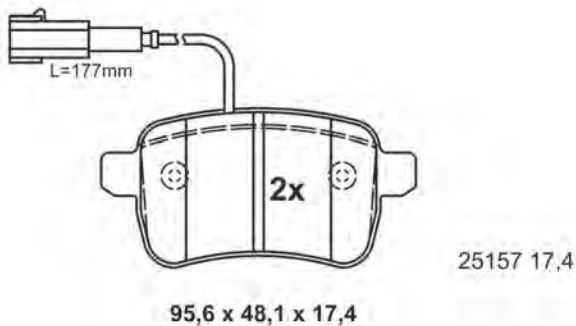
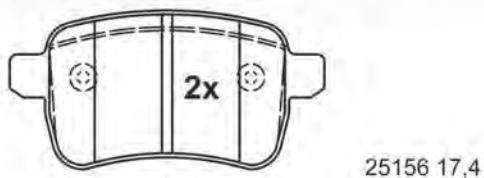

13.0460-2768.2 602768

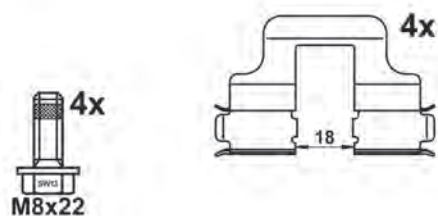
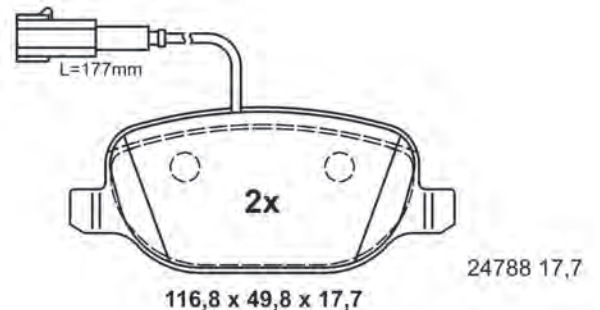
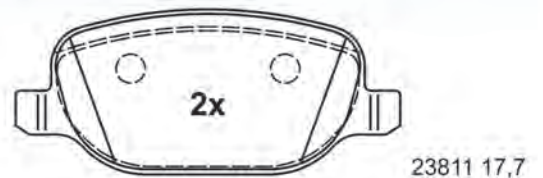

Abbildungen Scheibenbremsbeläge

Illustrations disc brake pads - Ilustraciones de pastillas - Illustrations Plaquettes de frein à disque - Illustrazioni Pastiglie Freno

13.0460-2769.2 602769

B · H · D

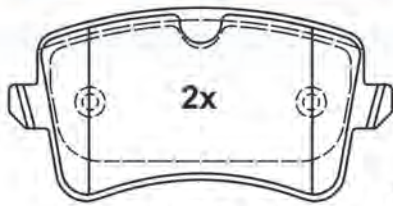

116,4 x 58,5 x 17,4

24606 17,4

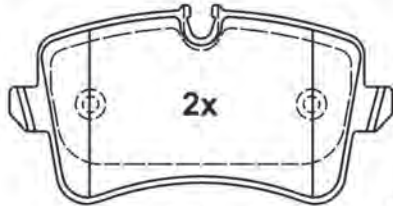

116,4 x 59,8 x 17,4

25214 17,4



L=215mm



4x

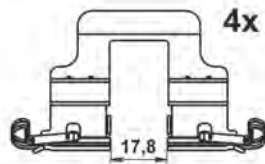

4x

17,8

13.0460-2770.2 602770

B · H · D

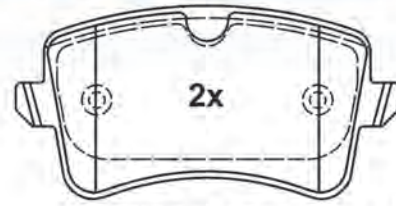

116,4 x 58,5 x 17,4

24606 17,4

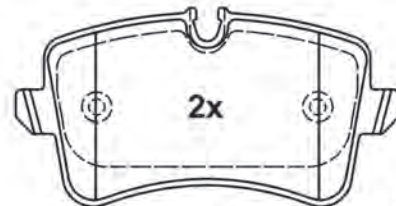

116,4 x 59,8 x 17,4

25214 17,4



L=215mm



4x

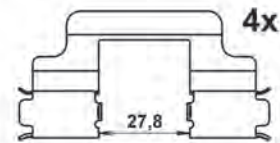

4x

27,8

13.0460-2771.2 602771

B · H · D

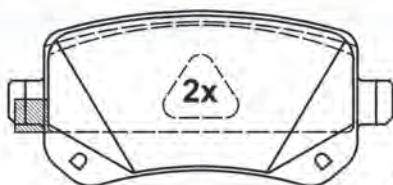

24822 15,7

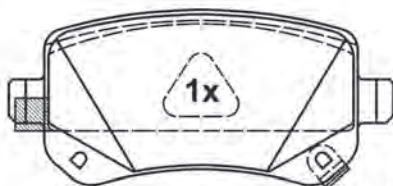

24823 15,7

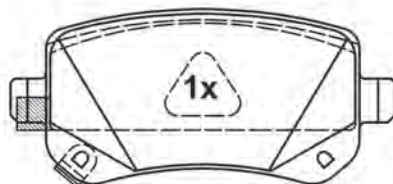

24824 15,7

116,6 x 52,5 x 15,7

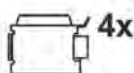

4x



4x

13.0460-2772.2 602772

B · H · D

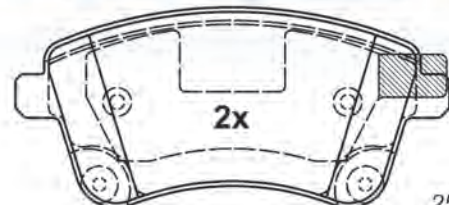

25184 19,4

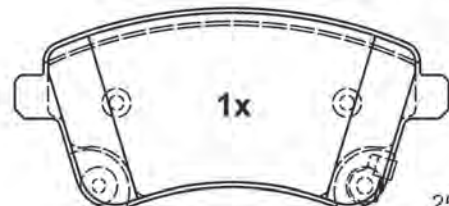

25185 19,4

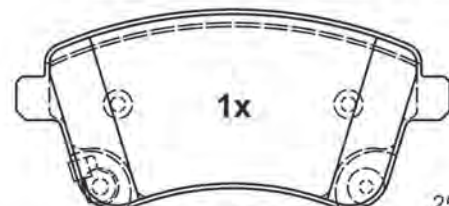

25186 19,4

131,6 x 60,6 x 19,4



4x

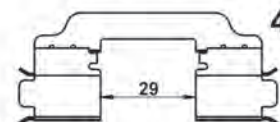

4x

29

Abbildungen Scheibenbremsbeläge

Illustrations disc brake pads - Ilustraciones de pastillas - Illustrations Plaquettes de frein à disque - Illustrazioni Pastiglie Freno

13.0460-2773.2 602773

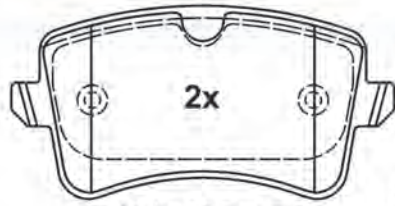

24606 17,4

116,4 x 58,5 x 17,4

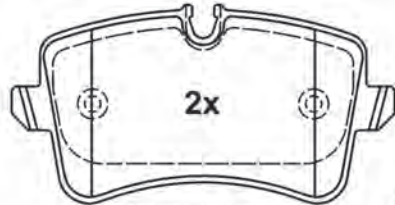

25214 17,4

116,4 x 59,8 x 17,4

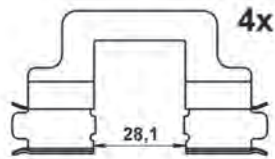
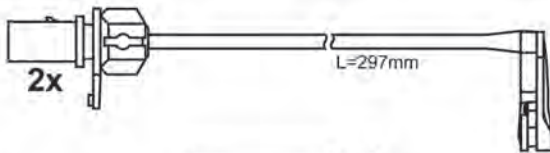

13.0460-2774.2 602774

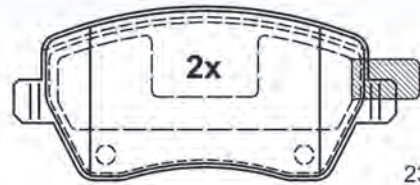

23973 17,4

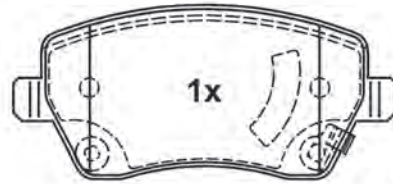

24403 17,4

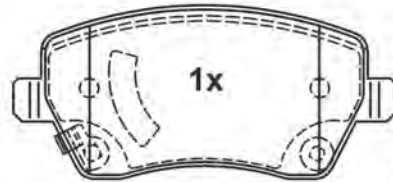

24403 17,4

116,3 x 52,4 x 17,4

13.0460-2775.2 602775

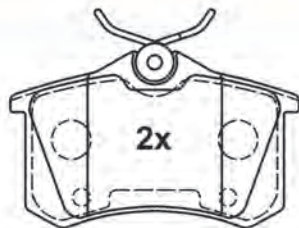

23554 17,0

87,6 x 52,9 x 17,0

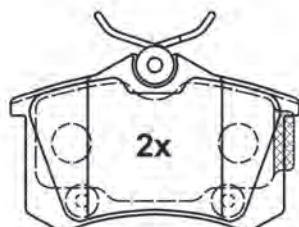

23554 16,4

87,6 x 52,9 x 16,4



13.0460-2776.2 602776

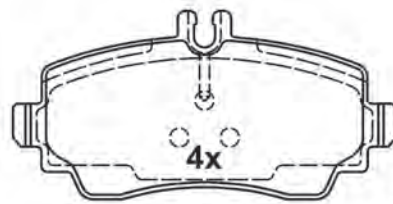

23070 17,0

116,5 x 57,1 x 17,0

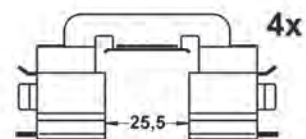

Abbildungen Scheibenbremsbeläge

Illustrations disc brake pads - Ilustraciones de pastillas - Illustrations Plaquettes de frein à disque - Illustrazioni Pastiglie Freno

13.0460-2778.2 602778

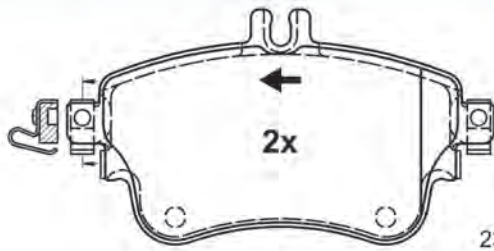

23526 19,3

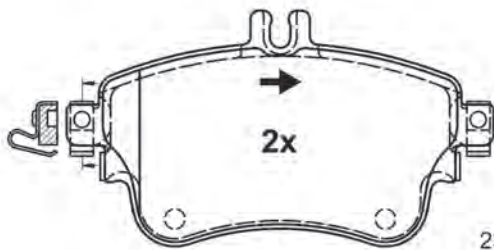

23526 19,3

129,0 x 71,3 x 19,3



13.0460-2779.2 602779

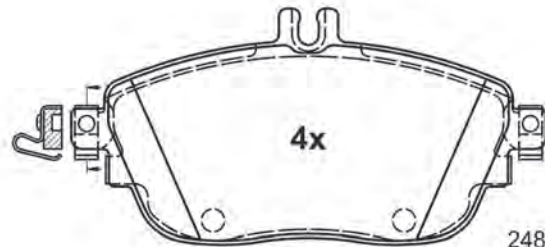

24869 19,3

144,0 x 71,6 x 19,3



13.0460-2780.2 602780



25072 18,8

116,2 x 54,7 x 18,8

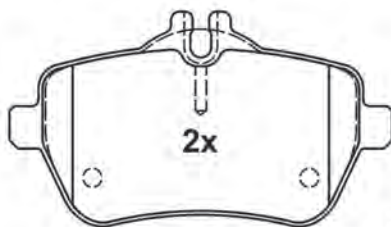

25071 18,8

116,2 x 65,0 x 18,8

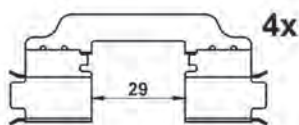

13.0460-2781.2 602781



25215 18,6

116,3 x 49,8 x 18,6

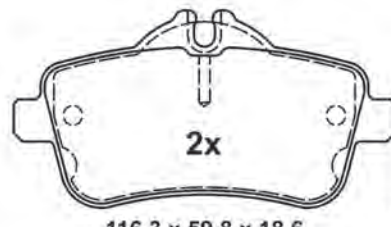

25216 18,6

116,3 x 59,8 x 18,6

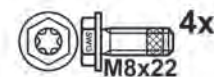
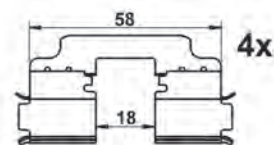

Abbildungen Scheibenbremsbeläge

Illustrations disc brake pads - Ilustraciones de pastillas - Illustrations Plaquettes de frein à disque - Illustrazioni Pastiglie Freno

13.0460-2782.2 602782



25215 18,6

116,3 x 49,8 x 18,6

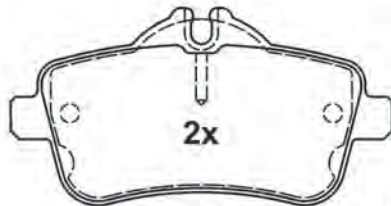

25216 18,6

116,3 x 59,8 x 18,6

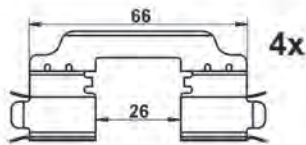

13.0460-2783.2 602783

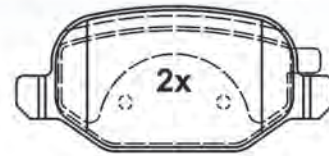

25410 14,4

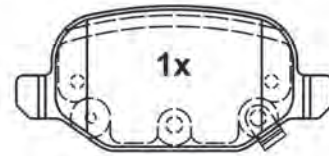

25411 14,4

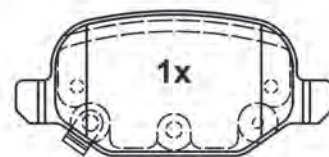

25412 14,4

95,4 x 43,8 x 14,4

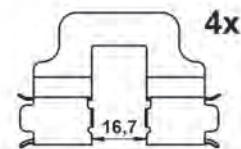

13.0460-2784.2 602784



25134 17,2

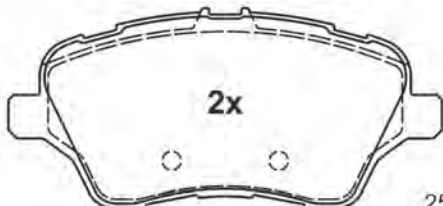

25135 17,2

131,5 x 60,0 x 17,2

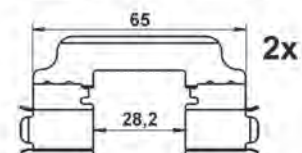
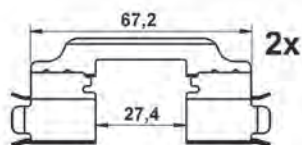

13.0460-2785.2 602785

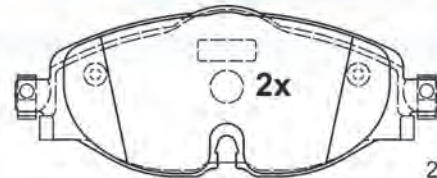

25683 20,4

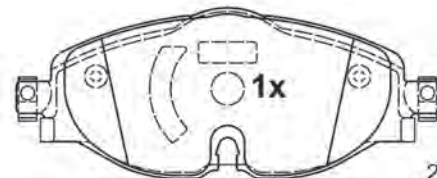

25684 20,4



25684 20,4

160,0 x 64,5 x 20,4

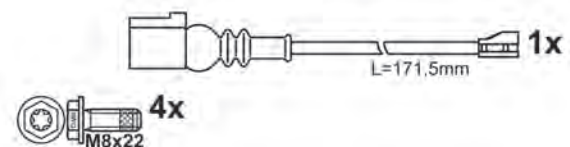

Abbildungen Scheibenbremsbeläge

Illustrations disc brake pads - Ilustraciones de pastillas - Illustrations Plaquettes de frein à disque - Illustrazioni Pastiglie Freno

13.0460-2786.2 602786

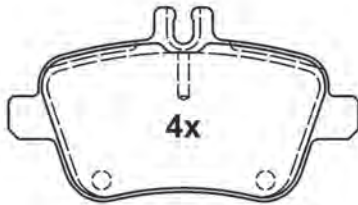

24848 18,3

106,4 x 58,9 x 18,3

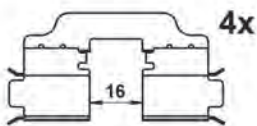

4x

M8x22

13.0460-2787.2 602787

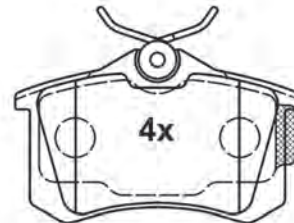

23554 17,3

57,5 x 52,9 x 17,3



4x

M8x22

13.0460-2789.2 602789



25652 17,1



25653 17,1

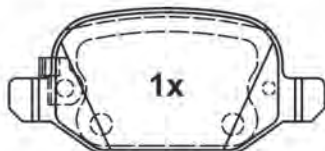

25654 17,1

95,8 x 43,8 x 17,1

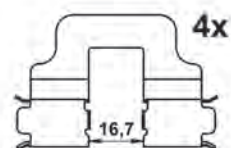

4x



4x

M8x22

13.0460-2792.2 602792

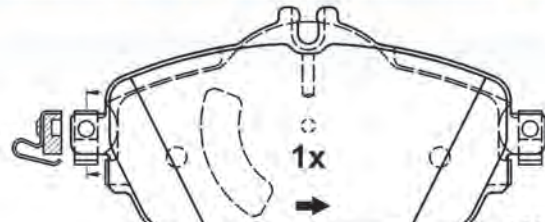

22031 19,6

144,0 x 70,0 x 19,6

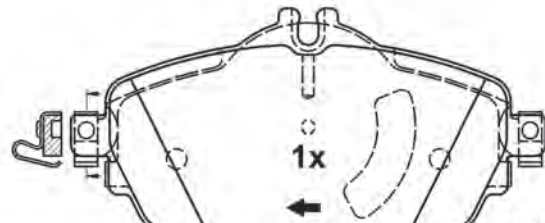

22031 19,6

144,0 x 70,0 x 19,6

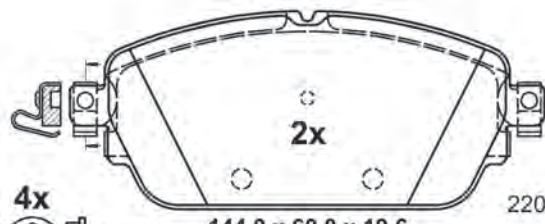

22032 19,6

144,0 x 60,0 x 19,6



4x

M8x22

Abbildungen Scheibenbremsbeläge

Illustrations disc brake pads - Ilustraciones de pastillas - Illustrations Plaquettes de frein à disque - Illustrazioni Pastiglie Freno

13.0460-2793.2 602793



25973 17,2

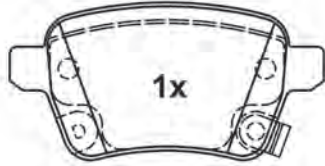

25974 17,2

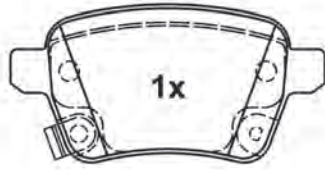

25975 17,2

95,5 x 47,7 x 17,2

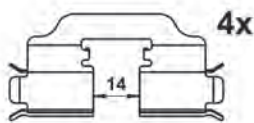

13.0460-2800.2 602800

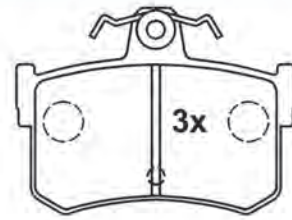

20087 14,6

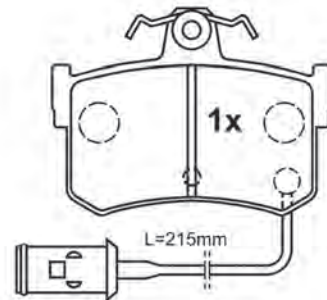

20091 14,6

85,1 x 62,2 x 14,6

13.0460-2803.2 602803

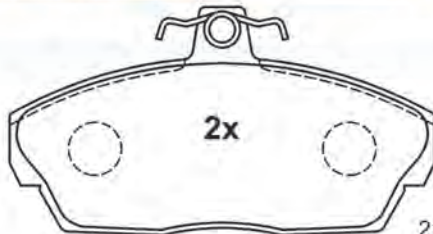

21515 17,5

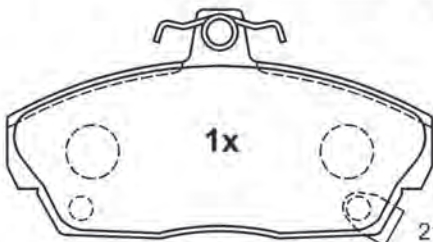

21516 17,5

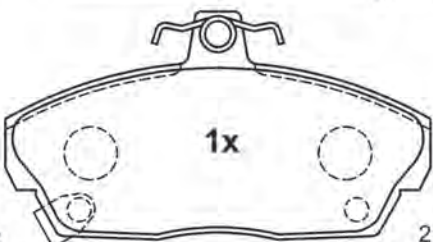

21517 17,5

129,1 x 68,8 x 17,5



13.0460-2804.2 602804

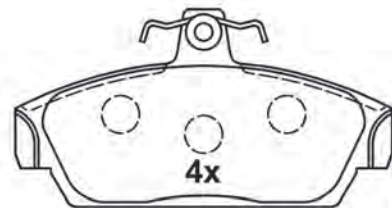

21518 17,0

115,2 x 60,4 x 17,0

Abbildungen Scheibenbremsbeläge

Illustrations disc brake pads - Ilustraciones de pastillas - Illustrations Plaquettes de frein à disque - Illustrazioni Pastiglie Freno

13.0460-2805.2 602805

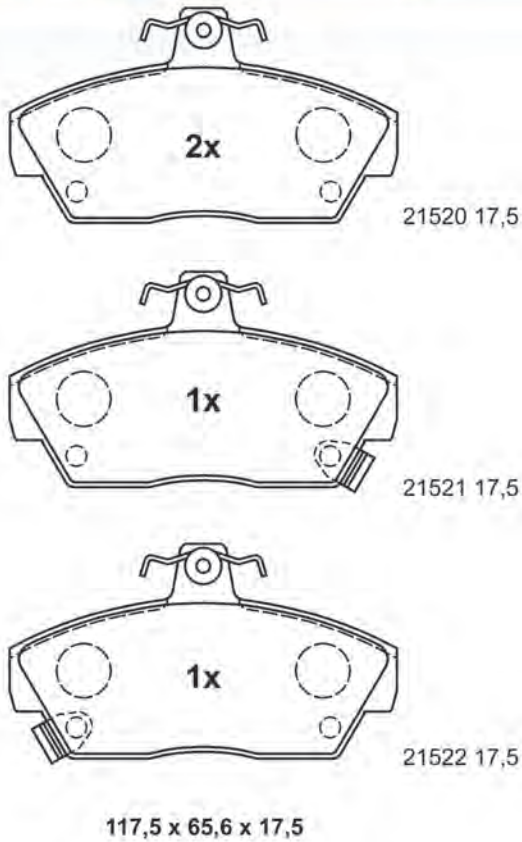

13.0460-2806.2 602806

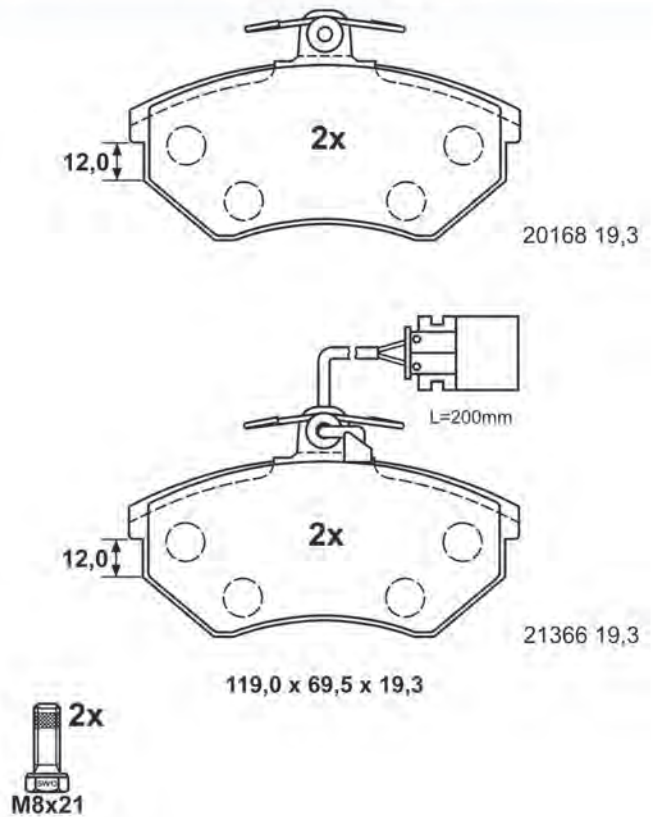

13.0460-2809.2 602809

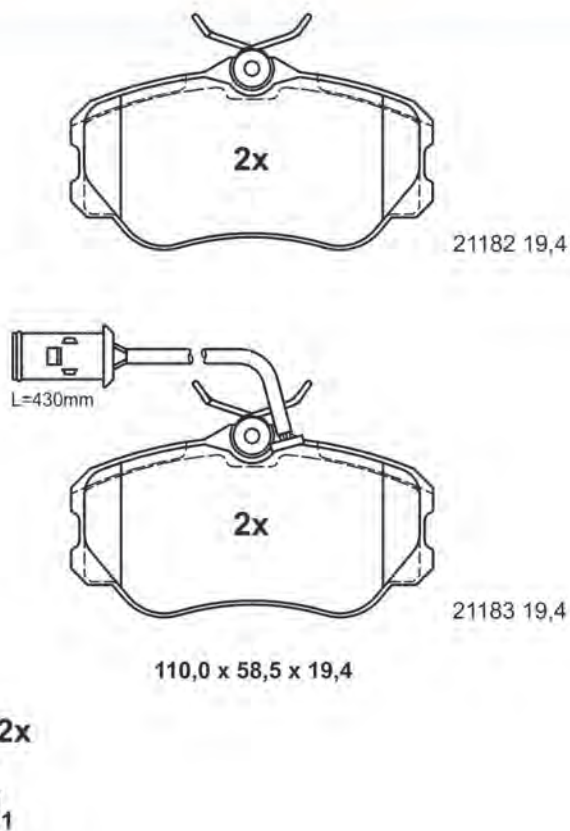

13.0460-2810.2 602810

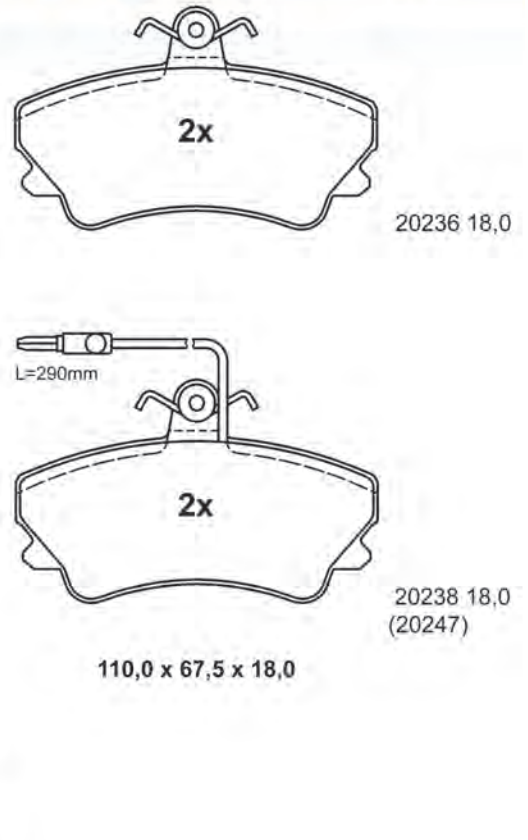

Abbildungen Scheibenbremsbeläge

Illustrations disc brake pads - Ilustraciones de pastillas - Illustrations Plaquettes de frein à disque - Illustrazioni Pastiglie Freno

13.0460-2811.2 602811

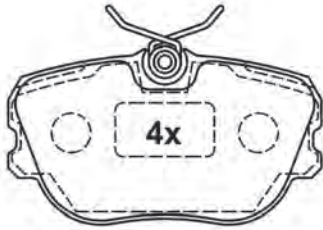

21068 17,0

94,8 x 52,6 x 17,0



13.0460-2812.2 602812

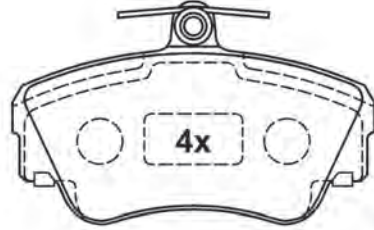

21217 18,0

109,9 x 67,5 x 18,0



13.0460-2815.2 602815

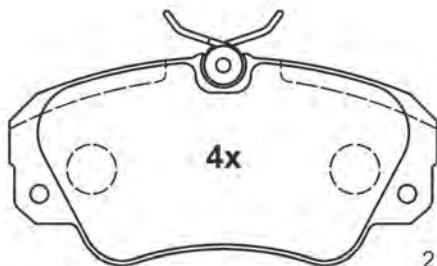

21368 18,3

129,9 x 63,8 x 18,3



13.0460-2816.2 602816

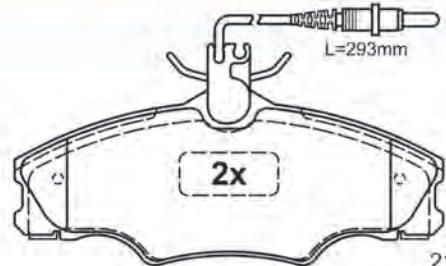

21724 19,3

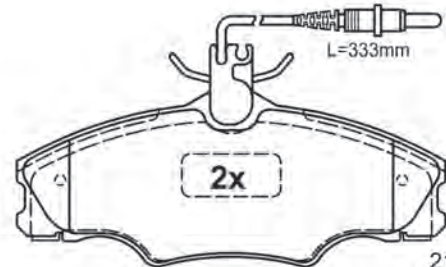

21749 19,3

130,0 x 52,8 x 19,3



Abbildungen Scheibenbremsbeläge

Illustrations disc brake pads - Ilustraciones de pastillas - Illustrations Plaquettes de frein à disque - Illustrazioni Pastiglie Freno

13.0460-2817.2 602817

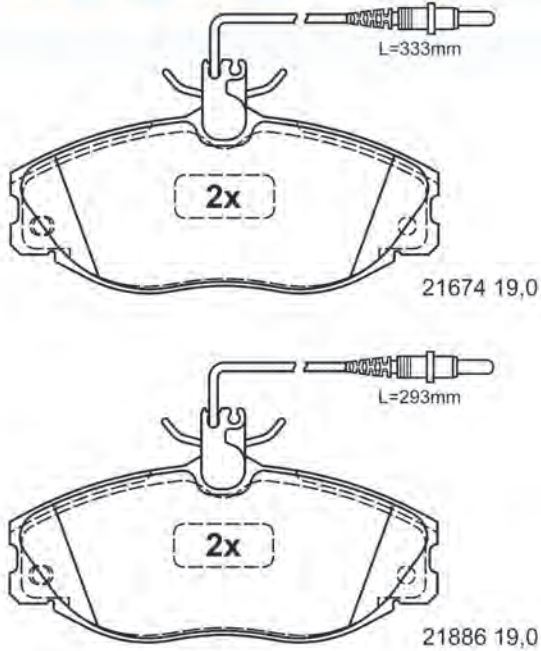

129,9 x 56,4 x 19,0



13.0460-2819.2 602819

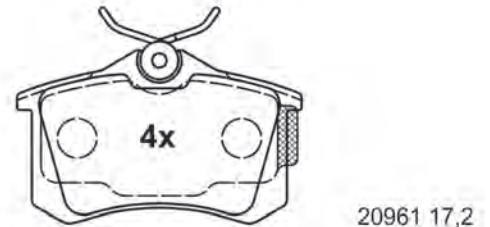

13.0460-2820.2 602820

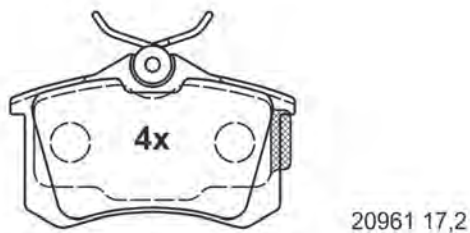

13.0460-2821.2 602821

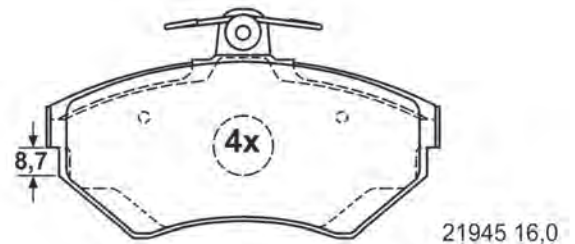

Abbildungen Scheibenbremsbeläge

Illustrations disc brake pads - Ilustraciones de pastillas - Illustrations Plaquettes de frein à disque - Illustrazioni Pastiglie Freno

13.0460-2822.2 602822

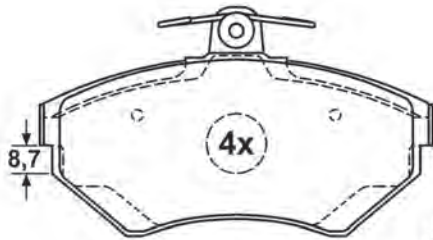

21945 19,6

119,1 x 69,5 x 19,6



13.0460-2824.2 602824

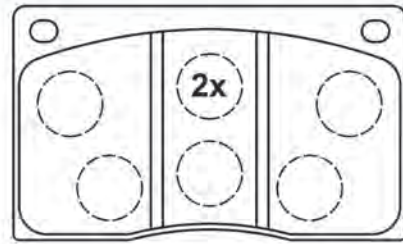

20380 15,6

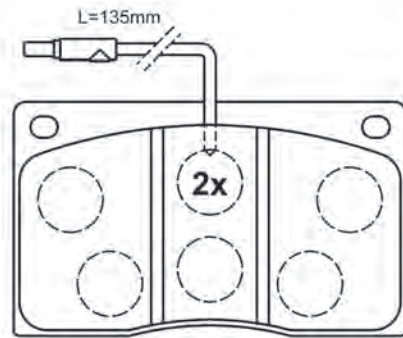

21110 15,6

119,7 x 71,0 x 15,6

13.0460-2825.2 602825

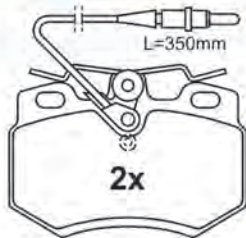

21616 17,7

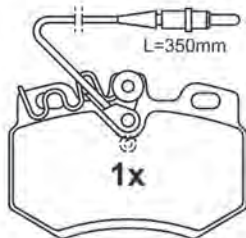

21614 17,7

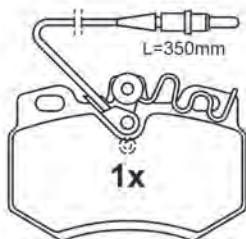

21615 17,7

89,9 x 62,9 x 17,7

13.0460-2826.2 602826

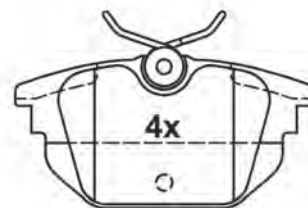

23177 14,2

87,0 x 44,6 x 14,2



Abbildungen Scheibenbremsbeläge

Illustrations disc brake pads - Ilustraciones de pastillas - Illustrations Plaquettes de frein à disque - Illustrazioni Pastiglie Freno

13.0460-2827.2 602827

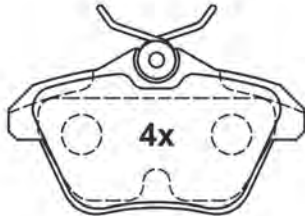

21606 16,7

89,8 x 49,9 x 16,7



13.0460-2828.2 602828

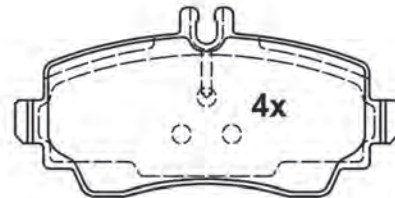

23070 19,5

116,5 x 57,1 x 19,5



13.0460-2829.2 602829

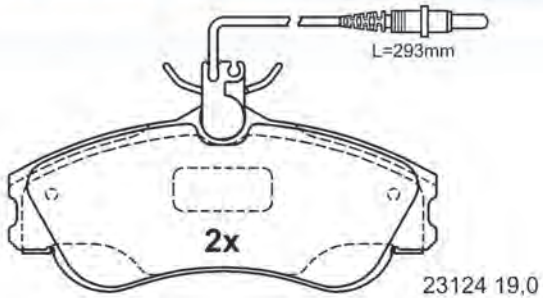

23124 19,0

129,9 x 56,2 x 19,0



13.0460-2830.2 602830

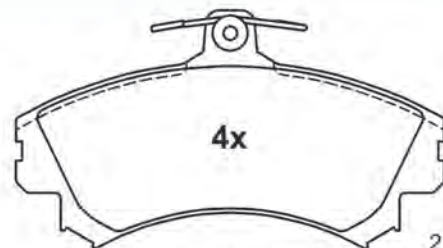

21920 14,6

129,9 x 72,7 x 14,6

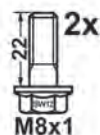
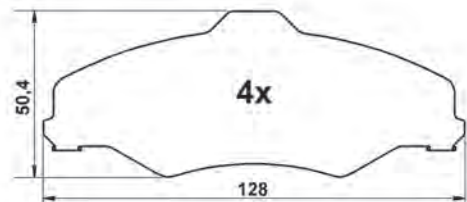

Abbildungen Scheibenbremsbeläge

Illustrations disc brake pads - Ilustraciones de pastillas - Illustrations Plaquettes de frein à disque - Illustrazioni Pastiglie Freno

13.0460-2831.2 602831

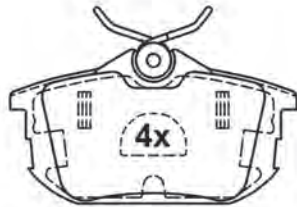

21861 15,2

87,0 x 47,0 x 15,2



13.0460-2832.2 602832

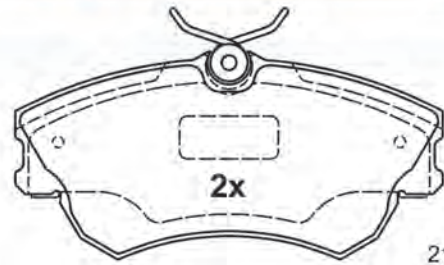

21888 18,1

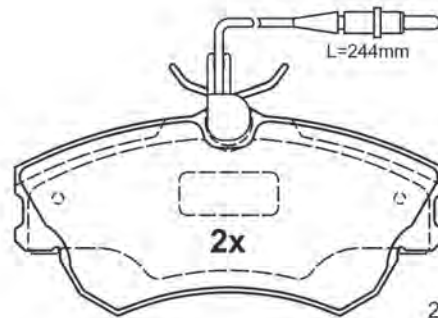

21889 18,1

129,8 x 63,0 x 18,1



13.0460-2833.2 602833

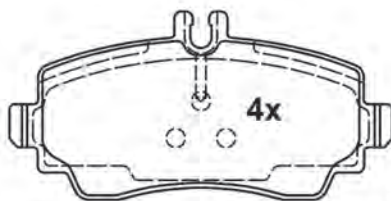

23070 17,0

116,5 x 57,1 x 17,0

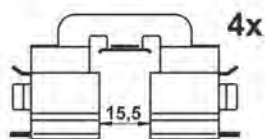
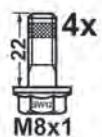

13.0460-2834.2 602834

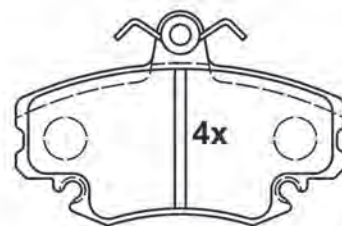

21463 18,0

99,9 x 64,9 x 18,0

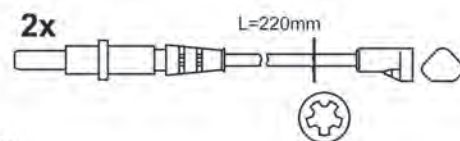

Abbildungen Scheibenbremsbeläge

Illustrations disc brake pads - Ilustraciones de pastillas - Illustrations Plaquettes de frein à disque - Illustrazioni Pastiglie Freno

13.0460-2835.2 602835

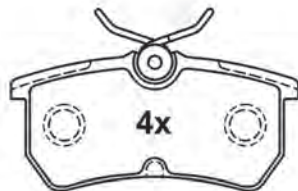

23353 14,8

87,5 x 42,4 x 14,8



13.0460-2836.2 602836

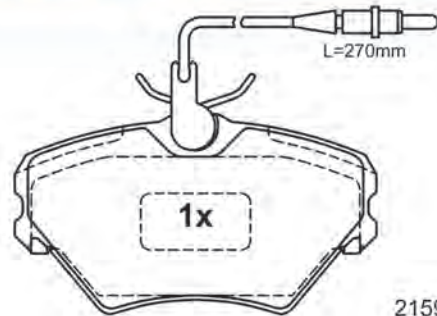

21595 18,3

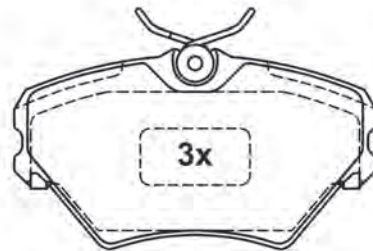

21596 18,3

109,9 x 60,7 x 18,3



13.0460-2837.2 602837

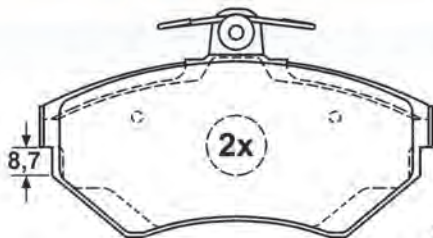

21945 19,6

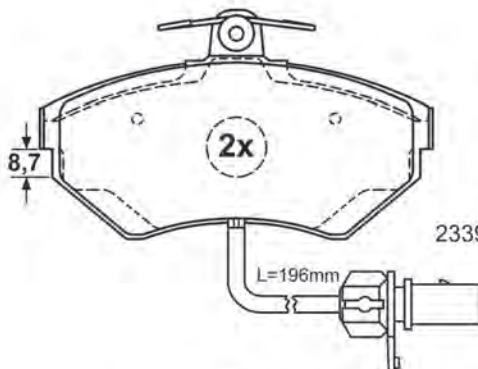

23393 19,6

119,1 x 69,5 x 19,6



13.0460-2838.2 602838

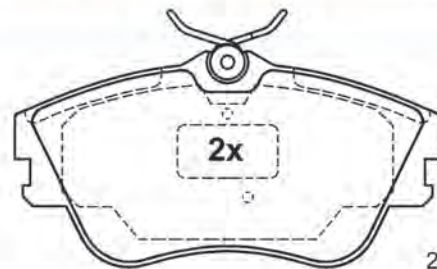

21479 19,2

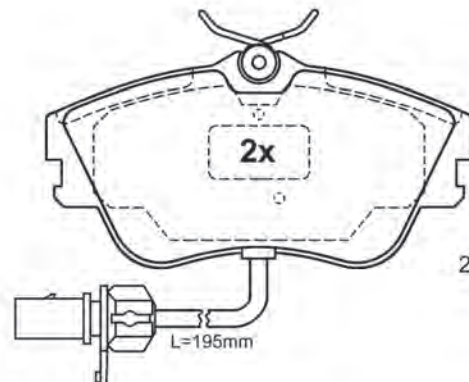

23445 19,2

129,9 x 65,2 x 19,2



Abbildungen Scheibenbremsbeläge

Illustrations disc brake pads - Ilustraciones de pastillas - Illustrations Plaquettes de frein à disque - Illustrazioni Pastiglie Freno

13.0460-2839.2 602839  **13.0460-2840.2 602840** 

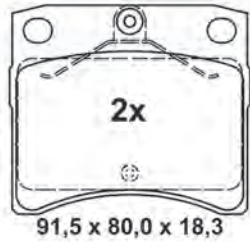

20651 18,3

91,5 x 80,0 x 18,3



21635 18,7

91,7 x 80,0 x 18,7

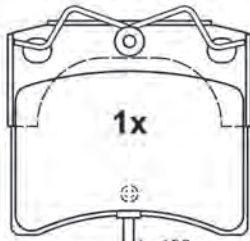

23176 18,7

91,7 x 80,0 x 18,7

L=196mm

91,7 x 80,0 x 18,7

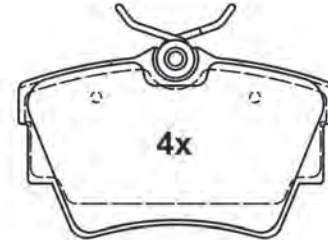

23980 16,5

94,4 x 57,2 x 16,5



13.0460-2842.2 602842  **13.0460-2844.2 602844** 



20961 15,2

86,8 x 52,9 x 15,2

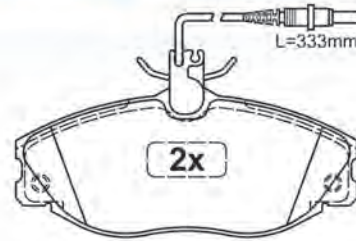

21674 19,4

L=333mm

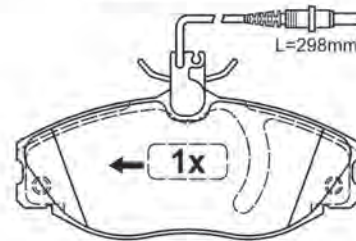

21886 19,4

L=298mm

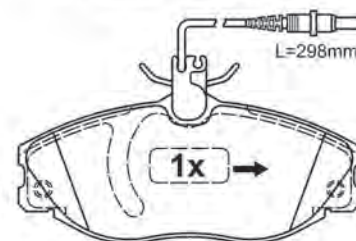

21886 19,4

L=298mm

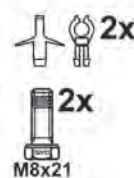

129,8 x 56,4 x 19,4



Abbildungen Scheibenbremsbeläge

Illustrations disc brake pads - Ilustraciones de pastillas - Illustrations Plaquettes de frein à disque - Illustrazioni Pastiglie Freno

13.0460-2845.2 602845

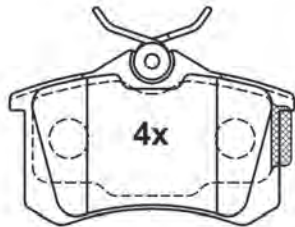

23554 16,4

87,6 x 52,9 x 16,4

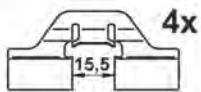

13.0460-2846.2 602846

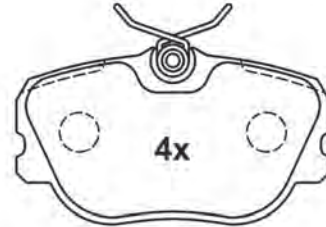

21010 15,8

95,0 x 52,3 x 15,8



13.0460-2850.2 602850

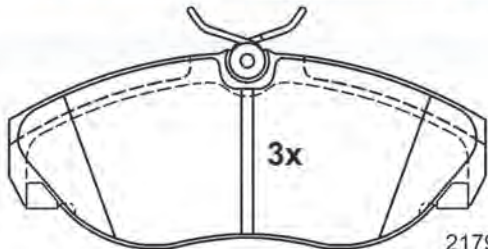

21797 19,7

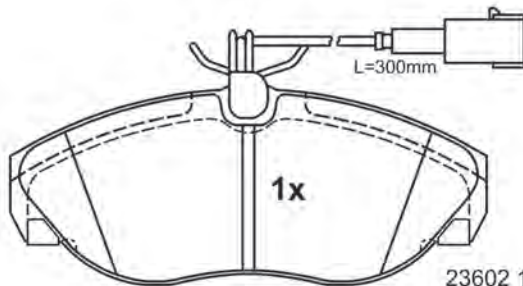

23602 19,7

144,8 x 60,8 x 19,7



13.0460-2852.2 602852

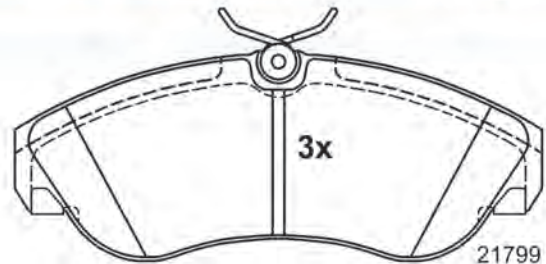

21799 19,7

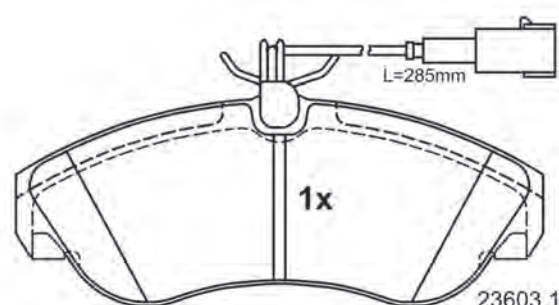

23603 19,7

159,8 x 64,1 x 19,7



Abbildungen Scheibenbremsbeläge

Illustrations disc brake pads - Ilustraciones de pastillas - Illustrations Plaquettes de frein à disque - Illustrazioni Pastiglie Freno

13.0460-2853.2 602853  13.0460-2855.2 602855 

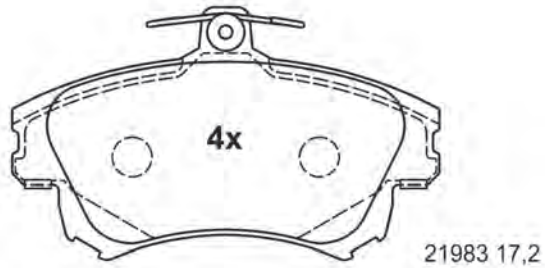

129,9 x 76,7 x 17,2

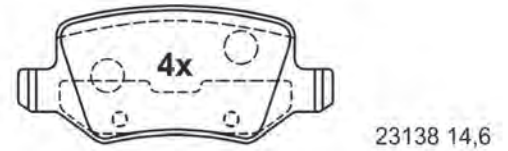

95,7 x 41,3 x 14,6



13.0460-2857.2 602857  13.0460-2858.2 602858 

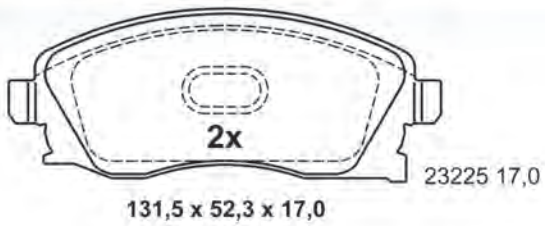

131,5 x 52,3 x 17,0



131,5 x 55,4 x 17,0

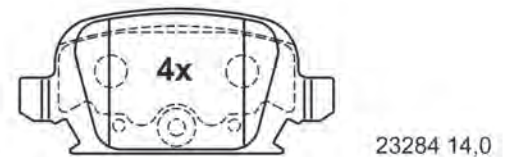
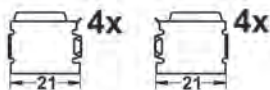
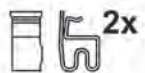
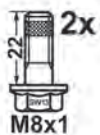

95,6 x 43,8 x 14,0



Abbildungen Scheibenbremsbeläge

Illustrations disc brake pads - Ilustraciones de pastillas - Illustrations Plaquettes de frein à disque - Illustrazioni Pastiglie Freno

13.0460-2859.2 602859

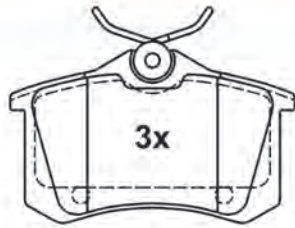

20961 17,0

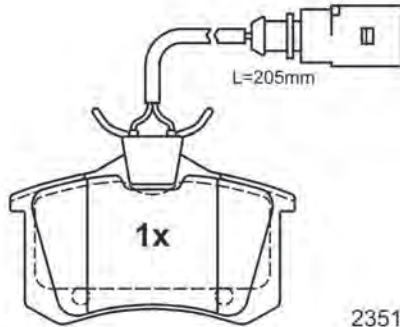

23516 17,0

87,6 x 52,9 x 17,0

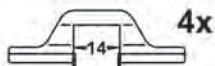

13.0460-2860.2 602860

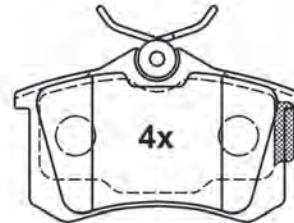

23554 16,4

87,6 x 52,9 x 16,4



13.0460-2862.2 602862

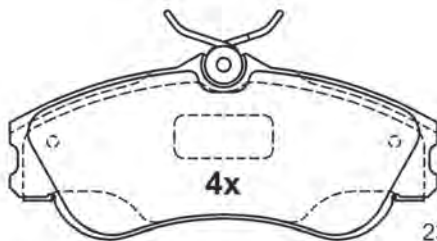

23346 19,0

129,9 x 56,2 x 19,0



13.0460-2863.2 602863

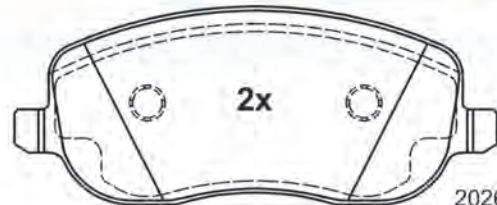

20261 19,0

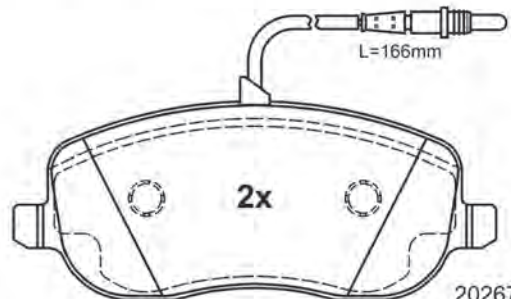

20267 19,0

146,6 x 60,0 19,0

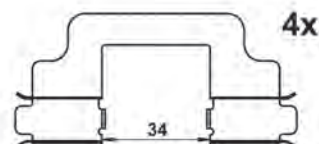
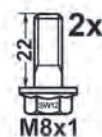

Abbildungen Scheibenbremsbeläge

Illustrations disc brake pads - Ilustraciones de pastillas - Illustrations Plaquettes de frein à disque - Illustrazioni Pastiglie Freno

13.0460-2864.2 602864  13.0460-2867.2 602867 

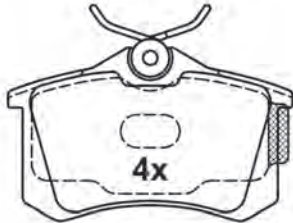

20961 17,2

87,6 x 52,9 x 17,2

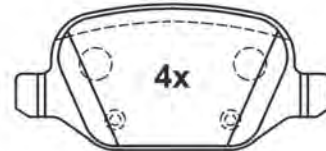

23517 16,6

95,6 x 43,9 x 16,6



13.0460-2868.2 602868  13.0460-2869.2 602869 



23417 15,3

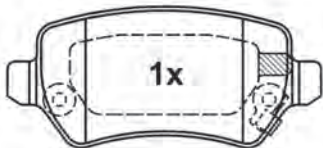

23654 15,3

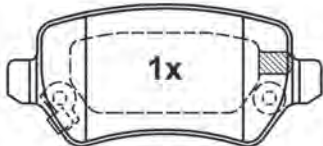

23655 15,3

95,3 x 42,8 x 15,3

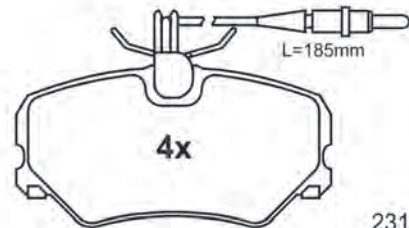

23169 19,4

94,8 x 48,9 x 19,4

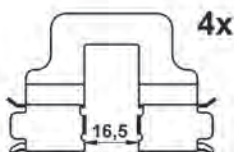

Abbildungen Scheibenbremsbeläge

Illustrations disc brake pads - Ilustraciones de pastillas - Illustrations Plaquettes de frein à disque - Illustrazioni Pastiglie Freno

13.0460-2870.2 602870

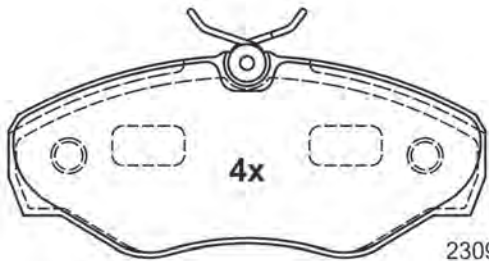

23099 18,4

145,0 x 62,4 x 18,4



13.0460-2871.2 602871

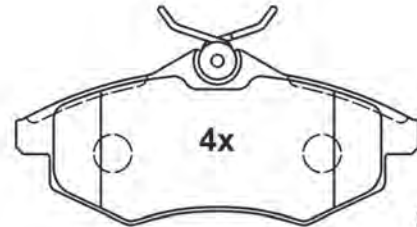

23407 19,0

122,6 x 53,2 x 19,0



13.0460-2872.2 602872

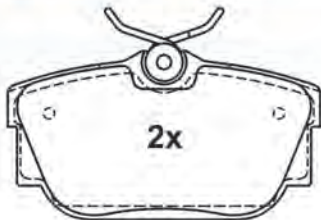

23224 16,5

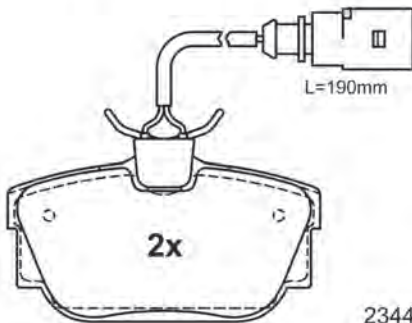

23446 16,5

94,7 x 50,9 x 16,5

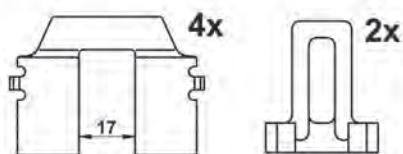

13.0460-2874.2 602874

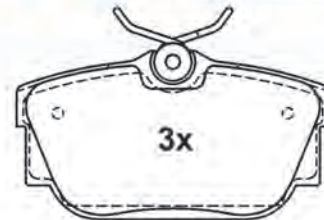

23224 16,5

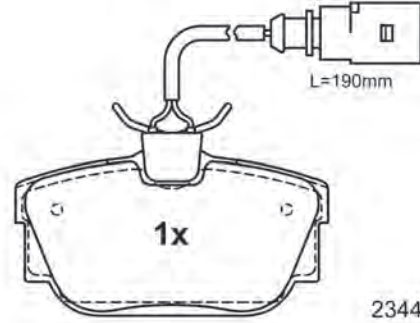

23446 16,5

94,7 x 50,9 x 16,5

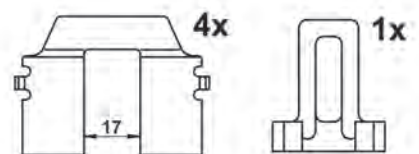

Abbildungen Scheibenbremsbeläge

Illustrations disc brake pads - Ilustraciones de pastillas - Illustrations Plaquettes de frein à disque - Illustrazioni Pastiglie Freno

13.0460-2875.2 602875



77,1 x 74,7 x 17,5

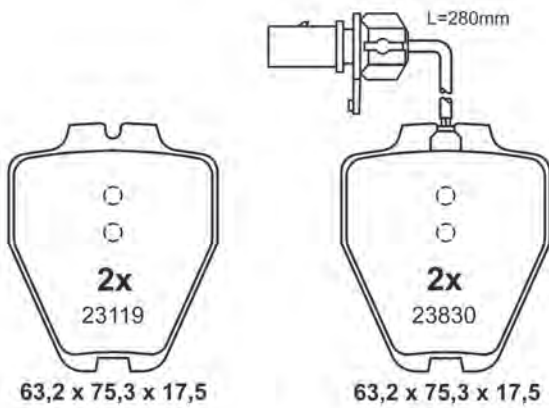

13.0460-2876.2 602876



77,1 x 74,7 x 17,5

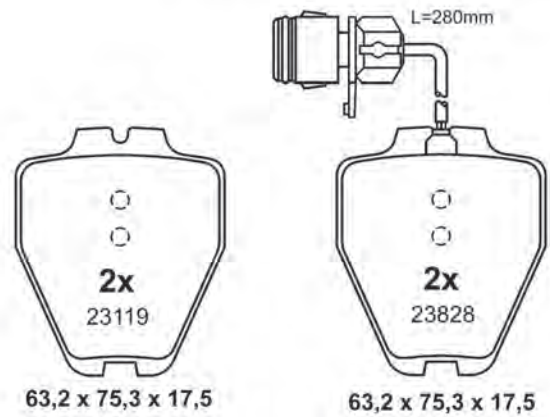

13.0460-2877.2 602877

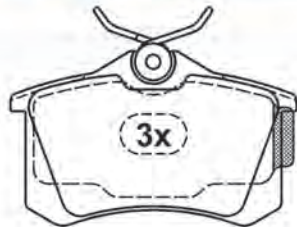

23554 17,2

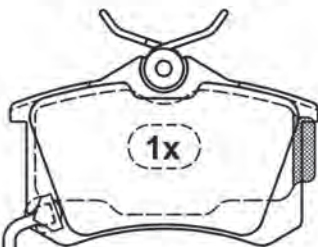

23823 17,2

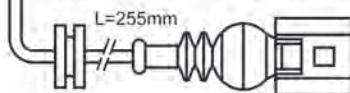

87,6 x 52,9 x 17,2

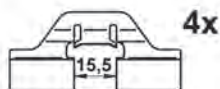

13.0460-2878.2 602878

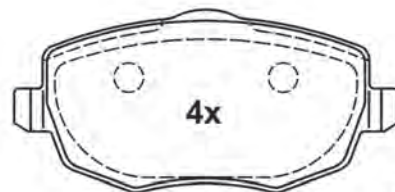

24073 16,7

116,8 x 55,2 x 16,7



Abbildungen Scheibenbremsbeläge

Illustrations disc brake pads - Ilustraciones de pastillas - Illustrations Plaquettes de frein à disque - Illustrazioni Pastiglie Freno

13.0460-2879.2 602879

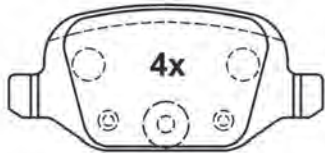

23601 13,7

95,6 x 43,9 x 13,7



13.0460-2880.2 602880

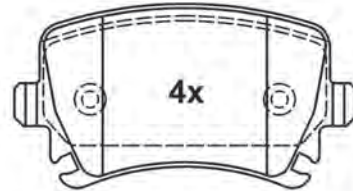

23914 17,1

105,3 x 55,9 x 17,1

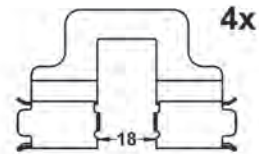

13.0460-2881.2 602881

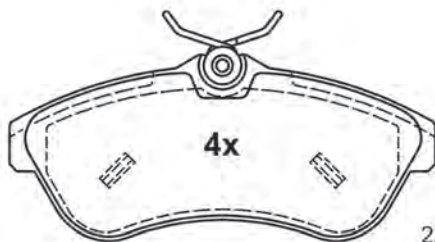

23409 19,3

128,8 x 56,1 x 19,3



13.0460-2882.2 602882

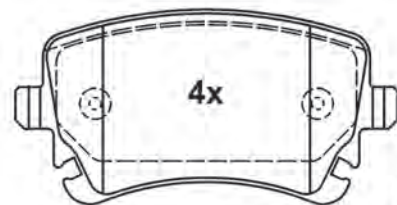

23326 17,4

116,1 x 59,0 x 17,4

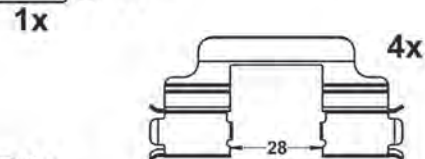
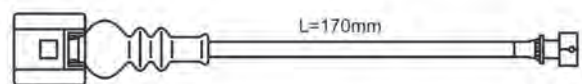

Abbildungen Scheibenbremsbeläge

Illustrations disc brake pads - Ilustraciones de pastillas - Illustrations Plaquettes de frein à disque - Illustrazioni Pastiglie Freno

13.0460-2883.2 602883

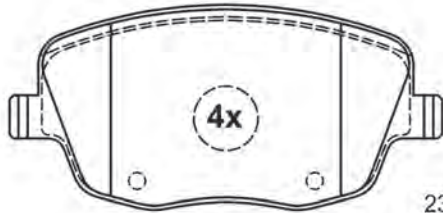

23581 18,8

131,4 x 62,0 x 18,8



13.0460-2884.2 602884

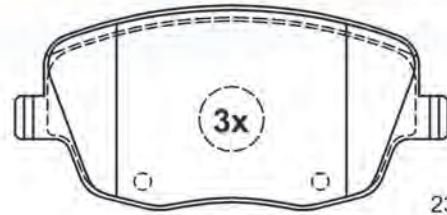

23581 18,8

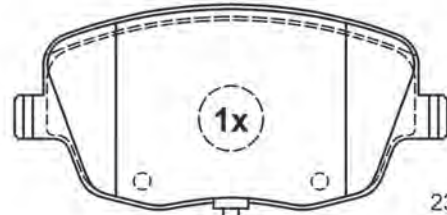

23843 18,8

L=160mm

131,4 x 62,0 x 18,8



13.0460-2885.2 602885

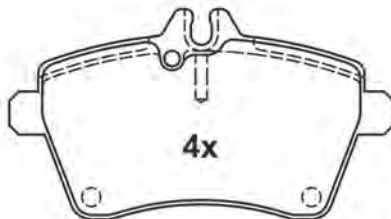

24077 19,1

116,4 x 63,8 x 19,1

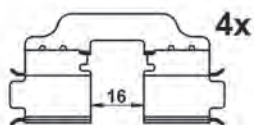

13.0460-2886.2 602886

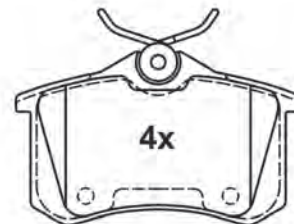

20961 16,0

87,6 x 52,9 x 16,0



Abbildungen Scheibenbremsbeläge

Illustrations disc brake pads - Ilustraciones de pastillas - Illustrations Plaquettes de frein à disque - Illustrazioni Pastiglie Freno

13.0460-2887.2 602887

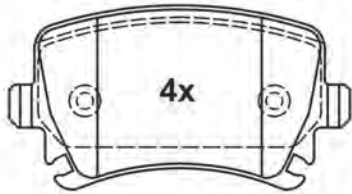

23914 17,1

105,3 x 55,9 x 17,1

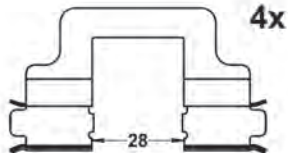

M8x22

13.0460-2888.2 602888

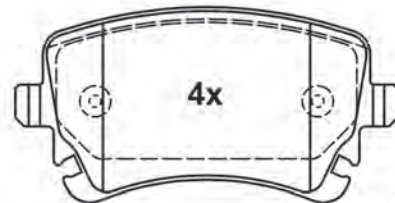

23326 17,4

116,1 x 59,0 x 17,4



M8x21

13.0460-2889.2 602889

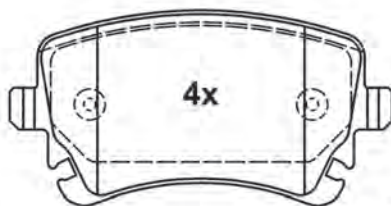

23326 17,4

116,1 x 59,0 x 17,4



M8x22

13.0460-2890.2 602890

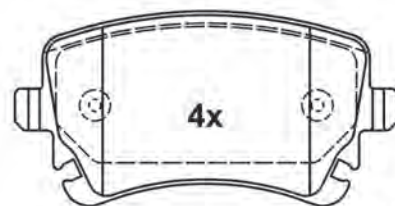

23326 17,4

116,1 x 59,0 x 17,4



M8x22

Abbildungen Scheibenbremsbeläge

Illustrations disc brake pads - Ilustraciones de pastillas - Illustrations Plaquettes de frein à disque - Illustrazioni Pastiglie Freno

13.0460-2891.2 602891

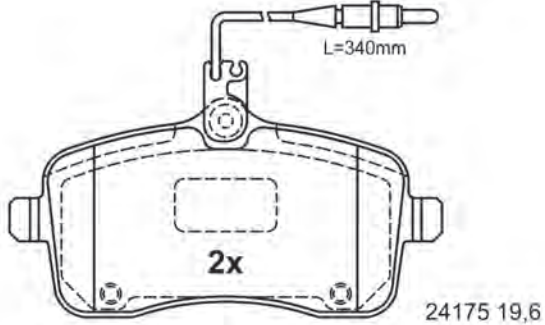
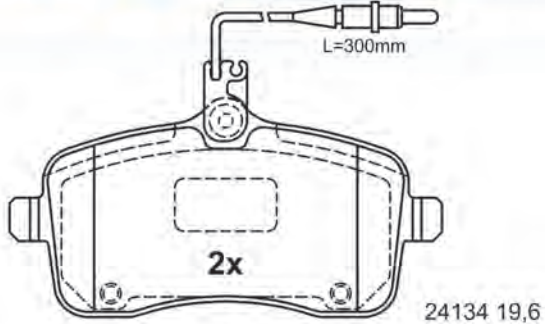

131,4 x 67,5 x 19,6

13.0460-2892.2 602892

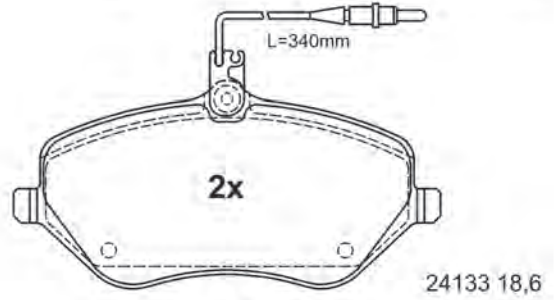
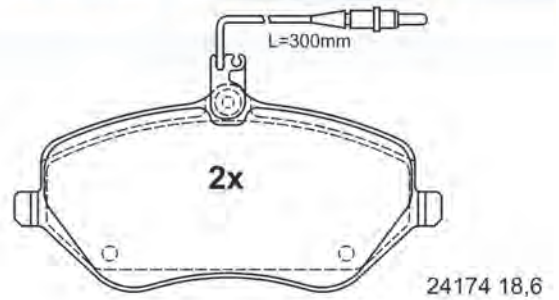

162,3 x 79,0 x 18,6

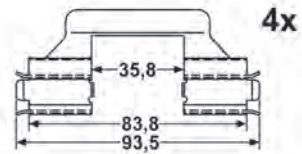

13.0460-2893.2 602893

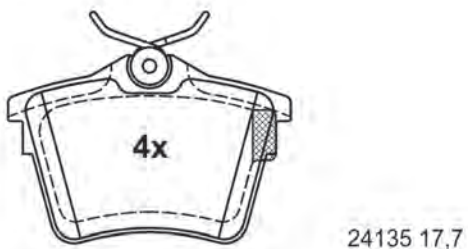

86,1 x 56,9 x 17,7



13.0460-2894.2 602894

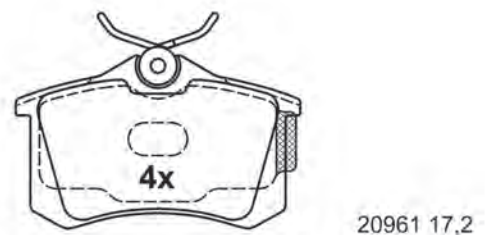

87,6 x 52,9 x 17,2

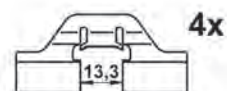

Abbildungen Scheibenbremsbeläge

Illustrations disc brake pads - Ilustraciones de pastillas - Illustrations Plaquettes de frein à disque - Illustrazioni Pastiglie Freno

13.0460-2895.2 602895

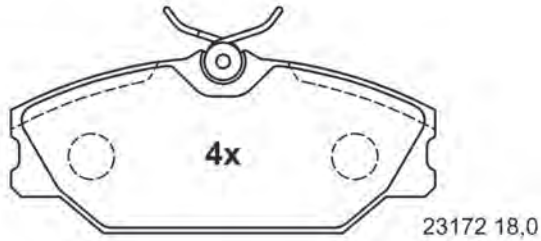

128,6 x 55,5 x 18,0

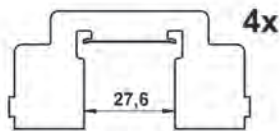

13.0460-2896.2 602896

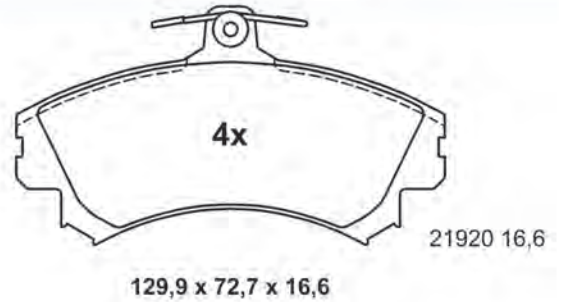

129,9 x 72,7 x 16,6

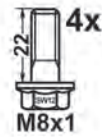
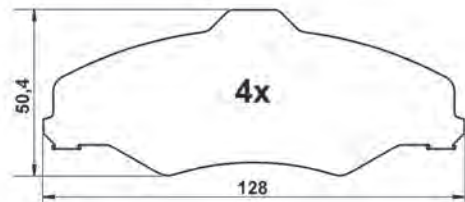

13.0460-2897.2 602897

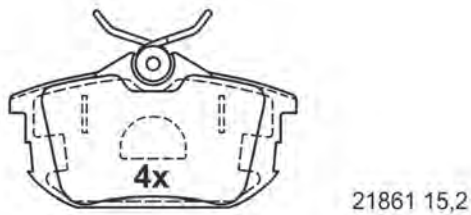

87,0 x 47,0 x 15,2



13.0460-2898.2 602898

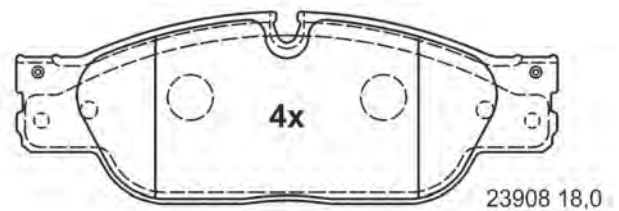

164,3 x 58,1 x 18,0

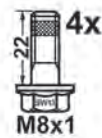

Abbildungen Scheibenbremsbeläge

Illustrations disc brake pads - Ilustraciones de pastillas - Illustrations Plaquettes de frein à disque - Illustrazioni Pastiglie Freno

13.0460-2899.2 602899

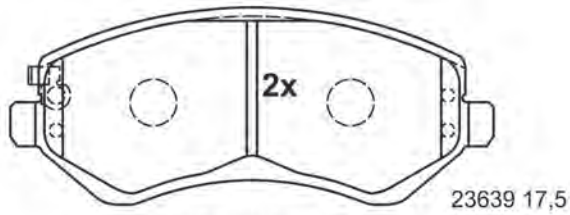
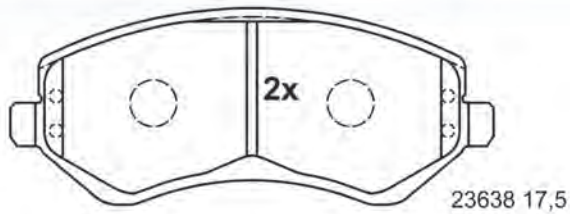

146,4 x 59,4 x 17,5

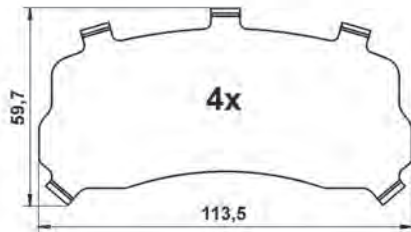

13.0460-2925.2 602925

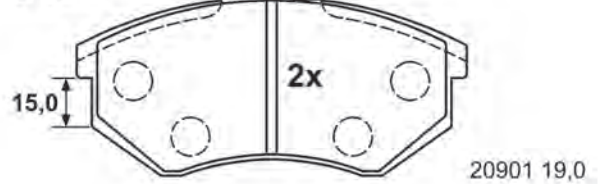
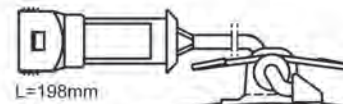
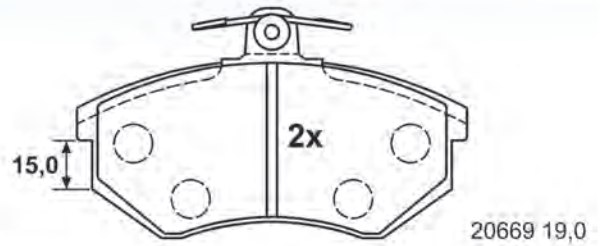

119,0 x 69,5 x 19,0



13.0460-2927.2 602927

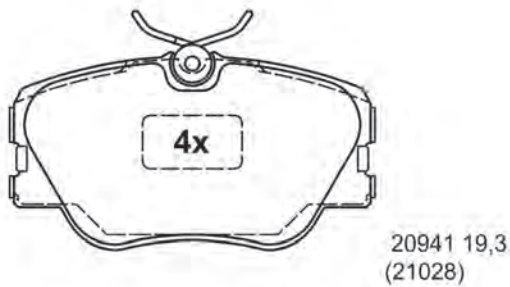

110,0 x 59,6 x 19,3



13.0460-2928.2 602928

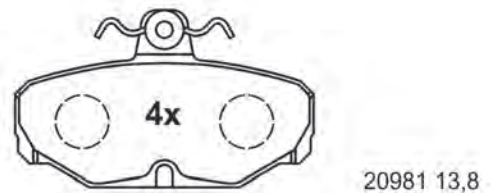

90,0 x 53,8 x 13,8



Abbildungen Scheibenbremsbeläge

Illustrations disc brake pads - Ilustraciones de pastillas - Illustrations Plaquettes de frein à disque - Illustrazioni Pastiglie Freno

13.0460-2934.2 602934

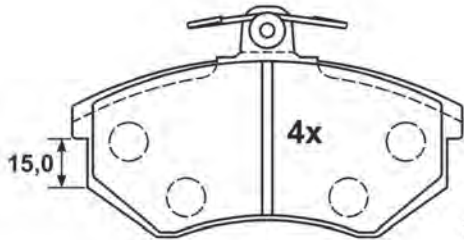

20669 19,0

119,0 x 69,5 x 19,0



M8x21

13.0460-2935.2 602935

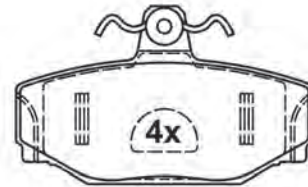

21385 13,8

89,9 x 53,5 x 13,8



M8x21

13.0460-2937.2 602937

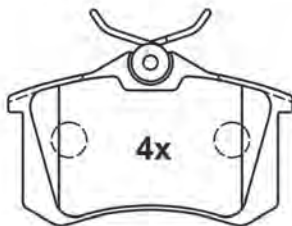

20961 15,2

87,6 x 52,9 x 15,2

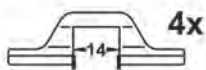

4x



M8x21

13.0460-2941.2 602941

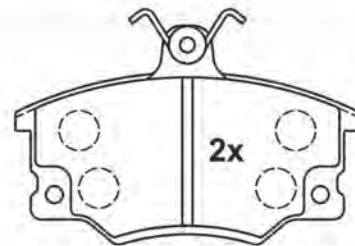

20838 17,0

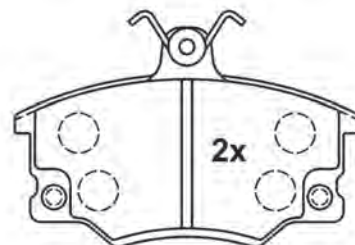

20839 17,0

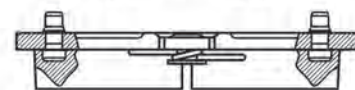

104,6 x 66,6 x 17,0



M8x21

Abbildungen Scheibenbremsbeläge

Illustrations disc brake pads - Ilustraciones de pastillas - Illustrations Plaquettes de frein à disque - Illustrazioni Pastiglie Freno

13.0460-2943.2 602943

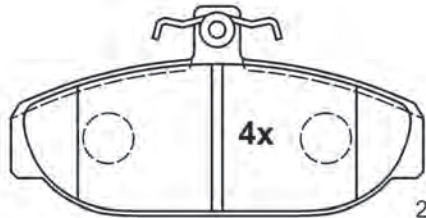

21266 17,0

124,8 x 64,8 x 17,0



2x

M8x21

13.0460-2948.2 602948

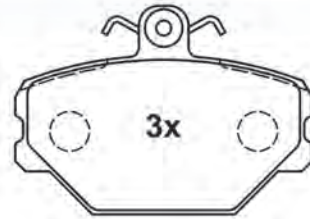

21100 16,7

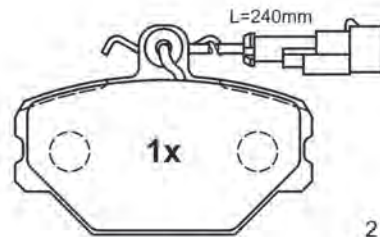

21105 16,7

90,0 x 63,0 x 16,7



2x

M8x21

13.0460-2949.2 602949

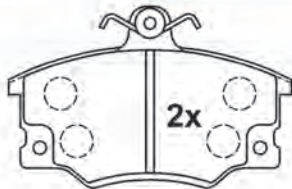

20838 17,0

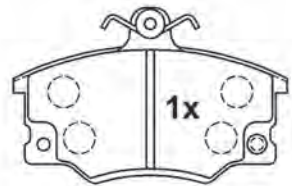

20833 17,0

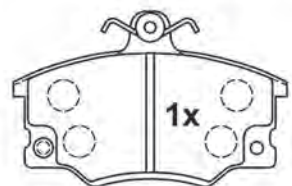
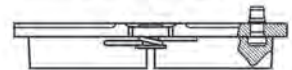

20834 17,0

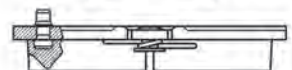

104,0 x 67,0 x 17,0



2x

M8x21

13.0460-2951.2 602951

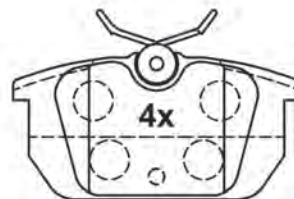

21103 14,2

87,0 x 44,6 x 14,2







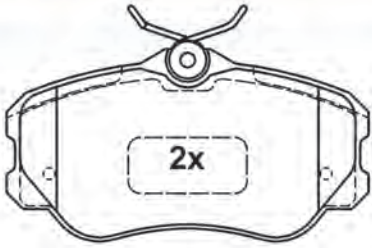
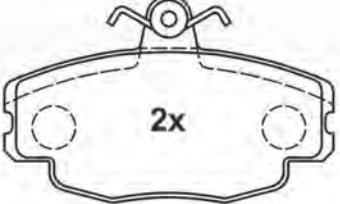
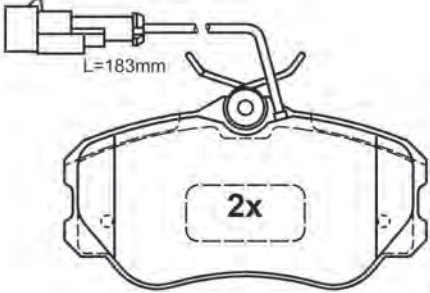
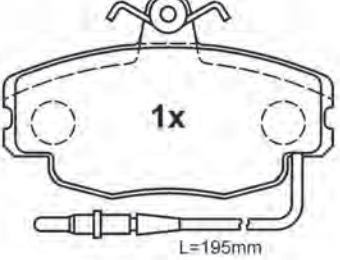

2x

M8x21

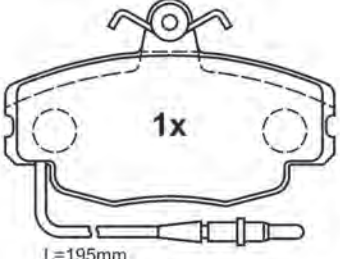
Abbildungen Scheibenbremsbeläge

Illustrations disc brake pads - Ilustraciones de pastillas - Illustrations Plaquettes de frein à disque - Illustrazioni Pastiglie Freno

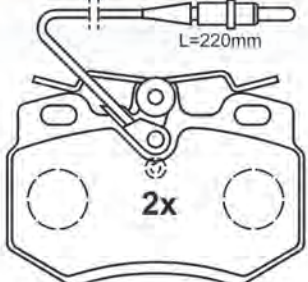
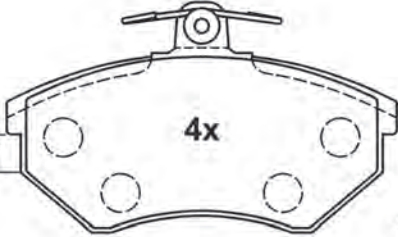
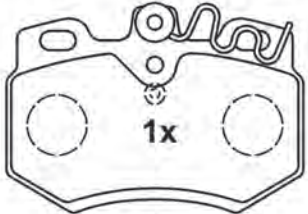
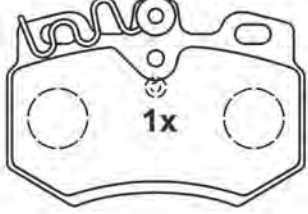
13.0460-2952.2 602952	13.0460-2955.2 602955
 <p>2x</p> <p>21182 19,4</p>	 <p>2x</p> <p>20772 18,0</p>
 <p>L=183mm</p> <p>2x</p> <p>21185 19,4</p>	 <p>1x</p> <p>20937 18,0</p> <p>L=195mm</p>
<p>2x</p> <p>109,8 x 58,5 x 19,4</p>  <p>M8x21</p>	 <p>1x</p> <p>20938 18,0</p> <p>L=195mm</p>  <p>M8x21</p> <p>2x</p> <p>100,0 x 63,5 x 18,0</p>

13.0460-2956.2 602956	13.0460-2957.2 602957
 <p>L=220mm</p> <p>2x</p> <p>20989 17,7</p>	 <p>4x</p> <p>20168 16,0</p>
 <p>1x</p> <p>21022 17,7</p>	<p>12,0</p> <p>119,0 x 69,5 x 16,0</p>
 <p>1x</p> <p>21023 17,7</p> <p>90,0 x 62,9 x 17,7</p>  <p>M8x21</p> <p>2x</p>	

Abbildungen Scheibenbremsbeläge

Illustrations disc brake pads - Ilustraciones de pastillas - Illustrations Plaquettes de frein à disque - Illustrazioni Pastiglie Freno

13.0460-2958.2 602958

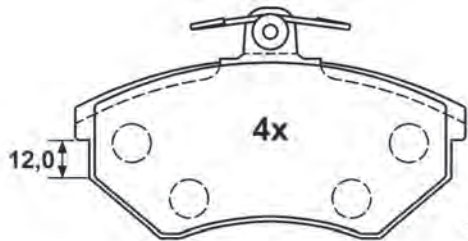

20168 19,3

119,0 x 69,5 x 19,3



13.0460-2959.2 602959

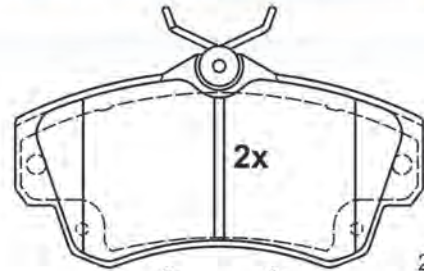

23532 21,0

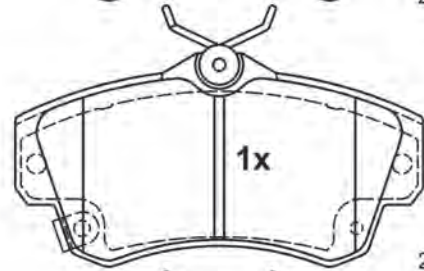

23533 21,0

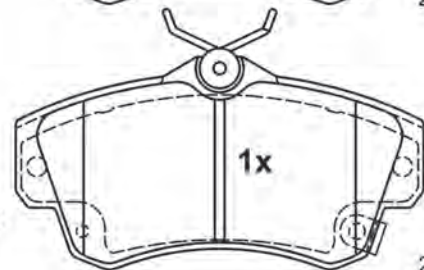

23534 21,0



123,9 x 64,6 x 21,0

13.0460-2962.2 602962

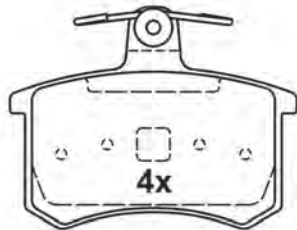

20668 16,6

87,0 x 66,8 x 16,6



13.0460-2963.2 602963

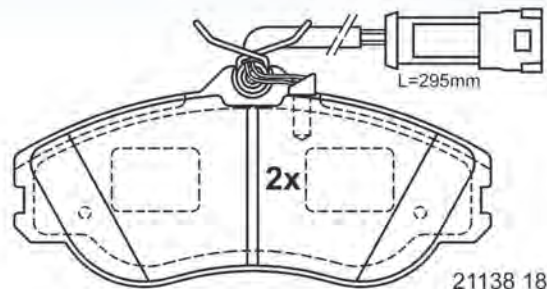

21138 18,8

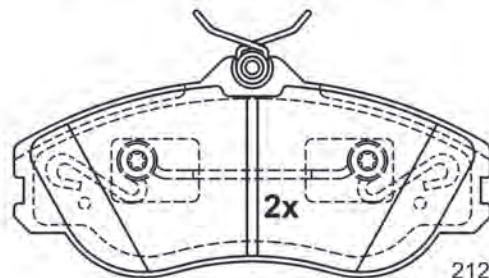

21288 18,8

144,9 x 67,0 x 18,8



Abbildungen Scheibenbremsbeläge

Illustrations disc brake pads - Ilustraciones de pastillas - Illustrations Plaquettes de frein à disque - Illustrazioni Pastiglie Freno

13.0460-2964.2 602964

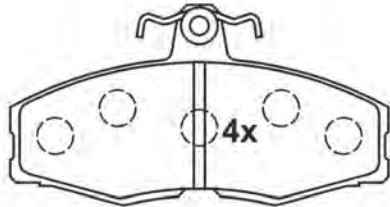

20861 17,5

114,8 x 60,6 x 17,5



13.0460-2965.2 602965

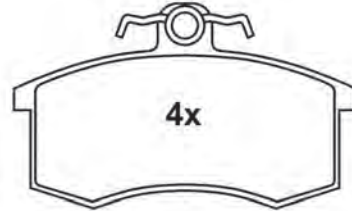

21170 17,3

104,3 x 62,1 x 17,3

13.0460-2966.2 602966



20166 16,0

83,9 x 60,5 x 16,0

13.0460-2971.2 602971

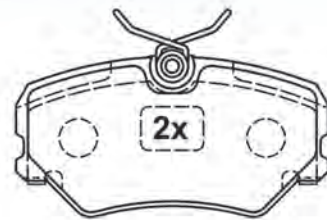

21209 18,5



21210 18,5

94,9 x 48,9 x 18,5



Abbildungen Scheibenbremsbeläge

Illustrations disc brake pads - Ilustraciones de pastillas - Illustrations Plaquettes de frein à disque - Illustrazioni Pastiglie Freno

13.0460-2972.2 602972

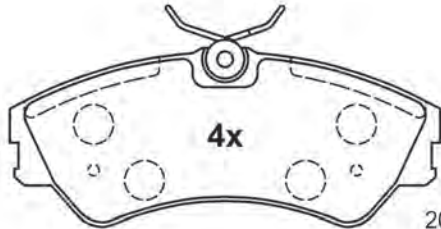

20124 18,9

129,8 x 54,5 x 18,9



13.0460-2973.2 602973

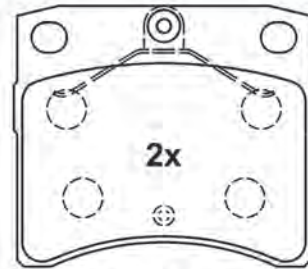

20651 18,0

91,5 x 80,0 x 18,0

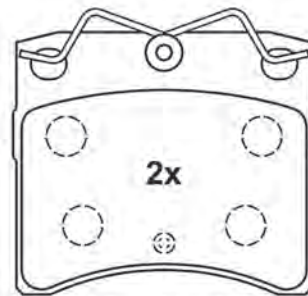

21635 18,0

91,5 x 80,0 x 18,0

13.0460-2975.2 602975

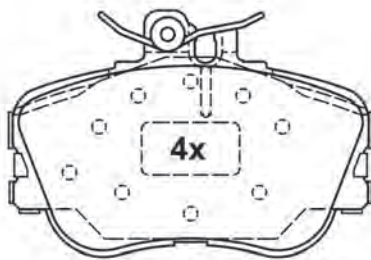

21439 20,3

110,0 x 74,5 x 20,3



13.0460-2976.2 602976

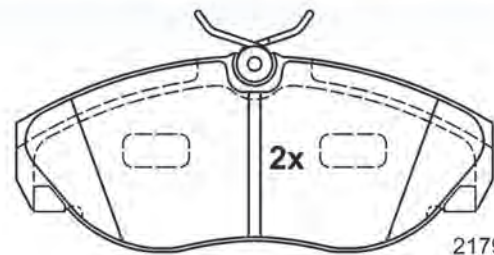

21797 19,7

144,8 x 60,8 x 19,7

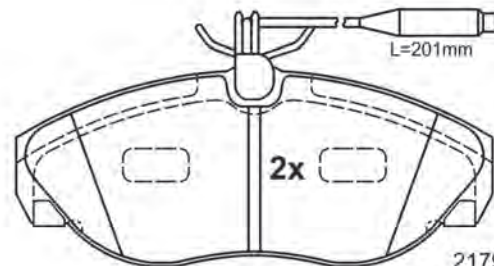

21798 19,7



Abbildungen Scheibenbremsbeläge

Illustrations disc brake pads - Ilustraciones de pastillas - Illustrations Plaquettes de frein à disque - Illustrazioni Pastiglie Freno

13.0460-2977.2 602977

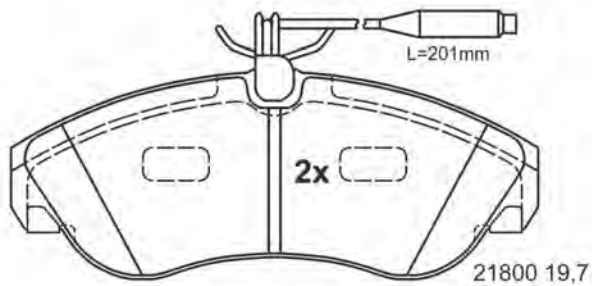
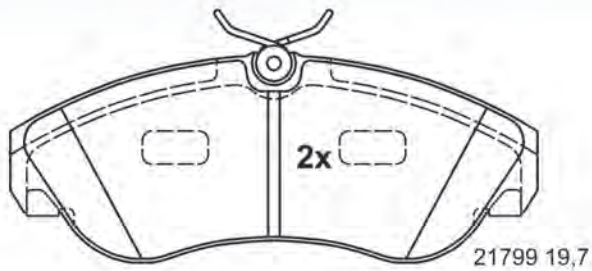

159,8 x 64,1 x 19,7



13.0460-2978.2 602978

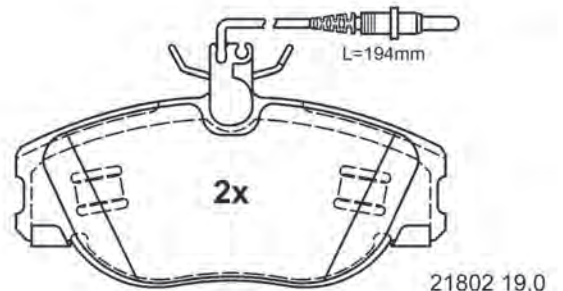
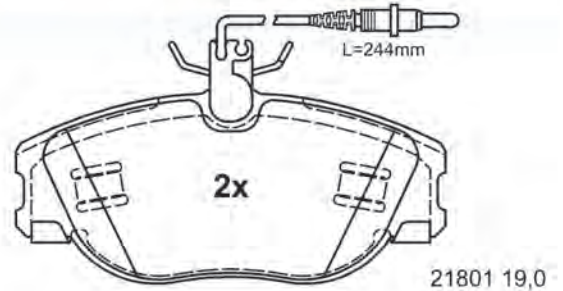

129,8 x 58,7 x 19,0



13.0460-2979.2 602979

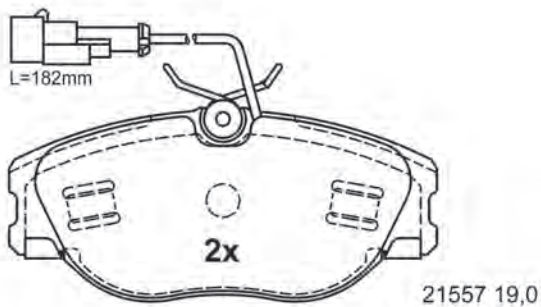
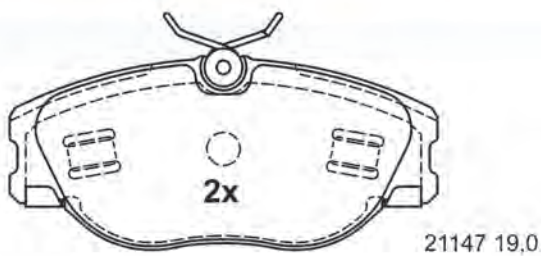

130,0 x 58,7 x 19,0



13.0460-2980.2 602980

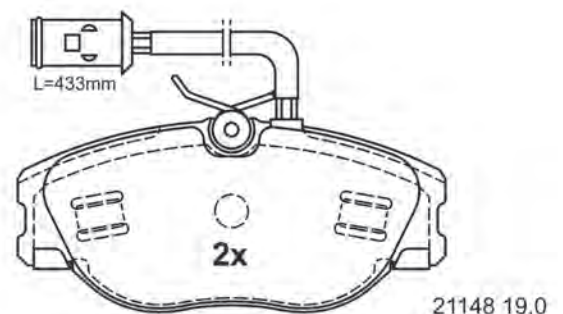
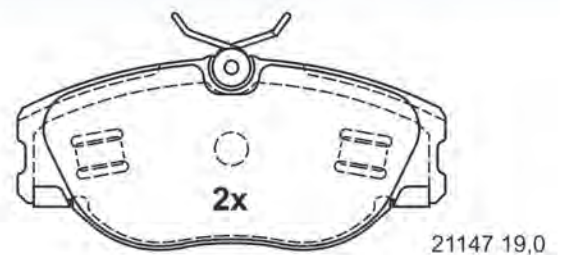

130,0 x 58,7 x 19,0



Abbildungen Scheibenbremsbeläge

Illustrations disc brake pads - Ilustraciones de pastillas - Illustrations Plaquettes de frein à disque - Illustrazioni Pastiglie Freno

13.0460-2981.2 602981

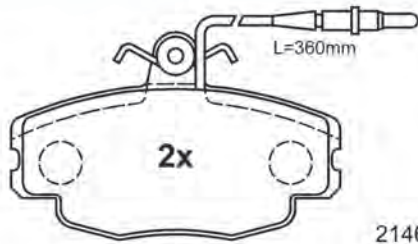

21460 18,0

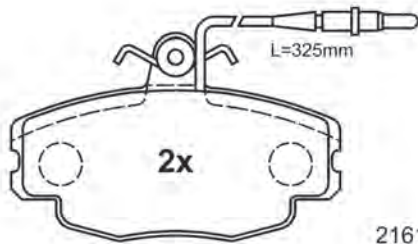

21613 18,0

100,0 x 63,5 x 18,0



13.0460-2982.2 602982

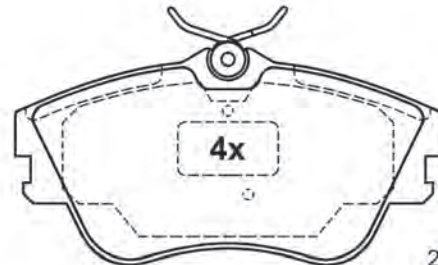

21479 19,2

129,9 x 65,2 x 19,2



13.0460-2983.2 602983

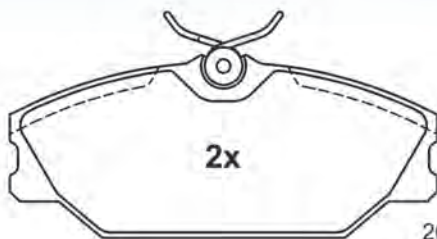

20919 18,0

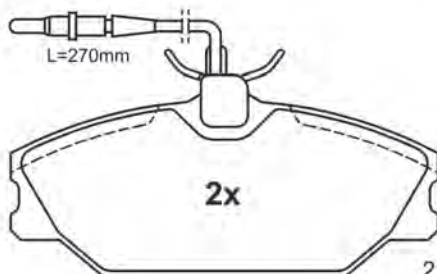

21388 18,0

129,9 x 55,5 x 18,0



13.0460-2984.2 602984

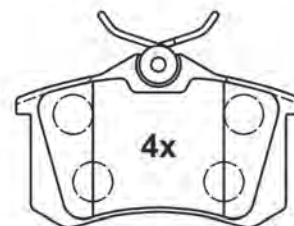

20961 17,2

87,6 x 52,9 x 17,2



Abbildungen Scheibenbremsbeläge

Illustrations disc brake pads - Ilustraciones de pastillas - Illustrations Plaquettes de frein à disque - Illustrazioni Pastiglie Freno

13.0460-2985.2 602985

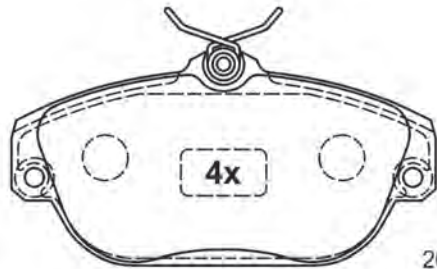

20164 18,2

128,9 x 64,7 x 18,2

13.0460-2987.2 602987

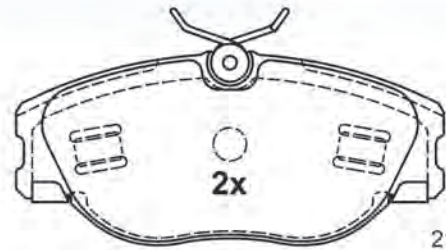

21147 19,0

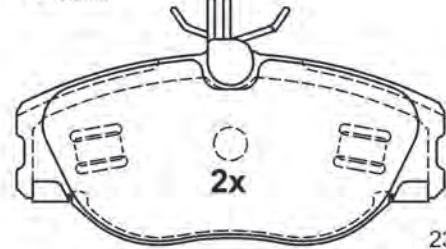
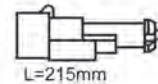

23168 19,0

130,0 x 58,7 x 19,0



13.0460-2997.2 602997

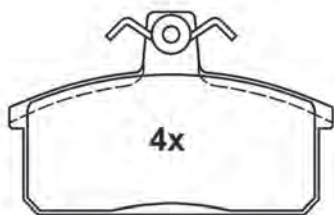

20708 15,8

98,9 x 61,6 x 15,8



13.0460-3306.2 603306



21090 15,0



21089 15,0

125,0 x 37,4 x 15,0

Abbildungen Scheibenbremsbeläge

Illustrations disc brake pads - Ilustraciones de pastillas - Illustrations Plaquettes de frein à disque - Illustrazioni Pastiglie Freno

13.0460-3401.2 603401



20755 14,4

61,5 x 56,4 x 14,4

13.0460-3403.2 603403

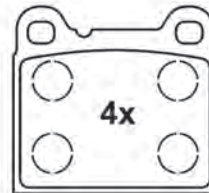

20755 14,4

61,5 x 56,4 x 14,4

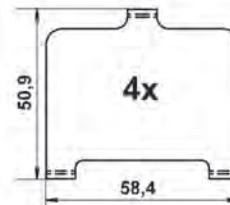

13.0460-3504.2 603504

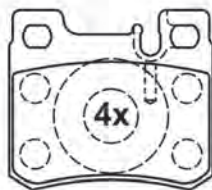

21301 15,5

61,9 x 53,9 x 15,5

13.0460-3602.2 603602

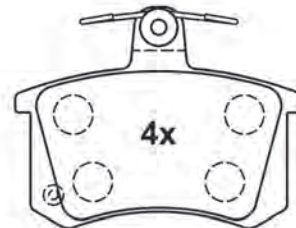

21144 15,8

87,6 x 66,8 x 15,8



Abbildungen Scheibenbremsbeläge

Illustrations disc brake pads - Ilustraciones de pastillas - Illustrations Plaquettes de frein à disque - Illustrazioni Pastiglie Freno

13.0460-3605.2 603605



20180 17,3

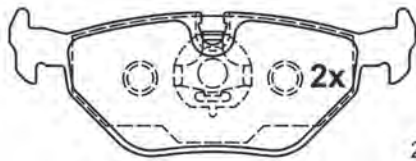

20181 17,3

123,0 x 44,9 x 17,3

13.0460-3800.2 603800



23613 17,7

138,7 x 79,6 x 17,7

13.0460-3803.2 603803

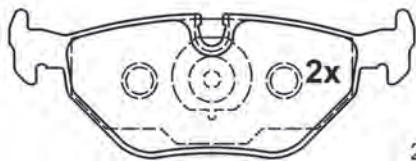

20995 17,3

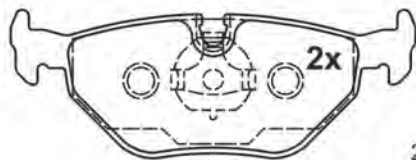

20996 17,3

123,0 x 44,9 x 17,3

13.0460-3805.2 603805

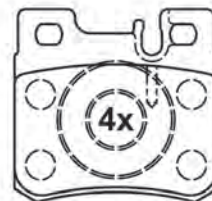

21197 15,0

61,8 x 58,6 x 15,0

Abbildungen Scheibenbremsbeläge

Illustrations disc brake pads - Ilustraciones de pastillas - Illustrations Plaquettes de frein à disque - Illustrazioni Pastiglie Freno

13.0460-3806.2 603806



23669 16,8

115,9 x 51,4 x 16,8



13.0460-3807.2 603807

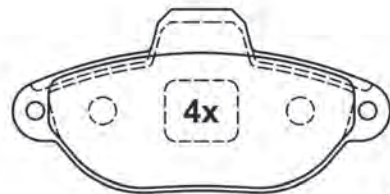

21436 17,0

114,8 x 55,5 x 17,0

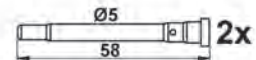

13.0460-3809.2 603809

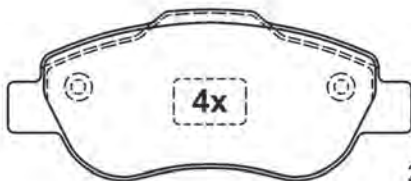

24072 17,9

122,8 x 51,7 x 17,9

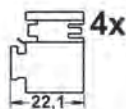
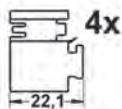
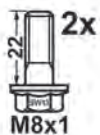

13.0460-3810.2 603810



23705 18,1

122,8 x 53,3 x 18,1

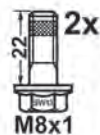

Abbildungen Scheibenbremsbeläge

Illustrations disc brake pads - Ilustraciones de pastillas - Illustrations Plaquettes de frein à disque - Illustrazioni Pastiglie Freno

13.0460-3811.2 603811



23708 19,2

136,8 x 57,4 x 19,2



13.0460-3813.2 603813



24150 17,6

94,8 x 46,9 x 17,6

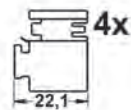
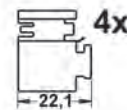

13.0460-3814.2 603814

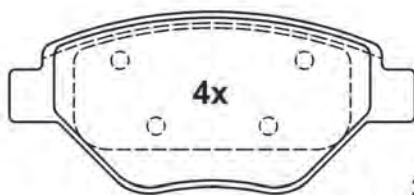

23934 18,2

122,8 x 54,3 x 18,2



13.0460-3815.2 603815

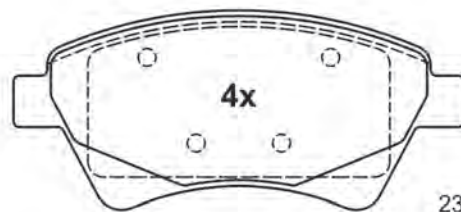

23930 18,2

136,8 x 59,5 x 18,2

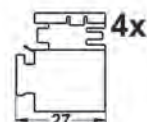
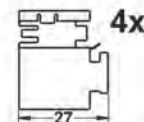

Abbildungen Scheibenbremsbeläge

Illustrations disc brake pads - Ilustraciones de pastillas - Illustrations Plaquettes de frein à disque - Illustrazioni Pastiglie Freno

13.0460-3818.2 603818

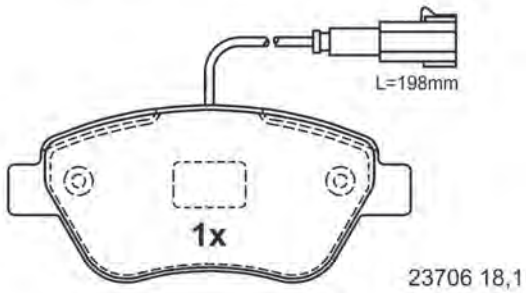
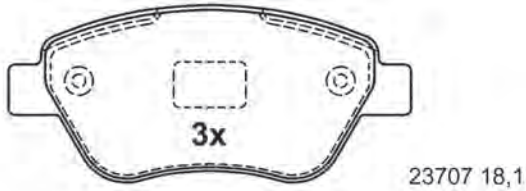

13.0460-3819.2 603819

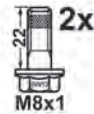
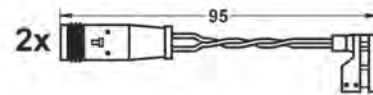
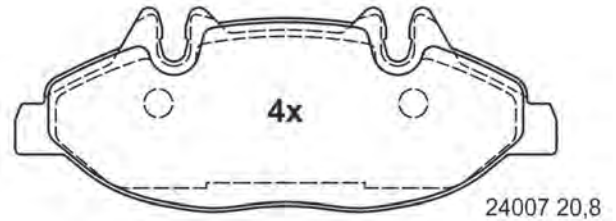

13.0460-3821.2 603821

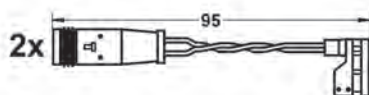
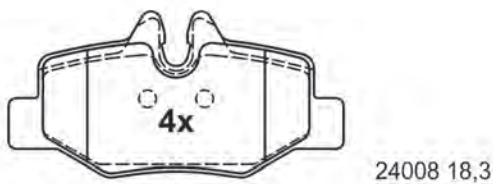

13.0460-3822.2 603822

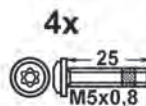
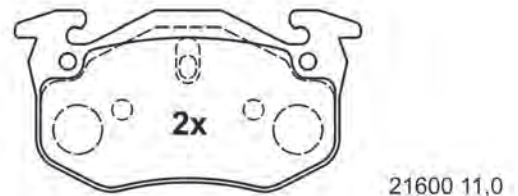
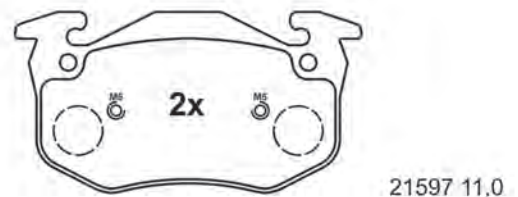

Abbildungen Scheibenbremsbeläge

Illustrations disc brake pads - Ilustraciones de pastillas - Illustrations Plaquettes de frein à disque - Illustrazioni Pastiglie Freno

13.0460-3823.2 603823

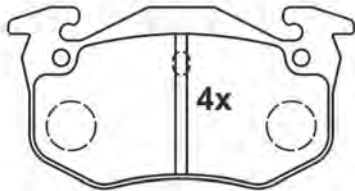

20974 11,0

105,0 x 54,9 x 11,0

13.0460-3824.2 603824

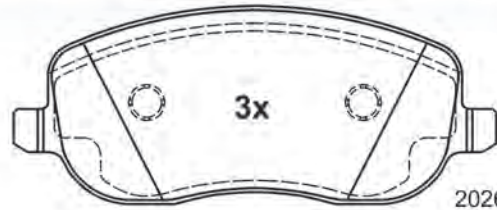

20261 19,0

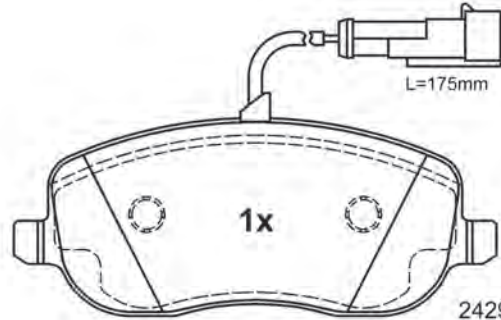

24294 19,0

146,6 x 60,0 x 19,0



13.0460-3825.2 603825

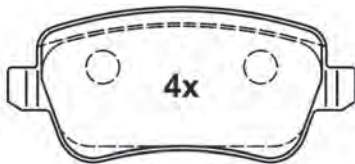

24348 17,1

105,5 x 46,4 x 17,1



13.0460-3826.2 603826

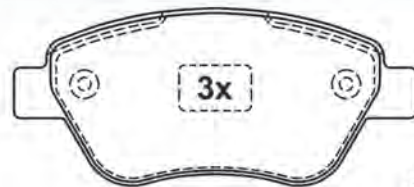

23707 18,0

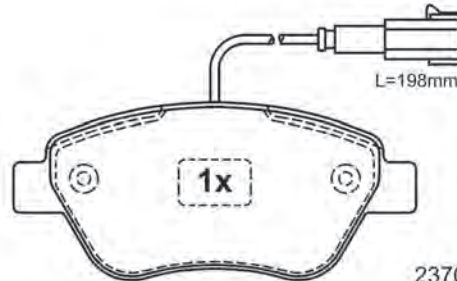

23706 18,0

122,8 x 53,3 x 18,0

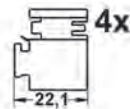
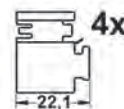

Abbildungen Scheibenbremsbeläge

Illustrations disc brake pads - Ilustraciones de pastillas - Illustrations Plaquettes de frein à disque - Illustrazioni Pastiglie Freno

13.0460-3827.2 603827

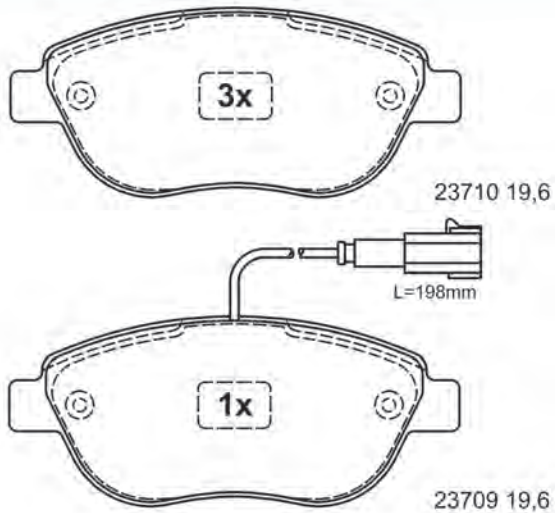

136,8 x 57,4 x 19,6

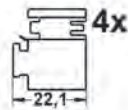
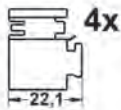
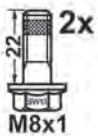

13.0460-3828.2 603828

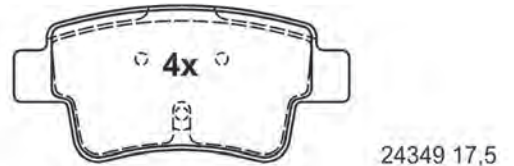

101,8 x 47,1 x 17,5



13.0460-3829.2 603829

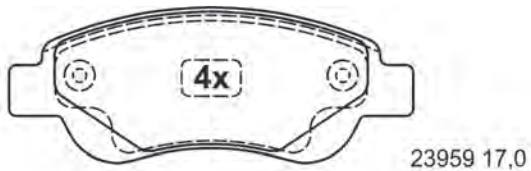

122,6 x 46,9 x 17,0

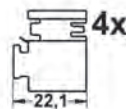
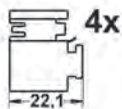

13.0460-3831.2 603831

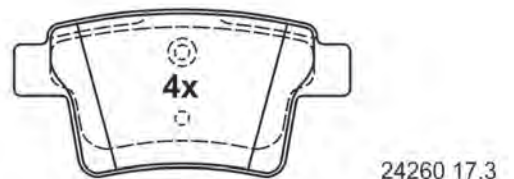

101,8 x 50,5 x 17,3

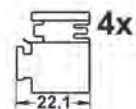
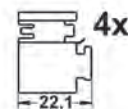
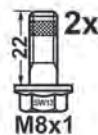

Abbildungen Scheibenbremsbeläge

Illustrations disc brake pads - Ilustraciones de pastillas - Illustrations Plaquettes de frein à disque - Illustrazioni Pastiglie Freno

13.0460-3832.2 603832

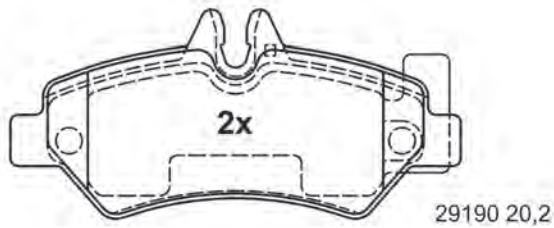
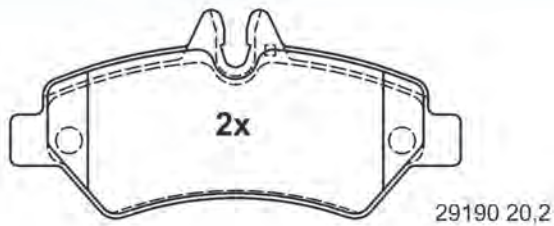

136,8 x 63,0 x 20,2

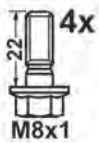

13.0460-3833.2 603833

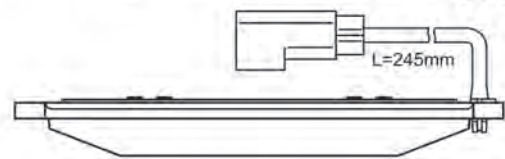
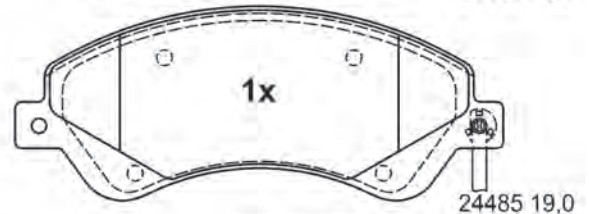
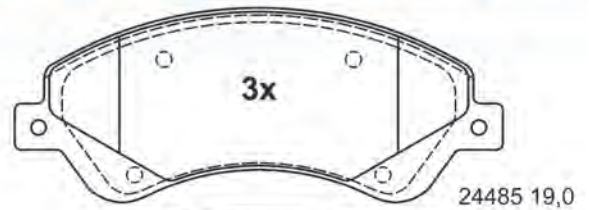

164,8 x 65,5 x 19,0

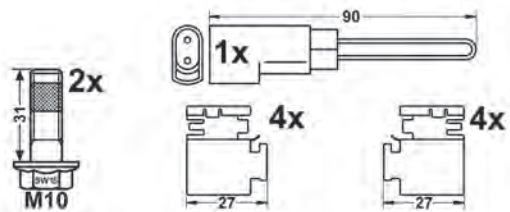

13.0460-3834.2 603834

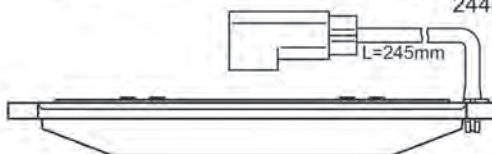
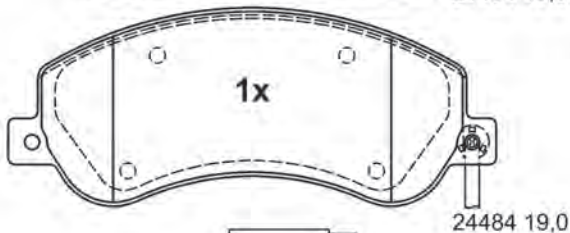
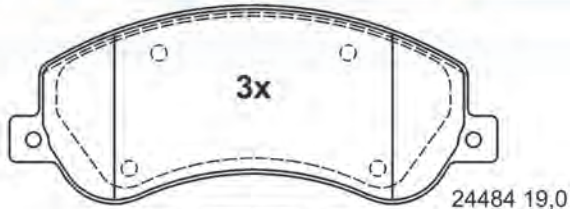

164,8 x 66,8 x 19,0

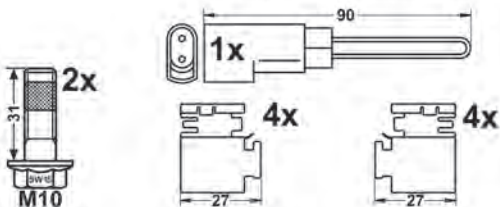

13.0460-3835.2 603835

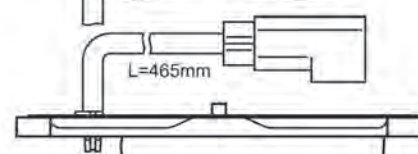
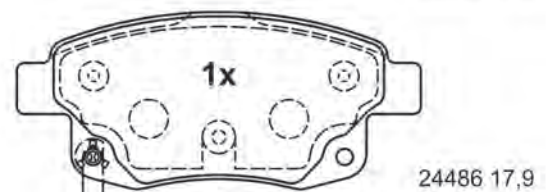
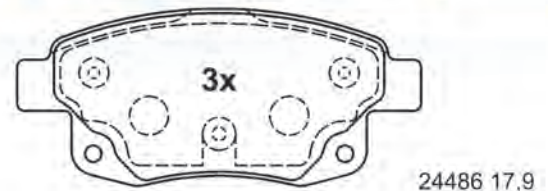

122,8 x 53,6 x 17,9

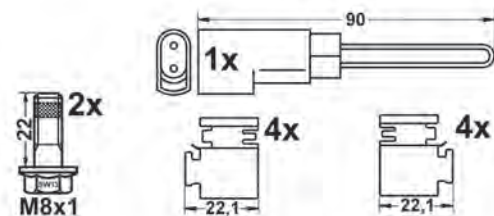

Abbildungen Scheibenbremsbeläge

Illustrations disc brake pads - Ilustraciones de pastillas - Illustrations Plaquettes de frein à disque - Illustrazioni Pastiglie Freno

13.0460-3836.2 603836

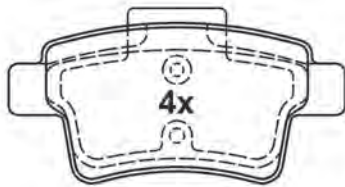

24540 16,3

101,8 x 48,3 x 16,3

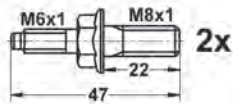

2x



2x

M8x1

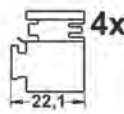

4x

22,1

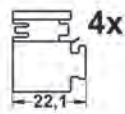

4x

22,1

13.0460-3837.2 603837

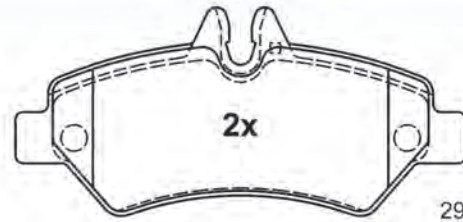

2x

29190 20,2

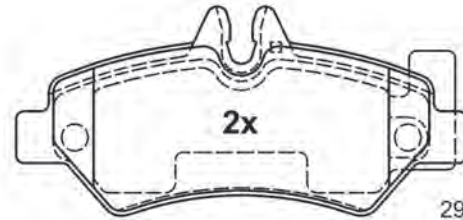

2x

29190 20,2

136,8 x 63,0 x 20,2

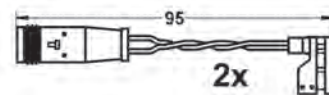

2x



2x

M8x1

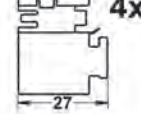

4x

27

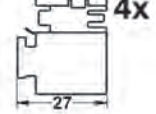

4x

27

13.0460-3838.2 603838

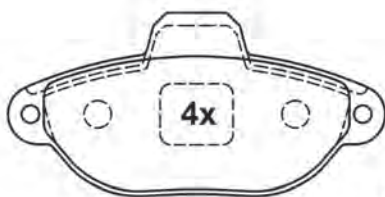

21436 17,0

114,8 x 55,5 x 17,0



2x

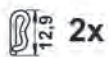

2x

12,9

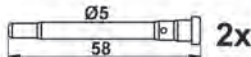

2x

58

13.0460-3839.2 603839



2x

23982 18,1

122,8 x 53,3 x 18,1

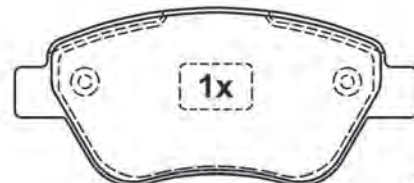

1x

23707 17,9

122,8 x 53,3 x 17,9

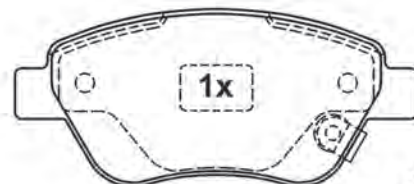

1x

24288 17,9

122,8 x 53,3 x 17,9



2x

M8x1

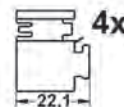

4x

22,1

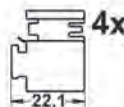

4x

22,1



Abbildungen Scheibenbremsbeläge

Illustrations disc brake pads - Ilustraciones de pastillas - Illustrations Plaquettes de frein à disque - Illustrazioni Pastiglie Freno

13.0460-3840.2 603840



23981 19,6



24549 19,6

136,9 x 57,4 x 19,6

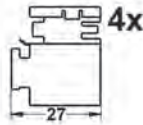
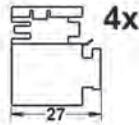

13.0460-3841.2 603841



24550 19,5



24551 19,5

150,9 x 54,9 x 19,5

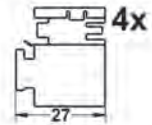
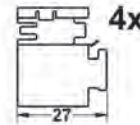
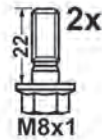

13.0460-3842.2 603842

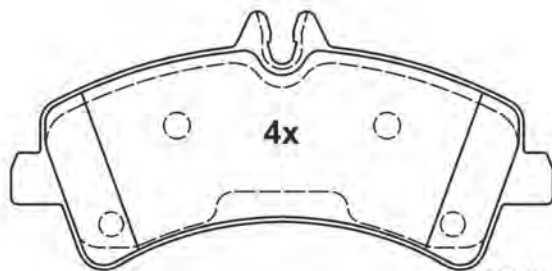

29217 20,5

164,8 x 78,2 x 20,5

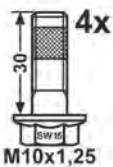

13.0460-3846.2 603846

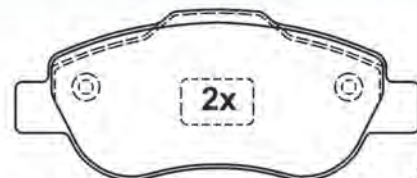

24072 17,9

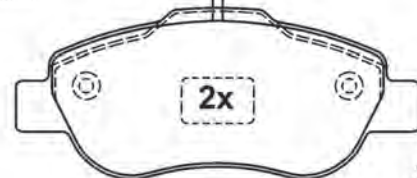

24764 17,9

122,8 x 51,7 x 17,9

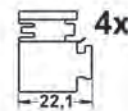
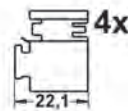
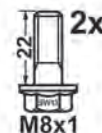

Abbildungen Scheibenbremsbeläge

Illustrations disc brake pads - Ilustraciones de pastillas - Illustrations Plaquettes de frein à disque - Illustrazioni Pastiglie Freno

13.0460-3847.2 603847

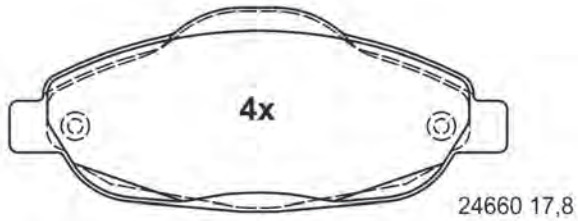

24660 17,8

151,0 x 62,0 x 17,8

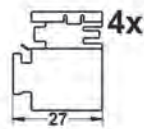
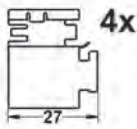

13.0460-3848.2 603848

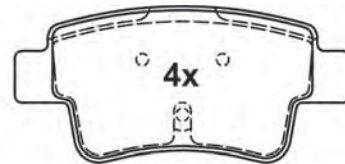

24349 17,6

101,8 x 47,1 x 17,6



13.0460-3849.2 603849

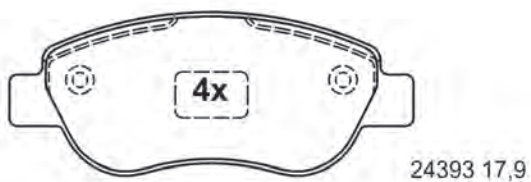

24393 17,9

122,8 x 49,3 x 17,9

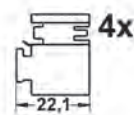
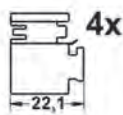
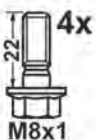

13.0460-3850.2 603850



23707 18,0

122,9 x 53,3 x 18,0

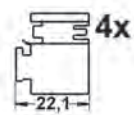
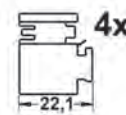
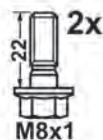

Abbildungen Scheibenbremsbeläge

Illustrations disc brake pads - Ilustraciones de pastillas - Illustrations Plaquettes de frein à disque - Illustrazioni Pastiglie Freno

13.0460-3851.2 603851

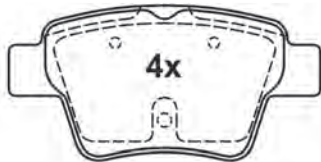

24150 17,6

94,8 x 46,9 x 17,6

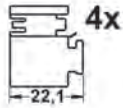
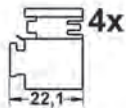
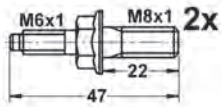

13.0460-3852.2 603852

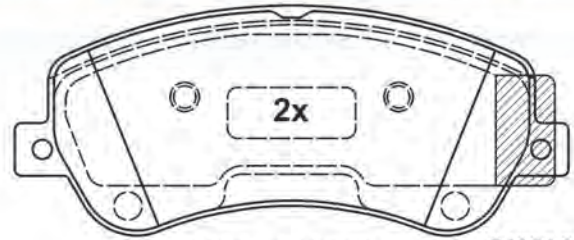

165,1 x 68,3 x 20,7

24867 20,7

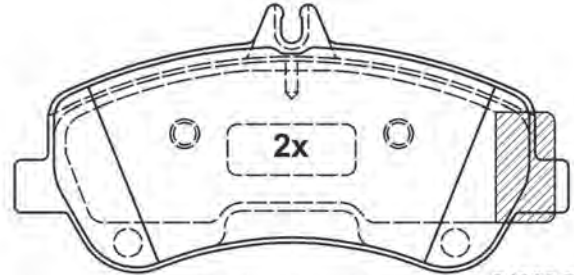

165,1 x 79,5 x 20,7

24868 20,7

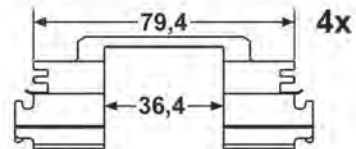
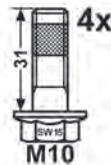

13.0460-3853.2 603853



24885 16,8

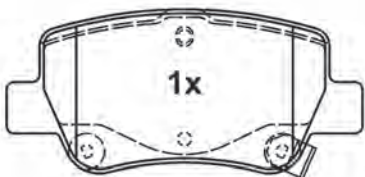

24886 16,8

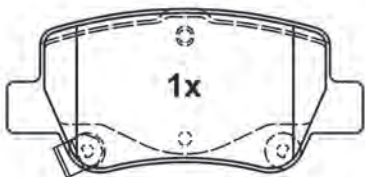

24887 16,8

108,8 x 49,8 x 16,8

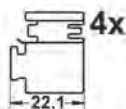
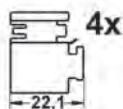

13.0460-3854.2 603854



101,8 x 48,7 x 16,5

24926 16,5

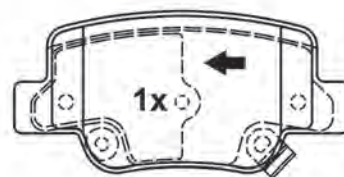

101,8 x 48,7 x 17,1

24927 17,1

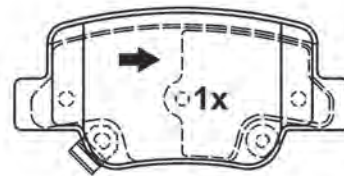

101,8 x 48,7 x 17,1

24928 17,1

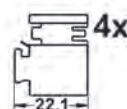
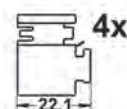

Abbildungen Scheibenbremsbeläge

Illustrations disc brake pads - Ilustraciones de pastillas - Illustrations Plaquettes de frein à disque - Illustrazioni Pastiglie Freno

13.0460-3855.2 603855

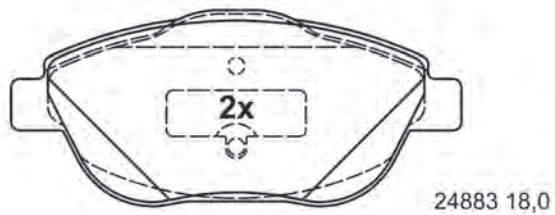
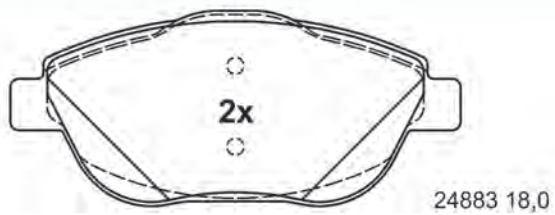

136,8 x 59,2 x 18,0

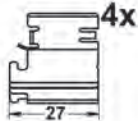
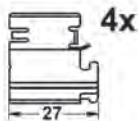
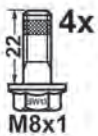

13.0460-3856.2 603856 [1]

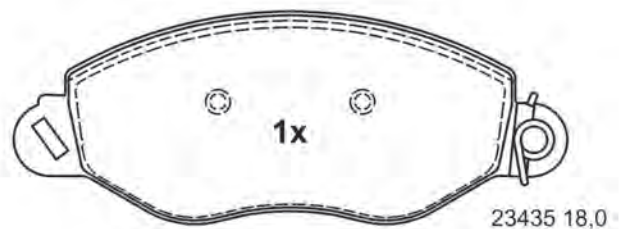
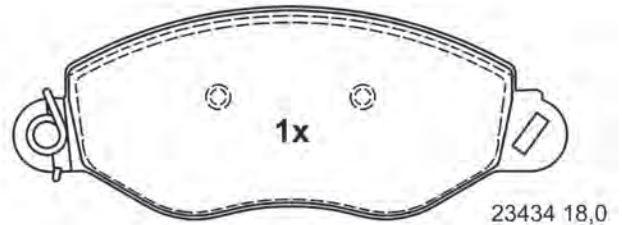

168,3 x 63,9 x 18,0

13.0460-3856.2 603856 [2]

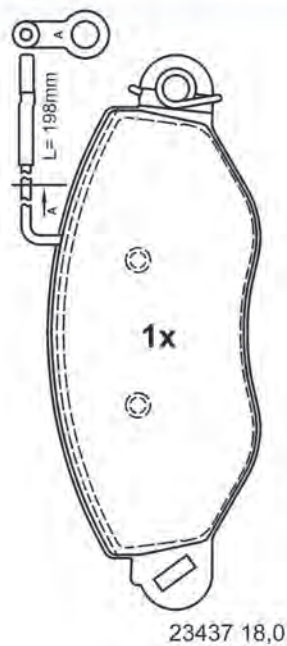
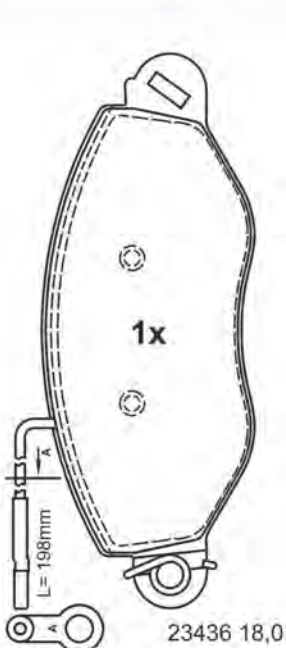

168,3 x 63,9 x 18,0

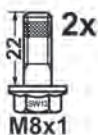

13.0460-3857.2 603857

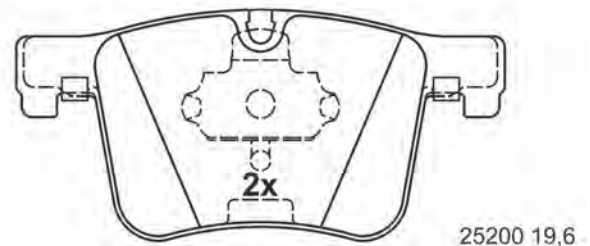
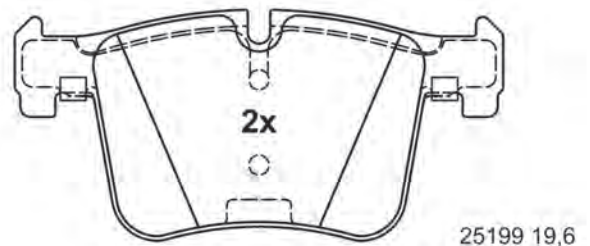

148,2 x 69,8 x 19,6



Abbildungen Scheibenbremsbeläge

Illustrations disc brake pads - Ilustraciones de pastillas - Illustrations Plaquettes de frein à disque - Illustrazioni Pastiglie Freno

13.0460-3858.2 603858

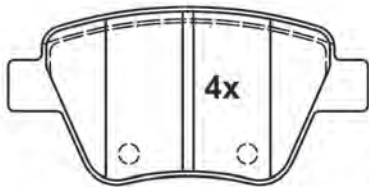

24563 17,7

109,3 x 53,4 x 17,7

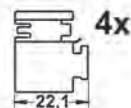
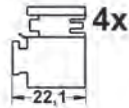
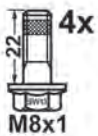

13.0460-3859.2 603859

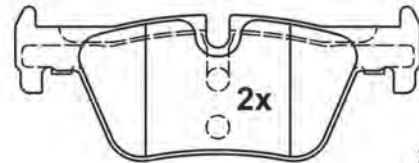

25307 17,5

123,0 x 46,7 x 17,5

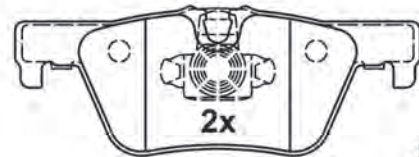

25308 17,5

123,0 x 45,3 x 17,5

13.0460-3860.2 603860

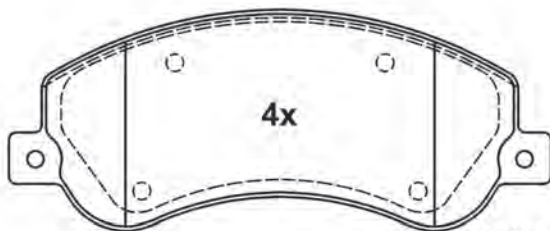

24484 18,8

164,8 x 66,8 x 18,8

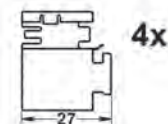
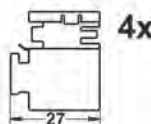

13.0460-3861.2 603861



23714 17,6

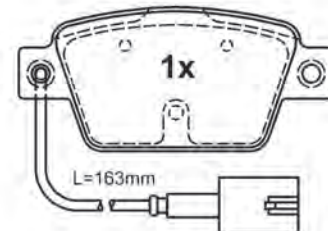

25527 17,6

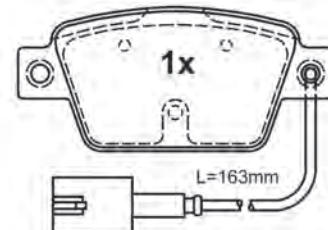

25526 17,6

94,8 x 42,9 x 17,6

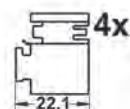

Abbildungen Scheibenbremsbeläge

Illustrations disc brake pads - Ilustraciones de pastillas - Illustrations Plaquettes de frein à disque - Illustrazioni Pastiglie Freno

13.0460-3862.2 603862



25451 17,6
(24349)

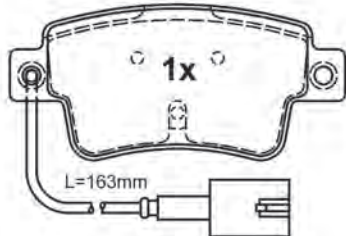

25357 17,6

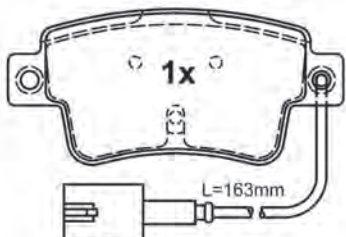

25357 17,6

L=163mm

101,8 x 47,1 x 17,6

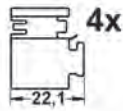
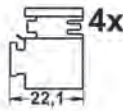
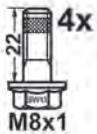

13.0460-3863.2 603863

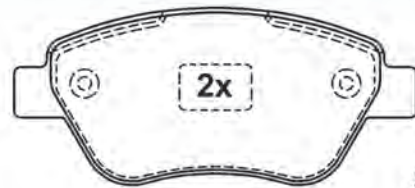

23707 18,0

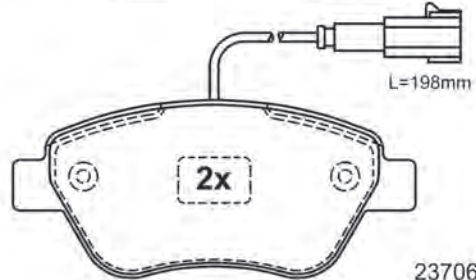

23706 18,0

122,8 x 53,3 x 18,0

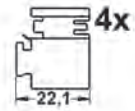
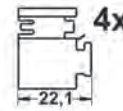

13.0460-3864.2 603864

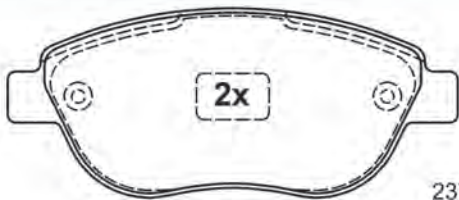

23710 19,6

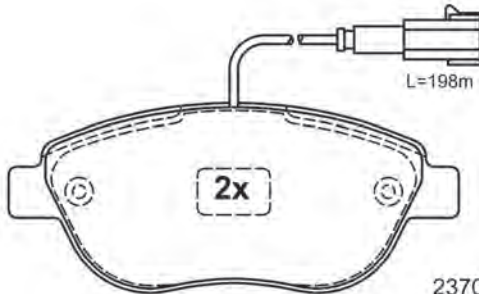

23709 19,6

136,8 x 57,4 x 19,6

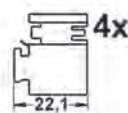
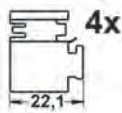
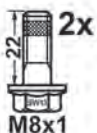

13.0460-3865.2 603865



25014 18,2

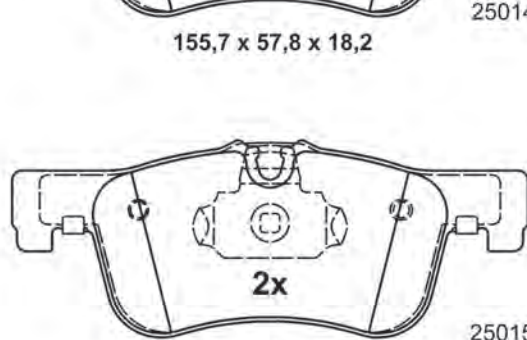

25015 18,2

155,7 x 57,8 x 18,2

156,7 x 59,7 x 18,2

Abbildungen Scheibenbremsbeläge

Illustrations disc brake pads - Ilustraciones de pastillas - Illustrations Plaquettes de frein à disque - Illustrazioni Pastiglie Freno

13.0460-3866.2 603866

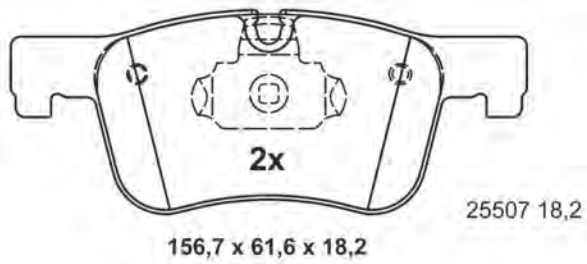
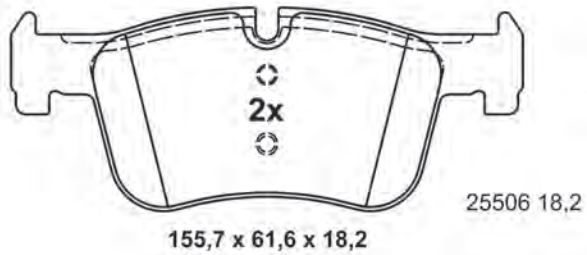

13.0460-3867.2 603867

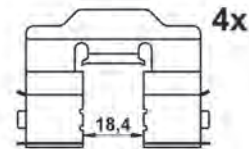
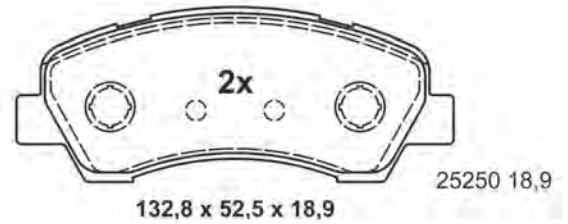
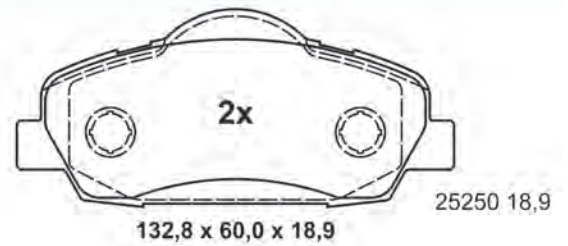

13.0460-3870.2 603870

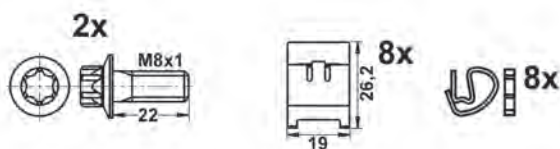
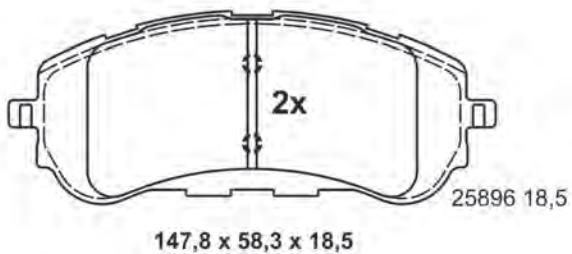
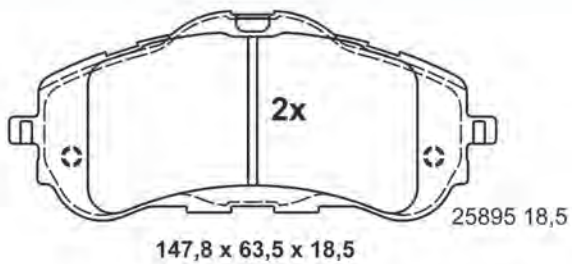

13.0460-3871.2 603871

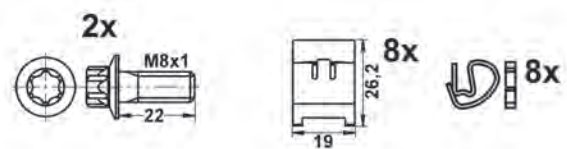
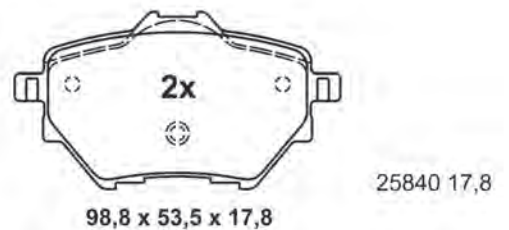

Abbildungen Scheibenbremsbeläge

Illustrations disc brake pads - Ilustraciones de pastillas - Illustrations Plaquettes de frein à disque - Illustrazioni Pastiglie Freno

13.0460-3872.2 603872



25827 17,7

105,8 x 51,9 x 17,7



25828 17,7

105,8 x 55,4 x 17,7

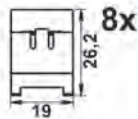
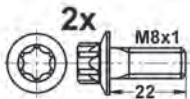

13.0460-3902.2 603902

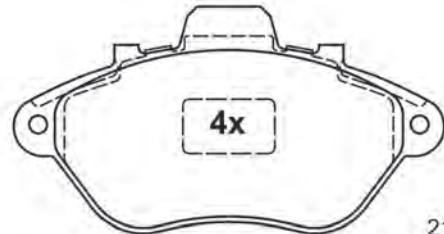

21299 17,0
(21300)
(20035)
(20036)

130,8 x 68,7 x 17,0



13.0460-3904.2 603904

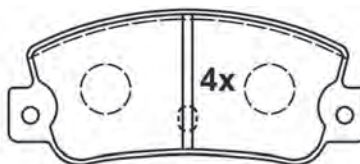

21107 12,0

108,9 x 47,1 x 12,0

13.0460-3911.2 603911

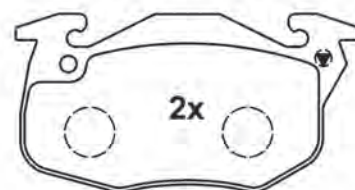

20905 18,0
(20986)

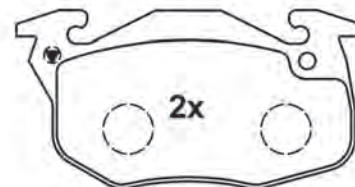

20906 18,0
(20987)

105,0 x 54,0 x 18,0



Abbildungen Scheibenbremsbeläge

Illustrations disc brake pads - Ilustraciones de pastillas - Illustrations Plaquettes de frein à disque - Illustrazioni Pastiglie Freno

13.0460-3914.2 603914

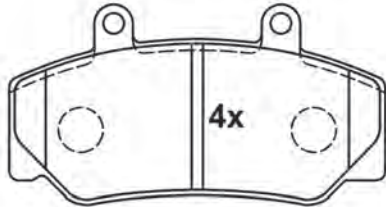

21233 16,7

113,8 x 62,2 x 16,7

13.0460-3926.2 603926

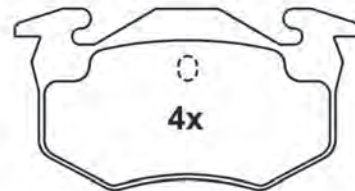

20974 10,8

105,0 x 54,8 x 10,8

13.0460-3933.2 603933

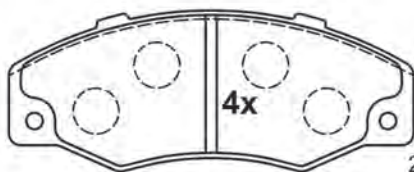

21016 17,0
(21086)
(21087)

123,1 x 48,8 x 17,0

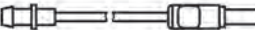
L=380mm  2x

13.0460-3936.2 603936

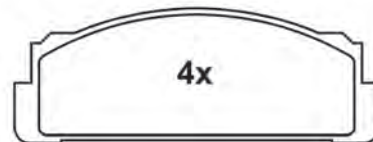

20073 17,3

108,9 x 39,0 x 17,3

Abbildungen Scheibenbremsbeläge

Illustrations disc brake pads - Ilustraciones de pastillas - Illustrations Plaquettes de frein à disque - Illustrazioni Pastiglie Freno

13.0460-3939.2 603939  13.0460-3940.2 603940 

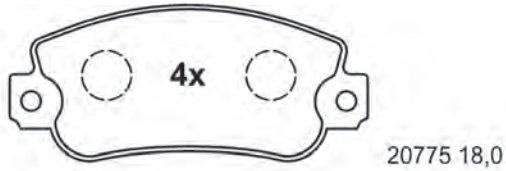

108,9 x 47,4 x 18,0

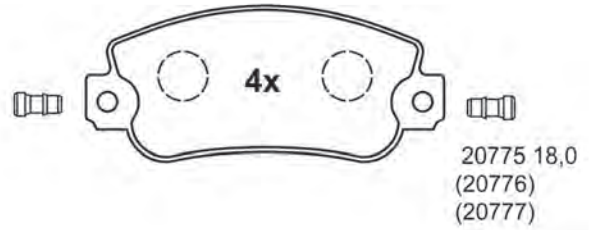

109,0 x 47,4 x 18,0

13.0460-3942.2 603942  13.0460-3943.2 603943 

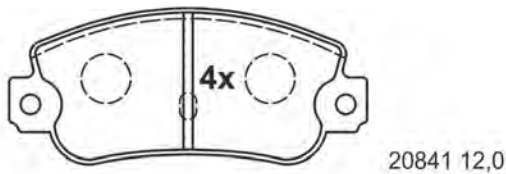

109,0 x 47,4 x 12,0

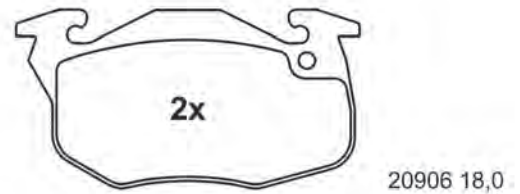
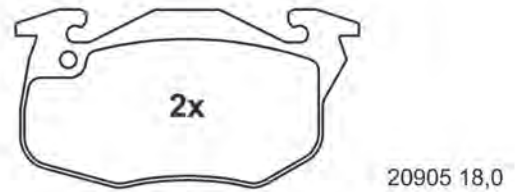

105,0 x 54,3 x 18,0



Abbildungen Scheibenbremsbeläge

Illustrations disc brake pads - Ilustraciones de pastillas - Illustrations Plaquettes de frein à disque - Illustrazioni Pastiglie Freno

13.0460-3945.2 603945

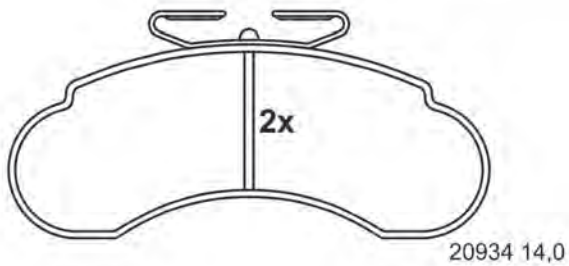
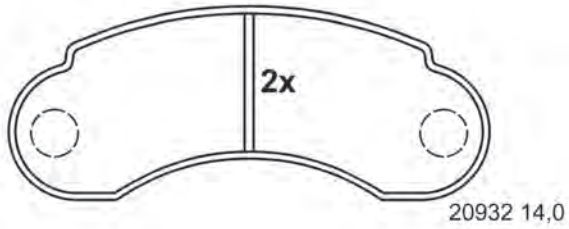

145,5 x 59,0 x 14,0

13.0460-3946.2 603946



138,8 x 66,5 x 18,0

13.0460-3947.2 603947

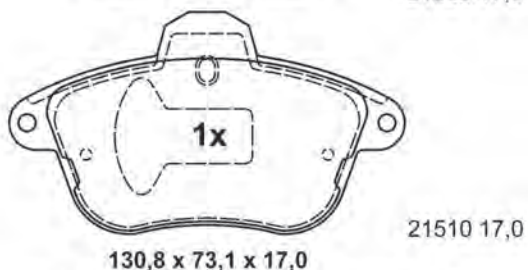
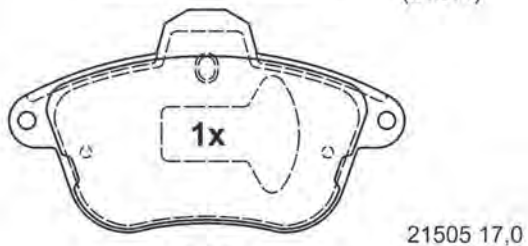
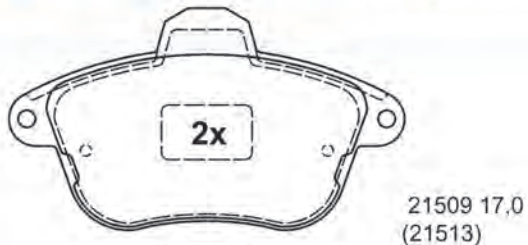

130,8 x 73,1 x 17,0

L=125mm 2x

L=345mm 2x

13.0460-3948.2 603948

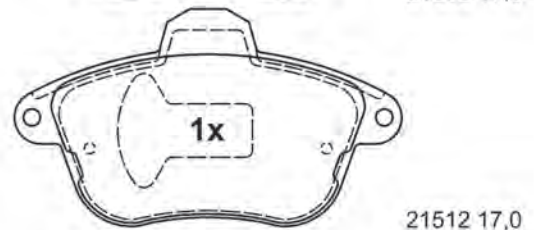
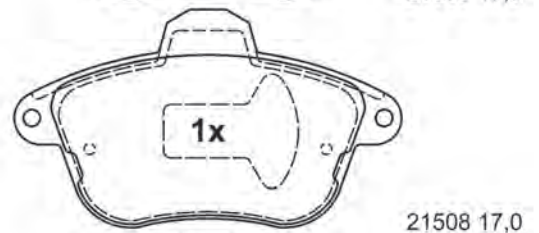
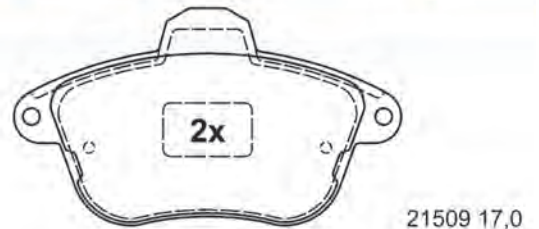

130,8 x 73,1 x 17,0

L=125mm 2x

L=345mm 2x

Abbildungen Scheibenbremsbeläge

Illustrations disc brake pads - Ilustraciones de pastillas - Illustrations Plaquettes de frein à disque - Illustrazioni Pastiglie Freno

13.0460-3949.2 603949

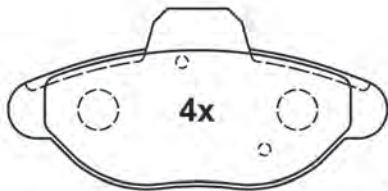

21365 17,0

114,8 x 54,8 x 17,0

13.0460-3950.2 603950

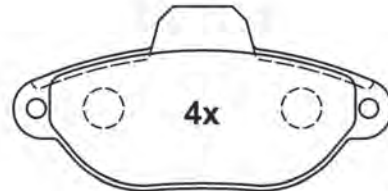

21436 17,0

115,0 x 55,2 x 17,0

13.0460-3951.2 603951

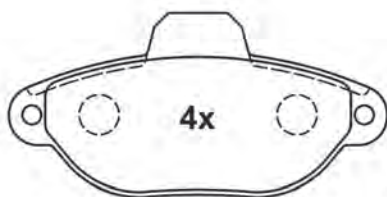

21436 16,2

114,8 x 55,2 x 16,2



13.0460-3952.2 603952

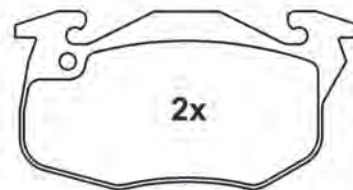

20905 18,0

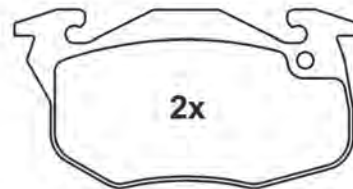

20906 18,0

105,0 x 54,3 x 18,0

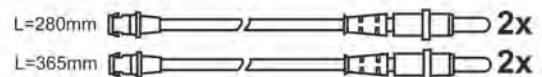

Abbildungen Scheibenbremsbeläge

Illustrations disc brake pads - Ilustraciones de pastillas - Illustrations Plaquettes de frein à disque - Illustrazioni Pastiglie Freno

13.0460-3953.2 603953

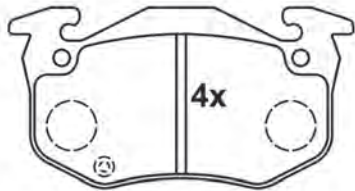

20634 15,0

105,0 x 54,9 x 15,0

13.0460-3954.2 603954

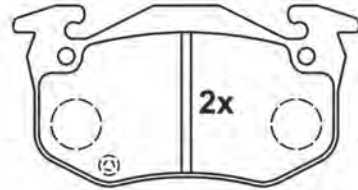

20973 11,0

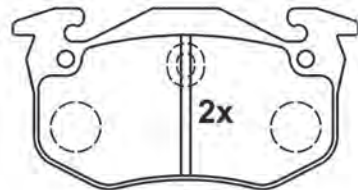

20974 11,0

105,0 x 54,9 x 11,0

13.0460-3955.2 603955

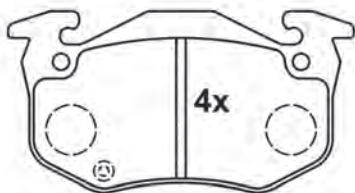

20634 15,0
(21096)
(21097)

105,0 x 54,9 x 15,0

L=183mm 2x

13.0460-3956.2 603956



21631 17,0

130,8 x 60,0 x 17,0

L=152mm 2x

L=364mm 2x

Abbildungen Scheibenbremsbeläge

Illustrations disc brake pads - Ilustraciones de pastillas - Illustrations Plaquettes de frein à disque - Illustrazioni Pastiglie Freno

13.0460-3957.2 603957

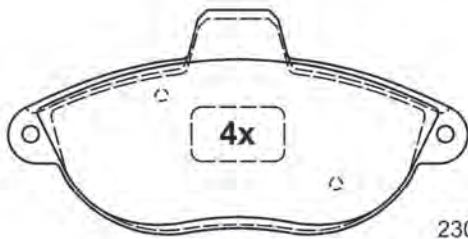

23042 19,0

139,8 x 68,8 x 19,0

L=270mm  2x

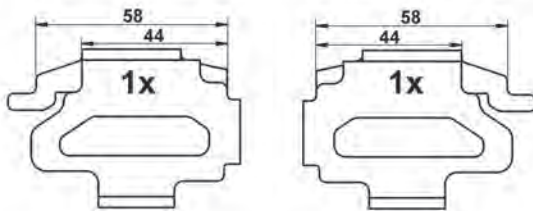
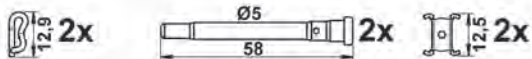

13.0460-3959.2 603959

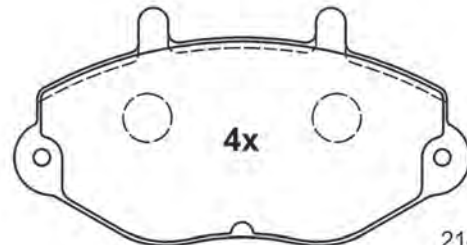

21469 18,0

138,7 x 72,1 x 18,0

13.0460-3960.2 603960



21470 18,0

138,7 x 64,1 x 18,0

13.0460-3961.2 603961

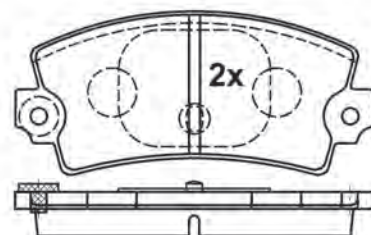

20336 14,0

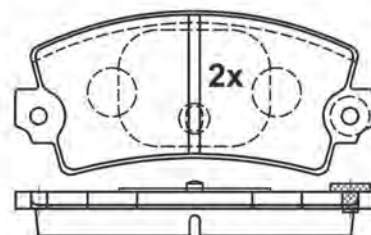

20337 14,0

108,9 x 49,8 x 14,0

 2x



Abbildungen Scheibenbremsbeläge

Illustrations disc brake pads - Ilustraciones de pastillas - Illustrations Plaquettes de frein à disque - Illustrazioni Pastiglie Freno

13.0460-3962.2 603962

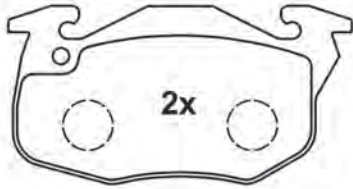

20905 18,0

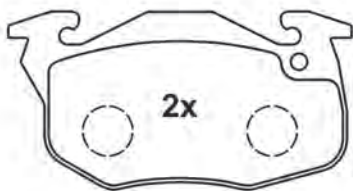

20906 18,0

105,0 x 54,0 x 18,0

13.0460-3963.2 603963



21586 15,0

115,7 x 53,6 x 15,0

13.0460-3964.2 603964



23410 15,0
(21586)

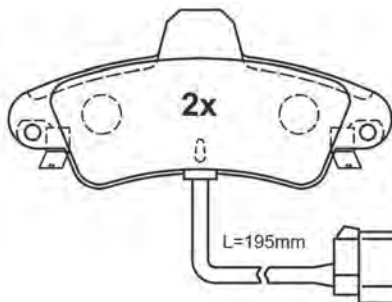

23411 15,0

115,7 x 53,6 x 15,0

13.0460-3965.2 603965

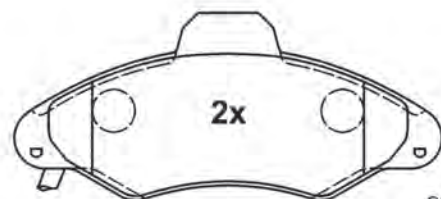

23300 18,0

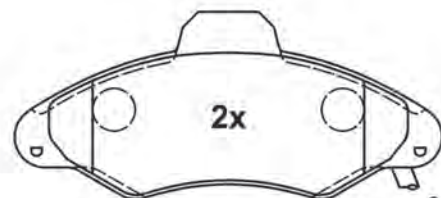

23301 18,0

130,8 x 57,3 x 18,0

Abbildungen Scheibenbremsbeläge

Illustrations disc brake pads - Ilustraciones de pastillas - Illustrations Plaquettes de frein à disque - Illustrazioni Pastiglie Freno

13.0460-3966.2 603966

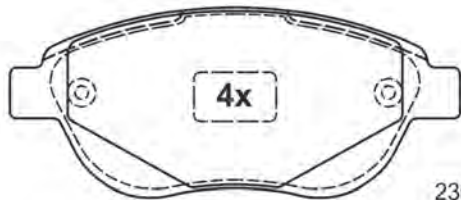

23600 19,4

136,8 x 57,5 x 19,4

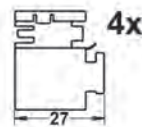
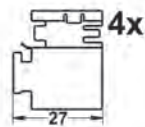

13.0460-3968.2 603968

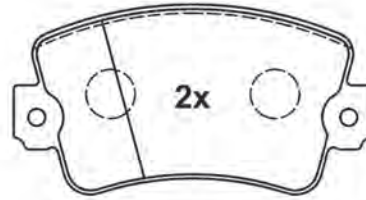

20488 18,5
(20570)

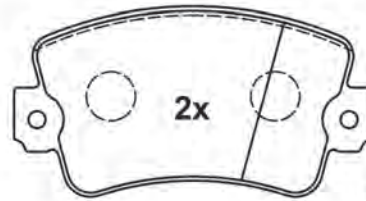

20489 18,5
(20571)

108,9 x 57,5 x 18,5



13.0460-3969.2 603969

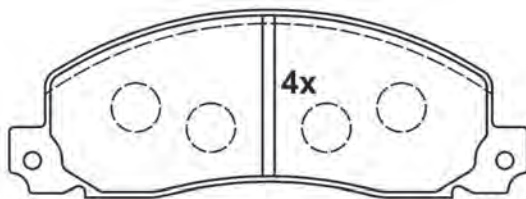

20926 18,5
(20927)
(20928)
(20929)

155,8 x 56,6 x 18,5



13.0460-3972.2 603972



21632 16,0

130,9 x 69,0 x 16,0



Abbildungen Scheibenbremsbeläge

Illustrations disc brake pads - Ilustraciones de pastillas - Illustrations Plaquettes de frein à disque - Illustrazioni Pastiglie Freno

13.0460-3973.2 603973

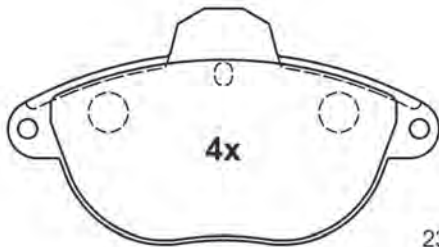

23146 17,0

130,8 x 71,4 x 17,0

L=168mm 2x

L=364mm 2x

13.0460-3975.2 603975

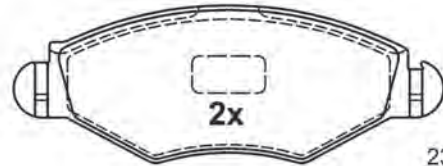

23597 18,0

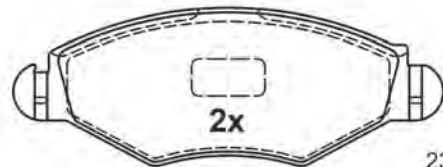

23598 18,0

131,0 x 47,3 x 18,0



M8x20



8x

13.0460-3976.2 603976

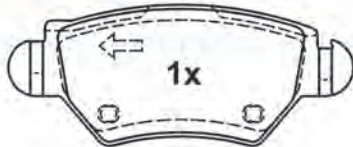

23258 16,5

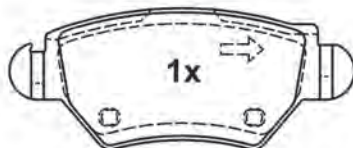

23259 16,5

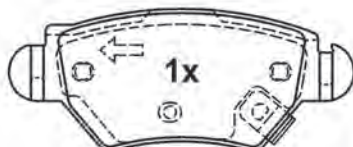

23262 16,5

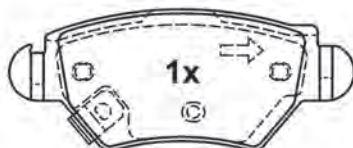

23263 16,5

104,6 x 42,7 x 16,5



M8x20



8x

13.0460-3977.2 603977



21980 18,0

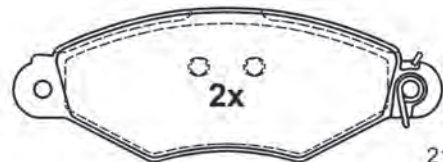

21981 18,0

130,7 x 47,2 x 18,0



M8x20

Abbildungen Scheibenbremsbeläge

Illustrations disc brake pads - Ilustraciones de pastillas - Illustrations Plaquettes de frein à disque - Illustrazioni Pastiglie Freno

13.0460-3978.2 603978

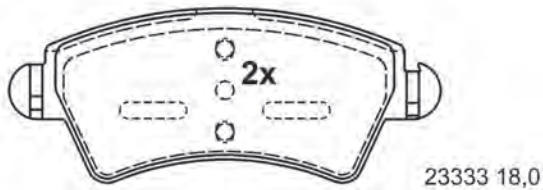
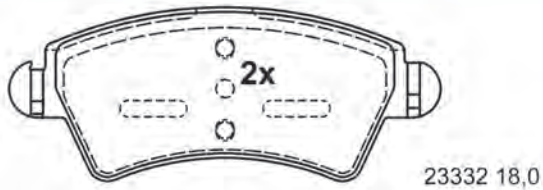

130,8 x 52,4 x 18,0



13.0460-3979.2 603979

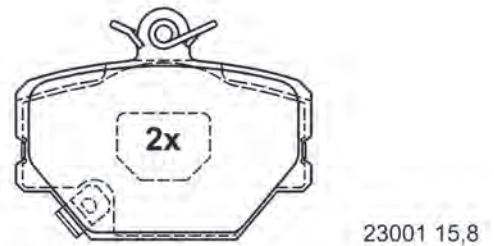
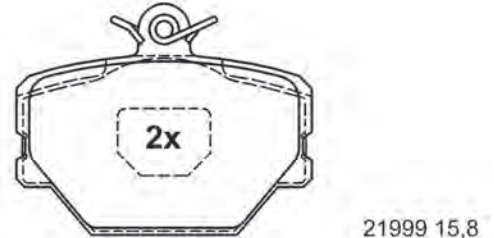

90,0 x 70,1 x 15,8

13.0460-3980.2 603980

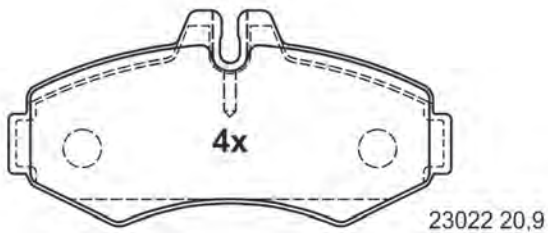

134,4 x 64,5 x 20,9

13.0460-3982.2 603982

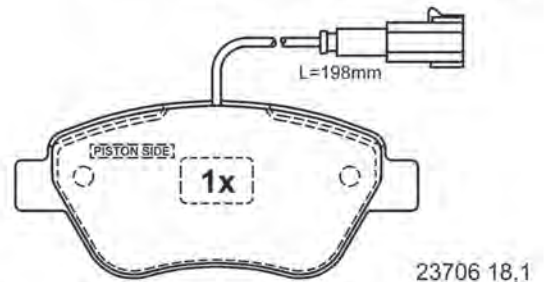
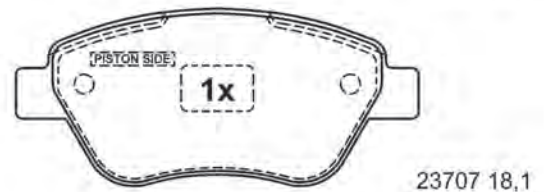
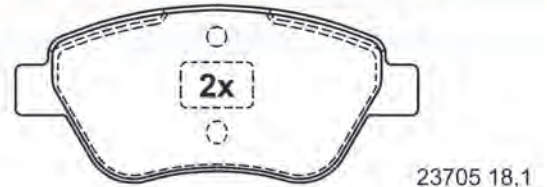

122,8 x 53,3 x 18,1



Abbildungen Scheibenbremsbeläge

Illustrations disc brake pads - Ilustraciones de pastillas - Illustrations Plaquettes de frein à disque - Illustrazioni Pastiglie Freno

13.0460-3983.2 603983

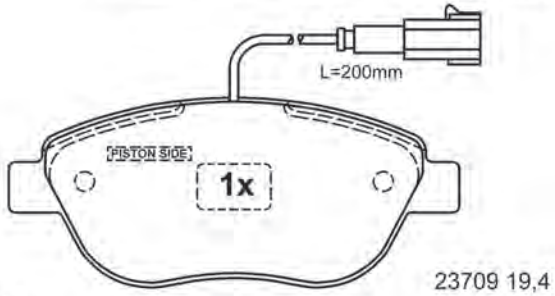
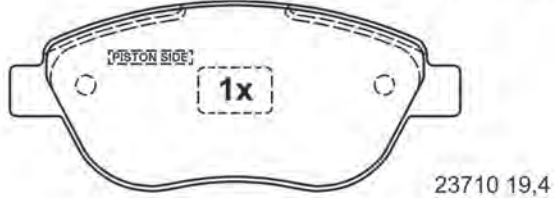
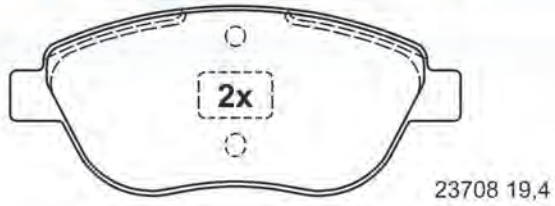

136,8 x 57,4 x 19,4

13.0460-3984.2 603984

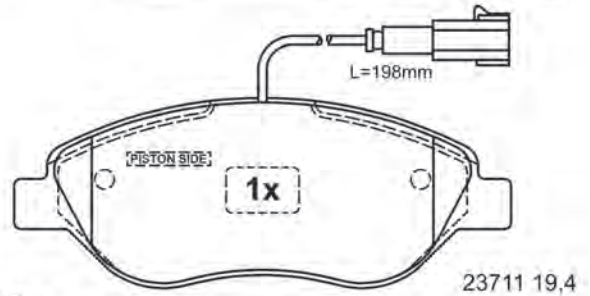
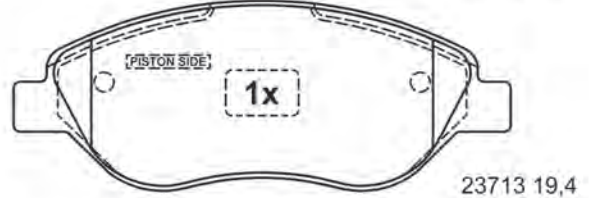
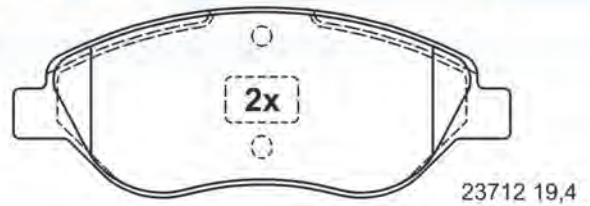

150,8 x 57,4 x 19,4

13.0460-3985.2 603985

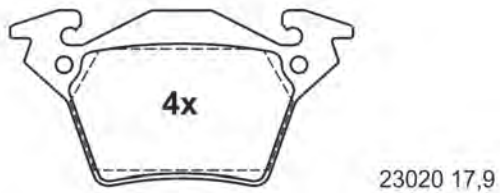

105,0 x 52,9 x 17,9

13.0460-3986.2 603986

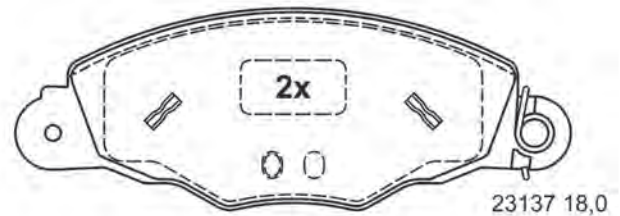
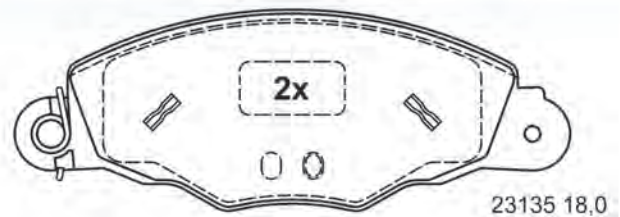

168,9 x 61,1 x 18,0



L=410mm 2x

L=180mm 2x

Abbildungen Scheibenbremsbeläge

Illustrations disc brake pads - Ilustraciones de pastillas - Illustrations Plaquettes de frein à disque - Illustrazioni Pastiglie Freno

13.0460-3987.2 603987

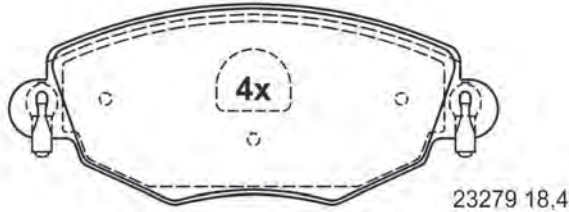

23279 18,4

148,8 x 60,5 x 18,4



13.0460-3988.2 603988

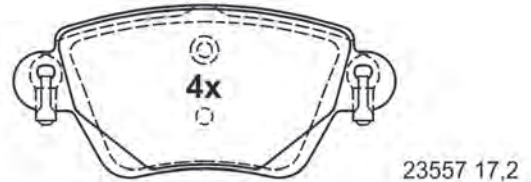

23557 17,2

115,7 x 52,0 x 17,2



13.0460-3990.2 603990

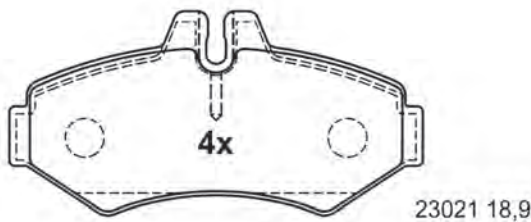

23021 18,9

125,8 x 61,9 x 18,9

13.0460-3991.2 603991

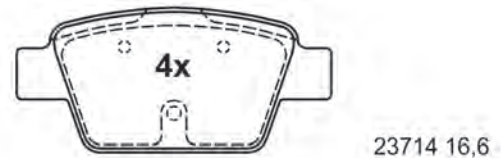

23714 16,6

94,8 x 42,9 x 16,6



Abbildungen Scheibenbremsbeläge

Illustrations disc brake pads - Ilustraciones de pastillas - Illustrations Plaquettes de frein à disque - Illustrazioni Pastiglie Freno

13.0460-3992.2 603992

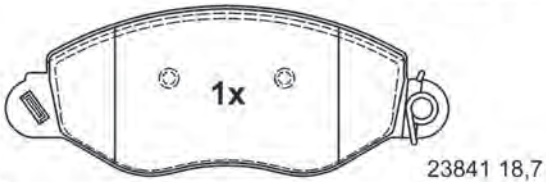
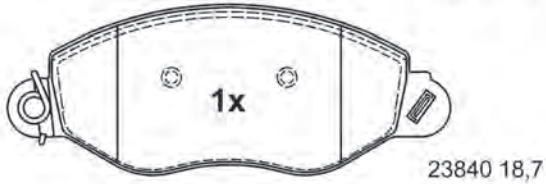
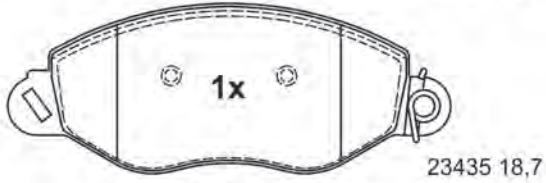
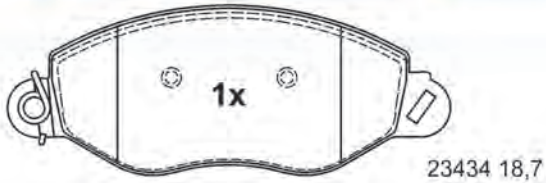

168,3 x 63,9 x 18,7

13.0460-3993.2 603993

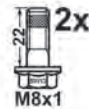
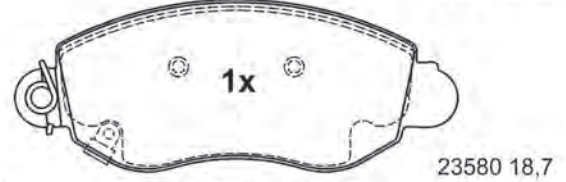
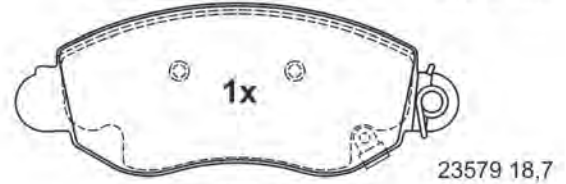
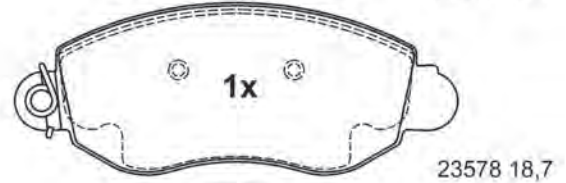
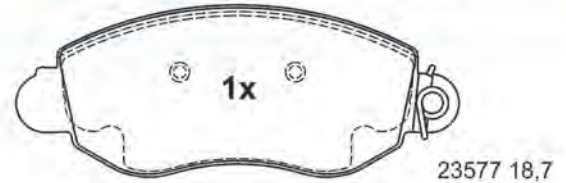

168,5 x 65,1 x 18,7

13.0460-3994.2 603994

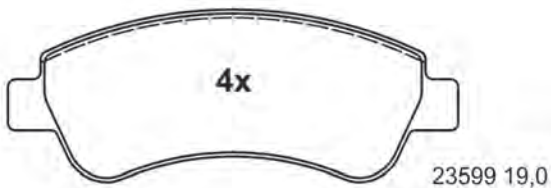

136,8 x 52,0 x 19,0

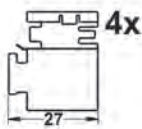

13.0460-3995.2 603995

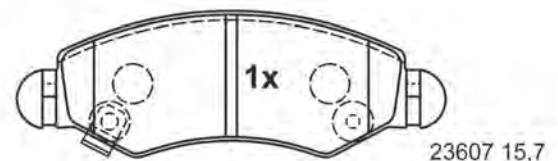
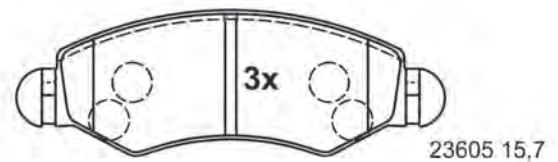

130,7 x 43,9 x 15,7



Abbildungen Scheibenbremsbeläge

Illustrations disc brake pads - Ilustraciones de pastillas - Illustrations Plaquettes de frein à disque - Illustrazioni Pastiglie Freno

13.0460-3996.2 603996

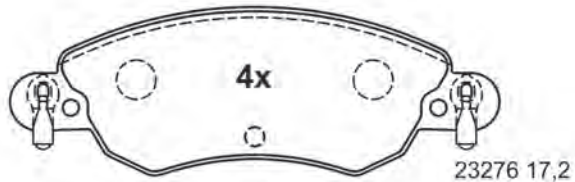

148,8 x 50,9 x 17,2

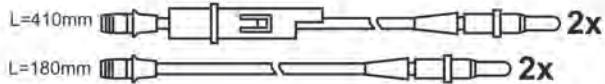

13.0460-3997.2 603997

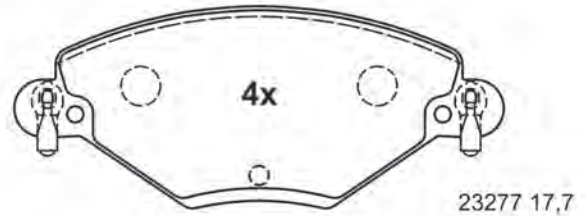

148,7 x 61,2 x 17,7

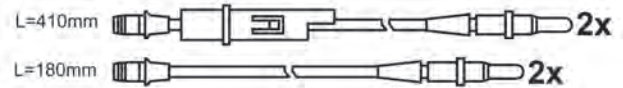

13.0460-3998.2 603998

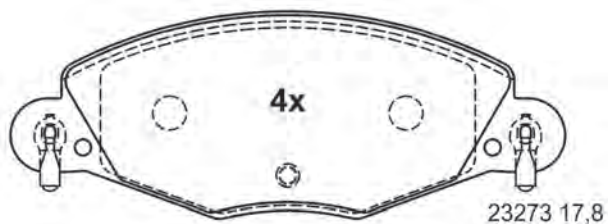

168,7 x 62,8 x 17,8

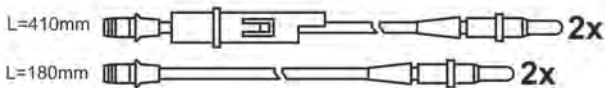

13.0460-3999.2 603999 [1]

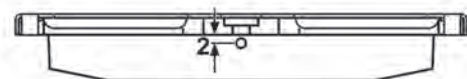
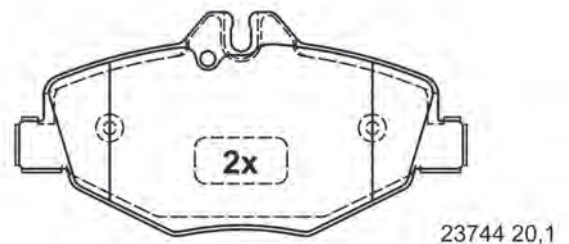
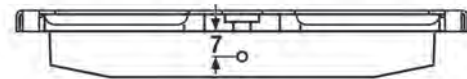
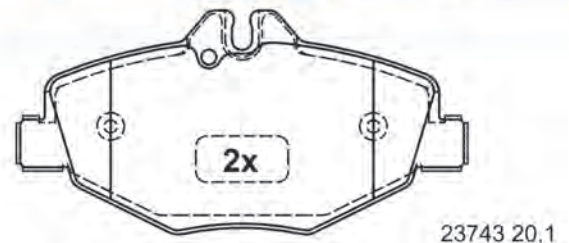

137,0 x 67,8 x 20,1

Abbildungen Scheibenbremsbeläge

Illustrations disc brake pads - Ilustraciones de pastillas - Illustrations Plaquettes de frein à disque - Illustrazioni Pastiglie Freno

13.0460-3999.2 603999 [2]



13.0460-4014.2 604014

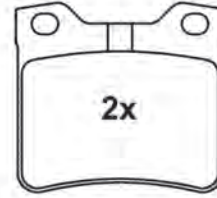
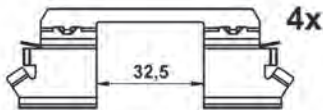
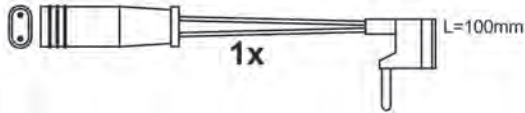
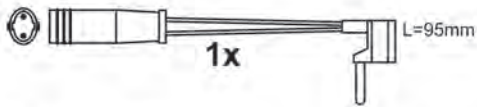
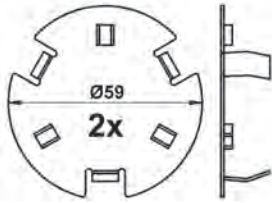

21278 16,4

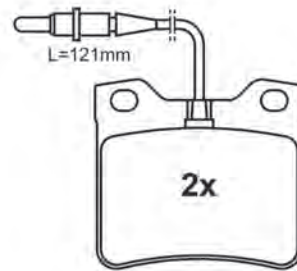

21279 16,4

63,7 x 57,8 x 16,4

13.0460-4034.2 604034



13.0460-4040.2 604040



20687 15,5

61,8 x 54,3 x 15,5



21050 15,8

61,6 x 61,2 x 15,8

Abbildungen Scheibenbremsbeläge

Illustrations disc brake pads - Ilustraciones de pastillas - Illustrations Plaquettes de frein à disque - Illustrazioni Pastiglie Freno

13.0460-4041.2 604041

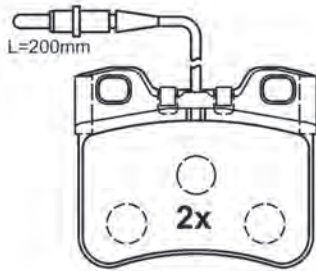

21289 16,8

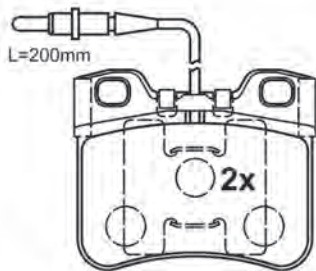

21179 16,8

72,9 x 60,6 x 16,8

13.0460-4042.2 604042

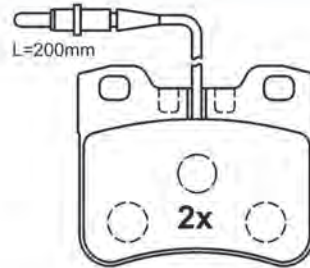

21267 16,8

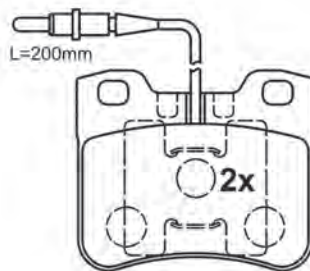

21191 16,8

71,9 x 60,6 x 16,8

13.0460-4043.2 604043



21140 15,0

61,7 x 57,5 x 15,0

13.0460-4044.2 604044

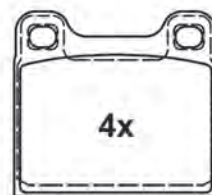

20755 15,1

61,8 x 56,5 x 15,1

Abbildungen Scheibenbremsbeläge

Illustrations disc brake pads - Ilustraciones de pastillas - Illustrations Plaquettes de frein à disque - Illustrazioni Pastiglie Freno

13.0460-4047.2 604047

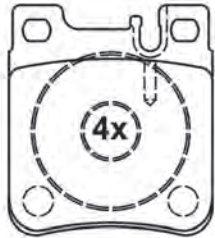

21305 15,7

61,7 x 69,5 x 15,7

13.0460-4056.2 604056

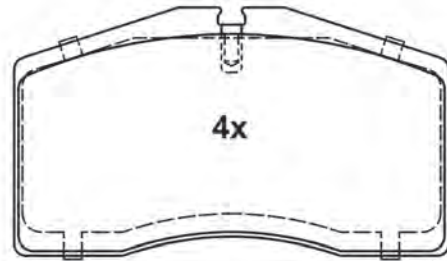

21402 17,5

131,7 x 75,0 x 17,5

13.0460-4058.2 604058



21832 14,9

61,7 x 51,1 x 14,9

13.0460-4059.2 604059

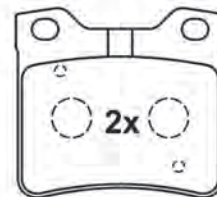

21278 16,4

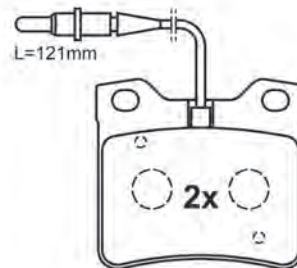

21279 16,4

63,7 x 57,8 x 16,4

Abbildungen Scheibenbremsbeläge

Illustrations disc brake pads - Ilustraciones de pastillas - Illustrations Plaquettes de frein à disque - Illustrazioni Pastiglie Freno

13.0460-4060.2 604060



21900 15,0

63,7 x 63,2 x 15,0

13.0460-4064.2 604064

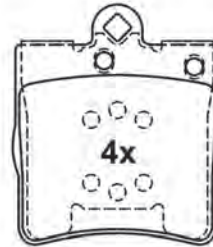

21919 15,3

63,8 x 72,8 x 15,3

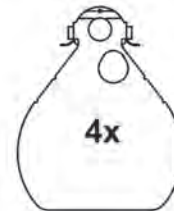

13.0460-4065.2 604065

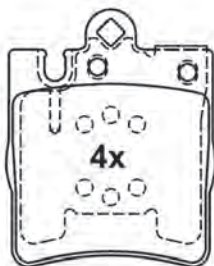

21899 15,3

63,7 x 78,0 x 15,3

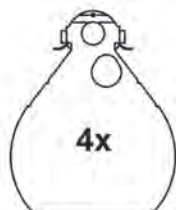

13.0460-4066.2 604066

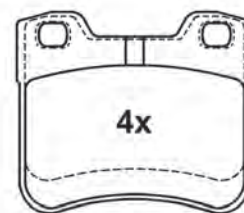

21857 17,7

71,9 x 60,6 x 17,7

Abbildungen Scheibenbremsbeläge

Illustrations disc brake pads - Ilustraciones de pastillas - Illustrations Plaquettes de frein à disque - Illustrazioni Pastiglie Freno

13.0460-4069.2 604069

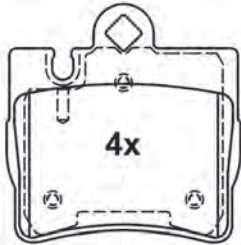

23078 15,9

70,9 x 72,1 x 15,9

13.0460-4201.2 604201

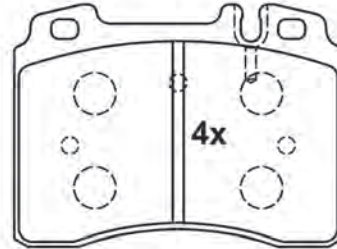

21153 17,5

99,8 x 73,6 x 17,5

13.0460-4202.2 604202

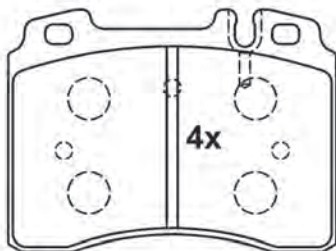

21153 16,0

99,8 x 73,6 x 16,0

13.0460-4401.2 604401

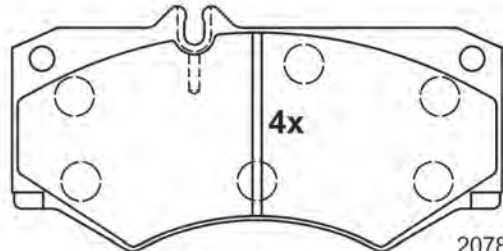

20784 18,0

149,0 x 75,0 x 18,0

Abbildungen Scheibenbremsbeläge

Illustrations disc brake pads - Ilustraciones de pastillas - Illustrations Plaquettes de frein à disque - Illustrazioni Pastiglie Freno

13.0460-4800.2 604800

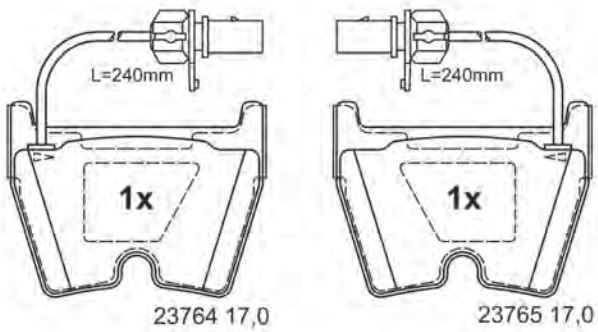
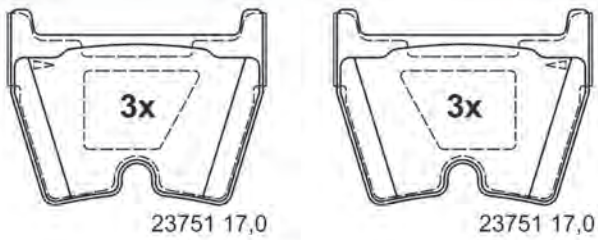

97,3 x 73,9 x 17,0

13.0460-4801.2 604801

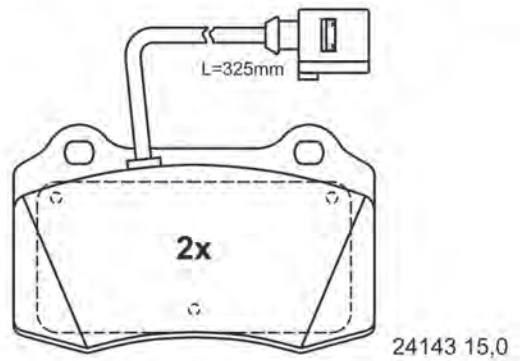
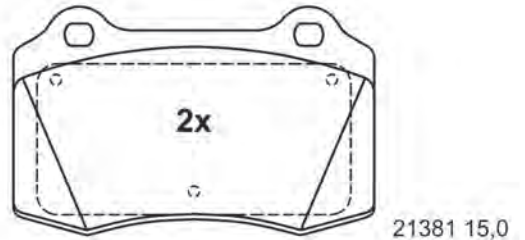

109,8 x 69,2 x 15,0

13.0460-4802.2 604802

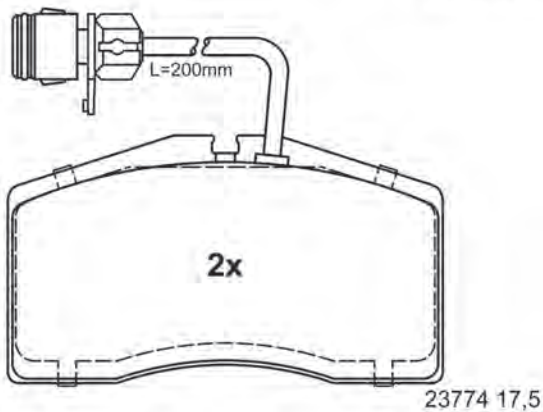
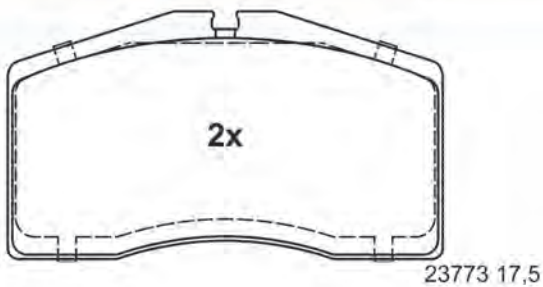

131,7 x 75,0 x 17,5

13.0460-4803.2 604803 [1]

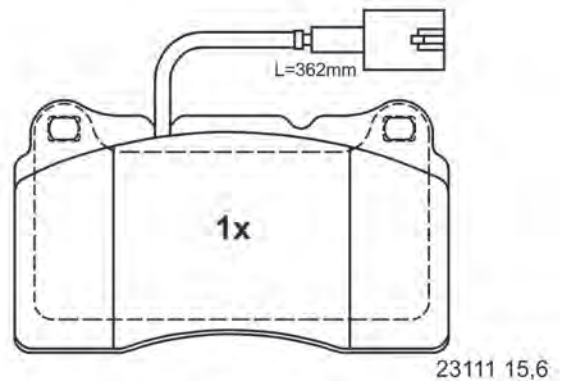
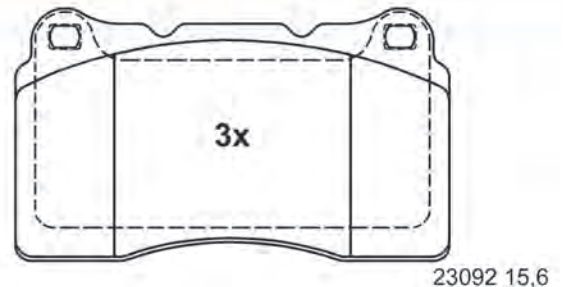

131,8 x 77,2 x 15,6

Abbildungen Scheibenbremsbeläge

Illustrations disc brake pads - Ilustraciones de pastillas - Illustrations Plaquettes de frein à disque - Illustrazioni Pastiglie Freno

13.0460-4803.2 604803 [2]

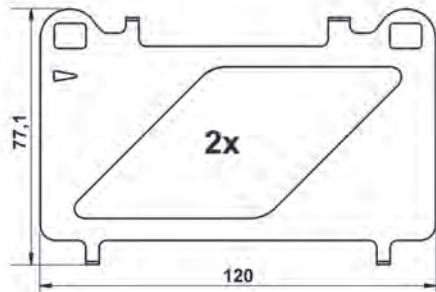
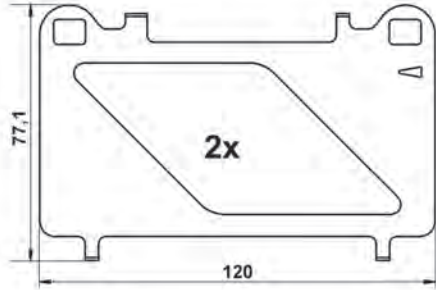

13.0460-4804.2 604804



23092 15,6

131,8 x 77,2 x 15,6

13.0460-4805.2 604805

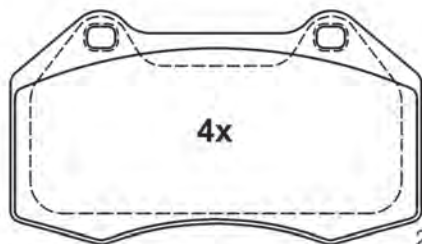

24162 15,2

124,6 x 70,4 x 15,2

13.0460-4806.2 604806

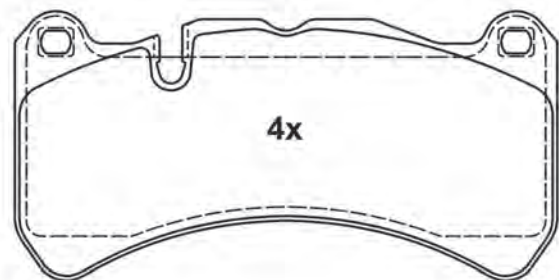

23955 16,2

164,6 x 81,5 x 16,2

Abbildungen Scheibenbremsbeläge

Illustrations disc brake pads - Ilustraciones de pastillas - Illustrations Plaquettes de frein à disque - Illustrazioni Pastiglie Freno

13.0460-4807.2 604807

B.H.P.

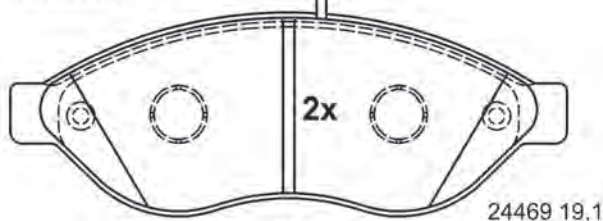
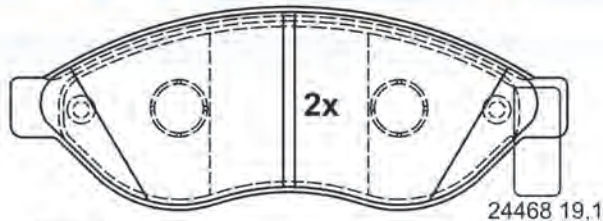

169,2 x 61,5 x 19,1

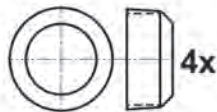
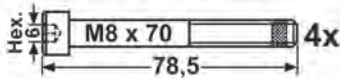
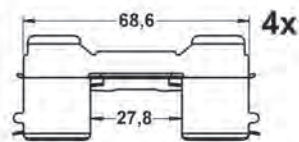

13.0460-4809.2 604809

B.H.P.

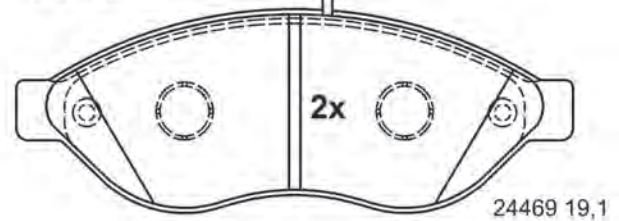
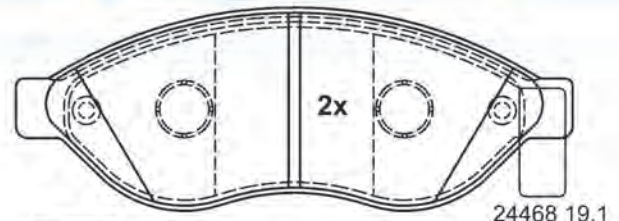

169,3 x 61,5 x 19,1

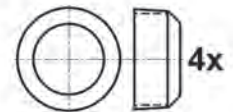
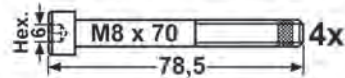
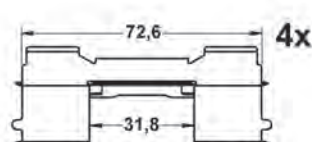

13.0460-4810.2 604810

B.H.P.

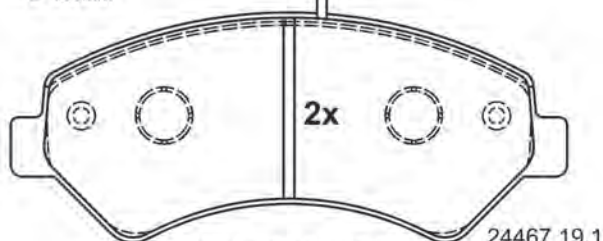
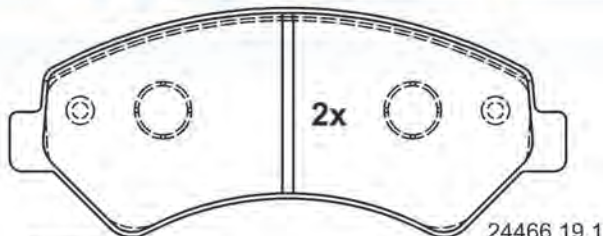

169,3 x 69,1 x 19,1

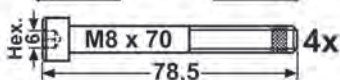
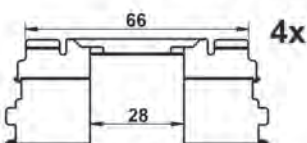

13.0460-4811.2 604811

B.H.P.

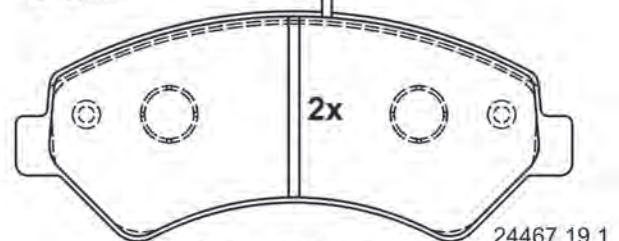
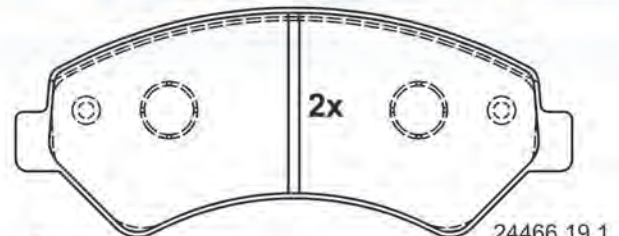

169,3 x 69,1 x 19,1

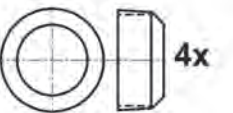
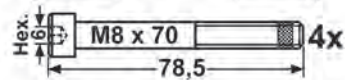
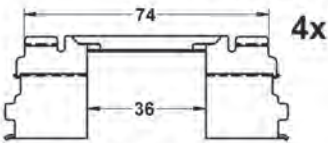

Abbildungen Scheibenbremsbeläge

Illustrations disc brake pads - Ilustraciones de pastillas - Illustrations Plaquettes de frein à disque - Illustrazioni Pastiglie Freno

13.0460-4812.2 604812

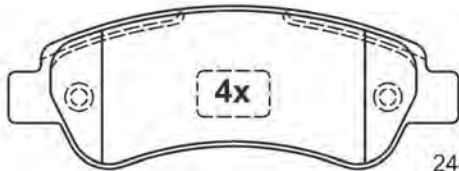

24465 19,2

136,8 x 48,9 x 19,2

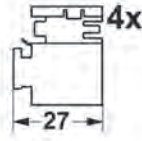
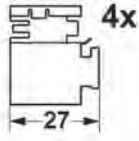

13.0460-4814.2 604814

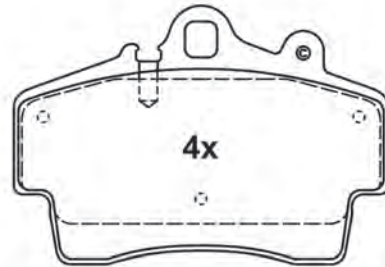

21937 15,5

114,0 x 78,0 x 15,5

13.0460-4815.2 604815



21937 15,5

114,0 x 78,0 x 15,5

13.0460-4816.2 604816

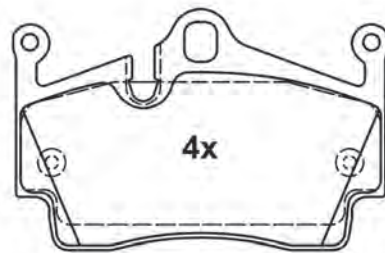

24541 15,5

112,0 x 73,0 x 15,5

Abbildungen Scheibenbremsbeläge

Illustrations disc brake pads - Ilustraciones de pastillas - Illustrations Plaquettes de frein à disque - Illustrazioni Pastiglie Freno

13.0460-4817.2 604817

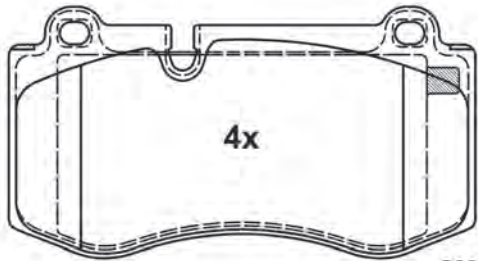

23960 18,3

141,6 x 75,8 x 18,3

13.0460-4818.2 604818

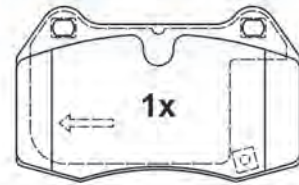

23142 15,1



23142 15,1

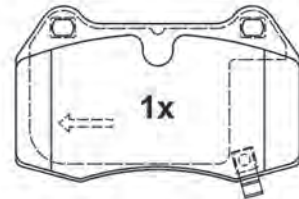

23143 15,1

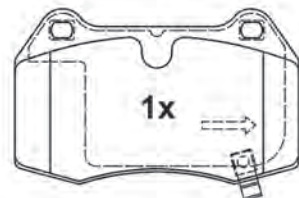

23143 15,1

4x



120,0 x 73,5 x 15,1

13.0460-4819.2 604819

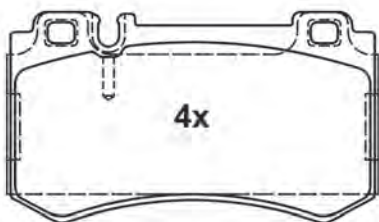

23478 14,6

112,0 x 64,0 x 14,6

13.0460-4823.2 604823

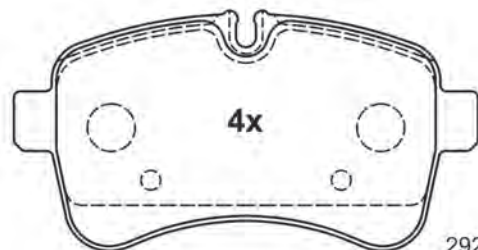

29232 21,0

141,1 x 72,6 x 21,0

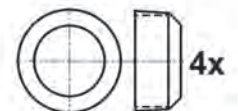
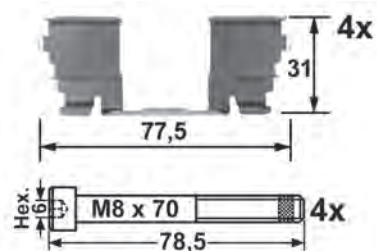

Abbildungen Scheibenbremsbeläge

Illustrations disc brake pads - Ilustraciones de pastillas - Illustrations Plaquettes de frein à disque - Illustrazioni Pastiglie Freno

13.0460-4826.2 604826

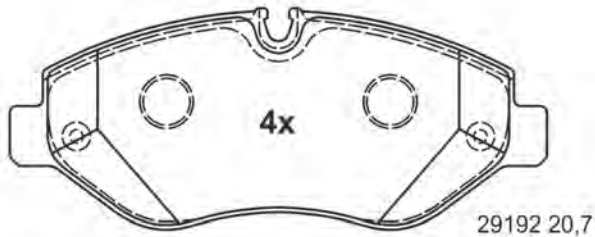

163,1 x 67,1 x 20,7

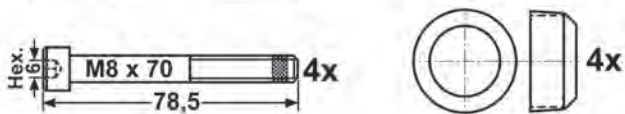
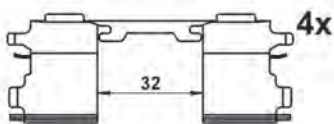

13.0460-4827.2 604827

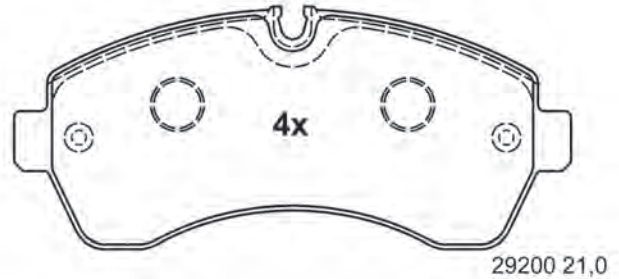

169,1 x 73,4 x 21,0

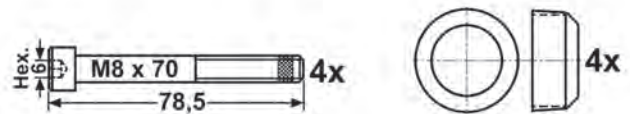

13.0460-4828.2 604828

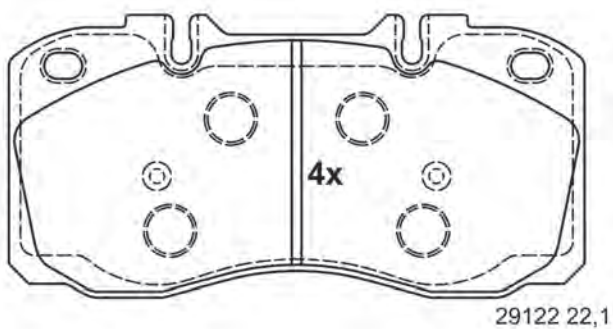

174,7 x 85,5 x 22,1

13.0460-4829.2 604829

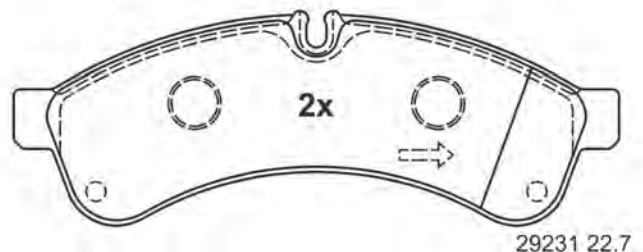
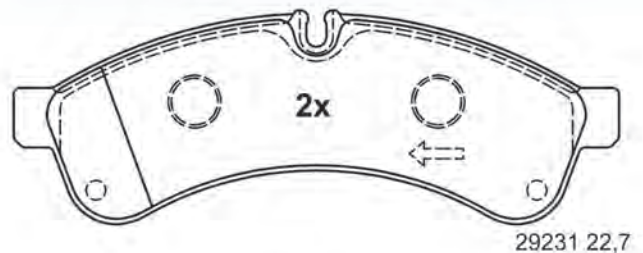

184,2 x 64,7 x 22,7

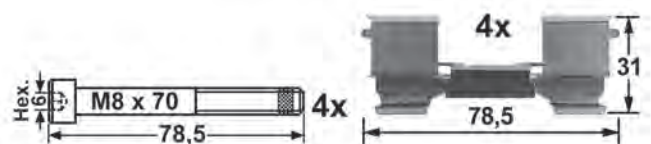

Abbildungen Scheibenbremsbeläge

Illustrations disc brake pads - Ilustraciones de pastillas - Illustrations Plaquettes de frein à disque - Illustrazioni Pastiglie Freno

13.0460-4830.2 604830

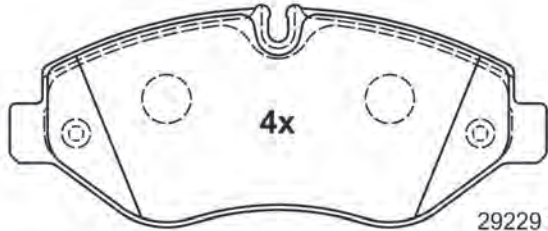

29229 20,7

163,1 x 67,1 x 20,7

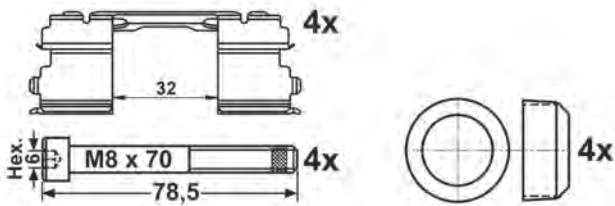

13.0460-4832.2 604832

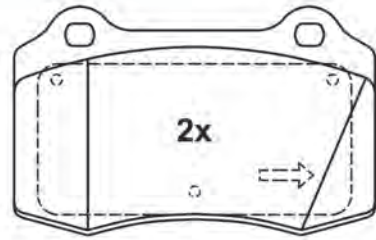

21381 18,0

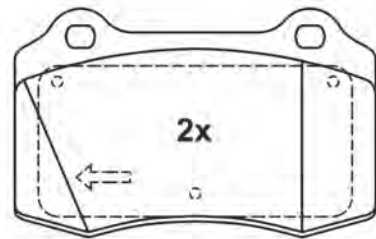

21381 18,0

109,8 x 69,2 x 18,0

13.0460-4833.2 604833

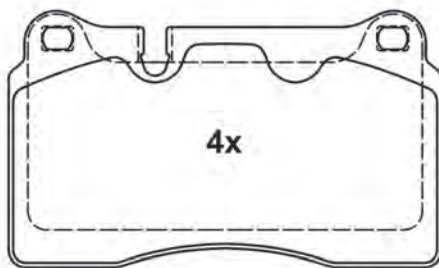

24098 17,1

131,6 x 77,3 x 17,1

13.0460-4834.2 604834

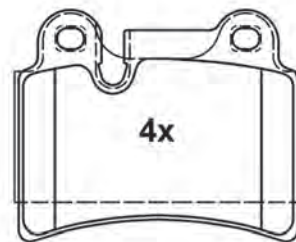

24097 17,1

86,8 x 70,1 x 17,1

Abbildungen Scheibenbremsbeläge

Illustrations disc brake pads - Ilustraciones de pastillas - Illustrations Plaquettes de frein à disque - Illustrazioni Pastiglie Freno

13.0460-4837.2 604837

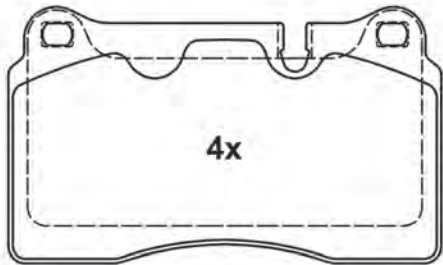

20217 17,1

131,6 x 77,3 x 17,1

13.0460-4839.2 604839

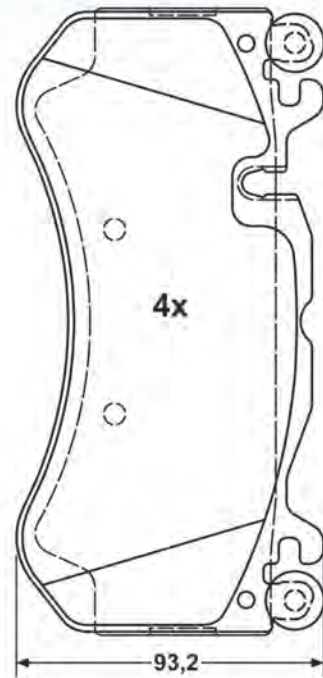

24455 16,8

189,8 x 93,2 x 16,8

13.0460-4840.2 604840

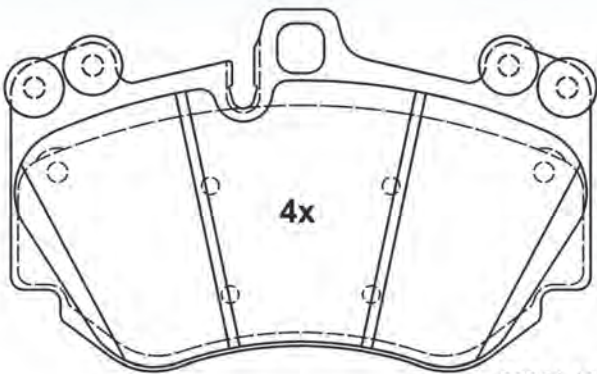

23961 16,8

176,0 x 109,6 x 16,8

13.0460-4841.2 604841



23489 16,3

144,7 x 75,3 x 16,3

Abbildungen Scheibenbremsbeläge

Illustrations disc brake pads - Ilustraciones de pastillas - Illustrations Plaquettes de frein à disque - Illustrazioni Pastiglie Freno

13.0460-4842.2 604842

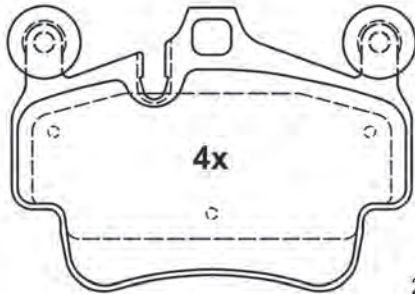

24049 17,0

121,0 x 86,0 x 17,0

13.0460-4843.2 604843

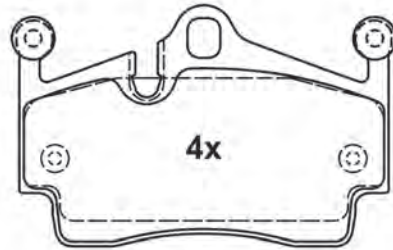

15,5

112,0 x 73,0 x 15,5

13.0460-4847.2 604847

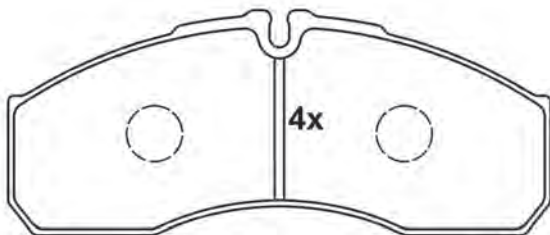

29160 20,3

164,6 x 68,0 x 20,3

13.0460-4848.2 604848

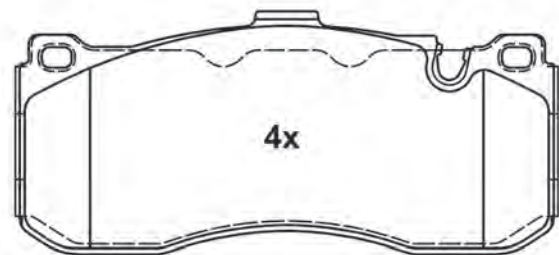

24316 16,9

164,7 x 73,5 x 16,9

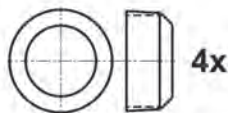
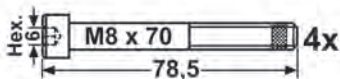

Abbildungen Scheibenbremsbeläge

Illustrations disc brake pads - Ilustraciones de pastillas - Illustrations Plaquettes de frein à disque - Illustrazioni Pastiglie Freno

13.0460-4849.2 604849

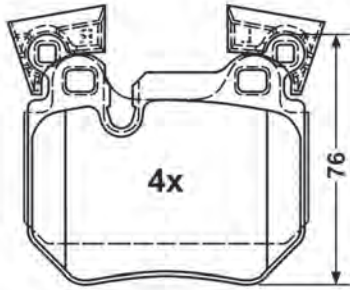

24315 16,2

86,7 x 76,0 x 16,2

13.0460-4850.2 604850

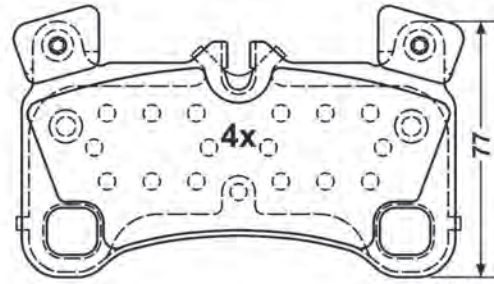

24296 16,3

132,1 x 77,0 x 16,3

13.0460-4851.2 604851

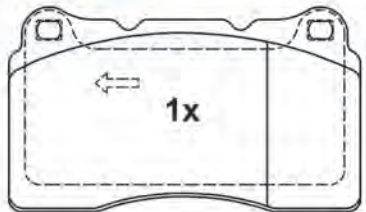

23092 16,0

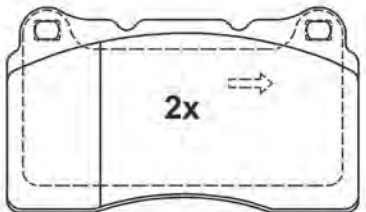

23092 16,0

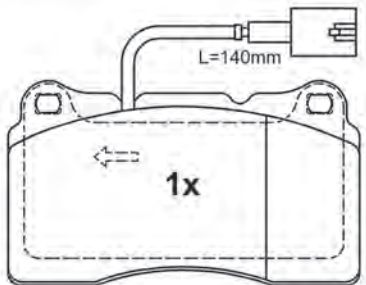

23111 16,0

131,8 x 77,2 x 16,0

13.0460-4852.2 604852

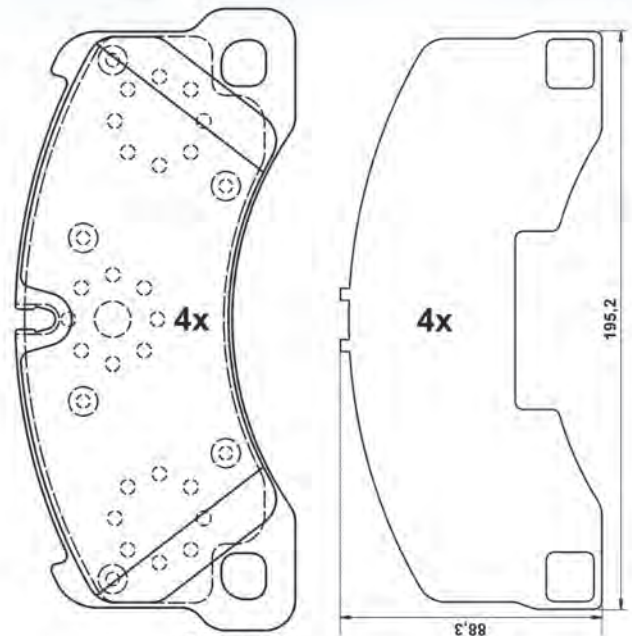

24553 15,8

209,5 x 94,2 x 15,8

Abbildungen Scheibenbremsbeläge

Illustrations disc brake pads - Ilustraciones de pastillas - Illustrations Plaquettes de frein à disque - Illustrazioni Pastiglie Freno

13.0460-4853.2 604853

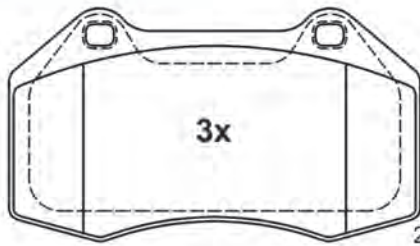

24162 15,2

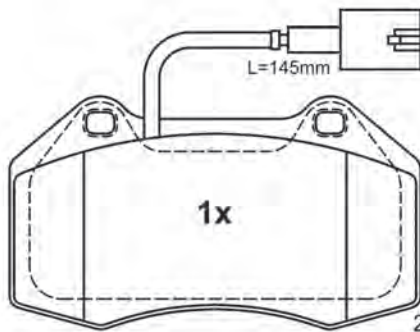

24687 15,2

124,6 x 70,4 x 15,2

13.0460-4854.2 604854 [1]

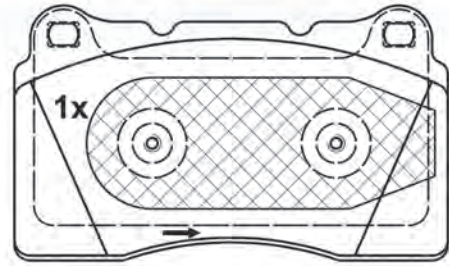

23092 16,3

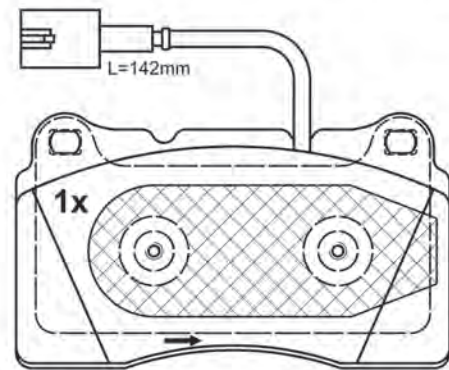

23756 16,3

131,8 x 77,2 x 16,3

13.0460-4854.2 604854 [2]

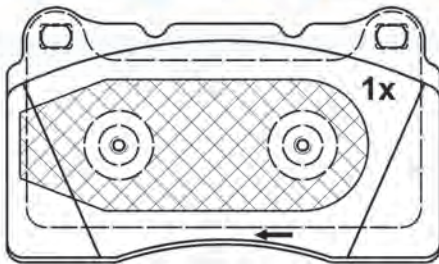

23092 16,3

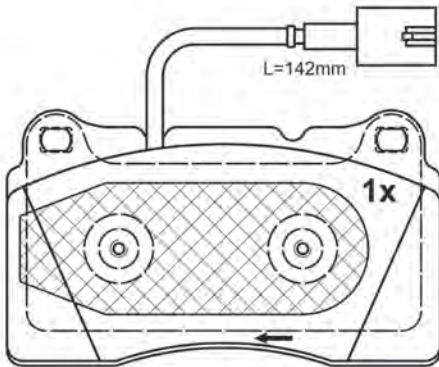

23756 16,3

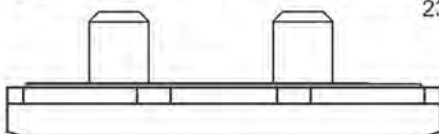

131,8 x 77,2 x 16,3

13.0460-4855.2 604855

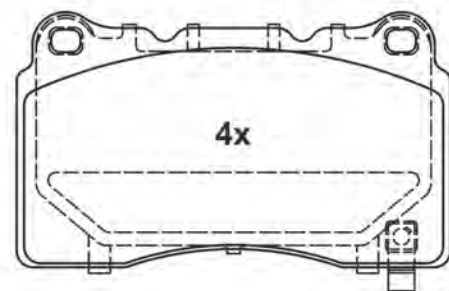

23325 16,4

131,6 x 77,2 x 16,4



Abbildungen Scheibenbremsbeläge

Illustrations disc brake pads - Ilustraciones de pastillas - Illustrations Plaquettes de frein à disque - Illustrazioni Pastiglie Freno

13.0460-4856.2 604856

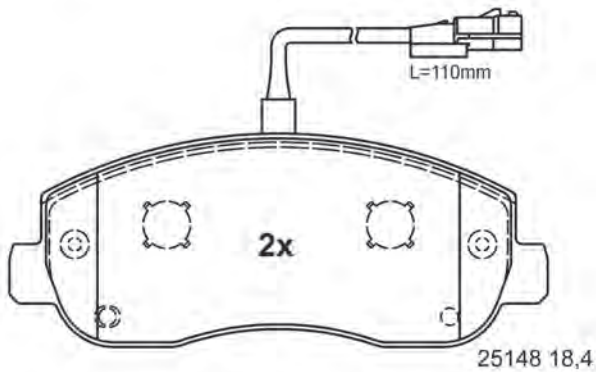
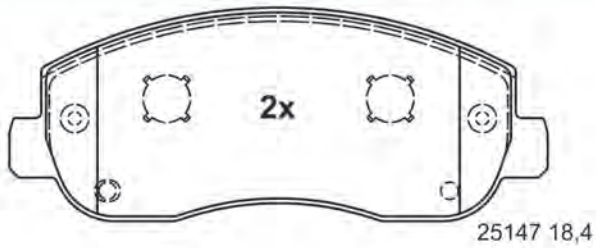

163,5 x 64,6 x 18,4

13.0460-4857.2 604857

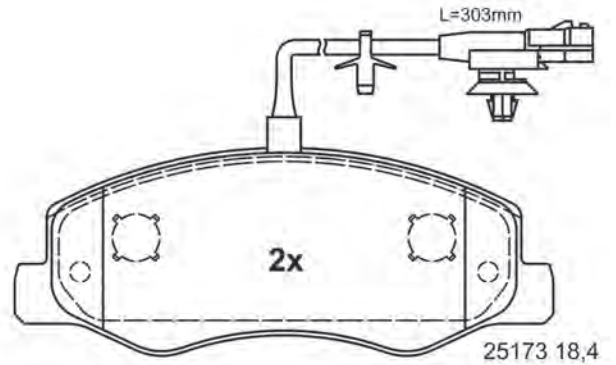
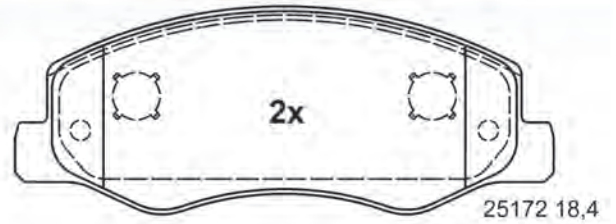

163,5 x 62,9 x 18,4

13.0460-4858.2 604858

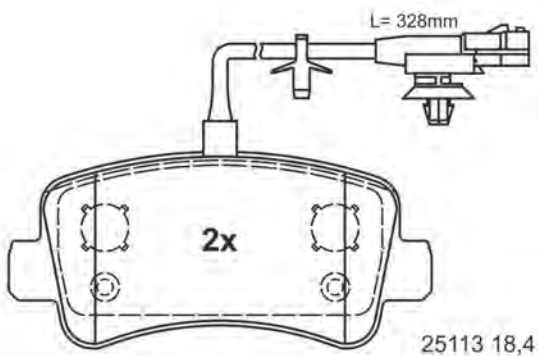
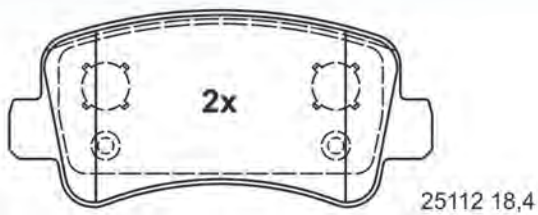

128,5 x 59,5 x 18,4

13.0460-4859.2 604859

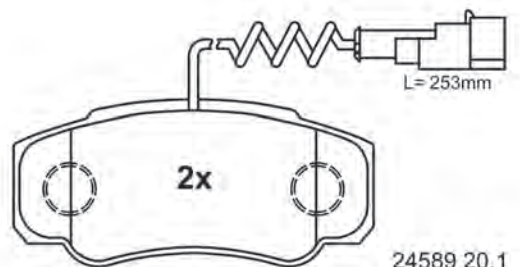
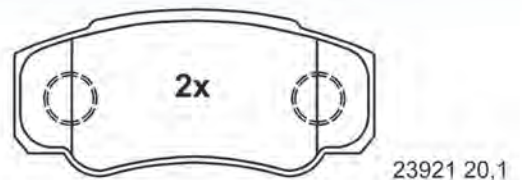

109,6 x 50,0 x 20,1

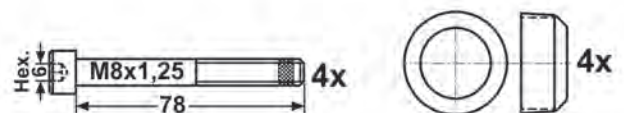

Abbildungen Scheibenbremsbeläge

Illustrations disc brake pads - Ilustraciones de pastillas - Illustrations Plaquettes de frein à disque - Illustrazioni Pastiglie Freno

13.0460-4860.2 604860

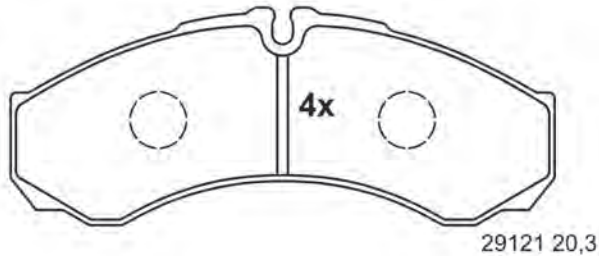

164,6 x 66,5 x 20,3

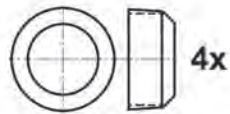
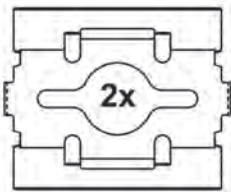

13.0460-4861.2 604861

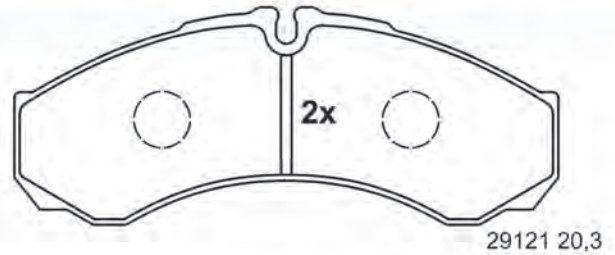

29121 20,3

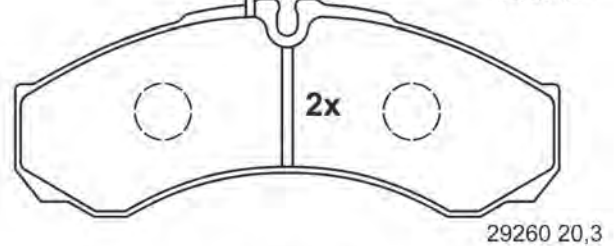

29260 20,3

164,6 x 66,5 x 20,3

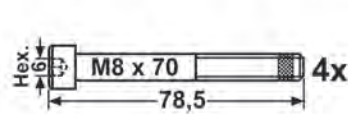

13.0460-4862.2 604862

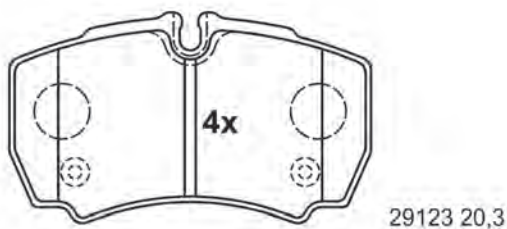

29123 20,3

109,6 x 63,7 x 20,3

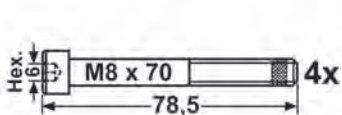
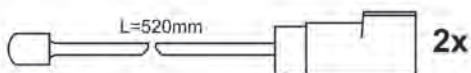

13.0460-4863.2 604863

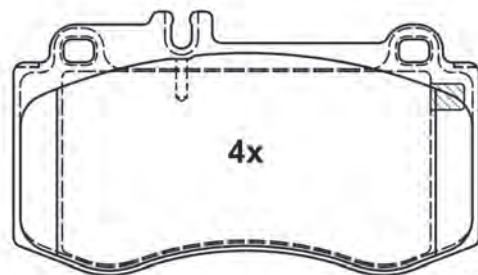

24976 17,5

141,5 x 79,8 x 17,5

Abbildungen Scheibenbremsbeläge

Illustrations disc brake pads - Ilustraciones de pastillas - Illustrations Plaquettes de frein à disque - Illustrazioni Pastiglie Freno

13.0460-4864.2 604864

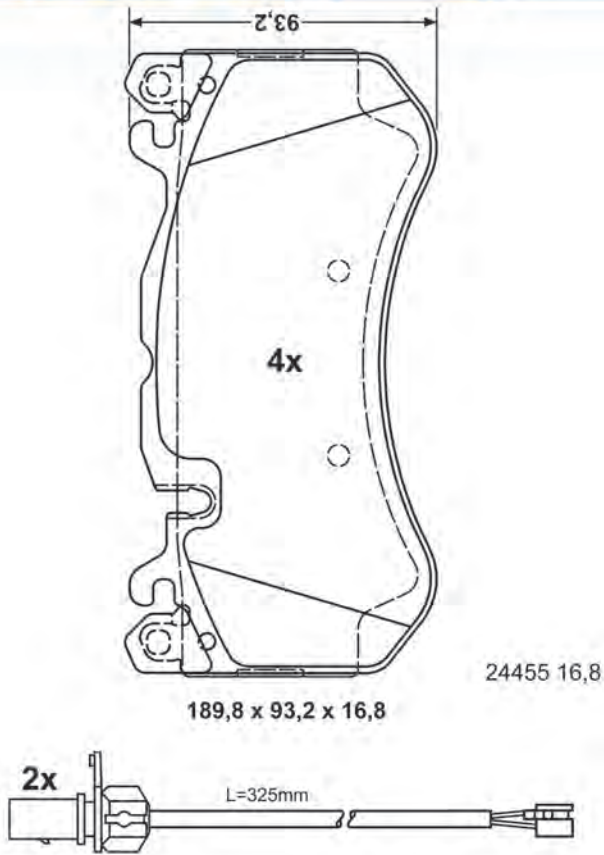

13.0460-4865.2 604865

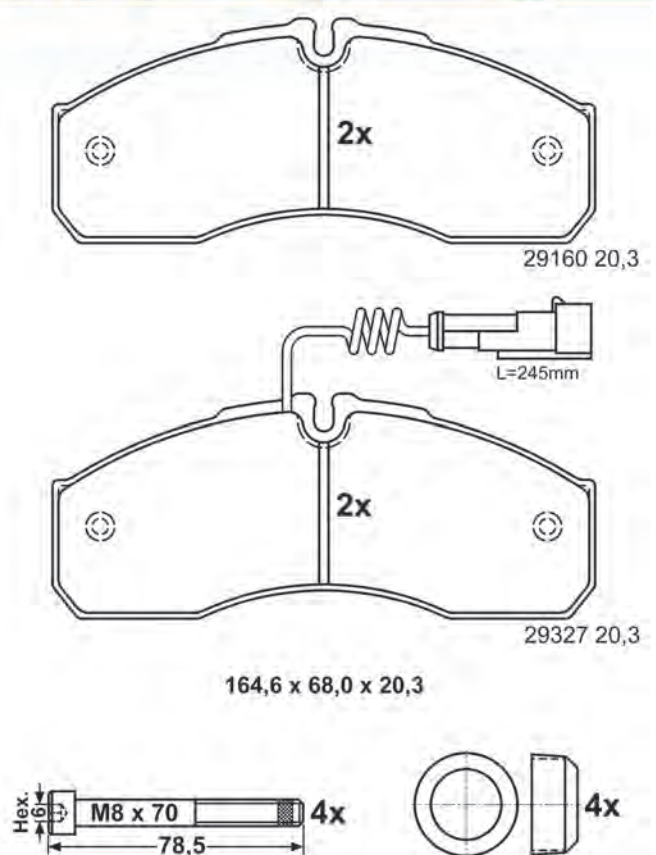

13.0460-4866.2 604866

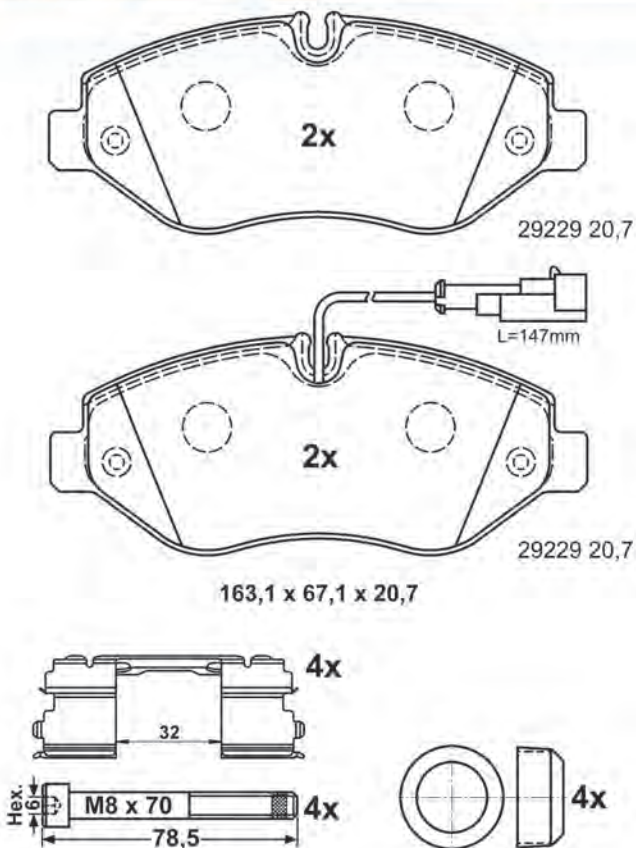

13.0460-4867.2 604867

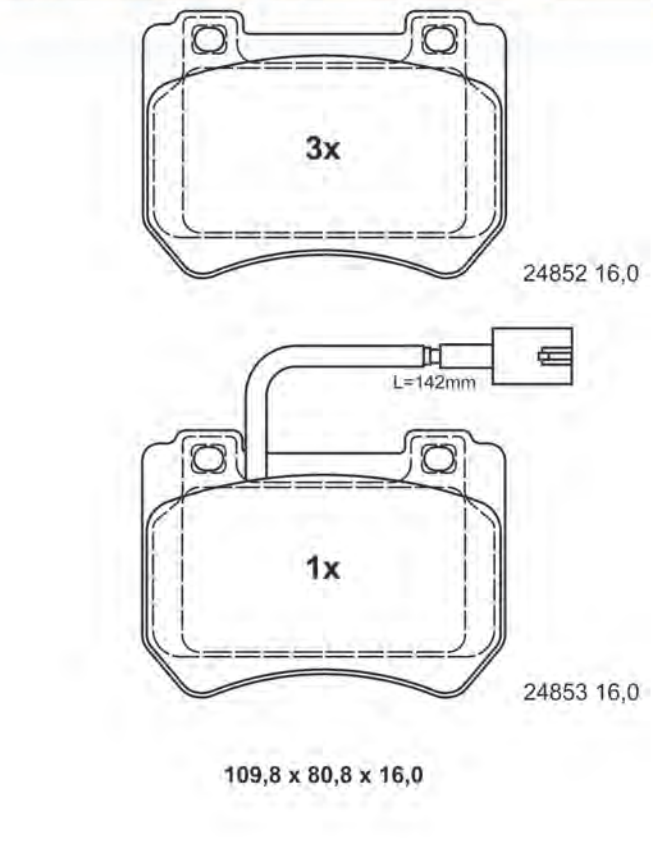

Abbildungen Scheibenbremsbeläge

Illustrations disc brake pads - Ilustraciones de pastillas - Illustrations Plaquettes de frein à disque - Illustrazioni Pastiglie Freno

13.0460-4869.2 604869

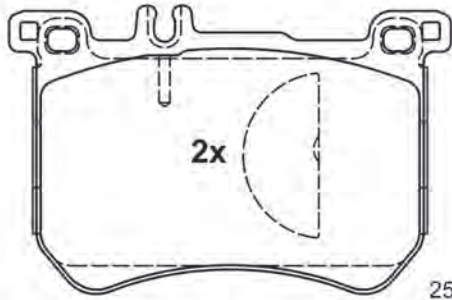

25183 17,9

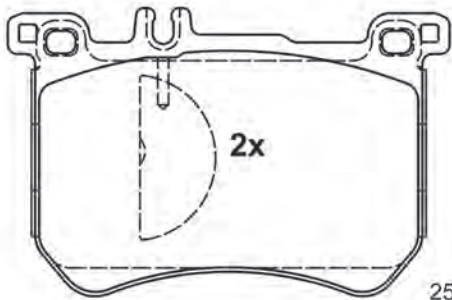

25183 17,9

134,4 x 86,0 x 17,9

13.0460-4870.2 604870

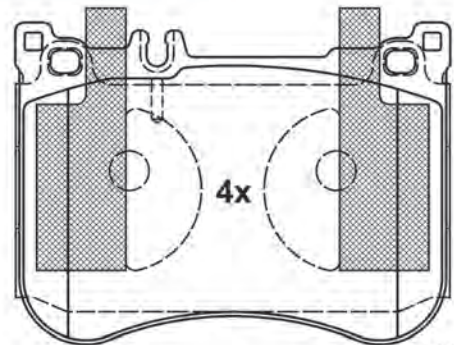

25179 17,8

132,0 x 97,5 x 17,8

13.0460-4872.2 604872

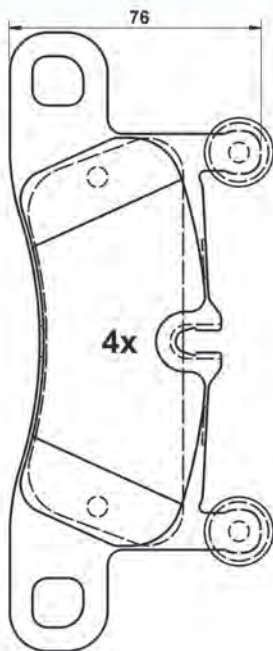

24721 16,9

187,5 x 76,0 x 16,9

13.0460-4873.2 604873

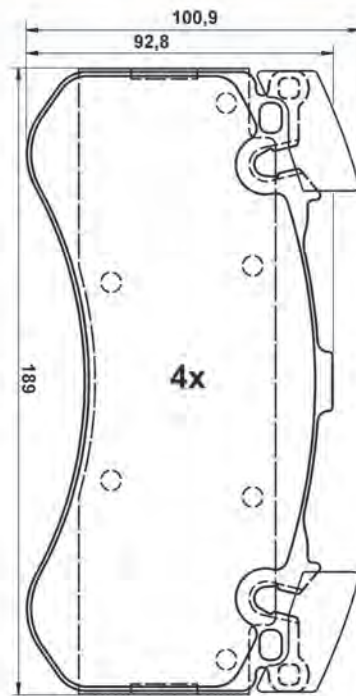

24847 17,0

189,0 x 92,8 x 17,0



Abbildungen Scheibenbremsbeläge

Illustrations disc brake pads - Ilustraciones de pastillas - Illustrations Plaquettes de frein à disque - Illustrazioni Pastiglie Freno

13.0460-4874.2 604874

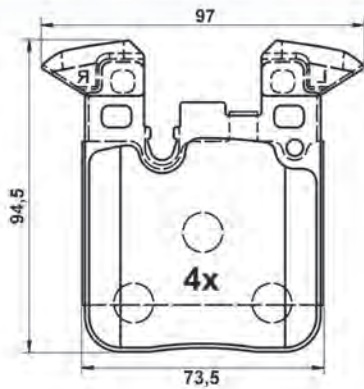

25029 16,7

73,5 x 94,5 x 16,7

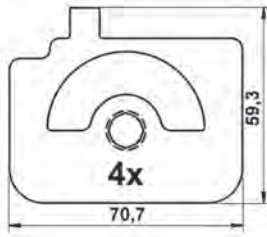

13.0460-4875.2 604875

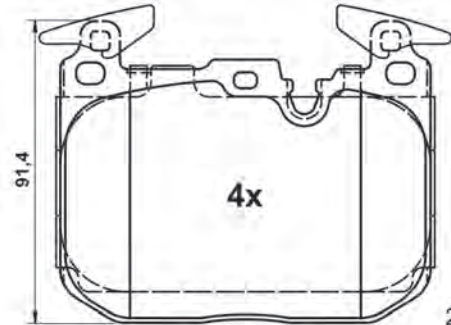

25028 18,0

114,5 x 91,4 x 18,0

13.0460-4877.2 604877

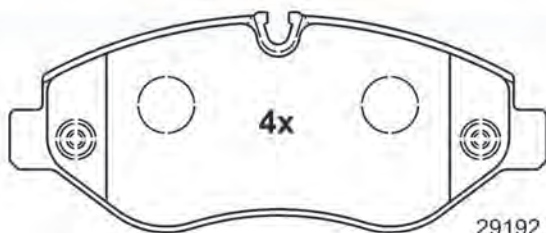

29192 20,3

163,2 x 66,8 x 20,3

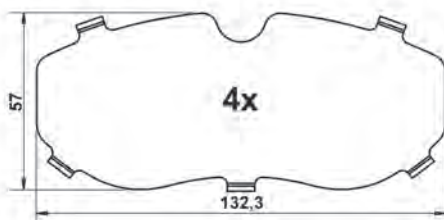

13.0460-4879.2 604879

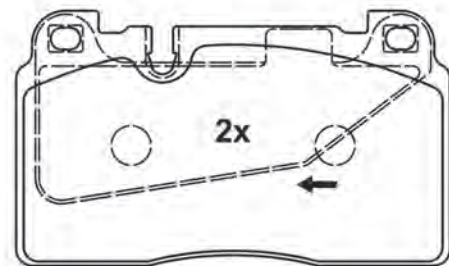

25643 16,8

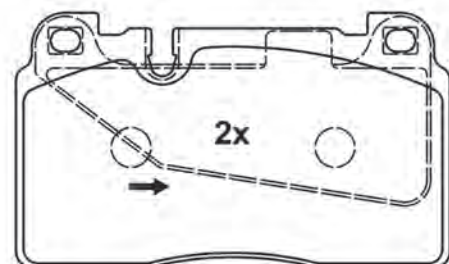

25643 16,8

131,8 x 77,2 x 16,8

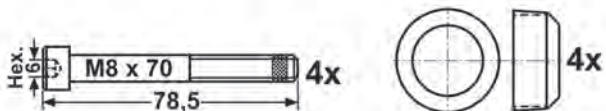

Abbildungen Scheibenbremsbeläge

Illustrations disc brake pads - Ilustraciones de pastillas - Illustrations Plaquettes de frein à disque - Illustrazioni Pastiglie Freno

13.0460-4882.2 604882

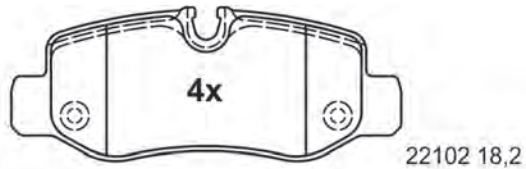

22102 18,2

118,5 x 46,4 x 18,2

13.0460-4884.2 604884

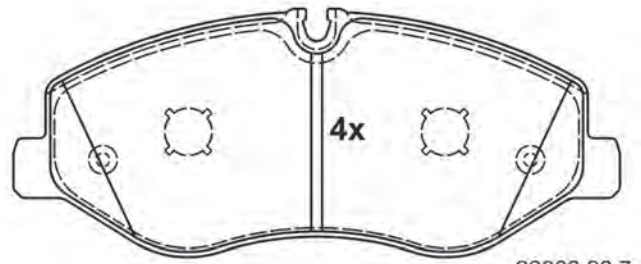

22062 20,7

184,1 x 75,0 x 20,7

13.0460-4911.2 604911

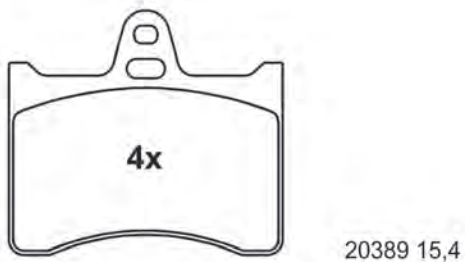

20389 15,4

82,9 x 75,0 x 15,4

13.0460-4918.2 604918

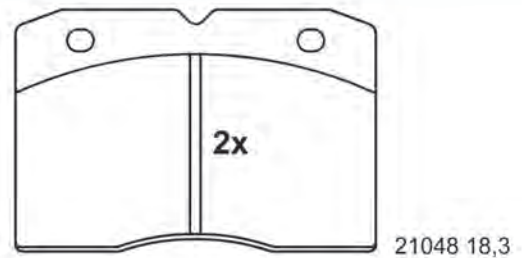

21048 18,3

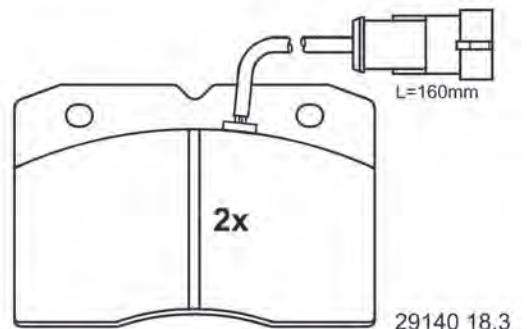

29140 18,3

109,5 x 73,0 x 18,3

Abbildungen Scheibenbremsbeläge

Illustrations disc brake pads - Ilustraciones de pastillas - Illustrations Plaquettes de frein à disque - Illustrazioni Pastiglie Freno

13.0460-4921.2 604921

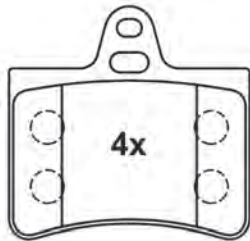

23305 15,2

72,9 x 70,6 x 15,2

13.0460-4955.2 604955

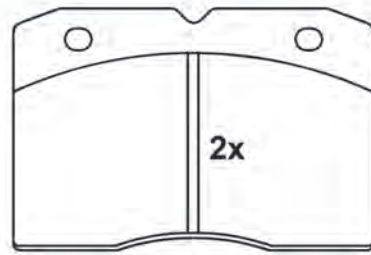

21048 18,3

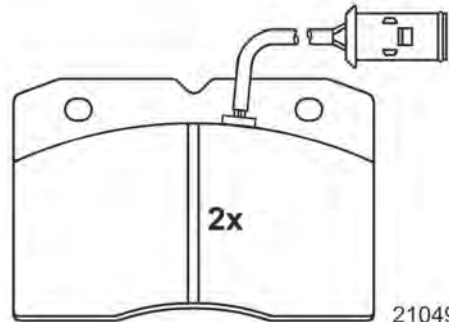

21049 18,3

109,5 x 73,0 x 18,3

13.0460-4956.2 604956



20162 15,4

54,0 x 64,7 x 15,4

13.0460-4957.2 604957

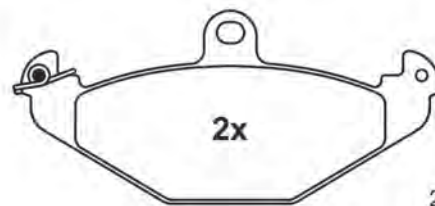

20410 15,0

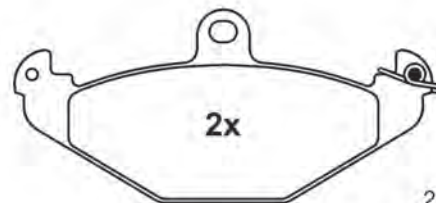

20423 15,0

126,0 x 58,0 x 15,0

Abbildungen Scheibenbremsbeläge

Illustrations disc brake pads - Ilustraciones de pastillas - Illustrations Plaquettes de frein à disque - Illustrazioni Pastiglie Freno

13.0460-4958.2 604958 [1]

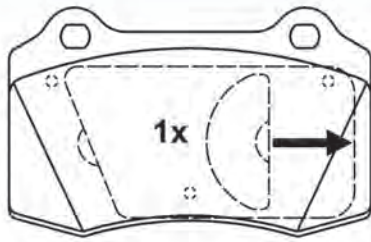

21381 17,3

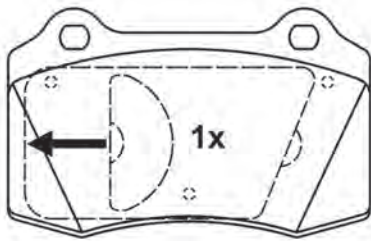

21381 17,3

109,8 x 69,2 x 17,3

13.0460-4958.2 604958 [2]

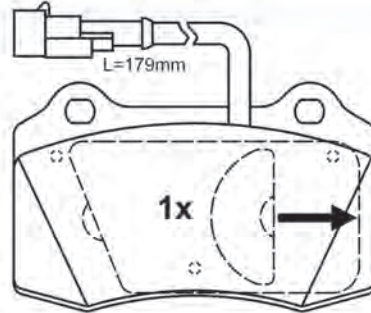

21382 17,3

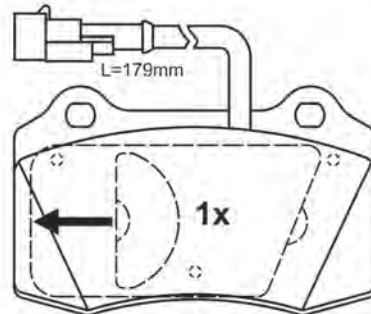

21382 17,3

109,8 x 69,2 x 17,3

13.0460-4964.2 604964

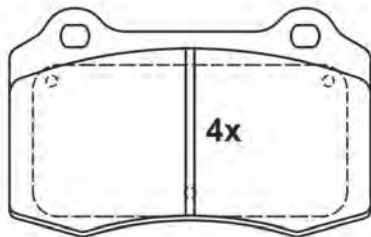

21381 15,0

109,8 x 69,3 x 15,0

13.0460-4965.2 604965

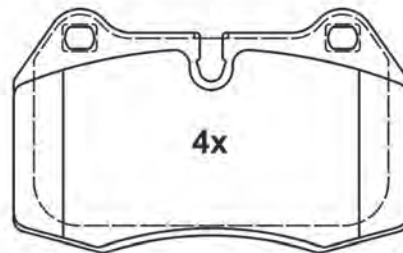

21471 18,0

119,8 x 73,6 x 18,0

Abbildungen Scheibenbremsbeläge

Illustrations disc brake pads - Ilustraciones de pastillas - Illustrations Plaquettes de frein à disque - Illustrazioni Pastiglie Freno

13.0460-4966.2 604966

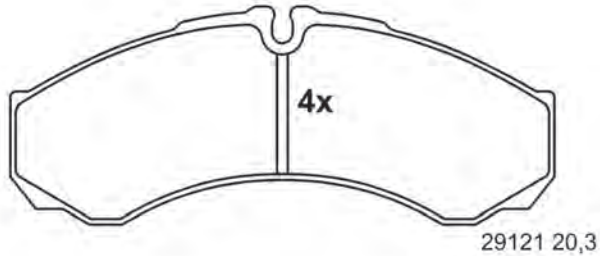

29121 20,3

164,6 x 66,5 x 20,3

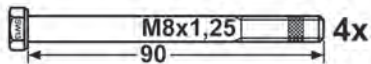

13.0460-4968.2 604968

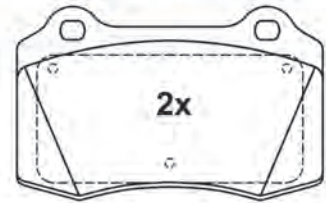

21381 18,0

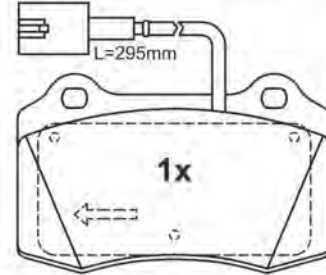

23206 18,0

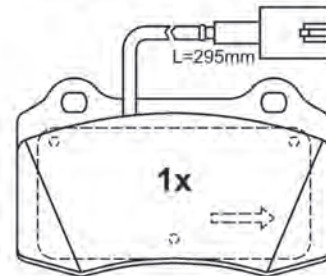

23207 18,0

109,8 x 69,2 x 18,0

13.0460-4969.2 604969

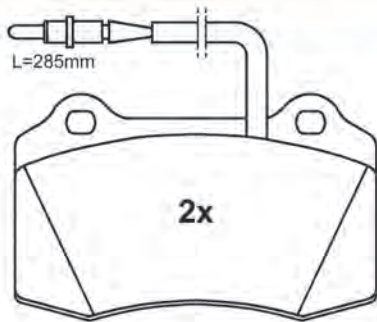

23754 18,0

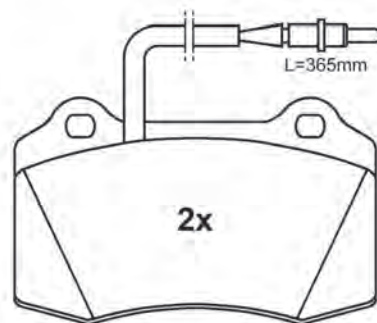

23753 18,0

109,8 x 69,2 x 18,0

13.0460-4971.2 604971 [1]

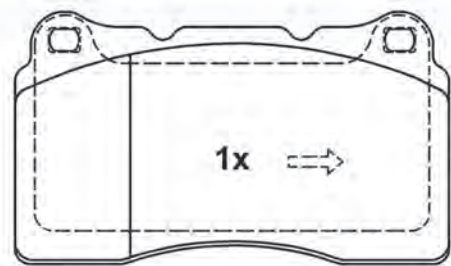

23092 16,0

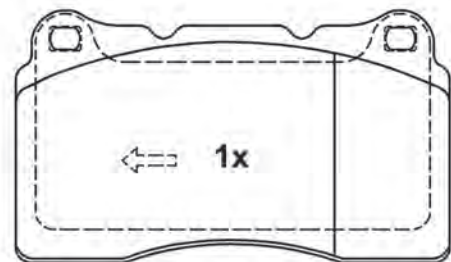

23092 16,0

131,8 x 77,2 x 16,0

Abbildungen Scheibenbremsbeläge

Illustrations disc brake pads - Ilustraciones de pastillas - Illustrations Plaquettes de frein à disque - Illustrazioni Pastiglie Freno

13.0460-4971.2 604971 [2]

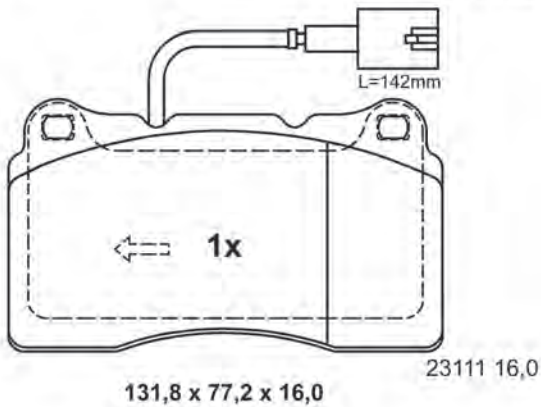
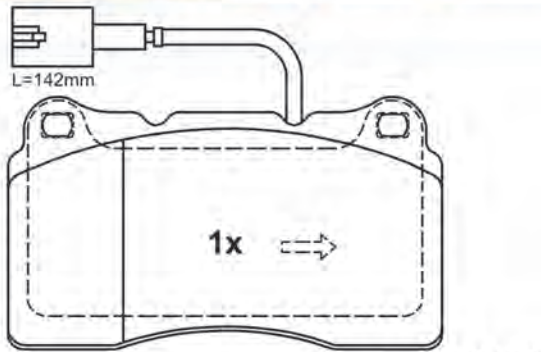

13.0460-4972.2 604972

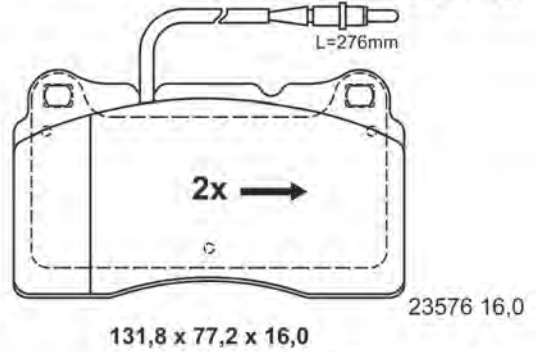
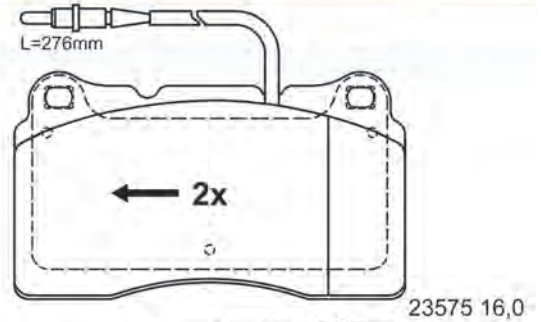

91,7 4x

(UK) Brake pad paste	1x
To avoid disk brake squeaking	
(D) Bremsklotzpaste	
Gegen Quietschen von Scheibenbremsen	
(I) Grasso per freni	
Contro il fischio in frenatura	
(F) Pâte pour plaquette de freins	
Contre le grincement de freins	

13.0460-4973.2 604973 [1]

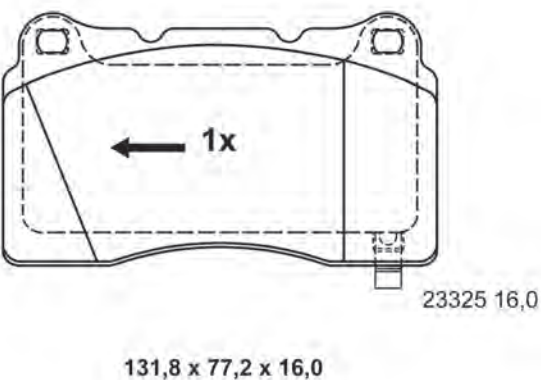
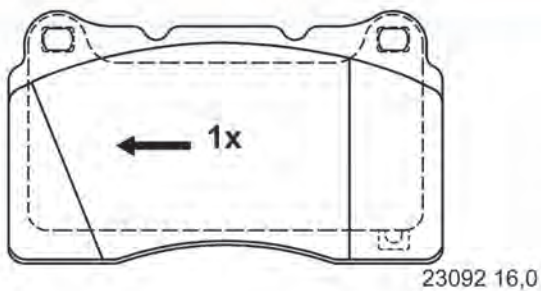

13.0460-4973.2 604973 [2]

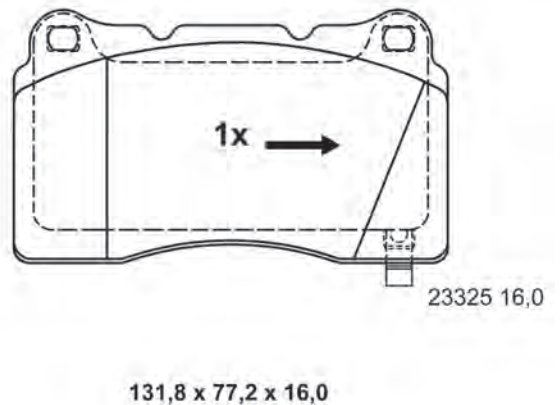
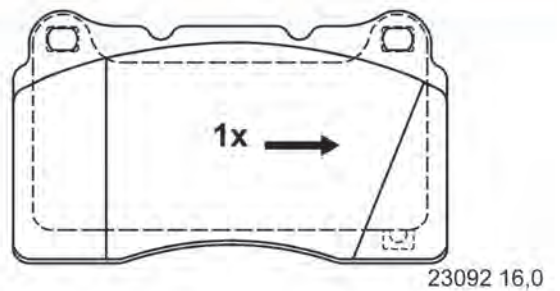

Abbildungen Scheibenbremsbeläge

Illustrations disc brake pads - Ilustraciones de pastillas - Illustrations Plaquettes de frein à disque - Illustrazioni Pastiglie Freno

13.0460-4974.2 604974

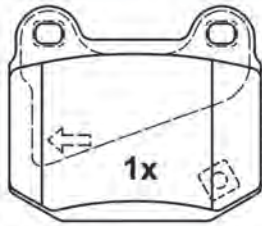

21580 14,6

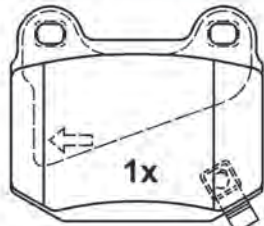

23323 14,6

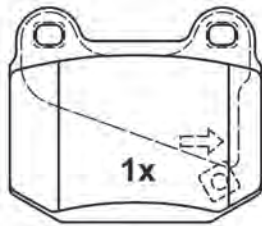

21580 14,6

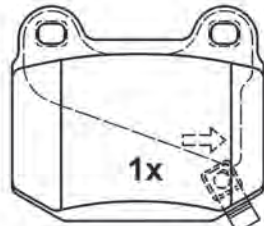

23323 14,6

76,9 x 65,5 x 14,6

13.0460-4975.2 604975

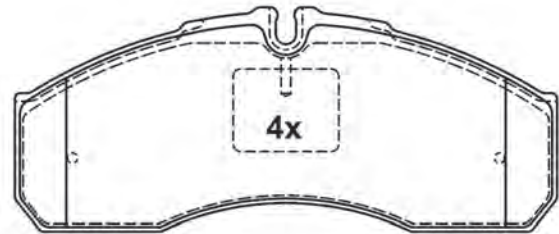

29160 20,8

164,8 x 68,0 x 20,8

13.0460-4976.2 604976

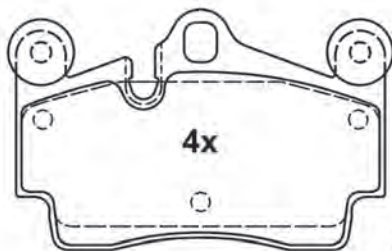

23694 16,7

112,0 x 73,0 x 16,7

13.0460-4977.2 604977

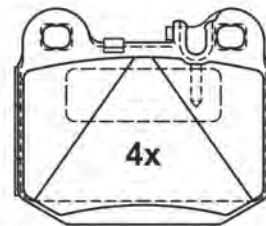

23157 15,8

76,5 x 65,5 x 15,8

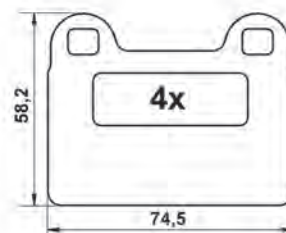

Abbildungen Scheibenbremsbeläge

Illustrations disc brake pads - Ilustraciones de pastillas - Illustrations Plaquettes de frein à disque - Illustrazioni Pastiglie Freno

13.0460-4978.2 604978

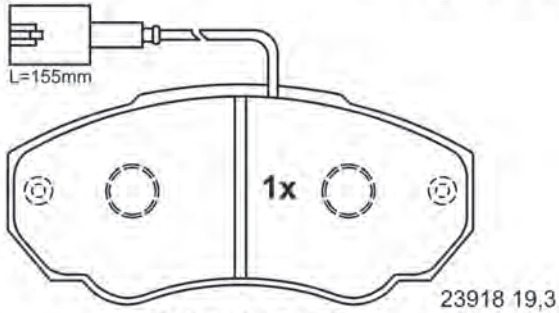
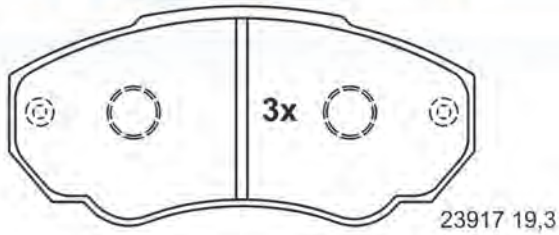

140,6 x 66,0 x 19,3

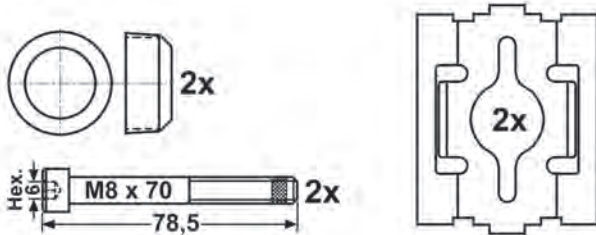

13.0460-4979.2 604979

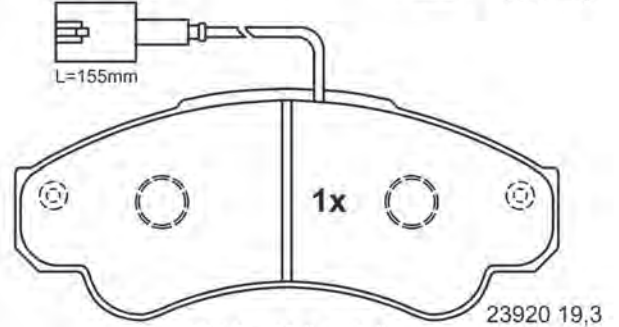
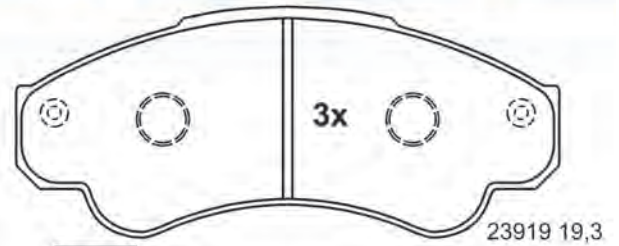

164,6 x 69,3 x 19,3

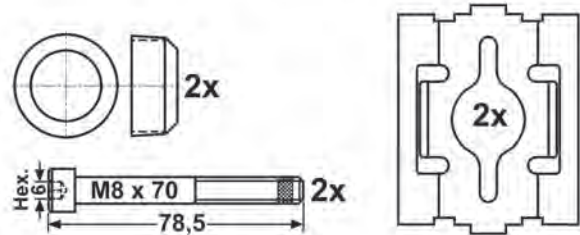

13.0460-4980.2 604980

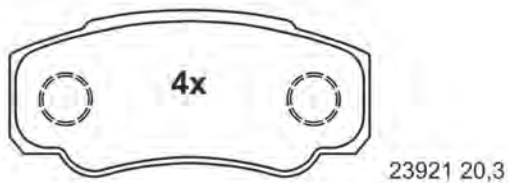

109,6 x 50,0 x 20,3

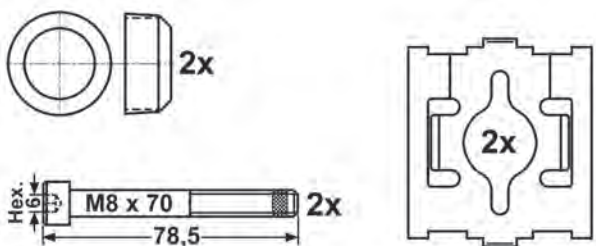

13.0460-4984.2 604984

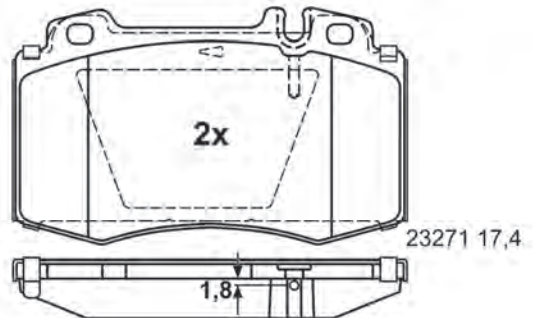
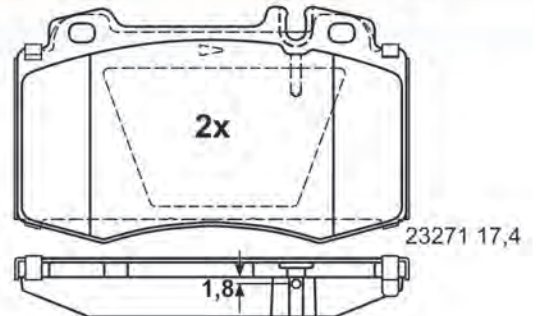

119,5 x 71,7 x 17,4



Abbildungen Scheibenbremsbeläge

Illustrations disc brake pads - Ilustraciones de pastillas - Illustrations Plaquettes de frein à disque - Illustrazioni Pastiglie Freno

13.0460-4985.2 604985 [1]

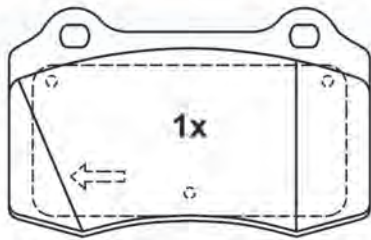

21381 18,0

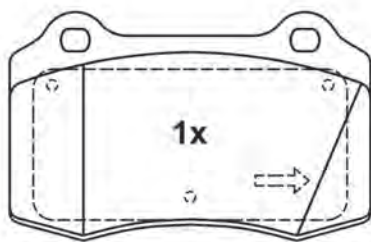

21381 18,0

109,8 x 69,2 x 18,0

13.0460-4985.2 604985 [2]

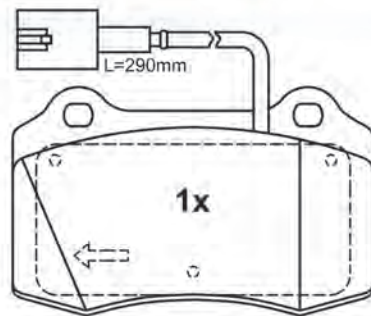

23207 18,0

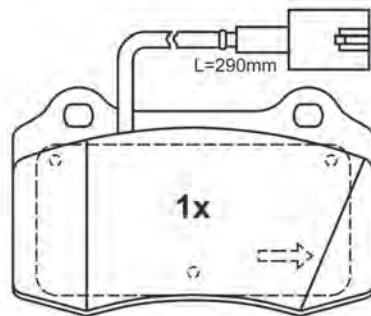

23206 18,0

109,8 x 69,2 x 18,0

13.0460-4986.2 604986

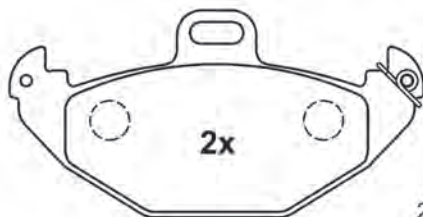

21965 15,0



21966 15,0

126,1 x 63,0 x 15,0

13.0460-4987.2 604987

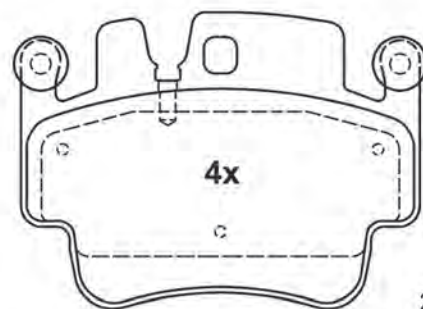

23329 17,0

121,3 x 90,3 x 17,0

Abbildungen Scheibenbremsbeläge

Illustrations disc brake pads - Ilustraciones de pastillas - Illustrations Plaquettes de frein à disque - Illustrazioni Pastiglie Freno

13.0460-4988.2 604988

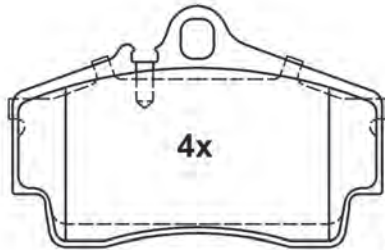

21792 15,2

112,2 x 73,0 x 15,2

13.0460-4989.2 604989

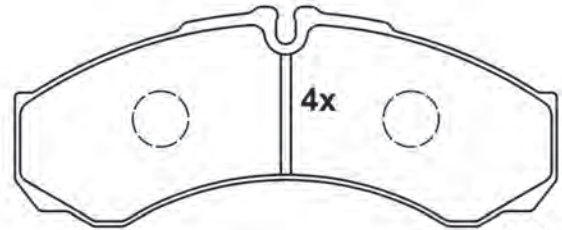

29212 17,3

164,8 x 66,5 x 17,3

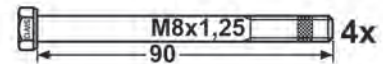

13.0460-4990.2 604990 [1]

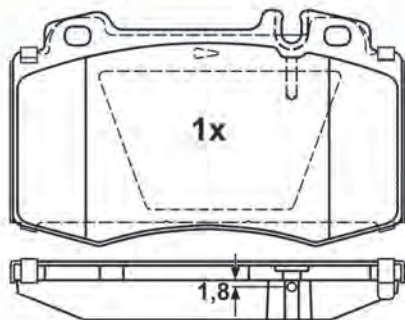

23271 17,4

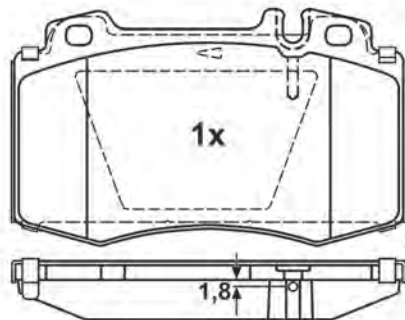

23271 17,4

119,5 x 71,7 x 17,4

13.0460-4990.2 604990 [2]

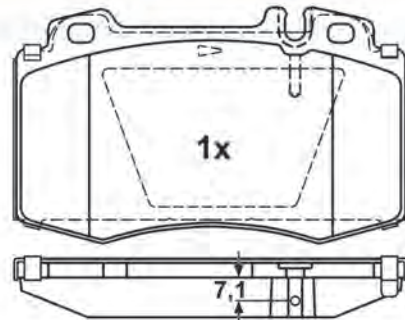

23745 17,4

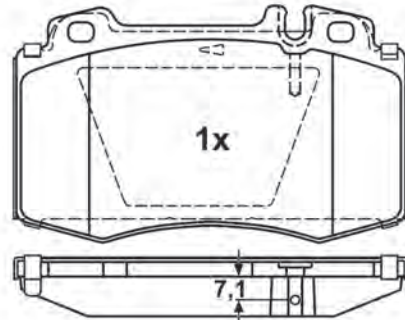

23745 17,4

119,5 x 71,7 x 17,4

Abbildungen Scheibenbremsbeläge

Illustrations disc brake pads - Ilustraciones de pastillas - Illustrations Plaquettes de frein à disque - Illustrazioni Pastiglie Freno

13.0460-4991.2 604991 [1]

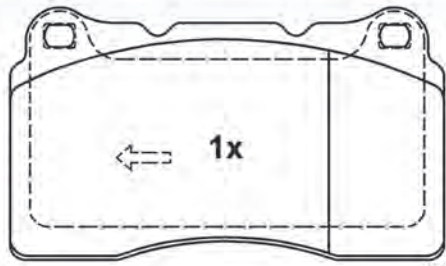

23092 16,0

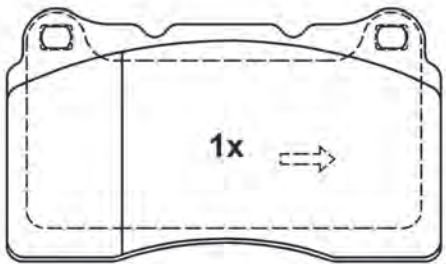

23092 16,0

131,8 x 77,2 x 16,0

13.0460-4991.2 604991 [2]

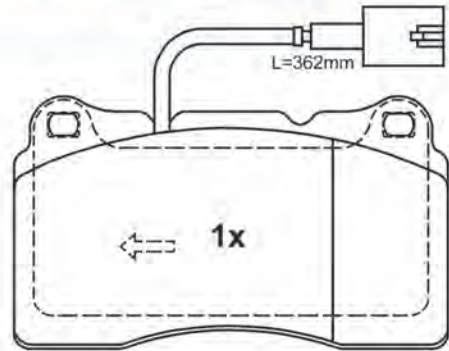

24273 16,0

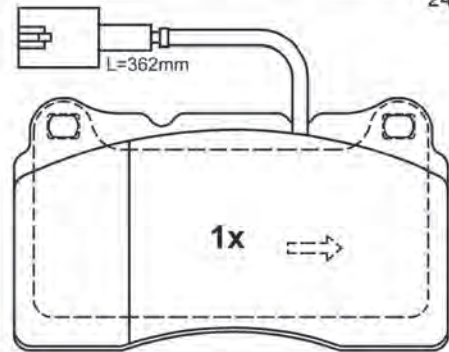

24274 16,0

131,8 x 77,2 x 16,0

13.0460-4992.2 604992

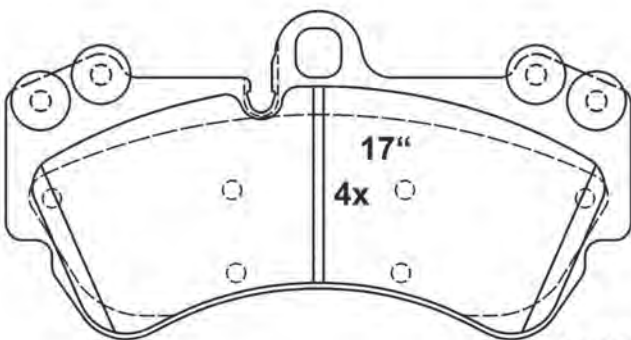

23692 16,6

190 x 99,4 x 16,6

13.0460-4993.2 604993

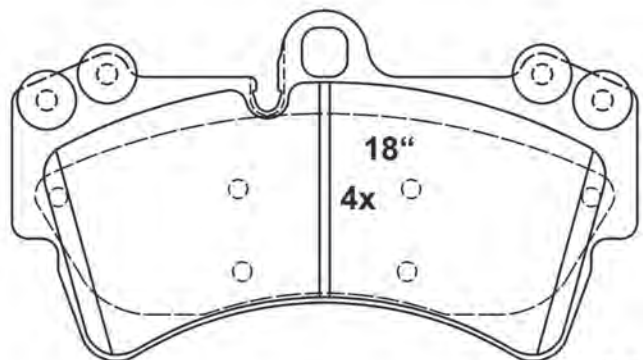

23693 16,6

190,0 x 106,4 x 16,6

Abbildungen Scheibenbremsbeläge

Illustrations disc brake pads - Ilustraciones de pastillas - Illustrations Plaquettes de frein à disque - Illustrazioni Pastiglie Freno

13.0460-4994.2 604994

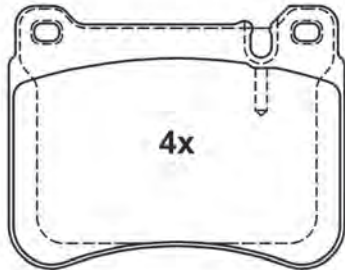

23945 16,5

101,7 x 79,3 x 16,5

13.0460-4995.2 604995 [1]

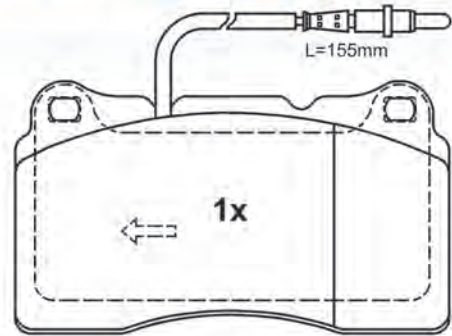

23576 15,6

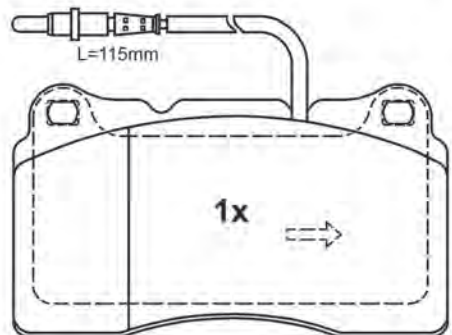

23575 15,6

131,8 x 77,2 x 15,6

13.0460-4995.2 604995 [2]

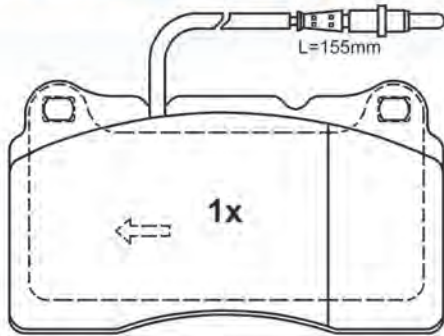

23576 15,6

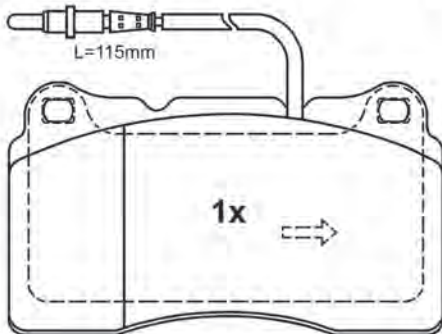

23575 15,6

131,8 x 77,2 x 15,6

13.0460-4996.2 604996

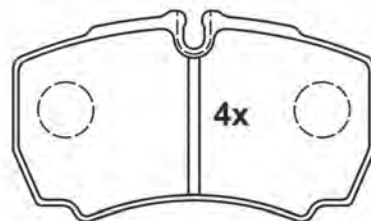

29123 20,3

109,8 x 63,8 x 20,3

Abbildungen Scheibenbremsbeläge

Illustrations disc brake pads - Ilustraciones de pastillas - Illustrations Plaquettes de frein à disque - Illustrazioni Pastiglie Freno

13.0460-4997.2 604997

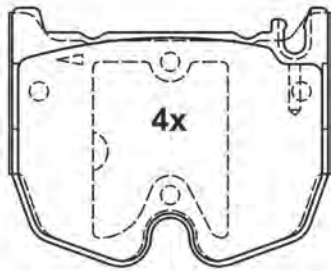

23944 17,5
(23943)

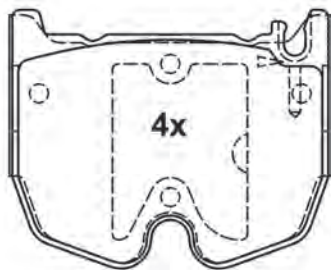

23944 17,5
(23943)

97,8 x 78,5 x 17,5

13.0460-4998.2 604998

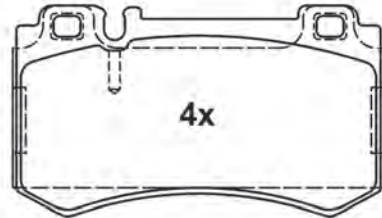

23478 16,5

112,0 x 63,8 x 16,5

13.0460-4999.2 604999

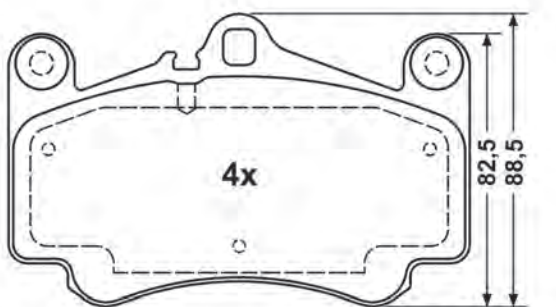

23330 17,0

140,0 x 88,5 x 17,0

13.0460-5405.2 605405

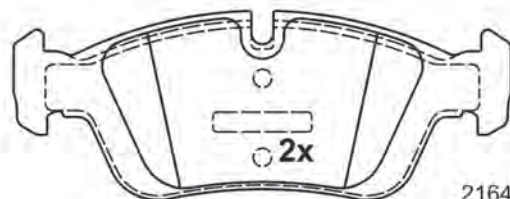

21643 17,8

151,3 x 57,3 x 17,8

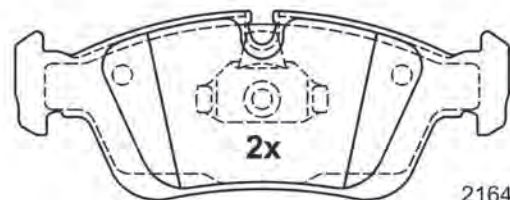

21644 17,8

150,1 x 57,3 x 17,8

Abbildungen Scheibenbremsbeläge

Illustrations disc brake pads - Ilustraciones de pastillas - Illustrations Plaquettes de frein à disque - Illustrazioni Pastiglie Freno

13.0460-5409.2 605409

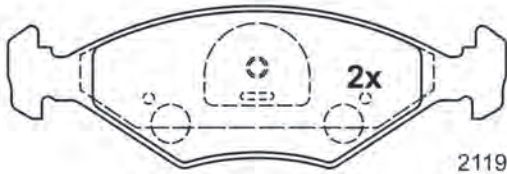

21193 18,0

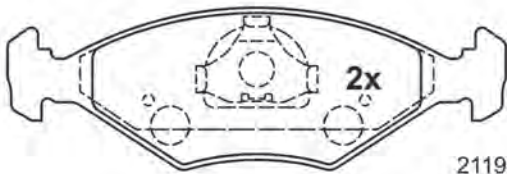

21194 18,0

151,3 x 49,2 x 18,0

13.0460-5410.2 605410

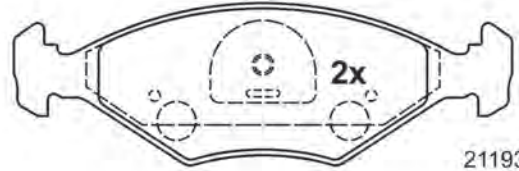

21193 18,0

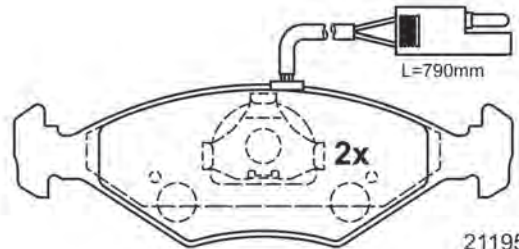

21195 18,0

151,3 x 49,2 x 18,0

13.0460-5600.2 605600

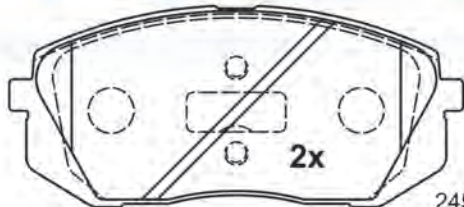

24501 16,7

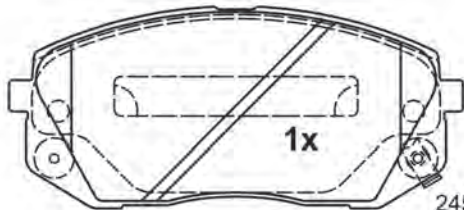

24502 16,7

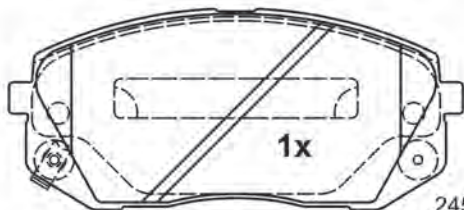

24503 16,7

137,8 x 60,9 x 16,7

13.0460-5601.2 605601

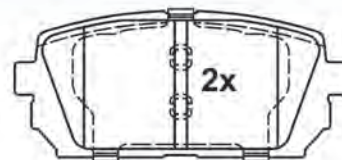

24491 16,0

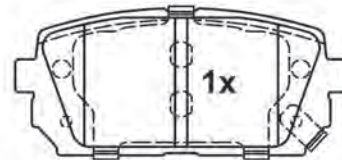

24492 16,0

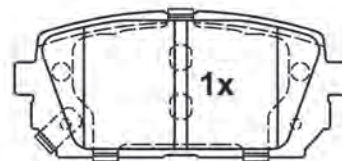

24493 16,0

100,7 x 44,0 x 16,0



Abbildungen Scheibenbremsbeläge

Illustrations disc brake pads - Ilustraciones de pastillas - Illustrations Plaquettes de frein à disque - Illustrazioni Pastiglie Freno

13.0460-5602.2 605602

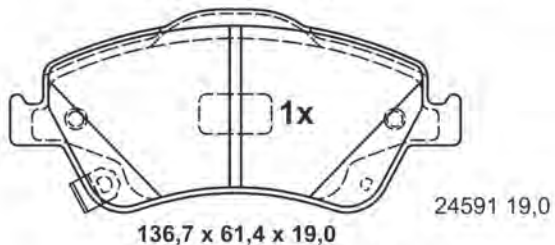
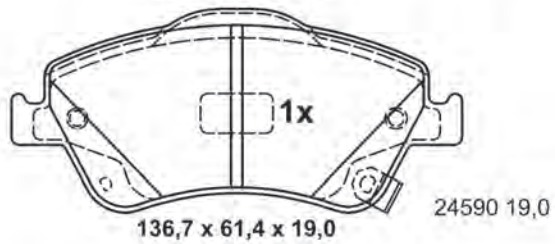
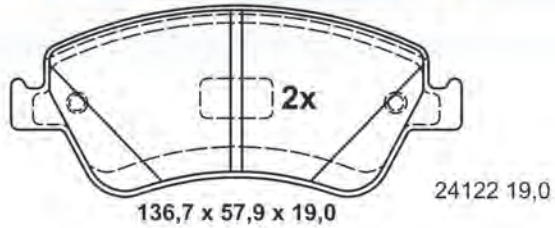

13.0460-5603.2 605603

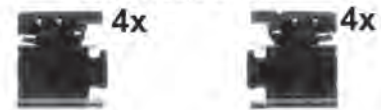
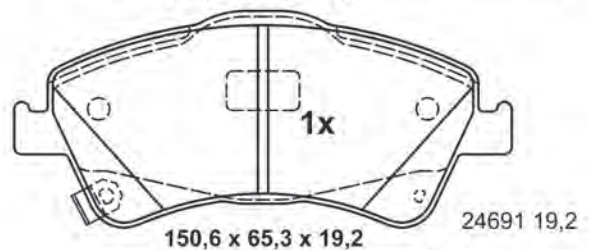
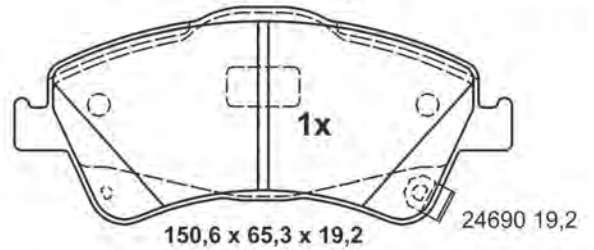
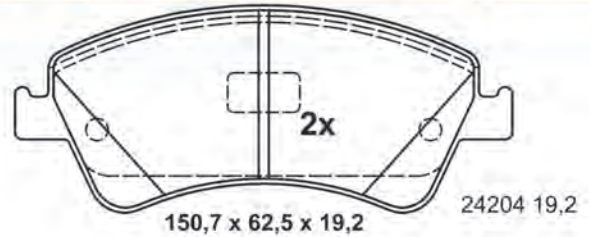

13.0460-5604.2 605604

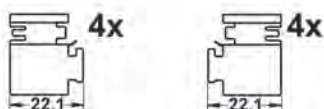
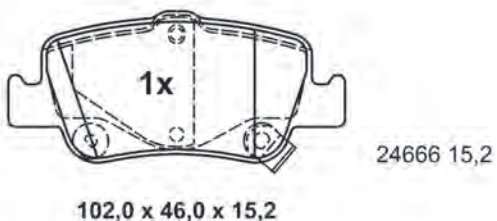
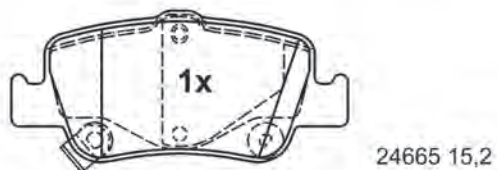
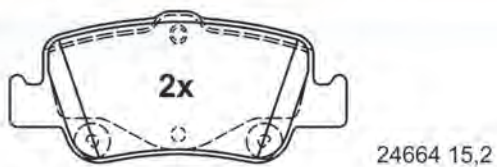

13.0460-5605.2 605605

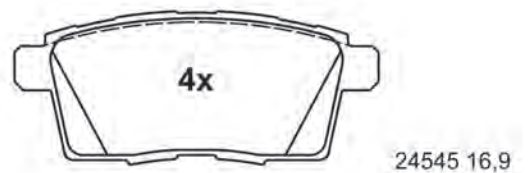

110,6 x 47,1 x 16,9

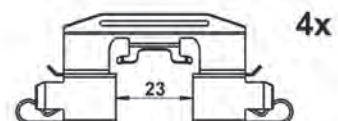
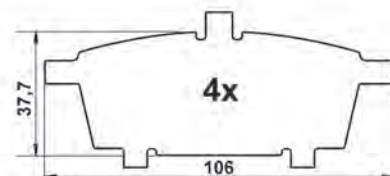

Abbildungen Scheibenbremsbeläge

Illustrations disc brake pads - Ilustraciones de pastillas - Illustrations Plaquettes de frein à disque - Illustrazioni Pastiglie Freno

13.0460-5606.2 605606

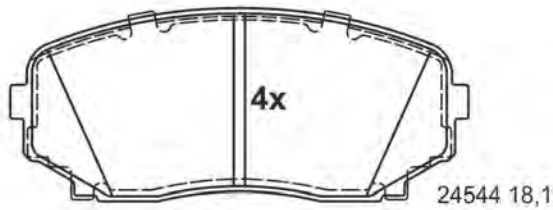

138,9 x 58,0 x 18,1

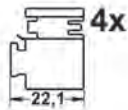
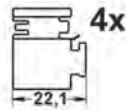

13.0460-5607.2 605607

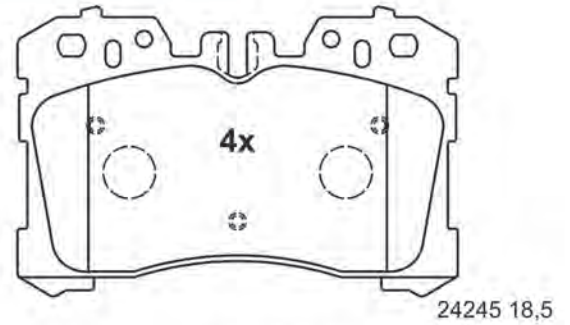

133,7 x 87,9 x 18,5

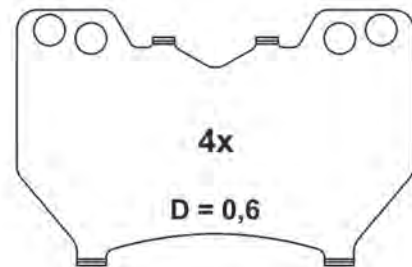

13.0460-5608.2 605608

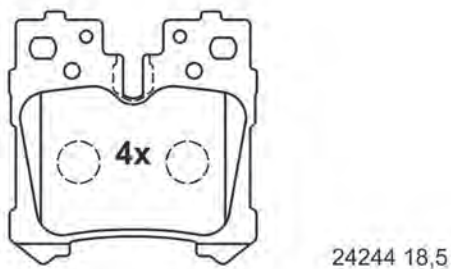

75,0 x 76,7 x 18,5

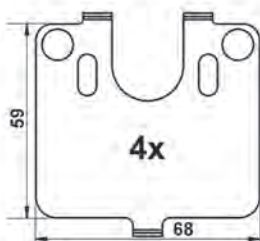

13.0460-5609.2 605609

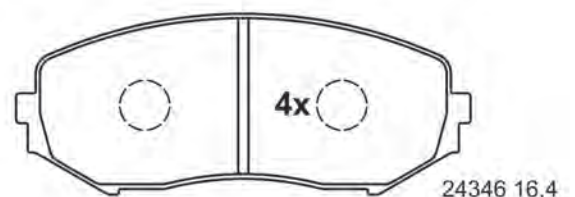

138,0 x 54,7 x 16,4

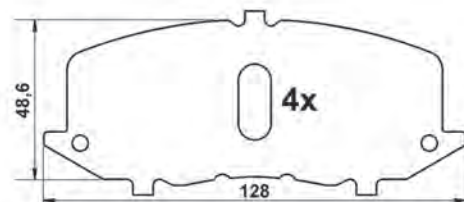

Abbildungen Scheibenbremsbeläge

Illustrations disc brake pads - Ilustraciones de pastillas - Illustrations Plaquettes de frein à disque - Illustrazioni Pastiglie Freno

13.0460-5610.2 605610

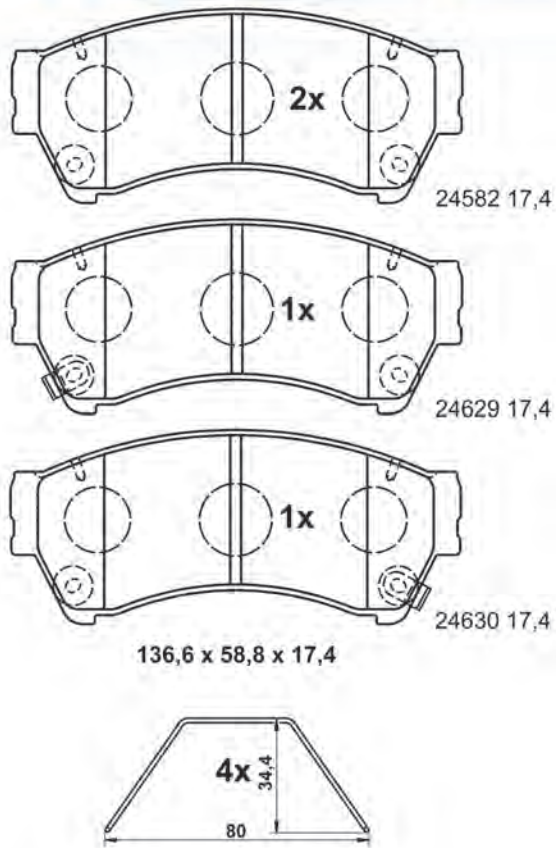

13.0460-5611.2 605611 [1]

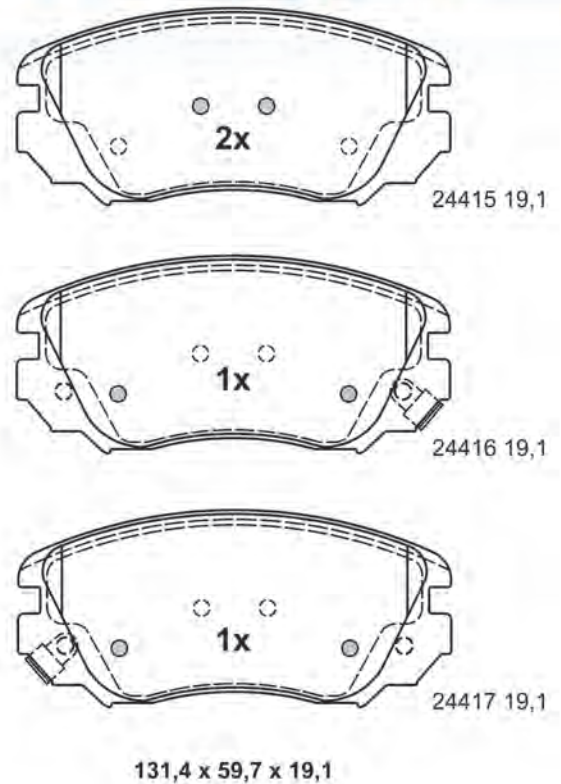

13.0460-5611.2 605611 [2]

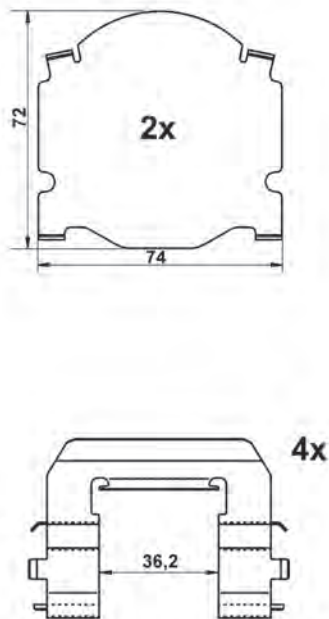

13.0460-5612.2 605612 [1]

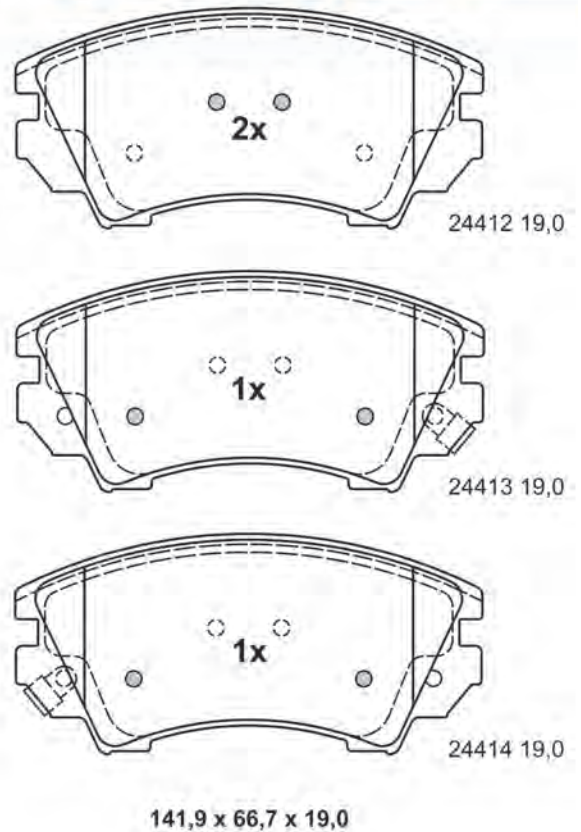

Abbildungen Scheibenbremsbeläge

Illustrations disc brake pads - Ilustraciones de pastillas - Illustrations Plaquettes de frein à disque - Illustrazioni Pastiglie Freno

13.0460-5612.2 605612 [2]

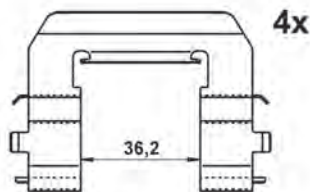
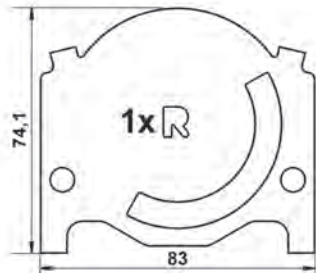
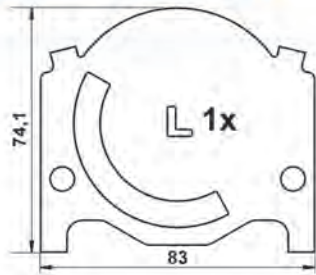

13.0460-5613.2 605613

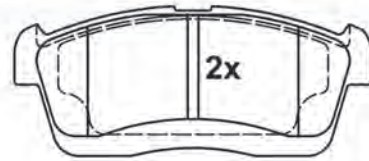

25262 15,0

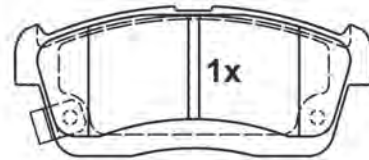

25274 15,0

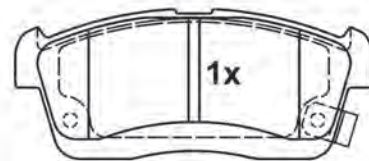

25273 15,0

108,4 x 45,6 x 15,0

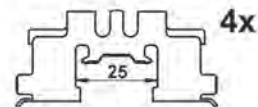

13.0460-5614.2 605614

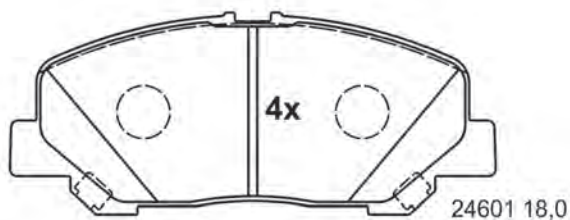

24601 18,0

147,6 x 60,8 x 18,0

13.0460-5615.2 605615

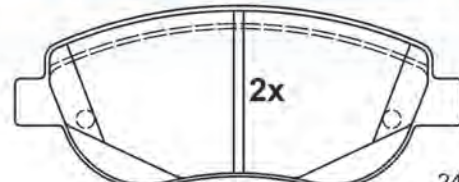

24946 19,0

150,9 x 61,3 x 19,0

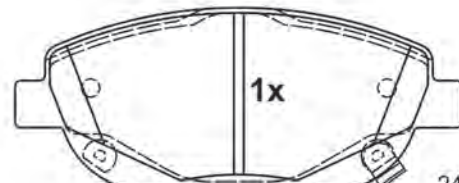

24947 19,6

150,9 x 61,3 x 19,6

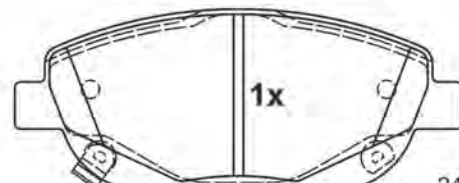

24948 19,6

150,9 x 61,3 x 19,6

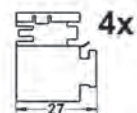

Abbildungen Scheibenbremsbeläge

Illustrations disc brake pads - Ilustraciones de pastillas - Illustrations Plaquettes de frein à disque - Illustrazioni Pastiglie Freno

13.0460-5616.2 605616

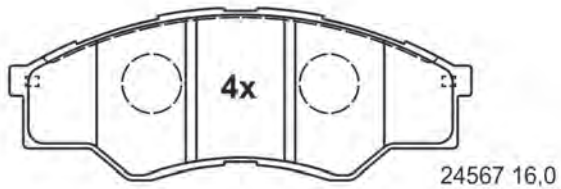

140,1 x 52,0 x 16,0

13.0460-5617.2 605617

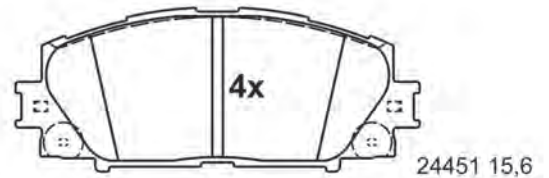

122,7 x 49,6 x 15,6

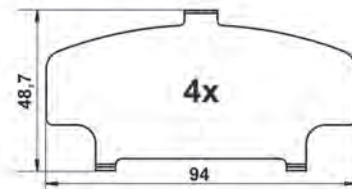

13.0460-5618.2 605618

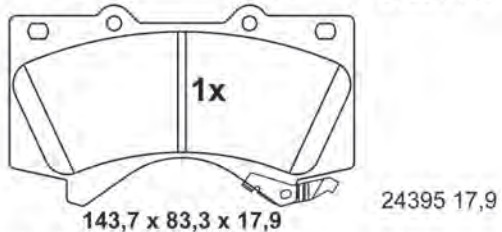
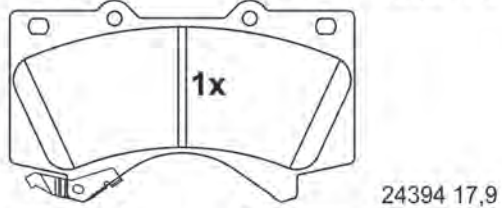
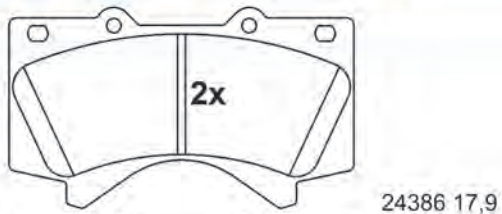

143,7 x 83,3 x 17,9

13.0460-5619.2 605619

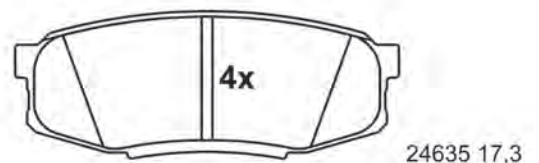

116,3 x 44,6 x 17,3

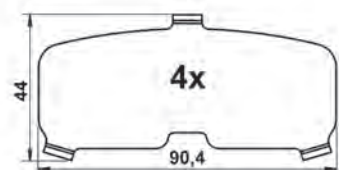

Abbildungen Scheibenbremsbeläge

Illustrations disc brake pads - Ilustraciones de pastillas - Illustrations Plaquettes de frein à disque - Illustrazioni Pastiglie Freno

13.0460-5620.2 605620

B.H.P.

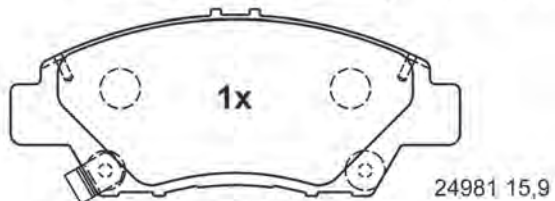
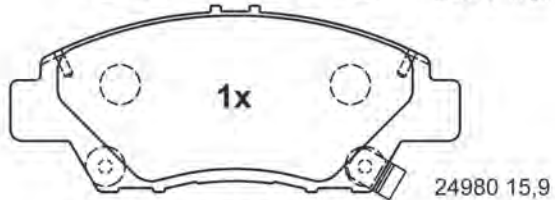

136,4 x 56,4 x 15,9

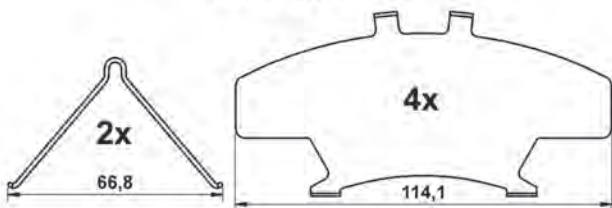

13.0460-5621.2 605621

B.H.P.

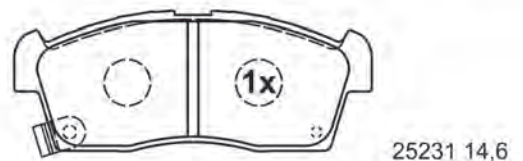
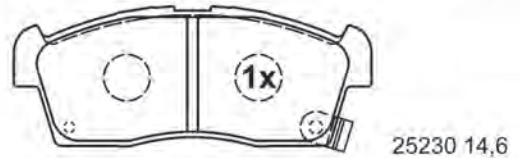
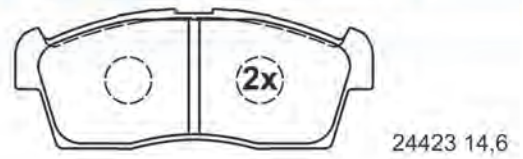

108,5 x 42,2 x 14,6

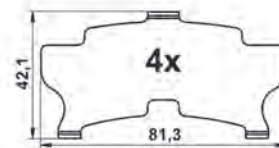

13.0460-5622.2 605622

B.H.P.

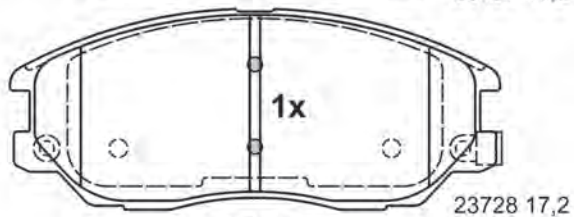
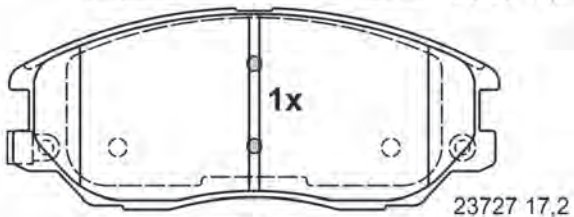
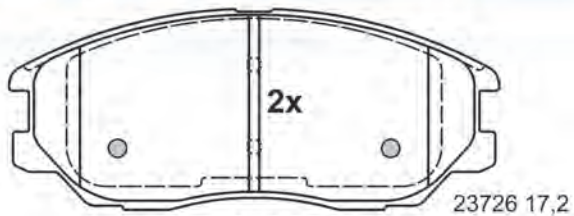

148,8 x 60,8 x 17,2

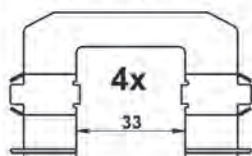

13.0460-5623.2 605623

B.H.P.

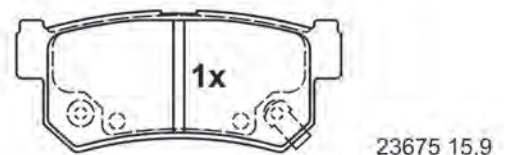
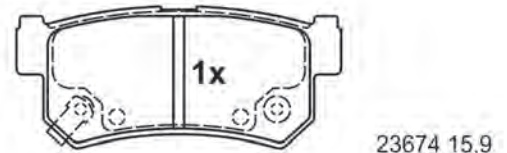
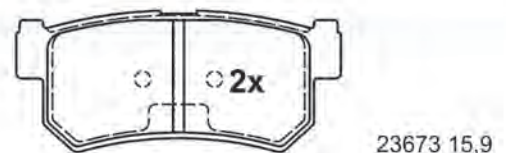

98,5 x 42,8 x 15,9

Abbildungen Scheibenbremsbeläge

Illustrations disc brake pads - Ilustraciones de pastillas - Illustrations Plaquettes de frein à disque - Illustrazioni Pastiglie Freno

13.0460-5625.2 605625

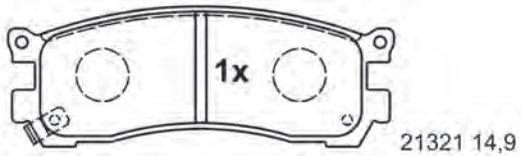
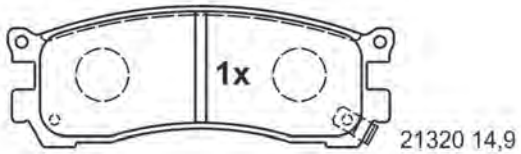
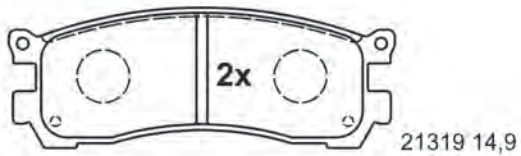

117,1 x 42,5 x 14,9

13.0460-5626.2 605626

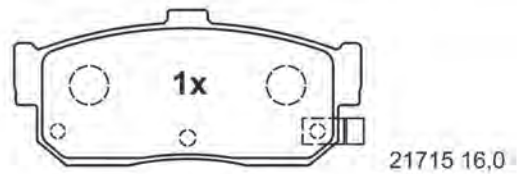
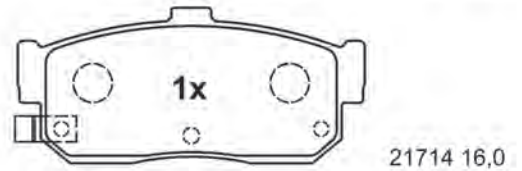
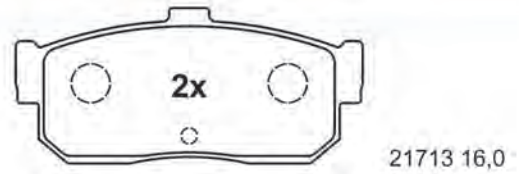

105,3 x 47,0 x 16,0



13.0460-5627.2 605627

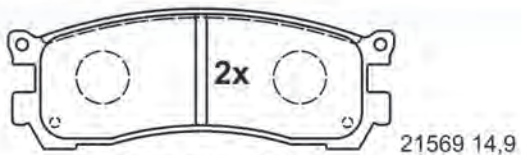

117,1 x 42,5 x 14,9

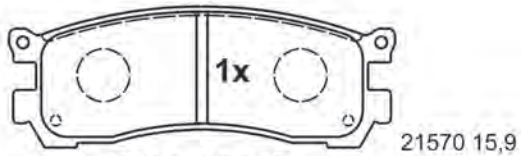

117,1 x 42,5 x 15,9

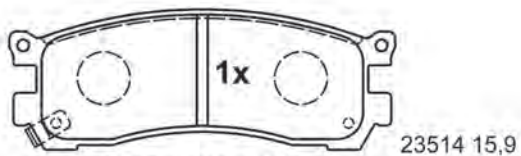

117,1 x 42,5 x 15,9

13.0460-5628.2 605628

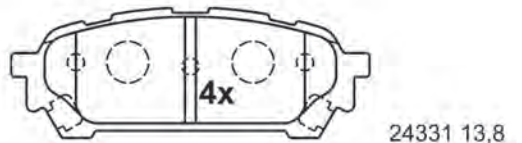

108,7 x 39,3 x 13,8

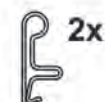
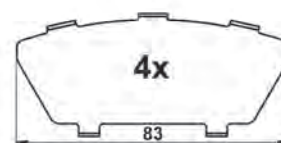

Abbildungen Scheibenbremsbeläge

Illustrations disc brake pads - Ilustraciones de pastillas - Illustrations Plaquettes de frein à disque - Illustrazioni Pastiglie Freno

13.0460-5629.2 605629

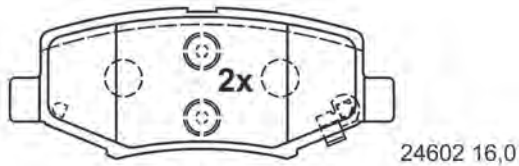
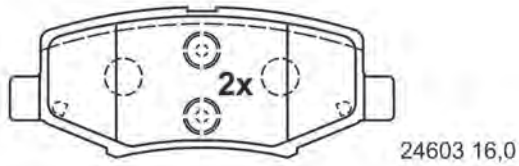

116,7 x 45,5 x 16,0

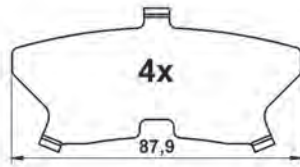

13.0460-5631.2 605631

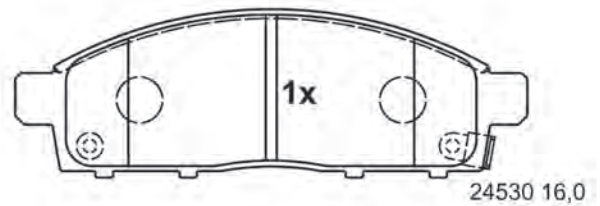
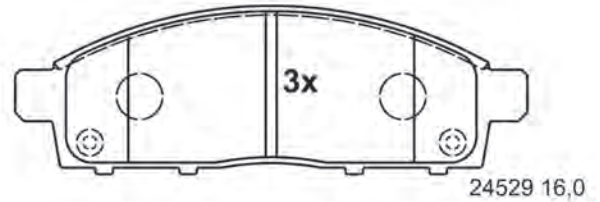

155,4 x 50,9 x 16,0

13.0460-5632.2 605632

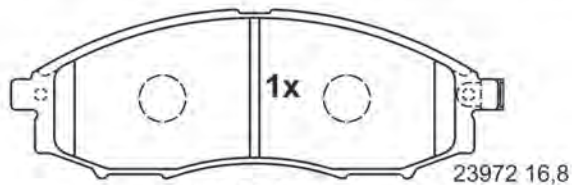
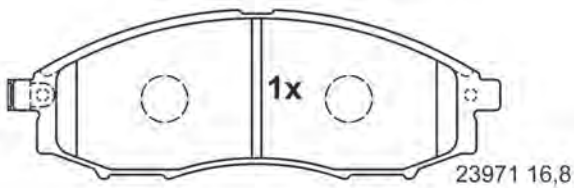
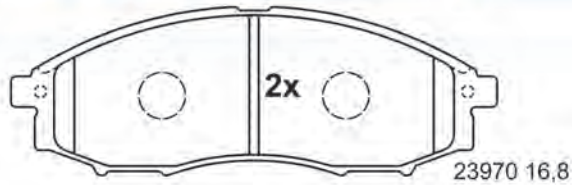

164,2 x 56,7 x 16,8

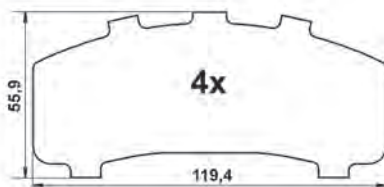

13.0460-5633.2 605633

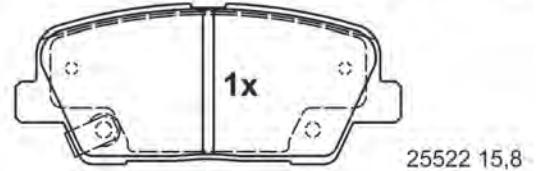
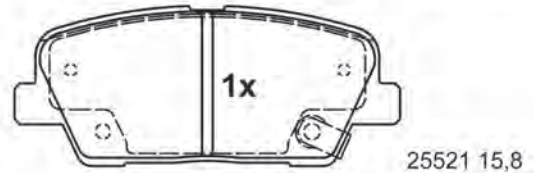
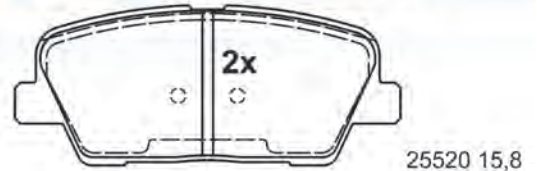

117,0 x 48,4 x 15,8

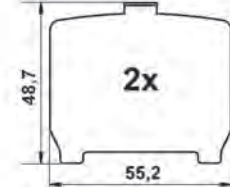
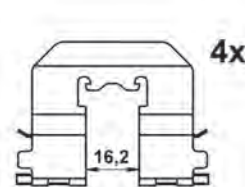

Abbildungen Scheibenbremsbeläge

Illustrations disc brake pads - Ilustraciones de pastillas - Illustrations Plaquettes de frein à disque - Illustrazioni Pastiglie Freno

13.0460-5634.2 605634

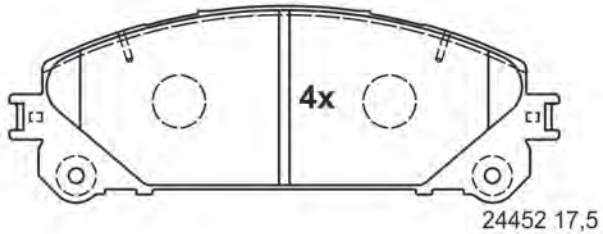

167,0 x 59,4 x 17,5

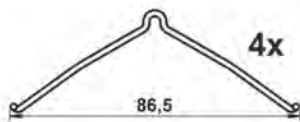

13.0460-5635.2 605635

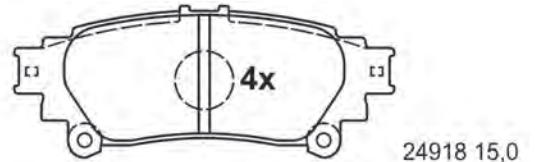

115,2 x 45,7 x 15,0

13.0460-5636.2 605636

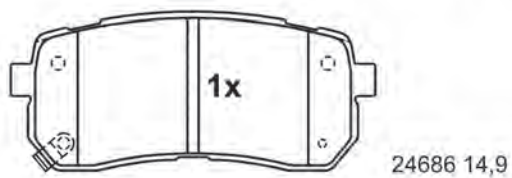
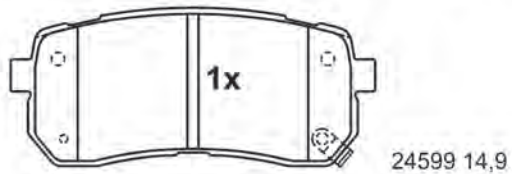
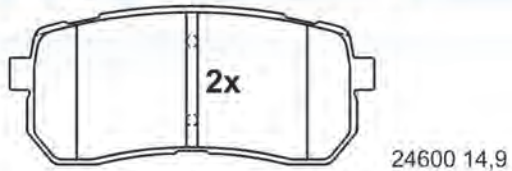

110,6 x 47,7 x 14,9

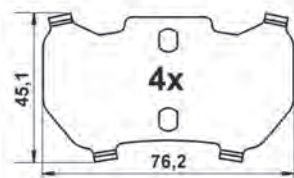
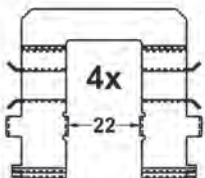

13.0460-5637.2 605637

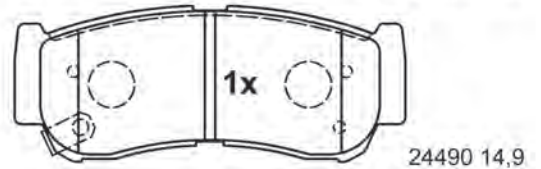
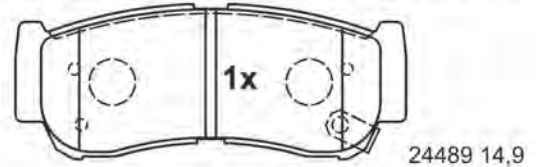
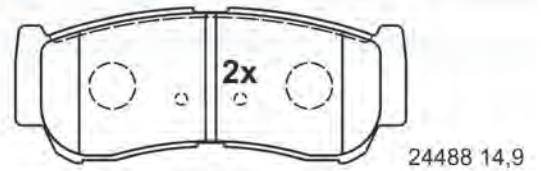

118,6 x 47,0 x 14,9

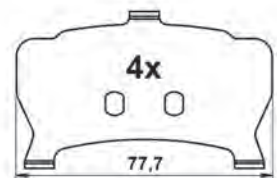
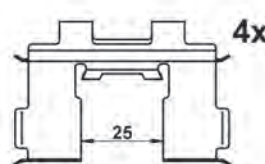

Abbildungen Scheibenbremsbeläge

Illustrations disc brake pads - Ilustraciones de pastillas - Illustrations Plaquettes de frein à disque - Illustrazioni Pastiglie Freno

13.0460-5638.2 605638

B.H.P.D

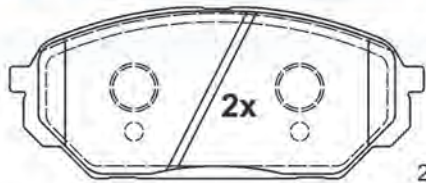

25119 16,9

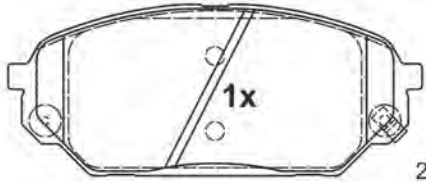

25889 16,9

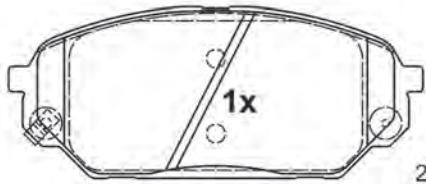

25890 16,9

155,0 x 64,5 x 16,9

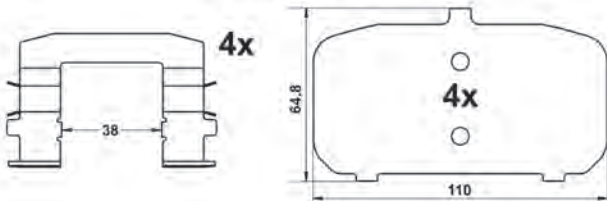

13.0460-5639.2 605639

B.H.P.D



24618 17,5

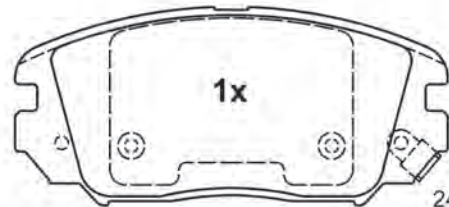

24619 17,5

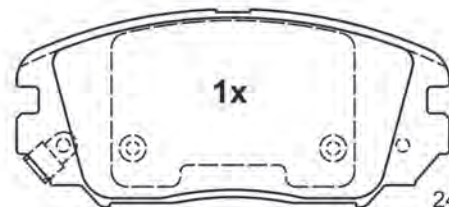

24620 17,5

131,3 x 59,9 x 17,5

13.0460-5640.2 605640

B.H.P.D

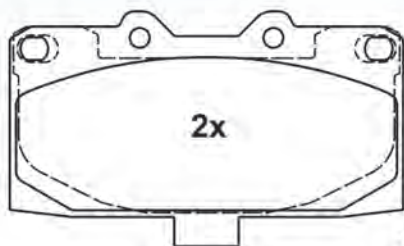

21856 15,0

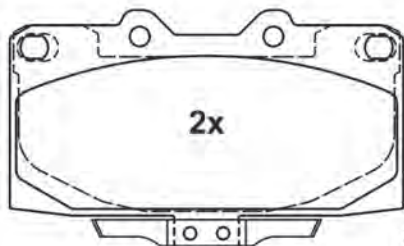

21854 15,0

119,3 x 71,2 x 15,0

13.0460-5641.2 605641 [1]

B.H.P.D

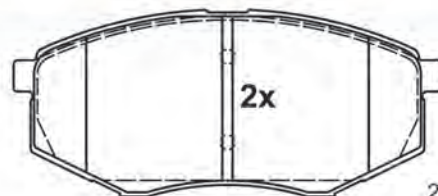

25187 17,8

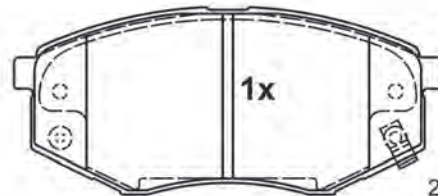

25188 17,8

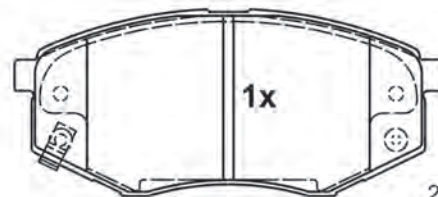

25188 17,8

131,3 x 59,9 x 17,8

Abbildungen Scheibenbremsbeläge

Illustrations disc brake pads - Ilustraciones de pastillas - Illustrations Plaquettes de frein à disque - Illustrazioni Pastiglie Freno

13.0460-5641.2 605641 [2]

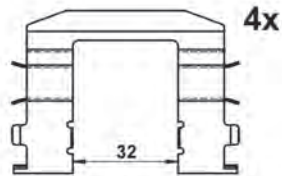
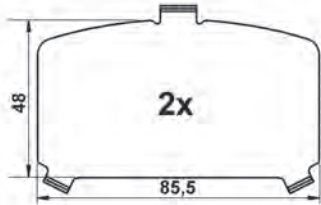

13.0460-5642.2 605642

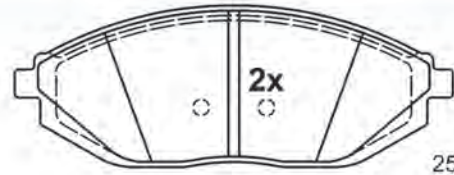

25268 17,8

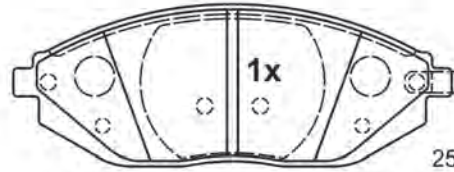

25269 17,8

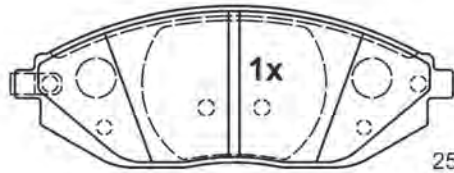

25270 17,8

133,2 x 49,0 x 17,8

13.0460-5645.2 605645 [1]

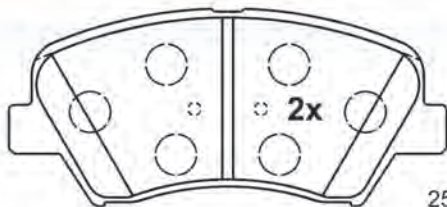

25692 17,2

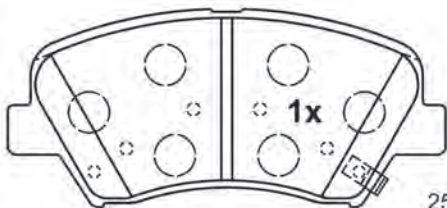

25693 17,2

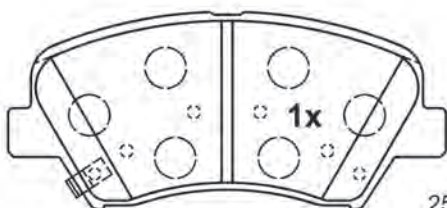

25694 17,2

132,9 x 60,0 x 17,2

13.0460-5645.2 605645 [2]

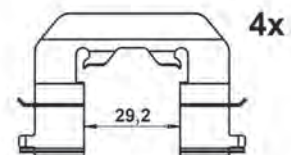
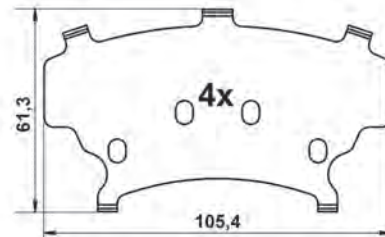

Abbildungen Scheibenbremsbeläge

Illustrations disc brake pads - Ilustraciones de pastillas - Illustrations Plaquettes de frein à disque - Illustrazioni Pastiglie Freno

13.0460-5646.2 605646 [1]

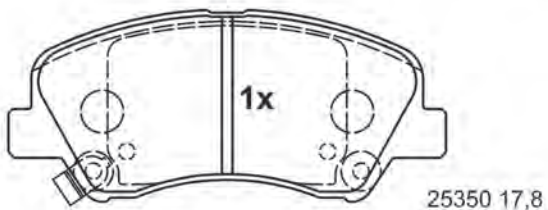
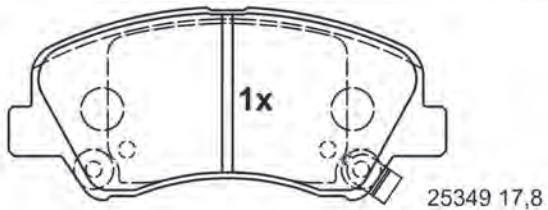
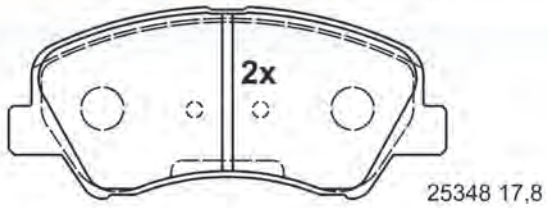

132,7 x 57,9 x 17,8

13.0460-5646.2 605646 [2]

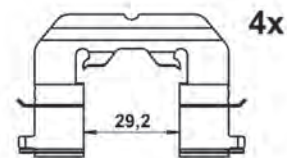
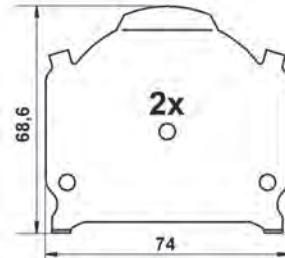

13.0460-5648.2 605648

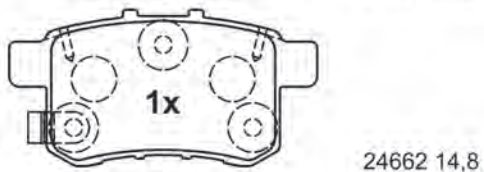
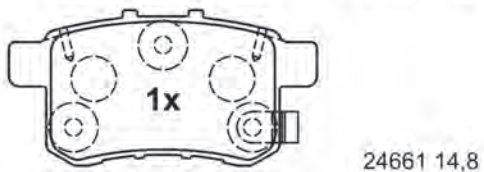
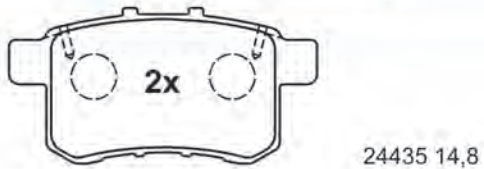

93,5 x 47,1 x 14,8

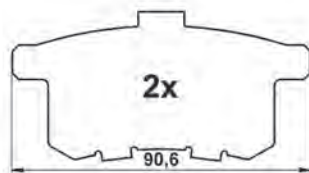

13.0460-5649.2 605649

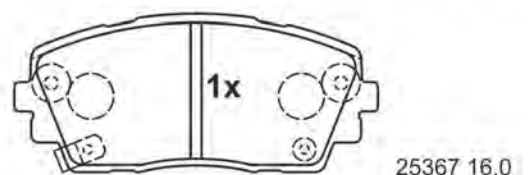
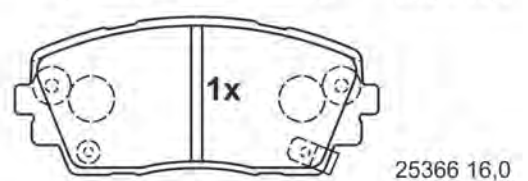
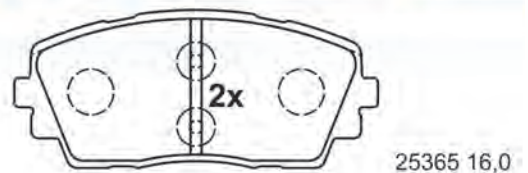

110,2 x 47,6 x 16,0

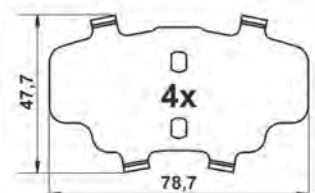
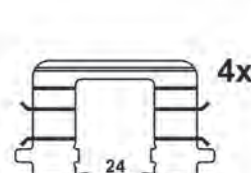

Abbildungen Scheibenbremsbeläge

Illustrations disc brake pads - Ilustraciones de pastillas - Illustrations Plaquettes de frein à disque - Illustrazioni Pastiglie Freno

13.0460-5700.2 605700

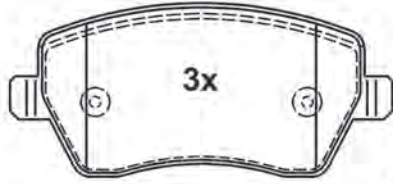

23973 17,0

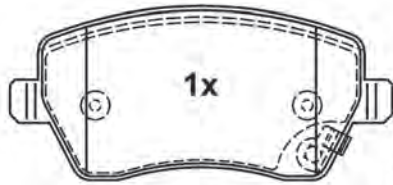

24403 17,0

116,3 x 52,4 x 17,0



M8x21

13.0460-5701.2 605701

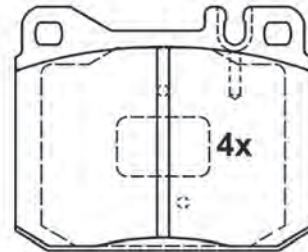

20392 18,5

89,7 x 73,8 x 18,5

13.0460-5703.2 605703

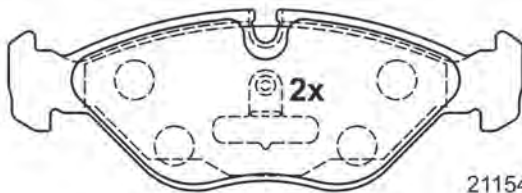

21154 19,5

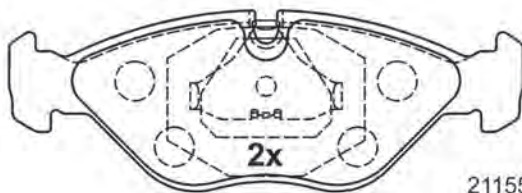

21155 19,5

156,4 x 54,6 x 19,5

13.0460-5709.2 605709

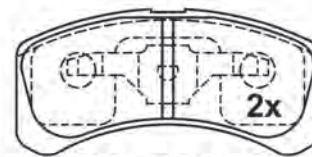

24229 14,8

91,9 x 44,3 x 14,8

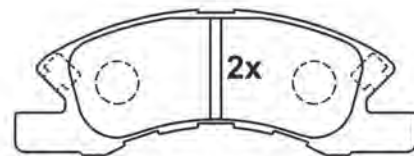

24230 15,3

121,9 x 44,3 x 15,3

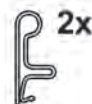

2x



2x

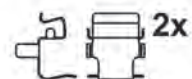

2x

Abbildungen Scheibenbremsbeläge

Illustrations disc brake pads - Ilustraciones de pastillas - Illustrations Plaquettes de frein à disque - Illustrazioni Pastiglie Freno

13.0460-5710.2 605710  13.0460-5711.2 605711 

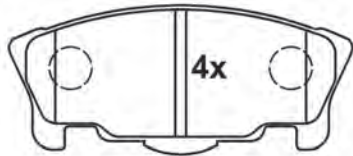

23783 14,0

104,6 x 45,1 x 14,0

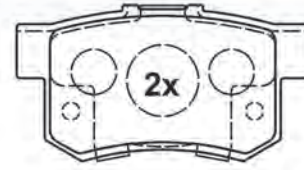

23736 15,7

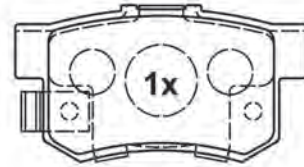

23652 15,7

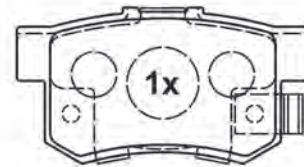

23653 15,7

88,8 x 47,5 x 15,7

13.0460-5712.2 605712  13.0460-5713.2 605713 

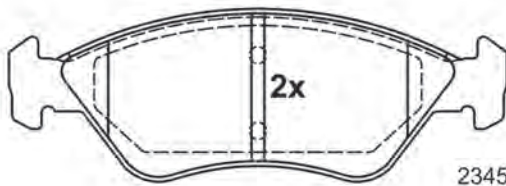

23451 17,5

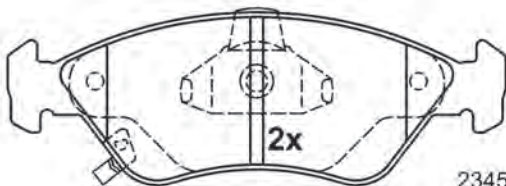

23450 17,5

151,4 x 52,4 x 17,5

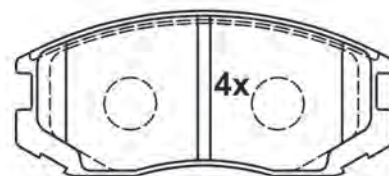

21650 15,5

114,1 x 50,0 x 15,5

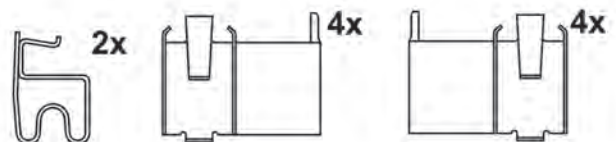

Abbildungen Scheibenbremsbeläge

Illustrations disc brake pads - Ilustraciones de pastillas - Illustrations Plaquettes de frein à disque - Illustrazioni Pastiglie Freno

13.0460-5714.2 605714

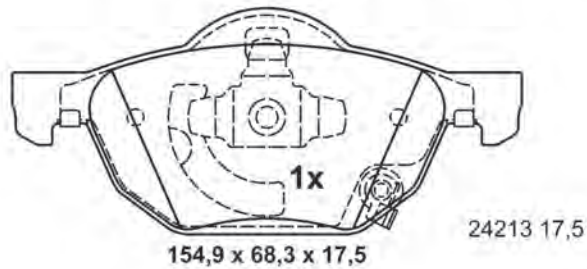
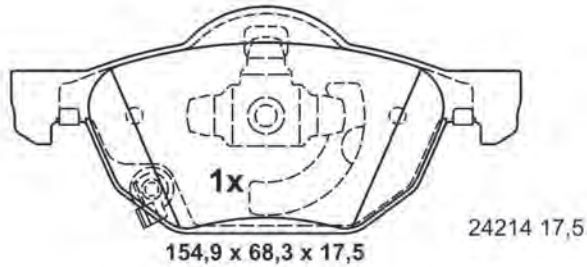
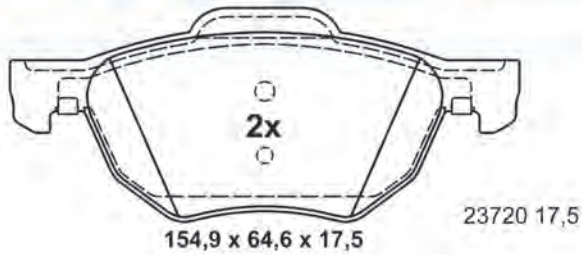

13.0460-5716.2 605716

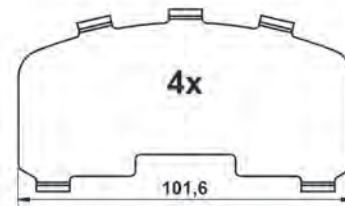
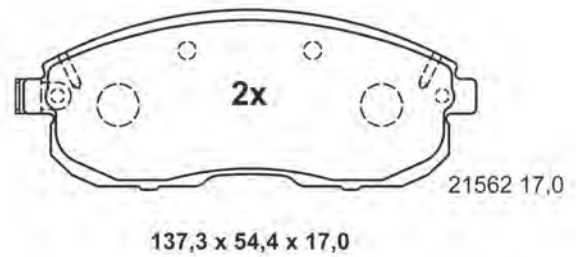
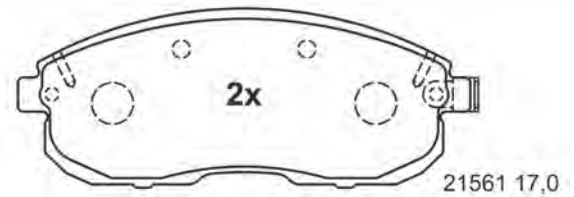

13.0460-5717.2 605717

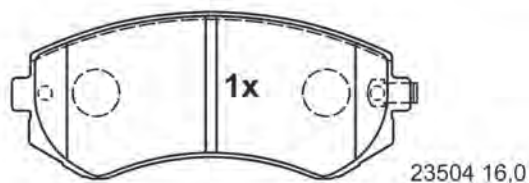
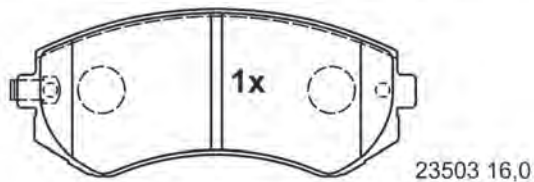
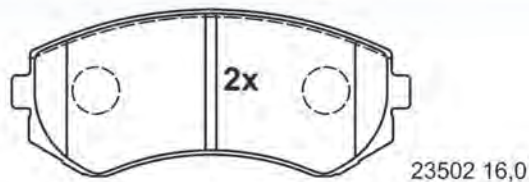

13.0460-5718.2 605718

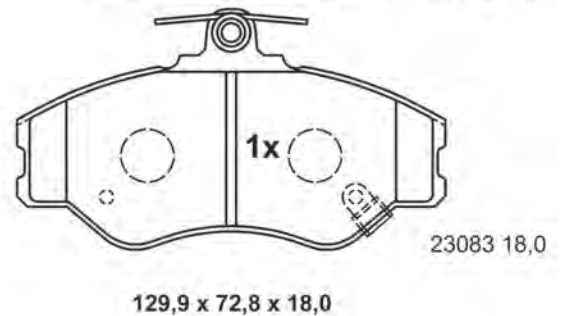
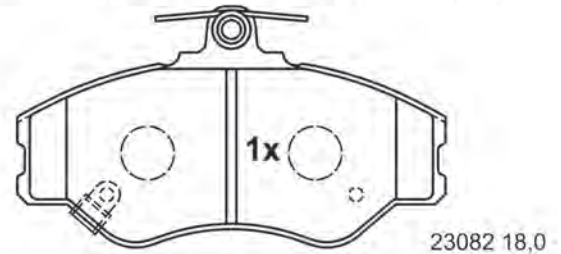
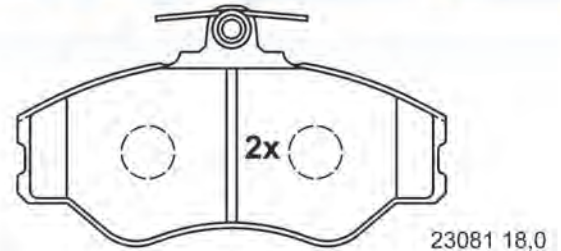

Abbildungen Scheibenbremsbeläge

Illustrations disc brake pads - Ilustraciones de pastillas - Illustrations Plaquettes de frein à disque - Illustrazioni Pastiglie Freno

13.0460-5720.2 605720

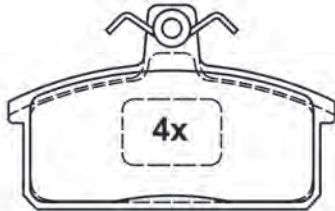

20708 14,5

98,9 x 61,5 x 14,5



13.0460-5722.2 605722

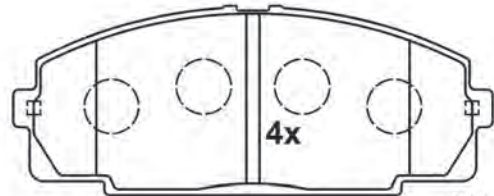

21468 15,5

145,4 x 57,0 x 15,5

13.0460-5725.2 605725

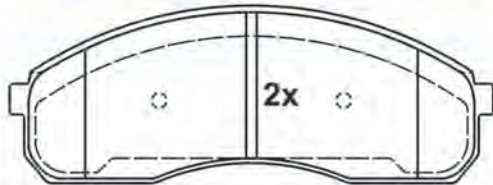

23649 17,2

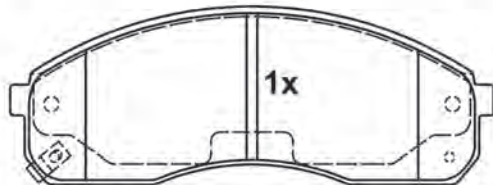

23650 17,2

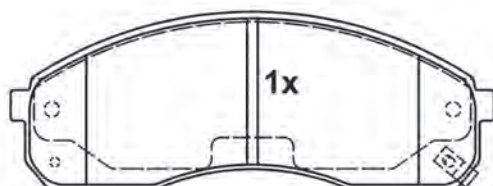

23651 17,2

154,1 x 56,5 x 17,2

13.0460-5727.2 605727

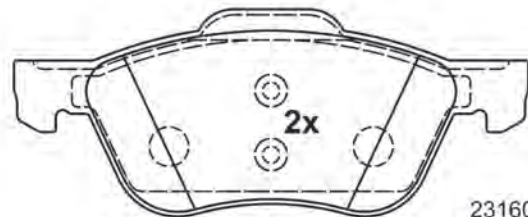

23160 17,3

156,3 x 62,8 x 17,3

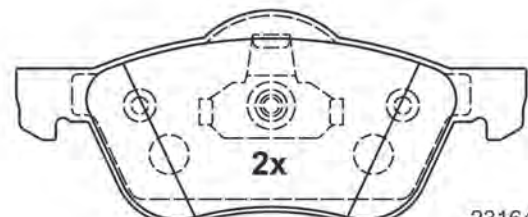

23164 17,3

155,0 x 64,9 x 17,3



Abbildungen Scheibenbremsbeläge

Illustrations disc brake pads - Ilustraciones de pastillas - Illustrations Plaquettes de frein à disque - Illustrazioni Pastiglie Freno

13.0460-5731.2 605731

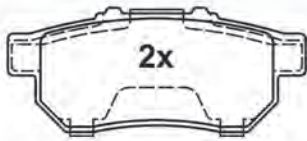

21738 13,5

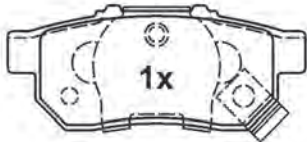

23343 13,5

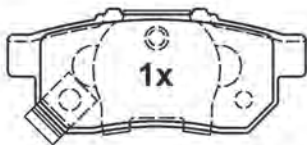

23344 13,5

88,8 x 37,6 x 13,5

13.0460-5732.2 605732



24029 12,5

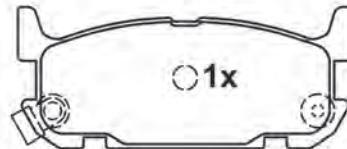

24030 12,5

102,1 x 42,7 x 12,5

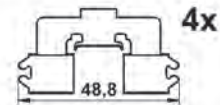
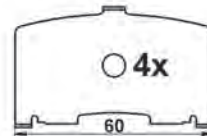

13.0460-5734.2 605734

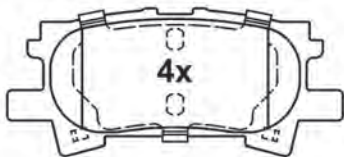

23967 15,1

101,8 x 44,0 x 15,1

13.0460-5735.2 605735

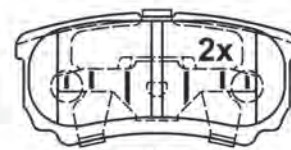

24014 16,0

85,5 x 40,1 x 16,0

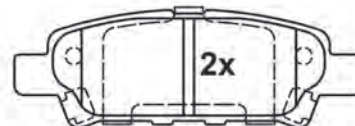

24015 16,0

105,9 x 35,7 x 16,0



Abbildungen Scheibenbremsbeläge

Illustrations disc brake pads - Ilustraciones de pastillas - Illustrations Plaquettes de frein à disque - Illustrazioni Pastiglie Freno

13.0460-5736.2 605736

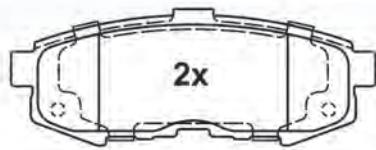

24215 15,7

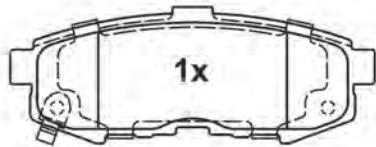

24216 15,7

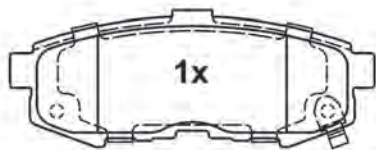

24217 15,7

110,4 x 41,1 x 15,7

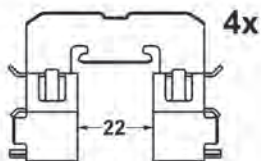

13.0460-5738.2 605738

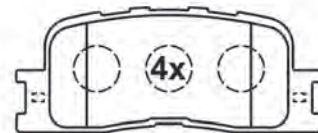

23702 15,1

92,6 x 37,7 x 15,1

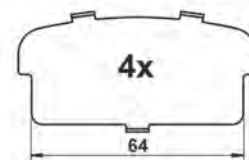

13.0460-5739.2 605739

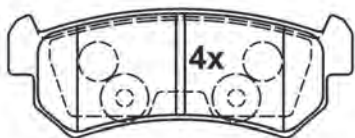

24071 14,9

104,3 x 38,9 x 14,6

13.0460-5742.2 605742

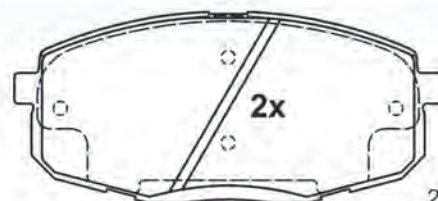

23966 17,7

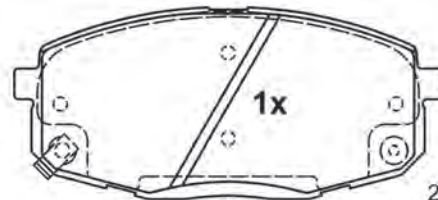

23987 17,7

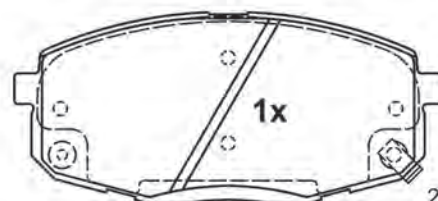

23988 17,7

130,0 x 57,9 x 17,7

Abbildungen Scheibenbremsbeläge

Illustrations disc brake pads - Ilustraciones de pastillas - Illustrations Plaquettes de frein à disque - Illustrazioni Pastiglie Freno

13.0460-5743.2 605743

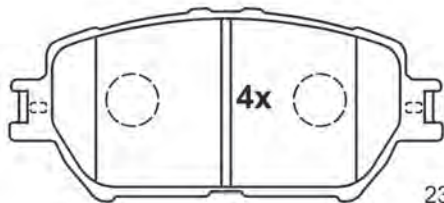

23928 17,3

131,4 x 58,5 x 17,3

13.0460-5744.2 605744

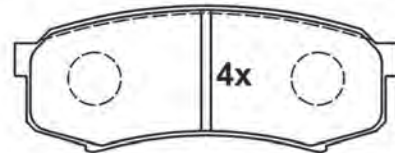

23947 15,4

116,2 x 44,0 x 15,4

13.0460-5745.2 605745

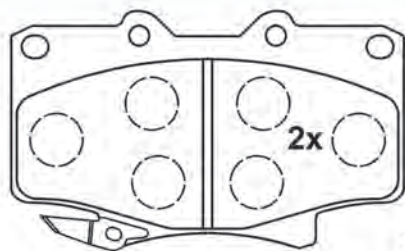

21775 15,0

119,1 x 71,9 x 15,0

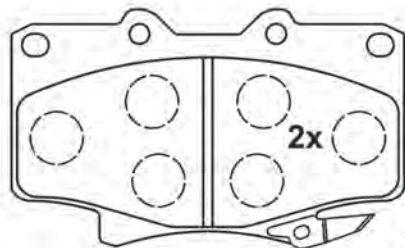

21776 15,0

13.0460-5746.2 605746

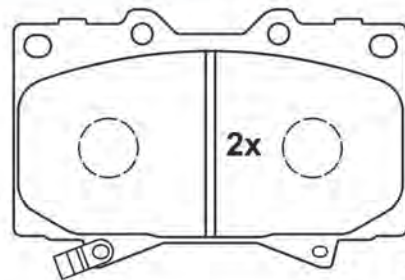

23524 17,4

119,3 x 78,0 x 17,4

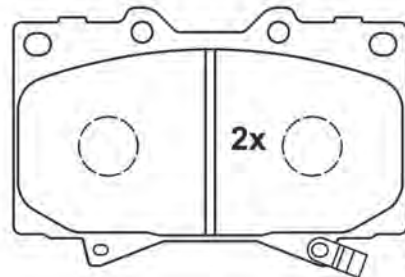

23525 17,4

Abbildungen Scheibenbremsbeläge

Illustrations disc brake pads - Ilustraciones de pastillas - Illustrations Plaquettes de frein à disque - Illustrazioni Pastiglie Freno

13.0460-5747.2 605747

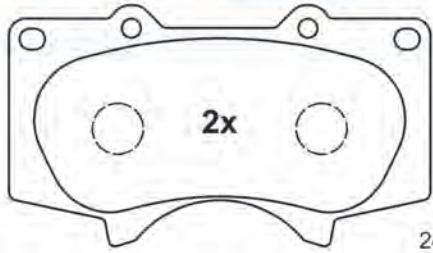

24024 17,0

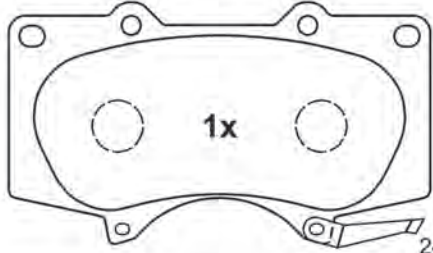

24026 17,0

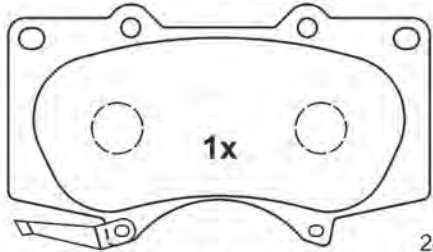

24025 17,0

134,2 x 76,9 x 17,0

13.0460-5748.2 605748

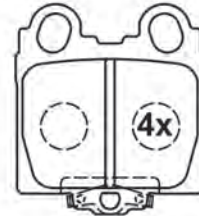

23429 15,5

57,2 x 63,8 x 15,5

13.0460-5749.2 605749

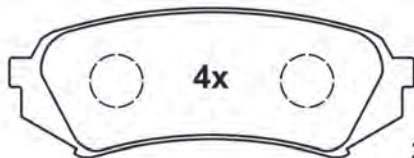

23539 17,3

123,0 x 45,1 x 17,3

13.0460-5750.2 605750

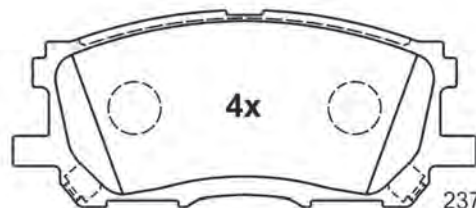

23734 16,8

140,8 x 59,5 x 16,8

Abbildungen Scheibenbremsbeläge

Illustrations disc brake pads - Ilustraciones de pastillas - Illustrations Plaquettes de frein à disque - Illustrazioni Pastiglie Freno

13.0460-5751.2 605751

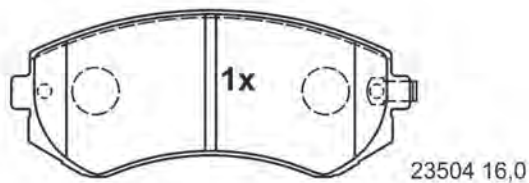
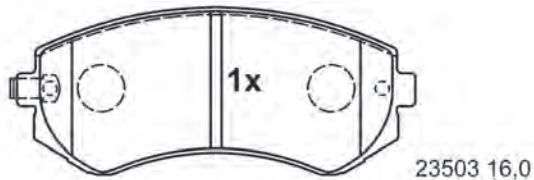
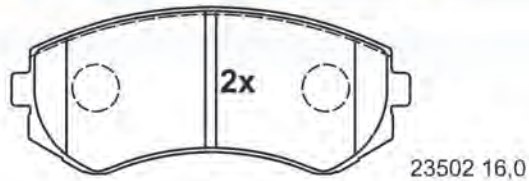

121,0 x 50,5 x 16,0

13.0460-5752.2 605752

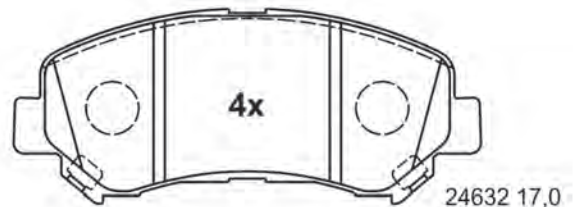

142,0 x 59,0 x 17,0

13.0460-5753.2 605753

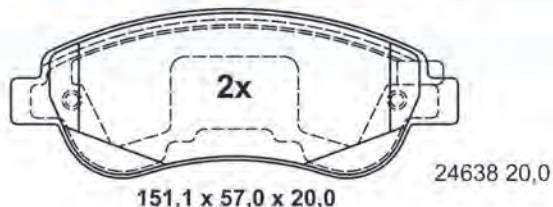

151,1 x 57,0 x 20,0

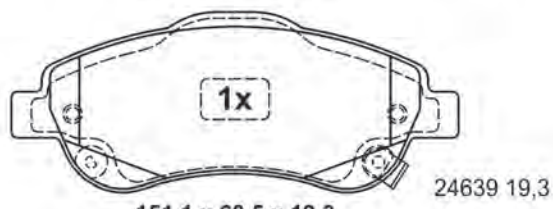

151,1 x 60,5 x 19,3

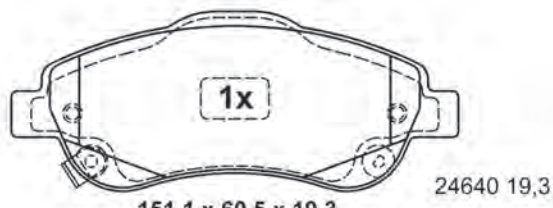

151,1 x 60,5 x 19,3

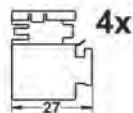
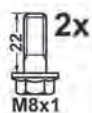

13.0460-5754.2 605754

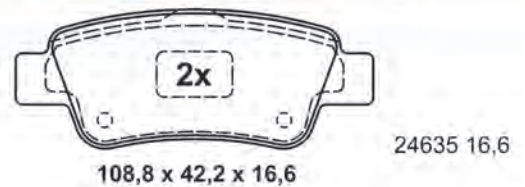

108,8 x 42,2 x 16,6

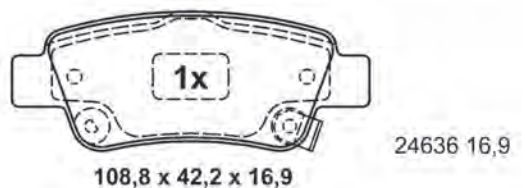

108,8 x 42,2 x 16,9

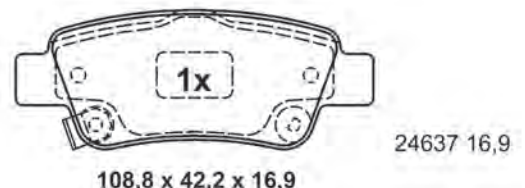

108,8 x 42,2 x 16,9

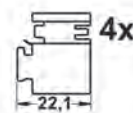
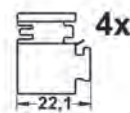
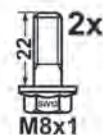

Abbildungen Scheibenbremsbeläge

Illustrations disc brake pads - Ilustraciones de pastillas - Illustrations Plaquettes de frein à disque - Illustrazioni Pastiglie Freno

13.0460-5755.2 605755

B.H.I.P.

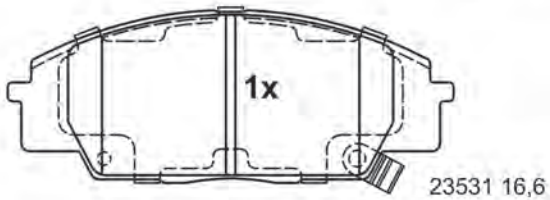
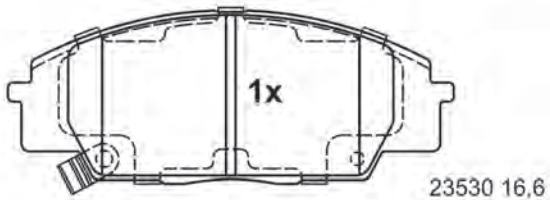
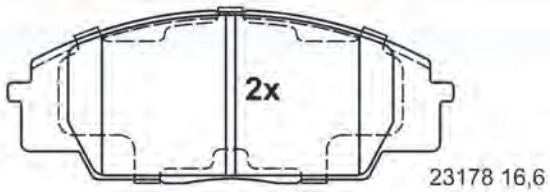

135,3 x 52,4 x 16,6

13.0460-5756.2 605756

B.H.I.P.

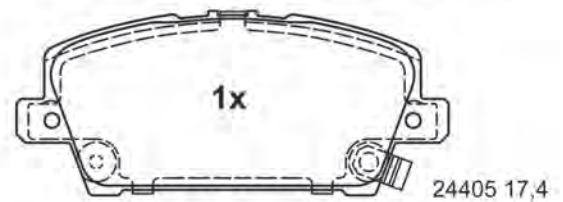
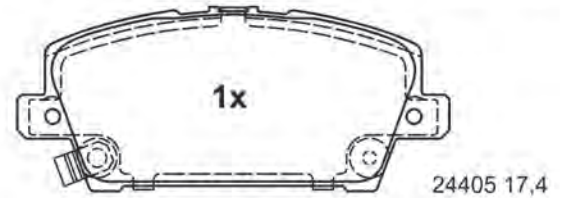
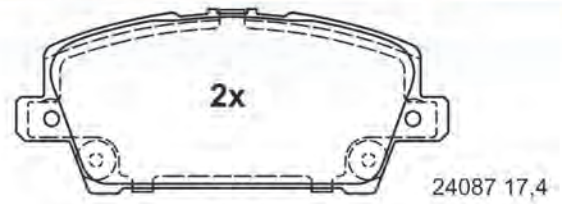

131,5 x 55,7 x 17,4

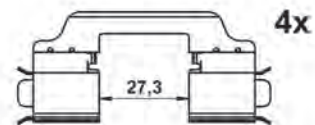
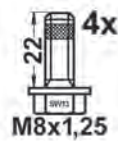

13.0460-5757.2 605757

B.H.I.P.

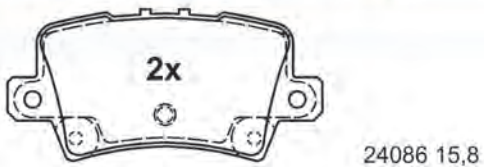

95,7 x 46,2 x 15,8



13.0460-5760.2 605760

B.H.I.P.

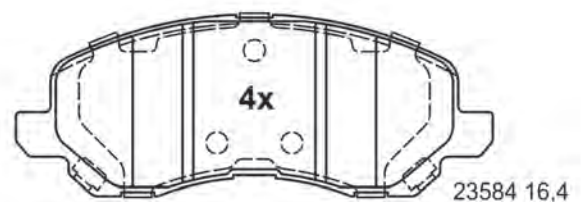

144,8 x 54,9 x 16,4



Abbildungen Scheibenbremsbeläge

Illustrations disc brake pads - Ilustraciones de pastillas - Illustrations Plaquettes de frein à disque - Illustrazioni Pastiglie Freno

13.0460-5761.2 605761

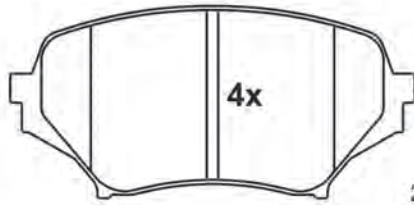

24297 14,4

122,9 x 58,3 x 14,4

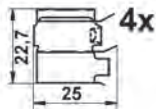
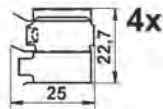
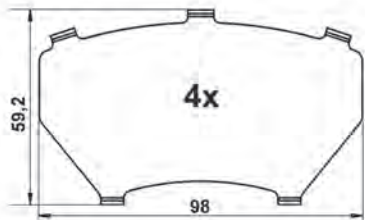

13.0460-5762.2 605762

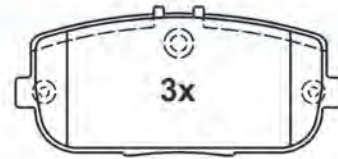

24298 14,0

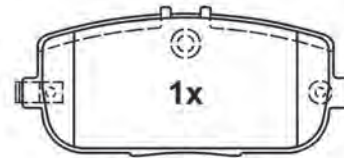

24299 14,0

99,2 x 45,0 x 14,0

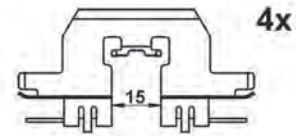
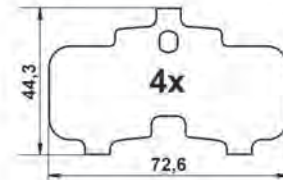

13.0460-5763.2 605763



21730 14,0

109,2 x 43,8 x 14,0



21730 14,9

109,2 x 43,8 x 14,9



13.0460-5764.2 605764

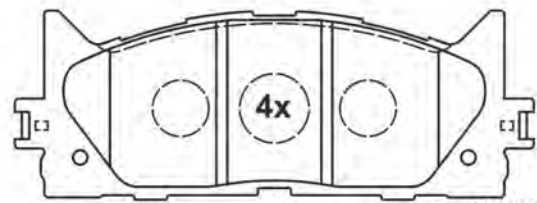

24350 17,3

157,6 x 57,0 x 17,3

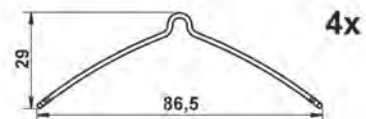

Abbildungen Scheibenbremsbeläge

Illustrations disc brake pads - Ilustraciones de pastillas - Illustrations Plaquettes de frein à disque - Illustrazioni Pastiglie Freno

13.0460-5765.2 605765

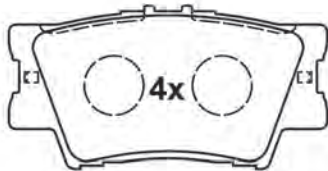

24338 15,5

96,6 x 49,2 x 15,5

13.0460-5766.2 605766

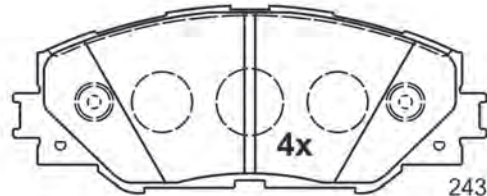

24337 17,5

146,4 x 56,8 x 17,5

13.0460-5767.2 605767

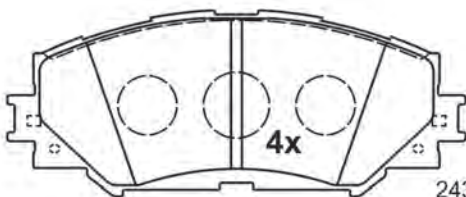

24336 17,5

139,0 x 56,1 x 17,5

13.0460-5768.2 605768

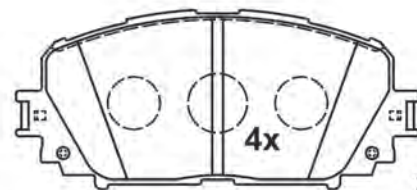

24347 17,5

122,7 x 54,0 x 17,5

Abbildungen Scheibenbremsbeläge

Illustrations disc brake pads - Ilustraciones de pastillas - Illustrations Plaquettes de frein à disque - Illustrazioni Pastiglie Freno

13.0460-5769.2 605769

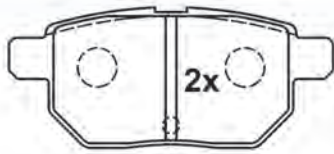

24612 15,0

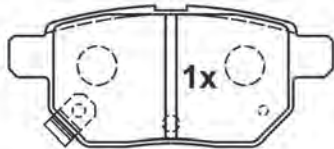

24610 15,0

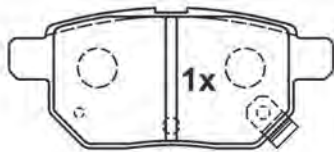

24611 15,0

98,5 x 42,4 x 15,0

13.0460-5770.2 605770



23983 17,0

154,6 x 59,5 x 17,0

13.0460-5771.2 605771

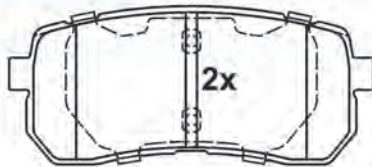

24600 14,9

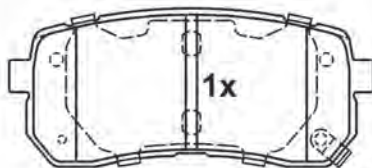

24599 14,9

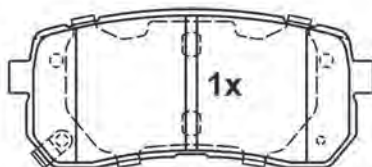

24686 14,9

110,6 x 47,7 x 14,9

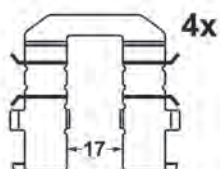

13.0460-5772.2 605772

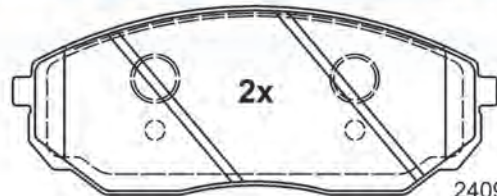

24092 17,1

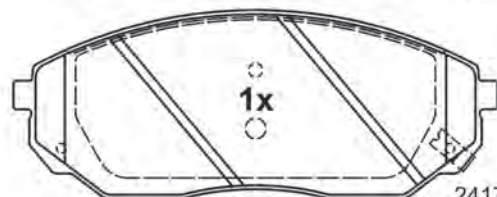

24178 17,1

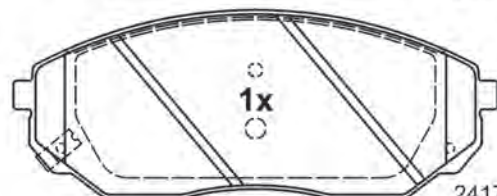

24179 17,1

154,8 x 60,0 x 17,1

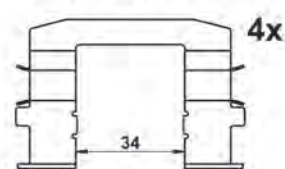

Abbildungen Scheibenbremsbeläge

Illustrations disc brake pads - Ilustraciones de pastillas - Illustrations Plaquettes de frein à disque - Illustrazioni Pastiglie Freno

13.0460-5773.2 605773

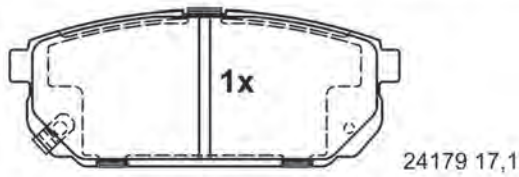
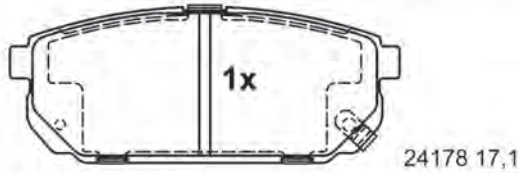
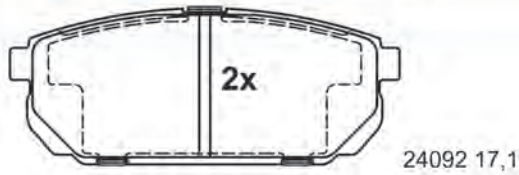

154,8 x 60,1 x 17,1

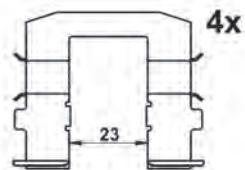

13.0460-5774.2 605774

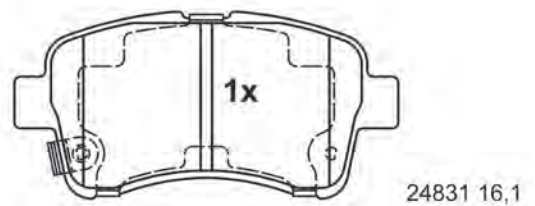
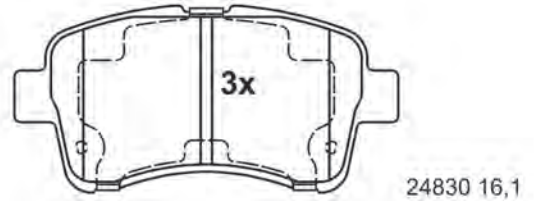

116,6 x 56,0 x 16,1

13.0460-5775.2 605775

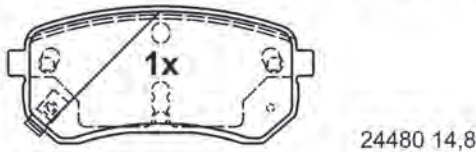
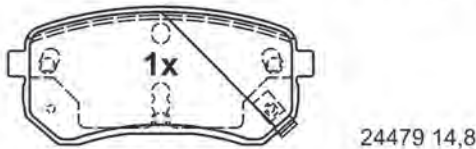
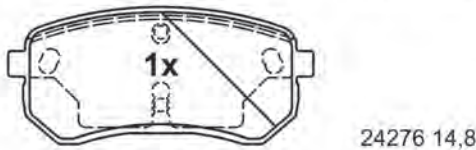
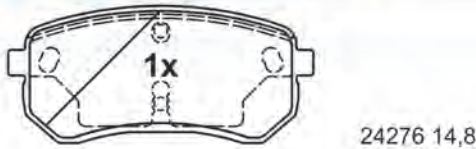

92,4 x 41,0 x 14,8

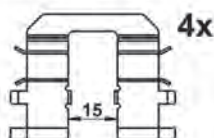

13.0460-5776.2 605776

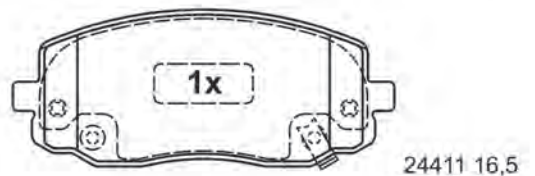
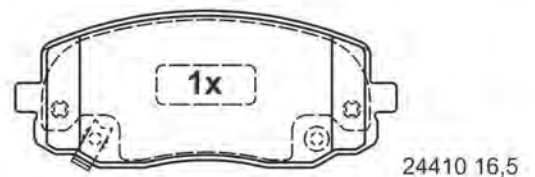
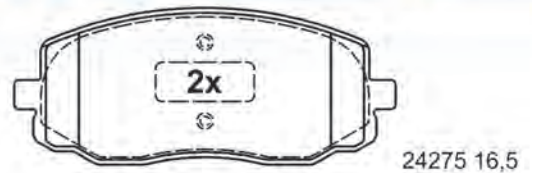

115,9 x 47,3 x 16,5

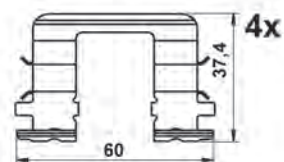

Abbildungen Scheibenbremsbeläge

Illustrations disc brake pads - Ilustraciones de pastillas - Illustrations Plaquettes de frein à disque - Illustrazioni Pastiglie Freno

13.0460-5777.2 605777 [1]

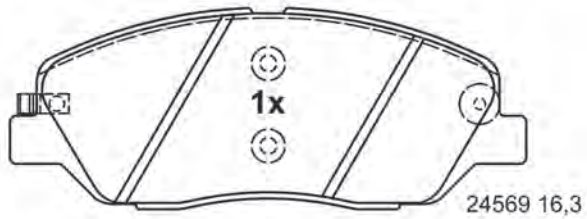
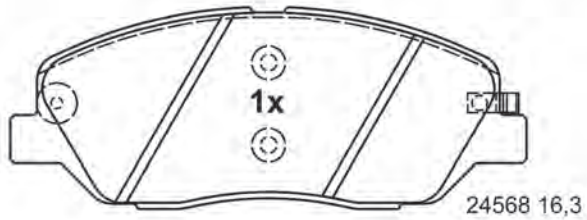
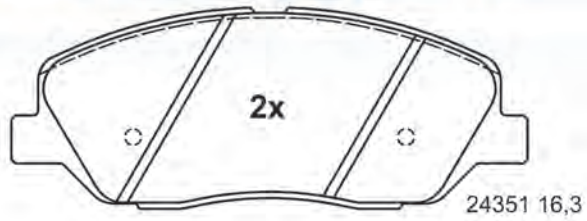

156,7 x 60,9 x 16,3

13.0460-5777.2 605777 [2]

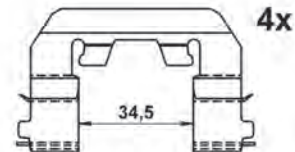
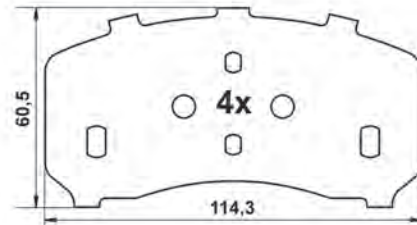

13.0460-5778.2 605778

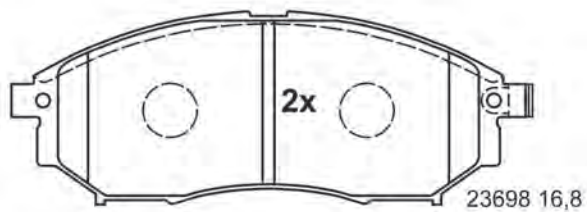
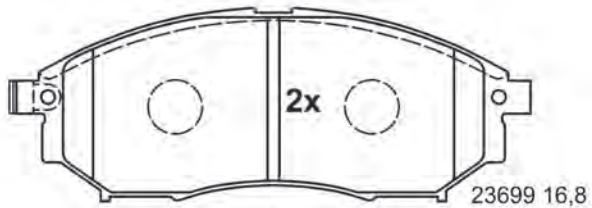

157,0 x 58,5 x 16,8

13.0460-5779.2 605779

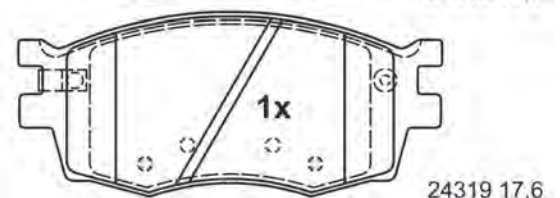
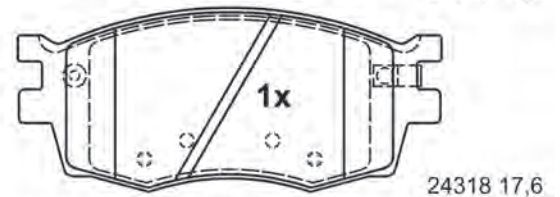
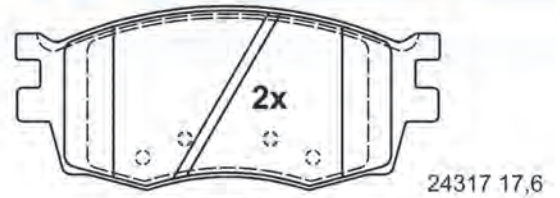

129,6 x 55,9 x 17,6

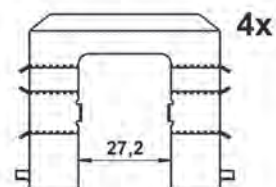

Abbildungen Scheibenbremsbeläge

Illustrations disc brake pads - Ilustraciones de pastillas - Illustrations Plaquettes de frein à disque - Illustrazioni Pastiglie Freno

13.0460-5780.2 605780

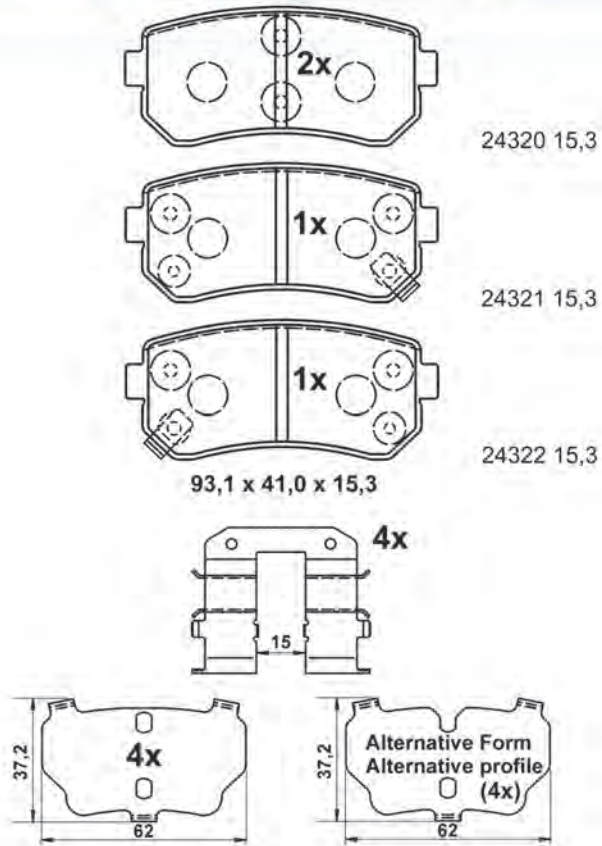

13.0460-5782.2 605782

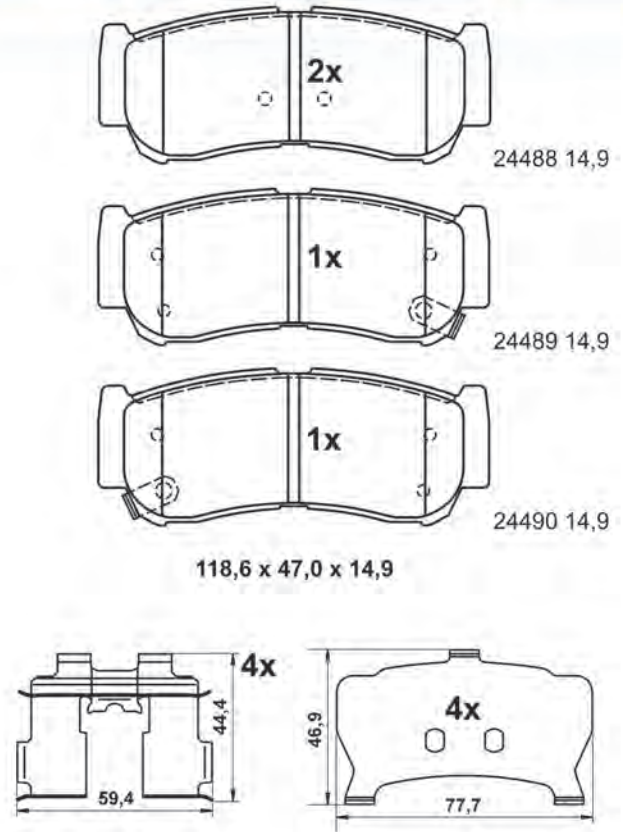

13.0460-5783.2 605783

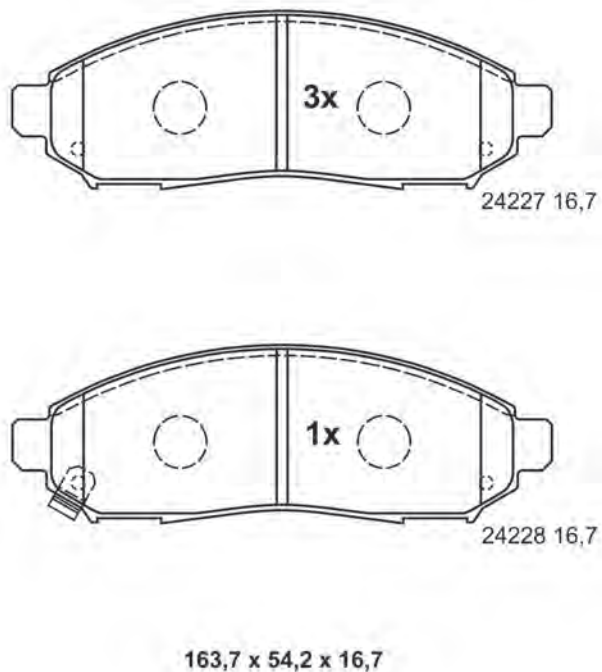

13.0460-5784.2 605784

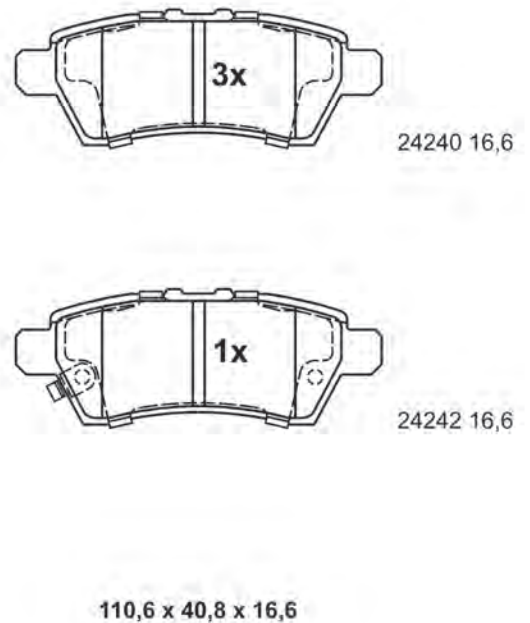

Abbildungen Scheibenbremsbeläge

Illustrations disc brake pads - Ilustraciones de pastillas - Illustrations Plaquettes de frein à disque - Illustrazioni Pastiglie Freno

13.0460-5785.2 605785

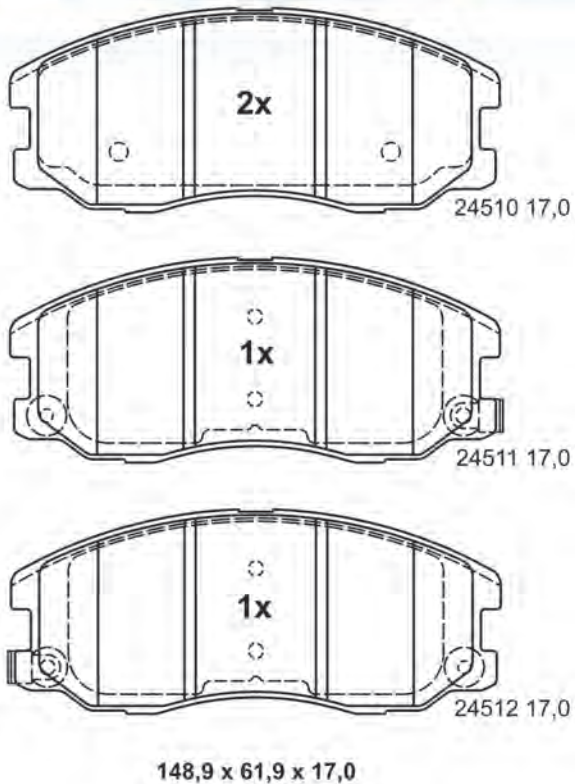

13.0460-5786.2 605786

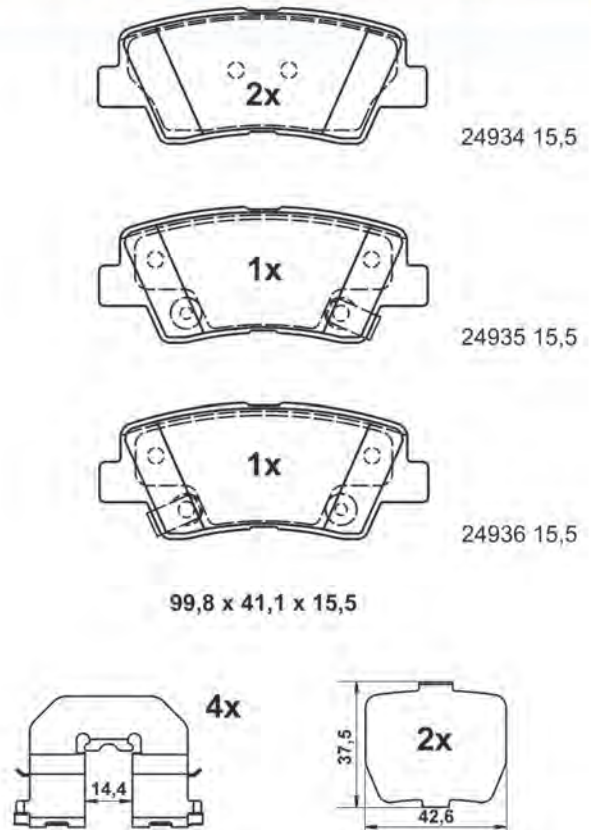

13.0460-5787.2 605787

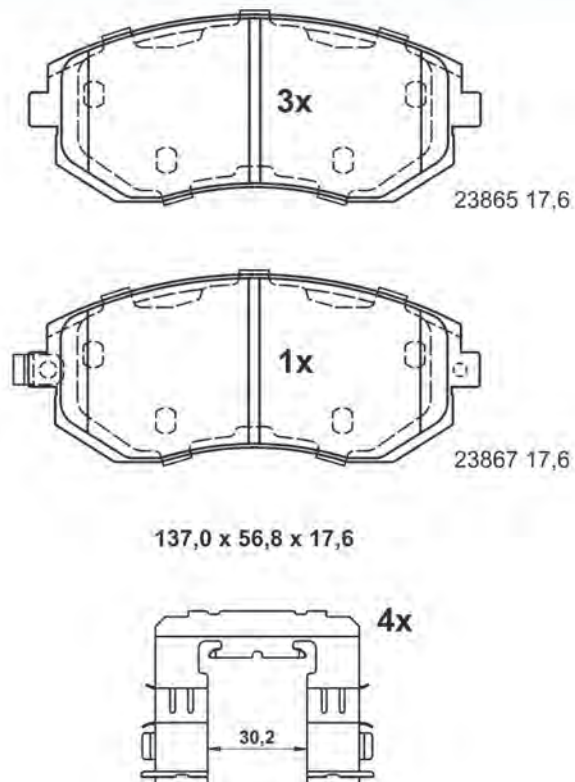

13.0460-5788.2 605788

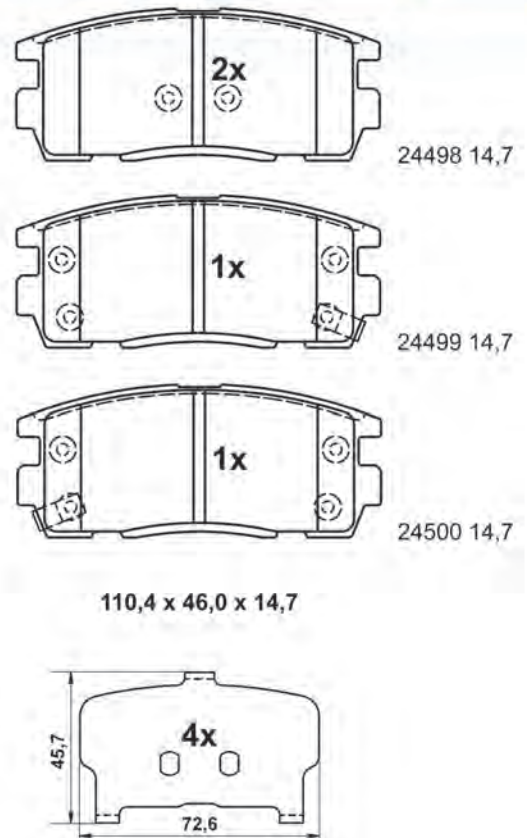

Abbildungen Scheibenbremsbeläge

Illustrations disc brake pads - Ilustraciones de pastillas - Illustrations Plaquettes de frein à disque - Illustrazioni Pastiglie Freno

13.0460-5789.2 605789

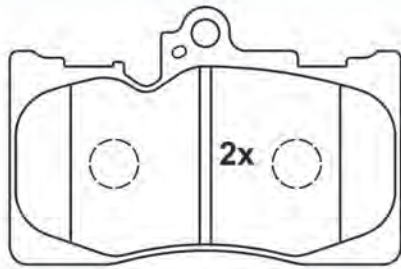

20325 17,2

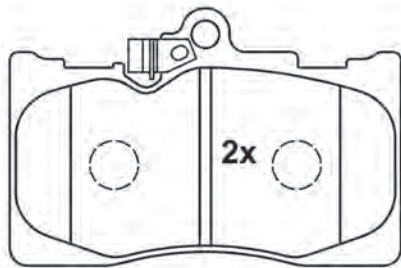

24396 17,2

118,5 x 77,7 x 17,2

13.0460-5790.2 605790

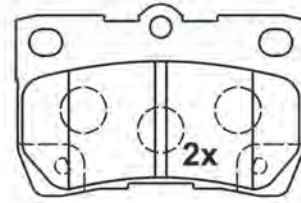

24323 15,5

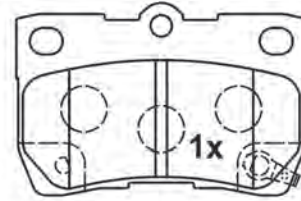

24324 15,5

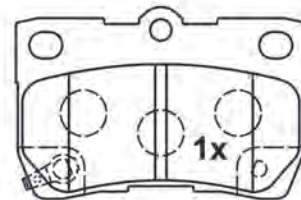

24325 15,5

88,0 x 58,2 x 15,5

13.0460-5791.2 605791



24220 17,5

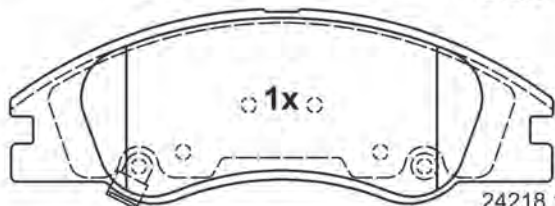

24218 17,5

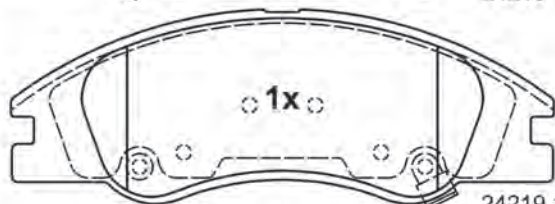

24219 17,5

164,9 x 59,0 x 17,5

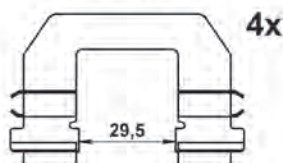

29,5

13.0460-5792.2 605792

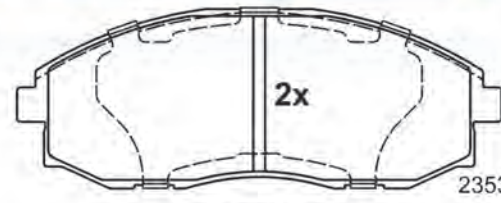

23536 17,6

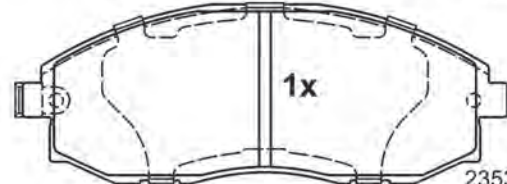

23537 17,6

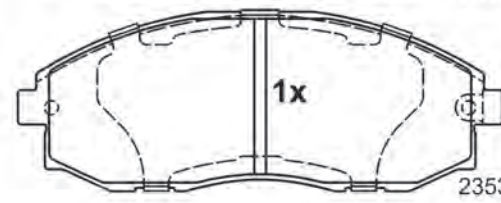

23538 17,6

147,1 x 53,6 x 17,6

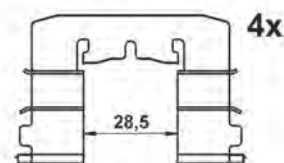

28,5

Abbildungen Scheibenbremsbeläge

Illustrations disc brake pads - Ilustraciones de pastillas - Illustrations Plaquettes de frein à disque - Illustrazioni Pastiglie Freno

13.0460-5793.2 605793

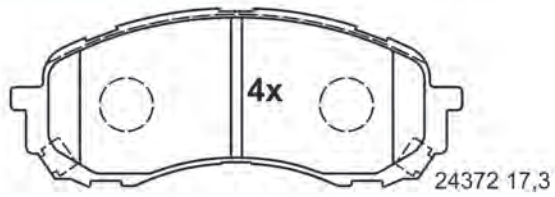

137,1 x 54,1 x 17,3

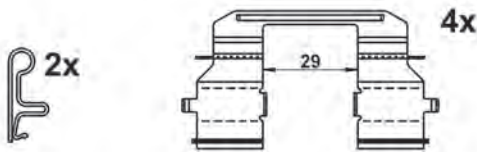
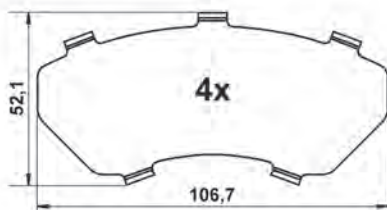

13.0460-5794.2 605794 [1]

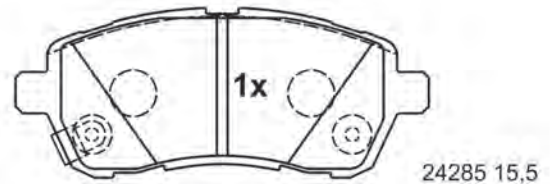
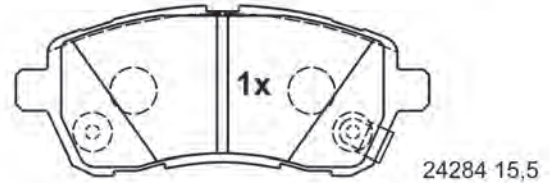
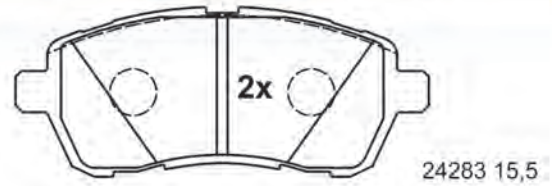

125,4 x 51,4 x 15,5

13.0460-5794.2 605794 [2]

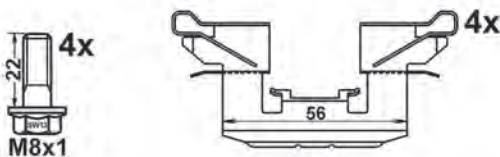
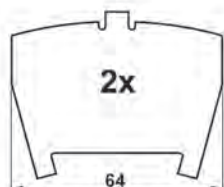
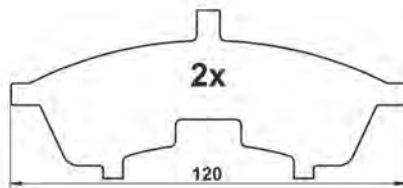

13.0460-5795.2 605795

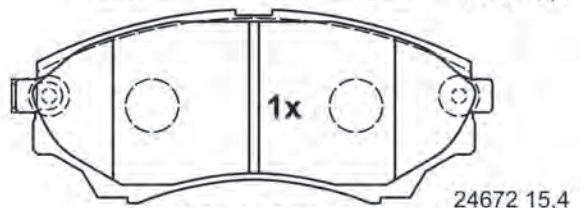
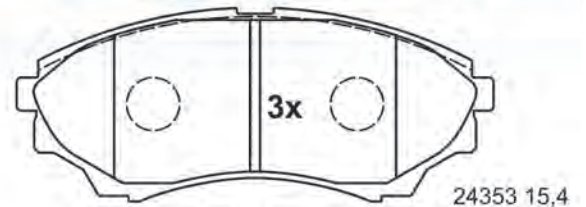

145,0 x 58,5 x 16,0

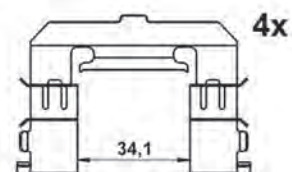
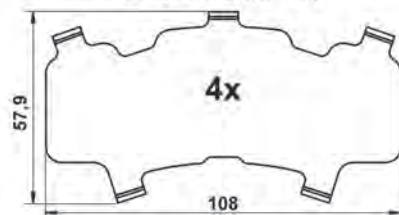

Abbildungen Scheibenbremsbeläge

Illustrations disc brake pads - Ilustraciones de pastillas - Illustrations Plaquettes de frein à disque - Illustrazioni Pastiglie Freno

13.0460-5797.2 605797 [1]

B.H.P.

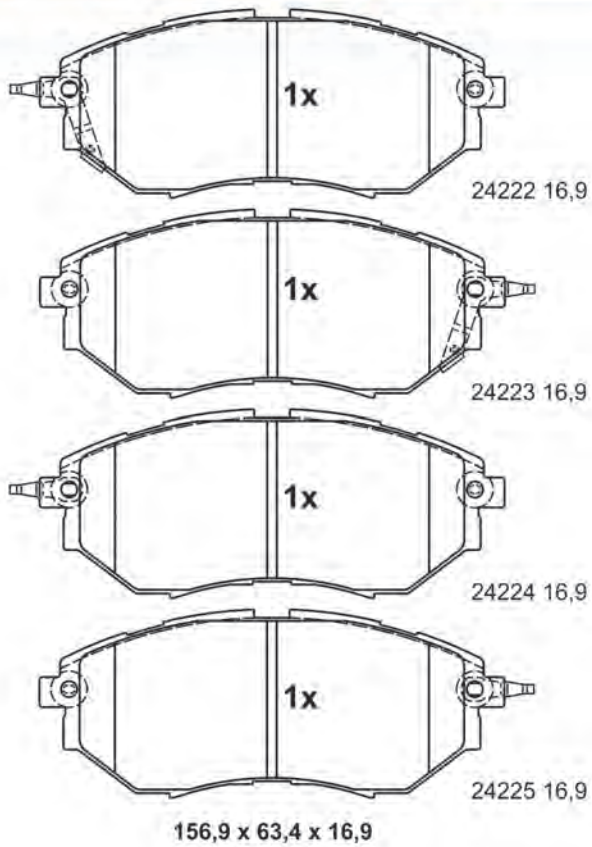

13.0460-5797.2 605797 [2]

B.H.P.

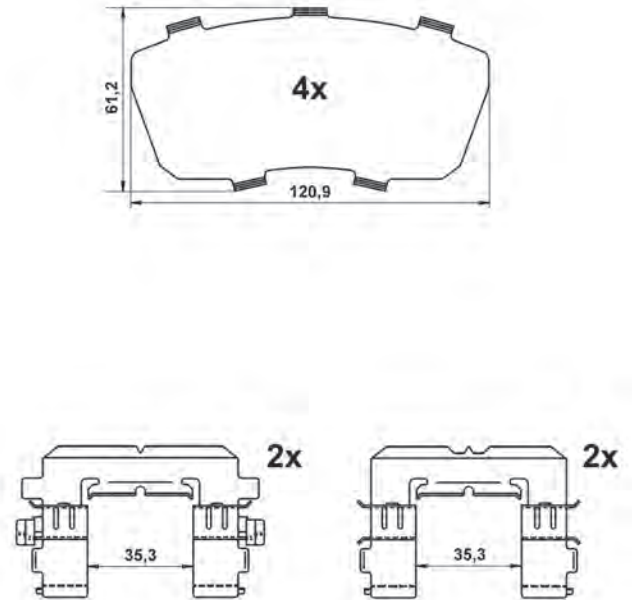

13.0460-5799.2 605799

B.H.P.

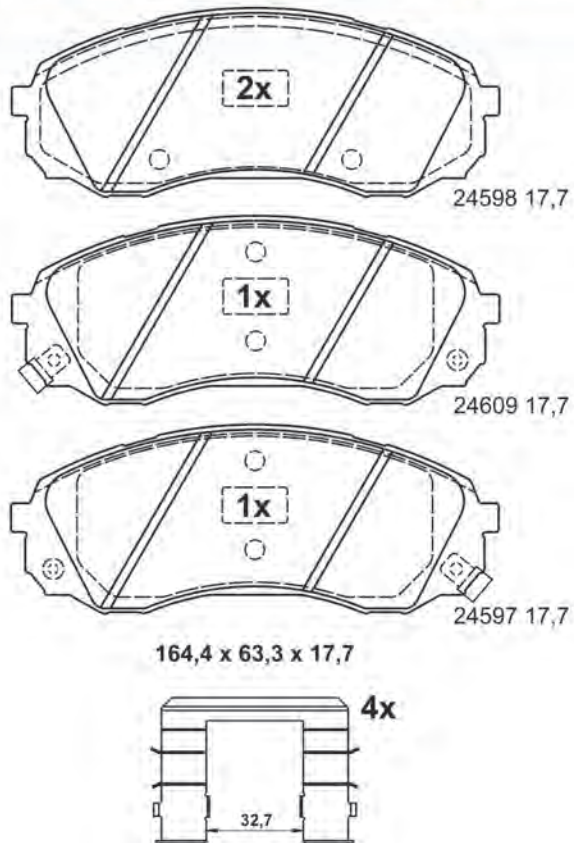

13.0460-5800.2 605800

B.H.P.

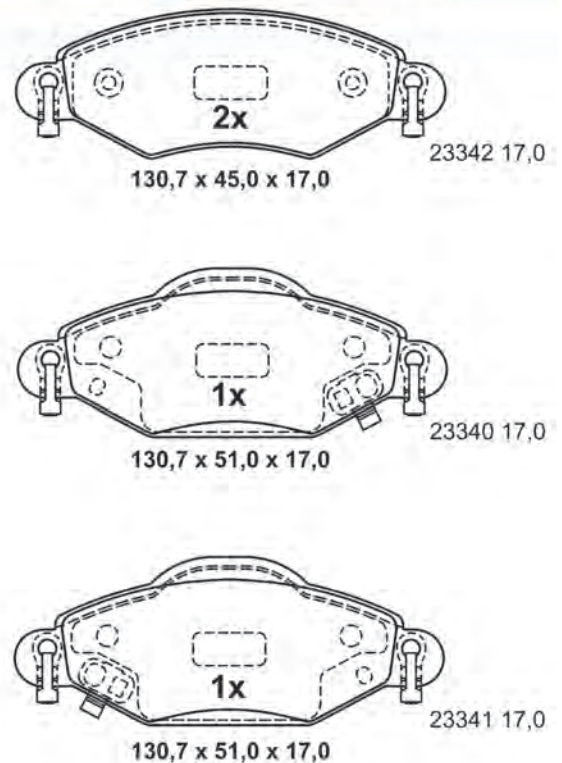

Abbildungen Scheibenbremsbeläge

Illustrations disc brake pads - Ilustraciones de pastillas - Illustrations Plaquettes de frein à disque - Illustrazioni Pastiglie Freno

13.0460-5801.2 605801



23973 17,1

116,3 x 52,4 x 17,1



13.0460-5802.2 605802

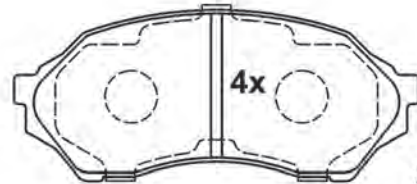

23490 15,4

123,2 x 51,8 x 15,4

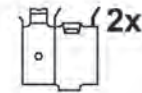

13.0460-5803.2 605803

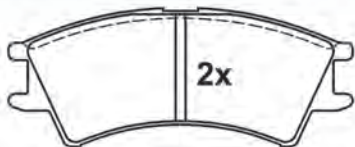

23238 16,0

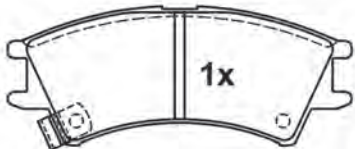

23239 16,0

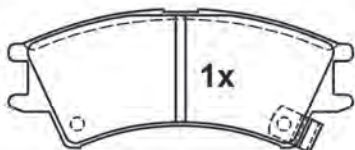

23240 16,0

104,7 x 41,7 x 16,0

13.0460-5804.2 605804

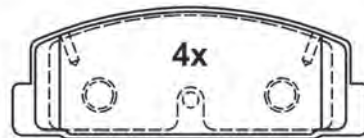

24045 13,7

107,7 x 39,4 x 13,7

Abbildungen Scheibenbremsbeläge

Illustrations disc brake pads - Ilustraciones de pastillas - Illustrations Plaquettes de frein à disque - Illustrazioni Pastiglie Freno

13.0460-5806.2 605806

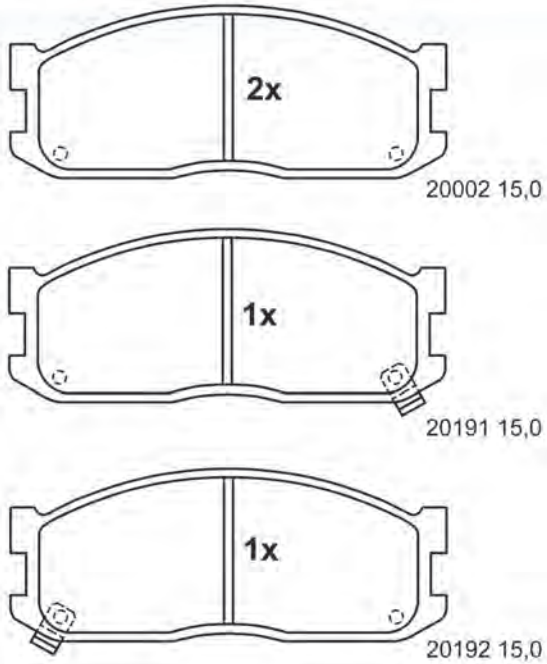

133,1 x 52,1 x 15,0

13.0460-5807.2 605807

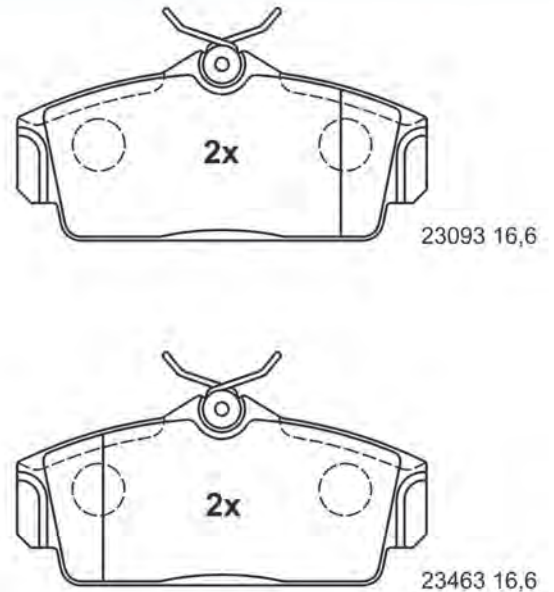

124,0 x 57,2 x 16,6

13.0460-5808.2 605808

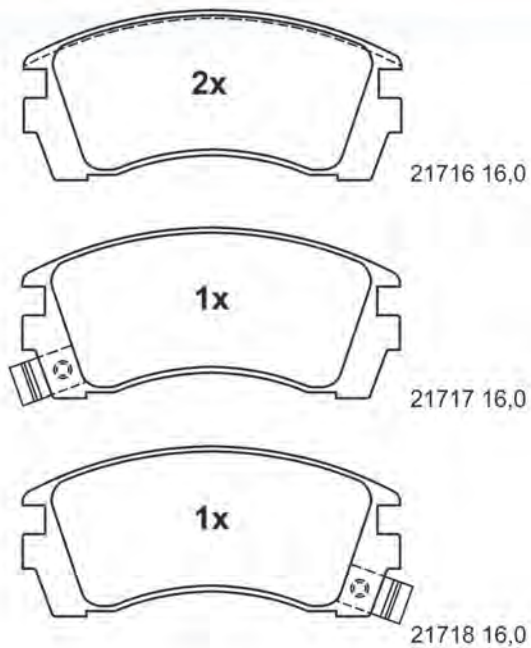

114,9 x 51,5 x 16,0

13.0460-5809.2 605809

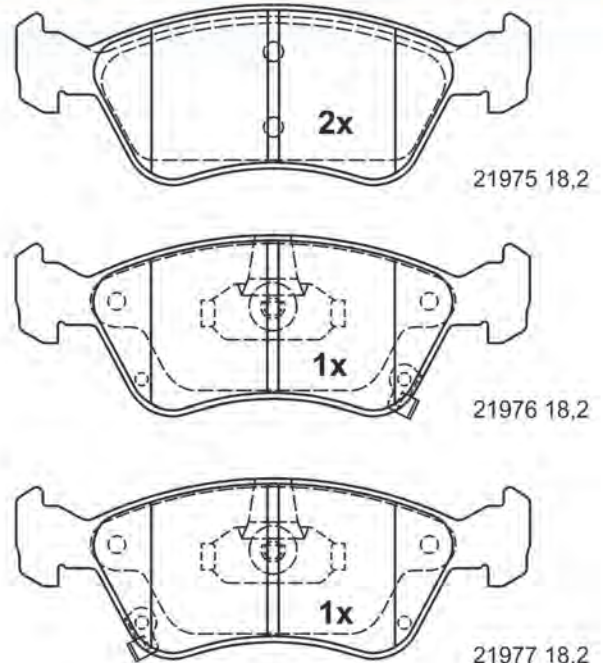

156,3 x 54,8 x 18,2



Abbildungen Scheibenbremsbeläge

Illustrations disc brake pads - Ilustraciones de pastillas - Illustrations Plaquettes de frein à disque - Illustrazioni Pastiglie Freno

13.0460-5810.2 605810

B.H.P.

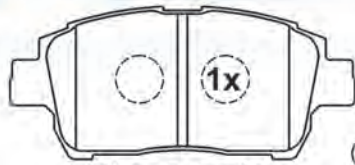

23904 16,5
(23510/24778)

116,3 x 51,6 x 16,5

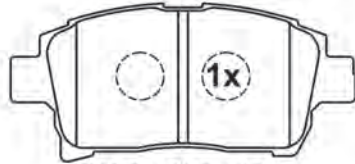

23905 16,5
(24779)

116,5 x 54,5 x 16,5

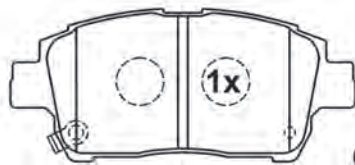

23906 16,5
(23511/24780)

116,3 x 51,6 x 16,5

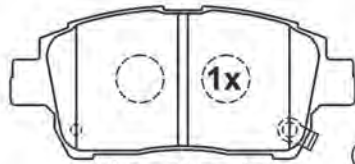

23907 16,5
(23512/24781)

116,3 x 51,6 x 16,5

13.0460-5811.2 605811

B.H.P.

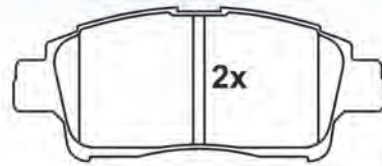

23348 16,5

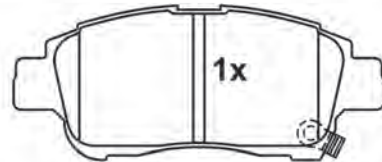

23349 16,5

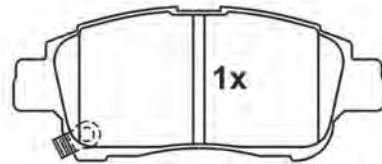

23350 16,5

112,4 x 46,7 x 16,5

13.0460-5812.2 605812

B.H.P.

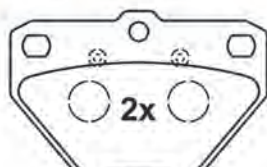

23521 14,0

78,5 x 52,0 x 14,0

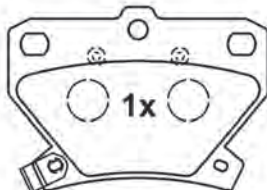

23522 14,0

78,5 x 55,6 x 14,0

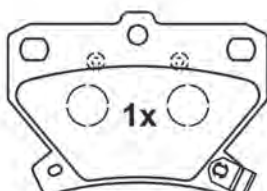

23523 14,0

78,5 x 55,6 x 14,0

13.0460-5813.2 605813

B.H.P.

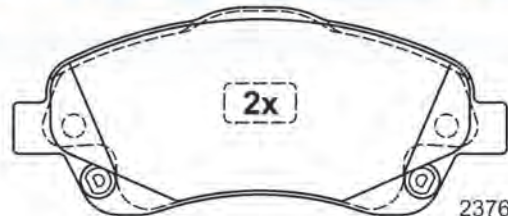

23768 19,3

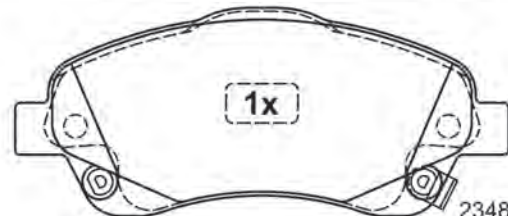

23480 19,3

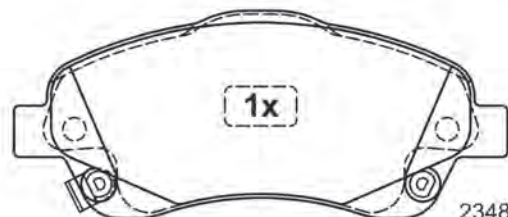

23481 19,3

150,8 x 63,0 x 19,3

Abbildungen Scheibenbremsbeläge

Illustrations disc brake pads - Ilustraciones de pastillas - Illustrations Plaquettes de frein à disque - Illustrazioni Pastiglie Freno

13.0460-5814.2 605814

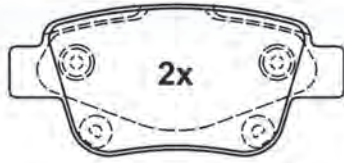

23620 16,4

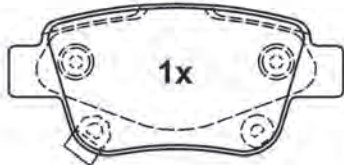

23621 16,4

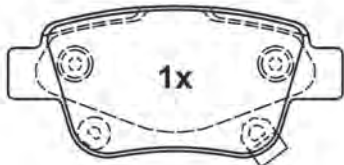

23622 16,4

101,8 x 45,9 x 16,4

13.0460-5815.2 605815

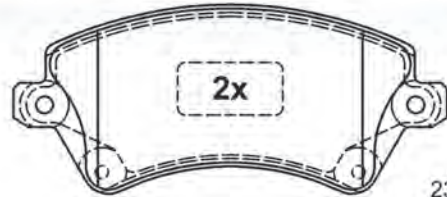

23766 17,8

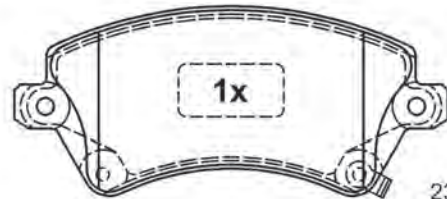

23818 17,8

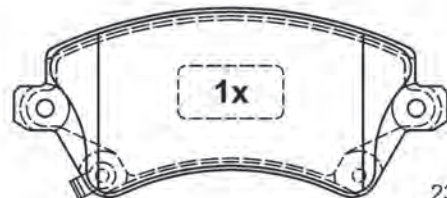

23819 17,8

131,5 x 57,3 x 17,8

13.0460-5816.2 605816

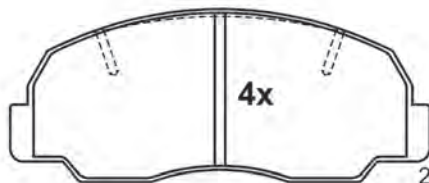

21243 14,0

127,8 x 52,3 x 14,0

13.0460-5817.2 605817

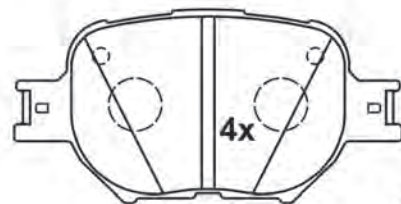

23526 17,5

117,9 x 58,6 x 17,5



Abbildungen Scheibenbremsbeläge

Illustrations disc brake pads - Ilustraciones de pastillas - Illustrations Plaquettes de frein à disque - Illustrazioni Pastiglie Freno

13.0460-5819.2 605819



23816 16,0

95,6 x 37,9 x 16,0



13.0460-5820.2 605820

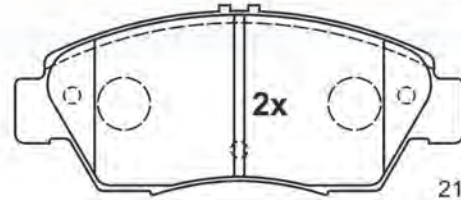

21694 16,3

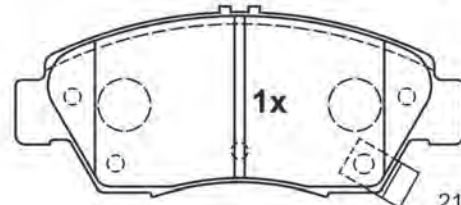

21696 16,3

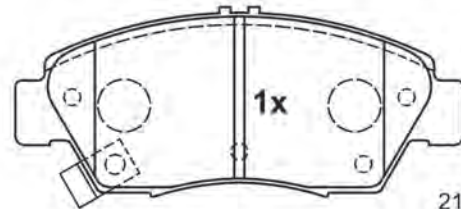

21695 16,3

136,7 x 57,4 x 16,3

13.0460-5821.2 605821

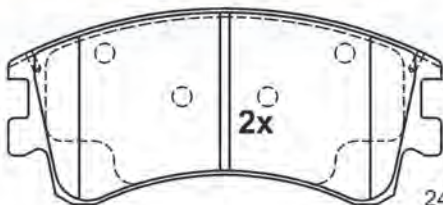

24046 18,6

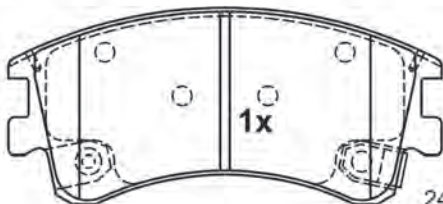

24047 18,6

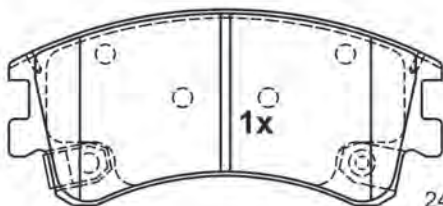

24048 18,6

131,8 x 59,5 x 18,0

13.0460-5822.2 605822

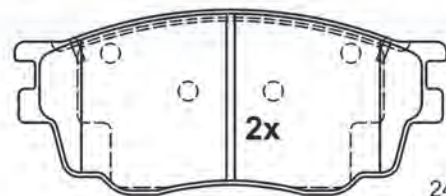

24246 16,8

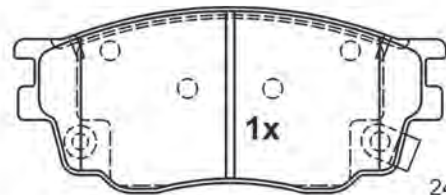

24249 16,8

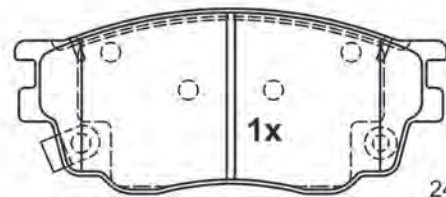

24248 16,8

131,3 x 56,1 x 16,8

Abbildungen Scheibenbremsbeläge

Illustrations disc brake pads - Ilustraciones de pastillas - Illustrations Plaquettes de frein à disque - Illustrazioni Pastiglie Freno

13.0460-5824.2 605824

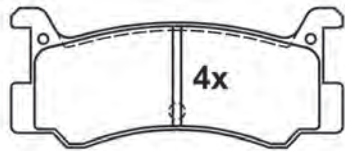

20008 13,0

101,7 x 42,2 x 13,0

13.0460-5825.2 605825 [1]

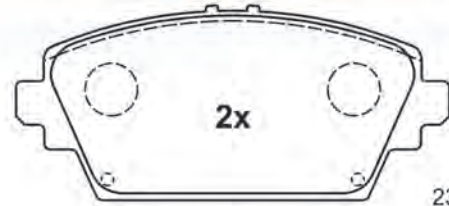

23094 16,5

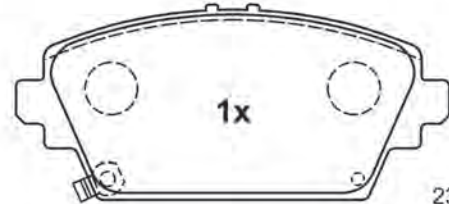

23563 16,5

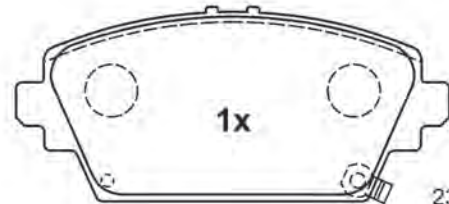

23564 16,5

131,8 x 58,5 x 16,5

13.0460-5825.2 605825 [2]

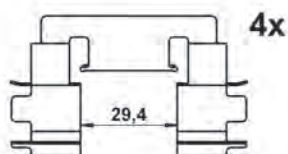
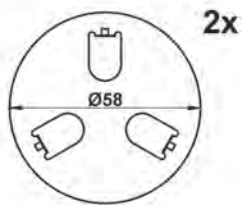

13.0460-5826.2 605826

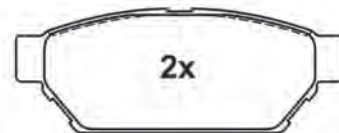

21872 14,5

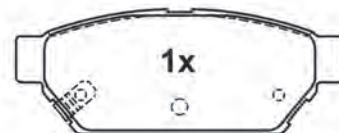

21873 14,5

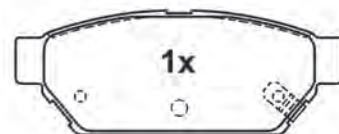

21874 14,5

99,0 x 37,8 x 14,5



Abbildungen Scheibenbremsbeläge

Illustrations disc brake pads - Ilustraciones de pastillas - Illustrations Plaquettes de frein à disque - Illustrazioni Pastiglie Freno

13.0460-5827.2 605827

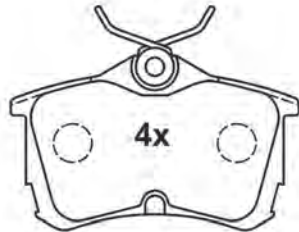

23527 14,5

87,1 x 53,0 x 14,5



13.0460-5829.2 605829

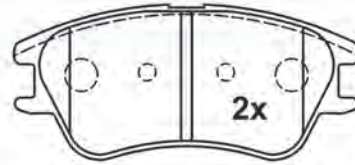

24277 16,0

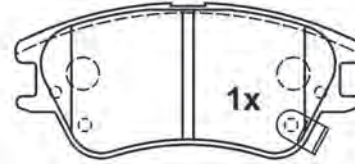

24397 16,0

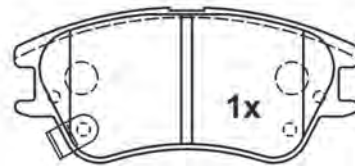

24398 16,0

104,7 x 47,3 x 16,0

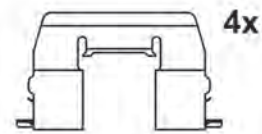

13.0460-5830.2 605830

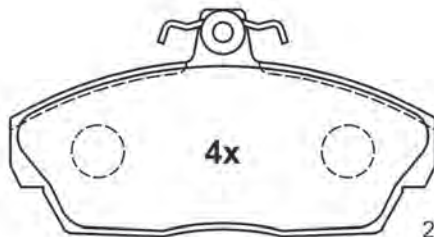

23158 17,5

129,1 x 68,7 x 17,5

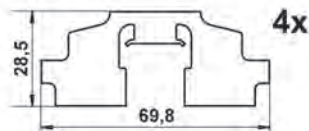
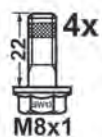

13.0460-5831.2 605831

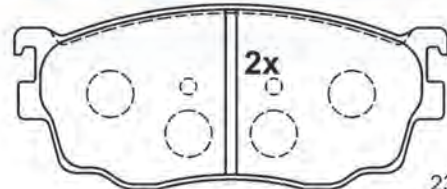

23777 16,0

131,5 x 56,2 x 16,0

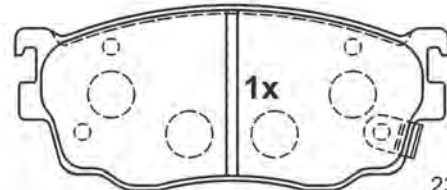

23778 17,0

131,5 x 56,2 x 17,0

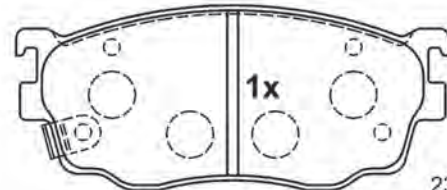

23779 17,0

131,5 x 56,2 x 17,0

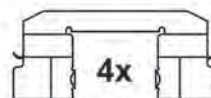

Abbildungen Scheibenbremsbeläge

Illustrations disc brake pads - Ilustraciones de pastillas - Illustrations Plaquettes de frein à disque - Illustrazioni Pastiglie Freno

13.0460-5832.2 605832

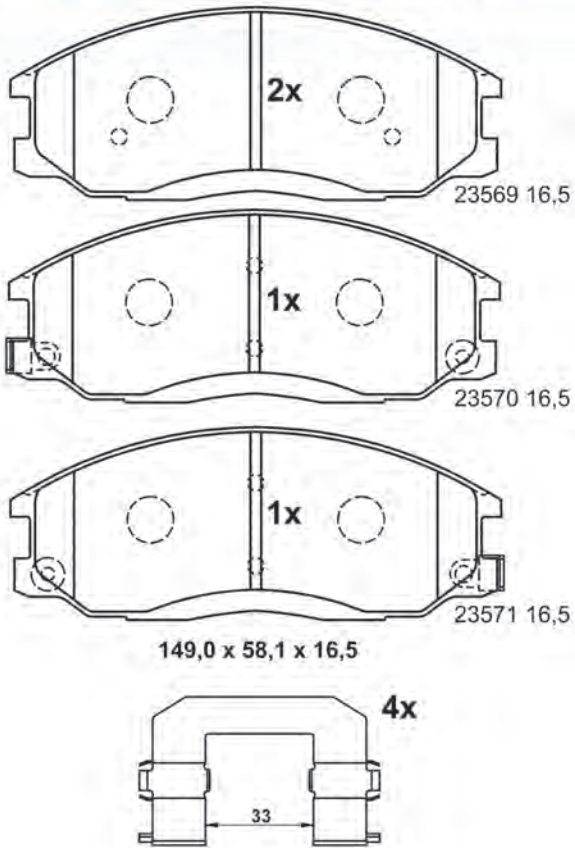

13.0460-5833.2 605833

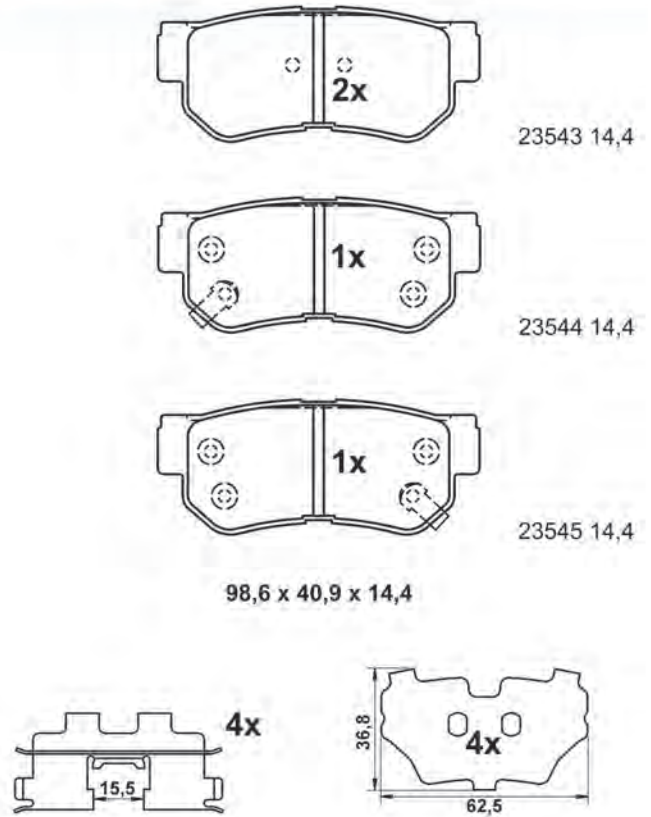

13.0460-5834.2 605834

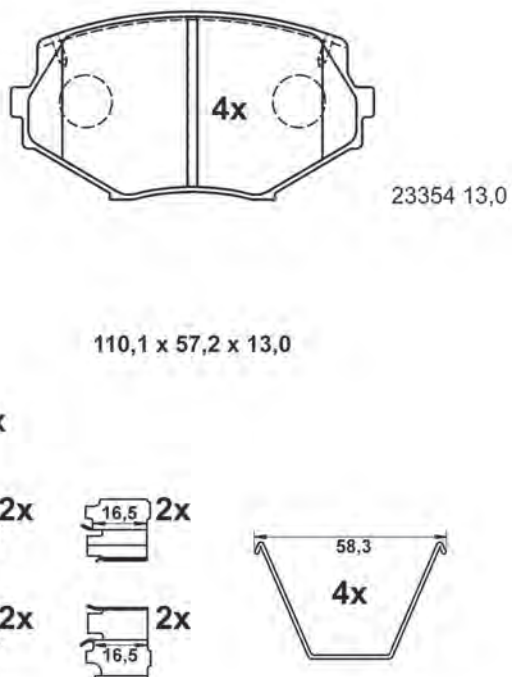

13.0460-5835.2 605835

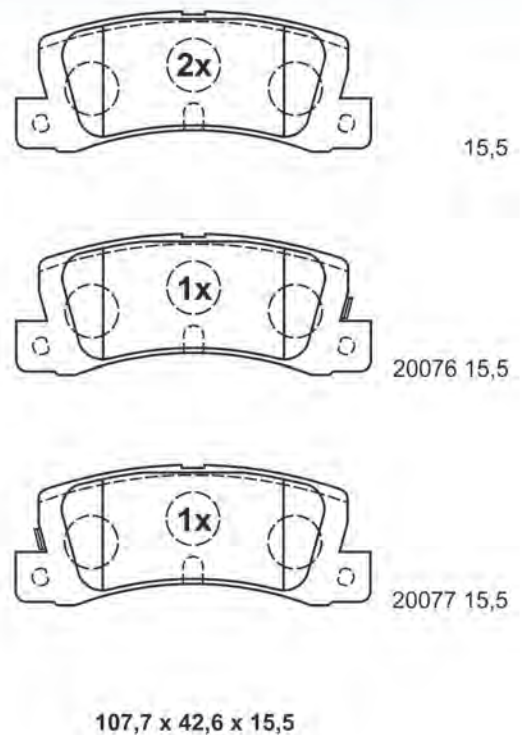

Abbildungen Scheibenbremsbeläge

Illustrations disc brake pads - Ilustraciones de pastillas - Illustrations Plaquettes de frein à disque - Illustrazioni Pastiglie Freno

13.0460-5836.2 605836

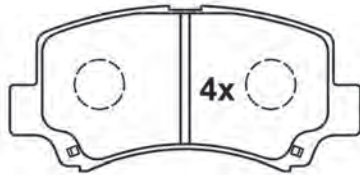

23662 15,0

106,1 x 50,1 x 15,0

 2x

13.0460-5837.2 605837

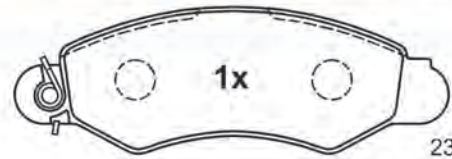

23296 14,5

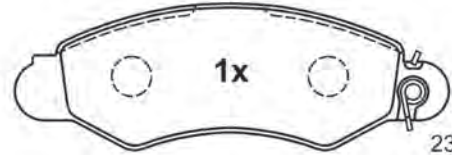

23297 14,5

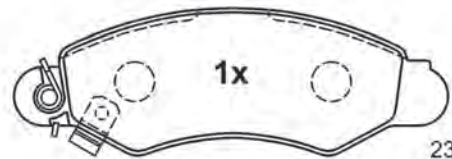

23298 14,5

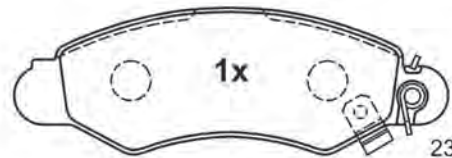

23299 14,5

131,0 x 44,5 x 14,5

13.0460-5838.2 605838

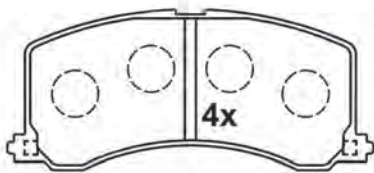

23400 15,5

111,5 x 48,7 x 15,5

 4x

13.0460-5839.2 605839

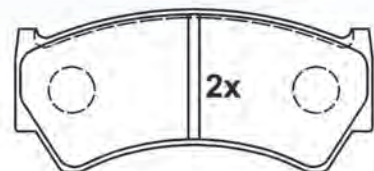

23795 15,0

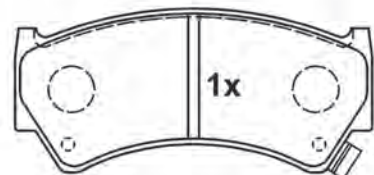

23796 15,0

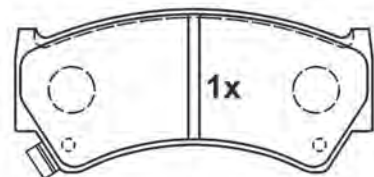

23797 15,0

108,6 x 47,9 x 15,0

Abbildungen Scheibenbremsbeläge

Illustrations disc brake pads - Ilustraciones de pastillas - Illustrations Plaquettes de frein à disque - Illustrazioni Pastiglie Freno

13.0460-5840.2 605840

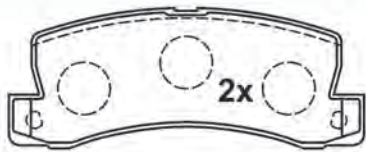

15,0

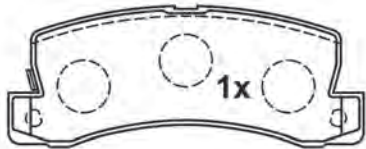

23833 15,0

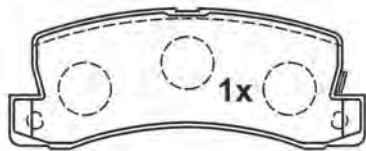

23834 15,0

107,7 x 42,6 x 15,0

13.0460-5841.2 605841

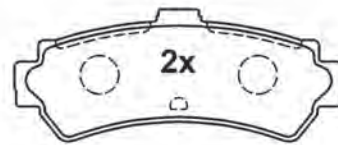

23023 14,8

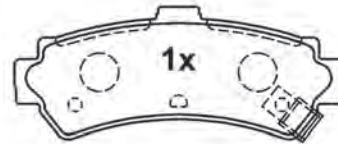

23024 14,8

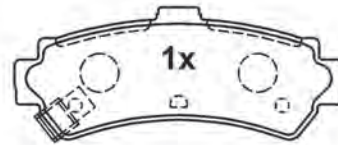

23025 14,8

99,4 x 40,1 x 14,8

13.0460-5842.2 605842

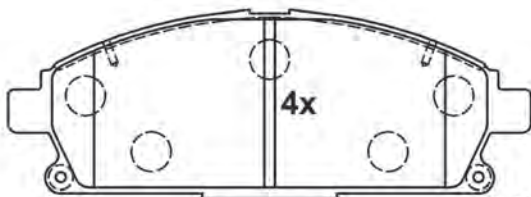

23420 16,5

158,8 x 56,3 x 16,5

13.0460-5843.2 605843

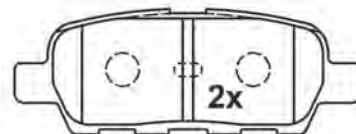

23871 14,3

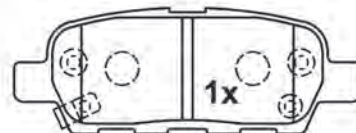

23872 14,3

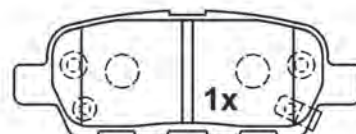

14,3

105,5 x 38,1 x 14,3

Abbildungen Scheibenbremsbeläge

Illustrations disc brake pads - Ilustraciones de pastillas - Illustrations Plaquettes de frein à disque - Illustrazioni Pastiglie Freno

13.0460-5844.2 605844

B x H x D

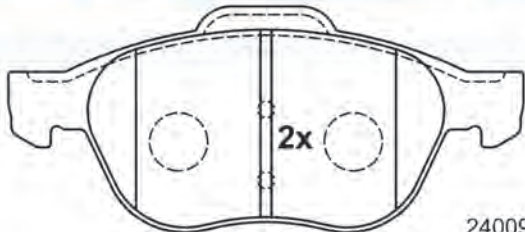

156,3 x 68,6 x 17,5

24009 17,5

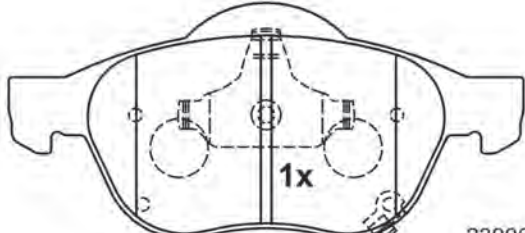

155,1 x 71,1 x 17,5

23996 17,5

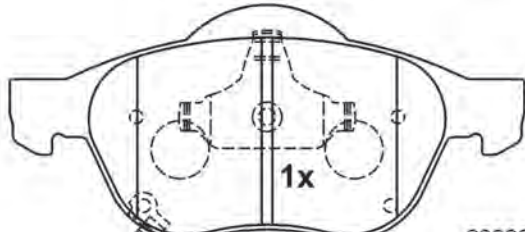

155,1 x 71,1 x 17,5

23998 17,5

13.0460-5845.2 605845

B x H x D

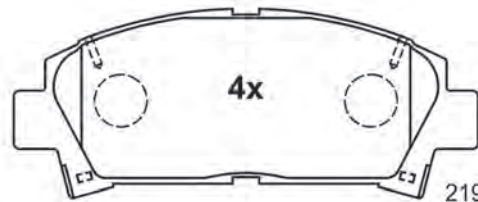

21961 15,5

140,9 x 56,0 x 15,5



13.0460-5846.2 605846

B x H x D

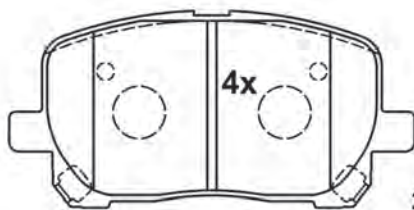

23836 17,0

123,1 x 59,6 x 17,0

13.0460-5847.2 605847

B x H x D

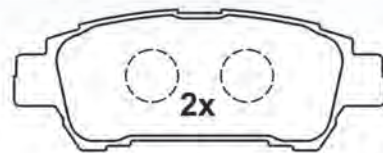

23646 16,5

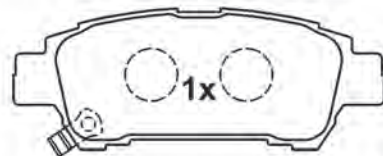

23647 16,5

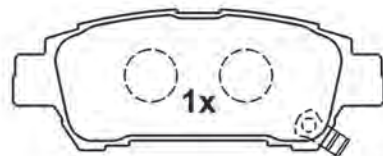

23648 16,5

112,8 x 43,0 x 16,5

Abbildungen Scheibenbremsbeläge

Illustrations disc brake pads - Ilustraciones de pastillas - Illustrations Plaquettes de frein à disque - Illustrazioni Pastiglie Freno

13.0460-5848.2 605848

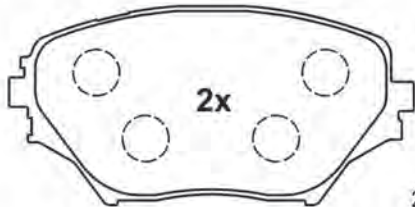

23585 17,4

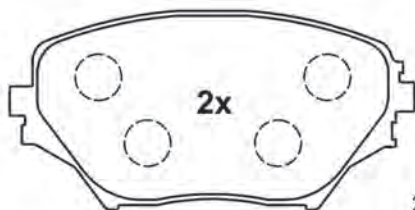

23586 17,4

123,0 x 60,4 x 17,4

13.0460-5849.2 605849

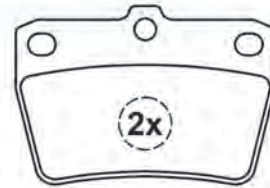

23656 14,0

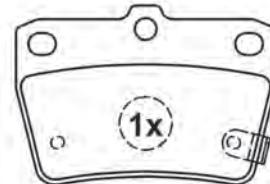

23658 14,0

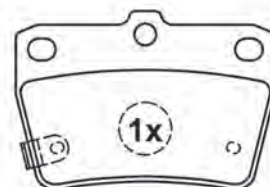

23657 14,0

78,5 x 54,1 x 14,0

13.0460-5850.2 605850

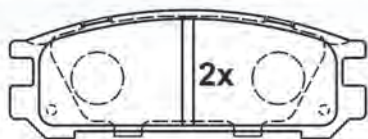

21703 15,0

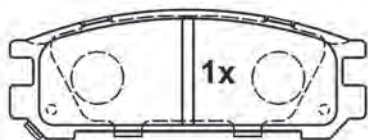

21704 15,0

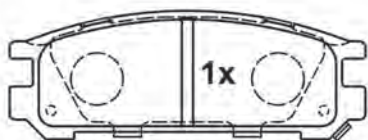

21705 15,0

107,8 x 38,7 x 15,0

13.0460-5851.2 605851

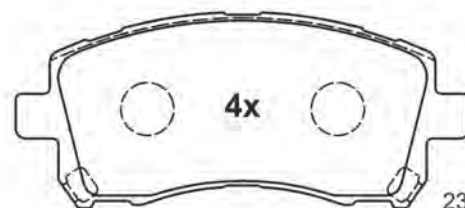

23558 17,2

137,7 x 59,6 x 17,2

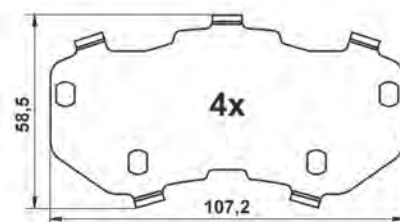

Abbildungen Scheibenbremsbeläge

Illustrations disc brake pads - Ilustraciones de pastillas - Illustrations Plaquettes de frein à disque - Illustrazioni Pastiglie Freno

13.0460-5852.2 605852

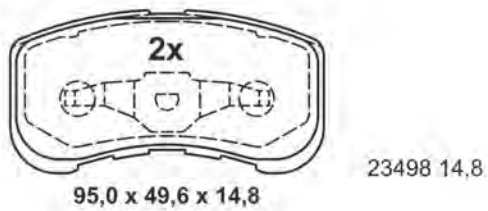
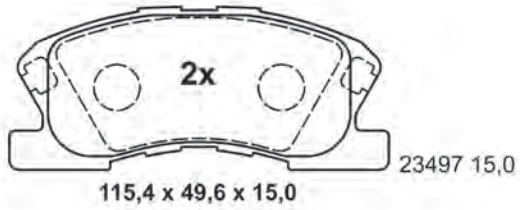

13.0460-5853.2 605853

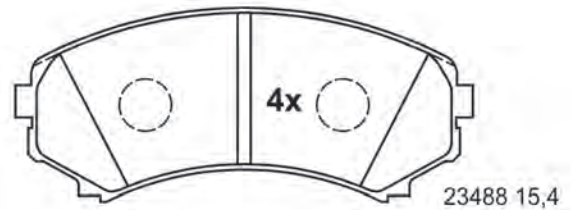

139,0 x 58,6 x 15,4



13.0460-5854.2 605854

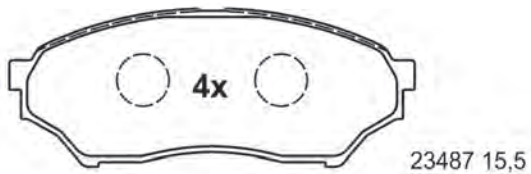

123,0 x 47,9 x 15,5

13.0460-5855.2 605855

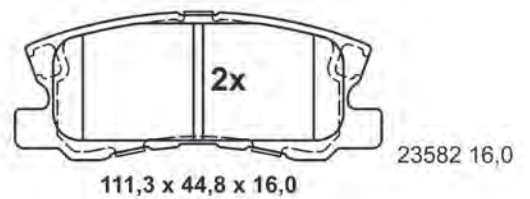

111,3 x 44,8 x 16,0

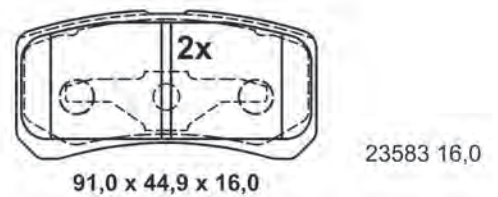

91,0 x 44,9 x 16,0

Abbildungen Scheibenbremsbeläge

Illustrations disc brake pads - Ilustraciones de pastillas - Illustrations Plaquettes de frein à disque - Illustrazioni Pastiglie Freno

13.0460-5856.2 605856

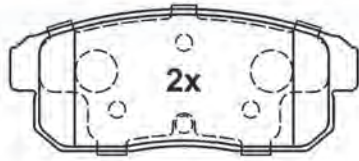

24039 14,4

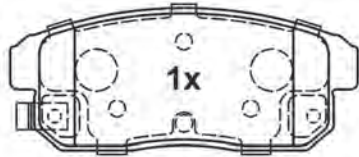

24040 14,4

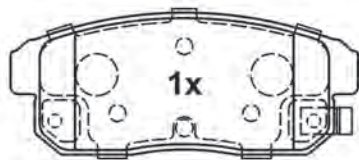

24041 14,4

105,6 x 43,1 x 14,4

13.0460-5857.2 605857

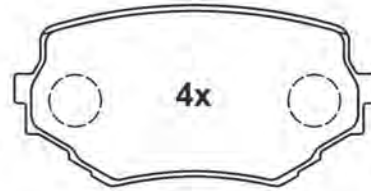

23313 15,0

110,1 x 55,0 x 15,0

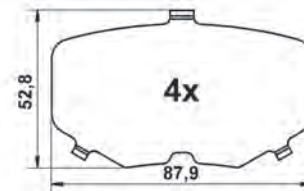

13.0460-5859.2 605859

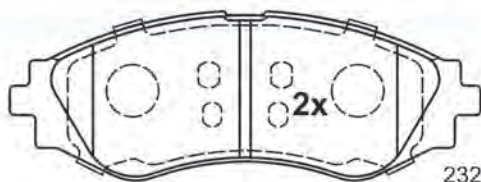

23234 16,9

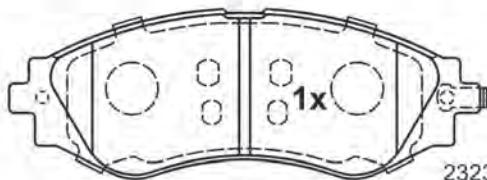

23235 16,9

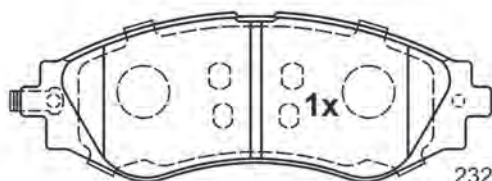

23236 16,9

143,0 x 51,2 x 16,9

13.0460-5860.2 605860 [1]

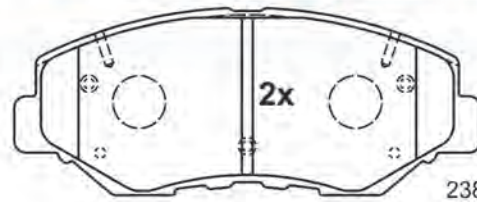

23868 17,1

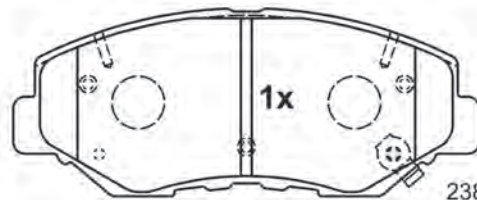

23869 17,1

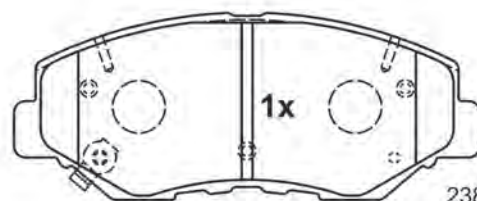

23870 17,1

141,7 x 56,7 x 17,1



Abbildungen Scheibenbremsbeläge

Illustrations disc brake pads - Ilustraciones de pastillas - Illustrations Plaquettes de frein à disque - Illustrazioni Pastiglie Freno

13.0460-5860.2 605860 [2]

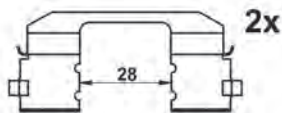
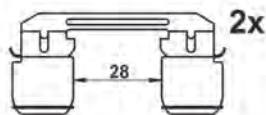
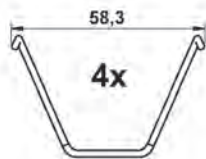
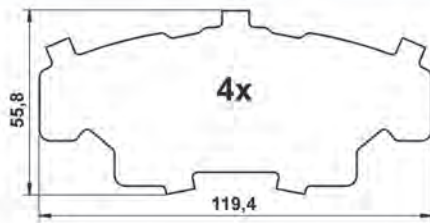

13.0460-5861.2 605861

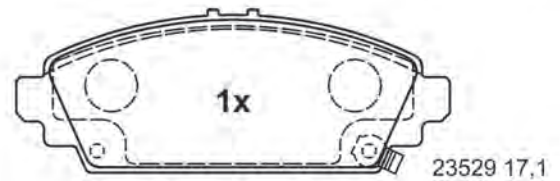
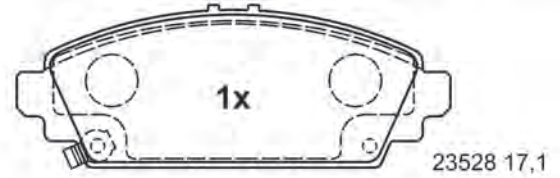
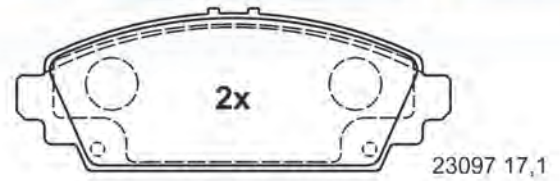

131,7 x 49,2 x 17,1

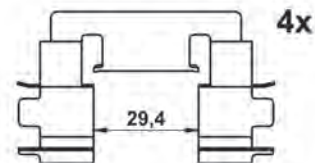

13.0460-5862.2 605862

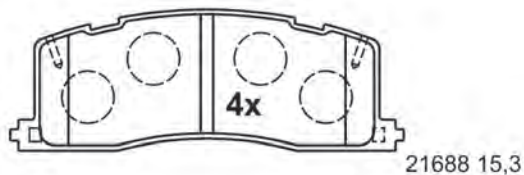

119,7 x 42,8 x 15,3

13.0460-5863.2 605863

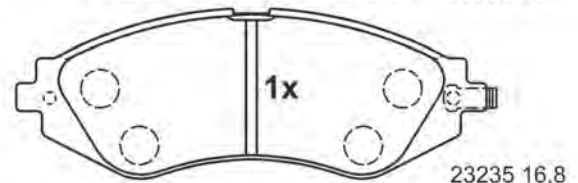
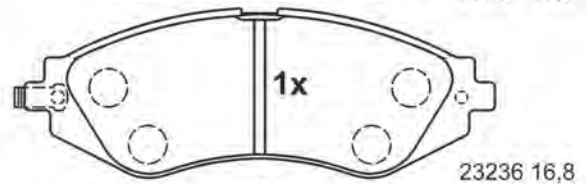
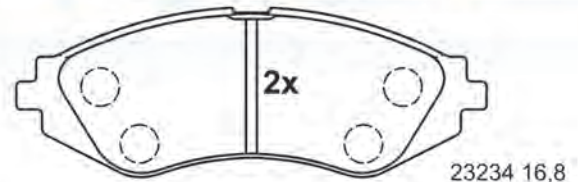

143,0 x 51,4 x 16,8

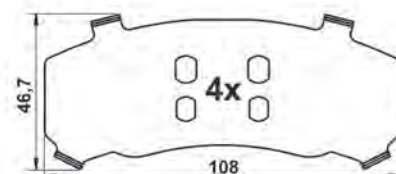

Abbildungen Scheibenbremsbeläge

Illustrations disc brake pads - Ilustraciones de pastillas - Illustrations Plaquettes de frein à disque - Illustrazioni Pastiglie Freno

13.0460-5864.2 605864



21907 15,5

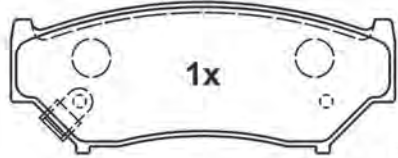

21908 15,5

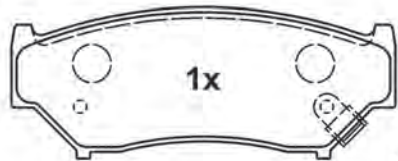

21909 15,5

116,6 x 45,6 x 15,5

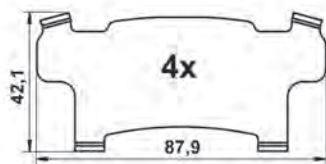

13.0460-5865.2 605865



23387 12,6

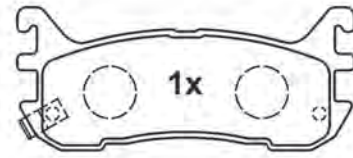

23388 12,6

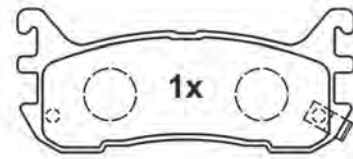

23389 12,6

102,2 x 43,0 x 12,6

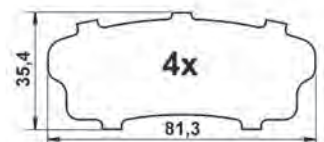
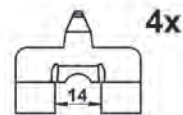

13.0460-5867.2 605867

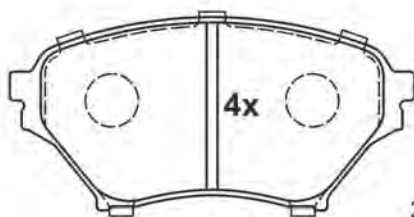

23863 14,3

123,1 x 58,5 x 14,3

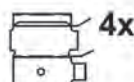

13.0460-5868.2 605868

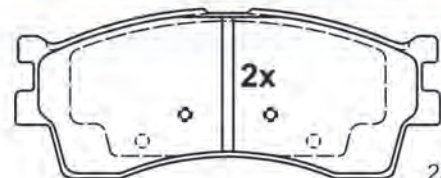

23873 16,5

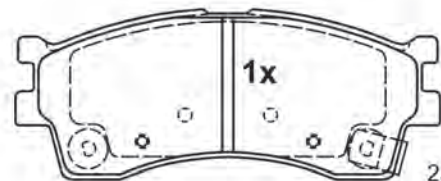

23874 16,5

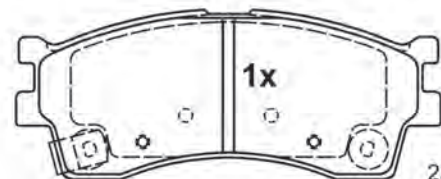

23875 16,5

129,0 x 51,3 x 16,5

Abbildungen Scheibenbremsbeläge

Illustrations disc brake pads - Ilustraciones de pastillas - Illustrations Plaquettes de frein à disque - Illustrazioni Pastiglie Freno

13.0460-5869.2 605869

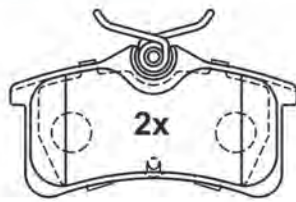

24013 14,9

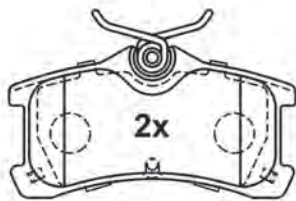

24020 14,9

87,0 x 46,0 x 14,9



13.0460-5871.2 605871

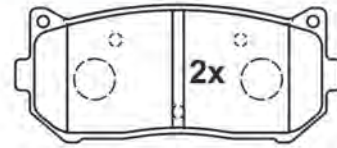

23455 13,7

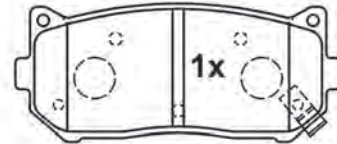

23456 13,7

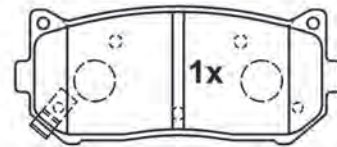

23457 13,7

98,8 x 41,8 x 13,7

13.0460-5872.2 605872

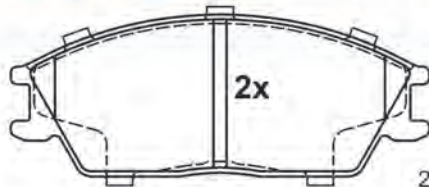

21012 15,0

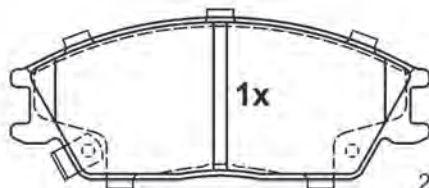

21773 15,0

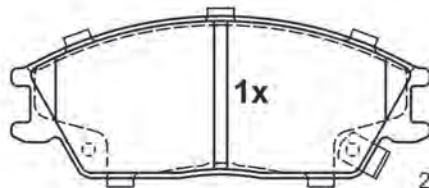

21774 15,0

127,5 x 49,0 x 15,0

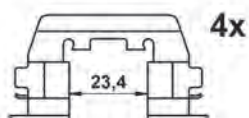

23,4

13.0460-5873.2 605873



23891 16,9

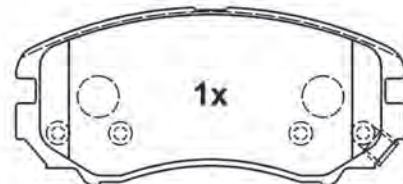

23892 16,9

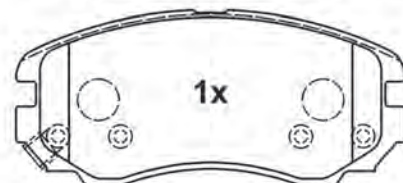

23893 16,9

131,5 x 60,3 x 16,9

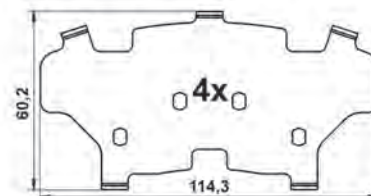

60,2

114,3

Abbildungen Scheibenbremsbeläge

Illustrations disc brake pads - Ilustraciones de pastillas - Illustrations Plaquettes de frein à disque - Illustrazioni Pastiglie Freno

13.0460-5874.2 605874

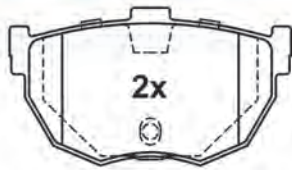

21553 14,0

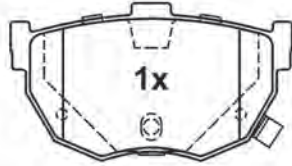

21554 14,0

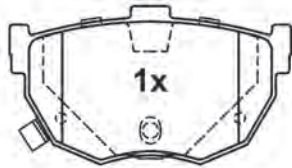

21555 14,0

85,3 x 46,6 x 14,0

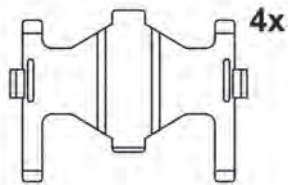

13.0460-5875.2 605875

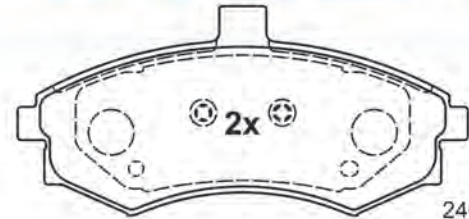

24033 17,7

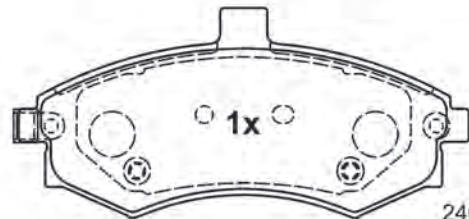

24031 17,7

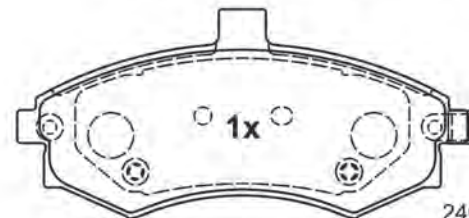

24032 17,7

137,3 x 63,5 x 17,7

13.0460-5876.2 605876

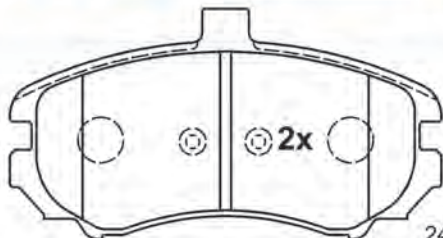

24369 17,2

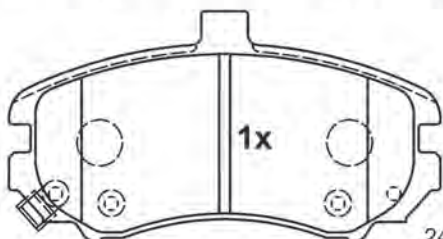

24374 17,2

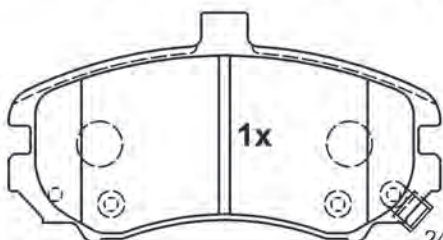

24373 17,2

131,2 x 70,1 x 17,2

13.0460-5877.2 605877

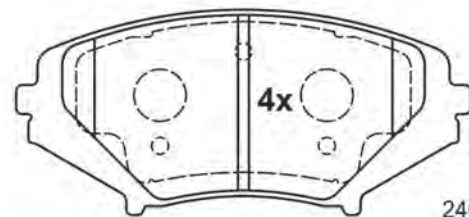

24042 16,3

137,9 x 62,1 x 16,3



Abbildungen Scheibenbremsbeläge

Illustrations disc brake pads - Ilustraciones de pastillas - Illustrations Plaquettes de frein à disque - Illustrazioni Pastiglie Freno

13.0460-5878.2 605878

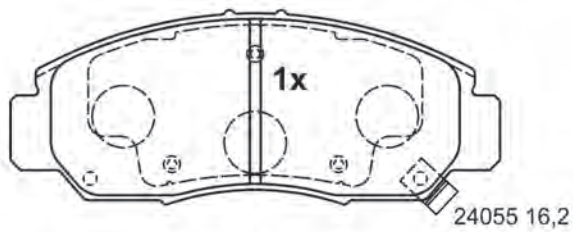
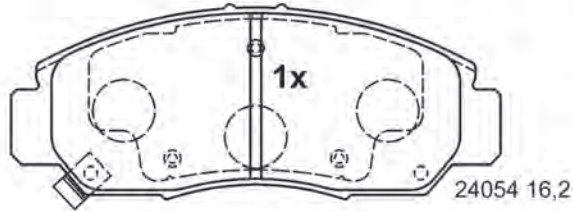
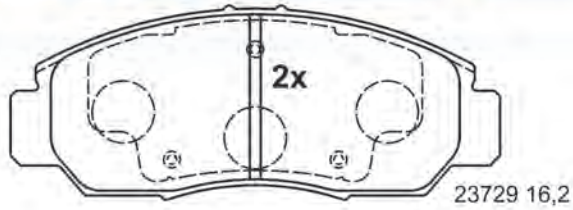

148,7 x 59,0 x 16,2

13.0460-5879.2 605879

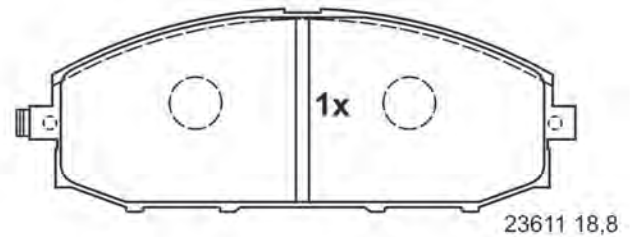
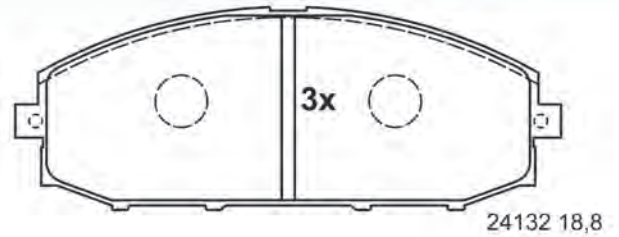

165,8 x 61,4 x 18,8

13.0460-5880.2 605880

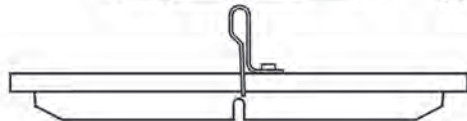
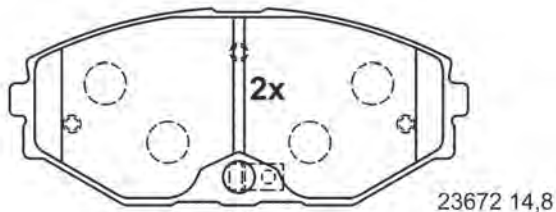
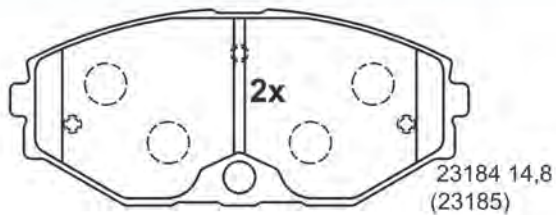

139,1 x 59,5 x 14,8

13.0460-5881.2 605881

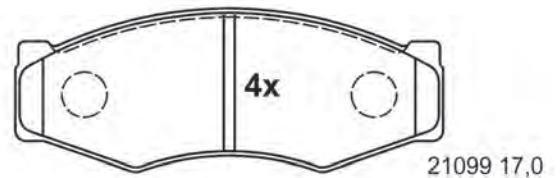

130,0 x 49,5 x 17,0

Abbildungen Scheibenbremsbeläge

Illustrations disc brake pads - Ilustraciones de pastillas - Illustrations Plaquettes de frein à disque - Illustrazioni Pastiglie Freno

13.0460-5882.2 605882

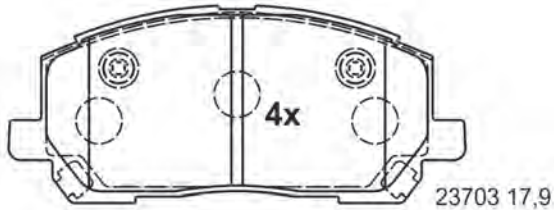

138,7 x 59,6 x 17,9

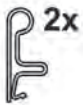

13.0460-5884.2 605884

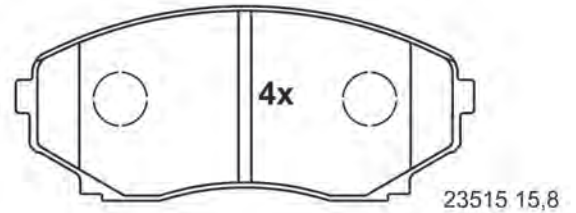

139,2 x 60,2 x 15,8

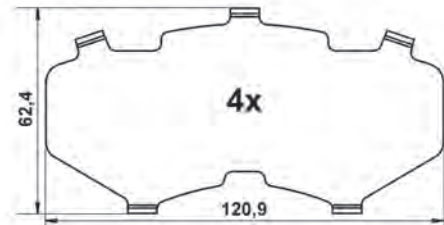

13.0460-5885.2 605885

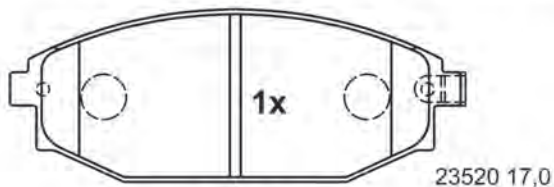
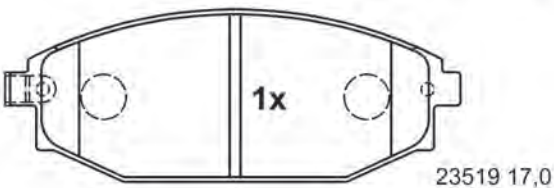
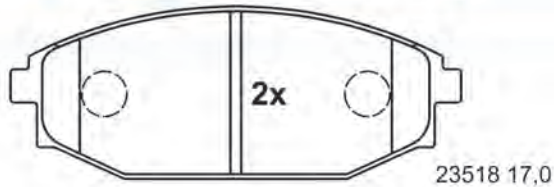

137,1 x 52,4 x 17,0

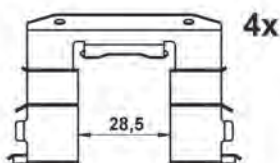

13.0460-5886.2 605886

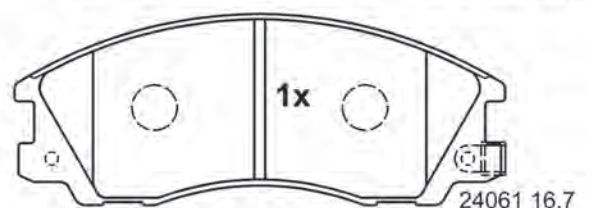
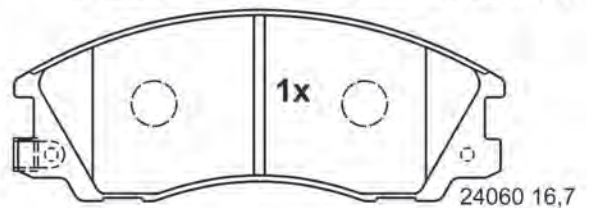
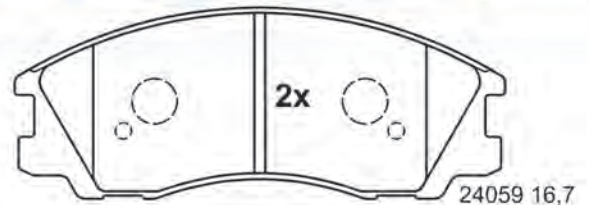

148,8 x 58,0 x 16,7

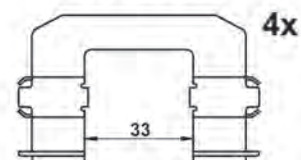

Abbildungen Scheibenbremsbeläge

Illustrations disc brake pads - Ilustraciones de pastillas - Illustrations Plaquettes de frein à disque - Illustrazioni Pastiglie Freno

13.0460-5887.2 605887

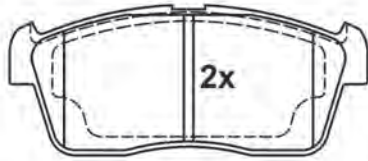

23507 15,2

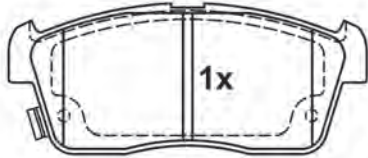

23508 15,2

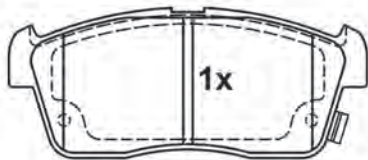

23509 15,2

108,4 x 45,6 x 15,2

13.0460-5888.2 605888

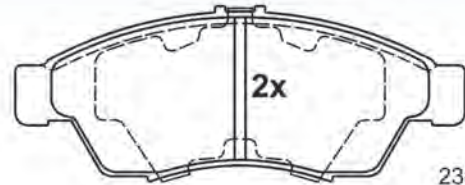

23817 16,6

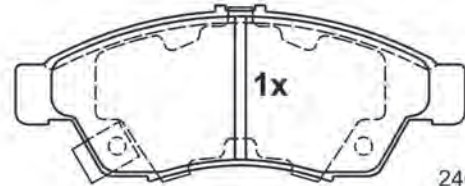

24034 16,6

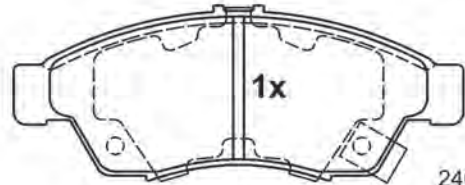

24035 16,6

136,5 x 53,3 x 16,6

13.0460-5889.2 605889

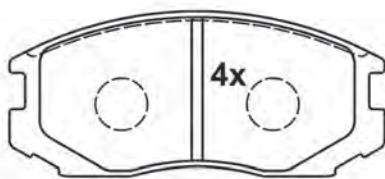

21650 15,0

114,1 x 50,0 x 15,0

13.0460-5890.2 605890

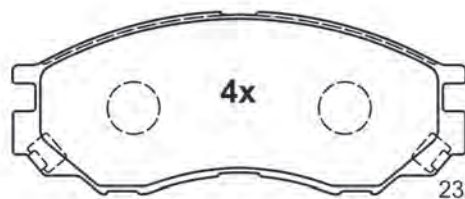

23290 15,5

137,6 x 55,1 x 15,5

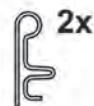

Abbildungen Scheibenbremsbeläge

Illustrations disc brake pads - Ilustraciones de pastillas - Illustrations Plaquettes de frein à disque - Illustrazioni Pastiglie Freno

13.0460-5891.2 605891

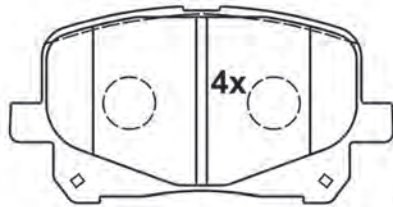

23513 17,0

116,6 x 59,4 x 17,0

13.0460-5892.2 605892

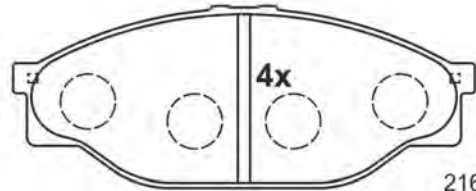

21689 15,5

140,1 x 54,9 x 15,5

13.0460-5894.2 605894

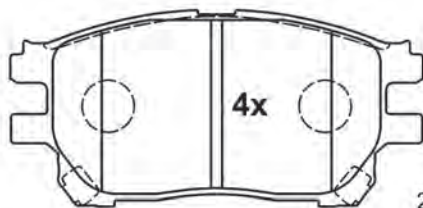

23759 17,0

125,6 x 59,5 x 17,0

13.0460-5895.2 605895

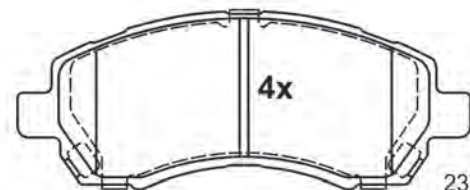

23780 16,7

137,8 x 53,8 x 16,7

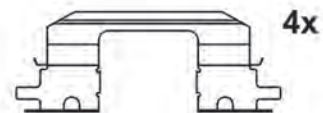
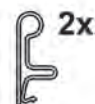

Abbildungen Scheibenbremsbeläge

Illustrations disc brake pads - Ilustraciones de pastillas - Illustrations Plaquettes de frein à disque - Illustrazioni Pastiglie Freno

13.0460-5896.2 605896

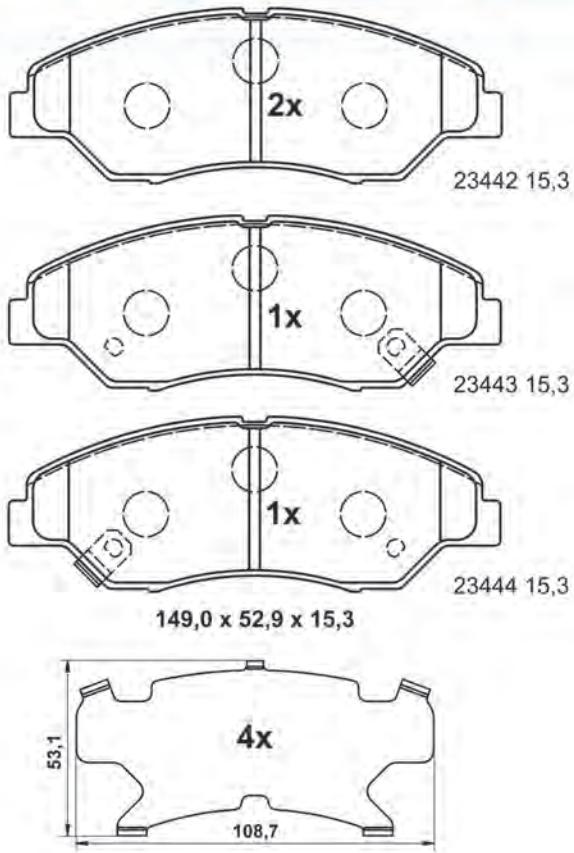

13.0460-5897.2 605897

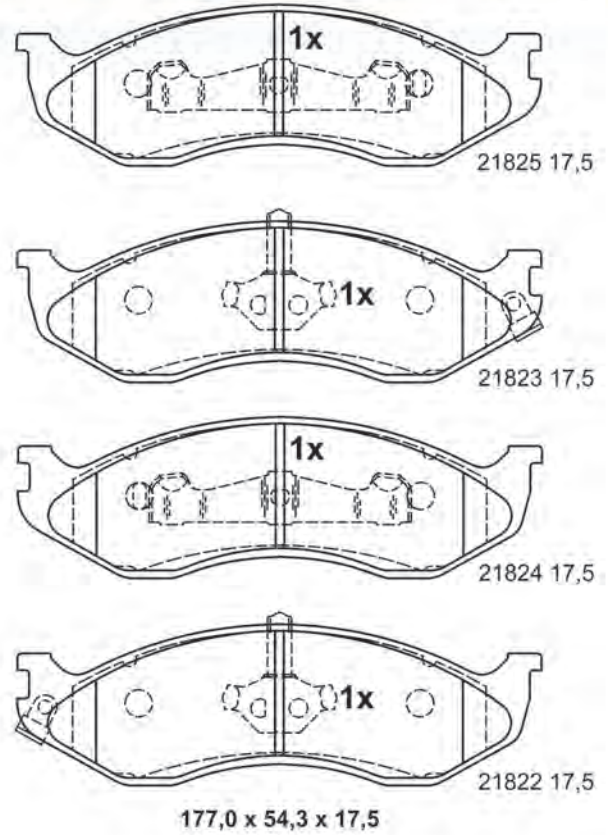

13.0460-5898.2 605898

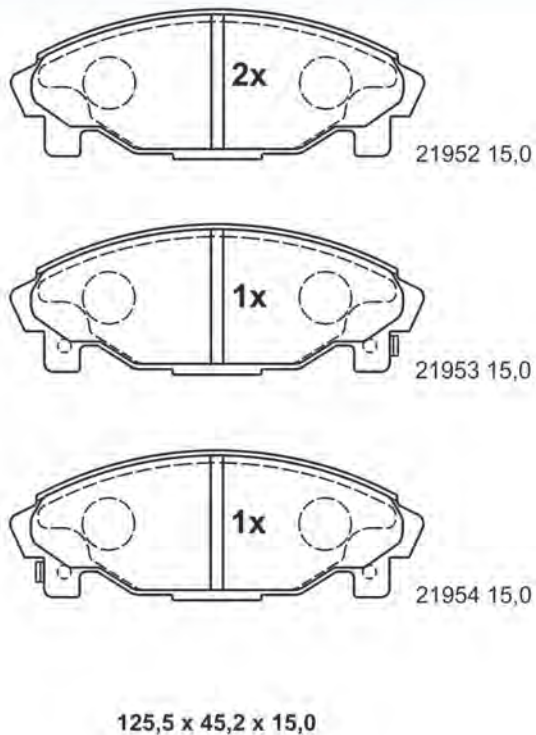

13.0460-5899.2 605899

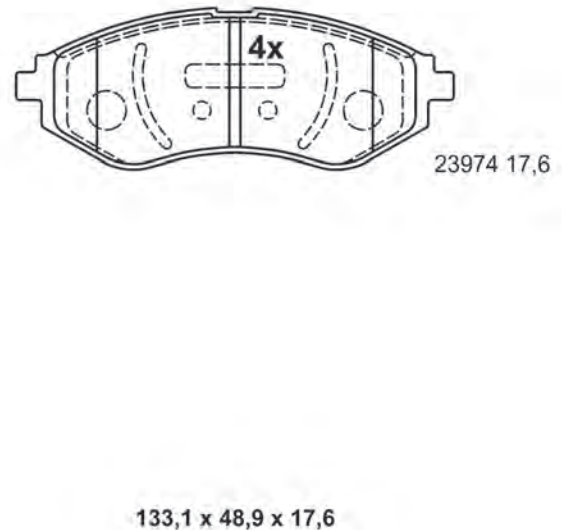

Abbildungen Scheibenbremsbeläge

Illustrations disc brake pads - Ilustraciones de pastillas - Illustrations Plaquettes de frein à disque - Illustrazioni Pastiglie Freno

13.0460-5916.2 605916

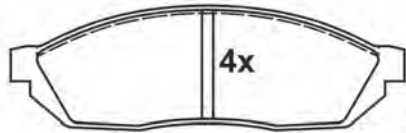

20731 15,3

119,4 x 38,2 x 15,3

13.0460-5919.2 605919

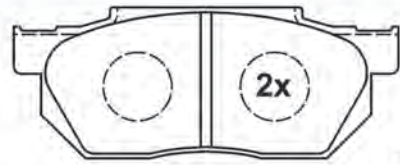

20959 15,0

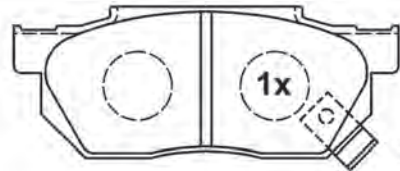

20193 15,0

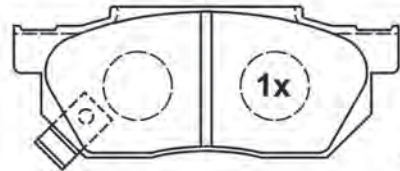

20194 15,0

115,8 x 45,0 x 15,0

13.0460-5920.2 605920

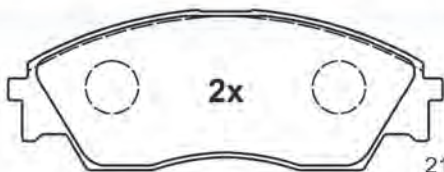

21322 15,0

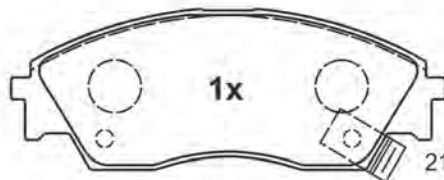

21323 15,0

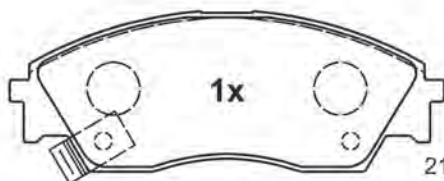

21324 15,0

132,2 x 50,0 x 15,0

13.0460-5923.2 605923

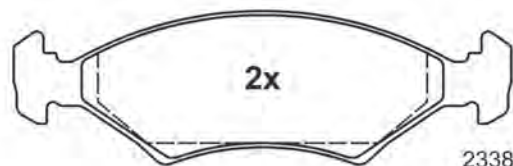

23384 18,4

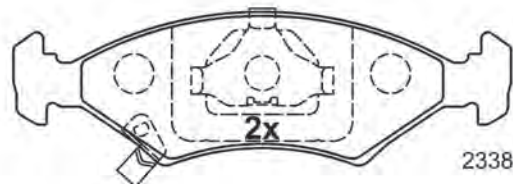

23385 18,3

151,3 x 46,4 x 18,3

Abbildungen Scheibenbremsbeläge

Illustrations disc brake pads - Ilustraciones de pastillas - Illustrations Plaquettes de frein à disque - Illustrazioni Pastiglie Freno

13.0460-5924.2 605924



21832 14,9

61,7 x 51,1 x 14,9

13.0460-5926.2 605926

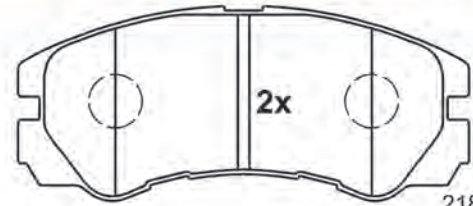

21845 16,5

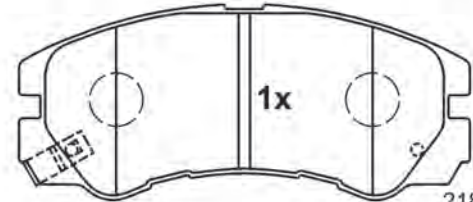

21846 16,5

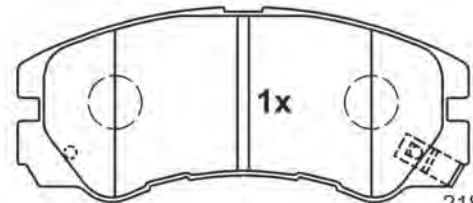

21847 16,5

137,7 x 58,6 x 16,5

13.0460-5927.2 605927

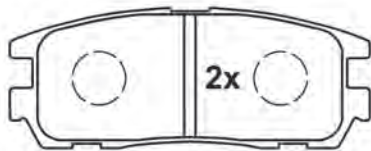

21875 16,0

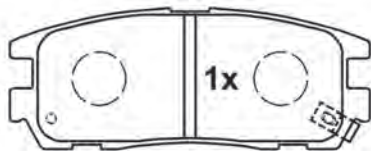

21876 16,0

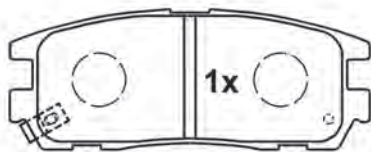

21877 16,0

109,6 x 42,8 x 16,0

13.0460-5929.2 605929

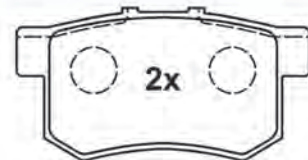

21719 15,0

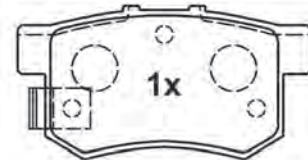

21720 15,0

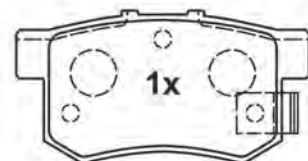

21721 15,0

88,9 x 47,1 x 15,0

Abbildungen Scheibenbremsbeläge

Illustrations disc brake pads - Ilustraciones de pastillas - Illustrations Plaquettes de frein à disque - Illustrazioni Pastiglie Freno

13.0460-5932.2 605932

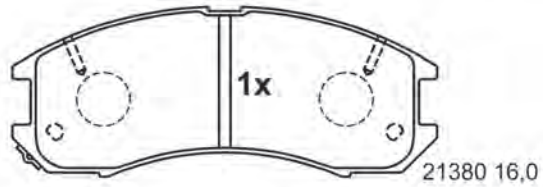
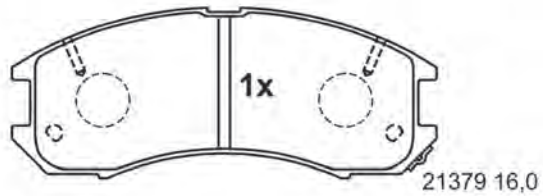
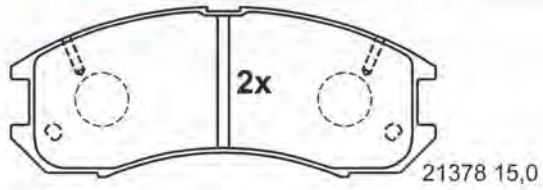

130,0 x 52,5 x 16,0

13.0460-5933.2 605933

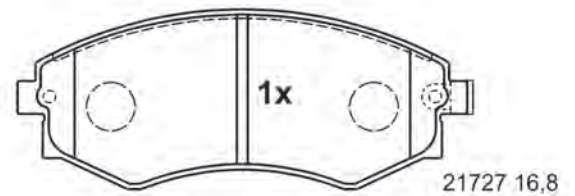
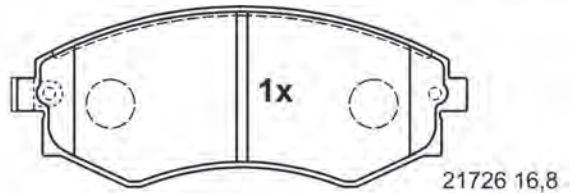
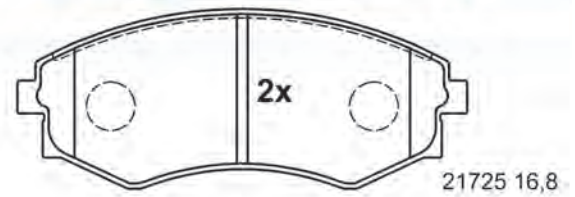

137,0 x 54,5 x 16,8

13.0460-5935.2 605935

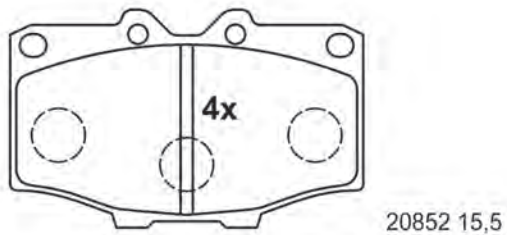

107,1 x 65,7 x 15,5

13.0460-5936.2 605936

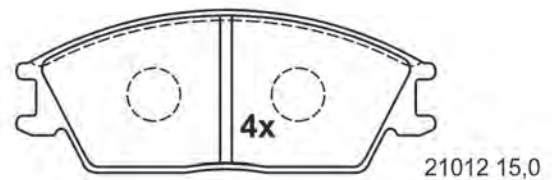

127,5 x 49,0 x 15,0

Abbildungen Scheibenbremsbeläge

Illustrations disc brake pads - Ilustraciones de pastillas - Illustrations Plaquettes de frein à disque - Illustrazioni Pastiglie Freno

13.0460-5937.2 605937

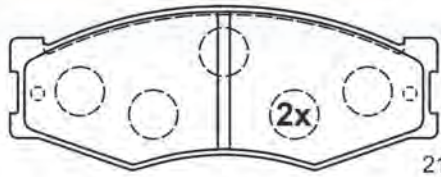

21229 17,0

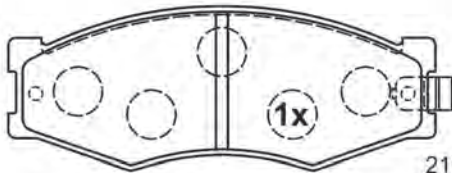

21119 17,0

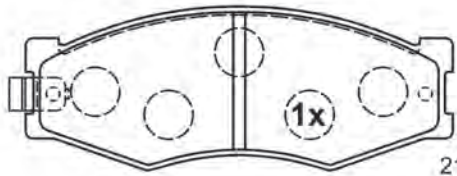

21130 17,0

130,2 x 49,7 x 17,0

13.0460-5938.2 605938

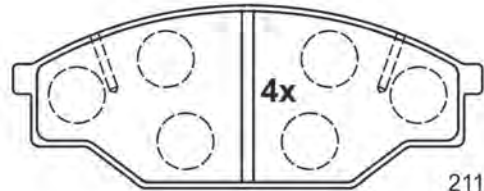

21158 15,5

142,7 x 55,5 x 15,5

13.0460-5940.2 605940

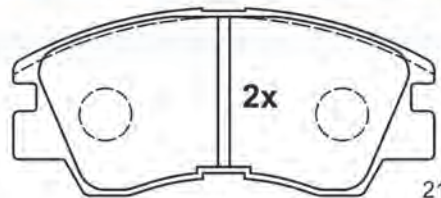

21375 16,0

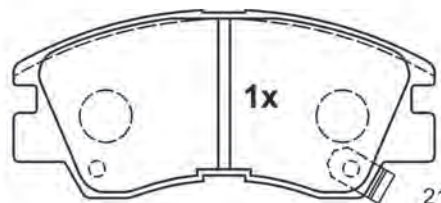

21373 16,0

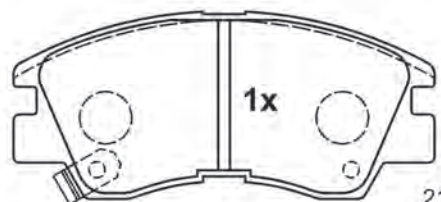

21374 16,0

127,9 x 57,1 x 16,0

13.0460-5941.2 605941

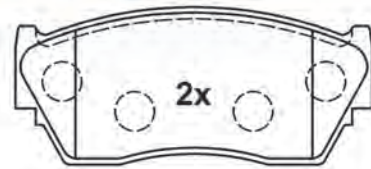

21657 16,4

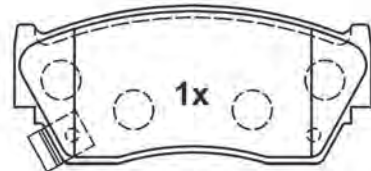

21658 16,4

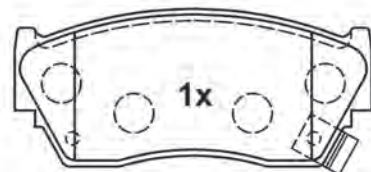

21659 16,4

108,3 x 47,9 x 16,4

Abbildungen Scheibenbremsbeläge

Illustrations disc brake pads - Ilustraciones de pastillas - Illustrations Plaquettes de frein à disque - Illustrazioni Pastiglie Freno

13.0460-5942.2 605942

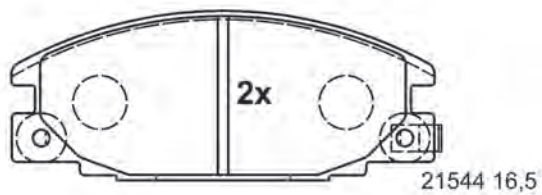
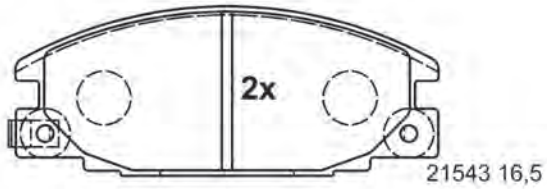

127,1 x 50,9 x 16,5

13.0460-5943.2 605943

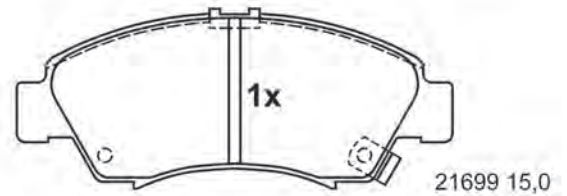
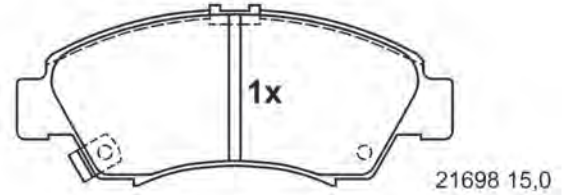
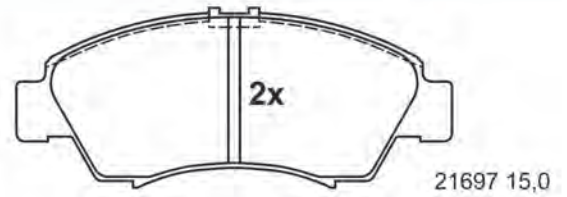

131,3 x 54,6 x 15,0

13.0460-5944.2 605944

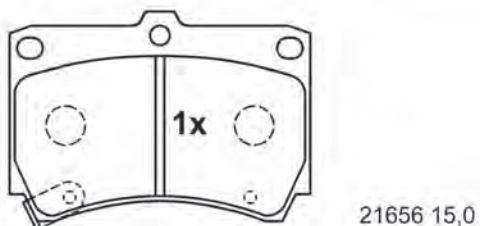
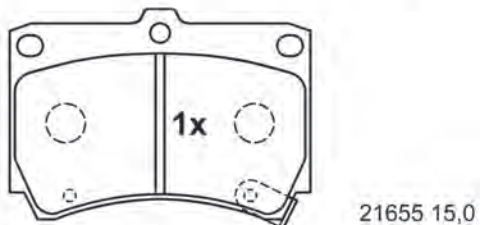
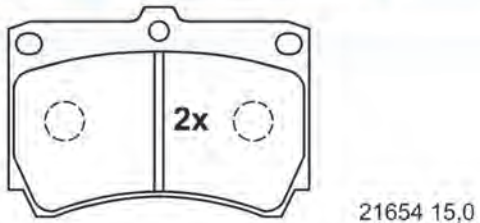

91,6 x 64,2 x 15,0

13.0460-5949.2 605949

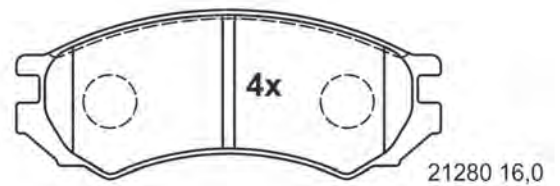

127,6 x 50,4 x 16,0

Abbildungen Scheibenbremsbeläge

Illustrations disc brake pads - Ilustraciones de pastillas - Illustrations Plaquettes de frein à disque - Illustrazioni Pastiglie Freno

13.0460-5950.2 605950

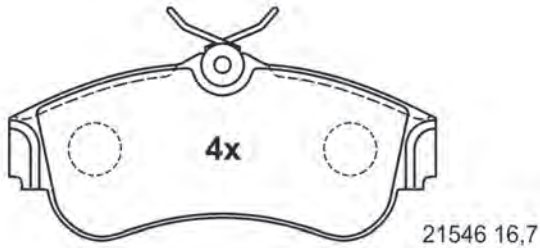

129,2 x 57,4 x 16,7

13.0460-5951.2 605951

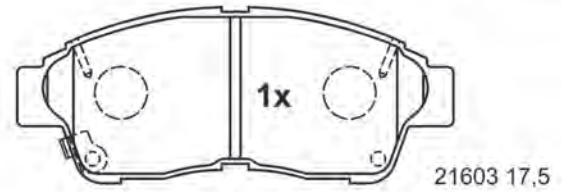
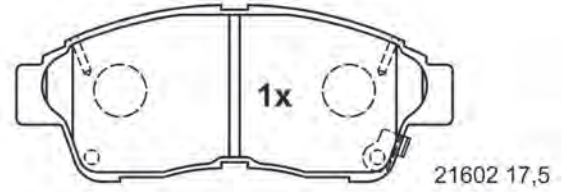
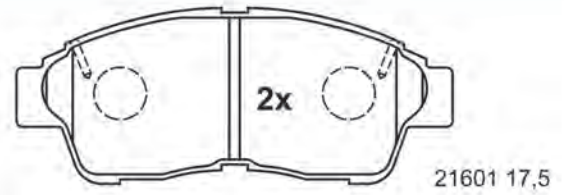

133,0 x 53,0 x 17,5

13.0460-5952.2 605952

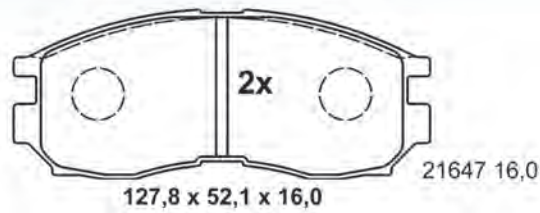

127,8 x 52,1 x 16,0

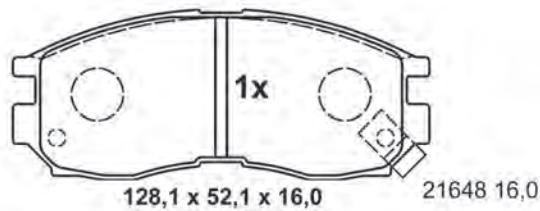

128,1 x 52,1 x 16,0

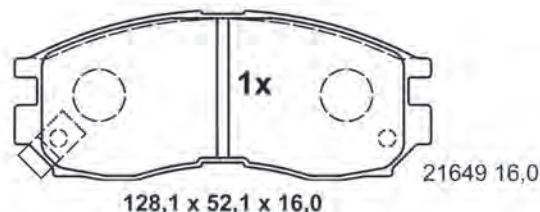

128,1 x 52,1 x 16,0

13.0460-5953.2 605953

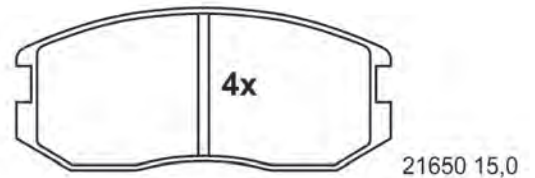

114,1 x 50,0 x 15,0

Abbildungen Scheibenbremsbeläge

Illustrations disc brake pads - Ilustraciones de pastillas - Illustrations Plaquettes de frein à disque - Illustrazioni Pastiglie Freno

13.0460-5954.2 605954

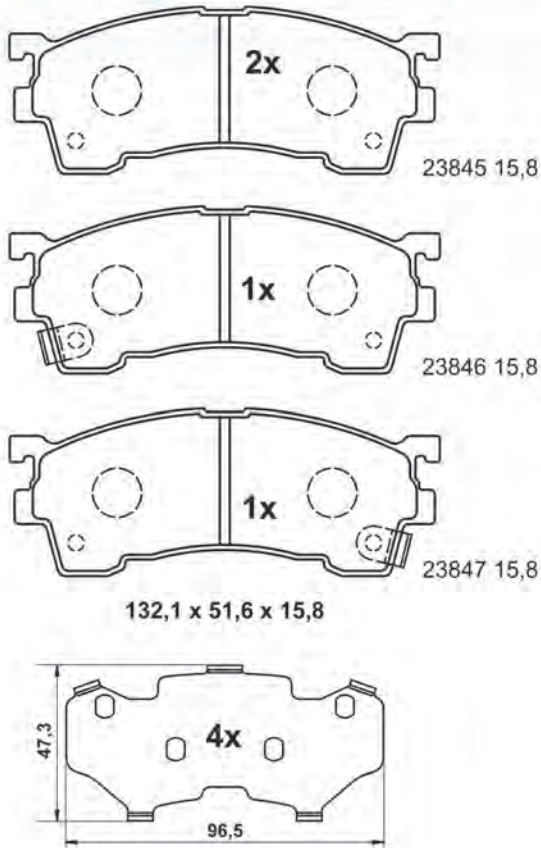

13.0460-5955.2 605955

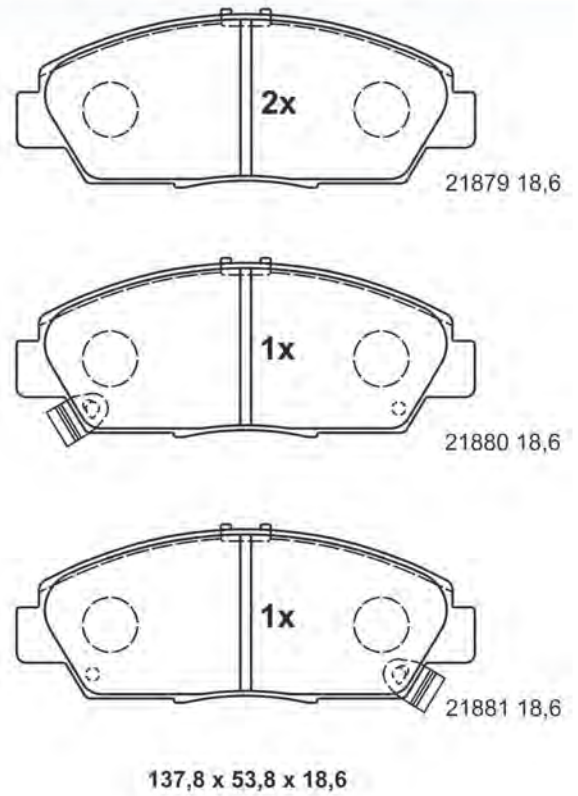

13.0460-5956.2 605956

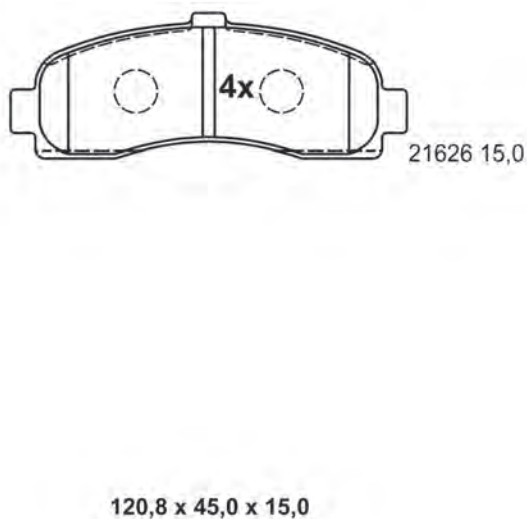

13.0460-5957.2 605957

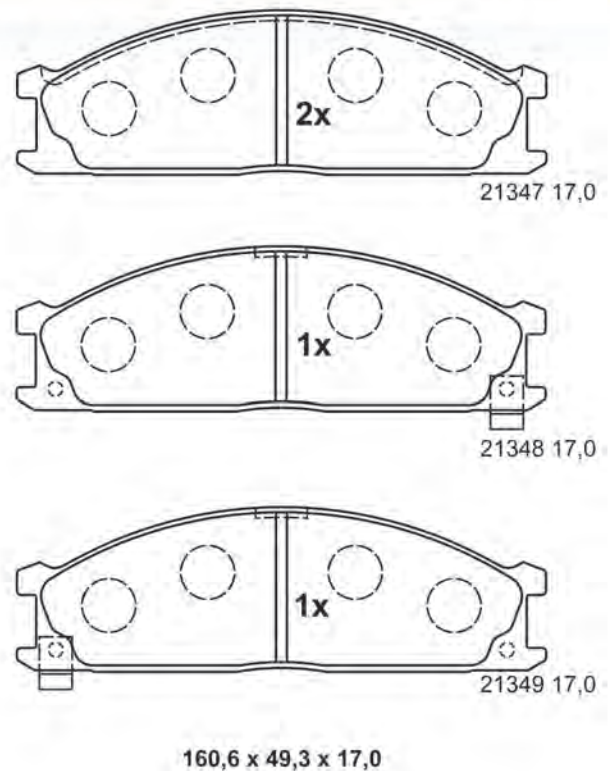

Abbildungen Scheibenbremsbeläge

Illustrations disc brake pads - Ilustraciones de pastillas - Illustrations Plaquettes de frein à disque - Illustrazioni Pastiglie Freno

13.0460-5958.2 605958

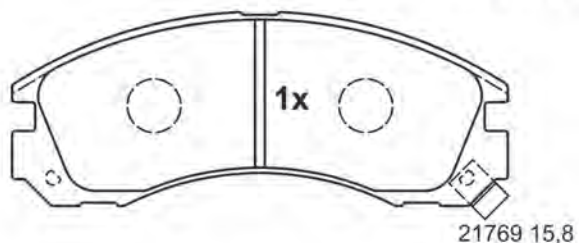
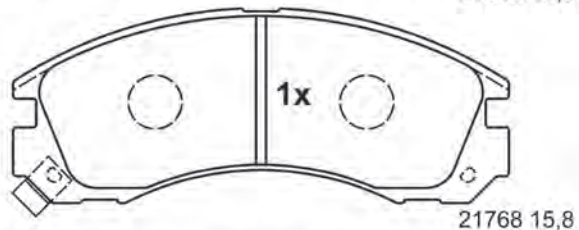
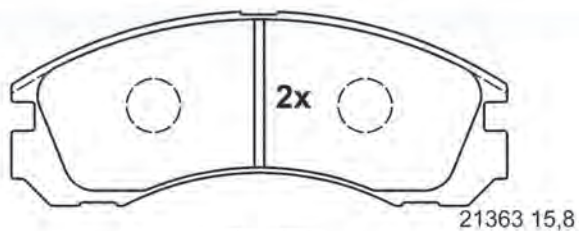

149,9 x 58,8 x 15,8

13.0460-5959.2 605959

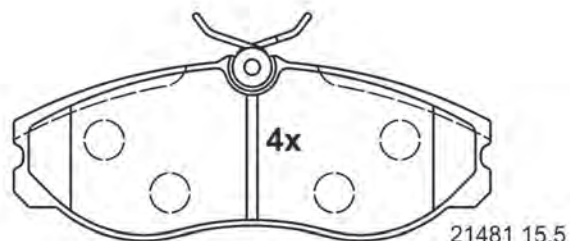

144,9 x 55,6 x 15,5

13.0460-5960.2 605960

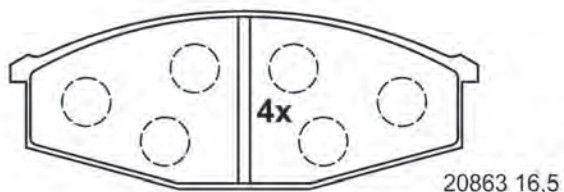

142,1 x 53,5 x 16,5

13.0460-5963.2 605963

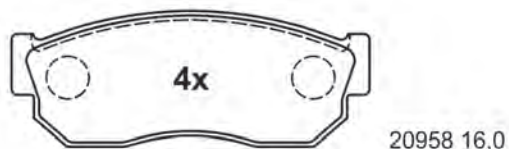

108,7 x 40,5 x 16,0

Abbildungen Scheibenbremsbeläge

Illustrations disc brake pads - Ilustraciones de pastillas - Illustrations Plaquettes de frein à disque - Illustrazioni Pastiglie Freno

13.0460-5966.2 605966

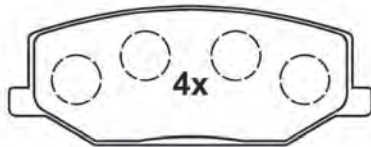

21142 15,0

110,4 x 41,6 x 15,0

13.0460-5967.2 605967

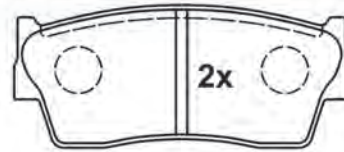

21500 15,0

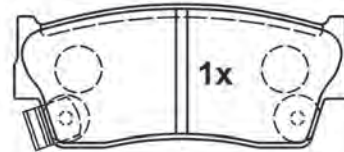

21501 15,0

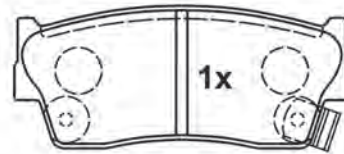

21502 15,0

103,4 x 43,7 x 15,0

13.0460-5968.2 605968

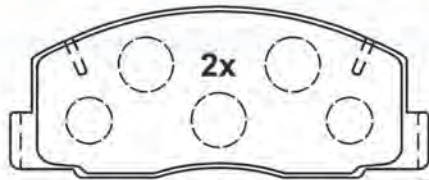

21369 15,5

128,3 x 52,1 x 15,5

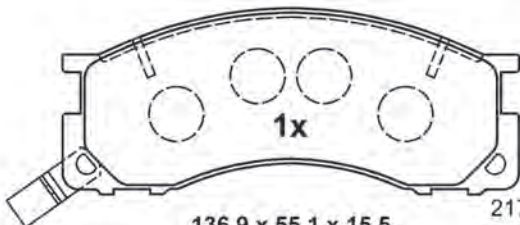

21780 15,5

136,9 x 55,1 x 15,5

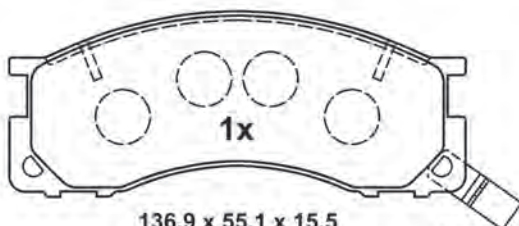

21781 15,5

136,9 x 55,1 x 15,5

13.0460-5969.2 605969



21948 13,5

131,9 x 54,3 x 13,5

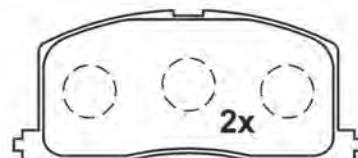

21949 13,5

106,1 x 45,7 x 13,5

Abbildungen Scheibenbremsbeläge

Illustrations disc brake pads - Ilustraciones de pastillas - Illustrations Plaquettes de frein à disque - Illustrazioni Pastiglie Freno

13.0460-5970.2 605970



21357 13,5

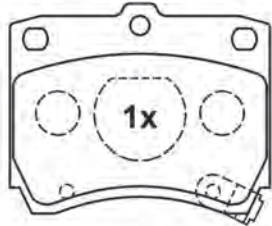

21355 13,5

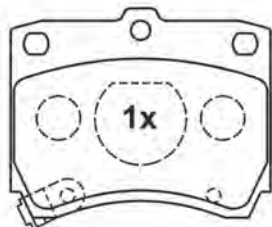

21356 13,5

78,7 x 63,4 x 13,5

13.0460-5972.2 605972

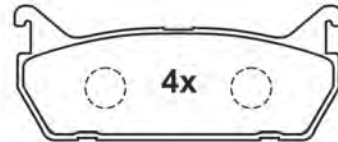

21559 11,5

102,3 x 39,3 x 11,5

13.0460-5973.2 605973

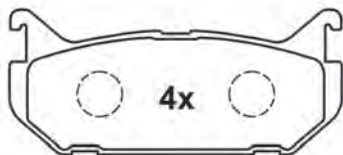

21766 13,5

99,9 x 43,6 x 13,5

13.0460-5974.2 605974

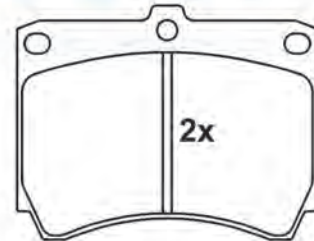

21539 15,0

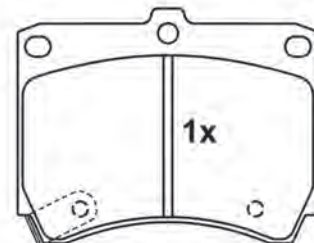

21540 15,0

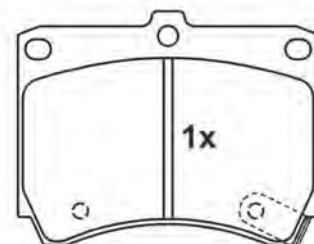

21541 15,0

91,6 x 70,5 x 15,0

Abbildungen Scheibenbremsbeläge

Illustrations disc brake pads - Ilustraciones de pastillas - Illustrations Plaquettes de frein à disque - Illustrazioni Pastiglie Freno

13.0460-5976.2 605976

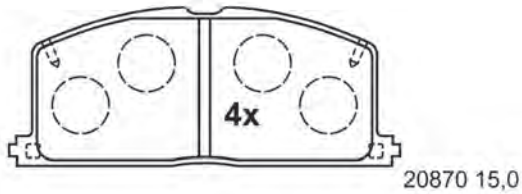

20870 15,0

119,8 x 47,6 x 15,0

13.0460-5978.2 605978

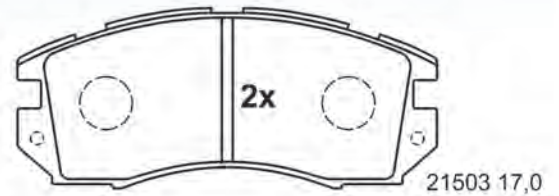

21503 17,0

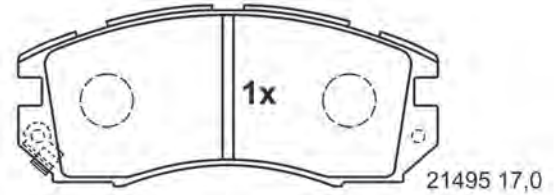

21495 17,0

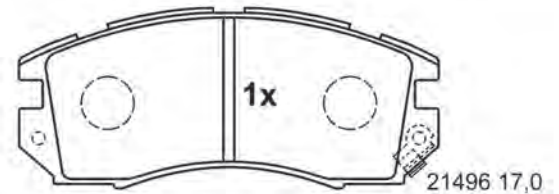

21496 17,0

127,7 x 54,4 x 17,0

13.0460-5980.2 605980

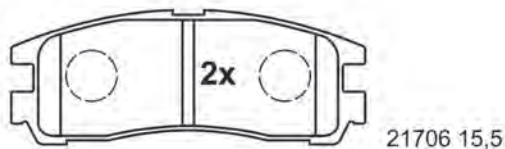

21706 15,5

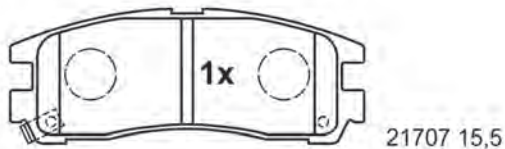

21707 15,5

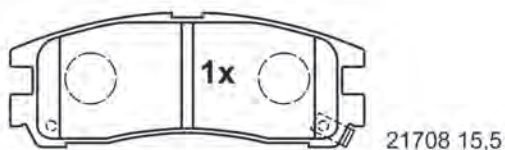

21708 15,5

107,7 x 41,3 x 15,5

13.0460-5981.2 605981

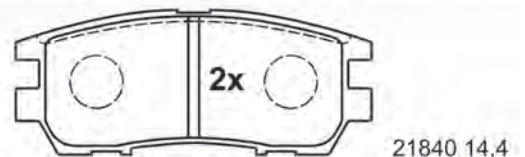

21840 14,4

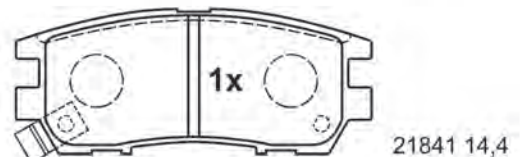

21841 14,4

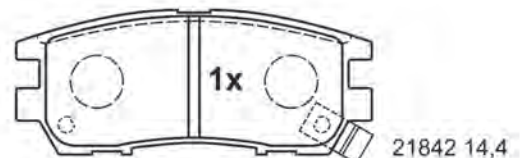

21842 14,4

107,8 x 43,8 x 14,4

Abbildungen Scheibenbremsbeläge

Illustrations disc brake pads - Ilustraciones de pastillas - Illustrations Plaquettes de frein à disque - Illustrazioni Pastiglie Freno

13.0460-5982.2 605982

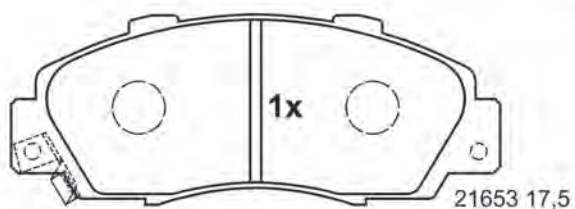
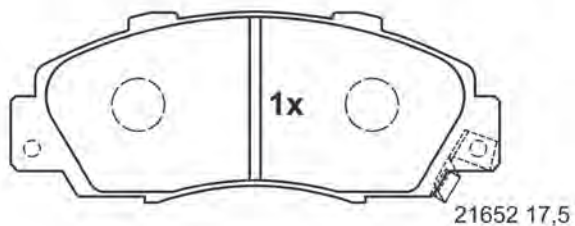
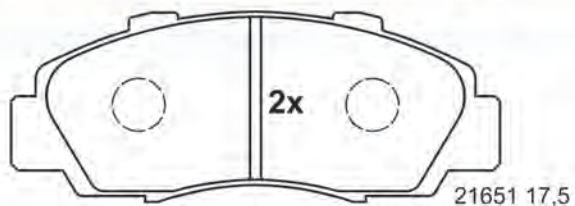

148,7 x 57,8 x 17,5

13.0460-5983.2 605983

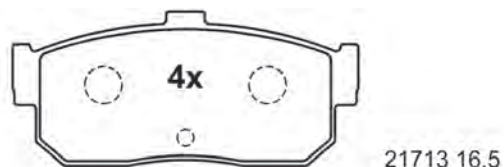

105,3 x 47,0 x 16,5

13.0460-5985.2 605985

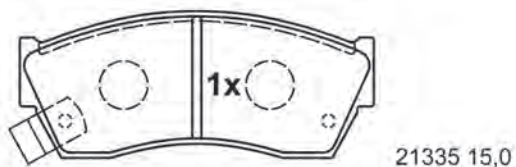
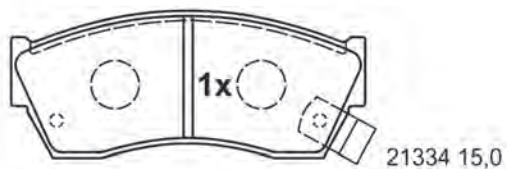
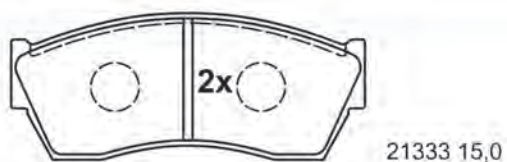

107,5 x 44,6 x 15,0

13.0460-5986.2 605986

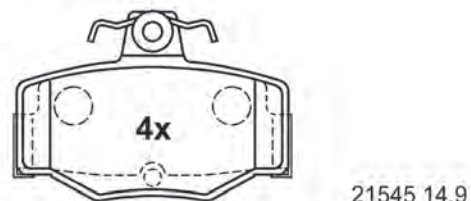

82,2 x 57,0 x 14,9

Abbildungen Scheibenbremsbeläge

Illustrations disc brake pads - Ilustraciones de pastillas - Illustrations Plaquettes de frein à disque - Illustrazioni Pastiglie Freno

13.0460-5987.2 605987

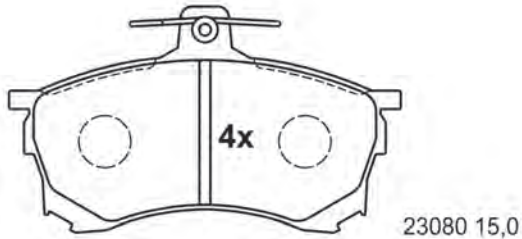

23080 15,0

119,3 x 68,6 x 15,0

13.0460-5988.2 605988

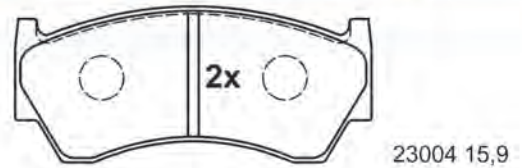

23004 15,9

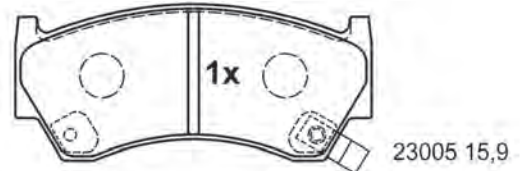

23005 15,9

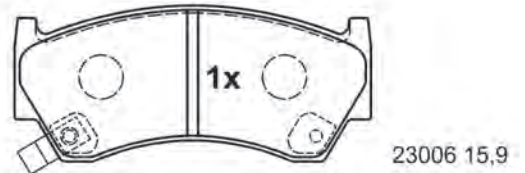

23006 15,9

108,6 x 47,9 x 15,9

13.0460-5989.2 605989



23454 14,9

88,7 x 45,4 x 14,9

13.0460-5992.2 605992

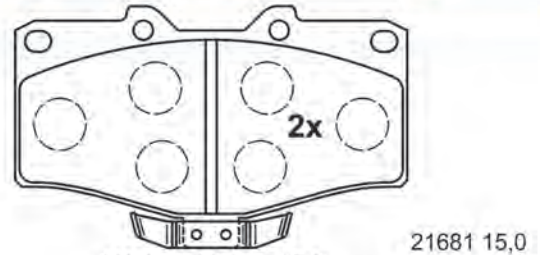

21681 15,0

119,3 x 73,5 x 15,0

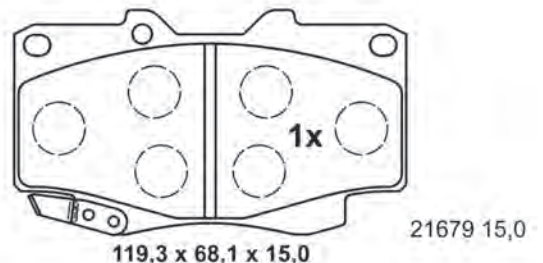

21679 15,0

119,3 x 68,1 x 15,0

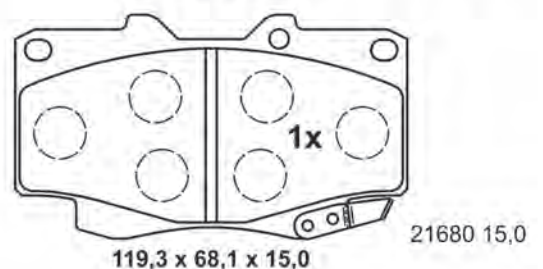

21680 15,0

119,3 x 68,1 x 15,0

Abbildungen Scheibenbremsbeläge

Illustrations disc brake pads - Ilustraciones de pastillas - Illustrations Plaquettes de frein à disque - Illustrazioni Pastiglie Freno

13.0460-5993.2 605993

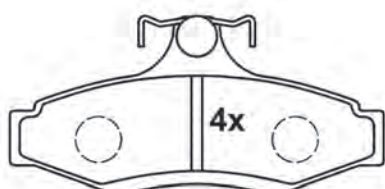

23237 14,5

114,0 x 55,1 x 14,5

13.0460-5994.2 605994

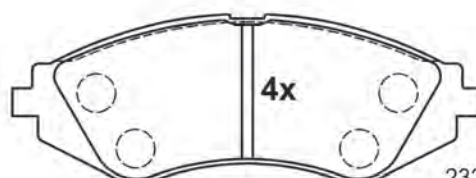

23234 16,8

143,0 x 51,4 x 16,8

13.0460-5995.2 605995

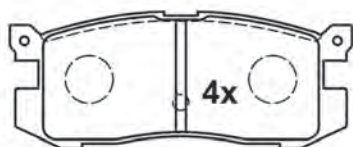

21558 13,0

104,2 x 41,6 x 13,0

13.0460-5996.2 605996



23241 16,1

127,1 x 48,2 x 16,1

Abbildungen Scheibenbremsbeläge

Illustrations disc brake pads - Ilustraciones de pastillas - Illustrations Plaquettes de frein à disque - Illustrazioni Pastiglie Freno

13.0460-5998.2 605998

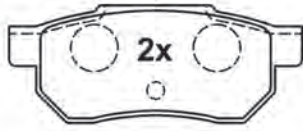

21312 12,8

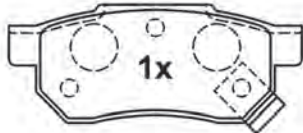

21313 12,8

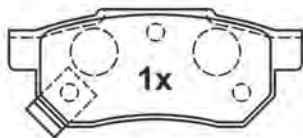

21314 12,8

89,0 x 35,2 x 12,8

13.0460-6015.2 606015

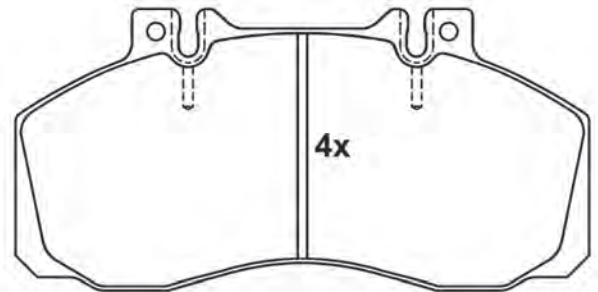

29835 22,0

174,6 x 85,5 x 22,0

13.0460-6033.2 606033

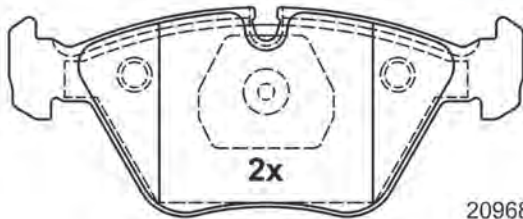

20968 20,3

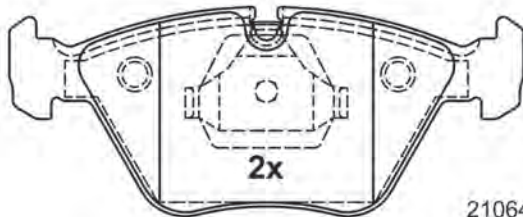

21064 20,3

156,3 x 63,5 x 20,3

13.0460-6036.2 606036

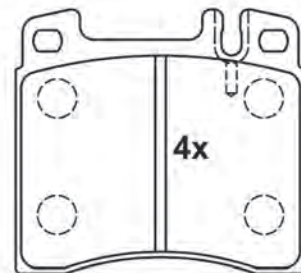

21304 18,5

89,5 x 81,2 x 18,5

Abbildungen Scheibenbremsbeläge

Illustrations disc brake pads - Ilustraciones de pastillas - Illustrations Plaquettes de frein à disque - Illustrazioni Pastiglie Freno

13.0460-6914.2 606914



20038 14,0

74,2 x 64,1 x 14,0

13.0460-6916.2 606916

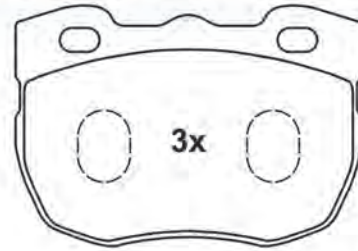

21459 18,5

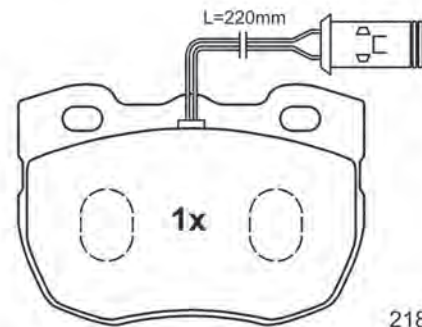

21897 18,5

104,8 x 72,4 x 18,5

13.0460-6917.2 606917

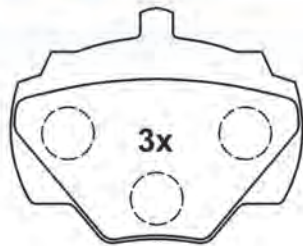

21237 15,5
(21238)

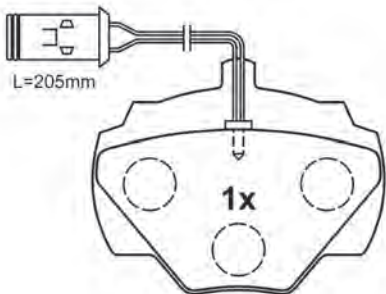

21514 15,5

88,6 x 72,1 x 15,5

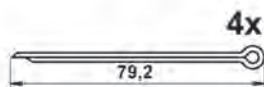
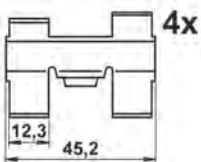

13.0460-6921.2 606921

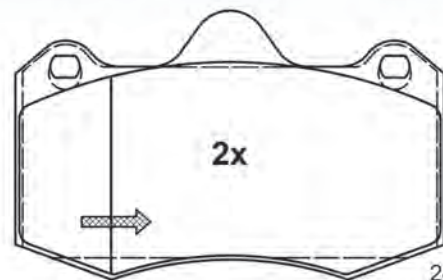

24974 16,8

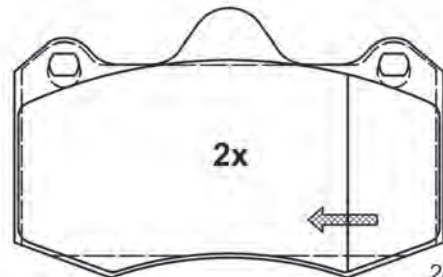

24974 16,8

130,0 x 81,6 x 16,8

Abbildungen Scheibenbremsbeläge

Illustrations disc brake pads - Ilustraciones de pastillas - Illustrations Plaquettes de frein à disque - Illustrazioni Pastiglie Freno

13.0460-6922.2 606922



21459 17,5

104,8 x 72,4 x 17,5

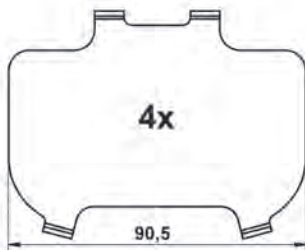

90,5

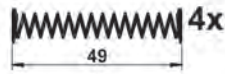
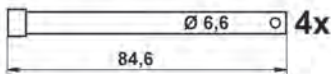
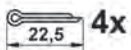

13.0460-6923.2 606923

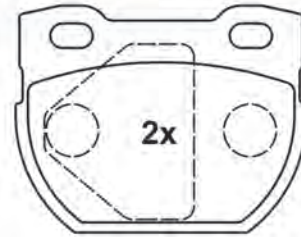

23471 14,5

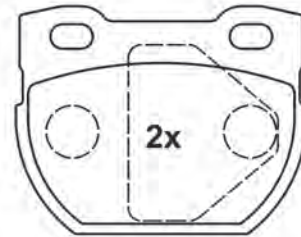

23471 14,5

88,4 x 68,9 x 14,5

13.0460-6924.2 606924

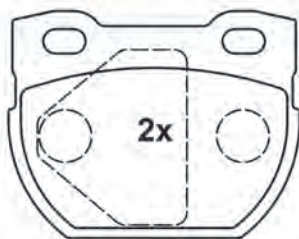

23471 17,5

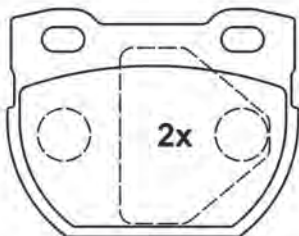

23471 17,5

88,4 x 68,9 x 17,5

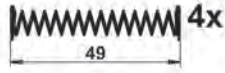
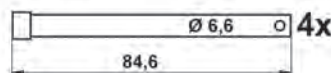
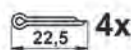

13.0460-6925.2 606925

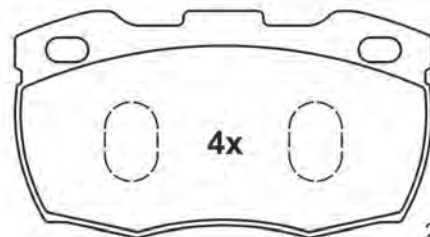

21519 17,8

126,5 x 68,6 x 17,8

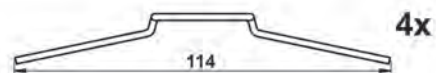

Abbildungen Scheibenbremsbeläge

Illustrations disc brake pads - Ilustraciones de pastillas - Illustrations Plaquettes de frein à disque - Illustrazioni Pastiglie Freno

13.0460-6926.2 606926



13.0460-7030.2 607030



20359 19,2

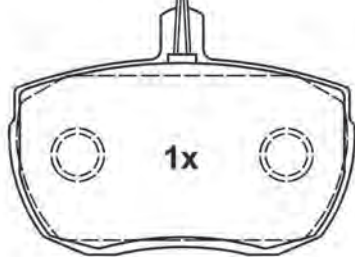
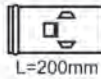

21160 19,2

104,9 x 74,7 x 19,2

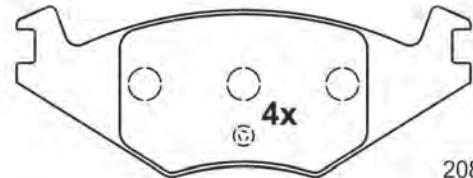
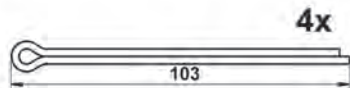
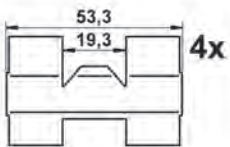

20889 17,3

137,8 x 51,5 x 17,3



13.0460-7032.2 607032



13.0460-7033.2 607033

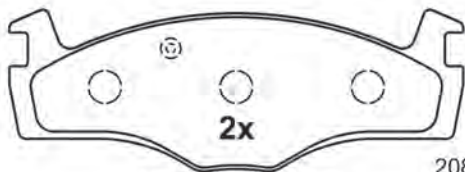

20887 19,7

137,8 x 48,9 x 19,7



20888 19,7

137,8 x 51,5 x 19,7

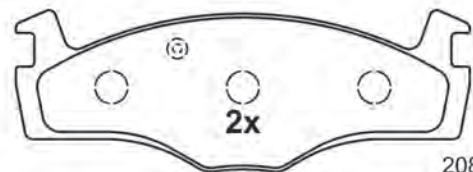
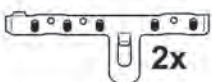

20887 15,3

137,8 x 48,9 x 15,3

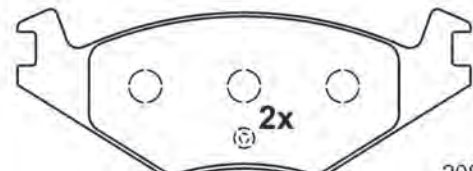

20888 15,3

137,8 x 51,5 x 15,3

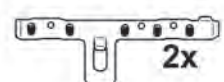

Abbildungen Scheibenbremsbeläge

Illustrations disc brake pads - Ilustraciones de pastillas - Illustrations Plaquettes de frein à disque - Illustrazioni Pastiglie Freno

13.0460-7040.2 607040



20907 18,0

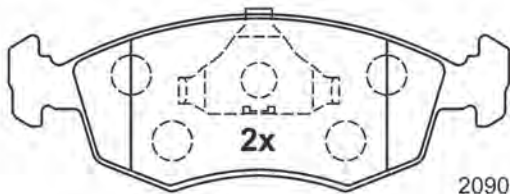

20908 18,0

151,3 x 52,5 x 18,0

13.0460-7048.2 607048

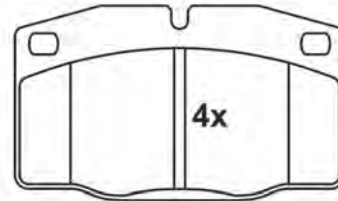

20939 15,8

100,0 x 59,0 x 15,8

13.0460-7050.2 607050

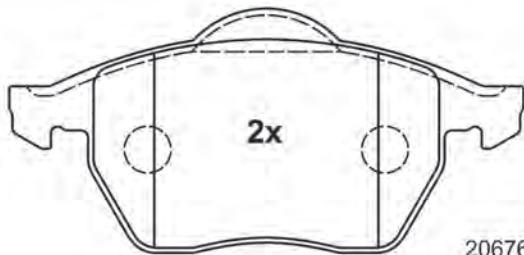

20676 19,5

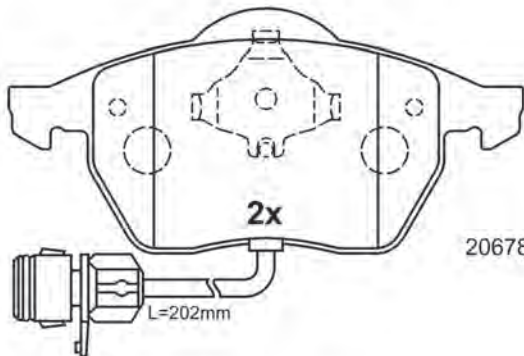

20678 19,5

156,3 x 74,0 x 19,5

13.0460-7051.2 607051

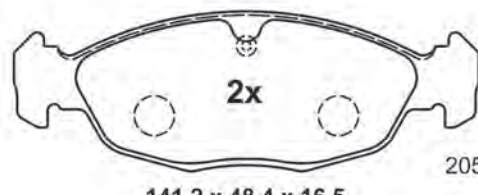

20547 16,5

141,2 x 48,4 x 16,5

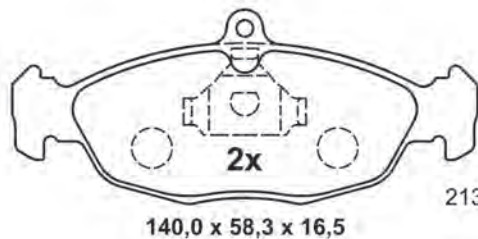

21353 16,5

140,0 x 58,3 x 16,5

Abbildungen Scheibenbremsbeläge

Illustrations disc brake pads - Ilustraciones de pastillas - Illustrations Plaquettes de frein à disque - Illustrazioni Pastiglie Freno

13.0460-7052.2 607052

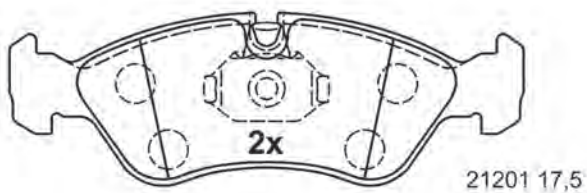
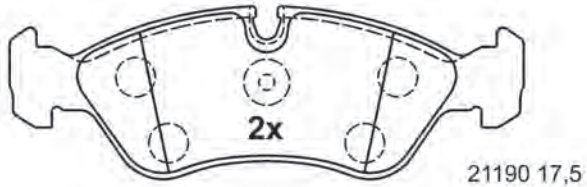

156,3 x 52,3 x 17,5

13.0460-7053.2 607053

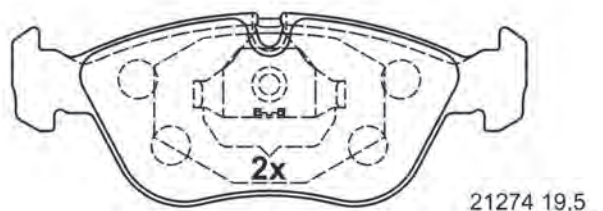
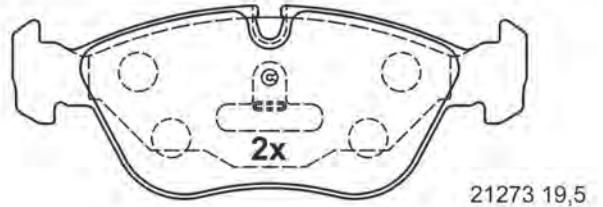

156,3 x 58,5 x 19,5

13.0460-7056.2 607056

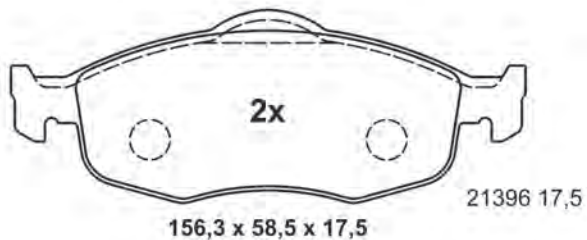

156,3 x 58,5 x 17,5

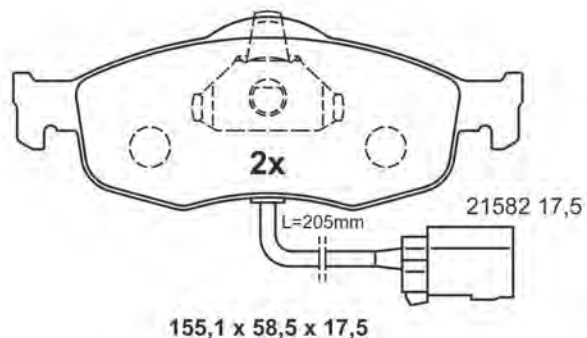

155,1 x 58,5 x 17,5

13.0460-7057.2 607057

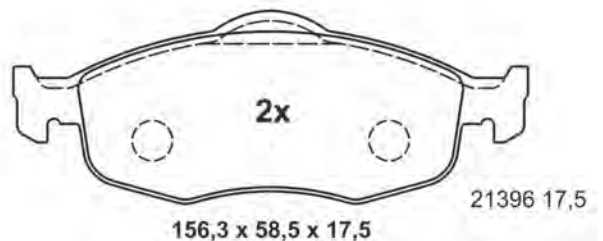

156,3 x 58,5 x 17,5

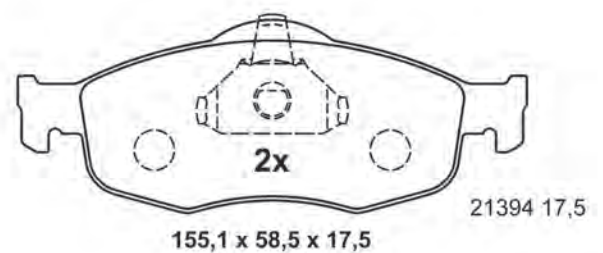

155,1 x 58,5 x 17,5

Abbildungen Scheibenbremsbeläge

Illustrations disc brake pads - Ilustraciones de pastillas - Illustrations Plaquettes de frein à disque - Illustrazioni Pastiglie Freno

13.0460-7058.2 607058

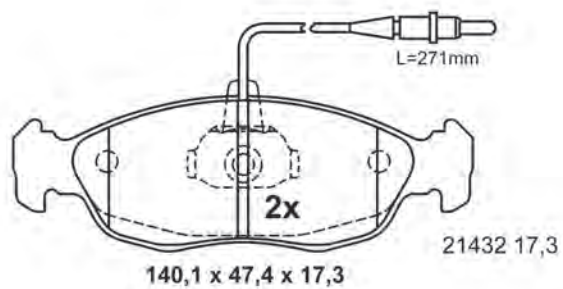
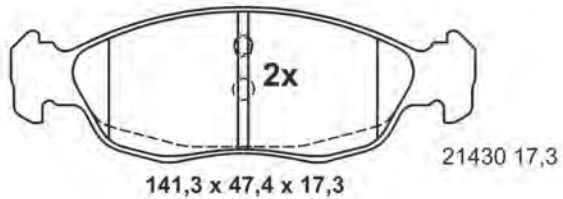

13.0460-7059.2 607059

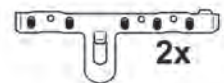
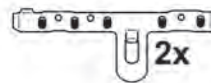
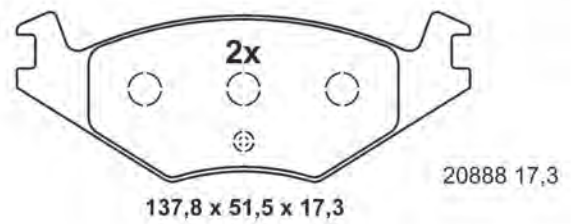
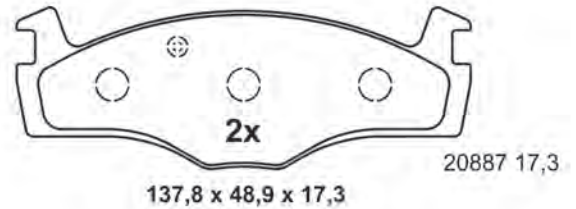

13.0460-7061.2 607061

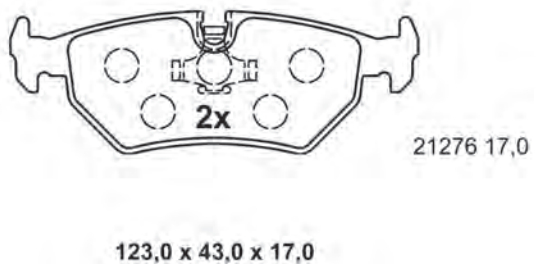
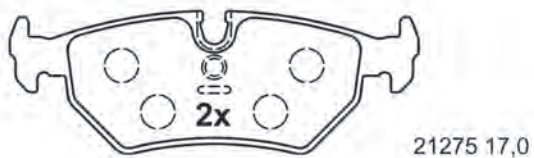

13.0460-7063.2 607063

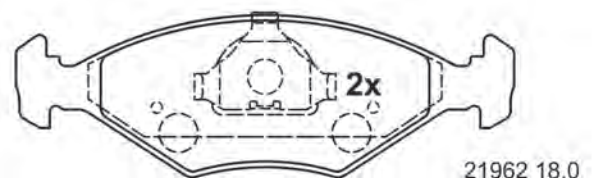
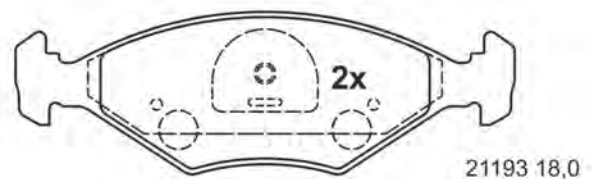

151,3 x 49,2 x 18,0

Abbildungen Scheibenbremsbeläge

Illustrations disc brake pads - Ilustraciones de pastillas - Illustrations Plaquettes de frein à disque - Illustrazioni Pastiglie Freno

13.0460-7064.2 607064

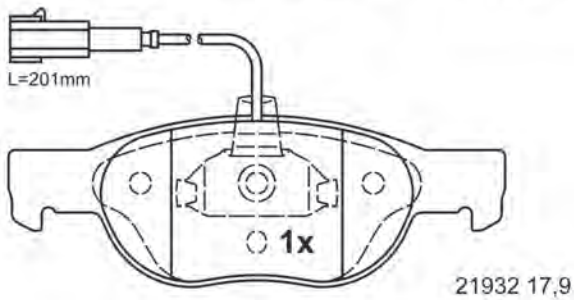
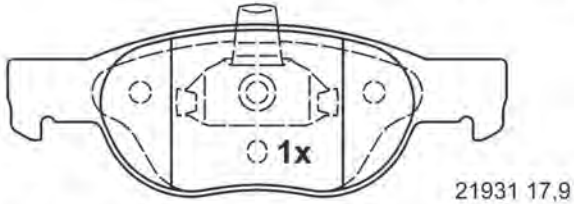
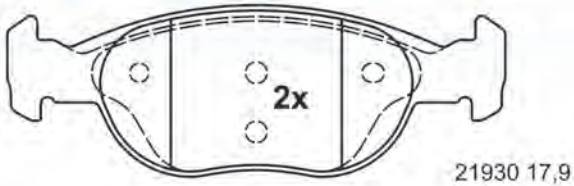

151,3 x 52,0 x 17,9

13.0460-7065.2 607065

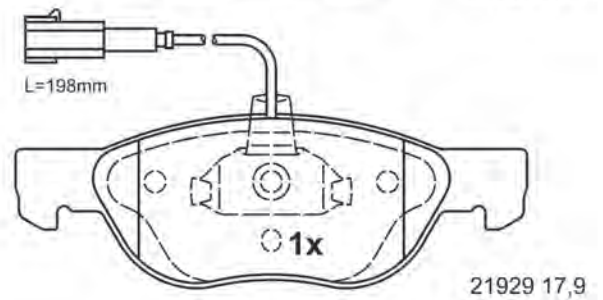
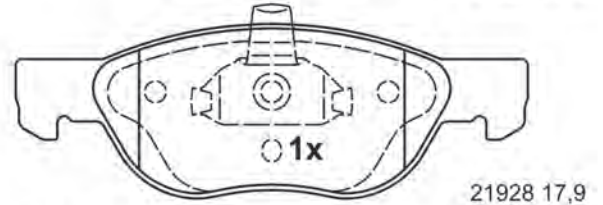
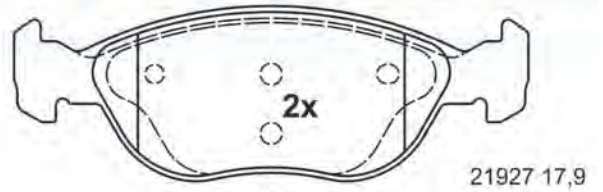

156,3 x 52,7 x 17,9

13.0460-7067.2 607067

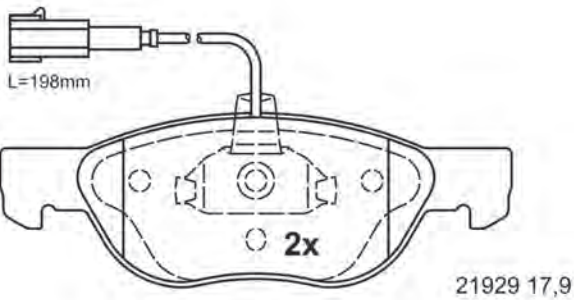
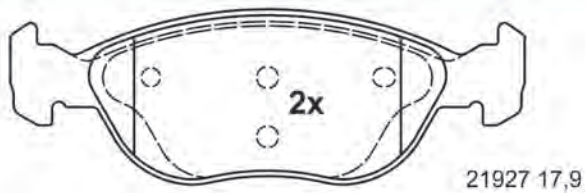

156,3 x 52,7 x 17,9

13.0460-7068.2 607068

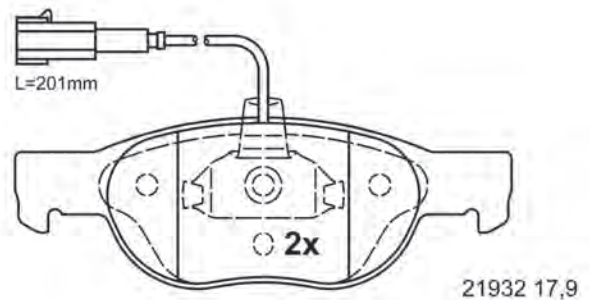
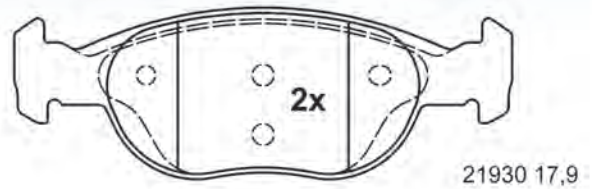

151,3 x 52,0 x 17,9

Abbildungen Scheibenbremsbeläge

Illustrations disc brake pads - Ilustraciones de pastillas - Illustrations Plaquettes de frein à disque - Illustrazioni Pastiglie Freno

13.0460-7069.2 607069



21637 19,3

156,3 x 59,1 x 19,3

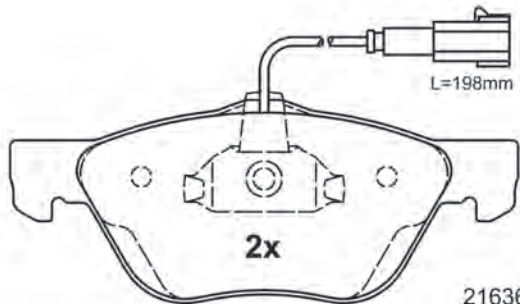

21636 19,3

155,1 x 61,8 x 19,3

13.0460-7071.2 607071

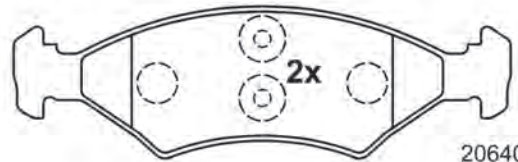

20640 17,5

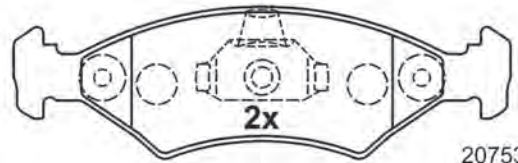

20753 17,5

151,3 x 46,4 x 17,5

13.0460-7072.2 607072



21866 19,7

141,8 x 51,2 x 19,7

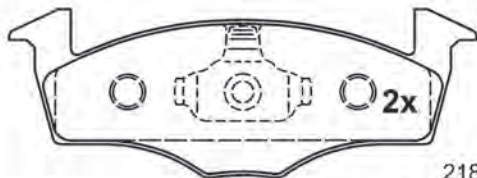

21868 19,7

141,8 x 50,6 x 19,7

13.0460-7073.2 607073

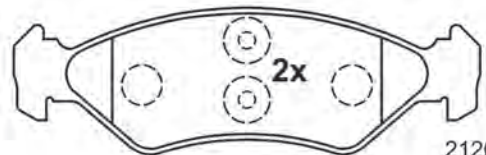

21202 16,9

141,3 x 44,4 x 16,9

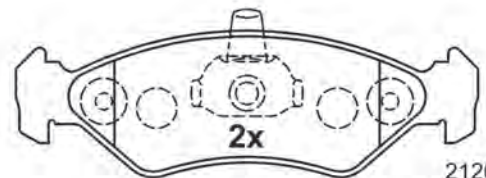

21203 16,9

140,1 x 44,4 x 16,9



Abbildungen Scheibenbremsbeläge

Illustrations disc brake pads - Ilustraciones de pastillas - Illustrations Plaquettes de frein à disque - Illustrazioni Pastiglie Freno

13.0460-7076.2 607076

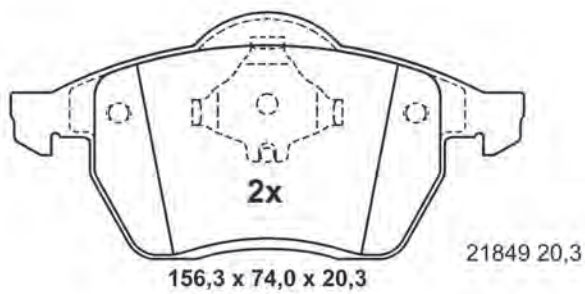
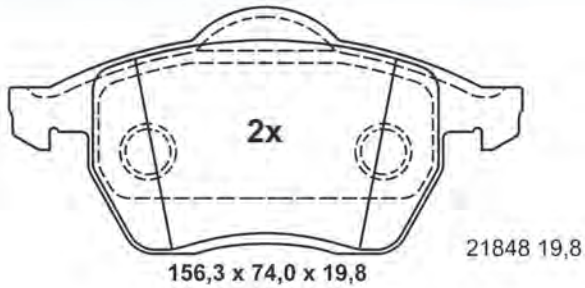

13.0460-7077.2 607077

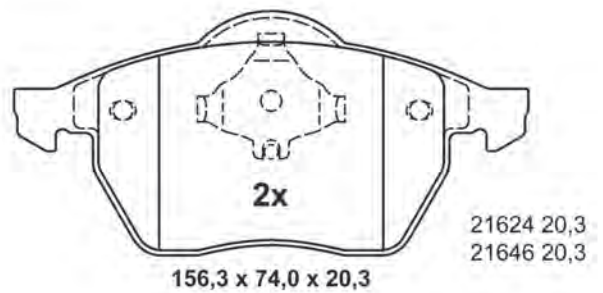
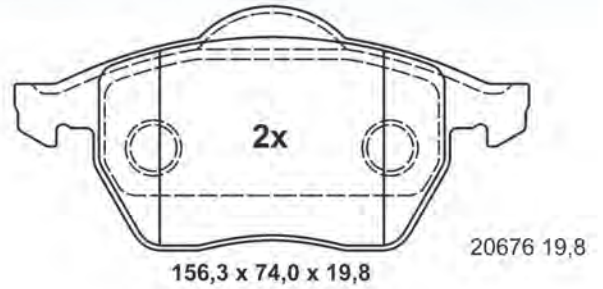

13.0460-7078.2 607078

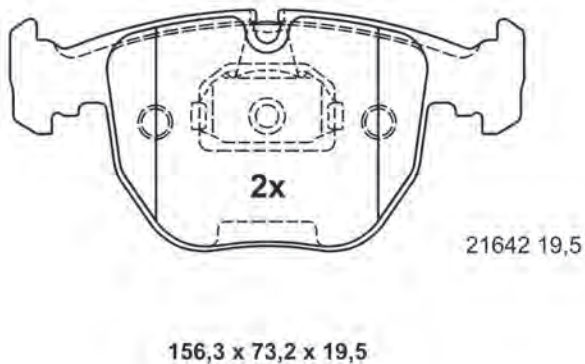
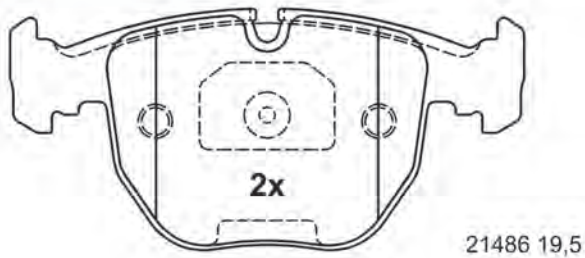

13.0460-7079.2 607079

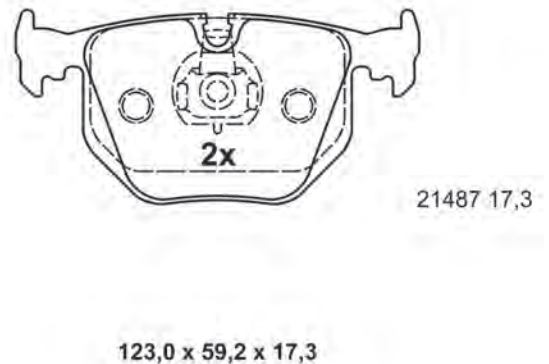
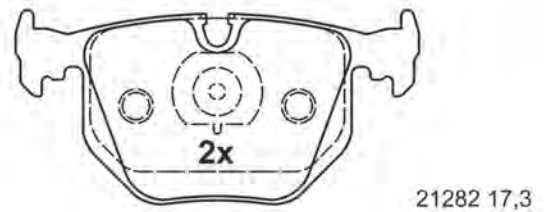

Abbildungen Scheibenbremsbeläge

Illustrations disc brake pads - Ilustraciones de pastillas - Illustrations Plaquettes de frein à disque - Illustrazioni Pastiglie Freno

13.0460-7080.2 607080

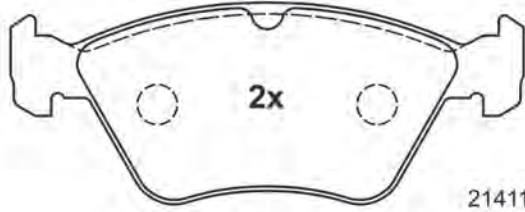

156,3 x 60,7 x 17,5

21411 17,5

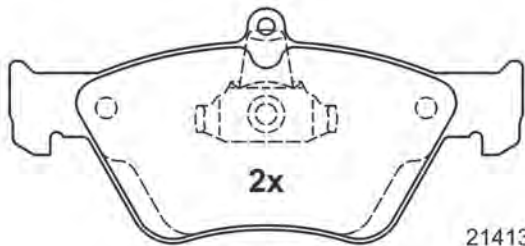

155,1 x 70,6 x 18,3

21413 18,3

13.0460-7081.2 607081

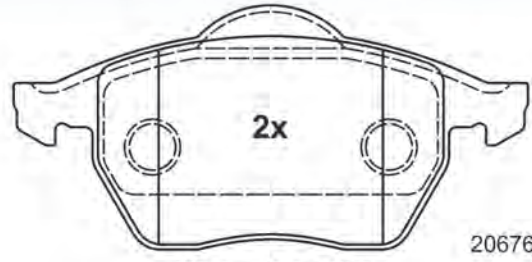

156,3 x 74,0 x 19,8

20676 19,8

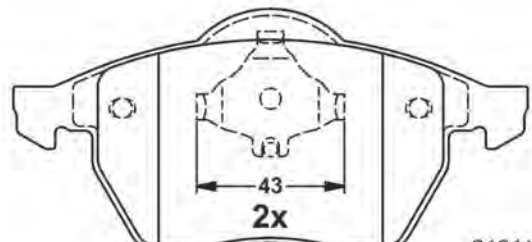

156,3 x 74,0 x 20,3

21911 20,3

13.0460-7083.2 607083

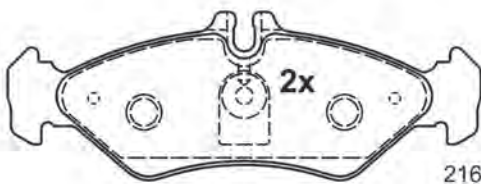

21621 17,3

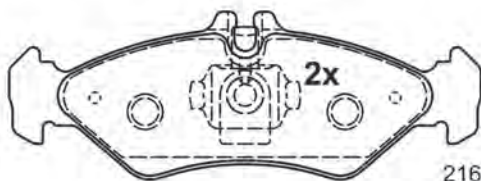

141,3 x 49,9 x 17,3

21622 17,3

13.0460-7084.2 607084

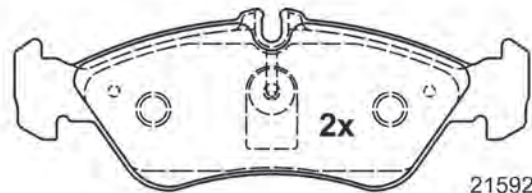

21592 18,8

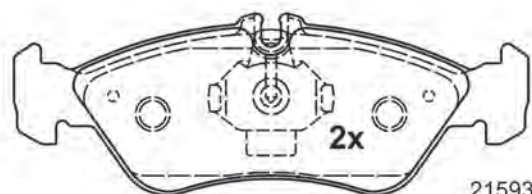

156,3 x 54,8 x 18,8

21593 18,8

Abbildungen Scheibenbremsbeläge

Illustrations disc brake pads - Ilustraciones de pastillas - Illustrations Plaquettes de frein à disque - Illustrazioni Pastiglie Freno

13.0460-7085.2 607085

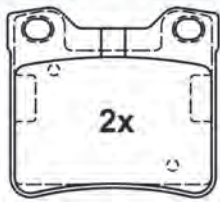

21278 16,9

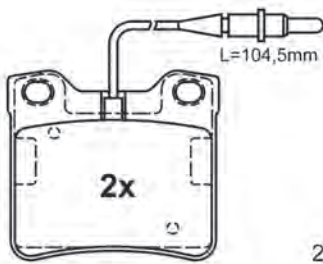

21904 16,9

63,7 x 57,4 x 16,9

13.0460-7086.2 607086

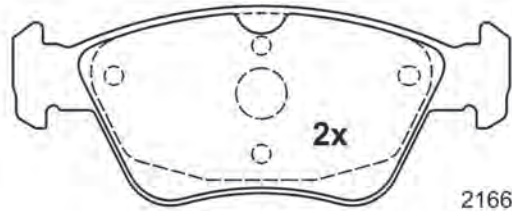

21664 19,8

151,3 x 59,8 x 19,8

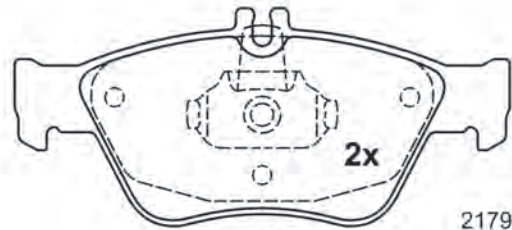

21795 19,8

150,1 x 66,2 x 19,8

13.0460-7087.2 607087

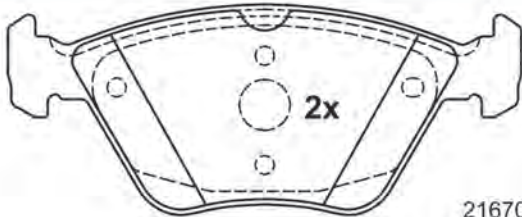

21670 19,3

156,3 x 63,5 x 19,4

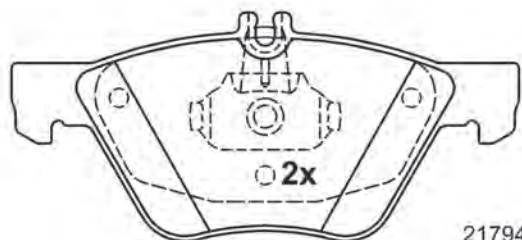

21794 19,3

155,1 x 69,3 x 19,3

13.0460-7088.2 607088

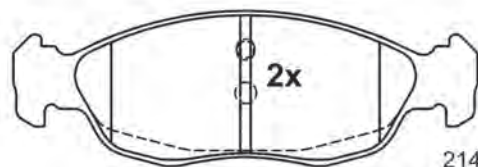

21430 17,3

141,3 x 47,4 x 17,3

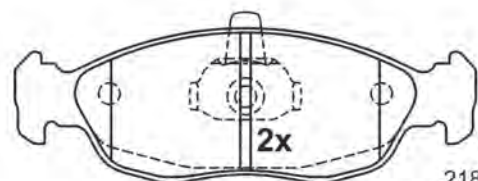

21827 17,3

140,1 x 47,4 x 17,3

Abbildungen Scheibenbremsbeläge

Illustrations disc brake pads - Ilustraciones de pastillas - Illustrations Plaquettes de frein à disque - Illustrazioni Pastiglie Freno

13.0460-7089.2 607089

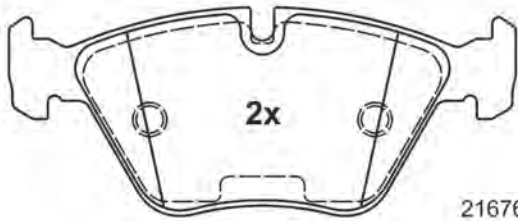

21676 20,3

154,6 x 63,5 x 20,3

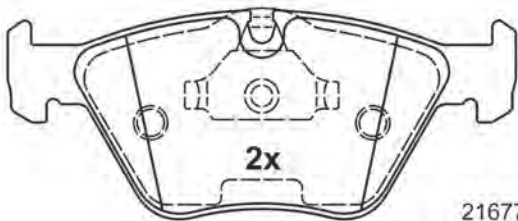

21677 20,3

155,1 x 63,5 x 20,3

13.0460-7090.2 607090



21891 17,3



21691 17,3

123,0 x 44,9 x 17,3

13.0460-7091.2 607091

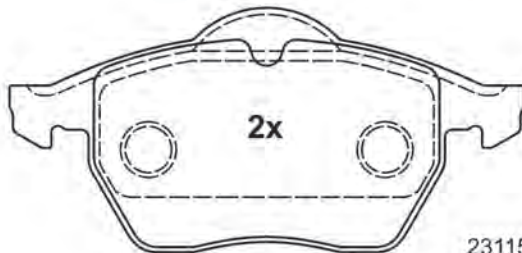

23115 19,8

156,3 x 74,0 x 19,8

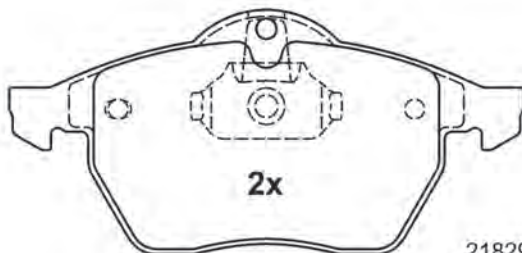

21829 20,3

155,1 x 74,0 x 20,3

13.0460-7100.2 607100

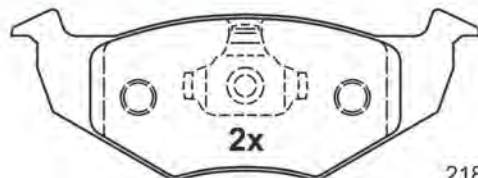

21866 17,2

141,8 x 51,2 x 17,2

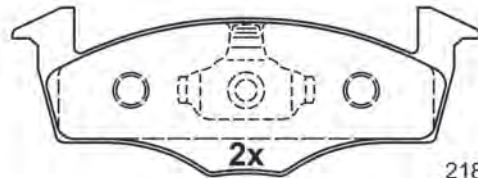

21868 17,2

141,8 x 50,6 x 17,2



Abbildungen Scheibenbremsbeläge

Illustrations disc brake pads - Ilustraciones de pastillas - Illustrations Plaquettes de frein à disque - Illustrazioni Pastiglie Freno

13.0460-7101.2 607101



141,8 x 51,2 x 15,3

21866 15,3

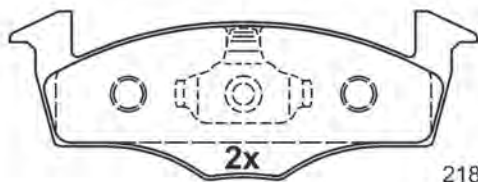

141,8 x 50,6 x 15,3

21868 15,3

13.0460-7102.2 607102

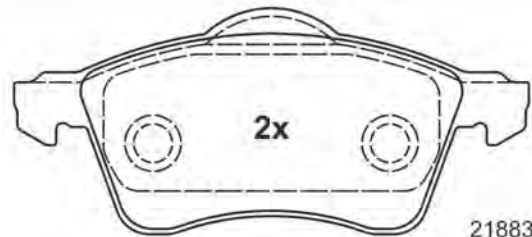

156,3 x 68,5 x 19,8

21883 19,8

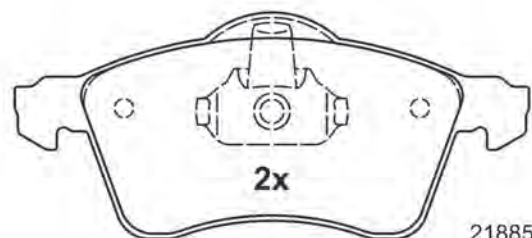

156,3 x 68,5 x 20,4

21885 20,4

13.0460-7105.2 607105

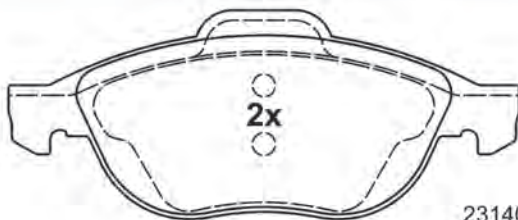

156,3 x 63,8 x 19,4

23140 19,4



L=198mm

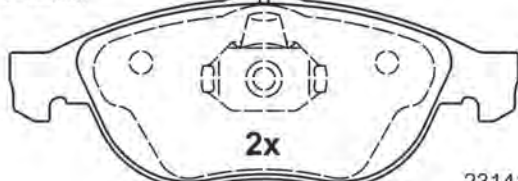

155,1 x 59,3 x 19,4

23141 19,4

13.0460-7107.2 607107

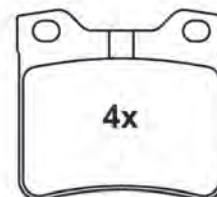

21278 16,4

63,7 x 57,8 x 16,4

Abbildungen Scheibenbremsbeläge

Illustrations disc brake pads - Ilustraciones de pastillas - Illustrations Plaquettes de frein à disque - Illustrazioni Pastiglie Freno

13.0460-7108.2 607108

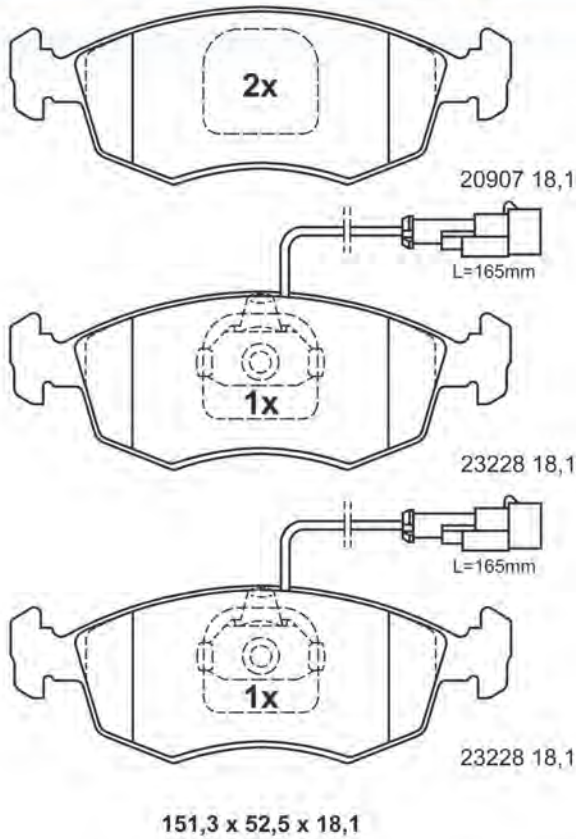

13.0460-7110.2 607110

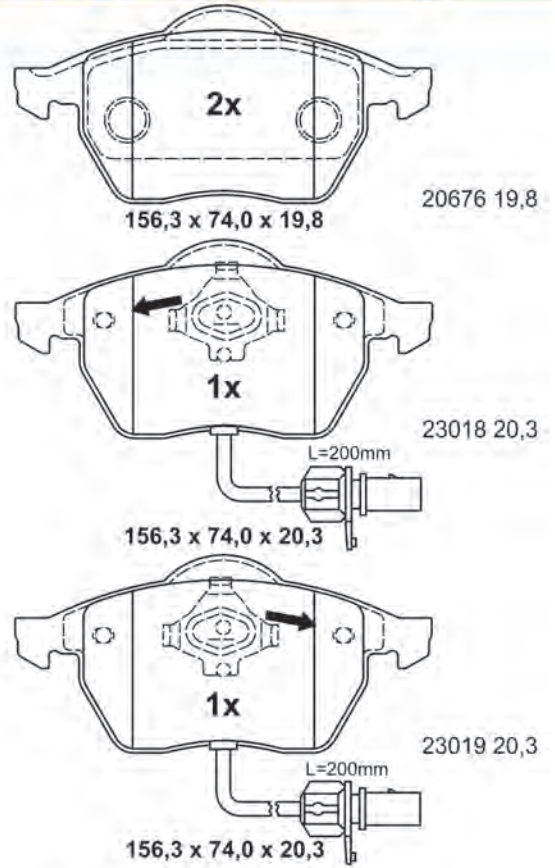

13.0460-7111.2 607111

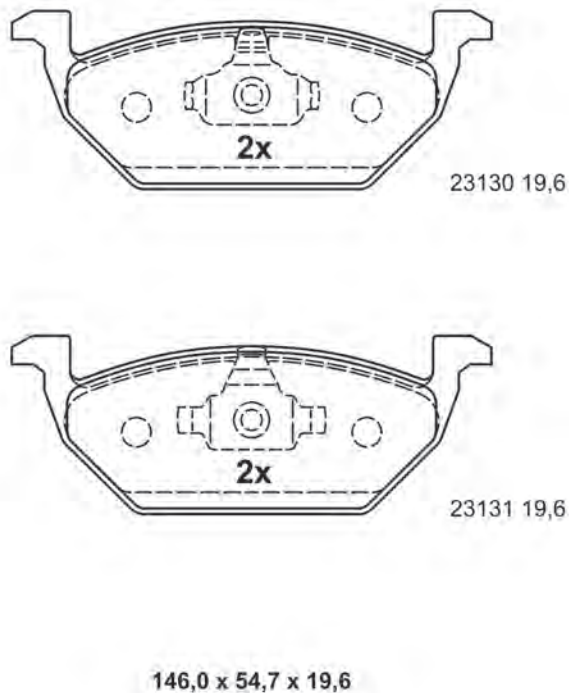

13.0460-7112.2 607112

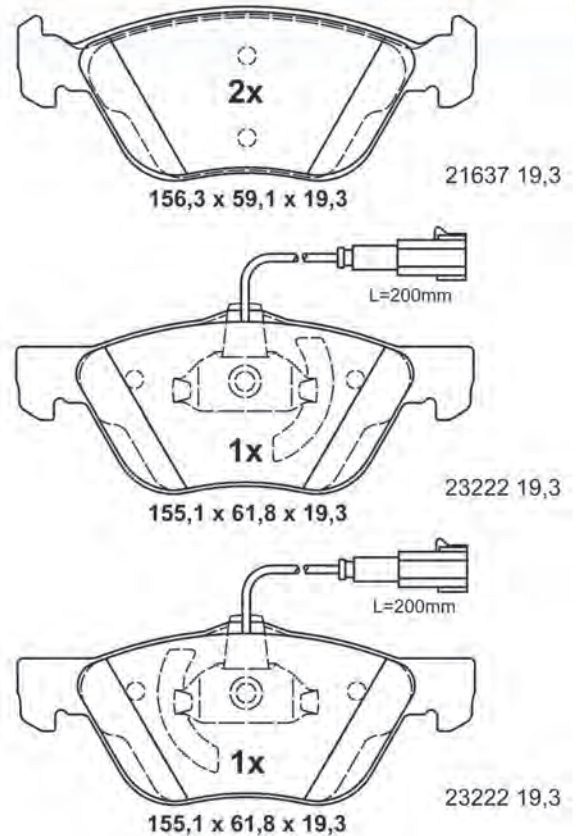

Abbildungen Scheibenbremsbeläge

Illustrations disc brake pads - Ilustraciones de pastillas - Illustrations Plaquettes de frein à disque - Illustrazioni Pastiglie Freno

13.0460-7113.2 607113



23218 18,0

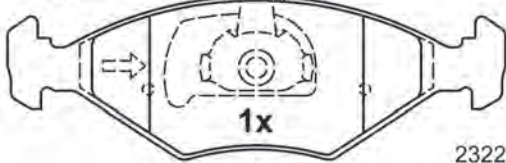
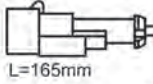

23220 18,0

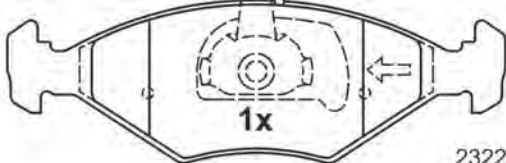
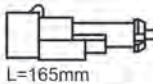

23220 18,0

151,3 x 49,2 x 18,0

13.0460-7114.2 607114

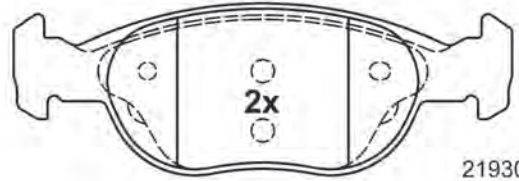

21930 17,9

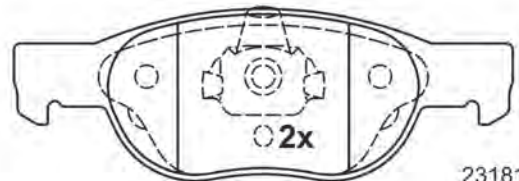

23181 17,9

151,3 x 52,0 x 17,9

13.0460-7115.2 607115 [1]

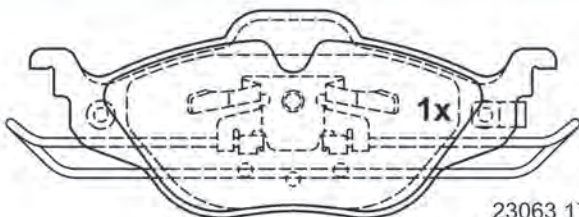

23063 17,5

160,0 x 63,0 x 17,5

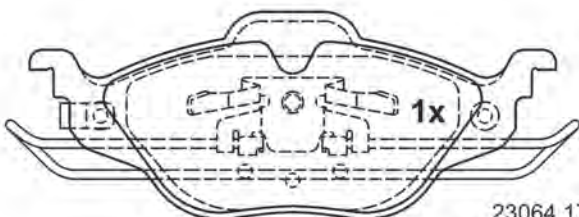

23064 17,5

160,0 x 63,0 x 17,5

13.0460-7115.2 607115 [2]

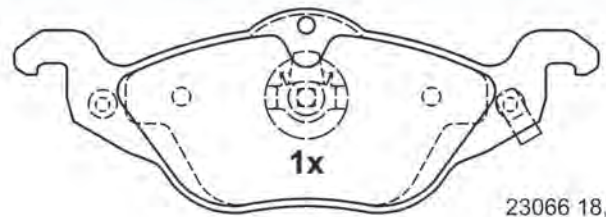

23066 18,5

177,6 x 62,0 x 18,5

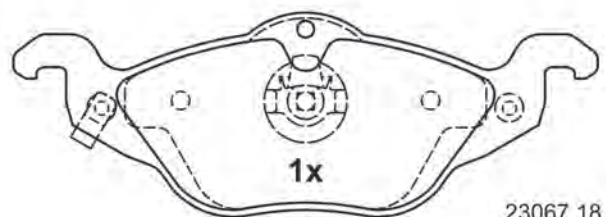

23067 18,5

177,6 x 62,0 x 18,5

Abbildungen Scheibenbremsbeläge

Illustrations disc brake pads - Ilustraciones de pastillas - Illustrations Plaquettes de frein à disque - Illustrazioni Pastiglie Freno

13.0460-7116.2 607116 [1]

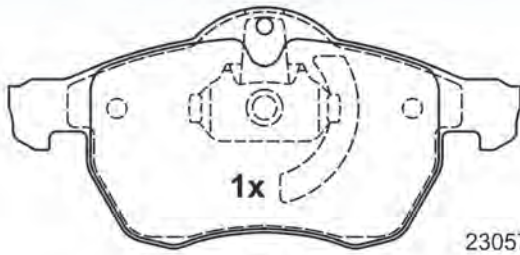

23057 20,2

155,1 x 71,4 x 20,2

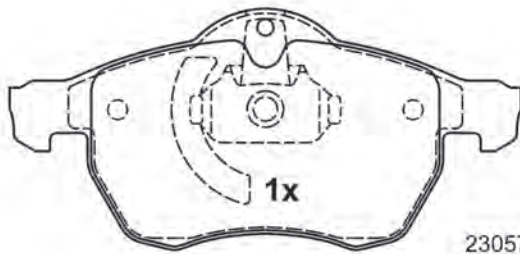

23057 20,2

155,1 x 71,4 x 20,2

13.0460-7116.2 607116 [2]

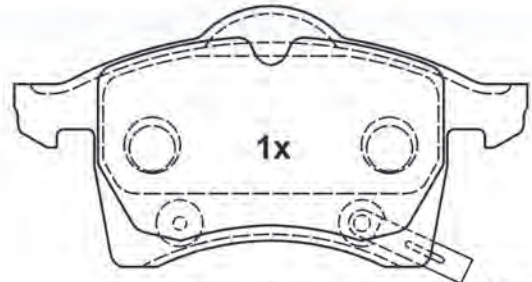

23058 19,6

156,3 x 78,5 x 19,6

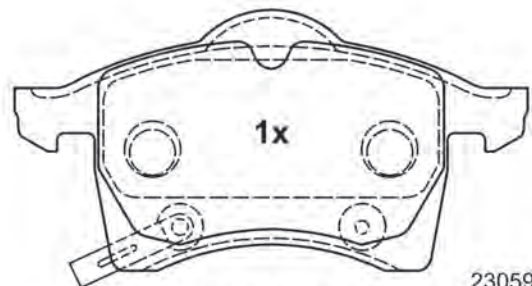

23059 19,6

156,3 x 78,5 x 19,6

13.0460-7117.2 607117

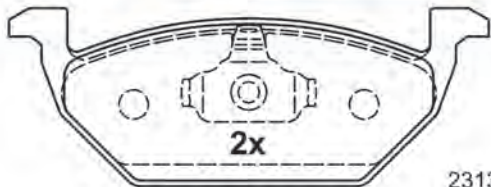

23130 19,6

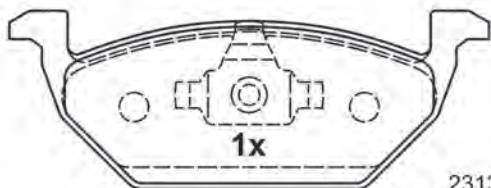

23131 19,6

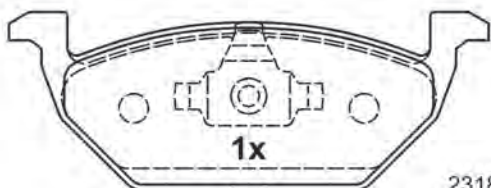

23187 19,6

146,0 x 54,7 x 19,6

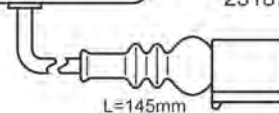

L=145mm

13.0460-7121.2 607121

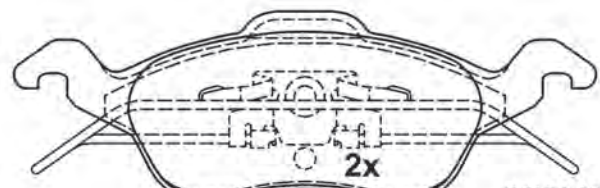

23154 19,4

177,8 x 58,2 x 19,4

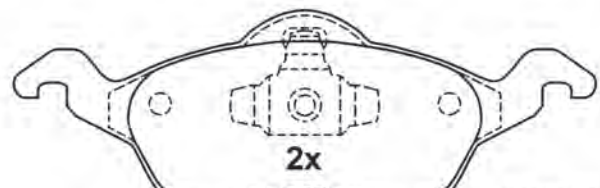

23155 19,4

177,8 x 60,8 x 19,4

Abbildungen Scheibenbremsbeläge

Illustrations disc brake pads - Ilustraciones de pastillas - Illustrations Plaquettes de frein à disque - Illustrazioni Pastiglie Freno

13.0460-7122.2 607122

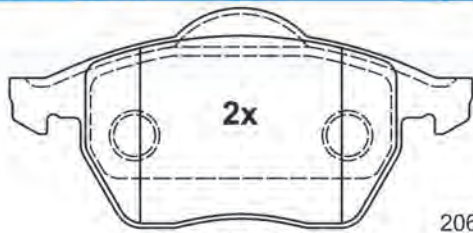

2x

20676 19,8

156,3 x 74,0 x 19,8

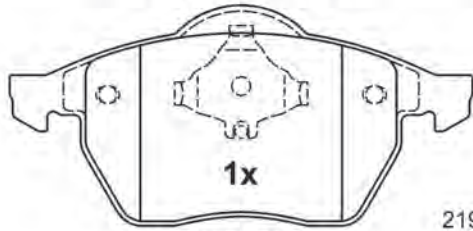

1x

21911 20,3

156,3 x 74,0 x 20,3

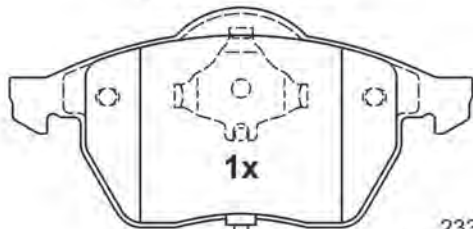

1x

23392 20,3

156,3 x 74,0 x 20,3

L=145mm

13.0460-7123.2 607123

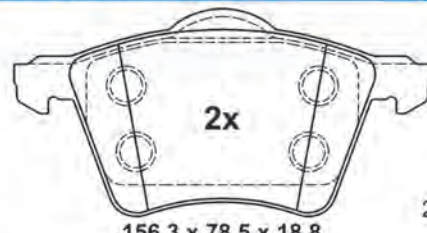

2x

23034 18,8

156,3 x 78,5 x 18,8

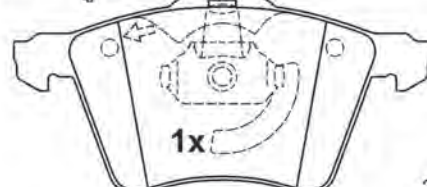
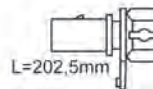

1x

23036 19,4

156,3 x 78,5 x 19,4

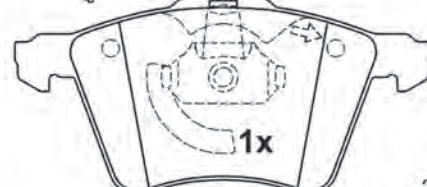
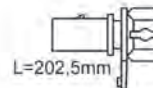

1x

23036 19,4

156,3 x 78,5 x 19,4

13.0460-7124.2 607124

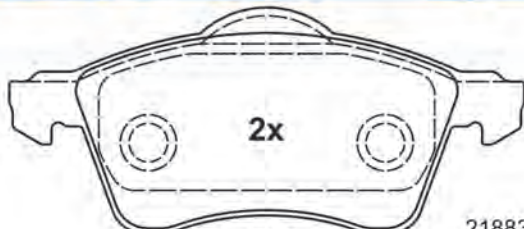

2x

21883 19,8

156,3 x 68,5 x 19,8

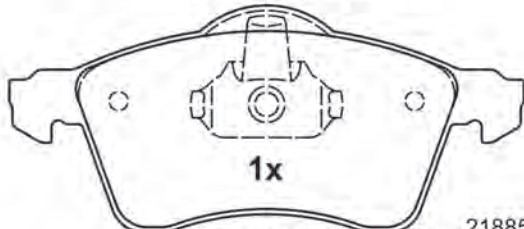

1x

21885 20,4

156,3 x 68,5 x 20,4

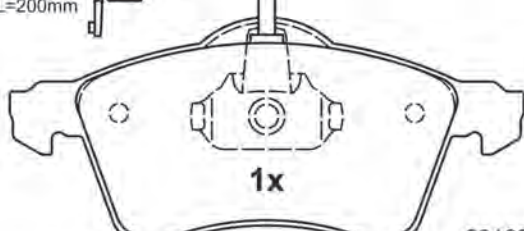
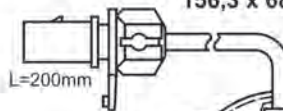

1x

23163 20,4

156,3 x 68,5 x 20,4

13.0460-7125.2 607125

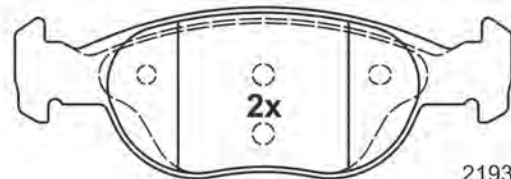

2x

21930 17,9

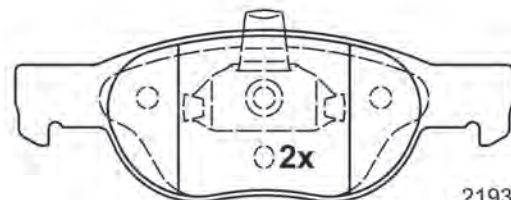

2x

21931 17,9

151,3 x 52,0 x 17,9

Abbildungen Scheibenbremsbeläge

Illustrations disc brake pads - Ilustraciones de pastillas - Illustrations Plaquettes de frein à disque - Illustrazioni Pastiglie Freno

13.0460-7126.2 607126

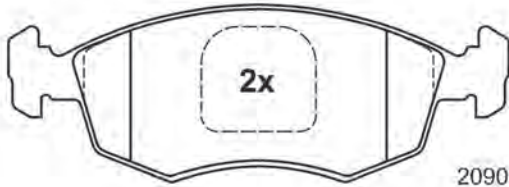

20907 18,1

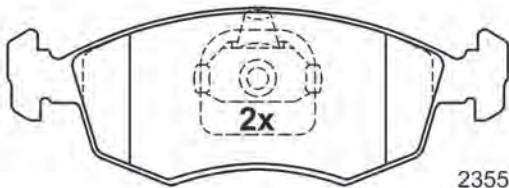

23552 18,1

151,3 x 52,5 x 18,1

13.0460-7128.2 607128



23218 18,0

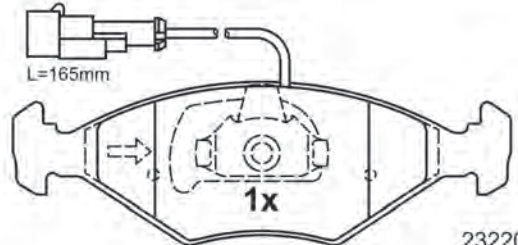

23220 18,0

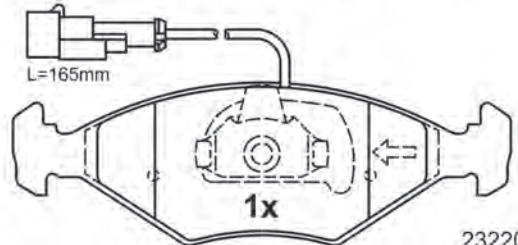

23220 18,0

151,3 x 49,2 x 18,0

13.0460-7129.2 607129

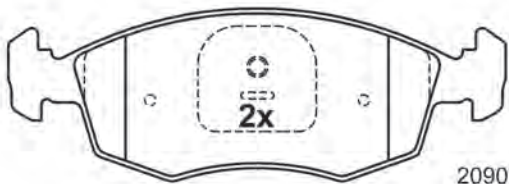

20907 18,1

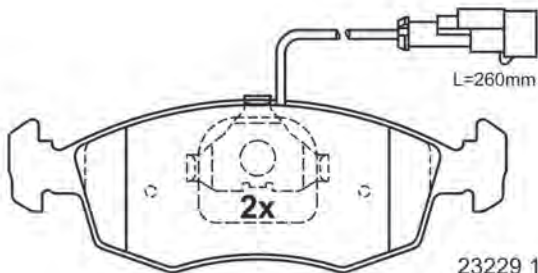

23229 18,1

151,3 x 52,5 x 18,1

13.0460-7131.2 607131



21193 18,0

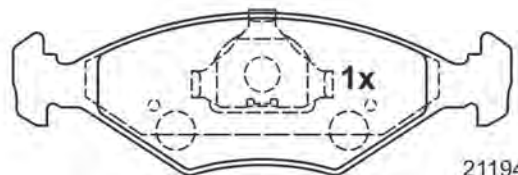

21194 18,0

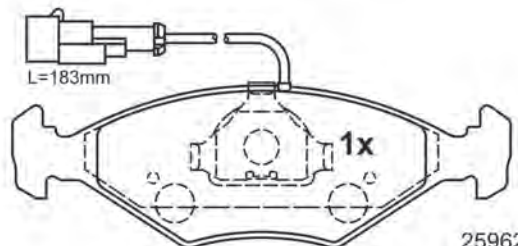

25962 18,0

151,3 x 49,2 x 18,0

Abbildungen Scheibenbremsbeläge

Illustrations disc brake pads - Ilustraciones de pastillas - Illustrations Plaquettes de frein à disque - Illustrazioni Pastiglie Freno

13.0460-7132.2 607132



23218 18,0

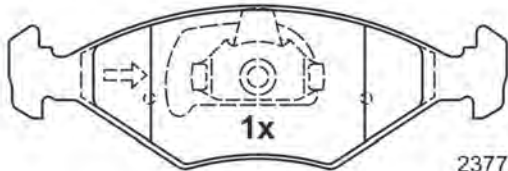

23775 18,0

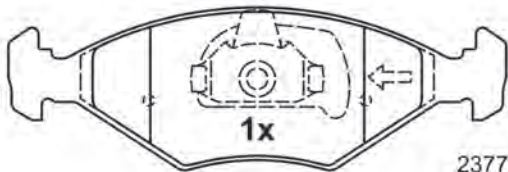

23775 18,0

151,3 x 49,2 x 18,0

13.0460-7133.2 607133



21927 17,9

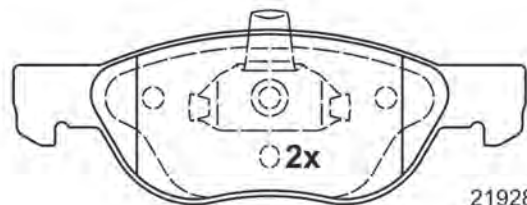

21928 17,9

156,3 x 52,7 x 17,9

13.0460-7134.2 607134

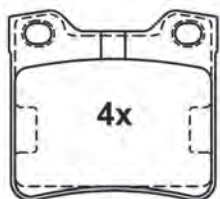

21278 16,4

63,7 x 57,8 x 16,4

13.0460-7135.2 607135

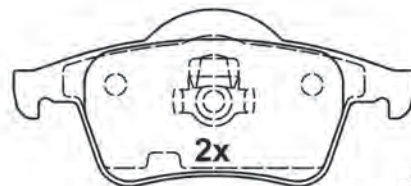

23076 17,5

122,4 x 53,7 x 17,5

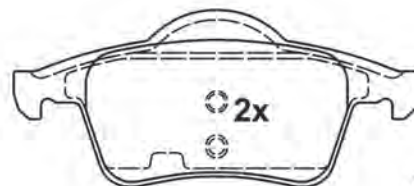

23077 17,5

123,6 x 53,7 x 17,5

Abbildungen Scheibenbremsbeläge

Illustrations disc brake pads - Ilustraciones de pastillas - Illustrations Plaquettes de frein à disque - Illustrazioni Pastiglie Freno

13.0460-7137.2 607137



23482 15,8

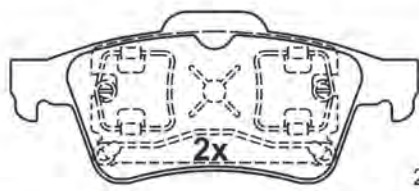

23483 15,8

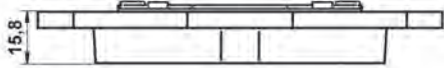

123,0 x 51,9 x 15,8

13.0460-7138.2 607138

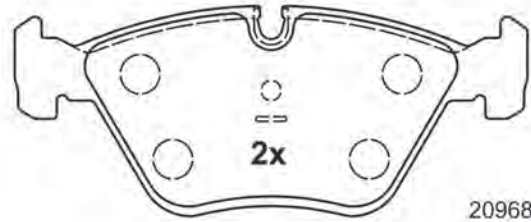

20968 17,5

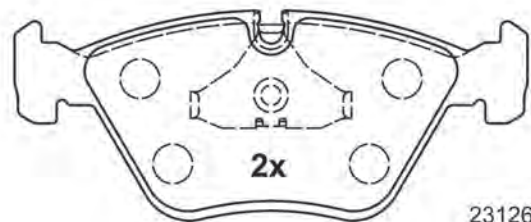

23126 17,5

156,4 x 64,0 x 17,5

13.0460-7139.2 607139

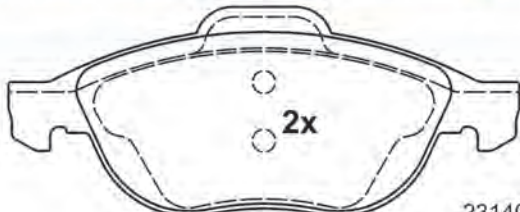

23140 19,4

156,3 x 63,8 x 19,4

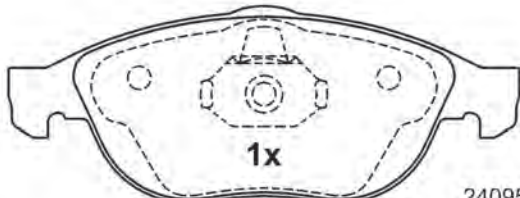

24095 19,4

155,1 x 59,3 x 19,4

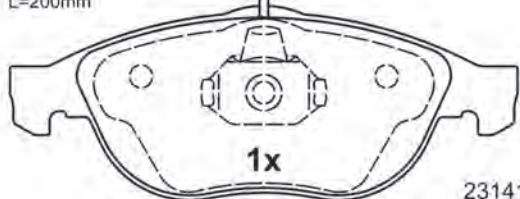
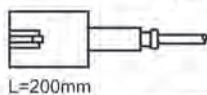

23141 19,4

155,1 x 59,3 x 19,4

13.0460-7140.2 607140

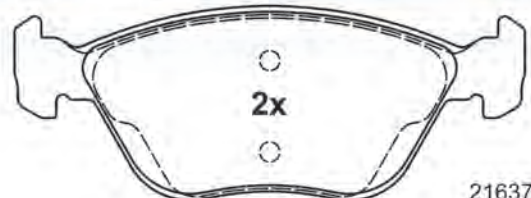

21637 19,3

156,3 x 59,1 x 19,3

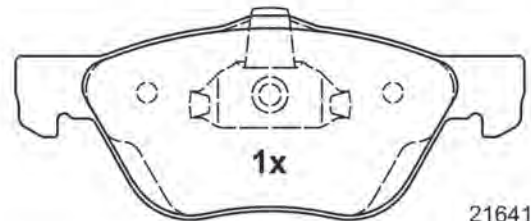

21641 19,3

155,1 x 61,8 x 19,3

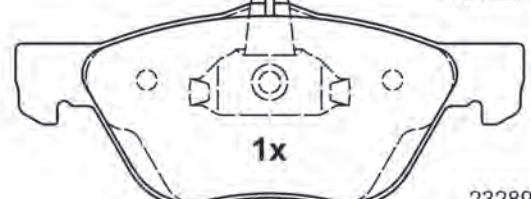

23289 19,3

155,1 x 61,8 x 19,3

Abbildungen Scheibenbremsbeläge

Illustrations disc brake pads - Ilustraciones de pastillas - Illustrations Plaquettes de frein à disque - Illustrazioni Pastiglie Freno

13.0460-7141.2 607141

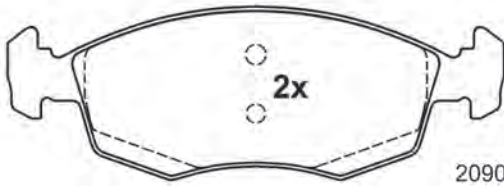

20907 18,1

151,3 x 52,5 x 18,1

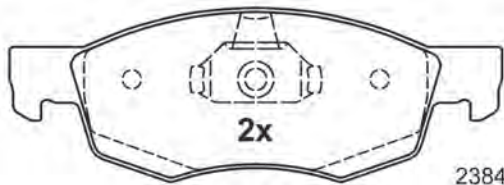

23842 18,1

150,1 x 52,5 x 18,1

13.0460-7142.2 607142



23202 17,8

151,3 x 58,2 x 17,8

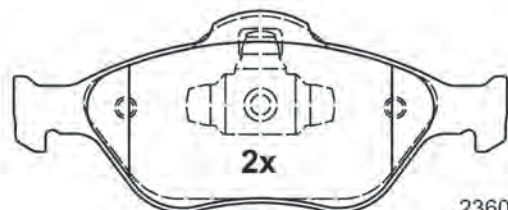

23604 17,8

150,1 x 61,0 x 17,8

13.0460-7143.2 607143

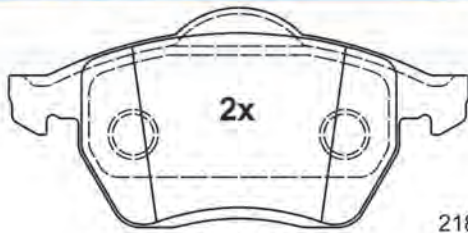

21848 19,8

156,3 x 74,0 x 19,8

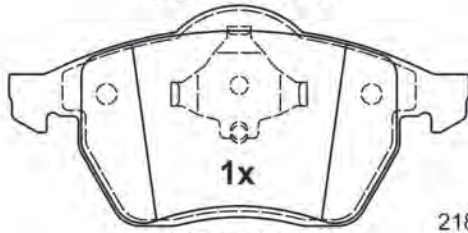

21849 20,3

156,3 x 74,0 x 20,3

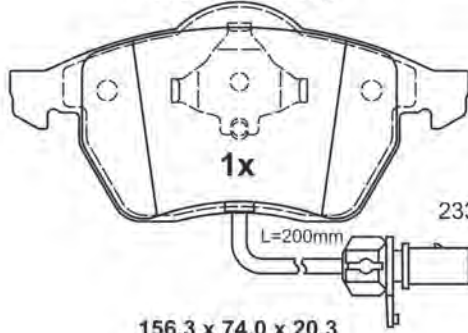

23324 20,3

156,3 x 74,0 x 20,3

13.0460-7144.2 607144

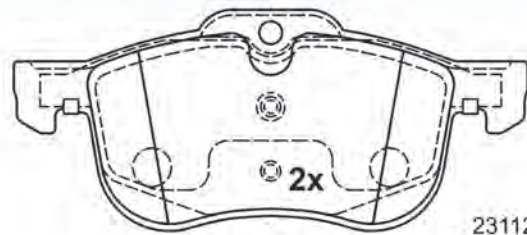

23112 19,1

156,4 x 67,2 x 19,1

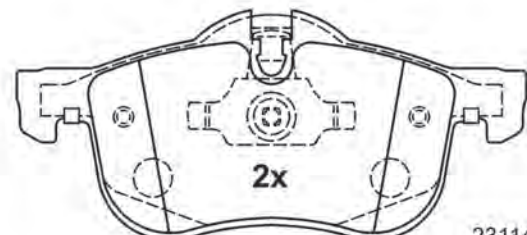

23114 19,1

155,1 x 70,1 x 19,1

Abbildungen Scheibenbremsbeläge

Illustrations disc brake pads - Ilustraciones de pastillas - Illustrations Plaquettes de frein à disque - Illustrazioni Pastiglie Freno

13.0460-7145.2 607145

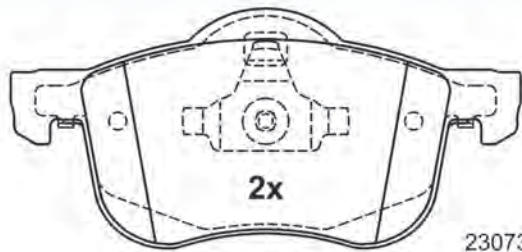

155,1 x 72,5 x 18,8

23073 18,8

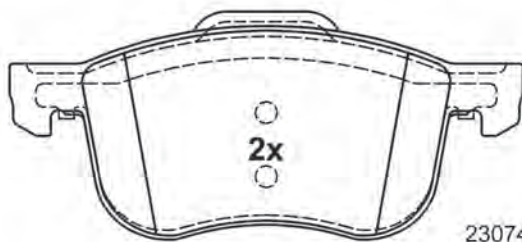

156,3 x 69,1 x 18,8

23074 18,8

13.0460-7146.2 607146



20147 17,0

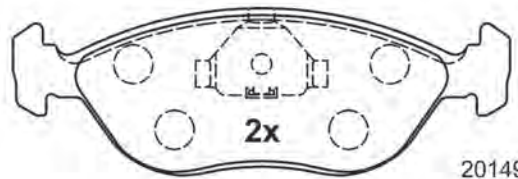

20149 17,0

151,3 x 50,6 x 17,0

13.0460-7147.2 607147

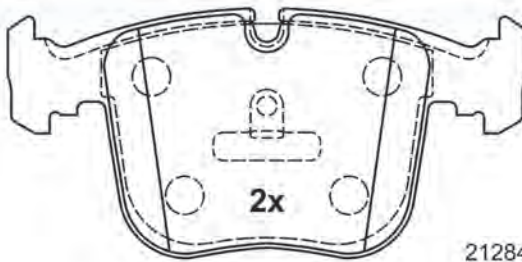

21284 19,1

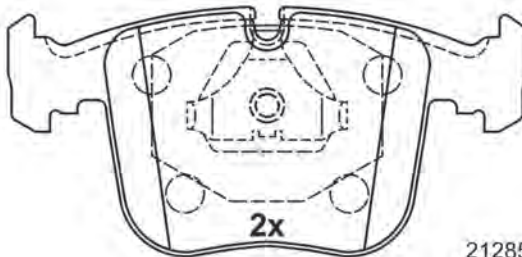

156,4 x 75,0 x 19,1

21285 19,1

13.0460-7148.2 607148

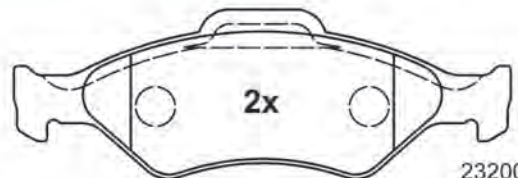

23200 18,0

151,3 x 51,3 x 18,0

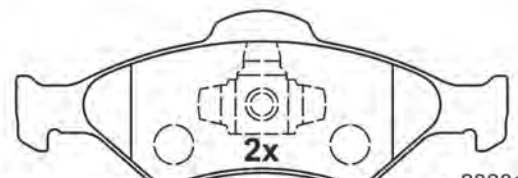

23201 18,0

150,1 x 54,1 x 18,0



Abbildungen Scheibenbremsbeläge

Illustrations disc brake pads - Ilustraciones de pastillas - Illustrations Plaquettes de frein à disque - Illustrazioni Pastiglie Freno

13.0460-7153.2 607153

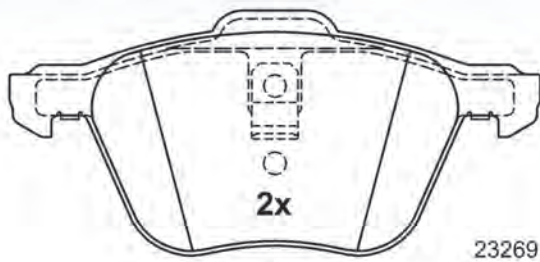

161,3 x 74,4 x 19,8

23269 19,8

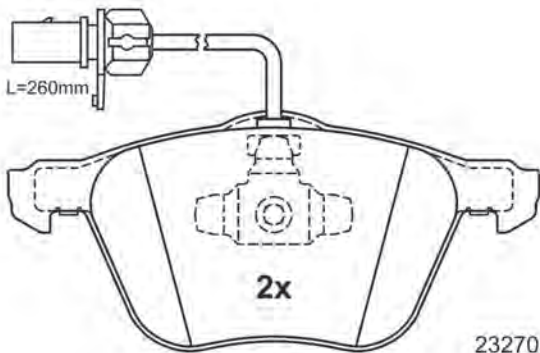

161,3 x 72,9 x 19,8

23270 19,8

13.0460-7154.2 607154

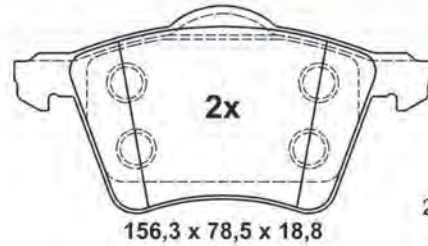

156,3 x 78,5 x 18,8

23034 18,8

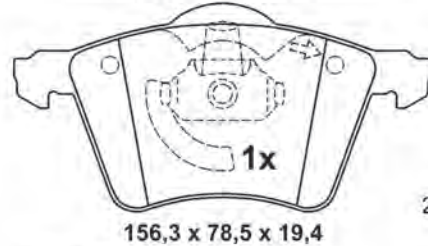

156,3 x 78,5 x 19,4

23418 19,4

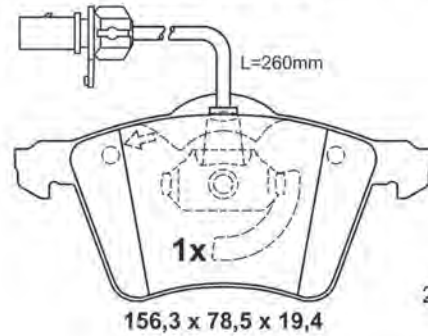

156,3 x 78,5 x 19,4

23419 19,4

13.0460-7155.2 607155

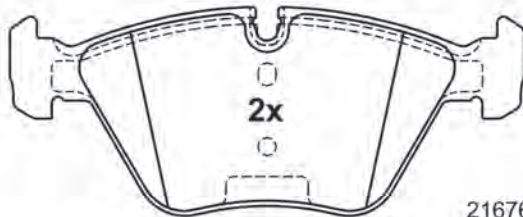

156,3 x 63,5 x 20,3

21676 20,3

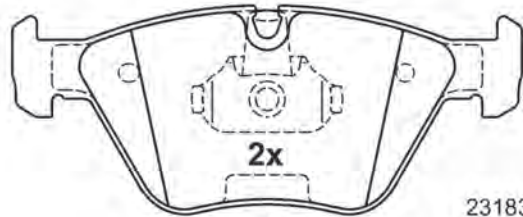

155,1 x 63,5 x 20,3

23183 20,3

13.0460-7156.2 607156

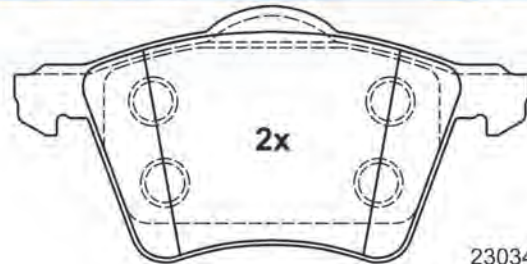

23034 19,4

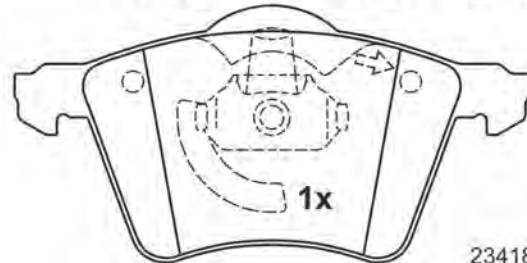

23418 19,4

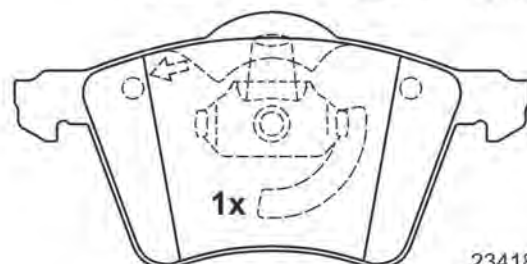

156,3 x 78,5 x 19,5

23418 19,4

Abbildungen Scheibenbremsbeläge

Illustrations disc brake pads - Ilustraciones de pastillas - Illustrations Plaquettes de frein à disque - Illustrazioni Pastiglie Freno

13.0460-7157.2 607157

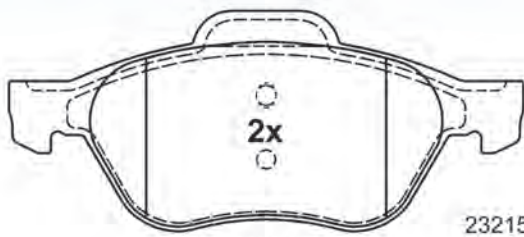

156,3 x 66,8 x 18,3

23215 18,3

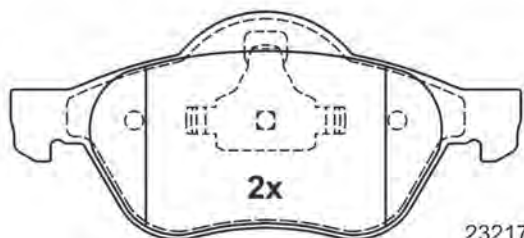

155,1 x 68,9 x 18,3

23217 18,3

13.0460-7158.2 607158

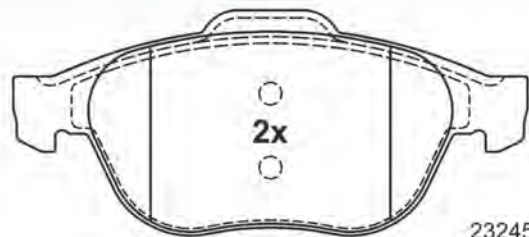

156,3 x 68,3 x 18,3

23245 18,3

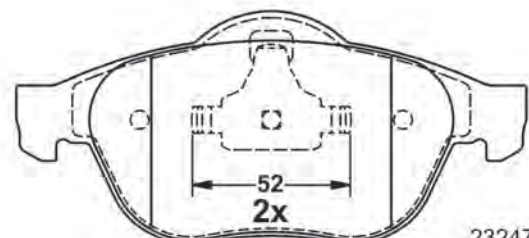

155,1 x 70,8 x 18,3

23247 18,3

13.0460-7159.2 607159

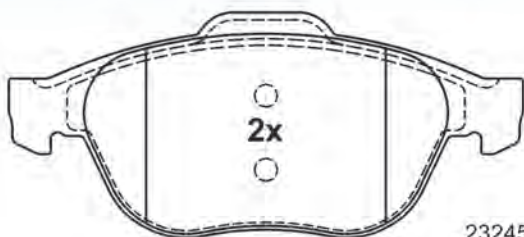

156,3 x 68,3 x 18,3

23245 18,3

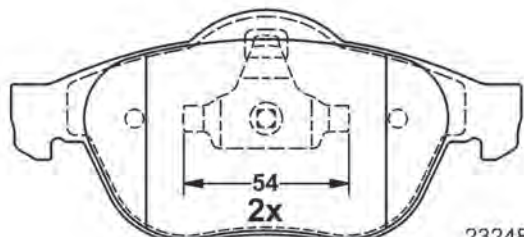

155,1 x 70,8 x 18,3

23248 18,3

13.0460-7160.2 607160

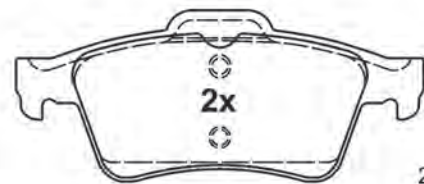

23482 15,8

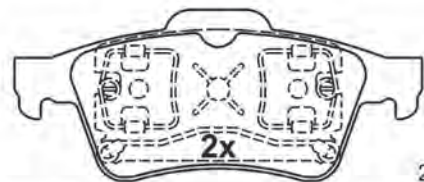

23483 15,8

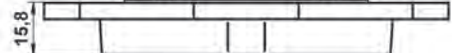

123,0 x 51,9 x 15,8



Abbildungen Scheibenbremsbeläge

Illustrations disc brake pads - Ilustraciones de pastillas - Illustrations Plaquettes de frein à disque - Illustrazioni Pastiglie Freno

13.0460-7161.2 607161

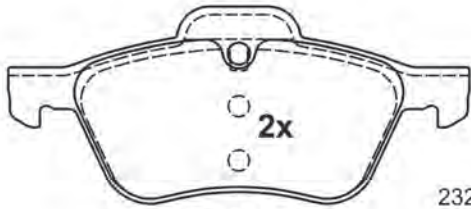

23281 18,3

140,1 x 59,8 x 18,3

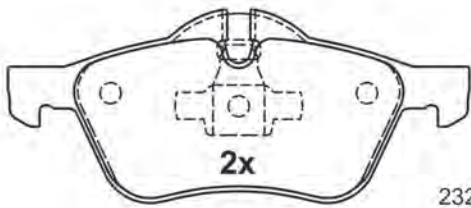

23282 18,3

140,1 x 58,7 x 18,3

13.0460-7162.2 607162

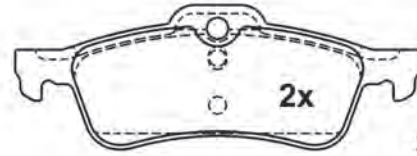

23716 15,8

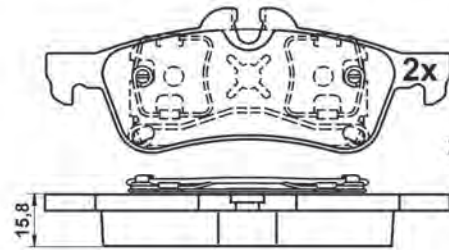

23717 15,8

123,0 x 43,8 x 15,8

13.0460-7163.2 607163

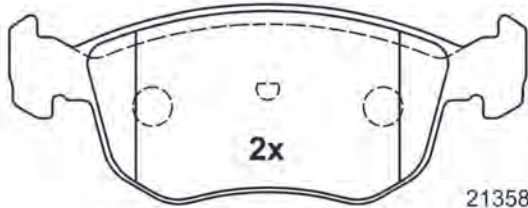

21358 19,8

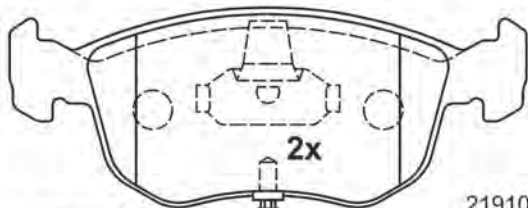

21910 19,8

L=210mm

156,4 x 60,0 x 19,8

13.0460-7164.2 607164

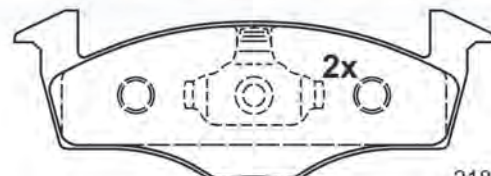

21868 17,2

141,8 x 50,6 x 17,2

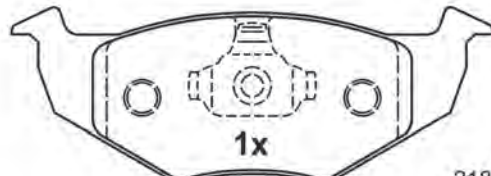

21866 17,2

141,8 x 51,2 x 17,2

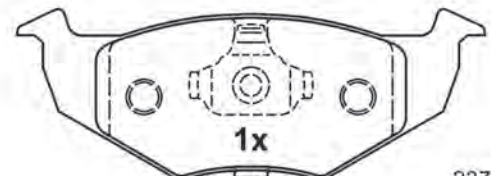

23752 17,2

L=150mm

141,8 x 51,2 x 17,2

Abbildungen Scheibenbremsbeläge

Illustrations disc brake pads - Ilustraciones de pastillas - Illustrations Plaquettes de frein à disque - Illustrazioni Pastiglie Freno

13.0460-7165.2 607165

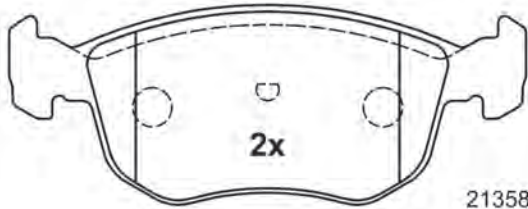

21358 19,8

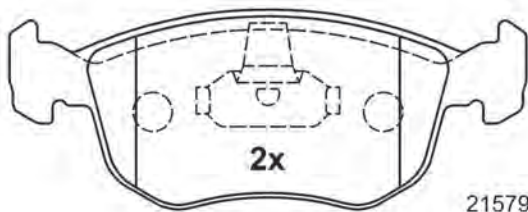

21579 19,8

156,4 x 60,0 x 19,8

13.0460-7166.2 607166

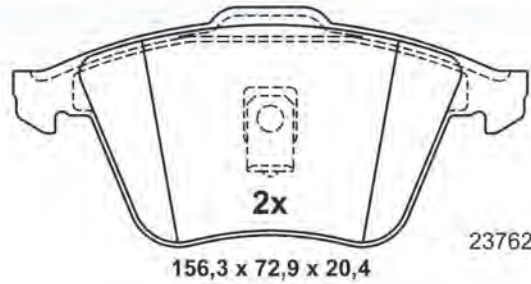

23762 20,4

156,3 x 72,9 x 20,4

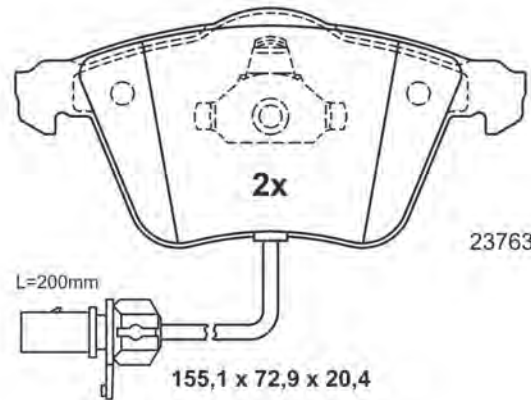

23763 20,4

155,1 x 72,9 x 20,4

L=200mm

13.0460-7167.2 607167

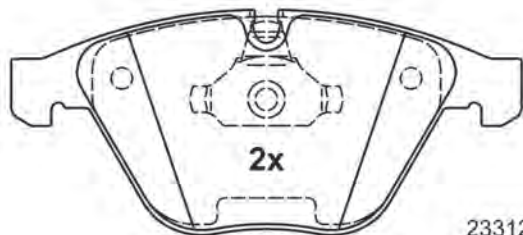

23312 20,3

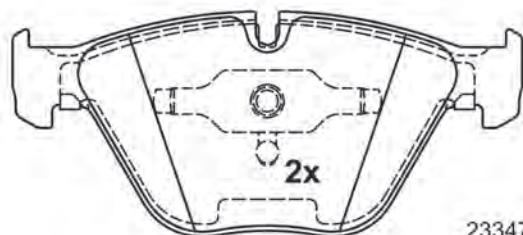

23347 20,3

155,1 x 68,3 x 20,3

13.0460-7168.2 607168

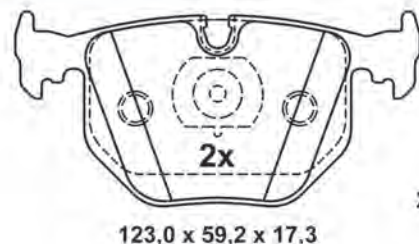

21282 17,3

123,0 x 59,2 x 17,3

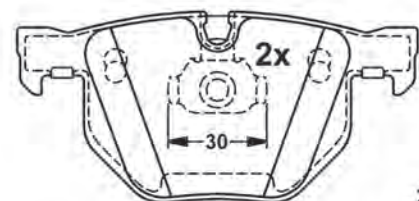

23447 17,3

121,8 x 57,8 x 17,3

Abbildungen Scheibenbremsbeläge

Illustrations disc brake pads - Ilustraciones de pastillas - Illustrations Plaquettes de frein à disque - Illustrazioni Pastiglie Freno

13.0460-7169.2 607169

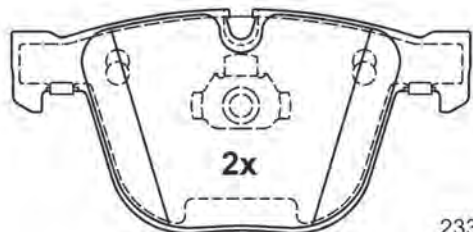

23309 17,3



23310 17,3

139,5 x 67,8 x 17,3

13.0460-7170.2 607170

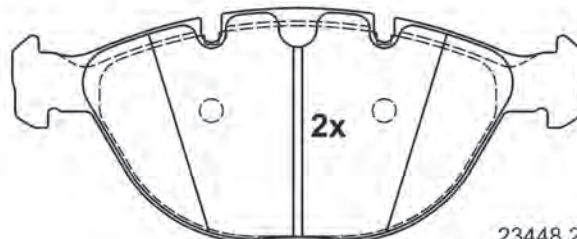

23448 20,8

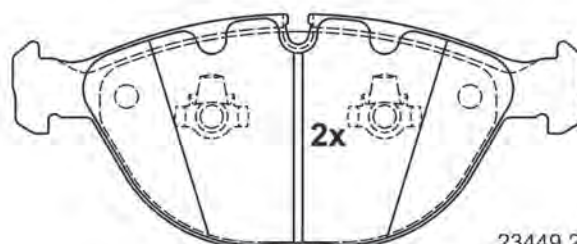

23449 20,8

193,0 x 79,0 x 20,8

13.0460-7171.2 607171

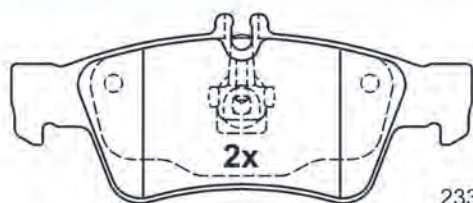

23334 16,7

140,1 x 57,5 x 16,7

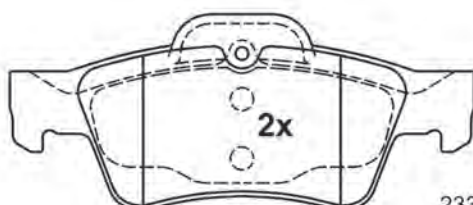

23335 16,7

141,3 x 59,4 x 16,7

13.0460-7172.2 607172

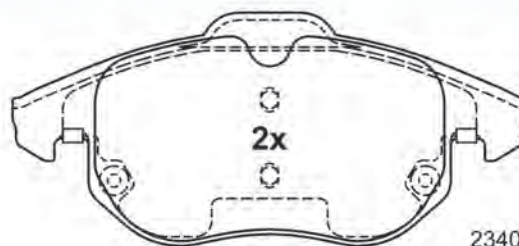

23403 20,1

156,3 x 70,7 x 20,1

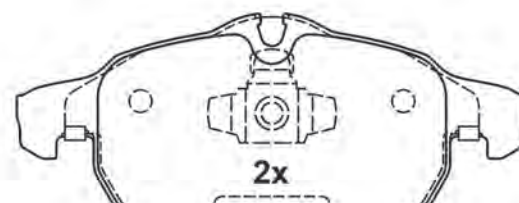

23402 20,1

155,1 x 69,6 x 20,1

Abbildungen Scheibenbremsbeläge

Illustrations disc brake pads - Ilustraciones de pastillas - Illustrations Plaquettes de frein à disque - Illustrazioni Pastiglie Freno

13.0460-7173.2 607173

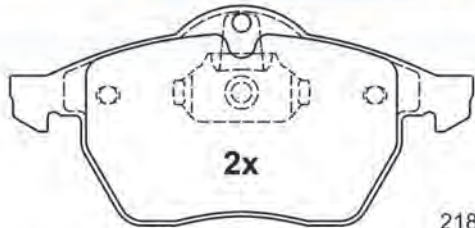

155,1 x 74,0 x 20,3

21829 20,3

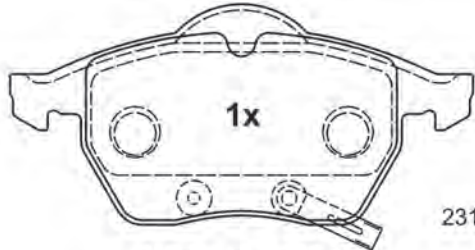

156,3 x 74,0 x 19,6

23116 19,6

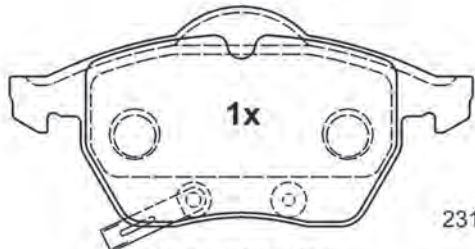

156,3 x 74,0 x 19,6

23117 19,6

13.0460-7174.2 607174

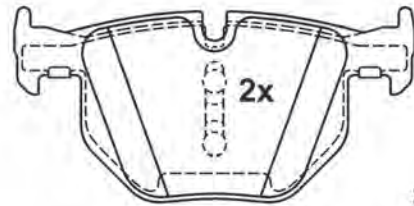

121,8 x 59,2 x 17,3

23732 17,3

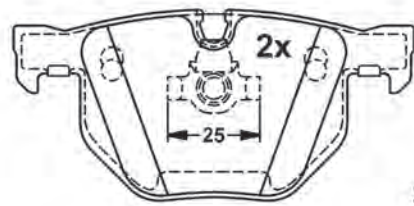

121,8 x 57,8 x 17,3

23737 17,3

13.0460-7176.2 607176

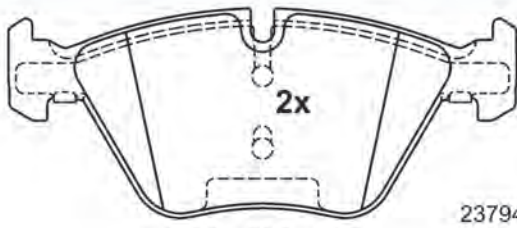

154,6 x 63,5 x 20,3

23794 20,3

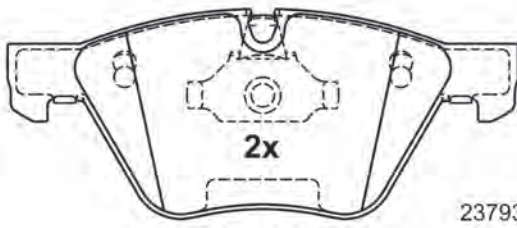

155,1 x 63,5 x 20,3

23793 20,3

13.0460-7177.2 607177

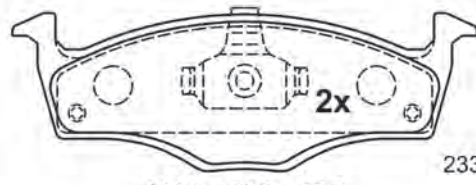

141,6 x 48,0 x 13,7

23394 13,7

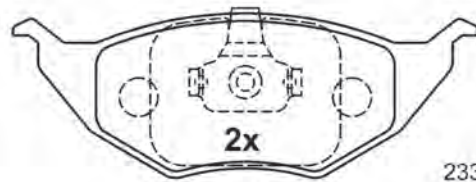

141,6 x 49,9 x 13,7

23395 13,7

Abbildungen Scheibenbremsbeläge

Illustrations disc brake pads - Ilustraciones de pastillas - Illustrations Plaquettes de frein à disque - Illustrazioni Pastiglie Freno

13.0460-7178.2 607178

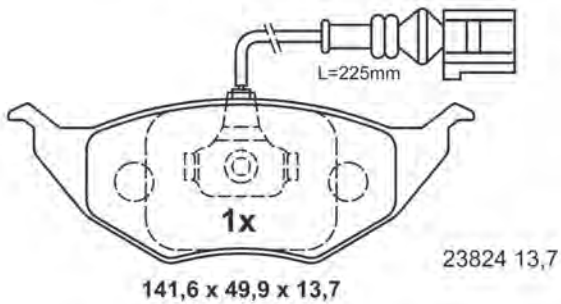
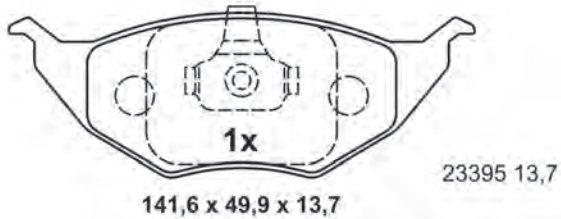
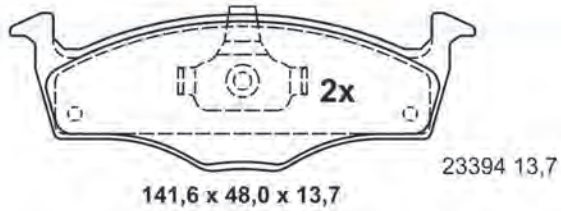

13.0460-7179.2 607179 [1]

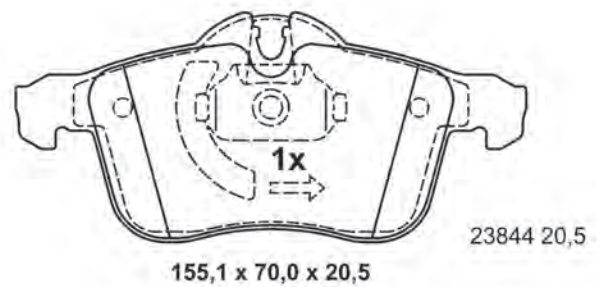
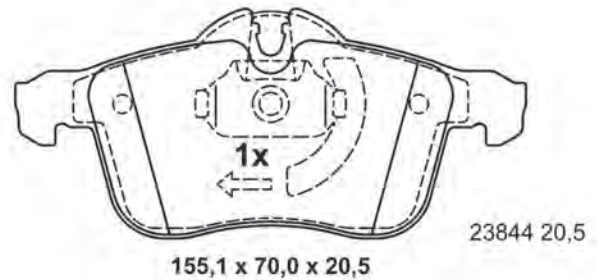

13.0460-7179.2 607179 [2]

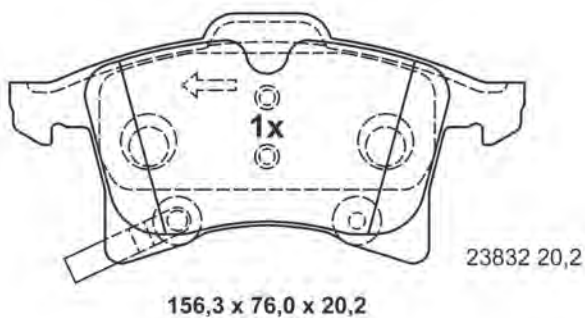
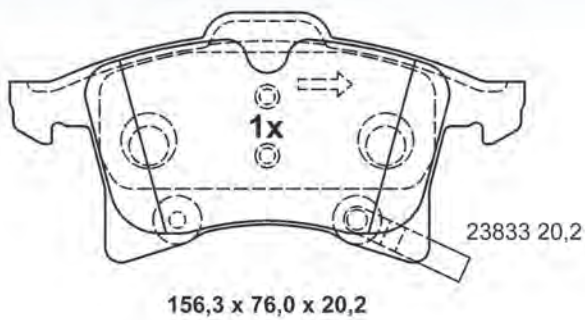

13.0460-7180.2 607180

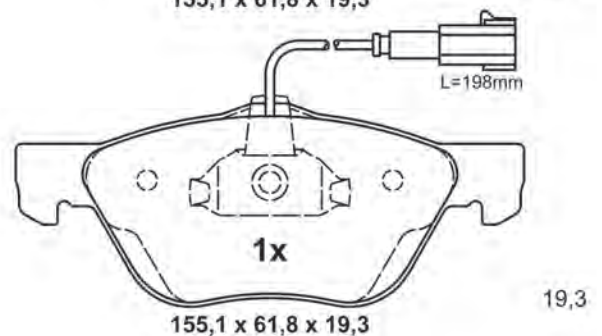
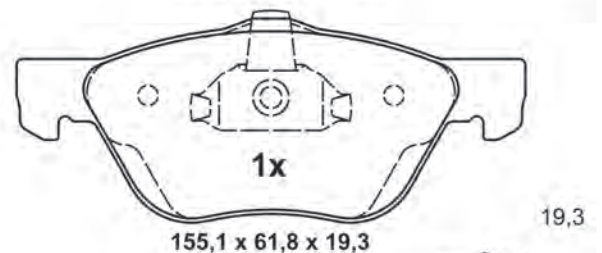
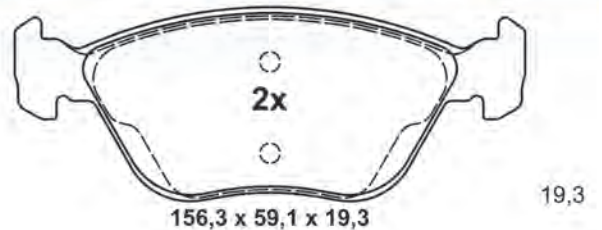

Abbildungen Scheibenbremsbeläge

Illustrations disc brake pads - Ilustraciones de pastillas - Illustrations Plaquettes de frein à disque - Illustrazioni Pastiglie Freno

13.0460-7181.2 607181

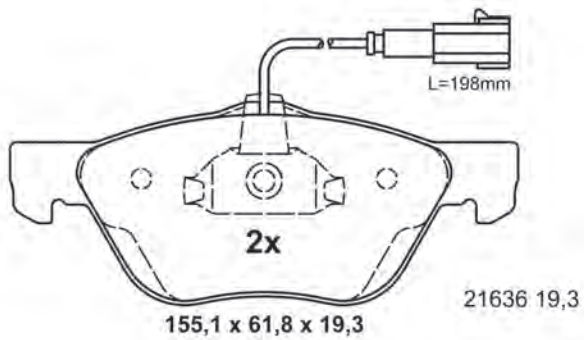
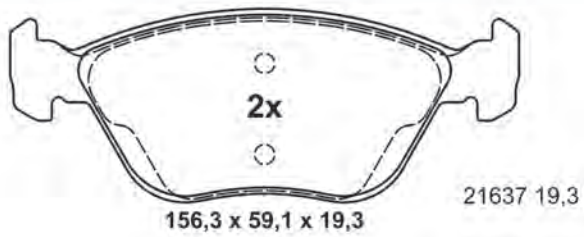

13.0460-7182.2 607182

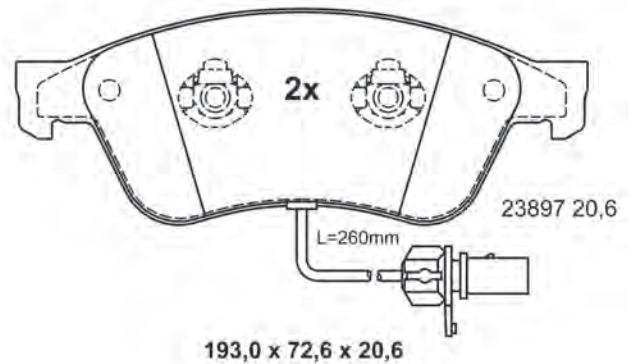
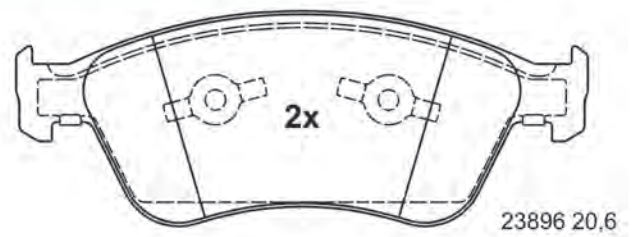

13.0460-7183.2 607183

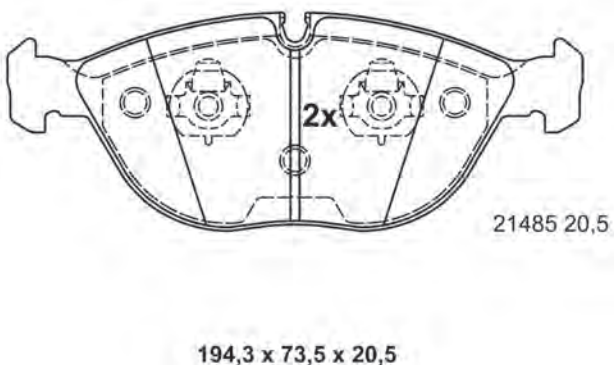
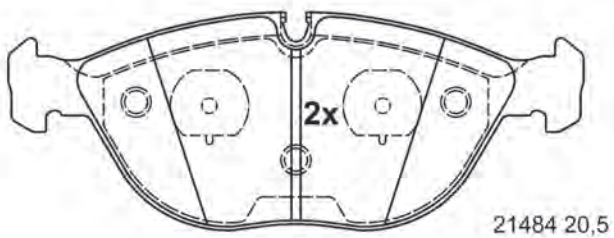

13.0460-7184.2 607184

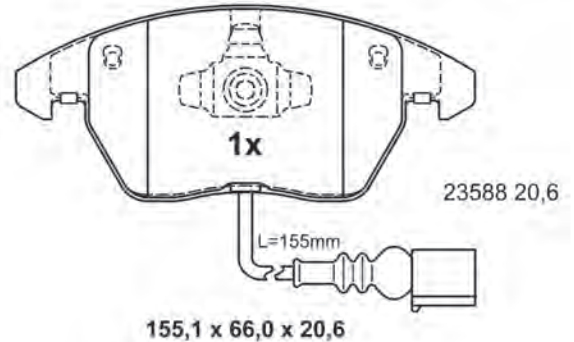
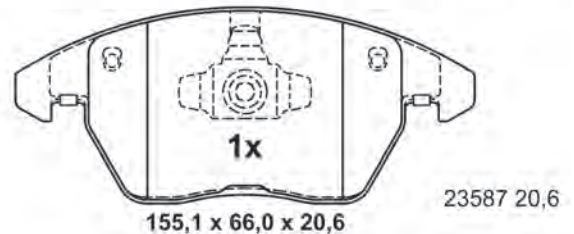
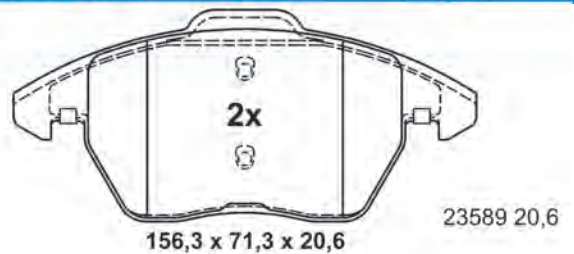

Abbildungen Scheibenbremsbeläge

Illustrations disc brake pads - Ilustraciones de pastillas - Illustrations Plaquettes de frein à disque - Illustrazioni Pastiglie Freno

13.0460-7185.2 607185



20968 20,3

156,3 x 63,5 x 20,3

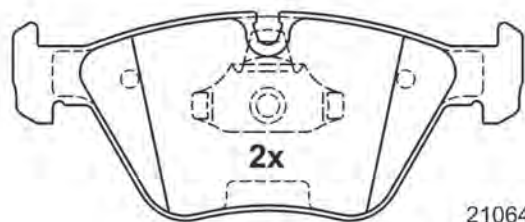

21064 20,3

155,1 x 63,5 x 20,3

13.0460-7186.2 607186



23440 17,6

156,3 x 67,3 x 17,6

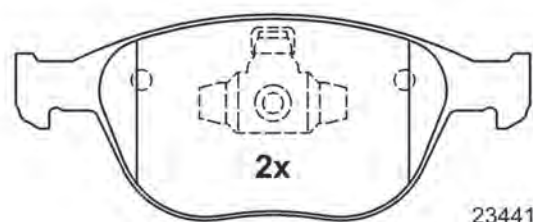

23441 18,1

156,3 x 62,5 x 18,1

13.0460-7187.2 607187

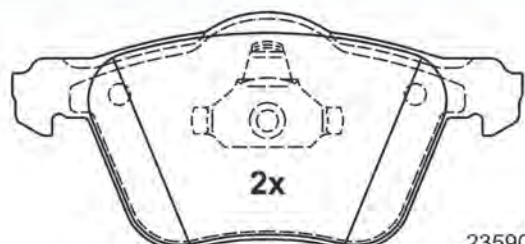

23590 19,5

155,1 x 72,0 x 19,5

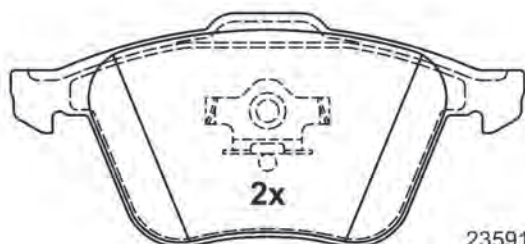

23591 18,0

156,3 x 71,0 x 18,0

13.0460-7188.2 607188

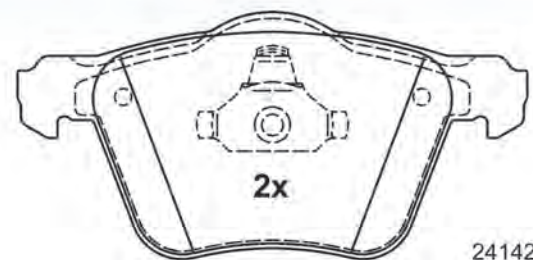

24142 20,6

155,1 x 75,1 x 20,6

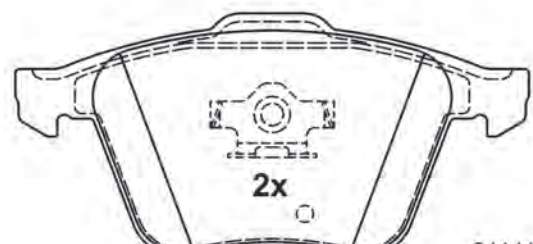

24141 19,1

156,3 x 74,1 x 19,1

Abbildungen Scheibenbremsbeläge

Illustrations disc brake pads - Ilustraciones de pastillas - Illustrations Plaquettes de frein à disque - Illustrazioni Pastiglie Freno

13.0460-7189.2 607189



123,0 x 61,7 x 18,7

24011 18,7

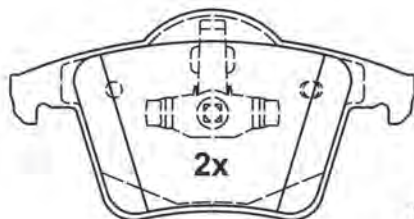

123,0 x 63,7 x 18,7

24012 18,7

13.0460-7190.2 607190



141,3 x 50,9 x 19,1

24367 19,1

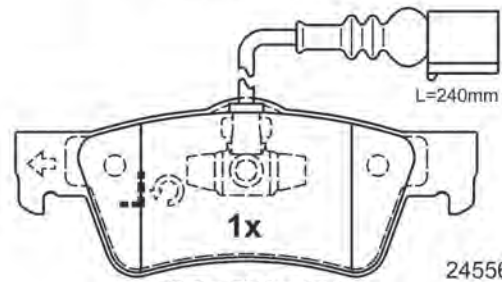

140,7 x 53,9 x 19,1

24556 19,1

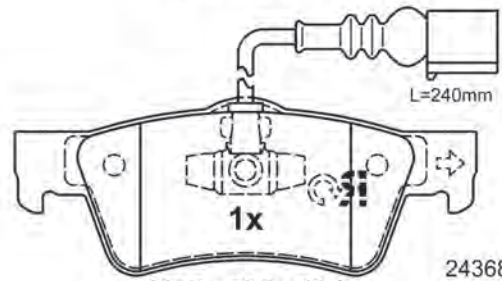

140,7 x 53,9 x 19,1

24368 19,1

13.0460-7191.2 607191

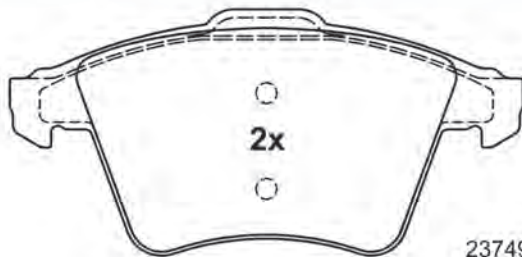

156,2 x 74,8 x 19,1

23749 19,1

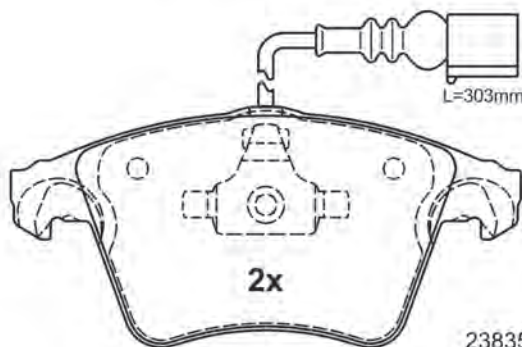

155,0 x 73,3 x 19,6

23835 19,6

13.0460-7193.2 607193

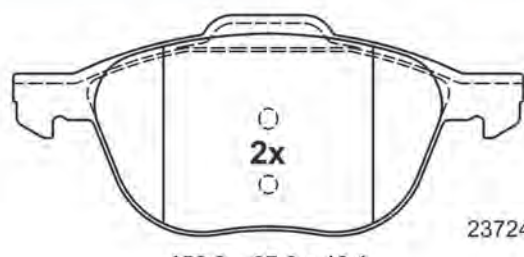

156,3 x 67,0 x 18,1

23724 18,1

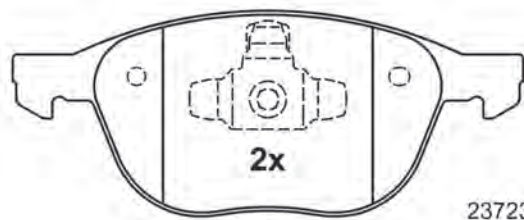

155,1 x 62,4 x 18,1

23723 18,1

Abbildungen Scheibenbremsbeläge

Illustrations disc brake pads - Ilustraciones de pastillas - Illustrations Plaquettes de frein à disque - Illustrazioni Pastiglie Freno

13.0460-7194.2 607194

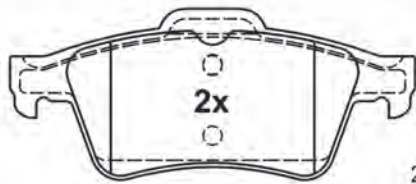

23482 16,6

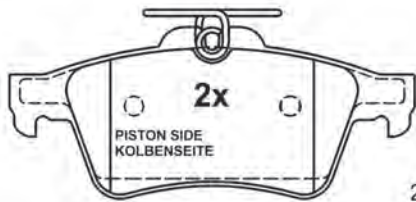

24137 16,6

123,0 x 52,0 x 16,6

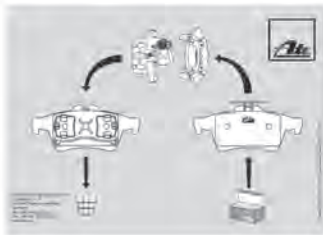

13.0460-7195.2 607195

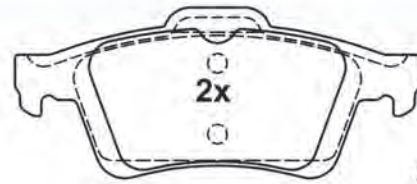

23482 16,6

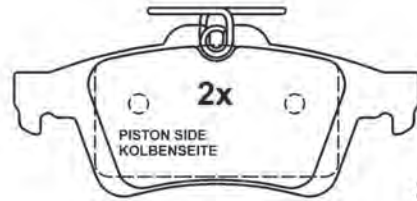

24137 16,6

123,0 x 52,0 x 16,6

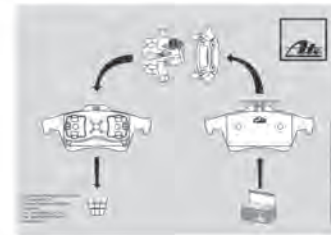

13.0460-7196.2 607196

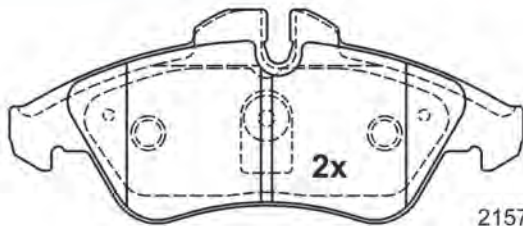

21576 20,7

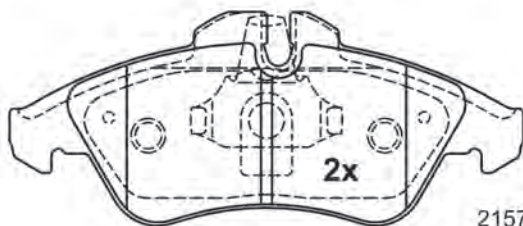

21577 20,7

156,3 x 64,8 x 20,7

13.0460-7199.2 607199

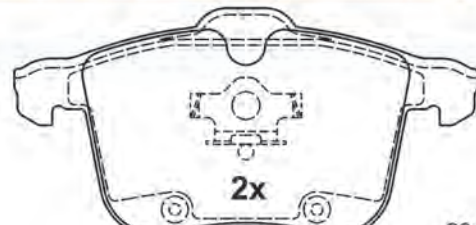

23405 20,1

156,4 x 77,6 x 20,1

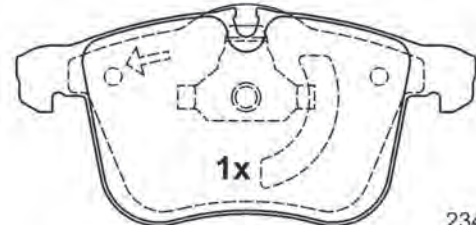

23404 20,6

155,1 x 74,5 x 20,6

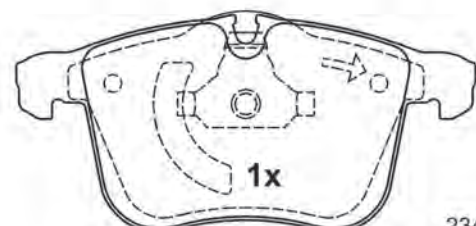

23404 20,6

155,1 x 74,5 x 20,6

Abbildungen Scheibenbremsbeläge

Illustrations disc brake pads - Ilustraciones de pastillas - Illustrations Plaquettes de frein à disque - Illustrazioni Pastiglie Freno

13.0460-7200.2 607200

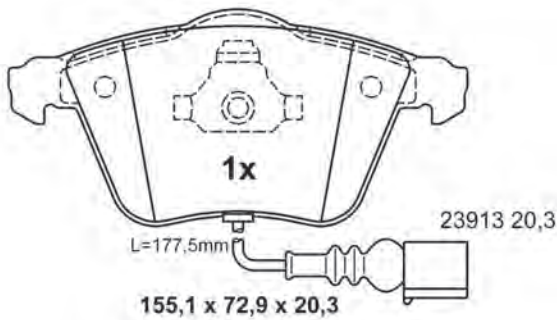
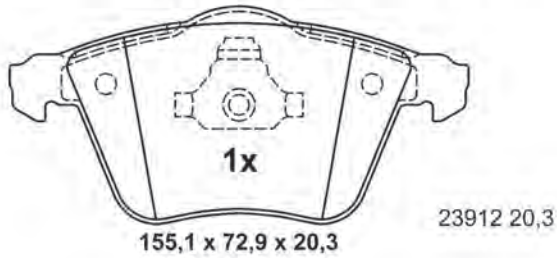
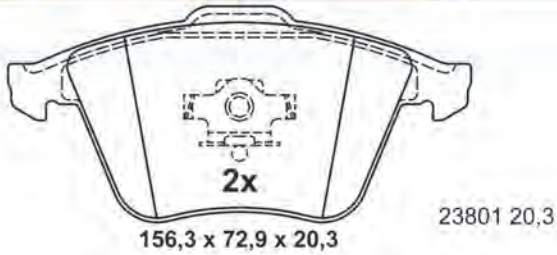

13.0460-7201.2 607201

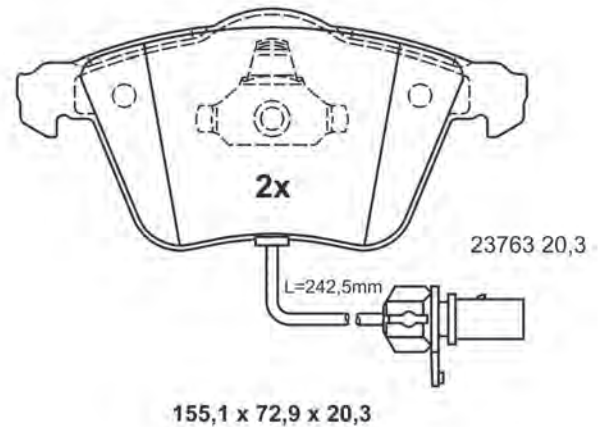
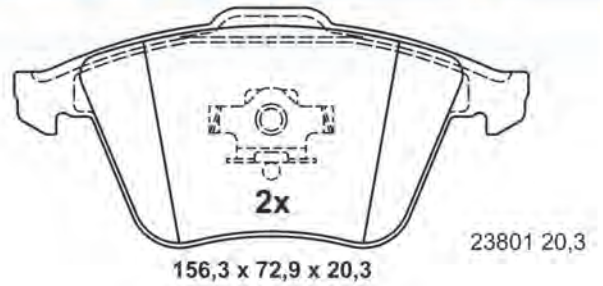

13.0460-7202.2 607202

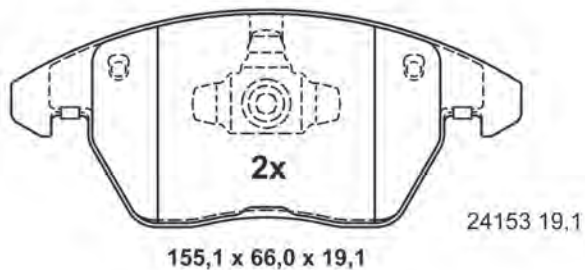
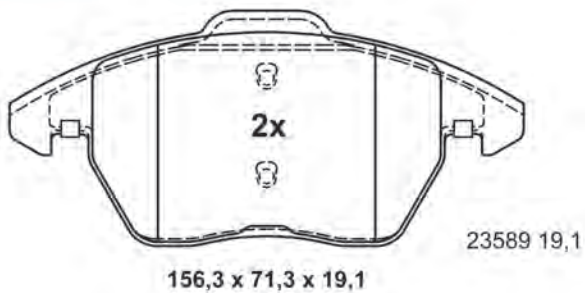

13.0460-7203.2 607203

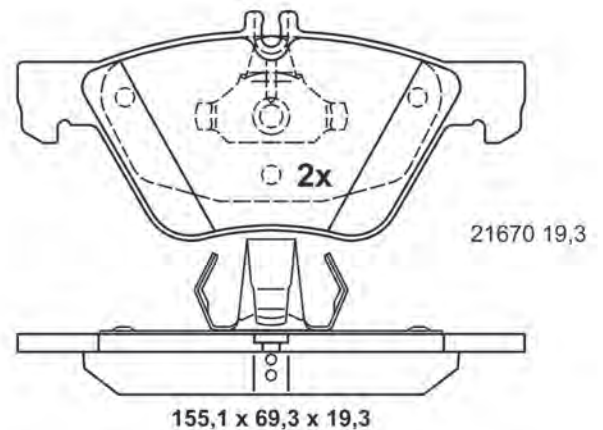
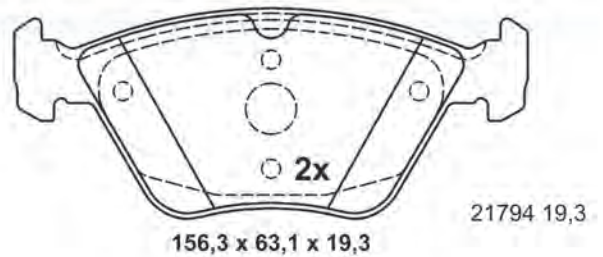

Abbildungen Scheibenbremsbeläge

Illustrations disc brake pads - Ilustraciones de pastillas - Illustrations Plaquettes de frein à disque - Illustrazioni Pastiglie Freno

13.0460-7204.2 607204

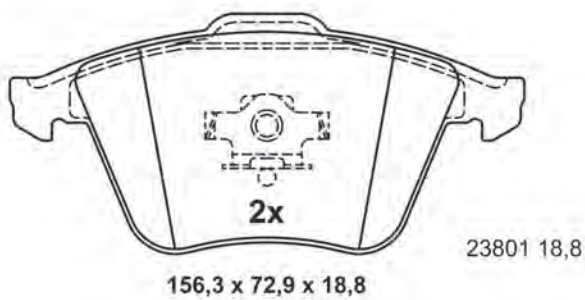
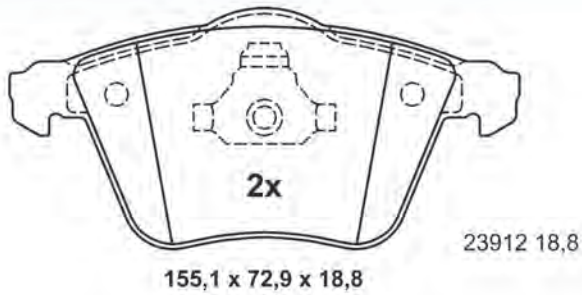

13.0460-7205.2 607205

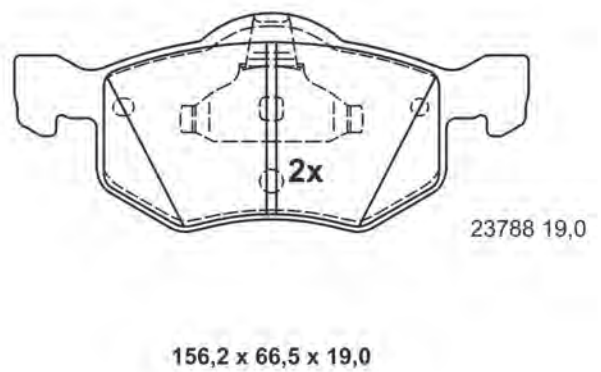
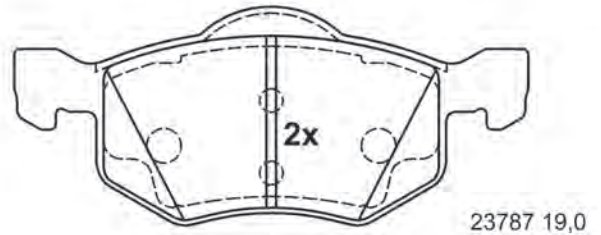

13.0460-7206.2 607206

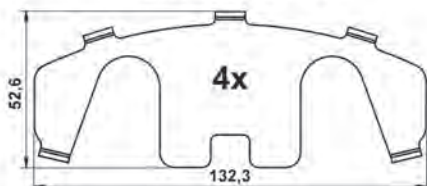
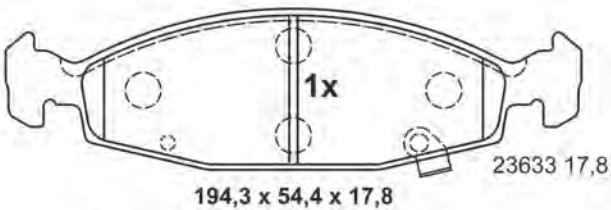
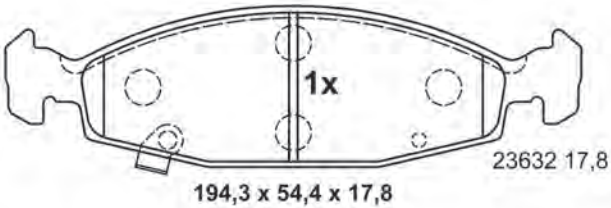
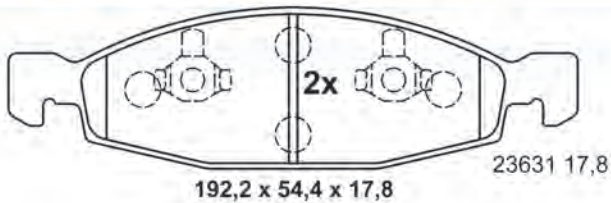

13.0460-7207.2 607207

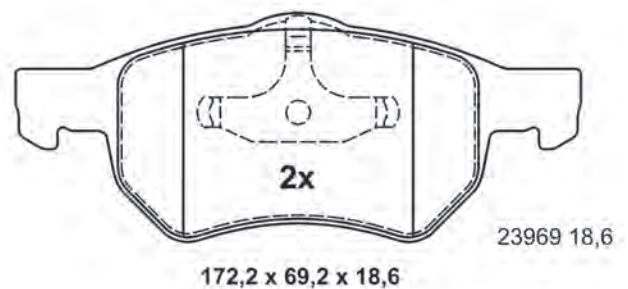
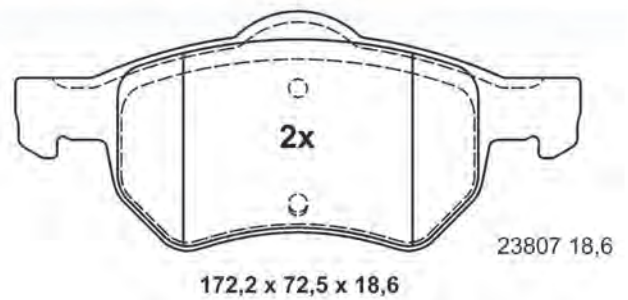

Abbildungen Scheibenbremsbeläge

Illustrations disc brake pads - Ilustraciones de pastillas - Illustrations Plaquettes de frein à disque - Illustrazioni Pastiglie Freno

13.0460-7209.2 607209

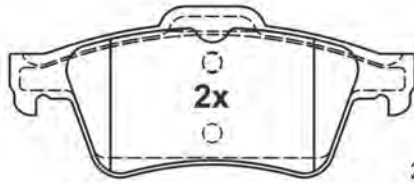

23482 16,6

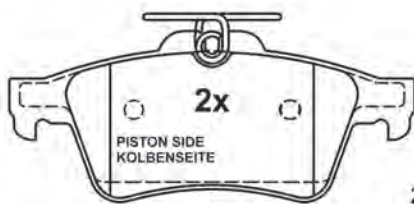

24137 16,6

123,0 x 52,0 x 16,6

13.0460-7210.2 607210

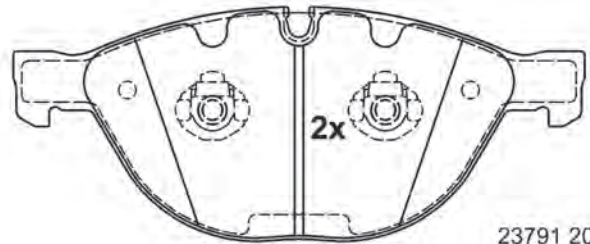

23791 20,8

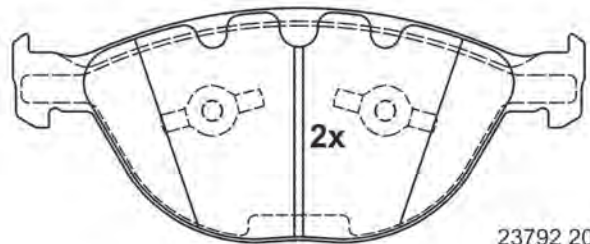

23792 20,8

193,0 x 79,0 x 20,8

13.0460-7211.2 607211

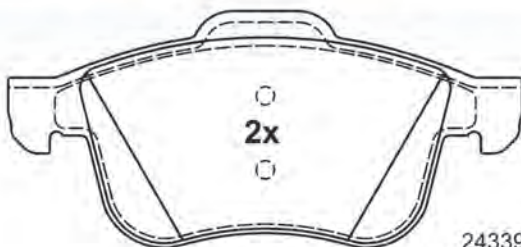

24339 20,5

156,3 x 71,5 x 20,5

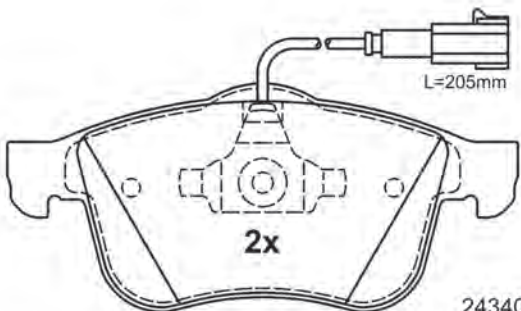

24340 20,3

155,1 x 69,0 x 20,3

13.0460-7212.2 607212

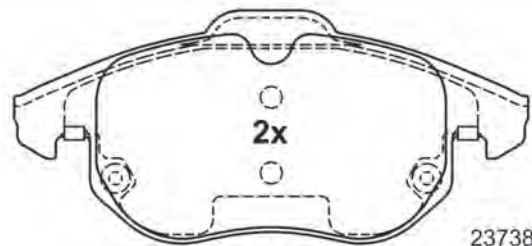

23738 20,1

156,3 x 70,7 x 20,1

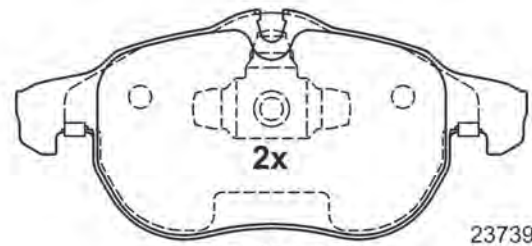

23739 20,1

155,1 x 69,6 x 20,1

Abbildungen Scheibenbremsbeläge

Illustrations disc brake pads - Ilustraciones de pastillas - Illustrations Plaquettes de frein à disque - Illustrazioni Pastiglie Freno

13.0460-7213.2 607213

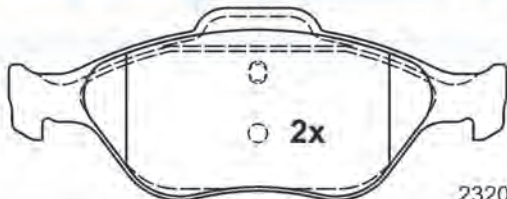

151,3 x 58,2 x 17,8

23202 17,8

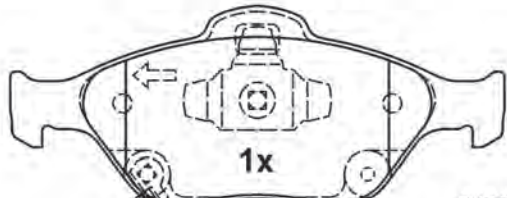

150,1 x 61,0 x 17,8

24022 17,8

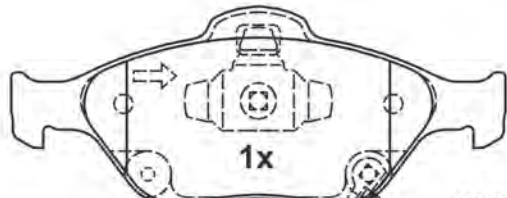

150,1 x 61,0 x 17,8

24023 17,8

13.0460-7214.2 607214

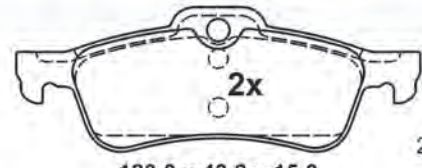

123,0 x 43,8 x 15,0

24574 15,0

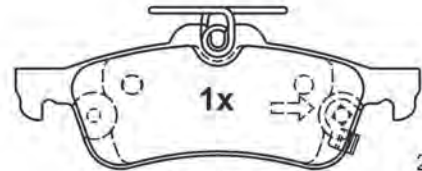

123,0 x 43,8 x 14,8

24575 14,8

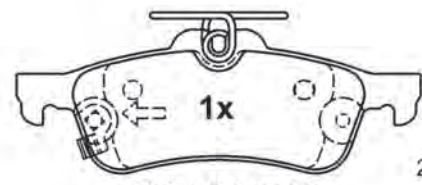

123,0 x 43,8 x 14,8

24576 14,8

13.0460-7215.2 607215

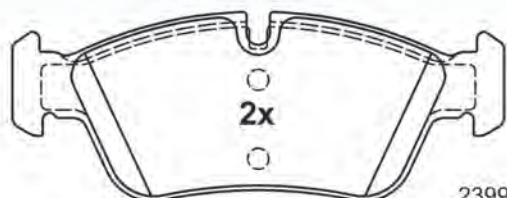

149,3 x 57,3 x 17,8

23999 17,8

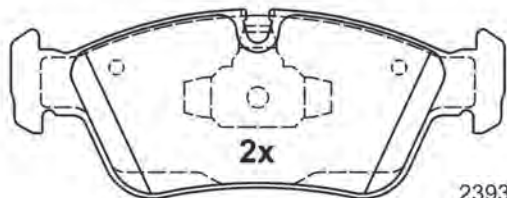

150,1 x 57,3 x 17,8

23935 17,8

13.0460-7216.2 607216

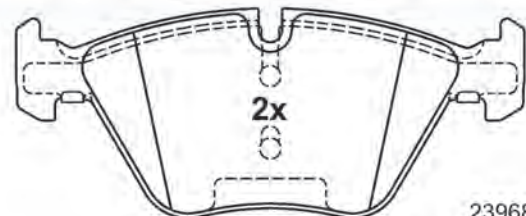

154,6 x 63,5 x 20,3

23968 20,3

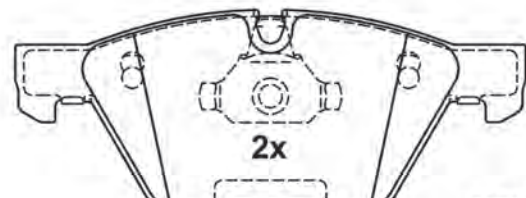

155,1 x 63,5 x 20,3

23793 20,3

Abbildungen Scheibenbremsbeläge

Illustrations disc brake pads - Ilustraciones de pastillas - Illustrations Plaquettes de frein à disque - Illustrazioni Pastiglie Freno

13.0460-7217.2 607217



23927 17,3

123,0 x 48,1 x 17,3

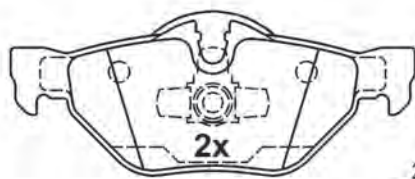

23926 17,3

123,0 x 49,7 x 17,3

13.0460-7218.2 607218

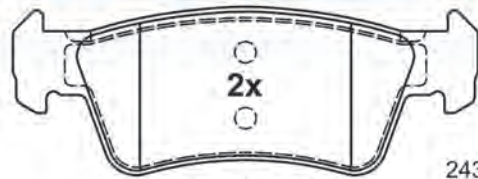

24367 19,1

141,3 x 50,9 x 19,1

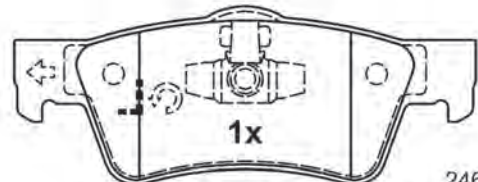

24645 19,1

140,7 x 53,9 x 19,1

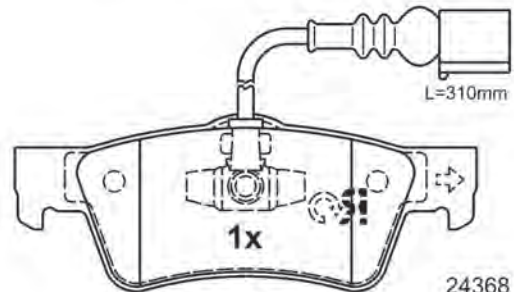

24368 19,1

140,7 x 53,9 x 19,1

13.0460-7219.2 607219

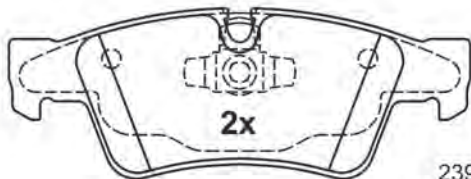

23923 17,6

140,1 x 51,6 x 17,6

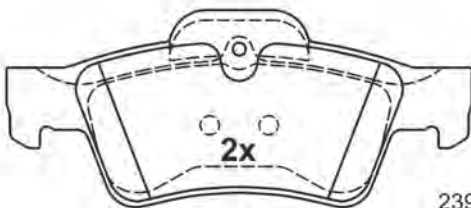

23924 17,6

141,3 x 59,6 x 17,6

13.0460-7220.2 607220

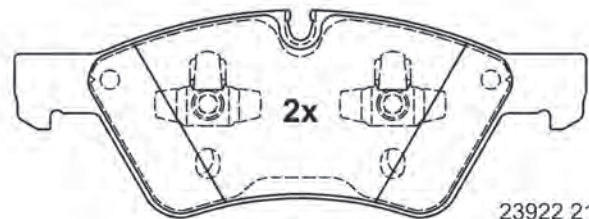

23922 21,0

192,9 x 69,9 x 21,0

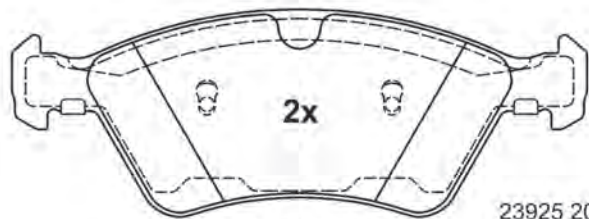

23925 20,5

194,3 x 70,0 x 20,5

Abbildungen Scheibenbremsbeläge

Illustrations disc brake pads - Ilustraciones de pastillas - Illustrations Plaquettes de frein à disque - Illustrazioni Pastiglie Freno

13.0460-7221.2 607221

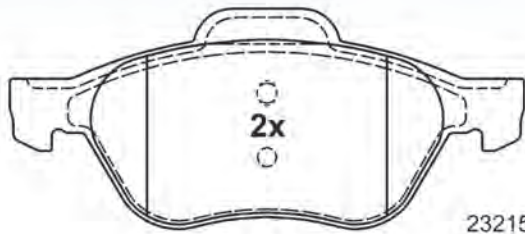

23215 18,3

156,3 x 66,8 x 18,3

13.0460-7222.2 607222

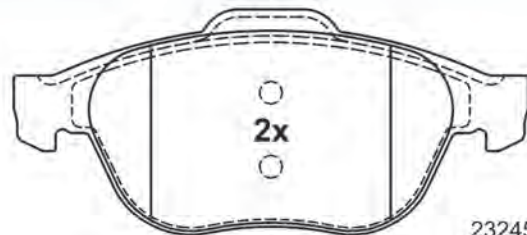

23245 18,3

156,3 x 68,3 x 18,3

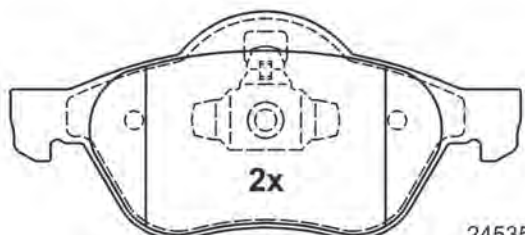

24535 18,3

155,1 x 68,9 x 18,3

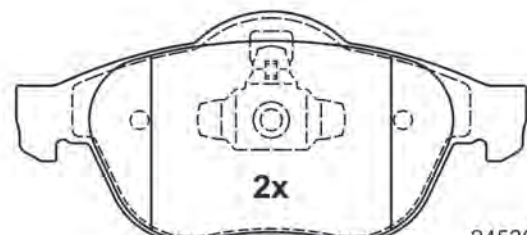

24536 18,3

155,1 x 70,8 x 18,3

13.0460-7223.2 607223

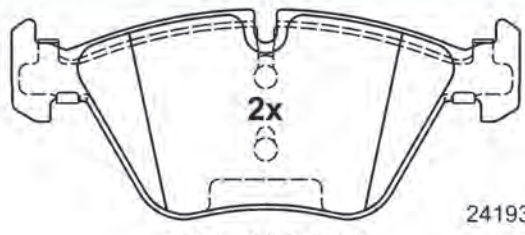

24193 20,3

154,6 x 63,5 x 20,3

13.0460-7224.2 607224

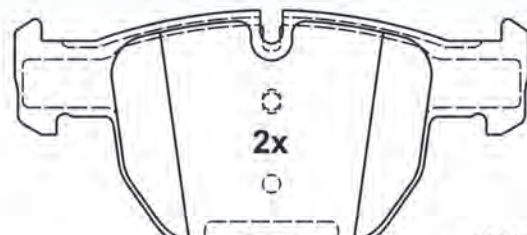

23397 19,4

156,3 x 73,2 x 19,4



24096 20,3

155,1 x 63,5 x 20,3

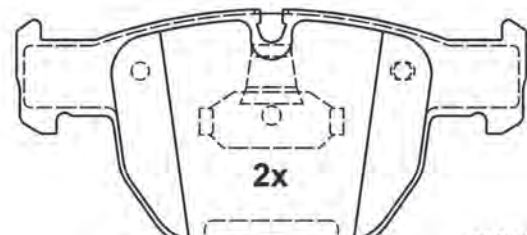

23399 19,4

155,0 x 73,2 x 19,4

Abbildungen Scheibenbremsbeläge

Illustrations disc brake pads - Ilustraciones de pastillas - Illustrations Plaquettes de frein à disque - Illustrazioni Pastiglie Freno

13.0460-7225.2 607225



123,0 x 59,2 x 17,3

23551 17,3

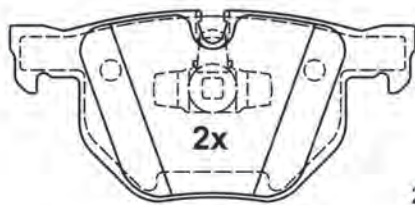

123,0 x 58,0 x 17,3

23550 17,3

13.0460-7226.2 607226

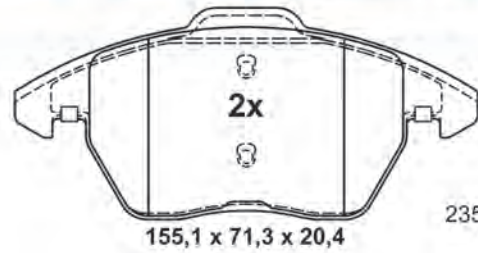

155,1 x 71,3 x 20,4

23589 20,4

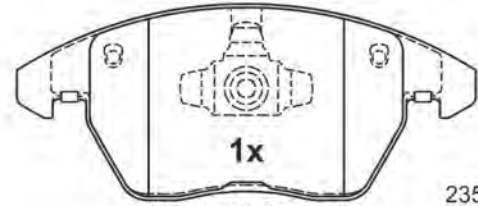

155,1 x 66,0 x 20,8

23587 20,8

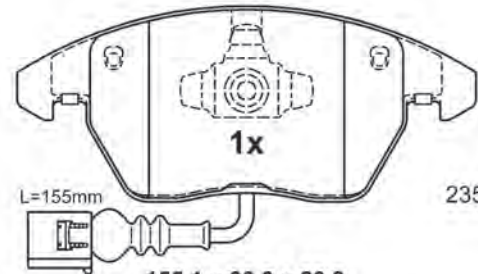

155,1 x 66,0 x 20,8

23588 20,8

13.0460-7227.2 607227

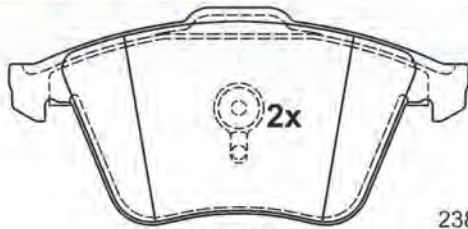

156,3 x 72,9 x 20,3

23801 20,3

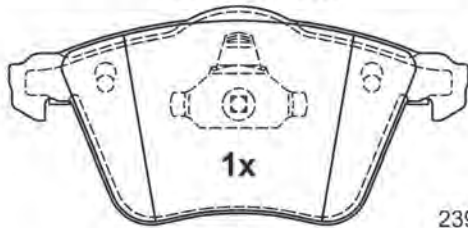

155,1 x 72,9 x 20,3

23912 20,3

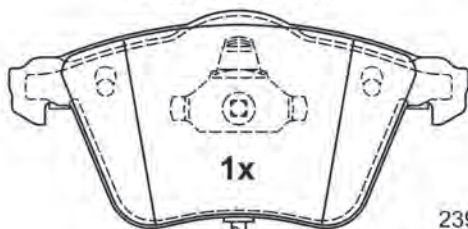

155,1 x 72,9 x 20,3

23913 20,3

13.0460-7228.2 607228

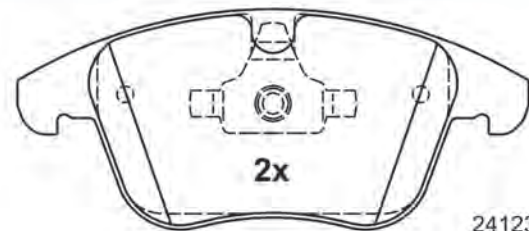

155,1 x 66,6 x 20,3

24123 20,3



156,3 x 72,0 x 19,3

24124 19,3

Abbildungen Scheibenbremsbeläge

Illustrations disc brake pads - Ilustraciones de pastillas - Illustrations Plaquettes de frein à disque - Illustrazioni Pastiglie Freno

13.0460-7229.2 607229

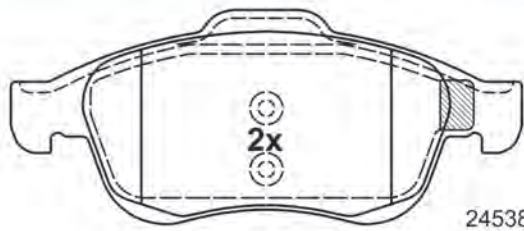

24538 18,5

155,1 x 64,7 x 18,5

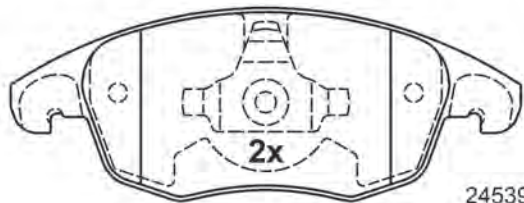

24539 18,5

155,1 x 58,3 x 18,5

13.0460-7230.2 607230



24557 19,4

155,1 x 72,0 x 19,4

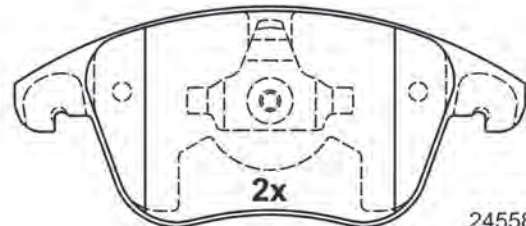

24558 18,7

155,1 x 66,6 x 18,7

13.0460-7231.2 607231

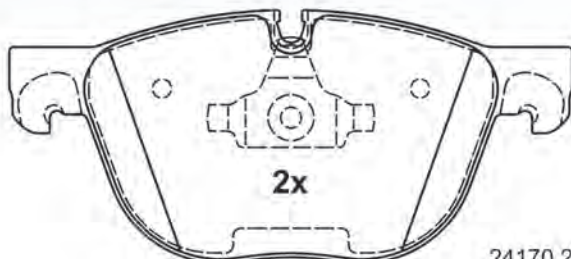

24170 20,2

171,1 x 76,8 x 20,2



24171 20,9

170,2 x 76,8 x 20,9

13.0460-7232.2 607232

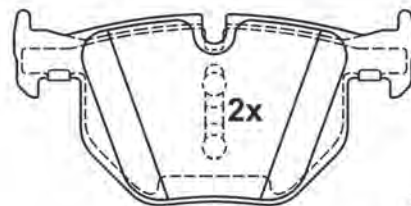

21282 17,3

121,8 x 59,2 x 17,3

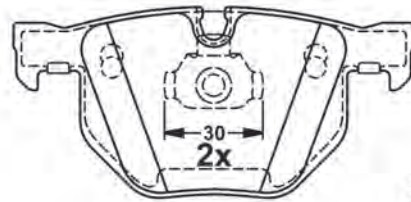

23447 17,3

121,8 x 57,8 x 17,3

Abbildungen Scheibenbremsbeläge

Illustrations disc brake pads - Ilustraciones de pastillas - Illustrations Plaquettes de frein à disque - Illustrazioni Pastiglie Freno

13.0460-7234.2 607234

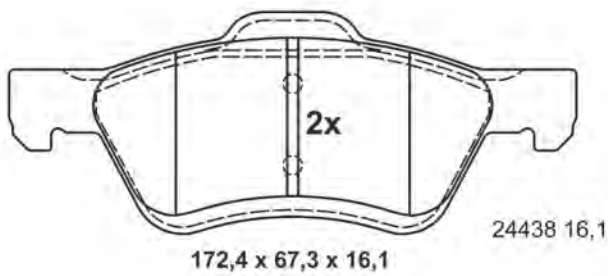
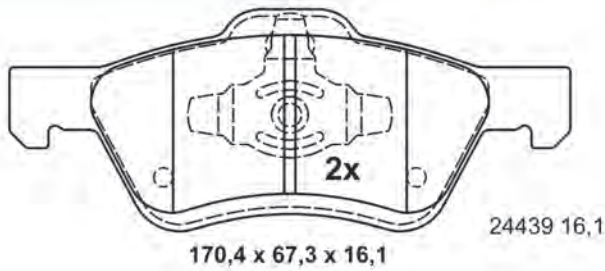

13.0460-7235.2 607235

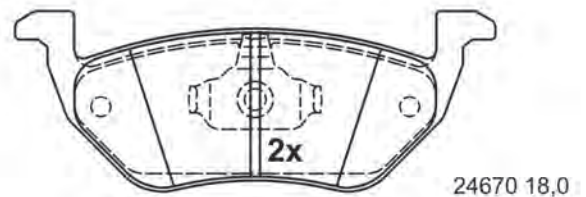
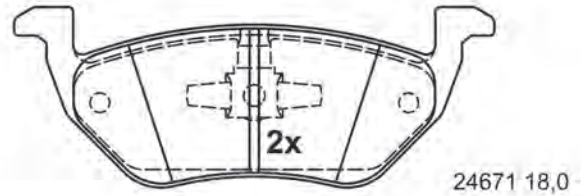

146,0 x 54,0 x 18,0

13.0460-7236.2 607236

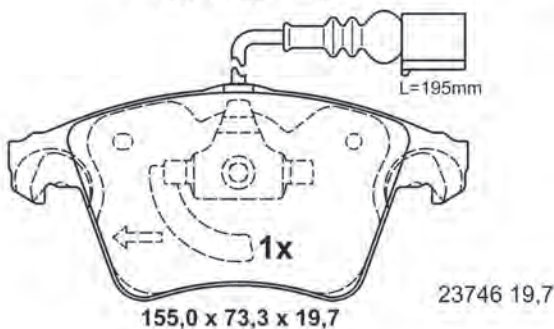
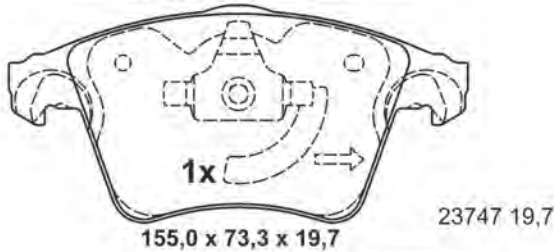
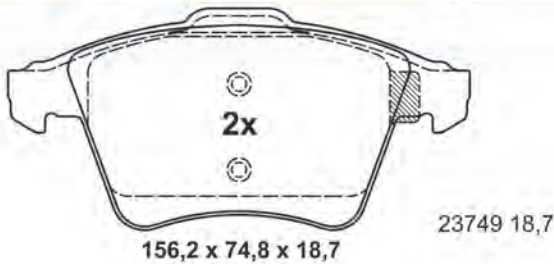

13.0460-7237.2 607237

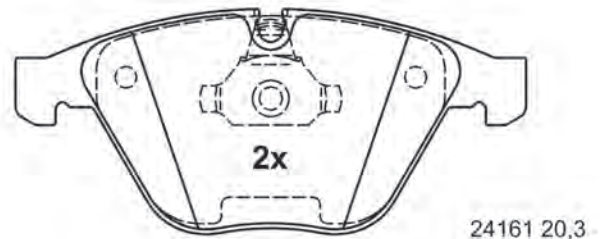
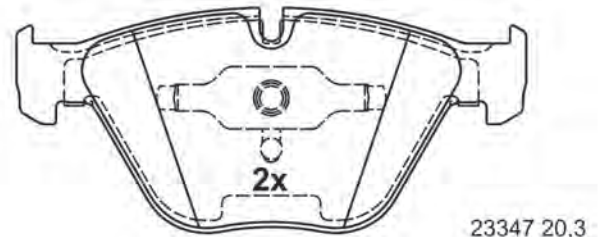

155,1 x 68,3 x 20,3

Abbildungen Scheibenbremsbeläge

Illustrations disc brake pads - Ilustraciones de pastillas - Illustrations Plaquettes de frein à disque - Illustrazioni Pastiglie Freno

13.0460-7238.2 607238

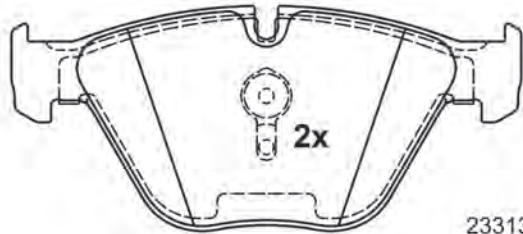

23313 20,3

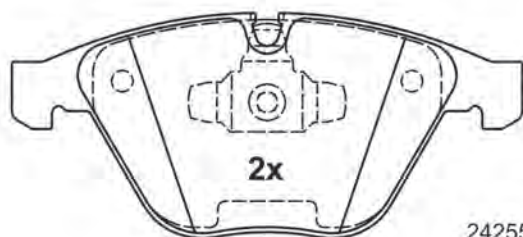

24255 20,3

155,1 x 68,3 x 20,3

13.0460-7239.2 607239

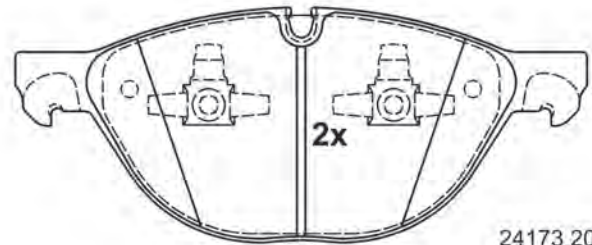

24173 20,0

193,0 x 79,0 x 20,0

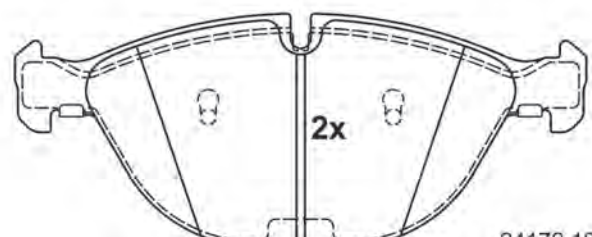

24172 19,0

193,0 x 79,0 x 19,0

13.0460-7240.2 607240



23749 17,6

156,2 x 74,8 x 17,6

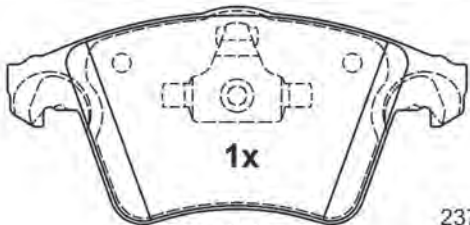

23747 18,1

155,0 x 73,3 x 18,1

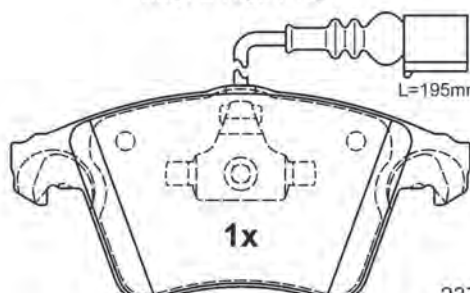

23746 18,1

155,0 x 73,3 x 18,1

13.0460-7241.2 607241

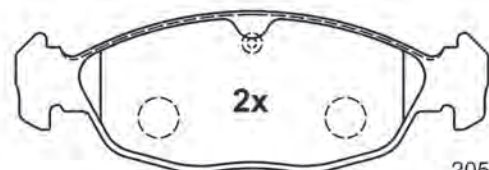

20547 16,5

141,2 x 48,4 x 16,5

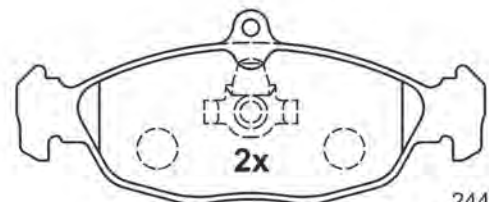

24487 16,5

140,0 x 58,3 x 16,5

Abbildungen Scheibenbremsbeläge

Illustrations disc brake pads - Ilustraciones de pastillas - Illustrations Plaquettes de frein à disque - Illustrazioni Pastiglie Freno

13.0460-7242.2 607242

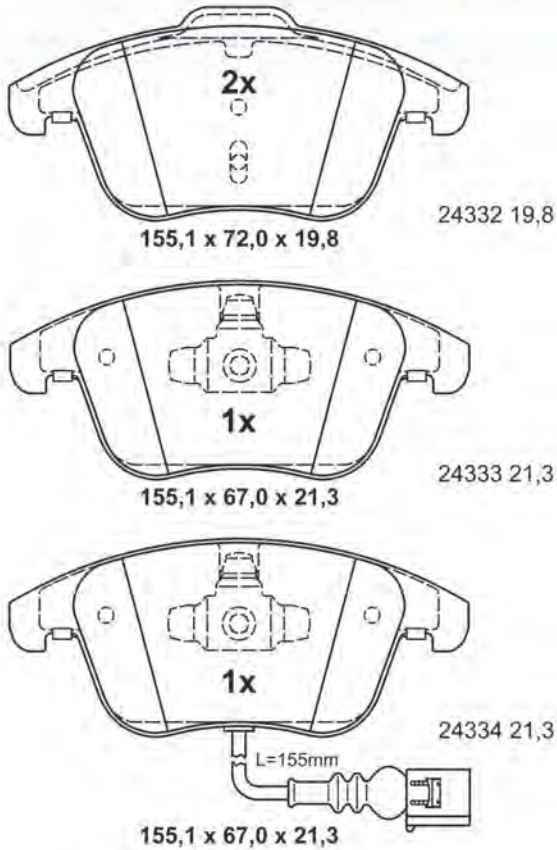

13.0460-7243.2 607243

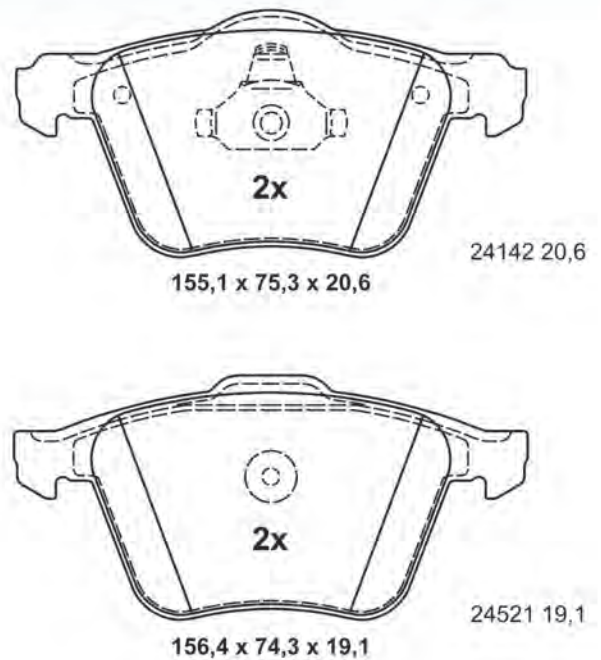

13.0460-7244.2 607244

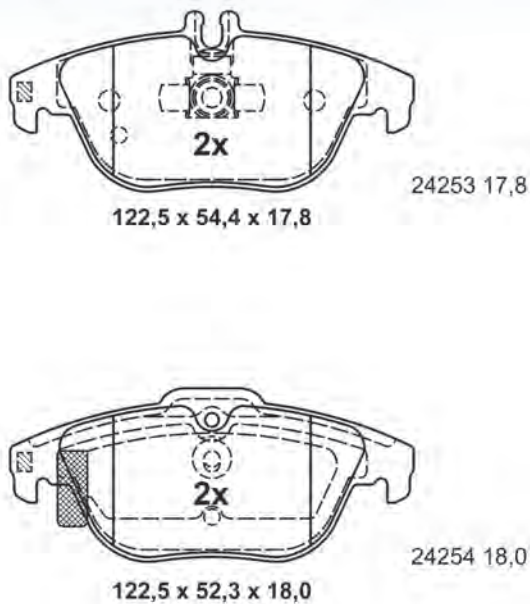

13.0460-7245.2 607245

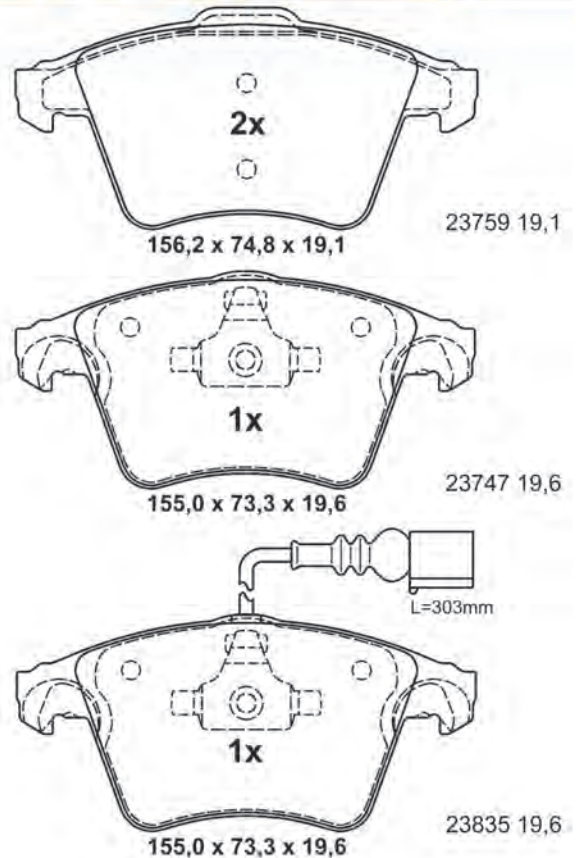

Abbildungen Scheibenbremsbeläge

Illustrations disc brake pads - Ilustraciones de pastillas - Illustrations Plaquettes de frein à disque - Illustrazioni Pastiglie Freno

13.0460-7246.2 607246

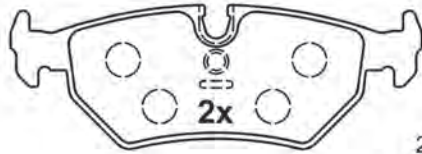

21275 17,0

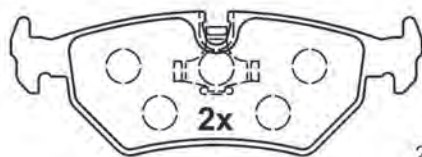

21276 17,0

123,0 x 43,0 x 17,0

13.0460-7247.2 607247



24367 19,2

141,3 x 50,9 x 19,2

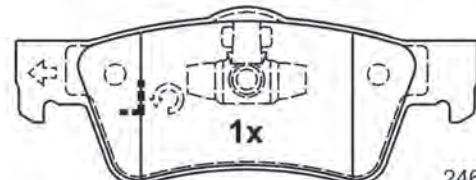

24645 19,2

140,7 x 53,9 x 19,2

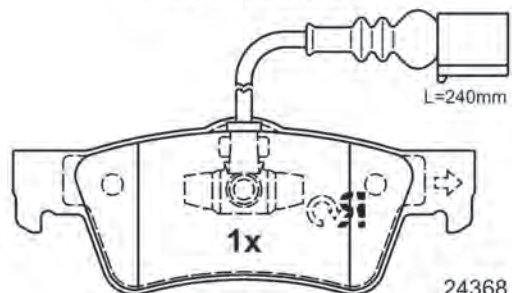

24368 19,2

140,7 x 53,9 x 19,2

13.0460-7248.2 607248



23215 17,5

156,3 x 67,0 x 17,5

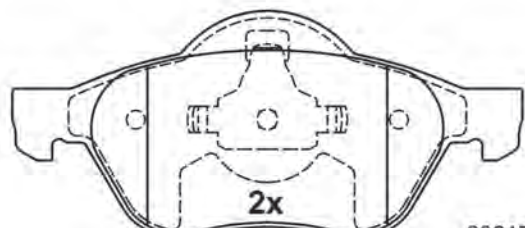

23217 17,5

155,2 x 69,0 x 17,5

13.0460-7249.2 607249

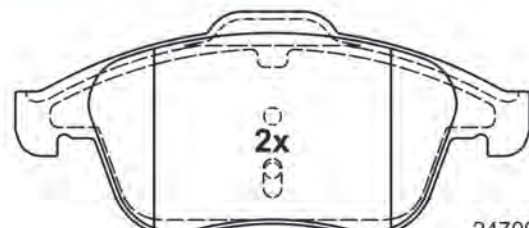

24709 18,6

156,3 x 68,3 x 18,6

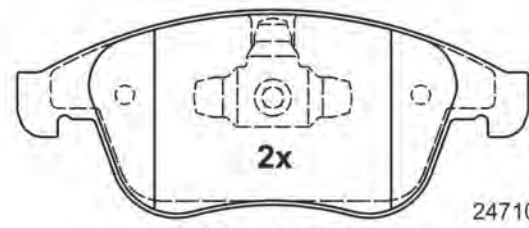

24710 18,6

155,1 x 63,0 x 18,6

Abbildungen Scheibenbremsbeläge

Illustrations disc brake pads - Ilustraciones de pastillas - Illustrations Plaquettes de frein à disque - Illustrazioni Pastiglie Freno

13.0460-7250.2 607250

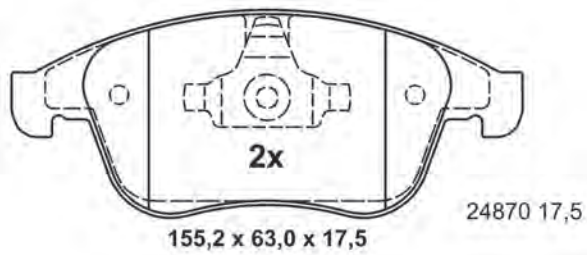
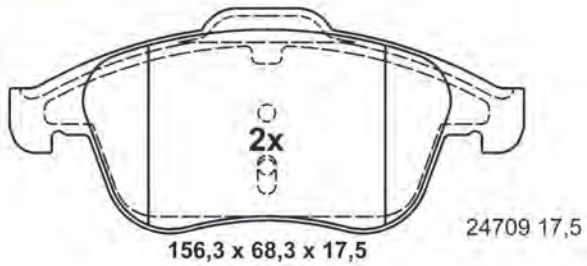

13.0460-7251.2 607251

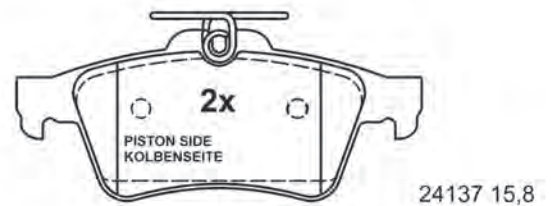
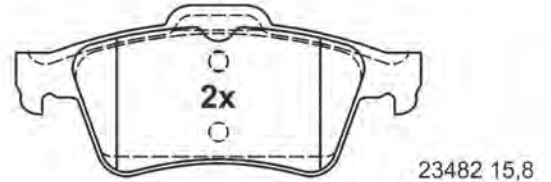

13.0460-7252.2 607252

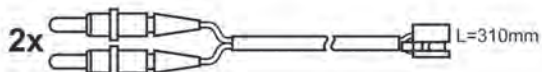
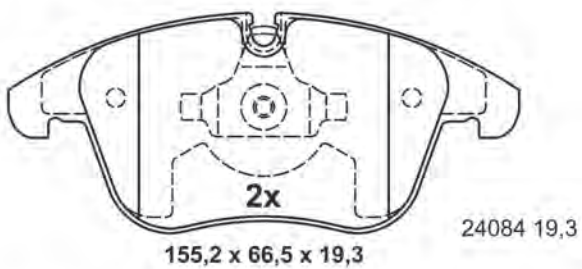

13.0460-7253.2 607253

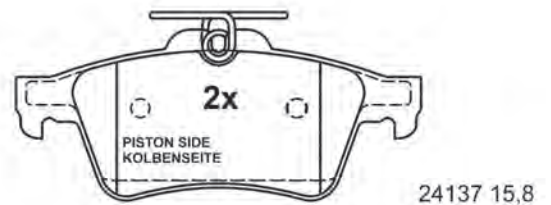
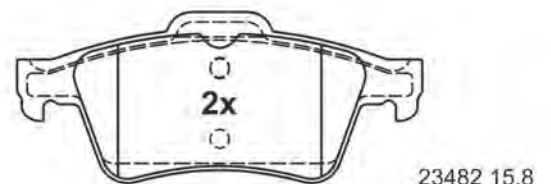

123,0 x 52,0 x 15,8

Abbildungen Scheibenbremsbeläge

Illustrations disc brake pads - Ilustraciones de pastillas - Illustrations Plaquettes de frein à disque - Illustrazioni Pastiglie Freno

13.0460-7255.2 607255

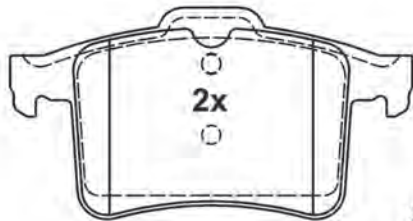

25114 15,8

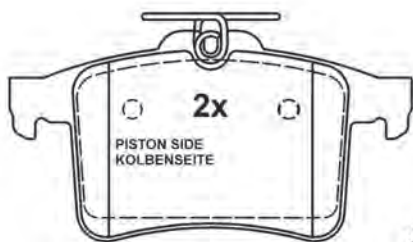

25115 15,8

122,0 x 64,1 x 15,8

13.0460-7256.2 607256



24705 19,8

155,1 x 72,0 x 19,8

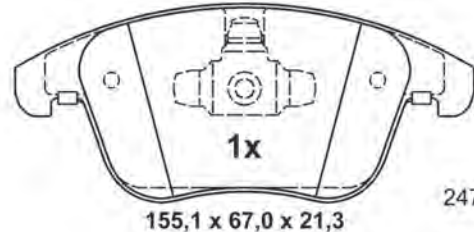

24706 21,3

155,1 x 67,0 x 21,3

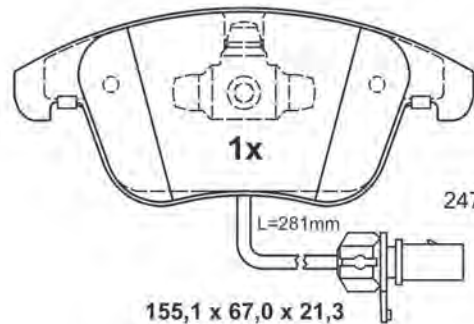

24707 21,3

155,1 x 67,0 x 21,3

13.0460-7257.2 607257

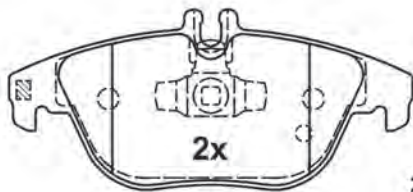

24253 18,0

122,5 x 54,4 x 18,0



24254 18,0

122,5 x 52,3 x 18,0

13.0460-7259.2 607259

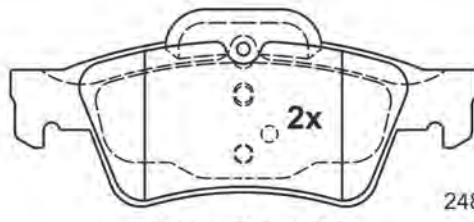

24862 16,7

141,1 x 59,6 x 16,7

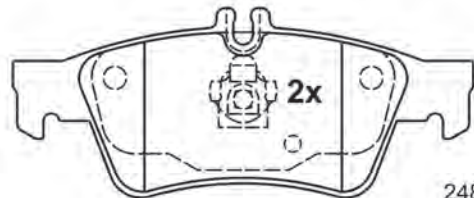

24863 16,7

139,8 x 57,5 x 16,7

Abbildungen Scheibenbremsbeläge

Illustrations disc brake pads - Ilustraciones de pastillas - Illustrations Plaquettes de frein à disque - Illustrazioni Pastiglie Freno

13.0460-7260.2 607260

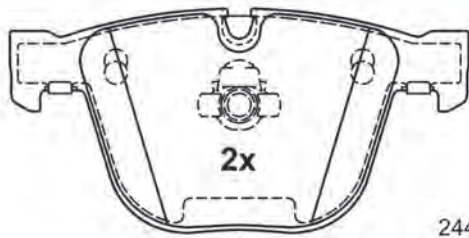

24458 17,3



24495 17,3

139,5 x 67,8 x 17,3

13.0460-7261.2 607261

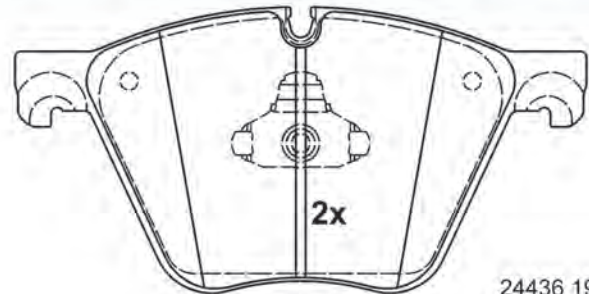

24436 19,7

192,8 x 96,5 x 19,7

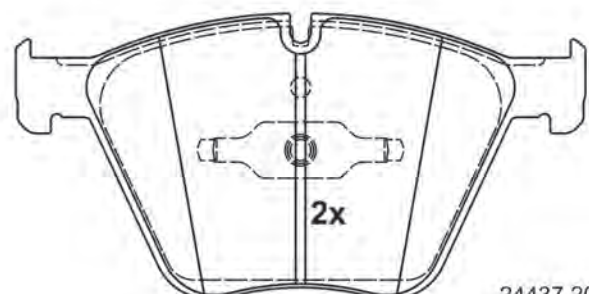

24437 20,2

192,2 x 96,5 x 20,2

13.0460-7262.2 607262



25031 19,1

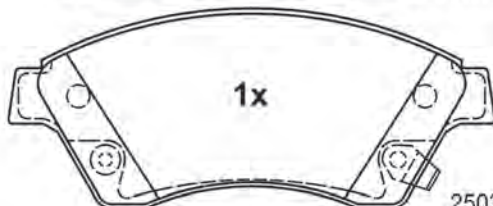

25032 19,1

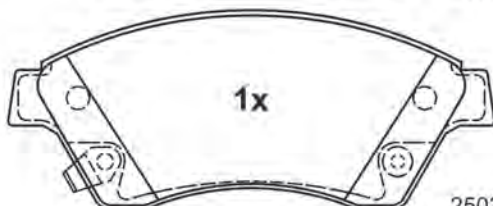

25033 19,1

148,2 x 60,1 x 19,1

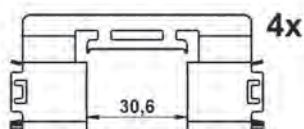

30,6

13.0460-7263.2 607263

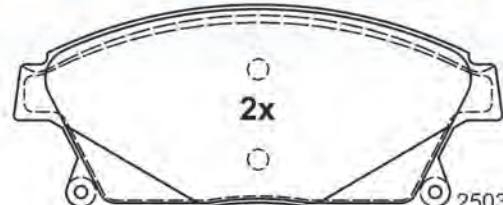

25034 19,1

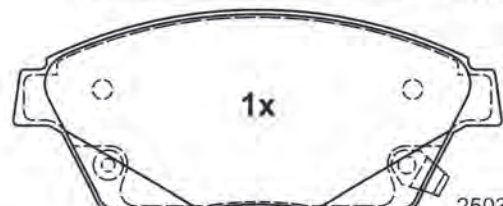

25035 19,1



25036 19,1

148,2 x 61,1 x 19,1

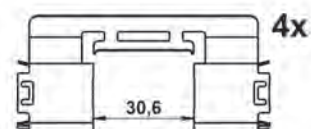

30,6

Abbildungen Scheibenbremsbeläge

Illustrations disc brake pads - Ilustraciones de pastillas - Illustrations Plaquettes de frein à disque - Illustrazioni Pastiglie Freno

13.0460-7264.2 607264

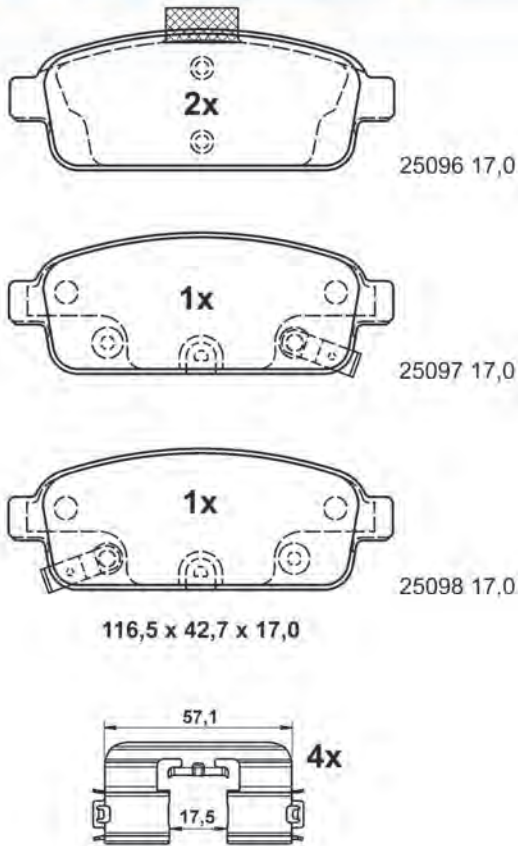

13.0460-7265.2 607265

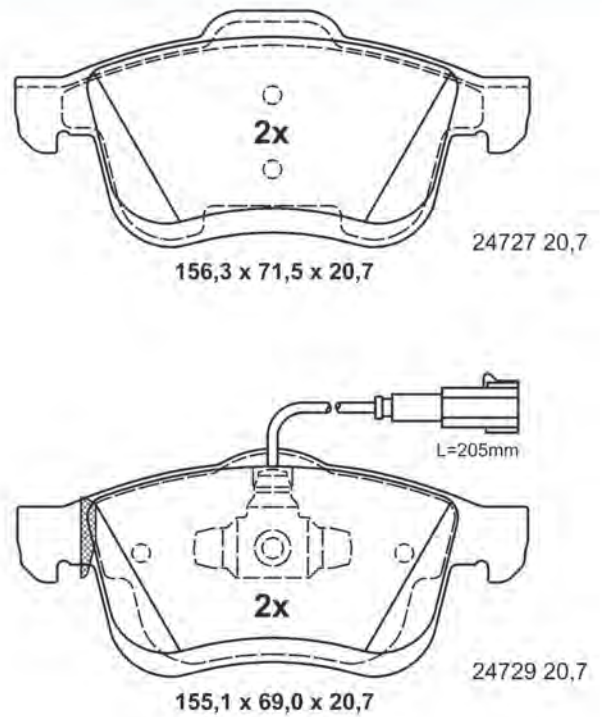

13.0460-7266.2 607266

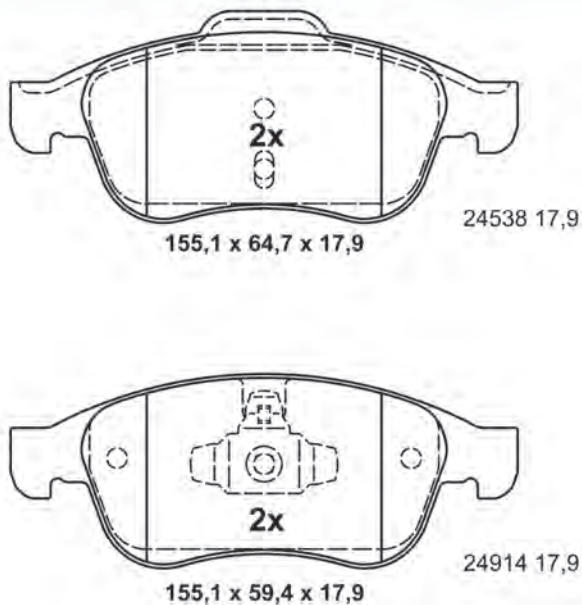

13.0460-7267.2 607267

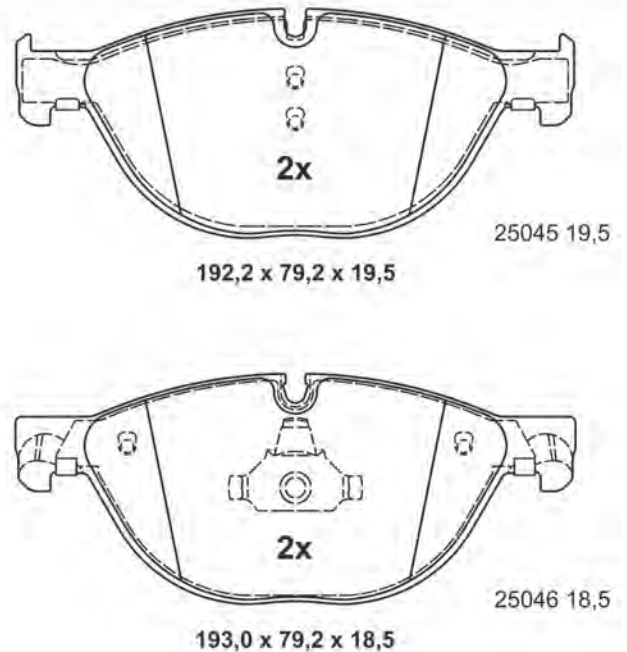

Abbildungen Scheibenbremsbeläge

Illustrations disc brake pads - Ilustraciones de pastillas - Illustrations Plaquettes de frein à disque - Illustrazioni Pastiglie Freno

13.0460-7268.2 607268

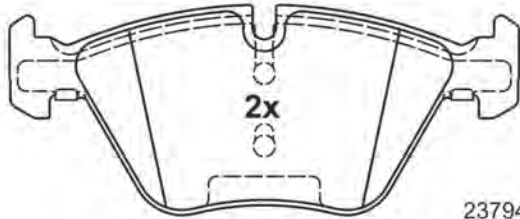

154,6 x 63,5 x 20,3

23794 20,3

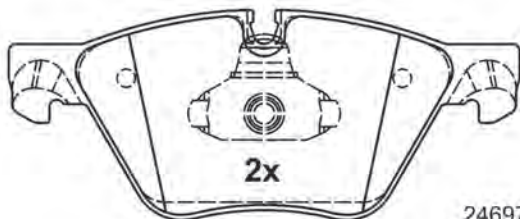

155,1 x 63,5 x 19,3

24697 19,3

13.0460-7269.2 607269

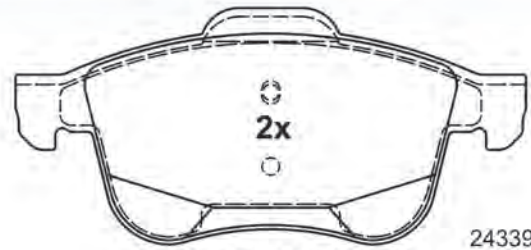

155,1 x 71,5 x 19,5

24339 19,5

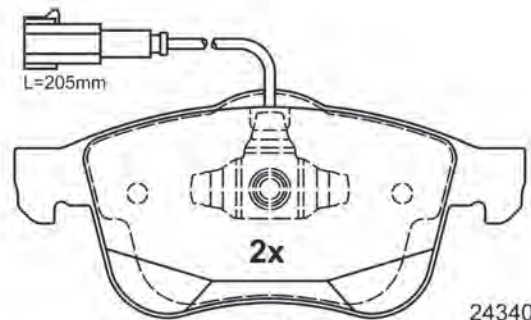

155,1 x 69,0 x 19,5

24340 19,5

13.0460-7270.2 607270



151,3 x 52,5 x 17,5

24673 17,5

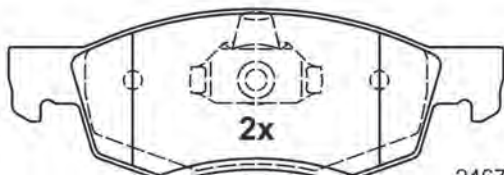

150,1 x 52,5 x 17,5

24674 17,5

13.0460-7271.2 607271

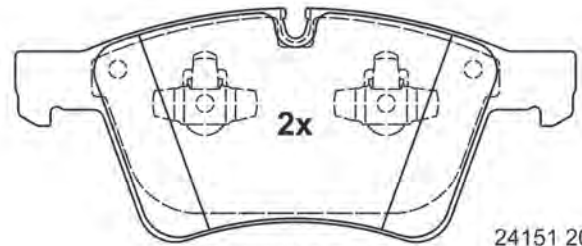

193,1 x 80,4 x 20,9

24151 20,9



193,0 x 80,4 x 20,3

24152 20,3

Abbildungen Scheibenbremsbeläge

Illustrations disc brake pads - Ilustraciones de pastillas - Illustrations Plaquettes de frein à disque - Illustrazioni Pastiglie Freno

13.0460-7272.2 607272

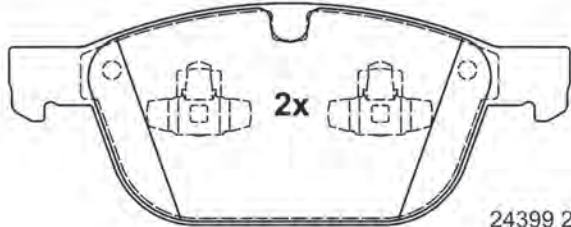

24399 20,4

193,1 x 76,2 x 20,4



24875 19,8

194,3 x 76,2 x 19,8

13.0460-7273.2 607273



24538 19,4

155,1 x 64,7 x 19,4

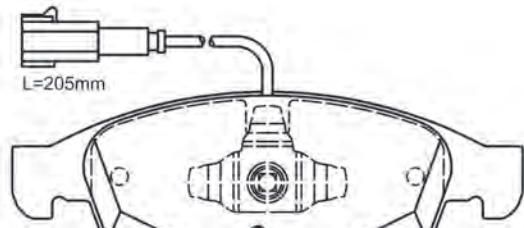

25180 19,0

155,1 x 59,4 x 19,0

13.0460-7274.2 607274



23731 17,3

2x

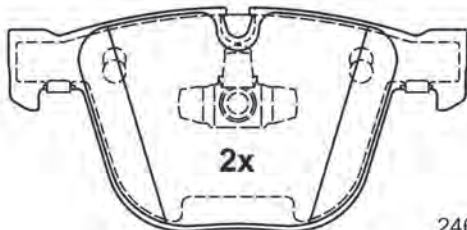

24695 17,3

2x

139,5 x 67,8 x 17,3

13.0460-7275.2 607275

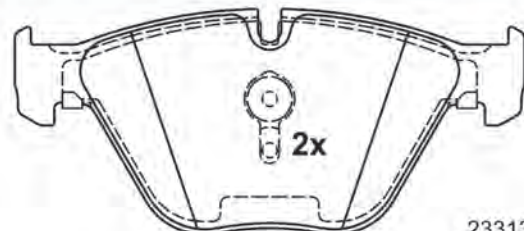

23313 20,2

154,1 x 68,4 x 20,2

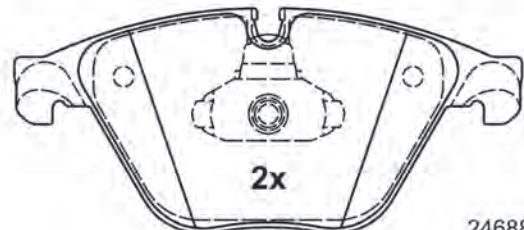

24688 19,2

154,1 x 68,4 x 19,2

Abbildungen Scheibenbremsbeläge

Illustrations disc brake pads - Ilustraciones de pastillas - Illustrations Plaquettes de frein à disque - Illustrazioni Pastiglie Freno

13.0460-7276.2 607276

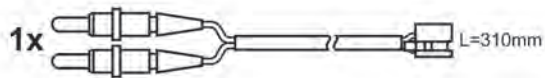
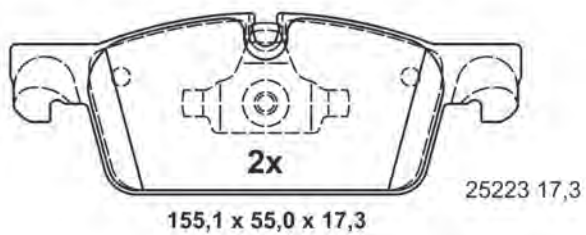
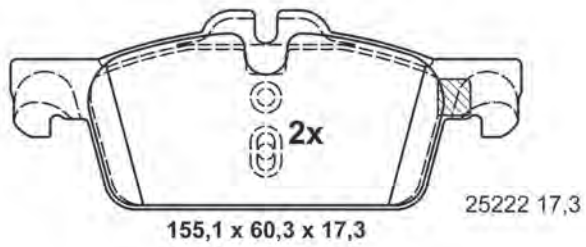

13.0460-7277.2 607277

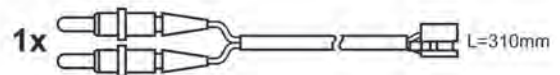
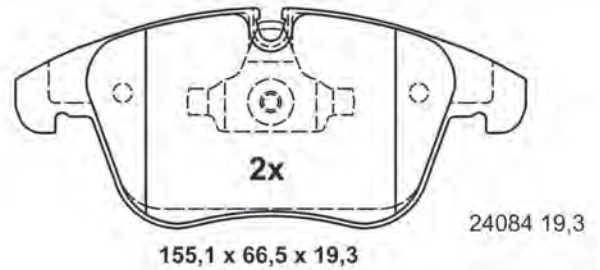

13.0460-7278.2 607278

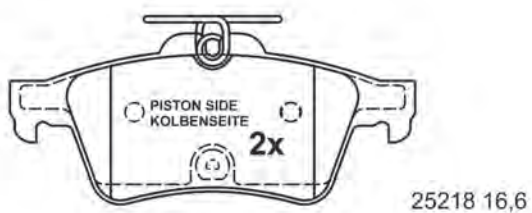
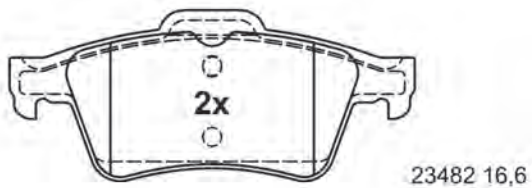

13.0460-7279.2 607279

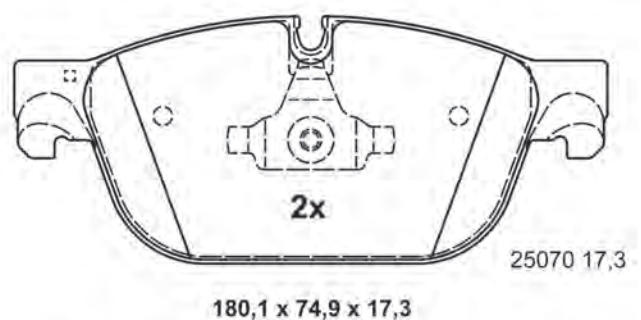
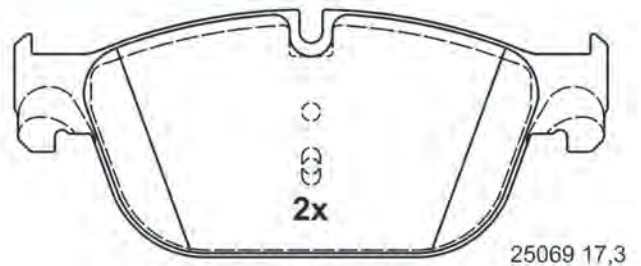

Abbildungen Scheibenbremsbeläge

Illustrations disc brake pads - Ilustraciones de pastillas - Illustrations Plaquettes de frein à disque - Illustrazioni Pastiglie Freno

13.0460-7280.2 607280

B.H.P.

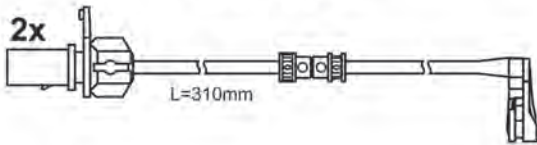
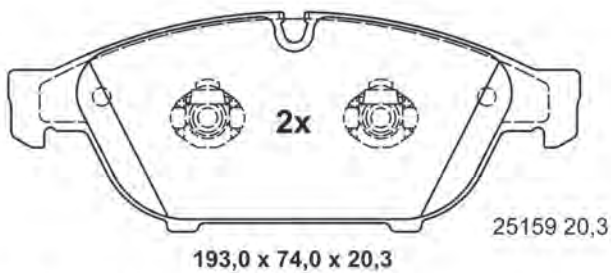
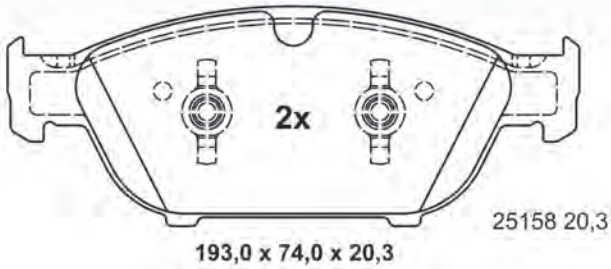

13.0460-7281.2 607281

B.H.P.

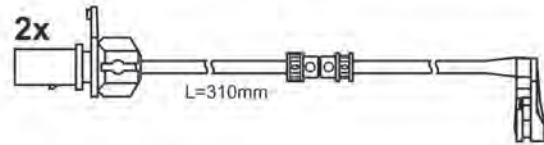
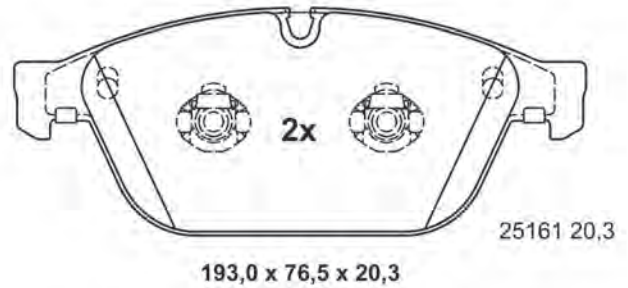
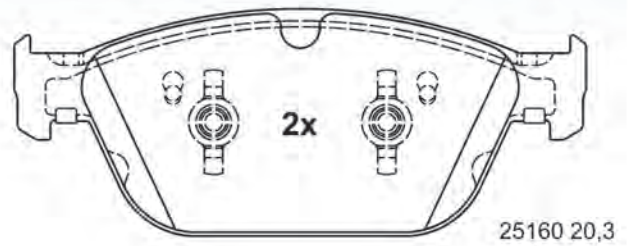

13.0460-7282.2 607282

B.H.P.

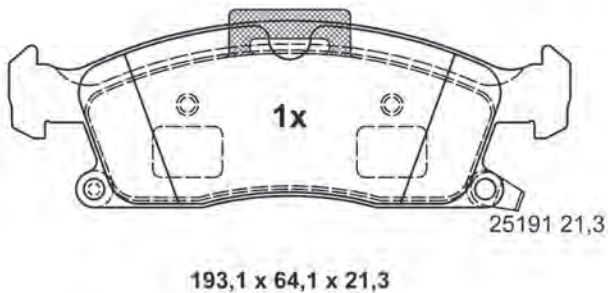
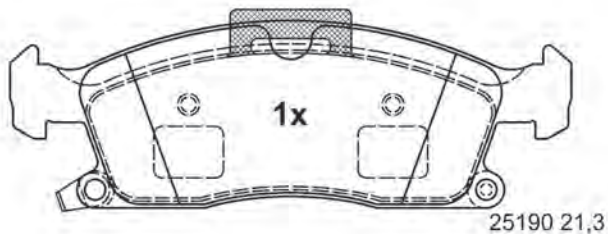
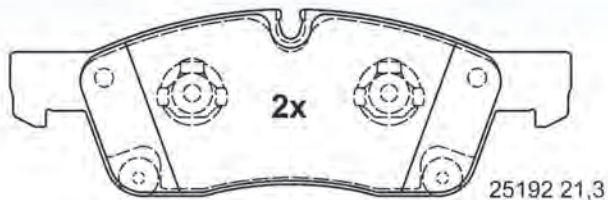

13.0460-7283.2 607283

B.H.P.

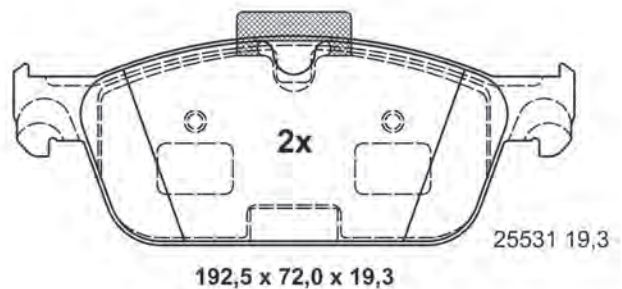
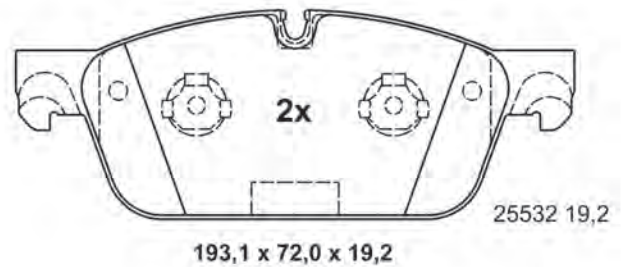

Abbildungen Scheibenbremsbeläge

Illustrations disc brake pads - Ilustraciones de pastillas - Illustrations Plaquettes de frein à disque - Illustrazioni Pastiglie Freno

13.0460-7284.2 607284

B.H.P.

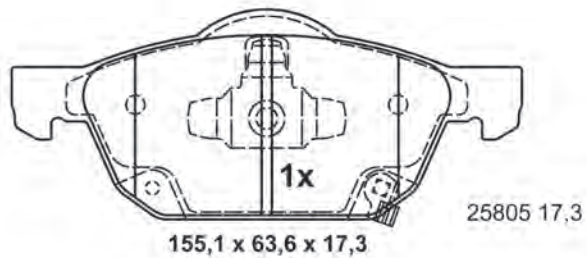
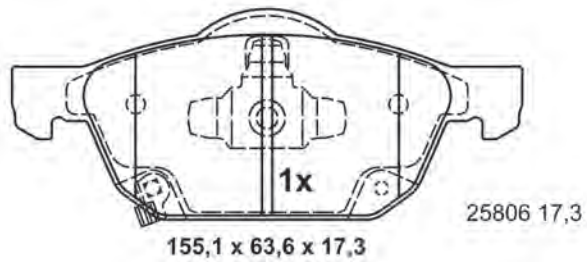
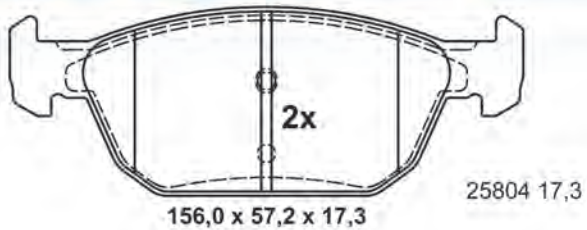

13.0460-7285.2 607285

B.H.P.

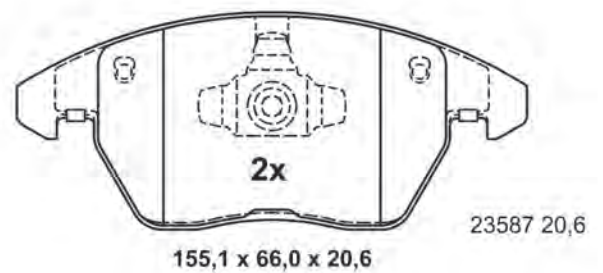
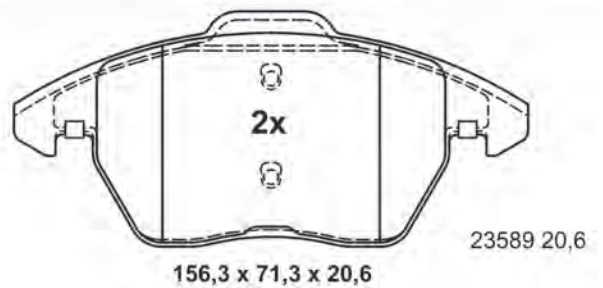

13.0460-7286.2 607286

B.H.P.

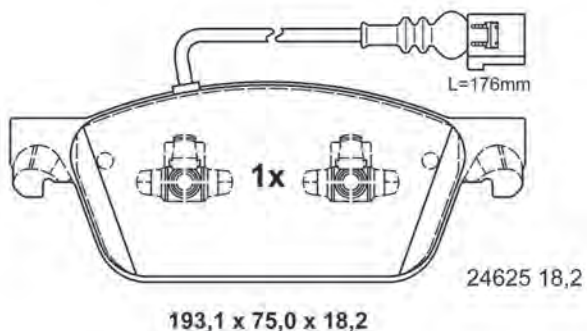
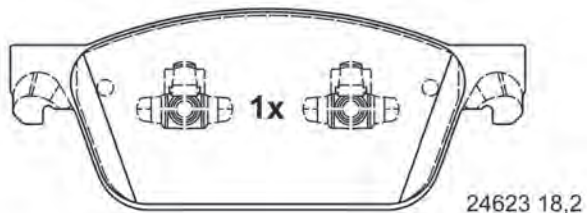
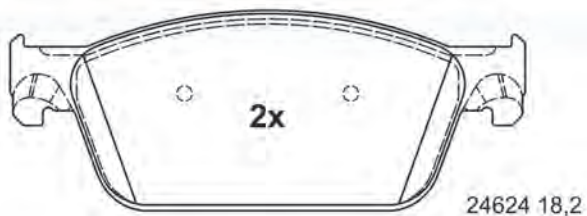

13.0460-7287.2 607287

B.H.P.

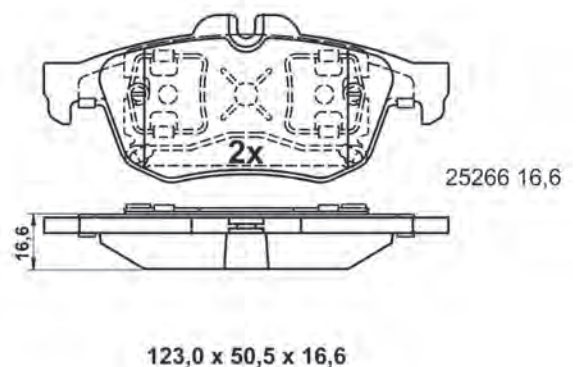
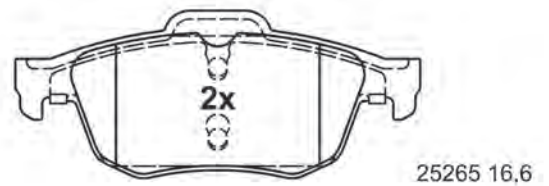

Abbildungen Scheibenbremsbeläge

Illustrations disc brake pads - Ilustraciones de pastillas - Illustrations Plaquettes de frein à disque - Illustrazioni Pastiglie Freno

13.0460-7288.2 607288

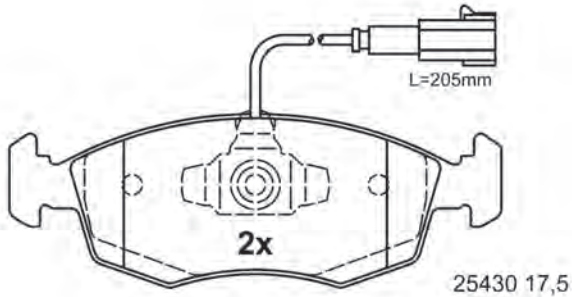

149,2 x 52,5 x 17,5

13.0460-7289.2 607289

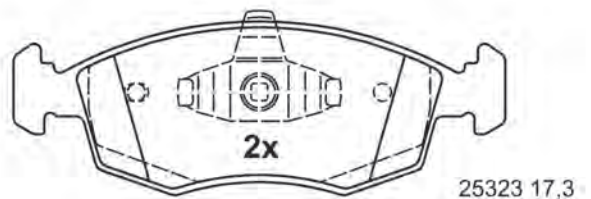
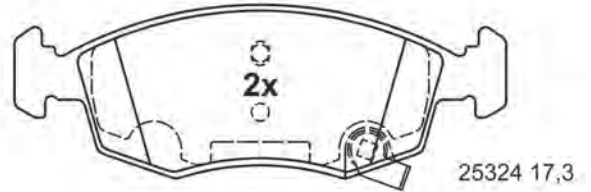

149,4 x 52,6 x 17,3

13.0460-7290.2 607290

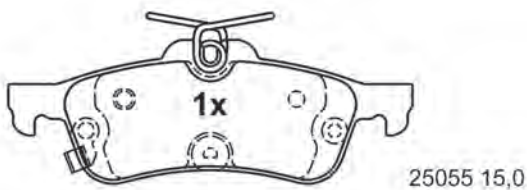
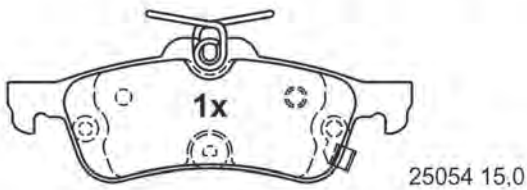
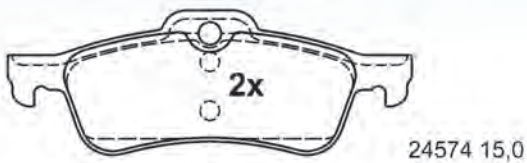

123,1 x 43,8 x 15,0

13.0460-7293.2 607293

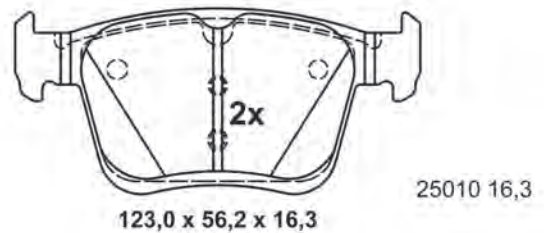
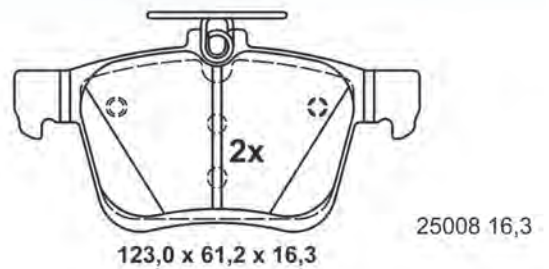

Abbildungen Scheibenbremsbeläge

Illustrations disc brake pads - Ilustraciones de pastillas - Illustrations Plaquettes de frein à disque - Illustrazioni Pastiglie Freno

13.0460-7294.2 607294

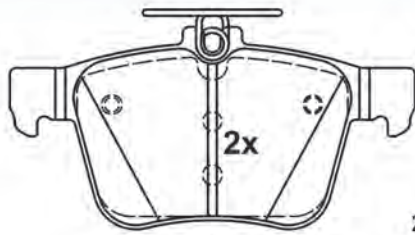

25009 16,4

123,0 x 61,2 x 16,4

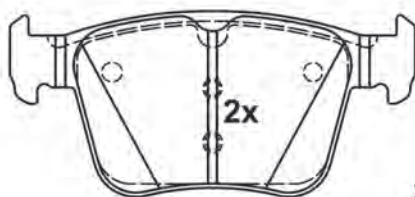

25011 16,4

123,0 x 56,2 x 16,4

13.0460-7295.2 607295



25968 16,1

123,0 x 41,2 x 16,1

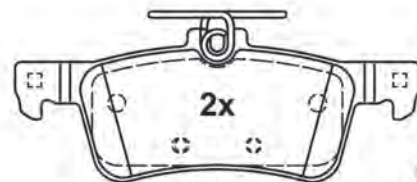

25969 16,1

123,0 x 46,2 x 16,1

13.0460-7296.2 607296

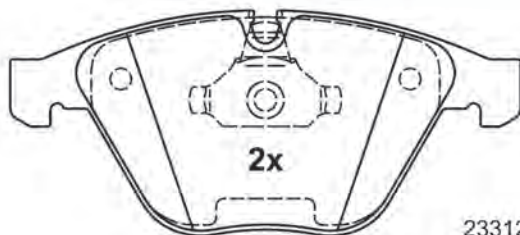

23312 20,3



23313 20,3

155,1 x 68,3 x 20,3

13.0460-7298.2 607298



25702 18,2

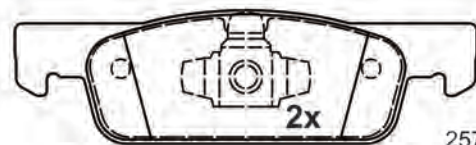

25703 18,2

140,1 x 40,0 x 18,2

Abbildungen Scheibenbremsbeläge

Illustrations disc brake pads - Ilustraciones de pastillas - Illustrations Plaquettes de frein à disque - Illustrazioni Pastiglie Freno

13.0460-7300.2 607300

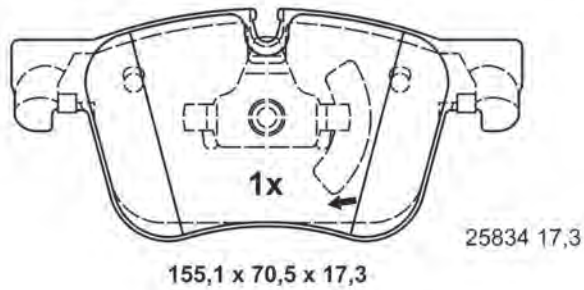
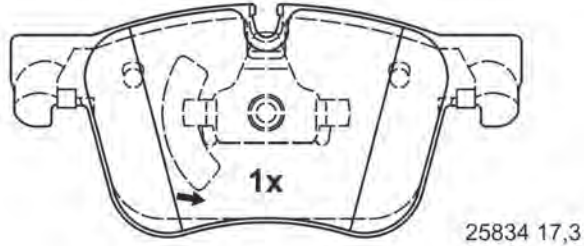
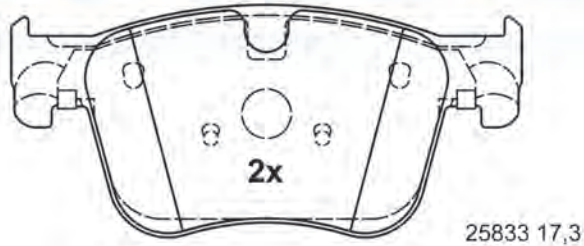

13.0460-7301.2 607301

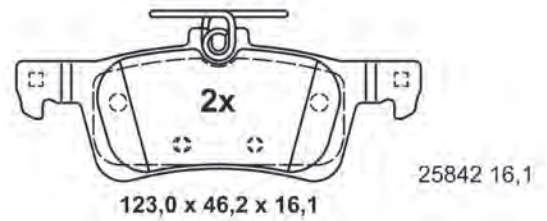
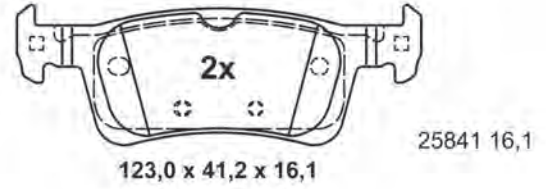

13.0460-7303.2 607303

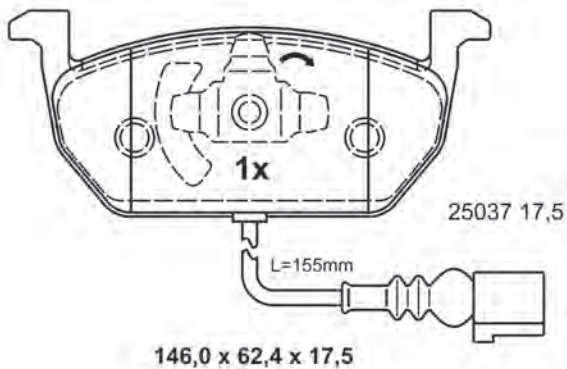
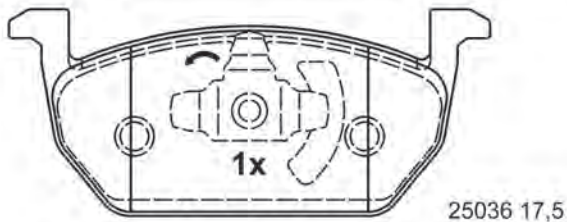
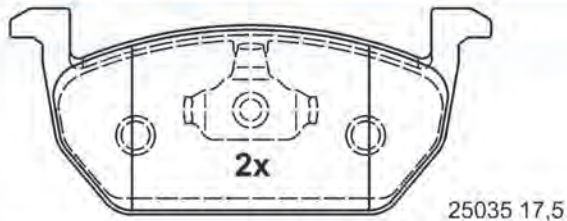

13.0460-7305.2 607305

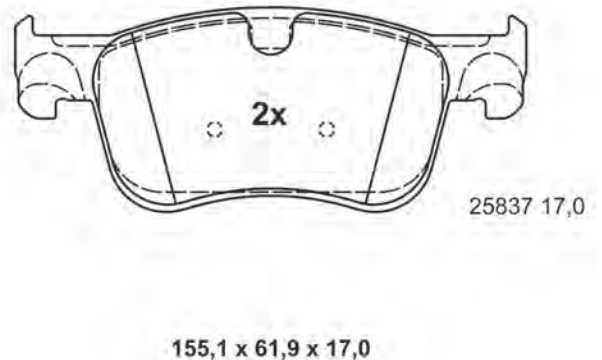
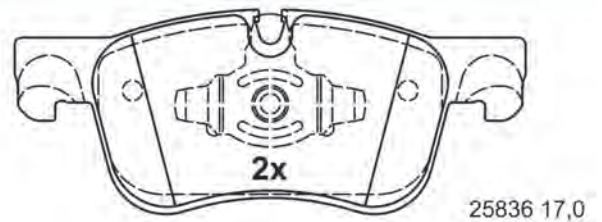

Abbildungen Scheibenbremsbeläge

Illustrations disc brake pads - Ilustraciones de pastillas - Illustrations Plaquettes de frein à disque - Illustrazioni Pastiglie Freno

13.0460-7307.2 607307

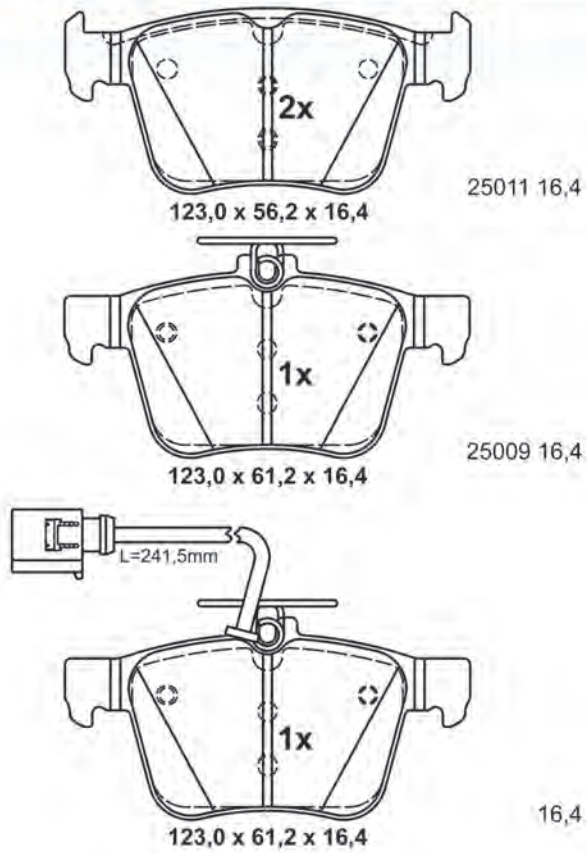

13.0460-7903.2 607903

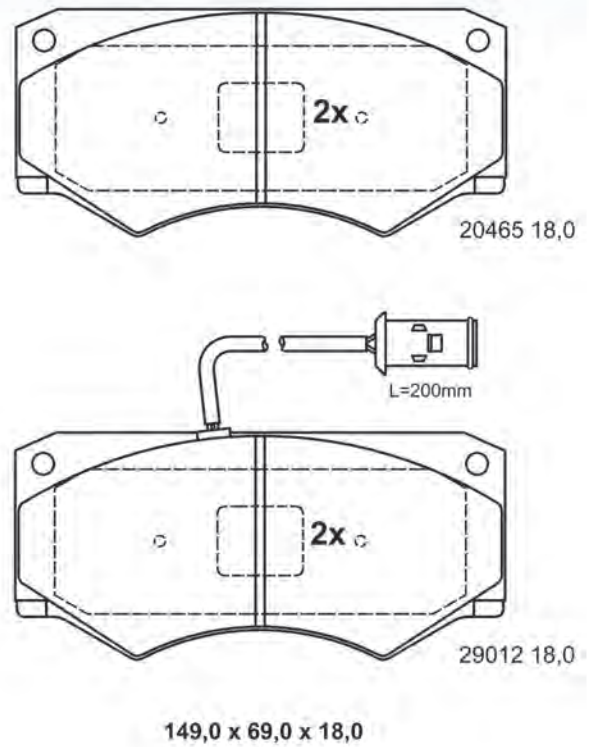

13.0460-7906.2 607906

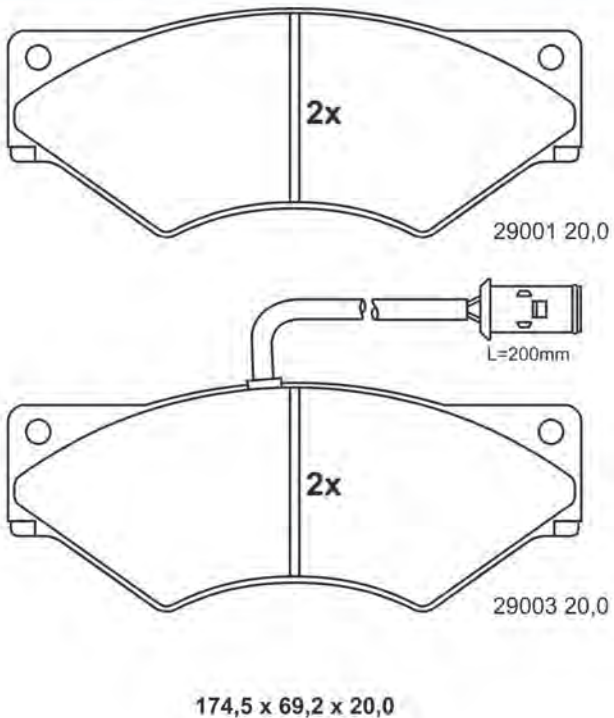

13.0460-7909.2 607909

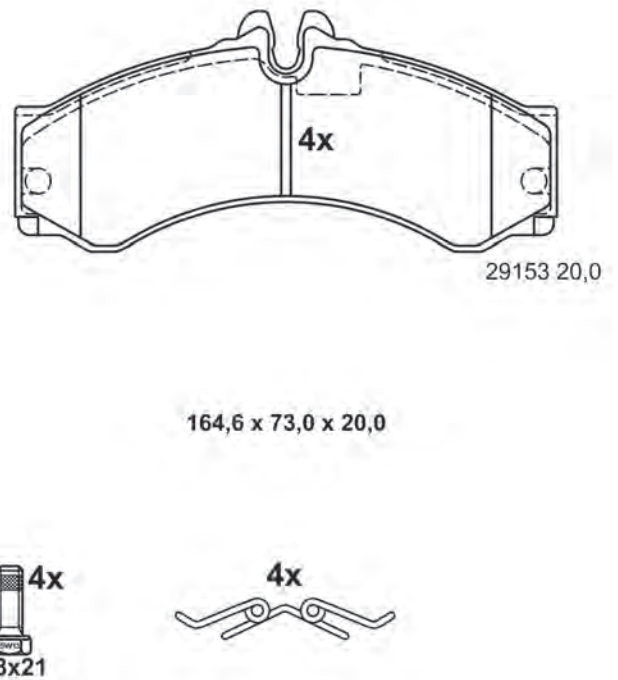

Abbildungen Scheibenbremsbeläge

Illustrations disc brake pads - Ilustraciones de pastillas - Illustrations Plaquettes de frein à disque - Illustrazioni Pastiglie Freno

13.0460-8002.2 608002

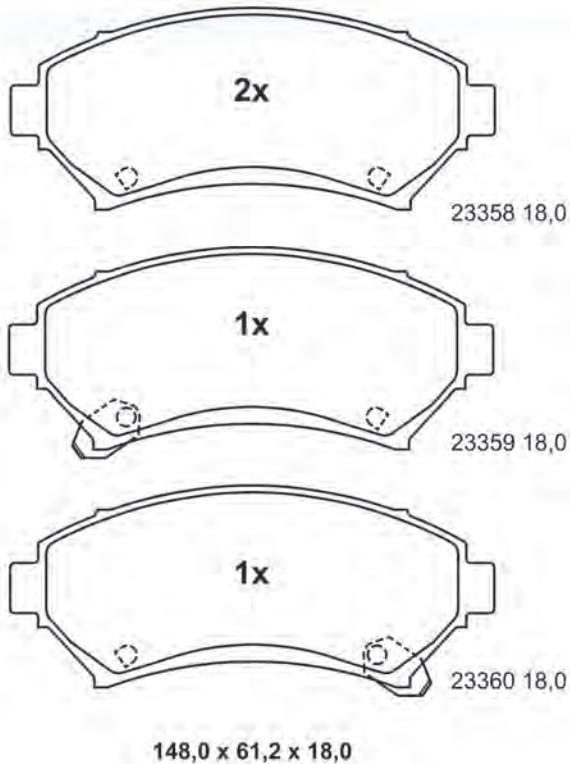

13.0460-8003.2 608003

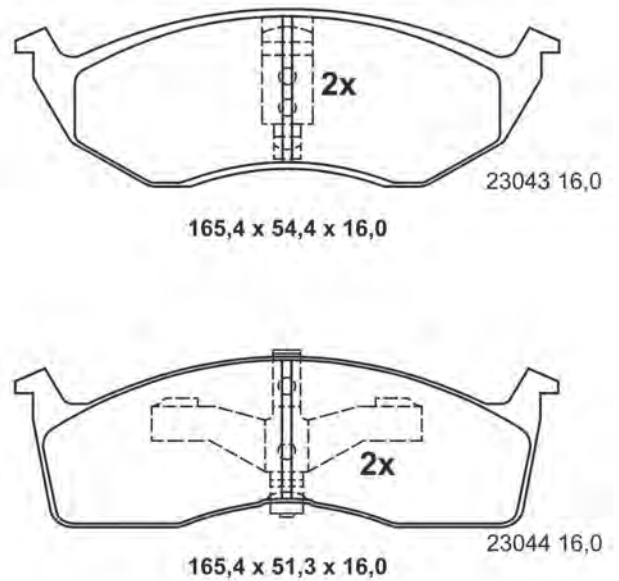

13.0460-8004.2 608004 [1]

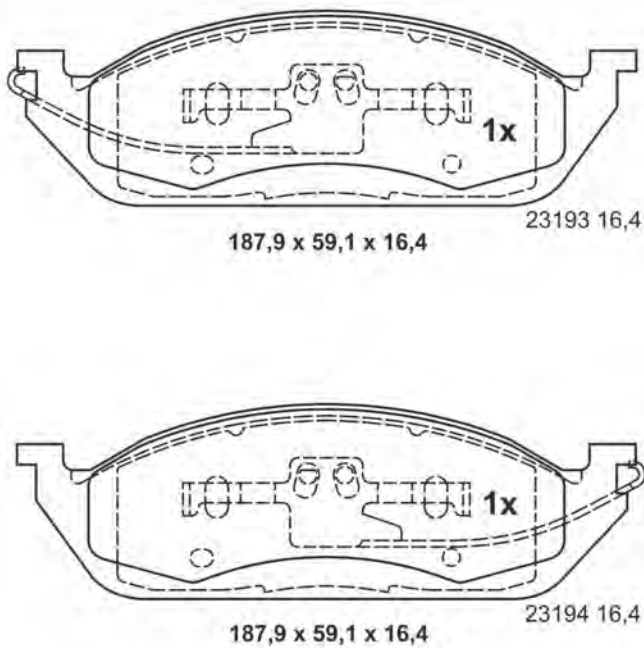

13.0460-8004.2 608004 [2]

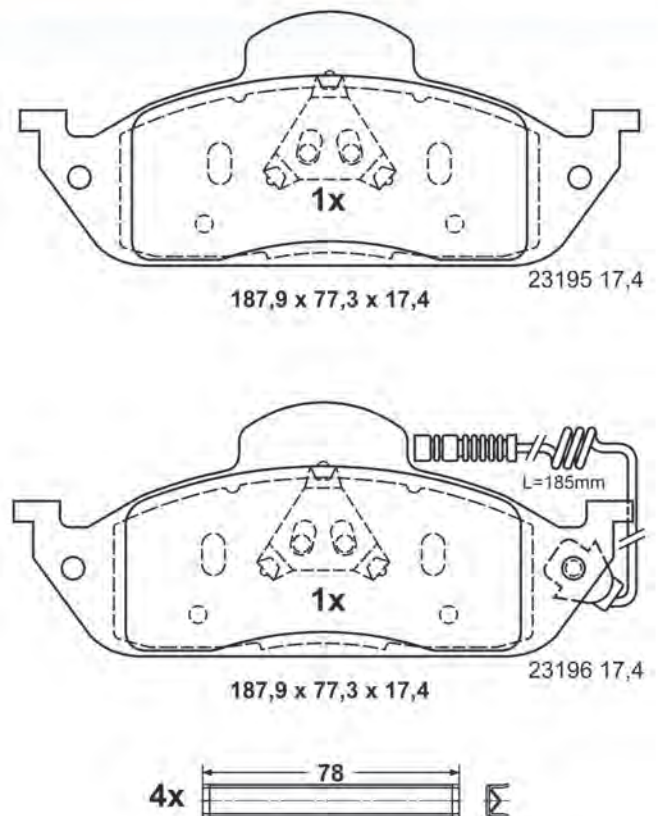

Abbildungen Scheibenbremsbeläge

Illustrations disc brake pads - Ilustraciones de pastillas - Illustrations Plaquettes de frein à disque - Illustrazioni Pastiglie Freno

13.0460-8005.2 608005

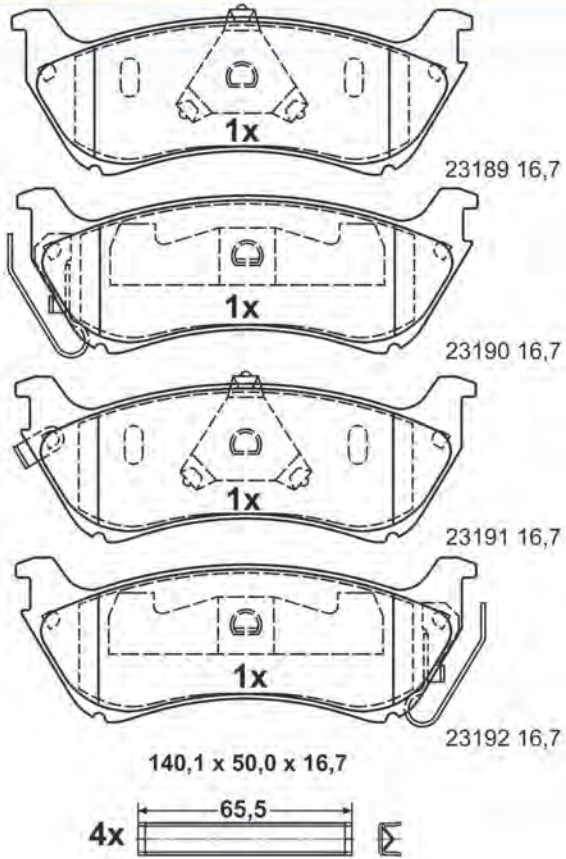

13.0460-8006.2 608006

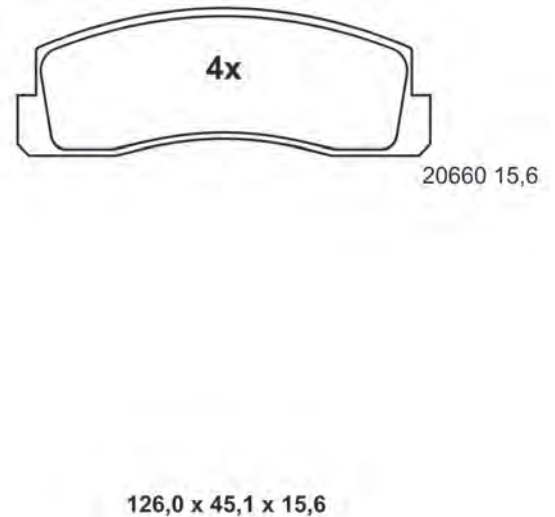

13.0460-8007.2 608007 [1]

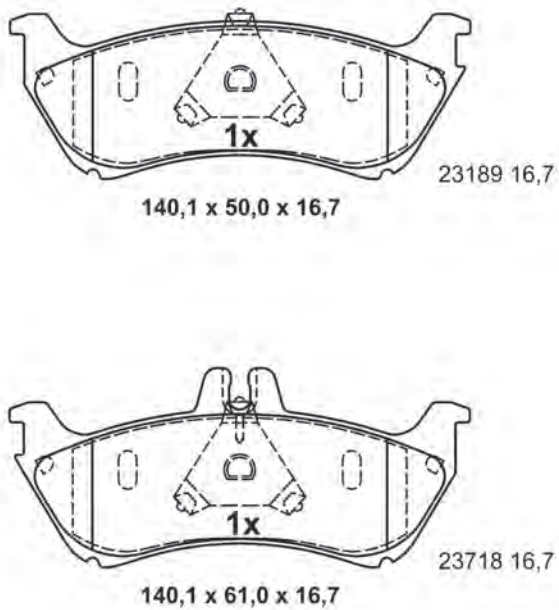

13.0460-8007.2 608007 [2]

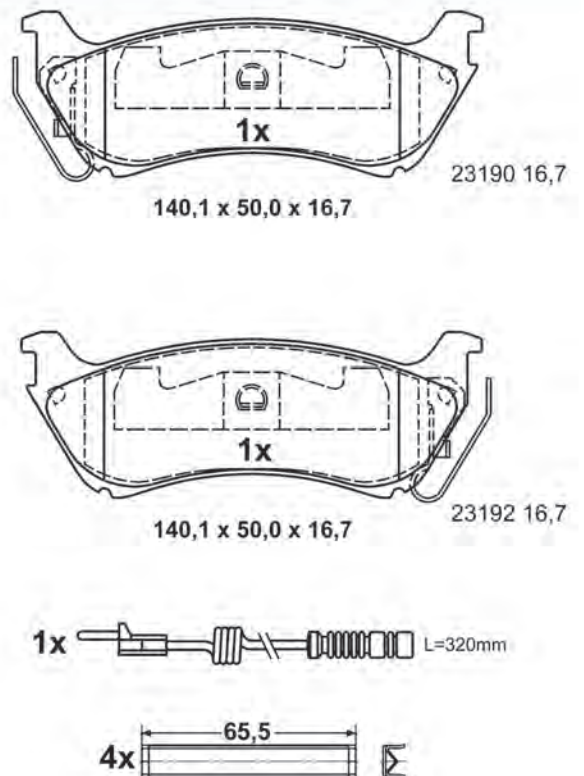

Abbildungen Scheibenbremsbeläge

Illustrations disc brake pads - Ilustraciones de pastillas - Illustrations Plaquettes de frein à disque - Illustrazioni Pastiglie Freno

13.0460-8008.2 608008

B.H.P.

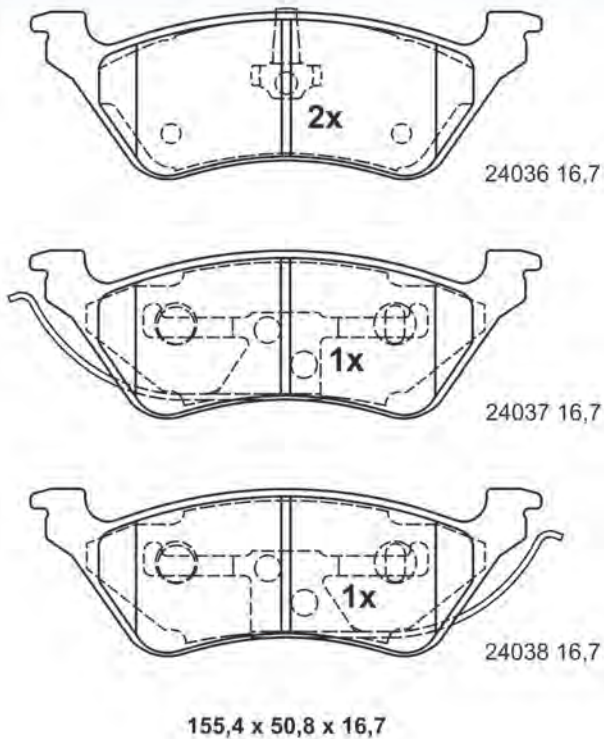

13.0460-8009.2 608009

B.H.P.

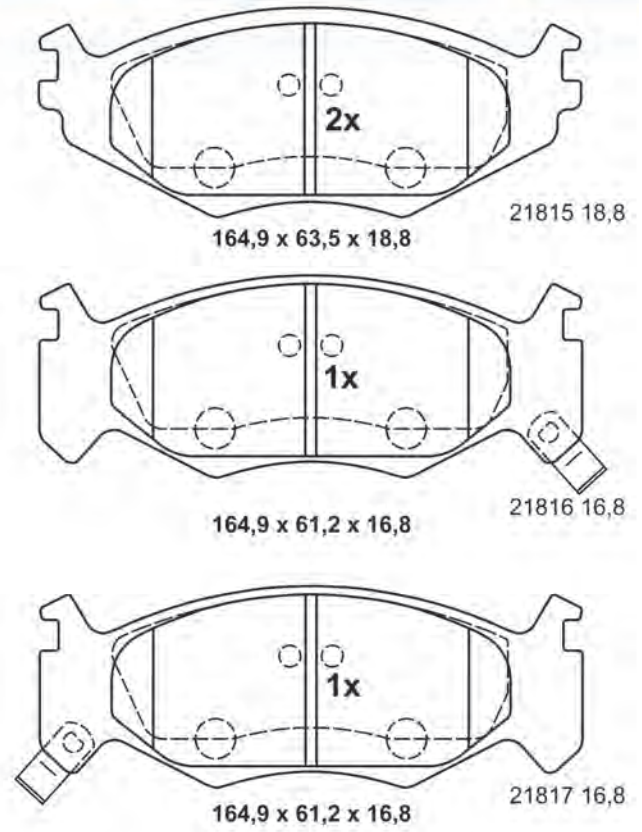

13.0460-8010.2 608010

B.H.P.

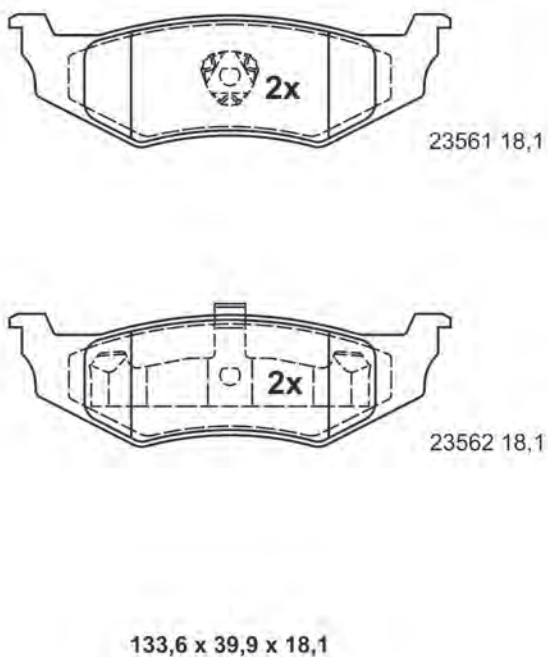

13.0460-8011.2 608011

B.H.P.

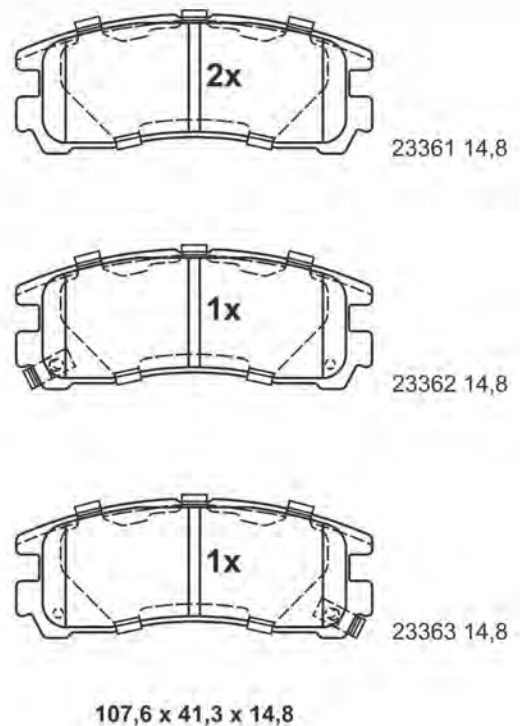

Abbildungen Scheibenbremsbeläge

Illustrations disc brake pads - Ilustraciones de pastillas - Illustrations Plaquettes de frein à disque - Illustrazioni Pastiglie Freno

13.0460-8013.2 608013

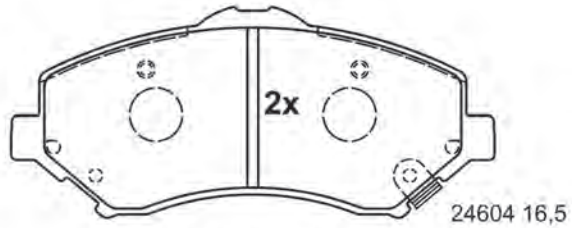
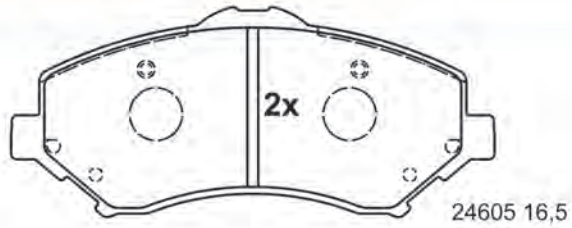

146,7 x 63,8 x 16,5

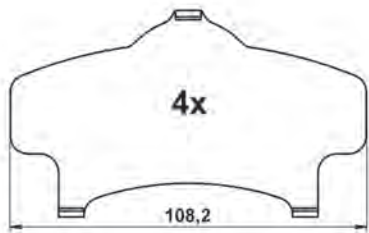

13.0460-8014.2 608014 [1]

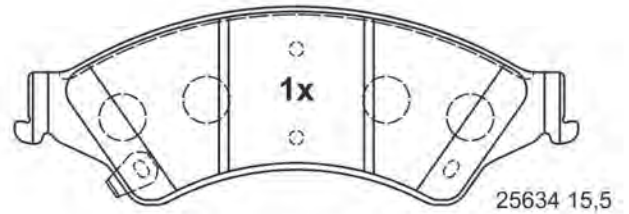
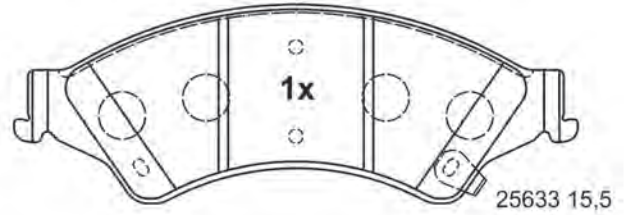
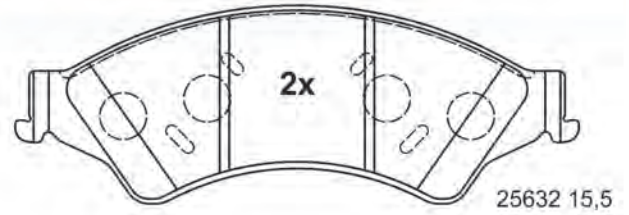

194,0 x 68,1 x 15,5

13.0460-8014.2 608014 [2]

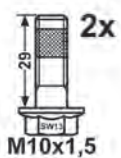
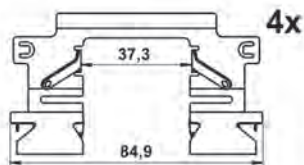

13.0460-9033.2 609033

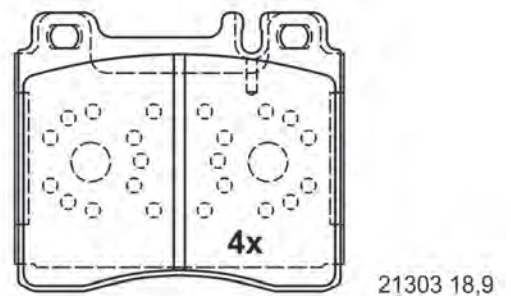

99,6 x 84,5 x 18,9

Abbildungen Scheibenbremsbeläge

Illustrations disc brake pads - Ilustraciones de pastillas - Illustrations Plaquettes de frein à disque - Illustrazioni Pastiglie Freno

13.0460-9037.2 609037

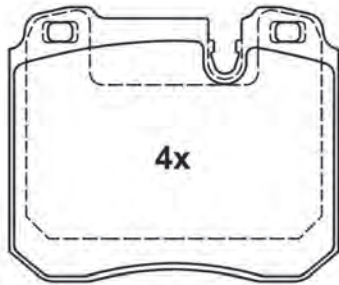

20309 17,9

99,8 x 83,0 x 17,9

13.0470-2707.2 LD2707



ATE Ceramic

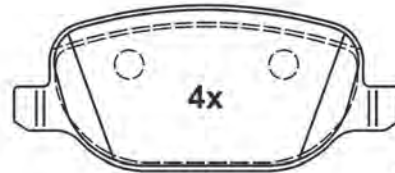

23760 17,7

116,8 x 49,8 x 17,7

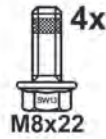

13.0470-2708.2 LD2708



ATE Ceramic

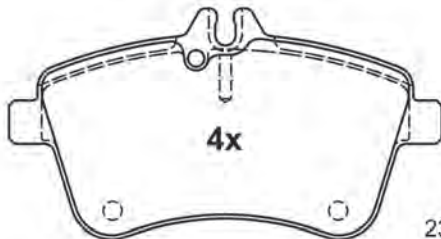

23881 20,0

131,3 x 69,8 x 20,0

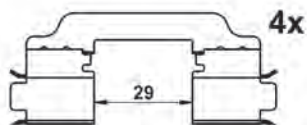

13.0470-2709.2 LD2709



ATE Ceramic



23973 17,1

116,3 x 52,4 x 17,1

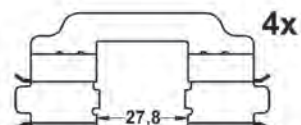

Abbildungen Scheibenbremsbeläge

Illustrations disc brake pads - Ilustraciones de pastillas - Illustrations Plaquettes de frein à disque - Illustrazioni Pastiglie Freno

13.0470-2710.2 LD2710

ATE Ceramic

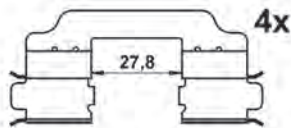
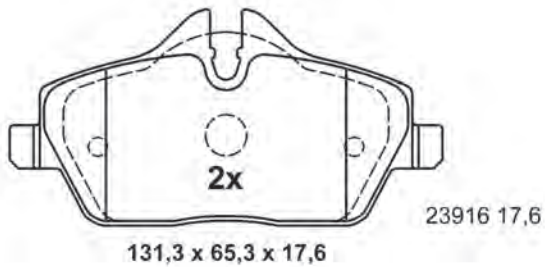
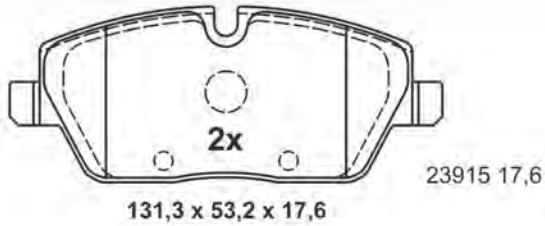

13.0470-2711.2 LD2711

ATE Ceramic

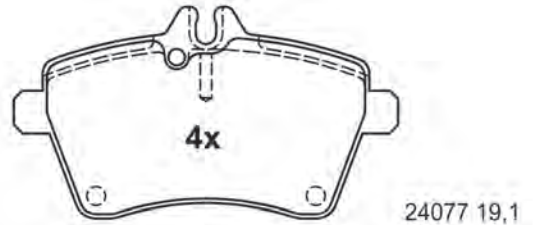

116,4 x 63,8 x 19,1

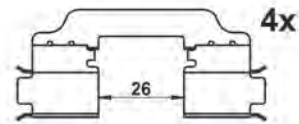

13.0470-2712.2 LD2712

ATE Ceramic



95,7 x 41,3 x 14,6

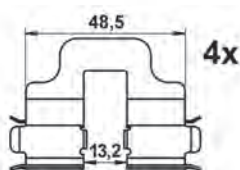

13.0470-2713.2 LD2713

ATE Ceramic

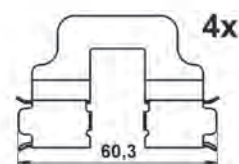
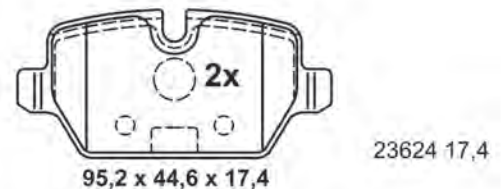
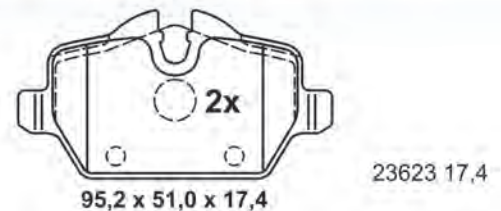

Abbildungen Scheibenbremsbeläge

Illustrations disc brake pads - Ilustraciones de pastillas - Illustrations Plaquettes de frein à disque - Illustrazioni Pastiglie Freno

13.0470-2714.2 LD2714

ATE Ceramic

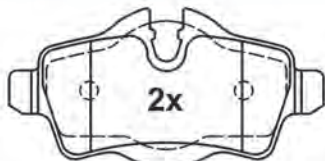

95,3 x 48,3 x 16,9

24289 16,9

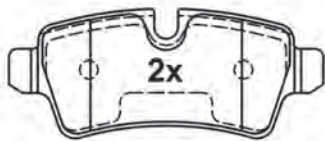

95,3 x 39,0 x 16,9

24290 16,9

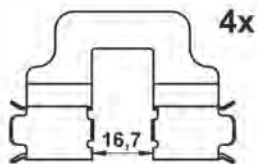

16,7



13.0470-2716.2 LD2716

ATE Ceramic

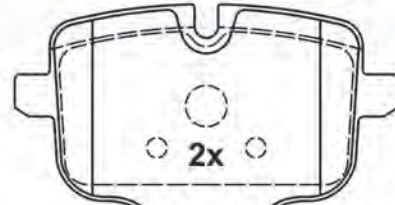

166,0 x 65,5 x 17,8

24703 17,8

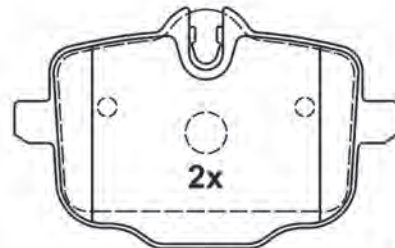

166,0 x 72,4 x 17,8

24704 17,8

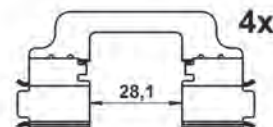

28,1



13.0470-2722.2 LD2722

ATE Ceramic

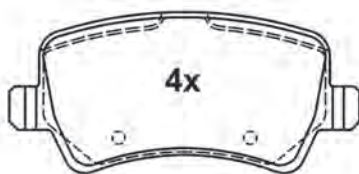

106,0 x 48,7 x 17,3

24496 17,3

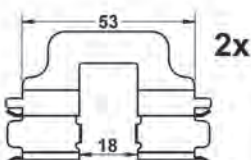

53

18

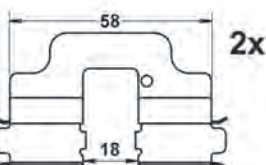

58

18



13.0470-2723.2 LD2723

ATE Ceramic



95,1 x 43,2 x 16,1

24537 16,1

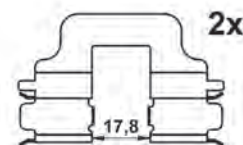

17,8

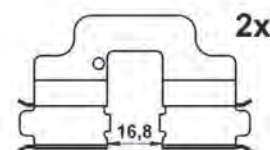

16,8



Abbildungen Scheibenbremsbeläge

Illustrations disc brake pads - Ilustraciones de pastillas - Illustrations Plaquettes de frein à disque - Illustrazioni Pastiglie Freno

13.0470-2725.2 LD2725

ATE Ceramic

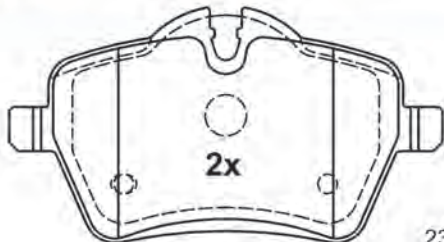

131,6 x 71,3 x 17,8

23984 17,8

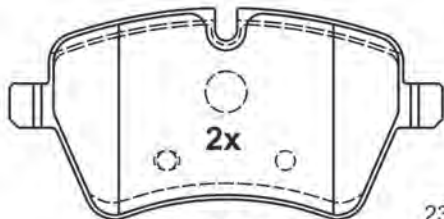

131,6 x 63,9 x 17,8

23985 17,8

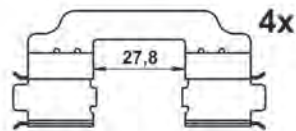

13.0470-2726.2 LD2726

ATE Ceramic

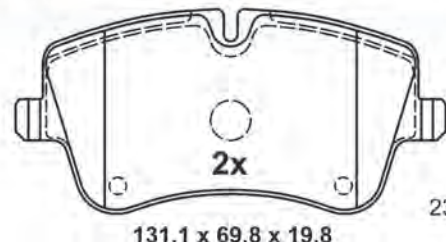

131,1 x 69,8 x 19,8

23145 19,8

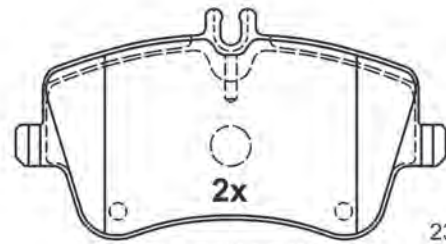

131,1 x 62,1 x 19,8

23144 19,8

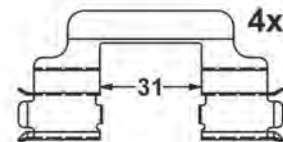

13.0470-2727.2 LD2727

ATE Ceramic

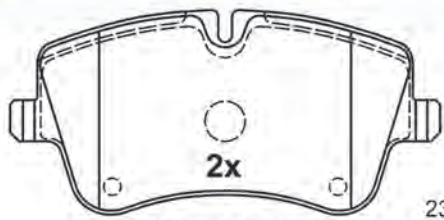

131,1 x 69,8 x 19,8

23145 19,8

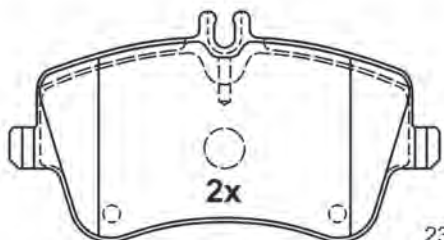

131,1 x 62,1 x 19,8

23144 19,8

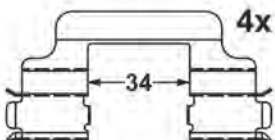
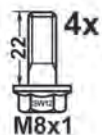

13.0470-2732.2 LD2732

ATE Ceramic

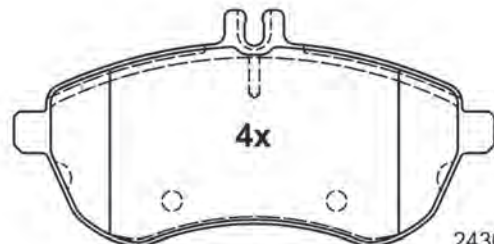

24306 20,3

146,0 x 71,5 x 20,3

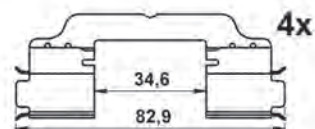

Abbildungen Scheibenbremsbeläge

Illustrations disc brake pads - Ilustraciones de pastillas - Illustrations Plaquettes de frein à disque - Illustrazioni Pastiglie Freno

13.0470-2733.2 LD2733

ATE Ceramic

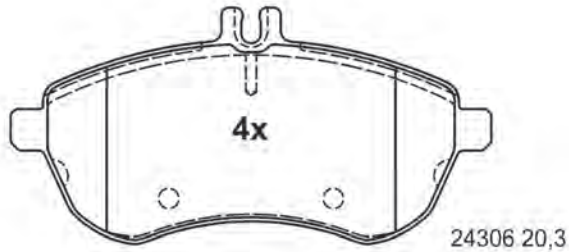

146,0 x 71,5 x 20,3

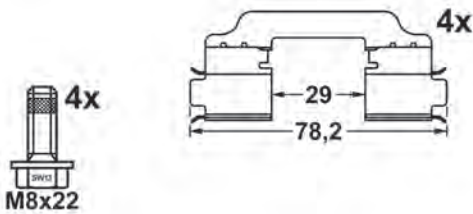

13.0470-2734.2 LD2734

ATE Ceramic

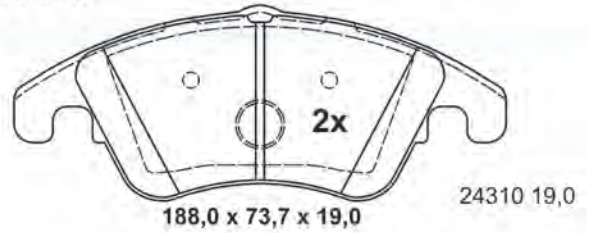

188,0 x 73,7 x 19,0

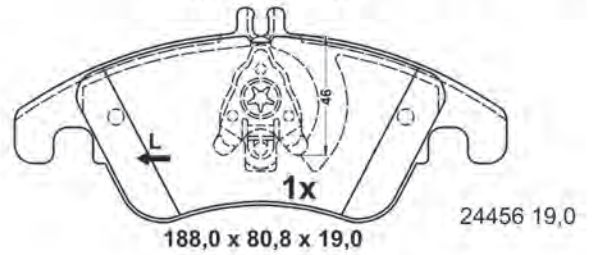

188,0 x 80,8 x 19,0

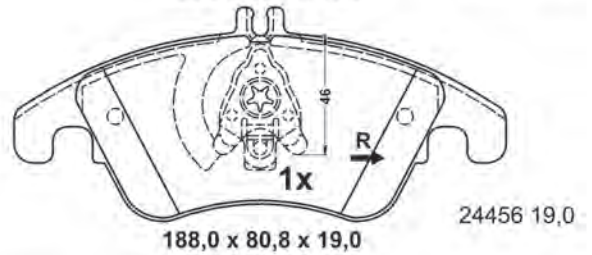

188,0 x 80,8 x 19,0

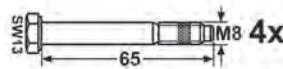

13.0470-2736.2 LD2736

ATE Ceramic



106,1 x 48,7 x 17,3

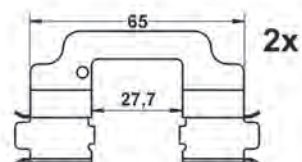
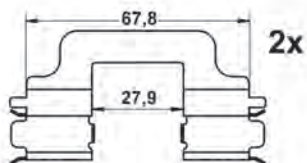

13.0470-2740.2 LD2740

ATE Ceramic

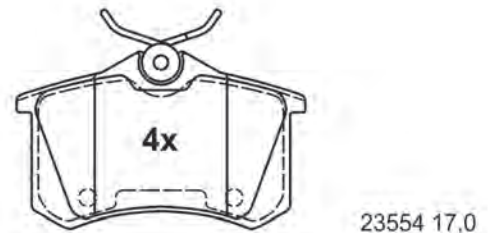

87,6 x 52,9 x 17,0

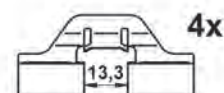

Abbildungen Scheibenbremsbeläge

Illustrations disc brake pads - Ilustraciones de pastillas - Illustrations Plaquettes de frein à disque - Illustrazioni Pastiglie Freno

13.0470-2746.2 LD2746

B.H.P.

ATE Ceramic

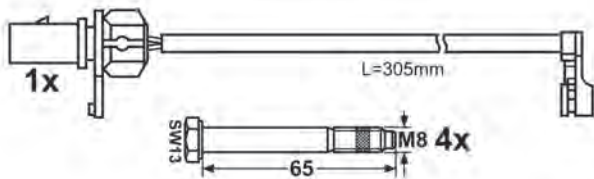
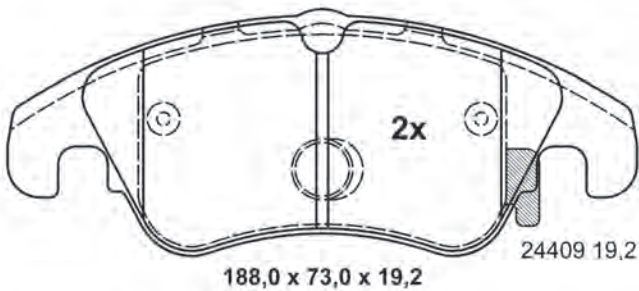
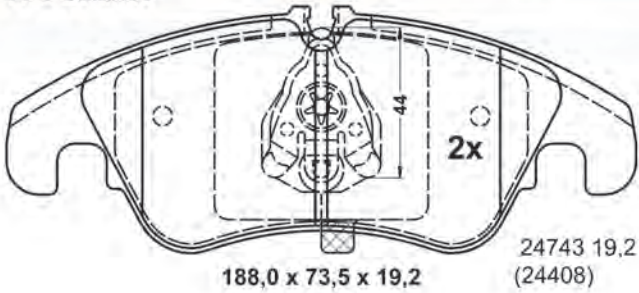

13.0470-2747.2 LD2747

B.H.P.

ATE Ceramic

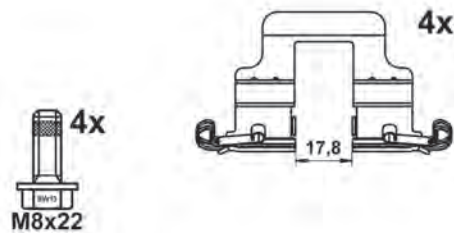
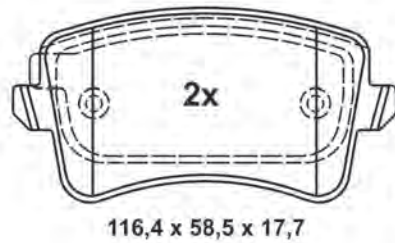
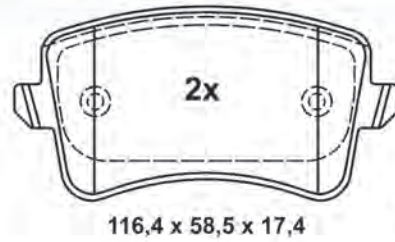

13.0470-2748.2 LD2748

B.H.P.

ATE Ceramic

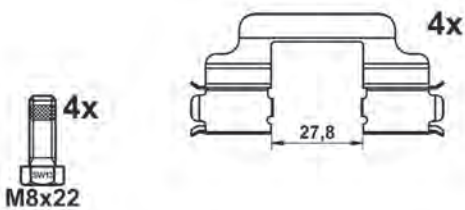
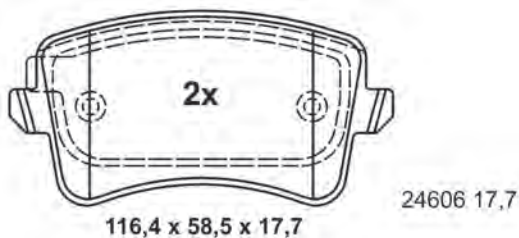
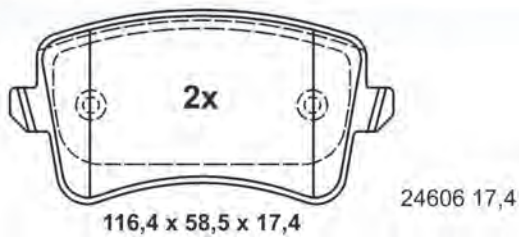

13.0470-2755.2 LD2755

B.H.P.

ATE Ceramic

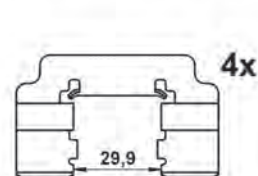
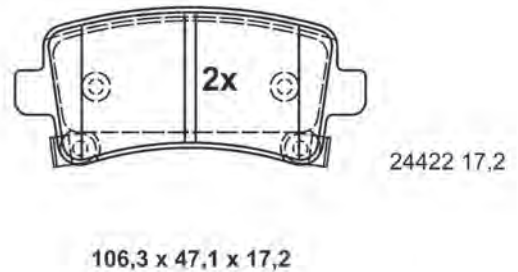
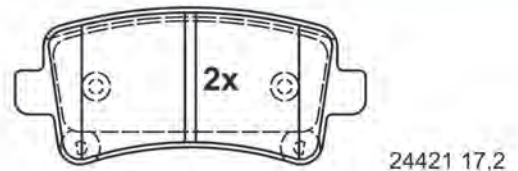

Abbildungen Scheibenbremsbeläge

Illustrations disc brake pads - Ilustraciones de pastillas - Illustrations Plaquettes de frein à disque - Illustrazioni Pastiglie Freno

13.0470-2758.2 LD2758

ATE Ceramic

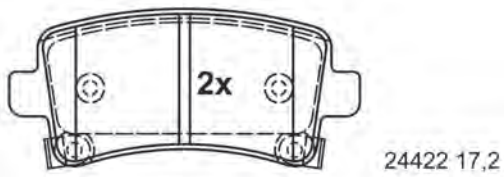
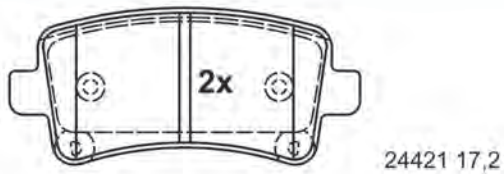

106,3 x 47,1 x 17,2

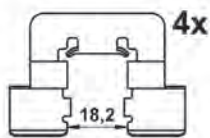

13.0470-2760.2 LD2760

ATE Ceramic

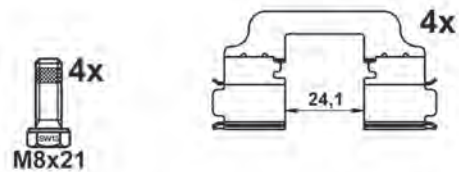
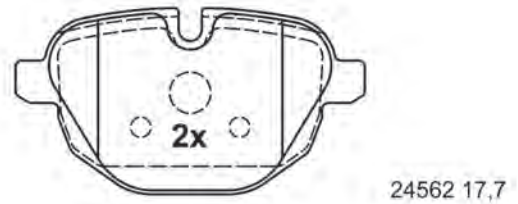
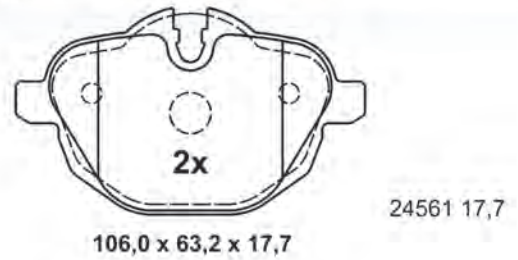

13.0470-2764.2 LD2764

ATE Ceramic

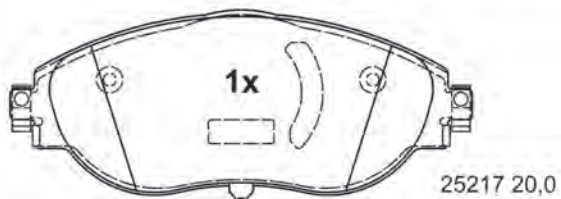
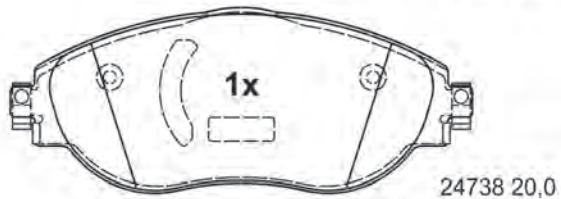
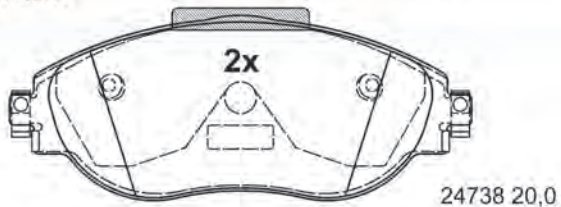

175,0 x 70,0 x 20,0



13.0470-2765.2 LD2765

ATE Ceramic

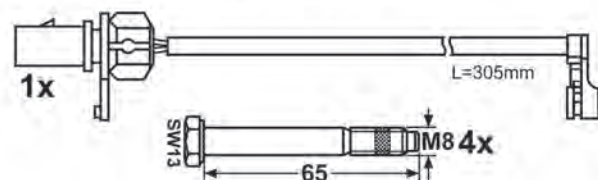
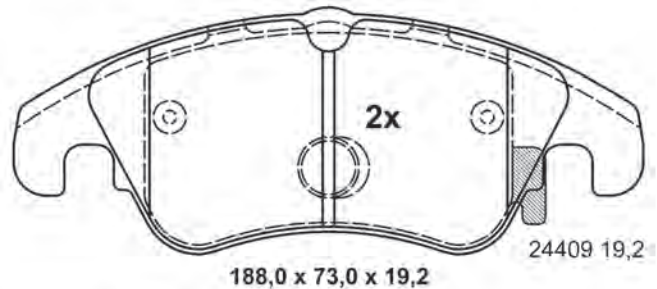
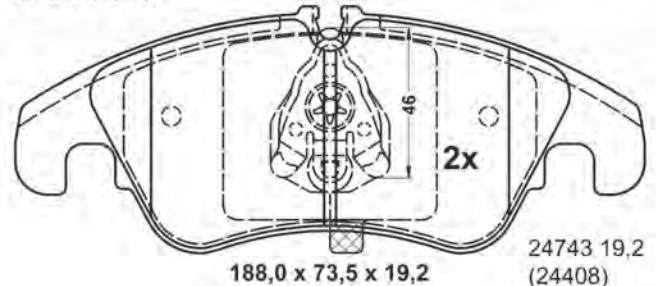

Abbildungen Scheibenbremsbeläge

Illustrations disc brake pads - Ilustraciones de pastillas - Illustrations Plaquettes de frein à disque - Illustrazioni Pastiglie Freno

13.0470-2767.2 LD2767

ATE Ceramic

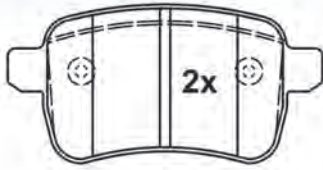

25156 17,4

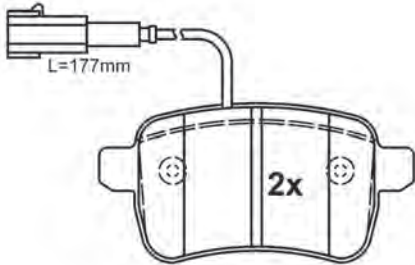

25157 17,4

95,6 x 48,1 x 17,4

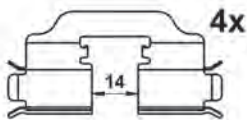

13.0470-2768.2 LD2768

ATE Ceramic

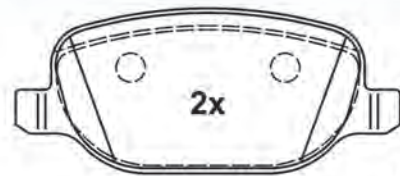

23811 17,7

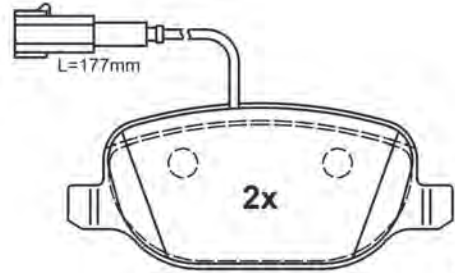

24788 17,7

116,8 x 49,8 x 17,7

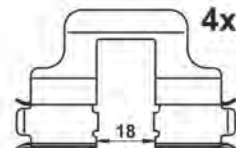

13.0470-2769.2 LD2769

ATE Ceramic

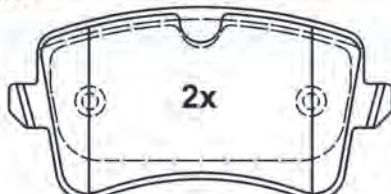

24606 17,4

116,4 x 58,5 x 17,4

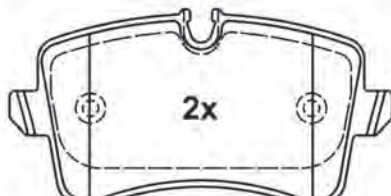

25214 17,4

116,4 x 59,8 x 17,4

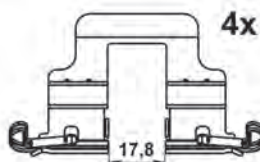

13.0470-2770.2 LD2770

ATE Ceramic

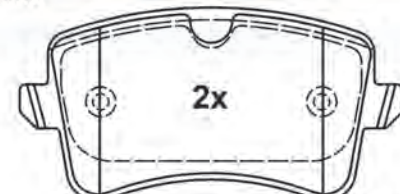

24606 17,4

116,4 x 58,5 x 17,4

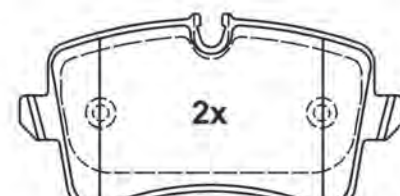

25214 17,4

116,4 x 59,8 x 17,4

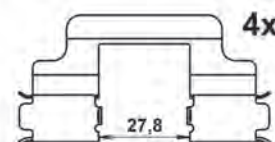
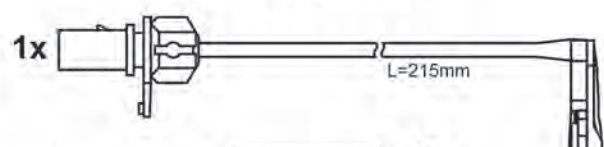

Abbildungen Scheibenbremsbeläge

Illustrations disc brake pads - Ilustraciones de pastillas - Illustrations Plaquettes de frein à disque - Illustrazioni Pastiglie Freno

13.0470-2773.2 LD2773

ATE Ceramic

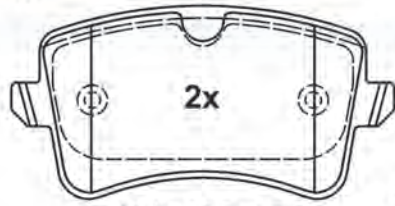

24606 17,4

116,4 x 58,5 x 17,4

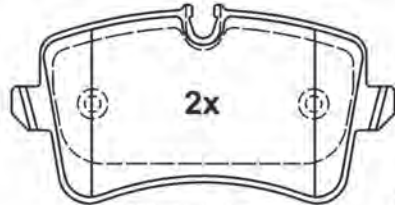

25214 17,4

116,4 x 59,8 x 17,4

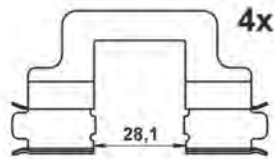
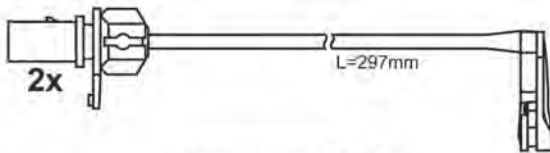

13.0470-2776.2 LD2776

ATE Ceramic

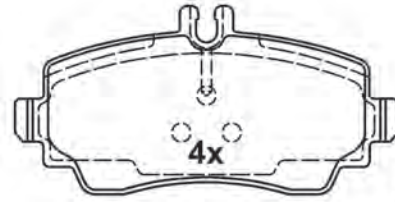

23070 17,0

116,5 x 57,1 x 17,0

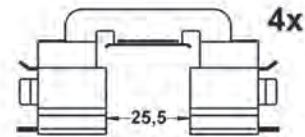

13.0470-2778.2 LD2778

ATE Ceramic

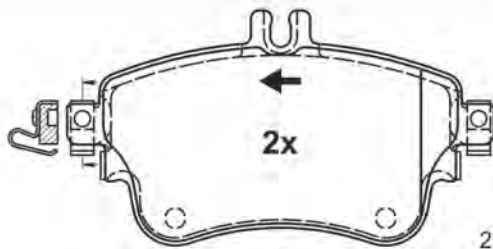

23526 19,3

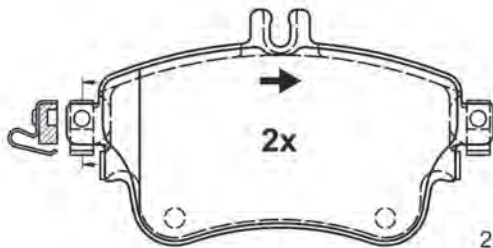

23526 19,3

129,0 x 71,3 x 19,3



13.0470-2779.2 LD2779

ATE Ceramic

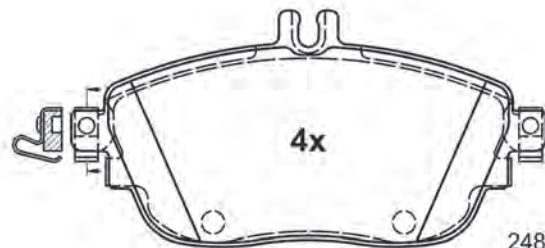

24869 19,3

144,0 x 71,6 x 19,3



Abbildungen Scheibenbremsbeläge

Illustrations disc brake pads - Ilustraciones de pastillas - Illustrations Plaquettes de frein à disque - Illustrazioni Pastiglie Freno

13.0470-2781.2 LD2781

ATE Ceramic

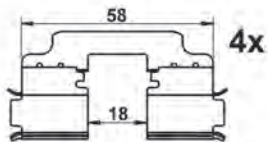
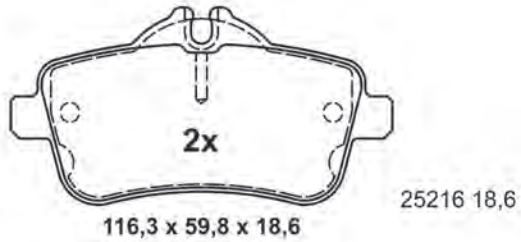
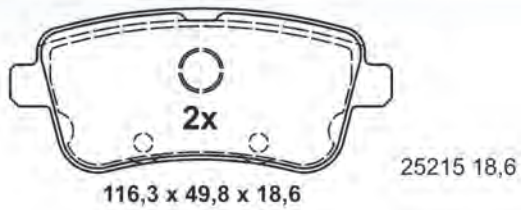

13.0470-2782.2 LD2782

ATE Ceramic

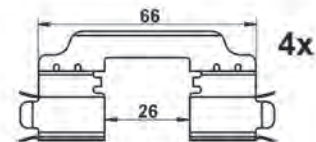
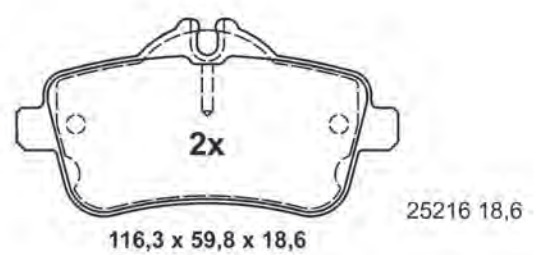
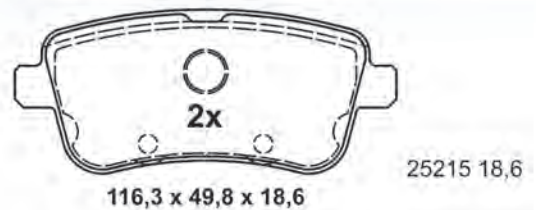

13.0470-2784.2 LD2784

ATE Ceramic

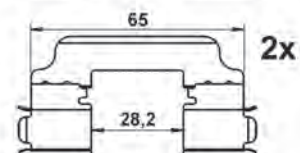
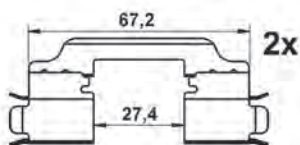
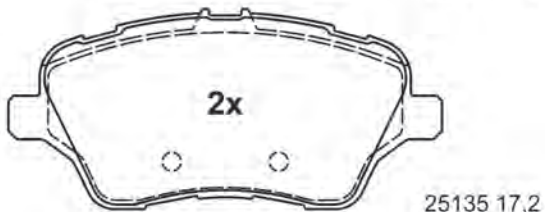
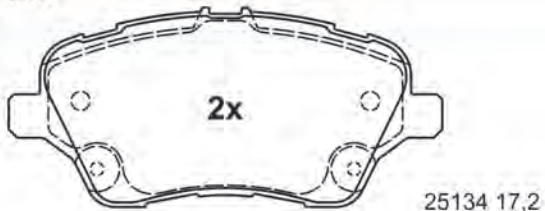

13.0470-2785.2 LD2785

ATE Ceramic

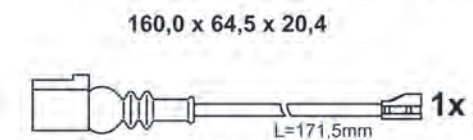
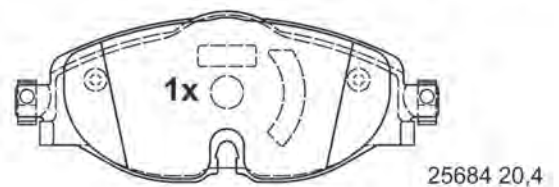
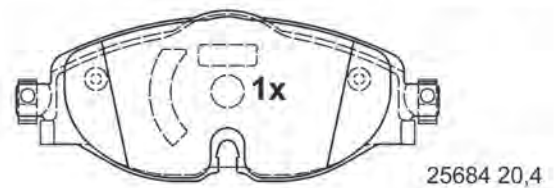
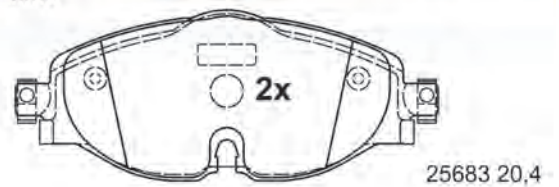

Abbildungen Scheibenbremsbeläge

Illustrations disc brake pads - Ilustraciones de pastillas - Illustrations Plaquettes de frein à disque - Illustrazioni Pastiglie Freno

13.0470-2786.2 LD2786



ATE Ceramic

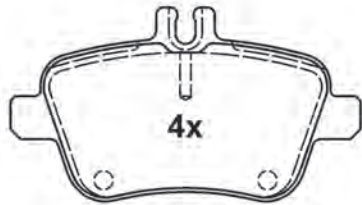

24848 18,3

106,4 x 58,9 x 18,3

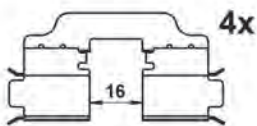

13.0470-2789.2 LD2789



ATE Ceramic



25652 17,1

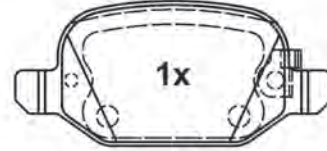

25653 17,1

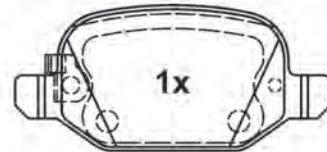

25654 17,1

95,8 x 43,8 x 17,1

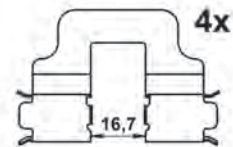

13.0470-2792.2 LD2792



ATE Ceramic

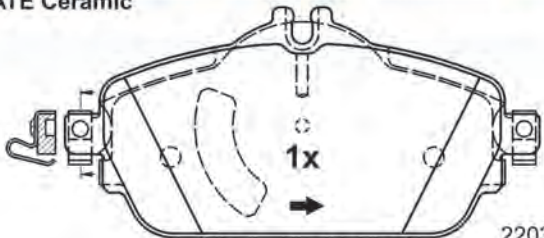

22031 19,6

144,0 x 70,0 x 19,6

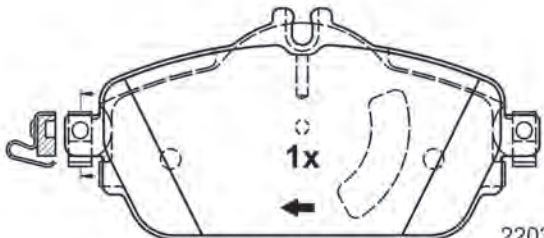

22031 19,6

144,0 x 70,0 x 19,6

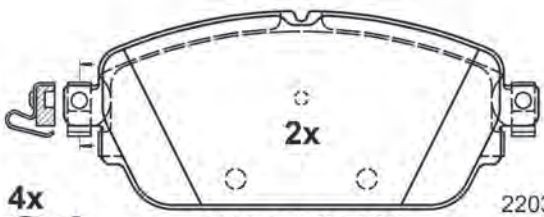

22032 19,6

144,0 x 60,0 x 19,6



13.0470-2820.2 LD2820



ATE Ceramic

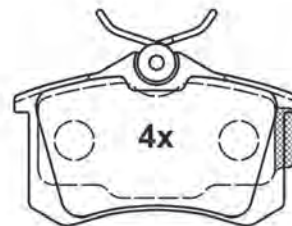

20961 17,2

87,6 x 52,9 x 17,2



Abbildungen Scheibenbremsbeläge

Illustrations disc brake pads - Ilustraciones de pastillas - Illustrations Plaquettes de frein à disque - Illustrazioni Pastiglie Freno

13.0470-2823.2 LD2823

ATE Ceramic

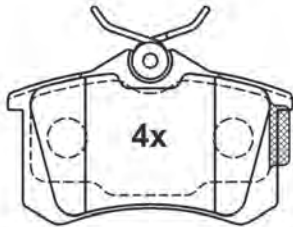

23554 17,2

86,8 x 52,9 x 17,2



13.0470-2833.2 LD2833

ATE Ceramic

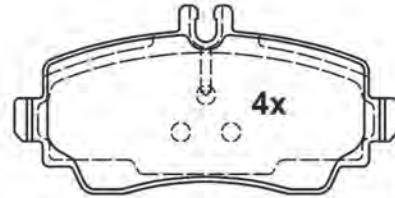

23070 17,0

116,5 x 57,1 x 17,0

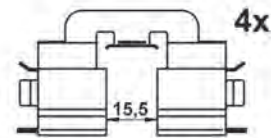

13.0470-2837.2 LD2837

ATE Ceramic

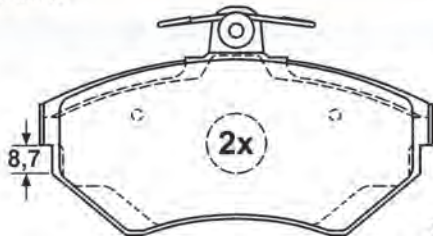

21945 19,6

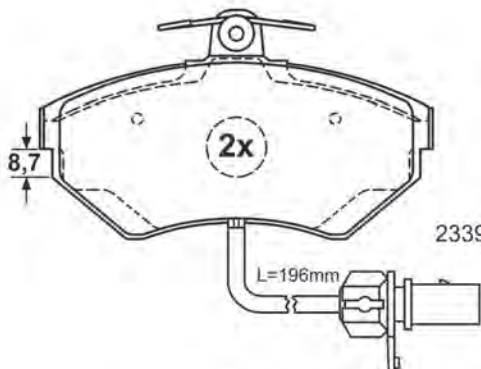

23393 19,6

119,1 x 69,5 x 19,6



13.0470-2845.2 LD2845

ATE Ceramic

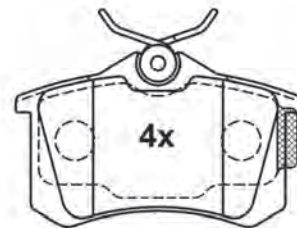

23554 16,4

87,6 x 52,9 x 16,4



Abbildungen Scheibenbremsbeläge

Illustrations disc brake pads - Ilustraciones de pastillas - Illustrations Plaquettes de frein à disque - Illustrazioni Pastiglie Freno

13.0470-2855.2 LD2855



ATE Ceramic



23138 14,6

95,7 x 41,3 x 14,6



13.0470-2857.2 LD2857



ATE Ceramic

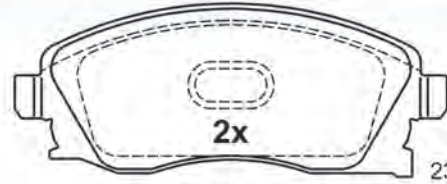

23225 17,0

131,5 x 52,3 x 17,0

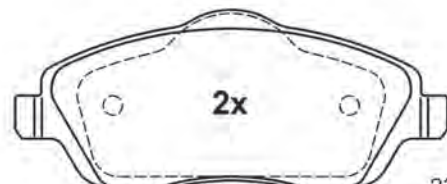

23226 17,0

131,5 x 55,4 x 17,0



13.0470-2858.2 LD2858



ATE Ceramic

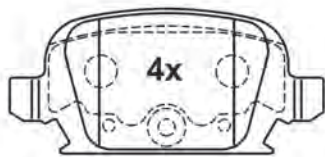

23284 14,0

95,6 x 43,8 x 14,0



13.0470-2860.2 LD2860



ATE Ceramic

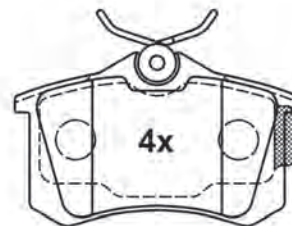











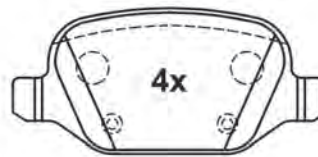

23554 16,4

87,6 x 52,9 x 16,4

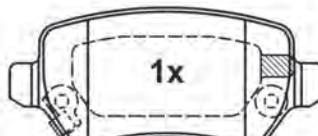

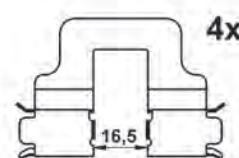
Abbildungen Scheibenbremsbeläge

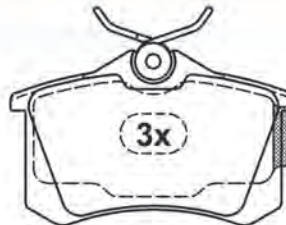
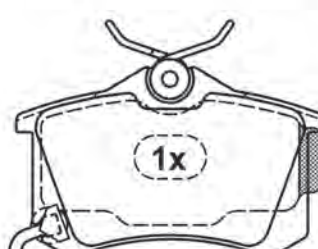
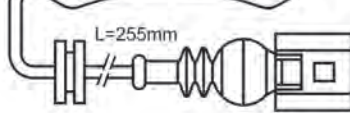
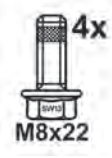
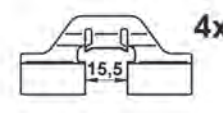
Illustrations disc brake pads - Ilustraciones de pastillas - Illustrations Plaquettes de frein à disque - Illustrazioni Pastiglie Freno

13.0470-2867.2 LD2867 	13.0470-2868.2 LD2868 
<p>ATE Ceramic</p>  <p>23517 16,6</p> <p>95,6 x 43,9 x 16,6</p>  <p>4x M8x22</p>	<p>ATE Ceramic</p>  <p>23417 15,3</p>  <p>23654 15,3</p>  <p>23655 15,3</p> <p>95,3 x 42,8 x 15,3</p>  <p>4x M8x22</p>  <p>4x 16,5</p>
13.0470-2877.2 LD2877 	13.0470-2879.2 LD2879 
<p>ATE Ceramic</p>  <p>23554 17,2</p>  <p>23823 17,2</p>  <p>L=255mm</p> <p>87,6 x 52,9 x 17,2</p>  <p>4x M8x22</p>  <p>4x 15,5</p>	<p>ATE Ceramic</p>  <p>23601 13,7</p> <p>95,6 x 43,9 x 13,7</p>  <p>2x M8x22</p>



Abbildungen Scheibenbremsbeläge

Illustrations disc brake pads - Ilustraciones de pastillas - Illustrations Plaquettes de frein à disque - Illustrazioni Pastiglie Freno

13.0470-2880.2 LD2880

ATE Ceramic

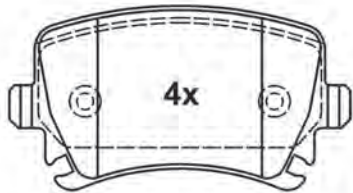

23914 17,1

105,3 x 55,9 x 17,1

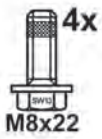
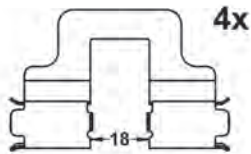

M8x22

13.0470-2884.2 LD2884

ATE Ceramic



23581 18,8

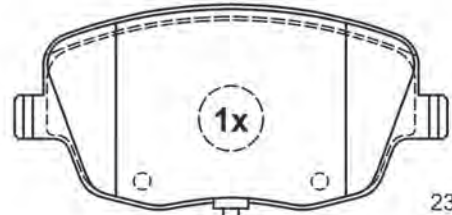

23843 18,8

L=160mm

131,4 x 62,0 x 18,8



M8x1

13.0470-2885.2 LD2885

ATE Ceramic

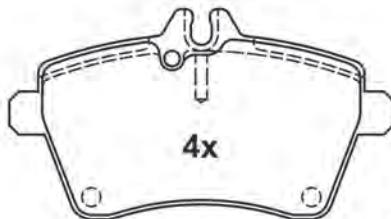

24077 19,1

116,4 x 63,8 x 19,1

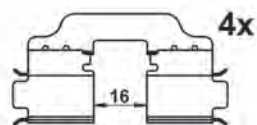

M8x21

13.0470-2886.2 LD2886

ATE Ceramic

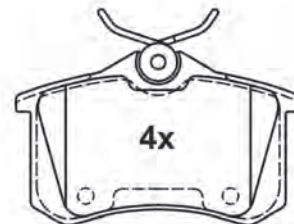

20961 16,0

87,6 x 52,9 x 16,0



M8x21

Abbildungen Scheibenbremsbeläge

Illustrations disc brake pads - Ilustraciones de pastillas - Illustrations Plaquettes de frein à disque - Illustrazioni Pastiglie Freno

13.0470-2887.2 LD2887

ATE Ceramic

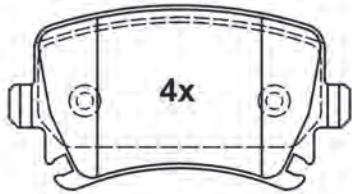

23914 17,1

105,3 x 55,9 x 17,1

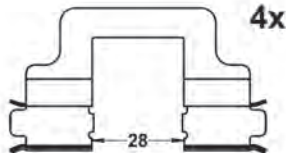

13.0470-2888.2 LD2888

ATE Ceramic

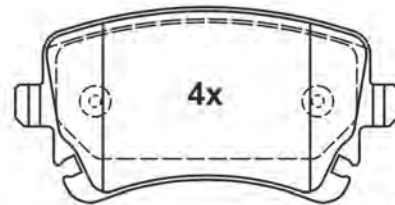

23326 17,4

116,1 x 59,0 x 17,4



13.0470-2891.2 LD2891

ATE Ceramic

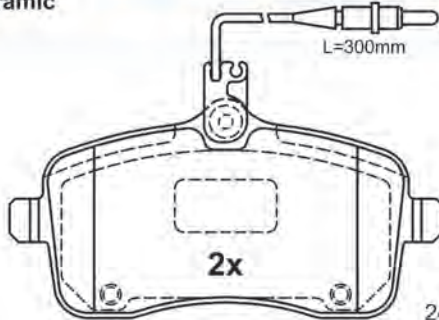

24134 19,6

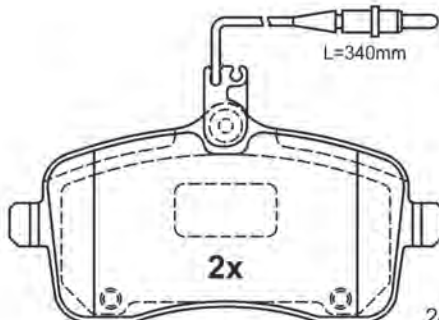

24175 19,6

131,4 x 67,5 x 19,6



13.0470-2892.2 LD2892

ATE Ceramic

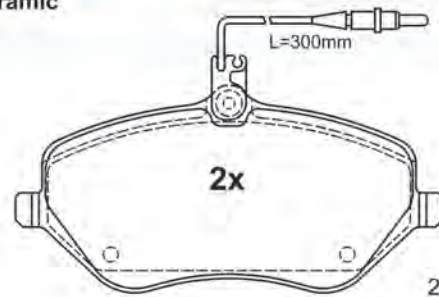

24174 18,6

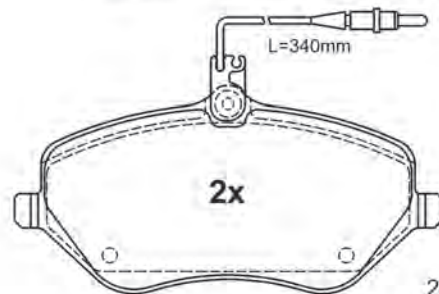

24133 18,6

162,3 x 79,0 18,6

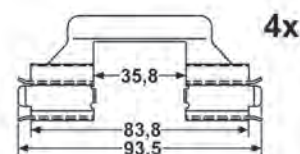

Abbildungen Scheibenbremsbeläge

Illustrations disc brake pads - Ilustraciones de pastillas - Illustrations Plaquettes de frein à disque - Illustrazioni Pastiglie Freno

13.0470-2893.2 LD2893



ATE Ceramic

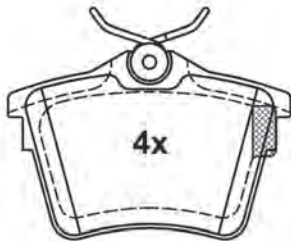

24135 17,7

86,1 x 56,9 x 17,7



13.0470-2894.2 LD2894



ATE Ceramic

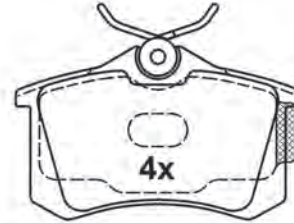

20961 17,2

87,6 x 52,9 x 17,2

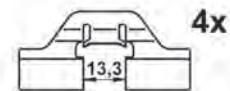

13.0470-2927.2 LD2927



ATE Ceramic

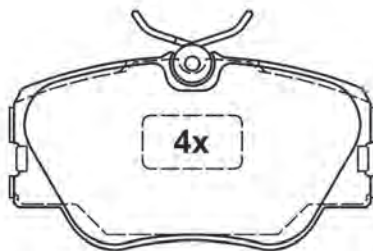

20941 19,3
(21028)

110,0 x 59,6 x 19,3



13.0470-2975.2 LD2975



ATE Ceramic

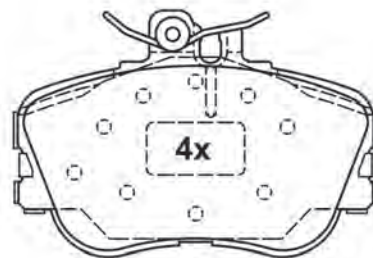

21439 20,3

110,0 x 74,5 x 20,3



Abbildungen Scheibenbremsbeläge

Illustrations disc brake pads - Ilustraciones de pastillas - Illustrations Plaquettes de frein à disque - Illustrazioni Pastiglie Freno

13.0470-3605.2 LD3605



ATE Ceramic



20180 17,3

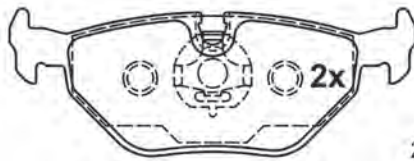

20181 17,3

123,0 x 44,9 x 17,3

13.0470-3805.2 LD3805



ATE Ceramic

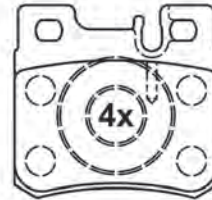

21197 15,0

61,8 x 58,6 x 15,0

13.0470-3812.2 LD3812



ATE Ceramic



23714 17,6

94,8 x 42,9 x 17,6

13.0470-3813.2 LD3813



ATE Ceramic



24150 17,6

94,8 x 46,9 x 17,6

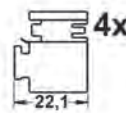
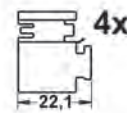

Abbildungen Scheibenbremsbeläge

Illustrations disc brake pads - Ilustraciones de pastillas - Illustrations Plaquettes de frein à disque - Illustrazioni Pastiglie Freno

13.0470-3814.2 LD3814

ATE Ceramic

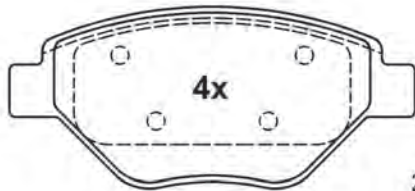

23934 18,2

122,8 x 54,3 x 18,2



13.0470-3815.2 LD3815

ATE Ceramic

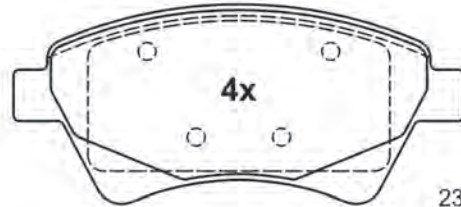

23930 18,2

136,8 x 59,5 x 18,2

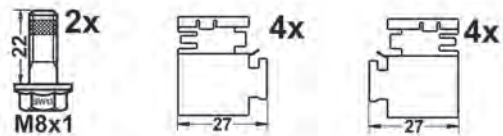

13.0470-3826.2 LD3826

ATE Ceramic

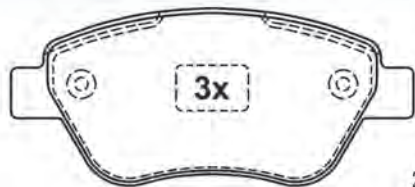

23707 18,0

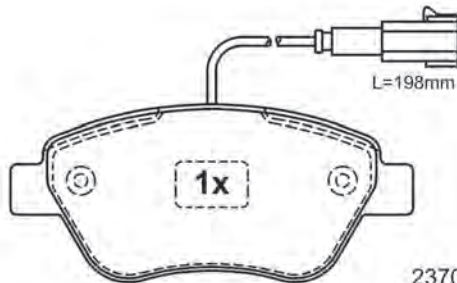

23706 18,0

122,8 x 53,3 x 18,0

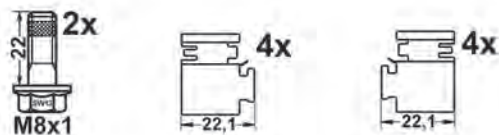

13.0470-3827.2 LD3827

ATE Ceramic

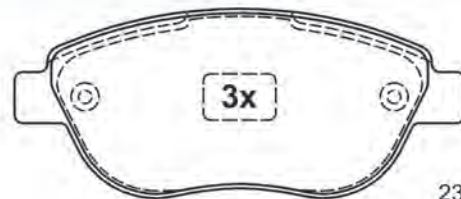

23710 19,6

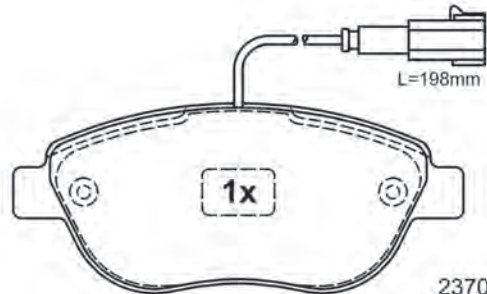

23709 19,6

136,8 x 57,4 x 19,6

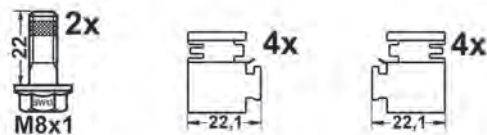

Abbildungen Scheibenbremsbeläge

Illustrations disc brake pads - Ilustraciones de pastillas - Illustrations Plaquettes de frein à disque - Illustrazioni Pastiglie Freno

13.0470-3828.2 LD3828

ATE Ceramic

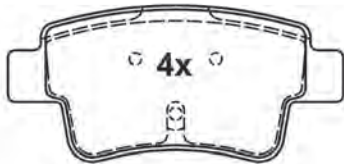

24349 17,5

101,8 x 47,1 x 17,5

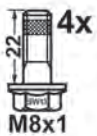

13.0470-3831.2 LD3831

ATE Ceramic



24260 17,3

101,8 x 50,5 x 17,3

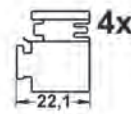
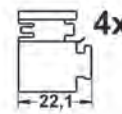

13.0470-3836.2 LD3836

ATE Ceramic

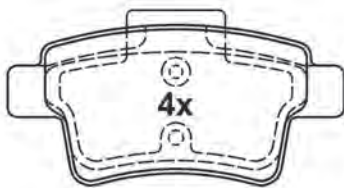

24540 16,3

101,8 x 48,3 x 16,3

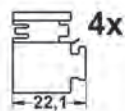
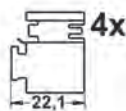
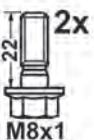
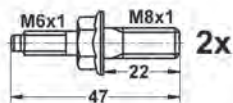

13.0470-3838.2 LD3838

ATE Ceramic

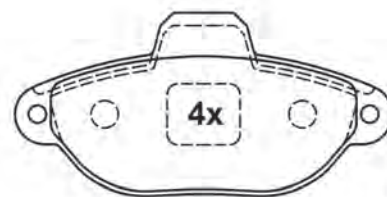

21436 17,0

114,8 x 55,5 x 17,0

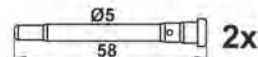
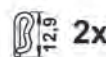
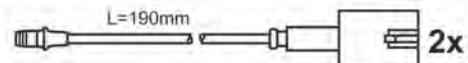

Abbildungen Scheibenbremsbeläge

Illustrations disc brake pads - Ilustraciones de pastillas - Illustrations Plaquettes de frein à disque - Illustrazioni Pastiglie Freno

13.0470-3839.2 LD3839

ATE Ceramic



23982 18,1

122,8 x 53,3 x 18,1

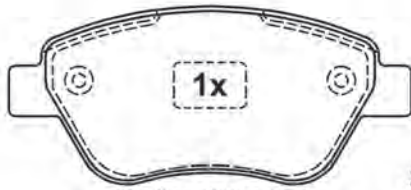

23707 17,9

122,8 x 53,3 x 17,9

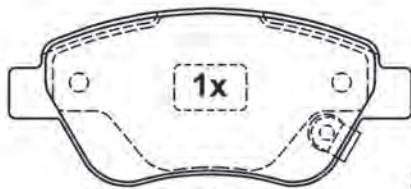

24288 17,9

122,8 x 53,3 x 17,9

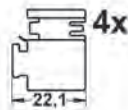
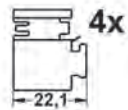

13.0470-3840.2 LD3840

ATE Ceramic



23981 19,6

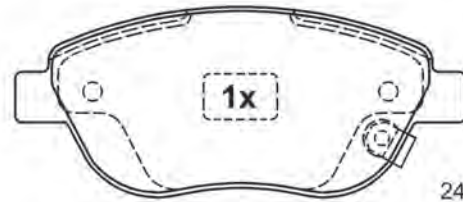

24549 19,6

136,9 x 57,4 x 19,6

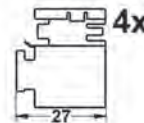
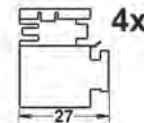

13.0470-3846.2 LD3846

ATE Ceramic

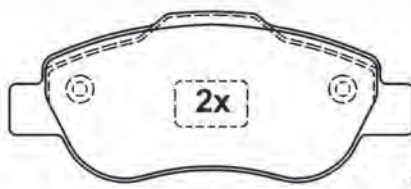

24072 17,9

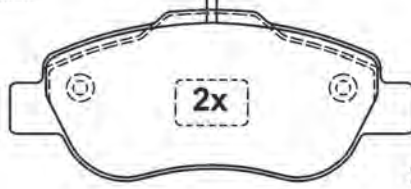
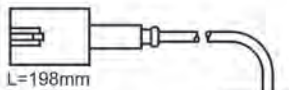

24764 17,9

122,8 x 51,7 x 17,9

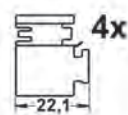
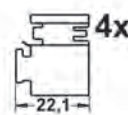
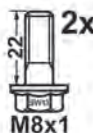

13.0470-3847.2 LD3847

ATE Ceramic

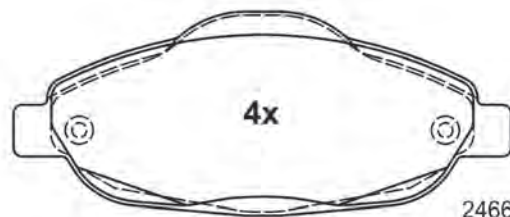

24660 17,8

151,0 x 62,0 x 17,8

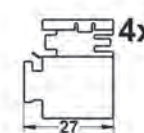
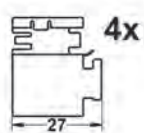
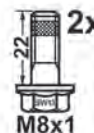

Abbildungen Scheibenbremsbeläge

Illustrations disc brake pads - Ilustraciones de pastillas - Illustrations Plaquettes de frein à disque - Illustrazioni Pastiglie Freno

13.0470-3852.2 LD3852

ATE Ceramic

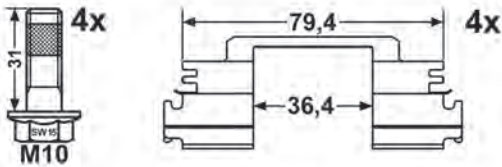
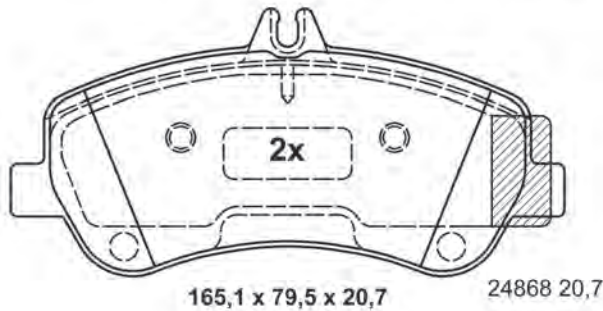
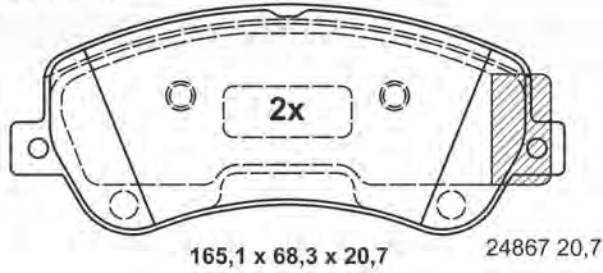

13.0470-3857.2 LD3857

ATE Ceramic

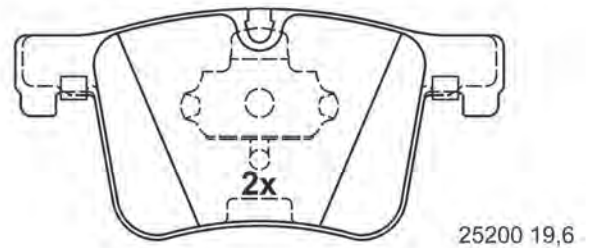
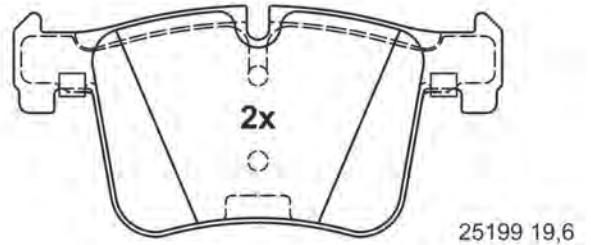

148,2 x 69,8 x 19,6

13.0470-3858.2 LD3858

ATE Ceramic

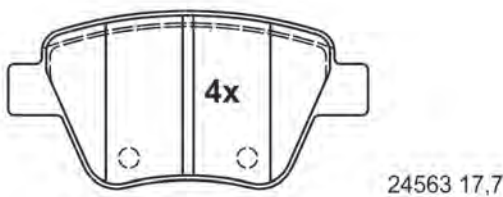

109,3 x 53,4 x 17,7

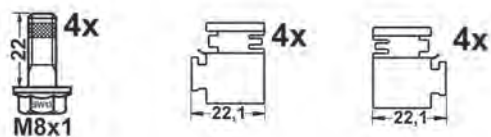

13.0470-3859.2 LD3859

ATE Ceramic

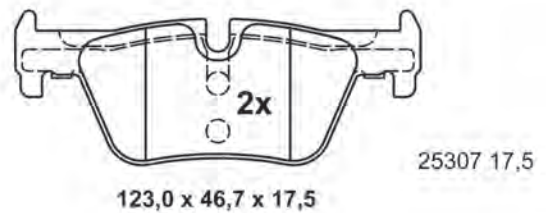

123,0 x 46,7 x 17,5

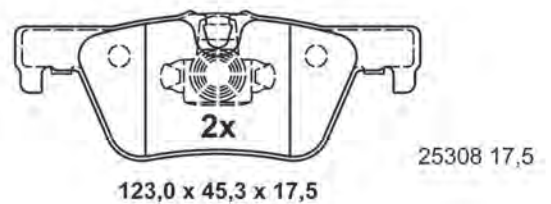

123,0 x 45,3 x 17,5

Abbildungen Scheibenbremsbeläge

Illustrations disc brake pads - Ilustraciones de pastillas - Illustrations Plaquettes de frein à disque - Illustrazioni Pastiglie Freno

13.0470-3860.2 LD3860

ATE Ceramic

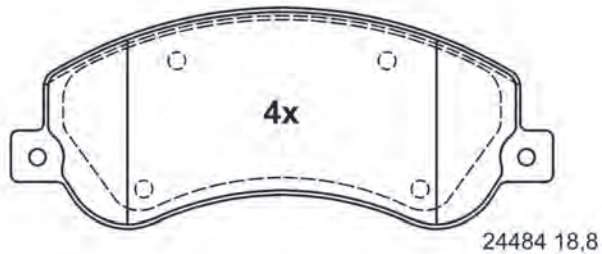

164,8 x 66,8 x 18,8

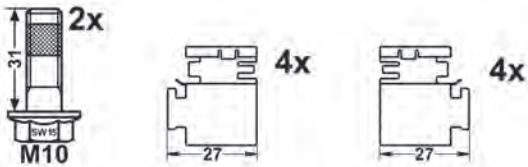

13.0470-3865.2 LD3865

ATE Ceramic

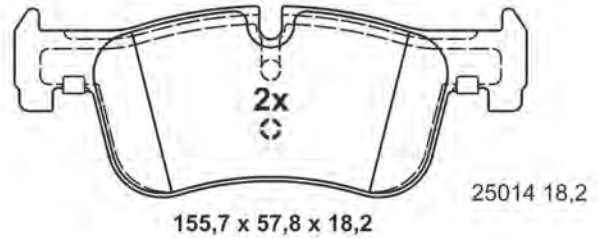

155,7 x 57,8 x 18,2

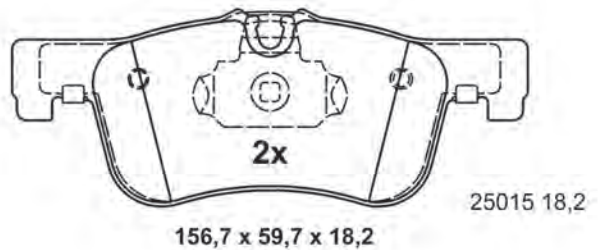

156,7 x 59,7 x 18,2

13.0470-3866.2 LD3866

ATE Ceramic

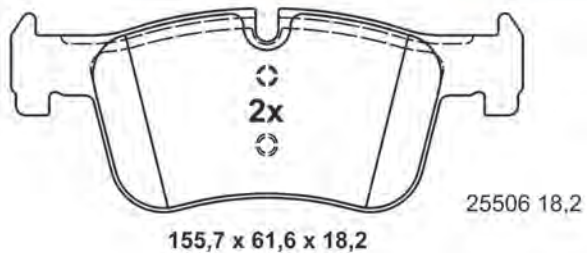

155,7 x 61,6 x 18,2

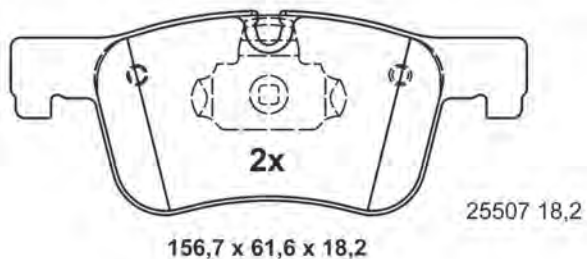

156,7 x 61,6 x 18,2

13.0470-3870.2 LD3870

ATE Ceramic

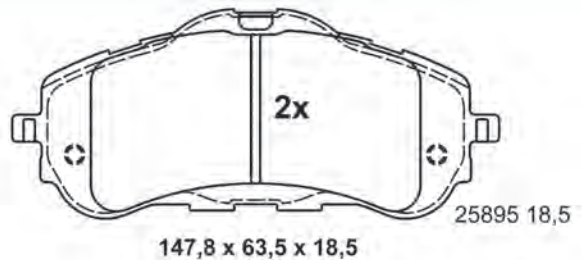

147,8 x 63,5 x 18,5

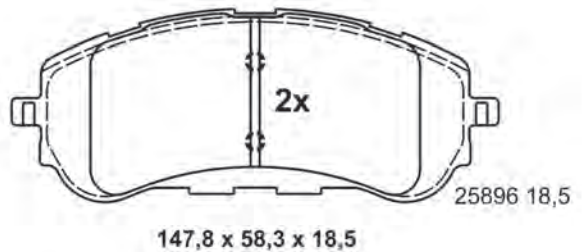

147,8 x 58,3 x 18,5

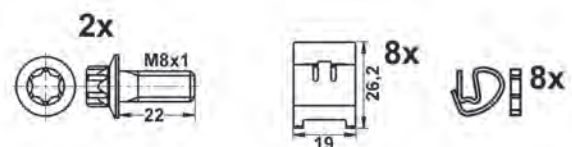

Abbildungen Scheibenbremsbeläge

Illustrations disc brake pads - Ilustraciones de pastillas - Illustrations Plaquettes de frein à disque - Illustrazioni Pastiglie Freno

13.0470-3871.2 LD3871

ATE Ceramic



25839 17,8

98,8 x 49,9 x 17,8



25840 17,8

98,8 x 53,5 x 17,8

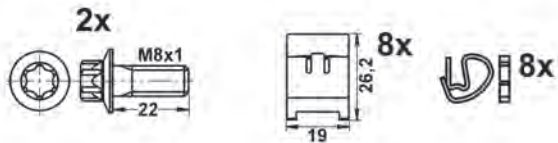

13.0470-3872.2 LD3872

ATE Ceramic



25827 17,7

105,8 x 51,9 x 17,7



25828 17,7

105,8 x 55,4 x 17,7

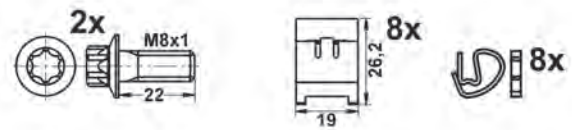

13.0470-3966.2 LD3966

ATE Ceramic

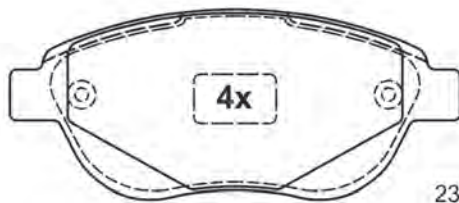

23600 19,4

136,8 x 57,5 x 19,4

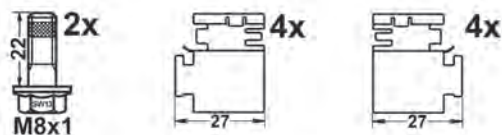

13.0470-3982.2 LD3982

ATE Ceramic

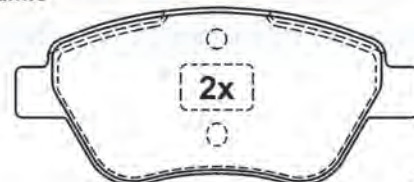

23705 18,1

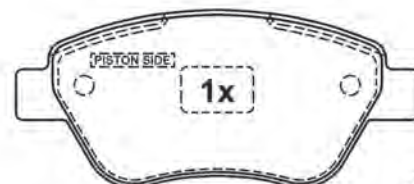

23707 18,1

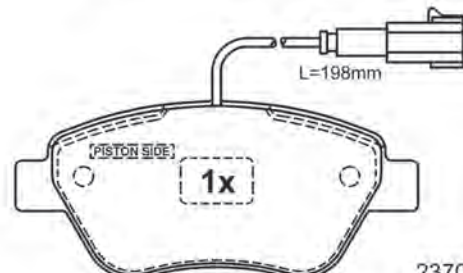

23706 18,1

122,8 x 53,3 x 18,1



Abbildungen Scheibenbremsbeläge

Illustrations disc brake pads - Ilustraciones de pastillas - Illustrations Plaquettes de frein à disque - Illustrazioni Pastiglie Freno

13.0470-3983.2 LD3983

ATE Ceramic

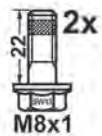
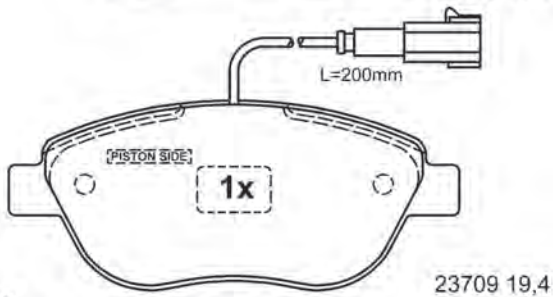
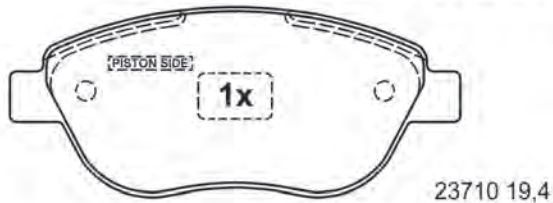
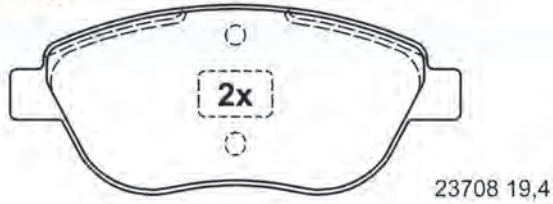

136,8 x 57,4 x 19,4

13.0470-3984.2 LD3984

ATE Ceramic

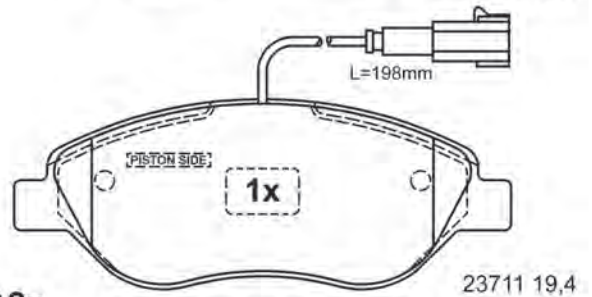
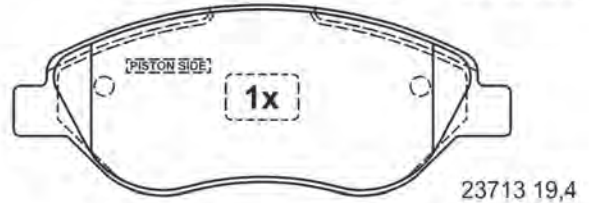
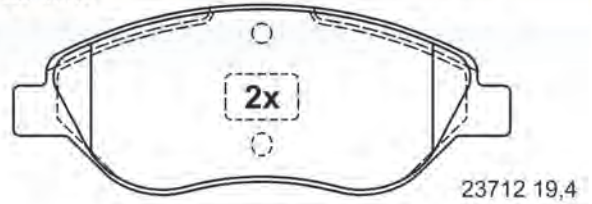

150,8 x 57,4 x 19,4

13.0470-3987.2 LD3987

ATE Ceramic

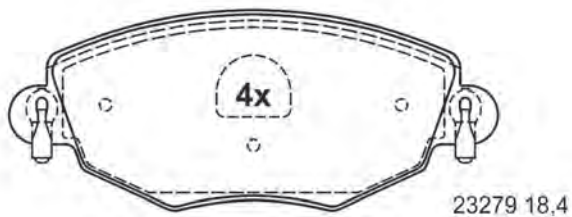

148,8 x 60,5 x 18,4

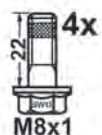

13.0470-3988.2 LD3988

ATE Ceramic

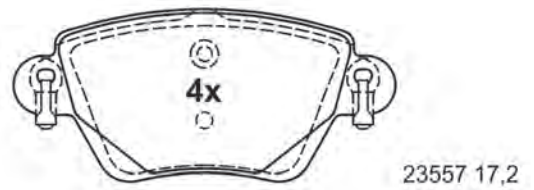

115,7 x 52,0 x 17,2



Abbildungen Scheibenbremsbeläge

Illustrations disc brake pads - Ilustraciones de pastillas - Illustrations Plaquettes de frein à disque - Illustrazioni Pastiglie Freno

13.0470-3994.2 LD3994

ATE Ceramic

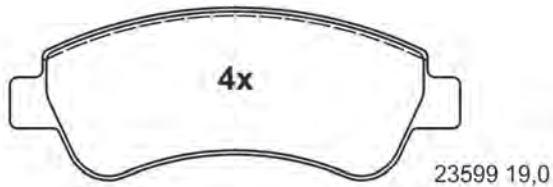

136,8 x 52,0 x 19,0

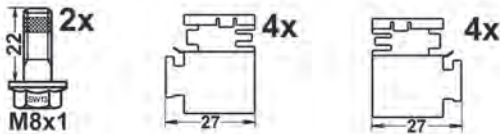

13.0470-3999.2 LD3999 (1)

ATE Ceramic

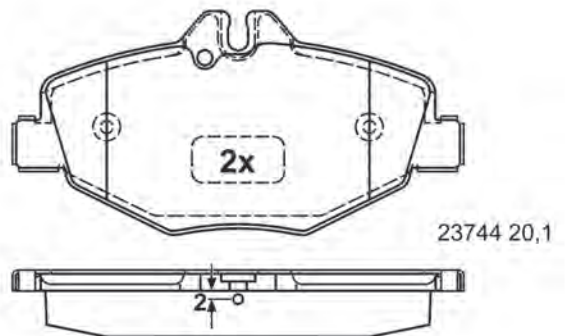
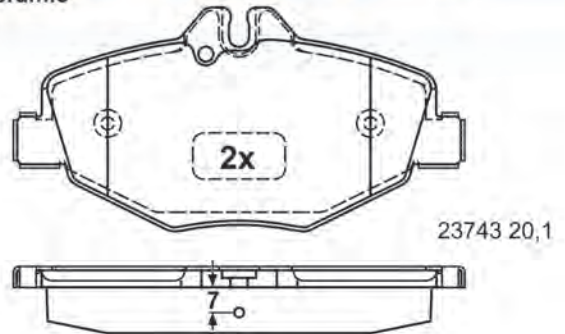

137,0 x 67,8 x 20,1

13.0470-3999.2 LD3999 (2)

ATE Ceramic

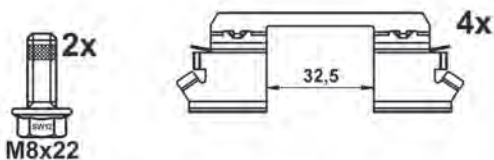
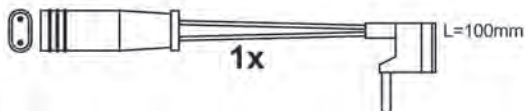
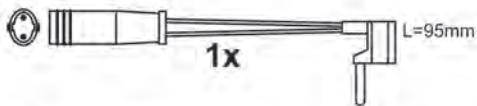
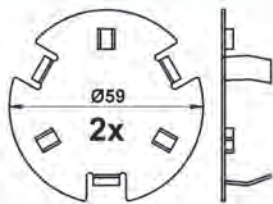

13.0470-4044.2 LD4044



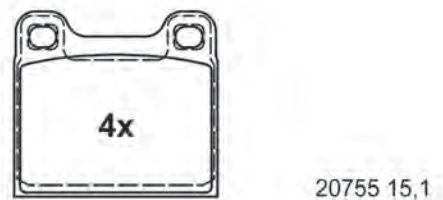

ATE Ceramic



61,8 x 56,5 x 15,1

Abbildungen Scheibenbremsbeläge

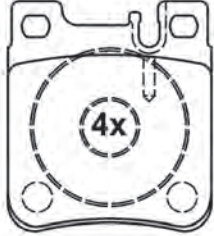
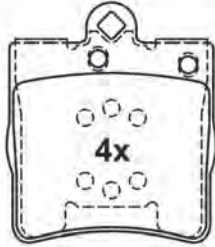
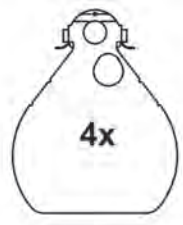
Illustrations disc brake pads - Ilustraciones de pastillas - Illustrations Plaquettes de frein à disque - Illustrazioni Pastiglie Freno

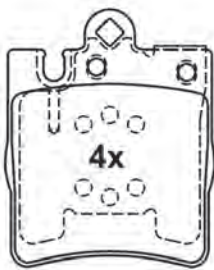
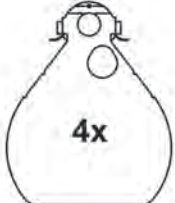
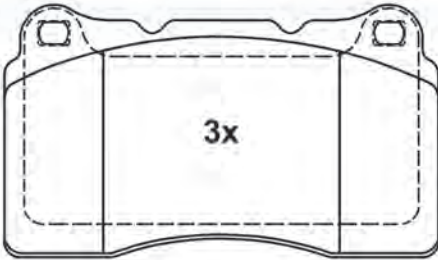
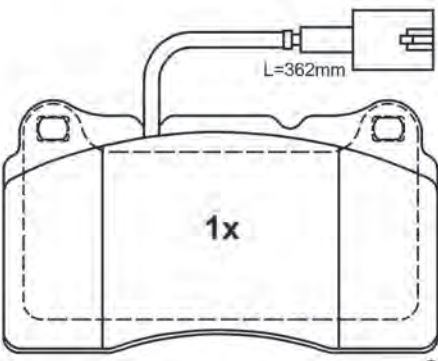
13.0470-4047.2 LD4047 	13.0470-4064.2 LD4064 
<p>ATE Ceramic</p>  <p>21305 15,7</p> <p>61,7 x 69,5 x 15,7</p>	<p>ATE Ceramic</p>  <p>21919 15,3</p> <p>63,8 x 72,8 x 15,3</p> 
13.0470-4065.2 LD4065 	13.0470-4803.2 LD4803 [1] 
<p>ATE Ceramic</p>  <p>21899 15,3</p> <p>63,7 x 78,0 x 15,3</p> 	<p>ATE Ceramic</p>  <p>23092 15,6</p>  <p>L=362mm</p> <p>23111 15,6</p> <p>131,8 x 77,2 x 15,6</p>

Abbildungen Scheibenbremsbeläge

Illustrations disc brake pads - Ilustraciones de pastillas - Illustrations Plaquettes de frein à disque - Illustrazioni Pastiglie Freno

13.0470-4803.2 LD4803 [2]



ATE Ceramic

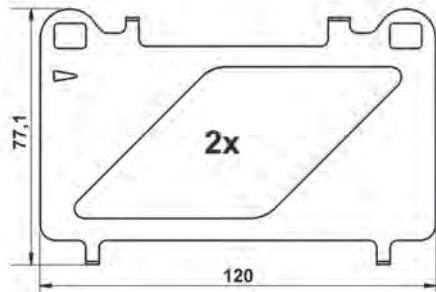
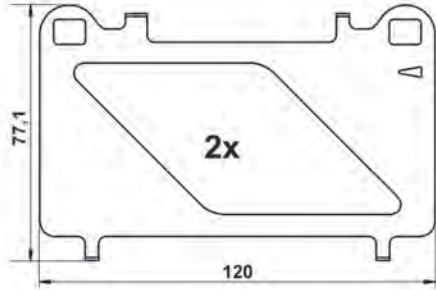

13.0470-4814.2 LD4814



ATE Ceramic

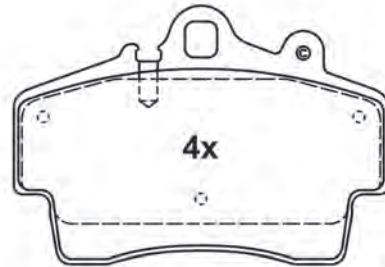

21937 15,5

114,0 x 78,0 x 15,5

13.0470-4833.2 LD4833



ATE Ceramic

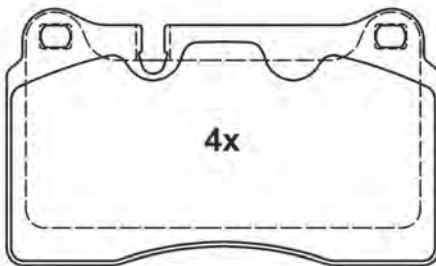

24098 17,1

131,6 x 77,3 x 17,1

13.0470-4834.2 LD4834



ATE Ceramic

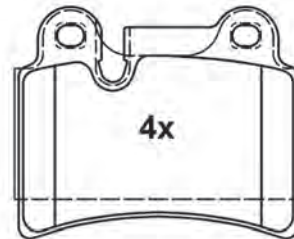

24097 17,1

86,8 x 70,1 x 17,1

Abbildungen Scheibenbremsbeläge

Illustrations disc brake pads - Ilustraciones de pastillas - Illustrations Plaquettes de frein à disque - Illustrazioni Pastiglie Freno

13.0470-4850.2 LD4850

ATE Ceramic

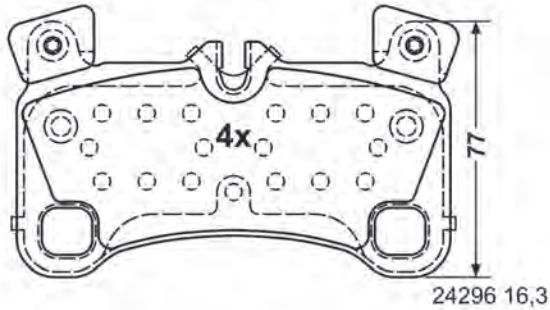

132,1 x 77,0 x 16,3

13.0470-4851.2 LD4851

ATE Ceramic

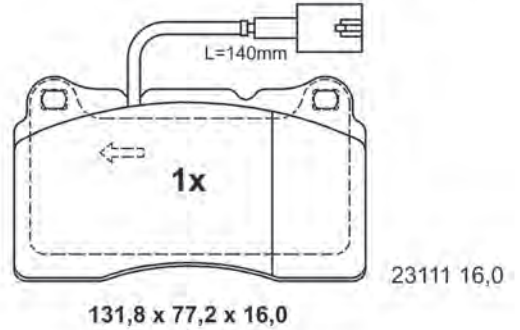
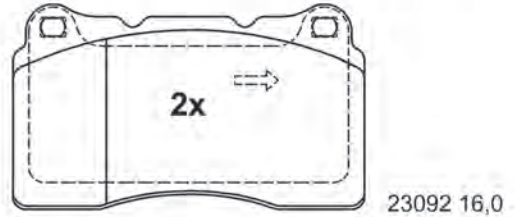
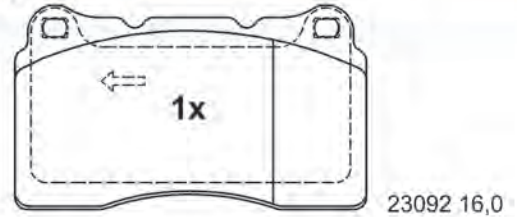

131,8 x 77,2 x 16,0

13.0470-4853.2 LD4853

ATE Ceramic

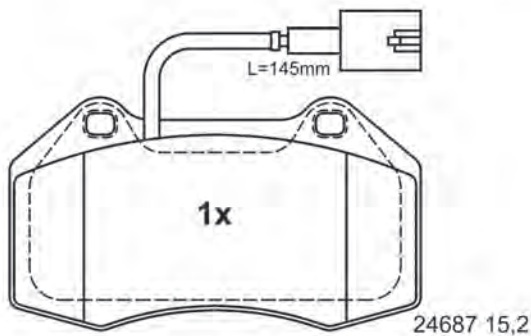
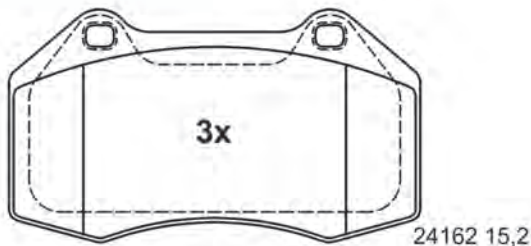

124,6 x 70,4 x 15,2

13.0470-4854.2 LD4854 [1]

ATE Ceramic

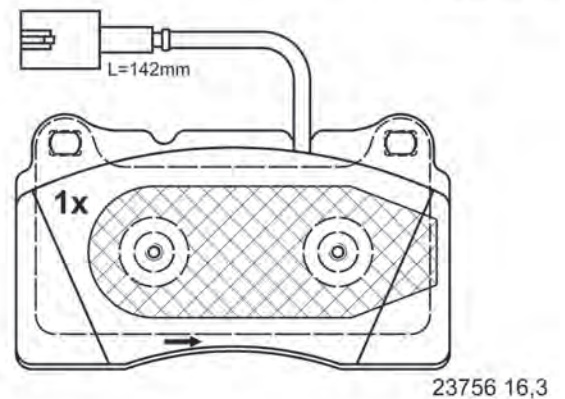
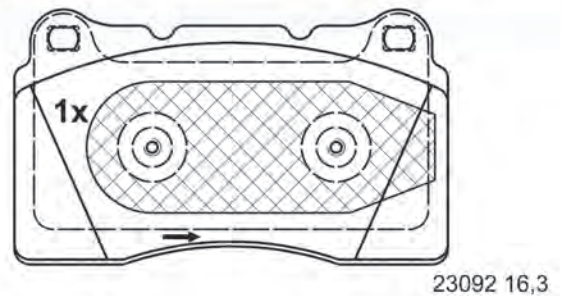

131,8 x 77,2 x 16,3

Abbildungen Scheibenbremsbeläge

Illustrations disc brake pads - Ilustraciones de pastillas - Illustrations Plaquettes de frein à disque - Illustrazioni Pastiglie Freno

13.0470-4854.2 LD4854 [2]

ATE Ceramic

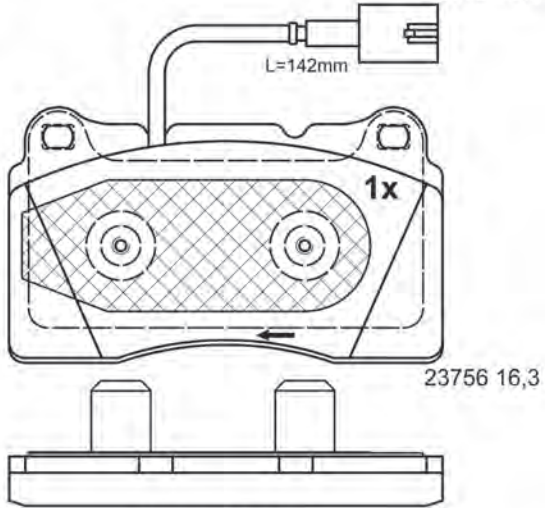
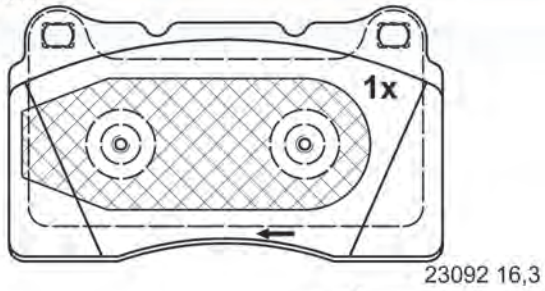

131,8 x 77,2 x 16,3

13.0470-4867.2 LD4867

ATE Ceramic

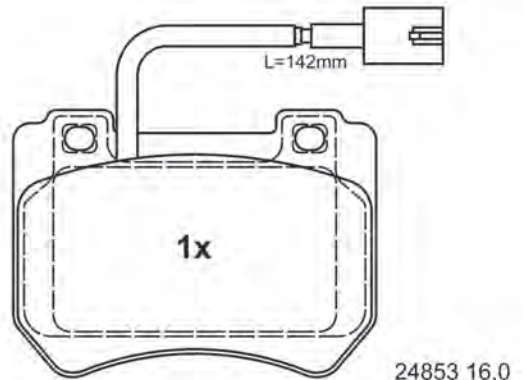
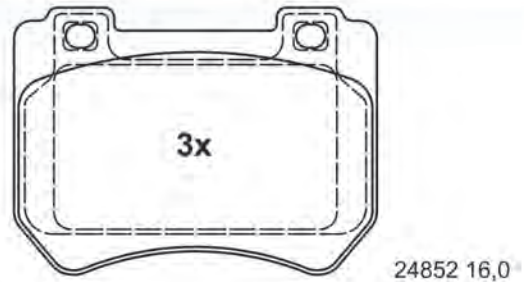

109,8 x 80,8 x 16,0

13.0470-4872.2 LD4872

ATE Ceramic

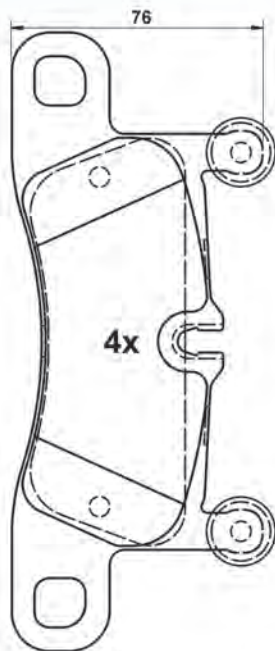

187,5 x 76,0 x 16,9

13.0470-4879.2 LD4879

ATE Ceramic

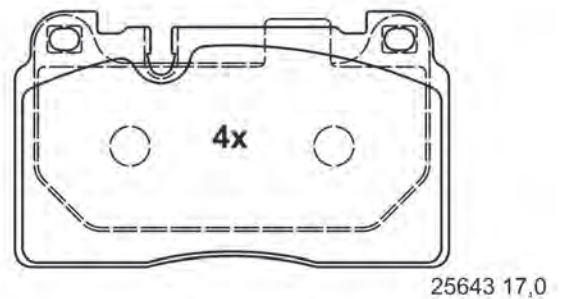

131,8 x 77,2 x 17,0

Abbildungen Scheibenbremsbeläge

Illustrations disc brake pads - Ilustraciones de pastillas - Illustrations Plaquettes de frein à disque - Illustrazioni Pastiglie Freno

13.0470-4971.2 LD4971 [1]

ATE Ceramic

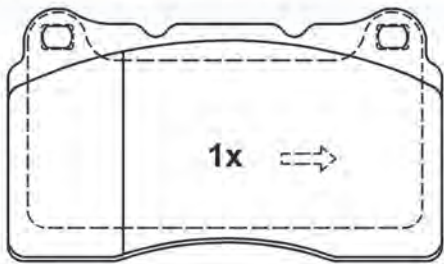

23092 16,0

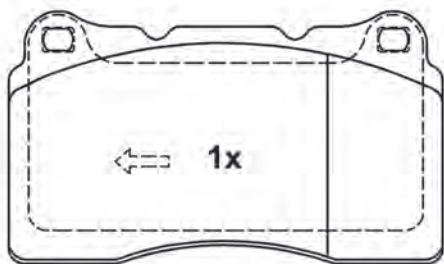

23092 16,0

131,8 x 77,2 x 16,0

13.0470-4971.2 LD4971 [2]

ATE Ceramic

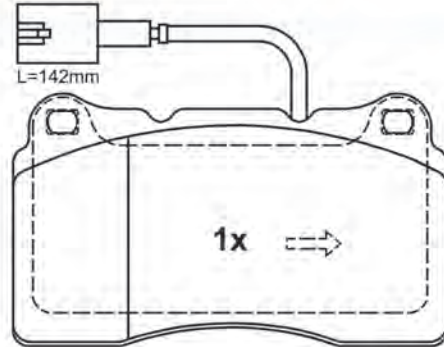

23110 16,0

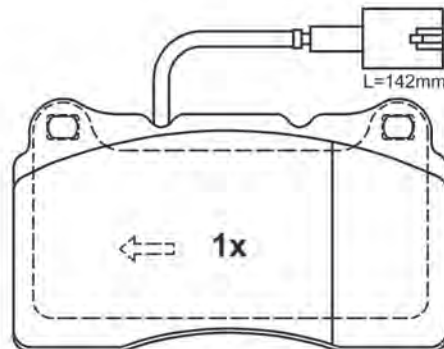

23111 16,0

131,8 x 77,2 x 16,0

13.0470-4976.2 LD4976

ATE Ceramic

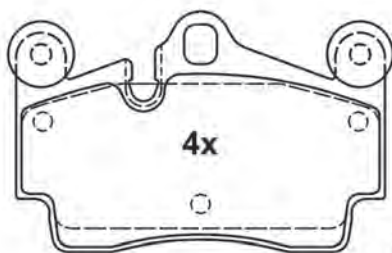

23694 16,4

112,0 x 73,0 x 16,4

13.0470-4977.2 LD4977

ATE Ceramic

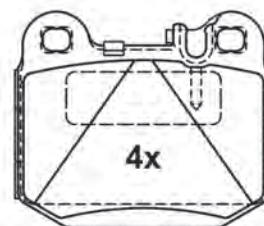

23157 15,8

76,5 x 65,5 x 15,8

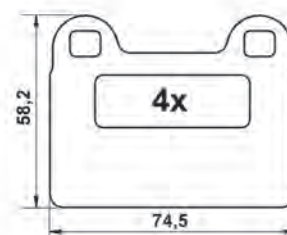

Abbildungen Scheibenbremsbeläge

Illustrations disc brake pads - Ilustraciones de pastillas - Illustrations Plaquettes de frein à disque - Illustrazioni Pastiglie Freno

13.0470-4984.2 LD4984

ATE Ceramic

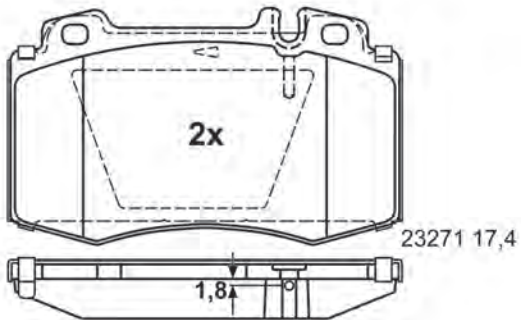
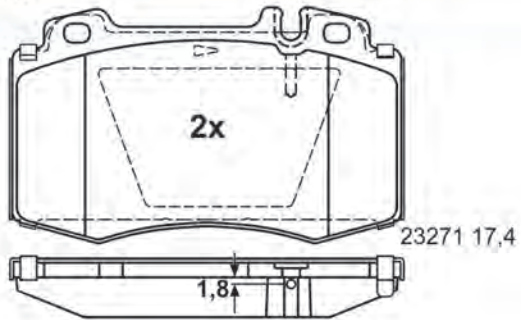

119,5 x 71,7 x 17,4

13.0470-4990.2 LD4990 [1]

ATE Ceramic

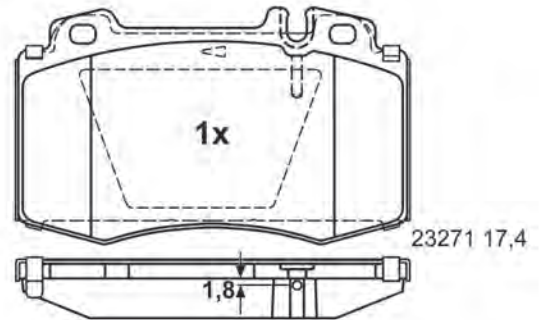
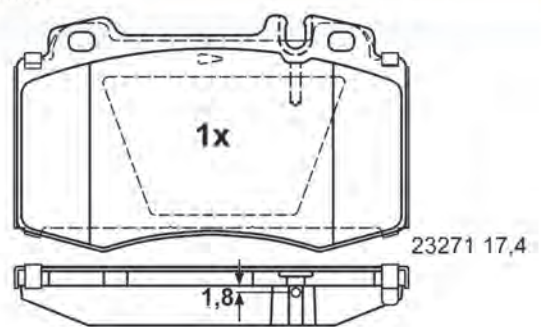

119,5 x 71,7 x 17,4

13.0470-4990.2 LD4990 [2]

ATE Ceramic

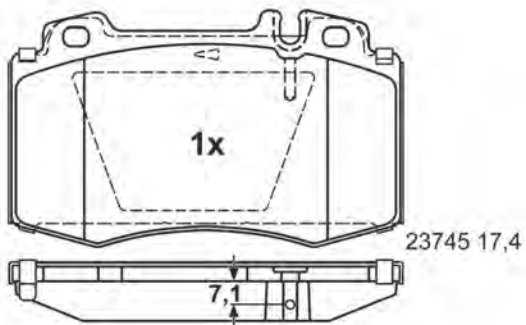
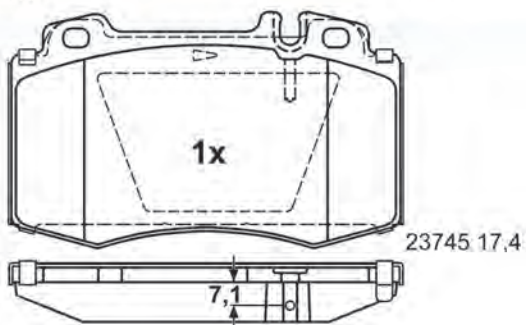

119,5 x 71,7 x 17,4

13.0470-4992.2 LD4992

ATE Ceramic

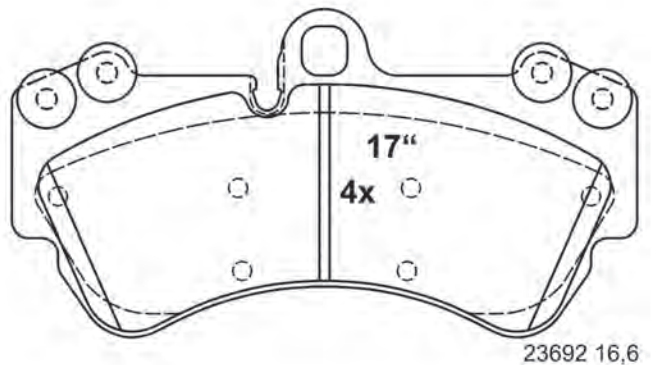

190 x 99,4 x 16,6

Abbildungen Scheibenbremsbeläge

Illustrations disc brake pads - Ilustraciones de pastillas - Illustrations Plaquettes de frein à disque - Illustrazioni Pastiglie Freno

13.0470-4993.2 LD4993



ATE Ceramic

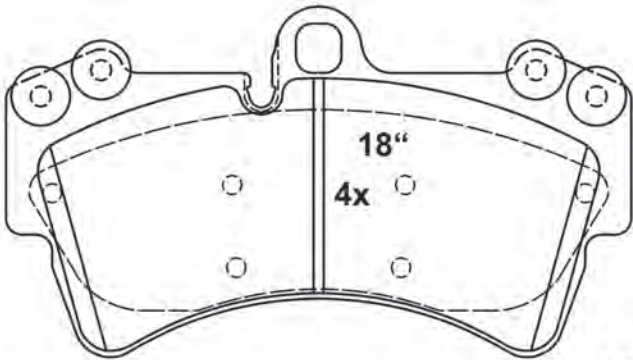

23693 16,6

190,0 x 106,4 x 16,6

13.0470-4994.2 LD4994



ATE Ceramic

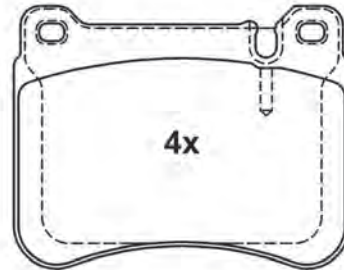

23945 16,5

101,7 x 79,3 x 16,5

13.0470-5405.2 LD5405



ATE Ceramic

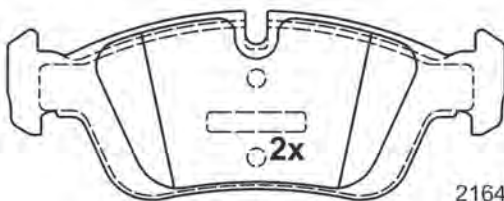

21643 17,8

151,3 x 57,3 x 17,8

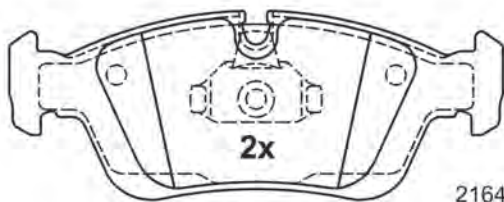

21644 17,8

150,1 x 57,3 x 17,8

13.0470-5611.2 LD5611 [1]



ATE Ceramic

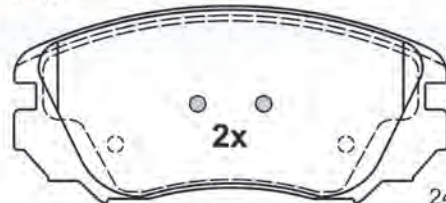

24415 19,1

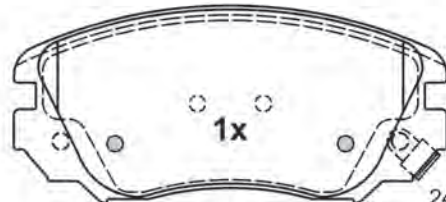

24416 19,1

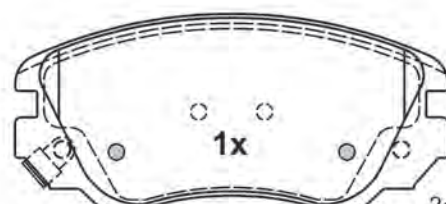

24417 19,1

131,4 x 59,7 x 19,1

Abbildungen Scheibenbremsbeläge

Illustrations disc brake pads - Ilustraciones de pastillas - Illustrations Plaquettes de frein à disque - Illustrazioni Pastiglie Freno

13.0470-5611.2 LD5611 [2]



ATE Ceramic

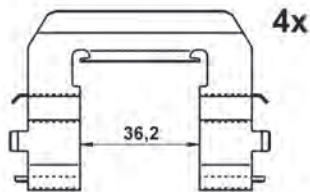
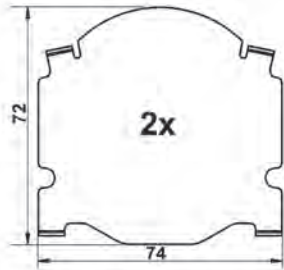

13.0470-5612.2 LD5612 [1]



ATE Ceramic

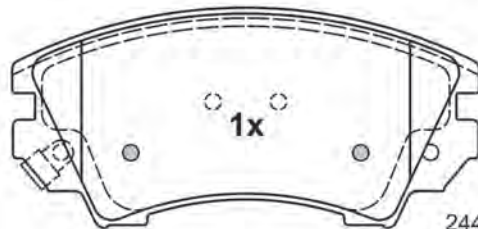
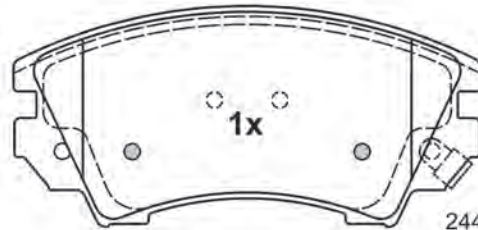
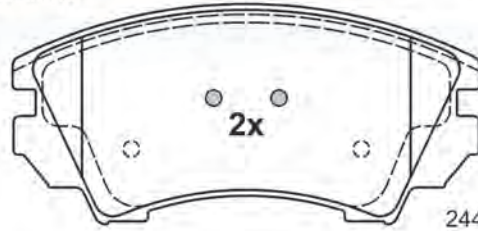

141,9 x 66,7 x 19,0

13.0470-5612.2 LD5612 [2]



ATE Ceramic

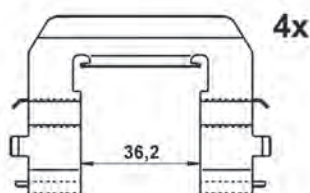
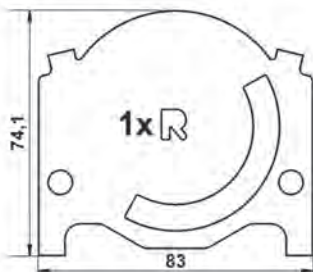
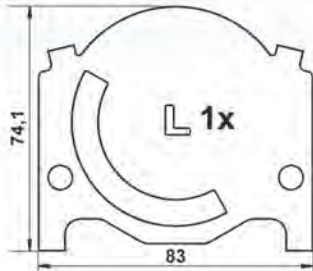

13.0470-5634.2 LD5634



ATE Ceramic

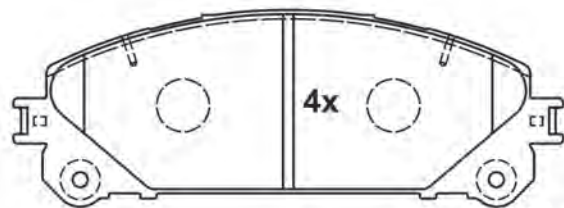

167,0 x 59,4 x 17,5

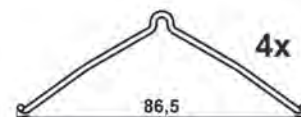

Abbildungen Scheibenbremsbeläge

Illustrations disc brake pads - Ilustraciones de pastillas - Illustrations Plaquettes de frein à disque - Illustrazioni Pastiglie Freno

13.0470-5635.2 LD5635



ATE Ceramic

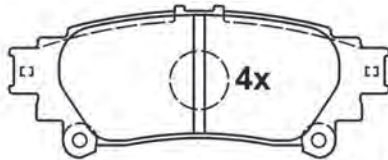

24918 15,0

115,2 x 45,7 x 15,0

13.0470-5752.2 LD5752



ATE Ceramic

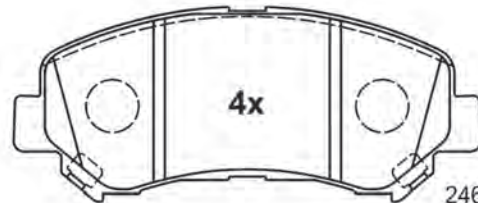

24632 17,0

142,0 x 59,0 x 17,0

13.0470-5786.2 LD5786



ATE Ceramic



24934 15,5

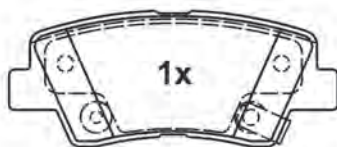

24935 15,5

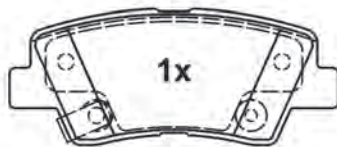

24936 15,5

99,8 x 41,1 x 16,6

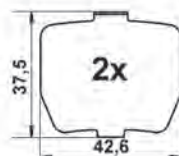
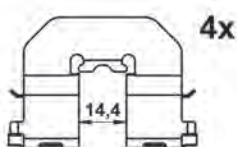

13.0470-7053.2 LD7053



ATE Ceramic

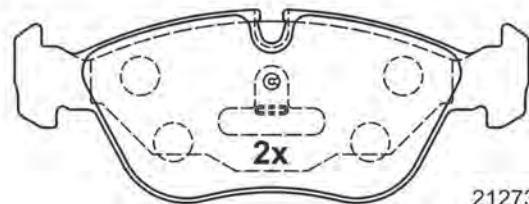

21273 19,5

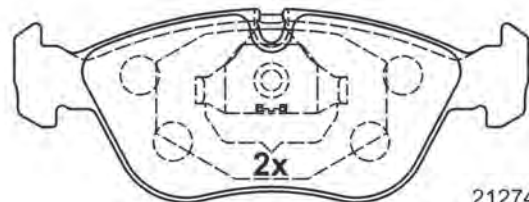

21274 19,5

156,3 x 58,5 x 19,5

Abbildungen Scheibenbremsbeläge

Illustrations disc brake pads - Ilustraciones de pastillas - Illustrations Plaquettes de frein à disque - Illustrazioni Pastiglie Freno

13.0470-7078.2 LD7078



ATE Ceramic

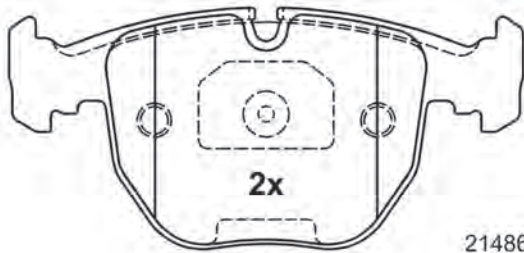

21486 19,5

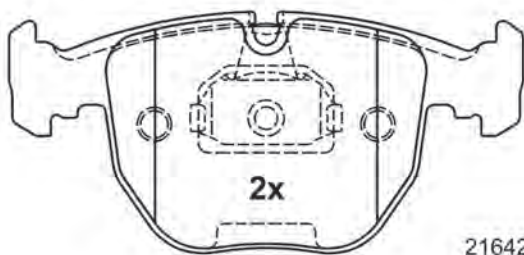

21642 19,5

156,3 x 73,2 x 19,5

13.0470-7079.2 LD7079



ATE Ceramic

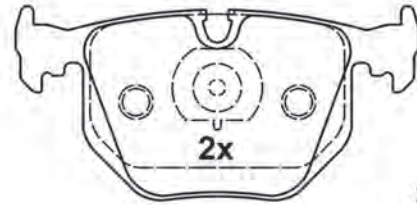

21282 17,3

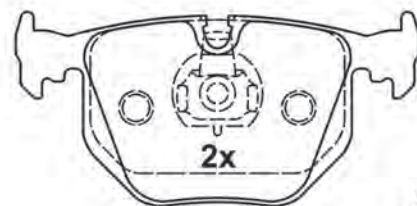

21487 17,3

123,0 x 59,2 x 17,3

13.0470-7081.2 LD7081



ATE Ceramic

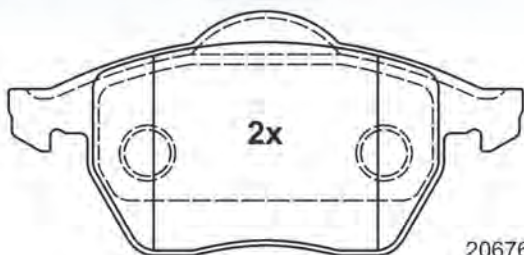

20676 19,8

156,3 x 74,0 x 19,8

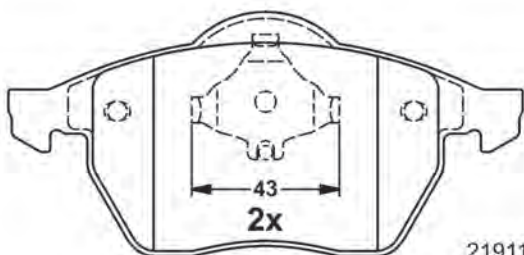

21911 20,3

156,3 x 74,0 x 20,3

13.0470-7086.2 LD7086



ATE Ceramic

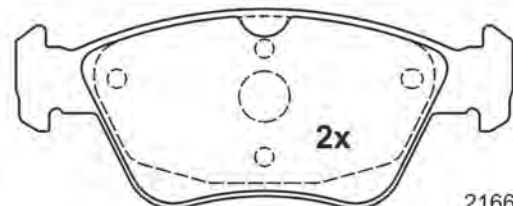

21664 19,8

151,3 x 59,8 x 19,8

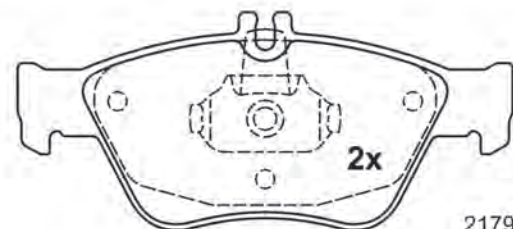

21795 19,8

150,1 x 66,2 x 19,8

Abbildungen Scheibenbremsbeläge

Illustrations disc brake pads - Ilustraciones de pastillas - Illustrations Plaquettes de frein à disque - Illustrazioni Pastiglie Freno

13.0470-7087.2 LD7087

ATE Ceramic

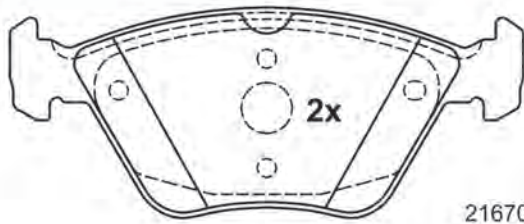

21670 19,3

156,3 x 63,5 x 19,4

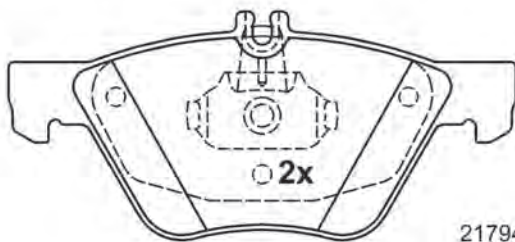

21794 19,3

155,1 x 69,3 x 19,3

13.0470-7089.2 LD7089

ATE Ceramic



21676 20,3

154,6 x 63,5 x 20,3

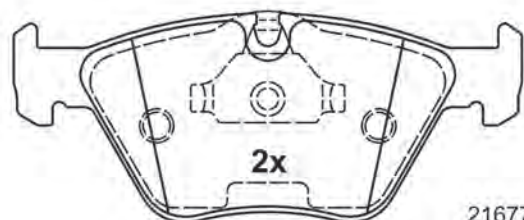

21677 20,3

155,1 x 63,5 x 20,3

13.0470-7090.2 LD7090

ATE Ceramic

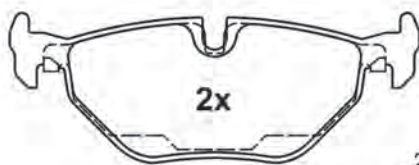

21891 17,3



21691 17,3

123,0 x 44,9 x 17,3

13.0470-7100.2 LD7100

ATE Ceramic

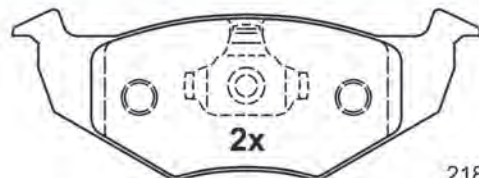

21866 17,2

141,8 x 51,2 x 17,2

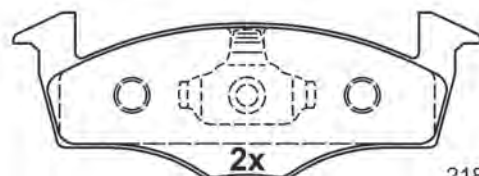

21868 17,2

141,8 x 50,6 x 17,2

Abbildungen Scheibenbremsbeläge

Illustrations disc brake pads - Ilustraciones de pastillas - Illustrations Plaquettes de frein à disque - Illustrazioni Pastiglie Freno

13.0470-7110.2 LD7110

ATE Ceramic

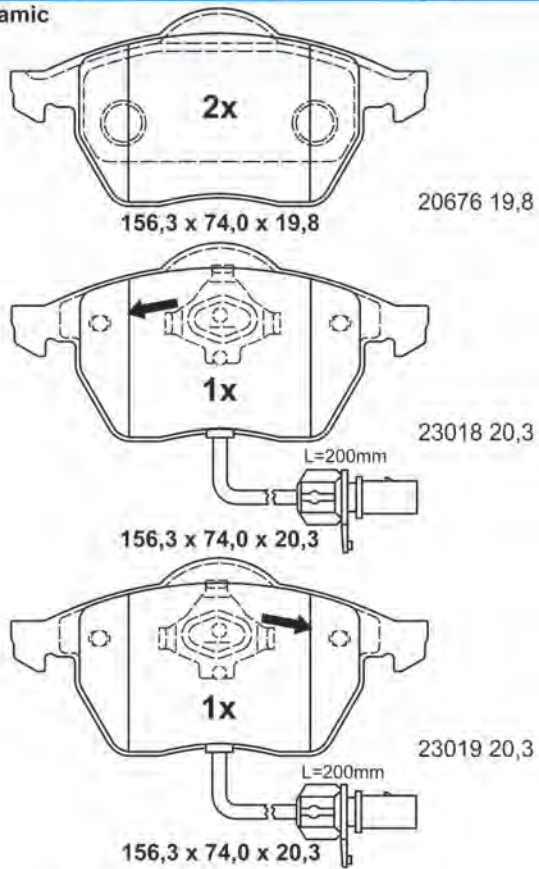

13.0470-7111.2 LD7111

ATE Ceramic

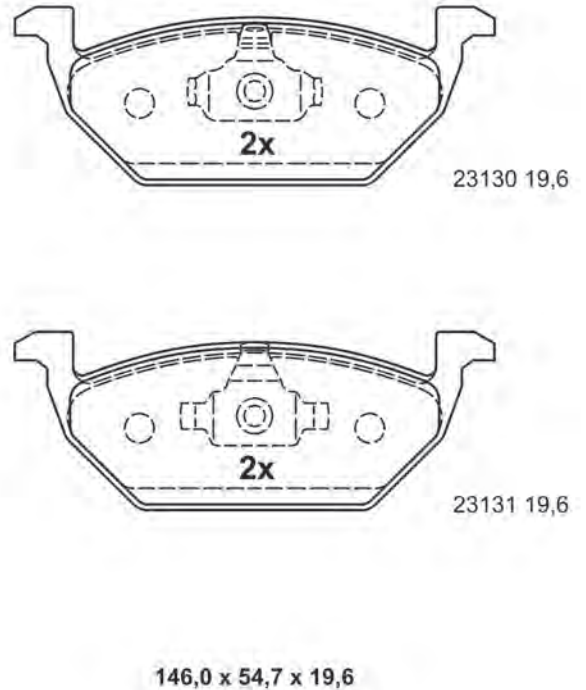

13.0470-7115.2 LD7115 (1)

ATE Ceramic

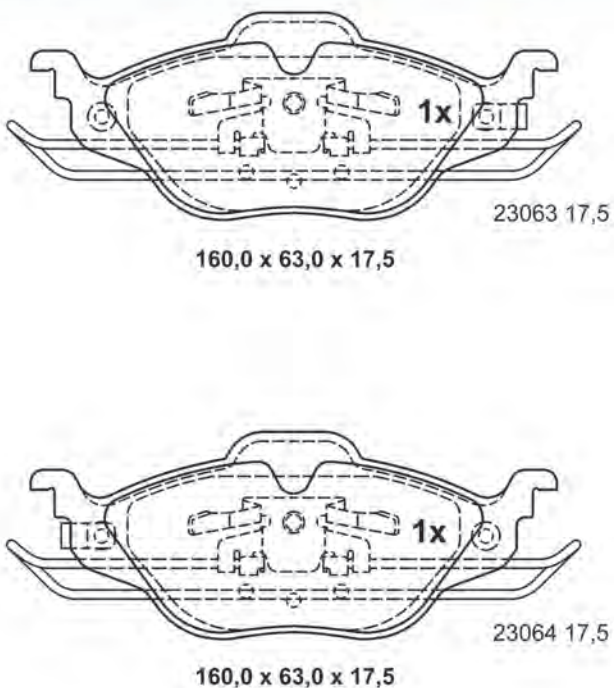

13.0470-7115.2 LD7115 (2)

ATE Ceramic

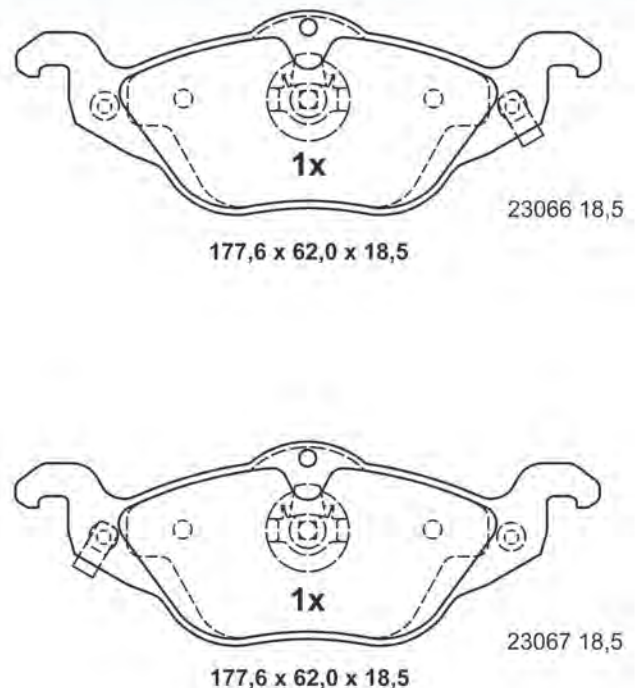

Abbildungen Scheibenbremsbeläge

Illustrations disc brake pads - Ilustraciones de pastillas - Illustrations Plaquettes de frein à disque - Illustrazioni Pastiglie Freno

13.0470-7116.2 LD7116 [1] 

ATE Ceramic

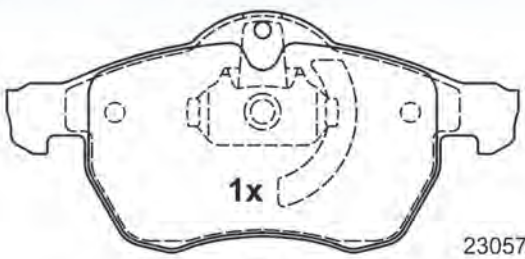

1x

23057 20,2

155,1 x 71,4 x 20,2

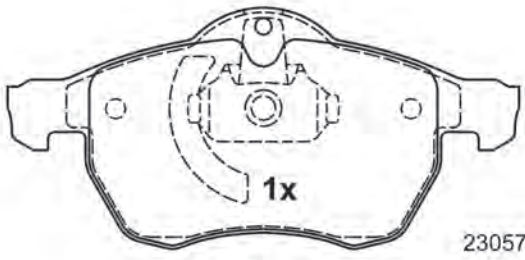

1x

23057 20,2

155,1 x 71,4 x 20,2

13.0470-7116.2 LD7116 [2] 

ATE Ceramic

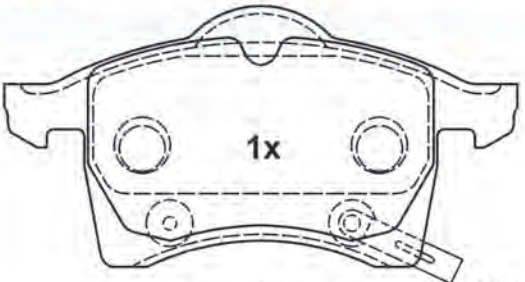

1x

23058 19,6

156,3 x 78,5 x 19,6

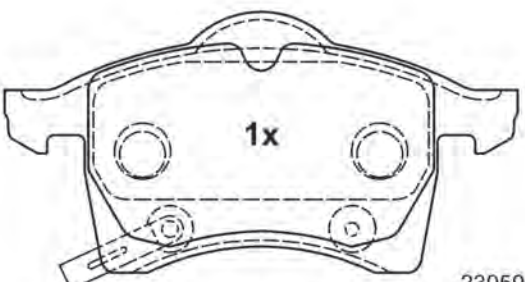

1x

23059 19,6

156,3 x 78,5 x 19,6

13.0470-7117.2 LD7117 

ATE Ceramic

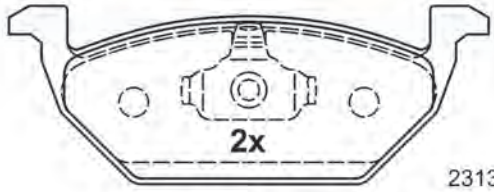

2x

23130 19,6

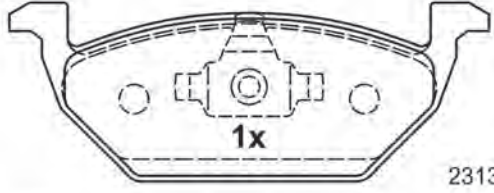

1x

23131 19,6

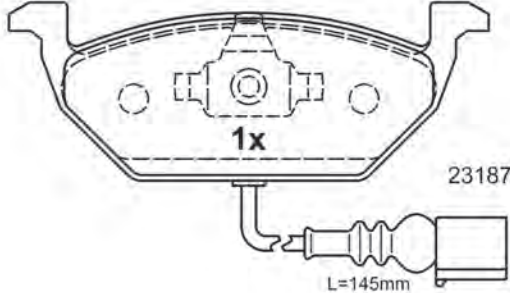

1x

23187 19,6

L=145mm

146,0 x 54,7 x 19,6

13.0470-7122.2 LD7122 

ATE Ceramic

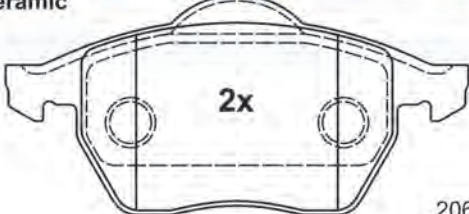

2x

20676 19,8

156,3 x 74,0 x 19,8

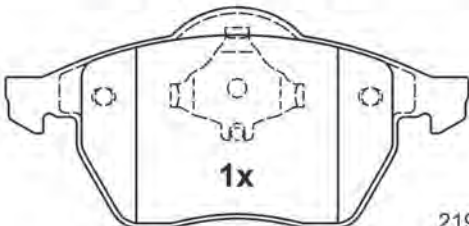

1x

21911 20,3

156,3 x 74,0 x 20,3

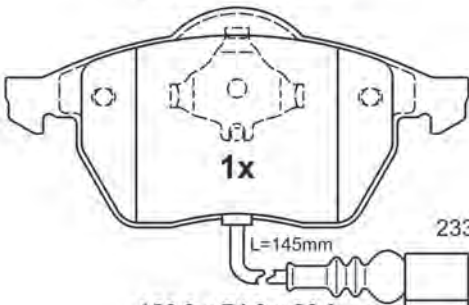

1x

23392 20,3

L=145mm

156,3 x 74,0 x 20,3

Abbildungen Scheibenbremsbeläge

Illustrations disc brake pads - Ilustraciones de pastillas - Illustrations Plaquettes de frein à disque - Illustrazioni Pastiglie Freno

13.0470-7135.2 LD7135

ATE Ceramic

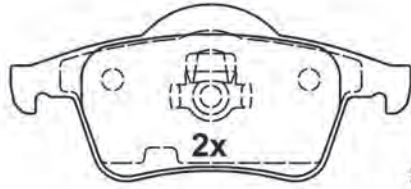

23076 17,5

122,4 x 53,7 x 17,5

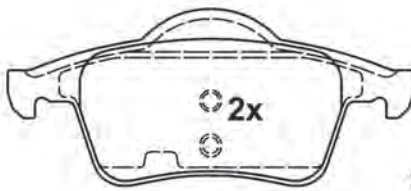

23077 17,5

123,6 x 53,7 x 17,5

13.0470-7137.2 LD7137

ATE Ceramic

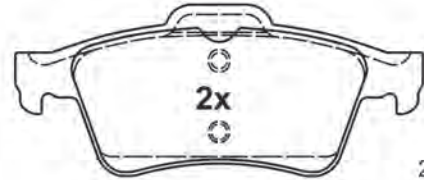

23482 15,8

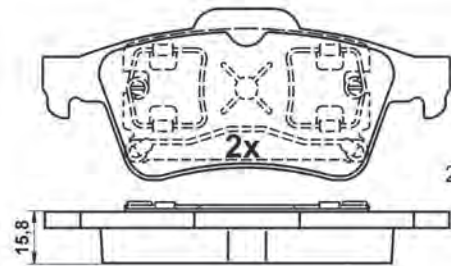

23483 15,8

123,0 x 51,9 x 15,8

13.0470-7139.2 LD7139

ATE Ceramic

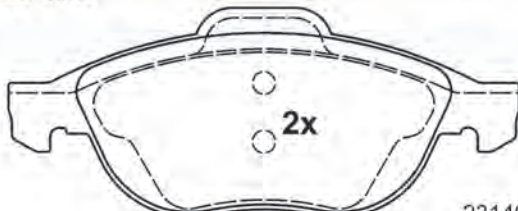

23140 19,4

156,3 x 63,8 x 19,4

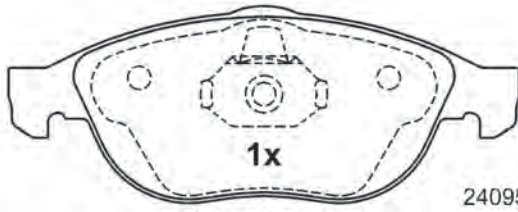

24095 19,4

155,1 x 59,3 x 19,4

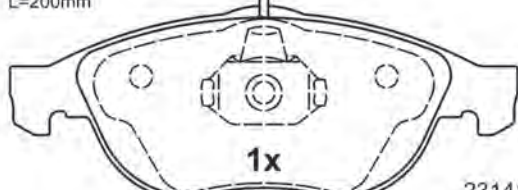
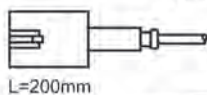

23141 19,4

155,1 x 59,3 x 19,4

13.0470-7140.2 LD7140

ATE Ceramic



21637 19,3

156,3 x 59,1 x 19,3

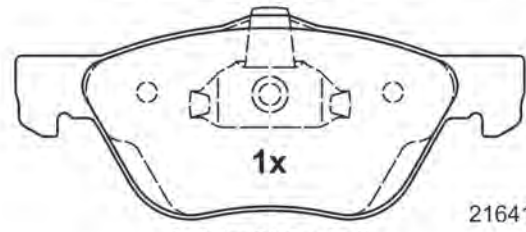

21641 19,3

155,1 x 61,8 x 19,3

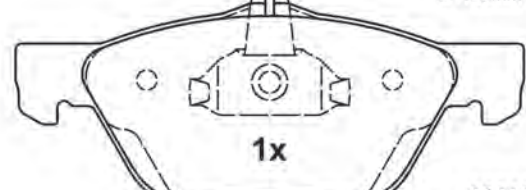

23289 19,3

155,1 x 61,8 x 19,3

Abbildungen Scheibenbremsbeläge

Illustrations disc brake pads - Ilustraciones de pastillas - Illustrations Plaquettes de frein à disque - Illustrazioni Pastiglie Freno

13.0470-7145.2 LD7145

ATE Ceramic

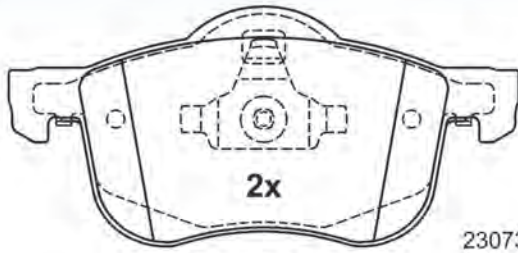

155,1 x 72,5 x 18,8

23073 18,8

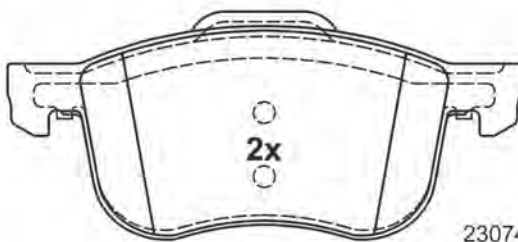

156,3 x 69,1 x 18,8

23074 18,8

13.0470-7155.2 LD7155

ATE Ceramic

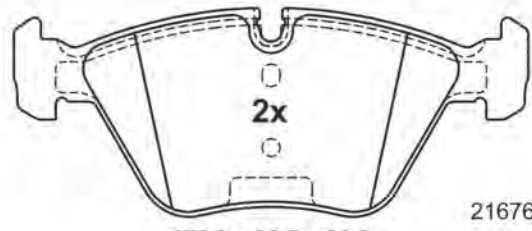

156,3 x 63,5 x 20,3

21676 20,3

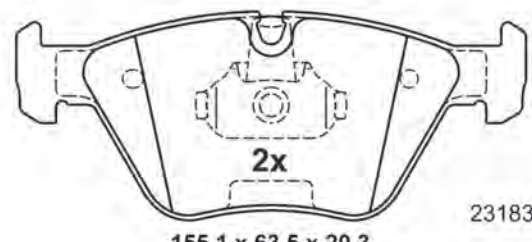

155,1 x 63,5 x 20,3

23183 20,3

13.0470-7157.2 LD7157

ATE Ceramic



156,3 x 66,8 x 18,3

23215 18,3

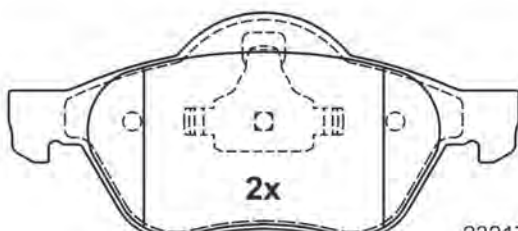

155,1 x 68,9 x 18,3

23217 18,3

13.0470-7158.2 LD7158

ATE Ceramic

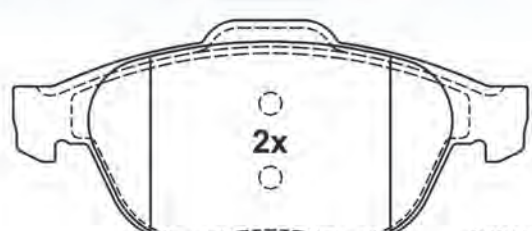

156,3 x 68,3 x 18,3

23245 18,3

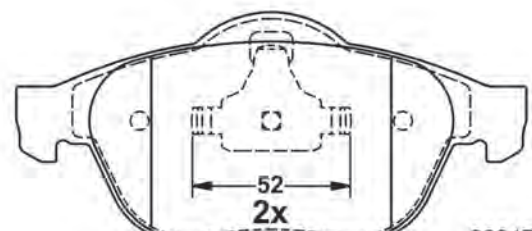

155,1 x 70,8 x 18,3

23247 18,3

Abbildungen Scheibenbremsbeläge

Illustrations disc brake pads - Ilustraciones de pastillas - Illustrations Plaquettes de frein à disque - Illustrazioni Pastiglie Freno

13.0470-7159.2 LD7159

ATE Ceramic

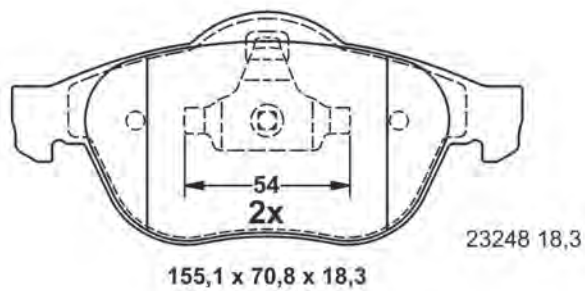
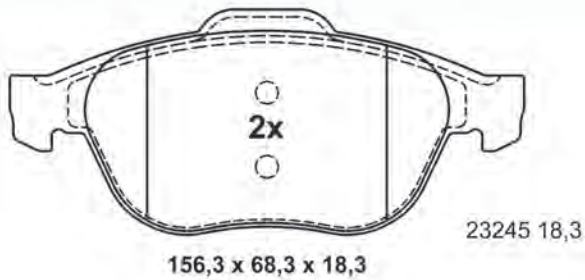

13.0470-7161.2 LD7161

ATE Ceramic

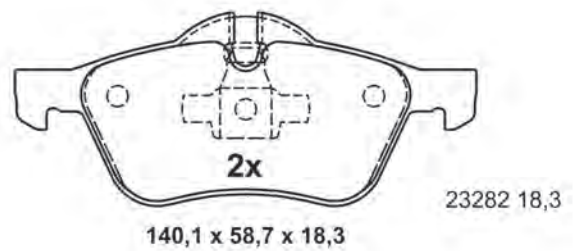
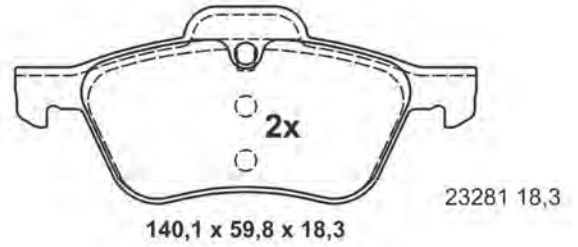

13.0470-7162.2 LD7162

ATE Ceramic

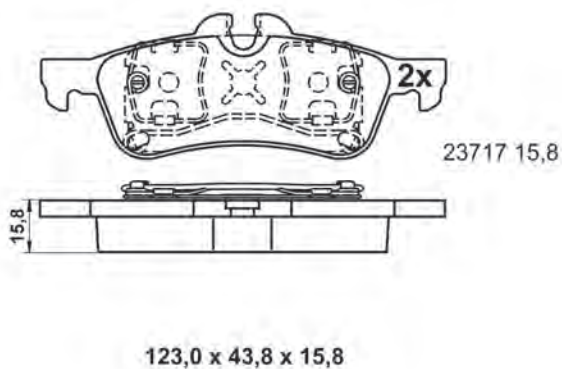
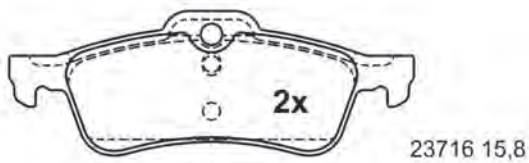

13.0470-7166.2 LD7166

ATE Ceramic

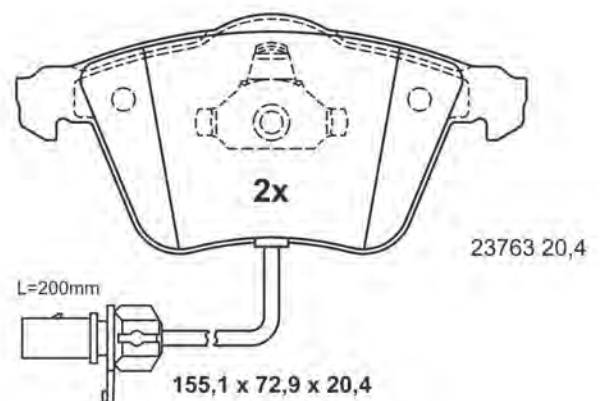
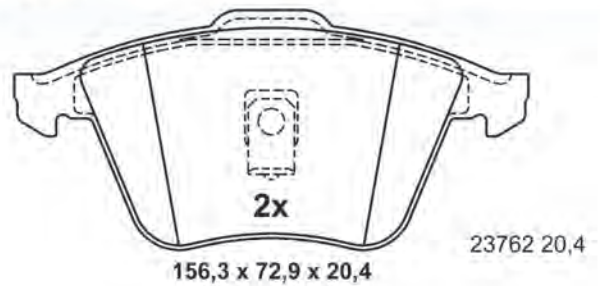

Abbildungen Scheibenbremsbeläge

Illustrations disc brake pads - Ilustraciones de pastillas - Illustrations Plaquettes de frein à disque - Illustrazioni Pastiglie Freno

13.0470-7167.2 LD7167



ATE Ceramic

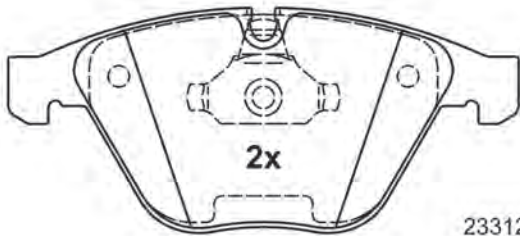

23312 20,3

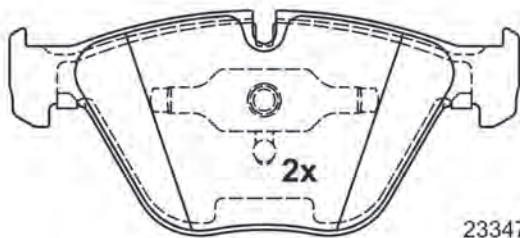

23347 20,3

155,1 x 68,3 x 20,3

13.0470-7168.2 LD7168



ATE Ceramic

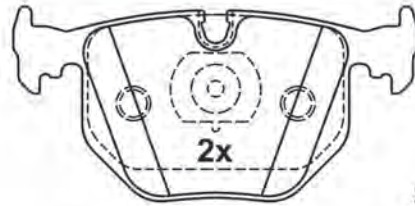

21282 17,3

123,0 x 59,2 x 17,3

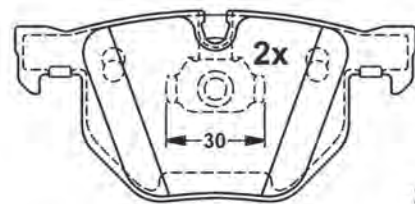

23447 17,3

121,8 x 57,8 x 17,3

13.0470-7169.2 LD7169



ATE Ceramic

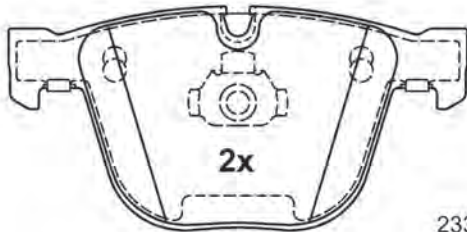

23309 17,3



23310 17,3

139,5 x 67,8 x 17,3

13.0470-7171.2 LD7171



ATE Ceramic

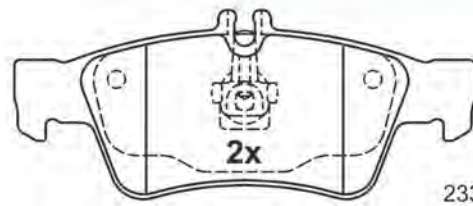

23334 16,7

140,1 x 57,5 x 16,7

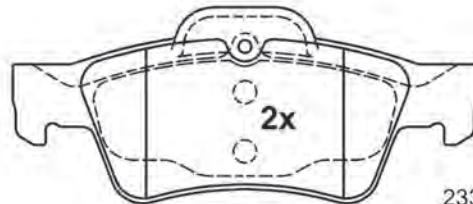

23335 16,7

141,3 x 59,4 x 16,7

Abbildungen Scheibenbremsbeläge

Illustrations disc brake pads - Ilustraciones de pastillas - Illustrations Plaquettes de frein à disque - Illustrazioni Pastiglie Freno

13.0470-7172.2 LD7172

ATE Ceramic

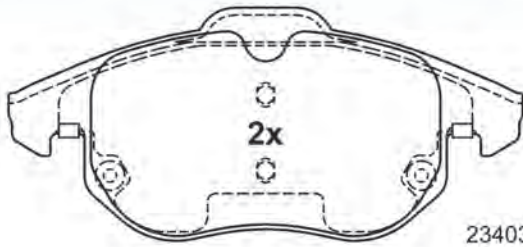

23403 20,1

156,3 x 70,7 x 20,1

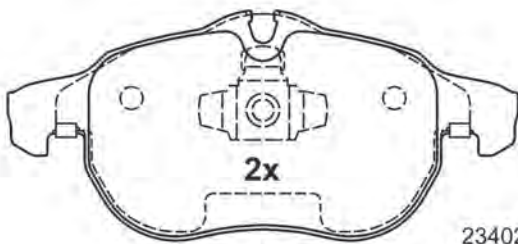

23402 20,1

155,1 x 69,6 x 20,1

13.0470-7174.2 LD7174

ATE Ceramic

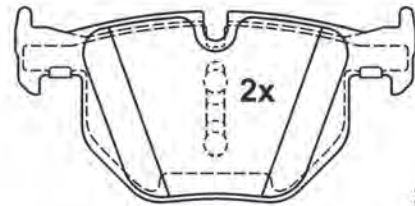

23732 17,3

121,8 x 59,2 x 17,3

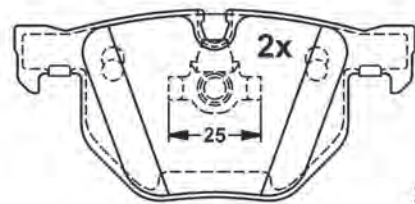

23737 17,3

121,8 x 57,8 x 17,3

13.0470-7176.2 LD7176

ATE Ceramic

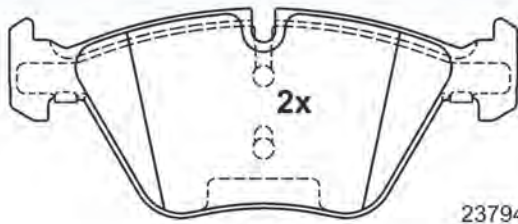

23794 20,3

154,6 x 63,5 x 20,3

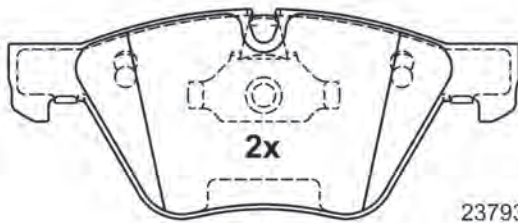

23793 20,3

155,1 x 63,5 x 20,3

13.0470-7179.2 LD7179 [1]

ATE Ceramic

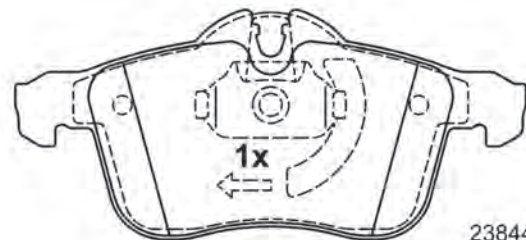

23844 20,5

155,1 x 70,0 x 20,5

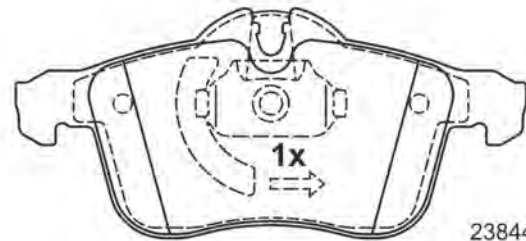

23844 20,5

155,1 x 70,0 x 20,5

Abbildungen Scheibenbremsbeläge

Illustrations disc brake pads - Ilustraciones de pastillas - Illustrations Plaquettes de frein à disque - Illustrazioni Pastiglie Freno

13.0470-7179.2 LD7179 [2]



ATE Ceramic

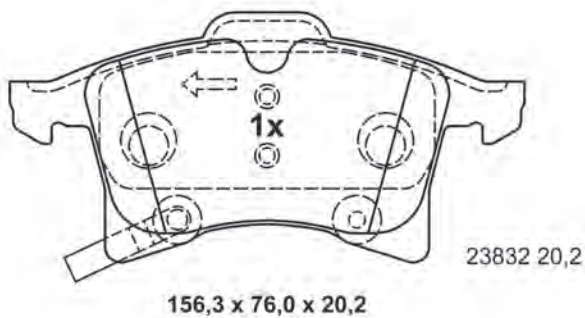
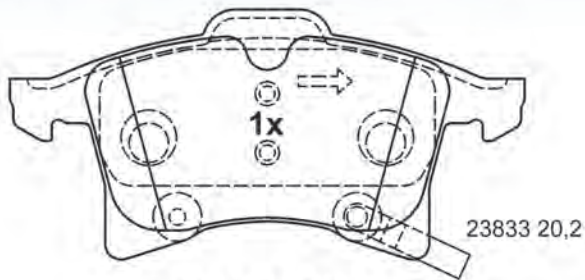

13.0470-7181.2 LD7181



ATE Ceramic

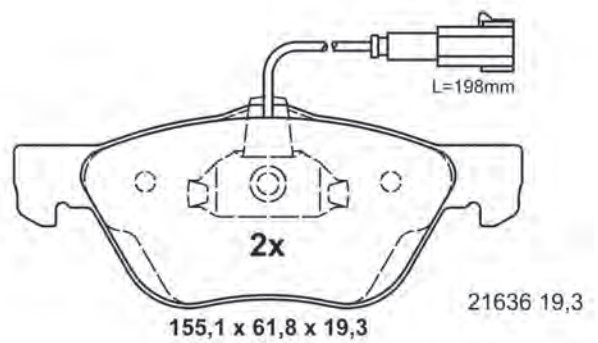
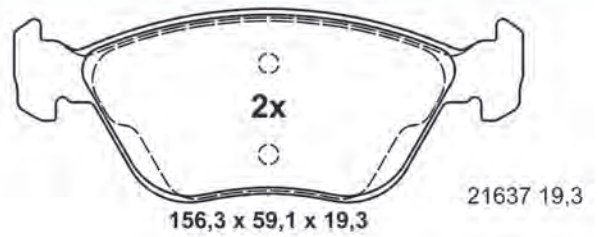

13.0470-7184.2 LD7184



ATE Ceramic

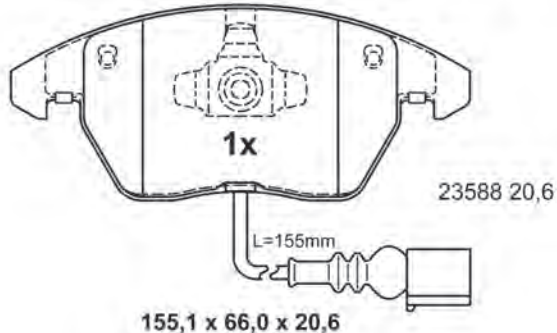
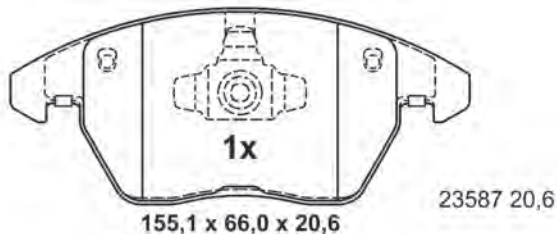
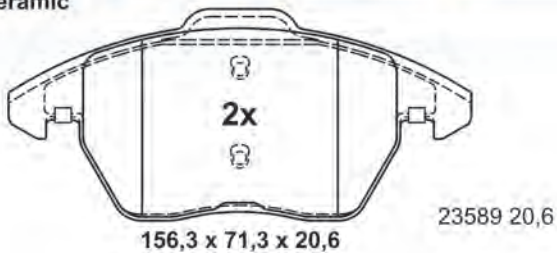

13.0470-7187.2 LD7187



ATE Ceramic

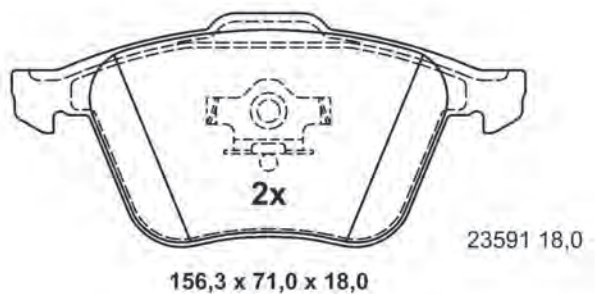
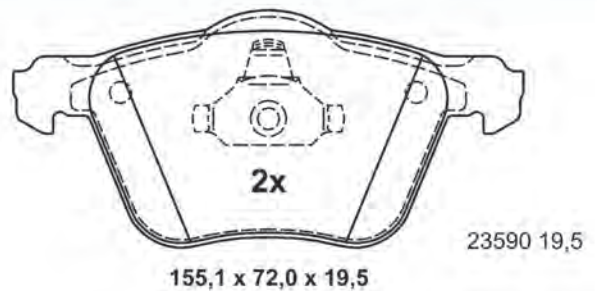

Abbildungen Scheibenbremsbeläge

Illustrations disc brake pads - Ilustraciones de pastillas - Illustrations Plaquettes de frein à disque - Illustrazioni Pastiglie Freno

13.0470-7188.2 LD7188

ATE Ceramic

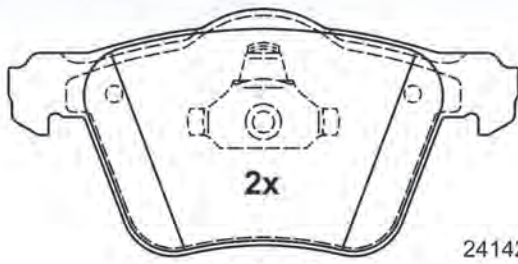

155,1 x 75,1 x 20,6

24142 20,6

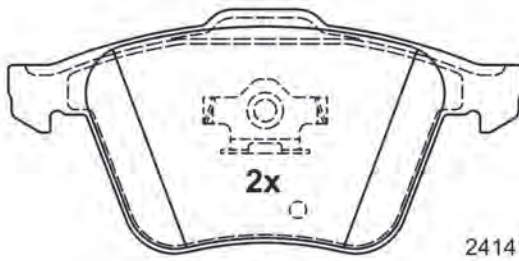

156,3 x 74,1 x 19,1

24141 19,1

13.0470-7190.2 LD7190

ATE Ceramic

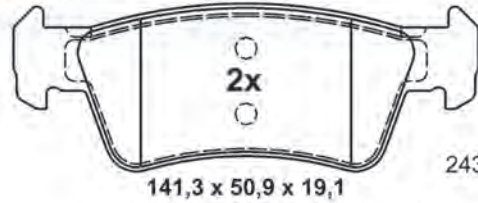

141,3 x 50,9 x 19,1

24367 19,1

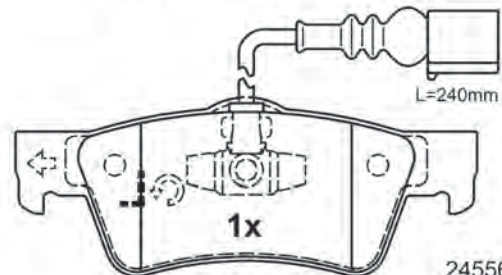

140,7 x 53,9 x 19,1

24556 19,1

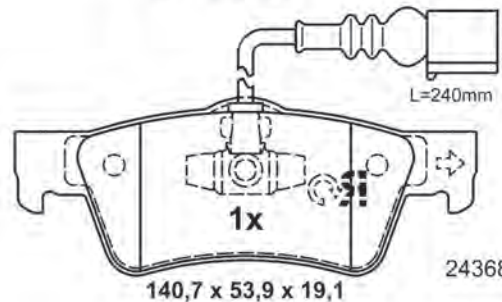

140,7 x 53,9 x 19,1

24368 19,1

13.0470-7191.2 LD7191

ATE Ceramic

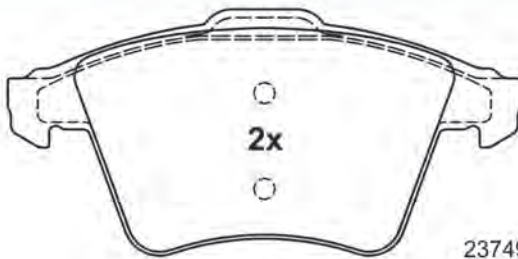

156,2 x 74,8 x 19,1

23749 19,1

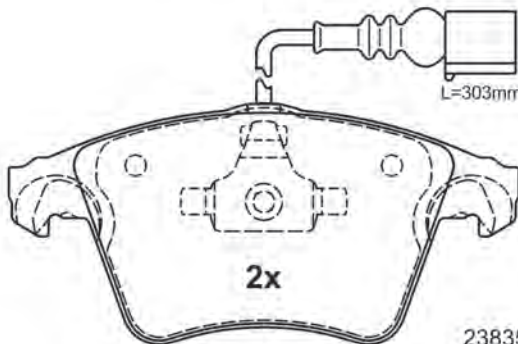

155,0 x 73,3 x 19,6

23835 19,6

13.0470-7193.2 LD7193

ATE Ceramic

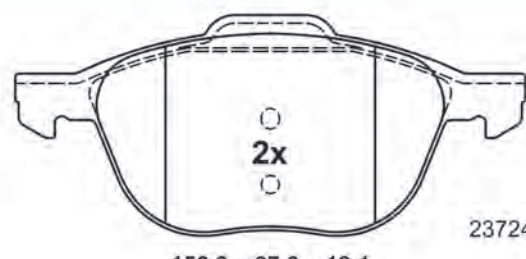

156,3 x 67,0 x 18,1

23724 18,1

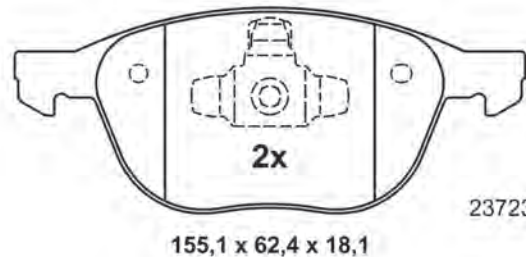

155,1 x 62,4 x 18,1

23723 18,1

Abbildungen Scheibenbremsbeläge

Illustrations disc brake pads - Ilustraciones de pastillas - Illustrations Plaquettes de frein à disque - Illustrazioni Pastiglie Freno

13.0470-7194.2 LD7194

ATE Ceramic

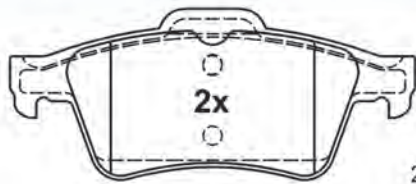

23482 16,6

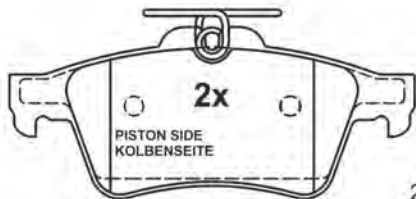

24137 16,6

123,0 x 52,0 x 16,6

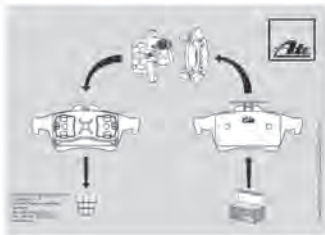

13.0470-7195.2 LD7195

ATE Ceramic

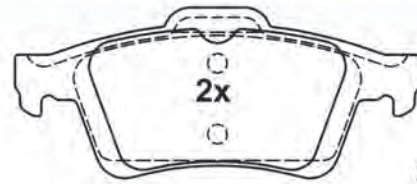

23482 16,6

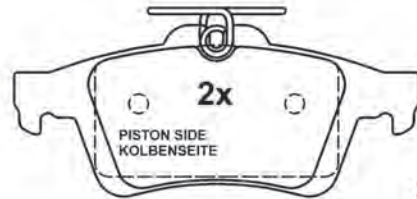

24137 16,6

123,0 x 52,0 x 16,6

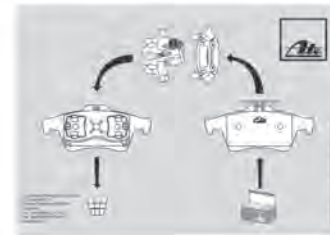

13.0470-7200.2 LD7200

ATE Ceramic

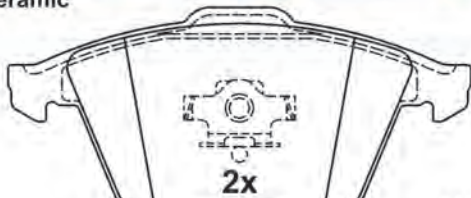

23801 20,3

156,3 x 72,9 x 20,3

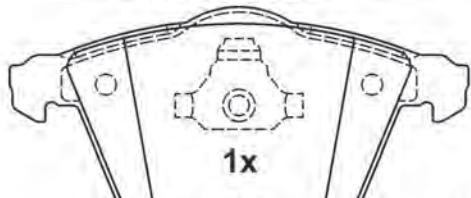

23912 20,3

155,1 x 72,9 x 20,3

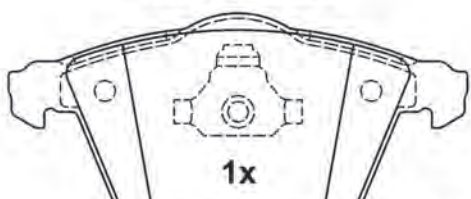

23913 20,3

L=177,5mm

155,1 x 72,9 x 20,3

13.0470-7201.2 LD7201

ATE Ceramic



23801 20,3

156,3 x 72,9 x 20,3

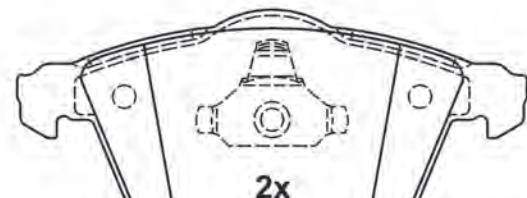

23763 20,3

L=242,5mm

155,1 x 72,9 x 20,3

Abbildungen Scheibenbremsbeläge

Illustrations disc brake pads - Ilustraciones de pastillas - Illustrations Plaquettes de frein à disque - Illustrazioni Pastiglie Freno

13.0470-7202.2 LD7202

ATE Ceramic

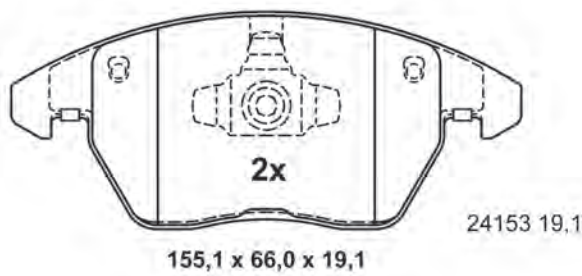
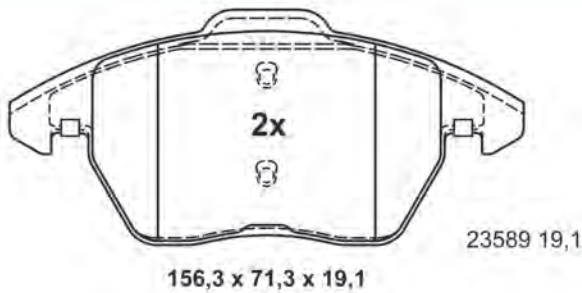

13.0470-7203.2 LD7203

ATE Ceramic

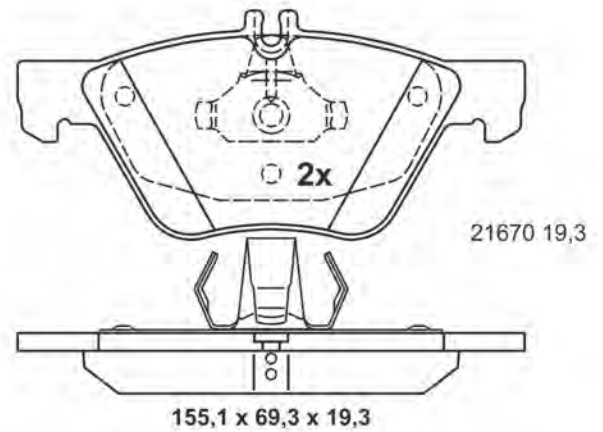
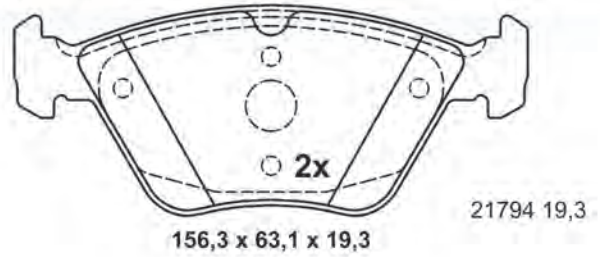

13.0470-7204.2 LD7204

ATE Ceramic

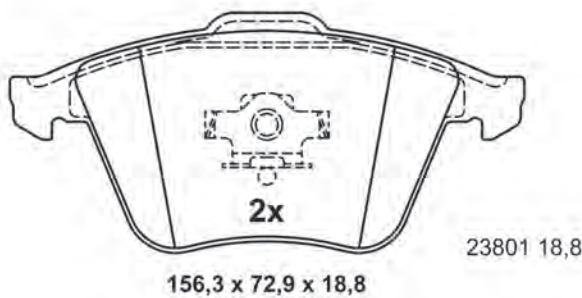
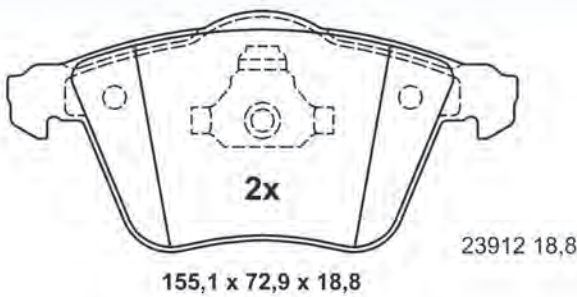

13.0470-7210.2 LD7210

ATE Ceramic

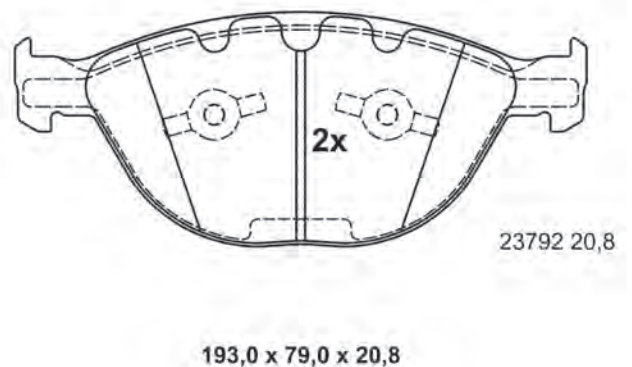
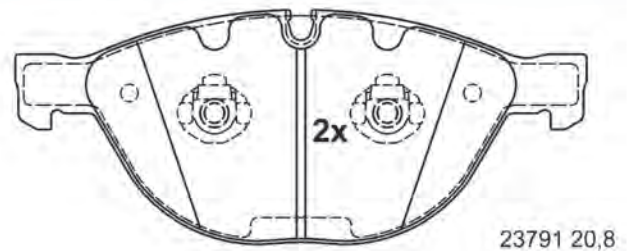

Abbildungen Scheibenbremsbeläge

Illustrations disc brake pads - Ilustraciones de pastillas - Illustrations Plaquettes de frein à disque - Illustrazioni Pastiglie Freno

13.0470-7211.2 LD7211

ATE Ceramic

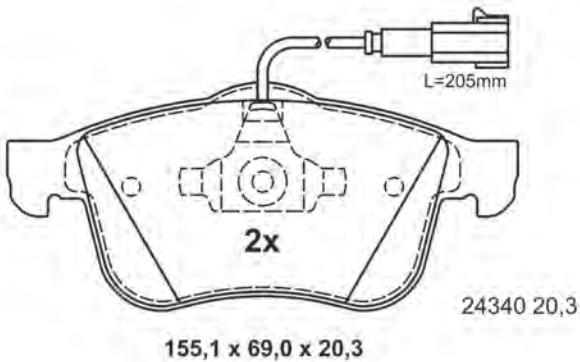
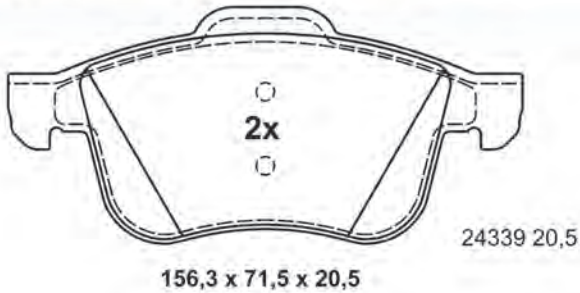

13.0470-7215.2 LD7215

ATE Ceramic

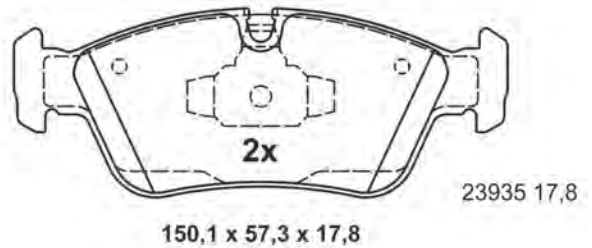
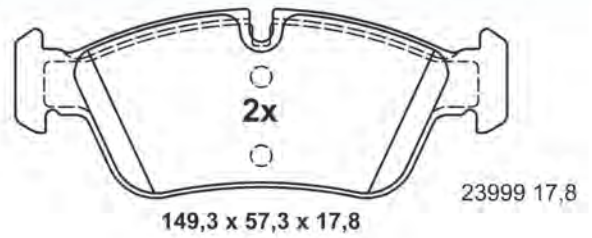

13.0470-7216.2 LD7216

ATE Ceramic

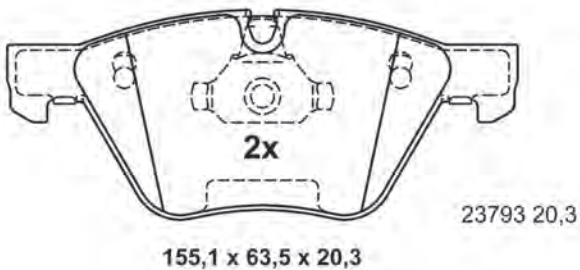
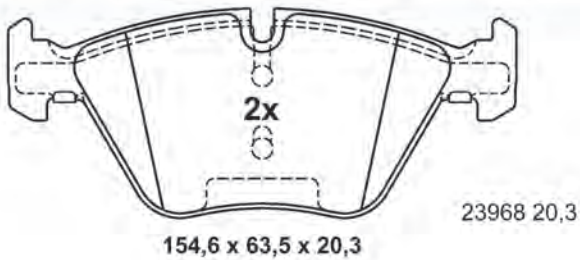

13.0470-7217.2 LD7217

ATE Ceramic

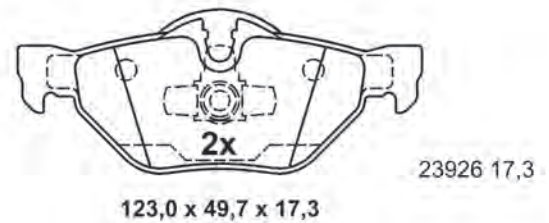
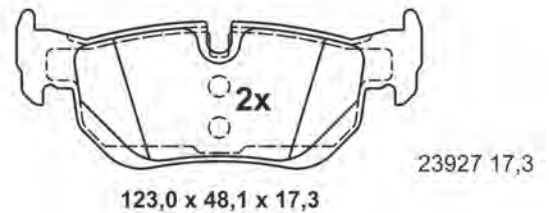

Abbildungen Scheibenbremsbeläge

Illustrations disc brake pads - Ilustraciones de pastillas - Illustrations Plaquettes de frein à disque - Illustrazioni Pastiglie Freno

13.0470-7219.2 LD7219

ATE Ceramic

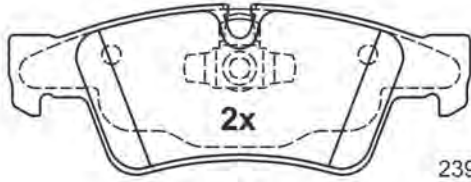

140,1 x 51,6 x 17,6

23923 17,6

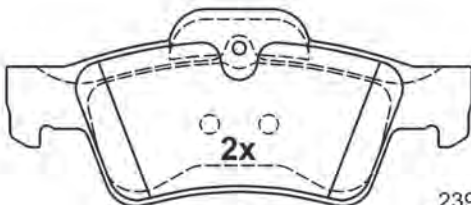

141,3 x 59,6 x 17,6

23924 17,6

13.0470-7220.2 LD7220

ATE Ceramic

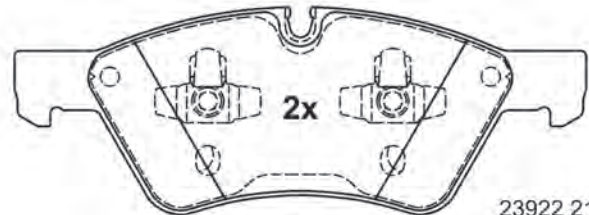

192,9 x 69,9 x 21,0

23922 21,0

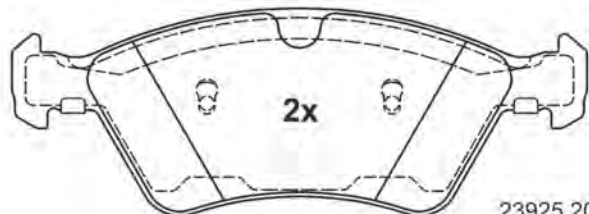

194,3 x 70,0 x 20,5

23925 20,5

13.0470-7221.2 LD7221

ATE Ceramic

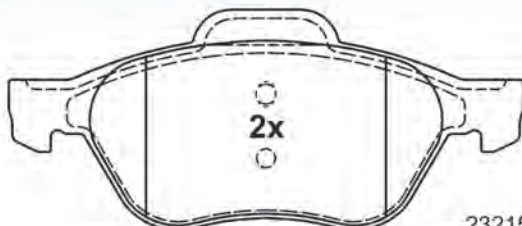

156,3 x 66,8 x 18,3

23215 18,3

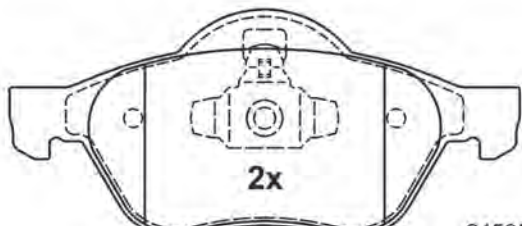

155,1 x 68,9 x 18,3

24535 18,3

13.0470-7223.2 LD7223

ATE Ceramic

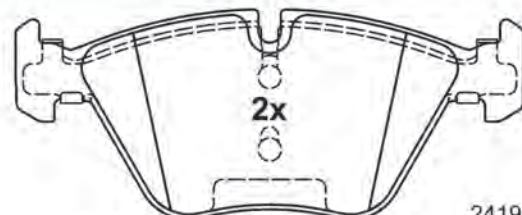

154,6 x 63,5 x 20,3

24193 20,3

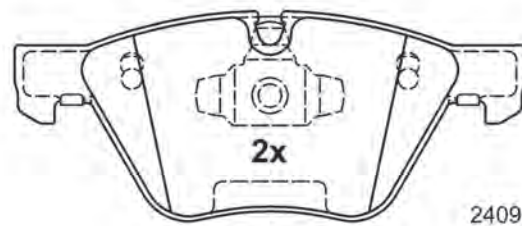

155,1 x 63,5 x 20,3

24096 20,3

Abbildungen Scheibenbremsbeläge

Illustrations disc brake pads - Ilustraciones de pastillas - Illustrations Plaquettes de frein à disque - Illustrazioni Pastiglie Freno

13.0470-7225.2 LD7225

ATE Ceramic



123,0 x 59,2 x 17,3

23551 17,3

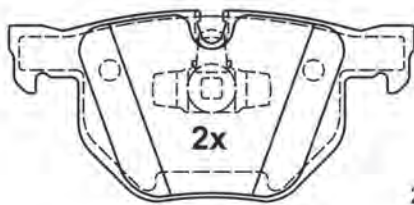

123,0 x 58,0 x 17,3

23550 17,3

13.0470-7226.2 LD7226

ATE Ceramic

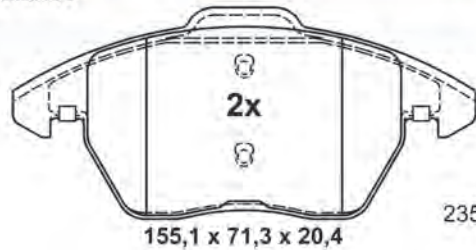

155,1 x 71,3 x 20,4

23589 20,4

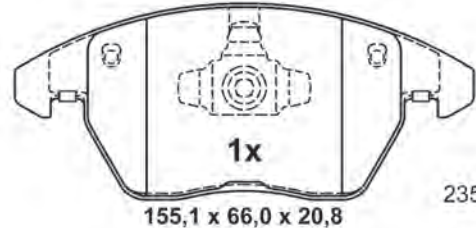

155,1 x 66,0 x 20,8

23587 20,8

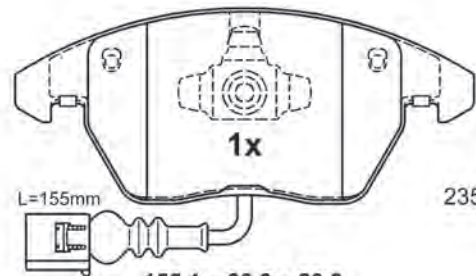

155,1 x 66,0 x 20,8

23588 20,8

13.0470-7227.2 LD7227

ATE Ceramic

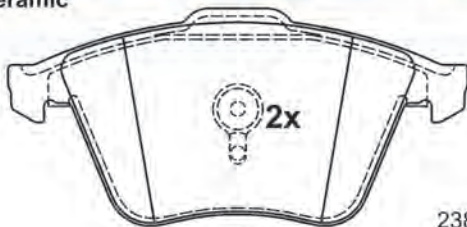

156,3 x 72,9 x 20,3

23801 20,3

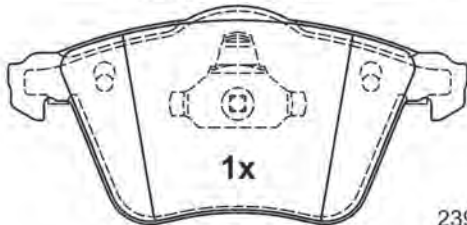

155,1 x 72,9 x 20,3

23912 20,3

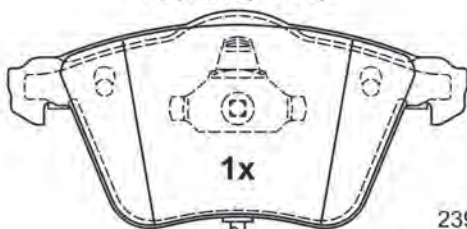

155,1 x 72,9 x 20,3

23913 20,3

13.0470-7228.2 LD7228

ATE Ceramic

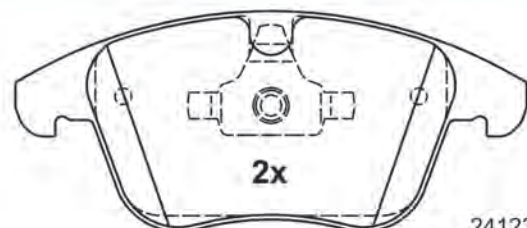

155,1 x 66,6 x 20,3

24123 20,3



156,3 x 72,0 x 19,3

24124 19,3

Abbildungen Scheibenbremsbeläge

Illustrations disc brake pads - Ilustraciones de pastillas - Illustrations Plaquettes de frein à disque - Illustrazioni Pastiglie Freno

13.0470-7229.2 LD7229

ATE Ceramic

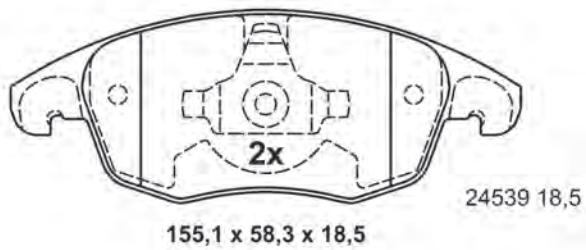
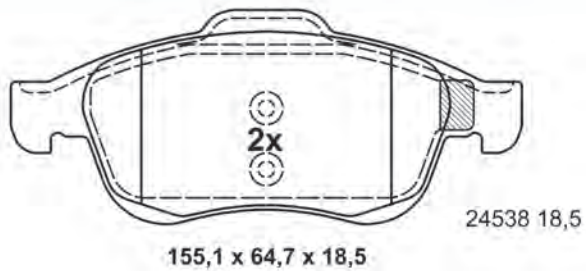

13.0470-7230.2 LD7230

ATE Ceramic

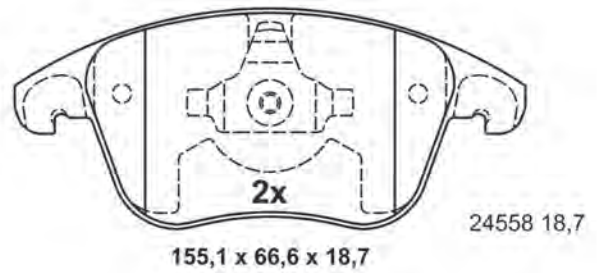
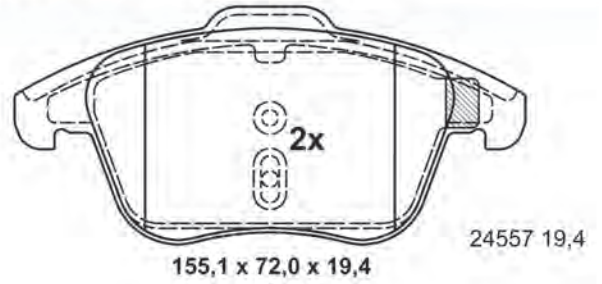

13.0470-7231.2 LD7231

ATE Ceramic

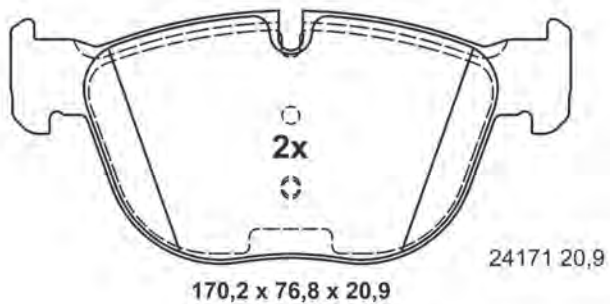
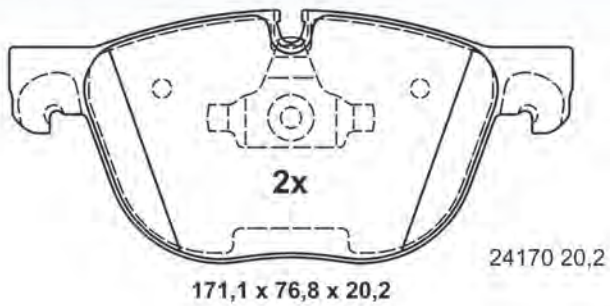

13.0470-7232.2 LD7232

ATE Ceramic

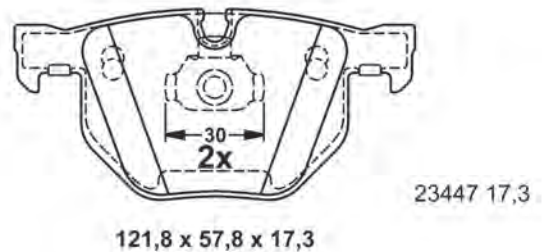
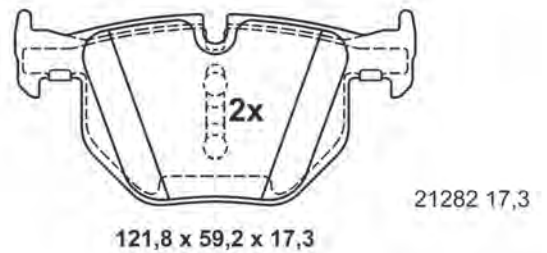

Abbildungen Scheibenbremsbeläge

Illustrations disc brake pads - Ilustraciones de pastillas - Illustrations Plaquettes de frein à disque - Illustrazioni Pastiglie Freno

13.0470-7237.2 LD7237

ATE Ceramic

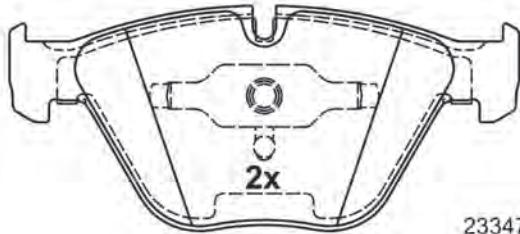

23347 20,3

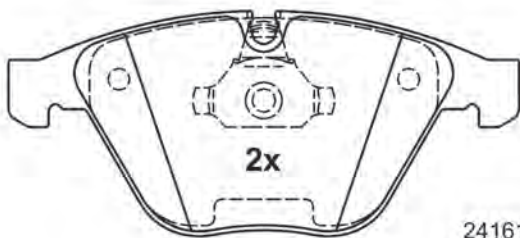

24161 20,3

155,1 x 68,3 x 20,3

13.0470-7238.2 LD7238

ATE Ceramic

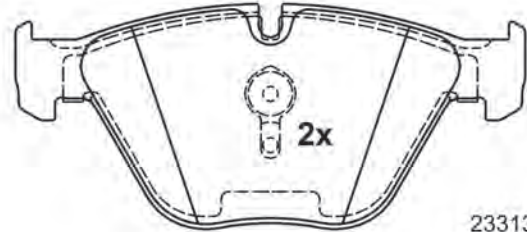

23313 20,3

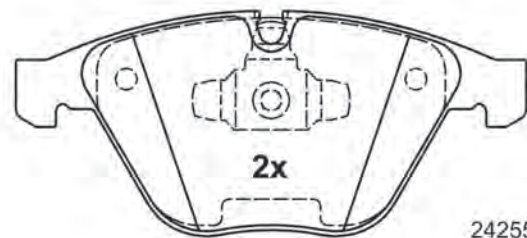

24255 20,3

155,1 x 68,3 x 20,3

13.0470-7239.2 LD7239

ATE Ceramic

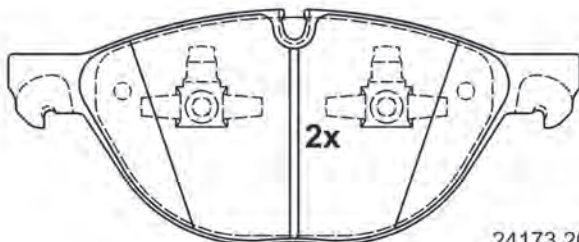

24173 20,0

193,0 x 79,0 x 20,0

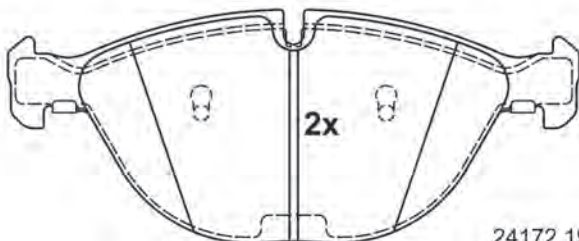

24172 19,0

193,0 x 79,0 x 19,0

13.0470-7242.2 LD7242

ATE Ceramic



24332 19,8

155,1 x 72,0 x 19,8

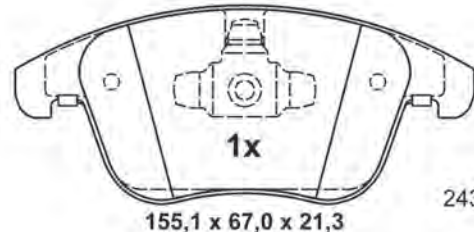

24333 21,3

155,1 x 67,0 x 21,3

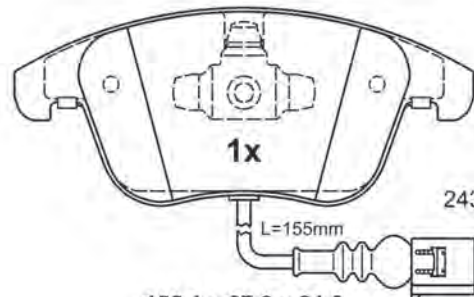

24334 21,3

155,1 x 67,0 x 21,3

Abbildungen Scheibenbremsbeläge

Illustrations disc brake pads - Ilustraciones de pastillas - Illustrations Plaquettes de frein à disque - Illustrazioni Pastiglie Freno

13.0470-7243.2 LD7243

ATE Ceramic

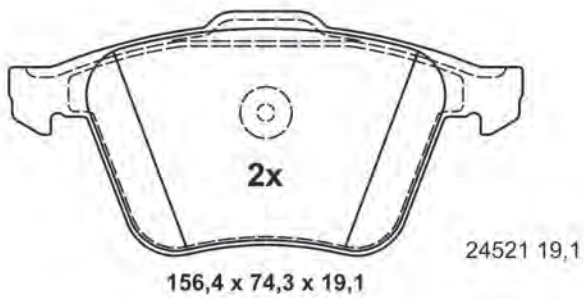
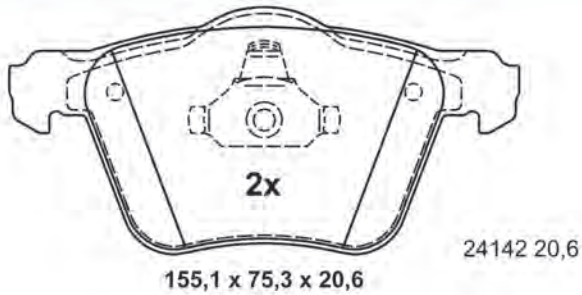

13.0470-7244.2 LD7244

ATE Ceramic

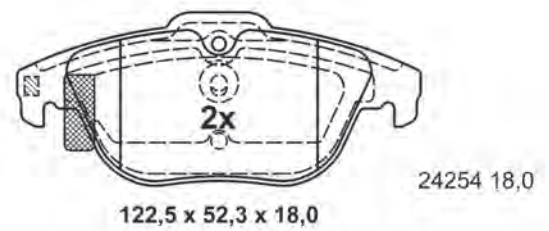
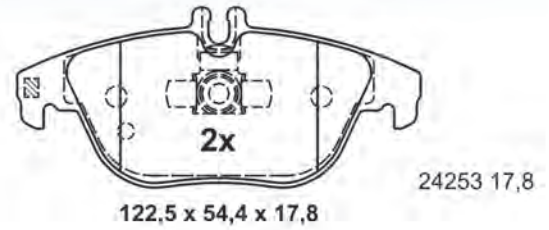

13.0470-7249.2 LD7249

ATE Ceramic

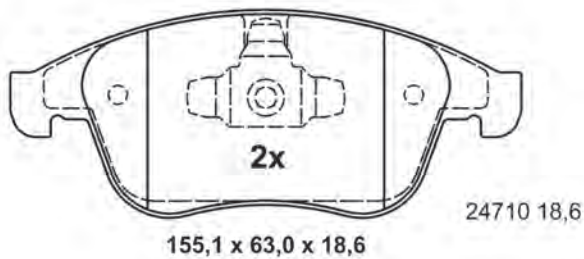

13.0470-7251.2 LD7251

ATE Ceramic

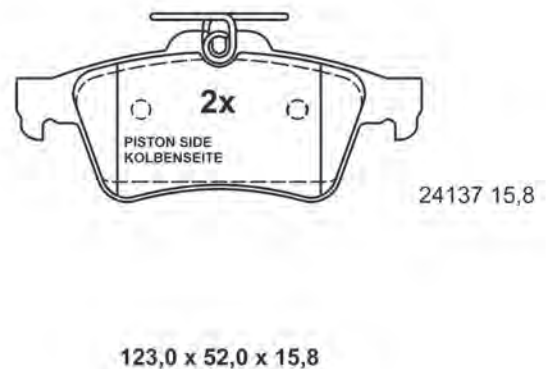

Abbildungen Scheibenbremsbeläge

Illustrations disc brake pads - Ilustraciones de pastillas - Illustrations Plaquettes de frein à disque - Illustrazioni Pastiglie Freno

13.0470-7252.2 LD7252

ATE Ceramic

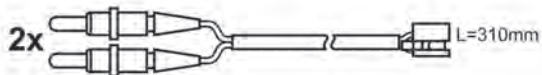
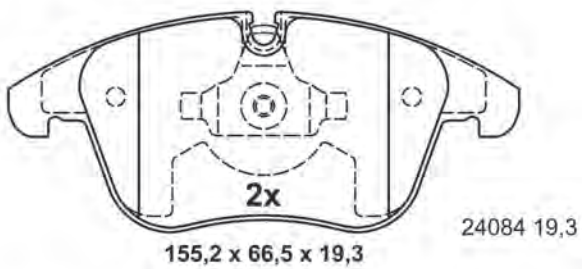

13.0470-7256.2 LD7256

ATE Ceramic

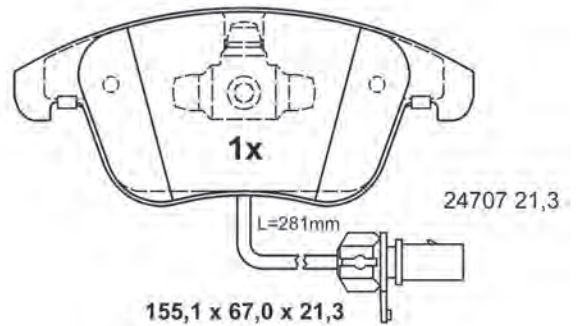
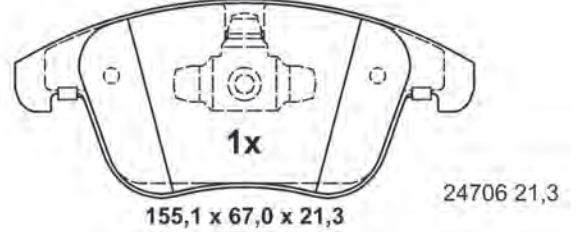
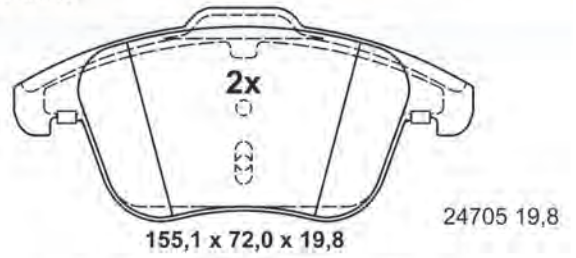

13.0470-7257.2 LD7257

ATE Ceramic

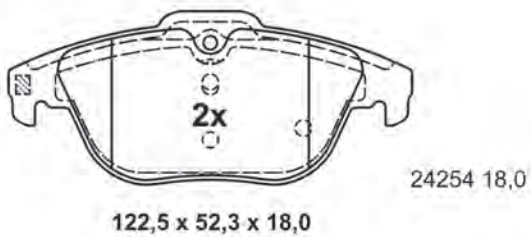
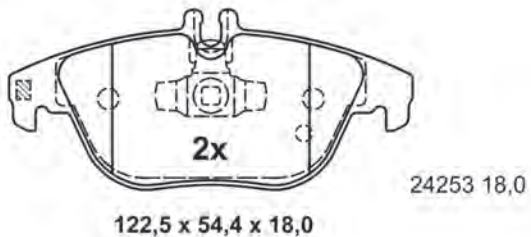

13.0470-7259.2 LD7259

ATE Ceramic

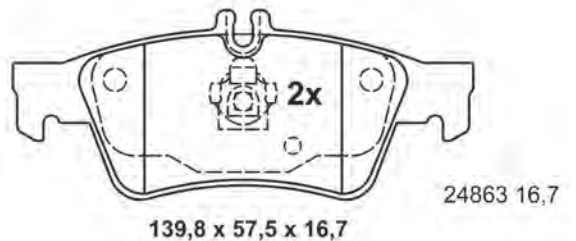
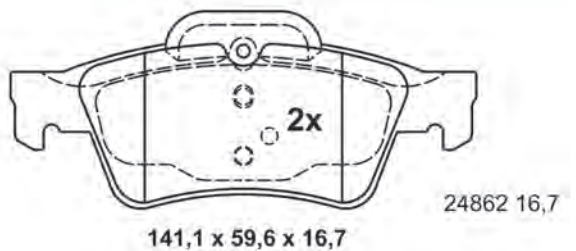

Abbildungen Scheibenbremsbeläge

Illustrations disc brake pads - Ilustraciones de pastillas - Illustrations Plaquettes de frein à disque - Illustrazioni Pastiglie Freno

13.0470-7262.2 LD7262

B.H.P.

ATE Ceramic

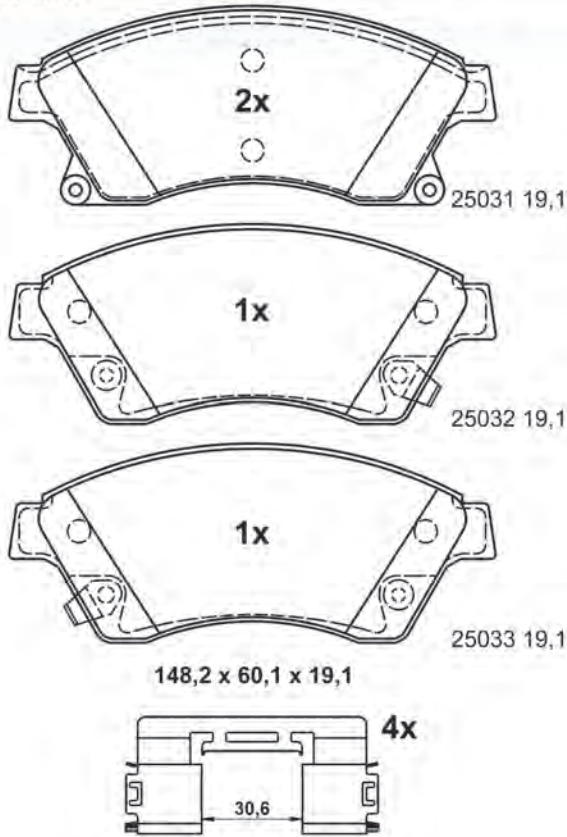

13.0470-7263.2 LD7263

B.H.P.

ATE Ceramic

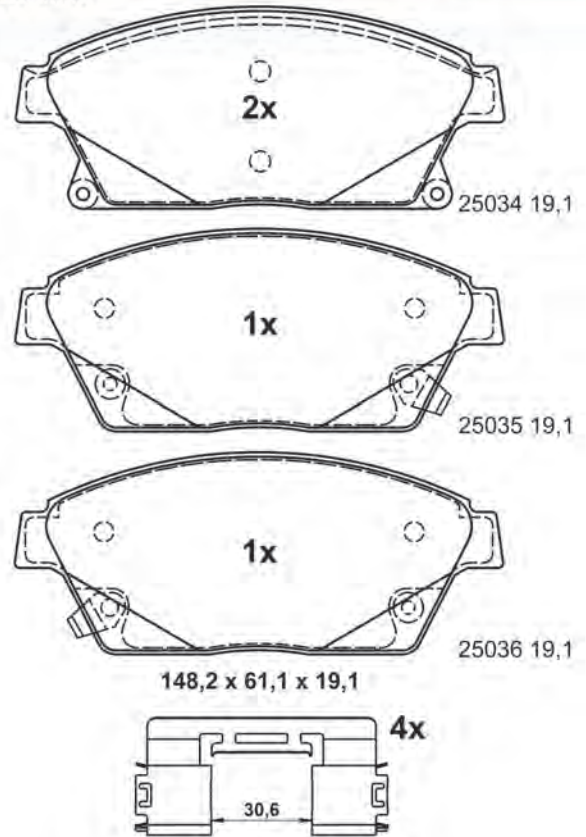

13.0470-7264.2 LD7264

B.H.P.

ATE Ceramic

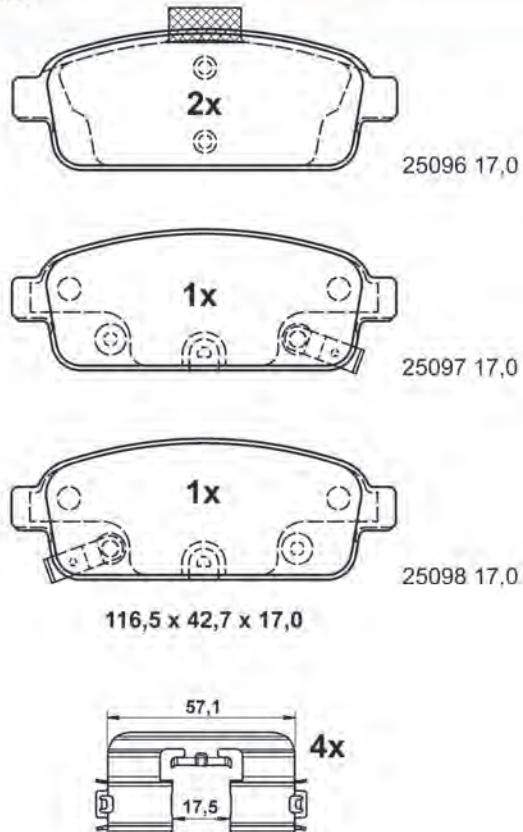

13.0470-7266.2 LD7266

B.H.P.

ATE Ceramic

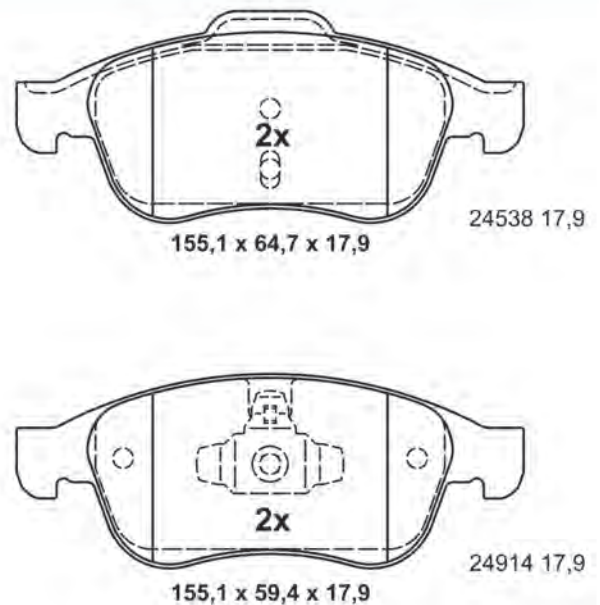

Abbildungen Scheibenbremsbeläge

Illustrations disc brake pads - Ilustraciones de pastillas - Illustrations Plaquettes de frein à disque - Illustrazioni Pastiglie Freno

13.0470-7267.2 LD7267

ATE Ceramic

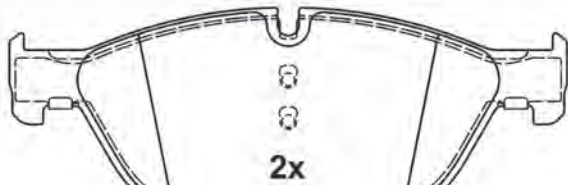

192,2 x 79,2 x 19,5

25045 19,5

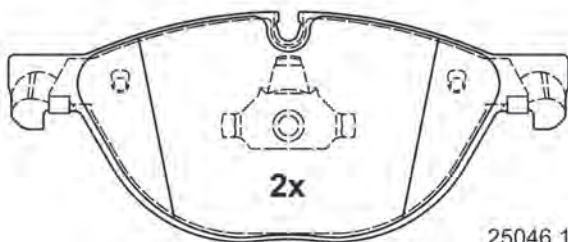

193,0 x 79,2 x 18,5

25046 18,5

13.0470-7268.2 LD7268

ATE Ceramic

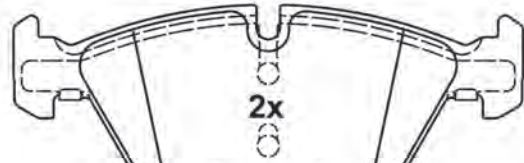

154,6 x 63,5 x 20,3

23794 20,3

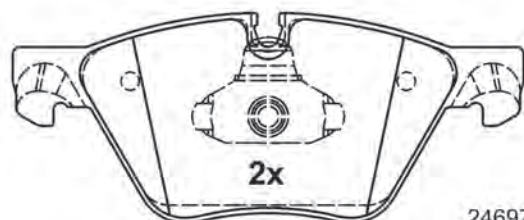

155,1 x 63,5 x 19,3

24697 19,3

13.0470-7269.2 LD7269

ATE Ceramic



155,1 x 71,5 x 19,5

24339 19,5

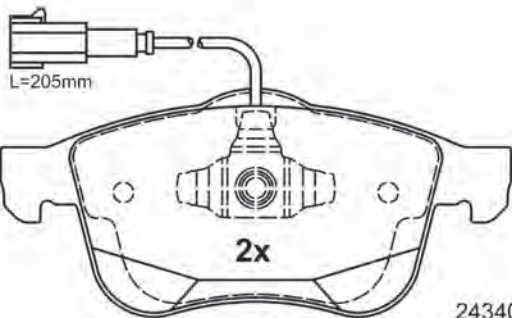

155,1 x 69,0 x 19,5

24340 19,5

13.0470-7273.2 LD7273

ATE Ceramic

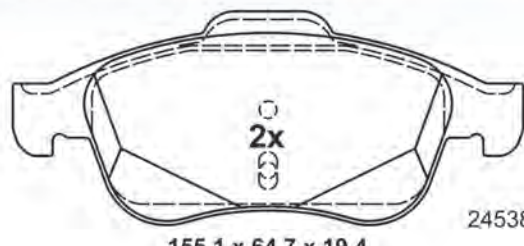

155,1 x 64,7 x 19,4

24538 19,4

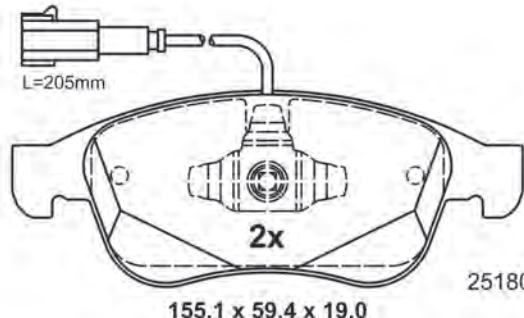

155,1 x 59,4 x 19,0

25180 19,0

Abbildungen Scheibenbremsbeläge

Illustrations disc brake pads - Ilustraciones de pastillas - Illustrations Plaquettes de frein à disque - Illustrazioni Pastiglie Freno

13.0470-7275.2 LD7275

ATE Ceramic

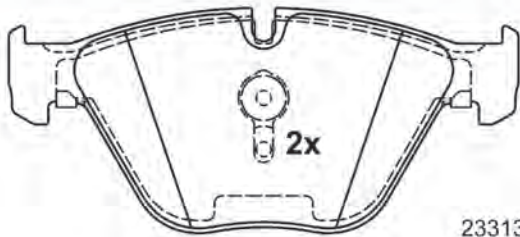

23313 20,2

154,1 x 68,4 x 20,2

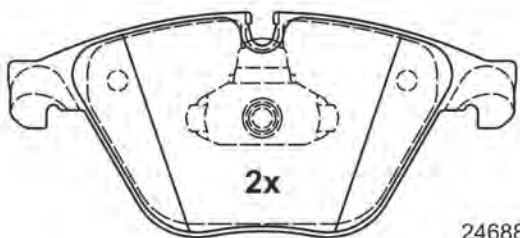

24688 19,2

154,1 x 68,4 x 19,2

13.0470-7280.2 LD7280

ATE Ceramic

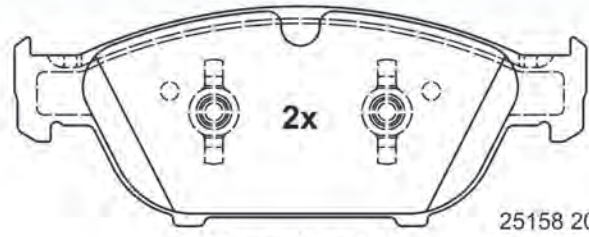

25158 20,3

193,0 x 74,0 x 20,3

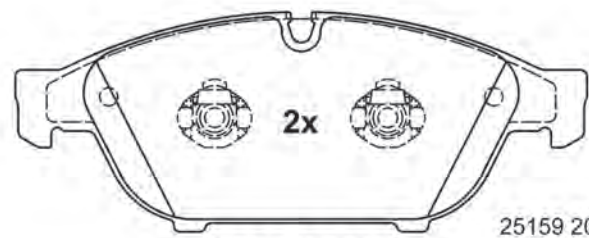

25159 20,3

193,0 x 74,0 x 20,3

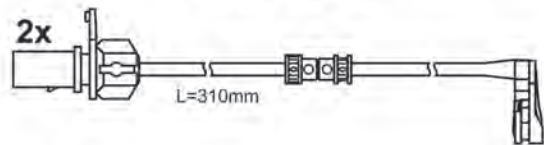

13.0470-7281.2 LD7281

ATE Ceramic

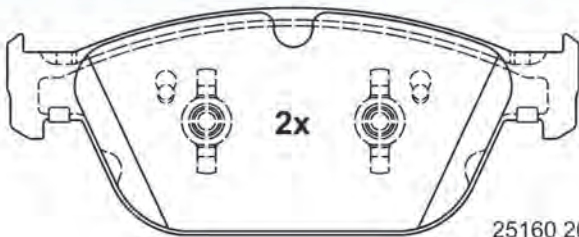

25160 20,3

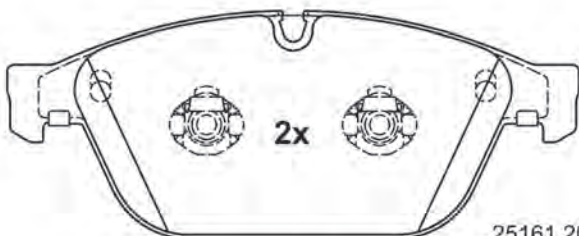

25161 20,3

193,0 x 76,5 x 20,3

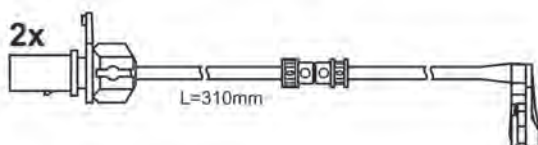

13.0470-7282.2 LD7282

ATE Ceramic

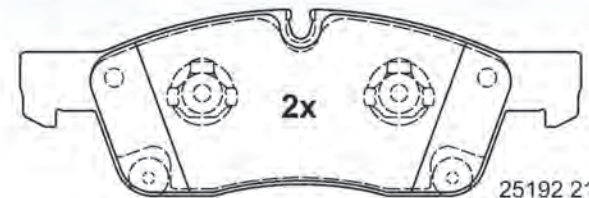

25192 21,3

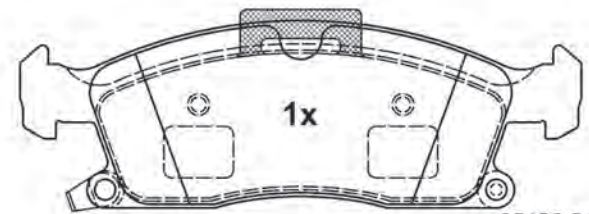

25190 21,3

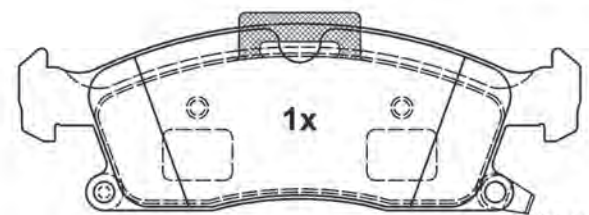

25191 21,3

193,1 x 64,1 x 21,3

Abbildungen Scheibenbremsbeläge

Illustrations disc brake pads - Ilustraciones de pastillas - Illustrations Plaquettes de frein à disque - Illustrazioni Pastiglie Freno

13.0470-7285.2 LD7285

ATE Ceramic

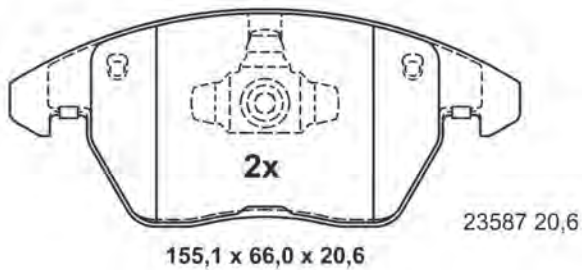
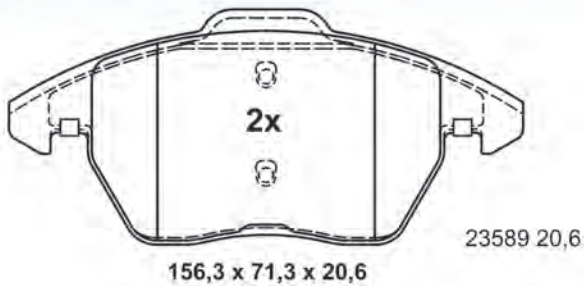

13.0470-7288.2 LD7288

ATE Ceramic

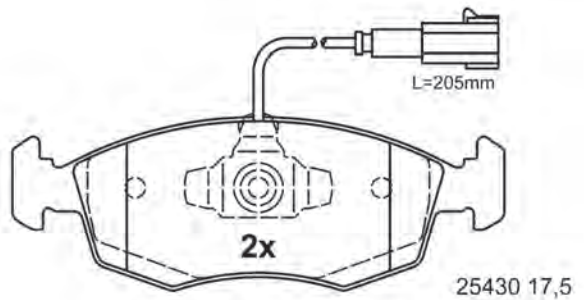
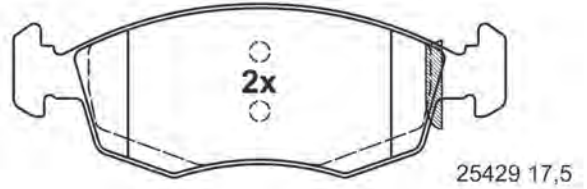

149,2 x 52,5 x 17,5

13.0470-7294.2 LD7294

ATE Ceramic

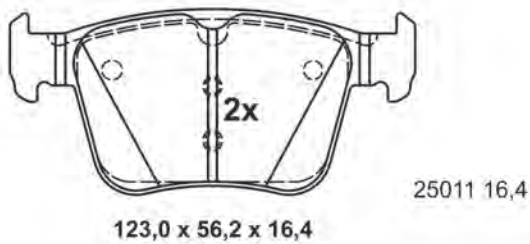
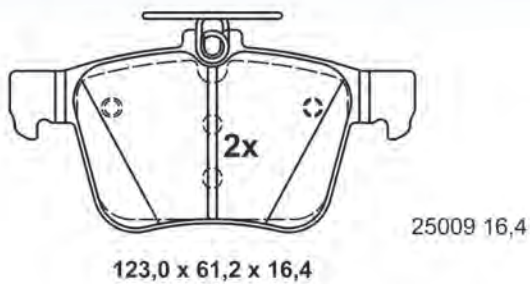

13.0470-7295.2 LD7295

ATE Ceramic

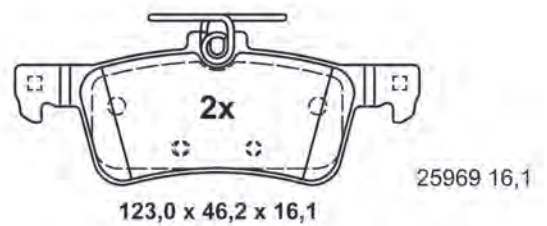
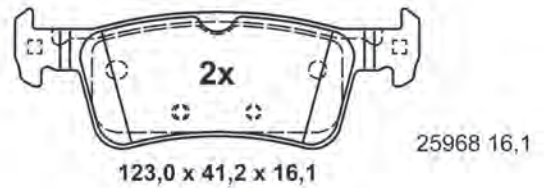

123,0 x 46,2 x 16,1

Abbildungen Scheibenbremsbeläge

Illustrations disc brake pads - Ilustraciones de pastillas - Illustrations Plaquettes de frein à disque - Illustrazioni Pastiglie Freno

13.0470-7296.2 LD7296



ATE Ceramic

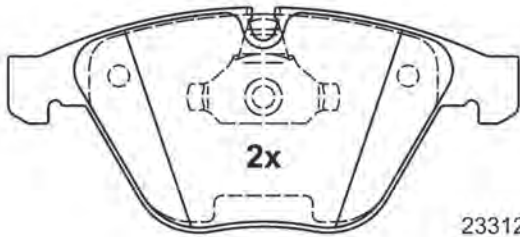

23312 20,3

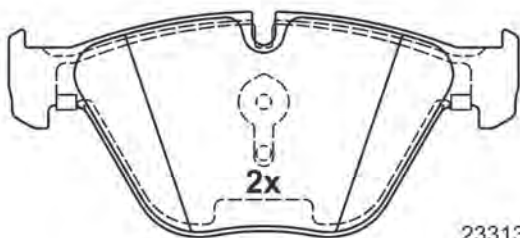

23313 20,3

155,1 x 68,3 x 20,3

13.0470-7300.2 LD7300



ATE Ceramic

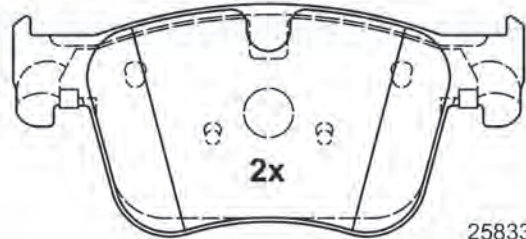

25833 17,3

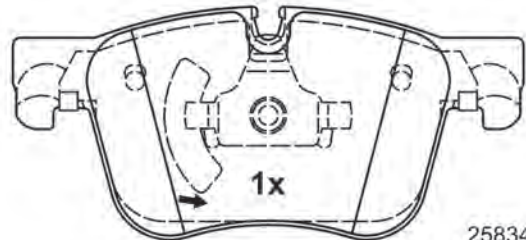

25834 17,3

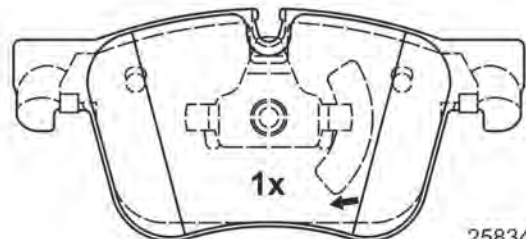

25834 17,3

155,1 x 70,5 x 17,3

13.0470-7301.2 LD7301



ATE Ceramic

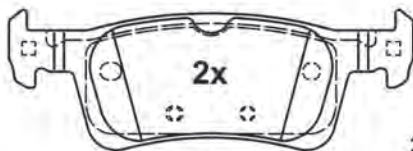

25841 16,1

123,0 x 41,2 x 16,1



25842 16,1

123,0 x 46,2 x 16,1

13.0470-7303.2 LD7303



ATE Ceramic

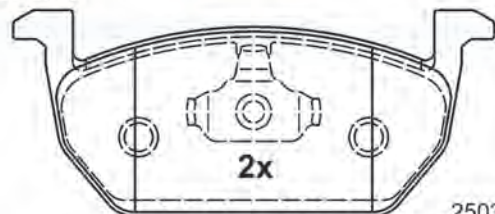

25035 17,5

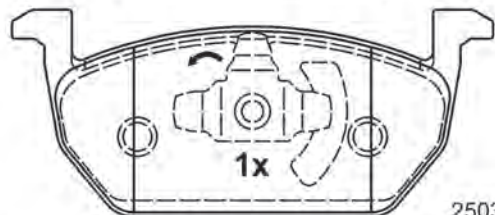

25036 17,5

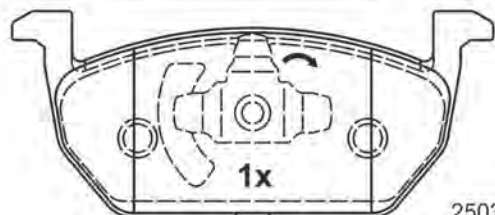

25037 17,5

146,0 x 62,4 x 17,5

L=155mm



Abbildungen Scheibenbremsbeläge

Illustrations disc brake pads - Ilustraciones de pastillas - Illustrations Plaquettes de frein à disque - Illustrazioni Pastiglie Freno

13.0470-7305.2 LD7305



ATE Ceramic

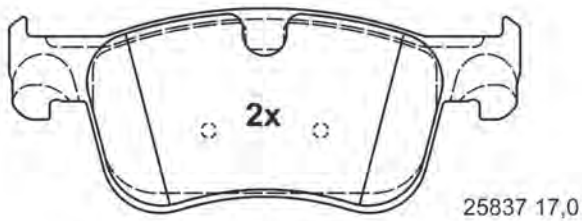
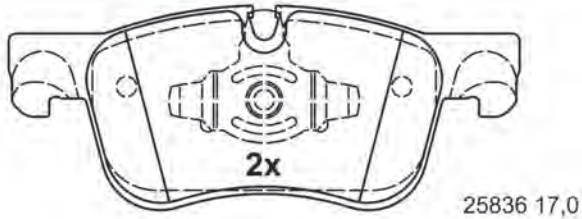

155,1 x 61,9 x 17,0

13.0470-9000.2 LD9000



ATE Ceramic

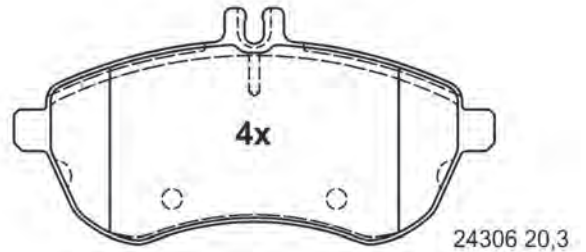

146,0 x 71,5 x 20,3

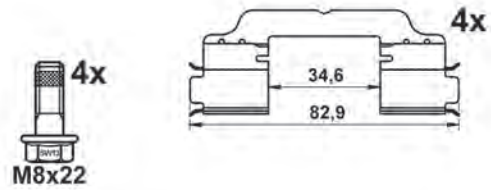

13.0470-9001.2 LD9001



ATE Ceramic

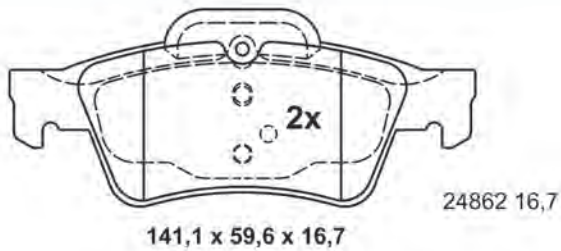

141,1 x 59,6 x 16,7

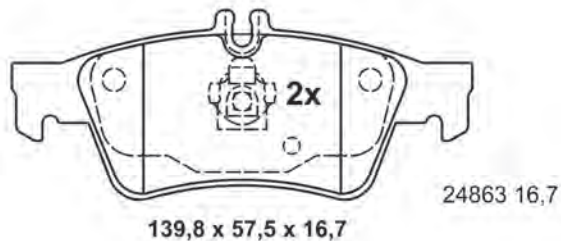

139,8 x 57,5 x 16,7



- DE** Abbildungen Bremsbelag-Einbausätze
- EN** Illustrations brake pad installation kits
- ES** Ilustraciones juegos de montaje pastillas
- FR** Illustrations Lots de montage pour plaquettes de frein à disque
- IT** Illustrazioni kit installazione pastiglie freno

2018



Abbildungen Bremsbelag-Einbausätze

Illustrations brake pad installation kits - Ilustraciones juegos de montaje pastillas - Illustrations Lots de montage pour plaquettes de frein à disque - Illustrazioni kit installazione pastiglie freno

13.0460-0017.2 610017 13.0460-0023.2 610023 13.0460-0024.2 610024

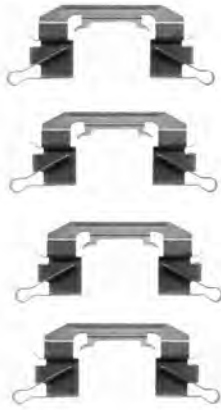

13.0460-0035.2 610035 13.0460-0060.2 610060 13.0460-0072.2 610072

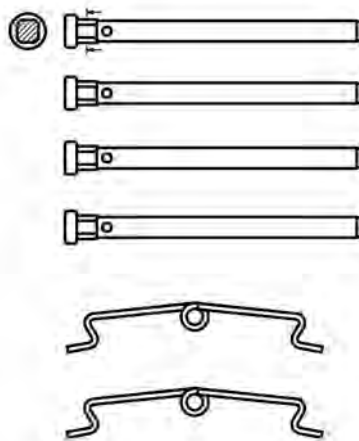



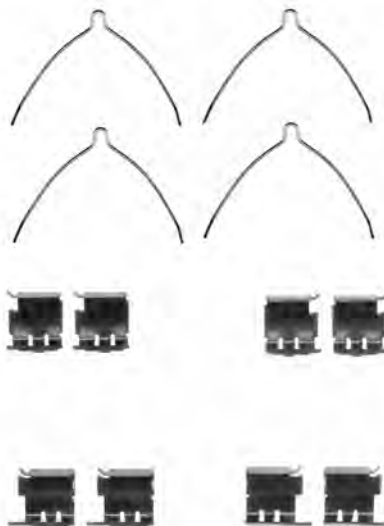

13.0460-0073.2 610073 13.0460-0074.2 610074 13.0460-0075.2 610075



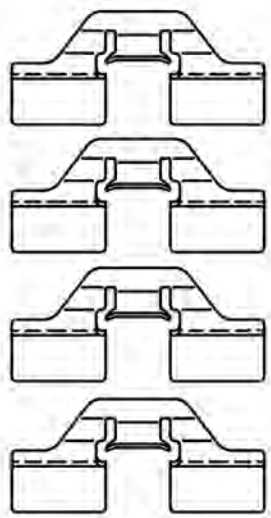
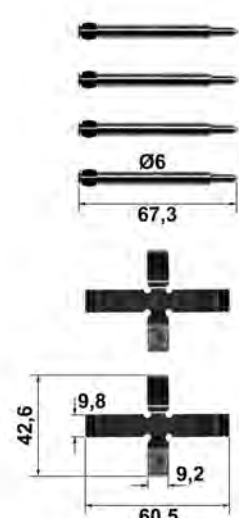

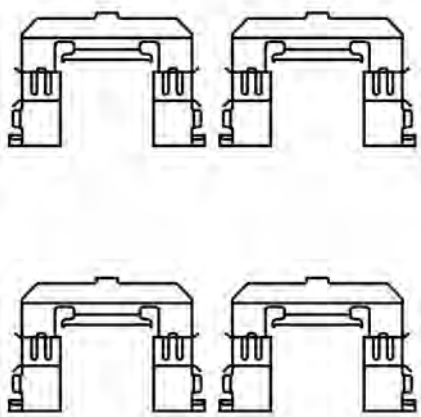
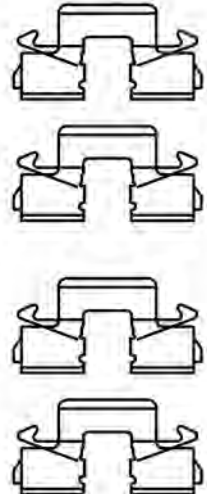
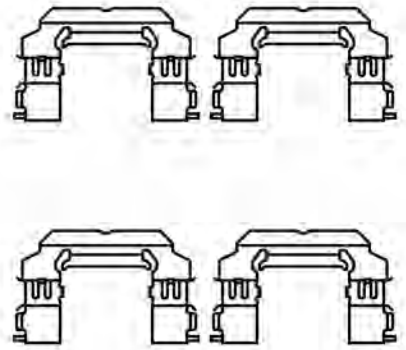



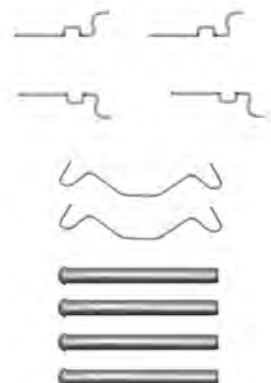

Abbildungen Bremsbelag-Einbausätze

Illustrations brake pad installation kits - Ilustraciones juegos de montaje pastillas - Illustrations Lots de montage pour plaquettes de frein à disque - Illustrazioni kit installazione pastiglie freno

13.0460-0077.2 610077	13.0460-0088.2 610088	13.0460-0091.2 610091
		
13.0460-0107.2 610107	13.0460-0112.2 610112	13.0460-0116.2 610116
		
13.0460-0117.2 610117	13.0460-0127.2 610127	13.0460-0134.2 610134
		

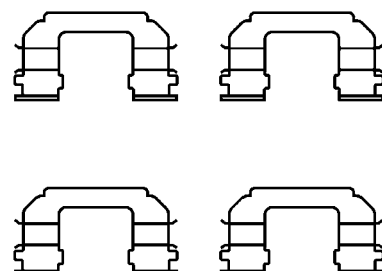
Abbildungen Bremsbelag-Einbausätze

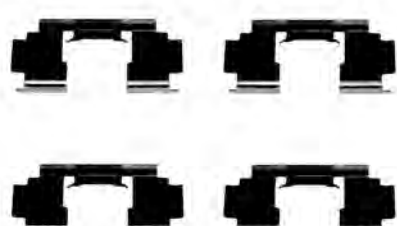
Illustrations brake pad installation kits - Ilustraciones juegos de montaje pastillas - Illustrations Lots de montage pour plaquettes de frein à disque - Illustrazioni kit installazione pastiglie freno

13.0460-0135.2 610135	13.0460-0136.2 610136	13.0460-0137.2 610137
		
13.0460-0138.2 610138	13.0460-0139.2 610139	13.0460-0140.2 610140
		
13.0460-0141.2 610141	13.0460-0142.2 610142	13.0460-0143.2 610143
		

Abbildungen Bremsbelag-Einbausätze

Illustrations brake pad installation kits - Ilustraciones juegos de montaje pastillas - Illustrations Lots de montage pour plaquettes de frein à disque - Illustrazioni kit installazione pastiglie freno

13.0460-0144.2 610144 13.0460-0146.2 610146 13.0460-0148.2 610148

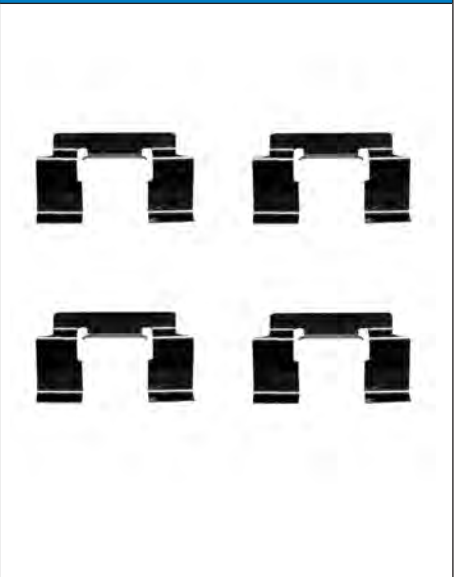
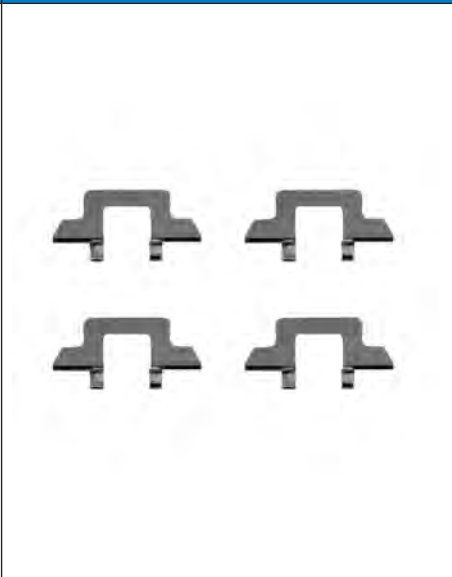

13.0460-0149.2 610149 13.0460-0150.2 610150 13.0460-0154.2 610154

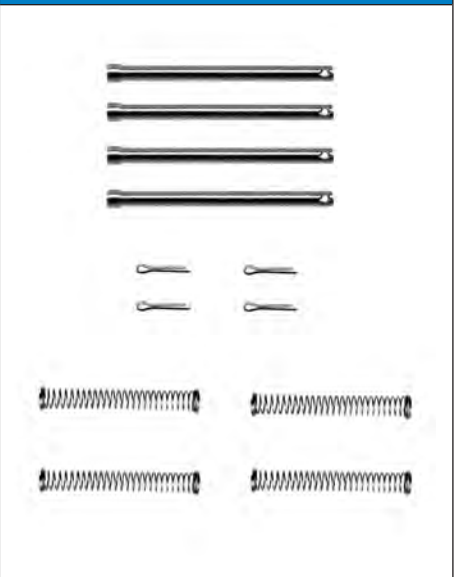
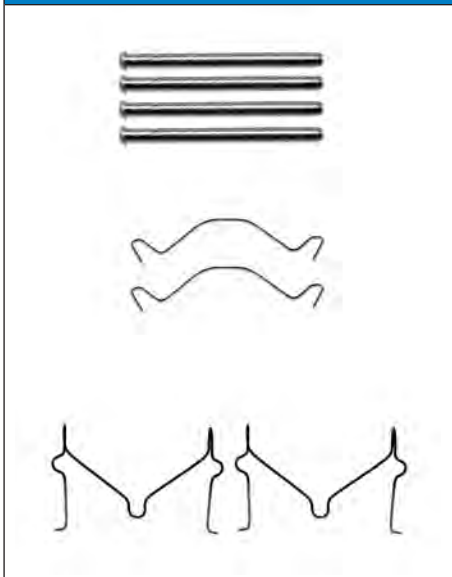



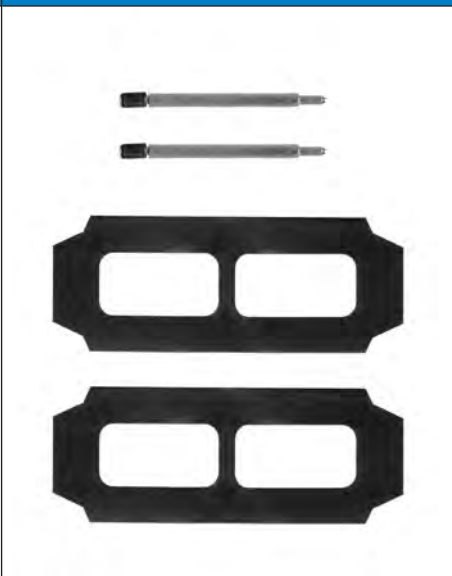
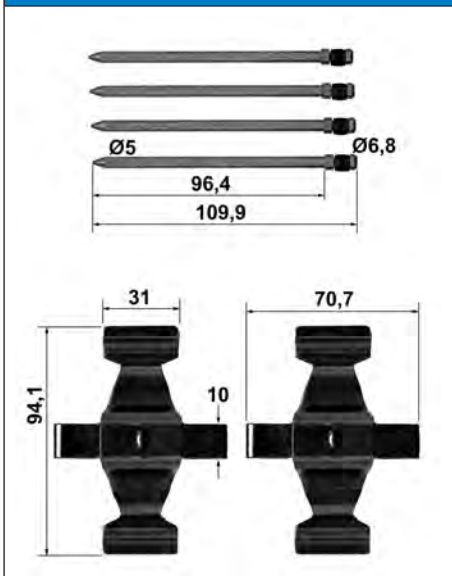



13.0460-0155.2 610155 13.0460-0158.2 610158 13.0460-0160.2 610160

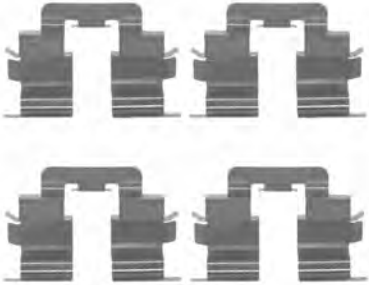

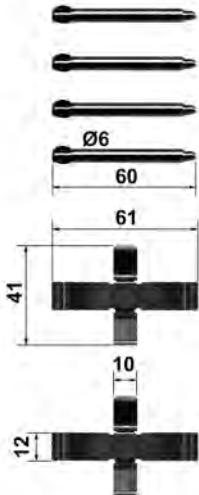
Abbildungen Bremsbelag-Einbausätze

Illustrations brake pad installation kits - Ilustraciones juegos de montaje pastillas - Illustrations Lots de montage pour plaquettes de frein à disque - Illustrazioni kit installazione pastiglie freno

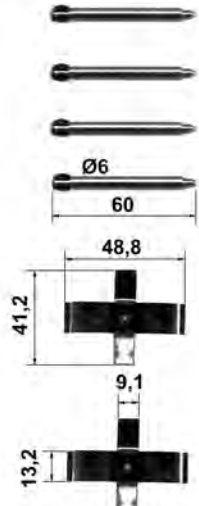
13.0460-0163.2 610163	13.0460-0170.2 610170	13.0460-0175.2 610175
		
13.0460-0186.2 610186	13.0460-0203.2 610203	13.0460-0206.2 610206
		
13.0460-0212.2 610212	13.0460-0213.2 610213	13.0460-0215.2 610215
		



Abbildungen Bremsbelag-Einbausätze

Illustrations brake pad installation kits - Ilustraciones juegos de montaje pastillas - Illustrations Lots de montage pour plaquettes de frein à disque - Illustrazioni kit installazione pastiglie freno

13.0460-0217.2 610217 13.0460-0219.2 610219 13.0460-0222.2 610222

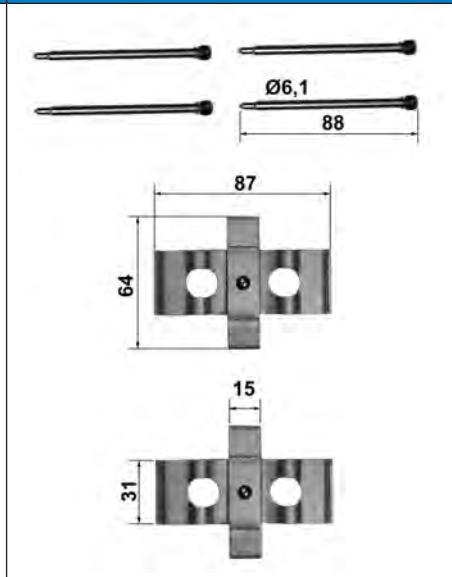
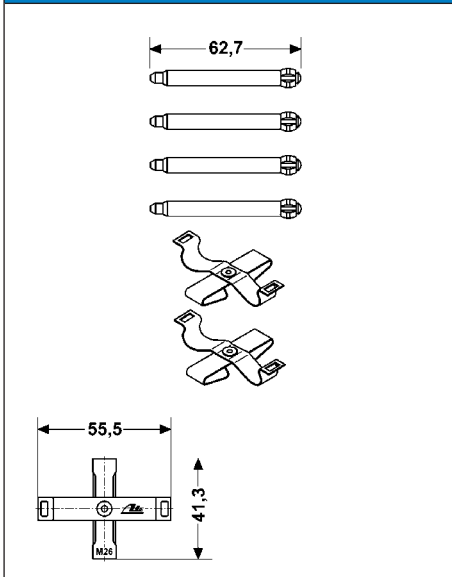

13.0460-0225.2 610225 13.0460-0229.2 610229 13.0460-0231.2 610231

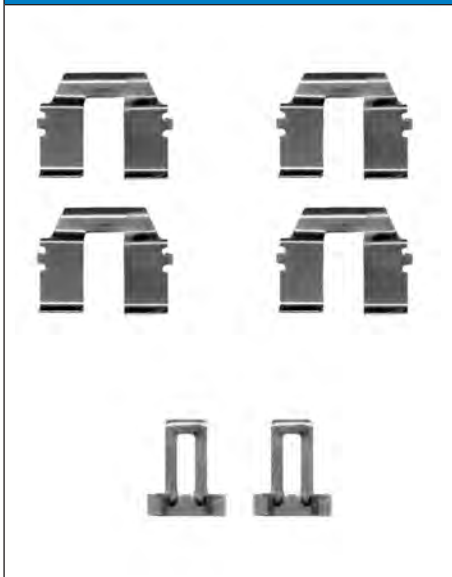

13.0460-0233.2 610233 13.0460-0234.2 610234 13.0460-0235.2 610235

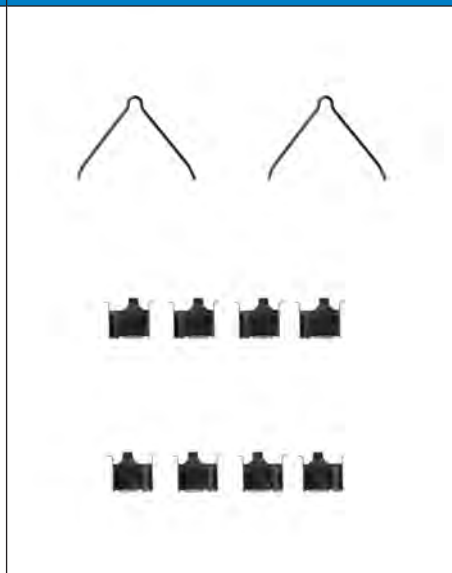

Abbildungen Bremsbelag-Einbausätze

Illustrations brake pad installation kits - Ilustraciones juegos de montaje pastillas - Illustrations Lots de montage pour plaquettes de frein à disque - Illustrazioni kit installazione pastiglie freno

13.0460-0236.2 610236 13.0460-0237.2 610237 13.0460-0238.2 610238



13.0460-0239.2 610239 13.0460-0245.2 610245 13.0460-0246.2 610246

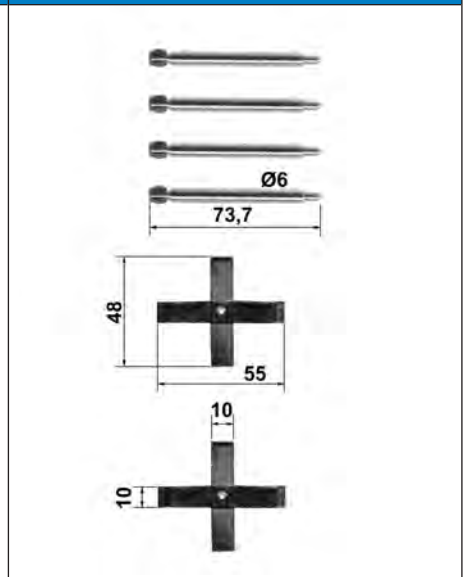
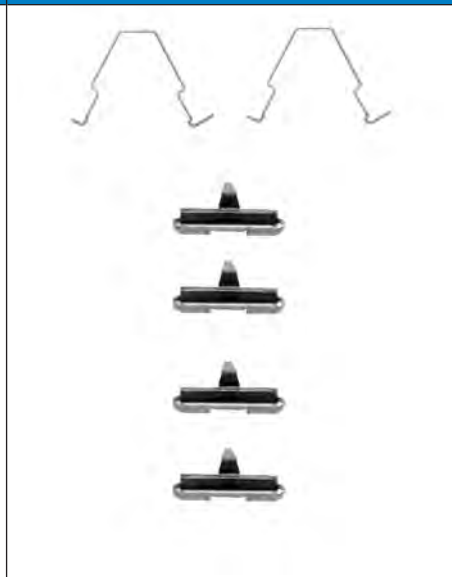

13.0460-0248.2 610248 13.0460-0250.2 610250 13.0460-0252.2 610252

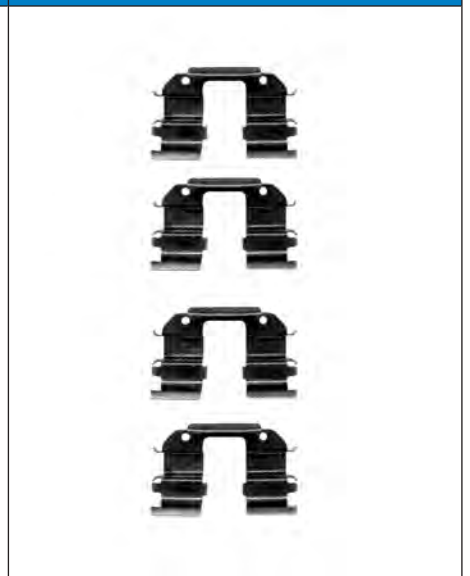
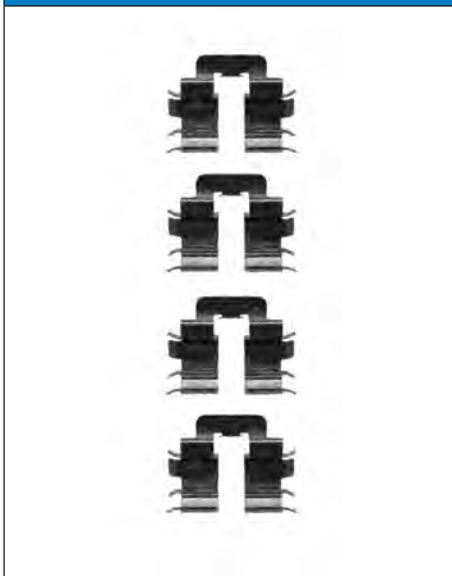

Abbildungen Bremsbelag-Einbausätze

Illustrations brake pad installation kits - Ilustraciones juegos de montaje pastillas - Illustrations Lots de montage pour plaquettes de frein à disque - Illustrazioni kit installazione pastiglie freno

13.0460-0254.2 610254 13.0460-0256.2 610256 13.0460-0257.2 610257

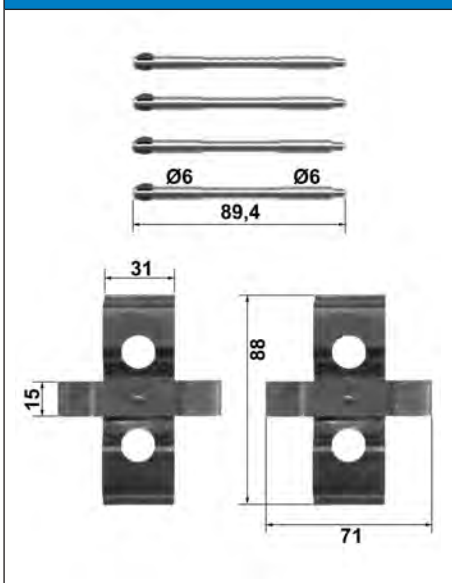

13.0460-0258.2 610258 13.0460-0259.2 610259 13.0460-0260.2 610260

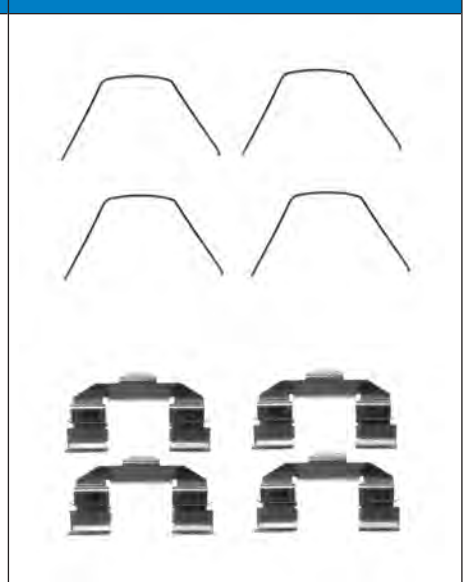
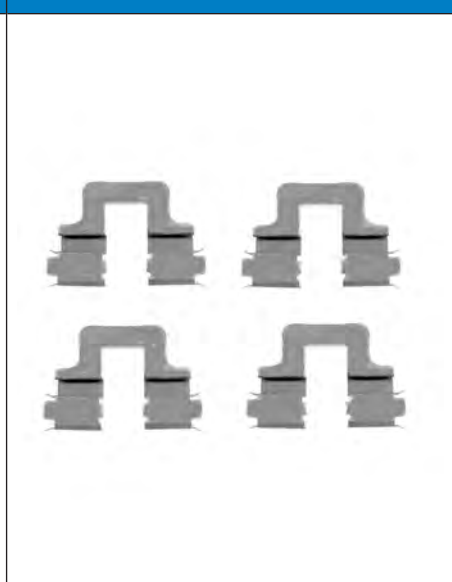

13.0460-0261.2 610261 13.0460-0262.2 610262 13.0460-0263.2 610263

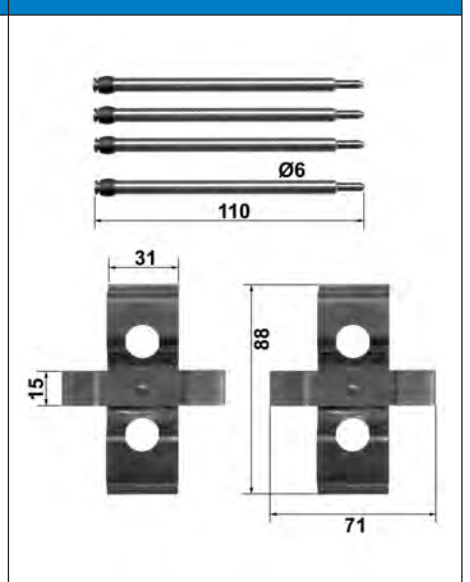







Abbildungen Bremsbelag-Einbausätze

Illustrations brake pad installation kits - Ilustraciones juegos de montaje pastillas - Illustrations Lots de montage pour plaquettes de frein à disque - Illustrazioni kit installazione pastiglie freno

13.0460-0264.2 610264	13.0460-0265.2 610265	13.0460-0267.2 610267
13.0460-0268.2 610268	13.0460-0269.2 610269	13.0460-0275.2 610275
13.0460-0278.2 610278	13.0460-0279.2 610279	13.0460-0280.2 610280

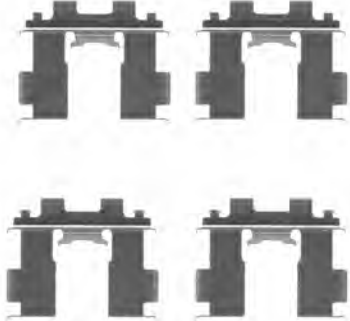
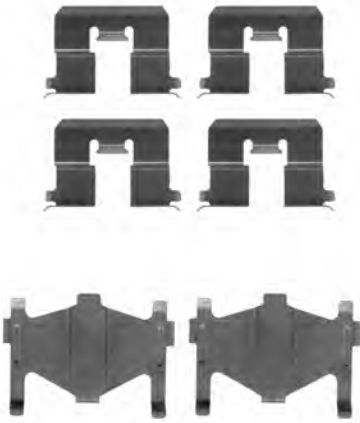
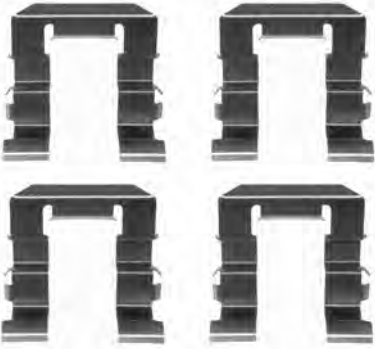

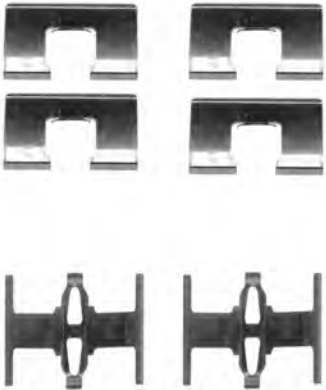
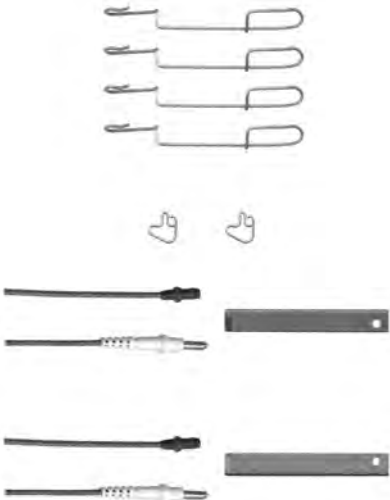

Abbildungen Bremsbelag-Einbausätze

Illustrations brake pad installation kits - Ilustraciones juegos de montaje pastillas - Illustrations Lots de montage pour plaquettes de frein à disque - Illustrazioni kit installazione pastiglie freno

13.0460-0281.2 610281	13.0460-0282.2 610282	13.0460-0283.2 610283
		
13.0460-0284.2 610284	13.0460-0285.2 610285	13.0460-0286.2 610286
		
13.0460-0287.2 610287	13.0460-0288.2 610288	13.0460-0289.2 610289
		

Abbildungen Bremsbelag-Einbausätze

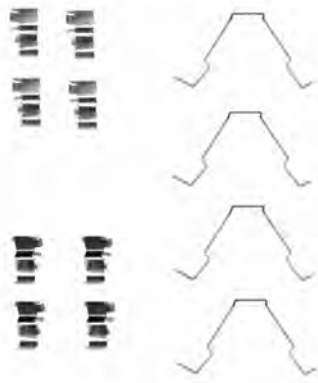
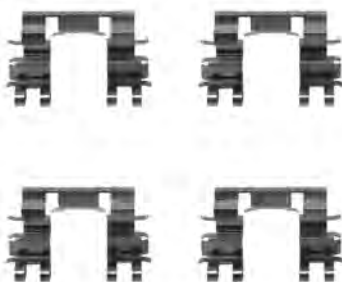
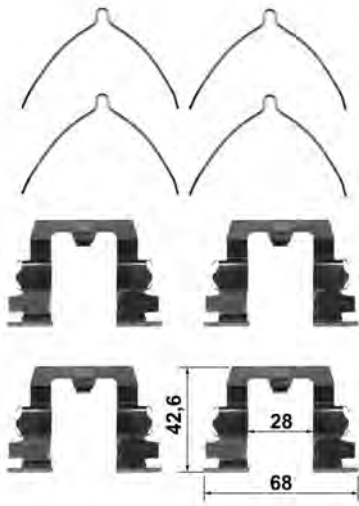

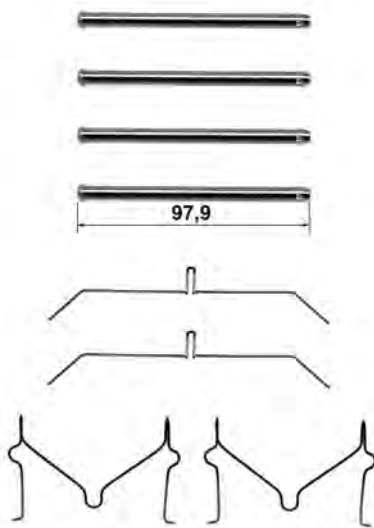
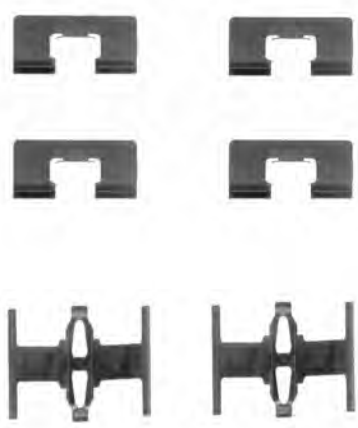



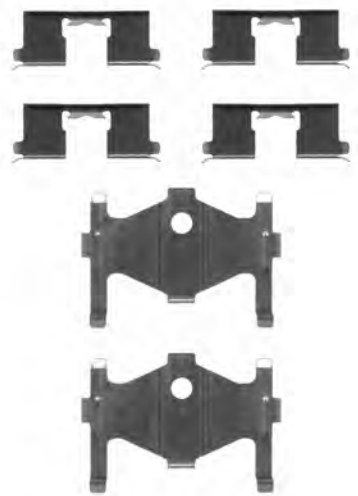

Illustrations brake pad installation kits - Ilustraciones juegos de montaje pastillas - Illustrations Lots de montage pour plaquettes de frein à disque - Illustrazioni kit installazione pastiglie freno

13.0460-0291.2 610291	13.0460-0295.2 610295	13.0460-0296.2 610296
		
13.0460-0308.2 610308	13.0460-0313.2 610313	13.0460-0322.2 610322
		
13.0460-0325.2 610325	13.0460-0327.2 610327	13.0460-0329.2 610329
		

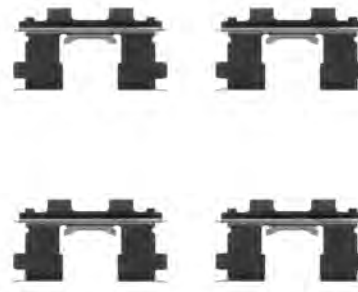



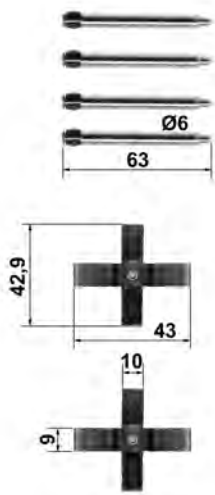

Abbildungen Bremsbelag-Einbausätze

Illustrations brake pad installation kits - Ilustraciones juegos de montaje pastillas - Illustrations Lots de montage pour plaquettes de frein à disque - Illustrazioni kit installazione pastiglie freno

13.0460-0332.2 610332	13.0460-0335.2 610335	13.0460-0336.2 610336
		
13.0460-0337.2 610337	13.0460-0339.2 610339	13.0460-0340.2 610340
		
13.0460-0341.2 610341	13.0460-0344.2 610344	13.0460-0347.2 610347
		

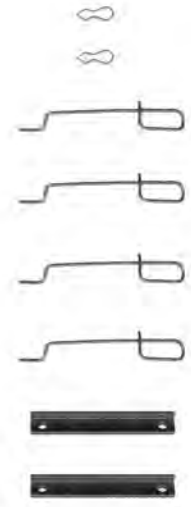
Abbildungen Bremsbelag-Einbausätze

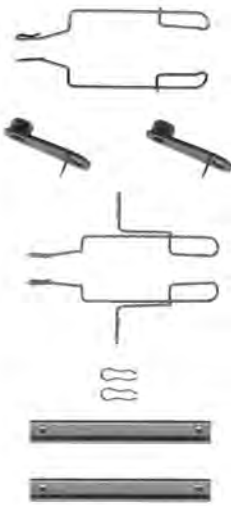
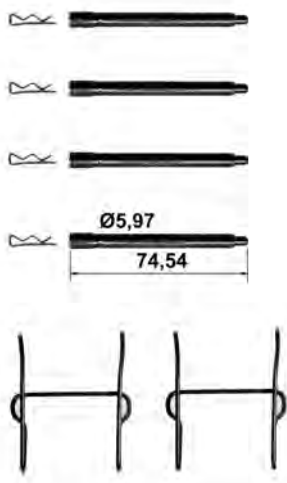
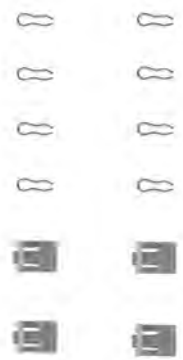
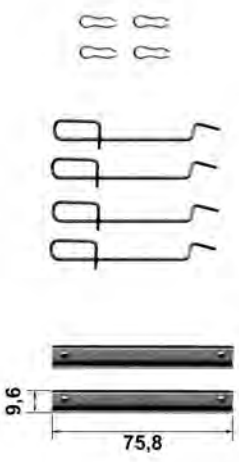
Illustrations brake pad installation kits - Ilustraciones juegos de montaje pastillas - Illustrations Lots de montage pour plaquettes de frein à disque - Illustrazioni kit installazione pastiglie freno

13.0460-0402.2 610402	13.0460-0403.2 610403	13.0460-0404.2 610404
		
13.0460-0406.2 610406	13.0460-0409.2 610409	13.0460-0410.2 610410
		
13.0460-0411.2 610411	13.0460-0412.2 610412	13.0460-0413.2 610413
		



Abbildungen Bremsbelag-Einbausätze

Illustrations brake pad installation kits - Ilustraciones juegos de montaje pastillas - Illustrations Lots de montage pour plaquettes de frein à disque - Illustrazioni kit installazione pastiglie freno

13.0460-0414.2 610414 13.0460-0415.2 610415 13.0460-0419.2 610419

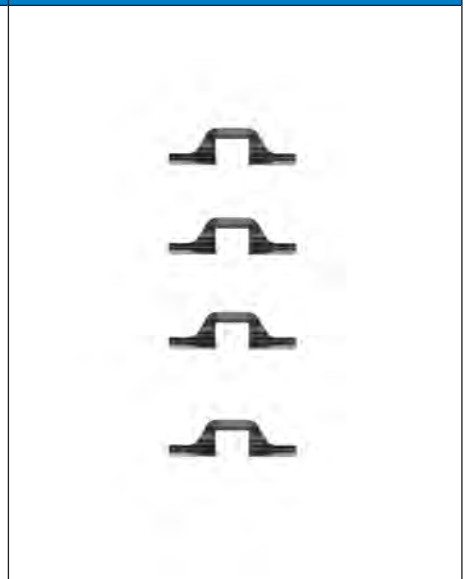
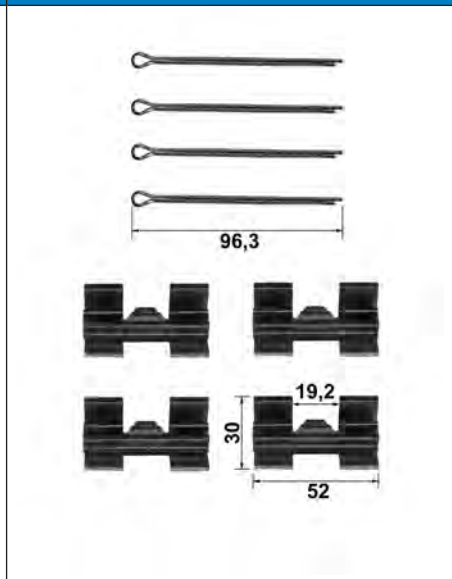
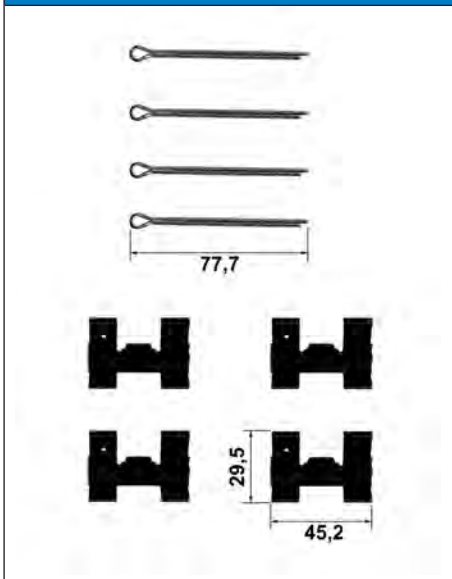

13.0460-0423.2 610423 13.0460-0424.2 610424 13.0460-0427.2 610427

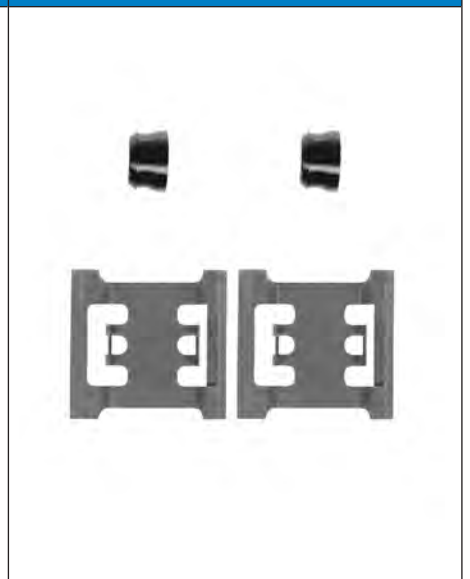
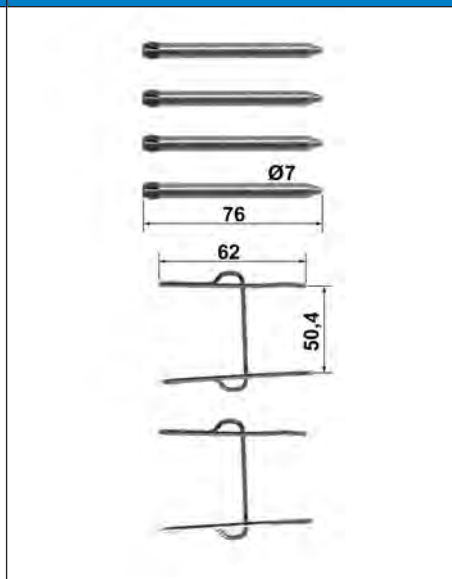
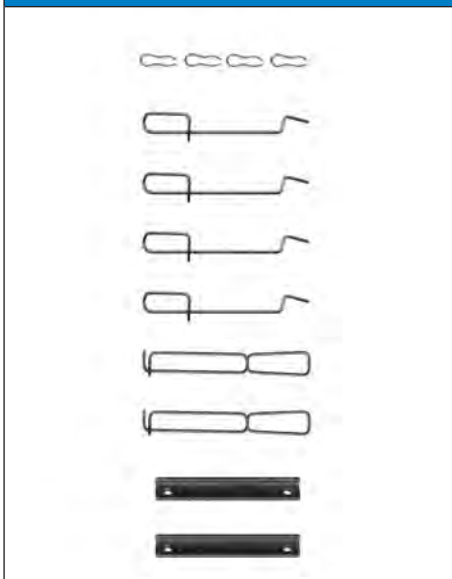

13.0460-0428.2 610428 13.0460-0429.2 610429 13.0460-0430.2 610430

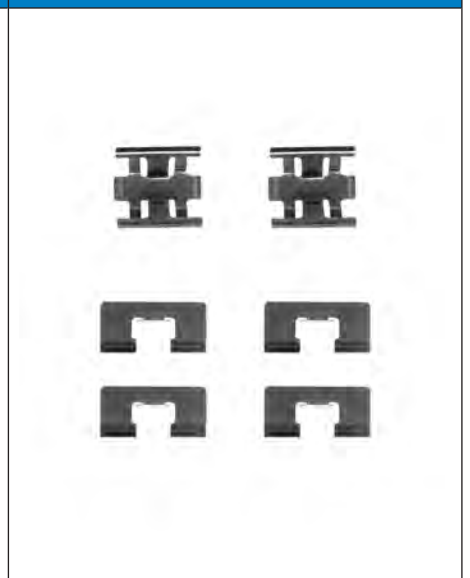
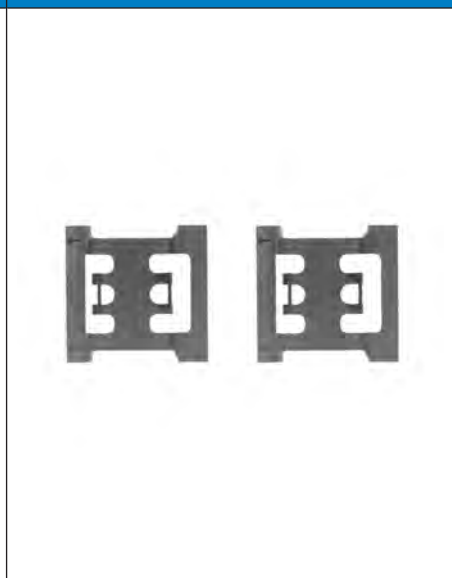

Abbildungen Bremsbelag-Einbausätze

Illustrations brake pad installation kits - Ilustraciones juegos de montaje pastillas - Illustrations Lots de montage pour plaquettes de frein à disque - Illustrazioni kit installazione pastiglie freno

13.0460-0434.2 610434 13.0460-0435.2 610435 13.0460-0436.2 610436

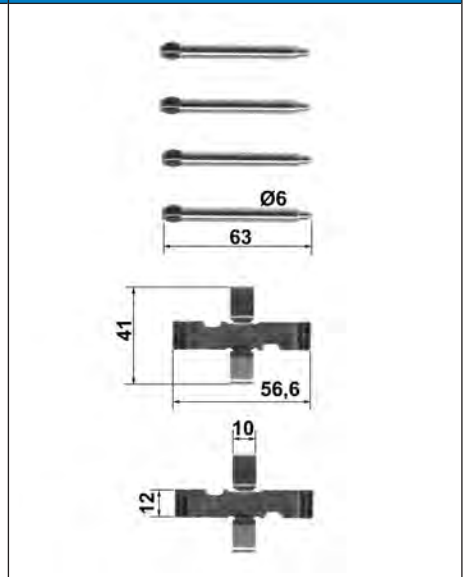
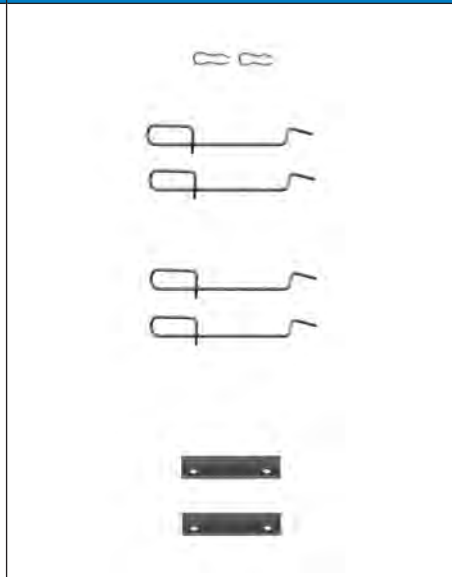
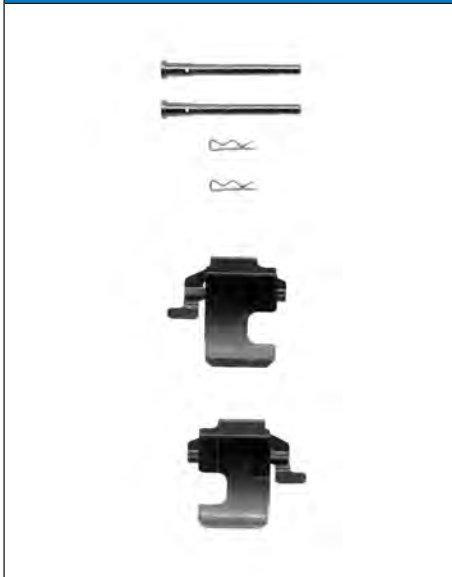

13.0460-0437.2 610437 13.0460-0438.2 610438 13.0460-0439.2 610439

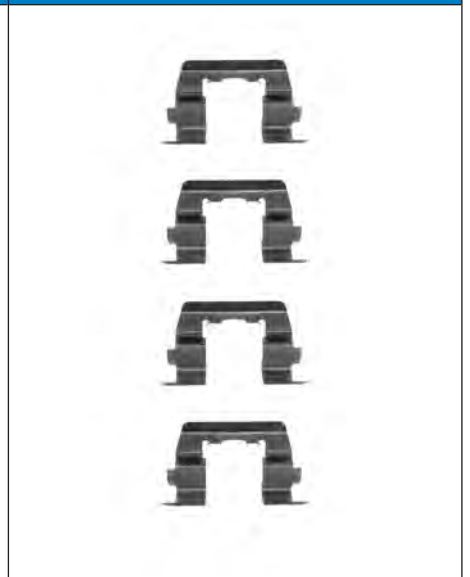
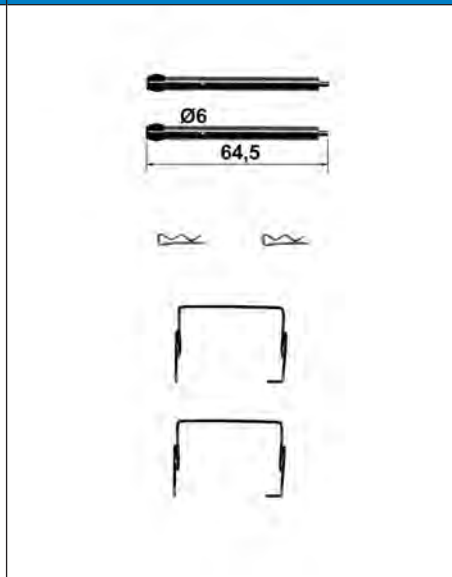
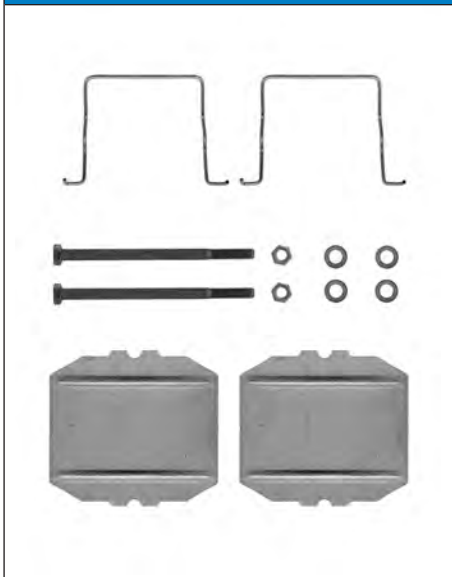



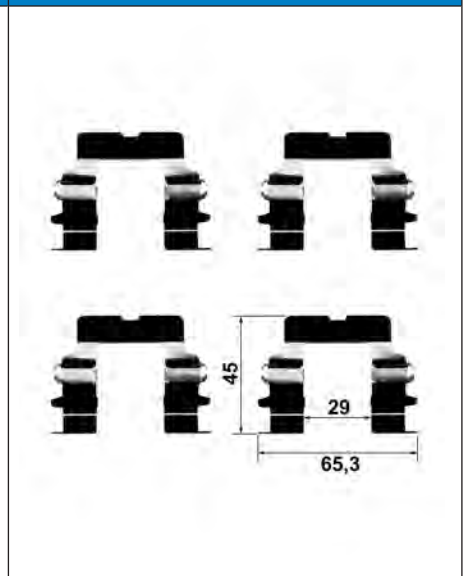



13.0460-0440.2 610440 13.0460-0441.2 610441 13.0460-0442.2 610442

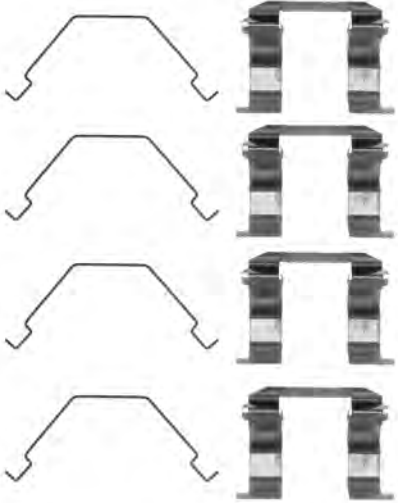

Abbildungen Bremsbelag-Einbausätze

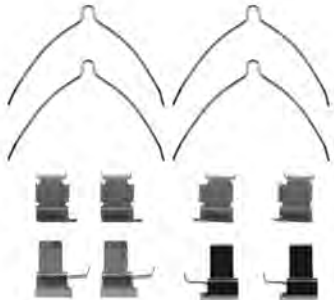
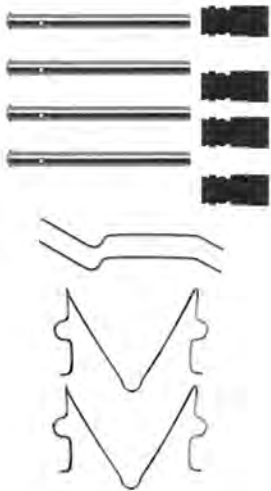
Illustrations brake pad installation kits - Ilustraciones juegos de montaje pastillas - Illustrations Lots de montage pour plaquettes de frein à disque - Illustrazioni kit installazione pastiglie freno

13.0460-0443.2 610443	13.0460-0446.2 610446	13.0460-0447.2 610447
		
13.0460-0448.2 610448	13.0460-0449.2 610449	13.0460-0450.2 610450
		
13.0460-0451.2 610451	13.0460-0452.2 610452	13.0460-0453.2 610453
		

Abbildungen Bremsbelag-Einbausätze

Illustrations brake pad installation kits - Ilustraciones juegos de montaje pastillas - Illustrations Lots de montage pour plaquettes de frein à disque - Illustrazioni kit installazione pastiglie freno

13.0460-0454.2

610454

13.0460-0918.2

610918

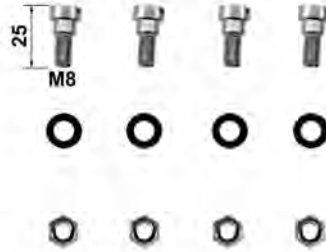



- DE** Abbildungen Warnkontakte
- EN** Illustrations wear indicators
- ES** Ilustraciones contactos de desgaste
- FR** Illustrations témoins d'usure
- IT** Illustrazioni rilevatori usura

2018



Abbildungen Warnkontakte

Pictures Warning Contacts - Fotos de advertencia Contactos - Photos Avertissement Contacts - Immagini di avvertimento Contatti

24.8190-0066.2 620066



Warnkontakt, Bremsbelagverschleiß

Scheibenbremse

L= 397,4

PORSCHE
CAYENNE (9PA)

24.8190-0067.2 620067



Warnkontakt, Bremsbelagverschleiß

Scheibenbremse

L= 92,5

MERCEDES-BENZ

A-CLASS (W176) / B-CLASS (W246, W242) / C-CLASS (W205) / C-CLASS Cabriolet (A205) / C-CLASS Coupe (C205) / C-CLASS T-Model (S205) / CLA Coupe (C117) / CLA Shooting Brake (X117) / E-CLASS (W213) / E-CLASS All-Terrain (S213) / E-CLASS Cabriolet (A238) / E-CLASS Coupe (C238) / E-CLASS T-Model (S213) / GLA-CLASS (X156) / GLC (X253) / GLC Coupe (C253)

24.8190-0068.2 620068



Warnkontakt, Bremsbelagverschleiß

Scheibenbremse

L= 332

AUDI

A7 Sportback (4GA, 4GF) / Q5 (8R)

24.8190-0069.2 620069



Warnkontakt, Bremsbelagverschleiß

Scheibenbremse

L= 248

PORSCHE

911 (991) / 911 Cabriolet (991) / 911 Targa (991) / BOXSTER (981) / CAYMAN (981)

24.8190-0070.2 620070



Warnkontakt, Bremsbelagverschleiß

Scheibenbremse

L= 268

PORSCHE

718 BOXSTER (982) / 718 CAYMAN (982) / BOXSTER (981) / CAYMAN (981)

Abbildungen Warnkontakte

Pictures Warning Contacts - Fotos de advertencia Contactos - Photos Avertissement Contacts - Immagini di avvertimento Contatti

24.8190-0071.2 620071



Warnkontakt, Bremsbelagverschleiß

Scheibenbremse

L= 945

BMW

X5 (E70) / X5 (F15, F85) / X6 (E71, E72) / X6 (F16, F86)

24.8190-0106.2 620106



Warnkontakt, Bremsbelagverschleiß

Scheibenbremse

L= 270

AUDI

TT (8N3) / TT Roadster (8N9)

VW

GOLF IV (1J1)

24.8190-0107.2 620107



Warnkontakt, Bremsbelagverschleiß

Scheibenbremse

L= 235

VW

PASSAT (3B3) / PASSAT Variant (3B6)

24.8190-0206.2 620206



Warnkontakt, Bremsbelagverschleiß

Scheibenbremse

L= 790

BMW

3 (E36) / 3 Cabriolet (E36) / 3 Coupe (E36) / 3 Touring (E36)

24.8190-0207.2 620207



Warnkontakt, Bremsbelagverschleiß

Scheibenbremse

L= 786

BMW

3 (E36) / 3 Cabriolet (E36) / 3 Compact (E36) / 3 Coupe (E36) / 3 Touring (E36) / Z3 Coupe (E36) / Z3 Roadster (E36)

Abbildungen Warnkontakte

Pictures Warning Contacts - Fotos de advertencia Contactos - Photos Avertissement Contacts - Immagini di avvertimento Contatti

24.8190-0208.2 620208



Warnkontakt, Bremsbelagverschleiß

Scheibenbremse

L= 569

BMW
7 (E38)

24.8190-0209.2 620209



Warnkontakt, Bremsbelagverschleiß

Scheibenbremse

L= 620

BMW
7 (E38)

24.8190-0210.2 620210



Warnkontakt, Bremsbelagverschleiß

Scheibenbremse

L= 810

BMW
3 (E36) / 3 Cabriolet (E36) / 3 Coupe (E36) / Z3 Coupe (E36) / Z3 Roadster (E36)

24.8190-0211.2 620211



Warnkontakt, Bremsbelagverschleiß

Scheibenbremse

L= 840

BMW
3 Compact (E36) / Z3 Coupe (E36) / Z3 Roadster (E36)

24.8190-0214.2 620214



Warnkontakt, Bremsbelagverschleiß

Scheibenbremse

L= 235

BMW
5 (E28) / 5 (E34) / 5 Touring (E34) / 6 (E24) / 7 (E32) / 8 (E31)

Abbildungen Warnkontakte

Pictures Warning Contacts - Fotos de advertencia Contactos - Photos Avertissement Contacts - Immagini di avvertimento Contatti

24.8190-0218.2 620218



Warnkontakt, Bremsbelagverschleiß

Scheibenbremse

L= 545

BMW
5 (E39) / Z8 Roadster (E52)

24.8190-0219.2 620219



Warnkontakt, Bremsbelagverschleiß

Scheibenbremse

L= 764

BMW
5 (E39) / 5 Touring (E39)

24.8190-0220.2 620220



Warnkontakt, Bremsbelagverschleiß

Scheibenbremse

L= 601

BMW
3 (E46) / 3 Cabriolet (E46) / 3 Compact (E46) / 3 Coupe (E46) / 3 Touring (E46) / Z4 Roadster (E85)

24.8190-0221.2 620221

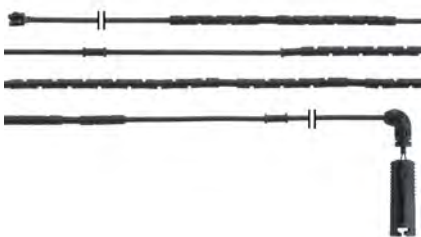

Warnkontakt, Bremsbelagverschleiß

Scheibenbremse

L= 1.338

BMW
3 (E46) / 3 Cabriolet (E46) / 3 Compact (E46) / 3 Coupe (E46) / 3 Touring (E46)

Abbildungen Warnkontakte

Pictures Warning Contacts - Fotos de advertencia Contactos - Photos Avertissement Contacts - Immagini di avvertimento Contatti

24.8190-0065.2 620065



Warnkontakt, Bremsbelagverschleiß

Scheibenbremse

L= 172

AUDI

A3 (8V1, 8VK) / A3 Limousine (8VS, 8VM) / A3 Sportback (8VA, 8VF) / Q2 (GA) / TT (FV3) / TT Roadster (FV9)

SEAT

ATECA (KH7) / LEON (5F1) / LEON SC (5F5) / LEON ST (5F8)

SKODA

KODIAQ (NS7) / SUPERB III (3V3) / SUPERB III Kombi (3V5)

VW

GOLF VII (5G1, BQ1, BE1, BE2) / GOLF VII Kombi (BA5, BV5) / PASSAT (3G2) / PASSAT ALLTRACK (3G5) / PASSAT Variant (3G5) / TIGUAN (AD1) / TOURAN (5T1)

24.8190-0223.2 620223



Warnkontakt, Bremsbelagverschleiß

Scheibenbremse

L= 261

BMW

8 (E31)

24.8190-0224.2 620224



Warnkontakt, Bremsbelagverschleiß

Scheibenbremse

L= 311

BMW

5 (E34) / 5 Touring (E34)

24.8190-0225.2 620225



Warnkontakt, Bremsbelagverschleiß

Scheibenbremse

L= 794

BMW

X5 (E53)

Abbildungen Warnkontakte

Pictures Warning Contacts - Fotos de advertencia Contactos - Photos Avertissement Contacts - Immagini di avvertimento Contatti

24.8190-0226.2 620226



Warnkontakt, Bremsbelagverschleiß

Scheibenbremse

L= 712

BMW
X5 (E53)

24.8190-0227.2 620227



Warnkontakt, Bremsbelagverschleiß

Scheibenbremse

L= 651

BMW
3 (E46) / 3 Cabriolet (E46) / 3 Coupe (E46) / 3 Touring (E46)

24.8190-0228.2 620228



Warnkontakt, Bremsbelagverschleiß

Scheibenbremse

L= 1.353

BMW
3 Cabriolet (E46) / 3 Coupe (E46)

24.8190-0229.2 620229



Warnkontakt, Bremsbelagverschleiß

Scheibenbremse

L= 1.143

BMW
Z4 Coupe (E86) / Z4 Roadster (E85)

24.8190-0230.2 620230

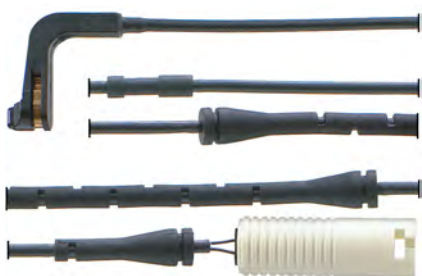

Warnkontakt, Bremsbelagverschleiß

Scheibenbremse

L= 814

BMW
7 (E65, E66, E67)

Abbildungen Warnkontakte

Pictures Warning Contacts - Fotos de advertencia Contactos - Photos Avertissement Contacts - Immagini di avvertimento Contatti

24.8190-0231.2 620231

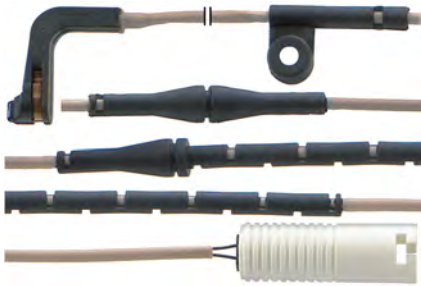

Warnkontakt, Bremsbelagverschleiß

Scheibenbremse

L= 830

BMW
7 (E65, E66, E67)

24.8190-0232.2 620232



Warnkontakt, Bremsbelagverschleiß

Scheibenbremse

L= 578

BMW
7 (E38)

24.8190-0233.2 620233



Warnkontakt, Bremsbelagverschleiß

Scheibenbremse

L= 758

BMW
Z8 Roadster (E52)

24.8190-0234.2 620234



Warnkontakt, Bremsbelagverschleiß

Scheibenbremse

L= 585

BMW
7 (E38)

24.8190-0235.2 620235



Warnkontakt, Bremsbelagverschleiß

Scheibenbremse

L= 883

MINI
MINI (R50, R53) / MINI Cabriolet (R52)

Abbildungen Warnkontakte

Pictures Warning Contacts - Fotos de advertencia Contactos - Photos Avertissement Contacts - Immagini di avvertimento Contatti

24.8190-0236.2 620236



Warnkontakt, Bremsbelagverschleiß

Scheibenbremse

L= 1.130

MINI

MINI (R50, R53) / MINI Cabriolet (R52)

24.8190-0240.2 620240



Warnkontakt, Bremsbelagverschleiß

Scheibenbremse

L= 735

BMW

X3 (E83)

24.8190-0241.2 620241



Warnkontakt, Bremsbelagverschleiß

Scheibenbremse

L= 1.055

BMW

X3 (E83)

24.8190-0244.2 620244



Warnkontakt, Bremsbelagverschleiß

Scheibenbremse

L= 611

BMW

Z4 Coupe (E86) / Z4 Roadster (E85)

24.8190-0245.2 620245

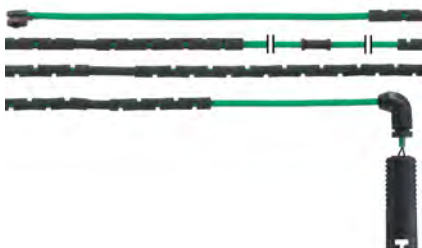

Warnkontakt, Bremsbelagverschleiß

Scheibenbremse

L= 1.163

BMW

Z4 Coupe (E86) / Z4 Roadster (E85)

Abbildungen Warnkontakte

Pictures Warning Contacts - Fotos de advertencia Contactos - Photos Avertissement Contacts - Immagini di avvertimento Contatti

24.8190-0254.2 620254



Warnkontakt, Bremsbelagverschleiß

Scheibenbremse

L= 745

BMW
X3 (E83)

24.8190-0028.2 620028



Warnkontakt, Bremsbelagverschleiß

Scheibenbremse

L= 977

BMW
X5 (E70) / X5 (F15, F85) / X6 (E71, E72) / X6 (F16, F86)

24.8190-0027.2 620027



Warnkontakt, Bremsbelagverschleiß

Scheibenbremse

L= 514,6

PORSCHE
911 Targa (997)

24.8190-0026.2 620026



Warnkontakt, Bremsbelagverschleiß

Scheibenbremse

L= 312

FORD
TOURNEO CUSTOM Bus / TRANSIT Bus / TRANSIT CUSTOM Bus / TRANSIT CUSTOM Kasten / TRANSIT Kasten / TRANSIT Pritsche/Fahrgestell

24.8190-0025.2 620025



Warnkontakt, Bremsbelagverschleiß

Scheibenbremse

L= 349,6

PORSCHE
911 (997) / BOXSTER (987) / BOXSTER Spyder (987) / CAYMAN (987)

Abbildungen Warnkontakte

Pictures Warning Contacts - Fotos de advertencia Contactos - Photos Avertissement Contacts - Immagini di avvertimento Contatti

24.8190-0024.2 620024



Warnkontakt, Bremsbelagverschleiß

Scheibenbremse

L= 369,6

PORSCHE

911 (997) / BOXSTER (987) / BOXSTER Spyder (987) / CAYMAN (987)

24.8190-0023.2 620023



Warnkontakt, Bremsbelagverschleiß

Scheibenbremse

L= 484,6

PORSCHE

911 (997) / 911 Cabriolet (997) / 911 Targa (997)

24.8190-0021.2 620021



Warnkontakt, Bremsbelagverschleiß

Scheibenbremse

L= 478

FORD

TOURNEO CUSTOM Bus / TRANSIT CUSTOM Bus / TRANSIT CUSTOM Kasten

24.8190-0020.2 620020



Warnkontakt, Bremsbelagverschleiß

Scheibenbremse

L= 443,3

AUDI

A6 (4G2, C7, 4GC) / A6 Avant (4G5, C7, 4GD) / A7 Sportback (4GA, 4GF) / A8 (4H_)

24.8190-0019.2 620019



Warnkontakt, Bremsbelagverschleiß

Scheibenbremse

L= 254

AUDI

A6 (4G2, C7, 4GC) / A6 Avant (4G5, C7, 4GD) / A7 Sportback (4GA, 4GF) / A8 (4H_)

Abbildungen Warnkontakte

Pictures Warning Contacts - Fotos de advertencia Contactos - Photos Avertissement Contacts - Immagini di avvertimento Contatti

24.8190-0018.2 620018



Warnkontakt, Bremsbelagverschleiß

Scheibenbremse

L= 755

OPEL

ASTRA G Cabriolet (F67) / ASTRA G Caravan (F35_) / ASTRA G CC (F48_, F08_) / ASTRA G Coupe (F07_) / ASTRA G Kasten (F70) / ASTRA G Stufenheck (F69_) / ZAFIRA A (F75_)

VAUXHALL

ASTRA Mk IV (G) CC / ASTRA Mk IV (G) Convertible / ASTRA Mk IV (G) Coupe (F67) / ASTRA Mk IV (G) Estate / ASTRA Mk IV (G) Sedan / ASTRAVAN Mk IV (G) / ZAFIRA Mk I (A) (F75)

24.8190-0017.2 620017



Warnkontakt, Bremsbelagverschleiß

Scheibenbremse

L= 388,3

AUDI

A4 Avant (8K5, B8) / A4 Cabriolet (8H7, B6, 8HE, B7) / A5 Cabriolet (8F7) / R8 (422, 423) / R8 Spyder (427, 429)

24.8190-0016.2 620016



Warnkontakt, Bremsbelagverschleiß

Scheibenbremse

L= 359,6

PORSCHE

911 (997) / 911 Cabriolet (997)

24.8190-0015.2 620015



Warnkontakt, Bremsbelagverschleiß

Scheibenbremse

L= 138

PORSCHE

CAYENNE (92A) / PANAMERA (970)

VW

TOUAREG (7P5)

24.8190-0014.2 620014



Warnkontakt, Bremsbelagverschleiß

Scheibenbremse

L= 296

PORSCHE

CAYENNE (92A) / PANAMERA (970)

VW

TOUAREG (7P5)

Abbildungen Warnkontakte

Pictures Warning Contacts - Fotos de advertencia Contactos - Photos Avertissement Contacts - Immagini di avvertimento Contatti

24.8190-0013.2 620013



Warnkontakt, Bremsbelagverschleiß

Scheibenbremse

L= 323

VW
TOUAREG (7P5)

24.8190-0012.2 620012



Warnkontakt, Bremsbelagverschleiß

Scheibenbremse

L= 272,4

AUDI
Q7 (4L)

24.8190-0011.2 620011



Warnkontakt, Bremsbelagverschleiß

Scheibenbremse

L= 362,5

AUDI
Q7 (4L)

24.8190-0010.2 620010



Warnkontakt, Bremsbelagverschleiß

Scheibenbremse

L= 1.141

MINI
MINI (R56) / MINI Cabriolet (R57) / MINI CLUBMAN (R55) / MINI CLUBVAN (R55) / MINI Coupe (R58) / MINI Roadster (R59)

24.8190-0009.2 620009



Warnkontakt, Bremsbelagverschleiß

Scheibenbremse

L= 808

MINI
MINI CLUBVAN (R55) / MINI Coupe (R58) / MINI Roadster (R59)

Abbildungen Warnkontakte

Pictures Warning Contacts - Fotos de advertencia Contactos - Photos Avertissement Contacts - Immagini di avvertimento Contatti

24.8190-0008.2 620008



Warnkontakt, Bremsbelagverschleiß

Scheibenbremse

L= 1.000

BMW

5 (F10) / 6 Cabriolet (F12) / 6 Coupe (F13) / 6 Gran Coupe (F06)

24.8190-0007.2 620007



Warnkontakt, Bremsbelagverschleiß

Scheibenbremse

L= 1.045

BMW

1 (F20) / 1 (F21) / 2 Cabriolet (F23) / 2 Coupe (F22, F87) / 3 (F30, F80) / 3 Gran Turismo (F34) / 3 Kombi (F31) / 4 Cabriolet (F33, F83) / 4 Coupe (F32, F82) / 4 Gran Coupe (F36)

24.8190-0006.2 620006



Warnkontakt, Bremsbelagverschleiß

Scheibenbremse

L= 675

BMW

1 (F20) / 1 (F21) / 2 Cabriolet (F23) / 2 Coupe (F22, F87) / 3 (F30, F80) / 3 Gran Turismo (F34) / 3 Kombi (F31) / 4 Cabriolet (F33, F83) / 4 Coupe (F32, F82) / 4 Gran Coupe (F36)

24.8190-0005.2 620005



Warnkontakt, Bremsbelagverschleiß

Scheibenbremse

L= 84

MERCEDES-BENZ

SPRINTER 4,6-t Kasten (906) / SPRINTER 4,6-t Pritsche/Fahrgestell (906) / SPRINTER 5-t Bus / SPRINTER 5-t Kasten (906) / SPRINTER 5-t Pritsche/Fahrgestell (906) / SPRINTER CLASSIC 4,6-t Bus (909)

VW

CRAFTER 30-35 Bus (2E_) / CRAFTER 30-50 Kasten (2E_) / CRAFTER 30-50 Pritsche/Fahrgestell (2F_)

24.8190-0222.2 620222



Warnkontakt, Bremsbelagverschleiß

Scheibenbremse

L= 1.090

BMW

5 Touring (E39)

Abbildungen Warnkontakte

Pictures Warning Contacts - Fotos de advertencia Contactos - Photos Avertissement Contacts - Immagini di avvertimento Contatti

24.8190-0260.2 620260



Warnkontakt, Bremsbelagverschleiß

Scheibenbremse

L= 1.060

BMW

5 Gran Turismo (F07) / 7 (F01, F02, F03, F04)

24.8190-0261.2 620261



Warnkontakt, Bremsbelagverschleiß

Scheibenbremse

L= 1.045

BMW

7 (F01, F02, F03, F04)

24.8190-0262.2 620262



Warnkontakt, Bremsbelagverschleiß

Scheibenbremse

L= 1.338

BMW

Z4 Roadster (E89)

24.8190-0263.2 620263



Warnkontakt, Bremsbelagverschleiß

Scheibenbremse

L= 969

BMW

Z4 Roadster (E89)

24.8190-0264.2 620264



Warnkontakt, Bremsbelagverschleiß

Scheibenbremse

L= 630

BMW

1 (E81) / 1 (E87) / 1 Cabriolet (E88) / 1 Coupe (E82) / 3 (E90) / 3 Cabriolet (E93) / 3 Coupe (E92) / 3 Touring (E91)

Abbildungen Warnkontakte

Pictures Warning Contacts - Fotos de advertencia Contactos - Photos Avertissement Contacts - Immagini di avvertimento Contatti

24.8190-0265.2 620265



Warnkontakt, Bremsbelagverschleiß

Scheibenbremse

L= 1.086

BMW

1 (E81) / 1 (E87) / 1 Cabriolet (E88) / 1 Coupe (E82) / 3 (E90) / 3 Cabriolet (E93) / 3 Coupe (E92) / 3 Touring (E91)

24.8190-0266.2 620266



Warnkontakt, Bremsbelagverschleiß

Scheibenbremse

L= 840

BMW

3 (E90) / 3 Coupe (E92) / 3 Touring (E91) / X1 (E84)

24.8190-0267.2 620267



Warnkontakt, Bremsbelagverschleiß

Scheibenbremse

L= 679

BMW

1 (E81) / 1 (E87) / 1 Cabriolet (E88) / 1 Coupe (E82) / 3 (E90) / 3 Cabriolet (E93) / 3 Coupe (E92) / 3 Touring (E91)

24.8190-0268.2 620268



Warnkontakt, Bremsbelagverschleiß

Scheibenbremse

L= 905

BMW

X5 (E70) / X6 (E71, E72)

24.8190-0269.2 620269



Warnkontakt, Bremsbelagverschleiß

Scheibenbremse

L= 965

BMW

X5 (E70) / X6 (E71, E72)

Abbildungen Warnkontakte

Pictures Warning Contacts - Fotos de advertencia Contactos - Photos Avertissement Contacts - Immagini di avvertimento Contatti

24.8190-0270.2 620270



Warnkontakt, Bremsbelagverschleiß

Scheibenbremse

L= 898

BMW
X5 (E70) / X6 (E71, E72)

24.8190-0271.2 620271



Warnkontakt, Bremsbelagverschleiß

Scheibenbremse

L= 659

BMW
1 Coupe (E82) / 3 (E90) / 3 Cabriolet (E93) / 3 Coupe (E92)

24.8190-0272.2 620272



Warnkontakt, Bremsbelagverschleiß

Scheibenbremse

L= 672

BMW
3 (E90) / 3 Cabriolet (E93) / 3 Coupe (E92)

24.8190-0273.2 620273



Warnkontakt, Bremsbelagverschleiß

Scheibenbremse

L= 662

BMW
5 (E60) / 5 Touring (E61) / 6 (E63) / 6 Cabriolet (E64)

24.8190-0274.2 620274



Warnkontakt, Bremsbelagverschleiß

Scheibenbremse

L= 664

BMW
5 (E60) / 6 (E63) / 6 Cabriolet (E64)

Abbildungen Warnkontakte

Pictures Warning Contacts - Fotos de advertencia Contactos - Photos Avertissement Contacts - Immagini di avvertimento Contatti

24.8190-0275.2 620275



Warnkontakt, Bremsbelagverschleiß

Scheibenbremse

L= 872

BMW
5 Touring (E61)

24.8190-0276.2 620276



Warnkontakt, Bremsbelagverschleiß

Scheibenbremse

L= 674

BMW
5 Touring (E61) / 6 (E63) / 6 Cabriolet (E64)

24.8190-0277.2 620277



Warnkontakt, Bremsbelagverschleiß

Scheibenbremse

L= 802

MINI
MINI (R56) / MINI Cabriolet (R57) / MINI CLUBMAN (R55)

24.8190-0278.2 620278



Warnkontakt, Bremsbelagverschleiß

Scheibenbremse

L= 1.130

MINI
MINI (R56) / MINI Cabriolet (R57) / MINI CLUBMAN (R55)

24.8190-0279.2 620279



Warnkontakt, Bremsbelagverschleiß

Scheibenbremse

L= 992

BMW
5 Touring (E61)

Abbildungen Warnkontakte

Pictures Warning Contacts - Fotos de advertencia Contactos - Photos Avertissement Contacts - Immagini di avvertimento Contatti

24.8190-0280.2 620280



Warnkontakt, Bremsbelagverschleiß

Scheibenbremse

L= 930

BMW
X6 (E71, E72)

24.8190-0281.2 620281



Warnkontakt, Bremsbelagverschleiß

Scheibenbremse

L= 962

BMW
X5 (E70) / X6 (E71, E72)

24.8190-0282.2 620282



Warnkontakt, Bremsbelagverschleiß

Scheibenbremse

L= 1.120

BMW
X1 (E84)

24.8190-0283.2 620283



Warnkontakt, Bremsbelagverschleiß

Scheibenbremse

L= 632

BMW
X1 (E84)

24.8190-0284.2 620284



Warnkontakt, Bremsbelagverschleiß

Scheibenbremse

L= 650

BMW
1 (E81) / 1 (E87) / 1 Cabriolet (E88) / 1 Coupe (E82) / 3 (E90) / 3 Cabriolet (E93) / 3 Coupe (E92) / 3 Touring (E91)

Abbildungen Warnkontakte

Pictures Warning Contacts - Fotos de advertencia Contactos - Photos Avertissement Contacts - Immagini di avvertimento Contatti

24.8190-0285.2 620285



Warnkontakt, Bremsbelagverschleiß

Scheibenbremse

L= 1.107

BMW

1 (E81) / 1 (E87) / 1 Cabriolet (E88) / 1 Coupe (E82) / 3 (E90) / 3 Cabriolet (E93) / 3 Coupe (E92) / 3 Touring (E91)

24.8190-0286.2 620286



Warnkontakt, Bremsbelagverschleiß

Scheibenbremse

L= 867

BMW

3 (E90) / 3 Coupe (E92) / 3 Touring (E91) / X1 (E84)

24.8190-0287.2 620287



Warnkontakt, Bremsbelagverschleiß

Scheibenbremse

L= 723

BMW

1 (E81) / 1 (E87) / 1 Cabriolet (E88) / 1 Coupe (E82) / 3 (E90) / 3 Cabriolet (E93) / 3 Coupe (E92) / 3 Touring (E91)

24.8190-0288.2 620288



Warnkontakt, Bremsbelagverschleiß

Scheibenbremse

L= 698

BMW

1 Cabriolet (E88)

24.8190-0289.2 620289



Warnkontakt, Bremsbelagverschleiß

Scheibenbremse

L= 938

BMW

X5 (E70) / X5 (F15, F85) / X6 (E71, E72) / X6 (F16, F86)

Abbildungen Warnkontakte

Pictures Warning Contacts - Fotos de advertencia Contactos - Photos Avertissement Contacts - Immagini di avvertimento Contatti

24.8190-0290.2 620290



Warnkontakt, Bremsbelagverschleiß

Scheibenbremse

L= 1.002

BMW

X5 (E70) / X5 (F15, F85) / X6 (E71, E72) / X6 (F16, F86)

24.8190-0291.2 620291



Warnkontakt, Bremsbelagverschleiß

Scheibenbremse

L= 974

BMW

X5 (E70) / X5 (F15, F85) / X6 (E71, E72) / X6 (F16, F86)

24.8190-0294.2 620294



Warnkontakt, Bremsbelagverschleiß

Scheibenbremse

L= 1.361

BMW

Z4 Roadster (E89)

24.8190-0295.2 620295



Warnkontakt, Bremsbelagverschleiß

Scheibenbremse

L= 1.013

BMW

Z4 Roadster (E89)

24.8190-0296.2 620296



Warnkontakt, Bremsbelagverschleiß

Scheibenbremse

L= 1.141

BMW

X1 (E84)

Abbildungen Warnkontakte

Pictures Warning Contacts - Fotos de advertencia Contactos - Photos Avertissement Contacts - Immagini di avvertimento Contatti

24.8190-0297.2 620297



Warnkontakt, Bremsbelagverschleiß

Scheibenbremse

L= 676

BMW
X1 (E84)

24.8190-0298.2 620298



Warnkontakt, Bremsbelagverschleiß

Scheibenbremse

L= 1.087

BMW
5 (F10) / 5 Gran Turismo (F07) / 5 Touring (F11) / 6 Cabriolet (F12) / 6 Coupe (F13) / 6 Gran Coupe (F06) / 7 (F01, F02, F03, F04)

24.8190-0299.2 620299



Warnkontakt, Bremsbelagverschleiß

Scheibenbremse

L= 1.065

BMW
7 (F01, F02, F03, F04)

24.8190-0300.2 620300



Warnkontakt, Bremsbelagverschleiß

Scheibenbremse

L= 1.054

BMW
5 Gran Turismo (F07)

24.8190-0301.2 620301



Warnkontakt, Bremsbelagverschleiß

Scheibenbremse

L= 311,6

AUDI
A6 (4G2, C7, 4GC) / A6 Allroad (4GH, 4GJ) / A6 Avant (4G5, C7, 4GD) / A7 Sportback (4GA, 4GF) / A8 (4H_) / Q5 (8R)

Abbildungen Warnkontakte

Pictures Warning Contacts - Fotos de advertencia Contactos - Photos Avertissement Contacts - Immagini di avvertimento Contatti

24.8190-0302.2 620302



Warnkontakt, Bremsbelagverschleiß

Scheibenbremse

L= 367,4

AUDI

A3 Sportback (8PA) / TT (8J3) / TT Roadster (8J9)

SEAT

LEON (5F1) / LEON SC (5F5) / LEON ST (5F8)

24.8190-0303.2 620303



Warnkontakt, Bremsbelagverschleiß

Scheibenbremse

L= 296,6

AUDI

A8 (4H_)

24.8190-0304.2 620304



Warnkontakt, Bremsbelagverschleiß

Scheibenbremse

L= 724

LAND ROVER

RANGE ROVER III (LM_)

24.8190-0305.2 620305



Warnkontakt, Bremsbelagverschleiß

Scheibenbremse

L= 1.158

LAND ROVER

RANGE ROVER III (LM_)

24.8190-0306.2 620306



Warnkontakt, Bremsbelagverschleiß

Scheibenbremse

L= 908

MINI

MINI COUNTRYMAN (R60) / MINI PACEMAN (R61)

Abbildungen Warnkontakte

Pictures Warning Contacts - Fotos de advertencia Contactos - Photos Avertissement Contacts - Immagini di avvertimento Contatti

24.8190-0307.2 620307



Warnkontakt, Bremsbelagverschleiß

Scheibenbremse

L= 957

MINI

MINI COUNTRYMAN (R60) / MINI PACEMAN (R61)

24.8190-0308.2 620308



Warnkontakt, Bremsbelagverschleiß

Scheibenbremse

L= 1.110

BMW

5 Touring (F11)

24.8190-0309.2 620309



Warnkontakt, Bremsbelagverschleiß

Scheibenbremse

L= 954

BMW

X3 (F25) / X4 (F26)

24.8190-0310.2 620310



Warnkontakt, Bremsbelagverschleiß

Scheibenbremse

L= 1.243

BMW

X3 (F25) / X4 (F26)

24.8190-0311.2 620311



Warnkontakt, Bremsbelagverschleiß

Scheibenbremse

L= 300

AUDI

A6 Allroad (4GH, 4GJ) / A6 Avant (4G5, C7, 4GD) / A7 Sportback (4GA, 4GF) / Q5 (8R)

Abbildungen Warnkontakte

Pictures Warning Contacts - Fotos de advertencia Contactos - Photos Avertissement Contacts - Immagini di avvertimento Contatti

24.8190-0312.2 620312



Warnkontakt, Bremsbelagverschleiß

Scheibenbremse

L= 915

BMW

5 (F10) / 6 Cabriolet (F12) / 6 Coupe (F13) / 6 Gran Coupe (F06)

24.8190-0313.2 620313



Warnkontakt, Bremsbelagverschleiß

Scheibenbremse

L= 217

AUDI

A6 (4G2, C7, 4GC) / A6 Allroad (4GH, 4GJ) / A6 Avant (4G5, C7, 4GD) / A7 Sportback (4GA, 4GF)

PORSCHE

MACAN (95B)

24.8190-0401.2 620401



Warnkontakt, Bremsbelagverschleiß

Scheibenbremse

L= 95

MERCEDES-BENZ

190 (W201) / A-CLASS (W168) / CABRIOLET (A124) / C-CLASS (W202) / C-CLASS Kombi (S202) / CLK (C208) / CLK Cabriolet (A208) / COUPE (C123) / COUPE (C124) / E-CLASS (W124) / E-CLASS (W210) / E-CLASS Cabriolet (A124) / E-CLASS Coupe (C124) / E-CLASS Kombi (S124) / E-CLASS Kombi (S210) / G-CLASS (W460) / KOMBI Kombi (S123) / KOMBI Kombi (S124) / SALOON (W123) / SALOON (W124) / S-CLASS (W116) / S-CLASS (W126) / S-CLASS (W140) / S-CLASS Coupe (C126) / S-CLASS Coupe (C140) / SL (R107) / SL (R129) / SL Coupe (C107) / SLK (R170) / T1/TN Kasten/Kombi / T1/TN Pritsche/Fahrgestell / T1 Bus (601) / T1 Bus (602) / T1 Kasten (601, 611) / T1 Kasten (602) / T1 Pritsche/Fahrgestell (601) / T1 Pritsche/Fahrgestell (602) / T2/LN1 Kasten/Kombi / T2/LN1 Kipper / T2/LN1 Pritsche/Fahrgestell

PUCH

G-MODELL (W 460)

24.8190-0402.2 620402



Warnkontakt, Bremsbelagverschleiß

Scheibenbremse

L= 68

L= 150

MERCEDES-BENZ

190 (W201) / COUPE (C124) / E-CLASS (W124) / E-CLASS Cabriolet (A124) / E-CLASS Coupe (C124) / E-CLASS Kombi (S124) / KOMBI Kombi (S124) / SALOON (W124)

Abbildungen Warnkontakte

Pictures Warning Contacts - Fotos de advertencia Contactos - Photos Avertissement Contacts - Immagini di avvertimento Contatti

24.8190-0406.2 620406



Warnkontakt, Bremsbelagverschleiß

Scheibenbremse

L= 261

MERCEDES-BENZ

G-CLASS (W460) / G-CLASS (W461) / G-CLASS (W463) / G-CLASS Cabrio (W463)

PUCH

G-MODELL (W 460) / G-MODELL (W 463)

24.8190-0407.2 620407



Warnkontakt, Bremsbelagverschleiß

Scheibenbremse

L= 84

L= 185

MERCEDES-BENZ

G-CLASS (W461) / G-CLASS (W463) / G-CLASS Cabrio (W463) / SPRINTER 2-t Bus (901, 902) / SPRINTER 2-t Kasten (901, 902) / SPRINTER 2-t Pritsche/Fahrgestell (901, 902) / SPRINTER 3-t Bus (903) / SPRINTER 3-t Kasten (903) / SPRINTER 3-t Pritsche/Fahrgestell (903) / V-CLASS (638/2) / VITO Bus (638) / VITO Kasten (638)

VW

LT 28-35 II Bus (2DB, 2DE, 2DK) / LT 28-46 II Kasten (2DA, 2DD, 2DH) / LT 28-46 II Pritsche/Fahrgestell (2DC, 2DF, 2DG, 2DL, 2DM)

24.8190-0410.2 620410



Warnkontakt, Bremsbelagverschleiß

Scheibenbremse

L= 97,5

MAYBACH

MAYBACH (240_)

MERCEDES-BENZ

A-CLASS (W169) / B-CLASS (W245) / C-CLASS (W203) / C-CLASS (W204) / C-CLASS (W205) / C-CLASS Coupe (C204) / C-CLASS Coupe (C205) / C-CLASS Coupe (CL203) / C-CLASS T-Model (S203) / C-CLASS T-Model (S204) / CLC-CLASS (CL203) / CLK (C209) / CLK Cabriolet (A209) / CLS (C218) / CLS (C219) / CLS Shooting Brake (X218) / E-CLASS (W211) / E-CLASS (W212) / E-CLASS Cabriolet (A207) / E-CLASS Coupe (C207) / E-CLASS T-Model (S211) / E-CLASS T-Model (S212) / GL-CLASS (X166) / GLE (W166) / GLE Coupe (C292) / GLK-CLASS (X204) / GLS (X166) / M-CLASS (W166) / S-CLASS (W220) / S-CLASS (W221) / S-CLASS (W222, V222, X222) / S-CLASS Cabriolet (A217) / S-CLASS Coupe (C215) / S-CLASS Coupe (C216) / S-CLASS Coupe (C217) / SL (R230) / SL (R231) / SLC (R172) / SLK (R171) / SLK (R172) / SLR (R199) / SLR Roadster (R199) / Vaneo (414)

24.8190-0411.2 620411



Warnkontakt, Bremsbelagverschleiß

Scheibenbremse

L= 72

MERCEDES-BENZ

G-CLASS (W463) / M-CLASS (W163)

PUCH

G-MODELL (W 463)

Abbildungen Warnkontakte

Pictures Warning Contacts - Fotos de advertencia Contactos - Photos Avertissement Contacts - Immagini di avvertimento Contatti

24.8190-0412.2 620412



Warnkontakt, Bremsbelagverschleiß

Scheibenbremse

L= 114

MERCEDES-BENZ
M-CLASS (W163)

24.8190-0415.2 620415

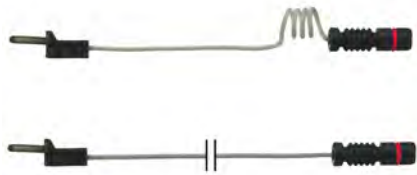

Warnkontakt, Bremsbelagverschleiß

Scheibenbremse

L= 238

L2= 148

MERCEDES-BENZ
SPRINTER 5-t Pritsche/Fahrgestell (905) / SPRINTER Kipper (905) / T2/LN1 Bus / T2/LN1 Kasten/Kombi / T2/LN1 Kipper / T2/LN1 Pritsche/Fahrgestell / VARIO Bus / VARIO Kasten/Kombi / VARIO Kipper / VARIO Pritsche/Fahrgestell / VARIO Triebkopf

24.8190-0416.2 620416



Warnkontakt, Bremsbelagverschleiß

Scheibenbremse

L= 100

MERCEDES-BENZ
CLK Cabriolet (A209) / CLS (C219) / E-CLASS (W211) / E-CLASS T-Model (S211) / S-CLASS (W220)

24.8190-0417.2 620417



Warnkontakt, Bremsbelagverschleiß

Scheibenbremse

L= 99

L= 167

MERCEDES-BENZ
SPRINTER 2-t Bus (901, 902) / SPRINTER 2-t Kasten (901, 902) / SPRINTER 2-t Pritsche/Fahrgestell (901, 902) / SPRINTER 3-t Bus (903) / SPRINTER 3-t Kasten (903) / SPRINTER 3-t Pritsche/Fahrgestell (903) / SPRINTER 4-t Bus (904) / SPRINTER 4-t Kasten (904) / SPRINTER 4-t Pritsche/Fahrgestell (904) / SPRINTER 5-t Pritsche/Fahrgestell (905) / SPRINTER Kipper (905) / V-CLASS (638/2) / VITO Bus (638) / VITO Kasten (638)

VW

LT 28-35 II Bus (2DB, 2DE, 2DK) / LT 28-46 II Kasten (2DA, 2DD, 2DH) / LT 28-46 II Pritsche/Fahrgestell (2DC, 2DF, 2DG, 2DL, 2DM)

Abbildungen Warnkontakte

Pictures Warning Contacts - Fotos de advertencia Contactos - Photos Avertissement Contacts - Immagini di avvertimento Contatti

24.8190-0418.2 620418



Warnkontakt, Bremsbelagverschleiß

Scheibenbremse

L= 95

MERCEDES-BENZ

SPRINTER 3,5-t Bus (906) / SPRINTER 3,5-t Kasten (906) / SPRINTER 3,5-t Pritsche/Fahrgestell (906) / SPRINTER 3-t Bus (906) / SPRINTER 3-t Kasten (906) / SPRINTER 3-t Pritsche/Fahrgestell (906) / SPRINTER CLASSIC 3,5-t Kasten (909) / VIANO (W639) / VITO / MIXTO Kasten (W639) / VITO Bus (W639)

VW

CRAFTER 30-35 Bus (2E_) / CRAFTER 30-50 Kasten (2E_) / CRAFTER 30-50 Pritsche/Fahrgestell (2F_)

24.8190-0419.2 620419



Warnkontakt, Bremsbelagverschleiß

Scheibenbremse

L= 74

MERCEDES-BENZ

C-CLASS (W202) / C-CLASS Kombi (S202) / CLK (C208) / CLK Cabriolet (A208) / E-CLASS (W210) / E-CLASS Kombi (S210) / SLK (R170)

24.8190-0420.2 620420



Warnkontakt, Bremsbelagverschleiß

Scheibenbremse

L= 119

MERCEDES-BENZ

C-CLASS (W204) / C-CLASS Coupe (C204) / C-CLASS Coupe (C205) / C-CLASS T-Model (S204) / CLK (C209) / CLK Cabriolet (A209) / CLS (C218) / CLS (C219) / CLS Shooting Brake (X218) / E-CLASS (W211) / E-CLASS (W212) / E-CLASS T-Model (S211) / E-CLASS T-Model (S212) / GL-CLASS (X166) / GLE (W166) / GLE Coupe (C292) / GLS (X166) / M-CLASS (W166) / S-CLASS (W221) / S-CLASS (W222, V222, X222) / S-CLASS Cabriolet (A217) / S-CLASS Coupe (C216) / S-CLASS Coupe (C217) / SL (R230) / SL (R231) / SLK (R171) / SLS AMG (C197) / SLS AMG Roadster (R197)

24.8190-0423.2 620423

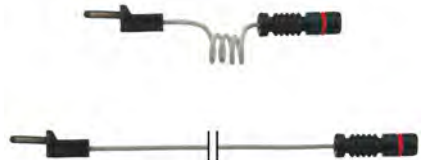

Warnkontakt, Bremsbelagverschleiß

Scheibenbremse

L= 199

L2= 144

MERCEDES-BENZ

SPRINTER 5-t Pritsche/Fahrgestell (905) / SPRINTER Kipper (905)

Abbildungen Warnkontakte

Pictures Warning Contacts - Fotos de advertencia Contactos - Photos Avertissement Contacts - Immagini di avvertimento Contatti

24.8190-0424.2 620424



Warnkontakt, Bremsbelagverschleiß

Scheibenbremse

L= 103,2

MERCEDES-BENZ

SPRINTER 3,5-t Bus (906) / SPRINTER 3,5-t Kasten (906) / SPRINTER 3,5-t Pritsche/Fahrgestell (906) / SPRINTER 3-t Bus (906) / SPRINTER 3-t Kasten (906) / SPRINTER 3-t Pritsche/Fahrgestell (906) / SPRINTER 4,6-t Kasten (906) / SPRINTER 4,6-t Pritsche/Fahrgestell (906) / SPRINTER 5-t Bus / SPRINTER 5-t Kasten (906) / SPRINTER 5-t Pritsche/Fahrgestell (906) / SPRINTER CLASSIC 3,5-t Kasten (909) / SPRINTER CLASSIC 4,6-t Bus (909) / V-CLASS (W447) / VIANO (W639) / VITO / MIXTO Kasten (W639) / VITO Bus (W639) / VITO Kasten (W447) / VITO Mixto (W447) / VITO Tourer (W447)

VW

CRAFTER 30-35 Bus (2E_) / CRAFTER 30-50 Kasten (2E_) / CRAFTER 30-50 Pritsche/Fahrgestell (2F_)

24.8190-0425.2 620425



Warnkontakt, Bremsbelagverschleiß

Scheibenbremse

L= 98

MERCEDES-BENZ

E-CLASS (W211) / E-CLASS T-Model (S211) / G-CLASS (W463) / GL-CLASS (X164) / GL-CLASS (X166) / GLE (W166) / GLE Coupe (C292) / GLS (X166) / M-CLASS (W164) / M-CLASS (W166) / R-CLASS (W251, V251) / S-CLASS (W220)

24.8190-0704.2 620704



Warnkontakt, Bremsbelagverschleiß

Scheibenbremse

L= 660

OPEL

VECTRA A (86_, 87_) / VECTRA A CC (88_, 89_)

VAUXHALL

CAVALIER Mk III (87) / CAVALIER Mk III CC

24.8190-0705.2 620705



Warnkontakt, Bremsbelagverschleiß

Scheibenbremse

L= 670

OPEL

ASTRA F (56_, 57_) / ASTRA F Cabriolet (53_B) / ASTRA F Caravan (51_, 52_) / ASTRA F CC (53_, 54_, 58_, 59_) / ASTRA F Van (55_) / CALIBRA A (85_) / VECTRA A (86_, 87_) / VECTRA A CC (88_, 89_)

VAUXHALL

ASTRA Mk III (F) / ASTRA Mk III (F) CC / ASTRA Mk III (F) Convertible / ASTRA Mk III (F) Estate / ASTRAVAN Mk III (F) / CALIBRA / CAVALIER Mk III (87) / CAVALIER Mk III CC

Abbildungen Warnkontakte

Pictures Warning Contacts - Fotos de advertencia Contactos - Photos Avertissement Contacts - Immagini di avvertimento Contatti

24.8190-0707.2 620707



Warnkontakt, Bremsbelagverschleiß

Scheibenbremse

L= 685

OPEL

ASTRA F (56_, 57_) / ASTRA F Cabriolet (53_B) / ASTRA F Caravan (51_, 52_) / ASTRA F CC (53_, 54_, 58_, 59_) / ASTRA F CLASSIC CC / ASTRA F CLASSIC Stufenheck / ASTRA F Van (55_) / CALIBRA A (85_) / VECTRA A (86_, 87_) / VECTRA A CC (88_, 89_)

VAUXHALL

ASTRA Mk III (F) / ASTRA Mk III (F) CC / ASTRA Mk III (F) Convertible / ASTRA Mk III (F) Estate / ASTRAVAN Mk III (F) / CALIBRA / CAVALIER Mk III (87) / CAVALIER Mk III CC

24.8190-0710.2 620710



Warnkontakt, Bremsbelagverschleiß

Scheibenbremse

L= 730

OPEL

OMEGA B (25_, 26_, 27_) / OMEGA B Caravan (21_, 22_, 23_)

VAUXHALL

OMEGA (B) / OMEGA (B) Estate

24.8190-0711.2 620711



Warnkontakt, Bremsbelagverschleiß

Scheibenbremse

L= 730

OPEL

OMEGA B (25_, 26_, 27_) / OMEGA B Caravan (21_, 22_, 23_)

VAUXHALL

OMEGA (B) / OMEGA (B) Estate

24.8190-0713.2 620713



Warnkontakt, Bremsbelagverschleiß

Scheibenbremse

L= 685

OPEL

CALIBRA A (85_)

VAUXHALL

CALIBRA

24.8190-0714.2 620714

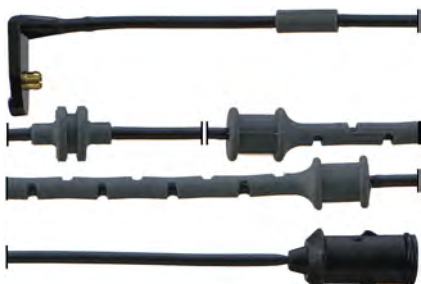

Warnkontakt, Bremsbelagverschleiß

Scheibenbremse

L= 660

OPEL

VECTRA B (36_) / VECTRA B Caravan (31_) / VECTRA B CC (38_)

VAUXHALL

VECTRA (B) / VECTRA (B) CC / VECTRA (B) Estate

Abbildungen Warnkontakte

Pictures Warning Contacts - Fotos de advertencia Contactos - Photos Avertissement Contacts - Immagini di avvertimento Contatti

24.8190-0715.2 620715



Warnkontakt, Bremsbelagverschleiß

Scheibenbremse

L= 660

OPEL

VECTRA B (36_) / VECTRA B Caravan (31_) / VECTRA B CC (38_)

VAUXHALL

VECTRA (B) / VECTRA (B) CC / VECTRA (B) Estate

24.8190-0718.2 620718



Warnkontakt, Bremsbelagverschleiß

Scheibenbremse

L= 720

OPEL

ASTRA G Cabriolet (F67) / ASTRA G Caravan (F35_) / ASTRA G CC (F48_, F08_) / ASTRA G Coupe (F07_) / ASTRA G Kasten (F70) / ASTRA G Stufenheck (F69_) / ZAFIRA A (F75_)

SAAB

9-3 (YS3D) / 9-3 Cabriolet (YS3D) / 9-5 (YS3E) / 9-5 Kombi (YS3E) / 900 II / 900 II Cabriolet / 900 II Coupe

VAUXHALL

ASTRA Mk IV (G) CC / ASTRA Mk IV (G) Convertible / ASTRA Mk IV (G) Coupe (F67) / ASTRA Mk IV (G) Estate / ASTRA Mk IV (G) Sedan / ASTRAVAN Mk IV (G) / ZAFIRA Mk I (A) (F75)

24.8190-0719.2 620719



Warnkontakt, Bremsbelagverschleiß

Scheibenbremse

L= 685,5

FIAT

CROMA (194_)

OPEL

SIGNUM / VECTRA C / VECTRA C Caravan / VECTRA C GTS

VAUXHALL

SIGNUM / VECTRA Mk II (C) / VECTRA Mk II (C) Estate / VECTRA Mk II (C) GTS

24.8190-0720.2 620720



Warnkontakt, Bremsbelagverschleiß

Scheibenbremse

L= 287

OPEL

ASTRA CLASSIC (L48) / ASTRA H (L48) / ASTRA H Caravan (L35) / ASTRA H GTC (L08) / ASTRA H Kasten (L70) / ASTRA H Stufenheck (L69) / ASTRA H TwinTop (L67) / SIGNUM / VECTRA C / VECTRA C Caravan / VECTRA C GTS / ZAFIRA B (A05) / ZAFIRA B Van

VAUXHALL

ASTRA Mk V (H) CC / ASTRA Mk V (H) Estate / ASTRA Mk V (H) Sport Hatch / ASTRA Mk V (H) TwinTop / ASTRAVAN Mk V (H) / SIGNUM / VECTRA Mk II (C) / VECTRA Mk II (C) Estate / VECTRA Mk II (C) GTS / ZAFIRA Mk II (B) (M75)

Abbildungen Warnkontakte

Pictures Warning Contacts - Fotos de advertencia Contactos - Photos Avertissement Contacts - Immagini di avvertimento Contatti

24.8190-0721.2 620721



Warnkontakt, Bremsbelagverschleiß

Scheibenbremse

L= 700

OPEL

SIGNUM / VECTRA C / VECTRA C Caravan / VECTRA C GTS

VAUXHALL

SIGNUM / VECTRA Mk II (C) / VECTRA Mk II (C) Estate / VECTRA Mk II (C) GTS

24.8190-0722.2 620722



Warnkontakt, Bremsbelagverschleiß

Scheibenbremse

L= 302

OPEL

SIGNUM / VECTRA C / VECTRA C Caravan / VECTRA C GTS

VAUXHALL

SIGNUM / VECTRA Mk II (C) / VECTRA Mk II (C) Estate / VECTRA Mk II (C) GTS

24.8190-0910.2 620910



Warnkontakt, Bremsbelagverschleiß

Scheibenbremse

L= 515

PORSCHE

928

24.8190-0916.2 620916



Warnkontakt, Bremsbelagverschleiß

Scheibenbremse

L= 395

PORSCHE

944 / 944 Cabriolet / 968 / 968 Cabriolet

24.8190-0917.2 620917



Warnkontakt, Bremsbelagverschleiß

Scheibenbremse

L= 518

PORSCHE

911 (964) / 911 (993) / 911 Cabriolet (964) / 911 Cabriolet (993) / 911 Speedster (964) / 911 Targa (964) / 911 Targa (993)

Abbildungen Warnkontakte

Pictures Warning Contacts - Fotos de advertencia Contactos - Photos Avertissement Contacts - Immagini di avvertimento Contatti

24.8190-0919.2 620919



Warnkontakt, Bremsbelagverschleiß

Scheibenbremse

L= 638

PORSCHE
928

24.8190-0920.2 620920



Warnkontakt, Bremsbelagverschleiß

Scheibenbremse

L= 698

PORSCHE
911 (993) / 911 Cabriolet (993) / 911 Targa (993)

24.8190-0921.2 620921



Warnkontakt, Bremsbelagverschleiß

Scheibenbremse

L= 440

PORSCHE
911 (996) / 911 (997) / 911 Cabriolet (996) / 911 Cabriolet (997) / 911 Targa (996) / BOXSTER (986)

24.8190-0949.2 620949



Warnkontakt, Bremsbelagverschleiß

Scheibenbremse

L= 1.228

LAND ROVER
RANGE ROVER SPORT (LS_)

24.8190-0950.2 620950



Warnkontakt, Bremsbelagverschleiß

Scheibenbremse

L= 525

PORSCHE
911 (997) / 911 Cabriolet (997) / 911 Targa (997)

Abbildungen Warnkontakte

Pictures Warning Contacts - Fotos de advertencia Contactos - Photos Avertissement Contacts - Immagini di avvertimento Contatti

24.8190-1302.2 621302



Warnkontakt, Bremsbelagverschleiß

Scheibenbremse

L= 276

DAIMLER
XJ 40, 81

JAGUAR

XJ (X300_, X330_) / XJ (XJ40_) / XJ Coupe / XJSC Convertible / XK 8 Convertible (X100_, QDV_) / XK 8 Coupe (X100_, QEV_)

24.8190-1304.2 621304



Warnkontakt, Bremsbelagverschleiß

Scheibenbremse

L= 289

IVECO

DAILY II Kasten/Kombi / DAILY II Kipper / DAILY II Pritsche/Fahrgestell / DAILY III Kasten/Kombi / DAILY III Pritsche/Fahrgestell

24.8190-1305.2 621305



Warnkontakt, Bremsbelagverschleiß

Scheibenbremse

L= 1.147

LAND ROVER

DISCOVERY III (LA_)

24.8190-1306.2 621306



Warnkontakt, Bremsbelagverschleiß

Scheibenbremse

L= 1.156

LAND ROVER

DISCOVERY III (LA_) / DISCOVERY IV (LA_) / RANGE ROVER SPORT (LS_)

24.8190-1307.2 621307



Warnkontakt, Bremsbelagverschleiß

Scheibenbremse

L= 1.185

LAND ROVER

RANGE ROVER SPORT (LS_)

Abbildungen Warnkontakte

Pictures Warning Contacts - Fotos de advertencia Contactos - Photos Avertissement Contacts - Immagini di avvertimento Contatti

24.8190-1308.2 621308



Warnkontakt, Bremsbelagverschleiß

Scheibenbremse

L= 1.118

LAND ROVER
RANGE ROVER III (LM_)

24.8190-2801.2 622801



Warnkontakt, Bremsbelagverschleiß

Scheibenbremse

L= 1.103

MG
MG ZT / MG ZT- T

ROVER
75 (RJ) / 75 Tourer (RJ)

24.8190-2802.2 622802



Warnkontakt, Bremsbelagverschleiß

Scheibenbremse

L= 846

MG
MG ZT / MG ZT- T

ROVER
75 (RJ) / 75 Tourer (RJ)

24.8190-0948.2 620948



Warnkontakt, Bremsbelagverschleiß

Scheibenbremse

L= 1.212

LAND ROVER
RANGE ROVER SPORT (LS_)

24.8190-0946.2 620946



Warnkontakt, Bremsbelagverschleiß

Scheibenbremse

L= 1.175

LAND ROVER
DISCOVERY III (LA_) / DISCOVERY IV (LA_)

Abbildungen Warnkontakte

Pictures Warning Contacts - Fotos de advertencia Contactos - Photos Avertissement Contacts - Immagini di avvertimento Contatti

24.8190-0945.2 620945



Warnkontakt, Bremsbelagverschleiß

Scheibenbremse

L= 1.227

LAND ROVER
RANGE ROVER SPORT (LS_)

24.8190-0944.2 620944



Warnkontakt, Bremsbelagverschleiß

Scheibenbremse

L= 841,5

LAND ROVER
RANGE ROVER III (LM_)

24.8190-0943.2 620943



Warnkontakt, Bremsbelagverschleiß

Scheibenbremse

L= 504,6

PORSCHE
911 (997) / 911 Cabriolet (997)

24.8190-0942.2 620942



Warnkontakt, Bremsbelagverschleiß

Scheibenbremse

L= 641

BMW
2 Active Tourer (F45) / 2 Gran Tourer (F46) / X1 (F48)

MINI
MINI (F55) / MINI (F56) / MINI Cabriolet (F57) / MINI CLUBMAN (F54) / MINI COUNTRYMAN (F60)

24.8190-0941.2 620941



Warnkontakt, Bremsbelagverschleiß

Scheibenbremse

L= 648

MINI
MINI (F55) / MINI (F56) / MINI Cabriolet (F57)

Abbildungen Warnkontakte

Pictures Warning Contacts - Fotos de advertencia Contactos - Photos Avertissement Contacts - Immagini di avvertimento Contatti

24.8190-0940.2 620940



Warnkontakt, Bremsbelagverschleiß

Scheibenbremse

L= 227,4

PORSCHE
CAYENNE (92A) / PANAMERA (970)

24.8190-0939.2 620939



Warnkontakt, Bremsbelagverschleiß

Scheibenbremse

L= 372,4

PORSCHE
CAYENNE (92A) / PANAMERA (970)

24.8190-0938.2 620938



Warnkontakt, Bremsbelagverschleiß

Scheibenbremse

L= 495

PORSCHE
911 (997) / 911 Cabriolet (997) / CARRERA GT (980)

24.8190-0937.2 620937



Warnkontakt, Bremsbelagverschleiß

Scheibenbremse

L= 247,4

AUDI
Q7 (4L)
PORSCHE
CAYENNE (9PA)

24.8190-0936.2 620936



Warnkontakt, Bremsbelagverschleiß

Scheibenbremse

L= 367,4

PORSCHE
CAYENNE (9PA)
VW
TOUAREG (7LA, 7L6, 7L7)

Abbildungen Warnkontakte

Pictures Warning Contacts - Fotos de advertencia Contactos - Photos Avertissement Contacts - Immagini di avvertimento Contatti

24.8190-0935.2 620935



Warnkontakt, Bremsbelagverschleiß

Scheibenbremse

L= 315

PORSCHE
CAYMAN (987)

24.8190-0934.2 620934



Warnkontakt, Bremsbelagverschleiß

Scheibenbremse

L= 295

PORSCHE
BOXSTER (987) / CAYMAN (987)

24.8190-0933.2 620933



Warnkontakt, Bremsbelagverschleiß

Scheibenbremse

L= 305

PORSCHE
911 (997) / 911 Cabriolet (997) / BOXSTER (987) / CAYMAN (987)

24.8190-0932.2 620932



Warnkontakt, Bremsbelagverschleiß

Scheibenbremse

L= 461

PORSCHE
BOXSTER (987) / CAYMAN (987)

24.8190-0931.2 620931



Warnkontakt, Bremsbelagverschleiß

Scheibenbremse

L= 336

PORSCHE
911 (997) / 911 Cabriolet (997)

Abbildungen Warnkontakte

Pictures Warning Contacts - Fotos de advertencia Contactos - Photos Avertissement Contacts - Immagini di avvertimento Contatti

24.8190-0930.2 620930



Warnkontakt, Bremsbelagverschleiß

Scheibenbremse

L= 252,4

AUDI
Q7 (4L)

PORSCHE
CAYENNE (9PA)

VW
TOUAREG (7LA, 7L6, 7L7)

24.8190-0929.2 620929



Warnkontakt, Bremsbelagverschleiß

Scheibenbremse

L= 417,4

AUDI
Q7 (4L)

PORSCHE
CAYENNE (9PA)

VW
TOUAREG (7LA, 7L6, 7L7)

24.8190-0926.2 620926



Warnkontakt, Bremsbelagverschleiß

Scheibenbremse

L= 475

PORSCHE
911 (964) / 911 (993) / 911 Cabriolet (993)

24.8190-0925.2 620925



Warnkontakt, Bremsbelagverschleiß

Scheibenbremse

L= 265

PORSCHE
928

Abbildungen Warnkontakte

Pictures Warning Contacts - Fotos de advertencia Contactos - Photos Avertissement Contacts - Immagini di avvertimento Contatti

24.8190-0922.2 620922



Warnkontakt, Bremsbelagverschleiß

Scheibenbremse

L= 440

PORSCHE

BOXSTER (986) / BOXSTER (987) / BOXSTER Spyder (987) / CAYMAN (987)



DE Abmessungen Bremsscheiben

EN Dimensions brake discs

ES Medidas disco de freno

FR Dimensions Disques de frein

IT Misure dischi freno

2018



Abmessungen Bremsscheiben

Dimensions brake discs - Medidas disco de freno - Dimensions Disques de frein - Misure dischi freno

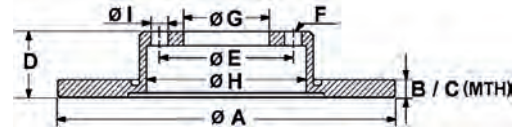

S Fixierschraube - fixing screw - tornillo quefija - vis de fixation - vite di riparazione
 B beschichtet - coated - recubierto - revêtu - rivestito
 HC hochgekohlt - high carbon - altamente carbonizado - à haute teneur en carbone - ad alto tenore di carbonio

L legiert - alloyed - aleado - allié - alligato/legato
 V ventiliert - ventilated - ventilado - ventilé - ventilato
 * gelocht - perforated - perforado - poinçonné - perforato

		S	B	HC L	V	A	B	C	D	E	F	G	H	I
24.0107-0108.1	407108					234	7	6	39,5	100	4	68	140	12,8
24.0107-0109.1	407109		B			240	7	6	41	100	4	61	140	12,6
24.0108-0104.1	408104	+ S	B			238	8,2	7	41	100	4	61	129,5	12,4
24.0108-0105.1	408105					247,5	8	6,5	20,3	108	4	71	133	13
24.0108-0106.1	408106	+ S	B			247	8	6	25,3	108	4	71,1	133,5	13
24.0108-0107.1	408107	+ S	B			238	8	6	29	98	3	57	124,5	13
24.0108-0108.1	408108		B			238	8	7	74,6	100	4	52	52,3	M12x1,5
24.0108-0109.1	408109					238	8	7	74,6	100	4	68		M12x1,5
24.0108-0111.1	408111		B			258	8	7	55,3	112	5	67	164	13
24.0108-0113.1	408113	+ S	B			258	8	7	57,3	112	5	67	164	15
24.0108-0114.2	408114		B			240	8	7	80,6	100	4	52,3	55	M12x1,5
24.0108-0116.2	408116		B			260	8	7	86,2	114,3	5	52,3	55	M12x1,5
24.0108-0117.2	408117		B			238	8	7	74,6	100	4	52,3	52	M12x1,5
24.0108-0118.2	408118		B			260	8	7	86,2	114,3	5	52,3	62	M12x1,5
24.0109-0100.2	409100		B			249	9	7	69,2	108	4	56	62	M12x1,25
24.0109-0103.1	409103		B			278	9	7,3	58,5	112	5	67	164	15
24.0109-0108.1	409108					244,5	9	7	43,8	86	3	62	109	10
24.0109-0111.1	409111	+ S	B			239	9	8	47,6	100	4	61	155	13
24.0109-0114.1	409114	+ S	B			278	9	7,3	55,5	112	5	67	164	13,2
24.0109-0120.1	409120	+ S	B			258	9	7,3	55,5	112	5	67	164	12,8
24.0109-0121.2	409121					224	9	8	63,2	108	5	71	135	13
24.0109-0122.1	409122		B			224	9	7	57,5	108	4	71,1	132,7	13
24.0109-0123.1	409123	+ S	B			230	9	7	40,6	100	5	65	125,8	15,6
24.0109-0124.1	409124		B			232	9	7	39,5	100	4	65	125	13,6
24.0109-0125.1	409125					228	9	8	39,5	100	4	60	127	13,5
24.0109-0127.1	409127					231	9	8	34,5	100	4	65	125	13
24.0109-0129.1	409129					258	9	8	44,5	114,3	4	68	154	12,8
24.0109-0130.1	409130					258	9	7,5	43,5	108	4	68	160,7	15,5
24.0109-0131.1	409131		B			251	9	8	34,5	100	4	55	125	13
24.0109-0132.1	409132					282	9	7,5	61	114,3	5	70	170	12,6
24.0109-0133.1	409133	+ S	B			239	8,9	7	33,4	100	5	65	132,5	15,8
24.0109-0137.1	409137	+ S	B			247	9	8	35	108	4	71,1	133	13
24.0109-0138.1	409138		B			258	9	8	55,5	100	4	55	172	14,5
24.0109-0139.1	409139		B			269	9	8	56	100	4	55	173	14,5
24.0109-0140.1	409140		B			279	9	8	55,5	100	4	55	172	14,5
24.0109-0141.1	409141	+ S				260	9	8	42,3	114,3	4	64,1	157	12,6
24.0109-0142.1	409142		B			278	9	7	24,7	100	4	55	147	14,3
24.0109-0143.1	409143	+ S				260	9	8	48,2	100	4	61	156	13
24.0109-0144.1	409144	+ S	B			282	9	8	58,3	114,3	5	64,1	170	12,5
24.0109-0145.1	409145					260	9	8	48,1	114,3	4	64,1	157	12,6
24.0109-0146.1	409146		B			270	9	7,3	53,3	100	5	57,5	172	14,5
24.0109-0147.1	409147					258	9	8	46,5	114,3	5	68	154	12,5
24.0109-0148.1	409148					269	9	8	65	100	5	55	170	14,5
24.0109-0150.2	409150		B			249	9	8	67,1	108	4	55,9	60	M12x1,25
24.0109-0151.1	409151	+ S	B			304,5	9	7,5	61	114,3	5	64,1	200	12,8
24.0109-0152.1	409152		B			303	9	8	62,1	114,3	5	62	190	14,5
24.0109-0154.1	409154	+ S	B			278	9	7,3	57,5	112	5	67	164	15
24.0109-0155.1	409155		B			259	9	7,5	30,5	114,3	5	62	156	14,8
24.0109-0156.1	409156		B			259	9	7,5	30,3	100	4	55	156	14,5
24.0109-0157.1	409157		B			291,5	9	8	62	114,3	5	68	172	12,7
24.0109-0158.1	409158	+ S	B			260	9	8	42,2	114,3	5	64,2	140,5	12,6
24.0109-0159.1	409159		B			266	9	8	36,2	100	4	55	131	14,5
24.0109-0160.1	409160		B			278	9	8	43,1	114,3	5	62	169	12,7
24.0109-0161.1	409161		B			282	9	7,5	61,1	114,3	5	64,2	170	12,6
24.0109-0162.1	409162	+ S	B			260	9	8	31,1	100	4	61	142,4	12,6
24.0109-0163.1	409163		B			259	9	7,5	30,2	100	5	55	156,2	14,5
24.0109-0166.1	409166		B			292	9	8	62	114,3	4	68	172	12,5
24.0109-0167.1	409167		B			278	9	8	43,2	114,3	5	62	169	14
24.0109-0168.1	409168	+ S	B			239	9	8	47,7	100	4	61	151,1	13
24.0109-0169.1	409169	+ S	B			282	9	8	48,7	114,3	5	64,2	157	12,5
24.0109-0170.1	409170		B			259	9	7,5	40,8	100	5	55	156	16,5
24.0109-0171.2	409171		B			249	9	8	73,2	108	4	56	62	M12x1,25
24.0109-0173.1	409173	+ S	B	HC L		276	9	7,3	44	112	5	67	153	15
24.0109-0174.1	409174	+ S	B			232	9	7	39,6	100	5	65	123,8	15,6
24.0109-0175.1	409175		B			259	9	8	43,2	100	4	62	150	14
24.0109-0178.1	409178		B			239	9	8	33,2	100	4	61	148	12,6
24.0109-0181.1	409181		B			265	9	7	39	114,3	5	68	143	13
24.0109-0182.1	409182		B			259,4	9	8	43,2	114,3	5	62	146,6	14
24.0109-0709.1	409709					260	9	8	48,1	114,3	5	64,1	157	12,6



Abmessungen Bremsscheiben

Dimensions brake discs - Medidas disco de freno - Dimensions Disques de frein - Misure dischi freno

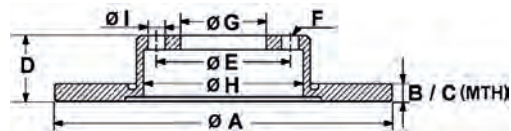

S Fixierschraube - fixing screw - tornillo quefija - vis de fixation - vite di riparazione
 B beschichtet - coated - recubierto - revêtu - rivestito
 HC hochgekohlt - high carbon - altamente carbonizado - à haute teneur en carbone - ad alto tenore di carbonio

L legiert - alloyed - aleado - allié - alligato/legato
 V ventiliert - ventilated - ventilado - ventilé - ventilato
 * gelocht - perforated - perforado - poinçonné - perforato

		S	B	HC	L	V	A	B	C	D	E	F	G	H	I
24.0109-0711.1	409711		B				269	9	7,5	56	100	5	55	173	14,5
24.0110-0111.1	410111		B				226	10	8	71,2	100	4	39,8	121,4	M12x1,5
24.0110-0115.1	410115		B				253	10,2	8,9	33	108	4	63,5	155	13,7
24.0110-0116.1	410116		B				245	10	8	46,5	112	5	68	135,5	15,4
24.0110-0117.1	410117	+ S	B	HC			300	10	8,4	61	120	5	75	180	14,5
24.0110-0136.1	410136						215	10	8	33	102	4	86	106	M10x1,25
24.0110-0144.1	410144						261	9,9	8	82,1	100	4	39,8	160	M12x1,5
24.0110-0151.1	410151	+ S	B				239	10	8	38,9	100	4	65	124,5	13,6
24.0110-0178.1	410178		B				245	10	8	59,5	108	4	68	135,8	15,4
24.0110-0182.1	410182		B				245	10	8	40,1	108	4	68	135,5	15,4
24.0110-0183.1	410183						266	10	8	27	108	4	66	133,2	13
24.0110-0187.1	410187	+ S	B				247	10	9	34,2	108	4	66	133	13
24.0110-0189.1	410189		B				281	9,6	8,4	73,2	108	5	68	160	16,5
24.0110-0190.1	410190		B				251,5	10	9	50,7	98	4	59	127,5	13
24.0110-0192.1	410192						289,8	10	9	46	140	5	107	177	13
24.0110-0196.1	410196		B				239,7	10	8	43	108	4	63,6	136	13,8
24.0110-0199.1	410199						247	10	8	34,3	108	4	71	133	13
24.0110-0201.1	410201		B				245	10	8	64,2	112	5	68	135,5	15,4
24.0110-0202.1	410202	+ S	B	HC			280	10	8,4	60	120	5	75	160,8	14,5
24.0110-0203.1	410203		B				226	10	8	71,2	100	5			M14x1,5
24.0110-0204.1	410204		B				260	10	8	69,2	100	4	57	160	14
24.0110-0205.1	410205		B				270	9,9	8	77	100	4	57	160	14
24.0110-0206.1	410206						265	10	8	53	108	5	68	160	16
24.0110-0209.1	410209		B				251,4	10	9	50,5	98	5	59	127,5	13
24.0110-0210.1	410210		B				245	10	8	83,6	112	5	45,2	135,5	M14x1,5
24.0110-0211.1	410211	+ S	B	HC			272	10	8,4	78	120	5	75	160,8	14,5
24.0110-0212.1	410212	+ S	B				238,5	10	8	48,1	100	4	61	154,5	13
24.0110-0214.1	410214		B				295	9,6	8,4	72	108	5	68	178	14,5
24.0110-0215.1	410215		B				258	10	9	45	114,3	4	68	154	12,6
24.0110-0216.1	410216						295	9,6	8,4	72	108	4	68	178	14,5
24.0110-0217.1	410217	+ S	B				290	10	8,3	55,5	112	5	67	164	13,3
24.0110-0218.1	410218		B				295	10	8	56	98	5	59	180	15
24.0110-0219.1	410219		B				265	10,5	9,5	44,3	100	4	66	149,6	13,5
24.0110-0220.1	410220		B				265	10,5	9,5	44,3	108	5	66	149,6	14,5
24.0110-0223.1	410223	+ S	B				268	10	8	45,8	112	5	68,2	154,5	16,8
24.0110-0224.1	410224		B				245	10	8	48	112	5	68	135,5	15,4
24.0110-0225.1	410225	+ S	B				270	10	8	69,3	100	4	57	160	14
24.0110-0226.1	410226	+ S	B				286	10	8	69,3	110	5	65,5	160	14
24.0110-0227.1	410227	+ S	B	HC			298	10	8,4	61	120	5	75	185	14,5
24.0110-0228.1	410228	+ S	B	HC L			280	10	8	65,2	112	5	67	178	15
24.0110-0229.1	410229		B				260	10	8,4	41	114,3	4	90	154	12,6
24.0110-0230.1	410230		B				290,5	10	8	60	108	4	71	185	13
24.0110-0231.1	410231						290	10	8	40	108	5	71	185	13
24.0110-0232.1	410232	+ S	B				239	9,9	8	33,6	100	4	65	125	13,8
24.0110-0233.1	410233	+ S	B				260	10	8	48,7	114,3	4	64,1	155	12,8
24.0110-0234.1	410234		B				261	10	8	40	114,3	5	72	142,5	13
24.0110-0235.1	410235						211	10	9	35	88	4	70	98	M10x1,25
24.0110-0237.1	410237		B				266	10	8,5	65,8	100	5	58	170	12,8
24.0110-0239.1	410239						213,5	9,6	8,6	61,2	73	4	55,6	85	3/8"
24.0110-0240.1	410240		B				262	10	8,4	60,1	114,3	4	90	168	12,6
24.0110-0242.1	410242		B				290	10	8	46,2	139,5	5	107	182,5	13
24.0110-0243.1	410243						265	10	8,4	49	114,3	5	90	154	12,6
24.0110-0249.1	410249						260	10	8	69,2	110	5	65,5	160	14,3
24.0110-0250.1	410250	+ S	B				264	9,8	8	42	110	5	65,5	145	14
24.0110-0251.1	410251	+ S	B				240	9,8	8	42	100	4	57	140,8	14
24.0110-0253.1	410253						270	10	8	77	110	5	65,5	160,1	12,8
24.0110-0255.1	410255						260	10	8	43,1	114,3	4	64,1	158,8	12,5
24.0110-0256.1	410256						259	10	8	72	114,3	5	47,9	63,9	12,5
24.0110-0258.1	410258		B				245	10	8	54,1	112	5	68	135,5	15,3
24.0110-0259.1	410259		B				255	10	8	54,1	112	5	68	144,5	15,3
24.0110-0260.1	410260		B				255	10	8	48,1	112	5	68	144,5	15,3
24.0110-0261.1	410261	+ S	B				245	10	8	40	112	5/9	68	135,5	15,3
24.0110-0262.1	410262						300	10	8,4	95	120	5	75	180	14,5
24.0110-0264.1	410264		B				258	10	8	40,4	114,3	4	76	154	12,6
24.0110-0266.1	410266						236	10	8,4	41	100	4	64	144	12,6
24.0110-0267.1	410267						260	10	8	43,2	114,3	4	64,1	159	12,6
24.0110-0268.1	410268		B				240	10,2	8,2	40,5	100	4	57	126	14
24.0110-0269.1	410269		B				261	10	8	39,9	100	4	55	124,3	13
24.0110-0270.1	410270		B				280	10	8	61,9	100	5	64	161	15

Abmessungen Bremsscheiben

Dimensions brake discs - Medidas disco de freno - Dimensions Disques de frein - Misure dischi freno

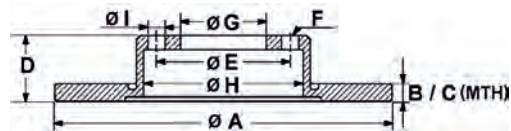

S Fixierschraube - fixing screw - tornillo quefija - vis de fixation - vite di riparazione
 B beschichtet - coated - recubierto - revêtu - rivestito
 HC hochgekohlt - high carbon - altamente carbonizado - à haute teneur en carbone - ad alto tenore di carbonio

L legiert - alloyed - aleado - allié - alligato/legato
 V ventiliert - ventilated - ventilado - ventilé - ventilato
 * gelocht - perforated - perforado - poinçonné - perforato

		S	B	HC L	V	A	B	C	D	E	F	G	H	I
24.0110-0271.1	410271		B			259	10	8,4	44,1	100	4	64,2	163	16
24.0110-0272.1	410272					290	10	8	51	108	5	71	185	13
24.0110-0273.1	410273	+ S	B	HC		272	10	8,4	83	120	5	75	161	14,5
24.0110-0274.1	410274	+ S	B			286	10	8	69	110	5	65,5	160	14
24.0110-0275.2	410275		B			226	10	8	71,5	100	4	39,9		M12x1,5
24.0110-0276.2	410276		B			226	10	8	71,5	100	5	39,9		M14x1,5
24.0110-0277.1	410277	+ S	B			253	10	8	51,6	112	5/9	65	140	15,3
24.0110-0278.1	410278	+ S	B			300	10	8,3	68,3	112	5	67	180	15,3
24.0110-0279.1	410279	+ S	B			260	10	8	48,7	114,3	5	64,2	157	12,6
24.0110-0280.1	410280	+ S	B			296	10	8	57,7	112	5	67	186	15
24.0110-0281.1	410281					262	9,5	8,4	60,1	114,3	5	90	168	12,6
24.0110-0282.1	410282					258	10,3	8	64,7	114,3	5	57	168	13
24.0110-0283.1	410283		B			276	10	9	45,7	98	5	59	138	13,2
24.0110-0284.1	410284		B			271	10	9	60,7	100	5	55	151	14,5
24.0110-0285.1	410285		B			278	10	9	45	114,3	5	68	154	12,5
24.0110-0286.1	410286		B			284	10	8,4	61	114,3	5	76	190	12,6
24.0110-0287.1	410287	+ S	B	HC		280	10	8,4	75	120	5	75	160,8	14,7
24.0110-0289.1	410289					265	10	8	71	108	5	68	160,1	16
24.0110-0290.1	410290		B			276	10	9	51,5	108	5	59	138	14,7
24.0110-0291.1	410291	+ S	B			264	10	8	42	100	4	57	145	14
24.0110-0292.1	410292					283	10	8	62	108	5	68	190	16
24.0110-0293.1	410293		B	L		290	10	8,3	57	112	5	67	164	13,2
24.0110-0295.1	410295		B			260	10	8	63,7	114,3	4	64,1	155	12,7
24.0110-0298.1	410298					258	10	8	45,3	114,3	5	76	154	12,6
24.0110-0299.1	410299					305	10	8,5	75,2	127	5	72,2	194,5	15,5
24.0110-0300.1	410300					270	10	8	61	100	4	57	180	13
24.0110-0301.1	410301		B			261	10	8	39,9	100	4	57	142,8	13
24.0110-0302.1	410302		B			280	10	8	40,2	114,3	5	72	142	13
24.0110-0304.1	410304		B			250	10	8	38,6	114,3	4	69	147	12,6
24.0110-0305.1	410305		B			288	10	8,5	64,9	100	5	55	170	14,5
24.0110-0307.1	410307					276	10	8	34,9	100	4	55	125	13
24.0110-0308.1	410308	+ S	B			261	10	8	40	114,3	4	72	142,5	13
24.0110-0310.1	410310		B			278	10	9	45	114,3	4	68	154	12,6
24.0110-0311.1	410311		B			280	10	9	56	100	5	55	173	14,7
24.0110-0312.1	410312		B			262	10	8,4	64	100	4	62,5	168	12,6
24.0110-0313.1	410313					280	10,2	8,9	33	108	4	63,5	155	13,7
24.0110-0314.1	410314	+ S	B	HC		280	10	8,4	65,5	120	5	75	160,8	14,5
24.0110-0315.1	410315	+ S	B	HC		296	10,4	8,9	65,5	120	5	75	160,8	14,5
24.0110-0316.1	410316		B			288	10	8,5	69,8	114,3	5	62	190	14,5
24.0110-0317.1	410317					262	10	8,4	61	114,3	4	76	168	12,8
24.0110-0318.1	410318		B			262	10	8,4	61	114,3	5	76	168	12,6
24.0110-0319.1	410319					295	10	8,8	88	120,7	5	73,8	180	13,4
24.0110-0320.1	410320		B			290	10	8,5	56,8	114,3	5	62	180	14,5
24.0110-0321.1	410321		B			260	10	8	49	114,3	5	64,2	140,4	12,6
24.0110-0323.1	410323		B			264	10	8	40,5	100	4/6	60	136,8	14
24.0110-0324.1	410324		B			234	10	8	37,5	100	4	62,5	142	12,6
24.0110-0325.2	410325		B			270	10	9	80,7	100	4	55	52,3	M12x1,5
24.0110-0326.1	410326					260	10	8	48,5	100	4	61	148,5	12,3
24.0110-0328.1	410328	+ S	B			300	10	8,3	57,5	112	5	67	164	15,3
24.0110-0329.1	410329	+ S	B			302	10	8	61	114,3	5	64,1	200	12,5
24.0110-0330.1	410330		B			302	10	8	58,7	114,3	5	80	190	12,6
24.0110-0331.1	410331	+ S	B	HC		280	9,6	8	38	112	3	58	153,5	12,5
24.0110-0332.1	410332		B			262	10	8	61,1	114,3	5	76	168	12,5
24.0110-0333.1	410333		B			280	10	8,5	59,2	114,3	5	62	173	14,7
24.0110-0334.1	410334		B			258	10	8	41,4	114,3	4	76	154	13
24.0110-0335.1	410335		B			291	10	8,5	61,3	114,3	5	62	190	14,5
24.0110-0336.1	410336		B			284	10	8,4	54,5	114,3	5	76	190	12,6
24.0110-0337.1	410337		B			270	9,9	8	36,8	114,3	5	62	166	14,8
24.0110-0338.1	410338		B			262	10	8,4	61	114,3	5	76	168	12,5
24.0110-0339.1	410339	+ S	B			278	10	8	42	110	5/7	65,5	149	14
24.0110-0340.1	410340	+ S	B			258	10,5	8	57,2	114,3	4	60	168	12,6
24.0110-0341.1	410341		B			275	10	8,4	61	114,3	5	76	168	12,5
24.0110-0344.1	410344		B			302	10	8,4	58,7	114,3	5	69	190	12,5
24.0110-0345.1	410345		B			262	10	8,4	60,1	114,3	5	80	168	12,5
24.0110-0346.1	410346		B			298	10	8,5	64,4	114,3	5	62	190	14,5
24.0110-0347.1	410347		B			264	10	8	40,5	110	5	70	136,8	14
24.0110-0349.1	410349		B			251	10	9	40,5	98	4	59	128	13,2
24.0110-0350.1	410350		B			269	10	9	64,7	100	5	55	170	14,5
24.0110-0351.1	410351	+ S	B	HC L		300	10	8,3	58,3	112	5	67	180	15,3



Abmessungen Bremsscheiben

Dimensions brake discs - Medidas disco de freno - Dimensions Disques de frein - Misura dischi freno

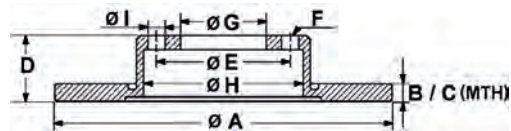

S Fixierschraube - fixing screw - tornillo quefija - vis de fixation - vite di riparazione
 B beschichtet - coated - recubierto - revêtu - rivestito
 HC hochgekohlt - high carbon - altamente carbonizado - à haute teneur en carbone - ad alto tenore di carbonio

L legiert - alloyed - aleado - allié - alligato/legato
 V ventiliert - ventilated - ventilado - ventilé - ventilato
 * gelocht - perforated - perforado - poinçonné - perforato

	S	B	HC L	V	A	B	C	D	E	F	G	H	I	
24.0110-0352.1	410352		B	HC L		299	10,4	8,5	67,6	139,5	6	105,6	190	16
24.0110-0355.1	410355		B			290	10	8	46	139,5	5	108,2	183	12,8
24.0110-0356.1	410356	+ S	B			272	9,7	8	48,2	112	9	65	174,5	15,3
24.0110-0357.1	410357		B			258	10	8	40,5	114,3	5	76	154	12,5
24.0110-0358.1	410358	+ S	B			280	10	8,4	50,2	120	5	79	151,8	16,5
24.0110-0359.1	410359	+ S	B			264	10	8	40,5	110	5/5	70	136,8	14/11
24.0110-0360.1	410360		B			302	10	8,4	60,1	114,3	5	80	168	12,6
24.0110-0362.1	410362		B			262	10	8,4	63,8	114,3	5	76	168	12,6
24.0110-0363.1	410363		B			262	10	8,4	60,2	114,3	5	80	168	12,6
24.0110-0364.1	410364		B			279	10	8,5	30,6	100	5	55	155,8	14,5
24.0110-0366.1	410366		B			286	10	8,5	63,5	100	5	58	190	13
24.0110-0367.1	410367		B			284	10	8,4	54,3	114,3	5	76	168	12,5
24.0110-0368.1	410368		B			262	10	8,4	45,9	114,3	5	76	162,3	12,5
24.0110-0369.1	410369		B			300	10	8,4	24,5	114,3	5	76	155	12,5
24.0110-0370.1	410370		B			284	10	8,4	24,7	114,3	5	76	154,5	12,5
24.0110-0372.1	410372		B	HC L		302	10	8,4	60,3	114,3	5	80	168	12,6
24.0110-0374.1	410374		B			281	10	8,5	66,8	114,3	5	62	173	14,5
24.0110-0378.1	410378		B			251	10	9	40,5	98	5	59	128	13,2
24.0110-0379.1	410379		B	HC L		262	10	8,4	45,1	114,3	5	76	162	12,5
24.0110-0380.1	410380		B			276	10	8	31,6	114,3	5	64	143	12,7
24.0110-0381.1	410381		B			303	10	8	39,8	114,3	5	68	143	13
24.0110-0382.1	410382	+ S	B			295	10	8,3	44	112	5	67	161	15,2
24.0110-0383.1	410383		B	HC L		284	10	8,4	25,9	114,3	5	76	155,2	12,5
24.0110-0384.1	410384		B			273,8	10	8,5	63,4	100	5	58	170	13
24.0110-0388.1	410388		B	HC L		284	10	8,4	55,3	114,3	5	76	168	12,5
24.0110-0389.2	410389		B			270	10	9	80,7	108	5	52	55	M12x1,5
24.0110-0391.1	410391	+ S	B	HC L		300	10	8,3	43	112	5	67	161	15,2
24.0110-0392.1	410392					284	10	8,4	45	114,3	5	76	184,2	12,5
24.0110-0393.1	410393		B			264	10	8	40,5	98	5	59	137	13
24.0110-0394.1	410394		B			234	10	8,4	44,9	100	4	62,4	142	13
24.0110-0395.1	410395		B			302	10	8,4	36,2	114,3	5	69	144,3	12,6
24.0110-0396.1	410396	+ S	B	HC		259	10	8,4	50,6	112	5	67	155	16,5
24.0110-0398.1	410398		B	HC		262	10	8,4	44	100	4	62,5	162	12,6
24.0110-0400.1	410400		B	HC		284	10	8,4	31,9	144,3	5	76	155	12,5
24.0110-0401.1	410401	+ S	B	HC		280	10	8,4	50,8	112	5	67	155	16,5
24.0110-0700.1	410700					269	10	9	64,8	114,3	5	62	170	14,5
24.0110-0704.1	410704		B			262	10	8,4	60,1	114,3	5	90	168	12,5
24.0110-0712.1	410712		B			288	10	8,5	60	114,3	5	62	170	14,5
24.0110-0714.1	410714					258	10,3	8	64,7	100	4	57	168	13
24.0110-0728.1	410728		B			273,8	10	8,5	67,5	100	5	58	170	13
24.0111-0100.2	411100		B			300	11	9,5	84,7	108	5	62	52,3	M14x1,5
24.0111-0101.2	411101		B			274	10,9	9,5	82,2	108	5	62	52,3	M12x1,5
24.0111-0115.1	411115		B			252,5	10	9	65	98	4	68	118	13
24.0111-0119.1	411119		B			240,5	11	9,2	40	98	4	59	123	13
24.0111-0122.1	411122					255	10,5	9,5	30,6	100	4	66	134	12,6
24.0111-0125.1	411125		B			230	11	8,4	43,8	114,3	4	67,4	142	12,6
24.0111-0130.1	411130		B			227	10,8	9	45,8	98	4	62	117	13
24.0111-0133.1	411133		B			278	11	9	50,2	117,8	5	70,7	175,3	16,2
24.0111-0139.1	411139					234	11	10	47	100	4	56	128,5	13,4
24.0111-0141.1	411141					256	10,8	8	41,1	100	6	60	123	14,3
24.0111-0142.1	411142		B			240,5	11	9,2	40	98	5	59	123	13,2
24.0111-0144.1	411144		B			265	10,5	9,5	44,3	108	5	61	149,5	15,5
24.0111-0145.1	411145	+ S	B			302	10,9	9	50,8	108	5	63,5	177,6	15,8
24.0111-0146.1	411146		B			302	11	9,4	71,5	114,3	5	69	190	12,5
24.0111-0147.1	411147	+ S	B			302	11	9	40,8	108	5	63,5	177,6	16
24.0111-0148.2	411148		B			274	10,9	9,5	82,2	100	4	62	52,3	M12x1,5
24.0111-0149.1	411149					240,5	11	9,2	40	98	4	59	124,5	13
24.0111-0150.1	411150					257	10,5	9,5	35,3	100	4	61	134	12,6
24.0111-0151.1	411151		B			265	10,5	9,5	54,3	108	5	66	149,6	15,5
24.0111-0152.1	411152		B			240	11	8	41	100	4/6	60	126	14,5
24.0111-0153.1	411153		B			300	11	9,3	58,5	112	5	67	180	15
24.0111-0154.1	411154		B			278	11	9	53,7	108	5	63,5	146	13,7
24.0111-0155.1	411155		B			265	11	9	40,8	108	5	63,5	152	13,7
24.0111-0158.1	411158	+ S	B			280	11	9	41	108	5	63,5	192	13,7
24.0111-0159.1	411159		B			211	11	10	40,9	100	4	55,1	125	13,2
24.0111-0160.1	411160		B			280	11	9	40,8	114,3	5	72	154	14
24.0111-0164.1	411164		B			265	11	9	40,7	114,3	5	72	152	14
24.0111-0165.1	411165		B			302	11	9	40,8	114,3	5	72	153	13,7
24.0111-0166.2	411166		B			274	10,9	9,5	82,2	100	4	62	52,3	M12x1,5

Abmessungen Bremsscheiben

Dimensions brake discs - Medidas disco de freno - Dimensions Disques de frein - Misure dischi freno

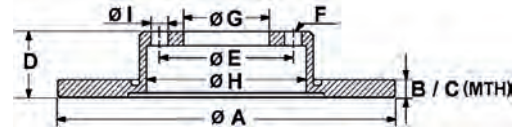

S Fixierschraube - fixing screw - tornillo quefija - vis de fixation - vite di riparazione
 B beschichtet - coated - recubierto - revêtu - rivestito
 HC hochgekohlt - high carbon - altamente carbonizado - à haute teneur en carbone - ad alto tenore di carbonio

L legiert - alloyed - aleado - allié - alligato/legato
 V ventiliert - ventilated - ventilado - ventilé - ventilato
 * gelocht - perforated - perforado - poinçonné - perforato

		S	B	HC L	V	A	B	C	D	E	F	G	H	I
24.0111-0167.2	411167		B			300	11	9,5	84,7	108	5	62	52,3	M12x1,5
24.0111-0168.1	411168		B			297	11	9	58,5	114,3	5	62	180	14,5
24.0111-0169.1	411169		B			290	11	9	33,7	114,3	5	62	155	14,5
24.0111-0170.1	411170		B	HC L		302	11	9,4	71,5	114,3	5	69	190	12,5
24.0111-0171.1	411171		B			271	11	9	40,7	108	5	63,5	152	13,8
24.0111-0172.1	411172		B			280	11	9	50,7	108	5	63,5	153,5	13,7
24.0111-0173.2	411173		B			300	11	9,5	81,7	114,3	5	52	62	M14x1,5
24.0111-0174.2	411174		B			274	11	9,5	88,2	108	5	52	62	M12x1,5
24.0111-0175.1	411175	+ S	B	HC		290	11	9,4	66	120	5	75	160,8	16,5
24.0111-0176.1	411176		B		*	240,5	11	9,2	40	98	4	59	123	13
24.0111-0180.2	411180		B			274	11	9,5	86,2	114,3	5	52,3	62	M12x1,5
24.0111-0181.2	411181		B			300	11	9,5	101,7	114,3	5	52	62	M14x1,5
24.0111-0182.2	411182		B			274	11	9,5	88,2	108	5	52	62	M12x1,5
24.0111-0183.2	411183		B			300	11	9,5	102,2	108	5	52,3	62	M14x1,5
24.0111-0184.2	411184		B			290	11	9,5	90,2	114,3	5	52,3	62	M12x1,5
24.0111-0185.1	411185		B			302	11	9,5	50,8	108	5	63,5	177,3	13,8
24.0111-0186.2	411186		B			290	11	9,5	104,6	114,3	5	52,3	62	M12x1,5
24.0112-0106.1	412106	+ S	B			239	12	10	35,4	100	4	65	124,5	13,6
24.0112-0112.1	412112					257	12	10,8	51,5	98	4	62	135	13
24.0112-0116.1	412116	+ S	B			238	12	10,5	41	100	4	61	129,5	13,5
24.0112-0117.1	412117	+ S	B			284	12	10	46,5	112	5	67	154,3	15
24.0112-0122.1	412122					240	12	10,8	46,5	98	4	59	127,5	13
24.0112-0124.1	412124	+ S	B	HC		302	12	10,4	76	120	5	79	149	14,5
24.0112-0125.1	412125		B			239	12	10,8	42,5	98	4	58,5	127	13,1
24.0112-0126.1	412126	+ S	B			286	12	10,4	51,5	120	5	79	148	14,5
24.0112-0127.1	412127		B			257,5	12	10,2	40,5	98	4	59	123	13
24.0112-0128.1	412128	+ S	B			284	12	10	43,5	112	5	67	154,3	12,8
24.0112-0129.1	412129		B	HC		290	12	9,8	60	112	5	67	164	17
24.0112-0130.1	412130					272	11	9,9	50,5	140	5	108	157	14,5
24.0112-0131.1	412131		B			286	12	10	69,5	110	5	65,5	160	14
24.0112-0132.1	412132	+ S	B	HC		324	12	10,4	61	120	5	75	180	14,5
24.0112-0133.1	412133					253,8	12	10,5	54,2	108	5	66	134	14,7
24.0112-0134.1	412134					253,8	12	10,5	54,2	100	4	66	134	12,6
24.0112-0135.1	412135					260	12	10,8	40	100	4/6	61	127	13
24.0112-0136.2	412136					251	12	10,8	62,3	108	5	71	134,7	13
24.0112-0137.1	412137		B			234	12	10	45,2	100	4	59	129,5	12,5
24.0112-0138.1	412138	+ S	B			280	12	10	40,4	112	5	68,2	153	16,5
24.0112-0141.1	412141		B			239,5	12	10	42,9	108	4	63,5	136	13,7
24.0112-0142.1	412142	+ S	B	HC L		258	12	10	96,7	130	5	85	160	15
24.0112-0143.1	412143					251	12	10,8	62,4	108	4	71,1	135	13
24.0112-0144.1	412144	+ S	B	HC L		260	12	10	40,4	112	5	67	145	13,3
24.0112-0148.1	412148		B			255	12	10	40	112	5/9	68	144,5	15,3
24.0112-0149.1	412149		B			290	12	10,3	56	112	5	67	164	13
24.0112-0150.1	412150		B			277	11,9	10	71	108	5	68	160	16,5
24.0112-0151.1	412151		B			288	11,9	10	64,8	108	5	68	178	16,5
24.0112-0152.1	412152		B	HC		324	12	10,4	80,2	120	5	75	185	16,8
24.0112-0153.1	412153		B			247	12	10,5	44	100	4	60	125	12,8
24.0112-0154.1	412154		B			280	12	10	34	108	5	63,5	151	13,7
24.0112-0155.1	412155	+ S	B			305	12	10,5	66,8	130	5	90	169,5	15,5
24.0112-0156.1	412156		B			272	12	10	28	98	5	59	134	15
24.0112-0157.1	412157	+ S	B			278	11,9	10	41,4	110	5	65,5	145,2	14
24.0112-0158.1	412158	+ S	B			256	12	10	48,6	112	5/9	65	140	15,3
24.0112-0159.1	412159	+ S	B			302	12	10	49,4	112	5/9	68	177	15,3
24.0112-0160.1	412160		B			280,5	12	11	45,1	100	4	61	149	13,5
24.0112-0162.1	412162	+ S	B			290	12	10	35	108	5	71,1	151,2	13
24.0112-0164.1	412164		B			291	12	10,5	68,4	114,3	5	62	190	14,5
24.0112-0165.1	412165		B			288	12	10	62	108	5	68	178	16
24.0112-0166.1	412166		B			288	12	10	36	112	5	68	162	15,3
24.0112-0167.1	412167	+ S	B	HC L		276	12	10	44,5	112	5	67	145	15,3
24.0112-0168.1	412168		B			354	11,9	10,4	74,9	120	5	79	210	16,6
24.0112-0169.1	412169	+ S	B			282	12	10	48,6	112	5/9	65	159	15,3
24.0112-0170.1	412170	+ S	B			278	12	10	43,2	110	5	70	139	16,6
24.0112-0171.1	412171	+ S	B			259	12	10,6	40,9	100	4	61	130	13,5
24.0112-0172.1	412172	+ S				282	12	10	58,5	114,3	5	64,2	170	12,8
24.0112-0173.1	412173		B			232	12	9,5	51	114,3	4	64	137	12,7
24.0112-0174.1	412174		B			290	12	10	50	108	5	71,1	144	13
24.0112-0175.1	412175	+ S	B			286	12	10	58,6	112	5	65	140	15,3
24.0112-0176.1	412176		B	HC L		302	12	10	42,4	112	5/9	68	176,5	15,3
24.0112-0177.2	412177		B			280	12	10	102,2	118	5	68	64,5	M14x1,5



Abmessungen Bremsscheiben

Dimensions brake discs - Medidas disco de freno - Dimensions Disques de frein - Misure dischi freno

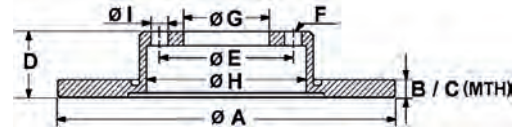

S Fixierschraube - fixing screw - tornillo quefija - vis de fixation - vite di riparazione
 B beschichtet - coated - recubierto - revêtu - rivestito
 HC hochgekohlt - high carbon - allamente carbonizado - à haute teneur en carbone - ad alto tenore di carbonio

L legiert - alloyed - aleado - allié - alligato/legato
 V ventiliert - ventilated - ventilado - ventilé - ventilato
 * gelocht - perforated - perforado - poinçonné - perforato

	S	B	HC L	V	A	B	C	D	E	F	G	H	I
24.0112-0178.1	412178	+ S	B		300	12	10	36,4	112	5	68	169	15,3
24.0112-0180.1	412180	+ S	B		302	12	10	69,2	108	5	63,5	178	15,8
24.0112-0181.1	412181		B		302	12	11	56,1	114,3	5	72	185	14,2
24.0112-0183.1	412183	+ S	B		300	12	10	58,3	112	5	67	180	15,3
24.0112-0184.1	412184	+ S	B		257	12	10	40,5	100	4/6	60	127	14,3
24.0112-0185.1	412185				324	11,9	10,4	69,5	139,6	6	96,3	210	12,5
24.0112-0186.1	412186		B		302	12	10	66	108	5	63,6	185	15,7
24.0112-0187.1	412187	+ S	B		292	12	10,5	48	120	5	67,4	171,5	16,3
24.0112-0188.1	412188	+ S	B		268	12	10	44,9	105	5	60	147	14,2
24.0112-0189.1	412189	+ S	B		292	12	10	45	115	5	70,7	157	14,2
24.0112-0190.1	412190	+ S	B	HC L	305	12	10	71,5	130	5	91	167,5	17
24.0112-0191.1	412191	+ S	B	HC L	305	12	10	71,4	130	5	90	167	15,5
24.0112-0193.1	412193		B		316	12	10,4	68,6	127	5	72	206	16,6
24.0112-0194.2	412194		B		268	12	10	73,2	108	4	56	62	M12x1,25
24.0112-0195.1	412195		B		278	12	11	46	114,3	5	62	169,2	12,8
24.0112-0197.1	412197	+ S	B		290	12	10	44	108	5	71,1	136	13
24.0112-0198.1	412198	+ S	B		290	12	10	35	108	4	71,1	151,2	13
24.0112-0199.1	412199		B	HC	305	12	10,4	33	127	5	72,5	167,5	14
24.0112-0202.1	412202		B		292	12	10,5	48	120	5	67,4	171,5	16,3
24.0112-0203.1	412203		B		290	12	10,5	53,2	114,3	5	62	180	14,4
24.0112-0210.1	412210	+ S	B		300	12	10	48,2	112	5/9	65	173	15,3
24.0112-0211.1	412211	+ S	B		268	12	10	35	108	5	71,1	133	13,2
24.0112-0212.1	412212	+ S	B		290	12	10	35	108	5	71,1	133	13,2
24.0112-0213.1	412213	+ S	B	HC L	300	12	9	57,9	112	5	67	186	15,3
24.0112-0214.1	412214	+ S	B		278	12	10,4	33,2	110	5	70	137	15,7
24.0112-0215.1	412215	+ S	B		320	12	10,4	33,2	110	5/5	70	180,7	15,7/11
24.0112-0216.1	412216	+ S	B		290	12	10	59	108	5	71,1	136	13,2
24.0112-0703.1	412703		B		306,6	12	10,5	63,2	114,3	5	62	190	14,5
24.0112-0707.1	412707				282	12	10	39,7	114,3	5	64,2	142	12,6
24.0112-0714.1	412714		B		281	12	10,5	55	114,3	5	62	172	14,5
24.0113-0105.1	413105				302	12,5	11,5	48	139,5	6	100	168,5	15
24.0113-0128.1	413128				273	13	10,7	43	98	4	76	132	10,3
24.0113-0161.1	413161	+ S	B		236	12,7	9,7	41	100	4/6	60	123	14
24.0113-0165.1	413165				219	13	11	37	94	4	75	119	10,5
24.0113-0166.1	413166		B		256	13	11	56,5	108	4	68	134,5	15,4
24.0113-0169.1	413169				236	12,8	11,4	45,6	98	4	62	124,6	13
24.0113-0178.1	413178	+ S	B		255,6	12,9	11	39,2	100	4	65	135,5	13,6
24.0113-0179.1	413179		B	HC	280	13	11	56,5	108	4	68	159	15,4
24.0113-0181.1	413181		B	HC	280	13	11	46,5	112	5	68	159	15,4
24.0113-0182.1	413182		B		236	12,8	11,4	45,7	100	4	62	125,5	14,8
24.0113-0184.1	413184	+ S	B		266	13	11	27,2	108	4	66	133	13
24.0113-0185.1	413185	+ S	B		247,5	13	11	34,2	108	4	66	133	13
24.0113-0186.1	413186				234	13	11,4	45	100	4	64	126	12,6
24.0113-0188.1	413188				238	12,7	10,7	47,2	100	4	61	123	13
24.0113-0189.1	413189		B		290	12,5	11,7	61,5	127	5	101,6	160,5	10
24.0113-0190.1	413190				240	12,8	11,6	43	95,2	4	66	122	13
24.0113-0193.1	413193				236	12,8	11,4	48,9	100	4	62	124,7	13
24.0113-0194.1	413194		B		294	13,5	11,5	41	112	5	68,2	165	16,5
24.0113-0195.1	413195		B		236	12,6	9,7	35,4	102	4	86	107,5	M10x1,25
24.0113-0196.1	413196		B		290	12,5	11,3	56	114,3	5	72	180	14,5
24.0113-0197.1	413197		B		304,5	12,6	11,7	62,8	120	5	70	161,5	14,3
24.0113-0198.1	413198		B		262	13	11	44,5	100	4	64,2	141	13
24.0113-0200.1	413200		B		290	13	11	47	114,3	5	68	158	12,7
24.0114-0102.1	414102				257,5	14	12,8	50,7	98	4	59	128,7	13,2
24.0114-0108.1	414108		B		298,5	14	13	70	127	5	101,6	160,5	10
24.0114-0110.2	414110	+ S			267	14,2	12,8	111	170	6	58,3	115	M18x1,5
24.0114-0111.1	414111		B		331	13,9	12,3	55,3	112	5	67	184	15,3
24.0114-0112.1	414112	+ S	B		276	14	12	62	108	4	71	136,5	13
24.0114-0113.1	414113		B		262	14	11	51	114,3	5	66,1	140,8	12,6
24.0114-0114.1	414114	+ S	B	HC L	330	14	11,4	63	112	5	67	210	15,2
24.0114-0115.1	414115				298	14	13	59	127	5	101,6	159,6	10,2
24.0114-0116.1	414116	+ S	B		290	14	12	49	108	5	71	143,7	13,2
24.0114-0118.1	414118		B		320	14	12,5	66,3	127	5	72	205	16,2
24.0114-0119.1	414119	+ S	B	HC L	325	14	11,4	54	112	5	67	183	15
24.0114-0120.1	414120		B		330	14	12,5	63,4	127	5	72	206,2	17
24.0115-0105.1	415105		B	HC	288	15	13	46,5	112	5	68	135,5	15,4
24.0115-0108.1	415108		B		281	15	13,2	44,7	98	5	59	127	13
24.0115-0109.1	415109		B	HC	239	15	13	34,5	100	4/6	65	124,7	13,6
24.0115-0111.1	415111		B		285	15	13	52,5	112	5	67	184	15

Abmessungen Bremsscheiben

Dimensions brake discs - Medidas disco de freno - Dimensions Disques de frein - Misura dischi freno

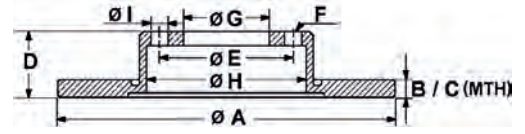

S Fixierschraube - fixing screw - tornillo quefija - vis de fixation - vite di riparazione
 B beschichtet - coated - recubierto - revêtu - rivestito
 HC hochgekohlt - high carbon - altamente carbonizado - à haute teneur en carbone - ad alto tenore di carbonio

L legiert - alloyed - aleado - allié - alligato/legato
 V ventiliert - ventilated - ventilado - ventilé - ventilato
 * gelocht - perforated - perforado - poinçonné - perforato

	S	B	HC L	V	A	B	C	D	E	F	G	H	I
24.0115-0112.1	415112				281	15	13,2	44,7	98	4	59	127	13
24.0116-0100.1	416100	B			280	16	13	78,6	112	5	88	133,5	12,5
24.0116-0107.2	416107	+ S	B		238,5	16	14,5	79	140	5	102	138	M14x1,5
24.0116-0108.1	416108				260	16	13	64	112	5	68,2	144	16,5
24.0116-0110.1	416110	+ S	B	HC L	272	16	14	96,7	130	5	85	160	15
24.0116-0116.2	416116		B		280	16	13	68,7	160	5	96	120	M10x1,5
24.0116-0117.1	416117		B		273	16	15	37,5	114,3	5	66,5	162	14
24.0116-0118.1	416118			V	234	16	14	37	88	4	70	111	M10
24.0116-0119.1	416119		B	V	292	16	14	62	114,3	5	68	172	12,7
24.0116-0121.1	416121	+ S	B		298	16	14	71	130	6	85	180	15
24.0116-0122.1	416122		B	V	308	16	14	62	114,3	5	68	190	12,8
24.0116-0123.1	416123		B		300	16	14,2	80	130	5	79	172	17,5
24.0116-0124.1	416124		B		280	16	14,2	82	118	5	72	172	15,6
24.0116-0125.1	416125		B		280	16	14,2	82	130	5	79	172	17,5
24.0116-0126.1	416126		B		280	16	13	16,3	124	5/10	107,5	144,5	10,7
24.0116-0128.1	416128				276	16	13	69,5	118	5	73	145	15,5
24.0116-0129.1	416129				276	16	13	69,5	118	5	73	145	15,5
24.0116-0130.1	416130		B	V	234	16	15	41	100	4	55	125	14
24.0116-0131.1	416131		B		280	16	13	66,8	127	6	108	164,6	10,8
24.0116-0132.1	416132		B		280	16	13	62,1	127	6	108	164,5	10,8
24.0116-0133.1	416133	+ S	B		303	16	13	83	130	5	85	158,5	15
24.0116-0134.1	416134		B		284	16	13	43,9	124	10	107,1	148	10,7
24.0117-0101.1	417101			V	231	17	15	44	100	4	61	124	12,6
24.0117-0103.1	417103		B	V	231,2	17	15	50	114,3	4	64	137,5	12,8
24.0117-0104.1	417104			V	287	17	15	46,1	140	5	107	183	13
24.0117-0105.1	417105		B	V	231	17	15	49,2	100	4	60	125	12,8
24.0117-0106.1	417106		B	V	253	17	15	49	100	4	60	153	12,5
24.0117-0107.1	417107		B	V	246	17	16	41,9	100	4	55,1	137	13,2
24.0117-0108.1	417108		B	V	257	17	15	49,2	100	4	60	151	12,7
24.0117-0109.1	417109			V	287	17	15	29	140	5	108,2	181,7	13
24.0117-0110.1	417110		B	V	257	17	15	38,3	100	4	64	123,5	12,6
24.0118-0101.1	418101			V	238	18	16	31	94	4	75	143,5	10,5
24.0118-0105.1	418105		B		282	18	15	64,5	112	5	68,2	144	16,5
24.0118-0106.1	418106	+ S	B	HC	239	18	16	34,5	100	4	65	125	13,6
24.0118-0107.1	418107		B	V	240	18	16	45,2	100	4	61	130	12,6
24.0118-0108.1	418108		B		280	18	15,9	65,5	118	5	73	141,3	15,5
24.0118-0110.1	418110			V	238	18	17	48,2	100	4	54,1	127	14,5
24.0118-0111.1	418111	+ S	B	HC	282	18	15	55	112	5	68,2	144	16,5
24.0118-0113.1	418113		B	V	235	18	16	45	100	4	55	125	13
24.0118-0116.1	418116			V	240	18	15,5	36,5	94	4	65,1	150,5	M10x1,25
24.0118-0117.1	418117			V	247	18	16	45,2	100	4	61	130	12,7
24.0118-0118.1	418118			V	232	18	16	45,2	100	4	61	130	12,8
24.0118-0120.1	418120		B	V	236	18	16,4	45	100	4	64	126	12,6
24.0118-0121.1	418121			V	277	18	17	32,5	118	5	96	176	10,6
24.0118-0122.1	418122		B	V	313,5	18	16,6	80,2	139,6	6	101	210	12,6
24.0118-0124.1	418124		B	V	238	18	17	42,8	100	4	55	127	14,6
24.0118-0125.1	418125			V	242	18	16	52,5	100	5	58	128	13
24.0118-0126.1	418126			V	234,5	18	17	47	100	4	56	128,5	13
24.0118-0129.1	418129		B	V	302	18	16	46,2	114,3	5	62	156,7	14,6
24.0118-0131.1	418131		B	V	235	17,9	16	43,2	100	4	55	129,5	14,5
24.0118-0136.1	418136			V	316	18	16	80	139,7	6	111	189	12,8
24.0118-0137.1	418137	+ S	B	HC	239	18	16	35	100	5	65	125	15,6
24.0118-0138.1	418138		B	V	234	18	16	50,7	100	4	62,2	126	12,6
24.0118-0139.1	418139		B	V	238	18	16	46,2	100	4	59	130	12,5
24.0118-0140.1	418140		B		315	18	16,4	84,2	139,7	6	108	197	12,5
24.0118-0141.1	418141			V	266	18	16,4	60,2	114,3	4	90	168	12,6
24.0118-0143.1	418143		B	V	329,2	18	16	102,6	150	5	110	230	16,7
24.0118-0144.1	418144		B	V	252	18	16	49	100	4	62,2	126	12,6
24.0118-0145.1	418145		B	V	241	18	16	49	100	4	62,2	126	12,6
24.0118-0146.1	418146		B	V	332	18	16	74,4	139,7	6	94	210	12,8
24.0118-0147.1	418147		B	V	310	18	16,5	67,5	114,3	5	62	190	14,5
24.0118-0148.1	418148		B	V	286	18	16	58,7	114,3	5	72	190	13
24.0118-0149.1	418149		B	V	302	18	16	43,3	114,3	5	72	142,8	13
24.0118-0150.1	418150		B	V	301,6	18	16	56,6	114,3	5	72	190	13
24.0118-0151.1	418151		B	V	256	18	16	46,9	100	4	62,2	126	12,5
24.0118-0153.1	418153		B		302	18	15	51	140	8	120	164	10,9
24.0118-0154.1	418154		B	V	324	18	16	67	114,3	5	69	210	12,5
24.0118-0157.1	418157		B	V	309	18	16,5	69,8	114,3	5	62	210	14,5
24.0118-0158.1	418158		B	V	324	18	16	56,7	114,3	5	72	190	13



Abmessungen Bremsscheiben

Dimensions brake discs - Medidas disco de freno - Dimensions Disques de frein - Misure dischi freno

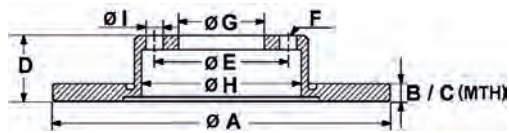

S Fixierschraube - fixing screw - tornillo quefija - vis de fixation - vite di riparazione
 B beschichtet - coated - recubierto - revêtu - rivestito
 HC hochgekohlt - high carbon - altamente carbonizado - à haute teneur en carbone - ad alto tenore di carbonio

L legiert - alloyed - aleado - allié - alligato/legato
 V ventiliert - ventilated - ventilado - ventilé - ventilato
 * gelocht - perforated - perforado - poinçonné - perforato

	S	B	HC L	V	A	B	C	D	E	F	G	H	I	
24.0118-0159.1	418159		B		V	266	18	16	67,5	100	5	58	170	12,8
24.0118-0160.1	418160		B		V	278	18	16	63,3	100	5	58	170	13
24.0118-0709.1	418709		B		V	312	18	16	68	139,7	6	106	210	14,5
24.0118-0724.1	418724		B		V	308	18	16	62,7	114,3	5	68	190	12,7
24.0118-0725.1	418725		B		V	290	18	16	67,4	100	5	58	170	13
24.0119-0106.1	419106				V	242	19	17	44,1	100	4	61	122	12,6
24.0119-0107.1	419107	+ S	B	HC	V	276	19	17,4	60,3	120	5	75	160,8	14,5
24.0119-0108.1	419108	+ S	B	HC	V	294	18,9	17,4	59,7	120	5	75	160,8	14,8
24.0119-0109.1	419109		B		V	242	19,1	17	40,5	104	4	86	143	M10x1,25
24.0119-0111.1	419111				V	242	19,2	17	37,2	104	4	86	126	10,4
24.0119-0112.1	419112	+ S	B	HC	V	294	19	17,4	74,7	120	5	75	160,8	14,7
24.0119-0113.1	419113	+ S	B	HC	V	294	19	17,4	60,5	120	5	75	184	14,7
24.0119-0114.1	419114		B		V	241	19	17	52,1	100	4	62,2	126	12,5
24.0119-0115.1	419115		B		V	241	19	17	47,8	100	4	62,2	126	12,5
24.0119-0116.1	419116		B		V	256	19	17	47,9	100	4	62,2	125	12,5
24.0120-0114.2	420114		B			281	19,9	18	80,5	115	5	91	128,5	M14x1,5
24.0120-0115.1	420115	+ S	B	HC L	V	236	20	17	41	100	4/6	60	123	14
24.0120-0119.1	420119				V	295	20	18	29	137	6	104	178	M12x1,25
24.0120-0122.1	420122		B		V	308	20	18	64,5	108	5	68	178	16,5
24.0120-0123.1	420123	+ S	B	HC L	V	239	20	18	39	100	4	65	123,8	13,6
24.0120-0125.1	420125	+ S	B		V	238	20,1	17,7	41	100	4	61	128	12,5
24.0120-0126.1	420126		B		V	259	20,2	17,7	46,4	100	4	61	130	12,8
24.0120-0128.1	420128	+ S	B	HC L	V	256	20	18	38,8	100	4	65	131,5	13,8
24.0120-0131.1	420131				V	247	20,4	18,5	44,2	108	4	66	133,2	12,8
24.0120-0132.1	420132	+ S	B		V	247	20,4	18,5	34,2	108	4	66	133,2	12,8
24.0120-0133.1	420133	+ S	B		V	266	20,5	18,5	27,6	108	4	66	133	13
24.0120-0134.1	420134				V	265	20,5	17,7	31,6	100	4	61	127	12,8
24.0120-0135.1	420135				V	244	20,5	17,7	31,6	100	4	61	127	12,5
24.0120-0137.1	420137		B		V	269	19,9	18	46	112	5	68	156	15,5
24.0120-0140.1	420140	+ S	B	HC L	V	256	20	17	41	100	4/6	60	123	14
24.0120-0142.1	420142		B	HC L	V	257,5	20	18,2	40,5	98	4	59	126,7	13
24.0120-0143.1	420143				V	240	20	18,2	46,5	98	4	59	124,5	13
24.0120-0146.1	420146		B		V	253	20	18	43,7	108	4	63,5	153	13,7
24.0120-0147.1	420147		B		V	239,5	20	18	43	108	4	63,5	136	13,7
24.0120-0152.1	420152				V	242	20	18	49,2	114,3	4	68	138	12,5
24.0120-0153.1	420153				V	302	20	19	48	139,7	6	100	166,5	15
24.0120-0154.1	420154	+ S	B	HC	V	298	20	18,4	61,3	120	5	75	185	14,5
24.0120-0155.1	420155		B	HC L	V	257,5	20	18,2	40,5	98	5	59	126,7	16,5
24.0120-0159.1	420159				V	257	20	18,2	40,5	98	5	59	126,4	13,2
24.0120-0163.1	420163				V	235	20	18	49,5	100	4	60	125,2	12,7
24.0120-0166.1	420166				V	253	20	18,4	28,6	104	5	84	148	10,6
24.0120-0168.1	420168				V	289	20	18	64,2	127	6	100	156	10,7
24.0120-0169.1	420169		B		V	255	20	18	45	100	4	55	125	13
24.0120-0171.1	420171		B		V	286	20	18	67	110	5	65,5	160	14
24.0120-0172.1	420172			HC L	V	269	19,9	18	59,5	112	5/10	68	156	15,3
24.0120-0173.1	420173	+ S	B		V	292	19,9	18	41,4	110	5	65,5	162,5	14
24.0120-0174.1	420174	+ S	B		V	240	20	17	41	100	4/6	60	126	14
24.0120-0175.1	420175		B		V	255	20	18	43,1	100	4	55	129	14,5
24.0120-0176.1	420176		B	HC L	V	292	20	18	67	130	5	98	164	15,4
24.0120-0177.1	420177				V	242	20	18	43,5	100	4	57	136	13
24.0120-0178.1	420178		B	HC	V	324	20	18,4	67	120	5	79	185	16,5
24.0120-0180.1	420180	+ S	B		V	247	20	18	35,3	100	4	55	129	13,2
24.0120-0181.1	420181		B	HC	V	300	20	18,4	61	120	5	75	180	14,5
24.0120-0182.1	420182	+ S	B	HC	V	328	20	18,4	61	120	5	75	180	14,5
24.0120-0183.1	420183	+ S	B	HC	V	320	20	18,4	63,2	120	5	75	185	14,5
24.0120-0184.1	420184		B		V	240,5	20	18,2	40,5	98	4	59	146,5	13
24.0120-0186.1	420186				V	239	19,5	18	41,8	98	4	58,5	154	13
24.0120-0187.1	420187				V	260	20	18,5	42	98	4	58,5	174	13
24.0120-0188.1	420188		B		V	305	20	18,5	67,9	120,7	5	73,8	180	13,3
24.0120-0189.1	420189	+ S	B	HC	V	312	20	18,4	61	120	5	75	180	14,5
24.0120-0190.1	420190	+ S	B	HC	V	312	20	18,4	61	120	5	75	180	14,5
24.0120-0191.1	420191		B	HC	V	324	20	18,4	80,3	120	5	75	185	16,6
24.0120-0193.1	420193				V	240	20	18,2	46,5	98	4	59	124,5	13,2
24.0120-0195.1	420195	+ S	B	HC	V	300	20	18,4	66	120	5	75	160,8	14,5
24.0120-0196.1	420196	+ S	B		V	300	20	18	69,1	110	5	65,5	160	14,2
24.0120-0197.1	420197		B		V	246	20	18	50	100	4	60	125	12,8
24.0120-0199.1	420199			HC L	V	278	19,9	17,4	55,2	112	5	67	164	15
24.0120-0200.1	420200		B	HC L	V	354	20	17	74,9	120	5	79	210	16,6
24.0120-0201.1	420201		B		V	350	20	17	59	120	5	79	210	15

Abmessungen Bremsscheiben

Dimensions brake discs - Medidas disco de freno - Dimensions Disques de frein - Misure dischi freno

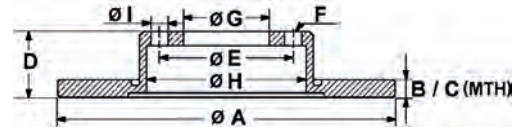

S Fixierschraube - fixing screw - tornillo quefija - vis de fixation - vite di riparazione
 B beschichtet - coated - recubierto - revêtu - rivestito
 HC hochgekohlt - high carbon - altamente carbonizado - à haute teneur en carbone - ad alto tenore di carbonio

L legiert - alloyed - aleado - allié - alligato/legato
 V ventiliert - ventilated - ventilado - ventilé - ventilato
 * gelocht - perforated - perforado - poinçonné - perforato

		S	B	HC L	V	A	B	C	D	E	F	G	H	I
24.0120-0202.1	420202				V	315	20	18,4	87,5	139,7	5	96,3	190	12,5
24.0120-0203.1	420203		B		V	252	20	18	45,2	100	4	61	144	12,6
24.0120-0204.1	420204	+ S	B	HC	V	300	20	18,4	66,1	120	5	75	185	14,5
24.0120-0206.1	420206	+ S	B	HC	V	320	19,9	18,4	78,5	120	5	75	185	16,5
24.0120-0207.1	420207		B		V	315	20	18,4	78,5	139,7	5	96,3	190	12,5
24.0120-0208.1	420208	+ S	B	HC L	V	300	22	19,4	57,5	112	5	67	164	15,3
24.0120-0209.1	420209		B	HC L	V	303	20	18,4	71,6	115	5	70,7	190	12,8
24.0120-0210.1	420210		B		V	325	20	17	59	120	5	79	210	15
24.0120-0211.1	420211	+ S	B		V	252	20	18	40	100	4	60	127	12,5
24.0120-0212.1	420212		B	HC L	V*	299	20	18	67	130	5	98	180	15,4
24.0120-0213.1	420213	+ S	B	HC	V	320	20	18,4	86,1	120	5	75	185	14,5
24.0120-0214.1	420214	+ S	B	HC	V	300	20	18,4	76	120	5	75	160,8	14,5
24.0120-0215.1	420215	+ S	B	HC	V	300	20	18,4	76,2	120	5	75	185	14,5
24.0120-0216.1	420216		B		V	276	20	18	40	114,3	5	62	146,5	12,7
24.0120-0217.1	420217		B	HC	V	324	20	18,4	74	120	5	79	185	16,5
24.0120-0218.1	420218		B		V	302	20	18	66	108	5	63,6	185	15,8
24.0120-0219.1	420219		B		V	255	20	18	46,2	100	4	55	131	14,5
24.0120-0221.2	420221	+ S	B	HC	V*	328	20	18,4	61	120	5	75	185	14,5
24.0120-0222.2	420222	+ S	B	HC	V*	328	20	18,4	61	120	5	75	185	14,5
24.0120-0225.1	420225		B		V	231	20	18	51,4	100	4	60	125	12,7
24.0120-0226.1	420226	+ S	B	HC	V	300	20	18,4	54,2	120	5	75	174	14,5
24.0120-0227.1	420227	+ S	B	HC	V	236	20	18	41	100	6	59	123	12,4
24.0120-0228.1	420228	+ S	B	HC	V	324	20	18,4	54,1	120	5	75	174	14,5
24.0120-0229.2	420229	+ S	B	HC	V	330	20	18,4	68,8	120	5	75	185	16,5
24.0120-0232.1	420232		B		V	303	20	18,4	92,5	120	5	75	190	14,5
24.0120-0234.1	420234	+ S	B	HC	V	330	20	18,4	71	120	5	75	154	16,5
24.0120-0235.1	420235		B		V	303	20	18,4	92,5	140	6	75	190	12,3
24.0120-0237.1	420237	+ S	B	HC	V	300	20	18,4	66	120	5	75	160,8	16,5
24.0120-0238.1	420238		B	HC	V	326	20	18	38	108	5	64,5	160,4	14
24.0120-0239.1	420239		B		V	292	20	18	43,7	110	5/7	70	162,2	14
24.0120-0240.1	420240	+ S	B	HC	V	300	20	18,4	66	120	5	75	185	16,5
24.0120-0243.1	420243	+ S	B	HC	V	330	20	18,4	66,2	120	5	75	185	16,5
24.0120-0246.1	420246	+ S	B		V	320	20	17,5	43	108	5	63,5	141	15,8
24.0120-0247.1	420246	+ S	B		V	340	20	17,5	43	108	5	63,5	141	15,8
24.0120-0708.1	420708		B		V	288	20	18,5	32,5	108	5	64,5	160	14
24.0121-0100.1	421100				V	285	21	19	51,2	114,3	4	64,1	141	12,7
24.0121-0104.1	421104	+ S	B		V	240	21	19	44,8	100	4	61	126	13
24.0121-0105.1	421105	+ S	B		V	262	21	19	44,7	100	4	64,1	141	13
24.0121-0106.1	421106	+ S	B		V	259	20,7	17,7	41	100	4	61	130	12,7
24.0121-0107.1	421107				V	262	21	19	47,2	100	4	64,1	141	13
24.0121-0110.1	421110				V	262	21	18	51	114,3	4	64,1	141	12,6
24.0121-0113.1	421113	+ S	B		V	240	21	19	39,2	100	4	61	126,5	13
24.0121-0114.1	421114		B		V	277	21	18	51	114,3	5	66,1	141	12,5
24.0121-0115.1	421115	+ S	B		V	258	21	19	39,2	100	4	64,1	141,3	12,6
24.0121-0702.1	421702	+ S	B		V	262	21	19	47,2	114,3	5	64,2	141	12,6
24.0122-0100.1	422100		B	HC	V	280	22	20	28,5	100	5	65	141	15,6
24.0122-0101.1	422101		B	HC	V	280	22	20	39,5	100	4	65	137	13,6
24.0122-0103.1	422103	+ S	B	HC	V	302	22	20,4	76	120	5	79	149	14,5
24.0122-0107.1	422107		B		V	284	22	20,2	39,4	98	4	59	127	13
24.0122-0108.1	422108		B	HC	V	256	22	20	56,5	108	4	68	132,7	15,4
24.0122-0115.1	422115	+ S	B	HC	V	286	22	20,4	51,5	120	5	79	147,5	14,5
24.0122-0123.1	422123	+ S	B	HC L	V	284	22	19,4	43,5	112	5	67	154,3	15
24.0122-0130.1	422130				V	257,2	22	20,2	50,7	98	4	59	127	13,2
24.0122-0132.1	422132	+ S	B	HC L	V	284	22	19,4	43,5	112	5	67	154,3	12,8
24.0122-0133.1	422133			HC	V	300	22	19,4	60	112	5	67	164	17
24.0122-0134.1	422134		B	HC L	V	284	22	19,4	43,5	112	5	67	152	15
24.0122-0136.1	422136		B	HC L	V	295	22	19,4	49,5	112	5	67	154,3	15
24.0122-0137.1	422137				V	287	22	20	56	108	5	68	157	14
24.0122-0139.1	422139		B	HC	V	280	22	20	56,5	108	4	68	146	15,4
24.0122-0140.1	422140			HC		280	22	19	78,6	112	5	88	133,5	12,5
24.0122-0141.1	422141				V	276	22	20	48	108	5	71	130,5	13
24.0122-0142.1	422142		B	HC L	V	283	22	20	28,2	108	4	66,1	133,5	13
24.0122-0143.1	422143				V	280	22	20	58	108	5	61	131,5	14,7
24.0122-0145.1	422145		B		V	284	22	20,2	43,5	98	5	59	127	13
24.0122-0146.1	422146		B		V	257	22	20	49,2	114,3	4	68	144	12,6
24.0122-0147.1	422147		B		V	284	22	20,2	43,5	98	4	59	127	13
24.0122-0148.1	422148	+ S	B	HC L	V	262	22	19,8	44	100	4	61	132	13,5
24.0122-0149.1	422149			HC L	V	262	22	19,8	44	108	5	61	132	15,5
24.0122-0150.1	422150	+ S	B	HC	V	280	22	19	36,7	100	5	65	133,5	15,6



Abmessungen Bremsscheiben

Dimensions brake discs - Medidas disco de freno - Dimensions Disques de frein - Misure dischi freno

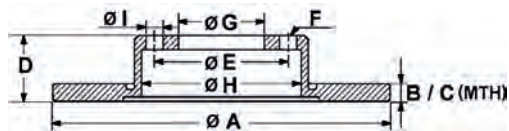

S Fixierschraube - fixing screw - tornillo quefija - vis de fixation - vite di riparazione
 B beschichtet - coated - recubierto - revêtu - rivestito
 HC hochgekohlt - high carbon - altamente carbonizado - à haute teneur en carbone - ad alto tenore di carbonio

L legiert - alloyed - aleado - allié - alligato/legato
 V ventiliert - ventilated - ventilado - ventilé - ventilato
 * gelocht - perforated - perforado - poinçonné - perforato

		S	B	HC	L	V	A	B	C	D	E	F	G	H	I
24.0122-0151.1	422151	+ S	B	HC		V	256	22	19	36,7	100	5	65	133,5	15,6
24.0122-0152.1	422152	+ S	B	HC		V	280	22	20	46,3	112	5/9	68	146,5	15,3
24.0122-0155.1	422155					V	258	22	20,4	33,5	104	5	84	153,5	10,8
24.0122-0156.1	422156					V	257	22	20,6	36	109	6	88	152,5	M12x1,25
24.0122-0158.1	422158		B			V	255	22	20	48,1	100	4	55	131,1	14,5
24.0122-0159.1	422159	+ S	B	HC		V	296	22	20,4	76,3	120	5	79	148,8	14,5
24.0122-0160.1	422160	+ S	B	HC		V	300	22	20,4	51,8	120	5	79	164	14,5
24.0122-0161.1	422161	+ S	B	HC L		V	276	22	19	77,2	130	5	85	156,3	15
24.0122-0162.1	422162	+ S	B	HC L		V	276	22	19	60	112	5	67	153	15
24.0122-0163.1	422163		B	HC		V	256	22	20	36,6	100	5	65	135	15,6
24.0122-0165.1	422165					V	257	22	20	45	100	4	55	125	13
24.0122-0166.1	422166		B			V	235	22	20	45	100	4	55	125	13
24.0122-0167.1	422167					V	250	22	20	30	95	4	73	140	10,8
24.0122-0168.1	422168	+ S	B	HC L		V	260	22	19,4	40,4	112	5	67	145	13,3
24.0122-0169.1	422169					V	257	22	20	44	114,3	4	69	160	12,6
24.0122-0170.1	422170					V	257	22	20	34	104	4	86	160,5	10,6
24.0122-0172.1	422172		B			V	258	22	20	43,4	108	4	63,5	136	13,7
24.0122-0177.1	422177		B			V	240,5	22	20	43	95,2	4	66	122	13
24.0122-0179.1	422179		B			V	280	22	20	49,2	114,3	4	68	143,5	12,5
24.0122-0180.1	422180					V	267	22	20	39,5	124	6	100	167	M10x1,25
24.0122-0181.1	422181					V	280	22,2	20,7	77	114	5	72	147,5	15,5
24.0122-0183.1	422183		B			V	279	22	20	52,8	114,3	5	62	147	14,6
24.0122-0185.1	422185					V	319	22	20	70,2	139,7	6	108	173	14,6
24.0122-0191.1	422191					V	281	22	20,2	47,5	108	5/10	59	134	14,7
24.0122-0192.1	422192		B	HC L		V	300	22	19,4	58,5	112	5	67	180	15
24.0122-0193.1	422193					V	250	22	20	50,2	114,3	5	68	140	12,7
24.0122-0194.1	422194	+ S	B			V	266	22	20	34,2	108	4	66	133,1	13
24.0122-0196.1	422196		B	HC L		V	285	21,9	19	93	145	6	120	169	15
24.0122-0197.1	422197		B			V	257,5	22	20,2	40,5	98	4	59	127	13
24.0122-0198.1	422198		B	HC		V	269	21,9	20	46,4	112	5	68	135	15,3
24.0122-0199.1	422199		B	HC L		V	270	22	19,4	35,5	112	5	67	145	13,3
24.0122-0200.1	422200					V	310	22	20	29	140	5	108,3	181,2	13
24.0122-0201.1	422201	+ S	B			V	300	22	19,4	68	112	5	67	180	15,3
24.0122-0202.1	422202		B	HC		V	280	22	20	42,4	112	5	68	158,5	15,3
24.0122-0203.1	422203		B	HC		V	269	22	20	47,9	112	5/10	68	135	15,3
24.0122-0204.1	422204		B	HC		V	276	22	20,4	44,2	100	4	64,2	150	14,7
24.0122-0206.1	422206		B			V	284	22	19	38,2	100	5	64,2	142	15,3
24.0122-0207.1	422207		B			V	235	22	20	46	100	4	55	125	13
24.0122-0208.1	422208		B	HC L		V	276	22	19,4	35,5	112	5	67	145	13,3
24.0122-0209.1	422209	+ S	B	HC		V	320	22	20,4	60,5	120	5	75	185	14,5
24.0122-0210.1	422210	+ S	B	HC		V	280	22	19	49,9	112	5/9	65	144	15,3
24.0122-0211.1	422211	+ S	B	HC		V	294	21,9	19,5	44,4	120	5	76	154,6	16,6
24.0122-0212.1	422212		B	HC		V	310	22	20	42,4	112	5	68	178	15,3
24.0122-0213.1	422213		B	HC L		V	315	22	19,4	59,3	112	5	67	180	15
24.0122-0214.1	422214		B	HC		V	335	22	20	42,4	112	5	68	191,5	15,3
24.0122-0215.1	422215	+ S	B			V	314	22	18	75,5	120	5	76	185	16,6
24.0122-0216.1	422216	+ S	B	HC		V	260	22	19,8	44	100	4	61	125	13,6
24.0122-0218.1	422218		B	HC L		V	300	22	19,4	57,5	112	5	67	164	15
24.0122-0219.1	422219		B	HC		V	310	22	20	48,5	112	5/9	65	169	15,3
24.0122-0220.1	422220		B	HC		V	300	22	20	36,2	112	5/9	68	172	15,3
24.0122-0221.1	422221		B	HC		V	256	22	20	48,1	112	5	68	135	15,3
24.0122-0222.1	422222		B	HC		V	269	22	20	54,1	112	5	68	135	15,4
24.0122-0223.1	422223		B	HC		V	330	22	20	49,4	112	5	68	138	15,3
24.0122-0224.1	422224	+ S	B	HC		V	320	22	20,4	79,7	120	5	75	185	16,5
24.0122-0225.1	422225					V	284	22	20,2	39,4	98	5	59	127	13
24.0122-0226.1	422226	+ S	B	HC L		V	330	22	19,4	63	112	5	67	210	15,2
24.0122-0227.1	422227					V	235	22	20	45	100	4	55	124,5	13
24.0122-0228.1	422228		B	HC L		V	300	22	19,4	55,3	112	5	67	164	13,2
24.0122-0229.1	422229		B	HC L		V	300	22	19,4	58,3	112	5	67	180	15,2
24.0122-0230.1	422230		B			V	285	22	20,4	38,5	114,3	5	69	145	12,5
24.0122-0231.1	422231	+ S	B			V	257	22	20	40,5	100	4/6	60	126	14,5
24.0122-0232.1	422232	+ S	B	HC L		V	276	22	19,4	44,5	112	5	67	145	15,3
24.0122-0233.1	422233	+ S	B			V	292	22	20	43,2	110	5	70	139	16,6
24.0122-0234.1	422234					V	281	22	20,2	47,5	108	5	59	133,8	14,7
24.0122-0235.1	422235					V	270	22	20	46	100	4	55	125	13
24.0122-0236.1	422236	+ S	B	HC		V	336	22	20,4	67,3	120	5	75	185	14,5
24.0122-0237.1	422237		B			V	277	22	20,4	45,5	108	6	87	170	10,5
24.0122-0238.1	422238	+ S	B	HC		V	292	22	20,4	73,3	120	5	79	151,5	14,5
24.0122-0239.1	422239	+ S	B	HC		V	284	22	20,4	73,3	120	5	79	151,5	16,6

Abmessungen Bremsscheiben

Dimensions brake discs - Medidas disco de freno - Dimensions Disques de frein - Misure dischi freno

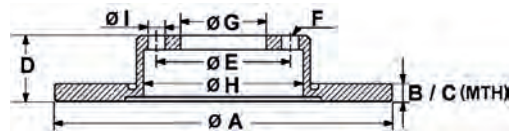

S Fixierschraube - fixing screw - tornillo quefija - vis de fixation - vite di riparazione
 B beschichtet - coated - recubierto - revêtu - rivestito
 HC hochgekohlt - high carbon - altamente carbonizado - à haute teneur en carbone - ad alto tenore di carbonio

L legiert - alloyed - aleado - allié - alligato/legato
 V ventiliert - ventilated - ventilado - ventilé - ventilato
 * gelocht - perforated - perforado - poinçonné - perforato

		S	B	HC L	V	A	B	C	D	E	F	G	H	I
24.0122-0240.1	422240		B		V	258	22	20	46	100	4	55	131	14,3
24.0122-0241.1	422241	+ S	B		V	284	22	20	43,5	100	4/6	60	127	14,2
24.0122-0242.1	422242	+ S	B	HC	V	310	22	20	58,6	112	5	65	140	15,3
24.0122-0243.1	422243		B	HC	V	330	22	20	42,5	112	5	68	146	15,3
24.0122-0244.1	422244		B	HC	V	294	22	20,4	44,2	100	4	64,2	150	14,7
24.0122-0245.1	422245		B	HC L	V	285	22	19	72	130	5	85	156,3	15
24.0122-0246.1	422246		B		V	255	22	19	46,3	100	4	55	131	14,5
24.0122-0247.1	422247		B	HC	V	294	22	20,4	44,2	100	4	64,2	150	16,2
24.0122-0248.1	422248		B	HC	V	280	22	20,4	44,2	100	4	64,2	150	16,2
24.0122-0249.1	422249		B		V	290	22	20	45	114,3	5	72	142,8	13
24.0122-0252.1	422252		B		V	280	22	20	47	114,3	5	62	146,3	12,7
24.0122-0253.1	422253				V	297	22	20	70,2	139,7	6	108	170	14,5
24.0122-0254.1	422254		B		V	275	22	19	46,5	100	4	55	131	14,5
24.0122-0255.1	422255				V	302	22	20	35	108	5	71,1	132,7	13
24.0122-0256.1	422256		B		V	275	22	19	46,3	114,3	5	62	145	14,8
24.0122-0257.1	422257	+ S	B	HC	V	324	22	20,4	77,3	120	5	75	185	14,5
24.0122-0258.1	422258		B		V	255	22	20	49,3	100	5	55	131	14,5
24.0122-0259.1	422259	+ S	B	HC	V	302	22	20	40,8	108	5	63,5	165	15,8
24.0122-0260.1	422260		B		V	256	22	20	46,6	100	4	62,2	126	12,5
24.0122-0261.1	422261		B	HC	V	302	22	20	50,7	108	5	63,5	165	15,7
24.0122-0262.1	422262				V	276	22	19	72,5	118	5	73	145	15,5
24.0122-0263.1	422263		B		V	254	22	20	42	100	4	55	137	13
24.0122-0264.1	422264		B		V	290	22	19	78	127	8	110	172	10,7
24.0122-0266.1	422266		B	HC L	V	290	22	19	42,5	120	10	102	144,3	10,5
24.0122-0267.1	422267		B	HC L	V	290	22	19	78	132	8	115	172	10,8
24.0122-0268.1	422268		B		V	322	22	20,2	62	114,3	5	68	172	12,7
24.0122-0270.1	422270	+ S	B	HC	V	258	22	19,8	44	100	4	61	125,3	13,5
24.0122-0271.1	422271	+ S	B	HC	V	294	22	20,4	45,2	120	5	79	152	16,5
24.0122-0272.1	422272	+ S	B	HC	V	330	21,9	20	36	112	5	68	147,7	15,3
24.0122-0273.1	422273	+ S	B	HC	V	356	22	20	36,2	112	5	68	159,8	15,3
24.0122-0276.1	422276		B		V	275	22	19	46,3	100	5	55	131	14,5
24.0122-0277.1	422277		B		V	260	22	20	44	100	4	61	130	12,8
24.0122-0278.1	422278	+ S	B	HC	V	300	22	20,4	73	120	5	79	152	16,5
24.0122-0280.1	422280		B		V	256	22	20	40,2	100	4	60	132,8	12,5
24.0122-0281.1	422281	+ S	B	HC	V	256	22	19	36,7	100	4	65	132	13,8
24.0122-0282.1	422282		B		V	272	22	20	40,2	100	4	60	150	12,5
24.0122-0283.1	422283		B		V*	284	22	20,2	43,5	98	4	59	127	13,2
24.0122-0286.1	422286		B		V	284	22	20	43,5	98	5	59	127	13,5
24.0122-0287.1	422287	+ S	B	HC L	V*	330	22	19,4	54	112	5	67	184	15
24.0122-0288.1	422288	+ S	B	HC L	V	330	22	19,4	54	112	5	67	184	15
24.0122-0289.1	422289	+ S	B	HC L	V	258	22	19,8	43,9	100	4	61	126,5	13,5
24.0122-0290.1	422290		B		V	280	22	20	47	114,3	5	62	146,3	12,7
24.0122-0291.1	422291	+ S	B	HC L	V	266	22	20	48	108	5	71,1	137	13
24.0122-0292.1	422292	+ S	B	HC	V	280	22	20,4	45,1	112	5	67	150,5	16,5
24.0122-0296.1	422296	+ S	B	HC	V	345	22	19,4	54	112	5	67	189	15
24.0122-0724.1	422724		B		V	300	22	20,4	72,3	139,7	6	94	199	12,6
24.0123-0101.1	423101				V	280	23,4	21,5	43,5	108	4	68	152,8	15
24.0123-0103.1	423103				V	260	23	21	34	114,3	4	92	160	M10x1,25
24.0123-0104.1	423104	+ S	B		V	282	23	21	47,1	114,3	5	70,2	148,5	12,6
24.0123-0105.1	423105				V	260	23	21	47,2	114,3	4	64,1	141	12,8
24.0123-0106.1	423106				V	282	23	21	47,2	114,3	4	64,1	141	13
24.0123-0107.1	423107		B	HC L	V	280	23	21,4	39,2	100	5	61	132	14
24.0123-0108.1	423108				V	295	22,5	21	66,5	120,7	5	80	154,3	13,4
24.0123-0109.1	423109	+ S	B		V	282	23	21	47,1	114,3	5	64,1	141	12,5
24.0123-0110.1	423110	+ S	B		V	282	23	21	47,2	114,3	5	64,2	141	12,6
24.0123-0111.1	423111	+ S	B		V	260	23	21	44,5	100	4	64,1	141,5	13
24.0123-0112.1	423112		B	HC	V	258	23	21	43,9	100	4	55	135,8	13
24.0123-0113.1	423113		B	HC	V	258	23	21	43,8	108	4	63,5	136	13
24.0123-0114.1	423114	+ S	B		V	315	22,9	21,5	48	120	5	67,4	172	16,3
24.0123-0116.1	423116	+ S	B		V	315	23	20	45	115	5	70,7	172	14,2
24.0123-0118.1	423118		B	HC L	V	280	23,1	21,4	44,3	114,3	5	69	143,5	12,6
24.0123-0119.1	423119	+ S	B	HC	V	269	22,5	19,8	44,1	114,3	5	68	141	15,7
24.0123-0120.1	423120	+ S	B	HC	V	282,5	23	21,4	32,2	100	5	61	142	14
24.0123-0122.1	423122		B		V	278	23	21	43,9	108	4	63,5	136	13
24.0123-0123.1	423123		B	HC	V	280	23,1	21	44,4	114,3	5	69	143,4	12,7
24.0124-0103.1	424103		B		V	252,5	24	22	53,5	95	6	76	105	M10x1,5
24.0124-0105.1	424105				V	264	24	22	46,5	114,3	5	64	137	12,6
24.0124-0115.1	424115	+ S	B	HC L	V	256	24	21	41	100	4/6	60	123	14
24.0124-0116.1	424116		B	HC L	V	299	24	22	71	130	5	103	180	15,4



Abmessungen Bremsscheiben

Dimensions brake discs - Medidas disco de freno - Dimensions Disques de frein - Misure dischi freno

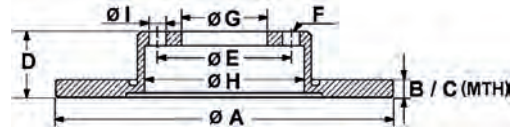

S Fixierschraube - fixing screw - tornillo quefija - vis de fixation - vite di riparazione
 B beschichtet - coated - recubierto - revêtu - rivestito
 HC hochgekohlt - high carbon - altamente carbonizado - à haute teneur en carbone - ad alto tenore di carbonio

L legiert - alloyed - aleado - allié - alligato/legato
 V ventiliert - ventilated - ventilado - ventilé - ventilato
 * gelocht - perforated - perforado - poinçonné - perforato

	S	B	HC L	V	A	B	C	D	E	F	G	H	I	
24.0124-0117.1	424117			HC L	V	299	24	22	100	130	5	103	180	15,4
24.0124-0118.1	424118		B	HC L	V	280	24	20	64,5	112	5	68,2	144	16,5
24.0124-0119.1	424119		B	HC L	V	286	24	21	58,4	110	5	70	139	14
24.0124-0120.1	424120		B		V	260	24	22,2	47	108	4	63,5	136	13,6
24.0124-0125.1	424125				V	260	24,2	22,2	44	108	4	63,5	136	13,7
24.0124-0127.1	424127		B		V	280	24	21,9	67,6	118	5	73	142	15,5
24.0124-0128.1	424128	+ S	B	HC	V	280	24	20	55,2	112	5	68,2	144	16,5
24.0124-0129.1	424129		B		V	258	24	22	48,6	114,3	5	72	142,5	13
24.0124-0131.1	424131		B		V	254	24,2	22,2	43	100	5	78,5	104	M10
24.0124-0132.1	424132		B		V	270	24,2	22,2	43	100	5	78,5	104	M10
24.0124-0133.1	424133			HC L	V	284	24	21	41	110	5/8	70	145	14
24.0124-0136.1	424136		B		V	256	24	21,5	45,5	114,3	4	69	145	12,6
24.0124-0137.1	424137				V	278	24	22	70	120	6	95	136	M12x1
24.0124-0138.1	424138		B		V	300	24	21,9	65,5	130	5	80	161	17,5
24.0124-0139.1	424139	+ S	B		V	260	24	22	28	108	4	66	133,5	13
24.0124-0140.1	424140		B		V	276	24	22,4	45,1	108	6	87	136	10,6
24.0124-0141.1	424141		B		V	260	24	22	56,8	100	5	58	129	12,8
24.0124-0142.1	424142				V	256	24	22,4	45,3	114,3	5	69	145	12,6
24.0124-0143.1	424143		B		V	298,5	24	22	70	127	5	101,6	158	10
24.0124-0144.1	424144				V	276	24	22,4	45,2	114,3	5	69	165	12,6
24.0124-0145.1	424145		B		V	277	24	22	56,5	100	5	58	129	13
24.0124-0146.1	424146		B		V	256	24	22,4	45,3	114,3	4	69	145	12,6
24.0124-0148.1	424148				V	278	24	22,2	35,5	108	4	63,5	137	13,7
24.0124-0149.1	424149		B		V	278	24,1	22,2	46,9	108	4	63,5	136	13,6
24.0124-0152.1	424152	+ S	B	HC L	V	256	23,8	21	41,1	100	4	60	123	14,3
24.0124-0158.1	424158	+ S	B	HC L	V	280	24	21,8	44	100	4	61	140	13,6
24.0124-0159.1	424159		B		V	281	23,9	21,5	45,7	114,3	4	69	146,5	12,5
24.0124-0161.1	424161		B		V	300	23,9	22	47	108	5	63,5	155	13,7
24.0124-0162.1	424162		B		V	280	24	21	61,5	110	6	79,5	119	M10
24.0124-0163.1	424163	+ S			V	256	24	22	47,1	100	4/6	60	134	13,2
24.0124-0164.1	424164		B		V	258	24	22	47	100	4	55	125	13
24.0124-0165.1	424165		B	HC L	V	298	24	22	67	130	5	98	164	15,4
24.0124-0166.1	424166	+ S	B	HC L	V	260	24	21	41	100	4/6	60	126	14,5
24.0124-0167.1	424167		B		V	276	24,5	22,1	43	100	5	82	136	M10
24.0124-0168.1	424168		B		V	294	24,5	22,1	43	100	5	82	136	M10
24.0124-0169.1	424169		B	HC	V	280	24	21,8	46,9	108	5	61	139,8	13,5
24.0124-0170.1	424170		B		V	276	24	22,4	45	114,3	4	69	145	12,5
24.0124-0171.1	424171	+ S	B	HC L	V	280	24	21,8	44	108	5	61	140	15,5
24.0124-0173.1	424173				V	258	24	22	48,6	114,3	4	72	143,7	13
24.0124-0174.1	424174				V	284	24,2	22,9	60,5	111,1	5	82,6	138,5	11,5
24.0124-0175.1	424175		B		V	273,5	24	22	47,5	114,3	5	72	143	13
24.0124-0176.1	424176		B	HC L	V*	299	24	22	75	130	5	98	180	15,4
24.0124-0177.1	424177		B	HC	V	345	24	22,4	67	120	5	79	185	16,5
24.0124-0178.1	424178		B		V	282,5	24	22,4	38	114,3	5	73,5	159,8	14
24.0124-0179.1	424179		B		V	278	24	22	44,5	108	5	63,5	136	13,7
24.0124-0181.1	424181	+ S	B	HC	V	310	24	22,4	77	120	5	79	161	14,5
24.0124-0182.1	424182				V	276	24	22,4	45	114,3	5	69	145	12,5
24.0124-0183.1	424183		B	HC L	V*	299	24	22	65	130	5	103	180	15,4
24.0124-0184.1	424184		B		V	257	24	22,1	46,7	114,3	4	69	141,5	12,7
24.0124-0185.1	424185				V	258	24	22	48,5	100	4	57	143,6	13
24.0124-0186.1	424186			HC	V	370	24	22,4	67	120	5	79	185	16,5
24.0124-0187.1	424187		B		V	254	24	22	50,7	100	4	55	141	13
24.0124-0188.1	424188		B	HC L	V	278	24	21,4	55,5	112	5	67	164	15
24.0124-0191.1	424191	+ S	B	HC	V	300	24	21,8	43,9	100	4	61	139,8	13,5
24.0124-0192.1	424192		B		V	256	24	21,5	45,6	114,3	4	69	139	12,7
24.0124-0193.1	424193				V	282,5	24	22,4	38	114,3	5	73,5	144	14
24.0124-0194.1	424194		B	HC L	V*	299	24	22	67	130	5	98	180	15,4
24.0124-0195.1	424195				V	274	24,1	22	40,5	114,3	5	72	142,5	13
24.0124-0196.1	424196		B		V	293,5	24	22	56,7	100	5	58	129	13
24.0124-0197.1	424197	+ S	B	HC	V	300	24	22,4	73,5	120	5	79	152	14,5
24.0124-0198.1	424198				V	300	24	22	44,5	108	4	63,5	156,5	13,7
24.0124-0199.1	424199	+ S	B		V	256	24	21	46,8	114,3	4	60	141	12,6
24.0124-0200.1	424200	+ S	B	HC	V	330	24	22,4	73,3	120	5	79	174	14,5
24.0124-0201.2	424201	+ S	B	HC	V	345	24	22,4	63,2	120	5	75	185	14,5
24.0124-0202.1	424202				V	276	24	22,4	45,2	114,3	6	93	137	10,6
24.0124-0203.1	424203	+ S	B	HC	V	312	23,9	22,4	73,1	120	5	79	152	16,5
24.0124-0207.1	424207				V	254	24	22,4	39	108	6	67	132,6	10,6
24.0124-0210.1	424210		B	HC L	V*	298	24	22	67	130	5	98	164	15,4
24.0124-0211.1	424211		B	HC L	V*	298	24	22	67	130	5	98	164	15,4

Abmessungen Bremsscheiben

Dimensions brake discs - Medidas disco de freno - Dimensions Disques de frein - Misure dischi freno

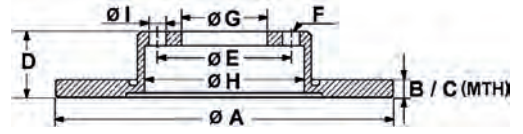

S Fixierschraube - fixing screw - tornillo quefija - vis de fixation - vite di riparazione
 B beschichtet - coated - recubierto - revêtu - rivestito
 HC hochgekohlt - high carbon - altamente carbonizado - à haute teneur en carbone - ad alto tenore di carbonio

L legiert - alloyed - aleado - allié - alligato/legato
 V ventiliert - ventilated - ventilado - ventilé - ventilato
 * gelocht - perforated - perforado - poinçonné - perforato

		S	B	HC L	V	A	B	C	D	E	F	G	H	I
24.0124-0212.1	424212	+ S	B	HC L	V	320	24	21,4	58,2	112	5	67	180	15,2
24.0124-0213.1	424213		B	HC	V	345	24	22,4	74	120	5	79	185	16,5
24.0124-0214.1	424214		B	HC	V	370	24	22,4	74	120	5	79	185	16,5
24.0124-0215.1	424215		B		V	294	24	22,4	45,5	114,3	5	69	147,8	12,6
24.0124-0216.1	424216	+ S	B	HC	V	345	24	22,4	78,5	120	5	75	185	16,5
24.0124-0217.1	424217		B		V	302,5	24	22	45	114,3	5	72	144	13
24.0124-0218.1	424218		B		V	322,6	24	22	45	114,3	5	72	144	13
24.0124-0219.2	424219	+ S	B	HC	V	385	24	22,4	78,5	120	5	75	185	16,5
24.0124-0220.1	424220				V	254	24	22,4	40	108	5	87	153,5	10,6
24.0124-0221.1	424221	+ S	B	HC	V	280	24	21,8	44	114,3	5	68	140	15,8
24.0124-0222.1	424222	+ S	B	HC	V	280	24	21,8	44	108	5	61	140	15,8
24.0124-0223.1	424223	+ S	B	HC	V	280	24	21,8	44	108	5	61	140	15,8
24.0124-0224.1	424224	+ S	B	HC	V	300	24	21,8	44	108	5	61	140	15,8
24.0124-0226.1	424226	+ S	B	HC L	V*	320	24	22	58,2	112	5	67	180	15,2
24.0124-0228.1	424228		B		V	294	24	21	87,5	108	8	84	142	10,5
24.0124-0229.1	424229		B		V	263	24	22	53	118	6	96	144	M12x1,5
24.0124-0231.2	424231	+ S	B	HC	V*	350	24	22,4	66,5	120	5	75	185	14,5
24.0124-0232.2	424232	+ S	B	HC	V*	350	24	22,4	66,5	120	5	75	185	14,5
24.0124-0233.2	424233	+ S	B	HC	V	345	24	22,4	69	120	5	75	185	16,5
24.0124-0234.2	424234	+ S	B	HC	V*	370	24	22,4	61,6	120	5	75	185	14,5
24.0124-0235.2	424235	+ S	B	HC	V*	370	24	22,4	61,6	120	5	75	185	14,5
24.0124-0236.1	424236	+ S	B	HC L	V	320	24	21,1	68,2	112	5	67	180	15,2
24.0124-0237.1	424237		B		V	278	24	22	47,3	114,3	4	60	141	12,5
24.0124-0238.1	424238		B		V	280	24	22	44	114,3	4	68	143,2	13
24.0124-0239.2	424239	+ S	B	HC	V	330	24	22,4	66	120	5	75	172	16,5
24.0124-0240.1	424240	+ S	B	HC	V	307	24	22,4	45,2	120	5	79	152	16,5
24.0124-0241.1	424241	+ S	B	HC	V	370	23,9	22,4	69	120	5	75	185	16,6
24.0124-0242.2	424242	+ S	B	HC	V	330	24	22,4	73,1	120	5	79	171,8	14,5
24.0124-0243.1	424243			HC L	V	254,5	24	22,4	40	108	5	87	152,5	10,6
24.0124-0245.1	424245			HC	V	256	24	22	24	108	6	86	155	10,8
24.0124-0247.1	424247		B		V	280	24	22	44	114,3	5	68	144	12,7
24.0124-0248.1	424248	+ S	B	HC	V	330	24	22,4	73	120	5	79	164	16,5
24.0124-0250.2	424250	+ S	B	HC	V	345	24	22,4	66,1	120	5	75	160,8	16,5
24.0124-0251.2	424251	+ S	B	HC	V	345	24	22,4	66,2	120	5	75	185	16,5
24.0124-0252.1	424252		B		V	256	24	21	45,3	100	4	60	124,8	12,6
24.0124-0253.1	424253	+ S	B	HC	V	280	24	21,8	44	100	4	61	140	13,5
24.0124-0258.1	424258	+ S	B	HC	V	276	24	21	49,7	112	9	65	144	15,3
24.0124-0259.1	424259	+ S	B	HC	V	330	24	22,4	45,1	112	5	67	151,4	16,5
24.0124-0260.1	424260	+ S	B	HC	V	307	24	22,4	45,1	112	5	67	151	16,5
24.0124-0702.1	424702		B		V	280	24	22,7	81,5	114,3	5	72	159	15,5
24.0124-0706.1	424706				V	257	24	22,4	45,5	114,3	4	69	141,5	12,5
24.0124-0723.1	424723				V	256	24	21	46,8	114,3	5	60	137	12,6
24.0124-0724.1	424724		B		V	314	24	22,4	45,2	108	6	87	136	10,6
24.0124-0735.1	424735		B		V	278	24	22	47	114,3	5	72	143	14,2
24.0125-0105.1	425105	+ S	B	HC	V	288	25	23	46,5	112	5/9	68	135	15,4
24.0125-0106.1	425106		B	HC	V	276	25	23	56,5	108	4	68	135	15,4
24.0125-0107.1	425107		B	HC L	V	294	25	22,4	49,5	112	5	67	154,3	15
24.0125-0108.1	425108		B	HC	V	288	25	23	28,5	100	5	65	136	15,6
24.0125-0110.1	425110	+ S	B	HC L	V	288	25	22,4	46,5	112	5	67	154,3	13,2
24.0125-0113.1	425113	+ S	B	HC	V	288	25	22	34,5	100	5	65	136	15,6
24.0125-0114.1	425114	+ S	B	HC	V	288	25,1	21	55,4	112	5	68,2	144,2	16,5
24.0125-0115.1	425115		B	HC	V	282,5	25	23	46,5	112	5	68	135	15,3
24.0125-0116.1	425116				V	255	25	23	52,6	114,3	5	62	147	14,4
24.0125-0117.1	425117		B	HC	V	278	25	23	48,5	108	5	63,5	140	13,7
24.0125-0118.1	425118				V	257	25	23	46,6	110	5	84	145	M10x1,25
24.0125-0119.1	425119	+ S	B	HC L	V	288	25	22	42	110	5/7	70	139	14
24.0125-0123.1	425123	+ S	B	HC	V	310	25	22	34,5	100	5/9	65	135	15,6
24.0125-0124.1	425124		B		V	255	24,9	24	49,2	100	5	55	156	14,5
24.0125-0125.1	425125				V	280	25	23	44	108	4	68	144	15
24.0125-0126.1	425126				V	271	25	23	52,8	114,3	5	62	147	14,6
24.0125-0129.1	425129				V	258	25	24	47	114,3	5	62	145,5	14,5
24.0125-0130.1	425130				V	282	25	23	34,5	114,3	4	92	171	M10x1,25
24.0125-0131.1	425131	+ S	B	HC L	V	280	24,8	22	42	110	5/7	70	139	14
24.0125-0135.1	425135				V	291	25	23	65,8	127	6	100	155	10,7
24.0125-0136.1	425136			HC	V	256	25	23	39,5	100	4	65	132,2	13,6
24.0125-0137.1	425137	+ S	B	HC	V	312	25	23	46,5	112	5/9	68	158	15,3
24.0125-0138.1	425138	+ S	B	HC	V	325	24,9	23,4	52,6	120	5	79	174	14,5
24.0125-0139.1	425139		B	HC L	V	276	24,9	23	56,5	112	5	68	135	15,5
24.0125-0140.1	425140		B		V	260	25	23	49,2	100	5	55	131	14,5



Abmessungen Bremsscheiben

Dimensions brake discs - Medidas disco de freno - Dimensions Disques de frein - Misure dischi freno

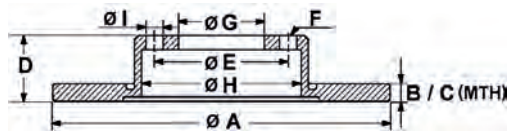

S Fixierschraube - fixing screw - tornillo quefija - vis de fixation - vite di riparazione
 B beschichtet - coated - recubierto - revêtu - rivestito
 HC hochgekohlt - high carbon - allamente carbonizado - à haute teneur en carbone - ad alto tenore di carbonio

L legiert - alloyed - aleado - allié - alligato/legato
 V ventiliert - ventilated - ventilado - ventilé - ventilato
 * gelocht - perforated - perforado - poinçonné - perforato

	S	B	HC L	V	A	B	C	D	E	F	G	H	I	
24.0125-0141.1	425141	+ S	B	HC	V	285	24,9	22	42,1	110	5/7	70	139	14
24.0125-0142.1	425142	+ S	B	HC L	V	308	25	22	42	110	5/8	70	139	14
24.0125-0143.1	425143		B		V	275	25	23	49,3	114,3	5	62	144	14,5
24.0125-0145.1	425145	+ S	B	HC	V	288	25	22	49,9	112	5/9	65	144	15,3
24.0125-0146.1	425146		B		V	282	25	23	47	114,3	4	64	142,5	13
24.0125-0147.1	425147		B		V	282,5	25	23	48,5	114,3	5	72	142	13
24.0125-0148.1	425148	+ S	B	HC L	V	280	25	22	42	100	4/6	60	139	14,5
24.0125-0149.1	425149		B	HC	V	314	25	23	59,7	112	5	68	144	15,3
24.0125-0155.1	425155		B		V	255	25	23	49,3	100	4	55	131	14,5
24.0125-0156.1	425156		B		V	276	25	23	49,2	100	5	55	131	14,5
24.0125-0157.1	425157		B		V	275	25	23	49,2	100	4	55	129	14,5
24.0125-0158.1	425158	+ S	B	HC	V	312	25	22	49,9	112	5/9	65	146	15,3
24.0125-0160.1	425160	+ S	B	HC	V	325	25	23,4	62,2	120	5	75	174	16,5
24.0125-0161.1	425161				V	282	25	23	44,5	100	4	64,2	143	12,6
24.0125-0162.1	425162		B	HC	V	300	25	23	48,5	108	5	63,5	140	13,7
24.0125-0164.1	425164		B		V	297	25	22	64,7	120	5	70	161,5	14,3
24.0125-0165.1	425165		B	HC	V	278	25	23	48,5	114,3	5	72	140	14
24.0125-0167.1	425167	+ S	B	HC L	V	288	25	22,4	44,5	112	5	67	154,3	15,3
24.0125-0168.1	425168		B		V	275	25	23	49,2	100	4	55	131	14,6
24.0125-0170.1	425170		B	HC	V	300	25	23	48,5	114,3	5	72	140	14
24.0125-0171.1	425171		B	HC	V	288	25	23	46,5	112	5/10	68	137	15,3
24.0125-0172.1	425172		B	HC	V	312	25	23	46,5	112	5/10	68	140	15,3
24.0125-0173.1	425173	+ S	B		V	300	25	23	47,2	114,3	5	64,1	141	12,7
24.0125-0174.1	425174		B		V	300	25	23	47,2	114,3	5	64,2	142	12,6
24.0125-0176.1	425176		B		V	297,5	25	22	91,5	120	5	70,1	161,1	14,3
24.0125-0177.1	425177		B		V	257	24,5	22,4	47,6	114,3	4	69	141,5	12,5
24.0125-0178.1	425178		B		V	275	25	22	46,5	114,3	5	62	145	14,5
24.0125-0179.1	425179	+ S	B	HC L	V	288	25	22	64,5	112	5	67	154,3	15,2
24.0125-0182.1	425182	+ S			V	300	25	23	47,1	114,3	5	64,1	141	12,7
24.0125-0183.1	425183				V	282	25	23	47	114,3	5	64,1	142,5	13
24.0125-0184.1	425184	+ S	B	HC	V	314	25	23	52,4	112	5	68	154	15,3
24.0125-0187.1	425187		B		V	280	25	23	47,2	114,3	5	64,1	142,2	13
24.0125-0188.1	425188		B		V	299	25	23	48,4	114,3	5	72	142,8	13
24.0125-0189.1	425189	+ S	B		V	281,5	25	23	47,2	114,3	5	64,1	142,5	12,5
24.0125-0190.1	425190		B		V	294,5	25	23	49	114,3	5	62	154	12,6
24.0125-0192.1	425192		B		V	297	24,9	23,5	67,3	140	6	108	170	14,5
24.0125-0195.1	425195		B	HC	V	320	25	23	48,5	114,3	5	72	148	13,7
24.0125-0196.1	425196		B		V	255	25	22	49,2	100	5	55	136	14,5
24.0125-0197.1	425197		B	HC	V	320	25	23	48,5	108	5	63,5	148	13,7
24.0125-0198.1	425198	+ S	B	HC L	V	280	25	22	43,2	100	4/6	60	139	14,5
24.0125-0199.1	425199		B	HC	V	278	25	23	48,5	108	5	63,5	140	13,7
24.0125-0200.1	425200	+ S	B	HC L	V	280	25	22,4	51	112	5	67	144,5	15
24.0125-0201.1	425201		B		V	280	25	22,4	47,2	114,3	5	64,1	142,2	12,6
24.0125-0202.1	425202		B	HC	V	300	25	23	48,4	108	5	63,5	139,7	13,8
24.0125-0203.1	425203		B	HC	V	278	25	23	48,5	108	5	63,5	140	13,6
24.0125-0208.1	425208		B		V	295	25	23	51,5	114,3	5	68	143	13
24.0125-0209.1	425209		B	HC	V	320	25	23	48,7	108	5	63,5	148	13,7
24.0125-0210.1	425210		B		V	278	25	23	39,8	108	4	63,5	136,2	14
24.0125-0211.1	425211	+ S	B		V	296	25	23	47,2	114,3	5	64,1	142	12,6
24.0125-0700.1	425700				V	275	25	23	49,2	100	5	55	129	14,5
24.0125-0706.1	425706				V	300	25	23	39,7	114,3	5	70,2	142,5	12,6
24.0126-0100.1	426100			HC L	V	283	26	24	48	108	5	71	130,5	13
24.0126-0101.1	426101				V	280,3	26	23	50,3	108	4	68	139	14,5
24.0126-0102.1	426102		B		V	280,3	26	23	50,3	108	5	68	139	14,5
24.0126-0103.1	426103				V	281	26	24,2	43,7	98	5	59	127	13
24.0126-0104.1	426104		B		V	281	26	24,2	43,7	98	5	59	127	16,5
24.0126-0105.1	426105		B		V	280	26	23	56,3	108	5	68	139	14
24.0126-0106.1	426106	+ S	B		V	283	26	24,2	28,2	108	4	66	133,5	13
24.0126-0107.1	426107		B	HC	V	302	26	23	50	108	5	68	151	14,4
24.0126-0108.1	426108		B		V	257	26	24	52,5	114,3	5	68	139,5	12,8
24.0126-0109.1	426109		B		V	277	26	24	39	124	6	100	164	M10x1,25
24.0126-0111.1	426111		B		V	280	26	24,6	36	109	6	88	175	M12x1,25
24.0126-0112.1	426112				V	257	26	24	45,5	100	4	61	148	12,8
24.0126-0114.1	426114				V	281	26	24,2	54,2	98	5	59	127	13,2
24.0126-0115.1	426115		B	HC	V	300	26	22	56	112	5	68,2	144	16,5
24.0126-0116.1	426116		B	HC	V	303	26	23	51,5	112	5	67	168	15
24.0126-0119.1	426119		B	HC	V	313	25,9	22	56,2	112	5	68,2	148	16,5
24.0126-0120.1	426120	+ S	B		V	283	26	24	34,2	108	4	66	133,5	13
24.0126-0121.1	426121	+ S	B	HC L	V	283	26	24	48,3	108	5	71,1	133	13,2

Abmessungen Bremsscheiben

Dimensions brake discs - Medidas disco de freno - Dimensions Disques de frein - Misure dischi freno

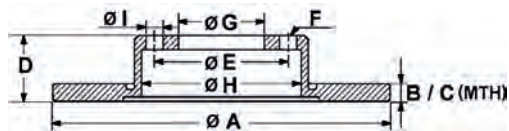

S Fixierschraube - fixing screw - tornillo quefija - vis de fixation - vite di riparazione
 B beschichtet - coated - recubierto - revêtu - rivestito
 HC hochgekohlt - high carbon - altamente carbonizado - à haute teneur en carbone - ad alto tenore di carbonio

L legiert - alloyed - aleado - allié - alligato/legato
 V ventiliert - ventilated - ventilado - ventilé - ventilato
 * gelocht - perforated - perforado - poinçonné - perforato

		S	B	HC L	V	A	B	C	D	E	F	G	H	I
24.0126-0122.1	426122		B		V	285,5	26	23	50,3	108	5	68	139	16,5
24.0126-0123.1	426123		B	HC	V	300	26	22,8	47	108	5	61	139,6	13,5
24.0126-0125.1	426125		B		V	281	26	24,2	43,5	98	4	59	127	13
24.0126-0126.1	426126		B		V	276	26	24	46,2	114,3	5	69	141,5	12,6
24.0126-0127.1	426127		B		V	294	26	24,4	46,1	114,3	5	69	145	12,6
24.0126-0128.1	426128		B	HC L	V	280	26	24,4	47,4	114,3	5	69	141,5	12,5
24.0126-0129.1	426129		B		V	280	26	24,4	47,3	114,3	4	69	141,4	12,7
24.0126-0130.1	426130		B		V	305	26	24,5	63,5	127	5	72	170	15,5
24.0126-0131.1	426131		B		V	276	26	24,4	45,5	114,3	4	69	145	12,5
24.0126-0133.1	426133				V	281	26	24,2	47,2	108	5/10	59	134	14,5
24.0126-0134.1	426134		B		V	276	26	24,4	45,5	114,3	5	69	145	12,5
24.0126-0135.1	426135		B		V	274	26,2	24	48,5	114,3	5	72	140,5	13
24.0126-0136.1	426136		B	HC L	V*	330	26	24	68,2	112	5	67	180	15
24.0126-0137.1	426137		B	HC L	V*	330	26	24	61	112	5	67	180	17
24.0126-0138.1	426138		B		V	295	26	24	49,2	114,3	5	62	141	14,5
24.0126-0139.1	426139		B		V	277	26	24	49,5	100	5	55	129	14,5
24.0126-0140.1	426140	+ S	B		V	302	26	24	34,2	108	4	66	133	13
24.0126-0141.1	426141		B		V	295	26	24	49,5	100	5	55	141	14,5
24.0126-0142.1	426142			HC	V	300	26	22,8	44	108	5	61	139,6	15,6
24.0126-0143.1	426143	+ S	B	HC L	V	280	26	24	48,5	114,3	4	72	143,5	13
24.0126-0144.1	426144			HC L	V	290	26	23	70	96	8	70	135	14,5
24.0126-0145.1	426145		B		V	290	26	24,4	46,3	139,7	6	94	171	12,8
24.0126-0146.1	426146		B	HC L	V	278	26	23	43,3	110	5/7	70	136	14
24.0126-0148.1	426148		B		V	273	26	23	49,2	114,3	5	62	142	14,8
24.0126-0149.1	426149	+ S	B	HC L	V	330	26	23,4	58,2	112	5	67	180	15
24.0126-0150.1	426150		B	HC L	V	280	26	24,4	47,2	114,3	5	69	143,5	12,5
24.0126-0151.1	426151		B		V	303	26	24	47	114,3	5	72	159	14
24.0126-0152.2	426152	+ S	B	HC	V	338	25,9	24,4	73	120	5	79	171,5	14,5
24.0126-0154.1	426154		B		V	295,5	26	24	44	114,3	5	68	146,5	12,7
24.0126-0155.1	426155	+ S	B		V	275	26	24	47,3	114,3	4	69	141,6	13
24.0126-0156.1	426156		B		V	295	26	23	49,1	114,3	5	62	143,2	14,8
24.0126-0157.1	426157				V	275	26	24	47,4	114,3	5	69	143,3	12,5
24.0126-0158.1	426158	+ S	B	HC L	V	296	26	23,4	44	114,3	5	68	147,7	15,8
24.0126-0159.1	426159	+ S	B		V	302	26	24	34,2	108	4	66	133,2	13
24.0126-0160.1	426160		B		V	320	26	23	49,3	114,3	5	62	143	14,5
24.0126-0161.1	426161		B	HC L	V	290	26	23	42,5	120	10	102	144,5	10,5
24.0126-0162.1	426162		B		V	290	26	24,4	45,8	114,3	5	69	145,5	12,6
24.0126-0163.1	426163		B		V	290	26	23	53	118	6	96	134	M12x1,5
24.0126-0164.1	426164		B		V	276	26	24,4	45,5	114,3	5	69	146	12,5
24.0126-0165.1	426165	+ S	B		V	276	26	23	45,5	105	5	60	139	14,2
24.0126-0166.1	426166	+ S	B	HC	V	300	26	23	45,5	115	5	70,7	149	14,2
24.0126-0168.1	426168	+ S	B		V	281	26,2	24,2	39,8	110	5/5	70	138	16,6
24.0126-0169.1	426169				V	274	26	24,4	44,2	108	5	87	132	10,5
24.0126-0170.1	426170		B		V	294	26	24,4	45,8	114,3	5	69	145	13,1
24.0126-0171.1	426171		B	HC L	V	280	26	24	47,3	114,3	5	69	141,5	12,6
24.0126-0172.1	426172		B		V	300	26	24	49,5	114,3	5	62	150	12,8
24.0126-0174.1	426174		B	HC L	V	376	26	24	42	108	5	64,5	167,6	14
24.0126-0175.1	426175		B		V	257	26	24	53,7	114,3	4	68	144	12,8
24.0126-0176.1	426176	+ S	B	HC L	V	302	26	24	34,2	108	5	66	133,5	13,2
24.0126-0177.1	426177		B		V	296	26	24	44	114,3	5	68	146	12,7
24.0126-0179.1	426179		B	HC	V	297	26	24,4	54	114,3	5	73,4	157,5	14
24.0126-0180.1	426180	+ S	B	HC L	V	280	26	23,8	45	108	5	61	139,8	15,8
24.0126-0182.1	426182	+ S	B	HC	V	300	26	23	45,2	105	5	60	149	14,2
24.0126-0183.1	426183	+ S	B	HC L	V	283	26	24	48	108	5	71	134	13,3
24.0126-0184.1	426184		B		V	277	26	23	49,3	114,3	5	62	142	14,6
24.0126-0185.1	426185		B	HC L	V	296	26	24	44	114,3	5	68	148	12,8
24.0126-0186.1	426186	+ S	B	HC	V	280	26	23,8	45	108	5	61	139,7	15,8
24.0127-0100.1	427100		B		V	281	27	25,4	42,7	108	6	87	136	10,6
24.0127-0101.1	427101				V	276	27	25,4	45,2	108	6	87	136	10,6
24.0128-0100.1	428100	+ S	B	HC L	V*	295	28	26	64,5	112	5	67	154,2	15,2
24.0128-0101.1	428101		B	HC	V	302	28	26,4	75,9	120	5	79	149	14,5
24.0128-0103.1	428103		B	HC L	V	300	28	25,4	45,5	112	5	67	154,3	15
24.0128-0104.1	428104	+ S	B	HC L	V	296	28	25	58,4	110	5	70	139	14
24.0128-0105.1	428105	+ S	B	HC	V	316	28	26,4	77	120	5	79	159	14,5
24.0128-0106.1	428106	+ S	B	HC L	V	300	28	25,4	46,5	112	5	67	154	13,3
24.0128-0113.1	428113				V	255	28	26	49,2	100	5	55	131	14,5
24.0128-0114.1	428114				V	255	28	26	49,1	114,3	5	62	146,5	14,6
24.0128-0115.1	428115		B		V	275	28	26	49,2	114,3	5	62	158,5	14,8
24.0128-0116.1	428116				V	255	28	26	49,3	100	5	55	155,5	14,5



Abmessungen Bremsscheiben

Dimensions brake discs - Medidas disco de freno - Dimensions Disques de frein - Misure dischi freno

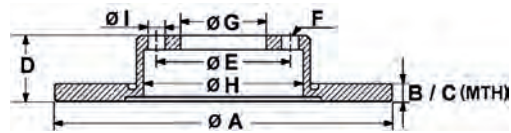

S Fixierschraube - fixing screw - tornillo quefija - vis de fixation - vite di riparazione
 B beschichtet - coated - recubierto - revêtu - rivestito
 HC hochgekohlt - high carbon - altamente carbonizado - à haute teneur en carbone - ad alto tenore di carbonio

L legiert - alloyed - aleado - allié - alligato/legato
 V ventiliert - ventilated - ventilado - ventilé - ventilato
 * gelocht - perforated - perforado - poinçonné - perforato

		S	B	HC L	V	A	B	C	D	E	F	G	H	I
24.0128-0118.1	428118				V	310	28	26	47,3	108	5/10	59	141,5	14,7
24.0128-0119.1	428119				V	305	28	26	44,7	98	5	59	151	13,2
24.0128-0120.1	428120				V	305	28	26	44,7	98	4	59	151	13,2
24.0128-0122.1	428122		B	HC	V	296	28	26,4	55	120	5	79	145,5	14,5
24.0128-0123.1	428123		B		V	305	27,9	25	50,3	108	5	68	139	16,5
24.0128-0125.1	428125		B	HC L	V*	312	28	26	76	112	5	67	154	15
24.0128-0126.1	428126		B	HC L	V	316	28	25,4	46,5	112	5	67	154,3	13
24.0128-0127.1	428127		B	HC L	V	310	28	25,4	82	112	5	67	154	17
24.0128-0128.1	428128	+ S	B		V	288	28	26	34	108	4	66	133	13
24.0128-0129.1	428129	+ S	B		V	305,5	28	25	77,8	130	5	90	157	15,8
24.0128-0130.1	428130		B	HC L	V*	318	28	26	67	130	5	98	158,8	15,4
24.0128-0131.1	428131		B	HC L	V*	318	28	26	67	130	5	98	158,8	15,4
24.0128-0132.1	428132	+ S	B	HC	V	305	28	24	49,7	118	5	72	154	15,5
24.0128-0133.1	428133		B	HC	V	324	28	25,4	47	108	5	61	150	15,5
24.0128-0134.1	428134		B		V	305	28	26	44	108	5	61	132	15,5
24.0128-0135.1	428135		B	HC	V	308	28	25,8	47	108	5	61	140	15,5
24.0128-0136.1	428136		B		V	285	28	26	43,7	98	5	59	127	16,5
24.0128-0137.1	428137	+ S	B	HC	V	302	28	25	45	110	5/7	70	139	14
24.0128-0138.1	428138		B		V	291	28,1	26	64,8	120,7	5	80	175	13,5
24.0128-0140.1	428140		B		V	280	28	26	49,1	114,3	5	68	144	12,8
24.0128-0142.1	428142		B	HC L	V	312	28	25,4	64,5	112	5	67	154	15,3
24.0128-0143.1	428143				V	305	28	26	28	108	4	66	132,9	13
24.0128-0144.1	428144		B	HC	V	316	28	25	50	108	5	68	144	16,5
24.0128-0145.1	428145	+ S	B	HC L	V	300	28	25	58,5	112	5	67	153	15
24.0128-0147.1	428147		B	HC	V	302	28	26,5	39	114,3	5	73,5	146,3	14
24.0128-0148.1	428148				V	281	28	25,3	38	114,3	5	73,5	146	14
24.0128-0149.1	428149	+ S	B	HC	V	330	28	26	73,5	130	5	85	210	15,4
24.0128-0153.1	428153		B	HC	V	320	28	26	49	114,3	5	68	144,5	13
24.0128-0154.1	428154	+ S	B	HC	V	300	28	26	52	108	5	63,5	140	15,8
24.0128-0155.1	428155	+ S	B	HC L	V	295	28	25,4	64,5	112	5	67	154,3	15,2
24.0128-0156.1	428156	+ S	B		V	280	28	25	54,5	111	5	93	136	M10x1,5
24.0128-0157.1	428157	+ S	B		V	300	28	25	54,5	111	5	93	136	M10x1,5
24.0128-0158.1	428158		B		V	321	28	26,4	49,1	114,3	5	69	143	12,5
24.0128-0159.1	428159		B		V	296	28	25	49,2	114,3	5	62	145	14,5
24.0128-0162.1	428162	+ S	B	HC	V	316	28	26	52	108	5	63,5	144	16
24.0128-0163.1	428163		B	HC L	V*	312	28	26	64,5	112	5	67	155,2	15
24.0128-0164.1	428164	+ S	B	HC	V	314	28	25	44,9	110	5/7	70	139	14
24.0128-0166.1	428166				V	300	28	26	38	124	6	100	184	M10x1
24.0128-0167.1	428167		B	HC L	V	298	28	26	74	130	5	103	157	15,4
24.0128-0169.1	428169		B	HC L	V	358	28	26	73,5	130	5	85	210	15,4
24.0128-0175.1	428175				V	273,5	28	26	51	114,3	5	72	142,8	13
24.0128-0176.1	428176	+ S	B	HC L	V	295	28	25,4	54,5	112	5	67	154	15,3
24.0128-0177.1	428177		B	HC L	V*	330	28	26	46,5	112	5	67	154	13
24.0128-0178.1	428178				V	288	28	26	50	108	5	71	130,5	13
24.0128-0179.1	428179		B		V	305,5	28	26	44,8	108	5/10	59	138,9	14,6
24.0128-0180.1	428180				V	296	28	26	51	114,3	5	72	142,8	13
24.0128-0182.1	428182		B	HC	V	308	28	25,4	47	108	5	61	140	13,5
24.0128-0183.1	428183		B		V	275	28	26	49,2	100	5	55	132	14,5
24.0128-0184.1	428184		B	HC	V	320	28	25	50	108	5	68	151	16,5
24.0128-0185.1	428185		B	HC	V	305	28	26	44,7	110	5/7	70	138	14,2
24.0128-0186.1	428186		B		V	296	28	26	49,3	114,3	5	62	141	14,7
24.0128-0188.1	428188	+ S	B	HC L	V	330	28	26	46,5	112	5	67	154	13
24.0128-0189.1	428189				V	285	28	26	45,5	127	6	84	149	M10x1,25
24.0128-0190.1	428190				V	296	28	26	49,2	114,3	5	62	156	14,7
24.0128-0191.1	428191	+ S	B		V	330	28	26	39,7	110	5	70	151	16,6
24.0128-0192.1	428192	+ S	B		V	305	28	26	39,7	110	5	70	138	16,6
24.0128-0194.1	428194		B		V	338	28	26	67,5	139,7	6	108	172	14,5
24.0128-0195.1	428195				V	295	28	26	50	108	5	71	130,6	13
24.0128-0196.1	428196		B	HC L	V*	330	28	26	75	130	5	98	180	15,4
24.0128-0197.1	428197		B	HC L	V*	330	28	26	75	130	5	98	180	15,4
24.0128-0198.1	428198	+ S	B	HC	V	315	28	26,4	52,5	120	5	79	152	14,5
24.0128-0199.1	428199	+ S	B	HC	V	315	28	26,4	52,5	120	5	79	152	14,5
24.0128-0200.1	428200		B		V	302	28	26	54	139,6	5	96,3	163	12,5
24.0128-0201.1	428201		B	HC L	V	321	28	25	44	110	5/7	70	139	14
24.0128-0202.1	428202		B	HC L	V	303	28	25	93	145	6	120	172	15
24.0128-0203.1	428203	+ S	B	HC L	V	300	28	25	68,5	130	6	85	155	15
24.0128-0204.2	428204	+ S	B	HC	V	315	28	26,4	52,5	120	5	79	155	14,5
24.0128-0205.2	428205	+ S	B	HC	V	315	28	26,4	52,5	120	5	79	155	14,5
24.0128-0206.2	428206	+ S	B	HC	V*	325	28	26,4	52,5	120	5	79	154,8	14,5

Abmessungen Bremsscheiben

Dimensions brake discs - Medidas disco de freno - Dimensions Disques de frein - Misure dischi freno

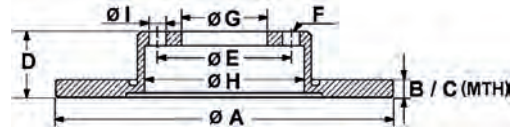

S Fixierschraube - fixing screw - tornillo quefija - vis de fixation - vite di riparazione
 B beschichtet - coated - recubierto - revêtu - rivestito
 HC hochgekohlt - high carbon - altamente carbonizado - à haute teneur en carbone - ad alto tenore di carbonio

L legiert - alloyed - aleado - allié - alligato/legato
 V ventiliert - ventilated - ventilado - ventilé - ventilato
 * gelocht - perforated - perforado - poinçonné - perforato

		S	B	HC	L	V	A	B	C	D	E	F	G	H	I
24.0128-0207.2	428207	+ S	B	HC		V*	325	28	26,4	52,5	120	5	79	154,8	14,5
24.0128-0208.2	428208	+ S	B	HC		V*	345	28	26,4	52,5	120	5	79	0	14,5
24.0128-0209.2	428209	+ S	B	HC		V*	345	28	26,4	52,5	120	5	79	0	14,5
24.0128-0210.1	428210	+ S	B	HC		V	336	28	26	52	108	5	63,5	152	16
24.0128-0211.1	428211		B			V	274	28,3	26	50,6	114,3	5	72	140	13
24.0128-0212.1	428212					V	296	28	26	49,5	114,3	5	62	141,3	14,5
24.0128-0213.1	428213		B			V	280	28	25,9	71,5	118	5	73	142	15,5
24.0128-0214.1	428214	+ S	B			V	280	28	26	48	108	5	71,1	152	13,2
24.0128-0215.1	428215		B			V	332	28	26	56,3	139,7	6	94	171	12,8
24.0128-0216.1	428216	+ S	B			V	304	28	26	48	108	5	71	145,5	13,2
24.0128-0217.1	428217	+ S	B			V	293	28	26	47,1	114,3	5	64,1	155	12,7
24.0128-0219.1	428219		B			V	305	28	26	44,7	100	4	60	139	14,2
24.0128-0220.1	428220		B			V	300	28	26	54	139,6	6	96,3	163	12,5
24.0128-0223.1	428223	+ S	B	HC		V	312,5	28	26	63	100	5	61	151	15,5
24.0128-0224.1	428224		B			V	303,5	28	26,4	42,7	108	6	87	147	10,6
24.0128-0226.1	428226		B	HC L		V	289	28	26	70,2	140	6	98	164	13
24.0128-0227.1	428227		B			V	302	28	26,4	54	139,6	5	96,3	163	12,5
24.0128-0228.1	428228		B			V	295,6	28	26	48,2	114,3	5	72	142,8	13
24.0128-0229.1	428229		B			V	325	28,3	26	49,5	120,7	5	73,8	155	13,5
24.0128-0231.1	428231		B	HC		V	305	28	26	44,8	98	4	59	139	13,2
24.0128-0232.1	428232		B			V	296	28	25	62	114,3	5	62	154	14,5
24.0128-0233.1	428233		B			V	320	28	26	48,2	114,3	5	72	143	13
24.0128-0234.1	428234		B			V	300	28	26,4	47,3	114,3	5	69	141,5	12,5
24.0128-0238.1	428238		B			V	300	28	25	74,5	125	6	78	156	15,5
24.0128-0239.1	428239		B			V	290	28	25	46	95	9	64	123	12,5
24.0128-0240.1	428240		B	HC L		V	320	28	26	38	114,3	6	68	175	12,8
24.0128-0241.1	428241		B	HC L		V	296	28	26	38	114,3	6	68	161	12,8
24.0128-0242.1	428242		B			V	320	28	26	44	114,3	5	68	146,5	12,7
24.0128-0243.1	428243		B	HC L		V	305	28	26	44,7	98	4	59	191	13
24.0128-0244.1	428244		B	HC L		V	276	28	26	45,2	118	5	94	151,5	M12x1,5
24.0128-0245.1	428245	+ S	B	HC L		V	320	28	25,4	44	114,3	5	68	147,7	15,8
24.0128-0246.1	428246		B	HC L		V*	330	28	26	69	130	5	98	159,7	15,4
24.0128-0247.1	428247		B	HC L		V*	330	28	26	69	130	5	98	159,7	15,4
24.0128-0248.1	428248		B	HC L		V	321	28	26,4	49,1	114,3	5	69	143	12,5
24.0128-0249.1	428249					V	258	28	26	62	114,3	5	62	141	14,5
24.0128-0250.1	428250		B	HC		V	300	28	26	52	108	5	63,5	140	13,8
24.0128-0251.1	428251		B	HC		V	303	28	26	56,9	120	5	76	165,2	16,6
24.0128-0252.1	428252	+ S	B			V	302	28	24,5	69,9	130	5	90	160,5	17,4
24.0128-0253.1	428253		B	HC L		V	305	28	26	45,7	98	5	59,2	127	13
24.0128-0254.1	428254	+ S	B	HC		V	328	28	26,4	73,1	120	5	75	153,8	16,5
24.0128-0255.1	428255		B	HC L		V	350	28	26	68,1	127	5	72	205	16,2
24.0128-0256.1	428256		B	HC L		V	300	28	26,4	47,3	114,3	5	69	142,5	12,5
24.0128-0258.1	428258		B	HC L		V	320	28,1	26,4	47,3	114,3	5	69	145	12,5
24.0128-0259.1	428259		B			V	332	28	26,4	64	114,3	5	72	165,3	16,6
24.0128-0260.1	428260		B	HC L		V*	315	28	26	69	130	5	98	159	15,4
24.0128-0261.1	428261	+ S	B	HC L		V	340	28	26	63	114,3	5	68	162	13,5
24.0128-0262.1	428262	+ S	B	HC L		V*	295	28	26	51,1	112	5	67	154,6	15
24.0128-0263.1	428263		B	HC		V	302	28	26,4	38,2	127	5	72,5	166	14
24.0128-0264.1	428264		B	HC L		V*	350	28	26	75	130	5	98	180	15,4
24.0128-0265.1	428265		B	HC L		V*	350	28	26	75	130	5	98	180	15,4
24.0128-0266.1	428266		B	HC		V	320	28	26,5	54,5	115	5	72,6	162,8	16,8
24.0128-0268.1	428268		B			V	283	28	26	44	114,3	5	68	154,2	12,8
24.0128-0269.1	428269	+ S	B	HC		V	304	28	26	48	108	5	71	133,2	13,2
24.0128-0270.1	428270		B	HC		V	302	28	26,4	64	114,3	5	72	165	16,6
24.0128-0273.1	428273		B	HC L		V*	315	28	26	69	130	5	98	159	15,4
24.0128-0274.1	428274		B	HC		V	296	28	25	49,4	114,3	5	62	145	14,5
24.0128-0275.1	428275	+ S	B	HC L		V	295	28	25,4	51,1	112	5	67	154,6	15
24.0128-0276.1	428276	+ S	B	HC L		V	295	28	25,4	51	112	5	67	155	15
24.0128-0277.1	428277		B			V	297	28	26	51,5	114,3	5	68	143	13,2
24.0128-0279.1	428279		B			V	297	28	26	51,4	114,3	5	68	143	13,3
24.0128-0280.1	428280		B	HC L		V	300	28	26,4	47,2	114,3	5	69	142,5	12,5
24.0128-0282.1	428282	+ S	B	HC L		V/	330	28	26	75	130	5	98	180	15,4
24.0128-0283.1	428283	+ S	B	HC L		V/	330	28	26	75	130	5	98	180	15,4
24.0128-0286.1	428286		B	HC L		V	300	28	26,5	50,9	108	5	63,5	139,7	13,8
24.0128-0287.1	428287	+ S	B	HC		V	296	28	23,4	44	114,3	5	68	147,7	15,5
24.0128-0288.1	428288	+ S	B	HC L		V/	340	28	26	63	114,3	5	68	162	13,5
24.0128-0289.1	428289	+ S	B	HC L		V	356	28	26	36,1	112	5	68	143,5	15,3
24.0128-0291.1	428291		B			V	320	28	26	44	114,3	5	68	153,7	12,7
24.0128-0292.1	428292	+ S	B			V	305	28	26	39,7	110	5/5	70	138	16,7/11



Abmessungen Bremsscheiben

Dimensions brake discs - Medidas disco de freno - Dimensions Disques de frein - Misure dischi freno

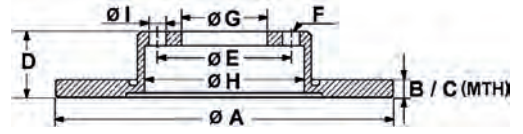

S Fixierschraube - fixing screw - tornillo quefija - vis de fixation - vite di riparazione
 B beschichtet - coated - recubierto - revêtu - rivestito
 HC hochgekohlt - high carbon - allamente carbonizado - à haute teneur en carbone - ad alto tenore di carbonio

L legiert - alloyed - aleado - allié - alligato/legato
 V ventiliert - ventilated - ventilado - ventilé - ventilato
 * gelocht - perforated - perforado - poinçonné - perforato

		S	B	HC L	V	A	B	C	D	E	F	G	H	I
24.0128-0293.1	428293		B		V	300	28	24	54,5	113,5	5	93	136	M12x1,5
24.0128-0296.1	428296	+ S	B	HC	V	350	28	26	36,2	112	5	68	150	15,3
24.0128-0300.1	428300	+ S	B	HC	V	305	28	25,4	62,8	112	5	69	155	15,4
24.0128-0708.1	428708			HC	V	288	28	26	64,8	114,3	5	72	158	15,5
24.0128-0722.1	428722				V	282	28	26	47	114,3	5	70,2	148,2	12,6
24.0128-0740.1	428740		B		V	296	28	26	49,2	114,3	5	62	149	14,5
24.0128-0753.1	428753		B		V	319	28	26	49,3	114,3	5	62	178,5	14,7
24.0129-0100.1	429100		B		V	305	28,5	26	49,5	120,7	5	73,8	154,5	13,4
24.0129-0101.1	429101		B	HC L	V	296	29	27,5	51,6	115	5	70,7	154,5	12,8
24.0129-0102.1	429102	+ S	B	HC	V	345	29,5	28	52,1	112	5	68	154	15,3
24.0130-0100.1	430100		B	HC L	V	320	30	27,4	82	112	5	67	154,3	15,2
24.0130-0101.1	430101	+ S	B	HC	V	324	30	28,4	77	120	5	79	149	14,5
24.0130-0103.1	430103			HC L	V	324	30	26	91	140	6	118	122	M12x1,5
24.0130-0104.1	430104		B	HC	V	314	30	28	59,7	112	5/10	68	136	15,3
24.0130-0107.1	430107	+ S	B	HC	V	324	29,9	28,4	73,7	120	5	79	149	14,8
24.0130-0109.1	430109	+ S	B	HC	V	332	29,9	28,4	62,1	120	5	75	158	16,5
24.0130-0113.1	430113	+ S	B	HC	V	320	30	28	46,5	112	5/9	68	137	15,3
24.0130-0114.1	430114		B	HC	V	308	29,5	25,5	55,6	120	5	76	154,6	16,6
24.0130-0115.1	430115		B	HC	V	345	30	27	49,9	112	5/9	65	140	15,3
24.0130-0116.1	430116		B	HC	V	336	30	27	51	108	5	68	150	16,5
24.0130-0117.1	430117		B	HC	V	324	30	28,4	81	120	5	79	169	16,5
24.0130-0118.1	430118		B	HC	V	348	30	28,4	81	120	5	79	164	16,5
24.0130-0119.1	430119		B	HC	V	345	30	28	46,5	112	5/9	68	142	15,3
24.0130-0120.1	430120		B		V	300	30	28	43	108	5	71	143,5	14
24.0130-0121.1	430121		B	HC L	V	320	30	28	50,5	112	5	67	154	13
24.0130-0122.1	430122		B	HC L	V	320	30	28	50,5	112	5	67	154	13
24.0130-0171.1	430171		B	HC L	V	345	30	27,4	46,5	112	5	67	154	13
24.0130-0172.1	430172		B	HC L	V*	304	30	27,4	47,5	112	5	67	154	15
24.0130-0173.1	430173	+ S	B	HC	V	324	30	28,4	77	120	5	79	165	14,5
24.0130-0174.1	430174		B	HC	V	321	30	28	52,5	112	5/10	68	135	15,3
24.0130-0175.1	430175	+ S	B	HC	V	321	30	28	59,7	112	5	68	144,8	15,3
24.0130-0176.1	430176	+ S	B	HC	V	347	30	28	59,7	112	5	68	158	15,3
24.0130-0177.1	430177		B	HC	V	345	30	28	59,7	112	5/10	68	135	15,3
24.0130-0178.1	430178		B		V	317	30	27	62	120	5	79	165	15
24.0130-0179.1	430179		B	HC L	V	304	30	27,4	47,5	112	5	67	154	15
24.0130-0180.1	430180		B	HC L	V*	345	30	28	46,5	112	5	67	154,2	13,1
24.0130-0181.1	430181	+ S	B		V	330	30	28	48	108	5	71,1	171,8	13,2
24.0130-0182.1	430182		B		V	320	30	28,4	43	108	5	71	143,5	14
24.0130-0183.1	430183		B	HC	V	323	30	28	59,7	112	5/9	68	144	15,3
24.0130-0184.1	430184		B	HC	V	344	29,9	28,4	75,9	120	5	79	172,8	16,6
24.0130-0185.1	430185		B	HC	V*	320	30	28	46,5	112	5/9	68	137	15,3
24.0130-0186.2	430186	+ S	B	HC	V	348	30	28,4	77,1	120	5	79	187,3	14,5
24.0130-0188.1	430188		B		V	337,5	30	27	62	120	5	79	166	15
24.0130-0189.1	430189		B	HC	V	345	29,9	27,5	45,3	110	5	70	142	14,2
24.0130-0190.1	430190			HC L	V	304	29,9	26	120,5	192	6	157	134	M12x1,5
24.0130-0191.1	430191			HC L	V	324	29,9	26	120,5	192	6	157	134	M12x1,5
24.0130-0192.1	430192	+ S	B	HC	V	348	30	28,4	73,1	120	5	79	186,8	14,5
24.0130-0193.1	430193	+ S	B	HC	V	320	30	28	52,4	112	5	68	153,4	15,3
24.0130-0195.1	430195		B		V	360	30	27	62	120	5	79	175	15
24.0130-0196.1	430196		B		V	344	30	27	76	120	5	79	172	16,6
24.0130-0197.1	430197		B		V	360	30	27	81	120	5	79	175	16,6
24.0130-0198.1	430198			HC L	V	304	30	26	91	140	6	118	122	M12x1,5
24.0130-0199.1	430199	+ S	B	HC	V	348	29,9	28,4	62,1	120	5	75	154	16,5
24.0130-0200.1	430200	+ S	B	HC	V	332	29,9	28,4	62,1	120	5	75	153	16,5
24.0130-0201.1	430201		B		V	334	30	27	51	114,3	5	62	143,5	14,5
24.0130-0202.1	430202		B		V	334	30	27	51	114,3	5	62	143,5	14,5
24.0130-0203.1	430203		B		V	326	30	28	52,7	114,3	5	58	148	12,8
24.0130-0204.1	430204		B		V	316	30	28	56,8	100	5	58	149	13
24.0130-0206.1	430206	+ S	B	HC L	V	330	30	28	48	108	5	71,1	138	13
24.0130-0207.1	430207	+ S	B	HC L	V	296	30	27	51	120	5	67,4	163,7	16,3
24.0130-0208.1	430208	+ S	B	HC	V	337	30	27	51	120	5	67,4	159,7	16,3
24.0130-0209.1	430209	+ S	B	HC	V	321	30	27	51	120	5	67,4	160	16,3
24.0130-0212.1	430212		B	HC	V	328	30	28	52	108	5	63,5	165,5	15,7
24.0130-0213.2	430213	+ S	B	HC	V*	360	30	28,4	62,3	120	5	79	185	14,5
24.0130-0214.2	430214	+ S	B	HC	V*	360	30	28,4	62,3	120	5	79	185	14,2
24.0130-0215.1	430215		B	HC	V	324	30	28,4	49	114,3	5	68	152	12,7
24.0130-0216.2	430216	+ S	B	HC	V	348	30	28,4	73	120	5	79	186,8	14,5
24.0130-0217.1	430217	+ S	B	HC L	V	315	30	27,4	83	130	5	85	157	15
24.0130-0218.2	430218	+ S	B	HC	V	348	30	28,4	66	120	5	75	186,8	16,5

Abmessungen Bremsscheiben

Dimensions brake discs - Medidas disco de freno - Dimensions Disques de frein - Misure dischi freno

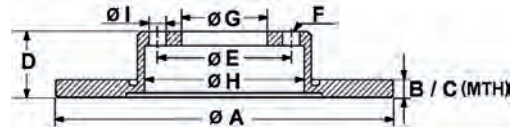

S Fixierschraube - fixing screw - tornillo quefija - vis de fixation - vite di riparazione
 B beschichtet - coated - recubierto - revêtu - rivestito
 HC hochgekohlt - high carbon - altamente carbonizado - à haute teneur en carbone - ad alto tenore di carbonio

L legiert - alloyed - aleado - allié - alligato/legato
 V ventiliert - ventilated - ventilado - ventilé - ventilato
 * gelocht - perforated - perforado - poinçonné - perforato

		S	B	HC	L	V	A	B	C	D	E	F	G	H	I
24.0130-0219.1	430219	+ S	B	HC		V	340	30	28	49,2	112	5	65	139,7	15,3
24.0130-0220.1	430220	+ S	B	HC		V	314	30	27	49,6	112	9	65	145	15,3
24.0130-0221.1	430221	+ S	B	HC		V	320	30	28	52,2	112	5	68	149,3	15,3
24.0130-0222.1	430222	+ S	B	HC		V	345	30	28	52,1	112	5	68	164,6	15,3
24.0130-0223.1	430223		B			V	328	30	28,5	53	127	5	72	177	16,2
24.0130-0224.1	430224	+ S	B	HC		V	321	30	27	45,5	115	5	70,7	160	14,2
24.0130-0225.1	430225	+ S	B	HC		V	340	30	27	49,6	112	5/9	65	145	15,3
24.0130-0226.1	430226		B	HC		V	326	30	28	46,1	108	5	71	161	14
24.0130-0227.1	430227	+ S	B	HC L		V	340	30	28	48	108	5	71,1	136	13,2
24.0130-0229.1	430229	+ S	B	HC L		V	340	30	28	34,2	108	5	71,1	133	13,2
24.0130-0230.1	430230	+ S	B	HC L		V	340	30	28	34,2	108	4	71,1	133	13,2
24.0130-0231.1	430231		B	HC L		V	345	30	28	56,5	114,3	5	69	144	12,5
24.0130-0233.2	430233	+ S	B	HC		V	340	30	28,4	73,2	120	5	79	153,7	16,5
24.0130-0234.2	430234	+ S	B	HC		V	370	30	28,4	73,1	120	5	79	184	16,5
24.0130-0236.1	430236	+ S	B	HC		V	345	30	28	62,1	112	5	68	154	15,3
24.0130-0237.1	430237	+ S	B	HC L		V	320	30	28	51	112	5	67	154	15
24.0130-0238.1	430238	+ S	B	HC L		V*	320	30	28	51	112	5	67	154	15
24.0130-0239.1	430239		B	HC L		V	300	30	28,4	52,4	139,7	6	96,3	163	12,5
24.0130-0240.1	430240		B	HC		V	327,5	30	27	51,3	108	5	68	140	16,5
24.0130-0241.1	430241	+ S	B	HC L		V	330	30	28	48	108	5	71,1	138	13,2
24.0132-0100.1	432100	+ S	B	HC L		V*	322	32	30	64,5	112	5	67	154,3	15,2
24.0132-0101.1	432101	+ S	B	HC L		V	322	32	29,4	64,5	112	5	67	154,3	15,2
24.0132-0110.1	432110					V	278	32,2	30,7	52	118	5	70,6	150	16,2
24.0132-0111.1	432111					V	311	32	30	58	139,7	6	105	204	M12x1,25
24.0132-0113.1	432113	+ S	B	HC		V	334	31,9	30,4	76,9	120	5	79	159	14,8
24.0132-0114.1	432114		B	HC		V	345	31,9	30	51	112	5	67	156,5	15,3
24.0132-0115.1	432115		B	HC L		V*	330	32	30	76	112	5	67	154	15
24.0132-0116.1	432116	+ S	B	HC		V	333	32,5	28,5	55,6	120	5	76	154,6	16,6
24.0132-0117.1	432117	+ S	B	HC L		V	330	32	30	68,5	130	5	85	174	15,4
24.0132-0118.1	432118	+ S	B	HC L		V	330	32	30	68,5	130	5	85	174	15,4
24.0132-0125.1	432125		B	HC L		V*	345	32	30	76	112	5	67	154	15
24.0132-0126.1	432126					V	310	32	30	43,8	98	5	59	138	16,5
24.0132-0129.1	432129			HC		V	330	32	30	44,7	98	5	59	149	13
24.0132-0131.1	432131		B			V	300	32	29,9	73,5	130	5	80	161	18
24.0132-0136.1	432136		B	HC L		V*	330	32	30	47,5	112	5	67	154	15
24.0132-0137.1	432137	+ S	B	HC L		V*	335	32	30	64,5	112	5	67	154	15,2
24.0132-0138.1	432138	+ S	B	HC L		V*	350	32	30	64,5	112	5	112	154	15,2
24.0132-0139.1	432139	+ S	B	HC L		V	350	32	29,4	64,5	112	5	67	154	15,2
24.0132-0142.1	432142		B	HC L		V*	304	32	30	72	130	5	103	161	15,4
24.0132-0143.1	432143		B	HC L		V*	304	32	30	72	130	5	103	161	15,4
24.0132-0144.1	432144	+ S	B	HC L		V	330	32	29,4	64,5	112	5	67	154	15
24.0132-0147.1	432147		B	HC L		V*	334	32	30	51,5	112	5	67	154	13
24.0132-0148.1	432148		B			V	313	32	30	70	144	5	115	172,5	12,5
24.0132-0152.1	432152					V	309	32	30	43,1	108	5	71,1	136	13
24.0132-0153.1	432153	+ S	B	HC L		V*	330	32	30	64,5	112	5	67	154	15
24.0132-0154.1	432154		B	HC L		V	330	32	29,4	47,5	112	5	67	154	15
24.0132-0157.1	432157	+ S	B	HC L		V	350	32	29,4	54,5	112	5	67	156,3	15,2
24.0132-0158.1	432158	+ S	B	HC L		V	330	32	29,4	54,5	112	5	67	156,3	15,2
24.0132-0159.1	432159		B	HC L		V	330	32	29,4	46,5	112	5	67	154	13
24.0132-0160.1	432160	+ S		HC		V	334	31,9	30,4	62,9	120	5	79	159	14,8
24.0132-0161.2	432161	+ S	B	HC		V	345	32	30,4	77	120	5	79	159,5	14,5
24.0132-0162.2	432162	+ S	B	HC		V	345	32	30,4	77	120	5	79	159,5	14,5
24.0132-0163.2	432163		B	HC L		V*	322	32	30	72	130	5	103	157	15,4
24.0132-0164.2	432164		B	HC L		V*	322	32	30	72	130	5	103	157	15,4
24.0132-0165.2	432165		B	HC		V	334	32	30	35	100	5/9	65	146	15,6
24.0132-0166.2	432166		B	HC		V	334	32	30	35	100	5/9	65	146	15,6
24.0132-0167.1	432167	+ S	B	HC L		V	375	32	29,4	54,5	112	5	67	156,3	15,2
24.0132-0168.1	432168	+ S	B	HC L		V*	344	32	30	64,5	112	5	67	154,3	15
24.0132-0169.1	432169		B	HC		V	321	32	30	51	114,3	5	69	143	12,5
24.0132-0170.1	432170	+ S	B	HC L		V*	322	32	30	51,5	112	5	67	154,2	15,2
24.0132-0172.1	432172	+ S	B	HC		V	320	32	30	47,2	114,3	5	64,2	151	12,6
24.0132-0174.1	432174		B			V	338	32	29	68,2	139,7	6	108	172	14,5
24.0132-0175.1	432175	+ S	B	HC L		V*	344	32	30	64,5	112	5	67	154,3	15,2
24.0132-0176.1	432176		B			V	302	32	30	61	140	6	98	164	13,2
24.0132-0178.1	432178	+ S	B	HC L		V	330	32	29,4	54,5	112	5	67	158	15
24.0132-0179.1	432179	+ S	B	HC L		V*	350	32	29,4	54	112	5	67	158	15
24.0132-0180.1	432180	+ S	B	HC L		V*	344	32	30	51,5	112	5	67	154	15
24.0132-0181.1	432181		B			V	330	32	30,5	54,5	127	5	72	173	17
24.0132-0184.1	432184	+ S	B	HC L		V	350	32	29,4	54,5	112	5	67	158	15



Abmessungen Bremsscheiben

Dimensions brake discs - Medidas disco de freno - Dimensions Disques de frein - Misure dischi freno

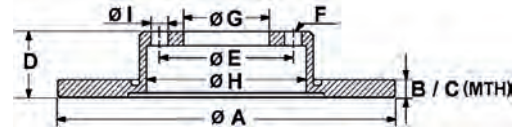

S Fixierschraube - fixing screw - tornillo quefija - vis de fixation - vite di riparazione
 B beschichtet - coated - recubierto - revêtu - rivestito
 HC hochgekohlt - high carbon - altamente carbonizado - à haute teneur en carbone - ad alto tenore di carbonio

L legiert - alloyed - aleado - allié - alligato/legato
 V ventiliert - ventilated - ventilado - ventilé - ventilato
 * gelocht - perforated - perforado - poinçonné - perforato

		S	B	HC L	V	A	B	C	D	E	F	G	H	I
24.0132-0701.1	432701		B		V	296	32	30	50,8	114,3	5	62	143,5	14,5
24.0133-0100.1	433100	+ S	B	HC	V	340	32,6	29,5	55,6	120	5	76	154,8	16,6
24.0133-0101.1	433101	+ S	B	HC L	V	288	33	30	55,3	111	5	93,1	136	M10x1,5
24.0133-0102.1	433102	+ S	B	HC L	V	308	33	30	55,3	111	5	93,1	136	M10x1,5
24.0134-0100.1	434100		B	HC	V	360	34	31	59,7	112	5	68	135	15
24.0134-0101.1	434101		B	HC L	V*	330	34	32	69,5	130	5	98	173,5	15,4
24.0134-0102.1	434102		B	HC L	V*	330	34	32	69,5	130	5	98	173,5	15,4
24.0134-0103.1	434103	+ S	B	HC	V	356	34	31,5	52,4	112	5	68	149	15,3
24.0134-0104.1	434104		B		V	328	34	31	49,2	114,3	5	62	142,5	14,5
24.0134-0105.1	434105		B	HC L	V*	350	34	32	67,5	130	5	98	185	15,4
24.0134-0106.1	434106		B	HC L	V*	350	34	32	67,5	130	5	98	185	15,4
24.0134-0107.1	434107	+ S	B	HC	V	356	34	31,5	62,4	112	5	68	149,5	15,3
24.0134-0110.1	430110	+ S	B	HC	V	349	34	32	57,1	112	5	68	151,3	15,3
24.0134-0123.1	434123		B	HC L	V	350	34	32	68,5	130	5	85	185	15,4
24.0134-0124.1	434124		B	HC L	V	350	34	32	68,5	130	5	85	185	15,4
24.0136-0101.1	436101		B	HC	V	374	36	34,4	81	120	5	79	187	16,5
24.0136-0102.1	436102		B	HC L	V*	360	36	34	64,5	112	5	67	154	15,2
24.0136-0103.1	436103		B	HC	V	385	36	33,5	59,7	112	5	68	135	15,3
24.0136-0104.1	436104		B	HC	V	356	36	34,4	61,9	120	5	75	158	16,5
24.0136-0105.1	436105		B	HC L	V*	360	36	34	76	112	5	67	154	15
24.0136-0106.2	436106	+ S	B	HC	V	348	36	34,4	77	120	5	79	154,3	14,5
24.0136-0107.1	436107		B	HC	V	385	36	33,5	61,4	112	5	68	135	15,2
24.0136-0108.1	436108	+ S	B	HC L	V*	360	36	34	64,5	112	5	67	154	15,2
24.0136-0109.1	436109	+ S	B	HC	V	365	36	34,4	62	120	5	75	168	16,5
24.0136-0110.1	436110		B	HC	V	348	35,9	34,4	80,9	120	5	79	154	16,5
24.0136-0111.1	436111		B	HC	V	368	36	34	68,7	130	5	85	157	15,4
24.0136-0112.2	436112	+ S	B	HC	V	385	36	34,4	62	120	5	75	153,7	16,5
24.0136-0113.2	436113	+ S	B	HC	V	385	36	34,4	62	120	5	75	153,7	16,5
24.0136-0114.2	436114	+ S	B	HC	V	348	36	34,4	66	120	5	75	153,7	16,5
24.0136-0115.2	436115	+ S	B	HC	V	348	36	34,4	66	120	5	75	153,7	16,5
24.0136-0116.2	436116	+ S	B	HC	V*	374	36	34,4	77	120	5	79	174	14,5
24.0136-0117.2	436117	+ S	B	HC	V*	374	36	34,4	77	120	5	79	174	14,5
24.0136-0118.2	436118	+ S	B	HC	V	374	36	34,4	66	120	5	75	186,8	16,5
24.0136-0119.2	436119	+ S	B	HC	V	374	36	34,4	66	120	5	75	186,8	16,5
24.0136-0120.2	436120	+ S	B	HC	V	374	36	34,4	66	120	5	75	153,8	16,5
24.0136-0121.2	436121	+ S	B	HC	V	374	36	34,4	66	120	5	75	153,8	16,5
24.0136-0122.1	436122		B	HC	V	380	36	34	48	108	5	71	163	14
24.0136-0123.1	436123	+ S	B	HC	V	360	36	34	68,5	130	5	85	160	15,4
24.0136-0124.1	436124	+ S	B	HC	V	360	36	34	68,5	130	5	85	160	15,4
24.0136-0125.2	436125	+ S	B	HC	V*	400	36	34,4	63,2	120	5	75	198	16,5
24.0136-0126.2	436126	+ S	B	HC	V*	400	36	34,4	63,2	120	5	75	198	16,5
24.0136-0127.1	436127	+ S	B	HC L	V/	360	36	34	68,6	130	5	98	160	15,4
24.0136-0128.1	436128	+ S	B	HC L	V/	360	36	34	68,6	130	5	98	160	15,4
24.0308-0111.1	508111		B			258	8	7	55,3	112	5	67	164	13
24.0308-0113.1	508113	+ S	B			258	8	7	57,3	112	5	67	164	15
24.0309-0114.1	509114	+ S	B			278	9	7,3	55,5	112	5	67	164	13,2
24.0309-0120.1	509120	+ S	B			258	9	7,3	55,5	112	5	67	164	12,8
24.0309-0123.1	509123	+ S	B			230	9	7	40,6	100	5	65	125,8	15,6
24.0309-0133.1	509133	+ S	B			239	8,9	7	33,4	100	5	65	132,5	15,8
24.0309-0154.1	509154	+ S	B			278	9	7,3	57,5	112	5	67	164	15
24.0310-0115.1	510115		B			253	10,2	8,9	33	108	4	63,5	155	13,7
24.0310-0117.1	510117	+ S	B	HC		300	10	7,6	61	120	5	75	180	14,5
24.0310-0151.1	510151	+ S	B			239	10	8	38,9	100	4	65	124,5	13,6
24.0310-0201.1	510201		B			245	10	8	64,2	112	5	68	135,5	15,4
24.0310-0202.1	510202	+ S	B	HC		280	10	7,6	60	120	5	75	160,8	14,5
24.0310-0217.1	510217	+ S	B			290	10	8,3	55,5	112	5	67	164	13,3
24.0310-0223.1	510223	+ S	B			268	10	8	45,8	112	5	68,2	154,5	16,8
24.0310-0224.1	510224		B			245	10	8	48	112	5	68	135,5	15,4
24.0310-0225.1	510225	+ S	B			270	10	8	69,3	100	4	57	160	14
24.0310-0226.1	510226	+ S	B			286	10	8	69,3	110	5	65,5	160	14
24.0310-0227.1	510227	+ S	B	HC		298	10	7,6	61	120	5	75	185	14,5
24.0310-0250.1	510250	+ S	B			264	9,8	8	42	110	5	65,5	145	14
24.0310-0251.1	510251	+ S	B			240	9,8	8	42	100	4	57	140,8	14
24.0310-0260.1	510260		B			255	10	8	48,1	112	5	68	144,5	15,3
24.0310-0261.1	510261		B			245	10	8	40	112	5/9	68	135,5	15,3
24.0310-0271.1	510271		B			259	10	7,6	44,1	100	4	64,2	163	16
24.0310-0277.1	510277	+ S	B			253	10	8	51,6	112	5/9	65	140	15,3
24.0310-0278.1	510278	+ S	B			300	10	8,3	68,3	112	5	67	180	15,3
24.0310-0291.1	510291	+ S	B			264	10	8	42	100	4	57	145	14

Abmessungen Bremsscheiben

Dimensions brake discs - Medidas disco de freno - Dimensions Disques de frein - Misure dischi freno

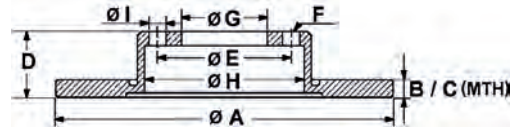

S Fixierschraube - fixing screw - tornillo quefija - vis de fixation - vite di riparazione
 B beschichtet - coated - recubierto - revêtu - rivestito
 HC hochgekohlt - high carbon - altamente carbonizado - à haute teneur en carbone - ad alto tenore di carbonio

L legiert - alloyed - aleado - allié - alligato/legato
 V ventiliert - ventilated - ventilado - ventilé - ventilato
 * gelocht - perforated - perforado - poinçonné - perforato

		S	B	HC	L	V	A	B	C	D	E	F	G	H	I
24.0310-0314.1	510314	+ S	B	HC			280	10	7,6	65,5	120	5	75	160,8	14,5
24.0310-0315.1	510315	+ S	B	HC			296	10,4	8,1	65,5	120	5	75	160,8	14,5
24.0310-0328.1	510328	+ S	B				300	10	8,3	57,5	112	5	67	164	15,3
24.0310-0349.1	510349		B				251	10	9	40,5	98	4	59	128	13,2
24.0310-0356.1	510356	+ S	B				272	9,7	8	48,2	112	9	65	174,5	15,3
24.0311-0141.1	511141		B				256	10,8	8	41,1	100	6	60	123	14,3
24.0311-0145.1	511145		B				302	10,9	9	50,8	108	5	63,5	177,6	15,8
24.0311-0155.1	511155		B				265	11	9	40,8	108	5	63,5	152	13,7
24.0311-0158.1	511158		B				280	11	9	41	108	5	63,5	192	13,7
24.0311-0171.1	511171		B				271	11	9	40,7	108	5	63,5	152	13,8
24.0312-0106.1	512106	+ S	B				239	12	10	35,4	100	4	65	124,5	13,6
24.0312-0125.1	512125		B				239	12	10,8	42,5	98	4	58,5	127	13,1
24.0312-0126.1	512126	+ S	B				286	12	9,6	51,5	120	5	79	148	14,5
24.0312-0141.1	512141		B				239,5	12	10	42,9	108	4	63,5	136	13,7
24.0312-0144.1	512144	+ S	B	HC L			260	12	10	40,4	112	5	67	145	13,3
24.0312-0148.1	512148		B				255	12	10	40	112	5/9	68	144,5	15,3
24.0312-0151.1	512151		B				288	11,9	10	64,8	108	5	68	178	16,5
24.0312-0152.1	512152		B	HC			324	12	9,6	80,2	120	5	75	185	16,8
24.0312-0154.1	512154		B				280	12	10	34	108	5	63,5	151	13,7
24.0312-0157.1	512157	+ S	B				278	11,9	10	41,4	110	5	65,5	145,2	14
24.0312-0158.1	512158		B				256	12	10	48,6	112	5/9	65	140	15,3
24.0312-0159.1	512159		B				302	12	10	49,4	112	5/9	68	177	15,3
24.0312-0166.1	512166		B				288	12	10	36	112	5	68	162	15,3
24.0312-0167.1	512167	+ S	B	HC L			276	12	10	44,5	112	5	67	145	15,3
24.0312-0169.1	512169	+ S	B				282	12	10	48,6	112	5/9	65	159	15,3
24.0312-0178.1	512178	+ S	B				300	12	10	36,4	112	5	68	169	15,3
24.0312-0187.1	512187	+ S	B				292	12	10,5	48	120	5	67,4	171,5	16,3
24.0312-0188.1	512188	+ S	B				268	12	10	44,9	105	5	60	147	14,2
24.0312-0189.1	512189	+ S	B				292	12	10	45	115	5	70,7	157	14,2
24.0313-0161.1	513161	+ S	B				236	12,7	9,7	41	100	4	60	123	14
24.0313-0178.1	513178	+ S	B				255,6	12,9	11	39,2	100	4	65	135,5	13,6
24.0313-0181.1	513181		B	HC			280	13	11	46,5	112	5	68	159	15,4
24.0313-0184.1	513184	+ S	B				266	13	11	27,2	108	4	66	133	13
24.0313-0185.1	513185	+ S	B				247,5	13	11	34,2	108	4	66	133	13
24.0315-0105.1	515105		B	HC			288	15	13	46,5	112	5	68	135,5	15,4
24.0318-0106.1	518106	+ S	B	HC	V		239	18	16	34,5	100	4	65	125	13,6
24.0318-0137.1	518137	+ S	B	HC	V		239	18	16	35	100	5	65	125	15,6
24.0319-0107.1	519107	+ S	B	HC	V		276	19	16,6	60,3	120	5	75	160,8	14,5
24.0319-0108.1	519108	+ S	B	HC	V		294	18,9	16,6	59,7	120	5	75	160,8	14,8
24.0320-0115.1	520115	+ S	B	HC L	V		236	20	17	41	100	4	60	123	14
24.0320-0123.1	520123	+ S	B	HC L	V		239	20	18	39	100	4	65	123,8	13,6
24.0320-0128.1	520128	+ S	B	HC L	V		256	20	18	38,8	100	4	65	131,5	13,8
24.0320-0132.1	520132	+ S	B		V		247	20,4	18,5	34,2	108	4	66	133,2	12,8
24.0320-0133.1	520133	+ S	B		V		266	20,5	18,5	27,6	108	4	66	133	13
24.0320-0142.1	520142		B	HC L	V		257,5	20	18,2	40,5	98	4	59	126,7	13
24.0320-0146.1	520146		B		V		253	20	18	43,7	108	4	63,5	153	13,7
24.0320-0147.1	520147		B		V		239,5	20	18	43	108	4	63,5	136	13,7
24.0320-0154.1	520154	+ S	B	HC	V		298	20	17,6	61,3	120	5	75	185	14,5
24.0320-0173.1	520173	+ S	B		V		292	19,9	18	41,4	110	5	65,5	162,5	14
24.0320-0175.1	520175		B		V		255	20	18	43,1	100	4	55	129	14,5
24.0320-0183.1	520183	+ S	B	HC	V		320	20	17,6	63,2	120	5	75	185	14,5
24.0320-0195.1	520195	+ S	B	HC	V		300	20	17,6	66	120	5	75	160,8	14,5
24.0320-0204.1	520204	+ S	B	HC	V		300	20	17,6	66,1	120	5	75	185	14,5
24.0320-0213.1	520213	+ S	B	HC	V		320	20	17,6	86,1	120	5	75	185	14,5
24.0320-0234.1	520234	+ S	B	HC	V		330	20	17,6	71	120	5	75	154	16,5
24.0322-0100.1	522100		B	HC	V		280	22	20	28,5	100	5	65	141	15,6
24.0322-0103.1	522103	+ S	B	HC	V		302	22	19,6	76	120	5	79	149	14,5
24.0322-0115.1	522115	+ S	B	HC	V		286	22	19,6	51,5	120	5	79	147,5	14,5
24.0322-0132.1	522132	+ S	B	HC L	V		284	22	19,4	43,5	112	5	67	154,3	12,8
24.0322-0150.1	522150	+ S	B	HC	V		280	22	19	36,7	100	5	65	133,5	15,6
24.0322-0151.1	522151	+ S	B	HC	V		256	22	19	36,7	100	5	65	133,5	15,6
24.0322-0152.1	522152		B	HC	V		280	22	20	46,3	112	5/9	68	146,5	15,3
24.0322-0159.1	522159	+ S	B	HC	V		296	22	19,6	76,3	120	5	79	148,8	14,5
24.0322-0160.1	522160	+ S	B	HC	V		300	22	19,6	51,8	120	5	79	164	14,5
24.0322-0161.1	522161	+ S	B	HC L	V		276	22	19	77,2	130	5	85	156,3	15
24.0322-0162.1	522162	+ S	B	HC L	V		276	22	19	60	112	5	67	153	15
24.0322-0163.1	522163		B	HC	V		256	22	20	36,6	100	5	65	135	15,6
24.0322-0168.1	522168	+ S	B	HC L	V		260	22	19,4	40,4	112	5	67	145	13,3
24.0322-0170.1	522170				V		257	22	20	34	104	4	86	160,5	10,6



Abmessungen Bremsscheiben

Dimensions brake discs - Medidas disco de freno - Dimensions Disques de frein - Misure dischi freno

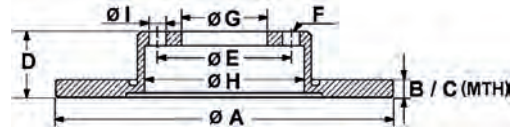

S Fixierschraube - fixing screw - tornillo quefija - vis de fixation - vite di riparazione
 B beschichtet - coated - recubierto - revêtu - rivestito
 HC hochgekohlt - high carbon - altamente carbonizado - à haute teneur en carbone - ad alto tenore di carbonio

L legiert - alloyed - aleado - allié - alligato/legato
 V ventiliert - ventilated - ventilado - ventilé - ventilato
 * gelocht - perforated - perforado - poinçonné - perforato

	S	B	HC L	V	A	B	C	D	E	F	G	H	I	
24.0322-0172.1	522172		B		V	258	22	20	43,4	108	4	63,5	136	13,7
24.0322-0197.1	522197		B		V	257,5	22	20,2	40,5	98	4	59	127	13
24.0322-0199.1	522199		B	HC L	V	270	22	19,4	35,5	112	5	67	145	13,3
24.0322-0204.1	522204		B	HC	V	276	22	19,6	44,2	100	4	64,2	150	14,7
24.0322-0209.1	522209	+ S	B	HC	V	320	22	19,6	60,5	120	5	75	185	14,5
24.0322-0210.1	522210	+ S	B	HC	V	280	22	19	49,9	112	5/9	65	144	15,3
24.0322-0223.1	522223		B	HC	V	330	22	20	49,4	112	5	68	138	15,3
24.0322-0224.1	522224	+ S	B	HC	V	320	22	19,6	79,7	120	5	75	185	16,5
24.0322-0231.1	522231	+ S	B		V	257	22	20	40,5	100	4/6	60	126	14,5
24.0322-0232.1	522232	+ S	B	HC L	V	276	22	19,4	44,5	112	5	67	145	15,3
24.0322-0236.1	522236	+ S	B	HC	V	336	22	19,6	67,3	120	5	75	185	14,5
24.0322-0238.1	522238	+ S	B	HC	V	292	22	19,6	73,3	120	5	79	151,5	14,5
24.0322-0239.1	522239	+ S	B	HC	V	284	22	19,6	73,3	120	5	79	151,5	16,6
24.0322-0247.1	522247		B	HC	V	294	22	19,6	44,2	100	4	64,2	150	16,2
24.0322-0248.1	522248		B	HC	V	280	22	19,6	44,2	100	4	64,2	150	16,2
24.0323-0113.1	523113		B	HC	V	258	23	21	43,8	108	4	63,5	136	13
24.0323-0114.1	523114	+ S	B		V	315	22,9	21,5	48	120	5	67,4	172	16,3
24.0324-0115.1	524115	+ S	B	HC L	V	256	24	21	41	100	4	60	123	14
24.0324-0120.1	524120		B		V	260	24	22,2	47	108	4	63,5	136	13,6
24.0324-0152.1	524152	+ S	B	HC L	V	256	23,8	21	41,1	100	4	60	123	14,3
24.0324-0158.1	524158	+ S	B	HC L	V	280	24	21,8	44	100	4	61	140	13,6
24.0324-0159.1	524159		B		V	281	23,9	21,5	45,7	114,3	4	69	146,5	12,5
24.0324-0161.1	524161		B		V	300	23,9	22	47	108	5	63,5	155	13,7
24.0324-0166.1	524166		B	HC L	V	260	24	21	41	100	4/6	60	126	14,5
24.0324-0171.1	524171	+ S	B	HC L	V	280	24	21,8	44	108	5	61	140	15,5
24.0324-0181.1	524181	+ S	B	HC	V	310	24	21,6	77	120	5	79	161	14,5
24.0324-0197.1	524197	+ S	B	HC	V	300	24	21,6	73,3	120	5	79	152	14,5
24.0324-0200.1	524200	+ S	B	HC	V	330	24	21,6	73,3	120	5	79	174	14,5
24.0324-0203.1	524203	+ S	B	HC	V	312	23,9	21,6	73,1	120	5	79	152	16,5
24.0325-0105.1	525105		B	HC	V	288	25	23	46,5	112	5/9	68	135	15,4
24.0325-0110.1	525110	+ S	B	HC L	V	288	25	22,4	46,5	112	5	67	154,3	13,2
24.0325-0113.1	525113	+ S	B	HC	V	288	25	22	34,5	100	5	65	136	15,6
24.0325-0114.1	525114	+ S	B	HC	V	288	25,1	21	55,4	112	5	68,2	144,2	16,5
24.0325-0115.1	525115		B	HC	V	282,5	25	23	46,5	112	5	68	135	15,3
24.0325-0117.1	525117		B	HC	V	278	25	23	48,5	108	5	63,5	140	13,7
24.0325-0119.1	525119	+ S	B	HC L	V	288	25	22	42	110	5/7	70	139	14
24.0325-0123.1	525123		B	HC	V	310	25	22	34,5	100	5/9	65	135	15,6
24.0325-0131.1	525131	+ S	B	HC L	V	280	24,8	22	42	110	5/7	70	139	14
24.0325-0137.1	525137		B	HC	V	312	25	23	46,5	112	5/9	68	158	15,3
24.0325-0138.1	525138	+ S	B	HC	V	325	24,9	22,6	52,6	120	5	79	174	14,5
24.0325-0141.1	525141	+ S	B	HC	V	285	24,9	22	42,1	110	5	70	139	14
24.0325-0142.1	525142	+ S	B	HC L	V	308	25	23	42	110	5/8	70	139	14
24.0325-0145.1	525145	+ S	B	HC	V	288	25	22	49,9	112	5/9	65	144	15,3
24.0325-0148.1	525148	+ S	B	HC L	V	280	25	22	42	100	4/6	60	139	14,5
24.0325-0149.1	525149		B	HC	V	314	25	23	59,7	112	5	68	144	15,3
24.0325-0158.1	525158	+ S	B	HC	V	312	25	22	49,9	112	5/9	65	146	15,3
24.0325-0160.1	525160	+ S	B	HC	V	325	25	22,6	62,2	120	5	75	174	16,5
24.0325-0162.1	525162		B	HC	V	300	25	23	48,5	108	5	63,5	140	13,7
24.0325-0167.1	525167	+ S	B	HC L	V	288	25	22,4	44,5	112	5	67	154,3	15,3
24.0325-0171.1	525171		B	HC	V	288	25	23	46,5	112	5/10	68	137	15,3
24.0325-0172.1	525172		B	HC	V	312	25	23	46,5	112	5/10	68	140	15,3
24.0325-0179.1	525179	+ S	B	HC L	V	288	25	22	64,5	112	5	67	154,3	15,2
24.0325-0184.1	525184	+ S	B	HC	V	314	25	23	52,4	112	5	68	154	15,3
24.0325-0197.1	525197		B	HC	V	320	25	23	48,5	108	5	63,5	148	13,7
24.0325-0198.1	525198	+ S	B	HC L	V	280	25	22	43,2	100	4/6	60	139	14,5
24.0325-0199.1	525199		B	HC	V	278	25	23	48,5	108	5	63,5	140	13,7
24.0326-0106.1	526106	+ S	B		V	283	26	24,2	28,2	108	4	66	133,5	13
24.0326-0107.1	526107		B	HC	V	302	26	23	50	108	5	68	151	14,4
24.0326-0115.1	526115		B	HC	V	300	26	22	56	112	5	68,2	144	16,5
24.0326-0119.1	526119		B	HC	V	313	25,9	22	56,2	112	5	68,2	148	16,5
24.0326-0120.1	526120	+ S	B		V	283	26	24	34,2	108	4	66	133,5	13
24.0326-0123.1	526123		B	HC	V	300	26	22,8	47	108	5	61	139,6	13,5
24.0326-0165.1	526165	+ S	B		V	276	26	23	45,5	105	5	60	139	14,2
24.0326-0166.1	526166	+ S	B	HC	V	300	26	23	45,5	115	5	70,7	149	14,2
24.0328-0106.1	528106	+ S	B	HC L	V	300	28	25,4	46,5	112	5	67	154	13,3
24.0328-0123.1	528123		B		V	305	27,9	25	50,3	108	5	68	139	16,5
24.0328-0129.1	528129	+ S	B		V	305,5	28	25	77,8	130	5	90	157	15,8
24.0328-0136.1	528136		B		V	285	28	26	43,7	98	5	59	127	16,5
24.0328-0137.1	528137	+ S	B	HC	V	302	28	25	45	110	5	70	139	14

Abmessungen Bremsscheiben

Dimensions brake discs - Medidas disco de freno - Dimensions Disques de frein - Misure dischi freno

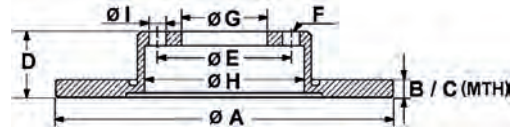

S Fixierschraube - fixing screw - tornillo quefija - vis de fixation - vite di riparazione
 B beschichtet - coated - recubierto - revêtu - rivestito
 HC hochgekohlt - high carbon - altamente carbonizado - à haute teneur en carbone - ad alto tenore di carbonio

L legiert - alloyed - aleado - allié - alligato/legato
 V ventiliert - ventilated - ventilado - ventilé - ventilato
 * gelocht - perforated - perforado - poinçonné - perforato

	S	B	HC L	V	A	B	C	D	E	F	G	H	I	
24.0328-0142.1	528142		B	HC L	V	312	28	25,4	64,5	112	5	67	154	15,3
24.0328-0154.1	528154	+ S	B	HC	V	300	28	26	52	108	5	63,5	140	15,8
24.0328-0155.1	528155	+ S	B	HC L	V	295	28	25,4	64,5	112	5	67	154,3	15,2
24.0328-0162.1	528162	+ S	B	HC	V	316	28	26	52	108	5	63,5	144	16
24.0328-0176.1	528176		B	HC L	V	295	28	25,4	54,5	112	5	67	154	15,3
24.0328-0198.1	528198	+ S	B	HC	V	315	28	25,6	52,5	120	5	79	152	14,5
24.0328-0199.1	528199	+ S	B	HC	V	315	28	25,6	52,5	120	5	79	152	14,5
24.0328-0250.1	528250		B	HC	V	300	28	26	52	108	5	63,5	140	13,8
24.0328-0254.1	528254	+ S	B	HC	V	328	28	25,6	73,1	120	5	75	153,8	16,5
24.0330-0107.1	530107	+ S	B	HC	V	324	29,9	27,6	73,7	120	5	79	149	14,8
24.0330-0109.1	530109	+ S	B	HC	V	332	29,9	27,6	62,1	120	5	75	158	16,5
24.0330-0113.1	530113		B	HC	V	320	30	28	46,5	112	5/9	68	137	15,3
24.0330-0115.1	530115		B	HC	V	345	30	27	49,9	112	5/9	65	140	15,3
24.0330-0173.1	530173	+ S	B	HC	V	324	30	27,6	77	120	5	79	165	14,5
24.0330-0175.1	530175	+ S	B	HC	V	321	30	28	59,7	112	5	68	144,8	15,3
24.0330-0176.1	530176	+ S	B	HC	V	347	30	28	59,7	112	5	68	158	15,3
24.0330-0193.1	530193	+ S	B	HC	V	320	30	28	52,4	112	5	68	153,4	15,3
24.0330-0207.1	530207	+ S	B	HC L	V	296	30	27	51	120	5	67,4	163,7	16,3
24.0330-0209.1	530209	+ S	B	HC	V	321	30	27	51	120	5	67,4	160	16,3
24.0332-0101.1	532101	+ S	B	HC L	V	322	32	29,4	64,5	112	5	67	154,3	15,2
24.0332-0144.1	532144	+ S	B	HC L	V	330	32	29,4	64,5	112	5	67	154	15
24.0332-0158.1	532158	+ S	B	HC L	V	330	32	29,4	54,5	112	5	67	156,3	15,2







- DE** Vergleichsliste WVA → ATE
- EN** Cross reference list WVA → ATE
- ES** Lista referencias WVA → ATE
- FR** Liste des correspondances WVA → ATE
- IT** Tabella di conversione codici WVA → ATE

2018



Vergleichsliste WVA → ATE



Cross reference list WVA → ATE - Lista referencias WVA → ATE - Liste des correspondances WVA → ATE - Tabella di conversione codici WVA → ATE

WVA D 				WVA D 				WVA D 			
XXXX				20887	19,7	13.0460-7032.2	607032	21154	19,5	13.0460-5703.2	605703
X	15,5	13.0460-4843.2	604843	20888	15,3	13.0460-7033.2	607033	21158	15,5	13.0460-5938.2	605938
20008	13,0	13.0460-5824.2	605824	20888	17,3	13.0460-7059.2	607059	21170	17,3	13.0460-2965.2	602965
20035	17,0	13.0460-3902.2	603902	20889	17,3	13.0460-7030.2	607030	21182	19,4	13.0460-2809.2	602809
20038	14,0	13.0460-6914.2	606914	20901	19,0	13.0460-2925.2	602925	21185	19,4	13.0460-2952.2	602952
20073	17,3	13.0460-3936.2	603936	20905	18,0	13.0460-3952.2	603952	21193	18,0	13.0460-5409.2	605409
20076	15,5	13.0460-5835.2	605835	20906	18,0	13.0460-3911.2	603911	21193	18,0	13.0460-7063.2	607063
20091	14,6	13.0460-2800.2	602800	20906	18,0	13.0460-3943.2	603943	21195	18,0	13.0460-5410.2	605410
20124	18,9	13.0460-2972.2	602972	20906	18,0	13.0460-3962.2	603962	21197	15,0	13.0460-3805.2	603805
20149	17,0	13.0460-7146.2	607146	20907	18,1	13.0460-7126.2	607126	21197	15,0	13.0470-3805.2	LD3805
20162	15,4	13.0460-4956.2	604956	20907	18,1	13.0460-7129.2	607129	21201	17,5	13.0460-7052.2	607052
20164	18,2	13.0460-2985.2	602985	20908	18,0	13.0460-7040.2	607040	21202	16,9	13.0460-7073.2	607073
20166	16,0	13.0460-2966.2	602966	20927	18,5	13.0460-3969.2	603969	21209	18,5	13.0460-2971.2	602971
20168	16,0	13.0460-2957.2	602957	20934	14,0	13.0460-3945.2	603945	21217	18,0	13.0460-2812.2	602812
20168	19,3	13.0460-2806.2	602806	20938	18,0	13.0460-2955.2	602955	21229	17,0	13.0460-5937.2	605937
20168	19,3	13.0460-2958.2	602958	20939	15,8	13.0460-7048.2	607048	21233	16,7	13.0460-3914.2	603914
20180	17,3	13.0470-3605.2	LD3605	20941	19,3	13.0460-2927.2	602927	21237	15,5	13.0460-6917.2	606917
20181	17,3	13.0460-3605.2	603605	20958	16,0	13.0460-5963.2	605963	21243	14,0	13.0460-5816.2	605816
20192	15,0	13.0460-5806.2	605806	20961	15,2	13.0460-2842.2	602842	21266	17,0	13.0460-2943.2	602943
20194	15,0	13.0460-5919.2	605919	20961	15,2	13.0460-2937.2	602937	21267	16,8	13.0460-4042.2	604042
20217	17,1	13.0460-4837.2	604837	20961	16,0	13.0460-2886.2	602886	21273	19,5	13.0460-7053.2	607053
20236	18,0	13.0460-2810.2	602810	20961	16,0	13.0470-2886.2	LD2886	21273	19,5	13.0470-7053.2	LD7053
20261	19,0	13.0460-2863.2	602863	20961	17,2	13.0460-2819.2	602819	21276	17,0	13.0460-7061.2	607061
20261	19,0	13.0460-3824.2	603824	20961	17,2	13.0460-2820.2	602820	21276	17,0	13.0460-7246.2	607246
20309	17,9	13.0460-9037.2	609037	20961	17,2	13.0460-2864.2	602864	21278	16,4	13.0460-7107.2	607107
20325	17,2	13.0460-5789.2	605789	20961	17,2	13.0460-2894.2	602894	21278	16,4	13.0460-7134.2	607134
20337	14,0	13.0460-3961.2	603961	20961	17,2	13.0460-2984.2	602984	21279	16,4	13.0460-4014.2	604014
20359	19,2	13.0460-6926.2	606926	20961	17,2	13.0470-2820.2	LD2820	21279	16,4	13.0460-4059.2	604059
20389	15,4	13.0460-4911.2	604911	20961	17,2	13.0470-2894.2	LD2894	21280	16,0	13.0460-5949.2	605949
20392	18,5	13.0460-5701.2	605701	20968	17,5	13.0460-7138.2	607138	21282	17,3	13.0460-7168.2	607168
20410	15,0	13.0460-4957.2	604957	20974	10,8	13.0460-3926.2	603926	21282	17,3	13.0460-7232.2	607232
20489	18,5	13.0460-3968.2	603968	20974	11,0	13.0460-3823.2	603823	21284	19,1	13.0460-7147.2	607147
20547	16,5	13.0460-7241.2	607241	20974	11,0	13.0460-3954.2	603954	21289	16,8	13.0460-4041.2	604041
20634	15,0	13.0460-3953.2	603953	20981	13,8	13.0460-2928.2	602928	21301	15,5	13.0460-3504.2	603504
20640	17,5	13.0460-7071.2	607071	20989	17,7	13.0460-2956.2	602956	21303	18,9	13.0460-9033.2	609033
20660	15,6	13.0460-8006.2	608006	20996	17,3	13.0460-3803.2	603803	21304	18,5	13.0460-6036.2	606036
20668	16,6	13.0460-2962.2	602962	21010	15,8	13.0460-2846.2	602846	21305	15,7	13.0460-4047.2	604047
20676	19,5	13.0460-7050.2	607050	21012	15,0	13.0460-5936.2	605936	21305	15,7	13.0470-4047.2	LD4047
20676	19,8	13.0460-7077.2	607077	21016	17,0	13.0460-3933.2	603933	21314	12,8	13.0460-5998.2	605998
20676	19,8	13.0460-7110.2	607110	21028	19,3	13.0470-2927.2	LD2927	21319	14,9	13.0460-5625.2	605625
20676	19,8	13.0470-7081.2	LD7081	21048	18,3	13.0460-4918.2	604918	21322	15,0	13.0460-5920.2	605920
20687	15,5	13.0460-4034.2	604034	21048	18,3	13.0460-4955.2	604955	21333	15,0	13.0460-5985.2	605985
20708	14,5	13.0460-5720.2	605720	21050	15,8	13.0460-4040.2	604040	21348	17,0	13.0460-5957.2	605957
20708	15,8	13.0460-2997.2	602997	21064	20,3	13.0460-6033.2	606033	21353	16,5	13.0460-7051.2	607051
20731	15,3	13.0460-5916.2	605916	21064	20,3	13.0460-7185.2	607185	21355	13,5	13.0460-5970.2	605970
20741	15,0	13.0460-2750.2	602750	21068	17,0	13.0460-2811.2	602811	21358	19,8	13.0460-7165.2	607165
20755	14,4	13.0460-3401.2	603401	21089	15,0	13.0460-3306.2	603306	21363	15,8	13.0460-5958.2	605958
20755	14,4	13.0460-3403.2	603403	21096	15,0	13.0460-3955.2	603955	21365	17,0	13.0460-3949.2	603949
20755	15,1	13.0460-4044.2	604044	21099	17,0	13.0460-5881.2	605881	21368	18,3	13.0460-2815.2	602815
20755	15,1	13.0470-4044.2	LD4044	21100	16,7	13.0460-2948.2	602948	21369	15,5	13.0460-5968.2	605968
20775	18,0	13.0460-3939.2	603939	21103	14,2	13.0460-2951.2	602951	21373	16,0	13.0460-5940.2	605940
20777	18,0	13.0460-3940.2	603940	21107	12,0	13.0460-3904.2	603904	21378	15,0	13.0460-5932.2	605932
20778	19,0	13.0460-2934.2	602934	21110	15,6	13.0460-2824.2	602824	21381	15,0	13.0460-4801.2	604801
20784	18,0	13.0460-4401.2	604401	21138	18,8	13.0460-2963.2	602963	21381	15,0	13.0460-4964.2	604964
20833	17,0	13.0460-2949.2	602949	21140	15,0	13.0460-4043.2	604043	21381	18,0	13.0460-4832.2	604832
20838	17,0	13.0460-2941.2	602941	21142	15,0	13.0460-5966.2	605966	21381	18,0	13.0460-4968.2	604968
20841	12,0	13.0460-3942.2	603942	21144	15,8	13.0460-3602.2	603602	21381	18,0	13.0460-4985.2	604985
20852	15,5	13.0460-5935.2	605935	21147	19,0	13.0460-2979.2	602979	21382	17,3	13.0460-4958.2	604958
20861	17,5	13.0460-2964.2	602964	21148	19,0	13.0460-2980.2	602980	21385	13,8	13.0460-2935.2	602935
20863	16,5	13.0460-5960.2	605960	21153	16,0	13.0460-4202.2	604202	21388	18,0	13.0460-2983.2	602983
20870	15,0	13.0460-5976.2	605976	21153	17,5	13.0460-4201.2	604201	21396	17,5	13.0460-7056.2	607056





Vergleichsliste WVA → ATE

Cross reference list WVA → ATE - Lista referencias WVA → ATE - Liste des correspondances WVA → ATE - Tabella di conversione codici WVA → ATE

WVA D 				WVA D 				WVA D 			
21396	17,5	13.0460-7057.2	607057	21637	19,3	13.0460-7180.2	607180	21861	15,2	13.0460-2831.2	602831
21402	17,5	13.0460-4056.2	604056	21637	19,3	13.0460-7181.2	607181	21861	15,2	13.0460-2897.2	602897
21411	17,5	13.0460-7080.2	607080	21641	19,3	13.0460-7140.2	607140	21868	15,3	13.0460-7101.2	607101
21418	15,5	13.0460-2751.2	602751	21641	19,3	13.0470-7140.2	LD7140	21868	17,2	13.0460-7100.2	607100
21432	17,3	13.0460-7058.2	607058	21642	19,5	13.0460-7078.2	607078	21868	17,2	13.0470-7100.2	LD7100
21436	16,2	13.0460-3951.2	603951	21643	17,8	13.0460-5405.2	605405	21868	19,7	13.0460-7072.2	607072
21436	17,0	13.0460-3807.2	603807	21644	17,8	13.0470-5405.2	LD5405	21874	14,5	13.0460-5826.2	605826
21436	17,0	13.0460-3838.2	603838	21649	16,0	13.0460-5952.2	605952	21877	16,0	13.0460-5927.2	605927
21436	17,0	13.0460-3950.2	603950	21650	15,0	13.0460-5889.2	605889	21879	18,6	13.0460-5955.2	605955
21436	17,0	13.0470-3838.2	LD3838	21650	15,0	13.0460-5953.2	605953	21885	20,4	13.0460-7102.2	607102
21439	20,3	13.0460-2975.2	602975	21650	15,5	13.0460-5713.2	605713	21889	18,1	13.0460-2832.2	602832
21439	20,3	13.0470-2975.2	LD2975	21653	17,5	13.0460-5982.2	605982	21891	17,3	13.0470-7090.2	LD7090
21452	18,5	13.0460-2700.2	602700	21656	15,0	13.0460-5944.2	605944	21897	18,5	13.0460-6916.2	606916
21452	18,5	13.0460-2705.2	602705	21659	16,4	13.0460-5941.2	605941	21899	15,3	13.0460-4065.2	604065
21459	17,5	13.0460-6922.2	606922	21664	19,8	13.0470-7086.2	LD7086	21899	15,3	13.0470-4065.2	LD4065
21463	18,0	13.0460-2834.2	602834	21670	19,3	13.0460-7087.2	607087	21900	15,0	13.0460-4060.2	604060
21468	15,5	13.0460-5722.2	605722	21670	19,3	13.0470-7087.2	LD7087	21904	16,9	13.0460-7085.2	607085
21469	18,0	13.0460-3959.2	603959	21670	19,3	13.0470-7203.2	LD7203	21907	15,5	13.0460-5864.2	605864
21470	18,0	13.0460-3960.2	603960	21674	19,0	13.0460-2817.2	602817	21910	19,8	13.0460-7163.2	607163
21471	18,0	13.0460-4965.2	604965	21674	19,4	13.0460-2844.2	602844	21911	20,3	13.0460-7081.2	607081
21479	19,2	13.0460-2982.2	602982	21676	20,3	13.0460-7155.2	607155	21919	15,3	13.0460-4064.2	604064
21481	15,5	13.0460-5959.2	605959	21676	20,3	13.0470-7089.2	LD7089	21919	15,3	13.0470-4064.2	LD4064
21485	20,5	13.0460-7183.2	607183	21677	20,3	13.0460-7089.2	607089	21920	14,6	13.0460-2830.2	602830
21486	19,5	13.0470-7078.2	LD7078	21681	15,0	13.0460-5992.2	605992	21920	16,6	13.0460-2896.2	602896
21487	17,3	13.0460-7079.2	607079	21688	15,3	13.0460-5862.2	605862	21927	17,9	13.0460-7133.2	607133
21487	17,3	13.0470-7079.2	LD7079	21689	15,5	13.0460-5892.2	605892	21929	17,9	13.0460-7065.2	607065
21502	15,0	13.0460-5967.2	605967	21691	17,3	13.0460-7090.2	607090	21929	17,9	13.0460-7067.2	607067
21503	17,0	13.0460-5978.2	605978	21696	16,3	13.0460-5820.2	605820	21930	17,9	13.0460-7064.2	607064
21505	17,0	13.0460-3947.2	603947	21699	15,0	13.0460-5943.2	605943	21930	17,9	13.0460-7068.2	607068
21513	17,0	13.0460-3948.2	603948	21705	15,0	13.0460-5850.2	605850	21930	17,9	13.0460-7114.2	607114
21517	17,5	13.0460-2803.2	602803	21708	15,5	13.0460-5980.2	605980	21931	17,9	13.0460-7125.2	607125
21518	17,0	13.0460-2804.2	602804	21713	16,5	13.0460-5983.2	605983	21937	15,5	13.0460-4814.2	604814
21519	17,8	13.0460-6925.2	606925	21715	16,0	13.0460-5626.2	605626	21937	15,5	13.0460-4815.2	604815
21522	17,5	13.0460-2805.2	602805	21718	16,0	13.0460-5808.2	605808	21937	15,5	13.0470-4814.2	LD4814
21541	15,0	13.0460-5974.2	605974	21721	15,0	13.0460-5929.2	605929	21945	16,0	13.0460-2821.2	602821
21543	16,5	13.0460-5942.2	605942	21727	16,8	13.0460-5933.2	605933	21945	19,6	13.0460-2822.2	602822
21545	14,9	13.0460-5986.2	605986	21730	14,0	13.0460-5763.2	605763	21945	19,6	13.0460-2837.2	602837
21546	16,7	13.0460-5950.2	605950	21738	13,5	13.0460-5731.2	605731	21947	15,4	13.0460-5744.2	605744
21555	14,0	13.0460-5874.2	605874	21749	19,3	13.0460-2816.2	602816	21949	13,5	13.0460-5969.2	605969
21558	13,0	13.0460-5995.2	605995	21766	13,5	13.0460-5973.2	605973	21954	15,0	13.0460-5898.2	605898
21559	11,5	13.0460-5972.2	605972	21774	15,0	13.0460-5872.2	605872	21961	15,5	13.0460-5845.2	605845
21562	17,0	13.0460-5716.2	605716	21775	15,0	13.0460-5745.2	605745	21966	15,0	13.0460-4986.2	604986
21569	14,9	13.0460-5627.2	605627	21792	15,2	13.0460-4988.2	604988	21975	18,2	13.0460-5809.2	605809
21577	20,7	13.0460-7196.2	607196	21794	19,3	13.0460-7203.2	607203	21980	18,0	13.0460-3977.2	603977
21580	14,6	13.0460-4974.2	604974	21795	19,8	13.0460-7086.2	607086	21983	17,2	13.0460-2853.2	602853
21586	15,0	13.0460-3963.2	603963	21798	19,7	13.0460-2976.2	602976	21999	15,8	13.0460-3979.2	603979
21592	18,8	13.0460-7084.2	607084	21799	19,7	13.0460-2852.2	602852	22032	19,6	13.0460-2792.2	602792
21595	18,3	13.0460-2836.2	602836	21799	19,7	13.0460-2977.2	602977	22032	19,6	13.0470-2792.2	LD2792
21600	11,0	13.0460-3822.2	603822	21801	19,0	13.0460-2978.2	602978	22035	17,5	13.0460-7303.2	607303
21603	17,5	13.0460-5951.2	605951	21817	16,8	13.0460-8009.2	608009	22037	17,5	13.0470-7303.2	LD7303
21606	16,7	13.0460-2827.2	602827	21825	17,5	13.0460-5897.2	605897	22061	18,7	13.0460-4883.2	604883
21613	18,0	13.0460-2981.2	602981	21827	17,3	13.0460-7088.2	607088	22062	20,7	13.0460-4884.2	604884
21614	17,7	13.0460-2825.2	602825	21829	20,3	13.0460-7173.2	607173	22062	20,7	13.0470-4884.2	LD4884
21621	17,3	13.0460-7083.2	607083	21832	14,9	13.0460-4058.2	604058	22065	17,7	13.0460-5652.2	605652
21626	15,0	13.0460-5956.2	605956	21832	14,9	13.0460-5924.2	605924	22076	19,6	13.0460-2610.2	602610
21631	17,0	13.0460-3956.2	603956	21834	15,0	13.0460-5840.2	605840	22097	19,6	13.0470-2610.2	LD2610
21632	16,0	13.0460-3972.2	603972	21842	14,4	13.0460-5981.2	605981	22102	18,2	13.0460-4882.2	604882
21635	18,0	13.0460-2973.2	602973	21845	16,5	13.0460-5926.2	605926	22102	18,2	13.0470-4882.2	LD4882
21636	19,3	13.0470-7181.2	LD7181	21848	19,8	13.0460-7076.2	607076	22124	18,2	13.0460-7308.2	607308
21637	19,3	13.0460-7069.2	607069	21856	15,0	13.0460-5640.2	605640	22143	17,5	13.0460-7310.2	607310
21637	19,3	13.0460-7112.2	607112	21857	17,7	13.0460-4066.2	604066	23006	15,9	13.0460-5988.2	605988

Vergleichsliste WVA → ATE



Cross reference list WVA → ATE - Lista referencias WVA → ATE - Liste des correspondances WVA → ATE - Tabella di conversione codici WVA → ATE

WVA D 				WVA D 				WVA D 			
23019	20,3	13.0470-7110.2	LD7110	23157	15,8	13.0470-4977.2	LD4977	23313	20,3	13.0460-7306.2	607306
23020	17,9	13.0460-3985.2	603985	23158	17,5	13.0460-5830.2	605830	23314	15,0	13.0460-5857.2	605857
23021	18,9	13.0460-3990.2	603990	23163	20,4	13.0460-7124.2	607124	23324	20,3	13.0460-7143.2	607143
23022	20,9	13.0460-3980.2	603980	23164	17,3	13.0460-5727.2	605727	23325	16,0	13.0460-4973.2	604973
23025	14,8	13.0460-5841.2	605841	23168	19,0	13.0460-2987.2	602987	23325	16,4	13.0460-4855.2	604855
23034	18,8	13.0460-7123.2	607123	23169	19,4	13.0460-2869.2	602869	23326	17,4	13.0460-2882.2	602882
23034	18,8	13.0460-7154.2	607154	23172	18,0	13.0460-2895.2	602895	23326	17,4	13.0460-2888.2	602888
23042	19,0	13.0460-3957.2	603957	23176	18,7	13.0460-2839.2	602839	23326	17,4	13.0460-2889.2	602889
23044	16,0	13.0460-8003.2	608003	23177	14,2	13.0460-2826.2	602826	23326	17,4	13.0460-2890.2	602890
23057	20,2	13.0470-7116.2	LD7116	23178	16,6	13.0460-5755.2	605755	23326	17,4	13.0470-2888.2	LD2888
23058	19,6	13.0460-7116.2	607116	23183	20,3	13.0470-7155.2	LD7155	23329	17,0	13.0460-4987.2	604987
23067	18,5	13.0460-7115.2	607115	23187	19,6	13.0460-7117.2	607117	23330	17,0	13.0460-4999.2	604999
23067	18,5	13.0470-7115.2	LD7115	23192	16,7	13.0460-8005.2	608005	23332	18,0	13.0460-3978.2	603978
23070	17,0	13.0460-2776.2	602776	23193	16,4	13.0460-8004.2	608004	23334	16,7	13.0470-7171.2	LD7171
23070	17,0	13.0460-2833.2	602833	23201	18,0	13.0460-7148.2	607148	23335	16,7	13.0460-7171.2	607171
23070	17,0	13.0470-2776.2	LD2776	23202	17,8	13.0460-7213.2	607213	23342	17,0	13.0460-5800.2	605800
23070	17,0	13.0470-2833.2	LD2833	23202	18,3	13.0460-7142.2	607142	23346	19,0	13.0460-2862.2	602862
23070	19,5	13.0460-2828.2	602828	23213	20,3	13.0460-7296.2	607296	23347	20,3	13.0470-7167.2	LD7167
23073	18,8	13.0460-7145.2	607145	23213	20,3	13.0470-7296.2	LD7296	23348	16,5	13.0460-5811.2	605811
23074	18,8	13.0470-7145.2	LD7145	23215	18,3	13.0460-7157.2	607157	23353	14,8	13.0460-2835.2	602835
23077	17,5	13.0460-7135.2	607135	23217	17,5	13.0460-7248.2	607248	23354	13,0	13.0460-5834.2	605834
23077	17,5	13.0470-7135.2	LD7135	23217	18,3	13.0470-7157.2	LD7157	23358	18,0	13.0460-8002.2	608002
23078	15,9	13.0460-4069.2	604069	23218	18,0	13.0460-7113.2	607113	23363	14,8	13.0460-8011.2	608011
23080	15,0	13.0460-5987.2	605987	23218	18,0	13.0460-7128.2	607128	23379	20,1	13.0470-7172.2	LD7172
23081	18,0	13.0460-5718.2	605718	23224	16,5	13.0460-2874.2	602874	23385	18,3	13.0460-5923.2	605923
23092	15,6	13.0460-4803.2	604803	23226	17,0	13.0460-2857.2	602857	23389	12,6	13.0460-5865.2	605865
23092	15,6	13.0460-4804.2	604804	23226	17,0	13.0470-2857.2	LD2857	23392	20,3	13.0460-7122.2	607122
23092	16,0	13.0460-4991.2	604991	23228	18,1	13.0460-7108.2	607108	23392	20,3	13.0470-7122.2	LD7122
23092	16,0	13.0470-4971.2	LD4971	23234	16,8	13.0460-5994.2	605994	23393	19,6	13.0470-2837.2	LD2837
23092	16,3	13.0470-4854.2	LD4854	23234	16,9	13.0460-5859.2	605859	23394	13,7	13.0460-7177.2	607177
23093	16,6	13.0460-5807.2	605807	23236	16,8	13.0460-5863.2	605863	23397	19,4	13.0460-7224.2	607224
23094	16,5	13.0460-5825.2	605825	23237	14,5	13.0460-5993.2	605993	23400	15,5	13.0460-5838.2	605838
23099	18,4	13.0460-2870.2	602870	23238	16,0	13.0460-5803.2	605803	23402	20,1	13.0460-7172.2	607172
23100	18,4	13.0460-2735.2	602735	23241	16,1	13.0460-5996.2	605996	23405	20,1	13.0460-7199.2	607199
23111	15,6	13.0470-4803.2	LD4803	23245	18,3	13.0460-7158.2	607158	23407	19,0	13.0460-2871.2	602871
23111	16,0	13.0460-4851.2	604851	23245	18,3	13.0470-7158.2	LD7158	23409	19,3	13.0460-2881.2	602881
23111	16,0	13.0460-4971.2	604971	23248	18,3	13.0460-7159.2	607159	23411	15,0	13.0460-3964.2	603964
23111	16,0	13.0470-4851.2	LD4851	23248	18,3	13.0470-7159.2	LD7159	23418	19,4	13.0460-7156.2	607156
23114	19,1	13.0460-7144.2	607144	23263	16,5	13.0460-3976.2	603976	23420	16,5	13.0460-5842.2	605842
23115	19,8	13.0460-7091.2	607091	23270	19,8	13.0460-7153.2	607153	23423	17,8	13.0460-2729.2	602729
23119	17,5	13.0460-2875.2	602875	23271	17,4	13.0460-4984.2	604984	23424	17,6	13.0460-2730.2	602730
23119	17,5	13.0460-2876.2	602876	23271	17,4	13.0460-4990.2	604990	23429	15,5	13.0460-5748.2	605748
23125	19,0	13.0460-2829.2	602829	23271	17,4	13.0470-4984.2	LD4984	23434	18,7	13.0460-3992.2	603992
23130	19,6	13.0470-7117.2	LD7117	23273	17,8	13.0460-3998.2	603998	23437	18,0	13.0460-3856.2	603856
23131	19,6	13.0460-7111.2	607111	23276	17,2	13.0460-3996.2	603996	23441	18,1	13.0460-7186.2	607186
23131	19,6	13.0470-7111.2	LD7111	23277	17,7	13.0460-3997.2	603997	23444	15,3	13.0460-5896.2	605896
23137	18,0	13.0460-3986.2	603986	23279	18,4	13.0460-3987.2	603987	23445	19,2	13.0460-2838.2	602838
23138	14,6	13.0460-2712.2	602712	23279	18,4	13.0470-3987.2	LD3987	23446	16,5	13.0460-2872.2	602872
23138	14,6	13.0460-2855.2	602855	23281	18,3	13.0460-7161.2	607161	23447	17,3	13.0470-7168.2	LD7168
23138	14,6	13.0470-2712.2	LD2712	23282	18,3	13.0470-7161.2	LD7161	23447	17,3	13.0470-7232.2	LD7232
23138	14,6	13.0470-2855.2	LD2855	23284	14,0	13.0460-2858.2	602858	23448	20,8	13.0460-7170.2	607170
23141	19,4	13.0460-7105.2	607105	23284	14,0	13.0470-2858.2	LD2858	23451	17,5	13.0460-5712.2	605712
23141	19,4	13.0460-7139.2	607139	23290	15,5	13.0460-5890.2	605890	23452	19,0	13.0460-2720.2	602720
23142	15,1	13.0460-4818.2	604818	23296	14,5	13.0460-5837.2	605837	23454	14,9	13.0460-5989.2	605989
23144	19,8	13.0460-2726.2	602726	23300	18,0	13.0460-3965.2	603965	23455	13,7	13.0460-5871.2	605871
23145	19,8	13.0460-2727.2	602727	23302	18,0	13.0460-3946.2	603946	23458	15,6	13.0460-2721.2	602721
23145	19,8	13.0470-2726.2	LD2726	23305	15,2	13.0460-4921.2	604921	23471	14,5	13.0460-6923.2	606923
23145	19,8	13.0470-2727.2	LD2727	23310	17,3	13.0460-7169.2	607169	23471	17,5	13.0460-6924.2	606924
23146	17,0	13.0460-3973.2	603973	23310	17,3	13.0470-7169.2	LD7169	23478	14,6	13.0460-4819.2	604819
23155	19,0	13.0460-7121.2	607121	23312	20,3	13.0460-7167.2	607167	23478	16,5	13.0460-4998.2	604998
23157	15,8	13.0460-4977.2	604977	23313	20,3	13.0460-7238.2	607238	23480	19,3	13.0460-5813.2	605813





Vergleichsliste WVA → ATE

Cross reference list WVA → ATE - Lista referencias WVA → ATE - Liste des correspondances WVA → ATE - Tabella di conversione codici WVA → ATE

WVA D 				WVA D 				WVA D 			
23482	15,8	13.0470-7137.2	LD7137	23589	20,6	13.0470-7285.2	LD7285	23732	17,3	13.0470-7174.2	LD7174
23482	16,6	13.0460-7195.2	607195	23590	19,5	13.0470-7187.2	LD7187	23734	16,8	13.0460-5750.2	605750
23483	15,8	13.0460-7137.2	607137	23591	18,0	13.0460-7187.2	607187	23736	15,7	13.0460-5711.2	605711
23483	15,8	13.0460-7160.2	607160	23597	18,0	13.0460-3975.2	603975	23737	17,3	13.0460-7174.2	607174
23487	15,5	13.0460-5854.2	605854	23599	19,0	13.0460-3994.2	603994	23738	20,1	13.0460-7212.2	607212
23488	15,4	13.0460-5853.2	605853	23599	19,0	13.0470-3994.2	LD3994	23743	20,1	13.0460-3999.2	603999
23489	16,3	13.0460-4841.2	604841	23600	19,4	13.0460-3966.2	603966	23744	20,1	13.0470-3999.2	LD3999
23490	15,4	13.0460-5802.2	605802	23600	19,4	13.0470-3966.2	LD3966	23745	17,4	13.0470-4990.2	LD4990
23498	14,8	13.0460-5852.2	605852	23601	13,7	13.0460-2879.2	602879	23747	19,7	13.0460-7236.2	607236
23502	16,0	13.0460-5751.2	605751	23601	13,7	13.0470-2879.2	LD2879	23749	17,6	13.0460-7240.2	607240
23504	16,0	13.0460-5717.2	605717	23602	19,7	13.0460-2850.2	602850	23749	19,1	13.0460-7191.2	607191
23509	15,2	13.0460-5887.2	605887	23607	15,7	13.0460-3995.2	603995	23749	19,1	13.0470-7191.2	LD7191
23510	16,5	13.0460-5810.2	605810	23613	17,7	13.0460-3800.2	603800	23752	17,2	13.0460-7164.2	607164
23513	17,0	13.0460-5891.2	605891	23615	18,3	13.0460-2718.2	602718	23754	18,0	13.0460-4969.2	604969
23515	15,8	13.0460-5884.2	605884	23620	16,4	13.0460-5814.2	605814	23757	16,3	13.0460-4854.2	604854
23516	17,0	13.0460-2859.2	602859	23623	17,4	13.0470-2713.2	LD2713	23759	17,0	13.0460-5894.2	605894
23517	16,6	13.0460-2867.2	602867	23624	17,4	13.0460-2713.2	602713	23760	17,7	13.0460-2707.2	602707
23517	16,6	13.0470-2867.2	LD2867	23633	17,8	13.0460-7206.2	607206	23760	17,7	13.0470-2707.2	LD2707
23517	17,2	13.0460-2763.2	602763	23639	17,5	13.0460-2899.2	602899	23761	18,8	13.0460-2704.2	602704
23520	17,0	13.0460-5885.2	605885	23648	16,5	13.0460-5847.2	605847	23763	20,3	13.0460-7201.2	607201
23521	14,0	13.0460-5812.2	605812	23650	17,2	13.0460-5725.2	605725	23763	20,3	13.0470-7201.2	LD7201
23524	17,4	13.0460-5746.2	605746	23655	15,3	13.0460-2868.2	602868	23763	20,4	13.0460-7166.2	607166
23526	17,5	13.0460-5817.2	605817	23655	15,3	13.0470-2868.2	LD2868	23763	20,4	13.0470-7166.2	LD7166
23527	14,5	13.0460-5827.2	605827	23656	14,0	13.0460-5849.2	605849	23765	17,0	13.0460-4800.2	604800
23529	17,1	13.0460-5861.2	605861	23662	15,0	13.0460-5836.2	605836	23766	17,8	13.0460-5815.2	605815
23534	20,1	13.0460-2959.2	602959	23669	16,8	13.0460-3806.2	603806	23774	17,5	13.0460-4802.2	604802
23538	17,6	13.0460-5792.2	605792	23672	14,8	13.0460-5880.2	605880	23775	18,0	13.0460-7132.2	607132
23539	17,3	13.0460-5749.2	605749	23675	15,9	13.0460-5623.2	605623	23779	17,0	13.0460-5831.2	605831
23545	14,4	13.0460-5833.2	605833	23692	16,6	13.0460-4992.2	604992	23780	16,7	13.0460-5895.2	605895
23550	17,3	13.0470-7225.2	LD7225	23692	16,6	13.0470-4992.2	LD4992	23783	14,0	13.0460-5710.2	605710
23551	17,3	13.0460-7225.2	607225	23693	16,6	13.0460-4993.2	604993	23788	19,0	13.0460-7205.2	607205
23554	16,0	13.0460-2753.2	602753	23693	16,6	13.0470-4993.2	LD4993	23792	20,8	13.0460-7210.2	607210
23554	16,4	13.0460-2775.2	602775	23694	16,4	13.0470-4976.2	LD4976	23792	20,8	13.0470-7210.2	LD7210
23554	16,4	13.0460-2845.2	602845	23694	16,7	13.0460-4976.2	604976	23793	20,3	13.0460-7176.2	607176
23554	16,4	13.0460-2860.2	602860	23699	16,8	13.0460-5778.2	605778	23794	20,3	13.0460-7268.2	607268
23554	16,4	13.0470-2845.2	LD2845	23702	15,1	13.0460-5738.2	605738	23794	20,3	13.0470-7176.2	LD7176
23554	16,4	13.0470-2860.2	LD2860	23703	17,9	13.0460-5882.2	605882	23794	20,3	13.0470-7268.2	LD7268
23554	17,0	13.0460-2740.2	602740	23705	18,1	13.0460-3810.2	603810	23797	15,0	13.0460-5839.2	605839
23554	17,0	13.0470-2740.2	LD2740	23705	18,1	13.0460-3982.2	603982	23801	20,3	13.0460-7227.2	607227
23554	17,2	13.0460-2877.2	602877	23706	18,0	13.0460-3826.2	603826	23811	17,7	13.0460-2768.2	602768
23554	17,2	13.0470-2823.2	LD2823	23707	18,0	13.0460-3850.2	603850	23811	17,7	13.0470-2768.2	LD2768
23554	17,3	13.0460-2787.2	602787	23707	18,0	13.0460-3863.2	603863	23816	16,0	13.0460-5819.2	605819
23556	17,2	13.0470-2877.2	LD2877	23707	18,0	13.0470-3826.2	LD3826	23824	13,7	13.0460-7178.2	607178
23557	17,2	13.0460-3988.2	603988	23707	18,1	13.0460-3818.2	603818	23825	18,5	13.0460-2717.2	602717
23557	17,2	13.0470-3988.2	LD3988	23707	18,1	13.0470-3982.2	LD3982	23829	18,5	13.0460-2701.2	602701
23560	17,2	13.0460-5851.2	605851	23708	19,2	13.0460-3811.2	603811	23835	19,6	13.0460-7245.2	607245
23562	18,1	13.0460-8010.2	608010	23709	19,6	13.0470-3827.2	LD3827	23836	17,0	13.0460-5846.2	605846
23571	16,5	13.0460-5832.2	605832	23710	19,4	13.0460-3983.2	603983	23842	18,1	13.0460-7141.2	607141
23575	15,6	13.0460-4995.2	604995	23710	19,4	13.0470-3983.2	LD3983	23843	18,8	13.0460-2884.2	602884
23576	16,0	13.0460-4972.2	604972	23710	19,6	13.0460-3827.2	603827	23843	18,8	13.0470-2884.2	LD2884
23577	18,7	13.0460-3993.2	603993	23710	19,6	13.0460-3864.2	603864	23844	20,5	13.0460-7179.2	607179
23581	18,8	13.0460-2883.2	602883	23711	19,4	13.0470-3984.2	LD3984	23844	20,5	13.0470-7179.2	LD7179
23583	16,0	13.0460-5855.2	605855	23713	19,4	13.0460-3984.2	603984	23847	15,8	13.0460-5954.2	605954
23584	16,4	13.0460-5760.2	605760	23714	16,6	13.0460-3991.2	603991	23863	14,3	13.0460-5867.2	605867
23586	17,4	13.0460-5848.2	605848	23714	17,6	13.0470-3812.2	LD3812	23867	17,6	13.0460-5787.2	605787
23588	20,8	13.0470-7226.2	LD7226	23717	15,8	13.0460-7162.2	607162	23870	17,1	13.0460-5860.2	605860
23589	19,1	13.0470-7202.2	LD7202	23717	15,8	13.0470-7162.2	LD7162	23873	15,8	13.0460-5868.2	605868
23589	20,4	13.0460-7226.2	607226	23718	16,7	13.0460-8007.2	608007	23881	20,0	13.0460-2708.2	602708
23589	20,6	13.0460-7184.2	607184	23724	18,1	13.0460-7193.2	607193	23881	20,0	13.0470-2708.2	LD2708
23589	20,6	13.0460-7285.2	607285	23724	18,1	13.0470-7193.2	LD7193	23893	16,9	13.0460-5873.2	605873
23589	20,6	13.0470-7184.2	LD7184	23726	16,5	13.0460-5622.2	605622	23897	20,6	13.0460-7182.2	607182

Vergleichsliste WVA → ATE



Cross reference list WVA → ATE - Lista referencias WVA → ATE - Liste des correspondances WVA → ATE - Tabella di conversione codici WVA → ATE

WVA D 				WVA D 				WVA D 			
23908	18,0	13.0460-2898.2	602898	24036	16,7	13.0460-8008.2	608008	24191	18,1	13.0460-2728.2	602728
23912	18,8	13.0460-7204.2	607204	24036	19,1	13.0460-7263.2	607263	24192	17,1	13.0460-2731.2	602731
23912	18,8	13.0470-7204.2	LD7204	24036	19,1	13.0470-7263.2	LD7263	24192	17,4	13.0460-2719.2	602719
23913	20,3	13.0460-7200.2	607200	24041	14,4	13.0460-5856.2	605856	24214	17,5	13.0460-5714.2	605714
23913	20,3	13.0470-7200.2	LD7200	24042	16,3	13.0460-5877.2	605877	24217	15,7	13.0460-5736.2	605736
23913	20,3	13.0470-7227.2	LD7227	24045	13,7	13.0460-5804.2	605804	24220	17,5	13.0460-5791.2	605791
23914	17,1	13.0460-2880.2	602880	24048	18,6	13.0460-5821.2	605821	24225	16,9	13.0460-5797.2	605797
23914	17,1	13.0460-2887.2	602887	24049	17,0	13.0460-4842.2	604842	24227	16,7	13.0460-5783.2	605783
23914	17,1	13.0470-2880.2	LD2880	24055	16,9	13.0460-5878.2	605878	24230	15,3	13.0460-5709.2	605709
23914	17,1	13.0470-2887.2	LD2887	24061	16,7	13.0460-5886.2	605886	24243	16,6	13.0460-5784.2	605784
23916	17,6	13.0460-2710.2	602710	24071	14,6	13.0460-5739.2	605739	24244	18,5	13.0460-5608.2	605608
23916	17,6	13.0460-2795.2	602795	24072	17,9	13.0460-3809.2	603809	24245	18,5	13.0460-5607.2	605607
23916	17,6	13.0470-2710.2	LD2710	24072	17,9	13.0470-3846.2	LD3846	24246	16,8	13.0460-5822.2	605822
23918	19,3	13.0460-4978.2	604978	24073	16,7	13.0460-2878.2	602878	24253	17,8	13.0460-7244.2	607244
23919	19,3	13.0460-4979.2	604979	24077	19,1	13.0460-2711.2	602711	24253	18,0	13.0460-7257.2	607257
23921	20,3	13.0460-4980.2	604980	24077	19,1	13.0460-2885.2	602885	24254	18,0	13.0470-7244.2	LD7244
23923	17,6	13.0460-7219.2	607219	24077	19,1	13.0470-2711.2	LD2711	24254	18,0	13.0470-7257.2	LD7257
23924	17,6	13.0470-7219.2	LD7219	24077	19,1	13.0470-2885.2	LD2885	24255	20,3	13.0470-7238.2	LD7238
23925	20,5	13.0460-7220.2	607220	24084	19,3	13.0460-7252.2	607252	24260	17,3	13.0460-3831.2	603831
23925	20,5	13.0470-7220.2	LD7220	24084	19,3	13.0460-7277.2	607277	24260	17,3	13.0470-3831.2	LD3831
23926	17,3	13.0470-7217.2	LD7217	24095	19,4	13.0470-7139.2	LD7139	24275	16,5	13.0460-5776.2	605776
23927	17,3	13.0460-7217.2	607217	24096	20,3	13.0460-7223.2	607223	24276	14,8	13.0460-5775.2	605775
23928	17,3	13.0460-5743.2	605743	24096	20,3	13.0470-7223.2	LD7223	24283	17,3	13.0460-2605.2	602605
23930	18,2	13.0460-3815.2	603815	24097	17,1	13.0460-4834.2	604834	24284	15,5	13.0460-5794.2	605794
23930	18,2	13.0470-3815.2	LD3815	24097	17,1	13.0470-4834.2	LD4834	24288	17,9	13.0460-3839.2	603839
23934	18,2	13.0460-3814.2	603814	24098	17,1	13.0460-4833.2	604833	24288	17,9	13.0470-3839.2	LD3839
23934	18,2	13.0470-3814.2	LD3814	24098	17,1	13.0470-4833.2	LD4833	24290	16,9	13.0460-2714.2	602714
23935	17,8	13.0460-7215.2	607215	24122	19,0	13.0460-5602.2	605602	24290	16,9	13.0470-2714.2	LD2714
23944	17,5	13.0460-4997.2	604997	24123	20,3	13.0460-7228.2	607228	24296	15,5	13.0460-4850.2	604850
23945	16,5	13.0460-4994.2	604994	24123	20,3	13.0470-7228.2	LD7228	24296	15,5	13.0470-4850.2	LD4850
23945	16,5	13.0470-4994.2	LD4994	24132	18,8	13.0460-5879.2	605879	24297	14,4	13.0460-5761.2	605761
23955	16,2	13.0460-4806.2	604806	24133	18,6	13.0460-2892.2	602892	24299	14,0	13.0460-5762.2	605762
23959	17,0	13.0460-3829.2	603829	24134	19,6	13.0460-2891.2	602891	24306	20,3	13.0460-2732.2	602732
23960	18,3	13.0460-4817.2	604817	24135	17,7	13.0460-2893.2	602893	24306	20,3	13.0460-2733.2	602733
23961	16,8	13.0460-4840.2	604840	24135	17,7	13.0470-2893.2	LD2893	24306	20,3	13.0470-2732.2	LD2732
23966	17,7	13.0460-5742.2	605742	24137	15,8	13.0460-7251.2	607251	24306	20,3	13.0470-2733.2	LD2733
23967	15,1	13.0460-5734.2	605734	24137	15,8	13.0460-7253.2	607253	24306	20,3	13.0470-9000.2	LD9000
23968	20,3	13.0460-7216.2	607216	24137	15,8	13.0470-7251.2	LD7251	24310	19,0	13.0460-2734.2	602734
23968	20,3	13.0470-7216.2	LD7216	24137	16,6	13.0460-7194.2	607194	24315	16,2	13.0460-4849.2	604849
23969	18,6	13.0460-7207.2	607207	24137	16,6	13.0460-7209.2	607209	24316	16,9	13.0460-4848.2	604848
23972	16,8	13.0460-5632.2	605632	24137	16,6	13.0470-7194.2	LD7194	24319	17,6	13.0460-5779.2	605779
23973	17,1	13.0460-2709.2	602709	24137	16,6	13.0470-7195.2	LD7195	24322	15,3	13.0460-5780.2	605780
23973	17,1	13.0460-5801.2	605801	24141	19,1	13.0460-7188.2	607188	24323	15,5	13.0460-5790.2	605790
23973	17,1	13.0470-2709.2	LD2709	24142	20,6	13.0470-7188.2	LD7188	24326	18,3	13.0460-7292.2	607292
23974	17,6	13.0460-5899.2	605899	24142	20,6	13.0470-7243.2	LD7243	24331	13,8	13.0460-5628.2	605628
23980	16,5	13.0460-2840.2	602840	24150	17,6	13.0460-3813.2	603813	24332	18,3	13.0470-7252.2	LD7252
23983	17,0	13.0460-5770.2	605770	24150	17,6	13.0460-3851.2	603851	24332	19,8	13.0460-7242.2	607242
23985	17,8	13.0460-2725.2	602725	24150	17,6	13.0470-3813.2	LD3813	24332	19,8	13.0470-7242.2	LD7242
23985	17,8	13.0470-2725.2	LD2725	24151	21,0	13.0460-7271.2	607271	24336	17,5	13.0460-5767.2	605767
23997	15,5	13.0460-5773.2	605773	24153	19,1	13.0460-7202.2	607202	24337	17,5	13.0460-5766.2	605766
23999	17,8	13.0470-7215.2	LD7215	24161	20,3	13.0460-7237.2	607237	24338	15,5	13.0460-5765.2	605765
24007	20,8	13.0460-3819.2	603819	24161	20,3	13.0470-7237.2	LD7237	24339	19,5	13.0470-7269.2	LD7269
24008	18,3	13.0460-3821.2	603821	24162	15,2	13.0460-4805.2	604805	24339	20,5	13.0460-7211.2	607211
24009	17,5	13.0460-5844.2	605844	24162	15,2	13.0470-4853.2	LD4853	24339	20,5	13.0470-7211.2	LD7211
24012	18,7	13.0460-7189.2	607189	24170	20,2	13.0460-7231.2	607231	24340	19,5	13.0460-7269.2	607269
24013	14,9	13.0460-5869.2	605869	24171	20,9	13.0470-7231.2	LD7231	24346	16,4	13.0460-5609.2	605609
24014	16,0	13.0460-5735.2	605735	24173	20,0	13.0460-7239.2	607239	24347	17,5	13.0460-5768.2	605768
24026	17,0	13.0460-5747.2	605747	24173	20,0	13.0470-7239.2	LD7239	24348	17,1	13.0460-3825.2	603825
24029	12,5	13.0460-5732.2	605732	24174	18,6	13.0470-2892.2	LD2892	24349	17,5	13.0460-3828.2	603828
24033	17,7	13.0460-5875.2	605875	24175	19,6	13.0470-2891.2	LD2891	24349	17,5	13.0470-3828.2	LD3828
24035	16,6	13.0460-5888.2	605888	24179	17,1	13.0460-5772.2	605772	24349	17,6	13.0460-3848.2	603848





Vergleichsliste WVA → ATE

Cross reference list WVA → ATE - Lista referencias WVA → ATE - Liste des correspondances WVA → ATE - Tabella di conversione codici WVA → ATE

WVA D 				WVA D 				WVA D 			
24349	17,6	13.0460-3862.2	603862	24519	15,8	13.0460-5757.2	605757	24686	14,9	13.0460-5636.2	605636
24350	17,3	13.0460-5764.2	605764	24521	19,1	13.0460-7243.2	607243	24686	14,9	13.0460-5771.2	605771
24367	19,1	13.0460-7218.2	607218	24529	16,0	13.0460-5631.2	605631	24687	15,2	13.0460-4853.2	604853
24367	19,1	13.0470-7190.2	LD7190	24535	18,3	13.0460-7221.2	607221	24688	19,2	13.0460-7275.2	607275
24367	19,2	13.0460-7247.2	607247	24535	18,3	13.0470-7221.2	LD7221	24688	19,2	13.0470-7275.2	LD7275
24369	17,2	13.0460-5876.2	605876	24536	18,3	13.0460-7222.2	607222	24690	19,2	13.0460-5603.2	605603
24372	17,3	13.0460-5793.2	605793	24537	15,8	13.0460-2737.2	602737	24692	15,9	13.0460-2744.2	602744
24376	17,5	13.0460-5639.2	605639	24537	16,1	13.0460-2723.2	602723	24693	17,5	13.0460-2742.2	602742
24386	17,9	13.0460-5618.2	605618	24537	16,1	13.0470-2723.2	LD2723	24693	17,5	13.0460-2743.2	602743
24391	16,6	13.0460-2715.2	602715	24538	18,5	13.0460-7229.2	607229	24693	18,5	13.0460-2741.2	602741
24393	17,9	13.0460-3849.2	603849	24538	19,4	13.0460-7273.2	607273	24695	17,3	13.0460-7274.2	607274
24398	16,0	13.0460-5829.2	605829	24539	18,5	13.0470-7229.2	LD7229	24703	17,8	13.0470-2716.2	LD2716
24399	20,4	13.0460-7272.2	607272	24540	16,3	13.0460-3836.2	603836	24704	17,8	13.0460-2716.2	602716
24403	17,0	13.0460-5700.2	605700	24540	16,3	13.0470-3836.2	LD3836	24705	19,8	13.0460-7256.2	607256
24403	17,4	13.0460-2774.2	602774	24541	15,5	13.0460-4816.2	604816	24707	21,3	13.0470-7256.2	LD7256
24406	17,4	13.0460-5756.2	605756	24544	18,1	13.0460-5606.2	605606	24709	18,6	13.0460-7249.2	607249
24409	19,2	13.0460-2746.2	602746	24545	16,9	13.0460-5605.2	605605	24710	18,6	13.0470-7249.2	LD7249
24409	19,2	13.0470-2746.2	LD2746	24549	19,6	13.0460-3840.2	603840	24727	20,7	13.0460-7265.2	607265
24412	19,0	13.0460-5612.2	605612	24549	19,6	13.0470-3840.2	LD3840	24738	20,0	13.0460-2764.2	602764
24412	19,0	13.0470-5612.2	LD5612	24550	19,5	13.0460-3841.2	603841	24743	19,2	13.0460-2765.2	602765
24415	19,1	13.0460-5611.2	605611	24553	15,8	13.0460-4852.2	604852	24743	19,2	13.0470-2765.2	LD2765
24415	19,1	13.0470-5611.2	LD5611	24556	19,1	13.0460-7190.2	607190	24764	17,9	13.0460-3846.2	603846
24420	17,0	13.0460-2754.2	602754	24557	19,4	13.0470-7230.2	LD7230	24765	16,5	13.0460-2745.2	602745
24422	17,2	13.0460-2755.2	602755	24558	18,7	13.0460-7230.2	607230	24820	16,1	13.0460-2756.2	602756
24422	17,2	13.0460-2758.2	602758	24559	17,8	13.0460-2759.2	602759	24820	16,1	13.0460-2757.2	602757
24422	17,2	13.0470-2755.2	LD2755	24561	17,7	13.0460-2760.2	602760	24824	15,7	13.0460-2771.2	602771
24422	17,2	13.0470-2758.2	LD2758	24561	17,7	13.0470-2760.2	LD2760	24831	16,1	13.0460-5774.2	605774
24435	14,8	13.0460-5648.2	605648	24563	17,7	13.0460-3858.2	603858	24839	19,4	13.0460-2752.2	602752
24436	19,7	13.0460-7261.2	607261	24563	17,7	13.0470-3858.2	LD3858	24847	17,0	13.0460-4873.2	604873
24438	16,1	13.0460-7234.2	607234	24567	16,0	13.0460-5616.2	605616	24848	18,3	13.0460-2786.2	602786
24451	15,6	13.0460-5617.2	605617	24569	16,3	13.0460-5777.2	605777	24848	18,3	13.0470-2786.2	LD2786
24452	17,5	13.0460-5634.2	605634	24576	14,8	13.0460-7214.2	607214	24853	16,0	13.0460-4867.2	604867
24452	17,5	13.0470-5634.2	LD5634	24578	16,5	13.0460-2739.2	602739	24853	16,0	13.0470-4867.2	LD4867
24455	16,8	13.0460-4839.2	604839	24582	17,4	13.0460-5610.2	605610	24862	16,7	13.0470-7259.2	LD7259
24455	16,8	13.0460-4864.2	604864	24589	20,1	13.0460-4859.2	604859	24862	16,7	13.0470-9001.2	LD9001
24456	19,0	13.0470-2734.2	LD2734	24601	18,0	13.0460-5614.2	605614	24863	16,7	13.0460-7259.2	607259
24462	16,7	13.0460-2706.2	602706	24602	16,0	13.0460-5629.2	605629	24867	20,7	13.0470-3852.2	LD3852
24465	19,2	13.0460-4812.2	604812	24604	18,7	13.0460-2766.2	602766	24868	20,7	13.0460-3852.2	603852
24466	19,1	13.0460-4811.2	604811	24605	16,5	13.0460-8013.2	608013	24869	19,3	13.0460-2779.2	602779
24467	19,1	13.0460-4810.2	604810	24606	17,4	13.0460-2747.2	602747	24869	19,3	13.0470-2779.2	LD2779
24468	19,1	13.0460-4807.2	604807	24606	17,4	13.0460-2769.2	602769	24870	17,5	13.0460-7250.2	607250
24469	19,1	13.0460-4809.2	604809	24606	17,4	13.0460-2770.2	602770	24883	18,0	13.0460-3855.2	603855
24483	16,9	13.0460-2749.2	602749	24606	17,4	13.0470-2747.2	LD2747	24887	16,8	13.0460-3853.2	603853
24483	16,9	13.0470-2749.2	LD2749	24606	17,4	13.0470-2770.2	LD2770	24914	17,9	13.0460-7266.2	607266
24484	18,8	13.0460-3860.2	603860	24606	17,7	13.0460-2748.2	602748	24914	17,9	13.0470-7266.2	LD7266
24484	18,8	13.0470-3860.2	LD3860	24606	17,7	13.0470-2748.2	LD2748	24918	15,0	13.0460-5635.2	605635
24484	19,0	13.0460-3834.2	603834	24608	18,5	13.0460-2738.2	602738	24918	15,0	13.0470-5635.2	LD5635
24485	19,0	13.0460-3833.2	603833	24609	17,7	13.0460-5799.2	605799	24922	17,5	13.0460-2761.2	602761
24486	17,9	13.0460-3835.2	603835	24611	15,0	13.0460-5769.2	605769	24928	17,1	13.0460-3854.2	603854
24488	14,9	13.0460-5637.2	605637	24625	18,2	13.0460-7286.2	607286	24936	15,0	13.0460-5786.2	605786
24490	14,9	13.0460-5782.2	605782	24632	17,0	13.0460-5752.2	605752	24936	15,0	13.0470-5786.2	LD5786
24493	16,0	13.0460-5601.2	605601	24632	17,0	13.0470-5752.2	LD5752	24946	19,0	13.0460-5615.2	605615
24495	17,3	13.0460-7260.2	607260	24635	16,6	13.0460-5754.2	605754	24974	16,8	13.0460-6921.2	606921
24496	17,3	13.0460-2722.2	602722	24638	20,0	13.0460-5753.2	605753	24976	17,5	13.0460-4863.2	604863
24496	17,3	13.0460-2736.2	602736	24653	17,3	13.0460-5619.2	605619	24981	15,9	13.0460-5620.2	605620
24496	17,3	13.0470-2722.2	LD2722	24660	17,8	13.0460-3847.2	603847	25009	16,4	13.0460-7307.2	607307
24496	17,3	13.0470-2736.2	LD2736	24660	17,8	13.0470-3847.2	LD3847	25009	16,4	13.0470-7294.2	LD7294
24500	14,7	13.0460-5788.2	605788	24666	15,2	13.0460-5604.2	605604	25010	16,3	13.0460-7293.2	607293
24501	16,7	13.0460-5600.2	605600	24671	18,0	13.0460-7235.2	607235	25010	16,3	13.0470-7293.2	LD7293
24512	17,0	13.0460-5785.2	605785	24672	15,4	13.0460-5795.2	605795	25011	16,4	13.0460-7294.2	607294
24515	16,7	13.0460-2724.2	602724	24674	18,0	13.0460-7270.2	607270	25014	18,2	13.0460-3865.2	603865

Vergleichsliste WVA → ATE

Cross reference list WVA → ATE - Lista referencias WVA → ATE - Liste des correspondances WVA → ATE - Tabella di conversione codici WVA → ATE

WVA D 				WVA D 				WVA D 			
25014	18,2	13.0470-3865.2	LD3865	25367	16,0	13.0460-5649.2	605649	29190	20,2	13.0460-3837.2	603837
25028	18,0	13.0460-4875.2	604875	25410	14,4	13.0460-2783.2	602783	29192	20,3	13.0460-4877.2	604877
25029	16,7	13.0460-4874.2	604874	25429	17,5	13.0460-7288.2	607288	29192	20,7	13.0460-4826.2	604826
25031	19,1	13.0470-7262.2	LD7262	25430	17,5	13.0470-7288.2	LD7288	29200	21,0	13.0460-4827.2	604827
25033	19,1	13.0460-7262.2	607262	25506	18,2	13.0470-3866.2	LD3866	29212	17,3	13.0460-4989.2	604989
25045	19,5	13.0460-7267.2	607267	25507	18,2	13.0460-3866.2	603866	29217	20,5	13.0460-3842.2	603842
25045	19,5	13.0470-7267.2	LD7267	25520	15,8	13.0460-5633.2	605633	29229	20,7	13.0460-4830.2	604830
25055	15,0	13.0460-7290.2	607290	25527	17,6	13.0460-3861.2	603861	29229	20,7	13.0460-4866.2	604866
25070	17,3	13.0460-7279.2	607279	25532	19,2	13.0460-7283.2	607283	29231	22,7	13.0460-4829.2	604829
25071	18,8	13.0460-2780.2	602780	25633	15,5	13.0460-8014.2	608014	29232	21,0	13.0460-4823.2	604823
25096	16,7	13.0460-7309.2	607309	25643	16,8	13.0460-4879.2	604879	29835	22,0	13.0460-6015.2	606015
25096	16,7	13.0470-7309.2	LD7309	25643	17,0	13.0470-4879.2	LD4879				
25096	17,0	13.0470-7264.2	LD7264	25652	17,1	13.0470-2789.2	LD2789				
25098	17,0	13.0460-7264.2	607264	25654	17,1	13.0460-2789.2	602789				
25110	17,5	13.0460-2790.2	602790	25683	20,4	13.0470-2785.2	LD2785				
25110	17,5	13.0470-2790.2	LD2790	25684	20,4	13.0460-2785.2	602785				
25113	18,4	13.0460-4858.2	604858	25690	14,4	13.0460-5654.2	605654				
25114	15,8	13.0460-7255.2	607255	25694	17,2	13.0460-5645.2	605645				
25134	17,2	13.0460-2784.2	602784	25698	18,7	13.0460-3868.2	603868				
25134	17,2	13.0470-2784.2	LD2784	25703	18,2	13.0460-7298.2	607298				
25148	18,4	13.0460-4856.2	604856	25720	17,7	13.0460-2604.2	602604				
25157	17,4	13.0460-2767.2	602767	25778	14,3	13.0460-5843.2	605843				
25157	17,4	13.0470-2767.2	LD2767	25780	15,0	13.0460-2794.2	602794				
25159	20,3	13.0460-7280.2	607280	25806	17,3	13.0460-7284.2	607284				
25159	20,3	13.0470-7280.2	LD7280	25827	17,7	13.0470-3872.2	LD3872				
25160	20,3	13.0470-7281.2	LD7281	25828	17,7	13.0460-3872.2	603872				
25161	20,3	13.0460-7281.2	607281	25834	17,3	13.0460-7300.2	607300				
25173	18,4	13.0460-4857.2	604857	25834	17,3	13.0470-7300.2	LD7300				
25179	17,8	13.0460-4870.2	604870	25836	17,0	13.0470-7305.2	LD7305				
25180	19,0	13.0470-7273.2	LD7273	25837	17,0	13.0460-7305.2	607305				
25183	17,9	13.0460-4869.2	604869	25840	17,8	13.0460-3871.2	603871				
25185	19,4	13.0460-2772.2	602772	25840	17,8	13.0470-3871.2	LD3871				
25187	17,8	13.0460-5641.2	605641	25841	16,1	13.0470-7301.2	LD7301				
25191	21,3	13.0460-7282.2	607282	25842	16,1	13.0460-7301.2	607301				
25192	21,3	13.0470-7282.2	LD7282	25875	15,9	13.0460-5658.2	605658				
25199	19,6	13.0460-3857.2	603857	25890	16,9	13.0460-5638.2	605638				
25200	19,6	13.0470-3857.2	LD3857	25895	18,5	13.0460-3870.2	603870				
25204	18,5	13.0460-2762.2	602762	25896	18,5	13.0470-3870.2	LD3870				
25214	17,4	13.0460-2773.2	602773	25907	20,7	13.0460-7302.2	607302				
25214	17,4	13.0470-2769.2	LD2769	25962	18,0	13.0460-7131.2	607131				
25214	17,4	13.0470-2773.2	LD2773	25967	15,0	13.0460-2600.2	602600				
25215	18,6	13.0470-2781.2	LD2781	25969	16,1	13.0460-7295.2	607295				
25216	18,6	13.0460-2781.2	602781	25969	16,1	13.0470-7295.2	LD7295				
25217	20,0	13.0470-2764.2	LD2764	25973	17,2	13.0460-2793.2	602793				
25218	16,6	13.0460-7278.2	607278	25980	16,8	13.0470-2797.2	LD2797				
25222	17,3	13.0460-7276.2	607276	25981	16,8	13.0460-2797.2	602797				
25231	14,6	13.0460-5621.2	605621	25997	18,7	13.0460-4880.2	604880				
25251	18,9	13.0460-3867.2	603867	25997	18,7	13.0470-4880.2	LD4880				
25266	16,6	13.0460-7287.2	607287	29001	20,0	13.0460-7906.2	607906				
25270	17,8	13.0460-5642.2	605642	29012	18,0	13.0460-7903.2	607903				
25274	15,0	13.0460-5613.2	605613	29121	20,3	13.0460-4860.2	604860				
25308	17,5	13.0460-3859.2	603859	29121	20,3	13.0460-4861.2	604861				
25308	17,5	13.0470-3859.2	LD3859	29121	20,3	13.0460-4966.2	604966				
25324	17,3	13.0460-7289.2	607289	29122	22,1	13.0460-4828.2	604828				
25326	19,3	13.0460-2778.2	602778	29123	20,3	13.0460-4862.2	604862				
25326	19,3	13.0470-2778.2	LD2778	29123	20,3	13.0460-4996.2	604996				
25331	16,2	13.0470-7315.2	LD7315	29153	20,0	13.0460-7909.2	607909				
25332	16,2	13.0460-7315.2	607315	29160	20,3	13.0460-4847.2	604847				
25350	17,8	13.0460-5646.2	605646	29160	20,3	13.0460-4865.2	604865				
25353	16,2	13.0460-7304.2	607304	29160	20,8	13.0460-4975.2	604975				
25354	16,2	13.0470-7304.2	LD7304	29190	20,2	13.0460-3832.2	603832				







- DE** Vergleichsliste ATE → WVA
- EN** Cross reference list ATE → WVA
- ES** Lista referencias ATE → WVA
- FR** Liste des correspondances ATE → WVA
- IT** Tabella di conversione codici ATE → WVA

2018

Vergleichsliste ATE → WVA



Cross reference list ATE → WVA - Lista referencias ATE → WVA - Liste des correspondances ATE → WVA - Tabella di conversione codici ATE → WVA

	WVA D				WVA D				WVA D		
13.0460-2600.2	602600	25967	15,0	13.0460-2759.2	602759	24559	17,8	13.0460-2835.2	602835	23353	14,8
13.0460-2604.2	602604	25720	17,7	13.0460-2760.2	602760	24561	17,7	13.0460-2836.2	602836	21595	18,3
13.0460-2605.2	602605	24283	17,3	13.0460-2761.2	602761	24922	17,5	13.0460-2837.2	602837	21945	19,6
13.0460-2610.2	602610	22076	19,6	13.0460-2762.2	602762	25204	18,5	13.0460-2838.2	602838	23445	19,2
13.0460-2700.2	602700	21452	18,5	13.0460-2763.2	602763	23517	17,2	13.0460-2839.2	602839	23176	18,7
13.0460-2701.2	602701	23829	18,5	13.0460-2764.2	602764	24738	20,0	13.0460-2840.2	602840	23980	16,5
13.0460-2704.2	602704	23761	18,8	13.0460-2765.2	602765	24743	19,2	13.0460-2842.2	602842	20961	15,2
13.0460-2705.2	602705	21452	18,5	13.0460-2766.2	602766	24604	18,7	13.0460-2844.2	602844	21674	19,4
13.0460-2706.2	602706	24462	16,7	13.0460-2767.2	602767	25157	17,4	13.0460-2845.2	602845	23554	16,4
13.0460-2707.2	602707	23760	17,7	13.0460-2768.2	602768	23811	17,7	13.0460-2846.2	602846	21010	15,8
13.0460-2708.2	602708	23881	20,0	13.0460-2769.2	602769	24606	17,4	13.0460-2850.2	602850	23602	19,7
13.0460-2709.2	602709	23973	17,1	13.0460-2770.2	602770	24606	17,4	13.0460-2852.2	602852	21799	19,7
13.0460-2710.2	602710	23916	17,6	13.0460-2771.2	602771	24824	15,7	13.0460-2853.2	602853	21983	17,2
13.0460-2711.2	602711	24077	19,1	13.0460-2772.2	602772	25185	19,4	13.0460-2855.2	602855	23138	14,6
13.0460-2712.2	602712	23138	14,6	13.0460-2773.2	602773	25214	17,4	13.0460-2857.2	602857	23226	17,0
13.0460-2713.2	602713	23624	17,4	13.0460-2774.2	602774	24403	17,4	13.0460-2858.2	602858	23284	14,0
13.0460-2714.2	602714	24290	16,9	13.0460-2775.2	602775	23554	16,4	13.0460-2859.2	602859	23516	17,0
13.0460-2715.2	602715	24391	16,6	13.0460-2776.2	602776	23070	17,0	13.0460-2860.2	602860	23554	16,4
13.0460-2716.2	602716	24704	17,8	13.0460-2778.2	602778	25326	19,3	13.0460-2862.2	602862	23346	19,0
13.0460-2717.2	602717	23825	18,5	13.0460-2779.2	602779	24869	19,3	13.0460-2863.2	602863	20261	19,0
13.0460-2718.2	602718	23615	18,3	13.0460-2780.2	602780	25071	18,8	13.0460-2864.2	602864	20961	17,2
13.0460-2719.2	602719	24192	17,4	13.0460-2781.2	602781	25216	18,6	13.0460-2867.2	602867	23517	16,6
13.0460-2720.2	602720	23452	19,0	13.0460-2783.2	602783	25410	14,4	13.0460-2868.2	602868	23655	15,3
13.0460-2721.2	602721	23458	15,6	13.0460-2784.2	602784	25134	17,2	13.0460-2869.2	602869	23169	19,4
13.0460-2722.2	602722	24496	17,3	13.0460-2785.2	602785	25684	20,4	13.0460-2870.2	602870	23099	18,4
13.0460-2723.2	602723	24537	16,1	13.0460-2786.2	602786	24848	18,3	13.0460-2871.2	602871	23407	19,0
13.0460-2724.2	602724	24515	16,7	13.0460-2787.2	602787	23554	17,3	13.0460-2872.2	602872	23446	16,5
13.0460-2725.2	602725	23985	17,8	13.0460-2789.2	602789	25654	17,1	13.0460-2874.2	602874	23224	16,5
13.0460-2726.2	602726	23144	19,8	13.0460-2790.2	602790	25110	17,5	13.0460-2875.2	602875	23119	17,5
13.0460-2727.2	602727	23145	19,8	13.0460-2792.2	602792	22032	19,6	13.0460-2876.2	602876	23119	17,5
13.0460-2728.2	602728	24191	18,1	13.0460-2793.2	602793	25973	17,2	13.0460-2877.2	602877	23554	17,2
13.0460-2729.2	602729	23423	17,8	13.0460-2794.2	602794	25780	15,0	13.0460-2878.2	602878	24073	16,7
13.0460-2730.2	602730	23424	17,6	13.0460-2795.2	602795	23916	17,6	13.0460-2879.2	602879	23601	13,7
13.0460-2731.2	602731	24192	17,1	13.0460-2797.2	602797	25981	16,8	13.0460-2880.2	602880	23914	17,1
13.0460-2732.2	602732	24306	20,3	13.0460-2800.2	602800	20091	14,6	13.0460-2881.2	602881	23409	19,3
13.0460-2733.2	602733	24306	20,3	13.0460-2803.2	602803	21517	17,5	13.0460-2882.2	602882	23326	17,4
13.0460-2734.2	602734	24310	19,0	13.0460-2804.2	602804	21518	17,0	13.0460-2883.2	602883	23581	18,8
13.0460-2735.2	602735	23100	18,4	13.0460-2805.2	602805	21522	17,5	13.0460-2884.2	602884	23843	18,8
13.0460-2736.2	602736	24496	17,3	13.0460-2806.2	602806	20168	19,3	13.0460-2885.2	602885	24077	19,1
13.0460-2737.2	602737	24537	15,8	13.0460-2809.2	602809	21182	19,4	13.0460-2886.2	602886	20961	16,0
13.0460-2738.2	602738	24608	18,5	13.0460-2810.2	602810	20236	18,0	13.0460-2887.2	602887	23914	17,1
13.0460-2739.2	602739	24578	16,5	13.0460-2811.2	602811	21068	17,0	13.0460-2888.2	602888	23326	17,4
13.0460-2740.2	602740	23554	17,0	13.0460-2812.2	602812	21217	18,0	13.0460-2889.2	602889	23326	17,4
13.0460-2741.2	602741	24693	18,5	13.0460-2815.2	602815	21368	18,3	13.0460-2890.2	602890	23326	17,4
13.0460-2742.2	602742	24693	17,5	13.0460-2816.2	602816	21749	19,3	13.0460-2891.2	602891	24134	19,6
13.0460-2743.2	602743	24693	17,5	13.0460-2817.2	602817	21674	19,0	13.0460-2892.2	602892	24133	18,6
13.0460-2744.2	602744	24692	15,9	13.0460-2819.2	602819	20961	17,2	13.0460-2893.2	602893	24135	17,7
13.0460-2745.2	602745	24765	16,5	13.0460-2820.2	602820	20961	17,2	13.0460-2894.2	602894	20961	17,2
13.0460-2746.2	602746	24409	19,2	13.0460-2821.2	602821	21945	16,0	13.0460-2895.2	602895	23172	18,0
13.0460-2747.2	602747	24606	17,4	13.0460-2822.2	602822	21945	19,6	13.0460-2896.2	602896	21920	16,6
13.0460-2748.2	602748	24606	17,7	13.0460-2824.2	602824	21110	15,6	13.0460-2897.2	602897	21861	15,2
13.0460-2749.2	602749	24483	16,9	13.0460-2825.2	602825	21614	17,7	13.0460-2898.2	602898	23908	18,0
13.0460-2750.2	602750	20741	15,0	13.0460-2826.2	602826	23177	14,2	13.0460-2899.2	602899	23639	17,5
13.0460-2751.2	602751	21418	15,5	13.0460-2827.2	602827	21606	16,7	13.0460-2925.2	602925	20901	19,0
13.0460-2752.2	602752	24839	19,4	13.0460-2828.2	602828	23070	19,5	13.0460-2927.2	602927	20941	19,3
13.0460-2753.2	602753	23554	16,0	13.0460-2829.2	602829	23125	19,0	13.0460-2928.2	602928	20981	13,8
13.0460-2754.2	602754	24420	17,0	13.0460-2830.2	602830	21920	14,6	13.0460-2934.2	602934	20778	19,0
13.0460-2755.2	602755	24422	17,2	13.0460-2831.2	602831	21861	15,2	13.0460-2935.2	602935	21385	13,8
13.0460-2756.2	602756	24820	16,1	13.0460-2832.2	602832	21889	18,1	13.0460-2937.2	602937	20961	15,2
13.0460-2757.2	602757	24820	16,1	13.0460-2833.2	602833	23070	17,0	13.0460-2941.2	602941	20838	17,0
13.0460-2758.2	602758	24422	17,2	13.0460-2834.2	602834	21463	18,0	13.0460-2943.2	602943	21266	17,0





Vergleichsliste ATE → WVA

Cross reference list ATE → WVA - Lista referencias ATE → WVA - Liste des correspondances ATE → WVA - Tabella di conversione codici ATE → WVA

	WVA D				WVA D				WVA D		
13.0460-2948.2	602948	21100	16,7	13.0460-3834.2	603834	24484	19,0	13.0460-3961.2	603961	20337	14,0
13.0460-2949.2	602949	20833	17,0	13.0460-3835.2	603835	24486	17,9	13.0460-3962.2	603962	20906	18,0
13.0460-2951.2	602951	21103	14,2	13.0460-3836.2	603836	24540	16,3	13.0460-3963.2	603963	21586	15,0
13.0460-2952.2	602952	21185	19,4	13.0460-3837.2	603837	29190	20,2	13.0460-3964.2	603964	23411	15,0
13.0460-2955.2	602955	20938	18,0	13.0460-3838.2	603838	21436	17,0	13.0460-3965.2	603965	23300	18,0
13.0460-2956.2	602956	20989	17,7	13.0460-3839.2	603839	24288	17,9	13.0460-3966.2	603966	23600	19,4
13.0460-2957.2	602957	20168	16,0	13.0460-3840.2	603840	24549	19,6	13.0460-3968.2	603968	20489	18,5
13.0460-2958.2	602958	20168	19,3	13.0460-3841.2	603841	24550	19,5	13.0460-3969.2	603969	20927	18,5
13.0460-2959.2	602959	23534	20,1	13.0460-3842.2	603842	29217	20,5	13.0460-3972.2	603972	21632	16,0
13.0460-2962.2	602962	20668	16,6	13.0460-3846.2	603846	24764	17,9	13.0460-3973.2	603973	23146	17,0
13.0460-2963.2	602963	21138	18,8	13.0460-3847.2	603847	24660	17,8	13.0460-3975.2	603975	23597	18,0
13.0460-2964.2	602964	20861	17,5	13.0460-3848.2	603848	24349	17,6	13.0460-3976.2	603976	23263	16,5
13.0460-2965.2	602965	21170	17,3	13.0460-3849.2	603849	24393	17,9	13.0460-3977.2	603977	21980	18,0
13.0460-2966.2	602966	20166	16,0	13.0460-3850.2	603850	23707	18,0	13.0460-3978.2	603978	23332	18,0
13.0460-2971.2	602971	21209	18,5	13.0460-3851.2	603851	24150	17,6	13.0460-3979.2	603979	21999	15,8
13.0460-2972.2	602972	20124	18,9	13.0460-3852.2	603852	24868	20,7	13.0460-3980.2	603980	23022	20,9
13.0460-2973.2	602973	21635	18,0	13.0460-3853.2	603853	24887	16,8	13.0460-3982.2	603982	23705	18,1
13.0460-2975.2	602975	21439	20,3	13.0460-3854.2	603854	24928	17,1	13.0460-3983.2	603983	23710	19,4
13.0460-2976.2	602976	21798	19,7	13.0460-3855.2	603855	24883	18,0	13.0460-3984.2	603984	23713	19,4
13.0460-2977.2	602977	21799	19,7	13.0460-3856.2	603856	23437	18,0	13.0460-3985.2	603985	23020	17,9
13.0460-2978.2	602978	21801	19,0	13.0460-3857.2	603857	25199	19,6	13.0460-3986.2	603986	23137	18,0
13.0460-2979.2	602979	21147	19,0	13.0460-3858.2	603858	24563	17,7	13.0460-3987.2	603987	23279	18,4
13.0460-2980.2	602980	21148	19,0	13.0460-3859.2	603859	25308	17,5	13.0460-3988.2	603988	23557	17,2
13.0460-2981.2	602981	21613	18,0	13.0460-3860.2	603860	24484	18,8	13.0460-3990.2	603990	23021	18,9
13.0460-2982.2	602982	21479	19,2	13.0460-3861.2	603861	25527	17,6	13.0460-3991.2	603991	23714	16,6
13.0460-2983.2	602983	21388	18,0	13.0460-3862.2	603862	24349	17,6	13.0460-3992.2	603992	23434	18,7
13.0460-2984.2	602984	20961	17,2	13.0460-3863.2	603863	23707	18,0	13.0460-3993.2	603993	23577	18,7
13.0460-2985.2	602985	20164	18,2	13.0460-3864.2	603864	23710	19,6	13.0460-3994.2	603994	23599	19,0
13.0460-2987.2	602987	23168	19,0	13.0460-3865.2	603865	25014	18,2	13.0460-3995.2	603995	23607	15,7
13.0460-2997.2	602997	20708	15,8	13.0460-3866.2	603866	25507	18,2	13.0460-3996.2	603996	23276	17,2
13.0460-3306.2	603306	21089	15,0	13.0460-3867.2	603867	25251	18,9	13.0460-3997.2	603997	23277	17,7
13.0460-3401.2	603401	20755	14,4	13.0460-3868.2	603868	25698	18,7	13.0460-3998.2	603998	23273	17,8
13.0460-3403.2	603403	20755	14,4	13.0460-3870.2	603870	25895	18,5	13.0460-3999.2	603999	23743	20,1
13.0460-3504.2	603504	21301	15,5	13.0460-3871.2	603871	25840	17,8	13.0460-4014.2	604014	21279	16,4
13.0460-3602.2	603602	21144	15,8	13.0460-3872.2	603872	25828	17,7	13.0460-4034.2	604034	20687	15,5
13.0460-3605.2	603605	20181	17,3	13.0460-3902.2	603902	20035	17,0	13.0460-4040.2	604040	21050	15,8
13.0460-3800.2	603800	23613	17,7	13.0460-3904.2	603904	21107	12,0	13.0460-4041.2	604041	21289	16,8
13.0460-3803.2	603803	20996	17,3	13.0460-3911.2	603911	20906	18,0	13.0460-4042.2	604042	21267	16,8
13.0460-3805.2	603805	21197	15,0	13.0460-3914.2	603914	21233	16,7	13.0460-4043.2	604043	21140	15,0
13.0460-3806.2	603806	23669	16,8	13.0460-3926.2	603926	20974	10,8	13.0460-4044.2	604044	20755	15,1
13.0460-3807.2	603807	21436	17,0	13.0460-3933.2	603933	21016	17,0	13.0460-4047.2	604047	21305	15,7
13.0460-3809.2	603809	24072	17,9	13.0460-3936.2	603936	20073	17,3	13.0460-4056.2	604056	21402	17,5
13.0460-3810.2	603810	23705	18,1	13.0460-3939.2	603939	20775	18,0	13.0460-4058.2	604058	21832	14,9
13.0460-3811.2	603811	23708	19,2	13.0460-3940.2	603940	20777	18,0	13.0460-4059.2	604059	21279	16,4
13.0460-3813.2	603813	24150	17,6	13.0460-3942.2	603942	20841	12,0	13.0460-4060.2	604060	21900	15,0
13.0460-3814.2	603814	23934	18,2	13.0460-3943.2	603943	20906	18,0	13.0460-4064.2	604064	21919	15,3
13.0460-3815.2	603815	23930	18,2	13.0460-3945.2	603945	20934	14,0	13.0460-4065.2	604065	21899	15,3
13.0460-3818.2	603818	23707	18,1	13.0460-3946.2	603946	23302	18,0	13.0460-4066.2	604066	21857	17,7
13.0460-3819.2	603819	24007	20,8	13.0460-3947.2	603947	21505	17,0	13.0460-4069.2	604069	23078	15,9
13.0460-3821.2	603821	24008	18,3	13.0460-3948.2	603948	21513	17,0	13.0460-4201.2	604201	21153	17,5
13.0460-3822.2	603822	21600	11,0	13.0460-3949.2	603949	21365	17,0	13.0460-4202.2	604202	21153	16,0
13.0460-3823.2	603823	20974	11,0	13.0460-3950.2	603950	21436	17,0	13.0460-4401.2	604401	20784	18,0
13.0460-3824.2	603824	20261	19,0	13.0460-3951.2	603951	21436	16,2	13.0460-4800.2	604800	23765	17,0
13.0460-3825.2	603825	24348	17,1	13.0460-3952.2	603952	20905	18,0	13.0460-4801.2	604801	21381	15,0
13.0460-3826.2	603826	23706	18,0	13.0460-3953.2	603953	20634	15,0	13.0460-4802.2	604802	23774	17,5
13.0460-3827.2	603827	23710	19,6	13.0460-3954.2	603954	20974	11,0	13.0460-4803.2	604803	23092	15,6
13.0460-3828.2	603828	24349	17,5	13.0460-3955.2	603955	21096	15,0	13.0460-4804.2	604804	23092	15,6
13.0460-3829.2	603829	23959	17,0	13.0460-3956.2	603956	21631	17,0	13.0460-4805.2	604805	24162	15,2
13.0460-3831.2	603831	24260	17,3	13.0460-3957.2	603957	23042	19,0	13.0460-4806.2	604806	23955	16,2
13.0460-3832.2	603832	29190	20,2	13.0460-3959.2	603959	21469	18,0	13.0460-4807.2	604807	24468	19,1
13.0460-3833.2	603833	24485	19,0	13.0460-3960.2	603960	21470	18,0	13.0460-4809.2	604809	24469	19,1

Vergleichsliste ATE → WVA



Cross reference list ATE → WVA - Lista referencias ATE → WVA - Liste des correspondances ATE → WVA - Tabella di conversione codici ATE → WVA

	WVA D				WVA D				WVA D		
13.0460-4810.2	604810	24467	19,1	13.0460-4956.2	604956	20162	15,4	13.0460-5625.2	605625	21319	14,9
13.0460-4811.2	604811	24466	19,1	13.0460-4957.2	604957	20410	15,0	13.0460-5626.2	605626	21715	16,0
13.0460-4812.2	604812	24465	19,2	13.0460-4958.2	604958	21382	17,3	13.0460-5627.2	605627	21569	14,9
13.0460-4814.2	604814	21937	15,5	13.0460-4964.2	604964	21381	15,0	13.0460-5628.2	605628	24331	13,8
13.0460-4815.2	604815	21937	15,5	13.0460-4965.2	604965	21471	18,0	13.0460-5629.2	605629	24602	16,0
13.0460-4816.2	604816	24541	15,5	13.0460-4966.2	604966	29121	20,3	13.0460-5631.2	605631	24529	16,0
13.0460-4817.2	604817	23960	18,3	13.0460-4968.2	604968	21381	18,0	13.0460-5632.2	605632	23972	16,8
13.0460-4818.2	604818	23142	15,1	13.0460-4969.2	604969	23754	18,0	13.0460-5633.2	605633	25520	15,8
13.0460-4819.2	604819	23478	14,6	13.0460-4971.2	604971	23111	16,0	13.0460-5634.2	605634	24452	17,5
13.0460-4823.2	604823	29232	21,0	13.0460-4972.2	604972	23576	16,0	13.0460-5635.2	605635	24918	15,0
13.0460-4826.2	604826	29192	20,7	13.0460-4973.2	604973	23325	16,0	13.0460-5636.2	605636	24686	14,9
13.0460-4827.2	604827	29200	21,0	13.0460-4974.2	604974	21580	14,6	13.0460-5637.2	605637	24488	14,9
13.0460-4828.2	604828	29122	22,1	13.0460-4975.2	604975	29160	20,8	13.0460-5638.2	605638	25890	16,9
13.0460-4829.2	604829	29231	22,7	13.0460-4976.2	604976	23694	16,7	13.0460-5639.2	605639	24376	17,5
13.0460-4830.2	604830	29229	20,7	13.0460-4977.2	604977	23157	15,8	13.0460-5640.2	605640	21856	15,0
13.0460-4832.2	604832	21381	18,0	13.0460-4978.2	604978	23918	19,3	13.0460-5641.2	605641	25187	17,8
13.0460-4833.2	604833	24098	17,1	13.0460-4979.2	604979	23919	19,3	13.0460-5642.2	605642	25270	17,8
13.0460-4834.2	604834	24097	17,1	13.0460-4980.2	604980	23921	20,3	13.0460-5645.2	605645	25694	17,2
13.0460-4837.2	604837	20217	17,1	13.0460-4984.2	604984	23271	17,4	13.0460-5646.2	605646	25350	17,8
13.0460-4839.2	604839	24455	16,8	13.0460-4985.2	604985	21381	18,0	13.0460-5648.2	605648	24435	14,8
13.0460-4840.2	604840	23961	16,8	13.0460-4986.2	604986	21966	15,0	13.0460-5649.2	605649	25367	16,0
13.0460-4841.2	604841	23489	16,3	13.0460-4987.2	604987	23329	17,0	13.0460-5652.2	605652	22065	17,7
13.0460-4842.2	604842	24049	17,0	13.0460-4988.2	604988	21792	15,2	13.0460-5654.2	605654	25690	14,4
13.0460-4843.2	604843	XXXX X	15,5	13.0460-4989.2	604989	29212	17,3	13.0460-5658.2	605658	25875	15,9
13.0460-4847.2	604847	29160	20,3	13.0460-4990.2	604990	23271	17,4	13.0460-5700.2	605700	24403	17,0
13.0460-4848.2	604848	24316	16,9	13.0460-4991.2	604991	23092	16,0	13.0460-5701.2	605701	20392	18,5
13.0460-4849.2	604849	24315	16,2	13.0460-4992.2	604992	23692	16,6	13.0460-5703.2	605703	21154	19,5
13.0460-4850.2	604850	24296	15,5	13.0460-4993.2	604993	23693	16,6	13.0460-5709.2	605709	24230	15,3
13.0460-4851.2	604851	23111	16,0	13.0460-4994.2	604994	23945	16,5	13.0460-5710.2	605710	23783	14,0
13.0460-4852.2	604852	24553	15,8	13.0460-4995.2	604995	23575	15,6	13.0460-5711.2	605711	23736	15,7
13.0460-4853.2	604853	24687	15,2	13.0460-4996.2	604996	29123	20,3	13.0460-5712.2	605712	23451	17,5
13.0460-4854.2	604854	23757	16,3	13.0460-4997.2	604997	23944	17,5	13.0460-5713.2	605713	21650	15,5
13.0460-4855.2	604855	23325	16,4	13.0460-4998.2	604998	23478	16,5	13.0460-5714.2	605714	24214	17,5
13.0460-4856.2	604856	25148	18,4	13.0460-4999.2	604999	23330	17,0	13.0460-5716.2	605716	21562	17,0
13.0460-4857.2	604857	25173	18,4	13.0460-5405.2	605405	21643	17,8	13.0460-5717.2	605717	23504	16,0
13.0460-4858.2	604858	25113	18,4	13.0460-5409.2	605409	21193	18,0	13.0460-5718.2	605718	23081	18,0
13.0460-4859.2	604859	24589	20,1	13.0460-5410.2	605410	21195	18,0	13.0460-5720.2	605720	20708	14,5
13.0460-4860.2	604860	29121	20,3	13.0460-5600.2	605600	24501	16,7	13.0460-5722.2	605722	21468	15,5
13.0460-4861.2	604861	29121	20,3	13.0460-5601.2	605601	24493	16,0	13.0460-5725.2	605725	23650	17,2
13.0460-4862.2	604862	29123	20,3	13.0460-5602.2	605602	24122	19,0	13.0460-5727.2	605727	23164	17,3
13.0460-4863.2	604863	24976	17,5	13.0460-5603.2	605603	24690	19,2	13.0460-5731.2	605731	21738	13,5
13.0460-4864.2	604864	24455	16,8	13.0460-5604.2	605604	24666	15,2	13.0460-5732.2	605732	24029	12,5
13.0460-4865.2	604865	29160	20,3	13.0460-5605.2	605605	24545	16,9	13.0460-5734.2	605734	23967	15,1
13.0460-4866.2	604866	29229	20,7	13.0460-5606.2	605606	24544	18,1	13.0460-5735.2	605735	24014	16,0
13.0460-4867.2	604867	24853	16,0	13.0460-5607.2	605607	24245	18,5	13.0460-5736.2	605736	24217	15,7
13.0460-4869.2	604869	25183	17,9	13.0460-5608.2	605608	24244	18,5	13.0460-5738.2	605738	23702	15,1
13.0460-4870.2	604870	25179	17,8	13.0460-5609.2	605609	24346	16,4	13.0460-5739.2	605739	24071	14,6
13.0460-4873.2	604873	24847	17,0	13.0460-5610.2	605610	24582	17,4	13.0460-5742.2	605742	23966	17,7
13.0460-4874.2	604874	25029	16,7	13.0460-5611.2	605611	24415	19,1	13.0460-5743.2	605743	23928	17,3
13.0460-4875.2	604875	25028	18,0	13.0460-5612.2	605612	24412	19,0	13.0460-5744.2	605744	21947	15,4
13.0460-4877.2	604877	29192	20,3	13.0460-5613.2	605613	25274	15,0	13.0460-5745.2	605745	21775	15,0
13.0460-4879.2	604879	25643	16,8	13.0460-5614.2	605614	24601	18,0	13.0460-5746.2	605746	23524	17,4
13.0460-4880.2	604880	25997	18,7	13.0460-5615.2	605615	24946	19,0	13.0460-5747.2	605747	24026	17,0
13.0460-4882.2	604882	22102	18,2	13.0460-5616.2	605616	24567	16,0	13.0460-5748.2	605748	23429	15,5
13.0460-4883.2	604883	22061	18,7	13.0460-5617.2	605617	24451	15,6	13.0460-5749.2	605749	23539	17,3
13.0460-4884.2	604884	22062	20,7	13.0460-5618.2	605618	24386	17,9	13.0460-5750.2	605750	23734	16,8
13.0460-4911.2	604911	20389	15,4	13.0460-5619.2	605619	24653	17,3	13.0460-5751.2	605751	23502	16,0
13.0460-4918.2	604918	21048	18,3	13.0460-5620.2	605620	24981	15,9	13.0460-5752.2	605752	24632	17,0
13.0460-4921.2	604921	23305	15,2	13.0460-5621.2	605621	25231	14,6	13.0460-5753.2	605753	24638	20,0
13.0460-4955.2	604955	21048	18,3	13.0460-5622.2	605622	23726	16,5	13.0460-5754.2	605754	24635	16,6
				13.0460-5623.2	605623	23675	15,9	13.0460-5755.2	605755	23178	16,6





Vergleichsliste ATE → WVA

Cross reference list ATE → WVA - Lista referencias ATE → WVA - Liste des correspondances ATE → WVA - Tabella di conversione codici ATE → WVA

	WVA D				WVA D				WVA D		
13.0460-5756.2	605756	24406	17,4	13.0460-5825.2	605825	23094	16,5	13.0460-5891.2	605891	23513	17,0
13.0460-5757.2	605757	24519	15,8	13.0460-5826.2	605826	21874	14,5	13.0460-5892.2	605892	21689	15,5
13.0460-5760.2	605760	23584	16,4	13.0460-5827.2	605827	23527	14,5	13.0460-5894.2	605894	23759	17,0
13.0460-5761.2	605761	24297	14,4	13.0460-5829.2	605829	24398	16,0	13.0460-5895.2	605895	23780	16,7
13.0460-5762.2	605762	24299	14,0	13.0460-5830.2	605830	23158	17,5	13.0460-5896.2	605896	23444	15,3
13.0460-5763.2	605763	21730	14,0	13.0460-5831.2	605831	23779	17,0	13.0460-5897.2	605897	21825	17,5
13.0460-5764.2	605764	24350	17,3	13.0460-5832.2	605832	23571	16,5	13.0460-5898.2	605898	21954	15,0
13.0460-5765.2	605765	24338	15,5	13.0460-5833.2	605833	23545	14,4	13.0460-5899.2	605899	23974	17,6
13.0460-5766.2	605766	24337	17,5	13.0460-5834.2	605834	23354	13,0	13.0460-5916.2	605916	20731	15,3
13.0460-5767.2	605767	24336	17,5	13.0460-5835.2	605835	20076	15,5	13.0460-5919.2	605919	20194	15,0
13.0460-5768.2	605768	24347	17,5	13.0460-5836.2	605836	23662	15,0	13.0460-5920.2	605920	21322	15,0
13.0460-5769.2	605769	24611	15,0	13.0460-5837.2	605837	23296	14,5	13.0460-5923.2	605923	23385	18,3
13.0460-5770.2	605770	23983	17,0	13.0460-5838.2	605838	23400	15,5	13.0460-5924.2	605924	21832	14,9
13.0460-5771.2	605771	24686	14,9	13.0460-5839.2	605839	23797	15,0	13.0460-5926.2	605926	21845	16,5
13.0460-5772.2	605772	24179	17,1	13.0460-5840.2	605840	21834	15,0	13.0460-5927.2	605927	21877	16,0
13.0460-5773.2	605773	23997	15,5	13.0460-5841.2	605841	23025	14,8	13.0460-5929.2	605929	21721	15,0
13.0460-5774.2	605774	24831	16,1	13.0460-5842.2	605842	23420	16,5	13.0460-5932.2	605932	21378	15,0
13.0460-5775.2	605775	24276	14,8	13.0460-5843.2	605843	25778	14,3	13.0460-5933.2	605933	21727	16,8
13.0460-5776.2	605776	24275	16,5	13.0460-5844.2	605844	24009	17,5	13.0460-5935.2	605935	20852	15,5
13.0460-5777.2	605777	24569	16,3	13.0460-5845.2	605845	21961	15,5	13.0460-5936.2	605936	21012	15,0
13.0460-5778.2	605778	23699	16,8	13.0460-5846.2	605846	23836	17,0	13.0460-5937.2	605937	21229	17,0
13.0460-5779.2	605779	24319	17,6	13.0460-5847.2	605847	23648	16,5	13.0460-5938.2	605938	21158	15,5
13.0460-5780.2	605780	24322	15,3	13.0460-5848.2	605848	23586	17,4	13.0460-5940.2	605940	21373	16,0
13.0460-5782.2	605782	24490	14,9	13.0460-5849.2	605849	23656	14,0	13.0460-5941.2	605941	21659	16,4
13.0460-5783.2	605783	24227	16,7	13.0460-5850.2	605850	21705	15,0	13.0460-5942.2	605942	21543	16,5
13.0460-5784.2	605784	24243	16,6	13.0460-5851.2	605851	23560	17,2	13.0460-5943.2	605943	21699	15,0
13.0460-5785.2	605785	24512	17,0	13.0460-5852.2	605852	23498	14,8	13.0460-5944.2	605944	21656	15,0
13.0460-5786.2	605786	24936	15,0	13.0460-5853.2	605853	23488	15,4	13.0460-5949.2	605949	21280	16,0
13.0460-5787.2	605787	23867	17,6	13.0460-5854.2	605854	23487	15,5	13.0460-5950.2	605950	21546	16,7
13.0460-5788.2	605788	24500	14,7	13.0460-5855.2	605855	23583	16,0	13.0460-5951.2	605951	21603	17,5
13.0460-5789.2	605789	20325	17,2	13.0460-5856.2	605856	24041	14,4	13.0460-5952.2	605952	21649	16,0
13.0460-5790.2	605790	24323	15,5	13.0460-5857.2	605857	23314	15,0	13.0460-5953.2	605953	21650	15,0
13.0460-5791.2	605791	24220	17,5	13.0460-5859.2	605859	23234	16,9	13.0460-5954.2	605954	23847	15,8
13.0460-5792.2	605792	23538	17,6	13.0460-5860.2	605860	23870	17,1	13.0460-5955.2	605955	21879	18,6
13.0460-5793.2	605793	24372	17,3	13.0460-5861.2	605861	23529	17,1	13.0460-5956.2	605956	21626	15,0
13.0460-5794.2	605794	24284	15,5	13.0460-5862.2	605862	21688	15,3	13.0460-5957.2	605957	21348	17,0
13.0460-5795.2	605795	24672	15,4	13.0460-5863.2	605863	23236	16,8	13.0460-5958.2	605958	21363	15,8
13.0460-5797.2	605797	24225	16,9	13.0460-5864.2	605864	21907	15,5	13.0460-5959.2	605959	21481	15,5
13.0460-5799.2	605799	24609	17,7	13.0460-5865.2	605865	23389	12,6	13.0460-5960.2	605960	20863	16,5
13.0460-5800.2	605800	23342	17,0	13.0460-5867.2	605867	23863	14,3	13.0460-5963.2	605963	20958	16,0
13.0460-5801.2	605801	23973	17,1	13.0460-5868.2	605868	23873	15,8	13.0460-5966.2	605966	21142	15,0
13.0460-5802.2	605802	23490	15,4	13.0460-5869.2	605869	24013	14,9	13.0460-5967.2	605967	21502	15,0
13.0460-5803.2	605803	23238	16,0	13.0460-5871.2	605871	23455	13,7	13.0460-5968.2	605968	21369	15,5
13.0460-5804.2	605804	24045	13,7	13.0460-5872.2	605872	21774	15,0	13.0460-5969.2	605969	21949	13,5
13.0460-5806.2	605806	20192	15,0	13.0460-5873.2	605873	23893	16,9	13.0460-5970.2	605970	21355	13,5
13.0460-5807.2	605807	23093	16,6	13.0460-5874.2	605874	21555	14,0	13.0460-5972.2	605972	21559	11,5
13.0460-5808.2	605808	21718	16,0	13.0460-5875.2	605875	24033	17,7	13.0460-5973.2	605973	21766	13,5
13.0460-5809.2	605809	21975	18,2	13.0460-5876.2	605876	24369	17,2	13.0460-5974.2	605974	21541	15,0
13.0460-5810.2	605810	23510	16,5	13.0460-5877.2	605877	24042	16,3	13.0460-5976.2	605976	20870	15,0
13.0460-5811.2	605811	23348	16,5	13.0460-5878.2	605878	24055	16,9	13.0460-5978.2	605978	21503	17,0
13.0460-5812.2	605812	23521	14,0	13.0460-5879.2	605879	24132	18,8	13.0460-5980.2	605980	21708	15,5
13.0460-5813.2	605813	23480	19,3	13.0460-5880.2	605880	23672	14,8	13.0460-5981.2	605981	21842	14,4
13.0460-5814.2	605814	23620	16,4	13.0460-5881.2	605881	21099	17,0	13.0460-5982.2	605982	21653	17,5
13.0460-5815.2	605815	23766	17,8	13.0460-5882.2	605882	23703	17,9	13.0460-5983.2	605983	21713	16,5
13.0460-5816.2	605816	21243	14,0	13.0460-5884.2	605884	23515	15,8	13.0460-5985.2	605985	21333	15,0
13.0460-5817.2	605817	23526	17,5	13.0460-5885.2	605885	23520	17,0	13.0460-5986.2	605986	21545	14,9
13.0460-5819.2	605819	23816	16,0	13.0460-5886.2	605886	24061	16,7	13.0460-5987.2	605987	23080	15,0
13.0460-5820.2	605820	21696	16,3	13.0460-5887.2	605887	23509	15,2	13.0460-5988.2	605988	23006	15,9
13.0460-5821.2	605821	24048	18,6	13.0460-5888.2	605888	24035	16,6	13.0460-5989.2	605989	23454	14,9
13.0460-5822.2	605822	24246	16,8	13.0460-5889.2	605889	21650	15,0	13.0460-5992.2	605992	21681	15,0
13.0460-5824.2	605824	20008	13,0	13.0460-5890.2	605890	23290	15,5	13.0460-5993.2	605993	23237	14,5

Vergleichsliste ATE → WVA



Cross reference list ATE → WVA - Lista referencias ATE → WVA - Liste des correspondances ATE → WVA - Tabella di conversione codici ATE → WVA

	WVA D				WVA D				WVA D		
13.0460-5994.2	605994	23234	16,8	13.0460-7111.2	607111	23131	19,6	13.0460-7183.2	607183	21485	20,5
13.0460-5995.2	605995	21558	13,0	13.0460-7112.2	607112	21637	19,3	13.0460-7184.2	607184	23589	20,6
13.0460-5996.2	605996	23241	16,1	13.0460-7113.2	607113	23218	18,0	13.0460-7185.2	607185	21064	20,3
13.0460-5998.2	605998	21314	12,8	13.0460-7114.2	607114	21930	17,9	13.0460-7186.2	607186	23441	18,1
13.0460-6015.2	606015	29835	22,0	13.0460-7115.2	607115	23067	18,5	13.0460-7187.2	607187	23591	18,0
13.0460-6033.2	606033	21064	20,3	13.0460-7116.2	607116	23058	19,6	13.0460-7188.2	607188	24141	19,1
13.0460-6036.2	606036	21304	18,5	13.0460-7117.2	607117	23187	19,6	13.0460-7189.2	607189	24012	18,7
13.0460-6914.2	606914	20038	14,0	13.0460-7121.2	607121	23155	19,0	13.0460-7190.2	607190	24556	19,1
13.0460-6916.2	606916	21897	18,5	13.0460-7122.2	607122	23392	20,3	13.0460-7191.2	607191	23749	19,1
13.0460-6917.2	606917	21237	15,5	13.0460-7123.2	607123	23034	18,8	13.0460-7193.2	607193	23724	18,1
13.0460-6921.2	606921	24974	16,8	13.0460-7124.2	607124	23163	20,4	13.0460-7194.2	607194	24137	16,6
13.0460-6922.2	606922	21459	17,5	13.0460-7125.2	607125	21931	17,9	13.0460-7195.2	607195	23482	16,6
13.0460-6923.2	606923	23471	14,5	13.0460-7126.2	607126	20907	18,1	13.0460-7196.2	607196	21577	20,7
13.0460-6924.2	606924	23471	17,5	13.0460-7128.2	607128	23218	18,0	13.0460-7199.2	607199	23405	20,1
13.0460-6925.2	606925	21519	17,8	13.0460-7129.2	607129	20907	18,1	13.0460-7200.2	607200	23913	20,3
13.0460-6926.2	606926	20359	19,2	13.0460-7131.2	607131	25962	18,0	13.0460-7201.2	607201	23763	20,3
13.0460-7030.2	607030	20889	17,3	13.0460-7132.2	607132	23775	18,0	13.0460-7202.2	607202	24153	19,1
13.0460-7032.2	607032	20887	19,7	13.0460-7133.2	607133	21927	17,9	13.0460-7203.2	607203	21794	19,3
13.0460-7033.2	607033	20888	15,3	13.0460-7134.2	607134	21278	16,4	13.0460-7204.2	607204	23912	18,8
13.0460-7040.2	607040	20908	18,0	13.0460-7135.2	607135	23077	17,5	13.0460-7205.2	607205	23788	19,0
13.0460-7048.2	607048	20939	15,8	13.0460-7137.2	607137	23483	15,8	13.0460-7206.2	607206	23633	17,8
13.0460-7050.2	607050	20676	19,5	13.0460-7138.2	607138	20968	17,5	13.0460-7207.2	607207	23969	18,6
13.0460-7051.2	607051	21353	16,5	13.0460-7139.2	607139	23141	19,4	13.0460-7209.2	607209	24137	16,6
13.0460-7052.2	607052	21201	17,5	13.0460-7140.2	607140	21641	19,3	13.0460-7210.2	607210	23792	20,8
13.0460-7053.2	607053	21273	19,5	13.0460-7141.2	607141	23842	18,1	13.0460-7211.2	607211	24339	20,5
13.0460-7056.2	607056	21396	17,5	13.0460-7142.2	607142	23202	18,3	13.0460-7212.2	607212	23738	20,1
13.0460-7057.2	607057	21396	17,5	13.0460-7143.2	607143	23324	20,3	13.0460-7213.2	607213	23202	17,8
13.0460-7058.2	607058	21432	17,3	13.0460-7144.2	607144	23114	19,1	13.0460-7214.2	607214	24576	14,8
13.0460-7059.2	607059	20888	17,3	13.0460-7145.2	607145	23073	18,8	13.0460-7215.2	607215	23935	17,8
13.0460-7061.2	607061	21276	17,0	13.0460-7146.2	607146	20149	17,0	13.0460-7216.2	607216	23968	20,3
13.0460-7063.2	607063	21193	18,0	13.0460-7147.2	607147	21284	19,1	13.0460-7217.2	607217	23927	17,3
13.0460-7064.2	607064	21930	17,9	13.0460-7148.2	607148	23201	18,0	13.0460-7218.2	607218	24367	19,1
13.0460-7065.2	607065	21929	17,9	13.0460-7153.2	607153	23270	19,8	13.0460-7219.2	607219	23923	17,6
13.0460-7067.2	607067	21929	17,9	13.0460-7154.2	607154	23034	18,8	13.0460-7220.2	607220	23925	20,5
13.0460-7068.2	607068	21930	17,9	13.0460-7155.2	607155	21676	20,3	13.0460-7221.2	607221	24535	18,3
13.0460-7069.2	607069	21637	19,3	13.0460-7156.2	607156	23418	19,4	13.0460-7222.2	607222	24536	18,3
13.0460-7071.2	607071	20640	17,5	13.0460-7157.2	607157	23215	18,3	13.0460-7223.2	607223	24096	20,3
13.0460-7072.2	607072	21868	19,7	13.0460-7158.2	607158	23245	18,3	13.0460-7224.2	607224	23397	19,4
13.0460-7073.2	607073	21202	16,9	13.0460-7159.2	607159	23248	18,3	13.0460-7225.2	607225	23551	17,3
13.0460-7076.2	607076	21848	19,8	13.0460-7160.2	607160	23483	15,8	13.0460-7226.2	607226	23589	20,4
13.0460-7077.2	607077	20676	19,8	13.0460-7161.2	607161	23281	18,3	13.0460-7227.2	607227	23801	20,3
13.0460-7078.2	607078	21642	19,5	13.0460-7162.2	607162	23717	15,8	13.0460-7228.2	607228	24123	20,3
13.0460-7079.2	607079	21487	17,3	13.0460-7163.2	607163	21910	19,8	13.0460-7229.2	607229	24538	18,5
13.0460-7080.2	607080	21411	17,5	13.0460-7164.2	607164	23752	17,2	13.0460-7230.2	607230	24558	18,7
13.0460-7081.2	607081	21911	20,3	13.0460-7165.2	607165	21358	19,8	13.0460-7231.2	607231	24170	20,2
13.0460-7083.2	607083	21621	17,3	13.0460-7166.2	607166	23763	20,4	13.0460-7232.2	607232	21282	17,3
13.0460-7084.2	607084	21592	18,8	13.0460-7167.2	607167	23312	20,3	13.0460-7234.2	607234	24438	16,1
13.0460-7085.2	607085	21904	16,9	13.0460-7168.2	607168	21282	17,3	13.0460-7235.2	607235	24671	18,0
13.0460-7086.2	607086	21795	19,8	13.0460-7169.2	607169	23310	17,3	13.0460-7236.2	607236	23747	19,7
13.0460-7087.2	607087	21670	19,3	13.0460-7170.2	607170	23448	20,8	13.0460-7237.2	607237	24161	20,3
13.0460-7088.2	607088	21827	17,3	13.0460-7171.2	607171	23335	16,7	13.0460-7238.2	607238	23313	20,3
13.0460-7089.2	607089	21677	20,3	13.0460-7172.2	607172	23402	20,1	13.0460-7239.2	607239	24173	20,0
13.0460-7090.2	607090	21691	17,3	13.0460-7173.2	607173	21829	20,3	13.0460-7240.2	607240	23749	17,6
13.0460-7091.2	607091	23115	19,8	13.0460-7174.2	607174	23737	17,3	13.0460-7241.2	607241	20547	16,5
13.0460-7100.2	607100	21868	17,2	13.0460-7176.2	607176	23793	20,3	13.0460-7242.2	607242	24332	19,8
13.0460-7101.2	607101	21868	15,3	13.0460-7177.2	607177	23394	13,7	13.0460-7243.2	607243	24521	19,1
13.0460-7102.2	607102	21885	20,4	13.0460-7178.2	607178	23824	13,7	13.0460-7244.2	607244	24253	17,8
13.0460-7105.2	607105	23141	19,4	13.0460-7179.2	607179	23844	20,5	13.0460-7245.2	607245	23835	19,6
13.0460-7107.2	607107	21278	16,4	13.0460-7180.2	607180	21637	19,3	13.0460-7246.2	607246	21276	17,0
13.0460-7108.2	607108	23228	18,1	13.0460-7181.2	607181	21637	19,3	13.0460-7247.2	607247	24367	19,2
13.0460-7110.2	607110	20676	19,8	13.0460-7182.2	607182	23897	20,6	13.0460-7248.2	607248	23217	17,5





Vergleichsliste ATE → WVA

Cross reference list ATE → WVA - Lista referencias ATE → WVA - Liste des correspondances ATE → WVA - Tabella di conversione codici ATE → WVA

	WVA D				WVA D				WVA D		
13.0460-7249.2	607249	24709	18,6	13.0460-8002.2	608002	23358	18,0	13.0470-2833.2	LD2833	23070	17,0
13.0460-7250.2	607250	24870	17,5	13.0460-8003.2	608003	23044	16,0	13.0470-2837.2	LD2837	23393	19,6
13.0460-7251.2	607251	24137	15,8	13.0460-8004.2	608004	23193	16,4	13.0470-2845.2	LD2845	23554	16,4
13.0460-7252.2	607252	24084	19,3	13.0460-8005.2	608005	23192	16,7	13.0470-2855.2	LD2855	23138	14,6
13.0460-7253.2	607253	24137	15,8	13.0460-8006.2	608006	20660	15,6	13.0470-2857.2	LD2857	23226	17,0
13.0460-7255.2	607255	25114	15,8	13.0460-8007.2	608007	23718	16,7	13.0470-2858.2	LD2858	23284	14,0
13.0460-7256.2	607256	24705	19,8	13.0460-8008.2	608008	24036	16,7	13.0470-2860.2	LD2860	23554	16,4
13.0460-7257.2	607257	24253	18,0	13.0460-8009.2	608009	21817	16,8	13.0470-2867.2	LD2867	23517	16,6
13.0460-7259.2	607259	24863	16,7	13.0460-8010.2	608010	23562	18,1	13.0470-2868.2	LD2868	23655	15,3
13.0460-7260.2	607260	24495	17,3	13.0460-8011.2	608011	23363	14,8	13.0470-2877.2	LD2877	23556	17,2
13.0460-7261.2	607261	24436	19,7	13.0460-8013.2	608013	24605	16,5	13.0470-2879.2	LD2879	23601	13,7
13.0460-7262.2	607262	25033	19,1	13.0460-8014.2	608014	25633	15,5	13.0470-2880.2	LD2880	23914	17,1
13.0460-7263.2	607263	24036	19,1	13.0460-9033.2	609033	21303	18,9	13.0470-2884.2	LD2884	23843	18,8
13.0460-7264.2	607264	25098	17,0	13.0460-9037.2	609037	20309	17,9	13.0470-2885.2	LD2885	24077	19,1
13.0460-7265.2	607265	24727	20,7	13.0470-2610.2	LD2610	22097	19,6	13.0470-2886.2	LD2886	20961	16,0
13.0460-7266.2	607266	24914	17,9	13.0470-2707.2	LD2707	23760	17,7	13.0470-2887.2	LD2887	23914	17,1
13.0460-7267.2	607267	25045	19,5	13.0470-2708.2	LD2708	23881	20,0	13.0470-2888.2	LD2888	23326	17,4
13.0460-7268.2	607268	23794	20,3	13.0470-2709.2	LD2709	23973	17,1	13.0470-2891.2	LD2891	24175	19,6
13.0460-7269.2	607269	24340	19,5	13.0470-2710.2	LD2710	23916	17,6	13.0470-2892.2	LD2892	24174	18,6
13.0460-7270.2	607270	24674	18,0	13.0470-2711.2	LD2711	24077	19,1	13.0470-2893.2	LD2893	24135	17,7
13.0460-7271.2	607271	24151	21,0	13.0470-2712.2	LD2712	23138	14,6	13.0470-2894.2	LD2894	20961	17,2
13.0460-7272.2	607272	24399	20,4	13.0470-2713.2	LD2713	23623	17,4	13.0470-2927.2	LD2927	21028	19,3
13.0460-7273.2	607273	24538	19,4	13.0470-2714.2	LD2714	24290	16,9	13.0470-2975.2	LD2975	21439	20,3
13.0460-7274.2	607274	24695	17,3	13.0470-2716.2	LD2716	24703	17,8	13.0470-3605.2	LD3605	20180	17,3
13.0460-7275.2	607275	24688	19,2	13.0470-2722.2	LD2722	24496	17,3	13.0470-3805.2	LD3805	21197	15,0
13.0460-7276.2	607276	25222	17,3	13.0470-2723.2	LD2723	24537	16,1	13.0470-3812.2	LD3812	23714	17,6
13.0460-7277.2	607277	24084	19,3	13.0470-2725.2	LD2725	23985	17,8	13.0470-3813.2	LD3813	24150	17,6
13.0460-7278.2	607278	25218	16,6	13.0470-2726.2	LD2726	23145	19,8	13.0470-3814.2	LD3814	23934	18,2
13.0460-7279.2	607279	25070	17,3	13.0470-2727.2	LD2727	23145	19,8	13.0470-3815.2	LD3815	23930	18,2
13.0460-7280.2	607280	25159	20,3	13.0470-2732.2	LD2732	24306	20,3	13.0470-3826.2	LD3826	23707	18,0
13.0460-7281.2	607281	25161	20,3	13.0470-2733.2	LD2733	24306	20,3	13.0470-3827.2	LD3827	23709	19,6
13.0460-7282.2	607282	25191	21,3	13.0470-2734.2	LD2734	24456	19,0	13.0470-3828.2	LD3828	24349	17,5
13.0460-7283.2	607283	25532	19,2	13.0470-2736.2	LD2736	24496	17,3	13.0470-3831.2	LD3831	24260	17,3
13.0460-7284.2	607284	25806	17,3	13.0470-2740.2	LD2740	23554	17,0	13.0470-3836.2	LD3836	24540	16,3
13.0460-7285.2	607285	23589	20,6	13.0470-2746.2	LD2746	24409	19,2	13.0470-3838.2	LD3838	21436	17,0
13.0460-7286.2	607286	24625	18,2	13.0470-2747.2	LD2747	24606	17,4	13.0470-3839.2	LD3839	24288	17,9
13.0460-7287.2	607287	25266	16,6	13.0470-2748.2	LD2748	24606	17,7	13.0470-3840.2	LD3840	24549	19,6
13.0460-7288.2	607288	25429	17,5	13.0470-2749.2	LD2749	24483	16,9	13.0470-3846.2	LD3846	24072	17,9
13.0460-7289.2	607289	25324	17,3	13.0470-2755.2	LD2755	24422	17,2	13.0470-3847.2	LD3847	24660	17,8
13.0460-7290.2	607290	25055	15,0	13.0470-2758.2	LD2758	24422	17,2	13.0470-3852.2	LD3852	24867	20,7
13.0460-7292.2	607292	24326	18,3	13.0470-2760.2	LD2760	24561	17,7	13.0470-3857.2	LD3857	25200	19,6
13.0460-7293.2	607293	25010	16,3	13.0470-2764.2	LD2764	25217	20,0	13.0470-3858.2	LD3858	24563	17,7
13.0460-7294.2	607294	25011	16,4	13.0470-2765.2	LD2765	24743	19,2	13.0470-3859.2	LD3859	25308	17,5
13.0460-7295.2	607295	25969	16,1	13.0470-2767.2	LD2767	25157	17,4	13.0470-3860.2	LD3860	24484	18,8
13.0460-7296.2	607296	23213	20,3	13.0470-2768.2	LD2768	23811	17,7	13.0470-3865.2	LD3865	25014	18,2
13.0460-7298.2	607298	25703	18,2	13.0470-2769.2	LD2769	25214	17,4	13.0470-3866.2	LD3866	25506	18,2
13.0460-7300.2	607300	25834	17,3	13.0470-2770.2	LD2770	24606	17,4	13.0470-3870.2	LD3870	25896	18,5
13.0460-7301.2	607301	25842	16,1	13.0470-2773.2	LD2773	25214	17,4	13.0470-3871.2	LD3871	25840	17,8
13.0460-7302.2	607302	25907	20,7	13.0470-2776.2	LD2776	23070	17,0	13.0470-3872.2	LD3872	25827	17,7
13.0460-7303.2	607303	22035	17,5	13.0470-2778.2	LD2778	25326	19,3	13.0470-3966.2	LD3966	23600	19,4
13.0460-7304.2	607304	25353	16,2	13.0470-2779.2	LD2779	24869	19,3	13.0470-3982.2	LD3982	23707	18,1
13.0460-7305.2	607305	25837	17,0	13.0470-2781.2	LD2781	25215	18,6	13.0470-3983.2	LD3983	23710	19,4
13.0460-7306.2	607306	23313	20,3	13.0470-2784.2	LD2784	25134	17,2	13.0470-3984.2	LD3984	23711	19,4
13.0460-7307.2	607307	25009	16,4	13.0470-2785.2	LD2785	25683	20,4	13.0470-3987.2	LD3987	23279	18,4
13.0460-7308.2	607308	22124	18,2	13.0470-2786.2	LD2786	24848	18,3	13.0470-3988.2	LD3988	23557	17,2
13.0460-7309.2	607309	25096	16,7	13.0470-2789.2	LD2789	25652	17,1	13.0470-3994.2	LD3994	23599	19,0
13.0460-7310.2	607310	22143	17,5	13.0470-2790.2	LD2790	25110	17,5	13.0470-3999.2	LD3999	23744	20,1
13.0460-7315.2	607315	25332	16,2	13.0470-2792.2	LD2792	22032	19,6	13.0470-4044.2	LD4044	20755	15,1
13.0460-7903.2	607903	29012	18,0	13.0470-2797.2	LD2797	25980	16,8	13.0470-4047.2	LD4047	21305	15,7
13.0460-7906.2	607906	29001	20,0	13.0470-2820.2	LD2820	20961	17,2	13.0470-4064.2	LD4064	21919	15,3
13.0460-7909.2	607909	29153	20,0	13.0470-2823.2	LD2823	23554	17,2	13.0470-4065.2	LD4065	21899	15,3

Vergleichsliste ATE → WVA

Cross reference list ATE → WVA - Lista referencias ATE → WVA - Liste des correspondances ATE → WVA - Tabella di conversione codici ATE → WVA

	WVA D				WVA D				WVA D		
13.0470-4803.2	LD4803	23111	15,6	13.0470-7176.2	LD7176	23794	20,3	13.0470-7295.2	LD7295	25969	16,1
13.0470-4814.2	LD4814	21937	15,5	13.0470-7179.2	LD7179	23844	20,5	13.0470-7296.2	LD7296	23213	20,3
13.0470-4833.2	LD4833	24098	17,1	13.0470-7181.2	LD7181	21636	19,3	13.0470-7300.2	LD7300	25834	17,3
13.0470-4834.2	LD4834	24097	17,1	13.0470-7184.2	LD7184	23589	20,6	13.0470-7301.2	LD7301	25841	16,1
13.0470-4850.2	LD4850	24296	15,5	13.0470-7187.2	LD7187	23590	19,5	13.0470-7303.2	LD7303	22037	17,5
13.0470-4851.2	LD4851	23111	16,0	13.0470-7188.2	LD7188	24142	20,6	13.0470-7304.2	LD7304	25354	16,2
13.0470-4853.2	LD4853	24162	15,2	13.0470-7190.2	LD7190	24367	19,1	13.0470-7305.2	LD7305	25836	17,0
13.0470-4854.2	LD4854	23092	16,3	13.0470-7191.2	LD7191	23749	19,1	13.0470-7309.2	LD7309	25096	16,7
13.0470-4867.2	LD4867	24853	16,0	13.0470-7193.2	LD7193	23724	18,1	13.0470-7315.2	LD7315	25331	16,2
13.0470-4879.2	LD4879	25643	17,0	13.0470-7194.2	LD7194	24137	16,6	13.0470-9000.2	LD9000	24306	20,3
13.0470-4880.2	LD4880	25997	18,7	13.0470-7195.2	LD7195	24137	16,6	13.0470-9001.2	LD9001	24862	16,7
13.0470-4882.2	LD4882	22102	18,2	13.0470-7200.2	LD7200	23913	20,3				
13.0470-4884.2	LD4884	22062	20,7	13.0470-7201.2	LD7201	23763	20,3				
13.0470-4971.2	LD4971	23092	16,0	13.0470-7202.2	LD7202	23589	19,1				
13.0470-4976.2	LD4976	23694	16,4	13.0470-7203.2	LD7203	21670	19,3				
13.0470-4977.2	LD4977	23157	15,8	13.0470-7204.2	LD7204	23912	18,8				
13.0470-4984.2	LD4984	23271	17,4	13.0470-7210.2	LD7210	23792	20,8				
13.0470-4990.2	LD4990	23745	17,4	13.0470-7211.2	LD7211	24339	20,5				
13.0470-4992.2	LD4992	23692	16,6	13.0470-7215.2	LD7215	23999	17,8				
13.0470-4993.2	LD4993	23693	16,6	13.0470-7216.2	LD7216	23968	20,3				
13.0470-4994.2	LD4994	23945	16,5	13.0470-7217.2	LD7217	23926	17,3				
13.0470-5405.2	LD5405	21644	17,8	13.0470-7219.2	LD7219	23924	17,6				
13.0470-5611.2	LD5611	24415	19,1	13.0470-7220.2	LD7220	23925	20,5				
13.0470-5612.2	LD5612	24412	19,0	13.0470-7221.2	LD7221	24535	18,3				
13.0470-5634.2	LD5634	24452	17,5	13.0470-7223.2	LD7223	24096	20,3				
13.0470-5635.2	LD5635	24918	15,0	13.0470-7225.2	LD7225	23550	17,3				
13.0470-5752.2	LD5752	24632	17,0	13.0470-7226.2	LD7226	23588	20,8				
13.0470-5786.2	LD5786	24936	15,0	13.0470-7227.2	LD7227	23913	20,3				
13.0470-7053.2	LD7053	21273	19,5	13.0470-7228.2	LD7228	24123	20,3				
13.0470-7078.2	LD7078	21486	19,5	13.0470-7229.2	LD7229	24539	18,5				
13.0470-7079.2	LD7079	21487	17,3	13.0470-7230.2	LD7230	24557	19,4				
13.0470-7081.2	LD7081	20676	19,8	13.0470-7231.2	LD7231	24171	20,9				
13.0470-7086.2	LD7086	21664	19,8	13.0470-7232.2	LD7232	23447	17,3				
13.0470-7087.2	LD7087	21670	19,3	13.0470-7237.2	LD7237	24161	20,3				
13.0470-7089.2	LD7089	21676	20,3	13.0470-7238.2	LD7238	24255	20,3				
13.0470-7090.2	LD7090	21891	17,3	13.0470-7239.2	LD7239	24173	20,0				
13.0470-7100.2	LD7100	21868	17,2	13.0470-7242.2	LD7242	24332	19,8				
13.0470-7110.2	LD7110	23019	20,3	13.0470-7243.2	LD7243	24142	20,6				
13.0470-7111.2	LD7111	23131	19,6	13.0470-7244.2	LD7244	24254	18,0				
13.0470-7115.2	LD7115	23067	18,5	13.0470-7249.2	LD7249	24710	18,6				
13.0470-7116.2	LD7116	23057	20,2	13.0470-7251.2	LD7251	24137	15,8				
13.0470-7117.2	LD7117	23130	19,6	13.0470-7252.2	LD7252	24332	18,3				
13.0470-7122.2	LD7122	23392	20,3	13.0470-7256.2	LD7256	24707	21,3				
13.0470-7135.2	LD7135	23077	17,5	13.0470-7257.2	LD7257	24254	18,0				
13.0470-7137.2	LD7137	23482	15,8	13.0470-7259.2	LD7259	24862	16,7				
13.0470-7139.2	LD7139	24095	19,4	13.0470-7262.2	LD7262	25031	19,1				
13.0470-7140.2	LD7140	21641	19,3	13.0470-7263.2	LD7263	24036	19,1				
13.0470-7145.2	LD7145	23074	18,8	13.0470-7264.2	LD7264	25096	17,0				
13.0470-7155.2	LD7155	23183	20,3	13.0470-7266.2	LD7266	24914	17,9				
13.0470-7157.2	LD7157	23217	18,3	13.0470-7267.2	LD7267	25045	19,5				
13.0470-7158.2	LD7158	23245	18,3	13.0470-7268.2	LD7268	23794	20,3				
13.0470-7159.2	LD7159	23248	18,3	13.0470-7269.2	LD7269	24339	19,5				
13.0470-7161.2	LD7161	23282	18,3	13.0470-7273.2	LD7273	25180	19,0				
13.0470-7162.2	LD7162	23717	15,8	13.0470-7275.2	LD7275	24688	19,2				
13.0470-7166.2	LD7166	23763	20,4	13.0470-7280.2	LD7280	25159	20,3				
13.0470-7167.2	LD7167	23347	20,3	13.0470-7281.2	LD7281	25160	20,3				
13.0470-7168.2	LD7168	23447	17,3	13.0470-7282.2	LD7282	25192	21,3				
13.0470-7169.2	LD7169	23310	17,3	13.0470-7285.2	LD7285	23589	20,6				
13.0470-7171.2	LD7171	23334	16,7	13.0470-7288.2	LD7288	25430	17,5				
13.0470-7172.2	LD7172	23379	20,1	13.0470-7293.2	LD7293	25010	16,3				
13.0470-7174.2	LD7174	23732	17,3	13.0470-7294.2	LD7294	25009	16,4				





DE Technische Übersetzungen

EN Technical translations

ES Traducciones técnicas

FR Traductions techniques







IT Traduzioni tecniche

2018



Technische Übersetzungen

Technical translations - Traducciones técnicas - Traductions techniques - Traduzioni tecniche

DE		DE	
	Bremsbelagsatz, Scheibenbremse	+ WK	inkl. Verschleißwarnkontakt mit integriertem Verschleißwarnkontakt mit akustischer Verschleißwarnung
	Bremsscheibe	+ Zub	mit Zubehör
	hinten	ABE	mit Allgemeiner Betriebserlaubnis (ABE)
	Hinterachse links	Abmessungen beachten	Abmessungen beachten
	Hinterachse rechts	- ABS	für Fahrzeuge ohne ABS nicht für ABS
	Vorderachse links	- ABS Ring	ohne ABS-Sensorring
	Vorderachse rechts	Achsnummer	Achsnummer
+ ABS	für Fahrzeuge mit ABS für ABS	Achszapfen-durchmesser [mm]	Achszapfendurchmesser [mm]
+ ABS Ring	mit ABS-Sensorring	Adapter, Bremsleitung	Adapter, Bremsleitung
+ ASR	für Fahrzeuge mit ASR	ADV	Bremssystem, Advics
+ D	Deutschland	AIS	Bremssystem, Aisin
+ eFSB	für Fahrzeuge mit elektronischer Feststellbremse	AKE	Bremssystem, Akebono
+ ESP	für Fahrzeuge mit ESP	Allrad	Allrad
+ ETS	für Fahrzeuge mit ETS	ALU	Bremssattel aus Aluminium
+ EU	Europa	Anschluss-gewinde	Anschlussgewinde
+ J	Japan	Anschluss links	Anschluss links
+ LG	mit Lager	Anschluss rechts	Anschluss rechts
+ Performance Parts	für Fahrzeuge mit Performance Bremse	Anschluss-tutzen, Schlauchleitung	Anschlussstutzen, Schlauchleitung
+POC	für POC	Anzahl der Bohrungen	Anzahl der Bohrungen
+PR	für PR-Nummer	Anzahl Sitz-plätze	Anzahl Sitzplätze
+ RO	Rumänien	AP	Bremssystem, AP Lockheed
+ RUS	Russland	Artikel-nummer des empfohlenen Zubehörs	Artikelnummer des empfohlenen Zubehörs
+ S	mit Schrauben	- ASR	für Fahrzeuge ohne ASR
+SA	für SA Code	ATE Ceramic	Artikelzusatzbezeichnung, ATE Ceramic
+ SKA	Skandinavien		
+ TR	Türkei		
+ USA	USA		
+ WE	für Verschleißwarnanzeiger vorbereitet		



Technische Übersetzungen

Technical translations - Traducciones tecnicas - Traductions techniques - Traduzioni tecniche

DE		DE	
Außendurchmesser [mm]	Außendurchmesser [mm]	Brems-scheibe zwei-teilig	Bremsscheibe zweiteilig
Automatikgetriebe	Automatikgetriebe	- CDN	Kanada
B	beschichtet	China-made	China
B1=	Breite 1 [mm]	CIT	Bremssystem, Citroen
B2=	Breite 2 [mm]	CVT-Automatikgetriebe (Stufenlos)	CVT-Automatikgetriebe (Stufenlos)
Baumuster	Baumuster	- D	Deutschland
BDX	Bremssystem, Bendix	DEL	Bremssystem, Delco
Bearbeitung	Bearbeitung	Dichtung, Unterdruck-Anschlusstutzen BKV	Dichtung, Unterdruck-Anschlusstutzen BKV
Bohrung-Ø 1 [mm]	Bohrung-Ø 1 [mm]	DIN/ISO	DIN/ISO
Bohrung-Ø 2 [mm]	Bohrung-Ø 2 [mm]	DIN 74235 Form EL	DIN 74235 Form EL
Bördelform	Bördelform	DIN 74235 Form FL	DIN 74235 Form FL
BOS	Bremssystem, Bosch	DOHC	DOHC
BRE	Bremssystem, Brembo	Durchmesser Aufnahme [mm]	Durchmesser Aufnahme [mm]
Brems-/Fahrdyn. Artikelbezug	Brems-/Fahrdyn. Artikelbezug	E	E
Bremsbelagsatz, Scheibenbremse	Bremsbelagsatz, Scheibenbremse	- eFSB	für Fahrzeuge ohne elektronische Feststellbremse
Bremsleitung	Bremsleitung	einteilig	einteilig
Brems-sattel(1-Kolben)	Bremssattel(1-Kolben)	Einzelradaufhängung	Einzelradaufhängung
Brems-sattel(2-Kolben)	Bremssattel(2-Kolben)	elektrisch-hydraulisch	elektrisch-hydraulisch
Brems-sattel(4-Kolben)	Bremssattel(4-Kolben)	Entlüfterschraube/-ventil	Entlüfterschraube/-ventil
Bremssattelfarbe	Bremssattelfarbe	EPDM (Ethylen-Propylen-Dien-Kautschuk)	EPDM (Ethylen-Propylen-Dien-Kautschuk)
Bremssattel mit 1 Haltestift	Bremssattel mit 1 Haltestift	- ESP	für Fahrzeuge ohne ESP
Bremssattel mit 2 Haltestiften	Bremssattel mit 2 Haltestiften	- ETS	für Fahrzeuge ohne ETS
Brems-scheibe	Bremsscheibe	Europa	Europa
		F	F

Technische Übersetzungen

Technical translations - Traducciones técnicas - Traductions techniques - Traduzioni tecniche

DE		DE	
Felge Lochzahl	Felge Lochzahl	für Fahrzeuge mit Active City Stop	für Fahrzeuge mit Active City Stop
Felgengröße [Zoll]	Felgengröße [Zoll]	für Fahrzeuge mit AMG-Sportpaket	für Fahrzeuge mit AMG-Sportpaket
Flachstecker	Flachstecker	für Fahrzeuge mit Bremsassistent	für Fahrzeuge mit Bremsassistent
Flanschbefestigung	Flanschbefestigung	für Fahrzeuge mit Keramikbremse	für Fahrzeuge mit Keramikbremse
FPM (Fluor-Kautschuk)/ACM (Polyacryl-Kautschuk)	FPM (Fluor-Kautschuk)/ACM (Polyacryl-Kautschuk)	für Fahrzeuge mit Klimaanlage	für Fahrzeuge mit Klimaanlage
Frankreich	Frankreich	für Fahrzeuge mit Niveauregulierung	für Fahrzeuge mit Niveauregulierung
Frontantrieb	Frontantrieb	für Fahrzeuge mit Panorama-Sonnendach	für Fahrzeuge mit Panorama-Sonnendach
für Automatikgetriebe	für Automatikgetriebe	für Fahrzeuge mit PCS (Pre-Crash Safety System)	für Fahrzeuge mit PCS (Pre-Crash Safety System)
für Behördenfahrzeuge	für Behördenfahrzeuge	für Fahrzeuge mit Scheibenbremse an der Hinterachse	für Fahrzeuge mit Scheibenbremse an der Hinterachse
für Bremsattel mit Kunststoffkolben	für Bremsattel mit Kunststoffkolben	für Fahrzeuge mit Schlechtwegeausführung	für Fahrzeuge mit Schlechtwegeausführung
für Bremsattel mit Stahlkolben	für Bremsattel mit Stahlkolben	für Fahrzeuge mit Servolenkung	für Fahrzeuge mit Servolenkung
für Bremscheibendicke [mm]	für Bremscheibendicke [mm]	für Fahrzeuge mit Sportfahrwerk	für Fahrzeuge mit Sportfahrwerk
für Bremscheibendurchmesser [mm]	für Bremscheibendurchmesser [mm]		
für Bremscheibendurchmesser [Zoll]	für Bremscheibendurchmesser [Zoll]		
für Doppelbereifung	für Doppelbereifung		
für Einfachbereifung	für Einfachbereifung		
für erhöhte Nutzlast	für erhöhte Nutzlast		
für ESP	für ESP		
für Fahrzeuge mit 3. Sitzreihe	für Fahrzeuge mit 3. Sitzreihe		

Technische Übersetzungen

Technical translations - Traducciones técnicas - Traductions techniques - Traduzioni tecniche

DE		DE	
für Fahrzeuge mit Sportpaket	für Fahrzeuge mit Sportpaket	für Fahrzeuge ohne Keramikbremse	für Fahrzeuge ohne Keramikbremse
für Fahrzeuge mit Start-Stopp-Funktion	für Fahrzeuge mit Start-Stopp-Funktion	für Fahrzeuge ohne Klimaanlage	für Fahrzeuge ohne Klimaanlage
für Fahrzeuge mit Trommelbremse an der Hinterachse	für Fahrzeuge mit Trommelbremse an der Hinterachse	für Fahrzeuge ohne Motorbremse	für Fahrzeuge ohne Motorbremse
für Fahrzeuge mit verstärktem Fahrwerk	für Fahrzeuge mit verstärktem Fahrwerk	für Fahrzeuge ohne Panorama-Sonnendach	für Fahrzeuge ohne Panorama-Sonnendach
für Fahrzeuge mit verstärkter Bremse	für Fahrzeuge mit verstärkter Bremse	für Fahrzeuge ohne PCS (Pre-Crash Safety System)	für Fahrzeuge ohne PCS (Pre-Crash Safety System)
für Fahrzeuge mit Vierradlenkung	für Fahrzeuge mit Vierradlenkung	für Fahrzeuge ohne Schlechtwegeausführung	für Fahrzeuge ohne Schlechtwegeausführung
für Fahrzeuge ohne 3. Sitzreihe	für Fahrzeuge ohne 3. Sitzreihe	für Fahrzeuge ohne Servolenkung	für Fahrzeuge ohne Servolenkung
für Fahrzeuge ohne Active City Stop	für Fahrzeuge ohne Active City Stop	für Fahrzeuge ohne Sportfahrwerk	für Fahrzeuge ohne Sportfahrwerk
für Fahrzeuge ohne AMG-Performance Package	für Fahrzeuge ohne AMG-Performance Package	für Fahrzeuge ohne Sportpaket	für Fahrzeuge ohne Sportpaket
für Fahrzeuge ohne AMG-Sportpaket	für Fahrzeuge ohne AMG-Sportpaket	für Fahrzeuge ohne Start-Stopp-Funktion	für Fahrzeuge ohne Start-Stopp-Funktion
für Fahrzeuge ohne Bordcomputer	für Fahrzeuge ohne Bordcomputer	für Fahrzeuge ohne verstärktes Fahrwerk	für Fahrzeuge ohne verstärktes Fahrwerk
für Fahrzeuge ohne Bremsassistent	für Fahrzeuge ohne Bremsassistent	für Fahrzeuge ohne Vierradlenkung	für Fahrzeuge ohne Vierradlenkung
		für gepanzerte Fahrzeuge	für gepanzerte Fahrzeuge

Technische Übersetzungen

Technical translations - Traducciones tecnicas - Traductions techniques - Traduzioni tecniche

DE	DE
für Geschwindigkeitsregelanlage	Höhe 1 [mm] Höhe 1 [mm]
für Geschwindigkeitsregelanlage	Höhe 2 [mm] Höhe 2 [mm]
für Leichtmetallfelgen	Hohl-schraube Hohlschraube
für Linkslenker	Informati-onsart Informationsart
für OE-Nummer	Innendurch-messer [mm] Innendurchmesser [mm]
für Polizeifahrzeuge	Innen-Torx Innen-Torx
für Rechtslenker	- J Japan
für Schaltgetriebe	Japan Japan
für Sonderfahrzeuge	Kanada Kanada
für Stahlfelgen	Kasten/Kombi Kasten/Kombi
für Taxifahrzeuge	Kombi Kombi
gelb	Kunststoff Kunststoff
Generischer Artikel	kurzer Radstand kurzer Radstand
Geschlossen	L legiert
Gewindeausführung	L= Länge [mm]
Gewindelänge [mm]	L= Länge über Alles [mm] Warnkontaktlänge [mm]
GG	L1= Länge 1 [mm]
Groß Britan-nien	L2= Länge 2 [mm]
grün	langer Radstand langer Radstand
Halbauto-matik	Leichtmetall-felge Leichtmetallfelge
Halter, Bremsleitung	- LG ohne Lager
Halter, Brems-schlauch	Lochanzahl Lochanzahl
HC	Lochkreis-Ø [mm] Lochkreis-Ø [mm]
HC L	luftgefederte Achse luftgefederte Achse
Herstellereinschränkung	Made in Fahrzeugproduktionsland
	MAN Bremssystem, Mando
	mit Anti-Quietsch-Blech mit Anti-Quietsch-Blech
	mit Brems-sattel-schrauben mit Bremssattelschrauben



Technische Übersetzungen

Technical translations - Traducciones tecnicas - Traductions techniques - Traduzioni tecniche

DE		DE	
mit Doppelbereifung	mit Doppelbereifung	nicht für gepanzerte Fahrzeuge	nicht für gepanzerte Fahrzeuge
mit Einfachbereifung	mit Einfachbereifung	nicht für Leichtmetallfelgen	nicht für Leichtmetallfelgen
mit Entlüfterventil	mit Entlüfterventil	nicht für Motorcode	nicht für Motorcode
mit Feder	mit Feder	nicht für Multi-link Achse	nicht für Multi-link Achse
mit geregelterem (3-Wege) Katalysator	mit geregelterem (3-Wege) Katalysator	nicht für Polizeifahrzeuge	nicht für Polizeifahrzeuge
mit Leichtmetallfelge	mit Leichtmetallfelge	nicht für Postfahrzeuge	nicht für Postfahrzeuge
mit Stahlfelge	mit Stahlfelge	nicht für SA Code	nicht für SA Code
Motorcode	Motorcode	nicht für Sonderfahrzeuge	nicht für Sonderfahrzeuge
Multi-link Achse	Multi-link Achse	nicht für Taxifahrzeuge	nicht für Taxifahrzeuge
Nabendurchmesser [mm]	Nabendurchmesser [mm]	NIS	Bremssystem, Nissin
nicht für Ausstattungsvariante	nicht für Ausstattungsvariante	nur für Mineralöl	nur für Mineralöl
nicht für Automatikgetriebe	nicht für Automatikgetriebe	nur in Verbindung mit	nur in Verbindung mit
nicht für Baumuster	nicht für Baumuster	Nutzlast [kg]	Nutzlast [kg]
nicht für Behördenfahrzeuge	nicht für Behördenfahrzeuge	Nutzlast ab [kg]	Nutzlast ab [kg]
nicht für Bremssattelfarbe	nicht für Bremssattelfarbe	Nutzlast bis [kg]	Nutzlast bis [kg]
nicht für erhöhte Nutzlast	nicht für erhöhte Nutzlast	OE-Hersteller	OE-Hersteller
nicht für Fahrzeuge mit verstärkter Bremse	nicht für Fahrzeuge mit verstärkter Bremse	OE-Nummer	OE-Nummer
nicht für Felgenreöße [Zoll]	nicht für Felgenreöße [Zoll]	OE-Referenz	OE-Referenz
		ohne integrierten Verschleißsensor	ohne integrierten Verschleißsensor
		ohne Katalysator	ohne Katalysator
		ohne Leichtmetallfelge	ohne Leichtmetallfelge
		Orga →	Organisationsnummer ab

Technische Übersetzungen

Technical translations - Traducciones tecnicas - Traductions techniques - Traduzioni tecniche

DE		DE	
passend für Felgengröße [Zoll]	passend für Felgengröße [Zoll]	Slowakische Republik	Slowakische Republik
PER	Bremssystem, Perrot	SOHC/OHC	SOHC/OHC
- Performance Parts	für Fahrzeuge ohne Performance Bremse	Sortiment, Armaturen	Sortiment, Armaturen
Pol-Anzahl	Pol-Anzahl	Sortiment, Befestigungselemente	Sortiment, Befestigungselemente
Power Disc	Artikelzusatzbezeichnung, Power Disc	Sortiment, Entlüfterschrauben	Sortiment, Entlüfterschrauben
Prüfanschluss, Rohrleitungen	Prüfanschluss, Rohrleitungen	Spezialaufbau	Spezialaufbau
Raddurchmesser [Zoll]	Raddurchmesser [Zoll]	Stahlfelge	Stahlfelge
Radstand [mm]	Radstand [mm]	Starrachse	Starrachse
Ringstutzen, Rohrleitung	Ringstutzen, Rohrleitung	Steckerausführung	Steckerausführung
- RLG	ohne Radlager	Stopfen, Bremsflüssigkeitsbehälter	Stopfen, Bremsflüssigkeitsbehälter
rot	rot	SUM	Bremssystem, Sumitomo
Rückschlagventil	Rückschlagventil	Textbaustein	Textbaustein
Russia-made	Russland	T-Form (T-Stück)	T-Form (T-Stück)
Schalter, Bremsleuchte	Schalter, Bremsleuchte	TOK	Bremssystem, Tokico
Schaltgetriebe	Schaltgetriebe	TRW	Bremssystem, Lucas / TRW
Schaltgetriebe, automatisch betätigt	Schaltgetriebe, automatisch betätigt	Tschechische Republik	Tschechische Republik
Schaltgetriebe 5 Gang	Schaltgetriebe 5 Gang	Türenanzahl	Türenanzahl
Scheibenbremse	Scheibenbremse	Überwurfmutter	Überwurfmutter
Schlauch	Schlauch	Überwurfschraube	Überwurfschraube
Schlüsselweite	Schlüsselweite	Ungarn	Ungarn
Schraubanschluss	Schraubanschluss	USA	USA
Schraubkontakt	Schraubkontakt	- USA	USA
schwarz	schwarz	V	Innenbelüftet belüftet
silber	silber	V/	geschlitzt/innenbelüftet
		Ventil, Unterdruckleitung	Ventil, Unterdruckleitung









Technische Übersetzungen

Technical translations - Traducciones tecnicas - Traductions techniques - Traduzioni tecniche

DE		DE
Verbindungs-/ Verteilerstück, Rohrleitungen	Verbindungs-/Verteilerstück, Rohrleitungen	→ Baujahr ab Fahrgestellnummer ab
		→ Baujahr bis Fahrgestellnummer bis
Verschluss, Bremsflüssigkeitsbehälter	Verschluss, Bremsflüssigkeitsbehälter	→ Orga Organisationsnummer bis
		→ VET VET-Nummer bis
		→ Ø Durchmesser bis [mm]
Verschluss-/ Schutzkappe	Verschluss-/Schutzkappe	
Verschluss-schraube	Verschluss-schraube	
Version	Version	
VET →	VET-Nummer ab	
Vollautomatik	Vollautomatik	
VW	Bremssystem, Volkswagen	
V•	Gelocht/innenbel.	
wahlweise	wahlweise	
Warnkontakt, Bremsbelagverschleiß	Warnkontakt, Bremsbelagverschleiß	
- WE	nicht für Verschleißwarnanzeiger vorbereitet	
- WK	exkl. Verschleißwarnkontakt ohne integrierten Verschleißwarnkontakt	
x	Breite [mm] Höhe [mm]	
x	Anzahl Verschleißanzeiger [pro Achse] Anschlussanzahl	
Zentrierungsdurchmesser [mm]	Zentrierungsdurchmesser [mm]	
- Zub	ohne Zubehör	
Zubehörsatz, Scheibenbremsbelag	Zubehörsatz, Scheibenbremsbelag	
zul. Gesamtgewicht [kg]	zul. Gesamtgewicht [kg]	
Ø	Durchmesser [mm]	
Ø1	Durchmesser 1 [mm]	
Ø2	Durchmesser 2 [mm]	
•	Gelocht	

Technische Übersetzungen

Technical translations - Traducciones tecnicas - Traductions techniques - Traduzioni tecniche

EN		EN	
	Brake Pad Set, disc brake	+ Zub	with accessories
	Brake Disc	ABE	with General Certification (ABE)
	Rear	Abmessungen beachten	Observe dimensions
	Rear Axle Left	- ABS	for vehicles without ABS not for ABS
	Rear Axle Right	- ABS Ring	without ABS sensor ring
	Front Axle Left	Achsnummer	Axle Number
	Front Axle Right	Achszapfendurchmesser [mm]	Axle Stub Diameter [mm]
+ ABS	for vehicles with ABS for ABS	Adapter, Bremsleitung	Adapter, brake lines
+ ABS Ring	with ABS sensor ring	ADV	Brake System, Advics
+ ASR	for vehicles with ASR	AIS	Brake System, Aisin
+ D	Germany	AKE	Brake System, Akebono
+ eFSB	for vehicles with electric handbrake	Allrad	All-wheel Drive
+ ESP	for vehicles with ESP	ALU	Aluminium brake caliper
+ ETS	for vehicles with ETS	Anschlussgewinde	Connecting thread
+ EU	Europe	Anschluss links	Left Connector
+ J	Japan	Anschluss rechts	Right Connector
+ LG	with bearing(s)	Anschlussstutzen, Schlauchleitung	Connection Piece, hose line
+ Performance Parts	for vehicles with Performance brakes	Anzahl der Bohrungen	Number of Bores
+POC	for POC	Anzahl Sitzplätze	Number of Seats
+PR	for PR number	AP	Brake System, AP Lockheed
+ RO	Romania	Artikelnummer des empfohlenen Zubehörs	Part number of recommended accessories
+ RUS	Russia	- ASR	for vehicles without ASR
+ S	with screws	ATE Ceramic	additional article information, ATE Ceramic
+SA	for SA code	Außendurchmesser [mm]	Outer diameter [mm]
+ SKA	Scandinavia		
+ TR	Turkey		
+ USA	USA		
+ WE	prepared for wear indicator		
+ WK	incl. wear warning contact with integrated wear warning contact with acoustic wear warning		

Technische Übersetzungen

Technical translations - Traducciones tecnicas - Traductions techniques - Traduzioni tecniche

EN		EN	
Automatikgetriebe	Automatic Transmission	China-made	China
B	Coated	CIT	Brake System, Citroen
B1=	Width 1 [mm]	CVT-Automatikgetriebe (Stufenlos)	CVT (Stepless)
B2=	Width 2 [mm]	- D	Germany
Baumuster	Type	DEL	Brake System, Delco
BDX	Brake System, Bendix	Dichtung, Unterdruck-Anschlusstutzen BKV	Seal, vacuum hose connector pipe
Bearbeitung	Machining	DIN/ISO	DIN / ISO
Bohrung-Ø 1 [mm]	Bore Ø 1 [mm]	DIN 74235 Form EL	DIN 74235 Form EL
Bohrung-Ø 2 [mm]	Bore Ø 2 [mm]	DIN 74235 Form FL	DIN 74235 Form FL
Bördelform	Flange Shape	DOHC	DOHC
BOS	Brake System, Bosch	Durchmesser Aufnahme [mm]	Support plate diameter [mm]
BRE	Brake System, Brembo	E	E
Brems-/ Fahrdyn. Artikelbezug	Brakes- / Drive Dynamics Articles	- eFSB	for vehicles without electronic hand-brake
Bremsbelag-satz, Scheibenbremse	Brake Pad Set, disc brake	einteilig	One-piece
Bremsleitung	Brake Lines	Einzelradaufhängung	Independent wheel suspension
Brems-sattel(1-Kolben)	Brake Caliper (1 piston)	elektrisch-hydraulisch	Electric-hydraulic
Brems-sattel(2-Kolben)	Brake Caliper (2 pistons)	Entlüfterschraube/-ventil	Breather Screw / Valve
Brems-sattel(4-Kolben)	Brake Caliper (4 pistons)	EPDM (Ethylen-Propylen-Dien-Kautschuk)	EPDM (ethylene propylene diene Monomer (M-class) rubber)
Bremssattel-farbe	Brake Caliper Colour	- ESP	for vehicles without ESP
Bremssattel mit 1 Haltestift	Brake Caliper with 1 holding pin	- ETS	for vehicles without ETS
Bremssattel mit 2 Haltestiften	Brake Caliper with 2 holding pins	Europa	Europe
Brems-scheibe	Brake Disc	F	F
Brems-scheibe zwei-teilig	Two-piece Brake Disc	Felge Lochzahl	Rim Hole Number
- CDN	Canada	Felgengröße [Zoll]	Rim Size [in]

Technische Übersetzungen

Technical translations - Traducciones tecnicas - Traductions techniques - Traduzioni tecniche

EN		EN	
Flachstecker	Blade Terminal	für Fahrzeuge mit AMG-Sportpaket	for vehicles with AMG Sports Package
Flanschbefestigung	Flange mounting	für Fahrzeuge mit Bremsassistent	for vehicles with brake assist
FPM (Fluor-Kautschuk)/ACM (Polyacryl-Kautschuk)	FPM (fluoride rubber)/ACM (polyacrylate rubber)	für Fahrzeuge mit Keramikbremse	for vehicles with ceramic brakes
Frankreich	France	für Fahrzeuge mit Klimaanlage	for vehicles with air conditioning
Frontantrieb	Front Wheel Drive	für Fahrzeuge mit Niveauregulierung	for vehicles with leveling control
für Automatikgetriebe	for automatic transmission	für Fahrzeuge mit Panorama-Sonnendach	for vehicles with panorama sunroof
für Behördenfahrzeuge	for government vehicles	für Fahrzeuge mit PCS (Pre-Crash Safety System)	for vehicles with PCS (Pre-Crash Safety System)
für Bremsattel mit Kunststoffkolben	for brake calipers with plastic pistons	für Fahrzeuge mit Scheibenbremse an der Hinterachse	for vehicles with disc brakes on the rear axle
für Bremsattel mit Stahlkolben	for brake calipers with steel pistons	für Fahrzeuge mit Schlechtwegausführung	for vehicles with off-road suspension
für Brems Scheibendicke [mm]	for brake disc thickness [mm]	für Fahrzeuge mit Servolenkung	for vehicles with power steering
für Brems Scheibendurchmesser [mm]	for brake disc diameter [mm]	für Fahrzeuge mit Sportfahrwerk	for vehicles with sports suspension
für Brems Scheibendurchmesser [Zoll]	for brake disc diameter [inch]	für Fahrzeuge mit Sportpaket	for vehicles with sports package
für Doppelbereifung	for dual tyres		
für Einfachbereifung	for single tyres		
für erhöhte Nutzlast	for increased payload		
für ESP	for ESP		
für Fahrzeuge mit 3. Sitzreihe	for vehicles with 3rd seating row		
für Fahrzeuge mit Active City Stop	for vehicles with Active City Stop		



Technische Übersetzungen

Technical translations - Traducciones tecnicas - Traductions techniques - Traduzioni tecniche

EN		EN	
für Fahrzeuge mit Start-Stopp-Funktion	for vehicles with start-stop function	für Fahrzeuge ohne Klimaanlage	for vehicles without air conditioning
für Fahrzeuge mit Trommelbremse an der Hinterachse	for vehicles with drum brakes on the rear axle	für Fahrzeuge ohne Motorbremse	for vehicles without engine brake
für Fahrzeuge mit verstärktem Fahrwerk	for vehicles with heavy duty suspension	für Fahrzeuge ohne Panorama-Sonnendach	for vehicles without panorama sunroof
für Fahrzeuge mit verstärkter Bremse	for vehicles with reinforced brakes	für Fahrzeuge ohne PCS (Pre-Crash Safety System)	for vehicles without PCS (Pre-Crash Safety System)
für Fahrzeuge mit Vierradlenkung	for vehicles with four wheel steering	für Fahrzeuge ohne Schlechtwegausführung	for vehicles without off-road suspension
für Fahrzeuge ohne 3. Sitzreihe	for vehicles without 3rd seating row	für Fahrzeuge ohne Servolenkung	for vehicles without power steering
für Fahrzeuge ohne Active City Stop	for vehicles without Active City Stop	für Fahrzeuge ohne Sportfahrwerk	for vehicles without sports suspension
für Fahrzeuge ohne AMG-Performance Package	for vehicles without AMG Performance Package	für Fahrzeuge ohne Sportpaket	for vehicles without sports package
für Fahrzeuge ohne AMG-Sportpaket	for vehicles without AMG sports package	für Fahrzeuge ohne Start-Stopp-Funktion	for vehicles without start-stop function
für Fahrzeuge ohne Bordcomputer	for vehicles without on-board computer	für Fahrzeuge ohne verstärktes Fahrwerk	for vehicles without heavy duty suspension
für Fahrzeuge ohne Bremsassistent	for vehicles without brake assist	für Fahrzeuge ohne Vierradlenkung	for vehicles without four wheel steering
für Fahrzeuge ohne Keramikbremse	for vehicles without ceramic brakes	für gepanzerte Fahrzeuge	for armoured vehicles
		für Geschwindigkeitsregelanlage	for cruise control system

Technische Übersetzungen

Technical translations - Traducciones tecnicas - Traductions techniques - Traduzioni tecniche

EN		EN	
für Leichtmetallfelgen	for light alloy rims	Hohl-schraube	Hollow Screw
für Linkslenker	for left-hand drive vehicles	Informati-onsart	Information Type
für OE-Nummer	for OE number	Innendurch-messer [mm]	Inner diameter [mm]
für Polizeifahrzeuge	for police vehicles	Innen-Torx	Female Torx
für Rechtslenker	for right-hand drive vehicles	- J	Japan
für Schaltgetriebe	for manual transmission	Japan	Japan
für Sonderfahrzeuge	for special-purpose vehicles	Kanada	Canada
für Stahlfelgen	for steel rims	Kasten/Kombi	Box Body / Estate
für Taxifahrzeuge	for taxis	Kombi	Estate
gelb	Yellow	Kunststoff	Plastic
Generischer Artikel	Generic article	kurzer Radstand	Short Wheelbase
Geschlossen	Closed	L	Alloyed
Gewindeausführung	Thread Type	L=	Length [mm]
Gewindelänge [mm]	Thread Length [mm]	L=	Overall Length [mm] Warning Contact Length [mm]
GG	Cast iron brake caliper	L1=	Length 1 [mm]
Groß Britan-nien	Great Britain	L2=	Length 2 [mm]
grün	Green	langer Radstand	Long Wheelbase
Halbauto-matik	Semi-automatic	Leichtmetall-felge	Light Alloy Rim
Halter, Bremsleitung	Holder, brake lines	- LG	without bearing(s)
Halter, Brems-schlauch	Holding Bracket, brake hose	Lochanzahl	Number of Holes
HC	High-carbon	Lochkreis-Ø [mm]	Bolt Hole Circle Ø [mm]
HC L	Alloyed / High-carbon	luftgefederte Achse	Air Suspension Axle
Herstellereinschränkung	Manufacturer Restriction	Made in	Vehicle Production Country
Höhe 1 [mm]	Height 1 [mm]	MAN	Brake System, Mando
Höhe 2 [mm]	Height 2 [mm]	mit Anti-Quietsch-Blech	with anti-squeak plate
		mit Brems-sattel-schrauben	with brake caliper screws
		mit Doppel-bereifung	with dual tyres



Technische Übersetzungen

Technical translations - Traducciones tecnicas - Traductions techniques - Traduzioni tecniche

EN		EN	
mit Einfachbereifung	with single tyres	nicht für Leichtmetallfelgen	not for light alloy rims
mit Entlüfterventil	with breather valve	nicht für Motorcode	not for engine code
mit Feder	with spring	nicht für Multi-link Achse	not for multi-link axle
mit geregeltem (3-Wege) Katalysator	with 3 way catalyst	nicht für Polizeifahrzeuge	not for police vehicles
mit Leichtmetallfelge	with light alloy rim	nicht für Postfahrzeuge	not for post office vehicles
mit Stahlfelge	with steel rim	nicht für SA Code	not for SA code
Motorcode	Engine Code	nicht für Sonderfahrzeuge	not for special purpose vehicles
Multi-link Achse	Multilink Axle	nicht für Taxifahrzeuge	not for taxis
Nabendurchmesser [mm]	Hub Diameter [mm]	NIS	Brake System, Nissin
nicht für Ausstattungsvariante	not for equipment variant	nur für Mineralöl	Only for mineral oil
nicht für Automatikgetriebe	not for automatic transmission	nur in Verbindung mit	only in connection with
nicht für Baumuster	not for model	Nutzlast [kg]	Payload [kg]
nicht für Behördenfahrzeuge	not for government vehicles	Nutzlast ab [kg]	Payload from [kg]
nicht für Bremssattel-farbe	not for brake caliper colour	Nutzlast bis [kg]	Payload to [kg]
nicht für erhöhte Nutzlast	not for increased payload	OE-Hersteller	OE manufacturer
nicht für Fahrzeuge mit verstärkter Bremse	not for vehicles with reinforced brakes	OE-Nummer	OE reference number
nicht für Felgenreöße [Zoll]	not for rim size [in]	OE-Referenz	OE reference
nicht für gepanzerte Fahrzeuge	not for armoured vehicles	ohne integrierten Verschleißsensor	without integrated wear sensor
		ohne Katalysator	without catalytic convertor
		ohne Leichtmetallfelge	without light alloy rim
		Orga →	Organisation number from
		passend für Felgenreöße [Zoll]	Fits rim size [inch]

Technische Übersetzungen

Technical translations - Traducciones tecnicas - Traductions techniques - Traduzioni tecniche

EN		EN	
PER	Brake System, Perrot	SOHC/OHC	SOHC/OHC
- Performance Parts	for vehicles without Performance brakes	Sortiment, Armaturen	Assortment, fittings
Pol-Anzahl	Number of Poles	Sortiment, Befestigungselemente	Assortment, fasteners
Power Disc	additional article information, Power Disc	Sortiment, Entlüfterschrauben	Assortment, breather screws
Prüfanschluss, Rohrleitungen	Test Connection, piping	Spezialaufbau	Special Design
Raddurchmesser [Zoll]	Wheel Diameter [in]	Stahlfelge	Steel Rim
Radstand [mm]	Wheelbase [mm]	Starrachse	Rigid Axle
Ringstutzen, Rohrleitung	Connector, metal pipes	Steckerausführung	Plug Type
- RLG	without wheel bearing	Stopfen, Bremsflüssigkeitsbehälter	Plug, brake fluid reservoir
rot	Red	SUM	Brake System, Sumitomo
Rückschlagventil	Non-return Valve	Textbaustein	text module
Russia-made	Russia	T-Form (T-Stück)	T-Piece
Schalter, Bremsleuchte	Switch, stop light	TOK	Brake System, Tokico
Schaltgetriebe	Manual Transmission	TRW	Brake System, Lucas / TRW
Schaltgetriebe, automatisch betätigt	Automated Manual Transmission	Tschechische Republik	Czech Republic
Schaltgetriebe 5 Gang	Manual Transmission, 5-speed	Türenanzahl	Number of Doors
Scheibenbremse	Disc Brake	Überwurfmutter	Union Nut
Schlauch	Hose	Überwurfschraube	Union Bolt
Schlüsselweite	Spanner Size	Ungarn	Hungary
Schraubanschluss	Screw Connection	USA	USA
Schraubkontakt	Screw Contact	- USA	USA
schwarz	Black	V	Internally Vented Vented
silber	Silver	V/	Slotted / Internally Vented
Slowakische Republik	Slovakia	Ventil, Unterdruckleitung	Valve, vacuum hose









Technische Übersetzungen

Technical translations - Traducciones tecnicas - Traductions techniques - Traduzioni tecniche

EN		EN	
Verbindungs-/ Verteilerstück, Rohrleitungen	Connector, pipes	→	Construction year to Chassis number to
		→ Orga	Organisation number to
		→ VET	VET Number to
		→ Ø	Diameter to [mm]
Verschluss, Bremsflüssigkeitsbehälter	Sealing Cap, brake fluid reservoir		
Verschluss-/ Schutzkappe	Sealing/Protective Cap		
Verschluss-schraube	Screw Plug		
Version	Version		
VET →	VET Number from		
Vollautomatik	Fully Automatic		
VW	Brake System, Volkswagen		
V•	Perforated / Vented		
wahlweise	Alternatively		
Warnkontakt, Bremsbelagverschleiß	Warning Contact, brake pad wear		
- WE	not prepared for wear indicator		
- WK	excl. wear warning contact without integrated wear warning contact		
x	Width [mm] Height [mm]		
x	Number of wear indicators [per axle] Number of connectors		
Zentrierungsdurchmesser [mm]	Centering Diameter [mm]		
- Zub	without accessories		
Zubehörsatz, Scheibenbremsbelag	Accessory Kit, disc brake pads		
zul. Gesamtgewicht [kg]	Gross Vehicle Weight [kg]		
Ø	Diameter [mm]		
Ø1	Diameter 1 [mm]		
Ø2	Diameter 2 [mm]		
•	Perforated		
→	Construction year from Chassis number from		

Technische Übersetzungen

Technical translations - Traducciones técnicas - Traductions techniques - Traduzioni tecniche

ES		ES	
	Juego de pastillas de freno	+ WK	con contacto avisador de desgaste con contacto de aviso de desgaste incorporado con avisador acústico de desgaste
	Disco de freno	+ Zub	con accesorios
	posterior	ABE	con Certificado General de Funcionamiento (ABE)
	Eje trasero izquierda	Abmessungen beachten	Observar dimensiones
	Eje trasero, derecha	- ABS	para vehículos sin ABS no para ABS
	Eje delantero, izquierda	- ABS Ring	sin anillo sensor ABS
	Eje delantero, derecha	Achsnummer	Número de eje
+ ABS	para vehículos con ABS para ABS	Achszapfendurchmesser [mm]	Diám. muñón del eje [mm]
+ ABS Ring	con anillo sensor ABS	Adapter, Bremsleitung	Adaptador, tubería de freno
+ ASR	para vehículos con ASR	ADV	Sistema de frenos, Advics
+ D	Alemania	AIS	Sistema de frenos, Aisin
+ eFSB	para vehículos con freno de detención electrónico	AKE	Sistema de frenos, Akebono
+ ESP	para vehículos con ESP	Allrad	A las 4 ruedas
+ ETS	para vehículos sin ETS	ALU	Pinza de frenos de aluminio
+ EU	Europa	Anschlussgewinde	Rosca empalme
+ J	Japón	Anschluss links	Conexión izquierda
+ LG	con apoyo	Anschluss rechts	Conexión derecha
+ Performance Parts	para vehículos con frenos alto rendimiento	Anschlusstutzen, Schlauchleitung	Racores, tubería flexible
+POC	para POC	Anzahl der Bohrungen	Número de taladros
+PR	Número de PR	Anzahl Sitzplätze	Número de asientos
+ RO	Rumania	AP	Sistema de frenos, AP Lockheed
+ RUS	Rusia	Artikelnummer des empfohlenen Zubehörs	Nº art. de accesorio recomendado
+ S	con tornillos	- ASR	para vehículos sin ASR
+SA	para código SA		
+ SKA	Escandinavia		
+ TR	Turquía		
+ USA	EE UU		
+ WE	preparado para indicador desgaste		

Technische Übersetzungen

Technical translations - Traducciones técnicas - Traductions techniques - Traduzioni tecniche

ES		ES	
ATE Ceramic	Denominación adicional del artículo, ATE Ceramic	Brems-scheibe zwei-teilig	Disco de freno de dos piezas
Außendurch-messer [mm]	Diámetro exterior [mm]	- CDN	Canadá
Automatikge-triebe	Transmisión automática	China-made	China
B	revestido	CIT	Sistema de frenos, Citroen
B1=	Ancho 1 [mm]	CVT-Automa-tikgetriebe (Stufenlos)	Transmisión automática CVT (continua)
B2=	Ancho 2 [mm]	- D	Alemania
Baumuster	Modelo de construcción	DEL	Sistema de frenos, Delco
BDX	Sistema de frenos, Bendix	Dichtung, Unterdruck-Anschlusss-tutzen BKV	Junta, racor de conexión de vacío
Bearbeitung	Procesamiento	DIN/ISO	DIN / ISO
Bohrung-Ø 1 [mm]	Taladro Ø 1 [mm]	DIN 74235 Form EL	DIN 74235 Forma EL
Bohrung-Ø 2 [mm]	Taladro Ø 2 [mm]	DIN 74235 Form FL	DIN 74235 Forma FL
Bördelform	Tipo rebordeado	DOHC	DOHC
BOS	Sistema de frenos, Bosch	Durchmesser Aufnahme [mm]	Diámetro alojamiento [mm]
BRE	Sistema de frenos, Brembo	E	E
Brems-/ Fahrdyn. Artikelbezug	Ref. artículo dinámica frenado/marcha	- eFSB	para vehículos sin freno de detención electrónico
Bremsbelag-satz, Schei-benbremse	Juego de pastillas de freno	einteilig	una pieza
Bremsleitung	Tubería de frenos	Einzelradauf-hängung	Suspensión independiente
Brems-sattel(1-Kolben)	Pinza de freno (1 émbolo)	elektrisch-hydraulisch	electrohidráulico
Brems-sattel(2-Kolben)	Pinza de freno (2 émbolos)	Entlüfter-schraube/-ventil	Válvula/tornillo de purga de aire
Brems-sattel(4-Kolben)	Pinza de freno (4 émbolos)	EPDM (Ethylen-Propylen-Dien-Kaut-schuk)	EPDM (Ethylen-Propylen-Dien-Caucho)
Bremssattel-farbe	Color pinza freno	- ESP	para vehículos sin ESP
Bremssattel mit 1 Halte-stift	Pinza de freno con 1 pasador de soporte	- ETS	para vehículos sin ETS
Bremssattel mit 2 Halte-stiften	Pinza de freno con 2 pasadores de soporte	Europa	Europa
Brems-scheibe	Disco de freno	F	F

Technische Übersetzungen

Technical translations - Traducciones técnicas - Traductions techniques - Traduzioni tecniche

ES		ES	
Felge Lochzahl	Llanta, nº de taladros	für Fahrzeuge mit Active City Stop	para vehículos con Active City Stop
Felgengröße [Zoll]	Tamaño de llanta [in]	für Fahrzeuge mit AMG-Sportpaket	para vehículos con paquete sport AMG
Flachstecker	Conector plano	für Fahrzeuge mit Bremsassistent	para vehículos con asistencia a la frenada
Flanschbefestigung	Fijación con brida	für Fahrzeuge mit Keramikbremse	para vehículos con freno de cerámica
FPM (Fluor-Kautschuk)/ACM (Polyacryl-Kautschuk)	FPM (caucho fluorado)/ACM (caucho poliacrílico)	für Fahrzeuge mit Klimaanlage	para vehículos con climatizador
Frankreich	Francia	für Fahrzeuge mit Niveauregulierung	para vehículos con regulación de nivel
Frontantrieb	Tracción delantera	für Fahrzeuge mit Panorama-Sonnendach	para vehículos con techo solar panorámico
für Automatikgetriebe	para transmisión automática	für Fahrzeuge mit PCS (Pre-Crash Safety System)	para vehículos con PCS (Pre-Crash Safety System)
für Behördenfahrzeuge	para vehículos admon. pública	für Fahrzeuge mit Scheibenbremse an der Hinterachse	para vehículos con freno de disco en eje trasero
für Bremsattel mit Kunststoffkolben	para pinzas de freno con émbolos de plástico	für Fahrzeuge mit Schlechtwegausführung	para vehículos con dispositivo auxiliar para caminos malos
für Bremsattel mit Stahlkolben	para pinzas de freno con émbolos de acero	für Fahrzeuge mit Servolenkung	para vehículos con dirección asistida
für Brems Scheibendicke [mm]	para espesor de disco [mm]	für Fahrzeuge mit Sportfahrwerk	para vehículos con chasis deportivo
für Brems Scheibendurchmesser [mm]	para diámetro disco de freno [mm]		
für Brems Scheibendurchmesser [Zoll]	para diám. disco de frenos [inch]		
für Doppelbereifung	para neumáticos gemelos		
für Einfachbereifung	para neumáticos sencillos		
für erhöhte Nutzlast	para carga útil aumentada		
für ESP	para ESP		
für Fahrzeuge mit 3. Sitzreihe	para vehículos con 3 hileras de asientos		



Technische Übersetzungen

Technical translations - Traducciones técnicas - Traductions techniques - Traduzioni tecniche

ES		ES	
für Fahrzeuge mit Sportpaket	para vehículos con paquete sport	für Fahrzeuge ohne Keramikbremse	para vehículos sin frenos de cerámica
für Fahrzeuge mit Start-Stopp-Funktion	para vehículos con sistema Start&Stop	für Fahrzeuge ohne Klimaanlage	para vehículos sin aire acondicionado
für Fahrzeuge mit Trommelbremse an der Hinterachse	para vehículos con freno de tambor en eje trasero	für Fahrzeuge ohne Motorbremse	para vehículos sin freno de motor
für Fahrzeuge mit verstärktem Fahrwerk	para vehículos con chasis reforzado	für Fahrzeuge ohne Panorama-Sonnendach	para vehículos sin techo solar panorámico
für Fahrzeuge mit verstärkter Bremse	para vehículos con freno reforzado	für Fahrzeuge ohne PCS (Pre-Crash Safety System)	para vehículos sin PCS (Pre-Crash Safety System)
für Fahrzeuge mit Vierradlenkung	para vehículos con dirección en las 4 ruedas	für Fahrzeuge ohne Schlechtwegausführung	para vehículos sin dispositivo auxiliar para caminos malos
für Fahrzeuge ohne 3. Sitzreihe	para vehículos sin 3 hileras de asientos	für Fahrzeuge ohne Servolenkung	para vehículos sin dirección asistida
für Fahrzeuge ohne Active City Stop	para vehículos sin Active City Stop	für Fahrzeuge ohne Sportfahrwerk	para vehículos sin chasis deportivo
für Fahrzeuge ohne AMG-Performance Package	para vehículos sin paquete AMG performance	für Fahrzeuge ohne Sportpaket	para vehículos sin paquete sport
für Fahrzeuge ohne AMG-Sportpaket	para vehículos sin paquete deportivo AMG	für Fahrzeuge ohne Start-Stopp-Funktion	para vehículos sin sistema Start&Stop
für Fahrzeuge ohne Bordcomputer	para vehículos sin ordenador de a bordo	für Fahrzeuge ohne verstärktes Fahrwerk	para vehículos sin chasis reforzado
für Fahrzeuge ohne Bremsassistent	Para vehículos sin asistencia a la frenada	für Fahrzeuge ohne Vierradlenkung	para vehículos sin dirección en las 4 ruedas
		für gepanzerte Fahrzeuge	para vehículos blindados

Technische Übersetzungen

Technical translations - Traducciones técnicas - Traduccions techniques - Traduzioni tecniche

ES	ES
für Geschwindigkeitsregelanlage para instalación reguladora de velocidad	Höhe 1 [mm] Altura 1 [mm]
für Leichtmetallfelgen para llantas de metal ligero	Höhe 2 [mm] Altura 2 [mm]
für Lenkslenker para vehic. dirección izquierda	Hohl-schraube Tronillo hueco
für OE-Nummer para OE N°	Informati-onsart Tipo información
für Polizei-fahrzeuge para vehículo de policía	Innendurch-messer [mm] Diámetro interior [mm]
für Rechts-lenker para vehíc. dirección a la derecha	Innen-Torx Torx interior
für Schaltge-triebe para transmisión manual	- J Japón
für Sonder-fahrzeuge para vehículos especiales	Japan Japón
für Stahl-felgen para llantas de acero	Kanada Canadá
für Taxifahr-zeuge para taxis	Kasten/Kombi Furgón/ranchera familiar
gelb amarillo	Kombi Ranchera familiar
Generischer Artikel Número de artículo genérico	Kunststoff Plástico
Geschlossen cerrada	kurzer Radstand distancia corta entre ejes
Gewindeaus-führung Tipo de rosca	L aleado
Gewinde-länge [mm] Long. de rosca [mm]	L= Longitud [mm]
GG Pinza de frenos de hierro fundido	L= Longitud total [mm] Longitud contacto de aviso
Groß Britan-nien Gran Bretaña	L1= Longitud 1 [mm]
grün verde	L2= Longitud 2 [mm]
Halbauto-matik semiautomática	langer Radstand Distancia larga entre ejes
Halter, Bremsleitung Soporte, tubería de freno	Leichtmetall-felge Llantas de aleación ligera
Halter, Brems-schlauch Soporte, tubo flexible de freno	- LG sin apoyo
HC altamente carbonizado	Lochanzahl Número de orificios
HC L aleado/alt. carburado	Lochkreis-Ø [mm] corona de agujeros - Ø [mm]
Herstellerein-schränkung Restricción de fabricante	luftgeder-te Achse Eje con suspensión neumática
	Made in País producción vehículo
	MAN Sistema de frenos, Mando
	mit Anti-Quietsch-Blech Chapa antichirridos
	mit Brems-sattel-schrauben con tornillos pinza freno



Technische Übersetzungen

Technical translations - Traducciones técnicas - Traductions techniques - Traduzioni tecniche

ES		ES	
mit Doppelbereifung	con neumáticos gemelos	nicht für gepanzerte Fahrzeuge	no para vehículos blindados
mit Einfachbereifung	con neumáticos sencillos	nicht für Leichtmetallfelgen	no para llantas de metal ligero
mit Entlüfterventil	con válvula de ventilación	nicht für Motorcode	no para código de motor
mit Feder	con muelle	nicht für Multi-link Achse	no para eje multilink
mit geregeltem (3-Wege) Katalysator	con catalizador regulado (3 vías)	nicht für Polizeifahrzeuge	no para veh. policía
mit Leichtmetallfelge	con llantas de aleación ligera	nicht für Postfahrzeuge	no para veh. correos
mit Stahlfelge	con llantas de acero	nicht für SA Code	no para código SA
Motorcode	Código de motor	nicht für Sonderfahrzeuge	no para veh. especiales
Multi-link Achse	Eje multilink	nicht für Taxifahrzeuge	no para taxis
Nabendurchmesser [mm]	Diamétero cubo [mm]	NIS	Sistema de frenos, Nissin
nicht für Ausstattungsvariante	no para variante de equipamiento	nur für Mineralöl	sólo para aceite mineral
nicht für Automatikgetriebe	no para transmisión automática	nur in Verbindung mit	sólo con
nicht für Baumuster	no para tipo de construcción	Nutzlast [kg]	Carga útil [kg]
nicht für Behördenfahrzeuge	no para veh. admon. pública	Nutzlast ab [kg]	carga útil desde [kg]
nicht für Bremssattel-farbe	no para color pinza freno	Nutzlast bis [kg]	carga útil hasta [kg]
nicht für erhöhte Nutzlast	no para carga útil aumentada	OE-Hersteller	
nicht für Fahrzeuge mit verstärkter Bremse	no para vehículos con frenos reforzados	OE-Nummer	
nicht für Felgenreöße [Zoll]	no para dimensión de llantas	OE-Referenz	
		ohne integrierten Verschleißsensor	sin sensor de desgaste
		ohne Katalysator	sin catalizador
		ohne Leichtmetallfelge	sin llantas de aleación ligera
		Orga →	nº de organización desde

Technische Übersetzungen

Technical translations - Traducciones técnicas - Traductions techniques - Traduzioni tecniche

ES		ES	
passend für Felgenreöße [Zoll]	adecuado para tamaño llanta [inch]	silber	plateado
PER	Sistema de frenos, Perrot	Slowakische Republik	República eslovaca
- Performance Parts	para vehículos sin frenos alto rendimiento	SOHC/OHC	SOHC/OHC
Pol-Anzahl	Número de polos	Sortiment, Armaturen	Surtido de armaduras
Power Disc	Denominación adicional del artículo, Power Disc	Sortiment, Befestigungselemente	Surtido, elementos de sujeción
Prüfanschluss, Rohrleitungen	Conexión de prueba, tuberías	Sortiment, Entlüfterschrauben	Surtido, tornillos de purga de aire
Raddurchmesser [Zoll]	Diámetro de rueda [in]	Spezialaufbau	Carrocería especial
Radstand [mm]	Distancia entre ejes [mm]	Stahlfelge	Llanta de acero
Ringstutzen, Rohrleitung	Tubuladura anular, tubería	Starrachse	Eje rígido
- RLG	sin cojinete rueda	Steckerausführung	Modelo de conector
rot	rojo	Stopfen, Bremsflüssigkeitsbehälter	Tapón, depósito líquido de frenos
Rückschlagventil	Válvula de retención	SUM	Sistema de frenos, Sumitomo
Russia-made	Rusia	Textbaustein	módulo de texto
Schalter, Bremsleuchte	Interruptor, luz de freno	T-Form (T-Stück)	en T
Schaltgetriebe	Caja de cambios manual	TOK	Sistema de frenos, Tokico
Schaltgetriebe, automatisch betätigt	Manual, automatizada	TRW	Sistema de frenos, Lucas / TRW
Schaltgetriebe 5 Gang	Manual, 5 vel.	Tschechische Republik	República Checa
Scheibenbremse	Discos	Türenanzahl	Número de puertas
Schlauch	Tubo flexible	Überwurfmutter	Tuerca racor
Schlüsselweite	Ancho de llave	Überwurfschraube	Tornillo de unión
Schraubanschluss	Conexión roscada	Ungarn	Hungría
Schraubkontakt	contacto roscado	USA	EE UU
schwarz	negro	- USA	EE UU
		V	Ventilación interna ventilado
		V/	ranurado/vent. interior



Technische Übersetzungen

Technical translations - Traducciones técnicas - Traductions techniques - Traduzioni tecniche

ES		ES	
Ventil, Unterdruckleitung	Válvula, tubería de depresión	•	Perforado
		→	año construcción desde nº de chasis desde
Verbindungs-/Verteilerstück, Rohrleitungen	Piezas distribuidoras/unión, tuberías	→	año construcción hasta nº de chasis hasta
		→ Orga	nº de organización hasta
Verschluss, Bremsflüssigkeitsbehälter	Tapa, depósito de líquido de frenos	→ VET	nº VET hasta
		→ Ø	Diámetro hasta [mm]
Verschluss-/Schutzkappe	Tapa de cierre/protección		
Verschluss-schraube	Tapón roscado		
Version	Versión		
VET →	nº VET desde		
Vollautomatik	completamente automática		
VW	Sistema de frenos, Volkswagen		
V•	Perforado/ventil. int.		
wahlweise	opcional		
Warnkontakt, Bremsbelagverschleiß	Contacto de aviso, desgaste de los frenos		
- WE	no preparado para indicador de desgaste		
- WK	excl. contacto de avisador de desgaste sin contacto de aviso de desgaste		
x	Ancho [mm] Altura [mm]		
x	cantidad indicadores de desgaste [por eje] Número de conexiones		
Zentrierungsdurchmesser [mm]	Diámetro de centrado [mm]		
- Zub	sin accesorios		
Zubehörsatz, Scheibenbremsbelag	Kit de accesorios, pastillas de frenos		
zul. Gesamtgewicht [kg]	Peso total autorizado [kg]		
Ø	Diámetro [mm]		
Ø1	Diámetro 1 [mm]		
Ø2	Diámetro 2 [mm]		

Technische Übersetzungen

Technical translations - Traducciones técnicas - Traductions techniques - Traduzioni tecniche

FR		FR	
	Kit de plaquettes de frein, frein à disque	+ WK	contact de signal d'usure inclu avec contact du palpeur d'usure intégré avec indicateur d'usure
	Disque de frein	+ Zub	avec accessoires
	arrière	ABE	avec autorisation d'exploitation
	Essieu arrière gauche	Abmessungen beachten	Respecter les dimensions
	Essieu arrière droit	- ABS	pour véhicules sans système antiblo-cage pas pour ABS
	Essieu avant gauche	- ABS Ring	sans bague ABS
	Essieu avant droit	Achsnummer	Numéro d'essieu
+ ABS	pour véhicules avec système antiblo-cage pour ABS	Achszapfen-durchmesser [mm]	Diamètre du bout d'essieu [mm]
+ ABS Ring	avec bague ABS	Adapter, Bremsleitung	Adaptateur, conduite de frein
+ ASR	pour véhicules avec ASR	ADV	Système de freinage, Advics
+ D	Allemagne	AIS	Système de freinage, Aisin
+ eFSB	pour véhicules avec frein d'arrêt électronique	AKE	Système de freinage, Akebono
+ ESP	pour véhicules avec ESP	Allrad	Traction intégrale
+ ETS	pour véhicules avec ETS	ALU	Étrier de frein en aluminium
+ EU	Europe	Anschluss-gewinde	Filetage de raccordement
+ J	Japon	Anschluss links	Raccord gauche
+ LG	avec bague	Anschluss rechts	Raccord droite
+ Performance Parts	pour véhicule avec frein Performance	Anschlusstutzen, Schlauchleitung	Raccord, tuyau flexible
+POC	pour POC	Anzahl der Bohrungen	Nombre d'alésages
+PR	pour numéro PR	Anzahl Sitz-plätze	Nombre de sièges
+ RO	Roumanie	AP	Système de freinage, AP Lockheed
+ RUS	Russie	Artikel-nummer des empfohlenen Zubehörs	Référence de l'accessoire recommandé
+ S	avec vis/boulons	- ASR	pour véhicules sans ASR
+SA	pour SA code	ATE Ceramic	Designation d'article complémentaire, ATE Ceramic
+ SKA	Scandinavie		
+ TR	Turquie		
+ USA	USA		
+ WE	préparé pour indicateur d'usure		



Technische Übersetzungen

Technical translations - Traducciones técnicas - Traductions techniques - Traduzioni tecniche

FR		FR	
Außendurchmesser [mm]	Diamètre extérieur [mm]	Brems-scheibe zwei-teilig	Disque de frein en deux pièces
Automatikgetriebe	Boîte automatique	- CDN	Canada
B	revêtu	China-made	Chine
B1=	Largeur 1 [mm]	CIT	Système de freinage, Citroen
B2=	Largeur 2 [mm]	CVT-Automatikgetriebe (Stufenlos)	Boîte de vitesses à variateur classique (CVT, continu)
Baumuster	Modèle type	- D	Allemagne
BDX	Système de freinage, Bendix	DEL	Système de freinage, Delco
Bearbeitung	Traitement	Dichtung, Unterdruck-Anschlusstutzen BKV	Joint, tubulure de prise de dépression
Bohrung-Ø 1 [mm]	Alésage-Ø 1 [mm]	DIN/ISO	DIN/ISO
Bohrung-Ø 2 [mm]	Alésage-Ø 2 [mm]	DIN 74235 Form EL	DIN 74235 forme EL
Bördelform	Forme du bord relevé	DIN 74235 Form FL	DIN 74235 forme FL
BOS	Système de freinage, Bosch	DOHC	DOHC
BRE	Système de freinage, Brembo	Durchmesser Aufnahme [mm]	Diamètre réception [mm]
Brems-/ Fahrdyn. Artikelbezug	Lien d'article avec dynamique de freinage et de mouvement	E	E
Bremsbelagsatz, Scheibenbremse	Kit de plaquettes de frein, frein à disque	- eFSB	pour véhicules sans frein d'arrêt électronique
Bremsleitung	Conduite de frein	einteilig	à une seule pièce
Brems-sattel(1-Kolben)	Etrier de frein (1 piston)	Einzelradaufhängung	Suspension roue indépendante
Brems-sattel(2-Kolben)	Etrier de frein (2 pistons)	elektrisch-hydraulisch	électrique-hydraulique
Brems-sattel(4-Kolben)	Etrier de frein (4 pistons)	Entlüfterschraube/-ventil	Soupape/vis de purge d'air
Bremssattel-farbe	Couleur de l'étrier	EPDM (Ethylen-Propylen-Dien-Kautschuk)	EPDM (éthylène-propylène-diène-caoutchouc)
Bremssattel mit 1 Haltestift	Etrier à une goupille	- ESP	pour véhicules sans ESP
Bremssattel mit 2 Haltestiften	Etrier à deux goupilles	- ETS	pour véhicules sans ETS
Brems-scheibe	Disque de frein	Europa	Europe
		F	F

Technische Übersetzungen

Technical translations - Traducciones técnicas - Traductions techniques - Traduzioni tecniche

FR		FR	
Felge Lochzahl	Jante, nombre de trous	für Fahrzeuge mit Active City Stop	pour véhicule avec Active City Stop
Felgengröße [Zoll]	Dimension de la jante [pouces]	für Fahrzeuge mit AMG-Sportpaket	pour véhicules avec équipement-sport AMG
Flachstecker	Fiche plate	für Fahrzeuge mit Bremsassistent	pour véhicules avec assistant au freinage
Flanschbefestigung	Fixation par bride	für Fahrzeuge mit Keramikbremse	pour véhicules avec frein céramique
FPM (Fluor-Kautschuk)/ACM (Polyacryl-Kautschuk)	FPM (caoutchouc fluoré) / ACM (caoutchouc polyacrylique)	für Fahrzeuge mit Klimaanlage	pour véhicules avec système de climatisation
Frankreich	France	für Fahrzeuge mit Niveauregulierung	pour véhicules avec correcteur d'assiette
Frontantrieb	Traction avant	für Fahrzeuge mit Panorama-Sonnendach	pour véhicules avec toit panoramique soleil
für Automatikgetriebe	pour boîtes de vitesses automatiques	für Fahrzeuge mit PCS (Pre-Crash Safety System)	pour véhicules avec PCS (Pre-Crash Safety System)
für Behördenfahrzeuge	pour véhicules d'administration	für Fahrzeuge mit Scheibenbremse an der Hinterachse	pour véhicules avec frein à disques à l'essieu arrière
für Bremsattel mit Kunststoffkolben	pour étrier de frein avec pistons en plastique	für Fahrzeuge mit Schlechtwegausführung	pour véhicules préparés pour routes dégradées
für Bremsattel mit Stahlkolben	pour étrier de frein avec pistons en acier	für Fahrzeuge mit Servolenkung	pour véhicules avec direction assistée
für Brems Scheibendicke [mm]	pour épaisseur de disque de frein [mm]	für Fahrzeuge mit Sportfahrwerk	pour véhicules avec châssis sportif
für Brems Scheibendurchmesser [mm]	pour diamètre du disque de frein [mm]		
für Brems Scheibendurchmesser [Zoll]	pour diamètre disque de frein [pouce]		
für Doppelbereifung	pour pneus doubles		
für Einfachbereifung	pour pneus simples		
für erhöhte Nutzlast	pour charge utile surélevée		
für ESP	pour ESP		
für Fahrzeuge mit 3. Sitzreihe	pour véhicules avec 3ième rangée de sièges		

Technische Übersetzungen

Technical translations - Traducciones técnicas - Traductions techniques - Traduzioni tecniche

FR		FR	
für Fahrzeuge mit Sportpaket	pour véhicules avec équipement sport	für Fahrzeuge ohne Keramikbremse	pour véhicules sans frein en céramique
für Fahrzeuge mit Start-Stopp-Funktion	pour véhicules avec fonction Stop/Start	für Fahrzeuge ohne Klimaanlage	pour véhicules sans système de climatisation
für Fahrzeuge mit Trommelbremse an der Hinterachse	pour véhicules avec frein à tambour à l'essieu arrière	für Fahrzeuge ohne Motorbremse	pour véhicules sans frein-moteur
für Fahrzeuge mit verstärktem Fahrwerk	pour véhicules avec châssis renforcé	für Fahrzeuge ohne Panorama-Sonnendach	pour véhicules sans toit panoramique soleil
für Fahrzeuge mit verstärkter Bremse	pour véhicules avec frein assisté	für Fahrzeuge ohne PCS (Pre-Crash Safety System)	pour véhicules sans PCS (Pre-Crash Safety System)
für Fahrzeuge mit Vierradlenkung	pour véhicules avec direction par quatre roues	für Fahrzeuge ohne Schlechtwegausführung	pour véhicules non-préparés pour routes dégradées
für Fahrzeuge ohne 3. Sitzreihe	pour véhicules sans 3ième rangée de sièges	für Fahrzeuge ohne Servolenkung	pour véhicules sans direction assistée
für Fahrzeuge ohne Active City Stop	pour véhicule sans Active City Stop	für Fahrzeuge ohne Sportfahrwerk	pour véhicules sans châssis sportif
für Fahrzeuge ohne AMG-Performance Package	pour véhicule sans AMG Performance Package	für Fahrzeuge ohne Sportpaket	pour véhicules sans équipement sport
für Fahrzeuge ohne AMG-Sportpaket	pour véhicules sans paquet-sport AMG	für Fahrzeuge ohne Start-Stopp-Funktion	pour véhicules sans fonction Stop/Start
für Fahrzeuge ohne Bordcomputer	pour véhicules sans ordinateur de bord	für Fahrzeuge ohne verstärktes Fahrwerk	pour véhicules sans châssis renforcé
für Fahrzeuge ohne Bremsassistent	pour véhicules sans assistant de freinage	für Fahrzeuge ohne Vierradlenkung	pour véhicules sans direction par quatre roues
		für gepanzerte Fahrzeuge	pour véhicules blindés

Technische Übersetzungen

Technical translations - Traducciones técnicas - Traductions techniques - Traduzioni tecniche

FR	FR
für Geschwindigkeitsregelanlage pour régulateur de vitesse	Höhe 1 [mm] Hauteur 1 [mm]
für Leichtmetallfelgen pour jante en alliage léger	Höhe 2 [mm] Hauteur 2 [mm]
für Linkslenker pour véhicules avec direction à gauche	Hohl-schraube Vis creuse
für OE-Nummer pour numéro OE	Informati-onsart Genre d'information
für Polizeifahrzeuge pour voitures de police	Innendurch-messer [mm] Diamètre intérieur [mm]
für Rechtslenker pour véhicules avec direction à droite	Innen-Torx Torx intérieur
für Schaltge-triebe pour boîte de vitesses manuelle	- J Japon
für Sonder-fahrzeuge pour véhicules spéciaux	Japan Japon
für Stahl-felgen pour jante en acier	Kanada Canada
für Taxifahr-zeuge pour taxis	Kasten/Kombi Camionnette/Break
gelb jaune	Kombi Break
Generischer Artikel Référence générique de l'article	Kunststoff Matière plastique
Geschlossen Carrosserie couverte	kurzer Radstand Empattement court
Gewindeaus-führung Filetage/taroudage	L allié
Gewinde-länge [mm] Longueur du filetage [mm]	L= Longueur [mm]
GG Étrier de frein en fonte	L= Longueur globale Longueur de contacts d'avertissement [mm]
Groß Britan-nien Grande-Bretagne	L1= Longueur 1 [mm]
grün vert	L2= Longueur 2 [mm]
Halbauto-matik semi-automatique	langer Radstand Empattement long
Halter, Bremsleitung Support, conduite de frein	Leichtmetall-felge Jante en alliage léger
Halter, Brems-schlauch Support, flexible de frein	- LG sans palier
HC à haute teneur en carbone	Lochanzahl Nombre de trous
HC L allié/carbonisé	Lochkreis-Ø [mm] Cercle de perçage -Ø [mm]
Herstellerein-schränkung Montage d'origine	luftgederterte Achse Essieu à ressorts pneumatiques
	Made in Pays constructeur du véhicule
	MAN Système de freinage, Mando
	mit Anti-Quietsch-Blech avec tôle anti-bruit



Technische Übersetzungen

Technical translations - Traducciones técnicas - Traductions techniques - Traduzioni tecniche

FR		FR	
mit Brems-sattel-schrauben	avec boulon/vis d'étrier de frein	nicht für Felgenreöße [Zoll]	pas pour dimension de jante [pouce]
mit Doppel-bereifung	avec pneus doubles	nicht für gepanzerte Fahrzeuge	pas pour véhicules blindés
mit Einfach-bereifung	avec pneus simples	nicht für Leichtmetall-felgen	pas pour jante en alliage léger
mit Entlüfter-ventil	avec soupape de reniflard	nicht für Motorcode	pas pour code moteur
mit gere-geltem (3-Wege) Kata-lysatoren	avec catalyseur réglé	nicht für Multi-link Achse	pas pour essieu multilink
mit Leichtme-tallfelge	avec jante en alliage léger	nicht für Poli-zeifahrzeuge	pas pour voitures de police
mit Stahl-felge	avec jante en acier	nicht für Postfahr-zeuge	pas pour véhicules de la poste
Motorcode	Code moteur	nicht für SA Code	pas pour SA code
Multi-link Achse	Essieu multilink	nicht für Sonderfahr-zeuge	pas pour véhicules spéciaux
Nabendurch-messer [mm]	Diamètre du moyeu [mm]	nicht für Taxifahr-zeuge	pas pour taxis
nicht für Ausstat-tungsvari-ante	pas pour version d'équipement	NIS	Système de freinage, Nissin
nicht für Automatikge-triebe	pas pour boîte de vitesses automatique	nur für Mine-ralöl	seulmt. pour huile minérale
nicht für Baumuster	pas pour modèle type	nur in Verbin-dung mit	uniquement en connexion avec
nicht für Behörden-fahrzeuge	pas pour véhicules de l'administration	Nutzlast [kg]	Charge utile [kg]
nicht für Bremssattel-farbe	pas pour couleur de l'étrier-frein	Nutzlast ab [kg]	Charge utile à partir de [kg]
nicht für erhöhte Nutz-last	non pour charge utile surélevée	Nutzlast bis [kg]	Charge utile jusqu'à [lb]
nicht für Fahrzeuge mit verstärkter Bremse	pas pour véhicules avec frein assisté	OE-Hersteller	
		OE-Nummer	
		OE-Referenz	
		ohne integ-rierten Verschleiß-sensor	sans palpeur d'usure intégré
		ohne Kataly-sator	sans catalyseur

Technische Übersetzungen

Technical translations - Traducciones técnicas - Traductions techniques - Traduzioni tecniche

FR		FR	
ohne Leichtmetallfelge	sans jante en alliage léger	Schraubkontakt	Type de vis
Orga →	N° d'organisation à partir de	schwarz	noir
passend für Felgenreöße [Zoll]	va pour taille de jantes [pouces]	silber	argent
PER	Système de freinage, Perrot	Slowakische Republik	République slovaque
- Performance Parts	pour véhicules sans frein Performance	SOHC/OHC	SOHC/OHC
Pol-Anzahl	Nombres de pôles	Sortiment, Armaturen	Assortiment, robinetterie et accessoires
Power Disc	Designation d'article complémentaire, Power Disc	Sortiment, Befestigungselemente	Assortiment, éléments de fixation
Prüfanschluss, Rohrleitungen	Raccord d'essai, tuyaux	Sortiment, Entlüfterschrauben	Assortiment, vis de purge d'air
Raddurchmesser [Zoll]	Diamètre de roue [pouces]	Spezialaufbau	Carrosserie spéciale
Radstand [mm]	Empattement [mm]	Stahlfelge	Jante en acier
Ringstutzen, Rohrleitung	Raccord annulaire, tuyauterie	Starrachse	Essieu rigide
- RLG	sans roulement de roue	Steckerausführung	Type de fiche
rot	rouge	Stopfen, Bremsflüssigkeitsbehälter	Bouchon, filtre déshydratant du liquide de frein
Rückschlagventil	Soupape de retenue	SUM	Système de freinage, Sumitomo
Russia-made	Russie	Textbaustein	module de texte
Schalter, Bremsleuchte	Contacteur, feu stop	T-Form (T-Stück)	forme de T (pièce T)
Schaltgetriebe	boîte de vitesses manuelle	TOK	Système de freinage, Tokico
Schaltgetriebe, automatisch betätigt	Boîte de vitesse commandée automatiquement	TRW	Système de freinage, Lucas / TRW
Schaltgetriebe 5 Gang	Boîte de vitesses manuelle à 5 vitesses	Tschechische Republik	République tchèque
Scheibenbremse	Frein à disque	Türenanzahl	Nombre de portes
Schlauch	Tuyau	Überwurfmutter	Écrou de raccord
Schlüsselweite	Ouverture de la clé	Überwurfschraube	Vis de raccord
Schraubanschluss	Raccord fileté	Ungarn	Hongrie
		USA	USA
		- USA	USA









Technische Übersetzungen

Technical translations - Traducciones técnicas - Traductions techniques - Traduzioni tecniche

FR		FR	
V	ventilé de l'intérieur ventilé	Ø1	Diamètre 1 [mm]
V/	fendu/ventilé de l'intérieur	Ø2	Diamètre 2 [mm]
Ventil, Unterdruckleitung	Soupape, tuyau de dépression	•	poinçonné
Verbindungs-/ Verteilerstück, Rohrleitungen	Pièce de raccord / distributeur, tuyaux	→	Année à partir de N° de châssis à partir de
Verschluss, Bremsflüssigkeitsbehälter	Bouchon, réservoir du liquide	→	Année jusqu'à N° de châssis jusqu'à
Verschluss-/ Schutzkappe	Capuchon de fermeture/de protection	→Orga	N° d'organisation jusqu'à
Verschluss-schraube	Boulon de fermeture	→VET	Numéro VET jusqu'à
Version	Version	→Ø	Diamètre jusqu'à [mm]
VET →	Numéro VET à partir de		
Vollautomatik	entièrement automatique		
VW	Système de freinage, Volkswagen		
V•	poinçonné/ventilé		
wahlweise	au choix		
Warnkontakt, Bremsbelagverschleiß	Contact d'avertissement, usure des plaquettes de frein		
- WE	non préparé pour indicateur d'usure		
- WK	contact de signal d'usure exclu sans contact du palpeur d'usure intégré		
x	Largeur [mm] Hauteur [mm]		
x	Nombre d'indicateurs d'usure [par essieu] Nombre de connexions		
Zentrierungsdurchmesser [mm]	Diamètre du centrage [mm]		
- Zub	sans accessoires		
Zubehörsatz, Scheibenbremsbelag	Kit d'accessoires, plaquette de frein à disque		
zul. Gesamtgewicht [kg]	Poids total autorisé en charge [kg]		
Ø	Diamètre [mm]		

Technische Übersetzungen

Technical translations - Traducciones técnicas - Traductions techniques - Traduzioni tecniche

IT		IT	
	Kit pastiglie freno, Freno a disco	+ WK	Con contatto segnalazione usura con segnalatore usura integrato con segnalazione acustica usura
	Disco freno	+ Zub	con accessori
	posteriore	ABE	con autorizzazione generale all'uso (ABE)
	Assale posteriore Sx	Abmessungen beachten	Osservare le misure
	Assale posteriore Dx	- ABS	per veicoli senza ABS Non per ABS
	Assale anteriore Sx	- ABS Ring	senza anello sensore ABS
	Assale anteriore Dx	Achsnummer	N° assale
+ ABS	per veicoli con ABS per ABS	Achszapfendurchmesser [mm]	Diametro fusello [mm]
+ ABS Ring	con anello sensore ABS	Adapter, Bremsleitung	Adattatore, Tubazione freno
+ ASR	per veicoli con ASR	ADV	Sistema frenante, Advics
+ D	Germania	AIS	Sistema frenante, Aisin
+ eFSB	per veicoli con freno stazionamento elettronico	AKE	Sistema frenante, Akebono
+ ESP	per veicoli con ESP	Allrad	Trazione integrale
+ ETS	per veicoli con ETS	ALU	Pinza freno in alluminio
+ EU	Europa	Anschlussgewinde	Filettatura di raccordo
+ J	Giappone	Anschluss links	Attacco/Raccordo Sx
+ LG	con supporto/cuscinetto	Anschluss rechts	Attacco/Raccordo Dx
+ Performance Parts	per veicoli con freno Performance	Anschluss-tutzen, Schlauchleitung	Bocchettone raccordo, tubo flessibile
+POC	per POC	Anzahl der Bohrungen	N° fori
+PR	per N° PR	Anzahl Sitzplätze	N° posti a sedere
+ RO	Romania	AP	Sistema frenante, AP Lockheed
+ RUS	Russia	Artikelnummer des empfohlenen Zubehörs	N° articolo accessorio consigliato
+ S	con bulloni/viti	- ASR	per veicoli senza ASR
+SA	per codice SA	ATE Ceramic	Denominazione aggiuntiva dell'articolo, ATE Ceramic
+ SKA	Scandinavia		
+ TR	Turchia		
+ USA	USA		
+ WE	Predisposto per contatto segnalazione usura		



Technische Übersetzungen

Technical translations - Traducciones técnicas - Traductions techniques - Traduzioni tecniche

IT		IT	
Außendurchmesser [mm]	Diametro esterno [mm]	Brems-scheibe zwei-teilig	Disco freno in due parti
Automatikgetriebe	Trasmissione automatica	- CDN	Canada
B	rivestito	China-made	Cina
B1=	Larghezza 1 [mm]	CIT	Sistema frenante, Citroen
B2=	Larghezza 2 [mm]	CVT-Automatikgetriebe (Stufenlos)	CVT-Cambio automatico (a variazione continua)
Baumuster	Modello	- D	Germania
BDX	Sistema frenante, Bendix	DEL	Sistema frenante, Delco
Bearbeitung	Lavorazione/Trattamento	Dichtung, Unterdruck-Anschlusstutzen BKV	Guarnizione, Depressione-manicotto d'attacco servofreno
Bohrung-Ø 1 [mm]	Alesaggio-Ø 1 [mm]	DIN/ISO	DIN/ISO
Bohrung-Ø 2 [mm]	Alesaggio-Ø 2 [mm]	DIN 74235 Form EL	DIN 74235 Form EL
Bördelform	Forma bordatura	DIN 74235 Form FL	DIN 74235 Form FL
BOS	Sistema frenante, Bosch	DOHC	DOHC
BRE	Sistema frenante, Brembo	Durchmesser Aufnahme [mm]	Diametro sede [mm]
Brems-/ Fahrdyn. Artikelbezug	Dinamica frenata/guida. Riferim. articolo	E	E
Bremsbelagsatz, Scheibenbremse	Kit pastiglie freno, Freno a disco	- eFSB	per veicoli senza freno stazionamento elettronico
Bremsleitung	Tubazione freno	einteilig	monopezzo
Brems-sattel(1-Kolben)	Pinza freno (1 pistone)	Einzelradaufhängung	Sospensione a ruote indipendenti
Brems-sattel(2-Kolben)	Pinza freno (2 pistoni)	elektrisch-hydraulisch	elettrico-idraulico
Brems-sattel(4-Kolben)	Pinza freno (4 pistoni)	Entlüfterschraube/-ventil	Vite / Valvola di sfiato
Bremssattel-farbe	Colore pinza freno	EPDM (Ethylen-Propylen-Dien-Kautschuk)	EPDM (Etilene-Propilene-Diene-Caucciù)
Bremssattel mit 1 Haltestift	Pinza freno con 1 spina di fermo	- ESP	per veicoli senza ESP
Bremssattel mit 2 Haltestiften	Pinza freno con 2 spine di fermo	- ETS	per veicoli senza ETS
Brems-scheibe	Disco freno	Europa	Europa
		F	F

Technische Übersetzungen

Technical translations - Traducciones técnicas - Traductions techniques - Traduzioni tecniche

IT		IT	
Felge Lochzahl	Cerchione, N° fori	für Fahrzeuge mit Active City Stop	per veicoli con Active City Stop
Felgengröße [Zoll]	Misura cerchione [pollici]	für Fahrzeuge mit AMG-Sportpaket	per veicoli con pacchetto sportivo AMG
Flachstecker	Spina piatta	für Fahrzeuge mit Bremsassistent	per veicoli con brake assist
Flanschbefestigung	Fissaggio a flangia	für Fahrzeuge mit Keramikbremse	per veicoli con freni in ceramica
FPM (Fluor-Kautschuk)/ACM (Polyacryl-Kautschuk)	FPM (Fluoro-Caucciù)/ACM (Poliacrilato-Caucciù)	für Fahrzeuge mit Klimaanlage	per veicoli con aria condizionata
Frankreich	Francia	für Fahrzeuge mit Niveauregulierung	per veicoli con impianto correzione altezza
Frontantrieb	Trazione anteriore	für Fahrzeuge mit Panorama-Sonnendach	per veicoli con tetto vetrato-panoramico
für Automatikgetriebe	per cambio automatico	für Fahrzeuge mit PCS (Pre-Crash Safety System)	per veicoli con PCS (Pre-Crash Safety System)
für Behördenfahrzeuge	per veicoli dell'amministrazione pubblica	für Fahrzeuge mit Scheibenbremse an der Hinterachse	per veicoli con freni a disco ad assale posteriore
für Bremsattel mit Kunststoffkolben	per pinza freno con pistone in plastica	für Fahrzeuge mit Schlechtwegausführung	per veicoli con dotazione per strade dissestate
für Bremsattel mit Stahlkolben	per pinza freno con pistone in acciaio	für Fahrzeuge mit Servolenkung	per veicoli con servosterzo
für Brems Scheibendicke [mm]	per spessore disco freno [mm]	für Fahrzeuge mit Sportfahrwerk	per veicoli con autotelaio sportivo
für Brems Scheibendurchmesser [mm]	per diametro disco freno [mm]		
für Brems Scheibendurchmesser [Zoll]	per diametro disco freno [pollici]		
für Doppelbereifung	per pneumatici gemellati		
für Einfachbereifung	per pneumatici singoli		
für erhöhte Nutzlast	per elevata portata utile		
für ESP	per ESP		
für Fahrzeuge mit 3. Sitzreihe	per veicoli con 3ª fila sedili		



Technische Übersetzungen

Technical translations - Traducciones técnicas - Traductions techniques - Traduzioni tecniche

IT		IT	
für Fahrzeuge mit Sportpaket	per veicoli con pacchetto sportivo	für Fahrzeuge ohne Keramikbremse	per veicoli senza freni in ceramica
für Fahrzeuge mit Start-Stopp-Funktion	per veicoli con funzione di start-stop	für Fahrzeuge ohne Klimaanlage	per veicoli senza aria condizionata
für Fahrzeuge mit Trommelbremse an der Hinterachse	per veicoli con freni a tamburo ad assale posteriore	für Fahrzeuge ohne Motorbremse	per veicoli senza freno motore
für Fahrzeuge mit verstärktem Fahrwerk	per veicoli con autotelaio rinforzato	für Fahrzeuge ohne Panorama-Sonnendach	per veicoli senza tetto vetrato-panoramico
für Fahrzeuge mit verstärkter Bremse	per veicoli con freno rinforzato	für Fahrzeuge ohne PCS (Pre-Crash Safety System)	per veicoli senza PCS (Pre-Crash Safety System)
für Fahrzeuge mit Vierradlenkung	per veicoli con quattro ruote sterzanti	für Fahrzeuge ohne Schlechtwegausführung	per veicoli senza dotazione per strade dissestate
für Fahrzeuge ohne 3. Sitzreihe	per veicoli senza 3 ^a fila sedili	für Fahrzeuge ohne Servolenkung	per veicoli senza servosterzo
für Fahrzeuge ohne Active City Stop	per veicoli senza Active City Stop	für Fahrzeuge ohne Sportfahrwerk	per veicoli senza autotelaio sportivo
für Fahrzeuge ohne AMG-Performance Package	per veicoli senza pacchetto Performance AMG	für Fahrzeuge ohne Sportpaket	per veicoli senza pacchetto sportivo
für Fahrzeuge ohne AMG-Sportpaket	per veicoli senza pacchetto sportivo AMG	für Fahrzeuge ohne Start-Stopp-Funktion	per veicoli senza funzione di start-stop
für Fahrzeuge ohne Bordcomputer	per veicoli senza computer di bordo	für Fahrzeuge ohne verstärktes Fahrwerk	per veicoli senza autotelaio rinforzato
für Fahrzeuge ohne Bremsassistent	per veicoli senza brake assist	für Fahrzeuge ohne Vierradlenkung	per veicoli senza quattro ruote sterzanti
		für gepanzerte Fahrzeuge	per veicoli corazzati

Technische Übersetzungen

Technical translations - Traducciones técnicas - Traductions techniques - Traduzioni tecniche

IT	IT
für Geschwindigkeitsregel-anlage per impianto regolazione velocità	Höhe 1 [mm] Altezza 1 [mm]
für Leichtmetallfelgen per cerchi in lega leggera	Höhe 2 [mm] Altezza 2 [mm]
für Lenkslenker per veicolo con guida a Sx	Hohl-schraube Vite cava
für OE-Nummer per N° OE	Informati-onsart Tipo informazione
für Polizei-fahrzeuge per veicoli della polizia	Innendurch-messer [mm] Diametro interno [mm]
für Rechts-lenker per veicolo con guida a Dx	Innen-Torx Torx interno
für Schaltge-triebe per cambio manuale	- J Giappone
für Sonder-fahrzeuge per veicoli speciali	Japan Giappone
für Stahl-felgen per cerchi in acciaio	Kanada Canada
für Taxifahr-zeuge per taxi	Kasten/Kombi Cassone / Furgonato / Promiscuo
gelb giallo	Kombi Station wagon
Generischer Artikel Numero generico dell'articolo	Kunststoff Plastica
Geschlossen Chiuso	kurzer Radstand Passo ruote corto
Gewindeaus-führung Versione filettatura	L alligato/legato
Gewinde-länge [mm] Lunghezza filettatura [mm]	L= Lunghezza [mm]
GG Pinza freno in ghisa	L= Lunghezza totale [mm] Lunghezza contatti di segnalazione [mm]
Groß Britan-nien Gran Bretagna	L1= Lunghezza 1 [mm]
grün verde	L2= Lunghezza 2 [mm]
Halbauto-matik Semiautomatico	langer Radstand Passo ruote lungo
Halter, Bremsleitung Supporto, Tubazione freno	Leichtmetall-felge Cerchione in lega leggera
Halter, Brems-schlauch Supporto, Flessibile freno	- LG senza supporto
HC ad alto tenore di carbonio	Lochanzahl N° fori
HC L legato /ad alto tenore di carbonio	Lochkreis-Ø [mm] Cerchio foro-Ø [mm]
Herstellerein-schränkung Limitazione costruttore	luftgefederte Achse Assale a sospensione pneumatica
	Made in Paese produzione veicolo
	MAN Sistema frenante, Mando
	mit Anti-Quietsch-Blech con lamierino anticigolio



Technische Übersetzungen

Technical translations - Traducciones técnicas - Traductions techniques - Traduzioni tecniche

IT		IT	
mit Brems-sattel-schrauben	con bulloni pinza freno	nicht für Felgenreöße [Zoll]	non per misura cerchione [pollici]
mit Doppel-bereifung	con pneumatici gemellati	nicht für gepanzerte Fahrzeuge	Non per veicoli corazzati
mit Einfach-bereifung	con pneumatici singoli	nicht für Leichtmetall-felgen	non per cerchioni in lega leggera
mit Entlüfter-ventil	con valvola di sfiato	nicht für Motorcode	non per codice motore
mit gere-geltem (3-Wege) Kata-lysatör	con catalizzatore a tre vie	nicht für Multi-link Achse	Non per assale multilink
mit Leichtme-tallfelge	con cerchioni in lega leggera	nicht für Poli-zeifahrzeuge	Non per mezzi della polizia
mit Stahl-felge	con cerchione in acciaio	nicht für Postfahr-zeuge	non per veicoli delle poste
Motorcode	Codice motore	nicht für SA Code	non per codice SA
Multi-link Achse	Assale multilink	nicht für Sonderfahr-zeuge	Non per veicoli speciali
Nabendurch-messer [mm]	Diametro mozzo [mm]	nicht für Taxifahr-zeuge	Non per taxi
nicht für Ausstat-tungsvari-ante	non per tipo equipaggiamento	NIS	Sistema frenante, Nissin
nicht für Automatikge-triebe	Non per trasmissione automatica	nur für Mine-ralöl	Solo per olio minerale
nicht für Baumuster	non per modello	nur in Verbin-dung mit	solo unitamente a
nicht für Behörden-fahrzeuge	Non per veicoli dell'amministrazione pubbl.	Nutzlast [kg]	Portata utile [kg]
nicht für Bremssattel-farbe	non per colore pinza freno	Nutzlast ab [kg]	Portata utile da [kg]
nicht für erhöhte Nutz-last	Non per elevata portata utile	Nutzlast bis [kg]	Portata utile fino a [kg]
nicht für Fahrzeuge mit verstärkter Bremse	Non per veicoli con freno rinforzato	OE-Hersteller	
		OE-Nummer	
		OE-Referenz	
		ohne integ-rierten Verschleiß-sensor	senza sensore usura integrato
		ohne Kataly-sator	senza catalizzatore

Technische Übersetzungen

Technical translations - Traducciones técnicas - Traductions techniques - Traduzioni tecniche

IT		IT	
ohne Leichtmetallfelge	senza cerchione in lega leggera	Schraubkontakt	Contatto a vite
Orga →	N° organizzazione da	schwarz	nero
passend für Felgenreöße [Zoll]	idoneo per misura cerchione [pollici]	silber	argento
PER	Sistema frenante, Perrot	Slowakische Republik	Repubblica slovacca
- Performance Parts	per veicoli senza freno Performance	SOHC/OHC	SOHC/OHC
Pol-Anzahl	N° poli	Sortiment, Armaturen	Assortimento, Strumentazione
Power Disc	Denominazione aggiuntiva dell'articolo, Power Disc	Sortiment, Befestigungselemente	Assortimento, Elementi di fissaggio
Prüfanschluss, Rohrleitungen	Collegamento di controllo, tubazioni	Sortiment, Entlüfterschrauben	Assortimento, Bulloni spurgo aria
Raddurchmesser [Zoll]	Diametro ruota [pollici]	Spezialaufbau	Carrozzeria speciale
Radstand [mm]	Passo ruote [mm]	Stahlfelge	Cerchione in acciaio
Ringstutzen, Rohrleitung	Bocchettone anulare, Tubazione	Starrachse	Assale rigido
- RLG	senza cuscinetto ruota	Steckerausführung	Tipo spina
rot	rosso	Stopfen, Bremsflüssigkeitsbehälter	Tappo, Serbatoio liquido freni
Rückschlagventil	Valvola di non ritorno	SUM	Sistema frenante, Sumitomo
Russia-made	Russia	Textbaustein	
Schalter, Bremsleuchte	Interruttore, Luce posteriore di stop	T-Form (T-Stück)	Forma a T (pezzo T)
Schaltgetriebe	Cambio manuale	TOK	Sistema frenante, Tokico
Schaltgetriebe, automatisch betätigt	Cambio manuale, azionamento automatico	TRW	Sistema frenante, Lucas / TRW
Schaltgetriebe 5 Gang	Cambio manuale a 5 marce	Tschechische Republik	Repubblica ceca
Scheibenbremse	Freno a disco	Türenanzahl	N° portiere
Schlauch	Flessibile	Überwurfmutter	Dado a risvolto
Schlüsselweite	Apertura chiave	Überwurfschraube	Vite a cappello
Schraubanschluss	Raccordo a vite	Ungarn	Ungheria
		USA	USA
		- USA	USA



Technische Übersetzungen

Technical translations - Traducciones técnicas - Traductions techniques - Traduzioni tecniche

IT		IT	
V	Autoventilato ventilato	Ø1	Diametro 1 [mm]
V/	intagliato /autoventilato	Ø2	Diametro 2 [mm]
Ventil, Unterdruckleitung	Valvola, Condotto depressione	•	perforato
Verbindungs-/ Verteilerstück, Rohrleitungen	Pezzo di raccordo / Ripartitore, Tubazioni	→	Anno da N° telaio da
Verschluss, Bremsflüssigkeitsbehälter	Chiusura, serbatoio liquido freni	→	Anno fino a N° telaio fino a
Verschluss-/ Schutzkappe	Cappa di chiusura/protezione	→Orga	N° organizzazione fino a
Verschluss-schraube	Vite di chiusura	→VET	N° VET fino a
Version	Versione	→Ø	Diametro fino a [mm]
VET →	N° VET da		
Vollautomatik	Interamente automatizzato		
VW	Sistema frenante, Volkswagen		
V•	perforato / autoventilato		
wahlweise	a scelta		
Warnkontakt, Bremsbelagverschleiß	Contatto segnalazione, Usura past. freno/mat. d'attrito		
- WE	Non predisposto per contatto segnalazione usura		
- WK	senza contatto segnalazione usura senza segnalatore usura integrato		
x	Larghezza [mm] Altezza [mm]		
x	N° indicatori usura [per asse] N° raccordi		
Zentrierungsdurchmesser [mm]	Diametro centraggio [mm]		
- Zub	senza accessori		
Zubehörsatz, Scheibenbremsbelag	Kit accessori, Pastiglia freno		
zul. Gesamtgewicht [kg]	Peso complessivo omologato [kg]		
Ø	Diametro [mm]		

ATE – A Trademark of the
Continental Corporation

Continental Aftermarket GmbH

Guerickestraße 7
D-60488 Frankfurt am Main
Tel. +49 (0) 69 7603-1
Fax +49 (0) 69 761061

www.ate.de

**Continental Automotive Trading
Italia S.r.l.**

Divisione ATE
Via Matteotti, 62
I-20092 Cinisello Balsamo (MI)
Tel. +39 02 35680 1
Fax +39 02 35680 325
E-Mail: [info.consumatori@
continental-corporation.com](mailto:info.consumatori@continental-corporation.com)

www.ate-freni.it

Continental AutomotiveFrance SAS

Parc Ariane Bâtiment Vénus
Rue Hélène Boucher
F-78280 Guyancourt
Tél. +33 (0)1 39 44 10 30
Fax +33 (0)1 39 44 10 40
E-Mail: [07GYFMate-technique@
continental-corporation.com](mailto:07GYFMate-technique@continental-corporation.com)

www.ate-freinage.fr

Continental Automotive Spain, S.A.

C/ Sepúlveda, 11
E-28108 Alcobendas (Madrid)
Phone +34 (0) 657 21 21
Fax +34 (0)91 657 21 49

www.frenos-ate.es

