



**C3**

## **ATE Classic 2014 (Volkswagen)**

**Bremsen-Ersatzteilprogramm  
Brake Parts Program**



# Kompetenz und Aktualität

## Competence and topicality

### Besuch uns auf Facebook

#### Visit us at facebook



[www.facebook.com/ATE](http://www.facebook.com/ATE)

### ATE Online-Katalog

#### ATE online-catalog



Noch aktuellere Informationen finden Sie im **Online-Katalog** von ATE. Hier werden die Kataloginformationen mindestens monatlich aktualisiert. Sie finden den ATE Online-Katalog in der Rubrik "Kataloge -> Ersatzteile online" im Internet auf unserer Homepage unter [www.ate.de](http://www.ate.de).

Even more current information you find in the ATE **online-catalog**. Here the spare part information are posted at least monthly. You find the ATE online-catalog in the column "Catalogs -> replacement parts" on the Internet on our homepage [www.ate.de](http://www.ate.de).

### ATE wird mobil

#### ATE goes mobile



Das Produktportfolio des Bremsenspezialisten ATE ist jetzt auch mobil

über die Smartphonereihe von Apple zu erreichen. Mit dieser Applikation können Anwender alle Produkte der Marke ATE auf vielfältige Weise suchen und identifizieren. Die Software steht kostenlos im App Store von Apple zum Download bereit. Sie kann über Suchbegriffe wie „ATE“ oder „Bremsen“ leicht gefunden und installiert werden.

The product range of brake specialists ATE is now also accessible on the move using smartphones from Apple. With this application, users can search for and identify all products belonging to the ATE brand in a number of different ways. The software is available for download free of charge in Apple's App Store. It can easily be found and installed using search terms such as "ATE" or "brakes".

Jetzt auch für iPad und Android  
Now also for iPad and Android

### ATE Werkzeugkatalog

#### ATE Catalog Brake service equipment and tools



Die aktuelle Ausgabe heisst WK4 und ist zur Zeit in 7 Sprachen erhältlich.

The current edition called WK4 is by that time available in 7 languages.

# So benutzen Sie den C3

Fahrzeugtypen		Einbauzeitraum (von/bis)		ATE-Artikelnummer (lang)		Bemerkung (Artikel)			
Vorder-/Hinterachse	Fahrgestellnummer (von/bis)	Bemerkung (Fahrzeug)		ATE-Artikelnummer (kurz)		Artikeldefinition			
	kW								
 1,8 T 1,8 T Quattro 2,0 2,0 TFSI	◀ 120 ◀ 120 ◀ 96 ◀ 120	8E-55-99999 04.02 05.03 05.04	08.06 08.06 08.06	PR: 1LB,1LE PR: 1LB,1LE PR: 1LB,1LE PR: 1LB,1LE	11.3571-8522.2 11.3571-8521.2 11.0441-5704.2 11.0101-5409.2	220320 220319 250034 260035	+ ESP + ESP	D=57, - Halter D=57, - Halter Dichtungssatz Hülsenatz	ATE ATE ATE ATE
*	**					***		****	

## \*Produktgruppen

	<b>Bremskraftverstärker</b>		<b>Bremstrommel</b>
	<b>Hauptbremszylinder</b>		<b>ATE Original Kit ATE Original TopKit</b>
	<b>Ausgleichsbehälter</b>		<b>Trommelbremsbacken für Feststellbremse</b>
	<b>Bremssattel</b>		<b>Handbremsseil</b>
	<b>Scheibenbremsbeläge</b>		<b>Bremskraftregler</b>
	<b>Bremsscheibe ATE PowerDisc</b>		<b>Kupplungs- Geberzylinder</b>
	<b>Bremsschlauch</b>		<b>Kupplungs- Nehmerzylinder</b>
	<b>Radsensor</b>		<b>Kupplungsschlauch</b>
	<b>Radzylinder</b>		<b>Kupplungsseil</b>
	<b>Trommelbremsbacken</b>		

## \*\*Lenkungsart

- ◀ Linkslenker
- ▶ Rechtslenker

## \*\*\*\*Herstellerkennung

ATE	Continental Teves (ATE)
AKE	Akebono
AP	AP Lockheed
BDX	Bendix
BOS	Bosch
BRE	Brembo
CIT	Citroën
DEL	Delco
FI	Fiat
FTE	FTE Automotive
LUC	Lucas (TRW)
PER	Perrot
SUM	Sumitomo
TOK	Tokico
VW	Volkswagen

## \*\*\*Einbauposition

	vorne
	hinten
	links
	rechts
	links vorne
	links hinten
	rechts vorne
	rechts hinten
	mitte
	oben
	unten
	Vorderachse
	Vorderachse links
	Vorderachse rechts
	Hinterachse
	Hinterachse links
	Hinterachse rechts

Sämtliche Positionsangaben beziehen sich immer auf die Fahrtrichtung.



























## Abkürzungen

-	Ohne / nicht	L	Legiert / hochgekoht
+	Mit / nur / für	L=	Länge
AUT	Automatische Nachstel- lung	Nz	Nehmerzylinder
B	Beschichtet	PD	PowerDisc
BG	Bremskraftbegrenzer	Rz	Radzylinder
BR	Bremskraftregler	RzR	Radzylinder mit integriertem Regler
BRE	Einschraubregler	S	Fixierschraube / Sattelschraube
BRES	Einschraubreglersatz	THz	Tandem-Hauptzylinder
BRL	Bremskraftregler lastabhängig	V	Belüftet
D=	Durchmesser	WE	Warneinrichtung
Gz	Geberzylinder	WK	Warnkontakt
HEB	Hebel	Zub	Zubehör
H	Hauptzylinder		





# Artikelinformationen

		KURZNUMMER				KURZNUMMER																					
	03.6199-xxxx.4 → 03.61dy-xxxx.4 → 03.67dy-xxxx.4 → 03.68dy-xxxx.4 → 03.69dy-xxxx.4 → 03.77dy-xxxx.4 →	30nnnn 30nnnn 30nnnn 30nnnn 30nnnn 30nnnn	Bremskraftverstärker T50 T51 T52/3 T52 T53 T52/4	<table border="1" data-bbox="550 369 790 582"> <tr> <td>d</td> <td>y</td> </tr> <tr> <td></td> <td>0 = Einfachgerät 5 = Tandemgerät</td> </tr> <tr> <td>2 = 6"</td> <td></td> </tr> <tr> <td>3 = 7"</td> <td></td> </tr> <tr> <td>4 = 8"</td> <td>0 = Einfachgerät</td> </tr> <tr> <td>5 = 9"</td> <td>3 = Einfachgerät BA</td> </tr> <tr> <td>6 = 10"</td> <td>5 = Einfachgerät</td> </tr> <tr> <td></td> <td>8 = Einfachgerät BA</td> </tr> <tr> <td></td> <td>BA = Bremsassistent</td> </tr> <tr> <td></td> <td>Z = Zugankerbremsgeräte</td> </tr> </table>	d	y		0 = Einfachgerät 5 = Tandemgerät	2 = 6"		3 = 7"		4 = 8"	0 = Einfachgerät	5 = 9"	3 = Einfachgerät BA	6 = 10"	5 = Einfachgerät		8 = Einfachgerät BA		BA = Bremsassistent		Z = Zugankerbremsgeräte		24.02dd-dxxx.x →  230/231 × 47	48nnnn  Durchmesser / maximaler Durchmesser × Tiefe
d	y																										
	0 = Einfachgerät 5 = Tandemgerät																										
2 = 6"																											
3 = 7"																											
4 = 8"	0 = Einfachgerät																										
5 = 9"	3 = Einfachgerät BA																										
6 = 10"	5 = Einfachgerät																										
	8 = Einfachgerät BA																										
	BA = Bremsassistent																										
	Z = Zugankerbremsgeräte																										
	03.78dy-xxxx.4 → 03.78dy-xxxx.4 → 03.78dy-xxxx.4 → 03.78dy-xxxx.4 → 03.78dy-xxxx.4 → 03.78dy-xxxx.4 → 03.78dy-xxxx.4 →	30nnnn 30nnnn 30nnnn 30nnnn 30nnnn 30nnnn 30nnnn	T52/4 T52/4Z T52/5 T52/5Z T55/1 T55/1Z		▲ 03.27dd-xxxx.3 → ▲ 03.32dd-xxxx.3 → 03.040x-xxdd.2 → 03.0470-xxdd.2 →	02nnnn 02nnnn 06nnnn 06nnnn	einseitig wirkender Radzylinder Radzylinder Reparatur-Satz (mit Kolben) Dichtungs-Satz (ohne Kolben)																				
	03.78dy-xxxx.4 → 03.78dy-xxxx.4 → 03.78dy-xxxx.4 → 03.78dy-xxxx.4 → 03.78dy-xxxx.4 → 03.78dy-xxxx.4 → 03.78dy-xxxx.4 →	30nnnn 30nnnn 30nnnn 30nnnn 30nnnn 30nnnn 30nnnn	T52/4 T52/4Z T52/5 T52/5Z T55/1 T55/1Z		03.0137-0xxx.2 → 03.0137-9xxx.2 →	650xxx 669xxx	Trommelbremsbacken Bremsbacken-Zubehör																				
	▲ 03.20dd-xxxx.3 → ▲ 03.21dd-xxxx.3 → ▲ 03.23dd-xxxx.3 → ▲ 03.31dd-xxxx.3 →  03.0370-xxdd.2 →	01nnnn 01nnnn 01nnnn 01nnnn  05xxdd	Tandem-Hauptzylinder gestuft Tandem-Hauptzylinder Stufen-Hauptzylinder Hauptzylinder (z. B. 03.2122-: Ø=22,20) Reparaturatz		185 × 31 AUT HEB Zub		Durchmesser × Breite mit automatischer Nachstellung mit Hebel mit Zubehör																				
	03.3508-xxxx.x → 03.3509-xxxx.x → 03.3558.0xxx.x → 03.0101-xxxx.2 →	31nnnn 31nnnn 31nnnn 39nnnn	Ausgleichsbehälter Ausgleichsbehälter Ausgleichsbehälter Reparaturatz		03.0420-xxdd.3 → 03.0520-xxdd.3 →	68xxdd 69xxdd	ATE Original Kit ATE Original TopKit (Radzylinder + Trommelbrems- backen + Einbausatz) dd = Nennmaß Radzylinder																				
	▲ 11.3ddx-xxxx.2 → 11.9ddx-xxxx.2 → ▲ 13.2ddx-xxxx.2 → ▲ 13.4ddx-xxxx.2 → 13.9ddx-xxxx.2 → 24.3ddx-xxxx.5 → 11.0441-ddxx.2 → 13.0441-ddxx.2 → 11.0230-xxxx.2 →  24.0101-xxxx.2 →  ▲ 11.0101-xxxx.2 → 11.8116-xxxx.1 →	22nnnn 22nnnn 21nnnn 21nnnn 21nnnn 24nnnn 25nnnn 25nnnn 26nnnn  26nnnn  26nnnn 39nnnn	Faustsattel Faustsattel 2-Zyl. Festsattel 4-Zyl. Festsattel Festsattel Austauschsattel Faustsattel Dichtungs-Satz Dichtungs-Satz Faustsattelhalter-Satz (Halter, Schiebehülzensatz, Führungsbolzen) Bremsattel-Zubehör (Schiebehülzensatz, Führungsbolzen) Schiebehülzensatz Haltefeder		03.0137-0xxx.2 → 03.0137-9xxx.2 →	650xxx 669xxx	Feststellbremse (Trommelbremsbacken) Einbausatz																				
	13.0460-xxxx.2 → 13.0460-0xxx.2 → 24.8190-xxxx.2 →	60xxxx 610xxx 62xxxx	Scheibenbremsbelag Belagsatz-Zubehör Warnkontakt		185 × 31 AUT HEB Zub		Durchmesser × Breite mit automatischer Nachstellung mit Hebel mit Zubehör																				
	20034 15,0 + WE WK S Zub		WVA-Nummer / Dicke weitere WVA-Nummern siehe Anhang Warneinrichtung mit Warnkontakt mit Sattelschraube mit Zubehör		24.3727-xxxx.2 →	58xxxx	Handbremsseil																				
					83.5yxx-LLLL.3 → 83.6yxx-LLLL.3 → 83.7yxx-LLLL.3 →	33nnnn 33nnnn 33nnnn	Brems-/Kupplungsschlauch Brems-/Kupplungsschlauch Brems-/Kupplungsschlauch  y = 1: Gewinde 1 × innen/1 × außen y = 2: Gewinde 2 × innen y = 3: Gewinde 2 × außen																				
					03.60xx-xxxx.3 → 03.65xx-xxxx.3 → 03.0101-xxxx.2 →	32nnnn 32nnnn 32nnnn	Bremskraftregler (BR) Bremskraftbegrenzer (BG) Einschraubregler (BRE) Bremskraftregler lastabhängig (BRL) Einschraubregler-Satz (BRES)																				
					35/3 braun (4)		Kennzeichen, Farbmarkierung (Anzahl der Anschlüsse)																				
					▲ 03.24dd-xxxx.3 → 03.0350-ddxx.2 →	03nnnn 07ddxx	Kupplungs-Geberzylinder (z. B. 03.2419-: Ø=19,05) Dichtungs-Satz																				
	24.01dd-xxxx.x → 24.03dd-xxxx.x →	4ddxxx 5ddxxx	Bremsscheibe ATE PowerDisc dd = Dicke (z.B. 24.0322- : Dicke = 22)		▲ 03.25dd-xxxx.3 → 03.0450-ddxx.2 →	04nnnn 08ddxx	Kupplungs-Nehmerzylinder (z. B. 03.2525-: Ø=25,40) Dichtungs-Satz																				
	284 22 20 V L PD B V L S PD		Durchmesser / Dicke / Mindestdicke beschichtet belüftet legiert / hochgekohlt Fixierschraube ATE PowerDisc		24.3728-xxxx.2 →	59xxxx	Kupplungsseil																				
					24.07xx-xxxx.x →	36nnnn	Radsensor																				

nnnn = Die letzten vier Ziffern entsprechen einer Zählnummer.

dd = Nennmaß

▲ Auch 24. bei gleicher Benummerungssystematik möglich.

■ Auch 03., 24. und 83. bei gleicher Benummerungssystematik möglich.

Nachdruck, auch auszugsweise, nur mit unserer Genehmigung gestattet. Ersatzansprüche auf Grund von Angaben in diesem Katalog können nicht anerkannt werden. Konstruktionsänderungen vorbehalten. Soweit wir in unseren Unterlagen Bezug nehmen auf die Ersatzteilnummer des Fahrzeugherstellers, dient dies nur zu Vergleichszwecken. Eine Verwendung derartiger Angaben in Rechnungen an den Fahrzeugbesitzer ist nicht statthaft.

Die Modell- und Ersatzteilmultifalt einiger Fahrzeughersteller erlaubt nicht immer eine genaue Zuordnung. Bitte beachten Sie daher besonders die im Katalog aufgeführten Bemerkungen und Ersatzteilbeschreibungen.

# C3

## **(D)** Inhaltsverzeichnis

ATE Classic	2
Bremsflüssigkeit	4
Fahrzeugregister	7
Fahrzeugverwendungen	11
Abmessungen Bremsscheiben	385
Armaturen	397
Bremsgeräte komplett	411
Reparatursätze	425
Vergleichsliste	439
Technische Übersetzungen	479
So benutzen Sie den C3	489

## **(EN)** Table of contents

ATE Classic	2
Brake fluid	4
Index of vehicles	7
Applications of vehicles	11
Dimensions brake discs	385
Fittings	397
Booster units complete	411
Repair kits	425
Cross reference list	439
Technical translations	479
How to use the C3	489

## **(FR)** Table des matières

ATE Classic	2
Liquides de frein	4
Liste des véhicules	7
Applications	11
Dimensions Disques de frein	385
Composants et accessoires	397
Servo-freins complets	411
Nécessaires de réparation	425
Liste des correspondances	439
Traductions techniques	479
Utilisation du catalogue C3	489

## **(ES)** Índice

ATE Classic	2
Líquido de freno	4
Índice de vehículos	7
Aplicaciones	11
Medidas disco de freno	385
Assesorios	397
Servofreno completo	411
Juegos de reparación	425
Lista comparativa WVA	439
Traducciones técnicas	479
Use así el C3	489

# ATE Classic – Teile und Service

Originalgetreue Bremseninstandsetzung  
für Old- und Youngtimer

Wir lieben Oldies

**Old- und Youngtimer wecken Emotionen. Sie werden liebevoll restauriert und gepflegt. Denn sie sollen ihren Besitzern möglichst lange erhalten bleiben. Neben dem optischen Anspruch sollen sie natürlich auch sicher im Straßenverkehr unterwegs sein. Hierzu brauchen sie vor allem intakte Bremsen.**

#### Originalgetreue Bremseninstandsetzung

Mit der neuen Produktfamilie ATE Classic unterstützen wir von Continental Freunde klassischer Automobile bei der professionellen und originalgetreuen Bremseninstandsetzung. ATE Classic bietet ein breit gefächertes Programm an Bremsenersatzteilen speziell für Old- und Youngtimer. Zudem gibt es unter dem neuen Produktnamen Classic einen zielgruppenorientierten Service für das Beschaffen rar gewordener Komponenten von Bremssystemen.

#### Nachschlagewerk für Bremsenersatzteile

In unserem neuen ATE Classic Katalog finden Fachleute ein breites Spektrum verfügbarer Bremsenersatzteile. Dieses Programm haben wir speziell für Pkw und Nkw zusammengestellt, die älter sind als 20 Jahre. Das ATE Classic Programm umfasst alle Produktgruppen innerhalb des Bremssystems und reicht von Verschleißteilen bis hin zu mechanischen und hydraulischen Betätigungskomponenten.

#### Besonderer Service für besondere Fahrzeuge

Sollte ein Bremsenersatzteil nicht im ATE Classic Katalog zu finden sein, können Sie sich mit Hilfe eines Anfrageformulars unter [www.ate-classic.de](http://www.ate-classic.de) direkt an unsere ATE Classic Vertriebs-Spezialisten wenden. Wir prüfen, ob das benötigte Ersatzteil im Lager verfügbar ist oder neu produziert werden kann. Darüber hinaus beraten wir Sie über technisch gleichwertige Alternativen und geben Hinweise auf mögliche Bezugsquellen.

#### Klassik-Kompetenz steigern - neue Kunden gewinnen

Die Marke ATE hat eine lange Tradition in der Automobilgeschichte. Schon seit mehr als hundert Jahren entwickelt und produziert ATE innovative Bremssysteme. Zahlreiche wegweisende Entwicklungen in der Bremsentechnik sind auf das Know-how von ATE zurückzuführen. Mit ATE Classic bündeln wir von Continental im Automotive Aftermarket nun diese Erfahrungen und helfen Ihnen, den Fachleuten aus Handel und Kfz-Werkstätten, ihre Klassik-Kompetenz auszubauen. Zudem öffnet ATE Classic den Zugang zu neuen Kundengruppen.



#### ATE Classic: Vorteile im Überblick

- umfangreiches Produktprogramm – speziell für Pkw und Nfz, die älter sind als 20 Jahre
- Übersichtlicher ATE Classic Katalog
- schnelle Lieferung der im Katalog gelisteten Ersatzteile über den Fachhandel
- Verfügbarkeit des ATE Classic Programms in elektronischen Teilekatalogen (TecDoc)
- sichere und originalgetreue Bremsenreparatur dank ATE Bremsenersatzteilen in OE-Qualität
- Beratung über technisch gleichwertige Alternativen
- Hilfestellung beim Beschaffen vergriffener Ersatzteile

# ATE Classic – parts and service

Brake repairs with authentic parts for classic  
and near-classic cars



We love classic cars

**Classic cars – and those that are on the way to becoming classics – evoke strong emotions. They are restored and maintained with loving care, and their owners want to keep them in top condition for as long as possible. While preserving a first-rate appearance is an important goal, these cars must be safe on the road as well. And that means having effective brakes.**

#### **Brake repairs with authentic parts**

Continental's new ATE Classic product family allows classic car enthusiasts to carry out professional brake repairs with parts that match the originals. ATE Classic provides an extensive line of replacement parts suited especially for classic and near-classic cars. In addition, the new Classic service helps owners to procure brake system components that have become hard to find.

#### **Reference work for replacement brake parts**

Our new ATE Classic catalog offers professionals a wide range of replacement parts for brakes. We've put together this selection especially for cars and commercial vehicles that are over 20 years old. The ATE Classic product family includes all brake system product groups, from wear parts all the way up to mechanical and hydraulic actuation components.

#### **A special service for special vehicles**

If you do not find a particular replacement part in the ATE Classic catalog, you can contact our ATE Classic sales specialists directly using a query form at [www.ate-classic.com](http://www.ate-classic.com). We'll check whether we have the part in stock and, if not, whether we can produce a new one. Moreover, we'll advise you on alternatives that are equally effective from a technical standpoint and tell you where you can obtain them.

#### **Enhance your classic car expertise and win new customers**

The ATE brand has a longstanding reputation in the automotive industry. For more than one hundred years, ATE has developed and manufactured innovative brake systems, introducing many groundbreaking advances. Now, with ATE Classic, Continental has brought all this experience together. ATE Classic will help you as a dealer or repair facility to enhance your expertise in classic cars, enabling you to gain access to new customer groups.



#### **ATE Classic: summary of the advantages**

- Extensive product range geared to cars and commercial vehicles over 20 years old
- Easy-to-use ATE Classic catalog
- Quick delivery, via specialist dealers, of spare parts listed in the catalog
- Availability of ATE Classic products in electronic parts catalogs (TecDoc)
- Reliable brake repairs that are true to the original, using ATE spare parts in OEM quality
- Advisory service for finding equally effective alternatives
- Support in procuring spare parts that are no longer on the market
- Enhancement of classic car expertise for dealers and repair facilities, thus providing access to new customer groups
- Further information at [www.ate-classic.com](http://www.ate-classic.com)

# Original ATE Bremsflüssigkeiten

Bremsflüssigkeitswechsel: Für Ihre Sicherheit unverzichtbar

## Original ATE Brake Fluids

Brake fluid changes: mandatory for optimum safety



Bremsflüssigkeit Brake Fluid	ATE G	ATE SL	ATE SL.6	ATE TYP 200
	<b>DOT 3</b>	<b>DOT 4</b>	<b>DOT 4</b> <b>ISO-Klasse 6 · ISO Class 6</b>	<b>DOT 4</b> <b>The new racing quality</b>
	Unsere Traditionsreichel!	Millionenfach bewährte DOT 4-Qualität	Niedrigviskose Flüssigkeit, ersetzt die Super DOT 4, für elektronische Bremsysteme	Minimaler Siede- punktabfall durch hervorragendes Wasserbindungs- vermögen
	Our tradition- steeped fluid!	DOT 4 quality proven millions of times	Low-viscosity fluid, replaces Super DOT 4, for electronic brake systems	Minimal drop in boiling point due to outstanding water binding properties
<b>Siedepunkt mind.</b> <b>Boiling point min.</b>	245°C	260°C	265°C	280°C
<b>Nass-Siedepunkt mind.</b> <b>Wet boiling point min.</b>	150°C	165°C	175°C	198°C
<b>Viskosität bei -40°C</b> <b>Viscosity at -40°C</b>	max.1500 mm <sup>2</sup> /s	max. 1400 mm <sup>2</sup> /s	max. 700 mm <sup>2</sup> /s	max.1400 mm <sup>2</sup> /s
<b>Wechselintervall</b> <b>Change interval</b>	<b>bis 1 Jahr</b> <b>up to 1 year</b>	<b>bis 1 Jahr</b> <b>up to 1 year</b>	<b>bis 2 Jahre</b> <b>up to 2 years</b>	<b>bis 3 Jahre</b> <b>up to 3 years</b>

für Fahrzeugbaujahre bis ca. 1990  
for vehicles built up to 1990

Zur Erhaltung der Funktionssicherheit der Bremsanlage muss Bremsflüssigkeit entsprechend der vom Fahrzeughersteller vorgegebenen Qualität und den Wechselintervallen gewechselt werden.

To maintain the functional reliability of the brake system, brake fluid must be changed according to the specifications of the vehicle manufacturer (quality and change interval).

ATE Bremsflüssigkeiten (ausser LHM PLUS) dürfen nicht in Bremsanlagen eingefüllt werden, die für den Betrieb mit Mineral-Hydrauliköl ausgelegt sind.

ATE Brake Fluids (except LHM PLUS) must not be poured into brake systems that are designed for use with mineral hydraulic oil.

DOT = US-amerikanisches Sicherheitsgesetz für Bremsflüssigkeit

DOT = US Department of Transportation legal safety standards for brake fluids



Typ Type	ATE Sachnummer ATE partnumber	EAN-Nr. 4006633 EAN-No. 4006633	Gebinde Container size	Paletteneinheit* Pallet units*
<b>G</b> SAE Spezifikation J1703-FMVSS 116/DOT 3	<b>705302</b> 03.9901-5302.2/02	10199 8	1 l	D
	<b>705303</b> 03.9901-5303.2/02	10201 8	5 l	F
größere Gebinde auf Anfrage - <a href="#">Bigger container sizes on demand</a>				
<b>SL</b> SAE Spezifikation J1703-FMVSS 116/DOT 4	<b>705808</b> 03.9901-5808.2/02	49000 9	1/4 l	A
	<b>705801</b> 03.9901-5801.2/02	49001 6	1/2 l	B
	<b>705802</b> 03.9901-5802.2/02	49002 3	1 l	D
	<b>705803</b> 03.9901-5803.2/02	49003 0	5 l	F
	<b>705811</b> 03.9901-5811.2/02	29907 7	20 l	R
	<b>705820</b> 03.9901-5820.2/01	10824 9	30 l	H
	<b>705814</b> 03.9901-5814.2/01	10366 4	50 l	P
	<b>705805</b> 03.9901-5805.2/01	49005 4	200 l	S
<b>NEW</b> <b>SL.6</b> SAE Spezifikation J1703-FMVSS 116/DOT 4 ISO Klasse 6 - <b>niedrigviskos</b>	<b>706408</b> 03.9901-6408.2/02	22762 9	1/4 l	A
	<b>706402</b> 03.9901-6402.2/02	20746 1	1 l	D
	<b>706403</b> 03.9901-6403.2/02	20748 5	5 l	F
	<b>706411</b> 03.9901-6411.2/02	20750 8	20 l	R
	<b>706420</b> 03.9901-6420.2/02	23120 6	30 l	H
	<b>706414</b> 03.9901-6414.2/02	23005 6	50 l	P
	<b>706405</b> 03.9901-6405.2/02	23121 3	200 l	S
<b>TYP 200</b> The new racing quality SAE Spezifikation J1703-FMVSS 116/DOT 4	<b>706202</b> 03.9901-6202.2/02	10825 6	1 l	D
	<b>706203</b> 03.9901-6203.2/02	12166 8	5 l	F
	<b>706220</b> 03.9901-6220.2/01	12780 6	30 l	H
	<b>706214</b> 03.9901-6214.2/01	12779 0	50 l	P
	<b>706205</b> 03.9901-6205.2/01	12778 3	200 l	S
<b>SUPER DOT 4</b> SAE Spezifikation J1703-FMVSS 116/DOT 4	<b>706020</b> 03.9901-6020.2/01	14544 2	30 l	H
	<b>706005</b> 03.9901-6005.2/01	07769 9	200 l	S
<b>LHM PLUS</b> Mineral-Hydrauliköl, ISO 7308 <b>Mineral-Hydraulic Oil, ISO 7308</b>	<b>700016</b> 24.9903-5001.2/02	07259 5	1 l	N
	<b>700017</b> 24.9903-5005.2/02	07261 8	5 l	O
<b>ATE Bremszylinder-Paste</b> <b>ATE Brake Cylinder Paste</b>	<b>700009</b> 03.9902-0501.2/02	13536 8	180 g	L
	<b>700010</b> 03.9902-0503.2/01	13532 0	5 kg	K
	<b>700011</b> 03.9902-0504.2/01	13530 6	40 kg	P
<b>ATE Prüfflüssigkeit</b> <b>ATE Testing Fluid</b>	<b>700002</b> 03.9902-0116.2/02	10374 9	5 l	F
<b>ATE plastilube®</b>	<b>700014</b> 03.9902-1001.2/02	05176 7	35 ml	I
	<b>700015</b> 03.9902-1002.2/02	05184 2	75 ml	J
<b>ATE Leerkanne</b> <b>ATE neutral empty container</b>	<b>740169</b> 03.9302-1474.1/01	07782 8	25 l	-
<b>Ausgiesser für 5-l-Kanne</b> <b>Spout for 5l Container</b>	<b>760070</b> 03.9314-5940.3/01	07786 6	-	-
<b>Kannen-Auslass-Hahn für 5l &amp; 20l Kanne</b> <b>Tap for 5l and 20l Container</b>	<b>760153</b> 03.9314-5960.3/02	30855 7	-	-

**\*Paletteneinheit:**

A = 1728 Kannen je Palette (24 Kannen je Karton)	J = 1728 Tuben je Palette (12 Tuben je Karton)
B = 1200 Kannen je Palette (20 Kannen je Karton)	K = 60 Eimer je Palette
C = 600 Kannen je Palette (20 Kannen je Karton)	L = 1800 Tuben je Palette (40 Tuben je Karton)
D = 600 Kannen je Palette (10 Kannen je Karton)	M = 18 Kannen je Palette
E = 360 Kannen je Palette (10 Kannen je Karton)	N = 300 Kannen je Palette (10 Kannen je Karton)
F = 144 Kannen je Palette ( 4 Kannen je Karton)	O = 64 Kannen je Palette ( 4 Kannen je Karton)
G = 50 Kannen je Palette	P = 12 Kannen je Palette
H = 22 Kannen je Palette	R = 36 Kannen je Palette
I = 5040 Tuben je Palette (24 Tuben je Karton)	S = 1 Stück

**\*Pallet units:**

A = 1728 containers per pallet (24 containers per box)	J = 1728 tubes per pallet (12 tubes per box)
B = 1200 containers per pallet (20 containers per box)	K = 60 buckets per pallet
C = 600 containers per pallet (20 containers per box)	L = 1800 tubes per pallet (40 tubes per box)
D = 600 containers per pallet (10 containers per box)	M = 18 containers per pallet
E = 360 containers per pallet (10 containers per box)	N = 300 containers per pallet (10 tubes per box)
F = 144 containers per pallet ( 4 containers per box)	O = 64 containers per pallet ( 4 containers per box)
G = 50 containers per pallet P	= 12 containers per pallet
H = 22 containers per pallet R	= 36 containers per pallet
I = 5040 tubes per pallet (24 tubes per box)	S = 1 piece





A series of horizontal lines for writing, filling the majority of the page.



Ⓛ **Fahrzeugregister**

Ⓛ **Index of vehicles**

Ⓛ **Liste des véhicules**

Ⓛ **Índice de vehículos**



## VOLKSWAGEN

GOLF II (84-93)	12
KÄFER (TYP 1) (49-03)	16
1500/1600 (TYP 3) (61-75)	17
CADDY I (83-92)	18
CORRADO (88-95)	18
DERBY/POLO Stufenheck (77-88)	20
GOLF I Cabriolet (79-93)	21
GOLF I (74-83)	22
JETTA I (79-83)	24
JETTA II (84-92)	26
PASSAT Limousine (85-88)	29
PASSAT Variant (73-84)	31
PASSAT Variant (85-88)	33
PASSAT/SANTANA Limousine (73-84)	34
PASSAT (88-93)	37
POLO I (75-81)	40
POLO II (81-94)	41
SCIROCCO I (74-83)	42
SCIROCCO II (84-92)	43
TRANSPORTER (Typ 2) (60-79)	44
TRANSPORTER (Typ 2) (79-92)	46
TYP 181 (69-79)	48







A large rectangular area containing 30 horizontal lines, intended for writing or drawing.



Ⓓ Fahrzeugverwendungen

Ⓔ Applications of vehicles

Ⓕ Applications

Ⓖ Aplicaciones



**VOLKSWAGEN GOLF II (84-93)**

	1.6	◀		08.83	07.87	- ABS/ + Automatikgetriebe <sup>1)</sup>	03.6750-0202.4	300033		9"	ATE	
	1.6	◀		08.87	12.93	- ABS						
	1.6 D	◀		08.83	07.89	- ABS/ + Automatikgetriebe <sup>1)</sup>						
	1.6 TD	◀		08.83	07.89	- ABS						
	1.8	◀		08.83	07.89	- ABS						
	1.8 GTI	◀		1G-KW240000	01.84	- ABS						
	1.8 GTI	◀		1G-KB075000	01.84	- ABS						
	1.8 GTI 16V	◀		1G-KW240000	02.86	- ABS						
	1.8 GTI 16V	◀		1G-KB075000	02.86	- ABS						
	1.8 Rallye	◀			04.89	07.92	- ABS					
1.8 Syncro	◀			08.85	07.92	- ABS						
1.8 Syncro G60	◀			04.89	07.92	- ABS						
	1.6 D	◀		08.89	07.92	- ABS	03.7750-4302.4	300076		9"	ATE	
	1.6 TD	◀		08.89	12.93	- ABS						
	1.8	◀		08.89	07.92	- ABS						
	1.8 G60	◀		04.90	07.92	- ABS						
	1.8 GTI	◀	1G-KW240001		07.92	- ABS						
	1.8 GTI	◀	1G-KB075001		07.92	- ABS						
	1.8 GTI 16V	◀	1G-KW240001		07.92	- ABS						
	1.8 GTI 16V	◀	1G-KB075001		07.92	- ABS						
	1.6	▶		08.89	12.93	- ABS	03.7750-4902.4	300079		9"	ATE	
	1.6 D	▶		08.89	07.92	- ABS						
1.6 TD	▶		08.89	12.93	- ABS							
1.8	▶		08.89	07.92	- ABS							
1.8 G60	▶		04.90	07.92	- ABS							
1.8 GTI	▶	1G-KW240001		07.92	- ABS							
1.8 GTI	▶	1G-KB075001		07.92	- ABS							
1.8 GTI 16V	▶	1G-KW240001		07.92	- ABS							
1.8 GTI 16V	▶	1G-KB075001		07.92	- ABS							
	1.0			08.83	10.91	- ABS	03.2120-2031.3	010106		THz 20,64	ATE	
	1.3			08.83	12.93	- ABS	03.3517-0101.2	390322		Verschlußschraube		
	1.6			08.83	12.93	- ABS						
	1.6 D			08.83	07.89	- ABS						
	1.6 TD			08.83	07.89	- ABS						
	1.8			08.83	07.89	- ABS						
	1.8 GTI			1G-KW240000	01.84	- ABS						
	1.8 GTI			1G-KB075000	01.84	- ABS						
	1.8 GTI 16V			1G-KW240000	02.86	- ABS						
	1.8 GTI 16V			1G-KB075000	02.86	- ABS						
1.8 Rallye				04.89	07.92	- ABS						
1.8 Syncro				08.85	07.92	- ABS						
1.8 Syncro G60				04.89	07.92	- ABS						
	1.6 D			08.89	07.92	- ABS	03.2120-3943.3	010532		THz 20,64	ATE	
	1.6 TD			08.89	12.93	- ABS	03.3517-0101.2	390322		Verschlußschraube		
	1.8			08.89	07.92	- ABS						
	1.8 G60			04.90	07.92	- ABS	03.2122-1042.3	010137		THz 22,20	ATE	
1.8 GTI		1G-KB075001		07.92	- ABS	03.3517-0101.2	390322		Verschlußschraube			
1.8 GTI		1G-KW240001		07.92	- ABS							
1.8 GTI 16V		1G-KB075001		07.92	- ABS							
1.8 GTI 16V		1G-KW240001		07.92	- ABS							
	1.0	▶		19-E-855000	08.83		24.3481-1745.5	240277	☐	D=48, - Halter	ATE	
	1.0	◀			08.83	07.86	24.3481-1746.5	240278	☐	D=48, - Halter	ATE	
	1.0				08.86	10.91	- ABS	11.0441-4808.2	250022		Dichtungssatz	ATE
	1.3	▶		19-E-855000	08.83		11.0101-4803.2	260008		Hülssensatz	ATE	
	1.3	◀			08.83	07.86	24.0102-4803.2	260086		Hülssensatz+Schrauben	ATE	
	1.3				08.86	12.93	- ABS					
	1.6 D	▶		19-E-855000	08.83							
	1.6 D				08.83	07.86	- Ⓟ					
	1.6 D	◀			08.83	07.86	- Ⓟ					
	1.6 D				08.86	07.92	+ Schaltgetriebe <sup>2)</sup>					
1.0	▶	19-E-855001		08.89	07.86		11.0441-4808.2	250022		Dichtungssatz	ATE	
1.0				08.89	10.91	+ ABS	11.0101-4801.2	260006		Hülssensatz	ATE	
1.3	▶	19-E-855001			07.86		24.0102-4801.2	260085		Hülssensatz+Schrauben	ATE	
1.3				08.89	12.93	+ ABS						
1.6				08.83	12.93							
1.6 D	▶	19-E-855001			07.86	- Ⓟ						
1.6 D				08.83	07.86	+ Ⓟ						
1.6 D				08.86	07.92	+ Automatikgetriebe <sup>3)</sup>						
1.6 TD				08.83	12.93							
1.8				08.83	07.92							
1.8 GT				08.85	07.92							
1.8 GT Special				08.85	07.92							
1.8 GTI				01.84	07.92							
1.8 GTI 16V				1G-KW240000	02.86							
1.8 GTI 16V				1G-KB075000	02.86							
1.8 Syncro				08.85	07.92							
1.8 GTI 16V		1G-KW240001			07.92		24.3541-1609.5	240039	☐	D=54, - Halter	LUC	
1.8 GTI 16V		1G-KB075001			07.92		24.3541-1610.5	240040	☐	D=54, - Halter	LUC	
							24.0101-4301.2	260047		Bremssattel-Zubehör	LUC	
							11.0101-5403.2	260010		Faltenbalgsatz	LUC	
1.8 G60			1G-MW720000	04.90			24.0101-4301.2	260047		Bremssattel-Zubehör	LUC	
1.8 G60			1G-MB225000	04.90			11.0101-5403.2	260010		Faltenbalgsatz	LUC	
1.8 Rallye			1G-MW720000	04.89								
1.8 Rallye			1G-MB225000	04.89								
1.8 Syncro G60			1G-MW720000	04.89								
1.8 Syncro G60			1G-MB225000	04.89								

<sup>1)</sup> - ABS/ + autom.transmission / - ABS/ + scatola cambio autom. / - ABS/ + transmission automatique / - ABS/ + cambio automático

<sup>2)</sup> + manual transmission / + scatola cambio velocità / + transmission mécanique / + cambio de velocidad

<sup>3)</sup> + autom.transmission / + scatola cambio automatico / + transmission automatique / + cambio automático





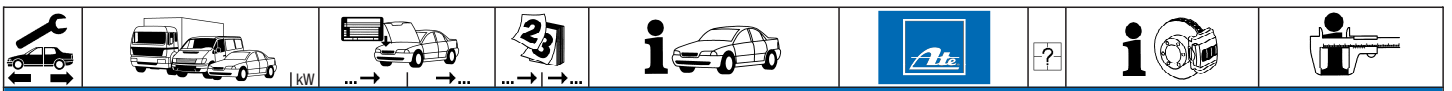

**VOLKSWAGEN GOLF II (84-93)**

	1.8 G60	1G-MW720001		07.92	24.3541-1731.5	240061	D=54, - Halter D=54, - Halter	LUC LUC			
	1.8 G60	1G-MB225001		07.92	24.3541-1732.5	240062					
	1.8 Rallye	1G-MW720001		07.92							
	1.8 Rallye	1G-MB225001		07.92							
	1.8 Syncro G60	1G-MW720001		07.92							
	1.8 Syncro G60	1G-MB225001		07.92							
	1.0		19-E-855000	08.83	07.86	13.0460-7030.2	607030	20889 17,3 /Zub Belagsatz-Zubehör	VW VW		
	1.0			08.83	07.86	13.0460-0184.2	610184				
	1.0			08.86	10.91 - ABS						
	1.3		19-E-855000	08.83	07.86						
	1.3			08.83	07.86						
	1.3			08.86	12.93 - ABS						
	1.6	53		08.83	07.86						
	1.6 D		19-E-855000	08.83	07.86						
	1.6 D			08.83	07.86						
	1.6 D			08.86	07.92 + Schaltgetriebe 1)						
	1.0		19-E-855001	08.89	10.91 + ABS	13.0460-7032.2	607032			20887 19,7 +/Zub	VW
	1.0			08.89	07.86						
	1.3		19-E-855001	08.89	12.93 + ABS						
	1.3			08.89	07.86						
	1.6			08.86	12.93						
	1.6	55		08.83	07.86						
	1.6 D		19-E-855001	08.83	07.86						
	1.6 D			08.83	07.86						
1.6 D			08.86	07.92 + Automatikgetriebe 2)							
1.6 TD			08.83	12.93							
1.8	62		01.84	07.92 - ABS/ - GT							
1.8	66		01.84	07.92 - ABS/ - GT							
1.8 Syncro			08.85	07.92							
1.8	62	19-JH560001		07.92 + ABS	13.0460-7033.2	607033	20887 15,3 +/Zub	VW			
1.8	66	19-JH560001		07.92 + ABS							
1.8	77		08.88	07.92 + ⌚							
1.8 GT			08.85	07.92							
1.8 GT Special			08.85	07.92							
1.8 GTI			01.84	07.92							
1.8 GTI 16V			02.86								
1.8 GTI 16V			02.86								
1.8 GTI 16V		1G-KW240000		07.92	13.0460-2957.2	602957	20168 16,0 /S	LUC			
1.8 GTI 16V		1G-KB075001		07.92							
1.8 G60			04.90	07.92	13.0460-2958.2	602958	20168 19,3 /S	LUC			
1.8 Rallye			04.89	07.92							
1.8 Syncro G60			04.89	07.92							
	1.0		19-E-855000	08.83	07.86	24.0110-0151.1	410151	239 10,0 8,0 +S +B 239 10,0 8,0 +S +B PD			
	1.0			08.83	07.86	24.0310-0151.1	510151				
	1.0			08.86	10.91 - ABS						
	1.3		19-E-855000	08.83	07.86						
	1.3			08.83	07.86						
	1.3			08.86	12.93 - ABS						
	1.6	53		08.83	07.86						
	1.6 D		19-E-855000	08.83	07.86						
	1.6 D			08.83	07.86						
	1.6 D			08.86	07.92 + Schaltgetriebe 1)						
	1.0		19-E-855001	08.89	07.86	24.0112-0106.1	412106			239 12,0 10,0 +S +B 239 12,0 10,0 +S +B PD	
	1.0			08.89	10.91 + ABS	24.0312-0106.1	512106				
	1.3		19-E-855001	08.89	07.86						
	1.3			08.89	12.93 + ABS						
	1.6			08.86	12.93						
	1.6	55		08.83	07.86						
	1.6 D		19-E-855001	08.83	07.86						
	1.6 D			08.83	07.86						
1.6 D			08.86	07.92 + Automatikgetriebe 2)							
1.6 TD			08.83	12.93							
1.8	62		01.84	07.92 - ABS/ - GT							
1.8	66		01.84	07.92 - ABS/ - GT							
1.8 Syncro			08.85	07.92							
1.8			01.84	07.92	24.0120-0123.1	420123	239 20,0 18,0 V L +S +B 239 20,0 18,0 V L +S +B PD				
1.8	62	19-JH560001		07.92 + ABS	24.0320-0123.1	520123					
1.8	66	19-JH560001		07.92 + ABS							
1.8	77		08.88	07.92 + ⌚							
1.8 GT			08.85	07.92							
1.8 GT Special			08.85	07.92							
1.8 GTI			01.84	07.92							
1.8 GTI 16V			02.86								
1.8 GTI 16V			02.86								
1.8 GTI 16V		1G-KW240001		07.92	24.0120-0128.1	420128	256 20,0 18,0 V L +S +B 256 20,0 18,0 V L +S +B PD				
1.8 GTI 16V		1G-KB075001		07.92	24.0320-0128.1	520128					
1.8 G60			04.90	07.92	24.0122-0101.1	422101	280 22,0 20,0 V L +B				
1.8 Rallye			04.89	07.92							
1.8 Syncro G60			04.89	07.92							
	1.0			08.83	10.91	24.5170-0315.3	331309	L=315			
	1.3			08.83	12.93						
	1.6			08.83	12.93						
	1.6 D			08.83	07.92						
	1.6 TD			08.83	12.93						
	1.8			08.83	07.92						
1.8 GTI			01.84								
			1G-KW240000	01.84							

1) + manual transmission / + scatola cambio velocità / + transmission mécanique / + cambio de velocidad  
 2) + autom.transmission / + scatola cambio automatico / + transmission automatique / + cambio automático



**VOLKSWAGEN GOLF II (84-93)**

	1.8 GTI		1G-KB075000	01.84		24.5170-0315.3	331309	2		L=315		
	1.8 GTI 16V		1G-KW240000	02.86								
	1.8 GTI 16V		1G-KB075000	02.86								
	1.8 Syncro			08.85	07.92							
	1.8 GTI		1G-KW240001		07.92		83.6225-0287.3	330735	2		L=285	
	1.8 GTI		1G-KB075001		07.92							
	1.8 GTI 16V		1G-KW240001		07.92							
	1.8 GTI 16V		1G-KB075001		07.92							
	1.8 G60			04.90	07.92		83.7813-0330.3	330800	2		L=330	
	1.8 Rallye			04.89	07.92							
	1.8 Syncro G60			04.89	07.92							
	1.0				08.86	10.91		24.0711-1313.3	360016	2		Radsensor L=1130
	1.3				08.86	12.93						
	1.6				08.86	12.93						
	1.6 D				08.86	07.92						
	1.6 TD				08.86	12.93						
	1.8				08.86	07.92						
	1.8 G60				04.90	07.92						
	1.8 GTI				08.86	07.92						
	1.8 GTI 16V				02.86	07.92						
	1.8 Rallye				04.89	07.92						
	1.8 Syncro				02.86	07.92						
	1.8 Syncro G60				04.89	07.92						
	1.8 GT				08.85	07.88	- ABS / - Special 1)	24.3364-1605.5	240011		D=36, - Halter	LUC
	1.8 GTI				01.84	07.88	- ABS	24.3364-1606.5	240012		D=36, - Halter	LUC
	1.8 GTI 16V				02.86	07.88	- ABS	24.0101-3601.2	260044		Bremssattel-Zubehör	LUC
								11.0101-5403.2	260010		Faltenbalgsatz	LUC
	1.8	62	19-JH480001			07.88	+ ABS	24.3384-1603.5	240015		D=38, - Halter	LUC
	1.8	66	19-JH480001			07.88	+ ABS	24.3384-1604.5	240016		D=38, - Halter	LUC
	1.8 GT		19-JH480001			07.88	+ ABS / - Special 2)	24.0101-3601.2	260044		Bremssattel-Zubehör	LUC
	1.8 GTI		19-JH480001			07.88	+ ABS					
1.8 GTI 16V		19-JH480001			07.88	+ ABS						
1.8 Rallye			1G-LW330000	04.89								
1.8 Rallye			1G-LB085000	04.89								
1.8 Syncro G60			1G-LW330000	04.89								
1.8 Syncro G60			1G-LB085000	04.89								
1.8	62			08.88	07.89	+ ABS	24.3364-1605.5	240011		D=36, - Halter	LUC	
1.8	66			08.88	07.89	+ ABS	24.3364-1606.5	240012		D=36, - Halter	LUC	
1.8 GT				08.88	07.89	- Special 3)	24.0101-3601.2	260044		Bremssattel-Zubehör	LUC	
1.8 GTI				08.88	07.89		11.0101-5403.2	260010		Faltenbalgsatz	LUC	
1.8 GTI 16V				08.88	07.89							
1.8	62			08.89	07.92	+ ABS	24.3384-1603.5	240015		D=38, - Halter	LUC	
1.8	66			08.89	07.92	+ ABS	24.3384-1604.5	240016		D=38, - Halter	LUC	
1.8 G60				04.90	07.92		24.0101-3601.2	260044		Bremssattel-Zubehör	LUC	
1.8 GT				08.89	07.92							
1.8 GT Special				08.85	07.92							
1.8 GTI				08.89	07.92							
1.8 GTI 16V				08.89	07.92							
1.8 Rallye		1G-LB085001			07.92							
1.8 Rallye		1G-LW330001			07.92							
1.8 Syncro G60		1G-LB085001			07.92							
1.8 Syncro G60		1G-LW330001			07.92							
	1.8	62	19-JH480001		07.92	+ ABS	13.0460-2937.2	602937			20961 15,2 /Zub/S	LUC
	1.8	66	19-JH480001		07.92	+ ABS	13.0460-0419.2	610419			Belagsatz-Zubehör	LUC
	1.8 G60			04.90	07.92							
	1.8 GT				08.85	07.92						
	1.8 GT Special				08.85	07.92						
	1.8 GTI				01.84	07.92						
	1.8 GTI 16V				02.86	07.92						
	1.8 Rallye				04.89	07.92						
	1.8 Syncro G60				04.89	07.92						
	1.8	62	19-JH480001		07.92	+ ABS	24.0110-0111.1	410111		ohne Sensorring 4)	226 10,0 8,0 +B	
	1.8	66	19-JH480001		07.92	+ ABS	24.0110-0275.2	410275		mit Sensorring 5)	226 10,0 8,0	
	1.8 G60			04.90	07.92							
	1.8 GT				08.85	07.92						
	1.8 GT Special				08.85	07.92						
	1.8 GTI				01.84	07.92						
1.8 GTI 16V				02.86	07.92							
1.8 Rallye				04.89	07.92		24.0110-0151.1	410151			239 10,0 8,0 +S +B	
1.8 Syncro G60				04.89	07.92							
	1.0				08.83	07.88		83.7824-0180.3	330812	2		L=180
	1.3				08.83	07.88						
	1.6				08.83	07.88						
	1.6 D				08.83	07.88						
	1.6 TD				08.83	07.88						
	1.8	62			01.84	07.88	- ABS					
	1.8	66			01.84	07.88	- ABS					
	1.8 Rallye				04.89	07.92						
	1.8 Syncro G60				04.89	07.92						
	1.0				08.88	10.91		83.7804-0160.3	330811	2		L=160
	1.3				08.88	12.93						
	1.6				08.88	12.93						
1.6 D				08.88	07.92							
1.6 TD				08.88	12.93							
1.8	62			08.88	07.92	- ABS						
1.8	66			08.88	07.92	- ABS						

1) - ABS/ - Special / - ABS/ - Speciale / - ABS/ - Spécial / - ABS/ - Especial  
 2) + ABS/ - Special / + ABS/ - Speciale / + ABS/ - Spécial / + ABS/ - Especial  
 3) - Special / - Speciale / - Spécial / - Especial  
 4) without sensor ring / senza sensori / sans secours ABS / sin anillo sensor ABS  
 5) with sensor ring / con sensori / avec secours ABS / con anillo sensor ABS





**VOLKSWAGEN GOLF II (84-93)**

	1.8	62	19-JH480001		07.92	+ ABS	24.5170-0161.3	331308	2		L=161	
	1.8	66	19-JH480001		07.92	+ ABS						
	1.8 G60				04.90	07.92						
	1.8 GT				08.85	07.92						
	1.8 GTI				01.84	07.92						
	1.8 GTI 16V				02.86	07.92						
1.8 Syncro				08.85	07.92		83.7804-0160.3	330811	2		L=160	
	1.0		1G-M-000001		10.91		24.0721-1925.1	360039	2		Radsensor L=1220	
	1.3		1G-M-000001		12.93							
	1.6		1G-M-000001		12.93							
	1.6 D		1G-M-000001		07.92							
	1.6 TD		1G-M-000001		12.93							
	1.8		1G-M-000001		07.92							
	1.8 G60		1G-M-000001		07.92							
	1.8 GTI		1G-M-000001		07.92							
	1.8 GTI 16V		1G-M-000001		07.92							
		1.0				08.83	10.91	- Bremskraftregler 1)	03.3214-0812.3	020011	+ GG 2)	Rz 14,29
1.3					08.83	12.93	- Bremskraftregler 1)	24.3214-0902.3	020147	+ ALU 3)	Rz 14,29	
1.6					08.83	12.93	- Bremskraftregler 1)					
1.6 D					08.83	07.92	- Bremskraftregler 1)					
1.6 TD					08.83	12.93	- Bremskraftregler 1)					
1.8		62			01.84	07.92	- Bremskraftregler 1)					
1.8		66			01.84	07.92	- Bremskraftregler 1)					
1.8		77	1G-KW593279		08.88		+ 4)					
1.0					08.83	10.91	+ Bremskraftregler 4)	03.3217-2112.3	020027	+ GG 2)	Rz 17,46	
1.3					08.83	12.93	+ Bremskraftregler 4)	24.3217-0908.3	020167	+ ALU 3)	Rz 17,46	
1.6					08.83	12.93	+ Bremskraftregler 4)					
1.6 D					08.83	07.92	+ Bremskraftregler 4)					
1.6 TD					08.83	12.93	+ Bremskraftregler 4)					
1.8		62			01.84	07.92	+ Bremskraftregler 4)					
1.8		66			01.84	07.92	+ Bremskraftregler 4)					
1.8		77	1G-KW593280		07.92		+ 4)					
1.8 Syncro					08.85	07.92		24.3219-0909.3	020188			Rz 19,05
		1.0				08.83	10.91		03.0137-0126.2	650126		180 x 31 HEB
	1.3				08.83	12.93		03.0137-9008.2	669008		Bremsbacken-Zubehör	
	1.6				08.83	12.93						
	1.6 D				08.83	07.92						
	1.6 TD				08.83	12.93	- 4)					
	1.8	62			01.84	07.92	- ABS					
	1.8	66			01.84	07.92	- ABS					
	1.8	77			08.88	07.92	- ABS + 4)					
	1.6 TD				08.89	12.93	+ 4)	03.0137-0268.2	650268		200 x 40 HEB	
	1.8	77			08.88	07.92	+ ABS + 4)	03.0137-9168.2	669168		Bremsbacken-Zubehör	
1.8 Syncro				08.85	07.92		03.0137-0264.2	650264		230 x 40 HEB		
	1.0				08.83	10.91		24.0218-0007.1	480003		180/181 x 38,5 - Lager	
	1.3				08.83	12.93		24.0218-0707.2	480211		180/181 x 38,5 + Lager	
	1.6				08.83	12.93						
	1.6 D				08.83	07.92						
	1.6 TD				08.83	12.93	- 4)					
	1.8	62			01.84	07.92	- ABS					
	1.8	66			01.84	07.92	- ABS					
	1.8	77			08.88	07.92	- ABS + 4)					
	1.6 TD				08.89	12.93	+ 4)	24.0220-0018.1	480019	ohne Sensorring 5)	200/201,5 x 50,5 - Lager	
	1.8	77			08.88	07.92	+ ABS + 4)	24.0220-0718.2	480209	ohne Sensorring 5)	200/201,5 x 50,5 + Lager	
1.8 Syncro				08.85	07.92		24.0223-0017.1	480135		230/231,5 x 48,5		
	1.0				08.83	10.91	- Bremskraftregler/ - 4) 6)	03.0520-0114.3	690114		14,29/180x31 TopKit	
	1.3				08.83	12.93	- Bremskraftregler/ - 4) 6)				VW	
	1.6				08.83	12.93	- Bremskraftregler/ - 4) 6)					
	1.6 D				08.83	07.92	- Bremskraftregler/ - 4) 6)					
	1.6 TD				08.83	12.93	- Bremskraftregler/ - 4) 6)					
	1.8	62			01.84	07.92	- Bremskraftregler/ - 4) 6)					
	1.8	66			01.84	07.92	- Bremskraftregler/ - 4) 6)					
	1.0				08.83	10.91	+ Bremskraftregler/ - 4) 7)	03.0420-0617.3	680617	+ Rz GG 8)	17,46/180x31 Kit	
	1.3				08.83	12.93	+ Bremskraftregler/ - 4) 7)	03.0520-3917.3	693917	+ Rz ALU 9)	17,46/180x31 TopKit	
	1.6				08.83	12.93	+ Bremskraftregler/ - 4) 7)					
	1.6 D				08.83	07.92	+ Bremskraftregler/ - 4) 7)					
	1.6 TD				08.83	12.93	+ Bremskraftregler/ - 4) 7)					
	1.8	62			01.84	07.92	+ Bremskraftregler/ - 4) 7)					
	1.8	66			01.84	07.92	+ Bremskraftregler/ - 4) 7)					
1.6 TD				08.89	12.93		03.0420-1517.3	681517		17,46/200x40 Kit		
1.8	77	1G-KW593280		07.92			03.0520-1517.3	691517		17,46/200x40 TopKit		
	1.0				08.83	07.88		24.3727-0118.2	580118	2	L=1748	
	1.3				08.83	07.88						
	1.6				08.83	07.88						
	1.6 D				08.83	07.88						
	1.6 TD				08.83	07.88						
	1.8				01.84	07.88	- ABS					
	1.8	66			01.84	07.88	- ABS					
	1.0				08.88	10.91		24.3727-0132.2	580132	2	L=1527	
	1.3				08.88	12.93						
	1.6				08.88	12.93						
1.6 D				08.88	07.92							
1.6 TD				08.88	12.93							
1.8	62			08.88	07.92	- ABS						
1.8	66			08.88	07.92	- ABS						

1) - brake pressure regulator / - correttore di frenata / - correcteur de freinage / - corrector de frenado

2) + cast iron / + ghisa / + fonte grise / + fundición de gris

3) + aluminium / + alluminio / + aluminio / + aluminium

4) + brake pressure regulator / + correttore di frenata / + correcteur de freinage / + corrector de frenado

5) without sensor ring / senza sensori / sans secours ABS / sin anillo sensor ABS

6) - brake pressure regulator/ - 4) / - correttore di frenata/ - 4) / - correcteur de freinage/ - 4) / - corrector de frenado/ - 4)

7) + brake pressure regulator/ - 4) / + correttore di frenata/ - 4) / + correcteur de freinage/ - 4) / + corrector de frenado/ - 4)

8) + WC cast iron / + CR ghisa / + CR fonte grise / + CR fundición de gris

9) + WC aluminium / + CR alluminio / + CR aluminium / + CR aluminio

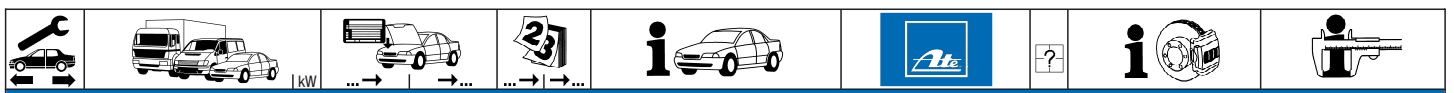

## VOLKSWAGEN GOLF II (84-93)

	1.8 GT			08.85	07.88	- ABS	24.3727-0123.2	580123	2		L=1800
	1.8 GTI			01.84	07.88	- ABS					
	1.8 GTI 16V			02.86	07.88	- ABS					
	1.8				07.88	+ ABS	24.3727-0124.2	580124	2		L=1840
	1.8 GT	19-JH480001			07.88	+ ABS					
	1.8 GTI	19-JH480001			07.88	+ ABS					
	1.8 GTI 16V	19-JH480001			07.88	+ ABS					
	1.8			08.88	07.92	+ ABS	24.3727-0133.2	580133	2		L=1622
	1.8 GT			08.88	07.92						
	1.8 GTI			08.88	07.92						
	1.8 GTI 16V			08.88	07.92						
	1.8 Syncro			08.85	07.92		24.3727-0166.2	580166	2		L=1567
	1.8 G60			04.90	07.92		24.3727-0134.2	580134	2		L=1613
	1.0			08.83	10.91		03.6584-0015.3	320109			BRL 8/4 (4) ATE
	1.3			08.83	12.93						
	1.6			08.83	12.93						
	1.6 D			08.83	07.92						
	1.6 TD			08.83	12.93						
	1.8			08.83	07.92						
	1.8 G60			08.89	07.92						
	1.8 GTI			01.84	07.92						
	1.8 GTI 16V			02.86	07.92						
	1.8 Rallye			04.89	07.92						
	1.8 Syncro			04.89	07.92						
	1.8 Syncro G60			04.89	07.92						
	1.8 G60			04.90	07.92		03.2419-9310.3	030027			Gz 19,05
	1.8 GTI			08.89	07.92						
	1.8 GTI 16V			08.89	07.92						
	1.8 Rallye			04.89	07.92						
	1.8 Syncro G60			04.89	07.92						
	1.8 G60			04.90	07.92		24.2523-0908.3	040049			Nz 23,81
	1.8 GTI			08.89	07.92						
	1.8 GTI 16V			08.89	07.92						
	1.8 Rallye			04.89	07.92						
	1.8 Syncro G60			04.89	07.92						
	1.0	◀		08.83	10.91		24.3728-0113.2	590113		- autom. Nachstellung <sup>1)</sup>	L=1098
	1.3	◀		08.83	12.93						
	1.6	◀		08.83	12.93		24.3728-0111.2	590111		- autom. Nachstellung <sup>1)</sup>	L=806
	1.8	◀		08.83	07.92						
	1.6	◀		08.83	12.93		24.3728-0121.2	590121		+ autom. Nachstellung <sup>2)</sup>	L=800, + AUT
	1.6 D	◀		08.83	07.92						
	1.6 TD	◀ 51		08.83	12.93						
	1.8	◀		08.83	07.92						
1.6 TD	◀ 59		04.89	12.93		24.3728-0120.2	590120			L=1081, + AUT	
	1.8 G60	◀		08.89	07.92		24.3728-0111.2	590111		- autom. Nachstellung <sup>1)</sup>	L=806
	1.8 GTI 16V	◀		02.86	07.92		24.3728-0121.2	590121		+ autom. Nachstellung <sup>2)</sup>	L=800, + AUT
	1.8 Syncro	◀		08.85	07.92						

## VOLKSWAGEN KÄFER (TYP 1) (49-03)

	1200			01.54	07.64		03.3119-0507.3	010264			Hz 19,05 ATE
	1200			08.64	07.69		03.3117-1408.3	010255			Hz 17,46 ATE
	1300			08.65	07.67						
	1200			08.69	07.81		03.2119-8511.3	010062			THz 19,05 ATE
	1300			08.67	12.74	+ VA-Trommelbremse <sup>3)</sup>					
	1500	◀		08.67	12.70						
	1200			08.81	12.85		03.2119-8711.3	010064			THz 19,05 + WE ATE
	1300	◀		08.67	12.74	+ VA-Scheibenbremse <sup>4)</sup>	03.2119-8911.3	010066		- USA	THz 19,05 ATE
	1302	◀		08.70	07.72		03.2119-9111.3	010068		+ USA	THz 19,05 + WE ATE
	1303	◀		08.72	07.79						
	1302	▶		08.70	07.72		03.2119-9011.3	010067			THz 19,05 ATE
	1303	▶		08.72	07.79						
	1500	▶		08.67	12.70		03.2119-8611.3	010063			THz 19,05 ATE
	1300		1122076274	1332013626			13.2401-8007.2	210047	◻		D=40 ATE
	1302		1122076274	1332013626	08.66	12.70	13.2401-8008.2	210048	◻		D=40 ATE
	1500					13.0441-4002.2	250074			bis 07.72 verwenden <sup>5)</sup>	ATE
						13.0441-4008.2	250076			ab 08.72 verwenden <sup>6)</sup>	ATE
	1200		1122076274	1332013626			13.0460-3010.2	603010			20009 15,0 ATE
	1300		1122076274	1332013626			13.0460-0014.2	610014			Belagsatz-Zubehör ATE
	1302		1122076274	1332013626							
	1303				08.72	07.79	13.0460-2905.2	602905			20286 16,2 LUC
							13.0460-0908.2	610908			Belagsatz-Zubehör LUC
	1200			01.54	12.77		24.0110-0142.1	410142			278 9,5 8,0
	1300			08.67	12.74						
	1302			08.70	07.72						
	1303			08.72	07.79						
	1500			08.66	12.70						
	1200			01.54	12.57		24.5165-0450.3	331259	2		L=450
	1200			01.57	07.64		83.6101-0240.3	330202	2		L=240
	1200			08.64	12.66		24.5165-0425.3	331258	2		L=425
	1300			08.65	07.66						
	1200			01.67	12.85		24.5165-0350.3	331257	2		L=350
	1300			08.66	07.67						
1500			08.67	12.70							

<sup>1)</sup> - automatic adjustment / - correzione automatica / - ajustage automatique / - reajuste automatico  
<sup>2)</sup> + automatic adjustment / + correzione automatica / + ajustage automatique / + reajuste automatico  
<sup>3)</sup> + FA drum brake / + A freno a tamburo / + frein à tambour ess.AV / + ED tambores de freno  
<sup>4)</sup> + FA disc brake / + A disco freno / + frein à disque essieu AV / + ED disco de freno  
<sup>5)</sup> reuse up to 07.72 / riutilizzare fino a 07.72 / utiliser jusqu'au 07.72 / hasta 07.72 emplear  
<sup>6)</sup> reuse from 08.72 / utilizzare dal 08.72 / utiliser à partir de 08.72 / desde 08.72 emplear



VOLKSWAGEN KÄFER (TYP 1) (49-03)											
	1300			08.67	12.74	83.6101-0325.3	330206	2		L=325	
	1500			08.66	07.67						
	1302			08.70	07.72	24.5224-0295.3	331261	2		L=295	
	1303			08.72	07.73						
	1200			08.73	07.79	24.5230-0285.3	331322	2		L=285	
	1200			01.54	12.57	03.3219-0411.3	020038			Rz 19,05	
						03.0470-2619.2	060051			Rz Dichtungssatz	
	1200			01.57	07.64	03.3222-5211.3	020081			Rz 22,20	
	1300			08.64	12.85	03.3222-5211.3	020081			Rz 22,20	
	1302			08.65	12.74						
	1303			08.70	07.72	03.3223-0611.3	020091			Rz 23,81	
	1303			08.72	07.74						
	1200			01.68	12.85	03.0137-0041.2	650041			230 x 40	ATE
	1300			08.67	12.74	03.0137-9229.2	669229			Brmsbacken-Zubehör	ATE
	1302			08.70	07.72	03.0137-0073.2	650073			248 x 46	
	1303			08.72	07.74	03.0137-9009.2	669009			Brmsbacken-Zubehör	
	1200		118000001	01.68	12.85	24.0223-0002.1	480032			230/231 x 47	
	1300				12.74						
	1200			01.54	12.85 + Schaltgetriebe 1)	24.5224-0240.3	331260	2		L=240	
	1300			08.65	12.74 + Schaltgetriebe 1)						
	1500			08.66	12.70 + Schaltgetriebe 1)						
	1200			08.69	12.77 + Automatikgetriebe 2)	83.6101-0210.3	330201	2		L=210	
	1300			08.67	07.71 + Automatikgetriebe 2)	24.5165-0215.3	331319	2		L=215	
	1302			08.70	07.72						
	1303			08.72	07.79						
	1500			08.67	12.70 + Automatikgetriebe 2)						
	1200			01.54	12.57	03.3217-0211.3	020021			Rz 17,46	
	1200			01.57	07.64	03.3219-3211.3	020048			Rz 19,05	
	1200			08.64	12.66	03.3219-3211.3	020048			Rz 19,05	
	1300			08.65	07.67						
	1500			08.66	07.67						
	1200			01.67	12.85	03.3217-1811.3	020026			Rz 17,46	
	1300			08.67	12.74						
	1302			08.70	07.72						
	1500			08.72	07.79						
	1200			08.67	12.70						
	1200			01.68	12.85	03.0137-0041.2	650041			230 x 40	ATE
	1300			08.67	12.74	03.0137-9005.2	669005			Brmsbacken-Zubehör	
	1302			08.70	07.72						
	1303			08.72	07.79						
	1500			08.66	12.70						
	1200			01.68	12.85	24.0223-0003.1	480033			230/231 x 50,5	
	1300			08.67	12.74						
	1302			08.70	07.72						
	1303			08.72	07.79						
	1600 i			10.93	08.03 + ⊕						
	1200			01.67	12.85	03.0420-2917.3	682917			17,46/230x40 Kit	ATE
	1300			08.67	12.74						
	1302			08.70	07.72						
	1303			08.72	07.79						
	1500			08.67	12.70						
	1200		1182100001		12.85	24.3727-0101.2	580101	2	↓	L=1750	
	1303			08.72	07.79						
	1600 i			10.93	08.03 + ⊕						
	1200		1122000001	1142663259		24.3728-0106.2	590106			L=2285	
	1300		1122000001		12.74						
	1302		1122000001		07.72						
	1303			1342663259	08.72						

### VOLKSWAGEN 1500/1600 (TYP 3) (61-75)

	1500 A Limousine			08.65	07.67	03.3119-6457.3	010269			Hz 19,05	ATE
	1500 Variant			01.66	12.67						
	1600			08.65	07.67						
	1600			08.67	12.73	03.2119-6713.3	010061			THz 19,05	ATE
	1500		3112268738	01.66		13.0441-4204.2	250085			Dichtungssatz	ATE
	1500		3112268739		12.67	13.0441-4209.2	250088			Dichtungssatz	ATE
	1600			08.65	12.73						
	1500			01.66	12.67	13.0460-3010.2	603010			20009 15,0	ATE
	1600			08.65	07.71	13.0460-0014.2	610014			Belagsatz-Zubehör	ATE
	1600			08.71	12.73	13.0460-4033.2	604033			20034 15,0	ATE
	1600			13.0460-0029.2	610029					Belagsatz-Zubehör	ATE
	1500			01.66	12.67	24.0110-0142.1	410142			278 9,5 8,0	
	1600			08.65	07.71						
	1500 Limousine			01.61	12.73	24.5171-0393.3	331311	2		L=393	
	1500 Variant			01.61	12.65						
	1500 A			01.66	12.67	24.5165-0350.3	331257	2		L=350	
	1500 Variant			01.66	12.67						
	1600 Limousine			08.65	07.68						
	1600 Variant			08.65	07.67						
↓	1600 Limousine			08.68	12.73	83.6101-0325.3	330206	2		L=325	

1) + manual transmission / + scatola cambio velocità / + transmission mécanique / + cambio de velocidad

2) + autom.transmission / + scatola cambio automatico / + transmission automatique / + cambio automático

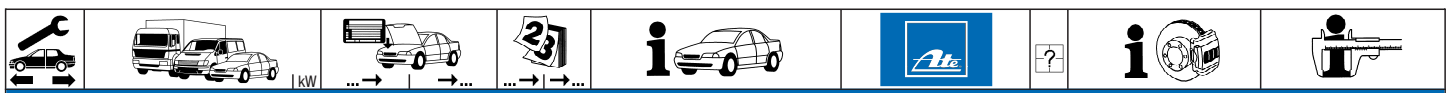

### VOLKSWAGEN 1500/1600 (TYP 3) (61-75)

	1600 Variant			08.67	12.73		83.6101-0325.3	330206	2		L=325
	1500			01.61	12.73		24.5224-0240.3	331260	2		L=240
	1600 Limousine			08.65	07.68						
	1600 Variant			08.65	07.67						
	1600 Limousine			08.68	12.73		83.6101-0250.3	330203			L=250
	1600 Variant			08.67	07.71						
	1600 Variant			08.71	12.73		24.5224-0240.3	331260	2		L=240
	1500 Variant			08.64	12.65		03.3223-0611.3	020091			Rz 23,81
	1500 Limousine	221975			12.73		03.3222-5011.3	020462			Rz 22,20
	1500 Variant			01.66							
	1600			08.65	12.73						

### VOLKSWAGEN CADDY I (83-92)

	1.5			08.82	07.83		03.2120-1531.3	010092			THz 20,64	ATE
	1.6		14-M-010000	08.83			03.2120-1491.3	010089			THz 20,64 + WE	ATE
	1.6 D		14-M-010000	08.82								
	1.8		14-M-010000	08.85								
	1.6	◀	14-N-000001		07.92		03.2120-3943.3	010532			THz 20,64	ATE
	1.6 D	◀	14-N-000001		07.92							
	1.8	◀	14-N-000001		07.92							
	1.6	▶	14-N-000001		07.92		03.2120-1531.3	010092			THz 20,64	ATE
	1.6 D	▶	14-N-000001		07.92							
	1.8	▶	14-N-000001		07.92							
	1.5		14-D-010000	08.82			11.0441-4808.2	250022		f.Vornr -8007/8008 -8503/8504 <sup>1)</sup>	Dichtungssatz	ATE
	1.6		14-D-010000	08.83			11.0441-4804.2	250019			Dichts.a.(+Sich.Ring)	ATE
	1.6 D		14-D-010000	08.82			11.0101-4801.2	260006			Hülsensatz	ATE
							24.0102-4801.2	260085			Hülsensatz+Schrauben	ATE
	1.6		14-E-010001		07.92		11.0441-4808.2	250022			Dichtungssatz	ATE
	1.6 D		14-E-010001		07.92		11.0101-4801.2	260006			Hülsensatz	ATE
	1.8			08.85	07.92		24.0102-4801.2	260085			Hülsensatz+Schrauben	ATE
	1.5			08.82	07.83		13.0460-7032.2	607032			20887 19,7 +/Zub	VW
	1.6			08.83	07.92							
	1.6 D			08.82	07.92							
	1.8			08.85	07.92							
	1.5			08.82	07.83		24.0112-0106.1	412106			239 12,0 10,0 +S +B	
	1.6			08.83	07.92		24.0312-0106.1	512106			239 12,0 10,0 +S +B PD	
	1.6 D			08.82	07.92							
	1.8			08.85	07.92							
	1.5			08.82	07.83		24.5170-0315.3	331309	2		L=315	
	1.6			08.83	07.92							
	1.6 D			08.82	07.92							
	1.8			08.85	07.92							
	1.5			08.82	07.83		83.6299-0807.3	330901	2		L=430/430	
	1.6			08.83	07.92							
	1.6 D			08.82	07.92							
	1.8			08.85	07.92							
	1.5			08.82	07.83		03.3217-2112.3	020027		+ GG <sup>2)</sup>	Rz 17,46	
	1.6			08.83			24.3217-0908.3	020167		+ ALU <sup>3)</sup>	Rz 17,46	
	1.6 D		14-H-011048	08.82								
	1.8		14-H-011048	08.82								
			14-H-011048	08.85								
	1.6		14-H-011049		07.92		24.3219-0909.3	020188			Rz 19,05	
	1.6 D		14-H-011049		07.92							
	1.8		14-H-011049		07.92							
	1.5			08.82	07.83		03.0137-0264.2	650264			230 x 40 HEB	VW
	1.6		14-M-006000	08.83			03.0137-9044.2	669044			Bremsbacken-Zubehör	VW
	1.6 D		14-M-006000	08.82								
	1.8		14-M-006000	08.85								
	1.6		14-M-006001		07.92		03.0137-0264.2	650264			230 x 40 HEB	VW
	1.6 D		14-M-006001		07.92		03.0137-9164.2	669164			Bremsbacken-Zubehör	VW
	1.8		14-M-006001		07.92							
	1.5			08.82	07.83		03.0420-1217.3	681217			17,46/230x40 Kit	VW
	1.6		14-H-011048	08.83								
	1.6 D		14-H-011048	08.82								
	1.8		14-H-011048	08.85								
	1.5			08.82	07.83		24.3727-0150.2	580150	2		L=2020	
	1.6			08.83	07.92							
	1.6 D			08.82	07.92							
	1.8			08.85	07.92							
	1.5	◀		08.82	07.83		24.3728-0108.2	590108			L=794	
	1.6	◀		08.83	07.92							
	1.6 D	◀		08.82	07.92							
	1.8	◀		08.85	07.92							

### VOLKSWAGEN CORRADO (88-95)

	1.8 16V	◀		04.89	07.92	- ABS	03.7750-4302.4	300076			9"	ATE
	1.8 G60	◀		10.88	09.93	- ABS						
	2.0	◀		04.93	07.95	- ABS						
	2.0 16V	◀		08.91	07.95	- ABS						
	2.9 VR6	◀		08.91	07.95	- ABS						
	1.8 16V	▶		04.89	07.92	- ABS	03.7750-4902.4	300079			9"	ATE
	1.8 G60	▶		10.88	09.93	- ABS						
	2.0	▶		04.93	07.95	- ABS						

<sup>1)</sup> f.partno.-8007/8008 -8503/8504 / p.no.codice -8007/8008 -8503/8504 / p.AV ref. -8007/8008 -8503/8504 / p.antes ref. -8007/8008 -8503/8504

<sup>2)</sup> + cast iron / + ghisa / + fonte grise / + fundición de gris

<sup>3)</sup> + aluminium / + alluminio / + aluminium / + aluminio



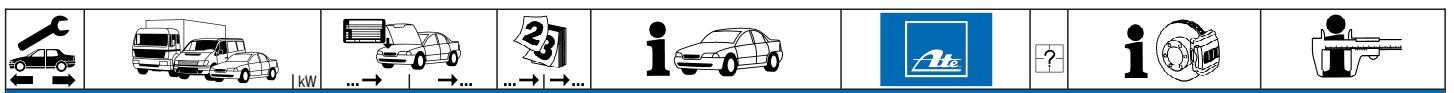

**VOLKSWAGEN CORRADO (88-95)**

	2.0 16V 2.9 VR6			08.91 08.91	07.95 07.95	- ABS - ABS	03.7750-4902.4	300079		9"	ATE
	1.8 16V 1.8 G60 2.0 2.0 16V 2.9 VR6			04.89 10.88 04.93 08.91 08.91	07.92 09.93 07.95 07.95 07.95	- ABS - ABS - ABS - ABS - ABS	03.2122-1042.3 03.3517-0101.2	010137 390322		THz 22,20 Verschlusschraube	ATE
	1.8 16V 2.0 2.0 16V			04.89 04.93 08.91	07.92 07.95 07.95		24.3541-1609.5 24.3541-1610.5 24.0101-4301.2 11.0101-5403.2	240039 240040 260047 260010	<input type="checkbox"/> <input type="checkbox"/>	D=54, - Halter D=54, - Halter Bremsattel-Zubehör Fallenbalgsatz	LUC LUC LUC LUC
	1.8 G60		50-M-027000	10.88			24.0101-4301.2 11.0101-5403.2	260047 260010		Bremsattel-Zubehör Fallenbalgsatz	LUC LUC
	1.8 G60 2.9 VR6		50-M-027001		09.93 08.91		24.3541-1731.5 24.3541-1732.5	240061 240062	<input type="checkbox"/> <input type="checkbox"/>	D=54, - Halter D=54, - Halter	LUC LUC
	1.8 16V 2.0 2.0 16V			04.89 04.93 08.91	07.92 07.95 07.95		13.0460-2957.2	602957		20168 16,0 /S	LUC
	1.8 G60 2.9 VR6			10.88 08.91	09.93 07.95		13.0460-2958.2	602958		20168 19,3 /S	LUC
	1.8 16V 2.0 2.0 16V			04.89 04.93 08.91	07.92 07.95 07.95		24.0120-0128.1 24.0320-0128.1	420128 520128		256 20,0 18,0 V L +S +B 256 20,0 18,0 V L +S +B PD	
	1.8 G60			10.88	09.93		24.0122-0101.1	422101		280 22,0 20,0 V L +B	
	2.9 VR6			08.91	07.95		24.0122-0100.1 24.0322-0100.1	422100 522100		280 22,0 20,0 V L +B 280 22,0 20,0 V L +B PD	
	1.8 16V 1.8 G60		50-M-035000 50-M-035000	04.89 10.88			83.7813-0330.3	330800	2	L=330	
	1.8 16V 1.8 G60 2.0 2.0 16V 2.9 VR6		50-N-000001 50-N-000001		07.92 09.93 07.95 07.95 07.95		83.7713-0435.3	330792	2	L=435	
	1.8 16V 1.8 G60		50-L-035000 50-L-035000	04.89 10.88			24.0711-1313.3	360016	2 <input type="checkbox"/>	Radsensor L=1130	
	1.8 16V 1.8 G60		50-M-000001 50-M-000001				24.0711-1313.3	360016	2 <input type="checkbox"/>	Radsensor L=1130	
	1.8 16V 1.8 G60 2.0 2.0 16V 2.9 VR6		50-N-000001 50-N-000001		07.92 09.93		24.0711-1361.3 24.0711-1362.3	360022 360023	<input type="checkbox"/> <input type="checkbox"/>	Radsensor Radsensor	
	2.0 2.0 16V 2.9 VR6		50-R-003691 50-R-003691 50-R-003691		07.95 07.95 07.95		24.0711-1361.3 24.0711-1362.3	360022 360023	<input type="checkbox"/> <input type="checkbox"/>	Radsensor Radsensor	
	1.8 16V 1.8 G60 2.0 16V 2.9 VR6		50-P-009000 50-P-009000 50-P-009000	04.89 10.88 08.91 08.91	07.92 07.95		24.3384-1603.5 24.3384-1604.5 24.0101-3601.2	240015 240016 260044	<input type="checkbox"/> <input type="checkbox"/>	D=38, - Halter D=38, - Halter Bremsattel-Zubehör	LUC LUC LUC
	1.8 G60 2.0 2.0 16V 2.9 VR6		50-P-009001 50-P-009001 50-P-009001		09.93 07.95 07.95 07.95		24.3384-1707.5 24.3384-1708.5 24.0101-3601.2 11.0101-5403.2	240171 240172 260044 260010	<input type="checkbox"/> <input type="checkbox"/>	D=38, - Halter D=38, - Halter Bremsattel-Zubehör Fallenbalgsatz	LUC LUC LUC LUC
	1.8 16V 1.8 G60 2.0 2.0 16V 2.9 VR6		50-P-009000 50-P-009000	04.89 10.88 04.93 08.91 08.91	07.92 07.95 07.95 07.95		13.0460-2937.2 13.0460-0419.2	602937 610419		20961 15,2 /Zub/S Belagsatz-Zubehör	LUC LUC
	1.8 G60 2.9 VR6		50-P-009001 50-P-009001		09.93 07.95		13.0460-2984.2 13.0460-0072.2	602984 610072		20961 17,2 /Zub/S Belagsatz-Zubehör	LUC LUC
	1.8 16V 1.8 G60 2.0 2.0 16V			04.89 10.88 04.93 08.91	07.92 09.93 07.95 07.95		24.0110-0111.1 24.0110-0275.2	410111 410275		ohne Sensorring <sup>1)</sup> mit Sensorring <sup>2)</sup>	226 10,0 8,0 +B 226 10,0 8,0
	2.9 VR6			08.91	07.95		24.0110-0203.1 24.0110-0276.2	410203 410276		mit Sensorring <sup>2)</sup>	226 10,0 8,0 226 10,0 8,0
	1.8 16V 1.8 G60 2.0 2.0 16V			04.89 10.88 04.93 08.91	07.92 09.93 07.95 07.95		83.7804-0160.3 24.5170-0161.3	330811 331308	2 2	am Bremsattel <sup>3)</sup>	L=160 L=161
	2.9 VR6			08.91	07.95		83.7836-0135.3 24.5170-0161.3	330816 331308	2 2	am Bremsattel <sup>3)</sup>	L=135 L=161
	1.8 16V 1.8 G60 2.0 2.0 16V 2.9 VR6		50-M-000001 50-M-000001		07.92 09.93		24.0721-1925.1	360039	2 <input type="checkbox"/>	Radsensor L=1220	
	2.0 2.0 16V 2.9 VR6		50-R-003691 50-R-003691 50-R-003691	04.93 08.91 08.91	07.95 07.95 07.95		24.0721-1937.1	360040	2 <input type="checkbox"/>	Radsensor L=1062	

<sup>1)</sup> without sensor ring / senza sensori / sans secours ABS / sin anillo sensor ABS  
<sup>2)</sup> with sensor ring / con sensori / avec secours ABS / con anillo sensor ABS  
<sup>3)</sup> on the brake caliper / sulla pinza freno / sur l'étrier de frein / a la pinza de freno

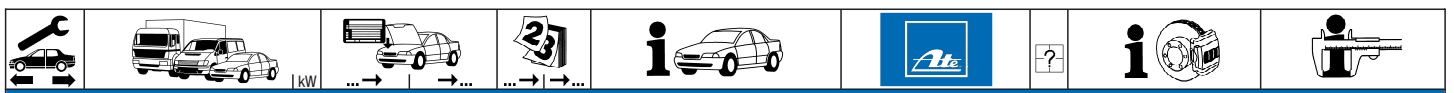

### VOLKSWAGEN CORRADO (88-95)

	1.8 16V			04.89	07.92	24.3727-0134.2	580134	2		L=1613
	1.8 G60			10.88	09.93					
	2.0		50-S-000361	04.93		03.6584-0015.3	320109			BRL 8/4 (4)
	2.0 16V		50-S-000361	08.91						
	2.9 VR6		50-S-000361	08.91						
	2.0		50-S-000362	07.95						
	2.0 16V		50-S-000362	07.95		24.3727-0156.2	580156	2		L=1616
	2.9 VR6		50-S-000362	07.95						
	2.0		50-S-000362	07.95						
	1.8 16V			04.89	07.92	03.6584-0113.3	320109			BRL 8/4 (4)
	1.8 G60			10.88	09.93					
	2.0			04.93	07.95					
	2.0 16V			08.91	07.95					
	2.9 VR6			08.91	07.95					
	1.8 16V			04.89	07.92	03.2419-9310.3	030027			Gz 19,05
	1.8 G60			10.88	09.93					
	2.0			04.93						
	2.0 16V		50-R-000786	08.91						
	2.9 VR6		50-R-000786	08.91						
	2.0		50-R-000787	07.95		03.2419-1206.3	030074			Gz 19,05
	2.0 16V		50-R-000787	07.95						
	2.9 VR6		50-R-000787	07.95						
	1.8 16V			04.89	07.92	24.2523-0908.3	040049			Nz 23,81
	1.8 G60			10.88	09.93					
	2.0			04.93	07.95					
	2.0 16V			08.91	07.95					
	2.9 VR6			08.91	07.95					

### VOLKSWAGEN DERBY/POLO Stufenheck (77-88)

	0.9			01.77	09.81	03.2117-3311.3	010040			THz 17,46
	1.0			10.81	02.85					
	1.1			01.77	02.85					
	1.3			01.77	02.85					
	1.0		..-F-127903	10.81		03.2120-1531.3	010092			THz 20,64
	1.1		..-F-127903	10.81						
	1.1		..-F-127903	01.77	09.81					
	1.3		..-F-127903	10.81						
	1.3		..-F-127903	01.77	09.81					
	1.0		..-F-127904	12.88		03.2120-2031.3	010106			THz 20,64
	1.1		..-F-127904	12.88						
	1.3		..-F-127904	12.88						
	1.3		..-F-127904	12.88						
	1.3 D			08.86	12.88					
	0.9			01.77	09.81	11.0441-4402.2	250014			Dichtungssatz
	1.1			01.77	09.81					
	1.3			01.77	09.81					
	1.0		..-F-127903	10.81						
	1.1		..-F-127903	10.81		11.0441-4402.2	250014			Dichtungssatz
	1.3		..-F-127903	10.81						
	1.0		..-F-127904	12.88						
	1.1		..-F-127904	12.88						
	1.3		..-F-127904	12.88						
	1.3 D			08.86	12.88	24.3481-1745.5	240277			D=48, - Halter
	1.0		..-F-127904	12.88						
	1.1		..-F-127904	12.88						
	1.3		..-F-127904	12.88						
	1.3 D			08.86	12.88					
	0.9			01.77	09.81	13.0460-4028.2	604028			20228 15,3
	1.1			01.77	09.81					
	1.3			01.77	09.81					
	1.0		..-F-127903	10.81						
	1.1		..-F-127903	10.81						
	1.3		..-F-127903	10.81		13.0460-4028.2	604028			20228 15,3
	1.0		..-F-127904	12.88						
	1.1		..-F-127904	12.88						
	1.3		..-F-127904	12.88						
	1.3 D		..-F-127904	08.86	12.88					
	0.9			01.77	09.81	24.0108-0100.1	408100			239 8,0 7,0
	1.1			01.77	09.81					
	1.3			01.77	09.81					
	1.0			10.81	12.88					
	1.1			10.81	12.88	24.0110-0151.1	410151			239 10,0 8,0 +S +B
	1.3			10.81	12.88					
	1.3 D			08.86	12.88					
	1.0			10.81	12.88					
	0.9			01.77	09.81	83.7734-0290.3	330809	2		L=290
	1.0			01.77	12.88					
	1.1			01.77	12.88					
	1.3			01.77	12.88					
	1.3 D			08.86	12.88	83.7824-0180.3	330812	2		L=180
	0.9			01.77	09.81					
	1.0			01.77	12.88					
	1.1			01.77	12.88					
	1.3			01.77	12.88	03.3214-0812.3	020011			Rz 14,29
	1.3 D			08.86	12.88					
	0.9			01.77	09.81					
	1.0		..-F-127903	10.81						
	1.1		..-F-127903	01.77						+ GG <sup>4)</sup>
	1.3		..-F-127903	01.77						
	1.3		..-F-127903	01.77						

1) - booster unit / - servofreno / - servo-frein / - servofreno  
2) + booster unit / + servofreno / + servo-frein / + servofreno  
3) - brake pressure regulator / - correttore di frenata / - correcteur de freinage / - corrector de frenado  
4) + cast iron / + ghisa / + fonte grise / + fundición de gris





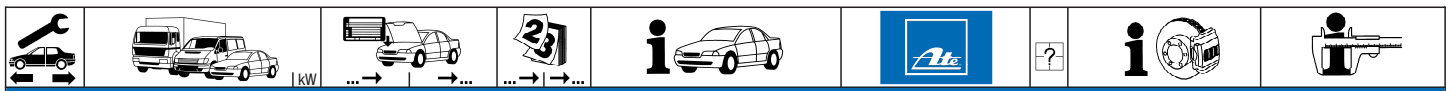

**VOLKSWAGEN DERBY/POLO Stufenheck (77-88)**

	1.0	...F-127904		12.88	- Bremskraftregler <sup>1)</sup>	03.3215-2311.3	020018	+ GG <sup>2)</sup>	Rz 15,87
	1.1	...F-127904		12.88	- Bremskraftregler <sup>1)</sup>	24.3215-0903.3	020154	+ ALU <sup>3)</sup>	Rz 15,87
	1.3	...F-127904		12.88	- Bremskraftregler <sup>1)</sup>				
	1.3 D			08.86	12.88	- Bremskraftregler <sup>1)</sup>			
	0.9			01.77	+ Bremskraftregler <sup>4)</sup>	03.3217-2112.3	020027	+ GG <sup>2)</sup>	Rz 17,46
	1.0	...F-127903		10.81	+ Bremskraftregler <sup>4)</sup>				
	1.1	...F-127903		01.77	+ Bremskraftregler <sup>4)</sup>				
	1.3	...F-127903		01.77	+ Bremskraftregler <sup>4)</sup>				
	1.0	...F-127904		12.88	+ Bremskraftregler <sup>4)</sup>	24.3219-0909.3	020188		Rz 19,05
	1.1	...F-127904		12.88	+ Bremskraftregler <sup>4)</sup>				
	1.3	...F-127904		12.88	+ Bremskraftregler <sup>4)</sup>				
	1.3 D			08.86	12.88	+ Bremskraftregler <sup>4)</sup>			
	0.9			01.77	07.78	03.0137-9006.2	669006	- autom. Nachstellung <sup>5)</sup>	Bremsbacken-Zubehör
	1.1			01.77	07.78				
	1.3			01.77	07.78				
	0.9			08.78	09.81	03.0137-0126.2	650126		180 x 31 HEB
	1.0			10.81	12.88	03.0137-9008.2	669008		Bremsbacken-Zubehör
	1.1			08.78	12.88				
	1.3 D			08.78	12.88				
	0.9			01.77	09.81	24.0218-0007.1	480003		180/181 x 38,5 - Lager
	1.0			10.81	12.88	24.0218-0707.2	480211		180/181 x 38,5 + Lager
	1.1			01.77	12.88				
	1.3 D			08.86	12.88				
	0.9			08.78	09.81	03.0520-0114.3	690114		14,29/180x31 TopKit VW
	1.0	...F-127903		10.81	- Bremskraftregler <sup>1)</sup>				
	1.1	...F-127903		08.78	- Bremskraftregler <sup>1)</sup>				
	1.3	...F-127903		08.78	- Bremskraftregler <sup>1)</sup>				
	0.9			08.78	09.81	03.0420-0617.3	680617	+ Rz GG <sup>6)</sup>	17,46/180x31 Kit VW
	1.0	...F-127903		10.81	+ Bremskraftregler <sup>4)</sup>	03.0520-3917.3	693917	+ Rz ALU <sup>7)</sup>	17,46/180x31 TopKit VW
	1.1	...F-127903		08.78	+ Bremskraftregler <sup>4)</sup>				
	1.3	...F-127903		08.78	+ Bremskraftregler <sup>4)</sup>				
	1.0	...F-127904		12.88	- Bremskraftregler <sup>1)</sup>	03.0520-0215.3	690215		15,87/180x31 TopKit VW
	1.1	...F-127904		12.88	- Bremskraftregler <sup>1)</sup>				
	1.3	...F-127904		12.88	- Bremskraftregler <sup>1)</sup>				
	1.3 D			08.86	12.88	- Bremskraftregler <sup>1)</sup>			
	0.9			01.77	09.81	24.3727-0146.2	580146	1 ⬆	L=794
	1.0	...E-200000		10.81		24.3727-0103.2	580103	1 ⬇	L=1960
	1.1	...E-200000		01.77					
	1.3	...E-200000		01.77					
	1.0	...F-000001		12.88		24.3727-0137.2	580137	1 ⬆	L=1594
	1.1	...F-000001		12.88		24.3727-0129.2	580129	2 ⬇	L=633
	1.3	...F-000001		12.88					
	1.3 D			08.86	12.88				
	1.0	...F-000001		12.88		03.6584-0015.3	320109		BRL 8/4 (4) ATE
	1.1	...F-000001		12.88					
	1.3	...F-000001		12.88					
	1.3 D			08.86	12.88				
	0.9			01.77	09.81	24.3728-0101.2	590101		L=607
	1.0	...F-127903		10.81					
	1.1	...F-127903		01.77					
	1.3	...F-127903		01.77					

**VOLKSWAGEN GOLF I Cabriolet (79-93)**

	1.1			01.79	07.83	03.2120-1531.3	010092		THz 20,64 ATE	
	1.5			01.79	07.83	03.2120-1491.3	010089		THz 20,64 + WE ATE	
	1.6			08.83	07.79	03.3517-0101.2	390322		Verschlußschraube ATE	
	1.6 GLI		15-E-011290	08.83	07.79					
	1.6		15-E-011291	15-L-015000		03.2120-2031.3	010106		THz 20,64 ATE	
	1.8		15-E-011291	15-L-015000		03.3517-0101.2	390322		Verschlußschraube ATE	
	1.6	◀	15-L-015001		12.92	03.2120-3943.3	010532		THz 20,64 ATE	
	1.8	◀	15-L-015001		08.93					
	1.1			01.79	07.83	11.0441-4402.2	250014		Dichtungssatz ATE	
	1.5			01.79	07.80	+ Schwimmsättel <sup>8)</sup>				
	1.6 GLI			01.79	07.80	+ Schwimmsättel <sup>8)</sup>			Dichtungssatz ATE	
	1.5			09.79	07.83	+ Faustsättel <sup>9)</sup>	11.0441-4808.2	250022	f.Vornr -8007/8008 -8503/8504 <sup>10)</sup>	Dichtungssatz ATE
	1.6		15-E-011290	08.83	+ Faustsättel <sup>9)</sup>	11.0441-4804.2	250019		Dichts.a.(+Sich.Ring) ATE	
	1.6 GLI			09.79	07.82	+ Faustsättel <sup>9)</sup>	11.0101-4801.2	260006		Hülensatz ATE
	1.8		15-E-011290	08.82		24.0102-4801.2	260085		Hülensatz+Schrauben ATE	
	1.6		15-E-011291		12.92	11.0441-4808.2	250022		Dichtungssatz ATE	
	1.8		15-E-011291		08.93	11.0101-4801.2	260006		Hülensatz ATE	
						24.0102-4801.2	260085		Hülensatz+Schrauben ATE	
	1.1			01.79	07.83	13.0460-4028.2	604028		20228 15,3 ATE	
	1.5			01.79	07.80	+ Schwimmsättel <sup>8)</sup>	13.0460-0115.2	610115		Belagsatz-Zubehör ATE
	1.5			09.79	07.83	+ Faustsättel <sup>9)</sup>	13.0460-0905.2	610905		Belagsatz-Zubehör LUC
	1.6			08.83	12.92					
	1.6 GLI			07.79	07.80	+ Schwimmsättel <sup>8)</sup>	13.0460-4029.2	604029		20228 18,5 ATE
	1.6 GLI			09.79	07.82	+ Faustsättel <sup>9)</sup>	13.0460-7032.2	607032		20887 19,7 +/Zub VW
	1.8			08.82	08.93					
						13.0460-4028.2	604028		20228 15,3 ATE	
						13.0460-7033.2	607033		20887 15,3 +/Zub VW	

1) - brake pressure regulator / - correttore di frenata / - correcteur de freinage / - corrector de frenado  
 2) + cast iron / + ghisa / + fonte grise / + fundición de gris  
 3) + aluminium / + alluminio / + aluminio / + aluminio  
 4) + brake pressure regulator / + correttore di frenata / + correcteur de freinage / + corrector de frenado  
 5) - automatic adjustment / - correzione automatica / - ajustage automatique / - reajuste automatico  
 6) + WC cast iron / + CR ghisa / + CR fontgrise / + CR fundición de gris  
 7) + WC aluminium / + CR alluminio / + CR aluminio / + CR aluminio  
 8) + floating calipers / + pinze flottante / + étriers flottant / + pinzas flotante  
 9) + fist type calipers / + pinza freno flottante / + étriers à griffe / + pinza de puno

10) f.partno.-8007/8008 -8503/8504 / p.no.codice -8007/8008 -8503/8504 / p.AV ref. -8007/8008 -8503/8504 / p. antes ref. -8007/8008 -8503/8504





**VOLKSWAGEN GOLF I Cabriolet (79-93)**

	1.1			01.79	07.83		24.0110-0151.1	410151			239 10,0 8,0 +S +B	
	1.5			01.79	07.83		24.0310-0151.1	510151			239 10,0 8,0 +S +B PD	
	1.6			08.83	12.92		24.0112-0106.1	412106			239 12,0 10,0 +S +B	
	1.6 GLI			08.83	12.92		24.0312-0106.1	512106			239 12,0 10,0 +S +B PD	
	1.1			07.79	07.82		24.0120-0123.1	420123			239 20,0 18,0 V L +S +B	
	1.8			08.82	08.93		24.0320-0123.1	520123			239 20,0 18,0 V L +S +B PD	
	1.1			01.79	07.83		24.5170-0315.3	331309	2		L=315	
	1.5			01.79	07.83		24.5108-0266.3	330038	2		L=266	LUC
	1.1			08.83	08.93							
	1.6 GLI			07.79	07.82							
	1.8			08.82	08.93							
	1.6			08.83	07.93		83.7824-0180.3	330812	2		L=180	
	1.1			01.79	07.83							
	1.5			01.79	07.83							
	1.6 GLI			07.79	07.82							
	1.8			08.82	07.83							
	1.6			08.83	07.93		83.7804-0160.3	330811	2		L=160	
	1.8			08.83	07.93							
	1.1			01.79	07.83		03.3214-0812.3	020011		+ GG <sup>2)</sup>	Rz 14,29	
	1.5			01.79	07.83		24.3214-0902.3	020147		+ ALU <sup>3)</sup>	Rz 14,29	
	1.6		15-E-011290	08.83								
	1.6 GLI			07.79	07.82							
	1.8		15-E-011290	08.82								
	1.1			01.79	07.83							
	1.5			01.79	07.83							
	1.6			08.83								
	1.6 GLI	15-E-011291		12.92								
	1.8			07.79	07.82							
	1.8		15-E-011291	08.82								
	1.1			01.79	07.83		03.3217-2112.3	020027		+ GG <sup>2)</sup>	Rz 17,46	
	1.5			01.79	07.83		24.3217-0908.3	020167		+ ALU <sup>3)</sup>	Rz 17,46	
	1.6			08.83								
	1.6 GLI			12.92								
	1.8			07.79	07.82							
	1.8		15-E-011291	08.82								
	1.8		15-E-011291	08.93								
	1.1			01.79	07.83		03.0137-0126.2	650126			180 x 31 HEB	
	1.5			01.79	07.83		03.0137-9008.2	669008			Bremsbacken-Zubehör	
	1.6			08.83	08.93							
	1.6 GLI			07.79	07.82							
	1.8			08.82	08.93							
	1.1			01.79	07.83		24.0218-0007.1	480003			180/181 x 38,5 - Lager	
	1.5			01.79	07.83		24.0218-0707.2	480211			180/181 x 38,5 + Lager	
	1.6			08.83	08.93							
	1.6 GLI			07.79	07.82							
	1.8			08.82	08.93							
	1.1			01.79	07.83		03.0520-0114.3	690114			14,29/180x31 TopKit	VW
	1.5			01.79	07.83							
	1.6			08.83								
	1.6 GLI			09.79	07.82							
	1.8		15-E-011290	08.82								
	1.1			01.79	07.83		03.0420-0617.3	680617		+ Rz GG <sup>5)</sup>	17,46/180x31 Kit	VW
	1.5			01.79	07.83		03.0520-3917.3	693917		+ Rz ALU <sup>6)</sup>	17,46/180x31 TopKit	VW
	1.6			08.83								
	1.6 GLI	15-E-011291		12.92								
	1.8			07.79	07.82							
	1.8		15-E-011291	08.82								
	1.8		15-E-011291	08.93								
	1.1			01.79	07.83		24.3727-0102.2	580102	2		L=1690	
	1.5			01.79	07.83							
	1.6			08.83	04.92							
	1.6 GLI			07.79	07.82							
	1.8			08.82	04.93							
	1.1			01.79	07.83		03.6565-0101.3	320097			BRL 6/5 (4)	ATE
	1.5			01.79	07.83							
	1.6			08.83								
	1.6 GLI			01.79	07.82							
	1.8			08.82								
	1.1			01.79	07.83		24.3728-0107.2	590107			L=1055	
	1.5			01.79	07.83		24.3728-0108.2	590108			L=794	
	1.6			08.83	12.92							
	1.6 GLI			01.79	07.82							
	1.8			08.82	08.93							

**VOLKSWAGEN GOLF I (74-83)**

	1.1			04.74	07.79	+ Bremsgerät <sup>7)</sup>	03.2120-1531.3	010092			Thz 20,64	ATE
	1.5			02.74	07.79	+ Bremsgerät <sup>7)</sup>						
	1.6			04.74	07.79	+ Bremsgerät <sup>7)</sup>						
	1.5 D			08.79	07.80	+ Bremsgerät <sup>7)</sup>	03.2120-1491.3	010089			Thz 20,64 + WE	ATE
	1.6 D			08.80	07.81	+ Bremsgerät <sup>7)</sup>						
	1.1			08.79	10.83	+ Bremsgerät <sup>7)</sup>	03.2120-1531.3	010092			Thz 20,64	ATE
	1.3			08.79	10.83	+ Bremsgerät <sup>7)</sup>	03.2120-1491.3	010089			Thz 20,64 + WE	ATE
	1.5			08.79	10.83	+ Bremsgerät <sup>7)</sup>						
	1.6			08.79	10.83	+ Bremsgerät <sup>7)</sup>						
	1.6 D			08.81	10.83	+ Bremsgerät <sup>7)</sup>						
	1.6 GTI			08.79	07.82		03.2120-1491.3	010089			Thz 20,64 + WE	ATE
	1.6 TD			03.82	10.83							
	1.8 GTI			08.82	10.83							
	1.1			08.76	08.80	+ USA	03.2120-1821.3	010100			Thz 20,64	ATE
	1.3			08.79	08.80	+ USA						
	1.5			08.76	08.80	+ USA						

1) - brake pressure regulator / - correttore di frenata / - correcteur de freinage / - corrector de frenado  
2) + cast iron / + ghisa / + fonte grise / + fundición de gris  
3) + aluminium / + alluminio / + aluminium / + aluminio  
4) + brake pressure regulator / + correttore di frenata / + correcteur de freinage / + corrector de frenado  
5) + WC cast iron / + CR ghisa / + CR fontgrise / + CR fundición de gris  
6) + WC aluminium / + CR alluminio / + CR aluminium / + CR aluminio  
7) + booster unit / + servofreno / + servo-frein / + servofreno





**VOLKSWAGEN GOLF I (74-83)**

	1.5 D 1.6 1.6 GTI		08.76 08.76 08.76	08.80 08.80 08.80	+ USA + USA + USA	03.2120-1821.3	010100		Thz 20,64	ATE
	1.1 1.3 1.5 1.6 1.6 D 1.6 GTI 1.6 TD 1.8 GTI		09.80 09.80 09.80 09.80 08.80 09.80 03.82 08.82	10.83 10.83 10.83 10.83 10.83 07.82 10.83 10.83	+ USA + USA + USA + USA + USA + USA + USA + USA	03.2120-1821.3	010100		Thz 20,64	ATE
	1.1 1.5 1.6		04.74 02.74 04.74	07.75 07.80 07.80	+ Schwimmsättel 1) + Schwimmsättel 1)	11.0441-4402.2	250014		Dichtungssatz	ATE
	1.1 1.3 1.5 D 1.6 D		08.75 08.79 08.76 08.80	10.83 10.83 07.80 10.83		11.0441-4402.2	250014		Dichtungssatz	ATE
	1.6 GTI		06.76	07.80	+ Schwimmsättel 1)	11.0441-4402.2	250014		Dichtungssatz	ATE
	1.5 1.6 1.6 GTI 1.6 TD 1.7 1.8 GTI		08.78 08.78 04.79 03.82 08.80 08.82	10.83 10.83 07.82 10.83 10.83 10.83	+ Faustsättel 2) + Faustsättel 2) + Faustsättel 2)  + J	11.0441-4808.2 11.0441-4804.2 11.0101-4801.2 24.0102-4801.2	250022 250019 260006 260085	f.Vornr -8007/8008 -8503/8504 3)	Dichtungssatz Dichts.a. (+Sich.Ring) Hülensatz Hülensatz+Schrauben	ATE ATE ATE ATE
	1.1 1.5 1.6		04.74 02.74 04.74	07.75 07.80 07.80	+ Schwimmsättel 1) + Schwimmsättel 1)	13.0460-4029.2	604029		20228 18,5	ATE
	1.1 1.5 D		08.75 08.76	02.78 02.78		13.0460-4028.2 13.0460-0010.2 13.0460-0905.2	604028 610010 610905		20228 15,3 Belagsatz-Zubehör Belagsatz-Zubehör	ATE ATE LUC
	1.1 1.3 1.5 D 1.6 D		03.78 08.79 03.78 08.80	10.83 10.83 07.80 10.83		13.0460-4028.2 13.0460-0115.2 13.0460-0905.2	604028 610115 610905		20228 15,3 Belagsatz-Zubehör Belagsatz-Zubehör	ATE ATE LUC
	1.5 1.6 1.6 TD		08.78 08.78 03.82	10.83 10.83 10.83	+ Faustsättel 2) + Faustsättel 2)	13.0460-7032.2	607032		20887 19,7 +/Zub	VW
	1.6 GTI 1.6 GTI 1.8 GTI		06.76 04.79 08.82	07.80 07.82 10.83	+ Schwimmsättel 1) + Faustsättel 2)	13.0460-4028.2 13.0460-7033.2	604028 607033		20228 15,3 20887 15,3 +/Zub	ATE VW
	1.1 1.5 1.6 1.6 TD 1.7		04.74 02.74 08.75 03.82 08.80	07.75 10.83 10.83 10.83 10.83		24.0112-0106.1 24.0312-0106.1	412106 512106		239 12,0 10,0 +S +B 239 12,0 10,0 +S +B PD	
	1.1 1.3 1.5 D 1.6 D		08.75 08.79 08.76 08.80	10.83 10.83 07.80 10.83		24.0110-0151.1 24.0310-0151.1	410151 510151		239 10,0 8,0 +S +B 239 10,0 8,0 +S +B PD	
	1.6 GTI 1.8 GTI		06.76 08.82	07.82 10.83		24.0120-0123.1 24.0320-0123.1	420123 520123		239 20,0 18,0 V L +S +B 239 20,0 18,0 V L +S +B PD	
	1.1 1.5 1.5 D 1.6 1.6 GTI		04.75 02.74 08.76 04.74 06.76	10.78 10.78 10.78 10.78 10.78	+ VA-Scheibenbremse 4)	83.6104-0325.3	330246	2	L=325	ATE
	1.1 1.3 1.5 1.5 D 1.6 1.6 D 1.6 GTI 1.6 TD 1.8 GTI		11.78 08.79 11.78 11.78 11.78 08.80 11.78 03.82 08.82	10.83 10.83 10.83 07.80 10.83 10.83 07.82 10.83 10.83		24.5170-0315.3 24.5108-0266.3	331309 330038	2 2	L=315 L=266	LUC
	1.1 1.3 1.5 1.5 D 1.6 1.6 D 1.6 GTI 1.6 TD 1.8 GTI		04.74 08.79 02.74 08.76 04.74 08.80 06.76 03.82 08.82	10.83 10.83 10.83 07.80 10.83 10.83 07.82 10.83 10.83		83.7804-0160.3	330811	2	L=160	
	1.1 1.3 1.5 1.5 D 1.6 1.6 D 1.6 GTI 1.6 TD		04.74 08.79 02.74 08.76 04.74 08.80 06.76 03.82	10.83 10.83 10.83 07.80 10.83 10.83 07.82 10.83	+ Schaltgetriebe 7) + Schaltgetriebe 7) + Schaltgetriebe/- (S) 8) + Schaltgetriebe 7)	03.3214-0812.3 24.3214-0902.3	020011 020147	+ GG 5) + ALU 6)	Rz 14,29 Rz 14,29	
	1.5 1.5 D		02.74 08.76	10.83 07.80	+ Automatikgetriebe 9) + Automatikgetriebe 9)	03.3217-2112.3 24.3217-0908.3	020027 020167	+ GG 5) + ALU 6)	Rz 17,46 Rz 17,46	

1) + floating calipers / + pinze flottante / + étriers flottant / + pinzas flotante  
 2) + fist type calipers / + pinza freno flottante / + étriers à griffe / + pinza de puno  
 3) f.partno.-8007/8008 -8503/8504 / p.no.codice -8007/8008 -8503/8504 / p.AV ref. -8007/8008 -8503/8504 / p. antes ref. -8007/8008 -8503/8504  
 4) + FA disc brake / + A disco freno / + frein à disque essieu AV / + ED disco de freno  
 5) + cast iron / + ghisa / + fonte grise / + fundición de gris  
 6) + aluminium / + alluminio / + aluminium / + aluminio  
 7) + manual transmission / + scatola cambio velocità / + transmission mécanique / + cambio de velocidad

8) + manual transmission / - (S) / + scatola camb.velocità / - (S) / + transmission mécanique / - (S) / + cambio de velocidad / - (S)  
 9) + autom.transmission / + scatola cambio automatico / + transmission automatique / + cambio automático



**VOLKSWAGEN GOLF I (74-83)**

	1.6 1.6 D 1.6 GTI 1.7 1.8 GTI		04.74 04.74 08.80 06.76 08.80 08.82	10.83 10.83 10.83 07.82 10.83 10.83	+ (S) + Automatikgetriebe 3) + Automatikgetriebe 3)	03.3217-2112.3 24.3217-0908.3	020027 020167	+ GG 1) + ALU 2)	Rz 17,46 Rz 17,46
	1.1 1.5 1.6 1.6 GTI		04.74 02.74 04.74 06.76	07.78 07.78 07.78 07.78		03.0137-9006.2	669006	- autom. Nachstellung 4)	Bremsbacken-Zubehör
	1.1 1.3 1.5 1.5 D 1.6 1.6 D 1.6 GTI 1.6 TD 1.7 1.8 GTI		08.78 08.79 08.78 08.78 08.78 08.80 08.78 03.82 08.80 08.82	10.83 10.83 10.83 07.80 10.83 10.83 07.82 10.83 10.83 10.83	+ (J)	03.0137-0126.2 03.0137-9008.2	650126 669008		180 x 31 HEB Bremsbacken-Zubehör
	1.1 1.3 1.5 1.5 D 1.6 1.6 D 1.6 GTI 1.6 TD 1.8 GTI		04.74 08.79 02.74 08.76 04.74 08.80 06.76 03.82 08.82	10.83 10.83 10.83 07.80 10.83 10.83 07.82 10.83 10.83		24.0218-0007.1 24.0218-0707.2	480003 480211		180/181 x 38,5 - Lager 180/181 x 38,5 + Lager
	1.1 1.3 1.5 1.5 D 1.6 1.6 D 1.6 TD		08.78 08.79 08.78 08.78 08.78 08.80 03.82	10.83 10.83 10.83 07.80 10.83 10.83 10.83	+ Schaltgetriebe 5) + Schaltgetriebe 5) + Schaltgetriebe/ - (S) 6) + Schaltgetriebe 5)	03.0520-0114.3	690114		14,29/180x31 TopKit VW
	1.5 1.5 D 1.6 1.6 D 1.6 GTI 1.7 1.8 GTI		08.78 08.78 08.78 08.80 08.78 08.80 08.82	10.83 07.80 10.83 10.83 07.82 10.83 10.83	+ Automatikgetriebe 3) + Automatikgetriebe 3) (S) + Automatikgetriebe 3) + Automatikgetriebe 3)	03.0420-0617.3 03.0520-3917.3	680617 693917	+ Rz GG 7) + Rz ALU 8)	17,46/180x31 Kit 17,46/180x31 TopKit VW VW
	1.1 1.3 1.5 1.5 D 1.6 1.6 D 1.6 GTI 1.6 TD 1.8 GTI		01.74 08.79 02.74 08.76 04.74 08.80 06.76 03.82 08.82	10.83 10.83 10.83 07.80 10.83 10.83 07.82 10.83 10.83		24.3727-0102.2	580102	2 (J)	L=1690
	1.1 1.3 1.5 1.5 D 1.6 1.6 D 1.6 GTI 1.6 TD 1.8 GTI		04.74 08.79 02.74 08.76 04.74 08.80 06.76 03.82 08.82	10.83 10.83 10.83 07.80 10.83 10.83 07.82 10.83 10.83		03.6565-0101.3	320097		BRL 6/5 (4) ATE
	1.1 1.5 1.5 D 1.6 1.6 D 1.6 GTI 1.6 TD 1.7 1.8 GTI		08.75 02.74 08.76 04.74 08.80 06.76 03.82 08.80 08.82	10.83 10.83 07.80 10.83 10.83 07.82 10.83 10.83 10.83	+ (J)	24.3728-0107.2 24.3728-0108.2	590107 590108		L=1055 L=794

**VOLKSWAGEN JETTA I (79-83)**

	1.1 1.3 1.5 1.6		08.79 08.79 08.79 08.80	07.83 07.83 07.83 07.83		03.2120-1531.3 03.2120-1491.3	010092 010089		Thz 20,64 Thz 20,64 + WE ATE ATE
	1.6 1.6 D 1.6 i 1.6 TD 1.7 1.8		08.81 08.80 08.79 03.82 08.80 08.82	07.83 07.81 07.82 07.83 07.83 07.83	+ (S) (J)	03.2120-1491.3	010089		Thz 20,64 + WE ATE
	1.6 D		08.81	07.83		03.2120-1531.3 03.2120-1491.3	010092 010089		Thz 20,64 Thz 20,64 + WE ATE ATE

1) + cast iron / + ghisa / + fonte grise / + fundición de gris

2) + aluminium / + alluminio / + aluminium / + aluminio

3) + autom.transmission / + scatola cambio automatico / + transmission automatique / + cambio automático

4) - automatic adjustment / - correzione automatica / - ajustage automatique / - reajuste automatico

5) + manual transmission / + scatola cambio velocità / + transmission mécanique / + cambio de velocidad

6) + manual transmission / - (S) / + scatola camb.velocità / - (S) / + transmission mécanique / - (S) / + cambio de velocidad / - (S)

7) + WC cast iron / + CR ghisa / + CR fonte grise / + CR fundición de gris

8) + WC aluminium / + CR alluminio / + CR aluminium / + CR aluminio





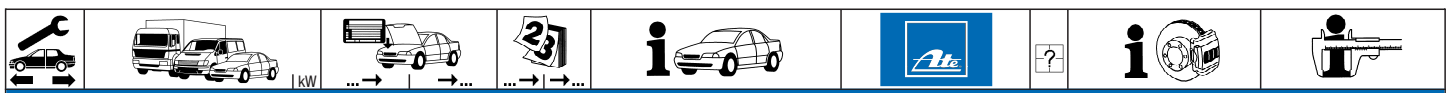

**VOLKSWAGEN JETTA I (79-83)**

	1.1	08.79	07.83	11.0441-4402.2	250014		Dichtungssatz	ATE
	1.3	08.79	07.83					
	1.6 D	08.80	07.83	+ Schwimmsättel <sup>1)</sup>				
	1.5	08.79	07.80	+ Schwimmsättel <sup>1)</sup>	11.0441-4402.2	250014	Dichtungssatz	ATE
	1.6	01.79	07.80	+ Schwimmsättel <sup>1)</sup>				
	1.5	08.79	07.83	+ Faustsättel <sup>2)</sup>	11.0441-4808.2	250022	Dichtungssatz	ATE
	1.6	08.80	07.83	+ Faustsättel <sup>2)</sup>	11.0441-4804.2	250019	Dichts.a.(+Sich.Ring)	ATE
	1.6 D	08.80	07.83	+ Faustsättel <sup>2)</sup>	11.0101-4801.2	260006	Hülzensatz	ATE
1.6 i	08.79	07.82		24.0102-4801.2	260085	Hülzensatz+Schrauben	ATE	
1.6 TD	03.82	07.83						
1.7	08.80	07.83	+ Ⓟ					
1.8	08.82	07.83						
	1.1	08.79	07.83	13.0460-4028.2	604028		20228 15,3	ATE
	1.3	08.79	07.83	13.0460-0115.2	610115		Belagsatz-Zubehör	ATE
	1.6 D	08.80	07.83	+ Schwimmsättel/- Ⓟ <sup>4)</sup>	13.0460-0905.2	610905	Belagsatz-Zubehör	LUC
	1.5	08.79	07.80	+ Schwimmsättel <sup>1)</sup>	13.0460-4029.2	604029	20228 18,5	ATE
	1.6	01.79	07.80	+ Schwimmsättel <sup>1)</sup>				
	1.5	08.79	07.83	+ Faustsättel <sup>2)</sup>	13.0460-7032.2	607032	20887 19,7 +/Zub	VW
	1.6	08.80	07.83	+ Faustsättel <sup>2)</sup>				
	1.6 D	08.80	07.83	+ Ⓟ / + Faustsättel <sup>5)</sup>				
1.6 TD	03.82	07.83						
1.7	08.80	07.83	+ Ⓟ					
1.6 i	08.79	07.82		13.0460-7033.2	607033	20887 15,3 +/Zub	VW	
1.8	08.82	07.83						
	1.1	08.79	07.83	24.0110-0151.1	410151		239 10,0 8,0 +S +B	
	1.3	08.79	07.83	24.0310-0151.1	510151		239 10,0 8,0 +S +B PD	
	1.6 D	08.80	07.83	- Ⓟ				
	1.5	08.79	07.83		24.0112-0106.1	412106	239 12,0 10,0 +S +B	
	1.6	08.80	07.83		24.0312-0106.1	512106	239 12,0 10,0 +S +B PD	
	1.6 D	08.80	07.83	+ Ⓟ				
	1.6 TD	03.82	07.83					
	1.7	08.80	07.83	+ Ⓟ				
1.6 i	08.79	07.82		24.0120-0123.1	420123	239 20,0 18,0 V L +S +B		
1.8	08.82	07.83		24.0320-0123.1	520123	239 20,0 18,0 V L +S +B PD		
	1.1	08.79	07.83	24.5170-0315.3	331309	2	L=315	
	1.3	08.79	07.83	24.5108-0266.3	330038	2	L=266	LUC
	1.5	08.79	07.83					
	1.6	08.80	07.83					
	1.6 D	08.80	07.83					
	1.6 i	08.79	07.82					
	1.6 TD	03.82	07.83					
	1.7	08.80	07.83	+ Ⓟ				
1.8	08.82	07.83						
	1.1	08.79	07.83	83.7804-0160.3	330811	2	L=160	
	1.3	08.79	07.83					
	1.5	08.79	07.83					
	1.6	08.80	07.83					
	1.6 D	08.80	07.83					
	1.6 i	08.79	07.82					
	1.6 TD	03.82	07.83					
	1.7	08.80	07.83	+ Ⓟ				
1.8	08.82	07.83						
	1.1	08.79	07.83	03.3214-0812.3	020011		Rz 14,29	
	1.3	08.79	07.83	24.3214-0902.3	020147		+ ALU <sup>7)</sup>	Rz 14,29
	1.5	08.79	07.83	+ Schaltgetriebe <sup>8)</sup>				
	1.6	08.80	07.83	+ Schaltgetriebe <sup>8)</sup>				
	1.6 D	08.80	07.83	+ Schaltgetriebe <sup>8)</sup>				
	1.6 TD	03.82	07.83					
	1.5	08.79	07.83	+ Automatikgetriebe <sup>9)</sup>	03.3217-2112.3	020027	+ GG <sup>6)</sup>	Rz 17,46
	1.6	08.80	07.83	+ Automatikgetriebe <sup>9)</sup>	24.3217-0908.3	020167	+ ALU <sup>7)</sup>	Rz 17,46
1.6 D	08.80	07.83	+ Automatikgetriebe <sup>9)</sup>					
1.6 i	08.79	07.82						
1.7	08.80	07.83	+ Ⓟ					
1.8	08.82	07.83						
	1.1	08.79	07.83	03.0137-0126.2	650126		180 x 31 HEB	
	1.3	08.79	07.83	03.0137-9008.2	669008		Bremsbacken-Zubehör	
	1.5	08.79	07.83					
	1.6	08.80	07.83					
	1.6 D	08.80	07.83					
	1.6 i	08.79	07.82					
	1.6 TD	03.82	07.83					
	1.7	08.80	07.83	+ Ⓟ				
1.8	08.82	07.83						
	1.1	08.79	07.83	24.0218-0007.1	480003		180/181 x 38,5 - Lager	
	1.3	08.79	07.83	24.0218-0707.2	480211		180/181 x 38,5 + Lager	
	1.5	08.79	07.83					
	1.6	08.80	07.83					
	1.6 D	08.80	07.83					
	1.6 i	08.79	07.82					
	1.6 TD	03.82	07.83					
	1.7	08.80	07.83	+ Ⓟ				
1.8	08.82	07.83						

<sup>1)</sup> + floating calipers / + pinze flottante / + étriers flottant / + pinzas flotante

<sup>2)</sup> + fist type calipers / + pinza freno flottante / + étriers à griffe / + pinza de puno

<sup>3)</sup> f.partno.-8007/8008 -8503/8504 / p.no.codice -8007/8008 -8503/8504 / p.AV ref. -8007/8008 -8503/8504 / p. antes ref. -8007/8008 -8503/8504

<sup>4)</sup> + floating calipers/ - Ⓟ / + pinze flottante/ - Ⓟ / + étriers flottant/ - Ⓟ / + pinzas flotante/ - Ⓟ

<sup>5)</sup> + Ⓟ / + fist type calipers / + Ⓟ / + pinza flottante / + Ⓟ / + étriers à griffe / + Ⓟ / + pinza de puno

<sup>6)</sup> + cast iron / + ghisa / + fonte grise / + fundición de gris

<sup>7)</sup> + aluminium / + alluminio / + aluminium / + aluminio

<sup>8)</sup> + manual transmission / + scatola cambio velocità / + transmission mécanique / + cambio de velocidad

<sup>9)</sup> + autom.transmission / + scatola cambio automatico / + transmission automatique / + cambio automático



**VOLKSWAGEN JETTA I (79-83)**





	1.1			08.79	07.83		03.0520-0114.3	690114			14,29/180x31 TopKit	VW
	1.3			08.79	07.83							
	1.5			08.79	07.83	+ Schaltgetriebe <sup>1)</sup>						
	1.6			08.80	07.83	+ Schaltgetriebe <sup>1)</sup>						
	1.6 D			08.80	07.83	+ Schaltgetriebe <sup>1)</sup>						
	1.6 TD			03.82	07.83							
	1.5			08.79	07.83	+ Automatikgetriebe <sup>2)</sup>	03.0420-0617.3	680617		+ Rz GG <sup>3)</sup>	17,46/180x31 Kit	VW
	1.6			08.80	07.83	+ Automatikgetriebe <sup>2)</sup>	03.0520-3917.3	693917		+ Rz ALU <sup>4)</sup>	17,46/180x31 TopKit	VW
	1.6 D			08.80	07.83	+ Automatikgetriebe <sup>2)</sup>						
	1.6 i			08.79	07.82							
	1.7			08.80	07.83	+						
	1.8			08.82	07.83							
	1.1			08.79	07.83		24.3727-0102.2	580102	2		L=1690	
	1.3			08.79	07.83							
	1.5			08.79	07.83							
	1.6			08.80	07.83							
	1.6 D			08.80	07.83							
	1.6 TD			03.82	07.83							
	1.1			08.79	07.83		03.6565-0101.3	320097			BRL 6/5 (4)	ATE
	1.3			08.79	07.83							
	1.5			08.79	07.83							
	1.6			08.80	07.83							
	1.6 D			08.80	07.83							
	1.6 TD			03.82	07.83							
	1.1			08.79	07.83		24.3728-0107.2	590107			L=1055	VW
	1.3			08.79	07.83							
	1.5			08.79	07.83		24.3728-0108.2	590108			L=794	
	1.6			08.80	07.83							
	1.6 D			08.80	07.83							
	1.6 TD			03.82	07.83							

**VOLKSWAGEN JETTA II (84-92)**

	1.6	◀		01.84	07.87	- ABS/ + Automatikgetriebe <sup>5)</sup>	03.6750-0202.4	300033			9"	ATE
	1.6	◀ 51		10.86	07.92	- ABS						
	1.6	◀ 53		03.86	07.92	- ABS						
	1.6	◀ 55	1G-LW400000	01.84		- ABS						
	1.6	◀ 55	1G-LB125000	01.84		- ABS						
	1.6 D	◀		01.84	07.89	- ABS/ + Automatikgetriebe <sup>5)</sup>						
	1.6 TD	◀		01.84	07.89	- ABS						
	1.8	◀		01.84	07.89	- ABS						
	1.8 16V	◀	1G-KW240000	08.86		- ABS						
	1.8 16V	◀	1G-KB075000	08.86		- ABS						
	1.8 Syncro	◀		08.87	07.92	- ABS						
	1.6	◀ 55	1G-LW400001		07.92	- ABS	03.7750-4302.4	300076			9"	ATE
	1.6	◀ 55	1G-LB125001		07.92	- ABS						
	1.6 D	◀		08.89	07.92	- ABS						
	1.6 TD	◀		08.89	07.92	- ABS						
	1.8	◀		08.89	07.92	- ABS						
	1.8 16V	◀	1G-KW240001		07.92	- ABS						
	1.8 16V	◀	1G-KB075001		07.92	- ABS						
	1.6	▶		08.89	07.92	- ABS	03.7750-4902.4	300079			9"	ATE
	1.6 D	▶		08.89	07.92	- ABS						
	1.6 TD	▶		08.89	07.92	- ABS						
	1.8	▶		08.89	07.92	- ABS						
	1.3			08.83	07.92	- ABS	03.2120-2031.3	010106			THz 20,64	ATE
	1.6			01.84	07.92	- ABS	03.3517-0101.2	390322			Verschlußschraube	
	1.6 D			01.84	07.89	- ABS						
	1.6 TD			01.84	07.89	- ABS						
	1.8			01.84	07.89	- ABS						
	1.8 16V		1G-KW240000	08.86		- ABS						
	1.8 16V		1G-KB075000	08.86		- ABS						
	1.8 Syncro			08.87	07.92	- ABS						
	1.6 D			08.89	07.92	- ABS	03.2120-3943.3	010532			THz 20,64	ATE
	1.6 TD			08.89	07.92	- ABS	03.3517-0101.2	390322			Verschlußschraube	
	1.8			08.89	07.92	- ABS						
	1.8 16V		1G-KB075001		07.92	- ABS	03.2122-1042.3	010137			THz 22,20	ATE
	1.8 16V		1G-KW240001		07.92	- ABS	03.3517-0101.2	390322			Verschlußschraube	
	1.3	▶	16-E-855000	08.83		- ABS	24.3481-1745.5	240277			D=48, - Halter	ATE
	1.3	◀		08.83	07.86	- ABS	24.3481-1746.5	240278			D=48, - Halter	ATE
	1.3			08.86	07.92	- ABS	11.0441-4808.2	250022			Dichtungssatz	ATE
	1.6 D	▶	16-E-855000	01.84		-	11.0101-4803.2	260008			Hülzensatz	ATE
	1.6 D	◀		01.84	07.86	-	24.0102-4803.2	260086			Hülzensatz+Schrauben	ATE
	1.6 D			08.86	07.92	+ Schaltgetriebe <sup>1)</sup>						

1) + manual transmission / + scatola cambio velocità / + transmission mécanique / + cambio de velocidad  
2) + autom.transmission / + scatola cambio automatico / + transmission automatique / + cambio automático  
3) + WC cast iron / + CR ghisa / + CR fonte grise / + CR fundición de gris  
4) + WC aluminium / + CR alluminio / + CR aluminium / + CR aluminio  
5) - ABS/ + autom.transmission / - ABS/ + scatola cambio autom. / - ABS/ + transmission automatique / - ABS/ + cambio automático



VOLKSWAGEN JETTA II (84-92)												
	1.3	▶	16-E-855001		07.86		11.0441-4808.2	250022		Dichtungssatz	ATE	
	1.3				08.89	+ ABS	11.0101-4801.2	260006		Hülsensatz	ATE	
	1.6				01.84	07.92	24.0102-4801.2	260085		Hülsensatz+Schrauben	ATE	
	1.6 D	▶	16-E-855001		07.86	- (J)						
	1.6 D				01.84	+ (J)						
	1.6 D				08.86	+ Automatikgetriebe 1)						
	1.6 TD				01.84	07.92						
	1.8				01.84	07.92						
	1.8 16V			1G-KW240000	08.86							
	1.8 16V			1G-KB075000	08.86							
1.8 Syncro				08.87	07.92							
1.8 16V			1G-KW240001		07.92		24.3541-1609.5	240039	☐	D=54, - Halter	LUC	
1.8 16V			1G-KB075001		07.92		24.3541-1610.5	240040	☐	D=54, - Halter	LUC	
							24.0101-4301.2	260047		Bremssattel-Zubehör	LUC	
							11.0101-5403.2	260010		Faltenbalgsatz	LUC	
	1.3	▶	16-E-855000	08.83	07.86		13.0460-7030.2	607030		20889 17,3 /Zub	VW	
	1.3	◀		08.83	07.84	- ABS	13.0460-0184.2	610184		Belagsatz-Zubehör	VW	
	1.3			08.83	07.84	- ABS						
	1.6	▶	53	16-E-855000	03.86	07.86						
	1.6 D	▶			01.84	- (J)						
	1.6 D	◀			01.84	07.86						
	1.6 D				08.86	+ Schaltgetriebe 2)						
	1.3	▶	16-E-855001		07.86		13.0460-7032.2	607032		20887 19,7 +/Zub	VW	
	1.3				08.89	+ ABS						
	1.6				08.86	07.92						
1.6	▶	55	16-E-855001	01.84	07.86							
1.6 D	▶			07.86	- (J)							
1.6 D				01.84	+ (J)							
1.6 D				08.86	+ Automatikgetriebe 1)							
1.6 TD				01.84	07.92							
1.8		62		08.86	07.92	- ABS						
1.8		66		08.84	07.92	- ABS						
1.8 Syncro				08.87	07.92							
1.8		62	16-JH560001		07.92	+ ABS	13.0460-7033.2	607033		20887 15,3 +/Zub	VW	
1.8		66	16-JH560001		07.92	+ ABS						
1.8		77		08.88	07.92	+ (J)						
1.8		79		08.85	07.92							
1.8		82		01.84	07.92							
1.8 16V			1G-KW240000	08.86								
1.8 16V			1G-KB075000	08.86								
1.8 16V			1G-KW240001		07.92		13.0460-2957.2	602957		20168 16,0 /S	LUC	
1.8 16V			1G-KB075001		07.92							
	1.3	▶	16-E-855000	08.83	07.86		24.0110-0151.1	410151		239 10,0 8,0 +S +B		
	1.3	◀		08.83	07.86	- ABS	24.0310-0151.1	510151		239 10,0 8,0 +S +B PD		
	1.3			08.86	07.92	- ABS						
	1.6	▶	53	16-E-855000	03.86	07.86						
	1.6 D	▶			01.84	- (J)						
	1.6 D	◀			01.84	07.86						
	1.6 D				08.86	+ Schaltgetriebe 2)						
	1.3	▶	16-E-855001		07.86		24.0112-0106.1	412106		239 12,0 10,0 +S +B		
	1.3				08.89	+ ABS	24.0312-0106.1	512106		239 12,0 10,0 +S +B PD		
	1.6				08.86	07.92						
1.6	▶	55	16-E-855001	01.84	07.86							
1.6 D				07.86	- (J)							
1.6 D				01.84	+ (J)							
1.6 D				08.86	+ Automatikgetriebe 1)							
1.6 TD				01.84	07.92							
1.8		62		08.86	07.92	- ABS						
1.8		66		08.84	07.92	- ABS						
1.8 Syncro				08.87	07.92							
1.8		62	16-JH560001		07.92	+ ABS	24.0120-0123.1	420123		239 20,0 18,0 V L +S +B		
1.8		66	16-JH560001		07.92	+ ABS	24.0320-0123.1	520123		239 20,0 18,0 V L +S +B PD		
1.8		77		08.88	07.92	+ (J)						
1.8		79		08.85	07.92							
1.8		82		01.84	07.92							
1.8 16V			1G-KW240000	08.86								
1.8 16V			1G-KB075000	08.86								
1.8 16V			1G-KW240001		07.92	+ ABS	24.0120-0128.1	420128		256 20,0 18,0 V L +S +B		
1.8 16V			1G-KB075001		07.92	+ ABS	24.0320-0128.1	520128		256 20,0 18,0 V L +S +B PD		
	1.3			08.83	07.92		24.5170-0315.3	331309	2	L=315		
	1.6			01.84	07.92							
	1.6 D			01.84	07.92							
	1.6 TD			01.84	07.92							
	1.8			01.84	07.92							
	1.8 16V			1G-KW240000	02.86							
	1.8 16V			1G-KB075000	02.86							
	1.8 Syncro				08.87	07.92						
	1.8 16V			1G-KW240001		07.92		83.6225-0287.3	330735	2	L=285	
	1.8 16V			1G-KB075001		07.92						
	1.3			08.86	07.92		24.0711-1313.3	360016	2	Radsensor L=1130		
	1.6			08.86	07.92							
	1.6 D			08.86	07.92							
	1.6 TD			08.86	07.92							
	1.8			08.86	07.92							
	1.8 16V			08.86	07.92							
	1.8 Syncro			08.87	07.92							

1) + autom.transmission / + scatola cambio automatico / + transmission automatique / + cambio automático

2) + manual transmission / + scatola cambio velocità / + transmission mécanique / + cambio de velocidad

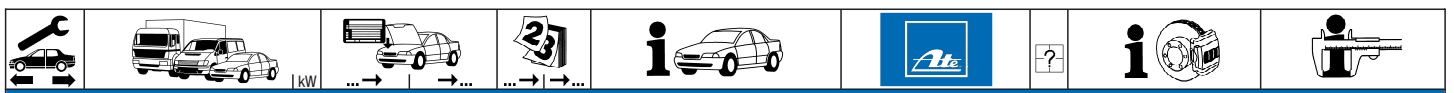

**VOLKSWAGEN JETTA II (84-92)**

	1.8			01.84	07.88	- ABS	24.3364-1605.5	240011		D=36, - Halter	LUC
	1.8 16V			08.86	07.88	- ABS	24.3364-1606.5	240012		D=36, - Halter	LUC
	1.8 GT			08.85	07.88	- ABS	24.0101-3601.2	260044		Bremssattel-Zubehör	LUC
							11.0101-5403.2	260010		Faltenbalgsatz	LUC
	1.8	62	16-JH480001		07.88	+ ABS	24.3384-1603.5	240015		D=38, - Halter	LUC
	1.8	66	16-JH480001		07.88	+ ABS	24.3384-1604.5	240016		D=38, - Halter	LUC
	1.8	82	16-JH480001		07.88	+ ABS	24.0101-3601.2	260044		Bremssattel-Zubehör	LUC
	1.8 16V				07.88	+ ABS					
	1.8 GT				07.88	+ ABS					
	1.8	62			08.88	+ ABS	24.3364-1605.5	240011		D=36, - Halter	LUC
	1.8	66			08.88	+ ABS	24.3364-1606.5	240012		D=36, - Halter	LUC
	1.8	82			08.88		24.0101-3601.2	260044		Bremssattel-Zubehör	LUC
	1.8 16V				08.88		11.0101-5403.2	260010		Faltenbalgsatz	LUC
	1.8 GT				08.88						
	1.8	62			08.89	+ ABS	24.3384-1603.5	240015		D=38, - Halter	LUC
	1.8	66			08.89	+ ABS	24.3384-1604.5	240016		D=38, - Halter	LUC
	1.8	82			08.89		24.0101-3601.2	260044		Bremssattel-Zubehör	LUC
	1.8 16V				08.89						
	1.8 GT				08.89						
	1.8	62	16-JH480001		07.92	+ ABS	13.0460-2937.2	602937		20961 15,2 /Zub/S Belagsatz-Zubehör	LUC
	1.8	66	16-JH480001		07.92	+ ABS	13.0460-0419.2	610419			LUC
	1.8	82			01.84						
	1.8 16V				08.86						
	1.8 GT				08.85						
	1.8	62	16-JH480001		07.92	+ ABS	24.0110-0111.1	410111	ohne Sensorring <sup>1)</sup> mit Sensorring <sup>2)</sup>	226 10,0 8,0 +B	
	1.8	66	16-JH480001		07.92	+ ABS	24.0110-0275.2	410275		226 10,0 8,0	
	1.8	82			01.84						
	1.8 16V				08.86						
	1.8 GT				08.85						
	1.3				08.83		83.7824-0180.3	330812	2	L=180	
	1.6				01.84		83.7804-0160.3	330811		L=160	
	1.6 D				01.84						
	1.6 TD				01.84						
	1.8	62			08.86	- ABS					
	1.8	66			08.84	- ABS					
	1.3				08.88		83.7804-0160.3	330811	2	L=160	
	1.6				08.88						
	1.6 D				08.88						
	1.6 TD				08.88						
	1.8	62			08.88	- ABS					
	1.8	66			08.88	- ABS					
	1.8 Syncro				08.87						
	1.8	62	16-JH480001		07.92	+ ABS	24.5170-0161.3	331308	2	L=161	
	1.8	66	16-JH480001		07.92	+ ABS					
	1.8	82			01.84						
	1.8 16V				08.86						
	1.3		1G-M-000001		07.92		24.0721-1925.1	360039	2	Radsensor L=1220	
	1.6		1G-M-000001		07.92						
	1.6 D		1G-M-000001		07.92						
	1.6 TD		1G-M-000001		07.92						
	1.8		1G-M-000001		07.92						
	1.8 16V		1G-M-000001		07.92						
	1.3				08.83	07.92	- Bremskraftregler <sup>3)</sup>	03.3214-0812.3	020011	+ GG <sup>4)</sup> + ALU <sup>5)</sup>	Rz 14,29
	1.6				01.84	07.92	- Bremskraftregler <sup>3)</sup>	24.3214-0902.3	020147		Rz 14,29
	1.6 D				01.84	07.92	- Bremskraftregler <sup>3)</sup>				
	1.6 TD				01.84	07.92	- Bremskraftregler <sup>3)</sup>				
	1.8	62			08.86	07.92	- Bremskraftregler <sup>3)</sup>				
	1.8	66			08.84	07.92	- Bremskraftregler <sup>3)</sup>				
	1.8	77	1G-KW593279		08.88	+					
	1.3				08.83	07.92	+ Bremskraftregler <sup>6)</sup>	03.3217-2112.3	020027	+ GG <sup>4)</sup> + ALU <sup>5)</sup>	Rz 17,46
	1.6				01.84	07.92	+ Bremskraftregler <sup>6)</sup>	24.3217-0908.3	020167		Rz 17,46
	1.6 D				01.84	07.92	+ Bremskraftregler <sup>6)</sup>				
	1.6 TD				01.84	07.92	+ Bremskraftregler <sup>6)</sup>				
	1.8	62			08.86	07.92	+ Bremskraftregler <sup>6)</sup>				
	1.8	66			08.84	07.92	+ Bremskraftregler <sup>6)</sup>				
	1.8	77	1G-KW593280		07.92	+					
	1.8 Syncro				08.87	07.92		24.3219-0909.3	020188		Rz 19,05
	1.3				08.83	07.92		03.0137-0126.2	650126		180 x 31 HEB
	1.6				01.84	07.92		03.0137-9008.2	669008		Bremssack-Zubehör
	1.6 D				01.84	07.92					
	1.6 TD				01.84	07.92	-				
	1.8	62			08.86	07.92	- ABS				
	1.8	66			08.84	07.92	- ABS				
	1.8	77	1G-KW593279		08.88		- ABS +				
	1.6 TD				08.89	07.92	+	03.0137-0268.2	650268		200 x 40 HEB
	1.8	77	1G-KW593280		07.92	+ ABS/ +	03.0137-9168.2	669168		Bremssack-Zubehör	VW
	1.8 Syncro				08.87	07.92		03.0137-0264.2	650264		230 x 40 HEB
	1.3				08.83	07.92		24.0218-0007.1	480003		180/181 x 38,5 - Lager
	1.6				01.84	07.92		24.0218-0707.2	480211		180/181 x 38,5 + Lager
	1.6 D				01.84	07.92					
	1.6 TD				01.84	07.92	-				
	1.8	62			08.86	07.92	- ABS				
	1.8	66			08.84	07.92	- ABS				
	1.8	77	1G-KW593279		08.88		+				

<sup>1)</sup> without sensor ring / senza sensori / sans secours ABS / sin anillo sensor ABS

<sup>2)</sup> with sensor ring / con sensori / avec secours ABS / con anillo sensor ABS

<sup>3)</sup> - brake pressure regulator / - correttore di frenata / - correcteur de freinage / - corrector de frenado

<sup>4)</sup> + cast iron / + ghisa / + fonte grise / + fundición de gris

<sup>5)</sup> + aluminium / + alluminio / + aluminium / + aluminio

<sup>6)</sup> + brake pressure regulator / + correttore di frenata / + correcteur de freinage / + corrector de frenado





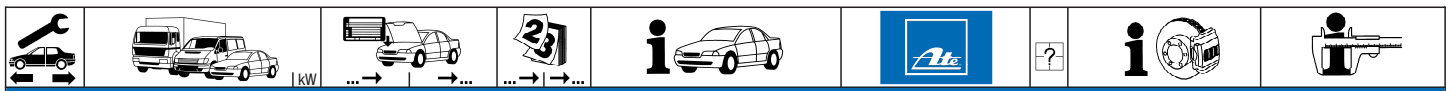

## VOLKSWAGEN JETTA II (84-92)

	1.6 TD 1.8	77 1G-KW593280	08.89 07.92	07.92 + ② 07.92 + ②	24.0220-0018.1 24.0220-0718.2	480019 480209	ohne Sensorring 1) ohne Sensorring 1)	200/201,5 x 50,5 - Lager 200/201,5 x 50,5 + Lager	
	1.8 Syncro		08.87	07.92	24.0223-0017.1	480135		230/231,5 x 48,5	
	1.3 1.6 1.6 D 1.6 TD 1.8 1.8	62 66	08.83 01.84 01.84 01.84 08.86 08.84	07.92 - Bremskraftregler/ - ②) 07.92 - Bremskraftregler/ - ②) 07.92 - Bremskraftregler/ - ②) 07.92 - Bremskraftregler/ - ②) 07.92 - Bremskraftregler/ - ②) 07.92 - Bremskraftregler/ - ②)	03.0520-0114.3	690114		14,29/180x31 TopKit	VW
	1.3 1.6 1.6 D 1.6 TD 1.8 1.8	62 66	08.83 01.84 01.84 01.84 08.86 08.84	07.92 + Bremskraftregler/ - ③) 07.92 + Bremskraftregler/ - ③) 07.92 + Bremskraftregler/ - ③) 07.92 + Bremskraftregler/ - ③) 07.92 + Bremskraftregler/ - ③) 07.92 + Bremskraftregler/ - ③)	03.0420-0617.3 03.0520-3917.3	680617 693917	+ Rz GG 4) + Rz ALU 5)	17,46/180x31 Kit 17,46/180x31 TopKit	VW VW
	1.6 TD 1.8	77 1G-KW593280	08.89 07.92	07.92 + ① 07.92 + ①	03.0420-1517.3 03.0520-1517.3	681517 691517		17,46/200x40 Kit 17,46/200x40 TopKit	VW VW
	1.3 1.6 1.6 D 1.6 TD 1.8 1.8	62 66	08.83 01.84 01.84 01.84 08.86 08.84	07.88 07.88 07.88 07.88 07.88 - ABS 07.88 - ABS				L=1748	
	1.3 1.6 1.6 D 1.6 TD 1.8 1.8 1.8	62 66 77	08.88 08.88 08.88 08.88 08.88 08.88 08.88	07.92 07.92 07.92 07.92 07.92 - ABS 07.92 - ABS 07.92 + ①	24.3727-0132.2	580132		L=1527	
	1.8 1.8 16V	82	01.84 08.86	07.92 - ABS 07.92 - ABS	24.3727-0123.2	580123		L=1800	
	1.8 1.8 16V	82 16-JH480001 16-JH480001	07.88 07.88	+ ABS + ABS	24.3727-0124.2	580124		L=1840	
	1.8 1.8 16V	82	08.88 08.88	07.92 + ABS 07.92 + ABS	24.3727-0133.2	580133		L=1622	
	1.8 Syncro		08.87	07.92	24.3727-0166.2	580166		L=1567	
	1.3 1.6 1.6 D 1.6 TD 1.8 1.8 16V 1.8 Syncro		08.83 01.84 01.84 01.84 01.84 08.86 08.87	07.92 07.92 07.92 07.92 07.92 07.92 07.92	03.6584-0015.3	320109		BRL 8/4 (4)	ATE
	1.3 1.6 1.8 1.8 16V		08.83 01.84 01.84 08.86	07.92 07.92 07.92 07.92	24.3728-0113.2 24.3728-0111.2	590113 590111		L=1098 L=806	
	1.6 D 1.6 TD 1.6 TD	51	01.84 01.84 04.89	07.92 07.92 07.92	24.3728-0121.2 24.3728-0120.2	590121 590120	+ autom. Nachstellung 7) + autom. Nachstellung 7)	L=800, + AUT L=1081, + AUT	
	1.8 Syncro		08.87	10.91	24.3728-0111.2 24.3728-0121.2	590111 590121	- autom. Nachstellung 6) + autom. Nachstellung 7)	L=806 L=800, + AUT	

## VOLKSWAGEN PASSAT Limousine (85-88)

	1.3 1.6 1.6 D 1.6 TD 1.8 2.0 2.2		08.84 08.84 08.84 08.84 08.84 08.84 08.85	07.86 03.88 03.88 03.88 03.88 03.88 03.88	03.7750-0302.4	300071		9"	ATE
	1.3 1.6 1.6 D 1.6 TD 1.8 2.0 2.2		08.84 08.84 08.84 08.84 08.84 08.84 08.85	07.86 03.88 03.88 03.88 03.88 03.88 03.88	03.2120-2191.3	010108		Thz 20,64	ATE
	2.2	85	01.85	03.88	03.2122-9612.3	010159		Thz 22,20	ATE
	1.3 1.6 1.6 D 1.6 TD 1.8 2.0 2.2		08.84 08.84 08.84 08.84 08.84 08.84 08.85	07.86 03.88 03.88 03.88 03.88 03.88 03.88	03.2120-2331.3	010110		Thz 20,64	ATE
	1.3 1.6 1.6 D 1.6 TD 1.8 2.0 2.2		08.84 08.84 08.84 08.84 08.84 08.84 08.85	07.86 03.88 03.88 03.88 03.88 03.88 03.88	11.0441-4808.2 11.0101-4801.2 24.0102-4801.2	250022 260006 260085		Dichtungssatz Hülsensatz Hülsensatz+Schrauben	ATE ATE ATE
	2.2	85	08.85	03.88					

1) without sensor ring / senza sensori / sans secours ABS / sin anillo sensor ABS

2) - brake pressure regulator/ - ②) / - correttore di frenata/ - ②) / - correcteur de freinage/ - ②) / - corrector de frenado/ - ②)























3) + brake pressure regulator/ - ②) / + correttore di frenata/ - ②) / + correcteur de freinage/ - ②) / + corrector de frenado/ - ②)

4) + WC cast iron / + CR ghisa / + CR fontegrise / + CR fundición de gris

5) + WC aluminium / + CR alluminio / + CR aluminium / + CR aluminio

6) - automatic adjustment / - correzione automatica / - ajustage automatique / - reajuste automático

7) + automatic adjustment / + correzione automatica / + ajustage automatique / + reajuste automático

										
<b>VOLKSWAGEN PASSAT Limousine (85-88)</b>										
	2.2	100		01.85	03.88	24.3541-1610.5	240040		D=54, - Halter D=54, - Halter Bremsattel-Zubehör Fallenbaldsatz	LUC LUC LUC LUC
	1.3 1.6 1.6 D 1.6 TD 1.8			08.84 08.84 08.84 08.84 08.84	07.86 03.88 03.88 03.88 03.88	13.0460-7032.2	607032		20887 19,7 +Zub	VW
	2.0 2.2	85		08.84 08.85	03.88 03.88	13.0460-7033.2	607033		20887 15,3 +Zub	VW
	2.2	100		01.85	03.88	13.0460-2957.2	602957		20168 16,0 /S	LUC
	1.3 1.6 1.6 D 1.6 TD 1.8			08.84 08.84 08.84 08.84 08.84	07.86 03.88 03.88 03.88 03.88	24.0112-0106.1 24.0312-0106.1	412106 512106		239 12,0 10,0 +S +B 239 12,0 10,0 +S +B PD	
	2.0 2.2	85		08.84 08.85	03.88 03.88	24.0120-0123.1 24.0320-0123.1	420123 520123		239 20,0 18,0 V L +S +B 239 20,0 18,0 V L +S +B PD	
	2.2	100		01.85	03.88	24.0120-0128.1 24.0320-0128.1	420128 520128		256 20,0 18,0 V L +S +B 256 20,0 18,0 V L +S +B PD	
	1.3 1.6 1.6 D 1.6 TD 1.8 2.0 2.2			08.84 08.84 08.84 08.84 08.84 08.84 08.85	07.86 03.88 03.88 03.88 03.88 03.88 03.88	24.5170-0315.3	331309	2	L=315	
	2.2	100		01.85	03.88	24.3364-1605.5 24.3364-1606.5 24.0101-3601.2 11.0101-5403.2	240011 240012 260044 260010		D=36, - Halter D=36, - Halter Bremsattel-Zubehör Fallenbaldsatz	LUC LUC LUC LUC
	2.2	100		01.85	03.88	13.0460-2937.2 13.0460-0419.2	602937 610419		20961 15,2 /Zub/S Belagsatz-Zubehör	LUC LUC
	2.2	100		01.85	03.88	24.0110-0111.1 24.0110-0275.2	410111 410275	ohne Sensorring <sup>1)</sup> mit Sensorring <sup>2)</sup>	226 10,0 8,0 +B 226 10,0 8,0	
	1.3 1.6 1.6 D 1.6 TD 1.8			08.84 08.84 08.84 08.84 08.84	07.86 03.88 + Schaltgetriebe <sup>3)</sup> 03.88 + Schaltgetriebe <sup>3)</sup> 03.88 + Schaltgetriebe <sup>3)</sup> 03.88 + Schaltgetriebe <sup>3)</sup>	83.7804-0160.3	330811	2	L=160	
	1.6 1.6 D 1.6 TD 1.8 2.0 2.2	85		08.84 08.84 08.84 08.84 08.84 08.85	03.88 + Automatikgetriebe <sup>4)</sup> 03.88 + Automatikgetriebe <sup>4)</sup> 03.88 + Automatikgetriebe <sup>4)</sup> 03.88 + Automatikgetriebe <sup>4)</sup> 03.88	83.7824-0180.3 83.7804-0160.3	330812 330811		L=180 L=160	
	2.2	100		01.85	03.88 - ABS	24.5170-0161.3	331308	2	L=161	
	1.3 1.6 1.8			08.84 08.84 08.84	07.86 - verstärkte Bremse <sup>5)</sup> 03.88 - verstärkte Br./+ Schaltgetr. <sup>8)</sup> 03.88 - verstärkte Br./+ Schaltgetr. <sup>8)</sup>	03.3215-2311.3 24.3215-0903.3	020018 020154	+ GG <sup>6)</sup> + ALU <sup>7)</sup>	Rz 15,87 Rz 15,87	
	1.6 D			08.84	03.88 - verstärkte Br./+ Schaltgetr. <sup>8)</sup>	03.3214-0812.3 24.3214-0902.3	020011 020147	+ GG <sup>6)</sup> + ALU <sup>7)</sup>	Rz 14,29 Rz 14,29	
	1.3 1.6 1.6 D 1.6 D 1.6 TD 1.8 1.8 2.0 2.2	85		08.84 08.84 08.84 08.84 08.84 08.84 08.84 08.84 08.85	07.86 + verstärkte Bremse <sup>5)</sup> 03.88 + verstärkte Bremse/+ Schaltgetr. <sup>10)</sup> 03.88 + Automatikgetriebe <sup>4)</sup> 03.88 + verstärkte Bremse/+ Schaltgetr. <sup>10)</sup> 03.88 + Automatikgetriebe <sup>4)</sup> 03.88 + verstärkte Bremse/+ Schaltgetr. <sup>10)</sup> 03.88 + Automatikgetriebe <sup>4)</sup> 03.88 + verstärkte Bremse/+ Schaltgetr. <sup>10)</sup> 03.88 + Automatikgetriebe <sup>4)</sup>	03.3217-2112.3 24.3217-0908.3	020027 020167	+ GG <sup>6)</sup> + ALU <sup>7)</sup>	Rz 17,46 Rz 17,46	
	1.3 1.6 1.6 D 1.8			08.84 08.84 08.84 08.84	07.86 - verstärkte Bremse <sup>5)</sup> 03.88 - verstärkte Br./+ Schaltgetr. <sup>8)</sup> 03.88 - verstärkte Br./+ Schaltgetr. <sup>8)</sup> 03.88 - verstärkte Br./+ Schaltgetr. <sup>8)</sup>	03.0137-0126.2 03.0137-9008.2	650126 669008		180 x 31 HEB Bremsbacken-Zubehör	
	1.3 1.6 1.6 D 1.6 D 1.6 TD 1.8 1.8 2.0 2.2	85		08.84 08.84 08.84 08.84 08.84 08.84 08.84 08.84 08.85	07.86 + verstärkte Bremse <sup>5)</sup> 03.88 + verstärkte Bremse/+ Schaltgetr. <sup>10)</sup> 03.88 + Automatikgetriebe <sup>4)</sup> 03.88 + verstärkte Bremse/+ Schaltgetr. <sup>10)</sup> 03.88 + Automatikgetriebe <sup>4)</sup> 03.88 + verstärkte Bremse/+ Schaltgetr. <sup>10)</sup> 03.88 + Automatikgetriebe <sup>4)</sup>	03.0137-0146.2 03.0137-9041.2	650146 669041		200 x 40 HEB Bremsbacken-Zubehör	
	1.3 1.6 1.6 D 1.8			08.84 08.84 08.84 08.84	07.86 - verstärkte Bremse <sup>5)</sup> 03.88 - verstärkte Br./+ Schaltgetr. <sup>8)</sup> 03.88 - verstärkte Br./+ Schaltgetr. <sup>8)</sup> 03.88 - verstärkte Br./+ Schaltgetr. <sup>8)</sup>	24.0218-0007.1 24.0218-0707.2	480003 480211		180/181 x 38,5 - Lager 180/181 x 38,5 + Lager	

<sup>1)</sup> without sensor ring / senza sensori / sans secours ABS / sin anillo sensor ABS

<sup>2)</sup> with sensor ring / con sensori / avec secours ABS / con anillo sensor ABS

<sup>3)</sup> + manual transmission / + scatola cambio velocità / + transmission mécanique / + cambio de velocidad

<sup>4)</sup> + autom.transmission / + scatola cambio automatico / + transmission automatique / + cambio automático

<sup>5)</sup> - heavy duty brake / - freno rinforzato / - frein renforcé / - freno reforzado

<sup>6)</sup> + cast iron / + ghisa / + fonte grise / + fundición de gris

<sup>7)</sup> + aluminium / + alluminio / + aluminium / + aluminio

<sup>8)</sup> - heavy duty br./+ manual trans. / - fr.rinforzato/+ scatola camb.velocità / - frein renforcé/ + transm.mécanique / - freno reforzado/ + camb.velocidad

<sup>9)</sup> + heavy duty brake / + freno rinforzato / + frein renforcé / + freno reforzado

<sup>10)</sup> + heavy duty br./+manual transm. / + fr.rinforzato/+ scatola camb.velocità / + frein renforcé/ + transm.mécanique / + freno reforzado/ + camb.de velocidad



**VOLKSWAGEN PASSAT Limousine (85-88)**

	1.3		08.84	07.86	+ verstärkte Bremse <sup>1)</sup>	24.0220-0018.1	480019		ohne Sensorring <sup>2)</sup>	200/201,5 x 50,5 - Lager 200/201,5 x 50,5 + Lager
	1.6		08.84	03.88	+ verstärkte Bremse/+ Schaltgetr. <sup>3)</sup>	24.0220-0718.2	480209			
	1.6		08.84	03.88	+ Automatikgetriebe <sup>4)</sup>					
	1.6 D		08.84	03.88	+ Automatikgetriebe <sup>4)</sup>					
	1.6 D		08.84	03.88	+ verstärkte Bremse/+ Schaltgetr. <sup>3)</sup>					
	1.6 TD		08.84	03.88						
	1.8		08.84	03.88	+ verstärkte Bremse/+ Schaltgetr. <sup>3)</sup>					
	2.0		08.84	03.88	+ Automatikgetriebe <sup>4)</sup>					
2.2	85	08.85	03.88							
	1.3		08.84	07.86	- verstärkte Bremse <sup>5)</sup>	03.0520-0215.3	690215			15,87/180x31 TopKit <b>VW</b>
	1.6		08.84	03.88	- verstärkte Br./+ Schaltgetr. <sup>6)</sup>					
	1.8		08.84	03.88	- verstärkte Br./+ Schaltgetr. <sup>6)</sup>					
	1.6 D		08.84	03.88	- verstärkte Br./+ Schaltgetr. <sup>6)</sup>	03.0520-0114.3	690114			
	1.3		08.84	07.86	+ verstärkte Bremse <sup>1)</sup>	03.0420-0417.3	680417			
	1.6		08.84	03.88	+ verstärkte Bremse/+ Schaltgetr. <sup>3)</sup>					
	1.6		08.84	03.88	+ Automatikgetriebe <sup>4)</sup>					
	1.6 D		08.84	03.88	+ verstärkte Bremse/+ Schaltgetr. <sup>3)</sup>					
1.6 D		08.84	03.88	+ Automatikgetriebe <sup>4)</sup>						
1.6 TD		08.84	03.88							
1.8		08.84	03.88	+ verstärkte Bremse/+ Schaltgetr. <sup>3)</sup>						
1.8		08.84	03.88	+ Automatikgetriebe <sup>4)</sup>						
2.0		08.84	03.88							
2.2	85	08.85	03.88							
	1.3		08.84	07.86		24.3727-0108.2	580108	1		L=2565
	1.6		08.84	03.88						
	1.6 D		08.84	03.88						
	1.6 TD		08.84	03.88						
	1.8		08.84	03.88						
	2.0		08.84	03.88						
2.2	85	08.85	03.88							
	2.0	◀	08.84	03.88		03.2419-8150.3	030019			Gz 19,05
	2.2	◀	08.85	03.88						
	2.0		08.84	03.88		03.2522-4211.3	040017			Nz 22,20
	2.2		08.85	03.88						
	1.3	◀	08.84	07.86		24.3728-0114.2	590114			L=944
	1.6	◀	08.84	03.88						
	1.8	◀	08.84	03.88						

**VOLKSWAGEN PASSAT Variant (73-84)**

	1.3	▶	08.81	07.84		03.2120-2331.3	010110			Thz 20,64 <b>ATE</b>
	1.6	▶	10.82	07.84						
	1.6 D	▶	02.79	07.84						
	1.6 TD	▶	12.81	07.84						
	1.8 i	▶	08.83	07.84						
	2.0	▶	01.81	07.83						
	1.3		05.73	01.80		11.0441-4402.2	250014			Dichtungssatz <b>ATE</b>
	1.5		05.73	08.75						
	1.5 D		08.77	01.80	+ Schwimmsättel <sup>7)</sup>					
	1.6		09.75	07.78						
	1.6		08.78	01.80	+ Schaltgetriebe <sup>8)</sup>					
	1.6 i		06.78	01.80	+ Ⓢ Ⓟ / + Schwimmsättel <sup>9)</sup>					
	1.3		02.80	11.83		11.0441-4808.2	250022			
	1.5 D		02.80	07.80	+ Faustsättel <sup>10)</sup>	11.0101-4801.2	260006			
	1.6		02.80	11.83		24.0102-4801.2	260085			
	1.6 D		02.79	11.83						
	1.6 i		06.78	07.80	+ Ⓢ Ⓟ / + Faustsättel <sup>11)</sup>					
	1.6 TD		12.81	11.83						
1.8		01.83	11.83							
1.9		01.81	07.83							
2.0		08.83	11.83							
2.2		01.81	07.83	+ Ⓢ						
	1.3		12.83	07.84		11.0441-4808.2	250022			Dichtungssatz <b>ATE</b>
	1.6		12.83	07.84		11.0101-4801.2	260006			
	1.6 D		12.83	07.84		24.0102-4801.2	260085			
	1.6 TD		12.83	07.84						
	1.8		12.83	07.84						
	2.0		12.83	07.84						
	1.3		05.73	01.80		13.0460-4029.2	604029			20228 18,5 <b>ATE</b>
	1.5		05.73	08.75						
	1.5 D		08.77	01.80	+ Schwimmsättel <sup>7)</sup>					
	1.6		09.75	07.78						
	1.6		08.78	01.80	+ Schaltgetriebe <sup>8)</sup>					
	1.6 i		06.78	01.80	+ Ⓢ Ⓟ / + Schwimmsättel <sup>9)</sup>					
1.3		02.80	07.84		13.0460-7032.2	607032				
1.5 D		02.80	07.80	+ Faustsättel <sup>10)</sup>						
1.6		02.80	07.84							
1.6 D		02.79	07.84							
1.6 i		02.80	07.80	+ Ⓢ Ⓟ / + Faustsättel <sup>11)</sup>						
1.6 TD		12.81	07.84							
1.8		01.83	07.84							
1.8 i		12.83	07.84		13.0460-7033.2	607033				

1) + heavy duty brake / + freno reforzado / + frein renforcé / + freno reforzado  
 2) without sensor ring / senza sensori / sans secours ABS / sin anillo sensor ABS  
 3) + heavy duty br./+manual transm. / + fr.rinforzato/+ scatola camb.velocità / + frein renforcé/ + transm.mécanique / + freno reforzado/ + camb.de velocidad  
 4) + autom.transmission / + scatola cambio automatico / + transmission automatique / + cambio automático  
 5) - heavy duty brake / - freno reforzado / - frein renforcé / - freno reforzado  
 6) - heavy duty br./+ manual trans. / - fr.rinforzato/+ scatola camb.velocità / - frein renforcé/ + transm.mécanique / - freno reforzado/ + camb.velocidad

7) + floating calipers / + pinze flottante / + étriers flottant / + pinzas flotante  
 8) + manual transmission / + scatola cambio velocità / + transmission mécanique / + cambio de velocidad  
 9) + Ⓢ Ⓟ / + floating calipers / + Ⓢ Ⓟ / + pinze flottanti / + Ⓢ Ⓟ / + étriers flottant / + Ⓢ Ⓟ / + pinza flotante  
 10) + fist type calipers / + pinza freno flottante / + étriers à griffe / + pinza de puno  
 11) + Ⓢ Ⓟ / + fist type caliper / + Ⓢ Ⓟ / + pinza flottante / + Ⓢ Ⓟ / + étriers à griffe / + Ⓢ Ⓟ / + pinza de puno



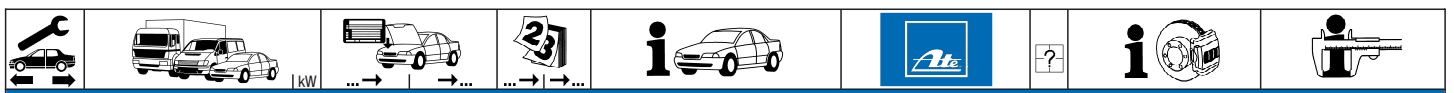

**VOLKSWAGEN PASSAT Variant (73-84)**

	1.9 2.0 2.2		01.81 07.83 08.83 07.84 01.81 07.83 + (S)	13.0460-7033.2 607033		20887 15,3 +/Zub <b>VW</b>
	1.3 1.5 1.5 D 1.6 1.6 D 1.6 i 1.6 TD 1.8 1.8 i 1.9 2.0 2.2		05.73 07.84 05.73 08.75 08.77 07.80 09.75 07.84 02.79 07.84 06.78 07.80 + (S) (J) 12.81 07.84 01.83 07.84 12.83 07.84 01.81 07.83 08.83 07.84 01.81 07.83 + (S)	24.0112-0106.1 412106 24.0312-0106.1 512106 24.0120-0123.1 420123 24.0320-0123.1 520123		239 12,0 10,0 +S +B 239 12,0 10,0 +S +B PD 239 20,0 18,0 V L +S +B 239 20,0 18,0 V L +S +B PD
	1.3 1.5 1.5 D 1.6 1.6 D 1.6 i 1.6 TD 1.8 1.9 2.0 2.2		05.73 07.84 05.73 08.75 08.77 07.80 09.75 07.84 02.79 07.84 06.78 07.80 + (S) (J) 12.81 07.84 01.83 07.84 01.81 07.83 08.83 07.84 01.81 07.83 + (S)	24.5170-0315.3 331309 24.5108-0266.3 330038	2 2	L=315 L=266 <b>LUC</b>
	1.3 1.5 1.5 D 1.6 1.6 i		05.73 07.80 05.73 08.75 08.77 07.80 09.75 07.80 06.78 07.80 + (S) (J)	83.7824-0180.3 330812	2	L=180
	1.3 1.6 1.6 D 1.6 TD 1.9 2.0 2.2		08.80 07.84 08.80 07.84 02.79 07.84 12.81 07.84 01.81 07.83 08.83 07.84 01.81 07.83 + (S)	83.7824-0180.3 330812 83.7804-0160.3 330811		L=180 L=160
	1.9 2.2 1.3 1.5 1.5 D 1.6 1.6 D 1.6 i 1.6 TD 1.8 1.9 2.0 2.2		01.81 07.81 01.81 07.81 + (S) 05.73 07.84 05.73 08.75 08.77 07.80 09.75 07.84 02.79 07.84 06.78 07.80 + (S) (J) 12.81 07.84 01.83 07.84 08.81 07.83 08.83 07.84 08.81 07.83 + (S)	03.3215-2311.3 020018 24.3215-0903.3 020154 03.3217-2112.3 020027 24.3217-0908.3 020167	+ GG <sup>1)</sup> + ALU <sup>2)</sup> + GG <sup>1)</sup> + ALU <sup>2)</sup>	Rz 15,87 Rz 15,87 Rz 17,46 Rz 17,46
	1.3 1.5 D 1.6 1.6 D 1.6 i 1.6 TD 1.8 1.9 2.0 2.2		08.78 07.84 08.78 07.80 08.78 07.84 02.79 07.84 08.78 07.80 + (S) (J) 12.81 07.84 01.83 07.84 08.81 07.83 08.83 07.84 01.81 07.83 + (S)	03.0137-0146.2 650146 03.0137-9041.2 669041		200 x 40 HEB Bremsbacken-Zubehör
	1.3 1.5 1.5 D 1.6 1.6 D 1.6 i 1.6 TD 1.8 1.9 2.0 2.2		05.73 07.84 05.73 08.75 08.77 07.80 09.75 07.84 02.79 07.84 06.78 07.80 + (S) (J) 12.81 07.84 01.83 07.84 01.81 07.83 08.83 07.84 01.81 07.83 + (S)	24.0220-0018.1 480019 24.0220-0718.2 480209	ohne Sensorring <sup>3)</sup> ohne Sensorring <sup>3)</sup>	200/201,5 x 50,5 - Lager 200/201,5 x 50,5 + Lager
	1.3 1.5 D 1.6 1.6 D 1.6 i 1.6 TD 1.8 1.9 2.0 2.2		08.78 07.84 08.78 07.80 08.78 07.84 02.79 07.84 06.78 07.80 + (S) (J) 12.81 07.84 01.83 07.84 08.81 07.83 08.83 07.84 08.81 07.83 + (S)	03.0420-0417.3 680417		17,46/200x40 Kit <b>VW</b>

<sup>1)</sup> + cast iron / + ghisa / + fonte grise / + fundición de gris

<sup>2)</sup> + aluminium / + alluminio / + aluminium / + aluminio

<sup>3)</sup> without sensor ring / senza sensori / sans secours ABS / sin anillo sensor ABS



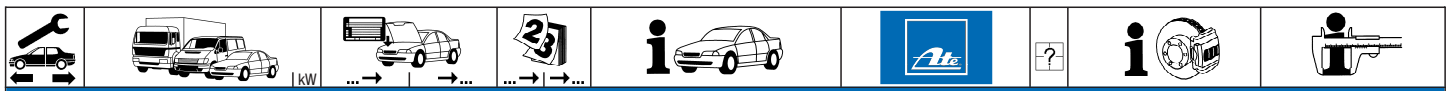

VOLKSWAGEN PASSAT Variant (73-84)										
	1.3 1.6 1.6 D 1.6 TD 1.8 1.9 2.0 2.2			08.80 08.80 02.79 12.81 01.83 01.81 08.83 01.81	07.84 07.84 07.84 07.84 07.84 07.83 07.84 07.83 + S		24.3727-0108.2	580108	1	L=2565
	1.3 1.5 1.5 D 1.6 1.6 i	32-42143626 32-42143626 32-42143626 32-42143626 32-42143626		07.80 08.75 07.80 07.80 07.80			03.6565-0101.3	320097		BRL 6/5 (4) ATE
	1.3 1.6 1.8	◀ ◀ ◀ 66		08.83 08.83 08.83	07.84 07.84 07.84		24.3728-0114.2	590114		L=944

VOLKSWAGEN PASSAT Variant (85-88)										
	1.3 1.6 1.6 D 1.6 TD 1.8 2.0 2.2	◀ ◀ ◀ ◀ ◀ ◀ ◀		08.84 08.84 08.84 08.84 08.84 08.84 08.85	07.86 03.88 03.88 03.88 03.88 03.88 03.88		03.7750-0302.4	300071		9" ATE
	1.3 1.6 1.6 D 1.6 TD 1.8 2.0 2.2	◀ ◀ ◀ ◀ ◀ ◀ ◀		08.84 08.84 08.84 08.84 08.84 08.84 08.85	07.86 03.88 03.88 03.88 03.88 03.88 03.88		03.2120-2191.3	010108		THz 20,64 ATE
	1.3 1.6 1.6 D 1.6 TD 1.8 2.0 2.2	▶ ▶ ▶ ▶ ▶ ▶ ▶		08.84 08.84 08.84 08.84 08.84 08.84 08.85	07.86 03.88 03.88 03.88 03.88 03.88 03.88		03.2120-2331.3	010110		THz 20,64 ATE
	1.3 1.6 1.6 D 1.6 TD 1.8 2.0 2.2			08.84 08.84 08.84 08.84 08.84 08.84 08.85	07.86 03.88 03.88 03.88 03.88 03.88 03.88		11.0441-4808.2 11.0101-4801.2 24.0102-4801.2	250022 260006 260085		Dichtungssatz ATE Hülzensatz ATE Hülzensatz+Schrauben ATE
	1.8 Syncro 2.0 Syncro 2.2 2.2 Syncro		85 100	01.86 08.84 01.85 08.84	07.88 07.88 03.88 07.88		24.3541-1610.5 24.3541-1609.5 24.0101-4301.2 11.0101-5403.2	240040 240039 260047 260010	<input type="checkbox"/> <input type="checkbox"/>	D=54, - Halter LUC D=54, - Halter LUC Bremsattel-Zubehör LUC Fallenbalgsatz LUC
	1.3 1.6 1.6 D 1.6 TD 1.8			08.84 08.84 08.84 08.84 08.84	07.86 03.88 03.88 03.88 03.88		13.0460-7032.2	607032		20887 19,7 +/Zub VW
	2.0 2.2		85	08.84 08.85	03.88 03.88		13.0460-7033.2	607033		20887 15,3 +/Zub VW
	1.8 Syncro 2.0 Syncro 2.2 2.2 Syncro		100	01.86 08.84 01.85 08.84	07.88 07.88 03.88 07.88		13.0460-2957.2	602957		20168 16,0 /S LUC
	1.3 1.6 1.6 D 1.6 TD 1.8			08.84 08.84 08.84 08.84 08.84	07.86 03.88 03.88 03.88 03.88		24.0112-0106.1 24.0312-0106.1	412106 512106		239 12,0 10,0 +S +B 239 12,0 10,0 +S +B PD
	2.0 2.2		85	08.84 08.85	03.88 03.88		24.0120-0123.1 24.0320-0123.1	420123 520123		239 20,0 18,0 V L +S +B 239 20,0 18,0 V L +S +B PD
	1.8 Syncro 2.0 Syncro 2.2 2.2 Syncro		100	01.86 08.84 01.85 08.84	07.88 07.88 03.88 07.88		24.0120-0128.1 24.0320-0128.1	420128 520128		256 20,0 18,0 V L +S +B 256 20,0 18,0 V L +S +B PD
	1.3 1.6 1.6 D 1.6 TD 1.8 1.8 Syncro 2.0 2.0 Syncro 2.2 2.2 Syncro			08.84 08.84 08.84 08.84 08.84 01.86 08.84 08.84 01.85 08.84	07.86 03.88 03.88 03.88 03.88 07.88 03.88 07.88 03.88 07.88		24.5170-0315.3	331309	2	L=315





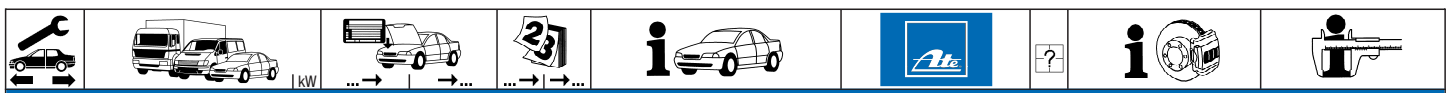

**VOLKSWAGEN PASSAT Variant (85-88)**

	2.2	100		01.85	03.88	24.3364-1605.5	240011		D=36, - Halter	LUC
						24.3364-1606.5	240012		D=36, - Halter	LUC
						24.0101-3601.2	260044		Bremssattel-Zubehör	LUC
						11.0101-5403.2	260010		Faltenbalgsatz	LUC
	1.8 Syncro			01.86	07.88	24.3384-1603.5	240015		D=38, - Halter	LUC
	2.0 Syncro			08.84	07.88	24.3384-1604.5	240016		D=38, - Halter	LUC
	2.2 Syncro			08.84	07.88	24.0101-3601.2	260044		Bremssattel-Zubehör	LUC
	1.8 Syncro			01.86	07.88	13.0460-2937.2	602937		20961 15,2 /Zub/S	LUC
	2.0 Syncro			08.84	07.88	13.0460-0419.2	610419		Belagsatz-Zubehör	LUC
	2.2	100		01.85	03.88					
	2.2 Syncro			08.84	07.88					
	2.2	100		01.85	03.88	24.0110-0111.1	410111		ohne Sensorring <sup>1)</sup>	226 10,0 8,0 +B
						24.0110-0275.2	410275		mit Sensorring <sup>2)</sup>	226 10,0 8,0
	1.8 Syncro			01.86	07.88	24.0110-0151.1	410151			239 10,0 8,0 +S +B
	2.0 Syncro			08.84	07.88					
	2.2 Syncro			08.84	07.88					
	1.3			08.84	07.86	83.7824-0180.3	330812			L=180
	1.6			08.84	03.88	83.7804-0160.3	330811			L=160
	1.6 D			08.84	03.88					
	1.6 TD			08.84	03.88					
	1.8			08.84	03.88					
	2.0			08.84	03.88					
	2.2	85		08.85	03.88					
	2.2	100		01.85	03.88	24.5170-0161.3	331308	2		L=161
	1.8 Syncro			01.86	07.88	83.6204-0240.3	330718	2		L=240
	2.0 Syncro			08.84	07.88	24.5170-0161.3	331308	2	am Bremssattel <sup>3)</sup>	L=161
	2.2 Syncro			08.84	07.88					
	1.3			08.84	07.86	03.3217-2112.3	020027		+ GG <sup>4)</sup>	Rz 17,46
	1.6			08.84	03.88	24.3217-0908.3	020167		+ ALU <sup>5)</sup>	Rz 17,46
	1.6 D			08.84	03.88					
	1.6 TD			08.84	03.88					
	1.8			08.84	03.88					
	2.0			08.84	03.88					
	2.2	85		08.85	03.88					
	1.3			08.84	07.86	03.0137-0146.2	650146			200 x 40 HEB
	1.6			08.84	03.88	03.0137-9041.2	669041			Bremsbacken-Zubehör
	1.6 D			08.84	03.88					
	1.6 TD			08.84	03.88					
	1.8			08.84	03.88					
	2.0			08.84	03.88					
	2.2	85		08.85	03.88					
	1.3			08.84	07.86	24.0220-0018.1	480019		ohne Sensorring <sup>1)</sup>	200/201,5 x 50,5 - Lager
	1.6			08.84	03.88	24.0220-0718.2	480209		ohne Sensorring <sup>1)</sup>	200/201,5 x 50,5 + Lager
	1.6 D			08.84	03.88					
	1.6 TD			08.84	03.88					
	1.8			08.84	03.88					
	2.0			08.84	03.88					
	2.2	85		08.85	03.88					
	1.3			08.84	07.86	03.0420-0417.3	680417			17,46/200x40 Kit
	1.6			08.84	03.88					
	1.6 D			08.84	03.88					
	1.6 TD			08.84	03.88					
	1.8			08.84	03.88					
	2.0			08.84	03.88					
	2.2	85		08.85	03.88					
	1.3			08.84	07.86	24.3727-0108.2	580108	1		L=2565
	1.6			08.84	03.88					
	1.6 D			08.84	03.88					
	1.6 TD			08.84	03.88					
	1.8			08.84	03.88					
	2.0			08.84	03.88					
	2.2	85		08.85	03.88					
	1.8 Syncro			01.86	07.88	03.6058-0301.3	320072			BR 25/5 (3)
	2.0 Syncro			08.84	07.88					
	2.2 Syncro			08.84	07.88					
	1.8 Syncro			01.86	07.88	03.2419-8150.3	030019			Gz 19,05
	2.0			08.84	03.88					
	2.0 Syncro			08.84	07.88					
	2.2			08.85	03.88					
	2.2 Syncro			08.84	07.88					
	1.8 Syncro			01.86	07.88	03.2522-4211.3	040017			Nz 22,20
	2.0			08.84	03.88					
	2.0 Syncro			08.84	07.88					
	2.2			08.85	03.88					
	2.2 Syncro			08.84	07.88					
	1.3			08.84	07.86	24.3728-0114.2	590114			L=944
	1.6			08.84	03.88					
	1.8			08.84	03.88					

**VOLKSWAGEN PASSAT/SANTANA Limousine (73-84)**

	1.3			05.73	07.79	+ Bremsgerät <sup>6)</sup>	03.2120-1531.3	010092		Thz 20,64	ATE
	1.5			05.73	08.75	+ Bremsgerät/ + Schaltgetriebe <sup>7)</sup>					
	1.6			09.75	07.79	+ Bremsgerät/ + Schaltgetriebe <sup>7)</sup>					

<sup>1)</sup> without sensor ring / senza sensori / sans secours ABS / sin anillo sensor ABS

<sup>2)</sup> with sensor ring / con sensori / avec secours ABS / con anillo sensor ABS

<sup>3)</sup> on the brake caliper / sulla pinza freno / sur l'étrier de frein / a la pinza de freno

<sup>4)</sup> + cast iron / + ghisa / + fonte grise / + fundición de gris

<sup>5)</sup> + aluminium / + alluminio / + aluminium / + aluminio

<sup>6)</sup> + booster unit / + servofreno / + servo-frein / + servofreno

<sup>7)</sup> + booster unit/ + manual transm. / + servofreno/ + scatola camb.velocità / + servo-frein/ + transm.mécanique / + servofreno/ + camb.de velocidad





**VOLKSWAGEN PASSAT/SANTANA Limousine (73-84)**

	1.3			08.79	07.83	+ Bremsgerät <sup>1)</sup>	03.2120-1531.3	010092		THz 20,64	ATE
	1.6			08.79	07.83	+ Bremsgerät/ + Schaltgetriebe <sup>2)</sup>	03.2120-1491.3	010089		THz 20,64 + WE	ATE
	1.6	◀		08.81	07.83	+ Automatikgetriebe <sup>3)</sup>	03.2120-1531.3	010092		THz 20,64	ATE
	1.6 D	◀		08.80	07.83	+ Schaltgetriebe <sup>4)</sup>	03.2120-1491.3	010089		THz 20,64 + WE	ATE
	1.8 i			01.83	07.83	+ Schaltgetriebe <sup>4)</sup>					
	1.9	◀		08.81	07.83		03.2120-1531.3	010092		THz 20,64	ATE
	1.3	▶		08.83	07.84	+ Bremsgerät/ + Schaltgetriebe <sup>2)</sup>	03.2120-2331.3	010110		THz 20,64	ATE
	1.6	▶		08.83	07.84	+ Bremsgerät/ + Schaltgetriebe <sup>2)</sup>					
	1.6	▶		08.81	07.83	+ Automatikgetriebe <sup>3)</sup>	03.2120-2331.3	010110		THz 20,64	ATE
	1.6 D	▶		08.80	07.84						
1.6 TD	▶		12.81	07.84							
1.8 i	▶		01.83	07.84	+ Automatikgetriebe <sup>3)</sup>						
1.9	▶		01.81	07.83							
2.0	▶		08.83	07.84							
	1.3			05.73	07.82		11.0441-4402.2	250014		Dichtungssatz	ATE
	1.5 D			08.77	07.80						
	1.6 D			08.80	08.81						
	1.5			05.73	08.75		11.0441-4402.2	250014		Dichtungssatz	ATE
	1.6			09.75	07.78						
	1.6			08.78	01.80	+ Schaltgetriebe <sup>4)</sup>					
	1.6 i			10.76	01.80	+ S J					
	1.3			08.82	11.83		11.0441-4808.2	250022	f.Vornr -8007/8008 -8503/8504 <sup>5)</sup>	Dichtungssatz	ATE
	1.6			02.80	11.83		11.0441-4804.2	250019		Dichts.a. (+Sich.Ring)	ATE
	1.6 D			09.81	11.83		11.0101-4801.2	260006		Hülensatz	ATE
1.6 i			02.79	07.80		24.0102-4801.2	260085		Hülensatz+Schrauben	ATE	
1.6 TD			12.81	11.83							
1.8 i			01.83	11.83							
1.9			01.81	07.83							
2.0			08.83	11.83							
2.2			01.81	07.83	+ S						
1.3			12.83	07.84		11.0441-4808.2	250022		Dichtungssatz	ATE	
1.6			12.83	07.84		11.0101-4801.2	260006		Hülensatz	ATE	
1.6 D			12.83	07.84		24.0102-4801.2	260085		Hülensatz+Schrauben	ATE	
1.6 TD			12.83	07.84							
1.8 i			12.83	07.84							
2.0			12.83	07.84							
	1.3			05.73	02.78		13.0460-4028.2	604028		20228 15,3	ATE
	1.5 D			08.77	07.78	+ Schaltgetriebe <sup>4)</sup>	13.0460-0010.2	610010		Belagsatz-Zubehör	ATE
	1.3			03.78	07.82		13.0460-4028.2	604028		20228 15,3	ATE
	1.5			05.73	08.75	+ Schaltgetriebe <sup>4)</sup>	13.0460-0115.2	610115		Belagsatz-Zubehör	ATE
	1.5 D			08.78	07.80	+ Schaltgetriebe <sup>4)</sup>	13.0460-0905.2	610905		Belagsatz-Zubehör	LUC
	1.6 D			08.80	08.81	+ Schaltgetriebe <sup>4)</sup>					
	1.5			05.73	08.75	+ Automatikgetriebe <sup>3)</sup>	13.0460-4029.2	604029		20228 18,5	ATE
	1.5 D			08.77	07.78	+ Automatikgetriebe <sup>3)</sup>					
	1.6			09.75	07.78	+ Automatikgetriebe <sup>3)</sup>					
	1.6			09.75	01.80	+ Schaltgetriebe <sup>4)</sup>					
1.6 i			09.75	07.78	+ Automatikgetriebe <sup>3)</sup>						
1.3			08.82	07.84		13.0460-7032.2	607032		20887 19,7 +/Zub	VW	
1.6 D			09.81	07.84	+ Schaltgetriebe <sup>4)</sup>						
1.6 TD			12.81	07.84							
1.8 i			01.83	07.84	- GT						
1.5 D			02.80	07.80	+ Automatikgetriebe <sup>3)</sup>	13.0460-7032.2	607032		20887 19,7 +/Zub	VW	
1.6			02.80	07.84	+ Schaltgetriebe <sup>4)</sup>						
1.6			02.80	07.84	+ Automatikgetriebe <sup>3)</sup>						
1.6 D			08.80	07.84	+ Automatikgetriebe <sup>3)</sup>						
1.6 i			02.80	07.80	+ Automatikgetriebe <sup>3)</sup>						
1.6 TD			12.81	07.84	+ Automatikgetriebe <sup>3)</sup>						
1.8 GT			12.83	07.84	+ Automatikgetriebe <sup>3)</sup>						
1.8 i			01.83	07.84	+ Automatikgetriebe <sup>3)</sup>						
1.9			01.81	07.83	+ Automatikgetriebe <sup>3)</sup>						
2.0			08.83	07.84	+ Automatikgetriebe <sup>3)</sup>						
1.6 i			09.75	07.80	+ S J	13.0460-7033.2	607033		20887 15,3 +/Zub	VW	
1.6 i			02.79	07.80							
1.8 GT			12.83	07.84							
1.9			01.81	07.83							
2.0			08.83	07.84							
2.2			01.81	07.83	+ S						
	1.3			05.73	07.82		24.0110-0151.1	410151		239 10,0 8,0 +S +B	
	1.5 D			08.77	07.80		24.0310-0151.1	510151		239 10,0 8,0 +S +B PD	
	1.6 D			08.80	08.81						
	1.3			08.82	07.84		24.0112-0106.1	412106		239 12,0 10,0 +S +B	
	1.5			05.73	08.75		24.0312-0106.1	512106		239 12,0 10,0 +S +B PD	
	1.6			09.75	07.84						
	1.6 D			09.81	07.84						
	1.6 TD			12.81	07.84						
	1.8 i			01.83	07.84	- GT					
	1.6 i			09.75	07.80	+ S J	24.0120-0123.1	420123		239 20,0 18,0 V L +S +B	
1.6 i			02.79	07.80		24.0320-0123.1	520123		239 20,0 18,0 V L +S +B PD		
1.8 GT			12.83	07.84							
1.9			01.81	07.83							
2.0			08.83	07.84							
2.2			01.81	07.83	+ S						

<sup>1)</sup> + booster unit / + servofreno / + servo-frein / + servofreno

<sup>2)</sup> + booster unit / + manual transm. / + servofreno / + scatola camb.velocità / + servo-frein / + transm.mécanique / + servofreno / + camb.de velocidad

<sup>3)</sup> + autom.transmission / + scatola cambio automatico / + transmission automatique / + cambio automático

<sup>4)</sup> + manual transmission / + scatola cambio velocità / + transmission mécanique / + cambio de velocidad

<sup>5)</sup> f.partno. -8007/8008 -8503/8504 / p.no.codice -8007/8008 -8503/8504 / p.AV ref. -8007/8008 -8503/8504 / p.antes ref. -8007/8008 -8503/8504



**VOLKSWAGEN PASSAT/SANTANA Limousine (73-84)**

	1.3	05.73	07.84	24.5170-0315.3	331309	2		L=315	<b>LUC</b>
	1.5	05.73	08.75	24.5108-0266.3	330038	2		L=266	
	1.5 D	08.77	07.80						
	1.6	09.75	07.84						
	1.6 D	08.80	07.84						
	1.6 i	09.75	07.80						
	1.6 TD	12.81	07.84						
	1.8 GT	12.83	07.84						
	1.8 i	01.83	07.84						
	1.9	01.81	07.83						
	2.0	08.83	07.84						
	1.3	05.73	07.80	83.7824-0180.3	330812	2		L=180	
	1.5	05.73	08.75						
	1.5 D	08.77	07.80						
	1.6	09.75	07.80						
	1.6 i	09.75	07.80						
	1.3	08.80	07.84	83.7804-0160.3	330811	2		L=160	
	1.6	08.80	07.84 + Schaltgetriebe <sup>1)</sup>						
	1.6 D	08.80	07.84 + Schaltgetriebe <sup>1)</sup>						
	1.6	08.80	07.84 + Automatikgetriebe <sup>2)</sup>	83.7824-0180.3	330812			L=180	
	1.6 D	08.80	07.84 + Automatikgetriebe <sup>2)</sup>	83.7804-0160.3	330811			L=160	
	1.6 TD	12.81	07.84						
1.9	01.81	07.83							
2.0	08.83	07.84							
2.2	01.81	07.83 + $\text{\textcircled{S}}$							
	1.3	05.73	07.84	03.3214-0812.3	020011		+ GG <sup>3)</sup>	Rz 14,29	
	1.5	05.73	08.75 + Schaltgetriebe <sup>1)</sup>	24.3214-0902.3	020147		+ ALU <sup>4)</sup>	Rz 14,29	
	1.5 D	08.77	07.80 + Schaltgetriebe <sup>1)</sup>						
	1.6	09.75	07.81 + Schaltgetriebe <sup>1)</sup>						
	1.6 D	08.80	07.81 + Schaltgetriebe <sup>1)</sup>						
	1.6	08.81	07.84 + Schaltgetriebe <sup>1)</sup>	03.3215-2311.3	020018		+ GG <sup>3)</sup>	Rz 15,87	
	1.6 D	08.81	07.84 + Schaltgetriebe <sup>1)</sup>	24.3215-0903.3	020154		+ ALU <sup>4)</sup>	Rz 15,87	
	1.8 i	01.83	07.84 - GT/ + Schaltgetriebe <sup>5)</sup>						
	1.9	01.81	07.81						
	2.2	01.81	07.81 + $\text{\textcircled{S}}$						
	1.5	05.73	08.75 + Automatikgetriebe <sup>2)</sup>	03.3217-2112.3	020027		+ GG <sup>3)</sup>	Rz 17,46	
1.5 D	08.77	07.80 + Automatikgetriebe <sup>2)</sup>	24.3217-0908.3	020167		+ ALU <sup>4)</sup>	Rz 17,46		
1.6	09.75	07.84 + Automatikgetriebe <sup>2)</sup>							
1.6 D	08.80	07.84 + Automatikgetriebe <sup>2)</sup>							
1.6 i	09.75	07.80							
1.6 TD	12.81	07.84							
1.8 i	01.83	07.84 - GT/ + Automatikgetriebe <sup>6)</sup>							
1.9	08.81	07.83							
2.0	08.83	07.84							
2.2	08.81	07.83 + $\text{\textcircled{S}}$							
	1.3	05.73	07.78	03.0137-9006.2	669006			Bremsbacken-Zubehör	
	1.5	05.73	08.75 + Schaltgetriebe <sup>1)</sup>						
	1.5 D	08.77	07.78 + Schaltgetriebe <sup>1)</sup>						
	1.6	09.75	07.78 + Schaltgetriebe <sup>1)</sup>						
	1.3	08.78	07.84	03.0137-0126.2	650126			180 x 31 HEB	
	1.5 D	08.78	07.80 + Schaltgetriebe <sup>1)</sup>	03.0137-9008.2	669008			Bremsbacken-Zubehör	
	1.6	08.78	07.84 + Schaltgetriebe <sup>1)</sup>						
	1.6 D	08.80	07.84 + Schaltgetriebe <sup>1)</sup>						
	1.5 D	08.78	07.80 + Automatikgetriebe <sup>2)</sup>	03.0137-0146.2	650146			200 x 40 HEB	
	1.6	08.78	07.84 + Automatikgetriebe <sup>2)</sup>	03.0137-9041.2	669041			Bremsbacken-Zubehör	
	1.6 D	08.80	07.84 + Automatikgetriebe <sup>2)</sup>						
	1.6 i	02.79	07.80						
	1.6 TD	12.81	07.84						
	1.8 i	01.83	07.84						
	1.9	01.81	07.83						
2.0	08.83	07.84							
2.2	01.81	07.83 + $\text{\textcircled{S}}$							
	1.3	05.73	07.84	24.0218-0007.1	480003			180/181 x 38,5 - Lager	
	1.5	05.73	08.75 + Schaltgetriebe <sup>1)</sup>	24.0218-0707.2	480211			180/181 x 38,5 + Lager	
	1.5 D	08.77	07.80 + Schaltgetriebe <sup>1)</sup>						
	1.6	09.75	07.84 + Schaltgetriebe <sup>1)</sup>						
	1.6 D	08.80	07.84 + Schaltgetriebe <sup>1)</sup>						
	1.5	05.73	08.75 + Automatikgetriebe <sup>2)</sup>	24.0220-0018.1	480019		ohne Sensorring <sup>7)</sup>	200/201,5 x 50,5 - Lager	
	1.5 D	08.77	07.80 + Automatikgetriebe <sup>2)</sup>	24.0220-0718.2	480209		ohne Sensorring <sup>7)</sup>	200/201,5 x 50,5 + Lager	
	1.6	09.75	07.84 + Automatikgetriebe <sup>2)</sup>						
	1.6 D	08.80	07.84 + Automatikgetriebe <sup>2)</sup>						
	1.6 i	02.79	07.80						
	1.6 TD	12.81	07.84						
1.8 i	01.83	07.84							
1.9	01.81	07.83							
2.0	08.83	07.84							
2.2	01.81	07.83 + $\text{\textcircled{S}}$							
	1.3	08.78	07.84	03.0520-0114.3	690114			14,29/180x31 TopKit	
	1.5 D	08.78	07.80 + Schaltgetriebe <sup>1)</sup>						
	1.6	08.78	07.81 + Schaltgetriebe <sup>1)</sup>						
	1.6 D	08.80	07.81 + Schaltgetriebe <sup>1)</sup>						
	1.6	08.81	07.84 + Schaltgetriebe <sup>1)</sup>	03.0520-0215.3	690215			15,87/180x31 TopKit	
1.6 D	08.81	07.84 + Schaltgetriebe <sup>1)</sup>							
1.5 D	08.78	07.80 + Automatikgetriebe <sup>2)</sup>	03.0420-0417.3	680417			17,46/200x40 Kit		
1.6	08.78	07.84 + Automatikgetriebe <sup>2)</sup>							

<sup>1)</sup> + manual transmission / + scatola cambio velocità / + transmission mécanique / + cambio de velocidad  
<sup>2)</sup> + autom.transmission / + scatola cambio automatico / + transmission automatique / + cambio automático  
<sup>3)</sup> + cast iron / + ghisa / + fonte grise / + fundición de gris  
<sup>4)</sup> + aluminium / + alluminio / + aluminium / + aluminio  
<sup>5)</sup> - GT/ + manual transm. / - GT/+ scatola cambio velocità / - GT/ + transmission mécanique / - GT/ + cambio de velocidad  
<sup>6)</sup> - GT/ + autom.transmission / - GT/+ scatola cambio autom. / - GT/ + transmission automatique / - GT/ + cambio automático  
<sup>7)</sup> without sensor ring / senza sensori / sans secours ABS / sin anillo sensor ABS





**VOLKSWAGEN PASSAT/SANTANA Limousine (73-84)**















	1.6 D		08.80	07.84	+ Automatikgetriebe <sup>1)</sup>	03.0420-0417.3	680417		17,46/200x40 Kit	VW
	1.6 i		02.79	07.80						
	1.6 TD		12.81	07.84						
	1.8 i		01.83	07.84	- GT/ + Automatikgetriebe <sup>2)</sup>					
	1.9		08.81	07.83						
	2.0		08.83	07.84						
	2.2		08.81	07.83	+					
	1.3		08.80	07.84		24.3727-0108.2	580108	1	L=2565	
	1.6		08.80	07.84						
	1.6 D		08.80	07.84						
	1.6 TD		12.81	07.84						
	1.8 GT		12.83	07.84						
	1.8 i		01.83	07.84						
	1.9		01.81	07.83						
2.0		08.83	07.84							
	1.3			07.80		03.6565-0101.3	320097		BRL 6/5 (4)	ATE
	1.5	32-42143626		08.75						
	1.5 D	32-42143626		07.80						
	1.6	32-42143626		07.80						
	1.6 i	32-42143626		07.80						
	1.3		08.83	07.84		24.3728-0114.2	590114		L=944	
	1.6		08.83	07.84						
	1.8	66	08.83	07.84						

**VOLKSWAGEN PASSAT (88-93)**

	1.6		04.88	10.93	- ABS	03.7750-4302.4	300076		9"	ATE																																								
	1.6 TD		08.88	10.93	- ABS																																													
	1.8		04.88	10.93	- ABS																																													
	1.8 16V		04.88	07.92	- ABS																																													
	1.9 D		05.89	10.93	- ABS																																													
	1.9 TD		03.91	10.93	- ABS																																													
	2.0		03.90	10.93	- ABS																																													
	2.0 16V		04.88	10.93	- ABS																																													
	2.8 VR6		06.91	10.93	- ABS																																													
		1.6		04.88	10.93						- ABS	03.7750-4902.4	300079		9"	ATE																																		
1.6 TD			08.88	10.93	- ABS																																													
1.8			04.88	10.93	- ABS																																													
1.8 16V			04.88	07.92	- ABS																																													
1.9 D			05.89	10.93	- ABS																																													
1.9 TD			03.91	10.93	- ABS																																													
2.0			03.90	10.93	- ABS																																													
2.0 16V			04.88	10.93	- ABS																																													
2.8 VR6			06.91	10.93	- ABS																																													
		1.6		04.88	07.91	- ABS	03.2120-3943.3	010532		THz 20,64	ATE																																							
	1.6 TD		08.88	07.91	- ABS																																													
	1.8	55	08.90	07.91	- ABS																																													
	1.9 D		05.89	07.91	- ABS																																													
	1.9 TD		03.91	07.91	- ABS																																													
	2.0		03.90	07.91	- ABS																																													
	1.6		08.91	10.93	- ABS	03.2122-1042.3	010137		THz 22,20	ATE																																								
	1.6 TD		08.91	10.93	- ABS																																													
	1.8	55	08.91	10.93	- ABS																																													
	1.8	66	04.88	10.93	- ABS																																													
	1.8	79	04.88	07.90	- ABS																																													
	1.8	82	04.88	07.90	- ABS																																													
	1.8 16V		04.88	07.91	- ABS																																													
	1.9 D		08.91	10.93	- ABS																																													
	1.9 TD		08.91	10.93	- ABS																																													
	2.0		08.91	10.93	- ABS																																													
2.0 16V		08.88	07.91	- ABS																																														
	1.6 Limousine		04.88	09.89	- ABS	24.3541-1609.5	240039	<input type="checkbox"/>	D=54, - Halter	LUC																																								
											24.3541-1610.5	240040	<input type="checkbox"/>	D=54, - Halter	LUC																																			
																11.0441-4808.2	250022		Dichtungssatz	ATE																														
																					11.0101-4801.2	260006		Hülssensatz	ATE																									
																										24.0102-4801.2	260085		Hülssensatz+Schrauben	ATE																				
																															24.0101-4301.2	260047		Bremsattel-Zubehör	LUC															
																																				11.0101-5403.2	260010		Fallenbalsatz	LUC										
	1.6		10.89	10.93																																					24.3541-1609.5	240039	<input type="checkbox"/>	D=54, - Halter	LUC					
	1.6 Limousine		04.88	09.89	+ ABS																																									24.3541-1610.5	240040	<input type="checkbox"/>	D=54, - Halter	LUC
	1.6 TD		08.88	10.93																																														
1.6 Variant		04.88	09.89		11.0101-5403.2	260010		Fallenbalsatz	LUC																																									
1.8		04.88	10.93																																															
1.8 16V		04.88	07.92																																															
1.9 D		05.89	10.93																																															
1.9 TD		03.91	10.93																																															
2.0		03.90	10.93																																															
2.0 16V		08.88	10.93																																															
2.0 Syncro		10.90	10.93																																															
1.8 Syncro G60		08.88	10.93																																										24.3541-1731.5	240061	<input type="checkbox"/>	D=54, - Halter	LUC	
2.8 VR6		06.91	10.93																																															24.3541-1732.5
	1.6 Limousine		04.88	09.89	- ABS	13.0460-7032.2	607032		20887 19,7 +Zub																																									
										13.0460-2958.2	602958		20168 19,3 /S	LUC																																				
	1.6 Limousine		10.89	10.93	+ ABS										13.0460-2958.2	602958		20168 19,3 /S	LUC																															
	1.6 Limousine		04.88	10.93	+ ABS																																													
1.6 TD		08.88	10.93																																															
1.6 Variant		04.88	10.93																																															











<sup>1)</sup> + autom.transmission / + scatola cambio automatico / + transmission automatique / + cambio automático  
<sup>2)</sup> - GT/ + autom.transmission / - GT/+ scatola cambio autom. / - GT/ + transmission automatique / - GT/ + cambio automático



											
<b>VOLKSWAGEN PASSAT (88-93)</b>											
	1.8	55		04.88	10.93		13.0460-2958.2	602958	20168 19,3 /S	LUC	
	1.8	66		04.88	10.93						
	1.8 Syncro G60			08.88	10.93						
	1.9 D			05.89	10.93						
	1.9 TD			03.91	10.93						
	2.8 VR6			06.91	10.93						
	1.8	79		04.88	07.90		13.0460-2957.2	602957	20168 16,0 /S	LUC	
	1.8	82		04.88	07.90						
	1.8 16V			04.88	07.92						
	2.0			03.90	10.93						
	2.0 16V			08.88	10.93						
	2.0 Syncro			10.90	10.93						
	1.6			04.88	10.93		24.0113-0178.1	413178	256 12,9 11,0 +S +B		
	1.6 TD			08.88	10.93		24.0313-0178.1	513178	256 12,9 11,0 +S +B PD		
	1.8	55		04.88	10.93						
	1.8	66		04.88	10.93						
	1.9 D			05.89	10.93						
	1.9 TD			03.91	10.93						
	1.8	79		04.88	07.90		24.0120-0128.1	420128	256 20,0 18,0 V L +S +B		
	1.8	82		04.88	07.90		24.0320-0128.1	520128	256 20,0 18,0 V L +S +B PD		
	1.8 16V			04.88	07.92						
	2.0			03.90	10.93						
	2.0 16V			08.88	10.93						
	2.0 Syncro			10.90	10.93						
	1.8 Syncro G60			08.88	10.93		24.0122-0101.1	422101	280 22,0 20,0 V L +B		
	2.8 VR6	31-N-255990			10.93		24.0122-0100.1	422100	280 22,0 20,0 V L +B		
							24.0322-0100.1	522100	280 22,0 20,0 V L +B PD		
	1.6			04.88	10.93		83.7813-0330.3	330800	2	L=330	
	1.6 TD			08.88	10.93						
	1.8			04.88	10.93						
	1.8 16V			04.88	07.92						
	1.8 Syncro G60			08.88	10.93						
	1.9 D			05.89	10.93						
	1.9 TD			03.91	10.93						
	2.0			03.90	10.93						
	2.0 16V			08.88	10.93						
	2.0 Syncro			10.90	10.93						
2.8 VR6			06.91	10.93							
	1.6			04.88	10.93		24.0711-1313.3	360016	2	Radsensor L=1130	
	1.6 TD			08.88	10.93						
	1.8			04.88	10.93						
	1.8 16V			04.88	07.92						
	1.8 Syncro G60			09.89	10.93						
	1.9 D			05.89	10.93						
	1.9 TD			03.91	10.93						
	2.0			03.90	10.93						
	2.0 16V			04.88	10.93						
	2.0 Syncro			10.90	10.93						
2.8 VR6			06.91	10.93							
	1.8	79		04.88	07.90		24.3384-1603.5	240015	☐	D=38, - Halter LUC	
	1.8	82		04.88	07.90		24.3384-1604.5	240016	☐	D=38, - Halter LUC	
	1.8 16V			04.88	07.92		24.0101-3601.2	260044	☐	Bremssattel-Zubehör LUC	
	1.8 Syncro G60			31-P-080000	08.88						
	2.0			31-PE080000	03.90						
	2.0			31-PB080000	03.90						
	2.0 16V			31-PE080000	08.88						
	2.0 16V			31-PB080000	08.88						
	2.0 Syncro			31-P-080000	10.90						
	2.8 VR6			31-PE080000	06.91						
2.8 VR6			31-PB080000	06.91							
	1.8 Syncro G60	31-P-080001			10.93		24.3384-1707.5	240171	☐	D=38, - Halter LUC	
	2.0	31-PE080001			10.93		24.3384-1708.5	240172	☐	D=38, - Halter LUC	
	2.0	31-PB080001			10.93		24.0101-3601.2	260044		Bremssattel-Zubehör LUC	
	2.0 16V	31-PE080001			10.93		11.0101-5403.2	260010		Fallenbalsatz LUC	
	2.0 16V	31-PB080001			10.93						
	2.0 Syncro	31-P-080001			10.93						
	2.8 VR6	31-PE080001			10.93						
	2.8 VR6	31-PB080001			10.93						
		1.8	79		04.88	07.90		13.0460-2937.2	602937	20961 15,2 /Zub/S	LUC
		1.8	82		04.88	07.90		13.0460-0419.2	610419	Belagsatz-Zubehör	LUC
1.8 16V				04.88	07.92						
1.8 Syncro G60				31-P-080000	08.88						
2.0				31-PE080000	03.90						
2.0				31-PB080000	03.90						
2.0 16V				31-PE080000	08.88						
2.0 16V				31-PB080000	08.88						
2.0 Syncro				31-P-080000	10.90						
2.8 VR6				31-PE080000	06.91						
2.8 VR6			31-PB080000	06.91							
	1.8 Syncro G60	31-P-080001			10.93		13.0460-2984.2	602984	20961 17,2 /Zub/S	LUC	
	2.0	31-PE080001			10.93		13.0460-0072.2	610072	Belagsatz-Zubehör	LUC	
	2.0	31-PB080001			10.93						
	2.0 16V	31-PE080001			10.93						
	2.0 16V	31-PB080001			10.93						
	2.0 Syncro	31-P-080001			10.93						
2.8 VR6	31-PE080001			10.93							





VOLKSWAGEN PASSAT (88-93)															
	2.8 VR6		31-PB080001			10.93			13.0460-2984.2 13.0460-0072.2	602984 610072			20961 17,2 /Zub/S Belagsatz-Zubehör	LUC LUC	
	1.8	79			04.88	07.90			24.0110-0111.1	410111		ohne Sensorring <sup>1)</sup>	226 10,0 8,0 +B		
	1.8	82			04.88	07.90			24.0110-0275.2	410275		mit Sensorring <sup>2)</sup>	226 10,0 8,0		
	1.8 16V				04.88	07.92									
	2.0				03.90	10.93									
	2.0 16V				08.88	10.93									
	1.8 Syncro G60 2.0 Syncro					08.88 10.90	10.93 10.93			24.0110-0151.1	410151			239 10,0 8,0 +S +B	
	1.6				04.88	10.93			83.7824-0180.3	330812	2		L=180		
	1.6 TD				08.88	10.93									
	1.8	55			04.88	10.93									
	1.8	66			04.88	10.93									
	1.9 D				05.89	10.93									
	1.9 TD				03.91	10.93									
	1.8	79			04.88	07.90			83.7824-0180.3	330812	2		L=180		
	1.8	82			04.88	07.90			24.5170-0161.3	331308	2	am Bremsattel <sup>3)</sup>	L=161		
	2.0				03.90	10.93									
	2.0 16V 2.8 VR6				08.88 06.91	10.93 10.93									
	1.8 Syncro G60 2.0 Syncro				08.88 10.90	10.93 10.93			83.7804-0160.3 24.5170-0161.3	330811 331308	2 2	am Bremsattel <sup>3)</sup>	L=160 L=161		
	1.6 1.6 TD 1.8 1.8 16V 1.9 D 1.9 TD 2.0 2.0 16V 2.8 VR6				04.88 08.88 04.88 04.88 05.89 03.91 03.90 04.88 06.91	10.93 10.93 10.93 07.92 10.93 10.93 10.93 10.93 10.93			24.0721-1925.1	360039	2		Radsensor L=1220		
	1.8 Syncro G60 2.0 Syncro			31-M-367757 31-M-367757	09.89 10.90			24.0711-1135.3	360003	2		Radsensor L=1060			
	1.6 Limousine			31-L-085000	04.88			24.3219-0909.3	020188				Rz 19,05		
	1.6 Limousine		31-L-085001			10.93		24.3220-0909.3	020210				Rz 20,64		
	1.6 TD					08.88	10.93								
	1.6 Variant					04.88	10.93								
	1.8	55				04.88	10.93								
	1.8	66				04.88	10.93								
	1.9 D					05.89	10.93								
	1.9 TD					03.91	10.93								
	1.6 Limousine			31-L-085000	04.88			03.0137-0268.2 03.0137-9168.2	650268 669168				200 x 40 HEB Bremsbacken-Zubehör	VW VW	
	1.6 Limousine		31-L-085001	31-M-280000				03.0137-0264.2 03.0137-9164.2	650264 669164				230 x 40 HEB Bremsbacken-Zubehör	VW VW	
	1.6 TD			31-M-280000	08.88										
	1.6 Variant			31-M-280000	04.88										
	1.8	55		31-M-280000	04.88										
	1.8	66		31-M-280000	04.88										
	1.9 D			31-M-280000	05.89										
	1.6 Limousine		31-M-280001				10.93		03.0137-0264.2 03.0137-9149.2	650264 669149				230 x 40 HEB Bremsbacken-Zubehör	VW
	1.6 TD		31-M-280001				10.93								
	1.6 Variant		31-M-280001				10.93								
	1.8	55		31-M-280001			10.93								
	1.8	66		31-M-280001			10.93								
	1.9 D			31-M-280001			10.93								
	1.9 TD			31-M-280001	03.91		10.93								
	1.6 Limousine			31-L-085000	04.88			24.0220-0018.1 24.0220-0718.2	480019 480209			ohne Sensorring <sup>1)</sup> ohne Sensorring <sup>1)</sup>	200/201,5 x 50,5 - Lager 200/201,5 x 50,5 + Lager		
	1.6 Limousine		31-L-085001				10.93		24.0223-0012.1	480042		ohne Sensorring <sup>1)</sup>	230/231,5 x 51,5		
	1.6 TD					08.88	10.93								
1.8	55				04.88	10.93									
1.8	66				04.88	10.93									
1.9 D					05.89	10.93									
1.9 TD					03.91	10.93									
	1.6 Limousine			31-L-085000	04.88			03.0420-4219.3 03.0520-4219.3	684219 694219				19,05/200x40 Kit 19,05/200x40 TopKit	VW VW	
	1.6 Limousine		31-L-085001	31-M-280000				03.0520-6120.3	696120				20,64/230x40 TopKit	VW	
	1.6 TD			31-M-280000	08.88										
	1.6 Variant			31-M-280000	04.88										
	1.8	55		31-M-280000	04.88										
	1.8	66		31-M-280000	04.88										
	1.9 D			31-M-280000	05.89										
	1.6 Limousine		31-M-280001				10.93		03.0520-6120.3	696120				20,64/230x40 TopKit	VW
	1.6 TD		31-M-280001				10.93								
	1.6 Variant		31-M-280001				10.93								
1.8	55		31-M-280001			10.93									
1.8	66		31-M-280001			10.93									
1.9 D			31-M-280001			10.93									
1.9 TD			31-M-280001	03.91		10.93									

<sup>1)</sup> without sensor ring / senza sensori / sans secours ABS / sin anillo sensor ABS

<sup>2)</sup> with sensor ring / con sensori / avec secours ABS / con anillo sensor ABS

<sup>3)</sup> on the brake caliper / sulla pinza freno / sur l'étrier de frein / a la pinza de freno



### VOLKSWAGEN PASSAT (88-93)

	1.6			04.88	10.93	24.3727-0125.2	580125	2		L=1628					
	1.6 TD			08.88	10.93										
	1.8	55		04.88	10.93										
	1.8	66		04.88	10.93										
	1.9 D			05.89	10.93										
	1.9 TD			03.91	10.93										
	1.8	79		04.88	07.90						24.3727-0126.2	580126	2		L=1749
	1.8	82		04.88	07.90										
	1.8 16V			04.88	07.92										
	2.0			03.90	10.93										
2.0 16V			08.88	10.93											
2.8 VR6			06.91	10.93											
1.8 Syncro G60			08.88	10.93	24.3727-0167.2	580167	2		L=1718						
2.0 Syncro			10.90	10.93											
	1.6			04.88	10.93	03.6584-0015.3	320109			BRL 8/4 (4) <b>ATE</b>					
	1.6 TD			08.88	10.93										
	1.8			04.88	10.93										
	1.8 16V			04.88	07.92										
	1.8 Syncro G60			08.88	10.93										
	1.9 D			05.89	10.93										
	1.9 TD			03.91	10.93										
	2.0			03.90	10.93										
	2.0 16V			08.88	10.93										
	2.0 Syncro			10.90	10.93										
2.8 VR6			06.91	10.93											
	1.6 TD	◀		08.88	10.93	03.2419-9310.3	030027			Gz 19,05					
	1.8	◀ 79		04.88	07.90										
	1.8	◀ 82		04.88	07.90										
	1.8 16V	◀		04.88	07.92										
	1.8 Syncro G60	◀		08.88	10.93										
	1.9 D	◀		05.89	10.93										
	1.9 TD	◀		03.91	10.93										
	2.0	◀		03.90	10.93										
	2.0 16V	◀		08.88	10.93										
	2.0 Syncro	◀		10.90	10.93										
2.8 VR6	◀		06.91	10.93											
	1.6 TD			08.88	10.93	24.2523-0908.3	040049			Nz 23,81					
	1.8	79		04.88	07.90										
	1.8	82		04.88	07.90										
	1.8 16V			04.88	07.92										
	1.8 Syncro G60			08.88	10.93										
	1.9 D			05.89	10.93										
	1.9 TD			03.91	10.93										
	2.0			03.90	10.93										
	2.0 16V			08.88	10.93										
	2.0 Syncro			10.90	10.93										
2.8 VR6			06.91	10.93											
	1.6	◀		04.88	10.93	24.3728-0124.2	590124			L=1295, + AUT					
	1.6 TD	◀		08.88	10.93										
	1.8	◀ 55		04.88	10.93										
	1.8	◀ 66		04.88	10.93										
	1.9 D	◀		05.89	10.93										
	1.9 TD	◀		03.91	10.93										

### VOLKSWAGEN POLO I (75-81)

	0.9			04.75	09.81	03.2117-3311.3	010040			THz 17,46 <b>ATE</b>
	1.1			04.75	09.81 + Bremsgerät <sup>1)</sup>					
	1.3			12.76	09.81 + Bremsgerät <sup>1)</sup>					
	0.9			04.75	09.81	11.0441-4402.2	250014			Dichtungssatz <b>ATE</b>
	1.1			04.75	09.81					
	1.3			12.76	09.81					
	0.9			04.75	09.81	13.0460-4028.2	604028			20228 15,3 <b>ATE</b>
	1.1			04.75	09.81					
	1.3			12.76	09.81					
	0.9			04.75	09.81	24.0108-0100.1	408100			239 8,0 7,0
	1.1			04.75	09.81					
	1.3			12.76	09.81					
	0.9			04.75	09.81	83.7734-0290.3	330809	2		L=290
	1.1			04.75	09.81					
	1.3			12.76	09.81					
	0.9			04.75	09.81	83.7824-0180.3	330812	2		L=180
	1.1			04.75	09.81					
	1.3			12.76	09.81					
	0.9			04.75	09.81 - Bremskraftregler <sup>2)</sup>	03.3214-0812.3	020011			Rz 14,29
	1.1			04.75	09.81 - Bremskraftregler <sup>2)</sup>					
	1.3			12.76	09.81 - Bremskraftregler <sup>2)</sup>					
	0.9			04.75	09.81 + Bremskraftregler <sup>5)</sup>	03.3217-2112.3	020027			Rz 17,46
	1.1			04.75	09.81 + Bremskraftregler <sup>5)</sup>					
	1.3			12.76	09.81 + Bremskraftregler <sup>5)</sup>					
	0.9			04.75	07.78	03.0137-9006.2	669006			Bremsbacken-Zubehör
	1.1			04.75	07.78					
	1.3			12.76	07.78					
	0.9			08.78	09.81	03.0137-0126.2	650126			180 x 31 HEB
	1.1			08.78	09.81					
						03.0137-9008.2	669008			Bremsbacken-Zubehör

<sup>1)</sup> + booster unit / + servofreno / + servo-frein / + servofreno

<sup>2)</sup> - brake pressure regulator / - correttore di frenata / - correcteur de freinage / - corrector de frenado

<sup>3)</sup> + cast iron / + ghisa / + fonte grise / + fundición de gris

<sup>4)</sup> + aluminium / + alluminio / + aluminium / + aluminio

<sup>5)</sup> + brake pressure regulator / + correttore di frenata / + correcteur de freinage / + corrector de frenado

<sup>6)</sup> - automatic adjustment / - correzione automatica / - ajustage automatique / - reajuste automatico

<b>VOLKSWAGEN POLO I (75-81)</b>												
	1.3			08.78	09.81			03.0137-0126.2 03.0137-9008.2	650126 669008	180 x 31 HEB Bremsbacken-Zubehör		
	0.9			04.75	09.81			24.0218-0007.1 24.0218-0707.2	480003 480211	180/181 x 38,5 - Lager 180/181 x 38,5 + Lager		
	0.9			08.78	09.81	+ Bremskraftregler <sup>1)</sup>		03.0420-0617.3 03.0520-3917.3	680617 693917	+ Rz GG <sup>2)</sup> + Rz ALU <sup>3)</sup>	17,46/180x31 Kit 17,46/180x31 TopKit	VW VW
	1.1			08.78	09.81	+ Bremskraftregler <sup>1)</sup>						
	1.3			08.78	09.81	+ Bremskraftregler <sup>1)</sup>						
	0.9			04.75	09.81			24.3727-0146.2 24.3727-0103.2	580146 580103	1 1	L=794 L=1960	
	1.1			04.75	09.81							
	1.3			12.76	09.81							
	0.9			04.75	09.81			24.3728-0101.2	590101		L=607	
	1.1			04.75	09.81							
	1.3			12.76	09.81							

<b>VOLKSWAGEN POLO II (81-94)</b>												
	1.0			10.81	09.90	- Bremsgerät <sup>4)</sup>		03.2117-3311.3 03.3517-0101.2	010040 390322		THz 17,46 Verschlusschraube	ATE
	1.0			10.90	09.94	- Bremsgerät <sup>4)</sup>						
	1.0			10.81	07.83	+ Bremsgerät <sup>5)</sup>		03.2120-1531.3	010092		THz 20,64	ATE
	1.1			10.81	07.83							
	1.3			10.81	07.83							
	1.0			09.94	09.94	+ Bremsgerät <sup>5)</sup>		03.2120-2031.3	010106		THz 20,64	ATE
	1.3			09.94	09.94							
	1.3 D			08.86	09.90							
	1.3 G40			01.87	09.94							
	1.4 D			08.90	09.94							
	1.0			10.81	02.85			11.0441-4402.2	250014		Dichtungssatz	ATE
	1.1			10.81	07.83							
	1.3			10.81	02.85							
	1.0			03.85	09.94			24.3481-1745.5 24.3481-1746.5	240277 240278		D=48, - Halter D=48, - Halter	ATE ATE
	1.3			03.85	09.94			11.0441-4808.2	250022		Dichtungssatz	ATE
	1.3 D			08.86	09.90			11.0101-4803.2	260008		Hülssensatz	ATE
	1.4 D			08.90	09.94			24.0102-4803.2	260086		Hülssensatz+Schrauben	ATE
	1.3 G40			01.87	09.94			11.0441-4808.2 11.0101-4801.2 24.0102-4801.2	250022 260006 260085		Dichtungssatz Hülssensatz Hülssensatz+Schrauben	ATE ATE ATE
	1.0			10.81	02.85			13.0460-4028.2	604028		20228 15,3	ATE
	1.1			10.81	07.83			13.0460-0115.2	610115		Belagsatz-Zubehör	ATE
	1.3			10.81	02.85							
	1.0			03.85	09.94			13.0460-7059.2	607059		20887 17,3 +/Zub	VW
	1.3			03.85	09.94			13.0460-0184.2	610184		Belagsatz-Zubehör	VW
	1.3 D			08.86	09.90							
	1.4 D			08.90	09.94							
	1.3 G40			01.87	09.94			13.0460-7033.2	607033		20887 15,3 +/Zub	VW
	1.0			10.81	09.94			24.0110-0151.1 24.0310-0151.1	410151 510151		239 10,0 8,0 +S +B 239 10,0 8,0 +S +B PD	
	1.1			10.81	07.83							
	1.3			10.81	09.94							
	1.3 D			08.86	09.90							
	1.4 D			08.90	09.94							
	1.3 G40			01.87	09.94			24.0120-0123.1 24.0320-0123.1	420123 520123		239 20,0 18,0 V L +S +B 239 20,0 18,0 V L +S +B PD	
	1.0			10.81	09.94			83.7734-0290.3	330809	2	L=290	
	1.1			10.81	07.83							
	1.3			10.81	09.94							
	1.3 D			08.86	09.90							
	1.3 G40			01.87	09.94							
	1.4 D			08.90	09.94							
	1.0			10.81	09.94			83.7824-0180.3	330812	2	L=180	
	1.1			10.81	07.83							
	1.3			10.81	09.94							
	1.3 D			08.86	09.90							
	1.3 G40			01.87	09.94							
	1.4 D			08.90	09.94							
	1.0			10.81	07.83	- Bremskraftregler <sup>6)</sup>		03.3214-0812.3 24.3214-0902.3	020011 020147	+ GG <sup>7)</sup> + ALU <sup>8)</sup>	Rz 14,29 Rz 14,29	
	1.1			10.81	07.83	- Bremskraftregler <sup>6)</sup>						
	1.3			10.81	07.83	- Bremskraftregler <sup>6)</sup>						
	1.0			09.94	09.94	- Bremskraftregler <sup>6)</sup>		03.3215-2311.3 24.3215-0903.3	020018 020154	+ GG <sup>7)</sup> + ALU <sup>8)</sup>	Rz 15,87 Rz 15,87	
	1.3			09.94	09.94	- Bremskraftregler <sup>6)</sup>						
	1.3 D			08.86	09.90	- Bremskraftregler <sup>6)</sup>						
	1.3 G40			01.87	09.94	- Bremskraftregler <sup>6)</sup>						
	1.4 D			08.90	09.94	- Bremskraftregler <sup>6)</sup>						
	1.0			10.81	07.83	+ Bremskraftregler <sup>1)</sup>		03.3217-2112.3 24.3217-0908.3	020027 020167	+ GG <sup>7)</sup> + ALU <sup>8)</sup>	Rz 17,46 Rz 17,46	
	1.1			10.81	07.83	+ Bremskraftregler <sup>1)</sup>						
	1.3			10.81	07.83	+ Bremskraftregler <sup>1)</sup>						
	1.0			09.94	09.94	+ Bremskraftregler <sup>1)</sup>		24.3219-0909.3	020188		Rz 19,05	
	1.3			09.94	09.94	+ Bremskraftregler <sup>1)</sup>						
	1.3 D			08.86	09.90	+ Bremskraftregler <sup>1)</sup>						
	1.3 G40			01.87	09.94	+ Bremskraftregler <sup>1)</sup>						
	1.4 D			08.90	09.94	+ Bremskraftregler <sup>1)</sup>						

1) + brake pressure regulator / + correctore di frenata / + correcteur de freinage / + corrector de frenado  
2) + WC cast iron / + CR ghisa / + CR fontegrise / + CR fundición de gris  
3) + WC aluminium / + CR alluminio / + CR aluminium / + CR aluminio  
4) - booster unit / - servofreno / - servo-frein / - servofreno  
5) + booster unit / + servofreno / + servo-frein / + servofreno  
6) - brake pressure regulator / - correctore di frenata / - correcteur de freinage / - corrector de frenado  
7) + cast iron / + ghisa / + fonte grise / + fundición de gris  
8) + aluminium / + aluminio / + aluminium / + aluminio

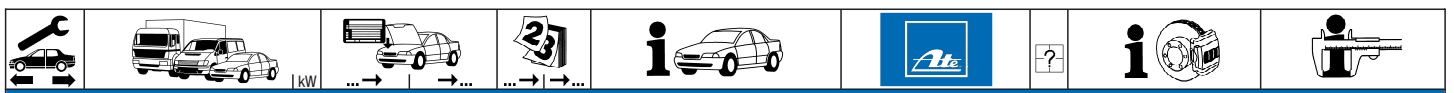

**VOLKSWAGEN POLO II (81-94)**

	1.0 1.1 1.3 1.3 D 1.3 G40 1.4 D			10.81 10.81 10.81 08.86 01.87 08.90	09.94 07.83 09.94 09.90 09.94 09.94	03.0137-0126.2 03.0137-9008.2	650126 669008			180 x 31 HEB Bremsbacken-Zubehör
	1.0 1.1 1.3 1.3 D 1.3 G40 1.4 D			10.81 10.81 10.81 08.86 01.87 08.90	09.94 07.83 09.94 09.90 09.94 09.94	24.0218-0007.1 24.0218-0707.2	480003 480211			180/181 x 38,5 - Lager 180/181 x 38,5 + Lager
	1.0 1.1 1.3		..-F-127903	10.81 10.81 10.81	- Bremskraftregler 1) - Bremskraftregler 1) - Bremskraftregler 1)	03.0520-0114.3	690114			14,29/180x31 TopKit VW
	1.0 1.1 1.3		..-F-127903	10.81 10.81 10.81	+ Bremskraftregler 2) + Bremskraftregler 2) + Bremskraftregler 2)	03.0420-0617.3 03.0520-3917.3	680617 693917	+ Rz GG 3) + Rz ALU 4)		17,46/180x31 Kit VW 17,46/180x31 TopKit VW
	1.0 1.3 1.3 D 1.3 G40 1.4 D	..-F-127904 ..-F-127904		08.86 01.87 08.90	09.94 - Bremskraftregler 1) 09.94 - Bremskraftregler 1) 09.90 - Bremskraftregler 1) 09.94 - Bremskraftregler 1) 09.94 - Bremskraftregler 1)	03.0520-0215.3	690215			15,87/180x31 TopKit VW
	1.0 1.3 1.3 D 1.3 G40 1.4 D	..-F-127904 ..-F-127904		08.86 01.87 08.90	09.94 + Bremskraftregler 2) 09.94 + Bremskraftregler 2) 09.90 + Bremskraftregler 2) 09.94 + Bremskraftregler 2) 09.94 + Bremskraftregler 2)	03.0520-1719.3	691719			19,05/180x31 TopKit VW
	1.0 1.1 1.3		..-E-200000	10.81 10.81 10.81	07.83	24.3727-0146.2 24.3727-0103.2	580146 580103	1 ↑ 1 ↓		L=794 L=1960
	1.0 1.3 1.3 D 1.3 G40 1.4 D	..-F-000001 ..-F-000001		08.86 01.87 08.90	09.94 09.94 09.90 09.94 09.94	24.3727-0137.2 24.3727-0129.2	580137 580129	1 ↑ 2 ↓		L=1594 L=633
	1.0 1.3 1.3 D 1.3 G40 1.4 D	..-F-000001 ..-F-000001		08.86 01.87 08.90	09.94 09.94 09.90 09.94 09.94	03.6584-0015.3	320109			BRL 8/4 (4) ATE
	1.0 1.1 1.3			10.81 10.81 10.81	02.85 07.83 02.85	24.3728-0101.2	590101			L=607
	1.0 1.3 1.3 G40			03.85 03.85 01.87	09.94 09.94 09.94	24.3728-0118.2	590118			L=607

**VOLKSWAGEN SCIROCCO I (74-83)**

	1.1 1.5 1.6			08.77 01.74 01.75	07.79 07.79 - (S) 07.79 - (S)	03.2120-1531.3	010092			ThZ 20,64 ATE
	1.1 1.3 1.5 1.6			08.79 08.79 08.79 08.79	07.80 07.83 07.83 07.83	03.2120-1531.3 03.2120-1491.3	010092 010089			ThZ 20,64 ATE ThZ 20,64 + WE ATE
	1.6 i 1.8			08.79 08.82	07.82 07.83	03.2120-1491.3	010089			ThZ 20,64 + WE ATE
	1.1 1.3 1.5 1.6 1.7 1.6 i			01.74 08.79 01.74 01.75 08.80 01.76	07.80 + Schwimmsättel 5) 07.80 + Schwimmsättel 5) 07.80 + Schwimmsättel 5) 07.80 + Schwimmsättel 5) 07.83 + (D) / + Schwimmsättel 6) 07.80 + Schwimmsättel 5)	11.0441-4402.2	250014			Dichtungssatz ATE
	1.1 1.3 1.5 1.6 1.6 i 1.7 1.8			08.78 08.79 08.78 08.78 04.79 08.80 08.82	07.80 + Faustsättel 7) 07.83 + Faustsättel 7) 07.83 + Faustsättel 7) 07.83 + Faustsättel 7) 07.82 + Faustsättel 7) 07.83 + (D) / + Faustsättel 8) 07.83 + Faustsättel 7)	11.0441-4808.2 11.0101-4801.2 24.0102-4801.2	250022 260006 260085			Dichtungssatz ATE Hülensatz ATE Hülensatz+Schrauben ATE
	1.1 1.3 1.5 1.6 1.7 1.6 i			01.74 08.79 01.74 01.75 08.80 01.76	07.80 + Schwimmsättel 5) 07.80 + Schwimmsättel 5) 07.80 + Schwimmsättel 5) 07.80 + Schwimmsättel 5) 07.83 + (D) / + Schwimmsättel 6) 07.80 + Schwimmsättel 5)	13.0460-4029.2	604029			20228 18,5 ATE
	1.1 1.3 1.5 1.6 1.7 1.6 i			08.78 08.79 08.78 08.78 08.80	07.80 + Faustsättel 7) 07.83 + Faustsättel 7) 07.83 + Faustsättel 7) 07.83 + Faustsättel 7) 07.83 + (D) / + Faustsättel 8)	13.0460-7032.2	607032			20887 19,7 +/Zub VW
	1.6 i 1.8			04.79 08.82	07.82 + Faustsättel 7) 07.83	13.0460-7033.2	607033			20887 15,3 +/Zub VW

1) - brake pressure regulator / - correttore di frenata / - correcteur de freinage / - corrector de frenado  
2) + brake pressure regulator / + correttore di frenata / + correcteur de freinage / + corrector de frenado  
3) + WC cast iron / + CR ghisa / + CR fonte grise / + CR fundición de gris  
4) + WC aluminium / + CR alluminio / + CR aluminium / + CR aluminio  
5) + floating calipers / + pinze flottante / + étriers flottant / + pinzas flotante  
6) + (D) / + floating calipers / + (D) / + pinze flottanti / + (D) / + étriers flottant / + (D) / + pinza flotante  
7) + fist type calipers / + pinza freno flottante / + étriers à griffe / + pinza de puno  
8) + (D) / + fist type calipers / + (D) / + pinza flottante / + (D) / + étriers à griffe / + (D) / + pinza de puno



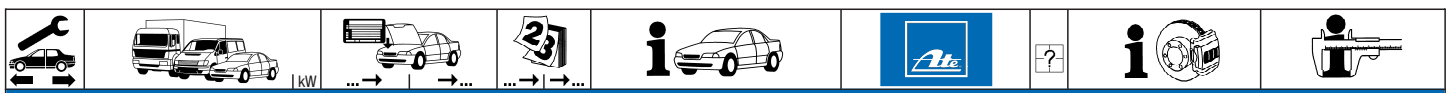

**VOLKSWAGEN SCIROCCO I (74-83)**

	1.1			01.74	07.80	24.0112-0106.1	412106		239 12,0 10,0 +S +B	
	1.3			08.79	07.83	24.0312-0106.1	512106		239 12,0 10,0 +S +B PD	
	1.5			01.74	07.83					
	1.6			01.75	07.83					
	1.7			08.80	07.83					
	1.6 i			01.76	07.82	24.0120-0123.1	420123		239 20,0 18,0 V L +S +B	
	1.8			08.82	07.83	24.0320-0123.1	520123		239 20,0 18,0 V L +S +B PD	
	1.1			01.74	10.78	83.6104-0325.3	330246	2	L=325	ATE
	1.5			01.74	10.78					
	1.6			01.75	10.78					
	1.1			11.78	07.80	24.5170-0315.3	331309	2	L=315	LUC
	1.3			08.79	07.83	24.5108-0266.3	330038	2	L=266	
	1.5			11.78	07.83					
	1.6			11.78	07.83					
	1.7			08.80	07.83					
	1.8			08.82	07.83					
	1.1			01.74	07.80	83.7804-0160.3	330811	2	L=160	
	1.3			08.79	07.83					
	1.5			01.74	07.83					
	1.6			01.75	07.83					
	1.7			08.80	07.83					
	1.8			08.82	07.83					
	1.1			01.74	07.80	03.3214-0812.3	020011		+ GG <sup>1)</sup>	Rz 14,29
	1.3			08.79	07.81	24.3214-0902.3	020147		+ ALU <sup>2)</sup>	Rz 14,29
	1.5			01.74	07.81	+ Schaltgetriebe <sup>3)</sup>				
	1.6			01.75	07.81	+ Schaltgetriebe <sup>3)</sup>				
	1.3			08.81	07.83	03.3217-2112.3	020027		+ GG <sup>1)</sup>	Rz 17,46
	1.5			01.74	07.81	+ Automatikgetriebe <sup>4)</sup>	020167		+ ALU <sup>2)</sup>	Rz 17,46
	1.6			01.75	07.81	+ Automatikgetriebe <sup>4)</sup>				
	1.6 i			01.76	07.82					
	1.7			08.80	07.83					
	1.8			08.82	07.83					
	1.1			01.74	07.78	03.0137-9006.2	669006		- autom. Nachstellung <sup>5)</sup>	Bremsbacken-Zubehör
	1.5			01.74	07.78					
	1.6			01.75	07.78					
	1.6 i			01.76	07.78					
	1.1			08.78	07.80	03.0137-0126.2	650126			180 x 31 HEB
	1.3			08.79	07.83	03.0137-9008.2	669008			Bremsbacken-Zubehör
	1.5			08.78	07.83					
	1.6			01.77	07.83					
	1.6 i			08.78	07.82					
	1.7			08.80	07.83					
	1.8			08.82	07.83					
	1.1			01.74	07.80	24.0218-0007.1	480003			180/181 x 38,5 - Lager
	1.3			08.79	07.83	24.0218-0707.2	480211			180/181 x 38,5 + Lager
	1.5			01.74	07.83					
	1.6			01.74	07.83					
	1.7			08.80	07.83					
	1.8			08.82	07.83					
	1.1			08.78	07.80	03.0520-0114.3	690114			14,29/180x31 TopKit VW
	1.3			08.79	07.81					
	1.5			08.78	07.81	+ Schaltgetriebe <sup>3)</sup>				
	1.6			08.78	07.81	+ Schaltgetriebe <sup>3)</sup>				
	1.3			08.81	07.83	03.0420-0617.3	680617		+ Rz GG <sup>6)</sup>	17,46/180x31 Kit VW
	1.5			08.78	07.81	+ Automatikgetriebe <sup>4)</sup>	693917		+ Rz ALU <sup>7)</sup>	17,46/180x31 TopKit VW
	1.6			08.78	07.81	+ Automatikgetriebe <sup>4)</sup>				
	1.6 i			08.78	07.82					
	1.7			08.80	07.83					
	1.8			08.82	07.83					
	1.1			01.74	07.80	24.3727-0102.2	580102	2	L=1690	
	1.3			08.79	07.83					
	1.5			01.74	07.83					
	1.6			01.75	07.83					
	1.7			08.80	07.83					
	1.8			08.82	07.83					
	1.1			08.76	07.80	03.6565-0101.3	320097		BRL 6/5 (4)	ATE
	1.3			08.79	07.83					
	1.5			08.76	07.83					
	1.6			08.76	07.83					
	1.7			08.80	07.83					
	1.8			08.82	07.83					
	1.1			09.75	07.80	24.3728-0107.2	590107		L=1055	
	1.3			08.79	07.83					
	1.5			09.75	07.83	24.3728-0109.2	590109		L=874	
	1.6			09.75	07.83					
	1.6 i			01.76	07.82					
	1.7			08.80	07.83					
	1.8			08.82	07.83					

**VOLKSWAGEN SCIROCCO II (84-92)**

	1.3	◀	53-E-022074	08.83		03.2120-1491.3	010089		THz 20,64 + WE	ATE
	1.3	▶	53-E-022075	07.84		03.3517-0101.2	390322		Verschlußschraube	
	1.6	▶	53-E-022074	08.83						
	1.6	▶	53-E-022075	07.92						
	1.8	◀	53-E-022074	08.83						

1) + cast iron / + ghisa / + fonte grise / + fundición de gris  
2) + aluminium / + alluminio / + aluminium / + aluminio  
3) + manual transmission / + scatola cambio velocità / + transmission mécanique / + cambio de velocidad  
4) + autom. transmission / + scatola cambio automatico / + transmission automatique / + cambio automático  
5) - automatic adjustment / - correzione automatica / - ajustage automatique / - reajuste automatico  
6) + WC cast iron / + CR ghisa / + CR fonte grise / + CR fundición de gris  
7) + WC aluminium / + CR alluminio / + CR aluminium / + CR aluminio





**VOLKSWAGEN SCIROCCO II (84-92)**

	1.8	▶	53-E-022075		07.92		03.2120-1491.3	010089		ThZ 20,64 + WE	ATE
	1.8 16V	▶	53-E-022075		07.92		03.3517-0101.2	390322		Verschlußschraube	
	1.3	◀	53-E-022075		07.84		03.2120-2031.3	010106		ThZ 20,64	ATE
	1.6	◀	53-E-022075	53-L-010000							
	1.8	◀	53-E-022075	53-L-010000							
	1.6	◀	53-L-010001		07.92		03.2120-3943.3	010532		ThZ 20,64	ATE
	1.8	◀	53-L-010001		07.92						
	1.8 16V	◀			10.85	07.92	03.2122-9812.3	010161		ThZ 22,20	ATE
	1.3		53-E-022074	08.83			11.0441-4808.2	250022		Dichtungssatz	ATE
	1.6		53-E-022074	08.83			11.0101-4801.2	260006		Hülssensatz	ATE
	1.8		53-E-022074	08.83			24.0102-4801.2	260085		Hülssensatz+Schrauben	ATE
	1.3		53-E-022075		07.84		11.0441-4808.2	250022		Dichtungssatz	ATE
	1.6		53-E-022075		07.92		11.0101-4801.2	260006		Hülssensatz	ATE
	1.8		53-E-022075		07.92		24.0102-4801.2	260085		Hülssensatz+Schrauben	ATE
	1.8 16V				10.85	07.92	24.3541-1609.5	240039		D=54, - Halter	LUC
							24.3541-1610.5	240040		D=54, - Halter	LUC
							24.0101-4301.2	260047		Bremssattel-Zubehör	LUC
							11.0101-5403.2	260010		Faltenbalgsatz	LUC
	1.3			08.83	07.84		13.0460-7032.2	607032		20887 19,7 +/Zub	VW
	1.6			08.83	07.92						
	1.8			08.83	07.92		13.0460-7033.2	607033		20887 15,3 +/Zub	VW
	1.8 16V			10.85	07.92		13.0460-2957.2	602957		20168 16,0 /S	LUC
	1.3			08.83	07.84		24.0112-0106.1	412106		239 12,0 10,0 +S +B	
	1.6			08.83	07.92		24.0312-0106.1	512106		239 12,0 10,0 +S +B PD	
	1.8			08.83	07.92		24.0120-0123.1	420123		239 20,0 18,0 V L +S +B	
	1.8 16V			10.85	07.92		24.0320-0123.1	520123		239 20,0 18,0 V L +S +B PD	
						24.0120-0128.1	420128		256 20,0 18,0 V L +S +B		
						24.0320-0128.1	520128		256 20,0 18,0 V L +S +B PD		
	1.3			08.83	07.84		24.5170-0315.3	331309	2	L=315	
	1.6			08.83	07.92						
	1.8			08.83	07.92						
	1.8 16V			10.85	07.92						
	1.8 16V			10.85	07.92		24.3364-1605.5	240011		D=36, - Halter	LUC
							24.3364-1606.5	240012		D=36, - Halter	LUC
							24.0101-3601.2	260044		Bremssattel-Zubehör	LUC
							11.0101-5403.2	260010		Faltenbalgsatz	LUC
	1.8 16V			10.85	07.92		13.0460-2937.2	602937		20961 15,2 /Zub/S	LUC
							13.0460-0419.2	610419		Belagsatz-Zubehör	LUC
	1.8 16V			10.85	07.92		24.0110-0111.1	410111		ohne Sensorring <sup>1)</sup>	
							24.0110-0275.2	410275		mit Sensorring <sup>2)</sup>	
										226 10,0 8,0 +B	
										226 10,0 8,0	
	1.3			08.83	07.84		83.7824-0180.3	330812	2	L=180	
	1.6			08.83	07.92						
	1.8			08.83	07.92						
	1.8 16V			10.85	07.92		24.5170-0161.3	331308	2	L=161	
	1.3		53-E-022074	08.83		- Bremskraftregler <sup>3)</sup>	03.3214-0812.3	020011	+ GG <sup>4)</sup>	Rz 14,29	
	1.6		53-E-022074	08.83		- Bremskraftregler <sup>3)</sup>	24.3214-0902.3	020147	+ ALU <sup>5)</sup>	Rz 14,29	
	1.8		53-E-022074	08.83		- Bremskraftregler <sup>3)</sup>					
	1.3			08.83	07.84	+ Bremskraftregler <sup>6)</sup>	03.3217-2112.3	020027	+ GG <sup>4)</sup>	Rz 17,46	
1.6			08.83	07.92	+ Bremskraftregler <sup>6)</sup>	24.3217-0908.3	020167	+ ALU <sup>5)</sup>	Rz 17,46		
1.8			08.83	07.92	+ Bremskraftregler <sup>6)</sup>						
	1.3			08.83	07.84		03.0137-0126.2	650126		180 x 31 HEB	
	1.6			08.83	07.92		03.0137-9008.2	669008		Bremsbacken-Zubehör	
	1.8			08.83	07.92						
	1.3			08.83	07.84		24.0218-0007.1	480003		180/181 x 38,5 - Lager	
	1.6			08.83	07.92		24.0218-0707.2	480211		180/181 x 38,5 + Lager	
	1.8			08.83	07.92						
	1.3		53-E-022074	08.83		- Bremskraftregler <sup>3)</sup>	03.0520-0114.3	690114		14,29/180x31 TopKit	VW
	1.6		53-E-022074	08.83		- Bremskraftregler <sup>3)</sup>					
	1.8		53-E-022074	08.83		- Bremskraftregler <sup>3)</sup>					
	1.3			08.83	07.84	+ Bremskraftregler <sup>6)</sup>	03.0420-0617.3	680617	+ Rz GG <sup>7)</sup>	17,46/180x31 Kit	VW
1.6			08.83	07.92	+ Bremskraftregler <sup>6)</sup>	03.0520-3917.3	693917	+ Rz ALU <sup>8)</sup>	17,46/180x31 TopKit	VW	
1.8			08.83	07.92	+ Bremskraftregler <sup>6)</sup>						
	1.3			08.83	07.84		24.3727-0102.2	580102	2	L=1690	
	1.6			08.83	07.92						
	1.8			08.83	07.92						
	1.3	◀	53-E-060000	08.83			24.3728-0107.2	590107		L=1055	
	1.6	◀			08.83	07.92	24.3728-0109.2	590109		L=874	
	1.8	◀			08.83	07.92					

**VOLKSWAGEN TRANSPORTER (Typ 2) (60-79)**

	1.6 Bus + Kasten		2142110466		04.79		03.6850-0502.4	300044		9"	ATE
	1.8 Bus + Kasten				08.73	07.75					
	2.0 Bus + Kasten				08.75	04.79					
	1.6 Bus + Kasten				05.79	09.79		03.6850-5402.4	300055		9"
	2.0 Bus + Kasten				05.79	07.79					
	1.1 (44593)		227019488		12.62	- Bremsgerät/ - (S) <sup>9)</sup>	03.2122-0704.3	010134		ThZ 22,20	ATE
	1.2 (21.23)		227019488	227072465		- Bremsgerät/ - (S) <sup>9)</sup>					
	1.2 (21.23)		227072466		07.67	- Bremsgerät/ - (S) <sup>9)</sup>	03.2122-0903.3	010136		ThZ 22,20	ATE
	1.2 (22.24.25.28)				11.62	07.69 - Bremsgerät/ - (S) <sup>9)</sup>					
	1.5 (21.23)				02.62	12.68 - Bremsgerät/ - (S) <sup>9)</sup>					

<sup>1)</sup> without sensor ring / senza sensori / sans secours ABS / sin anillo sensor ABS

<sup>2)</sup> with sensor ring / con sensori / avec secours ABS / con anillo sensor ABS

<sup>3)</sup> - brake pressure regulator / - correttore di frenata / - correcteur de freinage / - corrector de frenado

<sup>4)</sup> + cast iron / + ghisa / + fonte grise / + fundición de gris

<sup>5)</sup> + aluminium / + alluminio / + aluminium / + aluminio

<sup>6)</sup> + brake pressure regulator / + correttore di frenata / + correcteur de freinage / + corrector de frenado

<sup>7)</sup> + WC cast iron / + CR ghisa / + CR fontegrise / + CR fundición de gris

<sup>8)</sup> + WC aluminium / + CR alluminio / + CR aluminium / + CR aluminio

<sup>9)</sup> - booster unit/ - (S) / - servofreno/ - (S) / - servo-frein/ - (S) / - servofreno/ - (S)



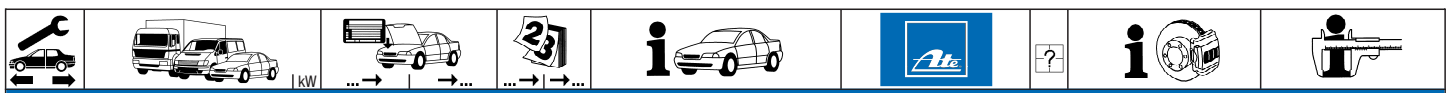

**VOLKSWAGEN TRANSPORTER (Typ 2) (60-79)**

	1.5 (22.24.25.28) 1.5 (26) 1.6 (21.23) 1.6 (22.24.25.28) 1.5 (26)		11.62 06.66 08.64 06.66 08.69	07.67 07.69 12.68 07.67 07.70	- Bremsgerät/ - (S) <sup>1)</sup> - Bremsgerät/ - (S) <sup>1)</sup> - Bremsgerät/ - (S) <sup>1)</sup> - Bremsgerät/ - (S) <sup>1)</sup> - Bremsgerät/ - (S) <sup>1)</sup>	03.2122-0903.3 03.2122-2905.3	010136 010141			Thz 22,20 Thz 22,20	ATE ATE
	1.6 Bus + Kasten 1.7 Bus + Kasten 1.8 Bus + Kasten 2.0 Bus + Kasten		08.70 08.71 08.73 08.75	07.79 12.73 07.75 07.79	- Bremsgerät/ - (S) <sup>1)</sup> - Bremsgerät/ - (S) <sup>1)</sup> - Bremsgerät/ - (S) <sup>1)</sup> - Bremsgerät/ - (S) <sup>1)</sup>	03.2120-8411.3	010125			Thz 20,64	ATE
	1.6 Bus + Kasten 1.7 Bus + Kasten 1.8 Bus + Kasten 2.0 Bus + Kasten	◀ ◀ ◀ ◀	08.70 08.70 08.73 08.75	07.79 12.73 07.75 07.79	+ Bremsgerät <sup>3)</sup> + Bremsgerät <sup>3)</sup> + Bremsgerät <sup>3)</sup> + Bremsgerät <sup>3)</sup>	03.2123-2604.3	010178			Thz 23,81 + WE	ATE
	1.6 Bus + Kasten 1.7 Bus + Kasten		08.70 08.71	07.72 07.72		13.0441-5415.2	250116			Dichtungssatz	ATE
	1.6 Bus + Kasten 1.7 Bus + Kasten 1.8 Bus + Kasten 2.0 Bus + Kasten		08.72 08.72 08.73 08.75	07.79 12.73 07.75 07.79		13.2541-8002.2 13.2541-8001.2 13.0441-5416.2	210111 210110 250117	■ ■		D=54 D=54 Dichtungssatz	ATE ATE ATE
	1.6 Bus + Kasten 1.7 Bus + Kasten		08.70 08.71	07.72 07.72		13.0460-6027.2	606027			20011 15,0	ATE
	1.6 Bus + Kasten 1.7 Bus + Kasten 1.8 Bus + Kasten 2.0 Bus + Kasten		08.72 08.72 08.73 08.75	07.79 12.73 07.75 07.79		13.0460-6028.2 13.0460-0157.2	606028 610157			20011 18,5 Belagsatz-Zubehör	ATE ATE
	1.6 Bus + Kasten 1.7 Bus + Kasten 1.8 Bus + Kasten 2.0 Bus + Kasten		08.72 08.72 08.73 08.75	07.79 12.73 07.75 07.79		24.0113-0132.1	413132			278 13,0 11,0	
	1.5 (26) 1.6 Bus + Kasten 1.7 Bus + Kasten 1.8 Bus + Kasten 2.0 Bus + Kasten		08.68 08.70 08.71 08.73 08.75	10.70 07.79 12.73 07.75 07.79		24.5224-0295.3	331261	2		L=295	
	1.2 (21.23) 1.2 (22.24.25.28) 1.5 (21.23) 1.5 (22.24.25.28) 1.5 (26) 1.6 (21.23) 1.6 (22.24.25.28)		08.63 08.63 08.63 08.63 06.66 08.64 06.66	07.67 08.66 12.68 07.67 07.70 12.68 07.67		24.2725-0903.3 24.2725-0904.3	020145 020146	2 ■ 2 ■		Rz 25,40 Rz 25,40	
	1.5 (26) 1.6 Bus + Kasten 1.7 Bus + Kasten 1.8 Bus + Kasten 2.0 Bus + Kasten		08.68 08.70 08.71 08.73 08.75	10.70 07.79 12.73 07.75 07.79		83.6101-0250.3 24.5224-0240.3	330203 331260	■ ■		L=250 L=240	
	1.1 (44593) 1.2 (21.23) 1.2 (22.24.25.28) 1.5 (21.23) 1.5 (22.24.25.28) 1.5 (26) 1.6 (21.23) 1.6 (22.24.25.28) 1.6 Bus + Kasten		01.60 01.60 11.62 02.62 11.62 06.66 08.64 06.66 08.70	12.62 07.67 08.66 12.68 07.67 10.70 12.68 07.67 07.71		03.3222-0801.3	020067			Rz 22,20	
	1.6 Bus + Kasten 1.7 Bus + Kasten 1.8 Bus + Kasten 2.0 Bus + Kasten		08.71 08.71 08.73 08.75	07.79 12.73 07.75 07.79		03.3223-1112.3	020092			Rz 23,81	
	1.6 Bus + Kasten 1.7 Bus + Kasten 1.8 Bus + Kasten 2.0 Bus + Kasten		08.73 08.73 08.73 08.75	07.79 12.73 07.75 07.79		03.0137-0055.2 03.0137-9024.2	650055 669024		+ autom. Nachstellung <sup>4)</sup>	252 x 56 Bremsbacken-Zubehör	
	1.6 Bus + Kasten 1.7 Bus + Kasten 1.8 Bus + Kasten 2.0 Bus + Kasten		08.70 08.71 08.73 08.75	04.79 12.73 07.75 04.79		24.0225-2001.2	480045			252/253,5 x 60	
	1.6 Bus + Kasten 2.0 Bus + Kasten		05.79 05.79	07.79 07.79		24.0225-2002.2	480046			252/253,5 x 61	
	1.6 Bus + Kasten 1.7 Bus + Kasten 1.8 Bus + Kasten 2.0 Bus + Kasten		08.71 08.71 08.73 08.75	05.79 12.73 07.75 05.79		24.3727-0107.2	580107	2 ▽		L=2958	
	1.6 Bus + Kasten 2.0 Bus + Kasten		06.79 06.79	07.79 07.79		24.3727-0109.2	580109	2 ▽		L=1455	
	1.6 Bus 2.0 Bus + Kasten	34	05.79 05.79	07.79 07.79	- luftgekühlt <sup>5)</sup>	03.2419-8212.3	030020			Gz 19,05	
	1.6 Bus 2.0 Bus + Kasten	34	05.79 05.79	07.79 07.79	- luftgekühlt <sup>5)</sup>	03.2525-2711.3 03.0450-2510.2	040030 082510			Nz 25,40 Nz Reparatursatz	

1) - booster unit/ - (S) / - servofreno/ - (S) / - servo-frein/ - (S) / - servofreno/ - (S)  
 2) - stop light switch / - interruttore luce di arresto / - contacteur stop / - interruptor de luz de freno  
 3) + booster unit / + servofreno / + servo-frein / + servofreno  
 4) + automatic adjustment / + correzione automatica / + ajustage automatique / + reajuste automático  
 5) - air cooled / - raffreddato ad aria / - refroidi par air / - refrigeración por aire



**VOLKSWAGEN TRANSPORTER (Typ 2) (60-79)**

	1.6 Bus 2.0 Bus + Kasten	34	05.79 05.79	07.79 07.79	- luftgekühlt <sup>1)</sup>	24.5803-0325.3	330051		L=325
	1.6 Bus 1.6 Kasten 2.0 Bus + Kasten	37	05.79 05.79 05.79	07.79 07.79 07.79	+ luftgekühlt <sup>2)</sup>	24.3728-0123.2	590123		L=3852

**VOLKSWAGEN TRANSPORTER (Typ 2) (79-92)**

	1.6 1.6 D 1.6 TD 1.6 TD Syncro 1.7 D 1.9 1.9 Syncro 2.0 2.1 2.1 Syncro		07.79 01.81 08.84 03.86 10.86 08.82 11.84 05.79 08.85 08.85	12.82 07.87 09.92 09.92 09.92 09.92 09.92 04.86 09.92 09.92		03.6850-5402.4	300055		9"	ATE
	1.6 1.6 D 1.9 2.0	24-D-200000 24-D-200000 24-D-200000 24-D-200000	07.79 01.81 08.82 05.79		- Bremsgerät <sup>3)</sup> - Bremsgerät <sup>3)</sup> - Bremsgerät <sup>3)</sup> - Bremsgerät <sup>3)</sup>	03.2120-0851.3	010082		Thz 20,64	ATE
	1.6 1.6 D 1.6 TD 1.6 TD Syncro 1.7 D 1.9 1.9 Syncro 2.0 2.1 2.1 Syncro		07.79 01.81 08.84 03.86 10.86 08.82 11.84 05.79 08.85 08.85	12.82 07.87 09.92 09.92 09.92 09.92 09.92 04.86 09.92 09.92	- ABS/ + Bremsgerät <sup>4)</sup> - ABS/ + Bremsgerät <sup>4)</sup> - ABS/ + Bremsgerät <sup>4)</sup> - ABS - ABS/ + Bremsgerät <sup>4)</sup> - ABS/ + Bremsgerät <sup>4)</sup> - ABS - ABS/ + Bremsgerät <sup>4)</sup> - ABS/ + Bremsgerät <sup>4)</sup> - ABS	03.2123-0291.3 03.2123-0271.3	010165 010164		Thz 23,81 Thz 23,81 + WE	ATE ATE
	1.6 1.6 D 1.6 TD 1.9 2.0	24-G-200000 24-G-200000 24-G-200000 24-G-200000 24-G-200000	07.79 01.81 08.84 08.82 05.79		+ Festsättel <sup>5)</sup> + Festsättel <sup>5)</sup> + Festsättel <sup>5)</sup> + Festsättel <sup>5)</sup> + Festsättel <sup>5)</sup>	13.2541-8002.2 13.2541-8001.2 13.0441-5416.2	210111 210110 250117		D=54 D=54 Dichtungssatz	ATE ATE ATE
	1.6 D 1.6 TD 1.6 TD Syncro 1.7 D 1.9 1.9 Syncro 2.0 2.1 2.1 Syncro		08.85 08.85 03.86 08.85 08.85 11.84 08.85 08.85 08.85	07.87 09.92 09.92 09.92 09.92 09.92 04.86 09.92 09.92	+ Faustsättel <sup>6)</sup> + Faustsättel <sup>6)</sup> + Faustsättel <sup>6)</sup> + Faustsättel <sup>6)</sup> + Faustsättel <sup>6)</sup> + Faustsättel <sup>6)</sup> + Faustsättel <sup>6)</sup> + Faustsättel <sup>6)</sup> + Faustsättel <sup>6)</sup>	24.3601-1601.5 24.3601-1602.5 11.0101-5403.2	240203 240204 260010		D=60, - Halter D=60, - Halter Faltenbalgsatz	LUC LUC LUC
	1.6 TD 1.6 TD Syncro 1.7 D 1.9 1.9 Syncro 2.1 2.1 Syncro	24-K-000001 24-J-105001 24-K-000001 24-K-000001 24-J-105001 24-K-000001 24-J-105001		09.92 09.92 09.92 09.92 09.92 09.92 09.92	+ Faustsättel <sup>6)</sup> + Faustsättel <sup>6)</sup> + Faustsättel <sup>6)</sup> + Faustsättel <sup>6)</sup> + Faustsättel <sup>6)</sup> + Faustsättel <sup>6)</sup> + Faustsättel <sup>6)</sup>	24.3601-1709.5 24.3601-1710.5 11.0441-6003.2 11.0101-6004.2	240275 240276 250037 260014		D=60, - Halter D=60, - Halter Dichtungssatz Hülssensatz	LUC LUC ATE
	1.6 1.6 D 1.6 TD 1.9 2.0	24-G-200000 24-G-200000 24-G-200000 24-G-200000 24-G-200000	07.79 01.81 08.84 08.82 05.79		+ Festsättel <sup>5)</sup> + Festsättel <sup>5)</sup> + Festsättel <sup>5)</sup> + Festsättel <sup>5)</sup> + Festsättel <sup>5)</sup>	13.0460-6028.2 13.0460-0157.2	606028 610157		20011 18,5 Belagsatz-Zubehör	ATE ATE
	1.6 D 1.6 TD 1.6 TD Syncro 1.7 D 1.9 1.9 Syncro 2.0 2.1 2.1 Syncro		08.85 08.85 03.86 08.85 08.85 11.84 08.85 08.85 08.85	07.87 09.92 09.92 09.92 09.92 09.92 04.86 09.92 09.92	+ Faustsättel <sup>6)</sup> + Faustsättel <sup>6)</sup> + Faustsättel <sup>6)</sup> + Faustsättel <sup>6)</sup> + Faustsättel <sup>6)</sup> + Faustsättel <sup>6)</sup> + Faustsättel <sup>6)</sup> + Faustsättel <sup>6)</sup> + Faustsättel <sup>6)</sup>	13.0460-2903.2	602903		20979 19,4 /S	LUC
	1.6 1.6 D 1.6 TD 1.9 2.0	24-G-200000 24-G-200000 24-G-200000 24-G-200000 24-G-200000	07.79 01.81 08.84 08.82 05.79		+ Festsättel <sup>5)</sup> + Festsättel <sup>5)</sup> + Festsättel <sup>5)</sup> + Festsättel <sup>5)</sup> + Festsättel <sup>5)</sup>	24.0113-0142.1	413142		278 13,0 11,0	
	1.6 D 1.6 TD 1.7 D 1.9 2.0 2.1		08.85 08.85 03.86 08.85 08.85 08.85	07.87 09.92 09.92 09.92 04.86 09.92	+ Faustsättel <sup>6)</sup> + Faustsättel <sup>6)</sup> + Faustsättel <sup>6)</sup> + Faustsättel <sup>6)</sup> + Faustsättel <sup>6)</sup> + Faustsättel <sup>6)</sup>	24.0116-0104.1	416104		258 16,0 13,0 +B	
	1.6 TD Syncro 1.9 Syncro 2.1 Syncro		03.86 11.84 08.85	09.92 09.92 09.92	+ 14" Rad <sup>7)</sup> + 14" Rad <sup>7)</sup> + 14" Rad <sup>7)</sup>	24.0116-0109.1	416109		258 16,0 13,0	
	1.6 1.6 D 1.6 TD 1.9		07.79 01.81 08.84 08.82	12.82 07.85 07.85 07.85		83.7824-0383.3	330856	2	L=380	

1) - air cooled / - raffreddato ad aria / - refroidi par air / - refrigeración por aire  
 2) + air cooled / + raffreddato ad aria / + refroidi par air / + refrigeración por aire  
 3) - booster unit / - servofreno / - servo-frein / - servofreno  
 4) - ABS/ + booster unit / - ABS/ + servofreno / - ABS/ + servo-frein / - ABS/ + servofreno  
 5) + fixed calipers / + pinze freno fisse / + étriers fixes / + pinza de fija  
 6) + fist type calipers / + pinza freno flottante / + étriers à griffe / + pinza de puno  
 7) + 14" wheel / + ruota 14" / + roue 14" / + ruota 14"





**VOLKSWAGEN TRANSPORTER (Typ 2) (79-92)**

			05.79	07.85		83.7824-0383.3	330856	2		L=380
	2.0									
	1.6 D		24-G-200000	08.85	+ Festsättel <sup>1)</sup>	24.5224-0295.3	331261	2		L=295
	1.6 TD		24-G-200000	08.85	+ Festsättel <sup>1)</sup>					
	1.7 D		24-G-200000	08.85	+ Festsättel <sup>1)</sup>					
	1.9		24-G-200000	08.85	+ Festsättel <sup>1)</sup>					
	2.0		24-G-200000	08.85	+ Festsättel <sup>1)</sup>					
	2.1		24-G-200000	08.85	+ Festsättel <sup>1)</sup>					
	1.6 D			08.85	+ Faustsättel <sup>2)</sup>	83.7834-0440.3	330813	2		L=440
	1.6 TD			08.85	+ Faustsättel <sup>2)</sup>					
	1.6 TD Syncro			03.86	09.92					
	1.7 D			08.85	09.92 + Faustsättel <sup>2)</sup>					
	1.9			08.85	09.92 + Faustsättel <sup>2)</sup>					
	1.9 Syncro			11.84	09.92					
	2.0			08.85	04.86 + Faustsättel <sup>2)</sup>					
	2.1			08.85	09.92 + Faustsättel <sup>2)</sup>					
	2.1 Syncro			08.85	09.92					
	1.6			07.79	12.82	83.7824-0180.3	330812	2		L=180
	1.6 D			01.81	07.87					
	1.6 TD			08.84	09.92					
	1.6 TD Syncro			03.86	09.92					
	1.7 D			10.86	09.92					
	1.9			08.82	09.92					
	1.9 Syncro			11.84	09.92					
	2.0			05.79	04.86					
	2.1			08.85	09.92					
	2.1 Syncro			08.85	09.92					
	1.6			07.79	12.82	03.3223-1112.3	020092			Rz 23,81
	1.6 D			01.81	07.87					
	1.6 TD			08.84	09.92					
	1.6 TD Syncro			03.86	09.92 + 14" Rad <sup>3)</sup>					
	1.7 D			10.86	09.92					
	1.9			08.82	09.92					
	1.9 Syncro			11.84	09.92 + 14" Rad <sup>3)</sup>					
	2.0			05.79	04.86					
	2.1			08.85	09.92					
	2.1 Syncro			08.85	09.92 + 14" Rad <sup>3)</sup>					
	1.6			07.79	12.82	03.0137-0148.2	650148			252 x 56 HEB
	1.6 D			01.81	07.87	03.0137-9035.2	669035			Bremsbacken-Zubehör
	1.6 TD			08.84	09.92					
	1.6 TD Syncro			03.86	09.92 + 14" Rad <sup>3)</sup>					
	1.7 D			10.86	09.92					
	1.9			08.82	09.92					
	1.9 Syncro			11.84	09.92 + 14" Rad <sup>3)</sup>					
	2.0			05.79	04.86					
	2.1			08.85	09.92					
	2.1 Syncro			08.85	09.92 + 14" Rad <sup>3)</sup>					
	1.6 TD Syncro	24-J-000001		09.92	+ 16" Rad <sup>4)</sup>	03.0137-0252.2	650252			270 x 66 HEB
	1.9 Syncro	24-J-000001		09.92	+ 16" Rad <sup>4)</sup>	03.0137-9152.2	669152			Bremsbacken-Zubehör
	2.1 Syncro	24-J-000001		09.92	+ 16" Rad <sup>4)</sup>					
	1.6			07.79	12.82	24.0225-2002.2	480046			252/253,5 x 61
	1.6 D			01.81	07.87					
	1.6 TD			08.84	09.92					
	1.6 TD Syncro			03.86	09.92 + 14" Rad <sup>3)</sup>					
	1.7 D			10.86	09.92					
	1.9			08.82	09.92					
	1.9 Syncro			11.84	09.92 + 14" Rad <sup>3)</sup>					
	2.0			05.79	04.86					
	2.1			08.85	09.92					
	2.1 Syncro			08.85	09.92 + 14" Rad <sup>3)</sup>					
	1.6 TD Syncro	24-J-000001		09.92	+ 16" Rad <sup>4)</sup>	24.0227-0003.1	480145			270/271,5 x 75,5
	1.9 Syncro	24-J-000001		09.92	+ 16" Rad <sup>4)</sup>					
	2.1 Syncro	24-J-000001		09.92	+ 16" Rad <sup>4)</sup>					
	1.6			07.79	12.82	03.0420-0423.3	680423			23,81/252x56 Kit
	1.6 D			01.81	07.87					
	1.6 TD			08.84	09.92					
	1.6 TD Syncro			03.86	09.92 + 14" Rad <sup>3)</sup>					
	1.7 D			10.86	09.92					
	1.9			08.82	09.92					
	1.9 Syncro			11.84	09.92 + 14" Rad <sup>3)</sup>					
	2.0			05.79	04.86					
	2.1			08.85	09.92					
	2.1 Syncro			08.85	09.92 + 14" Rad <sup>3)</sup>					
	1.6			07.79	12.82	24.3727-0109.2	580109	2		L=1455
	1.6 D			01.81	07.87					
	1.6 TD			08.84	09.92					
	1.7 D			10.86	09.92					
	1.9			08.82	09.92					
	2.0			05.79	04.86					
2.1			08.85	09.92						
	1.6 D			01.81	07.87	03.2419-8212.3	030020			Gz 19,05
	1.6 TD			08.84	09.92					
	1.6 TD Syncro			03.86	09.92					
	1.7 D			10.86	09.92					
	1.9			08.82	09.92					
	1.9 Syncro			11.84	09.92					
2.0			05.79	04.86						

1) + fixed calipers / + pinze freno fisse / + étriers fixes / + pinza de fija  
 2) + fist type calipers / + pinza freno flottante / + étriers à griffe / + pinza de puno  
 3) + 14" wheel / + ruota 14" / + roue 14" / + rueda 14"  
 4) + 16" wheel / + ruota 16" / + roue 16" / + rueda 16"  
 5) - air cooled / - raffreddato ad aria / - refroidi par air / - refrigeración por aire

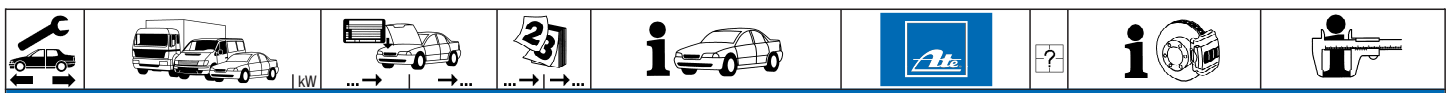

### VOLKSWAGEN TRANSPORTER (Typ 2) (79-92)

	2.1 2.1 Syncro		08.85 08.85	09.92 09.92	03.2419-8212.3	030020		Gz 19,05
	1.6 D 1.6 TD 1.6 TD Syncro 1.7 D 1.9 1.9 Syncro 2.0 2.1 2.1 Syncro		01.81 08.84 03.86 10.86 08.82 11.84 05.79 08.85 08.85	07.87 09.92 09.92 09.92 09.92 09.92 04.86 09.92 09.92	03.2525-2711.3 03.0450-2510.2	040030 082510		Nz 25,40 Nz Reparatursatz
	1.6 D 1.6 TD 1.7 D 1.9 2.0 2.1		01.81 08.84 10.86 08.82 05.79 08.85	07.87 09.92 09.92 09.92 04.86 09.92	24.5803-0325.3	330051		L=325
	1.6 2.0	◀ 37 ◀	07.79 05.79	12.82 12.82	24.3728-0123.2	590123		L=3852

### VOLKSWAGEN TYP 181 (69-79)

	1.5 1.6 1.6	◀ ◀ ◀	08.69 08.70 08.72	07.70 07.72 02.79	03.2119-8511.3 03.2119-8711.3 03.2119-8711.3	010062 010064 010064		THz 19,05 THz 19,05 + WE THz 19,05 + WE	ATE ATE ATE
	1.5 1.6	▶ ▶	08.69 08.70	07.70 07.72	03.2119-8611.3	010063		THz 19,05	ATE
	1.5 1.6		08.69 08.70	07.70 02.79	24.5171-0393.3	331311	2	L=393	
	1.5 1.6		08.69 08.70	07.70 02.79	03.3222-5211.3	020081		Rz 22,20	
	1.5 1.6		08.69 08.70	07.70 02.79	03.0137-0041.2 03.0137-9229.2	650041 669229		230 x 40 Bremsbacken-Zubehör	ATE ATE
	1.5 1.6		08.69 08.70	07.70 02.79	24.5224-0240.3	331260	2	L=240	
	1.6		03.73	02.79	03.3217-1811.3	020026		Rz 17,46	
	1.6	1832346255		02.79	03.0137-0041.2	650041		230 x 40	ATE
	1.6	1832346255		02.79	03.0420-2917.3	682917		17,46/230x40 Kit	ATE

1) - air cooled / - raffreddato ad aria / - refroidi par air / - refrigeración por aire

2) + air cooled / + raffreddato ad aria / + refroidi par air / + refrigeración por aire







Ⓓ **Abmessungen Bremsscheiben**

Ⓔ**N** **Dimensions brake discs**

Ⓕ**R** **Dimensions Disques de frein**

Ⓔ**S** **Medidas disco de freno**

# Abmessungen Bremsscheiben

## Dimensions brake discs - Misure dischi freno -

## Dimensions Disques de frein - Medidas disco de freno

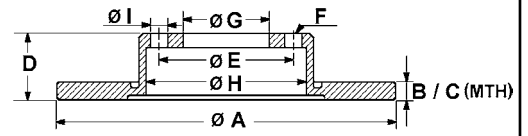

S Fixierschraube - fixing screw - vite di riparazione - vis de fixation - tornillo quejija  
 L legiert - alloyed - alligato/legato - allié - aleado ● gelocht - perforated - perforato - poinçonné - perforado  
 B beschichtet - coated - rivestito - revêtu - recubierto  
 V ventiliert - ventilated - ventilato - ventilé - ventilado  
 HC hochgekohlt - high carbon - ad alto tenore di carbonio - à haute teneur en carbone - altamente carbonizado

		S	B	H	C	L	V	A	B	C	D	E	F	G	H	I	OE - #	
24.0107-0100.1	407100							244,0	7,0	6,3	47,0	108,0	6	86,7	128,0	9,5	CITROEN	95 599 322
24.0107-0105.2	407105							224,0	7,0	5,0	56,5	108,0	4	71,0	133,0	13,0	CITROEN	95 582 061 95 661 849
24.0107-0108.1	407108							234,0	7,0	6,0	39,5	100,0	4	68,0	140,0	12,8	NISSAN	43206-58Y01
24.0108-0100.1	408100							239,0	8,0	7,0	44,0	100,0	4	65,0	124,5	12,9	AUDI/VW	861 615 301 B
24.0108-0104.1	408104	S	B					238,0	8,2	7,0	41,0	100,0	4	61,0	129,5	12,4	RENAULT	77 01 204 285
24.0108-0105.1	408105							247,5	8,0	6,5	20,3	108,0	4	71,0	133,0	13,0	PEUGEOT	4246 H0
24.0109-0101.1	409101							267,0	9,4	7,5	65,3	108,0	4	70,0	160,0	12,8	ALFA ROMEO	60516948
24.0109-0103.1	409103							278,0	9,0	7,3	58,5	112,0	5	67,0	164,0	15,0	MERCEDES BENZ	129 423 00 12
24.0109-0108.1	409108							244,5	9,0	7,0	43,8	86,0	3	62,0	109,0	10,0	CITROEN	75 485 825 210 423 09 12
24.0109-0120.1	409120	S	B					258,0	9,0	7,3	55,5	112,0	5	67,0	164,0	12,8	MERCEDES BENZ	202 423 00 12
24.0109-0121.2	409121							224,0	9,0	8,0	63,2	108,0	5	71,0	135,0	13,0	CITROEN	4246 T3 95 661 814
24.0109-0127.1	409127							231,0	9,0	8,0	34,5	100,0	4	65,0	125,0	13,0	MAZDA	B4Y2-26-251C
24.0109-0128.1	409128							242,0	9,0	8,0	36,4	100,0	4	54,0	130,9	14,5	TOYOTA	42431-12090 42431-12120
24.0109-0130.1	409130							258,0	9,0	7,5	43,5	108,0	4	68,0	160,7	15,5	SAAB	8970717
24.0109-0131.1	409131							251,0	9,0	8,0	34,5	100,0	4	55,0	125,0	13,0	MAZDA	BB4C-26-251C BR74-26-251A
24.0110-0109.1	410109							240,0	10,0	8,4	58,5	80,0	4	63,0	106,0	10,2	BMW	34 11 1 117 422
24.0110-0110.1	410110							272,0	9,5	7,9	61,5	120,0	5	75,0	160,0	14,5	BMW	34 21 1 163 132
24.0110-0111.1	410111							226,0	10,0	8,0	71,2	100,0	4	39,8	121,4	M12x1,5	SEAT/VW	357 615 601
24.0110-0115.1	410115							253,0	10,2	8,9	33,0	108,0	4	63,5	155,0	13,7	VOLKSWAGEN	6N0 615 601
24.0110-0116.1	410116							245,0	10,0	8,0	46,5	112,0	5	68,0	135,5	15,4	FORD	1514237 4083484 5022666 5030658
24.0110-0118.1	410118							300,0	9,9	8,4	67,9	120,0	5	75,0	180,0	14,5	AUDI	443 615 601 B
24.0110-0136.1	410136							215,0	10,0	8,0	33,0	102,0	4	86,0	106,0	M10x1,25	BMW	34 21 1 165 259
24.0110-0139.1	410139							228,0	10,0	9,0	38,5	99,0	6	83,0	102,5	M8	SUZUKI	55511-82001
24.0110-0142.1	410142							278,0	9,5	8,0	83,8	130,0	4	39,8	160,0	M14x1,5	RENAULT	77 01 466 540
24.0110-0144.1	410144							261,0	9,9	8,0	82,1	100,0	4	39,8	160,0	M12x1,5	VOLKSWAGEN	113 407 075 311 405 583 A
24.0110-0147.1	410147							280,0	10,0	8,4	68,1	120,0	5	75,0	160,0	14,5	OPEL/VAUXHALL	5 69 204/90348319
24.0110-0148.1	410148							221,0	10,0	8,7	42,0	108,0	4	72,0	131,0	13,4	BMW	34 21 1 165 255
24.0110-0150.1	410150							258,0	10,0	8,4	60,0	100,0	4	62,0	160,8	14,5	FORD	1575877 5022650 5022651 6119634
24.0110-0151.1	410151							239,0	10,0	8,0	38,9	100,0	4	65,0	124,5	13,6	BMW	34 21 6 755 407
24.0110-0152.1	410152	S	B					236,0	10,0	7,0	41,0	100,0	4/6	60,0	123,0	14,0	AUDI/SEAT/VW	811 615 301
24.0110-0154.1	410154	S						245,0	10,0	8,0	59,5	112,0	5	68,0	135,8	15,4	OPEL/VAUXHALL	5 69 028/90008003
24.0110-0166.1	410166							250,0	9,9	8,0	21,0	80,0	6	62,0	134,0	8,5	AUDI	437 615 601
24.0110-0174.1	410174							284,0	10,0	8,4	61,0	120,0	5	75,0	180,0	14,5	ALFA ROMEO	60526121
24.0110-0176.1	410176							284,0	10,0	8,4	68,0	120,0	5	75,0	180,0	14,5	BMW	34 21 1 162 968
24.0110-0178.1	410178							245,0	10,0	8,0	59,5	108,0	4	68,0	135,8	15,4	BMW	34 21 1 163 150
24.0110-0179.1	410179							250,0	9,9	8,0	21,0	80,0	6	62,0	134,0	10,5	AUDI	443 615 601
24.0110-0181.1	410181							259,0	10,0	8,0	72,0	114,3	5	48,0	58,0	12,5	ALFA ROMEO	60533971
24.0110-0182.1	410182							245,0	10,0	8,0	40,1	108,0	4	68,0	135,5	15,4	FORD	E92Z2C026A
24.0110-0183.1	410183							266,0	10,0	8,0	27,0	108,0	4	66,0	133,2	13,0	MAZDA	GJ25-26-251 GJ25-26-251A GJ25-26-251B GW55-26-251
24.0110-0185.1	410185							279,0	10,0	8,3	71,7	112,0	5	67,0	160,0	15,0	AUDI	8A0 615 601
24.0110-0186.1	410186	S	B					252,7	10,2	8,9	33,0	112,0	5	63,5	155,0	13,7	CITROEN	95 661 746
24.0110-0187.1	410187	S	B					247,0	10,0	9,0	34,2	108,0	4	66,0	133,0	13,0	PEUGEOT	4246 A9
24.0110-0189.1	410189							281,0	9,6	8,4	73,2	108,0	5	68,0	160,0	16,5	MERCEDES BENZ	126 423 00 12
24.0110-0190.1	410190							251,5	10,0	9,0	50,7	98,0	4	59,0	127,5	13,0	FORD	5027464 5027465
24.0110-0191.1	410191							270,0	10,0	8,0	67,0	110,0	5	65,5	160,0	14,0	CITROEN	95 661 748
24.0110-0192.1	410192							289,8	10,0	9,0	46,0	140,0	5	107,0	177,0	13,0	PEUGEOT	4246 A5 4249 95
24.0110-0193.1	410193							239,5	10,2	8,7	58,1	108,0	4	63,5	136,0	13,7	VOLVO	270736
24.0110-0196.1	410196							239,7	10,0	8,0	43,0	108,0	4	63,6	136,0	13,8	ALFA/FIAT/LANCIA	46758715 46831042 82434070 71738913
																	FIAT	71738913
																	OPEL/VAUXHALL	5 69 101/90272328
																	SUZUKI	55211-80000
																	FORD	5022947 5024744
																	FORD	5022652 5022653



# Abmessungen Bremsscheiben

## Dimensions brake discs - Misure dischi freno -

## Dimensions Disques de frein - Medidas disco de freno

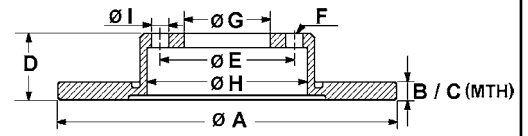

S Fixierschraube - fixing screw - vite di riparazione - vis de fixation - tornillo quefija

B beschichtet - coated - rivestito - revêtu - recubierto

HC hochgekohlt - high carbon - ad alto tenore di carbonio - à haute teneur en carbone - altamente carbonizado

L legiert - alloyed - alligato/legato - allié - aleado

V ventiliert - ventilated - ventilato - ventilé - ventilado

● gelocht - perforated - perforato - poinçonné - perforado

		S	B	H	C	L	V	A	B	C	D	E	F	G	H	I	OE - #		
24.0110-0198.1	410198							258,0	10,0	9,0	29,0	98,0	3	57,0	124,3	13,0	CITROEN	95 669 226	
24.0110-0199.1	410199							247,0	10,0	8,0	34,3	108,0	4	71,0	133,0	13,0	PEUGEOT	4246 G9	
24.0110-0200.1	410200							245,0	10,0	8,0	65,5	108,0	4	68,0	135,5	15,4	AUDI	443 615 601 E	
24.0110-0201.1	410201		B					245,0	10,0	8,0	64,2	112,0	5	68,0	135,5	15,4	AUDI/SKODAVW	4A0 615 601 A	
24.0110-0203.1	410203							226,0	10,0	8,0	71,2	100,0	5	39,8	50,2	M14x1,5	SEAT/VW	357 615 601 B	
24.0110-0206.1	410206							265,0	10,0	8,0	53,0	108,0	5	68,0	160,0	16,0	VOLVO	1359290	
24.0110-0207.1	410207							245,0	10,0	8,0	46,5	108,0	4	68,0	135,5	15,4	AUDI	443 615 601 A	
24.0110-0209.1	410209		B					251,4	10,0	9,0	50,5	98,0	5	59,0	127,5	13,0	ALFA/FIAT/LANCIA	7789267 60569164 60653479 60658566 60801787 82439939 82440275	
24.0110-0212.1	410212	S	B					238,5	10,0	8,0	48,1	100,0	4	61,0	154,5	13,0	HONDA	42510-SE0-010 42510-SH3-G00 42510-SK3-305 42510-SK3-E00	
24.0110-0213.1	410213							270,0	10,0	8,6	62,6	108,0	4	63,5	180,0	13,7	FORD	5025951	
24.0110-0233.1	410233	S	B					260,0	10,0	8,0	48,7	114,3	4	64,1	155,0	12,8	HONDA	42510-SN7-000 42510-SV1-A00 42510-SV4-A00 GBD90835	
24.0110-0235.1	410235							211,0	10,0	9,0	35,0	88,0	4	70,0	98,0	M10x1,25	ROVER	GBD90802	
24.0110-0236.1	410236							222,0	10,0	8,0	66,5	114,3	4	45,3	50,3	12,6	DAIHATSU	43512-87216-000	
24.0110-0238.1	410238							265,0	10,0	8,4	49,0	114,3	4	90,0	154,0	12,6	MAZDA	B107-26-251	
24.0110-0239.1	410239							213,5	9,6	8,6	61,2	73,0	4	55,6	85,0	3/8"	MITSUBISHI	MB500555 MB500556	
24.0110-0241.1	410241							269,0	10,0	9,0	64,5	100,0	5	54,0	188,5	14,5	AUSTIN/ROVER	GBD90806	
24.0110-0244.1	410244							258,0	10,0	9,0	45,0	114,3	5	68,0	154,0	12,6	TOYOTA	42431-20160	
24.0110-0255.1	410255							260,0	10,0	8,0	43,1	114,3	4	64,1	158,8	12,5	NISSAN	43206-88E03	
24.0110-0256.1	410256							259,0	10,0	8,0	72,0	114,3	5	47,9	63,9	12,5	HONDA	42510-SG9-000 42510-SG9-010 GBD90802	
24.0110-0263.1	410263							258,0	10,0	8,4	74,5	100,0	4	62,0	161,0	14,5	ROVER	MAZDA	G311-26-251A GM09-26-251B
24.0110-0265.1	410265							261,0	10,0	8,0	53,0	114,3	5	66,0	156,5	13,0	BMW	34 21 1 163 145	
24.0110-0267.1	410267							260,0	10,0	8,0	43,2	114,3	4	64,1	159,0	12,6	MAZDA	G0YD-26-251A	
24.0110-0275.2	410275							226,0	10,0	8,0	71,5	100,0	4	39,9	121,5	M12x1,5	HONDA	42510-SD4-000 42510-SS0-000 42510-SS0-J00	
24.0110-0276.2	410276							226,0	10,0	8,0	71,5	100,0	5	39,9	121,5	M14x1,5	SEAT/VW	357 615 601	
24.0110-0319.1	410319							295,0	10,0	8,8	88,0	120,7	5	73,8	180,0	13,4	VOLKSWAGEN	6N0 615 601	
24.0111-0115.1	411115		B					252,5	10,0	9,0	65,0	98,0	4	68,0	118,0	13,0	SEAT/VW	357 615 601 B	
24.0111-0116.1	411116							238,0	11,0	8,0	55,5	92,0	4	73,0	112,5	10,5	JAGUAR	JLM 10601 JLM 12424 JLM 1830	
24.0111-0119.1	411119		B					240,5	11,0	9,2	40,0	98,0	4	59,0	123,0	13,0	LADA	2101-3103002 2101-3501070	
24.0111-0120.1	411120							269,5	10,5	9,5	65,9	114,3	4	86,0	145,0	13,6	OPEL/VAUXHALL	5 69 041/90272326	
24.0111-0122.1	411122							255,0	10,5	9,5	30,6	100,0	4	66,0	134,0	12,6	ALFA/FIAT/LANCIA	7663465 7685656 46403960 51876438 60811879 71769481 71772238 51859078 1715410 BS51-1125-AA	
24.0111-0129.1	411129							251,0	11,0	9,5	51,0	98,0	4	62,0	135,0	13,0	FIAT	4377102	
24.0111-0130.1	411130		B					227,0	10,8	9,0	45,8	98,0	4	62,0	117,0	13,0	SEAT	SE022165002B	
24.0111-0137.1	411137	S	B					262,0	11,0	9,0	45,5	112,0	5	67,0	142,5	15,0	AUTOB/FIAT/LANCIA	4385812	
24.0111-0139.1	411139							234,0	11,0	10,0	47,0	100,0	4	56,0	128,5	13,4	SEAT	16500253 SE022165002A	
																	MERCEDES BENZ	201 421 12 12	
																	DAIHATSU	43512-87709-000 43512-87717-000 43512-87727-000	





# Abmessungen Bremsscheiben

## Dimensions brake discs - Misure dischi freno -

## Dimensions Disques de frein - Medidas disco de freno

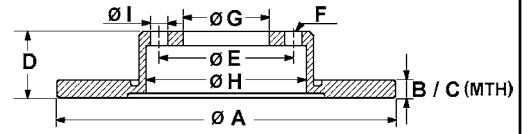

S Fixierschraube - fixing screw - vite di riparazione - vis de fixation - tornillo quefija

B beschichtet - coated - rivestito - revêtu - recubierto

HC hochgekohlt - high carbon - ad alto tenore di carbonio - à haute teneur en carbone - altamente carbonizado

L legiert - alloyed - alligato/legato - allié - aleado

V ventiliert - ventilated - ventilato - ventilé - ventilado

● gelocht - perforated - perforato - poinçonné - perforado

		S	B	H	C	L	V	A	B	C	D	E	F	G	H	I	OE - #	
24.0111-0149.1	411149							240,5	11,0	9,2	40,0	98,0	4	59,0	124,5	13,0	ALFA ROMEO	60576335 60805117
24.0112-0102.1	412102							231,0	12,0	10,0	44,0	100,0	4	61,0	124,0	12,6	HONDA ROVER	45251-SB2-030 45251-SB2-732 DBP3169 GBD90810 GBD90818 GBD90827
24.0112-0106.1	412106	S	B					239,0	12,0	10,0	35,4	100,0	4	65,0	124,5	13,6	AUDI/SEAT/VW AUDI/VW	321 615 301 175 615 301
24.0112-0111.1	412111							284,0	12,0	10,4	76,0	120,0	5	79,0	146,0	14,5	BMW	34 11 1 163 134
24.0112-0112.1	412112							257,0	12,0	10,8	51,5	98,0	4	62,0	135,0	13,0	FIAT/LANCIA	4448411
24.0112-0115.1	412115							239,8	12,0	11,0	35,0	96,0	4	76,0	128,8	8,3	NISSAN	40206-05A01
24.0112-0116.1	412116	S	B					238,0	12,0	10,5	41,0	100,0	4	61,0	129,5	13,5	DACIA RENAULT	60 01 549 211 60 01 549 211 77 01 204 282
24.0112-0117.1	412117	S	B					284,0	12,0	10,0	46,5	112,0	5	67,0	154,3	15,0	MERCEDES BENZ	124 421 13 12
24.0112-0120.1	412120			HC				300,0	12,0	10,4	67,9	120,0	5	75,0	180,0	14,5	BMW	34 21 1 165 257
24.0112-0121.1	412121							214,0	12,0	10,0	43,2	100,0	4	59,0	125,5	12,5	NISSAN	40206-01B00 40206-01B01
24.0112-0122.1	412122							240,0	12,0	10,8	46,5	98,0	4	59,0	127,5	13,0	AUTOB/FIAT/LANCIA	71738423
24.0112-0123.1	412123							240,3	12,0	11,0	45,1	100,0	4	61,0	126,5	12,6	NISSAN	40206-61A01 40206-61A11
24.0112-0127.1	412127		B					257,5	12,0	10,2	40,5	98,0	4	59,0	123,0	13,0	ALFA/FIAT/LANCIA	7663466 46820655 51859075 51866265 60808872 51866264
24.0112-0129.1	412129			HC				290,0	12,0	9,8	60,0	112,0	5	67,0	164,0	17,0	FIAT MERCEDES BENZ	140 423 06 12
24.0112-0130.1	412130							272,0	11,0	9,9	50,5	140,0	5	108,0	157,0	14,5	LADA	2121-3501070
24.0112-0133.1	412133							253,8	12,0	10,5	54,2	108,0	5	66,0	134,0	14,7	RENAULT	77 01 467 307
24.0112-0134.1	412134							253,8	12,0	10,5	54,2	100,0	4	66,0	134,0	12,6	RENAULT	77 01 467 306
24.0112-0136.2	412136							251,0	12,0	10,8	62,3	108,0	5	71,0	134,7	13,0	CITROEN	95 661 796
24.0112-0139.1	412139							214,0	12,0	10,0	46,2	100,0	4	61,0	126,6	12,6	NISSAN	40206-21B01
24.0112-0140.1	412140							238,0	12,0	11,0	48,2	100,0	4	54,1	127,0	14,5	TOYOTA	43512-12230 43512-12500
24.0112-0145.1	412145							265,6	12,0	10,6	48,0	139,7	6	96,5	171,6	12,6	ISUZU	8-94173-244-0 8-94173-244-2
24.0113-0102.2	413102							272,0	12,7	10,7	68,5	108,0	4	82,0	126,5	M12x1,5	ALFA ROMEO	60516371
24.0113-0105.1	413105							302,0	12,5	11,5	48,0	139,5	6	100,0	168,5	15,0	TOYOTA	43512-35070
24.0113-0111.1	413111							253,0	12,7	11,1	67,5	88,5	5	69,5	109,5	12,2	MERCEDES BENZ	110 421 01 12
24.0113-0112.1	413112							273,0	12,6	11,0	63,3	112,0	5	69,5	127,5	15,0	MERCEDES BENZ	115 421 11 12
24.0113-0113.1	413113							273,5	12,6	11,0	63,3	112,0	5	80,0	127,5	15,0	MERCEDES BENZ	115 421 13 12
24.0113-0117.1	413117							280,0	12,7	11,7	65,4	114,3	4	86,1	145,5	13,6	SAAB	32000298
24.0113-0118.1	413118							244,6	12,7	11,4	27,0	92,5	4	68,3	116,1	10,3	FORD	5022671 5023732
24.0113-0122.1	413122							247,6	12,7	11,4	26,9	92,5	4	68,3	118,1	10,5	FORD HYUNDAI	5022829 58161-31000 58161-31010
24.0113-0125.1	413125							246,0	12,7	9,7	55,5	92,0	4	73,0	114,0	10,5	OPEL/VAUXHALL	5 69 026/90008001
24.0113-0126.1	413126							271,0	12,7	9,7	59,4	108,0	5	88,0	130,0	10,5	OPEL/VAUXHALL	5 69 027/90008002
24.0113-0128.1	413128							273,0	13,0	10,7	43,0	98,0	4	76,0	132,0	10,3	PEUGEOT/TALBOT	4246 B2
24.0113-0132.1	413132							278,2	13,0	11,0	85,8	112,0	5	66,1	137,0	16,0	VOLKSWAGEN	211 615 301 B
24.0113-0137.1	413137		B					278,0	12,6	10,6	63,3	112,0	5	80,0	127,5	15,2	MERCEDES BENZ	123 421 00 12
24.0113-0138.1	413138							255,0	12,7	11,1	75,0	100,0	4	63,0	128,0	14,5	BMW	34 11 1 163 128
24.0113-0139.1	413139							280,0	12,7	11,1	78,0	120,0	5	74,0	143,0	14,5	BMW	34 11 1 163 144
24.0113-0141.1	413141							280,0	12,7	11,7	47,4	114,3	4	86,0	147,5	11,0	SAAB	8934036
24.0113-0142.1	413142							278,0	13,0	11,0	118,5	112,0	5	45,2	68,0	M14x1,5	VOLKSWAGEN	251 407 617 251 407 617 A
24.0113-0159.1	413159							243,0	12,7	11,4	33,7	104,0	4	86,0	127,5	10,6	MITSUBISHI	MB316676
24.0113-0160.1	413160		B					256,0	13,0	11,0	46,5	108,0	4	68,0	135,5	15,4	AUDI	443 615 301
24.0113-0161.1	413161	S	B					236,0	12,7	9,7	41,0	100,0	4/6	60,0	123,0	14,0	OPEL/VAUXHALL	5 69 020/90008005 5 69 030/90008031 5 69 013/93182290
24.0113-0165.1	413165							219,0	13,0	11,0	37,0	94,0	4	75,0	119,0	10,5	KIA	KK150-33-251 MDA01-33-251
24.0113-0167.1	413167		B					260,0	12,7	11,1	35,0	100,0	4	66,0	137,5	14,5	MAZDA BMW	DA01-33-251 34 11 6 752 434
24.0113-0168.1	413168							256,0	13,0	11,0	61,0	118,0	5	72,0	141,0	15,0	CITROEN	75 685 01 ZF 07 568 501
																	FIAT	4450931 7568501
																	PEUGEOT	4246 85 / 4246 B3

# Abmessungen Bremsscheiben

## Dimensions brake discs - Misure dischi freno -

## Dimensions Disques de frein - Medidas disco de freno

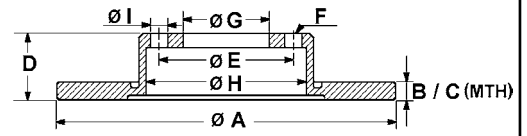

S Fixierschraube - fixing screw - vite di riparazione - vis de fixation - tornillo quefija

B beschichtet - coated - rivestito - revêtu - recubierto

HC hochgekohlt - high carbon - ad alto tenore di carbonio - à haute teneur en carbone - altamente carbonizado

L legiert - alloyed - alligato/legato - allié - aleado

V ventiliert - ventilated - ventilato - ventilé - ventilado

● gelocht - perforated - perforato - poinçonné - perforado

		S	B	HC	L	V	A	B	C	D	E	F	G	H	I	OE	#
24.0113-0170.1	413170						257,0	13,0	11,5	84,0	108,0	4	39,84	50,25	M14x1,5	PORSCHE	477 405 583 B
24.0113-0171.1	413171						239,0	12,6	9,0	46,0	98,0	4	58,5	128,0	13,0	ALFA ROMEO	60501453
24.0113-0172.1	413172						238,9	12,8	11,4	29,2	86,0	4	69,0	107,0	10,4	VOLVO	3210674
24.0113-0173.1	413173						239,5	12,7	11,4	58,1	108,0	4	63,5	136,0	13,7	FORD	5024745 6092165 6100043
24.0113-0174.1	413174						258,0	12,6	9,7	58,4	110,0	5	70,0	139,0	14,0	OPEL/VAUXHALL	5 69 040/90271135
24.0113-0178.1	413178	S	B				255,6	12,9	11,0	39,2	100,0	4	65,0	135,5	13,6	SEAT/VW	357 615 301
24.0113-0183.1	413183						234,0	13,0	11,4	34,0	104,0	4	86,0	126,0	10,6	MITSUBISHI	MB618737
24.0113-0189.1	413189		B				290,0	12,5	11,7	61,5	127,0	5	101,6	160,5	10,0	LAND ROVER	FRC9831 FTC1381
24.0114-0100.1	414100						270,0	14,3	12,9	71,2	100,0	5	78,5	120,0	M10	FORD	5022674 5022677
24.0114-0101.1	414101						263,0	14,3	12,7	65,0	108,0	5	68,1	139,0	16,3	VOLVO	270737
24.0114-0102.1	414102						257,5	14,0	12,8	50,7	98,0	4	59,0	128,7	13,2	FIAT/LANCIA	82434169
24.0114-0103.1	414103						254,0	14,3	12,9	31,5	100,0	5	78,5	138,0	M10	FORD	5022676
24.0114-0106.1	414106						250,0	14,0	12,5	34,6	94,0	4	75,0	129,0	10,6	MAZDA	GA97-33-251B
24.0114-0107.1	414107						280,0	14,0	12,6	55,5	138,0	5	112,0	150,0	M10x1,5	PEUGEOT	4246 69 4246 B8
24.0114-0108.1	414108		B				298,5	14,0	13,0	70,0	127,0	5	101,6	160,5	10,0	LAND ROVER	FRC7329 FRC7392 FTC3846
24.0114-0115.1	414115						298,0	14,0	13,0	59,0	127,0	5	101,6	159,6	10,2	LAND ROVER	SDB000330 SDB100980
24.0115-0105.1	415105		B	HC			288,0	15,0	13,0	46,5	112,0	5	68,0	135,5	15,4	AUDI	4A0 615 301 B
24.0115-0106.1	415106				V		214,0	15,0	13,0	46,2	100,0	4	61,0	126,5	12,6	NISSAN	40206-27B01
24.0116-0100.1	416100		B				280,0	16,0	13,0	78,6	112,0	5	88,0	133,5	12,5	MERCEDES BENZ	601 420 02 72 601 421 04 12
24.0116-0104.1	416104		B				258,0	16,0	13,0	95,5	112,0	5	45,2	67,9	M14x1,5	VOLKSWAGEN	251 407 617 M
24.0116-0105.1	416105		B				256,0	16,1	13,5	64,1	118,0	5	73,0	141,0	15,5	ALFA/FIAT	7531819 60809894 93500520
24.0116-0106.1	416106						290,0	16,0	14,8	61,0	118,0	5	73,0	141,0	15,5	CITROEN PEUGEOT	4246 N5 4246 B4 4249 L1
24.0116-0109.1	416109						258,0	16,0	13,0	57,5	112,0	5	67,0	135,0	15,5	CITROEN FIAT PEUGEOT	ZF 93 500 521 93500521 4246 H3
24.0116-0110.1	416110	S	B	HC	L		272,0	16,0	14,0	96,7	130,0	5	85,0	160,0	15,0	VOLKSWAGEN MERCEDES BENZ	251 407 615 Q 902 423 03 12 902 423 05 12
24.0116-0127.1	416127				V		211,0	16,0	14,0	41,0	88,0	4	70,0	97,0	M10x1,25	DAIHATSU	43512-87215-000
24.0116-0133.1	416133	S	B				303,0	16,0	13,0	83,0	130,0	5	85,0	158,5	15,0	MERCEDES BENZ	461 421 00 12 461 421 00 12
24.0117-0101.1	417101				V		231,0	17,0	15,0	44,0	100,0	4	61,0	124,0	12,6	HONDA	45251-SB2-932 45251-SB2-940
24.0117-0103.1	417103		B		V		231,2	17,0	15,0	50,0	114,3	4	64,0	137,5	12,8	ROVER	DBP7954 GBD90803 GBD90814 GBD90825
24.0118-0101.1	418101				V		238,0	18,0	16,0	31,0	94,0	4	75,0	143,5	10,5	SUBARU SUZUKI	5531180F03 55311-60B20 55311-72F00 55311M72F00
24.0118-0104.1	418104				V		242,0	18,0	16,0	43,9	90,0	4	70,0	100,0	M10	MAZDA	B107-33-251 BF68-33-251A
24.0118-0107.1	418107		B		V		240,0	18,0	16,0	45,2	100,0	4	61,0	130,0	12,6	SUBARU	25431GA171 25431GA200
24.0118-0109.1	418109				V		242,0	18,0	16,4	34,0	104,0	4	86,0	126,0	10,6	NISSAN	40206-58A00 40206-58A01 40206-60Y01
24.0118-0110.1	418110				V		238,0	18,0	17,0	48,2	100,0	4	54,1	127,0	14,5	MITSUBISHI	MB316677 MB366434
24.0118-0112.1	418112				V		236,0	18,0	16,4	34,0	104,0	4	86,0	141,0	10,6	TOYOTA	43512-12250 43512-12300 43512-12310 43512-12330 43512-12440 43512-12480
					V		236,0	18,0	16,4	34,0	104,0	4	86,0	141,0	10,6	MITSUBISHI	MB618734 MB618735





# Abmessungen Bremsscheiben

## Dimensions brake discs - Misure dischi freno -

## Dimensions Disques de frein - Medidas disco de freno

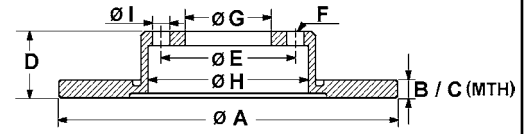

S Fixierschraube - fixing screw - vite di riparazione - vis de fixation - tornillo quefija

B beschichtet - coated - rivestito - revêtu - recubierto

HC hochgekohlt - high carbon - ad alto tenore di carbonio - à haute teneur en carbone - altamente carbonizado

L legiert - alloyed - alligato/legato - allié - aleado

V ventiliert - ventilated - ventilato - ventilé - ventilado

● gelocht - perforated - perforato - poinçonné - perforado

		S	B	HC	L	V	A	B	C	D	E	F	G	H	I	OE - #
24.0118-0113.1	418113		B			V	235,0	18,0	16,0	45,0	100,0	4	55,0	125,0	13,0	MAZDA NA01-33-25X NA01-33-25XA NA01-33-25XC
24.0118-0115.1	418115					V	212,0	18,0	15,5	36,5	94,0	4	65,1	99,0	M10x1,25	SUBARU 725431150 725431312
24.0118-0119.1	418119					V	291,0	18,0	17,0	68,4	114,3	5	60,0	190,0	14,5	TOYOTA 42431-14110
24.0118-0126.1	418126					V	234,5	18,0	17,0	47,0	100,0	4	56,0	128,5	13,0	DAIHATSU 43512-87710-000 43512-87718-000 43512-87725-000
24.0119-0104.1	419104					V	242,0	19,0	17,0	49,6	100,0	4	61,0	126,7	12,6	HONDA 45251-SE0-010
24.0119-0106.1	419106					V	242,0	19,0	17,0	44,1	100,0	4	61,0	122,0	12,6	HONDA 45251-SB2-990
24.0119-0109.1	419109					V	242,0	19,1	17,0	40,5	104,0	4	86,0	143,0	M10x1,25	HYUNDAI 51712-24100
24.0120-0100.1	420100					V	229,0	20,0	18,5	34,5	94,0	4	75,0	115,0	10,6	MAZDA GB40-33-251 GF15-33-251
24.0120-0103.1	420103			HC	L	V	282,5	20,5	19,1	35,3	126,0	5	107,0	145,0	8,4	PORSCHE 477 405 083 A 911 351 041 20
24.0120-0104.1	420104			HC	L	V	289,0	20,0	18,6	100,0	130,0	5	103,0	180,0	15,4	PORSCHE 944 352 041 03
24.0120-0108.1	420108					V	260,0	20,0	18,0	54,0	98,0	5	58,0	127,0	13,0	CITROEN 5 429 669 S 75 529 364
24.0120-0112.1	420112			HC	L	V	289,0	19,9	18,7	71,2	130,0	5	102,8	180,0	15,6	PORSCHE 944 352 041 02
24.0120-0113.1	420113			HC		V	300,0	20,0	18,4	68,0	120,0	5	75,0	180,0	14,5	BMW 34 21 1 162 967
24.0120-0115.1	420115	S	B	HC	L	V	236,0	20,0	17,0	41,0	100,0	4/6	60,0	123,0	14,0	CHEVROLET 90121445 DAEWOO 90121445 OPEL/VAUXHALL 5 69 054/90511111 NISSAN 40206-37J01 40206-C7000 40206-C7001 40206-G9500
24.0120-0119.1	420119					V	295,0	20,0	18,0	29,0	137,0	6	104,0	178,0	M12x1,25	AUDI 853 615 301 A 853 615 301 C
24.0120-0120.1	420120			HC		V	256,0	20,0	18,0	41,9	108,0	4	68,0	134,0	15,4	MAZDA GJ96-33-25XA
24.0120-0121.1	420121					V	242,0	20,0	18,0	37,5	94,0	4	75,0	113,0	10,6	AUDI/SEAT/VW 321 615 301 C
24.0120-0123.1	420123	S	B	HC	L	V	239,0	20,0	18,0	39,0	100,0	4	65,0	123,8	13,6	NISSAN 40206-00QAJ
24.0120-0125.1	420125	S	B			V	238,0	20,1	17,7	41,0	100,0	4	61,0	128,0	12,5	RENAULT 77 01 204 286 RENAULT 77 00 715 081 77 01 204 283
24.0120-0126.1	420126		B			V	259,0	20,2	17,7	46,4	100,0	4	61,0	130,0	12,8	SEAT/VW 321 615 301 D 6N0 615 301 D
24.0120-0128.1	420128	S	B	HC	L	V	256,0	20,0	18,0	38,8	100,0	4	65,0	131,5	13,8	ALFA/FIAT/LANCIA 60810227 82464702
24.0120-0129.1	420129					V	257,4	20,0	18,2	51,7	98,0	4	59,0	127,0	13,0	MITSUBISHI MB151387
24.0120-0130.1	420130					V	255,0	20,0	18,4	45,0	108,0	6	87,0	115,0	10,5	CITROEN 91 517 694
24.0120-0131.1	420131					V	247,0	20,4	18,5	44,2	108,0	4	66,0	133,2	12,8	PEUGEOT 4246 A6
24.0120-0132.1	420132	S	B			V	247,0	20,4	18,5	34,2	108,0	4	66,0	133,2	12,8	CITROEN 95 661 747 PEUGEOT 4246 A7 4249 96
24.0120-0133.1	420133	S	B			V	266,0	20,5	18,5	27,6	108,0	4	66,0	133,0	13,0	CITROEN 4249 F0 PEUGEOT 4246 97 4249 F0
24.0120-0134.1	420134					V	265,0	20,5	17,7	31,6	100,0	4	61,0	127,0	12,8	RENAULT 77 00 764 193 77 01 467 955
24.0120-0135.1	420135					V	244,0	20,5	17,7	31,6	100,0	4	61,0	127,0	12,5	RENAULT 77 00 758 901 77 01 204 954 77 01 467 954
24.0120-0137.1	420137		B			V	269,0	19,9	18,0	46,0	112,0	5	68,0	156,0	15,5	AUDI 447 615 601 A
24.0120-0139.1	420139					V	255,5	20,0	18,4	33,5	104,0	5	84,0	84,5	10,6	MITSUBISHI MB238495
24.0120-0142.1	420142		B	HC	L	V	257,5	20,0	18,2	40,5	98,0	4	59,0	126,7	13,0	ALFA/FIAT/LANCIA 7779409 71738145 51749124 60806137 60810076 60811256 60811266
24.0120-0143.1	420143					V	240,0	20,0	18,2	46,5	98,0	4	59,0	124,5	13,0	FIAT 7650707
24.0120-0147.1	420147		B			V	239,5	20,0	18,0	43,0	108,0	4	63,5	136,0	13,7	FORD/MAZDA 1019604 1066271 1320581 1320582 5028281
24.0120-0148.1	420148					V	238,0	20,1	17,7	46,0	100,0	4	61,0	132,0	12,5	RENAULT 77 01 466 782
24.0120-0153.1	420153					V	302,0	20,0	19,0	48,0	139,7	6	100,0	166,5	15,0	TOYOTA 43512-60011 43512-60040 43512-69015 43512-69016

# Abmessungen Bremsscheiben

Dimensions brake discs - Misure dischi freno -

Dimensions Disques de frein - Medidas disco de freno

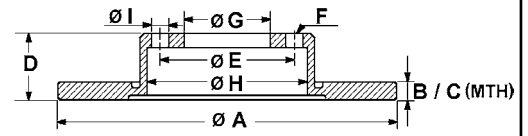

S Fixierschraube - fixing screw - vite di riparazione - vis de fixation - tornillo quefija

B beschichtet - coated - rivestito - revêtu - recubierto

HC hochgekohlt - high carbon - ad alto tenore di carbonio - à haute teneur en carbone - altamente carbonizado

L legiert - alloyed - alligato/legato - allié - aleado

V ventiliert - ventilated - ventilato - ventilé - ventilado

● gelocht - perforated - perforato - poinçonné - perforado

**S B H C L V A B C D E F G H I OE - #**

		S	B	H	C	L	V	A	B	C	D	E	F	G	H	I	OE - #		
24.0120-0157.1	420157						V	251,0	20,0	18,0	45,8	98,0	4	62,0	159,5	13,0	SEAT	SE021165002A	
24.0120-0168.1	420168						V	289,0	20,0	18,0	64,2	127,0	6	100,0	156,0	10,7	TOYOTA VOLKSWAGEN	43512-35190 J43 512 351 90	
24.0120-0172.1	420172			HC	L	V	269,0	19,9	18,0	59,5	112,0	5/10	68,0	156,0	15,3		AUDI	857 615 601	
24.0120-0185.1	420185			HC	L	V	290,0	20,0	18,7	83,0	130,0	5	90,0	180,0	15,4		PORSCHE	901 352 041 14	
24.0120-0199.1	420199			HC	L	V	278,0	19,9	17,4	55,2	112,0	5	67,0	164,0	15,0		MERCEDES BENZ	124 423 10 12	
24.0121-0100.1	421100						V	285,0	21,0	19,0	51,2	114,3	4	64,1	141,0	12,7		HONDA ROVER	45251-SG9-000 GBD90800 GBD90822
24.0121-0101.1	421101						V	285,0	21,0	19,0	31,8	108,0	5	61,0	134,0	14,5		RENAULT	77 00 801 101 77 01 204 298
24.0121-0102.1	421102						V	262,0	21,0	19,0	51,2	100,0	4	64,2	141,0	12,6		HONDA	45251-SF0-000
24.0121-0103.1	421103						V	285,0	21,0	19,0	31,8	100,0	4	61,0	134,0	12,5		RENAULT	77 00 801 213 77 01 204 299
24.0121-0105.1	421105	S	B				V	262,0	21,0	19,0	44,7	100,0	4	64,1	141,0	13,0		HONDA	45251-S5D-A10 45251-S6D-E10 45251-SCC-900 45251-SK7-A00 45251-SK7-A10 45251-SR0-A00 45251-SR0-A10 45251-ST3-E10 45251-TG5-H00 45251-TF3-E00
24.0121-0112.1	421112		B	HC	L	V	282,0	20,5	19,0	74,2	130,0	5	103,0	155,0	15,4		PORSCHE	944 351 041 05	
24.0122-0100.1	422100		B	HC		V	280,0	22,0	20,0	28,5	100,0	5	65,0	141,0	15,6		SEAT/VW	1H0 615 301 A	
24.0122-0101.1	422101		B	HC		V	280,0	22,0	20,0	39,5	100,0	4	65,0	137,0	13,6		SEAT/VW	535 615 301	
24.0122-0123.1	422103		S	B	HC	V	302,0	22,0	20,4	76,0	120,0	5	79,0	149,0	14,5		BMW	34 11 1 160 936	
24.0122-0106.1	422106						V	278,0	22,0	20,0	66,3	112,0	5	80,0	127,5	15,0		MERCEDES BENZ	116 420 02 05
24.0122-0107.1	422107		B			V	284,0	22,0	20,2	39,4	98,0	4	59,0	127,0	13,0		ALFA/FIAT/LANCIA	46403958 46427947 46427949 60811890 60812067 60812137	
24.0122-0109.1	422109						V	271,0	22,0	19,0	59,4	108,0	5	88,0	130,0	10,5		OPEL/VAUXHALL	5 69 029/90008004
24.0122-0111.1	422111						V	280,0	22,0	20,4	78,0	120,0	5	74,0	143,0	14,5		BMW	34 11 1 119 563 34 11 1 163 130
24.0122-0112.1	422112						V	255,0	22,0	20,4	75,0	100,0	4	63,0	128,0	14,5		BMW	34 11 1 163 126
24.0122-0114.1	422114						V	243,0	22,0	21,0	47,3	100,0	4	54,0	130,8	14,5		TOYOTA	43512-20100 43512-20110 43512-20150
24.0122-0116.1	422116						V	278,0	22,0	19,4	68,3	112,0	5	80,0	127,5	15,0		MERCEDES BENZ	126 420 00 05 126 421 00 12
24.0122-0118.1	422118		B			V	256,0	22,0	20,0	46,5	108,0	4	68,0	132,7	15,4		AUDI	443 615 301 B	
24.0122-0119.2	422119						V	269,0	22,0	20,0	51,5	98,0	5	72,0	120,0	M12x1,5		ALFA ROMEO	60522092
24.0122-0120.1	422120			HC	L	V	280,0	22,0	20,0	46,5	112,0	5	68,0	158,0	15,4			AUDI	437 615 301 A
24.0122-0122.1	422122		B	HC	L	V	260,0	22,0	20,4	35,0	100,0	4	66,0	138,0	14,5			BMW	34 11 1 160 915
24.0122-0123.1	422123		S	B	HC	L	V	284,0	22,0	19,4	43,5	112,0	5	67,0	154,3	15,0		MERCEDES BENZ	124 421 16 12 124 421 27 12
24.0122-0124.1	422124		B	HC	L	V	262,0	22,0	19,4	44,5	112,0	5	67,0	142,5	15,0		MERCEDES BENZ	201 421 15 12	
24.0122-0125.1	422125						V	286,0	22,0	19,4	60,0	112,0	5	80,0	127,5	15,0		MERCEDES BENZ	126 420 02 72
24.0122-0126.1	422126						V	271,0	22,0	19,0	59,4	108,0	5	94,0	130,0	10,5		OPEL/VAUXHALL	5 69 032/90008007
24.0122-0127.1	422127						V	263,0	22,0	20,4	67,3	108,0	5	68,0	139,0	16,5		VOLVO	270739
24.0122-0128.1	422128						V	239,2	22,0	20,2	46,1	98,0	4	58,5	127,4	13,0		ALFA ROMEO	60514881
24.0122-0129.1	422129						V	250,0	22,0	20,0	49,2	114,3	4	68,0	144,0	12,5		NISSAN	40206-15E00 40206-15E01
24.0122-0130.1	422130						V	257,2	22,0	20,2	50,7	98,0	4	59,0	127,0	13,2		ALFA/FIAT/LANCIA	46445005 60805172 60807625
24.0122-0133.1	422133			HC		V	300,0	22,0	19,4	60,0	112,0	5	67,0	164,0	17,0		MERCEDES BENZ	140 423 04 12	
24.0122-0134.1	422134		B	HC	L	V	284,0	22,0	19,4	43,5	112,0	5	67,0	152,0	15,0		MERCEDES BENZ	124 421 23 12	
24.0122-0135.1	422135						V	284,0	22,0	20,4	76,0	120,0	5	79,0	147,0	14,5		BMW	34 11 1 163 136
24.0122-0136.1	422136		B	HC	L	V	295,0	22,0	19,4	49,5	112,0	5	67,0	154,3	15,0		MERCEDES BENZ	124 421 15 12	
24.0122-0137.1	422137						V	287,0	22,0	20,0	56,0	108,0	5	68,0	157,0	14,0		VOLVO	1359908
24.0122-0138.1	422138						V	262,5	22,0	20,0	56,0	108,0	5	68,0	139,0	14,0		VOLVO	1359906
24.0122-0140.1	422140			HC			V	280,0	22,0	19,0	78,6	112,0	5	88,0	133,5	12,5		MERCEDES BENZ	601 420 03 72 601 421 05 12
24.0122-0141.1	422141						V	276,0	22,0	20,0	48,0	108,0	5	71,0	130,5	13,0		CITROEN PEUGEOT	95 661 812 4246 E8
24.0122-0143.1	422143						V	280,0	22,0	20,0	58,0	108,0	5	61,0	131,5	14,7		RENAULT	77 00 767 602 77 01 204 289



# Abmessungen Bremsscheiben

## Dimensions brake discs - Misure dischi freno -

## Dimensions Disques de frein - Medidas disco de freno

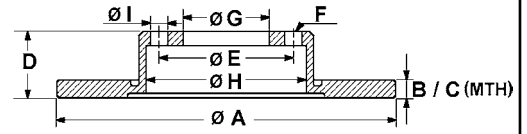

S Fixierschraube - fixing screw - vite di riparazione - vis de fixation - tornillo quefija

B beschichtet - coated - rivestito - revêtu - recubierto

HC hochgekohlt - high carbon - ad alto tenore di carbonio - à haute teneur en carbone - altamente carbonizado

L legiert - alloyed - alligato/legato - allié - aleado

V ventiliert - ventilated - ventilato - ventilé - ventilado

● gelocht - perforated - perforato - poinçonné - perforado

		S	B	HC	L	V	A	B	C	D	E	F	G	H	I	OE - #	
24.0122-0145.1	422145		B			V	284,0	22,0	20,2	43,5	98,0	5	59,0	127,0	13,0	ALFA/FIAT/LANCIA	46445006 60569163 60571548 60622077 60653478 60658565 60699518
24.0122-0146.1	422146		B			V	257,0	22,0	20,0	49,2	114,3	4	68,0	144,0	12,6	OPEL/VAUXHALL NISSAN	5 69 086/95511282 40206-71E02 40206-71E05 40206-71E06 40206-93J01
24.0122-0147.1	422147		B			V	284,0	22,0	20,2	43,5	98,0	4	59,0	127,0	13,0	ALFA/FIAT/LANCIA	46403959 46448168 46455892 46455892 46758714 60810404 82450657
24.0122-0153.1	422153					V	238,0	22,0	21,0	47,9	100,0	4	54,0	127,0	14,5	CITROEN PEUGEOT	4249 76 4249 75
24.0122-0154.1	422154					V	255,0	22,0	21,0	47,9	100,0	5	54,0	131,0	14,5	TOYOTA TOYOTA	43512-20260 43512-32090 43512-32180
24.0122-0155.1	422155					V	258,0	22,0	20,4	33,5	104,0	5	84,0	153,5	10,8	MITSUBISHI	MB407030
24.0122-0156.1	422156					V	257,0	22,0	20,6	36,0	109,0	6	88,0	152,5	M12x1,25	ISUZU OPEL/VAUXHALL	8-94172-376-1 5 69 801/94172376
24.0122-0165.1	422165					V	257,0	22,0	20,0	45,0	100,0	4	55,0	125,0	13,0	MAZDA	BB7E-33-25XD BR74-33-25X
24.0122-0166.1	422166		B			V	235,0	22,0	20,0	45,0	100,0	4	55,0	125,0	13,0	MAZDA	BR70-33-25XF
24.0122-0169.1	422169					V	257,0	22,0	20,0	44,0	114,3	4	69,0	160,0	12,6	HYUNDAI	51712-33001
24.0122-0174.1	422174					V	280,0	22,0	20,0	49,0	114,3	5	68,0	160,5	12,6	NISSAN	40206-2L903 40206-88E01 40206-88E04
24.0122-0175.1	422175					V	277,0	22,0	20,4	45,0	108,0	6	87,0	87,0	11,0	HYUNDAI MITSUBISHI	MN116706 MB407038 MB407039 MN116706
24.0122-0178.1	422178					V	255,0	22,0	20,0	46,5	100,0	5	54,0	148,5	14,5	TOYOTA	43512-20360 43512-20380
24.0122-0179.1	422179		B			V	280,0	22,0	20,0	49,2	114,3	4	68,0	143,5	12,5	NISSAN	40206-2F501 40206-55F01 40206-55F03
24.0122-0180.1	422180					V	267,0	22,0	20,0	39,5	124,0	6	100,0	167,0	M10x1,25	NISSAN	40206-10W00 40206-10W01 40206-35G00 40206-35G01
24.0122-0181.1	422181					V	280,0	22,2	20,7	77,0	114,0	5	72,0	147,5	15,5	JEEP	83 03 251 156 98 83 251 156 J325 1156
24.0122-0188.1	422188					V	258,0	22,0	21,0	48,0	100,0	4	54,0	131,0	14,6	TOYOTA	43512-12490
24.0122-0217.2	422217					V	262,5	22,0	20,0	72,0	108,0	5	46,0	60,0	M12x1,5	VOLVO	270876
24.0122-0218.1	422218		B	HC	L	V	300,0	22,0	19,4	57,5	112,0	5	67,0	164,0	15,0	MERCEDES BENZ	129 423 03 12
24.0123-0100.1	423100					V	246,0	23,0	21,0	55,5	92,0	4	73,0	115,0	10,6	OPEL/VAUXHALL	5 69 036/90009433
24.0123-0101.1	423101					V	280,0	23,4	21,5	43,5	108,0	4	68,0	152,8	15,0	SAAB	4002150 8965550
24.0123-0102.1	423102					V	282,0	23,0	21,0	34,0	114,3	4	92,0	160,0	M10x1,25	HONDA ROVER	45251-SM4-G02 GBD90837
24.0123-0103.1	423103					V	260,0	23,0	21,0	34,0	114,3	4	92,0	160,0	M10x1,25	HONDA ROVER	45251-SM4-020 GBD90836
24.0123-0108.1	423108					V	295,0	22,5	21,0	66,5	120,7	5	80,0	154,3	13,4	JAGUAR	JLM 1305
24.0124-0103.1	424103		B			V	252,5	24,0	22,0	53,5	95,0	6	76,0	105,0	M10x1,5	OPEL/VAUXHALL RENAULT	44 03 283/9111283 77 01 204 281
24.0124-0105.1	424105					V	264,0	24,0	22,0	46,5	114,3	5	64,0	137,0	12,6	FORD MAZDA	E92Z 1125A GJ25-33-25XD GJ55-33-25XC
24.0124-0109.1	424109					V	260,0	24,2	22,2	51,6	112,0	5	72,0	137,0	13,7	FORD	6158214
24.0124-0110.1	424110					V	280,0	24,0	21,0	58,4	110,0	5	70,0	139,0	14,0	OPEL/VAUXHALL	5 69 038/90271133
24.0124-0111.1	424111					V	258,0	24,0	21,0	58,4	110,0	5	70,0	139,0	14,0	OPEL/VAUXHALL	5 69 039/90271134
24.0124-0112.1	424112					V	239,5	24,2	22,2	58,1	108,0	4	63,5	136,0	13,7	FORD	5022659 5022660 5022948 5023573

# Abmessungen Bremsscheiben

## Dimensions brake discs - Misure dischi freno -

## Dimensions Disques de frein - Medidas disco de freno

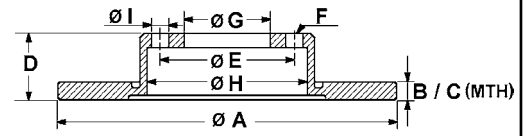

S Fixierschraube - fixing screw - vite di riparazione - vis de fixation - tornillo quefija

B beschichtet - coated - rivestito - revêtu - recubierto

HC hochgekohlt - high carbon - ad alto tenore di carbonio - à haute teneur en carbone - altamente carbonizado

L legiert - alloyed - alligato/legato - allié - aleado

V ventiliert - ventilated - ventilato - ventilé - ventilado

● gelocht - perforated - perforato - poinçonné - perforado

		S	B	HC	L	V	A	B	C	D	E	F	G	H	I	OE - #	
24.0124-0113.1	424113					V	260,0	24,2	22,2	58,1	108,0	4	63,5	136,0	13,7	FORD 1102560 5022663	
24.0124-0114.1	424114					V	266,0	24,0	22,4	45,2	114,3	4	69,0	144,0	12,6	MITSUBISHI MB366080 MB500968 MB500969	
24.0124-0115.1	424115	S	B	HC	L	V	256,0	24,0	21,0	41,0	100,0	4/6	60,0	123,0	14,0	DAEWOO OPEL/VAUXHALL 96179110 5 69 001/90487402	
24.0124-0116.1	424116			HC	L	V	299,0	24,0	22,0	71,0	130,0	5	103,0	180,0	15,4	PORSCHE 951 352 041 01	
24.0124-0117.1	424117			HC	L	V	299,0	24,0	22,0	100,0	130,0	5	103,0	180,0	15,4	PORSCHE 951 352 041 02	
24.0124-0121.1	424121					V	260,0	24,2	22,2	53,1	112,0	5	63,5	138,0	13,7	FORD 5027462 5027463	
24.0124-0125.1	424125					V	260,0	24,2	22,2	44,0	108,0	4	63,5	136,0	13,7	FORD 5025950	
24.0124-0131.1	424131		B			V	254,0	24,2	22,2	43,0	100,0	5	78,5	104,0	M10	FORD 5025610 5029815	
24.0124-0132.1	424132		B			V	270,0	24,2	22,2	43,0	100,0	5	78,5	104,0	M10	FORD 5029816	
24.0124-0136.1	424136		B			V	256,0	24,0	21,5	45,5	114,3	4	69,0	145,0	12,6	HYUNDAI/KIA MITSUBISHI 51712-M2000 MB407639 MB928995 MR128153 MR205585	
24.0124-0141.1	424141		B			V	260,0	24,0	22,0	56,8	100,0	5	58,0	129,0	12,8	VOLVO SUBARU 26300AE091 26310AA021 26310AA031 26310AA032 26310AC060	
24.0124-0143.1	424143		B			V	298,5	24,0	22,0	70,0	127,0	5	101,6	158,0	10,0	LAND ROVER FTC902	
24.0124-0145.1	424145		B			V	277,0	24,0	22,0	56,5	100,0	5	58,0	129,0	13,0	SUBARU 26300AE050 26300AE070 26300AE071 26310AA091 26310AA092 26310AA120 26310AA121	
24.0124-0148.1	424148					V	278,0	24,0	22,2	35,5	108,0	4	63,5	137,0	13,7	FORD 5024174 5026674	
24.0124-0151.1	424151					V	260,0	24,3	22,8	53,0	108,0	4	63,5	137,0	13,8	FORD 5022664	
24.0124-0155.1	424155					V	263,0	24,0	22,8	64,3	108,0	5	68,0	140,0	16,5	VOLVO 1229349	
24.0124-0188.1	424188		B	HC	L	V	278,0	24,0	21,4	55,5	112,0	5	67,0	164,0	15,0	MERCEDES BENZ 124 423 08 12	
24.0124-0189.1	424189			HC	L	V	282,5	24,0	22,6	35,0	126,0	5	107,0	145,0	8,4	PORSCHE 911 351 041 22	
24.0124-0190.1	424190			HC	L	V	290,0	24,0	22,6	83,0	130,0	5	90,0	180,0	15,4	PORSCHE 911 352 041 08	
24.0124-0702.1	424702		B			V	280,0	24,0	22,7	81,5	114,3	5	72,0	159,0	15,5	JEEP 5015 965AA	
24.0125-0100.1	425100			HC		V	280,0	25,0	23,4	78,0	120,0	5	74,0	144,0	14,5	BMW 34 11 1 121 902 34 11 1 152 296 34 11 1 163 141	
24.0125-0102.1	425102			HC	L	V	276,0	25,0	23,0	46,5	112,0	5	68,0	135,0	15,4	AUDI 447 615 301 A 447 615 301 B	
24.0125-0104.1	425104			HC		V	282,0	25,0	23,4	76,0	120,0	5	79,0	146,0	14,5	BMW 34 11 1 163 147	
24.0125-0105.1	425105		B	HC		V	288,0	25,0	23,0	46,5	112,0	5/9	68,0	135,0	15,4	AUDI/SKODA 4A0 615 301 C 8E0 615 301 Q 4A0 615 301 D	
24.0125-0107.1	425107		B	HC	L	V	294,0	25,0	22,4	49,5	112,0	5	67,0	154,3	15,0	AUDI MERCEDES BENZ 124 421 24 12	
24.0125-0118.1	425118					V	257,0	25,0	23,0	46,6	110,0	5	84,0	145,0	M10x1,25	TOYOTA 43512-26040 43512-26070 43512-35170 43512-35180	
24.0125-0125.1	425125					V	280,0	25,0	23,0	44,0	108,0	4	68,0	144,0	15,0	VOLKSWAGEN J43 512 351 80	
24.0125-0130.1	425130					V	282,0	25,0	23,0	34,5	114,3	4	92,0	171,0	M10x1,25	SAAB 4002143	
24.0125-0144.1	425144					V	277,0	25,0	23,0	46,2	100,0	5	54,0	131,0	14,5	HONDA 45251-SM5-A00	
24.0126-0100.1	426100			HC	L	V	283,0	26,0	24,0	48,0	108,0	5	71,0	130,5	13,0	TOYOTA 43512-20390	
24.0126-0105.1	426105		B			V	280,0	26,0	23,0	56,3	108,0	5	68,0	139,0	14,0	CITROEN 95 661 813 96 099 616	
24.0126-0112.1	426112					V	257,0	26,0	24,0	45,5	100,0	4	61,0	148,0	12,8	PEUGEOT VOLVO 4246 N8 31262209 3516567 6848902	
24.0126-0114.1	426114					V	281,0	26,0	24,2	54,2	98,0	5	59,0	127,0	13,2	NISSAN 40206-54C01	
24.0128-0101.1	428101		B	HC		V	302,0	28,0	26,4	75,9	120,0	5	79,0	149,0	14,5	LANCIA 82476515	
24.0128-0102.1	428102		B	HC	L	V	300,0	28,0	25,4	68,3	112,0	5	80,0	145,0	15,0	BMW 34 11 6 756 090	
24.0128-0103.1	428103		B	HC	L	V	300,0	28,0	25,4	45,5	112,0	5	67,0	154,3	15,0	MERCEDES BENZ 126 421 05 12	
24.0128-0104.1	428104		S	B	HC	L	V	296,0	28,0	25,0	58,4	110,0	5	70,0	139,0	14,0	MERCEDES BENZ 129 421 20 12
24.0128-0127.1	428127		B	HC	L	V	310,0	28,0	25,4	82,0	112,0	5	67,0	154,0	17,0	OPEL/VAUXHALL 5 69 044/90392559 5 69 016/93182283	
																MERCEDES BENZ 140 421 03 12	



# Abmessungen Bremsscheiben

## Dimensions brake discs - Misure dischi freno -

## Dimensions Disques de frein - Medidas disco de freno

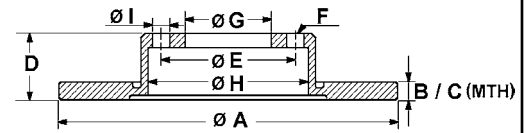

S Fixierschraube - fixing screw - vite di riparazione - vis de fixation - tornillo quefija

B beschichtet - coated - rivestito - revêtu - recubierto

HC hochgekohlt - high carbon - ad alto tenore di carbonio - à haute teneur en carbone - altamente carbonizado

L legiert - alloyed - alligato/legato - allié - aleado

V ventiliert - ventilated - ventilato - ventilé - ventilado

● gelocht - perforated - perforato - poinçonné - perforado

**S B HC L V A B C D E F G H I OE - #**

24.0128-0138.1	428138	B		V	291,0	28,1	26,0	64,8	120,7	5	80,0	175,0	13,5	JAGUAR	JLM 20341	
24.0128-0139.1	428139			V	275,0	28,0	26,0	50,8	114,3	5	60,1	143,5	14,5	LEXUS	43512-50060	
24.0128-0165.1	428165		HC L	V	298,0	28,0	26,0	50,0	126,0	5	107,0	156,0	8,4	PORSCHE	951 351 041 00	
24.0128-0167.1	428167	B	HC L	V	298,0	28,0	26,0	74,0	130,0	5	103,0	157,0	15,4	PORSCHE	951 351 041 01	
															951 351 041 02	
24.0128-0171.1	428171	B	HC L	V●	309,0	28,0	26,0	83,0	130,0	5	103,0	180,0	15,4	PORSCHE	930 352 045 01	
24.0128-0172.1	428172	B	HC L	V●	309,0	28,0	26,0	83,0	130,0	5	103,0	180,0	15,4	PORSCHE	930 352 046 01	
24.0128-0174.1	428174		HC L	V	298,0	28,0	26,0	80,0	130,0	5	103,0	161,0	15,4	PORSCHE	964 351 041 02	
24.0130-0100.1	430100	B	HC L	V	320,0	30,0	27,4	82,0	112,0	5	67,0	154,3	17,0	MERCEDES BENZ	140 421 09 12	
															140 421 10 12	
24.0130-0101.1	430101	S	B	HC	V	324,0	30,0	28,4	77,0	120,0	5	79,0	149,0	14,5	BMW	34 11 6 757 746
24.0130-0103.1	430103		HC L	V	324,0	30,0	26,0	91,0	140,0	6	118,0	122,0	M12x1,5	MERCEDES BENZ	668 421 02 12	
															670 421 03 12	
24.0130-0104.1	430104	B	HC	V	314,0	30,0	28,0	59,7	112,0	5/10	68,0	136,0	15,3	AUDI	441 615 301 AA	
24.0130-0121.1	430121	B	HC L	V	320,0	30,0	28,0	50,5	112,0	5	67,0	154,0	13,0	MERCEDES BENZ	129 421 15 12	
															129 421 17 12	
24.0130-0122.1	430122	B	HC L	V	320,0	30,0	28,0	50,5	112,0	5	67,0	154,0	13,0	MERCEDES BENZ	129 421 16 12	
															129 421 18 12	
24.0130-0198.1	430198		HC L	V	304,0	30,0	26,0	91,0	140,0	6	118,0	122,0	M12x1,5	MERCEDES BENZ	668 421 01 12	
															668 421 06 12	
24.0130-0217.1	430217	S	B	HC L	V	315,0	30,0	27,4	83,0	130,0	5	85,0	157,0	15,0	MERCEDES BENZ	463 421 00 12
															463 421 01 12	
															463 421 03 12	
24.0132-0127.1	432127		HC L	V	282,0	32,0	30,6	60,0	130,0	5	90,0	156,0	15,4	PORSCHE	928 351 043 01	
24.0132-0128.1	432128		HC L	V	282,0	32,0	30,6	60,0	130,0	5	90,0	156,0	15,4	PORSCHE	928 351 044 01	
24.0132-0140.1	432140	B	HC L	V●	304,0	32,0	30,6	56,7	126,0	5	107,0	172,0	8,4	PORSCHE	930 351 047 02	
24.0132-0146.1	432146	B	HC L	V●	304,0	32,0	30,6	56,7	126,0	5	107,0	172,0	8,4	PORSCHE	930 351 048 02	
24.0132-0150.1	432150	B	HC L	V	304,0	32,0	30,0	77,0	130,0	5	103,0	161,0	15,4	PORSCHE	928 351 044 03	
															928 351 044 60	
24.0132-0151.1	432151	B	HC L	V	304,0	32,0	30,0	77,0	130,0	5	103,0	161,0	15,4	PORSCHE	928 351 043 03	
															928 351 043 60	



# Abmessungen Bremsscheiben

## Dimensions brake discs - Misure dischi freno -

## Dimensions Disques de frein - Medidas disco de freno

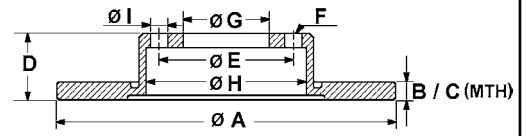

S Fixierschraube - fixing screw - vite di riparazione - vis de fixation - tornillo quefija

B beschichtet - coated - rivestito - revêtu - recubierto

HC hochgekohlt - high carbon - ad alto tenore di carbonio - à haute teneur en carbone - altamente carbonizado

L legiert - alloyed - alligato/legato - alié - aleado

V ventiliert - ventilated - ventilato - ventilé - ventilado

● gelocht - perforated - perforato - poinçonné - perforado

### PowerDisc

S B HC L V A B C D E F G H I OE - #

24.0309-0114.1	509114	S	B					278,0	9,0	7,3	55,5	112,0	5	67,0	164,0	13,2	CHRYSLER MERCEDES BENZ	5098 066AA 203 423 01 12 210 423 01 12 210 423 04 12 210 423 09 12
24.0310-0150.1	510150		B					258,0	10,0	7,6	60,0	100,0	4	62,0	160,8	14,5	BMW	34 21 6 755 407
24.0310-0151.1	510151	S	B					239,0	10,0	8,0	38,9	100,0	4	65,0	124,5	13,6	AUDI/SEAT/VW	811 615 301
24.0310-0201.1	510201		B					245,0	10,0	8,0	64,2	112,0	5	68,0	135,5	15,4	AUDI/SKODAVW	4A0 615 601 A
24.0312-0106.1	512106	S	B					239,0	12,0	10,0	35,4	100,0	4	65,0	124,5	13,6	AUDI/SEAT/VW AUDI/VW	321 615 301 175 615 301
24.0313-0161.1	513161	S	B					236,0	12,7	9,7	41,0	100,0	4/6	60,0	123,0	14,0	OPEL/VAUXHALL	5 69 020/90008005 5 69 030/90008031 5 69 013/93182290
24.0313-0178.1	513178	S	B					255,6	12,9	11,0	39,2	100,0	4	65,0	135,5	13,6	SEAT/VW	357 615 301
24.0315-0105.1	515105		B	HC				288,0	15,0	13,0	46,5	112,0	5	68,0	135,5	15,4	AUDI	4A0 615 301 B
24.0320-0115.1	520115	S	B	HC	L	V		236,0	20,0	17,0	41,0	100,0	4/6	60,0	123,0	14,0	CHEVROLET DAEWOO	90121445 90121445
24.0320-0123.1	520123	S	B	HC	L	V		239,0	20,0	18,0	39,0	100,0	4	65,0	123,8	13,6	OPEL/VAUXHALL AUDI/SEAT/VW	5 69 054/90511111 321 615 301 C
24.0320-0128.1	520128	S	B	HC	L	V		256,0	20,0	18,0	38,8	100,0	4	65,0	131,5	13,8	AUDI/VW SEAT/VW	321 615 301 A 321 615 301 D 6N0 615 301 D
24.0320-0132.1	520132	S	B			V		247,0	20,4	18,5	34,2	108,0	4	66,0	133,2	12,8	CITROEN PEUGEOT	95 661 747 4246 A7 4249 96
24.0320-0133.1	520133	S	B			V		266,0	20,5	18,5	27,6	108,0	4	66,0	133,0	13,0	CITROEN PEUGEOT	4249 F0 4246 97 4249 F0
24.0320-0142.1	520142		B	HC	L	V		257,5	20,0	18,2	40,5	98,0	4	59,0	126,7	13,0	ALFA/FIAT/LANCIA	7779409 71738145 51749124 60806137 60810076 60811256 60811266
24.0320-0147.1	520147		B			V		239,5	20,0	18,0	43,0	108,0	4	63,5	136,0	13,7	FORD/MAZDA	1019604 1066271 1320581 1320582 5028281
24.0322-0100.1	522100		B	HC		V		280,0	22,0	20,0	28,5	100,0	5	65,0	141,0	15,6	SEAT/VW	1H0 615 301 A
24.0322-0103.1	522103	S	B	HC		V		302,0	22,0	19,6	76,0	120,0	5	79,0	149,0	14,5	BMW	34 11 1 160 936
24.0322-0122.1	522122		B	HC	L	V		260,0	22,0	19,6	35,0	100,0	4	66,0	138,0	14,5	BMW	34 11 1 160 915
24.0324-0115.1	524115	S	B	HC	L	V		256,0	24,0	21,0	41,0	100,0	4/6	60,0	123,0	14,0	DAEWOO OPEL/VAUXHALL	96179110 5 69 001/90487402
24.0325-0105.1	525105		B	HC		V		288,0	25,0	23,0	46,5	112,0	5/9	68,0	135,0	15,4	AUDI/SKODA AUDI/VW	4A0 615 301 C 8E0 615 301 Q 4A0 615 301 D



A large rectangular area containing 30 horizontal lines, spaced evenly, intended for writing or drawing.



Ⓓ **Armaturen**

Ⓔ **Fittings**

Ⓕ **Composants et accessoires**

Ⓔ **Assesorios**

# Armaturen

Fittings - Attrezzature - Composants et accessoires - Accesorios

## Gewindedarstellung und Dichtflächen-Anordnung bei Innengewinden der Anschlußarmaturen

Representation of threads and sealing surface arrangement in case of internal-threads

Rappresentazione della filattatura e disposizione delle superfici di tenuta nella filettatura interna dei pezzi di attacco

Présentation de filet et arrangement de face d'étanchéité en case de filetage intérieure des armatures

Ilustración de roscas y disposición de superficies de contacto en roscas interiores de los accesorios de conexión

Abdichtung durch Bördel nach DIN 74234  
Sealing by flaring according to DIN 74234 tenuta  
Stagna tramite flangiatura DIN 74234  
Etanchement par colet selon DIN 74234  
Junta mediante reborde según DIN 74234

Abdichtung mit Dichtring nach DIN 7603  
Sealing by seal ring according to DIN 7603  
Tenuta stagna tramite guarnizione DIN 7603  
Etanchement par joint selon DIN 7603  
Junta con retén según DIN 7603

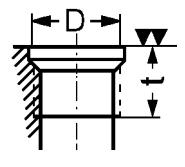
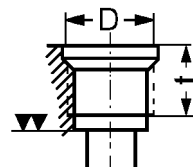
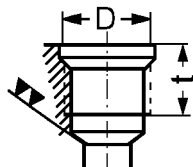
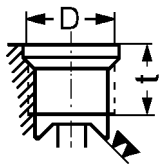

### Gewinde Ausführung

Thread design  
Esecuzione filettata  
Exécution filet  
Ejecución de rosca

**A 1**

**A 2**

**A 3**

**A 4**

### Bördel

Flare  
Bordatura tipo  
Colet  
Reborde

**E**

**F**

-

-

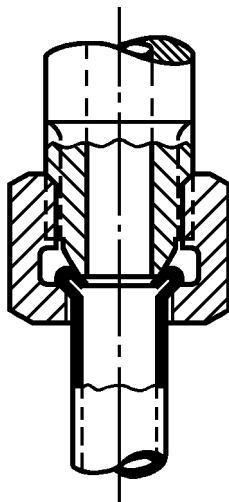

## DIN 74233

Überwurfschraube  
Union screw  
Viti con risvolto  
Vis chapeau  
Tornillos de racor

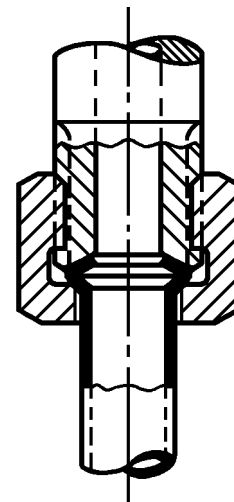

## DIN 74234





**E**

**F**

Bördel  
Flare  
Bordatura tipo  
Colet  
Reborde

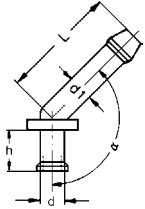
# Armaturen

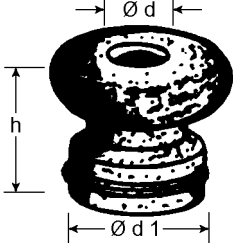
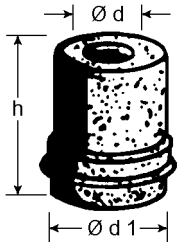
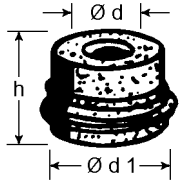
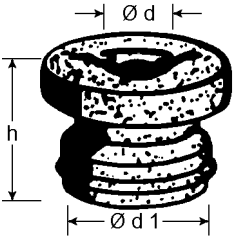
## Fittings - Attrezzature - Composants et accessoires - Accesorios

<b>Kniestücke</b> Elbows Raccordi a gomito Raccord en équerre Piezas acodadas	<b>Abmessungen - Dimensions -                      Dimensioni - Dimensions - Medidas [mm]</b>					
	$\varnothing d$	$\varnothing d_1$	h	L	$\alpha$	
	8,0	8,0	11,0	32,0	95°	03.3390-0055.1 390149
	8,0	8,0	11,0	21,0	160°	03.3390-0065.1 390150
	12,8	8,0	13,0	32,0	135°	03.3390-0130.1 390153
	12,8	8,0	13,0	32,0	105°	03.3390-0139.1 390154
	13,0	10,5	13,0	24,0	170°	03.3390-0165.1 390155
<b>Behälterstopfen</b> Reservoir seal Tappi per serbatoio Bouchon de réservoir Tapones de depósitos	<b>Abmessungen - Dimensions -                      Dimensioni - Dimensions - Medidas [mm]</b>					
	4,2	17,0	18,0	Kautschuk ①	03.3304-0600.1 390081	
	6,5	17,0	18,0	Kautschuk ①	03.3304-0700.1 390082	
	6,5	17,0	10,5	Kautschuk ①	03.3304-1100.1 390084	
	6,5	17,0	10,4	EPDM	03.3304-1102.1 390085	
	7,3	17,0	13,5	Kautschuk ①	03.3304-1000.1 390083	
	7,3	22,0	13,0		03.3304-1400.1 390088	
	12,3	22,0	13,0	EPDM	03.3304-2208.1 390090	
	① Kautschuk India rubber Caucciù Caoutchouc Caucho					
<b>Behälterschlauch</b> Reservoir tube Flessibile per serbatoio Flexible réservoir Manguera del depósito	<b>Abmessungen - Dimensions -                      Dimensioni - Dimensions - Medidas</b>					
	$\varnothing D$ [mm]	$\varnothing d$ [mm]	L [m]			
	13,5	7,5	5,0	03.3538-0005.1 390414		
	13,5	7,5	20,0	03.3538-0020.1 390415		



# Armaturen

Fittings - Attrezzature - Composants et accessoires - Accesorios

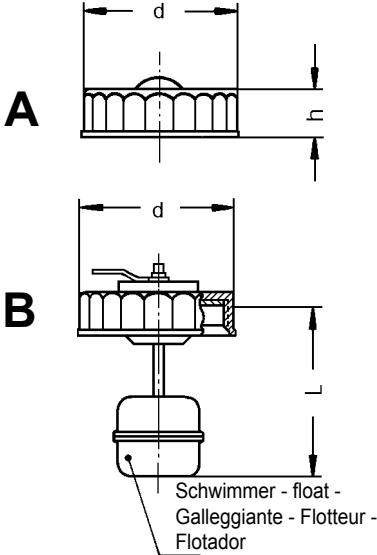

<b>Behälter Verschraubung</b> Reservoir screw fitting Tappi filettato per serbatoio Couvercle de réservoir Fijación de depósito	<b>Abmessungen - Dimensions -                      Dimensioni - Dimensions - Medidas [mm]</b>							
	<b>Ausführung - Design -                      Esecuzione - Exécution -                      Ejecución</b>	<b>d</b>	<b>h</b>	<b>L</b>				
<b>A</b>          <b>B</b>	<b>A</b>	max. 51	14,0					03.3556-1065.2 390425
		max. 51	14,0					03.3556-1141.2 390434
		max. 51	14,5					03.3556-1147.2 390435 M
		max. 51	14,0					03.3556-1164.2 390437
	<b>B</b>	max. 51					45,5	03.3556-1094.2 390427
		max. 51					51,2	03.3556-1113.2 390428
		max. 51					83,0	03.3556-1115.2 390431
		max. 51					54,0	03.3556-1124.2 390433
		max. 51					40,5	03.3556-1199.2 390440
	<b>M</b> nur für Mineralöl only for mineral oil solo per olio minerale seulement pour huile minérale sólo para aceite mineral							

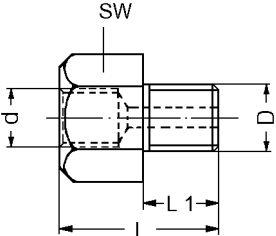
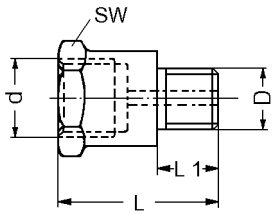
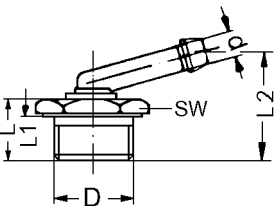
<b>Schraubstutzen</b> Screw adapters Raccordi filettati Raccord fileté Racores	<b>Abmessungen - Dimensions -                      Dimensioni - Dimensions - Medidas [mm]</b>								
	<b>D</b>	<b>d</b>	Gewinde Ausführung - Thread design - Esecuzione filettata - Exécution filet - Ejecución de rosca	<b>L</b>	<b>L<sub>1</sub></b>	<b>L<sub>2</sub></b>	<b>SW</b>		
	M 10 x 1	M 10 x 1	A 2	21,0	8,0		17	03.3510-0100.1 390271	
		M 12 x 1	A 1	24,0	8,0		17	03.3510-0300.1 390273	
	M 12 x 1	M 10 x 1	A 2	20,5	8,0		17	03.3510-0054.1 390269 ①	
		M 10 x 1	A 1	22,0	8,0		17	03.3510-0059.1 390270	
	M 12 x 1	A 1	24,0	9,0		17	03.3510-7900.1 390281		
	M 14 x 1,5	M 10 x 1	A 2	26,0	14,0		19	03.3510-4100.1 390279	
		M 12 x 1	A 2	27,0	12,0		19	03.3510-0800.1 390275	
1/2" -20 NF 3	M 12 x 1	A 1	30,0	14,0		19	03.3510-2100.1 390278		
① mit Drosselbohrung with throttle hole con foro calibrato di strozzamento avec d'étranglement con taladro estrangulador									
	M 10 x 1	M 10 x 1	A 2	32,0	8,0		17	03.3510-0200.1 390272	
	M 22 x 1,5	Ø 10		16,5	12,0	30,0	27	03.3510-0026.2 390266	



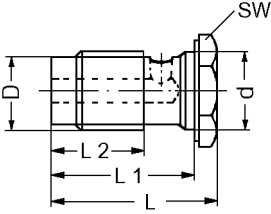
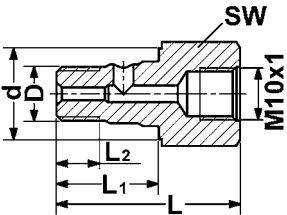

# Armaturen

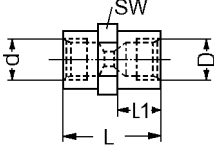
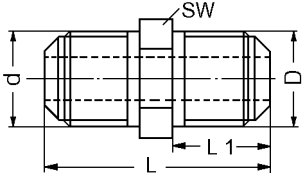
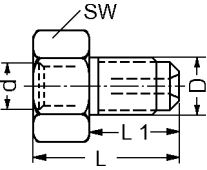
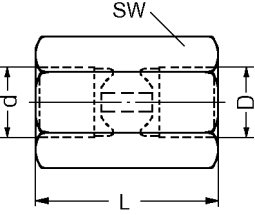
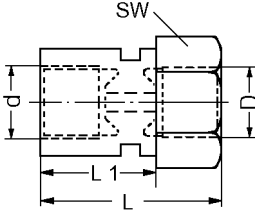
## Fittings - Attrezzature - Composants et accessoires - Accesorios

Hohlschrauben Hollow screws Viti cave Vis creuse Tornillos huecos	Abmessungen - Dimensions - Dimensioni - Dimensions - Medidas [mm]								
	D	d	L	L <sub>1</sub>	L <sub>2</sub>	SW			
	M 10 x 1	12,1	24,5	19,5	8,5	17	<b>03.3520-0302.1</b>	<b>390381</b>	
		12,1	30,0	24,5	12,0	17	<b>03.3520-0501.1</b>	<b>390382</b>	
	M 12 x 1	14,1	28,0	22,5	10,0	17	<b>03.3520-1003.1</b>	<b>390418</b>	
	M 14 x 1,5	14,1	33,5	27,5	15,0	17	<b>03.3520-2900.1</b>	<b>390390</b>	
	M 10 x 1	12,1	34,0	19,0	8,0	17	<b>03.3520-0600.1</b>	<b>390383</b>	
Zwischenstücke Pipe adapters Raccordi intermedi Raccord intermédiaire Piezas intercaladas	Abmessungen - Dimensions - Dimensioni - Dimensions - Medidas [mm]								
	D	Gewinde Ausführung - Thread design - Esecuzione Filettata - Exécution filet - Ejecución de rosca	d	Gewinde Ausführung - Thread design - Esecuzione Filettata - Exécution filet - Ejecución de rosca	L	L <sub>1</sub>			SW
	M 10 x 1	A 2	M 10 x 1	A 2	24,0	8,5	14	<b>03.3511-0800.1</b>	<b>390285</b> ①
	① In Sortimentbox <b>24.3516-0210.2</b> <b>390553</b> enthalten. Included in collection <b>24.3516-0210.2</b> <b>390553</b> . Contenuto nella scatola di assortimento <b>24.3516-0210.2</b> <b>390553</b> . Include dans collection <b>24.3516-0210.2</b> <b>390553</b> . Se incluye en caja de surtido <b>24.3516-0210.2</b> <b>390553</b> .								
	M 12 x 1		M 12 x 1		35,0	15,0	12	<b>03.3511-3800.1</b>	<b>390291</b>
	M 12 x 1		M 10 x 1	A 2	28,0	15,3	17	<b>03.3511-5200.1</b>	<b>390292</b>
	M 12 x 1	A 1	M 12 x 1	A 1	29,0	-	17	<b>03.3511-1000.1</b>	<b>390286</b>
	M 12 x 1	A 1	M 12 x 1	A 1	29,0	19,0	19	<b>03.3511-1100.1</b>	<b>390287</b>

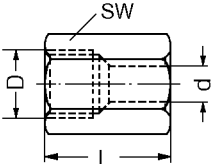
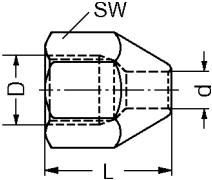

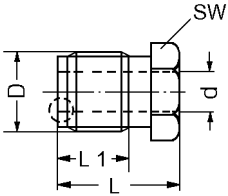
# Armaturen

## Fittings - Attrezzature - Composants et accessoires - Accesorios

Überwurfmutter Union nuts Dadi con risvolto Écrou-chapeau Tuerca de racor	Abmessungen - Dimensions - Dimensioni - Dimensions - Medidas [mm]						
	D	d	L	L <sub>1</sub>	für Bördel - for flare - bordatura tipo - pour colet - para reborde	SW	
	M 10 x 1	5,2	14,0		E	14	24.3516-0110.1 390549 ①
	3/8" -24 UNF-2B	5,2	17,5		E	14	24.3516-0111.1 390550 ①
	① In Sortimentbox <b>24.3516-0210.2 390553</b> enthalten. Included in collection <b>24.3516-0210.2 390553</b> . Contenuto nella scatola di assortimento <b>24.3516-0210.2 390553</b> . Include dans collection <b>24.3516-0210.2 390553</b> . Se incluye en caja de surtido <b>24.3516-0210.2 390553</b> .						
	② In Sortimentbox <b>24.3516-0210.2 390553</b> enthalten. Included in collection <b>24.3516-0210.2 390553</b> . Contenuto nella scatola di assortimento <b>24.3516-0210.2 390553</b> . Include dans collection <b>24.3516-0210.2 390553</b> . Se incluye en caja de surtido <b>24.3516-0210.2 390553</b> .						
Überwurfschrauben Union screws Viti con risvolto Vis chapeau Tornillos de racor	Abmessungen - Dimensions - Dimensioni - Dimensions - Medidas [mm]						
	D	d	L	L <sub>1</sub>	für Bördel - for flare - bordatura tipo - pour colet - para reborde	SW	
  E  F	M 10 x 1	4,75	17,0	11,0	E	10	03.3516-2300.1 390317
		5,2	16,7	9,5	E	10	24.3516-0020.1 390541 ②
		5,0	16,5	10,5	F	11	03.3516-3500.1 390318
		5,0	16,5	9,4	F	11	03.3516-0602.1 390412
		5,0	16,0	10,0	E	11	03.3516-0800.1 390313
		5,2	24,8	15,0	F	11	24.3516-0070.1 390546 ②
	M 10 x 1,25	5,2	19,5	13,5	F	10	24.3516-0050.1 390544 ②
		5,2	14,2	8,5	E	10	24.3516-0060.1 390545 ②
	M 12 x 1	6,0	18,0	11,4	E	12	24.3516-0080.1 390547
		5,0	20,0	13,0	F	12	24.3516-0090.1 390548
	3/8" -24 UNF-2A	5,0	14,0	7,5	E	10	03.3516-0100.1 390310
		5,2	18,0	12,0	E	10	24.3516-0040.1 390543 ②
		5,2	21,0	16,0	F	11	24.3516-0030.1 390542 ②

# Armaturen

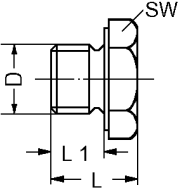
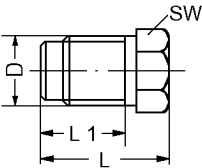
## Fittings - Attrezzature - Composants et accessoires - Accesorios

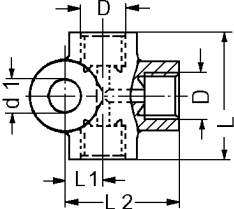
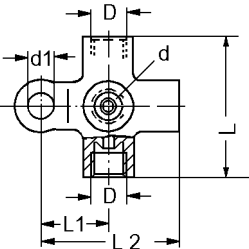
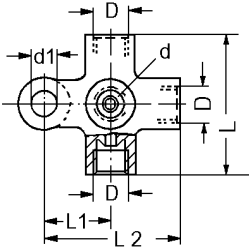
Verschlußstopfen Plugs Tappi Obturbateur Tapón de cierre	Abmessungen - Dimensions - Dimensioni - Dimensions - Medidas [mm]									
	D	d	L	L <sub>1</sub>	für Bördel - for flare - bordatura tipo - pour colet - para reborde	SW				
	M 10 x 1		12,5	7,5		14	<b>03.3517-0100.1</b>	<b>390321</b>		
	M 10 x 1		12,5	7,5		14	<b>03.3517-0101.2</b>	<b>390322</b> ①		
① mit Dichtring (CU) with sealing ring (CU) avec joint d'étanchéité (CU) con anello di tenuta (CU) con junta (CU)										
	M 10 x 1		18,0	11,5	E + F	10	<b>03.3517-5100.1</b>	<b>390326</b>		
	M 12 x 1		20,0	13,0	E	12	<b>03.3517-0300.1</b>	<b>390323</b>		
Verteiler distributors ripartitore distributeur distribuidor	Abmessungen - Dimensions - Dimensioni - Dimensions - Medidas [mm]									
	D	Gewinde Ausführung - Thread design - Esecuzione Filettata - Exécution filet - Ejecución de rosca	d	Gewinde Ausführung - Thread design - Esecuzione Filettata - Exécution filet - Ejecución de rosca	L	L <sub>1</sub>	L <sub>2</sub>			d <sub>1</sub>
3 Anschlüsse - 3 Connections - 3 Attacchi - 3 Raccords - 3 Conexiones 	M 10 x 1	A 2			30,0	8,0	23,0	7,1	<b>03.3513-0200.1</b>	<b>390297</b>
		A 1			30,0	8,0	23,0	8,4	<b>03.3513-1000.1</b>	<b>390299</b>
		A 1			36,0	9,0	27,0	8,4	<b>03.3513-2700.1</b>	<b>390300</b>
	M 12 x 1	A 1			36,0	10,0	31,5	8,3	<b>03.3513-0300.1</b>	<b>390298</b>
3 Anschlüsse - 3 Connections - 3 Attacchi - 3 Raccords - 3 Conexiones 	M 12 x 1	A 1	M 12 x 1		34,0	19,0	-	10,5	<b>03.3513-0109.2</b>	<b>390296</b>
	① mit Entlüfterventil with bleeder valve con valvola di spurgo avec vis de purge con válvula de ventilador									
4 Anschlüsse - 4 Connections - 4 Attacchi - 4 Raccords - 4 Conexiones 	M 10 x 1	A 2	M 10 x 1	A 2	32,0	17,0	33,0	8,4	<b>03.3514-2600.1</b>	<b>390306</b>
		A 2	M 10 x 1 ①	A 2	32,0	17,0	33,0	8,4	<b>03.3514-2600.2</b>	<b>390307</b>

# Armaturen

## Fittings - Attrezzature - Composants et accessoires - Accesorios

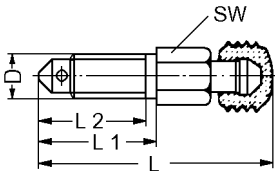
Entlüfterventil Bleeder valve Valvola di spurgo Vis de purge Válvula de ventilador	Abmessungen - Dimensions - Dimensioni - Dimensions - Medidas [mm]					
	D	L	L <sub>1</sub>	L <sub>2</sub>	SW	
 <p>Bestell-Nr. Staubkappe Part No. dust cap Codici ordinazione del parapolvere Référence capuchon de protection Referencia guardapolvo</p> <p><b>03.3590-0700.1 390456</b> <b>03.3590-0701.1 390457 M</b></p>	M 6	31,5	16,0	12,0	7	<b>03.3518-0100.2 390329</b>
		31,5	16,0	12,0	7	<b>03.3518-0102.2 390330 M</b>
		41,0	22,0	12,0	7	<b>03.3518-0200.2 390332</b>
		29,0	13,5	12,0	7	<b>03.3518-0300.2 390333</b>
		29,0	13,5	12,0	7	<b>03.3518-0302.2 390334 M</b>
	M 7	33,0	16,5	15,0	7	<b>03.3518-4200.2 390357</b>
		41,0	22,0	15,5	7	<b>03.3518-5900.2 390363</b>
		22,5	12,5	11,0	7	<b>03.3518-6800.2 390369 ①</b>
		29,5	12,5	11,0	7	<b>03.3518-6901.2 390370</b>
	M 8	35,0	18,5	17,0	9	<b>03.3518-0500.2 390337</b>
		35,0	18,5	17,0	9	<b>03.3518-0502.2 390339 M</b>
		44,0	22,0	20,0	9	<b>03.3518-0600.2 390340</b>
		49,0	32,0	20,0	9	<b>03.3518-0700.2 390342</b>
		59,0	42,0	20,0	9	<b>03.3518-0800.2 390343</b>
		52,0	32,0	20,0	9	<b>03.3518-6100.2 390364</b>
		90,0	35,0	18,0	9	<b>03.3518-8000.2 390373</b>
	M 10 x 1	32,0	16,0	13,0	11	<b>03.3518-0900.2 390345</b>
		32,0	16,0	13,0	11	<b>03.3518-0902.2 390346 M</b>
		38,0	21,0	18,0	11	<b>03.3518-1900.2 390354</b>
		32,0	16,0	13,0	10	<b>03.3518-5200.2 390358</b>
	M 12 x 1	31,5	15,5	13,0	12	<b>03.3518-1501.2 390349 ②</b>
	M 12 x 1,5	43,0	26,0	24,0	14	<b>03.3518-1300.2 390347</b>
	7/16"-20 UNF-2A	40,0	23,0	21,0	11	<b>03.3518-1700.2 390352</b>

M nur für Mineralöl  
only for mineral oil  
solo per olio minerale  
seulement pour huile minérale  
sólo para aceite mineral

① mit Staubkappe **03.3590-0044.1 390455**  
with dust cap **03.3590-0044.1 390455**  
con parapolvere **03.3590-0044.1 390455**  
avec capuchon de protection **03.3590-0044.1 390455**  
con guardapolvo **03.3590-0044.1 390455**

② mit 60° Innenkegel  
with 60° internal cone  
con cono interno 60°  
avec cône intérieur 60°  
con cono interior 60°

**Staubkappen**  
dust caps  
parapolvere  
capuchon de protection  
guardapolvo

**03.3590-0700.1 390456**

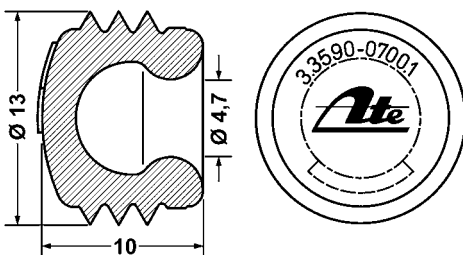

**03.3590-0701.1 390457**

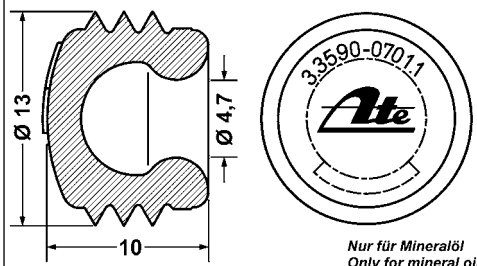



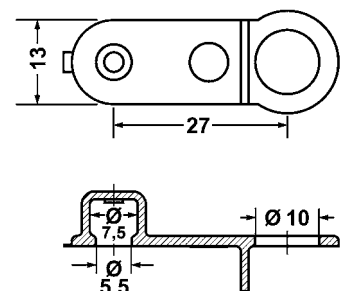

**13.8190-0296.1 390409**



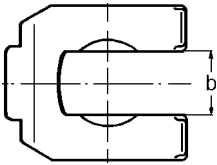
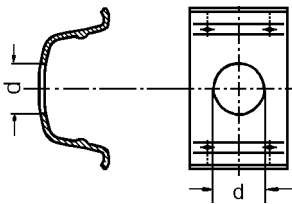
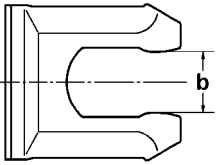

# Armaturen

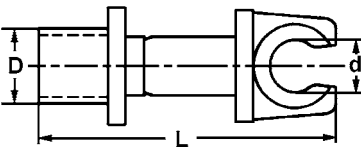
## Fittings - Attrezzature - Composants et accessoires - Accesorios

<b>Bremsschlauchhalter</b> Hose spring-clamp Mollette per flessibile freni Ressort de retenue de flexible de frein Soporte manguera de freno	<b>Abmessungen - Dimensions -                      Dimensioni - Dimensions - Medidas [mm]</b>		
	<b>b (d)</b>	<b>Blechstärke - Thickness of metal                      Spessore lamierino - Épaisseur de tôle -                      Espesor de chapa</b>	
	14,0	1,00	03.5004-0101.1 990010
	14,0	1,75	03.5004-0401.1 990014
	12,0	1,00	24.5004-0001.1 390568 ②
	10,0	0,70	24.5004-0002.1 390569 ②
	11,0	1,00	24.5004-0003.1 390570 ②
	② In Sortimentbox 24.3516-0230.2 390555 enthalten. Included in collection 24.3516-0230.2 390555. Contenuto nella scatola di assortimento 24.3516-0230.2 390555. Incluse dans collection 24.3516-0230.2 390555. Se incluye en caja de surtido 24.3516-0230.2 390555.		
<b>Bremsrohrhalter</b> Brake pipe line holder Supporto tubo freno Support de tuyau de freinage Soporte tubo de freno	<b>Abmessungen - Dimensions -                      Dimensioni - Dimensions - Medidas [mm]</b>		
	<b>D</b>	<b>d</b>	<b>L</b>
	6,3	4,7	28,0
			24.3590-0002.1 390567 ②
<b>Rohrleitungen DIN 74234</b> Pipe line DIN 74234 Tubazioni DIN 74234 Conduite tube DIN 74234 Tuberías DIN 74234	<b>Abmessungen - Dimensions -                      Dimensioni - Dimensions - Medidas</b>		
	<b>Ø</b>	<b>L</b>	
	4,75 mm	5,0 m	24.8134-0547.1 390571
	6,00 mm	5,0 m	24.8134-0560.1 390572
	8,00 mm	5,0 m	24.8134-0580.1 390573
	4,75 mm	31,5 m	24.8134-3147.1 390574

# Armaturen

## Fittings - Attrezzature - Composants et accessoires - Accesorios

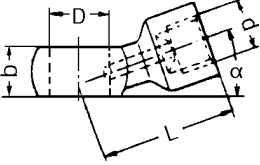
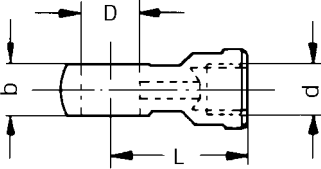
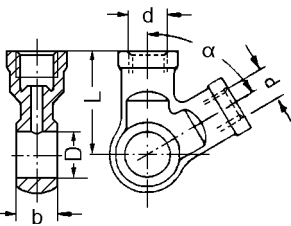
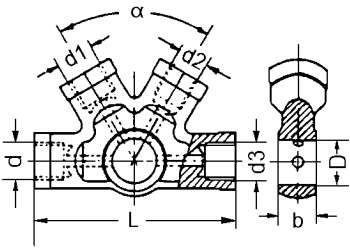
Ringstutzen Banjo fittings Raccordi anulari Manchon à oeillet Racores anulares	Abmessungen - Dimensions - Dimensioni - Dimensions - Medidas [mm]							
	D	d	Gewinde Ausführung - Thread design - Esecuzione filettata - Exécution filet - Ejecución de rosca	L	b	$\alpha$		
1 Anschluss - 1 Connection - 1 Attaccho - 1 Raccord - 1 Conexión 	12,0	M 10 x 1	A 2	27,0	10,0	20°	<b>03.3521-0100.1</b>	<b>390392</b>
		M 10 x 1	A 2	30,0	10,0	30°	<b>03.3521-0400.1</b>	<b>390394</b>
	14,0	M 10 x 1	A 2	32,0	12,0	20°	<b>03.3521-0800.1</b>	<b>390398</b>
		M 12 x 1	A 1	32,0	12,0	20°	<b>03.3521-0600.1</b>	<b>390395</b>
1 Anschluss - 1 Connection - 1 Attaccho - 1 Raccord - 1 Conexión 	12,0	M 10 x 1	A 2	26,0	10,0		<b>03.3521-0200.1</b>	<b>390393</b> ①
	① für Bremslichtschalter mit konischem Gewinde for stop-light switch with conical thread per interruttore luce di arresto con filettatura conica pour contacteur de stop avec filetage conique para interruptor de luz de freno con rosca cónica							
2 Anschlüsse - 2 Connections - 2 Attacchi - 2 Raccords - 2 Conexiones 	12,0	M 10 x 1	A 2	20,5	15,5	34°	<b>03.3522-0200.1</b>	<b>390402</b>
		M 12 x 1	A 1	32,0	12,0	60°	<b>03.3522-0500.1</b>	<b>390403</b>
	14,0	M 12 x 1	A 1	32,0	12,0	60°	<b>03.3522-1100.1</b>	<b>390404</b>
		M 10 x 1 ②	A 4					
② für Bremslichtschalter for stop-light switch per interruttore luce di arresto pour contacteur de stop para interruptor de luz de freno								
4 Anschlüsse - 4 Connections - 4 Attacchi - 4 Raccords - 4 Conexiones 	14,0	M 10 x 1	A 2	64,0	12,0	60°	<b>03.3524-0300.1</b>	<b>390407</b>



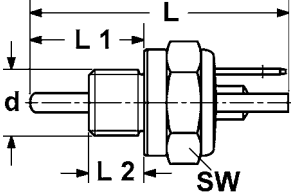
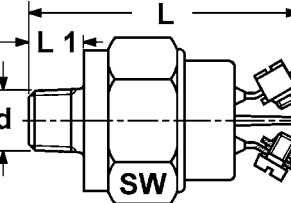
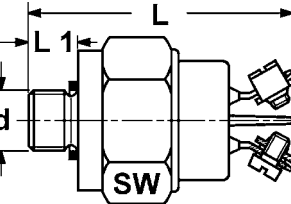
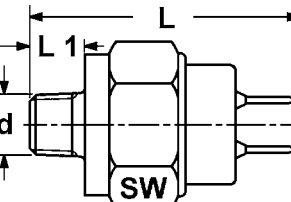
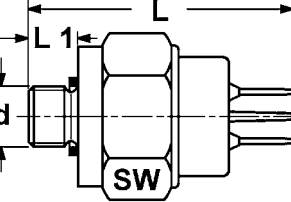
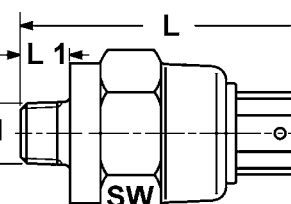

# Armaturen

## Fittings - Attrezzature - Composants et accessoires - Accesorios

<b>Bremslichtschalter</b> Stop-light switch Interruttore luce di arresto Contacteur de stop Interruptor de luz de freno	<b>Abmessungen - Dimensions -                      Dimensioni - Dimensions - Medidas [mm]</b>						
	<b>Ausführung - Design -                      Esecuzione - Exécution -                      Ejecución</b>	<b>d</b>	<b>L</b>	<b>L<sub>1</sub></b>	<b>L<sub>2</sub></b>		<b>SW</b>
	Steck-Anschluß Plug connection Attacco a spina Contact à fiches Enchufe de conexión	M 12 x 1	47,0	21,0	10,0	19	<b>24.3525-9120.1 340015</b>
	Klemm-Anschluß Clamp connection Collegamento a morsetto Borne de serrage Conexión por fijación	M 10 x 1	46,0	9,0		24	<b>24.3526-0100.3 340017</b>
		M 10 x 1	46,0	9,0		24	<b>24.3526-0600.3 340027 M</b>
	Klemm-Anschluß Clamp connection Collegamento a morsetto Borne de serrage Conexión por fijación	M 10 x 1	46,0	8,0		24	<b>24.3526-0110.3 340018</b>
		M 10 x 1	46,0	8,0		24	<b>24.3526-0610.3 340030 M</b>
	Steck-Anschluß Plug connection Attacco a spina Contact à fiches Enchufe de conexión	M 10 x 1	42,0	9,0		22	<b>03.3526-2002.3 340010</b>
	Steck-Anschluß Plug connection Attacco a spina Contact à fiches Enchufe de conexión	M 10 x 1	46,0	8,0		22	<b>24.3526-0810.3 340037</b>
	Steck-Anschluß Plug connection Attacco a spina Contact à fiches Enchufe de conexión	M 10 x 1	48,0	9,0		24	<b>24.3526-0800.3 340033</b>
		M 10 x 1	48,0	9,0		24	<b>24.3526-1900.0 340038 M</b>
		M 10 x 1	48,0	9,0		24	<b>24.3526-2200.0 340039</b>
	<b>M</b> nur für Mineralöl - only for mineral oil - solo per olio minerale seulement pour huile minérale - sólo para aceite mineral						

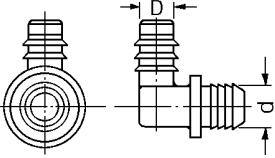

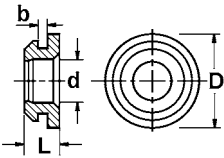
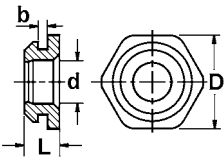

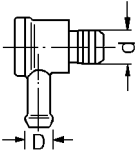
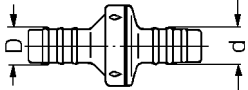



# Armaturen

Fittings - Attrezzature - Composants et accessoires - Accesorios

<b>Vakuum-Anschlußstück</b> Vacuum connection Pezzo di raccordo per depressione Raccord à dépression Terminal de empalme al vacío	<b>Abmessungen - Dimensions -                      Dimensioni - Dimensions - Medidas [mm]</b>				
	L	b	D	d	
			12,0	14,0	03.6118-6811.1 990030
<b>Dichtung</b> für Vakuum-Anschlußstück <b>Hexagon</b> for vacuum connection <b>Guarnizione</b> per pezzo di raccordo per depressione <b>Hexagone</b> pour raccord à dépression <b>Retén</b> para terminal de empalme al vacío	<b>Abmessungen - Dimensions -                      Dimensioni - Dimensions - Medidas [mm]</b>				
	L	b	D	d	
	9,5	1,5	28,0	13,0	03.7718-7203.1 390360
	9,5	2,5	28,0	13,0	03.7718-7202.1 390378
<b>Vakuum-Rückschlagventil</b> Vacuum check valve Valvola di non ritorno per depressione Soupape à dépression Válvula de retención al vacío	<b>Abmessungen - Dimensions -                      Dimensioni - Dimensions - Medidas [mm]</b>				
	L	b	D	d	
			12,4	16,5	03.6118-7305.2 990032
			10,5	16,5	03.6718-9931.2 990002
			11,8	11,8	24.7718-7301.2 990024
			13,0	13,0	03.6118-7307.2 990033

# Armaturen

## Fittings - Attrezzature - Composants et accessoires - Accesorios

<p><b>Prüfanschlüsse</b> Testing connectors attacchi di prova connexion d'essai conexiones de ensayo</p>	<p>Für den festen Einbau in die Bremsanlage (z.B. anstelle eines Verteilerstückes). Druckprüfgeräte können hier direkt über die Anschlußschlauchleitung verbunden werden, ohne die Bremsanlage nachträglich zu entlüften. For permanent installation in the braking system (e.g. in the place of a distributor piece). The pressure testing units can be connected here directly to the connection hose line without having to bleed the braking system afterwards. Per montaggio fisso nell'impianto di frenatura (p.e. al posto di un ripartitore a più vie). Apparecchi prova pressione possono essere collegati direttamente tramite il tubo di collegamento, senza dover spurgare l'impianto freni a posteriori. Pour installation permanente dans le système de freinage (par ex: à la place d' une pièce de distribution). Les appareils de vérification de la pression peuvent être directement reliés à la connexion. Le système de freinage n' a pas besoin d' être purgé par la suite. Para el montaje fijo en la instalación de frenos (p. ej. en lugar de un distribuidor). Los controladores de presión no pueden unirse aquí directamente a través de la línea de conexión sin tener que airear posteriormente la instalación de frenos.</p>			
	 <b>03.9305-0501.3 390481</b>	 <b>03.9305-0510.3 390483</b>	 <b>03.9305-0520.3 390485</b>	 <b>03.9305-0530.3 390486</b>
<p>Anzahl der Befestigungslaschen Number of mounting links Numero delle fascette Nombre de trous de fixation Número de las bridas de fijación</p>	1	1	2	2
<p>Anzahl der Anschlüsse Number of connections Numero di attacchi Nombre de raccordement Número de conexiones</p>	2	3	2	2
<p>Gewinde Ausführung Thread design Esecuzione filettata Exécution filet Ejecución de rosca</p>	M 12 x 1 A1	M 12 x 1 A1	M 10 x 1 A2	M 12 x 1 A1
<p>Richtung des Prüfanschlusses zur Befestigungslasche Direction of the testing connector to the mounting link Direzione del raccordo di prova alla fascetta di fissaggio Nens du raccord d' essai par rapport aux trous de fixation Dirección de la conexión de ensayo a la brida de fijación</p>	horizontal orizzontale	vertical verticale	vertical verticale	vertical verticale
	 <b>03.9305-0570.3 390488</b>	 <b>03.9305-0590.3 390489</b>	 <b>03.9305-0700.3 390491</b>	
<p>Anzahl der Befestigungslaschen Number of mounting links Numero delle fascette Nombre de trous de fixation Número de las bridas de fijación</p>	1	1	-	
<p>Anzahl der Anschlüsse Number of connections Numero di attacchi Nombre de raccordement Número de conexiones</p>	3	3	1	
<p>Gewinde Ausführung Thread design Esecuzione filettata Exécution filet Ejecución de rosca</p>	M 12 x 1 A1	M 10 x 1 A2	M 10 x 1	
<p>Richtung des Prüfanschlusses zur Befestigungslasche Direction of the testing connector to the mounting link Direzione del raccordo di prova alla fascetta di fissaggio Nens du raccord d' essai par rapport aux trous de fixation Dirección de la conexión de ensayo a la brida de fijación</p>	vertical verticale	horizontal orizzontale	-	
<p><b>Prüfanschlüsse - Einzelteile</b> Testing connectors - individual parts Attacchi di prova - pezzi singoli Connexion d' essai - pièces détachées Piezas sueltas - conexión de ensayo</p>	<p><b>03.9305-0502.0 390482</b> Schraubverschlusskappe Screw-type sealing cap Calotta per tappo filettato Capuchon à vis Tapa roscable</p>	<p><b>03.9305-0501.1 390480</b> Verbindungskette Connecting chain catena di collegamento chaîne de raccordement cadena de unión</p>	<p><b>03.3501-0021.1 390242</b> Gummidichtung in der Verschlusskappe Rubber seal in the sealing cap guarnizione in gomma nella calotta joint dans le capuchon junta de goma en la tapa de cierre</p>	



# Armaturen

Fittings - Attrezzature - Composants et accessoires - Accesorios

Sortimente  
Assortments  
Assortimenti  
Assortiments  
Surtidos

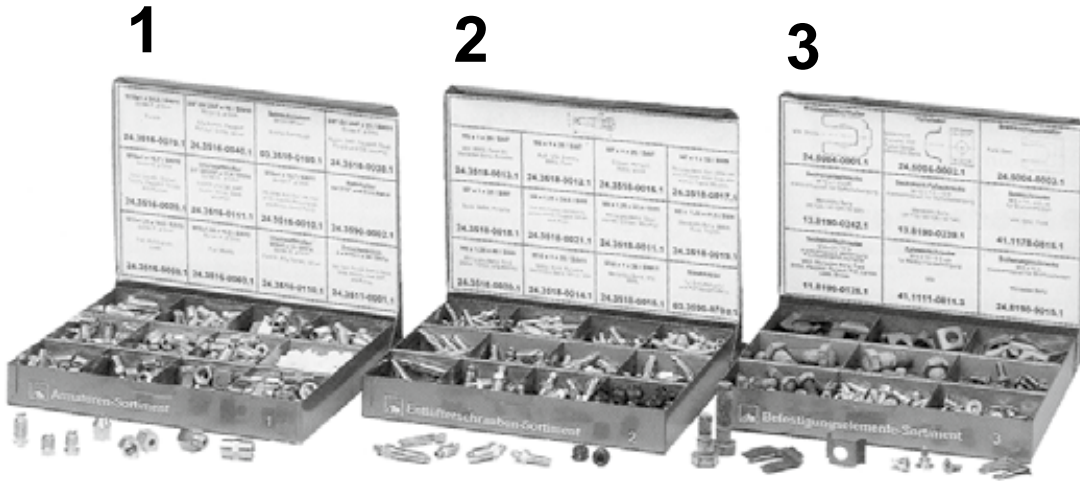

<p>① M10x1 x 24,8 / SW11 Bördel F, Ø5mm ● 24.3516-0070.1 390546</p>	<p>① 3/8"-24 UNF x 18/SW10 Bördel E, Ø5mm ● 24.3516-0040.1 390543</p>	<p>② Schraubstutzen M10x1/M10x1 ■ 03.3510-0100.1 390271</p>	<p>① 3/8"-24 UNF x 21/SW11 Bördel F, Ø5mm ● 24.3516-0030.1 390542</p>	<p><b>1</b> 24.3516-0210.2 390553 <b>Armaturen Sortiment</b> Fittings collection Serie di accessori Armatures collection Surtido de accesorios</p>
<p>① M10x1 x 16,7 / SW10 Bördel E, Ø5mm ● 24.3516-0020.1 390541</p>	<p>③ Überwurfmutter 3/8"-24UNFx17,5/SW11/E,Ø5mm ● 24.3516-0111.1 390550</p>	<p>① M10x1 x 16,7 / SW11 Bördel F, Ø5mm ● 24.3516-0010.1 390540</p>	<p>Rohrhalter ④ für 3/16" und 5mm ● 24.3590-0002.1 390567</p>	
<p>① M10x1,25 x 10,5 / SW10 Bördel F, Ø5mm ● 24.3516-0050.1 390544</p>	<p>① M10x1,25 x 14,2 / SW10 Bördel E, Ø5mm ● 24.3516-0060.1 390545</p>	<p>③ Überwurfmutter M10x1 x 13 / SW14 / E, Ø5mm ● 24.3516-0110.1 390549</p>	<p>⑤ Zwischenstück 2 x M10x1 x 24 SW14 ● 03.3511-0800.1 390285</p>	
<p>M6 x 1 x 29 SW7 ● 24.3518-0013.1 390558</p>	<p>M6 x 1 x 38 SW7 ● 24.3518-0012.1 390557</p>	<p>M7 x 1 x 26 SW7 ● 24.3518-0016.1 390561</p>	<p>M7 x 1 x 33 SW9 ● 24.3518-0017.1 390562</p>	<p><b>2</b> 24.3516-0220.2 390554 <b>Entlüfterschrauben Sortiment</b> Bleeder valve collection Viti di spurgo assortimento Vis de purge collection Surtido de tornillos de ventilador</p>
<p>M7 x 1 x 38 SW7 ● 24.3518-0018.1 390563</p>	<p>M8 x 1,25 x 24,5 SW8 ● 24.3518-0021.1 390566</p>	<p>M8 x 1,25 x 32,5 SW9 ● 24.3518-0011.1 390556</p>	<p>M8 x 1,25 x 41,5 SW9 ● 24.3518-0019.1 390564</p>	
<p>M8 x 1,25 x 49 SW9 ● 24.3518-0020.1 390565</p>	<p>M10 x 1 x 30 SW11 ● 24.3518-0014.1 390559</p>	<p>M10 x 1 x 36 SW11 ● 24.3518-0015.1 390560</p>	<p>⑥ Staubkappe ■ 03.3590-0700.1 390456</p>	
<p>⑦ Bremschlauchhalter ● 24.5004-0001.1 390568</p>	<p>⑧ Haltefeder ● 24.5004-0002.1 390569</p>	<p>⑦ Bremschlauchhalter ● 24.5004-0003.1 390570</p>	<p><b>3</b> 24.3516-0230.2 390555 <b>Befestigungselemente Sortiment</b> Fittings Collection Pezzi di fissaggio assortimento Fixation collection Surtido de elementos de fijación</p>	
<p>⑨ Sechskantschraube M12 x 1,5 x 45 ■ 13.8190-0242.1 990124</p>	<p>⑩ Sechskant-Paßschraube M12 x 1,5 - 10.9 ■ 13.8190-0239.1 990122</p>	<p>⑪ Senkschraube M6 x 14 -4.8 - H ● 41.1178-0815.1 990137</p>		
<p>⑨ Sechskantschraube M8 x 21 - 10.9 ● 11.8190-0125.1 990054</p>	<p>⑫ Zylinderschraube M6 x 10 -8.8 ● 41.1111-0811.3 990136</p>	<p>⑬ Sicherungsschraube M6 x 15,5 ● 24.8190-9015.1 990133</p>		
<p>① Bördel ② Schraubstutzen ③ Überwurfmutter ④ Rohrhalter für 3/16" und 5mm ⑤ Zwischenstück ⑥ Staubkappe ⑦ Bremschlauchhalter ⑧ Haltefeder ⑨ Sechskantschraube ⑩ Sechskant-Paßschraube ⑪ Senkschraube ⑫ Zylinderschraube ⑬ Sicherungsschraube</p>	<p>Flare Screw adapters Union nut Pipe holder Pipe adapter Dust cap Hose spring-clamp Fixation spring Hexagon screw Hexagone-fitting screw Countersunk screw Cylinder screw Locking screw</p>	<p>Bordatura tipo Raccordi filettati Dadi con risvolto Supporto Raccordi intermedi Parapolvere Mollette per flessibile freni Molla di ritegno Vite a testa esagonale Vite calibrata a testa esagonale Vite a testa svasata Vite a testa cilindrica Vite autobloccante</p>	<p>Colet Raccord fiteté Écrou-chapeau Support de tube pour 3/16" et 5mm Raccord intermédiaire Capuchon de protection Ressort de retenue de flexible de frein Ressort d'arret Boulon hexagonal Boulon hexagonal-vis Vis a tête conique Vis cylindrique Vis d'appui</p>	<p>Reborde Racores Tuerca de racor Soporte de tubo para 3/16" y 5mm Piezas intercaladas Guardapolvo Soporte manguera de freno Resorte de retención Resorte de retención Tornillo hexagonal Tornillo calibrado hexagonal Tornillo cilíndrico Tornillo de seguridad</p>
<p>● Nachfüllbeutel 10 Stück ■ Einzelteil</p>	<p>Refillbag with 10 pieces Single part</p>	<p>Sacchetto di riassortimento 10 pezzi Pezzo singolo</p>	<p>Sac de remplissage à 10 pièces Pièces dé tachées</p>	<p>Bolsa de relleno con 10 piezas Pieza suelta</p>



- ① **Bremsgeräte komplett**
- ② **Booster units complete**
- ③ **Servo-freins complets**
- ④ **Servofreno completo**



# Bremsgeräte komplett

**Booster units complete - Servofreni completi -  
Servo-freins complets - Servofreno completo**

● Die Nr. befindet sich auf dem im Fahrzeug eingebautem Aggregat.  
the number is on the unit build in the car  
il numero si trova sull'aggregato montato nella macchina  
le numéro se trouve sur la pièce montée dans le véhicule  
el n° se encuentra en el equipo montado en el vehículo



03.6121-0501.4	<b>03.3508-0264.3</b>	310009	Behälter
03.6122-0010.4	<b>03.3508-8302.3</b>	310046	Behälter
03.6122-0017.4	<b>03.3508-8302.3</b>	310046	Behälter
03.6122-0018.4	<b>03.3508-8302.3</b>	310046	Behälter
03.6122-0601.4	<b>03.3508-8302.3</b>	310046	Behälter
03.6122-1002.4	<b>03.3508-8302.3</b>	310046	Behälter
03.6122-1006.4	<b>03.3508-8302.3</b>	310046	Behälter
03.6122-1401.4	<b>03.3508-8302.3</b>	310046	Behälter
03.6122-2001.4	<b>03.2119-6207.3</b>	010060	THz 19,05
03.6122-2002.4	<b>03.2119-6207.3</b>	010060	THz 19,05
03.6122-2003.4	<b>03.2119-6207.3</b>	010060	THz 19,05
03.6122-2102.4	<b>03.3508-8302.3</b>	310046	Behälter
03.6122-2401.4	<b>03.2119-0525.3</b>	010046	THz 19,05 + Behälter
03.6122-2402.4	<b>03.2120-0148.3</b>	010070	THz 20,64 + Behälter
03.6122-2407.4	<b>03.2120-0148.3</b>	010070	THz 20,64 + Behälter
03.6127-0001.4	<b>03.2123-6802.3</b>	010186	THz 23,81
03.6127-0301.4	<b>03.2123-6802.3</b>	010186	THz 23,81
03.6127-0801.4	<b>03.2122-0142.3</b>	010128	THz 22,20
	<b>03.3558-0676.3</b>	310077	Behälter + WE
03.6127-0804.4	<b>03.3558-0676.3</b>	310077	Behälter + WE
03.6132-0702.4	<b>03.3508-8302.3</b>	310046	Behälter
03.6132-1103.4	<b>03.2120-0148.3</b>	010070	THz 20,64 + Behälter
03.6132-1401.4	<b>03.3508-8302.3</b>	310046	Behälter
03.6132-1501.4	<b>03.2122-0142.3</b>	010128	THz 22,20
	<b>03.3558-0676.3</b>	310077	Behälter + WE
03.6132-1502.4	<b>03.2122-0142.3</b>	010128	THz 22,20
	<b>03.3558-0676.3</b>	310077	Behälter + WE
03.6132-1701.4	<b>03.2123-1003.3</b>	010175	THz 23,81
03.6132-1901.4	<b>03.2120-5503.3</b>	010124	THz 20,64 + Behälter
03.6132-2001.4	<b>03.3508-8302.3</b>	310046	Behälter
03.6132-2701.4	<b>03.3508-7504.3</b>	310045	Behälter
03.6132-2901.4	<b>03.2120-0148.3</b>	010070	THz 20,64 + Behälter

03.6132-3401.4	<b>03.3508-8302.3</b>	310046	Behälter
03.6132-3905.4	<b>03.3508-7504.3</b>	310045	Behälter
03.6132-3907.4	<b>03.2120-1531.3</b>	010092	THz 20,64
	<b>03.3508-7504.3</b>	310045	Behälter
03.6132-3908.4	<b>03.3508-7504.3</b>	310045	Behälter
03.6132-3912.4	<b>03.2120-1531.3</b>	010092	THz 20,64
03.6132-4201.4	<b>03.2120-0148.3</b>	010070	THz 20,64 + Behälter
03.6132-4202.4	<b>03.2120-0148.3</b>	010070	THz 20,64 + Behälter
03.6132-4203.4	<b>03.2120-0148.3</b>	010070	THz 20,64 + Behälter
03.6132-4207.4	<b>03.2120-0148.3</b>	010070	THz 20,64 + Behälter
03.6132-4401.4	<b>03.2120-5503.3</b>	010124	THz 20,64 + Behälter
03.6132-4601.4	<b>03.3508-7504.3</b>	310045	Behälter
03.6132-4703.4	<b>03.3508-8302.3</b>	310046	Behälter
03.6132-4704.4	<b>03.3508-8302.3</b>	310046	Behälter
03.6132-4901.4	<b>03.3508-7504.3</b>	310045	Behälter
03.6132-5201.4	<b>03.3508-7504.3</b>	310045	Behälter
03.6132-5405.4	<b>03.2120-0538.3</b>	010077	THz 20,64
03.6132-5501.4	<b>03.2120-1531.3</b>	010092	THz 20,64
	<b>03.3508-7504.3</b>	310045	Behälter
03.6132-5502.4	<b>03.3508-7504.3</b>	310045	Behälter
03.6132-5701.4	<b>03.2120-1531.3</b>	010092	THz 20,64
03.6132-5802.4	<b>03.3508-7504.3</b>	310045	Behälter
03.6132-6301.4	<b>03.2120-2598.3</b>	010116	THz 20,64
03.6132-6302.4	<b>03.2120-2598.3</b>	010116	THz 20,64
03.6132-6304.4	<b>03.2120-2598.3</b>	010116	THz 20,64
03.6132-6305.4	<b>03.2120-2598.3</b>	010116	THz 20,64
03.6132-6306.4	<b>03.2120-2598.3</b>	010116	THz 20,64
03.6132-6501.4	<b>03.2120-1531.3</b>	010092	THz 20,64
03.6132-6512.4	<b>03.2120-1531.3</b>	010092	THz 20,64
03.6132-6515.4	<b>03.2120-1491.3</b>	010089	THz 20,64 + WE
03.6132-6706.4	<b>03.2120-1491.3</b>	010089	THz 20,64 + WE
03.6142-0301.4	<b>03.3508-8302.3</b>	310046	Behälter

# Bremsgeräte komplett

## Booster units complete - Servofreni completi - Servo-freins complets - Servofreno completo

● Die Nr. befindet sich auf dem im Fahrzeug eingebautem Aggregat.  
the number is on the unit build in the car  
il numero si trova sull'aggregato montato nella macchina  
le numéro se trouve sur la pièce montée dans le véhicule  
el n° se encuentra en el equipo montado en el vehículo



03.6142-0701.4	<b>03.3508-8302.3</b>	310046	Behälter	03.6142-4702.4	<b>03.2122-4902.3</b>	010144	THz 22,20
03.6142-1201.4	<b>03.2123-2604.3</b>	010178	THz 23,81 + WE	03.6142-4704.4	<b>03.2122-4902.3</b>	010144	THz 22,20
03.6142-1202.4	<b>03.2123-2604.3</b>	010178	THz 23,81 + WE	03.6142-4801.4	<b>03.2123-6207.3</b>	010185	THz 23,81
03.6142-1205.4	<b>03.2123-2604.3</b>	010178	THz 23,81 + WE		<b>03.3508-7504.3</b>	310045	Behälter
03.6142-1502.4	<b>03.2122-2202.3</b>	010140	THz 22,20	03.6142-4802.4	<b>03.3508-7504.3</b>	310045	Behälter
03.6142-1701.4	<b>03.2119-6207.3</b>	010060	THz 19,05	03.6142-4803.4	<b>03.3508-7504.3</b>	310045	Behälter
	<b>03.3558-0676.3</b>	310077	Behälter + WE	03.6142-5201.4	<b>03.2123-6207.3</b>	010185	THz 23,81
03.6142-1703.4	<b>03.2120-4504.3</b>	010123	THz 20,64		<b>03.3508-7504.3</b>	310045	Behälter
	<b>03.3558-0676.3</b>	310077	Behälter + WE	03.6142-5202.4	<b>03.3508-7504.3</b>	310045	Behälter
03.6142-1704.4	<b>03.2120-4504.3</b>	010123	THz 20,64	03.6142-5203.4	<b>03.3508-7504.3</b>	310045	Behälter
	<b>03.3558-0676.3</b>	310077	Behälter + WE	03.6142-5205.4	<b>03.2123-4911.3</b>	010182	THz 23,81
03.6142-2101.4	<b>03.2122-2202.3</b>	010140	THz 22,20	03.6142-5301.4	<b>03.3508-8302.3</b>	310046	Behälter
03.6142-2402.4	<b>03.2123-6207.3</b>	010185	THz 23,81	03.6142-5502.4	<b>03.3508-7504.3</b>	310045	Behälter
	<b>03.3508-7504.3</b>	310045	Behälter	03.6142-6803.4	<b>03.2122-4902.3</b>	010144	THz 22,20
03.6142-2403.4	<b>03.3508-7504.3</b>	310045	Behälter	03.6142-7203.4	<b>03.2120-1491.3</b>	010089	THz 20,64 + WE
03.6142-3001.4	<b>03.2120-5503.3</b>	010124	THz 20,64 + Behälter	03.6142-7204.4	<b>03.2120-1491.3</b>	010089	THz 20,64 + WE
03.6142-3201.4	<b>03.6058-0301.3</b>	320072	BR 25/5 (3)	03.6142-7205.4	<b>03.2120-1491.3</b>	010089	THz 20,64 + WE
03.6142-3203.4	<b>03.6058-0301.3</b>	320072	BR 25/5 (3)	03.6142-7301.4	<b>03.2120-1491.3</b>	010089	THz 20,64 + WE
03.6142-3204.4	<b>03.6058-0301.3</b>	320072	BR 25/5 (3)	03.6142-7302.4	<b>03.2120-1491.3</b>	010089	THz 20,64 + WE
03.6142-3205.4	<b>03.6058-0301.3</b>	320072	BR 25/5 (3)	03.6142-7303.4	<b>03.2120-1491.3</b>	010089	THz 20,64 + WE
03.6142-3301.4	<b>03.2123-6207.3</b>	010185	THz 23,81	03.6147-0401.4	<b>03.2125-1102.3</b>	010202	THz 25,40
	<b>03.3508-7504.3</b>	310045	Behälter		<b>03.3508-3600.3</b>	310030	Behälter
03.6142-3302.4	<b>03.3508-7504.3</b>	310045	Behälter	03.6147-0501.4	<b>03.2125-1102.3</b>	010202	THz 25,40
03.6142-4401.4	<b>03.2123-2604.3</b>	010178	THz 23,81 + WE	03.6147-1101.4	<b>03.2125-1302.3</b>	010203	THz 25,40
03.6142-4601.4	<b>03.2122-0142.3</b>	010128	THz 22,20	03.6147-1102.4	<b>03.2125-1302.3</b>	010203	THz 25,40
	<b>03.3558-0676.3</b>	310077	Behälter + WE	03.6147-1103.4	<b>03.2125-1302.3</b>	010203	THz 25,40
03.6142-4602.4	<b>03.2122-0142.3</b>	010128	THz 22,20	03.6147-1301.4	<b>03.2123-6802.3</b>	010186	THz 23,81
	<b>03.3558-0676.3</b>	310077	Behälter + WE	03.6147-1703.4	<b>03.2125-1302.3</b>	010203	THz 25,40
03.6142-4603.4	<b>03.2122-0142.3</b>	010128	THz 22,20	03.6147-2402.4	<b>03.2123-8611.3</b>	010195	THz 23,81
	<b>03.3558-0676.3</b>	310077	Behälter + WE	03.6152-0206.4	<b>03.2123-3402.3</b>	010181	THz 23,81
03.6142-4604.4	<b>03.2122-0142.3</b>	010128	THz 22,20		<b>03.3508-8753.3</b>	310049	Behälter + WE
	<b>03.3558-0676.3</b>	310077	Behälter + WE		<b>03.6850-0202.4</b>	300043	9"
03.6142-4605.4	<b>03.2122-0142.3</b>	010128	THz 22,20	03.6152-0209.4	<b>03.2023-0166.3</b>	010015	THz 23,81/19,05
	<b>03.3558-0676.3</b>	310077	Behälter + WE		<b>03.6850-0202.4</b>	300043	9"
03.6142-4701.4	<b>03.2122-4902.3</b>	010144	THz 22,20				

# Bremsgeräte komplett

**Booster units complete - Servofreni completi -  
Servo-freins complets - Servofreno completo**

● Die Nr. befindet sich auf dem im Fahrzeug eingebautem Aggregat.  
the number is on the unit build in the car  
il numero si trova sull'aggregato montato nella macchina  
le numéro se trouve sur la pièce montée dans le véhicule  
el n° se encuentra en el equipo montado en el vehículo



03.6152-0210.4	<b>03.2023-0166.3</b> <b>03.6850-0202.4</b>	010015 300043	THz 23,81/19,05 9"
03.6152-0401.4	<b>03.2122-6202.3</b>	010148	THz 22,20
03.6152-0601.4	<b>03.3508-8302.3</b>	310046	Behälter
03.6152-0701.4	<b>03.2123-6802.3</b>	010186	THz 23,81
03.6152-0702.4	<b>03.2122-6202.3</b>	010148	THz 22,20
03.6152-0703.4	<b>03.2122-6202.3</b>	010148	THz 22,20
03.6152-0803.4	<b>03.2123-6207.3</b> <b>03.3508-7504.3</b>	010185 310045	THz 23,81 Behälter
03.6152-1002.4	<b>03.2123-3302.3</b>	010180	THz 23,81
03.6152-1101.4	<b>03.3508-8302.3</b>	310046	Behälter
03.6152-1401.4	<b>03.2123-6802.3</b>	010186	THz 23,81
03.6152-1502.4	<b>03.2123-3302.3</b>	010180	THz 23,81
03.6152-1701.4	<b>03.2123-6207.3</b> <b>03.3508-7504.3</b>	010185 310045	THz 23,81 Behälter
03.6152-1801.4	<b>03.2122-0142.3</b> <b>03.3558-0676.3</b>	010128 310077	THz 22,20 Behälter + WE
03.6152-2001.4	<b>03.2123-6207.3</b> <b>03.3508-7504.3</b>	010185 310045	THz 23,81 Behälter
03.6152-2002.4	<b>03.3508-7504.3</b>	310045	Behälter
03.6152-2003.4	<b>03.2123-4911.3</b>	010182	THz 23,81
03.6152-2101.4	<b>03.3508-8302.3</b>	310046	Behälter
03.6157-0201.4	<b>03.3508-8302.3</b>	310046	Behälter
03.6157-0301.4	<b>03.2123-1003.3</b> <b>03.3508-8753.3</b> <b>03.6855-1202.4</b>	010175 310049 300056	THz 23,81 Behälter + WE 9" Tandem
03.6157-0302.4	<b>03.2123-1003.3</b> <b>03.3508-8753.3</b> <b>03.6855-1202.4</b>	010175 310049 300056	THz 23,81 Behälter + WE 9" Tandem
03.6157-0303.4	<b>03.2123-1003.3</b> <b>03.3508-8753.3</b> <b>03.6855-1202.4</b>	010175 310049 300056	THz 23,81 Behälter + WE 9" Tandem
03.6157-0304.4	<b>03.2123-3402.3</b> <b>03.3508-8753.3</b> <b>03.6855-1202.4</b>	010181 310049 300056	THz 23,81 Behälter + WE 9" Tandem
03.6157-0305.4	<b>03.2123-1003.3</b> <b>03.3508-8753.3</b> <b>03.6855-1202.4</b>	010175 310049 300056	THz 23,81 Behälter + WE 9" Tandem

03.6157-0306.4	<b>03.2123-3402.3</b> <b>03.3508-8753.3</b> <b>03.6855-1202.4</b>	010181 310049 300056	THz 23,81 Behälter + WE 9" Tandem
03.6157-0307.4	<b>03.6855-1202.4</b>	300056	9" Tandem
03.6157-0308.4	<b>03.2023-0166.3</b> <b>03.6855-1202.4</b>	010015 300056	THz 23,81/19,05 9" Tandem
03.6157-0309.4	<b>03.6855-1202.4</b>	300056	9" Tandem
03.6157-0310.4	<b>03.2023-0166.3</b> <b>03.6855-1202.4</b>	010015 300056	THz 23,81/19,05 9" Tandem
03.6157-0501.4	<b>03.2123-7002.3</b>	010187	THz 23,81
03.6157-0503.4	<b>03.2123-7002.3</b>	010187	THz 23,81
03.6197-1501.4	<b>03.3508-8302.3</b>	310046	Behälter
03.6197-2101.4	<b>03.3508-8302.3</b>	310046	Behälter
03.6197-2201.4	<b>03.3508-8302.3</b>	310046	Behälter
03.6197-2202.4	<b>03.3508-8302.3</b>	310046	Behälter
03.6197-2203.4	<b>03.3508-8302.3</b>	310046	Behälter
03.6197-2204.4	<b>03.3508-8302.3</b>	310046	Behälter
03.6197-2801.4	<b>03.3508-8302.3</b>	310046	Behälter
03.6197-3301.4	<b>03.3508-8302.3</b>	310046	Behälter
03.6197-3302.4	<b>03.3508-8302.3</b>	310046	Behälter
03.6732-0101.4	<b>03.2120-2031.3</b>	010106	THz 20,64
03.6732-0201.4	<b>03.2120-2031.3</b>	010106	THz 20,64
03.6732-0203.4	<b>03.2120-2031.3</b>	010106	THz 20,64
03.6732-0401.4	<b>03.2120-2031.3</b>	010106	THz 20,64
03.6732-0503.4	<b>03.2120-2598.3</b>	010116	THz 20,64
03.6732-0504.4	<b>03.2120-2598.3</b>	010116	THz 20,64
03.6732-0601.4	<b>03.2120-2031.3</b>	010106	THz 20,64
03.6732-0901.4	<b>03.2119-3389.3</b>	010057	THz 19,05
03.6732-1001.4	<b>03.2119-3389.3</b>	010057	THz 19,05
03.6732-1101.4	<b>03.2119-3389.3</b>	010057	THz 19,05
03.6732-1103.4	<b>03.2119-3389.3</b>	010057	THz 19,05
03.6732-1201.4	<b>03.2119-3389.3</b>	010057	THz 19,05
03.6732-3301.4	<b>03.2119-3389.3</b>	010057	THz 19,05



# Bremsgeräte komplett

## Booster units complete - Servofreni completi - Servo-freins complets - Servofreno completo

● Die Nr. befindet sich auf dem im Fahrzeug eingebautem Aggregat.  
the number is on the unit build in the car  
il numero si trova sull'aggregato montato nella macchina  
le numéro se trouve sur la pièce montée dans le véhicule  
el n° se encuentra en el equipo montado en el vehículo



03.6732-3501.4	<b>03.2119-3389.3</b>	010057	THz 19,05	03.6742-0401.4	<b>03.2120-2598.3</b>	010116	THz 20,64
03.6742-0101.4	<b>03.2120-2598.3</b>	010116	THz 20,64	03.6742-0402.4	<b>03.2120-2598.3</b>	010116	THz 20,64
03.6742-0102.4	<b>03.2120-2598.3</b>	010116	THz 20,64	03.6742-0404.4	<b>03.2120-2598.3</b>	010116	THz 20,64
03.6742-0103.4	<b>03.2120-2598.3</b>	010116	THz 20,64	03.6742-0406.4	<b>03.2120-2598.3</b>	010116	THz 20,64
03.6742-0104.4	<b>03.2120-2598.3</b>	010116	THz 20,64	03.6742-0407.4	<b>03.2120-2598.3</b>	010116	THz 20,64
03.6742-0105.4	<b>03.2120-2598.3</b>	010116	THz 20,64	03.6742-0409.4	<b>03.2120-2597.3</b>	010115	THz 20,64
03.6742-0106.4	<b>03.2120-2598.3</b>	010116	THz 20,64	03.6742-0410.4	<b>03.2120-2597.3</b>	010115	THz 20,64
03.6742-0107.4	<b>03.2120-2598.3</b>	010116	THz 20,64	03.6742-0411.4	<b>03.2120-2597.3</b>	010115	THz 20,64
03.6742-0108.4	<b>03.2120-2598.3</b>	010116	THz 20,64	03.6742-0412.4	<b>03.2120-2597.3</b>	010115	THz 20,64
03.6742-0109.4	<b>03.2120-2598.3</b>	010116	THz 20,64	03.6742-0413.4	<b>03.2120-2597.3</b>	010115	THz 20,64
03.6742-0110.4	<b>03.2120-2598.3</b>	010116	THz 20,64	03.6742-0414.4	<b>03.2120-2597.3</b>	010115	THz 20,64
03.6742-0111.4	<b>03.2120-2598.3</b>	010116	THz 20,64	03.6742-0415.4	<b>03.2120-2597.3</b>	010115	THz 20,64
03.6742-0112.4	<b>03.2120-2598.3</b>	010116	THz 20,64	03.6742-0416.4	<b>03.2120-2597.3</b>	010115	THz 20,64
03.6742-0113.4	<b>03.2120-2598.3</b>	010116	THz 20,64	03.6742-0419.4	<b>03.2120-2597.3</b>	010115	THz 20,64
03.6742-0114.4	<b>03.2120-2598.3</b>	010116	THz 20,64	03.6742-0420.4	<b>03.2120-2597.3</b>	010115	THz 20,64
03.6742-0115.4	<b>03.2120-2598.3</b>	010116	THz 20,64	03.6742-0421.4	<b>03.2120-2597.3</b>	010115	THz 20,64
03.6742-0116.4	<b>03.2120-2598.3</b>	010116	THz 20,64	03.6742-0422.4	<b>03.2120-2597.3</b>	010115	THz 20,64
03.6742-0117.4	<b>03.2120-2598.3</b>	010116	THz 20,64	03.6742-0423.4	<b>03.2120-2597.3</b>	010115	THz 20,64
03.6742-0118.4	<b>03.2120-2598.3</b>	010116	THz 20,64	03.6742-0601.4	<b>03.2122-0142.3</b> <b>03.3558-0676.3</b>	010128 310077	THz 22,20 Behälter + WE
03.6742-0119.4	<b>03.2120-2597.3</b>	010115	THz 20,64	03.6742-0701.4	<b>03.2119-3389.3</b>	010057	THz 19,05
03.6742-0120.4	<b>03.2120-2597.3</b>	010115	THz 20,64	03.6742-1201.4	<b>03.2119-3389.3</b>	010057	THz 19,05
03.6742-0121.4	<b>03.2120-2597.3</b>	010115	THz 20,64	03.6742-1501.4	<b>03.2120-2031.3</b>	010106	THz 20,64
03.6742-0122.4	<b>03.2120-2597.3</b>	010115	THz 20,64	03.6742-1701.4	<b>03.2120-2031.3</b>	010106	THz 20,64
03.6742-0123.4	<b>03.2120-2597.3</b>	010115	THz 20,64	03.6752-0201.4	<b>03.2120-2031.3</b> <b>03.6750-0202.4</b>	010106 300033	THz 20,64 9"
03.6742-0124.4	<b>03.2120-2597.3</b>	010115	THz 20,64	03.6752-0302.4	<b>03.2120-2031.3</b>	010106	THz 20,64
03.6742-0201.4	<b>03.2123-4911.3</b>	010182	THz 23,81	03.6752-0305.4	<b>03.2120-2331.3</b>	010110	THz 20,64
03.6742-0202.4	<b>03.2120-0538.3</b>	010077	THz 20,64	03.6752-0306.4	<b>03.2120-2031.3</b>	010106	THz 20,64
03.6742-0203.4	<b>03.2120-2598.3</b>	010116	THz 20,64	03.6752-0501.4	<b>03.2120-2598.3</b>	010116	THz 20,64
03.6742-0204.4	<b>03.2120-2598.3</b>	010116	THz 20,64	03.6752-0502.4	<b>03.2120-2598.3</b>	010116	THz 20,64
03.6742-0301.4	<b>03.2120-2598.3</b>	010116	THz 20,64	03.6752-0505.4	<b>03.2120-2597.3</b>	010115	THz 20,64
03.6742-0302.4	<b>03.2120-2598.3</b>	010116	THz 20,64				

# Bremsgeräte komplett

**Booster units complete - Servofreni completi -  
Servo-freins complets - Servofreno completo**

● Die Nr. befindet sich auf dem im Fahrzeug eingebautem Aggregat.  
the number is on the unit build in the car  
il numero si trova sull'aggregato montato nella macchina  
le numéro se trouve sur la pièce montée dans le véhicule  
el n° se encuentra en el equipo montado en el vehículo



03.6752-0506.4	<b>03.2120-2597.3</b>	010115	THz 20,64
03.6752-0507.4	<b>03.2120-2597.3</b>	010115	THz 20,64
03.6752-0508.4	<b>03.2120-2597.3</b>	010115	THz 20,64
03.6752-0701.4	<b>03.2120-2482.3</b>	010114	THz 20,64
03.6752-0801.4	<b>03.2122-9812.3</b>	010161	THz 22,20
03.6752-0902.4	<b>03.2120-2331.3</b> <b>03.7750-0302.4</b>	010110 300071	THz 20,64 9"
03.6752-0903.4	<b>03.2120-2191.3</b> <b>03.7750-0302.4</b>	010108 300071	THz 20,64 9"
03.6752-1002.4	<b>03.2120-2682.3</b> <b>03.6750-3502.4</b>	010118 300162	THz 20,64 9"
03.6752-1101.4	<b>03.2120-2331.3</b>	010110	THz 20,64
03.6752-1102.4	<b>03.2122-9612.3</b>	010159	THz 22,20
03.6752-1201.4	<b>03.2120-2331.3</b>	010110	THz 20,64
03.6752-1301.4	<b>03.2126-0512.3</b>	010217	THz 26,99
03.6752-1401.4	<b>03.2120-2331.3</b>	010110	THz 20,64
03.6752-1501.4	<b>03.2120-2482.3</b>	010114	THz 20,64
03.6752-1607.4	<b>03.2120-2597.3</b>	010115	THz 20,64
03.6752-1608.4	<b>03.2120-2597.3</b>	010115	THz 20,64
03.6752-1609.4	<b>03.2120-2597.3</b>	010115	THz 20,64
03.6752-1610.4	<b>03.2120-2597.3</b>	010115	THz 20,64
03.6752-1611.4	<b>03.2120-2597.3</b>	010115	THz 20,64
03.6752-1703.4	<b>03.2120-2597.3</b>	010115	THz 20,64
03.6752-1704.4	<b>03.2120-2597.3</b>	010115	THz 20,64
03.6752-1901.4	<b>03.2120-2031.3</b>	010106	THz 20,64
03.6752-2101.4	<b>03.2120-2682.3</b>	010118	THz 20,64
03.6752-2502.4	<b>03.2122-9631.3</b>	010160	THz 22,20
03.6752-2601.4	<b>03.2122-9631.3</b>	010160	THz 22,20
03.6752-2902.4	<b>03.2122-9631.3</b>	010160	THz 22,20
03.6752-2903.4	<b>03.2120-2682.3</b>	010118	THz 20,64
03.6752-3103.4	<b>03.2120-2682.3</b>	010118	THz 20,64
03.6752-3201.4	<b>03.2120-2031.3</b>	010106	THz 20,64

03.6752-3501.4	<b>03.2120-2682.3</b> <b>03.6750-3502.4</b>	010118 300162	THz 20,64 9"
03.6752-3601.4	<b>03.2120-2682.3</b>	010118	THz 20,64
03.6752-3702.4	<b>03.2122-9631.3</b>	010160	THz 22,20
03.6757-1004.4	<b>03.2023-0166.3</b> <b>03.6855-1202.4</b>	010015 300056	THz 23,81/19,05 9" Tandem
03.6762-0101.4	<b>03.2123-8311.3</b> <b>03.7760-0902.4</b>	010192 300088	THz 23,81 10"
03.6762-0102.4	<b>03.2122-6911.3</b> <b>03.7760-0902.4</b>	010153 300088	THz 22,20 10"
03.6762-0103.4	<b>03.2122-6911.3</b> <b>03.7760-0902.4</b>	010153 300088	THz 22,20 10"
03.6762-0104.4	<b>03.7760-0902.4</b>	300088	10"
03.6762-0105.4	<b>03.2020-0402.3</b> <b>03.7760-0902.4</b>	010001 300088	THz 20,64/19,05 10"
03.6762-0106.4	<b>03.2123-8311.3</b> <b>03.7760-0902.4</b>	010192 300088	THz 23,81 10"
03.6762-0107.4	<b>03.7760-0902.4</b>	300088	10"
03.6762-0108.4	<b>03.2120-2082.3</b> <b>03.7760-0902.4</b>	010107 300088	THz 20,64 10"
03.6762-0110.4	<b>03.2120-1802.3</b> <b>03.7760-0902.4</b>	010099 300088	THz 20,64 10"
03.6762-0111.4	<b>03.2020-0402.3</b> <b>03.7760-0902.4</b>	010001 300088	THz 20,64/19,05 10"
03.6762-0112.4	<b>03.2120-1802.3</b> <b>03.7760-0902.4</b>	010099 300088	THz 20,64 10"
03.6762-0114.4	<b>03.2020-0402.3</b> <b>03.7760-0902.4</b>	010001 300088	THz 20,64/19,05 10"
03.6762-0115.4	<b>03.2120-2082.3</b> <b>03.7760-0902.4</b>	010107 300088	THz 20,64 10"
03.6762-0116.4	<b>03.2123-8311.3</b> <b>03.7760-0902.4</b>	010192 300088	THz 23,81 10"
03.6762-0117.4	<b>03.7760-0902.4</b>	300088	10"
03.6762-0118.4	<b>03.2123-8311.3</b> <b>03.7760-0902.4</b>	010192 300088	THz 23,81 10"
03.6762-0312.4	<b>03.7760-2702.4</b>	300090	10"
03.6762-0401.4	<b>03.2023-0825.3</b> <b>03.7760-2702.4</b>	010028 300090	THz 23,81/19,05 10"

# Bremsgeräte komplett

## Booster units complete - Servofreni completi - Servo-freins complets - Servofreno completo

● Die Nr. befindet sich auf dem im Fahrzeug eingebautem Aggregat.  
the number is on the unit build in the car  
il numero si trova sull'aggregato montato nella macchina  
le numéro se trouve sur la pièce montée dans le véhicule  
el n° se encuentra en el equipo montado en el vehículo



03.6762-0402.4	<b>03.2023-0825.3</b>	010028	THz 23,81/19,05
	<b>03.7760-2702.4</b>	300090	10"
03.6762-0501.4	<b>03.2022-0702.3</b>	010007	THz 22,20/19,05
03.6762-0502.4	<b>03.2022-0702.3</b>	010007	THz 22,20/19,05
03.6762-0503.4	<b>03.2022-0702.3</b>	010007	THz 22,20/19,05
03.6762-0504.4	<b>03.2022-1402.3</b>	010010	THz 22,20/19,05
03.6762-0505.4	<b>03.2022-1402.3</b>	010010	THz 22,20/19,05
03.6762-0508.4	<b>03.2022-1602.3</b>	010011	THz 22,20/19,05
03.6762-0509.4	<b>03.2022-1602.3</b>	010011	THz 22,20/19,05
03.6762-0519.4	<b>03.2022-1402.3</b>	010010	THz 22,20/19,05
03.6762-0520.4	<b>03.2022-1602.3</b>	010011	THz 22,20/19,05
03.6762-0522.4	<b>03.2022-0702.3</b>	010007	THz 22,20/19,05
03.6762-0523.4	<b>03.2022-1402.3</b>	010010	THz 22,20/19,05
03.6762-0525.4	<b>03.2022-1602.3</b>	010011	THz 22,20/19,05
03.6762-0601.4	<b>03.2020-0402.3</b>	010001	THz 20,64/19,05
	<b>03.7760-0902.4</b>	300088	10"
03.6762-0602.4	<b>03.2120-1802.3</b>	010099	THz 20,64
	<b>03.7760-0902.4</b>	300088	10"
03.6832-0101.4	<b>03.2120-3412.3</b>	010121	THz 20,64
03.6832-0104.4	<b>03.6058-0501.3</b>	320074	BR 25/5 (4)
03.6832-0201.4	<b>03.2120-1531.3</b>	010092	THz 20,64
03.6832-0202.4	<b>03.2120-1531.3</b>	010092	THz 20,64
03.6832-0601.4	<b>03.2120-0322.3</b>	010074	THz 20,64 + WE
03.6832-0701.4	<b>03.2120-2462.3</b>	010113	THz 20,64 + WE
03.6832-1001.4	<b>03.2120-2462.3</b>	010113	THz 20,64 + WE
03.6832-1102.4	<b>03.2120-0148.3</b>	010070	THz 20,64 + Behälter
03.6832-1301.4	<b>03.2120-0151.3</b>	010071	THz 20,64
03.6832-1505.4	<b>03.2120-1531.3</b>	010092	THz 20,64
03.6832-1704.4	<b>03.2120-1531.3</b>	010092	THz 20,64
03.6832-1705.4	<b>03.2120-1531.3</b>	010092	THz 20,64
03.6832-1706.4	<b>03.2120-1531.3</b>	010092	THz 20,64
03.6842-0301.4	<b>03.2120-0622.3</b>	010079	THz 20,64

03.6842-0601.4	<b>03.2120-0538.3</b>	010077	THz 20,64
03.6842-0701.4	<b>03.2120-0538.3</b>	010077	THz 20,64
03.6842-0702.4	<b>03.2120-0538.3</b>	010077	THz 20,64
03.6842-0703.4	<b>03.2123-4911.3</b>	010182	THz 23,81
03.6842-0704.4	<b>03.2120-0538.3</b>	010077	THz 20,64
03.6842-1001.4	<b>03.2123-0162.3</b>	010162	THz 23,81 + WE
03.6842-1002.4	<b>03.2120-2462.3</b>	010113	THz 20,64 + WE
03.6842-1003.4	<b>03.2123-0162.3</b>	010162	THz 23,81 + WE
03.6842-1401.4	<b>03.2120-0151.3</b>	010071	THz 20,64
03.6842-1605.4	<b>03.2120-2598.3</b>	010116	THz 20,64
03.6842-1606.4	<b>03.2120-2598.3</b>	010116	THz 20,64
03.6842-1607.4	<b>03.2120-2598.3</b>	010116	THz 20,64
03.6842-1608.4	<b>03.2120-2598.3</b>	010116	THz 20,64
03.6842-1609.4	<b>03.2120-2598.3</b>	010116	THz 20,64
03.6842-1610.4	<b>03.2120-2598.3</b>	010116	THz 20,64
03.6842-1611.4	<b>03.2120-2598.3</b>	010116	THz 20,64
03.6842-1612.4	<b>03.2120-2598.3</b>	010116	THz 20,64
03.6842-1613.4	<b>03.2120-2598.3</b>	010116	THz 20,64
03.6842-1614.4	<b>03.2120-2598.3</b>	010116	THz 20,64
03.6842-3401.4	<b>03.2123-0162.3</b>	010162	THz 23,81 + WE
03.6852-0201.4	<b>03.2123-1003.3</b>	010175	THz 23,81
	<b>03.3508-8753.3</b>	310049	Behälter + WE
	<b>03.6850-0202.4</b>	300043	9"
03.6852-0202.4	<b>03.2123-3402.3</b>	010181	THz 23,81
	<b>03.3508-8753.3</b>	310049	Behälter + WE
	<b>03.6850-0202.4</b>	300043	9"
03.6852-0203.4	<b>03.2123-1003.3</b>	010175	THz 23,81
	<b>03.3508-8753.3</b>	310049	Behälter + WE
	<b>03.6850-0202.4</b>	300043	9"
03.6852-0204.4	<b>03.6850-0202.4</b>	300043	9"
03.6852-0205.4	<b>03.2023-0166.3</b>	010015	THz 23,81/19,05
	<b>03.6850-0202.4</b>	300043	9"
03.6852-0207.4	<b>03.2023-0166.3</b>	010015	THz 23,81/19,05
	<b>03.6850-0202.4</b>	300043	9"

# Bremsgeräte komplett

Booster units complete - Servofreni completi -  
Servo-freins complets - Servofreno completo

● Die Nr. befindet sich auf dem im Fahrzeug eingebautem Aggregat.  
the number is on the unit build in the car  
il numero si trova sull'aggregato montato nella macchina  
le numéro se trouve sur la pièce montée dans le véhicule  
el n° se encuentra en el equipo montado en el vehículo



03.6852-0210.4	<b>03.2023-0166.3</b> <b>03.6850-0202.4</b>	010015 300043	THz 23,81/19,05 9"
03.6852-0211.4	<b>03.2023-0166.3</b> <b>03.6850-0202.4</b>	010015 300043	THz 23,81/19,05 9"
03.6852-0501.4	<b>03.2123-2604.3</b> <b>03.6850-0502.4</b>	010178 300044	THz 23,81 + WE 9"
03.6852-0503.4	<b>03.2123-2604.3</b> <b>03.6850-0502.4</b>	010178 300044	THz 23,81 + WE 9"
03.6852-1001.4	<b>03.6850-5402.4</b>	300055	9"
03.6852-1002.4	<b>03.6850-5402.4</b>	300055	9"
03.6852-1006.4	<b>03.2123-0271.3</b> <b>03.6850-5402.4</b>	010164 300055	THz 23,81 + WE 9"
03.6852-1007.4	<b>03.2123-0271.3</b> <b>03.6850-5402.4</b>	010164 300055	THz 23,81 + WE 9"
03.6852-1008.4	<b>03.2123-0291.3</b> <b>03.6850-5402.4</b>	010165 300055	THz 23,81 9"
03.6852-1009.4	<b>03.2123-0291.3</b> <b>03.6850-5402.4</b>	010165 300055	THz 23,81 9"
03.6852-1012.4	<b>03.2123-0271.3</b> <b>03.6850-5402.4</b>	010164 300055	THz 23,81 + WE 9"
03.6852-1013.4	<b>03.2123-0271.3</b> <b>03.6850-5402.4</b>	010164 300055	THz 23,81 + WE 9"
03.6852-1014.4	<b>03.6850-5402.4</b>	300055	9"
03.6852-1015.4	<b>03.6850-5402.4</b>	300055	9"
03.6852-1301.4	<b>03.2123-6802.3</b>	010186	THz 23,81
03.6852-1302.4	<b>03.2123-6802.3</b>	010186	THz 23,81
03.6852-1303.4	<b>03.2123-6802.3</b>	010186	THz 23,81
03.6852-1304.4	<b>03.2122-6202.3</b>	010148	THz 22,20
03.6852-1601.4	<b>03.2123-6002.3</b> <b>03.6850-2602.4</b>	010184 300049	THz 23,81 9"
03.6852-1701.4	<b>03.2123-9002.3</b>	010198	THz 23,81 + WE
03.6852-1702.4	<b>03.2123-9002.3</b>	010198	THz 23,81 + WE
03.6852-1902.4	<b>03.2123-4911.3</b>	010182	THz 23,81
03.6852-1903.4	<b>03.2123-6207.3</b>	010185	THz 23,81
03.6852-2001.4	<b>03.2123-6002.3</b> <b>03.6850-2602.4</b>	010184 300049	THz 23,81 9"

03.6852-2101.4	<b>03.2120-0562.3</b>	010078	THz 20,64
03.6852-2201.4	<b>03.2123-4911.3</b>	010182	THz 23,81
03.6852-2202.4	<b>03.2123-6207.3</b>	010185	THz 23,81
03.6852-2205.4	<b>03.2120-0538.3</b>	010077	THz 20,64
03.6852-2307.4	<b>03.2120-1491.3</b>	010089	THz 20,64 + WE
03.6852-2401.4	<b>03.2120-0622.3</b>	010079	THz 20,64
03.6852-2402.4	<b>03.2120-0622.3</b>	010079	THz 20,64
03.6852-2404.4	<b>03.2120-1362.3</b>	010087	THz 20,64
03.6852-2405.4	<b>03.2120-0622.3</b>	010079	THz 20,64
03.6852-3801.4	<b>03.2120-1142.3</b>	010085	THz 20,64
03.6852-3802.4	<b>03.2123-9207.3</b>	010199	THz 23,81
03.6852-4403.4	<b>03.2122-8806.3</b>	010157	THz 22,20
03.6852-4404.4	<b>03.2122-8806.3</b>	010157	THz 22,20
03.6852-4405.4	<b>03.2122-8806.3</b>	010157	THz 22,20
03.6852-4406.4	<b>03.2122-8806.3</b>	010157	THz 22,20
03.6852-4407.4	<b>03.2122-8806.3</b>	010157	THz 22,20
03.6852-4408.4	<b>03.2122-8806.3</b>	010157	THz 22,20
03.6852-4409.4	<b>03.2122-8806.3</b>	010157	THz 22,20
03.6852-4603.4	<b>03.2123-7902.3</b> <b>03.7750-5702.4</b>	010191 300083	THz 23,81 + WE 9"
03.6852-4604.4	<b>03.2123-8902.3</b> <b>03.7750-5702.4</b>	010197 300083	THz 23,81 9"
03.6852-4605.4	<b>03.2023-0172.3</b> <b>03.7750-5702.4</b>	010016 300083	THz 23,81/19,05 9"
03.6852-4606.4	<b>03.2023-0172.3</b> <b>03.7750-5702.4</b>	010016 300083	THz 23,81/19,05 9"
03.6852-4702.4	<b>03.2123-7902.3</b>	010191	THz 23,81 + WE
03.6852-4703.4	<b>03.2123-8902.3</b>	010197	THz 23,81
03.6852-5002.4	<b>03.2120-1491.3</b>	010089	THz 20,64 + WE
03.6852-5003.4	<b>03.2120-1531.3</b>	010092	THz 20,64
03.6852-5401.4	<b>03.6850-5402.4</b>	300055	9"
03.6852-5402.4	<b>03.6850-5402.4</b>	300055	9"



# Bremsgeräte komplett

## Booster units complete - Servofreni completi - Servo-freins complets - Servofreno completo

● Die Nr. befindet sich auf dem im Fahrzeug eingebautem Aggregat.  
the number is on the unit build in the car  
il numero si trova sull'aggregato montato nella macchina  
le numéro se trouve sur la pièce montée dans le véhicule  
el n° se encuentra en el equipo montado en el vehículo



03.6852-5403.4	<b>03.6850-5402.4</b>	300055	9"	03.6857-1404.4	<b>03.2125-2102.3</b>	010207	THz 25,40
03.6852-5404.4	<b>03.6850-5402.4</b>	300055	9"		<b>03.6855-1402.4</b>	300057	9" Tandem
03.6852-5902.4	<b>03.2122-8012.3</b>	010156	THz 22,20	03.6857-1405.4	<b>03.6855-1402.4</b>	300057	9" Tandem
03.6852-6202.4	<b>03.2122-8012.3</b>	010156	THz 22,20	03.6857-1406.4	<b>03.6855-1402.4</b>	300057	9" Tandem
	<b>03.6058-0301.3</b>	320072	BR 25/5 (3)	03.6857-1407.4	<b>03.6855-1402.4</b>	300057	9" Tandem
03.6857-0101.4	<b>03.2023-0166.3</b>	010015	THz 23,81/19,05	03.6857-1408.4	<b>03.6855-1402.4</b>	300057	9" Tandem
	<b>03.6855-1202.4</b>	300056	9" Tandem	03.6857-1409.4	<b>03.6855-1402.4</b>	300057	9" Tandem
03.6857-0104.4	<b>03.6855-1202.4</b>	300056	9" Tandem	03.6857-1410.4	<b>03.6855-1402.4</b>	300057	9" Tandem
03.6857-0105.4	<b>03.2023-0166.3</b>	010015	THz 23,81/19,05	03.6857-1411.4	<b>03.6855-1402.4</b>	300057	9" Tandem
	<b>03.6855-1202.4</b>	300056	9" Tandem	03.6857-1413.4	<b>03.6855-1402.4</b>	300057	9" Tandem
03.6857-0108.4	<b>03.2023-0166.3</b>	010015	THz 23,81/19,05	03.6857-1416.4	<b>03.6855-1402.4</b>	300057	9" Tandem
	<b>03.6855-1202.4</b>	300056	9" Tandem	03.6857-1417.4	<b>03.6855-1402.4</b>	300057	9" Tandem
03.6857-0303.4	<b>03.2023-0166.3</b>	010015	THz 23,81/19,05	03.6857-1420.4	<b>03.6855-1402.4</b>	300057	9" Tandem
	<b>03.6855-1202.4</b>	300056	9" Tandem	03.6857-1421.4	<b>03.6855-1402.4</b>	300057	9" Tandem
03.6857-0304.4	<b>03.2023-0166.3</b>	010015	THz 23,81/19,05	03.6857-1422.4	<b>03.6855-1402.4</b>	300057	9" Tandem
	<b>03.6855-1202.4</b>	300056	9" Tandem	03.6857-1423.4	<b>03.6855-1402.4</b>	300057	9" Tandem
03.6857-1001.4	<b>03.2023-0166.3</b>	010015	THz 23,81/19,05	03.6857-1424.4	<b>03.6855-1402.4</b>	300057	9" Tandem
	<b>03.6855-1202.4</b>	300056	9" Tandem	03.6857-1425.4	<b>03.6855-1402.4</b>	300057	9" Tandem
03.6857-1002.4	<b>03.2023-0166.3</b>	010015	THz 23,81/19,05	03.6857-1426.4	<b>03.6855-1402.4</b>	300057	9" Tandem
	<b>03.6855-1202.4</b>	300056	9" Tandem	03.6857-1701.4	<b>03.2123-6002.3</b>	010184	THz 23,81
03.6857-1003.4	<b>03.2023-0166.3</b>	010015	THz 23,81/19,05		<b>03.3558-0676.3</b>	310077	Behälter + WE
	<b>03.6855-1202.4</b>	300056	9" Tandem	03.6857-1801.4	<b>03.2125-3801.3</b>	010215	THz 25,40
03.6857-1106.4	<b>03.2123-8512.3</b>	010194	THz 23,81	03.6857-1901.4	<b>03.6855-1902.4</b>	300059	9" Tandem
03.6857-1201.4	<b>03.2023-0166.3</b>	010015	THz 23,81/19,05	03.6857-1902.4	<b>03.6855-1902.4</b>	300059	9" Tandem
	<b>03.6855-1202.4</b>	300056	9" Tandem	03.6857-1905.4	<b>03.6855-1902.4</b>	300059	9" Tandem
03.6857-1202.4	<b>03.2023-0166.3</b>	010015	THz 23,81/19,05	03.6857-1906.4	<b>03.2125-1902.3</b>	010206	THz 25,40
	<b>03.6855-1202.4</b>	300056	9" Tandem		<b>03.6855-1902.4</b>	300059	9" Tandem
03.6857-1203.4	<b>03.2025-0111.3</b>	010033	THz 25,40/19,05	03.6857-1907.4	<b>03.6855-1902.4</b>	300059	9" Tandem
	<b>03.6855-1202.4</b>	300056	9" Tandem	03.6857-1910.4	<b>03.6855-1902.4</b>	300059	9" Tandem
03.6857-1204.4	<b>03.2025-0111.3</b>	010033	THz 25,40/19,05	03.6857-1911.4	<b>03.6855-1902.4</b>	300059	9" Tandem
	<b>03.6855-1202.4</b>	300056	9" Tandem	03.6857-1912.4	<b>03.6855-1902.4</b>	300059	9" Tandem
03.6857-1205.4	<b>03.2025-0111.3</b>	010033	THz 25,40/19,05	03.6857-1913.4	<b>03.2125-2102.3</b>	010207	THz 25,40
	<b>03.6855-1202.4</b>	300056	9" Tandem		<b>03.6855-1902.4</b>	300059	9" Tandem
03.6857-1401.4	<b>03.2126-0512.3</b>	010217	THz 26,99				
	<b>03.6855-1402.4</b>	300057	9" Tandem				
03.6857-1402.4	<b>03.2125-1902.3</b>	010206	THz 25,40				
	<b>03.6855-1402.4</b>	300057	9" Tandem				
03.6857-1403.4	<b>03.2125-1902.3</b>	010206	THz 25,40				
	<b>03.6855-1402.4</b>	300057	9" Tandem				



# Bremsgeräte komplett

**Booster units complete - Servofreni completi -  
Servo-freins complets - Servofreno completo**

● Die Nr. befindet sich auf dem im Fahrzeug eingebautem Aggregat.  
the number is on the unit build in the car  
il numero si trova sull'aggregato montato nella macchina  
le numéro se trouve sur la pièce montée dans le véhicule  
el n° se encuentra en el equipo montado en el vehículo



03.6857-2101.4	<b>03.2130-0102.3</b>	010221	THz 30,00
	<b>03.6855-2202.4</b>	300061	9" Tandem
03.6857-2103.4	<b>03.2123-0522.3</b>	010168	THz 23,81
	<b>03.6855-2202.4</b>	300061	9" Tandem
03.6857-2201.4	<b>03.2130-0102.3</b>	010221	THz 30,00
	<b>03.6855-2202.4</b>	300061	9" Tandem
03.6857-2202.4	<b>03.2123-0522.3</b>	010168	THz 23,81
	<b>03.6855-2202.4</b>	300061	9" Tandem
03.6857-2203.4	<b>03.6855-2202.4</b>	300061	9" Tandem
03.6857-2204.4	<b>03.6855-2202.4</b>	300061	9" Tandem
03.6857-2205.4	<b>03.6855-2202.4</b>	300061	9" Tandem
03.6857-2301.4	<b>03.2123-8512.3</b>	010194	THz 23,81
03.6857-2401.4	<b>03.2125-3801.3</b>	010215	THz 25,40
03.6857-2403.4	<b>03.2123-9207.3</b>	010199	THz 23,81
03.6862.0904.4	<b>03.7760-0902.4</b>	300088	10"
03.6862-0201.4	<b>03.2023-0166.3</b>	010015	THz 23,81/19,05
03.6862-0202.4	<b>03.2023-0166.3</b>	010015	THz 23,81/19,05
03.6862-0203.4	<b>03.2023-0166.3</b>	010015	THz 23,81/19,05
03.6862-0204.4	<b>03.2023-0166.3</b>	010015	THz 23,81/19,05
03.6862-0301.4	<b>03.2123-9002.3</b>	010198	THz 23,81 + WE
03.6862-0501.4	<b>03.2123-4911.3</b>	010182	THz 23,81
03.6862-0502.4	<b>03.2123-4911.3</b>	010182	THz 23,81
03.6862-0505.4	<b>03.2123-4911.3</b>	010182	THz 23,81
03.6862-0506.4	<b>03.2123-6207.3</b>	010185	THz 23,81
03.6862-0507.4	<b>03.2123-4911.3</b>	010182	THz 23,81
03.6862-0508.4	<b>03.2123-4911.3</b>	010182	THz 23,81
03.6862-0801.4	<b>03.2123-9002.3</b>	010198	THz 23,81 + WE
	<b>03.7760-0402.4</b>	300087	10"
03.6862-0802.4	<b>03.2023-0183.3</b>	010017	THz 23,81/19,05
	<b>03.7760-0402.4</b>	300087	10"
03.6862-0803.4	<b>03.7760-0402.4</b>	300087	10"
03.6862-0901.4	<b>03.2122-6911.3</b>	010153	THz 22,20
	<b>03.7760-0902.4</b>	300088	10"
03.6862-0902.4	<b>03.2122-6911.3</b>	010153	THz 22,20
	<b>03.7760-0902.4</b>	300088	10"

03.6862-0903.4	<b>03.2123-8311.3</b>	010192	THz 23,81
	<b>03.7760-0902.4</b>	300088	10"
03.6862-1001.4	<b>03.2123-9207.3</b>	010199	THz 23,81
03.6862-1101.4	<b>03.2125-3801.3</b>	010215	THz 25,40
03.6862-1103.4	<b>03.2123-9207.3</b>	010199	THz 23,81
03.6862-1105.4	<b>03.2125-3801.3</b>	010215	THz 25,40
03.6862-1201.4	<b>03.2023-0262.3</b>	010020	THz 23,81/20,64
03.6952-0201.4	<b>03.2122-8012.3</b>	010156	THz 22,20
03.6952-0202.4	<b>03.2122-8012.3</b>	010156	THz 22,20
	<b>03.6058-0301.3</b>	320072	BR 25/5 (3)
03.6952-0301.4	<b>03.2023-0172.3</b>	010016	THz 23,81/19,05
	<b>03.7750-5702.4</b>	300083	9"
03.6952-0302.4	<b>03.2023-0172.3</b>	010016	THz 23,81/19,05
	<b>03.7750-5702.4</b>	300083	9"
03.6952-0401.4	<b>03.2122-9612.3</b>	010159	THz 22,20
	<b>03.7750-0302.4</b>	300071	9"
03.6952-0501.4	<b>03.2122-9612.3</b>	010159	THz 22,20
	<b>03.7750-0302.4</b>	300071	9"
03.6952-0601.4	<b>03.2122-9612.3</b>	010159	THz 22,20
	<b>03.7750-0302.4</b>	300071	9"
03.6952-0701.4	<b>03.2122-9612.3</b>	010159	THz 22,20
	<b>03.7750-0302.4</b>	300071	9"
03.7732-0201.4	<b>03.2120-2031.3</b>	010106	THz 20,64
03.7732-0401.4	<b>03.2120-2031.3</b>	010106	THz 20,64
03.7742-0801.4	<b>03.2120-2031.3</b>	010106	THz 20,64
03.7742-0901.4	<b>03.2120-2031.3</b>	010106	THz 20,64
03.7742-1404.4	<b>03.2120-3943.3</b>	010532	THz 20,64
03.7742-2001.4	<b>03.2120-2031.3</b>	010106	THz 20,64
03.7742-2101.4	<b>03.2120-2031.3</b>	010106	THz 20,64
03.7752-0101.4	<b>03.2022-0602.3</b>	010006	THz 22,20/19,05
03.7752-0102.4	<b>03.2022-0602.3</b>	010006	THz 22,20/19,05
03.7752-0104.4	<b>03.2022-0602.3</b>	010006	THz 22,20/19,05
03.7752-0201.4	<b>03.2122-9612.3</b>	010159	THz 22,20
	<b>03.7750-0302.4</b>	300071	9"
03.7752-0204.4	<b>03.2122-9612.3</b>	010159	THz 22,20
	<b>03.7750-0302.4</b>	300071	9"

# Bremsgeräte komplett

## Booster units complete - Servofreni completi - Servo-freins complets - Servofreno completo

● Die Nr. befindet sich auf dem im Fahrzeug eingebautem Aggregat.  
the number is on the unit build in the car  
il numero si trova sull'aggregato montato nella macchina  
le numéro se trouve sur la pièce montée dans le véhicule  
el n° se encuentra en el equipo montado en el vehículo



03.7752-0302.4	<b>03.2122-9612.3</b> <b>03.7750-0302.4</b>	010159 300071	THz 22,20 9"	03.7752-1201.4	<b>03.2122-1042.3</b> <b>03.7750-4902.4</b>	010137 300079	THz 22,20 9"
03.7752-0401.4	<b>03.2023-0562.3</b> <b>03.7750-0302.4</b>	010025 300071	THz 23,81/20,64 9"	03.7752-1202.4	<b>03.2120-3943.3</b> <b>03.7750-4902.4</b>	010532 300079	THz 20,64 9"
03.7752-0402.4	<b>03.2023-0542.3</b> <b>03.7750-0302.4</b>	010024 300071	THz 23,81/20,64 9"	03.7752-1204.4	<b>03.2120-3943.3</b> <b>03.7750-4902.4</b>	010532 300079	THz 20,64 9"
03.7752-0404.4	<b>03.7750-5702.4</b>	300083	9"	03.7752-2601.4	<b>03.2120-3943.3</b>	010532	THz 20,64
03.7752-0405.4	<b>03.2023-0542.3</b> <b>03.7750-5702.4</b>	010024 300083	THz 23,81/20,64 9"	03.7752-2603.4	<b>03.2120-3943.3</b>	010532	THz 20,64
03.7752-0501.4	<b>03.2122-9612.3</b> <b>03.7750-0302.4</b>	010159 300071	THz 22,20 9"	03.7752-2604.4	<b>03.2120-3943.3</b>	010532	THz 20,64
03.7752-0707.4	<b>03.2122-0264.3</b>	010129	THz 22,20	03.7752-2607.4	<b>03.2120-3943.3</b>	010532	THz 20,64
03.7752-0708.4	<b>03.2122-0264.3</b>	010129	THz 22,20	03.7752-2608.4	<b>03.2120-3943.3</b>	010532	THz 20,64
03.7752-0709.4	<b>03.2122-0264.3</b>	010129	THz 22,20	03.7752-2701.4	<b>03.2120-3943.3</b>	010532	THz 20,64
03.7752-0710.4	<b>03.2122-0282.3</b>	010130	THz 22,20	03.7752-2801.4	<b>03.2122-0264.3</b>	010129	THz 22,20
03.7752-0713.4	<b>03.2122-0264.3</b>	010129	THz 22,20	03.7752-3101.4	<b>03.2120-3943.3</b>	010532	THz 20,64
03.7752-0714.4	<b>03.2122-0264.3</b>	010129	THz 22,20	03.7752-3103.4	<b>03.2120-3943.3</b>	010532	THz 20,64
03.7752-0715.4	<b>03.2122-0264.3</b>	010129	THz 22,20	03.7752-3401.4	<b>03.2122-0264.3</b>	010129	THz 22,20
03.7752-0716.4	<b>03.2122-0264.3</b>	010129	THz 22,20	03.7752-3402.4	<b>03.2122-0282.3</b>	010130	THz 22,20
03.7752-0717.4	<b>03.2122-0264.3</b>	010129	THz 22,20	03.7752-3405.4	<b>03.2122-0282.3</b>	010130	THz 22,20
03.7752-0718.4	<b>03.2122-0264.3</b>	010129	THz 22,20	03.7752-3501.4	<b>03.2122-0264.3</b>	010129	THz 22,20
03.7752-0722.4	<b>03.2122-0264.3</b>	010129	THz 22,20	03.7752-3502.4	<b>03.2122-0282.3</b>	010130	THz 22,20
03.7752-0808.4	<b>03.2122-0264.3</b>	010129	THz 22,20	03.7752-3510.4	<b>03.2122-0282.3</b>	010130	THz 22,20
03.7752-0809.4	<b>03.2122-0264.3</b>	010129	THz 22,20	03.7752-4302.4	<b>03.2122-1042.3</b> <b>03.7750-4302.4</b>	010137 300076	THz 22,20 9"
03.7752-0810.4	<b>03.2122-0282.3</b>	010130	THz 22,20	03.7752-4701.4	<b>03.2120-2031.3</b>	010106	THz 20,64
03.7752-0813.4	<b>03.2122-0264.3</b>	010129	THz 22,20	03.7752-4901.4	<b>03.2122-1042.3</b> <b>03.7750-4902.4</b>	010137 300079	THz 22,20 9"
03.7752-0814.4	<b>03.2122-0264.3</b>	010129	THz 22,20	03.7752-6102.4	<b>03.2122-1042.3</b>	010137	THz 22,20
03.7752-0815.4	<b>03.2122-0264.3</b>	010129	THz 22,20	03.7752-6104.4	<b>03.2122-1042.3</b>	010137	THz 22,20
03.7752-0816.4	<b>03.2122-0264.3</b>	010129	THz 22,20	03.7752-7401.4	<b>03.2122-1042.3</b>	010137	THz 22,20
03.7752-0819.4	<b>03.2122-0264.3</b>	010129	THz 22,20	03.7757-0101.4	<b>03.2023-0230.3</b>	010019	THz 23,81/19,05
03.7752-0901.4	<b>03.2122-1042.3</b> <b>03.7750-4302.4</b>	010137 300076	THz 22,20 9"	03.7757-0102.4	<b>03.2023-0825.3</b>	010028	THz 23,81/19,05
03.7752-0902.4	<b>03.2120-3943.3</b> <b>03.7750-4302.4</b>	010532 300076	THz 20,64 9"	03.7757-0201.4	<b>03.2025-0211.3</b>	010034	THz 25,40/19,05
				03.7757-0203.4	<b>03.7750-0302.4</b>	300071	9"

# Bremsgeräte komplett

Booster units complete - Servofreni completi -  
Servo-freins complets - Servofreno completo

● Die Nr. befindet sich auf dem im Fahrzeug eingebautem Aggregat.  
the number is on the unit build in the car  
il numero si trova sull'aggregato montato nella macchina  
le numéro se trouve sur la pièce montée dans le véhicule  
el n° se encuentra en el equipo montado en el vehículo



03.7757-0204.4	<b>03.7750-0302.4</b>	300071	9"
03.7757-0314.4	<b>03.2023-0642.3</b>	010026	THz 23,81/20,64
03.7757-0319.4	<b>03.2023-0642.3</b>	010026	THz 23,81/20,64
03.7757-0321.4	<b>03.2023-0642.3</b>	010026	THz 23,81/20,64
03.7757-0324.4	<b>03.2023-0642.3</b>	010026	THz 23,81/20,64
03.7762-0101.4	<b>03.2123-8311.3</b> <b>03.7760-0902.4</b>	010192 300088	THz 23,81 10"
03.7762-0102.4	<b>03.2122-6911.3</b> <b>03.7760-0902.4</b>	010153 300088	THz 22,20 10"
03.7762-0103.4	<b>03.2122-6911.3</b> <b>03.7760-0902.4</b>	010153 300088	THz 22,20 10"
03.7762-0104.4	<b>03.7760-0902.4</b>	300088	10"
03.7762-0108.4	<b>03.2120-2082.3</b> <b>03.7760-0902.4</b>	010107 300088	THz 20,64 10"
03.7762-0110.4	<b>03.2120-1802.3</b> <b>03.7760-0902.4</b>	010099 300088	THz 20,64 10"
03.7762-0112.4	<b>03.2120-1802.3</b> <b>03.7760-0902.4</b>	010099 300088	THz 20,64 10"
03.7762-0114.4	<b>03.2020-0402.3</b> <b>03.7760-0902.4</b>	010001 300088	THz 20,64/19,05 10"
03.7762-0115.4	<b>03.2120-2082.3</b> <b>03.7760-0902.4</b>	010107 300088	THz 20,64 10"
03.7762-0116.4	<b>03.2123-8311.3</b> <b>03.7760-0902.4</b>	010192 300088	THz 23,81 10"
03.7762-0117.4	<b>03.7760-0902.4</b>	300088	10"
03.7762-0118.4	<b>03.2123-8311.3</b> <b>03.7760-0902.4</b>	010192 300088	THz 23,81 10"
03.7762-0119.4	<b>03.2120-2082.3</b> <b>03.7760-0902.4</b>	010107 300088	THz 20,64 10"
03.7762-0120.4	<b>03.2120-2082.3</b> <b>03.7760-0902.4</b>	010107 300088	THz 20,64 10"
03.7762-0121.4	<b>03.2120-1802.3</b> <b>03.7760-0902.4</b>	010099 300088	THz 20,64 10"
03.7762-0122.4	<b>03.2120-1802.3</b> <b>03.7760-0902.4</b>	010099 300088	THz 20,64 10"
03.7762-0123.4	<b>03.2020-0402.3</b> <b>03.7760-0902.4</b>	010001 300088	THz 20,64/19,05 10"
03.7762-0124.4	<b>03.7760-0902.4</b>	300088	10"

03.7762-0201.4	<b>03.2020-0402.3</b> <b>03.7760-0902.4</b>	010001 300088	THz 20,64/19,05 10"
03.7762-0202.4	<b>03.2120-1802.3</b> <b>03.7760-0902.4</b>	010099 300088	THz 20,64 10"
03.7762-0204.4	<b>03.2120-2082.3</b> <b>03.7760-0902.4</b>	010107 300088	THz 20,64 10"
03.7762-0301.4	<b>03.2023-0825.3</b> <b>03.7760-2702.4</b>	010028 300090	THz 23,81/19,05 10"
03.7762-0302.4	<b>03.2023-0825.3</b> <b>03.7760-2702.4</b>	010028 300090	THz 23,81/19,05 10"
03.7762-0312.4	<b>03.2023-0825.3</b> <b>03.7760-2702.4</b>	010028 300090	THz 23,81/19,05 10"
03.7762-0313.4	<b>03.2023-0825.3</b> <b>03.7760-2702.4</b>	010028 300090	THz 23,81/19,05 10"
03.7762-0401.4	<b>03.2023-0262.3</b> <b>03.7760-0402.4</b>	010020 300087	THz 23,81/20,64 10"
03.7762-0402.4	<b>03.7760-0402.4</b>	300087	10"
03.7762-0501.4	<b>03.2120-1802.3</b> <b>03.7760-0902.4</b>	010099 300088	THz 20,64 10"
03.7762-0502.4	<b>03.2120-2082.3</b> <b>03.7760-0902.4</b>	010107 300088	THz 20,64 10"
03.7762-0503.4	<b>03.7760-0902.4</b>	300088	10"
03.7762-0504.4	<b>03.2120-1802.3</b> <b>03.7760-0902.4</b>	010099 300088	THz 20,64 10"
03.7762-0505.4	<b>03.2120-2082.3</b> <b>03.7760-0902.4</b>	010107 300088	THz 20,64 10"
03.7762-0506.4	<b>03.7760-0902.4</b>	300088	10"
03.7762-0701.4	<b>03.2022-1201.3</b> <b>03.7760-0902.4</b>	010009 300088	THz 22,20/17,46 10"
03.7762-0702.4	<b>03.2022-1201.3</b> <b>03.7760-0902.4</b>	010009 300088	THz 22,20/17,46 10"
03.7762-0703.4	<b>03.2022-1201.3</b> <b>03.7760-0902.4</b>	010009 300088	THz 22,20/17,46 10"
03.7762-0704.4	<b>03.2022-1201.3</b> <b>03.7760-0902.4</b>	010009 300088	THz 22,20/17,46 10"
03.7762-0705.4	<b>03.2022-1201.3</b> <b>03.7760-0902.4</b>	010009 300088	THz 22,20/17,46 10"
03.7762-0801.4	<b>03.2022-1201.3</b> <b>03.7760-0902.4</b>	010009 300088	THz 22,20/17,46 10"

# Bremsgeräte komplett

## Booster units complete - Servofreni completi - Servo-freins complets - Servofreno completo

● Die Nr. befindet sich auf dem im Fahrzeug eingebautem Aggregat.  
the number is on the unit build in the car  
il numero si trova sull'aggregato montato nella macchina  
le numéro se trouve sur la pièce montée dans le véhicule  
el n° se encuentra en el equipo montado en el vehículo



03.7762-0802.4	<b>03.2022-1201.3</b>	010009	THz 22,20/17,46
	<b>03.7760-0902.4</b>	300088	10"
03.7762-0901.4	<b>03.2022-1201.3</b>	010009	THz 22,20/17,46
	<b>03.7760-0902.4</b>	300088	10"
03.7762-0902.4	<b>03.2022-1201.3</b>	010009	THz 22,20/17,46
	<b>03.7760-0902.4</b>	300088	10"
03.7762-1001.4	<b>03.2125-3011.3</b>	010211	THz 25,40
03.7762-1002.4	<b>03.2125-3011.3</b>	010211	THz 25,40
03.7762-1203.4	<b>03.2125-3011.3</b>	010211	THz 25,40
03.7762-1204.4	<b>03.2125-3011.3</b>	010211	THz 25,40
03.7762-1801.4	<b>03.2125-3011.3</b>	010211	THz 25,40
03.7762-1802.4	<b>03.2125-3011.3</b>	010211	THz 25,40
03.7762-1901.4	<b>03.2125-3011.3</b>	010211	THz 25,40
03.7762-1902.4	<b>03.2125-3011.3</b>	010211	THz 25,40
03.7762-2001.4	<b>03.2125-3011.3</b>	010211	THz 25,40
03.7762-2002.4	<b>03.2125-3011.3</b>	010211	THz 25,40
03.7762-2701.4	<b>03.2023-0825.3</b>	010028	THz 23,81/19,05
	<b>03.7760-2702.4</b>	300090	10"
03.7767-0101.4	<b>03.2026-0462.3</b>	010728	THz 26,99/25,40
03.7767-0102.4	<b>03.2026-0462.3</b>	010728	THz 26,99/25,40
03.7767-0103.4	<b>03.2026-0512.3</b>	010038	THz 26,99/25,40
03.7767-0104.4	<b>03.2026-0512.3</b>	010038	THz 26,99/25,40
03.7767-0105.4	<b>03.2026-0462.3</b>	010728	THz 26,99/25,40
03.7767-0107.4	<b>03.2026-0462.3</b>	010728	THz 26,99/25,40
10.6350-2002.4	<b>10.6123-0522.3</b>	010633	THz 23,81
10.6352-0601.4	<b>10.6350-0603.4</b>	300159	9"
10.6352-0602.4	<b>10.6350-0603.4</b>	300159	9"
10.6352-0603.4	<b>10.6350-0603.4</b>	300159	9"
10.6352-0604.4	<b>10.6350-0603.4</b>	300159	9"



A large rectangular area containing 30 horizontal lines, intended for writing. The lines are evenly spaced and extend across most of the page width.





Ⓓ **Reparatursätze**







Ⓔ**N** **Repair kits**

Ⓕ**R** **Nécessaires de réparation**

Ⓖ**S** **Juegos de reparación**

# Reparatursätze







Repair kits - Corredi riparazione - Nécessaires de réparation - Juegos de reparación

					
03.2022-0702.3 010007	<b>03.0370-7522.2</b> 057522	THz Reparatursatz	11.3361-8504.2 220017	<b>11.0101-5402.2</b> 260009 <b>11.0441-3602.2</b> 250008 <b>11.8116-0066.1</b> 390577 <b>11.8171-0008.1</b> 990049	Hülsensatz Dichtungssatz Haltefeder Führungsbolzen
03.2122-2202.3 010140	<b>03.0370-3922.2</b> 053922	THz Reparatursatz	11.3361-8505.2 220024	<b>11.0101-5402.2</b> 260009 <b>11.0441-3602.2</b> 250008 <b>11.8171-0008.1</b> 990049	Hülsensatz Dichtungssatz Führungsbolzen
03.2122-4902.3 010144	<b>03.0370-3922.2</b> 053922	THz Reparatursatz	11.3361-8506.2 220025	<b>11.0101-5402.2</b> 260009 <b>11.0441-3602.2</b> 250008 <b>11.8171-0008.1</b> 990049	Hülsensatz Dichtungssatz Führungsbolzen
03.2419-3307.3 030014	<b>03.0350-1906.2</b> 071906	Gz Reparatursatz	11.3361-9975.2 220281	<b>11.0101-5407.2</b> 260011 <b>11.0441-3602.2</b> 250008 <b>11.8116-0073.1</b> 390498 <b>11.8171-0008.1</b> 990049	Hülsensatz Dichtungssatz Haltefeder Führungsbolzen
03.2419-7800.3 030016	<b>03.0350-1919.2</b> 071919	Gz Reparatursatz	11.3361-9976.2 220282	<b>11.0101-5407.2</b> 260011 <b>11.0441-3602.2</b> 250008 <b>11.8116-0073.1</b> 390498 <b>11.8171-0008.1</b> 990049	Hülsensatz Dichtungssatz Haltefeder Führungsbolzen
03.2419-9000.3 030025	<b>03.0350-1919.2</b> 071919	Gz Reparatursatz	11.3381-8501.2 220018	<b>11.0101-5402.2</b> 260009 <b>11.0441-3802.2</b> 250009 <b>11.8116-0066.1</b> 390577 <b>11.8171-0008.1</b> 990049	Hülsensatz Dichtungssatz Haltefeder Führungsbolzen
03.2515-1101.3 040001	<b>03.0450-1502.2</b> 081502	Nz Reparatursatz	11.3381-8502.2 220019	<b>11.0101-5402.2</b> 260009 <b>11.0441-3802.2</b> 250009 <b>11.8116-0066.1</b> 390577 <b>11.8171-0008.1</b> 990049	Hülsensatz Dichtungssatz Haltefeder Führungsbolzen
03.2520-1201.3 040011	<b>03.0450-2006.2</b> 082006	Nz Reparatursatz	11.3381-8503.2 220020	<b>11.0101-5402.2</b> 260009 <b>11.0441-3803.2</b> 250010 <b>11.8116-0066.1</b> 390577 <b>11.8171-0008.1</b> 990049	Hülsensatz Dichtungssatz Haltefeder Führungsbolzen
03.2523-0811.3 040019	<b>03.0450-2311.2</b> 082311	Nz Reparatursatz	11.3381-8504.2 220021	<b>11.0101-5402.2</b> 260009 <b>11.0441-3803.2</b> 250010 <b>11.8116-0066.1</b> 390577 <b>11.8171-0008.1</b> 990049	Hülsensatz Dichtungssatz Haltefeder Führungsbolzen
03.2525-1802.3 040025	<b>03.0450-2509.2</b> 082509	Nz Reparatursatz	11.3401-0055.2 220519	<b>11.0101-5407.2</b> 260011 <b>11.8116-0143.1</b> 390513 <b>11.8171-0008.1</b> 990049	Hülsensatz Haltefeder Führungsbolzen
03.2525-2602.3 040029	<b>03.0450-2510.2</b> 082510	Nz Reparatursatz	11.3401-0056.2 220520	<b>11.0101-5407.2</b> 260011 <b>11.8116-0143.1</b> 390513 <b>11.8171-0008.1</b> 990049	Hülsensatz Haltefeder Führungsbolzen
03.2525-2711.3 040030	<b>03.0450-2510.2</b> 082510	Nz Reparatursatz	11.3401-8503.2 220030	<b>11.0101-5402.2</b> 260009 <b>11.0441-4002.2</b> 250011 <b>11.8116-0066.1</b> 390577 <b>11.8171-0008.1</b> 990049	Hülsensatz Dichtungssatz Haltefeder Führungsbolzen
03.2538-0104.3 040035	<b>03.0450-3801.2</b> 083801	Nz Reparatursatz	11.3401-8504.2 220031	<b>11.0101-5402.2</b> 260009 <b>11.0441-4002.2</b> 250011 <b>11.8116-0066.1</b> 390577 <b>11.8171-0008.1</b> 990049	Hülsensatz Dichtungssatz Haltefeder Führungsbolzen
03.2728-2101.3 020008	<b>03.0402-1128.2</b> 060027	Rz Reparatursatz	11.3451-8501.2 220389	<b>11.0101-5407.2</b> 260011 <b>11.0101-5409.2</b> 260035 <b>11.8171-0008.1</b> 990049	Hülsensatz Hülsensatz Führungsbolzen
03.2728-2201.3 020009	<b>03.0402-1128.2</b> 060027	Rz Reparatursatz	11.3451-8502.2 220390	<b>11.0101-5407.2</b> 260011 <b>11.0101-5409.2</b> 260035 <b>11.8171-0008.1</b> 990049	Hülsensatz Hülsensatz Führungsbolzen
03.3128-1401.3 010295	<b>03.0370-1828.2</b> 051828	Hz Reparatursatz			
03.3138-2001.3 010310	<b>03.0370-1038.2</b> 051038 <b>03.0370-9998.2</b> 059998	Hz Reparatursatz Hz Rep. Satz,-Kolben			
03.3219-0102.3 020036	<b>03.0470-2619.2</b> 060051	Rz Dichtungssatz			
03.3219-0411.3 020038	<b>03.0470-2619.2</b> 060051	Rz Dichtungssatz			
03.3231-3401.3 020120	<b>03.0401-2031.2</b> 052031	Rz Reparatursatz			
03.3241-1801.3 020130	<b>03.0403-0341.2</b> 060031	Rz Reparatursatz			
11.3331-8501.2 220004	<b>11.0101-5402.2</b> 260009 <b>11.0441-3302.2</b> 250004 <b>11.8116-0015.1</b> 390492 <b>11.8171-0008.1</b> 990049	Hülsensatz Dichtungssatz Haltefeder Führungsbolzen			
11.3331-8502.2 220005	<b>11.0101-5402.2</b> 260009 <b>11.0441-3302.2</b> 250004 <b>11.8116-0015.1</b> 390492 <b>11.8171-0008.1</b> 990049	Hülsensatz Dichtungssatz Haltefeder Führungsbolzen			
11.3334-8001.2 220006	<b>11.0101-5407.2</b> 260011 <b>11.0441-3302.2</b> 250004 <b>11.8116-0047.1</b> 390494 <b>11.8171-0008.1</b> 990049	Hülsensatz Dichtungssatz Haltefeder Führungsbolzen			
11.3334-8002.2 220007	<b>11.0101-5407.2</b> 260011 <b>11.0441-3302.2</b> 250004 <b>11.8116-0047.1</b> 390494 <b>11.8171-0008.1</b> 990049	Hülsensatz Dichtungssatz Haltefeder Führungsbolzen			
11.3361-8503.2 220016	<b>11.0101-5402.2</b> 260009 <b>11.0441-3602.2</b> 250008 <b>11.8116-0066.1</b> 390577 <b>11.8171-0008.1</b> 990049	Hülsensatz Dichtungssatz Haltefeder Führungsbolzen			









# Reparatursätze

Repair kits - Corredi riparazione - Nécessaires de réparation - Juegos de reparación

  		  	
11.3481-8511.2 220337	<b>11.0101-5407.2</b> 260011 Hülsensatz <b>11.0441-4805.2</b> 250020 Dichtungssatz <b>11.8171-0008.1</b> 990049 Führungsbolzen	11.3541-8523.2 220115	<b>11.0101-5409.2</b> 260035 Hülsensatz <b>11.8116-0143.1</b> 390513 Haltefeder <b>11.8170-0306.1</b> 260102 Halter <b>11.8171-0008.1</b> 990049 Führungsbolzen
11.3481-8512.2 220338	<b>11.0101-5407.2</b> 260011 Hülsensatz <b>11.0441-4805.2</b> 250020 Dichtungssatz <b>11.8171-0008.1</b> 990049 Führungsbolzen	11.3541-8524.2 220116	<b>11.0101-5409.2</b> 260035 Hülsensatz <b>11.8116-0143.1</b> 390513 Haltefeder <b>11.8170-0306.1</b> 260102 Halter <b>11.8171-0008.1</b> 990049 Führungsbolzen
11.3481-8513.2 220335	<b>11.0101-5407.2</b> 260011 Hülsensatz <b>11.0441-4805.2</b> 250020 Dichtungssatz <b>11.8171-0008.1</b> 990049 Führungsbolzen	11.3541-8529.2 220341	<b>11.0101-5407.2</b> 260011 Hülsensatz <b>11.0441-5402.2</b> 250028 Dichtungssatz <b>11.8171-0008.1</b> 990049 Führungsbolzen
11.3481-8514.2 220336	<b>11.0101-5407.2</b> 260011 Hülsensatz <b>11.0441-4805.2</b> 250020 Dichtungssatz <b>11.8171-0008.1</b> 990049 Führungsbolzen	11.3541-8530.2 220342	<b>11.0101-5407.2</b> 260011 Hülsensatz <b>11.0441-5402.2</b> 250028 Dichtungssatz <b>11.8171-0008.1</b> 990049 Führungsbolzen
11.3481-8515.2 220365	<b>11.0101-5407.2</b> 260011 Hülsensatz <b>11.8171-0008.1</b> 990049 Führungsbolzen	11.3541-8531.2 220367	<b>11.0101-5407.2</b> 260011 Hülsensatz <b>11.8171-0008.1</b> 990049 Führungsbolzen
11.3481-8516.2 220366	<b>11.0101-5407.2</b> 260011 Hülsensatz <b>11.8171-0008.1</b> 990049 Führungsbolzen	11.3541-8532.2 220368	<b>11.0101-5407.2</b> 260011 Hülsensatz <b>11.8171-0008.1</b> 990049 Führungsbolzen
11.3481-9833.2 220561	<b>11.0101-5407.2</b> 260011 Hülsensatz <b>11.0441-4811.2</b> 250024 Dichtungssatz <b>11.8116-0129.1</b> 390591 Haltefeder <b>11.8171-0008.1</b> 990049 Führungsbolzen	11.3571-8008.2 220118	<b>11.0101-5407.2</b> 260011 Hülsensatz <b>11.0441-5702.2</b> 250033 Dichtungssatz <b>11.8116-0073.1</b> 390498 Haltefeder <b>11.8171-0008.1</b> 990049 Führungsbolzen
11.3481-9834.2 220562	<b>11.0101-5407.2</b> 260011 Hülsensatz <b>11.0441-4811.2</b> 250024 Dichtungssatz <b>11.8116-0129.1</b> 390591 Haltefeder <b>11.8171-0008.1</b> 990049 Führungsbolzen	11.3571-8506.2 220126	<b>11.0101-5409.2</b> 260035 Hülsensatz <b>11.0441-5704.2</b> 250034 Dichtungssatz <b>11.8116-0143.1</b> 390513 Haltefeder <b>11.8171-0008.1</b> 990049 Führungsbolzen
11.3521-8501.2 220391	<b>11.0101-5407.2</b> 260011 Hülsensatz <b>11.0101-5409.2</b> 260035 Hülsensatz <b>11.8171-0008.1</b> 990049 Führungsbolzen	11.3571-8508.2 220128	<b>11.0101-5409.2</b> 260035 Hülsensatz <b>11.0441-5704.2</b> 250034 Dichtungssatz <b>11.8116-0143.1</b> 390513 Haltefeder <b>11.8170-0306.1</b> 260102 Halter <b>11.8171-0008.1</b> 990049 Führungsbolzen
11.3521-8502.2 220392	<b>11.0101-5407.2</b> 260011 Hülsensatz <b>11.0101-5409.2</b> 260035 Hülsensatz <b>11.8171-0008.1</b> 990049 Führungsbolzen	11.3571-8509.2 220313	<b>11.0101-5407.2</b> 260011 Hülsensatz <b>11.8171-0008.1</b> 990049 Führungsbolzen
11.3541-8083.2 220241	<b>11.0101-5407.2</b> 260011 Hülsensatz <b>11.8171-0008.1</b> 990049 Führungsbolzen	11.3571-8510.2 220314	<b>11.0101-5407.2</b> 260011 Hülsensatz <b>11.8171-0008.1</b> 990049 Führungsbolzen
11.3541-8084.2 220242	<b>11.0101-5407.2</b> 260011 Hülsensatz <b>11.8171-0008.1</b> 990049 Führungsbolzen	11.3571-8511.2 220315	<b>11.0101-5407.2</b> 260011 Hülsensatz <b>11.8171-0008.1</b> 990049 Führungsbolzen
11.3541-8085.2 220287	<b>11.0101-5407.2</b> 260011 Hülsensatz <b>11.8116-0129.1</b> 390591 Haltefeder <b>11.8171-0008.1</b> 990049 Führungsbolzen	11.3571-8512.2 220316	<b>11.0101-5407.2</b> 260011 Hülsensatz <b>11.8171-0008.1</b> 990049 Führungsbolzen
11.3541-8091.2 220089	<b>11.0101-5407.2</b> 260011 Hülsensatz <b>11.0441-5402.2</b> 250028 Dichtungssatz <b>11.8171-0008.1</b> 990049 Führungsbolzen	11.3571-8517.2 220321	<b>11.0101-5409.2</b> 260035 Hülsensatz <b>11.0441-5704.2</b> 250034 Dichtungssatz <b>11.8116-0143.1</b> 390513 Haltefeder <b>11.8171-0008.1</b> 990049 Führungsbolzen
11.3541-8105.2 220339	<b>11.0101-5407.2</b> 260011 Hülsensatz <b>11.8171-0008.1</b> 990049 Führungsbolzen	11.3571-8518.2 220322	<b>11.0101-5409.2</b> 260035 Hülsensatz <b>11.0441-5704.2</b> 250034 Dichtungssatz <b>11.8116-0143.1</b> 390513 Haltefeder <b>11.8171-0008.1</b> 990049 Führungsbolzen
11.3541-8106.2 220340	<b>11.0101-5407.2</b> 260011 Hülsensatz <b>11.8171-0008.1</b> 990049 Führungsbolzen	11.3571-8521.2 220319	<b>11.0101-5409.2</b> 260035 Hülsensatz <b>11.0441-5704.2</b> 250034 Dichtungssatz <b>11.8116-0143.1</b> 390513 Haltefeder <b>11.8170-0306.1</b> 260102 Halter <b>11.8171-0008.1</b> 990049 Führungsbolzen
11.3541-8521.2 220113	<b>11.0101-5409.2</b> 260035 Hülsensatz <b>11.0441-5405.2</b> 250030 Dichtungssatz		
11.3541-8522.2 220114	<b>11.0101-5409.2</b> 260035 Hülsensatz <b>11.0441-5405.2</b> 250030 Dichtungssatz		







# Reparatursätze

Repair kits - Corredi riparazione - Nécessaires de réparation - Juegos de reparación

	 		 
11.3571-8522.2 220320	<b>11.0101-5409.2</b> 260035 Hülsensatz <b>11.0441-5704.2</b> 250034 Dichtungssatz <b>11.8116-0143.1</b> 390513 Haltefeder <b>11.8170-0306.1</b> 260102 Halter <b>11.8171-0008.1</b> 990049 Führungsbolzen	11.9347-7003.2 220565	<b>11.0101-5407.2</b> 260011 Hülsensatz <b>11.8171-0008.1</b> 990049 Führungsbolzen
11.3571-8526.2 220364	<b>11.0101-5407.2</b> 260011 Hülsensatz <b>11.0441-5704.2</b> 250034 Dichtungssatz <b>11.8171-0008.1</b> 990049 Führungsbolzen	11.9347-7004.2 220566	<b>11.0101-5407.2</b> 260011 Hülsensatz <b>11.8171-0008.1</b> 990049 Führungsbolzen
11.3601-8501.2 220145	<b>11.0101-5402.2</b> 260009 Hülsensatz <b>11.0441-6003.2</b> 250037 Dichtungssatz <b>11.8116-0083.1</b> 390501 Haltefeder <b>11.8171-0008.1</b> 990049 Führungsbolzen	11.9347-7006.2 220644	<b>11.0101-5407.2</b> 260011 Hülsensatz <b>11.8171-0008.1</b> 990049 Führungsbolzen
11.3601-8502.2 220146	<b>11.0101-5402.2</b> 260009 Hülsensatz <b>11.0441-6003.2</b> 250037 Dichtungssatz <b>11.8116-0083.1</b> 390501 Haltefeder <b>11.8171-0008.1</b> 990049 Führungsbolzen	11.9367-7001.2 220733	<b>11.0101-5407.2</b> 260011 Hülsensatz <b>11.8171-0008.1</b> 990049 Führungsbolzen
11.3601-8503.2 220147	<b>11.0101-5402.2</b> 260009 Hülsensatz <b>11.0441-6003.2</b> 250037 Dichtungssatz <b>11.8116-0083.1</b> 390501 Haltefeder <b>11.8171-0008.1</b> 990049 Führungsbolzen	11.9367-7002.2 220734	<b>11.0101-5407.2</b> 260011 Hülsensatz <b>11.8171-0008.1</b> 990049 Führungsbolzen
11.3601-8504.2 220148	<b>11.0101-5402.2</b> 260009 Hülsensatz <b>11.0441-6003.2</b> 250037 Dichtungssatz <b>11.8116-0083.1</b> 390501 Haltefeder <b>11.8171-0008.1</b> 990049 Führungsbolzen	11.9381-9957.2 220661	<b>11.0101-5407.2</b> 260011 Hülsensatz <b>11.8116-0143.1</b> 390513 Haltefeder <b>11.8171-0008.1</b> 990049 Führungsbolzen
11.3601-8505.2 220149	<b>11.0101-5402.2</b> 260009 Hülsensatz <b>11.0441-6003.2</b> 250037 Dichtungssatz <b>11.8116-0083.1</b> 390501 Haltefeder <b>11.8171-0008.1</b> 990049 Führungsbolzen	11.9381-9958.2 220662	<b>11.0101-5407.2</b> 260011 Hülsensatz <b>11.8116-0143.1</b> 390513 Haltefeder <b>11.8171-0008.1</b> 990049 Führungsbolzen
11.3601-8506.2 220150	<b>11.0101-5402.2</b> 260009 Hülsensatz <b>11.0441-6003.2</b> 250037 Dichtungssatz <b>11.8116-0083.1</b> 390501 Haltefeder <b>11.8171-0008.1</b> 990049 Führungsbolzen	11.9381-9959.2 220433	<b>11.0101-5402.2</b> 260009 Hülsensatz <b>11.0441-3803.2</b> 250010 Dichtungssatz <b>11.8116-0066.1</b> 390577 Haltefeder <b>11.8171-0008.1</b> 990049 Führungsbolzen
11.3601-8506.2 220150	<b>11.0101-5402.2</b> 260009 Hülsensatz <b>11.0441-6003.2</b> 250037 Dichtungssatz <b>11.8116-0083.1</b> 390501 Haltefeder <b>11.8171-0008.1</b> 990049 Führungsbolzen	11.9381-9960.2 220434	<b>11.0101-5402.2</b> 260009 Hülsensatz <b>11.0441-3803.2</b> 250010 Dichtungssatz <b>11.8116-0066.1</b> 390577 Haltefeder <b>11.8171-0008.1</b> 990049 Führungsbolzen
11.3601-8511.2 220155	<b>11.0101-5402.2</b> 260009 Hülsensatz <b>11.0441-6003.2</b> 250037 Dichtungssatz <b>11.8171-0008.1</b> 990049 Führungsbolzen	11.9381-9961.2 220435	<b>11.0101-5402.2</b> 260009 Hülsensatz <b>11.0441-3803.2</b> 250010 Dichtungssatz <b>11.8116-0066.1</b> 390577 Haltefeder <b>11.8171-0008.1</b> 990049 Führungsbolzen
11.3601-8512.2 220156	<b>11.0101-5402.2</b> 260009 Hülsensatz <b>11.0441-6003.2</b> 250037 Dichtungssatz <b>11.8171-0008.1</b> 990049 Führungsbolzen	11.9381-9962.2 220436	<b>11.0101-5402.2</b> 260009 Hülsensatz <b>11.0441-3803.2</b> 250010 Dichtungssatz <b>11.8116-0066.1</b> 390577 Haltefeder <b>11.8171-0008.1</b> 990049 Führungsbolzen
11.3601-8513.2 220393	<b>11.0441-6007.2</b> 250146 Dichtungssatz <b>11.8171-0008.1</b> 990049 Führungsbolzen	11.9387-7001.2 220397	<b>11.0101-5407.2</b> 260011 Hülsensatz <b>11.8171-0008.1</b> 990049 Führungsbolzen
11.3601-8514.2 220394	<b>11.0441-6007.2</b> 250146 Dichtungssatz <b>11.8171-0008.1</b> 990049 Führungsbolzen	11.9387-7002.2 220398	<b>11.0101-5407.2</b> 260011 Hülsensatz <b>11.8171-0008.1</b> 990049 Führungsbolzen
11.3601-8515.2 220323	<b>11.0101-5402.2</b> 260009 Hülsensatz <b>11.0441-6003.2</b> 250037 Dichtungssatz <b>11.8116-0083.1</b> 390501 Haltefeder <b>11.8171-0008.1</b> 990049 Führungsbolzen	11.9387-7003.2 220567	<b>11.0101-5407.2</b> 260011 Hülsensatz <b>11.8171-0008.1</b> 990049 Führungsbolzen
11.3601-8516.2 220324	<b>11.0101-5402.2</b> 260009 Hülsensatz <b>11.0441-6003.2</b> 250037 Dichtungssatz <b>11.8116-0083.1</b> 390501 Haltefeder <b>11.8171-0008.1</b> 990049 Führungsbolzen	11.9387-7004.2 220568	<b>11.0101-5407.2</b> 260011 Hülsensatz <b>11.8171-0008.1</b> 990049 Führungsbolzen
11.9347-7001.2 220473	<b>11.0101-5407.2</b> 260011 Hülsensatz <b>11.8171-0008.1</b> 990049 Führungsbolzen	11.9387-7005.2 220569	<b>11.0101-5407.2</b> 260011 Hülsensatz <b>11.8171-0008.1</b> 990049 Führungsbolzen
11.9347-7002.2 220474	<b>11.0101-5407.2</b> 260011 Hülsensatz <b>11.8171-0008.1</b> 990049 Führungsbolzen	11.9387-7006.2 220570	<b>11.0101-5407.2</b> 260011 Hülsensatz <b>11.8171-0008.1</b> 990049 Führungsbolzen
11.9347-7003.2 220473	<b>11.0101-5407.2</b> 260011 Hülsensatz <b>11.8171-0008.1</b> 990049 Führungsbolzen	11.9387-7015.2 220627	<b>11.0101-5407.2</b> 260011 Hülsensatz <b>11.8171-0008.1</b> 990049 Führungsbolzen
11.9347-7002.2 220474	<b>11.0101-5407.2</b> 260011 Hülsensatz <b>11.8171-0008.1</b> 990049 Führungsbolzen	11.9387-7016.2 220628	<b>11.0101-5407.2</b> 260011 Hülsensatz <b>11.8171-0008.1</b> 990049 Führungsbolzen

# Reparatursätze







Repair kits - Corredi riparazione - Nécessaires de réparation - Juegos de reparación

  			  		
11.9387-7021.2 220629	<b>11.0101-5407.2</b> 260011 Hülsensatz <b>11.8171-0008.1</b> 990049 Führungsbolzen		11.9421-9979.2 220497	<b>11.0101-5407.2</b> 260011 Hülsensatz <b>11.8171-0008.1</b> 990049 Führungsbolzen	
11.9387-7022.2 220630	<b>11.0101-5407.2</b> 260011 Hülsensatz <b>11.8171-0008.1</b> 990049 Führungsbolzen		11.9421-9980.2 220498	<b>11.0101-5407.2</b> 260011 Hülsensatz <b>11.8171-0008.1</b> 990049 Führungsbolzen	
11.9401-9951.2 220463	<b>11.0101-5402.2</b> 260009 Hülsensatz <b>11.8171-0008.1</b> 990049 Führungsbolzen		11.9426-9957.2 220895	<b>11.0101-5402.2</b> 260009 Hülsensatz <b>11.8171-0008.1</b> 990049 Führungsbolzen	
11.9401-9952.2 220464	<b>11.0101-5402.2</b> 260009 Hülsensatz <b>11.8171-0008.1</b> 990049 Führungsbolzen		11.9426-9958.2 220896	<b>11.0101-5402.2</b> 260009 Hülsensatz <b>11.8171-0008.1</b> 990049 Führungsbolzen	
11.9401-9959.2 220833	<b>11.0101-5402.2</b> 260009 Hülsensatz <b>11.0441-4002.2</b> 250011 Dichtungssatz <b>11.8171-0008.1</b> 990049 Führungsbolzen		11.9426-9959.2 220801	<b>11.0101-5407.2</b> 260011 Hülsensatz <b>11.8171-0008.1</b> 990049 Führungsbolzen	
11.9401-9960.2 220834	<b>11.0101-5402.2</b> 260009 Hülsensatz <b>11.0441-4002.2</b> 250011 Dichtungssatz <b>11.8171-0008.1</b> 990049 Führungsbolzen		11.9426-9960.2 220802	<b>11.0101-5407.2</b> 260011 Hülsensatz <b>11.8171-0008.1</b> 990049 Führungsbolzen	
11.9401-9977.2 220439	<b>11.0101-5402.2</b> 260009 Hülsensatz <b>11.8171-0008.1</b> 990049 Führungsbolzen		11.9426-9977.2 220897	<b>11.0101-5402.2</b> 260009 Hülsensatz <b>11.8171-0008.1</b> 990049 Führungsbolzen	
11.9401-9978.2 220440	<b>11.0101-5402.2</b> 260009 Hülsensatz <b>11.8171-0008.1</b> 990049 Führungsbolzen		11.9441-9949.2 220803	<b>11.0101-5409.2</b> 260035 Hülsensatz <b>11.8171-0008.1</b> 990049 Führungsbolzen	
11.9406-9993.2 220413	<b>11.0101-5402.2</b> 260009 Hülsensatz <b>11.8171-0008.1</b> 990049 Führungsbolzen		11.9441-9950.2 220804	<b>11.0101-5409.2</b> 260035 Hülsensatz <b>11.8171-0008.1</b> 990049 Führungsbolzen	
11.9406-9994.2 220414	<b>11.0101-5402.2</b> 260009 Hülsensatz <b>11.8171-0008.1</b> 990049 Führungsbolzen		11.9441-9957.2 220827	<b>11.0101-5402.2</b> 260009 Hülsensatz <b>11.8171-0008.1</b> 990049 Führungsbolzen	
11.9406-9995.2 220415	<b>11.0101-5402.2</b> 260009 Hülsensatz <b>11.8171-0008.1</b> 990049 Führungsbolzen		11.9441-9958.2 220828	<b>11.0101-5402.2</b> 260009 Hülsensatz <b>11.8171-0008.1</b> 990049 Führungsbolzen	
11.9406-9996.2 220416	<b>11.0101-5402.2</b> 260009 Hülsensatz <b>11.8171-0008.1</b> 990049 Führungsbolzen		11.9441-9967.2 220807	<b>11.0101-5409.2</b> 260035 Hülsensatz <b>11.8171-0008.1</b> 990049 Führungsbolzen	
11.9407-7001.2 220573	<b>11.0101-5407.2</b> 260011 Hülsensatz <b>11.8171-0008.1</b> 990049 Führungsbolzen		11.9441-9968.2 220808	<b>11.0101-5409.2</b> 260035 Hülsensatz <b>11.8171-0008.1</b> 990049 Führungsbolzen	
11.9407-7002.2 220574	<b>11.0101-5407.2</b> 260011 Hülsensatz <b>11.8171-0008.1</b> 990049 Führungsbolzen		11.9461-9981.2 220899	<b>11.0101-5402.2</b> 260009 Hülsensatz <b>11.8171-0008.1</b> 990049 Führungsbolzen	
11.9407-7005.2 220637	<b>11.0101-5407.2</b> 260011 Hülsensatz <b>11.8171-0008.1</b> 990049 Führungsbolzen		11.9461-9982.2 220900	<b>11.0101-5402.2</b> 260009 Hülsensatz <b>11.8171-0008.1</b> 990049 Führungsbolzen	
11.9407-7006.2 220638	<b>11.0101-5407.2</b> 260011 Hülsensatz <b>11.8171-0008.1</b> 990049 Führungsbolzen		11.9481-9811.2 220445	<b>11.0101-5407.2</b> 260011 Hülsensatz <b>11.8171-0008.1</b> 990049 Führungsbolzen	
11.9421-9911.2 220825	<b>11.0101-5402.2</b> 260009 Hülsensatz <b>11.8116-0066.1</b> 390577 Haltefeder <b>11.8171-0008.1</b> 990049 Führungsbolzen		11.9481-9812.2 220446	<b>11.0101-5407.2</b> 260011 Hülsensatz <b>11.8171-0008.1</b> 990049 Führungsbolzen	
11.9421-9912.2 220826	<b>11.0101-5402.2</b> 260009 Hülsensatz <b>11.8116-0066.1</b> 390577 Haltefeder <b>11.8171-0008.1</b> 990049 Führungsbolzen		11.9481-9871.2 220681	<b>11.0101-5407.2</b> 260011 Hülsensatz <b>11.0441-4811.2</b> 250024 Dichtungssatz <b>11.8116-0129.1</b> 390591 Haltefeder <b>11.8171-0008.1</b> 990049 Führungsbolzen	
11.9421-9963.2 220465	<b>11.0101-5402.2</b> 260009 Hülsensatz <b>11.8171-0008.1</b> 990049 Führungsbolzen		11.9481-9872.2 220682	<b>11.0101-5407.2</b> 260011 Hülsensatz <b>11.0441-4811.2</b> 250024 Dichtungssatz <b>11.8116-0129.1</b> 390591 Haltefeder <b>11.8171-0008.1</b> 990049 Führungsbolzen	
11.9421-9964.2 220466	<b>11.0101-5402.2</b> 260009 Hülsensatz <b>11.8171-0008.1</b> 990049 Führungsbolzen		11.9521-7001.2 220499	<b>11.0101-5407.2</b> 260011 Hülsensatz <b>11.8171-0008.1</b> 990049 Führungsbolzen	
11.9421-9965.2 220799	<b>11.0101-5407.2</b> 260011 Hülsensatz <b>11.8171-0008.1</b> 990049 Führungsbolzen		11.9521-7002.2 220500	<b>11.0101-5407.2</b> 260011 Hülsensatz <b>11.8171-0008.1</b> 990049 Führungsbolzen	
11.9421-9966.2 220800	<b>11.0101-5407.2</b> 260011 Hülsensatz <b>11.8171-0008.1</b> 990049 Führungsbolzen		11.9541-9543.2 220645	<b>11.0101-5407.2</b> 260011 Hülsensatz <b>11.8171-0008.1</b> 990049 Führungsbolzen	









# Reparatursätze

Repair kits - Corredi riparazione - Nécessaires de réparation - Juegos de reparación

					
11.9541-9544.2 220646	<b>11.0101-5407.2</b> 260011 Hülsensatz <b>11.8171-0008.1</b> 990049 Führungsbolzen		11.9571-9781.2 220659	<b>11.0101-5407.2</b> 260011 Hülsensatz <b>11.8171-0008.1</b> 990049 Führungsbolzen	
11.9541-9545.2 220625	<b>11.0101-5407.2</b> 260011 Hülsensatz <b>11.8171-0008.1</b> 990049 Führungsbolzen		11.9571-9782.2 220660	<b>11.0101-5407.2</b> 260011 Hülsensatz <b>11.8171-0008.1</b> 990049 Führungsbolzen	
11.9541-9546.2 220626	<b>11.0101-5407.2</b> 260011 Hülsensatz <b>11.8171-0008.1</b> 990049 Führungsbolzen		11.9571-9785.2 220595	<b>11.0101-5407.2</b> 260011 Hülsensatz <b>11.8171-0008.1</b> 990049 Führungsbolzen	
11.9541-9549.2 220575	<b>11.0101-5409.2</b> 260035 Hülsensatz		11.9571-9786.2 220596	<b>11.0101-5407.2</b> 260011 Hülsensatz <b>11.8171-0008.1</b> 990049 Führungsbolzen	
11.9541-9550.2 220576	<b>11.0101-5409.2</b> 260035 Hülsensatz		11.9571-9801.2 220577	<b>11.0101-5407.2</b> 260011 Hülsensatz <b>11.8171-0008.1</b> 990049 Führungsbolzen	
11.9541-9553.2 220563	<b>11.0101-5409.2</b> 260035 Hülsensatz <b>11.8171-0008.1</b> 990049 Führungsbolzen		11.9571-9802.2 220578	<b>11.0101-5407.2</b> 260011 Hülsensatz <b>11.8171-0008.1</b> 990049 Führungsbolzen	
11.9541-9554.2 220564	<b>11.0101-5409.2</b> 260035 Hülsensatz <b>11.8171-0008.1</b> 990049 Führungsbolzen		11.9571-9811.2 220485	<b>11.0101-5407.2</b> 260011 Hülsensatz <b>11.0441-5704.2</b> 250034 Dichtungssatz <b>11.8171-0008.1</b> 990049 Führungsbolzen	
11.9541-9569.2 220725	<b>11.0101-5407.2</b> 260011 Hülsensatz <b>11.8171-0008.1</b> 990049 Führungsbolzen		11.9571-9812.2 220486	<b>11.0101-5407.2</b> 260011 Hülsensatz <b>11.0441-5704.2</b> 250034 Dichtungssatz <b>11.8171-0008.1</b> 990049 Führungsbolzen	
11.9541-9570.2 220726	<b>11.0101-5407.2</b> 260011 Hülsensatz <b>11.8171-0008.1</b> 990049 Führungsbolzen		11.9571-9813.2 220647	<b>11.0101-5407.2</b> 260011 Hülsensatz <b>11.8171-0008.1</b> 990049 Führungsbolzen	
11.9541-9575.2 220829	<b>11.0101-5402.2</b> 260009 Hülsensatz <b>11.8171-0008.1</b> 990049 Führungsbolzen		11.9571-9814.2 220648	<b>11.0101-5407.2</b> 260011 Hülsensatz <b>11.8171-0008.1</b> 990049 Führungsbolzen	
11.9541-9576.2 220830	<b>11.0101-5402.2</b> 260009 Hülsensatz <b>11.8171-0008.1</b> 990049 Führungsbolzen		11.9571-9819.2 220469	<b>11.0441-5704.2</b> 250034 Dichtungssatz	
11.9541-9587.2 220419	<b>11.0101-5402.2</b> 260009 Hülsensatz <b>11.0441-5402.2</b> 250028 Dichtungssatz <b>11.8171-0008.1</b> 990049 Führungsbolzen		11.9571-9820.2 220470	<b>11.0441-5704.2</b> 250034 Dichtungssatz	
11.9541-9588.2 220420	<b>11.0101-5402.2</b> 260009 Hülsensatz <b>11.0441-5402.2</b> 250028 Dichtungssatz <b>11.8171-0008.1</b> 990049 Führungsbolzen		11.9571-9821.2 220579	<b>11.0101-5407.2</b> 260011 Hülsensatz <b>11.8171-0008.1</b> 990049 Führungsbolzen	
11.9541-9595.2 220501	<b>11.0101-5409.2</b> 260035 Hülsensatz <b>11.8116-0143.1</b> 390513 Haltefeder <b>11.8171-0008.1</b> 990049 Führungsbolzen		11.9571-9822.2 220580	<b>11.0101-5407.2</b> 260011 Hülsensatz <b>11.8171-0008.1</b> 990049 Führungsbolzen	
11.9541-9596.2 220502	<b>11.0101-5409.2</b> 260035 Hülsensatz <b>11.8116-0143.1</b> 390513 Haltefeder <b>11.8171-0008.1</b> 990049 Führungsbolzen		11.9571-9823.2 220471	<b>11.0101-5407.2</b> 260011 Hülsensatz <b>11.0441-5704.2</b> 250034 Dichtungssatz <b>11.8171-0008.1</b> 990049 Führungsbolzen	
11.9541-9667.2 220421	<b>11.0101-5402.2</b> 260009 Hülsensatz <b>11.0441-5402.2</b> 250028 Dichtungssatz <b>11.8171-0008.1</b> 990049 Führungsbolzen		11.9571-9824.2 220472	<b>11.0101-5407.2</b> 260011 Hülsensatz <b>11.0441-5704.2</b> 250034 Dichtungssatz <b>11.8171-0008.1</b> 990049 Führungsbolzen	
11.9541-9668.2 220422	<b>11.0101-5402.2</b> 260009 Hülsensatz <b>11.0441-5402.2</b> 250028 Dichtungssatz <b>11.8171-0008.1</b> 990049 Führungsbolzen		11.9571-9835.2 220427	<b>11.0101-5409.2</b> 260035 Hülsensatz <b>11.0441-5704.2</b> 250034 Dichtungssatz <b>11.8116-0143.1</b> 390513 Haltefeder <b>11.8171-0008.1</b> 990049 Führungsbolzen	
11.9541-9806.2 220504	<b>11.0101-5407.2</b> 260011 Hülsensatz <b>11.8116-0073.1</b> 390498 Haltefeder <b>11.8171-0008.1</b> 990049 Führungsbolzen		11.9571-9836.2 220428	<b>11.0101-5409.2</b> 260035 Hülsensatz <b>11.0441-5704.2</b> 250034 Dichtungssatz <b>11.8116-0143.1</b> 390513 Haltefeder <b>11.8171-0008.1</b> 990049 Führungsbolzen	
11.9571-9765.2 220663	<b>11.8171-0008.1</b> 990049 Führungsbolzen		11.9571-9841.2 220401	<b>11.0101-5407.2</b> 260011 Hülsensatz <b>11.8171-0008.1</b> 990049 Führungsbolzen	
11.9571-9766.2 220664	<b>11.8171-0008.1</b> 990049 Führungsbolzen		11.9571-9842.2 220402	<b>11.0101-5407.2</b> 260011 Hülsensatz <b>11.8171-0008.1</b> 990049 Führungsbolzen	
11.9571-9779.2 220657	<b>11.0101-5407.2</b> 260011 Hülsensatz <b>11.8171-0008.1</b> 990049 Führungsbolzen		11.9571-9861.2 220403	<b>11.0101-5407.2</b> 260011 Hülsensatz <b>11.8171-0008.1</b> 990049 Führungsbolzen	
11.9571-9780.2 220658	<b>11.0101-5407.2</b> 260011 Hülsensatz <b>11.8171-0008.1</b> 990049 Führungsbolzen				







# Reparatursätze

Repair kits - Corredi riparazione - Nécessaires de réparation - Juegos de reparación

					
11.9571-9862.2 220404	<b>11.0101-5407.2</b> 260011 Hülsensatz <b>11.8171-0008.1</b> 990049 Führungsbolzen		11.9606-9958.2 220816	<b>11.0101-5409.2</b> 260035 Hülsensatz <b>11.8171-0008.1</b> 990049 Führungsbolzen	
11.9571-9863.2 220513	<b>11.0101-5407.2</b> 260011 Hülsensatz <b>11.8171-0008.1</b> 990049 Führungsbolzen		11.9606-9959.2 220729	<b>11.8171-0008.1</b> 990049 Führungsbolzen	
11.9571-9864.2 220514	<b>11.0101-5407.2</b> 260011 Hülsensatz <b>11.8171-0008.1</b> 990049 Führungsbolzen		11.9606-9960.2 220730	<b>11.8171-0008.1</b> 990049 Führungsbolzen	
11.9571-9871.2 220425	<b>11.0101-5407.2</b> 260011 Hülsensatz <b>11.8171-0008.1</b> 990049 Führungsbolzen		11.9606-9961.2 220655	<b>11.0101-5409.2</b> 260035 Hülsensatz <b>11.8171-0008.1</b> 990049 Führungsbolzen	
11.9571-9872.2 220426	<b>11.0101-5407.2</b> 260011 Hülsensatz <b>11.8171-0008.1</b> 990049 Führungsbolzen		11.9606-9962.2 220656	<b>11.0101-5409.2</b> 260035 Hülsensatz <b>11.8171-0008.1</b> 990049 Führungsbolzen	
11.9571-9971.2 220605	<b>11.0101-5407.2</b> 260011 Hülsensatz <b>11.0441-5702.2</b> 250033 Dichtungssatz <b>11.8116-0073.1</b> 390498 Haltefeder <b>11.8171-0008.1</b> 990049 Führungsbolzen		11.9606-9962.2 220817	<b>11.0101-5409.2</b> 260035 Hülsensatz <b>11.8171-0008.1</b> 990049 Führungsbolzen	
11.9571-9972.2 220606	<b>11.0101-5407.2</b> 260011 Hülsensatz <b>11.0441-5702.2</b> 250033 Dichtungssatz <b>11.8116-0073.1</b> 390498 Haltefeder <b>11.8171-0008.1</b> 990049 Führungsbolzen		11.9606-9966.2 220818	<b>11.0101-5409.2</b> 260035 Hülsensatz <b>11.8171-0008.1</b> 990049 Führungsbolzen	
11.9576-9947.2 220809	<b>11.0101-5409.2</b> 260035 Hülsensatz <b>11.8171-0008.1</b> 990049 Führungsbolzen		11.9606-9967.2 220905	<b>11.0101-5402.2</b> 260009 Hülsensatz <b>11.8171-0008.1</b> 990049 Führungsbolzen	
11.9576-9948.2 220810	<b>11.0101-5409.2</b> 260035 Hülsensatz <b>11.8171-0008.1</b> 990049 Führungsbolzen		11.9606-9968.2 220906	<b>11.0101-5402.2</b> 260009 Hülsensatz <b>11.8171-0008.1</b> 990049 Führungsbolzen	
11.9576-9975.2 220649	<b>11.0101-5407.2</b> 260011 Hülsensatz <b>11.8171-0008.1</b> 990049 Führungsbolzen		11.9606-9971.2 220589	<b>11.0101-5407.2</b> 260011 Hülsensatz <b>11.8171-0008.1</b> 990049 Führungsbolzen	
11.9576-9976.2 220650	<b>11.0101-5407.2</b> 260011 Hülsensatz <b>11.8171-0008.1</b> 990049 Führungsbolzen		11.9606-9972.2 220590	<b>11.0101-5407.2</b> 260011 Hülsensatz <b>11.8171-0008.1</b> 990049 Führungsbolzen	
11.9576-9995.2 220651	<b>11.0101-5409.2</b> 260035 Hülsensatz <b>11.8171-0008.1</b> 990049 Führungsbolzen		11.9606-9979.2 220907	<b>11.8171-0008.1</b> 990049 Führungsbolzen	
11.9576-9996.2 220652	<b>11.0101-5409.2</b> 260035 Hülsensatz <b>11.8171-0008.1</b> 990049 Führungsbolzen		11.9606-9980.2 220908	<b>11.8171-0008.1</b> 990049 Führungsbolzen	
11.9601-9787.2 220585	<b>11.0101-5407.2</b> 260011 Hülsensatz <b>11.8171-0008.1</b> 990049 Führungsbolzen		13.2351-0013.2 210010	<b>13.0441-3506.2</b> 250052 Dichtungssatz	
11.9601-9788.2 220586	<b>11.0101-5407.2</b> 260011 Hülsensatz <b>11.8171-0008.1</b> 990049 Führungsbolzen		13.2351-0014.2 210011	<b>13.0441-3506.2</b> 250052 Dichtungssatz	
11.9601-9829.2 220505	<b>11.0101-5407.2</b> 260011 Hülsensatz <b>11.8171-0008.1</b> 990049 Führungsbolzen		13.2351-0025.2 210210	<b>13.0441-3506.2</b> 250052 Dichtungssatz	
11.9601-9830.2 220506	<b>11.0101-5407.2</b> 260011 Hülsensatz <b>11.8171-0008.1</b> 990049 Führungsbolzen		13.2351-0026.2 210211	<b>13.0441-3506.2</b> 250052 Dichtungssatz	
11.9606-9945.2 220727	<b>11.8171-0008.1</b> 990049 Führungsbolzen		13.2351-8005.2 210014	<b>13.0441-3505.2</b> 250051 Dichtungssatz	
11.9606-9946.2 220728	<b>11.8171-0008.1</b> 990049 Führungsbolzen		13.2351-8006.2 210015	<b>13.0441-3505.2</b> 250051 Dichtungssatz	
11.9606-9953.2 220587	<b>11.0101-5409.2</b> 260035 Hülsensatz <b>11.8171-0008.1</b> 990049 Führungsbolzen		13.2353-8003.2 210016	<b>13.0441-3504.2</b> 250050 Dichtungssatz	
11.9606-9954.2 220588	<b>11.0101-5409.2</b> 260035 Hülsensatz <b>11.8171-0008.1</b> 990049 Führungsbolzen		13.2353-8004.2 210017	<b>13.0441-3504.2</b> 250050 Dichtungssatz	
11.9606-9957.2 220815	<b>11.0101-5409.2</b> 260035 Hülsensatz <b>11.8171-0008.1</b> 990049 Führungsbolzen		13.2381-0039.2 210020	<b>13.0441-3812.2</b> 250068 Dichtungssatz	
			13.2381-0040.2 210021	<b>13.0441-3812.2</b> 250068 Dichtungssatz	
			13.2381-0087.2 210149	<b>13.0441-3819.2</b> 250072 Dichtungssatz	
			13.2381-0088.2 210150	<b>13.0441-3819.2</b> 250072 Dichtungssatz	
			13.2381-8027.2 210033	<b>13.0441-3811.2</b> 250067 Dichtungssatz	
			13.2381-8028.2 210034	<b>13.0441-3811.2</b> 250067 Dichtungssatz	
			13.2381-8029.2 210035	<b>13.0441-3811.2</b> 250067 Dichtungssatz	
			13.2381-8030.2 210036	<b>13.0441-3811.2</b> 250067 Dichtungssatz	
			13.2381-8033.2 210222	<b>13.0441-3817.2</b> 250071 Dichtungssatz	







# Reparatursätze

Repair kits - Corredi riparazione - Nécessaires de réparation - Juegos de reparación

					
13.2381-8034.2 210223	<b>13.0441-3817.2</b> 250071	Dichtungssatz	13.2481-9998.2 210102	<b>13.0441-4815.2</b> 250102	Dichtungssatz
13.2381-8035.2 210037	<b>13.0441-3817.2</b> 250071	Dichtungssatz	13.2481-9999.2 210103	<b>13.0441-4815.2</b> 250102	Dichtungssatz
13.2381-8036.2 210038	<b>13.0441-3817.2</b> 250071	Dichtungssatz	13.2541-8001.2 210110	<b>13.0441-5416.2</b> 250117	Dichtungssatz
13.2381-9996.2 210039	<b>13.0441-3801.2</b> 250058	Dichtungssatz	13.2541-8002.2 210111	<b>13.0441-5416.2</b> 250117	Dichtungssatz
13.2381-9997.2 210040	<b>13.0441-3801.2</b> 250058	Dichtungssatz	13.2571-8011.2 210121	<b>13.0441-5718.2</b> 250120	Dichtungssatz
13.2401-0027.2 210045	<b>13.0441-4014.2</b> 250079	Dichtungssatz	13.2571-8012.2 210122	<b>13.0441-5718.2</b> 250120	Dichtungssatz
13.2401-0028.2 210046	<b>13.0441-4014.2</b> 250079	Dichtungssatz	13.2571-8013.2 210123	<b>13.0441-5718.2</b> 250120	Dichtungssatz
13.2401-8007.2 210047	<b>13.0441-4002.2</b> 250074 <b>13.0441-4008.2</b> 250076	Dichtungssatz Dichtungssatz	13.2571-8014.2 210124	<b>13.0441-5718.2</b> 250120	Dichtungssatz
13.2401-8008.2 210048	<b>13.0441-4002.2</b> 250074 <b>13.0441-4008.2</b> 250076	Dichtungssatz Dichtungssatz	13.2571-8023.2 210127	<b>13.0441-5724.2</b> 250125	Dichtungssatz
13.2401-8013.2 210051	<b>13.0441-4020.2</b> 250084	Dichtungssatz	13.2571-8024.2 210128	<b>13.0441-5724.2</b> 250125	Dichtungssatz
13.2401-8014.2 210052	<b>13.0441-4020.2</b> 250084	Dichtungssatz	13.2571-9998.2 210133	<b>13.0441-5718.2</b> 250120	Dichtungssatz
13.2421-0025.2 210145	<b>13.0441-4206.2</b> 250087	Dichtungssatz	13.2571-9999.2 210134	<b>13.0441-5718.2</b> 250120	Dichtungssatz
13.2421-0026.2 210146	<b>13.0441-4206.2</b> 250087	Dichtungssatz	13.2601-7015.2 210230	<b>03.3518-6100.2</b> 390364 <b>03.3518-8000.2</b> 390373 <b>13.0441-6012.2</b> 250133	Entlüfterventil Entlüfterventil Dichtungssatz
13.2421-0043.2 210193	<b>13.0441-4216.2</b> 250093	Dichtungssatz	13.2601-7016.2 210231	<b>03.3518-6100.2</b> 390364 <b>03.3518-8000.2</b> 390373 <b>13.0441-6012.2</b> 250133	Entlüfterventil Entlüfterventil Dichtungssatz
13.2421-0044.2 210194	<b>13.0441-4216.2</b> 250093	Dichtungssatz	13.2601-8025.2 210157	<b>13.0441-6001.2</b> 250126	Dichtungssatz
13.2421-8005.2 210053	<b>13.0441-4205.2</b> 250086	Dichtungssatz	13.2601-8026.2 210158	<b>13.0441-6001.2</b> 250126	Dichtungssatz
13.2421-8006.2 210054	<b>13.0441-4205.2</b> 250086	Dichtungssatz	13.2601-8027.2 210159	<b>13.0441-6001.2</b> 250126	Dichtungssatz
13.2421-8007.2 210055	<b>13.0441-4205.2</b> 250086	Dichtungssatz	13.2601-8028.2 210160	<b>13.0441-6001.2</b> 250126	Dichtungssatz
13.2421-8008.2 210056	<b>13.0441-4205.2</b> 250086	Dichtungssatz	13.2601-8029.2 210161	<b>13.0441-6003.2</b> 250128	Dichtungssatz
13.2421-8021.2 210057	<b>13.0441-4206.2</b> 250087	Dichtungssatz	13.2601-8030.2 210162	<b>13.0441-6003.2</b> 250128	Dichtungssatz
13.2421-8022.2 210058	<b>13.0441-4206.2</b> 250087	Dichtungssatz	13.2601-8031.2 210163	<b>13.0441-6003.2</b> 250128	Dichtungssatz
13.2421-8025.2 210061	<b>13.0441-4216.2</b> 250093	Dichtungssatz	13.2601-8032.2 210164	<b>13.0441-6003.2</b> 250128	Dichtungssatz
13.2421-8026.2 210062	<b>13.0441-4216.2</b> 250093	Dichtungssatz	13.2601-8033.2 210165	<b>13.0441-6003.2</b> 250128	Dichtungssatz
13.2423-8009.2 210063	<b>13.0441-4206.2</b> 250087	Dichtungssatz	13.2601-8034.2 210166	<b>13.0441-6003.2</b> 250128	Dichtungssatz
13.2423-8010.2 210064	<b>13.0441-4206.2</b> 250087	Dichtungssatz	13.2601-8035.2 210167	<b>03.3518-6100.2</b> 390364 <b>03.3518-8000.2</b> 390373 <b>13.0441-6012.2</b> 250133	Entlüfterventil Entlüfterventil Dichtungssatz
13.2461-8001.2 210226	<b>13.0441-4601.2</b> 250099	Dichtungssatz	13.2601-8036.2 210168	<b>03.3518-6100.2</b> 390364 <b>03.3518-8000.2</b> 390373 <b>13.0441-6012.2</b> 250133	Entlüfterventil Entlüfterventil Dichtungssatz
13.2461-8002.2 210227	<b>13.0441-4601.2</b> 250099	Dichtungssatz	13.2601-8037.2 210169	<b>03.3518-6100.2</b> 390364 <b>03.3518-8000.2</b> 390373 <b>13.0441-6012.2</b> 250133	Entlüfterventil Entlüfterventil Dichtungssatz
13.2481-0075.2 210081	<b>13.0441-4819.2</b> 250104	Dichtungssatz	13.2601-8038.2 210170	<b>03.3518-6100.2</b> 390364 <b>03.3518-8000.2</b> 390373 <b>13.0441-6012.2</b> 250133	Entlüfterventil Entlüfterventil Dichtungssatz
13.2481-0076.2 210082	<b>13.0441-4819.2</b> 250104	Dichtungssatz	13.2601-9996.2 210176	<b>13.0441-6001.2</b> 250126	Dichtungssatz
13.2481-8011.2 210092	<b>13.0441-4825.2</b> 250107	Dichtungssatz			
13.2481-8012.2 210093	<b>13.0441-4825.2</b> 250107	Dichtungssatz			
13.2481-8013.2 210094	<b>13.0441-4825.2</b> 250107	Dichtungssatz			
13.2481-8067.2 210098	<b>13.0441-4819.2</b> 250104	Dichtungssatz			
13.2481-8068.2 210099	<b>13.0441-4819.2</b> 250104	Dichtungssatz			

# Reparatursätze







Repair kits - Corredi riparazione - Nécessaires de réparation - Juegos de reparación

					
13.2601-9997.2 210177	<b>13.0441-6001.2</b> 250126	Dichtungssatz	24.3361-8503.5 240513	<b>11.0101-5402.2</b> 260009	Hülsensatz
13.4341-8001.2 210151	<b>13.0441-3401.2</b> 250044	Dichtungssatz		<b>11.0441-3602.2</b> 250008	Dichtungssatz
13.4341-8002.2 210152	<b>13.0441-3401.2</b> 250044	Dichtungssatz		<b>11.8116-0066.1</b> 390577	Haltefeder
13.4401-8021.2 210189	<b>13.0441-4018.2</b> 250083	Dichtungssatz		<b>11.8171-0008.1</b> 990049	Führungsbolzen
13.4401-8022.2 210190	<b>13.0441-4018.2</b> 250083	Dichtungssatz	24.3361-8504.5 240514	<b>11.0101-5402.2</b> 260009	Hülsensatz
13.4401-8027.2 210191	<b>13.0441-4016.2</b> 250081	Dichtungssatz		<b>11.0441-3602.2</b> 250008	Dichtungssatz
13.4401-8028.2 210192	<b>13.0441-4016.2</b> 250081	Dichtungssatz		<b>11.8116-0066.1</b> 390577	Haltefeder
13.4421-8009.2 210228	<b>13.0441-4214.2</b> 250091	Dichtungssatz		<b>11.8171-0008.1</b> 990049	Führungsbolzen
13.4421-8010.2 210229	<b>13.0441-4214.2</b> 250091	Dichtungssatz	24.3361-9975.5 240541	<b>11.0101-5407.2</b> 260011	Hülsensatz
13.4571-0019.3 210249	<b>13.0441-5721.2</b> 250123	Dichtungssatz		<b>11.0441-3602.2</b> 250008	Dichtungssatz
13.4571-8005.3 210205	<b>13.0441-5721.2</b> 250123	Dichtungssatz		<b>11.8116-0073.1</b> 390498	Haltefeder
13.4571-8006.3 210206	<b>13.0441-5721.2</b> 250123	Dichtungssatz		<b>11.8171-0008.1</b> 990049	Führungsbolzen
13.9544-0021.2 210257	<b>13.0441-5417.2</b> 250118	Dichtungssatz	24.3361-9976.5 240542	<b>11.0101-5407.2</b> 260011	Hülsensatz
	<b>13.0471-5405.2</b> 250136	Rep. Satz Nachstellung		<b>11.0441-3602.2</b> 250008	Dichtungssatz
	<b>13.0471-5407.2</b> 250137	Verbindungsschrauben		<b>11.8116-0073.1</b> 390498	Haltefeder
	<b>13.0471-5408.2</b> 250138	Rep. Satz Rückstellwelle	24.3381-8503.5 240515	<b>11.8171-0008.1</b> 990049	Führungsbolzen
	<b>13.0471-5409.2</b> 250139	Rep. Satz Bremshebel		<b>11.0101-5402.2</b> 260009	Hülsensatz
	<b>13.8158-0020.1</b> 990113	Handbremshebel		<b>11.0441-3803.2</b> 250010	Dichtungssatz
	<b>13.8158-0021.1</b> 990114	Handbremshebel		<b>11.8116-0066.1</b> 390577	Haltefeder
13.9544-0022.2 210258	<b>13.0441-5417.2</b> 250118	Dichtungssatz	24.3381-8504.5 240516	<b>11.8171-0008.1</b> 990049	Führungsbolzen
	<b>13.0471-5405.2</b> 250136	Rep. Satz Nachstellung		<b>11.0101-5402.2</b> 260009	Hülsensatz
	<b>13.0471-5407.2</b> 250137	Verbindungsschrauben		<b>11.0441-3803.2</b> 250010	Dichtungssatz
	<b>13.0471-5408.2</b> 250138	Rep. Satz Rückstellwelle		<b>11.8116-0066.1</b> 390577	Haltefeder
	<b>13.0471-5409.2</b> 250139	Rep. Satz Bremshebel	24.3381-9959.5 240517	<b>11.8171-0008.1</b> 990049	Führungsbolzen
	<b>13.8158-0020.1</b> 990113	Handbremshebel		<b>11.0101-5402.2</b> 260009	Hülsensatz
	<b>13.8158-0021.1</b> 990114	Handbremshebel		<b>11.0441-3803.2</b> 250010	Dichtungssatz
24.3304-1701.5 240113	<b>24.0101-3004.2</b> 260042	Bremssattel-Zubehör		<b>11.8116-0066.1</b> 390577	Haltefeder
24.3304-1702.5 240114	<b>24.0101-3004.2</b> 260042	Bremssattel-Zubehör	24.3381-9960.5 240518	<b>11.8171-0008.1</b> 990049	Führungsbolzen
24.3331-8501.5 240509	<b>11.0101-5402.2</b> 260009	Hülsensatz		<b>11.0101-5402.2</b> 260009	Hülsensatz
	<b>11.0441-3302.2</b> 250004	Dichtungssatz		<b>11.0441-3803.2</b> 250010	Dichtungssatz
	<b>11.8116-0015.1</b> 390492	Haltefeder	24.3381-9961.5 240519	<b>11.8116-0066.1</b> 390577	Haltefeder
	<b>11.8171-0008.1</b> 990049	Führungsbolzen		<b>11.8171-0008.1</b> 990049	Führungsbolzen
24.3331-8502.5 240510	<b>11.0101-5402.2</b> 260009	Hülsensatz	24.3381-9962.5 240520	<b>11.0101-5402.2</b> 260009	Hülsensatz
	<b>11.0441-3302.2</b> 250004	Dichtungssatz		<b>11.0441-3803.2</b> 250010	Dichtungssatz
	<b>11.8116-0015.1</b> 390492	Haltefeder		<b>11.8116-0066.1</b> 390577	Haltefeder
	<b>11.8171-0008.1</b> 990049	Führungsbolzen	24.3381-9962.5 240520	<b>11.8171-0008.1</b> 990049	Führungsbolzen
24.3341-9991.5 240511	<b>11.0101-5402.2</b> 260009	Hülsensatz		<b>11.8171-0008.1</b> 990049	Führungsbolzen
	<b>11.8171-0008.1</b> 990049	Führungsbolzen	24.3384-1601.5 240013	<b>24.0101-3601.2</b> 260044	Bremssattel-Zubehör
24.3341-9992.5 240512	<b>11.0101-5402.2</b> 260009	Hülsensatz	24.3384-1602.5 240014	<b>24.0101-3601.2</b> 260044	Bremssattel-Zubehör
	<b>11.8171-0008.1</b> 990049	Führungsbolzen		<b>24.0101-3601.2</b> 260044	Bremssattel-Zubehör
24.3344-1701.5 240087	<b>24.0101-3401.2</b> 260043	Bremssattel-Zubehör	24.3384-1603.5 240015	<b>24.0101-3601.2</b> 260044	Bremssattel-Zubehör
24.3344-1702.5 240088	<b>24.0101-3401.2</b> 260043	Bremssattel-Zubehör	24.3384-1604.5 240016	<b>24.0101-3601.2</b> 260044	Bremssattel-Zubehör
24.3344-1703.5 240117	<b>24.0101-3601.2</b> 260044	Bremssattel-Zubehör	24.3384-1703.5 240055	<b>24.0101-3601.2</b> 260044	Bremssattel-Zubehör
24.3344-1704.5 240118	<b>24.0101-3601.2</b> 260044	Bremssattel-Zubehör	24.3384-1704.5 240056	<b>24.0101-3601.2</b> 260044	Bremssattel-Zubehör



# Reparatursätze







Repair kits - Corredi riparazione - Nécessaires de réparation - Juegos de reparación

					
24.3384-1707.5 240171	<b>11.0101-5403.2</b> 260010 Faltenbalsatz <b>24.0101-3601.2</b> 260044 Bremssattel-Zubehör		24.3481-1612.5 240030	<b>24.0101-4807.2</b> 260053	Bremssattel-Zubehör
24.3384-1708.5 240172	<b>11.0101-5403.2</b> 260010 Faltenbalsatz <b>24.0101-3601.2</b> 260044 Bremssattel-Zubehör		24.3481-1615.5 240031	<b>24.0101-4806.2</b> 260052	Bremssattel-Zubehör
24.3401-1703.5 240351	<b>11.0101-5402.2</b> 260009 Hülsensatz <b>11.0441-4002.2</b> 250011 Dichtungssatz <b>11.8116-0066.1</b> 390577 Haltefeder <b>11.8171-0008.1</b> 990049 Führungsbolzen		24.3481-1616.5 240032	<b>24.0101-4806.2</b> 260052	Bremssattel-Zubehör
24.3401-1704.5 240352	<b>11.0101-5402.2</b> 260009 Hülsensatz <b>11.0441-4002.2</b> 250011 Dichtungssatz <b>11.8116-0066.1</b> 390577 Haltefeder <b>11.8171-0008.1</b> 990049 Führungsbolzen		24.3481-1703.5 240051	<b>24.0101-4301.2</b> 260047	Bremssattel-Zubehör
24.3401-1705.5 240423	<b>11.0101-5402.2</b> 260009 Hülsensatz <b>11.0441-4002.2</b> 250011 Dichtungssatz <b>11.8116-0066.1</b> 390577 Haltefeder <b>11.8171-0008.1</b> 990049 Führungsbolzen		24.3481-1704.5 240052	<b>24.0101-4301.2</b> 260047	Bremssattel-Zubehör
24.3401-1706.5 240424	<b>11.0101-5402.2</b> 260009 Hülsensatz <b>11.0441-4002.2</b> 250011 Dichtungssatz <b>11.8116-0066.1</b> 390577 Haltefeder <b>11.8171-0008.1</b> 990049 Führungsbolzen		24.3481-1707.5 240073	<b>24.0101-3601.2</b> 260044	Bremssattel-Zubehör
24.3401-8503.5 240521	<b>11.0101-5402.2</b> 260009 Hülsensatz <b>11.0441-4002.2</b> 250011 Dichtungssatz <b>11.8116-0066.1</b> 390577 Haltefeder <b>11.8171-0008.1</b> 990049 Führungsbolzen		24.3481-1708.5 240074	<b>24.0101-3601.2</b> 260044	Bremssattel-Zubehör
24.3401-8504.5 240522	<b>11.0101-5402.2</b> 260009 Hülsensatz <b>11.0441-4002.2</b> 250011 Dichtungssatz <b>11.8116-0066.1</b> 390577 Haltefeder <b>11.8171-0008.1</b> 990049 Führungsbolzen		24.3481-1733.5 240213	<b>11.0101-5407.2</b> 260011 Hülsensatz <b>11.0441-4811.2</b> 250024 Dichtungssatz <b>11.8116-0129.1</b> 390591 Haltefeder <b>11.8171-0008.1</b> 990049 Führungsbolzen	
24.3401-9977.5 240523	<b>11.0101-5402.2</b> 260009 Hülsensatz <b>11.8171-0008.1</b> 990049 Führungsbolzen		24.3481-1734.5 240214	<b>11.0101-5407.2</b> 260011 Hülsensatz <b>11.0441-4811.2</b> 250024 Dichtungssatz <b>11.8116-0129.1</b> 390591 Haltefeder <b>11.8171-0008.1</b> 990049 Führungsbolzen	
24.3401-9978.5 240524	<b>11.0101-5402.2</b> 260009 Hülsensatz <b>11.8171-0008.1</b> 990049 Führungsbolzen		24.3481-1735.5 240283	<b>11.0101-4801.2</b> 260006 Hülsensatz <b>11.0441-4808.2</b> 250022 Dichtungssatz <b>24.0102-4801.2</b> 260085 Hülsensatz+Schrauben	
24.3421-9979.5 240475	<b>11.0101-5407.2</b> 260011 Hülsensatz <b>11.8171-0008.1</b> 990049 Führungsbolzen		24.3481-1736.5 240284	<b>11.0101-4801.2</b> 260006 Hülsensatz <b>11.0441-4808.2</b> 250022 Dichtungssatz <b>24.0102-4801.2</b> 260085 Hülsensatz+Schrauben	
24.3421-9980.5 240476	<b>11.0101-5407.2</b> 260011 Hülsensatz <b>11.8171-0008.1</b> 990049 Führungsbolzen		24.3481-1745.5 240277	<b>11.0101-4803.2</b> 260008 Hülsensatz <b>11.0441-4808.2</b> 250022 Dichtungssatz <b>24.0102-4803.2</b> 260086 Hülsensatz+Schrauben	
24.3434-1601.5 240019	<b>24.0101-4301.2</b> 260047 Bremssattel-Zubehör		24.3481-1746.5 240278	<b>11.0101-4803.2</b> 260008 Hülsensatz <b>11.0441-4808.2</b> 250022 Dichtungssatz <b>24.0102-4803.2</b> 260086 Hülsensatz+Schrauben	
24.3434-1602.5 240020	<b>24.0101-4301.2</b> 260047 Bremssattel-Zubehör		24.3481-1749.5 240281	<b>11.0101-4801.2</b> 260006 Hülsensatz <b>11.0441-4808.2</b> 250022 Dichtungssatz <b>24.0102-4801.2</b> 260085 Hülsensatz+Schrauben	
24.3434-1701.5 240357	<b>11.0101-5403.2</b> 260010 Faltenbalsatz		24.3481-1750.5 240282	<b>11.0101-4801.2</b> 260006 Hülsensatz <b>11.0441-4808.2</b> 250022 Dichtungssatz <b>24.0102-4801.2</b> 260085 Hülsensatz+Schrauben	
24.3434-1702.5 240358	<b>11.0101-5403.2</b> 260010 Faltenbalsatz		24.3481-8515.5 240477	<b>11.0101-5407.2</b> 260011 Hülsensatz <b>11.8171-0008.1</b> 990049 Führungsbolzen	
24.3481-0705.5 240021	<b>24.0101-4801.2</b> 990131 Bremssattel-Zubehör		24.3481-8516.5 240478	<b>11.0101-5407.2</b> 260011 Hülsensatz <b>11.8171-0008.1</b> 990049 Führungsbolzen	
24.3481-0706.5 240022	<b>24.0101-4801.2</b> 990131 Bremssattel-Zubehör		24.3481-9833.5 240479	<b>11.0101-5407.2</b> 260011 Hülsensatz <b>11.0441-4811.2</b> 250024 Dichtungssatz <b>11.8116-0129.1</b> 390591 Haltefeder <b>11.8171-0008.1</b> 990049 Führungsbolzen	
24.3481-0707.5 240023	<b>24.0101-4801.2</b> 990131 Bremssattel-Zubehör		24.3481-9834.5 240480	<b>11.0101-5407.2</b> 260011 Hülsensatz <b>11.0441-4811.2</b> 250024 Dichtungssatz <b>11.8116-0129.1</b> 390591 Haltefeder <b>11.8171-0008.1</b> 990049 Führungsbolzen	
24.3481-0708.5 240024	<b>24.0101-4801.2</b> 990131 Bremssattel-Zubehör		24.3521-1701.5 240001	<b>11.0101-5407.2</b> 260011 Hülsensatz <b>11.0441-5202.2</b> 250026 Dichtungssatz <b>11.8116-0097.1</b> 390590 Haltefeder <b>11.8171-0008.1</b> 990049 Führungsbolzen	
24.3481-1505.5 240047	<b>24.0101-4803.2</b> 260049 Bremssattel-Zubehör				
24.3481-1506.5 240048	<b>24.0101-4803.2</b> 260049 Bremssattel-Zubehör				
24.3481-1611.5 240029	<b>24.0101-4807.2</b> 260053 Bremssattel-Zubehör				









# Reparatursätze

Repair kits - Corredi riparazione - Nécessaires de réparation - Juegos de reparación

  		  	
24.3521-1702.5 240002	<b>11.0101-5407.2</b> 260011 Hülsensatz <b>11.0441-5202.2</b> 250026 Dichtungssatz <b>11.8116-0097.1</b> 390590 Haltefeder <b>11.8171-0008.1</b> 990049 Führungsbolzen	24.3541-8105.5 240485	<b>11.0101-5407.2</b> 260011 Hülsensatz <b>11.8171-0008.1</b> 990049 Führungsbolzen
24.3521-7001.5 240481	<b>11.0101-5407.2</b> 260011 Hülsensatz <b>11.8171-0008.1</b> 990049 Führungsbolzen	24.3541-8106.5 240486	<b>11.0101-5407.2</b> 260011 Hülsensatz <b>11.8171-0008.1</b> 990049 Führungsbolzen
24.3521-7002.5 240482	<b>11.0101-5407.2</b> 260011 Hülsensatz <b>11.8171-0008.1</b> 990049 Führungsbolzen	24.3541-8522.5 240488	<b>11.0101-5409.2</b> 260035 Hülsensatz <b>11.0441-5405.2</b> 250030 Dichtungssatz
24.3541-1603.5 240037	<b>24.0101-3601.2</b> 260044 Bremssattel-Zubehör	24.3541-8523.5 240551	<b>11.0101-5409.2</b> 260035 Hülsensatz <b>11.8116-0143.1</b> 390513 Haltefeder <b>11.8170-0306.1</b> 260102 Halter <b>11.8171-0008.1</b> 990049 Führungsbolzen
24.3541-1604.5 240038	<b>24.0101-3601.2</b> 260044 Bremssattel-Zubehör	24.3541-8524.5 240552	<b>11.0101-5409.2</b> 260035 Hülsensatz <b>11.8116-0143.1</b> 390513 Haltefeder <b>11.8170-0306.1</b> 260102 Halter <b>11.8171-0008.1</b> 990049 Führungsbolzen
24.3541-1609.5 240039	<b>11.0101-5403.2</b> 260010 Faltenbalgsatz <b>11.0101-5409.2</b> 260035 Hülsensatz <b>24.0101-4301.2</b> 260047 Bremssattel-Zubehör	24.3541-8529.5 240553	<b>11.0101-5407.2</b> 260011 Hülsensatz <b>11.0441-5402.2</b> 250028 Dichtungssatz <b>11.8171-0008.1</b> 990049 Führungsbolzen
24.3541-1610.5 240040	<b>11.0101-5403.2</b> 260010 Faltenbalgsatz <b>11.0101-5409.2</b> 260035 Hülsensatz <b>24.0101-4301.2</b> 260047 Bremssattel-Zubehör	24.3541-8530.5 240554	<b>11.0101-5407.2</b> 260011 Hülsensatz <b>11.0441-5402.2</b> 250028 Dichtungssatz <b>11.8171-0008.1</b> 990049 Führungsbolzen
24.3541-1701.5 240005	<b>11.0101-5407.2</b> 260011 Hülsensatz <b>11.0441-5402.2</b> 250028 Dichtungssatz <b>11.8171-0008.1</b> 990049 Führungsbolzen	24.3541-9587.5 240527	<b>11.0101-5402.2</b> 260009 Hülsensatz <b>11.0441-5402.2</b> 250028 Dichtungssatz <b>11.8171-0008.1</b> 990049 Führungsbolzen
24.3541-1702.5 240006	<b>11.0101-5407.2</b> 260011 Hülsensatz <b>11.0441-5402.2</b> 250028 Dichtungssatz <b>11.8171-0008.1</b> 990049 Führungsbolzen	24.3541-9588.5 240528	<b>11.0101-5402.2</b> 260009 Hülsensatz <b>11.0441-5402.2</b> 250028 Dichtungssatz <b>11.8171-0008.1</b> 990049 Führungsbolzen
24.3541-1707.5 240067	<b>24.0101-5401.2</b> 260059 Bremssattel-Zubehör	24.3541-9667.5 240529	<b>11.0101-5402.2</b> 260009 Hülsensatz <b>11.0441-5402.2</b> 250028 Dichtungssatz <b>11.8171-0008.1</b> 990049 Führungsbolzen
24.3541-1708.5 240068	<b>24.0101-5401.2</b> 260059 Bremssattel-Zubehör	24.3541-9668.5 240530	<b>11.0101-5402.2</b> 260009 Hülsensatz <b>11.0441-5402.2</b> 250028 Dichtungssatz <b>11.8171-0008.1</b> 990049 Führungsbolzen
24.3541-1723.5 240077	<b>24.0101-3601.2</b> 260044 Bremssattel-Zubehör	24.3571-1705.5 240069	<b>24.0101-3401.2</b> 260043 Bremssattel-Zubehör
24.3541-1725.5 240003	<b>11.0101-5403.2</b> 260010 Faltenbalgsatz <b>11.0441-5404.2</b> 250029 Dichtungssatz	24.3571-1706.5 240070	<b>24.0101-3401.2</b> 260043 Bremssattel-Zubehör
24.3541-1726.5 240004	<b>11.0101-5403.2</b> 260010 Faltenbalgsatz <b>11.0441-5404.2</b> 250029 Dichtungssatz	24.3571-1707.5 240079	<b>24.0101-3601.2</b> 260044 Bremssattel-Zubehör
24.3541-1731.5 240061	<b>24.0101-4301.2</b> 260047 Bremssattel-Zubehör	24.3571-1708.5 240080	<b>24.0101-3601.2</b> 260044 Bremssattel-Zubehör
24.3541-1732.5 240062	<b>24.0101-4301.2</b> 260047 Bremssattel-Zubehör	24.3571-1726.5 240314	<b>11.0101-5407.2</b> 260011 Hülsensatz <b>11.0441-5704.2</b> 250034 Dichtungssatz <b>11.8171-0008.1</b> 990049 Führungsbolzen
24.3541-1739.5 240223	<b>11.0101-5403.2</b> 260010 Faltenbalgsatz <b>11.0441-5404.2</b> 250029 Dichtungssatz	24.3571-1733.5 240349	<b>11.0101-5402.2</b> 260009 Hülsensatz <b>11.8171-0008.1</b> 990049 Führungsbolzen
24.3541-1740.5 240224	<b>11.0101-5403.2</b> 260010 Faltenbalgsatz <b>11.0441-5404.2</b> 250029 Dichtungssatz	24.3571-1734.5 240350	<b>11.0101-5402.2</b> 260009 Hülsensatz <b>11.8171-0008.1</b> 990049 Führungsbolzen
24.3541-1779.5 240249	<b>11.0101-5403.2</b> 260010 Faltenbalgsatz <b>11.0441-5404.2</b> 250029 Dichtungssatz	24.3571-1761.5 240461	<b>11.0101-5407.2</b> 260011 Hülsensatz <b>11.0441-5704.2</b> 250034 Dichtungssatz <b>11.8171-0008.1</b> 990049 Führungsbolzen
24.3541-1780.5 240250	<b>11.0101-5403.2</b> 260010 Faltenbalgsatz <b>11.0441-5404.2</b> 250029 Dichtungssatz	24.3571-8505.5 240489	<b>11.0101-5409.2</b> 260035 Hülsensatz <b>11.0441-5704.2</b> 250034 Dichtungssatz <b>11.8116-0143.1</b> 390513 Haltefeder <b>11.8171-0008.1</b> 990049 Führungsbolzen
24.3541-8083.5 240483	<b>11.0101-5407.2</b> 260011 Hülsensatz <b>11.8171-0008.1</b> 990049 Führungsbolzen		
24.3541-8084.5 240484	<b>11.0101-5407.2</b> 260011 Hülsensatz <b>11.8171-0008.1</b> 990049 Führungsbolzen		
24.3541-8085.5 240525	<b>11.0101-5407.2</b> 260011 Hülsensatz <b>11.8116-0129.1</b> 390591 Haltefeder <b>11.8171-0008.1</b> 990049 Führungsbolzen		
24.3541-8086.5 240526	<b>11.0101-5407.2</b> 260011 Hülsensatz <b>11.8116-0129.1</b> 390591 Haltefeder <b>11.8171-0008.1</b> 990049 Führungsbolzen		







# Reparatursätze

Repair kits - Corredi riparazione - Nécessaires de réparation - Juegos de reparación

					
24.3571-8506.5 240490	<b>11.0101-5409.2</b> 260035 Hülsensatz <b>11.0441-5704.2</b> 250034 Dichtungssatz <b>11.8116-0143.1</b> 390513 Haltefeder <b>11.8171-0008.1</b> 990049 Führungsbolzen		24.3601-1710.5 240276	<b>11.0101-6004.2</b> 260014 Hülsensatz <b>11.0441-6003.2</b> 250037 Dichtungssatz	
24.3571-8507.5 240555	<b>11.8170-0306.1</b> 260102 Halter		24.3601-1713.5 240355	<b>11.0101-5402.2</b> 260009 Hülsensatz <b>11.0441-6003.2</b> 250037 Dichtungssatz <b>11.8171-0008.1</b> 990049 Führungsbolzen	
24.3571-8508.5 240556	<b>11.8170-0306.1</b> 260102 Halter		24.3601-1714.5 240356	<b>11.0101-5402.2</b> 260009 Hülsensatz <b>11.0441-6003.2</b> 250037 Dichtungssatz <b>11.8171-0008.1</b> 990049 Führungsbolzen	
24.3571-8511.5 240491	<b>11.0101-5407.2</b> 260011 Hülsensatz <b>11.8171-0008.1</b> 990049 Führungsbolzen		24.3601-8501.5 240533	<b>11.0101-5402.2</b> 260009 Hülsensatz <b>11.0441-6003.2</b> 250037 Dichtungssatz <b>11.8116-0083.1</b> 390501 Haltefeder <b>11.8171-0008.1</b> 990049 Führungsbolzen	
24.3571-8512.5 240492	<b>11.0101-5407.2</b> 260011 Hülsensatz <b>11.8171-0008.1</b> 990049 Führungsbolzen		24.3601-8502.5 240534	<b>11.0101-5402.2</b> 260009 Hülsensatz <b>11.0441-6003.2</b> 250037 Dichtungssatz <b>11.8116-0083.1</b> 390501 Haltefeder <b>11.8171-0008.1</b> 990049 Führungsbolzen	
24.3571-8517.5 240493	<b>11.0101-5409.2</b> 260035 Hülsensatz <b>11.0441-5704.2</b> 250034 Dichtungssatz <b>11.8116-0143.1</b> 390513 Haltefeder <b>11.8171-0008.1</b> 990049 Führungsbolzen		24.3601-8503.5 240535	<b>11.0101-5402.2</b> 260009 Hülsensatz <b>11.0441-6003.2</b> 250037 Dichtungssatz <b>11.8116-0083.1</b> 390501 Haltefeder <b>11.8171-0008.1</b> 990049 Führungsbolzen	
24.3571-8518.5 240494	<b>11.0101-5409.2</b> 260035 Hülsensatz <b>11.0441-5704.2</b> 250034 Dichtungssatz <b>11.8116-0143.1</b> 390513 Haltefeder <b>11.8171-0008.1</b> 990049 Führungsbolzen		24.3601-8504.5 240536	<b>11.0101-5402.2</b> 260009 Hülsensatz <b>11.0441-6003.2</b> 250037 Dichtungssatz <b>11.8116-0083.1</b> 390501 Haltefeder <b>11.8171-0008.1</b> 990049 Führungsbolzen	
24.3571-8521.5 240495	<b>11.0101-5409.2</b> 260035 Hülsensatz <b>11.0441-5704.2</b> 250034 Dichtungssatz <b>11.8116-0143.1</b> 390513 Haltefeder <b>11.8170-0306.1</b> 260102 Halter <b>11.8171-0008.1</b> 990049 Führungsbolzen		24.3601-8505.5 240537	<b>11.0101-5402.2</b> 260009 Hülsensatz <b>11.0441-6003.2</b> 250037 Dichtungssatz <b>11.8116-0083.1</b> 390501 Haltefeder <b>11.8171-0008.1</b> 990049 Führungsbolzen	
24.3571-8522.5 240496	<b>11.0101-5409.2</b> 260035 Hülsensatz <b>11.0441-5704.2</b> 250034 Dichtungssatz <b>11.8116-0143.1</b> 390513 Haltefeder <b>11.8170-0306.1</b> 260102 Halter <b>11.8171-0008.1</b> 990049 Führungsbolzen		24.3601-8506.5 240538	<b>11.0101-5402.2</b> 260009 Hülsensatz <b>11.0441-6003.2</b> 250037 Dichtungssatz <b>11.8116-0083.1</b> 390501 Haltefeder <b>11.8171-0008.1</b> 990049 Führungsbolzen	
24.3571-9801.5 240497	<b>11.0101-5407.2</b> 260011 Hülsensatz <b>11.8171-0008.1</b> 990049 Führungsbolzen		24.3601-8527.5 240503	<b>11.0101-5407.2</b> 260011 Hülsensatz <b>11.0441-6007.2</b> 250146 Dichtungssatz <b>11.8171-0008.1</b> 990049 Führungsbolzen	
24.3571-9802.5 240498	<b>11.0101-5407.2</b> 260011 Hülsensatz <b>11.8171-0008.1</b> 990049 Führungsbolzen		24.3601-8528.5 240504	<b>11.0101-5407.2</b> 260011 Hülsensatz <b>11.0441-6007.2</b> 250146 Dichtungssatz <b>11.8171-0008.1</b> 990049 Führungsbolzen	
24.3571-9813.5 240557	<b>11.0101-5407.2</b> 260011 Hülsensatz <b>11.8171-0008.1</b> 990049 Führungsbolzen		24.3601-9787.5 240505	<b>11.0101-5407.2</b> 260011 Hülsensatz <b>11.8171-0008.1</b> 990049 Führungsbolzen	
24.3571-9814.5 240558	<b>11.0101-5407.2</b> 260011 Hülsensatz <b>11.8171-0008.1</b> 990049 Führungsbolzen		24.3601-9788.5 240506	<b>11.0101-5407.2</b> 260011 Hülsensatz <b>11.8171-0008.1</b> 990049 Führungsbolzen	
24.3571-9823.5 240499	<b>11.0101-5407.2</b> 260011 Hülsensatz <b>11.0441-5704.2</b> 250034 Dichtungssatz <b>11.8171-0008.1</b> 990049 Führungsbolzen		24.3601-9829.5 240507	<b>11.0101-5407.2</b> 260011 Hülsensatz <b>11.8171-0008.1</b> 990049 Führungsbolzen	
24.3571-9824.5 240500	<b>11.0101-5407.2</b> 260011 Hülsensatz <b>11.0441-5704.2</b> 250034 Dichtungssatz <b>11.8171-0008.1</b> 990049 Führungsbolzen		24.3601-9830.5 240508	<b>11.0101-5407.2</b> 260011 Hülsensatz <b>11.8171-0008.1</b> 990049 Führungsbolzen	
24.3571-9841.5 240501	<b>11.0101-5407.2</b> 260011 Hülsensatz <b>11.8171-0008.1</b> 990049 Führungsbolzen		24.9235-0013.5 230001	<b>13.0441-3506.2</b> 250052 Dichtungssatz	
24.3571-9842.5 240502	<b>11.0101-5407.2</b> 260011 Hülsensatz <b>11.8171-0008.1</b> 990049 Führungsbolzen		24.9235-0014.5 230002	<b>13.0441-3506.2</b> 250052 Dichtungssatz	
24.3601-1601.5 240203	<b>11.0101-5403.2</b> 260010 Faltenbalgsatz		24.9235-8005.5 230023	<b>13.0441-3505.2</b> 250051 Dichtungssatz	
24.3601-1602.5 240204	<b>11.0101-5403.2</b> 260010 Faltenbalgsatz		24.9235-8006.5 230024	<b>13.0441-3505.2</b> 250051 Dichtungssatz	
24.3601-1709.5 240275	<b>11.0101-6004.2</b> 260014 Hülsensatz <b>11.0441-6003.2</b> 250037 Dichtungssatz				

# Reparatursätze

Repair kits - Corredi riparazione - Nécessaires de réparation - Juegos de reparación

					
24.9238-0087.5 230035	<b>13.0441-3819.2</b> 250072	Dichtungssatz			
24.9238-0088.5 230036	<b>13.0441-3819.2</b> 250072	Dichtungssatz			
24.9238-8033.5 230015	<b>13.0441-3817.2</b> 250071	Dichtungssatz			
24.9238-8034.5 230016	<b>13.0441-3817.2</b> 250071	Dichtungssatz			
24.9238-8035.5 230025	<b>13.0441-3817.2</b> 250071	Dichtungssatz			
24.9238-8036.5 230026	<b>13.0441-3817.2</b> 250071	Dichtungssatz			
24.9240-0027.5 230017	<b>13.0441-4014.2</b> 250079	Dichtungssatz			
24.9240-0028.5 230018	<b>13.0441-4014.2</b> 250079	Dichtungssatz			
24.9240-8013.5 230019	<b>13.0441-4020.2</b> 250084	Dichtungssatz			
24.9240-8014.5 230020	<b>13.0441-4020.2</b> 250084	Dichtungssatz			
24.9242-8005.5 230027	<b>13.0441-4205.2</b> 250086	Dichtungssatz			
24.9242-8006.5 230028	<b>13.0441-4205.2</b> 250086	Dichtungssatz			
24.9242-8007.5 230029	<b>13.0441-4205.2</b> 250086	Dichtungssatz			
24.9242-8008.5 230030	<b>13.0441-4205.2</b> 250086	Dichtungssatz			
24.9242-8021.5 230031	<b>13.0441-4206.2</b> 250087	Dichtungssatz			
24.9242-8022.5 230032	<b>13.0441-4206.2</b> 250087	Dichtungssatz			
24.9246-8001.5 230021	<b>13.0441-4601.2</b> 250099	Dichtungssatz			
24.9246-8002.5 230022	<b>13.0441-4601.2</b> 250099	Dichtungssatz			
24.9257-8024.5 230034	<b>13.0441-5724.2</b> 250125	Dichtungssatz			
24.9260-8025.5 230041	<b>13.0441-6001.2</b> 250126	Dichtungssatz			
24.9260-8026.5 230042	<b>13.0441-6001.2</b> 250126	Dichtungssatz			
24.9260-8029.5 230043	<b>13.0441-6003.2</b> 250128	Dichtungssatz			
24.9260-8030.5 230044	<b>13.0441-6003.2</b> 250128	Dichtungssatz			
24.9260-8031.5 230045	<b>13.0441-6003.2</b> 250128	Dichtungssatz			
24.9260-8032.5 230046	<b>13.0441-6003.2</b> 250128	Dichtungssatz			
24.9440-8027.5 230051	<b>13.0441-4016.2</b> 250081	Dichtungssatz			
24.9440-8028.5 230052	<b>13.0441-4016.2</b> 250081	Dichtungssatz			
24.9442-8003.5 230053	<b>13.0441-4214.2</b> 250091	Dichtungssatz			
24.9442-8004.5 230054	<b>13.0441-4214.2</b> 250091	Dichtungssatz			

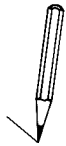

A large rectangular area containing numerous horizontal lines, designed for writing or drawing.





Ⓓ **Vergleichsliste**

Ⓔ **Cross reference list**

Ⓕ **Liste des correspondances**



Ⓖ **Lista referencias**



# Vergleichsliste

Cross reference list - Tabella di conversione codici



Liste des correspondances - Lista referencias

VAG		VAG		VAG				
191 609 721 E	24.3727-0132.2	580132	1H0 611 775	83.7836-0135.3	330816	211 615 107 A	13.2541-8002.2	210111
191 609 721 F	24.3727-0133.2	580133	1H0 612 151 C	03.6584-0113.3	320111	211 615 108 A	13.2541-8001.2	210110
191 611 019	03.2120-2031.3	010106	1H0 612 151 E	03.6584-0113.3	320111	211 615 301 B	24.0113-0132.1	413132
191 611 701	24.5170-0315.3	331309	1H0 615 301	24.0122-0100.1	422100	211 698 151	13.0460-6027.2	606027
191 611 701 A	83.6225-0287.3	330735	1H0 615 301	24.0322-0100.1	522100	211 698 151 A	13.0460-6027.2	606027
191 612 107 A	03.6750-0202.4	300033	1H0 615 301 A	24.0122-0100.1	422100	211 698 151 B	13.0460-6027.2	606027
191 612 151	03.6584-0015.3	320109	1H0 615 301 A	24.0322-0100.1	522100	211 698 151 D	13.0460-6027.2	606027
191 612 151 C	03.6584-0015.3	320109	1H0 615 423	24.3384-1707.5	240171	211 698 151 F	13.0460-6027.2	606027
191 615 123	24.3481-1745.5	240277	1H0 615 423 A	24.3384-1707.5	240171	211 698 471	13.0441-5415.2	250116
191 615 124	24.3481-1746.5	240278	1H0 615 423 B	24.3384-1707.5	240171	211 698 471 A	13.0441-5416.2	250117
191 615 423 A	24.3364-1605.5	240011	1H0 615 423 D	24.3384-1707.5	240171	211 698 471 C	13.0441-5415.2	250116
191 615 423 AX	24.3364-1605.5	240011	1H0 615 423 DX	24.3384-1707.5	240171	211 698 537 SX	03.0137-0055.2	650055
191 615 423 B	24.3384-1603.5	240015	1H0 615 424	24.3384-1708.5	240172	251 407 615 B	24.0116-0109.1	416109
191 615 424 A	24.3364-1606.5	240012	1H0 615 424 A	24.3384-1708.5	240172	251 407 615 Q	24.0116-0109.1	416109
191 615 424 AX	24.3364-1606.5	240012	1H0 615 424 B	24.3384-1708.5	240172	251 407 617	24.0113-0142.1	413142
191 615 424 B	24.3384-1604.5	240016	1H0 615 424 D	24.3384-1708.5	240172	251 407 617 A	24.0113-0142.1	413142
191 615 601	24.0110-0111.1	410111	1H0 615 424 DX	24.3384-1708.5	240172	251 407 617 D	24.0116-0104.1	416104
191 615 601	24.0110-0275.2	410275	1H0 698 071	03.0137-0268.2	650268	251 407 617 G	24.0116-0104.1	416104
191 615 601 B	24.0110-0111.1	410111	1H0 698 151	13.0460-7032.2	607032	251 407 617 K	24.0116-0104.1	416104
191 615 601 B	24.0110-0275.2	410275	1H0 698 451	13.0460-2984.2	602984	251 407 617 M	24.0116-0104.1	416104
191 698 151	13.0460-7030.2	607030	1H0 698 451 A	13.0460-2984.2	602984	251 609 531 M	03.0137-0148.2	650148
191 698 151 A	13.0460-7030.2	607030	1H0 698 451 B	13.0460-2937.2	602937	251 609 531 P	03.0137-0148.2	650148
191 698 151 B	13.0460-7033.2	607033	1H0 698 451 C	13.0460-2937.2	602937	251 609 532 M	03.0137-0148.2	650148
191 698 151 C	13.0460-7032.2	607032	1H0 698 451 D	13.0460-2984.2	602984	251 609 532 Q	03.0137-0148.2	650148
191 698 151 D	13.0460-7032.2	607032	1H0 698 451 E	13.0460-2937.2	602937	251 609 615	24.0225-2002.2	480046
191 698 151 E	13.0460-7030.2	607030	1H0 698 451 F	13.0460-2937.2	602937	251 609 615 A	24.0227-0003.1	480145
191 698 151 F	13.0460-7030.2	607030	1H0 698 451 G	13.0460-2984.2	602984	251 609 701 A	24.3727-0109.2	580109
191 698 151 G	13.0460-7033.2	607033	1H0 698 451 H	13.0460-2937.2	602937	251 609 701 B	24.3727-0109.2	580109
191 698 151 H	13.0460-7032.2	607032	1H0 698 520 V	03.0137-0268.2	650268	251 609 701 C	24.3727-0109.2	580109
191 698 151 J	13.0460-7032.2	607032	1H0 698 520 X	03.0137-0268.2	650268	251 611 021	03.2120-0851.3	010082
191 698 151 K	13.0460-7032.2	607032	1H0 698 525 V	03.0137-0268.2	650268	251 611 021 B	03.2123-0291.3	010165
191 698 447	11.0101-4803.2	260008	1H0 698 525 X	03.0137-0268.2	650268	251 611 021 C	03.2123-0271.3	010164
191 698 451	13.0460-2937.2	602937	1H0 698 545	03.0137-9168.2	669168	251 611 775 A	83.7824-0383.3	330856
191 698 451 A	13.0460-2937.2	602937	1H0 698 545 A	03.0137-9168.2	669168	251 611 775 B	83.7834-0440.3	330813
191 698 451 B	13.0460-2937.2	602937	1H0 698 545 B	03.0137-9168.2	669168	251 615 107	13.2541-8002.2	210111
191 698 451 C	13.0460-2937.2	602937	1H0 927 807	24.0711-1361.3	360022	251 615 107 A	13.2541-8002.2	210111
191 698 451 D	13.0460-2937.2	602937	1H0 927 807 A	24.0721-1937.1	360040	251 615 107 B	24.3601-1601.5	240203
191 721 335 AB	24.3728-0121.2	590121	1H0 927 808	24.0711-1362.3	360023	251 615 108	13.2541-8001.2	210110
191 721 335 C	24.3728-0111.2	590111	1H1 611 019 A	03.2120-3943.3	010532	251 615 108 A	13.2541-8001.2	210110
191 721 335 D	24.3728-0121.2	590121	1H1 611 019 B	03.2122-1042.3	010137	251 615 108 B	24.3601-1602.5	240204
191 721 335 E	24.3728-0113.2	590113	1H1 611 019 C	03.2120-3943.3	010532	251 615 123 B	24.3601-1601.5	240203
191 721 335 F	24.3728-0120.2	590120	1J0 611 053	24.3220-0909.3	020210	251 615 123 C	24.3601-1709.5	240275
191 721 335 G	24.3728-0121.2	590121	1J0 927 803	24.0711-1361.3	360022	251 615 123 D	24.3601-1601.5	240203
191 721 335 J	24.3728-0113.2	590113	1J0 927 804	24.0711-1362.3	360023	251 615 124 B	24.3601-1602.5	240204
191 721 335 M	24.3728-0111.2	590111	200 611 021	03.3119-0507.3	010264	251 615 124 C	24.3601-1710.5	240276
191 721 335 N	24.3728-0121.2	590121	211 609 537 N	03.0137-0055.2	650055	251 615 124 D	24.3601-1602.5	240204
191 721 335 Q	24.3728-0121.2	590121	211 609 615	24.0225-2001.2	480045	251 615 219	11.8171-0008.1	990049
191 721 335 R	24.3728-0113.2	590113	211 609 701 T	24.3727-0107.2	580107	251 698 151	13.0460-6028.2	606028
191 721 335 S	24.3728-0113.2	590113	211 611 021 AA	03.2123-2604.3	010178	251 698 151 A	13.0460-6028.2	606028
191 721 355 A	24.3728-0111.2	590111	211 611 021 AE	03.2120-8411.3	010125	251 698 151 C	13.0460-2903.2	602903
191 927 807	24.0711-1109.3	360001	211 611 021 AG	03.2120-8411.3	010125	251 698 151 D	13.0460-6028.2	606028
191 927 807 A	24.0711-1313.3	360016	211 611 021 AJ	03.2120-8411.3	010125	251 698 151 E	13.0460-6028.2	606028
191 927 807 D	24.0721-1925.1	360039	211 611 021 K	03.2122-0903.3	010136	251 698 151 F	13.0460-2903.2	602903
192 611 019	03.2120-2031.3	010106	211 611 021 L	03.2122-0903.3	010136	251 698 447	11.0101-6004.2	260014
192 611 019 B	03.2122-1042.3	010137	211 611 021 N	03.2123-2604.3	010178	251 698 471	13.0441-5416.2	250117
1E0 698 451	13.0460-2984.2	602984	211 611 021 Q	03.2122-0903.3	010136	251 698 471 B	11.0441-6003.2	250037
1E0 698 451 A	13.0460-2937.2	602937	211 611 021 T	03.2122-2905.3	010141	251 698 477	11.0101-6004.2	260014
1E0 698 451 C	13.0460-2984.2	602984	211 611 047	03.3222-0801.3	020067	251 698 531 LV	03.0137-0148.2	650148
1E0 698 451 D	13.0460-2984.2	602984	211 611 047 C	03.3222-0801.3	020067	251 698 531 LX	03.0137-0148.2	650148
1E0 698 451 E	13.0460-2984.2	602984	211 611 047 D	03.3223-1112.3	020092	251 698 545	03.0137-9035.2	669035
1E0 698 451 G	13.0460-2984.2	602984	211 611 047 F	03.3223-1112.3	020092	251 721 263 A	03.2525-2711.3	040030
1GD 698 151	13.0460-7032.2	607032	211 611 049 B	24.2725-0903.3	020145	251 721 335	24.3728-0123.2	590123
1H0 501 615 A	24.0220-0018.1	480019	211 611 050 B	24.2725-0904.3	020146	251 721 401 A	03.2419-8212.3	030020
1H0 501 615 A	24.0220-0718.2	480209	211 611 069 C	24.2725-0903.3	020145	251 721 477 D	24.5803-0325.3	330051
1H0 609 721 A	24.3727-0134.2	580134	211 611 070 C	24.2725-0904.3	020146	251 798 041	03.0450-2510.2	082510
1H0 609 721 E	24.3727-0156.2	580156	211 611 301 E	03.3508-8302.3	310046	281 611 771 C	83.6124-0362.3	330715
1H0 611 053	24.3219-0909.3	020188	211 611 701	24.5165-0425.3	331258	281 612 105	03.6850-5402.4	300055
1H0 611 053 A	24.3215-0903.3	020154	211 611 775 A	24.5224-0295.3	331261	291 609 527 H	03.0137-0252.2	650252
1H0 611 053 B	24.3214-0902.3	020147	211 611 775 B	24.5224-0240.3	331260	291 611 775	83.7834-0440.3	330813
1H0 611 701	83.7713-0435.3	330792	211 611 775 C	83.6101-0250.3	330203	291 698 527 GV	03.0137-0252.2	650252
1H0 611 701 F	83.7713-0435.3	330792	211 612 103 A	03.6850-0502.4	300044	291 698 527 GX	03.0137-0252.2	650252

# Vergleichsliste

Cross reference list - Tabella di conversione codici

Liste des correspondances - Lista referencias

VAG		VAG		VAG				
2D0 609 525	03.0137-4001.2	654001	357 611 019 A	03.2122-1042.3	010137	431 721 401 A	03.2419-9610.3	030029
2D0 609 538	03.0137-4001.2	654001	357 611 019 B	03.2122-1042.3	010137	433 611 707	83.6134-0332.3	330716
2D0 615 601 A	24.0116-0110.1	416110	357 611 053 B	24.3220-0909.3	020210	433 611 775 A	83.7824-0180.3	330812
2D0 615 601 D	24.0116-0110.1	416110	357 612 107	03.7750-4302.4	300076	437 611 775	24.5170-0161.3	331308
2D0 698 451 B	13.0460-3990.2	603990	357 612 107 A	03.7750-4302.4	300076	437 615 301	24.0122-0120.1	422120
2D0 698 471	11.0441-6007.2	250146	357 612 151	03.6584-0015.3	320109	437 615 301 A	24.0122-0120.1	422120
2D0 698 525	03.0137-4001.2	654001	357 612 151 A	03.6584-0015.3	320109	437 615 601	24.0110-0154.1	410154
2D0 698 525 B	03.0137-4001.2	654001	357 615 123 A	24.3541-1609.5	240039	437 698 151	13.0460-2934.2	602934
2D0 919 351	24.8190-0407.2	620407	357 615 123 AV	24.3541-1609.5	240039	437 698 451	13.0460-3602.2	603602
311 405 583 A	24.0110-0142.1	410142	357 615 123 AX	24.3541-1609.5	240039	441 611 021	03.2125-3210.3	010212
311 611 015 K	03.2119-6713.3	010061	357 615 123 B	24.3541-1731.5	240061	441 611 021 A	03.2125-3210.3	010212
311 611 015 L	03.2119-6713.3	010061	357 615 123 BX	24.3541-1731.5	240061	441 611 021 B	03.2125-3610.3	010214
311 611 023	03.3119-6457.3	010269	357 615 123 C	24.3541-1731.5	240061	441 611 707	83.7813-0252.3	330796
311 611 067 B	03.3222-5011.3	020462	357 615 124 A	24.3541-1610.5	240040	441 612 099 B	10.0124-3202.3	340011
311 611 067 C	03.3222-5011.3	020462	357 615 124 AV	24.3541-1610.5	240040	441 612 099 C	10.0124-3202.3	340011
311 611 701 B	83.6101-0325.3	330206	357 615 124 AX	24.3541-1610.5	240040	441 612 101 A	10.0124-3202.3	340011
311 698 151 A	13.0460-3010.2	603010	357 615 124 B	24.3541-1732.5	240062	441 612 101 B	10.0124-3202.3	340011
311 698 151 B	13.0460-3010.2	603010	357 615 124 BX	24.3541-1732.5	240062	441 615 301 AA	24.0130-0104.1	430104
311 698 151 C	13.0460-4033.2	604033	357 615 124 C	24.3541-1732.5	240062	441 698 151	13.0460-2847.2	602847
311 698 151 E	13.0460-4033.2	604033	357 615 301	24.0113-0178.1	413178	441 698 151 A	13.0460-2847.2	602847
311 698 471	13.0441-4204.2	250085	357 615 301	24.0313-0178.1	513178	441 698 151 D	13.0460-2847.2	602847
321 609 721 C	24.3727-0108.2	580108	357 615 601	24.0110-0111.1	410111	441 919 351 A	24.8190-0105.2	620105
321 611 019 N	03.2120-2191.3	010108	357 615 601	24.0110-0275.2	410275	443 501 615 A	24.0223-0007.1	480037
321 611 053 A	03.3217-2112.3	020027	357 615 601 B	24.0110-0203.1	410203	443 501 615 B	24.0223-0011.1	480041
321 611 701 B	24.5170-0315.3	331309	357 615 601 B	24.0110-0276.2	410276	443 609 525	03.0137-0146.2	650146
321 611 701 D	24.5108-0266.3	330038	357 698 151	13.0460-2958.2	602958	443 609 525 A	03.0137-0264.2	650264
321 611 775	83.7824-0180.3	330812	357 698 151 A	13.0460-2957.2	602957	443 609 526	03.0137-0146.2	650146
321 612 105	03.7750-0302.4	300071	357 698 151 B	13.0460-2958.2	602958	443 609 526 A	03.0137-0264.2	650264
321 615 301	24.0112-0106.1	412106	357 698 151 D	13.0460-2957.2	602957	443 609 527	03.0137-0146.2	650146
321 615 301	24.0312-0106.1	512106	357 698 525 CV	03.0137-0264.2	650264	443 609 527 A	03.0137-0264.2	650264
321 615 301 A	24.0120-0123.1	420123	357 698 525 CX	03.0137-0264.2	650264	443 609 528	03.0137-0146.2	650146
321 615 301 A	24.0320-0123.1	520123	357 698 525 V	03.0137-0268.2	650268	443 609 528 A	03.0137-0264.2	650264
321 615 301 B	24.0120-0123.1	420123	357 698 525 X	03.0137-0268.2	650268	443 609 721	24.3727-0119.2	580119
321 615 301 B	24.0320-0123.1	520123	357 721 261	24.2523-0908.3	040049	443 609 721 A	24.3727-0138.2	580138
321 615 301 C	24.0120-0123.1	420123	357 721 261 A	24.2523-0908.3	040049	443 609 721 E	24.3727-0130.2	580130
321 615 301 C	24.0320-0123.1	520123	357 721 335	24.3728-0124.2	590124	443 609 721 G	24.3727-0130.2	580130
321 615 301 D	24.0120-0128.1	420128	357 721 335 E	24.3728-0124.2	590124	443 609 721 K	24.3727-0119.2	580119
321 615 301 D	24.0320-0128.1	520128	357 721 401	03.2419-9310.3	030027	443 611 019	03.2122-8012.3	010156
321 698 151	13.0460-7032.2	607032	357 927 807	24.0721-1925.1	360039	443 611 019 A	03.2122-8012.3	010156
321 698 151 B	13.0460-7033.2	607033	357 927 807 A	24.0711-1135.3	360003	443 611 021	03.2123-8512.3	010194
321 698 151 C	13.0460-7032.2	607032	358 612 107	03.7750-4902.4	300079	443 611 190	03.3517-5100.1	390326
321 698 151 D	13.0460-7033.2	607033	358 612 107 B	03.7750-4902.4	300079	443 611 707	83.6134-0332.3	330716
321 698 151 E	13.0460-7033.2	607033	361 611 067 A	03.3223-0611.3	020091	443 611 707 C	24.5113-0380.3	331344
321 698 151 F	13.0460-7032.2	607032	3A0 611 053	24.3220-0909.3	020210	443 611 775	83.6224-0300.3	330730
321 698 151 G	13.0460-7032.2	607032	3A0 615 125	11.8170-0306.1	260102	443 611 775 A	83.6204-0240.3	330718
321 698 151 H	13.0460-7033.2	607033	3A0 615 125 A	11.8170-0306.1	260102	443 611 775 B	83.6301-0150.3	330342
321 698 445	13.0460-0905.2	610905	3A0 615 269	11.8116-0143.1	390513	443 611 775 F	24.5113-0220.3	331318
321 698 545	03.0137-9041.2	669041	3A0 698 545	03.0137-9149.2	669149	443 612 099	10.0124-3202.3	340011
321 721 335 H	24.3728-0114.2	590114	3A1 721 388	03.2419-1206.3	030074	443 612 099 B	10.0124-3202.3	340011
322 611 019	03.2120-2331.3	010110	3B0 615 125	11.8170-0306.1	260102	443 612 099 C	10.0124-3202.3	340011
322 611 019 A	03.2122-9612.3	010159	411 698 151 B	13.0460-4033.2	604033	443 614 151 A	03.6585-0108.3	320115
323 501 615	24.0220-0018.1	480019	411 698 471	13.0441-4209.2	250088	443 614 151 H	03.6585-0108.3	320115
323 501 615	24.0220-0718.2	480209	431 501 615	24.0223-0007.1	480037	443 615 107 C	11.3541-8521.2	220113
331 609 525	03.0137-0146.2	650146	431 501 615 A	24.0223-0007.1	480037	443 615 108 C	11.3541-8522.2	220114
331 609 526	03.0137-0146.2	650146	431 609 525	03.0137-0264.2	650264	443 615 108 C	24.3541-8522.5	240488
331 609 527 F	03.0137-0146.2	650146	431 609 526	03.0137-0264.2	650264	443 615 123	24.3541-1609.5	240039
331 609 528 F	03.0137-0146.2	650146	431 609 527 E	03.0137-0264.2	650264	443 615 123 E	11.3541-8521.2	220113
331 611 051 A	03.3217-2112.3	020027	431 609 528 E	03.0137-0264.2	650264	443 615 123 EX	11.3541-8521.2	220113
331 611 053	03.3217-2112.3	020027	431 611 707	83.6124-0362.3	330715	443 615 124	24.3541-1610.5	240040
331 611 053 A	03.3217-2112.3	020027	431 611 707 A	83.6134-0332.3	330716	443 615 124 E	11.3541-8522.2	220114
357 501 615	24.0223-0012.1	480042	431 611 775 A	83.7824-0180.3	330812	443 615 124 E	24.3541-8522.5	240488
357 609 525 C	03.0137-0264.2	650264	431 615 301	24.0113-0160.1	413160	443 615 124 EX	11.3541-8522.2	220114
357 609 526 C	03.0137-0264.2	650264	431 615 301 A	24.0122-0118.1	422118	443 615 124 EX	24.3541-8522.5	240488
357 609 527 E	03.0137-0264.2	650264	431 698 071 E	03.0137-0268.2	650268	443 615 301	24.0113-0160.1	413160
357 609 528 E	03.0137-0264.2	650264	431 698 073 E	03.0137-0268.2	650268	443 615 301 A	24.0122-0118.1	422118
357 609 721	24.3727-0125.2	580125	431 698 151 D	13.0460-2934.2	602934	443 615 301 B	24.0122-0118.1	422118
357 609 721 A	24.3727-0126.2	580126	431 698 151 F	13.0460-2934.2	602934	443 615 423 A	24.3384-1601.5	240013
357 609 721 C	24.3727-0167.2	580167	431 698 151 G	13.0460-2934.2	602934	443 615 423 AX	24.3384-1601.5	240013
357 609 721 D	24.3727-0126.2	580126	431 698 471	11.0441-5401.2	250027	443 615 424 A	24.3384-1602.5	240014
357 609 721 E	24.3727-0126.2	580126	431 721 261	03.2522-4211.3	040017	443 615 424 AX	24.3384-1602.5	240014
357 611 019	03.2120-3943.3	010532	431 721 401	03.2419-9610.3	030029	443 615 601	24.0110-0178.1	410178







# Vergleichsliste

Cross reference list - Tabella di conversione codici



Liste des correspondances - Lista referencias

VAG		VAG		VAG				
443 615 601 A	24.0110-0207.1	410207	4A0 611 707	83.7813-0270.3	330797	6Q0 698 525	03.0137-0268.2	650268
443 615 601 B	24.0110-0116.1	410116	4A0 611 775	24.5113-0209.3	331300	6Q0 698 525 A	03.0137-0268.2	650268
443 615 601 E	24.0110-0200.1	410200	4A0 615 123	24.3571-8505.5	240489	6Q0 698 525 B	03.0137-0268.2	650268
443 698 151 A	13.0460-2925.2	602925	4A0 615 123 A	24.3571-8507.5	240555	6Q0 698 545	03.0137-9168.2	669168
443 698 151 C	13.0460-2925.2	602925	4A0 615 124	11.3571-8506.2	220126	6U0 501 615 B	24.0220-0018.1	480019
443 698 151 D	13.0460-2925.2	602925	4A0 615 124	24.3571-8506.5	240490	6U0 501 615 B	24.0220-0718.2	480209
443 698 151 F	13.0460-2925.2	602925	4A0 615 124 A	11.3571-8508.2	220128	6U0 698 525	03.0137-0268.2	650268
443 698 151 F	13.0460-2934.2	602934	4A0 615 124 A	24.3571-8508.5	240556	6U0 698 525 A	03.0137-0268.2	650268
443 698 151 G	13.0460-2925.2	602925	4A0 615 125 A	11.8170-0306.1	260102	6U0 698 545	03.0137-9168.2	669168
443 698 151 J	13.0460-2925.2	602925	4A0 615 269	11.8116-0143.1	390513	7D0 698 471	11.0441-5704.2	250034
443 698 151 K	13.0460-2925.2	602925	4A0 615 301 B	24.0115-0105.1	415105	7M0 615 423	24.3384-1707.5	240171
443 698 447	11.0101-5409.2	260035	4A0 615 301 B	24.0315-0105.1	515105	7M0 615 424	24.3384-1708.5	240172
443 698 451	13.0460-3602.2	603602	4A0 615 301 C	24.0125-0105.1	425105	803 611 051	03.3215-0221.3	020013
443 698 451 A	13.0460-3602.2	603602	4A0 615 301 C	24.0325-0105.1	525105	803 611 051 A	03.3217-0401.3	020023
443 698 451 B	13.0460-3602.2	603602	4A0 615 301 D	24.0125-0105.1	425105	803 611 301	03.3508-8302.3	310046
443 698 451 C	13.0460-3602.2	603602	4A0 615 301 D	24.0325-0105.1	525105	803 611 707	24.5113-0220.3	331318
443 698 470	11.0101-5403.2	260010	4A0 615 301 E	24.0125-0105.1	425105	803 611 707 B	83.6124-0362.3	330715
443 698 471	11.0441-5405.2	250030	4A0 615 301 E	24.0325-0105.1	525105	803 611 775	24.5113-0220.3	331318
443 698 525 BV	03.0137-0264.2	650264	4A0 615 423	24.3384-1709.5	240257	803 612 303	03.6058-0301.3	320072
443 698 525 BX	03.0137-0264.2	650264	4A0 615 424	24.3384-1710.5	240258	803 698 151 A	13.0460-4033.2	604033
443 698 525 CX	03.0137-0264.2	650264	4A0 615 601 A	24.0110-0201.1	410201	803 698 151 C	13.0460-4033.2	604033
443 698 545	03.0137-9044.2	669044	4A0 615 601 A	24.0310-0201.1	510201	803 698 471	13.0441-4801.2	250100
443 698 647	11.0101-5409.2	260035	4A0 698 151	13.0460-7050.2	607050	803 698 471 C	11.0441-4802.2	250017
443 698 671 A	11.0441-3602.2	250008	4A0 698 151 B	13.0460-2717.2	602717	810 611 707	83.6124-0362.3	330715
443 721 261	03.2522-4211.3	040017	4A0 698 151 C	13.0460-7050.2	607050	811 609 525 A	03.0137-0146.2	650146
443 721 335 C	24.3728-0115.2	590115	4A0 698 151 D	13.0460-2717.2	602717	811 609 526 A	03.0137-0146.2	650146
443 721 335 D	24.3728-0115.2	590115	4A0 698 451	13.0460-3602.2	603602	811 609 527 A	03.0137-0146.2	650146
443 721 401 A	03.2419-9610.3	030029	4A0 698 471	11.0441-5704.2	250034	811 609 527 E	03.0137-0146.2	650146
443 919 081 D	10.0522-4005.1	340029	4A0 721 261	03.2522-4300.3	040085	811 609 528 A	03.0137-0146.2	650146
447 611 021	03.2125-2510.3	010209	4A0 721 401	03.2419-9610.3	030029	811 609 528 E	03.0137-0146.2	650146
447 615 301 A	24.0125-0102.1	425102	4A1 721 401	24.2419-1731.3	030121	811 609 721	24.3727-0136.2	580136
447 615 301 B	24.0125-0102.1	425102	4B0 615 125	11.8170-0306.1	260102	811 609 721 A	24.3727-0136.2	580136
447 615 423	24.3434-1701.5	240357	4D0 698 151 B	13.0460-2717.2	602717	811 609 721 B	24.3727-0136.2	580136
447 615 424	24.3434-1702.5	240358	4D0 698 151 D	13.0460-2717.2	602717	811 609 721 C	24.3727-0136.2	580136
447 615 601 A	24.0120-0137.1	420137	4D0 698 451	13.0460-3602.2	603602	811 609 721 H	24.3727-0136.2	580136
447 698 151 A	13.0460-2963.2	602963	4D0 698 451 A	13.0460-3602.2	603602	811 609 721 J	24.3727-0136.2	580136
447 698 151 B	13.0460-2963.2	602963	4D0 698 451 B	13.0460-3602.2	603602	811 609 722 A	24.3727-0139.2	580139
447 698 151 C	13.0460-5403.2	605403	4D0 698 451 F	13.0460-3602.2	603602	811 609 722 B	24.3727-0139.2	580139
447 698 151 E	13.0460-2963.2	602963	4D0 698 451 G	13.0460-3602.2	603602	811 609 722 D	24.3727-0139.2	580139
447 698 151 F	13.0460-2963.2	602963	4D0 698 647	11.0101-5409.2	260035	811 609 722 E	24.3727-0139.2	580139
447 698 447	11.0101-5409.2	260035	531 609 525	03.0137-0126.2	650126	811 611 019	03.2120-1531.3	010092
447 698 451	13.0460-3602.2	603602	531 609 526	03.0137-0126.2	650126	811 611 019 B	03.2120-1531.3	010092
447 698 451 A	13.0460-3602.2	603602	531 609 527	03.0137-0126.2	650126	811 611 019 D	03.2120-1531.3	010092
447 698 451 C	13.0460-3602.2	603602	531 609 528	03.0137-0126.2	650126	811 611 019 Q	03.2120-2331.3	010110
477 611 775	83.6201-0175.3	330663	531 721 335 C	24.3728-0109.2	590109	811 611 775	83.6224-0200.3	330729
477 612 107 F	03.7750-5702.4	300083	533 611 019	03.2122-9812.3	010161	811 611 775 A	83.7804-0150.3	330853
477 698 151 A	13.0460-3612.2	603612	533 698 151 A	13.0460-2957.2	602957	811 611 817	03.3304-1400.1	390088
481 611 701	83.6104-0250.3	330720	535 609 721 A	24.3727-0134.2	580134	811 612 107 C	03.7750-0302.4	300071
481 611 775	24.5170-0161.3	331308	535 611 701	83.7813-0330.3	330800	811 614 151	03.6565-0101.3	320097
481 611 776	83.7804-0160.3	330811	535 615 301	24.0122-0101.1	422101	811 615 301	24.0110-0151.1	410151
481 698 151 C	13.0460-5029.2	605029	535 615 423	24.3384-1603.5	240015	811 615 301	24.0310-0151.1	510151
481 698 151 E	13.0460-5029.2	605029	535 615 423 X	24.3384-1603.5	240015	811 698 071	03.0137-0268.2	650268
481 698 471	13.0441-3401.2	250044	535 615 424	24.3384-1604.5	240016	811 698 151	13.0460-4028.2	604028
4A0 501 615 A	24.0223-0014.1	480065	535 615 424 X	24.3384-1604.5	240016	811 698 525 AV	03.0137-0146.2	650146
4A0 501 615 B	24.0223-0014.1	480065	695 352 631	83.6101-0240.3	330202	811 698 525 AX	03.0137-0146.2	650146
4A0 609 721 B	24.3727-0142.2	580142	6K0 611 701	83.7713-0435.3	330792	823 501 615 B	24.0218-0007.1	480003
4A0 609 721 C	24.3727-0142.2	580142	6N0 611 053	24.3217-0908.3	020167	823 501 615 B	24.0218-0707.2	480211
4A0 609 721 D	24.3727-0154.2	580154	6N0 615 301 D	24.0120-0128.1	420128	823 611 707	24.5170-0315.3	331309
4A0 609 721 E	24.3727-0141.2	580141	6N0 615 301 D	24.0320-0128.1	520128	823 615 301	24.0110-0151.1	410151
4A0 609 721 F	24.3727-0142.2	580142	6N0 615 601	24.0110-0111.1	410111	823 615 301	24.0310-0151.1	510151
4A0 611 019	03.2123-0491.3	010167	6N0 615 601	24.0110-0275.2	410275	823 698 151	13.0460-4028.2	604028
4A0 611 019 A	24.2123-1602.3	010384	6Q0 609 525 A	03.0137-0268.2	650268	823 698 151 A	13.0460-4028.2	604028
4A0 611 019 B	24.2123-1601.3	010383	6Q0 609 525 B	03.0137-0268.2	650268	823 698 445	13.0460-0115.2	610115
4A0 611 019 C	03.2123-0491.3	010167	6Q0 609 526 A	03.0137-0268.2	650268	823 698 471	11.0441-4402.2	250014
4A0 611 019 D	24.2123-1602.3	010384	6Q0 609 526 B	03.0137-0268.2	650268	827 698 471	11.0441-4402.2	250014
4A0 611 019 E	24.2123-1601.3	010383	6Q0 609 527 A	03.0137-0268.2	650268	839 615 301	24.0112-0106.1	412106
4A0 611 021	24.2123-1601.3	010383	6Q0 609 527 B	03.0137-0268.2	650268	839 615 301	24.0312-0106.1	512106
4A0 611 021 A	24.2123-1602.3	010384	6Q0 609 528 A	03.0137-0268.2	650268	841 501 615 A	24.0220-0018.1	480019
4A0 611 021 B	03.2123-0491.3	010167	6Q0 609 528 B	03.0137-0268.2	650268	841 501 615 A	24.0220-0718.2	480209
4A0 611 021 D	24.2123-1602.3	010384	6Q0 611 053 B	24.3219-0909.3	020188	841 612 151	03.6565-0101.3	320097
			6Q0 611 053 C	24.3217-0908.3	020167			

# Vergleichsliste

Cross reference list - Tabella di conversione codici

Liste des correspondances - Lista referencias

VAG		VAG			
841 615 301	24.0120-0123.1	420123	893 611 019 A	03.2122-9612.3	010159
841 615 301	24.0320-0123.1	520123	893 611 019 C	24.2122-1601.3	010380
849 611 701 G	24.5170-0315.3	331309	893 611 019 E	03.2122-9612.3	010159
849 611 707 A	24.5170-0315.3	331309	893 611 019 F	24.2122-1601.3	010380
853 611 019	03.2122-9612.3	010159	893 611 021	03.2123-0566.3	010169
853 611 019 A	03.2122-9612.3	010159	893 611 021 A	24.2122-1601.3	010380
853 611 021	03.2123-0566.3	010169	893 611 021 B	03.2122-9612.3	010159
853 611 775	83.6104-0250.3	330720	893 611 707	83.7813-0285.3	330798
853 612 099	10.0124-3202.3	340011	893 611 775	83.6104-0250.3	330720
853 612 107 A	03.7750-0302.4	300071	893 611 775 A	24.5170-0161.3	331308
853 612 107 B	03.7750-0302.4	300071	893 612 099	10.0124-3202.3	340011
853 612 107 D	03.7750-0302.4	300071	893 612 107 A	03.7750-0302.4	300071
853 615 301 A	24.0120-0120.1	420120	893 612 107 B	03.7750-0302.4	300071
853 615 301 C	24.0120-0120.1	420120	893 615 107 A	11.3541-8522.2	220114
853 615 423 A	24.3384-1703.5	240055	893 615 107 A	24.3541-8522.5	240488
853 615 423 AX	24.3384-1703.5	240055	893 615 108 A	11.3541-8521.2	220113
853 615 424 A	24.3384-1704.5	240056	893 615 123 B	11.3541-8522.2	220114
853 615 424 AX	24.3384-1704.5	240056	893 615 123 B	24.3541-8522.5	240488
853 615 601	24.0110-0182.1	410182	893 615 124 B	11.3541-8521.2	220113
853 698 151 A	13.0460-2926.2	602926	893 721 261 A	03.2522-4300.3	040085
855 698 151 B	13.0460-2936.2	602936	893 721 401 B	03.2419-9210.3	030026
857 612 085	10.0515-0515.3	340024	893 721 401 D	03.2419-9210.3	030026
857 612 085 A	10.0515-0515.3	340024	894 611 021	03.2123-0566.3	010169
857 615 601	24.0120-0172.1	420172	895 698 151	13.0460-2963.2	602963
857 698 451	13.0460-3602.2	603602	895 698 151 A	13.0460-2963.2	602963
857 721 261	03.2522-4211.3	040017	895 698 151 B	13.0460-2963.2	602963
857 721 401	03.2419-8150.3	030019	8A0 611 021	03.2123-0491.3	010167
857 721 401 A	03.2419-8150.3	030019	8A0 615 601	24.0110-0182.1	410182
857 919 457	10.0522-4005.1	340029	8A0 698 151	13.0460-2934.2	602934
857 919 457 A	10.0522-4002.1	340028	8A0 698 151 A	13.0460-2934.2	602934
857 919 457 B	10.0522-4002.1	340028	8A0 698 151 B	13.0460-2934.2	602934
861 609 721 B	24.3727-0103.2	580103	8A0 698 151 C	13.0460-2934.2	602934
861 609 729	24.3727-0146.2	580146	8A0 698 151 E	13.0460-2934.2	602934
861 611 019 A	03.2117-3311.3	010040	8A1 612 099	10.0124-3202.3	340011
861 611 019 B	03.2120-1531.3	010092	8A2 612 107	03.7750-0302.4	300071
861 611 053	24.3219-0909.3	020188	8D0 611 775 D	24.5113-0220.3	331318
861 611 053 A	03.3215-2311.3	020018	8D0 698 151	13.0460-2934.2	602934
861 611 707 A	83.7734-0290.3	330809	8D0 698 151 L	13.0460-2934.2	602934
861 611 707 B	83.7734-0290.3	330809	8E0 615 301 Q	24.0125-0105.1	425105
861 611 707 C	83.7734-0290.3	330809	8E0 615 301 Q	24.0325-0105.1	525105
861 615 301	24.0108-0100.1	408100	8E0 615 601	24.0110-0201.1	410201
861 615 301 B	24.0108-0100.1	408100	8E0 615 601	24.0310-0201.1	510201
861 698 151	13.0460-4028.2	604028	8E0 698 151 A	13.0460-2934.2	602934
861 698 151 A	13.0460-4028.2	604028	8E0 698 470 B	11.0101-5403.2	260010
861 698 471	11.0441-4402.2	250014	8V0 698 647	11.0101-5407.2	260011
861 721 335 A	24.3728-0101.2	590101	9-8380-57-753	13.0460-3010.2	603010
861 721 335 C	24.3728-0118.2	590118	J04 465 350 20	13.0460-5938.2	605938
867 609 525	03.0137-0126.2	650126	J04 465 353 20	13.0460-5938.2	605938
867 609 526	03.0137-0126.2	650126	J04 491 352 00	13.0460-5938.2	605938
867 609 527	03.0137-0126.2	650126	J04 495 351 22	03.0137-0226.2	650226
867 609 528	03.0137-0126.2	650126	J43 512 351 80	24.0125-0118.1	425118
867 609 701	24.3727-0129.2	580129	J43 512 351 90	24.0120-0168.1	420168
867 609 721	24.3727-0137.2	580137			
867 698 151	13.0460-7059.2	607059			
867 698 520 X	03.0137-0126.2	650126			
867 698 525 V	03.0137-0126.2	650126			
867 698 525 X	03.0137-0126.2	650126			
867 721 335 A	24.3728-0101.2	590101			
867 721 335 C	24.3728-0101.2	590101			
867 721 335 E	24.3728-0118.2	590118			
867 721 335 F	24.3728-0118.2	590118			
867 721 335 H	24.3728-0118.2	590118			
893 501 615	24.0220-0016.1	480018			
893 501 615 A	24.0220-0017.1	480053			
893 609 721	24.3727-0128.2	580128			
893 609 721 F	24.3727-0143.2	580143			
893 609 721 G	24.3727-0128.2	580128			
893 609 722	24.3727-0127.2	580127			
893 609 722 F	24.3727-0144.2	580144			
893 609 722 G	24.3727-0127.2	580127			
893 611 019	03.2122-9612.3	010159			



A large rectangular area containing 30 horizontal lines, intended for writing or drawing.





④ Technische Übersetzungen

⑤ Technical translations

⑥ Traductions techniques

⑦ Traducciones técnicas

1-Kammer-Druckluftbremse	single-chamber air brake
1-Kolbensattel D=xx	single-piston caliper D=xx
2-Kolbensattel D=xx	2-piston caliper D=xx
4-Kolbensattel	4-piston caliper
1-Kreis-Bremse	single-circuit brake
2-Kreis-Bremse	two-circuit-brake
1-Kreis-Sättel	single-circuit caliper
2-Kreis-Sättel	two-circuit-caliper
1. Hinterachse	first rear axle
1. und 2. Hinterachse	first and second rear axle
4-Loch-Bremsscheibe	4-bore brake disc
6-Loch-Bremsscheibe	6-bore brake disc
3-Loch-Felge	3-bore wheel rim
4-Loch-Felge	4-bore wheel rim
5-Loch-Felge	5-bore wheel rim
6kt-Schraube	hexagon head screw
6kt-Schraube (innen)	hexagon socket screw
6"-Tandem	6"-tandem
8"-Tandem mit Gabelkopf	8"-tandem with yoke
8"-Tandem ohne Gabelkopf	8"-tandem without yoke
ABS	ABS (anti-lock brake system)
ABS-Dichtungssatz	ABS-gasket kit
Achtung: Kolbenstellung ändern !	attention: change piston position !
Adapter für Bördel E	adapter for bead type E
alle Typen	all types
Alu-Pumpe	alu-pump
Alu-Sättel	alu-calipers
am Bremssattel	on the brake caliper
am Hauptzylinder	on the master cylinder
A-Motor	A engine
Anschlagschraube oben	stop screw, top
Anschluß/Anschlüsse	connection/connections
Anti-Noise-Blech	shim
ASC (Automatische Stabilitäts Control)	ASC (automatic stability control)
ASR (Antriebsschlupfregelsystem)	ASR (traction control system TCS)
ATE nur über VAG erhältlich	ATE only available through VAG
auf Typenschild	on identification plate
aufgeschraubt	screwed on
Auslaß seitlich links	outlet lateral left-hand
Auslaß seitlich rechts	outlet lateral right-hand
außen	outer
automatische Nachstellung	automatic adjustment
Behälter	reservoir
Behälter Doppel-WE	reservoir with double warning device
Behälterbefestigung	reservoir fastening
Behälterstopfen	reservoir plug
Behälterverschraubung	reservoir cap
Behörde	authority cars
Beläge	brake pads
belüftete Scheiben	ventilated discs
Betätigungseinheit	actuation unit
blau	blue
Bodenventil	residual pressure center valve
Bodenventile tauschen	change residual pressure center valve
Bördel x	flare type x
braun	brown
breite Ausführung	wide design
Bremse	brake
Bremsgerät	booster unit
Bremskraftregler	brake pressure regulator
Bremsleitungen erneuern !	renew brake lines !
Bremslichtschalter	stop-light switch
Bremsscheiben	brake discs
Bremsschlauch beachten !	notice brake hose !
Buchse + Ausgleichbügel	bushing + compensating clip
Bus	bus (van)
Bypassregler	by-pass regulator
Citroen-Bremse	Citroen-brake
D (Durchmesser) =	D (diameter) =
Dichtring	sealing ring
Dichtung	seal
Dichtungssatz	gasket kit
Differentialsperre	differential lock
Differenzdruckschalter	differential-pressure switch
Differenzdruckventil	differential pressure valve
diverse Typen	various types
Doppelbereifung	twin tyres



frein pneumatique à 1 chambre	freno de aire de 1 cámara
étrier à 1 piston D=xx	mordaza de freno D=xx
étrier à 2 pistons D=xx	mordaza con dos pistones D=xx
étrier à 4 pistons	mordaza con 4 pistones
frein à 1 circuit	freno de 1 circuito
frein à deux circuits	freno de 2 circuitos
étriers frein à 1 circuit	pinza de 1 circuito
étriers frein à 2 circuits	pinza de 2 circuitos
1. essieu arrière	1. eje trasero
1. et 2. essieu arrière	1. + 2. eje trasero
disques de frein à 4 trous	disco freno con 4 taladros
disques de frein à 6 trous	disco freno con 6 taladros
jante à 3 trous	Llantas de 3 taladros
jante à 4 trous	Llantas de 4 taladros
jante à 5 trous	Llantas de 5 taladros
vis hex.	tornillo hexagonal
vis hex. (intérieure)	tornillo hexagonal ( interior)
6"-tandem	6"-tándem
8"-tandem avec chape	8"-tándem con cabeza de horquilla
8"-tandem sauf chape	8"-tándem sin cabeza de horquilla
ABS (système anti-blocage)	ABS (sistema de frenado antibloqueo)
jeu de joints de ABS	juego de reparación de juntas ABS
attention: position du piston à changer !	atención: cambiar posición pistón !
adaptateur pour colet E	adaptador para rebordes E
tous types	todos tipo
pompe en alu	bomba de aluminio
étriers en alu	mordaza de freno de aluminio
sur l'étrier de frein	a la pinza de freno
sur le maître-cylindre	a la bomba principal de freno
moteur A	motor de A
vis de butée en haut	tornillo de tope arriba
raccordement/raccordements	conexion/conexiones
tôle anti-bruit	placa anti-ruidos
ASC (contrôle de stabilité)	ASC (control automático de estabilidad)
ASR (anti-patinage)	ASR (sistemas antiderrapaje)
ATE (Teves) en vente chez VAG seulement	ATE solamente através de VAG
sur plaque d'identification	placa de identificación
vissé	fijado
échappement latéral gauche	salida lateral izquierda
échappement latéral droit	salida lateral derecha
mâle	exterior
ajustage automatique	reajuste automatico
réservoir	recipiente
réservoir avec témoin d'usure double	recipiente con doble aparato de aviso
fixation réservoir	recipiente de fijación
bouchon de réservoir	tapon
vissage de réservoir	fijación depósito
véhicule communal	vehiculos oficiales
plaquettes de frein	pastillas de freno
disques ventilés	disco ventilado
unité de commande	unidad de accionamiento
bleu	azul
soupape de pression résiduelle	válvula de fondo
soupape de pression résiduelle à changer	cambiar válvula de fondo
colet x	reborde x
marron	marron
exécution large	variante ancha
frein	freno
servo-frein	servofreno
correcteur de freinage	corrector de frenado
conduits de frein à renouveler !	renovar latiguillos de freno !
contacteur stop	interruptor de luz de freno
disques de frein	discos de freno
faire attention flexible de frein !	atención al latiguillo de freno !
douille + étrier de compensation	casquillo + estribo de compensación
autobus/car	autobus
régulateur à by-pass	regulador de by-pass
freins Citroen	freno Citroen
D (diamètre) =	D (diámetro) =
rondelle d'étanchéité	reten
joint	junta
jeu de joints	juego de reparación de juntas
blocage de différentiel	bloqueo diferencial
interrupteur à pression différentielle	interruptor de presión diferencial
pression différentielle de soupape	valvula de presión diferencial
types diverses	diversos tipo
pneu double	cubierta doble

Doppelkabine	double cab
Druckbegrenzungsventil	pressure limiting valve
Druckbolzen	tappet
Druckbolzen (kurz)	tappet (short)
Druckbolzen (lang)	tappet (long)
Druckluftbremse	air brake
Druckluftleitung	compressed-air line
Druckluftunterstützung	air brake assistance
Druckluftverstärker	air brake booster
Druck-Warnschalter	pressure warning switch
DS-Regler	DS-valve
EDS	EDS (electronic differential lock)
EDS-Ventilblock	EDS-valve block
EG-Vorschrift	accordance with EC regulation
Einbau hinter der Achse	installation aft of axle
Einbau vor der Achse	installation forward of axle
Einbausatz	installation kit
Einfachbereifung	single tyre
Einknöpfmaß xx mm	button-in dimension xx mm
Einlaß D=xx mm	inlet diameter=xx mm
Einlaß mit Gummistopfen	inlet with rubber plug
Einschraubregler	screw-in proportioning valve
elektr. Vergaser	electr. carburetor
Entlüfteranschluß	bleeding connection
Entlüfterventil	bleeder valve
erhöhte Zuladung	increased payload
Ersatz für Sättel D=xx	replacement for calipers D=xx
ETS	ETS (electronic trac control system)
Europa	Europe
Export	Export
Fahrschule	driving school
Faltenbalgsatz	bellow seal set
Faustsättel	fist-type calipers
Fenster	window
Festsättel	fixed calipers
Flanschdicke x mm	flange thickness x mm
Flanschmaß = xx,x	flange dimension = xx,x
Fuller-Getriebe	fuller-gearbox
für Belagsätze ohne Zubehör	for brake pads without accessories
für Bremssättel/Vorgänger	for calipers/predecessor
für Doppelmembran-Gerät	for twin diaphragm booster
Gabelkopfsatz	yoke kit
Gehäuse L=	housing L=
gelb	yellow
gepanzerte Fahrzeuge	armoured vehicles
Getriebe	gearbox
Getriebe-Nr.	gearbox-no.
GG-Pumpe	cast-iron-pump
GG-Sättel	cast iron-caliper
GG-THz/Vorgänger	cast-iron-TMC/predecessor
Golf-Staaten	Gulf States
Gz mit senkrechtem Flansch	CC with vertical flange
Gz (Geberzylinder)	CC (clutch cylinder)
Gz-Reparaturatz	CC-repair kit
HA (Hinterachse)	RA (rear axle)
Haltefeder	retaining spring
Halter	anchor
Haltersatz	anchor set
Halterschraube	anchor screw
Handbremsbetätigung	hand brake actuation
Handbremshebel	handbrake lever
HA-Scheibenbremse	rear axle disc brake
HA-Trommelbremse	rear axle drum brake
Hebel	lever
Hochdach	high roof
Hohlschraube	hollow screw
Hosei-Bremse	Hosei brake
Hub	stroke
Hülsensatz	sleeve kit
Hydraulikspeicher	hydraulic accumulator
Hydraulikverstärker	hydraulic booster
Hydraulikzylinder	hydraulic cylinder
Hydr. Steuereinheit	hydraulic unit
Hz (Hauptzylinder)	MC (master cylinder)
Hz-Reparaturatz	MC-repair kit
im Fahrerhaus	in cab
im Motorraum	in engine compartment



cabine double	cabina doble
soupape à réglage de pression	válvula de limitación de presión
boulon de pression	perno de presión
boulon de pression (court)	perno de presión (corto)
boulon de pression (long)	perno de presión (largo)
frein à pneumatique	freno de aire comprimido
conduite pneumatique	aire comprimido de flexible
assistance à pneumatique	freno de aire auxiliar
amplificateur à pneumatique	servo de aire a presión
avertisseur d'alerte de pression	interruptor de aviso de presión
correcteur de DS	regulador DS
EDS (blocage de différentiel électronique)	EDS (bloqueo diferencial electrónico)
EDS-bloc de vannes	EDS válvula de bloqueo
aux prescriptions CEE	según normativa CEE
montage derrière l'essieu	instalación después del eje
montage devant l'essieu	instalación antes del eje
lot de montage	juego de montaje
pneu simple	cubierta simple
mesure à boutonner xx mm	medida de alojamiento xx mm
admission diamètre=xx mm	admisión diámetro = xx mm
admission avec bouchon de caoutchouc	admisión con tapon de goma
compensateurs à visser	regulador roscado
carburateur électrique	carburador eléctrico
raccordement de purge	conexión de purga
soupape de purge	válvula de purga
charge utile augmentée	incremento de carga
remplacement pour étriers D=xx	sustitución para pinzas D=xx
ETS (contrôle trajectoire)	ETS (sistema de control electr. de tracción)
Europe	Europa
Export	Exportación
auto-école	escuela de conducción
jeu de joints-soufflets	juego de reparac. de suspensión neumática
étriers à griffe	pinza de puno
fenêtre	ventana
étriers fixes	pinza de fija
épaisseur de la bride x mmm	grosor de la brida x mm
dimension de la bride = xx,x	medida de brida = xx,x
boîte à vitesse fuller	Fuller caja de cambios
pour garnitures de frein sauf accessoire	para juego de pastilla sin accesorios
pour étriers de frein/prédécesseur	para pinza/avisador
pour appareil à double membrane	para servo freno con doble membrana
jeu de chape	juego de cabeza de horquilla
corps L=	carcasa L=
jaune	amarillo
véhicule blindé	vehículo blindado
boîte de vitesse	caja de cambios
no. boîte de vitesse	número de caja de cambios
pompe en fonte/prise	bomba de fundición de gris
étriers en fonte/prise	pinza de fundición de gris
MCT fonte/prise/prédécesseur	cil. principal de fundición de gris/avisador
pays du Golfe Persique	estados del Golfo Pérsico
émetteur d'embrayage avec bride	cilindro distribuidor con brida vertical
EE (émetteur d'embrayage)	CTR (cilindro distribuidor)
néc. de réparation EE	juego de reparación de juntas CTR
AR (essieu arrière)	HA (eje trasero)
ressort à retenu	muelle de sujeción
support	soporte
jeu de support	juego de soporte
vis de support	tornillo de soporte
frein à main	activación de freno de mano
levier de frein à main	palanca freno de mano
frein à disque essieu AR	eje trasero disco de freno
frein à tambour essieu AR	eje trasero tambores de freno
levier	palanca
toit surélevé	techo sobrealzado
vis creuse	tornillo hueco
freins Hosei	freno de Hosei
course	elevación
jeu de douilles	juego de vaina
accumulateur hydraulique	acumulador de hidráulico
amplificateur hydraulique	servo hidráulico
cylindre de hydraulique	cilindro de hidráulico
modulateur	modulador de hidráulico
MC (maître cylindre)	CM (cilindro maestro)
néc. de réparation MC	juego de reparación CM
dans la cabine du conducteur	en cabina
dans compartiment moteur	en compartimento de motor



innen	inside
Innengewinde	inner thread
Kastenwagen	van
Katalysator	catalytic converter
Kennzeichen: xx	registration number: xx
Kerbe am Flansch	notch on flange
Klasse	class
Kleinbus	minibus
Klimaanlage	air conditioning
Kolbenstange D=	piston rod diameter=
Kolbenstange L=	piston rod length=
Kombiwagen	station wagon
Kompakt THz	compact TMC
Krankenwagen	ambulance
Kupplung	clutch
Kupplungsabgang	outlet port for clutch connection
Kupplungsverstärker	clutch booster
kurzer Radstand	short wheel base
kurzes Bremsgerät	short brake booster
L (Länge) =	L (length) =
langer Radstand	long wheel base
Leckageanzeige	leakage indicator
lieferbar	available
links oben und rechts unten	upper left and lower right
links vor und rechts hinter der Achse	left in front and right behind axle
Linkslenker	left hand drive
Luftfederung	pneumatic suspension
luftgekühlt	air-cooled
M8-Führungsbolzen	M8-guide pin
MA-Getriebe	MA gearbox
mit 1 Haltestift	with 1 retaining pin
mit 2 Haltestiften	with 2 retaining pins
mit Alufelgen	with alu wheel rim
mit angegossenem Behälter	with cast-on reservoir
mit geregelter Katalysator	with controlled catalytic converter
mit Laschen	with straps
mit Leichtmetallrädern	with light alloy rims
MKII-Aggregat kpl.	MKII complete unit
Mod. (Modell)	Mod. (model)
Motor	engine
Motor-Nr.	engine number
Motor-Pumpen-Aggregat	motor pump unit
Multi-Link-Achse	multi-link axle
m.Z. (mit Zubehör)	m.Z. (with accessories)
Nachstellteile-Satz	adjuster parts set
ND-Schlauch	ND low pressure hose
Nebenabtrieb	power take-off
Niveauregulierung	suspension level-control
Nz (Nehmerzylinder)	SC (slave cylinder)
Nz-Reparaturatz	SC-repair kit
ohne Alufelgen	without alu wheel rim
ohne geregelten Katalysator	uncontrolled catalytic converter
ohne Laschen	without straps
ohne Leichtmetallräder	without light alloy rim
O-Ring	O-ring
Pedal Feststeller	lockable pedal
Polizei	Police
Rad	wheel
Radsensor	wheel sensor
Radstand xxxx mm	wheel base xxxx mm
rechts oben und links unten	upper right and lower left
Rechtslenker	right hand drive
Regler	regulator
Reihenmotor	R engine
Reisebus/Hochdecker	tourist bus/high decker
Reparaturatz	repair kit
Ringstutzen-Satz	ring type nipple set
Rohrleitung	pipe line
rot	red
roter Sattel	red caliper
Rückschlagventil	non-return valve
Rückstellwellen-Satz	resetting shaft set
Rz (Radzylinder)	WC (wheel cylinder)
Rz-Dichtungssatz	WC-seal kit
Rz-Reparaturatz	WC-repair kit
Salisbury-Achse	Salisbury axle
Sattel mit 1 Haltestift	caliper with 1 retaining pin

intérieur	interior
taraudage intérieure	rosca interior
fourgonnette	furgon
catalyseur	catalizador
indice: xx	distintivo: xx
entaille sur la bride	muesca en brida
classe	clase
petit autobus	mini-bus
air conditionné	aire acondicionado
tige de commande diamètre=	varilla de pistón diámetro =
tige de commande longueur=	varilla de pistón largo=
voiture familière	break (familiar)
MCT compact	cilindro maestro tandem compacto
véhicule à ambulance	ambulancia
embrayage	embrague
sortie d'embrayage	salida conexión embrague
amplificateur d'embrayage	refuerzo embrague
empattement court	distancia corta entre ejes
servo-frein court	servofreno corto
L (longueur) =	L (largo) =
empattement long	distancia larga entre ejes
avertissement de fuite	indicador pérdida liquido de freno
disponible	suministrable
à gauche, en haut et à droite, en bas	izquierda arriba + derecha abajo
à gauche devant essieu et à droite derrière essieu	izquierda adelante+derecha atrás de eje
direction à gauche	volante a la izquierda
suspension pneumatique	suspensión neumática
refroidir par air	refrigeración por aire
boulon de guidage M8	perno de guía M8
boîte de vitesse MA	caja de cambios MA
avec 1 bouchon d'arrêt	con 1 pasador
avec 2 bouchon d'arrêts	con 2 pasadores
avec jante en alu	con Llantas de aluminio
réservoir en fonte commun	con depósito anadido
avec cataliseur réglé	con catalizador regulado
avec collier	con brida
avec jantes en aluminium	con Llantas de aluminio
agrégat MKII complet	MKII sistema completo
Mod. (modèle)	Mod. (modelo)
moteur	motor
numéro de moteur	número de motor
agrégat moteur pompe	systema motor-bomba
essieu multi-link	eje Multi-Link
m.Z. (avec accessoire)	m.Z. (con accesorios)
jeu de pièces d'ajustage	juego de acoplamiento
flexible de ND	ND flexible
propulsion secondaire	potencia adicional
correcteur d'assiette	regulación de altura de suspensión
RE (récepteur d'embrayage)	CRE (cilindro receptor)
néc. de réparation RE	juego de reparación de juntas CRE
sauf jante en alu	sin Llantas de aluminio
sauf cataliseur réglé	sin catalizador regulado
sans collier	sin brida
sauf jantes en aluminium	sin Llantas de aluminio
joint torique	junta torica
fixation des pédales	eje pedal
Police	Police
roue	rueda
capteur de roue	sensores de rueda
empattement xxxx mm	distancia entre rueda xxxx mm
à droite, en haut et à gauche, en bas	derecha arriba + izquierda abajo
direction à droite	volante a la derecha
régulateur	regulador
moteur en ligne	motor de R
autobus/car avec cabine élevée	autobús
néc. de réparation	juego de reparación
jeux de raccord annulaire	juego de tubuladura anular
conduite tube	latiguillo
rouge	rojo
étrier rouge	pinza roja
clapet antiretour	valvula de retención
jeu d'arbres de rappel	juego de onda de retroceso
CR (cylindre roue)	CR (cilindro de rueda)
jeu de joints CR	juego de reparación de juntas CR
néc. de réparation CR	juego de reparación CR
essieu Salisbury	Salisbury eje
étrier avec 1 bouchon d'arrêt	pinza con 1 pasador

**D Technische Übersetzungen**

**EN Technical translations**

Sattel mit 2 Haltestiften	caliper with 2 retaining pins
Sättel mit Gussnoppen	calipers with cast-naps
Sattelschraube	caliper screw
Scheibenbremse	disc brake
Scheibenkupplung	disc clutch
Scheibenschraube	disc screw
Schlauchleitung	line hose
Schraubstutzen	screw neck
schwarz	black
Schwimmsättel	floating caliper
Schwingblech WE	sheet metal warning device
SCS	SCS (stop control system)
separater Behälter	separate reservoir
separates Druckstück/Vorgänger	separate thrust member/predecessor
Servolenkung	power steering
Skandinavien	Scandinavia
Sitzplätze	seats
Sonderfahrzeuge	special vehicle
Spezialaufbau	special body
Sportfahrwerk	sports suspension
Spur	track
Standard-Bremsgerät	standard booster unit
Standard-THz	standard tandem master cylinder
staubfeste Ausführung	dustproof design
Stufenheck	saloon
T50-Reparatursatz	T50-repair kit
Tandemregler	tandem proportioning valve
THz mit 3 Anschlüssen	TMC with 3 connections
THz mit Anschlagsschraube	TMC with stop screw
THz (Tandemhauptzylinder)	TMC (tandem master cylinder)
THz-Reparatursatz	TMC-repair kit
THz-RS (Montagehülse)	TMC-repair kit (assembly sleeve)
Timken-Achse	Timken axle
Topfmanschette	pot seal
Tragbolzensatz	supporting bolt set
Transporter	transporters
Triebkopf	drive head
Trommelbremse	drum brake
TBB (Trommelbremsbacken)	DBS (drum brake shoes)
Umbau 1-teilig auf 2-teilig	reconstruction 1-piece to 2-piece
Unterdruckverstärker	vacuum booster
ursprüngl. verschraubte Beläge	initial screwed pads
VA (Vorderachse)	FA (front axle)
VA-Girling-Bremse	front axle girling-brake
VA-Scheibenbremse	front axle disc brake
VA-Trommelbremse	front axle brake drums
Ventilblock	valve block
Ventilblock kpl.	valve block complete
Verbindungsschrauben	connection screws
Verschlusschraube	screw plug
Verschraubung	screw fitting
Verschraubung kpl.	screw fitting cpl.
verstärkte Bremse	heavy-duty brake
verstärkte Stoßdämpfer	reinforced dampers (shock absorber)
verstärktes Fahrwerk	reinforced suspension
Verteilerstück wiederverwenden	reuse distributor piece
V-Motor	V engine
Vorder- und Hinterachse	front and rear axle
Vorderachse	front axle
Vorderachse und 2. Hinterachse	front axle and second rear axle
Vordruckventil	residual pressure valve
Vorgänger	predecessor
Vorgänger / Abschirmkappe	predecessor / deflector cap
Vorgänger-THz, Einlaß D=xx	predecessor-TMC, inlet diameter=xx
Vorspannzylinder	pre-loaded cylinder
WK (Warnkontakt)	WI (wear indicator)
Warnkontakt 1-polig	wear indicator single connector
Warnkontakt 2-polig	wear indicator twin connector
Warnschalter	warning switch
WE (Warneinrichtung)	WD (warning device)
WE-Befestigung	WD fixture
Wegsensor	travel sensor
weiß	white
Zylinderschraube	cylinder screw



étrier avec 2 bouchon d'arrêt	pinza con 2 pasadores
étriers avec nopes en fonte	pinzas con protuberancias de fundición
vis d'étrier	tornillo de pinza
disques de frein	disco de freno
embrayage du disque	disco de embrague
disque vis	tornillo de disco
conduite flexible	latiguillo flexible
raccordement à vis	tornillo de fijación
noir	negro
étrier flottant	pinza flotante
tôle oscillante dispositif d'avertissement	chapa para avisador de desgaste
SCS (système de contrôle stop)	SCS (sistema de control de frenada)
réservoir séparé	depósito independiente
pièce d'appui/prédécesseur	tubería de presión independiente/avisador
direction assistée	dirección asistida
Scandinavie	Escandinavia
sièges	plazas
véhicule spécial	vehículos especial
carrosserie spéciale	construcción carrocería especial
châssis sport	suspensión deportiva
voie	distancia entre ruedas
servo-frein standard	servo freno standard
MC-tandem standard	cilindro tandem standard
exécution anti poussière	versión antipolución
à coffre	parte trasera escalonada
néc. de réparation T50	juego de reparación T50
compensateur tandem	tandem regulador
MCT avec 3 raccords	cilindro tandem con 3 conexions
MCT avec vis de butée	cilindro tandem con tornillo de tope
MCT (maître cylindre tandem)	CMT ( cilindro tandem)
néc. de réparation MCT	juego de reparación CMT
néc. de réparation MCT (douille d'assemblage)	juego de reparación CMT (vaina de montaje)
essieu Timken	Timken eje
coupelle	retén
jeu de boulons de suspension	juego de tornillo de soporte
transporter	furgoneta
tête de propulsion	grupo motriz
frein à tambour	tambores de freno
SGT (mâchoires de frein à tambour)	ZDF (zapatas de freno)
reconstruction 1 partie sur 2 parties	reconstrucción de 1 a 2 piezas
amplificateur à dépression	amplificador de depresion
à l'origine garnitures vissés	pastillas inicialmente montadas
VA (essieu avant)	VA (eje delantero)
frein à girling essieu avant	eje delantero - Girling freno
frein à disque essieu avant	eje delantero - disco de freno
tambours de frein essieu avant	eje delantero - tambores de freno
bloc de vannes	válvula de bloqueo
bloc de vannes complet	bloque de valvulas completo
vis de raccordement	tornillo de conexión
vis de fermeture	tornillo de cierre
couvercle	tornillo de fijación
couvercle complet	fijación completa
frein renforcé	freno reforzado
amortisseurs renforcés	amortiguadores reforzados
châssis renforcé	suspensión reforzada
distributeur à remettre	distribuidor de reemplazo
moteur en V	motor de V
essieu avant et essieu arrière	eje delantero + eje trasero
essieu avant	eje delantero
essieu avant et 2. essieu arrière	eje delantero + 2. eje trasero
soupape pression d'admission	válvula de presión previa
prédécesseur	predecesor
prédécesseur/défecteur	predecesor / tapa deflector
MCT prédécesseur, admission diamètre=xx	predecesor cilindro principal, admision D=xx
cylindre relais	cilindro preajustado
TU (témoin d'usure)	CD (contacto de desgaste)
témoin d'usure 1-borne	contacto de desgaste con 1 conexión
témoin d'usure 2-bornes	contacto de desgaste con 2 conexiones
interrupteur d'avertissement	interruptor de desgaste
DA (dispositif d'avertissement)	DD (dispositivo de desgaste)
fixation de DA	fijación del dispositivo de desgaste
capteur de course	sensor de ruta
blanc	blanco
vis cylindre	tornillo cilindrico



A large rectangular area containing 30 horizontal lines, intended for writing or drawing.





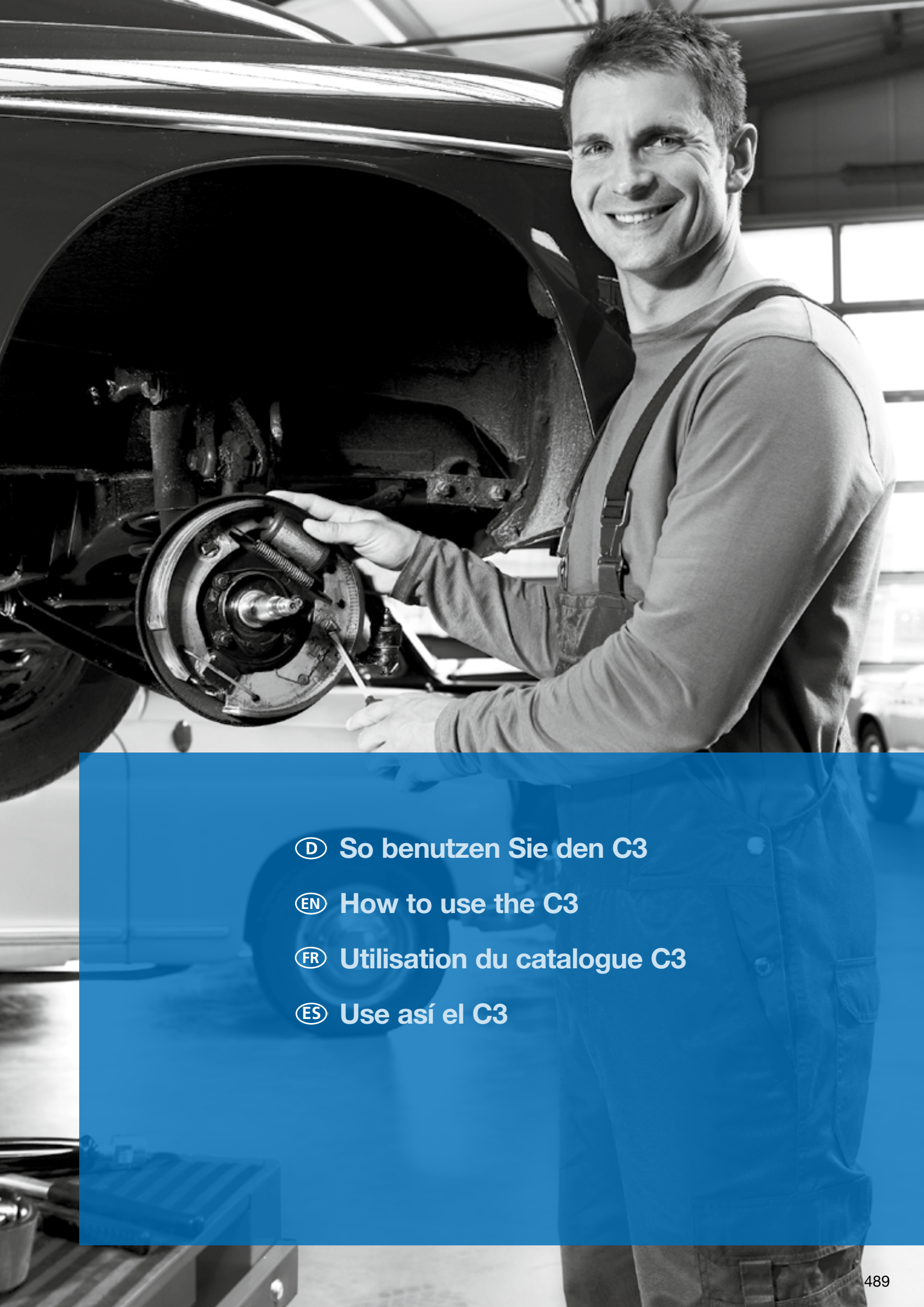

Ⓛ Ⓛ So benutzen Sie den C3

ⓁⓁ How to use the C3

ⓁⓁ Utilisation du catalogue C3

ⓁⓁ Use así el C3

# How to use the C3

Product groups		Type of vehicle		Installation period (from/to)		ATE number		Remark (spare part)		
Front/rear axle		Chassis number		Remark (car)		Short number		Definition		
		kW								
<b>AUDI A4 CABRIO (02-)</b>										
	1,8 T 1,8 T Quattro 2,0 2,0 TFSI	◀ 120 ◀ 120 ◀ 96 ◀ 120	8E-55-999999 8E-55-400001	04.02 05.03 08.06 08.06	PR: 1LB,1LE PR: 1LB,1LE PR: 1LB,1LE PR: 1LB,1LE	11.3571-8522.2 11.3571-8521.2 11.0441-5704.2 11.0101-5409.2	220320 220319 250034 260035	+ ESP + ESP	D=57, - Halter D=57, - Halter Dichtungssatz Hülsensatz	ATE ATE ATE ATE
*		**				***		****		

## \*Product groups

	<b>Booster unit</b>		<b>Brake drum</b>
	<b>Master cylinder</b>		<b>ATE Original Kit</b> <b>ATE Original TopKit</b>
	<b>Reservoir</b>		<b>Drum brake shoes for parking brake</b>
	<b>Brake caliper</b>		<b>Handbrake cable</b>
	<b>Disc brake pads</b>		<b>Brake pressure regulator</b>
	<b>Brake disc</b> <b>ATE PowerDisc</b>		<b>Clutch cylinder</b>
	<b>Brake hose</b>		<b>Kupplungs-Nehmerzylinder</b>
	<b>Wheel sensor</b>		<b>Clutch hose</b>
	<b>Wheel cylinder</b>		<b>Clutch cable</b>
	<b>Drum brake shoes</b>		

## \*\*Hand drive

- ◀ Left hand drive
- ▶ Right hand drive

## \*\*\*Manufacturer

ATE	Continental Teves (ATE)
AKE	Akebono
AP	AP Lockheed
BDX	Bendix
BOS	Bosch
BRE	Brembo
CIT	Citroën
DEL	Delco
FI	Fiat
FTE	FTE Automotive
LUC	Lucas (TRW)
PER	Perrot
SUM	Sumitomo
TOK	Tokico
VW	Volkswagen

## \*\*\*Installation Position

























- front
- rear
- left
- right
- upper left
- lower left
- upper right
- lower right
- center
- top
- bottom
- front axle
- front left
- front right
- rear axle
- rear left
- rear right

All position details are based on vehicle facing forwards

## Abbreviations

-	Without / not	L=	Length
+	With / only / for	Nz	Slave cylinder
AUT	Automatic adjustment	PD	PowerDisc
B	Coated	Rz	Wheel cylinder
BG	Brake force limiter	RzR	Wheel cylinder with built-in corrector
BR	Brake pressure regulator	S	Fixing screw / caliper screw
BRE	Screw-in regulator	THz	Tandem master cylinder
BRES	Screw-in regulator set	V	Ventilated
BRL	Brake pressure regulator, load sensitive	WE	Warning device
D=	Diameter	WK	Wear indicator
Gz	Clutch cylinder	Zub	Accessories
HEB	Lever		
HZ	Master cylinder		
L	Alloyed / highly carburized		

# Parts information

		SHORT NUMBER				SHORT NUMBER	
	03.6199-xxxx.4 → 03.61dy-xxxx.4 → 03.67dy-xxxx.4 → 03.68dy-xxxx.4 → 03.69dy-xxxx.4 → 03.77dy-xxxx.4 →	30nnnn 30nnnn 30nnnn 30nnnn 30nnnn 30nnnn	Brake booster T50 T51 T52/3 T52 T53 T52/4		24.02dd-dxxx.x → 230/231×47	48nnnn	Brake drums (e.g. 24.0223-0: Ø=230)  Diameter / max. diameter × depth
	03.78dy-xxxx.4 → 03.78dy-xxxx.4 → 03.78dy-xxxx.4 → 03.78dy-xxxx.4 → 03.78dy-xxxx.4 → 03.78dy-xxxx.4 →	30nnnn 30nnnn 30nnnn 30nnnn 30nnnn 30nnnn	T52/4 T52/4Z T52/5 T52/5Z T55/1 T55/1Z		▲ 03.27dd-xxxx.3 → ▲ 03.32dd-xxxx.3 → 03.040x-xxdd.2 → 03.0470-xxdd.2 →	02nnnn 02nnnn 06nnnn 06nnnn	Single piston wheel cylinder Wheel cylinder Repair kit (with pistons) Gasket kit (without pistons)
	03.78dy-xxxx.4 → 03.78dy-xxxx.4 → 03.78dy-xxxx.4 → 03.78dy-xxxx.4 → 03.78dy-xxxx.4 →	30nnnn 30nnnn 30nnnn 30nnnn 30nnnn	T52/4 T52/4Z T52/5 T52/5Z T55/1 T55/1Z		03.0137-0xxx.2 → 03.0137-9xxx.2 →	650xxx 669xxx	Drum brake shoes Brake shoe accessories
	03.78dy-xxxx.4 → 03.78dy-xxxx.4 → 03.78dy-xxxx.4 → 03.78dy-xxxx.4 →	30nnnn 30nnnn 30nnnn 30nnnn	T52/4 T52/4Z T52/5 T52/5Z		185×31 AUT HEB Zub		Diameter × width With automatic adjustment With lever With accessories
	▲ 03.20dd-xxxx.3 → ▲ 03.21dd-xxxx.3 → ▲ 03.23dd-xxxx.3 → ▲ 03.31dd-xxxx.3 → 03.0370-xxdd.2 →	01nnnn 01nnnn 01nnnn 01nnnn 05xxdd	Step-bore tandem master cylinder Tandem master cylinder Step-bore master cylinder Master cylinder (e.g. 03.2122-: Ø=22,20) Repair kit		03.0420-xxdd.3 → 03.0520-xxdd.3 →	68xxdd 69xxdd	ATE original Kit ATE original TopKit (wheel cylinder + drum brake shoes + installation kit) dd = nominal dimension wheel cylinder
	03.3508-xxxx.x → 03.3509-xxxx.x → 03.3558-xxxx.x → 03.0101-xxxx.2 →	31nnnn 31nnnn 31nnnn 39nnnn	Reservoir Reservoir Reservoir Repair kit		03.0137-0xxx.2 → 03.0137-9xxx.2 →	650xxx 669xxx	Parking brake (drum brake shoes) Installation kit
	▲ 11.3ddx-xxxx.2 → 11.9ddx-xxxx.2 → ▲ 13.2ddx-xxxx.2 → ▲ 13.4ddx-xxxx.2 → 13.9ddx-xxxx.2 → 24.3ddx-xxxx.5 → 11.0441-ddxx.2 → 13.0441-ddxx.2 → 11.0230-xxxx.2 → 24.0101-xxxx.2 → ▲ 11.0101-xxxx.2 → 11.8116-xxxx.1 →	22nnnn 22nnnn 21nnnn 21nnnn 21nnnn 24nnnn 25nnnn 25nnnn 26nnnn 26nnnn 26nnnn 39nnnn	Fist-type caliper Fist-type caliper 2 cyl. fixed caliper 4 cyl. fixed caliper Fixed caliper Remanufactured fist-type caliper Gasket kit Gasket kit Fist caliper holder set (holder, sliding sleeve set, guide pins) Brake calliper accessories (sliding sleeve set, guide pins) Sliding sleeve set Retaining spring		185×31 AUT HEB Zub		Diameter × width With automatic adjustment With lever With accessories
	▲ 11.0101-xxxx.2 → 11.8116-xxxx.1 →	26nnnn 39nnnn	Sliding sleeve set Retaining spring		24.3727-xxxx.2 →	58xxxx	Handbrake cable
	13.0460-xxxx.2 → 13.0460-0xxx.2 → 24.8190-xxxx.2 → 20034 15,0 + WE WK S Zub	60xxxx 610xxx 62xxxx	Disc brake pad Accessories for brake pad set Wear indicator		03.60xx-xxxx.3 → 03.65xx-xxxx.3 → 03.0101-xxxx.2 → 35/3 braun (4)	32nnnn 32nnnn 32nnnn	Brake pressure regulator (BR) Brake force limiter (BG) Screw-in regulator (BRE) Brake pressure regulator, load-sensitive (BRL) Screw-in regulator set (BRES)
	20034 15,0 + WE WK S Zub		WVA no. / thickness For further WVA no's. see appendix Warning device With wear indicator With caliper screw With accessories		▲ 03.24dd-xxxx.3 → 03.0350-ddxx.2 →	03nnnn 07ddxx	Clutch cylinder (e.g. 03.2419-: Ø=19,05) Gasket kit
	24.01dd-xxxx.x → 24.03dd-xxxx.x →	4ddxxx 5ddxxx	Brake disc ATE PowerDisc dd = thickness (e.g. 24.0322- : thickness = 22)		▲ 03.25dd-xxxx.3 → 03.0450-ddxx.2 →	04nnnn 08ddxx	Slave cylinder (e.g. 03.2525-: Ø=25,40) Gasket kit
	284 22 20 V L PD B V L S PD		Diameter / thickness / minimum thickness Coated Ventilated Alloyed / highly carburized Fixing screw ATE PowerDisc		24.3728-xxxx.2 →	59xxxx	Clutch cable
					24.07xx-xxxx.x →	36nnnn	Wheel sensor

nnnn = The last four digits correspond to a running number.

dd = Nominal dimension

▲ 24. also possible using same numbering system.  
■ 03. and 24. also possible using same numbering system.

Complete copies or extracts of this catalog only by permission. Damage claims on the basis of data in this catalog cannot be recognized. The right of modification in construction or design is reserved. As far as we refer in our documents to part numbers of the vehicle makers, this is for comparison purposes only. The use of such information on invoices to the vehicle owner is not admissible.

The multitude of car models and spare parts from numerous vehicle manufacturers do not always allow an exact allocation. Therefore please pay attention to the corresponding remarks and spare part descriptions. Please therefore pay attention to the corresponding comments and spare parts descriptions.



# Utilisation du catalogue C3

Groupes de produit		Type de véhicule	Date de montage (du/au)		Référence ATE		Remarque (référence)	
Essieu avant/arrière			No. de châssis (du/au)	Remarque (véhicule)		Référence Courte		Indication
			kW					
<b>AUDI A4 CABRIO (02-)</b>								
	1,8 T 1,8 T Quattro 2,0 2,0 TFSI	◀ 120 ◀ 120 ▲ 96 ◀ 120	8E-55-999999 8E-55-400001	04.02 05.03 08.06 08.06	PR: 1LB,1LE PR: 1LB,1LE PR: 1LB,1LE PR: 1LB,1LE	11.3571-8522.2 11.3571-8521.2 11.0441-5704.2 11.0101-5409.2	220320 220319 250034 260035	
								D=57, - Halter D=57, - Halter Dichtungssatz Hülzensatz
								ATE ATE ATE ATE

## \*Groupes de produit

	Servo-frein		Tambour de frein
	Maître cylindre		Kit d'origine ATE TopKit d'origine ATE
	Réservoir		Mâchoires de frein à tambour pour frein à main
	Etrier de frein		Câble de frein à main
	Plaquettes de frein		Correcteur de freinage
	Disque de frein ATE PowerDisc		Emetteur d'embrayage
	Flexible de frein		Récepteur d'embrayage
	Capteur ABS		Flexible d'embrayage
	Cylindre de roue		Câble d'embrayage
	Mâchoires de frein à tambour		

## \*\*Direction

- ◀ Conduite à gauche
- ▶ Conduite à droite

## \*\*\*\*Fabricant

ATE	Continental Teves (ATE)
AKE	Akebono
AP	AP Lockheed
BDX	Bendix
BOS	Bosch
BRE	Brembo
CIT	Citroën
DEL	Delco
FI	Fiat
FTE	FTE Automotive
LUC	Lucas (TRW)
PER	Perrot
SUM	Sumitomo
TOK	Tokico
VW	Volkswagen

## \*\*\*Positionnement

























- 
- 
- 
- 
- 
- 
- 
- 
- 
- 
- 
- 
- 
- 
- 
- 
- 

Toutes positions vues en position de conduite

## Abréviations

-	Sauf / sans	L=	Longueur
+	Avec / seulement / pour	Nz	Récepteur d'embrayage
AUT	Ajustage Automatique	PD	PowerDisc
B	Revêtu	Rz	Cylindre de roue
BG	Limiteur de freinage	RzR	Cylindre de roue avec correcteur intégré
BR	Correcteur de freinage	S	Vis d'étrier / vis de fixation
BRE	Correcteur à visser	THz	Maître cylindre tandem
BRES	Jeu de correcteur à visser	V	Ventilât
BRL	Correcteur de freinage asservi à la charge	WE	Dispositif d'avertissement
D=	Diamètre	WK	Témoin d'usure
Gz	Emmetteur ,embrayage	Zub	Accessoires
HEB	Levier		
HZ	Maître cylindre		
L	Allié / carbonise		

# Explications des références

		RÉF. COURTE				
	03.6199-xxxx.4 → 03.61dy-xxxx.4 → 03.67dy-xxxx.4 → 03.68dy-xxxx.4 → 03.69dy-xxxx.4 → 03.77dy-xxxx.4 →	30nnnn 30nnnn 30nnnn 30nnnn 30nnnn 30nnnn	Servo-frein T50 T51 T52/3 T52 T53 T52/4		24.02dd-dxxx.x → 230/231×47	48nnnn Diamètre / diamètre max. x largeur
	03.78dy-xxxx.4 → 03.78dy-xxxx.4 → 03.78dy-xxxx.4 → 03.78dy-xxxx.4 → 03.78dy-xxxx.4 → 03.78dy-xxxx.4 →	30nnnn 30nnnn 30nnnn 30nnnn 30nnnn 30nnnn	T52/4 T52/4Z T52/5 T52/5Z T55/1 T55/1Z		▲ 03.27dd-xxxx.3 → ▲ 03.32dd-xxxx.3 → 03.040x-xxdd.2 → 03.0470-xxdd.2 →	02nnnn 02nnnn 06nnnn 06nnnn
	03.78dy-xxxx.4 → 03.78dy-xxxx.4 → 03.78dy-xxxx.4 → 03.78dy-xxxx.4 → 03.78dy-xxxx.4 → 03.78dy-xxxx.4 →	30nnnn 30nnnn 30nnnn 30nnnn 30nnnn 30nnnn	T52/4 T52/4Z T52/5 T52/5Z T55/1 T55/1Z		03.0137-0xxx.2 → 03.0137-9xxx.2 →	650xxx 669xxx
	03.3508-xxxx.x → 03.3509-xxxx.x → 03.3558-xxxx.x → 03.0101-xxxx.2 →	31nnnn 31nnnn 31nnnn 39nnnn	Réservoir Réservoir Réservoir Néc. de réparation		185×31 AUT HEB Zub	Diamètre x largeur avec ajustage automatique avec levier avec accessoires
	▲ 03.20dd-xxxx.3 → ▲ 03.21dd-xxxx.3 → ▲ 03.23dd-xxxx.3 → ▲ 03.31dd-xxxx.3 → 03.0370-xxdd.2 →	01nnnn 01nnnn 01nnnn 01nnnn 05xxdd	Maître cylindre tandem étagé Maître cylindre tandem Maître cylindre étagé Maître cylindre simple circuit (p.ex. 03.2122-: Ø=22,20) Néc. de réparation		03.0420-xxdd.3 → 03.0520-xxdd.3 →	68xxdd 69xxdd
	▲ 11.3ddx-xxxx.2 → 11.9ddx-xxxx.2 → ▲ 13.2ddx-xxxx.2 → ▲ 13.4ddx-xxxx.2 → 13.9ddx-xxxx.2 → 24.3ddx-xxxx.5 → 11.0441-ddxx.2 → 13.0441-ddxx.2 → 11.0230-xxxx.2 → 24.0101-xxxx.2 → ▲ 11.0101-xxxx.2 → 11.8116-xxxx.1 →	22nnnn 22nnnn 21nnnn 21nnnn 21nnnn 24nnnn 25nnnn 25nnnn 26nnnn 26nnnn 26nnnn 39nnnn	Etrier à griffe Etrier à griffe Etrier à 2 pistons Etrier à 4 pistons Etrier fixe Etrier à griffe de réchange Jeu de joints Jeu de joints Jeu de supports d'étriers à griffe (support, jeu de douilles de guidage, boulon de guidage) Accessoires pour étriers de frein (jeu de douilles de guidage, boulon de guidage) Jeu de douilles de guidage Ressort à retenu		03.0137-0xxx.2 → 03.0137-9xxx.2 →	650xxx 669xxx
	▲ 11.3ddx-xxxx.2 → 11.9ddx-xxxx.2 → ▲ 13.2ddx-xxxx.2 → ▲ 13.4ddx-xxxx.2 → 13.9ddx-xxxx.2 → 24.3ddx-xxxx.5 → 11.0441-ddxx.2 → 13.0441-ddxx.2 → 11.0230-xxxx.2 → 24.0101-xxxx.2 → ▲ 11.0101-xxxx.2 → 11.8116-xxxx.1 →	22nnnn 22nnnn 21nnnn 21nnnn 21nnnn 24nnnn 25nnnn 25nnnn 26nnnn 26nnnn 26nnnn 39nnnn	Etrier à griffe Etrier à griffe Etrier à 2 pistons Etrier à 4 pistons Etrier fixe Etrier à griffe de réchange Jeu de joints Jeu de joints Jeu de supports d'étriers à griffe (support, jeu de douilles de guidage, boulon de guidage) Accessoires pour étriers de frein (jeu de douilles de guidage, boulon de guidage) Jeu de douilles de guidage Ressort à retenu		185×31 AUT HEB Zub	Diamètre x largeur avec ajustage automatique avec levier avec accessoires
	13.0460-xxxx.2 → 13.0460-0xxx.2 → 24.8190-xxxx.2 → 20034 15,0 + WE WK S Zub	60xxxx 610xxx 62xxxx	Plaquette de frein Accessoires pour jeux de garnitures Témoin d'usure Code no. de WVA/épaisseur autres no. de WVA voir annexe Dispositif d'avertissement avec témoin d'usure avec vis d'étrier avec accessoires		24.3727-xxxx.2 →	58xxxx
	24.01dd-xxxx.x → 24.03dd-xxxx.x →	4ddxxx 5ddxxx	Disques de frein ATE PowerDisc dd = épaisseur (p.ex. 24.0322- : épaisseur = 22)		83.5yxx-LLLL.3 → 83.6yxx-LLLL.3 → 83.7yxx-LLLL.3 →	33nnnn 33nnnn 33nnnn
	284 22 20 V L PD B V L S PD		Diamètre/épaisseur/épaisseur minimum Revêtu ventilé allié/carbonisé Vis de fixation ATE PowerDisc		03.60xx-xxxx.3 → 03.65xx-xxxx.3 → 03.0101-xxxx.2 → 35/3 braun (4)	32nnnn 32nnnn 32nnnn
					03.24dd-xxxx.3 → 03.0350-ddxx.2 →	03nnnn 07ddxx
					▲ 03.25dd-xxxx.3 → 03.0450-ddxx.2 →	04nnnn 08ddxx
					24.3728-xxxx.2 →	59xxxx
					24.07xx-xxxx.x →	36nnnn

nnnn = Les quatre derniers chiffres correspondent à un ordre numérique.

dd = Dimension nominale

▲ Le préfixe de ces familles de produit peut également être 03. ou 24.

■ Le préfixe de ces familles de produit peut également être 03., 24. ou 83.

Toute reproduction totale ou partielle de ce catalogue est interdite sauf notre autorisation préalable. Une demande de dommages et intérêts qui se baserait ou aurait pour objet un renseignement donné par le présent catalogue ne saurait être retenue. Nous nous réservons le droit de modifier les spécifications de nos produits sans préavis et, si cela est nécessaire, pour assurer les performances optimales de nos gammes de produits. Les références constructeurs fournies dans le présent catalogue sont données seulement à titre indicatif. L'utilisation de telles informations dans les factures d'un détenteur de véhicule n'est pas admise.

La diversité des modèles et des pièces de rechange ne permet pas toujours une affectation correcte. Par conséquent nous vous prions de bien vouloir tenir compte des observations et des descriptions contenues dans ce catalogue.



Grupo de producto		Modelo	periodo de montaje (desde/hasta)		Referencias ATE		Indicaciones (repuesto)				
Eje delantero-/ trasero	Número de chasis (desde/hasta)	Indicaciones (vehículo)	Referencia corta	Información adicional							
kW											
<b>AUDI A4 CABRIO (02-)</b>											
	1,8 T 1,8 T Quattro 2,0 2,0 TFSI	◀ 120 ◀ 120 ◀ 96 ◀ 120	8E-55-999999 8E-55-400001	04.02 05.03 05.04	08.06 08.06 08.06	PR: 1LB,1LE PR: 1LB,1LE PR: 1LB,1LE PR: 1LB,1LE	11.3571-8522.2 11.3571-8521.2 11.0441-5704.2 11.0101-5409.2	220320 220319 250034 260035	 + ESP + ESP	D=57, - Halter D=57, - Halter Dichtungssatz Hülsensatz	ATE ATE ATE ATE
*		**					***		****		

## \*Grupo de producto

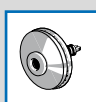

Servofreno

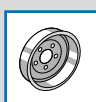

Tambores de freno

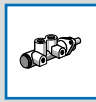

Cilindro maestro



ATE Original Kit  
ATE Original TopKit



Depósito



Zapatas de freno  
para freno de esta-  
cionamiento (mano)



Pinza de freno



Cable de freno  
de mano



Pastillas

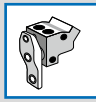

Corrector  
de frenado



Disco de freno  
ATE PowerDisc

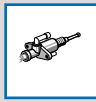

Cilindro transmisor  
de embrague



Tubo flexible de freno

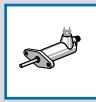

Cilindro receptor  
de embrague



Sensor de rueda



Cables de embrague

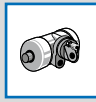

Cilindro de rueda



Cable de embrague



Zapatas de freno

## \*\*Dirección

- ◀ Volante a la izquierda
- ▶ Volante a la derecha

## \*\*\*Fabricante

ATE	Continental Teves (ATE)
AKE	Akebono
AP	AP Lockheed
BDX	Bendix
BOS	Bosch
BRE	Brembo
CIT	Citroën
DEL	Delco
FI	Fiat
FTE	FTE Automotive
LUC	Lucas (TRW)
PER	Perrot
SUM	Sumitomo
TOK	Tokico
VW	Volkswagen

## \*\*\*Posición de montaje























- ⬆ adelante
- ⬇ atrás
- ⬅ izquierda
- ➡ derecha
- ⬆ izquierda arriba
- ⬇ izquierda abajo
- ⬅ derecha arriba
- ➡ derecha abajo
- ◻ medio
- ⬆ arriba
- ⬇ abajo
- ⬅ eje delantero
- ➡ izquierda adelante
- ⬆ derecha adelante
- ⬇ eje trasero
- ⬅ izquierda atrás
- ➡ derecha atrás

Todas las indicaciones de posición se refieren siempre al sentido de la marcha.

## Abreviaturas

-	Sin / no	L=	Largo
+	Con / solo / para	Nz	Cilindro receptor de embrague
AUT	Reajuste automático	PD	PowerDisc
B	Recubierto	Rz	Cilindro de rueda
BG	Limitador de frenado	RzR	Cilindro de rueda con regulador integrado
BR	Corrector de frenado	S	Tornillo para pinza / tornillo quierfija
BRE	Regulador de rosca	THz	Cilindro maestro tándem
BRES	Juego regulador de rosca	V	Ventilado
BRL	Corrector de frenado dependiente de carga	WE	Dispositivo de desgaste
D=	Diámetro	WK	Contactode desgaste
Gz	Cilindro transmisor de embrague	Zub	Accesorios
HEB	Palanca		
HZ	Cilindro maestro		
L	Aleación especial		

# Información artículos

		NUEVA REFER.				NUEVA REFER.	
	03.6199-xxxx.4 → 03.61dy-xxxx.4 → 03.67dy-xxxx.4 → 03.68dy-xxxx.4 → 03.69dy-xxxx.4 → 03.77dy-xxxx.4 →	30nnnn 30nnnn 30nnnn 30nnnn 30nnnn 30nnnn	Refuerzo de la presión de frenada T50 T51 T52/3 T52 T53 T52/4		24.02dd-dxxx.x → 230/231×47	48nnnn	Tambores de freno (p. ej. 24.0223-0: Ø=230)  Diámetro / diámetro max. x ancho
	03.78dy-xxxx.4 → 03.78dy-xxxx.4 → 03.78dy-xxxx.4 → 03.78dy-xxxx.4 → 03.78dy-xxxx.4 → 03.78dy-xxxx.4 →	30nnnn 30nnnn 30nnnn 30nnnn 30nnnn 30nnnn	T52/4 T52/4Z T52/5 T52/5Z T55/1 T55/1Z		▲ 03.27dd-xxxx.3 → ▲ 03.32dd-xxxx.3 → 03.040x-xxdd.2 → 03.0470-xxdd.2 →	02nnnn 02nnnn 06nnnn 06nnnn	Cilindro de rueda de un pistón Cilindro de rueda Juego de reparación (con pistón) Juego de reparación de juntas (sin pistón)
	03.3508-xxxx.x → 03.3509-xxxx.x → 03.3558-xxxx.x → 03.0101-xxxx.2 →	31nnnn 31nnnn 31nnnn 39nnnn	Depósito Depósito Depósito Juego de reparación		03.0137-0xxx.2 → 03.0137-9xxx.2 →	650xxx 669xxx	Zapatas de freno Accesorios para zapatas de freno  Diámetro x ancho con reajuste automático con palanca con accesorios
	▲ 03.20dd-xxxx.3 → ▲ 03.21dd-xxxx.3 → ▲ 03.23dd-xxxx.3 → ▲ 03.31dd-xxxx.3 → 03.0370-xxdd.2 →	01nnnn 01nnnn 01nnnn 01nnnn 05xxdd	Cilindro maestro escalonado tándem Cilindro maestro tándem Cilindro escalonado maestro Cilindro maestro (p. ej. 03.2122-: Ø=22,20) Juego de reparación		03.0420-xxdd.3 → 03.0520-xxdd.3 →	68xxdd 69xxdd	Kit original ATE TopKit original ATE (juego de piezas de freno) (Cilindros de rueda + zapatas de freno + juego de montaje) dd = medida interior del cilindro de rueda
	03.3508-xxxx.x → 03.3509-xxxx.x → 03.3558-xxxx.x → 03.0101-xxxx.2 →	31nnnn 31nnnn 31nnnn 39nnnn	Depósito Depósito Depósito Juego de reparación		03.0137-0xxx.2 → 03.0137-9xxx.2 →	650xxx 669xxx	Freno de mano (zapatas de freno) Juego de montaje  Diámetro x ancho con reajuste automático con palanca con accesorios
	▲ 11.3ddx-xxxx.2 → 11.9ddx-xxxx.2 → ▲ 13.2ddx-xxxx.2 → ▲ 13.4ddx-xxxx.2 → 13.9ddx-xxxx.2 → 24.3ddx-xxxx.5 → 11.0441-ddxx.2 → 13.0441-ddxx.2 → 11.0230-xxxx.2 →  24.0101-xxxx.2 →  ▲ 11.0101-xxxx.2 → 11.8116-xxxx.1 →	22nnnn 22nnnn 21nnnn 21nnnn 21nnnn 24nnnn 25nnnn 25nnnn 26nnnn  26nnnn  26nnnn 39nnnn	Pinza de puño Pinza de puño Pinza fija 2-cilindros Pinza fija 4-cilindros Pinza fija Pinza de puño refabricada Juego de reparación de juntas Juego de reparación de juntas Juego de soportes de pinza de puño (soporte, juego de casquillos corredizos, perno de guía) Accesorios para pinza de freno (juego de casquillos corredizos, perno de guía) Juego casquillos corredizos Muelle de sujeción		24.3727-xxxx.2 →	58xxxx	Cable de freno mano
	▲ 83.5yxx-LLLL.3 → ▲ 83.6yxx-LLLL.3 → ▲ 83.7yxx-LLLL.3 →	33nnnn 33nnnn 33nnnn	Tubo flexible de freno-/embrague Tubo flexible de freno-/embrague Tubo flexible de freno-/embrague		83.5yxx-LLLL.3 → 83.6yxx-LLLL.3 → 83.7yxx-LLLL.3 →	33nnnn 33nnnn 33nnnn	Tubo flexible de freno-/embrague Tubo flexible de freno-/embrague Tubo flexible de freno-/embrague
	13.0460-0xxx.2 → 13.0460-0xxx.2 → 24.8190-0xxx.2 →  20034 15,0 + WE WK S Zub	60xxxx 610xxx 62xxxx  No. WVA/espesor para otros números WVA, véase suplemento Dispositivo de desgaste con contacto de desgaste con tornillo para pinza con accesorios	Pastilla de freno Accesorios para juego de pastillas Contacto de desgaste		03.60xx-xxxx.3 → 03.65xx-xxxx.3 → 03.0101-xxxx.2 → 35/3 marrón (4)	32nnnn 32nnnn 32nnnn	Corrector de frenado (BR) Limitador de frenado (BG) Regulador de rosca (BRE) Corrector de frenado dependiente de la carga (BRL) Juego de reguladores de rosca (BRES)  Característica / marcación de color (número de conexiones)
Las pastillas de freno tienen un certificado general de aptitud técnica (abrev. alemana: ABE) o bien homologación según normativa ECE-R 90, es decir, proceden de la misma fabricación y están sujetas al mismo control de calidad que las de origen.							
	24.01dd-xxxx.x → 24.03dd-xxxx.x →  284 22 20 V L PD B V L S PD	4ddxxx 5ddxxx  Diámetro / espesor / grosor mínimo Recubierta ventilado aleación especial Tornillo para pinza ATE PowerDisc	Disco de freno ATE PowerDisc dd = espesor (p.ex. 24.0322 : espesor = 22)		▲ 03.24dd-xxxx.3 → 03.0350-ddxx.2 →  ▲ 03.25dd-xxxx.3 → 03.0450-ddxx.2 →  24.3728-xxxx.2 →  24.07xx-xxxx.x →	03nnnn 07ddxx  04nnnn 08ddxx  59xxxx  36nnnn	Cilindro transmisor de embrague (p.ej. 03.2419-: Ø=19,05) Juego de reparación de juntas  Cilindro receptor de embrague (e.ej. 03.2525-: Ø=25,40) Juego de reparación de juntas  Cable de embrague  Sensor de rueda

nnnn = Las cuatro últimas cifras son números correlativos.

dd = Medida nominal

▲ También posible el 24. en caso del mismo sistema de numeración.

■ También posible el 03. y 24. en caso del mismo sistema de numeración de numeración.

Sólo se permite la reproducción total o parcial con nuestra autorización. No se atenderán reclamaciones motivadas por los datos contenidos en este catálogo. Quedan reservados los derechos de modificaciones en la construcción. Si en nuestros documentos hacemos referencia a números de piezas de recambio de los constructores de vehículos, esto únicamente es para establecer una comparación. No está permitido el uso de datos de este tipo en las facturas emitidas al propietario del vehículo.

La variedad de modelos y de piezas de recambio de algunos constructores de vehículos no permite siempre una distribución exacta. Por este motivo, por favor fíjese atentamente en las observaciones y descripciones de las piezas de recambio detalladas en el catálogo.

# ATE Classic Anfrage



Datum : \*

Continental Aftermarket GmbH  
 Guerickestraße 7  
 60488 Frankfurt a. M.

Telefax: 0049 (0) 69 7603-4830

www.ate-classic.de

## Kontaktdaten :

Firma :

Name : \*

Vorname :

Straße und Nr : \*

PLZ : \*

Ort : \*

Land : \*

E-Mail :

Telefon : \*

Telefax :

## Fahrzeugdaten :

Marke - Modell :

Typ :

Hubraum cc :

Kraftstoff :

Baujahr :

Leistung : PS  KW

KBA Zu 2 :  Zu 3 :

Lenkungsseite :

## Produktdaten:

	Artikel 1	Artikel 2	Artikel 3	Artikel 4
Produktbezeichnung : *				
ATE-Nummer :				
sonstige Referenz Nr.:				
Einbauseite :				
Einbauposition :				
Menge : *				
Bemerkung :				

## **Ihre Nachricht an uns:**

\* Pflichtfelder  
 Um Rückfragen zu vermeiden, füllen Sie bitte möglichst alle Felder aus.



# ATE Classic Request



Date : \*

Continental Aftermarket GmbH  
 Guerickestraße 7  
 60488 Frankfurt a. M.  
 Germany  
 Telefax: 0049 (0) 69 7603-4830

[www.ate-classic.de](http://www.ate-classic.de)

## Contact data :

Company :

Surname : \*

First name :

Street and No. : \*

Post (Zip) Code : \*

City : \*

Country : \*

E-Mail :

Telephone : \*

Telefax :

## Vehicle data :

Make - Model :

Type :

Engine displ. cc :

Fuel :

Year :

Performance HP  KW

Steering side :

## Product data:

	Article 1	Article 2	Article 3	Article 4
Productname : *				
ATE-Number :				
Other reference No.				
Install. Pos. left- right :				
Install. Pos. front-rear :				
Quantity : *				
Comment :				

## Your message to us :

\* Mandatory fields  
 To avoid callbacks, please fill all possible fields.



ATE – A Trademark of the Continental Corporation

**Continental Aftermarket GmbH**

Postfach 90 01 20 · D-60441 Frankfurt am Main · Germany  
Tel. +49 (0) 69 7603-1 · Fax +49 (0) 69 761061

**Continental Automotive Trading Italia S.r.l.**

Aftermarket ATE  
Via Vialba, 50 · I-20026 Novate Milanese (Mi)  
Tel. +39 02 35680 388 · Fax +39 02 35680 325  
[www.ate-freni.it](http://www.ate-freni.it)

**Continental Teves France SNC**

Aftermarket  
Parc Ariane, Bâtiment Vénus  
Rue Hélène Boucher · F-78280 Guyancourt  
Tél. +33 (0)1 39 44 10 30 · Fax +33 (0)1 39 44 10 40  
[www.ate-freinage.fr](http://www.ate-freinage.fr)

**Continental Automotive Spain, S.A.**

Aftermarket ATE  
C/ Sepúlveda, 11 · E-28108 Alcobendas (Madrid)  
Phone +34 (0)91 126 6934 · Fax +34 (0)91 657 2149  
[www.frenos-ate.es](http://www.frenos-ate.es)

[www.ate.de](http://www.ate.de)  
[www.ate-classic.de](http://www.ate-classic.de)

